



Learning Publics Journal of Agriculture and Environmental Studies Vol 2 (1). 24-55

ISSN-L: 2026-5654

Institutional Innovations for Building Impact-oriented Agricultural Research, Knowledge and Development Institutions

Tenywa, M.M¹., Rao, KPC²., Buruchara, R³., Kashaija, I⁴., Majaliwa, J.D¹., Tukahirwa, J.B⁵., Adekunle, A. A⁶., Fatunbi, AO⁶., Mugabe, J⁶., Wanjiku, C³., Mutabazi, S⁷., Pali, P⁸., Mapatano, S⁹., Lunze, L.¹⁰, Mugabo, J¹¹. and Ngaboyisonga, C.¹¹

¹Makerere University; ²International Crop Research Institute for Semi-Arid Tropics (ICRISAT); ³Centro Internacional de Agricultura Tropical (CIAT); ⁴Kachwekano Zonal Agricultural Research and Development Institute; ⁵Africa Highlands Initiative (AHI); ⁶Forum for Agricultural Research in Africa (FARA); ⁷Kabale District Local Government; ⁸International Livestock Research Institute (ILRI); ⁹Coordinateur de la Plate-forme Diobass au Kivu; ¹⁰The Institut de l'Environnement et de Recherches Agricoles (INERA) DRC; ¹¹ISAR (Institut des Sciences Agronomiques du Rwanda)

Received 12 November 2010, accepted 25 November 2010 and published 20 January 2011 - www.Learningpublics.org

Abstract

The central development question in African agriculture is how to catalyze a more competitive, equitable and sustainable agricultural growth within the context of smallholder production systems, inefficient agricultural marketing, inefficient investments by private sector amidst degradation prone natural resources base (Lynam and Blackie, 1994; IAC, 2004; World bank, 2006). Concerted scholarly analyses of Science and Technology (S&T) strategies have given birth to Integrated Agricultural Research for Development (IAR4D) an organizing concept of the Innovation Systems Approach (ISA) as the promise holder. It is hypothesized that the generation, diffusion and application of impactful innovations critically depend on systemic integration of knowledge systems that promote communication, interaction and cooperation between agricultural research, education, extension, farmers, private sector and policy regulatory systems. This paper examines how the different institutional innovations arising from various permutations of linkages and interactions of ARD organizations (national, international advanced agricultural research centres and universities) influenced the different outcomes in addressing identified ARD problems. A multi-institutional, multi-disciplinary phased Participatory Action Research approach was used to pool knowledge to address outstanding and emerging challenges in three countries

(DRC, Rwanda and Uganda) with 2, 16 and 24 years out of conflict, respectively) of the Lake Kivu Pilot Learning Site. A landmark institutional innovation was the participatory establishment of twelve (12) Innovation Platforms as tools for pooling knowledge across the agricultural business, education, research and extension systems. The knowledge “pool” was to generate, diffuse and apply innovations to reduce transactions costs and create value chain based “win-win” situations. A number of innovations (e.g. International Public Goods-IPGs, market binding contracts, registered brands and/or certification processes, diversity, density and quality of networks/collective action, bulking centres, ICT application and depth of knowledge pools) were initiated. There were major breakthroughs which included bringing on board non-traditional private sector and policy maker partners, overcoming the predominant “farmer handout syndrome”, building consensus and addressing common interest challenge. Making markets work, bringing various stakeholders including universities to the community and vice-versa, appreciation of indigenous knowledge system, propelling collective soil and water conservation and demand/utilization of technologies hitherto on-shelf were other very significant breakthroughs. Sustainable operations of the Innovation Systems knowledge “pool” nurturing institutional learning were ensured through the availability of a “functional body”. The body undertook the social enterprise of organizing farmers and traders, facilitating/brokering ARD organization linkages by using multi-media to build social capital to overcome emergent knowledge, credit, market, technology and resource degradation challenges under different policy regulatory systems.

Key words: Integration, Innovation System Approach, Innovation Platforms, IAR4D, farmers, Institutional learning, brokerage

Introduction

Agriculture in developing countries is characterised mainly by the practice of shielding against risks in the smallholder farming context. This manifests in several forms including staggered planting, use of well adapted but unimproved low yielding varieties that produce very limited surplus for the market. The small quantities produced increase the transaction costs of bulking and fetch lower income for the farmers. In poor economies characterized by low infrastructural development, limited access to input, output, credit and insurance markets, poor flow of information and high transport costs

farmers get caught up in low level equilibrium, economic and technological development trap. This is often accentuated by the increasing land degradation, which further pushes the farmers into a poverty abyss. Unfortunately, this reality impedes the economic growth processes of use, production and consumption of private goods and services. According to FAO (2006) and Thorpe et al. (2004), this sector has remained weak and uncompetitive characterized by natural resource degradation, low yields, low use of improved technologies, fragmentation of stakeholders, weak linkages and

interaction, low support and unfavourable policies, poor infrastructure and limited access to markets with the vast majority of end-users encapsulated in poverty, food insecurity, vulnerability, malnourishment often culminating in ill health and low life expectancy. Since the green revolution failed to make the complex and highly heterogeneous farming systems in Africa respond positively (Evenson and Gollin, 2003) to technological, infrastructural and institutional change, a major agricultural development question has been how to bring the smallholder farmers out of this poverty abyss. Unlike in the developed economies, poor economies present unique situations of lower produce volumes and densities of economic activity, smaller economic units, poorer infrastructure, and different traditions in common-property resource management (Doward et al., 2009). In such a situation, poor economies may fail to respond to conventional developmental approaches. Concerted efforts amongst Agriculture Research and Development (ARD) workers have been invested in searching for alternative approaches to addressing the social, economic and environmental goals (World Bank, 2006).

Along with the efforts of agriculture development policy in Africa, ARD scholars have spent significant time understanding the “push-pull forces” that govern the processes of generation, diffusion and application of knowledge to transform subsistence farming systems and increase productivity and profitability. The Innovation Systems Approach (ISA) has emerged as the promising alternative (World Bank, 2006). The ISA emphasizes institutional linkages and interactions amongst ARD actors in making decisions and taking actions involving use,

production and consumption of goods and services. However, ISA in African agriculture remains more of an analytical concept rather than an operational concept with policy options to nurture systemic innovations (Spielman, 2006). Most studies exhibit a “side dish syndrome” focusing more on capacitating of flexible networks to address challenges of mutual interest (Leeuwis, 2004; Röling, 2009). Little attention has been paid to the role of ARD organizations in ensuring an appropriate balance of integration of infrastructural development, technical change and institutional change and how these positively influence organizational change. The reasons cited for this discrepancy are many including institutional environment and arrangements, structure, infrastructure and anthropogenic hindrances.

First and foremost, the existing formal economic institutions and rules (policies) delink agricultural research, education, extension and business systems by the nature of their funding. There have not been many opportunities for sectoral, multidisciplinary, interdisciplinary and trans-disciplinary integration of efforts under different institutional environments and their analysis. Besides, there is lack of a structure and mechanism for central coordination of knowledge across South-south, North-south NARS and CGIAR centres. For the most part, CGIAR centres focussed on upstream research. Without centralized coordination of knowledge sharing and creation, a lot of duplication occurs with limited value addition and hardly any opportunities to plough back the lessons acquired from successes and failures.

Secondly, the infrastructure and tools for integration and analysis of networking (e.g. email, e-groups, teleconferencing, Social Network Analysis-SNA, website) were not yet in wide use. Finally, the

situation is accentuated by differences in incentive systems for public and private actors, mandates, IK, scientific knowledge, and ideological and social differences amongst Multi-stakeholders (Hall, 2006; Pant and Hambly-Odame, 2006; Gijssbers, 2009). The reconfiguration of agricultural research and extension in many African countries means that positive outcomes are particularly dependent upon strengthening the roles of farmers in knowledge sharing, relevant experimentation, and risk mitigation (Wennink and Heemskerk, 2006).

What is clearly lacking is a holistic empirical analysis of the ARD organizational change efforts to improve performance in both networking and delivery on core mandates and how they can be facilitated to foster institutional learning by redefining roles and responsibilities to address outstanding complex and emergent ARD challenges under conditions of weak institutional environment. The Sub Saharan Africa Challenge Programme (SSA CP) using IAR4D approach, aims to deliver principles, options and practices of how multi-stakeholders (End users/practitioners-rural communities, Enablers-policy actors, NGO practitioners, financial institutions, market chain actors and Service providers-researchers, extension workers) share and create knowledge efficiently and effectively to enhance innovations for technologies, strategies, techniques and policies at individual and institutional levels to overcome barriers to improved welfare and health resulting in desired impacts on their livelihoods (Science Council, 2005). Omamo (2003) warns against abstract conceptualization of alternative policy options by agricultural policy makers and

suggests a different approach to agricultural policy research, focusing more on “how” questions and emphasizing action research in case studies of initiatives involving promising institutional innovations.

This paper attempts to answer the following questions:

1. How can ARD multi-stakeholders (e.g. farmers, University, research, extension, private sector, and policy makers) be effectively involved, sharing and creating knowledge and fostering cooperation in addressing complex challenges?
2. How can farmers be empowered by mandated ARD organizations to articulate demand for knowledge and technology, access credit and markets, invest in natural resource management and proactively change unsupportive policies?
3. How can ARD institutional innovations be scaled-out and up?

This paper is organized as follows. In the next section we define what we mean by institutional innovations and review past institutional innovations to address inefficient markets, unavailability of inputs, low adoption of productivity enhancing and soil conservation technologies, difficulties in accessing credit/financial services and unsupportive policy environment in Africa. This is followed by a description of the epistemological and methodological approach and a discussion of institutional innovations accruing from institutional linkages, dynamics and implications for

ARD. We conclude with a brief summary of the lessons learned.

What are institutional innovations?

Institutional innovations refer to the changes made in redefining roles and responsibilities of different ARD organizations to deliver more returns to investments in research, education, extension and business systems. The roles

and responsibilities are defined institutions- rules and guidelines governing interactions and social behaviour. They can be looked at as a form of investment to improve the quality of institutions to better facilitate access to assets (e.g. land, capital), development of markets and investment in basic public goods (e.g. roads, research) in order to increase production and profitability for economic development (Fig. 1).

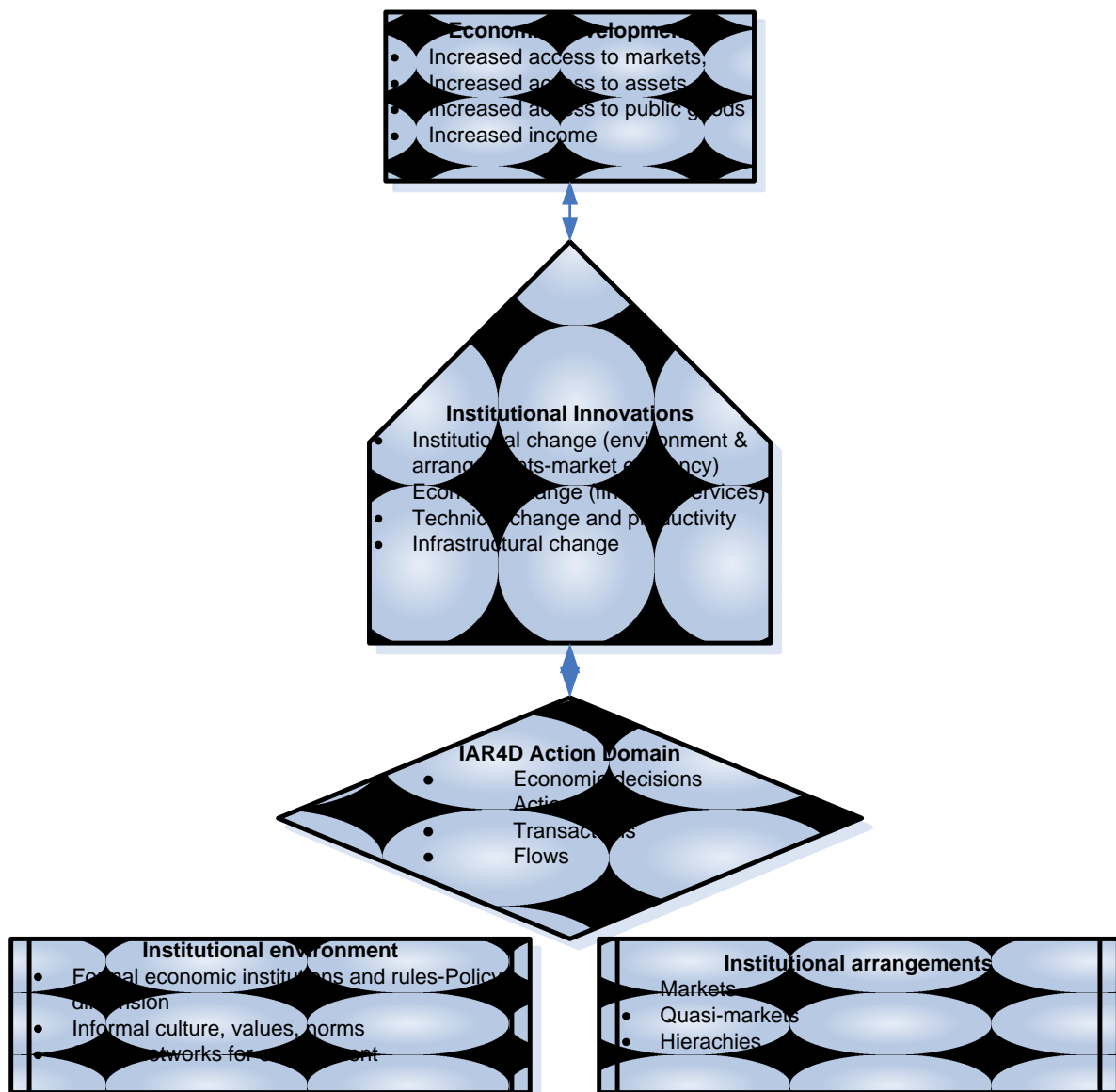

Fig. 1 Conceptualization of IAR4D derived Institutional Innovations

Institutional innovations are particularly valuable under weak institutional environments where most of the “escape routes” for smallholder farmers caught up in a poverty abyss at low economic and

technological equilibrium (Equation 1) are often blocked by various kinds of institutional impediments (Bardhan, 2001). Removal of these barriers is the prime focus of institutional innovations.

Agricultural growth and development

$$\propto \frac{1}{\text{Risks (Production, Market)} \times \text{Costs of Transactions \& Info flow}}$$

Equation 1

Development of quality institutions that can provide an integrated framework for simultaneous removal of technical, market and infrastructural barriers to agricultural growth and development is crucial. They not only have the capacity to change the institutional environment but also the arrangements pertaining to economic decisions, actions (selling and buying, and negotiating), transactions and flows of knowledge, resources among others. They

positively shape economic, political and social organization through simultaneous development and stabilization of input, credit and output markets, increasing production, reduction of transaction and information flow costs. As such it is important to understand not only how institutional innovations generate quality institutions but also how they influence organizational change.

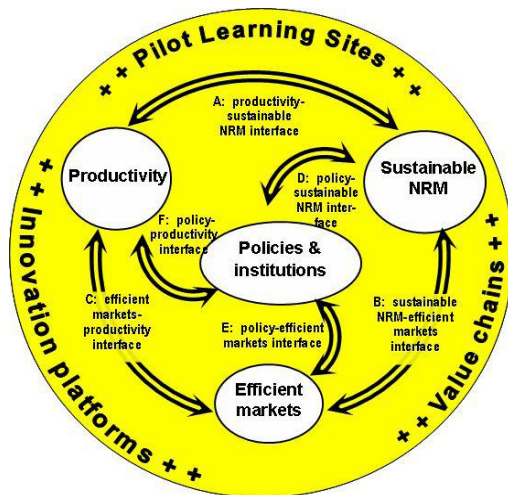

Fig. 2. Market-NRM-Productivity-Policy interfaces

Review of past work on institutional innovations

In this section we review the institutional innovations of ARD organizations in addressing challenges faced by African agriculture in the research, business,

extension, education and policy regulatory systems.

Research system: Agricultural research and development work in Africa is informed by the growing body of literature on the knowledge economy and one ISA. The major challenges of the research system relate to the process of identifying and defining research priorities, the role of various participants involved in generation, transfer and use of knowledge, the M&E, process of judging and rewarding, the means by which R&D projects are held accountable to different interest groups and societies and the processes through which organizations learn and adopt innovations. The major reforms in research organizations have been to address the challenge of generation and utilization of technologies. The trend constitutes a paradigm shift from the traditional “linear research-extension-farmer” model (NARS perspective) approaches that are supply driven and characterized by fragmentation through agricultural knowledge and information systems to a model more integrative of national innovation systems that emphasizes demand-led generation, diffusion and application of knowledge. According to Lynam et. al. (2003), the move to decentralized research and extension systems, principally funded by the World Bank, has resulted in institutional fragmentation rather than enhanced accountability and more effective research. Several reasons are cited including low ARD institutional capacity and lack of appropriate funding framework to cover both core and “transaction” costs of ARD organizations involved in institutional networking.

According to IAC (2004) the ratio of researchers to population in SSA ranges from 1:2500-50,000 compared to 1:400 reported for early 1980s in developed countries (Pardey et al. 1991). The Lake Kivu Pilot Learning site (DRC, Rwanda and Uganda) are rated with 101-250 Number of full time equivalent researchers compared to 1000-1500 for Nigeria and South Africa (Roseboom et al. 2004). Innovation systems for smallholder African agriculture are capacity constrained depending on technologies within a public goods development framework and predominately supply driven. Innovation systems in the North are not capacity constrained. They respond to consumer market demands by identifying alternative lines of investment into new technologies.

For innovation systems to be effective there is need to cover, not only the core or overhead costs of the organizations but also the “transaction” costs associated with institutional networking. This increases the overall costs of research and technology development. The predominant funding of the innovation systems still remains project competitive grants. There is lack of a financing framework to cover both core and transaction costs of organizations and at the same time provide for a mechanism for selecting the truly innovative ideas in the innovation systems. Reliance on project funding reduces rather than enhances the flexibility needed to shift resources based on learning in the innovation process. Moreover, it promotes competition rather than cooperation. Institutional innovations can reduce the transaction costs and improve performance. Rethinking the ARD

approach engenders discussing the institutional innovations needed to address the outstanding constraints faced by past paradigms.

Past economic growth and development analysis models to inform policy and strategy construction focused on the structure of tangible economy (supply-demand sides), infrastructure and factor controls neglecting the dynamic processes related to institution linkages, interactions, flow of knowledge and innovation. The ISA was developed as an alternative analytical framework to standard economics for assessing the performance of the economy towards overcoming poverty and attainment of sustainable development through application of knowledge. In developing countries (e.g. Africa), economic analysis perspective of innovation, management of innovation and innovation systems largely focus on Agriculture sector- AIS. The actualization of improving multi-stakeholder linkages and collective action around a commonly agreed challenge in the AIS is through Integrated Agricultural Research for Development-IAR4D (FARA, 2004). The IAR4D has emerged as one of the superior evolutionary participatory approaches for the integration of actors, technological, policy and institutional components of the AIS to respond to changing market and policy conditions and provide commercial, social and institutional solutions that achieve broad and multiple objectives, including poverty alleviation, environmental protection, social and gender equality.

The SSA-CP identified IAR4D as the organizing concept for the ISA. It is hypothesized that bringing together multi-institutional multi-stakeholder (farmers, extension, researchers, policy makers, private sector-interlinked markets, credit institutions) can result in institutional innovations and improved performance of the ARD organizations. This trend is reflected in the use of the IAR4D and rural innovations in addressing complex social, economic, environmental, technological, cultural, political, globalization and ideological problems of African agriculture, multi-institutional project oriented architecture and strategic plans (NARO-NAADS), various partnership networking processes, and in the rise of value chain based constraint analysis. It can also be seen by the number of on-going research projects.

Integrated Agricultural Research for development is predicated on the hypothesis that sustainable development is a function of institutional linkages and interactions that foster learning. A survey of 100 ARD workers (Table 1) revealed significant differences in their perception of the research problem (Tenywa, et al., 1999). The findings support the need for multi-stakeholder innovation platforms including Universities, RUFORUM, farmers, sectoral Ministry, NAADS, Private sector, service providers, CPU, CUG, MoU, DST, Learning model, M&E, Task Teams, Policy Teams, Branding, Certification, COL, CIP, Kulika.

Table 1. Differences in perception of critical constraints to agricultural production by various stakeholders

Factor	Farmer	Biological scientist	Social scientist	Extension workers
Gender	17	16	9	14
Pests & diseases	15	n/a	7	n/a
Marketing	16	1	1	10
Soil fertility	14	6	5	2
Climatic changes	6	1	12	1
Population density	10	n/a	n/a	n/a
Inputs/technologist	12	5	n/a	13
Technology transfer	<i>n/a</i>	1	2	<i>n/a</i>
Extension	n/a	n/a	5	6
Insecurity	1	“	n/a	n/a
Farming systems	8	“	“	“
Training/research/extension	4	“	“	“
Ignorance/illiteracy	6	“	“	7
Environmental degradation	12	“	“	n/a
Poverty	4	“	“	“
Culture	10	18	10	“
Health	8	“	n/a	“
Policy	2	“	“	9
Infrastructure	3	“	10	8
Prices of inputs	n/a	14	n/a	n/a
Price of outputs	“	14	“	“
Labour	“	11	4	5
Post harvest technology	“	12	8	n/a
Improved seed	“	4	n/a	“

Diseases	“	9	“	“
Pests	“	7	“	11
Land use planning	“	16	“	n/a
Erosion	“	10	“	“
Weeds	“	12	“	“
Credit/capital	“	“	2	10
Level of knowledge of farmer	“	“	n/a	3
Land availability	“	“	“	4
Land tenure	“	15	“	11
Income	“	n/a	“	10

Source: Tenywa et.al. (1999)

Business system: The agricultural business system consists of farm input, production and product marketing processes. In many African countries it was left weak and uncompetitive following the withdrawal of African governments from many market and service functions by structural adjustments and market liberalization policies. The supply of farm inputs, production, flow of agricultural products from the farm to ultimate consumers and support services are not harmonized. The input-output markets are often delinked, inefficient and characterized by inequitable sharing of benefits, poor market infrastructure, inadequate and untimely information flows, unclear basis for price decisions, unarticulated market demand requirements (quantity, quality and time), lack of access to credit, unsupportive policies and many uncertainties (Dorward, et al., 2009). The

situation is aggravated by the low capacities for postharvest handling and value addition to farm produce. These more than often reduce the profitability of farm production.

Low farm productivity is attributed to low levels of inputs, lack of access and low levels of use of improved technology, lack of access or inadequate support services (e.g. extension, credit), natural vagaries (drought, weeds, pests and diseases) and anthropogenic ally induced land degradation. More than often, production is subsistence oriented, fragmented with low volumes of low quality that leaves little marketable surplus. Production is highly heterogeneous and diverse with farmers often producing more than one and as many as 30 commodities on an acre of land. The growth status of farming systems is a function of the level of empowerment of farmers, influenced by the structure,

composition, infrastructure, organization, nature of support services in relation to production and post harvest technologies, natural resource management and marketing as well as the attitude and behaviour of the ARD actors. It can be

argued that where there have been “Islands of success”, the attitude and behaviour of both private and public actors has changed providing direction and support, respectively (Domain 4 of Table 2).

Table 2. Domains of Public-Private Partnership behavior and influence on innovation generation, diffusion and application in African agricultural business system

	Low density public support	High density public support
Low density private sector direction	1. Market informed-low levels of technology generation and low market activities in areas associated with high transaction costs	2. Market supported-supply driven knowledge generation, diffusion and use
High density private sector direction	3. Market directed unsupportive activities target surpluses of predominantly subsistence farming systems	4. Market coached knowledge generation, diffusion and application

Source: Authors (2010)

Markets: Past institutional innovations in input, output, and financial markets (inter-linked markets) have been geared towards filling the vacuum that was created when the cooperatives marketing boards were turned into middlemen by governments when in fact they were formed to minimize transaction costs between the producers and consumers and so got discredited in the business system. The question addressed is how to increase profits and returns to investments to increase efficiency. The thrust in improving input-output markets has been a push for greater involvement of public sector to support commercialization of agriculture. A major reform in addressing the markets has been the adoption of the value chain approach.

Analysis of the value chain composition, organization, infrastructural support and support service delivery reveal significant deficiencies. According to Kasenge (2010) what is referred to as “value chains” still largely remains a loose network of actors in a “supply chain”. Often not all the relevant actors (farmers, private sector (input-output market, credit, insurance, transporters, NGO, CBO, farmer organizations) are linked. The actors do not mutually support one another to add value and derive the concomitant benefits. Most innovations have focussed on developing market information systems and dissemination of market information using multimedia (e.g. website, telephone) without binding contracts. Besides,

literature is not explicit on how the different ARD actors along the value chains have organized to improve on their core mandates. According to Doward et al. (2009), some African governments frustrated by the meagre returns from painful agricultural market liberalization, are reinstating key elements of state intervention in agricultural markets. For example, in Rwanda, marketing boards are being resuscitated, top-down cooperatives resurrected and agricultural finance corporations granting low cost credit revived.

NRM: A great deal has been written about the “constraints to adoption” of improved production technologies and NRM practices in poor economies. Literature on analysis of innovations in NRM reveals that the approaches are still predominantly supply-driven with limited attention paid to institutional environment, arrangements and coordination. Most soil and water conservation approaches in SSA are supply-driven rather than demand-driven, and predominantly use the linear research-extension-farmer technology transfer model as opposed to the economic and institutional approach. According to Lopez (1977), if institutional rather than environmental dynamics dominate, new institutions that protect the land emerge, and consequently livelihoods of farmers improve. However, if environmental dynamics predominate institutional dynamics conflicts arise and the soil erosion problem is exacerbated. Ongoing environmental approaches have been in place. A baseline survey highlighted soil erosion and water quality deterioration as widespread and increasing, particularly under eucalyptus woodlots. A major reform has been in place area of approach to NRM. This has led to the evolution of the ‘Integrated Natural Resources Management’. According to Dormon

(2006) where farmers got higher prices, they were motivated to work together to collectively maintain the natural environment and reap the joint benefits. A key question remains how to balance direction of efforts towards the institutional rather than environmental dynamics

Credit services : Agricultural enterprises are characterized by high risks in relation to timely availability and accessibility of inputs (e.g. seeds and planting materials) in required quantity and quality (adulteration), high input prices, climate change and variability, drought, pest and diseases, labour demands at peak periods of planting and challenges of weeding and harvesting. The high risks render the collateral very uncertain. The situation is aggravated by the long growing periods and high interest rates (up to 37% per annum). Therefore, financial credit institutions prefer to loan non-agricultural sectors that have high turnover. Government interventions to support agricultural finance have not been helped by the lack of binding contracts. Often bumper harvests without options for storage result in low income that fall short of the production costs. This further demoralizes farmers from processing credit for fear of losing the property attached. Due to their "high risky" status, most banks are very sceptical and charge the farmers high interest on agribusiness activities loans. In addition, the farmers lack bargaining power for a lower interest rate because their investments take longer period to realise sales / profits. The feeling by banks is that it is better when the risk is distributed evenly. Insurance companies too are sceptical about insuring

agricultural activities and if they do, they still charge them a higher premium, which in turn makes the loan more expensive. Policy innovation is to convince the government and other organisations like WFP, Danida, among others to set a separate guarantee fund in favour of banks that will be lending to agribusiness and also develop business plans on how to bargain for better payment structure based on when they will realise income from their investments.

Access and use of credit still remain key to technology innovation for smallholder agriculture while mechanisms for financing innovation systems for smallholder agricultural technologies are critical components of developing an overall system for agricultural innovation. However, there is no framework on how innovation systems should be financed.

Whereas financing of technological innovation in the North relies majorly on the private sector; in Africa, it is largely supply driven and still depends on public funds, either nationally or internationally sourced. There is no market or “effective demand” for new technology, leaving many of them on the shelves. The question is how to organise efficient flows of financial services in an integrated package that motivates sustained investment by farmers in resource conservation and improved productivity.

Technologies (productivity enhancing and value adding): Past institutional innovations pertaining to technologies have traversed three phases, namely; generation, diffusion and use. Initial reforms were geared towards addressing the question of how to efficiently generate new technologies to address the emergent

agricultural challenges along the basic, applied, adaptive and strategic research continuum. Reforms of the 1980s and 1990s emphasized consolidation of research capacity and making internal organization and management more efficient (IAC, 2004). This redefined roles between the CGIAR centres focussing on upstream research and NARS addressing more adaptive research. Subsequent reforms addressed the issue of diffusion of technologies and caused agricultural research organizations to be more outward looking, client and impact oriented moving in a non-linear participatory manner towards generation and diffusion of technologies. Adoption of new technologies is influenced by other factors (e.g. markets, labour, land tenure, distribution of benefits) and requires a balance amongst new technical practices and alternative ways of organising (Dormon et al., 2007; Hekkert, 2007; Adjei-Nsiah et al., 2008). This paper highlights paradigm shift from supply led technology transfer to market led technology transfer and using the IAR4D approach.

Extension system: According to Haug (1999), the traditional publicly funded top-down extension services have outlived their usefulness. Reforms in the agricultural extension system have been geared towards improving efficiency of flow of knowledge and technologies to an increasing population. Conventional extension cannot cope with the demand. In a public testimony, an extension worker put the ratio of extension to farmer at 1:25,000 in Bufundi, Uganda (Pers. Comm. David Rusoma, 2010). This implies that working fulltime he can only spend 4 minute per year with each of the farmers. Currently, there is little consensus on how to tackle the problem of

technology diffusion. According to IAC (2004) recent innovations to improve extension have been in two-fold; privatization (e.g. Cote d'Ivoire, Senegal, Uganda-Nahdy et al. 2002) and cost-recovery schemes (e.g. Ghana, Tanzania). Zimbabwe merged its research and extension services. Currently, Uganda is exploring a merger between research and extension as further reform to the demand-driven service delivery.

Literature revealed that the extension systems have little linkage with NARIS or Universities in most of the African Universities (IAC, 2004). Scholars in institutional building have recommended systems approach to coordinating efforts in the research-extension-education systems. This approach is variously called an agricultural knowledge system (Röling, 1988); an agricultural knowledge information system (FAO and the World Bank, 2000) and the agricultural knowledge triangle (Eicher, 1999). The IAC (2004) recommended the farmer, research, extension and education quadrangle. These efforts have been supplemented by the FAO Farmer Field Schools for empowerment of farmers to bulk and market surpluses. Mozambique has been pursuing the learning-by-doing approach including privatization (Eicher, 2002)

Education system: Reforms in the higher agricultural education institutions have been geared toward making them contribute more to agricultural research and national development through competitive grant schemes. Effective innovation systems in Africa still require

appropriate skills and competencies embodied in human capital (Eicher, 2002). Adaptive approach has been used by higher agricultural education institutions in the last decade to introduce new courses, programmes and classroom orientation without necessarily rethinking the education philosophy. Unfortunately the changes have been slow. Theoretical knowledge continues to be seen as the most valuable expression of science. There is little attention paid to addressing practical problems that rural people face. Direct links and meaningful interactions between rural communities, staff and students remain rare. Conventional lecturing remains the dominant method of instructing students. In classrooms there is little room for critical reflection on the meaning of, reasons for and methods of learning itself. Some efforts are being made to change the situation. Internships have been initiated to promote experiential learning using a farmer focussed research and development approach. In addition participatory field action learning, a number of instructors are now realizing that it is essential to find ways to institutionalize these methods in higher agricultural education institutions. Unfortunately, it appears to be more difficult to integrate participatory learning and action into the University curricula than into some ARD organizations. Increasingly this is creating a gap between classroom knowledge generation and field utilization as higher education fails to keep pace with the increasingly serious problems of natural resource degradation and widespread rural poverty. Innovative curriculum development is the key to this bottleneck as it creates opportunity to introduce appropriate knowledge, skills

and approach to learning to the new generation of graduates.

Policy system

The rationale for policy innovations: **Although** the potential contribution of agricultural development to economic growth and poverty reduction has been recognized extensively in literature (World Bank, 2007), successes in African agriculture have been too limited in scope to significantly increase overall agricultural productivity and welfare of farmers across the continent. IFPRI (2009) indicates that agricultural development policies and weak institutional arrangements are among the many challenges contributing to this failure. Agricultural development policies in Africa have not generally worked; many policies have not been implemented or have been implemented in part or very poorly, and those that have been implemented well have often not delivered sustainable benefits. At the same time, weak institutions undermine private investment incentive (IFPRI, 2009). What is lacking is the analysis of institutions, behaviour of actors, activities and outcomes along value chains using the institutional analysis framework (Doward and Omamo, 2009).

Synthesis of Institutional Innovations :
The major institutional and organizational

reforms have been to address the challenge of how to organise integrated efficient flows of services in three areas, namely; i. technical change and productivity, ii. Market efficiency and iii. support services (e.g. financial, communication). Literature is not explicit on how the inputs, processes of linkages and interactions of public-private partnerships of ARD organizations can guide organizational reforms to improve performance on both core mandates and networking functions. Superficial descriptions of flexible networks of partners often shift attention away from the need for organizational capacity building to fulfil mandates, and often promote inter and intra competition for limited resources from CGS.

Methodology

In order to answer the three outstanding questions pertaining to multi-stakeholders' sharing and creation of knowledge; farmers empowerment to address IAR4D derived challenges and scaling up of institutional innovations, the SSA-CP methodology for "Proof of IAR4D concept" (FARA, 2008, Box 1) was implemented in LKPLS.

Twelve agricultural Innovation platforms were formed in each of the three countries of LKPLS (Uganda, Rwanda and Democratic Republic of Congo). In this section, an attempt to answer the stipulated questions is made through sharing our experiences and lessons learnt from implementing the proof of concept research.

Box 1. Outline of the SSACP methodology
--

The phases for IP formation are three (3):

Phase 1. Preparing to organize for innovation

1.1 Orientation

1.2 Consultation for diagnosis

1.3 Partnering for action planning

1.4 Learning for managing and researching

Phase 2 Innovation action

2.1 Action and learning to address critical issues

2.2 Monitoring for assessment and learning

Phase 3 Testing the comparative advantage of IAR4D

3.1 Baseline and assessment studies – indicators & steps

3.2 Comparison study and sampling

Innovations facilitate ARD Multi-stakeholders to share and create knowledge and foster cooperation in addressing complex challenges: Multi-stakeholders social capital is crucial in joint learning and knowledge accumulation to address complex challenges that are not amenable to conventional solutions. Unfortunately the current formal policy environment lacks a mechanism by which traditional ARD organizations (research, extension and universities) can jointly plan, implement and monitor activities of their core mandates even in a common site. The IP provides an alternative framework for bringing together relevant actors (e.g. farmers, the private sector, research, extension, policy makers) to cause economic development through simultaneous institutional, technological, and infrastructural change. They constitute

institutional innovation in both dimensions of formation as institutions for bringing together multi-actors to address outstanding ARD challenges and also in the function of responding to real-life IAR4D derived and emergent challenges facing the IP members. A landmark institutional innovation in the LKPLS was the establishment of four multi-stakeholders Innovation Platforms in each country (DR Congo, Rwanda and Uganda) (Tenywa et. al., 2010) with fully functional operational and strategic management structures from parish to district level. The IPs brought together various ARD organizations for knowledge sharing and joint learning.

The functional dimension of the IP has evolved in a dynamic way (Fig 3).

Initially, it was envisaged that all the identified value chain based stakeholders would meet face to face at regular meeting fora. However, this did not happen exactly so since the private sector viewed the process as a waste of time. This was due to the fact that the immediate benefits of partnerships were not clear from the start of the innovation platform. A decision was taken to proceed with interested organizations. However, in due course, it was realised that issues raised at the action

site level could be addressed by mobilizing more key stakeholders within or out of the action site. The turnaround was also witnessed when innovation platforms were oriented to respond to market demands with clear definition of input and derived value. Various organizations such as credit institutions (Equity Bank and Mecrego) and processing organisations were attracted.

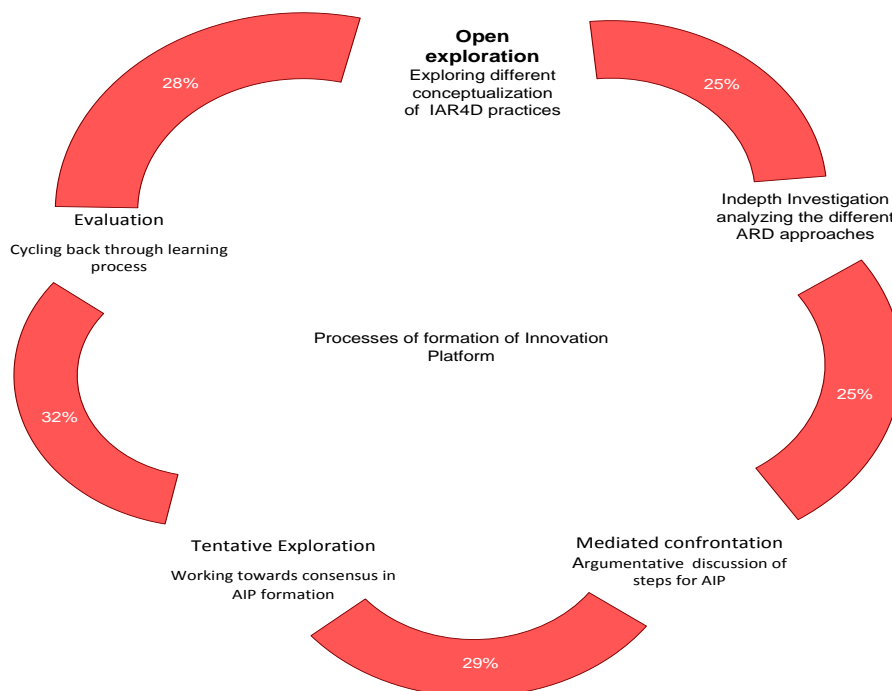

Figure. 3. Pre-formation phase of the Innovation Platforms

To stimulate research process innovations, task committees of relevant stakeholders were formed to brainstorm on an outstanding or emerging challenge and map out the course of action. This further attracted more stakeholders to understand farmers' situations and forge a way forward. A case in point was the attraction of consultative groups on international agricultural research member organisations (CIP, AHI, CIAT), Kampala Potato Traders Group, Open Distance Learning

Network for ICT service provision, NARS (Kachwekano Agricultural Research Development Institute-KAZARDI and Makerere University) to understand better why farmers of Chahi and Bufundi Potato Innovation Platforms in Uganda were more interested in growing Kinigi potato variety for which KAZARDI did not have basic seed yet had other improved varieties. The interaction of the different stakeholders led to farmers' acceptance of Victoria potato seed, initially rejected in

favour of the market preferred and high yielding Kinigi, as an equally good variety. In Uganda, it was put on the field research agenda vs other improved varieties and through participatory evaluations, Victoria variety hitherto rejected was adopted. Victoria was accepted because of the market assurance by Memorandum of Understanding following fertilizer trials that showed that it responds well. This has sharpened the research agenda prioritization for potato. In the research system in Rwanda, budgetary support has been allocated for re-introduction of Kinigi potato variety on the research agenda.

Similarly, in Rwanda ISAR and Makerere University researchers mobilized farmers to meet with Inyange Dairy milk plant management to establish why it rejects milk produced by Mudende Innovation Platform. Through interaction, it was established that the decision was based on poor hygiene standards exhibited by the

innovation platform. The meeting resolved that training on milk hygiene be conducted by Makerere University. It was done and the milk sales resumed. In DRC, researchers of CIAT and INERA mobilized farmers of Musanganya Banana Innovation Platform to meet with local leaders in Bukavu to negotiate for subsidized water transportation to reduce transaction costs and increase profitability. This request was granted by the local government.

Vertical and horizontal integration brought Equity bank to the realization of the new opportunity of working along value chains, loaning both farmers and traders through a buy-back mechanism. Consequently, the bank recruited and trained new staff to manage agricultural lending. The Kabale local government, on realizing the sharp focus of IPs aligned their budgets to accommodate the IPs plans. Collective efforts were also made to push through byelaws.

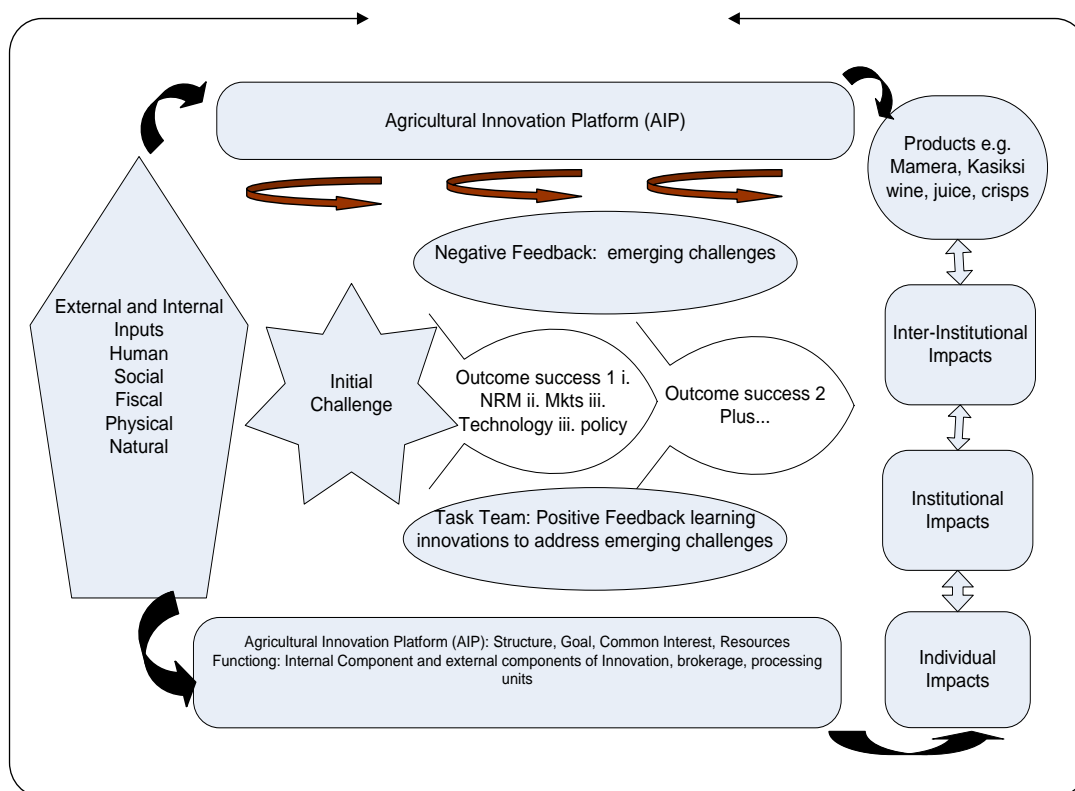

Fig. 4. Facilitation of Innovation Processes of addressing challenges along the Impact Pathway

Innovations for empowerment of farmers by mandated ARD organizations to address their identified problems

Institutional innovations for addressing disorganized markets: One of the commonly IAR4D identified issue was disorganized markets. The farmers did not know for whom to produce, the quantity, quality and time. The major innovation has always been vertical integration, linking farmers to traders to reduce production and market risks. This often benefitted the traders and pitted the farmers. An institutional arrangement along the value chain was used to structure and generate market surplus to reward farmers for the added value by actors in terms of increased

prices for the produce and reduced buying price for traders. Farmers were facilitated to reduce market risks through market guarantee and boost production through negotiating win-win agreements and signing MoU with traders as a tool to guide their production processes including quantity, quality, price, packaging and terms of payment. Market surplus calculated as difference between retail price (58,000/= equivalent to \$26 average for 2 weeks) and farm gate price (30,000/= equivalent to \$15 average for 2 weeks) per 100 kg potato bag was reduced by the cost (14,000/=) of handling (bagging, loading, transportation and offloading) to Kampala and shared 50:50. This created a win-win of (7,000/=) reducing the retail price to

51,000/= and increasing the farmers price to 37,000/=. This entailed in domains of existing markets and existing products (Table 3) demystifying the “middle-man syndrome” and increased profits for the

farmers. This has offered a significant opportunity for face to face linkages and interactions of farmers and traders hitherto not possible because of middlemen control.

Table 3. Market domains for IPs in the LKPLS

	Existing enterprise	New enterprise	Value added Products
Existing market	<ul style="list-style-type: none"> • Gataraga-Potato • Kisigari (Rumangabo)- Potato • Bufundi potato • Chahi potato • Kituva-Cassava • Remera-Bean/maize 	<ul style="list-style-type: none"> • Rwerere- Pepper (Chili) 	<ul style="list-style-type: none"> • Gataraga-Potato cleaned and packaged • Ntungamo Organic pineapple juice
New market	<ul style="list-style-type: none"> • Mudende-Milk in Kigali • Ntungamo Org. Pineapple- NOGAMU • Rubare-Beans (climbing) – Kinshasha Mufunyi Shanga (Bweremana)-Banana in Bukavu 		<ul style="list-style-type: none"> • Bubare Malted Sorghum porridge • Bweramana Kasiksi wine and juice

This has differential effects on price and operational efficiency where farmers who previously were price takers came face to face with traders to negotiate their prices. The use of binding contracts as negotiation tool has led to increased bargaining power for better prices. The assurance of market for farm produce enhanced operation efficiency to meet the market requirements.

However, this arrangement was not price efficient due to improved communication of market information which led to farmers’ continued sale of products on the open market without honouring their contracts. This was attributed to poor infrastructure such as lack of bulking and distribution centres and cold storage facilities. Special face to face meeting between traders and farmers was held in which market challenges related to quantities, price, quality requirements-

sorting, grading and packaging were shared and solutions found. This had phenomenal attitudinal change among the partners and improved their cooperation. The two parties agreed to meet face to face

whenever necessary. This has increased production and market efficiency of the farming communities (Table 4 and figure 4).

Table 4. Marketing progress for sorghum porridge in Bubare

Mamera sorghum porridge production and sale trends during incubation period (Feb-June, 2010)							
Month	Production (litres)	Sales (Ug. Shs)	Production cost based on 250ml cup	Sales per cup	Sales (U.S \$)	Net profit (Ug. Shs)	Net profit (US.\$)
Feb	400	960000	729600	960000	436.4	230400.0	104.7
March	400	960000	729600	960000	436.4	230400.0	104.7
April	600	1440000	1094400	1440000	654.5	345600.0	157.1
May	800	1920000	1459200	1920000	872.7	460800.0	209.5
June	1200	2880000	2188800	2880000	1309.1	691200.0	314.2

1 cup of 250ml costs Ug. Shs 600/= . 1 U.S.\$ = Ug.Shs. 2,200/=

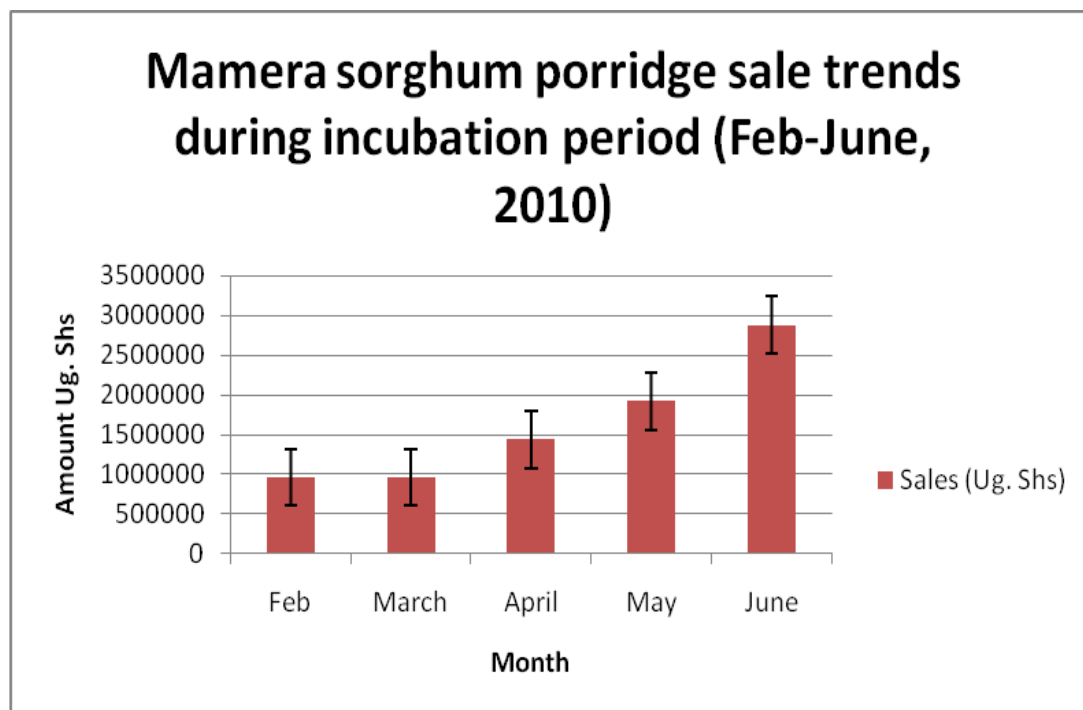

Institutional innovations for reducing transaction costs: Arrow (1969) noted that it is not costless to run an economic system. The costs associated with drafting, negotiating and monitoring agreements, mal-adaptation, haggling, governance and bonding (Williamson, 1985) can significantly reduce enterprise profitability. Various cost cutting innovations were used to bring down the costs of gathering data on price, quality of commodities, and labour inputs, identifying potential buyers and settlers, actor behaviour, ways of strengthening farmers' bargaining power, negotiation, contracts, monitoring implementation of contracts, enforcement against defaulting and protection of rights against third party encroachment and leakages.

Horizontal integration was used to reduce the transaction costs along the value chains. In the case of gathering data we conducted an initial survey of traders and producers that was used collectively. Subsequent updates of market information were done using ICT whereby farmers and traders could call one another directly by mobile phone or access information from the website using sms utility. Farmers were trained in participatory market research to increase their bargaining power while traders were trained in marketing management. For purposes of drafting and negotiating contracts farmers and traders were organized into associations from which representatives were elected for group representation in the face to face meetings. The first face to face meeting negotiated the terms including prices, quantities, quality and packing. The draft

MoU was thereafter crafted by a committee and reviewed and signed in the subsequent face to face meeting. This arrangement drastically brought down the costs and increased the market surplus.

Monitoring of implementation of contracts and enforcement against defaulting is very crucial but costly. At the time of signing MoU, only a few representatives were involved and agreed without all the requisite information. This posed a challenge in that some members would not fully abide by some conditions in the MoU. For example, when the farmers and potato traders signed an agreement at a price of 37,000/=per 100kg bag, farmers never honoured it because of low supply in relation to demand at the time of implementation. Because farmers did not communicate their grievances the potatoes were sold to open market. More costs for ICT-teleconferencing were incurred to bring the farmers and traders together to renegotiate and signed another MoU.

Transaction costs can also be reduced by establishing bulking centres for both producers and traders where farmers can gather their produce. At the bulking centre the produce can be sorted, graded, weighed, packed and labelled. Once the number of bags to fill a truck is bulked the transporter can be called to pick up and deliver at a single outlet where retail traders can pick small quantities from.

Institutional innovations for improving information flow: Breschi and Malerba (2001) observed: "A key feature of successful high-technology clusters is

related to the high-level embedded in local firms in a very thick network of knowledge sharing, which is supported by close interactions and by institutions building trust and encouraging informal relations among actors”. Multi-stakeholder real-time telephone based conferencing innovations were developed to facilitate value chain based linkages and interactions

for timely flow of relevant information (Figure 5). In this multi-stakeholder value chain based closed user low cost telephone group, members pay a monthly fixed fee of 10,000/= equivalent to \$5 for communication while inter-person calls amongst users are free of charge.

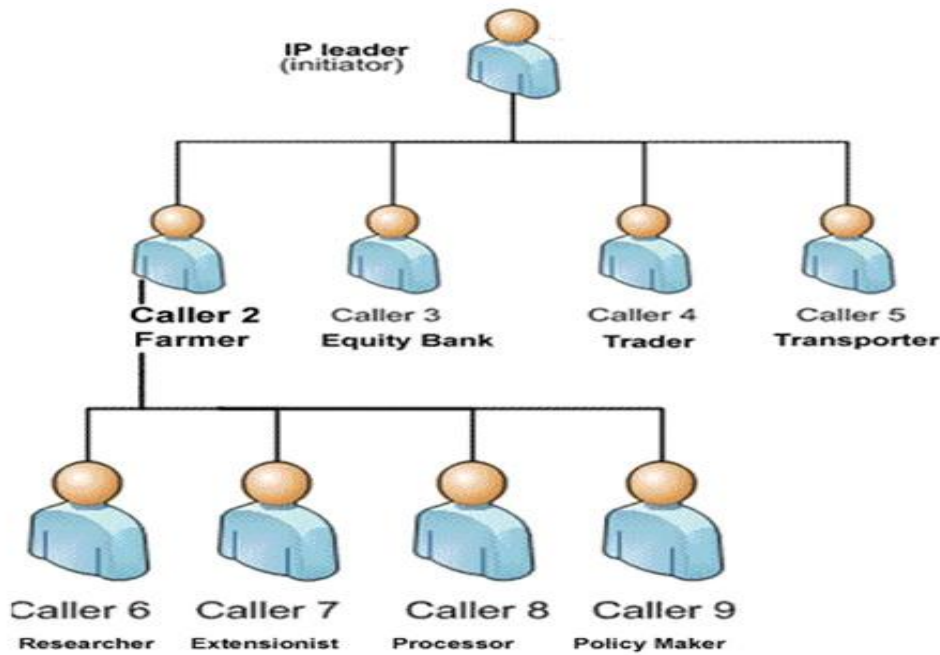

Figure 5. Value chain multiactor mobile phony teleconferencing innovations

Institutional innovations for accessing Credit: Not all organizations can access credit. Through working with various producer and trader organizations we found varying capacity to access credit. Inter-linked contract is a tool developed for involving micro-credit institutions in provision of services to farmers and traders. The financial institutions involved included MECREGO in D.R. Congo, Equity Bank in Uganda and Banque Populaire du Rwanda in Rwanda. Interlinked contracts along with the contract signed between traders and

farmers were used to sign the tripartite MoU (Table 4) through which financial institutions were to extend their services such as loans to farmers and traders. Through this arrangement, various groups are in the process of accessing credit. For instance, Chahi, Uganda and Maendeleo and Muungano in DRC, financial arrangements were made with MECREGO Micro finance institution and as such, negotiations are underway between Chahi Potato IP and MECREGO Micro Finance Institution (MFI) to get a loan of U.S.\$6,000 to purchase newly accepted

Victoria seed variety from UNESPPA to increase potato production. This was made possible because MFI were involved right from inception. Other forms of support were got from other stakeholders. For instance Kabale local Government with

support from Makerere University facilitated IP registration and proposal development as well as other documentation. KAZARDI verified UNESPPA potato quality and conducted the required indexing.

Table 4. Marketing arrangement institutional innovations in the IPs of LKPLS

IP	Constitution	Registration	MoU with a market, a bank or a processor	Bulking for group marketing	IP bank acc	Loan access	Loan repayment	Collective marketing	Remarks
Msanganya	✓	X	X	x	✓	X	na	✓	Collective marketing has not been successful so far
Buuma	✓	X	X	x	✓	X	na	x	Cassava farmers have yet to put their produce together for marketing ; cassava value chain survey scheduled for September 2010
Maendeleo	✓	X	✓	✓	✓	✓	✓	✓	This group is on its second loan and they had paid 50% of it by 13 th of August 2010
Muongano	✓	X	✓	x	✓	✓	poor	x	Potatoes harvested too early rot very fast and have very low price in the market
Chahi	✓	✓	✓	✓	✓	X	na	✓	Negotiations under way for credit access
Bufundi	✓	✓	✓	✓	X	X	na	✓	IP negotiations with SACCO to open up account for financial transactions with traders
Bubare	✓	✓	✓	✓	✓	X	na	✓	Have an account with SACCO
Ntungamo	✓	✓	✓	✓	X	X	na	✓	Bulk for group marketing being strengthened
Gataraga	✓								
Rwerere	✓								
Rwemera	✓								
Mudende	✓								

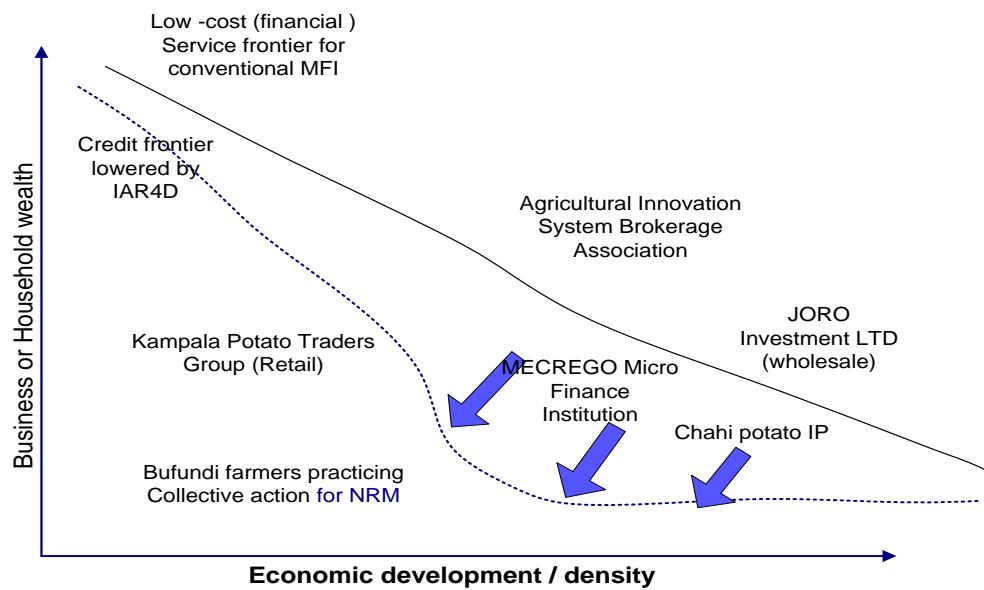

Fig. 6. Credit access domains for different organizations in the LKPLS. Source: Adapted from Doward, et al. 2010.

Innovations in NRM and value addition:

A major innovation has been to build social capital to respond to an incentive and/or market demand. This results into increased productivity to satisfy the markets. Initial efforts to organise and empower farmers involved formation of multi-stakeholder and multi-institutional IPs. The initial incentive for collective action by IPs was motivated by the protection of water springs before market linkage. Once the spring was protected, collective action broke down in preference of individual action. This was solved through institutional interventions by sensitisation of local leaders about benefits of collective action through exposure visits which resulted into a positive attitude change. The turnaround in sustainable natural resource investment is envisaged from demand-driven efforts that will

accrue from linking farmers to markets through binding contracts.

Scaling-out and –up of institutional innovations :

In the course of finding solutions to complex problems arising from action sites, participating stakeholders have learned a lot from the initiative and as such, have initiated several reforms in the business, education, research, extension and policy regulatory systems as described below.

Institutional innovations for scaling out in Education system:

A total of twenty university staff (from Uganda, Rwanda, DRC, Kenya, Netherlands, Germany) and seven PhD and twenty undergraduates have participated in IPs activities and

related field research. In Uganda the Universities involved include Makerere University, Kabale University and Kyambogo University. In Rwanda, it is National University of Rwanda while in DR Congo, it is Goma University. More university staff members from Egerton and Nairobi universities in Kenya have visited sites and lessons learnt have been shared with staff from Jomo Kenyatta University and other RUFORUM universities through various fora. Other universities whose staff visited the sites included Wageningen University (Neitherlands) and Dar es salaam University (Tanzania). At field level numerous farmers, researchers, extension workers, local leaders, private sector (input-output market, processors, financial credit institutions, and transporters) have also been engaged in the learning processes. Valuable lessons and strategies for incorporation of local knowledge into the curriculum have been identified.

The lessons learnt span the spectrum of many new attitudinal, conceptual, methodological and practical elements. It has started to yield transformative learning in adapting to new circumstances, designing one's own life path and learning about learning (Cranton, 2006). Noteworthy is that learning paths of different team members and participants are not the same nor are they all continuous. Different people go through different pathways and speeds although similarities were noted. The relevance and potential application of IAR4D to many problems embedded in complex and highly heterogeneous environments was discovered. Through efforts to bring these realities into the very core of the courses, a

M.Sc. Integrated Watershed Management was developed (Karuhanga et al. 2010 in press). The importance of creating and nurturing an enabling environment for continuously interacting and learning was realized- promotion of documentation and horizontal learning. Service learning is being practiced at Makerere University Agricultural Research, Institute, Kabanyolo.

To adopt the ISA and address the realities of life, the Faculty of Agriculture, Makerere University has taken steps to develop a new epistemological paradigm shift from disciplinary approach towards a systems perspective as a means to accommodate more integrative approaches to teaching and transformative learning processes and rural development.

The IPs have been found to be valuable tools for systemically capturing, connecting and understanding diverse but interdependent parts of reality-physical, biological, social, and technological that interact with their environments. IP based innovations in curricula review for development and transformations in teaching and learning practice particularly capturing indigenous knowledge have been generated. A number of multiplier Universities (e.g. Makerere, Egerton, KU, JKUAT, UoN, Dar es Salaam, Wageningen University Research, Siegen, Kabale, Kyambogo, National University of Rwanda) have directly and indirectly been involved with IPs promoting learning within the framework of the ISA to produce graduates who can work in the rural economy. Students (PhD, Masters, undergraduates) have been directly or indirectly supported in this area. A

number of projects have been developed and funded taking lessons from the impetus of IPs (e.g. BMGF Ag share Project <http://www.oerafrica.org/agshare> -).

Institutional innovations for scaling out in business system: The private non-farm sector can play a role in supporting provision of extension and horizontal transfer of knowledge (innovative public-private partnerships) for market-driven productivity improvement paradigm. This requires investments in communication and some coordination mechanism that well responds to farmers' needs for empowerment, a mechanism that has costs in the market place. We are facilitating horizontal learning farmer to farmer by facilitating them to write up their experiences in experimentation and asking them to share with others.

Where public funds are used to finance innovation systems such as in low income economies of SSA, there must be a mechanism, apart from the market, for aggregating demand and effectively linking to sources of innovation. In the case of IPs, centralized coordination of innovation process was achieved through the formation of a multidisciplinary and multifunctional ICT4D body that facilitates research, extension and multi-media learning. This body is rapidly evolving and has now registered as Agricultural Innovation System Brokerage Association (AISBA). This kind of body that works as a social enterprise is particularly valuable as there is low

capacity of private sector. It works to facilitate both forward and backward linkages without exploitation.

Productivity technology: The technology requirements for African smallholder agriculture are complex. The agro-ecologies of Africa, and particularly East Africa, are highly heterogeneous. Moreover, smallholder farming systems are highly diversified and no single intervention can lead to significant increases in incomes. 'Appropriate' under such conditions implies a high degree of location and system specificity in the technology design, something that is difficult to engineer across a wide range of crops and livestock systems when resources within agricultural research and development systems are significantly constrained. The search for this compatibility between technology design, dissemination systems, and market access has led, on one hand, to building more robustness into the technology (innovations) through integrated systems approaches, e.g. in pest control, soil management, crop livestock interactions, agroforestry among others. However, this trend has compounded (problem) the demands on the extension system, as technologies incorporate higher farmer management and information requirements, but more positively has lessened the dependence on input markets and farmer purchasing power. On the other hand, the increasing focus is on technology innovation within value chains, which link both producer and consumer requirements, combine production with post-harvest technological innovation, and tend to focus on higher value crops with significant

margins at all stages of the chain. Increasingly we are observing that IPs (Table 5) that have adopted value addition and are deriving income from their produce are demanding for soil conservation technologies. However, these

approaches tend to be biased against food staples, have real difficulty incorporating soil and resource management, and the impacts on the rural poor are uncertain, with a tendency to exclude this dominant group.

Table 5. Opportunities for enhancing competitiveness and targeting niche markets through local value addition and quality-based commodity exchange

IP	Enterprise	Enterprise Description	Niche market	Competitiveness
Gataraga	Potato	Cleaning and packaging	Super market, restaurant, hotels, processors	Varietal preferences, packaged preferences, size, etc
Maendeleo	Beans	Cleaning, sorting & bulking	Kinshasa	Sorted beans varieties
Bubare	Sorghum porridge	Packing	Urban centres	Hygienic branding

Institutional innovations for scaling out in a policy regulatory system: The major institutional innovations were arrangements to ensure formulation of bye-laws, strengthening policy review process, conflict management, institutionalization and sustainability of IPs. Formation of a committee to oversee review, formulation, sensitization of stakeholders and establishment of enforcement structure was done to increase the formulation and approval of byelaws. In order to strengthen policy review process workshops for stakeholders on bye-law/policy formulation and review as well as empowerment to attain legal status were found valuable. For conflict management team building seminars for IPs, policy advocacy and meeting with concerned parties (e.g. cattle keepers and

crop cultivators) to engage in dialogue were used. For institutionalization participatory discussions of how IPs fit into the African socio-economic development framework were held. In the case of sustainability, participatory engagement and alignment of IP workplans with the sub-county and district budgets and development programmes (e.g. Community Driven Development) were carried out.

Conclusion

Agriculture in developing countries, especially in Africa has remained unprofitable, despite the numerous reforms introduced in the ARD organisations. This has been attributed to weak institutions

and poor networking among stakeholders. The introduction of IPs in the LKPLS has led to the integration of business, education, extension, research and policy systems and strategies that nurture institutional innovations to address complex challenges while improving performance of the ARD organizations. The lessons learnt span the spectrum of many new attitudinal, conceptual, methodological and practical elements. They are as follows: (1) Institutional innovations are premised on reducing transaction costs within the value chain, not only in the joint activities, but also in core mandates. This has an effect of improving on the profitability of business for both the producers and traders; (2) Integration of the education, research, extension and policy domains has the potential to overcome outstanding constraints-human resource, technology

generation and use, inefficient interlinked output-input markets, unavailability of credit; and promotion of sustainability of the system; (3) successes in the application of institutional innovations depend critically on the quality of linkages and interactions and are highly context specific; (4) successful institutional innovations depends on the quality of facilitation and strong market-led and knowledge-based interactions; (5) there is need for a “public social enterprise body” to foster linkages and interactions, broker innovations and collective action within the broader public-private partnership framework. Institutional innovations evolve at different speeds depending on the interests of the different stakeholders: and (6) Involvement of stakeholders in the learning cycle leads to increased interaction and trust amongst them.

References

- Arrow, K.J. (1969). The organization of economic activity: Issues pertinent to the choice of market versus non-market allocation. In: The analysis and evaluation of public expenditures: The PBB-system, Joint Economic Committee, 91st Congress, first session, vol 1. Washington DC.: UA.Government Printing Office.
- Barhhan, P.K. (2001). Institutions reforms and agricultural performance. In current and emerging issues for economic analysis and policy research. In: Ed. K.G. Stamoulis. Rome: Economic and Social Department, Food and Agricultural Organization of the United Nations. Pp. 139.
- Biggs, S. (2007). 'Building on the positive: an actor innovation systems approach to finding and Promoting pro-poor natural resources institutional and technical innovations', International
- Cranton, P. (1994). Understanding and Promoting Transformative Learning: A Guide for Educators, San Francisco: Jossey-Bass.
- Dormon, E.N.A., Leeuwis, C., Fiadjoe, F.Y., Sakyi-Dawson, O. and Van Huis, A. (2007) 'Creating Space for innovation: the case of cocoa production in the Suhum-Krabo-Coalter district of Ghana', International Journal of Agricultural Sustainability, Vol. 5, Nos. 2-3, pp.232-246.
- Dormon, E.N.A. (2006). From a Technology Focus to Innovation Development: The Management of Cocoa Pests and Diseases in Ghana. Published doctoral dissertation, Wageningen University.
- Doward, A.R., Kydd, J., and Poulton, C. (2005a). Coordination risk and cost impacts on economic development in poor rural areas. Paper presented at the agricultural economics Society Conference, Nottingham, U.K., April.
- Doward, A.R., Kydd, J., and Poulton, C. (2005b). Beyond liberalization: "Developmental coordination" policies for African smallholder agriculture. IDS Bulletin 36(2): 80-85.
- Dorward, A.R. and Ammo, S.W. (2009). A Framework for analyzing Institutions. In: Eds. Kirsten, J.F., Doward, A.R., Poulton, C and Vink, N. Institutional Economics Perspectives on African Agricultural Development. Copyright ©IFPRI pp. 477.
- Evenson, R.E. and Gollin, D. (2003). Assessing the impact of the Green Revolution, 1960-2000. Science Review vol. 300:758-762.
- Eicher, C.K. (2002). Mozambique: An analysis of the implementation of the extension master plan. Maize and Wheat Improvement Centre (CIMMYT), Mexico D.F
- Gijsbers, G.W. (2009) 'Agricultural innovation in Asia. Drivers, paradigms and performance', PhD thesis, Erasmus Research Institute of Management, Rotterdam, The Netherlands

- Hekkert, M.P., Suurs, R.A.A., Negro, S.O., Kuhlmann, S. and Smits, R.E.H.M. (2007) 'Functions of innovation systems: a new approach for analysing technological change', *Technological Forecasting and Social Change*, Vol. 74, No. 4, pp.413–432.
- Hall, A. (2006) 'Public-private partnerships in an agricultural system of innovation: concepts and Challenges', *International Journal of Technology Management and Sustainable Development*, Vol. 5, No. 1, pp.3–20
- Hall, A., Bockett, G., Taylor, S., Sivamohan, M.V.K. and Clark, N. (2001) 'Why research Partnerships really matter: innovation theory, institutional arrangements and implications for developing new technology for the poor', *World Development*, Vol. 29, No. 5, pp.783–797.
- Haug, R. (1999). Some leading issues in international agricultural extension, a literature review. *The journal of agricultural extension and education*, 5(4): 263-274.
- IAC (InterAcademy Council) (2004). *Inventing a better future: A strategy for building worldwide capacities in science and technology*. Amsterdam: Inter Academy Council. Accessible at www.interacademycouncil.net
- Leeuwis, C. (2004) *Communication for Rural Innovation. Rethinking Agricultural Extension*, with contributions by A. van den Ban, Blackwell Science/CTA, Oxford/Wageningen.
- Lynam, J.K. and Blackie, M.J. (1994). *Building effective agricultural research capacity. The African challenge*. In: Anderson, J.R. (Ed.) *Agricultural Technology: Policy issues for the International Community*. Wallingford, UK. CAB International
- Land Management in Uganda: Challenges and opportunities*. SWCSU Technical Report No. 2.
- Nahdy, S., Byekwaso, F. and Neilson, D. (2002). *Decentralized farmer-owned extension in Uganda*. In Breith, S. (Ed.) *Food Security in Changing Africa*. Centre for Applied Studies in International Negotiations. Geneva.
- Omamo, S. W. (2003). *Policy research on African Agriculture: Trends, gaps, and challenges*. ISNAR Research Report 21. The Hague: International Service for National Agriculture Research
- Pant, L.P. and Hambly-Odame, H. (2006) 'Multi-stakeholder deliberation on dialectical divides: an Operational principle of the systems of innovation', *Knowledge Management for Development Journal*, Vol. 2, No. 3, pp.60–74.
- Pardey, P.G., Roseboom, J. and Anderson, J.R. (Eds.). (1991). *Agricultural research policy: International* Roseboom, J., Beintema, N. and Mitra, S. 2004. *Building Impact-Oriented R&D Institutions*

- Pande, R., and Udry, C.R. (2005). *Institutions and development: A view from below*. Economic Growth Centre Discussion Paper 928. New Haven, Conn., U.S.A.: Yale University
- Röling, N. (2009) 'Pathways for impact: scientists' different perspectives on agricultural Innovation', *International Journal of Agricultural Sustainability*, Vol. 7, No. 2, pp.83–94.
- Röling, N. (1988). *Extension science: Information systems in agricultural development*. Cambridge. Cambridge University Press. (FAO and the World Bank, 2000)
- Roseboom, J., Beintema, N. and Mitra, S. (2004). *Building Impact-Oriented R&D Institutions*.
- Spielman, D.J., Ekboir, J., Davis, K. and Ochieng, C.M.O. (2008) 'An innovation systems Perspective on strengthening agricultural education and training in sub-Saharan Africa', *Agricultural Systems* 98, Vol. 1, No. 1, pp.1–9.
- Staff paper (2002). East Lansing, MI.: Department of Agricultural Economics, Michigan State University. Available at < agecon.lib.umn.edu/msu/spoo2-31.pdf>
- Tenywa, M.M., Bekunda, A.M., Lufafa, A. and Taulya, G. (1999). *Participatory Soil Fertility and proceedings of a workshop on the theme "Towards building a Participatory Soil Fertility Management Initiative for Uganda" held 5-6th May 1999*. Pp.4. ISBN 9970 814 010
- Weenink, B. and Heemskerk, W. (2006). *Farmers' organizations and Agricultural Innovation: Case Studies from Benin, Rwanda and Tanzania*, Bulletin 374, Royal Tropical Institute, Amsterdam, The Netherlands.
- Williamson, O.E. (1975). *Market and hierarchies: Analysis and anti-trust implications*. New York: Free Press.
- World Bank. (2006). *Enhancing Agricultural Innovation: How to go beyond strengthening of Research Systems*, World Bank, Washington, DC.