

Soil, Crop,  
and  
Water Management  
in the  
Sudano-Sahelian Zone

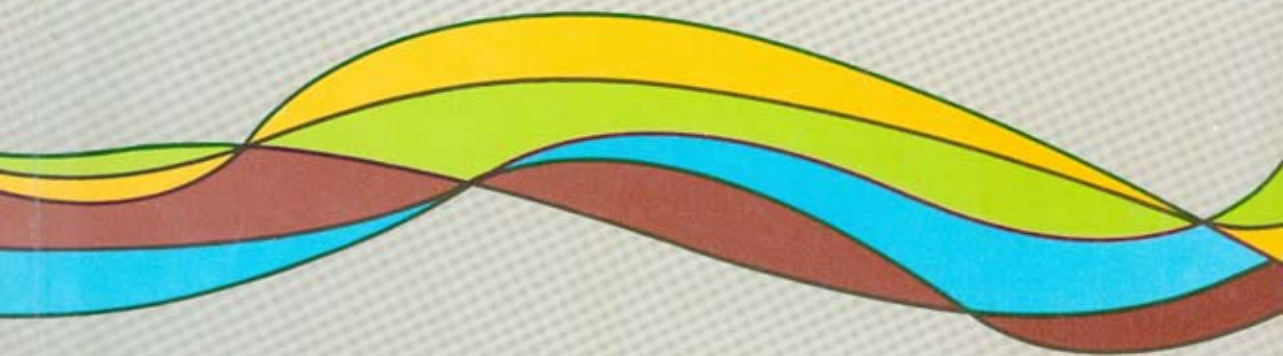

International Crops Research Institute for the Semi-Arid Tropics

**Soil, Crop, and Water Management Systems  
for Rainfed Agriculture  
in the Sudano-Sahelian Zone:  
proceedings of an International Workshop**

**11-16 January 1987  
ICRISAT Sahelian Center  
Niamey, Niger**

**Sponsored by**

**Institut national de recherches agronomiques du Niger (INRAN)**

**United States Department of Agriculture (USDA)**

**United States Agency for International Development (USAID)**

**Tropsoils (Texas A&M University)**

**International Crops Research Institute for the Semi-Arid Tropics (ICRISAT)**



**ICRISAT**

**International Crops Research Institute for the Semi-Arid Tropics  
Patancheru, Andhra Pradesh 502 324, India**

**Citation:** ICRISAT (International Crops Research Institute for the Semi-Arid Tropics). 1989. Soil, Crop, and Water Management Systems for Rainfed Agriculture in the Sudano-Sahelian Zone: proceedings of an International Workshop, 11-16 Jan 1987, ICRISAT Sahelian Center, Niamey, Niger. Patancheru, A.P. 502 324, India: ICRISAT.

**Symposium Organizing Committee**

R.E. Meyer, J.F. Parr, N. Persaud, C. Renard, Idrissa Soumana

**Scientific Editors**

C. Renard, R.J. Van Den Beldt, J.F. Parr

**Technical Reviewers**

N. Persaud  
R.I. Papendick

**Publication Editors**

T. Gaillard  
V. Sadhana

**Cover design**

Sheila Bhatnagar

The International Crops Research Institute for the Semi-Arid Tropics is a nonprofit, scientific, research and training institute receiving support from donors through the Consultative Group on International Agricultural Research. Donors to ICRISAT include governments and agencies of Australia, Belgium, Canada, Federal Republic of Germany, Finland, France, India, Italy, Japan, Netherlands, Norway, Sweden, Switzerland, United Kingdom, United States of America, and the following international and private organizations: Asian Development Bank, Deutsche Gesellschaft für Technische Zusammenarbeit (GTZ), International Development Research Centre, International Fund for Agricultural Development, The European Economic Community, The Opec Fund for International Development, The World Bank, and United Nations Development Programme. Information and conclusions in this publication do not necessarily reflect the position of the aforementioned governments, agencies, and international and private organizations.

The opinions in this publication are those of the authors and not necessarily those of ICRISAT. The designations employed and the presentation of the material in this publication do not imply the expression of any opinion whatsoever on the part of ICRISAT concerning the legal status of any country, territory, city, or area, or of its authorities, or concerning the delimitation of its frontiers or boundaries. Where trade names are used this does not constitute endorsement of or discrimination against any product by the Institute.

# Contents

|   |   |      |
|---|---|------|
| Preface   | Symposium Organizing Committee              | v    |
| Opening Speech  | R.C.Coulter                                 | vi   |
| Opening Speech  | R.W.Gibbons                                 | viii |
| Allocution d'accueil  | Illo Katché                                 | ix   |
| Objectifs de l'Atelier  | Idrissa Soumana                             | x    |
| Objectives of the Workshop  | Idrissa Soumana                             | xii  |
| <br><b>Overview of Rainfed Agriculture in the Sudano-Sahelian Zone</b>  |   |      |
| Les ressources en sols des régions sudano-sahéliennes   | R.Bertrand                                  | 3    |
| Agroclimatic Aspects of Rainfed Agriculture in the Sudano-Sahelian Zone   | M.V.K.Sivakumar                             | 17   |
| L'usage efficace des ressources en eau pour l'agriculture en zone soudano-sahélienne                                    | J.M.Chapotard                               | 39   |
| Gestion conservatoire des eaux et de la fertilité des sols dans les paysages soudano-sahéliens de l'Afrique Occidentale | Eric Roose                                  | 55   |
| <br><b>Soil/Water Management for Conservation/Production Systems in Low-Rainfall Areas</b>                              |   |      |
| Measurement and Characterization of Soil-Water Relationships  | D.J.Mulla                                   | 75   |
| Water-Use Efficiency of Crops in the Semi-Arid Tropics  | P.J.Gregory                                 | 85   |
| Soil Fertility Management and Water Relationships   | A.B.Onken and C.W.Wendt                     | 99   |
| Conjunctive Use of Rainfall and Irrigation in Semi-Arid Regions   | B.A.Stewart                                 | 107  |
| Wind Erosion: Mechanics, Measurement, and Control   | D.W.Fryrear                                 | 117  |
| A Study of Methods for the Revegetation of Barren Crusted Sahelian Forest Soils   | R.G.Chase and E.Boudouresque                | 125  |
| Characterization of the Microenvironment: Measurement Techniques  | C.K.Ong                                     | 137  |
| Soil Conservation and Water Resource Management in the Guinea and Sudanian Savanna Zones of Ghana                       | L.Sipkens and P.M.Nabila                    | 145  |
| Research Needs and Priorities for Rainfed Agriculture in Western Sudan  | B.A.Ibrahim and G.M.Madibo                  | 153  |
| <br><b>Crop/Livestock Relationships, Residue Management, and Agroforestry</b>   |   |      |
| Soil Fertility Management of the Pearl Millet-Producing Sandy Soils of Sahelian West Africa: The Niger Experience       | A.Bationo, C.B.Christianson, and U.Mokwunye | 159  |
| Crop Residue/Livestock Relationships  | S.G.Sandford                                | 169  |

|   |   |     |
|---|---|-----|
| The Value of Crop Residues for Water Conservation   | R.I.Papendick and J.F.Parr                                    | 183 |
| Agroforestry in the Semi-Arid Tropics: Strategies and Research Needs  | R.J.Van Den Beldt   | 191 |
| Réponse des cultures aux engrais et influence de facteurs agro-écologiques sur les rendements dans la zone soudano-sahélienne | C.Joly  | 201 |
| Causes and Effects of Acidity in Sahelian Soils   | L.P.Wilding and<br>L.R.Hossner                                | 215 |
| A Study of Crop Growth Variability in Sandy Sahelian Soils  | R.G.Chase, J.W.Wendt,<br>and L.R.Hossner                      | 229 |
| Soil Spatial Variability and Methods of Analysis  | D.J.Mulla   | 241 |
| <br><b>Cropping Systems and Cultural Practices</b>  |   |     |
| Potential for Response Farming in Sub-Saharan Africa  | J.I.Stewart   | 255 |
| Crop Response to Tillage Practices in a Sahelian Soil   | M.C.Klaij and<br>W.B.Hoogmoed                                 | 265 |
| Recent Developments in Pearl Millet/Cowpea Cropping Systems for Low-Rainfall Areas of the Sudano-Sahelian Zone of West Africa | B.R.Ntare, P.G.Serafini,<br>and L.K.Fussell                   | 277 |
| Design and Evaluation of Alternative Production Systems: Pearl millet/Maize and Cereal/Groundnut Systems in Mali              | S.V.R.Shetty  | 291 |
| Weed Management in Improved Rainfed Cropping Systems in Semi-Arid India   | M.R.Rao, S.V.R.Shetty,<br>S.L.N.Reddy, and<br>M.M.Sharma      | 303 |
| Résultats et priorités de la recherche pour l'amélioration de l'agriculture pluviale au Burkina Faso                          | L.Somé  | 317 |
| Effects of Tillage on a Corn-Cotton Sequence in Côte d'Ivoire   | J.L.Chopart   | 325 |
| Cultures alternatives pour le Sahel   | J.Vieira da Silva   | 333 |
| <br><b>Systems Modeling and Economic Considerations</b>   |   |     |
| Modeling Agroclimatic Systems: Guidelines and Perspectives  | J.L.Steiner   | 341 |
| Considérations économiques et agro-écologiques pour l'adoption des technologies nouvelles par l'exploitant                    | M.Krause, M.Kadi, Chandra<br>Reddy, R.Deuson,<br>et I.Mahaman | 353 |
| Economic Effects of Soil- and Water-Management Technologies: Preliminary Results from a Case Study Analysis in Mali           | J.C.Day and P.Aillery   | 363 |
| Recommandations   |   | 373 |
| Recommandations   |   | 376 |
| Participants  |   | 379 |
| Discours de clôture   | Illo Katché   | 385 |

# Preface

The International Workshop on "Soil, Crop and Water Management Systems for Rainfed Agriculture in the Sudano-Sahelian Zone" was held in Niamey, Niger from 11–16 January 1987. It was organized and cosponsored by the USDA/ USAID Dryland Agriculture Project, the Texas A&M TROP SOILS Project, the ICRISAT Sahelian Center, and l'Institut national de recherches agronomiques du Niger (INRAN) which served as the official host institution. Some 75 research scientists, extension workers, and agricultural administrators participated in the workshop that represented 10 African countries and numerous multilateral, bilateral, and mentor institutions from Europe and North America.

The objectives of the workshop were threefold:

1. To assess and discuss major problems and constraints to increasing the productivity and stability of soil, crop and water management systems in the sub-Saharan Region and particularly, the Sudano-Sahelian zone.
2. To review available data bases and current research activities, and to develop strategies to resolve major problems through research and agrotechnology transfer.
3. To consider the development of an effective and comprehensive research and training network which includes scientist-to-scientist linkages between national/regional scientists, and with scientists in developed countries working on similar problems of dryland or rainfed agriculture.

Following the presentation of formal papers, working groups formulated recommendations in the areas of (1) Agroecological constraints and production systems, (2) Soil and crop management for efficient use of water, (3) Soil fertility management, (4) Crop residue management in relation to livestock and soil and water conservation, (5) Socioeconomic impact of improved technologies for dryland farming systems.

A strong consensus of the Workshop participants was that one of the major constraints to increasing the productivity and stability of rainfed agriculture in the Sudano-Sahelian zone was the failure to adopt and implement basic soil- and water-management practices. It was also recognized that the entire sub-Saharan region constitutes a highly fragile land resource and environment, and that there is limited knowledge as to the technologies that would be appropriate for these conditions. Where research has been conducted, there has often been inadequate characterization of the research sites as to soil types, soil properties, and agroclimatic variables. Consequently, the extrapolation of research results and transfer of technology from such sites involve considerable risk.

The Workshop also recognized that plant breeding has contributed significantly to the development of improved cultivars to overcome disease, insect, nutrient, and moisture stresses. However, plant breeders, agronomists and soil scientists should now work together to develop resource-efficient conservation and production systems which include the best management practices for soil, water, and crop residues. The Workshop also emphasized the importance of having a sound technical data base of past and current research on various aspects of soil, water, and crop/livestock management systems for rainfed agriculture in countries of the Sudano-Sahelian zone of West Africa. It also stressed the need to integrate this information into agricultural production systems that are within the technical and economic capability of the farmer to achieve self-sufficiency and improved income, while allowing the conservation of limited natural resources.

The Workshop was an excellent example of what can be accomplished with a sincere collaborative effort by different donors, projects, and research agencies. This Workshop Proceedings will assist Niger as well as other countries in the Region to develop research priorities and strategies, improve communication and exchange of technical information among scientists in the Region, and foster linkages with scientists in developed countries who are involved in similar research.

**Symposium Organizing Committee**

# Opening Speech

**R.C. Coulter**  
**Deputy Director, USAID, Niamey**

I am extremely pleased and honored today to have the opportunity to address this regional Workshop on Soil, Crop, and Water Management Systems for Rainfed Agriculture in the Sudano-Sahelian Zone. I have reviewed the program, and it is evident that if you are to cover the topics as outlined, and develop resulting recommendations, you will need each available moment, so I'll keep my comments brief.

Let me take a moment to highlight a few broad critical constraints facing agricultural development in Niger, with particular emphasis on issues related to this workshop.

## **Policy Constraints**

Niger's agriculture sector is faced with a complex of interrelated institutional and policy constraints which must be resolved before the country can obtain a reasonable level of agricultural production and rural income. These include those pertaining to input supply and subsidies, agriculture marketing policies, agriculture credit, and the private and cooperative sector. Niger has made considerable progress in addressing these constraints, but there is still much work yet to be done.

## **Physical Constraints**

As we observe the effects of each successive drought (most recently the drought of 1985), we are constantly reminded of Niger's limited physical resource base for agriculture and livestock production, and the country's rapidly growing population. The long-term trend shows per capita crop production declining and the land's carrying capacity (both in terms of livestock and soil fertility) decreasing.

Of course this bleak picture is not unique to Niger, but is occurring in the other countries of the region as well.

The government and donor community must remain determined in their efforts to reverse this trend of environmental degradation. Proven technologies developed under past and present programs must be put into practice. Research in agroforestry and livestock/range management should continue, and efforts should also be made to incorporate (where appropriate) these efforts into the efforts being made in the area of farming systems research.

## **Constraints to Technology Transfer and Research**

The major constraints to technology transfer and research in the agriculture sector include a limited knowledge of appropriate technologies and institutional weaknesses, characterized in part by a lack of effective research extension, in part by a lack of effective research extension linkages and a national research strategy.

Niger is meeting the challenge and addressing these constraints head on in an attempt to lessen their negative effect on agriculture development. They have, with assistance from USAID and other members of the donor community, committed considerable human and financial resources to support major programs in research and technology transfer. Presently, with financial assistance from the world bank and technical assistance from the international service for national agricultural research (ISNAR), the Niger Government is developing a national agriculture research strategy.

Although much progress has been made in addressing these major constraints I have mentioned, Niger has a long way to go to alleviate these constraints. The Government of Niger and the donor community must stay committed to the task at hand, and work together to achieve these development objectives.

### **USAID's Contribution to Agricultural Development in Niger**

Through the years Niger's agricultural development activities have achieved real accomplishments in addressing the needs of the poor. The Government of Niger has made effective use of donor funds as well as its own resources in developing a national policy which stresses improving the living standard of its citizens. USAID is proud of the role it has played in Niger's agricultural development process. Our long term objective is to assist Niger to increase food production leading toward food self-reliance and to increase rural incomes through diversification.

An example of our assistance and the one most closely related to the workshop theme, is our long-term commitment to agricultural research, and Niger's national agricultural research institute INRAN (the host of this workshop). We began our assistance to the research subsector in 1975 with the Niger cereals project, followed by the Niger cereals research project (scheduled to be completed this year), and we are now designing a continuation project called the Niger applied agricultural research project. The new project will also develop INRAN's capacity (in collaboration with ONAHA) to conduct applied research on priority problems in irrigated agriculture. We also have three centrally funded research projects supporting INRAN's research program (INTSORMIL, the Peanut varietal improvement project, and, of course, the TROPSOILS Project).

In closing, workshops such as this enable you to pool your experiences, and draw from the experiences and educational background of others, to address your common agricultural development constraints. I truly expect the discussions and recommendations stemming from this workshop will give direction to the agricultural research, agricultural extension, and land use planning divisions of all your respective ministries.

Have a good workshop.



# Opening Speech

**R. W. Gibbons**

**Executive Director, ICRISAT Sahelian Center and West African Programs.**

Let me first welcome all of you to this workshop organized by INRAN, USDA, USAID, Tropsoils, and ICRISAT at Niamey.

The subject areas of this workshop are very broad but each of the individual facets—soil, water, and crop management are priority areas of research. Better management of any one of these facets may increase crop yields, but better management of the three together may have a synergistic effect, and could result in much greater increases.

In India, ICRISAT has already contributed to the development of a technology for Vertisols which illustrates the benefits of multiple-management factors. Twenty-two percent of the total area in India is covered by Vertisols, mostly rainfed, which currently produce 500-800 kg ha<sup>-1</sup> of food grain in a single season. These soils are hard when dry and sticky when wet, and are therefore difficult to manage. In the rainy season, they are prone to waterlogging, traditionally fallowed, and cultivated only in the postrainy season. The traditional system uses only 41% of the total available moisture.

The improved Vertisol technology, based on a broadbed-and-furrow system developed at ICRISAT, involves soil- and water-management and allows the cultivation of crops in both the rainy- and postrainy seasons and brings annual yield potentials to 4-7 t ha<sup>-1</sup> under conditions of dependable rainfall when using improved cultivars and cropping systems. There are possibilities of extending this technology to the Vertisols of Africa where rainfall is adequate.

Here in the Sahel, environmental conditions are much harsher. More than 50% of the soils are Arenosols, acidic and poor in nutrients. Sandblasting often occurs at the beginning of the rainy season, killing young, sensitive plants. Rains are erratic and the length of the growing season is also very variable. Much research has been done in the past in this region but due to a number of reasons the results have not been adopted by farmers. This is probably because most crop production and agronomic studies in the past (1) did not adequately characterize either the soils or the climatic conditions under which they were conducted, (2) did not measure enough variables to be able to specify appropriate recommendation domains, (3) did not indicate the likelihood of success in wet and dry years, and on the average over a long enough period to be able to assess medium-term risk or long-term sustainability, and (4) most of all did not evaluate how new technologies fit small farmers' goals and poor resource bases.

One of the reasons for this workshop is to bring together a broad spectrum of scientists to discuss these issues and formulate better ways in which to focus our work to help the farmers in the region.

Promising results have already been obtained in Niger, at ISC, in cooperation with institutions such as INRAN, IITA, Institute of Hydrology (UK), IFDC, the Dutch soil tillage group, and the University of Hohenheim. They show that better management practices can result in large increases in crop yields. You will hear more about the management systems that are being used during this workshop.

These management systems are still in the development stage and much more testing and refinement is required before they can be recommended to the farmers. The results will also have to be shown to be sustainable before they can be widely adopted. This will need cooperation and inputs from national, regional and international organizations. New cultivars will also play a part in newly developed systems, but until the energy can be put back into soil—probably by the extensive use of phosphorus in the sandy soils of the Sahel—plant breeding alone cannot increase the low yields by substantial amounts. Therefore the breakthrough will have to come from the combined efforts of all disciplines of agricultural science working together as teams.

I hope that the papers over the next few days, and the inputs of everyone in the discussions and working groups, will help all of us improve our cooperative efforts and research strategies in the future for the benefit of the small scale farmers of this region.

Thank you.

# Allocution d'accueil

**Illo Katché**

**Secrétaire Général du Ministère de l'Agriculture du Niger**

Monsieur le Représentant de la FAO au Niger, Monsieur le Directeur de l'USAID au Niger, Messieurs les Délégués, Messieurs les Invités, Mesdames et Messieurs,

Il m'est particulièrement agréable de vous souhaiter, au nom du Ministre de l'Agriculture, la bienvenue à Niamey, à l'occasion de l'Atelier international sur les systèmes d'aménagement des sols, de l'eau et des cultures pour l'agriculture pluviale dans la zone soudano-sahélienne.

Le Niger, pays sahélien, soumis aux aléas climatiques, attache une importance particulière à tout ce qui touche à la connaissance et à l'amélioration de l'environnement pour sa meilleure utilisation. La connaissance des sols revêt un intérêt primordial pour le développement de l'agriculture, des forêts et des pâturages. Le sol constitue en effet, un support, une source d'aliments et un réservoir d'eau pour les plantes. La recherche sur les systèmes d'aménagement de nos sols est d'autant plus importante que ces derniers, s'ils ne sont pas convenablement utilisés, se révèlent très fragiles et peuvent être dégradés irréversiblement. Ceci est particulièrement vrai lorsque l'introduction de la technologie moderne et les aléas climatiques mettent en cause l'équilibre millénaire, instauré par nos paysans et éleveurs traditionnels, entre l'homme et la nature.

Messieurs les séminaristes, le thème de votre atelier qui s'intitule "les systèmes d'aménagement des sols, de l'eau et des cultures dans la zone soudano-sahélienne" constitue pour nos pays une question de brûlante actualité. C'est pourquoi face aux aléas climatiques auxquels la sous-région est confrontée, votre réflexion sur ce thème et les résultats qui peuvent en découler apporteront, sans nul doute, des solutions aux problèmes du monde rural.

Toutefois au cours de vos débats, qui, nous en sommes convaincus, seront ouverts et constructifs, vous devez garder présent à l'esprit que toute orientation et toute proposition doivent être traduisibles en actions concrètes, sur le plan technique et financier.

C'est ainsi que, conscientes de tous ces problèmes, les Autorités nigériennes ont créé l'Institut national de recherches agronomiques, INRAN, qui conduit des programmes de recherche dans cinq grands domaines : agricole, écologique, forestier, vétérinaire et zootechnique et économie rurale.

Cet Institut a pour tâche de trouver des solutions scientifiques et techniques aux problèmes du monde rural.

Nos pays font face encore au douloureux et difficile problème de l'accession à l'autosuffisance alimentaire; c'est pourquoi au Niger, le Conseil militaire suprême et le Gouvernement en ont fait un objectif primordial qui conduit à la réalisation des aménagements hydro-agricoles dans les vallées du fleuve, de la Maggia, des Goulbi et du La.

Votre atelier me donne l'occasion de lancer un appel en vue d'une plus grande coopération scientifique et technique dans un combat pour un meilleur bien-être de nos populations et c'est avec satisfaction que je note parmi vous la présence d'éminents spécialistes venus représenter les pays de la sous-région et les Organisations internationales telles que la FAO, l'IITA, l'ICRISAT, et les institutions des pays amis.

Je ne terminerai pas sans souhaiter à tous ce qui ont bien voulu faire le déplacement, un agréable séjour au Niger.

Tout en souhaitant plein succès à vos travaux, je déclare ouvert l'Atelier sur les systèmes d'aménagement des sols, de l'eau et des cultures pour l'agriculture pluviale dans la zone soudano-sahélienne.

Vive la coopération internationale.

Je vous remercie.

# Objectifs de l'Atelier

**Idrissa Soumana**

**Directeur Général, Institut national de recherches agronomiques du Niger**

Le Comité d'organisation de l'atelier qui nous réunit ici m'a fait le très grand et redoutable honneur d'introduire ses travaux et d'en définir le but.

Avant toute chose, je voudrais souhaiter, au nom de l'Institut national de recherches agronomiques du Niger, la bienvenue au Niger aux participants qui, pour la première fois foulent le sol de notre pays et un agréable séjour à tous à Niamey, sa capitale.

L'Atelier sur les systèmes d'aménagement des sols, de l'eau et des cultures pour l'agriculture pluviale dans la zone soudano-sahélienne se tient après une campagne agricole pluviale assez satisfaisante dans la zone sahéenne malgré de graves attaques d'acridiens qui ont failli la compromettre totalement, démontrant s'il en était encore besoin toute la précarité de cette agriculture pluviale. Et aujourd'hui, à l'instant où je vous parle, les cultures dites de contre-saison qui se déroulent en cette période sont gravement menacées par les gerboises, au point qu'une semaine nationale de lutte contre ces rongeurs sera organisée dans les prochains jours.

Pendant trois jours et en cinq sessions techniques, 31 communications sur les aspects pédologiques, hydriques, culturels, économiques de l'agriculture pluviale dans la zone soudano-sahélienne seront entendues et discutées. Après une visite sur le terrain, cinq groupes analyseront les différents problèmes cités plus haut et feront des recommandations. Tout ce vaste programme sera exécuté en cinq jours! Mais je suis convaincu que l'intérêt et la qualité des communications feront paraître le temps court.

Comme vous le savez tous, l'agriculture est la principale sinon l'unique activité de plus de 90% de la population de la zone qui intéresse cet atelier, et l'agriculture pluviale en est et sera pendant longtemps encore la composante essentielle. Aussi convient-il, malgré le développement que connaît l'irrigation, de la maîtriser davantage.

Le problème est critique car la zone concernée subit aujourd'hui de graves pressions : l'une démographique et l'autre écologique, la désertification, qui toutes les deux aboutissent, dans notre contexte actuel, à la dégradation des sols et à l'inefficacité des systèmes de production traditionnels de plus en plus incapables de supporter ces agressions et de satisfaire les besoins des populations. Cette situation exige des solutions urgentes et durables que seule la recherche peut fournir. Ces solutions doivent réaliser, comme le dit H. Dupriez "les meilleures combinaisons possibles entre la terre, le capital biologique (plantes et animaux) et le travail tout en contrôlant au mieux le facteur d'incertitude, les aléas climatiques et biologiques, notamment les attaques parasitaires". Il s'agit en fait de définir, dans cet environnement menacé de fragilisation de plus en plus grande et de stérilisation, des systèmes de gestion variés, souples et modulables selon les caractéristiques de l'environnement physique et technico-sociologique qui sont essentiellement la variabilité et la variation spatiale et temporelle. Les objectifs sont donc clairs, mais complexes. En effet, ne s'agit-il pas en un mot de développer l'agriculture de cette région à partir d'une saisie scientifique de ces caractéristiques physiques, chimiques, biologiques et sociologiques? Il faut ensuite les intégrer en "un système de production" adapté à ce milieu que peu de chose suffit à modifier et qui soit acceptable et surtout faisable pour les paysans qui, à leur tour à la moindre difficulté, reviennent rapidement à leurs traditions ancestrales. Dès lors, on peut même se poser la question de la méthodologie de l'approche d'un tel milieu auquel la formule de M.P. Kefford "Progrès scientifique = Peuple + Nature + Méthode scientifique" paraît particulièrement adaptée. En effet, à la vulnérabilité de ses caractéristiques physiques et biologiques s'oppose une forte mentalité de subsistance qui ne veut d'ailleurs nullement dire un refus d'innovation. Dans un tel contexte, tout système d'aménagement des facteurs de production doit avant tout rechercher :

- la conservation des sols et le maintien de leur fertilité tant organique, minérale qu'hydrique à un niveau optimal;

- la réduction des risques encourus par les paysans notamment les risques climatiques, biologiques et monétaires; en effet, le nouveau système doit être techniquement et économiquement à la portée de l'agriculture;
- l'autosuffisance alimentaire, résultat d'un fonctionnement minimum mais simultanément et coordonné des différents facteurs.

Dans les pays développés, le développement de l'agriculture a été obtenu grâce à un accroissement de la consommation directe ou indirecte de l'énergie. Les systèmes de production sont pratiquement poussés à la limite de leur potentialité.

Comment obtenir les mêmes résultats dans un environnement tout différent et caractérisé par :

- une extrême fragilité physique;
- une précarité de l'activité biologique;
- une instabilité climatique;
- une pauvreté des paysans.

Il faut nécessairement développer la recherche agronomique et les ateliers, comme celui-ci, sont absolument indispensables dans un environnement où la documentation scientifique est rare et les communications scientifiques difficiles. De plus, cette recherche doit explorer des voies nouvelles qui recherchent l'amélioration simultanée de tous les facteurs de production, une meilleure compréhension des systèmes de production qui passe par une plus grande interprétation des disciplines de la science agronomique, notamment la science des sols, la zootechnie, l'agroclimatologie, l'économie rurale, la sociologie. C'est cette interdisciplinarité qui permettra de mieux définir et de saisir les besoins de recherche et de développement de systèmes nouveaux d'exploitation adaptés à différentes régions. Ces préoccupations de recherche et d'intégration disciplinaires doivent être les préoccupations de cet atelier. Pour atteindre cet objectif, les différents participants doivent rechercher le dépassement quant à leur discipline. En effet, bien que tous agronomes au sens large, chaque spécialiste a ses propres critères, éléments d'appréciation et d'analyse de la situation agricole fondés sur sa sensibilité "disciplinaire". Dans cet esprit d'une approche globale des problèmes de l'agriculture pluviale en zone soudano-sahélienne, il ne s'agit évidemment pas d'apporter des solutions à tous les problèmes soulevés, mais plutôt d'explorer des voies nouvelles et d'y réfléchir ensemble.

C'est persuadé de cette nécessité et convaincu aussi que l'amélioration de l'agriculture dans la zone traitée ici comme ailleurs, ne peut être obtenue de manière valable et durable sans une collaboration étroite et féconde entre les paysans, les cadres de terrain, les chercheurs et les planificateurs, que l'Institut national de recherches agronomiques du Niger (INRAN) a cru utile d'inviter à cet atelier les responsables de différents projets de développement agricole de notre pays, afin qu'ils apportent aux autres participants l'expérience nigérienne dans ce domaine. Avant de terminer, je me permettrai de faire une suggestion relative au programme de visite. Ne serait-il pas aussi judicieux bien qu'on ne parle que d'agriculture pluviale, de visiter un site de cultures de contre-saison?

Je voudrais en terminant remercier les Drs Parr, Meyer, de l'USDA, les Drs Persaud et Renard et M. Annou, membres du Comité d'Organisation qui n'ont ménagé aucun effort pour la tenue de cet atelier. Mes remerciements s'adressent aussi aux représentants des instituts de recherche de la zone qui nous ont fait l'amabilité de répondre favorablement à l'invitation de l'INRAN.

Je voudrais enfin adresser ma profonde gratitude à tous les participants qui ont fait souvent un long déplacement, manifestant ainsi leur volonté de contribuer au développement de cette zone en apportant leur contribution et leurs espérances scientifiques à l'approche de solutions à quelques-uns de ses problèmes.

Vive la Coopération scientifique.

Je vous remercie.

# Objectives of the Workshop

**Idrissa Soumana**  
**Director General, INRAN**

The organizing Committee has given me the great honor but formidable task of introducing the theme and defining the goals of this Workshop.

First, on behalf of the National Institute of Agricultural Research of Niger, INRAN, let me first welcome the participants here, and wish you all a very pleasant stay in Niamey.

The International Workshop on Soil, Crop, and Water Management Systems for Rainfed Agriculture in the Sudano-Sahelian Zone is being held after a rather satisfactory rainfed cropping season despite the serious locust attacks that nearly jeopardized the whole crop, once again showing how precarious rainfed farming is. And at this very time, the so-called off-season crops are suffering jerboa attacks of such magnitude that a national campaign has been launched against these jumping rodents.

You will be hearing some 35 papers on the soil, water, cropping, and economic aspects of rainfed agriculture during five technical sessions. After a field trip, five technical groups will delve into the problems mentioned above to formulate recommendations. This titanic program is to carry you through five days which will seem very short because of the interesting, high quality presentations.

As you all know, over 90% of the population is engaged mainly, or exclusively, in farming, especially rainfed farming which is, and for long will continue to be, the main system, despite the development of irrigation.

The problem is of the greatest immediacy, for the zone of rainfed farming is also a region yoked by demographic and ecological pressure (better known as desertification) which together lead to degraded soils and waning, traditional systems increasingly powerless when confronted with these pressures, and unable to meet the needs of the populations. Urgent, permanent solutions to this situation must come from research. These solutions must be banked, as H. Dupriez said, "on the best possible combination of land, and labor all the while seeking greater mastery of risks, climatic and biological hazards". Our environment is becoming increasingly fragile and barren. The answer lies in flexible, varied management systems that can be adjusted to meet the demands of the physical, technological and social characteristics of the environment, in essence spatial and temporal variation and variability. Our goals are clear but complicated. In sum, aren't we seeking to develop agriculture in the region, using as our basis, a scientific understanding of these physical, chemical, biological and sociological characteristics which, thereupon, need to be incorporated into a production system that is adapted to the environment we know to be so vulnerable?

The farmer must realize that the system is feasible because the slightest obstacle will make him revert to the traditional methods. Going further, let us look into the methodology of the approach to such an environment. We can draw on the especially fitting equation by M.P. Kefford who holds that: scientific progress = people + nature + scientific method. Because of the exceedingly vulnerable physical and biological environment, the farmers are committed to subsistence farming but this does not mean that they systematically reject innovation. Under these conditions, systems designed to control factors of production must first and foremost seek to ensure:

- soil conservation which include maintaining satisfactory organic and mineral fertility and water reserves;
- fewer climatic, biological and financial risk for the farmer, in other words, the new systems should be technically and economically within the farmer's capacity; and
- food self-sufficiency which involves a well orchestrated application of various factors of production.

Agriculture progressed in the developed countries, thanks to increased consumption of energy, direct and indirect. Production systems have practically exhausted their potentials.

How can the same results be obtained in an environment characterized by:

- extreme physical fragility,

- precarious biological capacity,
- unstable climate, and
- impoverished farmers?

Agronomic research and workshops such as this are crucial in a region where scientific documentation is scarce, and communications are complicated. This research moreover should explore new ways to improve all the factors of production simultaneously, to enhance an overall understanding of production systems. This research must call more upon agronomic sciences. By this we refer to soil sciences, husbandry, agroclimatology, rural economics, and sociology. Interdisciplinarity will enable a clearer definition and understanding of research and development of new systems adapted to our various regions. This workshop must think diligently about such research and interdisciplinarity which means that participants must look in from outside of their special fields of interest. Every specialist in the broader agronomic classification has his own criteria, its standards for evaluation and analysis based on his personal home discipline. The global approach being sought for the problem of rainfed agriculture in the Sudano-Sahelian zone will not solve all the problems; it is merely expected to explore new avenues and benefit from joint reflection.

We are convinced of this need, and also convinced that improving agriculture in this zone, and elsewhere, can only be permanent and worthwhile if partnerships include farmers, field workers, scientists, planners. With this in mind, INRAN has invited leaders of a variety of our country's agricultural projects. They can contribute to the Niger experience. Before ending I should like to suggest that in our field visits we briefly leave rainfed agriculture aside and look at the off-season crops.

In conclusion, an expression of gratitude is to be extended to Dr. Parr, Dr Meyer of USDA, to Dr Persaud, Dr Renard, Mr Annou who, as members of the organizing committee have done their utmost for this workshop. Let me also thank the representatives of the research institutes in this area for entertaining INRAN's invitation.

My appreciation goes to all the participants many of who, in many cases, are showing their will to contribute to the development of this zone by traveling so far to bring us their thoughts and scientific expertise to solve some of our problems.

Long live scientific cooperation.

Thank you.



# **Overview of Rainfed Agriculture in the Sudano-Sahelian Zone**





# Les ressources en sols des régions soudano-sahéliennes

R. Bertrand<sup>1</sup>

## Résumé

*En liaison avec l'influence de roches variées, les paléoclimats, tantôt très humides, tantôt hyperarides, sont responsables de l'organisation spatiale et des caractéristiques des couvertures pédologiques des régions soudano-sahéliennes. Les taxonomies pédologiques sont insuffisantes pour assurer le transfert des connaissances sur les ressources en sol. L'évaluation de ces dernières dépend des facteurs du milieu autres que pédologiques, tels que des contraintes socio-économiques et politiques. Il convient donc d'adopter des démarches d'évaluation interdisciplinaires pour en compléter l'inventaire qui est pratiquement achevé à petite échelle pour bien des pays de la région. Les problèmes de classification des sols semblent dépassés et non prioritaires. Pour assurer le transfert des résultats des recherches agronomiques, la connaissance des relations spatiales, temporelles et dynamiques entre les résultats expérimentaux et les autres facettes de la couverture pédologique locale et régionale, est indispensable. La classification nécessite des cartographies et études de sols interdisciplinaires à différents niveaux.*

## Abstract

*Soil resources in the Sudano-Sahelian regions: The various rocks and paleoclimates (sometimes very wet and sometimes very dry) together influence the spatial organization and characteristics of the soils in the Sudano-Sahelian region. But, correct soil classification, preliminary to the transfer of knowledge about soil resources, also depends on other environmental, socioeconomic, and political factors. To make any resource inventory complete, an interdisciplinary approach must be used. Small-scale resource inventories have already been made for many countries in the region. The problem of soil classification may seem outdated and of low priority, but successful transfer of results from agronomic research depends on an understanding of the spatial, temporal, and dynamic relations between experiments and the local or regional characteristics of the land surface, which indicates the need for cartographic and interdisciplinary soil studies at various scales.*

## Définition de la zone soudano-sahélienne

Parler des ressources en sols de la zone Soudano-Sahélienne suppose résolu le problème de la délim-

itation de cette zone. S'il s'agissait seulement des régions intermédiaires entre ce qui est soudanien et ce qui est véritablement sahélien, les espaces à considérer seraient relativement limités. Aussi nous considérerons ici les régions dont le climat tropical a deux saisons contrastées, une saison sèche longue,

---

1. Agropédologue, IRAT/CIRAD, Montpellier, France.

ICRISAT (International Crops Research Institute for the Semi-Arid Tropics). 1989. Soil, Crop, and Water Management Systems for Rainfed Agriculture in the Sudano-Sahelian Zone: proceedings of an International Workshop, 7-11 Jan 1987. ICRISAT Sahelian Center, Niamey, Niger. Patancheru, A.P. 502 324, India: ICRISAT.

une saison pluvieuse caractérisée par une pluviométrie qui va de 1000 à 1200 mm an<sup>-1</sup> jusque vers 400 mm an<sup>-1</sup>, de 8° à 16° de latitude Nord.

En terme écologique, c'est la zone des savanes : d'abord savanes à ligneux à feuilles caduques et herbacées vivaces puis à herbacées annuelles, puis savanes à ligneux épineux et herbacées annuelles passant vers la limite sahélienne à des steppes discontinues piquetées d'épineux.

En termes agroclimatiques, ces régions sont celles où les cultures vivrières principales sont le sorgho et le mil cultivés sous la pluie.

Depuis une quinzaine d'années, on a assisté à une péjoration du climat vers un pôle plus aride. Aussi on peut considérer que l'ensemble de la zone doit être décalé vers le sud d'une centaine de kilomètres. Cet aléa vécu comme une catastrophe naturelle n'est pourtant qu'une péripétie par rapport aux oscillations climatiques de grande amplitude du quaternaire récent et de l'ensemble du quaternaire en général. Ces oscillations climatiques ont laissé des traces indélébiles dans la nature et répartition des ressources en sol dans la région considérée.

## Répartition et organisation spatiale des sols

### Effets des variations climatiques quaternaires

#### Héritages pédologiques

En effet, des changements climatiques profonds et de longue durée ont imprimé leur marque dans les sols au cours du quaternaire (Fig. 1). Ainsi on peut considérer que, dans leur majorité, les caractères pédologiques, observés aujourd'hui, sont hérités d'un passé plus ou moins lointain. Or ces propriétés sont responsables à la fois des potentialités mais aussi des problèmes agronomiques avec lesquels les agriculteurs doivent composer.

On en a pour preuve les grands plateaux ou glacis à cuirasses ferrugineuses incultivables qui entourent au nord comme au sud la ville de Niamey. Leur genèse suppose à la fois : plusieurs variations climatiques successives et plusieurs variations dans les régimes hydrologiques des nappes.

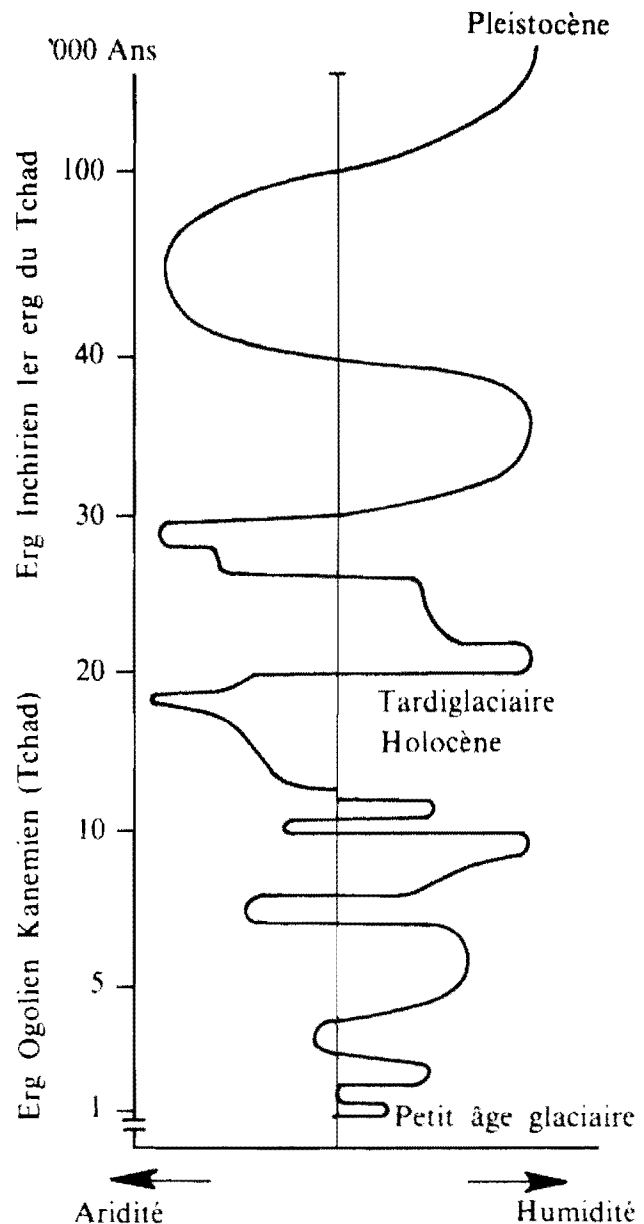

Figure 1. Evolution du climat au cours du quaternaire récent.

Ces cuirasses ferrugines, si caractéristiques des paysages soudaniens à forte pluviosité, remontent au quaternaire moyen ou ancien, il y a plus de 500 000 ans. Stables dans les zones semi-arides soudaniennes ou sahéliennes, elles se démantèlent sous forme de nappes de gravats en climat équatorial ou guinéen. Dans toutes ces régions la présence des sols à nappes de gravats permet souvent de supposer que des cuirasses existaient, qui se sont désagrégées et dont on trouve ici et là des témoins encore conservés. Ces témoins attestent de variations climatiques très importantes. En effet, ils supposent la succession dans le temps d'une part de

longues périodes à climat éminemment plus humides que le climat actuel et d'autre part de longues périodes à climat sinon semi-aride mais au moins très contrasté. Au cours des phases pluviales les nappes phréatiques oscillent, sont hautes et induisent la formation d'horizons tachetés, de plinthites (de pétro-plinthites ou "iron pans"). Au cours des phases interpluviales les nappes phréatiques sont basses et les horizons tachetés s'induisent en cuirasse ou carapace par oxygénation poussée et recristallisation du fer des plinthites précédentes. Le retour à des conditions plus humides conduit à la désagrégation ou démantèlement partiel ou total, avec ou sans érosion et transport latéral des matériaux libérés ou résiduels.

La zone soudano-sahélienne se place pratiquement au centre de la zone de variation des climats au cours du quaternaire, elle en conserve donc beaucoup de traces inextricablement mêlées.

Dans les zones à climat intermédiaire véritablement soudano-sahélien à la faveur des conditions topographiques et hydrologiques particulières, les nappes de gravats se recimentent en carapaces moins indurées.

### **Héritages morphoclimatiques**

La succession dans le temps de climats variés nous a laissé des héritages au niveau des sols proprement dits. Elle a aussi laissé des traces encore plus visibles au niveau des paysages soudano-sahéliens dont l'organisation spatiale est largement commandée par les traces des grandes variations climatiques passées. Les grands glacis cuirassés qui forment l'armature ou le squelette des paysages qui nous entourent ne seront plus mentionnés ici, mais on évoquera simplement les grands ensembles dunaires qui s'étendent depuis la côte sénégalaise ou mauritanienne jusqu'au Soudan. Ces matériaux sableux éoliens sont des héritages morphoclimatiques. Ils recouvrent de très vastes superficies dans les régions sahéniennes. Ces ensembles dunaires ou ergs se sont mis en place au cours de deux périodes beaucoup plus arides que celle que nous vivons. La dernière de ces périodes (ogolien) remonte à peine à 18 millénaires avant l'époque actuelle. Les confins du Sahara étaient alors à 400 km plus au sud qu'actuellement. Par exemple, au Sénégal le désert étendait ses dunes jusqu'à proximité de la Gambie dont le climat est actuellement soudanien avec

environ 800 à 1000 mm de pluies. Ces périodes ont été suivies de phases climatiques beaucoup plus humides que l'actuelle. Il y a à peine 8000 à 10 000 ans au cours de la dernière période pluviale, ces matériaux dunaires ont été rubéfiés et ont partiellement acquis les propriétés pédologiques que nous observons aujourd'hui. Des restes de couvertures sableuses éoliennes plus anciennes (40 000 ans) sont connus dans la même zone. Les sols y sont beaucoup plus évolués, plus rouges et plus argiliés que ceux de l'erg ogolien précédent (Michel 1973, Pias 1970, Bertrand 1972, McIntosh et McIntosh 1983).

En remontant le temps, à intervalle plus ou moins long, on pourrait voir que les principales propriétés et les principales organisations de la couverture pédologique, de l'échelle microscopique comme à celle du paysage, sont pour l'essentiel, héritées des phases climatiques passées qui se sont succédées sur les mêmes lieux. Ce que nous vivons chaque année, cette alternance de conditions arides de la saison sèche et de conditions humides de la saison des pluies, ce déplacement du front inter-tropical de convergence du sud vers le nord et vice-versa nous donne une image de ce qui s'est passé au cours du dernier million d'années avec bien évidemment un pas de temps beaucoup plus grand et aussi plus irrégulier. Les peintures rupestres de l'Air, les outillages lithiques découverts en milieu maintenant saharien sont notre mémoire vive de ces événements tandis que l'organisation de la couverture pédologique, les propriétés des sols représentent la mémoire de masse.

### **Effets des divers substrats géologiques**

Ainsi on peut considérer que beaucoup des caractères des sols, et que l'essentiel de l'organisation de la couverture pédologique sont hérités. Mais de nombreux autres facteurs ont, soit facilité, soit rendu plus difficile l'impression et la conservation, dans la couverture pédologique, des traces de la succession de climats. Il s'agit ici du rôle du substratum géologique.

Par exemple la carte des milieux agro-écologiques du Burkina Faso dressée au 1/1 000 000 en 1985 par Guillobez (1985) d'après divers inventaires pédologiques à des échelles variées (Cartes de l'Institut français de recherche scientifique pour le développement en coopération (ORSTOM) au

1/500 000, cartes de l'Institut de recherches agronomiques tropicales et des cultures vivrières (IRAT) au 1/100 000, au 1/20 000), montre que les témoins des cuirasses ferriques du quaternaire ancien et moyen se sont bien conservés autour des gisements de roches riches en fer (schistes et autres roches basiques). Ailleurs, c'est à dire pour l'essentiel sur granitogneiss, ces cuirasses ont été démantelées en nappe de gravats plus ou moins recimentées ultérieurement en carapaces. La pauvreté relative en fer n'a pas permis leur conservation.

Sur les substrats gréseux se sont développés des sols qui tendent soit vers les sols ferrugineux tropicaux plus ou moins lessivés, soit vers les sols ferrallitiques peu désaturés (des Alfisols). Ces types de sols sont très voisins les uns des autres du point de vue géochimique. Ici, les roches mères gréseuses ou grèso-argileuses (à dominance de kaolinite) conduisent quasiment à une pédogenèse univoque. Cependant ces sols sont le résultat de l'action de périodes tantôt pluviales (évolution vers le pôle ferrallitique ou même oxysol) et tantôt arides (évolution avec individualisation, redistribution, cristallisation, induration du fer en nodules voire en cuirasses, "iron nodules, iron pans"). Les marques de ces évolutions restent imprimées d'une part, dans les profils de sols jusqu'au niveau des micro-organisations et d'autre part, dans les couvertures pédologiques à l'échelle du paysage au niveau de la distribution géographique des divers types de sols (cuiressés, concrétionnés ou non). Il s'agit alors dans l'ensemble de couvertures pédologiques polycycliques ou polyphasées. Non seulement les caractères intrinsèques du sol, hérités des diverses phases, y sont étroitement associés avec les caractères récents ou actuels mais plus encore, au niveau du paysage, certaines parties de la couverture pédologique sont quasi strictement héritées (cuiresses) tandis que d'autres sont plus récentes voire en partie actuelles.

Ces exemples de couvertures pédologiques développées sur des substrats variés, en zone soudano-sahélienne, montrent que les sols sont à la fois (1) le résultat d'héritages pédogénétiques divers liés aux climats variés qui se sont succédés dans la zone pendant le quaternaire et (2) le reflet de l'influence parfois prépondérante des substrats géologiques favorables ou non à tel ou tel type de pédogenèse ou, à la conservation des caractères acquis au travers du temps. Dans le détail, ils résultent aussi de la réorganisation des éléments sous l'influence des conditions actuelles.

## **Inadéquation des classifications à rendre compte des caractères des couvertures pédologiques**

Ainsi dans le milieu soudano-sahélien, les héritages pédologiques, caractéristiques des conditions climatiques passées, variées sinon opposées, dominent à la fois (1) les grands traits de l'organisation du paysage pédologique, c'est-à-dire, de la répartition spatiale du sol, objet essentiel de la cartographie pédologique et (2) les caractéristiques structurales et physico-chimiques des sols. Dans ce contexte, on comprendra toutes les difficultés d'utilisation des classifications de sols pour structurer et transmettre les connaissances :

- Echec d'abord des classifications zonales non seulement mises en défaut par le rôle souvent important des roches mères mais surtout par l'interpénétration profonde, dans l'espace géographique, de divers types de sols, hérités des climats différents.
- Insuffisances notoires sinon échec des classifications actualistes comme la Soil Taxonomy ou la légende de l'Organisation des Nations Unies pour l'alimentation et l'agriculture (FAO) car les types de sols observés sont souvent en total désaccord avec les conditions climatiques actuelles. En outre, ces taxonomies ne prennent que très peu en compte des caractères essentiels tels que les aspects structuraux ou organisationnels des sols et des paysages. Elles ne permettent donc aucun transfert sérieux des connaissances vers, ou depuis, des zones climatiquement ou pédologiquement similaires (au moins en apparence).
- Echec relatif ou insuffisance des classifications morphogénétiques, la classification française Commission de pédologie et de cartographie des sols (CPCS) par exemple, qui, comme les précédentes, classent des unités totalement artificielles : les profils verticaux ou les pédons.

Ces insuffisances, dans la connaissance des sols des régions soudano-sahéliennes et par conséquent dans l'appréciation des contraintes ou des potentialités de ces couvertures pédologiques, incitent à revoir nos démarches de caractérisation des sols ainsi que des couvertures pédologiques. Ceci est

nécessaire afin d'une part (1) d'en mieux évaluer les contraintes et les potentialités, mais aussi (2) de pouvoir "transférer géographiquement, d'un milieu pédologique à un autre, les résultats, des expériences de mise en valeur, acquis sur un sol donné dans des conditions bien connues" (Ruellan 1984).

Cela suppose : la reconnaissance d'unités pédologiques naturelles dans la couverture pédologique, leur caractérisation à la fois large (interdisciplinaire) et détaillée, mettant l'accent sur l'organisation morphologique à toutes les échelles. Cela suppose la réalisation d'analyses physico-chimiques et biologiques et l'étude de la dynamique de fonctionnement basées sur les résultats de l'analyse de l'organisation à la fois au niveau du paysage et au niveau du sol lui-même.

Dans cet ordre d'idées, depuis une quinzaine d'années, les pédologues de l'Institut de recherches agronomiques tropicales et des cultures vivrières (IRAT) ont tenté de répondre à ces objectifs en mettant au point une méthode de cartographie des sols plus naturalistes, la morphopédologie (Bertrand et al. 1985). Le sol n'y est plus considéré explicitement que comme un des éléments de caractérisation de la couverture pédologique, replacée dans son contexte spatial temporel.

Cette démarche interdisciplinaire, morphologique, apparue explicitement en 1970-1971, a été initiée en 1960 par plusieurs pédologues de l'IRAT en Afrique et à Madagascar et enfin par beaucoup de pédologues cartographes de l'Institut français de recherche scientifique pour le développement en coopération (ORSTOM) un peu partout en Afrique. En Australie, la démarche proposée par la Commonwealth Scientific and Industrial Research Organization (CSIRO) fait figure de précurseur en la matière mais n'a malheureusement pas été suivie de mises au point ou de réflexions méthodologiques approfondies.

Plus récemment des démarches parallèles ont été suivies par des équipes de chercheurs de l'ORSTOM (pédologues, géomorphologues, géographes), notamment en Amérique du Sud (cf plus loin). D'autres équipes de chercheurs de l'ORSTOM se sont penchées sur la mise au point de l'analyse structurale détaillée de la couverture pédologique : identification de volumes, études des contacts et des transitions, séquences d'organisations, analyses des organisations élémentaires et de leurs relations temporo-spatiales (Boulet et al. 1982, Humbel 1984).

## Etat actuel des inventaires dans les pays soudano-sahéliens francophones

L'exposé de ces orientations vers une approche d'étude, des couvertures pédologiques, naturaliste ou interdisciplinaire permet de comprendre que les travaux d'inventaire, de cartographie pédologique systématique, ont été quelque peu réduits ces dernières années au profit de recherches répondant mieux à la mise au point de nouvelles démarches.

Cependant malgré les critiques fondamentales exposées plus haut, les connaissances acquises sur les sols et leur répartition spatiale sont considérables. Il est vrai que les pédologues cartographes plus ou moins conscients de ces problèmes ont souvent largement transgressé les règles d'application des classifications de sorte que leurs cartes constituent souvent un bon support pour le transfert des connaissances; le meilleur actuel, et ce, pour de nombreuses années encore, compte tenu de l'ampleur et du niveau scientifique du travail réalisé.

La première carte présentée (Fig. 2) montre l'état de l'inventaire à très petite échelle 1/1 000 000 à 1/500 000 et de l'inventaire à moyenne échelle 1/200 000 à 1/100 000. L'ensemble de la zone considérée est pratiquement couverte, seuls, le Mali, la Mauritanie et la Guinée n'ont pas été étudiés. Mais des études localisées existent. Si l'on tenait compte des études agrostologiques, qui comportent presque toujours un volet sol, et des études géomorphologiques, les régions encore inconnues seraient sensiblement réduites au Mali.

La seconde carte (Fig. 3) présente l'ensemble des inventaires pédologiques à petite et moyenne échelle allant de l'échelle de 1/200 000 à 1/100 000. Ici encore les superficies couvertes sont considérables. Les vides sont bien entendu plus grands que précédemment. Ils concernent, (1) la quasi totalité du Mali, de la Mauritanie, de la Guinée, du Burkina Faso et du Niger et (2) le Nord du Sénégal à vocation pastorale connu grâce aux études agrostologiques, et une petite portion du nord du Togo et du sud-est du Tchad.

Il n'a pas été possible de faire l'inventaire des cartes pédologiques plus détaillées réalisées pour les études de factibilité, car ces cartes restent non publiées ou bien sont très difficiles d'accès pour des raisons diverses. Sous l'égide de l'Agence de coopération culturelle et technique (ACCT), un inven-

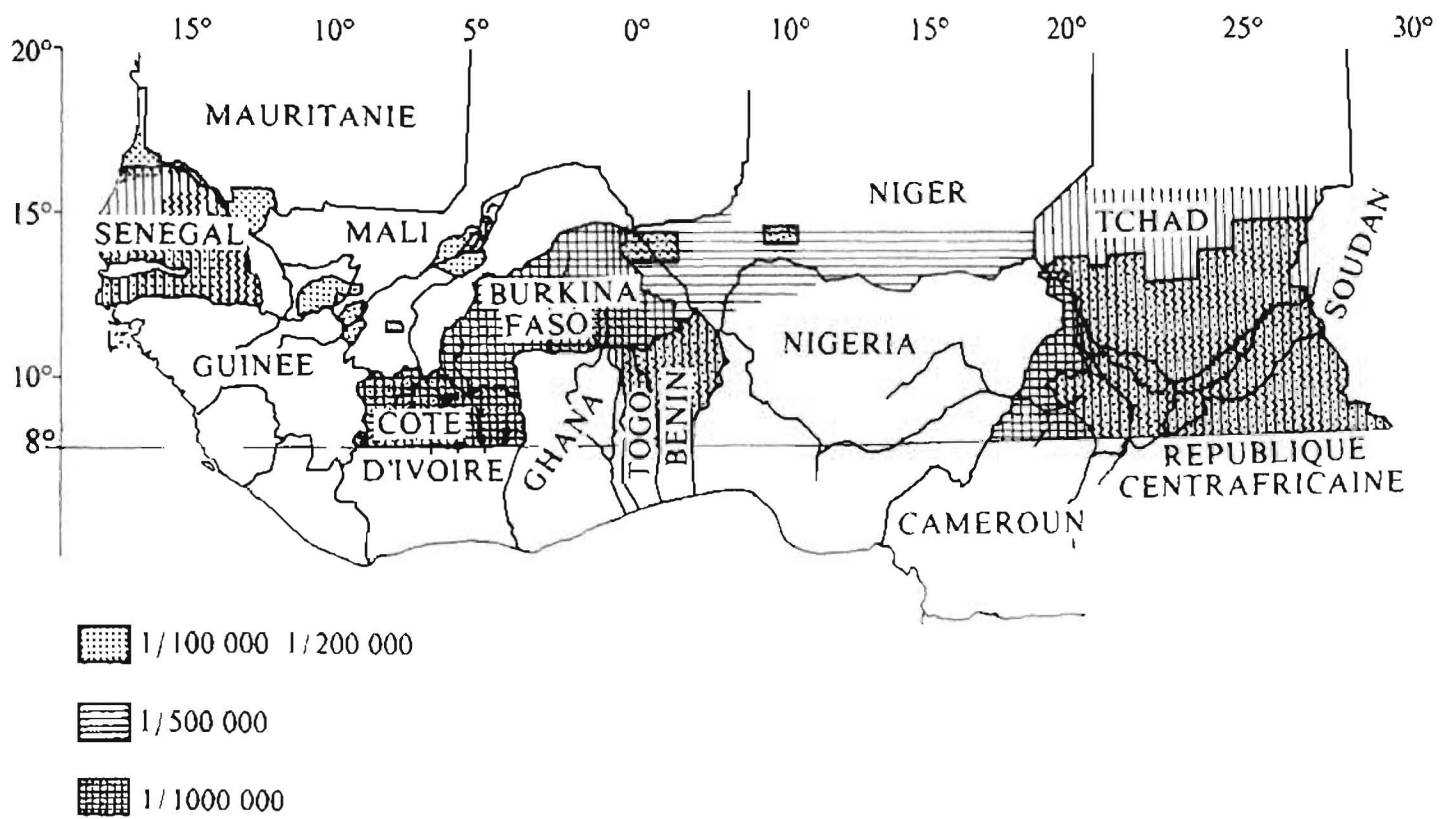

Figure 2. Etat actuel des cartographies pédologiques en Afrique occidentale francophone (toutes échelles confondues).

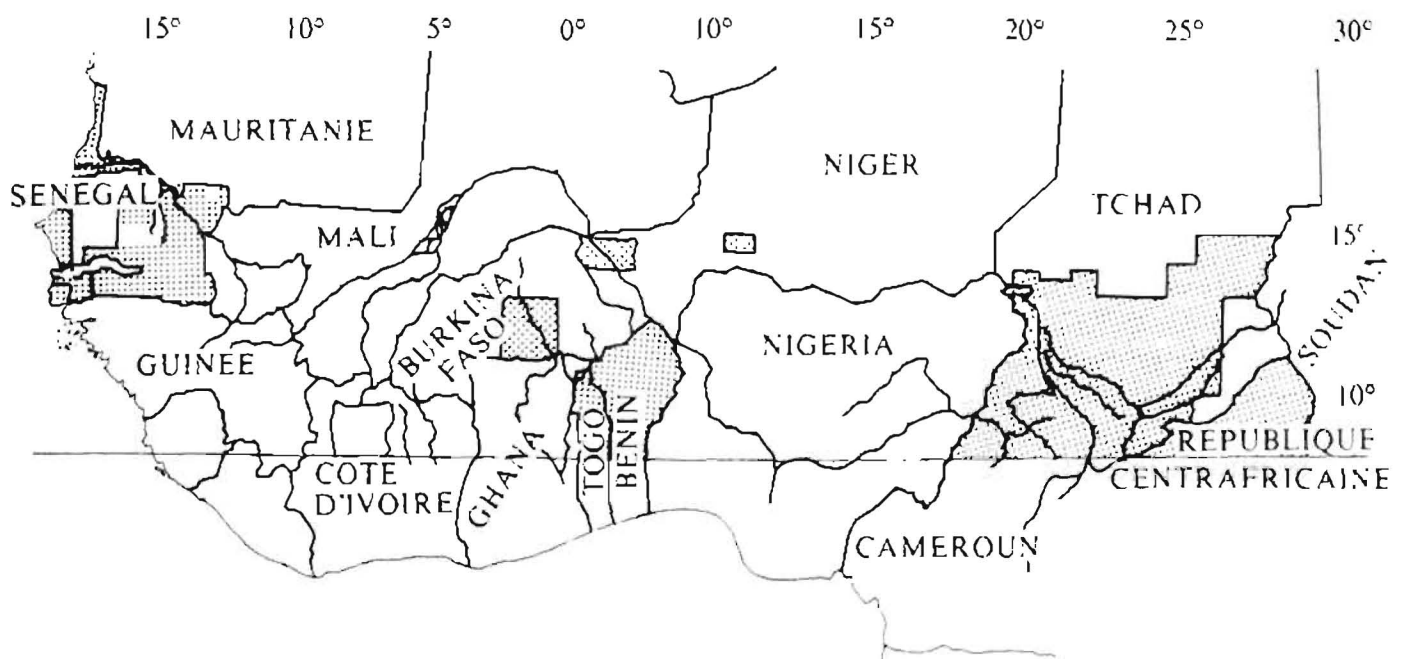

Figure 3. Cartographies des sols au 1/100 000 et au 1/200 000 en Afrique occidentale francophone.

taire probablement incomplet mais très bien renseigné a été élaboré et mis en banque de données.

## Utilisation agronomique des inventaires à petite échelle

Compte tenu de l'immensité des espaces à prospecter (10 millions de km<sup>2</sup>), ces cartes pédologiques ont été pour l'essentiel réalisées à l'échelle de 1/200 000 ou de 1/500 000. Donc, il s'agit plutôt d'études exploratoires, d'inventaires préliminaires destinés à combler le vide absolu des connaissances dans la nature et la répartition générale des sols sur cette portion du globe. C'est un premier pas avant d'affiner les recherches et les connaissances. Mais en même temps ces travaux ont fait beaucoup pour faire évoluer notre vision du sol, pour la mise au point de méthodes d'études plus larges et pour la mise en relation des sols et de leur milieu.

Ce dernier aspect nous intéresse plus particulièrement ici car l'étude des liaisons des sols et de leur milieu est le préalable indispensable à l'évaluation des ressources en sol. Il est clair cependant que la petite échelle des inventaires réalisés ne permet pas des analyses ni très fines, ni très détaillées. Aussi, ce fond cartographique, par son esprit nécessairement synthétique, est-il le plus souvent essentiellement adapté à la planification et à l'élaboration des politiques agricoles régionales et nationales. Son intérêt didactique doit aussi être souligné.

Ces inventaires permettent d'avoir les éléments préliminaires pour une première conception et un positionnement préliminaire des projets agricoles. Ils ne sont pas du tout destinés ou adaptés ni à la mise en oeuvre des études de factibilité, ni à la réalisation opérationnelle de ces projets car l'échelle est trop petite.

En général ces cartes sont des cartes pédologiques au sens strict du terme. Aussi est-il clair que cet aspect, par trop monodisciplinaire, en limite la portée pour l'évaluation des ressources en sols.

En effet les ressources en sols dépendent non seulement des caractéristiques intrinsèques du sol mais aussi de l'ensemble des caractéristiques du milieu physique : climat, agressivité climatique, régime hydrologique, caractères du relief, etc. Plus encore les ressources en sol ne sont pas dissociables du milieu humain. En effet les ressources en sol sont aussi déterminées par le contexte socio-économique ou technologique. Ainsi "croire que les ressources en sols ne dépendent que de la valeur

des sols, celle-ci n'étant basée que sur les conditions pédologiques", (Hallaire 1981) est une erreur grossière car les ressources en sols dépendent aussi des aspects sociologiques, économiques, technologiques et politiques, et que le milieu naturel est indissociable du milieu humain. En effet milieux naturel et humain n'évoluent pas indépendamment mais participent à une même dynamique de l'espace rural.

Ainsi pour passer d'une carte pédologique à une carte des ressources en sols, il est d'abord nécessaire d'injecter dans le processus de cartogenèse un certain nombre de données extrinsèques au sol à proprement parler. Ainsi dans les cartes morphopédologiques, l'essentiel des données pertinentes des autres facteurs du milieu est-il clairement exprimé. Mais il faut aussi y introduire des données sociologiques, économiques et politiques, ethnologiques, culturelles voire religieuses ou psychologiques qui dépassent largement le cadre des compétences des pédologues.

Il s'ensuit qu'il est nécessaire de concevoir une autre approche délibérément interdisciplinaire, si l'on veut évaluer les ressources en sols et puisque celles-ci ne sont pas figées ou momifiées, mais varient en fonction de l'évolution et des progrès des sociétés humaines considérées.

Pour toutes ces raisons la plupart des inventaires pédologiques à petite échelle réalisés jusqu'à ce jour ne permettent pas d'évaluer correctement les ressources en sols et toutes les cartes qui pourraient en être dérivées directement sont sujettes à caution. Il faut en prendre conscience. Ainsi au niveau régional, celui qui nous intéresse ici, la notion de ressources en sol est déterminée par diverses contraintes :

- au niveau du pédon, contraintes pédologiques et du milieu;
- au niveau de la parcelle, contraintes d'accessibilité, de mécanisation;
- au niveau de l'exploitation, contraintes socio-économiques et structures d'exploitation;
- au niveau régional, structures communautaires ou associatives;
- au niveau national, besoins en produits (Hallaire 1981), ainsi que par les interactions réciproques et complexes de toutes ces contraintes.

Ces mises en garde étant faites, il n'en reste pas moins que les inventaires pédologiques à petite échelle constituent un document irremplaçable et d'une très grande valeur pour la connaissance du milieu et une première approche des ressources en sols de ces régions soudano-sahéliennes. Aussi



doit-on souhaiter que ces inventaires soient complétés en adoptant une démarche plus naturaliste, plus interdisciplinaire dépassant le cadre pédologique strict.

## **Utilisation agronomique des cartes à moyenne et grande échelle**

### **Cartes à grande échelle**

Beaucoup de cartes à grande échelle (1/5000-1/20 000) ont été établies dans les régions soudano-sahéliennes à l'occasion d'études de factibilité de projets. Ces cartes sont nombreuses mais, comme nous l'avons signalé plus haut, elles sont peu accessibles. Il convient de souligner que ces documents exigent des dépenses importantes et des temps de réalisation très longs. Adaptés à des projets à forts investissements (projets d'irrigation), leur précision et leur coût sont superfétatoires eu égard aux besoins réels des projets d'agriculture pluviale. Cependant, lorsqu'il s'agit de transférer les résultats acquis par les recherches, il est clair que leur intérêt est important. Pour cela il importe que ces études détaillées, nécessairement limitées dans l'espace, soient référées aux structures des couvertures pédologiques environnantes par des cartographies à moyenne et à petite échelle. Les espaces considérés alors doivent être suffisamment larges pour rendre compte de l'essentiel des caractères des couvertures pédologiques environnantes, du rôle et de la place des divers éléments présents dans les points d'expérimentation, dans l'organisation morphologique et le fonctionnement de ces couvertures.

### **Cartes à moyenne échelle**

De même que précédemment, de nombreuses cartes à moyenne échelle (1/20 000-1/100 000), ont été établies dans les régions soudano-sahéliennes à l'occasion d'études de factibilité pour des projets divers. Comme précédemment et pour les mêmes raisons, elles restent difficiles d'accès (sauf cartes régulières au 1/50 000 au Cameroun).

Ce type de cartographie est particulièrement intéressant pour aborder les problèmes d'évaluation des ressources en sols pour l'agriculture pluviale. La précision relative est bien adaptée aux espaces

considérés par les projets. Par leur coût et temps de réalisation réduits, ces inventaires sont en rapport avec les niveaux d'investissement consentis dans ces projets.

Cependant, ces cartographies souffrent souvent, comme toutes les cartes pédologiques au sens strict, de leur manque d'ouverture sur les facteurs extrinsèques d'évaluation des ressources en sol. Ici comme plus haut les études pédologiques ne prennent en compte que les aspects sols, hors de leur contexte écologique ou socio-politique.

Une caractéristique générale de ces cartes pédologiques est qu'elles sont sous-tendues essentiellement par des systèmes de classification, de taxonomie des sols qui constituent "à la fois des langages, des outils de caractérisation, des outils de cartographie" (Ruellan 1984). Sans revenir sur les insuffisances de ces outils, déjà évoquées, il convient de souligner combien le langage des pédologues est considéré comme ésotérique par la plupart des utilisateurs. Il est certain que le foisonnement sinon l'interprétation des classifications, leurs révisions indispensables au cours du temps laissent l'utilisateur potentiel désarmé et pantois. Cet état de choses le conduit non seulement à trouver toutes les bonnes raisons pour ne pas demander la mise en oeuvre des études pédologiques qui s'imposent, mais aussi pour négliger d'utiliser les études qui existent déjà.

Pourtant beaucoup d'informations pédologiques peuvent être transmises en langage clair, compréhensible de la plupart des utilisateurs, des agronomes qui ont, au moins, été initiés à la pédologie au cours de leurs études. Il n'en reste pas moins que, comme dans toutes les sciences, l'exposé thématique n'est pas toujours compréhensible immédiatement du public non initié. Aussi, bien souvent, même sans tomber dans les abus soulignés plus haut, l'exposé ne peut être fait sans un minimum de langage spécialisé.

En d'autres termes cela veut dire que dans leur majorité les inventaires pédologiques sont difficiles à lire par le public auquel ils sont destinés. C'est pour cela que, par nécessité des cartes dérivées des cartes pédologiques sont établies. Ces cartes sont dites "d'utilisation ou d'aptitude des sols".

### **Cartes d'utilisation des sols**

Le but utilitaire le plus général des études pédologiques est d'évaluer les sols. Nous passerons sous

silence les méthodes d'appréciation globale de la valeur des terres, telles que :

- le "jugement agricole" qui procède d'une connaissance implicite du milieu lié, au référentiel de base, à l'expérience des agriculteurs;
- celle qui est tirée de la connaissance de la production (quantitative et/ou qualitative) qu'on peut tirer d'un sol qui dépend beaucoup des conditions socio-économiques;
- celles qui sont basées sur les possibilités d'utilisation d'un sol d'après l'examen de ce qu'il porte aujourd'hui (Hallaire 1981).

Nous nous attacherons plutôt aux méthodes d'évaluation analytiques. Parmi elles, la méthode la plus connue et la plus utilisée consiste à inventorier et classer les contraintes qui s'opposent à la mise en valeur agricole. Des cartes des contraintes ont ainsi été établies et publiées. Classer les contraintes consiste d'abord à déterminer, d'une part la nature de ces contraintes et, d'autre part, les intensités de ces contraintes, c'est à dire de définir des classes à partir de valeurs seuil choisies a priori. Ensuite, il s'agit de déterminer l'importance relative des contraintes les unes par rapport aux autres en fonction de leur nature et de leur intensité. Cette double démarche n'est pas sans poser des problèmes. Le plus souvent on les a résolus en classant les contraintes en quelques classes : absolues, majeures, mineures. La classe d'aptitude est finalement obtenue en se basant sur le nombre et sur l'importance des contraintes. Le principe de cette méthode a été mis au point par le Soil Conservation Survey, Département de l'agriculture des Etats-Unis.

Schématiquement "les sols sont ainsi classés d'après leur aptitude à la mise en valeur" pour l'agriculture, pour les pâturages, pour la forêt, pour la vie sauvage. Ainsi "le classement n'est pas un classement de la valeur des sols en termes de productivité mais un classement de l'éventail de leurs possibilités d'utilisation" (Hallaire 1981). Cela suppose au préalable, non seulement une hiérarchie entre les spéculations des plus exigeantes aux moins exigeantes, mais également une hiérarchie entre les divers usages. Ainsi par exemple "tous les sols utilisables en pâturage le sont en forêt et tous les sols utilisables en culture le sont en pâturage". On entre ici dans la pétition de principe et dans le cercle vicieux puisque le classement des contraintes suppose une idée préconçue sur la ou les spéculations que l'on désire trouver dans les meilleures classes. Cette critique fondamentale n'a

rien d'étonnant dans la mesure où les fondateurs de la méthode étaient essentiellement préoccupés par les risques d'érosion des sols.

La généralisation sans adaptation de cette méthode est pour le moins erronée, sinon désastreuse à bien des égards, car elle met les pédologues dans un cadre sécurisant demandant peu de réflexions personnelles. Elle conduit aussi à des inepties car elle ne peut tenir compte des exigences spécifiques de toutes les plantes cultivées et de tous les systèmes de mise en valeur. Ainsi par exemple, peut-on considérer que le riz serait adapté à la classe 1 à sols plats, profonds, fertiles et "bien drainés"? Peut-on considérer que les sols des classes 6 ou 7 des collines de Birmanie, de Madagascar ou des Philippines, aménagées en rizières, sont incultivables?

Par contre le principe de cette méthode ne souffre guère de critique lorsqu'on l'applique à une seule spéculation dans un contexte technologique déterminé dont on connaît les exigences spécifiques. C'est dans cette voie que les pédologues du Centre de coopération internationale en recherche agronomique pour le développement (CIRAD) ont orienté leurs efforts ces dernières années, qu'il s'agisse de cultures vivrières, industrielles ou fruitières. Ainsi des cartes d'aptitude à telle ou telle spéculation dans tel ou tel système technique ou socio-économique ont été tabliées ici et là tant dans les régions soudano-sahéliennes (Bertrand et al 1985) que tropicales humides.

Ce n'est donc pas tant le principe de la méthode qui est critiquable, mais la généralisation abusive qui en est faite.

Il est cependant clair que bien des questions restent en suspens, en particulier à partir de quel niveau de précision une carte des sols ne peut plus être dérivée en carte d'aptitude. Il convient alors de tenir compte d'un facteur essentiel, celui de l'hétérogénéité de la couverture pédologique. Ainsi dans certaines régions du Sénégal oriental, cette transposition pourra être envisagée pour des cartes au 1/200 000 et sera réalisée, sans trop d'aléas, à partir du 1/100 000, alors que dans les vallées des Voltas au Burkina Faso il faudra atteindre et même dépasser le 1/20 000 pour y prétendre sérieusement. Il est, bien entendu, inutile de préciser que dans ces deux exemples il ne s'agit pas de cartes pédologiques, au sens strict, mais de cartes morphopédologiques prenant en compte et explicitant les autres facteurs du milieu physique.

Il convient cependant de bien souligner que très

rare sont les cas, même dans ces travaux récents, où les aspects socio-économiques, technologiques ou politiques, sont pris en compte pour l'évaluation des ressources en sols. Ce manque d'intégration des aspects humains soulève des problèmes de méthodologie, de conception des études, qui relèvent de recherches de base.

## **Besoin en recherches de base relatifs à la cartographie et à la classification**

### **Cartographie**

#### **Compléments de l'inventaire à petite échelle**

Compte tenu des vides dans la cartographie des pays comme la Mauritanie, le Mali, la Guinée, il paraît indispensable de continuer les levés cartographiques à petite échelle (1/200 000) par exemple. Mais il est sûr que les méthodes de cartographie doivent évoluer. L'inventaire, la représentation cartographique de la couverture pédologique nécessitent, nous l'avons vu, une approche naturaliste ou interdisciplinaire, où le sol est étudié dans son contexte paysagique. La méthode morphopédologique est particulièrement adaptée à cela. En effet, les travaux des pédologues du CIRAD et de l'ORSTOM en Afrique et à Madagascar, la cartographie complète régulière au 1/200 000 de l'Equateur réalisée en une dizaine d'années, suivent cette méthode. Bien entendu cela suppose soit des pédologues ayant une solide formation en géomorphologie, soit l'intégration de géomorphologues au sein d'une équipe de pédologues. Cela suppose aussi l'intervention d'autres spécialistes : quaternaristes, géographes du milieu humain, agronomes, écologistes, etc., soit ponctuellement soit régulièrement. Dans ce contexte interdisciplinaire l'utilisation d'une taxonomie pédologique particulière ou d'une autre ne soulève pas de difficultés particulières puisque en Afrique la classification française a été utilisée (parfois la légende FAO), tandis qu'en Amérique du Sud la Soil Taxonomy a constitué le référentiel pédologique.

#### **Cartographies à moyenne échelle**

On a vu précédemment que si les inventaires à petite échelle pouvaient être utilisés à des fins de

planification et de politique de développement agricole, ces cartographies ne permettaient guère la mise en oeuvre de projets agricoles, si diffus soient-ils.

Aussi pour la réalisation de ces projets est-il nécessaire de conduire des cartographies, de la couverture pédologique, suffisamment détaillées et adaptées aux projets en question. Ce sont là des termes vagues qu'il conviendrait de préciser mais cela est rendu difficile :

- en raison notamment de l'hétérogénéité de la couverture pédologique d'une région à une autre (cf plus haut) nécessitant par conséquent une plus ou moins grande finesse des levés;
- en raison aussi de la nature et de l'intensité des actions, sur le milieu des projets agricoles.

Il paraît donc impossible, dans l'absolu, de fixer des normes. Cependant en fonction de l'importance des investissements agricoles consentis dans chaque projet il nous semble raisonnable de proposer qu'une enveloppe financière, qui pourrait être de l'ordre de 1% (+ 0,5) des dépenses, ayant trait à l'agriculture proprement dite soit réservée à ces études du milieu.

Il est bien entendu inutile de revenir sur la nécessité de l'aspect interdisciplinaire de ces études sur les cartographies de la couverture pédologique.

### **Cartographies destinées à assurer le transfert des résultats des recherches agronomiques**

On a évoqué plus haut que le transfert des résultats acquis d'un milieu pédologique à un autre exigeait la connaissance à toutes les échelles de la morphologie et de la dynamique de fonctionnement des couvertures pédologiques. Jusqu'à présent beaucoup de recherches agronomiques ou de recherche-développement ont été réalisées soit sans étude pédologique, soit avec des études pédologiques trop peu détaillées et insuffisantes, soit avec des études très détaillées mais confinées aux limites des points d'expérimentation.

Seuls les points d'expérimentation principaux et les sites de recherche-développement du Sénégal ont, à notre connaissance, fait l'objet d'un début de travaux de cartographie à différentes échelles, détaillés sur les stations, semi-détaillés ou de reconnaissance pour la région environnante. Il faut les poursuivre et les affiner.

Dans les autres pays il convient de les entreprendre rapidement. Les possibilités de généralisation ou d'extrapolation des résultats des expériences de mise en valeur sont à ce prix. Le but n'est pas de donner des noms aux sols des stations, d'après une quelconque classification. Il s'agit de bien situer les placettes expérimentales d'abord dans le contexte pédologique local puis régional. Enfin, et surtout, on essaiera de mettre en évidence des liaisons existant entre les sols particuliers des points d'expérimentation et l'ensemble de la couverture pédologique. La compréhension de ces relations spatiales, temporelles ou dynamiques permettront d'évaluer les possibilités d'extrapolation de tel ou tel résultat à d'autres milieux pédologiques similaires à tel ou tel point de vue.

### Recherches de base en matière de cartographie

En effet, l'inventaire de la nature des couvertures pédologiques suivant un référentiel taxonomique donné est déjà bien avancé dans les régions soudano-sahéliennes. Par contre, l'étude des organisations des couvertures pédologiques, à différentes échelles, pour en extraire les relations temporo-spatiales et de fonctionnement, est à peine abordée. Cependant les résultats fondamentaux et pratiques de ces premières recherches ont un tel intérêt, que ce soit au Nord Cameroun (Bocquier 1973), au Burkina Faso (Boulet et al. 1982), au Sénégal (Chauvel 1979, Nahon 1976), qu'il incite à un développement de plus en plus important de ce type de recherches cartographiques.

Il s'agit donc par des cartographies à différentes échelles, par des études analytiques, physico-chimiques et biologiques, en fonction des organisations morphologiques mises en évidence, de faire apparaître :

- les relations spatiales et temporelles des sols;
- leurs liaisons, leurs distributions verticales et latérales;

les transferts qui en sont à la fois les vecteurs et la résultante;

- des successions dans le temps des types de sols et autres caractéristiques pédologiques, soit en raison des modifications du climat ou du milieu environnant, soit par simple autodéveloppement (Ruellan 1985).

Ces études nécessitent à la fois des cartographies à petite, moyenne et grande échelle, basées sur la mise en exergue de la structure et de l'organisation

de la couverture pédologique. Elles doivent être poursuivies jusqu'au niveau des organisations microscopiques, en particulier des structures pédologiques de transformation, d'accumulation, d'agrégation, en liaison avec le système des vides dont le rôle est essentiel dans le comportement et l'évolution des sols mis en valeur.

Mais toutes ces recherches fondamentales faisant intervenir la cartographie ne dispensent pas bien de suivre l'évolution des sols agricoles particulièrement lors de leur mise en culture. Les conséquences de divers modes d'exploitation ou de faire valoir sont souvent lourdes de menaces de dégradation, voire de destruction, plus ou moins complète. En effet, les sols sont alors soumis à une pression humaine toujours plus forte et plus mal contrôlée. Ne pas observer, sinon mesurer, cette évolution conduit souvent à des situations désastreuses d'échec des opérations de développement, voire de dégradation des conditions de vie humaine. Etudier cette évolution a pour finalité de trouver à temps des solutions pour palier ces évolutions regressives. Il est très peu de projets de développement agricole de quelque importance ou intensité qu'ils soient qui consacrent à ce suivi ne serait-ce qu'une miette des dépenses consenties à la mise en oeuvre des projets. Il y a là un manque de prise de conscience grave pour l'avenir.

### Classification

En raison des diverses critiques exposées plus haut, une grande partie de la communauté pédologique francophone considère que "la classification des sols, semble aujourd'hui bien désuète, même si elle demeure encore la raison d'être de certaines écoles et surtout de beaucoup de néophytes. Cela n'est pas pour étonner, le problème de la classification constituant la maladie infantile de toutes les sciences jeunes. Ceci ne veut pas dire que la pédologie n'ait pas besoin de classification, car comme toute science naturelle, et devant la multitude des faits d'observation, la mise en ordre apparaît indispensable, mais cette classification doit être uniquement un référentiel scientifique, et non un système rigide et autoritaire, qui finit par classer des objets artificiels" et non représentatifs de la nature (Pedro 1984).

Aussi la révision de la classification française des sols s'oriente plutôt vers la mise sur pied d'un tel référentiel.

Si les problèmes de classification des sols ne sont pas considérés comme prioritaires ou bien paraissent dépassés, c'est sans doute aussi parce que les modèles d'organisation ou d'individus sol sont multiples et non uniques comme tendraient à nous le faire croire la démarche classificatrice des "profils de sol" ou des "pedons". On pourrait ainsi parallèlement concevoir et élaborer une classification des types de paysages pédologiques, des types de toposéquences (ex. cartes morphopédologiques), des types d'horizons (ex. soil taxonomy) des types d'organisation élémentaire des constituants (ex. micromorphologie).

## **Contraintes pédologiques limitant le développement de l'agriculture**

Les régions soudano-sahéliennes d'Afrique de l'Ouest présentent une grande diversité de sols. Au niveau régional il est possible d'en résumer les grandes tendances en distinguant trois grands types de couvertures pédologiques : celles qui dérivent de matériaux sableux d'origine éolienne, celles qui sont caractérisées par l'abondance d'argiles gonflantes, celles qui dérivent de glacis ou plateaux cuirassés.

### **Les couvertures pédologiques sur matériaux sableux**

Les couvertures pédologiques dérivées de matériaux sableux d'origine éolienne montrent une organisation générale en cordons très allongés avec une alternance transversale de dunes à sols sableux rubéfiés peu ou pas structurés et d'interdunes à sols plus argileux grisâtres à engorgement temporaire et structure le plus souvent massive. En raison de très faibles teneurs en colloïdes et en matières organiques, la CEC y est très faible. Aux déficiences minérales (N, P, K, Ca, Mg et oligo-éléments), natives mais peu importantes, se surimpose une sensibilité marquée à l'acidification sous l'effet de l'agriculture traditionnelle. Les fortes perméabilités superficielles, la grande profondeur d'enracinement et la faible énergie de rétention de l'eau compensent en partie la faible capacité totale du stockage de l'eau liée à la texture très grossière et la quasi absence de macro et de microstructure (sauf dans les sols dérivés des dépôts éoliens les plus anciens).

Sous l'effet des façons culturales et surtout du piétinement du bétail, les horizons superficiels deviennent très sensibles à la déflation éolienne dont le potentiel est très élevé (100 à 250 ha<sup>-1</sup> an<sup>-1</sup>). Ce problème est aggravé par la disparition de la végétation ligneuse.

### **Les couvertures pédologiques riches en argiles**

Les couvertures pédologiques abondant en argiles gonflantes sont très développées sur les glacis encore fonctionnels de la zone soudanienne semi-aride à saisons contrastées ( $P < 800$  mm). On les trouve essentiellement sur des roches riches en minéraux altérables (feldspaths ou minéraux ferromagnésiens) telles que les granito-gneiss, les schistes et autres roches métamorphiques, les alluvions anciennes.

Si dans le détail, ces couvertures ont une organisation verticale et latérale ordonnée il n'en reste pas moins qu'à l'échelle du paysage, la répartition spatiale des sols y est très complexe. Cette hétérogénéité constitue une contrainte majeure. Les limitations présentées par ces sols sont d'abord dues à leurs propriétés physiques et leur régime hydrique. La texture argileuse encore accusée par la nature gonflante des argiles en fait des sols lourds difficiles sinon impossibles à cultiver en milieu traditionnel. Peu perméables ils sont rapidement engorgés ce qui provoque des régimes hydriques très contrastés défavorables à l'installation et à la production des cultures. Ces aspects sont encore plus accusés dans les sols sodiques (Solonetz) et dans ceux qui présentent en outre des discontinuités texturales (planosols). Il en résulte aussi une grande sensibilité à l'érosion pluviale et au ruissellement.

Si les réserves minérales sont souvent convenables en raison de la présence de minéraux altérables (vertisols lithomorphes) les bases échangeables y sont souvent déséquilibrées en calcium-magnésium et sodium, ce qui conduit à des difficultés d'alimentation minérale, à l'apparition des déficiences induites en oligo-éléments ou à une réorganisation défavorable de l'azote. Le pouvoir fixateur en  $P_2O_5$ , parfois élevé induit une faible efficacité des engrais phosphatés.

Une faible proportion de ces sols à argiles gonflantes a, en Afrique de l'Ouest, des propriétés physiques de surfaces favorables. Ils sont alors intensément cultivés, notamment à la périphérie et

en contrebas de reliefs résiduels de roches vertes, (vertisols grumosoliques, sols bruns eutrophes plus ou moins vertiques) malgré les risques d'érosion.

### **Les couvertures pédologiques ferrallitiques ou ferrugineuses**

Les couvertures pédologiques dérivées de glacis ou plateaux plus ou moins cuirassés sont en grande partie héritées de l'action successive de paléoclimats quaternaires. Elles couvrent d'immenses superficies dans les régions soudano-sahéliennes sur des substrats très divers (grès, granito-gneiss, schistes, etc.). La profondeur du sol, limitée par la présence d'horizons indurés (cuirasse ferrique ou carapace) constitue souvent une contrainte majeure. La présence d'horizons gravillonnaires, de nappes de gravats, d'abord considérée comme défavorable est souvent, maintenant, considérée comme un avantage (macroporosité entraînant un enracinement profond et un ressuyage rapide). Sur les vastes plateaux de grès argileux les sols lessivés hydromorphes occupent des superficies importantes. L'engorgement saisonnier limite la profondeur d'enracinement et par suite l'accès aux réserves minérales et hydriques. Le fort développement du ruissellement en est une conséquence aggravée par la dégradation de la structure liée à la mise en culture et à l'appauvrissement consécutif en matières organiques.

Ces sols dérivés de vieilles altérites complètement ferrallitiques ont un complexe d'échange dominé par les colloïdes à faible activité ou à charges variables (kaolinites, sesquioxides). Les déficiences en éléments nutritifs sont communes mais peu importantes. Elles sont moins élevées dans les zones semi-arides. L'élévation de la fertilité minérale par l'application d'engrais est limitée par des faibles possibilités de stockages du complexe absorbant.

### **Bibliographie**

**Bertrand, R.** 1972. Morphopédologie et orientations culturelles des régions soudaniennes du Sine Saloum. *Agronomie Tropicale* 27 (11) : 1115-1190.

**Bertrand, R., Kilian, J., Raunet, M., Guillobez, S. et Bourgeon, G.** 1985. La connaissance des systèmes de paysages naturels, un préalable à la protection du milieu. L'approche morphopédologique. *Bulletin des Recherches Agronomiques de Gembloux* 20 (3/4) : 545-559.

**Bocquier, G.** 1973. Genèse et évolution de deux toposéquences de sols tropicaux au Tchad, interprétation biogéodynamique. Mémoires ORSTOM n° 62. Paris, France: Institut français de recherche scientifique pour le développement en coopération. 350 pp.

**Boulet, R., Chauvel, A., Humbel, F.X. et Lucas, Y.** 1982. Analyse structurale et cartographie en pédologie. 1. Prise en compte de l'organisation bidimensionnelle de la couverture pédologique : les études de toposéquences et leurs principaux apports à la connaissance des sols. 2. Une méthode d'analyse prenant en compte l'organisation tridimensionnelle des couvertures pédologiques. 3. Passage de la phase analytique à une cartographie générale synthétique. *Cahier ORSTOM, Série pédologie* 19 (4) : 309-351.

**Chauvel, A.** 1979. Recherches sur la transformation des sols ferrallitiques dans la zone tropicale à saisons contrastées. *Travaux et Documents de l'ORSTOM n° 62*. Paris, France : Institut français de recherche scientifique pour le développement en coopération. 532 pp.

**Guillobez, S.** 1985. Carte des milieux agropédologiques du Burkina Faso. Document interne. France : Institut de recherches agronomiques tropicales et des cultures vivrières.

**Hallaire, V.** 1981. La valeur des terres agricoles. Inventaire critique des méthodes d'évaluation. *Sols n° 2*. Paris, France : Institut national agronomique. 105 pp.

**Humbel, F.X.** 1984. L'analyse structurale des couvertures de sol. Une base pour la cartographie des sols en Guyane. Pages 181-191 *in* Livre jubilaire du cinquantenaire de l'Association Française d'Etude du sol.

**IRAT** (Institut de recherches agronomiques tropicales et des cultures vivrières). 1974. Aménagement écologique, réflexions méthodologiques, exemples pratiques. *Agronomie Tropicale* 29 (2-3) : 121-363.

**McIntosh, S.K. et McIntosh, R.J.** 1983. Current directions in West African Prehistory. Annual Review of Anthropology 12 : 215-258.

**Michel, P.** 1973. Les bassins des fleuves Sénégal et Gambie, étude géomorphologique. Mémoires ORSTOM n° 63. Paris, France : Institut français de recherche scientifique pour le développement en coopération. 752 pp.

**Nahon, D.** 1976. Cuirasses ferrugineuses et encroûtements calcaires au Sénégal occidental et en Mauritanie. Systèmes évolutifs, structures, relais et coexistence. Mémoire n° 44, Université Louis Pasteur, Strasbourg, France. 232 pp.

**Pedro, G.** 1984. La pédologie, cent ans après (1883-1983), conclusions. Sciences du sol 22 (2) : 183-184.

**Pias, J.** 1970. Les formations sédimentaires tertiaires et quaternaires de la cuvette Tchadienne et les sols qui en dérivent. Mémoires ORSTOM n° 43. Paris, France : Institut français de recherche scientifique pour le développement en coopération. 407 pp.

**Ruellan, A.** 1984. Les apports de la connaissance des sols intertropicaux au développement de la pédologie, contribution des pédologues français. Science du sol 22 (2) : 141-148.

**Ruellan, A.** 1985. Les apports de la connaissance des sols intertropicaux au développement de la pédologie : la contribution des pédologues français. Catena vol 12 : 87-98.

# Agroclimatic Aspects of Rainfed Agriculture in the Sudano-Sahelian Zone

M.V.K. Sivakumar<sup>1</sup>

## Abstract

*The Sudano-Sahelian Zone (SSZ) is one of the poorest regions of the world with the lowest per capita Gross National Product (GNP). In contrast to the existing definitions of the SSZ that use mean annual rainfall only, it is proposed that a 60-150 day growing period be used as the basis for the delineation of this zone. Characteristics of the rainfall in this region, such as temporal and spatial variability, persistency, and geographical patterns of variability are described with suitable examples. A brief review of rainfall intensities, infiltration, and runoff is presented. Cumulative frequency distribution of maximum and minimum air temperatures at the time of sowing and harvesting of crops in the SSZ show that maximum temperatures at the time of sowing could exceed 40°C. Such high temperatures, together with wind erosion, can cause crop establishment problems. Maps of potential evapotranspiration and growing-season length are presented.*

*The application of agroclimatic information for cropping strategies in the SSZ is described with examples. A significant relationship is established between the onset of rains and the length of growing season for several locations based on which a new concept of "Weather-responsive crop management tactics" is proposed. The application of rainfall and drought probabilities and water balance is discussed.*

## Résumé

**Aperçu de l'agroclimatologie de l'agriculture pluviale dans la zone soudano-sahélienne :** *On propose de délimiter la zone soudano-sahélienne sur la base d'une saison de croissance allant de 60 à 150 jours plutôt que sur des données pluviométriques moyennes annuelles. On décrit pour cette région des caractéristiques de la pluviométrie, telles la variabilité spatio-temporelle, la persistance et les modes géographiques. Les intensités des précipitations, l'infiltration et le ruissellement sont passés brièvement en revue, ainsi que les enregistrements des températures maximales et minimales de l'air et leur fréquence cumulée à l'époque du semis et de la récolte des cultures dans la zone. Il apparaît que la température maximale au semis peut excéder 40°C. Une conjonction de cette température élevée et de l'érosion éolienne compliquent particulièrement l'établissement des cultures. Des cartes d'évapotranspiration potentielle et de longueur des saisons de croissance sont présentées.*

*On décrit l'application de l'information agroclimatique à la stratégie culturale. Une relation significative est établie entre le début des pluies et la longueur de la saison de croissance pour*

---

1. Principal Agroclimatologist, ICRISAT, Niamey, Niger.

ICRISAT Conference Paper no. CP 410.

ICRISAT (International Crops Research Institute for the Semi-Arid Tropics)-1989. Soil, Crop, and Water Management Systems for Rainfed Agriculture in the Sudano-Sahelian Zone: proceedings of an International Workshop, 7-11 Jan 1987. ICRISAT Sahelian Center, Niamey, Niger. Patancheru, A.P. 502 324, India: ICRISAT.



*plusieurs lieux. Ceci a permis d'introduire le concept nouveau de "tactique d'aménagement des cultures en réponse au temps". On termine par l'examen du bilan hydrique de l'application des probabilités de pluies et de sécheresse.*

## Introduction

The Sudano-Sahelian climatic zone, which extends over several countries of West Africa, is one of the poorest regions of the world. Subsistence agriculture is the main mode of livelihood, since 90% of the population in this region lives in villages. The per capita Gross National Product (GNP) in this region is the lowest in the world, as recurrent droughts and several years of crop failures have led to near destruction of the rural economy. This is the only region in the world where the decline in per capita food production over the past two decades has led to an increase in the ratio of food

imports to total food consumption, thus creating an urgent need to develop new technologies that make the most efficient use of the limited climatic and soil resources. In this paper, an overview of the agroclimatic aspects of rainfed agriculture in the Sudano-Sahelian zone is presented.

## The Sudano-Sahelian Climatic Zone and Its Geographical Extent

Rainfall in West Africa shows a significant north-south gradient because of the interseasonal movement of the Intertropical Convergence Zone, north

**Table 1. Review of existing definitions of Sahelian and Sudanian climatic zones in West Africa.**

| Zones proposed (rainfall limits in mm) |                                   |                                   |                                       | Reference                      |
|--|-----------------------------------|-----------------------------------|---------------------------------------|--------------------------------|
|  | Sahelian<br>(300-750)             | Sudanian<br>(750-1250)            |                                       | Chevallier (1933)              |
|  | Sahelo-<br>Sudanian<br>(500-950)  |                                   |                                       | Aubréville (1949)              |
|  | Sahelo-<br>Sudanian<br>(500-750)  | Sudano-<br>Sahelian<br>(750-1000) |                                       | Trochain (1952)                |
| Sub-Saharan<br>(100-600)               |                                   | Sudanian<br>(600-1250)            |                                       | Keay (1959)                    |
| Northern<br>Sahelian<br>(100-300)      | Southern<br>Sahelian<br>(300-700) | Sudanian I<br>(700-1300)          | Sudanian II<br>and III<br>(1300-1800) | Rodier (1964)                  |
| Sahelian<br>(100-400)                  | Sahelo-<br>Sudanian<br>(400-600)  | Sudanian<br>(600-1200)            |                                       | Le Houerou (1976)              |
| Sahelian<br>(100-700)                  |                                   | Sudanian<br>(700-1100)            |                                       | Davy et al. (1976)             |
| Sahelian<br>(100-400)                  |                                   | Sudanian<br>(400-1200)            |                                       | Nicholson (1980)               |
| Sahelian<br>(200-400)                  | Sudano<br>Sahelian<br>(400-600)   | Northern<br>Sudanian<br>(600-800) | Southern<br>Sudanian<br>(800-1200)    | Le Houerou and<br>Popov (1981) |

and south of the equator. Hence a range of natural vegetation patterns developed along this gradient. Almost all the climatic zonation schemes developed for West Africa use two criteria—mean annual rainfall and vegetation. Although the terms ‘Sahelian’, ‘Sudanian’, and ‘Guinean’ zones were first used by Chevallier in 1933, it was Aubréville (1949) who recognized the transitory nature of the climatic zones and proposed the terms ‘Sahelo-Saharan’, ‘Sahelo-Sudanian’, and ‘Sudano-Guinean’ zones. After 1949, seven different rainfall limits have been proposed for delineating the Sahelian and Sudanian zones (Table 1). Rainfall limits used for the definition of the Sahelian zone by different authors vary substantially. Summarizing these different limits, Davy et al. (1976) argued about the need to use a broader range, and employed the 100–700 mm rainfall range for the Sahelian zone.

From the standpoint of rainfed agriculture, however, these schemes seem inadequate. Mean annual rainfall by itself cannot be considered a sufficiently useful index of probable season length, since the potential evapotranspiration, which varies from one region to another, influences the proportion of rainfall available for crop growth. For annual cereal crops, which are planted and harvested according to rainfall patterns in a given year, the most important constraint is the available season length. Hence Sivakumar (1986a) proposed a soil-climatic zonation scheme for West Africa, using the growing period that is calculated from rainfall and potential evapotranspiration. In this scheme, a growing period of 60–100 days was used for delimiting the Southern Sahelian zone, and 100–150 days for the Sudanian zone. One may question the choice of the lower limit of a 60-day growing period for the Sudano-Sahelian zone,

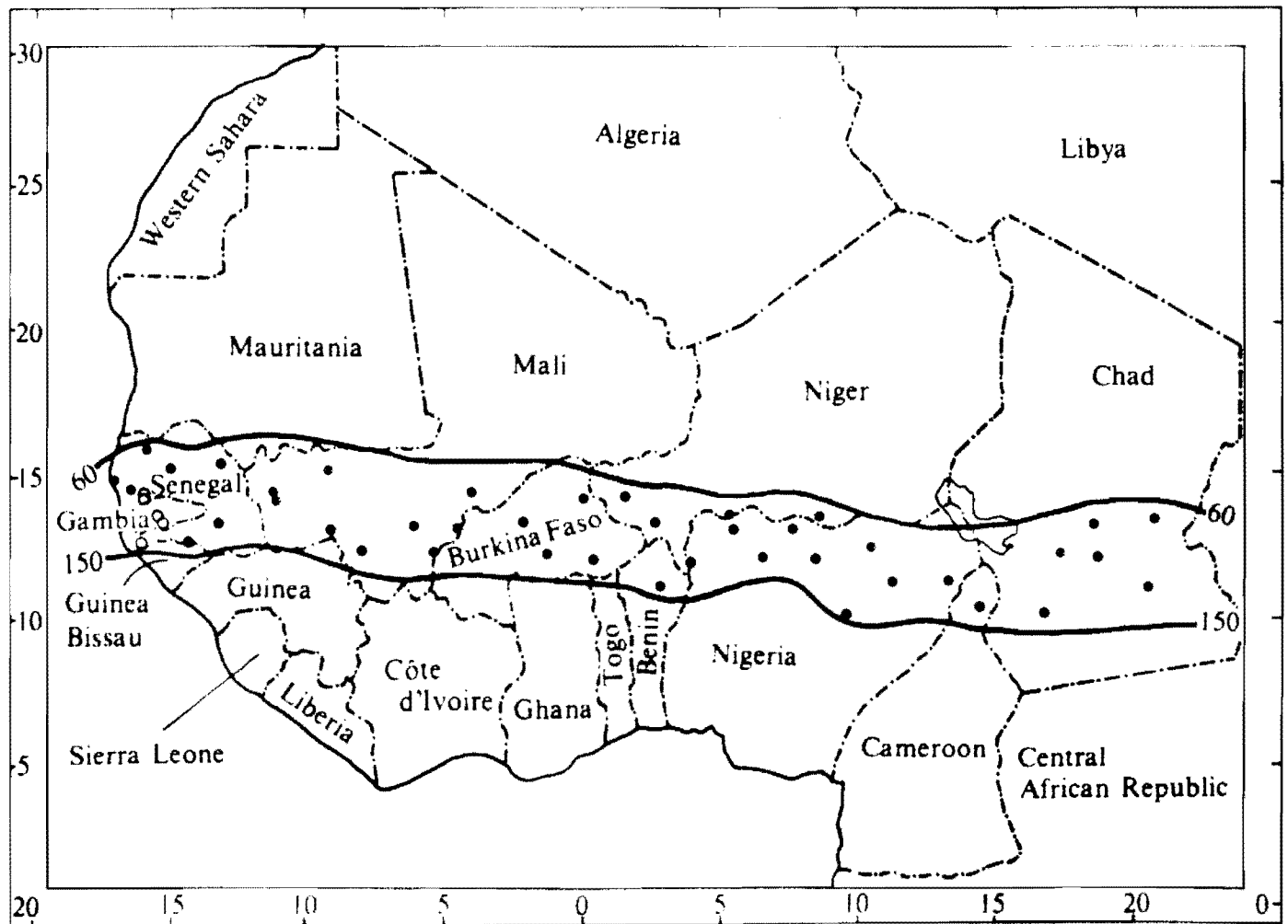

Figure 1. Geographical extent of the Sudano-Sahelian zone. (— 60 indicates isoline for growing season length).

since the word "Sahel" could imply much drier environments. Since this zoning scheme is primarily for use in formulating strategies for rainfed agriculture, the lower limit of 60 days has been adopted as the shortest season length.

The geographical extent of the Sudano-Sahelian zone, which is now defined as the West African climatic zone with an average growing period of 60–150 days, is shown in Figure 1.

## Rainfall

Rainfall in the Sudano-Sahelian zone is low, variable, and undependable. The rainfall gradients are very steep (Fig. 2). The further south one goes from the Saharan margin, the greater is the rainfall. The mean annual rainfall increases threefold from 400 mm on the northern limit to 1200 mm in the extreme south near 12°N, approximately 1 mm km<sup>-1</sup>. The isohyets run nearly parallel, with a ten-

dency to dip southwards as they extend towards east (Toupet 1965).

As Nicholson (1983) pointed out, the potential for development is limited not only by total rainfall, especially in the Sahelian zone, but also by other, less commonly considered characteristics of the area's rainfall, which is described below.

## Temporal Variability

Temporal or time-dependent variations in rainfall are quite common in this region, and can be represented at three time scales: annual, monthly, and daily.

### Annual Rainfall

The coefficient of variation (CV) of annual rainfall ranges between 15–30%. For example, the varia-

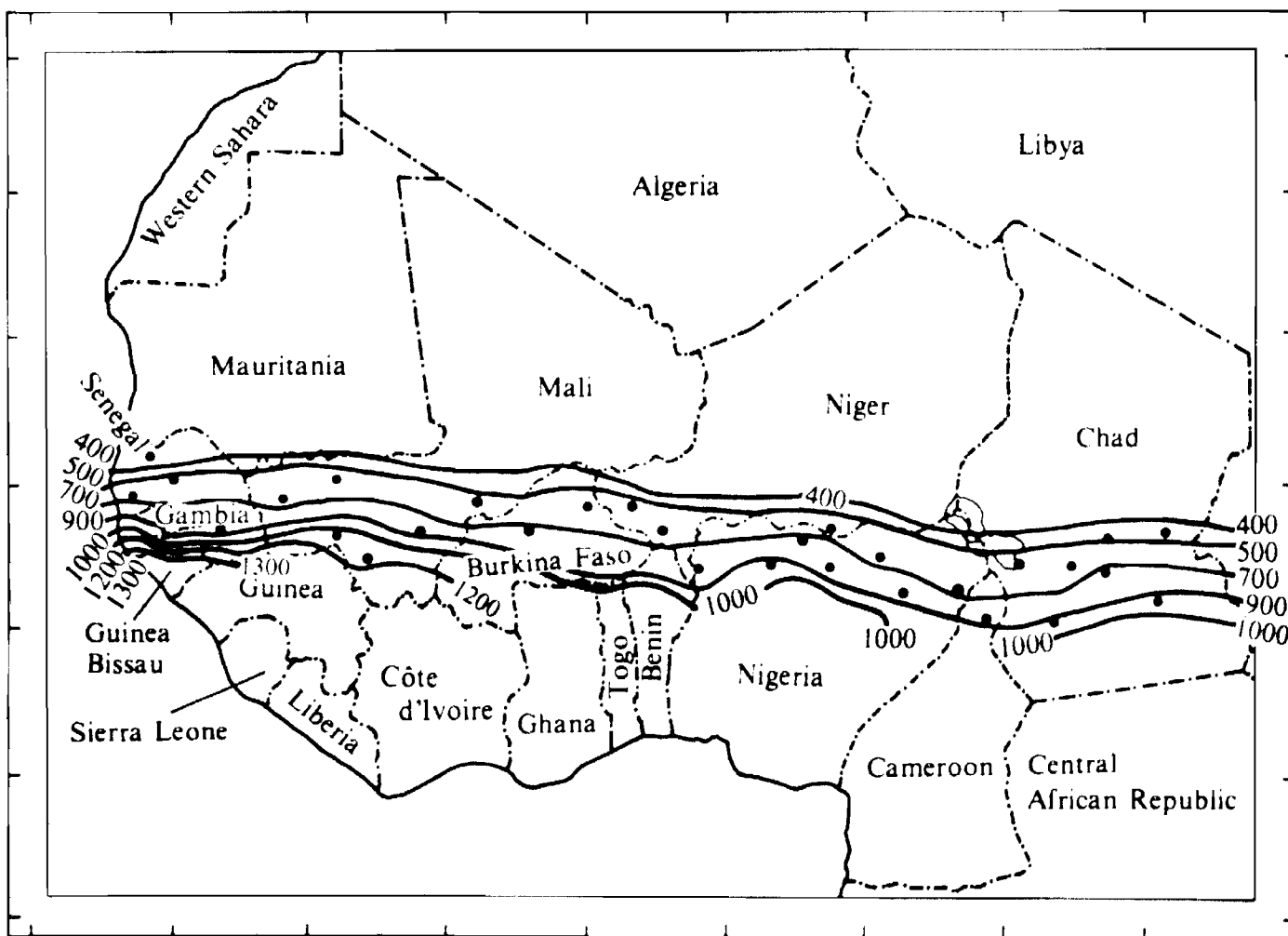

Figure 2. Mean annual rainfall (mm) in the Sudano-Sahelian zone.

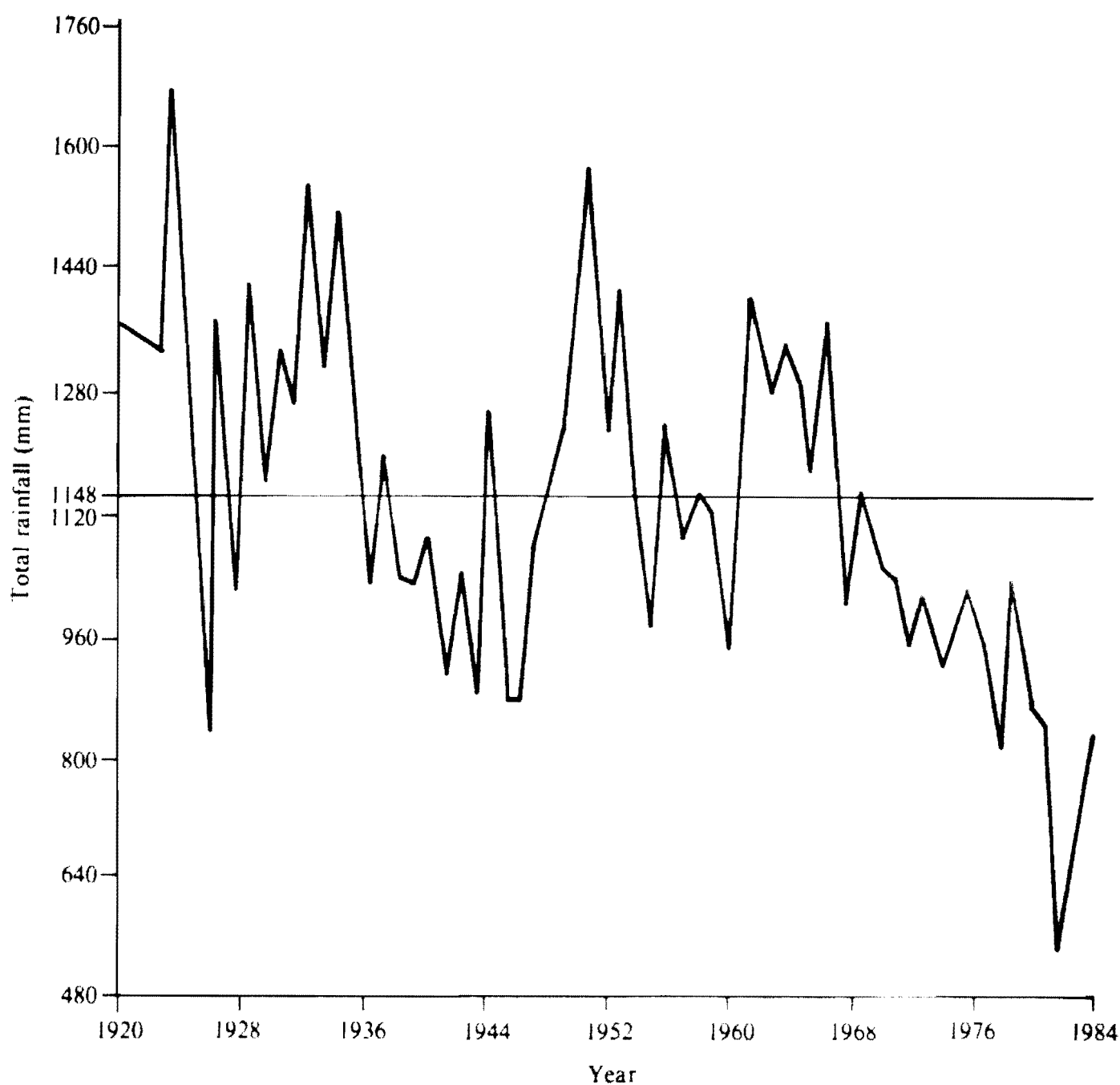

Figure 3. Annual rainfall variation in Banfora, Burkina Faso (mean annual rainfall—1148 mm).

tion in mean annual rainfall at Banfora in Burkina Faso (Fig. 3) over the last 64 years is about 25%. Although the mean annual rainfall at Banfora (represented by the horizontal line in the figure) is 1148 mm, since 1968, rainfall has been below normal; in 1983 it was only 480 mm.

### Monthly Rainfall

The variability in the monthly rainfall is larger since rainfall is usually limited to the summer

months, i.e., May to October. Aridity prevails during the rest of the year and is most pronounced from December to February.

An example of monthly rainfall variability is shown in Figure 4 for four locations: Hambori (Mali) and Niamey (Niger), which represent the low-rainfall locations, and Ouagadougou (Burkina Faso) and Kolda (Senegal), the high-rainfall locations. Large differences exist between the maximum, average, and minimum monthly rainfall recorded at all four locations. Average rainfall is always higher than the median. The rainy season at

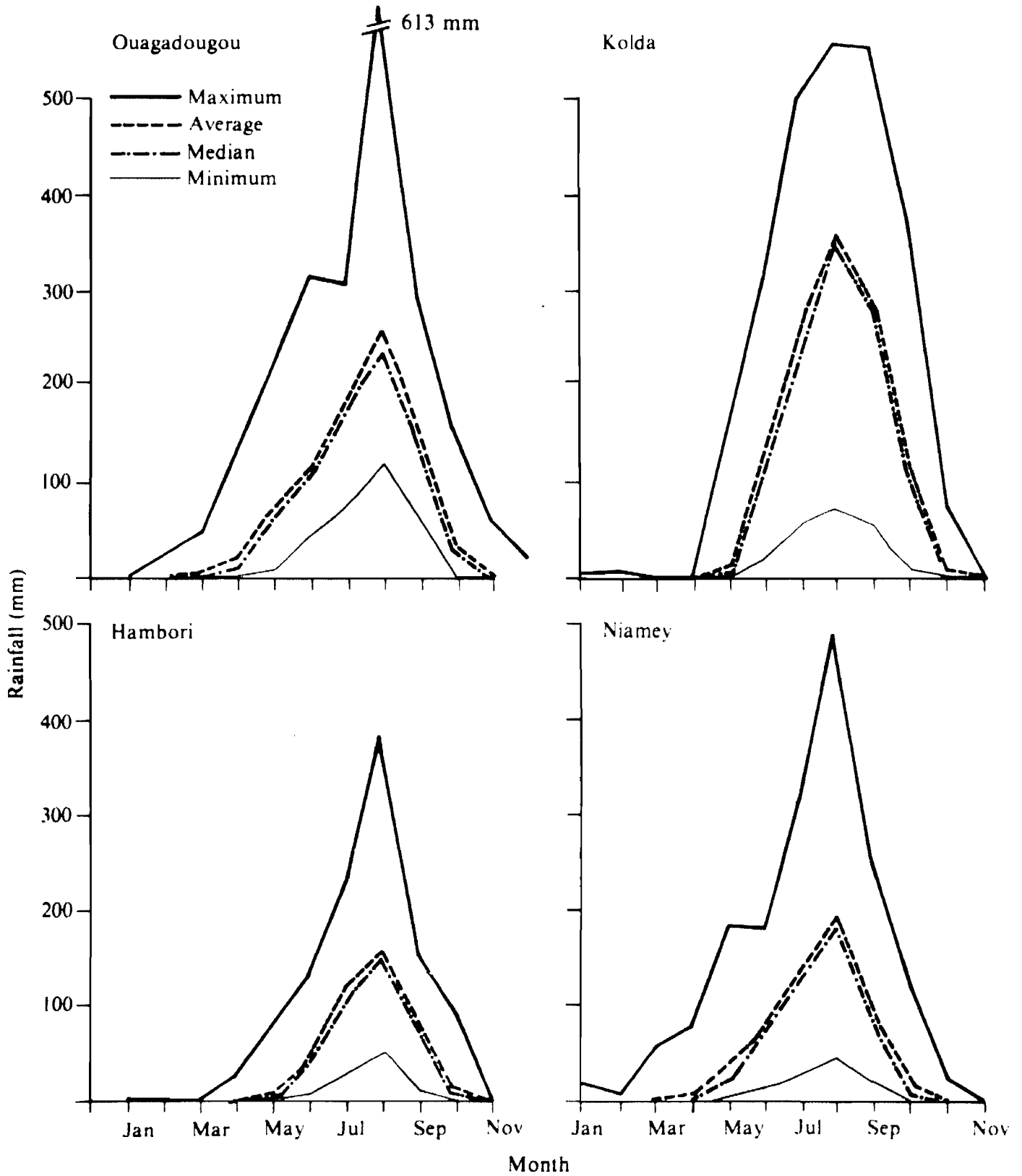

**Figure 4. Monthly maximum, average, median, and minimum rainfall at four locations in the Sudano-Sahelian zone.**



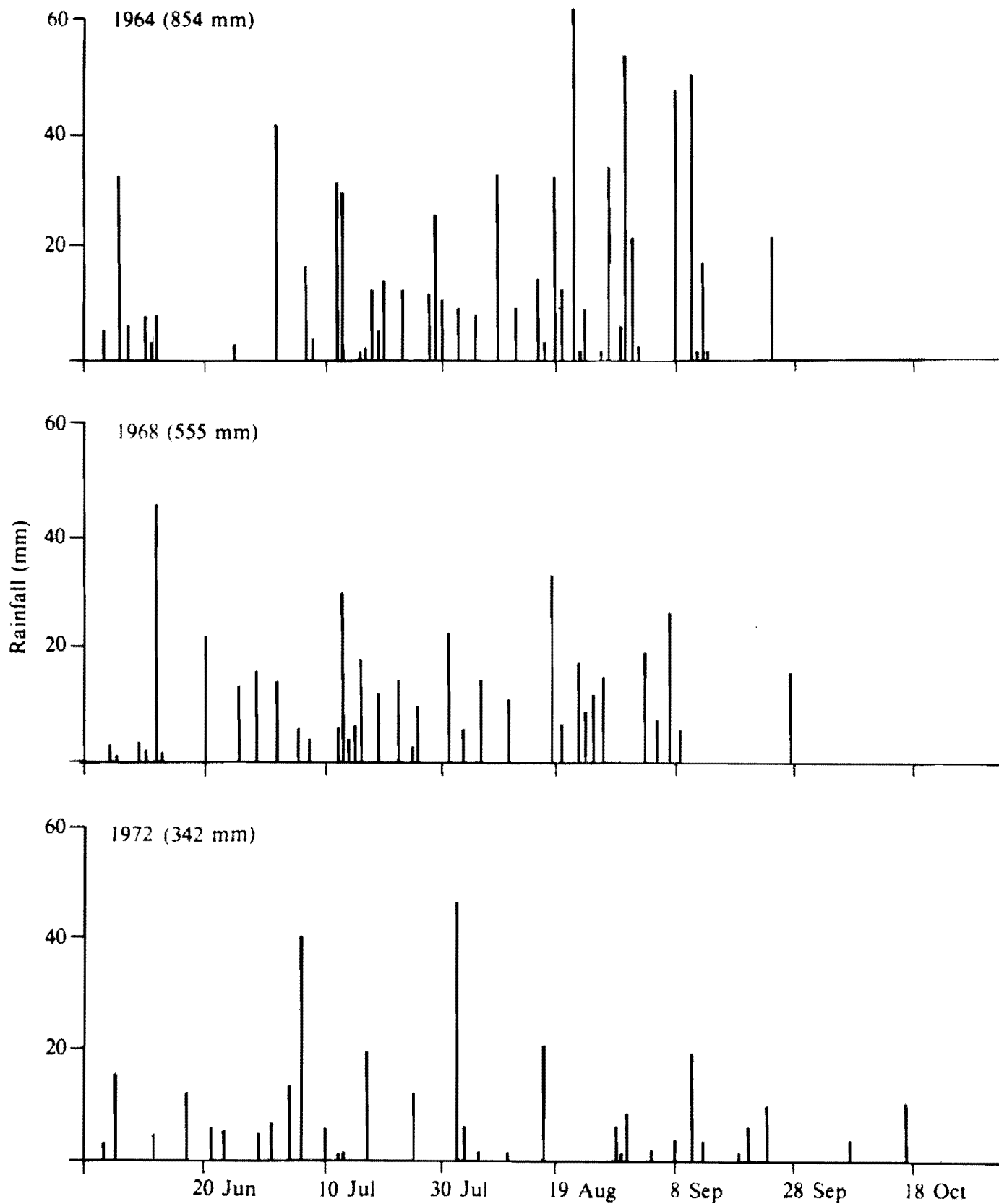

Figure 5. Daily rainfall variation at Niamey, Niger.

**Table 3. Generalized daily rainfall characteristics for four locations in the Sudano-Sahelian zone. (RD = Number of rainy days; RRD = Rain (mm) per rainy day; DRD = Duration between rainy days).**

| Station | May |      |      | Jun |      |     | Jul |      |      | Aug |      |     | Sep  |      |     | Oct  |      |     | Annual |      |      |
|---------|-----|------|------|-----|------|-----|-----|------|------|-----|------|-----|------|------|-----|------|------|-----|--------|------|------|
|         | RD  | RRD  | DRD  | RD  | RRD  | DRD | RD  | RRD  | DRD  | RD  | RRD  | DRD | RD   | RRD  | DRD | RD   | RRD  | DRD | RD     | RRD  | DRD  |
| Hambori | 2   | 5.0  | 20.1 | 5   | 8.4  | 9.1 | 10  | 11.7 | 14.1 | 11  | 14.1 | 7   | 9.6  | 4.6  | 2   | 6.5  | 19.1 | 38  | 9.1    | 9.1  | 9.1  |
| Niamey  | 4   | 8.8  | 11.5 | 7   | 11.0 | 5.3 | 10  | 14.2 | 2.8  | 13  | 15.0 | 8   | 11.0 | 4.1  | 2   | 8.0  | 18.6 | 44  | 11.7   | 11.7 | 11.7 |
| Ouaga   | 6   | 12.8 | 3.2  | 9   | 12.4 | 2.1 | 12  | 15.5 | 1.3  | 16  | 16.0 | 12  | 11.9 | 11.1 | 4   | 8.8  | 28.0 | 63  | 11.9   | 11.9 | 11.9 |
| Kolda   | 2   | 9.0  | 18.7 | 9   | 14.4 | 3.4 | 15  | 16.8 | 1.5  | 19  | 18.3 | 16  | 17.9 | 1.4  | 8   | 14.4 | 6.0  | 69  | 15.2   | 15.2 | 15.2 |

recorded at the ISC meteorological observatory. However, over the entire station, rainfall ranged from 34 mm in the northwest corner to 8.9 mm in the southeast corner (Fig. 6). In Tanzania, annual rainfall totals at stations only a few kilometers apart were uncorrelated (Sharon 1974). This spatial variability is not caused by local effects but is related to the randomness of the convective storms that prevail in these areas (Nicholson 1983).

### Persistency and Extreme Magnitude of Variability

The rainfall variability discussed above leads to instability in the traditional mean figures for crop production. The recent drought in the Sahel is not unique. Annual rainfall deviations from the mean at Niamey for the past 80 years (Fig. 7) indicate that droughts have occurred between 1910 and 1920, 1940 and 1950, 1968 and 1973, and 1976 and 1984. The 1950s were generally wet. Severe, extended droughts are a recurrent feature in the region's climatology (Nicholson 1982) but the 1960-80 drought around Niamey was unique in its persistence. Rainfall deviations 20-40% below the mean were common. Nicholson (1981) showed that in 1950, rainfall all over West Africa was above normal, at some locations even 250% above normal. However, in 1970, rainfall was below normal throughout the region.

### Geographical Patterns of Rainfall Variability

Rainfall fluctuations are associated with a preferred geographic pattern. For example, the reduction in the mean annual rainfall in Niger after 1969 (Fig. 8) is characteristic of the entire country. This figure uses pre- and post-1969 averages to examine the effect of the post-1969 droughts on the long-term averages of rainfall. The severity of droughts in the country is made evident by the southward movement of rainfall isohyets after 1969. Around 16°N, the region that received an average of 550 mm a<sup>-1</sup> before 1969 received only 400 mm after 1969. These patterns indicate that abnormal rainfall conditions are almost continental in scope.



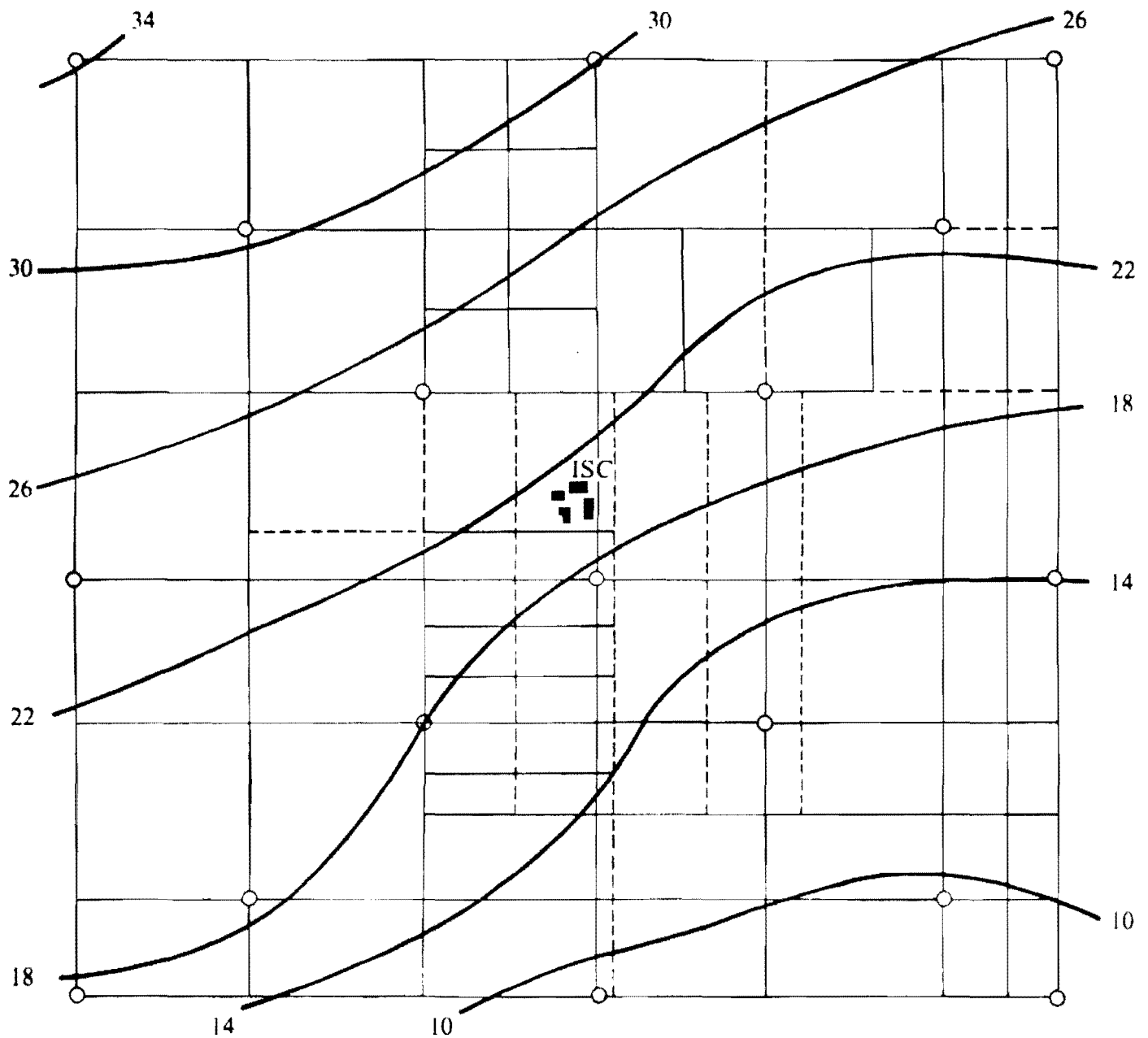

Figure 6. Rainfall variability at ISC, Sadoré, Niger, on 22 Jul 1986. (○ = Rain gauges).

### Rainfall Intensities, Infiltration, and Runoff

Rain in West Africa often occurs in short, intense storms, e.g., on 4 Aug 1985, at ISC, we received 82 mm or one-seventh of the seasonal normal rainfall in just under three hours. Rainfall intensities in the Sudano-Sahelian zone are much greater than in the temperate and subtropical zones and pose special problems in agricultural management and soil conservation (Kowal and Kassam 1978). At Bambey, Senegal, half of the rains fell with an intensity

greater than 27 mm h<sup>-1</sup> and a quarter with an intensity greater than 52 mm h<sup>-1</sup> (Charreau and Nicou 1971). At Sefa, in southern Senegal, the corresponding values were 32 and 62 mm h<sup>-1</sup> (Charreau 1974). In northern Nigeria, individual rainstorms of greater than 50 mm with peak intensities of 120–160 mm h<sup>-1</sup> are not uncommon (Kowal and Kassam 1976), and peak intensities of over 250 mm h<sup>-1</sup> for very short periods were reported (Kowal 1970).

Rainfall intensity data reported for Niono, Mali, by Hoogmoed and Stroosnijder (1984) show that

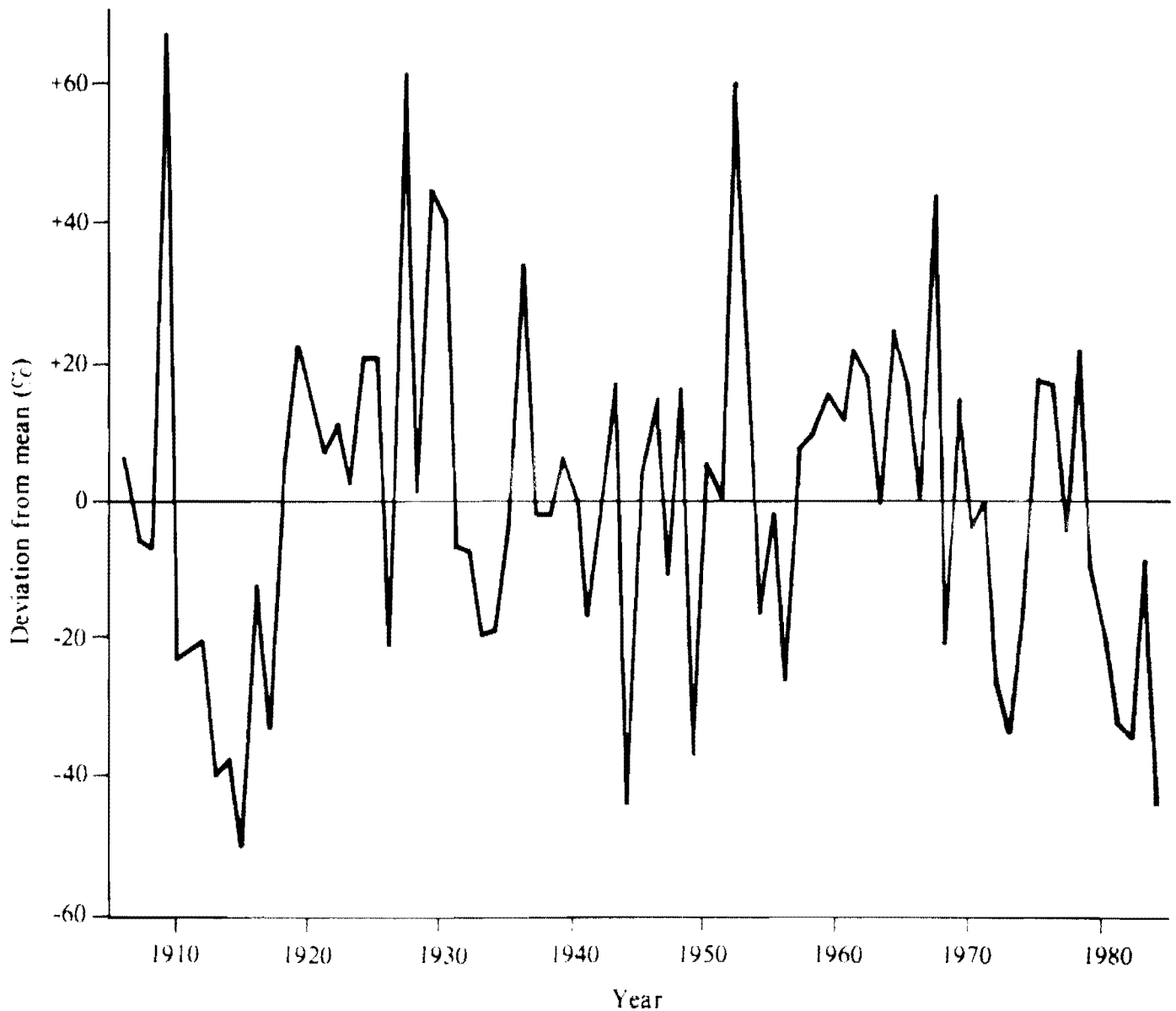

Figure 7. Percentage deviation of annual rainfall at Niamey, Niger.

in 50% of the cases, rainfall intensities exceed  $27 \text{ mm h}^{-1}$  while for 11% of all the storms, the intensities exceed  $100 \text{ mm h}^{-1}$ . Hoogmoed (1981) reported a peak intensity of  $300 \text{ mm h}^{-1}$  for Niono. From analyses of rainfall intensities over a 4-year period for Niamey in Niger, Hoogmoed (1981) showed that 36% of the rains fell with intensities of  $>50 \text{ mm h}^{-1}$ , and 13% with intensities of  $>100 \text{ mm h}^{-1}$ . Peak intensities reached  $253 \text{ mm h}^{-1}$  for six minutes. Hoogmoed (1986a) recently reported peak intensities of  $386 \text{ mm h}^{-1}$  for Niamey.

Infiltration rates in the Sudano-Sahelian zone have seldom been measured directly; they are affected by soil types, especially when there are

problems of soil crusting. On the bare, weakly-crusted soil surface of the sandy soils at ISC, infiltration rates of up to  $100 \text{ mm h}^{-1}$  have been reported (ICRISAT 1985). For the ferruginous soils with indurate crust at Saria in central Burkina Faso, Forest and Lidon (1984) reported lower infiltration rates of  $10.8 \text{ mm h}^{-1}$  in the first 6 h but after 5 days, infiltration rates reached  $32 \text{ mm h}^{-1}$ . However on the sandy soils in Mali near Niono, where crust formation causes problems of low permeability, final infiltration rates were about  $10 \text{ mm h}^{-1}$  (Hoogmoed and Stroosnijder 1984).

Under these conditions of high rainfall intensities, runoff and soil loss are quite common. Data

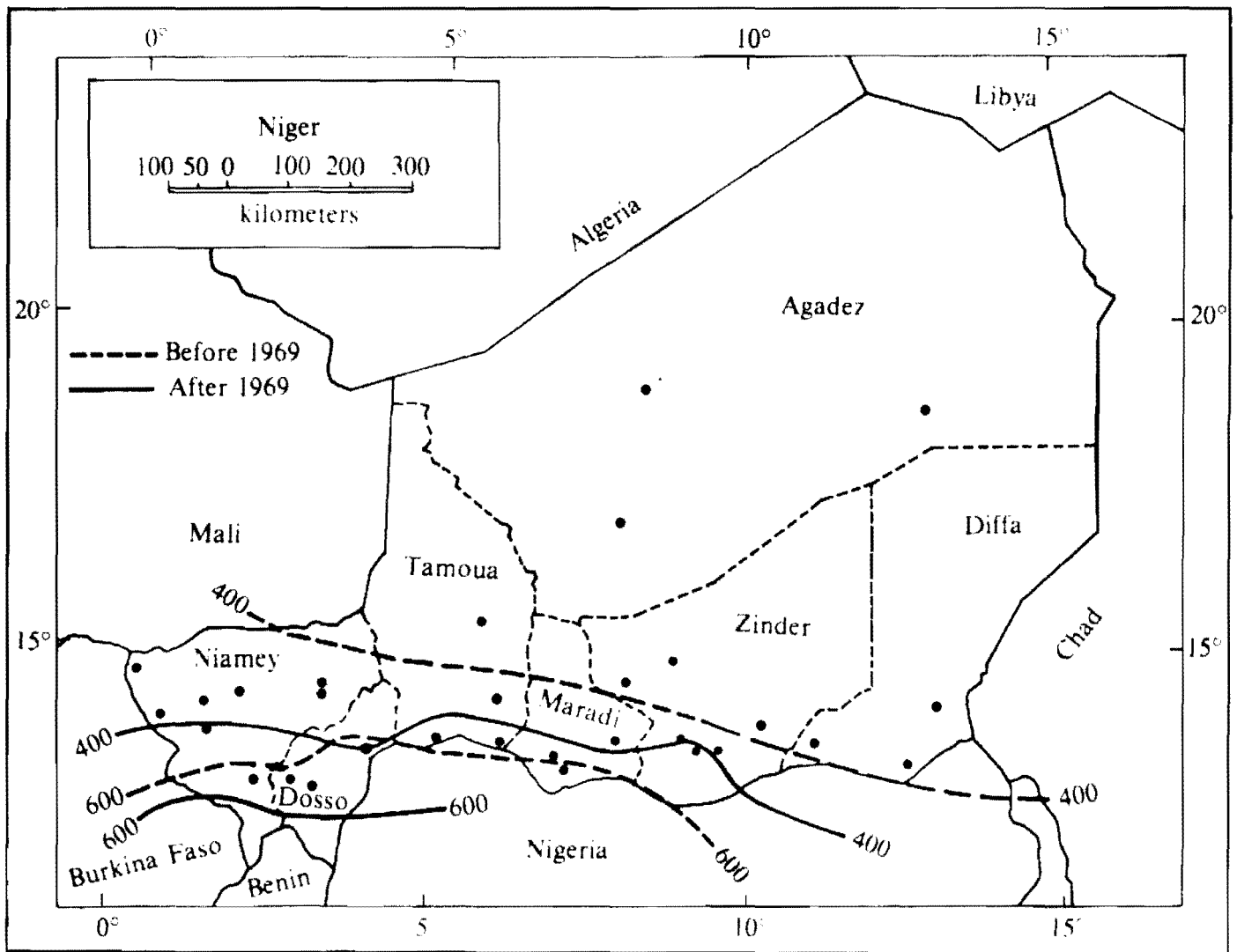

Figure 8. Rainfall isohyets in Niger before and after 1969.

compiled from eight different studies in the Sudano-Sahelian zone (Table 4) show that runoff and soil loss vary with location. Cropped soils, as one would expect, showed much lower runoff rates. An increase in rainfall does not necessarily result in an increase in the erosion. There are other important intervening factors such as soil erodibility, land form (slope, steepness, and shape) and management systems (Lal 1980).

### Rainfall Probabilities

Decadal precipitation totals for a long period of time are available for numerous locations in the Sudano-Sahelian zone and could be analyzed by fitting the most appropriate mathematical function to the rainfall data, for computing the proba-

bilities of receiving a certain amount of rainfall, say 10 mm, 20 mm, 30 mm, etc. Markov chain models for precipitation analysis, introduced by Gabriel and Neumann (1962), are in use widely, and the application of these models in agricultural planting has been discussed by Stern and Coe (1982). Rainfall probabilities for several locations in Niger (Sivakumar et al. 1979), Mali (Sivakumar et al. 1984), and Burkina Faso (Sivakumar and Faustin 1986) have been published.

Probabilities of receiving 10 mm or more rainfall during each decade (Fig. 9) for Hambori, Niamey, Ouagadougou, and Kolda clearly show the differences in the onset of rains from north to south in the Sudano-Sahelian zone. At Hambori, the probabilities do not reach the dependable level of 75% probability (Hargreaves 1974) until after decade 19, while at Ouagadougou located further south,

**Table 4. Runoff and soil loss data from the Sudano-Sahelian zone.**

| Country      | Location    | Mean annual rainfall (mm) | Slope (°) | Treatments                         | Runoff (mm) | Soil loss (t ha <sup>-1</sup> a <sup>-1</sup> ) | Reference  |
|--------------|-------------|---------------------------|-----------|------------------------------------|-------------|---|--|
| Benin        | Boukombe    | 875                       | 3.7       | Pearl millet, conventional tillage | 11.7        | 1.3   | Verney and Willaime (1965)   |
| Niger        | Allokoto    | 452                       | 3.0       | Sorghum, cotton                    | 16.3        | 8.6   | Roose and Bertrand (1971)  |
| Nigeria      | Samaru      | 1062                      | 0.3       | Bare soil                          | 25.2        | 3.8   | Kowal (1970)   |
| Senegal      | Sefa        | 1300                      | 1.2       | Bare soil                          | 39.5        | 21.0  | Charreau and Nicou (1971)  |
| Burkina Faso | Niangoloko  | 1140                      | 1.2       | Pearl millet                       | 7.5         | 6.4   | Christol (1966)  |
| Burkina Faso | Ouagadougou | 850                       | 0.5       | Bare soil                          | 40-60       | 10-20   | Roose and Birot (1970)<br>Charreau and Seguy (1969)<br>Charreau and Nicou (1971) |
| Mali         | Niono       |                           | 1-3       | Bare soil                          | 25          |   | Hoogmoed and Stroosnijder (1984)   |
| Niger        | Sadore      | 560                       |           | Pearl millet<br>Bare soil          | 1.5<br>0-20 |   | Klajj and Serafini (1988)  |

this occurs 40 days earlier by decade 15. Such large differences in the probabilities between these two locations are, however, not observed towards the end of the season. Use of these rainfall probabilities is discussed in the section on application of agro-climatological information.

## Temperature

Air temperatures in the Sudano-Sahelian zone are usually higher because of the high radiation load. From south to north, temperatures increase and rainfall decreases. In order to show the temperature patterns of mean monthly and mean annual maximum and minimum air temperatures, 64 stations in the Sudano-Sahelian zone have been used. The cumulative frequency distribution of minimum and maximum air temperatures for the whole year and for the rainy season is shown in Figure 10. For the Sudano-Sahelian zone as a whole, the annual as well as the rainy-season min-

imum temperature range is small compared with the maximum temperatures. When compared with the annual means, the minimum temperatures for the rainy season are about 2-2.5°C higher, while maximum temperatures are lower.

Mean temperatures for the rainy season could be misleading because, for certain crop growth phases, the air temperatures are much higher. Cumulative frequency distribution of minimum and maximum air temperatures at the time of sowing (May-Jun) and harvesting (Sep-Oct) (Figure 11) shows that mean maximum temperatures at the time of sowing can exceed 40°C. Probabilities of maximum air temperatures exceeding defined thresholds have been reported for Mali (Sivakumar et al. 1984) and Burkina Faso (Sivakumar and Faustin 1986).

## Wind

The main feature of the wind regimes in the Sudano-Sahelian zone is the distinction between

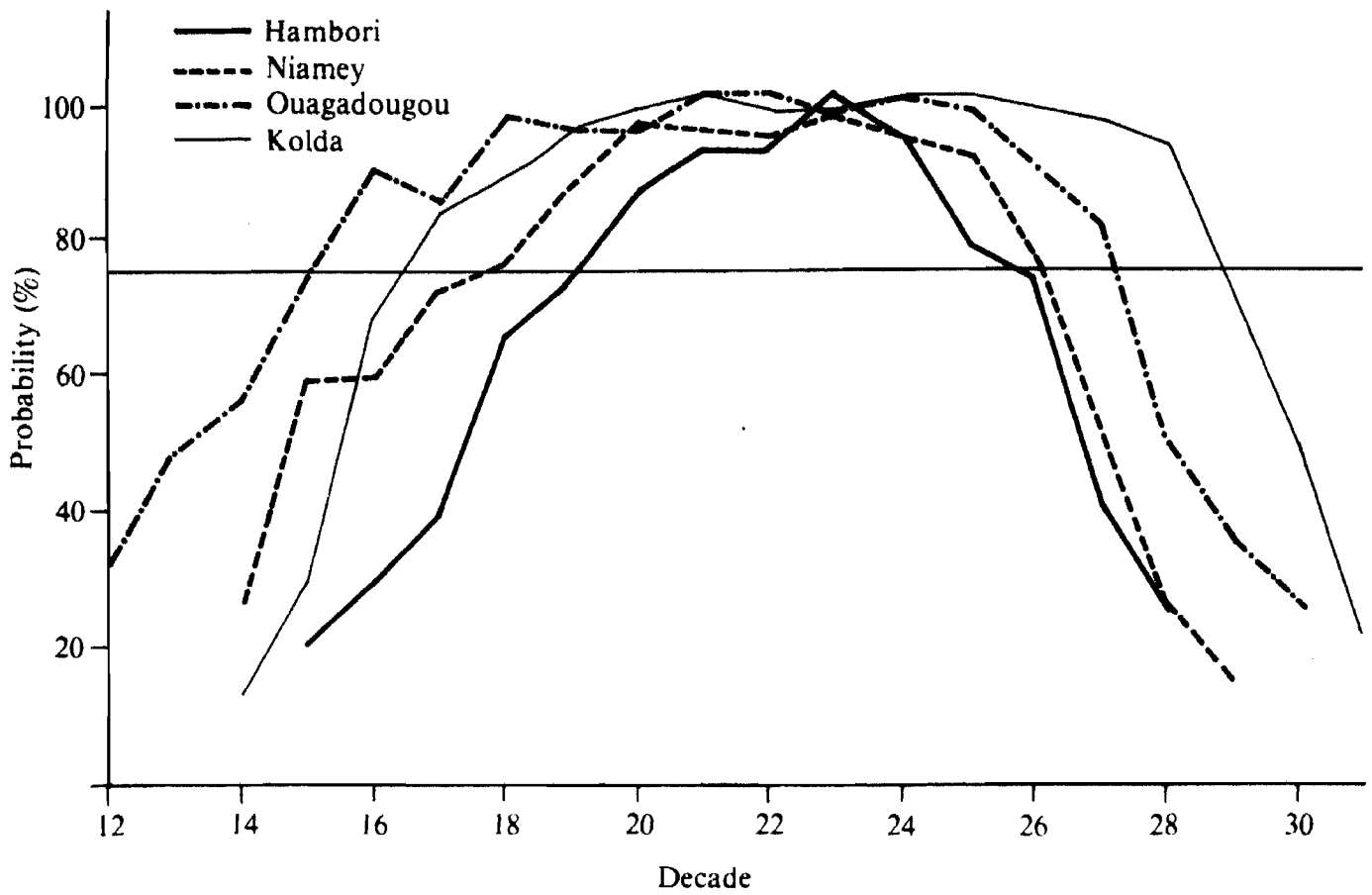

**Figure 9. Probability(%) of receiving 10 mm or more rainfall during each decade at four locations in the Sudano-Sahelian zone.**

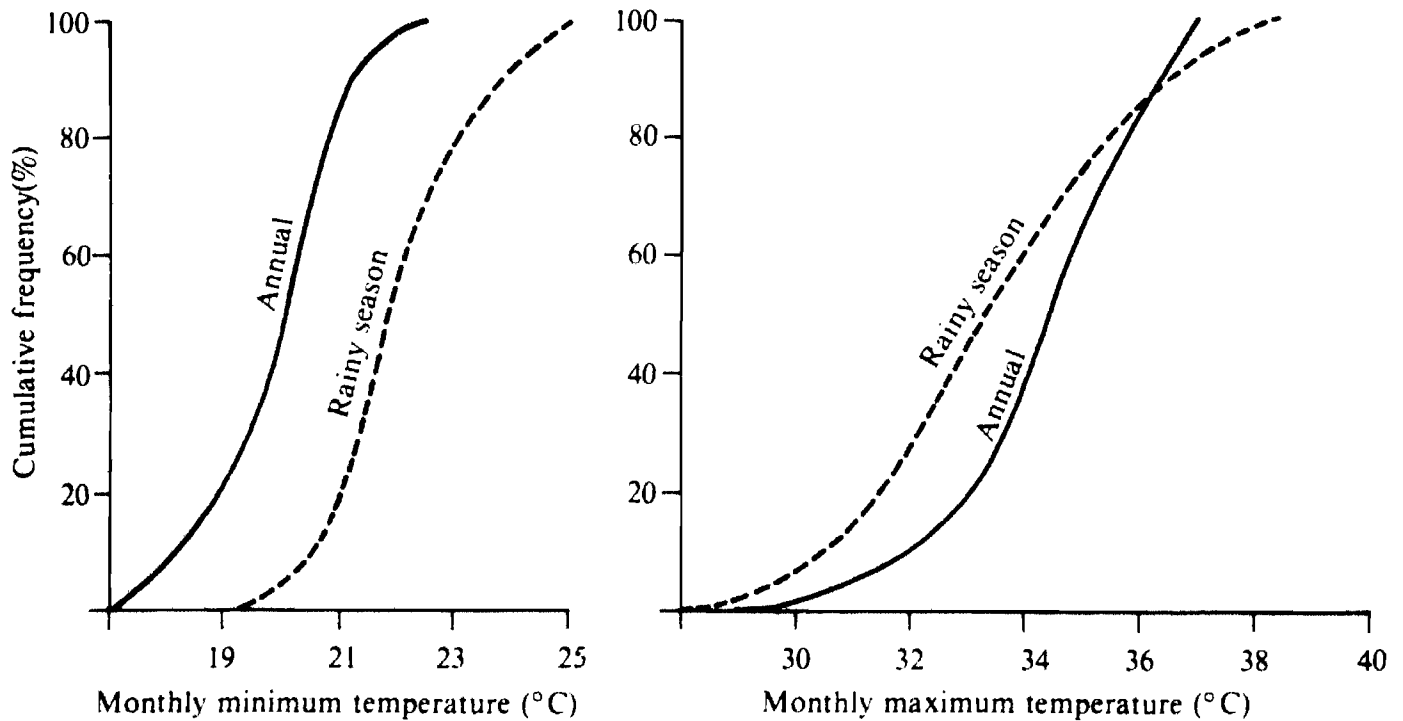

**Figure 10. Cumulative frequency distribution of minimum and maximum air temperatures for the whole year and for the rainy season (May-Oct) in the Sudano-Sahelian zone.**

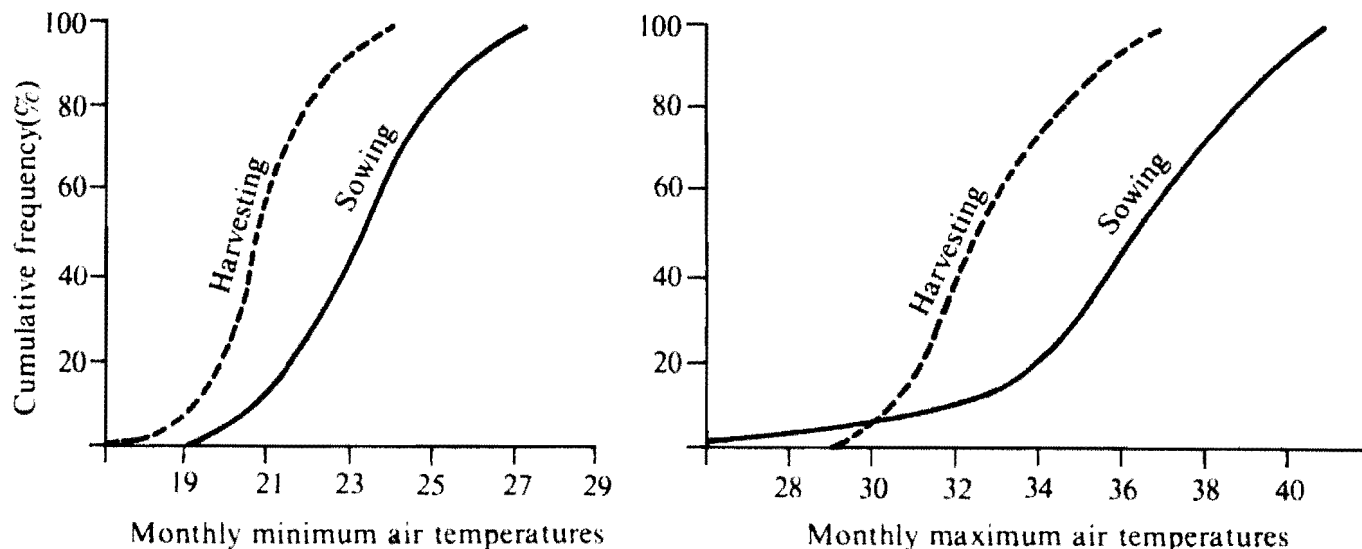

**Figure 11. Cumulative frequency distribution of minimum and maximum air temperatures at the time of sowing (May-Jun) and harvesting (Sep-Oct) of sorghum and pearl millet crops in the Sudano-Sahelian zone.**

the dry and wet seasons (Davy et al. 1976). During the dry season, the harmattan winds blow from the desert areas northeast of the region while in the rainy season, the monsoon regime brings humid winds from the Atlantic Ocean and equatorial Africa to the southwest.

Average wind speeds during the dry season are generally high but the highest record wind speeds for the year are expected during thunderstorms, early in the rainy season. Wind speeds exceeding  $100 \text{ km h}^{-1}$  have been recorded at ISC. Kowal and Kassam (1978) reported maximum speeds of  $110 \text{ km h}^{-1}$  at Samaru, Nigeria. In the Sahelian zone, because of high wind speeds, an enormous amount of dust from the bare, loose, sandy soils is carried in the air. During rainfall, this sand is deposited on the young pearl millet seedlings. The weight of the sand and the high soil temperature up to  $50^\circ\text{C}$  in the sand covering the seedling are often fatal to the seedlings and lead to crop establishment problems.

## Potential Evapotranspiration

Potential evapotranspiration (PET) relates to the evaporative demand of the atmosphere. Published PET data calculated using the Penman (1948) equation, are available for several locations in the Sudano-Sahelian zone, as shown in Figure 12. Considering the low rainfall (Fig. 2), PET is very high in the Sudano-Sahelian zone. Kowal and

Kassam (1978) computed that north of  $8^\circ 19'\text{N}$ , the annual deficit between rainfall and PET increases by 200 mm per degree latitude. Such a north-south gradient in PET is expected since the radiation and temperature are consistently high for locations situated in the north.

## Length of Growing Season

The work of Cochemé and Franquin (1967) helped elucidate crop-climate relationships in West Africa. Their proposal to give adequate importance to both precipitation (P) and PET in the zonation scheme for West Africa, by using the ratio of P/PET and computing the length of the growing season, is based on a realistic appraisal of crop response to available moisture. This system has been used in an FAO publication (1984) on agroclimatological data for Africa. Figure 13 shows the variation in the mean length of growing season in the Sudano-Sahelian zone.

## Application of Agroclimatic Information

Agroclimatic information has not been adequately used to derive cropping strategies in the Sudano-Sahelian zone. An analysis of historical rainfall

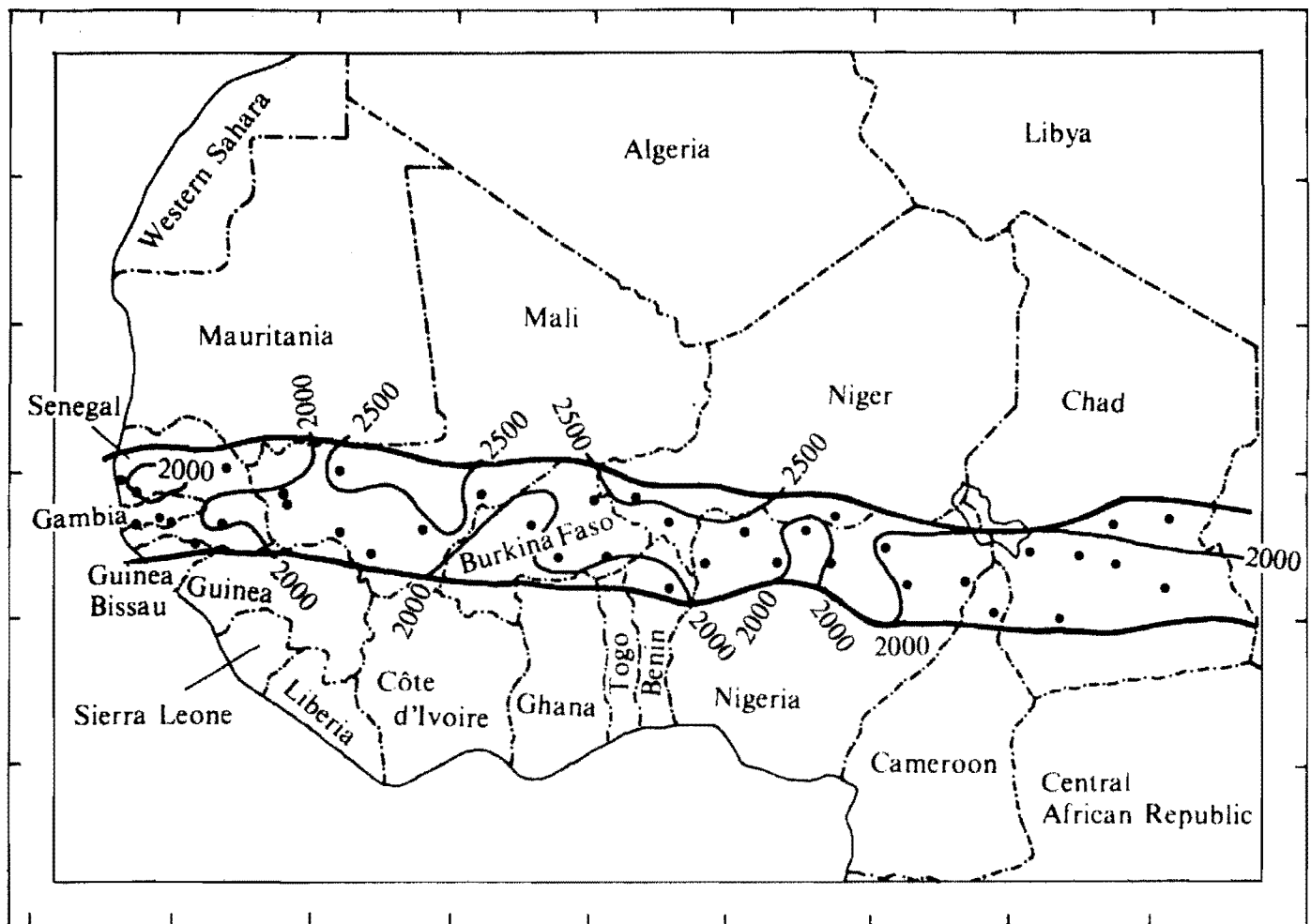

Figure 12. Mean annual potential evapotranspiration (mm) in the Sudano-Sahelian zone.

data can be used in assessing climatic resources for cropping potential and evaluating cropping risks, while current weather data facilitates tactical planning for intraseasonal crop-management decisions, and interpreting regional crop evaluation studies. Some examples of the application of agroclimatic information are given below.

### Date of Onset of Rains and Length of Growing Season

In West Africa, the date of the first rains is important in planning agricultural operations, particularly sowing. Several studies (Stanton and Cammack 1953, de Geus 1970, Jones and Stockinger 1972, Kassam and Andrews 1975) showed that early establishment of crops results in higher yields. Dancette 1976 estimated for Nioro du Rip,

Senegal, that dry sowing pearl millet on 5 Jun would have resulted in seedling death 12 years out of 44.

Sivakumar (1986b) computed the dates of the first and last rains and the length of the growing season for each year of the data base for 58 locations in the Sudano-Sahelian zone. A highly significant relationship was observed between the date of onset of rains and the length of the growing season across the southern Sahelian zone, and it has been suggested that the potential length of the growing season can be assessed with reference to the date of onset of rains. Early onset of rains, relative to the computed mean date of onset for a given location, results in a longer growing season. This is illustrated in Table 5 for Niamey, Niger (data base 1904–1984). The average date of beginning of rains at Niamey is computed as 12 Jun, and the average length of the growing season is 94 days. However, if the onset of rains occurs 20 days early,

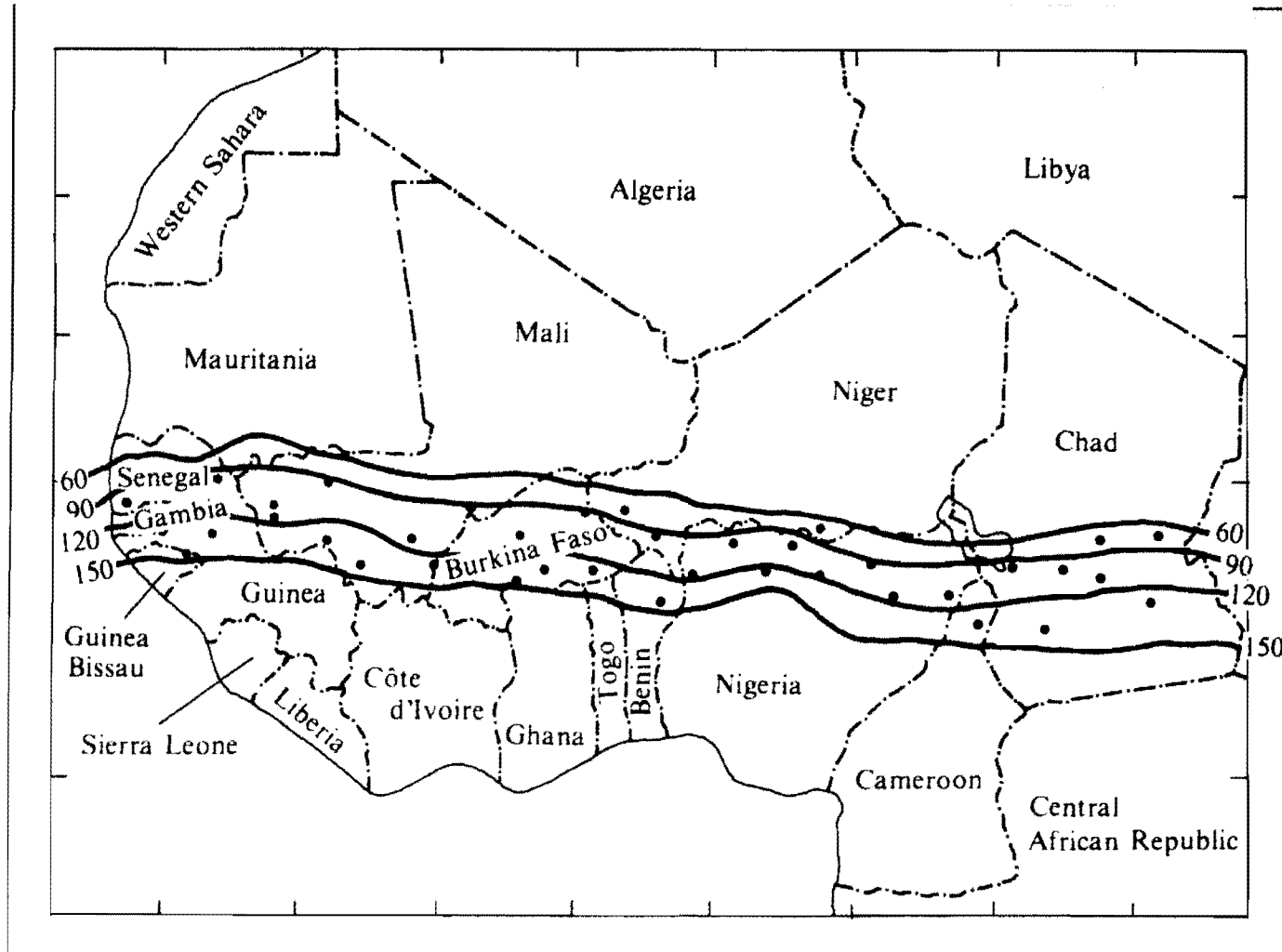

Figure 13. Mean length of the growing season (days) in the Sudano-Sahelian zone.

i.e., by 24 May, there is a 43% probability that the growing season will exceed 115 days. On the other hand, if the rains are delayed until the beginning of

July, there is only a 2% probability that the growing season will exceed 95 days.

The implications of the above analysis are that crop management tactics in the Sahelian zone may have to be altered depending upon the onset of rains. Sivakumar (1986b) described such analyses as the initial step in the concept of "Weather-responsive crop management tactics". If rains start early in a given location, it may be safe to plant cultivars of pearl millet and other crop species recommended for a median length season calculated for that location. If precipitation is delayed 10 days beyond the calculated average date of onset of rains, short-duration cultivars that mature early in the remaining growing season may be more productive. In addition, in terms of disaster planning, delayed rains signal the need for timely action, since traditional and improved cultivars of median season length are likely to give poor yields.

Table 5. Probabilities of growing season length exceeding specified durations for variable onset of rains for Niamey, Niger.

| Date of onset of rains | Length of growing season exceeding |         |          |          |
|------------------------|------------------------------------|---------|----------|----------|
|                        | 75 days                            | 95 days | 115 days | 135 days |
| 24 May                 | 100                                | 99      | 48       | 1        |
| 2 Jun                  | 100                                | 87      | 11       | 0        |
| 12 Jun                 | 99                                 | 48      | 1        | 0        |
| 22 Jun                 | 87                                 | 11      | 0        | 0        |
| 2 Jul                  | 48                                 | 1       | 0        | 0        |



## Rainfall Pattern and Soil Preparation

The benefits of preparatory tillage before sowing in the Sudano-Sahelian zone are beginning to receive considerable attention. In view of the short growing season and the farmer's limited capacity in terms of available power, the number of days available prior to the optimum date of sowing is an important issue. As Hoogmoed (1986b) showed in a recent analysis, the size of rainfall showers relevant for decision making with regard to preparatory tillage is fairly predictable, and one could calculate the total number of days available for preparatory tillage and for sowing.

### Use of Rainfall Probabilities

Rainfall probabilities could be effectively used to show the seasonal progression of rainfall dependability, thereby providing a useful means to differentiate locations. This point can be amply illustrated from the probabilities of decadal rainfall shown in Figure 9. At Ouagadougou, the rainfall probabilities by decade 12 are 35% but increase to 78% by decade 15 and stay above the dependable probability level of 70% (indicated by the horizontal line) until decade 27. At Kolda, which receives 1172 mm of mean annual rainfall, the rains start late (Fig. 4) and so the probabilities only reach the dependable level at decade 19 and stay below those at Ouagadougou until decade 21 and then increase.

The probability of receiving rains late in the season is also an important consideration. As Dancette and Hall (1979) reported, late rains can severely damage mature crops that have not been harvested, and jeopardize harvested crops stored outside without protection from rains. On the other hand, late rains increase the chances of post-harvest plowing.

### Drought Probabilities and Crop Breeding Priorities

The analyses described above provide useful information but are still insufficient to answer the specific question of probabilities of dry spell occurrences since there are occasions when the dry spell frequency is higher and seems unrelated to rainfall totals.

Assuming that the computed date of beginning of rains in each year is also the date of sowing, the length of dry spells (or days until next day with rainfall greater than a threshold value) at different probability levels can be computed for consecutive 10-day periods from sowing. Results of this analysis at 90% probability level for selected locations in the Sudano-Sahelian zone (Fig. 14) stress that the dry spells in the emergence-to-panicle-initiation phase are higher than those during panicle initiation to flowering phases specially at low-rainfall locations, i.e., Hambori and Niamey. At Hambori, the length of dry spells is progressively longer from 75 days after sowing (DAS), at Niamey from 90 DAS, and at Ouagadougou from 120 DAS. Data shown in Figure 14 could be used as a guide to select varieties to breed for different locations. Breeding strategies should be oriented towards maturity cycles of 80–90 days for Niamey and Hambori, 110–120 days for Ouagadougou, and 130 days for Kolda.

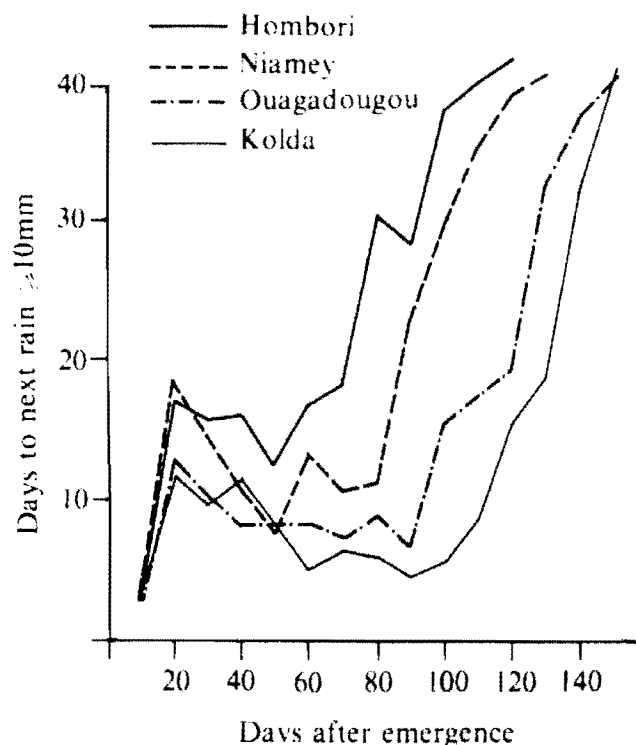

Figure 14. Number of days until next rainfall greater than 10mm (at 90% probability level) at selected locations in West Africa.

## Use of Soil-Climatic Zonation for Research Priorities

Rainfall and PET data indicate that where rainfed agriculture is concerned, the Sudano-Sahelian zone cannot be treated as one homogeneous zone. Research strategies for a given crop must accommodate both climatic variability and difference in soil types. Questions also remain on the criteria used to select research sites for regional programs, the representation of contrasting environments in regional networking, and the assessment of the national research programs' needs for strengthening research in important climatic zones.

Sivakumar (1986a) has developed a soil-climatic zonation for West Africa that superimposes the growing season lengths (shown in Figure 13) on the Soils Map of Africa (UNESCO 1977), in order to answer some of the above questions. Soil-climatic zones in the Sudano-Sahelian zone are prioritized and shown in Table 6.

### Evapotranspiration and Application of Water Balance

The real-time rainfall data collected through the large network of rain gauges that exists in the Sudano-Sahelian zone have not been adequately exploited in estimating available soil moisture for

crop growth. From the different soil-climatic zones (Table 6), it should be apparent that rainfall data per se can only be of limited use to predict crop performance in any given year. The systematic data collection of evapotranspiration of different crops in the region would be very helpful to develop suitable models for soil-moisture prediction. Commendable work has been carried out by Dancette in Senegal (Dancette 1974, 1976, and 1977) on crop-water requirements, which were given as 413 mm for pearl millet, 386 mm for groundnut, and 336 mm for cowpea. Using the water balance approach, Dancette (1976) estimated the maximum cycle lengths for pearl millet that will result in crop water needs being satisfied in 8 out of 10 years, and the probability that the water requirements of a 75-day pearl millet variety will be satisfied to at least the 80% level.

A subject of major concern in the agricultural systems of the Sudano-Sahelian zone is the low plant population used by the farmers. This practice, which may have evolved over time as a survival mechanism, leads to considerable losses of soil water through soil evaporation. Cooperative research with the Institute of Hydrology, UK, is currently underway at ISC to study separately the physical processes of soil evaporation and transpiration, in order to develop suitable agronomic techniques to minimize the losses and maximize the water-use efficiency.

**Table 6. Soil-climatic zones, their approximate extent, and priority ranking in the Sudano-Sahelian zone.**

| Soil type | Length of growing season (days) | Approximate extent ('000 ha) | Percentage of total area | Priority ranking |
|-----------|---------------------------------|------------------------------|--------------------------|------------------|
| Luvisols  | 100-150                         | 32 010                       | 24.0                     | 1                |
| Arenosols | 60-100                          | 29 973                       | 22.5                     | 2                |
| Luvisols  | 60-100                          | 10 268                       | 7.7                      | 3                |
| Vertisols | 100-150                         | 5 455                        | 4.1                      | 4                |
| Vertisols | 60-100                          | 4 030                        | 3.0                      | 5                |
| Regosols  | 100-150                         | 12 200                       | 9.1                      | 6                |
| Regosols  | 60-100                          | 7 473                        | 5.6                      | 7                |
| Nitosols  | 100-150                         | 2 855                        | 2.1                      | 8                |
| Fluvisols | 100-150                         | 3 920                        | 2.9                      | 9                |
| Fluvisols | 60-100                          | 2 538                        | 1.9                      | 10               |
| Arenosols | 100-150                         | 2 250                        | 1.7                      | 11               |
| Planosols | 60-100                          | 2 443                        | 1.8                      | 12               |
| Cambisols | 60-100                          | 1 758                        | 1.3                      | 13               |
| Cambisols | 100-150                         | 813                          | 0.6                      | 14               |

The water-balance model developed by IRAT (Forest 1984) is being applied to examine practical questions such as matching maturity cycles of different crops with water-availability patterns, water supply/yield relationships, etc. It is important that models such as these and others be taken to the operational phase in monitoring and developing agricultural early-warning systems.

## References

- Aubréville, A.** 1949. Climats, forêts et désertifications de l'Afrique tropicale. (In Fr.) Paris, France: Société d'Éditions Géographiques, Maritimes et Coloniales. 351 pp.
- Charreau, C.** 1974. Soils of tropical dry and dry-wet climatic areas of West Africa and their use and management. A series of lectures. Agronomy Mimeo 74-26. Ithaca, New York, USA: Cornell University, Department of Agronomy. 434 pp.
- Charreau, C., and Nicou, R.** 1971. L'amélioration du profil cultural dans les sols sableux et sablo-argileux de la zone tropicale sèche Ouest Africaine et ses incidences agronomiques. (In Fr.) *Agronomie Tropicale* 26:209-255, 565-631, 903-978, 1138-1237.
- Charreau, C., and Seguy, L.** 1969. Mesure de l'érosion et du ruissellement à Séfa en 1968. (In Fr.) *Agronomie Tropicale* 24:1055-1097.
- Chevallier, A.** 1933. Le territoire géobotanique de l'Afrique tropicale nord-occidentale et ses divisions. (In Fr.) *Bulletin Société Botanique*. 80:4-26.
- Christol, R.** 1966. Mesure de l'érosion et du ruissellement en Haute Volta. (In Fr.) *Oléagineux* 21: 531-534.
- Cochemé, J., and Franquin, P.** 1967. An Agroclimatology survey of a semi-arid area in Africa South of the Sahara. Technical Note no. 86. Geneva, Switzerland: WMO. 136 pp.
- Dancette, C.** 1974. Les besoins en eau des plantes de grande culture au Sénégal. (In Fr.) Pages 351-371 in *Isotope and radiation techniques in soil physics and irrigation studies*, 1973. Vienna, Austria: International Atomic Energy Agency.
- Dancette, C.** 1976. Cartes d'adaptation à la saison des pluies des mils à cycle court dans la moitié nord du Sénégal. (In Fr.) Pages 19-47 in *Efficiency of water and fertilizer use in semi-arid regions*. FAO/IAEA Technical Document 192. Vienna, Austria: International Atomic Energy Agency.
- Dancette, C.** 1977. Agroclimatologie appliquée à l'économie de l'eau en zone Soudano-Sahélienne. (In Fr.) Dakar, Sénégal: Institut Sénégalais de recherche agricole.
- Dancette, C., and Hall, A.E.** 1979. Agroclimatology applied to water management in the Sudanian and Sahelian zones of Africa. Pages 98-118 in *Agriculture in semi-arid environments* (Hall, A.E., Cannell, G.A., and Lawton, H.W., eds.). Berlin, Federal Republic of Germany: Springer-Verlag.
- Davy, E.G., Mattei F., and Solomon, S.I.** 1976. An evaluation of climate and water resources for development of agriculture in the Sudano-Sahelian zone of West Africa. Special Environmental Report no. 9. Geneva, Switzerland: WMO. 289 pp.
- de Geus, J.G.** 1970. Fertilizer guide for foodgrains in the tropics and subtropics. Zurich, Switzerland: Centre d'étude de l'azote.
- FAO.** 1984. Agroclimatological data for Africa. Vol. I. Countries north of equator. FAO Plant Production and Protection Series no. 22. Rome, Italy: FAO.
- Forest, F.** 1984. Simulation du bilan hydrique des cultures pluviales. Présentation et utilisation du logiciel BIP. GERDATDRD Montpellier, France.
- Forest, F., and Lidon, B.** 1984. Influence du régime pluviométrique sur la fluctuation du rendement d'une culture de sorgho intensifiée. (In Fr.) Pages 247-260 in *Agrometeorology of sorghum and millet in the semi-arid tropics: proceedings of the International Symposium, 15-20 Nov 1982, ICRI-SAT Center, India*. Patancheru, A.P. 502 324, India: International Crops Research Institute for the Semi-Arid Tropics.
- Gabriel, K.R., and Neumann, J.** 1962. A markov chain model for daily rainfall occurrence at Tel Aviv. *Quarterly Journal of the Royal Meteorological Society* 88:90-95.

- Hargreaves, G.H.** 1974. Precipitation dependability and potential for agricultural production in northeast Brazil. Publication no. 74-D155. Logan, Utah, USA: Utah State University, and Brazil: EMBRAPA (Empresa Brasileira de Pesquisa Agropecuária).
- Hoogmoed, W.B.** 1981. Analysis of rainfall in some locations of West Africa and India. *In* Development of criteria and methods for improving the efficiency of soil management and tillage operations with special reference to arid and semi-arid regions (Rawitz, E., Hoogmoed, W.B., and Morin Y., eds.). Appendix 5 to final report. Rehovot, Israel: Hebrew University. 23 pp.
- Hoogmoed, W.B.** 1986a. Analysis of rainfall characteristics relating to soil management from some selected locations in Niger and India. Report no. 86-3. Wageningen, Netherlands: Wageningen Agricultural University.
- Hoogmoed, W.B.** 1986b. Analysis of rainfall data relating to the number of days available for tillage and planting in some selected locations in Niger. Report no. 86-4. Wageningen, Netherlands: Wageningen Agricultural University.
- Hoogmoed, W.B., and Stroosnijder, L.** 1984. Crust formation on sandy soils in the Sahel. I. Rainfall and infiltration. *Soil and Tillage Research* 4:5-23.
- ICRISAT** (International Crops Research Institute for the Semi-Arid Tropics). 1985. Annual report 1984. Patancheru, A.P. 502 324, India: ICRISAT.
- Jackson, I.J.** 1977. Climate, water and agriculture in the tropics. London, UK: Longman.
- Jones, M.J., and Stockinger, K.R.** 1972. The effect of planting date on the growth and yield of maize at Samaru, Nigeria. *African Soils* 17:27-34.
- Kassam, A.H., and Andrews, D.J.** 1975. Effects of sowing date on growth, development and yield of photosensitive sorghum at Samaru, northern Nigeria. *Experimental Agriculture* 11:227-240.
- Keay, R.W.J.** 1959. Vegetation map of Africa south of the tropic of Cancer—explanatory notes. London, UK: Oxford University Press.
- Klaij, M.C., and Serafini, P.G.** 1988. Management options for intensifying millet based crop production systems on sandy soils in the Sahel. Presented at the International Conference on Dryland Farming, 15-19 August 1988, Amarillo, Bushland, Texas, USA.
- Kowal, J.M.** 1970. The hydrology of a small catchment basin at Samaru, Nigeria. III. Assessment of surface runoff under varied land management and vegetation cover. *Nigerian Agricultural Journal* 7:120-133.
- Kowal, J.M., and Kassam, A.H.** 1976. Energy load and instantaneous intensity of rainstorms at Samaru, northern Nigeria. *Tropical Agriculture (Trinidad)* 53:185-197.
- Kowal, J.M., and Kassam, A.H.** 1978. Agricultural ecology of savanna; a study of West Africa. Oxford, UK: Clarendon Press. 403 pp.
- Lal, R.** 1980. Soil erosion as a constraint to crop production. Pages 405-423 *in* Priorities for alleviating soil-related constraints to food production in the tropics. Los Baños, Laguna, Philippines: International Rice Research Institute.
- Le Houerou, H. N.** 1976. Nature and desertification, Consultation CILSS/UNSO/FAO sur le rôle de la foresterie dans les programmes de réhabilitation du Sahel, Dakar, 26 avril-1 mai 1976.
- Le Houerou, H.N., and Popov, G.F.** 1981. An eco-climatic classification of intertropical Africa. *FAO Plant Production and Protection Paper* no. 31. Rome, Italy: FAO. 40 pp.
- Nicholson, S.E.** 1980. The nature of rainfall fluctuations in subtropical West Africa. *Monthly Weather Review* 108:473-487.
- Nicholson, S.E.** 1981. Rainfall and atmospheric circulation during drought and wetter periods in West Africa. *Monthly Weather Review* 109:2191-2208.
- Nicholson, S.E.** 1982. The Sahel: a climatic perspective. Paris, France: Organization for Economic Cooperation and Development.
- Nicholson, S.E.** 1983. The climatology of Sub-Saharan Africa. Pages 71-92 *in* Environmental change in the West African Sahel. Washington, D.C., USA: National Academy Press.

- Penman, H.L.** 1948. Natural evaporation from open water, bare soil, and grasses. *Proceedings of the Royal Society of London, Series A* 193:120-145.
- Rodier, J.** 1964. Régimes hydrologiques de l'Afrique noire à l'ouest du Congo. (In Fr.) Paris, France: ORSTOM (Office de la recherche scientifique et technique d'outre-mer).
- Roose, R., and Bertrand, R. P.** 1971. Contribution à l'étude de la méthode des bandes d'arrêt pour lutter contre l'érosion hydrique en Afrique de l'Ouest. Résultats expérimentaux et observations sur le terrain. (In Fr.) *Agronomie Tropicale* 26: 1270- 1283.
- Roose, R., and Birot, Y.** 1970. Mesure de l'érosion et du lessivage oblique et vertical sous une savane arborée du plateau Mossi (Gonse, Haute-Volta Campagnes 1968-69) CIFT.1 ORSTOM. Paris, France: Office de la recherche scientifique et technique d'outre-mer. 148 pp.
- Sharon, D.** 1974. The spatial pattern of convective rainfall in Sukamaland, Tanzania: a statistical analysis. *Archives for Meteorology Geophysics and Bioclimatology, Series B* 22:201-218.
- Sivakumar, M.V.K.** 1986a. Soil-climatic zonation for West African semi-arid tropics: implications for millet improvement. Presented at the Regional Pearl Millet Workshop, 6-12 Sep 1986, Niamey, Niger.
- Sivakumar, M.V.K.** 1986b. Predicting rainy season potential from the onset of rains in the Sahelian and Sudanian climatic zones of West Africa. *Agricultural and Forest Meteorology* 34. (In press).
- Sivakumar, M.V.K., Virmani, S. M., and Reddy S. J.** 1980. Rainfall climatology of West Africa: Niger. *Information Bulletin* no. 5. Patancheru, A.P. 502 324, India: International Crops Research Institute for the Semi-Arid Tropics.
- Sivakumar, M.V.K., Konate, M., and Virmani, S. M.** 1984. *Agroclimatology of West Africa: Mali.* *Information Bulletin* no. 19. Patancheru, A.P., India: International Crops Research Institute for the Semi-Arid Tropics.
- Sivakumar, M.V.K., and Gnoumou, F.** 1987. *Agroclimatology of West Africa: Burkina Faso.* *Information Bulletin* no. 23. Patancheru, A.P. 502 324, India: International Crops Research Institute for the Semi-Arid Tropics.
- Stanton, W., and Cammack, R.H.** 1953. West African Maize Rust Research Unit: first annual report, Moor Plantation Nigeria. (Limited distribution.)
- Stern, R.D., and Coe, R.** 1982. The use of rainfall models in agricultural planning. *Agricultural Meteorology* 26:35-50.
- Toupet, C.** 1965. Les éléments annuels du climat. *International Atlas of West Africa.* Organization of African Unity/Scientific and Technical Research Commission. Dakar, Sénégal:OAU/STRC.
- Trochain, J.** 1952. Les territoires phytogéographiques de l'Afrique noire française d'après leur pluviométrie; revue des travaux du laboratoire de la Faculté de Science, Montpellier, Sèr. Bot. 5:113-124.
- UNESCO** 1977. *Soil map of the world. Vol VI. Africa.* Paris, France: UNESCO.
- Verne, R., and Williame, P.** 1965. Résultats des études de l'érosion au Dahomey. Communication au Colloque: Conservation et Amélioration de la fertilité des sols; Khartoum. Organization of African Unity/Scientific and Technical Research Commission, 98:43-53.

# L'usage efficace des ressources en eau pour l'agriculture en zone soudano-sahélienne

J.M. Chapotard<sup>1</sup>

## Résumé

*Le présent exposé se réfère géographiquement aux Etats africains francophones de la zone soudano-sahélienne. Orienté vers les problèmes de l'utilisation des ressources en eau pour l'agriculture, il rappelle d'abord ce que sont ces ressources et ce qu'on sait de leurs caractéristiques essentielles : pluie, eau souterraine et eau de surface. Il décrit ensuite, par quelques exemples de petits périmètres, divers modes de l'apport d'eau au profit de l'agriculture et en précise quelques résultats. Est présentée brièvement la situation de la recherche dans le domaine de l'exploitation des ressources en eau et les perspectives de cette recherche. L'étude sur ce sujet est globalement orientée vers une connaissance plus précise des besoins en eau et de l'usage économique des ressources en eau. L'article conclut au caractère indispensable de ces orientations, compte tenu de l'insécurité de la culture pluviale seule, mais aussi de la nécessité de réaliser des investissements adaptés et économiquement corrects.*

## Abstract

**Efficient use of water resources for agriculture in the Sudano-Sahelian zone:** *This paper deals with the problem of describing as well as utilizing water resources (rainfall, ground, and surface water) for agriculture in the French-speaking countries of the zone. It describes various methods of providing water for agriculture, using small irrigation schemes as examples, and then summarizes current research on exploitation of water resources, particularly efforts to quantify the need for water and to study how water can be used economically. The paper concludes that because of the uncertainty of rainfed agriculture, this approach, and appropriate, economic investments are essential.*

## Introduction

L'expression "zone soudano-sahélienne" n'est pas strictement employée pour désigner une aire déterminée. Tel géographe lui fait correspondre la zone des pluviométries de 500 à 900 mm, tel chargé d'étude l'applique à la ceinture subsaharienne de 200 à 600 mm, tandis que l'Organisation des Nations Unies pour l'alimentation et l'agriculture

(FAO) retient pour la décrire la fourchette de pluviométrie de 350 à 600 mm. Compte tenu de ces nuances ainsi que des oscillations récentes de position des isohyètes, on retiendra la notion de pays de la zone soudano-sahélienne, et plus spécifiquement, le Comité interafricain d'études hydrauliques (CIEH) évoquera seulement les Etats correspondants qui lui sont adhérents : Burkina Faso, Cameroun (pour sa partie nord), Mali, Mauritanie, Niger, Sénégal, et Tchad.

---

1. Ingénieur au Comité interafricain d'études hydrauliques (CIEH), B.P. 369, Ouagadougou, Burkina Faso.

## Les ressources en eau disponibles

Elles proviennent toutes des pluies, actuelles ou celles qui, au cours d'époques géologiques antérieures ont contribué à alimenter les nappes. La pluie actuelle est en partie directement utilisable par les plantes, le reliquat étant, dans l'immédiat, perdu par ruissellement ou par infiltration au dessous de la zone des racines.

### La pluie actuelle

La pluie actuelle est caractérisée par sa variabilité spatiale et temporelle. La variabilité spatiale est extrême pour la pluie journalière sur une petite zone et ceci est important dans le cas de suivi de culture, de diagnostic à la parcelle ou d'avertissement. On a pu observer la variabilité interannuelle à l'occasion de la séquence d'années sèches récentes. A propos de ceci, on précisera qu'il n'y a pas de "cycles" de sécheresse à périodicité déterminée.

Notons que pour l'agronome, la pluie "efficace" est celle qui est utilisable par les plantes alors que pour l'hydrogéologue, elle équivaut à l'écoulement total potentiel, c'est-à-dire à la somme du ruissellement et de l'infiltration alimentant les aquifères. La pluie efficace "agronomique" est difficile à évaluer avec précision, aucun modèle n'étant disponible pour calculer les pertes suivant les types de cultures, de sols et de travail du sol.

L'utilisation immédiate de la pluie seule implique une subordination à des facteurs aléatoires. La recherche de la sécurité conduit à rechercher une ressource complémentaire : eaux souterraines ou superficielles.

## Les eaux souterraines

### Localisation

Les eaux souterraines se partagent entre deux ensembles distincts :

- Le socle précambrien où les niveaux aquifères sont discontinus et liés à la fracturation ou à l'altération de la roche, les niveaux statiques généralement proches du sol, les débits exploitables ponctuellement faibles. On y rattache les formations infracambriennes et primaires aux nappes le plus souvent discontinues et profondes.

- Les formations sédimentaires postprimaires et les recouvrements récents avec des nappes continues parfois de grande dimension, pouvant être empilées en niveaux superposés séparés par des horizons moins perméables. Le niveau statique y est à une profondeur variable, parfois assez grande sous le sol; les débits de forages peuvent atteindre d'une dizaine de  $\text{m}^3 \text{h}^{-1}$  à  $200 \text{m}^3 \text{h}^{-1}$  ou plus.

Le socle précambrien est rencontré au Mali, en Mauritanie, au Burkina Faso, au Liptako Nigérien, à l'est et au centre du Tchad, au Nord Cameroun. Dans les schistes, les débits les plus intéressants sont obtenus dans la partie supérieure fissurée de la roche saine d'une trentaine de mètres en moyenne. Dans les roches cristallines, l'eau est emmagasinée dans les fissures de la roche saine ou dans les arènes à la base de la couche d'altération. L'épaisseur de celle-ci est de 15 à 25 m, au Burkina. Les débits ponctuels dans ces formations varient entre 1 et  $5 \text{m}^3 \text{h}^{-1}$  et dépassent rarement  $10 \text{m}^3 \text{h}^{-1}$ .

Les formations infracambriennes et primaires sont présentes au Mali, en Mauritanie, au nord du Burkina Faso. Les forages ou puits positifs du Gourma donnent 1 à  $8 \text{m}^3 \text{h}^{-1}$ , avec des niveaux statiques de 50, 60, voire 100 m.

Les grès infracambriens, de Bandiagara à la frontière du Sénégal et de la Guinée sont productifs s'ils sont fissurés. Les niveaux statiques sont souvent de 3 à 15 m (Koutiala, San, Tominian). Des débits de 1 à  $10 \text{m}^3 \text{h}^{-1}$  sont obtenus vers Bafoulabé-Kéniéban avec des forages de 60-70 m de profondeur. Les schistes de Nara sont aquifères là où ils sont fracturés. En Mauritanie, les grès contiennent probablement des nappes de fissures relativement productives ( $25$  à  $50 \text{m}^3 \text{h}^{-1}$  dans des dolomies infracambriennes au pied du Tagan). Les pélites du Hodh fracturés sur 15 à 20 m donnent de faibles débits ( $0,5 \text{m}^3 \text{h}^{-1}$ ).

Les formations sédimentaires se répartissent en grands bassins : bassin sénégalo-mauritanien, delta central du Niger (et bassin de Taoudéni), bassin nigérien et bassin du Tchad.

Le bassin sénégalo-mauritanien est constitué au Sénégal d'un empilement de couches qui contient quatre aquifères. Le maestrichtien, le plus profond, s'étend sur sensiblement l'ensemble du bassin. Epais de 200 à 250 m, son toit se situe entre 100 et 500 m suivant les régions, le niveau statique varie de 15 à 50 m, et est plus élevé que celui de la nappe phréatique. Les débits sont de  $150$  à  $200 \text{m}^3 \text{h}^{-1}$  par forage.

La nappe généralement libre du paléocène produit 200 à 500 m<sup>3</sup> h<sup>-1</sup> par ouvrage avec des niveaux statiques de 20 à 50 m. Le lutétien (ouest et nord du Sénégal) donne jusqu'à 100 m<sup>3</sup> h<sup>-1</sup> par ouvrage. Le continental terminal qui recouvre la plus grande partie du bassin contient une nappe libre dont le niveau est entre 20 et 90 m.

Les ouvrages y ont des débits spécifiques de 130 m<sup>3</sup> j<sup>-1</sup> m<sup>-1</sup> au Sénégal et 30 à 50 m<sup>3</sup> j<sup>-1</sup> m<sup>-1</sup> en Mauritanie. L'aquifère des sables dunaires entre Dakar et Saint-Louis est exploitable avec précaution du fait des risques de remontée d'eau salée. Les alluvions du fleuve Sénégal peuvent donner jusqu'à 30 m<sup>3</sup> h<sup>-1</sup> avec 2 m de rabattement à l'amont de Boghé (salure à l'aval).

En Mauritanie, la nappe du continental terminal s'enfonce jusqu'à 100 m au Centre du bassin. Le lutétien sous-jacent est aquifère (nappe libre) en bordure est du bassin.

Au Mali, les aquifères continues sont dans le continental intercalaire, le crétacé, l'éocène inférieur et le continental terminal. Dans le fossé de Nara, les sédiments du continental intercalaire atteignent 200 m au centre, mais l'aquifère n'est épais que de 25 m avec des débits de 10 à 15 m<sup>3</sup> h<sup>-1</sup> par forage. Autour de l'Adrar des Iforas, le continental intercalaire est atteint vers 120 à 150 m (Menaka); des forages de 150 à 200 m débitent une dizaine de m<sup>3</sup> h<sup>-1</sup>, le niveau statique étant entre 35 et 60 m.

Le crétacé et l'éocène inférieur donnent des débits d'une dizaine de m<sup>3</sup> h<sup>-1</sup>. Le continental terminal, dans le delta central du Niger est exploité notamment par les forages des centres urbains proches du fleuve qui ont une profondeur d'environ 75 m et des débits de quelques dizaines de m<sup>3</sup>. On retrouve cette formation dans l'Azaouad et le bassin de Taoudéni (puits de 40 à 60 m) et dans le Gondo, à proximité du nord-ouest du Burkina, où épaisse de 50 à 120 m, elle est faiblement aquifère avec des niveaux d'équilibre variables de 20 à 80 m.

Dans le bassin du Niger, on citera d'abord au nord-est un ensemble d'aquifères d'extension limitée : quatre niveaux dans les grès primaires dont une nappe ordovicienne puissante mais très profonde (800 m), la nappe des grès de Téloua, avec un niveau d'équilibre entre 30 et 90 m et la nappe captive des grès d'Agadez. Le continental intercalaire affleure dans le Tegama et le Damergou recouvert à l'Est par des formations mal connues, il s'enfonce à l'Ouest sous un recouvrement qui peut atteindre 600 m. La nappe y est en charge et

localement artésienne dans les vallées des Dallols.

La productivité est près du fleuve Niger, de dizaines de m<sup>3</sup> par mètre de rabattement, ailleurs les débits spécifiques sont de quelques m<sup>3</sup>.

Le continental terminal contient une nappe supérieure phréatique libre et dans sa partie est, deux nappes captives. La nappe supérieure, la plus exploitée est proche du sol dans les dallols, à 50 m sous les plateaux. Les puits ont une profondeur de 45 m et des débits de 5 m<sup>3</sup> h<sup>-1</sup>; les nappes captives ont des productivités de 250 à 3000 m<sup>3</sup> j<sup>-1</sup> pour la moyenne, 150 à 2000 m<sup>3</sup> j<sup>-1</sup> pour l'inférieure.

Dans le bassin du Tchad, les aquifères continues essentielles sont celles du continental terminal et du plioquaternaire. A noter cependant au nord-est un niveau cambrien qui donne par forage des débits de l'ordre de 1000 m<sup>3</sup> j<sup>-1</sup> à Faya Largeau. Le crétacé est accessoirement affleurant au Mayo Kebbi et dans la Bénoué, mais peu connu du fait de la présence des ressources de surface. Le continental terminal affleure depuis les Pays Bas du Tchad jusqu'au Batha avec des puits traditionnels jusqu'à 80 m; au sud du Guera, cette nappe est en relation directe avec les cours d'eau mais peut s'enfoncer à 90 m dans les interfleuves. Le plioquaternaire affleure tout autour du lac Tchad. Il renferme une nappe libre dans les dunes et horizons de surface, dont l'exploitation est rendue délicate par une granulométrie très fine. Les niveaux inférieurs renferment une nappe captive dite "nappe moyenne sous pression des formations du Tchad" avec d'excellentes ressources autour du lac où elle est artésienne.

Le toit de cette seconde aquifère est à 250-300 m. Il existerait enfin une nappe à une profondeur supérieure à 500 m avec une charge supérieure à celle de la nappe moyenne.

### Utilisation

En ce qui concerne la possibilité d'utilisation des aquifères évoquées, on rappellera les notions de ressources renouvelables naturelles et celle de réserve exploitable. La ressource renouvelable représente le volume d'eau par km<sup>2</sup> qui parvient en moyenne annuelle à l'aquifère. Elle n'est pas directement liée à la pluie "efficace" (des hydrogéologues) car elle dépend principalement de la lithologie des aquifères, de la morphologie de surface, de l'altération, de la fissuration, de la profondeur de la surface piézométrique et de la végétation. Des



travaux du Comité interafricain d'études hydrauliques/Bureau de recherches géologiques et minières (CIEH/BRGM) ont permis des évaluations de cette fraction. Les coefficients retenus, calés sur différents bilans et analyses de fluctuation de nappe ont été insérés à la carte Afrique soudano-sahélienne de planification des ressources en eaux souterraines publiée en 1976 (CIEH 1976). Les valeurs proposées sont indicatives à l'échelle d'une région et à vérifier localement. Des travaux locaux sur socle ont montré qu'une évaluation plus rigoureuse de la recharge annuelle demande de disposer en plus du coefficient d'emmagasinement du réservoir.

La réserve exploitable représente un volume emmagasiné dans l'aquifère, dont l'exploitation, si aucune ressource renouvelable ne venait la compenser, aboutirait à une vidange partielle de l'aquifère. La réserve est exploitable dans certaines conditions économiques; des évaluations en ont été faites également. On les trouve dans l'étude déjà citée, mais les éléments disponibles n'ont pas permis de donner des valeurs pour les aquifères discontinues, les mesures de tritium révélant pour le Sud, et à un degré le Centre du Burkina, un effet de dilution de celui-ci dans des réserves importantes. Pour que la disponibilité des eaux soit utile, il faut cependant que leur qualité chimique soit acceptable pour l'irrigation.

Beaucoup des eaux souterraines de la zone considérée sont très douces et peu minéralisées. L'alternance d'une saison sèche et d'une saison des pluies introduit des variations des caractères physico-chimique. Le phénomène de dilution provoqué par les apports météoriques est maximal en fin de saison humide avec éventuellement un certain décalage.

Des cartes d'aptitude des sols à l'irrigation (BRGM 1975) ont pu être établies en 1975 à partir de deux critères : la minéralisation totale d'une eau exprimée par sa conductivité d'une part, le taux d'absorption du sodium d'autre part. La combinaison de ces deux classifications permet de définir différentes classe regroupées en cinq degrés d'aptitude :

- eau excellente : utilisable globalement sans danger;
- eau bonne : utilisable pour l'irrigation de plantes moyennement tolérantes au sel sur sols de bonne perméabilité;
- eau admissible : utilisable pour l'irrigation de plantes tolérantes au sel et sur sols bien drainés

mais l'évolution de la salinité est à contrôler;

- eau médiocre : en général fortement minéralisée, irrigation d'espèces bien tolérantes au sel et sur sols bien drainés et lessivés;
- eau mauvaise : irrigation de plantes tolérant très bien le sel sur sols très perméables, à bon lessivage.

On indique ici les cas de situations délicates, en se limitant aux seules zones sédimentaires, et en rappelant qu'il s'agit d'indications globales :

**Sénégal.** Nappe maestrichtienne entre les méridiens 15 et 15°30 admissible, mauvaise près du fleuve Sénégal et entre les méridiens 15°30 et 15°45, nappes phréatiques mauvaises dans le Sine-Saloum et le delta sauf lentilles d'eau douce.

**Mauritanie.** Maestrichtien mauvais sauf bordure sud-est du bassin, éocène mauvais près d'Aleg, nappe phréatique pénétrée par les eaux marines, mais (est de Nouakchott) avec niveaux bon à admissible.

**Mali.** Zones admissibles à médiocres dans le continental intercalaire et le continental terminal. Eaux médiocres à l'est de Gao, mauvaises dans l'Azaouad Nord; admissible au centre, médiocre au nord du Gondo.

**Niger.** Dans le continental intercalaire, dégradation vers l'ouest, mauvaise qualité vers Didgiga et Dosso; nappe phréatique du continental terminal, admissible au sud-est de Tahoua, variable dans les alluvions des Dallols, la nappe la plus profonde est admissible vers Kouré-Toubi-Birni N'Gaoré; dans le pourtour de l'Air, nappe primaire près de l'Air, médiocre à mauvaise ailleurs.

**Bassin du Tchad.** Résultats inégaux dans le continental terminal; plioquaternaire : nappe profonde sous pression admissible dans le Nord avec zone mauvaise vers Goz Dibek, mais trop peu d'informations pour une cartographie complète. Nappe phréatique médiocre à mauvaise dans le Kanem oriental, les Pays Bas du Tchad, le Moji, admissible le long du Bahrel Ghazal jusqu'à Salah; eaux très chargées dans le Chari et le Harr oriental.

Comme élément de choix, il faut ajouter le coût (équipement et exploitation) des ouvrages. A partir des différents critères étudiés, le CIEH a proposé des zones privilégiées pour l'irrigation à partir

des eaux souterraines, caractérisées par une productivité par ouvrage d'au moins  $550 \text{ m}^3 \text{ j}^{-1}$ . Ceci rend possible un périmètre d'une dizaine d'hectares, un coût du  $\text{m}^3$  inférieur à 20 F CFA en 1975,

les eaux ayant des qualités excellentes à admissibles. Ces propositions sont cartographiées aux Figures 1-5.

Il s'agit pour une irrigation à partir des aquifères

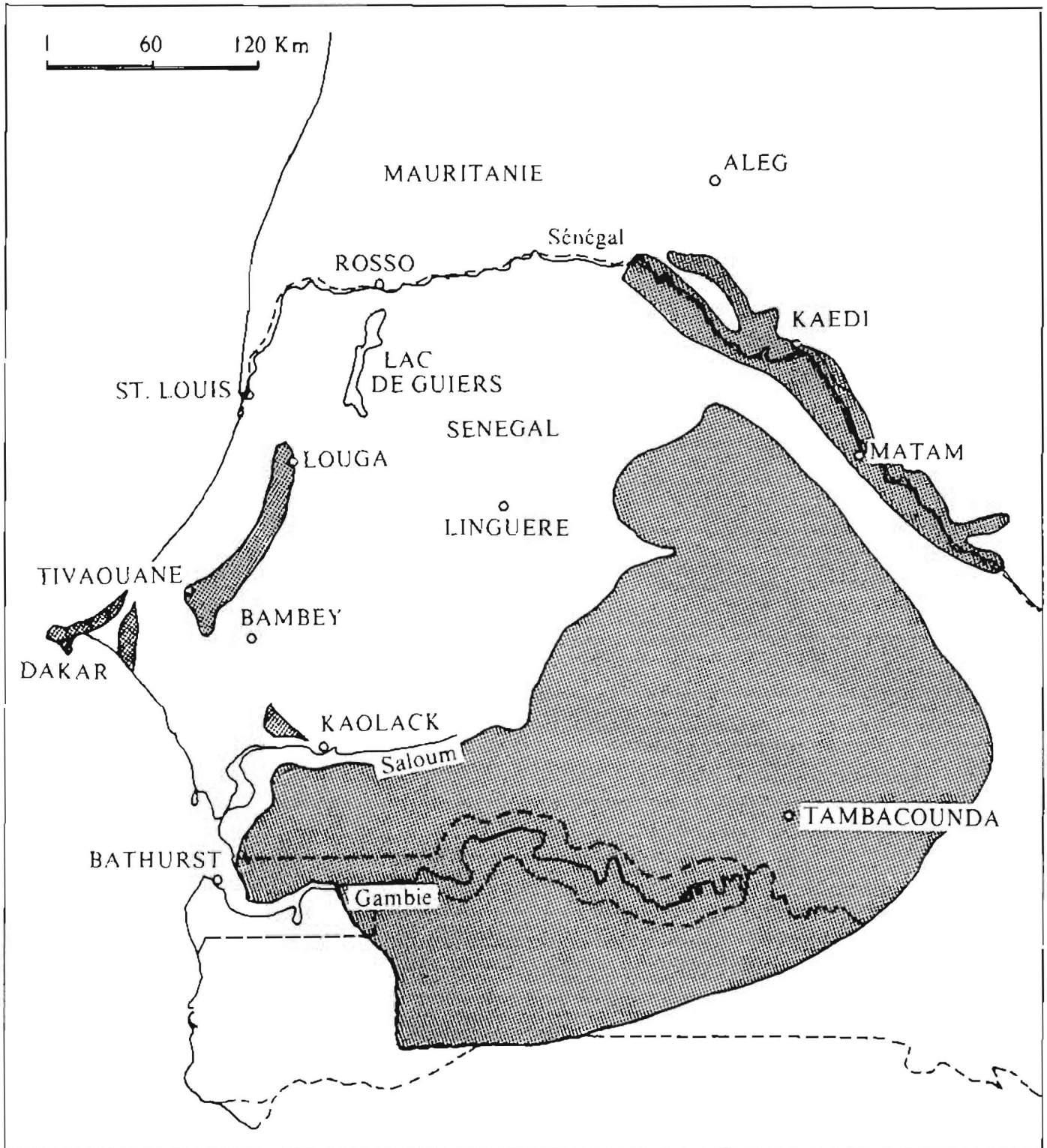

Figure 1. Irrigation à partir des eaux souterraines : Bassin SÉNÉGALO-Mauritanien. La partie hachurée indique la zone où l'irrigation à partir des eaux souterraines est techniquement et économiquement possible. Critères adoptés : Débit d'exploitation initial  $>550 \text{ m}^3 \text{ j}^{-1}$ ; coût de  $\text{m}^3 < 20 \text{ F CFA}$  (valeur 1975); qualité des eaux — excellente, bonne, admissible (d'après les normes du laboratoire de Riverside, Californie, États-Unis). Seul est représenté l'aquifère le plus proche de la surface du sol (Source BRGM 1975).

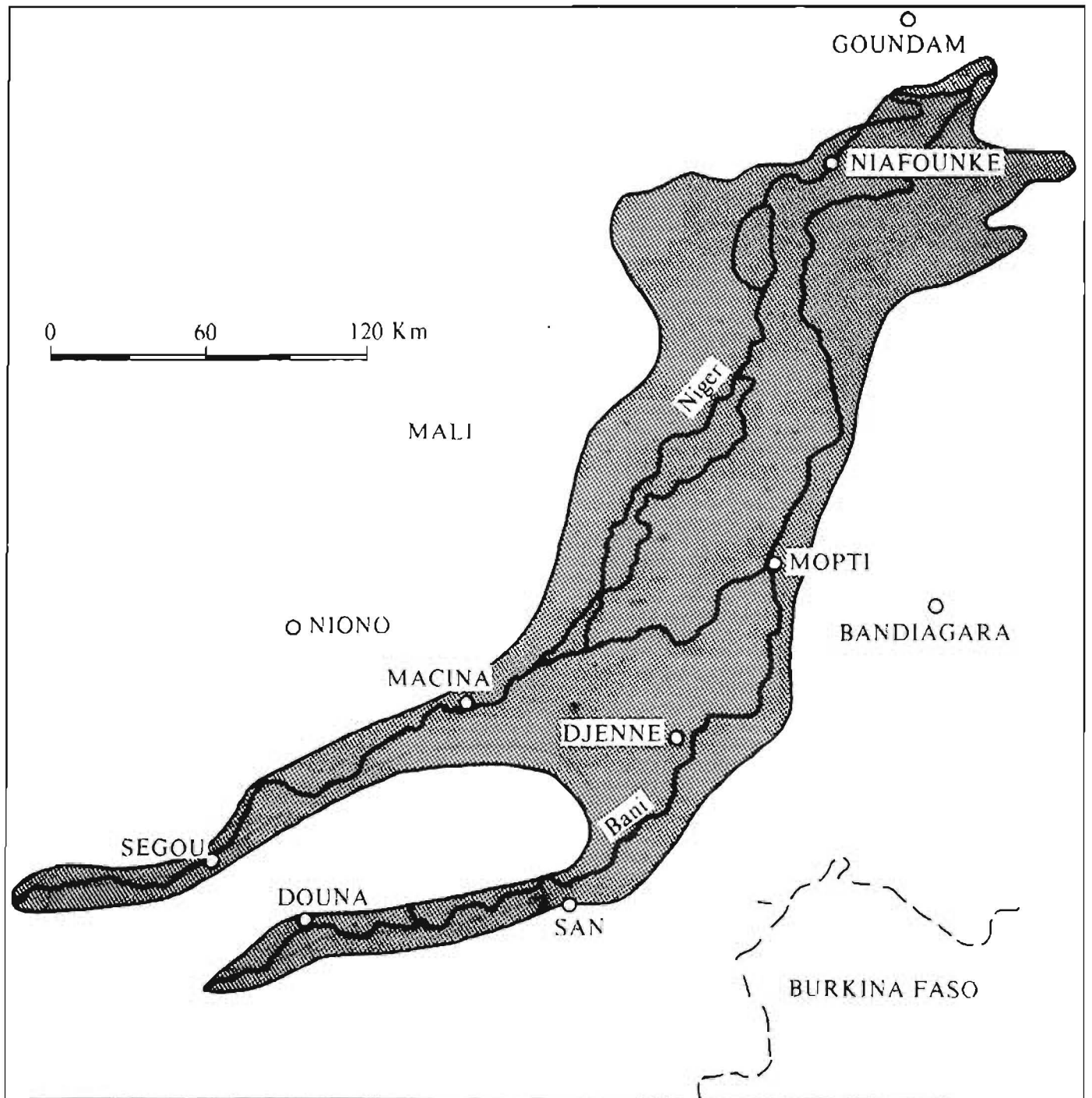

Figure 2. Irrigation à partir des eaux souterraines : Delta central du Niger (Voir note à la Figure 1 pour la partie hachurée) (Source BRGM 1975).

les plus proches du sol, du centre-est, du Sud Est et du sud du Sénégal (sauf zones côtières) de la vallée du Sénégal à l'amont de Boghé, des vallées du Bani et du Niger depuis Douna et l'amont de Ségoum la zone des lacs jusque vers Goundam, les régions de Filingué, Dosso, Dogondoutchi, nord de Tahoua, ouest de Keita, nord-est de Madaoua, les zones proches au nord du Lac Tchad, la région de N'Djaména, la région Koumra-Kelo. Pour une

irrigation à partir de nappes plus profondes, on retiendra le centre-est et le sud du Sénégal, le sud-est de Tahoua et l'ouest de Dosso-Filingué.

### Les eaux superficielles

Elles sont à considérer au niveau d'un réseau hydrographique. Le captage se fait soit sur un petit

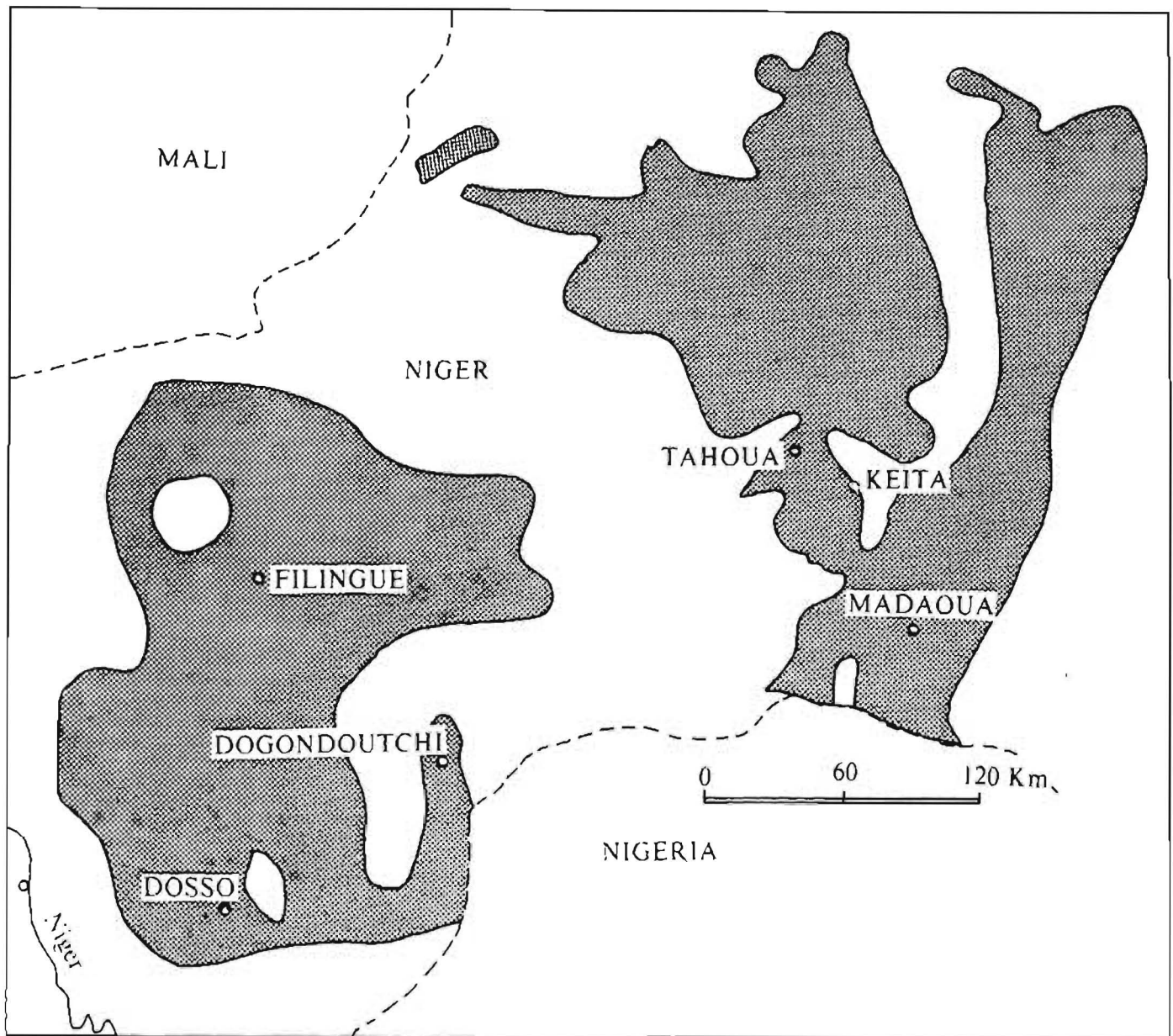

Figure 3. Irrigation à partir des eaux souterraines : Bassin du Niger (Voir note à la Figure 1 pour la partie hachurée) (Source BRGM 1975).

bassin versant dont on veut maîtriser et utiliser le ruissellement, soit sur un plus grand ensemble, généralement drainé par un fleuve permanent. Laissant dans ce cas de côté les grands ouvrages qui ont pour objet la maîtrise de l'eau dans un ensemble régional, on observera qu'existent sur ces fleuves des moyens de récupération d'eau plus modestes : stations de pompage ou réserves locales.

Que sait-on des ressources potentielles? En ce qui concerne les grands fleuves, des monographies existent qui rassemblent tous les résultats connus au moment de leur publication. Pour les petits bassins, une source de renseignements est un recueil de données de 1972 sur bassins expérimen-

taux (Dubreuil 1972). Pour ce qui est du recueil actuel des données et de leur exploitation, l'intérêt des aménagements locaux conduit à présent à équiper des bassins de moins de 1000 km<sup>2</sup>. Des annuaires hydrologiques nationaux paraissent ou sont prévus.

Pour ce qui est de l'évaluation des apports, ceux-ci peuvent être chiffrés sur les grands fleuves, grâce aux monographies, aux synthèses par pays et aux chroniques de débit des services nationaux. Pour les petits bassins versants, l'estimation est délicate car les stations sont rares et les périodes d'observations courtes. Les stations contrôlent des bassins de superficies très variées où la dégradation hydro-

logique est fort diverse, l'écoulement est très intermittent, la répartition spatiotemporelle des pluies y joue un grand rôle et la contribution au ruissellement peut venir d'une faible partie imperméable du bassin, enfin l'irrégularité interannuelle est énorme. Pour toutes ces raisons, les valeurs fournies par les

quelques stations en activité ne sont pas forcément représentatives des situations réelles. Une réflexion a été menée sur ce problème sachant que le coefficient d'écoulement médian dépend de la zone climatique et des sols.

D'une part, à partir d'observations sur bassins,

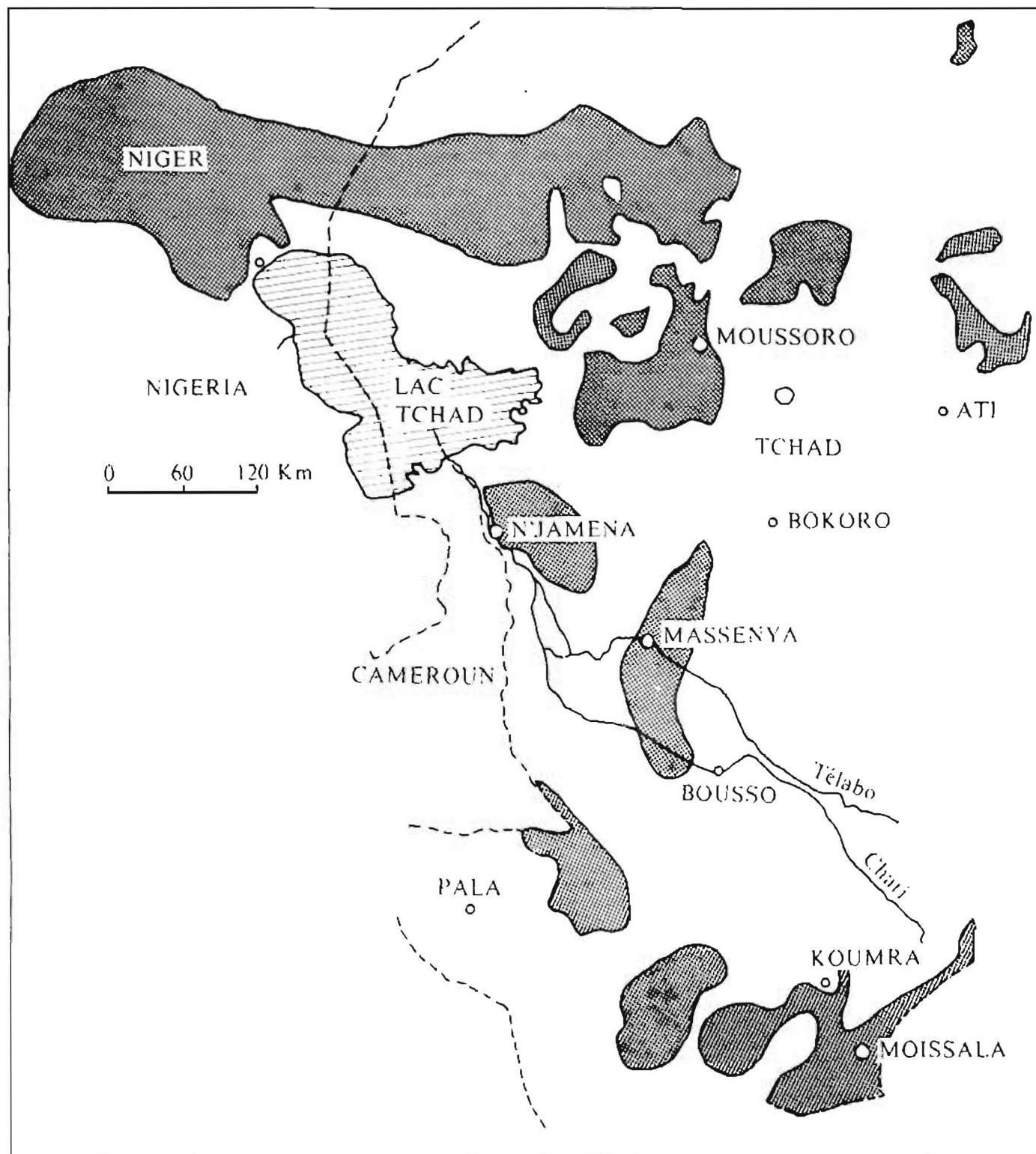

Figure 4. Irrigation à partir des eaux souterraines : Bassin du lac Tchad (Voir note à la Figure 1 pour la partie hachurée) (Source BRGM 1975).

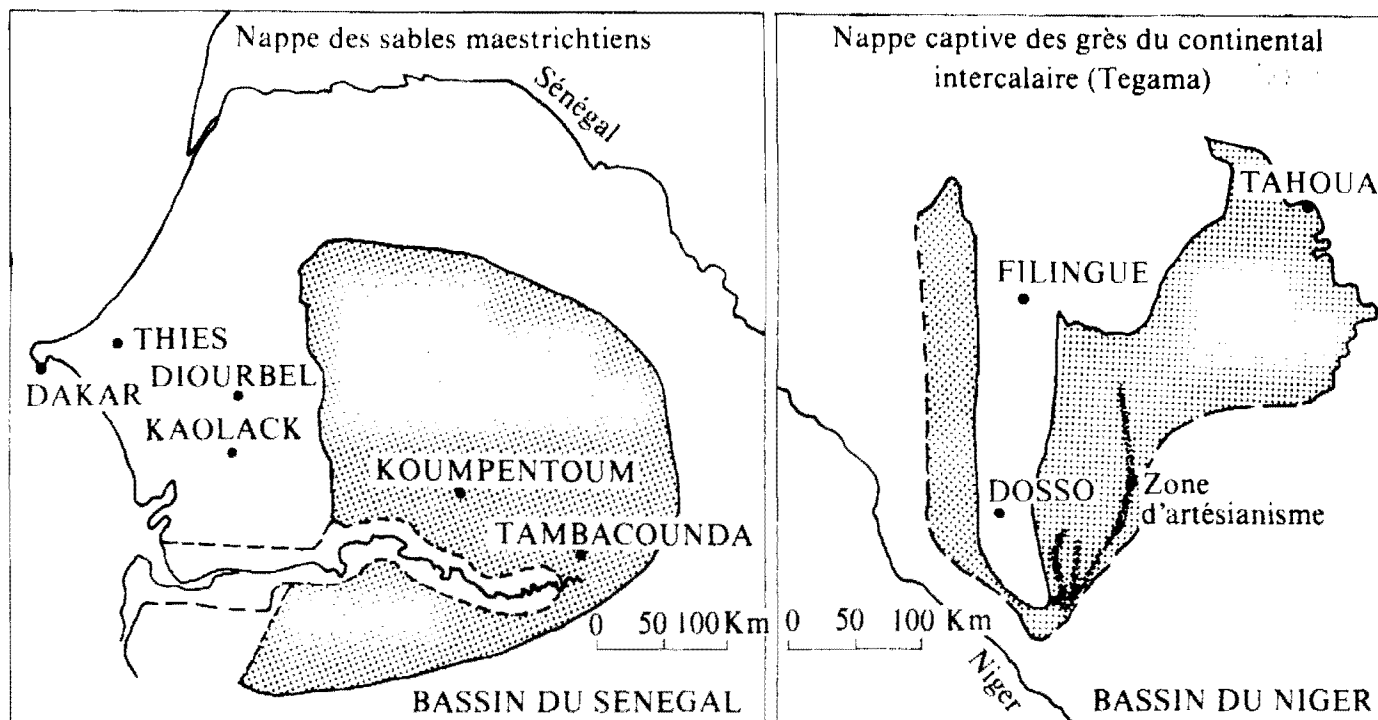

Figure 5. Irrigation à partir des eaux souterraines : Bassin du Sénégal et Bassin du Niger. (Voir note à la Figure 1 pour la partie hachurée) (Source BRGM 1975).

on a pu esquisser une approche statistique de la lame d'eau susceptible de s'écouler par région. La cartographie par zones de ces lames d'eau probables permet ensuite une estimation de l'écoulement dans les petits bassins versants.

Par ailleurs, des modèles théoriques ont été développés, partant de l'hypothèse que seule la fraction d'une pluie supérieure à un certain seuil peut ruisseler. Ces modèles permettent de reproduire les apports sur bassin expérimental et l'introduction des chroniques anciennes de pluies permet de reconstituer les apports antérieurs, d'où une étude statistique possible. Cette approche théorique a permis de compléter les données de bassins expérimentaux et pour le Sahel, de donner naissance à une méthode (Rodier 1975) d'estimation des apports, qui suppose des rapprochements avec des bassins types.

On retiendra l'extrême faiblesse des coefficients d'écoulement en zone sahélienne et de même en zone plus arrosée. Les coefficients pour une pluie donnée sont aussi faibles et irréguliers. On peut préciser que la sécheresse récente ne conduit pas à réduire les normes applicables aux relations pluie moyenne/lame ruisselée, les coefficients seraient plutôt à maximiser sur petits bassins.

Pour l'estimation des débits de crue les pro-

blèmes sont les mêmes que pour celle des apports. Pour les grands fleuves, monographies, annuaires, modèles mathématiques (en cours de réalisation pour le fleuve Niger) permettent de dominer la question. Pour les petits bassins versants par contre, il n'existe pas de modèle mathématique simple qui soit efficace pour estimer l'amplitude des crues.

Deux méthodes ont été mises au point dans nos régions qui permettent d'appréhender la valeur de la crue décennale : a) une méthode déterministe (Rodier et Auvray 1965) basée sur 60 bassins versants et une hypothèse de pluie homogène, valable jusqu'à des surfaces de 120 à 150 km<sup>2</sup>; b) une méthode statistique (Puech et Chabignonni 1983), basée sur 162 bassins expérimentaux, utilisable jusqu'à 1000 km<sup>2</sup>.

Ces méthodes ne visant qu'à écarter un risque d'erreur supérieur à 100 %, et pour mieux cerner le problème, des travaux sont en cours en vue d'appréhender plus précisément l'aptitude des sols au ruissellement à l'aide du simulateur de pluies.

En ce qui concerne les étiages, les écoulements dans les petits bassins s'interrompant rapidement après la saison des pluies, les problèmes de mesures ne concernent que les grands fleuves. Ils sont résolus comme pour les apports globaux et les débits de crue.

Quelques observations globales sont à formuler sur ces divers sujets :

- Sur les bassins petits et moyens jusqu'à 30 000 km<sup>2</sup>, la disparition, en période sèche, de la végétation entraîne une augmentation des débits en diminuant les temps de transferts. Il n'y a donc pas lieu de réviser les modules annuels et les modules d'occurrences décennale (sèche ou humide) habituellement retenus. Ce n'est pas vrai pour les plus grands bassins où on assiste dans ces cas à un effondrement des modules.
- En zone sahélienne, pour le calcul des débits de crue sur les petits bassins versants, on conservera les normes applicables aux crues décennales, malgré la récente sécheresse. Mais on utilise les abaques les plus récentes disponibles qui intègrent les observations de cette période. Pour l'évaluation des apports sur ces mêmes bassins, on utilisera la méthodologie déjà citée, mais actualisée en 1984 (Rodier 1986).
- Pour la conception des aménagements, si on veut constituer une réserve d'hivernage, il est prudent de retenir les valeurs admises pour l'année décennale sèche. Par contre, pour la protection d'un périmètre, on utilise les estimations de la crue décennale humide en surdimensionnant les ouvrages pour le cas de crue centennale et exceptionnelle.

Du point de vue de leur qualité chimique, les eaux de surface sont le plus souvent bonnes sauf dans le cas où l'écoulement était insignifiant ou annulé et on assiste à des remontées d'eau salée. C'était le cas du fleuve Sénégal jusqu'à la construction du barrage de Diama. Sur de petits bassins, on peut avoir une alimentation d'écoulements à partir d'une nappe souterraine salée. Cet inconvénient a été signalé dans l'Ader Douthi.

Un dernier point est à aborder concernant les eaux de surface : celui des transports solides. L'irrégularité des écoulements conduit à une notion de barrages ou autres réservoirs, donc la question se pose du rythme de comblement de ces ouvrages. Celui-ci dépend des caractéristiques géométriques, climatiques, géomorphologiques du bassin versant. Des mesures expérimentales au Burkina Faso ont cherché à évaluer la dégradation spécifique annuelle. Les valeurs trouvées pour des périodes d'études supérieures à 10 ans, des bassins de 40 à 150 km<sup>2</sup> et des pluviométries annuelles de 720 à 900 mm, ont été de 52 à 160 m<sup>3</sup> km<sup>-1</sup> de bassin versant et par an. Dans une situation physique défavorable : fortes pentes et intensités de pluie, de telles

valeurs peuvent être largement dépassées.

Au barrage d'Ibohamane (Niger), sous une pluviométrie annuelle moyenne de 360 mm, les apports sont de 2000 m<sup>3</sup> km<sup>-1</sup> de bassin versant par an. Des comblements aussi rapides sont de nature à remettre en cause la rentabilité des ouvrages. Contre l'érosion totale d'un bassin versant, l'incidence des seules cultures peut être identifiée, ceci permettant d'apprécier les modifications à attendre d'une opération de mise en valeur. Ce problème a déjà fait l'objet d'étude sur parcelle expérimentale où on fait varier les conditions d'érosions et de cultures. On peut se référer aux travaux de l'ORSTOM (Roose 1977).

## Les équipements de récolte des eaux

Il y a lieu à présent de voir qu'elle est, dans la zone, l'importance des équipements de captage des eaux à des fins agricoles, en particulier ceux de taille modeste, les modes d'utilisation de ces eaux et d'essayer d'en apprécier l'intérêt économique.

### Vallée du Sénégal

C'est là que se situe l'essentiel des irrigations du Sénégal et de la Mauritanie. Les captages qui sont constitués par des stations de pompage fixes ou mobiles puisant l'eau dans le fleuve ou un défluent ne constituent pas de véritables installations de récupération d'une eau dispersée dans une nappe ou un bassin versant. Cependant, il faut souligner l'existence en 1984 de 15 790 ha de périmètres villageois irrigués, encadrés ou non, en 616 unités recensées représentant 40% des surfaces irriguées de la Vallée avec une surface moyenne de 26 ha environ. Dans certains cas, le système est conçu pour une irrigation gravitaire en hautes eaux. La source d'énergie est l'électricité ou le gas-oil suivant les cas. La distribution, à partir souvent d'un bassin de stabilisation, est en général gravitaire, avec canaux en terre. Les modes de régulation et type de prises sont variables (modules à masque, partiteurs, siphons, vannes). Sur des périmètres enquêtés, l'efficacité globale (EG) a été calculée : EG = apports dans le sol/prélèvement à la ressource. L'EG est de 0,8 (riziculture) à 0,6 (autres cultures); l'importance des irrigations y est variable : 8500 à

10 500 m<sup>3</sup> ha<sup>-1</sup> à la parcelle sur riz d'hivernage contre 12 000 à 15 000 m<sup>3</sup> ha<sup>-1</sup> sur riz de contre-saison.

Les terres équipées sont consacrées à la riziculture et à la polyculture, les coefficients d'intensité culturale variant de 1 à 1,2. Du point de vue de la rentabilité, sur un groupe de périmètres où les exploitants remboursent les charges d'exploitation et de culture et une provision pour renouvellement du matériel de pompage, la marge nette pour le riz d'hivernage est de 216 à 314 000 F CFA ha<sup>-1</sup> suivant les années. Le maïs de contre-saison est de 137 à 166 000 F CFA ha<sup>-1</sup>. Ailleurs, on relève des marges de 179 à 392 000 F CFA ha<sup>-1</sup> pour le riz à l'hivernage et 679 à 863 000 F CFA ha<sup>-1</sup> pour la tomate de contre-saison suivant les périmètres.

### Sénégal intérieur

Une première expérience très différente a été conduite sur une douzaine de villages équipés d'un forage d'hydraulique villageoise, sur nappe très productive, et mobilisée très partiellement pour les besoins humains et pastoraux. En allongeant la durée de pompage, on obtient l'eau d'arrosage d'une unité de 2 ha. Les forages étant préalablement équipés de moyens d'exhaure, l'équipement hydroagricole se limite à un raccordement entre l'existant et la zone à irriguer. Le mode de distribution varie en fonction de la charge statique disponible en tête de réseau. Les cultures sont essentiellement maraîchères. Une fois déduites les charges liées à la campagne agricole, la marge a été de 200 000 F CFA ha<sup>-1</sup> en cultures vivrières traditionnelles et 840 000 F CFA ha<sup>-1</sup> en maraîchage de contre-saison, soit 520 000 F CFA ha<sup>-1</sup> par campagne. Si on impute à ce résultat, l'amortissement des investissements physiques et les interventions d'ingénieur et de formation, soit 370 000 F CFA ha<sup>-1</sup> par campagne, il reste une marge nette de 150 000 F CFA ha<sup>-1</sup> par campagne.

### Mali

Suivant une étude de 1985, les surfaces irriguées couvrent 183 000 ha, le potentiel étant de 496 000 ha, mais il s'agit surtout de grands aménagements. On relève cependant 7698 ha de petits périmètres existants ou en cours de réalisation et 5262 projetés. Ces derniers comprennent 2090 ha existants

équipés en pompes à énergie animale ou humaine pour des cultures autres que le riz (zone Office du Niger surtout) et 3730 ha de bas-fonds à vocation rizicole dont 1570 aménagés surtout dans le Sud. L'aménagement des bas fonds pour le riz d'hivernage repose sur des systèmes de digues de contrôle de la submersion de différents types suivant la nature du réseau hydrographique. Elles sont complétées éventuellement par des ouvrages en dur et des réservoirs de stockage. La faible maîtrise de l'eau est un handicap : la crainte des crues conduit à un repiquage tardif et le travail n'est pas valorisé du point de vue rendement.

### Burkina Faso

Le potentiel de cultures irrigables est de 150 000 ha dont 30 000 ha de bas-fonds aménageables, 6000 à 7000 ha à mettre en valeur à l'aval de petits barrages et le reste à prévoir en aménagements avec maîtrise totale de l'eau. Le développement des irrigations intéressait en 1982, en terme de surfaces aménagées 12 600 ha dont 3500 ha d'aménagements simples de bas-fonds, 800 ha de bas-fonds améliorées et 1260 ha à l'aval de barrages.

Les aménagements simples de bas-fonds permettent 1,5 t ha<sup>-1</sup> de paddy. Ils sont constitués de diguettes en terre en courbes de niveau, munies à l'amont d'un épi de dérivation et de canaux de drainage, avec ou sans déversoirs.

Les aménagements améliorés qui permettent de passer à 2,5 t ha<sup>-1</sup> comportent une digue en terre en principe insubmersible. Ils comportent aussi un déversoir latéral en maçonnerie de manière à former une réserve de 20 à 40 000 m<sup>3</sup>, de prises d'eau qui alimentent des diguettes en courbes de niveau, enfin des fossés collecteurs de ruissellement latéral.

A l'aval des barrages, à vocation initiale d'hydraulique agricole et pastorale, on fait une récolte de riz et du maraîchage de contre-saison sur 15 à 20 % de la surface agricole utile. Le rendement en paddy est de l'ordre de 4 t ha<sup>-1</sup>.

Les besoins en eau à la parcelle sont d'environ 7000 m<sup>3</sup> ha<sup>-1</sup> et 15 500 m<sup>3</sup> ha<sup>-1</sup> pour des riz d'hivernage et de contre-saison, 3500 m<sup>3</sup> ha<sup>-1</sup> pour le haricot vert, 11 000 m<sup>3</sup> ha<sup>-1</sup> pour la tomate. Pour un réseau gravitaire régulé par modules à masque et avec éléments principaux revêtus, l'EG est de 0,8, elle est de 0,7 à 0,8 à la parcelle suivant le type d'irrigation.



Sur le plan des résultats financiers, on déduit d'une étude du Comité permanent interétats de lutte contre la sécheresse dans le Sahel (CILSS) (1984) qu'en passant d'un aménagement de bas-fonds simple, à un aménagement amélioré puis à un aval de barrage avec seul le riz, le revenu brut à l'hectare passait de 100 500 F CFA à 167 500 F CFA. Le revenu net (coûts de production et redevance hydroagricole déduits) passait de 11 450 F CFA à 67 250 F CFA et 112 150 F CFA, les charges nettes restant à l'Etat étant de 32 650, 78 000 et 145 000 F CFA, amortissement et entretien du barrage exclus. Chaque fois que le paysan peut faire une culture maraîchère de contre-saison, son revenu s'améliore nettement (revenu net de plus de 1 300 000 F CFA ha<sup>-1</sup>) et il est en mesure d'assumer la totalité des charges.

### Niger

En 1985, les surfaces aménagées pour l'irrigation étaient d'environ 10 000 ha dont 5500 ha de casiers classiques en bordure du fleuve, 3550 ha irriguées depuis des barrages dans l'Ader Doutchi-Maggia et 800 ha alimentés par des forages près de Maradi.

L'un de ces périmètres alimentés par pompage dans les nappes a été étudié récemment. Constitué de parcelles d'irrigation indépendantes alimentées chacune par un forage équipé d'une pompe électrique, sa surface nette est de 512 ha.

Les infrastructures comprennent : forages de 35 m avec débits de 10 à 22 l sec<sup>-1</sup>, bassins de stockage de 650 m<sup>3</sup>, canaux partiellement revêtus, alimentation par prises "tout ou rien" et siphons. La consommation d'eau moyenne à la parcelle est de 12 500 m<sup>3</sup> ha<sup>-1</sup> : 2500 m<sup>3</sup> ha<sup>-1</sup> sur sorgho et 4000 m<sup>3</sup> ha<sup>-1</sup> sur coton en hivernage, 7000 m<sup>3</sup> ha<sup>-1</sup> sur blé et 11 500 m<sup>3</sup> ha<sup>-1</sup> sur tomate en contre-saison. L'EG des réseaux est de 0,9. L'intensité culturale de 1,71.

Le revenu brut prévu de 450 à 500 000 F CFA ha<sup>-1</sup> semble en fait moins élevé, de l'ordre de 330 000 F CFA, les rendements étant plus faibles. Les charges annuelles imputables aux paysans par l'aménagement : énergie, entretien des ouvrages de base et réseaux, amortissement des armoires et pompes, traitements phytosanitaires, dépenses administratives, s'élèvent à 206 000 F CFA ha<sup>-1</sup>.

Dans l'Ader Doutchi Maggia, au périmètre d'Ibohamane, l'eau est collectée derrière un barrage muni de deux déversoirs. Le réseau d'irrigation est gravitaire, les canaux revêtus, la régulation

se fait par modules à masque en tête des blocs. Sept cent quinze hectares ont été équipés et réduits à 611 après une rupture—réparée—du barrage. L'alluvionnement de la retenue condamne la culture de contre-saison. Restent en hivernage le sorgho (5250 m<sup>3</sup> ha<sup>-1</sup> d'eau depuis le barrage) et le coton (6750 m<sup>3</sup> ha<sup>-1</sup>). Le pilotage des irrigations se fait à partir du bilan hydrique. L'EG du réseau est de l'ordre de 0,4. Les rendements atteints sont, suivant les campagnes, de 1,7 à 2,5 t en coton, de 1,5 à 2,5 t en sorgho, soit un revenu brut moyen de 210 000 F CFA ha<sup>-1</sup>. Les charges d'aménagement calculées sont de 15 000 F CFA ha<sup>-1</sup> environ sans amortissement, ni provision pour réparation des équipements hydrauliques, ni charges de cultures.

### Nord Cameroun

Cité ici surtout pour mémoire, l'irrigation y concerne 15 000 ha le long du Logone, mais en grands périmètres de culture intensive, assez éloignés de la notion de périmètres villageois.

### Comparaison des coûts

Il serait vain de comparer ici les coûts d'équipement des différents spécimens d'aménagements qu'on vient d'évoquer, chacun ayant sa spécificité et son histoire. On dira seulement que ces coûts diminuent largement si on a une solution légère, une taille modeste de périmètre et une possibilité de participation paysanne. Encore faut-il tenir compte, hors coûts d'aménagement, des dépenses concernant l'installation et l'équipement de l'organisme de gestion et des exploitants, et les dépenses d'infrastructure générales liées à l'aménagement.

Hors de grandes vallées, le choix le plus fréquent se place entre le barrage qui collecte des eaux de ruissellement et le forage qui reprend des eaux infiltrées. Une comparaison des deux solutions a été étudiée par le CIEH vers 1980 (Diluca et Benamour 1980). Le coût du m<sup>3</sup> d'eau souterraine inclut le forage, son équipement et le matériel de pompage, tenant compte des durées d'amortissement et des dépenses énergétiques. On a donc comparé le coût du m<sup>3</sup> fourni par des barrages connus du Burkina Faso en supposant pour ceux-ci un amortissement sur 30 ans, avec un taux d'intérêt du capital de 8%. On a inclus les coûts d'entretien des ouvrages, avec le coût du m<sup>3</sup> fourni par un

ensemble de forages fournissant globalement le même volume utile, ayant une profondeur moyenne de 50 m, un débit de  $10 \text{ m}^3 \text{ j}^{-1}$ , une durée de vie de 20 ans et équipé en pompe à main (donc sans coûts d'énergie).

On concluait que la solution forage était plus avantageuse pour les volumes annuels nécessaires de 20 000  $\text{m}^3$  au plus, donc pour de petits périmètres villageois tels qu'on les rencontre au Burkina Faso.

Cette conclusion n'est qu'indicative. Les différents éléments de coûts ne variant pas identiquement dans le temps et là où il y a dépenses d'énergie, celles-ci sont très variables suivant le type d'irrigation.

### **Mise en oeuvre des ressources en eau et recherche : Situation actuelle**

Le développement de la maîtrise de l'eau pour l'usage agricole s'appuie sur les acquis de la recherche. Nous les évoquerons au niveau d'abord de la connaissance de la ressource. Sont assez bien connus les pluies annuelles, les isohyètes des pluies mensuelles, les pluies journalières de fréquence rare (10 et 100 ans), les pluies inférieures à 24 pour des durées de retour jusqu'à 20 ans. Concernant les eaux souterraines, outre les travaux cités, chaque forage nouveau constitue une occasion d'amélioration des connaissances. Il faut souligner par ailleurs que, si les résultats sont plus aléatoires sur socle, l'analyse systématique de l'environnement morphologique et géologique y a permis d'identifier les facteurs liés à l'obtention de débits élevés. En ce qui concerne les eaux de surface, les observations poursuivies complètent les acquis. L'intérêt de ces données est leur insertion dans une démarche de diffusion des systèmes de cultures permettant une valorisation optimale de l'eau, compte tenu des contraintes du milieu. Ceci suppose des études thématiques d'une part, des études concernant les systèmes de cultures et de production d'autre part.

#### **Etudes thématiques**

**Mesure, enregistrement, interprétation des paramètres climatiques.** Le fichier climatologique se complète d'études systématiques de fréquence et de

probabilité de pluies d'intérêt local, qui débouchent sur une meilleure définition des potentialités hydroagricoles. La mise au point d'un modèle de simulation de bilan hydrique des cultures donne un outil permettant d'effectuer un zonage agropédoclimatique, l'optimisation des choix agronomiques en fonction de l'eau disponible, la proposition d'un programme d'irrigation de base et l'identification des facteurs de risque liés à l'irrigation.

**Caractérisation hydrique et hydrodynamique des sols.** Une méthode a été mise au point pour la mesure au champ des stocks et flux d'eau dans le sol qui permet la caractérisation hydrique et hydrodynamique des sols, la définition de leur aptitude à l'irrigation et un suivi permanent.

L'étude du bilan hydrique a permis de montrer sur différents types de sol que le non travail du sol ne permet pas d'atteindre la capacité au champ et que le réservoir sol n'est jamais rempli.

**Evapotranspiration et besoins en eau des cultures.** Une méthode a été mise au point de définition de ces besoins pour les principales cultures vivrières, par la détermination, au long des cycles végétatifs du "coefficient cultural k" (Doorenbos et Pruitt 1975).

**Recherche de variétés à haut potentiel répondant à l'irrigation.** : Pour les principales cultures vivrières, des variétés à haut potentiel répondant à l'irrigation sont disponibles.

**Modes et paramètres d'irrigation.** Des expériences ont eu lieu en vue de tester et diffuser en milieu paysan des matériels d'irrigation adaptés au développement de la petite hydraulique dans ce milieu.

**Irrigation et énergie.** Des recherches ont été entreprises en vue de l'utilisation énergétique des ressources du milieu (soleil, vent, biomasse) et des résultats obtenus dans le domaine de la biomasse. Un créneau d'utilisation a été défini : petits périmètres rizicoles de 20 à 40 ha pour les gazogènes, petits périmètres maraîchers de 5 à 10 ha en association agriculture/élevage.

#### **Les systèmes de culture et de production**

Les résultats obtenus en stations doivent être localement adaptés. Ils constituent un référentiel

technique important qui de façon générale permet :

- la détermination des cultures et des variétés les mieux adaptées localement;
- l'établissement précis du meilleur itinéraire technique pour chaque culture;
- l'enregistrement précis des temps de travaux pour chaque opération culturale;
- la proposition des variantes de rotation.

Ce référentiel a servi de base à une étude comparée des systèmes de culture permettant la valorisation des disponibilités en eau, donc d'apprécier l'intérêt des cultures irriguées des points de vue de leur rentabilité financière, de la valorisation des ressources en eau et de la valorisation de la main d'oeuvre.

### **Mise en oeuvre des ressources en eau et recherche : Perspectives**

En ce qui concerne la connaissance des ressources, il importe de poursuivre rapidement l'analyse des aptitudes au ruissellement et la vérification locale de la recharge des nappes. Pour ce qui est de la recherche aux plans de la collecte des eaux et de leur utilisation rentable, on retiendra cinq axes de travail :

**Développement de la microirrigation de complément contre-aléatoire des pluies.** L'analyse fréquentielle des événements pluviométriques et la simulation du bilan hydrique permettent en un endroit donné la confrontation statistique des disponibilités hydriques avec les besoins en eau des cultures, d'où on déduit une optimisation des irrigations pour la sécurisation des productions. Sont à poursuivre à cet effet d'urgence les statistiques de pluies de 5 jours et 10 jours, la cartographie de l'ETP Penman et de l'évaporation Bac A et la validation locale des coefficients culturaux. Les modèles existants de simulation de bilan hydrique pourront être améliorés en y intégrant les composantes techniques culturales et en définissant une méthode de diagnostic au champ et en temps réel. Cette démarche doit être complétée par une optimisation de l'efficacité des ressources en eau qui semble difficile à atteindre avec les systèmes d'irrigation gravitaire mis en oeuvre. Il est donc urgent d'analyser en vraie grandeur ainsi qu'en milieu paysan les contraintes techniques, économiques et organisationnelles de nouvelles techniques (asper-

sion, rampe pivotante ou à avancement frontal).

**Mise au point en milieu paysan de techniques de petite hydraulique.** La valorisation des ressources hydriques dispersées demande un développement de la petite hydraulique en milieu paysan. En polyculture, un "panachage" des systèmes d'irrigation permettra la réalisation de l'eau et de la force de travail : irrigation localisée ou par goutte à goutte, par aspersion, gravitaire avec tuyaux à vanettes. Cette introduction s'accompagne d'un effort d'amélioration de la réalisation des ouvrages dans certaines zones (sables fins par exemple) et des moyens de pompage, les contraintes imposées étant une technologie simple, une fiabilité maximum et une maintenance réduite (et facilitées par une normalisation des pièces). Les pompes manuelles actuelles d'hydraulique villageoise sont à adapter pour des débits de 3-5 m<sup>3</sup> h<sup>-1</sup>; au delà les travaux sont à poursuivre sur l'utilisation des énergies renouvelables. Une recherche est à mener également sur l'amélioration des moyens de stockage des eaux de surface.

Des projets pilotes sont à prévoir rapidement, qui aient une dimension et une localisation significatives. Cette localisation doit tenir compte des potentialités du milieu physique, des caractéristiques de l'agriculture, de l'organisation sociale des ménages et de la production et de l'environnement économique.

**Mise en valeur agricole des aménagements hydro-agricoles classiques.** Il n'y a pas de solution identique applicable à tout projet. L'importance et la diversité des résultats disponibles (techniques culturales, variétés, méthodes et techniques d'irrigation) font que dans chaque cas, un ensemble de solutions techniques peut être proposé aux paysans pour qu'ils élaborent eux-mêmes leurs nouveaux systèmes de production. L'action de la recherche est indispensable pour les assister, réfléchir sur l'évolution à long terme et prévenir des effets secondaires de l'irrigation.

Les thèmes dont devra s'occuper la recherche seront orientés vers l'économie de l'eau : amélioration des dispositifs de régulation et distribution, connaissance du ruissellement sur les périmètres et analyse de l'intérêt d'une récupération d'eau à l'aval de ceux-ci, mise au point de revêtement économique pour les canaux. Ces préoccupations hydrauliques n'en exclueront pas d'autres telles que la lutte contre les parasites et les maladies des

végétaux qui connaissent un développement spécifique sous irrigation, l'ajustement aux différents sols de variétés répondant globalement bien à l'irrigation, la recherche de variétés résistant mieux au froid pour certaines cultures de contre-saison. Là aussi l'intérêt technique et l'impact potentiel des innovations en milieu paysan devra être testé avant diffusion à grande échelle.

**Mise en valeur des bassins versants et des bas-fonds.** On doit renforcer les programmes pilotes de défense et de restauration des sols qui ont pour objet d'améliorer le bilan hydrique au niveau de la parcelle et à celui du bassin versant. Ces programmes devront permettre la mise au point de techniques d'aménagement et de systèmes de culture qui conduiront à réduire l'érosion par la maîtrise du ruissellement, améliorer l'infiltration au niveau de la parcelle cultivée, stocker les eaux de ruissellement préalablement maîtrisées et canalisées, réutiliser les eaux stockées en période d'alimentation hydrique déficitaire.

Il y aura en corollaire à développer le plus tôt possible : une recherche sur la limitation dans les bassins de stockage et autres réservoirs des pertes par évaporation, le phénomène conduisant à des surdimensionnements d'ouvrages donc à des surcoûts. L'accent sera mis initialement sur la collecte d'informations pour connaître dans ce domaine le point des recherches et technologies dans d'autres parties du monde.

En ce qui concerne les bas-fonds, le programme d'action, conçu dans une optique d'intensification de la riziculture comportera dès que possible une caractérisation hydrologique et morphopédologique des bas-fonds ainsi que l'étude et la mise au point d'aménagements types simples. Ceci sera accompagné de recherches variétales et de mise au point de systèmes de cultures.

**Stratégie d'aide à la décision à partir de l'outil agrométéorologique.** Le but global souhaitable est de banaliser l'utilisation agricole des relevés agrométéorologiques. La démarche à poursuivre nécessitera notamment le zonage agropédologique ainsi que des actions de recherche et d'expérimentation pour tester et quantifier l'influence des techniques culturales sur l'amélioration du bilan hydrique. Elle devrait aboutir en particulier à une quantification du rôle de l'eau en tant que facteur de production.

Elle aura été l'occasion de faire le point de la

connaissance des sols dans leurs relations avec l'eau (caractérisation par la réserve utile), de cartographier et de compléter cette connaissance.

## Conclusion

On soulignera l'importance et la variété des ressources en eau existantes et pouvant être récupérées et utilisées de diverses manières pour l'agriculture. L'accent doit être mis sur les limites techniques et économiques des équipements habituellement utilisés jusqu'à présent pour l'utilisation de l'eau, la nécessité et l'importance des travaux de recherche encore à exécuter, car même là où l'eau est abondante, son exploitation est onéreuse, l'urgence enfin d'une meilleure perception des contraintes auxquelles est soumis le paysan, pour, d'abord, moduler le contenu de la recherche en fonction de ces contraintes et ensuite mieux faire passer à son niveau les résultats acquis.

## Bibliographie

**BRGM (Bureau de recherches géologiques et minières).** 1975. Notices explicatives et cartes de planification pour des eaux souterraines de l'Afrique sahélienne (Productivité de nappes, coût moyen de captage et d'exploitation de l'eau souterraine, aptitude des eaux à l'irrigation). BRGM B.P. 6009, 45060 Orléans, Cedex, France. 118 pp.

**CIEH (Comité interafricain d'études hydrauliques).** 1976. Carte de planification des ressources en eaux souterraines des Etats membres du CIEH de l'Afrique Soudano-Sahélienne. CIEH. B.P. 369, Ouagadougou, Burkina Faso. 118 pp.

**CILSS (Comité permanent inter-Etats de lutte contre la sécheresse dans le Sahel).** 1984. Pages 20 à 22 in Actualisation du bilan programme "Cultures irriguées en Haute-Volta". Rapport général. CILSS B.P. 7049, Ouagadougou, Burkina Faso.

**Diluca, C. et Benamour A.** 1980. Note introductive sur l'irrigation à partir des eaux souterraines. Pages 9-13 in Dixième réunion du Conseil des Ministres du Comité interafricain d'études hydrauliques: Comptes rendus des Journées Techniques. Tome I. CIEH B.P. 369 Ouagadougou, Burkina Faso.

**Doorenbos, J. et Pruitt, W.O.** 1975. Les besoins en eau des cultures. Bulletin d'irrigation et de drainage. Section distribution et vente. Rome, Italie : Organisation des Nations Unies pour l'Alimentation et l'Agriculture. 198 pp.

**Dubreuil, P.** 1972. Recueil de données de base des bassins représentatifs et expérimentaux—Années 1951-1969. Editions de l'ORSTOM. 70-74, route d'Aulnay, 93140 Bondy, France : Institut français de recherche scientifique pour le développement en coopération. 916 pp.

**Puech, C. et Chabigonni, D.** 1983. Méthode de calcul des débits de crues décennales pour les petits et moyens bassins versants en Afrique de l'Ouest et Centrale. B.P. 369 Ouagadougou, Burkina Faso : Comité interafricain d'études hydrauliques (CIEH). 91 pp.

**Rodier, J.A.** 1975. Evaluation de l'écoulement annuel dans le Sahel Tropical Africain. Série Travaux et Documents n°46, Editions de l'ORSTOM. 70-74, route d'Aulnay, 93140 Bondy, France : Institut français de recherche scientifique pour le développement en coopération. 121 pp.

**Rodier, J.A.** 1986. Caractéristiques des crues des petits bassins versants représentatifs au Sahel. Cahiers de l'ORSTOM. Série Hydrologie. Vol. XXI, n° 2. Editions de l'ORSTOM. 70-74 route d'Aulnay, 93140 Bondy, France : Institut français de recherche scientifique pour le développement en coopération. 40 pp.

**Rodier, J.A. et Auvray, C.** 1965. Estimation des débits de crue décennale pour les bassins versants de superficie inférieure à 200 km<sup>2</sup> en Afrique Occidentale. Editions de l'ORSTOM. 70-74 route d'Aulnay, 93140 Bondy, France : Institut français de recherche scientifique pour le développement en coopération. 30 pp.

**Roose, E.J.** 1977. Erosion et ruissellement en Afrique de l'Ouest. 20 ans de mesures sur parcelles expérimentales. Série Travaux et Documents n° 78. Editions de l'ORSTOM. 70-74, route d'Aulnay, 93140 Bondy, France : Institut français de recherche scientifique pour le développement en coopération. 108 pp.

# Gestion conservatoire des eaux et de la fertilité des sols dans les paysages soudano-sahéliens de l'Afrique Occidentale

Eric Roose<sup>1</sup>

## Résumé

*Depuis le début du siècle, on observe dans cette zone une dégradation de la végétation, du sol et des ressources hydrauliques. Cette dégradation est en relation avec le développement de la population et sa concentration en zone urbaine, avec l'extension des défrichements pour faire face aux besoins en énergie et en terres de culture, avec le surpâturage des parcours suite à l'extension des troupeaux en période humide et à la réduction des surfaces pâturables. L'érosion témoigne du déséquilibre entre la gestion du paysage et ses potentialités.*

*L'analyse des résultats de trente années de recherche de l'Institut français de recherche scientifique pour le développement en coopération (ORSTOM) et du Centre de coopération internationale en recherche agronomique pour le développement (CIRAD) montre que le milieu est sensible à l'énergie du vent, de la pluie et du ruissellement. L'intensité des averses est largement supérieure à la capacité d'infiltration des sols battants, instables et souvent carencés. Le couvert végétal, les techniques culturales et la pente sont les principaux facteurs permettant de réduire l'érosion. L'analyse des projets d'aménagements antiérosifs aboutit généralement à un constat d'échec parce qu'on a appliqué des méthodes étrangères non adaptées aux conditions locales, trop coûteuses, peu efficaces et peu acceptables par les paysans : on n'a observé ni l'entretien des dispositifs par les bénéficiaires, ni l'extension en tache d'huile.*

*L'auteur propose une approche globale (à l'échelle du village) et progressive (plan d'aménagement sur 10 ans) de l'aménagement du paysage en vue d'une gestion conservatoire de l'eau et de la fertilité des sols et de l'équilibre du système de production agro-sylvo-pastoral. Il préconise d'augmenter l'infiltration et de disperser l'énergie des eaux de ruissellement résiduelles par une série de techniques culturales et de structures composées de microbarrages perméables (connues dans la tradition africaine), l'intégration de l'élevage et de l'agriculture (fourrage-fumier-attelage), l'association des arbres à objectifs multiples sur la zone cultivée, le cloisonnement progressif du paysage pour former un bocage aménagé, en vue de cultures intensifiées mécanisées et l'aménagement des bas-fonds.*

*Les aménagements seront légèrement différents selon le type de climat et de population : diversion des eaux excédentaires en milieu soudanien (pluviométrie >700 mm), absorption totale en milieu soudano-sahélien et captage du ruissellement pour l'irrigation d'appoint en zone sahélienne (pluviométrie <400 mm). Le traitement simultané de l'érosion éolienne (rideaux d'arbres) de l'érosion en nappe et en ravine et de la dégradation de la fertilité des sols est indispensable pour rétablir l'équilibre du paysage.*

---

1. Directeur de recherche, ORSTOM, Montpellier, France.

ICRISAT (International Crops Research Institute for the Semi-Arid Tropics). 1989. Soil, Crop, and Water Management Systems for Rainfed Agriculture in the Sudano-Sahelian Zone: proceedings of an International Workshop, 7-11 Jan 1987. ICRISAT Sahelian Center, Niamey, Niger. Patancheru, A.P. 502 324, India: ICRISAT.

**Soil and water conservation in the Sudano-Sahelian zone of West Africa:** *Since the beginning of the century, vegetation, soil, and water resources in this zone have deteriorated. As populations grew and concentrated in urban zones, more lands were stripped to provide firewood and arable land, and expanding herds were forced to overgraze reduced rangelands. Erosion is the evidence of the imbalance between the present and potential land management.*

*The results of 30 years of research at ORSTOM and CIRAD show the extent of erosion caused by wind, rain, and runoff. The unstable impoverished soils have too slight an infiltration capacity to absorb heavy rains that are therefore lost due to runoff. Major factors in curbing erosion are vegetation cover, cultural practices, and slope management.*

*Projects to control erosion have often failed because methods borrowed from other regions were not adapted to the local conditions, either for reasons of cost, low efficiency, or acceptability to the farmers.*

*The author proposes a comprehensive approach for landscape management based on the conservation of water and soil fertility and a balanced, sustained agriculture/forestry/pasture production system. He suggests better use of runoff waters through a system of tillage, the creation of surface structures such as permeable microdams (a traditional African practice), mixed farming, the association of multipurpose trees with crops, the division of land into management units for intensive mechanized cultivation, and the development of valley bottoms. This type of a conservation management program would need to be adapted to climates and demography: diversion and collection of the excess water in the Sudanian zone (rainfall >700 mm), complete infiltration in the Sudano-Sahelian zone, and water harvesting for supplementary irrigation in the Sahelian zone (rainfall <400 mm). The simultaneous control of wind, sheet, and gully erosion, and of soil fertility, are essential to stabilize the landscape.*

## Introduction

Depuis les années 1950, et plus spécialement depuis la longue période sèche, on constate une évolution profonde des paysages soudano-sahéliens d'Afrique occidentale : dégradation de la végétation (disparition d'arbres et même de graminées pérennes), dénudation, encroûtement et décapage des sols, augmentation du ruissellement, ravinement des versants, changement du régime d'écoulement des rivières, baisses du niveau des nappes aquifères et finalement aridification du microclimat régional (Mulard et Groene 1961, Marchal 1979, Roose 1985a et b). Le climat a-t-il brutalement changé? Ou bien faut-il incriminer l'homme et sa gestion d'exploitation minière des paysages? En somme le développement?

Les causes principales sont les pressions démographiques (trop forte charge en hommes et en gros bétail pour une potentialité de production très variable) et socio-économiques (extention des surfaces défrichées, dessouchées et labourées mécaniquement en vue de cultures industrielles ou vivrières, surpâturage, réduction de la jachère, feux de

brousse, etc.). La sécheresse plus longue que d'habitude n'a fait qu'accélérer le déséquilibre entre la biomasse produite et les besoins de consommation (Peyre de Fabrègue 1985, Banque Mondiale 1985, Delwaulle 1973a, le Houerou 1979, Marchal 1983).

Face à cette dégradation des terres, une méthode antiérosive classique a été largement préconisée, celle des terrasses de diversion des eaux de ruissellement vers des exutoires aménagés (Bennet 1939, FAO 1967, Hudson 1973, CTFT 1980). Devant les échecs plus ou moins caractérisés de cette approche en milieu paysan ouest-africain, une analyse des principes de base, des résultats de mesure et des observations de terrain pourrait débloquer le problème. Une autre approche peut être suggérée qui s'appuie sur la pratique traditionnelle des microbarrages perméables (lignes de paille ou de pierres, bandes enherbées, haies vives, rideaux d'arbres, etc.), la fertilisation organique localisée, la plantation d'arbres et l'amélioration des réserves hydriques (Roose 1985a et b).

Mais les problèmes de conservation de l'eau et des sols ne sont pas seulement dans le choix de méthodes efficaces, judicieusement adaptées au

milieu physique (agressivité du climat, fragilité des sols, topographie) et au milieu économique (moyens financiers, main-d'oeuvre disponible, rentabilité des aménagements); ils sont profondément humains, enracinés dans les habitudes ancestrales (ex. travail intense du sol chez les Senoufos, travail très superficiel chez les Mossi), liés aux relations entre agriculteurs sédentaires, éleveurs semi-nomades et à la proximité de la ville (commercialisation des produits et en particulier du bois).

Dans cette note, on présentera rapidement un bilan de 30 ans de recherches par le CIRAD et l'ORSTOM sur le ruissellement et l'érosion dans la zone soudano-sahélienne d'Afrique occidentale (Sénégal, Mali, Burkina Faso, Niger, nord Bénin). On analysera ensuite les causes des échecs de bon nombre de programmes classiques d'aménagements antiérosifs avant de proposer une nouvelle stratégie d'aménagement partant des besoins exprimés par les paysans, de la nécessité d'équilibrer le développement de l'agriculture, de l'élevage et de la production forestière et faisant appel à diverses structures perméables et pratiques culturelles bien connues de la tradition paysanne en vue d'augmenter la capacité d'utilisation des eaux de surface à l'échelle du terroir villageois.

## Quelques résultats de la recherche

A la Figure 1 on a situé les stations où furent effectuées des mesures de ruissellement et de l'érosion (parcelles d'érosion, simulation de pluies ou microbassins) ou des études sur l'efficacité des aménagements antiérosifs. Sur le fond géographique, on a rapporté en outre une esquisse de la répartition de l'indice d'agressivité climatique annuel moyen (R USA de Wischmeier et Smith 1960) d'après une analyse des données pluviométriques arrêtées en 1975 (avant la fin des années sèches).

### Le milieu soudano-sahélien : fragile et diversifié

Sous cette appellation globale, Goudet (1985) distingue à juste titre trois sous régions écologiques : les régions sahélo-soudanienne (pluie de 300 à 600 mm), soudano-sahélienne (pluie de 600 à 900 mm) et soudano-guinéenne (pluie de 900 à 1200 mm).

Les précipitations annuelles décroissent donc de 1200 à 300 mm vers le Nord, mais elles ont diminué de 200 mm en moyenne ces dix dernières années. Les pluies tombent en 3 à 6 mois avec des intensités

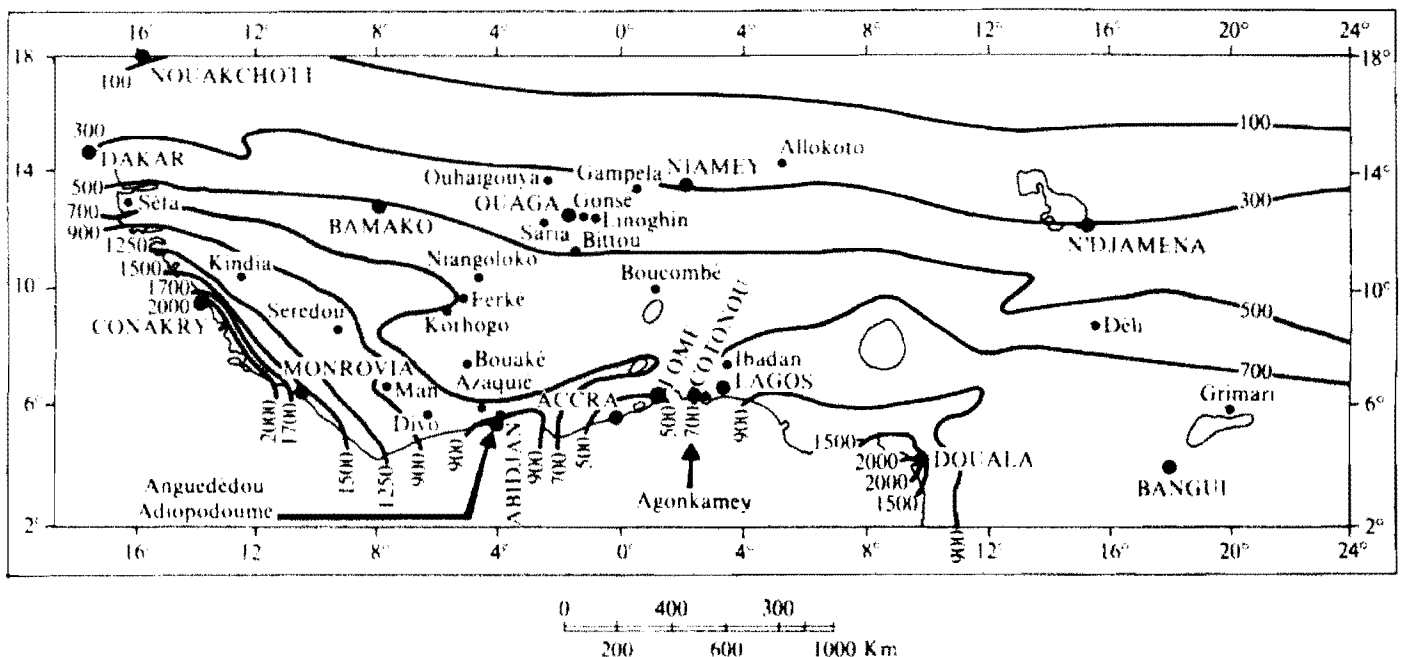

Figure 1. Esquisse de la répartition de l'indice d'agressivité climatique annuel moyen (R USA de Wischmeier) en Afrique de l'Ouest et du Centre. Situation des parcelles et sites de Recherche-Développement (Roose 1976b).



très élevées (55 à 80 mm h<sup>-1</sup> pendant 30 minutes) en comparaison avec la faible capacité d'infiltration des sols battants. Les averses journalières atteignent 60 à 75 mm tous les ans, 120 mm tous les 10 ans et 150 mm tous les 50 ans (Brunet-Moret 1963). L'indice d'érosivité des pluies "RUSA" diminue de 500 à 200 à mesure qu'on se rapproche du Sahel (Roose 1976b, 1978 et 1980) (Fig. 1).

Les paysages les plus fréquents sur granite et sur grès (Tab. 1) sont formés d'un plateau cuirassé plus ou moins vaste, d'un court éboulis de blocs, d'un long glacis gravillonnaire recouvert d'un voile sablo-limoneux de plus en plus épais, d'un bourrelet de berge et du lit mineur souvent encaissé. La majorité des pentes sont faibles (0 à 3%) mais très longues. Ils peuvent être envahis par des dunes plus ou moins anciennes ou être plus raides sur roches basiques.

Les sols ferrugineux tropicaux plus ou moins lessivés et hydromorphes en profondeur et les sols bruns plus ou moins hydromorphes ou vertiques des bas de pente sont pauvres chimiquement (carences NP, parfois K, pH 6 à 4) et de structure instable (peu de matières organique, beaucoup de

limons et sables fins). Dès qu'ils sont dénudés, il se forme en surface une croûte (de battance ou de sédimentation) très peu perméable (moins de 10 mm h<sup>-1</sup>). Après quelques années de cultures (coton, arachide, niébé, ou divers haricots alternant avec sorgho, maïs, mil, fonio) avec labour et deux sarclo-buttages par an exécutés avec la traction animale, il se forme vers 12-15 cm une discontinuité peu pénétrable aux racines (compacité, pH, carence ou toxicité?). Le pédoclimat est donc beaucoup plus sec encore pour les cultures. Les jachères sont en voie de disparition, trop courtes et surpâturées pour régénérer efficacement la fertilité des sols.

Les cultures laissent très peu de résidus. Les tiges de cotonnier sont brûlées; les fanes d'arachide et autres légumineuses sont utilisées comme fourrage. Les feuilles de céréales sont broutées sur place et les tiges restantes utilisées pour quelques travaux artisanaux ou brûlées.

La végétation, une savane arborée assez dense à l'origine, a été sérieusement dégradée ces dernières années du fait de l'extension des cultures, du ruissellement et de la baisse de niveau des nappes, des

**Tableau 1. Aménagement type en milieu soudano-sahélien.**

| Plateau cuirassé   | Talus éboulis | Glacis gravillon. | Glacis Sablo-limoneux   | Bas-fond limono-argileux  |
|--|---------------|-------------------|---|---|
| <b>Système de production</b>   |               |                   |   |   |
| Tradit. parcour extensif<br>Amélioré : reforestation, défense, arbustes fourragers   |               |                   | Cultures céréales en sec<br>Céréales - coton ou arachide  | Fourrages de contre-saison<br>Jardins potagers<br>Rizières, Vergers |
| <b>Aménagements</b>  |               |                   |   |   |
| Routage pour augmenter l'infiltration<br>Barrages collinaires et demi lunes pour le bétail<br>Exutoire : murettes en pierres |               |                   | Diguettes et fossés de diversion<br>Exutoires aménagés pour évacuer le ruissellement                          | Réseau d'irrigation<br>Réseau de drainage                           |
| <b>Suggestions</b>   |               |                   |   |   |
| Reforestation par enrichissement en fourragers et fruitiers  |               |                   | Agroforesterie<br>Diversification   | Rizières + Fourrages contresaison                                   |
| Routage + demi lunes pour les arbres   |               |                   | Cultures associées  | Jardins (potagers, vergers)   |
| Lignes de cailloux + litière de branchages   |               |                   | Segmentation du versant par cordons de pierres, haies vives, arbres à faible densité et à objectifs multiples | Microbarrages, Gabions en cascades                                  |
| Impluvium + citerne familiale  |               |                   |   |   |
| Mise en défens périodique  |               |                   | Augmenter l'infiltration par gestion des mat. organiques, travail du sol en sec, billonnage cloisonné         |   |

énormes besoins en bois de feu et du surpâturage. Les troupeaux se sont beaucoup développés durant les années humides dans tout le Sahel; aussi durant la période sèche, la biomasse produite en diminution, n'arrive plus à nourrir à la fois les troupeaux du village et les troupeaux transhumant du Sahel vers des zones plus humides (Hallamm et Van Campen 1985, Bus 1985, Quilfen et Milleville 1983).

### Perception par les villageois de la dégradation d'un terroir et stratégies d'adaptation

L'exemple schématisé au Tableau 2 est issu d'une enquête auprès d'une quarantaine de cultivateurs/éleveurs Bambara du village de Kaniko situé à 25 km de Koutiala (Mali) dans une zone densé-

ment peuplée, de production cotonnière intense où l'Institut d'économie rurale (IER, Bamako) et l'Institut royal des régions tropicales (IRRT, Amsterdam) collaborent dans un projet de recherche-développement intégré (y compris la conservation des sols) avec la Compagnie malienne des textiles (CMDT) (Roose 1985a, Kleene et Vierstra 1985).

Face à la poussée démographique (la population double en 25 ans) et à la dégradation du milieu, quatre stratégies sont mises en oeuvre plus ou moins successivement :

1. L'extension des cultures : la mécanisation grâce à la traction animale a permis l'extension des surfaces cultivées et une meilleure maîtrise des adventices. Cependant on constate aujourd'hui que la majorité des bonnes terres sont déjà cultivées et qu'avec l'augmentation de la durée de culture et le défrichage des terres plus fragiles, on aboutit rapidement à une augmentation des problèmes de dégradation de la ferti-

Tableau 2. Perception par les villageois de Kaniko, situé à 25 km de Koutiala au Mali de la dégradation d'un terroir (+ 40 ans).

| Epoque source                       | Vers 1940 souvenir (± mythiques)                                   | Observations en 1984  | Vers l'an 2000 Extrapolations   |
|-------------------------------------|--|---|---|
| Pluies                              | 900 mm   | 650 mm  | 900 mm  |
| Végétation                          | Savane arborée dense   | Savanne arbustive   | Sols nus cultivés ou surpâturés   |
| Cueillette                          | Fruits sauvages, poisson, gibier, Bois                             | Quelques vergers disparus/ élevage se raréfient près des villages                         | Vergers en extension pisciculture Elevage, plantation d'arbre                     |
| Terres                              | Riches fertiles  | Dégradées, asséchées  | Erodées ou restaurées   |
| Jachère                             | Longue   | Courte ou nulle   | Nulle   |
| Rivière                             | Permanente   | 6 mois sec, creusement puits  | Les puits s'assèchent sauf plant aménagement (barrages, diguettes d'infiltration) |
| Population                          | 200 habitants  | 1020  | + 1600 au rythme actuel (3%)  |
| Bétail                              | 50 bovins  | > 80 bovins<br>> 800 ovins, caprins<br>+ les transhumants                                 | En croissance<br>Limité par manque de fourrage en saison sèche                    |
| Surface cultivée par Unité paysanne | 1-3 ha   | 5 à 20 ha si traction animale   | 20 ha si motorisation   |
| Système                             | Culture itinérante extensif équilibré si <25 hab. km <sup>-2</sup> | Semi-intensif déséquilibré : éléments nutritifs, matière organique, fourrage-bois chauffe | Extension limitée, Intensification<br>Diversification + Migration + longue        |

lité des sols, de ruissellement et d'érosion.

2. L'émigration : solution très largement utilisée dans le Sahel pour mieux rentabiliser le travail soit durant la saison sèche, soit pendant des périodes plus longues. Mais cette stratégie aboutit à vider le pays de ses forces vives. Ceci constitue une limite supérieure à l'extension et à l'entretien des dispositifs antiérosifs dans le Sahel (Marchal 1983).

3. L'intensification : pour les paysans, il s'agissait jusqu'ici de raccourcir la jachère et d'aménager en rizière les bas-fonds (lieu de concentration des eaux, des éléments nutritifs et des matières organiques) traditionnellement utilisés pour la production fourragère en saison sèche.

Il faudrait dorénavant équilibrer les exportations par des apports d'éléments nutritifs organiques et minéraux, gérer au mieux les matières organiques, maîtriser la densité et la précocité des semis, améliorer la disponibilité en eau par l'irrigation, forcer toutes les eaux pluviales à s'infiltrer "Rain Farming", ou même capter le ruissellement venant d'amont pour assurer une irrigation d'appoint "Runoff Farming".

4. La diversification : pour faire face aux risques climatiques (sécheresse à un moment crucial), aux risques économiques (effondrement des prix) et biologiques (maladies, insectes), la diversification des productions permet d'améliorer la stabilité des revenus. Le coton et l'arachide ne sont pas les seules cultures rentables. Les vergers, les cultures légumières ou fourragères, l'élevage, le commerce du bois et l'artisanat assurent des rentrées substantielles.

Les besoins en bois de feu ( $0,5 \text{ m}^3 \text{ ha}^{-1} \text{ an}^{-1}$ ) soit 1/3 du budget des familles à Ouagadougou croissent parallèlement à la population. Or, la production des forêts naturelles est très faible ( $0,1$  à  $0,5 \text{ m}^3 \text{ ha}^{-1} \text{ an}^{-1}$ ). Pour augmenter cette production, il faudrait améliorer la gestion des forêts existantes (taillis à cycle court et enrichissement) et associer les arbres (en ligne à faible densité) aux cultures dans les bonnes terres pour aboutir à un bocage à production diversifiée (Banque Mondiale 1985, Bertrand 1985, Goudet 1985).

L'élevage, une fois le problème de la divagation du bétail réglé, a un rôle important à jouer dans le développement rural (traction, fumier, valorisation des résidus).

La solution aux problèmes d'érosion ne passe donc pas uniquement par la sélection des struc-

tures (Défense et restauration des sols-DRS) les plus efficaces, mais aussi par l'équilibre du système de production agro-sylvo-pastorale et par la levée de contraintes socio-économique (Lovejoy et Napier 1986).

### Les types d'érosion les plus fréquents et leurs causes

Ces paysages semi-arides sont sensibles à l'érosion éolienne, ainsi qu'à l'érosion hydrique, mais à des degrés divers.

**L'érosion éolienne.** Elle ne devient dangereuse que lorsque les précipitations annuelles sont inférieures à 600 mm, que la saison sèche dure plus de six mois, que les sols sont poudreux, riches en limons, en sables fins, mais pauvres en matières organiques et instables, lorsque la végétation est clairsemée et que les vents soufflent à plus de  $20 \text{ km h}^{-1}$ .

On observe alors des brumes sèches (suspension de matières organiques et minérales fines), des vents de sable (qui détruisent les jeunes semis) et des tourbillons (saltation et suspensions instables de sable fin), la formation de nappes de sables plus ou moins ridées "ripple marks" et de petites dunes piégées dans les touffes de végétation basse. Il existe très peu de recherches sur l'érosion éolienne en Afrique occidentale, mais les méthodes de lutte sont bien connues et souvent semblables à celles utilisées contre l'érosion hydrique, à savoir augmenter la stabilité et la rugosité du sol, éviter de pulvériser le lit de semence, couvrir le sol et réduire la vitesse du vent au sol par des haies et des arbres.

**L'érosion en nappe.** Elle provient de l'énergie des gouttes de pluie qui détruit les agrégats, forme une pellicule de battance très peu perméable et provoque un ruissellement en nappe abondant évoluant en griffes et ravines. Une carte des indices annuels moyens d'érosivité des pluies (R index de Wischmeier et Smith 1960) montre que l'agressivité des pluies augmente rapidement des zones arides ( $R = 100$  à  $500$ ) vers les zones tropicales humides ( $R = 500$  à plus de  $1500$ ) mais qu'elle est déjà considérable dans la zone soudano-sahélienne ( $R = 200$  à  $600$ ). On y observe des averses violentes mais avec une fréquence moindre qu'en zone tropicale humide; pourtant les manifestations d'érosion

y sont plus nombreuses qu'en zone humide où le couvert végétal est beaucoup plus rigoureux (couvrant).

**Le ravinement.** Tant que les eaux ruissellent en fine couche sur l'ensemble de la surface du sol, leur vitesse est faible, ainsi que leur capacité de transport et leur compétence (taille max. des sédiments charriés) car les forces de frottement à la surface du sol sont énormes. Mais dès que le ruissellement se concentre (fossé, billon, rupture de pente, etc.), et que l'eau prend de la vitesse, son énergie  $(M \times V^2)/2$  devient capable d'arracher des particules, de creuser des rigoles qui, sans intervention, évoluent en nappes ravinantes (décapage d'une nappe de 5 à 20 cm de profondeur sur 1 à 4 mètres de largeur), en ravines (sapement de berge, effondrement de tunnel ou simplement surcreusement du fond et érosion régressive).

Le ravinement transporte beaucoup de sédiments, dissèque les champs, coupe les routes et peut entraîner la dégradation de l'ensemble du paysage (badland ou ravinement généralisé ou rubine).

A chaque cause de l'érosion correspondent des méthodes de lutte différentes.

| Cause                    | Traitement  |
|--------------------------|---|
| Energie du Vent          | Augmenter la rugosité du sol et du paysage (haies)<br>Augmenter la stabilité du sol et le couvert végétal           |
| Energie des pluies       | Couvrir le sol<br>Augmenter la stabilité et la rugosité de la surface du sol  |
| Energie du ruissellement | Ralentir la vitesse du ruissellement, donc la pente<br>Diminuer le volume ruisselé et surtout les débits de pointe. |

Comme il y a très peu d'études en Afrique occidentale sur l'érosion éolienne et que les processus d'érosion en nappe sont à l'origine des processus de dégradation et d'érosion en ravines, nous allons résumer les résultats de la recherche sur les facteurs qui permettent de modifier l'importance de l'érosion potentielle en nappe et rigole à l'échelle du champ.

## Les facteurs modifiant l'érosion en nappe potentielle (quantifiée par le facteur C)

Quatre facteurs modifient l'érodibilité d'une terre : le couvert végétal associé aux techniques culturales, l'érodibilité du sol, la pente.

### Le couvert végétal—variation possible de 1 à 1/1000 du facteur C

Le facteur C (Wischmeier et Smith 1960) diminue de 1 sur sol nu à 1/1000 sous forêt et savane non dégradée, ou terre paillée à 80%; 1/100 sous prairie, savane claire paturée non dégradées; 0,9 à 0,01 sous différentes cultures en fonction de leur densité, date de semis; 0,2 à 0,8) sous coton, mil, sorgho, maïs, arachide, niébé.

C'est donc un moyen de lutte très efficace que de couvrir le sol. Il est donc recommandé de :

- planter tôt, très dense quitte à éclaircir plus tard en fonction des besoins en eau;
- ne défricher que les surfaces nécessaires, intensifier et diversifier la production;
- fertiliser et gérer les résidus de culture et apporter du paillis, du fumier;
- associer des cultures dans le temps et dans l'espace : agroforesterie.

### Les techniques culturales conservatrices—variation 1 à 0,1 du facteur C

Ce facteur a des interactions évidentes avec le couvert végétal, mais on peut proposer toute une série de techniques culturales conservatoires adaptées à différents niveaux :

- Labour minimum avec résidus de culture ou paillage en surface avec pièges de ruissellement et matières organiques attirant les termites (zaï des Mossi sur glacis battant).
- Travail grossier (socs ou dents) + affinage localisé du lit de semence.
- Billonnage isohypse cloisonné sur sol perméable et pente faible (sols sableux) (Roose 1967).
- Planches isohypses avec réseau de drainage vers une citerne (système ICRISAT sur Vertisol en Inde).
- Travail du sol en sec : simple grattage à deux dents sur 15-20 cm après récolte sur glacis bat-

tant, labour de fin de cycle après récolte (zone Soudano-guinéenne) (Charreau 1969, Charreau et Fauck 1970), routage en courbe de niveau (40-60 cm) pour éclater les horizons compacts sur terrains stables (Herblot 1985) (carapace ferrugineuse, croûte calcaire ou argileuse).

### Moyens de lutte

- Augmenter la stabilité des agrégats (matières organiques,  $\text{CaCO}_3$ ,  $\text{R}_2\text{O}_3$ , travail du sol en sec).
- Augmenter la profondeur d'enracinement et la rugosité de surface (mottes, billons, croissants, croissant associé à dépression—Zaï).
- Gestion des matières organiques (résidus, racines, fumier) et des éléments nutritifs organiques et minéraux.

### La pente topographique—variation de 0,1 à 5 du facteur C

Lorsque le sol n'est pas totalement couvert, la pente est le facteur qui influence le plus l'érosion :

**Forme.** Les pentes convexes apportent plus de sédiments à la rivière que les pentes concaves où l'on observe des piègeages de sédiments détachés : d'où les sols colluviaux.

**Longueur.** La longueur des pentes a en général peu d'effet sur le ruissellement et l'érosion en nappe car les frottements sur les rugosités du sol empêchent l'accélération des nappes ruisselantes. Par contre, la masse du ruissellement concentré en rigole peut s'accumuler le long d'une pente et avoir un impact exponentiel sur l'érosion linéaire.

**Inclinaison.** L'inclinaison du versant n'augmente pas toujours le ruissellement, lequel peut être très fort sur des pentes faibles, par exemple sur les glacis battants (Roose 1967). Par contre la charge solide et l'érosion augmentent de façon exponentielle et l'exposant peut varier de 1,2 à plus de 2 si le sol est mal couvert (Roose 1980).

### Moyens de lutte

- Evacuer latéralement les eaux pluviales non infiltrées pour éviter d'accumuler l'énergie du

ruissellement (voir plus loin terrasses de diversion).

- Cloisonner le paysage pour freiner les eaux ruisselantes (obstacles perméables) et provoquer une perte de charge et de compétence des eaux.
- Réduire la pente, au moins localement, pour provoquer la sédimentation (voir plus loin les terrasses progressives).

### L'érodibilité des sols

L'érodibilité d'un sol (k) dépend de propriétés analytiques des horizons superficiels (texture, matières organiques, cations échangeables,  $\text{R}_2\text{O}_3$  et des caractères morphologiques du profil (agrégation, capacité d'infiltration, discontinuités, hydromorphie) (Wischmeier et al. 1971, Roose 1980). Les sols sont d'autant plus fragiles qu'ils sont riches en limons, sables fins, Na échangeable ou hydromorphes, et d'autant plus résistants qu'ils sont cohérents, stables, riches en argiles, en sables grossiers et cailloux, en calcaire actif et en fer et alumine libres (Tab. 3).

Notons qu'il n'existe pas encore de méthode simple, rapide et fiable permettant aux pédologues d'évaluer la résistance des sols aux divers types d'érosion (test de stabilité structurale, de résistance au cisaillement par le ruissellement) surtout s'il s'agit de prévoir leur évolution avec défrichement et culture mécanisée (perte de 50 % de Matière organique en 2 ans, et de 50 à 90 % de leur capacité d'infiltration).

### Moyens de lutte

- Augmenter la cohésion et la stabilité des agrégats : ciments organiques, fer, gypse,  $\text{CaCO}_3$ ,  $\text{pH} > 5$ ;
- Augmenter la profondeur de l'infiltration par sous solage en présence d'amendements.

## Stratégie classique de lutte antiérosive

### Méthode

Il s'agit généralement de combiner trois approches complémentaires :

**Tableau 3. Classification des sols fréquents en zone soudano-sahélienne en fonction de leur érodibilité croissante (Source : Fauck 1977, Roose 1980).**

| Sols ferrallitiques gravillonnaires argileux et riches en fer |       |        | Sols dunaires sableux | Vertisols argileux       | Sols ferrugineux limoneux |        | Sols solonisés, sols arides limoneux poudreux |        |
|---|-------|--------|-----------------------|--------------------------|---------------------------|--------|---|--------|
| E <sup>1</sup>  | Nappe | Ravine | E vent                | Ruissellement Ravinement | Ruissellement Nappe       | Ravine | Ruissellement Nappe                           | Ravine |
| K <sup>2</sup>  | 0,01  | 0,20   | ?                     | 0,10                     | 0,05                      | 0,30   |   | ?      |

1. E = Erosion  
2. K = Erodibilité du sol

- une définition du milieu physique : agressivité des pluies, carte de stabilité géomorphologique, carte d'utilisation des terres et carte de contraintes et potentialités des terres (ex. les 8 classes du Soil Survey USA);
- une définition des structures de mise en valeur et de protection : villages, routes, ponts, barrages, drains, terrasses et exutoires, etc.;
- une définition de l'utilisation nouvelle des terres, adaptation des cultures et des techniques culturales (Bennet 1939, FAO 1967, Hudson 1973, Heusch 1977, Kilian 1974, Roose 1978 et 1980).

### Exemple d'un aménagement type en milieu soudano-sahélien

Au Tableau 1 sont présentés les productions, les aménagements classiques et les suggestions d'aménagement actuelles en face de chaque segment de la toposéquence classique en particulier dans la zone de Koutiala au Mali et de Ouahigouya au Burkina Faso.

#### Analyse de cette approche technocratique

Marchal (1979, 1983) a analysé en détail l'aménagement effectué par le Groupement européen de restauration des sols) dans la région de Ouahigouya (Burkina Faso). Ces projets proposent souvent une approche technique intéressante et bien diversifiée en fonction du milieu physique, mais ne tiennent pas assez compte des aspects socio-économiques et de la résistance du gestionnaire traditionnel de ces paysages face à ces nouvelles propositions.

Ce genre de projet qui exige un fort investissement en spécialistes étrangers, en matériel lourd et terrassement et en capitaux pour avoir un effet marquant sur une surface significative en un court laps de temps, aboutit très généralement à un échec pour les raisons suivantes :

**Sur le plan humain.** Les gestionnaires traditionnels se désintéressent de la lutte antiérosive puisqu'on leur démontre qu'elle exige des moyens considérables dont ils ne disposent pas. Cela se traduit par une absence d'entretien des dispositifs, par une absence d'extension, par un abandon de ces terres à l'Etat (qui a consenti un investissement en vue de leur aménagement) ou même par une tentative désespérée de réappropriation des terres par la destruction systématique des aménagements visibles.

**Sur le plan économique.** L'aménagement classique en terrasses ou diguettes de diversion aboutit à une perte de 5 à 15% de surface cultivable sans assurer une quelconque amélioration des rendements, ni dans l'immédiat, ni même à long terme. Ces terrasses sont donc mal acceptées par les paysans.

De plus ces projets sont coûteux (en hommes et en matériels) et sont très rarement justifiés par une culture rentable. Stocking et Peake (1985) ont à même montré qu'il était plus rentable de protéger les bonnes terres que de restaurer des terres marginales épuisées.

Ces projets seraient éventuellement justifiables s'ils servaient d'exemples indestructibles faisant tâche d'huile. Or on n'observe généralement aucune extension spontanée en milieu paysan : par ailleurs la durée de vie des dispositifs est souvent très limitée (2 à 6 ans) par manque d'entretien.

**Sur le plan technique (Fig. 2).** La méthode classique consiste à évacuer vers des exutoires aménagés les excès d'eaux pluviales qui n'arrivent pas à s'infiltrer. Or cette méthode exige une protection antérieure efficace des exutoires, l'entretien régulier des fossés et diguettes de diversion et l'absence de phénomènes importants d'érosion entre les diguettes : hypothèses généralement non vérifiées en milieu paysan. De plus, les dispositifs sont dimensionnés en vue d'évacuer le ruissellement causé par une pluie décennale. Or les coefficients

de ruissellement sont mal connus et la pluie 1/20 ou 1/100 peut arriver demain. On constate en définitive de nombreux débordements, destructions des diguettes et ravinelements sur le versant qu'on voulait protéger et sur les exutoires qui reçoivent brutalement une masse considérable d'eau. Les paysans eux-mêmes ouvrent des brèches dans les diguettes aux endroits où l'eau s'accumule et engorge les terres cultivées.

A la Figure 2 on peut voir les principes et les critiques de la méthode des diguettes de diversion.

● L'érosion est fonction de :

E.pluie : l'énergie des pluies (constante tout le long de la pente)

E.ruis. : l'énergie du ruissellement (qui croît avec la pente) :  $MV^2/2$

$$E = f(\text{longueur})^n \times (\text{pente})^m$$

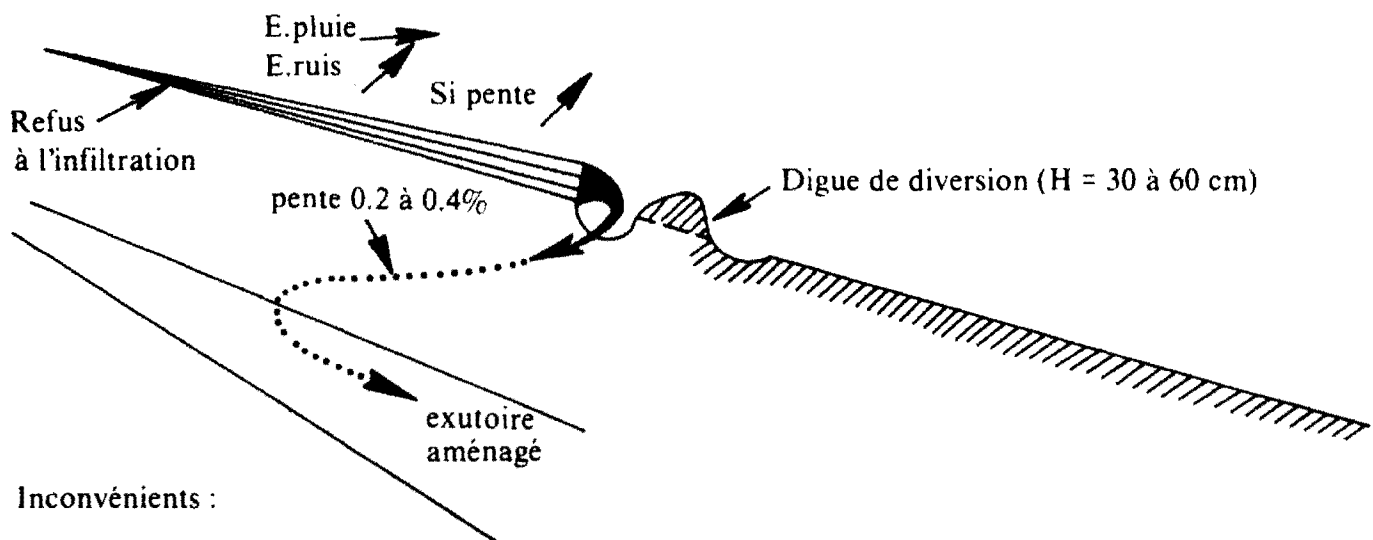

Inconvénients :

1. Nécessité d'équipes de topographes experts.
2. Important travail d'installation et d'entretien, d'où généralement :
  - digues non protégées
  - canaux encombrés de sédiments
  - exutoires non enherbés, ni protégés (surcreusés ou ensablés)
3. Perte de 5 à 20% de la surface cultivée sans augmentation de rendement.
4. Perte d'eau et éléments nutritifs pour les champs cultivés en aval.
5. L'aménagement doit rompre s'il advient une pluie de fréquence inférieure à 1/10 ans.
6. Variation de largeur des champs cultivés (mécanisation difficile).
7. N'arrête pas l'érosion en nappe ni la dégradation.
8. Finalement, risques graves de ravinement s'il y a rupture des digues (1 fois en 4 à 10 ans).
9. Accélération du temps de concentration des eaux (gros débits de pointe, érosion marigots et ravinement régressif).

**Figure 2. Méthode des fossés, diguettes ou terrasses de diversion.**

Si celle-ci semble mal adaptée aux conditions écologiques, socio-économiques et humaines de l'Afrique, que peut-on proposer comme alternative?

## **Stratégie nouvelle : la gestion conservatrice de l'eau et de la fertilité des sols**

### **Principes**

Le ruissellement et l'érosion étant considérés comme des signes d'une gestion déséquilibrante du paysage, il s'agit avant tout d'écarter les pratiques les plus dégradantes, de favoriser les techniques améliorantes et de définir un système d'exploitation permettant la gestion conservatrice des eaux disponibles et la fertilité des sols (Roose 1984).

Cette nouvelle stratégie s'appuie sur trois principes :

1. Partir d'une enquête sur la perception du problème par les paysans concernés, ainsi que sur les types d'érosion et leur extension dans le paysage. Choisir avec eux des méthodes conservatrices simples, adaptées au milieu physique et au contexte économique local; qu'ils puissent expérimenter sur leurs champs, en éprouver les avantages immédiats et les contraintes. Prévoir un système souple, des possibilités de correction après quelques années et dont les bénéficiaires restent totalement maîtres. De cette démarche interactive entre les réalités de terrains, les gestionnaires et les spécialistes naît une confiance et une formation réciproque très enrichissante.
2. Choisir des dispositifs efficaces permettant d'étaler les eaux à la surface du sol, de les ralentir, de disperser leur énergie, de réduire leur capacité de transport et leur compétence, plutôt que de les concentrer aux exutoires. Nous proposons de cloisonner le paysage par des microbarrages perméables en vue de piéger les sédiments et la majorité des eaux pluviales sur le versant (Fig. 3). Ces structures serviront de base spatiale pour l'introduction des méthodes d'intensification de la culture et de l'élevage. Ces méthodes sont connues dans la tradition paysanne, observées dans quatre continents et ont fait leur preuve depuis des siècles (Roose 1986a et b, Roose et Piot 1984). A la Figure 4 sont présentés trois exemples d'amélioration de l'in-

filtration d'un sol colluvial limono sableux battant situé près du Lac de BAM, environ 100 km au Nord de Ouagadougou.

- Le piochage superficiel du sol (B) a permis un gain d'infiltration de 46 mm par rapport au sol battant (A) mais après 100 millimètres de pluie sur ce sol assez peu stable, le ruissellement est devenu plus fort que sur sol trop travaillé, lequel bénéficie des macropores stables créés par la mésofaune
  - Le paillage sur un sol pioché (C) retarde le démarrage du ruissellement et maintient longtemps un bon niveau d'infiltration (de 30 mm h<sup>-1</sup>).
  - Le billonnage cloisonné permet le stockage des 60 premiers millimètres de pluie. Mais en cas d'averse exceptionnelle (60 mm) ou de dégradation des billons, les eaux boueuses se déversent d'un billon au suivant et provoquent un ravinement qui peut être dangereux sur les pentes en absence d'entretien. Le taux final d'infiltration (26 mm h<sup>-1</sup>) est nettement supérieur à ceux des sols battants (4 à 12 mm h<sup>-1</sup>).
3. Etablir un plan d'aménagement global associant les arbres, les cultures et l'élevage à l'échelle d'un bassin versant, d'un terroir ou d'une surface occupée par une communauté paysanne. L'aménagement doit être progressif en fonction de l'évolution de la perception des paysans et des moyens disponibles. Dans ce plan s'inscrira l'évolution dans le temps et dans l'espace de la maîtrise par l'homme de son environnement.

### **Exemples d'aménagements en cours**

**Au Mali.** Dans le cadre des recherches-développement de l'IER en collaboration avec l'IRRT et la CMDT dans les régions de Sikasso et Koutiala, les enquêtes et les discussions avec les groupements villageois ont fait ressortir les vœux des paysans concernant la lutte contre l'érosion dans l'ordre suivant (Hallam et Van Campen 1985, Van Campen et Kebe 1986) :

Se protéger des eaux ruisselant d'amont :

- cordons de pierres, haies vives et bandes enherbées sur le glacis gravillonnaire;
- exutoires stabilisés tous les 400 mètres, qui ser-



Microbarrages perméables aboutissent à des terrasses progressives.

- Cordons de pierres, de paille
- Bandes d'arrêt enherbées
- Haie vives
- Lignes d'arbres

Labour en courbe de niveau vers l'aval  
Erosion hydrique + Transport mécanique

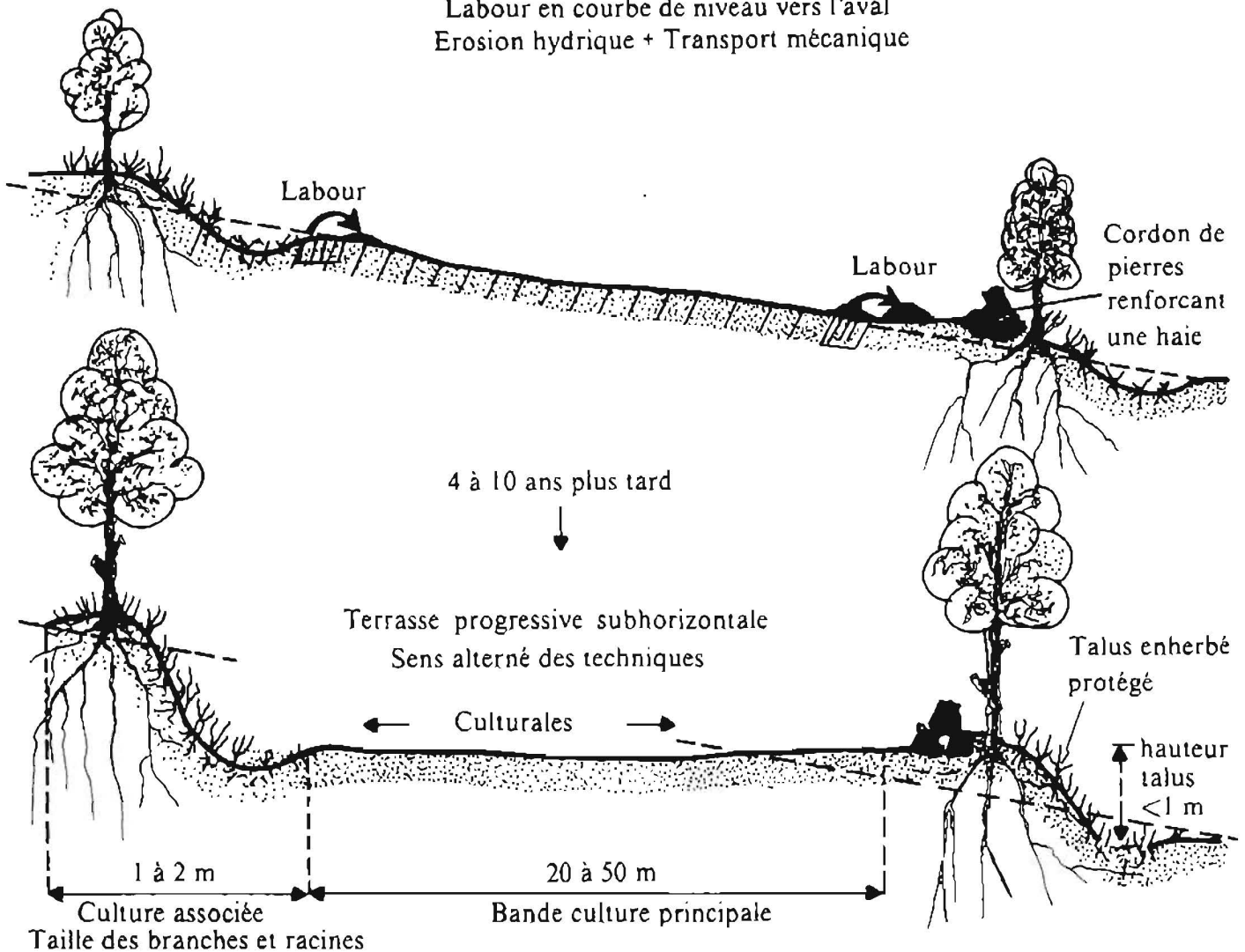

● Processus

Réduction de la vitesse du ruissellement par les barrages perméables

- dépôts de sédiments grossiers + mat. organiques
- augmentation de l'infiltration

Erosion mécanique par le travail du sol  
(1 à 10 t ha<sup>-1</sup> an<sup>-1</sup> de terre déplacée)

- Reptation lente du sol
- Accroissement des interactions biologiques racines, litières, mésofaune.

● Avantages

- La nature fait le travail
- Efficacité maintenue lors des fortes averses
- Mise en place facile, sans spécialiste topographe
- Bon marché, facile à entretenir, pas de place perdue
- Les risques d'érosion diminuent avec le temps
- Formation de terrasses horizontales
- Diversification de la production : bois, fourrage, fruit
- Maîtrise de l'érosion éolienne
- Le ruissellement n'engorge pas l'amont et irrigue l'aval

Figure 3. Méthode des microbarrages perméables.

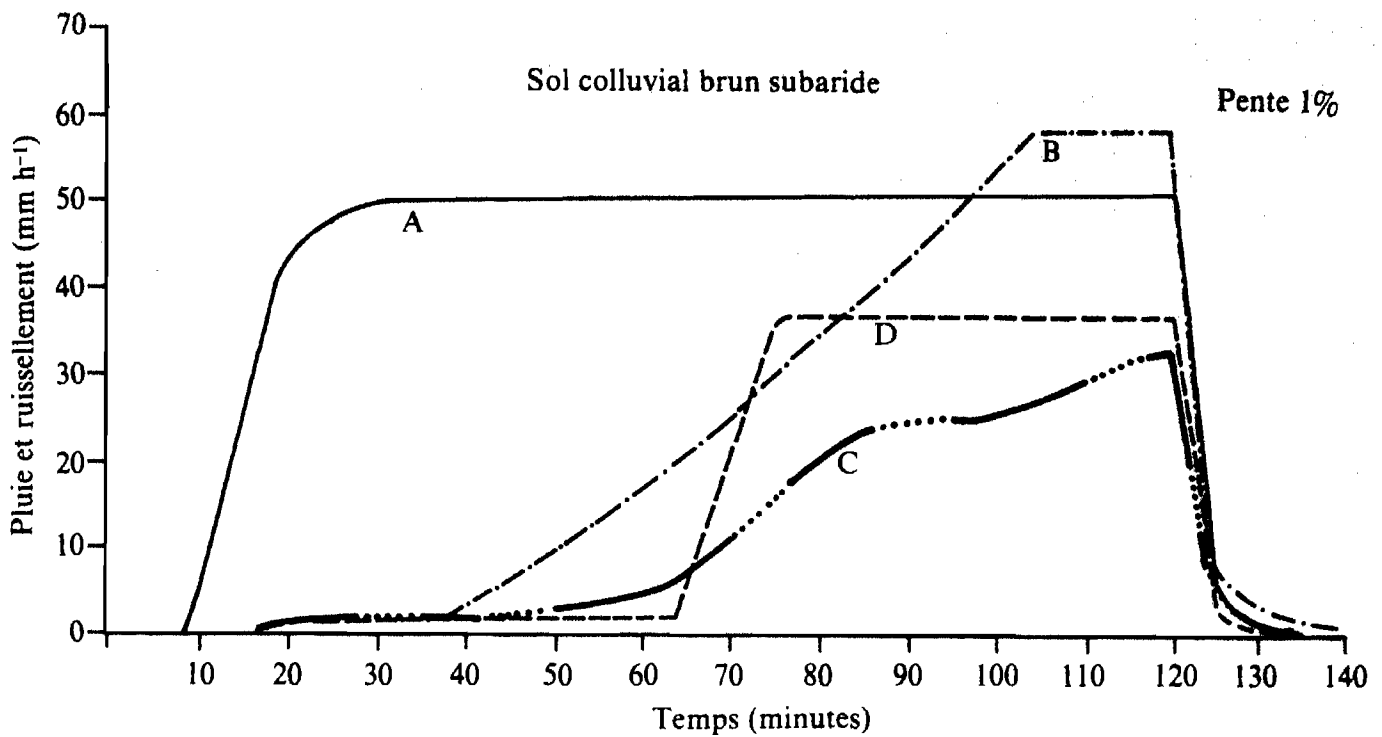

|   |                                      | Coeff. ruiss.<br>(%) | Ruiss. max.<br>(mm h <sup>-1</sup> ) | Infiltration<br>(mm) |
|---|--------------------------------------|----------------------|--------------------------------------|----------------------|
| A | Sol nu, non travaillé battant :      | 71                   | 50                                   | 36                   |
| B | Sol nu, pioché sur 10 cm :           | 33,5                 | 58                                   | 82                   |
| C | Sol nu pioché, paillé :              | 16                   | 29                                   | 104                  |
| D | Sol nu pioché, billonné, cloisonné : | 22                   | 36                                   | 97                   |

Figure 4. Evolution du ruissellement en fonction des traitements sous une averse simulée de 62 mm h<sup>-1</sup> pendant 2 h à Pouni, Burkina Faso.

vent de chemin d'exploitation en saison des récoltes :

- soit digue de protection en amont des blocs de culture (Sénoufos en milieu soudanien);
- soit cordons de pierres filtrants (Bambara et Mossi si pluie 600 mm).

Se protéger contre le bétail et les eaux rejetés par le voisin

- haies vives + arbres—piquets verts autour des exploitations. On notera les implications sur le statut foncier des terres aménagées.

Protéger les parcelles cultivées contre la dégradation de la fertilité et de l'infiltration

- haies vives + arbres entre parcelles (densité finale 20 à 40 arbres/ha<sup>-1</sup>);

- en complément tous les 25 m sur les parcelles, cordons de pierres en bande enherbée;
- techniques culturales en vue de l'amélioration de l'infiltration et de l'enracinement;
- grattage en sec, labour isohypse après la 1<sup>ère</sup> pluie, buttage cloisonné.
- soussolage tous les 4 ans,
- rotation (coton, céréale, légumineuse ou culture fourragère), fertilisation, pesticides,
- gestion des résidus de culture : paillage ou fumier pailleux, branchages de légumineuses de brousse non appréciées.

Aménagement des bas-fonds

- digues en terre (H < 2 m) avec exutoires latéraux revêtus de bloc de latérite : succession de

**Dennison, S.** 1986. Evaluation des brise-vent de la vallée de la Maggia au Niger, *Activité* 1980, CARE. 8 pp.

**Dugue P.** 1986. Appropriation des techniques de lutte contre l'érosion et le ruissellement par les paysans du Yatenga (Burkina-Faso). Communication au séminaire sur l'aménagement hydro-agricole et les systèmes de production. Montpellier, France : Centre de coopération internationale en recherche agronomique pour le développement/ Département systèmes agraires. 20 pp. Multi-graphié.

**Faho, Th.** 1986. Expérience de l'organisme régional de développement (ORD) au Yatenga, en matière de lutte contre l'érosion et de gestion des eaux de surface (Burkina Faso, Communication présentée au Séminaire CIRAD/DSA Montpellier, France : Centre de coopération internationale en recherche agronomique pour le développement/ Département systèmes agraires. 15 pp. Multi-graphié.

**FAO (Organisation des Nations Unies pour l'alimentation et l'agriculture).** 1967. La défense des terres cultivées contre l'érosion hydraulique. Rome, Italie : FAO. 202 pp.

**Fauck, R.** 1977. Soil erosion in the Sahelian zone of Africa: its control and its effect on agricultural production. Pages 371-397 in *Symposium on rain-fed agriculture in semi-arid regions*, Riverside, CA, Etats-Unis.

**Goudet, J.P.** 1985. Equilibre du milieu naturel en Afrique tropicale sèche. Végétation ligneuse et désertification. *Bois et Forêts des Tropiques* 207: 3-15.

**Grall, J.** 1986. Niger : l'eau piégée. Les femmes, les artisans et les machines : une participation vécue in "Le Monde" du 10 juin 1986.

**Hallam, G. et Van Campen, W.** 1985. Reacting to farmers' complaints of soil erosion on intensive farms in southern Mali. Communication au Colloque de l'International Soil Conservation Association, Macaray, Vénézuéla. 13 pp.

**Herblot, G.** 1985. Une expérimentation "travail du sol en sec en Haute Volta". *Machinisme Agricole Tropical* 85 : 3-41.

**Heusch, B.** 1977. La conservation des eaux et des sols dans la haute vallée de Keita. Sogreah Grenoble/Niger. Ministère de l'Economie Rurale, Niger. 24 pp.

**Hudson, N.** 1973. Soil conservation. B.T. Batsford Ltd. Londres, Royaume-Uni. 320 pp.

**Killian, J.** 1974. Etude du milieu physique en vue de son aménagement. Conceptions de travail. Méthodes cartographiques. *Agronomie Tropicale* 29 (2) : 141-153.

**Kleene, P. et Vierstra, G.** 1985. Contribution de la recherche-développement au développement agricole, IER/IRAT, Sikasso, Mali : Institut d'économie rurale/Institut de recherche agronomiques tropicales et des cultures vivrières. 30 pp.

**Le Houerou, H.N.** 1979. La désertification des régions arides. *La recherche* 99(10): 336-344.

**Lovejoy, S.B. et Napier, T.L.** 1986. Conserving soil : Sociological insights. *International Journal of Soil Conservation* 41(5) : 304-310.

**Marchal, J.Y.** 1979. L'espace des techniciens et celui des paysans. Histoire d'un périmètre anti-érosif en Haute Volta. Mémoire ORSTOM. Paris, France : Institut français de recherche scientifique pour le développement en coopération. N° 89 : 245- 252.

**Marchal, J.Y.** 1983. Société, espace et désertification dans le Yatenga (Haute Volta). La dynamique de l'espace rural soudano-sahélien, ORSTOM, Paris, France : Institut français de recherche scientifique pour le développement en coopération. 872 pp.

**Mulard, M. et Groene, D.** 1961. Les méthodes de lutte contre l'érosion du sol en Haute Volta. *Bois et Forêts des Tropiques* 79 : 7-16.

**Peyre de Fabregues, B.** 1985. Conséquences de la sécheresse dans le domaine pastoral de la République du Niger. *Bulletin des recherches agronomiques de Gembloux* 20(3-4) : 345-355.

**Quilfen, J.P. et Milleville, P.** 1983. Résidus de culture et fumure animale : un aspect des relations agriculture-élevage dans le Nord de la Haute-Volta. *Agronomie Tropicale* 38(3) : 206-212.

- Reij, C.** 1983. L'évolution de la lutte antiérosive en Haute Volta depuis l'indépendance vers une plus grande participation de la population. Institute for Environmental Studies, Free University, Amsterdam, Netherlands. 84 pp.
- Roose, E.J.** 1967. Dix années de mesure de l'érosion et du ruissellement au Sénégal. *Agronomie Tropicale* 22(2) : 123-152.
- Roose, E.J.** 1976a. Le problème de la conservation de l'eau et du sol en République du Bénin. Mise au point en 1976. FAO/ORSTOM Abidjan. Côte d'Ivoire : Organisation des Nations Unis pour l'alimentation et l'agriculture/Institut français de recherche scientifique pour le développement en coopération. 34 pp. Multigraphié.
- Roose, E.J.** 1976b. Use of the universal soil loss equation to predict erosion in West Africa. Pages 60-74 in *Soil erosion: prediction and control*. Iowa, Etats-Unis : Soil Conservation Society of America.
- Roose, E.J.** 1978. Pédogenèse actuelle d'un sol ferrugineux complexe issu de granite sous une savane arborescente du Centre Haute Volta—Gonsé : campagnes 1968 à 1974. *Cahiers ORSTOM : Pédologie* 16(2) : 193-223.
- Roose, E.J.** 1980. Dynamique actuelle de sols ferallitiques et ferrugineux tropicaux d'Afrique Occidentale. Etude expérimentale des transferts hydrologiques et biologiques de matières sous végétations naturelles ou cultivées. ORSTOM Paris, Travaux et Documents n° 130. Thèse Doctorale, Université d'Orléans, France. 587 pp.
- Roose, E.J.** 1984. Causes et facteurs de l'érosion hydrique sous climat tropical. Conséquences sur les méthodes anti-érosives. *Machinisme Agricole Tropical* 87 : 4-18.
- Roose, E.J.** 1985a. Rapport de mission auprès de DRSPR sur la conservation de l'eau et des sols dans la région sud Mali. Ministère de l'Agriculture, IER/KIT, Bamako, Mali : Institut d'économie rurale/Koninklijk Instituut van de Tropeu. 42 pp.
- Roose, E.J.** 1985b. Dégradation des terres et développement en Afrique de l'Ouest. *Bulletin des recherches agronomiques de Gembloux* 20 (3-4) : 505-537.
- Roose, E.J.** 1986a. Terrasses de diversion ou microbarrages perméables? Analyse de leur efficacité en milieu paysan ouest africain pour la conservation de l'eau et des sols dans la zone soudano-sahélienne. *Cahiers ORSTOM. Pédologie* 22(2) : 81-92.
- Roose, E.J.** 1986b. Problèmes posés par l'aménagement des terroirs en zone soudano-sahélienne d'Afrique Occidentale, Communication au séminaire sur l'aménagement hydro-agricole et systèmes de production. 16-19 déc 1986. CIRAD, Montpellier, France : Centre de coopération internationale en recherche agronomique pour le développement. 20 pp.
- Roose, E.J. et Piot, J.** 1984. Runoff, erosion and soil fertility restoration on the Mossi Plateau (Central Upper Volta), Zimbabwe-IASH N° 144 : 485-498.
- Serpentie, G.** 1986. Confrontation paysans-aménageurs au Yatenga (Burkina Faso). Communication au séminaire sur l'Aménagement hydro-agricoles et systèmes de production. CIRAD/DSA Montpellier, France : Centre de coopération internationale en recherche agronomique pour le développement/Division Systèmes agraires. 22 pp.
- Stocking, M. et Peake, L.** 1985. Erosion induced loss in soil productivity trends in research and international cooperation. Communication au Colloque de l'International Soil Conservation Association, Macaray, Vénézuéla.
- Valet, S.** 1985. Action villageoise bénévole de lutte antiérosive dans les unités expérimentales de Thyse-Sonkorong en 1984 (Siné Saloum, Sénégal). IRAT/DEVE Montpellier, France : Institut de recherches agronomiques tropicales et des cultures vivrières/Département Etudes et Valorisation de l'Eau. 63 pp.
- Van Campen, W. et Kebe, D.** 1986. Lutte antiérosive dans la zone cotonnière au Mali Sud. Communication au 3ème séminaire sur l'aménagement hydro-agricole et systèmes de production CIRAD/DSA Montpellier, France : Centre de coopération internationale en recherche agronomique pour le développement/Division systèmes agraires. 25 pp. Multigraphié.

**Wischmeier, W.H. et Smith, D.D.** 1960. A universal soil loss estimating equation to guide conservation farm planning. Pages 418-425 (Vol.I) du 7e Congrès International des Sciences du sol.

**Wischmeier, W.H., Johnson, C.B. et Cross, B.V.** 1971. A soil erodibility memograph for farmland and construction sites. Journal of Soil and Water Conservation 265 : 189-197.

**Soil/Water Management  
for Conservation/Production Systems  
in Low-Rainfall Areas**



# Measurement and Characterization of Soil-Water Relationships

D.J. Mulla<sup>1</sup>

## **Abstract**

*The measurement of soil content and soil-water potential are critical for efficient management of agricultural lands. A knowledge of these soil-water relationships facilitates improved irrigation scheduling and cropping decisions. In this paper, methods for measuring water content and water potential are discussed. A brief description of instrumentation is given along with a discussion of the principles upon which each method is based. Recommendations are made regarding the types of operating conditions in which each technique can be used, and the advantages and disadvantages of each method. For measuring soil-moisture content the methods discussed include gravimetric, neutron probe and microwave techniques. The measurement of soil-water potential using tensiometers, pressure chamber apparatus, hanging water columns, moisture blocks, and thermocouple psychrometers is discussed. It is shown that the wetting treatment applied prior to determining the moisture release curve can significantly affect the pore size distribution of the soil and the relation between water content and water potential.*

## **Résumé**

**Mesure et définition des relations sol/eau :** *Mesurer de façon précise le contenu en eau et le potentiel hydrique du sol est essentiel pour une gestion efficace de l'agriculture en zones arides. La connaissance des relations eau-sol concourra à améliorer les décisions prises pour les cultures et la conservation des sols. Dans cette communication, on discute diverses méthodes de mesure du contenu en eau et du potentiel hydrique. On donne une brève description de l'instrumentation; de même, on discute les principes sur lesquels chaque méthode se fonde. On émet des recommandations pour l'utilisation de chaque technique et on énumère leurs avantages et inconvénients. En ce qui concerne la mesure du contenu en eau du sol, on aborde les méthodes ayant recours aux données gravimétriques, à la sonde à neutron ou à la technique à microondes. Les méthodes du potentiel hydrique du sol par tensiomètre, presse à membrane, colonnes gravimétriques et psychromètres à thermocouples sont discutées. On démontre qu'un traitement d'humectation préalable à la détermination de la courbe de déshydratation peut avoir un effet significatif sur la répartition dimensionnelle des pores des sols très érodibles ou gonflants. A terme, ces modifications ont une incidence sur la relation entre le contenu en eau du sol et le potentiel hydrique.*

---

1. Assistant Professor of Soils, Dept. of Agronomy and Soils, Washington State University, Pullman, WA., 99164-6420, USA.



## Introduction

It is important to estimate soil moisture accurately and the energy with which soil water is held in the soil matrix. Soil water is essential for the germination of seeds, the growth of microorganisms, and is a major factor in determining crop yields in semi-arid regions.

Water stored in the soil is only one component of the dynamic water budget. Water is partitioned between that stored in the soil, draining through the profile, evaporating and transpiring to the atmosphere, or running off at the soil surface. Without a proper understanding of these soil-water relationships, it is likely that a poor understanding of the entire water budget including soil, plant, and atmospheric processes will result. Water in soils also affects physical properties such as soil conductivity, strength, aeration, and temperature.

Methods for measuring water content and potential in soils have been reviewed in several texts and papers (Gardner 1986, Holmes et al. 1967, Marshall and Holmes 1979, Hanks and Ashcroft 1980, Papendick and Campbell 1981, Schumgge et al. 1980). In this paper, a comparison and contrast of selected techniques for measuring water content and potential will be presented. The emphasis will be on general principles, instrumentation, and advantages or disadvantages of the techniques. Gravimetric, neutron probe, and microwave techniques for monitoring soil-water content will be discussed. The use of tensiometers, pressure plates, and hanging water columns for measuring soil-water potential will also be discussed.

## Methods for Measuring Soil-Water Content

### Gravimetric Methods

The gravimetric method is the simplest and most accurate method to measure soil-water content. Two types of gravimetric measurements may be obtained, depending upon the method used to collect soil from the field.

For disturbed samples, water content is usually determined on a mass basis ( $\text{kg ha}^{-1}$ ). The mass of the sample is determined when it is collected from the field and after oven drying to a constant weight at  $105^\circ\text{C}$  (12–24 h). The mass wetness ( $w$ ) is:

$$w = [(M_w + M_s) - M_s] / M_s \quad (1)$$

where

$M_w$  = the mass of water in the sample, and  
 $M_s$  = the mass of its solid particles.

The mass wetness is thus equivalent to the quantity (wet mass–dry mass)/dry mass.

When undisturbed soil samples are collected using a core sampler, the water content also may be expressed as a volumetric water content or  $\text{m}^3$  of water  $\text{m}^{-3}$  of soil. Volumetric water content ( $\theta$ ) is determined by the loss of water on oven drying at  $105^\circ\text{C}$ , and the known volume of the undisturbed core sample before drying ( $V_t$ ):

$$\theta = [(M_s + M_w) - M_s] / \rho_w V_t \quad (2)$$

where  $\rho_w$  is the density of liquid water (approximately  $1.0 \text{ Mg m}^{-3}$ ). Alternatively, if the mass wetness and soil bulk density ( $\rho_b$ ) are known, the volumetric water content can be calculated using the relation:

$$\theta = (\rho_b / \rho_w) w \quad (3)$$

The salient features of the Gravimetric method are given below:

Works best for : Infrequent sampling in uniform soils.

Not suited for : Frequent sampling or work in rocky, gravelly soils.

Advantages : Accurate and inexpensive.

Disadvantages : Destructive sampling required.

Care must be taken to take representative samples from each soil layer in heterogeneous profiles.

Time consuming to adequately characterize field variability in water content.

### Radiation Methods

Two useful radiation methods for measuring water content are the gamma-ray attenuation and neutron-scattering method. The latter is far easier, cheaper, and safer to use in the field than the gamma-ray method. For an explanation of the gamma-ray method the reader is to refer to articles by Nofziger and Swartzendruber (1974), Schumgge et al. (1980), and Marshall and Holmes (1979).

**Neutron scattering.** In the neutron-scattering method, a probe containing a source of fast neutrons is lowered into an access tube to a desired depth in the soil profile. The access tube must have good contact with the soil. As fast- or high-energy neutrons collide with, and are scattered from, protons on water molecules in the soil surrounding the access tube, their kinetic energy is reduced. After approximately 18 elastic collisions the neutrons will be slowed down (thermalized) sufficiently to be detected.

Since protons on water in the soil are the main agents to thermalize neutrons, the sphere of influence of the neutron probe measurement depends on soil-water content. As soil-water content increases, the distance traveled by neutrons before thermalization is reduced so that the sphere of influence decreases. Typically, the sphere of influence ranges from 16 cm at saturation to 70 cm at near-zero water content (Gardner 1986).

Typically, the source of radiation consists of 10 milliCurie (mCi) of a mixture of Americium and Beryllium. Neutrons emitted from such a source have an energy of approximately 2 million electron volts (MeV) and a velocity of  $1600 \text{ kms}^{-1}$ . The detector is suspended on a cable which transmits the resulting signal to an amplifier, discriminator, and counting device at the soil surface.

The rate of counts obtained with the neutron probe in the field is used along with a calibration curve to compute volumetric water content. A calibration curve usually can be described using linear regression expression of the form:

$$\theta = (R_s/R_{std})b-j \quad (4)$$

where

- $R_s$  = counting rate in the field,
- $R_{std}$  = counting rate for an access tube placed in soil of known water content,
- $b$  = slope of the regression line, and
- $j$  = a constant that accounts for background corrections and instrument dead time.

Manufacturers supply calibration curves with their instruments, but a researcher should establish new curves in order to correct for variations in soil properties. Special precautions are required to construct calibration curves in swelling soils (Jaywardane et al. 1983). For measurements near the soil surface (within about 15 cm) neutron probe measurements are inaccurate, and should be replaced by gravimetric measurements or the time

domain methods discussed in this paper.

The salient features of the neutron-scattering method are given below.

**Works best for** : Uniform-, coarse-, or medium-textured soils. Long-term experiments at fixed locations and depths.

**Not suited for** : Measurements near the soil surface or in shallow soils without specialized equipment. Rocky or gravelly soils. Soils containing appreciable boron or chloride. Highly stratified or layered soils.

**Advantages** : Frequent sampling at one depth or position possible. Measurements are made in situ and are nondestructive. Results do not vary with temperature and pressure.

**Disadvantages** : Radiation hazardous to operator. Limited, variable spatial resolution. Expensive equipment. Unable to measure soil water separately from water held in dense root systems or tubers.

### Time Domain Reflectometry

Water is a polar molecule which exhibits a large dielectric constant as a liquid. The dielectric constant is a measure of the capacity of a medium to absorb electromagnetic energy, such as that at infrared or microwave frequencies. Whereas the dielectric constant of liquid water is 80 at room temperature, it is about 3 in dry soil or ice. Hence, small amounts of liquid water in the soil dramatically increase its dielectric constant.

Time domain reflectometry (TDR) uses the variation in dielectric constant to measure the volumetric water content of a soil. The time required for a pulse of microwave energy to travel down and back, up the soil, between two parallel probes inserted into the soil will increase as the soil water content, and consequently the dielectric constant increases.

The dielectric constant (K) can be computed from the transmission time (t) and the probe length (L) using the relation:

$$K = [ct/(2L)]^2 \quad (6)$$

where  $c$  is the speed of light. A calibration curve is constructed to relate soil dielectric constant and volumetric water content. Topp et al. (1980) and Mulla (1985) have shown that this calibration curve is given by the relation:

$$\theta = -5.3 \times 10^{-2} + 2.92 \times 10^{-2}K - 5.5 \times 10^{-4}K^2 + 4.3 \times 10^{-6}K^3 \quad (7)$$

A plot of Equation (7) is given in Figure 1. The TDR method is advantageous because this calibration curve is unaffected by factors such as soil texture, salinity, bulk density, temperature, or organic matter content. Recent investigations by Dalton et al. (1984, 1986) have shown that the TDR method can also be used for simultaneous measurements of soil-water content and electrical conductivity.

Physically, the TDR unit consists of a signal generator for the broadband microwave pulse (1 to 500 MHz), a sampling head and an oscilloscope to display the reflected waveform (Dalton et al. 1984). This unit is connected via coaxial transmission line and an impedance matching transformer to two parallel stainless steel probes inserted into the soil at a distance of 3–7 cm. The length of the probes may vary from 15 to 50 cm, with a length of about 30 cm being optimal for measurements in the rooting zone. Good contact between the probes and soil is essential as the method is sensitive to the

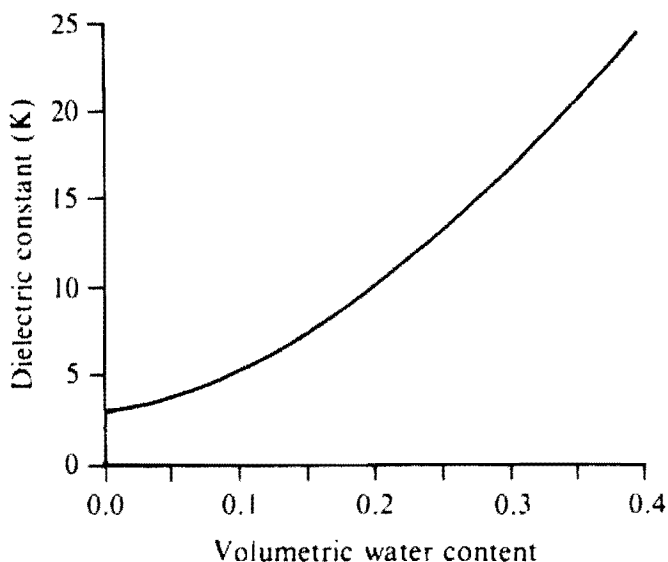

**Figure 1.** Time Domain Reflectometry (TDR) calibration curve from data of Topp et al. (1980) and Mulla (1985), showing the relationship between soil-water content and dielectric constant of the soil medium.

dielectric properties of the medium between the parallel probes, including air. Hence, the method yields an average value for water content of the soil volume contained between the probes along their entire length.

The probes are easily inserted into moist soil and reading may be obtained with some commercial instruments in as little as 5 s. Measurements in rocky, gravelly, or exceedingly dry clayey soils may be difficult due to problems in inserting probes into the soil. For research applications in which an accurate determination of soil-water content is needed at a specific depth, the TDR probes can be inserted into the soil horizontally from a soil trench (Topp and Davis 1982).

Soil Moisture Corporation is a commercial supplier of a portable TDR unit (IRAMS unit). This unit automatically calculates, displays, and records soil volumetric water content at each field sampling location. Tektronix, Inc. supplies a TDR unit (model 1502) suitable for laboratory use. The salient features of the Time Domain Reflectometry are given below:

- Works best for : Measurements in uniform soils.  
Rapid soil survey measurements.
- Not suited for : Highly stratified soils. Rocky or gravelly soils.
- Advantages : One calibration curve applies to all soils. Rapid, easy technique.  
Nondestructive, in situ measurements.  
Can measure water content and electrical conductivity simultaneously.  
Separately measures liquid-water content when ice and unfrozen water are present.
- Disadvantages : Probes inserted vertically cannot be used for measurements of water content in small depth increments. Expensive equipment. Limited testing in field experiments.

## Soil-Water Potential

Whereas soil-water content is a measure of the amount of water held in soil, soil-water potential is

a measure of the potential energy with which a unit mass, volume, or weight of water is held in the soil matrix. The SI units for water potential are joule  $\text{kg}^{-1}$ , when expressed per unit mass, megapascals (MPa) when expressed per volume of water and meters when expressed per weight of water. Traditionally, soil scientists have used the units of bars to express water potential. The relation between the above units is  $100 \text{ j kg}^{-1} = 0.1 \text{ MPa} = 10.24 \text{ m} = 1 \text{ bar}$ .

Plant-water stress is dependent primarily upon the water potential in the soil. Under conditions in which water potential and other atmospheric demands are equal, water stress may be equivalent in a coarse-textured soil having a volumetric water content of 0.05 and a fine-textured soil having a volumetric content of 0.15.

Water potential is measured relative to the energy of a reference pool of pure water at a specified elevation, pressure, and temperature (Papendick and Mulla 1986). Conventionally, this reference pool is assigned a potential energy of zero. When water flows from one depth to another, it flows from a region of higher to lower (more negative) total water potential. Traditionally, field capacity water content corresponds to a water potential of  $-0.01$  to  $-0.03$  MPa, while the permanent wilting point corresponds to a water potential of about  $-1.5$  MPa. Hence, water potential is often used as an index of the ability with which plants can extract water from the soil.

Total water potential ( $\psi$ ) refers to the total potential energy of water in the soil. In unsaturated soils,  $\psi$  is a negative quantity, since energy must be extended to remove the water from the soil. The total energy of the soil water is determined by the several different types of forces acting upon it, including gravity, ion solvation, hydrostatic pressure, absorption, and cohesion between water molecules. Each force provides a measurable component of the total water potential as expressed by:

$$\psi = \psi_g + \psi_p + \psi_m + \psi_o \quad (8)$$

where:

$\psi_g$  = gravity potential, which is zero at the reference evaluation, positive above it, and negative below it;

$\psi_p$  = pressure potential, which results from the hydrostatic pressure of water and is positive below the water table and zero above and at the water table surface;

$\psi_m$  = matric potential, which results from the

attractive forces between soil surfaces and water. It is negative in unsaturated soil and zero in saturated soil;

$\psi_o$  = osmotic potential, which results from the forces between water and dissolved solutes in the soil, and is always a negative quantity.

## Methods for Measuring Soil-Water Potential

Most methods for measuring water potential evaluate only the matric component of the total water potential. The discussion below will deal only with these methods. Note that it is convenient to refer to the absolute value of matric potential, which is always a positive quantity. The absolute value of matric potential is known as matric suction.

### Tensiometer

Tensiometers are widely used in situations when soils have a water potential greater than  $-0.08$  MPa. This corresponds to conditions in which the soil is relatively wet; hence tensiometers are particularly useful in helping farmers to schedule crop irrigation (Hanks and Ashcroft 1980). A tensiometer consists of a ceramic cup connected via a continuous column of water to a vacuum gauge which usually indicates matric suction on a scale ranging from 0 to 100 centibars (0.1 MPa). The cup must be in contact with soil. Equilibrium between the tensiometer and the soil water is established by the movement of water and ions through the porous cup. The suction established inside the tensiometer is read using the vacuum gauge. When the gauge reading is in centibars, the matric suction can be computed using the expression:

$$\psi_m = 0.001 \times (\text{gauge reading}) + gz_o \quad (9)$$

where  $z_o$  is the distance in meters between the gauge and the middle of the porous cup and  $\psi_m$  is expressed in units of MPa. For short tensiometers ( $<50$  cm), the last term in Equation (9) is small and can be omitted with little loss of accuracy.

Air bubbles inside the tensiometer column must be completely eliminated for the system to work properly. To achieve this, the column must be filled with de-gassed water obtained by causing water to boil for several minutes. Tensiometers are effective

only in relatively wet soils having a matric suction less than 0.08 MPa. Above this suction, air bubbles begin to pass through the porous cup, and the hanging water column may break. The exact suction at which this occurs can be computed using Kelvin's equation and the radius of pores in the cup. Hence, the range of operation for tensiometers is limited to 0–0.08 MPa. This range is characteristic only of fairly wet soils. Another limitation of tensiometers is that they are sensitive to temperature fluctuations (Taylor et al. 1961), and readings at different times of the day may vary. For automated recording of tensiometers, the vacuum gauge may be replaced with pressure transducers sensitive to pressure changes in the water column (Schmugge et al. 1980), and a datalogger may be used to record the measurements.

- Work best for :** Moist soil.  
 Irrigation scheduling.  
 Repeated measurements at fixed locations.  
 Rapid survey measurements.
- Not suited for :** Dry or sandy soil.
- Advantages :** Inexpensive and easy to install.  
 Rapid and accurate measurements.  
 Measurements are nondestructive and in situ.  
 Automated readings possible with pressure transducers.
- Disadvantages :** Limited to a range of 0–0.08 MPa. Water in column must be refilled periodically.  
 Readings are sensitive to temperature fluctuations.

### Pressure Plate

The pressure plate is used in the laboratory to study soils that may be much drier than those studied with tensiometers. Commercial pressure plates allow a wide range of matric suctions to be established for the soil, but usually these values range from about 0.005 to 1.5 MPa.

The pressure plate method involves the following steps. A dry disturbed soil sample or an undisturbed soil core is placed on the pressure plate and very slowly wet up to saturation. The porous plate

is placed in a sturdy steel chamber which can withstand as much as 1.5 MPa of applied pressure. The chamber is sealed, and air or nitrogen gas is applied to the chamber under controlled pressure.

Pressure in the chamber forces water and solutes from the soil through the plate into a body of free water at atmospheric pressure. When equilibrium is attained, water ceases to flow through the plate, and the total water potential of the soil water is the same as that of the free water below the plate. Hence, the matric suction at equilibrium is given by:

$$\psi_m = P \quad (10)$$

where  $P$  is the applied (constant) gas pressure in MPa. Attainment of equilibrium generally requires at least one and usually two or three days from the onset of pressure application. When equilibrium is reached the gas pressure is released, the soil samples are removed, and their mass basis water content is obtained using Equation (1). New samples can be prepared to determine their moisture content at other matric potentials.

The relationship between water content and matric suction is easily determined as outlined above using a pressure plate. This relationship, known as the moisture characteristic curve (Fig. 2), is an important, fundamental relation in soil science. It can be used to estimate the amount of plant available water in a soil. Also, once a field

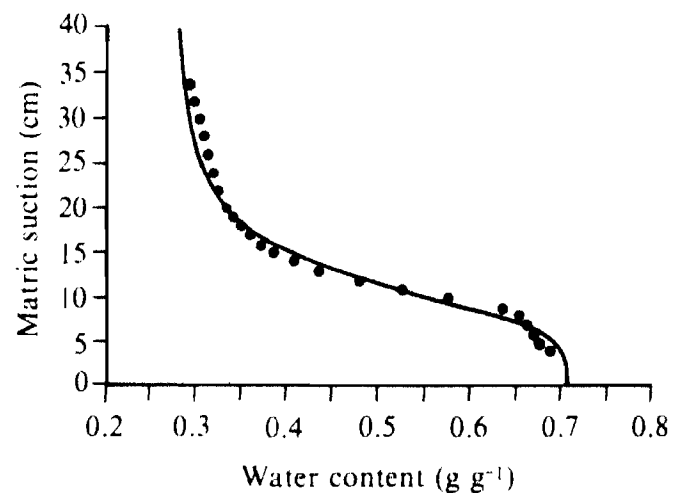

**Figure 2.** Moisture characteristic curve for a Palouse silt loam that was initially oven dry and was wet very slowly using a hanging water column.

measurement of matric suction is made for a soil whose moisture characteristic curve is known, the water content of the soil at that suction can be estimated (or vice versa).

The salient features of pressure plates are given below:

**Work best for** : Both disturbed and undisturbed soil samples.

**Not suited for** : Rapid measurements.

**Advantages** : Used for determining soil moisture characteristic curves.  
Large range of matric suctions (0.005–1.5 MPa). Many samples may be analyzed simultaneously.

**Disadvantages** : Destructive sampling required.  
Time consuming measurements.  
In situ measurements not possible.  
Moderately expensive equipment required.

### Hanging Water Column

A hanging water column can be used to obtain the low suction portion of the moisture release curve (Collis-George and Figueroa 1984). The apparatus has been described by Childs (1940) and Day et al. (1967). It consists of a Buchner funnel with a sintered glass plate connected to a tygon tube filled with water. The tygon tube is connected to a graduated pipette supported by a ring stand. The distance between the meniscus in the hanging water column and the middle of the soil sample on the sintered glass plate equals the soil-water suction.

In practice, the moisture release curve is determined by initially placing a 5–10 mm layer of oven-dry or air-dry soil on the sintered plate with the meniscus at a distance of about 20 cm below the sample. The mass of the oven-dry soil placed on the plate must be known. The meniscus is raised by one cm every two minutes until the distance between the meniscus and the middle of the soil layer is zero. At this point, the soil sample becomes saturated. The distance is increased by about 1 cm and the volume of water released by the soil measured using the pipette. The maximum suction possible using this technique depends upon the air entry suction of the sintered glass plate. At this point the soil sample is oven-dried for determination of the

final gravimetric water content. Based upon this value and the measured volume changes, one can compute the gravimetric water content of the soil at every applied soil-water suction. The procedure described above was used to determine the moisture characteristic curve for Palouse silt loams as shown in Figure 2.

Conventionally, the moisture characteristic curve is determined from a desorption experiment using a presaturated sample, as described above. For highly erodible or swelling soils, the form of the moisture characteristic curve is extremely sensitive to the rate at which the sample is initially wetted.

Figure 3 illustrates the moisture characteristic curve for a highly erodible, swelling Palouse silt loam subjected to a moderate fast-wetting treatment. This involved initially positioning the meniscus of the hanging water column at 8 cm and decreasing the distance by 2 cm each time until saturation occurred. A change in the distribution of pore sizes is evident in comparison to the results for the slowly wetted sample (Fig. 2). As a result of aggregate breakdown, the proportion of small pores is increased relative to the number of larger pores. The moisture characteristic curve for the moderate wetting rate treatment reflects an increased proportion of small pores as evidenced by higher water contents at suctions above 8 cm.

Wetting the Palouse silt loam sample by pouring it directly into standing water causes virtually complete slaking of aggregates and drastic changes

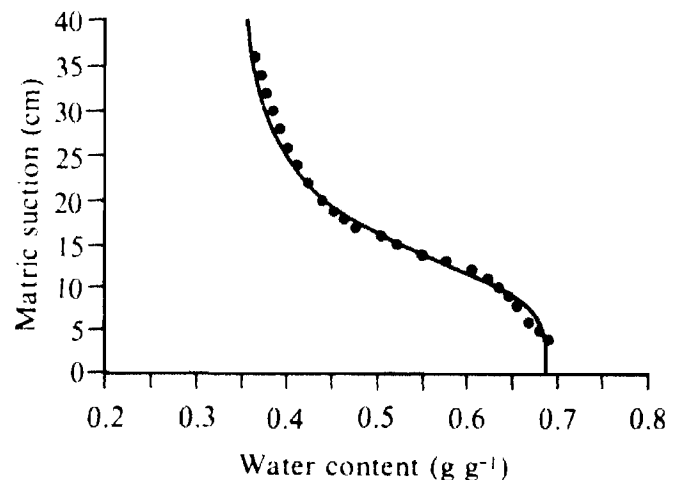
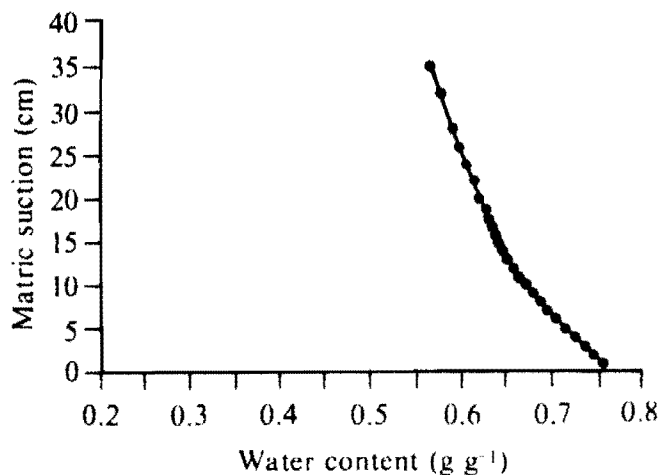

Figure 3. Moisture characteristic curve for a Palouse silt loam that was initially oven dry and was wet at a moderate rate using a hanging water column.

## References



**Figure 4.** Moisture characteristic curve for a Palouse silt loam that was initially oven dry and was wet at a very fast rate by pouring soil on the sintered glass plate into standing water.

in pore size distribution. The corresponding effect of this fast-wetting rate treatment on the moisture characteristic curve is shown in Figure 4. The results in Figures 2–4 are a striking illustration of the profound effect the rate of initial wetting has on the moisture characteristic curve. Researchers should always take extreme care in slowly wetting soil samples prior to determining the moisture characteristic curve, especially if the soil is highly erodible or swells.

Some salient features of hanging water columns are given below:

- Works best for : Disturbed or undisturbed soil samples.
- Not suited for : Analyzing many soil samples simultaneously.
- Advantages : Used for determining soil moisture characteristic curves.  
Used for assessing aggregate stability in response to changes in rate of initial wetting.  
Inexpensive equipment.
- Disadvantages : Destructive sampling required.  
In situ measurements not possible.  
Limited to matric suctions less than 200 cm (0.02 MPa).

**Childs, E. C.** 1940. The use of the soil moisture characteristic in soil studies. *Soil Science* 50: 239–252.

**Collis-George, N., and Figueroa, B.S.** 1984. The use of high energy moisture characteristic to assess soil stability. *Australian Journal of Soil Research* 22: 349–356.

**Dalton, F.N., Herkelrath, W.N., Rawlins, D.S., and Rhoades, J.D.** 1984. Time-domain reflectometry: simultaneous measurement of soil water content and electrical conductivity with a single probe. *Science* 224: 989–990.

**Dalton, F.N., and van Genuchten, M. Th.** 1986. The time-domain reflectometry method for measuring soil water content and salinity. *Geoderma* 38: 237–250.

**Day, P.R., Bolt, G.H., and Anderson, D.M.** 1967. Nature of soil water. Pages 193–208 in *Irrigation of agricultural lands* (Hagan, R.M., Haise, H.R., Edminster, T.W., and Dinauer, R.C., eds.). Agronomy no. 11. Madison, WI, USA: American Society of Agronomy.

**Gardner, W.H.** 1986. Water content. Pages 493–544 in *Methods of Soil Analysis, Part 1* (Klute, A. ed.). Agronomy monograph no. 9. Madison, WI, USA: American Society of Agronomy.

**Hanks, R.J., and Ashcroft, G.L.** 1980. *Applied soil physics*. Berlin, Federal Republic of Germany: Springer-Verlag.

**Holmes, J.W., Taylor, S.A., and Richards, S.J.** 1967. Measurement of soil water. Pages 275–303 in *Irrigation of agricultural lands* (Hagan, R.M., Haise, H.R., Edminster, T.W., and Dinauer, R.C., eds.). Agronomy no. 11. Madison, WI, USA: American Society of Agronomy.

**Jaywardane, N.S., Meyer, W.S., and Barrs, H.D.** 1983. Moisture measurement in a swelling clay soil using neutron moisture meters. *Australian Journal of Soil Research* 22: 109–117.

**Marshall, T.J., and Holmes, J.W.** 1979. *Soil physics*. Cambridge, UK: Cambridge University Press.

**Mulla, D.J.** 1985. Using time domain reflectometry to measure frost depth and unfrozen water content in soil. Water Research Center Report no. 64. Pullman, Washington, USA: Washington State University.

**Nofziger, D.L., and Swartzendruber, D.** 1974. Material content of binary physical mixtures as measured with a dual energy beam of gamma rays. *Journal of Applied Physics* 45(12): 5443–5449.

**Papendick, R.I., and Campbell, G.S.** 1981. Theory and measurement of water potential. Pages 1–22 *in* Water potential relations in soil microbiology (Parr, J.F., Gardner, W.R., and Elliot, L.F., eds.). Soil Science Society of America Special Publication no. 9. Madison, WI, USA.

**Papendick, R.I., and Mulla, D.J.** 1986. Basic principles of cell and tissue water relations. Pages 1–25 *in* Water, fungi and plants (Ayres, P., and Boddy, L., eds.). London, UK: Bath Press.

**Schmugge, T. J., Jackson, T.J., and McKim, H.L.** 1980. Survey of methods for soil moisture determination. *Water Resources Research* 16(6): 961–979.

**Taylor, S.A., Evans, D.D., and Kemper, W.D.** 1961. Evaluating soil water. Bulletin no. 426. Logan, Utah, USA: Utah Agricultural Experiment Station.

**Topp, G.C., Davis, J.L., and Annan, A.P.** 1980. Electromagnetic determination of soil water content. Measurement in coaxial transmission lines. *Water Resources Research* 16(3): 574–582.

**Topp, G.C., and Davis, J.L.** 1982. Measurement of soil water content using time domain reflectometry. Pages 269–287 *in* Proceedings of the Canadian Hydrology Symposium, Jun 1982. Fredericton, New Brunswick, Canada: National Research Council of Canada, Associate Committee on Hydrology.





# Water-Use Efficiency of Crops in the Semi-Arid Tropics

P.J. Gregory<sup>1</sup>

## Abstract

Water-use efficiency (*WUE*) can be defined in several ways but for the semi-arid tropics, it is best viewed in terms of the total shoot-dry matter production (*N*) and the various ways in which water can be lost:

$$WUE = \frac{N/T}{1 + (E+R+D)/T}$$

where *E* is evaporation, *R* is runoff, *D* is drainage, and *T* is transpiration. This expression shows that *WUE* can only be changed in three ways. First, by changing the fraction *N/T* (the transpiration efficiency); second, by increasing the total supply of water to increase *T*; and third, if the supply is limited, by altering the balance between *T* and the other pathways of loss: *E*, *R*, and *D*.

In this review, it is shown that *N/T* is a function of the saturation deficit and the biochemistry of the photosynthetic pathway so that there are currently few practical means of altering it substantially. However, there is a variety of management practices available for changing *WUE* by the other two methods. Runoff is an important component of water balance in semi-arid regions, and appropriate cultivation and cropping patterns that encourage infiltration of water will increase *WUE* markedly. Optimizing plant populations and fertilizer applications will also increase *WUE* by increasing *T* relative to the other pathways of loss.

However, because rainfall is frequently erratic in both amount and distribution, maximizing *WUE* may not be a major consideration of subsistence farmers. The desire for predictable, more stable yields may lead to underutilization of water in the years when rainfall is high.

## Résumé

**Efficacité de l'utilisation de l'eau pour les cultures dans les zones tropicales semi-arides :** Plusieurs définitions peuvent être données de l'efficacité de l'utilisation de l'eau (*EUE*) mais, dans les tropiques semi-arides, la meilleure est celle qui consiste à établir un rapport entre la production totale de matières sèches des pousses (*N*) et les diverses voies possibles de perte d'humidité :  $EUE = [N/T]/[1+(E+R+D)/T]$  où *E* est l'évaporation, *R* le ruissellement, *D* le drainage et *T*, la transpiration. Cette formule montre clairement que l'*EUE* ne peut être modifiée que de trois façons. La première consiste à modifier le rapport *N/T* (efficacité de la transpiration), la deuxième à augmenter l'approvisionnement total en eau pour accroître *T* et la troisième à modifier, au cas où cet approvisionnement serait limité, l'équilibre existant entre *T* et les autres facteurs entraînant une perte d'humidité *E*, *R*, ou *D*.

---

1. Department of Soil Science, University of Reading, London Road, Reading, RG1 5AQ, England, UK.

ICRISAT (International Crops Research Institute for the Semi-Arid Tropics). 1989. Soil, Crop, and Water Management Systems for Rainfed Agriculture in the Sudano-Sahelian Zone: proceedings of an International Workshop, 7-11 Jan 1987. ICRISAT Sahelian Center, Niamey, Niger. Patancheru, A.P. 502 324, India: ICRISAT.

*On montre dans cette étude que N/T est fonction du déficit de saturation et du processus biochimique de photosynthèse et qu'il existe peu de moyens pratiques de modifier sensiblement ce rapport. Par contre, plusieurs techniques permettent de modifier l'EUE en agissant sur les deux autres facteurs de perte d'humidité. Dans les tropiques semi-arides, le ruissellement est un élément important du bilan hydrique et l'EUE sera grandement améliorée par des travaux du sol et un aménagement cultural favorisant l'infiltration de l'eau. L'optimisation des populations végétales et l'application d'engrais augmenteront aussi l'EUE en élevant la part relative de la transpiration par rapport aux autres facteurs de perte d'humidité.*

*Néanmoins, étant donné l'irrégularité de la hauteur et de la répartition des précipitations, il se pourrait que la maximisation de l'EUE ne constitue pas l'un des éléments les plus importants de l'agriculture de subsistance. La recherche de rendements plus prévisibles et plus stables peut même entraîner une sous-utilisation de l'eau pendant les années les plus pluvieuses.*

## **Introduction**

The semi-arid regions of the world contain about 600 million people who are dependent upon seasonal rainfall for all or most of their food. Animals may occupy a key position in the agricultural systems of many seasonally arid regions (particularly in Africa). In the past, extensive grazing and movement of populations have meant that regions hit by drought in one year could be avoided and returned to in good years. Even where animals were not the major agricultural products, societies have often adopted extensive forms of shifting cultivation to allow soils to recover their fertility. However, owing to the increase in population and the pressures to form permanent settlements, there is a greater requirement for more intensive crop production, especially of annual crops.

Semi-arid regions are without rainfall for at least a part of the year. Grove (1977) states a mean annual rainfall of 200-500 mm but a more useful generalization is that average monthly precipitation exceeds the potential evaporation for at least two and at most seven months, and the mean annual temperature exceeds 18°C. Of greater importance, though, particularly in relation to intensifying agriculture, is the large seasonal difference both in the amount and distribution of rainfall. For example, at Sebele in southeast Botswana, the mean annual rainfall ranged from 188 mm to 737 mm over a 5-year period (DLFRS 1985, p. 10) and the distribution of rainfall within the cropping period was very different (Fig. 1). These differences in amount and distribution resulted in water stress during early growth in 1980-81, but in

waterlogging during the same growth period in 1982-83 (Rees 1986). Similarly, divergent patterns of rainfall have been shown in West Africa (Virmani et al. 1980) and India (Virmani et al. 1978). It is against this background that attempts to manage water and to increase production are set. In this paper I shall briefly outline the theoretical basis of the relation between growth and water use and suggest how management can be altered to change the amount of dry matter produced per unit of water used.

## **Relations between Growth and Water Use**

### **Water-Use Efficiency**

The early work of Lawes (1850) and Briggs and Shantz (1913) established that growth and transpiration were somehow linked but that the amount of water transpired by plants to produce dry matter differed with species, sites, and seasons. The term "water-use efficiency" (WUE) is often used to describe this basic relation between growth and water use. However as Sinclair et al. (1984) point out, this term "has been used interchangeably to refer to observations ranging from gas exchange by individual leaves for a few minutes to grain yield response to irrigation treatments through an entire season".

Strictly the word "efficiency" is wrong in this context, since true efficiency is a comparative term

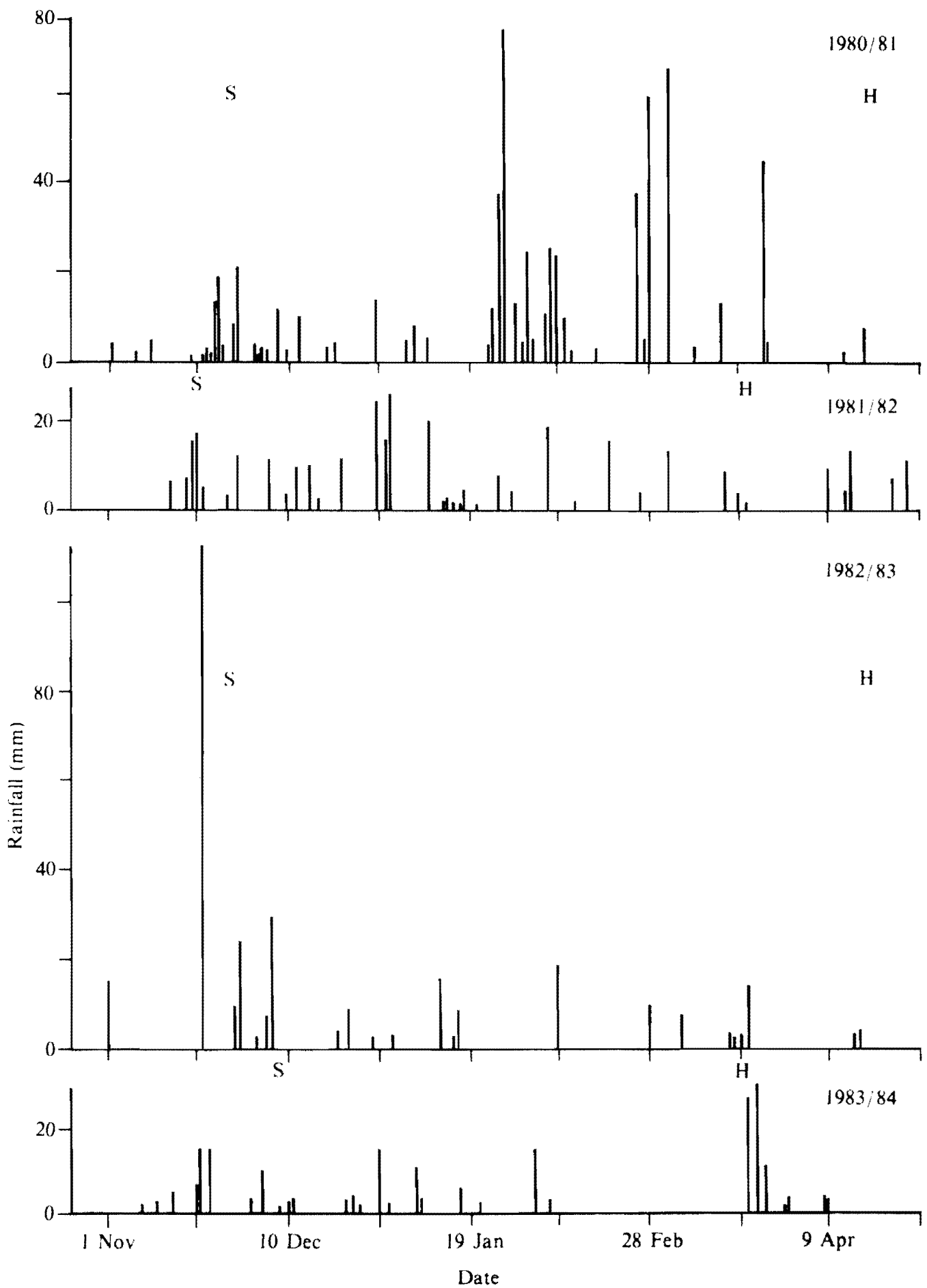

Figure 1. Seasonal patterns of rainfall at Sebele, Botswana. The time of sowing (S) and harvest (H) of sorghum crops is shown (Rees 1986).

and is dimensionless, requiring a knowledge of the theoretical maximum value. Some workers, therefore, prefer to use the term "water-use coefficient".

To the agronomist, WUE is often a seasonal value defined as:

$$WUE = \frac{\text{Yield per unit area}}{\text{Water used to produce yield}} \quad (1)$$

Both the numerator and the denominator may be expressed in several ways. Yield is frequently given as grain yield but for many rainfed environments, the grain straw has an economic value as great as that of the grain because it is used to sustain livestock. In this context, therefore, total shoot biomass is appropriate although it ignores the dry mass of the root system.

The root mass of cereals grown in semi-arid regions (e.g., millet) as a fraction of total plant mass is typically 0.10–0.15 at maturity (Gregory and Squire 1979), but in legumes it is frequently greater (Gregory 1987) at 0.15–0.20. The denominator may also be expressed in a number of ways. Generally it is expressed as the total water use [evaporation (E) plus transpiration (T)] during the growing season, but it may also be expressed as transpiration alone or may take account of the total water input to the system. For example, Bolton (1981) expresses WUE in relation to the rainfall within a fallow-barley crop rotation of two years duration. A more detailed review of these various methods for defining WUE is given by Sinclair et al. (1984).

## Growth and Transpiration

De Wit (1958) reviewed several experiments from around the world and established that crop yields and water use could be empirically related by:

$$N = mT/E_0n \quad (2)$$

where

- N = dry matter yield,
- T = amount of water transpired,
- E<sub>0</sub> = averaged rate of evaporation from an open pan,
- m = a constant depending upon the crop, and
- n = a constant depending upon the location.

In temperate regions, n was 0 but in more arid environments, n was 1 indicating that WUE was

directly related to the evaporative demand of the atmosphere. The theoretical basis of this relation has recently become clearer and is worth exploring since it helps to indicate the effects that different management practices may have on WUE.

The stomata in the leaf epidermis allow CO<sub>2</sub> to enter the leaf and simultaneously provide a pathway for water vapor to pass out of the leaf into the atmosphere. Transpiration (T<sub>L</sub>) and photosynthesis (N<sub>L</sub>) of individual leaves can be described in terms of the vapor pressure difference and the difference in CO<sub>2</sub> concentration between the intercellular spaces and the ambient air outside and the resistances to diffusion (Penman and Schofield 1951, Bierhuizen and Slatyer 1965):

$$T_L = \frac{e_i - e_a}{r_s + r_a} \quad (3)$$

$$N_L = \frac{c_a - c_i}{r_s + r_a} \quad (4)$$

where

- e<sub>i</sub> = saturated vapor pressure in the substomatal cavity,
- e<sub>a</sub> = vapor pressure of the ambient air,
- c<sub>a</sub> = the concentration (strictly the partial pressures) of the CO<sub>2</sub> in the air
- c<sub>i</sub> = concentration (strictly the partial pressure) of the CO<sub>2</sub> in the intercellular spaces, and

r<sub>s</sub> and r<sub>a</sub> are the stomatal and boundary layer resistances to water vapor (r'<sub>s</sub> and r'<sub>a</sub> for CO<sub>2</sub>).

It follows that the ratio of photosynthesis to transpiration can be written as:

$$\frac{N_L}{T_L} = \frac{(c_a - c_i)(r_s - r_a)}{(e_i - e_a)(r'_s + r'_a)} \quad (5)$$

This expression can be simplified in several ways. First, the stomatal and boundary layer resistance to both CO<sub>2</sub> and water transfer are related to the diffusion coefficients for the two gases which are approximately inversely related to the square roots of their molecular weights. This means that the ratio r<sub>s</sub> + r<sub>a</sub> to r'<sub>s</sub> + r'<sub>a</sub> is approximately constant with a value of 1.6. Second, the gradient of CO<sub>2</sub> is often maintained by stomata at an almost constant value depending upon the species (Wong et al. 1979, Percy and Ehleringer 1984). Finally, because over extended periods of time the leaf temperature is frequently close to air temperature, e<sub>i</sub> - e<sub>a</sub> can be

approximated by the saturation deficit of the air ( $e_s - e_a$ ), where  $e_s$  is the saturation vapor pressure of the air. Making these assumptions and further assuming that crops and individual leaves behave similarly (Sinclair et al. 1984), Equation 5 can be simplified and rewritten for crops as:

$$\frac{N}{T} = \frac{k}{e_s - e_a} \quad (6)$$

where  $k$  is a crop-specific constant. Further work is needed to test the validity of this expression for crops but Tanner (1981) and Rijtema and Endrodi (1970) have shown for potatoes that differences in saturation deficit between years may explain year-

to-year differences in transpiration efficiency (dry matter production per unit of water transpired). Table 1 shows values of  $k$  found in field experiments and Table 2 shows values of transpiration efficiency for some crops.

Three aspects of practical importance follow from this analysis. First, it is clear from equation 6 that transpiration efficiency will be higher in humid regions than in arid regions because  $e_s - e_a$  will be lower. Moreover, in semi-arid regions with a rainy season, changes in saturation deficit between seasons can have a marked effect on transpiration efficiency. For example, Monteith (1986a) has shown that for India and West Africa, saturation deficit decreases from a maximum of 3–4 kPa in the dry season to 0.5–1 kPa in the rainy season and that this decrease accounts for about half to one-third of the response of dry matter production to the rains. Second, equation 4 shows the importance of the  $CO_2$  gradient. For a range of conditions, several workers have shown that the fraction  $c_i/c_a$  is approximately constant (Goudriaan and van Laar 1978, Wong et al. 1979). The fraction is almost constant at 0.7 for species photosynthesizing by the  $C_3$  pathway and 0.3 for those with the  $C_4$  pathway. This means that  $C_4$  plants will have a greater transpiration efficiency than  $C_3$  plants. The greater transpiration efficiency of  $C_4$  plants does not however mean that they are more drought tolerant because the ability to withstand low water potentials is not directly related to the photosynthetic pathway. Finally, because equation 6 is physiologically based, it shows that transpiration efficiency will only be influenced slightly by variety, water stress, and agronomic practice. Farquhar and Richards (1984) have shown, however that carbon isotope discrimination may provide a means of selecting the most efficient varieties in  $C_3$  plants.

**Table 1. Values of the crop constant ( $k$ ) found in field experiments.**

| Author                     | Crop    | Location        | $k$ (m bar) |
|----------------------------|---------|-----------------|-------------|
| Gregory (1984)             | Barley  | Rothamsted, UK  | 0.016       |
| Rijtema and Endrodi (1970) | Potato  | The Netherlands | 0.009       |
| Tanner (1981)              | Potato  | Wisconsin, USA  | 0.065       |
| Tanner and Sinclair (1983) | Sorghum | Kansas, USA     | 0.138       |
|                            | Soybean | Kansas, USA     | 0.040       |

**Table 2. Values of transpiration efficiency ( $N/T$ ) for some crops.**

| Author                                      | Crop   | Location       | $N/T$<br>( $kg\ ha^{-1}\ mm^{-1}$ ) |
|---|--------|----------------|-------------------------------------|
| Day et al. (1978)                           | Barley | Rothamsted     | 30                                  |
| Gregory (1984)                              | Barley | Rothamsted     | 43                                  |
| Cooper, Gregory, Keatinge, and Brown (1987) | Barley | Syria          | 40–45                               |
| Squire et al. (1984)                        | Millet | India          | 39–45                               |
| Azam-Ali et al. (1984b)                     | Millet | Niger          | 21–47                               |
| Tanner (1981)                               | Potato | Wisconsin, USA | 36–55                               |

## Growth and Use of Soil Water

Water is used by crops directly by transpiration ( $T$ ) from the leaves and indirectly by evaporation ( $E$ ) from the soil surface; this is commonly referred to as evapotranspiration ( $ET$ ). Although the transpiration efficiency for a crop species does not vary widely, the WUE based on  $ET$  will vary considerably because it depends on the crop, climate, and soil factors. If equation 1 is expanded considering

transpiration and evaporation, WUE may be written as:

$$WUE = \frac{N/T}{1+E/T} \quad (7)$$

Because  $N/T$  is constant for a given saturation deficit and crop, improved WUE can result only if the fraction  $E/T$  is changed so that more water is transpired. Equation 7 was developed for Mediterranean regions where  $E$  plus  $T$  are generally equal to the annual precipitation; they are then equal to the input of water (Cooper, Gregory, Tully, and Harris 1987).

In semi-arid regions, both runoff ( $R$ ) and drainage ( $D$ ) may be substantial components of the total water balance so that, in the long term, WUE might best be expressed in relation to the input of water:

$$WUE = \frac{N/T}{1+(E+R+D)/T} \quad (8)$$

This equation indicates that to produce dry matter with the greatest WUE,  $T$  should be maximized with respect to all the other losses. It also shows that increasing the total amount of water available to a crop will only increase the WUE if  $T$  is increased proportionately more than  $(E+R+D)$ . A range of agronomic and management practices is used to change either the total water available or the balance between  $T$  and other losses. The precise form of practice will depend upon local conditions. Table 3 summarizes some of the most commonly used techniques that contribute to increased WUE.

---

**Table 3. Some agronomic practices used to improve water use efficiency (WUE) in semi-arid regions.**

---

**Increasing water supply available to plants:**

- Rain harvesting and supplementary irrigation.
- Cultivation to improve infiltration and reduce runoff.
- Fallowing.
- Selecting varieties with deeper roots; multiple cropping.
- Application of fertilizer.
- Weed control.

**Increasing transpiration relative to other losses:**

- Mulching.
  - Modifying spacing and numbers of plants.
  - Application of fertilizer.
- 

## Increasing Water Available to Plants

### Water Harvesting and Supplementary Irrigation

In many arid areas, water harvesting is used to increase the total water supply available to crops. Water is allowed to run off the higher slopes where soils are generally shallow and crop growth poor, onto the terraced valley bottoms where soils are deeper and able to store water. In these circumstances, runoff is deliberately encouraged. Soil depth must play a major role in determining the effective length of the growing season although there appears to be little information available for the semi-arid tropics. A soil depth gradient has been established recently at ICRISAT Center on an Alfisol though results from this are not yet available (J.M. Peacock, ICRISAT, personal communication). Soil depth can have marked effects on the length of the growing season in Mediterranean regions (Smith and Harris 1981). In dry years, the maximum water-holding capacity of soils is not fully utilized so there is little effect of soil depth but in wet years, the length of the growing season may be extended by up to 17 days as the water stored is doubled from 76 to 150 mm.

Water available to crops may also be increased by supplementary irrigation. However, as Monteith (1986b) points out, in a monsoon climate, rainfall affects both the supply of water to plant roots and the saturation deficit, which is a measure of the atmospheric demand for water from the top. In practice, this means that when crops are irrigated to sustain growth during dry periods in the rainy season, the marginal response to irrigation will be smaller than the response to rain because saturation deficit will be greater during irrigation than that during rain (Monteith 1986a). In very small crops where leaf area index (LAI) is  $<1$ , this conclusion might not apply because evaporation from the soil surface may keep the saturation deficit small (Ritchie 1983). Nevertheless the analysis is important also because it highlights the difficulties of extrapolating responses to irrigation from one season to another. Irrigation trials frequently employ either rain shelters to keep out rain in the rainy season or are conducted in dry seasons when there is no rain. Both of these practices change the balance of supply and demand from

that pertaining in open fields during the rainy season.

## Cultivation and Fallowing

On deeper soils, the control of runoff is important in increasing infiltration of water and improving crop growth. Cultivated soils are frequently left fallow during the dry season and are therefore bare when the rains commence. Studies at ICRISAT Center (Kampen and Burford 1980) have shown that up to 60% of the rainfall during the rainy season can run off the fallowed Vertisols; this is reduced to 19% if a crop can be established during the early rains. Similarly on Alfisols, 35% runoff was measured even when the soil was cropped.

Kilewe and Ulsaker (1984) working on Alfisols at Machakos, Kenya, where infiltration is reduced during the early part of the rainy season by surface sealing caused by raindrop impact, also showed that cultivation could reduce runoff substantially. Cultivation in wide furrows decreased runoff and allowed infiltration to continue long after the rainfall had ceased. This in turn increased maize yield and WUE (Table 4). However, in practice, animal draft power is poor during the early rains because animals are weak after the dry season. Mulches of straw might improve infiltration (if not used for fodder by grazing animals or eaten by termites) and may also reduce evaporation directly from the soil surface.

Fallowing is an important feature of many semi-arid regions and affects the chemical and physical properties of soils (Jones and Wild 1975, pp. 125–132). However, postharvest abandonment of

land to grazing and weed growth exhaust the remaining water in the root zone and frequently render the surface less penetrable by heavy rain. These factors also restrict the possible cultivation time. Work in Botswana (Jones 1987) concluded that periods of bare fallow between crops were essential to accumulate water so that crops were not planted into superficially wetted soils. However, the low water-holding capacity of the soils (50–120 mm in the top 1 m) indicates that whole-season fallows are probably inappropriate. This practice, together with the adaptation of cropping to suit tillage operations and not vice versa, should allow for greater productivity. Much work is still required to develop cropping and cultivation systems appropriate for semi-arid environments.

## Exploitation of Stored Resources of Water

In many semi-arid regions, deep percolation is a significant component of the water balance, and water frequently remains in the soil profile at the end of crop growth. For example, during the rainy season at ICRISAT Center, depending on the amount and distribution of rainfall, up to 10% of the rainfall may be lost as drainage (ICRISAT 1978), and substantial amounts of the water may remain in the soil profile after harvest of the rainy season crop (Fig. 2). These water reserves might be exploited in two ways. First, by effectively extending the growth period by planting another crop that extends the period of water extraction. This is achieved by relay cropping, intercropping, and agroforestry although there are few published examples quantifying the amounts of water utilized by each component of these typically mixed cropping systems. The second way is to have plants with deep root systems. Many trees in the savanna regions have deep root systems that allow the exploitation of deep water reserves during the dry season.

In crop plants, greater rooting density and deeper rooting depths would increase the amount of extractable soil water (Taylor and Klepper 1978). Variation in rooting depth is known for several species including millet, sorghum, and rice (Chang and Loresto 1986) so that improvement in root systems might be possible. However, in cereals, most of this additional rooting would have to be

**Table 4. Effects of cultivation on maize yield and WUE grown on an Alfisol at Machakos, Kenya (from Kilewe and Ulsaker, 1984).**

| Cultivation          | Maize yield<br>(kg ha <sup>-1</sup> ) |            | WUE <sup>1</sup><br>(kg ha <sup>-1</sup> mm <sup>-1</sup> ) |            |
|----------------------|---------------------------------------|------------|---|------------|
|                      | Short rains                           | Long rains | Short rains   | Long rains |
| Flat                 | 3722                                  | 256        | 7.1   | 0.7        |
| Conventional furrows | 5242                                  | 725        | 10.4  | 2.0        |
| Wide furrows         | 5458                                  | 844        | 10.7  | 2.4        |
| Mini bench           | 4680                                  | 643        | 8.9   | 1.7        |

1. Defined as grain yield rainfall<sup>-1</sup>.



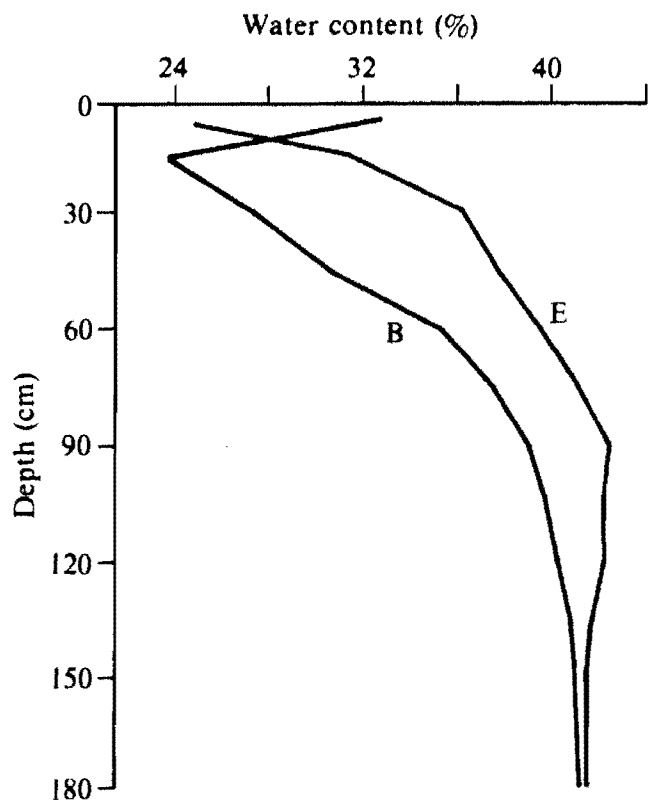

Figure 2. Water contents beneath a maize crop grown on a Vertisol at the beginning (B) and end (E) of the rainy season (ICRISAT 1978).

achieved before anthesis, after which carbohydrates are primarily used to fill the grain.

Larger root systems would require more carbohydrate for growth and maintenance in seasons where there are early rains, but if the rains fail later, they might utilize water early at the expense of

grain growth later on. The severity of this problem will depend upon the timing of drought relative to plant development and whether or not carbohydrate stored in stems can be translocated to growing grain.

### Increasing Transpiration Relative to Other Losses

Evaporation of water directly from the soil surface is an important component of the total water use of crops. For several crops grown on a Vertisol at ICRISAT Center, evaporation ranged from 19–46% of the total water use during the rainy season but was about 18% during the postrainy season (Table 5). Similarly, for a rainfed pearl millet crop grown on an Alfisol in the postrainy season (Squire et al. 1984), evaporation was 21% of the total evapotranspiration.

### Mulching

Mulching is a means of reducing E. Mulch may have other desirable effects such as reducing runoff, increasing infiltration, and decreasing surface temperatures, but it may also harbor plant diseases. The main disadvantages are the non-availability of suitable material and, frequently, the operation is uneconomic. Both the cost of labor and of nitrogen fertilizer needed to overcome immobilization may make this technique unprofitable for anything other than kitchen-garden plots.

Table 5. Components of the water balance for crops grown on a Vertisol (ICRISAT 1978).

| Crop                    | Precipitation (mm) | Evaporation (mm) | Runoff (mm) | Drainage (mm) | Transpiration (mm) |
|-------------------------|--------------------|------------------|-------------|---------------|--------------------|
| <b>Rainy season</b>     |                    |                  |             |               |                    |
| Maize + Pigeonpea       | 466                | 172              | 0           | 0             | 212                |
| Maize                   | 466                | 174              | 0           | 0             | 208                |
| Maize                   | 408                | 66               | 3           | 36            | 241                |
| <b>Postrainy season</b> |                    |                  |             |               |                    |
| Pigeonpea               | 122                | 28               | 0           | 0             | 220                |
| Chickpea                | 47                 | 35               | 0           | 0             | 162                |
| Sorghum                 | 72                 | 40               | 0           | 0             | 176                |

## Application of Fertilizers and Manures

Where soil nutrients are deficient for maximum growth of crops, application of fertilizers and manures may result not only in increased growth but also in increased WUE. Fertilizers may increase the total amount of water used (see Brown 1971, for an example with wheat in the USA; and Cooper, Gregory, Tully, and Harris 1987 for examples with barley in northern Syria), but the principal effect is to allow more rapid growth of the canopy and a larger canopy that shades the soil surface and so reduces the proportion of the total water that is evaporated (Gregory et al. 1984, Cooper, Gregory, Keatinge, and Brown 1987). This is particularly beneficial in Mediterranean climates where rain falls mainly during winter and saturation deficit is small, but may be less beneficial in summer rainfall regions where rapid early growth may result in insufficient water being available later in the season. There appears to be little published work on the effects of nutrients on WUE of crops in the semi-arid tropics. However, trials over a year, with millet at two locations in Niger with below-average rainfall show that application of N, P, and K fertilizers increased total shoot dry matter production, grain yield, and WUE (Table 6). The larger plant canopy of the crops where fertilizer was applied, apparently helped to reduce water loss by evaporation from the soil. The measurements of total shoot dry matter at Sadoré suggest that the crop with fertilizer ceased growth before the crop without fertilizer, indicating that it may have run out of water slightly earlier.

It is not definitely known at present that fertilizers change the transpiration efficiency, although evidence is against any substantial effect (Tanner and Sinclair 1983). Kalsen et al. (1984) grew spring barley on a sandy loam in New Mexico, USA, with

rates of nitrogen fertilizer ranging from 30 to 300 kg N ha<sup>-1</sup> in 2 years and found that grain yield and transpiration were linearly related irrespective of the rate of nitrogen application. Similarly, Walker and Richards (1985) have shown that potassium deficiency did not affect transpiration efficiency of alfalfa and maize. However, transpiration efficiency may be affected if the duration of crop growth is altered, so that the mean saturation deficit experienced by the crop is changed. In northern Syria, for instance, where soils are highly P-deficient, applications of phosphate fertilizer generally advance the date of anthesis and maturity by up to 10 days, depending upon the season, and result in slightly higher transpiration efficiencies, probably because of the lower saturation deficit (Cooper et al. 1987).

## Plant Spacing and Population

Establishing the optimum plant population is another way of maximizing yield and WUE. In temperate regions, it has been established that the production of dry matter by crops is largely dependent on the interception of radiation which, in turn, largely depends upon the size of the canopy. In more arid regions, the growth of a large canopy may prove disadvantageous (particularly to grain yield), because of the increased amount of water that must be transpired to sustain it, for the balance between the growth of roots supplying water and the growth of shoots transpiring water is crucial. This balance between water supply from the soil and the demand for water by the atmosphere has been discussed by Monteith (1986b) and has been the subject of several recent intensive studies.

Azam-Ali et al. (1984a and 1984b) grew millet on

**Table 6. Effects of N, P, and K fertilizer on total shoot dry matter (SDM), grain yield (GY), and WUE for crops of pearl millet (CIVT) grown at two sites in Niger during the 1984 rainy season, ICRISAT 1985.**

| Site   | Rainfall (mm) | Treatment     | Water use (mm) | SDM                    | GY   | WUE (kg ha <sup>-1</sup> mm <sup>-1</sup> ) |     |
|--------|---------------|---------------|----------------|------------------------|------|---|-----|
|        |               |               |                | (kg ha <sup>-1</sup> ) |      | SDM   | GY  |
| Sadoré | 260           | Fertilizer    | 165            | 4750                   | 410  | 28.8  | 2.5 |
|        |               | No fertilizer | 163            | 2417                   | 290  | 14.8  | 1.8 |
| Dosso  | 380           | Fertilizer    | 247            | 5000                   | 1120 | 20.2  | 4.5 |
|        |               | No fertilizer | 270            | 3100                   | 480  | 11.5  | 1.8 |

stored soil moisture at three different row spacings (0.38, 0.75, and 1.5 m) with constant within-row spacing (0.2 m) in sand at Niamey, Niger, in the postrainy season. The rate of dry matter production per unit ground area was different in the three spacings and was initially slowest for the wide spacing (Fig. 3). Between 31 and 59 days, however, the rate of growth at the widest spacing was almost constant and by 73 days, the widest spacing had the greatest dry mass. The dry mass of the medium spacing stopped increasing after 59 days and of the narrow spacing after 45 days. Differences in growth above ground were accompanied by differences below ground (Azam-Ali et al. 1984a) so that roots in the narrowest spacing penetrated rapidly downwards and branched profusely in the top 20 cm while roots in the widest spacing were less numerous deeper in the profile and exploited the interrow space of the upper 10–15 cm. The amounts and timing of water use were also affected so that the narrow spacing used less water than the other two spacings; it also used less water after anthesis at about 40–45 DAS. The widest spacing continued to use water until close to final harvest (Table 7). This experiment illustrates the principle that when crops are grown on stored soil water, yields are determined not only by the total amount of water available but also by the rate at which water

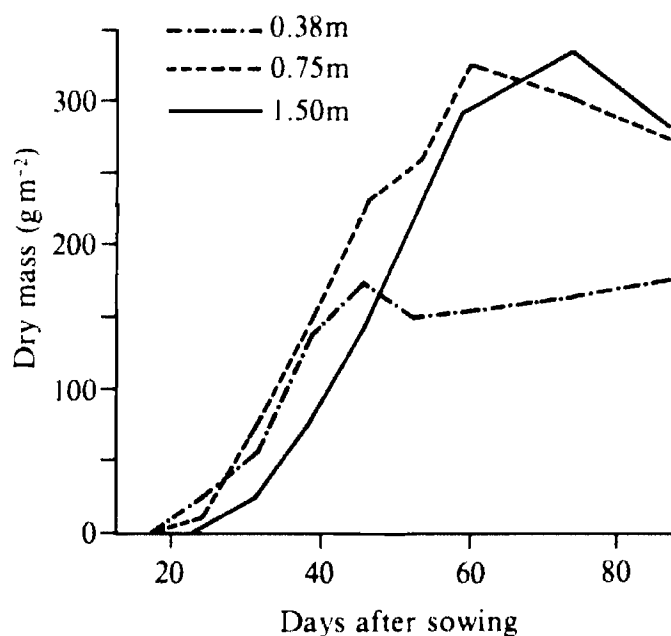

Figure 3. Shoot dry mass for pearl millet grown at 0.38m, 0.75m, and 1.50m row spacing (from Azam Ali et al. 1984).

Table 7. Effect of row spacing on water use by pearl millet grown on stored moisture in the postrainy season at Niamey, Niger, 1980.

| Row spacing (m) | Water use (mm) |            |                 |                 |
|-----------------|----------------|------------|-----------------|-----------------|
|                 | 16–29 days     | 29–43 days | 43 days harvest | 16 days harvest |
| 0.38            | 56.6           | 41.3       | 5.1             | 103             |
| 0.75            | 43.2           | 53.4       | 33.4            | 130             |
| 1.50            | 27.9           | 29.4       | 65.7            | 123             |

becomes accessible to the roots. The availability of water during grain filling helps to delay leaf senescence so that the duration of this phase is longer than when metabolites are drawn from resources in the stem. The maintenance of the plant during grain filling may be of even greater importance in indeterminate crops such as legumes.

The importance of below-ground competition for water supplies as a limitation to yield in semi-arid regions complements the importance of above-ground competition for light as the chief constraint to yield in temperate regions. The size and shape of root systems as affected by plant population will therefore be crucial. Simmonds and Azam-Ali (1989) analyzed results from an experiment in which groundnut was grown on stored water on an Alfisol at ICRISAT Center in the postrainy season. Their work shows that as the density of plants was increased, the plants had a substantially smaller root system relative to the shoot system (Rao, et al. 1989), and consequently, the limiting soil-water deficit (soil water content at which transpiration falls below its potential rate) also decreased. Because plant spacing altered the atmospheric demand substantially but had little influence on the size of the root system (and hence access to water), plants grown in rows 70 cm apart had a limiting soil-water deficit 30 mm more than those grown in rows 35 cm apart, and were able to maintain their potential rate of transpiration (2 mm d<sup>-1</sup>) for 2 weeks longer than the denser crop.

In some regions, skip-row planting systems are used to make available soil water from fallowed rows. However, in a 2-year study with cotton on a clay loam in Texas, Hons and McMichael (1986) found that yield, fiber quality, and WUE were unaffected by row spacing but their measurements of root length and water extraction suggested that

root length may be insufficient to extract all the stored water, particularly if multiple skipped rows are used.

The need for long-term research when proposing alterations to traditional planting patterns is illustrated by Rees (1986). In a series of trials with sorghum in Botswana over a 4-year period (see Fig. 1 for seasonal variations in rainfall), he found the highest overall average yields with plant densities in the range 40 000–80 000 plants ha<sup>-1</sup>, but coefficients of variation increased markedly as density increased from 10 000 to 80 000 plants ha<sup>-1</sup> (Fig. 4). This meant that although a low density did not yield as much or as frequently as high density in favorable conditions, it did not fail in harsh conditions, and yield was stable, though at a low level. In regions with highly variable rainfall, extensive planting at low density is a means of ensuring yield stability at the expense of more variable, higher yields achieved with intensive planting (see also Weatherwax 1954, for an example of maize planting by American Indians).

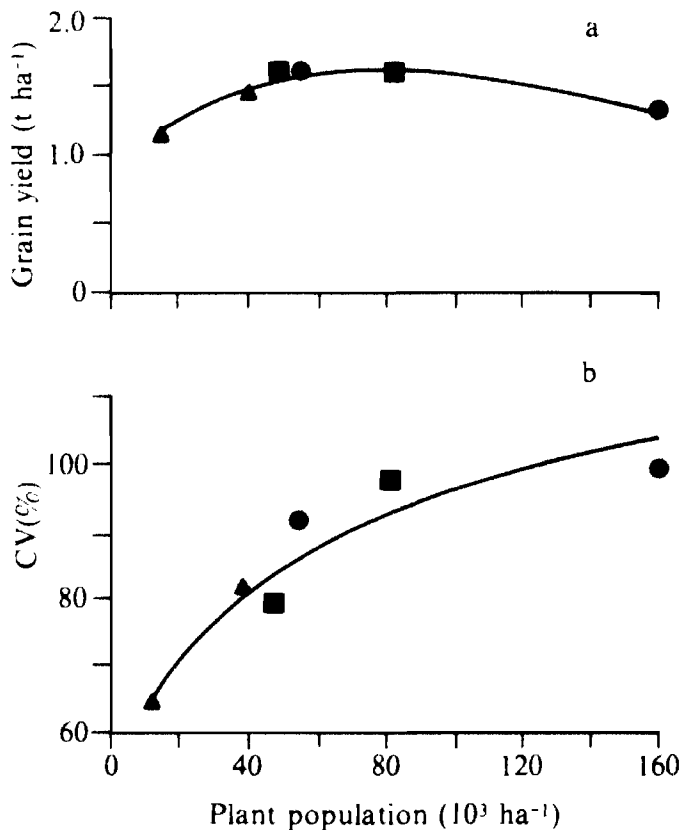

**Figure 4.** Grain yield (a) and coefficients of variation (CV) of yield (b) for sorghum averaged over several years. Crops were grown at 0.38m (●), 0.75m (◐), 1.50m (■), and 1.50m (▲) row spacings (Rees 1986).

Theoretical considerations of the components of what is commonly referred to as crop water-use efficiency make it clear that changes in WUE can only come about in three ways:

1. Changing the transpiration efficiency.
2. Increasing the total supply of water to increase the quantity transpired.
3. Altering the balance between transpiration and other pathways of loss.

Because the transpiration efficiency is a function of the saturation deficit and the biochemistry of the photosynthetic pathway, there are currently few practical opportunities for radically altering it except possibly by decreasing the saturation deficit by sheltering, intercropping, or modifying the length of the growing season.

Several management options are available for increasing WUE by options 2 and 3. In contrast to winter rainfall regions of the Mediterranean, the reduction of runoff and deep percolation by appropriate cultivation and cropping practices may prove to be the most rapid way to increase WUE. The interaction of fertilizers with the use of water appears to have received little attention in semi-arid regions and, in combination with appropriate tillage, should result in increases in WUE.

The interaction of WUE and yield stability is another major subject worthy of further investigation. Changing from extensive agriculture with low plant populations but relatively stable yield to intensive agriculture with higher populations but more unpredictable yield may improve WUE but may not improve the lot of the farmers. Attention needs to be given to long-term investigations of how yield and WUE can be increased without sacrificing yield stability.

## Acknowledgement

I am grateful to my colleagues at the O.D.A. Microclimatology Group, School of Agriculture, University of Nottingham and at the Department of Soil Science for access to their results. I thank the Overseas Development Administration of the UK for financial assistance.

## References

- Azam-Ali, S.N., Gregory, P.J., and Monteith, J.L.** 1984a. Effects of planting density on water use and productivity of pearl millet (*Pennisetum typhoides*) grown on stored water. I. Growth of roots and shoots. *Experimental Agriculture* 20:203–214.
- Azam-Ali, S.N., Gregory, P.J., and Monteith, J.L.** 1984b. Effects of planting density on water use and productivity of pearl millet (*Pennisetum typhoides*) grown on stored water. II. Water use, light interception and dry matter production. *Experimental Agriculture* 20:215–224.
- Bierhuizen, J.F., and Slatyer, R.O.** 1965. Effect of atmospheric concentration of water vapour and CO<sub>2</sub> in determining transpiration-photosynthesis relationship of cotton leaves. *Agricultural Meteorology* 2:259–270.
- Bolton, F.E.** 1981. Optimizing the use of water and nitrogen through soil and crop management. *Plant and Soil* 58:231–248.
- Briggs, L.J., and Shantz, H.L.** 1913. The water requirements of plants. II. A review of literature. *Bulletin, United States Department of Agriculture, Bureau of Plant Industry* no. 285.
- Brown, P.L.** 1971. Water use and soil water depletion by dryland winter wheat as affected by nitrogen fertilization. *Agronomy Journal* 63:43–46.
- Chang, T.T., and Loresto, G.C.** 1986. Screening techniques for drought resistance in rice. Pages 108–129 *in* Approaches for incorporating drought and salinity resistance in crop plants (Chopra, V.L., and Paroda, R.S., eds.). New Delhi, India: IBH.
- Cooper, P.J.M., Gregory, P.J., Keatinge, J.D.H., and Brown, S.C.** 1987. Effects of fertilizer, variety and location on barley production under rainfed conditions in northern Syria. 2. Soil water dynamics and crop water use. *Field Crops Research* 16:67–84.
- Cooper, P.J.M., Gregory, P.J., Tully, D., and Harris, H.C.** 1987. Improving water use efficiency of annual crops in the rainfed farming systems of West Asia and North Africa. *Experimental Agriculture* 23:113–158.
- Day, W., Legg, B.J., French, B.K., Johnston, A.E., Lawlor, D.W., and de C. Jeffers, W.** 1978. A drought experiment using mobile shelters: the effects of drought on barley yield, water use and nutrient uptake. *Journal of Agricultural Science (UK)* 91:599–623.
- de Wit, C.T.** 1958. Transpiration and crop yields. *Verslagen van Landbouwkundige Onderzoek* no. 64.6. Wageningen, Netherlands: Institute of Biology and Chemical Research on Field Crops and Herbage.
- DLFRS (Dryland Farming Research Scheme).** 1985. Phase III, final report. Vol.1. Spacing studies of sorghum and maize. Gaborone, Botswana: Ministry of Agriculture.
- Farquhar, G.D., and Richards, R.A.** 1984. Isotopic composition of plant carbon correlates with water-use efficiency of wheat genotypes. *Australian Journal of Plant Physiology* 11:539–552.
- Goudriaan, J., and van Laar, H.H.** 1978. Relations between leaf resistance, CO<sub>2</sub>-concentration and CO<sub>2</sub>-assimilation in maize, beans, lalang grass and sunflower. *Photosynthetica* 12:241–249.
- Gregory, P.J.** 1984. Water availability and crop growth in arid regions. *Outlook on Agriculture* 13:208–215.
- Gregory, P.J.** 1987. Root growth of legume crops (*Cicer arietinum*, *Lens culinaris*, *Pisum sativum* and *Vicia faba*) and effects of water and salt stress. *In* World crops: cool season food legumes (Summerfield, R.J., ed.). Dordrecht, Netherlands: Martinus Nijhoff.
- Gregory, P.J., Shepherd, K.D., and Cooper, P.J.M.** 1984. Effects of fertilizer on root growth and water use of barley in northern Syria. *Journal of Agricultural Science (UK)* 103:429–438.
- Gregory, P.J., and Squire, G.R.** 1979. Irrigation effects on roots and shoots of pearl millet (*Pennisetum typhoides*). *Experimental Agriculture* 15:161–168.
- Grove, A.T.** 1977. The geography of semi-arid lands. *Philosophical Transactions of the Royal Society of London*, B278:457–475.
- Hons, F.M., and McMichael, B.L.** 1986. Planting pattern effects on yield, water use and root growth of cotton. *Field Crops Research* 13:147–158.

- ICRISAT** (International Crops Research Institute for the Semi-Arid Tropics). 1978. Environmental physics: report of work 1977–1978. Patancheru, A.P. 502 324, India:ICRISAT (Limited distribution). 155 pp.
- ICRISAT** (International Crops Research Institute for the Semi-Arid Tropics). 1985. Agroclimatology: multilocal water-balance studies in Niger. Pages 298–301 in Annual report 1984. Patancheru, A.P. 502 324, India: ICRISAT.
- Jones, M.J.** 1987. Soil water and crop production in Botswana. *Soil Use and Management* 3:74–79.
- Jones, M.J., and Wild, A.** 1975. Soils of the West African Savanna. Technical Communication no. 55, Harpenden, UK: Commonwealth Bureau of Soils.
- Kallsen, C.E., Sammis, T.W., and Gregory, E.J.** 1984. Nitrogen and yields as related to water use of spring barley. *Agronomy Journal* 76:59–64.
- Kampen, J., and Burford, J.** 1980. Production systems, soil-related constraints, and potentials in the semi-arid tropics, with special reference to India. Pages 141–165 in *Priorities for alleviating soil-related constraints to food production in the tropics*. Los Baños, Laguna, Philippines: International Rice Research Institute.
- Kilewe, A.M., and Ulsaker, L.G.** 1984. Topographical modification of land to concentrate and redistribute runoff for crop production. *East African Agricultural and Forestry Journal* 44:254–265.
- Lawes, J.B.** 1850. Experimental investigation into the amount of water given off by plants during their growth; especially in relation to the fixation and source of their various constituents. *Journal of the Horticultural Society of London* 5:38–63.
- Monteith, J.L.** 1986a. Significance of the coupling between saturation vapour pressure deficit and rainfall in monsoon climates. *Experimental Agriculture* 22:329–338.
- Monteith, J.L.** 1986b. How do crops manipulate water supply and demand? *Philosophical Transactions of the Royal Society of London, A* 36:245–259.
- Pearcy, R.W., and Ehleringer, J.** 1984. Comparative ecophysiology of C<sub>3</sub> and C<sub>4</sub> plants. *Plant, Cell and Environment* 7:1–13.
- Penman, H.L., and Schofield, R.K.** 1951. Some physical aspects of assimilation and transpiration. *Symposium of the Society of Experimental Biology* 5:115–129.
- Rao, R.C.N., Simmonds, L.P., Azam-Ali, S.N., and Williams, J.H.** 1989. Population, growth and water use of groundnut maintained on stored water. 1. Root and shoot growth. *Experimental Agriculture* 25.
- Rees, D.J.** 1986. Crop growth, development and yield in semi-arid conditions in Botswana. I. The effects of population density and row spacing on *Sorghum bicolor*. *Experimental Agriculture* 22:153–167.
- Rijtema, P.E., and Endrodi, G.** 1970. Calculation of production of potatoes. *Netherlands Journal of Agricultural Science* 18:26–36.
- Ritchie, J.T.** 1983. Efficient water use in crop production: discussion on the generality of relations between biomass production and evapotranspiration. Pages 29–44 in *Limitations to efficient water use in crop production* (Taylor H.M., Jordan, W.R., and Sinclair, T.R., eds.). Madison, Wisconsin, USA: American Society of Agronomy.
- Simmonds, L.P., and Azam-Ali, S.N.** 1989. Population, growth and water use of groundnut maintained on stored water. IV. The influence of population on water supply and demand. *Experimental Agriculture* 25.
- Sinclair, T.R., Tanner, C.B., and Bennett, J.M.** 1984. Water-use efficiency in crop production. *Bioscience* 34:36–40.
- Smith, R.C.G., and Harris, H.C.** 1981. Environmental resources and restraints to agricultural production in a mediterranean-type environment. *Plant and Soil* 58:31–57.
- Squire, G.R., Gregory, P.J., Monteith, J.L., Russell, M.B., and Singh, P.** 1984. Control of water use by pearl millet (*Pennisetum typhoides*). *Experimental Agriculture* 20:135–149.
- Tanner, C.B.** 1981. Transpiration efficiency of potato. *Agronomy Journal* 73:59–64.

**Tanner, C.B. and Sinclair, T.R.** 1983. Efficient water use in crop production: research or research? Pages 1-27 *in* Limitations to efficient water use in crop production (Taylor, H.M., Jordan, W.R., and Sinclair, T.R., eds.). Madison, Wisconsin, USA: American Society of Agronomy.

**Taylor, H.M., and Klepper, B.** 1978. The role of rooting characteristics in the supply of water to plants. *Advances in Agronomy* 30:99-128.

**Virmani, S.M., Sivakumar, M.V.K., and Reddy, S.J.** 1978. Rainfall probability estimates for selected locations of semi-arid India. Research Bulletin no. 1. Patancheru, A.P. 502 324, India: International Crops Research Institute for the semi-arid Tropics. 127 pp.

**Virmani, S.M., Reddy, S.J., and Bose, M.N.S.** 1980. A handbook on the rainfall climatology of West Africa: data for selected locations. Information Bulletin no. 7. Patancheru, A.P. 502 324, India: International Crops Research Institute for the semi-arid Tropics.

**Walker, G.K., and Richards, J.E.** 1985. Transpiration efficiency in relation to nutrient status. *Agronomy Journal* 77:263-269.

**Weatherwax, P.** 1954. Indian corn in Old America. New York, USA: Macmillan.

**Wong, S.C., Cowan, I.R., and Farquhar, G.D.** 1979. Stomatal conductance correlates with photosynthetic efficiency. *Nature* 282:424-426.

# Soil Fertility Management and Water Relationships

A.B. Onken<sup>1</sup> and C.W. Wendt<sup>2</sup>

## Abstract

*In many arid and semi-arid regions, rainfall is the primary or only source of water. Cultural practices that reduce runoff and evaporation and enhance infiltration are important in making the maximum amount of water available to a crop. It is equally important for the crop to utilize water efficiently once it is made available. An important factor is the chemical nature of the soils, including, but not limited to, soil fertility which in West Africa is a major consideration, because most soils of the region are nutrient deficient, have low cation-exchange capacities, and a low pH. Data presented show the importance of selecting the proper variety for fertilizer response and nutrient sufficiency, and combining various other cultural practices having a positive effect on yield and water-use efficiency (WUE). There is also evidence to show that fertilizer and available water interact such that at some unestablished point, water becomes limiting and fertilizer applications will not increase yield or WUE. Water-conserving practices that increase available water by reducing runoff, increasing infiltration, and reducing evaporation can become economically feasible only when nutrient deficiencies are corrected. There is no doubt that research on the chemistry and fertility of soils in Sahelian Africa is one of the key factors to increase and sustain crop production there.*

## Résumé

**Gestion de la fertilité des sols et relations hydriques :** *Dans un grand nombre des régions semi-arides, les pluies constituent la source première, voire unique, d'eau. Les pratiques culturelles limitant le ruissellement et l'évaporation et accentuant l'infiltration sont essentielles pour mettre les quantités maximales d'eau à la disposition des cultures. Il est aussi important que les cultures utilisent efficacement l'eau mise à leur disposition. La chimie du sol est l'un des facteurs (incluant la fertilité, mais ne se limitant pas à cet aspect) qui influencent notablement l'efficacité de l'utilisation de l'eau par les cultures. En Afrique de l'Ouest, la fertilité revêt une importance primordiale du fait que la plupart des sols de la région manquent d'un ou plusieurs éléments nutritifs et souffrent de faibles pH et de médiocres capacités d'échange des bases.*

*Il ressort des données présentées qu'il est essentiel de sélectionner des variétés adaptées à l'application d'engrais, de remédier aux carences en éléments nutritifs et de combiner diverses autres pratiques culturelles ayant un effet positif sur le rendement pour accroître la productivité et l'efficacité de l'utilisation de l'eau (EUE). On a pu démontrer que l'humidité disponible et la fertilisation réagissent de telle sorte l'une sur l'autre que l'eau devient un facteur limitant à un certain point et que l'application d'engrais n'élèvera plus ni les rendements ni l'EUE. Les pratiques de conservation de l'eau qui augmentent les quantités d'eau disponibles en limitant le ruissellement, en élevant le taux d'infiltration et en réduisant l'évaporation ne sont économi-*

---

1. Texas Agricultural Experiment Station, Texas A&M University, RT 3, Box 29, Lubbock, TX, USA.

2. Ph.D. Candidate, Purdue University, West Lafayette, IN, USA.



*quement réalisables qu'après compensation des carences en éléments nutritifs. En définitive, l'augmentation de la production agricole et sa stabilité en zone sahélienne passent forcément par une connaissance approfondie de la chimie et de la fertilité des sols de la région.*

## Introduction

Population growing at a rate greater than food production in arid and semi-arid regions of the world emphasize the need for improved use of limited water resources. In many arid and semi-arid regions, rainfall is the primary or only source of water and each increment must be utilized to the fullest extent to increase food production. Cultural practices that reduce runoff and evaporation and enhance infiltration are important in making the maximum amount of the water resource available to a crop. However, this is only one component of the system. It is equally important that once water is made available, the crop utilizes it efficiently to produce the desired results.

A factor that significantly affects efficient water utilization by crops is the chemical nature of the soil, including, but not limited to, soil fertility. In West Africa, soil fertility is a major consideration because most soils of the region are deficient in one or more nutrients (Bationo et al. 1986, p. 39, and Christianson et al. 1986, p. 40). However, other soil chemistry problems exist, such as aluminum toxicity, that restrict yield in some areas and are not fully understood (Wendt et al. 1986, p. 45). This paper only considers the effects of soil fertility.

## Climate and Water

The influence of climate on water use has long been a subject of investigation. Briggs and Shantz (1913a) reported that the evaporation from a free water surface was 18% higher in northern Texas than at Akron, Colorado, and that the water requirement of wheat was 36% higher in northern Texas. The summary of de Wit (1958) further emphasized the effect of climate on water. He stated that in arid and semi-arid areas, water requirement also depends upon plant species and evaporative demand and has suggested that crop yield in dry climates is related to water use as follows:

$$Y = mT/E_0$$

where

Y = total dry matter,

T = total transpiration,

$E_0$  = mean daily free-water evaporation, and

m = a proportionality constant characteristic of the crop.

This relationship allows for correction of evaporative demand. Experimental support for this relationship has been shown and m values of 141 and 150 calculated for sorghum and millet under limited water production conditions (Hanks et al. 1969, Hanks 1983). Values of m are apparently affected by genotype and year-to-year climatic variability. Tanner and Sinclair (1983) suggest using vapor pressure deficit for E rather than evaporation. Through such corrections the authors suggest that the m values be the same in all climates.

Total dry matter (TDM) for grain sorghum has also been found to be linearly related in a positive way to evapotranspiration (ET) as well as transpiration (T) under limited water conditions (Hanks et al. 1969). Relationships between grain yield and ET are frequently less well defined, presumably due to more complex interactions between factors affecting grain yield.

Water-use efficiency (WUE) is defined as either yield per unit of transpired water or yield per unit of evapotranspiration and is expressed as follows:

$$WUE_T = Y/T$$

or

$$WUE_{ET} = Y/ET$$

Yield can be the total biomass or a usable product such as grain.  $WUE_T$  is known as the transpiration efficiency while  $WUE_{ET}$  is known as the evapotranspiration efficiency.  $WUE_T$  is important in basic studies of crops while  $WUE_{ET}$  is the common parameter evaluated under field conditions (Power 1983).

In the extensive review by Briggs and Shantz (1913b), the effects of soil moisture content, soil type, cultivation, cropping, soil temperature, climate, parasites, plant treatment, leaf area, age, and plant species on water requirement were discussed. Since the review, climate, soil (type and water re-

tention), plant species, and leaf area characteristics in relation to  $WUE_T$  have received considerable attention. Early studies were concerned with the  $WUE_T$  of different plant species (Briggs and Shantz 1913a, Shantz and Piemiesel 1927) at different locations. Crops such as wheat, oats, barley, and rye had lower  $WUE_T$  than corn, sorghum, and millet. Hanks (1983) points out that the C3 plants (wheat, oats, barley, and rye) have a lower  $WUE_T$  than C4 plants (corn, sorghum, and millet).

Viets (1962) has proposed six possible models for relationships between yield and ET, and yield and  $Y/ET$ . Published container and field data for several crops and forages suggest that yield relationships to ET and  $Y/ET$  most often fit two possible models suggested by Viets (1962), shown in Figure 1 (Viets 1962, Hanks et al. 1969, Hanks 1983). The case in Figure 1a is where a positive linear relationship exists between Y and ET, ET being a positive value when Y is zero. This results in a positive curvilinear relationship between Y and  $Y/ET$  since evaporation becomes a smaller proportion of ET as ET increases because evapora-

tion, when Y is zero, is wasted. The case in Figure 1b is where ET and Y are independent and is relevant after a substantially complete crop cover has been established. This results in a positive linear relationship between Y and  $Y/ET$ .

## Fertilizers and Water-Use Efficiency

Past reviews demonstrate that water requirement of crops grown on poor soil may be reduced by one-half to two-thirds by the addition of fertilizers (Briggs and Shantz 1913b, Power 1983, Viets 1962). Many studies have been conducted to show that fertilizers increase yield, but there has been little emphasis on the use of fertilizers to increase WUE. Management practices can increase the efficient use of water, but the influence of nutrients on  $WUE_T$  is difficult to assess under field conditions because of the variation in water loss to soil evaporation among treatments (Ritchie 1983).

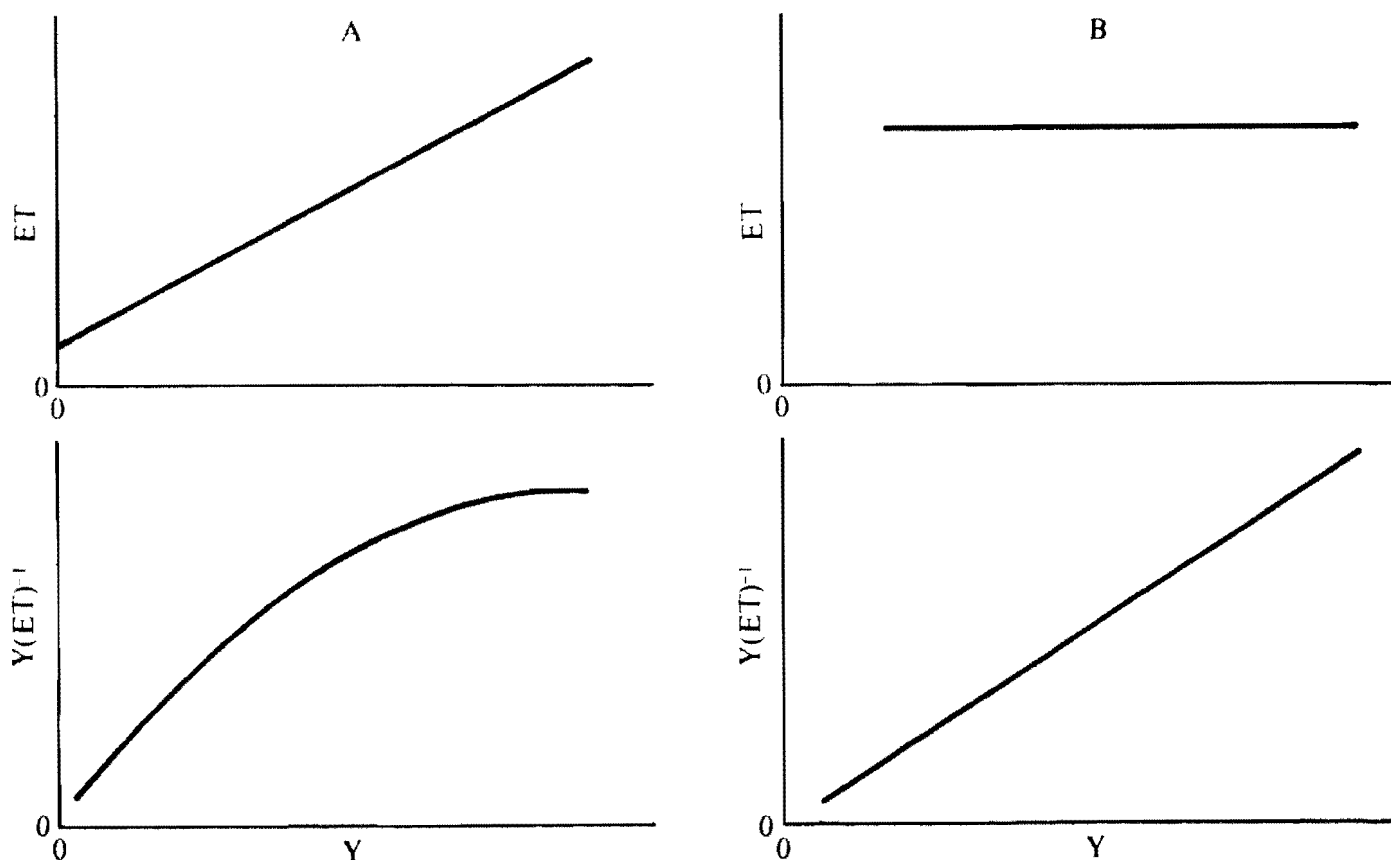

Figure 1. Two of six possible models of the relationships between evapotranspiration (ET) and dry matter yield (Y) and water use efficiency  $[Y(ET)^{-1}]$  and Y proposed by Viets 1962.

Since these studies were conducted, cultivars have been found which differ in nutrient-use efficiency. Further, as pointed out by Walker and Richards (1985), little consideration has been given to the effects of specific nutrients on  $WUE_T$ . Also, there is little quantitative data on the influence of different moisture levels on  $WUE_T$ .

We investigated the relationship between yield and ET, and yield and  $Y/ET$  for grain sorghum genotypes differing in nutrient-use efficiency (kg of grain  $kg^{-1}$  of nutrient available) on nutrient-deficient soils. Four genotypes were grown rainfed on nutrient (N or P)-deficient soils at three locations.

The data show a significant positive linear relationship between grain produced and ET (Fig. 2), and fits the model suggested by Viets (1962), shown in Figure 1A. The linear model in this case, however, was not as good as the one shown in Figure 3 between grain yield and  $WUE_{ET}$  which had a highly significant positive linear correlation.

Factors that affect grain yield in sorghum also affect ET and  $WUE_{ET}$ . Table 1, for example, shows the effects of fertilizer response of different sorghum lines. The four breeding lines were grown on low- and high-N soils under rainfed conditions. The line R6956 had the highest yield response to

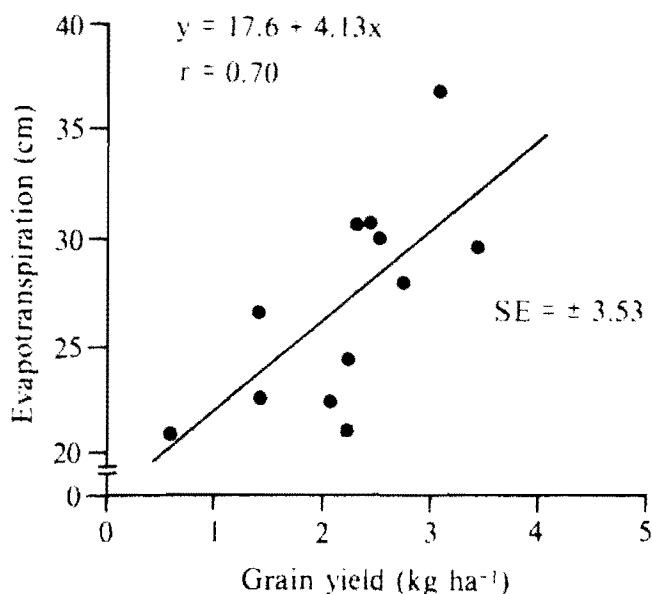

Figure 2. Relationship of evapotranspiration and grain yield of four sorghum genotypes grown under rainfed conditions on nutrient-deficient soils at three locations.

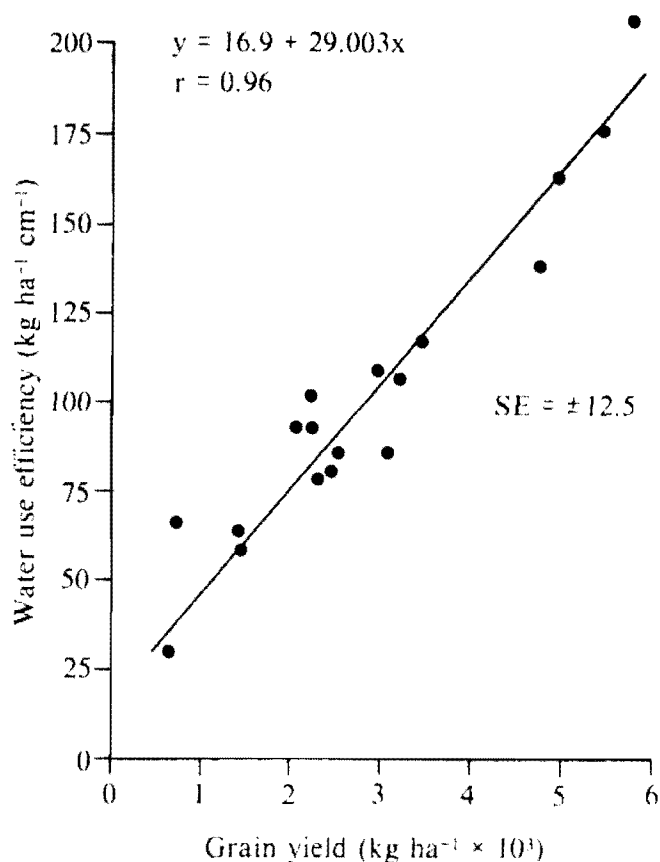

Figure 3. Relationship of water use efficiency ( $WUE_{ET}$ ) and grain yield for four sorghum genotypes grown under rainfed conditions on nutrient-deficient and nutrient-sufficient soils at two locations.

applied N and SC325 the lowest, with SC630-11E and 77CS1 being intermediate. ET increased with increasing yield due to the breeding line or N application in some cases, but changed little or decreased in other cases. Increased yield due to N application or the breeding line resulted in increased  $WUE_{ET}$ . The greatest increases in  $WUE_{ET}$  occurred with breeding lines most responsive to N application. Thus, if  $WUE_{ET}$  is to be increased through fertilizer application, it will be necessary to select sorghum varieties most responsive to fertilizer.

In another study it was found that grain yield of rainfed sorghum increased with increasing N levels and plant populations (Welch et al. 1966). Sorghum was grown in a factorial combination of 11.2, 27.4, 44.7, and 67.2 thousand plants  $ha^{-1}$  with 0, 56, and 112  $kg N ha^{-1}$ . Yields increased with N level and plant population with little increase in water use due to the limited supply available. Thus, any treatment of N or population that increased yield increased  $WUE_{ET}$ .

**Table 1. Grain yield (kg ha<sup>-1</sup>), ET (cm), and WUE<sub>ET</sub> (kg ha<sup>-1</sup> cm<sup>-1</sup>) for four grain sorghum genotypes grown at two N levels under rainfed conditions.<sup>1</sup>**

| Genotype  | Grain yield |        | ET    |        | WUE <sub>ET</sub> |        |
|-----------|-------------|--------|-------|--------|-------------------|--------|
|           | Low N       | High N | Low N | High N | Low N             | High N |
| R6956     | 2989        | 5837   | 27.7  | 28.5   | 108               | 205    |
| SC630-11E | 3107        | 5469   | 36.5  | 31.3   | 85                | 175    |
| 77CS1     | 2531        | 4786   | 29.8  | 34.9   | 85                | 137    |
| SC325     | 2354        | 3206   | 30.5  | 29.9   | 77                | 107    |

1. Low N = 40 kg of residual nitrate-N ha<sup>-1</sup> in top 90 cm. High N = 180 kg of fertilizer N applied ha<sup>-1</sup>.

In order to more carefully delineate the relationship between sorghum genotype, water level, and nutrient level on WUE<sub>ET</sub>, we conducted a controlled study in minilysimeters under a rainout shelter. There were two water levels one, where 100% of the transpired water was added weekly, and the other, where 50% of the transpired water was added weekly. Fertility levels were 0, 10, 20, 40, and 80 mg N kg<sup>-1</sup> of soil. SC630-11E and 77CS1 were the two sorghum cultivars evaluated. Two plants of each sorghum cultivar were grown in 75 L minilysimeters containing a N-deficient soil treated as indicated above. To prevent soil-water evaporation, the surface was covered with plastic and gravel leaving two holes through which water was added. These were covered with styrofoam. The containers were weighed twice weekly with a load cell-electric chain hoist system. At the end of the study, the water transpired, dry mass of shoots, and dry mass of roots were determined. From these data, the water requirement (WR = g H<sub>2</sub>O used per g dry matter produced) and m values were determined.

**Table 2. Growth and development of sorghum cultivars SC630-11E and 77CS1.**

| Stage                              | SC630-11E | 77CS1     |
|------------------------------------|-----------|-----------|
| Planted                            | 8 Jun     | 8 Jun     |
| Emergence                          | 11-13 Jun | 11-13 Jun |
| 7 leaf stage of growth             | 10 Jul    | 10 Jul    |
| Water requirement study initiation | 17 Jul    | 17 Jul    |
| Maximum leaf area                  | 6 Aug     | 21 Aug    |
| Full bloom                         | 10 Aug    | 26 Aug    |
| Harvest (black layer)              | 25 Sep    | 14 Oct    |
| Average pan evaporation            | 9.4 mm    | 8.6 mm    |

The pertinent data for the growth and development of sorghum are listed in Table 2. It can be seen that the average daily pan evaporation was less for 77CS1 because of the longer growing season.

Tanner and Sinclair (1983) corrected data by Briggs and Shantz (1913b) for differences in evaporative demand using pan evaporation (Table 3). Even after the correction, there were up to 16% differences in WR/pan. Such differences could be important in crop production.

The water requirement of the different treatments in our study are listed in Table 4. It can be seen that if only shoot mass is considered, differences due to treatment are not well delineated. However, when roots and shoots are included, there were significant differences in water requirement between cultivars (SC630 > 77CS1), fertility level (0 = 20 > 80 mg kg<sup>-1</sup>), and water level (high > low). These data indicate that roots as well as shoots should be included in WUE<sub>ET</sub>. Briggs and Shantz (1913a) included only shoot masses in their studies.

The same was true for m values. The higher the m value the more efficient the treatment (Table 5). The m values obtained are much higher than those

**Table 3. Water requirement (WR) of Grim alfalfa at different stations in the Great Plains (Briggs and Shantz 1913b).**

| Location                | WR   | Pan                                | WR/<br>Pan |
|-------------------------|--|------------------------------------|------------|
|                         | (g H <sub>2</sub> O<br>g <sup>-1</sup> DM) | average<br>(mm day <sup>-1</sup> ) |            |
| Williston, North Dakota | 518  | 4.04                               | 128        |
| Newell, South Dakota    | 630  | 4.75                               | 133        |
| Akron, Colorado         | 853  | 5.74                               | 149        |
| Dalhart, Texas          | 1005                                       | 7.77                               | 129        |

**Table 4. Water requirement (WR) of grain sorghum genotypes as influenced by fertility and water levels, Lubbock, Texas, 1985.**

| Genotype                                    | WR (g H <sub>2</sub> O g <sup>-1</sup> DM) |                  |
|---|--|------------------|
|   | Shoots                                     | Shoots and roots |
| SC630-11E                                   | 318 a <sup>1</sup>                         | 277 a            |
| 77CS1                                       | 305 a                                      | 221 b            |
| Fertility level<br>(mg N kg <sup>-1</sup> ) |  |                  |
| 0   | 316 a                                      | 258 a            |
| 10  | 317 a                                      |                  |
| 20  | 312 ab                                     | 256 a            |
| 40  | 317 a                                      |                  |
| 80  | 293 b                                      | 233 b            |
| Water level                                 |  |                  |
| High  | 315 a                                      | 265 a            |
| Low   | 307 a                                      | 233 b            |

1. Means followed by the same letter in the same column do not differ significantly at the  $P < 0.05$ .

**Table 5. Estimate of *m* for two sorghum genotypes as affected by water and fertility levels, Lubbock, Texas, 1985.**

| Genotype                                    | <i>m</i> values     |                  |
|---|---------------------|------------------|
|   | Shoots              | Shoots and roots |
| SC630-11E                                   | 30.0 a <sup>1</sup> | 34.3 b           |
| 77CS1                                       | 28.2 a              | 39.3 a           |
| Water level                                 |                     |                  |
| High  | 28.5 a              | 34.3 b           |
| Low   | 29.6 a              | 38.4 a           |
| Fertility level<br>(mg N kg <sup>-1</sup> ) |                     |                  |
| 0   | 28.6 a              | 35.6 b           |
| 10  | 28.7 a              |                  |
| 20  | 29.0 a              | 35.7 b           |
| 40  | 28.3 a              |                  |
| 80  | 30.7 a              | 39.2 a           |

1. Means followed by the same letter in the same column do not differ significantly at the  $P < 0.05$ .

calculated by Hanks (1983) and de Wit (1958) but were lower than those calculated by Howell and Musick (1985).

As previously indicated, treatment differences were due to significant changes in dry matter.

**Table 6. Dry matter production of two sorghum genotypes as influenced by fertility and water levels, Lubbock, Texas, 1985.**

| Genotype                                 | Dry matter means (g) |      |              |                  |
|--|----------------------|------|--------------|------------------|
|  | Shoot                | Root | Root + shoot | Root/shoot ratio |
| SC630                                    | 201 b <sup>1</sup>   | 25 b | 226 b        | 8.0 a            |
| 77CS1                                    | 224 a                | 79 a | 303 a        | 2.8 b            |
| Water level                              |                      |      |              |                  |
| High                                     | 256 a                | 55 a | 311 a        | 4.7 a            |
| Low                                      | 169 b                | 49 a | 218 b        | 3.4 b            |
| Fertility level (mg N kg <sup>-1</sup> ) |                      |      |              |                  |
| 0  | 187 c                | 46 b | 233 c        | 4.1 a            |
| 20                                       | 216 b                | 49 b | 265 b        | 4.4 a            |
| 80                                       | 235 a                | 61 a | 296 a        | 3.9 a            |

1. Means pairs or triplets in columns followed by the same letter do not differ significantly at the  $P < 0.05$ .

These data are presented in Table 6. Cultivar 77CS1 had 10% more shoot mass and 300% more root mass than SC630. Different water levels caused significant differences in shoot masses, while the different fertility levels caused significant differences in both shoot and root masses.

## Conclusion

The reported data show the importance of selecting the proper variety for fertilizer response, correcting nutrient deficiencies, and combining various other cultural practices having a positive effect on yield for increasing yield and WUE. There is also evidence to show that fertilizer and available water interact such that at some point water becomes limiting and fertilizer applications will not increase yield or WUE. Water-conserving practices that increase available water by reducing runoff, increasing infiltration, and reducing evaporation can become economically feasible only when nutrient deficiencies are corrected. Establishing the level of available water in a soil for which fertilizer applications or other cultural practices will have no effect is important and needs to be demonstrated experimentally since it will depend upon soil, crop, and climatic factors.

## References

- Bationo, A., Mkwunye, V., Henao, and Hellums, D.T.** 1986. The use of phosphate rock to build up phosphorus fertility in a West African Entisol. *Agronomy Abstracts*. 294 pp.
- Briggs, L.J., and Shantz, H.L.** 1913a. The water requirements of plants. I. Investigations in the Great Plains in 1910 and 1911. *Bulletin, United States Department of Agriculture, Bureau of Plant Industry* no. 284.
- Briggs, L.J., and Shantz, H.L.** 1913b. The water requirements of plants. II. A review of literature. *Bulletin, United States Department of Agriculture, Bureau of Plant Industry* no. 285.
- Christianson, B., Bationo, A., and Henao, J.** 1986. Nitrogen fertilizer efficiency in millet growing areas in Niger. *Agronomy Abstracts*. 294 pp.
- de Wit, C.T.** 1958. Transpiration and crop yields. *Verslagen van Landbouwkundig Onderzoek* no 64.6. Wageningen, Netherlands: Institute of Biology and Chemical Research on Field Crops and Herbage.
- Hanks, R.J., Gardner, H.R., and Florian, R.L.** 1969. Plant growth-evapotranspiration relations for several crops in the Central Great Plains. *Agronomy Journal* 61:30-34.
- Hanks, R.J.** 1983. Yield and water-use relationships: an overview. Pages 393-412 *in* Limitations to efficient water use in crop production (Taylor, H.M., Jordan, W.R., and Sinclair, T.R., eds.). Madison, Wisconsin, USA: American Society of Agronomy.
- Howell, T.A., and Musick, J.T.** 1985. Relationships of dry matter production of field crops to water consumption. Pages 247-269 *in* Les besoins en eau des cultures. Conférence internationale, 11-14 Sep 1984. INRA, Paris, France: Institut national de la recherche agronomique.
- Power, J.F.** 1983. Soil management for efficient water use: soil fertility. Pages 461-470 *in* Limitations to efficient water use in crop production (Taylor, H.M., Jordan, W.R., and Sinclair, T.R., eds.). Madison, Wisconsin, USA: American Society of Agronomy.
- Ritchie, J.T.** 1983. Efficient water use in crop production: discussion on the generality of relations between biomass production and evapotranspiration. Pages 29-44 *in* Limitations to efficient water use in crop production (Taylor, H.M., Jordan, W.R., and Sinclair, T.R., eds.). Madison, Wisconsin, USA: American Society of Agronomy.
- Shantz, H.L., and Piemiesel, L.N.** 1927. The water requirements of plants at Akron, Colorado. *Journal of Agricultural Research* 34:1093-1190.
- Tanner, C.B., and Sinclair, T.R.** 1983. Efficient water use in crop production: research or research? Pages 1-27 *in* Limitations to efficient water use in crop production (Taylor, H.M., Jordan, W.R., and Sinclair, T.R., eds.). Madison, Wisconsin, USA: American Society of Agronomy.
- Viets, F.G., Jr.** 1962. Fertilizers and efficient use of water. *In* *Advances in Agronomy* 14:223-264.
- Walker, G.K., and Richards, J.E.** 1985. Transpiration efficiency in relation to nutrient status. *Agronomy Journal* 77:263-269.
- Welch, N.H., Burnett, E., and Eck, H.V.** 1966. Effect of row spacing, plant population, and nitrogen fertilization on dryland sorghum production. *Agronomy Journal* 58:160-163.
- Wendt, J.W., Chase, R.G., and Hossner, L.R.** 1986. Aluminium toxicity and other causes of variability in millet growth in Niger, West Africa. *Agronomy Abstracts*.



# Conjunctive Use of Rainfall and Irrigation in Semi-Arid Regions

B.A. Stewart<sup>1</sup>

## *Abstract*

*Supplemental irrigation can be beneficial when there is sufficient rainfall to sustain, but not necessarily to increase crop production. The efficient use of such water, however, requires understanding of the relationship between transpiration, evapotranspiration, and water application rates to dry matter and grain yield. The objectives of this paper are (1) to assess the likely yield increase that can result from supplemental irrigation, and (2) to present strategies for application of limited amounts of irrigation water. When irrigation supplies are adequate, water is generally added in sufficient quantities to ensure the production of high yields. If water supplies are limited, operators must choose between cutting back on the amount of land irrigated or on the amount of water applied to each unit of land irrigated. Data presented for grain sorghum show that limited amounts of irrigation water can be used more efficiently by applying small amounts to more land than by fully irrigating less land. However, the extent of the benefits and economics of the practice depend on many factors.*

## *Résumé*

**Utilisation conjointe de l'eau de pluie et de l'irrigation dans les régions semi-arides :** *L'irrigation d'appoint peut être bénéfique dans une situation où elle complète l'apport de précipitations suffisantes pour assurer une stabilité de la production agricole mais où l'eau continue d'être un facteur limitant. Toutefois, l'utilisation efficace de cette eau dépend d'une bonne compréhension des relations existant entre taux de transpiration, évapotranspiration et apport d'eau d'une part, et rendements en matière sèche, en grain, d'autre part. Les objectifs de cette étude consistent : (1) à évaluer l'augmentation probable de rendement découlant d'une irrigation d'appoint et (2) à définir quelques stratégies d'apport d'eau d'irrigation en quantités limitées. Dans le cas où la réserve est satisfaisante, l'eau est ajoutée en quantités suffisantes pour assurer de hauts rendements. Si elle est insuffisante, les exploitants devront choisir entre la réduction des surfaces irriguées ou celle des quantités d'eau apportées par surface unitaire irriguée. Les données recueillies pour le sorgho montrent que dans le cas où l'apport d'eau est limité, l'application de petites quantités sur une plus grande surface assurera une meilleure efficacité d'utilisation qu'une irrigation complète pratiquée sur une surface moindre. Toutefois, les avantages et la rentabilité de l'opération dépendent d'un grand nombre d'autres facteurs.*

---

1. Laboratory Director, USDA-ARS, Conservation and Production Research Laboratory, P.O. Drawer 10, Bushland, TX 79012, USA. ICRISAT (International Crops Research Institute for the Semi-Arid Tropics). 1989. Soil, Crop, and Water Management Systems for Rainfed Agriculture in the Sudano-Sahelian Zone: proceedings of an International Workshop, 7-11 Jan 1987. ICRISAT Sahelian Center, Niamey, Niger. Patancheru, A.P. 502 324, India: ICRISAT.



## Introduction

Rainfed agriculture has not received adequate attention in the past because many policymakers feel that irrigation is the key element in food security. Irrigated cereal production in the Sahel region received almost three times more donor assistance than rainfed cereal production from 1975 to 1983, even though 95% of cereal production comes from dryland farming or traditional irrigation systems (Club du Sahel, CILSS 1985). Debate continues regarding the priority that should be given to irrigation development, but with costs for bringing new land under irrigation exceeding \$10000 ha<sup>-1</sup> in some cases, there is a clear need to give added attention to rainfed agriculture.

This paper deals with the conjunctive use of rainfall and irrigation, with emphasis on rainfall. In the semi-arid regions, several times, limited amounts of water from runoff or groundwater are available for supplemental irrigation to increase crop production significantly. The efficient use of such water, however, requires a good understanding of the relationship between transpiration, evapotranspiration, and water application rates to dry matter and grain yield. The objectives of this paper are (1) to assess the likely yield increase that can result from supplemental irrigation, and (2) to present strategies for application of limited amounts of irrigation water. The discussion will be limited to grain sorghum (*Sorghum bicolor* (L.) Moench), and examples will be based largely on studies at the USDA Conservation and Production Research Laboratory, Bushland, Texas, carried out on a Pullman clay loam soil (fine, mixed thermic Torrertic Paleustolls).

## Relationship Between Yield and Evapotranspiration

Strong correlations usually occur between cumulative seasonal dry matter and cumulative seasonal transpiration (de Wit 1958, Arkley 1963). De Wit showed that for dry climates with high radiation, yield and transpiration were related as

$$y/T = m/T_{\max},$$

where

- Y = total dry matter mass per area,  
T = total transpiration per area from emergence to harvest,

T<sub>max</sub> = mean daily 'free water evaporation' for the same period and

m = a constant governed mainly by species, and is largely independent of soil nutrition and water availability unless plant growth is seriously nutrient-limited, or soil water is too high, causing lack of aeration or leaching of nutrients.

Since transpiration is difficult to separate from evaporation from the soil surface, the total evapotranspiration (ET) is most often measured.

Transpiration and evapotranspiration are closely correlated, particularly after a plant canopy has formed. A theoretical representation of dry matter yield as a function of evapotranspiration is shown in Figure 1. Assuming linear extrapolation, the intercept on the evapotranspiration axis represents evaporation from the soil surface. Also, for crops that have a relatively constant harvest index, the harvestable portion of the crop can be substituted in the relationship. For grain sorghum, the yield of grain can be used on the Y axis.

Figure 2 shows a compilation of data from the Conservation and Production Research Laboratory, Bushland, Texas, for grain sorghum. The data of Jones (O.R. Jones, personal communication, of unpublished results, 1958-1983) represents

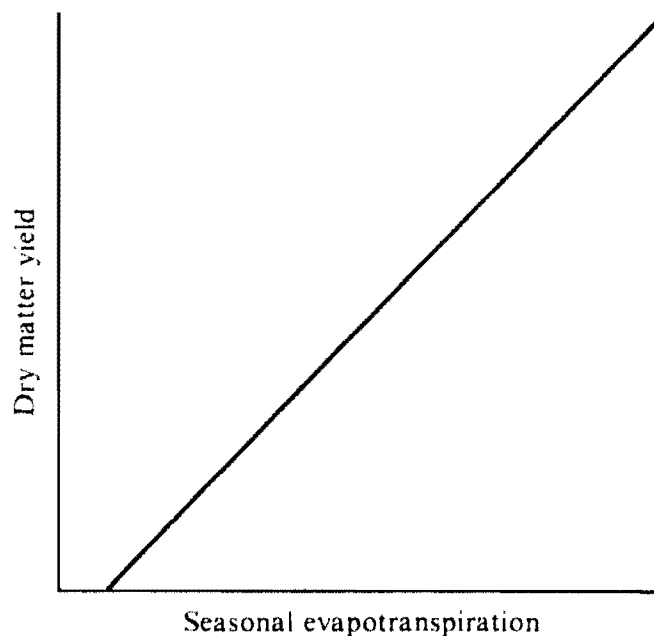
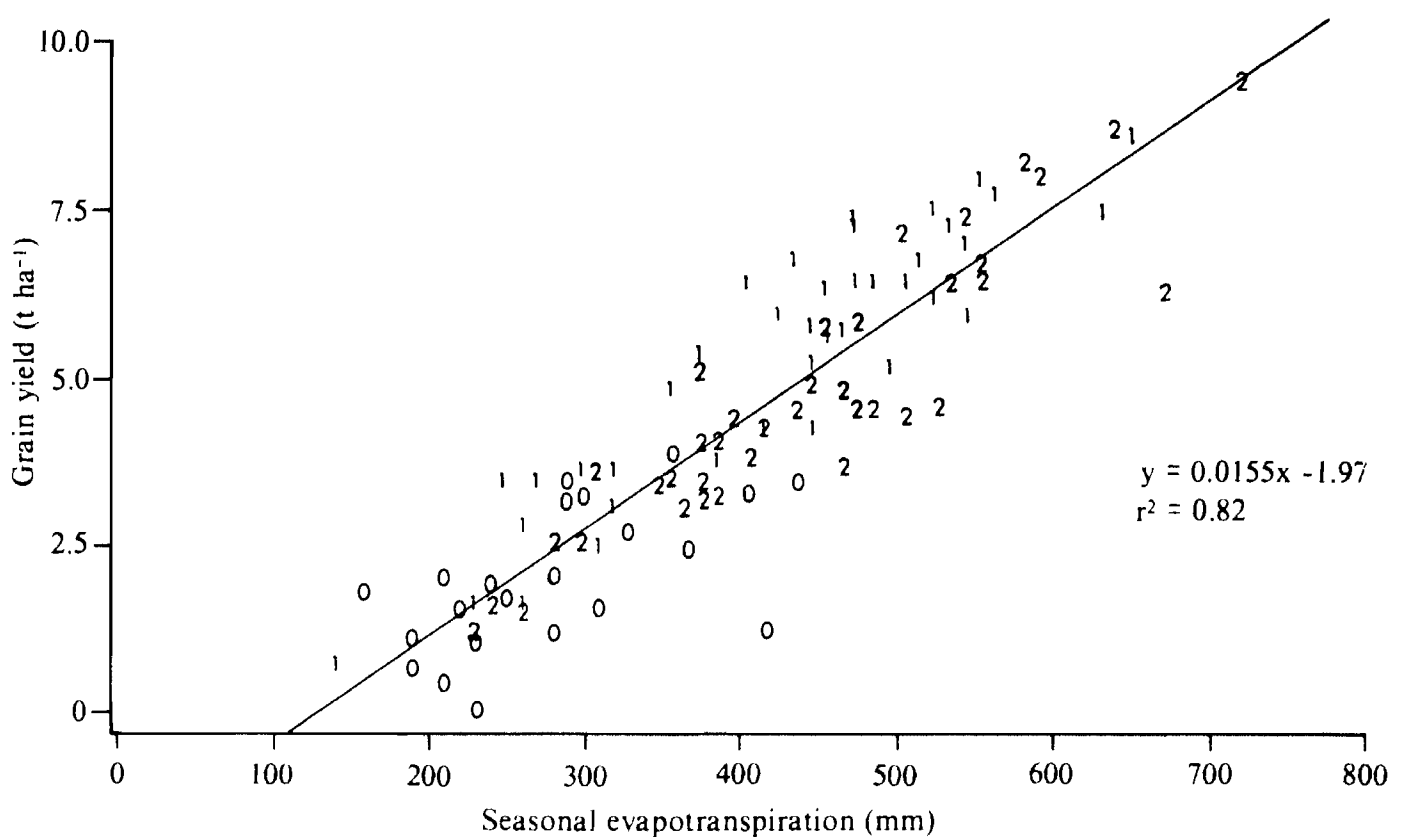

Figure 1. Representation of the relationship between dry matter yield and seasonal evapotranspiration.



**Figure 2. Relationship between yield of grain sorghum and seasonal evapotranspiration at the USDA Conservation and Production Research Laboratory, Bushland, Texas, USA (0 = O.R. Jones, personal communication; 1 = Musick and Dusek 1971; 2 = Stewart et al. 1983).**

26 years of dryland grain sorghum production. The data of Stewart et al. (1983) were collected in 1979–1981, and those of Musick and Dusek (1971) are from the years 1963–1965. There is a very good linear relationship between grain yield and evapotranspiration, with 15.5 kg ha<sup>-1</sup> of grain produced for each mm (1.55 kg m<sup>-3</sup>) of evapotranspiration above the estimated threshold value of 126 mm.

Figure 3 shows a similar relationship, but in addition to the Bushland, Texas, data used in Figure 2, it includes data from the United States, Israel, and several locations in India. The relationship found using these data showed that 15 kg ha<sup>-1</sup> of grain was produced for each mm (1.50 kg m<sup>-3</sup>) of evapotranspiration above an estimated threshold value of 94 mm. The relationship was surprisingly good, considering the diversity of the data used.

There is a tendency for a majority of the data from Bushland, Texas, and Israel to be below the regression line, and a majority of the data from India, Kansas, and College Station, Texas, to be above the line. This is probably because vapor-pressure deficits over the growing season are generally greater for the Bushland, Texas, and

Israel locations. As vapor-pressure deficit increases, maximum evapotranspiration increases, and it requires a greater evapotranspiration level to maintain a given yield level. As a 'first approximation', the relationship presented in Figure 3 can be used to estimate the benefit that can be expected from supplemental irrigation of adapted hybrid grain sorghum in semi-arid regions of the world. Certainly the actual yield increase for any specific location and year will vary, but this relationship can serve as a guideline until data for specific conditions are obtained.

The data in Figures 2 and 3 represent a variety of conditions with respect to the amount of water supplied by rainfall or irrigation, and the time of water application. Although grain sorghum does show a remarkable ability to compensate and adjust to stress conditions, there are growth stages that are more critical than others. Based on a large number of irrigation studies in the Southern High Plains of the United States, Musick (1984) concluded that good yield responses and efficient use of water are achieved when water is applied at the mid-boot and flowering stages, and that the

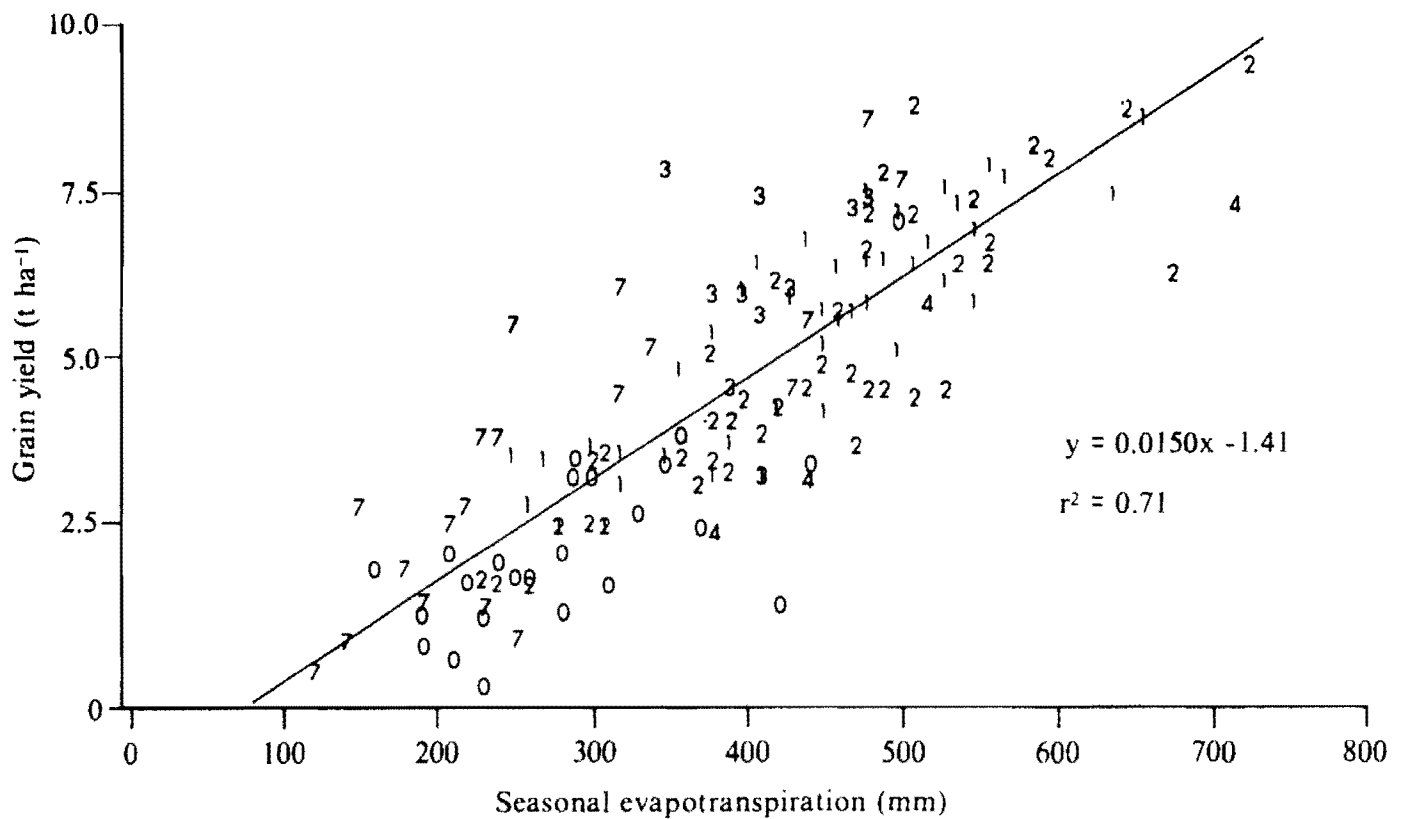

**Figure 3. Relationship between yield of grain sorghum and seasonal evapotranspiration for various locations (0 = O.R. Jones, personal communication, Texas, USA; 1 = Musick and Dusek 1971, Texas, USA; 2 = Stewart, et al. 1983, Texas, USA; 3 = Owonubi and Kanemasu 1982, Kansas, USA; 4 = Bielorai et al. 1964, Israel; 5 = Howell and Hiler 1975, Texas, USA; 6 = Stewart et al. 1975, California, USA; 7 = Seetharama et al. 1982, compilation of India studies; 8 = Stone et al. 1978, Kansas, USA; and 9 = Chaudhuri and Kanemasu, 1982, Kansas, USA).**

response and efficiency are much lower when water is applied at the 6–8 leaf stage and at the milk to soft dough stage. Similarly, Doorenbos and Kassam (1979) stated that where rainfall is not sufficient and irrigation water is limited, irrigation should be based on avoiding water deficits during the periods of peak water use, from flowering to the early yield formation period.

The timing of irrigation or rainfall can certainly influence where particular data points fall when plotted as shown in Figures 2 and 3. Timely additions will result in points above the fitted line, while untimely additions will result in lower than predicted efficiencies.

### **Relationship Between Evapotranspiration and Applied Water**

The relationship between yield and seasonal evapotranspiration is linear; the relationship between

evapotranspiration and applied water is usually not. The general effect of applied water (which can be rainfall, irrigation water, or a combination of the two) on evapotranspiration (Y axis) is shown in Figure 4. The amount on the left-hand side of zero on the X axis represents the amount of stored soil water utilized by the crop during the growing season. Some of the water added during the growing season from either rainfall or irrigation may be lost as runoff or deep percolation, or may remain in the soil at the end of the growing season. Small amounts of water added early in the growing season are lost through evaporation and may not increase transpiration or yield.

The extent to which the curve in Figure 4 deviates from a 1:1 slope indicates the extent of runoff and percolation losses or the amount of applied water that remains in the soil at harvest time. While it may be beneficial in some situations to have considerable quantities of soil water remaining at harvest time, it often lowers water-use

efficiency, because the storage efficiency of rainfall during the fallow period will be reduced if the profile is already partially charged. Musick (1970) showed a significant negative relationship between the antecedent soil water after harvest and pre-season storage efficiency. When less than 20 mm of

plant available soil water remained at harvest, more than 40% of the precipitation received during the non-growing season was present in the 1.2-m soil profile at seeding time of the next crop. When more than 90 mm remained at harvest time, less than 15% of the precipitation that occurred during the fallow season was stored as soil water.

The amount of water lost by runoff or deep percolation varies greatly depending on many site factors. Where rainfall occurs along with or closely following an irrigation, runoff can be very high, resulting in low water-use efficiency and high losses of soil by erosion.

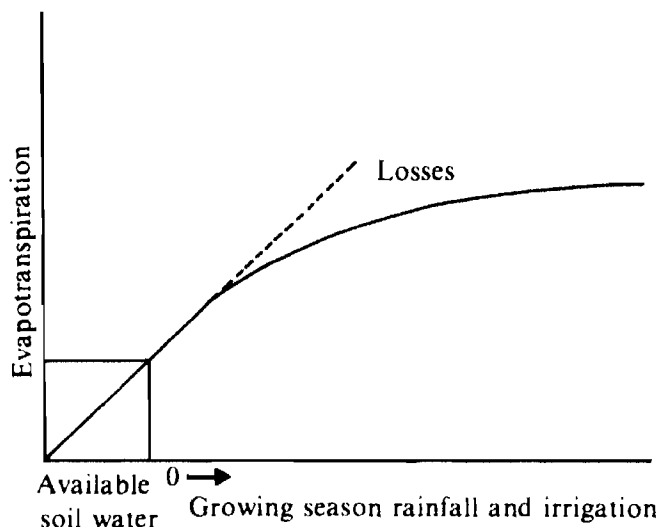

Figure 4. Generalized relationship between increasing growing season water inputs and seasonal evapotranspiration.

### Relationship Between Water-Use Efficiency and Yield

The term water-use efficiency (WUE) is used in many ways. It is generally defined as  $Y/ET$ , and the highest WUE will always be at the highest yield. This is necessarily so because the relationship of  $Y-ET$ , generalized in Figure 1, is linear, and the X intercept (evapotranspiration) is greater than zero. Therefore, the greater the yield, the greater the WUE. Figure 5 shows the data presented earlier in

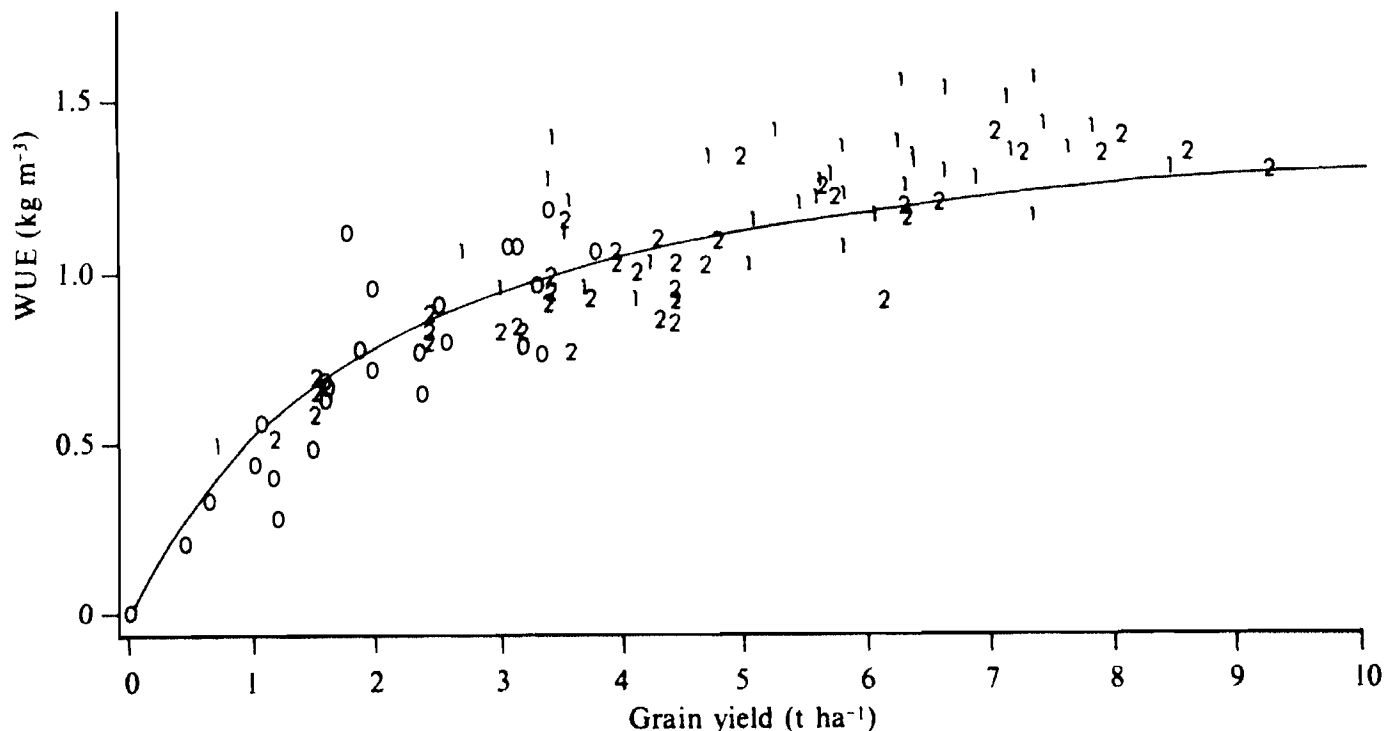

Figure 5. Relationship between water-use efficiency (WUE) and yield of grain sorghum at the USDA Conservation and Production Research Laboratory, Bushland, Texas (0 = O.R. Jones, personal communication; 1 = Musick and Dusek 1971; and 2 = Stewart et al. 1983).

Figure 2, plotted as a function of WUE against yield. WUE values were calculated as follows:

$$\text{WUE (kg m}^{-3}\text{)} = \text{yield (t ha}^{-1}\text{)} \times 100 / \text{seasonal ET (mm)}$$

The WUE value was about  $0.7 \text{ kg m}^{-3}$  at a yield level of  $2 \text{ t ha}^{-1}$  and about  $1.1 \text{ kg m}^{-3}$  at a yield level of  $5 \text{ t ha}^{-1}$ . The line drawn through the points was calculated from the regression line in Figure 2.

Since there is a linear relationship between evapotranspiration and yield, yield can be substituted for evapotranspiration on the Y axis (Fig. 4). In this case, WUE is defined as:

$$\text{WUE} = \text{yield} / \text{water available during growing season.}$$

It reaches an optimum level and then generally decreases as available water increases during the growing season. To achieve maximum yield, irrigation applications must be sufficient to meet maximum crop water demands, but this greatly increases the chance of deep percolation or runoff. In addition, considerable soil water will likely remain in the soil at harvest time, thus reducing WUE.

Supplemental irrigation can be beneficial when there is sufficient rainfall to sustain crop production and when lack of water still limits crop growth. If the irrigation source is adequate, water should be added in sufficient quantities, particularly at critical growth stages, to ensure production of high yields. If water available for supplemental irrigation is limited but the amount of dryland grain sorghum that must be irrigated is large, management decisions become more difficult. Should a small amount of land be irrigated for high yields or should the irrigation water be spread over more land? Figure 4 indicates that, especially with sorghum, a limited amount of water can be used more efficiently (in terms of evapotranspiration) by spreading it over more land because losses to runoff and leaching are less.

## Strategies for Applying Limited Irrigation Amounts

### Limited Irrigation-Dryland Farming Systems

Stewart et al. (1983) developed a limited irrigation-dryland (LID) farming system for the efficient use

of limited supplies of irrigation water for grain sorghum production. The objective of the LID concept is to maximize the conjunctive use of the growing-season rainfall, which varies for any given year, with a limited supply of irrigation water, which is fixed for a given year. The unique feature of the LID system is the flexible adjustment, during the crop growing season, of the amount of land irrigated, allowing more land to be irrigated during above average rainfall years than during dry years. Risk is low with the LID system, and response is good in favorable rainfall years.

The LID system concept is illustrated in Figure 6. A graded furrow field, 600 m long on a 0.3–0.4% slope, was divided into three water-management sections. The upper half of the field was the 'fully irrigated' section. The next one-fourth was the 'tailwater runoff' section that utilized furrow runoff from the fully irrigated section. The lower one-fourth was the 'dryland' section capable of receiving and utilizing runoff from irrigation or rainfall on the wetter, fully irrigated and tailwater runoff

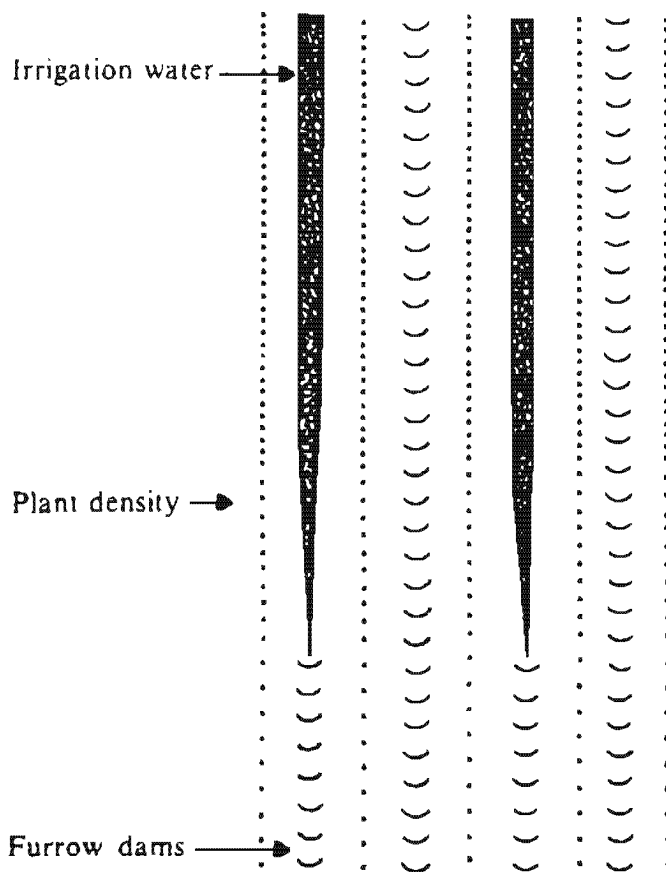
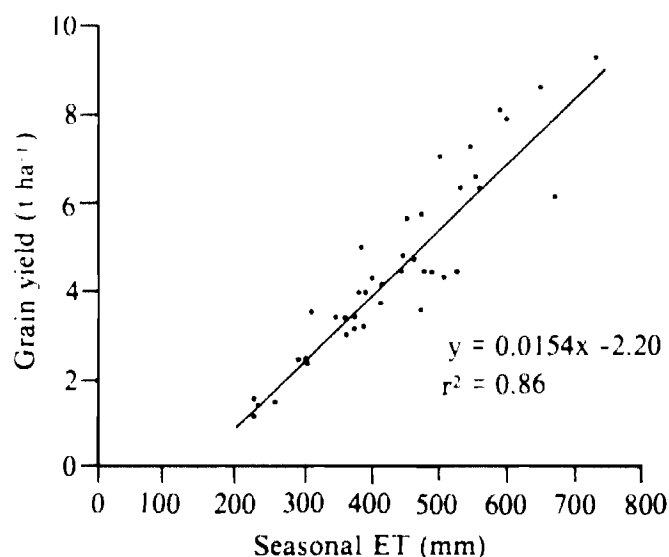

Figure 6 Schematic drawing of the Limited Irrigation-Dryland (LID) System.

sections. Plant densities were reduced down the field to alleviate stress because irrigation water was decreased as the distance down the field increased. Furrow dams (Clark and Jones 1980) were placed almost every 4 m throughout the length of the field. Alternate 76-cm furrows were irrigated, and the dams in the irrigated furrows were notched to ensure that irrigation water moved over dams and down the furrow rather than across the beds. The remaining furrow dams on the lower part of the field and the dams in the nonirrigated furrows for the entire length of the field prevented rainfall runoff. A predetermined amount of irrigation water was applied at regular time intervals. The extent to which the entire field was irrigated depended on the rainfall received. The wetter the year, the greater the advance of a fixed application down the field. The objective was to prevent or minimize any water from rainfall or irrigation from leaving the field. More recent studies with the LID system have utilized a medium-seeding rate throughout the field, and furrow dams in only alternate furrows that are not used for irrigation. These changes make the system somewhat easier to manage, and the benefits are similar. Removal of dams from irrigated furrows also minimizes deep drainage at the upper end of the field.

Results from using LID for three years are shown in Figures 7 and 8. When grain yields were plotted as a function of seasonal ET, a linear rela-



**Figure 7. Relationship between grain yield of sorghum and seasonal evapotranspiration for the Limited Irrigation-Dryland (LID) System.**

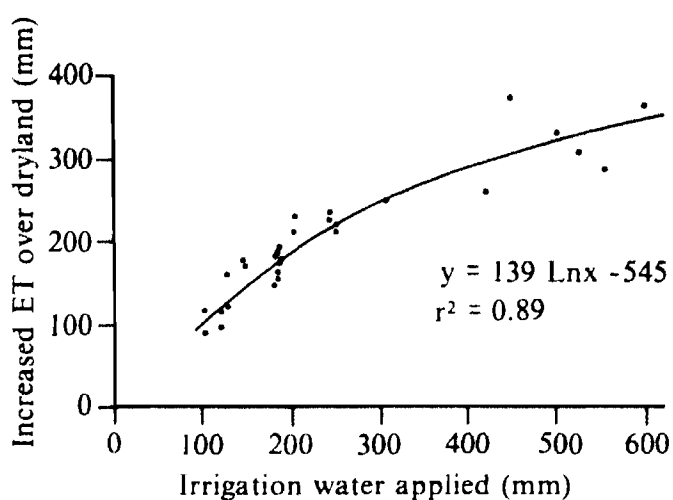

**Figure 8. Increase in evapotranspiration of irrigated grain sorghum over dryland grain sorghum as a result of the amount of supplemental irrigation water applied by the Limited Irrigation Dryland (LID) System.**

tionship was found, which is in consonance with the earlier discussion of Figures 1, 2, and 3. Therefore, the highest WUE, defined as yield of grain/seasonal ET, was obtained when the yield was highest. The highest yields were obtained by full irrigation of every furrow to supply sufficient water to meet evapotranspiration demands. The lowest yields, shown in Figure 7, were from dryland plots, and the remainder of the yields were from the LID system plots that received either 125, 185, or 250 mm of irrigation water during the growing season. The amounts of water were based on the entire field, but, as shown in Figure 6, the upper end of the field received a greater amount and the lower end of the field received none or very limited amounts of water. The values presented are the integrated yields and ET amounts for the entire field.

Figure 8 shows the increase in ET of the various plots as a function of the amount of irrigation water applied.

Evapotranspiration increased with increasing applied irrigation water, and as ET increased, grain yield increased (Fig. 7). However, the WUE defined as yield of grain/unit of irrigation water applied, decreased as amounts of irrigation water increased. When only 100–200 mm of irrigation water were applied (Fig. 8), there was almost an equivalent increase in ET. This is because the LID system prevents runoff, provides very little oppor-

tunity for leaching, and very little available soil water remains in the profile at harvest time. The highest grain yields occurred at the highest irrigation levels, but the data in Figure 8 illustrates that 500–600 mm of irrigation water had to be applied to produce an increase in ET of about 350 mm. This is because substantial amounts of rainfall and irrigation water are lost as runoff and large quantities of available soil water remaining in the soil at physiological maturity. Deep percolation losses were not considered remarkable in the reported study.

The data shown in Figure 8 for field conditions demonstrate the validity of the generalized relationship in Figure 5, and clearly show that limited amounts of irrigation water can be used more effi-

ciently on grain sorghum by applying small amounts to more land than by fully irrigating less land.

### Alternating Strips of Grain Sorghum with Wheat

Musick and Dusek (1975) conducted a six-year study in which grain sorghum and winter wheat (*Triticum aestivum* L.) were grown in alternating 4.5-m wide drill strips. Since the two crops have completely different growing seasons, outside crop rows could benefit from a border effect when no crop was growing on adjacent strips. Each strip contained six beds separated by five inside fur-

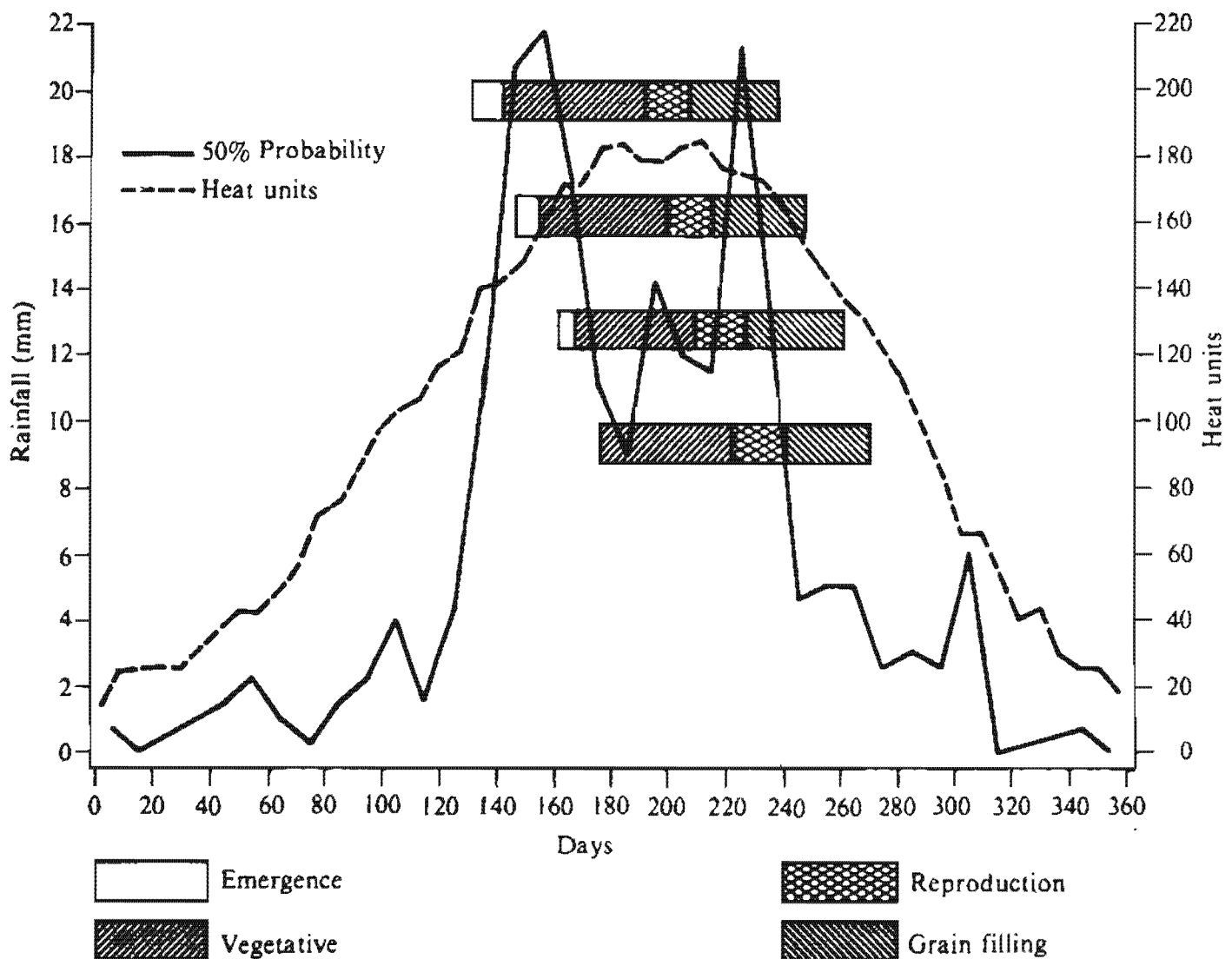

Figure 9. Weekly heat units ( $0^{\circ}\text{C}$ ) exceeded in 50% of the years and 10-day precipitation amounts exceeded in 50% of the years for the Conservation and Production Research Laboratory, Bushland, Texas. The four boxes represent grain sorghum seeded at four different dates.

rows. In one irrigation scheme, water was applied to two furrows in each six-bed strip. Each of the four inside beds had an irrigated furrow on one side and a nonirrigated furrow on the other. The two outside rows functioned as border rows and were not adjacent to an irrigated furrow.

The objective of the system was to utilize the rainfall during the non-growing period of one crop more efficiently than it would be if it was stored in the soil for the next crop. For example, rainfall during the non-growing period of annually cropped wheat averaged 207 mm per season during the study. Storage efficiency measured at wheat planting time in another study averaged only 21% (Johnson and Davis 1972). In principle, alternating strips of grain sorghum with winter wheat should allow for more efficient use of the rainfall. During the study, the irrigation water applied was about 45% less than in full irrigation conditions and yields were about 25%. Thus, the system offers considerable potential for increasing use efficiency of both rainfall and limited irrigation water. This concept could possibly apply to some intercropping systems where crops of different maturity lengths are grown in adjacent rows. The primary disadvantage of the system is that it requires moving irrigation equipment twice over the area being irrigated during a growing season.

### Timing of Supplemental Irrigation Water

The strategies discussed above were designed to add relatively small increments of irrigation water several times during the growing season. In some situations, water may be available only for one irrigation. As already stated, the best time to apply irrigation water to grain sorghum is at the mid-boot and flowering stages. However, the rainfall probability profile should be considered as well as the growth stage of the crop. For example, the data presented in Figure 9 show the growth stage of grain sorghum for four seeding dates. The 10-day rainfall amounts exceeded rainfall in 50% of the years and the number of weekly heat units ( $^{\circ}\text{C}$  above 0) exceeded the number of heat units in 50% of the years. If only one irrigation is applied to the early-seeded grain sorghum, it should be scheduled towards the end of the vegetative period when the air temperature is highest and the probability for

rainfall is relatively low. For late-seeded grain sorghum, irrigation should perhaps be applied somewhat earlier because rainfall is more likely to occur during the later growth stages.

## References

- Arkley, R.J.** 1963. Relationship between plant growth and transpiration. *Hilgardia* 34:559-584.
- Bielorai, H., Arnon, J., Blum, A., Elkana, Y., and Ress, A.** 1964. The effect of irrigation and interrow spacing on grain sorghum production. *Israel Journal of Agricultural Research* 14:227-236.
- Chaudhuri, U.N., and Kanemasu, E.T.** 1982. Effect of water gradient on sorghum growth, water relations, and yield. *Canadian Journal of Plant Science* 62:599-607.
- Clark, R.N., and Jones, O.R.** 1980. Furrow dams for conserving rainwater in a semi-arid climate. Pages 198-206 *in* Proceedings of the American Society of Agricultural Engineers Conference on Crop Production with Conservation in the 80's, 1-2 Dec 1980, Chicago, Illinois, USA. ASAE Publication 7-81. St. Joseph, Michigan, USA: American Society of Agricultural Engineers.
- Club du Sahel/CILSS** 1985. Official development assistance to CILSS member countries in 1983. Paris, France: Organization for Economic Cooperation and Development.
- de Wit, C.T.** 1958. Transpiration and crop yields. Verslagen van Landbouwkundige Onderzoek no. 64.6. Wageningen, Netherlands: Institute of Biology and Chemistry Research on Field Crops and Herbage.
- Doorenbos, J., and Kassam, A.H.** 1979. Yield response to water. *FAO Irrigation and Drainage Paper* no. 33. Rome, Italy: FAO.
- Howell, T.A., and Hiler, E.A.** 1975. Optimization of water-use efficiency and high frequency irrigation. I. Evapotranspiration and yield relationship. *Transactions of the American Society of Agricultural Engineers* 18:873-878.
- Johnson, W.C., and Davis, R.G.** 1972. Research on stubble-mulch farming of winter wheat. *Conservation Research Report* no. 16. Washington, D.C., USA: US Department of Agriculture.



**Musick, J.T.** 1970. Effect of antecedent soil water on pre-season rainfall storage in a slowly permeable irrigation soil. *Journal of Soil and Water Conservation* 25:99-101.

**Musick, J.T.** 1984. Irrigation water management research—Southern Ogallala Region. Pages 98-102 *in* Proceedings Ogallala Aquifer Symposium II, Jun 1984, Lubbock, Texas. USA: Texas Tech University, Water Resource Institute.

**Musick, J.T., and Dusek, D.A.** 1971. Grain sorghum response to number, timing, and size of irrigations in the Southern High Plains. *Transactions of the American Society of Agricultural Engineers* 14:401-404.

**Musick, J.T., and Dusek, D.A.** 1975. Limited irrigation of grain sorghum in alternating strips with wheat. *Transactions of the American Society of Agricultural Engineers* 18:544-548.

**Owonubi, J.J., and Kanemasu, E.T.** 1982. Water-use efficiency of three height isolines of sorghum. *Canadian Journal of Plant Science* 62:35-46.

**Seetharama, N., Mahalakshmi, V., Bidinger, F.R., and Singh, S.** 1982. Response of sorghum and pearl millet to drought stress in semi-arid India. Pages 159-173 *in* Agrometeorology of sorghum and millet in the semi-arid tropics: proceedings of the International Symposium, 15-20 Nov 1982, ICRISAT Center, India. Patancheru, A.P. 502 324, India: International Crops Research Institute for the semi-arid tropics.

**Stewart, B.A., Musick, J.T., and Dusek, D.A.** 1983. Yield and water-use efficiency of grain sorghum in a limited irrigation-dryland system. *Agronomy Journal* 75:629-634.

**Stewart, J.I., Misra, R.D., Pruitt, W.O., and Hagan, R.M.** 1975. Irrigating corn and grain sorghum with a deficient water supply. *Transactions of the American Society of Agricultural Engineers* 18:270-280.

**Stone, L.R., Gwin, R.E., Jr., and Dillon, M.A.** 1978. Corn and grain sorghum yield and water use in response to limited irrigation. *Kansas Water News* 21:12-21.

# Wind Erosion: Mechanics, Measurement, and Control

D.W. Fryrear<sup>1</sup>

## *Abstract*

*In semi-arid and arid regions, erosion of soil by wind is an annual problem. Wind erosion mechanics have been researched, and the flow processes of surface creep, saltation, and suspension have been described. The factors responsible for the detachment of erodible particles are well understood, but the measurement of wind erosion has been difficult because of inadequate field equipment. Recent advancements in measuring equipment have made it possible to collect samples for quantity and quality determinations. Surface residue management, tillage, and wind barriers are the major methods of controlling wind erosion. Lack of adequate rainfall influences the optimum wind erosion control technique. Available rainfall may limit the quantity of residue produced, but research has shown that 30% soil cover reduces soil erosion losses by 80%. The benefits of wind erosion control with crop residues must be weighed against the utilization of residues by livestock. Ridging soils reduces soil losses by 85%, except for deep sandy soils. Timing the wind erosion control technique is important because ridging a moist, noneroding soil may provide complete control, while ridging a dry, eroding soil may provide no control.*

## *Résumé*

**Erosion éolienne—mécanismes, mesures et contrôle :** *Dans les régions arides et semi-arides, l'érosion éolienne est un problème persistant dont les aspects mécaniques ont été étudiés et les phénomènes de reptation en surface, saltation et suspension décrits. Les facteurs responsables du détachement des particules érodibles ont été bien analysés, mais l'insuffisance de matériel sur le terrain a constitué un handicap pour mesurer l'érosion éolienne. Le perfectionnement des instruments de mesure a permis de recueillir des échantillons servant à la détermination quantitative et qualitative. La gestion des résidus en surface, le travail du sol et les brise-vents constituent des techniques importantes de maîtrise de l'érosion éolienne, sensibles à l'influence d'une pluviosité insuffisante. Les eaux de pluie disponibles pourraient diminuer les quantités de résidus produites mais des études ont montré qu'une couverture du sol de 30% réduirait de 80% les pertes dues à l'érosion. L'importance des résidus comme moyen de lutte contre l'érosion doit être évaluée par rapport à leur valeur pour l'élevage. Le billonnage devrait permettre de diminuer de 80% les pertes dues à l'érosion du sol, à l'exception des sables profonds. Il est essentiel de prévoir un calendrier d'exécution des techniques de maîtrise de l'érosion éolienne, car le billonnage peut assurer un contrôle total sur un sol humide non érodible, mais nul sur un sol sec érodible.*

---

1. Agricultural Engineer, United States Department of Agriculture, Big Spring, TX, USA.

ICRISAT (International Crops Research Institute for the Semi-Arid Tropics).1989. Soil, Crop, and Water Management Systems for Rainfed Agriculture in the Sudano-Sahelian Zone: proceedings of an International Workshop, 7-11 Jan 1987. ICRISAT Sahelian Center, Niamey, Niger. Patancheru, A.P. 502 324, India: ICRISAT.

## Introduction

Wind erosion is an annual problem in many arid and semi-arid areas of the world. As these areas are extensively utilized by man, the hazard of severe wind erosion increases. The lower the rainfall, the higher the average temperature, or the more limited the soil resources, the greater is the danger of irreversible damage to the ecosystem.

Wind erosion affects a broad range of environmental factors. The problem begins when soil particle movement is initiated and intensifies as the eroded particle fluxes increase to the point of destroying plant tissue. Particles deposited in entrapment zones or on distant landscapes provide evidence of wind erosion.

## Mechanics

The movement of soil particles by wind has been a part of man's environment since recorded history (Wilson and Cooke 1980). Major dust storms have been documented in history, but the scientific study of the initiation, transport, and deposition of sand was begun by Bagnold (1941). Numerous scientists have written on wind erosion, but the contribution by Chepil and Woodruff (1963) is most notable. Whenever wind velocity exceeds the threshold velocity for a particular soil surface condition, loose soil particles become unstable and are injected into the wind stream. The denser and larger particles return to the soil surface to dislodge additional particles. This detachment accelerates until the wind stream becomes saturated with soil particles. The absolute size and distribution of particles depends on the turbulent energy of the wind and composition of the soil surface.

The mechanics of wind erosion is evident in the three modes of transport of sand or soil particles by wind, i.e., surface creep, saltation, and suspension. Surface creep is when the largest particles cannot become airborne, but roll along the soil surface. Generally, surface creep comprises 7–25% of the soil movement and consists of particles 500–1000  $\mu\text{m}$  in diameter. Slightly smaller or less dense particles of 100–500  $\mu\text{m}$  in diameter may be temporarily airborne, but return to strike the soil surface at an angle of about  $8^\circ$ . This mode of transport is called saltation and comprises 55–72% of the total flow. The smallest and lightest particles become suspended in the air stream and may be trans-

ported hundreds or thousands of kilometers. This mode, called suspension flow, comprises 3–38% of the total flow and consists of particles 2–100  $\mu\text{m}$  in diameter (Chepil 1945).

## Measurement

When the wind velocity exceeds the threshold velocity for a particular soil surface, soil particles begin moving and suspension-size particles become airborne. If the concentration becomes sufficiently high, dust clouds develop, and if the storm continues to intensify, the dust may even blot out the sun. Accounts of red snow in Europe because of dust-laden winds from North Africa (Tullett 1978) illustrate the effect of wind erosion on distant regions.

Records of dust storms are particularly valuable to illustrate the variation in erosion between years. By rating dust storms on a numerical scale (Fryrear 1981), the intensity of erosion can be quantified. Table 1 shows the Dust Storm Rating System (DSRS), an arbitrary numerical scale used to rate

**Table 1. The Dust Storm Rating System (DSRS) developed at Big Spring, Texas, USA. (Fryrear 1981).**

| DSRS numerical value | Dust Storm Description (hours listed are minimum time) |
|----------------------|--|
| 1                    | Light blowing dust >0.5 h, minimum visibility 7 km     |
| 2                    | Light blowing dust >2 h, minimum visibility 5 km       |
| 3                    | Blowing dust >4 h, minimum visibility 1.6 km           |
| 4                    | Blowing dust >4 h, minimum visibility 800 m            |
| 5                    | Blowing dust >4 h, minimum visibility 400 m            |
| 6                    | Blowing dust >6 h, minimum visibility 300 m            |
| 7                    | Heavy blowing dust >8 h, minimum visibility 200 m      |
| 8                    | Heavy blowing dust >10 h, minimum visibility 100 m     |
| 9                    | Severe blowing dust >24 h, minimum visibility 50 m     |
| 10                   | Severe blowing dust >48 h, minimum visibility 5 m      |

natural dust storms. This system was initiated to establish uniformity in quantifying dust storms at Big Spring, Texas, and may not be directly transferable to other regions (Fryrear 1981).

Under severe conditions, soil losses owing to wind erosion can be determined by measuring changes in surface elevation. This is usually applicable only under extreme conditions because a few mm of soil is equivalent to a soil loss of several  $t\ ha^{-1}$  (Chepil 1960). The volume of soil in depositional zones downwind of eroding areas can be measured to determine accumulations from a single storm or total deposition during a wind erosion season. This is a conservative measure because suspended material may pass the depositional area and thus not be included in the measure of accumulated soil.

To measure natural wind erosion in the field, special equipment has been developed by Bagnold (1941), Armbrust (1967), Merva and Peterson (1983), Steen (1977), Leatherman (1978), Bocharov (1984), and Fryrear (1986). The most recent sampler, the Big Spring No.8 (BSNE), the eighth model tested, was developed by USDA-ARS at Big Spring, Texas (Fryrear 1986). The device is inexpensive, efficient, and operates unattended for weeks. Heights up to 4 m have been sampled with the BSNE to determine vertical distribution of eroded material. From severe storms, sufficient samples may be collected for detailed physical and chemical analyses. Details of the BSNE sampler are illustrated in Figures 1a and b.

With laboratory wind tunnels, studies of wind erosion processes can be conducted by holding all except one or two factors constant. This technique has been used to identify the influence of cover, roughness, and nonerodible elements, to measure plant injury, and to simulate wind-barrier influences. Field wind erosion from very short-duration storms can be measured by using portable wind tunnels. Various soil and vegetation treatments can be established under natural rainfall and weather conditions, and the changes in erosion evaluated. Field wind tunnel tests do not require that soil or plant conditions be simulated as in laboratory conditions, but the investigator has no control over the rainfall or weather conditions. Field wind tunnel tests represent only the extreme windward edge of the field unless eroded material is introduced into the tunnel, but the tests can be extremely valuable in comparing control practices under field conditions.

Wind erosion is most effectively controlled by reducing the wind velocity at the soil surface or creating a nonerosive soil surface. Wind velocities over large land masses cannot be controlled, but it is possible to reduce the wind velocity at the soil surface with standing vegetation, wind barriers, or nonerodible materials on the soil surface.

Standing vegetation is several times more effective in reducing wind erosion losses than the same quantity of vegetation lying flat on the soil surface (Siddoway et al. 1965). However, weeds must be controlled and in many developing countries crop residues are utilized by livestock, so it is not always possible to leave vegetation standing for extended periods of time. In many cropping systems, the entire plant is harvested and no residue is available for controlling wind erosion in the field.

The major objective of a wind barrier is to reduce wind velocities over the greatest distance from the lee of the barrier. The effectiveness of wind barriers depends on the porosity and shape of the barrier and the orientation of the barrier to the prevailing wind. The barrier should have about 40% porosity (Chepil et al. 1963) to protect a distance about 10 times the height of the barrier ( $H$ ) and to reduce wind erosion along the wind direction for a distance about 20 times the height of the barrier (Hagen 1976). Dense barriers have the greatest wind reduction adjacent to the barrier but shorter protected distance. If the protected crop between the barriers is susceptible to wind damage, the barrier must provide the maximum protection possible, and the barriers may be spaced closer than  $10H$ .

Nonerodible elements are material on the soil surface that will not be moved or transported by erosive winds. These include stable soil aggregates (sometimes called clods), gravel, or rock fragments larger than the maximum size that can be transported by wind, or even large sections of plant material that have not decomposed. Soil loss is reduced by 80% if 30% of the soil surface is covered with nonerodible material (Fig. 2).

A ridged soil surface reduces wind erosion losses on most soils (Fig. 3). The larger the ridge the greater the reduction in soil loss except for deep sands. Tillage will not control wind erosion on deep sands because the ridges are unstable after rainfall or irrigation. Once the surface has been consolidated or crusted, soil roughness can be

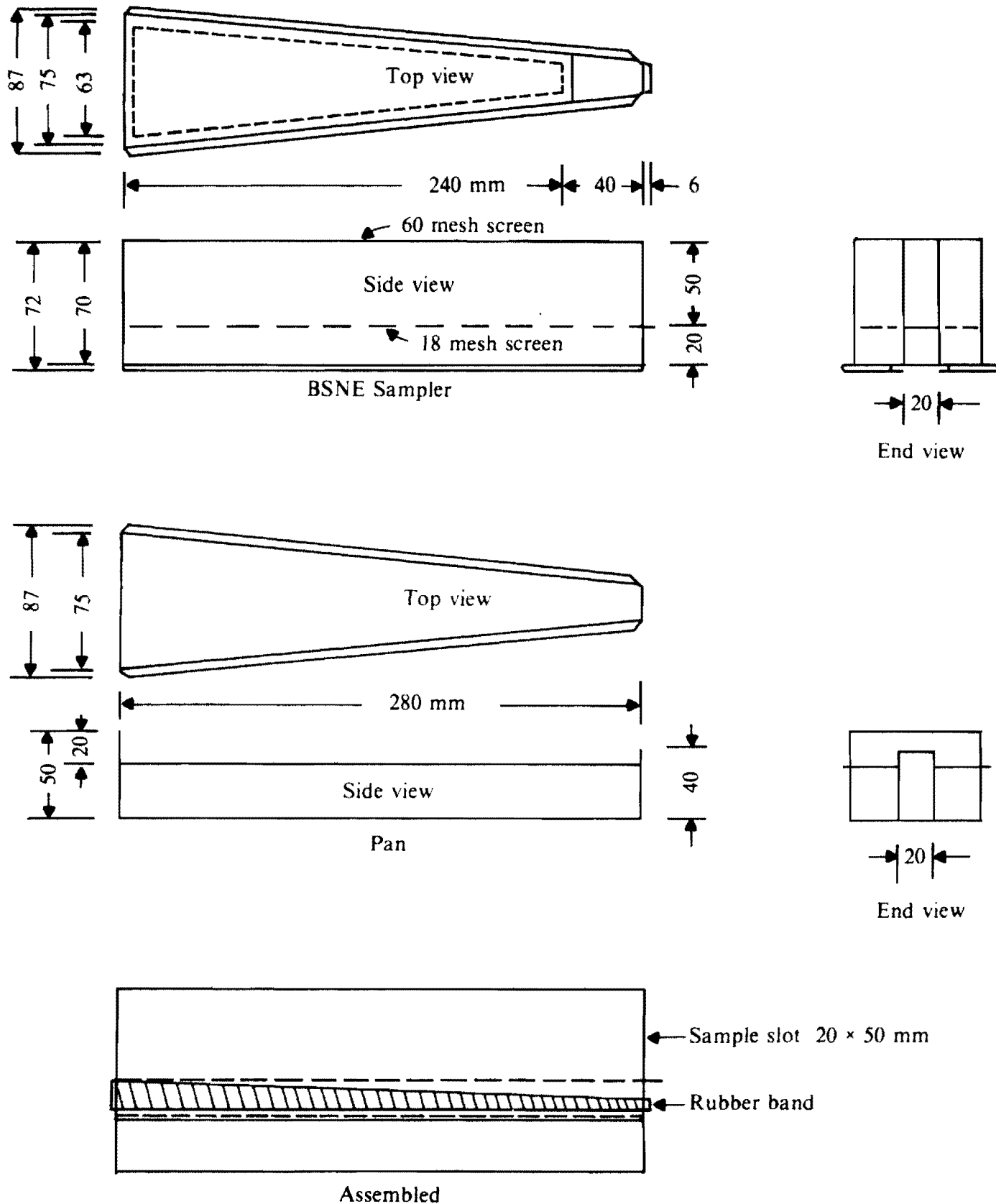

**Figure 1a. Details of the BSNE sampler. Tolerances on sample slot are  $\pm 0.1$  mm. All other dimensions are  $\pm 2$  mm. Sixty mesh screen must be made of stainless steel and 18 mesh screen must be made of steel. All joints and seams will be soldered. Rubber band must be cut from 9:50 x 15 inner tube.**

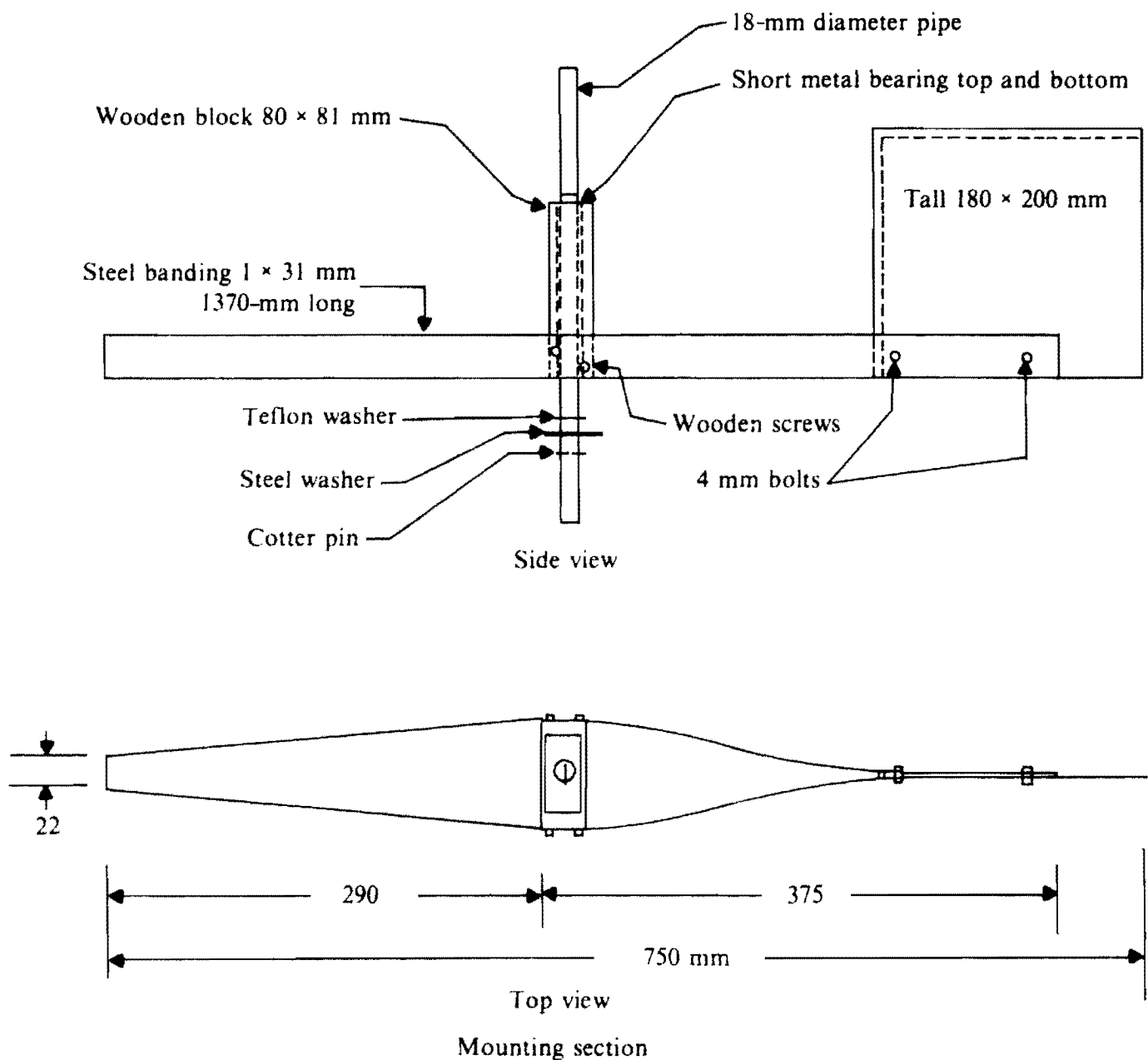

Figure 1b. Side and top view of the mounting section of the BSNE sampler. The 18-mm diameter pipe and cotter pin will be supplied by USDA. All dimensions are  $\pm 2$  mm.

increased with subsequent tillage while the surface soil is moist.

Several chemical products have been tested that successfully control wind erosion for a few weeks (Chepil et al. 1963). Armbrust and Lyles (1975) identified five polymers and one resin-in-water emulsion that reduced wind erosion for two months. However, such chemicals are expensive and their use interferes with other inputs such as herbicides and is only practical on high value crops.

Wind erosion during the crop establishment

period can destroy young seedlings, reduce crop quality, or delay crop growth. All crops are not equally susceptible to wind damage (Table 2). As crops mature, their susceptibility to wind damage decreases. Exceptions are crops such as tobacco and cabbage in which crop quality and marketability may be decreased because of tissue damage and the presence of sand grains. To protect young seedlings, farmers may use tillage implements to maintain soil roughness, or may grow wind-resistant, taller crops adjacent to the susceptible crop.

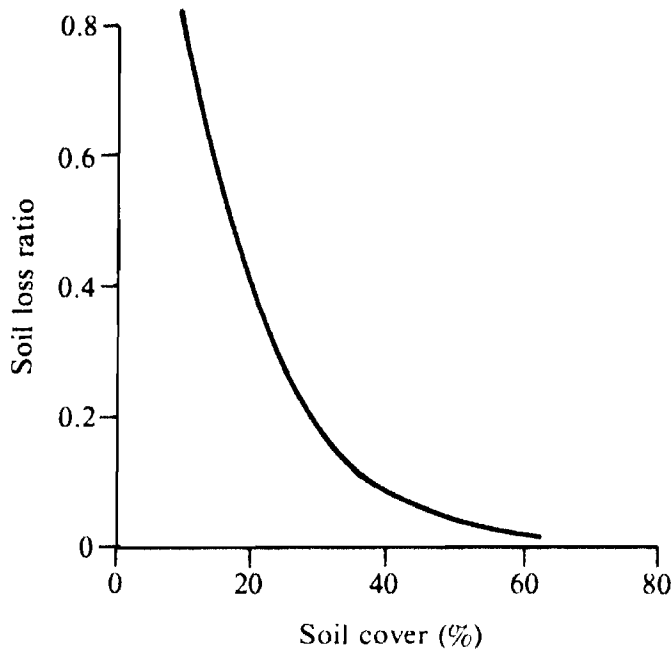

Figure 2. Relationship between soil loss ratios (soil loss with no cover equals 1), when various percentages of soil surface are covered with flat nonerodible material (Fryrear 1985).

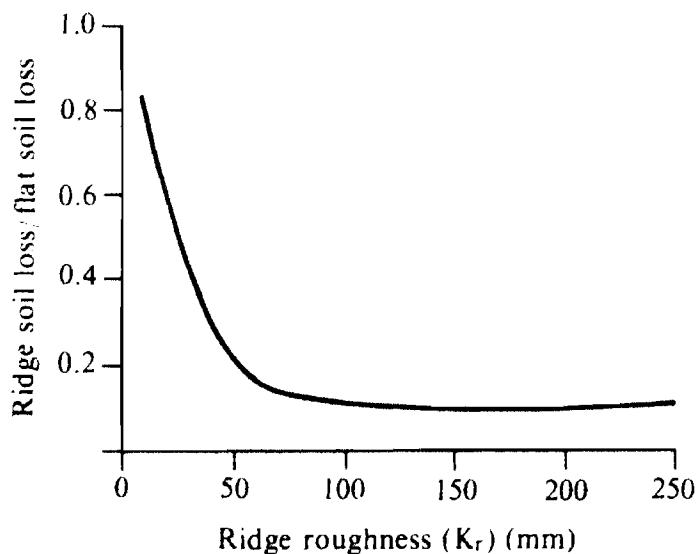

Figure 3. Relationship between soil loss ratio and soil ridge roughness ( $K_r$ ) with wind direction normal to ridges in the wind tunnel.

$$K_r = \left( \frac{4 (\text{Ridge height})^2}{\text{Distance between ridges}} \right) \quad (\text{Fryrear 1984})$$

Table 2. Crop survival rates as influenced by duration of exposure to a  $15 \text{ m s}^{-1}$  wind with a sand flux of  $0.05 \text{ kg m}^{-1} \text{ width s}^{-1}$  9–10 day old plants (Fryrear and Downes 1975).

| Crop         | Survival rates (%) at three exposure times (min) |     |     |
|--------------|--|-----|-----|
|              | 5  | 10  | 20  |
| Pepper       | 75   | 8   | 0   |
| Onion        | 100  | 100 | 100 |
| Cabbage      | 100  | 87  | 56  |
| Southern pea | 100  | 94  | 72  |
| Carrot       | 91   | 10  | 4   |
| Cucumber     | 100  | 100 | 46  |
| Cotton       | 100  | 85  | 15  |
| Sunflower    | 91   | 88  | 72  |
| Mean         | 95   | 72  | 46  |

## Conclusion

Wind erosion continues to be an annual problem in sandy areas with a semi-arid climate owing to bare, loose soil, high wind velocities, and insufficient vegetation to protect the surface. Effective wind erosion control systems have been developed for crops with much residue, e.g., conservation tillage and crop rotation. Without surface residues, the soil surface must be roughened with tillage after each rainstorm. The effectiveness of the tillage system will depend on the timeliness and type of tillage. Roughening the soil surface reduces soil movement by wind up to 90% but will not be effective on coarse-textured, single-grained soils.

Many crops will be destroyed or yields significantly reduced when seedlings are exposed to blowing sand for as little as 15 min. Farmers must strive to protect the young seedlings the first few days after emergence. Wind barriers or soil ridges oriented perpendicularly to the erosive winds can reduce crop injury. The most effective control is a well-calculated combination of surface residues, tillage, and wind barriers.

## References

- Armbrust, D.V. 1967. Design and operation of a portable soil blowing wind tunnel. USDA-ARS 41-131. Washington, D.C., USA: US Department of Agriculture.

- Armbrust, D.V., and Lyles, L.** 1975. Soil stabilizers to control wind erosion. Pages 77–82 *in* Soil conditioners. Special Publication no. 7. Madison, Wisconsin, USA: American Society of Agronomy.
- Bagnold, R.A.** 1941. The physics of blown sand and desert dunes. London, UK: Methuenard Co.
- Bocharov, A.P.** 1984. A description of devices used in the study of wind erosion of soils. New Delhi, India: Amerind Publishing Co.
- Chepil, W.S.** 1945. Dynamics of wind erosion. I. Nature of movement of soil by wind. *Soil Science* 60:305–320.
- Chepil, W.S.** 1960. Conversion of relative field erodibility to annual soil by wind. *Soil Science Society of America Proceedings* 24(2):143–145.
- Chepil, W.S., and Woodruff, N.P.** 1963. The physics of wind erosion and its control. *Advances in Agronomy* 15:211–302.
- Chepil, W.S., Woodruff, N.P., Siddoway, F.H., Fryrear, D.W., and Armbrust, D.V.** 1963. Vegetative and nonvegetative materials to control wind and water erosion. *Soil Science Society of America Proceedings* 27(1):86–89.
- Fryrear, D.W., and Downes, J.D.** 1975. Consider the plant in planning wind erosion control systems. *Transactions of the ASAE* 18(6):1070–1072, 1075.
- Fryrear, D.W.** 1981. Dust storms in the Southern Great Plains. *Transactions of the ASAE* 24(4):991–994.
- Fryrear, D.W.** 1984. Soil ridges—clods and wind erosion. *Transactions of the ASAE* 27(2):445–448.
- Fryrear, D.W.** 1985. Soil cover and wind erosion. *Transactions of the ASAE* 28(3):781–784.
- Fryrear, D.W.** 1986. A field dust sampler. *Journal of Soil and Water Conservation* 41(2):185–188.
- Hagen, L.J.** 1976. Windbreak design for optimum wind erosion control. Pages 31–36 *in* Proceedings of the Symposium on Shelterbelts on the Great Plains, 20–21 Apr 1976, Denver, Colorado, USA. Publication no. 78. Lincoln, Nebraska, USA: Great Plains Agricultural Council.
- Leatherman, S.P.** 1978. A new aeolian sand trap design. *Sedimentology* 25:303–306.
- Merva, K.R., and Peterson, G.** 1983. Wind erosion sampling in the North Central Region. ASAE Paper no. 83–2133. St. Joseph, Michigan, USA: American Society of Agricultural Engineers.
- Siddoway, F.H., Chepil, W.S., and Armbrust, D.V.** 1965. Effect of kind, amount, and placement of residue on wind erosion control. *Transactions of the ASAE* 8(3):327–331.
- Steen, B.** 1977. A possible method for the sampling of Saharan dust. Pages 279–288 *in* Saharan dust mobilization, transport, deposition: Proceedings of a Workshop, 25–28 Apr 1972, Gothenburg, Sweden. New York, USA: John Wiley.
- Tullett, M.T.** 1978. A dust fall on 6 March 1977. *Weather* 33:48–52.
- Wilson, S.J., and Cooke, R.U.** 1980. Wind erosion. Pages 217–252 *in* Soil erosion (Kirkby, M.J., and Morgan, R.P.C., eds.). New York, USA: John Wiley.





# A Study of Methods for the Revegetation of Barren Crusted Sahelian Forest Soils

R.G. Chase and E. Boudouresque<sup>1</sup>

## Abstract

*In a study on revegetation of barren crusted Sahelian forest soils, the following treatments: tillage (T), mulching with tree branches (M), and tillage followed by mulching (TM) were tested. Half the study area was exposed to grazing. No fertilizers or seeds were used. During the first rainy season (1983, rainfall 550 mm), winds and water-deposited sand left seed in the plots, particularly those with a mulch. After four months the TM-treatment area had an average dry matter stand equal to that found in naturally vegetated areas of the adjacent forest. Plots established in 1984 produced one-tenth the dry matter that the 1983 plots produced in their first year. The one-year-old TM plots produced five times more dry matter during the droughty 1984 season than did plots established in that season. The T treatment area lost and the M treatment area gained in relative dry matter production in the second year. By the third year, the T treatment lost most of its effectiveness. Plots exposed to grazing produced less biomass, partially due to the dispersal of branches by passing animals. Separate tests showed that natural areas of sand accumulation and termite activity decrease runoff rates. Mulch was shown to decrease and stabilize soil temperatures while permitting water to move deeper into crusted soil than even the tillage treatment. These effects help create a microenvironment that supports plant growth.*

## Résumé

**Etude des méthodes de régénération des sols dégradés des forêts sahéliennes :** Quatre traitements, travail du sol (T), paillage (M) au moyen de branchettes, ou travail suivi de paillage (TM) ont été appliqués à des sol superficiels et encroûtés des forêts sahéliennes. La moitié des parcelles a été exposée aux animaux et aucun apport d'engrais ou de semences ne fut réalisé. Lors de la première saison des pluies (1983, 550 mm de pluie), le vent et le ruissellement apportèrent des semences dans les parcelles particulièrement celles paillées. Au terme des quatre mois on notait dans le traitement TM une biomasse moyenne égale à celle des zones naturelles de la zone adjacente boisée. La production de la biomasse des parcelles établies en 1984 fut dix fois moindre que celle de première année des parcelles établies en 1983. Cela est dû à la sécheresse de 1984, cependant les traitements TM et M conservèrent leur avantage. Si en première année, l'effet du travail du sol semblait prédominant quant à la conservation de l'eau du sol, en seconde année l'effet du paillis fut supérieur, et en troisième année l'effet du travail du sol était pratiquement nul à cet égard. Là où le broutage était permis, la production de la biomasse fut nettement moindre, principalement à cause de l'éparpillement des branchettes par les animaux. Des essais annexes ont montré que là où le sable s'est accumulé naturellement et où les

---

1. Team Leader, South East Consortium for International Development (SECID), Farming Systems Project, Bamako, Mali; Botanist, Laboratoire de biologie et écologie végétale, Université d'Orléans, Orléans, France.

ICRISAT (International Crops Research Institute for the Semi-Arid Tropics). 1989. Soil, Crop, and Water Management Systems for Rainfed Agriculture in the Sudano-Sahelian Zone: proceedings of an International Workshop, 7-11 Jan 1987. ICRISAT Sahelian Center, Niamey, Niger. Patancheru, A.P. 502 324, India: ICRISAT.

*termites sont actives, le ruissellement était moindre. Le paillage diminue et stabilise les températures du sol tout en favorisant l'infiltration dans les sols encroûtés plus que dans le traitement T. Tous ces résultats positifs proviennent de la création d'un microenvironnement favorable à la croissance végétale.*

## Introduction

The population in the Sahel is growing rapidly. As farmers, herders, and city dwellers compete for forest products (Boudet 1970), the forests become overexploited (Grainger 1982, Weinstabel and Zech 1982). According to Delwaulle and Roederer (1973), city dwellers consume an average of 300 kg of firewood per person a<sup>-1</sup> resulting in severe pressure on nearby forests. The deterioration of forestland owing to clearing, overgrazing, drought, and erosion is a major cause of desertification in the Sahel (Timberlake 1985, National Research Council 1983a and 1983b, Grainger 1982).

Aerial photographs indicate that 35–65% of the vegetation in the area selected for the present study has been lost during the last 34 years. Policymakers have recognized the need to maintain forest vegetation and reclaim degraded forestland. Since the drought of 1968–74, U.S. \$160 million have been spent on forest-related projects in the Sahel (National Research Council 1984). However, application of reforestation techniques borrowed from temperate zones have either failed or have been economically impractical (Heermans 1984).

Practical and effective means must be evolved to reestablish a stable vegetative cover in degraded areas. Previous research has shown that soil tillage encourages the establishment of a herbaceous layer in sandy soils without seed or fertilizer application, but the treated areas routinely return to bare soil within a few years (Toutain 1977, Toutain and de Wespelaere 1977, Toutain and Piot 1980). Mulch, when placed on crusted soil surfaces in the tropics, often attracts termites whose channels provide stable macropores through which water can pass into the subsoil (Noirot and Alliot 1947, Bachelier 1978). Casual observations demonstrate that fallen branches and twigs tend to accumulate sediments, leaves, and seeds, creating a favorable microclimate for vegetative growth (Boudet 1972, Toutain and de Wespelaere 1977, Toutain and Piot 1980). The authors cited, however, conducted no experiments to study these effects. The value of mulching

bare, deep sandy soils with tree limbs cut and transported to the site and of tillage with fertilizer application was studied in Mali (Penning de Vries and Djiteye 1982). Although both methods were successful in producing vegetation, neither was considered economically viable due to the value of wood as firewood, the labor involved in tillage and transport of wood, and the cost of the fertilizer applied. Based partly on this experience in sandy soils, it seemed evident that shallow, lateritic soil could not be brought back into worthwhile production using these methods.

The objective of our study was to determine whether tilling and/or mulching shallow, lateritic soils would reestablish a stable layer of vegetation on the degraded forest soils near Niamey, Niger.

## Materials and Methods

### Soil and Vegetation

The primary research site was located at the Gueselbodi forest, 15 km southeast of Niamey, Niger. The area can be divided into three components (Chase and Boudouresque 1987). The first, approximately 18% of the total area, is a wooded layer, dominated by the family Combretaceae: *Combretum nigricans*, *C. glutinosum*, *C. micranthum*, and *Guiera senegalensis*. The second is a herbaceous zone that can be further subdivided into a denser stand of forage plants covering 33% of the study area, and a sparse stand of *Tripogon minimus* and *Microchloa indica*, covering 20% of the area, and located in micro-depressions that hold water for a short time after each rainfall. The wooded and productive herbaceous components are usually located on a sandy layer of surface soil, often raised above the level of the crusted soils. The psammophilous *Scytonema* sp (Cyanophyceae), associated with degraded grasslands (Dulieu et al. 1977), is also common in the micro-depression and covers some sandy areas effectively blocking other vegetative growth.

The third component, covering 29% of the study area comprises of shallow (10–40 cm), barren, crusted loamy sand, sandy loam, and sandy clay loam soils, tentatively classified as a sandy skeletal, isohyperthermic Typic Paleustult, (L. West, Texas A&M University Soil Laboratory, personal communication). The subsoil is a thick layer with 40–65% fractured laterite. These crusted soils are characterized by high runoff rates and high daytime surface soil temperature that result in a dry soil profile.

Studies on the effects of crusting and termite activity were carried out on a similar forest ecosystem located at the ICRISAT Sahelian Center (ISC), 40 km south of Niamey. The 10–30 cm deep crusted soil, a loamy, siliceous isohyperthermic shallow Petroferric Haplustult, is underlaid by an indurated or a fractured layer of laterite (West et al. 1984) Microdunes, 5–30 cm thick were observed on the crusted surface at irregular intervals. Intensive termite activity was seen in soils at both locations where leaves and branches had fallen.

### The Revegetation Experiment

In May 1983, twenty 10 × 10 m experimental plots were established in Geusselbodi forest on barren, crusted soils between vegetated areas. Ten plots were located within a fence erected 2 years earlier to protect the enclosed area from grazing. The other 10 plots were located outside and well away from the fence and exposed to grazing.

The experiment began in early June following the first rains of the 4-month rainy season. Each 10 × 10 m site was divided into four plots and the following treatments randomly applied:

- C = Control plots left untouched.
- T = Tillage with a traditional hoe to a depth of about 10 cm. An attempt was made to leave large clods to keep the surface as rough as possible.
- M = A mulch of branches placed on the crusted soil, creating a 15–20% shade on the soil surface as determined by a solarimeter. These branches are a byproduct of nearby firewood-cutting operations. Wooden stakes anchored the branches to keep strong prestorm winds from carrying them away.
- TM = Tillage followed by mulching with branches.

Soil samples (0–30 cm) were taken in all plots twice during the first year (7 Jul and 4 Oct) and every 2–3 weeks during the second year. Gravimetric soil-moisture content was determined and volumetric water content was then calculated using soil bulk density.

In September 1983, 1984, and 1985, at the end of the rainy season, a detailed inventory of the natural and induced vegetation was made (Chase and Boudouresque 1987), permitting a comparison between the two. Except for soil and plant sampling, the initial 20 plots were left undisturbed throughout the later years of the experiment.

During the second year of the experiment (1984), six additional parcels (three exposed to, and three protected from grazing) were established using the same experimental format as in the previous year.

### Supplemental Experiments

During the 1985 rainy season, three experiments were conducted to better understand the effects of applied mulch on natural accumulations of materials on crusted soils. The first experiment was conducted on the Gagani series soil at the ICRISAT Sahelian Center (ISC) to determine the effect of natural deposits of sand and ligneous matter on the otherwise crusted, barren soil. Plots were located in barren, debris-strewn, and micro-dune-covered areas of the forest. Five undisturbed 1 × 1 m micro-plots in each area were isolated by excavating around each of them to the laterite subsoil, and a cement casing was poured on all sides. A 4-cm high ridge was built above the plots on all but the downhill side, isolating the plots from outside surface runoff and permitting runoff from the plots to fall into a collecting trough. This water was pumped into a measuring container which permitted continuous monitoring of runoff. A rainfall simulator of the type described by Morin et al. (1970) was obtained from the Wageningen Tillage Laboratory project at the ISC and used to provide 100 mm h<sup>-1</sup> simulated rainfall on each plot for periods of 30–90 min. The time to initial runoff and 5-min readings of the accumulated volume of runoff were taken for each plot.

The second study, which was conducted at the Geusselbodi forest during the 1985 rainy season, monitored the effect of mulching and tillage of barren soils on infiltration rates. The advance of the wetting front was followed using the neutron

attenuation technique in barren soils which were undisturbed (except to install the neutron probe access tube) and in 5 × 5 m areas of crusted soils that were (a) hand tilled to an approximate depth of 10 cm and (b) mulched with tree branches, producing 25% shade as determined by a solarimeter. Three replications of each treatment were monitored.

In the last experiment, the effect of mulch on soil temperature was studied. In 1985, thermocouples were buried at 2, 5, 10, 25, 50, 100, 150, and 250-cm depths at two sites in a barren area and one site in an adjacent wooded area in the Guesselbodi forest. The shallow thermocouples (50 cm or less) were buried in a trench with 50 cm of lead wire at the depth of the junction to avoid heat transfer to the sensor. All others were placed in a vertical hole drilled by a well-drilling rig. Maximum and minimum soil temperatures of the entire profile were monitored daily and 15-min readings taken over a 24-h period once each month. All data were collected with a CR7 Campbell Scientific data logger and transferred to computer by cassette tape. After 1 mo of data collection, one of the two barren areas was mulched with tree branches, to a density producing 35% shade as determined by a solarimeter. Subsequent changes in soil temperature were compared with those in the wooded area (with 35%

natural shade) and those in a nonmulched control area.

## Results and Discussion

### The Revegetation Experiment

A drought in 1984 (241 mm rainfall) after the wetter 1983 rainy season (550 mm) provided an ideal contrast for vegetation studies under different rainfall regimes. More normal rainfall in 1985 (approximately 543 mm) permitted comparisons of vegetative development between similar years (1983 and 1985).

**Soil moisture.** Soil moisture was measured twice in all plots during the 1983 rainy season (Chase and Boudouresque 1987) and was compared with standing biomass in September that year. Both the soil moisture during the 1983 rainy season and the loss of soil moisture between sampling dates were highly correlated with standing biomass (Fig. 1).

During the second rainy season (1984), soil moisture was determined regularly in all plots (Figs. 2a and 2b). The crusted soils of the control plots contained little soil moisture during the rainy

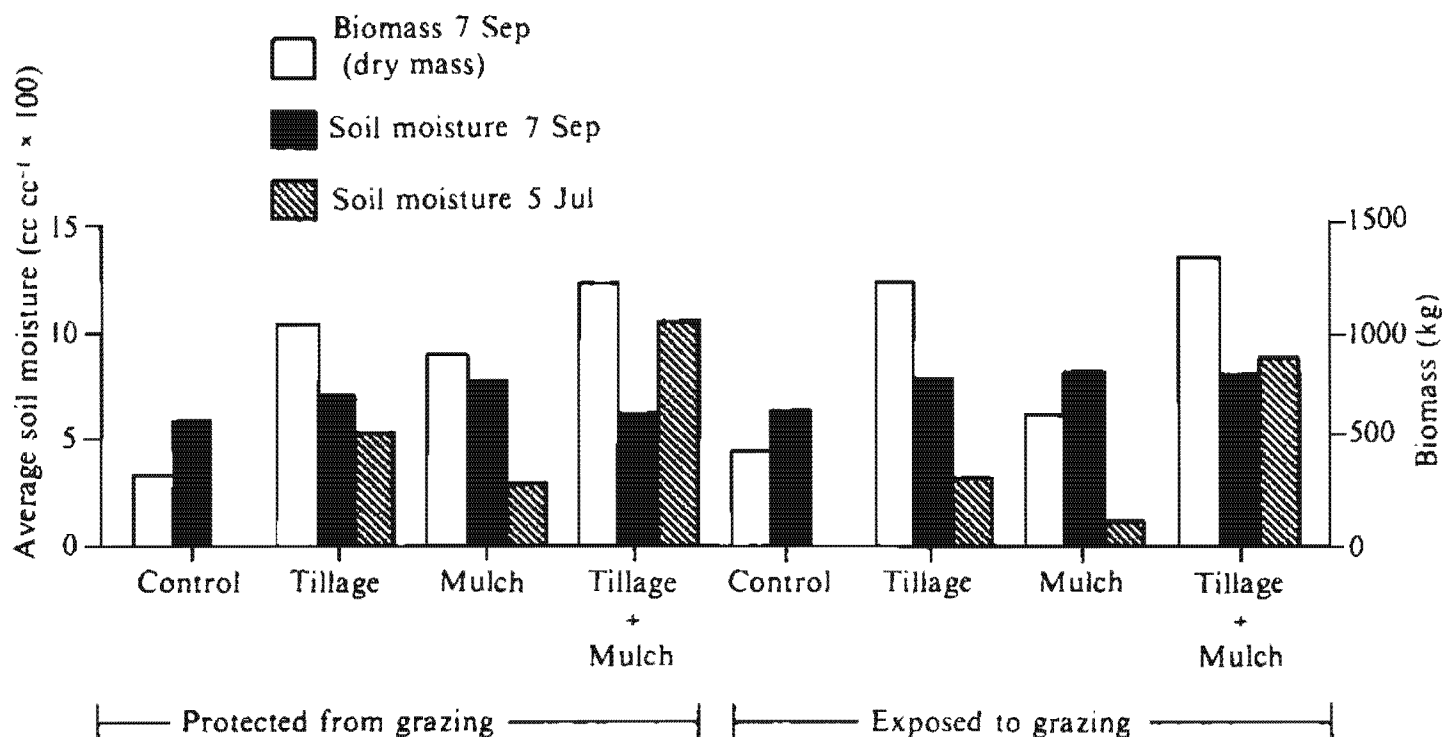

Figure 1. The increase/decrease of soil moisture (0–30 cm depth) between the middle and the end of the rainy season (1983) and the associated biomass yield. Note: Control plots were essentially devoid of vegetation.

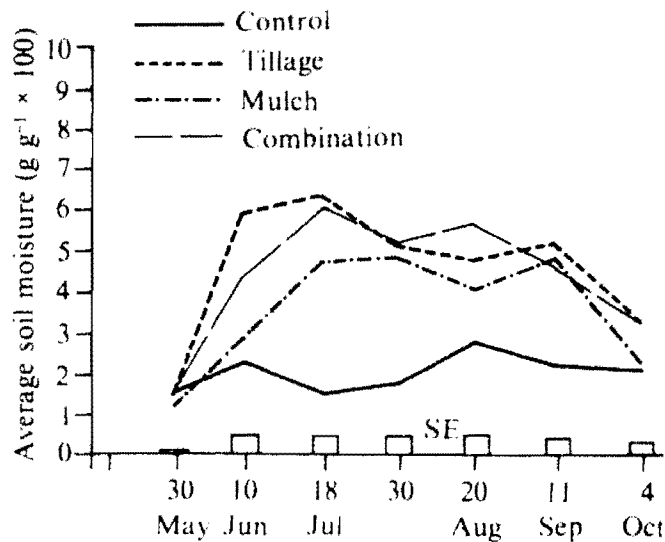

Figure 2a. Average soil gravimetric water content (0–30 cm depth) during the 1984 rainy season in newly established, protected plots.

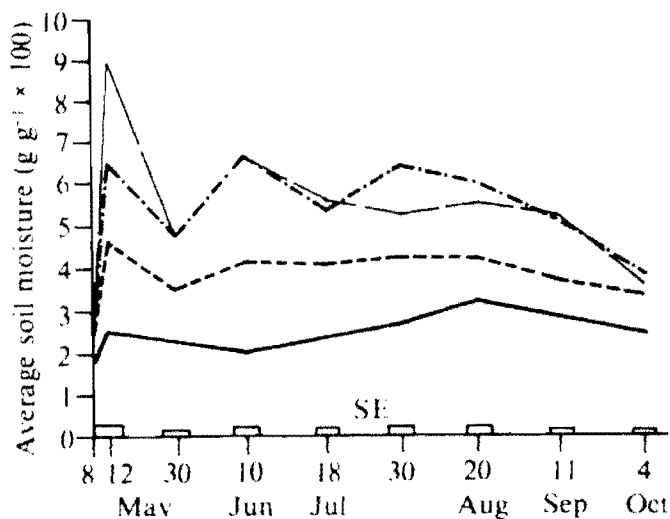

Figure 2b. Average soil gravimetric water content (0–30 cm depth) during the 1984 rainy season in 1-year old protected plots.

season. The new plots in Figure 2a were established after the first rainfall which moistened the soils in the 1983 plots (Fig 2b). Tillage, mulching, and a combination of the two were effective in raising soil moisture in the upper 30 cm for at least two rainy seasons after the treatments were established. In the newly established plots, tillage appears to be the dominant factor in increasing soil moisture above that found in the control. In 1-year-old plots, however, mulching appears to be the dominant factor. This change was undoubtedly related

to the crust that gradually re-formed on the tilled-only treatment. Mulched treatments had considerable termite activity and continuously accumulated sand and leaves that eventually affected the infiltration of water and soil-moisture retention.

**Vegetation.** A detailed description of the first year's results (herbaceous plant species found in each treatment, forage value, tree species, etc.) are reported elsewhere (Chase and Boudouresque 1987). To summarize, at the end of the first rainy season, the TM plots protected from grazing had an average vegetative cover of 96%, T plots had 48%, and M plots had 32%. Ninety-seven newly germinated Combretaceae seedlings were counted in 60% of the treated plots (50 seedlings in the protected, 47 in the nonprotected parcels). The greatest number of seedlings was found in the TM treatment, while the T treatment supported the fewest.

The flora was composed of 48 taxons, most of which were annuals and 34 of which were forage species. The nutritious leguminous annual *Zornia glochidiata* was the dominant species and, in the protected parcels, produced a cover averaging 61% on the TM plots. This induced pasture was found to be similar in composition to the natural grass cover growing on neighboring nondegraded soils.

Probably due to the drought in 1984, plots established in that year produced much less vegetative cover during their first rainy season than did those established in the previous year. Vegetative cover between plots established in 1984 was highly variable with an average cover of 11–13% for the three treatments. The high variability between replications and small differences between treatments indicate that factors other than the treatments were controlling the establishment of vegetation. These factors undoubtedly included the drought and the low frequency of windstorms in 1984 which blew sand, leaves, and seeds into the plots. The 1984 plots produced an average of less than one-third of the number of tree seedlings found in the 1983 plots at the end of the 1983 growing season.

Vegetative cover in the plots established in 1983 decreased considerably in 1984 and increased again in 1985 in response to the fluctuation in rainfall in those years (Table 1). A consistently high proportion of the *Zornia glochidiata* remained in all protected plots throughout the experiment.

During the dry 1984 season, the TM plots established in 1983 produced nearly five times as much dry matter as those newly established in 1984

**Table 1. Effects of tillage and mulching on the relative proportion of *Zornia glocholata* and the total vegetative coverage of experimental plots established in 1983.**

| Year | Rainfall (mm) | Protected from grazing   |      |      |       |      |      | Exposed to grazing       |      |      |       |      |      |
|------|---------------|--------------------------|------|------|-------|------|------|--------------------------|------|------|-------|------|------|
|      |               | <i>Zornia glocholata</i> |      |      | Total |      |      | <i>Zornia glocholata</i> |      |      | Total |      |      |
|      |               | T <sup>1</sup>           | M    | TM   | T     | M    | TM   | T                        | M    | TM   | T     | M    | TM   |
| 1983 | 550           | 25.5                     | 16.8 | 61.3 | 49.4  | 31.5 | 96.0 | 24.3                     | 12.1 | 44.0 | 42.1  | 25.2 | 70.0 |
| 1984 | 241           | 4.4                      | 16.3 | 44.6 | 5.7   | 24.0 | 54.9 | 3.8                      | 14.7 | 23.0 | 4.0   | 17.5 | 26.9 |
| 1985 | 543           | 4.0                      | 39.7 | 53.2 | 7.0   | 95.5 | 96.2 | 4.6                      | 13.1 | 29.5 | 8.2   | 34.2 | 59.5 |

T = tillage; M = mulch; TM = tillage followed by mulch.

(Table 2). This could be due to a combination of the following factors:

1. The new plots were established after the first rainfall (51 mm) so that runoff effectively nullified the effects of this relatively large storm.
2. The older plots had an accumulation of sand and leaf mulch at the beginning of the year, which increased infiltration rates from the onset of the season. New litter-free plots slowly accumulated litter during the rainy season due to the lack of windstorms.
3. The old plots had seeds already in place from the previous year's plant growth.

The fact that the 1983 M plots sustained significant quantities of dry matter even in a droughty year shows that the mulch treatment resulted in lasting changes in the soil's ability to absorb moisture and support plant growth.

In comparing the relative proportions of vegetation produced over years and treatments, the tillage treatment ranked second in 1983, but its productivity dropped substantially in 1984, when it ranked third. More important, however, the mulch-only treatment that ranked third in 1983, producing about 24% as much biomass as the TM treatment in that year, produced biomass nearly equivalent to the TM treatment by the third year (Table 2).

Vegetative growth potential in the Sahel is greatly influenced by rainfall (Le Houerou 1980). To study plant response to treatments between years of very different rainfall, the biomasses in the experimental plots in the natural forest areas were compared.

When using these ratios, one sees a continuing decrease in the relative productivity of the tillage treatment, and a continuous increase in that of the mulched plots over native vegetation in all years, particularly in the protected plots (Fig. 3). This further establishes that even in dry years, mulch applied to crusted soils continues to improve the soil environment for increased vegetative growth.

Exposure to grazing retards the reestablishment of vegetation (Fig. 3). Standing vegetation in areas exposed to grazing was approximately half of that found in the mulched treatments protected from animals. This could be due to the consumption of plant material, dispersal of the mulch by trampling, or due to other factors.

The high productivity of the mulched plots protected from grazing as compared with the native

**Table 2. Means of estimated standing biomass (kg ha<sup>-1</sup>) from 20 plots established in 1983 and 6 plots established in 1984.**

| Treatment                     | Newly established plots |        | 1983 plots in later years |        |
|-------------------------------|-------------------------|--------|---------------------------|--------|
|                               | 1983                    | 1984   | 1984                      | 1985   |
|                               | 550 mm                  | 241 mm | 241 mm                    | 543 mm |
| <b>Protected from grazing</b> |                         |        |                           |        |
| Control                       | 0 a <sup>1</sup>        | 0 a    | 0 a                       | 0 a    |
| Mulch                         | 290 b                   | 89 a   | 230 c                     | 1300 c |
| Tillage                       | 530 b                   | 190 a  | 37 ab                     | 80 a   |
| Mulch + Tillage               | 1030 c                  | 95 a   | 470 d                     | 1550 c |
| Native vegetation             | (890)                   | (230)  | (230)                     | (935)  |
| <b>Exposed to grazing</b>     |                         |        |                           |        |
| Control                       | 0 a                     | 0 a    | 0 a                       | 0 a    |
| Mulch                         | 140 b                   | 0 a    | 78 ab                     | 320 ab |
| Tillage                       | 350 b                   | 16 a   | 28 ab                     | 61 a   |
| Mulch + Tillage               | 890 c                   | 60 a   | 150 bc                    | 630 d  |
| Native vegetation             | (680)                   | (140)  | (140)                     | (580)  |

1. Values followed by the same letter are not significantly different at  $P \leq 0.05$  level.

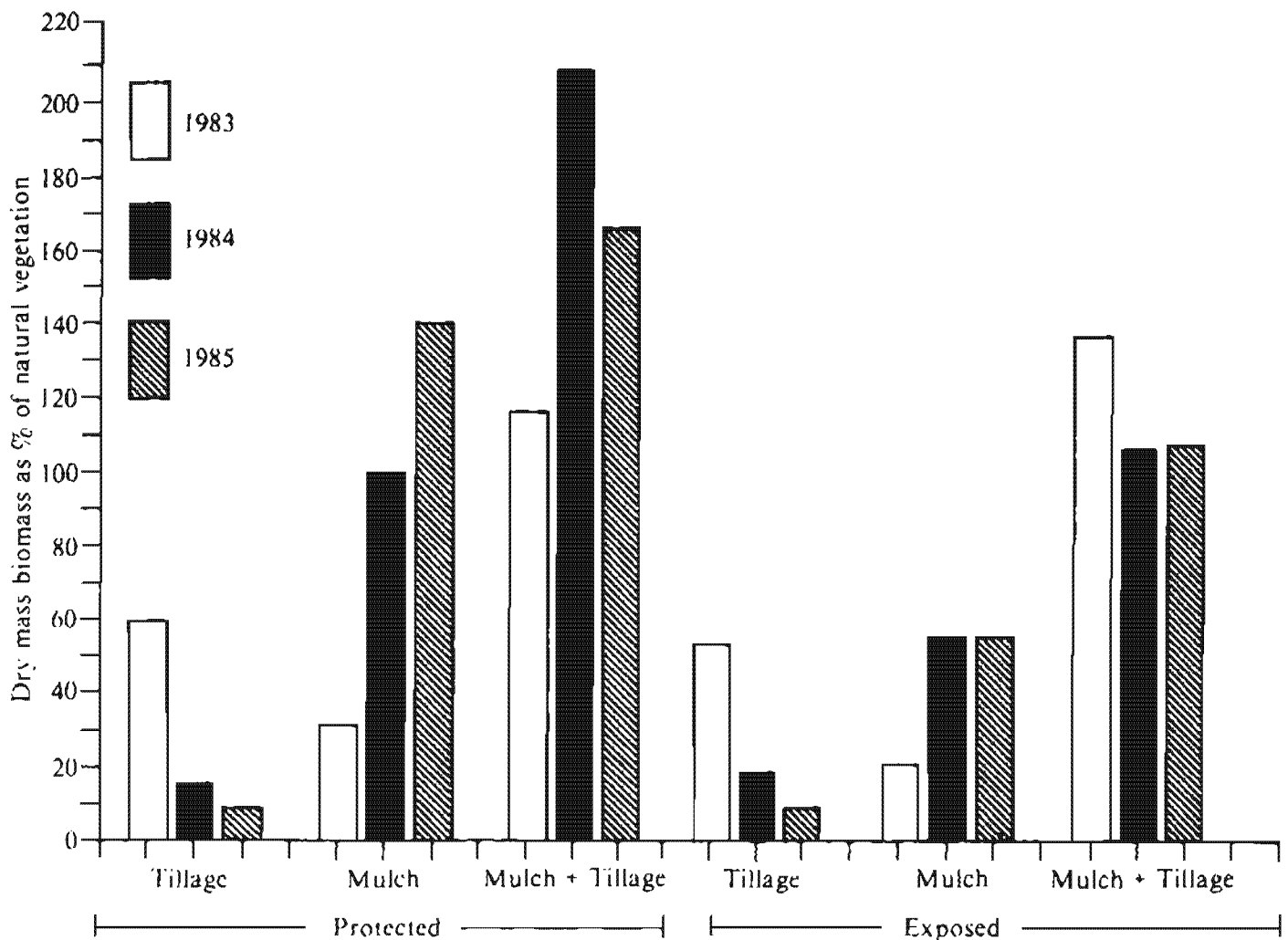

Figure 3. The ratio (%) of standing biomass in 1983 plots to the standing biomass found in naturally vegetated areas of the surrounding forest as a function of grazing and year.

vegetation may be due to the absence of trees nearby that compete with the herbaceous layer for moisture.

### Supplemental Experiments

Two effects observed of placing mulch on crusted surfaces are: (1) the accumulation of sand and leaves, and (2) termites attracted by branches and leaves trapped by the branches. The results of experiments on the effects of naturally occurring sand and termite activity and on the effects of applied mulch and tillage treatments show how these factors improve the soil environment, supporting vegetative regrowth.

**Simulated rainfall runoff in naturally occurring forest soils.** Runoff was strongly affected by sand

and litter accumulation on crusted forest soils. On crusted soils, standing water was seen almost immediately upon the initiation of artificial rainfall. Where water was not trapped by soil surface irregularities, runoff began almost immediately after rainfall initiation. Where termite activity had formed stable macropores in crusted soils with accumulated debris, runoff from test plots began later and total runoff after one hour was half the amount measured from the crusted soils (Fig. 4). There was a slow, irregular increase in runoff rate from this soil which appeared to be due, partly, to the gradual plugging of the termite channels with floating debris (Fig. 4).

Termite channels were shown to have an important effect on infiltration in another experiment where water was poured down a single 0.8 × 1.0 cm diameter termite channel. Flow rates of 500–700 mL min<sup>-1</sup> were sustained during the 30-min test. A



single channel located on one of the test plots would have had sufficient capacity to drain one-third of the  $1 \times 1$  m runoff plot of the  $100 \text{ mm h}^{-1}$  simulated rainfall applied.

Sand cover in the form of microdunes, 3-15 cm deep, resting on the crusted soil surface had a highly variable effect on runoff rates (Fig. 4). Runoff patterns were similar to those in soils with termite activity in two of the five sites tested. Runoff rates increased more slowly at the remaining three sites. The differences in infiltration appeared to be associated with the thickness of the microdune.

**The effect of tillage and mulch on infiltration in a crusted forest soil.** Although the results were variable, particularly early in the rainy season, mulching apparently permits water to move deeper into

the soil than does tillage (Fig. 5). This may be due to the fact that the tilled plots, like the crusted plots, were exposed to the heating effect of direct sunlight and the drying effect of the air. Mulch can reduce these effects by shading the surface, thereby reducing soil temperature. Mulch also decreases convective vapor loss to the air. These effects can reduce evaporation rates, permitting water to infiltrate further into the soil.

**The effects of mulch on soil temperature.** Soil temperature profiles were recorded before and after a mulch was applied to the crusted surface and then were compared with profiles from crusted "control" plots and naturally vegetated soils. The soil to be mulched was initially slightly cooler than the crusted control due to partial shading by nearby trees. When mulched, however, both the

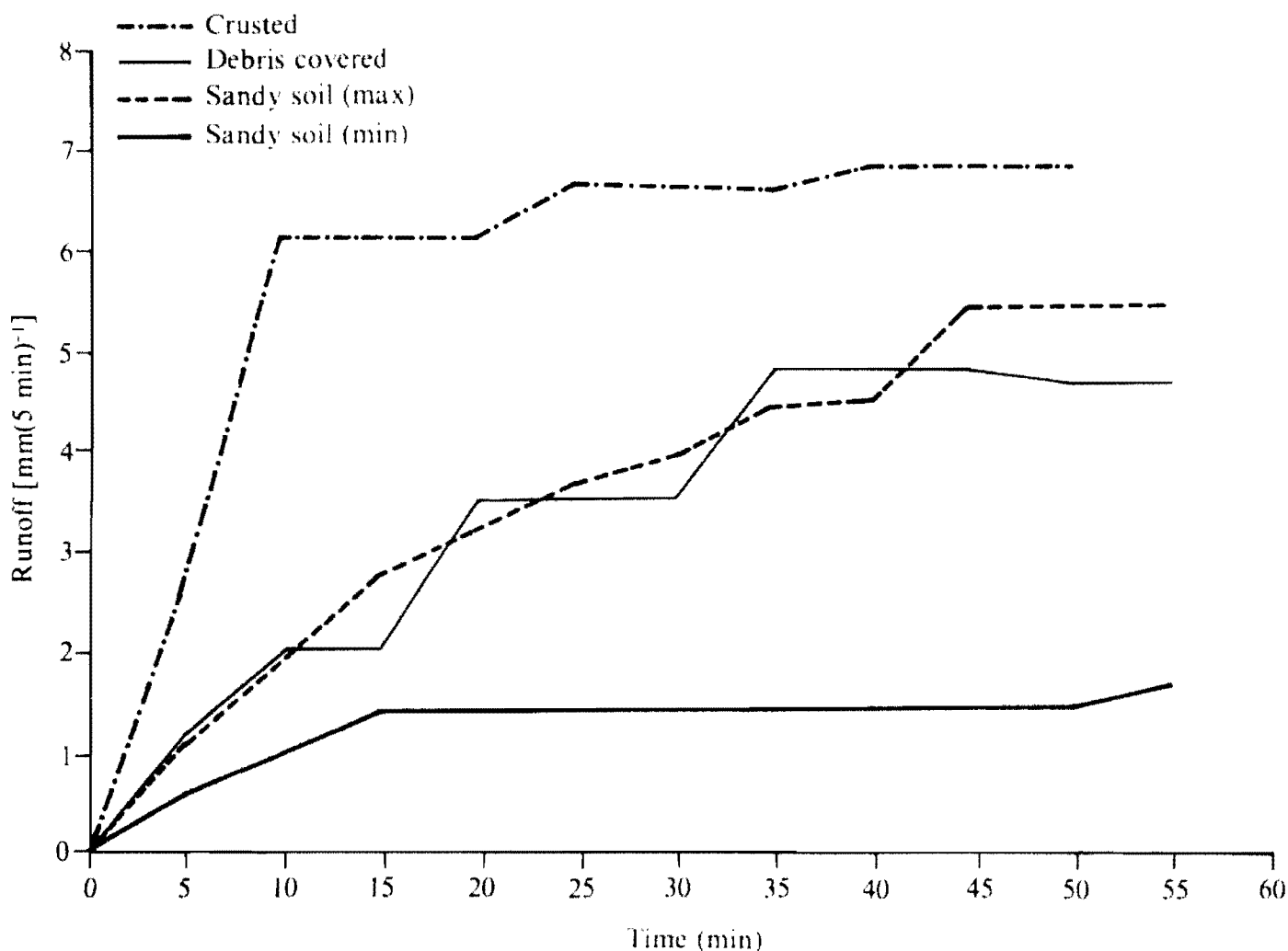

**Figure 4.** Five-minute rainfall runoff from representative trials on forest soil using a rainfall simulator, producing a rainfall of  $100 \text{ mm ha}^{-1}$ .

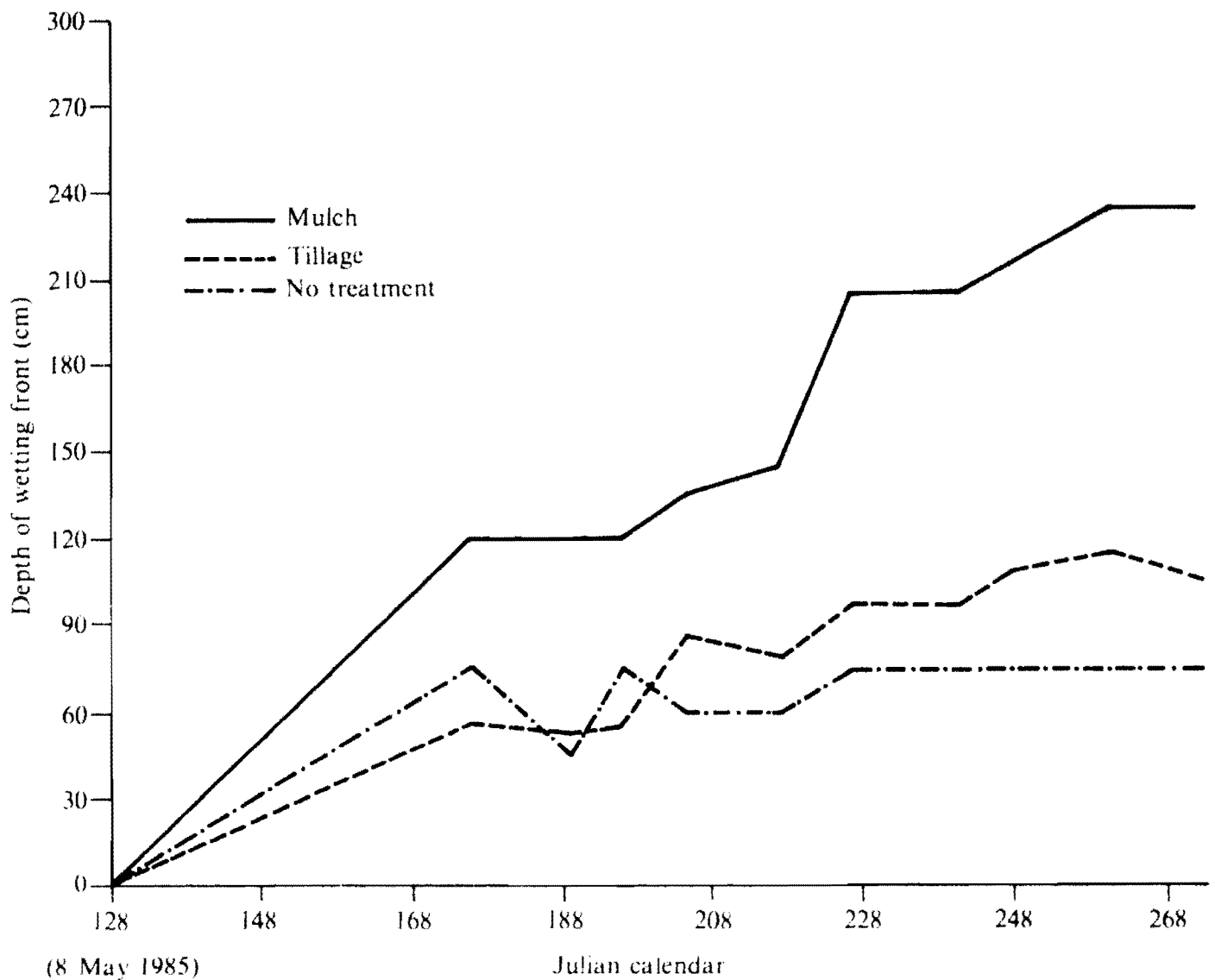

Figure 5. The effect of treatment on soil moisture.

daily fluctuation of the surface soil temperature and the temperature of the soil profile (Fig. 6) were reduced. Decreased temperature fluctuation may be a direct result of shading and the increase in soil moisture which, by increasing soil heat capacity, stabilizes soil temperatures.

## Conclusion

Tree branches are a waste product of firewood gathering in the Guesselbodi forest and are normally available immediately adjacent to crusted areas. Mulching these barren, crusted soils with branches provides an effective means to establish substantial vegetative growth over a period of

years, particularly if the area is protected from animals. The combination of tillage with mulching, while labor-intensive, has the effect of establishing a good vegetative cover during a single season of normal rainfall, which is not the case for tillage without mulch. More cost-effective, however, is the simple placement of mulch on degraded soils. Although it takes longer to establish a vegetative cover, it requires very little investment of time and energy. Exposure to grazing and trampling substantially decreases the advantages of mulching, but the treatment still has a positive effect under grazing pressure. Unless soils in this area are protected from the wind, solar radiation, and rainfall impact, rainfall runoff and evaporation limit infiltration. Impact of rainfall on tilled soils results

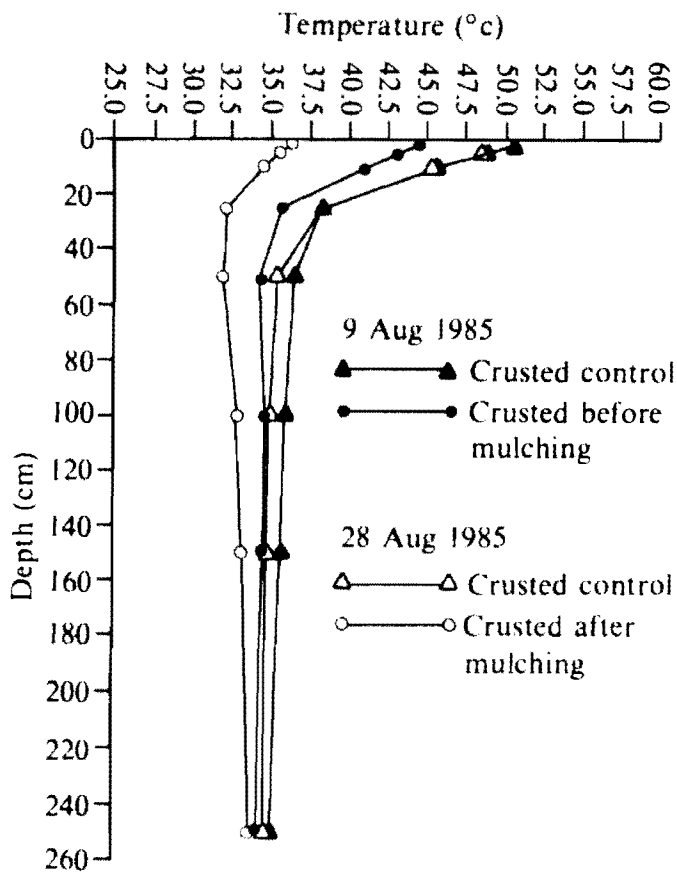

**Figure 6.** Soil temperature profiles ( $^{\circ}\text{C}$ ) 10 days before and 9 days after mulching a barren forest soil at Guesselbodi.

in the destruction of surface soil structure, the reformation of the crust, and a return to the original barren surface.

There appear to be several reasons for the positive effects of a branch mulch. Visibly, it collects sand, leaves, and seeds, particularly during the high winds associated with large storms in the area, and continues to do so as long as the mulch remains in place. The captured sand and leaves further mulch the soil, providing shade and a means for rainfall to pass more readily into the previously crusted soil. Termite activity, associated with both branches and leaves, also increases infiltration of rainwater. The moist soil beneath the mulch creates a more stable temperature regime due to an increase in the heat capacity of the soil. The shade provided by the branch, leaf, and sand mulch reduces heat influx, and results in a cooler soil. The cool, moist soil is conducive to the germination of seeds captured by the mulch and supports their growth.

The authors of this study suggest that the limited branches available for mulching the highly degraded forest soils are most effective:

1. when placed immediately adjacent to where the trees have been harvested, thus minimizing transport difficulties;
2. when placed along the edge of vegetated areas, taking advantage of any effect the vegetation may have on the nearby microclimate, i.e., shade, elevated humidity, decreased temperature, or mulch barren soils separating adjacent vegetated areas; and
3. when placed in narrow strips around or between vegetated areas. Since debris is captured at the leading edge of a mulched area, broad mulched areas may not be as efficient in collecting material as narrow strips.

The Forest and Land Use and Planning Project (FLUP) has shown that, in the forests studied, trees cut for firewood and protected from grazing regenerate in 5–8 years. FLUP has developed an incentive package where, over several years, villages can harvest large areas of previously protected firewood if the village agrees to use a percentage of its profits to guard cut areas from animals. Once resprouting trees grow large enough that they cannot be grazed, animals can return to the regenerated area. The research reported here lends itself well to this type of activity, providing a simple means to produce richer pastures for renewed grazing.

To optimize the use of these techniques, however, three questions must be answered:

1. What is the optimal (economic) density of branch mulch?
2. What is the optimal placement pattern with respect to vegetated and barren areas?
3. What are the optimal dimensions of a mulched area?

With these data, aerial photographs, and tree-stand estimates, a complete reclamation program and a cost/benefit ratio can be readily determined for large areas of degraded Sahelian forests.

### Acknowledgment

This work could not have been conducted without the collaborative agreements that exist between the Tropsoils Project and the Institut national de recherches agronomiques du Niger (INRAN), the International Crops Research Institute for the

Semi-Arid Tropics (ICRISAT), and the Forest and Land Use Planning Project (FLUP). The support and encouragement of Mr John Heermans, the FLUP forester, is particularly acknowledged.

## References

**Bachelier, G.** 1978. La faune des sols, son écologie et son action. (In Fr.) Paris, France: ORSTOM (Office de la recherche scientifique et technique d'outre-mer). 391 pp.

**Boudet, G.** 1970. Management of savannah woodland range in West Africa. Proceedings of the International Grassland Congress 11:1-3.

**Boudet, G.** 1972. Désertification de l'Afrique tropicale sèche. *Adansonia* séries 2:12(4), 505-524. France.

**Chase, R., and Boudouresque, E.** 1987. Methods to stimulate plant regrowth on bare Sahelian forest soils in the region of Niamey, Niger. *Agriculture Ecosystems and Environment* 18:211-221.

**Delwaulle, J.C., and Roederer** 1973. Le bois de feu à Niamey. (In Fr.) *Bois et Forêts des Tropiques* 152:55-60.

**Dulieu, D., Gustin, A., and Darley, J.** 1977. La dégradation des pâturages de la région de M'Damina (Rep. du Tchad) en relation avec la présence de Cyanophycies psammophiles. Etude préliminaire. (In Fr.) *Revue d'élevage et de Médecine Vétérinaire des Pays Tropicaux* 30(2):181-190.

**Grainger, A.** 1982. Desertification. London, UK: Earthscan.

**Heermans, J.** 1984. The Guesselbodi experiment: case study of bushland management in Niger. Report submitted to AID/Niger for the Forest Land Use and Planning Project.

**Le Houerou, H.N.** 1980. The rangelands of the Sahel. *Journal of Range Management* 33:41.

**Morin, J., Cliff, C.D., and Powers, W.R.** 1970. Realistic rainfall simulator for field investigation. Tucson, Arizona, USA: University of Arizona, Water Resources Research Center.

**National Research Council.** 1983a. Environment change in the West African Sahel, Advisory Committee on the Sahel. Washington, D.C., USA: National Academy Press.

**National Research Council.** 1983b. Agroforestry in the West African Sahel, Advisory Committee on the Sahel. Washington, D.C., USA: National Academy Press.

**Noirot, C., and Alliot, H.** 1947. La lutte contre les termites. Paris, France: Masson, 96 pp.

**Penning de Vries, F.W.T., and Djiteye, M.A.** 1982. La productivité des pâturages sahéliens. (In Fr.) Wageningen, Netherlands: PUDOC (Center for Agricultural Publishing and Documentation).

**Timberlake, L.** 1985. Africa in crises. London, UK: Earthscan.

**Toutain, B.** 1977. Essais de régénération mécanique de quelques parcours sahéliens dégradés. (In Fr.) *Revue d'Élevage et de Médecine Vétérinaire des Pays Tropicaux* 30(2):191-198.

**Toutain, B., and de Wespelaere, G.** 1977. Pâturages de l'ORD du Sahel et de la zone de délestage au nord-est de Fada N'Gourma (Haute Volta). Tome I Les pâturages naturels et leur mise en valeur. Institut d'Élevage et de Médecine Vétérinaire des Pays Tropicaux, Paris, France. 134 pp.

**Toutain, B., and Piot, J.** 1980. Mise en défense et possibilités de régénération des ressources fourragères sahéliennes. Etude expérimentale dans le bassin de la mare d'Oursi, (Haute Volta). Institute d'Élevage et de Médecine Vétérinaire des Pays Tropicaux—Centre Technique Forestier Tropical, France. 156 pp.



# Characterization of the Microenvironment: Measurement Techniques

C.K. Ong<sup>1</sup>

## *Abstract*

*Instruments and techniques are described for measuring the temperature, humidity, windspeed, light interception by crop canopy, and the duration of leaf wetness. Data loggers for monitoring these instruments are also reviewed. The performance of this equipment in the semi-arid tropics is evaluated in experiments designed to measure the microclimate in agroforestry and intercropping systems. The difficulties encountered in the field and in the interpretation of data are emphasized. References and details are provided on the principles and construction of individual instruments which are not commercially available.*

## *Résumé*

*Caractéristiques du microenvironnement et techniques de mesure : Cette étude décrit les techniques et instruments utilisés pour mesurer la température, l'humidité, la vitesse du vent, l'interception de la lumière par le couvert végétal et la persistance de l'eau sur les feuilles. En zone tropicale semi-aride, la performance de ces instruments et des enregistreurs de données qui les contrôlent a été évaluée lors d'expériences visant à mesurer le microclimat dans les systèmes agroforestiers et de cultures associées. L'accent est mis sur les difficultés rencontrées sur le terrain et lors de l'interprétation des données. Des précisions techniques et bibliographiques sont fournies sur les principes de fonctionnement et la fabrication de quelques instruments de mesure non commercialisés.*

## Introduction

In agricultural research, interest in the characterization of the microenvironment, especially in the semi-arid tropics, is largely determined by two factors. First, there is growing evidence that many basic processes in plants, insects, and diseases are more closely related to the microenvironment than to the conditions recorded in a standard meteorological site or in a Stevenson screen (Monteith 1979). This discrepancy between the environment

within or around the crop and at the meteorological station is even more serious in intercropping or agroforestry systems where the modification of the microenvironment by the taller canopy is apparent. Second, recent advances in the reliability and portability of instruments to measure microclimate have made it possible for scientists to use relatively sophisticated equipment in developing countries, where technical support and spare parts supply services are poor or undependable.

This review of measurement techniques based

---

1. Principal Agronomist, Agronomy Group, Resource Management Program, ICRISAT, Patancheru, A.P. 502 324, India.

ICRISAT Conference Paper no. CP 401.

ICRISAT (International Crops Research Institute for the Semi-Arid Tropics). 1989. Soil, Crop, and Water Management Systems for Rainfed Agriculture in the Sudano-Sahelian Zone: proceedings of an International Workshop, 7-11 Jan 1987. ICRISAT Sahelian Center, Niamey, Niger. Patancheru, A.P. 502 324, India: ICRISAT.

on my personal experience in the semi-arid tropics is mainly concerned with the practical criteria for choosing instruments for the characterization of the microenvironment and the interpretation of data. For a critical review of measurement techniques there is an excellent reference book called "Instrumentation for environmental physiology", edited by Marshall and Woodward (1985), which also gives both technical details and the physical principles involved in the measurement of radiation, water vapor, temperature, windspeed, water potential, and plant growth.

## **General Guidelines for the Choice of Instruments**

The following guidelines should be considered while selecting instruments from the several models or techniques currently available.

### **Accuracy and Precision**

The accuracy of the instrument denotes how close the measurements are to the actual value, and precision (repeatability) indicates how closely measurements made at one time agree with one another, independent of any systematic error involved (Bell and Rose 1985). In crop physiology, the accuracy of certain physical measurements need not be very high since the effects of a long-term temperature difference of  $0.2^{\circ}\text{C}$  on the growth and yield of plants can still not be differentiated. It is, however, important to have a more accurate measurement of leaf temperature when estimating the vapor pressure deficit, i.e., the moisture gradient from leaf to air. Even in such studies, thermocouples with an accuracy of  $0.4^{\circ}\text{C}$  are still preferred to thermistors (accuracy of  $0.2^{\circ}\text{C}$ ) because they are simple to make and have a short response time of 1 s compared to 10 s with thermistors.

### **Calibration and Stability**

All instruments should be calibrated regularly, or the accuracy may change over a period of time. For some instruments, the calibration procedure may require specialized equipment or there should be a constant environment for calibration. Therefore, it

would be wise to choose equipment that does not require a sophisticated calibration facility or only requires calibration after a long period of use. How many scientists in developing countries, for instance, have access to a wind tunnel to calibrate anemometers?

Some instruments are sensitive to the high temperatures of the tropics, and this is further exacerbated by enclosure in boxes or huts for security or protection from wind or rain. It is important to ensure that the room temperature does not exceed the working range of the instrument.

### **Ruggedness**

Instruments that perform well in the laboratory may not be the best choice for use in the field because of dust, wind, and rain. Some protection could be provided, but care must be taken to prevent the protective cover from modifying the measurement of the microclimate. The standard hot wire anemometer, for instance, is unsuitable for field use because it requires a clean environment (Grace 1985). All instruments, however rugged, need to be cleaned frequently to avoid dirt and dust from hindering their efficient functioning, e.g., in the wet bulb thermometer, the wick must be replaced regularly, and the tube solarimeters must be cleaned.

### **Interference with the Natural Environment**

It is important to minimize the interference often caused by sensors to the environment to be measured. Leaf or meristem temperature is particularly difficult to measure because the temperature sensor has to be small enough not to cover a large part of the leaf area. Only miniature thermistors and thermocouples are small enough to be inserted into the leaf sheath or to be pressed against the underside of the leaf.

### **Recording Environmental Measurements**

The results from laborious manual recording have often been underutilized because entering them

into the computer is too time consuming. The availability of reliable and cost-effective automatic devices to record environmental measurements, or data loggers, is the most significant breakthrough in instrumentation technology. Most data loggers can work on voltage output from a wide range of sensors. The major differences to consider are the number of channels for various sensors, storage capacity, and battery life. Some manufacturers supply a range of sensors for environmental monitoring along with a particular series of data loggers e.g., Campbell Instruments Inc. The market is changing so rapidly that it is rather difficult to choose between comparable data loggers. Our policy is to select a reliable model from a manufacturer who provides fast after-sales service, because a season lost due to data logger malfunction may prove to be very expensive. As many of the data loggers have recently appeared on the market, it is a good practice to ask current users about their reliability, precision, and accuracy.

## Measurement of Microclimate in Intercropping and Agroforestry Systems

Over the last three seasons, we have monitored the microclimate of an intercrop of groundnut (*Arachis hypogaea* L.) and pearl millet (*Pennisetum americanum* (L.) Leeke) at the International Crops Research Institute for the Semi-Arid Tropics (ICRISAT) in India. This is a multidisciplinary project involving pathologists, entomologists, physiologists, agroclimatologists, and agronomists. Last year we carried out similar measurements in alley cropping systems using *Leucaena leucocephala* (Lam) and pearl millet. The difficulties encountered in the field and in the interpretation of data are emphasized. For a general understanding of the principles of environmental physics, a book by Monteith (1973) and a general textbook on environmental biology by Woodward and Sheehy (1983) are recommended.

The intercropping experiment was designed to monitor the microclimate of a 1:3-row arrangement of pearl millet and groundnut, and to relate the incidence of leaf spot *Cercospora arachidicola* and *C. personatum* to the microenvironment. The crop was grown on flat, shallow Alfisols during

early July in large plots with a fetch of 30 m, and it was entirely rainfed. The agroforestry experiment was started in 1985 but microenvironment measurement only began in June 1986. The objective of this experiment was to monitor the effects of the leucaena hedgerows (3.5 m apart) on the microenvironment and the growth and yield of pearl millet. The size of each plot was 20.5 × 22 m, and the leucaena hedgerows were pruned to 0.8 m when the regrowth reached approximately 2 m in height, just before the time of sowing of pearl millet in June. The following type of measurements of the microenvironment were made in each experiment using the sensors listed in Table 1. All signals were recorded on an hourly basis using a data logger except for the radiation in the intercrop which was carried out with a polycorder (Omnidata Inc.). A list of the manufacturers of the equipment used is provided at the end of the paper.

In the intercrop experiment, the mast carrying the anemometers, leaf wetness sensors, and aspirated psychrometers was moved from one plot to another daily so that all three replicates could be monitored systematically. This practice was discontinued during the wet periods when moving the mast caused serious lodging. In each treatment a mast carrying two sets of sensors was placed.

In the agroforestry experiment where the canopy was denser than in the intercropping experiment, all measurements of windspeed and humidity were confined to one site to avoid damage to the plants by moving the mast. All the other environmental measurements were made in all the plots.

## Radiation

The choice of using a prototype quantum sensor system in the intercropping experiment was influenced by our desire to examine the horizontal variation in the light environment within the intercrop. Previous experiments indicated that groundnut planted close to pearl millet grew considerably better than groundnut planted farther away. (Harris and Natarajan, in press). This prototype system was developed by R. Mathews and R. A. Saffell of the University of Nottingham; Campbell Scientific will soon be marketing an improved commercial version. The major advantage of this system is that it provides a rapid measurement of radiation environment, thus obviating the need for costly investment in numerous tube solarimeters and



**Table 1. Types of measurements, sensors, and the number of levels recorded in the intercrop and agroforestry experiments.**

| Measurements             | Intercrop (millet/groundnut)   | Agroforestry (millet/leucaena)             |                             |
|--------------------------|--|--|-----------------------------|
| Intercepted radiation    | Spot measurements at 4 levels, twice weekly using a prototype quantum sensor system <sup>1</sup> | Tube solarimeters, row-wise (Delta T type) |                             |
| Temperature:             |  |  | } Same sensors as intercrop |
| Leaf                     | 2 levels, thermocouples  | 1 level                                    |                             |
| Soil                     | 5 cm, thermocouples  | 5 and 20 cm                                |                             |
| Air                      | 5 levels, aspirated with thermocouples   | 2 levels                                   |                             |
| Humidity                 | 5 levels, aspirated wet-bulb technique <sup>1</sup>  | 2 levels                                   |                             |
| Windspeed                | 3 levels (Met-one)   | 2 levels                                   |                             |
| Duration of leaf wetness | 2 levels (Campbell)  | None                                       |                             |
| Soil moisture            | 5 cm only (gypsum block, Campbell), to 1.2 m   | Neutron probe technique                    |                             |
| Data logger              | Campbell CR7   | Campbell CR21X                             |                             |

1. A prototype was used since commercial instruments were unsatisfactory for the purpose. Details of the prototype are given in Appendix 1.

data loggers in order to measure a large number of treatments. The system is used in conjunction with a polycorder (Omnidata, \$3500). Another advantage of the prototype is that it can measure radiation at 2- or 5-cm intervals, and measure 1.0–1.5 m distances in 2–3 min. However, it is necessary to calibrate the instantaneous radiation measurement, usually made around noon, against the fractional interception averaged over a whole day using tube solarimeters. Figure 1 illustrates a typical example of the radiation result obtained in the intercrop experiment.

Difficulties encountered in the field include dust and dirt which affect the smooth travel of the quantum sensor. This has been remedied by protecting the holes (see Appendix II) with a glass sheet. In very dense canopy, it causes considerable disturbance to the canopy structure. Therefore in the agroforestry experiment a permanent placement using tube solarimeters was preferred. With tube solarimeters, it is possible to obtain hourly values of radiation interception for short-term analysis of transpiration measured using a porometer (Marshall and Willey 1983).

## Temperature

In both experiments, copper-constantan thermocouples directly connected to the cold junction compensation unit of the data logger were used to measure temperature. The thermocouple cable from the logger to the site of measurement is thick and rugged (PR-T-24 Omega type) but the cable to leaf thermocouple should be thin and light (76P/50 type, Comark). For leaf or canopy temperature measurement, the soldered junction of the thermocouple is pressed on the underside of the leaf and held together by a plastic paper clip. Experiments in gluing thermocouples to the underside of the leaf have proved unsuccessful because of rain and wind. It is advisable to protect soil thermocouples with a teflon or plastic sheath and then seal with 'araldite' or other heavy-duty glue to prevent 'leakage' during rainy periods. We chose copper-constantan thermocouples for measuring temperature because the sensor unit is small, its response time is short, and defective units are inexpensive and readily available. It is important to remember that no thermocouple has a precisely linear rela-

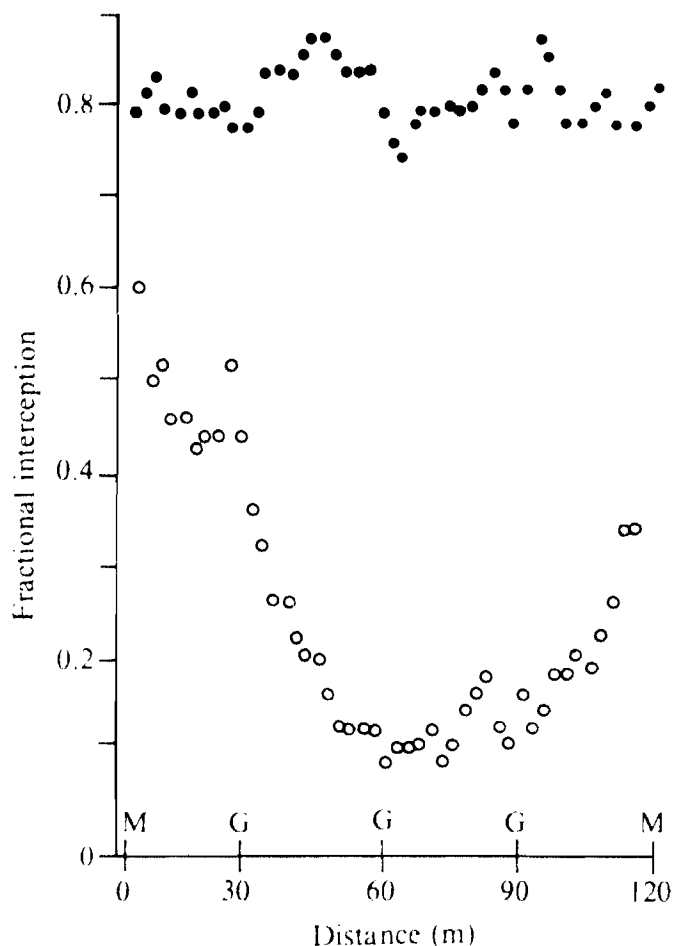

Figure 1. Horizontal distribution of fractional light interception by a 1:3 row pearl millet/groundnut intercrop at 41 days after sowing. Mean fractional interception across the 4 rows (●) was 0.83 and above the groundnut canopy (○) was 0.25. The crop was grown on an Alfisol, rainy season 1985. M indicates pearl millet and G groundnut rows.

relationship between electro-motive force (EMF) (millivolts) and temperature. A quadratic equation (6th polynomial in a Campbell Scientific logger) is more appropriate. Canopy temperature has been monitored by other groups at ICRISAT with an infrared thermometer having short response time (<1 s) and a resolution of 0.1°C (Teletemp AG-42).

### Humidity

Atmospheric humidity is usually monitored by a ventilated psychrometer unit that measures both wet and dry bulb temperatures. A miniature psychrometer unit is available for intermittent use (Delta

T). It can hold enough water to last five days of continuous operation in a temperate environment. In the semi-arid tropics, however, the fan does not last for more than one month and the water reservoir has to be filled daily. A prototype unit developed by R. A. Saffell and R. Mathews (University of Nottingham) performed satisfactorily in the semi-arid tropics (Appendix II). The prototype consists of a robust fan motor that can operate for over 10 mo and a large reservoir that can be continuously used for 5–7 days. This design has been successfully employed in both experiments.

### Duration of Leaf Wetness

The duration of leaf wetness is an important consideration in the study of the spread of fungal and bacterial pathogens in crop canopies. It is also perhaps one of the most difficult environmental factors to quantify accurately because the wetting and drying of leaf surfaces are largely determined by the surface properties, the angle, size, and shape of the leaves. In the absence of a satisfactory commercial sensor to monitor the duration of leaf wetness of the actual leaf, we have used a leaf wetness sensing grid (Campbell Scientific), consisting of a printed circuit board with interlacing strips of goldplated copper. The decrease in the resistance between two strips produced by water condensation on the surface was measured in terms of voltage by giving an excitation of five volts to the sensing grid half bridge. However, the rate of wetting and drying of the plate is not an accurate reflection of the actual drying of the crop canopy. It serves as an indicator of the incidence of rain and the duration of wetness on an inert surface. The metal framework method described by Weiss and Hagen (1983) is more satisfactory as the grid is placed over the actual leaf. But the performance of this grid in the field has to be assessed before it can be recommended for general use.

### Windspeed

The cup anemometers used in both the experiments have a starting speed of about 0.5 m s<sup>-1</sup>, can record windspeeds of up to 60 m s<sup>-1</sup>, and can measure the mean horizontal flow of wind. In our environment, the highest windspeed above the crop rarely exceeded 6 m s<sup>-1</sup>. Overrun and finite

starting thresholds are the major sources of error with these anemometers. Maximum errors may reach +20% in some conditions while average error is probably about +6% (Woodward and Sheehy 1983). We have not observed any mechanical problem with the Met-one anemometers during a period of two years of continuous use.

## Data Loggers

In both experiments, a data logger was needed because of the large number of sensors and channels required (110 in the agroforestry, and 72 in the intercrop experiment). Three multiplexes were used to increase the number of channels from 16 to 110 in the Campbell CR 21X data logger. The total cost for the CR 21X and the three multipliers was \$4000 while the CR7 cost \$8000. The output was stored on cassette tapes and then unloaded onto the main frame computer twice weekly.

The new series of Campbell Scientific data loggers are superior to the CR5 which is unreliable and does not allow direct readout of the measurement being recorded. Furthermore, the programming of the new data loggers is relatively simple and foolproof.

A new generation of data loggers ideally suited for use in remote locations is now in the market. They have fewer channels, thus require less power, and can operate for 6–12 mo at a stretch. The LI 1000 Datalogger by LI-COR has 8 channels with a variety of software, e.g., various integrating modes, maximum and minimum, running average, etc., and costs \$800. A similar data logger called CR10, manufactured by Campbell Scientific, will soon be available. Delta-T also markets a data logger with 30 channels. It can be equipped with 30 additional channels (at a cost of \$1650). A common feature of these small data loggers is the package of “menu-driven” software and the direct readout facility that allows persons without a good understanding of electronics to use them properly.

## Interpretation of Data

In a review of physical measurements in crop physiology, Monteith et al. (1981) wrote that “progress in experimental science is limited not only by the availability of reliable instruments but, at the end of the day, by the observer’s skill in extracting

general conclusions from a specific set of measurements.” The quality and usefulness of the measurements does not simply depend upon the choice of hardware, but more importantly, on a well-defined question or hypothesis of the subject to be investigated. A major temptation is to collect more information than can be usefully analyzed, to select only a few days’ good data to illustrate some relationships, and to ignore the rest of the measurements.

In the two experiments described above, we sought to relate weekly changes in the microenvironment to the response of the crop, therefore plants were harvested every week. In the intercrop experiment, the population of fungal spores (urediniospores) and the proportion of germinating spores were monitored continuously. Laboratory studies conducted on the general response of the urediniospores to temperature, humidity, and light (Subrahmanyam et al., ICRISAT, personal communication) have facilitated meaningful interpretation of their progress in the field. Similarly, the response of pearl millet or groundnut to the modification in the microenvironment could be interpreted from studies of the response of each crop in controlled environments where only one factor has been allowed to vary diurnally (e.g., Ong and Monteith 1985, for response of pearl millet to light and temperature; Leong and Ong 1983, and Ong et al. 1985, for the response of groundnut to temperature and to saturation deficit). Crop responses to their real microenvironment could not be realistically explained without such detailed information.

## Conclusion

As reliable instruments for the characterization of the microenvironment become more accessible, the temptation to collect more data will become difficult to resist. At present, there is a shortage of data on the environment in the tropics, but as technical difficulties encountered in the field subside, the situation will undoubtedly improve. For example, since the introduction of tube solarimeters at ICRISAT in 1978, radiation measurement in agronomic experiments has become almost a routine. However, the characterization of the microenvironment is unlikely to contribute much to our understanding of crop performance in the tropics unless it is combined with a closer integra-

tion of the physical and biological disciplines, i.e., formation of interdisciplinary groups.

## Acknowledgments

I wish to thank Mr R.A. Saffell and Dr R.M. Matthews (University of Nottingham, UK) for freely supplying me with the details of the prototypes described, and Mr A.A.H. Khan (ICRISAT) for his technical assistance in the field.

## Manufacturers

**Detla-T Devices**, 128 Low Road, Burwell, Cambridge CB5 0EJ, England.

**Campbell Scientific Inc.**, P.O. Box 551, Logan, UT. 8432, USA.

**LI-Cor Ltd.**, P.O. Box 4425, Lincoln, NE. 68504, USA.

**Telatemp Corporation**, P.O. Box 5160, Fullerton, CA. 92635, USA.

**Met. One. Inc.**, P.O. Box 1937, Grants Pass, OR. 97526, USA.

**Omnidata International Inc**, P.O. Box 3489, Logan, UT. 84321, USA.

**Omega Engineering Inc.**, P.O. Box 4047, Stanford, CT. 06907, USA.

**Comark Electronics Ltd.**, Rustington, Little Hampton, BN 163QZ, West Sussex, England.

## References

**Bell, C.J., and Rose, D.A.** 1985. The measurement of temperature. Pages 79–100 in *Instrumentation for environmental physiology* (Marshall, B., and Woodward, F.I., eds.). Cambridge, UK: Cambridge University Press.

**Grace, J.** 1985. The measurement of wind speed. Pages 101–122 in *Instrumentation for environmental physiology* (Marshall, B., and Woodward, F.I., eds.). Cambridge, UK: Cambridge University Press.

**Harris, D., and Natarajan, M.** (In press.) The physiological basis for yield advantage in sorghum: groundnut intercrop exposed to drought. 2. Plant temperature, water status and components of yield. *Field Crops Research*.

**Leong, S.K., and Ong, C.K.** 1983. The influence of temperature and soil water deficit on the development and morphology of groundnut (*Arachis hypogaea* L.). *Journal of Experimental Botany* 34:1551–1561.

**Marshall, B., and Willey, R.W.** 1983. Radiation interception and growth in an intercrop of pearl millet/groundnut. *Field Crop Research* 7:141–160.

**Marshall, B., and Woodward, F.I.** (eds.) 1985. *Instrumentation for environmental physiology*. Cambridge, UK: Cambridge University Press.

**Monteith, J.L.** 1973. *Principles of environmental physics*. London, UK: Edward Arnold.

**Monteith, J.L.** 1979. Soil temperature and crop growth in the tropics. Pages 249–262 in *Soil physical properties and crop production in the tropics* (Lal, R., and Greenland, D.J., eds.). New York, USA: John Wiley.

**Monteith, J.L., Gregory, P.J., Marshall, B., Ong, C.K., Saffell, R.A., and Squire, G.R.** 1981. Physical measurements in crop physiology. I. Growth and gas exchange. *Experimental Agriculture* 17:113–126.

**Ong, C.K., Black, C.R., Simmonds, L.P., and Saffell, R.A.** 1985. Influence of saturation deficit on leaf production and expansion in stands of groundnut (*Arachis hypogaea* L.) grown without irrigation. *Annals of Botany* 56:523–536.

**Ong, C.K., and Monteith, J.L.** 1985. Response of pearl millet to light and temperature. *Field Crops Research* 11:141–160.

**Weiss, A., and Hagen, A.F.** 1983. Further experiments on the measurement of leaf wetness. *Agricultural Meteorology* 29:207–212.

**Woodward, F.I., and Sheehy, J.** 1983. *Principles and measurements in environmental biology*. London, UK: Butterworths.

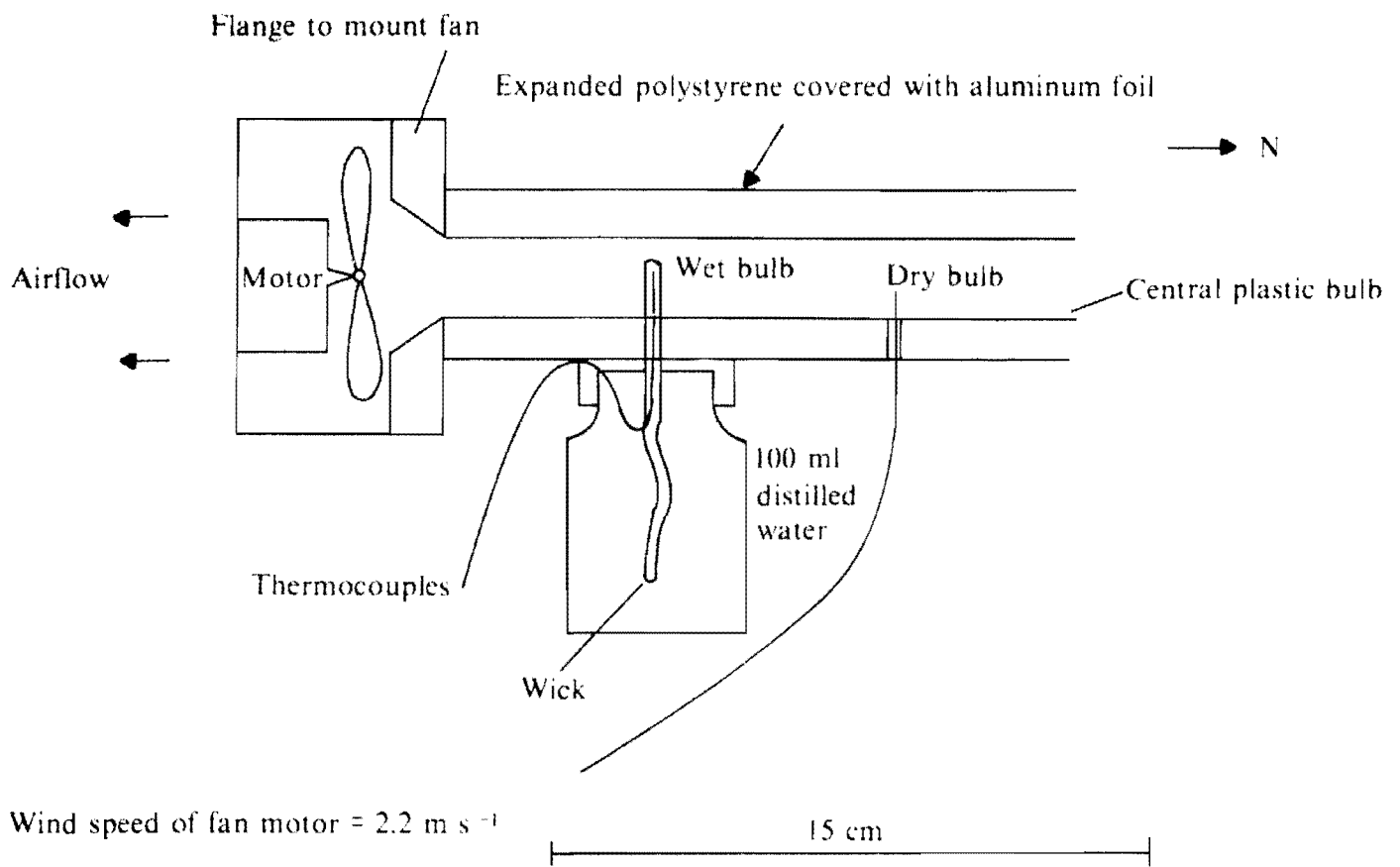

**Appendix 1. Details of aspirated psychrometer for continuous measurement of wet and dry bulb temperatures (after R.A. Saffell).**

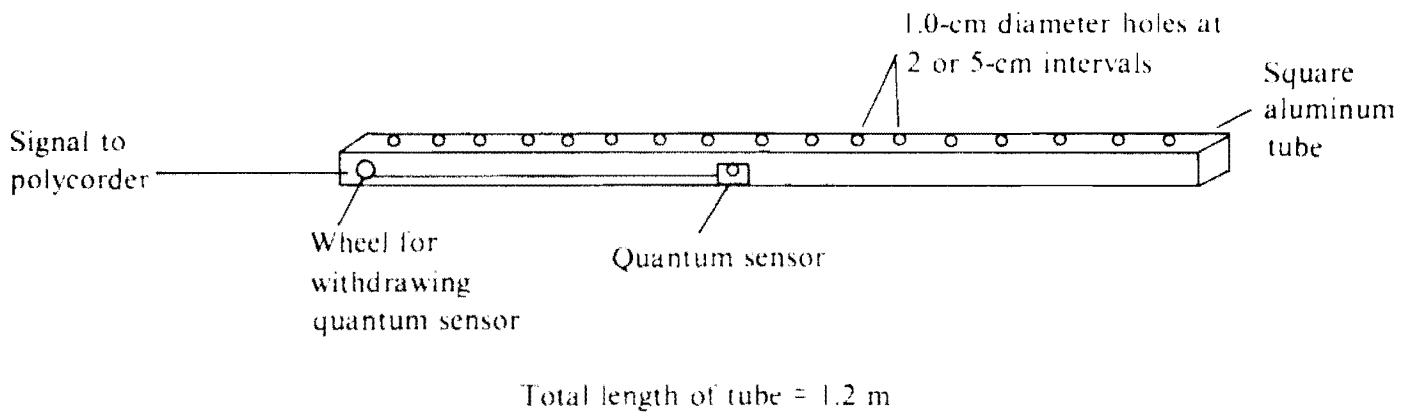

**Appendix II. Details of prototype quantum sensor (after R.S. Saffell and R. Mathews).**

# Soil Conservation and Water Resource Management in the Guinea and Sudanian Savanna Zones of Ghana

L. Sipkens and P.M. Nabila<sup>1</sup>

## *Abstract*

*Factors affecting soil erosion, conservation, and research as well as the water resource potential in the Guinea and Sudanian savanna of Ghana are reviewed. They include topography, soil type, vegetation, rainfall patterns, cropping techniques, and livestock management. The gradual change from subsistence to cash cropping has led to soil degradation. Soil conservation efforts in the area began long ago through bench terracing using stones collected from the farms. In the 1950s, land planning areas were introduced. Their partial failure is discussed. On-farm and on-station research is conducted on suitable cropping systems with a high proportion of legumes. In northern Ghana, 95 medium-scale irrigation schemes have been identified but only 3 have been constructed. Currently, the water resource utilization activities are centered around the small dams, the medium-scale irrigation projects, and the valley bottoms for rainfed rice farming.*

## *Résumé*

**Conservation des sols et gestion des ressources en eau dans la zone soudano-guinéenne du Ghana :** *On donne un aperçu de l'érosion du sol, de la conservation de l'eau et des recherches effectuées sur le potentiel des ressources hydriques dans la zone de savane soudano-guinéenne du Ghana. Les auteurs décrivent la topographie, les types de sols, la végétation, la répartition des pluies et les systèmes de culture et d'élevage. Le passage progressif d'une agriculture de subsistance à une agriculture de marché a entraîné une dégradation des sols. Dans cette région, on s'efforce depuis longtemps d'enrayer cette dégradation et d'adopter des mesures de conservation du sol telles que la culture en terrasses avec construction de murets en utilisant des pierres ramassées dans les fermes. Pendant les années 50, on a envisagé de mettre en oeuvre des plans d'aménagement foncier dont on analyse brièvement les raisons d'échec partiel. En station et chez le paysan, les recherches portent notamment sur l'identification de systèmes de culture adaptés comportant une forte proportion de légumineuses. Au Ghana septentrional, 3 des 95 projets d'irrigation de moyenne importance identifiés ont été mis en place. Actuellement, les foyers d'activité centrés sur l'utilisation de l'eau se regroupent près des petits barrages, des projets d'irrigation de moyenne importance et dans les bas-fonds des vallées occupés par des cultures de riz pluvial.*

---

1. Agronomists, Nyankpala Agricultural Experiment Station, Ghana.

ICRISAT (International Crops Research Institute for the Semi-Arid Tropics) 1989. Soil, Crop, and Water Management Systems for Rainfed Agriculture in the Sudano-Sahelian Zone: proceedings of an International Workshop, 7-11 Jan 1987. ICRISAT Sahelian Center, Niamey, Niger. Patancheru, A.P. 502 324, India: ICRISAT.

## Introduction

The northern Guinea and Sudan savanna zones of Ghana have been considered favorable for agriculture because of their vegetation. But now the desertification process has converted them into zones interestingly referred to as 'Sahel in the making', a situation that must be studied and controlled.

The Nyankpala Agricultural Experiment Station (NAES), located 16 km west of Tamale (approximately 9°N and 1°W), at an altitude of 200m, was established to study crop and soil improvement in the northern administrative region of Ghana, which more or less coincides geographically with the northern Guinea zone and Sudan savanna zone.

## Soil Erosion

Brammer (1962) wrote that soil erosion was not yet a serious problem except in very densely populated and intensively cropped areas around major towns in northern Ghana, i.e., the northern and upper regions. An FAO team (1967) concluded that 'a slow but steady erosion occurs almost everywhere'. This is also shown in a recent report by Serno and van de Weg (1985) that refers to a 1949 soil survey of NAES in which soil depths are said to be much greater than what are now observed.

A distinction must be made between soil degradation, where soil particles move vertically down the profile, and soil erosion, where soil particles move laterally and are entirely lost. Soil degradation is more widespread than soil erosion in northern Ghana. Soil erosion by wind occurs in the dry season after burning, but Brammer (1962) calls it 'more conspicuous than significant'.

Water is also a cause of soil erosion as we see below.

- Sheet erosion occurs when water runoff over the whole ground surface gradually removes the topsoil of vast areas. This is the most widespread and important form of erosion because most of the land in northern Ghana is gently sloping.
- In gully erosion, runoff becomes concentrated in channels, as can be observed along farm paths, roads, dam spillways, and in areas where poor plowing practices have been used.
- Soil-particle erosion affects gravelly soils that have become very unstable due to intensive

mechanical tillage, as near Kumasi, where water washed out the finest soil particles leaving a surface layer of gravel. It is also apparent in many farms around Bawku, where continuous use of animal traction has left a surface gravel layer 2–3 cm thick.

## Topography

Throughout the Volta basin, the main rivers drain into the Volta lake, which is surrounded by escarpments and hills. The Volta basin itself has a rolling landform at an altitude of 140–170 m, with slopes of 0–2% and scattered peneplains. The rivers slowly meander through seasonally flooded valleys of varying widths. The hilly areas to the west, north, and east of the basin have steeper slopes of about 3%, and occasionally as much as 7%, with hills as high as 500 m. The highest points are the escarpments which on the outside reach 500–700 m, and on the inside gradually descend to the Volta basin.

## Soil Types

Soils in the Volta basin are derived from sandstone and shale and can roughly be divided into alluvial soils in the valleys, and infertile upland soils. Soils in the hilly areas are derived from Birrimian schists and gneisses with basic or granitic intrusions. Poorly drained sandy and silty soils with hard pans cover large areas of the northern region. They are unfit for agricultural development (FAO 1967), but are sometimes cropped with cassava, late millet, bambara groundnut, or groundnuts. Upland soils derived from metamorphosed and sedimentary rocks are prone to erosion. A suitable system for classification of the savanna soils of northern Ghana is not yet available, although an attempt (Serno and van de Weg 1985) has been made to translate the Ghana classification into the modern classification (FAO 1967) based on drainage classes and soil depths.

## Vegetation

The natural vegetation cover of northern Ghana is composed of a fire proclimax tree savanna with species changing from the northern to the upper

regions. In farming areas, vegetation varies from continuous arable cropping to land rotation with bush or grass fallow. Characteristic trees in the northern region are *Parkia* spp, (dawadawa), *Butyrospermum parkii* (sheanut), *Bombax* spp, (kapok), and fruit trees like *Mangifera indica* (mango), *Diospyrum mespiliformis* (ebony fruits), and *Tamarix indica* (tamarind). These trees are grown in an orchard pattern with food crops underneath even in densely cropped areas of the northern region. In the upper east region, *Adansonia digitata* (baobab), *Acacia albida*, and *Azadirachta indica* (neem) grow near homes but not on farms.

### Rainfall Pattern

Northern Ghana is in the semi-arid tropics and has a dry season of over five months and a rainy season characterized by scattered rainstorms in March and April, variable dry spells in May, June, and July, high rainfall in August, September, until October, when they stop abruptly. Rainfall regimes of the upper east region (Manga), the center of the Volta Basin (Nyankpala), and of a higher rainfall area in the northern region (Damongo) are given in Figure 1.

### Agriculture

The geology of northern Ghana and the length of the dry season have largely determined the population distribution pattern. Although the upper east region has a longer and more severe dry season, it is much more densely populated because of the possibility to dig wells that continue to yield drinking water even in the dry season, and because the soils are of higher inherent fertility. Small dams to store surface water at relatively low cost were built and parts of the northern region that used to be inhabited only by wildlife and a few hunters are now gradually being occupied by migrating farmers. The development of a fairly dense network of village roads has recently opened up areas for market cropping, e.g., yams around Tamale.

In the northern region, maize, sorghum, late millet, rice, yams, cassava, groundnut, cowpea, and pigeonpea are grown in a variety of intercropping systems. Cotton which 'disappeared' in the 1970s, due to inefficient marketing, is beginning to

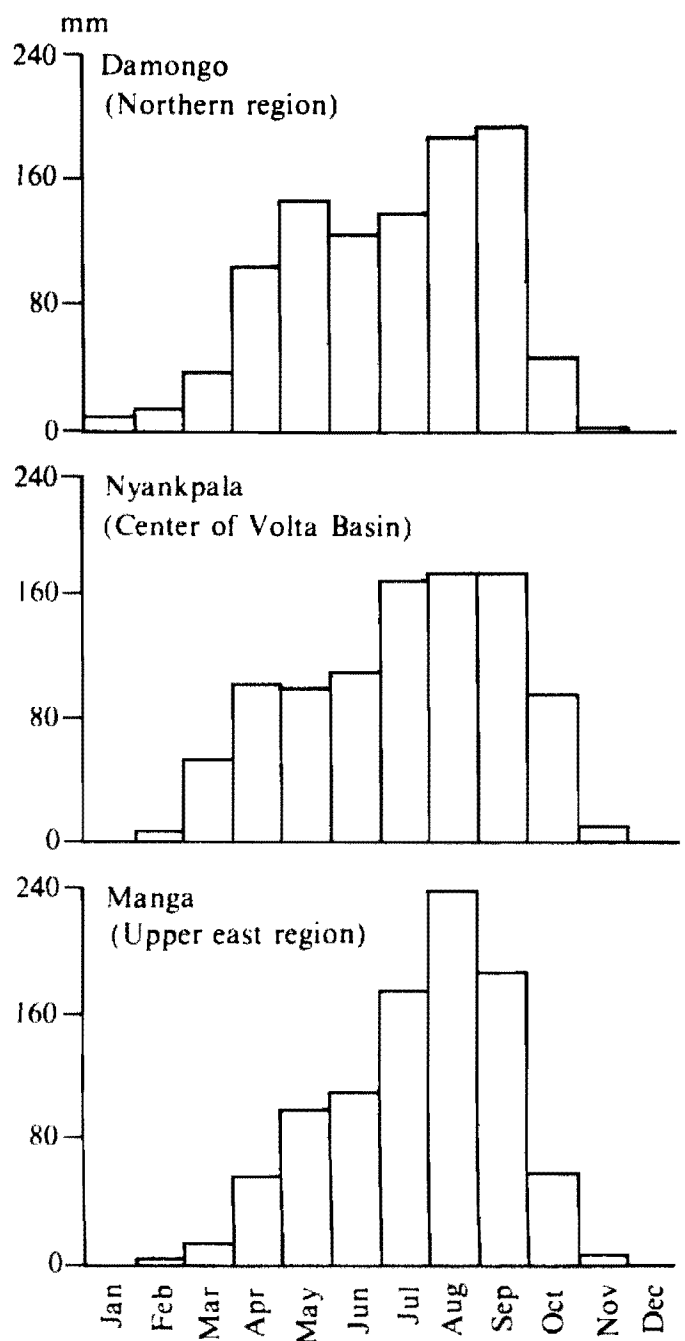

Figure 1. Average monthly rainfall in northern Ghana.

come back. The only export crop now is the shea nut from semi-wild trees.

In the upper regions, crops include sorghum, early and late millet, rice, some maize, groundnut, bambara groundnut, and cowpeas which, except for sorghum and millet, are usually grown as sole crops. Vegetables, especially tomatoes and onions, are important cash crops in the dry season for farmers who operate around the small irrigation dams in the upper east region.



Traditionally, the 'household head' of the compound family determines which crops to grow. In the upper east region, a large proportion of the early-millet crop is grown on the compound farms, whereas in the northern region maize and tobacco (the cash crops) are grown. The gradual change from subsistence farming to market-oriented farming has led to four new types of commercial farming:

1. Young, wage-earning farmers in the south grow market crops like groundnut and rice in the flooded valleys.
2. Women on the subsistence farms earn cash from small okra and pepper gardens in the rainy season and from trees in the northern region. The orchard/food crop system produces saleable fruits, shea nut, dawadawa, firewood, and charcoal. Firewood is still collected from fallow regrowth, but is becoming scarce around the population centers.
3. City-based entrepreneurs practice mechanized rainfed rice farming in the larger valleys and mechanized maize farming on the highlands. They also occupy large tracts of land in the medium-scale irrigation schemes of Tono, Vea, and Bontanga. When certain types of weeds, e.g., *Rotboellia exaltata* in rice and *Striga* spp in maize become too difficult to control, and lands become less productive even with fertilizers, they move on to other fertile land.
4. Traditional yam farming areas are being expanded in the southeast and west of the northern region. Vast areas have been cleared for cultivation, and in Accra, yam marketing facilities have been improved.

### Livestock and Bush Fires

The northern region does not seem to suffer from overgrazing. It is, however, impoverished by yearly bush fires. 'The harm done is out of all proportion to the benefits gained' (FAO 1967). People burn bushes for short-term benefits such as hunting, regrowth of grasses for livestock after burning and after the first rains, and pest control.

The densely populated upper east region has highly stocked areas where all crop residues are collected and fed to the animals during the dry season. So little vegetation remains that bush fires are rare.

The most ancient soil conservation system in the upper regions is bench terraces on steep slopes. Stones from the fields are placed to form banks which more or less follow the contour.

In the intensively cropped areas of the upper east region, six land-planning areas were established in the 1950s. They represented an early multidisciplinary approach by the Government to reverse soil degradation and to stop soil erosion. Each land planning area was divided into fenced areas for grazing, forest plantations to protect watersheds and to supply firewood, and arable land. Cropping systems were intensified with fertilizer application, bullock plowing, and application of kraal manure. Contour bunds were created on arable land with heavy machinery. Dams were constructed to control gully erosion and to provide drinking water, fishing areas, and simple valley bottom irrigation (Brammer 1962). In these land-planning areas today, the forest reserves still exist but they are farmed and heavily exploited for firewood. Bullock plowing and application of manure from the kraals are generally practiced, but fertilizer has been scarce since a long time. The cropping area has been vastly increased at the expense of the grazing area and the dams are silting up. The North-East Savanna Research project supported by the United States Agency for International Development (USAID) has started socioeconomic research to determine why people so staunchly rejected the land-planning approach.

### Research

Part of the NAES mandate is to develop cropping systems for the upper and northern regions that ensure stable and high yields while maintaining or increasing soil productivity. Implicitly, this involves soil conservation. High yields may reduce the need to shorten the fallow periods and to farm unsuitable land. Research is being conducted on crop improvement, soil fertility, agronomy, and economics. Trials and on-farm testing have led to the recommendation of higher-yielding varieties of sorghum (Naga White, Loc 29), groundnut (Fmix, Chinese, Manipintar), maize (Dobidi, Safita 2), cowpea (TVx series, Valenga), rice (Gr 19, Gr 20, Gr 21), and pigeonpea (ICPL 270). More efficient ways of utilizing fertilizer are also being deter-

mined. Nitrogen-fixation studies are leading to inclusion of other legumes in the cropping system.

The main focus of agronomy research is on developing cropping systems with a high proportion of legumes. Very good results have been obtained for upland crops in crop rotations using P and K fertilizers, chisel plowing, and mechanical plowing of groundnut residues (NAES 1986). This should appeal to commercial entrepreneurs who currently practice sole cropping till the land is exhausted. Subsistence farmers are very reluctant to consider crop rotation as a method to ensure yields (Sipkens and Diehl 1986). Alley cropping with pigeonpea on upland soils has been tested on-farm and on-station (NAES 1986), and shows promise in the higher rainfall areas of the northern region. Double cropping of cowpeas or mung before rice in the flooded valleys (NAES 1986, pp. 145-158), double or intercropping of cowpea and maize (NAES 1986, pp. 160-167), and relay cropping of maize or groundnut with pigeonpea also appear promising.

## Water Resources

The tributaries of the Volta River constitute the main water resources in the area and can be used for power, domestic consumption, and agriculture. To benefit from their high potential in semi-arid northern Ghana, the postindependence Government of Ghana sought the assistance of FAO to identify possible small- and medium-scale schemes for development; 95 were identified with irrigable lands with an area ranging between 240 and 4400 ha each. The majority were meant to be earth structures across tributaries of the main Volta River that drain the whole region (FAO 1967). The rest were diversions from the main Volta lake, to be pumped to suitable elevations and subsequently used to irrigate appropriate fields. A total of 104 000 ha were to be brought under irrigation.

The Nippon Koei Ltd. Co. of Japan, and then FAO proposed to construct a huge dam to irrigate 95 200 ha, and to generate hydroelectric power at Pwalugu for the northern and upper regions (NORRIP 1981). In addition, the FAO team recommended the construction of numerous small dams and dug-outs to meet small-scale irrigation and domestic water needs in more densely populated areas. About 100 dams were constructed in the upper east region. In the Bawku area, 63 dams

were constructed, of which only 28 are currently functional.

Considering the rainfall pattern of northern Ghana (Fig. 1), water resources are needed for the long dry season and to cultivate rice in valleys and depressions. The flourishing dry-season vegetable gardening industry around some dams in the upper east region is an indication of the possible importance of irrigated farming in northern Ghana. Further, fishing in the dams and lakes, and fish farming could both become important industries.

Unfortunately, mainly due to lack of funds, and to some extent, due to political unrest, many water resource projects have not materialized. Recently, the Ministry of Agriculture created the Irrigation Development Authority to administer medium- and small-scale irrigation projects. In the few places where projects have been initiated, e.g., small dams in the Bawku Area, medium-scale schemes at Tono, Vea, and Bontanga, and rainfed rice cultivation in valley bottoms, management problems have impeded progress.

### Small Dams and Dug-Outs

The government has built some small dams and developed irrigated areas in some cases without involving the local inhabitants. The dams that are functioning are used for small-scale irrigation.

Land holdings are very small, on an average, 0.1 ha per farmer at Binaba, Kamaga, Binari, and Bugri. Crop husbandry is very intensive, and yields are very high. At Binaba, two paddy crops are harvested before the dry-season gardening. Paddy yields of up to 8000 kg ha<sup>-1</sup> have been recorded.

At the deserted dam sites, where local inhabitants see no reason to maintain the dams, they farm the catchment area and pilfer spillway slabs and fencing material; the dams silt up, the dam walls gradually erode, and stray animals destroy the crops. Little effort has been made to organize fish farming.

### The Medium-Sized Schemes

Out of the 95 schemes recommended by FAO, only the three at Tono, Vea, and Bontanga, have been completed. Tono has 2490 ha and Vea has 850 ha of irrigable land. The Irrigation Company of the Upper Region (ICOUR) was established in 1984 by

the Ghana government to promote the production of food crops by small-scale farmers within organized irrigation schemes. The Tono and Vea projects together cater to 6000 small farmers in the area. Plot size per farmer varies from 0.2 to 0.6 ha. Paddy rice, tomatoes, onions, millet, maize, sorghum, and groundnut are grown during the rainy season on the upland area. Estimated rice yields are 1740–3760 kg ha<sup>-1</sup> in the rainy season and around 4700 kg ha<sup>-1</sup> in the dry season. To reach the production potential of these projects, certain lands are allocated to temporary users, e.g., the ICOUR farm, Government organizations, and private commercial farmers. Furrow irrigation is practised in the upland area and basin flooding in the lowlands.

In a medium-sized fish pond development scheme, ICOUR supplies Tilapia fingerlings, technical support, nets, and other inputs for the fish farmers who rent and operate project fish ponds at Tono (4.8 ha) and at Vea (3.2 ha).

A community forestry program for firewood, fruits, timber, and livestock fodder has been initiated to utilize lands unsuitable for cultivation.

At the Bontanga project, a dam has been constructed. An estimated 420 ha are irrigable; an additional 200 ha are yet to be developed. Land allocation has started and the first crops have been planted.

### Valleys for Rainfed Rice Farming

Huge areas (160 000–240 000 ha) of valleys, natural depressions, and relatively flat river basins with heavy textured hydromorphic soils and seasonal flooding along the Volta River are left uncultivated because farmers lack the required technology.

From the early 1970s, commercial farmers from Tamale began to utilize these fields for medium-scale mechanized paddy cultivation, including combine-harvesting. Small-scale paddy cultivation by young village farmers who sell their harvest in nearby towns has become important in the past 15 years.

### Current Practices and Future Research Needs

The discussions so far confirm the huge potential for irrigation farming and other forms of water

management in the Guinea and Sudan savanna of Ghana. In the authors' opinion some of the factors that militate against achieving this potential include the following issues:

- The Government alone cannot finance projects. Participation by international aid and financing organizations is needed to achieve the water resource potential of northern Ghana.
- Many small dams are not well maintained. Future projects should be planned to involve the local people from the beginning. They could bear part of the construction costs, and could be trained in dam maintenance techniques. On the other hand some small dams nearby are in excellent condition and are being well used. The reason for this difference in attitude should be studied.
- The question of land tenure must be solved before any irrigation project can be successfully implemented. The traditional land tenure system empowers the local chief to distribute lands, and the resulting personal attachment makes it difficult to reallocate lands for project development (Konings 1981).
- On the lowlands, great potential exists for optimizing the use of naturally available water. Small investments in land leveling and building of low dikes and bunds would greatly facilitate more efficient use of water and would substantially alleviate weed control problems (Cody 1981).

### References

- Brammer, H.** 1962. Soil erosion and conservation, in agriculture and land use in Ghana. (Wills, J.B. ed.). London, UK: Oxford University Press.
- Cody, W.** 1981. Agronomy in the northern region of Ghana. Northern Region Rural Integrated Program. Technical Unit, Ghana, Tamale.
- FAO** 1967. Final report on land and water survey in the upper and northern regions, Ghana. Rome, Italy: FAO.
- Konings, P.** 1981. Peasantry and state in Ghana. The example of the Vea irrigation project in the Upper Region of Ghana. Leiden, Netherlands: African Studies Centre.

**NAES** (Nyankpala Agricultural Experiment Station). 1986. Annual report for 1985–1986. Nyankpala, Ghana: NAES.

**NORRIP** (Northern Regional Rural Integrated Programme). 1981. Sectoral report. Preliminary assessment of water resources, irrigation-hydroelectric power-flood control-domestic water supplies. Tamale, Ghana: NORRIP.

**Serno, G., and Van de Weg, R.F.** 1985. Preliminary assessment of the available existing soil information of Nyankpala Agricultural Experiment Station, Tamale, Ghana. Wageningen, Netherlands.



# Research Needs and Priorities for Rainfed Agriculture in Western Sudan

B.A. Ibrahim and G.M. Madibo<sup>1</sup>

## *Abstract*

*A fundamental constraint to agriculture and livestock production for the traditional producers in western Sudan is an inefficient, and at times inappropriate, use of their resource base. Insufficient water availability, unreliable rainfall, poor genetic stock, low soil fertility, inefficient agronomic practices, crop pests and diseases, and inadequate infrastructure were singled out as the most important production-limiting constraints. Research priorities for the region as well as aspects for future development are discussed. The two most crucial measures suggested were the development of drought-resistant varieties and the improvement of soil/water management and conservation practices.*

## *Résumé*

**Besoins et priorités de la recherche pour l'agriculture pluviale dans les zones semi-arides du Soudan occidental :** *L'utilisation inefficace et parfois inappropriée des ressources dont disposent les producteurs traditionnels du Soudan occidental est l'une des contraintes fondamentales de leurs systèmes de production animale et végétale. Parmi d'autres facteurs limitant la production, les auteurs ont relevé l'insuffisance des quantités d'eau disponible, l'irrégularité des pluies, la médiocrité du matériel génétique, les pratiques agronomiques déficientes, la faible fertilité des sols, l'existence des ravageurs et des maladies des cultures et, enfin, l'absence d'une infrastructure appropriée. La mise au point de variétés résistantes à la sécheresse et l'amélioration des techniques d'aménagement des sols et de conservation de l'eau sont apparues comme étant les deux méthodes essentielles pour remédier à la situation.*

## Introduction

Sudan, the largest country in Africa, covers an area of over 2.5 million km<sup>2</sup>. Its climate is tropical continental with a marked rainfall transition from north to south. The south has a moist climate, with rainfall decreasing to less than 800 mm in the center, to a mere 75-250 mm in the desertic north. The air temperature in the north exceeds 50°C in July. Of Sudan's estimated 35 million ha of arable land,

less than 30% is cultivated. Of this, 1.68 million ha are irrigated, 2.31 million ha are under rainfed mechanized farms, and 6.72 million ha are under traditional rainfed agriculture (Nelson 1982), which is defined as agriculture with low inputs, largely hand or animal labor, and low mechanization. Agriculture accounted for 45% of the gross domestic product, and contributed over 90% of the total export in 1978 (EPL 1979). Over 80% of the population derive their living from land (Stuken 1963).

---

1. Western Sudan Agriculture Research Project, El Obeid, Sudan.

ICRISAT (International Crops Research Institute for the Semi-Arid Tropics) 1989. Soil, Crop, and Water Management Systems for Rainfed Agriculture in the Sudano-Sahelian Zone: proceedings of an International Workshop, 7-11 Jan 1987. ICRISAT Sahelian Center, Niamey, Niger. Patancheru, A.P. 502 324, India: ICRISAT.

In Sudan, as in most African countries, crop and livestock production interact to make a complex agricultural system, requiring an integrated multi-disciplinary approach to agricultural development (McCown et al. 1979). The Western Sudan Agricultural Research Project (WSARP, 1987 and 1983) has adopted this approach emphasizing farming systems, farmers, and their farms rather than a single crop.

WSARP operates in the Darfur and Kordofan regions (35% of Sudan's land area), known for gum arabic (*Acacia senegal*) production. Pearl millet (*Pennisetum americanum*) and sorghum (*Sorghum bicolor*) are the main staple food crops. Cash crops include sesame (*Sesamum indicum*), groundnuts (*Arachis hypogaea*), cotton (*Gossypium* spp.), roselle (*Hibiscus sabdariffa*), and watermelon (*Citrullus vulgaris*).

The main soil types of the region are the Goz sands (sandy, mixed, isohyperthermic, typic quartzsammments) that are very low in nitrogen, phosphorus, and organic matter, and the clay and clayey sand soils (Yermosols) locally known as "Gardud". This last soil type is difficult to cultivate with traditional tools because of compaction. Its chemical and physical characteristics are little understood. This is a major constraint to productivity and maintaining fertility status.

### Problems and Constraints to Crop and Livestock Production

Western Sudan produces a significant part of the total national crop and livestock production (Table 1). There are, however, serious problems and constraints that limit optimum production, such as:

1. Water scarcity. Insufficient water is the most serious constraint to agricultural production, especially in North Kordofan where rainfall is erratic.
2. Poor genetic stock. Lack of high-yielding adapted varieties of crops is an important constraint. Local varieties are generally late maturing, low yielding, and are not drought tolerant or disease resistant.
3. Low soil fertility. Goz soils are easy to cultivate and much of the traditional production activities are on these soils. However, decades of cultivation without soil amendments (fertilizers, manures, etc.), and without crop rotation has depleted the soil. Removal of natural vege-

**Table 1. Western Sudan's contribution to national agriculture (average of 4 years).**

| Commodity  | Percentage of national total |
|------------|------------------------------|
| Sorghum    | 17                           |
| Millet     | 90                           |
| Groundnut  | 46                           |
| Sesame     | 52                           |
| Gum arabic | 90                           |
| Cotton     | 6                            |
| Cattle     | 45                           |
| Sheep      | 37                           |
| Goats      | 32                           |
| Camels     | 65                           |

Source: Department of statistics and agricultural economics. Ministry of agriculture and irrigation, 1975-76, 1979-80, Khartoum, Sudan.

tation, overgrazing, range burning, and cutting of trees for fuel and construction have accelerated erosion of these unstable soils.

4. Poor cultural practices. In most cases, the cultural practices followed by farmers are not optimum. Research is needed on optimal plant density, spacing and cultivation, and on intercropping techniques.
5. Losses due to pests and diseases. Heavy losses occur due to pests and diseases like striga (*Striga hermonthica*), naffasha (*Raghuva albipunctella*), stem borers (*Acigona* spp, *Chilo partellus*, *Sesamia cretica*), and stored grain insects, such as *Callosobruchus maculatus*. Few farmers use proper control measures.
6. Transport difficulties and inadequate infrastructure. Lack of transportation in western Sudan limits the availability of agricultural inputs, basic services to the farmers, and access to markets. Problems with storage facilities, credit, and financing, marketing schemes, and other socioeconomic issues hamper agricultural development in the region.

### Research Activities and Needs

A few attempts, some by international organizations like ICRISAT and International Institute of Tropical Agriculture (IITA) in collaboration with the agricultural research stations, have been made to conduct agricultural research in western Sudan.

Much of the research has been focused on cotton breeding (Kadugli station) and varietal trials for crops like sorghum, cowpea, and sesame. Gum arabic research (El Obeid station) has focused on propagation and gum production of *Acacia senegal* and other acacia species. WSARP has identified the following research needs of the region:

- livestock production in the arid fringe of the desert;
- livestock production interspersed with crop production in the southern, semi-arid parts of the project area;
- integrated crop-livestock production on stabilized sands;
- integrated crop-livestock production on sandy clay soils;
- integrated crop-livestock production on Vertisols; and
- proper water and land-use management.

### Research Priorities

The following agricultural research topics are emphasized for future development in the Kordofan region. However, they may be applicable throughout western Sudan.

1. Varietal improvement through breeding and selection. Recurrent drought and erratic rainfall make it urgent to develop crop varieties that are early maturing, drought tolerant, high yielding, and resistant to pests and diseases.
2. Improvement of cultural practices. Very little is known about appropriate cultural practices like plant population, seedbed preparation, fertilizer application, weeding, intercropping, and crop sequence.
3. Soil and water management and conservation. High priority needs to be given to research on mulching and residue management, tillage, seed planting, runoff harvesting through contour bunds and terraces, and wind erosion control through the establishment of windbreaks.
4. Crop production. Suitable methods must be found to control prevailing pests and diseases. However emphasis should be on varietal resistance testing and improved cultural practices in the region rather than on expensive chemical control.
5. Improvement of range and livestock production. Research on improvement of indigenous

livestock species, proper use of crop residue and forages as animal feed, especially during the dry season, are priority areas.

6. Agroforestry research. Research must be conducted on integrating *Acacia senegal* (gum arabic) with agricultural crops. Supporting topics like selection of high-yielding trees and nursery management are also important.
7. Socioeconomic aspects that affect agricultural production. Three traditional production systems—nomadic, transhumant and sedentary—prevail in the region. Little is known about their dynamics and interaction.

### Conclusions

In a crop/livestock production system, a change in one component may affect the other components. Therefore research in western Sudan should use a multidisciplinary production systems approach in which all the components are given due consideration in the research plans.

### Acknowledgment

The authors are indebted to Dr El hag H. Abdel gasim, Director of El Obeid Research Station, for his cooperation.

### References

- EPL (Europa Publications Ltd.)** 1979. The Europe Year Book. London, UK: Europa Publications Ltd.
- McCown, R.L., Haaland, G., and De Haan, C.** 1979. The interaction between cultivation and livestock production in semi-arid Africa. Pages 297–332 in *Agriculture in semi-arid environments* (Hall, A.E., Cannell, G.M., and Lawton, H.W., eds.). Berlin, Federal Republic of Germany: Springer Verlag.
- Nelson, H.D.** 1982. Sudan country study. Foreign area studies. (Smith, W.E., ed.). Washington, D.C., USA: American University.



**Stucken, R.** 1963. *Entwicklungsbedingungen and Entwicklungschancen der Republik Sudan*. Berlin, Federal Republic of Germany: Verlag von Bucker and Humbolt.

**WSARP** (Western Sudan Agricultural Research Project). 1982. *General research programs and plans*. Publication no.13. Khartoum, Sudan: WSARP.

**WSARP** (Western Sudan Agricultural Research Project). 1983. *Research programs for El Obeid and Kadugli research stations*. Khartoum, Sudan: WSARP.

**Crop/Livestock Relationships,  
Residue Management, and Agroforestry**



# Soil Fertility Management of the Pearl Millet-Producing Sandy Soils of Sahelian West Africa: The Niger Experience

A. Bationo, C.B. Christianson, and U. Mokuwonye<sup>1</sup>

## Abstract

*Most of the information in this paper is the result of field trials conducted in Niger on the sources, management, fate, and efficiency of phosphorus and nitrogen fertilizers. Indigenous phosphate rock and partially acidulated phosphate rock can provide inexpensive alternatives to imported fertilizers. Because the sandy soils of the area have a low capacity to absorb phosphorus, management practices are being developed to maximize the good residual response to phosphorus. Moisture has proven important in the response of pearl millet to nitrogen fertilizers. Recent trials indicate that a combination of the appropriate nitrogen source (less volatile) and management practices (point placement) may help reduce nitrogen losses that have been as high as 50%. The addition of farmyard manure and crop residues improves the chemical properties of the soils, and organic materials complementary to mineral fertilizers help sustain productivity.*

## Résumé

**Gestion de la fertilité des sols sablonneux à vocation du mil au Sahel en Afrique de l'Ouest—l'expérience nigérienne :** *La majeure partie de l'information contenue dans cet article résulte d'essais au champ réalisés au Niger sur les sources, la gestion, l'état et l'efficacité des engrais phosphatés et azotés. Les roches phosphatées naturelles et roches phosphatées partiellement acidulées peuvent être des solutions de rechange peu coûteuses par rapport aux engrais importés. Les sols sablonneux de la région sont caractérisés par leur faible capacité d'absorber le phosphore. Développer des modes de gestion est essentiel pour maximiser la réponse résiduelle élevée aux engrais phosphatés. L'humidité s'est révélée importante pour la réponse du mil à l'azote. Des essais récents montrent que la combinaison de sources adéquates d'azote (moins volatile) et de modes de gestion (placement localisé) peut réduire les pertes d'azote qui peuvent atteindre 50%. L'addition de fumier et de résidus de récoltes améliore les propriétés chimiques des sols; la complémentarisation des engrais minéraux par la matière organique aide au maintien de la productivité.*

## Introduction

Pearl millet (*Pennisetum glaucum* (L.) R.Br) is the dominant food crop in the sandy, often drought-

prone areas of the semi-arid West Africa. The FAO estimated that, of the 27 million ha growing pearl millet in Africa, 56% is in West Africa (FAO 1985). In 1985, 22% of the pearl-millet growing area in

---

1. Soil scientists IFDC/ICRISAT, Niamey, Niger; IFDC Muscle Shoals, AL., USA.

ICRISAT Conference Paper no. CP 413.

ICRISAT (International Crops Research Institute for the Semi-Arid Tropics) 1989. Soil, Crop, and Water Management Systems for Rainfed Agriculture in the Sudano-Sahelian Zone: proceedings of an International Workshop, 7-11 Jan 1987. ICRISAT Sahelian Center, Niamey, Niger. Patancheru, A.P. 502 324, India: ICRISAT.

Africa was in the Republic of Niger (FAO 1985).

Between 1960 and 1985, land planted to pearl millet in Niger increased by 105%, from 1.6 million ha to 3.3 million ha. During the same period, pearl millet production increased only by 25%, from 0.8 million t to slightly over 1.0 million t. Since yield declined from 480 to 300 kg ha<sup>-1</sup>, the 25% increase in total production resulted primarily from an increase in the amount of land cropped to pearl millet. Yield and total production suffered from intermittent drought, expansion onto marginal lands with low crop production potential, and the deterioration of lands previously under cultivation. The pressure of population on available arable lands now prevents the farmer from maintaining soil fertility through extended fallow. Today there is little doubt that poor soil fertility rather than lack of water is the major constraint to increased food production in the Sahel (Penning de Vries and Djiteye 1982).

The FAO estimates that, if tropical Africa is to be able to feed itself by the year 2000, 51% of any increase in food production must come from increased yield per hectare (FAO 1981). Lessons from other areas of the developing world suggest that fertilizers have a key role to play in efforts to increase yield in sub-Saharan Africa. Most of the information in this paper is the result of field trials conducted in different locations in Niger by scientists of the International Fertilizer Development Center (IFDC) working with scientists of the International Crops Research Institute for the Semi-Arid Tropics (ICRISAT) on the sources, management, fate, and efficiency of phosphorus and nitrogen fertilizers.

### Characteristics of the Experimental Sites

The experimental sites are characterized by light sandy soils with low native fertility, and extremely low organic matter content, exchangeable cations, and 'available' phosphorus levels (Table 1). Rainfall is irregular, and infiltration rates are generally high. Since 1982, when the first trials were established, the mean annual rainfall recorded at Sadoré has ranged between 260 mm (1984) and 650 mm (1986). Soil-moisture measurements indicated that moisture stress limited production only in 1984. On the basis of 1% probability of a drought such as the one in 1984 (Sivakumar, ICRISAT, personal

**Table 1. Some physical and chemical properties of the soils at Sadoré and Gobéry, Niger.**

| Property  | Sadoré  | Gobéry  |
|---|---------|---------|
| Latitude  | 13°18'N | 13°05'N |
| Longitude   | 02°21'E | 02°54'E |
| Mean annual rainfall (mm)                               | 560     | 600     |
| Soil texture (%)  |         |         |
| Coarse sand   | 52      | 50      |
| Fine sand   | 42      | 45      |
| Silt  | 0.3     | 3       |
| pH  | 5.1     | 5.2     |
| Organic matter (%)                                      | 0.185   | 0.26    |
| Total nitrogen (%)                                      | 0.013   | 0.020   |
| C:N ratio   | 10      | 9       |
| Phosphorus  |         |         |
| Total ( $\mu\text{g P g}^{-1}$ soil)                    | 40.8    | 40.2    |
| Bray 1 P ( $\mu\text{g P g}^{-1}$ soil)                 | 2.66    | 2.60    |
| Exchangeable cations ( $\text{cmol}(+)\text{kg}^{-1}$ ) |         |         |
| Ca  | 0.30    | 0.60    |
| Mg  | 0.10    | 0.12    |
| K   | 0.05    | 0.05    |
| ECEC [ $\text{cmol}(+)\text{kg}^{-1}$ ]                 | 0.86    | 1.40    |
| Base saturation (%)                                     | 52      | 55      |

communication), it appears likely that the declining yields in the Sahel are a result of declining soil fertility.

### Nitrogen: Fertilizer Sources and Management

Although it is generally recognized that phosphorus is the most limiting nutrient for food production in the Sahel, a significant response to N is often obtained with pearl millet. As with any crop, the strength of the response of pearl millet to N can vary greatly, depending on the N source, the method and timing of its application, and the rainfall (Pieri 1973). In Niger as in the rest of tropical Africa, urea is the most widely used N source, though small amounts of calcium ammonium nitrate (CAN) are also available. Although urea is relatively cheap to produce, and its high N content (46% N by weight vs 26% for CAN) results in much lower transportation and storage costs, in the Sahel it is highly susceptible to losses through volatilization. (Ganry and Guiraud 1979).

Because of the low amounts of moisture avail-

able to the crop, wide (1 m × 1 m) spacing is employed in the planting of pearl millet in Niger. At the beginning of this program, we adopted the working hypothesis that nutrients could not be efficiently used by the plant if they are not placed near it. Experiments were conducted in Niger comparing band-placed CAN or urea with point-placed urea<sup>1</sup> to determine the effects of N source and management on pearl millet yield. The trials involved the use of <sup>15</sup>N at the 30 kg N ha<sup>-1</sup> rate so that a fertilizer N balance could be conducted at the end of each season. This allowed the determination of fertilizer N uptake by the plant, N distribution in the soil at harvest and, by subtraction, N loss.

During our experiment, we found that the strength of the N response in terms of increased yield, varied greatly depending on the rainfall amount and distribution. In the drought year of 1984 (260 mm total precipitation), crop growth was severely limited, and regardless of rate, no significant response to N was found. Conversely in 1985, a year of excellent rainfall, the N response was very strong with yield maxima approaching 1500 kg grain ha<sup>-1</sup> with 45 kg N ha<sup>-1</sup> as compared with 950 kg ha<sup>-1</sup> with no nitrogen. The distribution of precipitation received during the growing season is a more important factor affecting N response than the total annual rainfall. Although the total amounts received in 1983 (599 mm) and 1985 (543 mm) were approximately equivalent, pearl millet yields were higher in 1985 (1500 kg ha<sup>-1</sup>) than in 1983 (1100 kg ha<sup>-1</sup>). Approximately one-third of the total precipitation in 1983 was received very late in the season. It is speculated that the late rains had little positive effect on yield. In 1985, 293 mm was received during the mid-season interval of 10 Jul to 20 Aug and proved very beneficial to the crop.

Generally, no significant difference was found between N sources at the rate of 30 kg N ha<sup>-1</sup> or methods of application in any year. The data obtained in 1983 (mid-season rainfall from 10 Jul to 20 Aug of 153 mm) makes it evident that a strong response to N can be found in Niger in the presence of phosphorus and adequate moisture (Fig. 1).

1. Banding refers to the placement of fertilizer in a shallow trench 7-8 cm deep which runs parallel to and 10 cm from the plant row. With point placement, all the fertilizer for one plant is placed in a hole 10 cm from the plant at a depth of 7-8 cm. In both methods, the fertilizer is covered with soil.

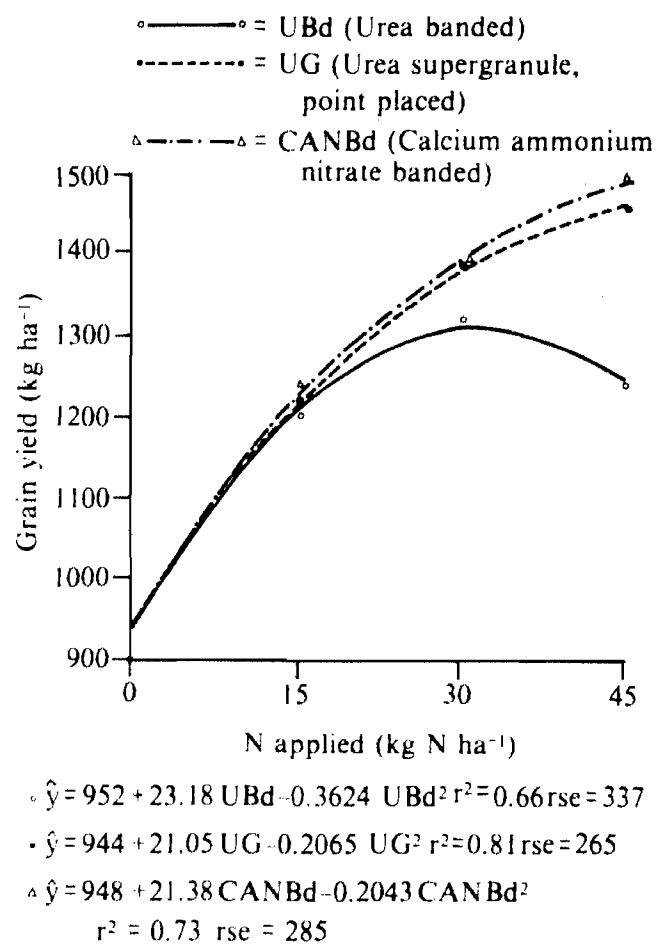

Figure 1. Effect of nitrogen sources, methods, and rates of application on pearl millet grain yield, ISC, Niger, rainy season 1985.

Maximum yield for all sources and management techniques was found at the 30 kg N ha<sup>-1</sup> rate of application where yields were increased from an average of 950 to 1300 kg grain ha<sup>-1</sup>. Each kilogram of fertilizer N applied by the farmer at this rate would therefore be expected to increase his pearl millet yield by almost 12 kg of grain. The fact that no significant difference was found in the efficiency of the various fertilizers or placement methods indicates that the farmer probably can achieve equivalent efficiency with either of the two sources or application methods tested.

Some trial data taken in 1983 illustrate the nitrogen balance in a pearl millet cropping system using <sup>15</sup>N. It was found that N losses were very high and, in the case of point-placed urea, exceeded 50% of the nitrogen applied (Table 2). An average of 24.6% of the applied N was taken up by the plant, of which 10.3% was found in the grain. Thus the

**Table 2. Recovery of  $^{15}\text{N}$  in the pearl millet plant and soil at harvest, Sadoré, 1983.**

| Treatment         | $^{15}\text{N}$ recovery |                    |      |      |
|-------------------|--------------------------|--------------------|------|------|
|                   | Grain                    | Plant <sup>2</sup> | Soil | Loss |
| CAN split         | 13                       | 28.8               | 34.2 | 37.0 |
| Urea split banded | 9                        | 22.8               | 39.2 | 38.0 |
| Urea point placed | 8                        | 22.0               | 25.3 | 52.5 |

1.  $^{15}\text{N}$ -fertilizer applied at 30 kg N ha<sup>-1</sup>.  
2. Total recovery in grain and stover fraction.

efficiency of the fertilizers used, in terms of uptake by pearl millet, was very poor. Although balance data showed that significantly higher losses of N occurred from point-placed urea than from urea that had been band applied, recovery of  $^{15}\text{N}$ -N by the plant was the same for both methods of application. Experiments are underway to explain this observation.

It is speculated that point placement may have had two conflicting effects on N efficiency. Laboratory studies using Niger soil, showed that concentrating the urea by point placement can greatly increase the potential N losses through volatilization as ammonia gas (Buresh 1987). Upon hydrolysis, concentrated urea, as found with point placement, yields a high level of slowly nitrifying ammonium in a zone of alkaline pH (Hauck and Stevenson 1965). The presence of a high concentration of ammonium in the sandy soils of Sadoré over a long period of time probably helped increase the volatilization losses. However, the positional effect of point-placed N near the plant, and therefore near the bulk of the root mass, allowed efficient use of the remaining fertilizer N. Thus, although losses were higher, uptake efficiency of the remaining fertilizer appears to have been augmented to the point of partially compensating for the increased losses.

At harvest, the distribution of fertilizer N in the soil was determined, and most of the N left in the soil was found to be in the surface 0–15 cm layer (Fig. 2). Although the  $^{15}\text{N}$  distribution at greater depths was the same for both methods of urea placement, the banded treatment contained much more  $^{15}\text{N}$  in the surface 0–15 cm layer than the point-placed treatment (27 vs 15% recovery). This is possibly due to the high volatilization losses that occurred with point placement. The absence of

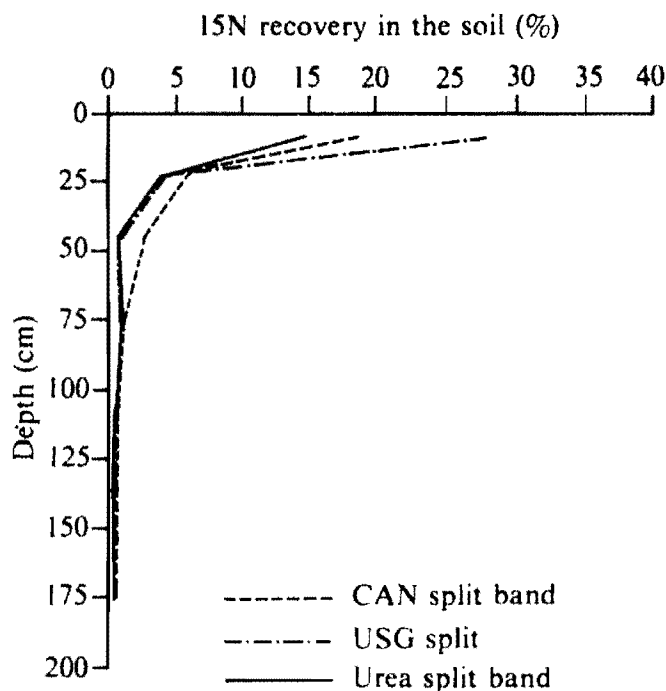

**Figure 2. Distribution of fertilizer N in soil at harvest, ISC, Niger, rainy season 1983. (Note: Datum points represent the percentage of the applied N recovered in each respective soil layer).**

urea-N at depth further indicates that urea leaching losses are limited. Because half of its N is in the form of nitrate, CAN is less volatile than urea. Nitrate is readily soluble in water and can be carried deep with infiltrating water. Less banded CAN than urea was found in the 0–15 cm layer, and enrichment of the  $^{15}\text{N}$  content at lower depths indicated that some leaching of CAN had occurred. Because of their very sandy nature, the soils of the experimental site dried rapidly, a factor that would have limited the availability of any fertilizer N trapped in the dry surface layers. Since the CAN had moved to the lower depths where more moisture was available, it would have been more readily available to the crop during the dry periods. Thus, this high solubility could help account for the slightly higher N uptake by the plant that occurred with this treatment.

### Phosphorus: Fertilizer Sources and Management

For over 50 years, investigators have observed that lack of phosphorus is a major constraint to crop growth in semi-arid West Africa (Hauck 1966,

Pichot and Roche 1972, Jones and Wild 1975). In the pearl-millet growing region of Niger, available P as measured by Bray 1 extraction hardly exceeds  $3 \text{ mg kg}^{-1}$  soil. These sandy soils also have a low capacity to absorb phosphates (Fig. 3). Results from several trials have shown that as little as  $20 \text{ kg P}_2\text{O}_5 \text{ ha}^{-1}$  can more than double the yield of pearl millet as compared with yield from unfertilized land.

One of the objectives of the IFDC/ICRISAT collaborative project in Niger was to assess the ability of indigenous phosphate rock (PR) to satisfy the phosphorus needs of crops such as pearl millet. Three phosphate rock deposits—Tahoua, Parc W (Tapoa), and Aschia Tinamou—are currently known in Niger (Fig. 4). Direct application of indi-

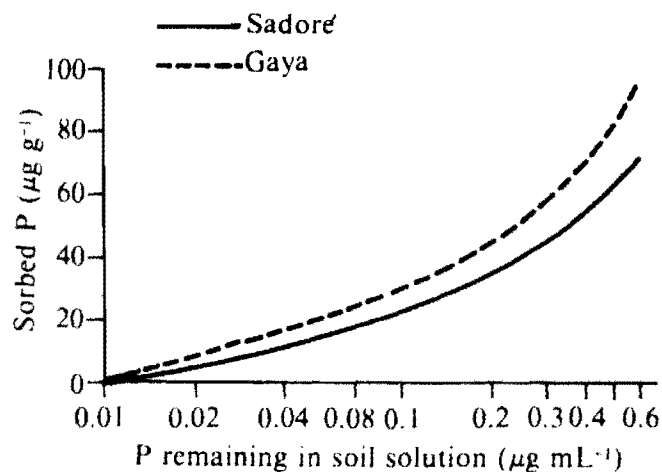

Figure 3. Relationship between P remaining in soil solution and sorbed P for Sadore' and Gaya soils, Niger.

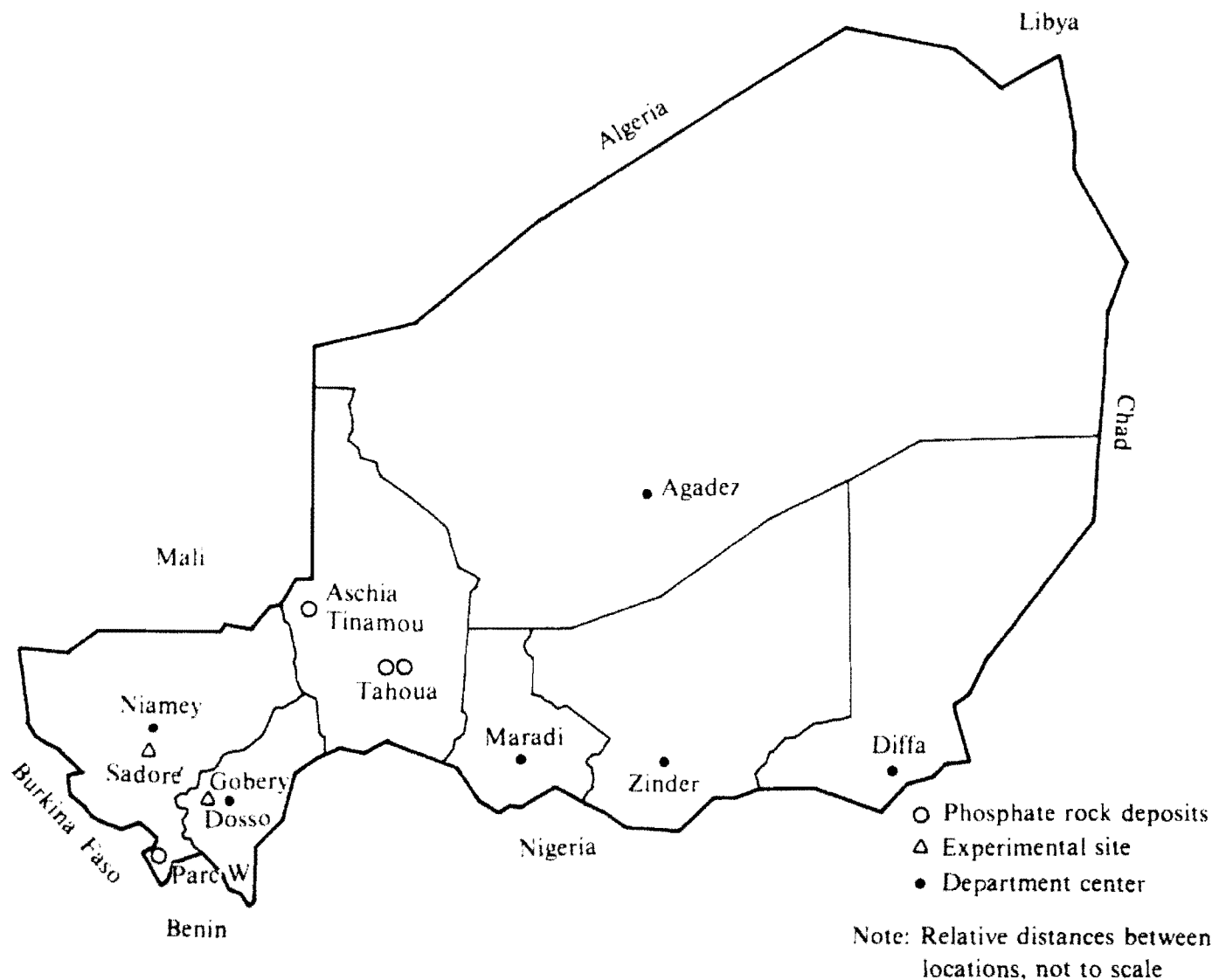

Figure 4. Phosphate rock deposits in Niger. Adapted from McClellan and Notholt (1986).



**Table 3. Chemical analysis of Parc-W and Tahoua phosphorus rock (% of total mass).**

| Components   | Parc-W | Tahoua  |
|--|--------|---------|
| Total P <sub>2</sub> O <sub>5</sub>                        | 28.5   | 27.9    |
| Citrate-soluble P <sub>2</sub> O <sub>5</sub> <sup>1</sup> | 2.6    | 2.5-5.0 |
| CaO  | 40.0   | 39.0    |
| Fe   | 3.4    | 2.8     |
| Al <sub>2</sub> O <sub>3</sub>                             | 1.5    | 2.1     |
| Fe <sub>2</sub> O <sub>3</sub>                             | 1.0    | 10.3    |
| MgO  | 0.13   | 0.20    |
| Na <sub>2</sub> O  | 0.13   | 0.15    |
| K <sub>2</sub> O   | 0.13   | 0.12    |
| Cl   | 0.005  | 0.005   |
| SiO <sub>2</sub>   | 23.0   | 11.7    |
| CO <sub>2</sub>  | 1.2    | 1.5     |

1. Measured in neutral ammonium citrate solution.

**Table 4. Characteristics of Parc-W and Tahoua rock compared with other West African phosphorus rocks.**

| Phosphate rock         | Total P <sub>2</sub> O <sub>5</sub> (%) | Citrate-soluble P <sub>2</sub> O <sub>5</sub> (%) | Citrate-soluble   |
|------------------------|---|---|---|
|                        |   |   | P <sub>2</sub> O <sub>5</sub> × 100 total P <sub>2</sub> O <sub>5</sub> |
| Parc-W (Niger)         | 28.5                                    | 2.6   | 9.0   |
| Tahoua (Niger)         | 27.9                                    | 2.5-5.0   | 9.0-18.0  |
| Kpme (Togo)            | 35.9                                    | 3.0   | 8.0   |
| Tilemsi (Mali)         | 28.6                                    | 4.2   | 15.0  |
| Kodjari (Burkina Faso) | 25.3                                    | 1.9   | 8.0   |
| Matam (Sénégal)        | 29.8                                    | 4.5   | 15.0  |

**Table 5. Chemical analyses of partially acidulated phosphate rock.**

| Rock source    | Level of acidulation <sup>1</sup> (%) | Type of material      | Total P <sub>2</sub> O <sub>5</sub> | WS <sup>2</sup>                          | CS <sup>3</sup>                          |
|----------------|---------------------------------------|-----------------------|-------------------------------------|--|--|
|                |                                       |                       |                                     | P <sub>2</sub> O <sub>5</sub> ----(wt %) | P <sub>2</sub> O <sub>5</sub> ----(wt %) |
| Parc-W (Niger) | 25                                    | Granular <sup>1</sup> | 23.8                                | 5.4                                      | 2.8                                      |
| Parc-W (Niger) | 40                                    | ROP <sup>5</sup>      | 21.6                                | 9.2                                      | 2.1                                      |
| Parc-W (Niger) | 50                                    | Granular <sup>4</sup> | 20.2                                | 9.9                                      | 1.9                                      |
| Tahoua (Niger) | 25                                    | Granular <sup>4</sup> | 25.0                                | 3.9                                      | 2.7                                      |
| Tahoua (Niger) | 50                                    | Granular <sup>4</sup> | 22.6                                | 6.5                                      | 2.9                                      |

1. Where 100% indicates the amount of H<sub>2</sub>SO<sub>4</sub> required for preparation of single superphosphate.

2. WS = Water soluble.

3. CS = Soluble in neutral ammonium citrate solution.

4. Analyses reported on minus 6- plus 14-mesh (Tyler).

5. ROP indicates nongranular (run-of-pile).

genous ground PR can be an economical alternative to imported commercial P fertilizers. The chemical properties of Tahoua and Parc W PR are presented in Table 3, and the relative reactivities of these rocks as compared with other deposits in West Africa are presented in Table 4. In a field trial at Gobéry where Parc W and Tahoua PR were compared with commercial single superphosphate (SSP), the less reactive Parc W PR was 48% as effective agronomically as SSP while the more reactive Tahoua rock was 76% as effective as SSP. These results agree with those obtained by Truong et al. (1978) in their study of the agronomic effectiveness of several West African phosphate rocks.

The findings at Gobéry clearly indicate that the agronomic effectiveness of PR is governed by the rock's physical, chemical, and mineralogical characteristics. One method of utilizing unreactive PR is to increase the plant-available P by chemical conversion to a partially acidulated phosphate rock (PAPR) product. The term PAPR refers to a phosphate rock that has been treated with only a portion of the sulfuric or phosphoric acid required to fully convert the insoluble tricalcium phosphate into a water soluble form, i.e., monocalcium phosphate monohydrate (IFDC 1986). Thus, the term PAPR-50 indicates that only 50% of the acid required to produce a fully acidulated superphosphate is used to make the product. PAPR products may be attractive to producers because less acid is used, resulting in significant saving in foreign exchange. For example, the factory-gate cost of P<sub>2</sub>O<sub>5</sub> obtained from sulfuric acid-based PAPR-50 is estimated at about 80% of that obtained with SSP (IFDC 1986).

**Table 6. Agronomic efficiency index of millet in Sadoré and Gobéry, Niger.**

| P Source              | Agronomic efficiency index |
|-----------------------|----------------------------|
| Parc-W phosphate rock | 60.3                       |
| PAPR-25               | 76.5                       |
| PAPR-50               | 93.4                       |
| TSP                   | 106.1                      |
| SSP                   | 100.0                      |

1. Source: Bationo et al. 1986.

Sulfuric acid-based PAPR products using Parc W PR have been tested in several field trials in the pearl-millet growing region of Niger (Table 5). Results from 5 years of testing at Sadoré and four years at Gobéry show that Parc W PAPR-50 is as effective agronomically as triple superphosphate (TSP) (Table 6). Wider testing of sulfuric-acid based PAPR using Parc W PR in Niger is recommended. Present results strongly indicate that this less expensive product can adequately meet the P needs of the staple crops.

Cost of transportation in a landlocked country such as Niger makes it necessary to use high-analysis fertilizers. However, high-analysis fertilizers like TSP and diammonium phosphate, contain little or no sulfur. The need to apply sulfur-containing fertilizers to many soil-crop systems in the Sudano-Sahelian zones of West Africa has long been recognized. (Greenwood 1951, Bromfield 1972). The greater response of pearl millet to SSP than to TSP in Sadoré in 1985 (Fig. 5) suggests significant crop response to sulfur after 4 years of continuous cropping on this soil. The higher P<sub>2</sub>O<sub>5</sub> content of sulfuric-acid based PAPR as compared with SSP, as well as the presence of sulfur in the product, provides added incentive to substitute this product for the more expensive imported fertilizers.

An advantage of the low P retention capacity of these sandy soils is the high residual effects of P fertilizers even when applied at low rates (Fig. 6). In one of the field trials at Sadoré, an attempt was made to take advantage of this high residual response to P fertilizers by adding Parc W PR at three times the annual fertilizer rate and cropping the land for 3 years without further addition of fertilizers (basal treatment). Although pearl millet yield and available P levels at the end of the 3-year

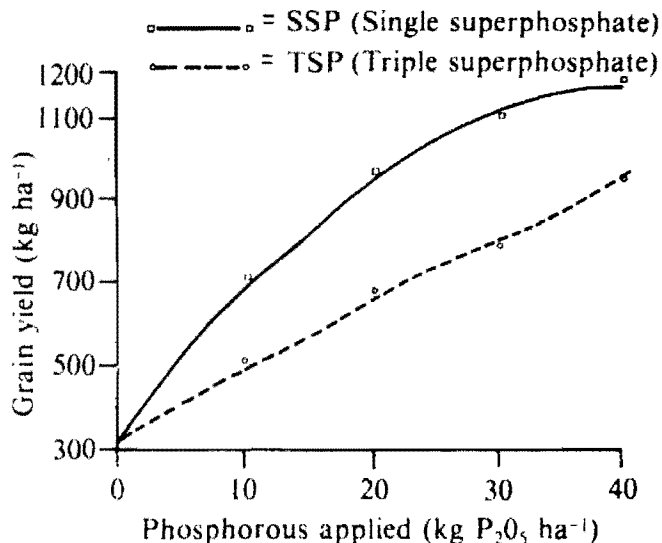

$$\hat{y} = 320 + 18.13 \text{ TPS} - 0.0569 \text{ TPS}^2 \quad r^2 = 0.44 \quad \text{rse} = 280$$

$$\hat{y} = 330 + 40.75 \text{ SSP} - 0.4890 \text{ SSP}^2 \quad r^2 = 0.46 \quad \text{rse} = 385$$

**Figure 5. Effect of P sources and rates of application on pearl millet grain yield, ISC, Niger, rainy season 1985.**

cycle were significantly higher where the PR was applied annually, substantial quantities of P were still present with a single basal treatment. A preliminary economic analysis indicated that added net return at the end of the cycle was the same for both systems of fertilization (Table 7).

The method of P fertilizer application can significantly influence its efficiency. Most farmers in Niger broadcast their P fertilizers without incorporating them into the soil. Preliminary results of field trials are inconclusive but yields were no different when fertilizers were broadcast and incorporated, banded or point-placed near the pearl millet hill.

### **Role of Crop Residues and Manures for Sustainable Crop Production**

Because of the poor buffering capacity of the soils of semi-arid West Africa, cereal yields cannot be maintained under continuous cultivation by using inorganic phosphate fertilizers alone. To maintain soil productivity, the organic matter levels must be

- — ● = TSP (Triple superphosphate)
- — ○ = SSP (Single superphosphate)
- ◻ — ◻ = PAPR40 (Partially acidulated phosphate rock at 40%)
- △ — △ = PR (Parc W phosphate rock)

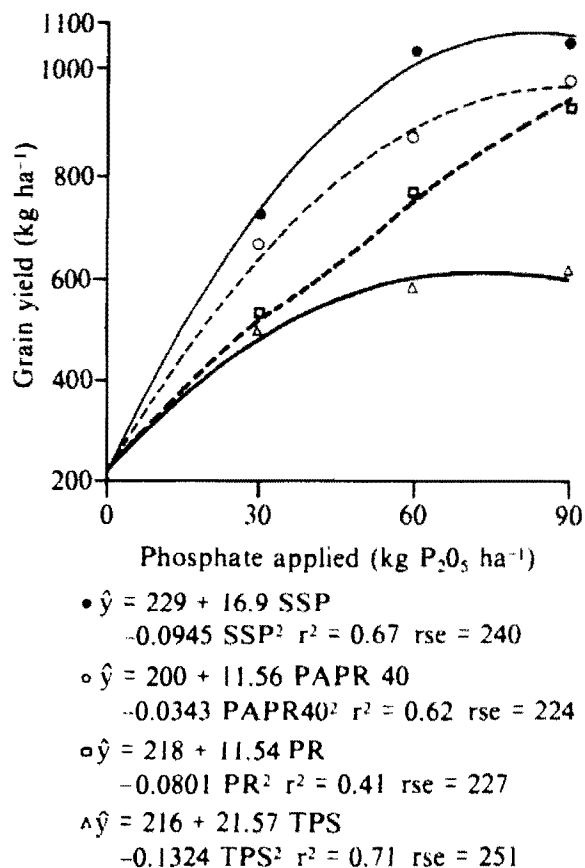

Figure 6. Effect of residual P sources and rates on pearl millet grain yield, Gobery, rainy season 1985.

kept high, (Sedogo 1981, p. 199). Soil organic matter can be improved by the addition of farmyard manure, green manure, crop residues, and compost. In a trial at Sadoré, the addition of 5 m ha<sup>-1</sup> of farmyard manure or 120 kg P<sub>2</sub>O<sub>5</sub> ha<sup>-1</sup> of Parc W PR in 1984 produced the same yield of pearl millet in 1985 as 20 kg P<sub>2</sub>O<sub>5</sub> ha<sup>-1</sup> of SSP applied in 1984 and again in 1985. PR and SSP treatments received 45 kg N ha<sup>-1</sup> as urea. Pearl millet yield was highest with the addition of 20 m manure ha<sup>-1</sup> (Fig. 7). These figures point out the obvious drawback to

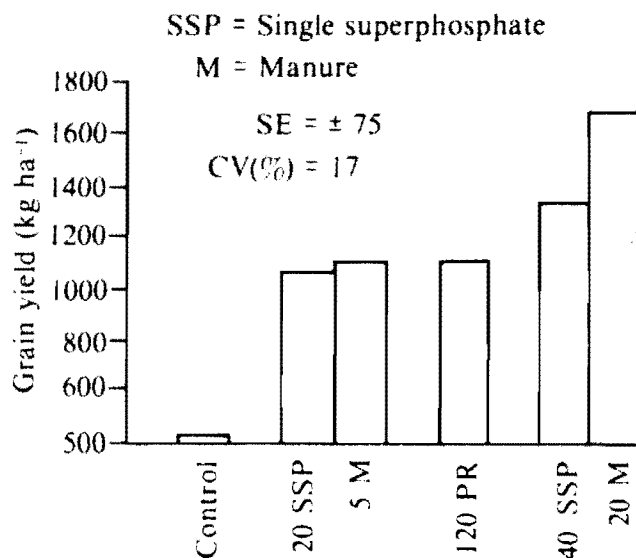

Figure 7. Residual response by pearl millet to farmyard manure and phosphate rock compared with direct response to single superphosphate (Sadoré 1985).

Table 7. Added net return to application of phosphate rock annually or basally.

| P-application (kg ha <sup>-1</sup> ) |     | Yearly net added return (US \$ ha <sup>-1</sup> ) |         | Present value of net added return, 1982 (US \$ ha <sup>-1</sup> ) |         | Total net return (US \$ ha <sup>-1</sup> ) |         |
|--------------------------------------|-----|---|---------|---|---------|--|---------|
| X                                    | X1  | 1982A <sup>1</sup>                                | 1984A   | 1982B <sup>2</sup>  | 1984B   | A  | B       |
| 0                                    | 0   | 0.0000  | 0.0000  | 0.0000  | 0.0000  | 0.0000                                     | 0.0000  |
| 10                                   | 30  | 31.6270   | 20.7562 | 45.1189   | 9.5798  | 52.3832                                    | 54.6987 |
| 20                                   | 60  | 39.9366   | 25.7379 | 53.2898   | 11.4682 | 64.6745                                    | 64.7580 |
| 30                                   | 90  | 44.8222   | 27.0349 | 57.7500   | 12.5840 | 71.8571                                    | 70.3340 |
| 40                                   | 120 | 48.2447   | 28.6319 | 60.6684   | 13.3789 | 76.8767                                    | 74.0473 |

1. A = Annual application.

2. B = Single basal application.

using farmyard manure, i.e., the large quantities required are not readily available to the farmer.

In 1983, a trial was conducted in Sadoré with the following treatments:

1. Crop residues (pearl millet straw) left on the soil surface after harvest.
2. Crop residues removed after harvest and recommended rates of fertilizers applied.
3. Crop residues removed and no fertilizers applied.
4. Crop residues left on the soil surface and fertilizers applied.

Rates of straw left on the soil surface have ranged from 1 m<sup>3</sup> ha<sup>-1</sup> year<sup>-1</sup> in treatment (1) to 4 m<sup>3</sup> ha<sup>-1</sup> in treatment (4). From the first year, the presence of crop residues in treatment (1) resulted in 25% increase in pearl millet yield over the control treatment (3). Addition of crop residues has continued to improve yields but, as can be seen in Figure 8, the highest yields were obtained when crop residues were supplemented with mineral fertilizers. The effects of the different fertility treatments on some soil chemical properties were measured after the 1986 crop (Table 8). After 4 years of continuous cropping, pearl millet production in the control plots where crop residues were completely removed was practically nil. Although production was reasonably high with fertilizers alone (816 kg ha<sup>-1</sup>), yields had steadily dropped since 1983. As would be expected, addition of fertilizers dramatically increased the 'available' P. It is pertinent to note the effects of crop residues with or without fertilizers on the organic matter contents and the degree of aluminum and hydrogen saturation of the exchange complex. In the final analysis, several factors may account for the good performance of treatments (1) and (4) but the drastic

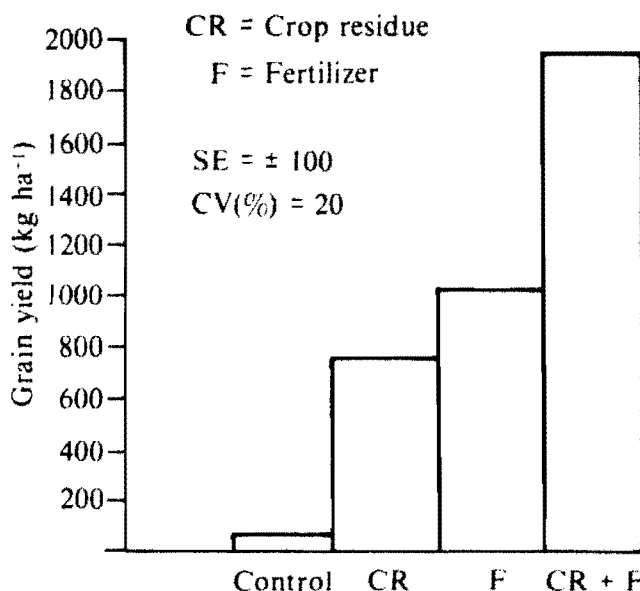

Figure 8. Effect of fertilizer and crop residue application on pearl millet grain yield (Sadoré 1985).

reduction in the exchangeable acidity obviously played a key role.

## Conclusion

Fertilizers are needed to improve crop production in the nutrient-poor sandy soils of the pearl-millet growing region of Niger. The results of several trials conducted at various locations in Niger show the agronomic value of P and N fertilizers. Fertilizers are essential but expensive inputs, and must therefore be properly managed to maximize effi-

Table 8. Effect of pearl millet residues on yield of pearl millet and soil chemical properties Sadoré (1986).

| Treatments                      | Grain yield<br>(kg ha <sup>-1</sup> ) | Bray P1<br>(mg P kg <sup>-1</sup> soil) | pH KCl | Total<br>organic<br>matter (%) | Total N<br>(mg kg <sup>-1</sup> soil) | Ca + Mg<br>[Cmol(+)kg <sup>-1</sup> ] | Al + H<br>saturation<br>(%) |
|---------------------------------|---------------------------------------|---|--------|--------------------------------|---------------------------------------|---------------------------------------|-----------------------------|
| Control                         | 56                                    | 2.59                                    | 4.11   | 0.24                           | 126                                   | 0.43                                  | 48                          |
| Crop residue                    | 743                                   | 2.97                                    | 4.36   | 0.29                           | 155                                   | 0.68                                  | 20                          |
| Fertilizers                     | 816                                   | 7.09                                    | 4.10   | 0.25                           | 151                                   | 0.44                                  | 43                          |
| Crop residue<br>and fertilizers | 1532                                  | 8.13                                    | 4.42   | 0.33                           | 170                                   | 0.72                                  | 16                          |
| SE                              | ±64                                   | ±0.46                                   | ±0.04  | ±0.01                          | ±8                                    | ±0.34                                 | ±3                          |
| CV (%)                          | 16                                    | 18                                      | 2.02   | 10                             | 10                                    | 11                                    | 19                          |

ciency. Indigenous PR and PAPR can provide cheaper alternatives to imported P fertilizers. Because the sandy soils have a low capacity to immobilize P, management practices are being developed to take advantage of the high residual response to P fertilizers.

Moisture availability has a significant effect on the response by pearl millet to N fertilizers. Nitrogen losses can exceed 50% of the N applied. In recent trials, a combination of a less volatile N and good management practices (point placement) has shown a potential to improve the nitrogen-use efficiency in this environment. Finally, the addition of farmyard manure and crop residues can improve the chemical properties of these chemically fragile soils as organic matter to complement inorganic fertilizers and help sustain productivity.

## References

- Bationo, A., Mughogho, S.K., and Mokwunye, A.U.** 1986. Agronomic evaluation of phosphate fertilizers in tropical Africa. *Management of Nitrogen and Phosphorus Fertilizers in Sub-Saharan Africa* (Mokwunye, A.W., and Vlek, P.L.G., eds.). Dordrecht, Netherlands: Martinus Nijhoff.
- Bromfield, A.R.** 1972. Sulfur in northern Nigerian soils. 1. The effects of cultivation and fertilization on total S and sulfate patterns of soil profiles. *Journal of Agricultural Science, UK* 78:465-470.
- Buresh, R.J.** 1987. Ammonia volatilization from point-placed urea in upland, sandy soils. *Fertilizer Research*.
- FAO.** 1981. *Crop Production Yearbook no. 37*. Rome, Italy:FAO.
- FAO.** 1985. *Agriculture toward 2000. Economic and Social Development Studies no. 23*. Rome, Italy:FAO.132 pp.
- Ganry, F., and Guiraud, G.** 1979. Mode d'application du fumier et bilan azoté dans un système mil-sol sableux du Sénégal:étude au moyen de l'azote-15. Pages 313-331 in *Isotopes and radiation in research on soil plant relationships*. Vienna, Austria: International Atomic Energy Agency.
- Greenwood, M.** 1951. Fertilizer trials with groundnuts in northern Nigeria. *Empire Journal of Experimental Agriculture* 19:225-241.
- Hauck, F.W.** 1966. Fertilizer needs and effectiveness with tropical crops in West Africa. *FFHC Bulletin*. Rome, Italy: FAO.
- Hauck, R.D., and Stevenson, H.F.** 1965. Nitrification of nitrogen fertilizers. Effect of nitrogen sources, size and pH of the granule, and concentration. *Journal of Agricultural and Food Chemistry* 13:486-492.
- IFDC (International Fertilizer Development Center).** 1986. Sulfuric acid-based partially acidulated phosphate rock: its production, cost, and use. *Technical Bulletin no. T-31*. Muscle Shoals, Alabama, USA: IFDC.
- Jones, M.J., and Wild, A.** 1975. *Soils of the West African Savanna*, Technical Communication no. 55, Harpende, UK: Commonwealth Agricultural Bureau.
- McClellan, G.H., and Notholt, A.J.G.** 1986. Phosphate deposits of tropical Sub-Saharan Africa. Pages 173-223 in *Management of nitrogen and phosphorous fertilizers in Sub-Saharan Africa*. (Mokwunye, V., and Vlek, P.L.G., eds.). Dordrecht, Netherlands: Martinus Nijhoff.
- Penning de Vries, F.W.T., and Djiteye, M.A.** 1982. La productivité des pâturages sahéliens: une étude des sols, des végétations et de l'exploitation de cette ressource naturelle. *Verslagen van Landbouwkundige Onderzdek no. 918*. Wageningen, Netherlands: Institute of Biology and Chemistry Research on Field Crops and Herbage. 525 pp.
- Pichot, J., and Roche, P.** 1972. Le phosphore dans les sols tropicaux. (In Fr.) *Agronomie Tropicale* 27:939-965.
- Pieri, C.** 1973. La fumure des céréales de culture sèche en République du Mali. Premier essai de synthèse. *Agronomie Tropicale* 28:751-766.
- Sedogo, M.,** 1981. Contribution à la valorisation des résidus culturaux en sol ferrugineux et sous climat semi-aride. Thesis, ENSAIA, Nancy, France. 199 pp.
- Truong, B., Pichot, J., and Bernard, P.,** 1978. Caractérisation et comparaison des phosphates naturels tricalciques d'Afrique de l'Ouest en vue de leur utilisation directe en agriculture. (In Fr.) *Agronomie Tropicale* 33:136-145.

# Crop Residue/Livestock Relationships

S.G. Sandford<sup>1</sup>

## Abstract

*Level, stability, and sustainability of output and income are important criteria for assessing farming systems, including the integration of crop and livestock activities in semi-arid areas. In integrated farming systems, cattle derive up to 45% of their total annual feed intake (DM) from crop residues and up to 80% during critical periods. Small ruminants derive much less. Up to 50% of the total yield of crop residues and up to 100% of the edible portion are eaten by livestock. The relative interannual variability of yield of grain and of crop residues is not well known. The variability of yield of the edible portion is less than that of total residue. Residue-derived livestock output may be very variable.*

*In principle, use of animal traction should improve the level, stability, and sustainability of crop yields. The empirical evidence about how farmers actually use it, is conflicting, but suggests that farmers often use it to increase cropped area rather than yields. If this is so, it probably reduces sustainability by reducing the fallow period. Farm surveys indicate that, as expected, manuring increases crop yields, but for any system to be sustainable, in terms of plant nutrients, from manure alone, requires nutrient transfer from grazing areas to cropped land. For this purpose, between 2 and 47 ha of grazing are required per ha cropped annually, depending on yield of grain and grass, and on the manuring system. In years of good crops, farmers often invest their profits in livestock and then sell these in bad years to buy food and thus stabilize their consumption.*

## Résumé

**Relations résidus des cultures/élevage :** Niveau, stabilité et maintien dans le temps de la production et du revenu sont d'importants critères d'évaluation des systèmes de production, y compris de ceux associant l'agriculture et l'élevage dans les régions semi-arides. Dans les systèmes associant l'agriculture et l'élevage, les résidus des cultures représentent près de 45% du régime alimentaire annuel total (matières sèches) des bovidés et peuvent même atteindre 80% en période critique. Les animaux consomment jusqu'à 50% de la production totale de résidus et près de 100% des parties comestibles. La variabilité relative des rendements des céréales et des résidus dans le temps n'est pas bien connue. La variabilité du rendement des parties comestibles est moindre que celle de la production totale des résidus. Les résultats consécutifs à l'effet de l'utilisation des résidus pour l'élevage peuvent être très variables.

*En principe, la traction animale devrait améliorer le niveau et la stabilité des rendements agricoles et leur maintien dans le temps. Les observations empiriques faites sur l'usage effectif de la culture attelée par les agriculteurs sont souvent divergentes mais tendent néanmoins à indiquer une utilisation visant à augmenter les surfaces cultivées plutôt que les rendements. Si tel est le cas, cela entraîne probablement une diminution de la stabilité de la production dans le temps du fait de la réduction des périodes de jachère. Les enquêtes réalisées chez les paysans*

---

1. Head of the Livestock Economics Unit, International Livestock Centre for Africa, (ILCA), P.O. Box 5689, Addis Ababa, Ethiopia. ICRISAT (International Crops Research Institute for the Semi-Arid Tropics) 1989. Soil, Crop, and Water Management Systems for Rainfed Agriculture in the Sudano-Sahelian Zone: proceedings of an International Workshop, 7-11 Jan 1987. ICRISAT Sahelian Center, Niamey, Niger. Patancheru, A.P. 502 324, India: ICRISAT.

*montrent que l'apport de fumure augmente, comme prévu, les rendements des cultures. Cependant pour qu'un système dépendant de la seule fumure soit viable du point de vue de l'apport de substances nutritives aux plantes, ces mêmes éléments fertilisants devront être transférés des zones de pâturages aux terres cultivées. Il faut de 2 à 47 ha de pâturages par ha cultivé et par an selon les rendements en céréales et en herbes et le système de fumure utilisé. Pendant les années de bonne récolte, les paysans investissent souvent leurs bénéfices dans l'élevage et vendent leurs animaux lors des mauvaises années afin d'acheter des aliments pour eux-mêmes et leurs familles et stabiliser ainsi leur niveau de consommation.*

## Introduction

The purpose of this paper is to clarify some concepts and to summarize what we appear to know about the relationships, in farming systems in this zone, between livestock and crops. The evidence drawn on for the most part comes from the semi-arid areas (90–180 plant growth days per annum) of West Africa. Where this evidence is inadequate, it is supplemented by evidence from the subhumid zone (180–270 plant growth days) with which, by some definition, there is some overlap of the Sudano-Sahelian zone. Evidence is also drawn from some studies made on small peasant farms (rather than on large farms or research stations) in other parts of sub-Saharan Africa.

### Key Concepts: Level, Stability, and Sustainability

We will start by clarifying some concepts that are important in determining what we consider desirable characteristics of farming systems. 'Level' means long term level, e.g., average level of output, income, or human consumption over several decades. Other things being equal, high levels of output, income, or consumption are more desirable than low ones.

'Stability' is a concept relating to 'variability' around a trend. Stability is measured, for example, by the coefficient of variation around the trend line.<sup>1</sup> More 'stable' systems are ones showing less variability and, in general, other things being equal, are usually preferred to less stable ones.

---

1. Coefficient of variation round the trend lines = Root mean residual sums of squares divided by mean value. When there is no trend (negative or positive) the value is identical with the conventional coefficient of variation, in which the standard deviation is measured from the mean value.

Semi-arid areas are characterized by highly variable rainfall so that annual values of crop and livestock output tend to be widely dispersed about a central value that may be constant, rising, or declining over time.

'Sustainability' is a concept relating to the direction of the long-term trend. Unsustainable systems, whatever the precise physical, biological, economic, or social mechanism involved, are ones where the long-term trend is downward ending in system collapse. 'Sustainable' systems are ones in which the long-term trend is flat or upwards.

### Crop/Livestock Interactions

Crop and livestock activities may complement or hinder each other in mixed farming systems. On the one hand, crops may be grown mainly to provide forage (unusual in sub-Saharan Africa) or they provide edible residues of other crops on which livestock feed, albeit at the cost of some displacement of natural grazing. On the other hand, livestock produce draft power for field operations and for transporting the harvest to the store and market. In addition, they provide manure that improves the nutrient status of the soil and affects its moisture content. Livestock devour crop residues and other vegetation which would otherwise act as a windbreak, as a mulch, and as a compost. Livestock trample the soil, thereby reducing its infiltration and moisture-holding capacity, by compaction, and often start erosion. During the growing season, livestock may destroy the growing crop by eating or trampling it.

Interactions also affect income and wealth. In many parts of sub-Saharan Africa's semi-arid zone, modern financial institutions do not exist, and it is technically difficult to save in the form of crop harvest since they shrink and deteriorate over time. As a consequence, in many semi-arid areas, in years when crops yield a harvest in excess of

household needs for subsistence or immediate cash, the peasants sell the excess and invest the proceeds in livestock whose natural rate of increase ranges from 5% (camels) to 30% (goats). Small stock reproduce more quickly but are labor-intensive and risky while larger ruminants are the reverse. In years of bad harvests, livestock can be sold and the proceeds used to buy extra grain for human consumption. Another interaction is that, in some areas or in some households, crops are mainly used for household subsistence while the sale of livestock provides households with their main source of cash with which to buy modern inputs, e.g., fertilizers, for crop production. Crops

and livestock also interact with each other by competing for scarce factors of production, e.g., labor, land, and capital.

## The Effects of Cropping on Livestock Output

### Levels

To measure the effect of the integration of residue-fed livestock on farm output (in the form of livestock products) means comparing cropping situations with—or without—livestock. Table 1 presents

**Table 1. Contribution of crop residues to annual and seasonal feed intake of ruminant livestock.**

| Species, environment                                      | Percentage of feed intake derived from crop residues in: |                           | Comment and source  |
|---|--|---------------------------|---|
|   | a year as a whole  | peak months of dry season |   |
| <b>Cattle</b>   |  |                           |   |
| -Agropastoral herd in semi-arid Mali                      | 43   | NA                        | GT <sup>1</sup> (Lambourne et al.1983)                                    |
| -Pearl millet-based agropastoral system in semi-arid Mali | 16   | 56                        | GT (Dicko and Sangare 1984)<br>3 mo of peak dry season                    |
| -Rice-based agropastoral system in semi-arid Mali         | 40   | 62                        | GT (Dicko and Sangare 1984)<br>6 mo of peak dry season                    |
| -Subhumid zone of Nigeria                                 | 20   | 50                        | GT (Powell 1986)<br>3 mo of peak dry season.<br>Sorghum/millet.           |
| -Semi-arid Nigeria  | NA   | 80                        | GT (van Raay and de Leeuw 1971) 1/2 mo of peak dry season. Sorghum/millet |
| -Subhumid zone of Nigeria (farming area)                  | 13   | 56                        | 1 mo of peak dry season (Bayer 1986)                                      |
| -Subhumid zone of Nigeria (grazing reserve)               | 7  | 50                        | 1 mo of peak dry season (Bayer 1986)                                      |
| <b>Sheep</b>  |  |                           |   |
| -Pearl millet-based agropastoral system in semi-arid Mali | 7  | NA                        | GT (Dicko and Sangare 1984)   |
| -Rice-based agropastoral system in semi-arid Mali         | 12   | NA                        | GT (Dicko and Sangare 1984)   |
| <b>Goats</b>  |  |                           |   |
| -Pearl millet-based agropastoral system in semi-arid Mali | 2  | NA                        | GT (Dicko and Sangare 1984)   |
| -Rice-based agropastoral system in semi-arid Mali         | 5  | NA                        | GT (Dicko and Sangare 1984)   |

1. J. GT = Estimates based on grazing time. 'Peak dry season' means months when dependence on crop residues is most pronounced.



the best quantified evidence available. On the assumption that the proportion of time spent eating a particular kind of feed is a good proxy for its quantitative contribution to diet, then, over the year as a whole, cattle in the systems concerned obtained between 16 and 40% of their total dietary dry matter intake from crop residues. However, during the peak months of the dry season when cattle are most dependent on residues, the proportion rose to 50–80%. In comparison with cattle, sheep and goats within the same systems obtained much less of their annual feed from crop residues, although in the case of sheep, it rose to over 40% in some months (Dicko and Sangare 1984). This lower dependence partly reflects dietary preferences, and partly shows that cattle are given access to crop residues first. Table 1, however, somewhat underestimates the linkage between small stock and cropping because it does not take into account time spent by them grazing fallow land, where plant communities are substantially different from those of natural grazing.

Crop residues are consumed by livestock because of both their quantity and quality. In the semi-arid zone of northern Nigeria, van Raay (1974) estimated that crop residues, from a surface area amounting to somewhat less than 33% of the total, supplied, in dry matter terms, 33% of the available annual fodder supply. In dry matter terms, yields of crop residues on similar soil are probably higher than that of natural pasture. In semi-arid areas, natural grazing probably has at least as high, and possibly higher, protein content than the cereal crop residues have and may, therefore, be the preferred feed if the total supply of feed available is greater than requirement. In higher rainfall areas, e.g., as one enters the subhumid zone, the protein content of natural grazing declines as a limited

source of nitrogen is diluted in more luxuriant growth. At the same time, the use of fertilizer on crops to improve their grain yield becomes more economic, and this increases both the phosphorus and protein content of the livestock residues as well. Powell (1986) reports, for the subhumid zone of Nigeria, that levels of the protein and phosphorus content (in terms of percentage) of the crop residues eaten by livestock are 2–3 times higher than that available in the natural grazing at the same time of the year.

Table 2 shows the proportion of the crop residues available at harvest, that are removed during use by livestock. It has not been possible to separate the amounts actually eaten from other disappearances (e.g. by windblow) occurring at the same time. As can be seen, between 60 and 100% of the more edible portions, i.e., the leaves, but only about 40% of the less edible stalks are removed. Powell (1985a) reports that the least edible lower stalks constitute about 50% of the total cereal residues and 60–70% of the total stalks. The data in Table 2 thus imply that, in the systems reported there, almost all the edible parts are being removed during use by livestock. McIntire and Fussell (1986) provide data on grain and residue yields and prices in local markets in Niger in 1982 and 1983. On fields of unfertilized local cultivars, grain yields averaged 236 kg ha<sup>-1</sup> and residue yields 1296 kg ha<sup>-1</sup>. Grain prices were 127 CFA kg<sup>-1</sup> and residue prices 8 CFA kg ha<sup>-1</sup>. They do not cite the proportions of residues actually sold or whether these had been preselected, prior to sale, for edibility. If only 50% of the total residues are edible and the price quoted applies to bundles preselected for edibility, then the value of crop residues produced could be about 17% of grain output. However, if the price they quote is for pearl millet residues which include

**Table 2. Proportion of crop residues used by livestock.**

| Crop, environment, and system                                 | Percentage (by weight) of crop residues present at harvest that disappeared later <sup>1</sup> |                 |       |
|---|--|-----------------|-------|
|   | Leaves   | Stalks          | Total |
| Sorghum, subhumid zone, Nigeria (Powell 1985a)                | 61   | 40              | 49    |
| Pearl millet, subhumid zone, Nigeria (Powell 1985a)           | 81   | 47              | 57    |
| Sorghum, semi-arid zone, Nigeria (van Raay and de Leeuw 1971) | 100  | NA <sup>2</sup> | 33    |

1. All disappearances are presumed to be due to removal during use by livestock.

2. NA = Not available.

inedible as well as edible fractions, then the value of crop residues could be as high as 34% of the grain output.

### Stability

Inter-year variability greatly affects stability of output and income. Inter-year variability of crop residue production is composed of area variability and yield variability. Presumably, the variability in area is identical for grain production and residue production, and integration into crop activities of use of residues by livestock will not lead to any differential degree of variability, arising from an area effect, as between the with—or without—livestock situations. Where yield effect is concerned, however, differences may arise from three sources:

- differential inter-year relative variability between yields of grain and of total crop residues;
- inter-year changes in the ratio between the edible and non-edible fractions within total crop residues; and
- changes in the ratio between crop residues eaten by livestock and consequent livestock output. In addition to production variability, there may also be variability in the unit value of crop residues.

There appears to be surprisingly little evidence, at any rate in sub-Saharan Africa, about the relative inter-year variability of mean annual grain and residue yields. Data on sorghum on experimental plots provided by Mohammed-Saleem (1986) suggest a coefficient of variation, over three years and around a sharply declining trend on a continuously cultivated soil, of 12% for grain and 9% for crop residues. However, this lower inter-year variability of residues—compared to grain yields—for sorghum differs from that in pearl millet, where, with only 2 years' data collected 'on farm', McIntire and Fussell (1986) found greater inter-year variability, and as much within-a-year inter-farm variability, for residues as for grain.

Evidence is also scanty on the ratio between edible and nonedible fractions of crop residues. In semi-arid Nigeria, van Raay and de Leeuw, 1971, found a negative correlation ( $r = 0.92$ ), across sorghum fields, between total crop residue yield and the edible fraction. This was because high residue yields were associated particularly with thicker (and more inedible) stalks. This negative correlation found across sorghum fields may also

occur across years, so that inter-year variations in total residue yields may be partially offset by changes in the edible/nonedible ratio. Pearl millet residues in years when the rain ends prematurely may also be more edible due to a lower rate of decay.

Our final point on variability concerns changes in the efficiency (or ratio) with which crop residues are transformed into useful animal products, e.g., meat and milk. Empirical on-farm evidence concerning this is not available. On grounds, using a model based on the amount of residues available per animal, one can argue that 'starving' livestock, ones that eat less than their minimal requirements for mere maintenance and 'overfed' livestock, (ones that are offered more feed than they can consume), will exhibit highly unstable feed-conversion ratios, because output of meat and milk does not respond to changes in the feed supply which are not sufficient to transform the livestock out of their 'starving' or 'overfed' status. However, 'well-fed' livestock, (intermediate between starving and well-fed livestock) will show more stable feed-conversion ratios. However, these ratios will not remain constant. At low levels of feed, the animal's maintenance requirement will consume most of the available feed and leave little over for output (growth or milk), resulting in a relatively high feed: output conversion ratio. At high levels of feed, the maintenance requirements will account for less than half of the feed intake and the balance will be available for output, resulting in a relatively low feed: output conversion ratio. Output, however, will be very responsive to changes in feed supply.

These changes in feed-conversion ratios will have the following effects. While livestock are mainly in 'starving' or 'overfed' statuses, changes in the feed-conversion ratio will tend to dampen the effects on output, of changes in feed supply, i.e., output from livestock will be more stable than the supply of crop residues. While livestock are mainly in a 'well fed' status, changes in the feed-conversion ratio will tend to exaggerate the effects of changes in feed supply, i.e., output from livestock will be less stable than the supply of crop residues.

### Summary of the Effect of Cropping on Livestock Output

We can now summarize this whole section on the effect that integrating residue-fed livestock has on

farm outputs in the form of livestock products. It appears that the use of these crop residues by livestock can have a substantial effect on the level of agricultural income. The example quoted from Niger suggested a range of 17–35% incremental gross value of output per hectare of cereals compared to a 'without livestock' situation. Compared to grain yields alone (the 'without livestock' situation) the use of crop residues to feed livestock has diverse effects on stability. The inter-year variability of total residue yields may be less (than that of grain) in the case of sorghum but the same or more in the case of pearl millet although our evidence on this is both meagre in quantity and weak in quality. With both sorghum and pearl millet, low total residue yields are offset by a higher edible fraction, so that the variability of edible residue yields is, on balance, probably lower than the variability of grain yields, at least on the lower side of the mean. However, the ratio between crop yields fed and consequent animal output is very unstable, as far as we can deduce, in the absence of on-farm empirical evidence from an a priori model based on per animal availability of residues. This instability would be much reduced at a herd scale if farmers varied the size of their herds to match the available feed.

## **The Effects of Livestock on Crop Output**

### **Five Pathways**

Livestock directly affect crop output through five main pathways. The first of these is through animal traction and transport, which involves field level operations such as land preparation, weeding, and harvesting and also the transportation of crops from field to homestead or market. The second pathway is through manure. The third pathway is through the effect that livestock's feeding practices have on the natural or cultivated vegetation. The fourth pathway is the effect that hooves of livestock have on soils and vegetation. The fifth pathway occurs when farmers start to grow feed, in particular forage and browse legumes, specifically for their livestock. The residual effects of these legumes affect the yield of subsequent crops. Through each of these pathways livestock affect the level, stability, and sustainability of crop production.

These five pathways in turn affect crop output in several ways. There is an 'area' effect, principally through the traction pathway, on the extent, in terms of area, of crop cultivation. There is a 'yield' effect which, in turn is a consequence of effects in terms of direct damage done by livestock to growing crops, and of plant nutrient and soil-structure and soil-moisture statuses. On the one hand the nutrient status is affected by the removal, as feed for livestock, of crop residues that might otherwise have returned to the soil through burning or some other process of natural degradation. On the other hand the nutrient status is affected by the residual effects of forage legumes, by timely cultivation made possible by animal traction, and by the deposit of animal manure that affects both the quantity of total nutrients available and their availability to the growing crop. The moisture status is affected by:

- techniques of soil cultivation made possible by animal traction;
- the effect of manuring and trampling on the porosity and water-holding capacity of the soil;
- the effect of removal, as livestock feed, of crop residues that would otherwise have acted as a mulch to reduce evaporation; and
- the effect that removal, for livestock feed, of crop residues or other vegetation, has on wind speed and consequent evapotranspiration.

Both nutrient and water statuses are affected by processes of water- and windborne soil erosion which remove the most fertile soils having high moisture-holding capacity. There may also be a 'cropping pattern' effect, where the integration of livestock into a cropping system changes the mix or succession of crops, and in particular leads to the growing of higher value or more market-oriented crops.

It is certainly not possible to cover all the details of the interrelationships involved in this paper. Instead my discussion will focus on some of the relationships affected by two key pathways, i.e., animal traction and manure.

### **Animal Traction**

Both calculations of resource use and experimental results indicate that the introduction of animal traction should, at least in the short term, lead to an increase in crop output. For example, a recent paper on management practices on millet in Africa (Fussell et al. 1987) reviews the evidence of the

positive effects of improved tillage, including the making of ridges, on millet yield. More thorough, more timely and better tillage, particularly when associated with other improved management practices, leads to more timely planting, lower soil bulk density, incorporation of organic matter, better weed control, and better pre- and postharvest moisture conservation. These lift average levels of yields and reduce downward fluctuations in years of poor rainfall. More and better tillage requires more power, for which the resources of hand labor are inadequate, in present conditions. Animal traction can provide the required power.

In the longer term these positive effects may be offset by two others. Animal traction, in addition to or instead of being used to provide more and better tillage to a fixed cropped area, may extend the area cropped, reducing thereby, the possibility of an extended fallow period during which to restore soil fertility over time. Secondly, more animal traction may involve a greater removal, from the fields, of standing crop residues or mulch that would otherwise resist wind erosion and evaporation. But I do not know of any evidence on the extent to which the inedible crop residues left after cattle have removed the edible residues are sufficient to resist this erosion and evaporation.

Turning from the theoretical and experimental to the evidence available about what happens in

practice, rough estimates indicate that about 23% of the total cropped (harvested) area in the five main Sahelian countries (Burkina Faso, Chad, Mali, Niger, Senegal) has had animal traction applied to it in at least one field operation, e.g., plowing, seeding, etc., ranging from only 3% in Niger to 57% in Senegal. Cereal yields in these countries average 0.6 t ha<sup>-1</sup>. Table 3 shows the details of the calculations. There is a very modest negative correlation ( $r = -0.37$ ,  $n = 5$ ) between the proportion of the national cropped area to which animal traction is applied and the proportion of the national potentially arable land which is currently being cropped; and there is quite a strong positive correlation ( $r = 0.89$ ) between a country's average cereal yield and the proportion of its cropped area to which animal traction is applied.

One needs to be careful about jumping to causal conclusions from mere associations, but these observations, based on national aggregate statistics, appear to be somewhat at variance with the findings of Pingali et al. (1986), which were based on a review of 22 farm-level studies in sub-Saharan Africa (nine of them in semi-arid areas). They found that the use of animal traction is associated with a growing land scarcity and that the introduction of animal traction is strongly associated with an expansion of area cultivated whereas its association with increased yield is indeterminate. These

**Table 3. The importance of animal traction in field operations in selected countries of West Africa<sup>1</sup>.**

| Country      | Potentially arable area (km <sup>2</sup> ) | Cropped (harvested) area (km <sup>2</sup> ) | Cropped area as percentage arable land | Cereal yield (t ha <sup>-1</sup> ) | No of draft animals | Animal traction area (km <sup>2</sup> ) | Animal traction area as percentage of cropped area |
|--------------|--|---|--|------------------------------------|---------------------|---|--|
| A            | B <sup>2</sup>                             | C <sup>3</sup>                              | D<br>(C/B × 100)                       | E                                  | F <sup>4</sup>      | G <sup>5</sup>                          | H<br>(G/C × 100)                                   |
| Burkina Faso | 80 700                                     | 30 120                                      | 37                                     | 0.45                               | 140 000             | 4 200                                   | 14   |
| Chad         | 172 000                                    | 16 400                                      | 10                                     | 0.74                               | 105 000             | 3 150                                   | 19   |
| Mali         | 135 180                                    | 19 040                                      | 14                                     | 0.79                               | 230 000             | 6 900                                   | 36   |
| Niger        | 114 440                                    | 40 450                                      | 35                                     | 0.41                               | 35 000              | 1 050                                   | 3  |
| Senegal      | 102 280                                    | 25 440                                      | 25                                     | 0.89                               | 480 000             | 14 400                                  | 57   |

1. Field operations include plowing, ridging, seeding, weeding but exclude on-farm transport. The data on cropped area are for 1975 and for draft animals are for the 1980s.

2. Source: FAO country tables (Table 5) for background data of FAO (1981).

3. Source: FAO country tables (Table 3) for background data of FAO (1981).

4. Source: Pingali et al. 1986 (p. 47).

5. Animal traction area is the area of cropped land to which some field operation, other than transport is applied. In the absence of specific information, this is assumed to be 3 ha per draft animal, i.e., 6 ha per pair.

two sources of empirical evidence on the effect of animal traction on the level of yield, therefore, somewhat conflict with the findings that are backed by the best evidence (i.e., Pingali et al. 1986) not supporting the theoretical arguments or experimental results. I know of no real farm-level data that throw light on the effects of animal traction on stability or sustainability.

### Manure

This subsection will start with a review of the principles likely to determine the use of manure. It will then summarize the evidence available from 'on farm' surveys to evaluate the usefulness of manure application in practice. While the positive effects of manure application on crop yield have been frequently demonstrated on research stations and are widely appreciated by farmers, two drawbacks have also been noticed: manuring may encourage weeds which compete with crops for both nutrients and moisture (Powell 1986); and manuring when the rainfall in the subsequent crop season is poor may encourage plentiful early leaf growth which is detrimental to the subsequent survival of the crop.

The benefits that livestock manure can bring can be divided into two classes: the physical and physio-chemical effects, and the provision of plant nutrients. The application of manure increases soil organic content, and this normally leads to improved moisture infiltration and to increased water-holding capacity. In addition, in acid soils, manuring raises the pH level. Manure also supplies significant amounts of the major crop nutrients N, P, and K and some micronutrients.

Other things being equal the benefits conferred by manure depend on:

- the extent to which the source of manure is feedstuff grown on the area manured only or also involves feedstuff grown elsewhere, i.e., the extent of nutrient and organic matter concentration on cropped areas by inward transfer from areas of natural grazing. The extent of inward transfer will depend both on cropping intensity (cropped land as a percentage of total land surface area) and on herders' practices in respect of corralling their animals at night on cropped areas after harvest or of year-round collection of manure at permanent nighttime pens coupled with transport of manure from pen to field.
- the extent that inward transfer from areas of

natural vegetation to cropped areas is not important, then a key issue will be the treatment of crop residues in the absence of livestock that would otherwise eat them. Residues may be totally removed from the field, in which case all nutrients and organic matter are lost; they may be burnt on site in which case organic matter and nitrogen and sulphur are lost; they may be composted in which case little is lost; or the residues may be fully incorporated back into the soil in which case almost nothing is lost (Balasubramanian and Nnadi 1980). Recycling nutrients through livestock is more efficient than the first two (removal of residues and burning them) but less efficient than the last.

- the way in which the manure itself is handled and stored. Kwakye (1980) found that between loosely stored dung and dung that had been kept buried in a pit until the cropping season, there was a 108% difference in N, 20% difference in P, and 62% difference in K content, all in favor of the buried manure.
- the yield of crops normally exported from the immediate vicinity of the area cropped and hence on the loss of nutrient in these exports and the need to replace these losses so as to sustain yields.
- the potential of the natural grazing to produce livestock feed, part of which emerges as manure.

Often requirements for, or responses to, manure treatment are expressed in terms of tonnes of manure applied per ha, but such results or recommendations cannot be extrapolated outside the particular combination of the variables identified in this paragraph.

Table 4 contains the results of a model that examines how much grazing and how many cattle are required to provide the manure needed to sustain specified levels of crop yields on a permanent basis. Several scenarios are simulated by providing alternative estimates of the key parameters. Two levels of productivity of natural grazing are simulated, a 'high potential area' that provides 3 t dry matter of livestock feed per ha and a 'low potential area' that provides only 1 t. Two manuring systems are simulated: a 'pen' system in which livestock use the same nighttime pen throughout the year and the manure is collected and carefully stored for transportation and spreading on the cropped area at the optimum time, and a 'farm' system in which cattle are corralled at night on the cultivated land in the four months between harvest time and culti-

**Table 4. Area of natural grazing and number of cattle required to support transfer of sufficient nutrients in manure from natural grazing to crop land to sustain grain yield.**

| Variables and scenarios                      | Grain (maize) yield to be sustained (kg ha <sup>-1</sup> ) |      |      |
|--|--|------|------|
|  | 1000   | 2000 | 3000 |
| <b>Area of natural grazing required (ha)</b> |  |      |      |
| a. In high potential area:                   |  |      |      |
| for pen manure system                        | 1.9  | 3.8  | 5.8  |
| for farm manure system                       | 5.1  | 10.3 | 15.6 |
| b. In low potential area:                    |  |      |      |
| for pen manure system                        | 5.7  | 11.6 | 17.4 |
| for farm manure system                       | 15.7   | 31.1 | 46.8 |
| <b>Number of cattle required (head)</b>      |  |      |      |
| for pen manure system                        | 4  | 7    | 11   |
| for farm manure system                       | 14   | 28   | 42   |

Source: These are the author's calculations based on the following assumptions:

- 50% of crop residues are eaten by livestock and 100% of their voiding of this is deposited in cropped area.
- High potential natural grazing yields 3 t dry matter of livestock feed and low potential yields 1 t.
- On an average, cattle weigh 200 kg and eat 2.5% of their weight daily, i.e., 5 kg of dry matter daily.
- Manure voided represents 45% of dry matter intake throughout the year.
- Pen manure is collected year round and stored carefully. 50% of all daily voidings of pasture grazed in this system are collected. It is high quality (N = 1.95%, P = 0.35%, K = 2.62% of manure dry matter).
- Farm manure is collected only for 4 mo of dry season by corralling animals on cropped land. During these 4 mo cattle eat 50% of grazing land's annual DM yield, and 50% of what is eaten is voided on the cropped land. The manure is of low quality (N = 1.4, P = 0.26, K = 1.78% of manure dry matter).
- All the plant nutrients contained in the manure in due course become available to crops.

vation of the land for the next crop, and where the quality of the manure is rather poor. Three levels of grain yield are simulated, at 1, 2, and 3 t of maize ha<sup>-1</sup>.

The table in the appendix to this paper sets out some of the basic calculations of the model indicating how much of the key nutrients are lost in the grain exported or in various ways of treating the residues. It also shows how much manure is required to replace lost nutrients in order to maintain productivity. The key technical parameters involved in the calculation are drawn from three main sources quoted to which reference should be

made for the details.

Table 4 indicates, for example, that to maintain a sustained 1 t maize yield on 1 ha of cropped land by nutrient transfer, a farmer needs 4 head of cattle and 1.9 ha of grazing in a high potential zone using an efficient ('pen') manuring system. That is equivalent to a cultivation density of 35%. Under the same conditions, he needs 11 head of cattle and 5.8 ha of natural grazing to sustain a grain yield of 3 t. Under an inefficient manuring system ('farm'), when both the quality of manure is poor and it is collected only during part of the year, he needs 5.7 ha of natural grazing to sustain a 1-t grain yield in high-potential areas, and 15.3 ha of natural grazing in low-potential areas.

Table 5 reports the results of three on-farm studies where the relationship between manure application and crop yield can be fairly clearly distinguished from other relationships. In one study on agropastoralists in subhumid Nigeria, manure application appears to be at the rate of about 5.5 t dry matter ha<sup>-1</sup> every 2 years, and manured fields out-yielded nonmanured fields by about 63%. However, it is unclear, in this study, how long the so-called 'nonmanured' fields had, in fact, been without manure. The annualized rate of application of manure in this system is somewhat lower than the apparent requirement to maintain a grain yield of about 2.3 t ha<sup>-1</sup>, (Tables 6 and 7). In the mixed farming system in the semi-arid zone of Zimbabwe reported in Table 5, the top level of manure application of 18 t ha<sup>-1</sup> of wet manure (about 5 t dry matter ha<sup>-1</sup>) is in excess of that required annually to replace nutrients lost at the corresponding grain yield of 0.9 t ha<sup>-1</sup>. But it is not known whether this amount of manure is applied annually or less frequently. It is difficult in these studies to tell whether one is observing the effect of manuring on one year's level of yield or observing farmers' attempts to ensure sustainability.

Neither study permits an inter-year comparison of relative stability between manured and nonmanured fields. In the Nigerian study, intra-year inter-field variability was slightly smaller in manured fields (CV of 27% compared to 34% for nonmanured). The only observation available on the effect of manure application on inter-year yield stability is one for semi-arid Kenya, where no reduction in inter-year yield variability appears to have been found from the adoption of a package of improved technologies that includes manure application (Bakhtri et al. 1984).

**Table 5. Effects of manure application on crop yields in farmers fields in selected farming systems in sub-Saharan Africa.**

| Dependent variable, farming system, ecological zone, country, year, and source                                 | Index of crop yield under different manure treatments<br>(No manure treatment = 100) |                   |        |       | Type of crop and comments  |
|--|--|-------------------|--------|-------|--|
|  | No manure  | Some manure       |        |       |  |
|  |  | Application level |        |       |  |
|  |  | Low               | Medium | Heavy |  |
| Fulbe agropastoralist in semi-arid Mali, 1982, (Swift 1985)  | 100  | 117               | 137    | 74    | Pearl millet. Unmanured yield is 72 kg ha <sup>-1</sup> . Manure applications are not quantified. Negative effect of heavy application due to alleged "burning". |
| Settled Fulani agropastoralist: subhumid Nigeria, 1982 (Powell 1986) <sup>1</sup>                              | 100  | 163               |        |       | Maize. Unmanured yield is 1350 kg ha <sup>-1</sup> . Manure application is not available.  |
| Mixed farmers in semi-arid Zimbabwe, 1969/70. (Theisen and Marasha, personal communication, 1974) <sup>2</sup> | 100  | 145               | 500    | 666   | Composite index for several crops. Unmanured yield is 135 kg ha <sup>-1</sup> . Data are very approximate since they involve visual intrapolation of graph.      |

1. Manure application is 5.5 t dry matter ha<sup>-1</sup> every 2 years.

2. Wet manure applications were: low 5 t ha<sup>-1</sup>, medium 11 t ha<sup>-1</sup>, and heavy 18 t ha<sup>-1</sup>.

**Table 6. Nutrient losses (kg ha<sup>-1</sup>) from a maize crop.**

| Grain yield of maize (kg ha <sup>-1</sup> )                                     | 1000 |     |    | 2000 |      |    | 3000 |      |    |
|---|------|-----|----|------|------|----|------|------|----|
| Crop residues (kg ha <sup>-1</sup> )<br>(Balasubramanian and Nnadi 1980, p.108) | 1330 |     |    | 2660 |      |    | 3990 |      |    |
| Nutrients   | N    | P   | K  | N    | P    | K  | N    | P    | K  |
| kg of nutrients in grain (Jones and Wild 1975, p.165)                           | 19   | 4.4 | 10 | 38   | 8.8  | 20 | 57   | 13.2 | 30 |
| kg of nutrients in crop residues<br>(Balasubramanian and Nnadi 1980, p.108)     | 9    | 1.9 | 19 | 19   | 3.7  | 38 | 28   | 5.6  | 57 |
| Total loss (in kg) of nutrients from field if crop residues are:                |      |     |    |      |      |    |      |      |    |
| a. removed from field   | 28   | 6.3 | 29 | 57   | 12.5 | 58 | 85   | 18.8 | 87 |
| b. burnt on field   | 28   | 4.4 | 10 | 57   | 8.8  | 20 | 85   | 13.2 | 30 |
| c. incorporated in soil   | 19   | 4.4 | 10 | 38   | 8.8  | 20 | 57   | 13.2 | 30 |

1. Crop residues in this table are aerial residues only, i.e. they exclude roots.

**Table 7. Requirements for livestock manure to replace soil fertility in relation to different levels of crop yield.**

| Kg of nutrient per t (dry matter) of manure (Kwakyé 1980, p.137)  | N       | P   | K       |         |
|---|---------|-----|---------|---------|
| pen manure system   | 20      | 3.5 | 26      |         |
| farm manure system  | 14      | 2.6 | 18      |         |
| Grain yield of maize (kg ha <sup>-1</sup> )   | 1000    |     | 2000    | 3000    |
| Tonnes of manure (DM) required under different manuring systems per cropped hectare to replace most constraining nutrients if crop residues <sup>1</sup> are: |         |     |         |         |
| a) removed from field <sup>2</sup>  |         |     |         |         |
| pen manure system   | 1.8 (P) |     | 3.6 (P) | 5.4 (P) |
| farm manure system  | 2.4 (P) |     | 4.8 (P) | 7.2 (P) |
| b) burnt on field   |         |     |         |         |
| pen manure system   | 1.4 (N) |     | 2.9 (N) | 4.2 (N) |
| farm manure system  | 2.0 (N) |     | 4.1 (N) | 6.1 (N) |
| c) incorporated in soil   |         |     |         |         |
| pen manure system   | 1.3 (P) |     | 2.5 (P) | 3.8 (P) |
| farm manure system  | 1.7 (P) |     | 3.4 (P) | 5.1 (P) |

1. Crop residues in this table are aerial residues only, i.e., they exclude roots.

2. Letters in brackets indicate which nutrient determines the amount of manure required, i.e., the constraining nutrient.

## Output, Wealth, and Consumption

We have so far discussed the effects of livestock on crops, and vice versa, in terms of specific pathways such as crop residues, traction, and manure. We now turn to more aggregate relations expressed, in the first place, in terms of gross crop output and wealth in the form of livestock, with the implicit assumption that gross crop output is closely correlated with net income, and that fluctuations in livestock wealth are partially used to smooth out fluctuations in levels of household consumption.

### Reciprocal Effects of Crop Outputs and Herd Sizes on Household Levels

Table 8 presents data from a number of surveys carried out in semi-arid sub-Saharan Africa that show the rather close relationship normally to be observed between the size of a household's herd and its crop output. Larger herds are associated with higher crop output, and this observation at the household level is also repeated at the regional and the national level. We shall return to this point later.

The data presented in Table 8 do not prove any particular causal connection. The association may

arise because more livestock provide more traction and manure, or because more crop output makes farmers richer and thereby enables them to invest in more livestock, which they can feed on their abundant crop residues. Alternatively, 'wealth' may come first and enable these farmers to be both successful croppers and herders simultaneously. Probably the causal connection flows in different directions, in different environments, at different times, and with different individuals. What Table 6 indicates is that higher 'levels' of crop output are associated with larger livestock holdings and, presumably, with higher levels of livestock output also.

### Investment, Disinvestment, and Stability

There is evidence that those mixed farmers whose crop output is in excess of their current needs for subsistence and operating expenses often invest the surpluses in livestock. For example, Fulton and Toulmin (1982) writing on the Bambara agropastoral system of central Mali state that "in general households want to convert millet, and formerly peanut surpluses into livestock... Cattle are a very widespread form of investment throughout the region... In the absence of epidemics there is a high



**Table 8. The association between the livestock holdings and the crop outputs of households in selected zones in semi-arid sub-Saharan Africa.**

| Zone and country   | Livestock holdings (TLU)/index of crop output <sup>1</sup> |                                   |
|--|--|-----------------------------------|
|  |  |                                   |
| Semi-arid central Zimbabwe (Theisen and Marasha, personal communication, 1974) | 0-1<br>/ 100   | 2-6<br>/ 182                      |
| Semi-arid southern Zimbabwe (Shumba 1981)                                      | 0<br>/ 100   | some<br>( $\bar{x}=8$ )<br>/ 273  |
| Semi-arid eastern Botswana (EFSaip 1984)                                       | 0<br>/ 100   | 1-7<br>/ 205                      |
| Semi-arid central Swaziland (Swaziland 1979)                                   | 0<br>/ 100   | some<br>( $\bar{x}=11$ )<br>/ 247 |

1. The figure above the diagonal line (/) is the size of the household's herd, expressed in terms of Tropical Livestock Units (TLU) of 250 kg liveweight.  $\bar{x}$  = average herd size. The figure below the diagonal line is the index of crop output, where 100 is the average level of output of those with no livestock or, one case, with 1 or less TLU.

potential rate of return in such investment... Millet cannot be stored indefinitely... Cattle provide a way in which risks in agriculture can be reduced." Dicko (1986) found in one village in southwestern Niger that up to one-third of the capital invested in livestock came from the sale of crop produce.

Conversely, in bad times, livestock are sold to purchase food and thereby to maintain levels of household consumption. Dicko (1986) found that in southwestern Niger in the drought year 1984-85, about 75% of livestock sales were made in order to purchase cereals, involving a 45-80% decline in village herd sizes (median about 70%). Data for Botswana quoted in Vierich and Sheppard (1980), reveal a moderate positive correlation ( $r = 0.62$ ) between group average income from sorghum production 'lost' due to drought and the average group income 'gained' by 'extra', due to drought, cattle sales. About 42% of the 'lost' sorghum income was recuperated through extra livestock sales. The relationship is somewhat confounded by systematic differences in the herd sizes of the groups, but Vierich and Sheppard (1980) claim "access to cattle buffers a household against the impact of drought".

### Crops and Livestock Complementarity and Competition

The preceding section has stressed the complementarity between livestock and crop production

output and a reciprocal buffering effect in which crop surpluses lead to investment in livestock in good years and subsequent disinvestment in bad years in order to purchase grain for household consumption. Two counter points to this rosy picture need to be mentioned. Firstly, the years of investment in livestock are those when crop prices are low and livestock prices high. In years when there is no investment, the exact opposite is the case, so that the 'high potential rate of return' in livestock investment mentioned by Fulton and Toulmin (1982) may disappear in adverse terms of trade just when a household most needs to realize it. Secondly, the complementarity between crops and livestock applies only over certain ranges of scale of activity; and there is evidence (not reviewed here) that above certain critical levels of herd sizes, and above critical cultivation densities, competition for scarce resources, especially labor and land, outweighs the complementarity.

### References

- Bakhtri, M.N., Garotti, S., and Kimemia, J.M. 1984. On-farm research at Katumani: the pre-extension trials experience (with special reference to semi-arid areas of eastern province of Kenya). *East African Agriculture and Forestry Journal* 44 (Special issue) 44: 437-444.

- Balasubramanian, V., and Nnadi, C.A.** 1980. Crop residue managements and soil productivity in savanna areas of Nigeria. Pages 106–120 *in* Organic recycling in Africa: Paper presented at the FAO/SIDA Workshop on the Use of Organic Materials as Fertilizers in Africa, 5–14 Dec 1977, Buea, Cameroon. Rome, Italy: FAO. 27 ref.
- Bayer, W.** 1986. Agro-pastoral herding practices and the grazing behaviour of cattle. Pages 427–440 *in* Livestock systems research in Nigeria's sub-humid zone: proceedings of the 2nd ILCA/NAPRI Symposium, 29 Oct–2 Nov 1984, Kaduna, Nigeria. Addis Ababa, Ethiopia: International Livestock Centre for Africa.
- Dicko, M.S., and Sangare, M.** 1984. Feeding behavior of domestic ruminants in Sahelian zones. Pages 388–389 *in* Proceedings of the 2nd International Rangelands Congress. "Rangelands: a resource under Siege". Adelaide, May 1984.
- Dicko, M.** 1986. ILCA-Niger programme. Document prepared for ILCA external programme review committee. Addis Ababa, Ethiopia: International Livestock Centre for Africa.
- FAO.** 1985. Agriculture toward 2000. Economic and Social Development Studies no. 23. Rome Italy: FAO. 132 pp.
- EFSAIP (Evaluation of Farming Systems and Agricultural Implements Project).** 1984. Report no. 8. Part II. Summary 1976–1984. Gaborone, Botswana: Ministry of Agriculture.
- Fulton D., and Toulmin, C.** 1982. Socio-economic study of an agropastoral system in central Mali. Addis Ababa, Ethiopia: International Livestock Centre for Africa.
- Fussell, L.K., Serafini, P.G., Bationo, A., and Klaij, M.C.** 1987. Management practices to increase yield and yield stability of pearl millet in Africa. Pages 255–268 *in* Proceedings of the International Pearl Millet Workshop, 7–11 Apr 1986, ICRISAT Center, India, Patancheru, A.P. 502324, India: ICRISAT.
- Jones, M.J., and Wild, A.** 1975. Soils of the West African Savanna. Technical communication no. 55. Harpenden, UK: Commonwealth Agricultural Bureaux.
- Kwakye, P.A.** 1980. The effects of method of dung storage and its nutrient (NPK) content and crop yield in the north-east savanna zone of Ghana. Pages 282–288 *in* Organic recycling in Africa: Paper presented at the FAO/SIDA Workshop on the Use of Organic Materials as Fertilizers in Africa, 5–14 Dec 1977, Buea, Cameroon. Rome, Italy: FAO. 27 ref.
- Lambourne, C.J., Dicko, M.S., Semenye, P., and Butterworth, M.** 1983. Animal nutrition. Pages 183–208 *in* Pastoral systems research in sub-saharan Africa: proceedings of the Workshop, 21–24 Mar 1983, Addis Ababa, Ethiopia. Addis Ababa, Ethiopia: International Livestock Centre for Africa.
- McIntire, J.M., and Fussell, L.K.** 1986. On-farm experiments with millet in Niger. III. Yields and economic analyses. ISC, Niamey, Niger: ICRI-SAT Sahelian Center. (Limited distribution.)
- Mohammed-Saleem, M.A.** 1986. The ecology, vegetation and land use of subhumid Nigeria. Pages 59–84 *in* Livestock systems research in Nigeria's subhumid zone: proceedings of the 2nd ILCA/NAPRI Symposium, 29 Oct–2 Nov 1984, Kaduna, Nigeria. Addis Ababa, Ethiopia: International Livestock Centre for Africa.
- Pingali, P.L., Bigot, Y., and Binswanger, H.P.** 1986. Agricultural mechanisation and the evolution of farming systems in sub-Saharan Africa. Discussion Paper ARU no. 40, Washington, D.C., USA: World Bank. 283 pp.
- Powell, J.M.** 1985a. Yields of sorghum and millet and stover consumption of livestock in Nigeria. *Tropical Agriculture (Trinidad)* 62(1): 77–81. 12 ref.
- Powell, J.M.** 1985b. Contribution of fractional crop residues to dry season livestock feed resources in the Abet plains, central Nigeria. *ILCA Newsletter* 4(4): 5–7.
- Powell, J.M.** 1986. Crop livestock interactions in the subhumid zone of Nigeria. Pages 268–303 *in* Livestock systems research in Nigeria's subhumid zone: proceedings of the 2nd ILCA/NAPRI Symposium, 29 Oct–2 Nov 1984, Kaduna, Nigeria. Addis Ababa, Ethiopia: International Livestock Centre for Africa. 44 ref.

**Shumba, E.M.** 1981. Farming systems research—a changing outlook towards experimental work to improve the quality of life in Zimbabwe small farm sector. Presented at a seminar on Farming Systems Research, 12 Nov 1981, organized by the Department of Land Management, University of Harare, Zimbabwe. (Limited distribution.)

**Swaziland.** 1979. Ministry of Agriculture. Farm management survey no.4. Swaziland: Ministry of Agriculture.

**Swift, J.** 1985. Pastoral and agropastoral systems in Central Mali: three case studies. Addis Ababa, Ethiopia: International Livestock Centre for Africa.

**van Raay, J.G.T.** 1974. Rural planning in a savanna region. Holland, Rotterdam, Netherlands: University Press.

**van Raay, J.G.T., and de Leeuw, P.N.** 1971. The importance of crop residues as fodder: a resource analysis in Katsina Province, Nigeria. Samaru Research Bulletin no. 139. Samaru, Zaria, Nigeria: Ahmadu Bello University.

**Vierich, H., and Sheppard, C.** 1980. Drought in rural Botswana: socio-economic impact and government policy. Gaborone, Botswana: Ministry of Agriculture.

# The Value of Crop Residues for Water Conservation

R.I. Papendick and J.F. Parr<sup>1</sup>

## Abstract

*Crop residues have long been recognized as an important resource for water conservation in dryland agriculture. Unfortunately, farmers in many areas are not aware of this potential benefit and as a result, do not manage residues for this purpose. Instead, after harvest, the crop residues may be buried by tillage or completely removed for alternative uses such as animal feed, fuel, or building materials. Without adequate surface cover during critical wet periods, runoff and evaporation may be increased causing severe deficits in available water for the subsequent crop.*

*The value of crop residues for water conservation depends upon several factors including the quantity, type, and placement of residues, potential evaporation, length of fallow, precipitation characteristics, tillage practices, and soil type. Studies in dryland areas of the USA show that 1000 kg ha<sup>-1</sup> of grain residues left on the surface during fallow are worth up to 85 kg of wheat in terms of water conserved for the next crop. Sorghum yield increases from water conserved by residues were considerably higher. Residues are most effective for water conservation during the rainy season. After rains cease, evaporation losses from residue-covered soils can exceed those from bare soils. This effect is most pronounced with fine-textured and untilled soils. During extended dry periods, residues may provide little direct benefit for water conservation.*

*Process-oriented soil-residue models are available for evaluating the effectiveness of residues for conserving water over a wide range of climatic conditions, and soil-and-crop management practices. While these models have manageable input requirements, some basic field experiments will be needed for validation. Future application of soil-water residue studies should give high priority to optimizing the use of residues in an integrated crop/livestock farming system.*

## Résumé

**Valeur des résidus des cultures pour la conservation de l'eau :** *L'importance des résidus des cultures pour la conservation de l'eau en zone d'agriculture pluviale est reconnue depuis longtemps. Malheureusement, les paysans dans maintes régions n'ont pas pris conscience du parti qu'ils pourraient tirer des résidus et ne les gèrent pas en conséquence. Au contraire, après la récolte, les résidus sont souvent enfouis par labour ou enlevés pour être utilisés comme fourrage, combustible ou matériau de construction. Si la surface du sol n'est pas suffisamment recouverte pendant les périodes critiques des pluies, le ruissellement et l'évaporation peuvent s'accroître et provoquer de graves déficits en eau disponible pour la culture suivante.*

*La valeur des résidus des cultures pour la conservation de l'eau dépend de multiples facteurs et, notamment, de la quantité, du type et de l'emplacement des résidus, de l'évaporation potentielle ainsi que de la durée de la jachère, des caractéristiques des précipitations, des pratiques de labour et des types de sols. Des études en zone d'agriculture pluviale aux Etats-Unis ont montré que l'eau conservée pour la culture suivante par 1000 kg ha<sup>-1</sup> de résidus laissés à la*

---

1. Soil Scientists and Research Leaders, USDA-ARS, Pullman, WA, USA; USDA-ARS, Beltsville, MD, USA.

ICRISAT (International Crops Research Institute for the Semi-Arid Tropics) 1989. Soil, Crop, and Water Management Systems for Rainfed Agriculture in the Sudano-Sahelian Zone: proceedings of an International Workshop, 7-11 Jan 1987. ICRISAT Sahelian Center, Niamey, Niger. Patancheru, A.P. 502 324, India: ICRISAT.

*surface permet de produire 85 kg supplémentaires de blé. Les augmentations de rendement obtenues sur le sorgho à partir de l'eau conservée par les résidus sont encore bien plus élevées. L'efficacité des résidus en tant que moyen de conservation de l'eau est plus grande en saison des pluies. Lorsque les pluies cessent, les pertes dues à l'évaporation sur les sols couverts de résidus peuvent dépasser celles des sols nus. Cet effet est plus marqué sur les sols non labourés à texture fine. En cas de sécheresse prolongée, les résidus peuvent n'entraîner que peu d'effets directement profitables à la conservation de l'eau.*

*Il existe des modèles déterministes sols/résidus permettant d'évaluer l'efficacité des résidus pour la conservation de l'eau dans une grande diversité de conditions climatiques et de techniques d'aménagement des sols et des cultures. Même si ces modèles n'exigent pas un trop grand nombre d'intrants, des expériences devront être organisées sur le terrain pour les valider. Les études réalisées à l'avenir sur les applications des résidus pour la conservation de l'eau devraient en priorité viser à optimiser l'utilisation de ces résidus dans un système de production intégrant l'élevage et l'agriculture.*

## **Introduction**

Crop residues have long been recognized as an important resource for water conservation in dry-land agriculture. Unfortunately, farmers in many areas are not aware of this potential benefit and as a result, make no real effort to manage residues for this purpose. In many regions of the world, crop residues are an important source of animal feed, building material, and fuel. Where such competition exists, use for water conservation is generally of much lower priority. Moreover, studies are lacking that show the economic value of crop residues for water conservation, relative to other uses for which they are removed from the land.

### **Effectiveness of Residues for Water Conservation**

Residues are generally most effective for water conservation when managed as a surface mulch. Surface residues facilitate infiltration by slowing runoff and absorbing raindrop impact that reduces soil puddling and crusting. Mulches also reduce evaporation by reflecting radiation, thermally insulating the soil, and decreasing the windspeed near the soil surface. However, the actual amount of water conserved by a residue mulch depends on a number of factors including type, amount, and placement of the residues, precipitation and other climatic characteristics, length of fallow, tillage practices, and soil type. Management of the residues during critical periods of high runoff and evaporation is especially important in determining

the effectiveness of residues for water conservation.

Greb (1983) summarized the results of studies conducted at four locations in the Great Plains, USA, on soil-water gains during fallow for different rates of surface mulches of small-grain residues. In most cases, the cropping system was alternate wheat-fallow. These long-term field experiments showed that increases in soil water from the mulches were significant and roughly proportional to the amounts of surface residues over the range of 2.2–6.6 t ha<sup>-1</sup> (Table 1). Storage efficiency appears to be slightly higher in the colder, more northern locations (Montana, Nebraska, Colorado) where winter snow catch is more important than at the southernmost site in Texas, where temperatures are higher and snow is less important. However, the data for the different locations cannot be compared directly because of the differences in soils, length of fallow, and other factors.

Table 1 shows that the water storage efficiency per unit of mulch decreases slightly with increase in mulch rate within the range used. Taking an average of all locations in the Great Plains, each t ha<sup>-1</sup> of crop residue saves about 9 mm of water from evaporation. This compares with approximately 4 mm of water conserved for each t ha<sup>-1</sup> of mulch during a 12-mo fallow in the Pacific Northwest, USA, where most of the precipitation is received in winter in contrast to most precipitation being received in summer in the Great Plains (R. I. Papendick, USA, personal communication).

Obviously, it should be expected that the efficiency of mulch for conserving water may vary considerably for different locations and management conditions. Studies by Unger (1978) in Texas

**Table 1. Soil water gained, additional to that from bare fallow, caused by straw mulch rates at four locations in Great Plains, USA, for one complete fallow season.**

| Location  | Soil water gain (mm)             |     |     |
|---|----------------------------------|-----|-----|
|   | Mulch rate (t ha <sup>-1</sup> ) |     |     |
|   | 2.2                              | 4.4 | 6.6 |
| Sidney, Montana                                   | 16                               | 41  | 49  |
| North Platte, Nebraska                            | 28                               | 51  | 69  |
| Akron, Colorado                                   | 16                               | 31  | 51  |
| Bushland, Texas                                   | 28                               | 28  | 36  |
| Mean  | 22                               | 38  | 51  |
| Efficiency (mm t <sup>-1</sup> ha <sup>-1</sup> ) | 10.0                             | 8.6 | 7.7 |

Source: Greb 1983.

showed that a 1 t ha<sup>-1</sup> application of wheat straw increased soil water during an 11-mo fallow by 36 mm; at a rate of 4 t ha<sup>-1</sup>, each t increased soil water by 12 mm and at 8 t ha<sup>-1</sup>, each t increased soil water by 10 mm. These latter values are more typical of the Great Plains studies reported by Greb (1983). Some experiments have shown that low residue rates (in the order of 1 t ha<sup>-1</sup>) can be effective for water conservation if the residues are properly managed, but this needs more study.

### Wheat Yield-Water Relationships

The importance of crop residues for water conservation can also be evaluated by the potential crop yield increase resulting from water conserved by residues. Wheat, like any seed crop, requires a certain threshold amount of water before grain is produced. Each increment above this amount usually increases yield until water is no longer limiting. The minimum amount of available water required to produce each increment of grain yield varies with soil, fertility, and climatic factors. Table 2 shows that, in the Pacific Northwest, USA, approximately 100 mm of water are required by winter wheat to grow the crop till grain production starts, after which 16 kg ha<sup>-1</sup> are produced for each additional mm of water. For the Central and Southern Great Plains, the amount of water to initiate grain production is greater, and less wheat is produced for each additional increment of water than in the Pacific Northwest.

**Table 2. Threshold water<sup>1</sup> and grain yield per mm of water for winter wheat at several locations in USA.**

| Location                           | Threshold water (mm) | Grain yield (kg ha <sup>-1</sup> mm <sup>-1</sup> ) |
|------------------------------------|----------------------|---|
| Pacific Northwest <sup>2</sup>     | 100                  | 16  |
| Northern Great Plains <sup>3</sup> | 130                  | 16  |
| Central Great Plains <sup>4</sup>  | 150                  | 13  |
| Southern Great Plains <sup>5</sup> | 150                  | 6   |

1. Threshold water is the available water in mm required to initiate grain production.

2. Leggett 1959.

3. Montana Cooperative Extension Service/Montana Agricultural Experiment Station, 1985.

4. Smika, D.E. USDA-ARS, Akron, CO., personal communication.

5. Stewart, B. A., USDA-ARS, Bushland, TX., personal communication.

There was 9 mm of water gain (Table 1) from 1 t ha<sup>-1</sup> of crop residue, each t ha<sup>-1</sup> of residue during fallow is worth approximately 144 kg ha<sup>-1</sup> of wheat in the following crop for the Northern, 117 kg ha<sup>-1</sup> for the Central, and 54 kg ha<sup>-1</sup> for the Southern Great Plains regions. For the Pacific Northwest, if 1 t ha<sup>-1</sup> of crop residue saves 4 mm of water (not shown), each t of residue will add about 64 kg of grain to the following crop. Obviously, the value of residues for water conservation will vary considerably for different locations depending upon climate, soil, and management factors. Nevertheless, these typical values show the benefit to grain production.

### Processes of Water Loss

The objective of water conservation in most cases is to maximize storage of water in soil. Losses from runoff and deep drainage below the root zone are often (but not always) secondary under dryland conditions, amounting to only a small percentage of the precipitation. Transpiration by weeds can be significant, but this usually can be controlled by tillage or herbicide application. Evaporation generally accounts for the bulk of moisture loss during fallow and is by far the most difficult process to control.

Researchers generally recognized at least two stages in the soil-water evaporation process, and sometimes three. The first or constant rate stage

## Principles of Water Conservation by Crop Residues

occurs when the soil surface is wet. The evaporation rate is at a maximum and is controlled by the evaporation demand of the atmosphere and the soil-surface conditions (e.g., surface residues) insofar as the latter influence the power of the atmosphere to evaporate water. During first stage drying, the evaporation rate from bare soil may approach pan evaporation (Fig. 1). Water moves as a liquid to the surface and the rate of movement keeps pace with the loss. As drying continues, the rate of water movement through the soil eventually begins to lag the potential evaporation rate.

As the soil surface becomes dry, the constant rate stage ends and the second or falling rate stage begins (Fig. 1). The second stage is characterized by a rapid decline in the rate of water loss. As drying continues, the fraction of water that moves to the surface as vapor increases. The duration of the first stage and the rate of the second stage of drying are both influenced by the water flow properties of the soil.

Sometimes a third stage of evaporation develops after a deep, dry soil layer forms (Fig. 1). Under this condition, the water loss rates are relatively low (fraction of  $1 \text{ mm d}^{-1}$  even under high evaporative demand) and essentially constant. Water must diffuse as vapor through the dry layer, which is a very slow process. Because the rate is so slow, atmospheric conditions have much less influence on soil-water evaporation during third stage drying than during the first two stages.

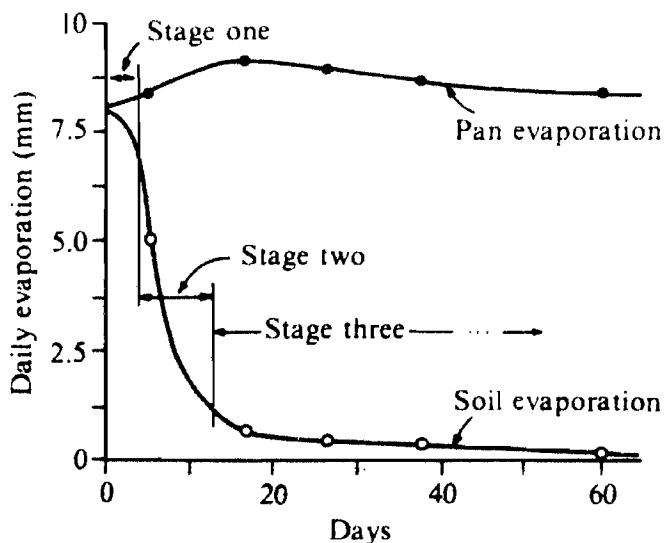

**Figure 1.** Different stages of soil drying as related to time and rate of soil-water evaporation (After Massee and Carey 1978).

The potential for significantly reducing evaporation lies in the first two stages of water loss. Evaporation requires heat. Any surface conditions that reduce the exchange of heat between the soil surface and atmosphere will slow the evaporation rate during either the first or second stage of drying. Surface conditions such as mulches of crop residues exert the greatest influence on the first stage (wet soil surface) of drying out the importance diminishes during the second stage.

A residue mulch conserves water in three ways. First, it tends to reflect more sunlight (that otherwise would be absorbed as heat) than most soils. Second, a mulch acts as a thermal insulator and restricts the flow of heat from the atmosphere to the soil. Third, the mulch creates a dead air space above the soil surface, which reduces the transfer of vapor from the soil to the atmosphere.

Based on these principles, it becomes evident that, generally, surface residues reduce evaporation most during the rainy season when the soil surface is wet and in first stage of drying. Slowing the evaporation rate in these conditions favors deeper soil-moisture penetration because it extends the duration of moisture movement. However, when rains cease and extended drying occurs, cumulative water loss from a residue-covered soil can exceed that from a bare soil. This is because the first stage of evaporation is slower and longer under residues, whereas the bare soil will dry at the surface and go into the second stage of drying more rapidly, thereby sharply decreasing the water loss rate and total amount.

In these conditions, water loss from both mulched and bare soils can be slowed by loosening the soil by tillage. This tillage disrupts the capillary continuity with the deeper layers and hastens formation of a dry surface layer that in turn increases resistance to upward flow. Thus, the proper kind, amount, and timing of tillage, combined with residue management, is needed to optimize water conservation by residues.

### Modeling Residue Effects on Water Conservation

It is very difficult to study the effect of residues on water conservation without the use of simulation

models, because of the number of factors involved that control water storage and loss. Moreover, most of these factors interact, which makes it difficult in field experiments to isolate their individual effects. A simulation model capable of describing the dynamics of mass and energy transfer in a soil-residue-atmosphere system has been developed, which is suitable for microcomputer application (Bristow et al. 1986). The model couples surface residue with soil atmosphere in a fundamental way and uses a network analysis approach to describe heat and moisture transfer. It accounts for short- and long-wave radiative interception by the residue layer, infiltration, redistribution, evaporation, and drainage. Daily input requirements for the model include global short-wave radiation, maximum and minimum screen temperatures, average wind speed, precipitation, and temperature and water content at one depth deep in the soil profile. General site, residue, and soil characteristics are needed as initial inputs.

A simulation comparing evaporation from a bare surface and a residue-covered surface of a deep loam soil was made for the period 1 Sep 1981–31 Aug 1982 using daily inputs of air temperatures, windspeed, precipitation, and solar radiation measured at Pullman, Washington, (latitude 47°46'N, longitude 117°12'S) (Bristow et al. 1986). The lower boundary for soil-water content and temperature was set at a depth of 1.75 m. The residue application rate was taken as 3 t ha<sup>-1</sup>, which gave an area index of unity and formed a layer about 1-cm thick. The soil was assumed to be untilled.

Monthly precipitation and simulated evaporation accumulated from the daily values for a bare- and residue-covered soil are shown in Figure 2. From late fall until early spring when most of the precipitation occurs, the soil surface is wet almost continuously. During this time, evaporation from the bare soil is considerably greater than that from the residue-covered soil for reasons already given.

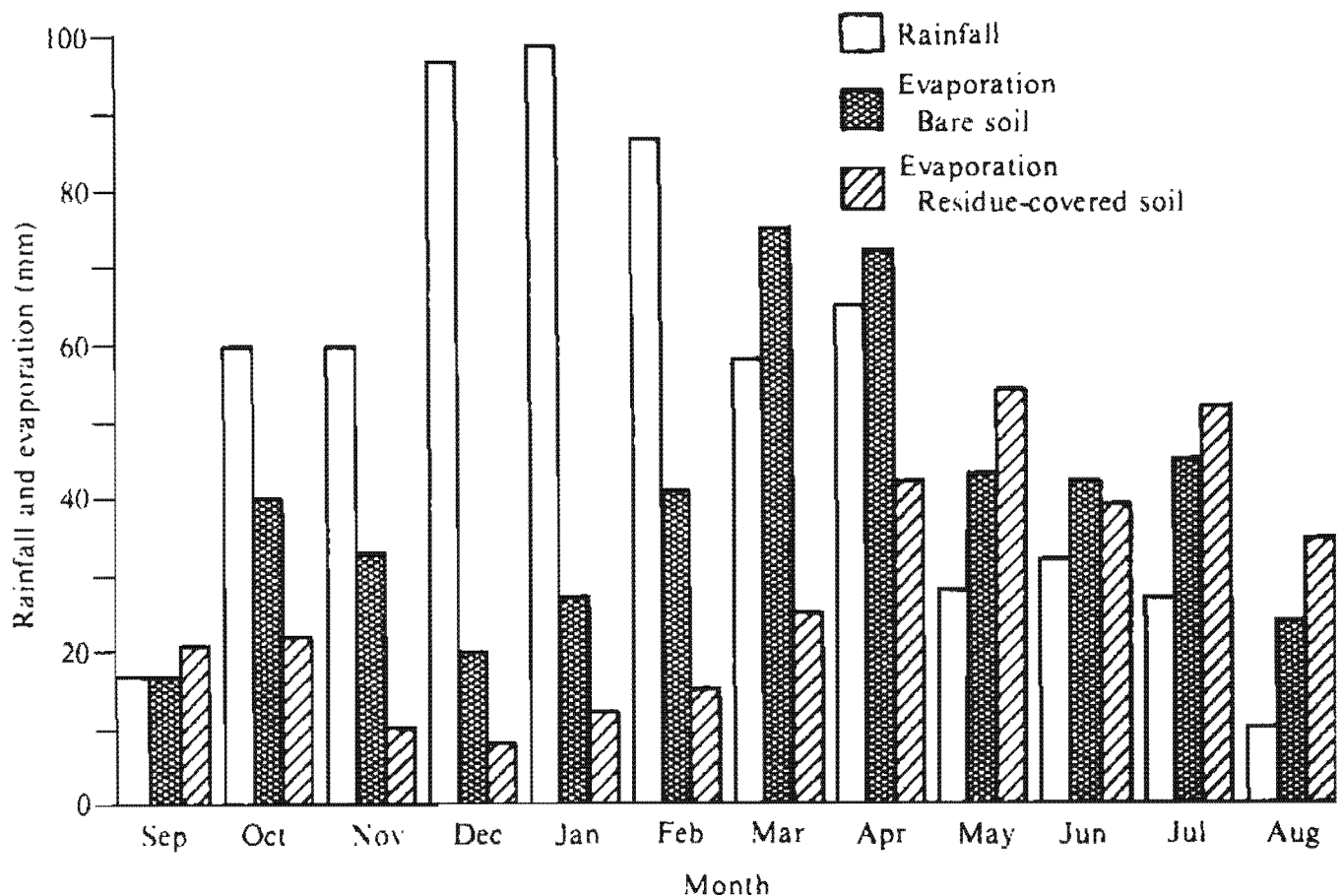

Figure 2. Monthly precipitation and simulated evaporation for the period 1 Sep 1981–31 Aug 1982 at Pullman, Washington (After Bristow et al. 1986).



After the rains decrease in May and throughout summer, simulated evaporation from the residue-covered soil exceeded that from the bare soil. The reason for this is that the duration of first stage drying is longer, and the transition to the second stage is slower for the residue-covered soil than for the bare surface. However, for the year, simulated evaporation from the residue-covered soil was 36% less than that from the bare soil.

To improve the simulation, Bristow et al. (1986) point out the need for further research to quantify the effects on water conservation, of spatial and temporal variation of residues in the field, spectral properties of residue as a function of time, changes in resistance of the residue to vapor flow due to water loss under both wet and dry conditions, and the effect of residue configuration such as standing, flattened, or incorporated.

More recent simulations have been made of tillage-residue and soil type-residue interactions on water loss by evaporation using the SHAW (Simultaneous Heat And Water) Model just developed by the USDA-ARS at Pullman, Washington. These runs were made starting with a moisture profile at field capacity in early May and inputting actual weather data for the summer of 1986 at Pullman. Recorded rainfall was used in one analysis but taken as zero in a second run to simulate extended drying. Simulations were made for about 10 weeks. In Figure 3, the soil thermal and hydraulic properties are representative of a loam soil. Figure 3 with precipitation (top graph), shows that evaporation loss is highest from the bare, untilled soil. Tillage has little effect on evaporative loss for residue-covered soil. Although initial evaporation from the tilled bare soil is higher than that from the residue-covered soil, cumulative evaporation at the end of the run is the same.

Figure 3, for the same soil and treatments, but with no precipitation (bottom graph) during the simulation period, shows that the initial evaporation rate and cumulative loss is highest in the bare, untilled soil. The no-till, residue-covered soil remains in first stage evaporation during the entire simulation and at the end of 10 weeks, the cumulative loss approaches that from the bare, untilled soil. Evaporative loss at the end of the simulation period for the tilled soils is half or less than for the untilled soils. For the tilled residue-covered soil, the cumulative loss early in the simulation period and at the end exceeded that for the bare, tilled soil. This occurred because the residue extended the

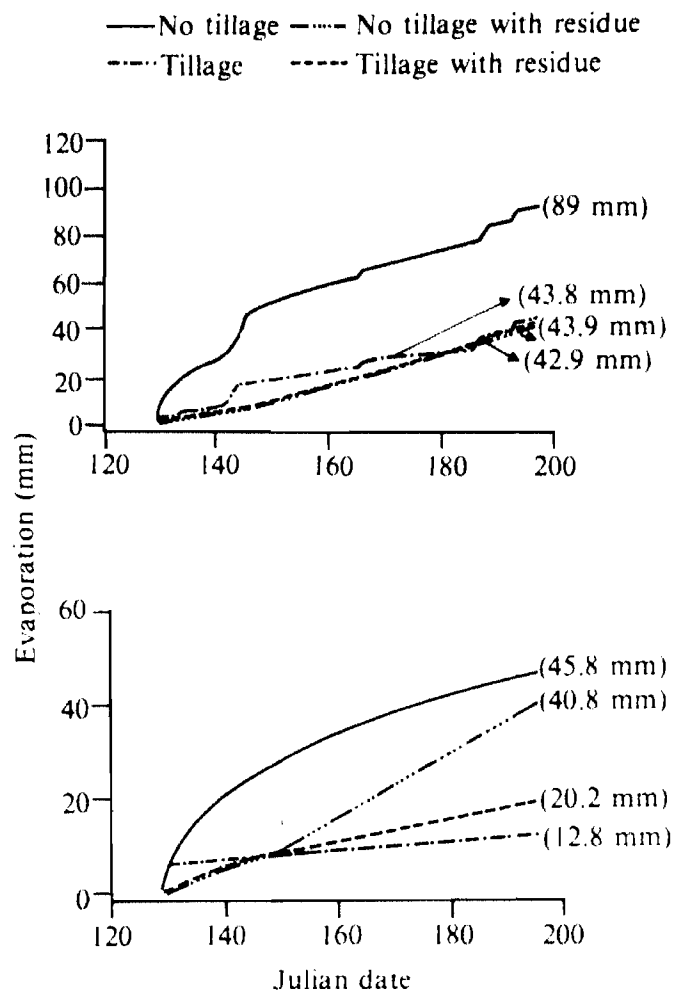

**Figure 3. Top: Simulated evaporation as affected by tillage and residue for an initially moist loam soil using weather inputs for 1986, Pullman, Washington. The number after each curve is the total evaporation at the end of the simulation. Bottom: Same as top graph, except without additional precipitation.**

duration of the first stage drying and delayed the transition to the second stage.

Figure 4 compares the effect of residues on evaporation for sandy and clayey soils. The top graph with precipitation shows a reduction in evaporation loss with residues (131% reduction with residue for the clay soil) and considerably lower losses with sand rather than clay soil for the same residue treatments. The clay soil, because of its much higher unsaturated conductivity, tends to remain in first stage of drying longer than the sand which forms a surface dry layer more rapidly. The sand with residue goes into the second stage of drying a little more than halfway through the run whereas the clay with residues remains in first stage drying throughout the run.

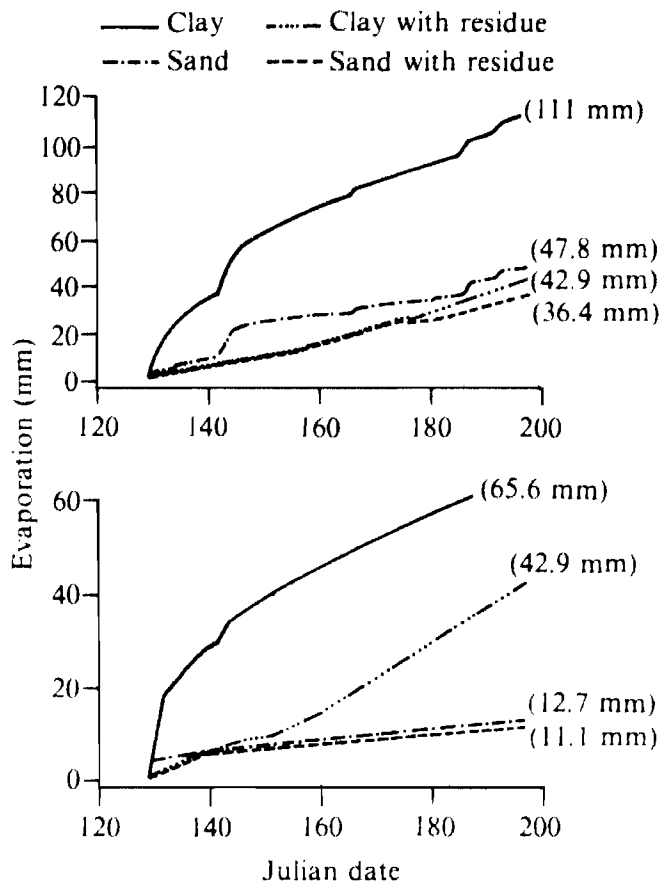

**Figure 4.** Top: Simulated evaporation for an initially moist clay and sand soil, bare and with residues using the same weather inputs as for top graph in Figure 3. The number after each curve is the total evaporation at the end of the simulation. Bottom: Same as top graph, except without additional precipitation.

Figure 4, without precipitation (bottom graph), shows that the bare clay soil has the highest evaporation rate and goes into the second stage of drying about 10 days after the run begins, whereas the clay with residues stays in the first stage throughout the simulation period. The evaporation loss for the clay with residues is the same with or without precipitation (compare top and bottom graph). The sand with residue remains in the first stage of drying for several days after the run is initiated and loses slightly less water at the end of the run than the sand without residue. In this case, cumulative losses from the clay soil far exceed those from the sand which is, as expected, based on differences in hydraulic properties of the two soils and the extended duration of drying without rain.

The new SHAW model provides researchers with a powerful tool for studying residue effects on water conservation over a wide range of climatic, soil, tillage, and residue conditions. However, carefully selected field experiments with judiciously planned measurements must accompany such modeling efforts to validate results and to provide essential soil and climate input values.

## Conclusions and Research Needs

A brief analysis of crop residue-water conservation relationships for some dryland areas in the USA shows that 1 t ha<sup>-1</sup> of crop residue managed as a surface mulch conserves about 9 mm of water during a fallow year in the Great Plains, and that this water can potentially produce from 50 to 140 kg ha<sup>-1</sup> of wheat in the following crop for the different locations in the region. The efficiency of residues for water conservation appears to decrease slightly as residue-loading rate increases over the range of residue rates normally produced under dryland conditions. However, it should be recognized that these values are averages for a wide range of climatic, soil, and residue conditions and that there could be a considerable spread for different locations and management.

Future studies should emphasize alternative residue-tillage management systems to improve residue efficiency for water conservation. Moreover, since production is limited with most dry farming systems, studies should also consider the effects of low amounts of residues (e.g., in the range of 1 or 2 t ha<sup>-1</sup> or less). Studies are also needed on crop rotations and integrated crop/livestock production systems to determine the best ways to use the additional water conserved by residues. Not until crop residue-water conservation relationships have been established can systematic studies be conducted on the economics of alternative uses of residues such as for animal feed, fuel, or building materials. Some specific research needs, in addition to some already mentioned include the following.

- For the range of crop residues produced, establish the relationship between amount and type of surface residues, percentage cover, and water conservation for some of the climates and soils of major dryland areas.
- Determine how residue efficiency and water-use efficiency can be maximized by tillage and

cropping sequence for the climates and soils of the major dryland areas.

- Determine how residue management (residue placement, timing, and tillage practice) can be optimized to achieve maximum efficiency of residues for water conservation.
- Establish percentage cover in relation to precipitation pattern for some different cropping and tillage systems as a means of maximizing residue efficiency for water conservation.
- Determine how the value of residues for water conservation compare economically with other uses where residues are removed from the land.

## References

**Bristow, K. L., Campbell, G. S., Papendick, R. I., and Elliot, L.F.** 1986. Simulation of heat and moisture transfer through a surface residue-soil system. *Agricultural and Forest Meteorology* 36: 193-214.

**Greb, B. W.** 1983. Water conservation: Central Great Plains. Pages 57-72 *in* Dryland agriculture (Dregne, H. E., and Willis, W. O., eds.). Agronomy no. 23. Madison, Wisconsin, USA: American Society of Agronomy.

**Leggett, G. E.** 1959. Relationships between wheat yield, available moisture and available nitrogen in eastern Washington dryland areas. Washington Agricultural Experiment Station Bulletin no. 609. Pullman, Washington, USA: Washington State University.

**Massee, T. W., and Cary, J. W.** 1978. Potential for reducing evaporation during summer fallow. *Journal of Soil and Water Conservation* 33: 126-129.

**Montana Agricultural Experiment Station.** 1985. The Montana small grain guide. Bozeman, Montana, USA: Montana State University.

**Unger, P. W.** 1978. Straw-mulch rate effect on soil water storage and sorghum yield. *Soil Science Society of America Journal* 42: 486-491.

# Agroforestry in the Semi-Arid Tropics: Strategies and Research Needs

R. J. Van Den Beldt<sup>1</sup>

## Abstract

*Preliminary analyses of the substantial data on agroforestry in the semi-arid tropics (SAT) through development and research efforts, as well as observation of traditional systems, suggest that agroforestry has a significant role to play in SAT agriculture. Agroforestry plays a part in increasing their agroenvironmental niches and the effect of competition that exists between crops and trees. Future research requirements, particularly the need to identify and decrease this competition, are listed. Attention is given to a multidisciplinary, networking approach, with emphasis on West Africa, to avoid the site specificity of adaptive research.*

## Résumé

**L'agroforesterie dans les zones tropicales semi-arides—stratégies et besoins de recherche :** *Les activités liées au développement et à la recherche ainsi que l'observation des systèmes traditionnels ont permis de recueillir toute une série d'informations sur l'agroforesterie dans les zones tropicales semi-arides. L'analyse préliminaire de ces données montre que l'agroforesterie joue un rôle significatif dans l'agriculture de ces zones en y augmentant la stabilité et la productivité des systèmes de production. Une description des systèmes agroforestiers les plus importants et une analyse des effets de la concurrence entre les cultures et les arbres sont suivies d'une énumération des besoins futurs de la recherche et notamment d'études sur les effets de cette concurrence et les moyens de les atténuer. Une approche multidisciplinaire fondée sur un réseau, notamment pour l'Afrique de l'Ouest, devrait permettre d'éviter une localisation trop étroite des activités de recherches d'adaptation.*

## Introduction

The adaptive nature of agroforestry research in the semi-arid tropics (SAT) has so far generated mostly site-specific technologies patterned after promising agroforestry systems of the more humid tropics. This has been due to several reasons. First, there has been a need to 'start somewhere', and testing the limits of agroforestry systems from out-

side the SAT was a logical first step. Secondly, until the last few years, there has been a lack of commitment from donor and national institutions to support agroforestry research in the SAT.

These initial efforts have yielded several important lessons which in turn, have given some idea of how best to proceed. This paper gives a brief overview of the findings of the past and present SAT agroforestry programs in India and West Africa,

---

1. Principal Agronomist, Resource Management Program, ICRISAT, Patancheru, A.P. 502 324, India.

ICRISAT Conference Paper no. CP 399.

ICRISAT (International Crops Research Institute for the Semi-Arid Tropics) 1989. Soil, Crop, and Water Management Systems for Rainfed Agriculture in the Sudano-Sahelian Zone: proceedings of an International Workshop, 7-11 Jan 1987. ICRISAT Sahelian Center, Niamey, Niger. Patancheru, A.P. 502 324, India: ICRISAT.

and proposes ways to expand and enhance them. Three main sections are presented:

- broad types of agroforestry systems for the SAT.
- research gaps, and
- research strategies.

### **Definition of SAT Agroforestry Systems**

Agroforestry has been defined by the International Council for Research on Agroforestry (ICRAF) as "a collective word for all land-use systems and practices in which woody perennials are deliberately grown on the same land management unit as crops and/or animals. This can be either in some form of spatial arrangement or in a time sequence. To qualify as agroforestry, a given land-use system or practice must permit significant economic and ecological interactions between the woody and non-woody components." (ICRAF 1983).

In the more humid parts of the tropics, agroforestry systems are characterized by relatively large numbers of trees per unit area, often intimately and intensively associated with crops. Examples of this include shaded plantation crops like coffee and tea, stratified and complex home gardens, and alley cropping. Such systems easily permit the ecological interaction of ICRAF's definition.

However, in drier areas, where trees compete more with crops, proper spacing and management become important; even one or two trees per hectare of cropped field could be viewed as agroforestry. Trees without significant or even direct interaction with crops must not be excluded as they may constitute an important part of the overall farming system. It is advantageous in some cases to consider the economic interaction between trees and crops prior to the ecological interactions, either as a source of income or as a means of stabilizing farm production.

### **The Role of Agroforestry in the SAT**

Although increased crop yields is an important justification for developing any new agricultural technology, SAT agroforestry will, as an emerging discipline, generally have a broader perspective that will include sustainability of agricultural systems, provision of raw materials, and increase of

net economic production of farming systems. The role agroforestry can play in farming systems of the SAT is briefly described below.

### **Source of Raw Materials**

Much has been written about tree products like food, fodder, wood, fiber, fuel, etc. Burley and von Carlowitz (1984) sum up the state of this knowledge, with appropriate descriptions of the limitations of trees in fulfilling the role of provider. Early identification of the products to emphasize and their ultimate use is important (Blair 1986). Emerging data from ICRISAT and various Indian research institutes show that many experimental SAT agroforestry systems have land equivalent ratios (LER) greater than one, mostly because of the high biomass productivity of the tree component. However, few examples of valid economic interpretation of these systems exist (Sumberg et al. 1985). It is the conversion of these biomass production figures into economic terms that will ultimately decide the potential value of agroforestry systems to the farmer.

### **Soil Amendment and Protection**

Incorporation of organic matter is an important part of agroforestry systems proposed for the humid tropics (Kang et al. 1984) and the SAT. Organic matter content, important for soil stability, cation exchange and supply, and many other properties, is decreasing in many SAT soils (El-Swaify et al. 1985). This problem is exacerbated by the growing competitive economic use of crop residues for fodder and the general decrease in use of manures and fallows. Agroforestry could provide a source for soil organic matter additions, either as loppings from trees grown in situ, or as litter and/or loppings transported from groups of trees established separately from cropped fields (Wilken 1977).

Agroforestry can also be used to penetrate impermeable layers in certain soils. Hulugalle and Lal (1986) propose the use of woody perennials to break up compacted gravelly layers in tropical Alfisols. Chaturvedi (1985) suggests that strongly rooted tree species may assist in the reclamation of alkaline, flooded soils in India by penetrating buried caliche layers created by improper irrigation.

## Environmental Protection

The role of trees and tree loppings in lessening the impact of harsh environments on crop growth has been suggested by Charreau (1974) and Chase and Boudouresque (1987). This effect has been studied in several agroforestry systems—windbreaks, traditional multitiered (parkland) mixtures of trees and crops, and the simple application of loppings to hills of newly sown crops. The use of trees and shrubs and their products can serve to reduce both soil temperature (thereby reducing soil evaporation and providing a better environment for early crop growth), and wind velocity (thereby decreasing evaporative demand and yield losses due to sand blasting).

## Agroforestry Systems for the SAT

Four categories of agroforestry technologies proposed for the SAT are discussed below. The purpose of this section is not to give an exhaustive review but rather to give an overview of these systems by emphasizing their limitations and their probable environmental niches in the SAT.

### Parkland Systems

Although no definitive estimates exist, it is quite possible that parkland systems, characterized by mature or nearly mature trees widely dispersed in cropped fields, is the largest single agricultural land use in sub-Saharan West Africa. Two such systems are reported—the *Prosopis cineraria*/pearl millet (*Pennisetum americanum*) mixtures of eastern Rajasthan, India, and the *Acacia albida*/grain system predominant throughout the Sudano-Saharan zone.

Several authors have conclusively shown the enhancing effect of *Acacia albida* on crops growing under it. Charreau (1974), for example, cites yield advantages of up to 152% for pearl millet and 44% for groundnut (*Arachis hypogaea*) grown under or near *Acacia albida* as against that grown in the open. This effect is attributed to increased soil fertility under the tree (Charreau 1974) owing to lack of competition from the tree itself, which is defoliated during most of the rainy (cropping) season.

Like *Acacia albida*, *Prosopis cineraria* has been

noted to increase understory crop yield, although most reports about this are more descriptive than definitive (Mann and Saxena 1980). However, several factors tend to support the observations. For one, the tree is heavily lopped for fodder before the cropping season, an operation that effectively removes its transpiring canopy. Also, the tree has a pronounced taproot, with few laterals at the surface (Muthana et al. 1984).

Other than these two most tree species compete with crops, and experiments to mimic the effect of *Prosopis cineraria* and *Acacia albida* have been inconclusive. Paroda and Muthana (1979) cited in Mann and Saxena (1980) reported a sevenfold increase in mung bean (*Vigna radiata*) grain production between lopped and unlopped treatments in a 12-year-old *Acacia tortilis* stand established at 4 × 4 m. However, their experiment did not have a sole crop control to allow comparison of the effect of this extremely competitive tree on crop yield.

A trial at ICRISAT on the effect of spacing on trees lopped at 3 m height twice during the cropping season showed that young leucaena trees, at low populations (400–1300 ha<sup>-1</sup>), had little effect on crop yield. However, competition increased linearly with increasing tree population (Fig. 1). At the extreme (10 000 stems ha<sup>-1</sup>), yield reduction was similar to that found in alley cropping experiments (about 30%).

In a related experiment with 4-year old leucaena trees, Hocking and Gangadhar Rao (unpublished data, cited in Singh et al. 1986) showed the importance of intensive lopping. Although plots under pollarded leucaena spaced at 2 × 6 m had half the sorghum (*Sorghum bicolor*) grain yield of sole sorghum, their yields were 10 times more than those observed in the lightly lopped treatment. The LER of this pollarded leucaena/sorghum mixture was 1.35.

Further work with such systems can be justified if in the often favorable LERs that are emerging from ongoing trials are economically advantageous, or if traditional systems such as the two mentioned above can be improved. It is likely that the first criterion can be met, as there are several tree species to select from which are already considered highly economical among farmers in both India and West Africa. Improvement of indigenous systems is also likely, as there appears to be a response to the management of the major tree species concerned that enhances their favorable qualities (Charreau 1974, Mische 1986). Further, selec-

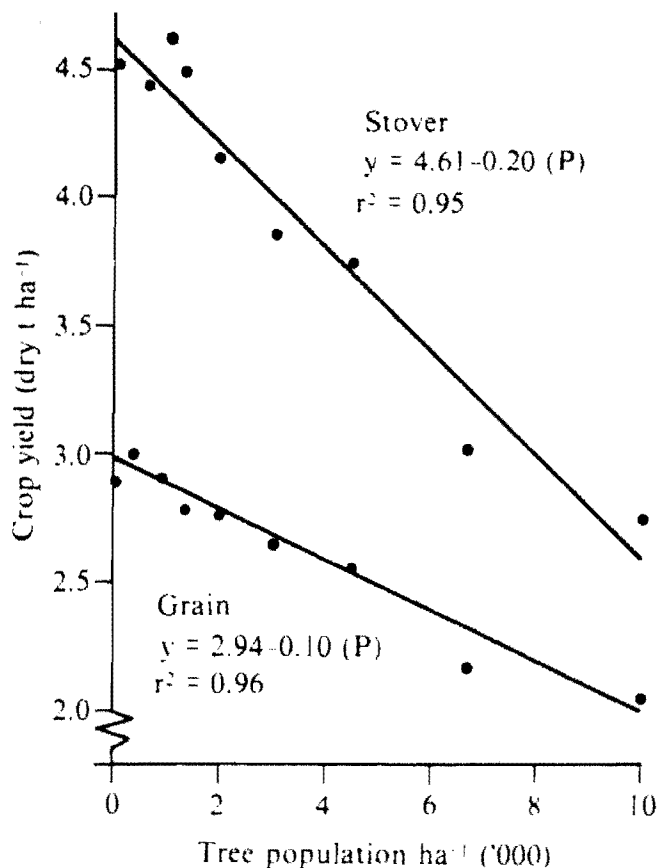

Figure 1. Effect of tree population on pearl millet yield.

tion of superior germplasm and improved nursery techniques have been shown to hasten the establishment of the often slow-growing *Acacia albida* (Poshen 1986).

### Windbreaks

In both temperate and tropical arid areas, windbreaks have long been used to lessen windspeed and consequently, evaporative demand, and to reduce damage by wind and wind-driven particles like sand and snow (WMO 1964). Their applicability in the SAT is probably limited to drier areas, particularly on sandy soils of the Sahel, where sandblasting and desiccation can affect crop establishment.

Short mechanical baffles have been shown to improve pearl millet yield by 20% at ICRISAT Sahelian Center (M.V.K. Sivakumar, ISC, personal communication). Vegetative windbreaks also have a good potential. Studies conducted at the 'CARE' neem (*Azadiracta indica*) windbreak pro-

ject in the Majia Valley, Niger, showed a 20% increase in pearl millet grain yield in crops grown between young (ca. 5 years) windbreaks spaced about 100 m apart (Bognetteau-Verlinden 1980). However, recently completed studies on the same windbreaks 5 years later showed that crops grown between them did not have significantly higher grain yields, but did produce more dry matter than control plots established outside the windbreaks (Long et al. 1986). This may have been caused by increased competition between the windbreaks and the crops, which extended 20 m into the cropped field, and did not exist in the earlier study.

The competition between widely-spaced arboreal windbreaks and crops will undoubtedly be a major constraint to the long-term sustainability of windbreak systems in the SAT. Windbreak research at the University of Agricultural Sciences, Bijapur, Karnataka (India), shows clear competition between rows of five tree species and safflower (G. Radder, UAS, personal communication, 1986), so the long-term research task of screening species is important.

Water relations of windbreaks in the SAT, particularly for soil depths exceeding the crop rooting zone, are not known. It is interesting to note that the free-water table in the Majia Valley site is only 7–10 m underground, probably within the neem rooting zone. Whether similar windbreaks would perform as well in areas with deep or inaccessible water tables remains to be seen.

Competition between windbreaks and crops might be reduced by silviculturally managing the trees. At the CARE project, partial pollarding of windbreaks still showed a 30% reduction in windspeed and yielded useful wood products (Persaud et al. 1986). Also, pollarded windbreaks lead to significantly higher grain yield in the adjacent zone of competition (Rorison and Dennison 1986).

### Alley Cropping

Alley cropping employs the use of pruned perennial hedgerows, regularly spaced to allow food crops to be grown in between. During the cropping season, the hedgerows are pruned to minimize competition with the developing crops for light and water. In the off-season, the hedgerows are either allowed to grow to cover the land (fallow) or are pruned again. Prunings are either used in situ as mulch or removed and used as fodder or fuelwood.

The usefulness of alley cropping in increasing and stabilizing crop yields in the more humid tropics has been clearly demonstrated at the International Institute of Tropical Agriculture (IITA). Kang et al. (1985) showed stabilized maize (*Zea mays*) yields of about 2 t ha<sup>-1</sup> over a 4-year period in alley cropped plots using no nitrogen fertilizer.

Alley cropping in the semi-arid tropics, however, does not appear as promising as in more humid regions (Singh et al. 1986). Citing work of the All India Coordinated Research Project for Dryland Agriculture (AICRPDA), the authors demonstrate that alley cropping, even at row widths nearly double those at IITA, markedly suppress crop yield (Fig. 2). As closely spaced (3.8 m) alleys age, crop losses approach 70% even when alleys are pruned up to 3 times during the short cropping season. This effect seems to be independent of rainfall. Mulching in such a competitive environment has little benefit (Singh et al. 1986).

Studies at ICRISAT demonstrate that competition in alley cropping in the SAT occurs mostly

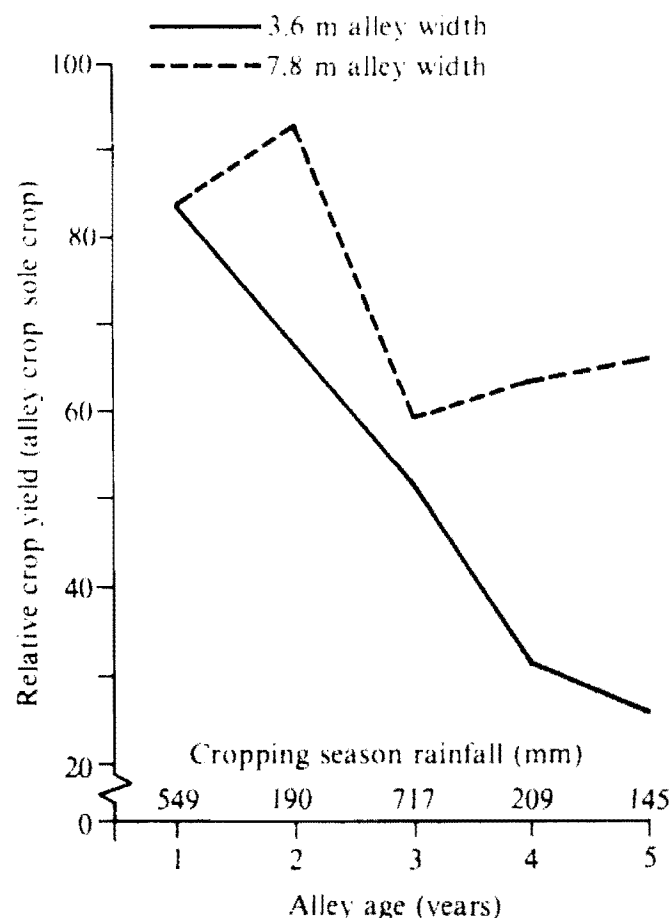

Figure 2. Effect of *Leucaena* alley width on sorghum yield (Adapted from Singh et al. 1986).

below ground. In one *leucaena* alley cropping trial, polythene barriers were installed alongside the hedgerows to a depth of 0.5 m and compared with control alleys without barriers. Grain yield of pearl millet in protected alleys was equivalent to sole-crop plots (about 2 t ha<sup>-1</sup>), while yields in unprotected alleys were 30% less (J. Corlett, ICRISAT, personal communication, 1986).

Despite these drawbacks, alley cropping may have a role in more assured rainfall areas of the SAT, where annual rainfall exceeds 800 mm and the soil-moisture-holding ability is good. Management options like lower pruning heights, careful choice of tree species, and much wider hedgerow spacings (e.g., 10-20 m) have been proposed and show some promise. The use of such widely-spaced alleys as an erosion-control measure on high risk soils, particularly Vertisols, is being studied in India, and has been accepted by farmers in at least one area of the State of Karnataka.

### Miscellaneous Systems

Paramount among these are the silvipastoral systems. The role of trees as browse and fodder in the SAT is well documented (Singh 1984 for India, Le Houerou 1980 for North Africa). Brewbaker (1986) suggests, as have many before him, that trees, particularly nitrogen-fixing trees, in the SAT, can serve the same purpose as herbaceous leguminous components in temperate and humid tropical pastures.

Although silvipastoral mixtures have been shown to be technically feasible in the SAT (Wildin 1986), there may be significant social constraints regarding 'where to use them' and 'who will use them there'. In India, common lands and wastelands are often considered to be target areas for such development. However, as Jodha (1985) points out, productivity of these lands is declining rapidly because of overuse. It may be difficult to surmount the ethic of free (mis)use of common lands, and it may be expensive to bring them into a state that supports an improved grazing regime.

Improvement of tree plantings for specific farm management objectives is of significant potential but there has been little study on it (Weber 1986). Vegetative fences, either live or in the form of thorny prunings, are widely used in the SAT. Similarly, boundaries between fields and farms could be made productive by tree or shrub planting for



browse and other uses. Trees play an important part in bank- and waterway-stabilization efforts, livestock drivemass vegetative contour strips for soil conservation, and for shade (Weber and Hoskins 1983).

Tree plantings can fill production 'gaps' in farming systems by making use of farm areas not usually cropped, e.g., bunds, field corners, rocky and unproductive field sections, and the like. It is here, perhaps, that the productive potential of trees can best be fulfilled, unhindered by limitations placed on management by the presence of crops and farming activities. Besides fodder and wood species, the role of hardy fruit and food species like *Zizyphus* spp, *Annona squamosa*, *Moringa* spp, *Punica granatum*, and even *Mangifera indica* need to be studied.

## Research Needs

All agroforestry research can ultimately be grouped into three major categories: the crop alone, the tree alone, and the tree/crop mixture. While most agroforestry studies emphasize the tree/crop mixture (even to the unfortunate extent of excluding necessary sole crop controls), thorough knowledge of the tree and crop as separate components, e.g., the germplasm and genetic variation, and response to management inputs and practices, is important. Obviously, there is much known about crop components of agroforestry systems that can be directly used without further work. This section will discuss the major gaps in the tree and tree/crop categories that need to be addressed.

### The Tree

It is not by chance that the tree species most studied in the past are most often selected for agroforestry research. For example, the emphasis on leucaena in current agroforestry research is as much due to its multiple uses as to the exceptional body of knowledge generated by forage-management studies and breeding of that species in Hawaii, Australia, and elsewhere over the past 40 years. Few species in the tropics have been more researched and collected.

The large gap in the knowledge between the crop and tree components must be narrowed. Management of above-ground growth of trees is impor-

tant, and more information about product quality, e.g., fodder and wood, response to grazing and lopping, and response to management inputs is needed. Of even greater priority in the SAT are below-ground growth and phenology studies. Little is known about the rooting patterns of the SAT tree species, the response of their roots to wetting and drying of the soil, and their allelopathic tendencies.

Greater knowledge of the genetic variation within species is also important. Variations in phenological cycles (e.g., *Acacia albida*), thorniness (e.g., *Prosopis pallida*, *Prosopis cineraria*, *Acacia tortilis*), growth form (e.g., *Acacia nilotica*, *Prosopis cineraria*) and other characteristics have been reported, but there have been few systematic attempts to collect, characterize, and exploit this huge genetic potential. The collection and increase of superior seed will be a major contribution to future SAT forestry and agroforestry projects (Burley 1984).

Despite years of effort, nursery practices and subsequent outplanting methods in arid and semi-arid environments remain a major constraint to forestry and agroforestry projects (Weber 1986). Better ways of growing healthy seedlings that can survive transplant shock and subsequent environmental stress need to be either adopted, or discovered. Systematic research that builds on current outplanting methods utilizing water and conservation techniques would be worthwhile.

### The Tree/Crop Interface

A common theme in the agroforestry technologies discussed in the previous sections is the competition between crops and trees. In the humid tropics, this competition is reported to be due to shading of the crops (Kang et al. 1985). Conclusions from the study cited earlier, the alley cropping polythene barrier, and numerous observations in the field make it clear that in most agroforestry associations in the SAT, a major factor is competition for soil water. This problem is severe enough in many cases to offset expected benefits from agroforestry systems like mulching and protection from wind.

Management studies like lopping intensity, and spacing provide clues on how to lessen this competitive effect. However, there is always the danger that in the long run, such solutions will prove to be specific only to certain locations or tree/crop

mixes. There is a crucial need to adopt a multidisciplinary approach in management studies to learn more about the fundamental relationships of the mixes.

Paramount among such studies is the need for research on water use and water balance, because the long-term water relations of these systems will ultimately determine their sustainability. Powerful new data-logging equipment that allow frequent repetitive measurement make this task easier (C.K. Ong, this volume). Improvements on old techniques like heat-pulse measurement of transpiration rates in trees should allow rapid advance in this area (Edwards 1987). Closely related to water relations research is the need to study rooting patterns in agroforestry mixtures and the response of roots to changes in degree of competition between crop and tree.

This is not to say that applied and adaptive work is not important. On the contrary, it can give (and in the case of SAT agroforestry, has given) insight into future needs in research and extension. Multi-locational trials, like the Indian alley cropping network, can overcome the danger of attempting to extend site-specific technologies and can also provide the common denominators for discussion among scientists. It is only through adaptive research that new systems can be developed and traditional ones improved. However, future applied research should focus on efforts to separate competitive effects from beneficial effects and find sound practical management methods that reduce competitive effects.

## **Strategies for Developing Agroforestry Systems in the SAT**

Agroforestry as a development package for the SAT, is unique in that the benefits of improving traditional systems or extending new ones to farmers' fields are countered by the length of time required for relevant research.

The time element can be greatly shortened by incorporating formal research components into ongoing demonstration (or even ad hoc research) and extension programs already underway in many parts of the SAT. This has three major advantages:

- It is cost effective because it does not require each institution to develop its own skills and/or programs in both research and extension.

- It lessens the risk of duplicating research.
- Networking and information-sharing is increased, and therefore, results with wide applicability are being produced.

In India, this has been simplified by the establishment, in 1983, of the All India Coordinated Research Project on Agroforestry (AICRPAF). With 20 centers now in operation and 11 others proposed for establishment in the current Five-Year Plan, the project has the potential of addressing some research questions vital to the future of agroforestry in India. The project covers four agroclimatic zones: hill regions, arid and semi-arid regions, the Gangetic Plain, and tropical regions. Three research programs are underway: (1) evaluation of traditional systems, (2) collection and evaluation of tree germplasm, and (3) studies of management mixes of agroforestry systems. Significant collaborative and financial input has been made or proposed by several foreign mentor and donor institutions. (Singh 1986).

In West Africa, there is no equivalent to AICRPAF program. However, several agroforestry programs in the region have been and are being undertaken by national governments and foreign institutions in the region. Figure 3, compiled by an ICRISAT consultant (Weber 1986), shows some of the more important of these programs. Most of the ongoing projects in the figure are located in the dry subregion of the Sahel. Although several feature a research component, much of this effort is informal or ad hoc. Nevertheless, a review of the findings of past and ongoing projects is of critical importance. Obviously, networking and task-sharing among these projects and other institutions developing agroforestry expertise can be very important (Torres 1985).

Much groundwork will have to be done to make collaboration effective. Before all else, a database of existing information must be established so that past efforts are not duplicated and new efforts are relevant. Institutions interested in collaboration should have closely allied priorities and comparative advantages that do not compete but rather complement one another. Lastly, networking with similar or identical methodologies, experimental designs, and data collection and evaluation procedures is important to ensure that generated information is widely adapted.

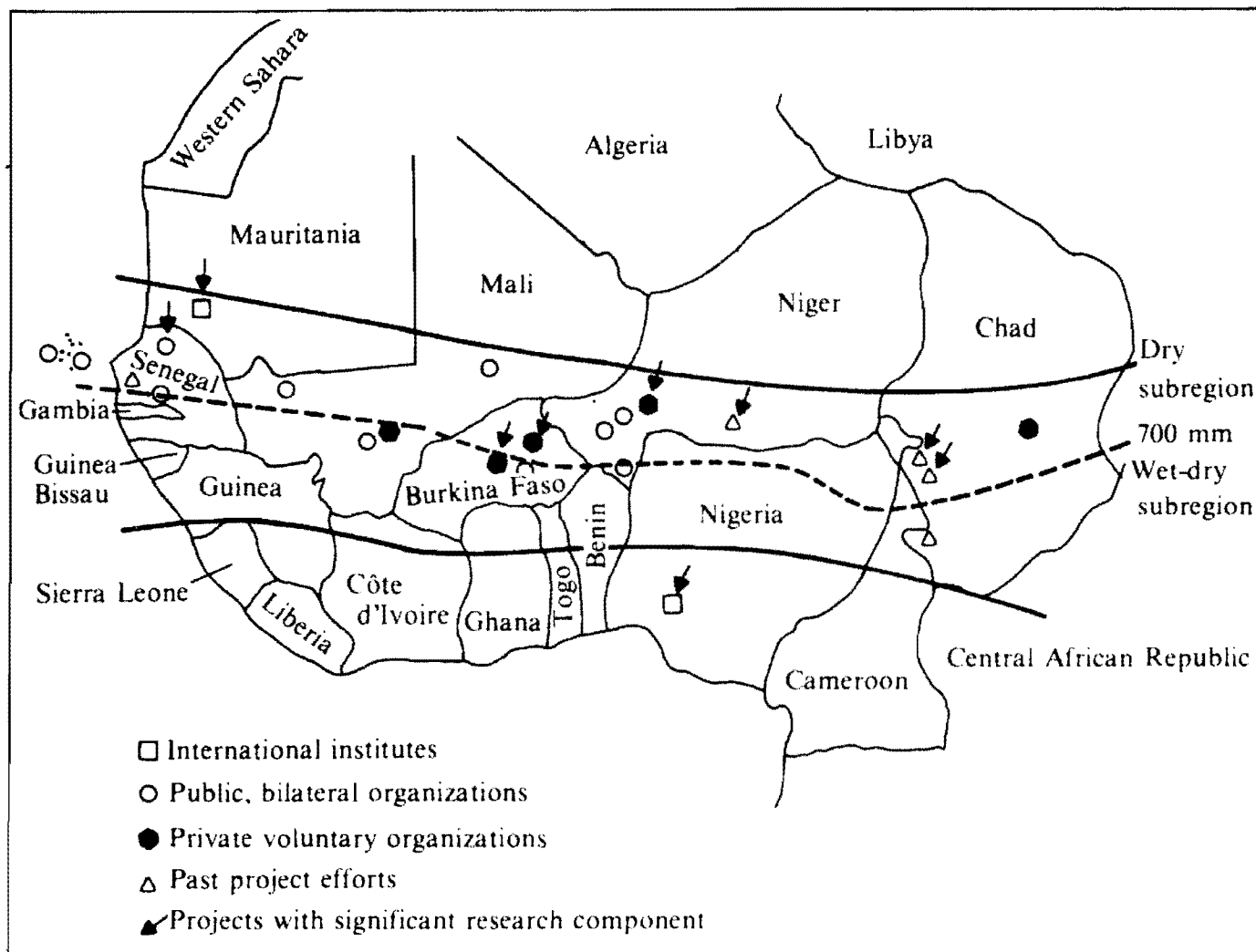

Figure 3. Ongoing and past agroforestry projects in the semi-arid tropics of sub-Saharan Africa (from Weber 1986).

## References

**Blair, H.W.** 1986. Social forestry: time to modify goals? *Economic and Political Weekly* 21(30): 1317-1321.

**Bognetteau-Verlinden, E.** 1980. Study on impact of windbreaks in Majia Valley, Niger. M.Sc. thesis, Wageningen University, Wageningen, Netherlands. 88 pp.

**Brewbaker, J.L.** 1986. Nitrogen fixing trees for browse in Africa. Presented at the Alley Cropping Workshop, 10-14 Mar 1986, Ibadan, Nigeria. Ibadan, Nigeria: International Institute of Tropical Agriculture.

**Burley, J.** 1984. Global needs and problems of collection, storage and distribution of multipurpose tree germplasm. Pages 43-89 in *Multipurpose tree germplasm: proceedings, recommendations and documents of a planning workshop to discuss international cooperation*, Jun 1983, Washington, D.C., USA (Burley, J., and von Carlowitz, P., eds.). Nairobi, Kenya: International Council for Research on Agroforestry. 298 pp.

**Burley, J., and von Carlowitz, P. (eds.)** 1984. *Multipurpose tree germplasm: proceedings, recommendations and documents of a planning workshop to discuss international cooperation*, Jun 1983, Washington, D.C., USA. Nairobi, Kenya: International Council for Research on Agroforestry. 298 pp.

- Charreau, C.** 1974. Soils of tropical dry and dry-wet climatic areas of West Africa and their use and management. A series of lectures. Agronomy Mimeo 74-26. Ithaca, New York, USA: Cornell University, Department of Agronomy. 434 pp.
- Chase, R.G., and Boudouresque, E.** 1987. Methods to stimulate plant growth on bare Sahelian forest soil in the region of Niamey, Niger. *Agricultural Ecosystems and Environment* 18: 211-221.
- Chaturvedi, A.N.** 1985. Biomass production on saline-alkaline soils. Nitrogen Fixing Tree Research Reports. Nitrogen Fixing Tree Association 3: 7-8.
- Edwards, W.R.N.** 1987. Report on visit to ICRI-SAT. Consultant's report. Patancheru, A.P. 502 324, India: International Crops Research Institute for the Semi-Arid Tropics. (Limited distribution.)
- El-Swaify, S.A., Pathak, P., Rego, T.J., and Singh, S.** 1985. Soil management for optimized production under rainfed conditions in the semi-arid tropics. *Advances in Soil Sciences* 1: 1-64.
- Hulugalle, N.R., and Lal, R.** 1986. Root growth of maize in a compacted gravelly tropical Alfisol as affected by rotation with a woody perennial. *Field Crops Research* 13: 33-44.
- ICRAF (International Council for Research on Agroforestry).** 1983. An account of the activities of the International Council for Research on Agroforestry. Nairobi, Kenya: ICRAF.
- Jodha, N.S.** 1985. Population growth and the decline of common property resources in Rajasthan, India. *Population and Development Review* 2(2): 247-264.
- Kang, B.T., Wilson, G.F., and Lawson, T.L.** 1984. Alley cropping: a stable alternative to shifting cultivation. Ibadan, Nigeria: International Institute of Tropical Agriculture.
- Kang, B.T., Grimme, H., and Lawson, T.L.** 1985. Alley cropping sequentially cropped maize and cowpea with *Leucaena* on a sandy soil in southern Nigeria. *Plant and Soil* 85: 267-277.
- Le Houerou, H.N.** 1980. Browse in northern Africa. Pages 55-82 in *Browse in Africa* (Le Houerou, H.N., ed.). Addis Ababa, Ethiopia: International Livestock Center for Africa.
- Long, S., Persaud, N., Gandah, M., and Ouattara, M.** 1986. Influence of neem (*Azadiracta indica*) wind-break plantation on millet yields and microclimate in Niger, West Africa. Pages 183-184 in *Proceedings of the International Symposium on Windbreak Technology*, 23-27 Jun 1986, Lincoln, Nebraska, USA (Hintz, D.L., and Brandle, J.R., eds.). Great Plains Agricultural Council (USDA) Publication no. 117. Washington, D.C., USA: US Department of Agriculture.
- Mann, H.S., and Saxena, S.K. (eds.)** 1980. Khejri (*Prosopis cineraria*) in the Indian desert—its role in agroforestry. Monograph no. 1. Jodhpur, Rajasthan: Central Arid Zone Research Institute. 78 pp.
- Miehe, S.** 1986. *Acacia albida* and other multipurpose trees on the fur farmlands in the Jebel Marra highlands, Western Darfur, Sudan. *Agroforestry Systems* 4: 89-119.
- Muthana, K.D., Meena, G.L., Bhatia, N.S., and Bhatia, O.P.** 1984. Root systems of desert tree species. *Myforest (India)* 20(1): 27-42.
- Persaud, N., Long, S., Gandah, M., and Ouattara, M.** 1986. Influence of wood-harvesting method on wind protection between rows of a neem (*Azadiracta indica*) plantation in Niger, West Africa. Pages 211-212 in *Proceedings of the International Symposium on Windbreak Technology*, 23-27 Jun 1986, Lincoln, Nebraska, USA (Hintz, D.L., and Brandle, J.R., eds.). Great Plains Agricultural Council (USDA) Publication no. 117. Washington, D.C., USA: US Department of Agriculture.
- Poshen, P.** 1986. An evaluation of the *Acacia albida*-based agroforestry practices in the Hararghe highlands of eastern Ethiopia. *Agroforestry Systems* 4: 129-143.
- Rorison, K., and Dennison, S.** 1986. Windbreak harvesting influences on crop production. Niamey, Niger: Care International. (Limited distribution.)
- Singh, G.B.** 1986. The ICAR Program. Page 25 in *Agroforestry research in the semi-arid tropics: a report on the Working Group Meeting*, 5-6 Aug 1985, ICRISAT Center, India. Patancheru, A.P. 502 324, India: International Crops Research Institute for the Semi-Arid Tropics. 59 pp.

**Singh, R.P., van Den Beldt, R.J., Hocking, D., and Korwar, G.R.** 1986. Alley cropping in the semi-arid regions of India. Presented at the Alley Cropping Workshop, 10-14 Mar 1986, Ibadan, Nigeria. Ibadan, Nigeria: International Institute of Tropical Agriculture.

**Singh, R.V.** 1984. Fodder trees of India. New Delhi: Oxford and IBH Publishing Co. 663 pp.

**Sumberg, J.E., McIntire, J., Okali, C., and Attakrah, A.** 1985. Economic analysis of alley farming with small ruminants. Addis Ababa, Ethiopia: International Livestock Center for Africa. 18 pp.

**Torres, F.** 1985. Networking for the generation of agroforestry technologies in Africa. Working Paper no. 11. Nairobi, Kenya: International Council for Research on Agroforestry. 24 pp.

**Weber, F.R.** 1986. Agroforestry research work in the semi-arid tropics of West Africa. A consultant's report. Patancheru, A.P. 502 324, India: International Crops Research Institute for the Semi-Arid Tropics. 36 pp. (Limited distribution.)

**Weber, F.R., and Hoskins, M.W.** 1983. Soil Conservation technical sheets. Idaho, Moscow, Idaho, USA: University of Idaho, Forest and Range Experiment Station.

**Wildin, J.H.** 1986. Trees in forage systems. Presented at the Alley Cropping Workshop, 10-14 Mar 1986, Ibadan, Nigeria. Ibadan, Nigeria: International Institute of Tropical Agriculture.

**Wilken, G.C.** 1977. Integrating forest and small-scale farm systems in middle America. *Agro-Ecosystems* 3: 291-302.

**WMO.** 1964. Windbreaks and shelterbelts. Technical Note no. 59. Geneva, Switzerland: WMO. 188 pp.

# Réponse des cultures aux engrais et influence des facteurs agroécologiques sur les rendements dans la zone soudano-sahélienne

C. Joly<sup>1</sup>

## Résumé

*Les résultats du Programme engrais de la FAO dans la zone soudano-sahélienne montrent que dans l'ensemble des pratiques culturales améliorées, la fumure—organique et minérale—est de loin le facteur le plus déterminant de l'augmentation des rendements. Une tentative d'estimation de l'influence des facteurs agroécologiques sur la réponse des cultures aux engrais fait ressortir l'importance de facteurs tels que : types de sols, zones agroécologiques et variations climatiques annuelles. L'influence entre l'utilisation des engrais et les facteurs humains tels que le niveau de technicité des agriculteurs et leur environnement économique est aussi mise en évidence. En conclusion, la fumure devrait jouer un rôle déterminant dans l'intensification des cultures, mais elle doit être placée dans le contexte plus large des systèmes intégrés de la nutrition des plantes. Enfin, le document rappelle que pour être efficaces, les stratégies de l'utilisation des engrais doivent être conçues à différents niveaux : exploitations agricoles, régions, zones homogènes et pays.*

## Abstract

**Crop response to fertilizers and influence of agroecological factors on crop yields in the Sudano-Sahelian zone:** *The results of the FAO Fertilizer Program in the Sudano-Sahelian zone for a large part show that among the improved agricultural practices, manuring, both organic and mineral, is by far the most important for obtaining yield increases. An attempt to assess the effects of agroecological components on crop response to fertilizer applications highlights the role of factors such as soil types, agroecological characteristics, and seasonal climatic variations. Attention is given to the influence of human factors such as the technical level of farmers, and the relationship between the economic environment and the use of fertilizers. In conclusion, it is felt that fertilizer use is important in agriculture intensification, and that manuring should be seen in the broader context of integrated plant nutrition systems. Finally it is stated that to be effective, fertilizer use strategies should be defined at different levels: the farm, the region, the agroecological zone, and the country as a whole.*

## Introduction

Reconnaissant le rôle que les engrais minéraux peuvent jouer dans l'augmentation de la produc-

tion agricole et dans l'élévation du niveau de vie des petits agriculteurs, l'Organisation des Nations Unies pour l'alimentation et l'agriculture (FAO) a créé dès 1961 le Programme engrais.

---

1. Coordonnateur pour l'Afrique du Programme engrais, FAO, Kinshasa, Zaïre.

ICRISAT (International Crops Research Institute for the Semi-Arid Tropics) 1989. Soil, Crop, and Water Management Systems for Rainfed Agriculture in the Sudano-Sahelian Zone: proceedings of an International Workshop, 7-11 Jan 1987. ICRISAT Sahelian Center, Niamey, Niger. Patancheru, A.P. 502 324, India: ICRISAT.

Il s'agit d'un programme unique en ce sens qu'il combine la coopération des gouvernements, des organisations non gouvernementales, de l'industrie des engrais, du personnel international de la FAO, des services de vulgarisation nationaux et des agriculteurs auxquels le programme est destiné.

Le principe général de cette coopération est d'élaborer des projets adaptés à la situation de chacun des pays destinataires.

Très vite, les projets de terrain du Programme ont étendu leur champ d'action aux autres facteurs de production—pratiques culturales améliorées et intrants connexes—liés à la fertilisation des sols ou favorisant celle-ci ainsi qu'aux opérations pilotes de distribution et de crédit pour les intrants agricoles saisonniers et à la formation.

L'impact des projets nationaux du Programme a été considérablement augmenté par la création, en 1974, du Programme international d'approvisionnement en engrais (PIE) de la FAO. Outre le fait que ce Programme a contribué à l'approvisionnement en engrais des pays en voie de développement, il a permis de développer les activités de terrain en ce sens que les sommes obtenues en contrepartie des ventes d'engrais livrés dans le cadre de ce Programme sont, avec l'accord des pays bénéficiaires, affectées aux activités des projets du Programme engrais.

## **Le Programme engrais de la FAO dans les pays de la zone soudano-sahélienne**

### **Origine**

Dès sa création, le Programme engrais a été opérationnel en Afrique notamment dans la zone soudano-sahélienne. Outre le Sénégal où les opérations ont commencé dès 1961, plusieurs pays de la zone ou proches de celle-ci ont bénéficié dans le passé des activités du Programme : Bénin, Gambie, Côte d'Ivoire, Nigéria (Etats du Nord) et Burkina Faso où l'assistance FAO s'est terminée en décembre 1986 (Joly 1985).

Actuellement, quatre projets sont en cours en Gambie, Guinée-Bissau, Niger et Soudan.

A la fin de chaque projet, un rapport final reprend pour chaque type d'activité, les résultats principaux, les contraintes identifiées et les conclusions; des recommandations sont émises.

### **Les types d'activité**

Placé sous la tutelle de Ministères techniques, Ministères de l'Agriculture ou Ministère du Développement Rural, un projet du Programme engrais constitue à terme un service spécialisé en matière d'engrais et de nutrition des plantes, souvent appelé "Programme national engrais".

Selon le concept FAO de Systèmes intégrés de la nutrition des plantes (SINP), le Programme engrais recherche les meilleurs moyens d'améliorer la fertilité des sols et la nutrition des plantes (Braun et Coursier 1985). Rappelons ici que ce concept prend en considération pour une rotation donnée et non plus pour une culture annuelle ou saisonnière, l'ensemble des sources d'éléments fertilisants disponibles au niveau des exploitations, à savoir :

- la fertilité naturelle du sol;
- les éléments nutritifs des applications de matière organique : fumure organique, résidus de récolte;
- l'azote provenant de la fixation biologique;
- les fumures minérales et leurs effets résiduels.

Les activités de terrain sont conduites en étroite collaboration avec les institutions nationales de recherche agronomique telles que l'Institut national d'études et de recherches agricoles (INERA), au Burkina Faso, l'Institut national de recherches agronomiques du Niger (INRAN) au Niger, etc. et des projets de développement rural tels que les Organismes régionaux de développement (ORD) au Burkina Faso et les projets de productivité au Niger.

### **La recherche appliquée**

A leur création, les projets du Programme engrais se sont souvent trouvés devant une absence relative de données en matière de fertilisation des cultures vivrières. Lorsqu'ils existaient, les résultats étaient souvent fragmentaires et localisés aux stations de recherches; l'aspect économique et en particulier la rentabilité de l'utilisation des engrais était le plus souvent ignoré.

Dès lors, une des premières missions des projets, sans toutefois perdre de vue leur vocation fondamentale qu'est la vulgarisation, a souvent consisté à vérifier l'efficacité des engrais et préciser leurs conditions d'utilisation techniques et économiques. Les résultats doivent être significatifs et représentatifs de la réalité paysanne—le paysan lui-même, son travail, son champ—et du pays et des régions

donc provenant d'un nombre d'implantations maximum.

Dans ce but, le Programme engrais recourt à la méthode des essais éclatés encore appelés essais simples ou tests. Cette méthode implique :

- une réduction du nombre de parcelles élémentaires par la suppression des répétitions classiques dans chaque implantation—chaque essai simple représentant dans une région donnée une répétition—et la simplification du protocole en réduisant le nombre de traitements par essai à l'essentiel;
- la non standardisation des facteurs autres que ceux spécifiquement étudiés à moins que l'un d'eux ne conditionne fondamentalement la réussite de la culture.

Les résultats analysés par ordinateur permettent d'obtenir les fonctions de production par éléments et les paramètres y afférant tandis que l'analyse économique (niveau de rentabilité maximum, niveau de rentabilité optimale, Rapport valeur sur coût—(RVC) est réalisée par le biais des courbes de réponse profit établies, si nécessaire, dans différentes conditions de prix (FAO 1971).

En complément de la détermination ou de l'affinement de formules de fumures adaptées et économiquement recommandables, le Programme engrais conduit aussi des essais de nouveaux types d'engrais (supergranules d'urée par exemple), des tests de matières fertilisantes locales tels que phosphates naturels, des tests de microéléments ainsi que des tests d'introduction de souches de rhizobium sur légumineuses.

### **Vulgarisation**

Sur la base des recommandations de la recherche agronomique ou des résultats obtenus par le Programme, des démonstrations sont mises en place dans les champs des agriculteurs.

Principal outil de la vulgarisation, les démonstrations ont pour but de familiariser l'agriculteur avec les techniques culturales améliorées, l'utilisation rationnelle des engrais et des intrants connexes.

Selon les pays et les cultures, les démonstrations comprennent de deux à quatre parcelles; le dispositif le plus souvent employé comprend les quatre parcelles suivantes :

- Techniques culturales traditionnelles sans engrais (témoin);
- techniques culturales traditionnelles avec engrais;

- Techniques culturales améliorées sans engrais;
- Techniques culturales améliorées avec engrais.

Des visites commentées sont organisées sur les champs de démonstrations à différents stades du cycle cultural. Elles permettent non seulement d'introduire la nouvelle technique ou l'intrant auprès des agriculteurs visiteurs mais aussi de souligner les différences croissantes entre les parcelles.

L'évaluation des résultats par des pesées de rendements est faite par les agriculteurs eux-mêmes; très souvent la rentabilité économique est estimée sur le site des démonstrations.

Les démonstrations permettent aussi de tester, si besoin en est, deux niveaux de fumure (faible/forte) ou encore d'effectuer le test de la potasse comparant une formule de fumure NP, sans potasse, avec une formule NPK.

### **Banques de données**

Les analyses des résultats des essais et des démonstrations sont réalisées par ordinateur soit au siège de la FAO soit, de plus en plus souvent, au sein des projets mêmes qui disposent de microordinateurs.

Des banques de données sont ainsi constituées; elles permettent le stockage des résultats par pays, régions, zones agroclimatiques et pour chacune des campagnes agricoles et cultures étudiées.

Pour chaque site d'implantation, la banque possède un enregistrement des traitements pratiqués, des variétés cultivées, des rendements obtenus ainsi qu'une série de données liées au types de sol, au climat et éventuellement à la date de semis (Van den Bergen 1986).

Les banques de données sont utilisées pour :

- résumer chaque année, les résultats obtenus par pays, par zone agro-écologique et par culture;
- synthétiser les résultats obtenus sur un certain nombre d'années et sous des conditions climatiques et économiques variables;
- calculer les doses optimales d'engrais pour des prix donnés des engrais et des produits agricoles et vérifier la rentabilité des traitements recommandés;
- stratifier les résultats en fonction des zones agroécologiques, des types de sols et des autres facteurs pouvant influencer les rendements.

### **Formation**

Une importance toujours croissante est accordée à la formation notamment celle des cadres natio-



naux des projets et du personnel de vulgarisation chargé des opérations de terrain.

### Distribution

Lorsqu'une demande est créée, le Programme engrais s'emploie à la satisfaire en contribuant à résoudre les problèmes d'approvisionnement et de distribution. Dans les villages sensibilisés, des projets pilotes de distribution à crédit sont mis en place. Ils ont pour but de procurer au moment adéquat, les types et quantités d'engrais nécessaires et de créer les conditions financières permettant aux agriculteurs de les acheter (FAO 1980).

## Résultats du Programme engrais dans la zone soudano-sahélienne

### Rôle de la fumure minérale et des pratiques culturales améliorées

Pour les pays où elle a pu être déterminée, l'importance relative de la fumure minérale et des pratiques culturales améliorées dans l'augmentation des rendements fait nettement ressortir la prédominance de la fumure minérale (Tab. 1 et Figs. 1 et 2).

Ces résultats très probants obtenus dans le Nord du Nigéria (Etats de Kano et de Sokoto) et au Burkina Faso montrent clairement les limites des pratiques culturales améliorées, y compris au Burkina Faso celle de l'introduction de la culture attelée, lorsque ces pratiques sont utilisées sans fumure minérale (FAO 1979a, 1979b, 1982).

Ils font aussi ressortir que plus de 50% de l'augmentation des rendements est dû à la fumure minérale. Il n'empêche que d'autres facteurs tels que le niveau de rendement de la parcelle témoin, le type de sol ainsi que des facteurs spécifiques (lutte phytosanitaire pour le coton par exemple) peuvent modifier sensiblement l'importance relative des divers facteurs de production dans l'augmentation des rendements.

**Importance des fumures organique et minérale.** L'importance de la fumure organique dans le maintien de la fertilité des sols n'est plus à démontrer. Son utilisation généralisée ne peut cependant se concevoir qu'en liaison avec l'introduction de la culture attelée.

En dehors de cette dernière, les sources de fumure organique sont peu abondantes et les applications sont souvent limitées aux parcelles les plus proches des habitations ainsi qu'aux petites superficies réservées aux cultures intensives, maraîchage notamment. En conséquence, les applications de fumure organique sur les champs de céréales ou de cultures mixtes sont de faibles quantités et espacées dans le temps.

Les résultats obtenus au Burkina Faso (Fig. 3) montrent clairement que des applications de fumier de ferme à raison de 4 ha<sup>-1</sup> donnent des augmentations de rendement importantes de sorgho de l'ordre de 230 kg ha<sup>-1</sup> correspondant à 37% de la parcelle témoin non fumée ou encore à 44% de l'augmentation due à une fumure minérale complète NPK plus Urée. L'apport conjoint d'une fumure organique et d'une fumure minérale double les rendements (FAO 1985a).

**Tableau 1. Importance relative de la fumure minérale et des pratiques culturales améliorées, Nigéria. Résultats du Programme engrais, Projet FAO GCP/NIR/021/NOR. (Moyenne sur quatre saisons culturales 1974-1977.)**

| Culture         | Rendement témoin<br>(Kg ha <sup>-1</sup> ) <sup>1</sup> | Augmentation de rendement en % du témoin (PT) due à |                   |                   |                        |
|-----------------|---|---|-------------------|-------------------|------------------------|
|                 |   | F <sup>2</sup>                                      | PA-F <sup>3</sup> | PA+F <sup>4</sup> | F avec PA <sup>5</sup> |
| Mil             | 760   | -   | 11                | 47                | 35                     |
| Sorgho          | 751   | 40  | 15                | 77                | 62                     |
| Arachide        | 683   | 37  | 19                | 85                | 66                     |
| Cultures mixtes | 529   | -   | 20                | 91                | 71                     |
| Coton           | 480   | -   | 29                | 87                | 58                     |

1. Rendement de la parcelle témoin, (T), pratiques traditionnelles (PT).

2. (PT+F) - (PT) = Augmentation due à la fumure minérale seule.

3. (PA-F) - (PT) = Augmentation due aux pratiques culturales améliorées sans fumure minérale.

4. (PA+F) - (PT) = Augmentation due à l'emploi conjugué de la fumure minérale et des pratiques culturales améliorées.

5. (PA+F) - (PA-F) = Augmentation due à la fumure minérale seule lorsque les pratiques culturales améliorées sont appliquées.

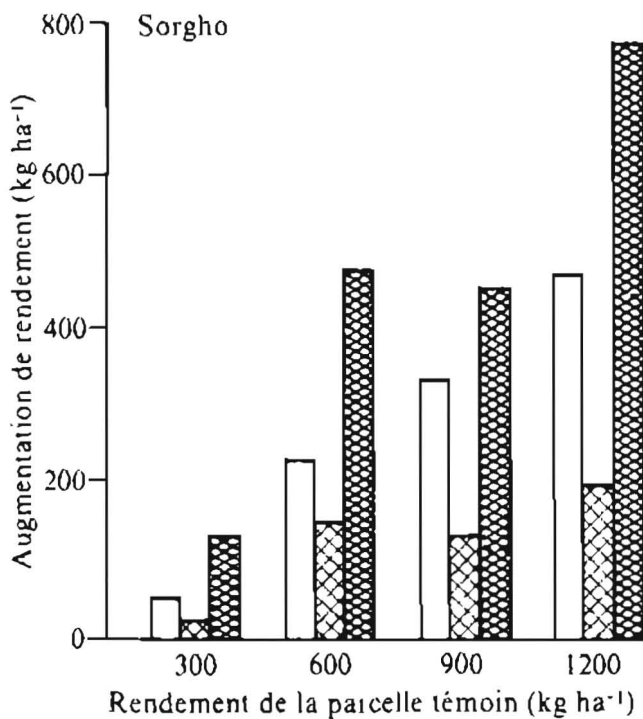
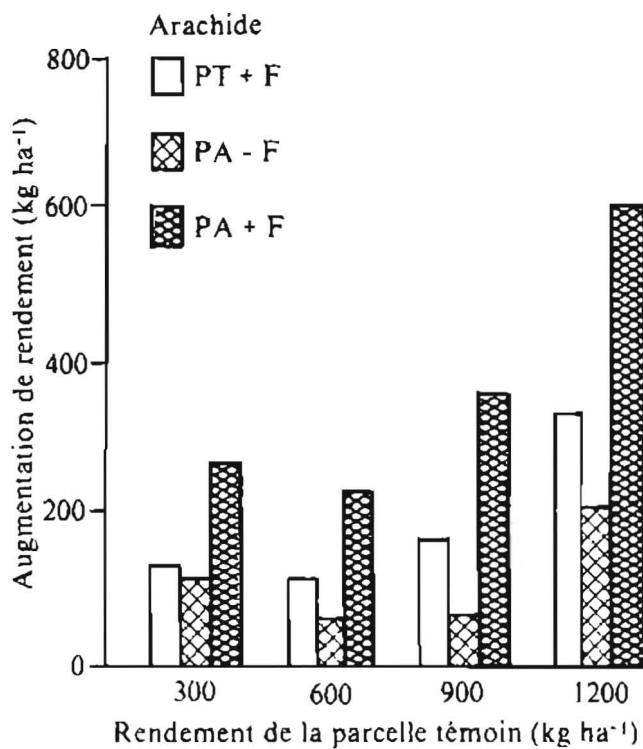

**Figure 1. Importance relative de la fumure minérale et des pratiques culturales améliorées. Nigéria : résultats du programme engrais FAO, Projet GCP/NIR/019/NOR. Moyenne des résultats sur 5 saisons culturales (1973-1977) (Voir note au Tableau 1 pour les symboles).**

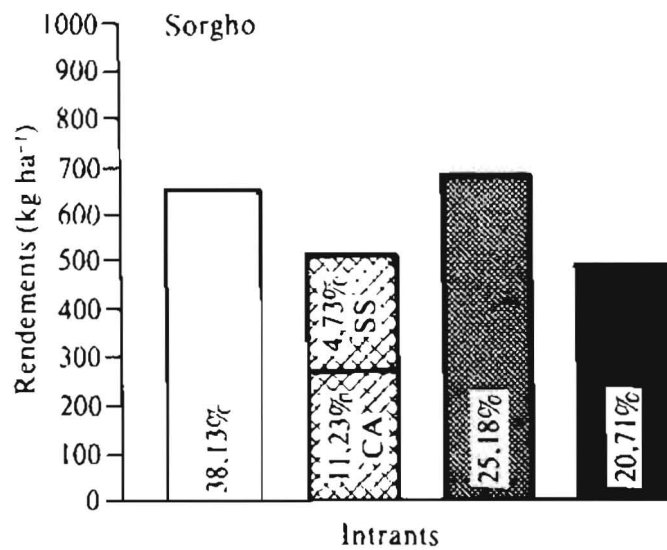
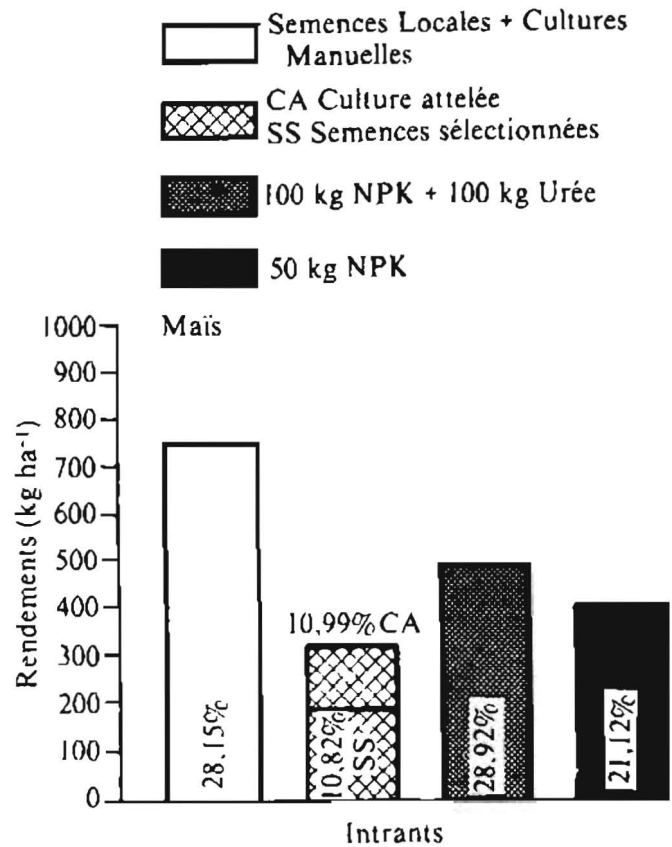

**Figure 2. Rôle des intrants dans les augmentations de rendement. Burkina Faso : résultats du programme national engrais, Projet FAO/GCPF/BKF/028/BEL. ORD de Bobo-Dioulasso, saison culturale 1981.**

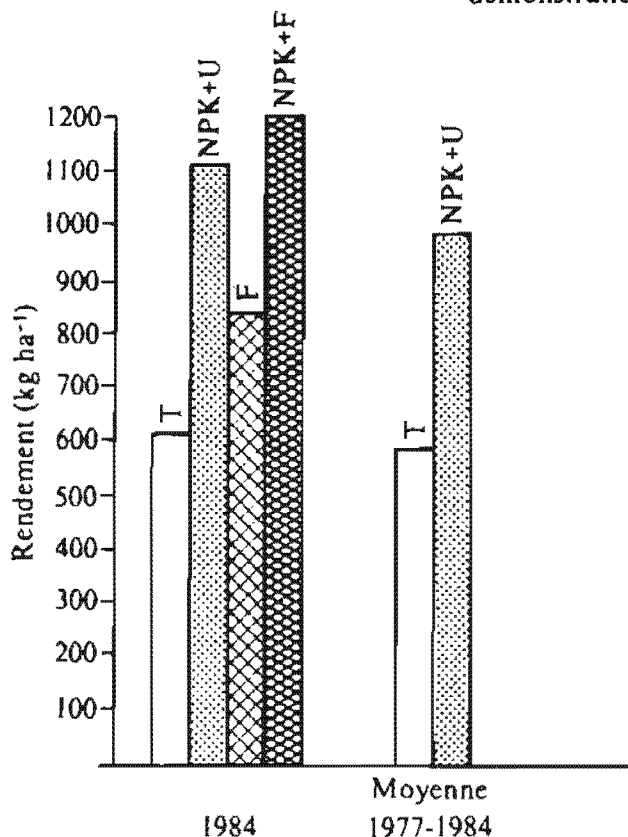

Figure 3. Rôle de la fumure organique et de la fumure minérale. Burkina Faso : résultats du programme national engrais, Projet FAO/GCPF/BKF/028/BEL. (NPK: 15-20-13, 100 kg ha<sup>-1</sup>; U=Urée, 50 kg ha<sup>-1</sup>, F=fumure organique, 4 t ha<sup>-1</sup>).

### Réponses des cultures aux fumures minérales

Le Programme engrais établit la réponse des cultures aux fumures minérales en prenant en considération les facteurs physiques et économiques suivants :

#### Facteurs physiques

- augmentation de rendement par rapport au témoin, exprimée en kg ha<sup>-1</sup>;
- pourcentage d'augmentation par rapport au témoin;
- indice de productivité (kg de produit agricole par unité fertilisante).

#### Facteurs économiques

- bénéfice dû à l'utilisation des engrais;
- RVC, rapport entre la valeur de l'augmentation de rendement due aux engrais et le coût des

engrais. (Le Programme engrais considère qu'une formule n'est vulgarisable chez les agriculteurs que si elle permet d'obtenir un multiplicateur d'investissement ou un RVC supérieur ou égal à 2);

- facteur risque qui exprime le pourcentage d'agriculteurs susceptibles d'obtenir avec une formule de fumure donnée un RVC inférieur à 2.

En ce qui concerne les essais, à partir des courbes de réponse production et profit, il est possible de calculer pour chaque élément nutritif N-P-K, la dose économique optimale, (niveau de production économique maximum, taux de revenu marginal = 0), l'augmentation de rendement, le bénéfice net maximum et le RVC dus à cette dose ainsi que la dose économique la plus intéressante (RCV de la dernière unité fertilisante appliquée est de 2, taux de revenu marginal = 1).

Les courbes de réponse N et P sur le mil pour les zones agricoles Sud et Nord du Niger sont présentées à la Figure 4 sur la base des résultats de trois saisons culturales (FAO 1985b).

Au Niger, sur la base des résultats des trois premières années de tests (1981-1983), on pouvait distinguer deux zones, Nord et Sud. Les résultats de

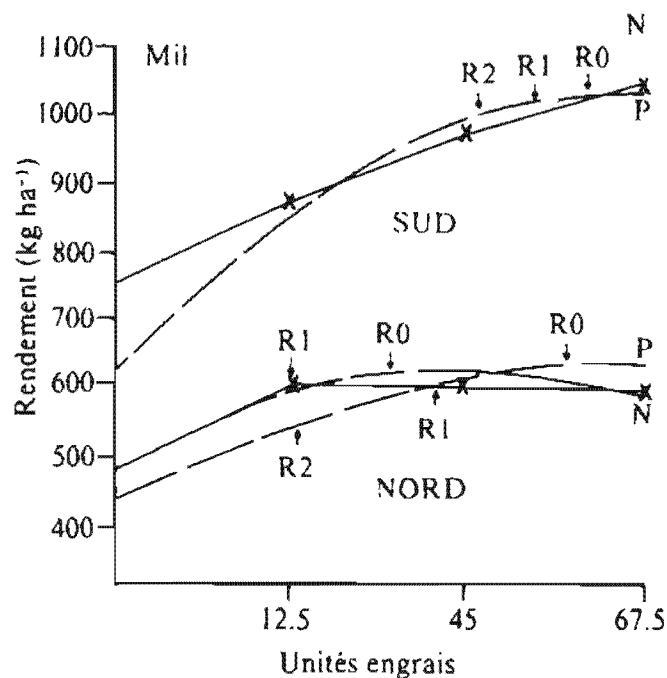

Figure 4. Fonction de production N et P. Niger : résultats du programme engrais nigérien, (saison culturale 1983), Projet FAO/GCPF/NER/020/DEN. (X=rendements observés pour N; R=rappport entre la valeur de l'augmentation de rendement due aux engrais et le coût des engrais).

l'année 1985, non repris dans la Figure 4, ont toutefois fait nettement apparaître une zone intermédiaire.

Les conclusions préliminaires de l'analyse des résultats disponibles sont les suivantes :

**Zone Sud.** Elle a moins d'aléas climatiques vraiment catastrophiques, la rentabilité de l'utilisation des engrais est à peu près assurée; les RVC étant de l'ordre de 2 à 3.

**Zone intermédiaire.** Les essais simples (tests) devront être poursuivis sur plusieurs années et dans de nouvelles implantations pour la circonscrire et y définir un gradient de risque croissant Sud-Nord.

**Zone Nord.** Elle ne peut pas être considérée comme zone agricole susceptible d'intensification par l'utilisation des engrais; la rentabilité étant nulle et le facteur risque très élevé.

### Réponse des cultures aux fumures NP

Les nombreux résultats montrent clairement une bonne réponse des céréales traditionnelles : mil-sorgho à l'azote et au phosphore avec toutefois un gradient de réponse diminuant du Sud au Nord de la zone en fonction de la pluviométrie.

Le mil qui, en conditions climatiques adéquates, répond moins bien à l'engrais que le sorgho, semble, grâce à sa période végétative plus courte et à sa capacité de résister au stress hydrique, valoriser mieux la fumure en zone à plus faible pluviométrie. Dans le nord du Nigéria (Etats de Kano et de Sokoto) ainsi que pour une grande partie du Niger (FAO 1979a, 1979b, Landez 1985), des augmentations de rendement de 350 à 500 kg ha<sup>-1</sup> peuvent être obtenues grâce à l'emploi conjugué des pratiques culturales améliorées et de la fumure minérale.

Au Burkina Faso, l'emploi des engrais sur mil semble plus aléatoire que sur sorgho, sauf dans l'ORD de Kaya (FAO 1984).

La culture du maïs, sans irrigation, est limitée à quelques régions de la frange sud de la zone soudano-sahélienne (ORD des Hauts Bassins au Burkina Faso, notamment) correspondant aux deux zones agroécologiques FAO G et H (FAO 1985a, 1979c). De manière générale et même en année climatique déficitaire, on constate une bonne réponse du maïs aux engrais, spécialement à l'urée;

les résultats de l'année 1984 se situent toutefois entre 10 et 15 %, en dessous de la moyenne (FAO 1985a).

Les céréales cultivées en conditions irriguées, riz et blé de contre-saison, sauf difficultés d'irrigation, sont peu dépendantes des conditions climatiques. Les réponses de ces cultures aux fumures NP sont excellentes. Ainsi dans l'extrême nord du Nigéria, des essais de blé de contre-saison ont montré des rendements de plus de 4 t ha<sup>-1</sup> (FAO 1979a) avec des réponses aux fumures NP très élevées.

Avec les légumineuses alimentaires, arachide et niébé, les résultats sont moins probants et plus variables.

Au Niger, sur arachide, seul l'acide phosphorique permet d'obtenir un résultat économique et ce pour autant que la productivité potentielle sans engrais soit supérieure à 750 kg ha<sup>-1</sup> considéré comme seuil de fertilité naturelle du sol (Landez 1985).

Au Nord du Nigéria comme au Burkina Faso, de faibles apports d'azote (10 à 20 unités ha<sup>-1</sup> considérés comme "azote starter" semblent être souhaitables (FAO 1979a, 1979b, 1985a).

L'expérience du Programme engrais sur le niébé cultivé en culture pure est limitée; au Niger aussi bien l'azote que le phosphore ont montré un effet technique, mais peu marqué. Les résultats ont aussi fait ressortir qu'en dessous d'un seuil de fertilité de 250 kg ha<sup>-1</sup>, la culture du niébé ne valorise plus l'engrais (Landez 1985).

Partout où il est cultivé, le coton a montré de bonnes réponses aux fumures NP (FAO 1979a, 1984). Les principaux facteurs limitants ne sont cependant pas la fumure minérale mais bien plutôt le semis tardif et l'absence totale ou partielle de contrôle phytosanitaire (FAO 1979a).

Bien que l'expérience du Programme engrais sur les cultures mixtes soit limitée au nord du Nigéria, celle-ci fait ressortir une rentabilité évidente des fumures minérales sur les associations légumineuses céréales du type arachide/céréales (mil, sorgho) et mil/niébé; l'association sorgho/mil semblant beaucoup moins intéressante (FAO 1979a, 1979b).

Compte tenu de l'effet starter de l'azote constaté sur les légumineuses, une fumure de fond N-P du type 18-46-0 à raison de 100 kg ha<sup>-1</sup> semble être bien adaptée aux associations culturales légumineuses/céréales. En conditions climatiques favorables, elle pourrait être complétée par une fumure azotée de couverture (20 kg N ha<sup>-1</sup>) appliquée sur

céréale uniquement. Pour le maïs, en zone Sud, cette dernière devrait être plus importante.

### Réponse des cultures à la potasse

A l'exception du Burkina Faso où l'engrais coton NPK est aussi appliqué sur céréales, les fumures comprennent rarement de la potasse.

Selon Pieri et Oliver (1986), la réponse des céréales à la fumure potassique dans les sols ferrugineux tropicaux d'Afrique est difficile à évaluer.

Au niveau de productivité actuelle des cultures traditionnelles, les réponses à la fumure potassique sont généralement trop faibles pour justifier l'apport systématique de cet élément (FAO 1979a, 1979b, Landez 1985). L'intensification des cultures et l'obtention de plus hauts rendements ainsi que la réduction de la jachère dans une grande partie de la zone, devraient à long terme donner une importance plus grande à la fumure potassique.

Dans certaines conditions, des carences relatives et des réponses aux apports de potasse ont été mises en évidence (FAO 1979a, Pieri et Oliver 1986).

Selon l'histogramme de la Figure 5, la rentabilité des engrais sur mil était pour l'année 1984, nettement inférieure à la rentabilité moyenne de la période 1977-1984. De plus, pour deux ORD sur quatre, la rentabilité était négative ce qui montre un

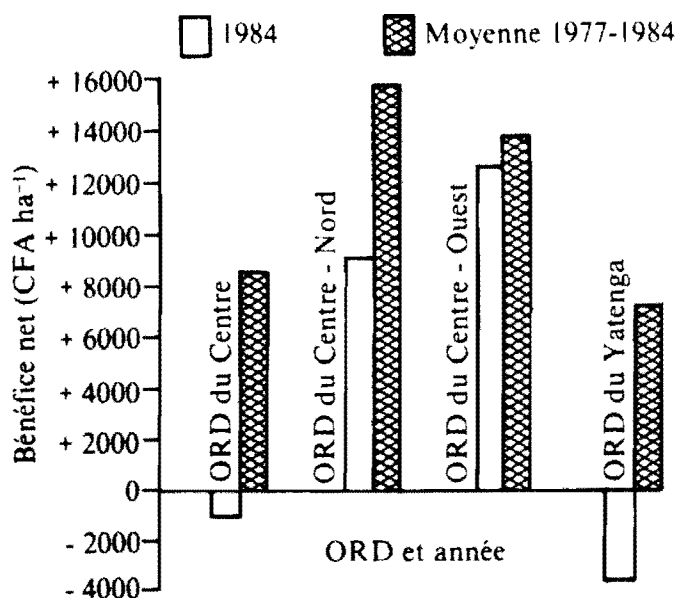

Figure 5. Influences des conditions climatiques annuelles sur les rendements. Burkina Faso : résultats du programme national engrais, Projet FAO/GCPF/BKF/028/BEL.

risque plus élevé pour les agriculteurs de ces ORD qui utiliseraient les engrais.

Pour les agriculteurs mais aussi d'un point de vue macroéconomique pour les gouvernements, il est extrêmement important de pouvoir déterminer les zones à risques et si possible de pouvoir chiffrer, à long terme, le pourcentage de risques pour chaque zone homogène.

### Influence des zones agro-écologiques sur les rendements

La zone soudano-sahélienne se caractérise aussi par un gradient pluviométrique décroissant du Sud au Nord de la zone. Dans son rapport sur les zones agro-écologiques, la FAO a déterminé, pour la zone soudano-sahélienne, cinq "zones de périodes de croissance" (FAO 1979c).

L'analyse des résultats des projets du Programme engrais dans la zone soudano-sahélienne montre clairement les tendances de niveau de production et de réponse aux engrais des principales cultures de la zone, mil, sorgho, arachide; de faibles rendements et réponse très limitées en zone aride et semi-aride jusqu'aux hauts niveaux de la zone marginale sub-humide.

Comme les courbes de réponse à l'azote et au phosphore du mil (Fig. 3), les courbes de la Figure 6 expriment ces tendances pour le sorgho et l'arachide dans les deux conditions de culture, à savoir pratiques culturales traditionnelles et pratiques culturales améliorées + fumure minérale (FAO 1979a, Joly 1979).

Les résultats ont aussi fait ressortir que, pour une zone donnée permettant une rentabilité suffisante de l'utilisation des engrais en conditions climatiques normales, la fumure pouvait être partiellement adaptée aux conditions climatiques annuelles. En effet, sur céréales, la fumure recommandée comprend souvent un apport d'azote en couverture au sarclage. En fonction de la pluviométrie enregistrée, plus ou moins favorable, l'agriculteur peut choisir d'effectuer ou non l'apport d'engrais azoté de couverture, adaptant ainsi sa fumure aux conditions climatiques locales et saisonnières.

La stratification des résultats par zone agro-écologique a cependant aussi ses limites car elle ne tient pas compte du niveau de développement agricole de la zone et de technicité des agriculteurs. Ainsi, au Burkina Faso où le niveau de développement agricole est plus élevé en zone cotonnière, il

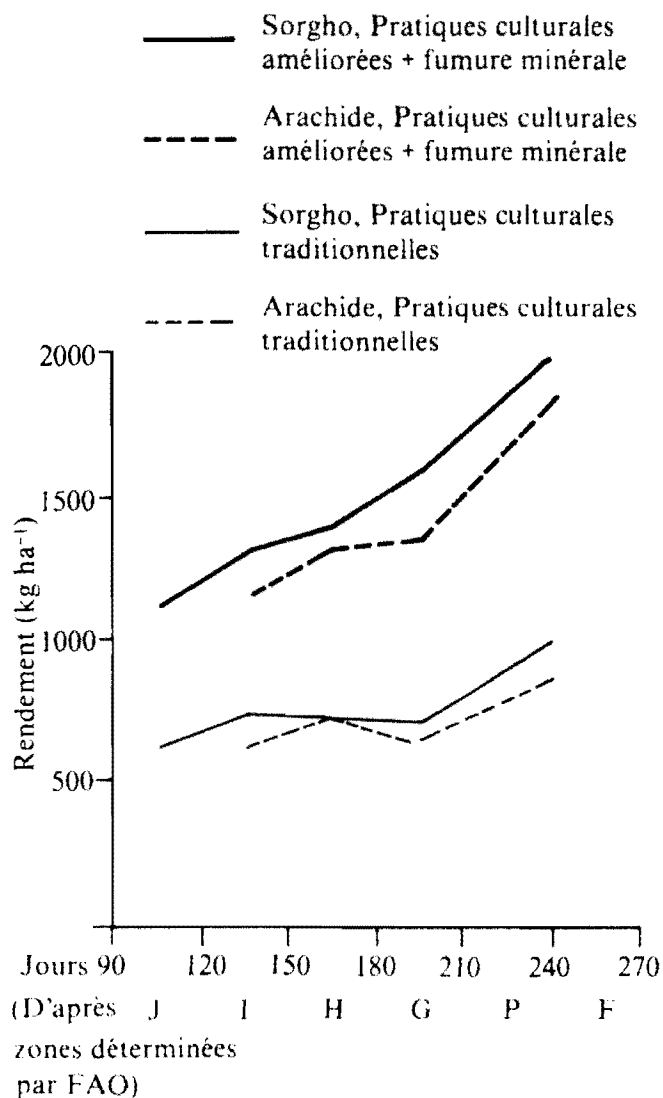

Figure 6. Influences des zones agroécologiques sur les rendements. Nigéria : résultats du programme engrais FAO, Projet GCP/NIR/021/NOR.

a été montré que les conclusions tirées des rendements moyens par zones agro-écologique pouvaient être estimées à la hausse en zone cotonnière et à la baisse pour les autres (FAO 1985a).

### Réponse des cultures aux engrais et aux types de sols

Il est établi que parmi les techniques susceptibles d'accroître la production, la fertilisation—au sens large du terme—est sans doute le facteur de production le plus puissant. Modifiant le sol, la fertilisation ne peut fondamentalement être étudiée que dans le cadre des relations sols/fertilisation. Il est donc logique de vouloir corrélérer les résultats d'expérimentation de la fertilisation avec les analyses

de sols.

La mise en évidence d'une telle corrélation n'est cependant pas facile car les contraintes à surmonter sont nombreuses :

- elle implique que la corrélation entre méthodes d'analyse/facteur étudié soit réelle et permanente or ce n'est pas toujours le cas, l'interprétation des bulletins d'analyse restant difficile;
- une des caractéristiques des sols sahéliers, souvent en voie d'épuisement, est leur extrême hétérogénéité : celle-ci engendre des coefficients de variation élevés et réduit considérablement la signification statistique des essais. De sorte que la précision peut ne pas être suffisante pour mettre en évidence les phénomènes;
- elle implique aussi que les échantillons de sols soient représentatifs, or l'hétérogénéité des sols déjà soulignée rend cette représentativité aléatoire;
- la précision nécessaire exige une grande régularité dans la réalisation des analyses, donc un personnel stable, expérimenté et soigneusement contrôlé ainsi que des moyens importants, conditions souvent difficiles à obtenir;
- l'interaction entre les différents facteurs de production et les conditions climatiques locales est souvent très importante.

L'action prépondérante de tel ou tel facteur dans des conditions diverses peut masquer ou atténuer la corrélation étudiée.

Les corrélations sols/fertilisation devraient fournir des recommandations précises sur l'amélioration de la productivité des engrais utilisés par les paysans. Or, peut-on demander à des paysans, dont la superficie des champs est le plus souvent de l'ordre de quelques dizaines d'ares, de supporter les frais élevés d'analyses de sol? Ces paysans pourront-ils toujours compter sur les techniciens nécessaires pour faire les prélèvements, les transmettre au laboratoire, traduire les résultats en recommandations?

On est donc contraint, dans un premier temps, de limiter les analyses à quelques sites sélectionnés et d'extrapoler éventuellement les résultats à de vastes zones homogènes en tenant compte des disparités techniques existant dans ces zones et des autres corrélations.

Ainsi, l'étude poussée de corrélations, résultats d'analyses de sols/fertilisation, pour aussi intéressante qu'elle soit, ne pourra déboucher sur quelque chose de concret qu'à long terme; elle exigera la mobilisation de gros moyens.

Sans pour autant abandonner les recherches en stations et pour certaines zones d'intensification précises, il est donc nécessaire de concentrer les efforts sur des objectifs plus immédiats, débouchant sur des techniques faciles à mettre en oeuvre par le paysan ainsi que sur des études de facteurs simples voire simplifiés. Par exemple, point n'est besoin d'analyser pour distinguer un sol lourd d'un sol léger. Pour aussi relative et empirique que soit une telle classification, elle peut être faite dans une zone réputée homogène quant aux autres facteurs (eau notamment) et montrer rapidement une corrélation entre ces types de sols et la réponse à la fertilisation.

Une corrélation de ce type a été établie à partir des résultats d'expérimentation sur blé irrigué, conduite conjointement par le Programme engrais nigérien et le Projet de développement rural de Maradi (FAO 1985b). Selon ces résultats, l'influence de la nature du sol s'est révélée hautement significative tant pour la productivité naturelle des sols (rendement du témoin sans engrais) que pour la réponse à l'azote. Ainsi, les rendements en grain du blé s'élevaient respectivement à 1700 et 2600 kg ha<sup>-1</sup> sur sols sableux et argileux, ceux en paille étaient respectivement de 3000 et 4000 kg ha<sup>-1</sup>.

De plus, la productivité des engrais paraît augmenter avec la légèreté du sol surtout pour l'azote, élément pour lequel les résultats sont exprimés dans le Tableau 2.

La stratification des résultats des démonstrations récoltés dans le nord du Nigéria (Etat de Sokoto) en fonction de trois types de sols (sablonneux, limoneux, argileux) reprise au Tableau 3, montre clairement l'importance du type de sols sur les rendements (FAO 1979a).

En ce qui concerne le mil, bien que les meilleurs rendements soient obtenus sur les bons sols, la réponse aux applications d'engrais semble être stabilisée à un plafond d'augmentation de l'ordre de

350 kg ha<sup>-1</sup>. Ce plafond reflète, sans doute, le faible potentiel de production du mil.

**Effets résiduels des fumures minérales.** Les résultats d'essais dans le nord du Nigéria ainsi qu'au Niger ont mis en évidence des effets résiduels importants des formules de fumure NP et NPK classiques.

Au Niger, il a été constaté que même l'azote a un effet résiduel marqué, cependant moindre que celui du phosphore (Landez 1985).

Pour trois années d'apports répétés d'une dose annuelle de 45 unités fertilisantes, la productivité résiduelle est respectivement de : 1,8 soit 0,6 par an pour l'azote, et de 3,6 soit 1,2 par an pour le phosphore.

Dans les conditions de la zone soudano-sahélienne, les fumures minérales surtout le phosphore mais aussi dans une moindre mesure l'azote ne sont pas entièrement utilisées en une seule saison culturale. Une partie reste donc disponible dans le sol, augmentant la fertilité naturelle.

En conséquence, la rentabilité de ces applications, calculée sur une seule saison culturale, ne donne pas une image réelle du bénéfice que les agriculteurs retirent de ces applications. Il apparaît donc important que les effets résiduels soient repris parmi les thèmes de vulgarisation liés à la fertilisation.

Si les effets résiduels des fumures minérales classiques ne sont pas négligeables, ceux des applications de phosphates naturels sont encore beaucoup plus importants tant du point de vue physique, augmentation des rendements, que du point de vue économique. Selon les nombreux résultats du Programme engrais FAO au Burkina Faso et au Niger, une rentabilité suffisante de la fumure phosphatée par apport de phosphate naturel ne peut être obtenue que si l'on prend en compte les effets sur deux ans ou mieux trois ans et ce pour autant et

**Tableau 2. Réponse du blé à l'azote selon les types de sols, Niger. Résultats du Programme engrais, Projet FAO GCPF/NER/020/NOR. (Culture de contre-saison 1984/1985.)**

| Types de sol     | Dose optimale (kg N ha <sup>-1</sup> ) | Augmentation Rdt. (kg ha <sup>-1</sup> ) |        | Indice productivité | Bénéfice net | RVC <sup>1</sup> |
|------------------|--|--|--------|---------------------|--------------|------------------|
|                  |  | Grain                                    | Paille |                     |              |                  |
| Argileux         | 68                                     | 810                                      | 2060   | 12                  | 136 757      | 16               |
| Argileux sableux | 76                                     | 1134                                     | 2860   | 15                  | 193 973      | 20               |
| Sableux          | 98                                     | 2062                                     | 3750   | 21                  | 358 089      | 28               |

1. RVC = Rapport valeur sur coût.

**Tableau 3. Influence du type de sol (structure) sur les rendements (kg ha<sup>-1</sup>), Nigéria. Résultats du Programme engrais, Projet FAO GCP/NIR/021/NOR.**

| Types de sols      | Mil               |                                   | Sorgho    |                                   | Arachide  |                                   | Coton     |                                   |
|--------------------|-------------------|-----------------------------------|-----------|-----------------------------------|-----------|-----------------------------------|-----------|-----------------------------------|
|                    | Rendement         | Augmen-<br>tation de<br>rendement | Rendement | Augmen-<br>tation de<br>rendement | Rendement | Augmen-<br>tation de<br>rendement | Rendement | Augmen-<br>tation de<br>rendement |
| Sols sablonneux    | (78) <sup>1</sup> |                                   | (32)      |                                   | (64)      | -                                 | -         |                                   |
| T <sup>2</sup>     | 679               | -                                 | 624       | -                                 | 633       | -                                 | -         | -                                 |
| T + F <sup>3</sup> | -                 | -                                 | 819       | 195                               | 884       | 251                               | -         | -                                 |
| PA <sup>4</sup>    | 782               | 103                               | 713       | 89                                | 750       | 117                               | -         | -                                 |
| PA + F             | 1040              | 361                               | 1049      | 425                               | 1186      | 553                               | -         | -                                 |
| Sols limoneux      | (53)              |                                   | (64)      |                                   | (28)      |                                   | (15)      |                                   |
| T                  | 798               | -                                 | 716       | -                                 | 810       | -                                 | 448       | -                                 |
| T + F              | -                 | -                                 | 1131      | 415                               | 1087      | 277                               | -         | -                                 |
| PA                 | 878               | 80                                | 880       | 164                               | 959       | 149                               | 571       | 123                               |
| PA + F             | 1146              | 348                               | 1368      | 652                               | 1465      | 655                               | 829       | 381                               |
| Sols argileux      | (5)               |                                   | (36)      |                                   |           |                                   | (13)      |                                   |
| T                  | 960               | -                                 | 884       | -                                 | -         | -                                 | 522       | -                                 |
| T + F              | -                 | -                                 | 1148      | 264                               | -         | -                                 | -         | -                                 |
| PA                 | 1030              | 70                                | 943       | 59                                | -         | -                                 | 681       | 159                               |
| PA + F             | 1320              | 360                               | 1514      | 630                               | -         | -                                 | 1005      | 483                               |

1. Chiffres entre parenthèses indiquent le nombre de résultats, résultats moyens 4 saisons culturales 1974-1977.

2. T = Parcelle témoin.

3. F = Fumure minérale.

4. PA = Pratiques culturales améliorées.

que l'on se situe dans les conditions climatiques favorables du sud de la zone (FAO 1985a, MDR/MESRS 1983).

#### Influence du rendement de la parcelle témoin sur les augmentations de rendement

Tant pour le nord du Nigéria que pour le Burkina Faso, la stratification des résultats de démonstration montre clairement une augmentation de l'accroissement des rendements par l'emploi de la même formule de fumure à mesure qu'augmente le rendement de la parcelle témoin. Cette augmentation est d'autre part plus nette avec une formule forte qu'avec une formule faible (FAO 1979b, 1984).

Les résultats du Tableau 3 mettent aussi en évidence que sur arachide, plus le rendement de la parcelle témoin est faible, plus l'importance relative des pratiques culturales améliorées est grande. A l'inverse, plus les rendements de la parcelle témoin sont élevés (les meilleurs agriculteurs ou ceux cultivant dans les meilleures conditions) plus l'im-

portance relative de la fumure est élevée. Ces résultats confirment aussi le fait que la combinaison des pratiques culturales améliorées et de la fumure donne de loin les meilleures augmentations de rendement (FAO 1979a).

#### Fumure et types d'engrais

L'application des fumures recommandées par cultures, pays ou régions, qu'elles soient des types P, NP ou NPK, implique de la part des gouvernements un choix dans la gamme des engrais disponibles localement ou sur le marché international.

Là où il est opérationnel et en collaboration avec les institutions nationales, le Programme engrais s'efforce de prendre en considération les différents éléments techniques et économiques pouvant influencer le choix du type d'engrais. Ainsi, au Nigéria :

- pour éviter l'acidification du sol par l'utilisation répétée du sulfate d'ammonium, l'application de l'ammonitrate calcique a été préférée et recommandée;
- l'engrais binaire NP, du type 1-1-0 plus facile à



l'emploi que les engrais simples, a été progressivement introduit;

- l'application du bore sur coton a été introduite par l'utilisation de superphosphate triple boraté. Ces dernières années, un gros effort a été fait par le Programme engrais pour tester (Niger et Burkina Faso) dans les conditions paysannes l'utilisation des phosphates naturels (FAO 1985a, Landez 1985, MDR/MESRS 1983).

Au Niger, le Programme engrais a entrepris récemment l'étude de l'application de supergranules d'urée sur riz irrigué.

## Le Programme d'action de la FAO pour l'agriculture africaine

Le "Programme d'action pour l'agriculture africaine" proposé par le Directeur Général de la FAO (FAO 1986a) a retenu parmi les quatre grands axes d'intervention qui constituent l'ossature du Plan d'action préconisé, l'amélioration des quatre "i" du développement agricole, à savoir : incitation, intrants, institutions et infrastructures.

Tel que défini dans l'étude FAO intitulée "L'agriculture africaine : les 25 prochaines années" (FAO 1986a, 1986b) l'objectif prioritaire entre tous est de relever durablement la productivité des terres actuellement cultivées. La FAO reconnaît que cet objectif ne peut être obtenu que par l'utilisation accrue des fumures organiques et minérales et l'amélioration des techniques culturales intégrées dans des systèmes d'exploitation adaptés aux conditions agro-écologiques et aux traditions locales. Les techniques définies devront comporter relativement peu de risques si l'on veut que le paysan abandonne rapidement les systèmes traditionnels à faible niveau de technicité et à basse productivité pour des systèmes faisant plus largement appel aux intrants externes.

En zone soudano-sahélienne, les techniques définies devront être d'autant mieux étudiées que la zone est soumise à des conditions climatiques très variables pouvant occasionner des déficits hydriques importants.

## Conclusion

La stratégie de l'utilisation des engrais en zone soudano-sahélienne doit être définie en fonction de l'environnement physique des agriculteurs et des

nombreux facteurs de cet environnement (zones agro-écologiques, types de sols, variations climatiques saisonnières, cultures, etc.) qui conditionnent les rendements des cultures, parfois de manière déterminante.

La stratégie doit aussi prendre en considération l'environnement économique plus ou moins favorable des agriculteurs, notamment la relation coût des engrais/prix des produits agricoles ainsi que l'évolution de cette relation.

La fumure minérale pour être bien comprise doit :

- être utilisée dans le contexte des systèmes intégrés de la nutrition des plantes;
- tenir compte du niveau de technicité des agriculteurs et l'application ou non des pratiques culturales améliorées, culture attelée notamment et de l'utilisation des autres intrants agricoles tels que semences améliorées et pesticides;
- tenir compte de l'existence ou non d'une culture de rente dans la rotation (coton, arachide) et/ou de l'existence d'un marché pour une production vivrière excédentaire.

Pour être efficace, la stratégie doit être conçue à différents niveaux, à savoir respectivement au niveau de l'exploitation agricole, des régions, des principales zones agro-écologiques homogènes et des pays concernés.

Le rôle des techniciens est de fournir les éléments techniques et économiques qui permettent aux planificateurs et décideurs de définir à bon escient les stratégies les mieux adaptées.

Les projets du Programme engrais de la FAO et les services spécialisés des Ministères, qui souvent en découlent, ont à coeur de contribuer à la fourniture de ces renseignements et à la préparation de dossiers techniques et économiques.

## Bibliographie

**Braun, H. et Coursier, C.** 1985. Systèmes intégrés de nutrition des plantes et fixation biologique de l'azote. Xème Consultation sur le programme engrais FAO, Kinshasa, Zaïre : Organisation des Nations Unies pour l'alimentation et l'agriculture.

**FAO (Organisation des Nations Unies pour l'alimentation et l'agriculture)** 1971. Manuel pour les enquêtes de fertilité de sols effectuées dans les champs des agriculteurs. Bulletin pédologique N° 11, Rome, Italie : FAO.

**FAO (Organisation des Nations Unies pour l'alimentation et l'agriculture) 1979a.** Project findings and recommendations. Terminal report. Volume 1. AG:GCP/NIR/021/NOR, Sokoto State, Nigeria Fertilizer demonstration and distribution programme. Rome, Italie : FAO.

**FAO (Organisation des Nations Unies pour l'alimentation et l'agriculture) 1979b.** Project findings and recommendations. Terminal report. Volume 1. AG : GCP/NIR/019/NOR fertilizer demonstration and distribution programme. Kano State, Nigéria : FAO.

**FAO (Organisation des Nations Unies pour l'alimentation et l'agriculture) 1979c.** Rapport sur le projet relatif aux zones agro-écologiques. Vol. 1. Méthodologie et résultats pour l'Afrique. Rome, Italie : FAO.

**FAO (Organisation des Nations Unies pour l'alimentation et l'agriculture) 1980.** Projets de distribution d'engrais à crédit, destinés aux petits agriculteurs. Bulletin engrais de la FAO N°1. Rome, Italie : FAO.

**FAO (Organisation des Nations Unies pour l'alimentation et l'agriculture) 1982.** Rapport annuel, saison culturale 1981. Programme national engrais en Haute Volta. Projet GCPF/UPV/028/BEL. Ouagadougou, Burkina Faso : FAO.

**FAO (Organisation des Nations Unies pour l'alimentation et l'agriculture) 1984.** Conclusions et recommandations du Projet. Rapport intérimaire AG:GCPF/UPV/018/BEL. Programme national engrais en Haute-Volta. Rome, Italie : FAO.

**FAO (Organisation des Nations Unies pour l'alimentation et l'agriculture) 1985a.** Rapport annuel saison culturale 1984. Programme national engrais en Haute Volta. Projet GCP/UPV/028/BEL, Ouagadougou, Burkina Faso : FAO.

**FAO (Organisation des Nations Unies pour l'alimentation et l'agriculture) 1985b.** Résultats d'expérimentation sur blé irrigué. Programme engrais nigérien/Projet de développement rural de Maradi, Niamey, Niger : FAO.

**FAO (Organisation des Nations Unies pour l'alimentation et l'agriculture) 1986a.** L'agriculture africaine : les 25 prochaines années, un programme d'action pour l'agriculture africaine. Rome, Italie : FAO.

**FAO (Organisation des Nations Unies pour l'alimentation et l'agriculture) 1986b.** L'agriculture africaine : les 25 prochaines années. Rapport principal, Annexe III. Accroître la productivité, et Annexe V. Les politiques d'incitation et d'approvisionnement en facteurs de production ARC/86/3, Rome, Italie : FAO.

**Joly, C. 1979.** The agro-ecological zones approach and the group of field data of the FAO Fertilizer Programme. FIAC Technical Sub-Committee. Rome, Italie : Organisation des Nations Unies pour l'alimentation et l'agriculture.

**Joly, C. 1985.** The FAO Fertilizer Programme in Africa, IFDC Workshop. Douala, Cameroon : Organisation des Nations Unies pour l'alimentation et l'agriculture.

**Landez, J. 1985.** L'utilisation bénéfique des engrais par les petits agriculteurs, Sous-comité technique FAO/FIAC. Rome, Italie : Organisation des Nations Unies pour l'alimentation et l'agriculture.

**MDR/MESRS (Ministère du Développement rural/ministère Enseignement supérieur et Recherche scientifique) 1983.** Synthèse des résultats de recherche sur les phosphates naturels de Haute-Volta, 1976-1982. Colloque national sur l'utilisation du Voltaphosphate 1-2 mar 1983, Ouagadougou, Burkina Faso.

**Pieri, C. et Oliver, R. 1986.** Analyses des sols et réponse de quelques céréales tropicales sèches à la fumure potassique. CIRAD, DA/août 86/N° 15, Montpellier, France : Centre de coopération internationale en recherche agronomique pour le développement.

**Van den Bergen, T.T. 1986.** Status of FAO fertilizer programme date processing, 29th FAO/FIAC Session, FAO, Rome, Italie.



# Causes and Effects of Acidity in Sahelian Soils

L.P. Wilding and L.R. Hossner<sup>1</sup>

## Abstract

*Extensive areas of the Sahel are covered with sandy acid soils with low buffering capacities and low activity clay systems. This is in marked contrast to most soils of North America, developed in semi-arid conditions. Acidity in these soils is believed to be a consequence of parent sands derived from acid continental terminal deposits, strong paleoclimate and contemporaneous leaching, and base-cycling processes. Acidity in these soils negatively affects land use, soil physical and chemical properties, and plant and crop diversification, and disturbs the balance of pastoral and agrarian agriculture of the region. Finally, it makes agronomic research difficult because random variability within plot treatments often exceeds systematic variability due to treatments. This is a significant problem worthy of continued efforts to determine the scale, magnitude, and extent of spatial soil variability directly or indirectly due to soil acidity.*

## Résumé

**Causes et effets de l'acidité des sols sahéliens :** *De vastes zones sahéliennes sont caractérisées par des sols sableux acides ayant de faibles pouvoirs tampon et des systèmes argileux d'activité réduite. Cette situation est en contraste avec celle de la plupart des sols soumis aux mêmes conditions de semi-aridité en Amérique du Nord. Dans le cas du Sahel, on pense généralement que l'acidité est l'une des multiples conséquences de sables d'origine déposés par le continental terminal, de paléoclimats plus humides et plus lessivants et de processus contemporains de lessivage et d'échange des bases. Elle a un effet négatif sur l'utilisation et les propriétés physico-chimiques des sols, la diversification des plantes et des cultures et les rendements. De plus, l'acidité est préjudiciable à l'équilibre existant entre les systèmes pastoraux et agricoles de la région. Enfin, elle gêne la recherche agronomique du fait que la variabilité aléatoire entre traitements appliqués sur les parcelles est souvent plus grande que la variabilité systématique due aux traitements eux-mêmes. C'est là un problème important dont l'étude mérite d'être poursuivie en vue de déterminer l'échelle, l'ordre de grandeur et la mesure dans laquelle la variabilité spatiale des sols est due, directement ou indirectement, à l'acidité de ces sols.*

## Introduction

Extensive areas of the Sahelian region in West Africa comprise red, sandy, strongly leached, acid soil resources utilized for pearl millet/cowpea production (Fig. 1). The soils vary greatly in thickness, associated geologic deposits, and geomorphic land-

forms, and reflect both semi-arid tropical environments and the more pluvial paleoclimate. Most of the soils are Ustalfs, Ustults, Tropepts, and Psamments, indicative of their diversity in soil texture, acidity, and subsoil clay enrichment (Daniel and Wilding 1983, West et al. 1984 and 1987, Wendt 1986, Bui 1986). Chemically and mineralogically,

---

1. Professors of Texas A&M University and Texas Agricultural Experiment Station, College Station, TX 77843, USA.

ICRISAT (International Crops Research Institute for the Semi-Arid Tropics) 1989. Soil, Crop, and Water Management Systems for Rainfed Agriculture in the Sudano-Sahelian Zone: proceedings of an International Workshop, 7-11 Jan 1987. ICRISAT Sahelian Center, Niamey, Niger. Patancheru, A.P. 502 324, India: ICRISAT.



Figure 1. Location of sandy acid soils in the semi-arid tropics of West Africa.

these sandy soils are uniquely different from their fertile base-rich, neutral-to-alkaline North American counterparts (Nettleton and Peterson 1983, Allen and Fanning 1983). The Sahelian soils are generally strongly acid, infertile, weakly buffered, kaolinitic systems with few weatherable mineral reserves. This fact is not well appreciated by many soil scientists and agronomists.

Hence, the purpose of this paper is to propose: (1) multiple working hypotheses for the observed acidity in sandy soils of the Sahel; and (2) effects of such acidity to their use and management. Recent

research conducted on sandy soils in Niger, which are representative of many soils in the Sahel, serves as the basis for this report.

## Stratigraphy, Geomorphology, and Soils

### Stratigraphy

Surface deposits are a sequence of sandy materials that cover ironstone caps, which in turn cover

loamy Miocene (possibly as young as Eocene) deposits (Continental Terminal). These units control the soils, geomorphology, and hydrology of the area. The Continental Terminal sediments that are about 25 million years old are deeply weathered and exposed only in road cuts, seldom at the surface (Sombroek and Zonneveld 1971, Gavaud 1966, Greigert 1966). Ironstone caps the Continental Terminal in most parts of the landscape and is exposed at escarpments or breakaways along multi-level plateaus and ledges within the Miocene sediments. The ironstone cap is a prominent pedogenic landscape feature formed during the late Pliocene or Early Quaternary periods (about 2 million years ago), presumably under wetter paleoclimates. It can be between 20 cm and 1 m or more thick, either as a continuous unit, as sesquioxide blocks, or as cemented ironstone gravels. The ironstone serves as an effective base for the modern soils and as a root-and-water restrictive layer. When on a sloping gradient, it is the interface along which interflow occurs. The sandy cover materials are between 2 and 8 cm or more in thickness, over an almost universal ironstone cap. The texture of this sandy cover is fine sand, fine loamy sand, and rarely, fine sandy loam. In the uplands, it is mostly of eolian origin while on low terraces, floodplains, and in the dallols, it may be a combination of fluvial and eolian processes. The age of these deposits range from a few thousand years in dallols to about 40 000 years in more stable uplands.

## Geomorphology

The area can be divided into four geomorphic elements (Daniels and Wilding 1983). The landscape is dominated by broad, gently-sloping plateaus with discontinuous sand cover, sandy valley systems that slope gently from the ironstone-capped plateau toward a dry stream bed, broad (terrace-like) sand plains, and dallols (dry fossil valleys).

Major plateaus, several kilometers across, are recognized at 220-, 240-, and 260-m elevations along the Niger River. They generally have thin sand covers with or without low dune forms. The valley systems start just below the ironstone cap of the plateaus, have thick sands near the escarpment breakaway with discontinuous paleosols in the lower sand unit, and slope smoothly to the valley floor. The sandy surfaces are apparently a combination of fluvial and eolian processes.

The sand plains consist of thick (2–6 m) eolian sands over “stepped” surfaces or levels of laterite gravels that slope gently toward adjacent river or stream systems. The sand has a well-expressed dune relief and some deflation depressions occur. The sand cover on all “stepped” levels only differs in color, texture, and pH. It abruptly overlies a cemented laterite gravel contact that probably represents a constructional floor of fluvial gravels. The sands were emplaced on these surfaces probably about 20 000 to 40 000 years ago; thus, the soils are more strongly developed than their dallol counterparts (Sombroek and Zonneveld 1971).

The dallols are unique, sand-plugged fossil stream valleys. Construction of these nearly level landforms was apparently by both fluvial and eolian processes. Surfaces express marked dunal relief and activity; these sandy deposits are probably less than 1000 years old, and commonly have shallow water tables between 1 and 5 m below the surface in southern Niger (Bui 1986).

## Soils

Soils on the ICRISAT Sahelian Center (West et al. 1984) are representative of extensive areas of major pearl millet/cowpea production centers in the vicinity of Niamey, including the sand plains and upper reaches of valley sand systems. The Center is located on a sand plain. These areas comprised deep, red, sandy soils with weakly developed subsoils (Psammentic Paleustalfs, Psammentic Haplustalfs, and Ustoxic Quartzipsamments). The Labucheri and Dayobu are extensive series in this area (Tables 1 and 2) and are deep arid soils on the sand plains. Dallols are also extensively used for pearl millet/cowpea production but the soils are coarser-textured, less red, and less acid than their upland counterparts (Bui 1986). Soils on nearly level, broad, laterite-capped plateaus are very acid, thin, and variable in texture and thickness of subsoils over laterite or laterite gravels. Most of these soils are Ustoxic Dystropepts and Petroferric subgroups of Haplustults, Haplustalfs, and Dystropepts (Daniels and Wilding 1983, Hagen et al. 1986). The Gagani is a representative soil on plateaus (Table 3). They are generally loamy in texture rather than sandy. These areas are not extensively used for pearl millet/cowpea production but are important forest and pastoral grazing lands.

Textures of soils in uplands are dominated by

**Table 1. Selected soil physical and chemical properties of the Labucheri soils in Niger (Psammentic Paleustalf; sandy, siliceous, isohyperthermic), sampled at the ICRISAT Sahelian Center, Sadoré, Niger, Africa.**

| Depth (cm) | Horizons | Particle size distribution (mm) |          |          | Organic C (%) | pH (H <sub>2</sub> O) 1:1 | pH (0.1 N KCl) | NH <sub>4</sub> OAC extractable bases |     |     |     | KCl extractable Al meg (100g) <sup>-1</sup> | NH <sub>4</sub> OAC |      | Base saturation (%) | Extr. Fe |
|------------|----------|---------------------------------|----------|----------|---------------|---------------------------|----------------|---------------------------------------|-----|-----|-----|---|---------------------|------|---------------------|----------|
|            |          | Sand (%)                        | Silt (%) | Clay (%) |               |                           |                | Ca                                    | Mg  | Na  | K   |   | CEC                 | ECEC |                     |          |
| 0-9        | A1       | 90.7                            | 6.2      | 3.2      | 0.31          | 4.9                       | 3.7            | 0.3                                   | 0.1 | 0.0 | 0.1 | 0.3   | 1.6                 | 0.8  | 30                  | 0.4      |
| 9-30       | A2       | 90.6                            | 5.6      | 3.8      | 0.18          | 4.9                       | 3.8            | 0.1                                   | 0.1 | 0.0 | 0.1 | 0.4   | 1.1                 | 0.7  | 28                  | 0.4      |
| 30-58      | Bt1      | 88.3                            | 5.7      | 6.1      | 0.13          | 4.9                       | 3.9            | 0.2                                   | 0.1 | 0.0 | 0.1 | 0.3   | 1.2                 | 0.8  | 36                  | 0.5      |
| 58-78      | Bt2      | 88.7                            | 5.5      | 5.9      | 0.11          | 5.0                       | 4.2            | 0.4                                   | 0.2 | 0.0 | 0.1 | 1.1   | 0.1                 | 0.8  | 60                  | 0.4      |
| 78-98      | Bt2      | 88.0                            | 5.3      | 6.8      | 0.10          | 5.1                       | 4.2            | 0.3                                   | 0.2 | 0.0 | 0.1 | 0.1   | 1.1                 | 0.7  | 55                  | 0.6      |
| 98-122     | Bt3      | 88.7                            | 5.0      | 6.4      | 0.09          | 5.6                       | 4.5            | 0.3                                   | 0.3 | 0.0 | 0.0 | 0.0   | 1.1                 | 0.7  | 63                  | 0.5      |
| 122-146    | Bt3      | 88.6                            | 3.5      | 8.0      | 0.07          | 5.5                       | 4.6            | 0.3                                   | 0.3 | 0.0 | 0.0 | 0.1   | 1.1                 | 0.7  | 61                  | 0.5      |
| 146-173    | Bt4      | 89.1                            | 4.2      | 6.8      | 0.10          | 5.5                       | 4.5            | 0.3                                   | 0.3 | 0.0 | 0.0 | 0.1   | 0.9                 | 0.6  | 66                  | 0.5      |
| 173-200    | Bt4      | 89.0                            | 4.1      | 7.0      | 0.07          | 5.8                       | 4.6            | 0.3                                   | 0.3 | 0.0 | 0.0 | 0.1   | 0.9                 | 0.7  | 68-0.6              |          |
| 430-460    | C        | 90.0                            | 7.3      | 5.1      | 0.04          | 5.1                       | 4.2            | 0.3                                   | 0.2 | 0.0 | 0.1 | 1.1   | 1.2                 | 0.6  | 39                  | 0.5      |

**Table 2. Selected soil physical and chemical properties of the Dayobu soils in Niger (Ustoxic Quartzipsamment, isohyperthermic, coated), sampled at the ICRISAT Sahelian Center, Niamey, Niger, Africa.**

| Depth (cm) | Horizons         | Particle size distribution (mm) |          |          | Organic C (%) | pH (H <sub>2</sub> O) 1:1 | pH (0.1 N KCl) | NH <sub>4</sub> OAC extractable bases |     |     |     | KCl extractable Al meg (100g) <sup>-1</sup> | NH <sub>4</sub> OAC |      | Base saturation (%) | Extr. Fe |
|------------|------------------|---------------------------------|----------|----------|---------------|---------------------------|----------------|---------------------------------------|-----|-----|-----|---|---------------------|------|---------------------|----------|
|            |                  | Sand (%)                        | Silt (%) | Clay (%) |               |                           |                | Ca                                    | Mg  | Na  | K   |   | CEC                 | ECEC |                     |          |
| 0-15       | A1               | 92.5                            | 3.0      | 4.5      | 0.25          | 5.1                       | 4.0            | 0.2                                   | 0.1 | 0.0 | 0.1 | 0.6   | 1.5                 | 0.9  | 22                  | 0.3      |
| 15-27      | A2               | 91.7                            | 3.2      | 5.1      | 0.15          | 4.9                       | 3.9            | 0.1                                   | 0.0 | 0.0 | 0.1 | 0.7   | 1.5                 | 0.9  | 10                  | 0.3      |
| 27-44      | Bt1              | 92.1                            | 3.2      | 4.7      | 0.11          | 4.8                       | 3.9            | 0.1                                   | 0.0 | 0.0 | 0.0 | 0.7   | 1.3                 | 0.9  | 11                  | 0.2      |
| 44-62      | Bt2              | 92.7                            | 3.0      | 4.3      | 0.08          | 4.8                       | 3.9            | 0.0                                   | 0.0 | 0.0 | 0.0 | 0.6   | 1.1                 | 0.7  | 11                  | 0.3      |
| 62-80      | Bt3              | 93.0                            | 2.5      | 4.5      | 0.08          | 4.8                       | 4.0            | 0.1                                   | 0.0 | 0.0 | 0.0 | 0.6   | 1.0                 | 0.7  | 12                  | 0.3      |
| 80-103     | BW               | 92.5                            | 3.2      | 4.3      | 0.07          | 4.8                       | 4.0            | 0.1                                   | 0.0 | 0.0 | 0.0 | 0.6   | 1.0                 | 0.7  | 13                  | 0.3      |
| 103-126    | BW               | 93.4                            | 2.5      | 4.1      | 0.09          | 4.9                       | 4.0            | 0.1                                   | 0.0 | 0.0 | 0.0 | 0.5   | 0.9                 | 0.7  | 20                  | 0.3      |
| 126-150    | BC               | 94.5                            | 1.9      | 3.6      | 0.06          | 4.8                       | 4.0            | 0.1                                   | 0.0 | 0.0 | 0.0 | 0.5   | 0.8                 | 0.7  | 23                  | 0.3      |
| 150-173    | BC               | 95.0                            | 2.0      | 3.0      | 0.05          | 4.5                       | 4.0            | 0.1                                   | 0.1 | 0.0 | 0.1 | 0.4   | 0.7                 | 0.7  | 39                  | 0.3      |
| 173-200    | C                | 94.6                            | 2.9      | 2.5      | 0.04          | 4.9                       | 4.1            | 0.1                                   | 0.0 | 0.0 | 0.0 | 1.4   | 0.7                 | 0.6  | 24                  | 0.3      |
| 200+       | Laterite contact |                                 |          |          |               |                           |                |                                       |     |     |     |   |                     |      |                     |          |

**Table 3. Selected soil physical and chemical properties of the Gagani soils in Niger (Petroferric Haplustult; loamy, siliceous isohyperthermic, shallow), sampled at the ICRISAT Sahelian Center, Niger, Niamey, Africa.**

| Depth (cm) | Horizons         | Particle size distribution (mm) |          |      | Organic C (%) | pH (H <sub>2</sub> O) 1:1 | pH (0.1 N KCl) | NH <sub>4</sub> OAC extractable bases |     |     |     | KCl extractable |     |      | Base saturation (%) | Extr. Fe |
|------------|------------------|---------------------------------|----------|------|---------------|---------------------------|----------------|---------------------------------------|-----|-----|-----|-----------------|-----|------|---------------------|----------|
|            |                  | Sand                            | Silt (%) | Clay |               |                           |                | Ca                                    | Mg  | Na  | K   | Al              | CEC | ECEC |                     |          |
| 0-9        | A1               | 81.1                            | 10.9     | 8.0  | 0.37          | 4.9                       | 3.8            | 0.3                                   | 0.2 | 0.0 | 0.1 | 0.8             | 2.6 | 1.4  | 22                  | 1.0      |
| 9-24       | Bt               | 79.6                            | 9.5      | 10.9 | 0.31          | 4.4                       | 3.8            | 0.2                                   | 0.1 | 0.0 | 0.0 | 1.3             | 3.2 | 1.6  | 9-1.0               |          |
| 24-34      | 2Bt <sup>1</sup> | 78.6                            | 8.4      | 13.0 | 0.26          | 4.6                       | 3.9            | 0.3                                   | 0.2 | 0.0 | 0.0 | 1.0             | 2.9 | 1.5  | 18                  | 1.1      |
| 34-35      | 2Bsm             | Laterite contact.               |          |      |               |                           |                |                                       |     |     |     |                 |     |      |                     |          |

<sup>1</sup>. Gravel content is 57% by weight.

sands and loamy sands, but shallow soils associated with plateaus are gravelly and finer textured (loamy sands and sandy loams, Table 3). Most, but not all of the upland soils on stable landforms have weakly expressed argilic horizons that slow the rate of saturated flow, increase the rate of unsaturated flow, and increase the sorptive capacity (West et al. 1984 and 1987). Water retention is low and plant-available water ranges from 0.05 to 0.1 cm cm<sup>-1</sup>. Infiltration and permeability are rapid but upon high intensity, short-duration storm events runoff has been observed even on these sandy soils.

Mineralogically, these soils are residual systems dominated by quartz/kaolinite/Fe-oxide (goethite) systems (West et al. 1984). Quartz comprises most of the skeleton grains interlinked together into a weakly cohesive soil matrix by kaolinite/Fe-oxide grain coatings. This matrix provides for large macropore conduits through which rapid water and solute transport occurs. The buffering capacity is low because of the low-activity clay system and low clay contents. Hence, soluble and readily-exchangeable components are rapidly transferred vertically to subsoils or restrictive layers via the wetting front. The low water retention characteristics of these soils favor this process.

Chemically, these soils have several properties in common; they are acidic, low in cation exchange capacity (CEC), mineral reserves, and organic matter, and have low buffering capacity. The pHs are acidic to strongly acidic and base saturations are generally less than 35% in the upper 50 cm (Tables 1 to 3, and Figs. 2 to 4). Extractable Al (1N KCl and Al percentages are correspondingly highest in superficial and upper subsoil zones (Figs. 2 to 4). Base saturations increase with depth in deep sandy soils with argilic horizons (Labucheri, Table 2 and Fig. 2) to more than 50% in lower Bt horizons. Exchangeable Al percentage is greatest between 9 and 30 cm. Parent sandy C horizons, when observed at 4-4.5 m below the surface, remain very strongly acidic and contain small quantities of exchangeable Al. Deep sandy soils without argilic horizons (Dayobu, Table 2 and Fig. 3) also increase in base saturation with depth but never more than 40%; exchangeable Al percentage in this soil is greater than 75% between 15 and 100 cm. The C horizons in these soils also remain extremely acidic with base saturation of about 25% and exchangeable Al percentage of about 65%. Shallow soils, representative of plateau surfaces (Gangani, Table



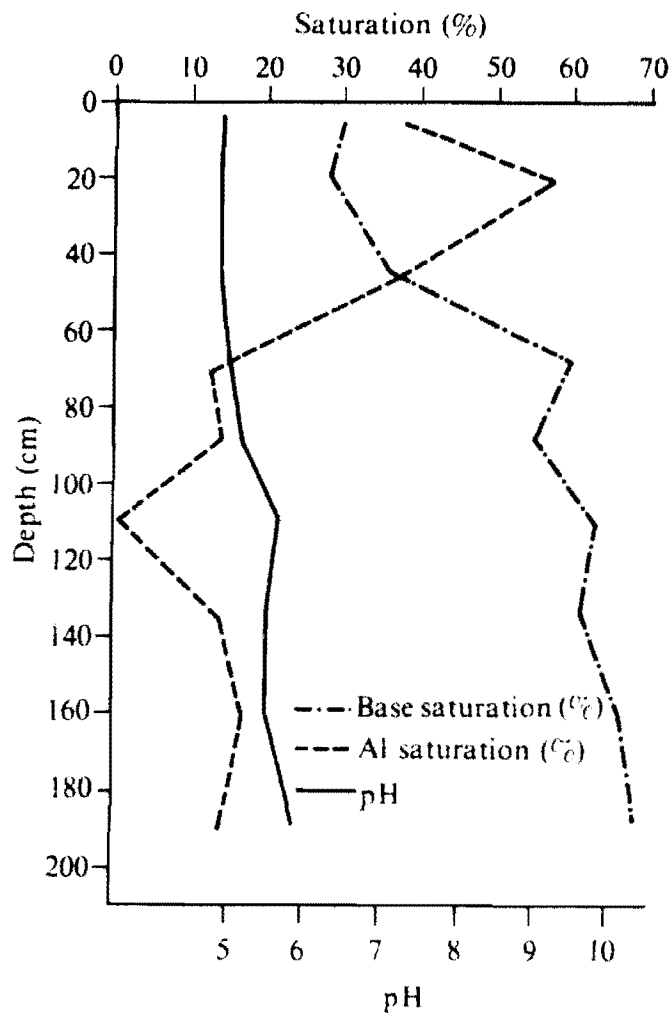

Figure 2. Depth distribution of pH, base saturation percentage, and aluminum saturation percentage in the Labucheri soils.

3 and Fig. 4), are extremely acidic in both A and Bt horizons of the sand mantle and in the 2Bt gravelly sandy loam horizons just above the laterite contact. These gravelly subsoils reflect the weathering profile into the Continental Terminal sandstones from which the laterite was also formed. The base saturations are commonly <25% with corresponding exchangeable-Al percentage values between 60 and 80%.

While degrees of soil acidity are associated with mappable differences in morphological properties of soils in the Sahel, remarkable spatial variability in acidity also occurs at lateral intervals too small to be delineated by conventional semi-detailed soil surveys. Detailed research on these poorly-responsive pearl millet areas are reported in this volume (Chase et al. 1989). Possible hypotheses to explain the origin of acidity in these semi-arid tropical environments are proposed in the following.

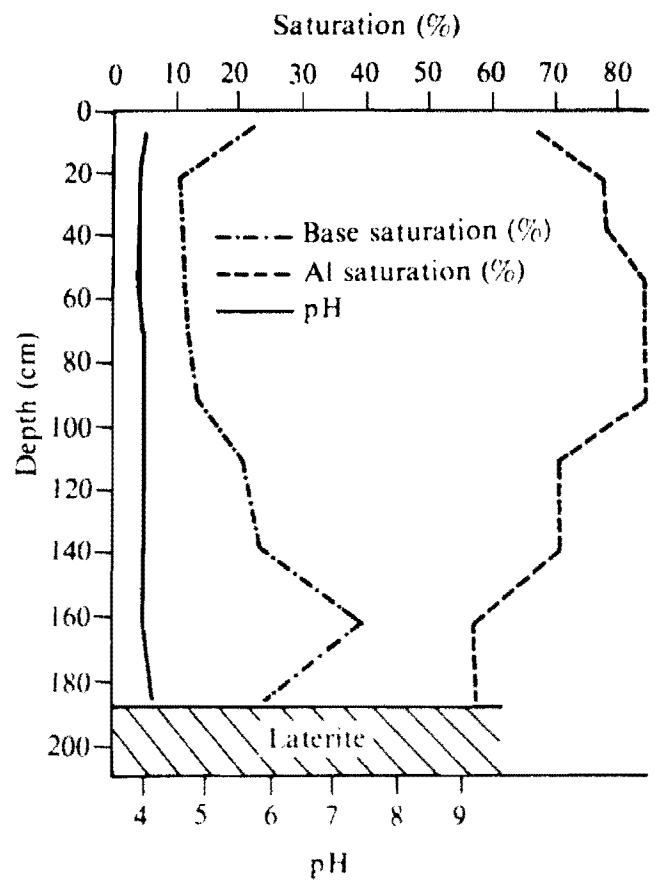

Figure 3. Depth distribution of pH, base saturation percentage, and aluminum saturation percentage in the Dayobu soils.

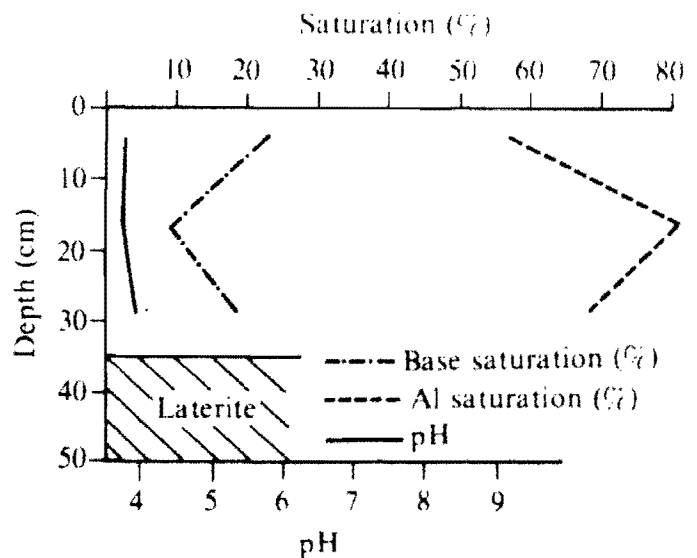

Figure 4. Depth distribution of pH, base saturation percentage, and aluminum saturation percentage in the Gagani soils.

## Origin of Soil Acidity

Acidity in soils of the Sahel may be attributed to the (1) indigenous acidity of the parent sands, (2) the development of acidity in soils weathered in wetter paleoclimates, (3) leaching of bases from shallow soil systems in contemporaneous climates with concomitant development of acidity, and (4) vector dynamics between base renewal at surface horizons and base loss at lower subsoils by leaching under contemporaneous climates. It is probable, however, that soil acidity in these soils reflects multiple causes and counterbalancing base renewal vectors.

### Effect of Parent Material

The parent sandy and fluvial sediments from which most of these acid soils developed, were apparently locally derived from polycycled and preweathered Continental Terminal sandstone bedrocks (Sombroek and Zonneveld 1971). Valley incision and dissection into the Continental Terminal provided an ample source of skeletal sand grains of the size, shape, and mineralogy as found in valleys and uplands of the surrounding soil landscapes. These parent sands are acidic, contain small quantities of exchangeable Al, and have kaolinitic/Fe-oxide grain coatings as found in sandy soils of the region; the coatings impart the color and acidity of these sediments. However, during the fluvial and eolian transport process, a large component of the easily detachable clay would be lost from the coatings about skeleton grains. The sands would then become less red, less clayey and less acidic; this condition more closely approximates observed sandy parent materials (C horizons) of soils in the valley sand system, sand plains, and dallols. In summary, evidence for soil acidity being an inherited property includes (1) the present semi-arid conditions, (2) the strongly acidic nature of soils and geologic material associated with the Continental Terminal deposits, and (3) the acidity of parent eolian and fluvial sandy C horizons of the soils in question.

From field morphology and laboratory analysis (Table 1 to 3), only part of the present clay, Fe-oxides, and acidity of these soils could be explained by inheritance. Pedogenesis of preweathered parent materials must also be taken into consideration to explain local regional patterns of soil. Following are several mechanisms by which this could occur.

## Effect of Paleoclimate

There is a wealth of reviews of paleogeographic studies in Africa that have been published (Fairbridge 1976, Williams and Faure 1980, Maley 1981). Reconstruction of the climatic history has been attempted on the basis of: (1) stratigraphic studies of stream terraces in northern Niger (Rognon and Williams 1977, Morel 1983, Durand et al. 1983); (2) correlations with lake-level fluctuations and paleoecologic (pollen and diatoms) indices in the Chad basin (Servant and Servant-Vildary 1980, Durant and Mathieu 1980, and Maley 1981); archeological sites (Hervieu 1977); geomorphic, sedimentologic, and pedologic correlations (Sombroek and Zonneveld 1971, Gavaud 1977).

The major cycles that are important to soil acidity in sandy soils of the Sahel are summarized in Table 4. Arid periods correspond to alluviation/fluvial aggradation and eolian activity, while more humid periods correspond to vegetative stabilization of the land surface, intense soil leaching, and weathering regimes. More humid climates would also reflect major periods of downcutting and the formation of multilevel plateaus in adjustment to stream-base levels.

In summary, the formation of laterite-capped multilevel plateaus (Sombroek and Zonneveld 1971), the deep weathering into Continental Terminal sandstone, the very thick acid argillic horizons in deep sandy upland soils (West et al. 1984), the presence of buried paleosols in thick eolian sandy deposits of the valley sand and sand plain systems (Daniels and Wilding 1983, West et al. 1984), and the evidence for climatic fluctuations from paleontological records are all indicative of at least a part of the soil acidity of these soils being a consequence of paleoclimatic leaching under more pluvial (wetter) conditions.

### Effect of Contemporaneous Climate on Acidity

#### Shallow Soils

Contemporaneous losses of bases from the solum are probable (Figs. 5 and 6) on plateau surfaces, upper segments of valley sand systems, and on the sand plains where shallow sandy soils overlay root and water restrictive layers (laterite, ironstone cemented gravels, and plinthic horizons). Restrict-

**Table 4. Summary of climatic history of West Africa (Bui 1986).**

| Years B.P.                   | Climate | Evidence  |
|------------------------------|---------|---|
| 0-4000                       | Arid    | Pollen and diatom assemblages;<br>Lake Chad fluctuations                  |
| 4000-12000<br>maximum 7000   | Humid   | Lake Chad high  |
| 12000-20000                  | Arid    | Lake Chad minimum; maximum<br>17000 deposition of Erg 2                   |
| 20000-29000<br>maximum 22000 | Humid   | Lake Chad maximum   |
| 29000-38000                  | Arid    | Fluvio-lacustrine and interdunal<br>evaporitic deposits in Lake Chad area |
| 38000-40000                  | Humid   | Southern margin of Lake Chad high   |
| 40000-50000                  | Arid    | Deposition of Erg 1   |

tive layers that form a graded surface serve as the interface along which water and mobile solutes are transferred beyond the limits of biocycling by plants in the immediate proximity (Fig 5A).

During periods of moisture deficit and high surface soil temperatures, water is lost by vapor transfer and thus any bases remaining in contact with the laterite are not moved back to the surface (Fig. 5B). Likewise, biocycling is not an effective mechanism of base recharge to the surface because of the paucity of bases left in the system. The only effective means of base renewal in these soils is dust inputs. However, because of the sparse vegetation, crusted soil surface, and extreme desertification on these shallow acid sandy soils, little dust can be entrapped; most will not be deposited, or if deposited, are readily removed by wind deflation and water erosion.

Where shallow sandy soils directly overlie the Continental Terminal sandstone or a plinthic horizon (iron-pan) at the interface, the soils are generally gravelly and strongly acidic. In this case, the impediment to vertical root-water movement is the plinthite horizon or the underlying sandstone. When these restrictive layers form a graded surface, losses of bases by interflow above the restrictive layers is the same as when laterite is the impediment. Acidity in these soils is a combination of strongly-weathered residual soil material coupled with contemporaneous base loss by leaching and lateral interflow.

### Deep Sandy Soils

Development of soil acidity in deep sandy soils is shown in Figure 6. During the rainy season (Fig 6A), bases and nutrients progressively move to deeper soil depths or to restrictive impermeable layers with the wetting front of successive rains. Marked soil acidity and Al saturation occurs at depths in the soil corresponding to those zones in which the greatest number and most frequent wetting fronts have occurred. Because these soils are so coarse-textured and poorly buffered, development of acidity may be closely correlated with leaching events and dynamically change seasonally with depth along the leaching front. Hydrological measurements at the ICRISAT Sahelian Center, Niger, indicate that during the rainy season, wetting fronts up to 2 m or more are possible. Hence, during these periods, bases would be transferred progressively downward depending upon the frequency and intensity of seasonal rainfall events. Where the laterite contact or other restrictive layer (Dayobu, Fig. 6A) is present within the wetting front, bases would be transferred laterally along the slope gradient as interflow similar to the process described for shallow soils. The Dayobu as an interdunal depression may also receive more intense leaching because of runoff water received from adjacent dunal crests.

Conversely, during periods of moisture stress between rainfall events of the wet season and during the long dry season, base movement is upwards

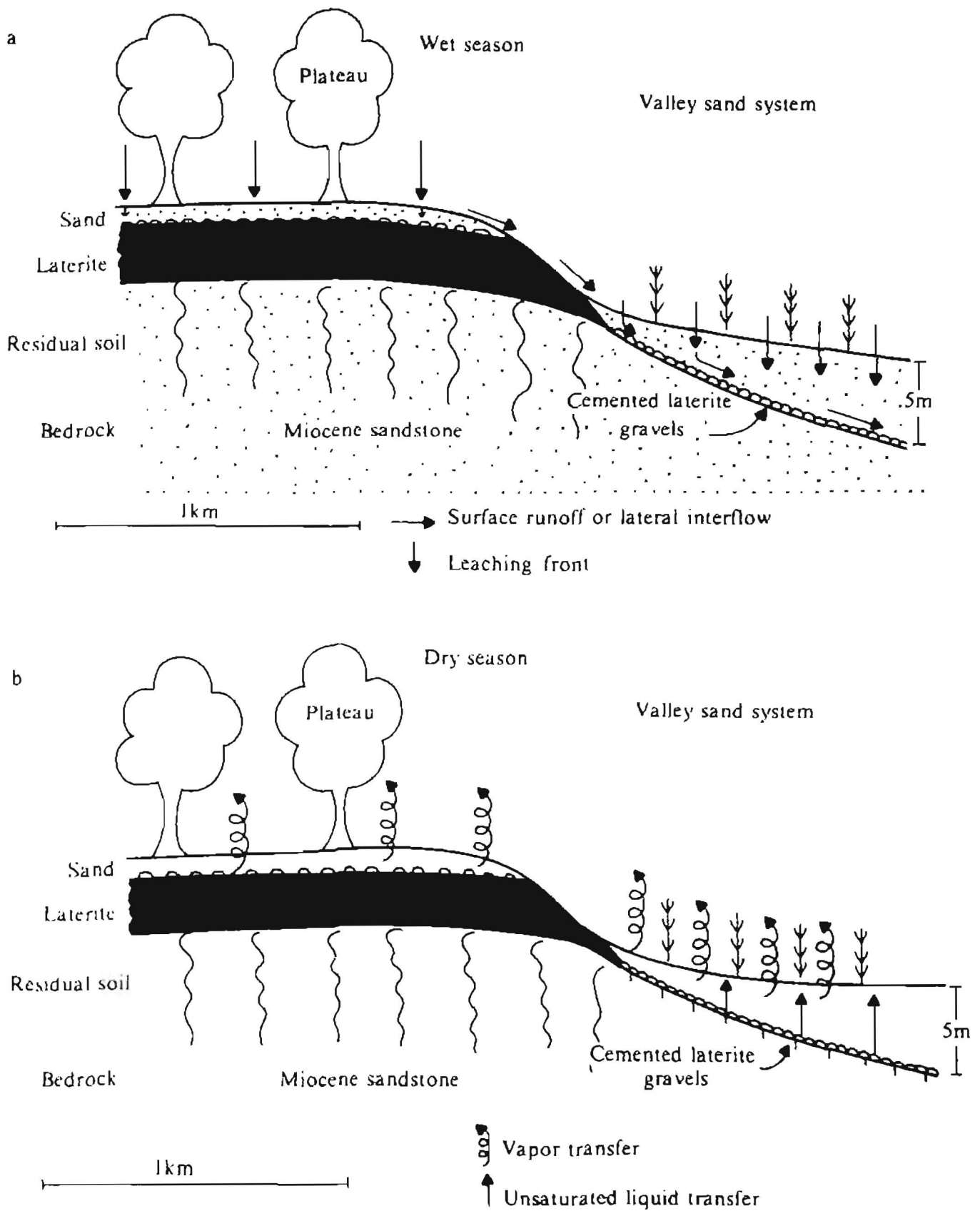

**Figure 5. Schematic illustration of plateau and associated valley sand systems. a. Vectors for leaching fronts and runoff during wet season, and b. vapor and unsaturated liquid transfer during the dry season.**

towards the soil surface via unsaturated liquid flow (evaporative or capillary pumping, (Fig. 6B). However, capillary rise is limited by the coarse-textured soils and by the depth at which most can be attributed to vapor transport

(Fig. 6B). Base recharge by evaporative pumping is thus not likely to reach the soil surface. The depth at which vapor loss of water is the primary mechanism is not known, but based on surface soil temperatures known to reach 60°C and higher dur-

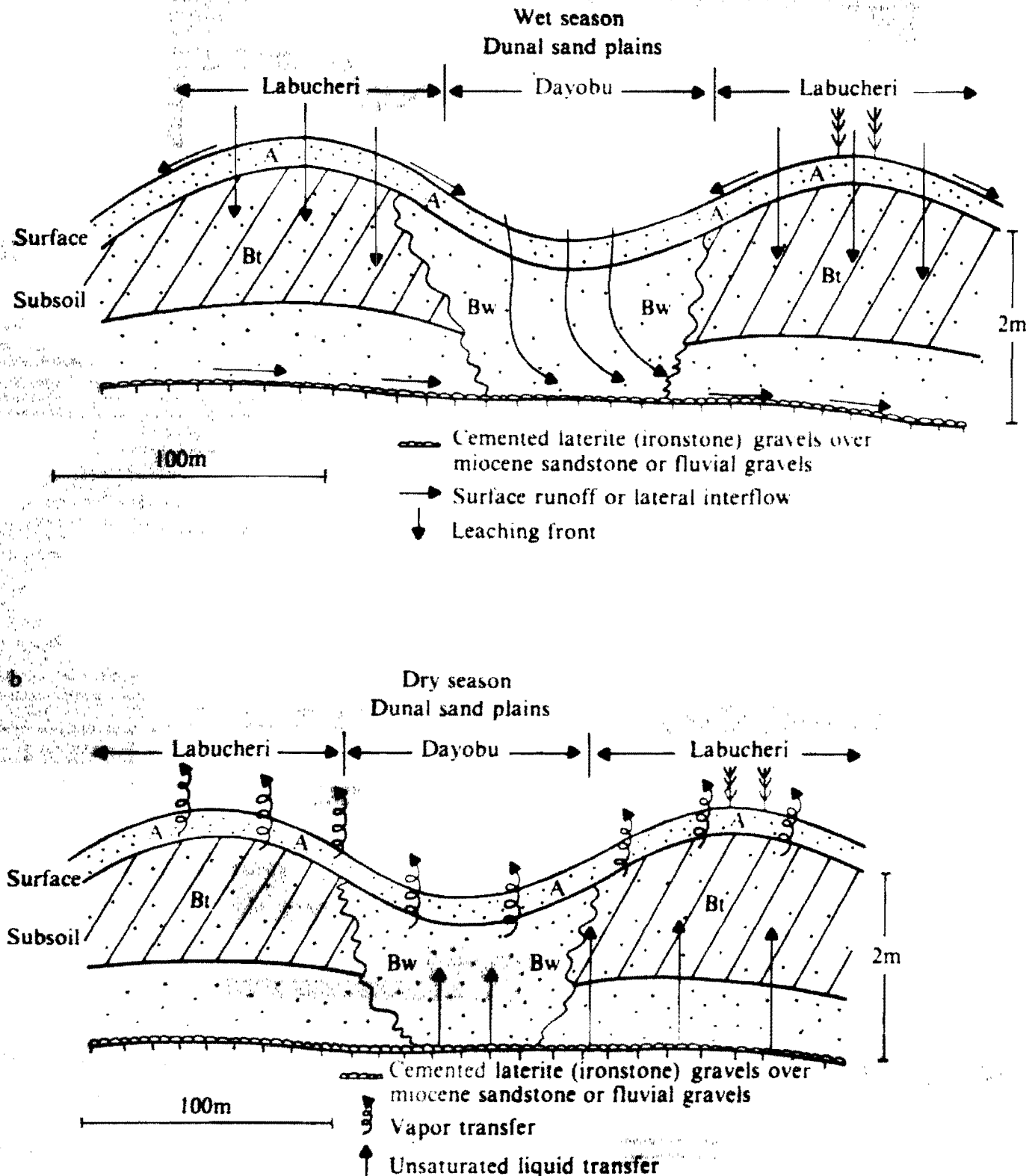

**Figure 6. Schematic illustration of dunal sand plains. a. Vectors for soil runoff and leaching fronts during the wet season, and b. vapor and unsaturated liquid transfer during the dry season.**

ing the dry season, the thermal gradient sustaining this process may be effective up to depths of 50–75 cm. Upward movement of bases that had been leached to lower depths can then be expected to rise to upper layers. At the soil surface base, renewal occurs in the form of biocycling by plants and animals (especially termites) and by dust inputs via harmattan winds from the Sahara Desert.

The vector dynamics of base loss via leaching and base renewal via biocycling, dust inputs, and evaporative pumping may help explain the base-saturation and Al-saturation depth functions observed in deep sandy soils (Figs. 2 and 3). Soils without a restrictive layer within the wetting front (Labucheri, Fig. 2) have maximum Al saturation and minimum base saturation in a zone immediately below the soil surface to a depth of about 60 cm. Soils such as Dayobu (Fig. 3) and Gagani (Fig. 4) with restrictive layers intercepting the wetting front have similar bases and Al-saturation depth functions but tend to remain more acidic throughout. This is explained by the fact that bases are seasonally lost from these systems as interflow leachates above the impediments to lower landscape positions. Evaporative pumping and biocycling of bases occur as in the Labucheri soils but there are relatively few bases in the system to be recycled except for dust inputs. Hence the soils tend to remain strongly acidic throughout, contrast to deep sandy soils without restrictive layers.

Considering the low buffering capacities of these soils and the proposed chemical dynamics, caution should be exercised in interpreting data sets collected at only one point in time. Data reported here were collected on soils sampled during the 1982 rainy season. One can only speculate on the nature of the chemical properties had these soils been sampled sequentially during the rainy season or during the dry season. This is an important agronomic question worthy of future research efforts. Such research is being planned within the SAT Tropsoils CRSP program.

## Effects of Soil Acidity

### Major Soil Constraint to Land Use

Spatial variability in farmers fields occurs on a broad scale in the Sahel. A significant proportion of this variability is apparently associated with soil acidity, although it is recognized that there are

other factors that contribute to the observed variability, e.g. termite mounds, and previous village sites. The exact land area where crops are affected by acid soils is unknown but preliminary observations indicate that it is substantial.

The primary effects of acid soils on agriculture on the Sahel are threefold: (1) crops and cropping systems are limited by their tolerance to acid soils, (2) the full potential for soil productivity cannot be realized until soil acidity problems are diagnosed and treated, and (3) areas devoid of vegetation owing to acid soils hasten desertification in the Sahel.

Acid soils affect a number of soil chemical and biological properties. Decreasing soil pH is associated with increasing aluminum (Al) and manganese (Mn) availability. Below pH values of approximately 5, concentrations of these elements may increase to levels that are toxic to plant. Low soil pH is also associated with lower concentrations of basic cations (calcium, magnesium, and potassium, Tables 1–3) available to plants. Root growth and water-use efficiency of plants are both restricted in acid soil systems with pH values low enough to have toxic levels of Al and/or Mn.

### Soil Acidity and Cropping Systems

Efficient use of native and applied nutrients and water can never be realized until soil acidity problems have been resolved. The choice of crops and, therefore, cropping systems will be limited to crops and cultivars that are acid tolerant in areas where soil acidity is extensive (Sanchez 1976, 223–253 pp.).

The presence of acid soils in the semi-arid region of the tropics is noteworthy in itself. That significant areas of the Sahel are negatively affected by soil acidity is particularly important. The introduction of higher-yielding cultivars of pearl millet, sorghum, or other crops that could be grown in the Sahel will be limited to acid-tolerant varieties.

Efficient use of water resources is limited in areas where crop growth is influenced by soil acidity. Introduction of fertilizers into the cropping system, particularly acid-forming ammonium-based materials, to the poorly buffered, sandy soils will tend to lower soil pH with time. Since the soil resource is very fragile, methods to correct acidity and chemical treatments to increase crop yields must be carefully considered.

## Desertification of the Sahel

Causes of desertification in the Sahel are both natural and man made (Thatcher 1979, Thomas 1980). Surface or subsurface soil acidity that negatively affects plant growth contributes to desertification in the Sahel. Bare or partially vegetated soil surfaces are subject to wind and water erosion (tiger bush plateau uplands), both of which may expose acid subsoils. Poorly-vegetated soil promotes water runoff due to a lack of impedece of water to overland flow, and due to crusting from rainfall impact that can result in clay and silt dispersion and partial surface sealing. Crusting of the sandy surface soils is expected to be minimal in the Sahel but exposure of the acid argilic subsoils could dramatically increase water runoff. Further, because such areas respond poorly to pearl millet/cowpea production, the land is used for pastoral grazing of animals and harvesting wood for fuel and for construction. This increases animal traffic and compaction, and intensifies the desertification process.

Lack of vegetation and soil litter also enhances wind erosion and movement of surface soil. Properly vegetated lands act as a deterrent to soil movement by wind erosion.

### Plant Response Variability

Fields with very acidic soils show striking plant response and spatial variability over very short distances. Pearl millet growth often decreases from very productive regions to completely barren areas over distances varying from 2 to 10 m. (Wendt 1986). The zones between these irregularly distributed productive and unproductive regions are characterized by gradually declining pearl millet growth, as defined by smaller plants, delayed maturity, shorter and more poorly filled heads, and diminished yields. Pearl millet germinates uniformly in all areas of the field and growth appears to be essentially uniform until one or two weeks after emergence. Differences in growth become apparent at this time. The plants in the most unproductive regions eventually die, leaving places in the fields devoid of vegetation. Completely barren areas appear to be larger in regions of marginal rainfall. Poor stands also appear to be associated, though not consistently, with micro-low regions in the field topography (Wendt 1986).

Potential pearl millet yield, lost owing to soil acidity problems in the Sahel have not yet been quantified. Extreme variability not only severely reduces yields, but is also a major obstacle to other field research efforts. Differences between treatments are difficult to detect because of large variation between replications within a given treatment. Hence, soil acidity is not only a soil management problem for farmers but has a significantly negative impact on agronomic research endeavors in the Sudano-Sahelian zone of Africa.

## References

- Allen, B.L., and Fanning, D.S.** 1983. Composition and soil genesis. Pages 141-192 in *Pedogenesis and soil taxonomy. I. Concepts and interactions* (Wilding L.P., Smeck N. E., and Hall, G.F., eds.). *Developments in Soil Science* no. 11A. Amsterdam, Netherlands: Elsevier.
- Bui, E.** 1986. Relationships between pedology, geomorphology, and stratigraphy in the Dallol Bosso of Niger, West Africa. Ph. D. thesis, Texas A&M University, College Station, Texas, USA. 226 pp.
- Chase, R., Wendt, J.W., and Hossner, L.** 1989. A study of crop growth variability in sandy Sahelian soils. Pages 229-240 in *Soil, Crop, and Water Management Systems for Rainfed Agriculture in the Sudano-Sahelian Zone: proceedings of an International Workshop, 11-16 Jan 1987, ICRISAT Sahelian Center, Niamey, Niger*. Patancheru, A.P. 502 324, India: ICRISAT.
- Daniels, R. B., and Wilding, L. P.** 1983. Report of soil/geomorphological relationships in areas surrounding ICRISAT Sahelian Center. College Station, Texas, USA: Texas A&M University, Soil and Crop Sciences Department.
- Durand, A., and Mathieu, P.** 1980. Evolution paléogéographique et paléoclimatique du bassin tchadien au Pléistocène supérieur. (In Fr.) *Revue de géologie dynamique et de géographie physique* 22: 329-341.
- Durand, A., Lang, J., Morel, A., and Roset, J.P.** 1983. Evolution géomorphologique, stratigraphique et paléoclimatologique au Pléistocène supérieur et à l'Holocène de l'Air oriental (Sahara méridional, Niger). (In Fr.) *Revue de géologie dynamique et de géographie physique* 24: 47-59.

- Fairbridge, R.W.** 1976. Effects of Holocene climatic change on some tropical geomorphic processes. *Quaternary Research* 6: 521–556.
- Gavaud, M.** 1966. Etude pédologique du Niger occidental—rapport général. Vols. 2 and 3. (In Fr.) Dakar, Sénégal: ORSTOM (Office de la recherche scientifique et technique d'outre-mer).
- Gavaud, M.** 1977. Les grands traits de la pédogénèse au Niger méridional, Travaux et documents de l'ORSTOM. (In Fr.) Paris, France: ORSTOM (Office de la recherche scientifique et technique d'outre-mer.)
- Greigert, J.** 1966. Descriptions des formations crétacées et tertiaires du Bassin des Iullemeden (Afrique Occidentale). (In Fr.) Paris, France: Bureau de recherches géologiques et minières.
- Hagen, R.J., Brown, J., and Sowers, F.** 1986. Agro-ecological zonation study of the Niamey Department, Niger. Prepared for USAID IQC No. PDC-1406-I-03-4093-00. Placerville, California, USA: Resources Development Association. 257 pp.
- Hervieu, J.** 1977. Témoins paléoclimatiques et environnement préhistorique dans le massif de Termit (Niger Oriental). (In Fr.) Cahiers ORSTOM, Série Géologie 9: 3-14.
- Maley, J.** 1981. Etude palynologique dans le bassin du lac Tchad et paléoclimatologie de l'Afrique nord-tropicale de 30 000 ans à l'époque actuelle. Travaux et documents de l'ORSTOM. (In Fr.) Paris, France: ORSTOM (Office de la recherche scientifique et technique d'outre-mer).
- Morel, A.** 1983. Erosion et sédimentation dans le massif de l'Aïr (Sahara méridional): essai d'interprétation paléoclimatique de la moyenne terrasse. (In Fr.) Cahiers ORSTOM, Série Géologie 13: 111–118.
- Nettleton, W.D., and Peterson, F. F.** 1983. Aridisols. Pages 165–215 in *Pedogenesis and soil taxonomy. II. The soil orders* (Wilding, L.P., Smeck, N.E., and Hall, G.F. eds.). *Developments in Soil Science* no. IIB. Amsterdam, Netherlands: Elsevier.
- Rognon, P., and Williams, M.A.J.** 1977. Late quaternary climatic change in Australia and North Africa: preliminary interpretation. *Palaeogeography, Palaeoclimatology, Palaeoecology* 21: 285–327.
- Sanchez, P.A.** 1976. Properties and management of soils in the tropics. New York, USA: John Wiley.
- Servant, M., and Servant-Vildary, S.** 1980. L'environnement quaternaire du lac Tchad. (In Fr.) Pages 133–162 in *The Sahara and the Nile* (Williams, M.A.J. and Faure, H., eds.). Rotterdam, Netherlands: A.A. Balkema.
- Sombroek, W.G., and Zonneveld, I.M.** 1971. Ancient dune fields and fluvial deposits in the Rima-Sokoto river basin (N.W. Nigeria). *Soil Survey Paper no. 5*. Wageningen, Netherlands: Netherlands Soil Survey Institute. 109 pp.
- Thatcher, P.S.** 1979. Desertification: the greatest single environmental threat. *UNEP Desertification Control Bulletin* 2(1).
- Thomas, G.** 1980. The Sahelian/Sudanian zones of Africa: profile of a fragile environment. *International Publication Series. Technical Information Publication no. 0001-81*. Las Cruces, New Mexico, USA: New Mexico State University.
- Wendt, J.W.** 1986. Pearl millet (*Pennisetum typhoides*) response to soil variability in sandy Ustalfs near Niamey, Niger, West Africa. M.S. thesis, Texas A&M University, College Station, Texas, USA.
- West, L.T., Wilding, L.P., Landeck, J.K., and Calhoun, F.G.** 1984. Soil survey of the ICRISAT Sahelian Center, Niamey, Niger. College Station, Texas, USA: Texas A&M University.
- West, L.T., Wilding, L.P., and Calhoun, F.G.** 1987. Argillic horizons in sandy soils of the Sahel, West Africa. Pages 221–225 in *Micromorphologie des sols: proceedings of the 8th International Working Meeting on Soil Micromorphology* (Federoff, N., Bresson, L.M., and Courty, M.A., eds.). Plaisir, France: Association française pour l'étude du sol.
- Williams, M.A.J., and Faure, H. (eds.)** 1980. *The Sahara and the Nile*. Rotterdam, Netherlands: A. A. Balkema. 607 pp.





# A Study of Crop Growth Variability in Sandy Sahelian Soils

R.G. Chase<sup>1</sup>, J. W. Wendt<sup>2</sup> and L.R. Hossner<sup>3</sup>

## Abstract

*Marked spatial variability in crop growth over short distances in sandy Sahelian soils (psammentic Palenstalf, sandy siliceous, isohyperthermic) causes yield reductions within a farmer's field and complicates analysis of results from field experiments. Planting pearl millet in a field for two consecutive years indicated that the location of the areas of poor soil does not change perceptibly between years, and that crops are more affected in bad years than in good years.*

*Relating plant height to soil physical and chemical properties at 101 points on two transects showed high correlations with soil acidity and other properties. Data taken from an area 20 km from Sadoré supported this finding. Analysis of surface soil samples and profiles taken along a transect between areas of healthy and poor crop growth show that acidity decreases and alkalinity increases as the healthy area is approached, and that healthy areas have soils with low acidity (<50% Al + H saturation) down to 35-cm depths, while poor soils are acidic on the surface (<5 cm).*

*Pot studies and subsequent plant analyses of 4-6 week-old seedlings showed high Al (>1400 mg kg<sup>-1</sup>) and Mn (>1600 mg kg<sup>-1</sup>) levels in plants grown in poor soils. Al tissue contents of >600 mg kg<sup>-1</sup> were consistently associated with poor plant growth. Liming poor soils two weeks before planting reduced Mn tissue but did not reduce Al tissue or improve plant growth. In sum, plants grown in good soils respond far more strongly to fertilizer applications than plants grown on poor soils.*

## Résumé

**Variabilité spatiale des cultures des sols sahéliens :** *Une forte variabilité spatiale de la croissance des cultures sur de petites distances dans les régions sahéliennes de sols sableux (psammentic Palenstalf, sables, silices, isohyperthermique) diminue les rendements des cultures et complique l'analyse des résultats découlant des expériences menées par les chercheurs. Des semis de mil pendant deux années consécutives dans un même champ ont indiqué : l'absence d'un déplacement perceptible des poches de sols médiocres d'une année à l'autre, et l'aggravation du préjudice porté aux cultures pendant les mauvaises années par rapport aux bonnes années.*

*La mise en relation de la hauteur des plantes et des propriétés physico-chimiques du sol le long de deux transects a montré une forte corrélation entre l'acidité du sol et les propriétés y afférentes. Les données recueillies dans un rayon de 20 km ont corroboré cette constatation. L'analyse des échantillons et des profils des sols en surface suivant une ligne transversale séparant les zones de bonne et médiocre croissance montre : une diminution de l'acidité et une augmentation des bases à mesure que l'on se rapproche de la zone où la croissance est bonne, et*

1. Team Leader, SECID: South East Consortium for International Development, Farming Systems Project, Bamako, Mali.

2. Ph.D. candidate, Purdue University, Lafayette, Indiana, USA.

3. Professor, Texas A&M University/ Tropsoils, College Station, Texas, USA.

*une faible acidité des bons sols (50% Al + saturation H) jusqu'à une profondeur de 35 cm tandis que les sols pauvres sont acides en surface (5 cm).*

*Des études en pot et l'analyse des plantules âgées de quatre à six semaines ont montré que les plantes cultivées sur sols médiocres étaient caractérisées par des teneurs élevées en Al (1400 ppm) et en Mn (1600 ppm). Les plantes ayant une teneur en Al 600 ppm étaient toujours associées à une faible croissance. D'une façon générale, la réponse des plantes aux engrais est de loin supérieure en sols riches qu'en sols pauvres. On a mis en évidence un effet positif de la chaux sur la diminution en Mn, mais non en Al.*

## Introduction

In many areas of the Sahel, crops grown on sandy soils display a marked degree of spatial variability in crop establishment, growth, and yield within a single field. In some cases, the variability in crop growth is because of the physical and biological properties of the coarse, poorly buffered soil system. While crop variability may frequently be attributed to the existence of termite mounds, proximity to trees, previous human activity (Chase 1984, Moorman and Kang 1978), soilborne pests (Germani and Reversat 1982), or various pedogenic processes (Wilding and Drees 1978, Van Wambeke and Dudal 1978), a particularly pronounced variability exists, which has a different cause. In such cases, patches of poor pearl millet growth, 6–30 m in diameter virtually next to highly productive stands cause yield losses and confound treatment effects in researchers' field experiments (Moorman and Kang 1978).

The objectives of the studies reported here were to determine the causes of variability, and to seek methods to eliminate the sources of this variability.

## Symptoms

In the agricultural fields near Niamey, Niger, patches of poor pearl millet (*Pennisetum americanum*) growth are often observed in farmers' fields and on research station plots. They are frequently associated with slightly depressed areas in the fields, and often have darker surface soil than that in adjacent productive regions, and a weak, porous crust. Productive regions, in contrast, are often associated with slightly elevated regions and loose, very sandy soils. Symptoms of poor growth begin to appear in pearl millet 1–2 weeks after emergence. The seedlings exhibit stunted growth and the leaves curl longitudinally, often turning yellow,

purple, or brown. If soil-moisture remains high, less-affected plants may continue to grow and may eventually produce a small head. The more-affected plants die if deprived of water even for a short period. Cowpea crops (*Vigna unguiculata*) when affected become yellow and grow more slowly but usually do not die.

## Materials and Methods

### The Site

Preliminary studies were conducted at the ICRI-SAT Sahelian Center (ISC), located approximately 40 km southeast of Niamey, Niger, West Africa (13° 15' N latitude 2° 18' E longitude), at an altitude of 240 m. The site is located on a sand plain with 2–8 m thick eolian sands covering one of a series of stepped surfaces comprised of cemented laterite gravels (West et al. 1984). The soil is sandy, siliceous, isohyperthermic Psammentic Paleustalf, comprised of approximately 90% sand. The surface horizon (25–30 cm thick) is a yellowish red sand underlain by a thick (>1 m) red loamy sand or red sand horizon.

Rainfall is highly irregular both in distribution and total amount during the short (approximately 4 mo) rainy season. Long-term mean annual rainfall for the Kolo research station, about 20 km from the ISC, is 574 mm, with a 90% probability of receiving more than 380 mm (Sivakumar et al. 1979). Annual rainfall at the ISC during the studies described here was between 240–680 mm.

The site had been used for a traditional pearl millet-fallow rotation before being donated to the ISC. Two years of fertilized crops had been grown on the 2-ha experimental field before the present studies were begun. Previous experiments there could not be interpreted due to the extreme variability in crop growth. Soils at the ISC are represen-

tative of the large surrounding pearl millet-growing areas. To extend the applicability of this on-station study, three additional sets of soil samples (per field) were taken from similar soils from three off-station fields within 20 km of the ISC site, where variability in crop growth had been observed.

### Soil Sampling and Analysis

To determine causes of crop variability, two 50 m × 50 m transects that intersected perpendicularly at their midpoint were established. They extended over both productive and unproductive crop growth areas. Soil samples (0–15 cm depth) were taken at 1-m intervals along each transect. They were analyzed by the Institut national de recherches agronomiques du Niger (INRAN) for organic matter, P (Bray I), particle-size distribution, cation exchange capacity (CEC), bases (K, Ca, Mg, and Na), and effective CEC. Soil pH (1:2.5 in both H<sub>2</sub>O and KCl), exchangeable acidity and Al, soil bulk density, soil surface elevation, and plant height were determined. All soil parameters were regressed against plant height of pearl millet grown in pockets adjacent to each sampling site.

In another study, 26 soil samples (0–15 cm depth) were collected at regular intervals along a 15-m transect where pearl millet development declined somewhat regularly (i.e., from superior growth to plant death). In addition, soil samples were collected in increments to a depth of 70 cm at each end and at an intermediate location on the transect. All soils were analyzed for bases, pH, and exchangeable Al and Al+H. The bulk of the 26 samples taken along the transect were then used in pot studies.

### ISC Field Studies

Field studies were conducted at the ISC from 1984 through 1985 to estimate the extent and severity of variability in crop growth. In 1984, pearl millet (var. CIVT) was machine-planted at a 1.0 × 0.75-m grid spacing in a 2-ha field. Simple superphosphate (SSP) was machine-banded at the time of seeding at a rate of 150 kg ha<sup>-1</sup> (15 kg P ha<sup>-1</sup>). Urea (100 kg ha<sup>-1</sup>) was applied by hand adjacent to each hill, half at planting and half at first weeding [about 15 days after planting (DAP)]. Approximately 30 DAP, plants were measured in the 50 × 50-m square defined by the intersecting transects described

above. Head number, length, and weight were recorded for each hill at harvest.

In 1985, the field was planted and fertilized at the same rates and times as in 1984. Hand planting permitted hills to be placed at the recommended 1 × 1-m spacing. Plant heights and yield parameters were recorded in the 50 × 50-m subplot as in 1984. Soil samples were collected on a 4 × 4-m grid and analyzed for pH (H<sub>2</sub>O and KCl), exchangeable acidity, and Al.

### Pot Studies

Four pot studies were conducted during the 1984–1985 dry season. Their objectives were:

- Study 1: To determine the effect of soils taken along a transect between productive and unproductive field regions on pearl millet seedling root and shoot growth, and shoot mineral composition.
- Study 2: To determine the effects of lime and Ca applied to productive and unproductive soils on pearl millet seedling root and shoot growth, and shoot mineral composition.
- Study 3: To determine the effect of nutrient applications, both individually and in selected combinations, on pearl millet seedling root and shoot growth, and shoot mineral composition.
- Study 4: To repeat the third study using different combinations and a soil-sterilization treatment to test for biotic factors.

For the first study, the 26 soil samples collected along the transect between productive and unproductive field regions, discussed above, were mixed individually. Four replications from each of the 26 soil sites, using 7.5 kg of air-dried soil per pot, were employed. Without further treatment, pearl millet was grown for 37 days, and then harvested. Plant shoots and roots were dried and weighed, and shoots digested and analyzed for mineral composition.

Studies 2, 3, and 4 were carried out using soils from extremely productive and unproductive areas of the experimental field. Each of the two types of soils was mixed and 10 kg of soil used in each pot. Amendments (Wendt 1986, Table 1) were added 2 weeks before pearl millet was planted. Five replications of each treatment were employed. Plants were thinned to four per pot after the first week, and were allowed to grow for 28 days before harvesting. Harvested plants were treated as in the first

**Table 1. Pearl millet shoot growth in liming trial (Wendt 1986).**

| Amendment                            | Rate<br>(kg ha <sup>-1</sup> ) | Lime<br>factor | Shoot wt.<br>(g pot <sup>-1</sup> ) | pH   |
|--------------------------------------|--------------------------------|----------------|-------------------------------------|------|
| <b>Productive soil site</b>          |                                |                |                                     |      |
| (Control)                            | 0                              | 0              | 0.831efg <sup>2</sup>               | 5.42 |
| Ca(OH) <sub>2</sub> +MgO             | 27                             | 1              | 0.999fgh                            | 5.69 |
| Ca(OH) <sub>2</sub> +MgO             | 54                             | 2              | 0.795ef                             | 5.69 |
| Ca(OH) <sub>2</sub> +MgO             | 108                            | 4              | 0.882efgh                           | 6.28 |
| Ca(OH) <sub>2</sub> +MgO             | 216                            | 8              | 0.686de                             | 6.96 |
| Ca(OH) <sub>2</sub> +MgO             | 540                            | 20             | 0.848efg                            | 8.18 |
| Ca(OH) <sub>2</sub>                  | 35                             | 1              | 0.876efgh                           | 6.02 |
| Ca(OH) <sub>2</sub>                  | 70                             | 2              | 0.799ef                             | 5.86 |
| Ca(OH) <sub>2</sub>                  | 140                            | 4              | 0.677de                             | 6.32 |
| Ca(OH) <sub>2</sub>                  | 280                            | 8              | 0.786ef                             | 7.18 |
| Ca(OH) <sub>2</sub>                  | 700                            | 20             | 0.489cd                             | 8.33 |
| CaCl <sub>2</sub> ·2H <sub>2</sub> O | 69                             | 1              | 1.115h                              | 5.97 |
| CaCl <sub>2</sub> ·2H <sub>2</sub> O | 139                            | 2              | 1.082gh                             | 5.72 |
| CaCl <sub>2</sub> ·2H <sub>2</sub> O | 278                            | 4              | 0.648de                             | 5.42 |
| CaCl <sub>2</sub> ·2H <sub>2</sub> O | 556                            | 8              | 1.105fgh                            | 5.94 |
| <b>Unproductive soil site</b>        |                                |                |                                     |      |
| (Control)                            | 0                              | 0              | 0.236b                              | 4.59 |
| Ca(OH) <sub>2</sub> +MgO             | 244                            | 1              | 0.250bc                             | 5.98 |
| Ca(OH) <sub>2</sub> +MgO             | 489                            | 2              | 0.194ab                             | 7.10 |
| Ca(OH) <sub>2</sub> +MgO             | 978                            | 4              | 0.148ab                             | 8.39 |
| Ca(OH) <sub>2</sub> +MgO             | 1955                           | 8              | 0.057ab                             | 9.25 |
| Ca(OH) <sub>2</sub>                  | 316                            | 1              | 0.233b                              | 6.02 |
| Ca(OH) <sub>2</sub>                  | 630                            | 2              | 0.141ab                             | 7.08 |
| Ca(OH) <sub>2</sub>                  | 1260                           | 4              | 0.121ab                             | 8.91 |
| Ca(OH) <sub>2</sub>                  | 2520                           | 8              | 0.078ab                             | 9.28 |
| CaCl <sub>2</sub> ·2H <sub>2</sub> O | 627                            | 1              | 0.067ab                             | 5.13 |
| CaCl <sub>2</sub> ·2H <sub>2</sub> O | 1254                           | 2              | 0.035ab                             | 5.09 |
| CaCl <sub>2</sub> ·2H <sub>2</sub> O | 2507                           | 4              | 0.000a                              | 5.15 |
| CaCl <sub>2</sub> ·2H <sub>2</sub> O | 5016                           | 8              | 0.000a                              | 4.88 |

1. Denotes the multiple of equivalents of exchangeable acidity in the soil that the applied lime can neutralize. For the CaCl<sub>2</sub>·2H<sub>2</sub>O treatments, it refers to the calcium equivalents relative to the limed soils.

2. Means not followed by the same letter are significantly at  $P = 0.05$  by Duncan's multiple range test.

pot study. In all four pot studies, pots were watered regularly with well water from ISC whose properties are nearly equivalent to rainwater.

## Results and Discussion

### Analysis of Soils

Chemical and physical parameters from the 101 soil samples collected from the intersecting 50-m transects were statistically compared to pearl millet

plant heights 35 DAP. The highest correlations were obtained between plant height and percentage of silt ( $r = -0.35^{**}$ ), exchangeable Al+H ( $r = 0.33^{**}$ ), exchangeable Al ( $r = -0.36^{**}$ ), and soil pH ( $r = 0.22^{**}$ ). Exchangeable bases and CEC, both related to pH in these acid soils, were also highly correlated with plant height.

To determine if soil acidity was related to poor crop growth in other areas as well, three paired samples from adjacent productive and unproductive regions were taken from similar soils in three farmers' fields within 20 km of the ISC. In all three

cases, the relationship between soil acidity parameters and plant growth was highly significant (Table 2). The same relationship was observed in the experiment using soils taken along the transect described above. Analyses of the surface 15-cm of soil showed that pH increased and exchangeable acidity (Al+H) decreased along the transect leading to the productive site (Fig. 1). Exchangeable Ca, Mg, and K also increased (Wendt 1986). Al saturation ( $r = -0.95$ ), exchangeable Ca ( $r = 0.88$ ), Mg ( $r = 0.94$ ), Al ( $r = -0.95$ ), Al+H ( $r = -0.96$ ), and pH ( $r = 0.96$ ) correlated strongly with the position on the transect.

Soil-profile samples at the two extremes and at the midpoint of the transect were analyzed. The chemical analyses indicated a very low effective CEC ( $<1.3 \text{ cmol kg}^{-1}$ ) and highly variable amounts of exchangeable cations. Of particular interest is the variation in the exchangeable Al+H saturation, i.e., the percentage of exchangeable Al+H vs the sum of the exchangeable Ca, K, Mg, Na, and Al+H (Fig. 2). All soils had a low Al+H saturation at the

**Table 2.** Soil chemical parameters in farmers' fields as a function of crop growth ( $n = 3$ ).

| Area                              | pH (H <sub>2</sub> O) | pH (KCl) | Exchangeable Al+H (cmol kg <sup>-1</sup> ) | Exchangeable Al (cmol kg <sup>-1</sup> ) |
|-----------------------------------|-----------------------|----------|--|--|
| Area with poor pearl millet yield | 5.06                  | 3.99     | 0.42                                       | 0.17                                     |
| Area with good pearl millet yield | 5.86                  | 4.74     | 0.15                                       | 0.00                                     |
| SE                                | ±0.19                 | ±0.18    | ±0.06                                      | ±0.04                                    |
| CV (%)                            | 8.50                  | 10.30    | 50.80                                      | -  |

surface, however the Al+H saturation of the unproductive extreme of the transect increased to 45% at a depth of only 3.5 cm. The Al+H saturation at the productive extreme increased more gradually,

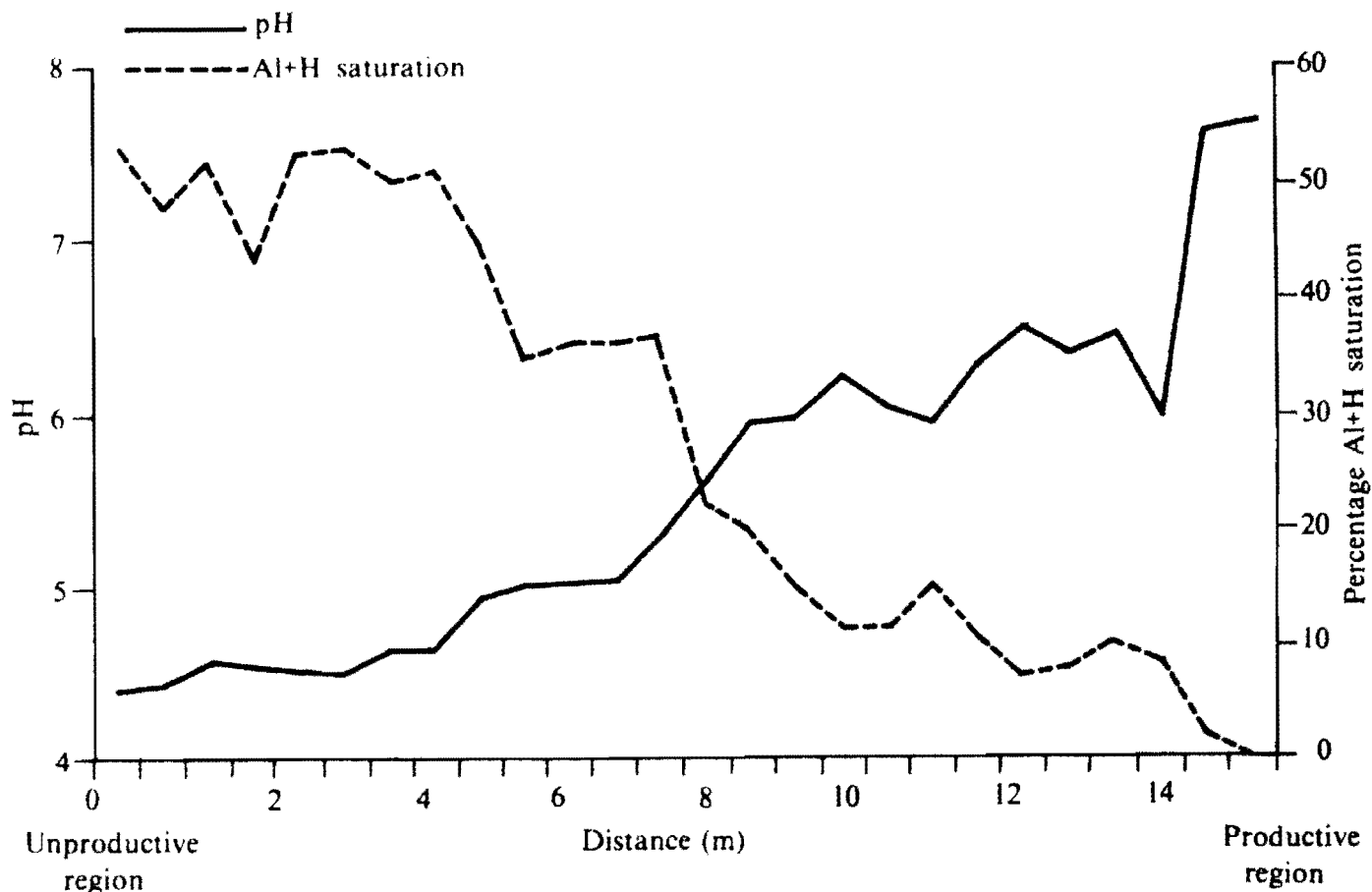

**Figure 1.** Percentage Al+H saturation and pH of the surface 15-cm of soil along a transect from an unproductive to a productive region (Wendt 1986).

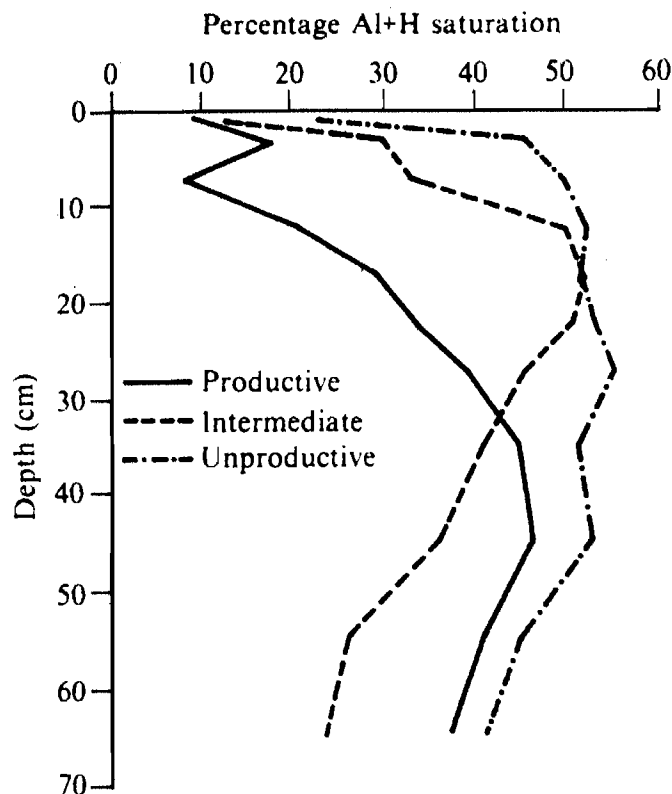

Figure 2. Percentage Al+H saturation with depth along a transect from an unproductive to a productive region (Wendt 1986).

reaching 45% saturation at a depth of 35-cm. The soil at the midpoint of the transect was saturated with 45% Al+H at about 12-cm. All soils had potentially toxic levels of exchangeable Al within 35-cm of the surface. Increases in exchangeable Al+H were accompanied by decreases in exchangeable Ca and K in all profiles (Wendt 1986).

### Field Studies

In 1984, 4.7% of the 2-ha research field used at ISC was found to be totally barren, while 9% was found

to produce exceptional pearl millet stands. To show the dramatic effect of short-distance changes in crop growth, two adjacent subplots were harvested and compared (Table 3). The better of the two plots yielded over eight times the grain harvested from the poor plot. Analysis of all sites in the 50 × 50 m area showed that if the entire area yielded at levels observed in the upper 10% of the sites, grain production for the field would quadruple. This suggests that far more than the 4.7% completely barren area is being affected and may respond to soil amendments.

A comparison of the growth patterns in 1984 and 1985 within the 50 × 50-m area made it apparent that given locations remained unproductive over the 2 years. However, the crop was less affected during the wetter 1985 season than in the droughty 1984 season. This difference is believed by the authors to be due to the death of marginal plants in the drier 1984 that would have survived under more humid conditions.

## Pot Studies

### Soil Collected Along a Transect

Plant biomass and pearl millet shoot mineral concentration as a function of position along the transect between unproductive and productive field regions were closely correlated with mineral concentration in the soil (Wendt 1986). Extremely high concentrations of Al (>1400  $\mu\text{g g}^{-1}$ ) and Mn (>1650  $\mu\text{g g}^{-1}$ ) suggest that both of these elements may have reached toxic levels in some plants. Pearl millet shoot weight correlated extremely well ( $r = -0.89$ ) with plant Al concentration (Fig. 3). The critical Al concentration for pearl millet growth appears to be <600  $\mu\text{g g}^{-1}$ . Plant Mn concentration correlated strongly with soil pH (Fig. 4). However, it did not correlate well with pearl millet shoot weight, and proved to be an insignificant factor in

Table 3. Pearl millet yields measured in two 7 m × 5.25 m plots separated uniformly by one meter in a research field and fertilized at the ICRISAT Sahelian Center in 1984.

| Total hills | Surviving hills | Number of heads | Head weight                        | Grain weight | Stalk weight |
|-------------|-----------------|-----------------|------------------------------------|--------------|--------------|
|             |                 |                 | ----- (kg ha <sup>-1</sup> ) ----- |              |              |
| 49          | 11              | 27              | 158                                | 124          | 470          |
| 49          | 44              | 157             | 1302                               | 1030         | 2340         |

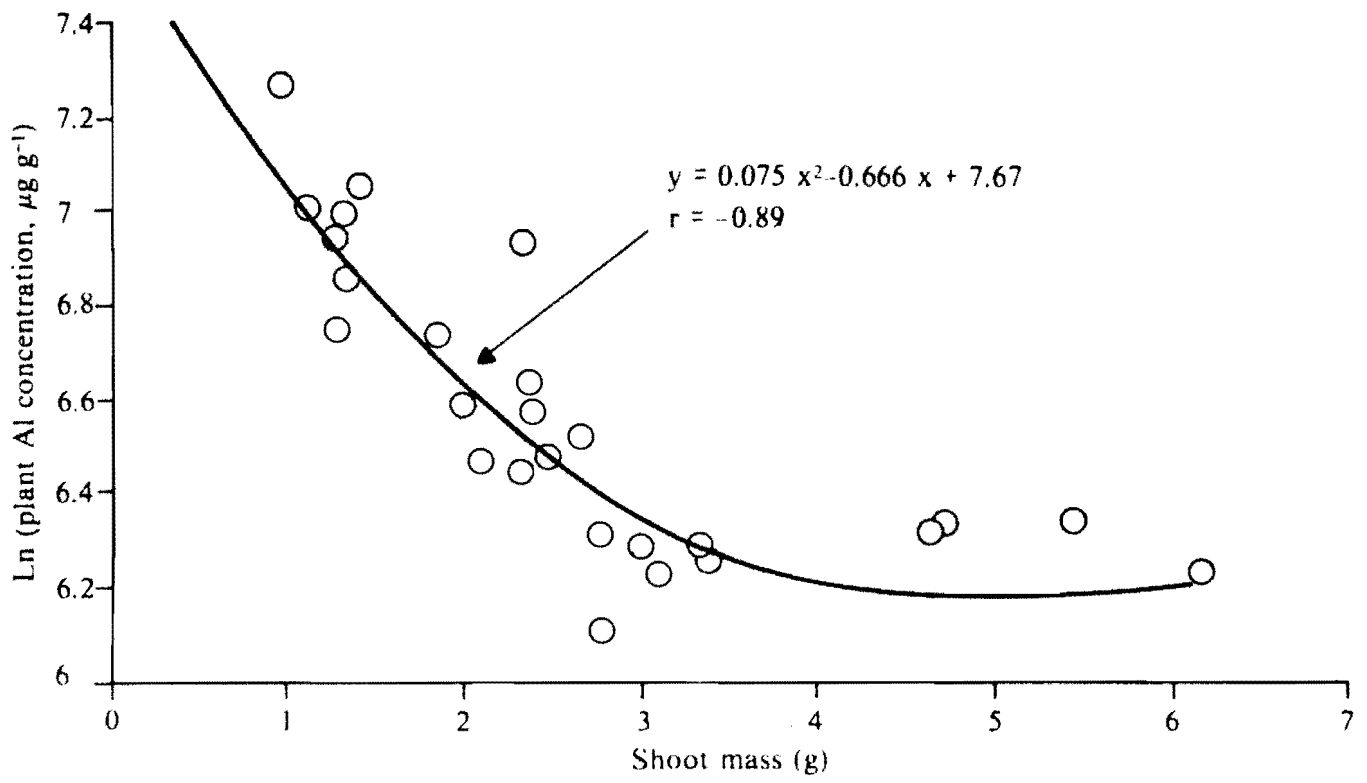

Figure 3. Ln (Al concentration) vs shoot mass for plants grown in the surface 15-cm of soil taken along a transect from an unproductive to a productive region (Wendt 1986).

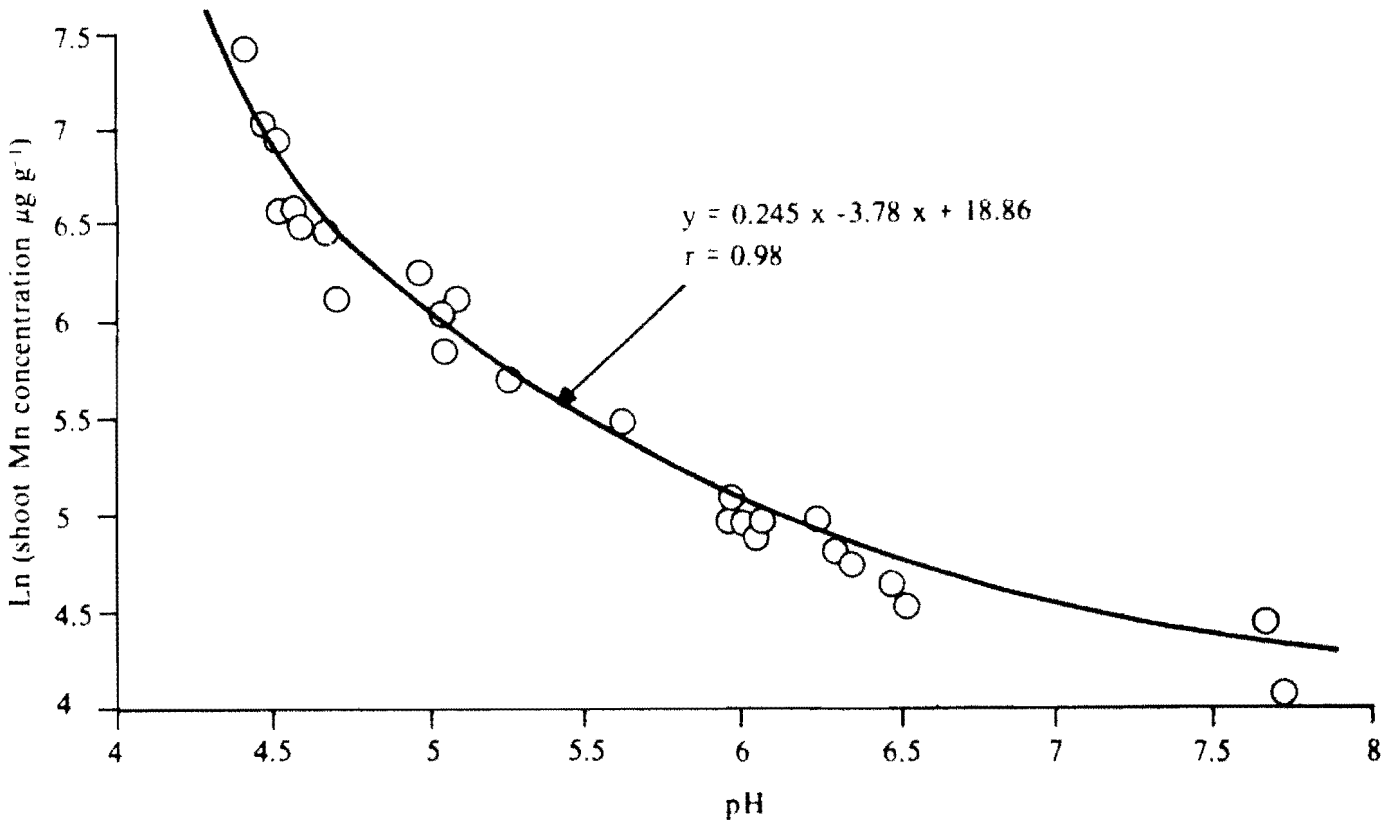

Figure 4. Ln (shoot Mn concentration) vs soil pH (1:1) for plants grown in the surface 15-cm of soil taken along a transect from an unproductive to a productive region (Wendt 1986).



estimating pearl millet shoot weight in a multiple regression analysis with plant Al concentrations. The effect of toxic levels of Mn may be obscured Al toxicity or other elemental deficiencies.

### The Liming Experiment

Selected chemical properties of soils collected for the liming study are summarized in Table 4. The

**Table 4.** Selected chemical properties of soils used in the liming experiment (Wendt 1986).

| Parameter                                       | Soil site    |            |
|---|--------------|------------|
|   | Unproductive | Productive |
| Exch. <sup>1</sup> Ca, cmol(+) kg <sup>-1</sup> | 0.47         | 0.68       |
| Exch. Mg, cmol(+) kg <sup>-1</sup>              | 0.04         | 0.09       |
| Exch. K, cmol(+) kg <sup>-1</sup>               | 0.06         | 0.12       |
| Exch. Na, cmol(+) kg <sup>-1</sup>              | 0.02         | 0.02       |
| Exch. Al, cmol(+) kg <sup>-1</sup>              | 0.36         | 0.03       |
| Exch. Al+H, cmol(+) kg <sup>-1</sup>            | 0.57         | 0.17       |
| E Bases, cmol(+) kg <sup>-1</sup>               | 0.59         | 0.87       |
| ECEC, cmol(+) kg <sup>-1</sup>                  | 1.19         | 1.07       |
| Al+H saturation (%)                             | 49           | 16         |
| pH, H <sub>2</sub> O                            | 4.58         | 5.67       |
| pH, 1 M KCl                                     | 3.86         | 4.56       |

1. Exch. = Exchangeable.

productive soil had higher pH, base saturation, and exchangeable Ca, Mg, and K levels, and less exchangeable Al than the unproductive soil.

Pearl millet seedling growth and soil pH of various treatments in the liming experiment are summarized in Table 1. Liming did not improve shoot weight in either soil. The productive soil produced higher shoot biomass than the unproductive soil in all treatments. In the unproductive soil, shoot biomass was further inhibited by the addition of CaCl<sub>2</sub>.H<sub>2</sub>O, which resulted in the death of the plant at the highest rates of application. However, low rates of CaCl<sub>2</sub>.H<sub>2</sub>O actually increased Al- and Mn-uptake in the unproductive soils. These unexpected results are explained by plant-tissue analysis (Table 5). Lime applications, while dramatically reducing Mn concentrations, did not reduce plant Al uptake. Additions of CaCl<sub>2</sub> actually increased Al and Mn uptake in the unproductive soils. Other authors (Farina et al. 1982, Fox et al. 1986, Soileau et al. 1969) have reported plant uptake of Al plants limed to neutrality. Hargrove (1986) hypothesized that this phenomenon may be due to the solubilization of Al-organic matter complexes at pH values between 5 and 7. Bloom et al (1979) concluded that Al-organic matter complexes control soil solution Al concentrations in soils with low CEC, even if the soils have low organic matter contents. Farina et al. (1982) suggest that availability of Al at near-neutral pH values may be due to increased micro-

**Table 5.** Elemental concentrations in selected treatments in the liming experiment (Wendt 1986).

| Amendment                            | Rate factor <sup>1</sup> | Shoot wt.           | Al      | Mn     |
|--------------------------------------|--------------------------|---------------------|---------|--------|
| <b>Productive soil type</b>          |                          |                     |         |        |
| Control                              | 0                        | 0.831e <sup>2</sup> | 397 A   | 156 A  |
| Ca(OH) <sub>2</sub>                  | 1                        | 0.876c              | 485 A   | 118 A  |
| CaCl <sub>2</sub> .2H <sub>2</sub> O | 1                        | 1.115d              | 606 A   | 221 A  |
| CaCl <sub>2</sub> .2H <sub>2</sub> O | 2                        | 1.082d              | 345 A   | 304 A  |
| <b>Unproductive soil type</b>        |                          |                     |         |        |
| Control                              | 0                        | 0.236b              | 2328 CD | 1373 B |
| Ca(OH) <sub>2</sub>                  | 1                        | 0.233b              | 1397 B  | 237 A  |
| Ca(OH) <sub>2</sub>                  | 2                        | 0.141ab             | 1574 BC | 83 A   |
| Ca(OH) <sub>2</sub>                  | 3                        | 0.067a              | 1697 BC | 78 A   |
| CaCl <sub>2</sub> .2H <sub>2</sub> O | 1                        | 0.035a              | 2539 D  | 2044 C |

1. The multiple of equivalents of acidity that the applied lime is capable of neutralizing. In the case of calcium chloride, refers to the equivalents of Ca, relative to the liming treatment for that soil.

2. Means not followed by the same letter are significantly different at  $P = 0.05$  by Duncan's multiple range test.

**Table 6. Yield response to fertilizer treatments in the first nutrient experiment (Wendt 1986).**

| Treatment                   | Nutrients applied  | Shoot wt<br>(g pot <sup>-1</sup> ) |                 |
|-----------------------------|--|------------------------------------|-----------------|
| <b>Unproductive type</b>    |  |                                    |                 |
| 1                           | P, Ca, Zn, S, B, N, Mo, K, Mg, lime, Mn, Cu <sup>1</sup> | 1.09                               | de <sup>2</sup> |
| 2                           | P, Ca, Zn, S, B, N, Mo, K, Mg, lime, Mn                  | 0.59                               | bc              |
| 3                           | P, Ca, Zn, S, B, N, Mo, K, Mg, lime                      | 1.03                               | de              |
| 4                           | P, Ca, Zn, S, B, N, Mo, K, Mg <sup>1</sup>               | 0.75                               | cd              |
| 5                           | P, Ca, Zn, S, B, N, Mo, K <sup>1</sup>                   | 0.27                               | ab              |
| 6                           | P, Ca, Zn, S, B, N, Mo <sup>1</sup>                      | 0.26                               | ab              |
| 7                           | P, Ca, Zn, S, B, N <sup>1</sup>                          | 0.20                               | ab              |
| 8                           | P, Ca, Zn, S, B <sup>1</sup>                             | 0.15                               | a               |
| 9                           | Zn, S, B <sup>1</sup>                                    | 0.09                               | a               |
| 10                          | Ca, B <sup>1</sup>                                       | 0.11                               | a               |
| 11                          | B  | 0.12                               | a               |
| 12                          | N, P, Zn, S  | 0.60                               | bc              |
| 13                          | P, Zn, S   | 0.26                               | ab              |
| 14                          | Zn, S  | 0.07                               | a               |
| 15                          | N, Mo  | 0.08                               | a               |
| 16                          | Mo   | 0.10                               | a               |
| 17                          | N  | 0.07                               | a               |
| 18                          | P  | 0.24                               | ab              |
| 19                          | K <sup>1</sup>   | 0.07                               | a               |
| 20                          | Control  | 0.12                               | a               |
| <b>Productive soil type</b> |  |                                    |                 |
| 21                          | Control  | 1.33                               | e               |
| 22                          | P, Ca, Zn, S, B, N, Mo, K, Mg, Mn, Cu <sup>1</sup>       | 3.11                               | f               |

1. These treatments contained chloride salts.

2. Means not followed by the same letter are significantly different at  $P = 0.05$  Duncan's multiple range test.

bial degradation of Al-organic matter at higher pH values and consequent release of plant-available Al-organic acid complexes.

### Nutrient Experiments

Soil properties in the nutrient experiment were similar to those in other trials. Productive soils had higher pH, base saturation, and exchangeable Ca, Mg, and K levels, and lower exchangeable acidity. Plant response to nutrient applications in the unproductive soils was sufficient to increase plant growth, which never exceeded growth of plants in the productive soils with no amendments applied (Table 6). Plant growth in productive soils improved dramatically in response to nutrient application.

A significant increase in pearl millet shoot weight in the unproductive soils occurred with the application of N, P, Zn, and S alone (Treatment 12). While several fertilizer combinations improved pearl millet production on the unproductive soil, all successful treatments involved P and N.

Tissue analyses (Table 7) indicate that unproductive soils did not supply adequate levels of P, K, and Mg, and were toxic to Al and Mn. Additions of P, K, and Mg increased plant growth by ameliorating apparent deficiencies of these nutrients in unproductive soils. Lime decreased plant Mn concentrations (Treatments 1, 2, and 3). Elimination of lime from treatments did not result in increased plant Al uptake. This is probably due to the presence of P in unlimed treatments. Elimination of P from the nutrient solution increased plant Al uptake (Treatment 18 vs 20) and decreased plant

**Table 7. Elemental concentrations in selected treatments in the first nutrient experiment (Wendt 1986).**

| Treatment                     | Shoot wt (g pot <sup>-1</sup> ) | Plant elemental concentration |         |       |       |        | Soil pH                     |
|-------------------------------|---------------------------------|-------------------------------|---------|-------|-------|--------|-----------------------------|
|                               |                                 | P                             | K       | Mg    | Al    | Mn     |                             |
|                               |                                 | (g kg <sup>-1</sup> )         |         |       |       |        | ( $\mu$ g g <sup>-1</sup> ) |
| <b>Unproductive soil type</b> |                                 |                               |         |       |       |        |                             |
| 1                             | 1.09de <sup>1</sup>             | 2.6cd                         | 35.9de  | 2.4b  | 417a  | 163a   | 5.44gh                      |
| 2                             | 0.59bc                          | 2.7bcd                        | 37.5ef  | 2.4b  | 484a  | 217a   | 5.48h                       |
| 3                             | 1.03de                          | 2.5cd                         | 35.2de  | 2.4b  | 397a  | 134a   | 5.29fgh                     |
| 4                             | 0.75cd                          | 3.3de                         | 38.7ef  | 1.9ab | 430a  | 818b   | 4.76abcd                    |
| 5                             | 0.27ab                          | 3.0cde                        | 40.8ef  | 1.4a  | 596a  | 1265bc | 4.87bcde                    |
| 12                            | 0.60bc                          | 2.8cd                         | 27.6cd  | 1.9ab | 268a  | 929b   | 5.22fgh                     |
| 13                            | 0.26ab                          | 2.5bcd                        | 17.5ab  | 1.7ab | 660a  | 939b   | 4.54a                       |
| 17                            | 0.07a                           | 1.4ab                         | 11.3a   | 1.8ab | 2237c | 1561c  | 4.69bc                      |
| 18                            | 0.24ab                          | 2.1bc                         | 23.8bc  | 2.0ab | 631a  | 967b   | 5.11efg                     |
| 20                            | 0.12a                           | 0.8a                          | 19.1abc | 1.7ab | 1248b | 786b   | 4.64ab                      |
| <b>Productive soil type</b>   |                                 |                               |         |       |       |        |                             |
| 21                            | 1.33e                           | 2.3bcd                        | 32.8de  | 4.6c  | 303a  | 122a   | 5.00cdef                    |
| 22                            | 3.11f                           | 4.1e                          | 45.4f   | 5.9d  | 332a  | 261a   | 5.09def                     |

1. Means not followed by the same letter are significantly different at  $P = 0.05$  by Duncan's multiple range test.

**Table 8. Yield response to fertilizer treatments in the second nutrient experiment (Wendt 1986).**

| Treatment                     | Nutrients applied                          | Shoot wt g pot <sup>-1</sup> |
|-------------------------------|--|------------------------------|
| <b>Unproductive soil type</b> |  |                              |
| 1                             | Control                                    | 0.05a <sup>1</sup>           |
| 2                             | P  | 0.31ab                       |
| 3                             | P, N                                       | 1.09bcd                      |
| 4                             | P, N, Ca <sup>2</sup>                      | 0.38ab                       |
| 5                             | P, N, Ca, Mg, S <sup>2</sup>               | 0.43ab                       |
| 6                             | P, N, Ca, Mg, S                            | 1.12bcd                      |
| 7                             | P, N, Ca, Mg, S, Zn <sup>2</sup>           | 0.31ab                       |
| 8                             | P, N, Ca, Mg, S, Zn, K <sup>2</sup>        | 0.47ab                       |
| 9                             | P, N, Ca, Mg, S, Zn, K, B <sup>2</sup>     | 0.56ab                       |
| 10                            | P, N, Ca, Mg, S, Zn, K, B, Mo <sup>2</sup> | 0.45ab                       |
| 11                            | P, N, Ca, Mg, S, Zn, K, B, Mo, lime        | 1.58cde                      |
| 12 <sup>1</sup>               | P, N, Ca, Mg, S, Zn, K, B, Mo, lime        | 1.62cde                      |
| 13                            | P, N, Mg, S, Zn, lime                      | 1.15bcd                      |
| <b>Productive type soil</b>   |  |                              |
| 14                            | Control                                    | 0.70abc                      |
| 15                            | P, N                                       | 2.00def                      |
| 16                            | P, N, Ca, Mg, S, Zn <sup>2</sup>           | 2.81f                        |
| 17                            | P, N, Ca, Mg, S, Zn, K, B, Mo <sup>2</sup> | 3.85g                        |
| 18 <sup>1</sup>               | P, N, Ca, Mg, S, Zn, K, B, Mo              | 2.22ef                       |

1. These soils were sterilized by heating at 105°C for 24 hours.

2. These treatments contained chloride salts.

3. Means not followed by the same letter are significantly different at  $P = 0.05$  by Duncan's multiple range test.

**Table 9. Elemental concentrations in selected treatments from the second nutrient experiment (Wendt 1986).**

| Treatment | Shoot wt           | Plant elemental concentration |        |        |        |       |         |       |
|-----------|--------------------|-------------------------------|--------|--------|--------|-------|---------|-------|
|           |                    | N                             | P      | K      | Ca     | Mg    | Al      | Mn    |
|           |                    | (g kg <sup>-1</sup> )         |        |        |        |       |         |       |
| 1         | 0.05a <sup>1</sup> | -                             | 0.7a   | 14.0a  | 8.7cd  | 1.5ab | 2574e   | 866e  |
| 2         | 0.31ab             | -                             | 1.8bc  | 15.4a  | 6.8abc | 1.3a  | 1052bcd | 438bc |
| 3         | 1.09bcd            | -                             | 2.3bcd | 14.3a  | 6.8abc | 2.0ab | 613abc  | 673de |
| 5         | 0.43ab             | -                             | 1.8bc  | 14.6a  | 8.2bcd | 2.2b  | 1148cd  | 774de |
| 6         | 1.12bcd            | -                             | 2.2bcd | 14.9a  | 6.6ab  | 2.4b  | 519abc  | 609cd |
| 10        | 0.45ab             | -                             | 1.5ab  | 32.8bc | 6.5ab  | 1.3a  | 1514d   | 826de |
| 11        | 1.58cde            | -                             | 2.7cd  | 42.4d  | 9.4de  | 1.7ab | 317a    | 152a  |
| 13        | 1.15bcd            | 43.2b                         | 2.8d   | 16.6a  | 11.0e  | 3.8c  | 420ab   | 222a  |
| 14        | 0.70abc            | 38.8ab                        | 1.6b   | 34.3c  | 8.3bcd | 4.9d  | 679abc  | 184a  |
| 15        | 2.00def            | 45.3b                         | 6.6e   | 25.3b  | 6.3a   | 4.6cd | 397ab   | 320ab |
| 16        | 2.81f              | 43.5b                         | 6.4e   | 29.5bc | 8.7cd  | 6.1e  | 509abc  | 208ab |
| 17        | 3.85g              | 37.4ab                        | 6.4e   | 45.0d  | 7.1abc | 3.6c  | 539abc  | 186a  |
| 18        | 2.22ef             | 34.9a                         | 6.9e   | 44.1d  | 9.8de  | 4.4cd | 638abc  | 174a  |

1. Means not followed by the same letter are significantly different at  $P = 0.05$  by Duncan's multiple range test.

biomass. All treatments that had P as an amendment showed reduced plant Al concentrations, clearly showing the effect of P in reducing Al toxicity. Additions of P had no effect on plant Mn concentrations.

Yields and plant mineral compositions for the second nutrient experiment are summarized in Tables 8 and 9. This experiment generally substantiated what had been observed in the first nutrient experiment. The combination of P and N reduced Al concentrations in pearl millet shoots grown on unproductive soils and improved biomass production substantially. Further, the detrimental effect of chloride salt additions is clearly evident (Treatment 3 vs 4, 5 vs 6, Table 8). The chloride salts had the effect of increasing Al uptake and decreasing shoot biomass. When sulfate salts were substituted for chloride salts (Treatment 4, Table 8) biomass production and shoot Al concentration improved dramatically. Soil sterilization did not improve the unproductive soils (Treatment 11 vs 12, Table 8) indicating that biological factors were not the cause of poor crop performance.

Phosphorus availability from applied P was higher in productive than in the unproductive soils (Treatments 1 and 3 vs 14 and 15). The apparent increase in P-fixation in unproductive soils suggests that P is being precipitated by Al in the solution (Birch 1951). Phosphorus can also be immobilized by Al in root tissue (Wright and Donahue

1953). Phosphate "liming", i.e., the precipitation of Al with P, may be an inefficient use of P fertilizer in acid Sahelian soils. Woodruff and Kamprath (1965) observed that P fertilizer addition for optimal pearl millet growth was reduced by 50% when the exchangeable soil Al was first neutralized by liming.

## Conclusion

Aluminum toxicity is the probable cause of poor pearl millet growth in the unproductive soils used in the pot studies and is probably the primary cause of variability in pearl millet stands in the fields examined. Mn toxicity may also be an important factor contributing to poor crop production, but in these studies it was at most a secondary problem.

Elemental deficiencies exist in these soils, compounding the variability problem. The unproductive soils in particular produced plants deficient in N, P, K, and Mg when compared to values given in the literature. These deficiencies may also play a role in soil variability as they are more pronounced in unproductive than in productive soils. Even soils taken from relatively productive areas in the field responded dramatically to fertilizer inputs. This indicates the need for comprehensive fertilizer research involving several nutrients and nutrient combinations.

Liming of unproductive soils with Ca(OH)<sub>2</sub> had a significant effect in increasing soil pH and reducing plant Mn uptake, but did not affect plant Al uptake or improve biomass production. The ineffectiveness of lime applications in reducing Al toxicity has been reported elsewhere and is still under investigation by the authors. The use of chloride salts increased plant Al uptake and decreased plant biomass on the unproductive soils, but did not adversely affect plant growth in productive soils. By comparison, the use of sulfate salts did not have an adverse effect on either productive or unproductive soils.

### Acknowledgment

This work was conducted within the collaborative agreements between Tropsoils, INRAN, and ICRISAT.

### References

- Birch, H.F.** 1951. The relationship between base saturation and crop response to phosphate in acid soils. *Nature* 168:388-389.
- Bloom, P.R., McBride, M.B., and Weaver, R.M.** 1979. Aluminum and organic matter in acid soils: buffering and solution aluminum activity. *Soil Science Society of America Journal* 43:488-493.
- Chase, R.G.** 1984. Rapport annuel (1983). Prepared for the INRAN Senior Staff Meeting, 12-22 Mar 1984, Maradi, Niger.
- Farina, M.P.W., Summer, M.E., and Channon, P.** 1982. Lime-induced yield depressions in maize (*Zea mays* L.) on highly weathered soils. *Proceedings of the 9th International Plant Nutrition Conference I*: 162-168.
- Fox, R.L., De Datta, S.K., and Wang, J.M.** 1964. Phosphorus and aluminium uptake by plants from latosols in relation to liming. Pages 595-603 in *Transactions of the 8th International Congress of Soil Science*. Bucharest.
- Germani, G., and Reversat, G.** 1982. Effet sur les rendements de l'arachide au Sénégal de deux produits nématicides, DBCP et EDB et d'un amendement organique. (In Fr.) *Oléagineux* 3(11):521-524.
- Hargrove, W.L.** 1986. The solubility of aluminum-organic matter and its implication in plant uptake of aluminum. *Soil Science* 142: 179-181.
- Moorman, F.R., and Kang, B.T.** 1978. Microvariability of soils in the tropics and its agronomic implications with special reference to West Africa. Pages 26-44 in *Diversity of soils in the tropics* (Stelly, M., ed.) ASA Special Publication no. 34. Madison, Wisconsin, USA: American Society of Agronomy.
- Sivakumar, M.V.K., Virmani, S.M., and Reddy, S.J.** 1980. Rainfall climatology of West Africa: Niger. *Information Bulletin* no. 5. Patancheru, A.P, India: International Crops Research Institute for the Semi-Arid Tropics.
- Soileau, J.M., Engelstad, O.P., and Martin, J.G., Jr.** 1969. Cotton growth on an acid fragipan subsoil. II. Effects of soluble calcium, magnesium, and aluminum on roots and tops. *Soil Science Society of America Proceedings* 33: 919-924.
- Van Wambeke, A., and Dudal, R.** 1978. Microvariability of soils of tropics. Pages 13-28 in *Diversity of soils in the tropics* (Stelly, M., ed.). ASA Special Publication no. 34. Madison, Wisconsin, USA: American Society of Agronomy.
- Wendt, J.W.** 1986. Pearl millet (*Pennisetum typhoides*) response to soil variability in sandy Ustalfs near Niamey, Niger, West Africa. M.S. thesis, Texas A&M University, College Station, Texas, USA. 87 pp.
- West, L.T., Wilding, L.P., Landeck, J.K., and Calhoun, F.G.** 1984. Soil survey of the ICRISAT Sahelian Center, Niger, West Africa. Texas, USA: Texas A&M University.
- Wilding, L.P., and Drees, L.R.** 1978. Spatial microvariability: a pedologist's viewpoint. Pages 1-12 in *Diversity of soils in the tropics* (Stelly, M., ed.). ASA Special Publication no. 34. Madison, Wisconsin, USA: American Society of Agronomy
- Woodruff, J.R., and Kamprath, E.J.** 1965. The phosphorus absorption maximum as measured by the Langmuir isotherm and its relationship to phosphorus availability. *Soil Science Society of America Proceedings* 29:148-150.
- Wright, K.E., and Donahue, B.A.** 1953. Aluminum toxicity studies with radioactive phosphorus. *Plant Physiology* 28:674-680.

# Soil Spatial Variability and Methods of Analysis

D.J. Mulla<sup>1</sup>

## *Abstract*

*Soil properties usually vary with distance according to a pattern. The nature and pattern of spatial variability must be determined in order to manage the soil efficiently. Geostatistical techniques are discussed for optimal design of sampling schemes in spatially-variable soils. Use of efficient sampling patterns optimizes labor and equipment demands, while facilitating quantitative understanding of the nature and pattern of variability. A very good linear unbiased estimator technique known as Kriging can be used to produce survey maps of spatially variable soil patterns involving a minimum number of field samples. Cokriging is a method for data interpolation that facilitates field sampling and spatial modeling. Kriging and Cokriging methods for describing and mapping spatially variable soil phosphorus and potassium are illustrated. These geostatistical methods can be used to improve management decisions regarding other soil or crop properties including soil salinity, soil alkalinity, aluminum toxicity, plant available water, or crop yield.*

## *Résumé*

**Variabilité spatiale des sols et méthodes d'analyse :** *Les propriétés du sol varient habituellement en fonction de la distance et non aléatoirement. Si ces propriétés sont variables dans l'espace, il est essentiel de déterminer la nature et le modèle de cette variabilité pour un aménagement efficace des sols ou pour interpréter correctement les essais au champ.*

*On discute des méthodes géostatistiques qui impliquent des variogrammes, des semi variogrammes croisés ou non, le kriging et le cokriging et ce, en vue de la cartographie et de l'aménagement des sols variables dans l'espace.*

*L'emploi de méthodes géostatistiques permet d'optimiser la demande de travail et d'équipement et de faciliter la compréhension quantitative de la nature et du modèle de la variabilité. Le kriging et le cokriging sont utilisés pour cartographier et aménager des données d'analyse de phosphore et de potassium. Ces méthodes géostatistiques peuvent également être utilisées pour améliorer des décisions d'aménagement pour une large gamme de propriétés des sols et des cultures, comme la capacité d'échange cationique, l'alcalinité des sols, la toxicité alumique, le pH, l'eau disponible ou le rendement.*

## **Introduction**

Soils are inherently variable. When spatial variability is controlled by topography, differences in

soil color, vegetative growth, or surface wetness across the landscape may indicate the extent or pattern of heterogeneity. In many cases, however, patterns of spatial variability in soil properties are

---

1. Assistant Professor of Soils, Department of Agronomy and Soils, Washington State University, Pullman, WA., USA.

ICRISAT (International Crops Research Institute for the Semi-Arid Tropics) 1989. Soil, Crop, and Water Management Systems for Rainfed Agriculture in the Sudano-Sahelian Zone: proceedings of an International Workshop, 7-11 Jan 1987. ICRISAT Sahelian Center, Niamey, Niger. Patancheru, A.P. 502 324, India: ICRISAT.

not apparently visible. Researchers often make the mistake of assuming that soil properties are relatively homogeneous in fields that are flat and that have no obvious visual evidence of heterogeneity. Even for simple topography, the extent of spatial variability in soil properties such as hydraulic conductivity (Vieira et al. 1981), moisture content (Wierenga 1985), soil test P levels (Dow and James 1973), A-horizon depth (Wilding 1985), or exchangeable sodium percentage (Uehara et al. 1985) may be appreciable.

In order to determine the nature and pattern of soil variability, systematic field sampling or field measurements are needed. Generally, the magnitude of variability that exists in the field is greater than the errors that arise in typical laboratory or field analytical measurements. Therefore, it is important to devise a sampling scheme that accurately measures the range of variability encountered at different locations in the sampling area (de Gruijter 1985). Sampling schemes that involve too few sampling locations will be inadequate for mapping and management requirements. Sampling schemes that are too dense may involve high labor and equipment costs, and are also undesirable. An efficient sampling scheme is one in which the minimum number of sample locations are obtained that will sufficiently characterize the magnitude and pattern of soil heterogeneity.

If the variation in soil properties occurs randomly, such that sample variance is not a function of sample separation distance, classical statistics can be used to analyze the data. These are standard techniques for analyzing soil samples, and are well known to soil scientists (Petersen and Calvin 1986). For most soils, however, the variance in measured soil properties depends upon separation distance. In such a situation, samples that are obtained from closely separated locations are more similar than samples separated by a larger distance. Classical statistics do not accurately describe patterns in spatial variability for samples exhibiting such spatial correlation, since classical statistical techniques do not account for the relation between the value of a sample and its location in a field. Instead, an analysis technique known generally as geostatistics is more useful.

The purpose of this paper is to show how geostatistical techniques involving semivariograms, cross-semivariograms, Kriging, or Cokriging can be used to model, map, and manage soils based on their spatial patterns. The example used to demonstrate

these techniques involves soil test P and K levels obtained from a commercial farm in the State of Washington.

## Methods

Dow and James (1973) measured soil test P on a commercial farm in the Columbia Basin of Washington, using a systematic sampling grid. At intervals of 30.48 m, five soil cores within a 1.83-m diameter circle were collected to a depth of 25.4 cm. These samples were oven-dried at 70°C, combined to form one composite sample, and screened. Each composite sample was extracted with sodium bicarbonate (Olsen et al. 1954) and analyzed for P and K. In the present study, statistical and geostatistical analyses of the data were conducted using a Hewlett Packard 9816S computer and 7470A plotter.

## Results and Discussion

To illustrate the use of geostatistical methods, consider an example involving soil test K and P values from a commercial field in the Columbia Basin of Washington. Data for this example are for a leveled, visually homogeneous area studied by Dow and James (1973). Figure 1 illustrates the variation in soil test K values on a regular grid with 42 sample locations separated by 30.48 m. Note that soil test K values do not vary randomly with distance, but are generally similar in value over short distances.

The results in Figure 1 could be used to design an approximate fertilizer-management scheme for crop production. Clearly, however, additional mapping detail is desirable. Since labor and equipment constraints are often important in field experimentation, the researcher may want to know if additional mapping detail can be obtained without additional field sampling. Geostatistical methods can be applied to provide the latter information.

Geostatistics is useful for interpolating between measured data points to provide additional data for detailed mapping. The geostatistical procedure known as Kriging involves computing the semivariance function of the data, fitting semivariogram models to the semivariance data, and producing a detailed spatial map. The geostatistical procedure known as Cokriging is similar in approach to Krig-

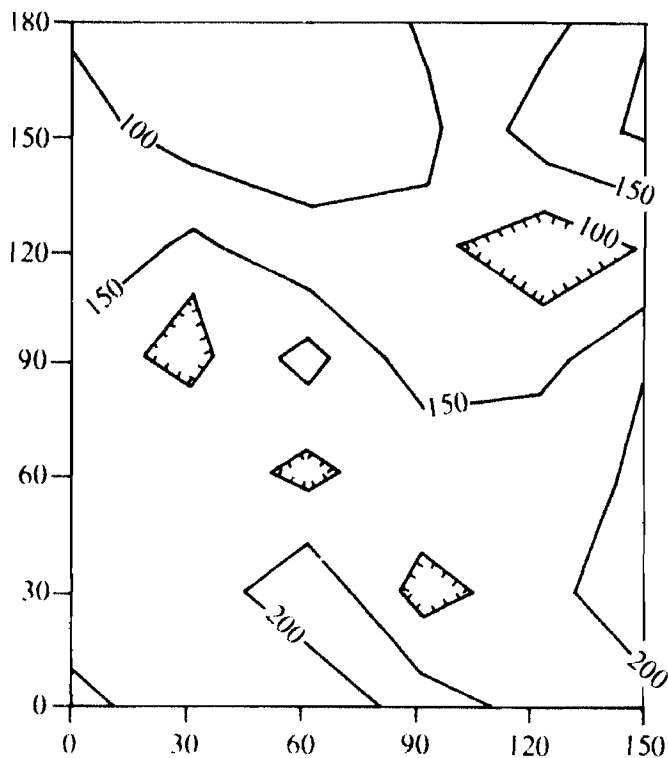

Figure 1. Contour map of 42 measured soil test K values ( $\text{mg kg}^{-1}$ ) from a commercial farm in the Columbia Basin of Washington State. Matched contours represent low-fertility regions.

ing, except that the mapping procedure also uses information concerning the covariation between the mapped property and a second, spatially correlated property. The covariation between the two different soil properties is described by the cross-semivariance function. These procedures have been described by Burgess and Webster (1980), Vieira et al. (1983), and by Warrick et al. (1986). The assumptions required for applying geostatistics are also discussed in these references.

**The semivariogram.** The semivariogram is a spatial model that determines the relation between the value of a measurement at a given location and values of neighboring measurements at increasing distances from it. As stated previously, if sample variation is random, the total sample variance will be the same regardless of the separation distance between samples. Samples that are correlated in space, however, will have lower sample variance at smaller separation distances than at larger separation distances.

One method for assessing the spatial correlation

of samples, therefore, is to compute sample variance as a function of sample separation distance. For interpolation and mapping purposes, however, it will be useful to compute a quantity known as semivariance,  $\gamma(h)$ , instead of computing variance. The expression for semivariance is:

$$\gamma(h) = [1/2n(h)] \sum_{i=1}^{n(h)} [Z(x_i) - Z(x_{i+h})]^2 \quad (1)$$

where

$n(h)$  = the number of samples separated by a distance of  $h$ ,

$Z(x_i)$  = the value of the measured property at location  $x_i$ , and

$Z(x_{i+h})$  = the value of the measured property at location  $x_{i+h}$ .

Figure 2 is a plot of values for semivariance of soil test K values in Figure 1 as a function of separation distance.

The semivariance in Figure 2 equals zero when  $h=0$ . This is expected, since there should theoretically be no variation in sample values that are measured at the same location. As separation distance increases, the semivariance increases because samples are less correlated when sampled at increasingly larger distances. For separation distances greater than about 91.44 m, the semivariance values cease to increase at an appreciable rate. This occurs because the sample pairs generally lack significant statistical correlation to one another when the separation distances are large. In this case, the K variations begin to occur in a truly random fashion.

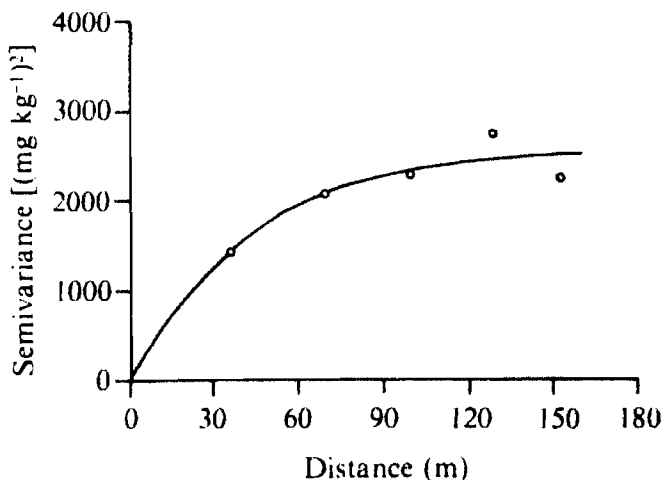

Figure 2. Semivariogram of 42 measured soil test K values from Figure 1.



Occasionally, the semivariance has none of the above characteristics. If the semivariance is relatively constant at all separation distances and varies randomly at a value approximately equal to the total sample variance, the researcher can conclude that the sample population exhibits no spatial correlation.

Once the semivariance function for the data is computed, standard semivariogram models can be fitted to the data by nonlinear least squares techniques. This provides the researcher with a quantitative model for spatial variations in the data. Three common semivariogram models are described below.

1. Linear model:

$$\begin{aligned}\gamma(h) &= C_0 + B h & 0 \leq h \leq a & \quad (2) \\ \gamma(h) &= C_0 + C_1 & h > a & \end{aligned}$$

2. Spherical model:

$$\begin{aligned}\gamma(h) &= C_0 + C_1[1.5(h/a) - 0.5(h/a)^3] & 0 \leq h \leq a & \quad (3) \\ \gamma(h) &= C_0 + C_1 & h > a & \end{aligned}$$

3. Exponential model:

$$\gamma(h) = C_0 + C_1[1 - \exp(-h/a_0)] \quad 0 \leq h \quad (4)$$

In these expressions,

$h$  = separation distance between observations,

$a$  = a model parameter known as the range,

$(C_0 + C_1)$  = a model parameter known as the sill,  
and

$C_0$  = a model parameter known as the nugget.

The nugget is nonzero whenever sampling error occurs due to measurement error or when sample spacing is too large to detect spatial correlation occurring at small separation distances. In ideal situations when measurement errors are absent and sample spacing is small, the nugget will equal zero.

For the linear model,  $B$  is simply the slope of the line for a plot of semivariance vs separation distance. For the spherical and exponential models, the sill is approximately equal to the total sample variance, and is the maximum value of semivariance that the model attains at large separation distances. For the exponential model,  $a_0$  is approximately equal to  $a/3$ . Physically, sample observations separated by distances smaller than the range are statistically correlated to one another, whereas measurements separated by a greater distance than the range are not correlated.

The semivariance values for soil test K shown in

Figure 2 were best described using the exponential semivariogram model in Eq. (4). The value of this model, for  $C_1$ , equals  $2587.6 \text{ (mg kg}^{-1}\text{)}^2$ , the value for  $a_0$  equals  $41.9 \text{ m}$  and that for  $C_0$  equals  $0$ .

**Kriging.** The data presented in Figure 1 is somewhat deficient for the purposes of constructing a detailed two dimensional map of soil test K levels. A geostatistical technique known as Kriging can be applied to the data to produce a detailed map. This procedure is described below.

Kriging is an interpolation technique that uses the semivariogram model in Figure 2 and the measured data to estimate data at specified locations, where no measured data are available. Estimated values,  $Z^*(x_0)$ , are obtained from the linear interpolation scheme:

$$Z^*(x_0) = \sum_{i=1}^N \lambda_i Z(x_i) \quad (5)$$

where, typically,

$x_0$  = a location where no samples were collected,

$N$  = the number of neighboring measured data points used in the interpolation scheme,

$\lambda_i$  = a weighting factor for the measured data that is yet to be determined, and

$Z(x_i)$  = the measured data at location  $x_i$ .

Thus, Kriging is a method that uses  $N$  nearest neighboring measured data points and their associated weighting factors to estimate data values at locations where data were not actually measured.

An advantage of the kriging method is that when Eq. (5) is used to estimate data at a location where a measured value is available, the method always generates an estimated value that is equal to the measured value. This occurs because, for such a situation, the weighting factor is unity for the observation located at the same place as the estimated value, while the weighting factors for all other neighboring data values are zero. Regardless of the location of the interpolated point, the weighting factors are always constrained to sum to unity:

$$\sum_{j=1}^N \lambda_j = 1 \quad (6)$$

Several other interpolation schemes are in use for mapping purposes, but these do not return estimated values that are equal to the measured values at locations where measured observations are available. Examples of such interpolation schemes include the linear regression and trend

surface models, which may have high correlation coefficients, but do not pass through all measured points.

In order to produce a detailed map of soil test K values using Kriging techniques, the values of the weighting factors  $\lambda_i$  in Eq. (5) must be determined. It can be shown that these values can be computed from a system of  $N+1$  unknowns in  $N+1$  simultaneous algebraic equations having the form:

$$\sum_{j=1}^N \lambda_j \gamma(x_i, x_j) + \mu = \gamma(x_i, x_0), i = 1 \text{ to } N \quad (7)$$

and

$$\sum_{j=1}^N \lambda_j = 1$$

where

$\gamma(x_i, x_j)$  = value of the semivariogram model in Figure 2 corresponding to the separation distance between two neighboring observations at locations  $x_i$  and  $x_j$ .

$\gamma(x_i, x_0)$  = value of the semivariogram model in Figure 2 corresponding to the separation distance between a measured observation at location  $x_i$  and an interpolated point located at  $x_0$ , and  $m$  is a constant known as the Lagrangian undetermined multiplier.

Computer programs are available which solve Eq. (7) for the weighting factors and the undetermined multiplier. The weighting factors are then used in Eq. (5) to calculate the value of soil test K at location  $x_0$ .

The Kriging equations (5) and (7) were used with the help of a computer to estimate soil test K values at 525 locations separated by 7.62 m increments in the study area represented by Figure 1. The results are presented as a detailed contour map in Figure 3. Maps of this detail are useful for planning efficient fertilizer management programs or for interpreting the results of field experiments involving crop yield.

The Kriging technique also yields a minimum estimation variance,  $\sigma^2(x_0)$ , which can be computed from the expression:

$$\sigma^2(x_0) = \mu + \sum_{i=1}^N \lambda_i \gamma(x_i, x_0) \quad (8)$$

where  $\mu$  is the undetermined multiplier, and  $\gamma(x_i, x_0)$  is the value of the semivariogram model in Figure 2, corresponding to the separation distance between the kriged point at  $x_0$  and the neighboring

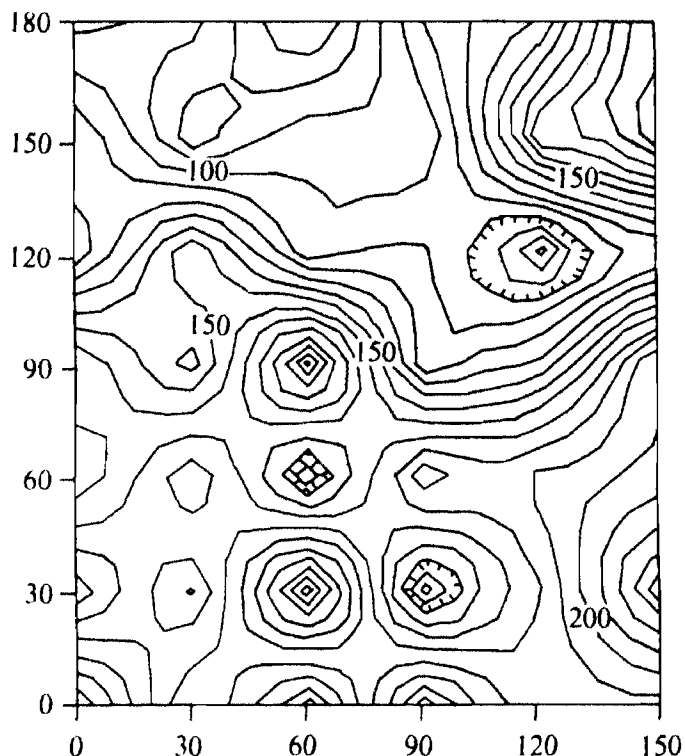

Figure 3. Contour map of 525 kriged soil test K values ( $\text{mg kg}^{-1}$ ).

measured point at  $x_i$ . Lower values of the estimation variance correspond to higher accuracies in interpolation, since the estimation variance is a measure of uncertainty in the estimation procedure.

**Cokriging.** Cokriging is an interpolation technique that uses information about the spatial pattern of two different, but spatially correlated properties to interpolate only one of the properties. Typically, cokriging is used for mapping a property that is difficult to measure (e.g., saturated hydraulic conductivity) based upon its covariation with a property that is relatively easy to measure (e.g., particle size distribution). A second situation in which cokriging would be useful could occur when several analyses from a field survey have to be discarded due to poor laboratory procedure.

As an example of the latter situation, consider the analysis of soil test P levels in the same commercial field for which soil test K levels are shown in Figure 1. Assume that nine of the soil analyses for P had to be discarded because of poor laboratory procedure. The remaining values of soil test P are shown in Figure 4, and the semivariogram for this data is shown in Figure 5. The semivariance values for soil test P shown in Figure 5 were best

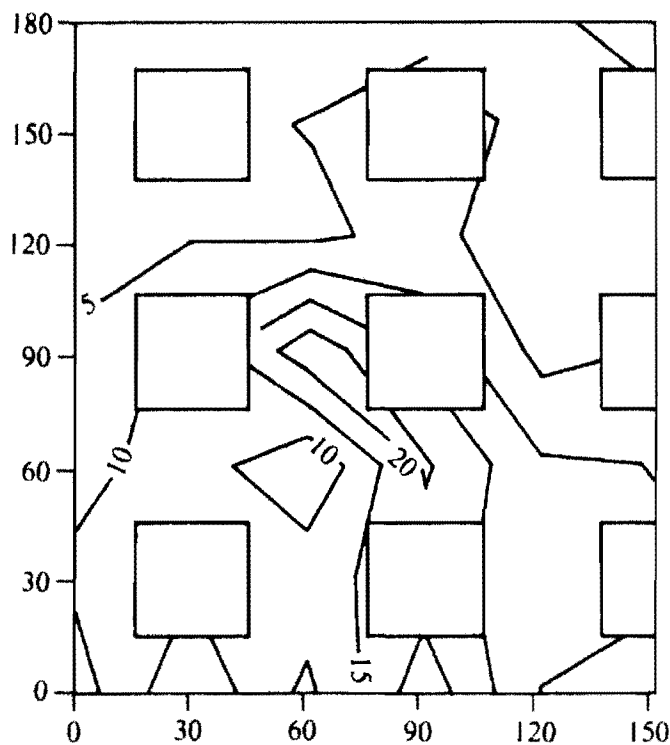

Figure 4. Contour map of 33 measured soil test P values ( $\text{mg kg}^{-1}$ ) from a commercial farm in the Columbia Basin of Washington State. The blank squares represent areas where missing data occurs.

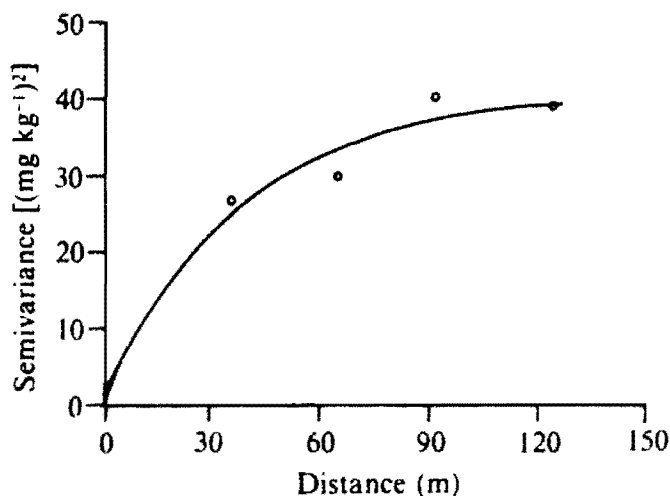

Figure 5. Semivariogram of 33 measured soil test P values from Figure 4.

described using the exponential semivariogram model in Eq. (4). The values in this model, for  $C_1$  equals  $41.2 (\text{mg kg}^{-1})^2$ , the value for  $a_0$  equals 37.9 m and that for  $C_0$  equals 0. The shape of the semivariogram for soil P appears to be similar to that for the semivariogram of soil K in Figure 2. This indicates that the two properties may be correlated to one another.

One method for assessing the spatial cross-correlation of samples is to compute sample cross-semivariance as a function of sample separation distance. The expression for cross-semivariance ( $\gamma_{12}(h)$ ) is:

$$\gamma_{12}(h) = [1/2n(h)] \sum_{i=1}^{n(h)} [Z_1(x_i) - Z_2(x_{i+h})]^2 \quad (9)$$

where

$n(h)$  = the number of samples separated by a distance of  $h$ ,

$Z_1(x_i)$  = the value of the measured K at location  $x_i$ , and

$Z_2(x_{i+h})$  = the value of the measured P at location  $x_{i+h}$ .

Figure 6 is a plot of values for cross-semivariance of soil test P and K values as a function of separation distance. An exponential model (Eq. (4)) hav-

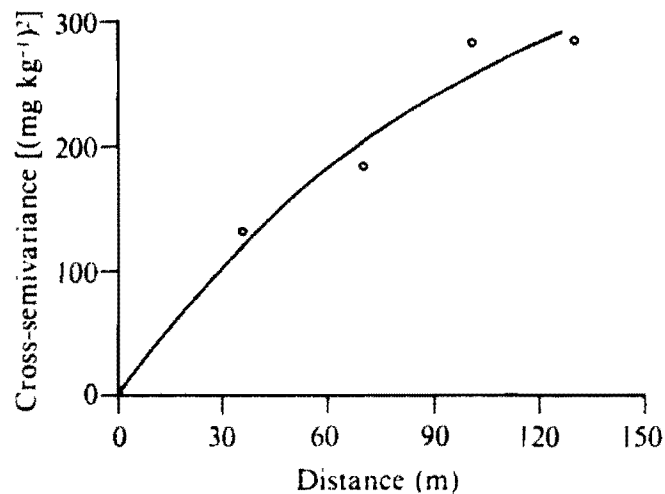

Figure 6. Cross-semivariogram of 33 measured soil test P values with 42 measured soil test K values.

ing a value of  $411.3 \text{ (mg kg}^{-1}\text{)}^2$  for  $C_1$ ,  $99.6 \text{ m}$  for  $a_0$ , and  $O$  for  $C_0$ , was found to be the best spatial model for this data. The relatively large value for  $a_0$  indicates that  $P$  and  $K$  have significant spatial covariation even at large separation distances.

Interpolation with Cokriging involves a system of equations with weighting factors ( $\lambda_{1j}$ ), semivariances ( $\gamma_{11}$ ), and unknown multiplier ( $\mu_1$ ) for soil test  $K$  as well as weighting factors ( $\lambda_{2j}$ ), semivariances ( $\gamma_{22}$ ), and unknown multiplier ( $\mu_2$ ) for soil test  $P$ . In addition, these equations involve values for the cross-semivariances ( $\gamma_{12}$ ) between soil test  $K$  and  $P$ . The system of equations for cokriging is:

$$\sum_{i=1}^{N_1} \lambda_{1i} \gamma_{11}(x_i, x_k) + \sum_{j=1}^{N_2} \lambda_{2j} \gamma_{12}(x_k, x_j) + \mu_1 = \gamma_{12}(x_k, x_0) \quad k=1, \dots, N_1 \quad (10)$$

$$\sum_{i=1}^{N_1} \lambda_{1i} \gamma_{12}(x_i, x_l) + \sum_{j=1}^{N_2} \lambda_{2j} \gamma_{22}(x_j, x_l) + \mu_2 = \gamma_{22}(x_l, x_0) \quad l=1, \dots, N_2$$

where  $x_i, x_j, x_k, x_l$  refer to locations where measured data exist, and  $x_0$  corresponds to the location where an interpolated value for soil test  $P$  is to be computed. As in Kriging, the weighting factors for  $K$  and  $P$  have constraints given by the equations:

$$\sum_{i=1}^{N_1} \lambda_{1i} = 0 \quad \text{and} \quad \sum_{j=1}^{N_2} \lambda_{2j} = 1. \quad (11)$$

Eqs. (10) and (11) represent the  $N_1+N_2+2$  Cokriging expressions that must be solved simultaneously for the weighting factors and unknown multipliers at every location where an interpolated value is to be obtained. They appear quite formidable, but can be solved in a relatively short time using modern microcomputers. Interpolated values of soil test  $P$  ( $Z_2^*$ ) are computed using the weighting factors from Eqs. (10) and (11) in the expression:

$$Z_2^*(x_0) = \sum_{i=1}^{N_1} \lambda_{1i} Z_1(x_i) + \sum_{j=1}^{N_2} \lambda_{2j} Z_2(x_j) \quad (12)$$

where  $Z_1$  is the measured value of soil test  $K$  and  $Z_2$  is the measured value of soil test  $P$  at locations nearest the point of interpolation.

Figure 7 is a contour plot of 525 Cokriged  $P$  values computed using Eqs. (10) through (12). In

contrast to the original set of 33 measured  $P$  values in Figure 4, the spatial pattern of  $P$  fertility is readily apparent from the interpolated values in Figure 7. It is clear that the upper portion of the field is low in  $P$  while a central portion has relatively high  $P$  levels. In addition, there is sufficient detail to identify several localized regions of low  $P$  fertility in the lower half of the field. Clearly, the variability in  $P$  fertility is quite complex.

The Cokriging technique, like the Kriging technique, permits the researcher to compute the estimation variance,  $\sigma^2(x_0)$ , which is associated with the interpolation process. The cokriging estimation variance is obtained from the expression:

$$\sigma^2(x_0) = \mu_2 + \sum_{i=1}^{N_1} \lambda_{1i} \gamma_{12}(x_i, x_0) + \sum_{j=1}^{N_2} \lambda_{2j} \gamma_{22}(x_j, x_0) \quad (13)$$

where

$\gamma_{12}(x_i, x_0)$  = the cross-semivariance (Figure 6) for the distance separating locations  $x_i$  and  $x_0$ , and

$\gamma_{22}(x_j, x_0)$  = the value for semivariance (Figure 5), corresponding to the distance separating the cokriged point at  $x_0$  and the neighboring measured point at  $x_j$ .

A contour plot of cokriging estimation variances for  $P$ , computed from Eq. (13) is shown in Figure 8. As in Kriging, the Cokriging estimation variance always equals zero at locations where measured values of  $P$  exist. In other words, cokriging always yields a value that equals the measured value at these locations. As the distance from a location where measured data exists increases, the uncertainty in the estimation procedure also increases. In general, the estimation variance is lower for Cokriging than for Kriging, whenever a comparison between the two techniques is made using the same set of data. This occurs because Cokriging uses information regarding the spatial patterns of both  $K$  and  $P$  whereas Kriging uses only information regarding the spatial pattern of  $P$ .

**Example of Cokriging Solution.** The researcher who is unfamiliar with Cokriging will find it difficult to understand how Eqs. (10) through (12) are actually used for interpolation. The following example will use actual data to illustrate the Cok-

ringing procedure. Eqs. (10) and (11) must first be expressed using matrix notation as:

$$[C][\lambda] = [b] \quad (14)$$

where

$[C]$  and  $[b]$  = matrices of semivariances and cross-semivariances, and

$[\lambda]$  = a matrix of weighting factors and undetermined multipliers whose values are ultimately solved using a computer.

In this example, assume that a value for soil test P is cokriged at the location  $x_0 = (15.24, 7.62)$ . The neighboring values of P from Figure 4 are  $6.8 \text{ mg kg}^{-1}$  at location  $x_1 = (0,0)$ ,  $19.7 \text{ mg kg}^{-1}$  at location  $x_2 = (0,30.48)$ , and  $11.2 \text{ mg kg}^{-1}$  at location  $x_3 = (30.48,0)$ . The neighboring values of K from Figure 1 are  $126 \text{ mg kg}^{-1}$  at location  $x_1 = (0,0)$ ,  $192 \text{ mg kg}^{-1}$  at location  $x_2 = (30.48,0)$ ,  $198 \text{ mg kg}^{-1}$  at location  $x_3 = (30.48,30.48)$ , and  $159 \text{ mg kg}^{-1}$  at location  $x_4 = (0,30.48)$ . Thus, the number (N1) of neighboring K values is 4 and the number (N2) of neighboring phosphorus values is 3. The specification of the neighbors used for interpolation determines the size of the matrices in Eq. (14). In general,  $[C]$  is an  $(N1+N2+2) \times (N1+N2+2)$  symmetric matrix, and both  $[\lambda]$  and  $[b]$  are  $(N1+N2+2) \times 1$  column matrices.

In this example, the matrices in Eq. (14) are expressed as:

$$[\lambda] = \begin{bmatrix} \lambda_{11} \\ \lambda_{12} \\ \lambda_{13} \\ \lambda_{14} \\ \lambda_{21} \\ \lambda_{22} \\ \lambda_{23} \\ \mu_1 \\ \mu_2 \end{bmatrix} \quad [b] = \begin{bmatrix} \gamma_{12}(x_1, x_0) \\ \gamma_{12}(x_2, x_0) \\ \gamma_{12}(x_3, x_0) \\ \gamma_{12}(x_4, x_0) \\ \gamma_{22}(x_1, x_0) \\ \gamma_{22}(x_2, x_0) \\ \gamma_{22}(x_3, x_0) \\ 0 \\ 1 \end{bmatrix}$$

while  $[C]$  is expressed as:

|                         |                         |                         |                         |                         |                         |                         |   |   |
|-------------------------|-------------------------|-------------------------|-------------------------|-------------------------|-------------------------|-------------------------|---|---|
| $\gamma_{11}(x_1, x_1)$ | $\gamma_{11}(x_2, x_1)$ | $\gamma_{11}(x_3, x_1)$ | $\gamma_{11}(x_4, x_1)$ | $\gamma_{12}(x_1, x_1)$ | $\gamma_{12}(x_1, x_2)$ | $\gamma_{12}(x_1, x_3)$ | 1 | 0 |
| $\gamma_{11}(x_1, x_2)$ | $\gamma_{11}(x_2, x_2)$ | $\gamma_{11}(x_3, x_2)$ | $\gamma_{11}(x_4, x_2)$ | $\gamma_{12}(x_2, x_1)$ | $\gamma_{12}(x_2, x_2)$ | $\gamma_{12}(x_2, x_3)$ | 1 | 0 |
| $\gamma_{11}(x_1, x_3)$ | $\gamma_{11}(x_2, x_3)$ | $\gamma_{11}(x_3, x_3)$ | $\gamma_{11}(x_4, x_3)$ | $\gamma_{12}(x_3, x_1)$ | $\gamma_{12}(x_3, x_2)$ | $\gamma_{12}(x_3, x_3)$ | 1 | 0 |
| $\gamma_{11}(x_1, x_4)$ | $\gamma_{11}(x_2, x_4)$ | $\gamma_{11}(x_3, x_4)$ | $\gamma_{11}(x_4, x_4)$ | $\gamma_{12}(x_4, x_1)$ | $\gamma_{12}(x_4, x_2)$ | $\gamma_{12}(x_4, x_3)$ | 1 | 0 |
| $\gamma_{12}(x_1, x_1)$ | $\gamma_{12}(x_2, x_1)$ | $\gamma_{12}(x_3, x_1)$ | $\gamma_{12}(x_4, x_1)$ | $\gamma_{22}(x_1, x_1)$ | $\gamma_{22}(x_1, x_2)$ | $\gamma_{22}(x_1, x_3)$ | 0 | 1 |
| $\gamma_{12}(x_1, x_2)$ | $\gamma_{12}(x_2, x_2)$ | $\gamma_{12}(x_3, x_2)$ | $\gamma_{12}(x_4, x_2)$ | $\gamma_{22}(x_2, x_1)$ | $\gamma_{22}(x_2, x_2)$ | $\gamma_{22}(x_2, x_3)$ | 0 | 1 |
| $\gamma_{12}(x_1, x_3)$ | $\gamma_{12}(x_2, x_3)$ | $\gamma_{12}(x_3, x_3)$ | $\gamma_{12}(x_4, x_3)$ | $\gamma_{22}(x_3, x_1)$ | $\gamma_{22}(x_3, x_2)$ | $\gamma_{22}(x_3, x_3)$ | 0 | 1 |
| 1                       | 1                       | 1                       | 1                       | 0                       | 0                       | 0                       | 0 | 0 |
| 0                       | 0                       | 0                       | 0                       | 1                       | 1                       | 1                       | 0 | 0 |

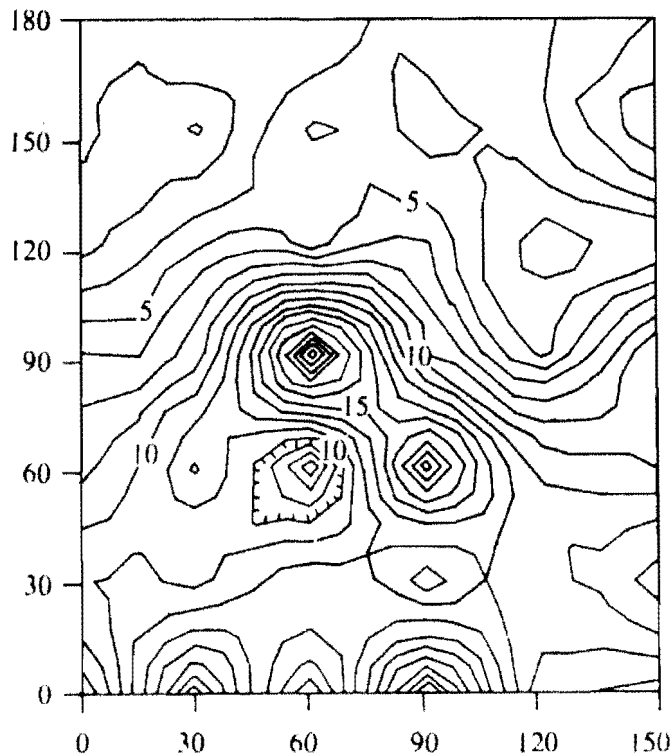

Figure 7. Contour map of 525 cokriged soil test P values ( $\text{mg kg}^{-1}$ ).

The matrices  $[b]$  and  $[C]$  can be evaluated in terms of semivariances and cross-semivariances from Figs. 2, 5, and 6. As an example,  $\gamma_{11}(x_2, x_1) = 1337.9 (\text{mg kg}^{-1})^2$  is obtained from Figure 2 at a separation distance of 30.48 m. The latter distance

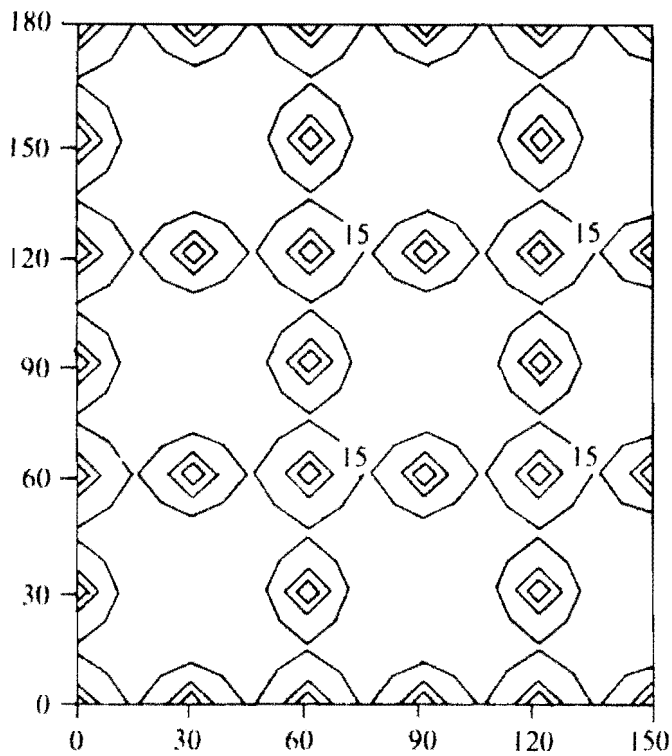

Figure 8. Contour map of estimation variance  $[(\text{mg kg}^{-1})^2]$  for 525 cokriged soil test P values. The contours enclosed by the 15  $(\text{mg kg}^{-1})^2$  contour represent the 10 and 5  $(\text{mg kg}^{-1})^2$  contours (decreasing inward).

is the separation between locations  $x_2$  and  $x_1$ . In a similar manner,  $\gamma_{22}(x_1, x_1) = 22.8 (\text{mg kg}^{-1})^2$  is obtained from the semivariogram in Figure 5, while  $\gamma_{12}(x_1, x_0) = 64.6 (\text{mg kg}^{-1})^2$  is obtained from the cross-semivariogram in Figure 6. Thus, matrices  $[C]$  and  $[b]$  are given by:

$$[C] = \begin{bmatrix} 0 & 1337.9 & 1337.9 & 1663.1 & 0 & 108.4 & 108.4 & 1 & 0 \\ 1337.9 & 0 & 1663.1 & 1337.9 & 108.4 & 0 & 144.4 & 1 & 0 \\ 1337.9 & 1663.1 & 0 & 1337.9 & 108.4 & 144.4 & 0 & 1 & 0 \\ 1663.1 & 1337.9 & 1337.9 & 0 & 144.4 & 108.4 & 108.4 & 1 & 0 \\ 0 & 108.4 & 108.4 & 144.4 & 0 & 22.8 & 22.8 & 0 & 1 \\ 108.4 & 0 & 144.4 & 108.4 & 22.8 & 0 & 28.1 & 0 & 1 \\ 108.4 & 144.4 & 0 & 108.4 & 108.4 & 22.8 & 28.1 & 0 & 1 \\ 1 & 1 & 1 & 1 & 0 & 0 & 0 & 0 & 0 \\ 0 & 0 & 0 & 0 & 1 & 1 & 1 & 0 & 0 \end{bmatrix}$$

and:

$$[b] = \begin{bmatrix} 64.6 \\ 64.6 \\ 99.1 \\ 99.1 \\ 15.0 \\ 15.0 \\ 21.3 \\ 0 \\ 1 \end{bmatrix}$$

The solution to Eq. (14) is obtained by matrix inversion using the expression:

$$[\lambda] = [C]^{-1}[b] \quad (15)$$

where  $[C]^{-1}$  is the inverse of  $[C]$ . For this example the solution to Eq. (15) is:

$$[\lambda] = \begin{bmatrix} -0.0027 \\ -0.0029 \\ -0.0049 \\ 0.0105 \\ 0.3907 \\ 0.4125 \\ 0.1967 \\ -8.4246 \\ 0.3800 \end{bmatrix}$$

This solution shows that the weighting factors for K are very small compared to the weighting factors for P. Furthermore, the largest weighting factor (0.4125) corresponds to the soil test P value that is nearest in location to the interpolated point. In general, the weighting factors for measurements located near the interpolated point are always larger than those for measurements farther away.

It is now possible to use Eq. (12) to estimate the soil test P level at location  $x_0$  using the measured values of soil test K, the measured values of soil test P and the calculated values for weighting factors in

matrix  $[\lambda]$ . The substitution of these values into Eq. (12) gives:

$$Z^*(x_0) = (-0.0027)126 + (-0.0029)192 + (-0.0049)198 \\ + (0.0105)159 + (0.3907)6.8 + (0.4125)19.7 \\ + (0.1967)11.2 = 12.8 \text{ mg kg}^{-1}.$$

In a similar fashion, the Cokriging estimation variance can be computed using Eq. (13). This computation gives:

$$\sigma^2(x_n) = 0.38 + (-0.0027)64.6 + (-0.0029)64.6 \\ + (-0.0049)99.1 + (0.0105)99.1 \\ + (0.3907)15.0 + (0.4125) 15.0 \\ + (0.1967)21.3 = 16.8 \text{ (mg kg}^{-1})^2.$$

This example demonstrates how essential it is to use a computer to make these computations, since, for this example, the procedure shown above is repeated at 524 other locations!

**Management application.** Soil test P levels in Figure 7 can be used to plan a fertility-management program for the commercial field where the samples were obtained. To achieve this, the relation between soil test levels and suggested P fertilizer application rates must be determined from yield-response curves. This information is given in Table 1 for alfalfa grown in the Columbia Basin of Washington, along with the percentage of maximum crop yield which could be expected if no fertilizer was added (Dow and James 1973). Also shown is the percentage of the area in Figure 7 that lies in each soil test P category. These areal percentages were computed from a frequency distribution plot of the cokriged soil test P values.

Three distinct types of fertility-management programs could be devised. These include (1) fertilizing based on the mean soil test P value (8.4 mg kg<sup>-1</sup>) for the entire field, (2) fertilizing based on the lowest soil test P value (1.6 mg kg<sup>-1</sup> for the entire field, or (3) fertilizing according to the spatial patterns of soil test P that exist in different portions of

the field. If method (1) is used, the recommended rate of P<sub>2</sub>O<sub>5</sub> application from Table 1 is 77 kg ha<sup>-1</sup> for the entire field. This approach obviously results in under production on approximately 46% of the field. If method (2) is used, the recommended rate of P<sub>2</sub>O<sub>5</sub> application is 308 kg ha<sup>-1</sup> for the entire field. Using this approach, maximum yields would be obtained, but yield increases will be offset by increased fertilizer cost.

The third method involves using the known spatial patterns of soil test P to manage fertilizer applications. Shown in Figure 9 is a contour map

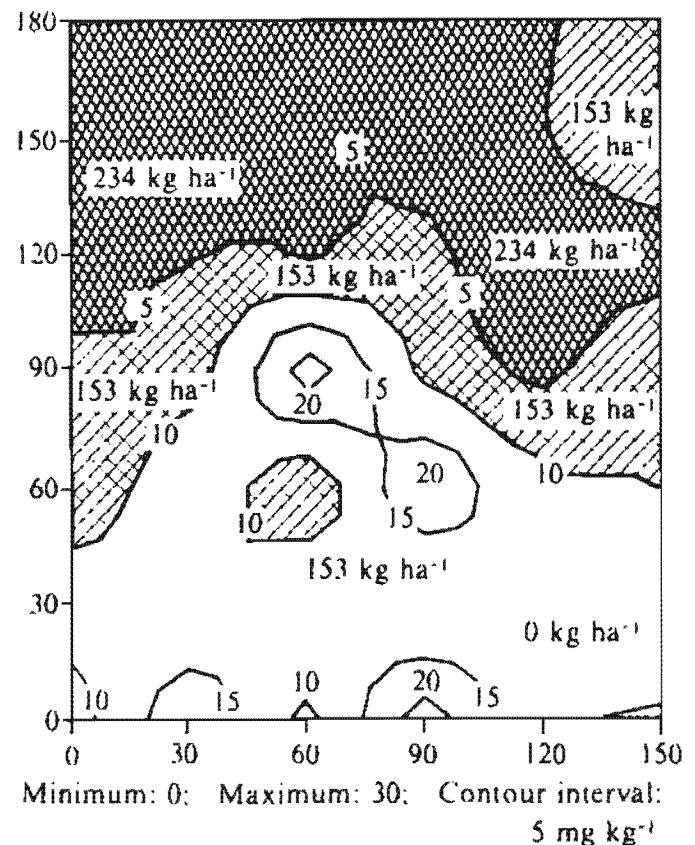

Figure 9. Suggested P<sub>2</sub>O<sub>5</sub> fertilizer management scheme for a commercial farm in the Columbia Basin of Washington State.

Table 1. Maximum alfalfa yield (%), P<sub>2</sub>O<sub>5</sub> fertilizer requirement, and area (%) for five soil test P categories in a commercial field in the Columbia Basin of Washington.

|   | Soil test phosphorus category (mg kg <sup>-1</sup> ) |         |         |          |      |
|---|--|---------|---------|----------|------|
|   | 0-2.5  | 2.6-5.0 | 5.1-7.5 | 7.6-10.0 | 10.1 |
| Maximum yield (%)   | 50   | 80      | 95      | 98       | 100  |
| P <sub>2</sub> O <sub>5</sub> needed (kg ha <sup>-1</sup> ) | 308  | 231     | 153     | 77       | 0    |
| Area affected (%)   | 5  | 28      | 13      | 12       | 42   |

of cokriged soil test P levels using a contour interval of 5 mg kg<sup>-1</sup>. This map is identical to that in Figure 7, except that fewer contour lines are drawn. The most efficient fertilizer application program for this field probably involves applying 221 kg P<sub>2</sub>O<sub>5</sub> ha<sup>-1</sup> to all areas having soil test P levels that are below 5 mg kg<sup>-1</sup>, and applying 137 kg P<sub>2</sub>O<sub>5</sub> ha<sup>-1</sup> to all areas having soil test P levels between 5 and 10 mg kg<sup>-1</sup>. No fertilizer is applied to portions of the field having greater than 10 mg kg<sup>-1</sup> soil P. An approach such as this is not difficult to implement, and results in efficient use of fertilizer resources as well as optimum crop production.

## Conclusions

Soil properties usually vary in a systematic, rather than random, fashion in the natural environment. Geostatistical methods provide a quantitative means for modeling and mapping this variability. In addition, efficient management decisions can be formulated once these spatial patterns are understood.

The basic steps involved in the geostatistical approach include: (1) collecting soil samples on transects or regular grids, (2) data analysis using the semivariogram or cross-semivariogram models, (3) data interpolation by either Kriging or Cokriging, (4) display of spatial patterns using contour maps, and (5) application of the knowledge concerning spatial variations for management decisions.

Researchers conducting plot experiments should consider the consequences of not considering spatial patterns in soil properties when conducting and designing field experiments. These consequences include: (1) The possibility of interpretation of fertility trials or breeding trials being inconclusive because classical statistical analyses cannot compensate for the effects of systematic spatial variability in soil properties. (2) Management decisions based upon insufficient soil data contributing to inefficient use of soil, water, crop, and fertilizer resources.

**Burgess, T. M., and Webster, R.** 1980. Optimal interpolation and isarithmic mapping of soil properties. I. The semi-variogram and punctual kriging. *Journal of Soil Science* 31: 315-331.

**de Gruijter, J. J.** 1985. Transect sampling for reliable information on mapping units. Pages 150-163 in *Soil spatial variability* (Nielson, D.R., and Bouma, J., eds.). Wageningen, Netherlands: PUDOC (Centre for Agricultural Publishing and Documentation).

**Dow, A. I., and James, D. W.** 1973. Intensive soil sampling. Washington Agricultural Experiment Station Bulletin no. 781.

**Olsen, S. R., Cole, C. V., Watanabe, F. S., and Dean, L. A.** 1954. Estimation of available phosphorus in soils by extraction with sodium bicarbonate. Circular, U.S. Department of Agriculture no. 939.

**Petersen, R. G., and Calvin, L. D.** 1986. Sampling. Pages 33-52 in *Methods of soil analysis* (Klute, A. ed.) Part 1, 2nd ed. Agronomy no. 9. Madison, Wisconsin, USA: American Society of Agronomy.

**Uehara, G., Trangmar, B. B., and Yost, R. S.** 1985. Spatial variability of soil properties. Pages 61-92 in *Soil spatial variability* (Nielson, R., and Bouma, J., eds.). Wageningen, Netherlands: PUDOC (Centre for Agricultural Publishing and Documentation).

**Vieira, S. R., Nielson, D. R., and Biggar, J. W.** 1981. Spatial variability of field-measured infiltration rate. *Soil Science Society of America Journal* 45:1040-1048.

**Vieira, S. R., Hatfield, J. L., Nielson, D. R., and Biggar, J. W.** 1983. Geostatistical theory and application to variability of some agronomical properties. *Hilgardia* 51(3):1-75.

**Warrick, A.W., Myers, D.E., and Nielsen, D.R.** 1986. Geostatistical methods applied to Soil Science. Pages 53-82 in *Methods of Soil Analysis* (Klute, A. ed.). Part 1. 2nd edn. Agronomy no.9. Madison, Wisconsin, USA: American Society of Agronomy.



**Wierenga, P. J.** 1985. Spatial variability of soil-water properties in irrigated soils. Pages 112-125 *in* Soil spatial variability (Nielson, D.R., and Bouma, J., eds.). Wageningen, Netherlands: PUDOC (Centre for Agricultural Publishing and Documentation).

**Wilding, L. P.** 1985. Spatial variability: its documentation, accomodation and implication to soil surveys. Pages 166-187 *in* Soil spatial variability (Nielson, D.R. and Bouma, J., eds.). Wageningen, Netherlands: PUDOC (Centre for Agricultural Publishing and Documentation).

# **Cropping Systems and Cultural Practices**



# Potential for Response Farming in Sub-Saharan Africa

J.I. Stewart<sup>1</sup>

## **Abstract**

*An analysis of rainfall during 1954–1983 at Niamey, Niger, shows that both amount and duration of rainfall in the rainy season are significantly correlated with the date of onset of rainfall, as defined here for crop production purposes. The correlations justify splitting the history of rainfall into two records, one representing the 'early onset' seasons (12 years) and the other the 'late onset' seasons (18 years). The two groupings differ in three essential features: amount of median rainfall in early seasons is 602 mm as against 400 mm in late seasons, median duration of early seasons is 113 days as against 83 days for late seasons, average rainfall per day within early seasons is 5.3 mm as against 4.7 mm in late seasons. Generalized farm-level recommendations for early vs late seasons are based on the above findings and on a flexible strategy that calls for adjusting the key variables of plant population and fertilizer-application rate, according to actual rainfall amount in the early season, e.g., the first 30 days after onset. Considerable potential exists for development and application of response farming in sub-Saharan Africa.*

## **Résumé**

**Potentiel de la culture réactive en Afrique au sud du Sahara :** *L'analyse des données pluviométriques recueillies à Niamey de 1954 à 1983 fait apparaître une corrélation significative entre hauteur et durée totales des précipitations d'une part, et date du début des pluies d'autre part, définie par l'auteur en fonction des objectifs de production agricole. Cette corrélation a permis de distinguer deux catégories de saison des pluies dont l'une est à début précoce (12 années) et l'autre à début tardif (18 années). Elles diffèrent par les trois caractéristiques essentielles suivantes : la hauteur médiane des précipitations en saison précoce atteint 602 mm et, en saison tardive, 400 mm; la durée médiane des saisons précoces est de 113 jours et celle des saisons tardives de 83 jours; enfin, la moyenne quotidienne des précipitations est de 5,3 mm pour les saisons précoces et de 4,7 mm pour les saisons tardives. Les recommandations adressées aux agriculteurs selon que les pluies sont précoces ou tardives se fondent sur les résultats de cette analyse et sur une stratégie permettant d'adapter les variables essentielles que sont la densité de plantation et le taux d'application des engrais à la quantité totale des précipitations enregistrées en début de saison, par exemple pendant 30 jours à compter de la date du début des pluies. On peut en conclure que l'avenir est prometteur pour la culture réactive en Afrique au sud du Sahara.*

---

1. President, WHARF (World Hunger Alleviation through Response Farming), Davis, California, USA.

ICRISAT (International Crops Research Institute for the Semi-Arid Tropics) 1989. Soil, Crop, and Water Management Systems for Rainfed Agriculture in the Sudano-Sahelian Zone: proceedings of an International Workshop, 7–11 Jan 1987. ICRISAT Sahelian Center, Niamey, Niger. Patancheru, A.P. 502 324, India: ICRISAT.

## Introduction

In response farming, the essential characteristics of the approaching rainy season are predicted, and crop decisions, farm practices, and input levels are matched to the expected rainfall. Rainy season characteristics that are essential are (1) date of onset, (2) when it ends (season duration, by difference), (3) the total amount of precipitation in the season, and (4) its time distribution within the season.

The forecast influences crop decisions such as selection of crop types and specific cultivars to grow and their relative apportionments within the cropping pattern, and whether to employ mixed cropping or sole cropping. Beginning season farm practices include land preparation and tillage as they relate to water retention versus surface drainage, pre-onset versus post-onset sowing, crop row spacings and weed-control measures, with special attention to the initial flush of weeds at the start of the season. Input levels of greatest significance are seeding rates and fertilizer rates, and in some instances, insecticides and/or herbicides.

The nature and degree of accuracy of the rainy season forecast depends upon the record of historical rainfall, and will differ in different climates, and sometimes localities. Similarly, the same factors, as well as the peculiarities of different crop enterprises, result in different farm-management decisions being influenced by the forecasts in different circumstances.

Response farming is therefore not a single, simply described system. However, in a given locality, with limited numbers of soil types and cropping systems, one can establish, on a one-time basis, a simple system of forecast criteria and response recommendations that will have equal validity in each rainy season thereafter. For example, in most cases it will be as simple as plan A for early onset versus plan B for later onset.

The conceptualization and research underlying the response farming development was begun by the author and his colleagues at the University of California, Davis, in 1967 (Stewart 1972). After field-testing in Kenya (Stewart and Hash 1982), research has been largely focused on the rainfall prediction aspect, with studies conducted in the Mediterranean and in India, Nepal, Rwanda, Virgin Islands and Yemen Arab Republic.

## Onset as a Predictor of Rainfall during the Rainy Season at Niamey

At Niamey, winter/spring rainfall is virtually non-existent, and season characterization as to the expected amount and duration of rainfall must instead be based on the actual date of onset. Onset has also been recognized as a predictor of the rainy season in India, where its relation to the duration of rainfall, and therefore to the selection of cultivar maturities, has particularly been emphasized (Ramana Rao et al. 1979).

Sivakumar (M.V.K. Sivakumar, ICRISAT Sahelian Center, personal communication) is presently successfully pursuing research on the onset/duration relationship throughout the Sahelian and Sudanian climatic zones. Persaud et al. (1986), find rainfall up to the middle of the rainy season (July) to be the first potentially reliable predictor.

Use of 'date of onset' as the pre-season predictor raises the question of how to define this term in a manner that meaningfully relates to the specific farming situation under study. Key considerations are the type of crop to be grown, the depth at which seed will be sown, the texture and water-holding capacity of the soil, the evaporative conditions of the atmosphere in the sowing/seedling period, and what the rainfall record shows about lengths and probabilities of dry spells that may occur following onsets in different time periods.

Onset, to be meaningful to the farmer, should mean that initial rains have penetrated beyond the seedling depth, storing sufficient water in the surface soil for germination and carry the seedlings through whatever dry spells may occur thereafter until further rains are assured. The evaporative rates and lengths of dry spells to be expected are the key questions. Both must be answered with reference to weather records. Thus, if evaporative rates are relatively high and expected dry spells are relatively long, onset must be defined as a relatively larger amount of early rainfall stored in the soil.

For example, Stewart and Hash (1982) suggest that the events that should be accepted as onset of the 'short rains' season for maize production in eastern Kenya begin on or after 20 Oct, and will persist for 1-11 days, with rainfall in this period totaling at least 30 mm. Evaporative rates (Class A pan) at this time are of the order of 6.0 mm day<sup>-1</sup>, and lengthy dry spells following this amount of rainfall are quite uncommon. Farmers wishing to 'dry plant' before onset, should do so because seed-

ling failure due to dry spells following germination has an extremely low probability in eastern Kenya (Stewart and Faught 1984).

On the other hand, the probability of an extended dry spell, say 2–3 weeks or more, following initial rains in the 'long rains' season is rather high, and more so if onset is early. Therefore, onset for this season is defined as at least 40 mm of rainfall in 1–8 days after 10 Feb. Evaporative rates then are about the same as mentioned for late October.

In Hyderabad, India, Hargreaves and Samani (1986) indicate that evaporation rates (Class A pan equivalent) are about 7.5 mm day<sup>-1</sup> in June when the rainy season usually starts, indicating that onset requirements should be fairly demanding. Thus onset in this case is defined as 40 mm or more rainfall stored in the soil from 1 Jun onward (Stewart 1988). This differs from the Kenya definitions mentioned above, which allude only to rainfall amounts, not directly to soil-water storage. The latter is a more stringent requirement. However, Virmani (1975) considered sowing rains at Hyderabad as receipt of at least 20 mm of rain, received in not more than two consecutive days. Virmani also points out that there is seldom a worrisome dry spell following sowing rains at Hyderabad, hence growers wishing to dry plant before the rains should do so.

In Niamey, Hargreaves and Samani (1986) indicate that onset evaporation rates (Class A pan equivalent) are 8.5 mm day<sup>-1</sup> or higher. Hence this paper defines onset as the first date from 1 Jun onward when 40 mm of new rainfall is stored in the surface soil<sup>1</sup>. Acceptable onsets in late May require correspondingly greater amounts of stored water. Using this, seedling failures were in the 30-year period from 1954 to 1983. This is not to say that there were no failed seasons at all.

## Niamey: Relationship of Onset to Essential Rainy-Season Characteristics

### Definitions

This paper, in relation to the example to be discussed, incorporates the following definitions:

- The date of onset is the first date after 1 June

1. Editors note: Reviewers of this paper agreed that the 40 mm of stored soil-water definition of onset is probably too high for Niamey conditions. However, this figure has been retained in the analysis by the author for illustrative purposes.

when stored surface soil water from new rains equals 40 mm or more. Exceptions allowed were 28 May (storage of 55 mm, 1976), and 31 May (storage of 99 mm, 1978).

- The final rain date is ascertained by counting backwards from the last rainy day in the annual record (in Sep or Oct; rain in Nov is rare and (is not taken into consideration here), until the total is 10+ mm; this date is accepted as the final meaningful rain date. For example, the last rains in 1957 were 5.0 mm on 1 Oct, 3.2 mm on 3 Oct, 4.0 mm on 15 Oct, and 2.5 mm on 21 Oct. Adding backwards, the total exceeds 10 mm on 1 Oct, which is accepted as the final effective rain date.
- Season total rainfall is that calculated to be stored in the profile as of the germination date, plus all rain thereafter until the final rain date.
- Duration of the rainy season is the number of days from (including) the date of onset to the final rain date.

The above definitions and the example analyses to be shown are not specific to any crop or cultivar. If, for example, the analyses were for the production of a 90-day millet, the amount and duration of rainfall in the season would both be limited to occurrences in that time period. Such analyses are required when assessing rainfall crops and cultivars. Other requirements to complete such analyses are water-balance and water-production function models. These needs and research techniques to fulfill them are discussed by Stewart (1986 a and b).

### Splitting the Rainfall Record: Early vs Late Onset

Table 1 shows details of rainfall characteristics at Niamey over the recent 30-year period, from 1954 to 1983. Median during the cropping season values are shown in the upper part of the table, while all inclusive ranges of values for the same series of years are in the lower part of the table.

Rows 1 and 4 of the table show values for the 30-year period as a whole. Rows 2 and 3 in each half of the table show values for portions of the 30 years, divided arbitrarily on the basis of dates of onset. Rows 2 and 5 represent 12 years in which onset was 'early', ranging from 28 May to 12 Jun (see row 5, col. 3). Rows 3 and 6 represent the other

**Table 1. Characteristics of the cropping seasons, and their prediction based on early vs late onset at Niamey, Niger, 30-year rainfall record, 1954-1983.**

| No. of years               | Onset period | Onset date    | Prediction date  | -----Cropping season----- |                 |                       |                     |
|----------------------------|--------------|---------------|------------------|---------------------------|-----------------|-----------------------|---------------------|
|                            |              |               |                  | Rainfall (mm)             | Duration (days) | Relative rainfall (%) | Values duration (%) |
| -----Median values-----    |              |               |                  |                           |                 |                       |                     |
| 30                         | All          | 20 Jun        | NA <sup>1</sup>  | 495                       | 93              | 100                   | 100                 |
| 12                         | Early        | 8/9 Jun       | Onset, to 15 Jun | 602                       | 113             | 122                   | 122                 |
| 18                         | Late         | 6 Jul         | 16 Jun           | 400                       | 83              | 81                    | 89                  |
| -----Ranges of values----- |              |               |                  |                           |                 |                       |                     |
| 30                         | All          | 28 May-21 Jul | NA               | 275-771                   | 71-154          | 100                   | 100                 |
| 12                         | Early        | 28 May-12 Jun | Onset, to 15 Jun | 484-771                   | 105-154         | 58                    | 60                  |
| 18                         | Late         | 19 Jun-21 Jul | 16 Jun           | 275-598                   | 71-109          | 65                    | 46                  |

1. NA = Not available.

18 years in which onset is termed 'late', i.e., from 19 Jun to 21 Jul.

Column 4 in Table 1, labeled 'Prediction Date', indicates that growing seasons with early onset, and presumably falling within the ranges of characteristics represented by row 5, are recognizable as of the date of onset—provided it occurs by 15 Jun. Late onset seasons are recognizable on 16 Jun, regardless of when onset actually occurs thereafter.

Columns 5 and 6 of Table 1 show that there are important practical and statistical differences in the historical record between cropping seasons with early versus late onset. The differences are both in the amount of rainfall in the season (col. 5) and its duration (col. 6).

A third difference, not shown in the table, deals with the average daily rainfall over the growing season, whatever the duration of the latter. Over the 30 years, this ranged from 3.0 to 8.1 mm day<sup>-1</sup>, with a median value of 4.8 mm day<sup>-1</sup>. However, of the 12 early onset years, none fell below 4.0 mm day<sup>-1</sup>, while 8 of the 18 late onset years (44%) ranged from 3.0 to 3.9 mm day<sup>-1</sup>. This would indicate that increased problems with intra-season rainfall distribution as well as lower rainfall totals and shorter durations may be expected in seasons with late onset.

Columns 7 and 8 in Table 1 show amount of rainfall in the season and duration in relative values, taking the 30-year values as 100%. Thus row 2 shows that median values of rainfall amount

and duration are each 22% higher for early seasons than for all seasons. Similarly, row 3 shows that late seasons fall below the 30-year medians in rainfall amount by 19% and duration by 11%.

Similarly, row 5 shows that rainfall amounts in early seasons fall within the upper 58% of the overall range, while late seasons (row 6) only fall within the lower 65% of the total range. With respect to season duration, early seasons only occupy the upper (longer season) 60% of the total range, while late seasons only fall within the lower 46% of the range—nearly a complete separation. The remainder of the paper will show the statistical, and more importantly, practical meaning of this information, in terms of farmers having to cope with highly-variable rainfall conditions.

### Rainfall Amount and Duration Regressed on Date of Onset: Practical Interpretations

Figure 1 shows the total rainfall during the growing season over the 30-year record regressed on date of onset. The coefficient of determination ( $r^2$ ) is 0.43, (highly significant at 1% level), with a student's  $t$  value of 4.6. Practically speaking, this shows that whenever onset occurs, the farmer is never faced with the entire range of possibilities indicated by the rainfall record. Rather, in Niamey, he is faced with only about 57% of the overall range of possibilities. The farmer would be greatly benefited if, at the start of each season, he were

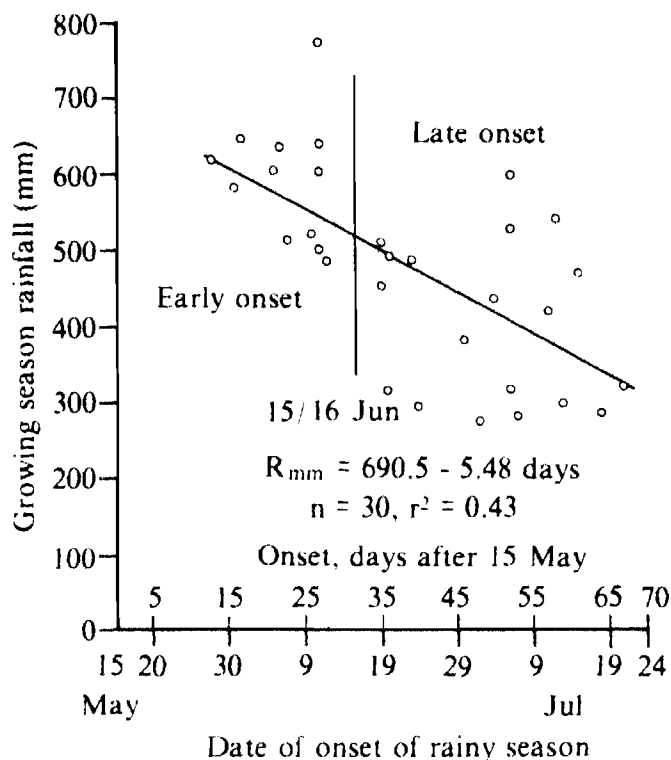

Figure 1. Regression of growing season rainfall from date of onset, showing that the historical range of rainfall occurrences is very much reduced when linked to any given date of onset. Niamey, Niger, 1954-1983.

aware of the 57% of the historical possibilities he is actually facing, and of the 43% he is not facing.

The slope of the regression line indicates that the growing season rainfall expectation declines more than 5 mm with each day's delay in onset. In practical terms this means a daily loss of at least 10 kg ha<sup>-1</sup> of sorghum grain yield potential and possibly as much as 60 kg ha<sup>-1</sup>, depending on the level of technology employed.

Figure 2 relates the duration of the growing season rainfall to the date of onset, and shows a still closer relationship than that seen in Figure 1 between rainfall amount and onset. The coefficient of determination in Figure 2 is 0.70 and the student's t value is 8.1, again significant at the 1% level. This is typical of earlier findings in a number of countries and localities, starting with Kenya in 1980.

The regression line slope of 1.06 in Figure 2 indicates that the crop production season tends to be shortened by slightly more than one day, with each day's delay in onset. Thus there is some tendency for late starting seasons to end earlier. The

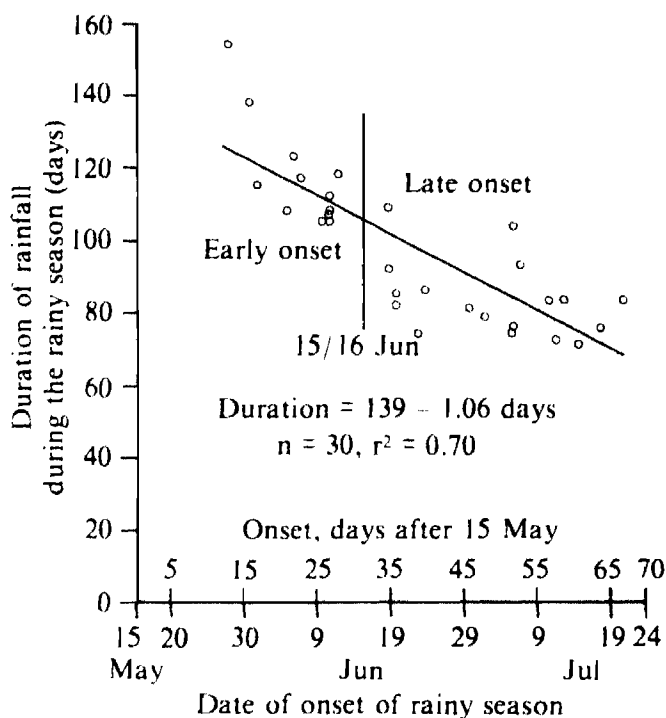

Figure 2. Regression of duration of rainy season from date of onset, showing that the historical range of occurrences is very much reduced when linked to any given date of onset. Niamey, Niger, 1954-1983.

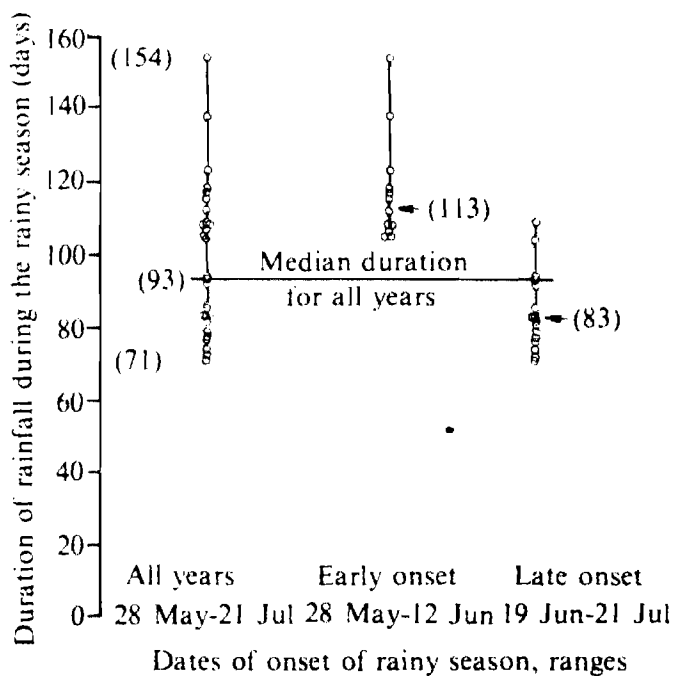

Figure 3. Division of historical range of duration of the rainy season into two ranges, based on date of onset. Median durations are shown for the entire range, and for early vs late onset. Niamey, Niger, 1954-1983.



median final rainfall date for the 12 early seasons was 28 Sep, while the median date for the 18 late seasons was 23 Sep. Figure 3 comprises a different and possibly more comprehensive way of viewing the relationship between season duration and date of onset.

### Early vs Late Onset: A Practical Approach to Farm-Level Decision Making

The data points in Figure 3 (as in all of the figures) each represent one year's occurrences in the 30-year record. The left hand vertical line contains the entire 30-year record, showing season duration ranging from 71 to 154 days, with a median value of 93 days. This represents the farmer's dilemma when information is lacking as to the significance of the date of onset. It is very difficult, if not impossible, to select crops and cultivars with optimal or near-optimal maturities with such a great range of uncertainties.

It is known that the farmers of the Sahelian zone are not ignorant of the fact that a relationship exists between season duration and date of onset, and that they do emphasize the planting of shorter-maturity crops with lower water requirements in later onset years. The booklet 'ICRISAT in Africa' (1986) provides evidence of this on page 29 as follows:

"On-farm studies by ICRISAT economists go hand-in-hand with crop improvement work. In the six villages studied in Burkina Faso, farmers used 40 different varieties of white sorghum; 19 of red sorghum, and 27 of pearl millet, choosing specific varieties for different periods in the planting sequence."

Stewart (1986 c) cites a number of research papers covering the same topic in India where farmers traditionally have practiced "contingency", switching to less demanding crops with later onset of the monsoon. Researchers are assisting them in this very sensible approach.

In Figure 3, the middle and right-hand strings of data represent a simple 2-part breakdown of the 30-year record into (as before) 12 years of early onset vs 18 years of late onset. No early onset growing season had a rainfall duration less than 105 days. The median duration for these years was 113 days, 20 more than the 30-year median of 93 days. Late onset seasons were of shorter duration,

with a median of 83 days, and a maximum of 109 days. It is apparent that crops and cultivars of different maturities are called for in these two different types of rainfall years.

Figure 4 is a similar representation to that seen in the last figure, but relates the amount of rainfall in the season rather than duration, to date of onset. Here we see the 30-year range of rainfall amounts in the left hand data string, ranging from 275 to 771 mm, with a median value of 495 mm. It is clear that providing farmers with advice on crops to plant, soil tillage, seeding rates, row spacing, intercropping vs sole cropping, fertilizer rates, etc., would be very difficult if this was all the information one had. Figure 4 also breaks the historical record into two different records—those with early onset, (the middle data-string in the figure), and those with late onset- (the right hand data-string in the figure).

Figure 4 also illustrates how an earlier-described (Stewart 1988) response farming strategy for cropping with seasonal variation in rainfall might be applied to the Niamey rainfall situation. The basic strategy applies, whatever the degree of predictability of the rainfall, even if there is no other

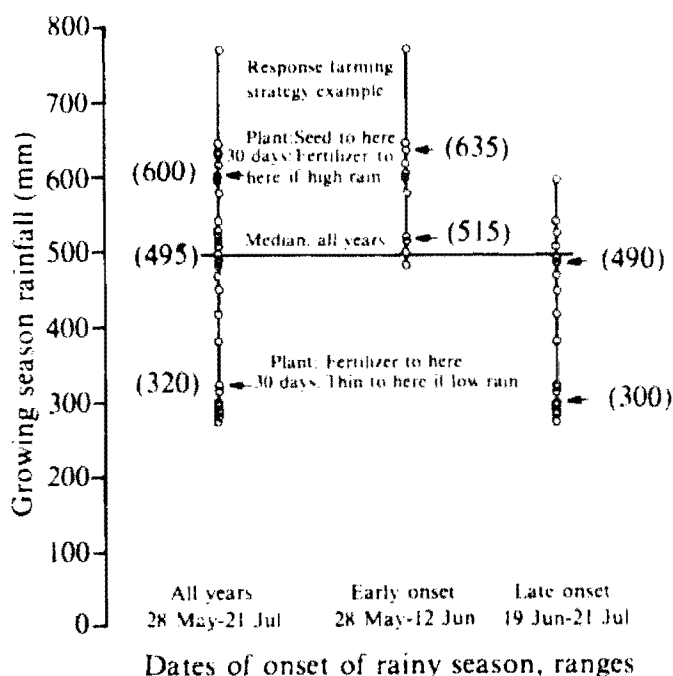

Figure 4. Division of historical growing season rainfall range of occurrences into two ranges based on date of onset. Example of response farming strategy indicated by arrows at each range. Niamey, Niger, 1954-1983.

information except that found in normal probability analyses. However, as the figure shows, the more the range of possible rainfall occurrences can be narrowed prior to planting the crop, the closer one can come each year to matching farm decisions to actual rainfall.

If there were no predictive capability, the farmer (and his advisers) would face the 30-year history indicated by the left hand data-string in Figure 4. The proposed strategy is indicated by the two arrows to the right of the data, one at 600 mm (the median for the upper half of the data range) and the other at 320 mm (median for the lower half). They are the water supply levels at which the key management variables of plant population and fertilizer application rates will be aimed. At planting time, seeding rates are aimed at the upper half of the range while fertilizer rates (if any) are aimed at the lower half of the range. After 30 days (actually at thinning/side-dressing time for the particular crop), if rainfall has been above normal, more fertilizer is side-dressed to meet the higher water supply expectation. But if rainfall is below normal, fertilizer remains as at planting, and plant population is reduced by thinning to correspond to the lower water supply expectations.

When there is predictability, that is to say when the possible rainfall range can be reduced, e.g., as based on date of onset in Figure 4, then the above strategy becomes even more effective, with closer fitting of practices and input levels to actual water supply. The way to go about matching plant populations and fertilizer rates to different water supply expectations is a subject that falls within what is termed water production function research (Stewart 1972). Line source design and lysimeter field experiments are the recommended techniques (Hanks et al. 1974, Stewart and Faught 1984, Stewart 1988).

## Conclusions

### Rainfall Predictability Considerations

The 30-year rainfall record (1954–1983 inclusive) from Niamey, Niger, exhibits considerable predictability of the rainfall during the growing season, based simply on the date of onset as the predictor.

The farm relevant characteristics predicted are:

### The Duration (Days) of the Rainy Period

Seventy percent of the variability in duration is explained by a simple linear regression on date of onset. When the rainfall record is split into 'early' (to 15 Jun) versus 'late' (from 16 Jun) onset years, early seasons (12 out of 30 years) are grouped within the upper 60% (longer duration) of the historical range, with a minimum duration of 105 days and a median value of 113 days.

By way of contrast, late seasons (18 years) are grouped in the lower 46% of the total range, with a maximum duration of 109 days and a median of 83 days. Traditional farmer practice in much of the Sahelian zone takes cognizance of this relationship, leading to selection of crops/cultivars of different maturities. This is a working example of the system termed "Response Farming" in this paper. **Conclusions:** The duration of the rainy season at Niamey is highly predictable as of the date of onset in early onset years, and as of 16 Jun in late onset years. The main practical application of this predictability will be to guide farmers in selecting the crops and cultivars most suitable for planting in the season at hand, in terms of their maturities. Although farmers already incorporate this approach in traditional cropping, trained analysts with detailed weather records and computer capabilities can certainly improve the information available to farmers, upon which their decisions may be based. A second major application will be to provide plant breeders with a clearer representation of the situation actually faced by the farmers for whom they are breeding/selecting improved genotypes.

### The Total Rainfall Amount Relevant to Crop Production

The regression of the amount of rainfall during the season on date of onset explains 43% of the variability. This is statistically significant at the 1% level with student's *t* value of 4.6 and the duration relationship above is statistically significant at the 1% level with student's *t* value of 8.1.

Practical utilization of this relationship may be accomplished as above, simply by dividing the rainfall record into two groups of years, representing early- versus late-onset seasons. When so divided, early-onset season rainfall amounts are all grouped in the upper 58% of the 30-year historical record, covering a range of 484–771 mm, with a

median value of 602 mm. However, late-onset seasons are grouped within the lower 65% of the record, ranging from a low of 275 mm to a high of 598 mm, with a median value of 400 mm.

From a farmer's viewpoint, the foregoing indicates that early-onset seasons will have moderate to high rainfall, and water problems, if any, will be those associated with excess water. Conversely, late-onset seasons will experience low to moderate rainfall, with high probabilities of crop water limitations and drought conditions, and little concern about excess water.

**Conclusion:** There is sufficient predictability of the amount of rainfall during the rainy season at Niamey, based on the date of onset, to divide the historical record into at least two records—here termed early onset versus late onset—and, at the start of each season, provide farmers an appropriate package of recommendations for the season at hand (note that 'package' here does not imply all or nothing—each farmer may benefit from selecting one or more of the recommendations as may fit his circumstances). Recommendations cover land preparation and tillage, selection of crops and their apportionment in the field, intercropping versus monocropping, pre-onset versus post-onset sowing, control of the initial weed flush, row spacings, seeding and initial fertilizer rates, and other factors as appropriate to the specific enterprises.

### **Intraseason Rainfall Distribution**

The present study of within-season rainfall distribution has been only cursory, but there is one aspect worthy of reporting. Early-onset seasons are not only of longer duration and generally higher rainfall total, but also average more rainfall per day, whatever the season's length. The median value for the 12 early onset seasons is 5.3 mm day<sup>-1</sup>, while that for the 18 late-onset seasons is 4.7 mm day<sup>-1</sup>. More importantly, the lowest average daily rainfall with early onset was 4.0 mm day<sup>-1</sup>, while 8 of 18 late-onset seasons ranged from 3.0 to 3.9 mm day<sup>-1</sup>.

**Conclusion:** Intraseason rainfall distribution predictability requires more rigorous analysis of the record than done here, but there is a clear indication that late-onset seasons, relative to early-onset seasons, may be more prone to rainfall distribution

problems in addition to shorter duration and less total rainfall.

### **Additional Response Farming Considerations**

**Strategy to Minimize the Effects of Seasonal Rainfall Variation.** Whatever the degree of rainfall predictability, the range of possible occurrences in the approaching season is still considerable. The usual way of dealing with this is to determine the probabilities of various occurrences, e.g., rainfall amounts within the range, and base farm level recommendations on the rainfall amount indicated at some arbitrarily selected probability, say 70%.

This strategy is not satisfactory because it practically means that the farmer is advised to do the same thing every year, and that is to operate in the lower part of the possible rainfall range. In lower rainfall zones, this provides no hope of ever escaping the poverty syndrome.

The response farming strategy is a flexible one, which offers in effect, four farming levels instead of one. First, there are two levels based on prediction as described above. Next, the key variables of plant population and fertilizer application rate are singled out for special treatment; that is to say for application within the remaining rainfall range of variation either in the upper half of the range or in the lower half, with the deciding factor being actual rainfall amount in the early part of the growing season, say 30 days following onset.

Seeding rates are calculated for the upper half of the range while initial fertilizer rates are calculated for the lower half. At 30 days, above-normal rainfall is the cue to increase fertilizer to accord with the upper half of the range, while below-normal rainfall signals that fertilizer should remain as is and plant populations should be thinned to accord with the lower half of the range.

The strategy just suggested is only technical and therefore incomplete. Many other factors may influence the strategy, e.g., social, economic or other factors. A factor introduced into the strategy put forth in this paper as an example for Niamey, is that priority be given to food security. Thus, full attention is given to matters affecting production for the market. In another setting, the opposite might well be the case. Therefore, the Response Farming approach implies not only responsiveness to weather conditions, but to the entire milieu within which the farmer must operate.

The present paper includes a set of generalized farm-level recommendations for Niamey, which are predicted on the rainfall analysis results and on the elements of flexibility and food security discussed. These recommendations are not intended to be definitive, because the writer is not sufficiently knowledgeable about the agricultural situation in Niger.

However, detailed crop-specific farm-level recommendations must be based on more rigorous, ongoing research and modeling of findings than those that are introduced here. Stewart (1988) provides information on the research needs and methods for fulfilling them.

Nevertheless, the simplified rainfall analysis and generalized farm-level recommendations developed in this paper are sufficient to make farmers more knowledgeable about their seasonal rainfall variation, and the types of alternatives they might consider in their decision making.

## Acknowledgment

Support for this study has been provided by the United States Agency for International Development (USAID), Science and Technology Bureau, and the United States Department of Agriculture (USDA), administered through USDA/OICD/WP under the USDA/USAID PASA/TSMMD Dryland Agriculture Project.

The writer is indebted to Dr Ed. Kanemasu, Kansas State University, who provided long-term daily rainfall records analyzed for Niamey, as well as other stations for later analyses.

## References

- Hanks, R.J., Keller, J., and Bauder, J.W.** 1974. Line source sprinkler plot irrigation for continuously variable water and fertilizer studies on small areas. CUSUSWASH 211(d)-7. Logan, Utah, USA: Utah State University. 13 pp.
- Hargreaves, G.H., and Samani, Z.A.** 1986. World water for agriculture precipitation management. Logan, Utah, USA: Utah State University. 617 pp.
- ICRISAT (International Crops Research Institute for the Semi-Arid Tropics).** 1986. ICRISAT in Africa. Patancheru, A.P. 502 324, India: ICRISAT. 60 pp.
- Norman, D.W., Newman, M.D., and Ouedraogo, I.** 1981. Farm and village production systems in the semi-arid tropics of West Africa: an interpretive review of research. Research Bulletin no. 4, Vol. 1. Patancheru, A.P. 502 324, India: International Crops Research Institute for the Semi-Arid Tropics. 100 pp.
- Persaud, N., Quattara, M., and Alfari, I.** 1986. Analysis of rainfall records and its implications for improving rain-use efficiency for cereal production in Niger. College Station, Texas, USA: Texas A&M University, Department of Soil and Crop Sciences. 26 pp.
- Rao, B.V.R., Biradar, B.R., and Surpur, S.S.** 1979. A study on occurrence of sowing rains for long, medium and short duration crops in Bangalore region. Annals of Arid Zone 18(1-2): 75-79.
- Stewart, J.I.** 1972. Prediction of water production functions and associated irrigation programs to minimize crop yield and profit losses due to limited water. Ph.D. thesis, University of California, Davis, California, USA. 200 pp.
- Stewart, J.I.** 1980a. Technical research report—Agrometeorology. USDA/USAID/KARI Project: Cropping Systems for Marginal Rainfall Areas. Pages 48-70 in Record of research, annual report, 1977-80. Muguga, Kenya: Kenya Agricultural Research Institute.
- Stewart, J.I.** 1980b. Effective rainfall analysis to guide farm practices and predict yields. Proceedings of the 4th Annual General Meeting of the Soil Science Society of East Africa, 27-28 Oct 1980. Arusha, Tanzania: Soil Science Society of East Africa. 34 pp.
- Stewart, J.I.** 1982a. Water production function research to optimize decisions on intercropping, plant populations and fertilizer rates in accordance with predicted season rainfall. Presented at the Third FAO/SIDA Seminar on Field Food Crops in Africa and the Near East, 6-12 Jun 1982, Nairobi, Kenya.
- Stewart, J.I.** 1982b. Technical research report—Agrometeorology. USDA/USAID/KARI Project: Dryland Cropping Systems Research Project. Pages 20-78 in Record of research, annual report. Muguga, Kenya: Kenya Agricultural Research Institute.

**Stewart, J.I.** 1986a. Mediterranean-type climate, wheat production and response farming. Presented at the Workshop on Soil, Water and Crop/Livestock Management Systems for Rainfed Agriculture in the Near East Region, 18–23 Jan 1986, Amman, Jordan.

**Stewart, J.I.** 1986b. Response farming for improvement of rainfed crop production in Jordan. Presented at the Workshop on Soil, Water and Crop/Livestock Management Systems for Rainfed Agriculture in the Near East Region, 18–23 Jan 1986, Amman, Jordan. 30 pp.

**Stewart, J.I.** 1988. Development of management strategies for minimizing the impact of seasonal rainfall variation. Pages 131–150 *in* Drought Research Priorities for Dryland Tropics (Bidinger, F.R., and Johansen, C., eds.). Patancheru, A.P. 502 324, India: International Crops Research Institute for the Semi-Arid Tropics.

**Stewart, J.I., Martin, P.E., Prato, J.D., Pruitt, W.O., Lenka, D., Henderson, D.W., and Hagan, R.M.** 1971. Summary report on two seasons of field experiments at UC Davis, measuring yield responses of corn (*Zea mays*) to varying levels of irrigation, nitrogen, and plant population. Report submitted to Iowa State University–U.S. Bureau of Reclamation Contract, Oct 1. 42 pp.

**Stewart, J.I., Hanks, R.J., Danielson, R.E., Jackson, E.B., Pruitt, W.O., Franklin, W.T., Riley, J.P., and Hagan, R.M.** 1977. Optimizing crop production through control of water and salinity levels in the soil. Tech Completion Report to USDI, OWRT. Joint Research by the Consortium for International Development (Univ of AZ; Univ of CA, Davis; Colo State Univ; Utah State Univ). Utah Water Research Laboratory Report no. PRWG151-1. 206 pp.

**Stewart, J.I., and Hash, C.T.** 1982. Impact of weather analysis on agricultural production and planning decisions for the semiarid areas of Kenya. *Journal of Applied Meteorology* 21(4):477–494.

**Stewart, J.I., and Kashasha, D.A.R.** 1984. Rainfall criteria to enable response farming through crop-base climate analysis. *East African Agricultural and Forestry Journal* 44 (Special issue): 58–79.

**Stewart, J.I., and Faught, W.A.** 1984. Response farming of maize and beans at Katumani, Machakos district, Kenya: recommendations, yield expectation and economic benefits. *East African Agricultural and Forestry Journal* 44 (Special issue): 29–51.

**Virmani, S.M.** 1975. The agricultural climate of Hyderabad region in relation to crop planning. Patancheru, A.P. 502 324, India: International Crops Research Institute for the Semi-Arid Tropics. 54 pp. (Limited distribution.)

# Crop Response to Tillage Practices in a Sahelian Soil

M.C. Klaij<sup>1</sup> and W.B. Hoogmoed<sup>2</sup>

## Abstract

*During the last 25 years in Niger, the pearl millet-cultivated area has doubled, while yields have declined, indicating that farmers must have expanded production onto more marginal areas. The three key constraints to an increase in yield are low fertility, limited and untimely cultural practices, and frequent drought. This paper describes the physical environment of the ICRISAT Sahelian Center, research on tillage and the use of alternative soil and crop-management practices to parry serious crop-establishment problems associated with wind-erodible sandy soils, crop water use and efficiency, and pearl millet yield. The results of 2 years of experimentation (one very dry, and one nearly normal year) show a positive interaction between presowing cultivation and other inputs such as fertilizers and crop residues for better crop establishment, yield, and water-use efficiency. The use of crop residue increased the organic matter content of the soil. Ridging seems most promising as a wind-erosion control measure, requires less energy than does plowing, and can be performed efficiently using animal power.*

## Résumé

**Réponses des cultures aux techniques de labour dans les sols sahéliens :** *Ces 25 dernières années au Niger, la surface emblavée en mil a doublé, tandis que les rendements ont décliné. Cela signifie que des terres de plus en plus marginales sont utilisées. Trois des principaux obstacles à l'augmentation des rendements sont la pauvreté des sols, les pratiques agricoles réduites et mal programmées et la sécheresse fréquente. On décrit l'environnement physique au Centre sahélien de l'ICRISAT, la recherche sur le travail du sol et enfin, l'emploi de pratiques différentes de gestion du sol et des cultures pour pallier les difficultés de l'établissement des cultures associées aux sables transportées par le vent, la consommation de l'eau par les cultures et son efficacité et les rendements de mil. Des résultats de deux années d'expérimentation (une année très sèche et une année quasi normale) montrent une interaction positive entre la préparation du sol avant semis et d'autres intrants comme les engrais, les résidus de récolte pour les rendements et une efficacité de l'utilisation de l'eau. L'emploi des résidus de récolte augmente le contenu en matière organique du sol. Le billonnage apparaît très prometteur pour un meilleur contrôle de l'érosion éolienne, il requiert moins de travail que le charruage et peut être réalisé efficacement au moyen de la traction animale.*

---

1. Principal Soil and Water Engineer, ICRISAT, Niamey, Niger.

2. Tillage Specialist, Tillage Laboratory, Agricultural University of Wageningen, Wageningen, Netherlands.

ICRISAT Conference Paper no.414.

ICRISAT (International Crops Research Institute for the Semi-Arid Tropics) 1989. Soil, Crop, and Water Management Systems for Rainfed Agriculture in the Sudano-Sahelian Zone: proceedings of an International Workshop, 7-11 Jan 1987. ICRISAT Sahelian Center, Niamey, Niger. Patancheru, A.P. 502 324, India: ICRISAT.

# Introduction

In sub-Saharan Africa, West Africa has had the slowest growth rate for food production. The per capita production of all crops, except rice, has declined during the last two decades, as have average yields, indicating that technical change has not yet had much impact on food production (Spencer 1985). Obviously, the increases in food production needed to feed a rapidly growing population have mainly come from the increase in area under cultivation. The decline in average yield suggests that production has expanded to increasingly marginal lands and that fallow periods have become too short to allow natural restoration of fertility.

To meet future food needs without decreasing the resource base, increased production will have to be realized from increased yields.

Pearl millet (*Pennisetum americanum* (L.) Leke) is a major staple crop grown on 14 million ha of the Sahelian and Sudanian semi-arid zones. The pearl millet acreage in Niger has doubled to 3.2 million ha in the last 25 years while average grain yields have fallen from 480 kg ha<sup>-1</sup> to a mere 300 kg ha<sup>-1</sup> (Sedes 1987). Only the agronomic constraints to production increases will be discussed here, although there are many others. The most limiting agronomic factors to increased yield levels of pearl millet production systems are, in order of priority: the inherent low soil fertility, limited and untimely cultural practices, and the occurrence of drought periods (Fussell et al. 1986).

This paper focuses on the effects of improved soil- and crop-management practices on the estab-

lishment, yield, and water use of millet. After describing the physical environment and briefly reviewing research on soil tillage and management, we focus on the management implications and results of experiments on soil- and crop-management practices, conducted at the ICRISAT Sahelian Center (ISC) during the 1984 and 1985 rainy seasons.

## The Physical Environment

Physically and chemically poor soils, low and uncertain rainfall, and high temperatures make the Sahelian zone a harsh environment for crop production.

Alfisols are the third most common soil order in the tropics, and are very prominent in semi-arid regions, especially in India and West Africa (Sanchez 1976). The soils at the ISC generally have sand contents of over 85%. The predominant soil is the Laboucheri soil series, classified as Psammentic paleustalf. Some of its chemical and physical properties are summarized in Table 1.

The Laboucheri sand is a very deep soil. The surface horizon is yellowish red up to about 30 cm. The Bt horizon is red sand with weak structural development to more than 2 m depth. Soil-bulk densities of the surface horizon are high ranging from 1.55 to 1.76 g cm<sup>-3</sup>; subsoil densities are lower ranging, from 1.44 to 1.65 g cm<sup>-3</sup>. Infiltration rates and internal drainage are rapid, with the saturated conductivity of the soil ranging from 150–200 cm day<sup>-1</sup>.

Table 1. Mean and standard errors for selected soil properties of Laboucheri sand at the ISC.

| Property                        | A horizon      |      |      | B horizon      |      |      |
|---------------------------------|----------------|------|------|----------------|------|------|
|                                 | No. of samples | Mean | SE   | No. of samples | Mean | SE   |
| Total sand (%)                  | 13             | 91.2 | ±0.5 | 35             | 87.8 | ±0.5 |
| Total silt (%)                  | 13             | 4.7  | ±0.3 | 35             | 4.7  | ±0.2 |
| Total clay (%)                  | 13             | 4.2  | ±0.4 | 35             | 7.6  | ±0.3 |
| 0.1 Bar H <sub>2</sub> O (%)    | 4              | 11.4 | ±1.9 | 6              | 14.6 | ±2.5 |
| 15 Bar H <sub>2</sub> O (%)     | 4              | 1.8  | ±0.4 | 15             | 2.5  | ±0.1 |
| pH                              | 13             | 4.9  | ±0.1 | 35             | 4.9  | ±0.1 |
| Al saturation (%)               | 13             | 23.5 | ±4.0 | 35             | 21.1 | ±2.4 |
| CEC, (meq 100 g <sup>-1</sup> ) | 13             | 1.3  | ±0.1 | 35             | 1.3  | ±0.1 |
| Base saturation (%)             | 13             | 41.9 | ±6.5 | 35             | 45.8 | ±3.0 |

Source: West et al. (1984).

Average annual rainfall at the ISC is 560 mm, with an average growing season of 94 days (Sivakumar 1989). A considerable variation of the amount of rainfall between and within years is to be expected. Rainfall intensities are high, e.g., 25% of the total annual rainfall comes in intensities higher than 75 mm h<sup>-1</sup> in Zinder (Niger), 55 mm h<sup>-1</sup> in Gaya (Niger) and, as a contrast, a 'low' 30 mm h<sup>-1</sup> in Patancheru (India) (Hoogmoed 1986, p. 48).

Soil temperatures can be extremely high. Three days after a planting rain, during crop emergence, maximum soil temperatures have been known to reach over 42°C at a depth of 5 cm and 55°C at the soil surface (ICRISAT 1984).

### Soil Management Effects and Implications

The sandy-textured soils on which pearl millet is grown, have low porosity (35-40%) in the surface layer, low organic matter, poor fertility, and are structurally weak.

Studies in West Africa have shown that soil-mechanical resistance due to high bulk densities limits root growth. Soil cultivation can reduce bulk density, and thereby facilitate root proliferation. Chopart (1983) measured root growth of pearl millet in sandy soils and found that as a result of plowing, the dry mass of pearl millet roots doubled in the first 50 days, and the roots penetrated deeper layers. Strong positive correlations between the reduction of bulk densities (increased porosity), root growth, and yield have been reported for many crops (Charreau and Nicou 1971). Nicou and Charreau (1985) reported that in 38 experiments on pearl millet, cultivation showed a 22% grain yield increase. Furthermore, when combined with fertilization and use of crop residues, plowing improved soil productivity and crop yield with time, even in the driest years (Pieri 1985a). Lately, the positive effects of modifying the soil surface to increase infiltration and reduce runoff have received attention (Nicou and Charreau 1985). Sanders and Roth (1985) report a two- to fourfold increase in sorghum yield, owing to fertilized tied ridges and fertilizer application in farmers' fields.

Generally, improved rainfall infiltration and reduced runoff are important effects of cultivation. However, the deep sandy soils at the ISC show little tendency to crust formation. Rain simulator

runs were made on an untilled, bare, initially dry soil. The high rainfall intensity used (100 mm h<sup>-1</sup>) did not cause runoff even after 2 h of continuous application (ICRISAT 1985). Therefore, the beneficial effects of tillage in these types of soils can be attributed to enhanced rooting in time and space, which results in better exploitation of natural and chemical fertility and soil moisture, leading to increased water-use efficiency (WUE). The question arises of the extent to which cultivation increases porosity and the duration of this effect. At the ISC, cultivation reduced soil-bulk density to 1.22 g cm<sup>-3</sup>, thus increasing pore space to 54%. Consolidation, resulting from raindrop impact during rainstorms totaling 100 mm, reduced soil porosity to 51±1.4%, which was well above that under field conditions.

Soil-surface modification has been important in overcoming wind erosion problems on the susceptible soils at the ISC. The worst damage caused by wind erosion in this environment occurs during crop establishment. As a result of the usually strong easterly winds, preceding and during rainstorms, sandblasting and burial of seedlings have led to poor establishment, often forcing farmers to resow their crops several times. Potential wind-erosion losses can be estimated using a wind erosion equation that estimates annual rates of erosion by the following factors (Woodruff and Siddoway 1965):

$$E = f(I, K, C, L, V)$$

where

- E = annual loss of soil,
- I = soil erodibility,
- K = soil ridge roughness factor,
- C = climatic factor,
- L = equivalent field width, and
- V = equivalent vegetation factor.

When prevailing winds cause erosion, K and L are particularly important manageable factors. Ridging of soils susceptible to wind erosion may reduce soil loss rates by 85% (Fryrear 1984). The width of a field can be reduced by windbreaks and may also effectively be reduced by strip cropping. The factor V is influenced by crop residue. Covering as little as 20% of the soil with crop residues (or 600 kg ha<sup>-1</sup> of corn stalks) reduces soil losses by 57% (Fryrear 1985).

Soil cultivation also plays an important role in improving and maintaining soil fertility by incor-



porating organic matter, crop residues, and manure, the latter being considered a necessary adjunct to the use of chemical fertilizer for long-term soil fertility maintenance and stability of crop production (Pieri 1985b).

End-of-season cultivation can kill weeds, preserve precious soil moisture, and may save a crop when the following season's rains are marginal (Dancette and Nicou 1974).

Last but not least is the effect that timely cultivation has on weeds and their control, and the effectiveness of interrow cultivation. In indigenous production systems, weeding poses a serious labor bottleneck, which might be relieved by the introduction of animal power for tillage and weeding operations (Norman et al. 1981).

## Soil Management Techniques

### Experimental Treatments

The objective of the program is to identify soil-management constraints and to develop appropriate soil-management techniques quickly for the resource-poor farmer. For this purpose, four contrasting presowing primary-tillage methods are used, in declining order of intensity: plowing to a depth of 15–20 cm, direct ridging (75-cm spaced ridges), sandfighting, and as a control zero tillage. The latter is predominant in the characteristically low input pearl millet production systems that rely almost exclusively on hand labor for field operations.

All experiments discussed are full factorial designs; fertility is kept at two levels—no chemical fertilizer, and modest doses of P (17 kg ha<sup>-1</sup>) and N (40 kg ha<sup>-1</sup>); where applicable, crop residue is studied at two levels, all residue removed or 4 t ha<sup>-1</sup> of pearl millet residue left.

A 0.75 × 1 m planting pattern (13 300 hills ha<sup>-1</sup>) was used in most experiments. The effects of cultivation will be explained in terms of crop establishment, crop water use, and yields from the results of experimentation at the ISC during 1984 and 1985.

### Results

**Effect of Soil and Crop Management on Plant Establishment.** In an exploratory factorial ex-

periment in 1984, we studied the effects of pre-planting tillage, planting method, planting depth, fertility levels, and distance from a windbreak on the establishment, early growth, and yield of local pearl millet. The use of a precision planter suitable for both hill planting, as in the traditional method, and drilling ensured a consistent placement (depth and compaction) and number of seeds.

Two small storms with high windspeeds during the first 2 weeks of crop establishment provided excellent wind erosion conditions for evaluating treatment effects in terms of plant stand and height. Significant effects at this stage were caused by tillage, planting method, and distance from the windbreak (Table 2). Plowing left the soil surface smooth as on the control plot, therefore the positive effect of plowing on stand and growth can be entirely attributed to improved subsurface conditions, resulting from reduced soil-bulk density and the incorporation of the P-fertilizer. The volume of soil loosened after ridging is much smaller than after plowing, yet the equally good seedling survival rate suggests that ridging is effective in reducing wind erosion.

Significantly fewer seedlings emerged from hill planting than from drilling, but in the latter case, the seedling survival rate was considerably lower. In hills, seedlings protect each other, apparently favoring the innermost seedlings that were much taller probably because of lower soil temperature and reduced sandblasting.

There was no significant fertility effect on stands or height. Planting depth and interaction effects were also not significant at this early stage. Increasing distance from the protected side of the field affected both stands and early growth, but these effects were confounded with natural fertility.

The crop was thinned to three plants per hill or a corresponding 3 plants m<sup>-1</sup> for drilled plots. During the growing cycle, soil moisture was a limiting factor; an average of 190 mm of rainfall was received, and used, by the crop. The earlier stand advantages traced to factors discussed above were nullified.

Hill sowing gave a significantly higher grain yield (510 kg ha<sup>-1</sup>) than drilled rows (410 kg ha<sup>-1</sup>). The addition of fertilizer in the driest year on record also increased grain yield from 370 to 540 kg ha<sup>-1</sup> (SE = ±31 kg ha<sup>-1</sup>). All other (interaction) effects were not significant.

The experiment was continued during the 1985 rainy season, which registered a near-normal total

**Table 2. Effect of cultivation, planting method, and location of block on early stands and crop height of pearl millet. ISC, 1984 rainy season.**

| Treatment                 | Stand decline (%)    |          | Plant stand      | Plant height |
|---------------------------|----------------------|----------|------------------|--------------|
|                           | 3-7 DAS <sup>1</sup> | 7-13 DAS | 13 DAS(000)      | 13 DAS (cm)  |
| Plowing                   | 14.8                 | -1.7     | 149              | 14.6         |
| Ridging                   | 0.9                  | 11.8     | 151              | 15.6         |
| Sandfighting <sup>2</sup> | 18.1                 | 18.8     | 84               | 13.1         |
| Zero tillage              | 16.1                 | 13.6     | 99               | 10.8         |
| SE                        | ±4.8                 | ±5.1     | ±20.9            | ±1.2         |
| Hill planting             | 11.9                 | -2.3     | 103 <sup>3</sup> | 16.9         |
| Drill planting            | 13.1                 | 23.5     | 139              | 10.2         |
| SE                        | ±3.4                 | ±3.6     | ±14.8            | ±0.86        |
| Block <sup>4</sup>        |                      |          |                  |              |
| 1                         | 12.0                 | 13.6     | 123              | 15.9         |
| 2                         | 20.4                 | 7.6      | 95               | 12.6         |
| 3                         | 11.4                 | 15.1     | 88               | 11.2         |
| 4                         | 6.2                  | 6.2      | 178              | 14.4         |
| SE                        | ±6.7                 | ±7.2     | ±29.6            | ±1.2         |

1. DAS = Days after sowing, decline in terms of number of hills, or seedlings. Day 3 and day 7 are computational bases for percentage change calculation.

2. Plots sandfought once.

3. Average of 8.5 seedlings hill<sup>-1</sup> or 12 100 hills ha<sup>-1</sup>.

4. Block 4 was located at the most protected eastern side of the field. The distance between blocks was 40 m, the last block being located at the western side of the field close to the next windbreak.

rainfall of 545 mm. Residual fertilizer effect and pearl millet cultivar were added as treatments; all plots were hill planted.

Again, tillage had positive effects on crop establishment and early growth, and on the yield of the pearl millet cultivars. Unlike in 1984, stands did not decline during the first 40 days after sowing (DAS): the effectiveness of posttillage roughness in limiting wind erosion apparently could not be assessed because storms were relatively mild.

However, later in the season, crop stands responded to tillage methods, pearl millet cultivars, and fertilizers added in 1985. Plant hill survival, after superficial sandfighting and zero tillage, was inferior to the more intensive tillage methods of plowing and ridging that loosen and invert the soil (Fig. 1).

At 40 DAS, significant varietal differences were observed ( $P < 0.05$ ), with 3/4 HK having 91%, CIVT 95%, and Sadoré Local 92% pocket emergence (SE = ±0.88). At harvest, stands differed significantly as a result of a residual fertility effect;

plots that received fertilizer in 1984 had 62%, and control plots 54% pocket stands (SE = ±2.6). A highly significant effect on stands at harvest resulted from the fertilizer applied in 1985. In plots that received fertilizer, 74% of the pockets survived, as against 43% on the control plots (SE = ±1.9). Yield depended on the number of pockets, number of grain-yielding heads, and yield per head. A multiple regression was done of the logarithm of grain yield on the logarithm of the percentage of pocket survival to harvest, number of heads per pocket, and grain yield per head. The regression equation obtained was:

$$y = 0.97 \ln (\% \text{ survival}) \\ + 0.75 \ln (\text{heads pocket}^{-1}) \\ + 0.24 \ln (\text{yield head}^{-1})$$

The multiple R was 0.926.

Variety grain yields were significantly different, and in 1985, CIVT responded best to fertilization

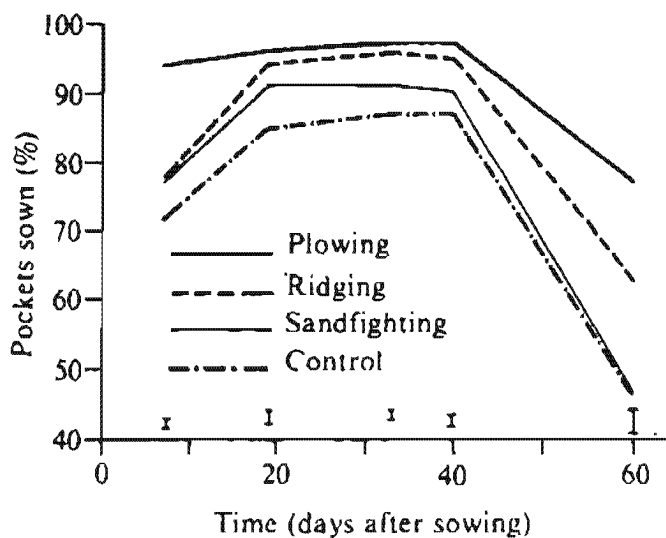

Figure 1. The effect of tillage on pocket stands of pearl millet over time, ISC, 1985.

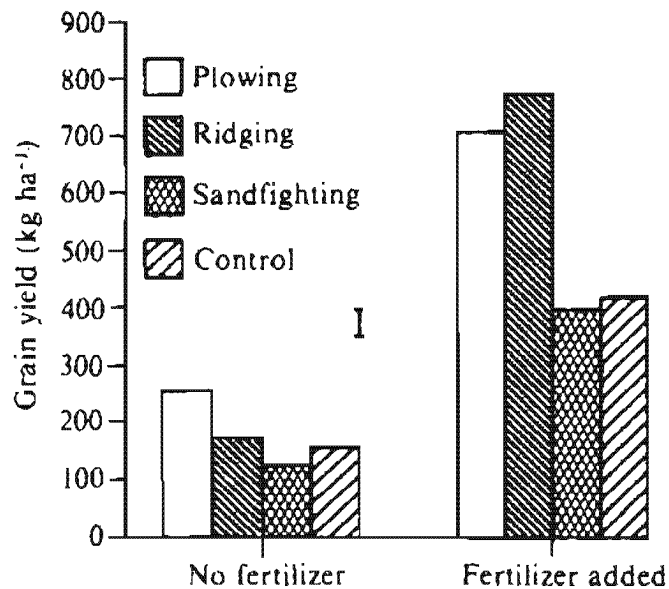

Figure 3. The interaction effect of tillage and fertilizer on grain yield of pearl millet, ISC, 1985.

(Fig. 2). Other significant effects were tillage method, and a tillage  $\times$  fertilizer interaction. Tillage by itself does not increase grain yield while the addition of fertilizer alone doubled yield. A strong synergistic effect was obtained by combining the two inputs and resulted in a fourfold yield increase over the control (Fig. 3).

Recent experience of the Operational Scale Research at the ISC shows similar effects (ICRI-

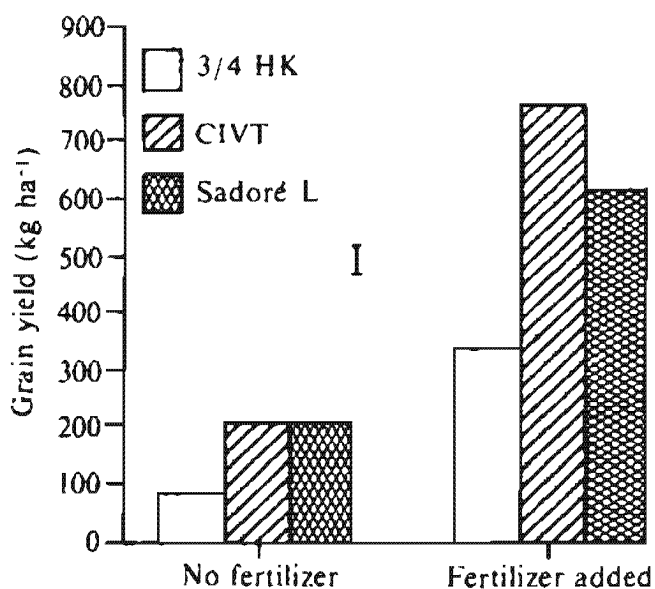

Figure 2. The interaction effect of pearl millet cultivar and fertilizer on grain yield, ISC, 1985.

SAT 1987). Ridging with animal traction increased pearl millet grain yield by 35% and straw yield by 57% over fertilized hand-cultivated plots, because of superior stands and better early growth. Since weed propagation was considerably reduced, less time was needed for weeding (from 168 man h ha<sup>-1</sup> to 80 man h ha<sup>-1</sup>).

**Crop Water-Use Efficiency.** Water-use efficiency (WUE) is expressed as:  $WUE = \text{crop production (g ha}^{-1}) / \text{water use (mm)}$  where production is expressed in total dry matter or grain. No attempt is made to distinguish between soil evaporation and crop transpiration. Total water use is calculated from rainfall, and the soil-moisture balance between the date of sowing and harvest of the crop.

The water content of the soil profile is measured in steps of 20 cm, using a neutron probe with the access tubes installed to a depth of 2.60 m. The amount of soil moisture stored in the profile is estimated by rectangular approximation of the soil-moisture content over depth.

The exceptionally dry 1984 rainy season received only 59% of the average annual rainfall. Two experiments, where soil moisture was measured, were planted to pearl millet Sadoré Local, on 13 and 22 June.

As described above, the effect of cultivation and fertilizer addition on establishment, early growth, and crop yield were significant. Differences in

biomass growth due to these factors are reflected by the measured soil-water profiles. Figure 4 shows a typical profile with the significantly different profiles due to different extraction rates caused by tillage at 45 DAS. Runoff did not occur during this season. Drainage beyond the maximum measured depth of 2.60 m had been negligible, even on the bare Wischmeyer plot where as much as 50% of the rainfall received was lost through evaporation. Hall and Dancette (1978) obtained much the same results on similar soils. Therefore the total amount of water used by the crop/soil complex can be calculated from rainfall and the soil moisture stored in the profile.

In the first planted experiment, plowing and ridging increased the extractable soil moisture even from the deeper layers. Figure 5 depicts the total soil moisture measured in the 25-110-cm, 110-210-cm, and 210-270-cm profile layers, during part of the season. The difference in soil moisture extraction due to tillage reached its maximum at 64 DAS, with 42 mm more soil moisture extracted from plowed plots than from control plots (SE =  $\pm 6.4$ ). Total water use was different ( $P < 0.10$ ) during this season and amounted to: 182 mm for plowed plots, 164 mm for ridged plots, and 154 mm for control plots. The WUE for pearl millet grain yield (on the average  $1.45 \text{ kg ha}^{-1} \text{ mm}^{-1}$ ) was not significantly different among treatments. The addition of fertilizer increased the WUE of total dry matter from 27.0 to  $29.6 \text{ kg ha}^{-1} \text{ mm}^{-1}$  (SE =  $\pm 0.94$ ).

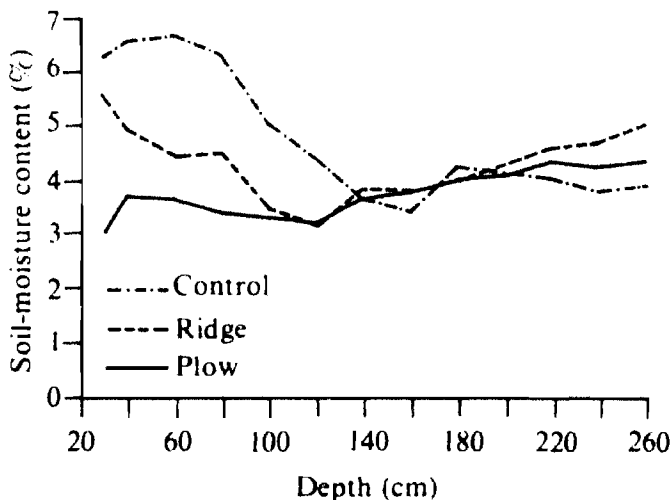

Figure 4. Effect of soil cultivation on soil-moisture content in the 30-260 cm profile, 45 days after sowing of a pearl millet crop, ISC, rainy season 1984.

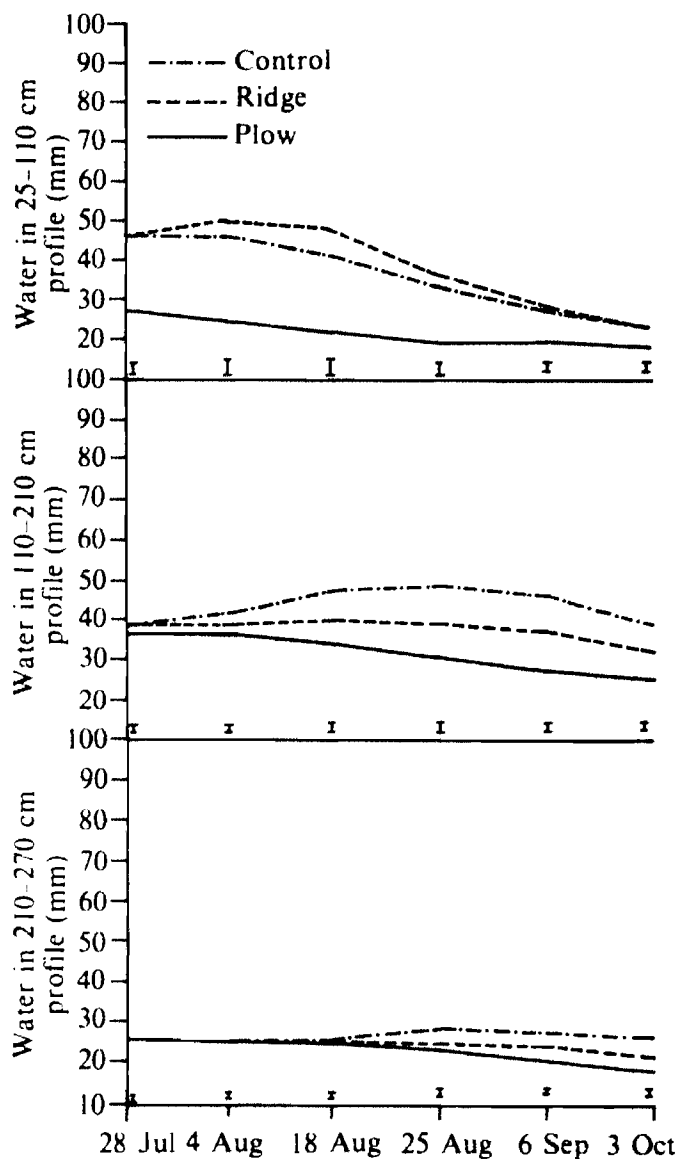

Figure 5. The effect of presowing cultivation on total soil-moisture content of the 25-110cm, 110-210 cm, and 210-270 cm profile layers during the rainy season, pearl millet crop, planted 13 Jun, ISC 1984.

The second experiment was planted 9 days later. Apparently, because of this delay, roots could not reach the residual water in the deeper layers as in the other field (Fig. 6), resulting in the premature death of the crop by the end of August. Total water use (158 mm) until this date did not differ significantly according to tillage treatments, but adding fertilizer increased WUE for dry matter from 15.0 to  $18.9 \text{ kg ha}^{-1} \text{ mm}^{-1}$  (SE =  $\pm 0.47$ ), whereas crop residue increased WUE from 15.7 to  $18.2 \text{ kg ha}^{-1} \text{ mm}^{-1}$  (SE =  $\pm 0.64$ ).

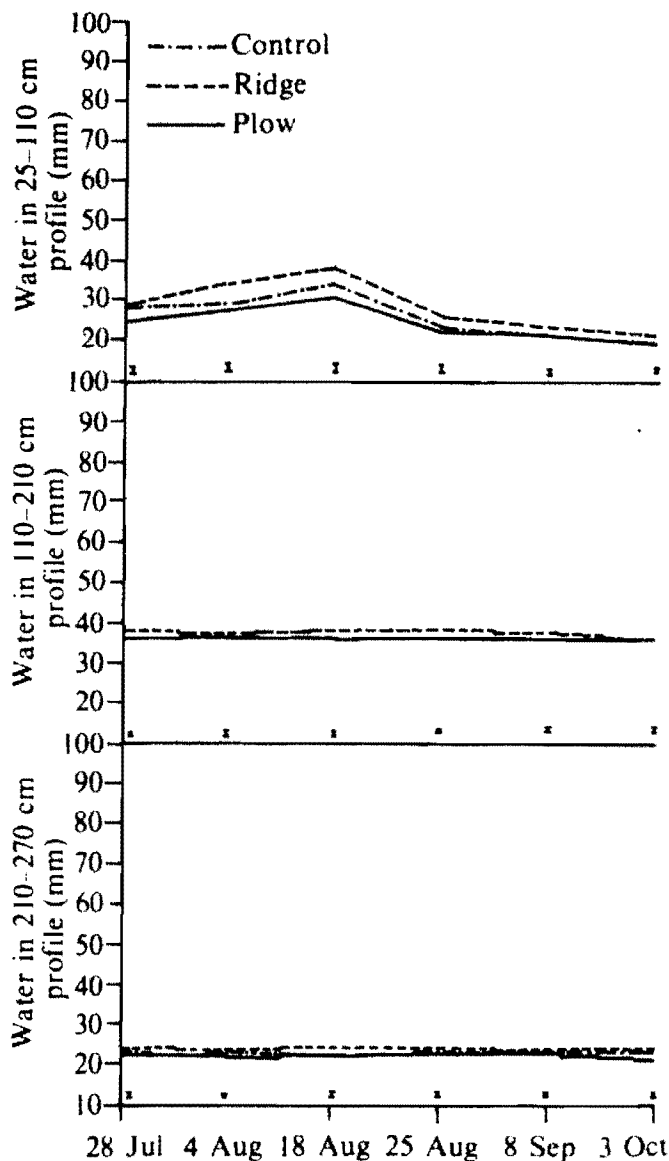

Figure 6. The effect of presowing cultivation on total soil-moisture content of the 25-110 cm, 110-210 cm, and 210-270 cm profile layers during the rainy season. Pearl millet crop, planted 22 Jun, ISC, 1984.

The 1985 season differed greatly from the 1984 season; rains started late (planting date: 26 June), a total of 545 mm well-distributed rain was received, and serious drought stress periods did not occur.

Deep drainage had to be included in the calculation of crop water use. Drainage occurred first on low input plots that had less biomass than high input plots.

However, owing to the unavailability of tensiometers, only drainage was estimated. If, between dates of soil-moisture measurements, the profile

was at field capacity and more water was lost from the profile of low-input plots than of high-input plots, the difference between the profile depletion was considered lost by deep drainage. This is likely to underestimate drainage.

Total soil moisture per profile layer of a long-term soil-management experiment during the season is shown for control plots, and fertilized plowed and ridged plots with crop residue (Fig. 7).

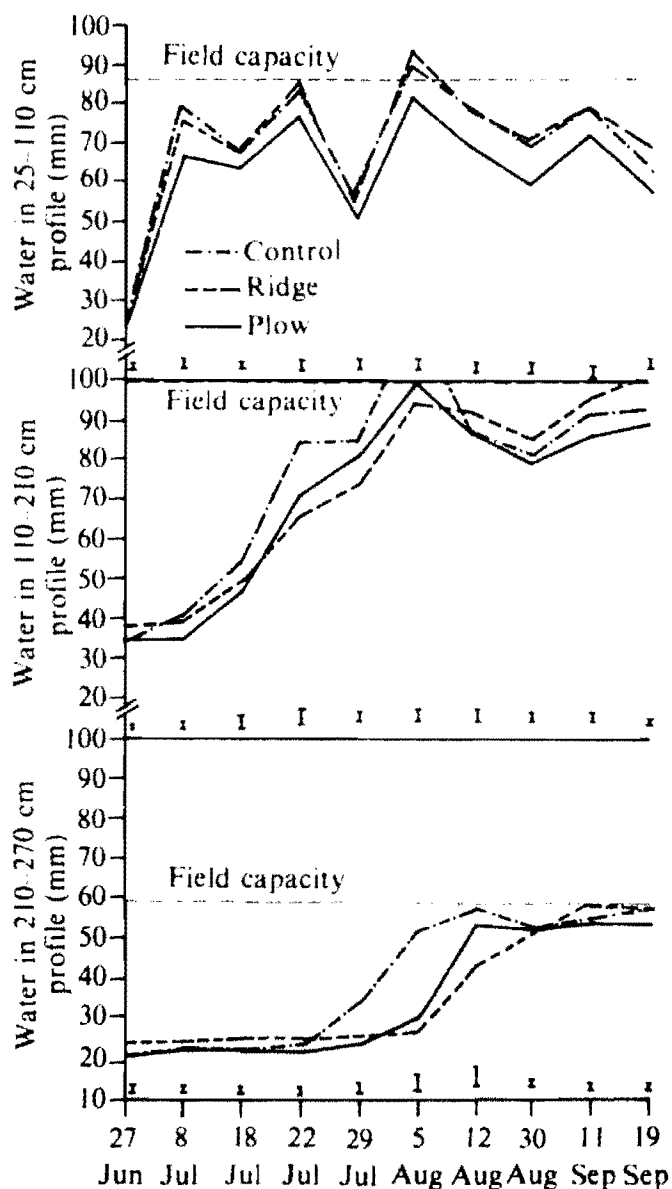

Figure 7. The effect of some management input combinations (control, plowed and ridged plots, both with addition of fertilizers and crop residue) on total soil-moisture content of the 25-110 cm, 110-210 cm, and 210-270 cm profile layers during the season. Pearl millet crop, ISC, 1985.

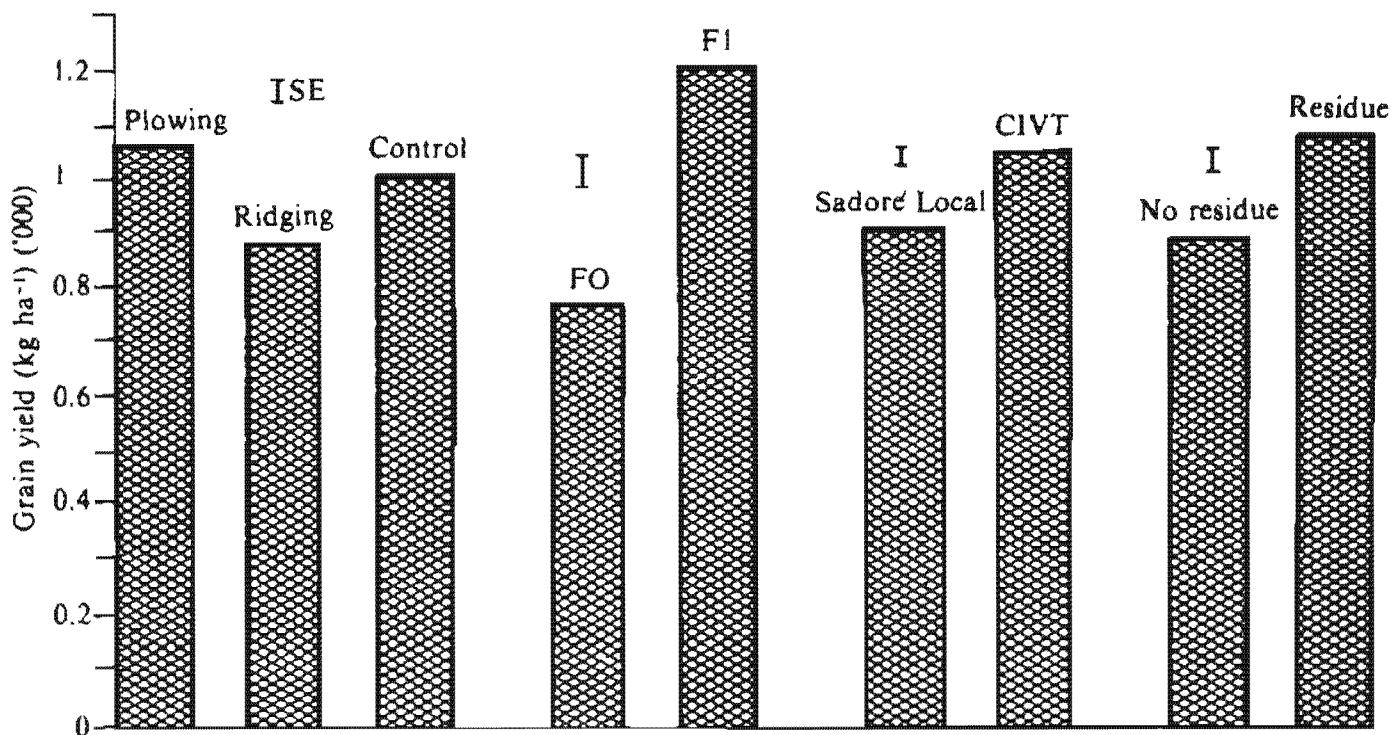

Figure 8. The effects of tillage, fertilizer (F0 = no fertilizer, F1 = fertilizer added), cultivar, and crop residue on grain yield of pearl millet, ISC, 1985.

From planting to harvest, rainfall was sufficient for crop evapotranspiration and to recharge the profile down to 2.70 m. On 5 Aug the crop on high-input plots had used 50 mm more of the rain received. The use of tillage, in combination with chemical fertilizer and crop residue, increased total water use from 287 to 320 mm in this average season. This figure is based on an estimated 40 mm being lost to deep drainage in the low-input plots. Water-use efficiencies ranged from 1.83 kg ha<sup>-1</sup> mm<sup>-1</sup> for ridged plots without fertilizer to 4.87 kg ha<sup>-1</sup> mm<sup>-1</sup> for mulched and plowed plots.

A relatively small portion of the rainfall was lost by drainage in 1985, a year of average rainfall. However, an average 93 mm of soil moisture stored in the 25–270 cm profile at harvest was subsequently lost by evaporation during the dry season.

Grain yield depended on tillage, mulching, and fertilizer, and pearl millet cultivar sown (Fig. 8). There is a strong interaction between mulching and fertilizer; mulching fertilized plots produced a smaller yield increase than mulching nonfertilized plots (Fig. 9). Crop residue increased the organic matter content from 0.26 to 0.29% (SE = ±0.0055).

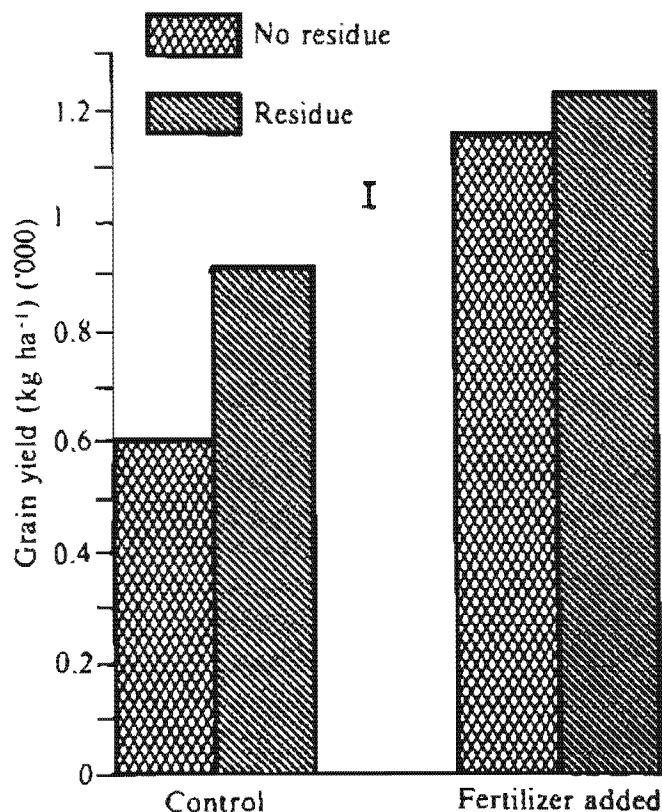

Figure 9. The interaction effect of fertilizer and crop residue on grain yield of pearl millet, ISC, 1985.

The single most important factor for increasing pearl millet yield is P fertilizer. Further, presowing tillage considerably improves crop establishment, early growth, and plant survival. The synergistic effects of tillage and fertilizer addition, in most cases increased crop grain and dry matter production, through higher plant population at harvest, and higher yields per plant.

Pearl millet yields responded to fertilizer applications in the driest year on record. In the average rainfall year, crops responded well to increased levels of inputs such as tillage, use of crop residue, and fertilizer addition, not by using much more moisture but by using it more efficiently. A large proportion of the soil moisture accumulated in the profile during a normal year is subsequently lost by evaporation during the dry season.

In terms of plant establishment, ridging seems the most promising technique as it is less energy- and time-consuming than plowing. Farmers already make ridges using animal traction. Recent experience at the ISC evidences the benefits of this technique in terms of labor use, early weed control, and crop yields.

Although a fair amount of information has already been generated on the effects of tillage and soil management on yield, we feel that research is needed on the following topics:

- the long-term effect of certain soil management options on the organic matter content of the soil and on soil-structure stability and crop growth, in particular the identification of critical levels;
- crop sequence, especially pearl millet-cowpea rotation and related possibilities for reduced tillage techniques;
- in situ determination of the hydraulic properties of the soil (strongly influenced by soil tillage and difficult to measure);
- measuring soil physical properties pertaining to soil strength to estimate wind erosion susceptibility, tillage (draft) resistance, and trafficability;
- rainfall analysis and soil-evaporation rates across environments to assess the number of available days for tillage and planting. These operations can be competitive in certain years as tillage might delay planting at the cost of yield reduction.

- Charreau, C., and Nicou, R.** 1971. L'amélioration du profil cultural dans les sols sableux et sablo-argileux de la zone tropicale sèche ouest-africaine et ses incidences agronomiques. (In Fr.) *Agronomie Tropicale* 26:209-255, 565-631, 903-978, 1183-1247.
- Chopart, J.L.** 1983. Etude du système racinaire du mil (*Pennisetum typhoides*) dans un sol sableux du Sénégal (In Fr.). *Agronomie Tropicale* 38:37-46.
- Dancette, C., and Nicou, R.** 1974. Economie de l'eau dans les sols sableux au Sénégal. Bambey, Sénégal: Institut de recherches agronomiques tropicales et des culture vivrières.
- Fryrear, D.W.** 1984. Soil ridges-clods and wind erosion. *Transactions of the ASAE* 27(2):445-448.
- Fryrear, D.W.** 1985. Soil cover and wind erosion. *Transactions of the ASAE* 28(3):781-784.
- Fussell, L.K., Serafini, P.G., Bationo, A., and Klaij, M.C.** 1987. Management practices to increase yield and yield stability of millet in Africa. Pages 255-268 in *Proceedings of the International Workshop on Pearl Millet*, 7-11 Apr 1986, ICRISAT Center, India. Patancheru, A.P. 502 324, India: International Crops Research Institute for the Semi-Arid Tropics.
- Hall, A.E., and Dancette, C.** 1978. Analysis of fallow-farming systems in semi-arid Africa using a model to simulate the hydrological budget. *Agronomy Journal* 70:816-823.
- Hoogmoed, W.B.,** 1986. *Analysis of rainfall characteristics relating to soil management for some selected locations in Niger and India.* Report no. 86-3. Wageningen, Netherlands: Wageningen Agricultural University.
- ICRISAT (International Crops Research Institute for the Semi-Arid Tropics).** 1985. Annual report 1984. Patancheru, A.P. 502 324, India: ICRISAT.
- ICRISAT (International Crops Research Institute for the Semi-Arid Tropics).** 1987. *ICRISAT West African Programs Annual Report 1986.* Niamey, Niger: ISC.
- ICRISAT (International Crops Research Institute for the Semi-Arid Tropics).** 1984. Annual report 1983. Patancheru, A.P. 502 324, India: ICRISAT.

**Nicou, R., and Charreau, C.** 1985. Soil tillage and water conservation in semi-arid West Africa. Pages 9–37 *in* *Appropriate technologies for farmers in semi-arid West Africa* (Ohm, H.W., and Nagy, J.G., eds.). West Lafayette, Indiana, USA: Purdue University.

**Norman, D.W., Newman, M.D., and Ouedraogo, I.** 1981. Farm and village production systems in the semi-arid tropics of West Africa: an interpretive review of research. Research Bulletin no. 4, Vol. 1. Patancheru, A.P. 502 324, India: International Crops Research Institute for the Semi-Arid Tropics.

**Pieri, C.** 1985a. Food crop fertilization and soil fertility: the IRAT experience. Pages 74–109 *in* *Appropriate technologies for farmers in semi-arid West Africa* (Ohm, H.W., and Nagy, J.G., eds.). West Lafayette, Indiana, USA: Purdue University.

**Pieri, C.** 1985b. Conduite de la fertilisation des cultures vivrières en zones semi-arides. Pages 363–381 *in* *La sécheresse en zone intertropicale : pour une lutte intégrée*. Centre de coopération internationale en recherche agronomique pour le développement (CIRAD). Paris, France: 591 pp.

**Sanchez, P.A.** 1976. Properties and management of soils in the tropics. New York, USA: John Wiley.

**Sanders, J.H., and Roth, M.** 1985. The development and evaluation of new systems of agricultural production. Some field and model results from Burkina Faso for tied ridges and fertilization. Pages 327–337 *in* *Appropriate technologies for farmers in semi-arid West Africa* (Ohm, H.W., and Nagy, J.G., eds.). West Lafayette, Indiana, USA: Purdue University.

**SEDES (Société d'études pour le développement économique et social).** 1987. Etude du secteur agricole du Niger. Bilan-diagnostic phase 1. Paris, France: SEDES. 267 pp.

**Sivakumar, M.V.K.** 1989. Agroclimatic aspects of rainfed agriculture in the Sudano-Sahelian zone. Pages 17–38 *in* *Soil, Crop, and Water Management Systems for Rainfed Agriculture in the Sudano-Sahelian Zone: proceedings of an International Workshop, 11–16 Jan 1987, ICRISAT Sahelian Center, Niamey, Niger*. Patancheru, A.P. India : International Crops Research Institute for the Semi-Arid Tropics.

**Spencer, D.S.C.** 1985. A research strategy for small farm development in sub Sahara Africa. Pages 308–325 *in* *Appropriate technologies for farmers in semi-arid West Africa* (Ohm, H.W., and Nagy, J.G., eds.). West Lafayette, Indiana, USA: Purdue University.

**West, L.T., Wilding, L.P., Landeck, J.K., and Calhoun, F.G.** 1984. Soil survey of the ICRISAT Sahelian Center, Niger, West Africa. Texas A&M University System/College Station, Texas, USA: Texas A&M University.

**Woodruff, N.P., and Siddoway, F.H.** 1965. A wind erosion equation. *Soil Science Society of America Proceedings* 29:602–608.





# Recent Developments in Pearl Millet/Cowpea Cropping Systems for Low-Rainfall Areas of the Sudano-Sahelian Zone of West Africa

B.R. Ntare<sup>1</sup>, P.G. Serafini<sup>2</sup>, and L.K. Fussell<sup>3</sup>

## Abstract

*Pearl millet (Pennisetum americanum (L.) Leeke) and cowpea (Vigna unguiculata (L.) Walp.) are two of the predominant food crops in the Sudano-Sahelian zone of West Africa and are often intercropped. A current review of research findings concluded that pearl millet/cowpea-based systems generally improved and stabilized overall yields. When pearl millet and cowpea are intercropped, time of sowing, crop densities and spacing, soil-fertility status, and the nature of varieties seem to be important to determine the degree of interaction between the two crops. Production characteristics, sources of production advantages, and the potential to improve the productivity of the intercrop system are outlined.*

*The limited information available from West Africa, on the effects of crop rotation indicate that yields improve when pearl millet follows a cowpea crop. This combination is being investigated at the ISC. Cowpea as a cash crop economically justifies the use of purchased inputs which fortunately, have a positive residual effect on the subsequent pearl millet crop. This is considered to be an important opportunity to contribute to the intensification of the cropping pattern.*

*The need to find compatible pearl millet/cowpea varietal combinations, rotation and intercrop systems, and cultural operations, while understanding their effects on soil fertility, productivity, and resource use is emphasized.*

## Résumé

**Evolution récente des systèmes de cultures associant mil/niébé dans les régions de faible pluviosité de la zone soudano-sahélienne de l'Afrique de l'Ouest :** *Le mil (Pennisetum glaucum (L.) R.Br.) et le niébé (Vigna unguiculata (L.) Walp.) font partie des cultures vivrières les plus importantes de la zone soudano-sahélienne de l'Afrique de l'Ouest et sont souvent associés dans les parcelles de production. Les recherches en cours ont permis de conclure que les systèmes basés sur l'association mil/niébé, permettent généralement d'améliorer et de stabiliser les rendements globaux. Lorsque mil et niébé sont cultivés en association, il semble que la date, la densité et l'espacement des semis, le bilan de fertilité des sols et la nature des variétés soient des facteurs importants pour déterminer le degré d'interaction entre les deux cultures. On relève les*

- 
1. Principal Cowpea Breeder/Agronomist, International Institute of Tropical Agriculture, Nigeria.
  2. Research Farm Manager, Farm Operations, ISC, Niamey, Niger.
  3. Principal Millet Agronomist, Pearl Millet Improvement Program, ISC, Niamey, Niger.

ICRISAT Conference Paper no. CP 412

ICRISAT (International Crops Research Institute for the Semi-Arid Tropics) 1989. Soil, Crop, and Water Management Systems for Rainfed Agriculture in the Sudano-Sahelian Zone: proceedings of an International Workshop, 7-11 Jan 1987. ICRISAT Sahelian Center, Niamey, Niger. Patancheru, A.P. 502 324, India: ICRISAT.

*caractéristiques de production du système d'association des cultures ainsi que les avantages et les possibilités d'amélioration des rendements qui en découlent.*

*Les informations limitées dont on dispose en Afrique de l'Ouest sur les effets de la rotation des cultures indiquent une élévation des rendements du mil lorsque le mil est cultivé après le niébé. Cette association est étudiée actuellement au Centre sahélien de l'ICRISAT. L'achat d'intrants agricoles se justifie sur le plan économique puisque le niébé est une culture de rente et que leur effet se fait encore sentir sur le mil cultivé après le niébé. Une telle rotation des cultures de mil et de niébé pourrait contribuer de façon sensible à intensifier les modes de cultures existants.*

*Enfin, l'accent a été mis sur la nécessité de trouver des combinaisons variétales mil/niébé compatibles, des systèmes de rotation et d'association ainsi que des techniques culturales appropriés tout en s'intéressant à leurs effets sur la fertilité du sol, la productivité et l'utilisation des ressources.*

## Introduction

Pearl millet (*Pennisetum americanum* (L.) Leeke) and cowpea (*Vigna unguiculata* (L.) Walp.) are two of the predominant food crops in the Sudano-Sahelian zone of West Africa (SSZWA). Pearl millet occupies 13 million ha of arable land and cowpea 6 million ha. Cowpeas are frequently grown as an intercrop with pearl millet. The two crops are generally grown in a mixture of one or more species.

In the last 20 years pearl millet grain production in West Africa has increased by 1%, cowpea production has remained static in most countries of the region. There are some exceptions such as Niger where output has doubled. Crop production increases in the region have primarily come from increases in the cultivated area (Pieri 1985). Much of the new land was more marginal for cropping. This has contributed to West Africa having the slowest growth rate for total food production of all the regions of sub-Saharan Africa (Spencer and Sivakumar 1986). However, the low and relatively stable production levels of the pearl millet/cowpea system have been one of the principal sources of sustenance for farmers and their families in the drier regions of the SSZWA.

Among the numerous agronomic factors responsible for the low productivity of pearl millet/cowpea-based cropping systems, are low soil fertility, untimely and inadequate cultural operations, non-availability of improved varieties, low and inconsistent plant densities, and farmers' inability to control pests and diseases. The traditional pearl millet/cowpea intercropping systems have been developed through man's interaction with an environment that involves a high degree of risk due to the

inherent poverty and variability of the cropping ecology. Farmers seek to stabilize productivity, reduce the risk of crop losses due to irregularities in climate, and make the best use of other scarce resources.

This paper considers the role of pearl millet and cowpea in traditional agriculture of SSZWA, pertinent research findings, and possibilities for these crops in the future. The discussion will be limited to systems involving pure or associated stands of pearl millet and cowpea.

## Traditional Pearl Millet/Cowpea Cropping Systems

Pearl millet with cowpea is the most common crop combination particularly in the drier, northern areas of SSZWA, though other combinations such as pearl millet/sorghum, sorghum/cowpea, pearl millet/sorghum/cowpea are also found. Farmers apparently seek to have a full pearl millet grain yield with some additional cowpea grain and fodder yields.

Pearl millet with a 90–110-day cycle is often planted some time before the cowpea intercrop. Cowpea generally has a 120–150-day cycle and is sown between pearl millet rows from 2 weeks to 2 months after the pearl millet, depending upon the early-season rains. This flexible decision-making pattern allows adjustments to be made as the rainy season progresses. If early-season rains are poor, cowpea seeding may be delayed or eliminated. If there is a poor pearl-millet stand, extra cowpea may be sown. Nonetheless, in some instances, notably where soils tend to crust, the two crops are sown on the same hill.

Late cowpea seeding assures pearl millet yields because the cereal effectively dominates cowpea. This may be particularly important if the rainy season ends early. Pearl millet is normally harvested before cowpea. Cowpea matures after the end of the rains on residual moisture. The late-maturing cowpea may produce little grain and be useful only for fodder when rainfall ends earlier than normal.

The extent and production of pearl millet/cowpea at the farm level is not clearly quantified. Norman (1974) found that cowpea was most frequently intercropped with pearl millet or sorghum (*Sorghum bicolor* (L.) Moench) although it was also grown in association with several other species in northern Nigeria. Swinton et al. (1985) reported that pearl millet was sown as a sole crop on 4% of the land, and cowpea on 12% of the land in the Madarounfa area of Niger in 1982. Pearl millet was grown as an intercrop situation on 65% of the cultivated land, pearl millet and cowpea were intercropped on 47%, and cowpea was grown as an intercrop on 52%. Around Filingué in Niger, near the drier limits of the cultivated zone, pearl millet/cowpea occupied 83% of the cultivated area (Swinton et al. 1985).

In Nedogo, Aorema, and Digre, three villages in central Burkina Faso, the area cultivated to pearl millet ranged from 29% to 32%. Pearl millet was intercropped with cowpea on 64–91% of that area (Sawadogo and Kabore 1985). Other studies in Burkina Faso confirm the predominance of this intercrop system (Kabore et al. 1983).

Farm level yield figures are scarce. However, national average yields range from 400 to 800 kg ha<sup>-1</sup> of pearl millet and 100–250 kg ha<sup>-1</sup> of cowpea.

## Research Results

Despite the importance of pearl millet/cowpea intercropping systems, research focused on understanding and improving them is a recent phenomenon. Early research indicates that, in general, intercropping gave better total yields than the component crops grown alone (Willey 1979a and 1979b). Norman (1971 and 1974) showed that intercropping increased economic returns, saved labor, and reduced risk. More recently, Fussell and Serafini (1985 and 1986) reviewed crop associations in semi-arid West Africa and concluded that pearl millet/cowpea-based systems generally im-

proved and stabilized overall yields. The reasons for the popularity of intercropping among farmers include flexibility, profit and resource maximization, risk minimization, soil conservation and maintenance, weed control, and nutritional aspects (Norman 1974, Finlay 1976).

A greater emphasis is being placed on cropping systems research because of the increasing awareness of the important role that resource management will play in improving yield in the semi-arid tropical areas. To manipulate production from an intercrop system, we need to understand the main growth-determining factors. Plants growing together compete for light, water, and nutrients. There may also be biochemical interactions. Competition for light arises when one crop is taller than the other. Competition for nutrients is greatest in relay crop situations. The second crop is often planted into a soil that has had its soil nutrient reserves depleted by the earlier crop. Competition for moisture is an important factor in low-rainfall situations.

In the pearl millet/cowpea system, time of sowing, crop densities and spacing, soil-fertility status, and the nature of varieties seem to be important to determine the degree of interaction between the two crops. These factors may be manipulated so that competition for light, water, and nutrients is minimized and the cropping system is able to fit into the ecology where it is to be practiced. To illustrate these points, examples will be used from recent pearl millet/cowpea intercropping studies.

## Production Advantages with Traditional Practices

Traditional pearl millet/cowpea intercropping practices give production advantages of 20–40%. Cowpea grain and hay yields are low (Table 1). Yield advantages are apparent whether pearl millet and cowpea grain production or the pearl millet grain and cowpea fodder yields are considered (Table 1) (Fussell and Serafini 1986). In the intercrop situation, pearl millet grain yields normally account for 60–90% of the pure pearl millet yields.

## Crop Maturity

Growing a very early-maturing cowpea with pearl millet is not a traditional practice, but it does

**Table 1. Means from trial of factorial experiments that included management factors such as intercrop density, fertility, planting date, and harvest time of pearl millet/cowpea intercrop.**

| Year | Type of experiment                          | Location                | Rainfall<br>(mm) | Cowpea fodder<br>(kg ha <sup>-1</sup> ) | Pearl millet<br>grain<br>(kg ha <sup>-1</sup> ) | Land equivalent ratios |                 |       |
|------|---|-------------------------|------------------|---|---|------------------------|-----------------|-------|
|      |   |                         |                  |   |   | Cowpea                 | Pearl<br>millet | Total |
| 1982 | Density × variety ×<br>intercrop proportion | Sadore', Niger          | 372              | 318 <sup>1</sup>                        | 277   | 0.58                   | 0.69            | 1.27  |
| 1983 | Intercrop proportion<br>× rotations         | Sadore', Niger          | 599              | 768                                     | 385   | 0.48                   | 0.69            | 1.17  |
| 1984 | Intercrop proportion<br>× rotations         | Sadore', Niger          | 216              | 22                                      | 435   | 0.09                   | 1.16            | 1.25  |
| 1985 | Intercrop proportion<br>× rotations         | Sadore', Niger          | 495              | 734                                     | 648   | 0.48                   | 0.72            | 1.20  |
| 1985 | Variety × intercrop                         | Sadore', Niger          | 495              | 360<br>(261) <sup>2</sup>               | 921<br>(0.50)                                   | 0.31<br>(1.43)         | 0.92            | 1.24  |
| 1979 | Density × intercrop                         | Multilocational<br>Mali | NA <sup>3</sup>  | 158                                     | 854   | 0.21                   | 0.96            | 1.17  |
| 1980 | Density × intercrop                         | Multilocational<br>Mali | NA               | 1460                                    | 980   | 0.50                   | 1.04            | 1.54  |
| 1981 | Intercrop harvesting<br>schedule            | Multilocational<br>Mali | NA               | 4050                                    | 800   | 0.83                   | 1.12            | 1.95  |

1. Hay yields are fresh weights.

2. Cowpea grain yields.

3. NA = Not available.

Source: Fussell and Serafini 1985.

**Table 2. Land equivalent ratios (LER) for three cowpea and four pearl millet cultivars from a trial conducted at the ISC, rainy season 1985.**

| Pearl millet cultivar | Cowpea<br>cultivar <sup>1</sup> | LERs of intercrops    |                 |              | Total<br>LER |
|-----------------------|---------------------------------|-----------------------|-----------------|--------------|--------------|
|                       |                                 | Pearl millet<br>grain | Cowpea<br>grain | Copea<br>hay |              |
| Local cv              | Local cv                        | 0.98                  | 0.31            | 0.16         | 1.29         |
| CIVT                  | Local cv                        | 0.74                  | 0.64            | 0.33         | 1.38         |
| 3/4 HK-B78            | Local cv                        | 0.87                  | 0.47            | 0.24         | 1.34         |
| ICMV 4(ICMS 7703)     |                                 | 0.67                  | 0.87            | 0.47         | 1.54         |
| Local cv              | TN88-63                         | 1.10                  | 0.29            | 0.13         | 1.39         |
| CIVT                  | TN88-63                         | 0.77                  | 0.45            | 0.24         | 1.22         |
| 3/4 HK-B78            | TN88-63                         | 1.13                  | 0.46            | 0.42         | 1.59         |
| ICMV 4(ICMS 7703)     |                                 | 1.03                  | 0.54            | 0.25         | 1.57         |
| Local cv              | IT82E-60                        | 1.05                  | 0.43            | 0.43         | 1.48         |
| CIVT                  | IT82E-60                        | 0.74                  | 0.96            | 0.70         | 1.70         |
| 3/4 HK-B78            | IT82E-60                        | 1.10                  | 0.58            | 0.43         | 1.68         |
| ICMV 4(ICMS 7703)     |                                 | 0.89                  | 0.74            | 0.55         | 1.63         |
| SE                    |                                 | ±0.113                | ±0.126          | ±0.066       | ±0.179       |

1. Local cv—photoperiod sensitive and late maturing (120–150 days).

TN88-63—photoperiod insensitive, medium maturing (75–80 days).

IT82E-60—photoperiod insensitive, early maturing (55–60 days).

appear advisable in some years. Pearl millet, particularly in the drier, more northerly areas of SSZWA, is sown in wide spacings, 2000–9000 hills ha<sup>-1</sup>. Substantial amounts of soil moisture, up to 40% of evapotranspiration, are lost due to soil evaporation. This loss will be greatest during the first month of the crop's growth when the pearl millet provides little vegetative cover (Sivakumar,

ISC, personal communication). By interplanting a very early-maturing grain-type cowpea cultivar, more of this moisture can be used with little competition to the pearl millet. The cowpea grain can be harvested before the pearl millet flowers. Yield advantages of up to 60% have been recorded. Pearl millet yields were not greatly affected by the presence of the early-maturing cowpea (Tables 2 and 3). In extreme drought years (1984), however, pearl millet yields may be substantially reduced, while cowpea production remains relatively high (Table 4).

**Table 3. Yield (kg ha<sup>-1</sup>) for three cowpea and four pearl millet cultivars from a trial conducted at the ISC, rainy season 1985.**

| Cultivar            | Sole crop yields   |              |            |
|---------------------|--------------------|--------------|------------|
|                     | Pearl millet grain | Cowpea grain | Cowpea hay |
| Pearl millet        |                    |              |            |
| Local cv            | 1300               |              |            |
| CIVT                | 1100               |              |            |
| 3/4 HK-B78          | 770                |              |            |
| ICMV 4 (ICMS 7703)  | 780                |              |            |
| SE                  | ±112               |              |            |
| Cowpea <sup>1</sup> |                    |              |            |
| Local cv            |                    | 421          | 1786       |
| TN 88-63            |                    | 951          | 1320       |
| IT82E-60            |                    | 193          | 366        |
| SE                  |                    | ±72.5        | ±164.0     |

## Planting and Harvest Scheduling

Adjusting the cowpea planting date, relative to the pearl millet's growth cycle and the probable length of the rainy season, is a management tool used to minimize the effects of cowpea competition on pearl millet yields. To better understand the impact of the planting schedule, two early- and one late-maturing cowpea cultivars, with contrasting plant types, were interplanted at different times with an improved local pearl millet cultivar. Intercrop and monoculture yields were compared in two successive seasons. The early cultivars were planted at a density of 25 000 plants ha<sup>-1</sup>, while the late cultivar was planted at 15 000 plants ha<sup>-1</sup>. Both densities are above those used traditionally. The results indicate that it is possible to improve cowpea yields

**Table 4. Grain yield (kg ha<sup>-1</sup>) of early-maturing cowpea and pearl millet in association, ISC, 1984<sup>1</sup>.**

| Cultivar          | Sole | Pearl millet cultivar |              |        |              |
|-------------------|------|-----------------------|--------------|--------|--------------|
|                   |      | CIVT                  |              | HKP    |              |
|                   |      | Cowpea                | Pearl millet | Cowpea | Pearl millet |
| Cowpea            |      |                       |              |        |              |
| IT82E 60          | 550  | 165                   | 227          | 160    | 75           |
| IT82D 716         | 740  | 320                   | 190          | 200    | 280          |
| TVX 3236          | 570  | 175                   | 268          | 150    | 45           |
| TN88-63           | 480  | 150                   | 285          | 130    | 70           |
| Pearl millet sole | -    | -                     | 668          | -      | 380          |
| SE (Cowpea)       | ±60  |                       |              |        |              |
| SE (Pearl millet) | ±72  |                       |              |        |              |

1. Total rainfall during the year was 260 mm.

without greatly affecting the performance of pearl millet crop by planting the cowpea with, or very shortly after the pearl millet (Table 5). Early planting allows the cowpea to grow without being shaded by pearl millet during the critical initial-growth stages. Planting cowpea 25 days after pearl millet resulted in an almost complete failure of the cowpea crop. Early-maturing cowpeas were particularly sensitive.

It is very advantageous to plant a forage-type cowpea at the same time as pearl millet and harvest it before the flowering of the pearl millet. In this situation, the negative effects of aggressive and/or high-density cowpeas on the cereal yield may be reduced or eliminated. Cowpea does not compete with pearl millet during flowering or grain filling.

Thus it is able to grow well before the pearl millet canopy closes (Table 6).

## Plant Population

Density effects have been studied primarily from two points of view. The first assumes that the farmer wants a full pearl millet grain yield and as much additional cowpea yield as possible. Therefore, the cowpea component is manipulated within a full pearl millet stand. Findings indicate that pearl millet grain yields are not greatly reduced by increasing cowpea densities when soil moisture and fertility are adequate (Fig. 1, Table 7, see also Serafini 1985). If either soil fertility or moisture are

**Table 5. Yields (kg ha<sup>-1</sup>) of cowpea and pearl millet at different dates of planting, of cowpea in relation to pearl millet, ISC, Niger, 1985 and 1986.**

| Year                              | Planting dates                    | Yield (kg ha <sup>-1</sup> ) |                |                 |         |      |      |                |      |      |
|-----------------------------------|-----------------------------------|------------------------------|----------------|-----------------|---------|------|------|----------------|------|------|
|                                   |                                   | IT82D 716 <sup>1</sup>       |                |                 | TVX3236 |      |      | Sadore' Local  |      |      |
|                                   |                                   | G <sup>2</sup>               | H <sup>2</sup> | PM <sup>2</sup> | G       | H    | PM   | G              | H    | PM   |
| 1985                              | Cowpea/pearl millet same day      | 350                          | 730            | 1055            | 485     | 930  | 1040 | - <sup>3</sup> | 2270 | 340  |
|                                   | Cowpea 6 days after pearl millet  | 200                          | 215            | 1255            | 240     | 750  | 1310 | -              | 1970 | 630  |
|                                   | Cowpea 25 days after pearl millet | 70                           | 185            | 1515            | 80      | 270  | 1120 | -              | 590  | 1310 |
|                                   | Cowpea sole <sup>4</sup>          | 600                          | 1260           | -               | 930     | 1160 | -    | -              | 2430 | -    |
|                                   | Pearl millet sole                 | -                            | -              | 1375            | -       | -    | 1375 | -              | -    | 1375 |
|                                   | SE cowpea grain                   | ±90                          |                |                 |         |      |      |                |      |      |
|                                   | SE cowpea hay                     | ±79                          |                |                 |         |      |      |                |      |      |
|                                   | SE pearl millet                   | ±54                          |                |                 |         |      |      |                |      |      |
|                                   | 1986                              | Cowpea/pearl millet same day | 150            | 273             | 980     | 185  | 380  | 570            | 40   | 1280 |
| Cowpea 7 days after pearl millet  |                                   | 180                          | 186            | 610             | 120     | 400  | 740  | 30             | 1310 | 660  |
| Cowpea 24 days after pearl millet |                                   | 120                          | 173            | 880             | 100     | 160  | 810  | 13             | 450  | 840  |
| Cowpea sole                       |                                   | 405                          | 460            | -               | 590     | 650  | -    | 204            | 2026 | -    |
| Pearl millet sole                 |                                   | -                            | -              | 1096            | -       | -    | 1096 | -              | -    | 1096 |
| SE cowpea grain                   |                                   | ±19                          |                |                 |         |      |      |                |      |      |
| SE cowpea hay                     |                                   | ±82                          |                |                 |         |      |      |                |      |      |
| SE pearl millet                   |                                   | ±72                          |                |                 |         |      |      |                |      |      |

1. Cowpea cultivars early erect (IT82D 716), early spreading (TVX3236), and late spreading (Sadore' Local).

2. G = Cowpea grain, H = Cowpea hay, and PM = Pearl millet grain.

3. No grain recorded in 1985.

4. Average over dates of planting.

**Table 6. The effects of different times of harvest of a cowpea hay intercrop on pearl millet and cowpea yields in Mali, 1981.**

| Harvest schedule       | Sole crop yields (kg ha <sup>-1</sup> ) |                         | Intercrop land equivalent ratios |        |       |
|------------------------|---|-------------------------|----------------------------------|--------|-------|
|                        | Pearl millet grain                      | Cowpea hay <sup>1</sup> | Pearl millet                     | Cowpea | Total |
| 40 days after planting | 900                                     | 3450                    | 1.31                             | 0.71   | 2.02  |
| 60 days after planting | 870                                     | 5670                    | 1.21                             | 1.25   | 2.46  |
| 80 days after planting | 740                                     | 4580                    | 1.01                             | 0.93   | 1.94  |
| End of season          | 680                                     | 2490                    | 0.94                             | 0.41   | 1.35  |
| SE                     | ±40                                     | ±248                    |                                  |        |       |

1. Fresh weight.

limiting, particularly early in the season, pearl millet grain yields may be considerably affected by higher densities of intercropped cowpea (Table 3).

The second point of view focuses on modifying the intercropping pattern while maintaining a constant total plant population. Cowpea performance may be improved and pearl millet yields that

approach pure stand levels may be obtained by manipulating row arrangements, planting dates, and the densities of the two crops. A full yield of the cereal and a considerable contribution from cowpea were obtained with paired rows of pearl millet and cowpeas. Planting in the same hill reduced cowpea yields (Tables 5, 8, and 9).

**Table 7. Grain yields (kg ha<sup>-1</sup>) of early-maturing cowpea and pearl millet in four planting systems, ISC, Niger, 1985 and 1986.**

| Year | Planting system                  | No. of plants | Distance apart (cm) | (Yield kg ha <sup>-1</sup> ) |              |
|------|----------------------------------|---------------|---------------------|------------------------------|--------------|
|      |                                  |               |                     | Cowpea                       | Pearl millet |
| 1985 | Pearl millet/cowpea <sup>1</sup> | 1             | 10                  | 580                          | 1090         |
|      | Pearl millet/cowpea              | 2             | 30                  | 490                          | 1205         |
|      | Pearl millet/cowpea              | 3             | 50                  | 500                          | 1305         |
|      | Pearl millet/cowpea              | 4             | 100                 | 325                          | 1825         |
|      | Traditional <sup>2</sup>         |               |                     | NA <sup>3</sup>              | 850          |
|      | SE                               |               |                     | ±34                          | ±148         |
|      | CV (%)                           |               | 30                  | 24                           |              |
| 1986 | Pearl millet/cowpea              | 1             | 10                  | 405                          | 880          |
|      | Pearl millet/cowpea              | 2             | 30                  | 430                          | 1010         |
|      | Pearl millet/cowpea              | 3             | 50                  | 240                          | 1115         |
|      | Pearl millet/cowpea              | 4             | 100                 | 105                          | 1077         |
|      | Traditional                      |               |                     | NA                           | 775          |
|      | SE                               |               |                     | ±56                          | ±137         |
|      | CV (%)                           |               | 27                  | 29                           |              |

1. Cowpea cultivar IT82D 716 is early and erect and pearl millet cultivar is CIVT.

2. Pearl millet sown with local long-duration cowpea at the same time.

3. NA = Not available.



## Fertility

Within an individual cropping year, cowpeas compete for nutrients, including nitrogen (N), with the cereal crop. In the absence of adequate N fertility pearl millet grain yields have been lowered in situations that favor cowpea competition such as simultaneous seeding, high cowpea densities or late cowpea harvest (Table 9). Adequate soil fertility, particularly phosphorus (P) and N, facilitates intensification of the intercropping system. Cereal yields have been shown to respond better to added fertility when cowpea densities are low (Table 8).

Cowpeas are known to be relatively efficient N fixers. Nitrogen fixed by cowpeas will contribute to crop yield in the following season such that it is not removed as grain, hay, or livestock feed. The importance and efficiency of this phenomenon has not yet been adequately studied.

## Varietal Selection

Cowpea and pearl millet varieties may be selected to improve their performance in intercrop situations. The selection criteria depend upon the objectives of the system. The type of cowpea that will be

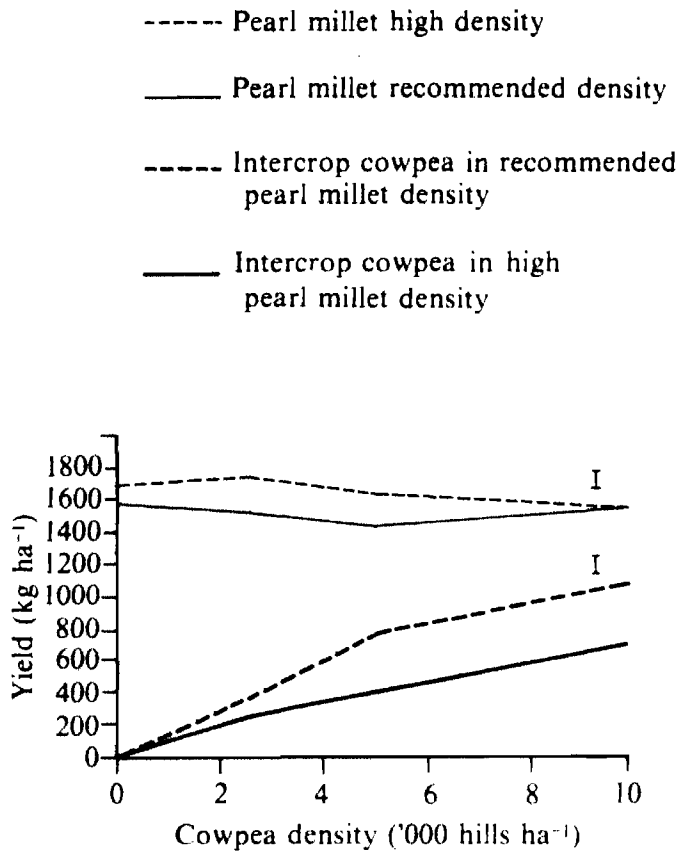

Figure 1. Pearl millet grain yield and cowpea hay responses at three cowpea densities in a pearl millet/cowpea intercropping system, ISC, Niger, rainy season 1985 (Source: Fussell et al. 1986).

Table 8. Grain yield (kg ha<sup>-1</sup>) of early cowpea and pearl millet in several planting systems, ISC, Niger<sup>1</sup>.

| Year | Planting system                  | Cowpea |      | Pearl millet | LER  |
|------|----------------------------------|--------|------|--------------|------|
|      |                                  | Grain  | Hay  |              |      |
| 1985 | Pearl millet (sole)              | -      | -    | 1243         | 1.00 |
|      | Pearl millet/cowpea, alternating | 583    | 645  | 867          | 1.18 |
|      | Pearl millet/cowpea paired rows  | 620    | 780  | 895          | 1.24 |
|      | Pearl millet/cowpea, same pocket | 84     | 110  | 1163         | 1.01 |
|      | Cowpea sole                      | 1185   | 1380 | -            | 1.00 |
|      | SE                               | ±57    | ±78  | ±133         |      |
|      | CV (%)                           | 23     | 26   | 31           |      |
| 1986 | Pearl millet (sole)              | -      | -    | 808          |      |
|      | Pearl millet/cowpea, alternating | 434    | 530  | 550          | 1.28 |
|      | Pearl millet/cowpea, paired rows | 529    | 660  | 687          | 1.58 |
|      | Pearl millet/cowpea, same pocket | 42     | 100  | 811          | 1.05 |
|      | Cowpea (sole)                    | 723    | 850  | -            | 1.00 |
|      | SE                               | ±56    | ±110 | ±83          |      |
|      | CV (%)                           | 24     | 26   | 22           |      |

1. Plot size 72 m<sup>2</sup>, RCBD 7 replications, cowpea cultivar, TVX 3236, and pearl millet CIVT.

**Table 9. The effect of nitrogen fertilizer on the yield (kg ha<sup>-1</sup>) of a pearl millet/cowpea intercrop and sole crops at Cinzana and Koporokeniepe, Mali, 1983.**

| Applied nitrogen/<br>location | Yield                 |                            | Land equivalent ratios |               |       |
|-------------------------------|-----------------------|----------------------------|------------------------|---------------|-------|
|                               | Pearl millet<br>grain | Cowpea<br>hay <sup>1</sup> | Pearl millet<br>grain  | Cowpea<br>hay | Total |
| <b>Cinzana</b>                |                       |                            |                        |               |       |
| 0 kg N ha <sup>-1</sup>       | 803                   | 371                        | 0.64                   | 0.09          | 0.73  |
| 40 kg N ha <sup>-1</sup>      | 1191                  | 392                        | 0.95                   | 0.09          | 1.09  |
| SE                            | ±47                   | ±36                        |                        |               |       |
| <b>Koporokeniepe</b>          |                       |                            |                        |               |       |
| 0 kg N ha <sup>-1</sup>       | 191                   | 653                        | 0.39                   | 0.27          | 0.66  |
| 40 kg N ha <sup>-1</sup>      | 444                   | 561                        | 0.91                   | 0.23          | 1.14  |
| SE                            | ±26                   | ±42                        |                        |               |       |

1. Dry weight.

selected for an early grain harvest in an intercrop is different from the one that will be used for an early forage harvest. Similarly, shade tolerance is a more important character for relay planted systems than in systems where the two crops are seeded simultaneously and where cowpea is harvested early. When the two crops are planted simultaneously, it may be desirable to have a cowpea that grows slowly early in the season so that it will not dominate the pearl millet.

In other situations, it may be desirable to have a cowpea cultivar that does not have a climbing growth habit. A variety or cultivar that has the ability to quickly spread over the ground to intercept the available light under the pearl millet canopy and assist in weed control may be the best choice in some situations.

At the ICRISAT Sahelian Center (ISC), contrasting cowpea plant types have been screened for intercropping situations since 1984. It has been shown, in three successive years, that intercrop combinations involving cowpea cultivars that mature in 55–65 days are the most productive. Acceptable cowpea yields are achieved and the pearl millet component's performance is not seriously affected.

Other results have shown that changing the varieties of pearl millet and cowpea have increased production of either pearl millet grain or cowpea fodder and grain (Tables 2 and 9, Reddy and Oumara 1985). In most cases, shifting the competitive advantage in favor of either crop, through

changes in varieties or agronomic practices, results in a reduction of the performance of the other.

## Diseases and Insects

The effects of pearl millet/cowpea cropping patterns on disease and insect pest incidence and damage are not well understood. Contradictory evidence on the effects of intercropping on insect behavior has been reported in maize/cowpea, sorghum/cowpea, and cassava/cowpea systems (Jackai et al. 1985). Intercropping has a greater impact on some insect pests than on others. Temperatures are reduced by the intercropping pattern. Some insect populations increase when shading and humidity are increased. It is suspected that the low cowpea densities, characteristic of many intercropping patterns, may reduce the movement of certain insects. No important interactions between the cowpea insect pest complex and intercropping systems have been observed at the ISC. This is also the case for diseases such as bacterial blight (*Xanthomonas campestris* pv. *vignicola*). No important differences in the incidence or severity of this disease have been observed in a variety of intercropping situations during two consecutive years when the disease was prevalent.

From the available information about intercropping/pest relationships in the pearl millet/cowpea system, it is clear that cowpea grain production can only be assured through judicious use

of insecticides. This may be enhanced by other pest-management approaches such as selecting for host-plant resistance as well as other crop-management techniques.

## Crop Rotation

It is also possible to improve productivity by rotating cowpeas and pearl millet. Legumes are known to increase soil N levels through their N-fixing capacity. The yields of cereal crops that follow them are often improved. In northwest India, pearl millet yields were increased by 24% when it was grown in rotation with cowpea rather than in a pearl millet-pearl millet sequence (Giri and De 1979). In another study, the same authors found that a cowpea rotation increased the following pearl millet crop's early seedling growth, plant growth rate, and grain production (Giri and De 1980). Unfertilized pearl millet removed 32.5 kg N ha<sup>-1</sup> from the soil when it was grown following cowpeas, compared with 18.9 kg N ha<sup>-1</sup> when it followed a pearl millet crop.

Very little information is available in West Africa on the effects of rotating pearl millet with cowpea or any other legume. In Niger, pearl millet yields were more than doubled when millet followed one year of groundnuts (Brown 1978). Similar observations have been made in Senegal. The relative contribution of N fixed by the legume and P fertilizer applied to the groundnuts is not clear (Pieri 1985). However, recent research at the ISC has shown a residual effect of applied P in the presence of adequate N (ICRISAT 1985).

At the ISC, we are investigating the role that a

pearl millet and cowpea rotation may play in the productivity of the rainfed system of the SSZWA. While we are only beginning to adequately quantify the degree and efficiency with which pearl millet uses residual N and P from the cowpea crop, it is clear that there is a positive effect. Cowpea is gaining popularity as a cash crop. There should be some elasticity of demand because of its popularity in the coastal region. As a result, it should be possible to use purchased inputs on the cowpea crop that have an impact on the pearl millet crop. The authors see this as a promising means of intensifying the cropping pattern.

## Sources of Production Advantages

Little research has been undertaken to determine the reasons for the production advantages that have been observed with pearl millet/cowpea intercropping systems in SSZWA. Results from the ISC indicate that intercrops have a greater leaf area than sole crops throughout the first half of the season (Fig. 2). This suggests a better use of available radiation (Table 10, Fussell 1985). Total moisture use has been shown to be marginally higher (3-9%) in the intercrop situation although water-use efficiency, in terms of total dry matter production, was not improved (Table 9, Fussell 1985). This may have come about because cowpea, a C3 plant, would logically have a lower water-use efficiency than pearl millet. However, it should be noted that the cowpea fodder portion of the total biomass is saleable whereas in pearl millet, only the grain contributes to the crop's value when it is not intercropped.

**Table 10. Mean pearl millet/cowpea intercropping effect on yield and resource use in a factorial experiment at ISC, Niger, 1985.**

| Cropping system                   | Pearl millet straw yield (kg ha <sup>-1</sup> ) | Pearl millet grain yield (kg ha <sup>-1</sup> ) | Cowpea fodder yield (kg ha <sup>-1</sup> ) | Total dry matter (kg ha <sup>-1</sup> ) | Seasonal moisture use (mm) | Combined water-use efficiency (kg mm <sup>-1</sup> ) | Maximum % radiation interception |
|-----------------------------------|---|---|--|---|----------------------------|--|----------------------------------|
| Sole pearl millet                 | 5170  | 1050  | 0  | 6220                                    | 352                        | 17.6   | 48.0                             |
| Pearl millet/<br>cowpea intercrop | 4260  | 925   | 653  | 5834                                    | 389                        | 15.0   | 55.8                             |
| SE                                | ±91   | ±23   | -  | NA <sup>1</sup>                         | ±3.3                       | NA   | ±0.78                            |

1. NA = Not available

## Research Needs

Cropping systems in the SSZWA are diverse. Within this ecological zone, crop combinations and rotations vary widely in response to local conditions. The complex cropping strategies of traditional systems contribute to their stability, diversity, as well as their productivity. It is rarely possible to substitute simplistic production packages. The objective should be to improve components within the system, which includes better varieties and agronomic practices. For the pearl millet/cowpea cropping system in the SSZWA, the risk of crop failure will be reduced by using more efficient crop combinations involving drought-tolerant cultivars.

The effects of crop mixtures and rotations, on soil productivity and cultural operations such as weed control, needs to be better understood. The benefits of residual N from cowpea to succeeding nonlegume crops need to be quantified for both intercropping and crop-rotation situations.

The resource-use patterns of pearl millet/cowpea sole- and intercropping systems have not been adequately studied. Understanding the effects of cropping patterns on water-use efficiency, particularly those that have an impact on moisture loss due to soil evaporation, will be important when developing strategies to improve and stabilize crop productivity in the region.

Some pearl millet and cowpea cultivars are more tolerant of interspecific competition than others. Systematic screening for tolerance to interspecific competition needs to be undertaken.

## References

- Brown, C.** 1978. Annual technical report, 1977-78. Niger Cereals Project. 17 pp. (Mimeograph document).
- Finlay, R.** 1976. The productivity of mixed cropping in the tropics. A review of theoretical considerations and experimental findings. Scientific Communication no.1. Nairobi, Kenya: University of Nairobi, Department of Applied Plant Science.

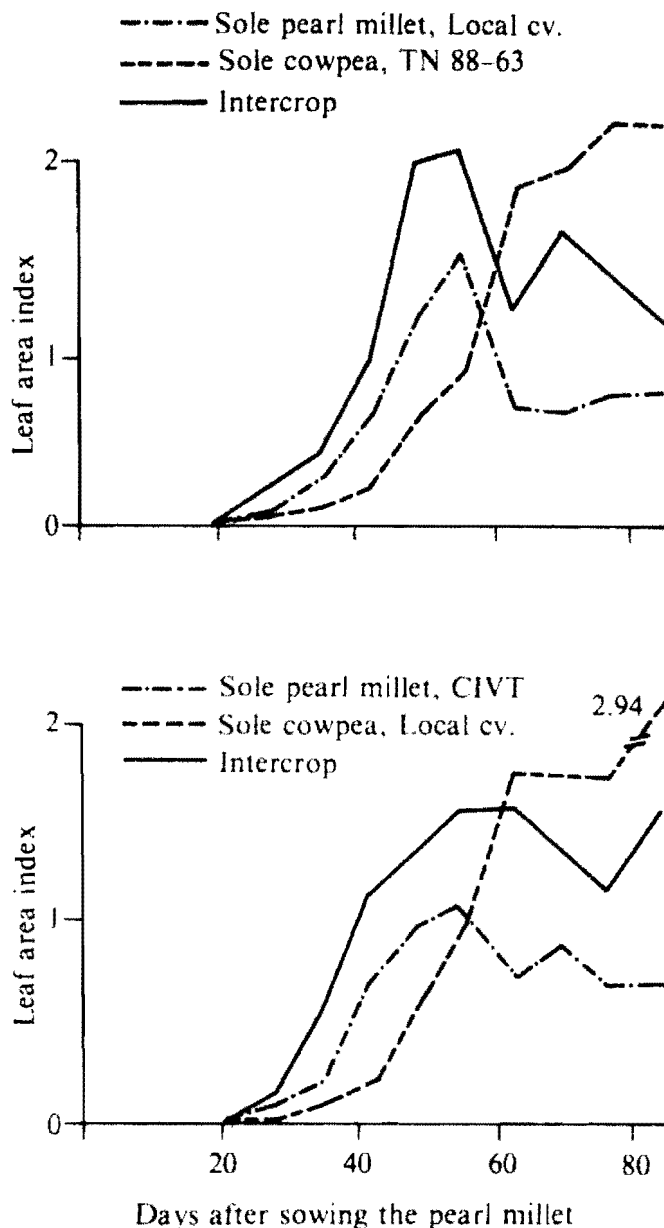

**Figure 2.** Leaf area development in sole crops and intercrops of pearl millet and cowpea at ISC, rainy season 1985.

When cowpea continues to grow after the pearl millet, it uses moisture from deep in the profile that would not otherwise be used in that year. This contributes to a better annual use of available moisture. In severe drought years, such as 1984 in Niger, when the profile was not fully recharged, areas where late-season cowpea had been grown in the previous year had lower pearl millet yields. The precedent cowpea crop had depleted moisture reserves deep in the profile thus compromising pearl millet yields that were 40% lower than in areas where pearl millet followed pearl millet (ICRISAT 1985).

- Fussell, L.K.** 1985. Evaluation of millet/cowpea intercropping systems in western Niger. Pages 26–39 in *Proceedings of the Regional Workshop on Intercropping in the Sahelian and Sahelo-Sudanian zones of West Africa*, 7–10 Nov 1984, Niamey, Niger. Bamako, Mali: Institut du Sahel.
- Fussell, L.K., and Serafini, P.G.** 1985. Associations de cultures dans les zones tropicales semi-arides d'Afrique de l'Ouest : stratégies de recherche antérieures et futures. (In Fr.) Pages 254–278 in *Technologies appropriées pour les paysans des zones semi-arides de l'Afrique de l'Ouest* (Ohm, W., and Nagy, J.G., eds.). West Lafayette, Indiana, USA: Purdue University.
- Fussell, L.K., and Serafini, P.G.** 1986. Intercropping—its future as a cropping system in the drought prone semi-arid tropics of West Africa. Presented at the International Drought Symposium, 19–24 May 1986, Nairobi, Kenya. 12 pp.
- Giri, G., and De, R.** 1979. Effect of preceding grain legumes on dryland pearl millet in northwest India. *Experimental Agriculture* 15(2):169–172.
- Giri, G., and De, R.** 1980. Effect of preceding grain legumes on growth and nitrogen uptake of dryland pearl millet. *Plant and Soil* 56(3):459–464.
- ICRISAT (International Crops Research Institute for the Semi-Arid Tropics).** 1985. ICRISAT Sahelian Center Annual report 1984. Niamey, Niger: ICRISAT Sahelian Center.
- ICRISAT (International Crops Research Institute for the Semi-Arid Tropics).** 1986. Annual report 1985. Patancheru, A.P. 502 324, India: ICRISAT.
- Jackai, L.E.N., Singh, S.R., Raheja, A.K., and Wiedijk, F.** 1985. Recent trends in the control of cowpea pests in Africa. Pages 233–247 in *Cowpea research, production and utilization*. (Singh, S.R., and Rachie, K.O., eds.). New York, USA: John Wiley.
- Kabore, P.D., Le Benne, Y., and Matlon, P.J.** 1983. Modèle de culture dans trois zones agro-climatiques de Haute Volta. ICRISAT West Africa Economics Program Report no. 9 Ougadougou, Burkina Faso: International Crops Research Institute for the Semi-Arid Tropics, West Africa Economics Program. 34 pp.
- Norman, D.W.** 1971. Intercropping of annual crops under indigenous conditions in the northern part of Nigeria. Samaru, Zaria, Nigeria: Ahmadu Bello University, Rural Economy Research Unit.
- Norman, D.W.** 1974. Rationalizing mixed cropping under indigenous conditions. The example of northern Nigeria. *Journal of Development Studies* 11:3–21.
- Pieri, C.** 1985. Fertilization des cultures vivrières et fertilité des sols en agriculture paysanne subsaharienne : l'expérience de l'IRAT. (In Fr.) Pages 254–278 in *Technologies appropriées pour les paysans des zones semi-arides de l'Afrique de l'Ouest* (Ohm, H.W., and Nagy, J.G., eds.). West Lafayette, Indiana, USA: Purdue University.
- Reddy, K.C., and Oumara, A.** 1985. Le niebe dans les systèmes des cultures au Niger. Presented at the Legume Workshop, 19–22 Nov 1985, University of Niamey, Niamey, Niger.
- Sawadogo, S., and Kabore, M.O.** 1985. Le point de la recherche sur les cultures associées en zone sahélo-soudanienne du Burkina Faso. (In Fr.) Pages 126–153 in *Proceedings of the Regional Workshop on Intercropping in the Sahelian and Sahelo-Sudanian Zones of West Africa*, 7–10 Nov 1984, Niamey, Niger. Bamako, Mali: Institut du Sahel. 1985.
- Serafini, P.G.** 1985. Intercropping systems: the ICRISAT/Mali experience: 1979–1983. Pages 154–179 in *Proceedings of the Regional Workshop on Intercropping in the Sahelian and Sahelo-Sudanian Zones of West Africa*, 7–10 Nov 1984, Niamey, Niger. Bamako, Mali: Institut du Sahel.
- Spencer, D.S.C., and Sivakumar, M.V.K.** 1987. Pearl millet in African agriculture. Pages 19–31 in *Proceedings of the International Pearl Millet Workshop*, 7–11 Apr 1986, ICRISAT Center, India. Patancheru, A.P. 502 324, India: International Crops Research Institute for the Semi-Arid Tropics.
- Swinton, S.M., Numa, G., and Ly, S.A.** 1985. Les cultures associées en milieu paysan dans deux régions du Niger : Filingué et Madarounfa. (In Fr.) Pages 183–194 in *Proceedings of the Regional Workshop on Intercropping in the Sahelian and Sahelo-Sudanian Zones of West Africa*, 7–10 Nov 1984, Niamey, Niger. Bamako, Mali: Institut du Sahel.

**Willey, R.** 1979a. Intercropping—its importance and research needs. Part 1. Competition and yield advantages. *Field Crop Abstracts* 32:1–10.

**Willey, R.** 1979b. Intercropping—its importance and research needs. Part 2. Agronomy and research approaches. *Field Crop Abstracts* 32:73–85.



# Design and Evaluation of Alternative Production Systems: Pearl Millet/Maize and Cereal/Groundnut Systems in Mali

S.V.R. Shetty<sup>1</sup>

## Abstract

*The paper summarizes recent experiences in the design and evaluation of improved sorghum-and-pearl millet based systems involving commercial crops such as groundnut and maize. The two major production systems studied in Mali—pearl millet/maize—and cereal/groundnut—are described in relation to their response to key agronomic factors like variety, density and geometry, date of planting and harvest, and added fertility. The package of technology for the pearl millet/maize system includes planting maize at a recommended density and fertility, and planting pearl millet when maize attains the 3–4 leaf stage. Results from on-farm testing of this improved system are also highlighted. Studies on the design and evaluation of cereal/groundnut systems indicated about 50% intercropping advantage. It was observed, that to obtain normal groundnut yields, higher densities of groundnuts had to be planted with crop stands of cereals. One row of cereal to four rows of groundnuts and delayed planting of cereal provided groundnuts competition-free early growth. It is recommended that because of poor adoption of sole-crop technology, studies on possible ways to incorporate sorghum and pearl millet into the existing production systems based on cash crops should be pursued. The need for the development and introduction of management-responsive cereal cultivars into the more potential areas of the Sahelo-Sudanian zone is also emphasized.*

## Résumé

**Conception et évaluation de systèmes de production alternatifs mil/maïs et céréales/arachide au Mali :** *Cet article présente brièvement des expériences récemment menées sur la conception et l'évaluation de ces systèmes traditionnels améliorés par l'adjonction de cultures de rente tels l'arachide et le maïs. Les deux systèmes de production les plus importants au Mali—mil/maïs et céréales/arachide—sont examinés par rapport à leur réponse à des facteurs agronomiques essentiels, tels la variété, la densité et la géométrie des cultures, les dates de semis et de récolte, ainsi que le complément de fertilité. La technologie recommande pour le système mil/maïs, de semer le maïs aux densités et dans les conditions de fertilité indiquées et de semer le mil lorsque le maïs atteint le stade 3 à 4 feuilles. L'accent est aussi mis sur les résultats obtenus par ce système amélioré en champs paysans.*

*Des études réalisées sur l'évaluation des systèmes associant céréales et arachide ont montré que leur adoption entraînait un gain de 50%. Un rendement normal en arachide dans l'association céréalière sera possible si l'on accroît la densité de semis de la légumineuse. Un rang de céréales pour quatre rangs d'arachide et le semis retardé des céréales permettent une croissance arachidière précoce sans concurrence. La méfiance des paysans vis-à-vis de la monoculture*

---

1. Principal Agronomist, ICRISAT, Bamako, Mali.

ICRISAT Conference Paper no. CP 411.

ICRISAT (International Crops Research Institute for the Semi-Arid Tropics) 1989. Soil, Crop, and Water Management Systems for Rainfed Agriculture in the Sudano-Sahelian Zone: proceedings of an International Workshop, 7–11 Jan 1987. ICRISAT Sahelian Center, Niamey, Niger. Patancheru, A.P. 502 324, India: ICRISAT.



*incite les chercheurs à étudier les modalités d'incorporer le sorgho et le mil dans les systèmes de production des cultures de rente. L'accent est mis sur la nécessité de mettre au point et d'introduire des cultivars de céréales adaptables aux techniques d'aménagement dans les régions à plus fortes potentialités de la zone soudano-sahélienne.*

## Introduction

By the year 2000, the seven Comité permanent inter-Etats de lutte contre la sécheresse dans le Sahel (CILSS) countries will require about 10 million t cereals to feed an estimated population of 50 million. This problem will be further confounded by a growing rural exodus to urban areas and a general degradation of the agricultural resource base. With the present rates of growth, a 4.7 million t cereal deficit is expected; 3 million t of the shortfall could be provided through improved sorghum and pearl millet production. Therefore, it is important to urgently accelerate food production in West Africa through the development and extension of intensified cropping strategies. Further diversification of the farming system is necessary to improve the sorghum- and pearl millet-based production patterns and to ensure efficient utilization of the agricultural resource base. Past experiences in West Africa have shown that available technology for increasing sorghum and pearl millet production has not been adopted, primarily because it does not generate the income to purchase the

associated inputs. As a result, it is felt that the new strategies should include income-generating crops, which will stimulate the use of production inputs on component cereal crops. More productive cropping systems that include income-generating components will encourage the use of management-responsive cultivars.

This paper attempts to describe traditional sorghum- and pearl millet-based production systems and our recent experiences with the design and evaluation of improved production patterns for these crops. Some of the more promising systems involve two commercial crops, maize and groundnuts.

## Sorghum- and Pearl Millet-based Systems in Mali

Sorghum and pearl millet occupy about 75% of the total of about 1.5 million ha cultivated area in Mali. They are generally grown in association with other crops such as cowpea, maize, groundnut, or vegetables. About 60% is grown in the southern

**Table 1. Mean annual rainfall (mm) in Mali.**

| Stations        | Mean annual rainfall from various sources | Mean annual rainfall for 17 years (1968-1984) | Decrease during 17 years (1968-1984) (%) | Rainfall in 1985 |
|-----------------|---|---|--|------------------|
| <b>Zone 1</b>   |   |   |  |                  |
| Sikasso         | 1373                                      | 994   | 18                                       | 1130             |
| Bamako          | 1088                                      | 868   | 20                                       | 907              |
| Kita            | 1151                                      | 867   | 25                                       | 641              |
| <b>Zone 2</b>   |   |   |  |                  |
| Segou (Cinzana) | 724                                       | 562   | 22                                       | 566              |
| <b>Zone 3</b>   |   |   |  |                  |
| Mopti (Koporo)  | 552                                       | 455   | 18                                       | 357              |
| Nioro (Bema)    | 709                                       | 388   | 45                                       | 433              |
| <b>Zone 4</b>   |   |   |  |                  |
| Timbouctou      | 225                                       | 147   | 35                                       | -                |

part of the country (800 mm annual rainfall). Of the rest about 30% is found in the central part of the country where the annual rainfall is 500-800 mm. In the south, sorghum and pearl millet usually follow cotton and groundnut in the rotation.

### Physical Resource Base

In Mali, the total annual rainfall varies from 0 mm in the north to 1300 mm in the south (Fig. 1). The season lasts up to 5-6 months in the south, beginning in May and lasting until Oct-Nov. As one moves north, the rains begin progressively later and end earlier. The spatial variation in rainfall is

very high. Effective moisture for plant growth is reduced by high evapotranspiration and runoff.

It is interesting to note that during 17 years (1968-1984) the annual rainfall has been 18-45% below the long-term average (Table 1). It is estimated that if rainfall isohyets were based on the 1968-1985 rainfall patterns, they would lie 75-90 km south of those based on long-term averages.

Most of the soils on which pearl millet is grown are classified as tropical ferruginous soils. The topography is typically characterized by gentle slopes of weathered ferralitic soil, altered by gravelly lateritic outcroppings or escarpments. They are classified within the Arenosol group in the north and Luvisols or Alfisols in the Sudanian

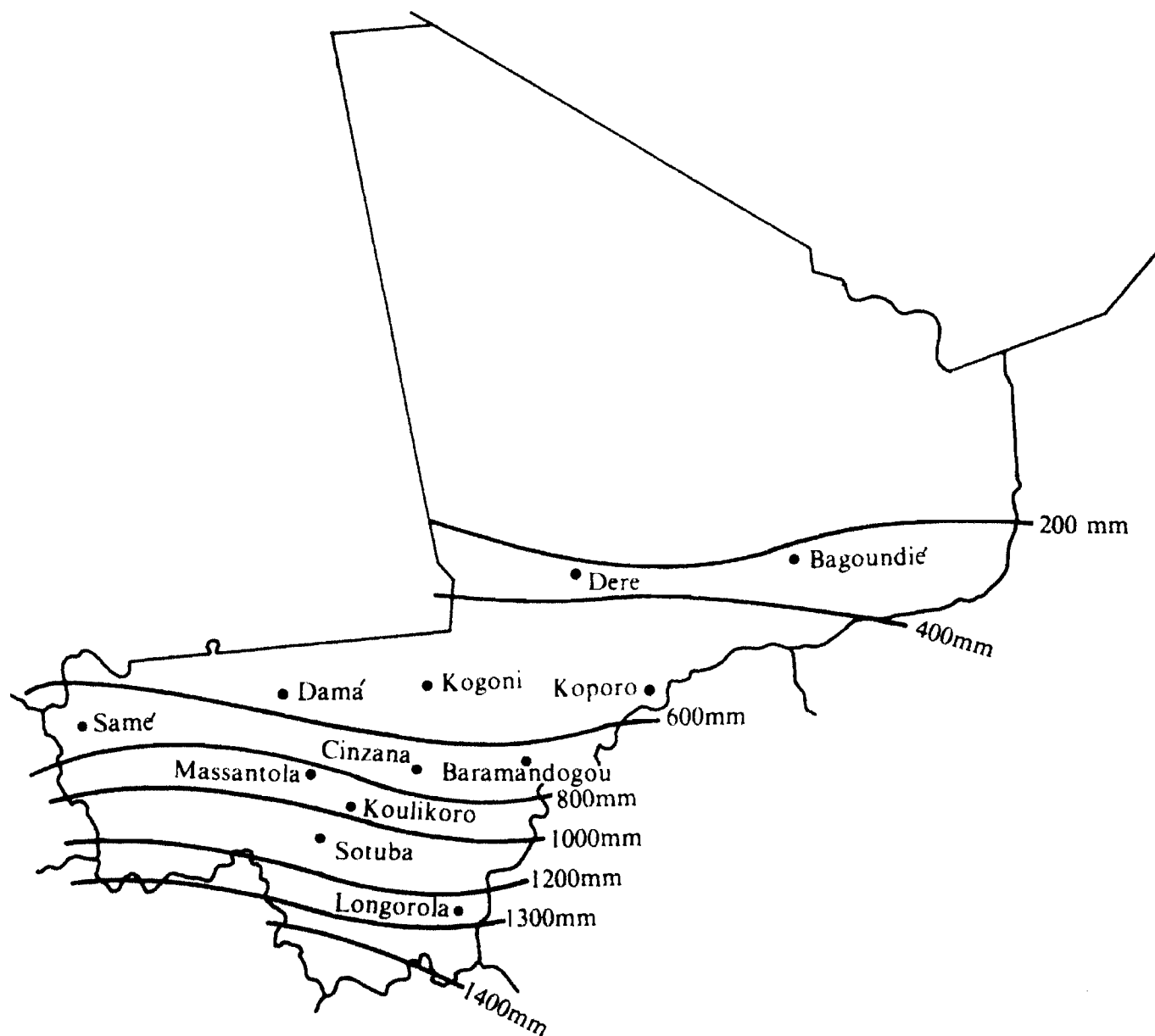

Figure 1. Mean annual rainfall in Mali.

ecological zone. They are generally loamy, loamy sand, sandy loam, or sandy soils. The distribution of parent materials from which these soils were derived is shown in Figure 2. Their main characteristics are:

- parent material rich in quartz,
- highly weathered and laterized nature, brought about by the loss of silica through leaching and the deposition of free iron in the profile as mottles and concretions,
- shallow profile (<125 cm),
- poor physical condition that results in a tendency to form crusts and moderate water-holding capacity,
- low cation exchange capacity (CEC),
- low level of soil organic matter, N and P content,
- widespread nutrient deficiencies, and

- a tendency to become more acidic with cropping and the use of acidifying chemical fertilizers.

A comparison of Alfisols at the ICRISAT Center (India) and the pearl millet soils at the Agronomic Research Station at Cinzana (ARSC) is given in Table 2. The soil environment at ARSC is characterized by its relatively low water-holding capacity, low clay content, low organic matter content, high erodibility, root-limiting layers, extreme structural instability, low CEC, and a limited ability to supply plant nutrients.

Spatial variability in soils is also high. The 230 ha at ARSC are composed of five distinct soil types. Within these soil types, variability in crop growth is frequently associated with differences in physical and chemical properties over relatively short distances. These differences may include toxicities and/or nutrient deficiencies.

### Traditional Systems

The subsistence-oriented sorghum-and pearl millet-based cropping systems have not been appreciably changed by recent innovations in agricultural production techniques. Mixed cropping with cowpea, maize, and groundnuts predominates. These cropping patterns are essentially replacement systems in time and space. Food self-sufficiency and risk avoidance for the farm families are among the principal objectives. Existing landraces are susceptible to leaf diseases, are drought-prone because of their relatively long growth cycle, and have a low yield potential. Sorghum yields are low, about 600 kg ha<sup>-1</sup>, compared with yield averages of 2000–3000 kg ha<sup>-1</sup>, at experimental stations nearby. Average pearl millet yields range from an estimated 300 kg ha<sup>-1</sup> in the sandier Sahelian regions to 700 kg ha<sup>-1</sup> in the higher-rainfall areas in the south. Yields of 1.5–2 t ha<sup>-1</sup> have been reported in experimental trials.

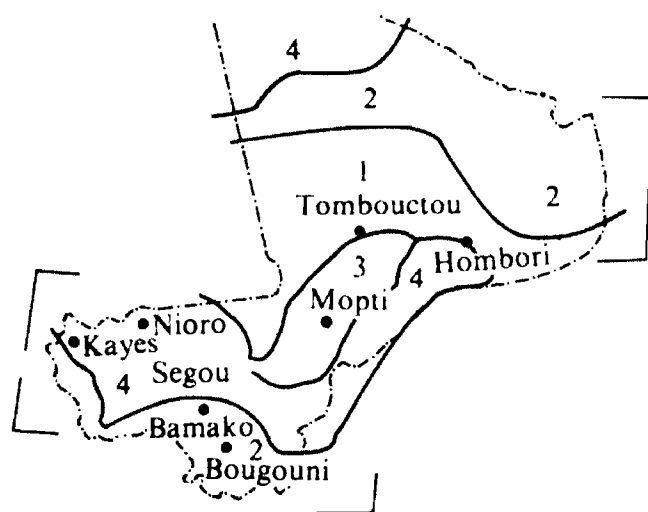

1. Extensive sandy areas
2. Continental sandstones, intercalaire
3. Alluvial fills, delta
4. Hard sandstones: precambrian or eocene clays: infracambrian

Figure 2. Geological map of Mali.

Table 2. A comparison of soil properties of an Alfisol from Patancheru (India) and Cinzana (Mali).

| Location   | Soil depth | pH  | % clay | % Organic carbon | Exchange cations<br>[meq(100 g) <sup>-1</sup> ] |     |     | CEC<br>(100 g) <sup>-1</sup> |
|------------|------------|-----|--------|------------------|---|-----|-----|------------------------------|
|            |            |     |        |                  | Ca  | Mg  | K   |                              |
| Patancheru | 0–18       | 6.7 | 29.6   | 0.55             | 6.7   | 1.5 | 0.7 | 17                           |
| Cinzana    | 0–18       | 5.5 | 9.0    | 0.30             | 1.13  | 0.6 | 0.1 | 2.9                          |

In Mali, technologies for increasing crop yields have been developed but have not been widely adopted by farmers. Agronomic practices that could increase crop yields include: primary tillage with animal traction, timely weed control, row planting, use of animal traction for cultivation and seeding, fungicide and insecticide seed treatment, high yield potential varieties, higher densities, crop rotations, application of chemical fertilizers and manure, and chemical crop protection. Combinations of techniques applicable to sorghum and pearl millet production systems and related yield expectations are given in Table 3. With a moderate dose of fertilizer, yield increases were substantial in both sorghum and pearl millet under normal rainfall conditions (IER 1974).

Attempts have been made to improve the indigenous cereal/cowpea intercropping system since 1980. Practices were developed to improve the overall productivity of sorghum/cowpea and pearl millet/cowpea associations. Productivity increases of up to 300% were demonstrated under experimental conditions (Serafini 1985, Shetty et al. 1986). But the adoption of these improved technologies is negligible. Understanding the low levels of adoption would require an economic and social evaluation. The use of chemical fertilizers on sorghum and pearl millet is not economical at current fertilizer and official grain prices.

Mali has been divided into rural zones, each covered by an extension agency called 'Opérations'. They were originally created to promote the production of cash crops (Fig. 3) and are qualified for foreign funding. In the past, they concentrated on production using chemical fertilizers and animal traction and marketing of single crop like cotton Compagnie Malienne de textiles (CMDT), and groundnuts Opération développement intégré pour la production arachidière et céréalière (ODIPAC). Sorghum and pearl millet were considered to be secondary crops. Mali consumes 30% of all chemical fertilizers used in the Sahelian countries, and has about 40% of the draft animals, 50% of the plows, and 25% of the ox carts. More than half the primary groundnut production area is treated with single superphosphate. A mixed cotton fertilizer is gaining popularity throughout the country. At present, both the cotton and groundnut extension agencies recommend pure stands of cereals following groundnut and cotton crops. Maize is usually the preferred cereal because of its relatively good response to fertilizers and its sales value. Attention has only recently been given to improving sorghum and pearl millet crops.

**Table 3. Sorghum and pearl millet package combination and yield expectation<sup>1</sup> (800–1000 mm rainfall).**

| Package   | Grain yield<br>(kg ha <sup>-1</sup> ) |              |
|---|---------------------------------------|--------------|
|   | Sorghum                               | Pearl millet |
| Traditional methods <sup>2</sup>  | 700                                   | 700          |
| Plus seed treatment   | 800                                   | 800          |
| Plus animal traction (tool bar) and thorough weeding  | 1200                                  | 1100         |
| Plus improved variety planting density  | 1400                                  | 1300         |
| Plus 100 kg ha <sup>-1</sup> ammonium phosphate and 50 kg ha <sup>-1</sup> urea 30 days after seeding | 1800                                  | 1700         |

1. Yield estimates based on IRAT annual research reports and results of pilot farmers in Operations (ODIPAC).
2. Traditional methods include hand seedbed preparation, one weeding, low plant population, and high application of manure.



**Figure 3. Agricultural development operations in Mali.**

## Recent Experiences with Improved Systems

ICRISAT, Mali, not only considered the agricultural resource base but also the existing infrastructure in the design of alternative production systems. The design strategy focused on incorporating intensified sorghum and pearl millet cropping patterns into cash-crop based production systems, because of the poor results that have been obtained in the past during attempts to intensify monoculture cereals in the region. It was hoped that the cereal crop would benefit from the advanced technology and the various inputs justified by the cash crop, so that investments made for the cash crop would also increase cereal yields.

Two agroecological areas were identified in the design phase, i.e., the southern cotton zone and the central and western groundnut zone. Two traditional systems were chosen for study. In the cotton zone, pearl millet/maize as a rotation following cotton was felt to be the most likely candidate for intensification. It also appeared that considerable improvements were possible with the cereal/groundnut intercrop system (Fig. 4). The two sys-

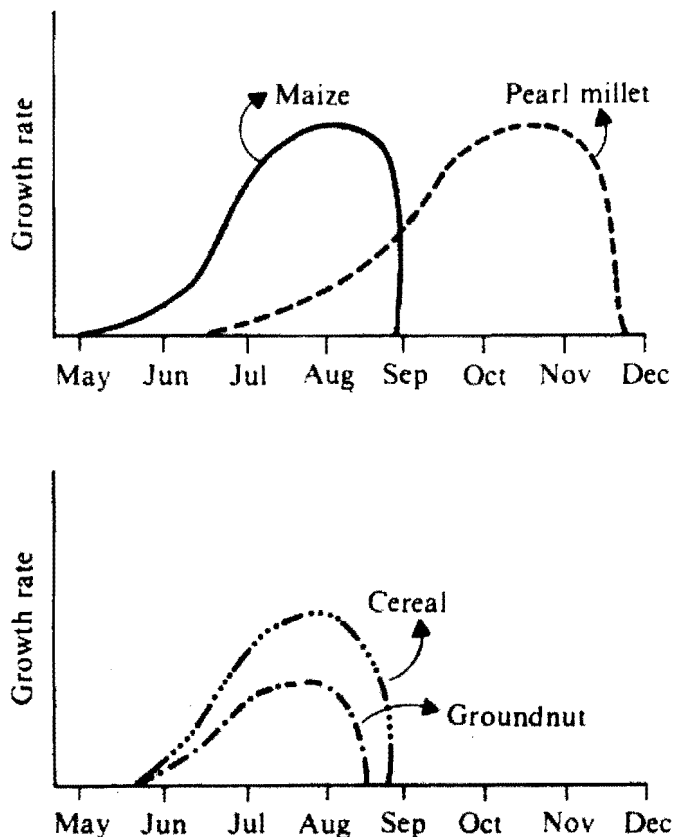

Figure 4. Schematic representation of maize/pearl millet and cereal/groundnut cropping systems.

tems differ in many respects: the pearl millet/maize association is a cereal/cereal intercrop while the cereal/groundnut association is a cereal/legume intercrop. The pearl millet/maize system is efficient because of the difference in resources used by the two crops over time while the cereal/groundnut exploits differences in crop architecture, and spatial differences to improve the efficiency of resource use. Maize is considered to be the principal crop in the pearl millet/maize intercrop, and groundnut in the cereal/groundnut intercrop.

## Maize/Pearl Millet Systems

Traditionally, in the south, maize is cultivated around family dwellings in villages. When grown on large fields, it is grown during the first few years of a cropping cycle as an intercrop with pearl millet. Cowpeas are also sometimes included in the crop mixture. Maize is sown on top of hills covered with organic matter from the weeding operations in the previous season. A mixture of pearl millet and cowpea is sown along the sides of hills when maize reaches the 3-4 leaf stage.

In the south of Mali, the use of animal traction and a more intensive approach to farming have developed during efforts to promote cotton production. Traditional 'slash and burn' farming patterns are being replaced by sedentary systems that include the use of organic and chemical fertilizers and the integration of livestock. Both maize and cotton have begun to benefit from these intensified farming practices. Farmers usually follow a 3-year rotation of cotton-maize-sorghum or pearl millet. Five to 30 t ha<sup>-1</sup> of manure and a complete package of NPK is recommended for both cotton and maize. Although the extension agency feels that maize can be more intensively grown as a sole crop, farmers still intercrop pearl millet in the maize rows. For best results, pearl millet is usually planted 25-30 days after maize. Maize completes its cycle in 100-120 days and pearl millet matures in about 150 days. About 13 000-20 000 pearl millet plants ha<sup>-1</sup> are planted between 30 000-60 000 maize plants ha<sup>-1</sup> (Johnson 1985). Farmers usually harvest about 1000 kg of maize ha<sup>-1</sup> and 500 kg of pearl millet ha<sup>-1</sup>.

Studies were begun in 1982 to define the requirements of this cropping system. Factorial experiments were used to examine the relationship between management factors such as time of sow-

**Table 4. Effect of pearl millet sowing date on grain yield (kg ha<sup>-1</sup>) of maize/pearl millet intercrops, Sotuba and Sikasso, Mali<sup>1</sup>, 1982 and 1984.**

| Year | Pearl millet sowing date | Grain yield (kg ha <sup>-1</sup> ) |              |         |              |
|------|--------------------------|------------------------------------|--------------|---------|--------------|
|      |                          | Sotuba                             |              | Sikasso |              |
|      |                          | Maize                              | Pearl millet | Maize   | Pearl millet |
| 1982 | At maize sowing date     | 2480                               | 1860         | 1600    | 810          |
|      | Maize at 4-leaf stage    | 3660                               | 510          | 1900    | 530          |
|      | Maize at 6-leaf stage    | 3400                               | 110          | 2040    | 270          |
|      | SE                       | ±96                                | ±63          | ±103    | ±70          |
| 1984 | Maize at 3-leaf stage    | 1110                               | 1040         | 1020    | 1240         |
|      | Maize at 6-leaf stage    | 1360                               | 520          | 980     | 710          |
|      | SE                       | ±48                                | ±50          | ±115    | ±75          |

1. Total rainfall: Sotuba: 1982—928 mm, 1984—850 mm, Normal—1100 mm.  
Sikasso: 1982—1112 mm, 1984—860 mm, Normal—1200 mm.

ing of the pearl millet intercrop, relative densities of the component crops, and N fertilizer application rates.

Early sowing of the pearl millet intercrop increased pearl millet yields at both Sotuba and Sikasso (Table 4). Pearl millet sown along with maize caused a marked reduction in maize yields, while delays in sowing pearl millet after maize reached the 3-4 leaf stage reduced pearl millet yields. Sowing at this stage gave pearl millet yields of 500 kg ha<sup>-1</sup>. When pearl millet was sown after the maize, increasing its seeding rate increased its yield without markedly reducing maize yield. Increasing maize density to the normal level for a sole crop increased maize yield and decreased pearl millet yield at Sotuba, but did not significantly reduce yield at Sikasso (Table 5).

Two levels of added N fertility, 40-60 kg ha<sup>-1</sup> and 80-120 kg ha<sup>-1</sup>, were compared because maize usually receives additional fertilizer. Maize responded to higher fertility in 1982 when rainfall was adequate. In 1984, a dry year, there was no difference (Table 6). Added fertilizer also increased pearl millet yields at Sikasso. Though interactions were not significant, there were indications that maize responded better to N when pearl millet was planted later, and that the yields of the later-sown pearl millet intercrop could be maintained by increasing its density. Early seeding of the pearl millet intercrop eliminated the effect of the higher N level on the maize.

In 1985, the effects of variety, density, and N-fertility on productivity were evaluated on an operational scale (Table 7). The local maize land-race performed as well as the recommended improved variety, Tiemanchie, in all locations. Higher maize densities did not result in higher maize yields. Maize yields, however, did respond

**Table 5. Effect of intercrop population on grain yield (kg ha<sup>-1</sup>) of maize/pearl millet intercrops, Sotuba and Sikasso, Mali<sup>1</sup>, 1982 and 1984.**

| Year | Plants ha <sup>-1</sup> | Grain yield (kg ha <sup>-1</sup> ) |              |         |              |
|------|-------------------------|------------------------------------|--------------|---------|--------------|
|      |                         | Sotuba                             |              | Sikasso |              |
|      |                         | Maize                              | Pearl millet | Maize   | Pearl millet |
| 1982 | Pearl millet            |                                    |              |         |              |
|      | 15000                   | 3240                               | 650          | 1830    | 450          |
|      | 30000                   | 3110                               | 1010         | 1880    | 620          |
|      | SE                      | ±30                                | ±80          | ±120    | ±90          |
| 1984 | Maize                   |                                    |              |         |              |
|      | 25000                   | 970                                | 870          | 920     | 870          |
|      | 50000                   | 1500                               | 680          | 1080    | 1080         |
|      | SE                      | ±48                                | ±50          | ±115    | ±75          |

1. Total rainfall: Sotuba: 1982—928 mm, 1984—850 mm  
Normal—1100 mm. Sikasso: 1982—1112 mm, 1984—860 mm, Normal—1200 mm.

**Table 6. Effect of fertilizer N rates on grain yield (kg ha<sup>-1</sup>) of maize/pearl millet intercrops, Sotuba and Sikasso, Mali, 1982 and 1984.**

| Year | Fertilizer N<br>(kg ha <sup>-1</sup> ) | Grain yield (kg ha <sup>-1</sup> ) |              |         |              |
|------|--|------------------------------------|--------------|---------|--------------|
|      |  | Sotuba                             |              | Sikasso |              |
|      |  | Maize                              | Pearl millet | Maize   | Pearl millet |
| 1982 | 60                                     | 2950                               | 790          | 1760    | 470          |
|      | 120                                    | 3400                               | 860          | 1940    | 590          |
|      | SE                                     | ±60                                | ±100         | ±36     | ±27          |
| 1984 | 40                                     | 1180                               | 690          | 1060    | 970          |
|      | 80                                     | 1320                               | 810          | 1300    | 980          |
|      | SE                                     | ±133                               | ±87          | ±125    | ±47          |

significantly to added N-fertility. The increased competition associated with higher N-fertility and maize 'on-farm' pre-extension trials have been conducted throughout southern Mali in collaboration with the Semi-Arid Food Grain Research and Development (SAFGRAD) to observe the potential and feasibility of this improved system. We compared the yields of sole crop maize, sole crop

pearl millet, and two intercropping systems (pearl millet planted in the interline and pearl millet planted in the maize row between maize hills). The interline system gave an LER of 1.54 in 1984 and 1.49 in 1985.

Studies to evaluate the performance of improved pearl millet cultivars in intercropping systems in 1986 indicated that very early pearl millet performed well in the beginning of the season but early flowering suffered from pollen-wash and damage by birds. Medium- and late-maturing pearl millet used available moisture more efficiently, but suffered because of early cessation of rains in the recent drought years. As a result, the program will concentrate on evaluating the high-yield potential, medium-duration pearl millets, available from breeding programs in West Africa.

The Institut d'Economie Rurale (IER) and the CMDT organized a joint research-extension workshop (IER/ICRISAT 1985) to examine the potential value of the intensified maize/pearl millet cropping system. The workshop recommended that the improved system be extended to farmers throughout the CMDT zone and that further research be devoted to fertility, land preparation, weed control, and density and varietal relationships in the intercropping situation.

**Table 7. Mean grain yields (kg ha<sup>-1</sup>) of intercropped maize/pearl millet, as affected by different agronomic factors at three locations in Mali, 1985.**

| Factor                               | Sikasso |              |      | Sotuba |              |      | Kita  |              |      |
|--------------------------------------|---------|--------------|------|--------|--------------|------|-------|--------------|------|
|                                      | Maize   | Pearl millet | LER  | Maize  | Pearl millet | LER  | Maize | Pearl millet | LER  |
| <b>Maize cultivars</b>               |         |              |      |        |              |      |       |              |      |
| Local                                | 2120    | 1360         | 1.66 | 2530   | 380          | 1.46 | 1520  | 900          | 1.35 |
| Tiemanchie                           | 1940    | 1320         | 1.59 | 2220   | 390          | 1.37 | 1430  | 640          | 1.15 |
| SE                                   | ±218    | ±93          |      | ±117   | ±65          |      | ±185  | ±87          |      |
| <b>Maize density ha<sup>-1</sup></b> |         |              |      |        |              |      |       |              |      |
| 26 000                               | 2130    | 1460         | 1.72 | 2340   | 495          | 1.58 | 1480  | 880          | 1.31 |
| 52 000                               | 1930    | 1230         | 1.50 | 2400   | 280          | 1.25 | 1475  | 660          | 1.18 |
| SE                                   | ±218    | ±88          |      | ±124   | ±59          |      | ±185  | ±88          |      |
| <b>N-fertility to maize</b>          |         |              |      |        |              |      |       |              |      |
| 0                                    | 1305    | 1530         | 1.49 | 2190   | 415          | 1.40 | 900   | 925          | 1.01 |
| 80                                   | 2750    | 1160         | 1.73 | 2560   | 360          | 1.43 | 2060  | 620          | 1.49 |
| SE                                   | ±116    | ±80          |      | ±115   | ±65          |      | ±108  | ±84          |      |

## Cereal/Groundnut Systems

The groundnut zone consists of a band, about 100 km wide, stretching across the upper-middle part of the arable area in Mali, from the Senegal-Guinea border to Burkina Faso (Fig. 3). There are about 100 000 farm units and 20% of the Malian population lives in this zone. There are a small number of well-equipped and innovative farmers, and a larger number of more traditional farmers who are just beginning to adopt improved cropping techniques. The use of improved varieties, a beneficial place in the crop rotation, and improved weed control have made it attractive for farmers to include groundnuts in their cropping pattern.

A crop rotation of groundnut-cereal-groundnut-fallow is currently recommended for the zone. The cereal benefits from the residual effects of the applied fertilizer and the nitrogen fixed by the groundnut crop. Cotton farmers are encouraged to include maize in their crop rotation in the CMDT zone. Fertilizer for maize can be bought on credit, whereas fertilizer for pearl millet or sorghum must be paid for in cash.

Compared with pearl millet and sorghum, increased maize production is constrained by:

- greater sensitivity to weeds,

- greater sensitivity to drought,
- harder to harvest and mill,
- greater sensitivity to *Striga*, and
- susceptibility to maize streak virus, which does not affect pearl millet and sorghum.

These limitations have resulted in the extension organization focusing on improving the productivity of pearl millet and sorghum in the cropping systems. The pearl millet/maize intercrop should be included in rotation with groundnut cropping strategies for the higher-rainfall areas. Since 1985 the research program has been studying a cereal/groundnut intercropping system in which the cereal benefits from the inputs applied to the groundnut crop without adversely affecting the latter's productivity. Management factors such as relative crop densities and planting dates, cultivar choice, and applied fertility level have been studied experimentally so that an 'optimum package' of practices may be developed for this cropping system.

## Sorghum/Groundnut System

Increasing groundnut density improves groundnut yields without significantly reducing sorghum yields (Table 8). Lowering sorghum densities improves

**Table 8.** Effect of different agronomic factors on the performance of sorghum/groundnut intercrop at two locations in Mali, 1985.

| Treatment                          | Sotuba                                    |   |           | Kita                                      |   |           |
|------------------------------------|---|---|-----------|---|---|-----------|
|                                    | Sorghum grain mass (kg ha <sup>-1</sup> ) | groundnut pod mass (kg ha <sup>-1</sup> ) | Total LER | Sorghum grain mass (kg ha <sup>-1</sup> ) | Groundnut pod mass (kg ha <sup>-1</sup> ) | Total LER |
| Groundnut density ha <sup>-1</sup> |   |   |           |   |   |           |
| 130 000                            | 1710                                      | 710                                       | 1.29      | 960                                       | 1340                                      | 1.69      |
| 200 000                            | 1640                                      | 910                                       | 1.40      | 890                                       | 1530                                      | 1.70      |
| 260 000                            | 1460                                      | 1020                                      | 1.43      | 850                                       | 1840                                      | 1.80      |
| SE                                 | ±180                                      | ±114                                      |           | ±63                                       | ±87                                       |           |
| Sorghum density ha <sup>-1</sup>   |   |   |           |   |   |           |
| 26 000                             | 1400                                      | 970                                       | 1.37      | 940                                       | 1740                                      | 1.85      |
| 52 000                             | 1800                                      | 790                                       | 1.38      | 860                                       | 1400                                      | 1.61      |
| SE                                 | ±141                                      | ±94                                       |           | ±51                                       | ±74                                       |           |
| Time of planting sorghum           |   |   |           |   |   |           |
| With groundnut                     | 2130                                      | 700                                       | 1.45      | 830                                       | 1380                                      | 1.56      |
| 4 weeks after groundnut            | 1070                                      | 1060                                      | 1.30      | 970                                       | 1760                                      | 1.89      |
| SE                                 | ±98                                       | ±88                                       |           | ±50                                       | ±72                                       |           |



groundnut yields but reduces sorghum yields.

When sorghum planting was delayed by 2–3 weeks, groundnut yields improved. Groundnut is sensitive to early competition and as a result, a small delay in sorghum planting favored groundnut establishment. However, delayed sorghum planting resulted in poor establishment and yield reductions. There were some indications that the loss in yield from late planting could be compensated for by maintaining high, pure stand, level, sorghum densities.

The advantages of the intercropping system shown in Table 8 indicate the gains in efficiency with this system. The optimum combination of practices includes a higher groundnut density (260 000 plants ha<sup>-1</sup>), planted along with a lower sorghum density. Simultaneous planting also reduces labor requirements for the system.

Our studies of sorghum/groundnut systems used the early improved local variety, 47–10, and an early, locally developed sorghum variety, MALISOR 84-7. The recommended dose of single superphosphate, 100 kg ha<sup>-1</sup>, was applied as a basal

dressing followed by 100 kg ha<sup>-1</sup> of band-applied urea for the sorghum, 25 days after planting. At present, several fertilizer rates for the sorghum component of the intercrop, as well as for new sorghum and groundnut varieties are being evaluated.

### Pearl Millet/Groundnut System

A pearl millet/groundnut intercropping system is being developed for areas in the groundnut belt. Increasing groundnut density and delaying pearl millet planting had no significant effect on pearl millet growth and yields. Furthermore, no significant difference in pearl millet yield was observed by increasing pearl millet density. Groundnut yields were improved when groundnut densities were increased. Late pearl millet planting improved groundnut yields (Table 9). Total intercropping advantages were improved with higher groundnut densities, lower pearl millet densities and delayed planting of the pearl millet component.

**Table 9. Effect of different agronomic factors on the performance of pearl millet/groundnut intercrops at two locations in Mali, 1985.**

| Treatment                                   | Kita   |   |           | Cinzana  |   |           |
|---|--|---|-----------|--|---|-----------|
|   | Pearl millet grain mass (kg ha <sup>-1</sup> ) | Groundnut pod mass (kg ha <sup>-1</sup> ) | Total LER | Pearl millet grain mass (kg ha <sup>-1</sup> ) | Groundnut pod mass (kg ha <sup>-1</sup> ) | Total LER |
| <b>Groundnut density ha<sup>-1</sup></b>    |  |   |           |  |   |           |
| 130 000                                     | 650  | 2720                                      | 1.41      | 550  | 510                                       | 1.41      |
| 200 000                                     | 570  | 3170                                      | 1.44      | 520  | 950                                       | 1.64      |
| 260 000                                     | 520  | 3580                                      | 1.51      | 430  | 1155                                      | 1.60      |
| SE  | ±49  | ±167                                      |           | ±70  | ±73                                       |           |
| <b>Pearl millet density ha<sup>-1</sup></b> |  |   |           |  |   |           |
| 26 000                                      | 560  | 3330                                      | 1.48      | 450  | 850                                       | 1.44      |
| 52 000                                      | 590  | 2990                                      | 1.42      | 550  | 890                                       | 1.65      |
| SE  | ±40  | ±150                                      |           | ±57  | ±81                                       |           |
| <b>Time of planting pearl millet</b>        |  |   |           |  |   |           |
| With groundnut                              | 580  | 2570                                      | 1.29      | 450  | 700                                       | 1.29      |
| 4 weeks after groundnut                     | 570  | 3750                                      | 1.60      | 550  | 1040                                      | 1.75      |
| SE  | ±40  | ±93                                       |           | ±57  | ±73                                       |           |

## Conclusion

There are clear indications that the cereal/groundnut intercropping system has good potential in Mali. An average of more than 50% advantage has been observed using this intercropping system. It has been generally found that normal groundnut yields can be obtained by planting a higher density of groundnuts with a cereal planted at densities that are below their optimal pure stand levels. The optimum row arrangement appears to be one row of cereal to four rows of groundnuts. Delaying the planting of the cereal 2–3 weeks in the southern zone would give groundnuts a competition-free period during its early growth. Availability of alternative cereal and groundnut cultivars would provide an excellent opportunity to identify ideal plant types for this intercropping situation. Future agronomic studies will consider the effect of alternative fertility rates and weed-control measures.

The results of the agronomic studies with maize/pearl millet and cereal/groundnut presented here, have clearly indicated the potential for designing improved, more productive, production systems in Mali. These systems may incorporate commercial crops as well as improved genotypes. Work in future will concentrate on developing practices that ensure the optimal performance of the component crops.

## References

CILSS (Comité permanent inter-états de lutte contre la sécheresse dans le Sahel). 1985. Bilan du développement économique des pays du CILSS et perspectives, 1973–1983. Etudes et Travaux de l'USED no. 2. Bamako, Mali: Institut du Sahel.

IER (Institut d'économie rurale) and IRAT (Institut de recherche agronomique tropicale et des cultures vivrières). 1974. Bilan technique et financier des recherches en matière d'agronomie générale et de cultures vivrières au Mali. 1962–1974 au Mali. Bamako, Mali: IER.

IER (Institut d'économie rurale)/ICRISAT. 1985. Proceedings of the IER/ICRISAT-Mali Workshop on Maize/Millet Intercropping Systems, 15–17 Jan 1985, Sikasso, Mali. Bamako, Mali: IER. 21 pp.

Johnson, T. 1985. The maize/millet intercrop: farmer practices in south Mali. Pages 5–7 in Proceedings of the IER/ICRISAT-Mali Workshop on Maize/Millet Intercropping Systems, 15–17 Jan 1985, Sikasso, Mali. Bamako, Mali: Institut d'économie rurale.

Serafini, P.G. 1985. Intercropping Systems: the ICRISAT/Mali experience: 1979–1983. Pages 154–179 in Proceedings of the Regional Workshop on Intercropping in the Sahelian and Sahelo-Sudanian Zone of West Africa, 7–10 Nov 1984, Niamey, Niger. Bamako, Mali: Institut du Sahel.

Shetty, S.V.R., Keita, B., Sow, A.A., and Serafini, P.G. 1987. Improving millet-based cropping systems in the Sahelo-Sudanian zone of Mali. Page 306 in Proceedings of the International Pearl Millet Workshop, 7–11 Apr 1986, ICRISAT Center, India. Patancheru, A.P. 502 324, India: International Crops Research Institute for the Semi-Arid Tropics. (Abstract).



# Weed Management in Improved Rainfed Cropping Systems in Semi-Arid India

M.R. Rao, S.V.R. Shetty, S.L.N. Reddy, and M.M. Sharma<sup>1</sup>

## Abstract

*In the semi-arid tropics (SAT), weeds compete severely with crops for limited resources of moisture and nutrients. Weed problems differ with crops, soils, and climate. Yield losses in rainfed crops varied from 30 to 80% depending upon the severity of infestation. The potential benefits of new technologies will not be realized until appropriate weed management practices are adopted. Weeds in SAT are controlled by hand weeding and mechanical interrow cultivation; herbicides are rarely used. Research efforts in recent years have been mostly to improve the efficiency of these traditional methods by developing improved hand tools and animal-drawn equipment. Some improved cropping systems posed new weed problems that could not be handled by the conventional methods. Double cropping of Vertisols by adopting broadbed- and furrow-systems, dry seeding of crops ahead of rains, and fertilization encouraged greater weed growth than the traditional single-season cropping. Improved sorghum genotypes were frequently attacked by Striga. Preemergence herbicides helped provide early weed control on Vertisols where the scope for timely hand weeding or intercultures in the rainy season is uncertain. Integrated weed control is suggested combining interculturing, judicious herbicide use, good agronomic practices, and minimum hand weeding for intrarow weed control. Low canopy smother crops such as cowpea could be utilized to substitute preemergence herbicide or one-hand weeding. Deep plowing in summer months reduced the infestation of certain perennials but control with systemic herbicides (e.g., glyphosate) seemed to be most effective. On-farm evaluation of prospective weed management practices should be an integral part of technology development. Some of the weed-management principles and methods employed in SAT India may have relevance to the Sudano-Sahelian zone.*

## Résumé

**Lutte contre les mauvaises herbes dans les systèmes améliorés d'agriculture pluviale des régions semi-arides de l'Inde :** *Dans les tropiques semi-arides, les mauvaises herbes entrent en sévère concurrence avec les cultures pour l'humidité et les éléments nutritifs déjà limités. Les problèmes varient selon les cultures, les sols et les climats. Les pertes de rendement des cultures pluviales varient de 30 à 80% en fonction du degré d'infestation. A moins que l'on adopte les pratiques de désherbage appropriées, il sera difficile de tirer parti des avantages potentiels des nouvelles technologies. Le désherbage est effectué manuellement et mécaniquement entre les rangs; les herbicides sont rarement utilisés. Les recherches des dernières années ont surtout porté sur l'amélioration de l'efficacité de ces méthodes traditionnelles par le perfectionnement des outils*

---

1. Sorghum and Millet Agronomist, IITA/IRA/USAID, B.P. 33, Maroua, Cameroon; Agronomist, ICRISAT c/o American Embassy, B.P. 34, Bamako, Mali; Research Associate, ICRISAT, Patancheru, A.P. 502 324 India.

ICRISAT Conference Paper no. CP 489.

ICRISAT (International Crops Research Institute for the Semi-Arid Tropics) 1989. Soil, Crop, and Water Management Systems for Rainfed Agriculture in the Sudano-Sahelian Zone: proceedings of an International Workshop, 7-11 Jan 1987. ICRISAT Sahelian Center, Niamey, Niger. Patancheru, A.P. 502 324, India: ICRISAT.

*agraires et du matériel de traction animale. Certains systèmes de culture améliorés ont fait apparaître de nouvelles difficultés empêchant l'utilisation des méthodes conventionnelles pour le désherbage. Ainsi, les pratiques telles que les cultures séquentielles par saison sur les vertisols en adoptant des lits de semis larges et des sillons, les semis effectués à sec avant les pluies et l'épandage d'engrais ont favorisé un développement des mauvaises herbes plus important que dans le cas d'une seule culture par saison. En outre, les génotypes améliorés du sorgho sont souvent infestés par le Striga. L'application d'herbicides avant la levée s'est avérée utile pour un contrôle précoce sur les vertisols pour lesquels il est difficile de prévoir la meilleure période d'arrachage ou de travail mécanique entre rangs en saison des pluies. Un contrôle intégré pourrait combiner culture intercalaire, utilisation judicieuse des herbicides et bonnes pratiques agronomiques complétées par un arrachage minimum pour désherber entre les rangs. L'usage en intercalaire de plantes touffues et prostrées comme le niébé pourrait remplacer l'application d'herbicides avant la levée ou un sarclage manuel. Le labour profond, pratiqué en été, réduit l'infestation de certaines herbes vivaces mais l'application d'herbicides systémiques (par exemple, le glyphosate) semble être très efficace. L'étude prospective des pratiques de désherbage dans le champ du paysan devrait faire partie intégrante du processus de développement des technologies. Certains des principes et des méthodes de désherbage employés dans les tropiques semi-arides en Inde pourraient être applicables à la zone soudano-sahélienne.*

## Introduction

The need for weed control does not have to be emphasized, for removal of weeds is the first activity that any farmer undertakes before raising a crop. Since weed competition is one of the most important constraints in crop production, weed management determines the production efficiency of a farm. Weed problems vary according to crop, region, and soil type. In the semi-arid tropics (SAT), weeds compete with crops for soil moisture and nutrients, which are the most limiting factors for crop growth. When improved agricultural technologies are adopted, efficient weed management becomes even more important, otherwise the weeds rather than the crops benefit from the costly inputs.

Weed problems in the SAT are much more complex than in temperate conditions because of heterogenous soil conditions, erratic rainfall, small farm holdings, illiteracy, and limited resources. SAT India has two predominant soil types, Alfisols and Vertisols. Alfisols are light-textured red soils cropped only in the rainy season. The first rains are accompanied by a flush of weeds dominated by *Digitaria*, *Eleusine*, *Celosia*, *Cyperus*, *Tridax*, *Phyllanthus*, *Eragrostis*, *Euphorbia*, *Trianthema*, *Brachiaria*, and others. The soils are sole-cropped with sorghum, pearl millet, finger millet, castor, and groundnut, or intercropped with cereals, low-canopy short-season legumes such as mung, groundnut, and cowpea or with later-

maturing pigeonpea. Vertisols are heavy-textured black soils, which, in the <750 mm rainfall zone, are cropped only in the postrainy season, and in the >750 mm rainfall zone, have potential for being cropped both in the rainy and postrainy seasons. Two flushes of weeds dominated by *Commelina*, *Cyanotis*, *Euphorbia*, etc. coincide with the two cropping seasons. Weed management needs have changed greatly with the introduction of double-cropping technology in high-rainfall areas.

This paper reviews the current developments in weed management research in rainfed cropping systems in India. It highlights the need for development of efficient, feasible, and cost-effective weed management practices as an important component of the overall regional technology development.

## Losses Due to Weeds

Losses due to weeds are greater in rainy-season crops than in postrainy-season crops because of limited fieldwork days, and heavy labor requirements for irrigated crops in the rainy season. Repeated cultivations during the fallow period can efficiently control weeds in postrainy-season crops grown after a rainy-season fallow. Most crops are sensitive to weed competition in the early stages of growth. Lack of effective weed control during the first 20–30 days (Table 1) causes maximum yield

**Table 1. Effect of different weedfree periods (days after sowing, DAS) on yields of some rainfed crops on Alfisols (ICRISAT 1976).**

| Crop                 | Weedfree period (DAS) and yield (kg ha <sup>-1</sup> ) |      |      |      |      |
|----------------------|--|------|------|------|------|
|                      | 0  | 8    | 42   | 56   | 70   |
| Sole sorghum         | 800  | 1500 | 1700 | 1800 | 1800 |
| Pearl millet         | 500  | 1200 | 1500 | 1700 | 1700 |
| Intercropped sorghum | 1040   | 2230 | 2510 | 2720 | 2780 |
| Groundnut            | 600  | 1300 | 1800 | 1900 | 1900 |

losses in crops with a 100-day cycle. The late-maturing crops (e.g., pigeonpea, castor) may require a much longer weedfree period. The extent of yield loss in rainy-season crops can vary from 37% to as high as 80%, depending on the severity of infestation (Friesen and Korwar 1982). Late removal of weeds in a finger millet crop at Bangalore resulted in a per ha nutrient loss of 27 kg N, 3.2 kg P, 76 kg K, 15.9 kg Ca, and 5 kg Mg. In another study at Dehra Dun, weeds removed 100% more Ca and N and 24% more K than crop plants.

## Mechanical Method of Weed Control

Traditional methods of weed control include hand tools such as the sickle or animal-drawn mechanical equipment which is also used for line sowing

and interrow cultivation, e.g., blade harrows, (Fig. 1).

Tillage immediately after harvest of crops helps: (1) kill crop stubble and late-season weeds, (2) conserve residual moisture, and (3) form a rough cloddy surface that facilitates infiltration of the ensuing rains. Compared to traditional tillage practices on Alfisols at Hyderabad (Table 2), year-round tillage, with and without herbicides and interculturing, reduced weed infestation in the rainy season and led to increased sorghum yields. At Ranchi, blade harrowing together with year-round tillage was found to control weeds effectively and increase yields of upland rice. However, on alluvial soils at Varanasi, there was no particular benefit from premonsoon tillage. Obviously, the benefit of year-round tillage is site- and soil-specific (Friesen and Korwar 1982).

Many centers of the All India Coordinated Research Project for Dryland Agriculture (AI-CRPDA) in recent years have developed effective and time-saving hand tools such as hand-operated wheel-hoes, cultivators, and bullock-drawn blade hoes for interrow cultivation. At Hisar, a newly developed hand-hoe that can be used to control weeds at an early stage of the crop when weeds are small, reduced weeding time and costs by 66-75%. At the Bhubaneswar center, newly designed agro-hoes and rake weeders were as effective as pre-emergence use of chloroxuron (1 kg a.i. ha<sup>-1</sup>) on finger millet. At Varanasi, sweep- and blade-type wheel-hoes or hand-hoes appeared to be more effi-

**Table 2. Effect of year-round tillage on weed control and sorghum yields on Alfisols at Hyderabad (Friesen and Korwar 1982).**

| Treatment  | Normal tillage                       |  | Year-round tillage                   |                           |
|--|--------------------------------------|--|--------------------------------------|---------------------------|
|  | Sorghum yield (kg ha <sup>-1</sup> ) | Weed control rating <sup>1</sup> (0-5) | Sorghum yield (kg ha <sup>-1</sup> ) | Weed control rating (0-5) |
| T1 Atrazine (1 kg a.i. ha <sup>-1</sup> ) <sup>2</sup> | 2150                                 | 3.2                                    | 2450                                 | 2.3                       |
| T2 Isoproturon (1 kg a.i.) <sup>2</sup>                | 2200                                 | 2.7                                    | 2600                                 | 1.3                       |
| T3 T1 + T2   | 2370                                 | 2.9                                    | 2620                                 | 1.5                       |
| T4 T1 + interculture <sup>3</sup>                      | 2800                                 | 1.5                                    | 3160                                 | 1.2                       |
| T5 T2 + interculture <sup>3</sup>                      | 2780                                 | 3.0                                    | 3280                                 | 1.9                       |
| T6 T3 + interculture <sup>3</sup>                      | 2730                                 | 2.2                                    | 2980                                 | 1.7                       |
| T7 Weedfree  | 2930                                 | 0.7                                    | 3200                                 | 0.2                       |
| Average  | 2560                                 | 2.3                                    | 2900                                 | 1.4                       |

1. Weed infestation at harvest. 0 = complete control, 5 = no control.

2. Atrazine applied at preemergence; Isoproturon applied at postemergence.

3. Interculture — two blade harrowings at 3 and 7 weeks after sowing.

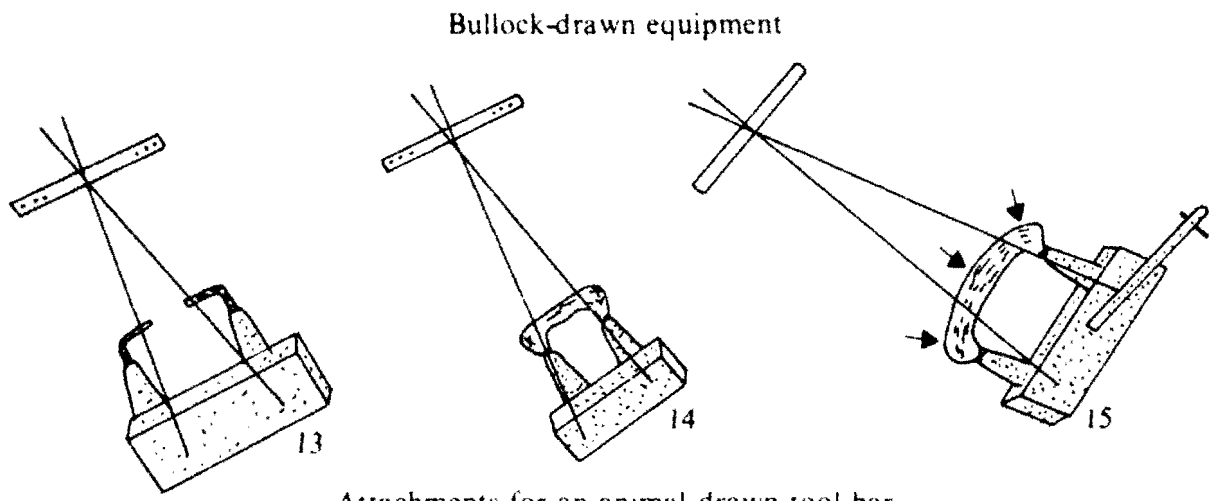
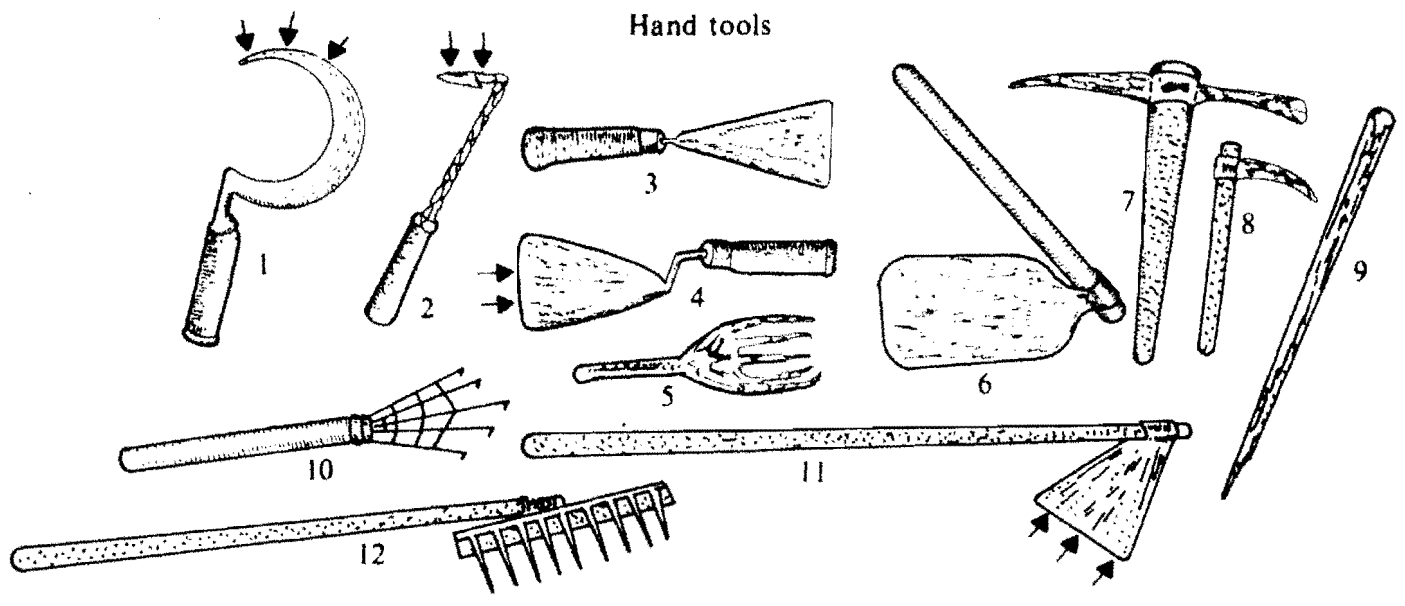

Attachments for an animal-drawn tool bar

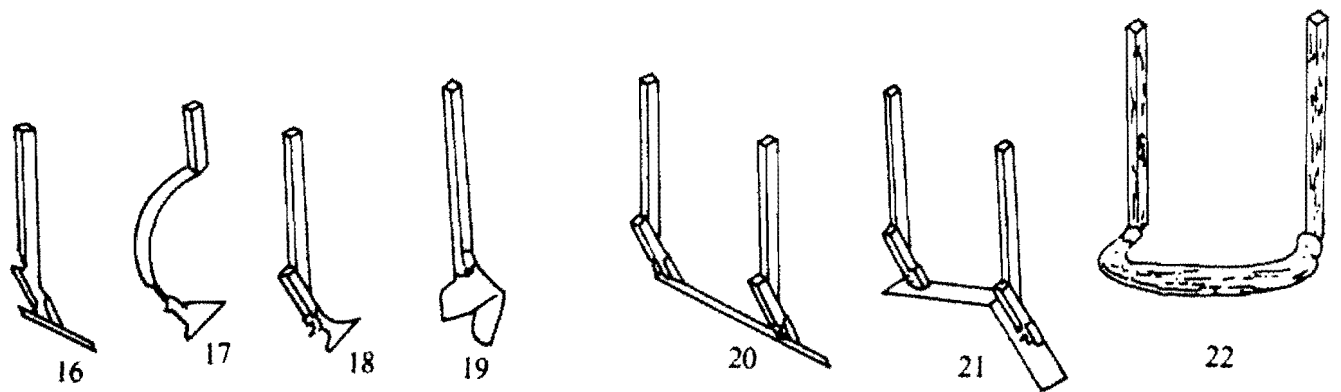

**Figure 1. Different types of tools and equipments employed to control weeds in semi-arid tropical India. 1. Sickle 2. Kaluvara 3. Flat khurpi 4. Khurpi 5. Weeding fork 6. Spade 7. Pick axe 8. Khudal 9. Crowbar 10. Tyned hand-hoe 11. Hand-hoe 12. Raker 13. Guntaka 14. Danthi 15-16. Blade harrow 17. Spring tyne cultivator 18. Rigid tyne cultivator 19. Interrow weeder 20. Straight blade harrow 21. V-blade harrow and 22. Blade harrow.**

**Table 3. Effect of intrarow hand weeding on castor yields (AICRPDA 1976).**

| Planting pattern (cm) | Blade harrow<br>interculture | Intrarow<br>hand weeding | Yield<br>(kg ha <sup>-1</sup> ) |
|-----------------------|------------------------------|--------------------------|---------------------------------|
| 90 × 22.5             | 2                            | -                        | 1210                            |
| 90 × 22.5             | 2                            | 2                        | 1500                            |
| 135 × 15              | 2                            | -                        | 1070                            |
| 135 × 15              | 2                            | 2                        | 1420                            |
| 90 × 40               | 2                            | -                        | 920                             |
| 90 × 40               | 2                            | 2                        | 1430                            |
| 135 × 27              | 2                            | -                        | 950                             |
| 135 × 27              | 2                            | 2                        | 1520                            |
| 45 × 45               | 2                            | -                        | 1200                            |
|                       | (Both directions)            |                          |                                 |
| 60 × 60               | 2                            | -                        | 1130                            |
|                       | (Both directions)            |                          |                                 |
| LSD (0.05)            |                              |                          | 380                             |

cient than tyned hoes or paddy weeders (Friesen and Korwar 1982). At the Hyderabad center, minor modifications carried out to the traditional blade harrow helped reduce weeding time by 50-60%. By adding a height adjustment mechanism to the blade-hoe, weeding time after crop emergence could be extended to 7 weeks (Gupta and Subareddy 1979).

Although intercultivation effectively controls interrow weeds, the intrarow weeds have to be removed manually even in crops such as castor, which can be sown in spatial arrangements that permit harrowings in two directions (Table 3). In closely-planted cereals, intercultivation is confined to the interrow area only. Cultivating close to plants is rather difficult with any equipment, and hand weeding with efficient hand tools or herbicides is the only alternative for controlling intrarow weeds (Table 4).

A wheeled-tool carrier to which tools such as plows, seeders, and interculture equipment can be attached for various field operations has been developed at ICRISAT. Since duckfoot shovels and tyned hoes, used widely for interculture, were not found effective for weed control, the traditional blade harrow has been adapted for use with the tool bar. In a weed-count test made at mid-season on maize and sorghum, maximum weed growth was observed when the blade harrow was used without any other weeding (Fig. 2). Weeds were not effectively controlled by runner blades or V-blade hoes either. Weed growth was minimum after treatment with a hand-hoe, which is a modi-

fied version of a traditional spade; it has a long handle to facilitate weeding without bending. Although it improved labor efficiency, it has the basic disadvantage of being totally dependent on human labor. The next best system involved band application of a preemergence herbicide to crop rows (to control intrarow weeds) and interculturing by blade harrow, with or without sweeps behind. The degree of weed control achieved by different interculturing treatments was less pronounced on sorghum yields than on maize yields.

**Table 4. Effect of atrazine, intercultivation, and hand weeding on yield of sorghum grown on Alfisols, Hyderabad (AICRPDA 1978).**

| Hermicide   | Inter<br>cultivations | Hand<br>weedings | Yield<br>(kg ha <sup>-1</sup> ) |
|---|-----------------------|------------------|---------------------------------|
| No herbicide  | 2                     | -                | 3090                            |
| No herbicide  | 2                     | 2                | 4360                            |
| Atrazine<br>(1 kg a.i. ha <sup>-1</sup> )                       | 2                     | -                | 4230                            |
| Atrazine<br>(1 kg a.i. ha <sup>-1</sup> )                       | 2                     | 2                | 4230                            |
| Atrazine band<br>application<br>(0.3 kg a.i. ha <sup>-1</sup> ) | 2                     | -                | 4580                            |
| Atrazine band<br>application<br>(0.3 kg a.i. ha <sup>-1</sup> ) | 2                     | 2                | 4420                            |
| LSD   |                       |                  | 525                             |



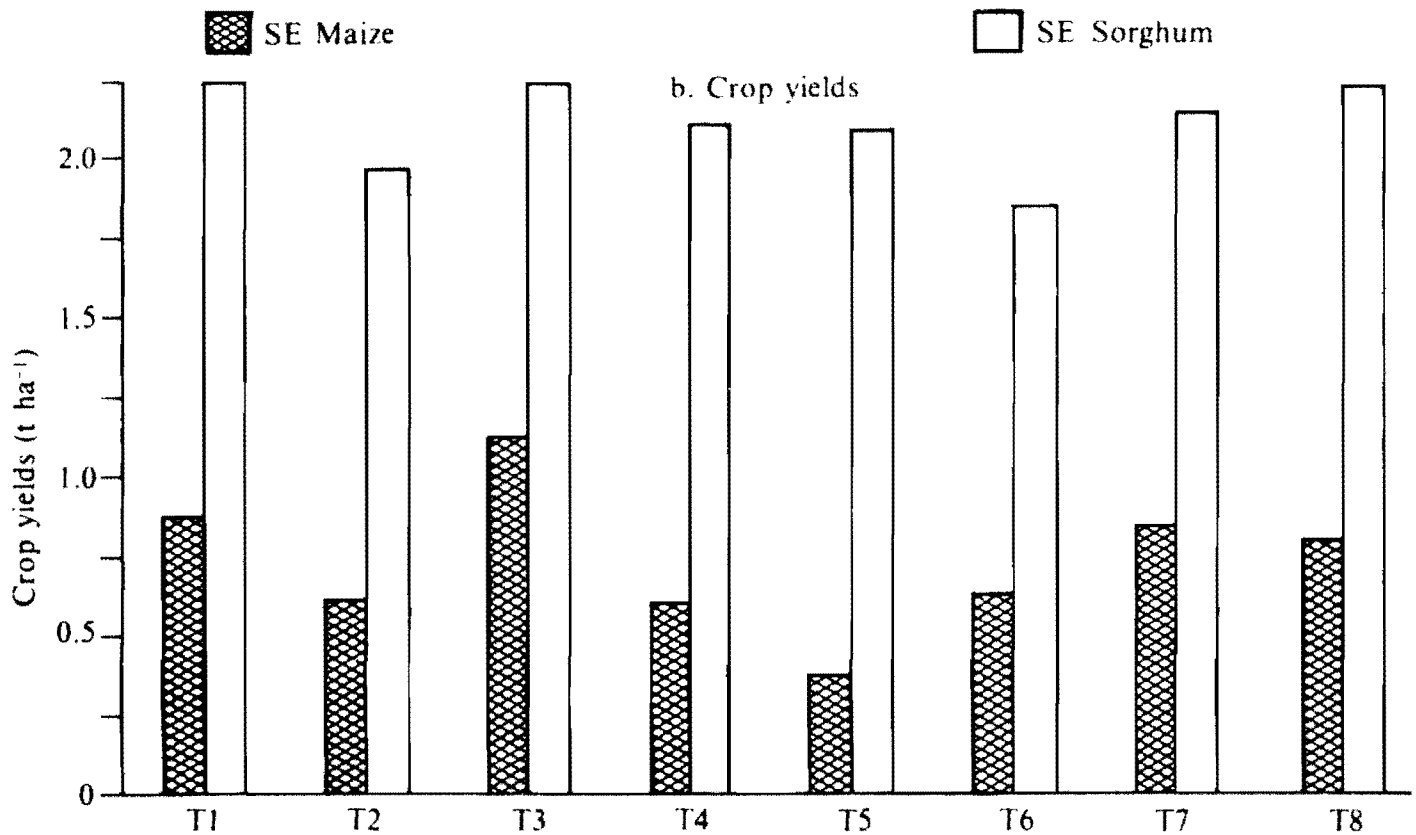
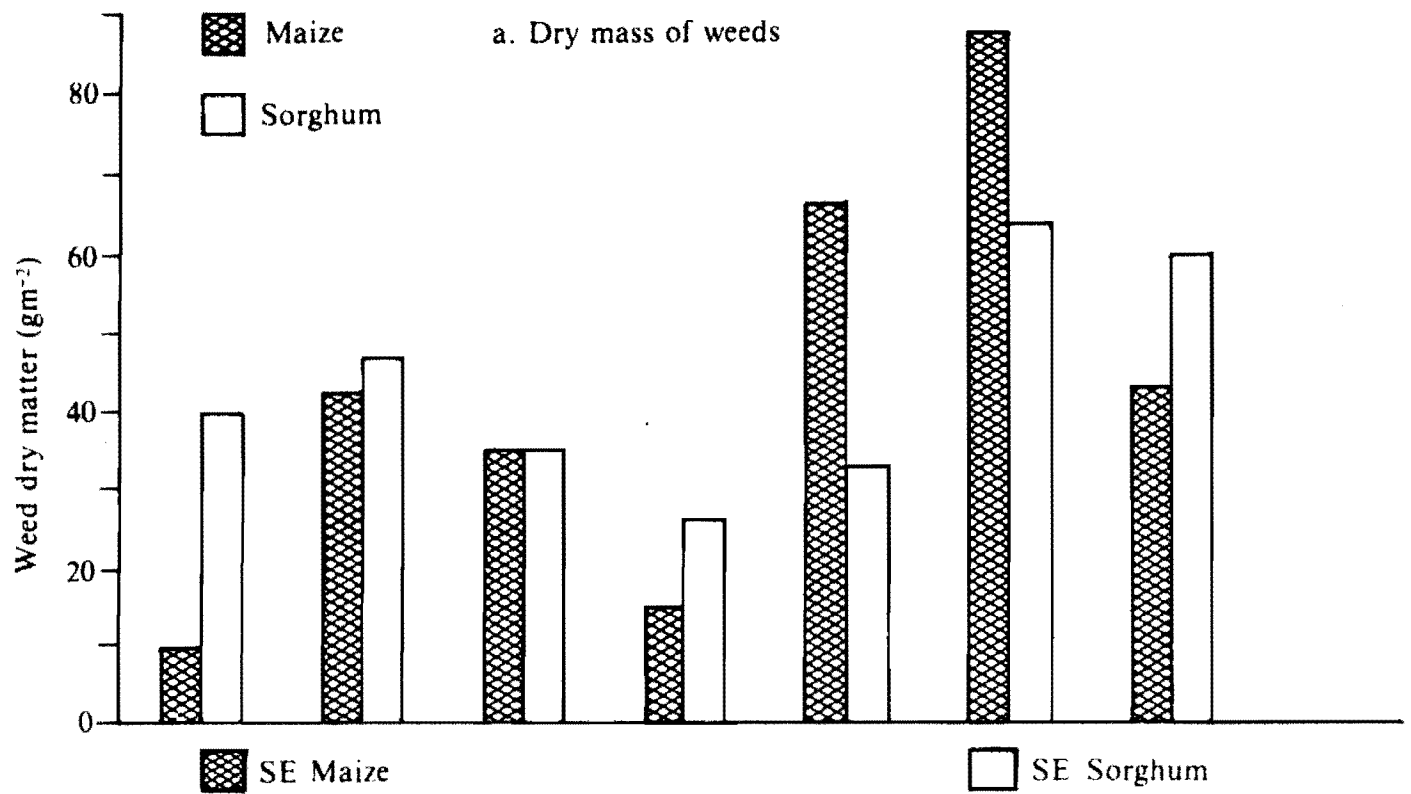

T1 = Blade harrow + band application of preemergence herbicide  
 T2 = Blade harrow + no herbicide  
 T3 = Blade harrow + 2 duckfoot sweeps behind blade harrow  
 T4 = 20-cm wide hand hoe

T5 = 20-cm, 120 degree V-blade hoe  
 T6 = Farmer's blade harrow + no hand weeding  
 T7 = 40-cm wide runner blade  
 T8 = Weed-free control

**Figure 2. Effect of interculturing with different mechanical equipment on weed growth in maize and sorghum and on yield of crops grown on Vertisols at ICRISAT Center, 1984.**

## Role of Herbicides in Rainfed Cropping Systems

Herbicides are seldom used in rainfed agriculture because they are often unavailable, expensive, not adapted for use in multiple cropping systems, not effective enough in traditional cropping systems, (Binswanger and Shetty 1977) and indirectly, because of illiteracy among farmers. A limited use of herbicides may soon become necessary because labor costs are increasing and very little labor is available when agricultural demand is highest. Herbicide costs may decline in the near future as patents expire.

Herbicides are important in the double-cropping technology that ICRISAT has developed for Vertisols, which were traditionally cropped only in the postrainy season. Research conducted by the Indian national programs and at ICRISAT indicates great potential for cropping these soils both in the rainy and postrainy seasons under appropriate soil-, crop-, and weed-management systems involving (1) the graded broadbed-and-furrow system (BBF) to reduce runoff and soil erosion, and improve surface drainage and workability (Fig. 3), (2) soil preparation immediately after the harvest of postrainy-season crops, (3) cropping systems that utilize both the rainy and postrainy seasons, (4) seeding of crops in the dry soil before the rains, and (5) improved implements for field operations (ICRISAT 1982). After dry seeding, weeds germinate along with crops, which means the early flush of weeds cannot be eliminated by mechanical means. In places where the probability of early-season rainfall is high, intercultural or hand weeding cannot be used on Vertisols whose high montmorillonitic clay content (50–60%) makes them too sticky when wet. Therefore, use of preemergence herbicides followed by intercultural and hand weeding appeared to be the most logical approach to weed management in rainy-season crops on Vertisols.

The most promising cropping systems for Vertisols were (1) an intercrop system based on long-season crops such as pigeonpea (sorghum/pigeonpea, maize/pigeonpea), and (2) a sequential system of two short-season crops (maize-chickpea). Experiments were conducted at ICRISAT Center to identify the best preemergence herbicides for these two systems. Of the various herbicides evaluated on sorghum/pigeonpea, S-triazine compounds such as prometryne, ametryne, and terbutryne gave the

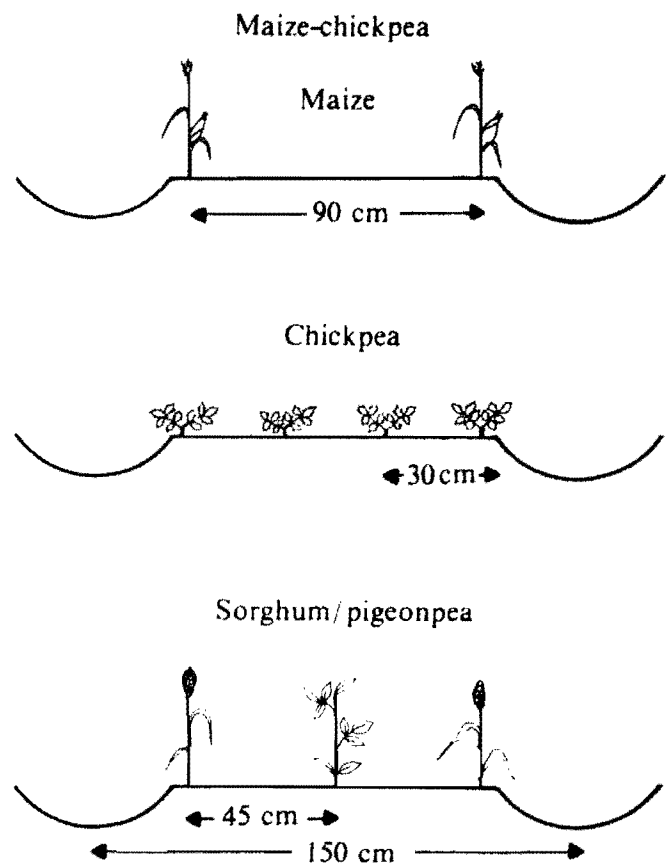

Figure 3. Broadbed-and-furrow system showing the planting pattern of crops in two improved cropping systems.

best results (Shetty and Rao 1979, ICRISAT 1978). Other chemicals such as tribenuron, dinitramine, pretilachlor, and fluchloralin also gave good results. Fluchloralin—the only chemical available at present in the country—was also effective in a number of sorghum/legume intercrops (Abraham and Singh 1984). However, it sometimes reduced the sorghum stand, thus creating a need for a higher planting rate, and for best results, had to be incorporated before seeding crops, which is rather difficult with traditional equipment.

Two methods of herbicide application were evaluated on maize in a sequential system: (1) blanket application of atrazine ( $1.5 \text{ kg ha}^{-1}$ ) and alachlor ( $0.5 \text{ kg ha}^{-1}$ ) and (2) band application of the same herbicides on crop rows at reduced rates ( $0.75 \text{ kg atrazine}$  and  $0.5 \text{ kg alachlor}$ ), supplemented later with hand weeding to control inter-row weeds (Table 5). The highest yield of maize was obtained from blanket application, whereas band application produced 76% of that obtained

**Table 5. Effect of different weed control methods on rainy-season maize grown on Vertisols (ICRISAT 1978).**

| Treatment  | Crop yield (kg ha <sup>-1</sup> ) | Weed dry matter at harvest (g m <sup>-2</sup> ) |
|--|-----------------------------------|---|
| 1. Atrazine (1.5 kg a.i.) + Alachlor (0.5 kg a.i.) blanket spray                 | 3160                              | 7   |
| 2. Atrazine (0.75 kg a.i.) + Alachlor (0.5 kg a.i.) band application on crop row | 2520                              | 13  |
| 3. Weedfree  | 3298                              | -   |
| 4. Weedy check   | 1438                              | 340   |
| LSD  | 691                               | -   |

with the weedfree treatment on the control plot. The second treatment seems financially more practical for small farmers. If intrarow weeds are controlled by herbicides, interrow weeds can be controlled later by mechanical means. To avoid working in wet soil, experiments were conducted applying preemergence herbicides to the dry soil during seeding. The results showed that herbicides such as atrazine have similar effects on dry and wet soils. In a sequential double-crop system, the residual effect of herbicides used on the first crop must be considered. The triazine compounds generally have longer residual effect on subsequent crops. However, low rates of atrazine (1–1.5 kg a.i. ha<sup>-1</sup>) on maize caused no damage to the following chickpea or on the intercropped pigeonpea grown the next year in rotation.

Since the second crop in rainfed areas relies solely on residual moisture, it should be planted as quickly as possible after the rainy-season crop. If herbicides are used, minimum-tillage techniques can be adopted in such situations to shorten cultivation and turn-around time and to conserve the residual moisture. Studies at ICRISAT showed that chickpea can be successfully planted without cultivation, following maize or sorghum by spraying 1 kg a.i. ha<sup>-1</sup> of paraquat (to kill crop stubble and existing weeds) and 0.75 kg a.i. ha<sup>-1</sup> of prometryne (to kill emerging weeds).

As in India, in northern Cameroon, about 215 000 ha of Vertisols are cropped only in the postrainy season with a transplanted sorghum. Weeds grow

luxuriantly to a height of 1 m during the rainy season fallow period, making weed removal labor-intensive. Apparently, a sizable area of these soils could be cropped both in the rainy and postrainy seasons, if some of the techniques employed on Indian Vertisols were adopted. The use of a pre-emergence herbicide in establishing the rainy-season crop is more important here because of the limited use of animal traction. In places where a rainy-season crop cannot be grown because of waterlogging, weeds can be cleared by using a cheap, effective contact herbicide, thereby reducing labor requirements and extending lands for cultivation during the postrainy season. Experiments are underway on double-cropping and weed-management strategies.

In many parts of SAT, availability of family labor for weeding often determines the area that can be cultivated. The use of selective preemergence herbicides can increase the acreage that a single family can cultivate (Ogborn 1969). Large areas infested with certain perennial weeds such as *Cyperus-rotundus*, *Cynodon-dactylon*, and *Ischemum* can be made productive by using herbicides.

## Integrated Weed Management

The traditional concept of controlling weeds by one particular method should be replaced by an economic combination of methods. Understanding factors that affect crop-weed balance, such as plant type, plant density, soil fertility, soil moisture, light, and tillage, is essential. Total weed control is not always required since each crop has a certain level of tolerance to weed infestation. The concept of integrated weed management aims at minimizing losses due to weeds by combining improved crop-management techniques, mechanical cultivation, and judicious use of herbicides.

## Weed Management Studies at ICRISAT

The improved BBF land- and water-management system consists of 90–100 cm beds on which crops are grown next to 50–60 cm furrows that serve as a path for draft animals and the wheels of the tool carrier. A significant advantage of the BBF in Vertisol technology is that the beds can be maintained on a semi-permanent basis and tillage requirements can be reduced over time. The system also

provides for drainage of excess water to prevent waterlogging. The new technology has resulted in six times higher returns than the traditional system (ICRISAT 1983), but there were greater weed problems because cultivation was restricted only to the bed area, leaving furrows and edges of furrows unweeded. Since timely intercultivation was difficult on the sticky Vertisols, alternate weed-management systems, involving preemergence herbicides, smother crops, and intercultures were evaluated in two improved cropping systems (Rao et al. 1985).

In the first set of experiments conducted between 1979 and 1982 (Table 6), the weedfree treatment resulted in the highest yield and returns. But two intercultures and two or three hand weedings (as done in this system) are difficult to provide because of labor shortage. Returns from the unweeded control plot were lowest because yields in some years did not even cover the cost of inputs. The great difference in returns from these two systems may be indicative of the potential benefits of complete weed control. One interculture and two hand weedings produced returns 3-4 times (72%) greater than those from the unweeded control plot. Similarly, the use of preemergence herbicide on the rainy-season crop resulted in 90% of the highest possible returns—which can only be obtained from a totally

weedfree plot—in a maize-chickpea sequence, and 79% in a sorghum/pigeonpea intercrop. Lower returns from the intercrop suggest the need for herbicides that are more effective than fluchloralin. The smother crop, mung (*Vigna radiata*) did not cover the ground well, and produced poor yields due to pests and diseases. Since smother crops were allowed to mature, they competed with the main crops. If they had been harvested after 45 days for fodder, they might have smothered weeds without affecting the main crop.

Further trials were conducted on an operational scale in 1984 and 1985 (Table 7), using only cowpeas as a smother crop. In one treatment, it was harvested for fodder at 45 days and in another, it was allowed to mature for grain. In 1985, below-normal rainfall and the consequent competition for moisture restrained weed growth and, therefore, the various weed-management systems did not produce significant differences. The hand-weeding system produced 87% of the returns obtained from the weedfree treatment. In 1984, weed control by mechanical interculture alone was less efficient, probably because of competition from intrarow weeds. Herbicides were effective, but metalochlor reduced yields of both components in a sorghum/pigeonpea intercrop. The smother crop controlled weeds very well, but sup-

Table 6. Effect of alternate weed-management systems on crop yields and net returns of maize-chickpea sequential and sorghum/pigeonpea intercrop systems grown on Vertisols (mean of four years 1979-82).

| Weed management                     | Maize-chickpea                  |        |                                   | Sorghum/pigeonpea                 |                                     |                                   |
|-------------------------------------|---------------------------------|--------|-----------------------------------|-----------------------------------|-------------------------------------|-----------------------------------|
|                                     | Maize<br>(kg ha <sup>-1</sup> ) | Cowpea | Returns<br>(Rs ha <sup>-1</sup> ) | Sorghum<br>(kg ha <sup>-1</sup> ) | Pigeonpea<br>(kg ha <sup>-1</sup> ) | Returns<br>(Rs ha <sup>-1</sup> ) |
| 1. Hand weed system <sup>1</sup>    | 2830                            | 550    | 3405                              | 3485                              | 685                                 | 4115                              |
| 2. Herbicide system <sup>2</sup>    | 3395                            | 610    | 4235                              | 2920                              | 1005                                | 4600                              |
| 3. Smother crop system <sup>3</sup> | 2775                            | 535    | 4080                              | 3230                              | 625                                 | 4520                              |
| a) Cowpea                           | (215) <sup>4</sup>              |        |                                   | (255)                             |                                     |                                   |
| b) Mungbean                         | 2390<br>(100)                   | 580    | 3360                              | 3100<br>(100)                     | 576                                 | 3980                              |
| 4. Weedfree <sup>4</sup>            | 3655                            | 690    | 4690                              | 4220                              | 1105                                | 5830                              |
| 5. Weedy check                      | 1270                            | 185    | 825                               | 1475                              | 335                                 | 1400                              |
| SE                                  | ±198                            | ±42    | ±268                              | ±185                              | ±65                                 | ±317                              |

1. One intercropping and two hand weedings.
2. Atrazine was used at 1.5 kg ha<sup>-1</sup> on maize in the sequential system and fluchloralin at 1.0 kg a.i. ha<sup>-1</sup> on intercropped sorghum/pigeonpea. In addition to herbicide, this system received two hand weedings.
3. Smother crops plus two hand weedings.
4. Two interculturations plus two to three hand weedings.
5. Values in parentheses are smother crop yields.

**Table 7. Effect of alternate weed management systems on crop yields and net returns of maize-chickpea sequential and sorghum/pigeonpea intercrop systems on operational-scale experiments on Vertisols.**

| Treatment  | 1984-85                           |                                     |                                       | 1985-86                         |                                    |                                       |
|--|-----------------------------------|-------------------------------------|---------------------------------------|---------------------------------|------------------------------------|---------------------------------------|
|  | Sorghum<br>(kg ha <sup>-1</sup> ) | Pigeonpea<br>(kg ha <sup>-1</sup> ) | Net returns<br>(Rs ha <sup>-1</sup> ) | Maize<br>(kg ha <sup>-1</sup> ) | chickpea<br>(kg ha <sup>-1</sup> ) | Net returns<br>(Rs ha <sup>-1</sup> ) |
| 1. Hand weed system <sup>1</sup>                   | 2565                              | 965                                 | 5785                                  | 1236                            | 626                                | 5022                                  |
| 2. Mechanical system <sup>2</sup>                  | 2280                              | 850                                 | 5045                                  | 1280                            | 655                                | 5338                                  |
| 3. Herbicide systems <sup>3</sup>                  |                                   |                                     |                                       |                                 |                                    |                                       |
| a) Fluchloralin<br>or Atrazine                     | 2510                              | 1110                                | 6080                                  | 1460                            | 442                                | 4802                                  |
| b) Metablochlor<br>(1.0 kg a.i. ha <sup>-1</sup> ) | 2220                              | 730                                 | 4645                                  | 1140                            | 654                                | 5128                                  |
| 4. Smother crop systems                            |                                   |                                     |                                       |                                 |                                    |                                       |
| a) cowpea grain                                    | 2305<br>(230) <sup>4</sup>        | 465                                 | 4560                                  | 1550                            | 595                                | 5700                                  |
| b) cowpea fodder                                   | 2200                              | 830                                 | 4865                                  | 1440                            | 549                                | 5444                                  |
| 5. Weedfree  | 2860                              | 1080                                | 6625                                  | 1364                            | 691                                | 5660                                  |
| SE   | ±343                              | ±214                                | ±920                                  | ±84                             | ±60                                | -                                     |

1. Two hand weedings only.

2. Two intercultivations only.

3. Fluchloralin at 1.0 kg a.i. ha<sup>-1</sup> was used on sorghum; pigeonpea whereas atrazine at 1.5 kg a.i. ha<sup>-1</sup> was used on maize. Treatments 3 and 4 received only one additional hand weeding.

4. Value in parentheses is smother crop yield.

pressed the yields of the main crops, probably because of high population pressure.

Thus, no single method gave satisfactory weed control, and when combinations of methods were employed, the results were all very similar. The choice of methods should, therefore, depend on the ease of execution and availability of resources. On Vertisols, a combination of preemergence herbicide, mechanical interculture and minimum hand weeding appears to be the best option. Smother crops such as cowpeas could be used instead of herbicides or intercropped in widely spaced crops like maize.

### Management of Special Weeds

Perennial weeds are difficult to control by conventional tillage. Deep plowing in summer months is advocated to expose and dry the underground reproductive structures, but this is very demanding and requires substantial draft power. The alternative is to employ systemic herbicides. But these are expensive and should be considered mainly for spot application of infested patches. However, they may become less expensive in the near future when they are produced within the country.

Experiments were conducted at ICRISAT on *Cynodon*-infested Vertisols to examine the type of tillage and management required for controlling this weed (Table 8). Double cropping on flat land managed by traditional tillage gave low yields; returns were reasonable because operational costs were low. But where no efforts were made to control *Cynodon*, double cropping resulted in negative returns. Of the three tillage systems on BBF, cross plowing and remaking of beds every year was most effective in checking *Cynodon*. Although it involved additional expense, it gave 51% higher returns in sorghum/pigeonpea, and 33% in maize/chickpea over other tillage systems. There was no significant difference between strip tillage and complete tillage on beds. Atrazine controlled the annual weeds but not *Cynodon* in maize. Without competition from other weeds, *Cynodon* became more competitive and suppressed crop yields, particularly of low-canopy chickpea in the post-rainy season (Table 9). Direct interrow application of glyphosate on *Cynodon* has helped increase chickpea yields, but was applied too late on maize, which had reached the 4-week stage. Another limitation of postemergence application of glyphosate is that it requires special equipment (e.g., wick applicators or sprayers with protective hoods) to

**Table 8. Effects of different tillage systems on the control of *Cynodon-dactylon*, crop yields, and net returns of sorghum/pigeonpea intercrop (mean of 2 years—1981-82 and 1982-83).**

| Treatment   | Sorghum<br>(kg ha <sup>-1</sup> ) | Pigeonpea<br>(kg ha <sup>-1</sup> ) | Net returns<br>(Rs ha <sup>-1</sup> ) | Dry matter of <i>Cynodon-dactylon</i> (g m <sup>-2</sup> ) |                          |                            |
|---|-----------------------------------|-------------------------------------|---------------------------------------|--|--------------------------|----------------------------|
|   |                                   |                                     |                                       | At first<br>inter-<br>culture                              | At<br>sorghum<br>harvest | At<br>pigeonpea<br>harvest |
| Strip tillage <sup>1</sup>                          | 3168                              | 569                                 | 4780                                  | 49   | 319                      | 113                        |
| Complete tillage <sup>2</sup>                       | 3535                              | 598                                 | 5093                                  | 31   | 239                      | 114                        |
| Deep plowing and<br>rebuilding of beds <sup>3</sup> | 4029                              | 1031                                | 7473                                  | 12   | 135                      | 82                         |
| Traditional <sup>4</sup>                            | 1106                              | -                                   | 2889                                  | 30   | 259                      | 54                         |
| SEM   | ±200                              | ±92                                 | ±507                                  | ±12  | ±32                      | ±16                        |

1. Plowing twice with a left and right plow which cultivates a 20-25 cm strip on both edges of the bed, furrow cleaning with a ridger, bed cultivation, and shaping.
2. Split-strip tillage: splitting the bed at the center followed by plowing with a pair of left and right plows in two passes, furrow cleaning, bed cultivation, and shaping.
3. Cross plowing of beds and reforming them every year.
4. Rainy-season fallow, frequent harrowing by blade harrow on flat land, postrainy-season cropping with sorghum, and planting and interculture with local implements.

avoid damage to the crop. Flauzifop butyl was as effective as glyphosate. One advantage of this post-emergence chemical is that it can be used safely on legume crops.

Intensive cultivation of two crops per year, espe-

cially with supplemental irrigation, was found to encourage *Cyperus* infestation. Discing generally aggravated the weed, probably by separating the underground rhizomes from each other. However, in a 2-year study that compared moldboard

**Table 9. Effect of different herbicide and tillage systems on the control of *Cynodon-dactylon*, crop yields and returns of a maize-chickpea sequential system, 1984-85.**

| Treatment  | Maize<br>(kg ha <sup>-1</sup> ) | Chickpea<br>(kg ha <sup>-1</sup> ) | Net returns<br>(Rs ha <sup>-1</sup> ) | Dry matter of <i>Cynodon-dactylon</i> (g m <sup>-2</sup> ) |                        |                           |
|--|---------------------------------|------------------------------------|---------------------------------------|--|------------------------|---------------------------|
|  |                                 |                                    |                                       | At first<br>inter-<br>culture                              | At<br>maize<br>harvest | At<br>chickpea<br>harvest |
| Strip tillage                                      | 1255                            | 433                                | 3772                                  | 6  | 8                      | 64                        |
| Complete tillage                                   | 876                             | 461                                | 3371                                  | 21   | 24                     | 76                        |
| Deep plowing and<br>rebuilding of beds             | 1170                            | 629                                | 4747                                  | 4  | 17                     | 58                        |
| Atrazine<br>(1.5 kg a.i. ha <sup>-1</sup> )        | 1270                            | 335                                | 2993                                  | 10   | 37                     | 159                       |
| Glyphosate at 1.5%                                 | 895                             | 726                                | 4485                                  | 2  | 12                     | 34                        |
| Flauzifop butyl<br>(0.3 kg a.i. ha <sup>-1</sup> ) | 826 <sup>1</sup>                | 560                                | 5652                                  | 4  | 5                      | 73                        |
| Flat (traditional)                                 | 863                             | 339                                | 3739                                  | 4  | 30                     | 61                        |
| Unweeded (control)                                 | 165                             | 29                                 | -334                                  | 10   | 23                     | 22                        |
| SE   | ±132                            | ±92                                | ±565                                  | ±1.3   | ±5.5                   | ±10                       |

1. Cowpea yields.

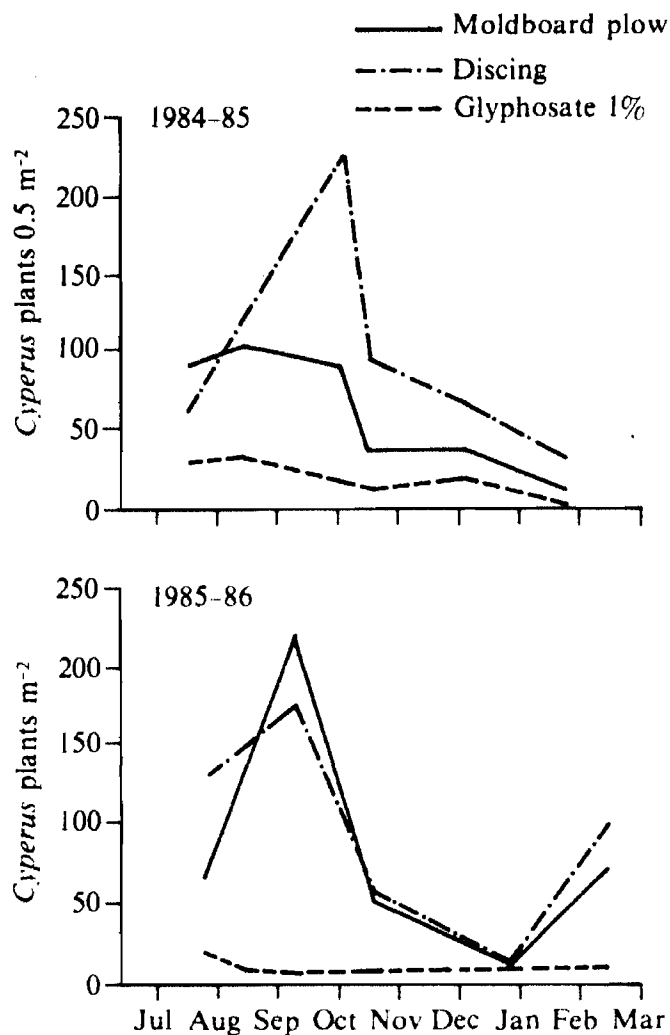

Figure 4. Effect of plowing by a moldboard plow vs discing and glyphosate on *Cyperus* infestation on Vertisols.

plowing with discing, plowing did not show much improvement over discing (Fig. 4). Glyphosate sprays at 1%, 2%, or 3% effectively controlled the weed, but two or three repeat sprayings were required for complete control. Although higher concentrations achieved slightly better control, the lower dose (1%) is suggested because of the high cost of the chemical.

*Ischemum* sp is commonly noticed on Vertisols. Farm observations indicate that it can be controlled effectively with a 1% glyphosate spray.

The parasitic weed *Striga* has been a serious problem in many sorghum-growing areas of India, particularly on high-yielding sorghum hybrids. Yield losses between 25 and 100% were noted (Hosmani 1978). In on-farm tests conducted by ICRISAT on Alfisols at Aurepally in 1980, the hybrid CSH-6 produced 1050 kg ha<sup>-1</sup> on *Striga*-infested plots compared with 1650 kg ha<sup>-1</sup> on *Striga*-free plots. The hybrid CSH-5 failed completely on a nearby field due to *Striga*, and yielded 3000 kg ha<sup>-1</sup> on *Striga*-free plots (Shetty and Sharma 1982). Hand pulling of *Striga* did not improve the sorghum yields, although it helped prevent *Striga* from seeding. Yaduraju (1975) suggested growing trap crops such as cotton, cowpea, groundnuts, castor, and sunflower in rotation with sorghum, but the effects of crop rotation on *Striga* take time. Experiments conducted by the Central Research Institute for Dryland Agriculture (CRIDA) at Hyderabad indicated that the chemical

Table 10. Effect of different chemical treatments on *Striga* incidence and yields of sorghum grown on Alfisols at Hyderabad (Korwar and Friesen 1984).

| Treatment<br>(and kg a.i. ha <sup>-1</sup> ) | Time of application        | Yield (kg ha <sup>-1</sup> ) |      | Striga plants m <sup>-2</sup> |      |
|--|----------------------------|------------------------------|------|-------------------------------|------|
|  |                            | 1980                         | 1981 | 1980                          | 1981 |
| Weed control                                 | -                          | 1915                         | 43   | 21.2                          | 23.3 |
| Hand-weed control                            | -                          | 1707                         | 385  | 26.2                          | 20.8 |
| Ethephon 1 kg                                | PPI <sup>1</sup>           | 2307                         | 70   | 16.6                          | 22.7 |
| 2,4-D (Na salt) 2 kg                         | 3 WAS <sup>2</sup>         | 2388                         | 623  | 13.6                          | 16.8 |
| Atrazine 1 kg                                | 4 WAS                      | 2227                         | 644  | 14.4                          | 19.2 |
| 2,4-D (Na salt) 2 kg                         | 4 WAS                      | 3534                         | 2116 | 7.2                           | 9.0  |
| 2,4-D (Na salt) 2 kg                         | Flowering of <i>Striga</i> | 2298                         | 1127 | 3.1                           | 7.9  |
| Urea 10%                                     | Flowering of <i>Striga</i> | 2845                         | 350  | 10.9                          | 16.5 |
| Ammonium sulphate 10%                        | Flowering of <i>Striga</i> | 2781                         | 557  | 14.6                          | 18.2 |
| Common salt 10%                              | Flowering of <i>Striga</i> | 2783                         | 320  | 8.5                           | 13.2 |
| LSD (0.05)                                   |                            | 1077                         | 555  | 4.6                           | 5.6  |

1. PPI = Preplant incorporation.

2. WAS = Weeks after sowing.

2,4-D at 2 kg a.i. ha<sup>-1</sup> applied 30 days after sowing was the best treatment. It gave an acceptable level of *Striga* control and increased sorghum yields (Table 10). This chemical is economical, easy to use and readily available in India. Other chemicals such as atrazine, 10% urea spray, ethephon, 10% ammonium sulphate, and common salt were not effective. Shetty and Sharma (1982), however, observed that a 20% urea spray at the flowering stage of *Striga* controlled 90% of the weed, but did not result in increased yield because the damage due to *Striga* had occurred earlier.

Although no single agronomic technique can fully control *Striga*, many practices such as early planting, higher plant density, application of N fertilizer, irrigation, crop rotation with trap crops and intercropping with legumes were found to reduce its incidence. An integrated approach combining the use of *Striga*-tolerant genotypes, the above agronomic practices, hand removal of *Striga*, and/or herbicide sprays seems to be most effective.

## Conclusion

When new technologies are transferred from the station to the farmer's field, they sometimes are accompanied by new weed problems as was seen in the BBF system tests, and with *Striga* on new high-yielding sorghum and maize genotypes.

Good crop husbandry practices such as early postharvest land preparation, growing crops from the beginning of the rains as far into the postrainy season as possible, intercropping with quick-growing, low canopy smother crops like cowpea, all contribute significantly to efficient weed management.

Some of the methods and equipment, e.g., animal-drawn blade harrows and interrow cultivation tools used in SAT India may have relevance to the Sudano-Sahelian zone. They should be examined critically with a view to adapting them to the local African conditions.

## References

Abraham, C.T., and Singh, S.P. 1984. Weed management in sorghum-legume intercropping systems. *Journal Agricultural Science (UK)* 103: 103-115.

AICRPDA (All India Coordinated Research Project for Dryland Agriculture). 1976-78. Annual reports of Hyderabad Center for 1976 and 1978. Hyderabad, Andhra Pradesh, India: AICRPDA.

Binswanger, H.P., and Shetty, S.V.R. 1977. The economics of weed control in selected areas of semi-arid tropical India. Pages 75-91 in *Proceedings of the Weed Science Conference in India*, 11-17 Jan 1977, Andhra Pradesh Agricultural University, Hyderabad, Andhra Pradesh, India.

Friesen, G.H., and Korwar, G.R. 1982. Weed management for dryland crops. Pages 152-167 in *A decade of dryland agricultural research in India 1971-80*. Hyderabad, Andhra Pradesh, India: All India Coordinated Research Project for Dryland Agriculture.

Korwar G.R., and Friesen, G.H. 1984. Control of witchweed (*Striga asiatica*) in sorghum. *Tropical Pest Management* 30:14-17.

Gupta, P.D., and Subbareddy G. 1979. Tillage for weed control and crop production. Presented at the Mini-Workshop on Tillage and Traction, Punjab Agricultural University, Ludhiana, Punjab, India.

Hosmani, M.M. 1978. *Striga* (a noxious parasitic weed). Bangalore, Karnataka, India: University of Agricultural Sciences. 165 pp.

ICRISAT (International Crops Research Institute for the Semi-Arid Tropics). 1982-83. Annual reports 1981 and 1982. Patancheru, A.P. 502 324, India: ICRISAT.

ICRISAT (International Crops Research Institute for the Semi-Arid Tropics). 1978. Report of work 1977-1978, Agronomy and Weed Science, Farming Systems Research Program. Patancheru, A.P. 502 324, India: ICRISAT. (Limited distribution.)

Ogborn, J. 1969. The potential use of herbicides in tropical peasant agriculture. *PANS* 15:9-11.

Rao, M.R., Shetty S.V.R., Reddy, S.L.N., and Sharma, M.M. 1985. Alternate weed management strategies in improved cropping systems on Vertisols in semi-arid India. Pages 203-208 in *Proceedings of the Tenth Asian-Pacific Weed Science Society Conference*, Chiang Mai, Thailand. Honolulu, Hawaii: Asian Pacific Weed Science Society.



**Shetty, S.V.R., and Rao, M.R.** 1979. Weed management studies in pigeonpea (*Cajanus cajan* L.) based intercropping. Pages 655–672 in Proceedings of the Sixth Asian-Pacific Weed Science Society Conference, 11–17 Jul 1977, Jakarta, Indonesia. Honolulu, Hawaii: Asian Pacific Weed Science Society.

**Shetty, S.V.R., and Sharma, M.M.** 1982. *Striga*-experience from farming systems research at ICRI-SAT. Pages 79–84 in Proceedings, AICSIP/ICRISAT Working Group Meeting on *Striga* Research, 30 Sep–1 Oct 1982, ICRISAT, India.

**Yaduraju, N.T.** 1975. Studies on *Striga* control in sorghum. M. Sc. thesis, University of Agricultural Sciences, Bangalore, Karnataka, India. 118 pp.

# Résultats et priorités de la recherche pour l'amélioration de l'agriculture pluviale au Burkina Faso

L. Somé<sup>1</sup>

## Résumé

*Après une présentation des contraintes climatiques et pédologiques rencontrées au Burkina Faso, on passe en revue les acquis de la recherche agricole nationale sur les variétés de mil, sorgho, maïs, soja et arachide, sur le maintien et la restauration des sols, et l'amélioration du bilan hydrique. On montre ainsi qu'à Saria avec une pente de 0,7%, le labour diminue le ruissellement de 30-35% à 20-25%, alors que le billonnage cloisonné l'annule. Des effets très positifs sur les rendements sont également obtenus. On donne enfin la structure des programmes de recherche de l'INERA.*

## Abstract

**Results and priorities of research for improvement of rainfed agriculture in Burkina Faso:** *After reviewing climate and soil problems, the national agricultural research on millet, sorghum, maize, soybean, and groundnut varieties, soil conservation and restoration, and the improvement of the water balance is examined. An example from Saria, where sloping is 0.7%, shows that plowing reduces runoff from 30-35% to 20-25% and that tied ridging may even arrest it completely. The report ends with a presentation of the priority research programs carried out at the national institute for agricultural research and studies, INERA.*

## Introduction

Depuis plusieurs décennies, le Burkina Faso, connaît à l'instar des autres pays sahéliens, une sécheresse endémique entravant la promotion de son agriculture essentiellement pluviale et pratiquée par environ 80% de la population active.

En effet les conditions pédoclimatiques qui prévalent sur la quasi-totalité du territoire burkinabè se caractérisent par :

- un bilan hydrique présentant au cours de la saison des pluies des périodes de déficits fréquents;
- du ruissellement et de l'érosion importants;
- un faible niveau de fertilité des sols et une réserve en eau souvent très limitée.

Il en résulte de fréquents accidents de végétation

en cours de cycle dus à une alimentation hydrique et minérale déficitaire; d'où des baisses de rendements très importantes en particulier pour les cultures vivrières. Ainsi en raison du déficit pluviométrique de 1984, la campagne 1984-1985 s'est soldée par un déficit céréalier de 163 000 tonnes.

La recherche agronomique doit proposer aux paysans des solutions qui permettent le maintien et l'amélioration de la productivité des sols cultivés. Au Burkina Faso, plusieurs efforts de recherche appréciables ont été entrepris avec l'appui de la coopération scientifique bilatérale et internationale.

Ils portent notamment sur :

- l'amélioration et la sélection de variétés résistantes à la sécheresse;
- la mise au point de formules de fumure permettant d'améliorer le niveau de fertilité des sols;

1. Institut national d'études et de recherches agricoles (INERA), B.P. 7192, Ouagadougou, Burkina Faso.

ICRISAT (International Crops Research Institute for the Semi-Arid Tropics) 1989. Soil, Crop, and Water Management Systems for Rainfed Agriculture in the Sudano-Sahelian Zone: proceedings of an International Workshop, 7-11 Jan 1987. ICRISAT Sahelian Center, Niamey, Niger. Patancheru, A.P. 502 324, India: ICRISAT.

- l'amélioration du bilan hydrique à la parcelle pour une meilleure économie de l'eau.

Le présent document présente succinctement les acquis de la recherche agricole nationale et les actions qu'elle se propose d'entreprendre dans une approche globale d'aménagement des sols, de l'eau, et des cultures pour la promotion de l'agriculture pluviale.

## Contexte pédoclimatique du Burkina Faso

### Contraintes pédologiques

Les sols du Burkina Faso dans l'ensemble, sont caractérisés par une grande hétérogénéité pédolo-

gique. Cependant les sols ferrugineux tropicaux et les sols peu évolués (65,3%) sont de loin les plus répandus. La disponibilité de ces sols est inégalement répartie dans l'espace et est fonction de la répartition démographique. Les Tableaux 1 et 2 donnent des exemples de contraintes chimiques et agropédologiques des sols.

En effet, les sols sont pour la plupart de texture sablo-limoneuse en surface, argilo-sableuse en profondeur (Tab. 1). La faible teneur en argile et la présence d'une cuirasse ou d'une carapace à profondeur variable, en déterminent le niveau de la réserve en eau. Du point de vue chimique, les sols sont généralement carencés en phosphore, avec des teneurs en matière organique très faibles. Le complexe absorbant est désaturé et pauvre en bases échangeables (Tab. 2).

**Tableau 1. Caractéristiques agronomiques des sols du Burkina Faso.**

| Site       | Nature du sol  | Texture         |                |                |          |      |      |          |      |      | Réserve en eau utile (mm) |         |
|------------|--|-----------------|----------------|----------------|----------|------|------|----------|------|------|---------------------------|---------|
|            |  | 0-10 cm         |                |                | 10-60 cm |      |      | 40-60 cm |      |      | 0-40 cm                   | 0-80 cm |
|            |  | EG <sup>1</sup> | A <sup>2</sup> | L <sup>3</sup> | EG       | A%   | L    | EG       | A    | L    |                           |         |
| Sabouna    | Sol brun eutrophe à recouvrement sableux                         | -               | 13,5           | 6,1            | -        | 31,2 | 11   | -        | 32,4 | 9,8  | 53                        | 149,8   |
| Saria Haut | Sol ferrugineux tropical lessivé gravillonnaire                  | 20              | 10,2           | 7,5            | 30       | 11,5 | 6,7  | 16,2     | 22,2 | 8,4  | 40,9                      | 80,5    |
| Saria Bas  | Sol ferrugineux tropical lessivé argilo-sableux cuirassé à 70 cm | 2,5             | 15,4           | 8,2            | 2,5      | 21,9 | 9,1  | 13,5     | 32,8 | 7,4  | 39,2                      | 67      |
| Gampela    | Sol ferrugineux tropical lessivé argilo-sableux                  | -               | 10,9           | 4,2            | -        | 23,2 | 3,9  | -        | 33,8 | 7,2  | 32,9                      | 77,3    |
| Farako-Bâ  | Sol faiblement ferrallique profond à texture sablo-argileuse     | -               | 5,0            | 10,4           | -        | 8,2  | 12,7 | -        | 29,0 | 13,0 | 34,1                      | 72,8    |

1. EG = pourcentage d'éléments grossiers.

2. A = pourcentage d'argile.

3. L = pourcentage de limon.

**Tableau 2. Principaux éléments du sol de Saria (parcelle 20) (d'après Sedogo 1981).**

| pH eau | C%   | N%   | C/N  | Ca% | Mg%  | K%  | P%    |
|--------|------|------|------|-----|------|-----|-------|
| 6,10   | 0,35 | 0,28 | 12,5 | 0,5 | 0,31 | 3,3 | 0,012 |

## Les acquis de la recherche agricole nationale

### Sélection et amélioration des plantes

L'essentiel des activités ont porté jusqu'à présent sur les céréales (sorgho, mil, maïs), les légumineuses (soja, arachide) et le cotonnier correspondant à la vocation des différents Instituts de recherches qui ont initié la recherche agronomique dans le pays avant la création de la structure nationale.

L'objectif de sélection vise à l'obtention des variétés à cycle court pouvant atteindre un haut rendement par rapport aux écotypes locaux. Ainsi, pour le sorgho, plusieurs variétés de 90 jours avec des rendements potentiels de 3 à 3,5 t ha<sup>-1</sup> sont identifiées : IRAT 204, SVP 35, IRAT 202, etc.

Pour le mil, de nouvelles créations telles que IRAT 172 et 173, IKWV 8101 et 8201 ont des rendements de 1,5 à 2 t ha<sup>-1</sup>.

Quant au maïs, la recherche a mis à la disposition de la vulgarisation des variétés améliorées, voire des hybrides inter-variétaux (IRAT 98, 100, et 102) ou complexe (IRAT 81) qui ont des rendements potentiels pouvant atteindre 5 à 6 t ha<sup>-1</sup>.

### Le maintien et la restauration de la fertilité des sols

Les résultats de recherche sur des essais de longue durée ont montré que la monoculture du sorgho aboutit à la stérilisation du sol malgré l'emploi d'une fertilisation minérale. Par contre la rotation céréale/légumineuse maintient la productivité à long terme tandis que l'apport de 5 t ha<sup>-1</sup> de fumier ou de compost tous les deux ans, conserve le statut organique.

La Figure 2 montre l'évolution du niveau des

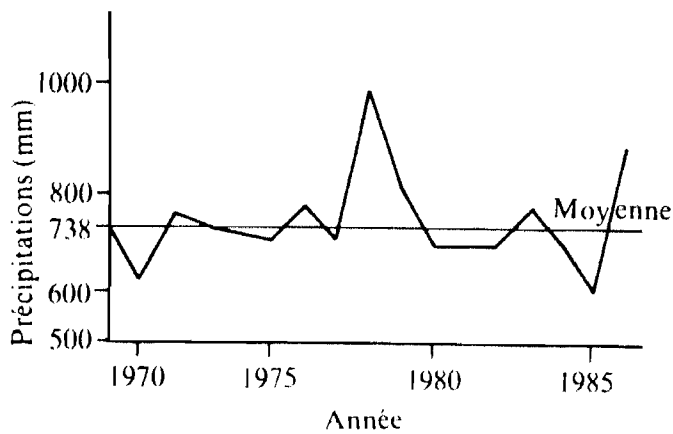

Figure 1. Variation de la pluviométrie à Saria (1970-1986).

### Risque climatique

Le risque climatique est très élevé au Burkina Faso où il est essentiellement lié au caractère aléatoire de la pluviométrie. Les saisons de pluie connaissent des débuts irréguliers souvent tardifs et des fins précoces. Pour l'ensemble du pays et en comparant les cartes des isohyètes de la période 1971-1980 à celle de 1984 par exemple, on observe un déplacement latitudinal vers le sud. C'est ainsi qu'en 1984, l'isohyète 1000 mm avait pratiquement disparu du pays. Au cours d'une même saison de pluie, on enregistre une grande variabilité spatio-temporelle des précipitations, ce qui enlève toute signification aux valeurs pluviométriques moyennes annuelles dans la détermination du risque climatique.

La Figure 1 montre la variation de la pluviométrie de la station de recherches agricoles de Saria pour la période 1970-1986. Il apparaît alors plus utile de raisonner en terme de fréquence au non dépassement d'une pluviométrie mensuelle ou annuelle donnée comme le montre le Tableau 3 pour la même Station de Saria.

Tableau 3. Analyse fréquentielle de la pluviométrie de Saria (1944-1978) (d'après Lidon et al. 1978).

| P1  | Pluviométrie mensuelle (mm) |     |      |       |      |       |      |
|-----|-----------------------------|-----|------|-------|------|-------|------|
|     | Annuelle                    | Mai | Juin | Juil. | Août | Sept. | Oct. |
| 0,8 | 704                         | 39  | 76   | 112   | 181  | 106   | 12   |
| 0,5 | 817                         | 66  | 109  | 164   | 236  | 148   | 32   |
| 0,2 | 938                         | 101 | 147  | 225   | 298  | 199   | 63   |

1. Niveau de probabilité.

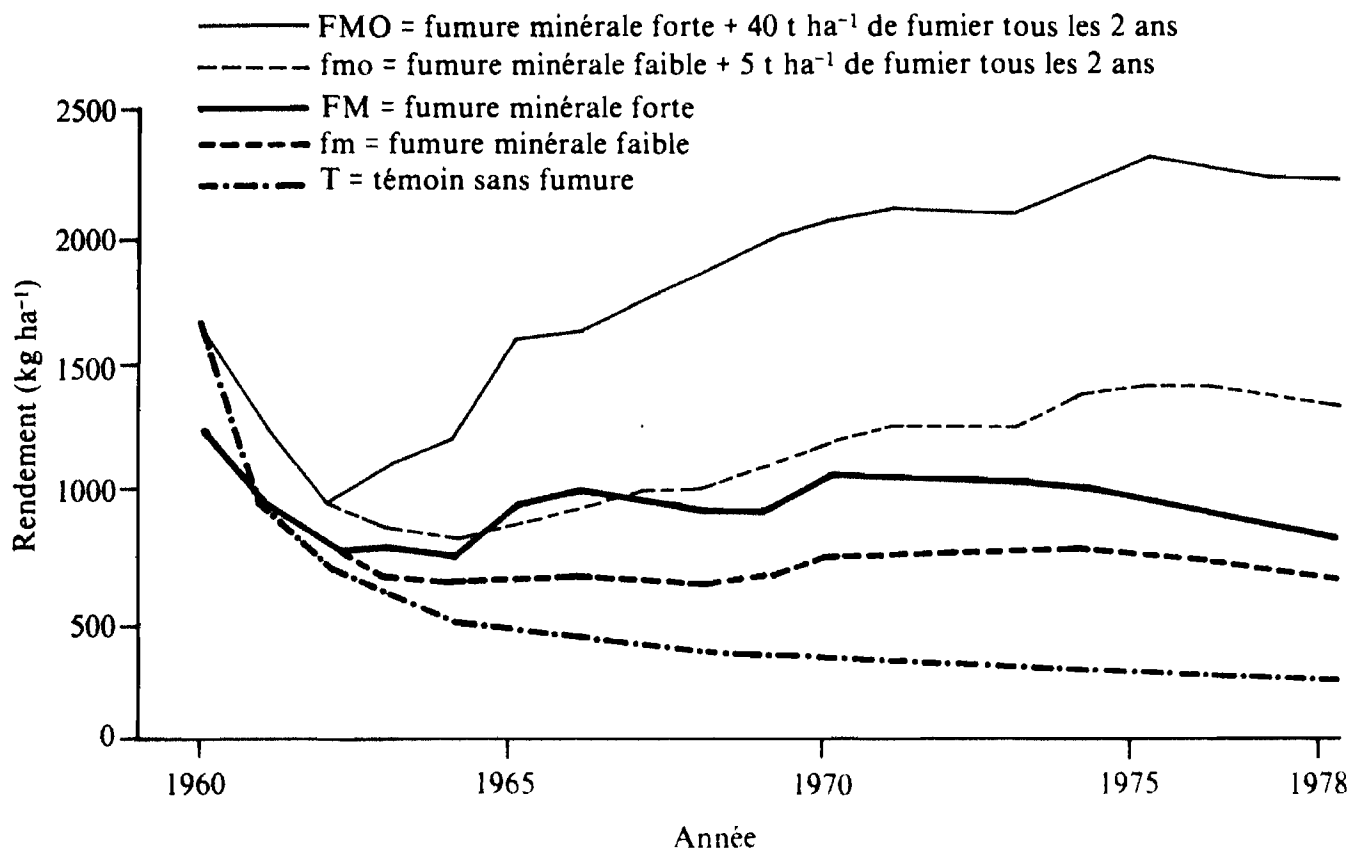

Figure 2. Evolution de la moyenne des rendements du sorgho. Essai entretien de la fertilité de Saria (d'après Sedogo 1981).

rendements pour le sorgho sur l'essai "entretien de la fertilité" conduit à Saria depuis 1960 à nos jours (Sedogo 1981).

De même les essais soustractifs et de correction des déficiences minérales menés dans la zone Ouest et du Centre en collaboration avec l'Institut de recherches du coton et des textiles exotiques (IRCT) depuis 1967 ont mis en évidence la baisse de la productivité du sol liée à une perte de la matière organique, au taux de minéralisation moyen annuel de 4% malgré une fertilisation minérale complète.

### Amélioration du bilan hydrique à la parcelle

Trois axes de recherche ont été entrepris dans ce domaine :

- l'étude des techniques d'économie de l'eau permettant une utilisation judicieuse de la pluviométrie;
- la détermination des besoins en eau des cultures;

- l'étude du ruissellement et de l'érosion.

L'étude sur les techniques d'économie de l'eau a débuté à partir de 1982. Actuellement elle couvre douze localités (Fig. 3) représentant toutes les situations pédoclimatiques du pays à l'exception de l'extrême nord.

En chaque situation, plusieurs techniques sont comparées à un témoin absolu, comme le montre le Tableau 4.

Les observations faites dans certains sites, sur la dynamique de l'eau, l'évolution du système racinaire et les modifications phénologiques de la culture permettent non seulement de mesurer et de comparer les rendements obtenus mais surtout d'expliquer ces rendements à travers la simulation du bilan hydrique à la parcelle d'après le modèle présenté par l'Institut de recherches agronomiques tropicales et des cultures vivrières (IRAT)/Centre de coopération internationale en recherche agronomique pour le développement (CIRAD) (Forest 1982).

Le niveau de satisfaction des besoins en eau de la culture au cours du cycle végétatif est donné par le rapport entre l'évapotranspiration réelle (ETR) de

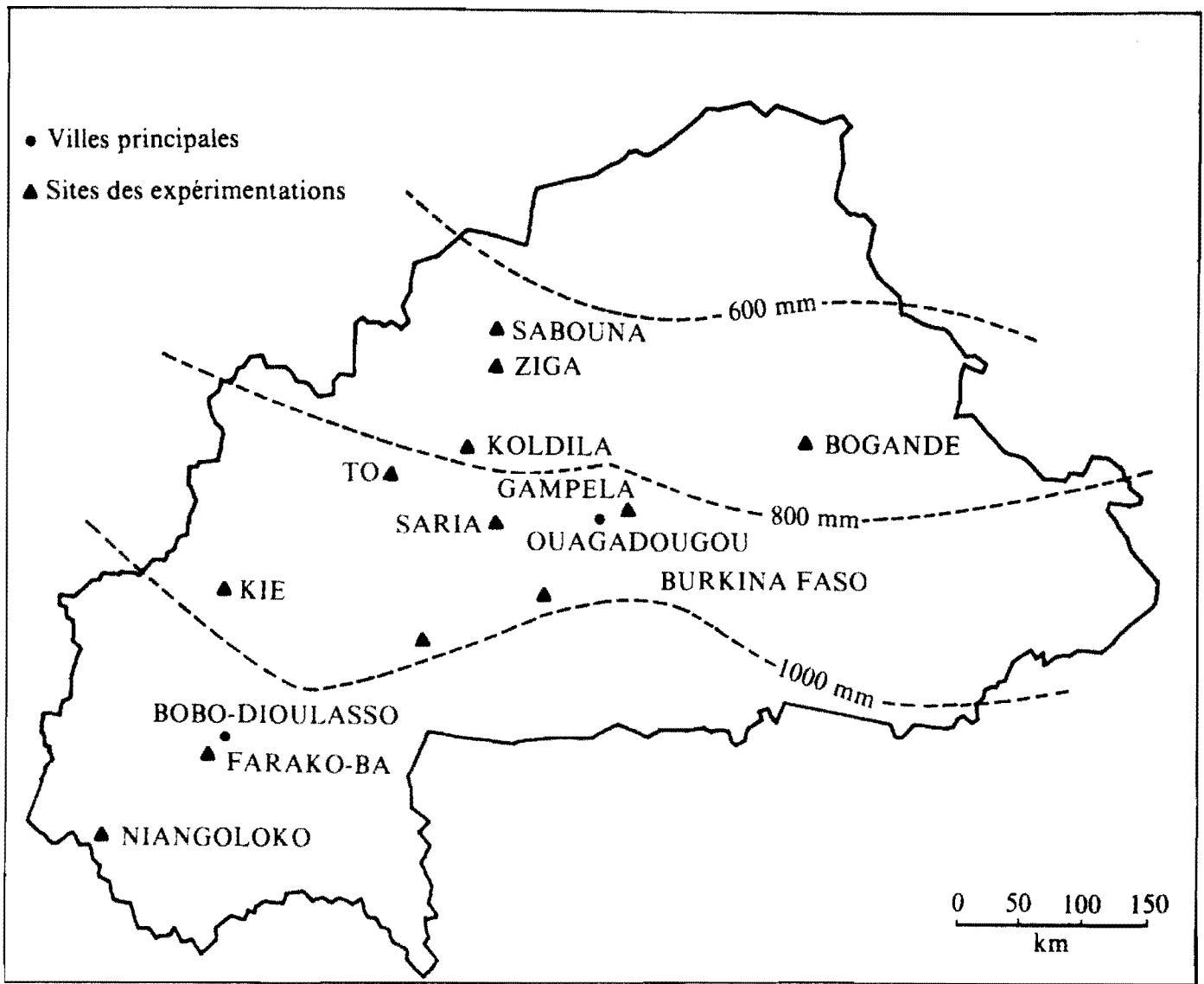

Figure 3. Localisation des sites d'étude de l'économie de l'eau au Burkina Faso (d'après Nicou et al. 1984).

la plante et son évapotranspiration maximale (ETM) possible du fait des conditions climatiques du milieu. En général la plante souffrira de stress hydrique quand le rapport  $ETR/ETM$  est inférieur à 0,80 (Tab. 5).

A ce jour, les principales céréales du pays (sorgho, mil, maïs) de même que l'arachide et le cotonnier ont été concernés par cette étude.

Le Tableau 6 présente les moyennes des rendements obtenus en cinq situations avec les céréales.

Les études des principaux termes du bilan hydrique se résument actuellement à la détermination des besoins en eau des cultures à travers une évaluation des coefficients cultureux  $K$  et à des mesures sur le ruissellement et l'érosion.

L'évaluation des  $K$  s'effectue au niveau de deux

dispositifs de cuves lysimétriques installées en 1983 sur les stations de Saria et de Farako-Ba. Des résultats satisfaisants ont été obtenus sur le sorgho et le maïs en culture pluviales et sur la tomate et le melon en culture de contre-saison.

Les études sur le ruissellement et l'érosion ont été entreprises depuis 1971 sur le site de Saria. A partir de 1982, le dispositif a été utilisé pour mesurer l'impact de certaines techniques d'économie de l'eau sur le contrôle du phénomène.

Les résultats ont montré que sur les sols ferrugineux tropicaux de Saria avec une pente de 0,7%, le ruissellement moyen atteint 30 à 35% sans aucun travail du sol; avec un bon labour à plat on diminue le ruissellement à 20-25% alors que le billonnage cloisonné le réduit fortement, voire l'annule. Les

**Tableau 4. Traitements réalisés dans cinq des sites d'expérimentation, au Burkina Faso (1982-1984).**

| Traitements  | Sabouna |      |      | Saria haut |      |      | Saria Bas |      |      | Gampela |      |      | Farako-Bâ |
|--|---------|------|------|------------|------|------|-----------|------|------|---------|------|------|-----------|
|  | 1982    | 1983 | 1984 | 1982       | 1983 | 1984 | 1982      | 1983 | 1984 | 1982    | 1983 | 1984 | 1982-1984 |
| Témoin non travail   | x       | x    | x    | x          | x    | x    | x         | x    | x    | x       | x    | x    | x         |
| Scarifiage en sec  |         |      |      | x          | x    |      | x         | x    |      | x       |      |      |           |
| Labour à plat  | x       | x    | x    | x          | x    | x    | x         | x    | x    | x       | x    | x    | x         |
| Labour en billons<br>(espacement<br>0,80 m)                              | x       | x    | x    | x          | x    | x    | x         | x    | x    | x       | x    | x    | x         |
| Labour en billons<br>resserés (espace-<br>ment 0,50 m)                   | x       |      |      |            |      |      |           |      |      |         |      |      |           |
| Labour en billons,<br>cloisonnement des<br>billons à chaque<br>extrémité |         |      |      |            |      |      |           |      |      |         |      |      | x         |
| Labour à plat<br>Buttage à 1 mois  |         |      |      |            |      |      | x         | x    | x    | x       | x    |      | x         |
| Labour à plat +<br>butage 1 mois +<br>cloisonnement<br>2 mois            |         |      |      |            |      |      |           |      |      |         |      |      |           |
| Scarifiage en<br>humide, Binage<br>après chaque pluie<br>>20 mm          | x       | x    | x    |            |      |      |           |      |      | x       |      |      |           |
| Semis à plat,<br>butage +<br>cloisonnement à<br>1 mois                   | x       |      | x    | x          | x    |      |           |      |      |         |      |      |           |
| Labour à plat,<br>butage +<br>cloisonnement<br>à 1 mois                  |         |      | x    |            |      | x    |           |      | x    |         |      | x    |           |

**Tableau 5. Satisfaction des besoins en eau des parcelles témoin exprimés par le rapport ETR/ETM.**

| Station<br>expérimentales | 1982  |                       | 1983  |                       | 1984  |                       |
|---------------------------|-------|-----------------------|-------|-----------------------|-------|-----------------------|
|                           | Cycle | Epiaison<br>Floraison | Cycle | Epiaison<br>Floraison | Cycle | Epiaison<br>Floraison |
| Sabouna                   | 0,65  | 0,59                  | 0,43  | 0,24                  | 0,25  | 0,06                  |
| Saria Haut                | 0,75  | 0,58                  | 0,77  | 0,40                  | 0,40  | 0,43                  |
| Saria Bas                 | 0,68  | 0,67                  | 0,74  | 0,33                  | 0,68  | 0,44                  |
| Gampela                   | 0,60  | 0,23                  | 0,79  | 0,59                  | 0,51  | 0,23                  |
| Farako-Bâ                 | -     | -                     | 0,96  | 0,97                  | 0,96  | 0,97                  |

**Tableau 6. Rendements (kg ha<sup>-1</sup>) moyens obtenus avec les techniques d'économie de l'eau.**

| Stations expérimentales | Témoin | Labour à plat | Labour en billon | Labour + buttage + cloisonnement | Culture |
|-------------------------|--------|---------------|------------------|----------------------------------|---------|
| Sabouna (82/83)         | 592    | 994           | 918              | 1020                             | Mil     |
| Saria Haut (82/84)      | 1112   | 1622          | 1417             | 1693                             | Sorgho  |
| Saria Bas (82/84)       | 1151   | 1598          | 1657             | 2115                             | Sorgho  |
| Gampela (82/84)         | 990    | 1937          | 1824             | 2238                             | Sorgho  |
| Farako-Bâ (82/84)       | 2024   | 3270          | 2624             | 3060                             | Maïs    |

quantités de terre érodées sont énormes et peuvent atteindre 20 t ha<sup>-1</sup>.

## Priorités de recherche pour la lutte contre la désertification

Les priorités de recherches ont été définies à travers huit programmes nationaux qui ont été adoptés par le Séminaire national de la recherche agronomique et zootechnique de février 1985.

La lutte contre la sécheresse pour une meilleure production végétale et animale constitue la stratégie de chacun de ces programmes déjà lancé par l'Institut d'études et de recherches agricoles (INERA), la structure nationale chargée de la recherche agronomique et zootechnique.

Les huit programmes nationaux sont :

- Eau/Sol/Fertilisation/Irrigation/Machinisme agricole (ESEIMA) avec pour objectif l'amélioration des conditions de milieu de production à travers une action sur l'eau, les fertilisants notamment locaux et l'équipement agricole;
- Recherche sur les systèmes de production (RSP) qui vise l'amélioration de la productivité du travail des agriculteurs et éleveurs dans le cadre de systèmes agricoles stables;
- Sorgho/Mil/Maïs pour la sélection et l'amélioration des cultivars à vulgariser;
- Cultures maraîchères et fruitières qui devraient proposer des résultats pour mieux valoriser le travail des agriculteurs durant la saison sèche;
- Oléagineux et légumineuses à grains;
- Riz et riziculture;
- Coton;
- Production animale.

Chaque programme a déjà défini les opérations prioritaires à exécuter dans le cadre du Plan quinquennal de développement populaire.

## Conclusion

L'agriculture et l'élevage constituent la base essentielle du développement socio-économique du Burkina Faso, la restauration d'un environnement propice à l'essor du monde rural est urgent pour arriver à l'autosuffisance alimentaire. Pour ce faire, il faut viser à augmenter les rendements des cultures en dépit des conditions pédoclimatiques défavorables, grâce à l'emploi de variétés adaptées, à l'acquisition d'un équipement agricole adéquat, et à la maîtrise des nouvelles techniques culturales. C'est un travail de longue haleine qui implique la participation de tous les acteurs du développement rural et en particulier les agents de la vulgarisation qui doivent résoudre la problématique du transfert de technologies bien connue dans les pays en voie de développement.

## Bibliographie

- Bureau national des sols.** 1985. Etat de connaissance de la fertilité des sols du Burkina Faso. Documentation technique n° 1. Ministère Agriculture et Elevage, Burkina Faso.
- Forest, F.** 1982. Le bilan hydrique, facteur de production des cultures pluviales. Document interne, IRAT. France : Institut de recherches agronomiques tropicales et des cultures vivrières.
- INERA** (Institut national d'études et de recherches agricoles). 1986. Lignes directrices d'administration de la recherche agricole, Ministère de l'enseignement supérieur et de la recherche scientifique, Burkina Faso.
- Lindon, B., Sola, G., Morant, P. et Sedogo, M.P.** 1978. Etude de ruissellement à la parcelle et de ses conséquences sur le bilan hydrique des cultures



pluviales en sol peu profond. Rapport CIEH 1978, Ouagadougou, Burkina Faso.

**Nicou, R., Ouattara, B. et Somé, L.** 1984. Techniques d'économie de l'eau. Rapport analytique des campagnes 1982-1983 et 1983-1984, IVRAZ/IRAT. Ministère de l'enseignement supérieur et de la recherche scientifique. République de Haute-Volta : Institut voltaïque de recherches agronomique et zootechnique/Institut de recherches agronomiques tropicales et des cultures vivrières.

**Sedogo, M.P.** 1981. Contribution à la valorisation des résidus culturaux en sol ferrugineux et sous climat tropical semi-aride. Thèse Docteur-Ingénieur. Institut National Polytechnique de Lorraine-ENSAIA. Nancy, France : Ecole nationale supérieure d'agronomie et des industries alimentaires.

# Effects of Tillage on a Corn-Cotton Sequence in Côte d'Ivoire

J.L. Chopart<sup>1</sup>

## Abstract

Central Côte d'Ivoire has bimodal, rather irregular rainfall (April to June and August to October) that is often insufficient for optimum crop yields. In a field trial established in 1980, the effects of the following tillage practices were studied in corn-cotton cropping sequences: (1) Manual tillage with mulching. (2) Direct mechanical sowing with mulching. (3) Plowing prior to corn and cotton. (4) Plowing prior to sowing of corn followed by direct drilling of cotton. Comparisons have been made on water-use efficiency, soil physical properties and root development, production costs and yields. The results of the study suggest the need for plowing prior to sowing of corn despite the added production costs. But direct drilling of cotton can replace plowing when a cotton crop follows a corn crop. A system that combines plowing prior to sowing of corn in the first rainy season and direct drilling of cotton in the second appears to be a profitable alternative to the currently recommended practice of two plowings a year.

## Résumé

**Effet du travail du sol dans une succession annuelle maïs-cotonnier en Côte-d'Ivoire :** La partie centrale de la Côte-d'Ivoire comprend deux saisons de pluie, d'avril à juin et d'août à octobre. La pluviosité est irrégulière et souvent insuffisante pour obtenir des rendements optimums. Dans un essai mis en place en 1980, les effets de différentes techniques de préparation du sol sont étudiés dans le cadre d'une double culture annuelle maïs-cotonnier : (1) travail du sol manuel avec paillage; (2) travail du sol mécanique avec paillage; (3) labour avant le maïs et le cotonnier; (4) labour avant le maïs suivi par un semis direct du cotonnier. Les traitements sont comparés suivant différents critères : efficacité de l'eau, propriétés physiques du sol et croissance racinaire, coût de production et rendements. Les résultats de l'étude montrent la nécessité de labourer avant l'implantation de maïs malgré le coût de production plus élevé. Par contre, le semis direct peut remplacer le labour pour une culture de cotonnier qui suit le maïs, si cette culture a bénéficié d'un labour. Un système qui associe le labour avant le maïs pendant la première saison des pluies et un semis direct du coton pendant la deuxième saison de pluies paraît être une alternative intéressante à la technique actuellement recommandée d'un labour avant chaque culture.

---

1. Soil physicist, IRAT-CIRAD, 04 B.P. 125, Bouaké, Côte d'Ivoire.

ICRISAT (International Crops Research Institute for the Semi-Arid Tropics) 1989. Soil, Crop, and Water Management Systems for Rainfed Agriculture in the Sudano-Sahelian Zone: proceedings of an International Workshop, 7-11 Jan 1987. ICRISAT Sahelian Center, Niamey, Niger. Patancheru, A.P. 502 324, India: ICRISAT.

# Introduction

The central zone of Côte d'Ivoire is characterized by irregular rainfall. Its bimodal character, however, permits double cropping, but there is a high climatic risk during a large part of both growing seasons.

To protect cereals (corn and rice) and cotton crops from water stress, cultural methods that ensure optimal water uptake by the plant should be used.

Techniques such as tillage and mulching can play a major role. Experiments carried out in different ecological zones of West Africa have, however, often given contradictory results, particularly with regard to the effects of plowing and mulching with no tillage. Whereas plowing was found to have a beneficial effect in Senegal (Charreau and Nicou 1971, Chopart and Nicou 1976, Nicou and Chopart 1979, Chopart et al. 1979), in Nigeria, the best results were obtained with no tillage (Lal 1974, 1976, Maurya and Lal 1979).

In Côte d'Ivoire, preliminary results have shown the value of deep soil tillage which, at least in some conditions, reduces erosion (Kalms 1977), and improves water relations (Chopart and Kone 1985) and weed control. With two cropping seasons a year, however, it is sometimes difficult to fit in two plowings.

In 1980, trials were set up to compare the agronomic effects of different soil-preparation techniques and to study the possibility of reducing soil tillage, the major objectives being to facilitate crop establishment, reduce production costs, and improve crop water use.

## The Trials

Trials have been carried out at Bouaké each year since 1980, using a two-crop sequence of corn and

cotton. Early-maturing (75–80 days) corn, variety CD (Dahomey composite), is sown in March as soon as enough rain falls, and a 140–150-day cotton crop is sown after the harvest in late June or early July.

## Treatments

The trials consist of three replications, each with four treatments on 450 m<sup>2</sup> plots. The first treatment involves hand cultivation:

- T1. No-tillage planting with straw, left as a surface mulch and hand sowing;

The three remaining treatments are mechanized:

- T2. Crop residues left on the soil: very shallow (5–8 cm) tillage only on the sowing lines, using two crenellated discs placed in front of the direct seeder;
- T3. Plowing, to depths of 25–30 cm, twice a year, with the straw incorporated by plowing;
- T4. 1980–82—chiseling, to 20–25 cm, before each crop, with straw incorporation; 1983–84—single plowing once prior to corn crop, direct seeding of cotton as in T2.

Soil chiseling (1980–1982) did not give satisfactory results. Incomplete incorporation of crop residues made sowing difficult, and yields obtained were regularly lower than those obtained after plowing. For these reasons, the treatment was replaced in 1983 by one plowing a year.

## Climate

The Bouaké region in central Côte d'Ivoire includes two wet seasons, March to June and August to October, separated by a short July early-August dry season. Total rainfall and Penman PET for the two growing seasons are given in Table 1.

Table 1. Rainfall and Penman PET during the corn- and cotton-growing season.

|                                    | Corn   |        |        |       |        | Cotton |        |       |       |        |
|------------------------------------|--------|--------|--------|-------|--------|--------|--------|-------|-------|--------|
|                                    | 1980   | 1981   | 1982   | 1983  | 1984   | 1980   | 1981   | 1982  | 1983  | 1984   |
| Sowing date                        | 22 Mar | 15 Mar | 15 Mar | 4 Apr | 14 Mar | 29 Jul | 25 Jun | 3 Jul | 8 Aug | 15 Jun |
| Rainfall (mm)                      | 346    | 434    | 357    | 330   | 218    | 689    | 578    | 450   | 222   | 843    |
| Penman PET (mm)                    | 438    | 466    | 403    | 389   | 410    | 547    | 532    | 467   | 426   | 513    |
| Average rainfall <sup>1</sup> (mm) | 345    | 318    | 318    | 357   | 320    | 440    | 536    | 524   | 428   | 579    |

1. 1953–80, sowing to harvest.

**Table 2. Average soil physical characteristics in a field trial at Bouaké.**

| Depth<br>(cm) | Particle size distribution |                          |  | Available<br>water<br>(mm) |
|---------------|----------------------------|--------------------------|--|----------------------------|
|               | Gravel<br>(>2 mm)          | Sand<br>(2mm-20 $\mu$ m) | Fine silt<br>and clay<br>(<20 $\mu$ m) |                            |
| 0-20          | 21                         | 59                       | 20                                     | 26                         |
| 20-40         | 32                         | 46                       | 22                                     | 19                         |
| 40-60         | 36                         | 38                       | 26                                     | 17                         |
| 60-80         | 30                         | 38                       | 32                                     | 18                         |
| 80-100        | 26                         | 41                       | 33                                     | 20                         |

## Soils

The trials are established on soils derived from pegmatite granite, classified in the French system as reworked, moderately desaturated ferralitic soils, containing variable but always high proportions of gravel, mainly quartz. Their chemical characteristics and available water-holding capacity are representative of the gravelly soils of the region. Some physical and chemical characteristics of the soil are presented in Tables 2 and 3.

**Table 3. Average soil chemical characteristics of the 0-30 cm upper layer in a field trial at Bouaké.**

| Soil characteristics                       | Mean value |
|--|------------|
| pH (water)                                 | 5.5        |
| Organic matter (%)                         | 2.2        |
| Total N (%)                                | 0.1        |
| Available P (mg kg <sup>-1</sup> )         | 40         |
| Exchangeable K [meq (100g) <sup>-1</sup> ] | 0.31       |
| CEC [meq (100g) <sup>-1</sup> ]            | 6.2        |
| Bases saturation (%)                       | 58         |

## Cultivation Methods

Soil-preparation techniques used with each treatment are described above. Fertilizer use is the same for all treatments and for both crops, i.e., 300 kg ha<sup>-1</sup> of a 10-18-10 mixture at planting, plus 100 kg ha<sup>-1</sup> urea (46%) subsequently; in addition, 200 kg ha<sup>-1</sup> of dolomitic limestone was applied before each corn crop. On the plowed plots, a selective postseeding and preemergence herbicide was ap-

plied. On the no-tillage planting plus mulch plots (T1), weeds are controlled with paraquat applied at sowing and between the lines during the growing season.

## Recording and Calculating Results

Water-use efficiency was calculated from determinations made with a neutron probe. Soil-bulk density was determined from cylinder samples of known volumes. Soil temperatures at 5-cm depth were recorded at different times of the day using mercury thermometers. The results given are for 1530 when temperatures are at their maximum and differences between treatments greatest. Corn root density was determined by measuring the length of roots extracted from soil cores 10-cm thick and 0.48 m<sup>2</sup> in area (Chopart 1983).

Production costs were calculated to include all hand labor and supplies (fertilizers, herbicides, etc.). For mechanized operations, the standard prices charged by the Ivoirian Agricultural Mechanization Centre (CIMA) were used. This made it possible to calculate gross returns from each treatment and earnings per day of work.

## Results

Compared to no tillage planting, plowing resulted in a reduction of soil-bulk density (Fig. 1), an increase in the rate of growth of corn roots (Table 4), and thus in an improvement in crop behavior during dry periods.

The direct seeding treatments benefited from a mulch composed of the residues of the preceding crop. Corn stover provided a slightly better soil

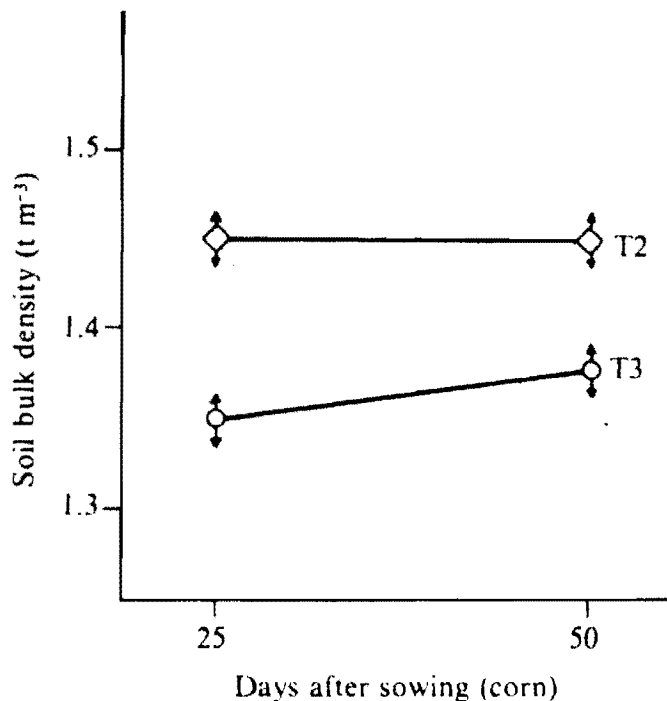

Figure 1. Plowing effect on bulk density.

cover than cotton stalk, but the percentage of soil cover was only 50–60% at sowing. In the climatic conditions of Côte d'Ivoire, mulch decomposed to <25% soil cover 2 months after sowing (Fig. 2). The corn stover mulch reduced soil temperatures during the first month of the cotton growing season (Fig. 3). Water-use efficiency was higher with the plowing treatment, both for the first-season crop (corn) and the second (cotton) (Fig. 4).

The corn variety used had a yield potential of 3000 kg ha<sup>-1</sup>. Its main advantage was its short growing season (75–80 days), which left time for a second crop to be planted the same year. Average corn yields over 5 years were always markedly higher (almost double) with plowing than with direct seeding (Fig. 5).

Table 4. Corn root length (dm) per dm<sup>3</sup> of soil, 25 days after emergence.

| Depth (cm) | Root length (dm dm <sup>-3</sup> ) |         |
|------------|------------------------------------|---------|
|            | No tillage                         | Plowing |
| 0–10       | 2.0                                | 2.4     |
| 10–20      | 0.6                                | 1.4     |
| 20–30      | 0.4                                | 0.9     |

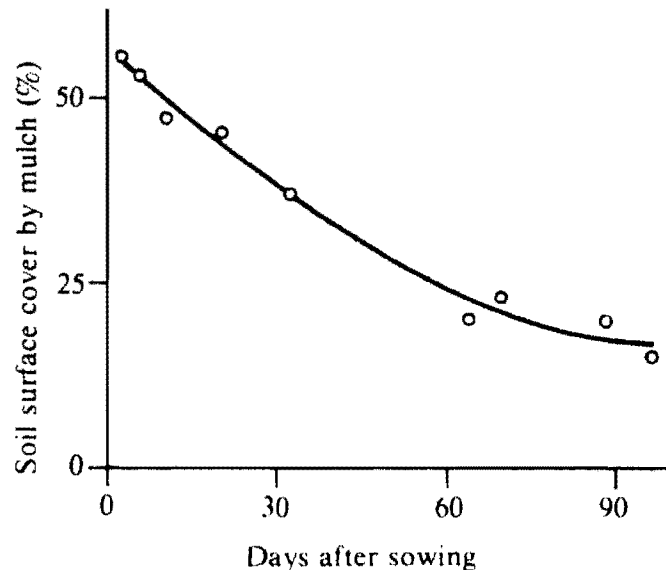

Figure 2. Percentage of soil cover by a corn stover mulch during cotton cropping.

The mechanized direct-seeding technique (T2), which tills the soil in the area near the seed results in better germination and a generally higher yield than hand cultivation (T1).

For cotton, differences between treatments are less than those for corn and are not significant.

Average returns for a day's work, calculated on the basis of the 1983 and 1984 results for both crops taken together (corn and cotton) are shown in Figure 6.

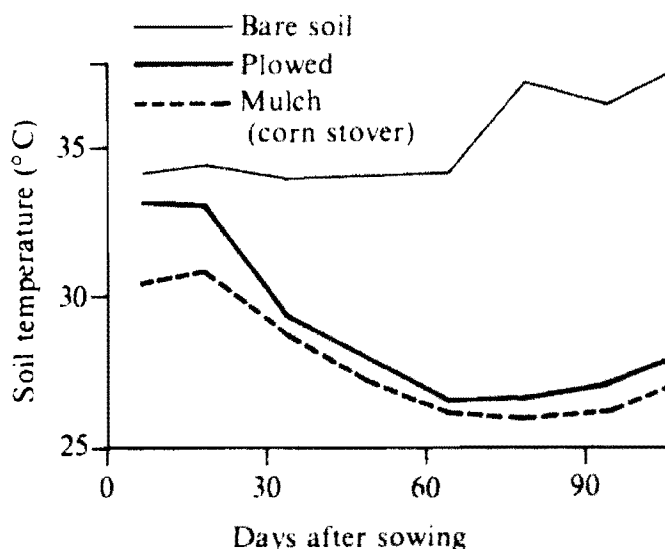

Figure 3. Effect of mulching on soil temperature at 5-cm depth during cotton cropping.

Treatment T3, with two plowings a year, gives the highest return per man per day; treatment T4, with plowing only before corn, is almost as high.

Mechanized direct seeding of the two crops (T2) reduces production costs slightly, but since yields are lower, returns are distinctly less.

With hand cultivation (no-tillage), yields—and costs—are much lower. Returns are thus higher than with mechanized direct seeding and almost as high as with plowing.

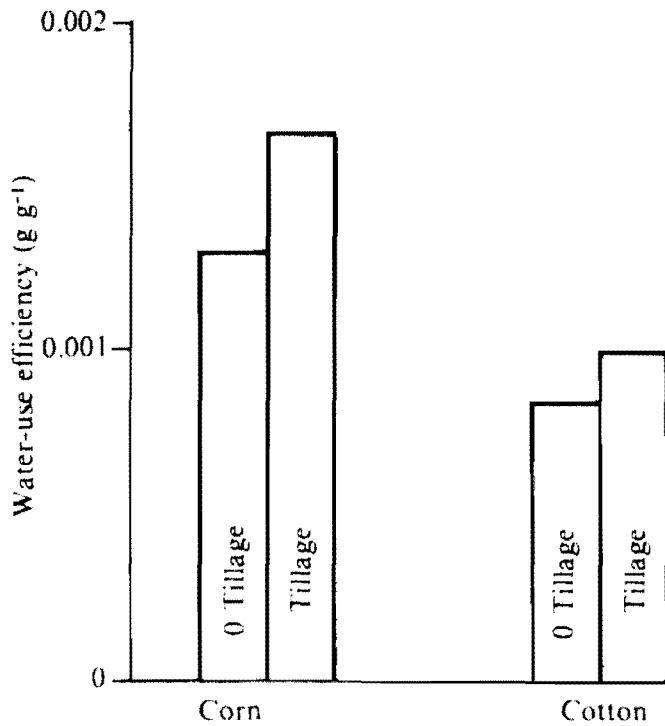

Figure 4. Water-use efficiency of corn and cotton, with (T3 and T4) and without (T1 and T2) soil tillage.

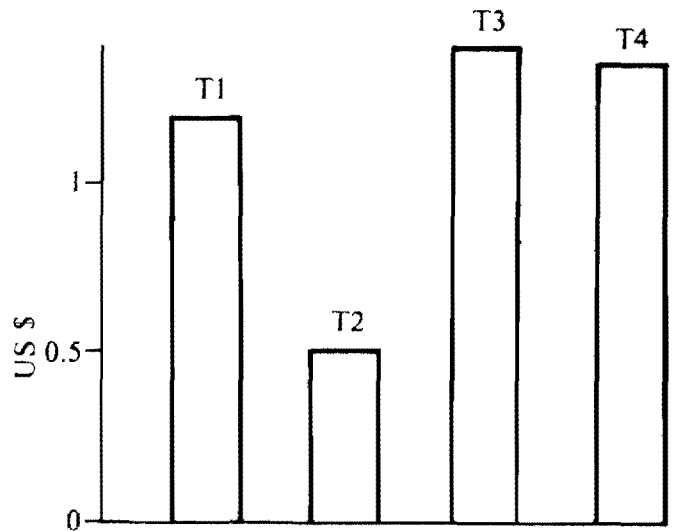

Figure 6. Returns (US \$) per working day for cotton and corn crops (mean 1983-1984).

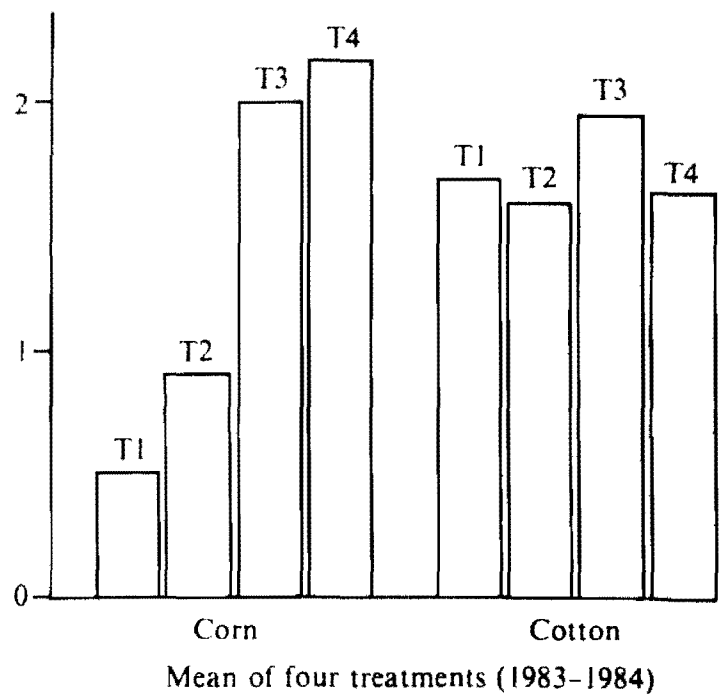
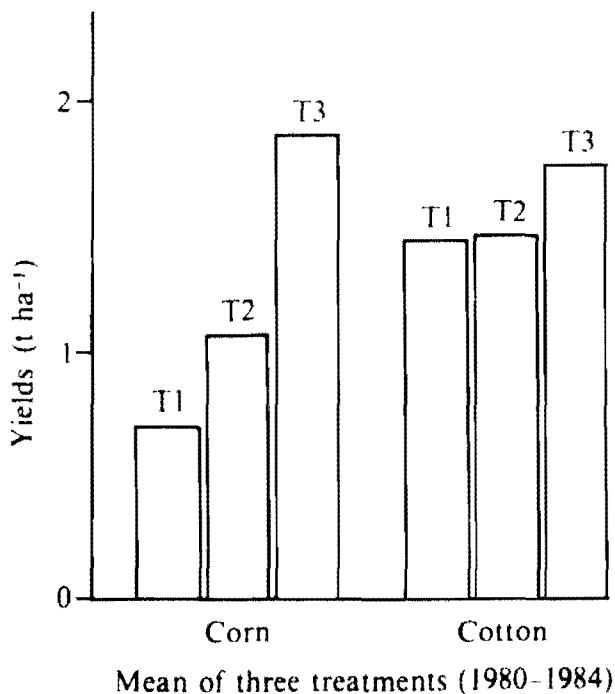

Figure 5. Yields of corn and cotton crops.

## Discussion

A comparison between conventional tillage (plowing) with residue incorporation and no-tillage planting with a crop residue mulch shows that each treatment has both favorable and unfavorable effects.

### Favorable Effects of No-Tillage Planting

Soil mulching reduces both soil temperature and evaporation during the early part of the cotton growing season. Production costs for direct drilling are slightly lower than for plowing.

### Favorable Effects of Conventional Tillage

During dry spells, because of plowing, the root system of first season corn can draw profitably on stored soil moisture. Since dry periods are frequent during the first rainy season, the effect of plowing on yields is always positive and, on the average, considerable. Returns per man per day consequently, are far better than with direct seeding. Plowing prior to sowing first-season corn, thus seems necessary, at least on soil not tilled the previous season.

During the second rainy season, rainfall is higher and corn stalk mulch has a greater effect on water and soil temperature. Further, cotton is less sensitive than corn to water shortages. These factors may explain in part, the better behavior of cotton, grown without plowing and the small differences in yield for the treatments studied.

If production costs are considered over the whole year (two crops), it appears that mechanized direct seeding is the least profitable. With a single plowing before the corn, returns are equal to those of two plowings a year, with the added advantage that cotton can be sown earlier. Hand cultivation is almost as profitable as plowing, because plowing costs are still high. It must, however, be emphasized that hand cultivation requires a lot of labor at sowing, which limits the area that can be put under cultivation.

## Conclusion

Plowing, particularly prior to sowing of first-season corn, remains the most effective soil-pre-

paration technique for an annual corn-cotton sequence in the central zone of Côte d'Ivoire.

Plowing twice a year, before each crop, is often difficult, as cotton can only benefit fully from the next rains if it is sown soon after the corn harvest, i.e., before the short dry season in July.

The new cultivation technique studied over the past 2 years, consisting of plowing before the corn crop and direct seeding of the second-season cotton, appears promising, particularly when there is not enough time to prepare the soil by plowing.

Trials are still underway to confirm past results and to study longer-term changes in physical and chemical soil characteristics, weed pressure, and yields.

Similar trials will be conducted at other sites in Côte d'Ivoire to assess to what extent the techniques studied are adapted to other soils and climates.

## References

- Charreau, C., and Nicou, R. 1971. L'amélioration du profil cultural dans les sols sableux et sablo-argileux de la zone tropicale sèche ouest-africaine et ses incidences agronomiques. (In Fr.) *Agronomie Tropicale* 26:209-255, 565-631, 903-978, 1183-1237.
- Chopart, J.L. 1983. Etude du système racinaire du mil (*Pennisetum typhoides*) dans un sol sableux du Sénégal. (In Fr.) *Agronomie Tropicale* 38(1):37-46.
- Chopart, J.L., and Kone, D. 1985. Influence de différentes techniques de travail du sol sur l'alimentation hydrique du maïs et du cotonnier en Côte d'Ivoire. (In Fr.) *Agronomie Tropicale* 40(3): 223-229.
- Chopart, J.L., and Nicou, R. 1976. Influence du labour sur le développement racinaire de différentes plantes cultivées au Sénégal—conséquence sur leur alimentation hydrique. *Agronomie Tropicale* 31(1):7-28.
- Chopart, J.L., Nicou, R., and Vachaud, G. 1979. Le travail du sol et le mulch pailleux, influence comparée sur l'économie de l'eau dans le système arachide-mil au Sénégal. (In Fr.) Pages 199-211 in *Isotopes and radiation in research on soil-plant relationships*. Vienna, Austria: International Atomic Energy Agency.

**Kalms, J.M.** 1977. Studies of cultivation techniques at Bouaké, Côte d'Ivoire. Pages 169–200 *in* Soil conservation and management in the humid tropics. Chichester, UK: John Wiley.

**Lal, R.** 1974. No-tillage effects on soil properties on maize production in western Nigeria. *Plant and soil* 40(2):321–331.

**Lal, R.** 1976. No-tillage effects on soil properties under different crops in western Nigeria. *Soil Science Society of America Proceedings* 40: 762–768.

**Maurya, P.R., and Lal, R.** 1979. No-tillage system for crop production on an ultisol in eastern Nigeria. Pages 204–219 *in* Soil tillage and crop production (Lal, R., ed.). IITA Proceedings Series no.2. Ibadan, Nigeria: International Institute of Tropical Agriculture.

**Nicou, R., and Chopart, J.L.** 1979. Les techniques d'économie de l'eau dans les sols sableux du Sénégal. (In Fr.) Pages 249–257 *in* Soil tillage and crop production (Lal, R., ed.). IITA Proceedings Series no. 2. Ibadan, Nigeria: International Institute of Tropical Agriculture.





# Cultures alternatives pour le Sahel

J.Vieira da Silva<sup>1</sup>

## Résumé

*La majorité des plantes cultivées a été domestiquée par l'homme au paléolithique et néolithique. Depuis l'effort le plus grand d'introduction de plantes a été fait après la découverte du Nouveau-Monde et à une moindre échelle après la création de grands jardins botaniques tropicaux et du Service d'introduction de plantes aux Etats-Unis. Le potentiel pour l'introduction de nouvelles cultures dans le Sahel est très grand, surtout à partir de deux origines : le Nord du Mexique et le Kalahari et Namib. Le Nordeste du Brésil, l'Australie et l'Inde aride sont aussi des sources de cultures potentielles. Quelques plantes utiles sont décrites et une proposition est faite de créer un Jardin botanique des zones arides, responsable de l'introduction des plantes, de la quarantaine, de la recherche de faisabilité et de la formation des chercheurs de ces zones.*

## Abstract

**Alternative crops for the Sahel:** *Most of the cultivated plants were domesticated by man in the paleolithic and neolithic times. Since then the biggest effort in plant introduction occurred just after the discovery of the New World and, on a more modest scale, after the creation of the Tropical Botanical Gardens and of the U.S. Plant Introduction Service. It may be well possible to introduce new crops in the Sahelian regions, especially from northern Mexico, Kalahari, and Namib. Northeast Brazil, Australia, and arid India are also sources of potential crops. Some useful plants are indicated with a proposal for the creation of an Arid Zone Botanical Garden for plant introductions and quarantine, feasibility research and teaching.*

## Introduction

Les régions semi-arides et arides sont caractérisées non seulement par une faible pluviosité pendant une période de l'année, plus ou moins longue, mais aussi par une variation annuelle importante de la quantité d'eau reçue, et/ou par des périodes sèches intervenant pendant la saison pluvieuse.

Certaines cultures humaines ont, soit domestiqué, soit utilisé un nombre considérable d'espèces de plantes, même dans les différentes régions arides et semi-arides du globe et il doit être reconnu que la période la plus riche d'innovations s'est située à l'aube de l'agriculture dans les cultures néolithiques

ou paléolithiques, dans l'ancien et dans le nouveau monde. Quelques milliers d'espèces végétales font ainsi partie du patrimoine agricole de l'humanité (Harlan 1975).

La découverte du Nouveau-Monde a apporté des modifications notables à la carte des productions végétales et l'Afrique, en particulier, a reçu un nombre important de nouvelles espèces qu'elle a su observer et adapter à ses besoins : le maïs, le manioc, la tomate, la pomme de terre, le piment, l'arachide, le haricot, le cacao, etc. D'autres espèces sont venues d'Orient : la banane, le cocotier, le riz, la canne à sucre. L'échange a aussi bénéficié à l'Amérique qui cultive maintenant le blé, le sorgho, le café, le soja (d'Asie) etc.

---

1. Professeur, Centre de recherche de botanique, Université Paris VII, Paris, France.

ICRISAT (International Crops Research Institute for the Semi-Arid Tropics) 1989. Soil, Crop, and Water Management Systems for Rainfed Agriculture in the Sudano-Sahelian Zone: proceedings of an International Workshop, 7-11 Jan 1987. ICRISAT Sahelian Center, Niamey, Niger. Patancheru, A.P. 502 324, India: ICRISAT.

Il faut cependant reconnaître que les grands mouvements et l'introduction d'espèces se sont faits, en général, en dehors d'une planification scientifique ou technique et d'une façon tout à fait empirique, et qu'ils ont été très facilement adoptés et assimilés par les populations agricoles africaines en particulier qui ont su les intégrer dans leurs régimes alimentaires souvent considérés comme très rigides.

D'autre part, rares sont les plantes qui ont fait l'objet d'une domestication après le néolithique ou paléolithique supérieur, et nous assistons à une simplification extrêmement dangereuse de l'agriculture mondiale qui se réduit à trois céréales majeures auxquelles on demande d'occuper tous les écosystèmes et conditions de culture.

A cette vision réductionniste et qui a de graves conséquences sur la productivité, en particulier dans les régions sèches, s'est opposée l'action des grands jardins botaniques du Monde : Kew, Sri-Lanka, Bogor, Rio de Janeiro, etc., qui ont eu un rôle majeur dans les échanges et introductions d'espèces dans le monde tropical, même si la région sèche, plus éloignée des préoccupations coloniales, ait peu bénéficié de leur action.

Il faut aussi reconnaître que le grand développement agricole des Etats-Unis a été aidé par leur extraordinaire service d'introduction de plantes, et que, pour parler seulement de cultures majeures, le sorgho et le soja ont considérablement modifié les systèmes de production.

Il faut observer cependant que la recherche actuelle dans la majorité des zones arides commence seulement à reconnaître la valeur d'un grand nombre d'espèces anciennement domestiquées, ou faisant l'objet de cueillette. En ce qui concerne le Sahel à part la proposition sporadique de quelques "plantes miracles", à intérêt douteux, aucun effort conséquent n'a été fait pour profiter de la grande richesse floristique de zones arides semblables.

## Présentation du problème

La production végétale est largement fonction de la quantité d'eau utilisée par la plante et déjà des travaux relativement anciens dans le Namib l'avaient clairement démontré (Walter 1955).

Pour les plantes annuelles la variation de productivité est donc un caractère fortement lié à la nature même de la région et l'introduction de nou-

velles espèces pourra seulement atténuer ou, tout au plus, éviter les échecs absolus.

Par contre, les espèces pérennes, par des mécanismes d'adaptation variables peuvent compenser les variations de pluviosité : soit qu'elles utilisent des réserves hydriques plus ou moins profondes, c'est le cas de certaines espèces ligneuses dans des biotopes favorables; soit qu'elles accumulent des réserves qui peuvent constituer des ressources disponibles même dans les années de disette. Ces espèces sont souvent plus productives que les espèces cultivées dans le Sahel, mais n'ont pas fait l'objet d'efforts de recherche importants.

## Les régions arides et les espèces potentiellement utiles pour le Sahel

Même si nous faisons référence à des espèces arborescentes, nous ne nous occupons pas de l'agroforesterie qui constitue un aspect particulier du système agricole qui sera traité par ailleurs dans cet atelier (Van Den Beldt 1989).

Deux régions principales, et trois secondaires constituent les sources de matériel végétal ayant de la valeur pour la région sahélienne. Ces régions se situent toutes dans la zone aride tropicale à l'exclusion de la zone aride méditerranéenne. Nous mettons en garde les chercheurs contre les introductions à partir de cette dernière, les diverses tentatives se sont toutes soldées par des échecs retentissants.

La première des régions principales est la zone aride mexicaine (*sensu lato*) à l'exclusion de la région indiquée au paragraphe précédent. Non seulement cette zone est riche en espèces de cueillettes, mais quelques domestications anciennes sont extrêmement prometteuses, comme le *Phaseolus acutifolius* par exemple (Nabhan et Felger 1985).

Nous mettons en évidence en particulier le genre *Cucurbita* qui présente une variabilité extraordinaire et dont certaines espèces doivent pouvoir surpasser les cultures traditionnelles du Sahel; le groupe xérophyte, *C. digitata*, *cylindrata*, *cordata*, *palmata*, produit de grandes quantités de graines riches en huile et en protéines (Bemis et Whitaker 1969) ainsi que *C. foetidissima* (Bemis et al. 1979). Ces courges sont, non seulement de grandes productrices de graines mais leur système racinaire puissant et tubéreux est une importante source d'amidon qui nous semble encore plus précieuse

comme ressource alimentaire. D'autre part, ces plantes sont une source importante de "cucurbitacine" utilisable pour la lutte biologique contre certains coléoptères.

Les *Cnidoscolus* offrent plusieurs espèces utiles (Nabhan et Felger 1985), soit par leurs racines tubéreuses (*C. palmeri* et *C. stimulosus*), soit par la richesse de leurs feuilles en protéine, qui peut atteindre 30% en matières sèche. La recherche de formes non prurigineuses, qui ont déjà été reconnues, est essentielle.

Nous devons aussi reconnaître la valeur des espèces du genre *Lycium*, en particulier le *L. fremontii* comme productrices de fruits utilisés par les indiens Piona.

Les haricots sont très prometteurs, depuis le *Phaseolus acutifolius*, déjà cultivé et qui doit pouvoir démontrer sa supériorité dans la région sahélienne (Theisen, et al. 1978) à *P. ritensis* et à *P. filiformis* encore plus résistants à la sécheresse. Le croisement de ces espèces avec *P. vulgaris* semble possible avec recours à la culture d'embryons.

Le genre *Ceiba* avec les deux espèces *C. acuminata* et *C. parvifolia* est utile par les grandes racines tubéreuses, riches en amidon, qui constituent une ressource pour les années sèches. Une autre espèce arborescente très résistante à la sécheresse et à enracinement profond est *Olneya tesota* dont les graines semblables à de petit cacahuètes, sont comestibles.

La deuxième région, et probablement la plus importante comme ressource génétique pour les régions arides, est celle du Kalahari et Namib. Les peuples de la région consomment plus de trois cents espèces, dont certaines méritent une attention particulière (Lee 1966, Tanaka 1976, Arnold et al. 1985, Taylor 1985).

Il n'est pas possible de donner toutes les références des espèces utiles dont certaines ont déjà été cultivées sans difficulté majeure. Il faut cependant faire ressortir l'importance des cucurbitacées comme : *Acanthosicyos horrida* vivant dans les régions les plus déshéritées du Namib. La pulpe du fruit est très nourrissante et les graines (30% de protéine) ont déjà été commercialisées comme succédané de l'amande (Meeuse 1962). A retenir aussi *A. naudiana*, concombre herero et surtout *Citrullus lanatus*, l'ancêtre de la pastèque, très polymorphe et qui soutient dans le Kalahari tant l'homme que l'animal; c'est probablement l'espèce avec laquelle les résultats les plus rapides pourront être obtenus. Autres espèces sont *Coccinia rehmannii* (racines tubé-

reuses), *C. sessiliflora* (cornichon rouge), *Cucumis anguria* var. *longipes* (dont la var. *anguria* est déjà cultivée aux Antilles), *C. africanus*, *C. metuliferus* et *C. Kalahariensis* (racines tubéreuses). Des graines particulièrement nutritives sont fournies par : *Bauhinia petersiana* subsp. *macrantha*, petit arbuste facilement cultivable, *Schotia afra* var. *angustifolia*, *Guidbourtia coleosperma* et surtout *Tylosema esculentum* de très grande valeur tant pour les graines que pour le tubercule (Bousquet 1982). Les tubercules de *Vigna lobatifolia* et *Pelargonium incrassatum* sont aussi très utiles ainsi que les cormes de *Babiana dregei*.

Mais les fruits les plus riches appartiennent aux espèces arborescentes très productives : *Schlerocarya birrea* subsp. *caffra* (dont une autre sous-espèce existe au Sahel) et surtout *Ricinodendron rautanenii* qui est la base de l'alimentation des Kung (Lee 1966). Ces fruits possèdent une noix très dure et difficile à casser, les espèces sont dioïques et rentrent en production tardivement : des difficultés que des techniques modernes pourront surmonter.

La première des trois autres régions, est le Nordeste du Brésil qui peut fournir non seulement des cultivars de manioc relativement résistants à la sécheresse, mais aussi *Cnidoscolus phyllacanthus*, euphorbiacée arborescente dont les feuilles et tiges sont très riches en protéine, *Spondias tuberosa*, anacardiacee à grande racine tubéreuse possédant des fruits très nutritifs, ainsi que *S. lutea*, *S. dulcis* et *S. purpurea*. Une légumineuse produisant d'énormes tubercules (jusqu'à 500 kg), *Dioclea sclerocarpa*, pourrait avoir un grand potentiel dans les zones arides. Les graines de *D. grandiflora* sont aussi utilisées pendant les périodes de sécheresse que cette plante supporte bien (Rizzini et Mors 1976).

L'Australie peut fournir un nombre considérable, et peu étudié encore, de plantes utilisées par les arborigènes et extrêmement résistantes à la sécheresse (Brand et Cherikoff 1985). Nous citerons pour l'exemple les graines de différentes espèces d'*Acacia* avec des pourcentages de protéines supérieures à 20%, le nombre important d'espèces du genre *Capparis* fournissant des fruits comestibles ainsi que les *Solanum* xérophytes. Le *Vigna lanceolata* produit des tubercules comme le *Dioscorea bulbifera*, igname qui pourrait être très utile au Sahel, et l'*Ipomea costata*.

La région indienne du Rajasthan nous fournit une espèce cultivée de haricot très résistante à la sécheresse, *Vigna aconitifolia*, et un autre *Vigna*

*asiatique*, le *Vigna radiata*, a aussi démontré de grandes capacités de résistance à la sécheresse.

## Propositions de recherche et développement

L'étude et l'introduction de nouvelles espèces est probablement une des méthodes les plus rapides pour augmenter et assurer la productivité agricole dans les régions arides, en particulier au Sahel. Même si seul un petit pourcentage des centaines d'espèces déjà identifiées a du succès, cela constituera une véritable révolution agricole semblable à celle qui a suivi l'introduction des espèces américaines.

Sachant l'importance que les jardins botaniques tropicaux ont eu pour l'agriculture, ainsi que celle du Service d'introduction de plantes des Etats-Unis, il nous semble urgent de créer un Jardin botanique des zones arides chargé de la récolte, l'introduction et l'étude des espèces potentiellement utiles et dont une des fonctions serait aussi la formation de chercheurs locaux dans la recherche en biologie végétale appliquée.

Les connaissances modernes en biologie végétale, en particulier en culture *in vitro*, permettent la levée de beaucoup de difficultés liées à la domestication des espèces utiles et à leur multiplication. D'autre part un tel Jardin botanique des zones arides pourrait se charger des banques de matériel génétique et de la quarantaine végétale pour toute la région sahélienne et soudano-sahélienne.

## Bibliographie

**Arnold, T.H., Wells, M.J. et Wehmeyer, A.S.** 1985. Khoisan food plants: taxa with potential for future economic exploitation. Pages 69-86 *in* Plants for Arid lands (Wickens, G.E., Goodin, J.R. et Field, D.V., eds). Londres, Royaume-Uni : George Allen & Unwin.

**Bemis, W.P., Berry, J.W. et Weber, C.W.** 1979. The buffalo gourd, a potential arid land crop. Pages 65-87 *in* New Agricultural Crops (Ritchie, G.A. ed) Boulder. CO. Etats-Unis : Westview Press.

**Bemis, W.P. et Whitaker, J.W.** 1969. The xerophytic Cucurbita of northwestern Mexico and southwestern United States. *Madrono* 20(2):33-80.

**Bousquet, J.** 1982. The Morama bean of the Kalahari as a potential food crop, with a summary of current research in Texas. *Desert Plants* 2(4): 213-215.

**Brand, J.C. et Cherikoff, V.** 1985. The nutritional composition of Australian arboriginal food plants of the desert regions. Pages 53-68 *in* Plants for arid lands (Wickens, G.E., Goodin, J.R. et Field, D.V. eds). Londres, Royaume-Uni : George Allen & Unwin.

**Harlan, J.R.** 1975. Crops and man. American Society of Agronomy. Madison, Etats-Unis. 295 pp.

**Lee, R.B.** 1966. Subsistence ecology of Kung Buschmen. *Annals Arboretum, Michigan* : University Microfilms. Michigan, Etats-Unis.

**Meeuse, A.D.J.** 1962. The Curcubitaceae of southern Africa. *Bothalia* 8(1):1-111.

**Nabhan, G.P. et Felger, R.S.** 1985. Wild desert relatives of crops: their direct uses as food. Pages 19-33 *in* Plants for arid lands (Wickens, G.E., Goodin, J.R. et Field, D.V., eds.) Londres, Royaume-Uni : George Allen & Unwin.

**Rizzini, C.T. et Mors, W.B.** 1976. *Botanica economica brasileira*, Sao Paulo, Brésil : Editoria da Universidade de Sao Paulo.

**Tanaka, J.** 1976. Subsistence ecology of central Kalahari San. Pages 99-119 *in* Kalahari hunter-gatherers: studies of the Kung San and their neighbours (Lee, R.B. et De Vore, I., eds.) Cambridge Massachusetts. Etats-Unis : Harvard University Press.

**Taylor, F.W.** 1985. The potential for the commercial utilization of indigenous plants in Botswana. Pages 231-242 *in* Plants for arid lands (Wickens, G.E., Goodin, J.R. et Field, D.V., eds.) Londres, Royaume-Uni : George Allen & Unwin.

**Theisen, A.A., Knox, E.G. et Mann, F.L.** 1978. Feasibility of introducing food crops better adapted to environmental stress. Washington, D.C., Etats-Unis : National Sciences Foundation. 210 pp.

**Van Den Beldt, R.** 1989. Agroforestry in the Semi-Arid Tropics : Strategies and Research Needs. *Ces comptes rendus*.

**Walter, J.** 1955. Le facteur eau dans les régions arides et sa signification pour l'organisation de la végétation dans les contrées sub-tropicales. Pages 272-283 *in* Colloques Internationaux du CNRS N° 59 : Les divisions écologiques du monde. Paris, France : Centre national de la recherche scientifique.



**Systems Modeling  
and Economic  
Considerations**





# Modeling Agroclimatic Systems: Guidelines and Perspectives

J.L. Steiner<sup>1</sup>

## Abstract

*Agroclimatic models offer many potential benefits including reduction of site-specific field experimentation, better interpretation of climatic limitations to crop production, evaluation of risks and benefits of proposed management practices, communication of research results, and enhanced understanding of biological and physical systems. To date, model development has far exceeded validation and implementation. Crop models range from simple, statistical models through complex, process-oriented models. Data required to support development and validation of these models are quite different, as are the potential applications. Simple models require large data sets for development and cannot be transferred outside the region for which they were developed, but utilize easily available data for implementation. Development of complex models contributes to scientific understanding and offers the potential for a wide range of applications, but requires detailed information. Intermediate level models have more manageable data requirements than the complex models and offer a greater level of transferability than simpler models, so are most promising for use in developing countries. Regardless of the complexity of the model, and regardless of whether existing models are utilized or a new model is developed, a successful modeling application must be carried out as a part of a broad approach to problem solving, which includes a clear statement of achievable goals, explicit statement of assumptions and hypotheses based on project will be conducted, careful formulation of the assumption and hypotheses into mathematical-based computer code, critical evaluation of the model outputs including validation, using independent data sets, and communication of results to the end user in a useful form.*

## Résumé

**Modélisation des systèmes agroclimatiques—lignes directrices et perspectives :** *Les modèles agroclimatiques présentent divers avantages potentiels et, entre autres, permettent de réduire l'expérimentation au champ, d'interpréter mieux les contraintes climatiques à la production, d'évaluer les risques et les avantages de pratiques d'aménagement, de mieux communiquer les résultats de recherche et d'améliorer la compréhension des systèmes biologiques et physiques. A ce jour, le développement de modèles est de loin en avance sur leur adoption et leur mise en place. La gamme va des simples modèles statistiques à ceux plus complexes et déterministes. Les données nécessaires pour développer et installer ces modèles sont bien différentes, tout comme les applications potentielles. Les modèles simples exigent beaucoup de données pour être développés et ne sont pas transférables en dehors de la région pour laquelle ils ont été générés, par contre leur mise en place requiert des données facilement accessibles.*

*Le développement de modèles complexes contribue à la compréhension scientifique et offre le*

---

1. Soil Scientist, USDA-ARS, Conservation and Production Research Laboratory, P.O. Drawer 10, Bushland, TX 79012, USA.

ICRISAT (International Crops Research Institute for the Semi-Arid Tropics) 1989. Soil, Crop, and Water Management Systems for Rainfed Agriculture in the Sudano-Sahelian Zone: proceedings of an International Workshop, 7-11 Jan 1987. ICRISAT Sahelian Center, Niamey, Niger. Patancheru, A.P. 502 324, India: ICRISAT.

*potentiel d'une large gamme d'applications; leur exigence en informations précises est par contre élevée. Les modèles intermédiaires ont des exigences en données plus faciles à gérer que bien des modèles complexes, leur degré de transférabilité est supérieur à celui des modèles plus simples et par là, ils sont plus prometteurs pour les pays en voie de développement.*

*Indépendamment de la complexité du modèle et du fait que certains modèles existants soient utilisés ou qu'un nouveau modèle soit développé, une bonne application doit être réalisée comme un maillon d'une approche large tendant à résoudre des problèmes. Cela inclut une définition claire des objectifs à atteindre, des estimations et hypothèses qui sous-tendent le projet, une formulation attentive de ces estimations et hypothèses en code mathématique pour ordinateur. On procédera à une évaluation critique des retombées du modèle en utilisant la mise en place à l'aide de données indépendantes et la communication des résultats à l'utilisateur final sous une forme exploitable.*

## Introduction

The use of agroclimatic models has increased in the past several years to the extent that hundreds of agricultural models are now documented in scientific literature (e.g., France and Thornley 1984). Ambitious goals have been set in many of these modeling efforts, but researchers, as a community, are just beginning to deal seriously with the problems of how to apply models to meet specific goals and objectives in agricultural research, production, and management. The resources being devoted to model development far outweigh those being devoted to model evaluation or to model implementation, and the time has come for scientists in the agricultural research community to set clear and realistic goals for future modeling efforts.

### Why Use Models?

The attractions of agroclimatic models are obvious as we deal with the complexities of cropping systems. While the suitability of current models for dealing with these complexities is not always clear, it is not possible to absorb and interrelate all the necessary factors to describe an agricultural system without the use of some type of model. Currently available models can offer the following benefits:

- reduction of site-specific, long-term field experiments;
- interpretation of climatological records in terms of production potential and limitations;
- evaluation of expected returns to soil- and crop-management practices;
- evaluation of risks associated with management practices;

- communication of research results between locations;
- enhanced understanding of biological and physical systems and their interactions; and
- conceptualization of multidisciplinary activities.

These factors are essential to improve the effectiveness of our research efforts, whether it be in a high-input or a low-input agricultural system. Evaluating the array of published models to determine the suitability of specific models to specific problems is a very complex process. The objective of this paper is to put forth some observations and suggestions on model evaluations and applications to agroclimatic systems.

## Agroclimatic Models

Agroclimatic models can be described at three general levels:

1. Simple, statistical models.
2. Intermediate, crop growth models.
3. Complex, process-oriented models.

Characteristics of these types of models as summarized by Norman (1981) and Stapper (1986) are shown in Figure 1. The data required to support development and utilization of these models are very different, as are the applications that can be made of the models after they have been developed and validated.

### Simple Models

Simple, statistical models are primarily based on regression analysis and empirical relationships. They require a large data set to develop and cannot

|               | Simple   | Intermediate  | Complex   |
|---------------|--|---|---|
| Category      | Emperical<br>Crop weather  | Crop growth<br>Crop systems                                     | Crop process  |
| Type          | Statistical static $\longrightarrow$ Mechanistic dynamic                       |   |   |
| Relationships | Empirical  | Correlative   |   |
|               | Phenomenological   | Mechanistic   |   |
| Scale         | Regional   | Field   | m <sup>2</sup> -> Leaf  |
| Time step     | Seasonal   | Daily   | Hourly  |
| Use           | Operational  | Operational/Research  | Research  |
| Character     | Requires data from many years to derive parameters to estimate yield           | Limited scope (yield, water use, growth stage, leaf area, etc.) | Broad scope (yield, ET, soil evaporation, canopy temperature, dew, canopy profiles, soil and canopy fluxes, stomatal behavior, etc) |
|               | Rely on plant being good integrator of environmental effects in time and space |   | Integration over time and space explicit  |

**Figure 1. Characteristics of crop models of different levels of complexity.**

be applied to simulations outside the region from which they were developed. An example of a simple regression model is given in Figure 2. Jones and Hauser (1975) developed a statistical model to describe sorghum yield as a function of available soil water at planting. They used data collected over a 14-year period for model development and it is doubtful if a more complex type of model could predict yields better for the research station at Bushland, Texas, where the data used to develop the model were collected. The grain sorghum yield at Bushland is strongly related to soil water stored in the profile at planting, and assuming that average rainfall and temperature conditions prevail during the growing season, the soil water at planting is a good predictor of yield.

Figure 3 shows the performance of the simple regression model from Figure 1 in predicting the yield of grain sorghum at Bushland using data from experiments that were not used to develop the original model. Many of the data sets are distributed

around the 1:1 line, with a similar amount of scatter as was seen in the original data set. However, sorghum grown during a high-rainfall season (represented by the ● symbol) yielded much more grain than would have been predicted by the model. In addition, the model cannot be used to predict yields for other locations, even those fairly close to Bushland, because all the data used to fit the model were collected at a single location. Bushland is located in a region of pronounced rainfall gradients (60 mm a<sup>-1</sup> for each 100 km in the EW direction) and temperature gradients in the NW to SE direction (first and last frost dates are particularly important). Therefore, a simple empirical model, dependent on average conditions across the range of data used to fit the model would not provide valid predictions for other locations. Regression models work when average conditions prevail but fall apart during unusual growing seasons. However, it is during the unusual seasons that predictions of crop performance are needed

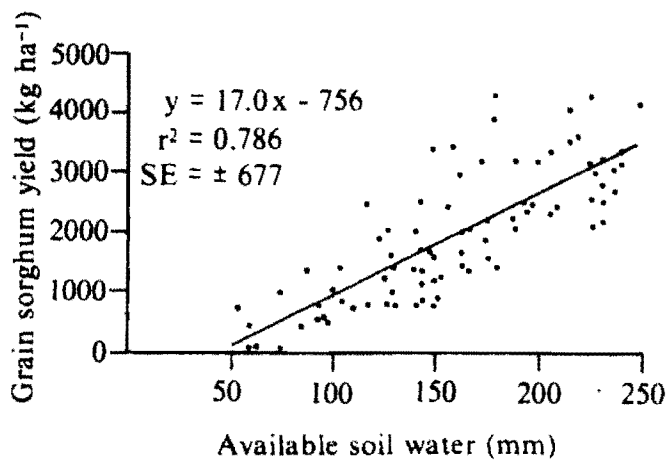

Figure 2. A simple regression model describing grain sorghum yield as a function of soil water at planting. Bushland, Texas, 1959–1972 (Jones and Hauser 1975).

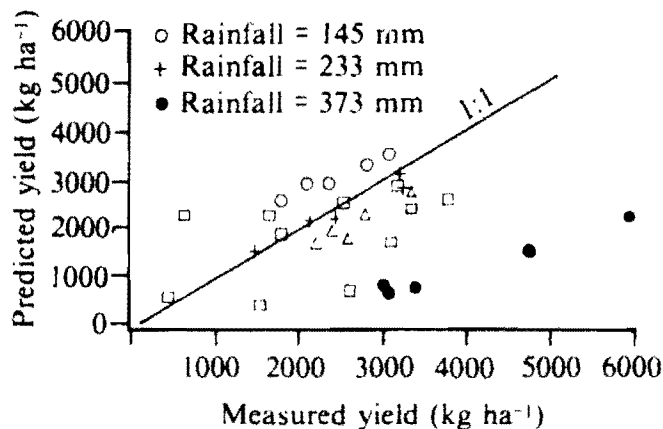

Figure 3. Evaluation of the Jones and Hauser model (Fig. 2) for predicting sorghum yields at Bushland, Texas. Data from (□) O.R. Jones, personal communication, 1973–84; (Δ) Unger 1984; and (•, +, O) Unger 1978 (1974, 1975, and 1976 data).

most. Thus, the use of these types of models is limited and often not practical.

Many simple crop models were developed for much broader applications than the Jones and Hauser (1975) model discussed above for illustration purposes. A useful discussion on the development of an empirical crop-weather model is given by Feyerherm and Paulsen (1986). Slabbers et al. (1979) have discussed the potential applications and evaluation of simple crop models.

Intermediate level models utilize descriptions of distinct processes such as photosynthesis and transpiration, which are known to be important in controlling crop growth. They generally operate on a daily time scale, because of the availability of daily climatic input data and because the knowledge of the biological and physiological processes on a shorter time scale is not adequately understood. Calculations are often made on the basis of a single plant or land area and then converted to the field level, assuming uniform soil and plant conditions across the field.

Daily growth is usually calculated in one of two ways—either the model calculates a daily net photosynthate production based on daily interception of solar radiation (e.g., Arkin et al. 1976, Charles-Edwards 1982, pp. 82–85, Gallagher and Biscoe 1978), or the model calculates photosynthesis and respiration separately, based on solar radiation and temperature, and determines net photosynthesis as the difference of the two (e.g., Baker et al. 1983, Goudriaan 1982).

Daily evapotranspiration is calculated as a function of the potential evapotranspiration (PET), crop canopy, and soil-moisture level. One of the most utilized approaches to the calculation of evapotranspiration is based on Ritchie's (1972) model, which partitions PET to crop and soil surfaces on the basis of leaf area index (LAI). Transpiration and evaporation are then calculated separately, because they are affected by different physical and physiological processes. PET rates are most often calculated by the Penman (1948) method, the Priestley and Taylor (1972) method, or using pan evaporation rates.

Crop phenology is calculated as a function of temperature or thermal units. The partitioning of dry matter is dependent on crop growth stage and is generally estimated from empirical relationships. Stress effects that are most often included in crop growth models are water stress, nitrogen stress, and, less frequently, phosphorus stress. The effects of water stress on various plant processes are calculated by empirical methods, generally based on soil-water content and sometimes on PET rate. Interactions among stresses are seldom considered.

Figure 4 illustrates the application of an intermediate level model, SORGF (Arkin et al. 1976) to determine the probability of grain sorghum

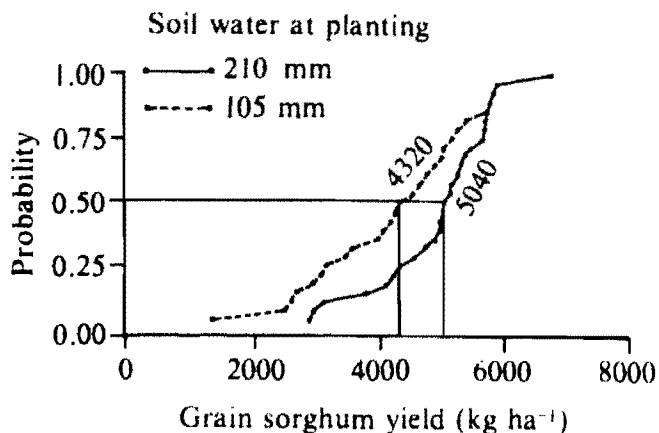

Figure 4. Use of an intermediate level model, SORGF (Arkin et al. 1976), to evaluate the effect of soil water at planting on grain sorghum yield. Bushland, Texas, 1958–1984, Pullman clay loam.

yield with high or low soil-water content at planting at Bushland, Texas. The graph illustrates predicted yields for a 26-year period, assuming high (210 mm) or low (105 mm) available soil water at the end of the fallow period, prior to planting grain sorghum. The predicted yields for each case (high or low soil water content) were ranked and plotted to illustrate the probability of obtaining yields as great as at a certain level. The graph shows that 80% of the time, the extra soil-water content made a substantial contribution to the yield level. At the 50% probability level, the high soil-water regime produced yield predictions of less than 4300 kg<sup>-1</sup>, and the low soil water regime produced yield predictions of less than 5000 kg ha<sup>-1</sup>. These yields are too high for the Bushland area compared to those in Figure 2. The reasons for yield overpredictions are not yet understood, but the principle of the response to soil water is valid. Under lower soil-water regimes (e.g., different soils or annual cropping), the two curves would come together in the driest 10–20% of the years, as well as in the wettest years because the rainfall would not provide adequate water to produce a crop without a contribution from stored soil water.

De Wit and Penning de Vries (1985) present a good overview of a hierarchy of models with increasingly complex models used when more limiting factors of production are considered—from light interception and temperature to water, nitrogen, phosphorus, and other minerals. Each level of model incorporates concepts from the previous

level of model and includes additional production-controlling processes.

Intermediate level models span research and operational applications. They allow researchers to interrelate knowledge from different disciplines. They have contributed considerably to the advancements of science by drawing attention of the scientists to description of processes and mechanisms, and to quantitative rather than qualitative descriptions of relationships. The data requirements are generally available, but an expert must oversee compilation of data sets to ensure high quality data. It is important to remember that there are still many empiricisms built into most of these models and few of them have been rigorously tested and validated. Norman (1981) illustrated that intermediate level models have a tendency to produce large errors.

### Complex Models

Complex models have not yet reached the point of general availability. Each model is generally linked to a specific researcher or research group. The goal of this type of model is to eliminate empiricism from the model; to describe the plant canopy in physical, biological, and physiological terms. When this type of model has been developed and validated, it is extremely flexible in potential applications. Norman has applied the CUPID model to such diverse applications as analysis of canopy temperature (Norman 1979), leaf wetness (Norman and Campell 1983), and microclimate and pest management (Norman 1982). The input requirements for complex models are quite extensive, including detailed hourly climatic data, soil and plant reflectance properties, leaf size, leaf angle distribution, root distribution, plant and canopy resistances, etc.

Complex models incorporate existing knowledge about crop production systems, and contribute to the advancement of the agricultural sciences by narrowing down gaps in the existing knowledge. Use of complex models requires an active and well-supported research program to allow investigation of relationships and processes that are not well understood. They are not used in operational programs at this time because the data required to support complex models are not generally available.

## Expert Systems

In future, many modeling applications will utilize 'expert systems,' which incorporate existing knowledge into computer-based systems, organized to aid in decision making (Grable, In press). Computer hardware and software are being developed, which will establish decision-making processes patterned after the human decision-making processes. The computer will make many of the 'trial and error' iterations involved in decision making, utilizing encoded rules, data bases, and user interface systems (Barrett et al. 1985). Expert systems provide a way of 'packaging' models that make them easily accessible to users and easy to interpret. The models embedded in current expert systems are generally sophisticated, intermediate-level models. An expert system, COMAX (Cotton Management expert), is currently being tested by cotton growers in the southeastern United States to aid in making management decisions, relating to in-season fertilizer application, irrigation, harvest date, and other factors (Agricultural Research Service 1986). COMAX incorporates a crop growth model called GOSSYM (Baker et al. 1983); user interface programs and built-in data bases differentiate between the 'model' and the 'expert system' that was developed specifically as a decision-making tool for farm managers.

## Systems Analysis

For any modeling effort to be successful, it must be undertaken as a part of a project that has specific and achievable objectives. A model should be viewed as a tool used to achieve a goal, rather than as an achievement by itself. The overall process of solving problems by the use of a model will be described in this paper as 'systems analysis'. The essential components of systems analysis are outlined in Figure 5. As is indicated, systems analysis is an iterative procedure—the results of each effort are used to refine and improve previous steps until a satisfactory level of performance 'as initially defined by the project team' is achieved.

### Setting Simulation Project Objectives

A crucial step in the problem-solving process is the statement of clear, obtainable goals.

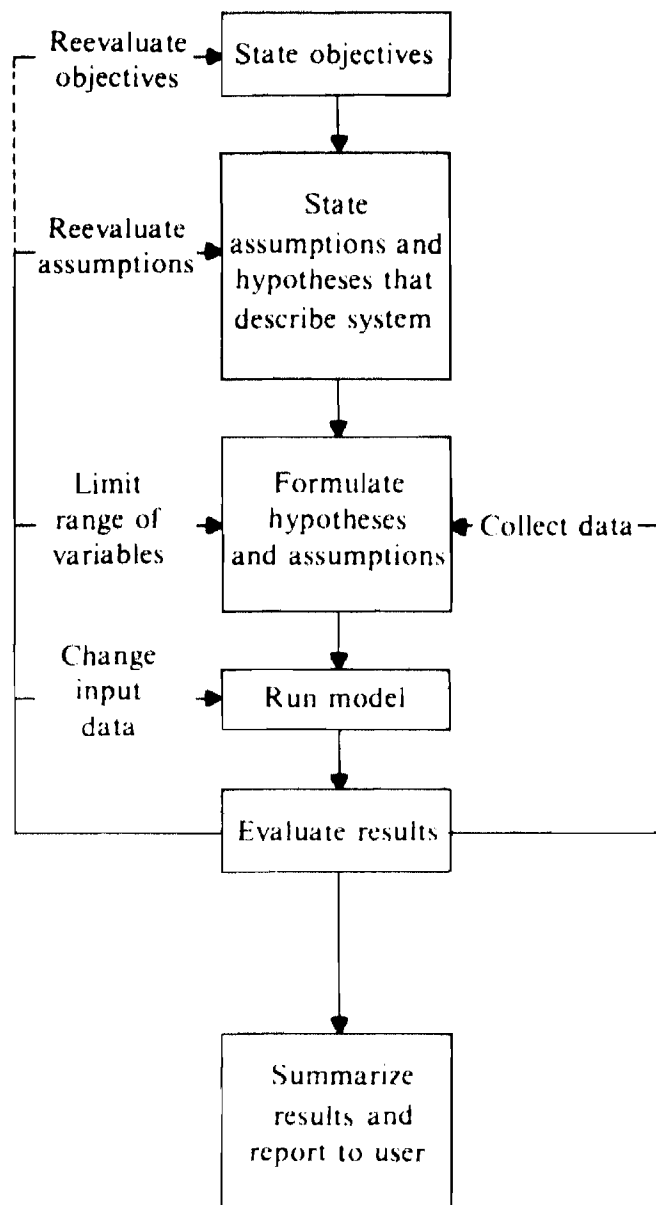

Figure 5. Schematic diagram of systems analysis including model development.

A group that sets a goal to 'stop soil erosion' or to 'end world hunger' will not achieve those goals in the foreseeable future. Instead their efforts might become so diffuse and the possibility of achieving their goal so hopeless that very little will actually be accomplished. Several components are necessary for goal setting. First, it is necessary to identify and then maintain active, two-way communication with the end user throughout the project. A model written to provide information about maize yields to a national agricultural ministry will

be very different from a model which is written to provide information to a farmer. It is important to be realistic in evaluating available resources including people, money, data, and facilities, and to specify a time frame for the completion of various stages of the project. An additional factor that is often omitted is the specification of required performance levels of the model and the evaluation techniques. An example of this might be that the model should be able to predict regional maize yields to the Agricultural Ministry within 25% of actual yields, 9 years out of 10, with a lead time of four weeks before harvest begins. If the goals are set keeping these criteria in mind, then the modeling group will be able to determine when they have met their goals and finished the project.

This goal-setting step should include the active participation of the end user, i.e., the research team that will be putting the model together, and the administrative hierarchy which will be overseeing the project.

### **State Hypotheses and Assumptions**

Once the objectives of the project are stated, then the process of trying to accomplish those goals can begin. At this point, the hypotheses and assumptions under which the team will be working should be clearly stated. In order to do this in a manner that will lead naturally into a modeling effort, the problem should be broken down into manageable subunits. The assumptions and hypotheses associated with each subunit must first be set out in specific and quantifiable statements, and then interactions among the various subunits must be defined. Rather than stating that 'growth is related to water use of plant', a more usable hypothesis would be that 'the daily dry-matter production of the crop decreases from some upper limit as transpiration for the plant on that day'. McKinion and Baker (1982) listed important hypotheses and assumptions that were identified and then incorporated into a cotton growth model.

As was the case in setting the overall objectives of the project, active participation at all levels from administrative through scientific to user levels is necessary to adequately define the assumptions and hypotheses under which the project will be conducted.

### **Formulate Hypotheses and Assumptions**

Formulation of hypotheses is the process of expressing ideas stated verbally in a mathematical form. The process of formulating hypotheses and assumptions associated with the project may be quite time consuming. However, a logical sequence of steps should be followed just as in the previous phases. The first step is to graph the interesting relationships using existing data or knowledge. Locating and evaluating the usefulness of available data requires considerable knowledge of the subject matter. After looking at the data in a graphical form, each hypothesis should be rewritten in an appropriate numerical form that describes the shape of the curve indicated by the points on the graph and the equations solved to obtain the coefficients associated with each equation (Ross 1981). In many cases, the dependent variable (unknown) of one equation will be used as the independent variable (known) of another equation. There are many statistical hazards associated with this procedure, but they are unavoidable in many types of model building. Consultation with a statistician at this point may produce a more valid and stable model (Chanter 1981). Equations must then be translated into computer code for solution.

This step of the systems analysis process differs from the other steps in that it must be conducted by people with specific scientific, technical, mathematical, statistical, and/or computing skills. If the team responsible for conducting the project is lacking in some of these skills, it can reasonably seek assistance from persons who have the necessary expertise (i.e., mathematicians, statisticians, systems analysts), and who have not been involved in setting the overall goals and defining the hypotheses and assumptions of the project. However, it is essential that at least one person be reasonably familiar with all levels of the project, including the system being modeled, the data sets available for model building, and the basic formulation procedures.

### **Make a Run of the Model**

Initial runs of the model should be made at a fairly early stage to evaluate the reasonableness of the overall approach taken and to identify areas that require or would respond most to additional



efforts. To make a run of the model, someone who knows the system well must assign initial values to variables and assign values to the identified constant. Scientists who have been involved in the formulation of the model and end users of the model are likely to provide the most reasonable initial input values.

### **Evaluate Model Output**

Once the earliest output of the model is obtained, the process of improvement and refinement begins. The first step, commonly referred to as 'debugging' involves checking that the computer code is working on the calculations which the programmers intended it to work on according to the hypotheses outlined by the project team. The next step is to verify that the results of the simulation make sense according to existing knowledge about the system, e.g., that predicted yields fall within a reasonable biological range or increase with increasing water or nutrient availability. It is likely that several iterative steps will be required before a reasonable prediction is made by the model. If the results of the simulation do not appear reasonable, there are several possible options. Sets of initial values for variables and constants can be tried to best describe the conditions of simulation. If no set produces a reasonable result, then the formulation of the project hypotheses should be examined. Perhaps inappropriate equation forms were used to describe the data. Some of the variables may need to be limited to a specific range of values (e.g.,  $0.0 < x < 1.0$ ) so that an equation may make physical or biological sense. Inadequate data may have been used to describe the process of interest. Field or controlled-environment experiments may have to be designed to collect the necessary data to describe certain relationships needed in the model.

The model predictions should be compared to independent field data to validate the predictions. A sensitivity analysis should be made to determine the degree of accuracy necessary in the input variables. If change in an input variable results in large changes in the model prediction, then that variable must be measured accurately. In models with many subroutines, each important relationship may need to be validated separately so that the model may reasonably predict the performance of the crucial processes.

If all the relationships taken separately seem

reasonable, and the model still fails to produce reasonable results, the hypotheses and assumptions under which the project is being conducted, or even the overall objectives of the project, should be reexamined and restated if necessary. Although the early evaluation processes may be carried out by programmers and technical people, in the later evaluations, the entire team must be involved.

### **Summarize the Project Results**

Once the model is performing at the level that was originally specified in the objectives, the necessary simulation analysis should be conducted, summarized, and communicated to the end user.

### **Using Existing Models in Systems Analysis**

Needless to say, the above process is time consuming and a considerable amount of expertise and resources are necessary to develop a model. When possible, it would help to utilize an existing model to accomplish a different set of objectives other than those for which it was originally written. When using an existing model, a group should use the same basic steps as described above, but the procedure can often be expedited by using an existing model as outlined in Figure 6. Once the project objectives are clearly defined, then one or more models should be identified that may be suitable for use in the simulation. The next step is to analyze each model in question quite thoroughly.

First the assumptions and hypotheses that are incorporated into the model should be identified to make sure they do not limit the model from the application in question. It is important to analyze all the assumptions incorporated in all the subroutines before using the model. This procedure is greatly facilitated by communication with the developer of the model. Sometimes, well written documentation of the model is available, but this is the exception rather than the rule. Certain parts of most models are much better documented than others. In some cases, documentation may describe earlier versions of the model that have since been modified, sometimes extensively. If most components of a model seem acceptable for the desired application but a few assumptions or hypotheses seem inappropriate or wrong, then modifi-

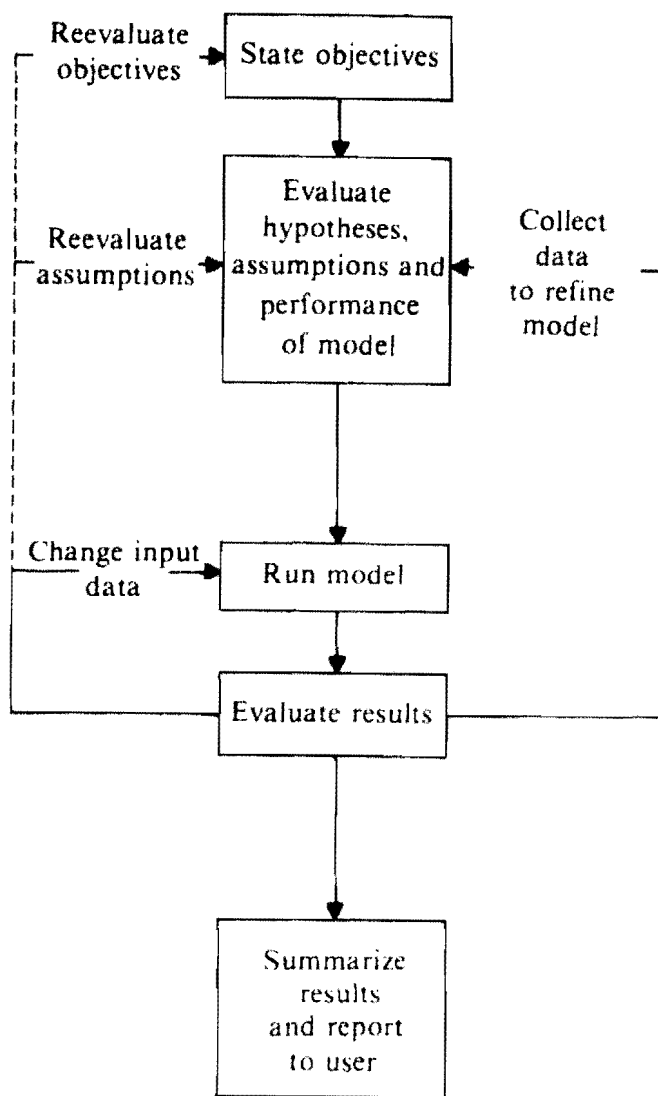

Figure 6. Schematic diagram of systems analysis using existing models.

cation of certain subunits of the model may be possible without developing a new model. Daneker (1984) discussed in some detail the evaluation of two published models—an empirical, regression based model (Hodges and Kanemasu 1977) and an intermediate level model (de Wit et al. 1978)—for use in yield prediction programs and climate-yield potential analysis. He was not satisfied with predictions of either model, so in order to use one of them, he would be required to reevaluate the assumptions built into the models. In this case, the tested models could not be used ‘off the shelf’, but improvement of the existing models might save a lot of time compared to developing an entirely new model for the desired application.

By the time a model is published and distributed to other users, the developers almost certainly will have verified that it performs reasonably well, i.e., it provides plausible answers. However, before the model is used for other applications, its performance should be evaluated using independent data sets, i.e., data sets that were not used in the model development or calibration procedure. The validation data sets should cover a wide range of conditions to ensure stable model performance as was illustrated by Slabbers et al. (1979). With intermediate to complex models, validation of the sub-components rather than validation of the entire model is often necessary (Bell 1981).

In another type of model evaluation, a sensitive analysis of the input variables needs to be done to know how sensitive the model is to a particular input variable in order to evaluate the quality of the input data required for simulation work. Terjung et al. (1982) describe a sensitivity analysis of the input variables to an evapotranspiration model.

The model developers or an independent group may have already conducted validation tests on the model. If not, this should be done before the model is utilized for simulation work. In most cases, the model must provide not only a plausible, but a reasonably accurate answer. The validation process defines the confidence with which you can accept the accuracy of the answers provided by the model.

When using a properly validated model, simulation analysis can progress fairly quickly to the stage of making the initial runs. At this point, the performance of the model is evaluated, and through an iterative procedure, the initial input values and formulation of the hypotheses are modified, if necessary. Satisfactory performance of the model should be expected relatively quickly. The project team can then complete its simulation, and report the results to the end user.

### Data Requirements and Availability

In order for any type of model to contribute to an agricultural research or development project, it is essential that good data sets be available. Historical data sets are essential for model development and validation. Ongoing data collection is essential for model improvement and operational programs where prediction of current or future production is desired.

Development of large-scale, statistical models requires data collected over long periods of time and from many locations. These types of data are seldom available in areas that have only recently been developed for agricultural production. The necessary agronomic data sets are seldom available to model new agricultural production techniques or strategies. Climatic data can be generated stochastically using climate models such as those described by Richardson (1981, 1982) to extend evaluation of management practices over long periods of time. However generated climatic data cannot be used for model development.

Complex models require a very technical, well-funded research program to support their development. Use of complex models requires detailed, accurate, and precise input, so data sets must be collected and monitored by highly trained technical staff and specialists. It is important for the development of complex models to continue, but they do not offer the potential for current applications. The models at this time are research-, not applications-oriented, and the payoff for their development may be far in the future.

Intermediate level models offer the combined benefit of a manageable data requirement and a greater level of transferability than simpler models. Within the broad category of intermediate level models, a wide range of model types is available for different applications. Developing agricultural programs can take advantage of existing models by concentrating on validation of models for the desired applications and modification of existing models, where necessary.

## Acknowledgment

The discussion of systems analysis in this paper was drawn partially from a presentation made by Dr Gorge S. Innis, (Soil Science: What Has Systems Analysis to Offer?), Soil Science Society of America Annual Meeting, Chicago, Illinois, 2 Dec 1985.

## References

Arkin, G. F., Vanderlip, R. L., and Ritchie, J. T. 1976. A dynamic grain sorghum growth model. *Transactions of the ASAE* 19: 622-626, 630.

Baker, D. N., Lambert, J. R., and McKinion, J. M. 1983. GOSSYM: a simulation of cotton crop growth and yield. South Carolina Agricultural Experiment Station Technical Bulletin no. 1089. 133 pp.

Barrett, J. R., Morrison, J. B., and Huggins, L. F. 1985. Artificial intelligence and expert systems in agricultural research and education. Paper no. 85-5516. St. Joseph, Michigan, USA: American Society of Agricultural Engineers.

Bell, C. J. 1981. The testing and validation of models. Pages 299-309 in *Mathematics and plant physiology* (Rose, D.A., and Charles-Edwards, D.A., eds.). New York, USA: Academic Press.

Chanter, D. O. 1981. The use and misuse of linear regression methods in crop modeling. Pages 253-267 in *Mathematics and plant physiology* (Rose, D.A., and Charles-Edwards, D.A., eds.). New York, USA: Academic Press.

Charles-Edwards, D. A. 1982. *Physiological determinants of crop growth*. Sydney, Australia: Academic Press.

Dannecker, H.W. 1984. Simulation of the biomass production of winter wheat and comparison with measured data for locations in different climatic regions. *Agricultural and Forest Meteorology* 32: 225-247.

de Wit, C.T., Goudriaan, J., van Laar, H.H., Penning de Vries, F.W.T., Rabbinge, R., van Keulen, H., Louwerse, W., Sibma, L., and De Jonge, C. 1978. *Simulation of assimilation, respiration and transpiration of crops*. Wageningen, Netherlands: PUDOC (Centre for Agricultural Publishing and Documentation). 140 pp.

de Wit, C.T., and Penning de Vries, F.W.T. 1985. Predictive models in agricultural production. *Philosophical Transactions of the Royal Society of London, Series B* 310: 309-315.

Feyerherm, A. M., and Paulsen, G. M. 1986. Development of a weather-yield function for winter wheat. *Agronomy Journal* 78: 1012-1017.

France, J., and Thornley, J. H. M. 1984. *Mathematical models in agriculture*. London, UK: Butterworth. 335 pp.

Gallagher, J. N., and Biscoe, P. V. 1978. Radiation absorption, growth and yield of cereals. *Journal of Agricultural Science (UK)* 91: 47-60.

- Goudriaan, J.** 1982. Potential production processes. Pages 98–113 in *Simulation of plant growth and crop production* (Penning de Vries, F.W.T., and van Laar, H.H., eds.). Wageningen, Netherlands: PUDOC (Centre for Agricultural Publishing and Documentation).
- Grable, A. R.** 1987. The future of applied plant growth modeling. Pages 141–156 in *Plant Growth Modeling for Resource Management, Vol. I.* (Wisnol, K., and Hesketh, J., eds.). Boca Raton, Florida, USA: CRC Press.
- Hodges, T., and Kanemasu, E. T.** 1977. Modeling daily dry matter production of winter wheat. *Agronomy Journal* 69: 974–978.
- Jones, O. R., and Hauser, V. L.** 1975. Runoff utilization for grain production. Pages 277–283 in *Proceedings of Water Harvest Symposium, 26–28 Mar 1974, Phoenix, Arizona, USA.* ARS-W-22. Washington, D.C., USA: United States Department of Agriculture.
- McKinion, J. M., and Baker, D. N.** 1982. Modeling, experimentation, verification and validation: closing the feedback loop. *Transactions of the ASAE* 25: 647–653.
- Norman, J. M.** 1979. Modeling the complete crop canopy. Pages 249–277 in *Modification of the aerial environment of plants* (Barfield, B. J., and Gerber, J.F. eds.). ASAE Monograph no. 2. St. Joseph, Michigan, USA: American Society of Agricultural Engineers.
- Norman, J.M.** 1981. Data requirements for generalized physiological models. Pages 201–212 in *Computer techniques and meteorological data applied to problems of agriculture and forestry: proceedings of a Workshop, 30–31 Mar 1981, Amain, California, USA.* Amain, California, USA: American Meteorological Society.
- Norman, J.M.** 1982. Simulation of microclimates. Pages 65–99 in *Biometeorology in integrated pest management* (Hatfield, J.L., and Thompson, I.J., eds.). New York, USA: Academic Press.
- Norman, J.M., and Campbell, G.** 1983. Application of a plant-environment model to problems in irrigation. Pages 155–188 in *Advances in irrigation* (Hillel, D., ed.). Vol. 2. New York, USA: Academic Press.
- Penman, H.L.** 1948. Natural evaporation from open water, bare soil and grasses. *Proceedings of the Royal Society of London, Series A* 193: 120–145.
- Priestley, C.H.B., and Taylor, R.J.** 1972. On the assessment of surface heat flux and evaporation using large-scale parameters. *Monthly Weather Review* 100: 81–92.
- Rachardson, C.W.,** 1981. Stochastic simulation of daily precipitation, temperature, and solar radiation. *Water Resources Research* 17: 182–190.
- Richardson, C.W.** 1982. Dependence structure of daily temperature and solar radiation. *Transactions of the ASAE* 25: 735–739.
- Ritchie, J.T.** 1972. Model for predicting evaporation from a row crop with incomplete cover. *Water Resources Research* 8: 1204–1213.
- Ross, G.J.S.** 1981. The use of non-linear regression methods in crop modelling. Pages 269–282 in *Mathematics and plant physiology* (Rose, D.A., and Charles-Edwards, D.A., eds.). New York, USA: Academic Press.
- Slabbers, P.J., Sorbello-Herrendorf, V., and Stapper, M.** 1979. Evaluation of simplified water-crop yield models. *Agricultural Water Management* 2:95–129.
- Stapper, M.** 1986. Modeling plant growth and development. Pages 249–272 in *Plant virus epidemics: monitoring, modeling and predicting outbreaks.* Sydney, Australia: Academic Press.
- Terjung, W.H., Hayes, J.T., O'Rourke, P.A., Burt, J.E., and Todhunter, P.E.** 1982. Consumptive water use response of maize to changes in environment and management practices: sensitivity analysis of a model. *Water Resources Research* 18: 1539–1550.
- Unger, P.W.** 1978. Straw-mulch rate effect on soil water storage and sorghum yield. *Soil Science Society of America Journal* 42: 486–491.
- Unger, P.W.** 1984. Tillage and residue effects on wheat, sorghum, and sunflower grown in rotation. *Soil Science Society of America Journal* 48: 885–891.
- USDA** (United States Department of Agriculture), *Agricultural Research Series.* 1986. When COMAX speaks, farmers listen. *Agricultural Research* 84(8)6–10.



# Considérations économiques et agro-écologiques pour l'adoption des technologies nouvelles par l'exploitant

M. Krause, M. Kadi, Chandra Reddy, R. Deuson et I. Mahaman<sup>1</sup>

## Résumé

*Des essais en milieu réel sur l'association des cultures de mil et de niébé ont été installés par l'INRAN en 1985 dans trois régions du Niger afin d'évaluer le potentiel pour l'adoption de nouvelles technologies prometteuses mises au point en station. L'analyse des résultats de 1985 montre que le traitement comprenant une variété améliorée de mil, une densité accrue, et des épandages d'engrais, a produit dans les trois villages des rendements significativement plus élevés que le traitement témoin utilisant la technologie traditionnelle, bien qu'il ne fut économiquement rentable que dans deux des trois villages. On démontre que la rentabilité relative des nouvelles technologies est fortement influencée par les variations des prix des produits, la valorisation du travail familial, la pluviométrie et la fertilité des sols. On discute également l'effet de la haute variabilité des rendements en 1985 sur la perception des aléas. Par conséquent, ces considérations affectent la rentabilité économique des nouvelles technologies qui doit être évaluée avant de formuler des recommandations agronomiques.*

## Abstract

**Economic and agroecological considerations for the adoption of new technologies by farmers:** *On-farm agronomic trials of associated millet and cowpeas were installed by INRAN in 1985 in three regions of Niger in order to evaluate the potential for adoption of promising new technologies from the research station. An analysis of the 1985 results in three villages shows that a treatment combining an improved variety of millet, increased density, and applications of fertilizer gives significantly higher yields than the traditional treatment, but was more profitable in only two of the three villages. Relative profitability of new technologies is shown to be highly influenced by variations in markets, the valuation of family labor, rainfall, and soil fertility. The effect of high variation in the 1985 yields on risk perception is also discussed. These considerations clearly affect the profitability of new technologies, which must be evaluated before agronomic recommendations can be made.*

## Introduction

Le développement des nouvelles technologies agricoles pour augmenter et stabiliser la production

alimentaire est un des buts principaux de la recherche agricole au Niger. Celles-ci peuvent inclure des variétés améliorées, des nouvelles pratiques pour la préparation du sol, des modes adé-

---

1. Chercheurs, Institut national de recherches agronomiques du Niger (INRAN), Niamey, Niger.

ICRISAT (International Crops Research Institute for the Semi-Arid Tropics) 1989. Soil, Crop, and Water Management Systems for Rainfed Agriculture in the Sudano-Sahelian Zone: proceedings of an International Workshop, 7-11 Jan 1987. ICRISAT Sahelian Center, Niamey, Niger. Patancheru, A.P. 502 324, India: ICRISAT.

quats de semis, la rotation des cultures, l'utilisation d'engrais, les traitements phytosanitaires, etc. Toutes ces nouvelles technologies, prises séparément ou dans leur ensemble, ont démontré leur potentiel pour augmenter la production alimentaire. Cependant, elles ne sont réellement profitables que dans la mesure où elles sont comprises et adoptées par les exploitants. Afin d'évaluer les potentialités d'adoption de nouvelles technologies performantes en station, le Département de recherche en économie rurale (DECOR) de l'Institut national de recherches agronomiques du Niger (INRAN) a initié des essais en milieu réel dans trois régions du Niger dès 1985. Bien que ne disposant que des résultats de deux campagnes agricoles dont ceux de la deuxième campagne ne sont pas encore analysés en détail, on a décelé plusieurs problèmes économiques et agro-économiques qui doivent être pris en considération dans l'évaluation de la potentialité de l'adoption de ces nouvelles technologies par les paysans nigériens.

## **Description de l'essai cultures associées**

Trois sites ont été sélectionnés pour y implanter les essais : Maiguéro (Arrondissement de Madarounfa, Département de Maradi), Liboré (Arrondissement de Kolo, Département de Niamey) et Kouka (Arrondissement de Filingué, Département de Niamey). Le site de Maiguéro représente une zone à pluviométrie moyenne (normalement 400 mm par an) et est caractérisé par des sols sablonneux et sablo-argileux. Le site de Liboré représente une zone à pluviométrie moyenne et à sol sablonneux. Et le site de Kouka représente une zone à faible pluviométrie (normalement 400 mm) et à sols sablonneux. Les trois sites ont fait l'objet d'enquêtes socio-économiques approfondies menées par le DECOR à partir de 1984.

Sur chaque site, 17-23 exploitants ont installé l'essai sur les cultures associées en 1985 (Samba et al. 1986). Chaque exploitant a cultivé le mil et le niébé en association dans quatre parcelles élémentaires de 1000 m<sup>2</sup>. Dans ces parcelles ils ont installé quatre traitements dont la technicité cumule des pratiques traditionnelles (Traitement 1) jusqu'au système qui combine les semences améliorées, une densité élevée, et l'application d'engrais (Traitement 4). Les quatre traitements s'emboîtent de la façon suivante :

- Traitement 1 : Système de l'exploitant (témoin).
- Traitement 2 : Système de l'exploitant avec mil amélioré.
- Traitement 3 : Association mil-niébé avec mil amélioré et densités de mil et de niébé élevées.
- Traitement 4 : Association mil-niébé avec mil amélioré, densités élevées et les applications d'engrais.

Des variétés différentes de mil et de niébé ont été utilisées dans les trois sites. Pour le traitement 1 les exploitants de chaque région ont utilisé la variété locale de mil propre à leur région. Pour les traitements 2, 3, et 4, le CIVT a été utilisé à Maiguéro, le P3 Kolo à Liboré et le HKP à Kouka. En 1985 les variétés locales de niébé ont été utilisées parce que les variétés améliorées de niébé n'étaient pas disponibles.

Pour les traitements 3 et 4 en 1985, la densité de mil était de 9000 poquets par hectare et la densité de niébé était de 27 000 poquets par hectare. Deux lignes de niébé ont été insérées entre deux lignes de mil. L'écartement entre les lignes de mil était de 1,5 m, et l'écartement entre les lignes de niébé de 0,5 m.

Pour le traitement 4, 100 kg de phosphate super simple et 50 kg d'urée ont été appliqués. Le phosphate super simple a été appliqué et enfoui par méthode locale avant le semis. L'urée a été appliquée à côté des poquets de mil en deux apports au moment du premier sarclage et au début de la montaison du mil.

Les rendements moyens pour ces quatre traitements en 1985 sont indiqués dans le Tableau 1 pour chaque village. Malheureusement, les variétés de niébé utilisées en 1985 n'ont pas donné des gousses, mais les fanes de niébé ont été récoltées.

## **Considérations économiques pour l'adoption des technologies nouvelles**

Nous posons comme hypothèse de départ que toute nouvelle technologie doit être rentable avant d'être adoptée par les exploitants. Beaucoup d'études économiques ont démontré qu'on peut bien expliquer le taux et la vitesse de l'adoption des nouvelles technologies agricoles par leur rentabilité et les contraintes à cette rentabilité. La première étude très connue qui a clairement démontré cette relation est celle de Griliches en 1957 à propos de l'adoption des hybrides de maïs aux Etats-Unis. Bien qu'il existe plusieurs facteurs sociaux et éco-

**Tableau 1. Rendements moyens de grains de mil et de fanes de niébé, par traitement et par village. Essais en milieu réel (EMR), 1985.**

| Site                         | Rendement par traitement (kg ha <sup>-1</sup> ) |     |      |      | Erreur Type<br>(kg ha <sup>-1</sup> ) |
|------------------------------|---|-----|------|------|---------------------------------------|
|                              | T1  | T2  | T3   | T4   |                                       |
| Liboré (n <sup>1</sup> = 17) |   |     |      |      |                                       |
| Mil, grain                   | 263   | 451 | 297  | 508  | 40.2                                  |
| Niébé, fanes sèches          | 472   | 541 | 941  | 991  | 68.5                                  |
| Kouka = (n=20)               |   |     |      |      |                                       |
| Mil, grain                   | 238   | 354 | 306  | 452  | 20.7                                  |
| Niébé, fanes sèches          | 78  | 66  | 192  | 164  | 15.7                                  |
| Maugéro (n=23)               |   |     |      |      |                                       |
| Mil, grain                   | 284   | 358 | 309  | 590  | 33.8                                  |
| Niébé, fanes sèches          | 778   | 787 | 1069 | 1387 | 97.0                                  |

Note: Les rendements portant des lettres différentes accusent des moindres différences significatives au niveau de 5%.

1. n = nombre d'exploitants.

logiques qui peuvent limiter l'adoption des nouvelles technologies, les études depuis celle de Griliches ont presque toujours démontré que les technologies qui sont clairement rentables et faisables techniquement sont rapidement adoptées (Feder et al. 1981).

Cependant la question de la rentabilité des nouvelles technologies évaluées dans l'essai sur les cultures associées de l'INRAN n'est pas simple. Les revenus bruts, bien qu'étant très souvent faciles à calculer, suscitent ici quelques difficultés d'appréciation à cause de leurs variations dans le temps et entre les régions. Les coûts des intrants achetés sont aussi faciles à calculer, mais l'intrant le plus important dans cet essai est celui de la main-d'oeuvre. Parfois les exploitants engagent de la main-d'oeuvre salariée, mais la plupart des opérations sont faites par la main-d'oeuvre familiale, dont la valeur est estimée en fonction de ce qu'elle pourrait gagner en se faisant engager. Pour les exploitants de Liboré, qui se trouvent 15 km de Niamey sur une route goudronnée, il y a très souvent des occasions de se faire engager pour un salaire journalier. Pour les exploitants de Kouka et Maiguréo ces occasions n'existent pas toujours. Donc, l'analyse de la rentabilité des nouvelles technologies comprend le coût de la main-d'oeuvre qui est valorisée au salaire journalier local, mais l'analyse indique aussi le revenu brut moins les coûts monétaires (coûts des semences et d'engrais).

Par ailleurs de nombreuses autres informations

sont nécessaires pour une analyse économique complète. On peut citer les pertes dues au stockage, les quantités moyennes consommées et leur prix à la période où elles ont été consommées, le coût de transport des produits sur les marchés régionaux et le coût de transport des intrants achetés ailleurs. Le DECOR n'est pas encore arrivé à intégrer toutes ces considérations dans son étude de même qu'il n'est pas arrivé à chiffrer l'apport et le coût de l'utilisation de la traction animale dans les essais.

## Résultats économiques des essais en 1985

Les résultats des analyses budgétaires pour la campagne 1985 sont largement influencés par la pluviométrie. Dans les deux villages où la pluviométrie était supérieure à 300 mm, Liboré et Maiguréo, chaque nouvelle technologie (Traitements 2, 3 et 4) a toujours augmenté les revenus bruts moins les coûts monétaires et le plus souvent a augmenté les revenus nets (Tab. 2, 3 et 4). Mais si on suppose qu'à Maiguréo les produits sont vendus juste après la récolte, le revenu net pour le traitement 3 (variété améliorée en haute densité) devient inférieur au revenu net pour la technologie traditionnelle (Témoins). Pour le troisième village, Kouka, où la pluviométrie était de 250 mm, seul le traitement 2 (variété améliorée à la densité traditionnelle) était plus rentable que la technologie traditionnelle



**Tableau 2. Calcul des revenus moyens et des indices économiques, basés sur les prix de janvier 1986, par traitement. EMR mil-niébé, Liboré, 1985.**

| Données techniques et Coûts   | Traitement |        |        |        |
|---|------------|--------|--------|--------|
|   | T1         | T2     | T3     | T4     |
| <b>Données techniques</b>   |            |        |        |        |
| <b>Rendements</b>   |            |        |        |        |
| Mil (kg ha <sup>-1</sup> )  | 263        | 451    | 297    | 508    |
| Fanes de Niébé (kg ha <sup>-1</sup> )   | 472        | 541    | 941    | 991    |
| Main-d'oeuvre familiale (HJE <sup>1</sup> ha <sup>1</sup> )                                 | 21.5       | 23.6   | 30.8   | 39.2   |
| <b>Coûts de production variables</b>  |            |        |        |        |
| Intrants (FCFA <sup>2</sup> ha <sup>-1</sup> )  | 2162       | 2218   | 4690   | 12190  |
| Main-d'oeuvre familiale (FCFA ha <sup>-1</sup> )  | 15050      | 16520  | 21560  | 27440  |
| Total (FCFA ha <sup>-1</sup> )  | 17212      | 18738  | 26250  | 39630  |
| <b>Coûts variables marginaux par rapport au Traitement précédent (FCFA ha<sup>-1</sup>)</b> |            |        |        |        |
| Témoin (T1) (FCFA ha <sup>-1</sup> )  |            | 1526   | 7512   | 13380  |
|   |            | 1526   | 9038   | 22418  |
| <b>Calculs des revenus globaux</b>  |            |        |        |        |
| Revenu brut (FCFA ha <sup>-1</sup> )  | 87113      | 110466 | 157532 | 179763 |
| Revenu brut moins coûts monétaires (FCFA ha <sup>-1</sup> )                                 | 84951      | 108248 | 152842 | 167573 |
| Revenu brut moins coûts monétaires par jour de travail (FCFA HJE <sup>-1</sup> )            | 3951       | 4587   | 4962   | 4275   |
| Revenu net <sup>3</sup> (FCFA ha <sup>-1</sup> )  | 69901      | 91728  | 131282 | 140133 |
| <b>Calcul des revenus marginaux par rapport au Traitement précédent</b>                     |            |        |        |        |
| Revenu brut-coûts monétaires (FCFA ha <sup>-1</sup> )                                       | 23297      | 44594  | 14731  |        |
| Revenu net (FCFA ha <sup>-1</sup> )   | 21827      | 39554  | 8851   |        |
| Taux marginal de rémunération (%)   | 1430       | 527    | 66     |        |
| <b>Témoin (T1)</b>  |            |        |        |        |
| Revenu brut-coûts monétaires (FCFA ha <sup>-1</sup> )                                       | 23297      | 67891  | 82622  |        |
| Revenu net (FCFA ha <sup>-1</sup> )   | 21827      | 61381  | 70232  |        |
| Taux marginal de rémunération (%)   | 1430       | 679    | 313    |        |

1. HJE = Homme Jour Equivalent.

2. FCFA = Franc de la Communauté Financière d'Afrique, 50 CFA = 1 Franc Français.

3. On ne tient pas compte des coûts fixes.

selon le revenu net ou selon le revenu brut moins les coûts monétaires. Il faut noter que les rendements du mil et du niébé pour le traitement 4 à Kouka étaient significativement supérieurs à ceux du traitement 1, mais le traitement 4 apparaît moins rentable que le traitement 1.

Le marché des produits détermine aussi la rentabilité des nouvelles technologies (Tab. 5). A Maiguéro, si on utilise les prix de trois mois après les récoltes ou les prix officiels de l'Office de produits vivriers du Niger (OPVN) au lieu des prix juste après les récoltes, le revenu net pour le traitement 3 reste supérieur à celui du traitement 1.

Donc, la variation des prix au cours de l'année toute comme l'existence d'un marché officiel avec des prix fixés peuvent rendre une nouvelle technologie rentable alors qu'elle ne l'est pas si les produits sont commercialisés après la récolte sur le marché local.

Les différences des prix de marché des régions différentes peuvent aussi influencer l'adoption ou non d'une nouvelle technologie dans une région. Au moment de la récolte 1985, le prix de mil était 57% plus élevé à Liboré qu'à Maiguéro, et trois mois plus tard ce prix était 97% plus élevé toujours en faveur de Liboré. De même, le prix de fanes de

**Tableau 3. Calcul des revenus moyens et des indices économiques, basés sur les prix de janvier 1986, par traitement. EMR mli-niébé, Kouka, 1985.**

| Données techniques et Coûts   | Traitement |        |        |        |
|---|------------|--------|--------|--------|
|   | T1         | T2     | T3     | T4     |
| <b>Données techniques</b>   |            |        |        |        |
| <b>Rendements</b>   |            |        |        |        |
| Mil (kg ha <sup>-1</sup> )  | 238        | 354    | 306    | 452    |
| Fanes de niébé (kg ha <sup>-1</sup> )   | 78         | 66     | 192    | 164    |
| Main-d'oeuvre familiale (HJE ha <sup>-1</sup> )                                     | 23.5       | 22.7   | 33.5   | 40.2   |
| <b>Coûts de production variables</b>  |            |        |        |        |
| Intrants (FCFA ha <sup>-1</sup> )   | 3095       | 2935   | 8275   | 15775  |
| Main-d'oeuvre familiale (FCFA ha <sup>-1</sup> )                                    | 16660      | 15890  | 23450  | 28140  |
| Total (FCFA ha <sup>-1</sup> )  | 19755      | 18825  | 31725  | 43915  |
| <b>Coûts variables marginaux par rapport au</b>                                     |            |        |        |        |
| Traitement précédent (FCFA ha <sup>-1</sup> )                                       |            | -930   | 12900  | 12190  |
| Témoin (T1) (FCFA ha <sup>-1</sup> )  |            | -930   | 11970  | 24160  |
| <b>Calculs des revenus globaux</b>  |            |        |        |        |
| Revenu brut (FCFA ha <sup>-1</sup> )  | 13050      | 17910  | 19530  | 25260  |
| Revenu brut moins coûts monétaires (FCFA ha <sup>-1</sup> )                         | 9955       | 14975  | 11255  | 9485   |
| Revenu brut moins coûts monétaires<br>par jour de travail (FCFA HJE <sup>-1</sup> ) | 418        | 660    | 336    | 236    |
| Revenu net (FCFA ha <sup>-1</sup> )   | -6705      | -915   | -12195 | -18655 |
| <b>Calcul des revenus marginaux par rapport au</b>                                  |            |        |        |        |
| Traitement précédent  |            |        |        |        |
| Revenu brut-coûts monétaires (FCFA ha <sup>-1</sup> )                               |            | 5020   | -3720  | -1770  |
| Revenu net (FCFA ha <sup>-1</sup> )   |            | -5790  | -11280 | -6460  |
| Taux marginal de rémunération (%)   |            | INFINI | -87    | -53    |
| <b>Témoin (T1)</b>  |            |        |        |        |
| Revenu brut-coûts monétaires (FCFA ha <sup>-1</sup> )                               |            | 5020   | 1300   | -470   |
| Revenu net (FCFA ha <sup>-1</sup> )   |            | 5790   | -5490  | -11950 |
| Taux marginal de rémunération (%)   |            | INFINI | -46    | -49    |

1. On ne tient pas compte des coûts fixes.

niébé à Liboré y était 3,5 fois plus élevé qu'à Maiguéro pendant ces deux périodes. C'est surtout à cause de cet écart de prix que les revenus nets par hectare pour les traitements (2 à 4 par rapport au traitement étaient seulement entre 2548 et 10 636 francs CFA à Maiguéro alors qu'ils étaient entre 21 827 et 70 232 francs CFA à Liboré (prix de janvier 1986). Il est dès lors évident que ces nouvelles technologies intéresseront plus les paysans de Liboré que ceux de Maiguéro si ces écarts de prix sont maintenus.

Il y a aussi les variations des prix de produits d'une année à l'autre. Surtout à cause du rendement nul en grains de niébé en 1985, le prix et les revenus de la vente de fanes de niébé étaient très importants. A Maiguéro, la vente de fanes de niébé

a constitué 60 à 70% des revenus bruts en utilisant les prix juste après la récolte et 70 à 79% des revenus bruts en utilisant les prix de janvier 1986. Cependant, en 1986 il y avait tant de fourrages préférés aux fanes de niébé que le marché pour ces fanes était négligeable à Maiguéro et les exploitants ont refusé de les récolter. Donc, la rentabilité d'une technologie basée sur la production en fanes dépend d'un marché stable et rémunérateur.

### **Autres observations économiques en 1985**

Deux autres considérations économiques se sont montrées importantes pour l'adoption des nou-

**Tableau 4. Calcul des revenus moyens et des indices économiques, basés sur les prix de janvier 1986, par traitement. EMR mil-niébé, Maignéro, 1985.**

| Données techniques et Coûts   | Traitement |       |       |       |
|---|------------|-------|-------|-------|
|   | T1         | T2    | T3    | T4    |
| <b>Données techniques</b>   |            |       |       |       |
| <b>Rendements</b>   |            |       |       |       |
| Mil (kg ha <sup>-1</sup> )  | 284        | 358   | 309   | 590   |
| Fanes de niébé (kg ha <sup>-1</sup> )   | 778        | 787   | 1069  | 1387  |
| Main-d'oeuvre familiale (HJE ha <sup>-1</sup> )                                     | 22.1       | 22.3  | 31.7  | 43.9  |
| <b>Coûts de production variables</b>  |            |       |       |       |
| Intrants (FCFA <sup>1</sup> ha <sup>-1</sup> )                                      | 2240       | 2560  | 6400  | 13900 |
| Main-d'oeuvre familiale (FCFA ha <sup>-1</sup> )                                    | 13260      | 13380 | 19020 | 26340 |
| Total (FCFA ha <sup>-1</sup> )  | 15500      | 15940 | 25420 | 40240 |
| <b>Coûts variables marginaux par rapport au</b>                                     |            |       |       |       |
| Traitement précédent (FCFA ha <sup>-1</sup> )                                       |            | 440   | 9480  | 14820 |
| Témoin (T1) (FCFA ha <sup>-1</sup> )  |            | 440   | 9920  | 24740 |
| <b>Calculs des revenus globaux</b>  |            |       |       |       |
| Revenu brut (FCFA ha <sup>-1</sup> )  | 41344      | 44368 | 53884 | 76720 |
| Revenu brut moins coûts monétaires (FCFA ha <sup>-1</sup> )                         | 39104      | 41808 | 47484 | 62820 |
| Revenu brut moins coûts monétaires<br>par jour de travail (FCFA HJE <sup>-1</sup> ) | 1769       | 1875  | 1498  | 1431  |
| Revenu net (FCFA ha <sup>-1</sup> )   | 25844      | 28428 | 28464 | 36480 |
| <b>Calcul des revenus marginaux par rapport au</b>                                  |            |       |       |       |
| Traitement précédent  |            |       |       |       |
| Revenu brut-coûts monétaires (FCFA ha <sup>-1</sup> )                               |            | 2704  | 5676  | 15336 |
| Revenu net (FCFA ha <sup>-1</sup> )   |            | 2584  | 36    | 8016  |
| Taux marginal de rémunération (%)   |            | 587   | 0     | 54    |
| <b>Témoin (T1)</b>  |            |       |       |       |
| Revenu brut-coûts monétaires (FCFA ha <sup>-1</sup> )                               |            | 2704  | 8380  | 23716 |
| Revenu net (FCFA ha <sup>-1</sup> )   |            |       |       |       |
| Taux marginal de rémunération (%)   |            | 587   | 26    | 43    |

1. On ne tient pas compte des coûts fixes.

velles technologies. D'abord il faut considérer l'incertitude des rendements, et les risques économiques que cette incertitude pose aux exploitants, surtout s'ils achètent des intrants. Deuxièmement, on doit considérer la structure d'approvisionnement des semences améliorées et les engrais et la disponibilité de l'argent en espèce ou du crédit agricole.

La plupart des analyses du comportement des exploitants paysans envers les risques économiques indique que leurs perceptions des risques influencent leur choix de cultures et de technologie (Abalu et Da Silva 1980, Anderson 1980, Binswanger et al. 1980, Lang et al. 1984). Donc, si même la recherche n'est pas sûre que la rentabilité d'une nouvelle

technologie soit supérieure à la technologie traditionnelle, il y a très peu de chance que les exploitants l'adoptent.

Enfin notons que toutes les recommandations qu'on peut faire suite à l'analyse de nos essais reposent sur l'hypothèse de l'existence d'un marché local des semences améliorées et des engrais. Il faut aussi considérer que la plupart des exploitants n'avait pas assez d'argent au début de la campagne de 1985 pour acheter les intrants agricoles à cause de la sécheresse de 1984. Puisqu'il n'existe pas d'institution de crédit accessible aux exploitants de Maignéro et de Kouka, il n'est pas du tout certain qu'ils auront régulièrement des moyens d'acheter des intrants.

**Tableau 5. Les prix de produits et les Revenus Bruts, par site, par marché, et par traitement. EMR mil-niébé, 1985.**

| Marché, Site, Produit           | Prix<br>(FCFA kg <sup>-1</sup> ) | Traitement |        |        |        |
|---------------------------------|----------------------------------|------------|--------|--------|--------|
|                                 |                                  | T1         | T2     | T3     | T4     |
| <b>Marché local (récolte) :</b> |                                  |            |        |        |        |
| Liboré                          |                                  |            |        |        |        |
| Mil, grains                     | 63                               | 16569      | 28413  | 18711  | 32004  |
| Niébé, fanes                    | 110                              | 51920      | 59510  | 103510 | 109010 |
| Total                           |                                  | 68489      | 87923  | 122221 | 141014 |
| Kouka                           |                                  |            |        |        |        |
| Mil, grains                     | 42                               | 9996       | 14868  | 12852  | 18984  |
| Niébé, fanes                    | 20                               | 1560       | 1320   | 3840   | 3280   |
| Total                           |                                  | 11556      | 16188  | 16692  | 22264  |
| Maiguéro                        |                                  |            |        |        |        |
| Mil, grains                     | 40                               | 11360      | 14320  | 12360  | 23600  |
| Niébé, fanes                    | 28                               | 21784      | 22036  | 29932  | 38836  |
| Total                           |                                  | 33144      | 36356  | 42292  | 62436  |
| <b>Marché local (Jan 86) :</b>  |                                  |            |        |        |        |
| Liboré                          |                                  |            |        |        |        |
| Mil, grains                     | 71                               | 18673      | 32021  | 21087  | 36068  |
| Niébé, fanes                    | 145                              | 68440      | 78445  | 136445 | 143695 |
| Total                           |                                  | 87113      | 110466 | 157532 | 179763 |
| Kouka                           |                                  |            |        |        |        |
| Mil, grains                     | 45                               | 10710      | 15930  | 13770  | 20340  |
| Niébé, fanes                    | 30                               | 2340       | 1980   | 5760   | 4920   |
| Total                           |                                  | 13050      | 17910  | 19530  | 25260  |
| Maiguéro                        |                                  |            |        |        |        |
| Mil, grains                     | 36                               | 10224      | 12888  | 11124  | 21240  |
| Niébé, fanes                    | 40                               | 31120      | 31480  | 42760  | 55480  |
| Total                           |                                  | 41344      | 44368  | 53884  | 76720  |
| <b>OPVN/SONARA :</b>            |                                  |            |        |        |        |
| Liboré                          |                                  |            |        |        |        |
| Mil, grains                     | 70                               | 18410      | 31570  | 20790  | 35560  |
| Niébé, fanes                    | 127.5                            | 60180      | 68978  | 119978 | 126353 |
| Total                           |                                  | 78590      | 100548 | 140768 | 161913 |
| Kouka                           |                                  |            |        |        |        |
| Mil, grains                     | 70                               | 16660      | 24780  | 21420  | 31640  |
| Niébé, fanes                    | 25                               | 1950       | 1650   | 4800   | 4100   |
| Total                           |                                  | 18610      | 26430  | 26220  | 35740  |
| Maiguéro                        |                                  |            |        |        |        |
| Mil, grains                     | 70                               | 19880      | 25060  | 21630  | 41300  |
| Niébé, fanes                    | 34                               | 26452      | 26758  | 36346  | 47158  |
| Total                           |                                  | 46332      | 51818  | 57976  | 88458  |

## Observations agro-écologiques en 1985

A part la pluviométrie, qui est discutée par ailleurs, la qualité des sols a fortement influencé les rende-

ments et donc la rentabilité des traitements dans le village de Maiguéro. A Maiguéro les rendements de mil étaient fortement liés (coefficients de corrélation par traitement de 66 à 84%) à la capacité d'échange cationique (CEC) qui est un des indicateurs principaux de la fertilité du sol. Il y avait aussi

une corrélation forte entre la CEC et les autres indicateurs de la fertilité du sol. Les observations de la CEC (exprimée en  $\text{meq } 100 \text{ g}^{-1}$ ) ont varié entre 1,4 et 2,9 à l'exception d'une observation à 4,2. Si on calcule les rendements et les revenus nets moyens pour les 11 exploitants (parmi les 23) pour lesquelles les observations de la CEC étaient de 2,0 ou moins, on décèle que les revenus nets pour les traitements 2, 3 et 4 sont tous inférieurs au revenu net du témoin (Tab. 6). Ces résultats indiquent que les sols avec très peu de CEC ne peuvent pas sup-

porter une haute densité de mil et de niébé même avec une application d'engrais commercial comprenant l'azote et le phosphore en dose moyenne. De tels problèmes du sol doivent être résolus avant de pratiquer une agriculture intensive.

## Conclusion

Il est évident que les différences significatives des rendements ne constituent pas une base suffisante

**Tableau 6. Calcul des revenus moyens et des indices économiques, pour les champs dont la CEC est moins que 2,0 basé sur les prix de janvier 1986. EMR mil-niébé, Maiguéro.**

| Données techniques et Coûts   | Traitement |       |       |       |
|---|------------|-------|-------|-------|
|   | T1         | T2    | T3    | T4    |
| <b>Données techniques</b>   |            |       |       |       |
| <b>Rendements</b>   |            |       |       |       |
| Mil ( $\text{kg ha}^{-1}$ )   | 194        | 209   | 139   | 330   |
| Fanes de niébé ( $\text{kg ha}^{-1}$ )  | 784        | 776   | 884   | 1219  |
| Main-d'oeuvre familiale ( $\text{HJE ha}^{-1}$ )                                  | 22.1       | 22.3  | 31.7  | 43.9  |
| <b>Coûts de production variables</b>  |            |       |       |       |
| Intrants ( $\text{FCFA}^1 \text{ ha}^{-1}$ )                                      | 2240       | 2560  | 6400  | 13900 |
| Main-d'oeuvre familiale ( $\text{FCFA ha}^{-1}$ )                                 | 13260      | 13380 | 19020 | 26340 |
| Total ( $\text{FCFA ha}^{-1}$ )   | 15500      | 15940 | 25420 | 40240 |
| <b>Coûts variables marginaux par rapport au</b>                                   |            |       |       |       |
| Traitement précédent ( $\text{FCFA ha}^{-1}$ )                                    |            | 440   | 9480  | 14820 |
| Témoin (T1) ( $\text{FCFA ha}^{-1}$ )   |            | 440   | 9920  | 24740 |
| <b>Calculs des revenus globaux</b>  |            |       |       |       |
| Revenu brut ( $\text{FCFA ha}^{-1}$ )   | 38344      | 38564 | 40364 | 60640 |
| Revenu brut moins coûts monétaires ( $\text{FCFA ha}^{-1}$ )                      | 36104      | 36004 | 33964 | 46740 |
| Revenu brut moins coûts monétaires par jour de travail ( $\text{FCFA HJE}^{-1}$ ) | 1634       | 1615  | 1071  | 1065  |
| Revenu net ( $\text{FCFA ha}^{-1}$ )  | 22844      | 22624 | 14944 | 20400 |
| <b>Calcul des revenus marginaux par rapport au</b>                                |            |       |       |       |
| Traitement précédent  |            |       |       |       |
| Revenu brut-coûts monétaires ( $\text{FCFA ha}^{-1}$ )                            |            | -100  | -2040 | 12776 |
| Revenu net ( $\text{FCFA ha}^{-1}$ )  |            | -220  | -7680 | 5654  |
| Taux marginal de rémunération (%)   |            | -50   | -81   | 37    |
| <b>Témoin (T1)</b>  |            |       |       |       |
| Revenu brut-coûts monétaires ( $\text{FCFA ha}^{-1}$ )                            |            | -100  | -2140 | 10636 |
| Revenu net ( $\text{FCFA ha}^{-1}$ )  |            | -220  | -7900 | -2444 |
| Taux marginal de rémunération (%)   |            | -50   | -80   | -10   |

1. On ne tient pas compte des coûts fixes.

pour recommander les nouvelles technologies. Les résultats de l'essai des nouvelles technologies que l'INRAN a installé en 1985 dans trois régions différentes du Niger ont montré une supériorité de rendements significative pour une technologie qui combine une variété améliorée, une densité élevée et l'application d'engrais (Traitement 1). Cependant, dans le village de Kouka cette supériorité de rendements n'était pas suffisante pour assurer la rentabilité de la nouvelle technologie. Même si on ignore le coût de la main-d'oeuvre en ne considérant que le revenu brut moins les coûts monétaires, le traitement 4 était moins rentable que le traitement 1 à Kouka. L'adoption des nouvelles technologies ne se fera que si elles s'avèrent rentables économiquement pour les exploitants. Une évaluation économique de la rentabilité d'une nouvelle technologie est donc indispensable avant sa recommandation en milieu paysan.

Plusieurs facteurs économiques et deux facteurs agro-écologiques ont clairement influencé la rentabilité des traitements. Parmi les facteurs économiques, l'influence des prix différents des produits explique largement les différences de rentabilité des traitements entre les trois sites. Le stockage des produits et leur commercialisation quelques mois après la récolte ou l'existence d'un marché officiel avec des prix fixés peuvent rendre des traitements rentables alors qu'ils ne le sont pas autrement. La valorisation de la main-d'oeuvre peut aussi influencer la rentabilité des traitements évalués; ce facteur doit de plus en plus être considéré dans l'évaluation de la rentabilité des nouvelles technologies afin de valoriser le travail familial et pouvoir écarter les thèmes pouvant constituer des goulots d'étranglement aux périodes de pointe de la campagne (semis, sarclages). A cause des variations élevées des rendements, il faut aussi considérer les risques qui se posent aux exploitants, surtout s'ils doivent acheter des intrants. Parmi les facteurs agro-écologiques, la pluviométrie et la qualité du sol ont parfois influencé fortement la rentabilité des nouvelles technologies.

Il apparaît que l'adoption potentielle des nouvelles technologies par les exploitants nigériens est une question complexe. Afin de résoudre cette question, il faut évaluer les nouvelles technologies en milieu paysan où il est possible de déceler les problèmes qui peuvent freiner leur adoption. L'INRAN à travers le DECOR vient d'entamer l'évaluation des facteurs socio-économiques qui peuvent influencer l'adoption des nouvelles tech-

nologies. Cependant, cette première année d'expérience a prouvé qu'il est aussi important de collecter et évaluer des informations concernant les marchés des intrants et des produits ainsi que des informations concernant la pluviométrie et les sols. Il faut considérer, par ailleurs, les différences et les variations des résultats économiques et agronomiques selon les régions, au sein de chaque année, et d'une année à l'autre, et les risques que ces variations posent aux exploitants.

## Bibliographie

- Abalu, G.O.I., et Da Silva, B.** 1980. Socioeconomic analysis of existing farming systems and practices in northern Nigeria, Pages 3-10, *in* Proceedings of the International Workshop on Socioeconomic Constraints to Development of Semi-Arid Tropical Agriculture, 19-23 fév 1979, ICRI-SAT Center, India, Patancheru, A.P. 502 324. Inde : International Crops Research Institute for the Semi-Arid Tropics.
- Anderson, J. R.** 1980. Nature and significance of risk in the exploitation of new technology. Pages 297-302 *in* Proceedings of the International Workshop on Socioeconomic Constraints to Development of Semi-Arid Tropical Agriculture, 19-23 fév 1979, ICRI-SAT Center, India, Patancheru, A.P. 502 324, Inde : International Crops Research Institute for the Semi-Arid Tropics.
- Binswanger, H. P., Jodha, N.S. et Barah, B.C.** 1980. The nature and significance of risk in the semi-arid tropics. Pages 303-316 *in* Proceedings of the International Workshop on Socioeconomic Constraints to Development of Semi-Arid Tropical Agriculture, 19-23 fév. 1979, ICRI-SAT Center, India, Patancheru, A.P. 502 324, Inde : International Crops Research Institute for the Semi-Arid Tropics.
- Feder, G., Just, R. et Silberman, D.** 1981. Adoption of agricultural innovations in developing countries: a survey. World Bank Staff Working Paper n°. 444. Banque Mondiale. Washington. D.C., Etats-Unis.
- Griliches, Z.** 1957. Hybrid corn: an exploration in the economics of technological change. *Econometrica* 25:501-522.

**Lang, M.G., Roth, M. et Preckel, P.** 1984. Risk perception and risk management by farmers in Burkina Faso. International programs in agriculture, Purdue University, West Lafayette, Indiana, Etats-Unis.

**Samba, L.A., Deuson, R., Maliki, K., Numa, G., Reddy, K.C. et Swinton, S.** 1986. Evaluation des essais en milieu réel sur les cultures associées mil-niébé : résultats de la campagne de 1985. Document n°. 14F. Niamey, Niger : Institut National de Recherches Agronomiques du Niger.

# Economic Effects of Soil- and Water-Management Technologies: Preliminary Results from a Case Study Analysis in Mali

J.C. Day and P. Aillery<sup>1</sup>

## Abstract

*For Sudano-Sahelian farmers to adopt recommended soil- and water-management practices, technologies must be appropriate to the specific site conditions found in the farm setting and be consistent with the farmers' objectives and available resources. A whole-farm modeling approach to this problem is described and preliminary estimates of the ability of representative low-resource farmers in Mali to pay for increased soil-moisture conservation are presented. By increasing rainfall infiltration rates from 40 to 60%, farmers can double or even quadruple their disposable income, depending on rainfall. Income can be increased by another 50%, if infiltration rates are raised to 80%.*

## Résumé

**Effets économiques des techniques d'aménagement des sols et de l'eau—résultats préliminaires de l'analyse d'une étude de cas au Mali :** *Les technologies doivent être adaptées aux conditions spécifiques du terrain en milieu paysan, aux objectifs des agriculteurs et aux ressources disponibles pour que les paysans de la zone soudano-sahélienne soient capables d'adopter les mesures de conservation recommandées pour les sols et pour l'eau. Le problème est décrit par l'approche d'un modèle basé sur une exploitation agricole réelle représentative au Mali et par la présentation d'évaluations préliminaires portant sur la capacité qu'auraient des agriculteurs maliens disposant de ressources précaires de couvrir les frais inhérents à la conservation de l'eau dans le sol. En augmentant le taux d'infiltration de pluie de 40 à 60%, les paysans peuvent doubler et même quadrupler leur revenu disponible selon l'importance des précipitations. Ce revenu peut être encore augmenté de 50% dans le cas où les taux d'infiltration seraient portés à 80%.*

## Introduction

Improved soil fertility and moisture-management practices are probably the two most important factors in increasing agricultural productivity in the Sudano-Sahelian zone of Africa. However, for farmers to adopt recommended soil- and water-management practices, technologies must be adapted to the specific physical site conditions

found on the farm. Improved technologies must also be consistent with the farmer's objectives and available resources. In this paper, the ability of a typical dryland farmer in western Mali to pay for increased soil moisture through improved rainfall infiltration is examined in the context of his whole farm operation.

The paper begins with an overview statement summarizing the physical characteristics of rainfed

---

1. Economists, Economic Research Service, USDA, Washington D.C., USA.

ICRISAT (International Crops Research Institute for the Semi-Arid Tropics) 1989. Soil, Crop, and Water Management Systems for Rainfed Agriculture in the Sudano-Sahelian Zone: proceedings of an International Workshop, 7-11 Jan 1987. ICRISAT Sahelian Center, Niamey, Niger. Patancheru, A.P. 502 324, India: ICRISAT.



agriculture in Mali. Next, a brief description of some appropriate emerging technology is provided. Finally, initial findings of a general case study dealing with the economics of soil-moisture conservation are presented.

### General Background: Dryland Farming in Mali

As in other countries of the Sudano-Sahelian zone, rainfall is the primary determinant of crop production in Mali. About 60% of the country receives less than 200 mm per year (Fig. 1). Rainfall in the

remaining portion is highly variable, both in terms of length of the rainy season (Fig. 2) and amount of rainfall. Given that 90% of Mali's arable land is currently farmed under strictly rainfed conditions, there is considerable uncertainty regarding agricultural production, as well as regarding investments in agricultural improvements, throughout the country.

Exacerbating the difficulties of dryland farming in Mali is the generally poor quality of soil resources. Crusting and sealing of soil is a widespread problem. Moisture infiltration is generally poor due to the combination of high rainfall intensity and poor absorptive capacity of the soils.

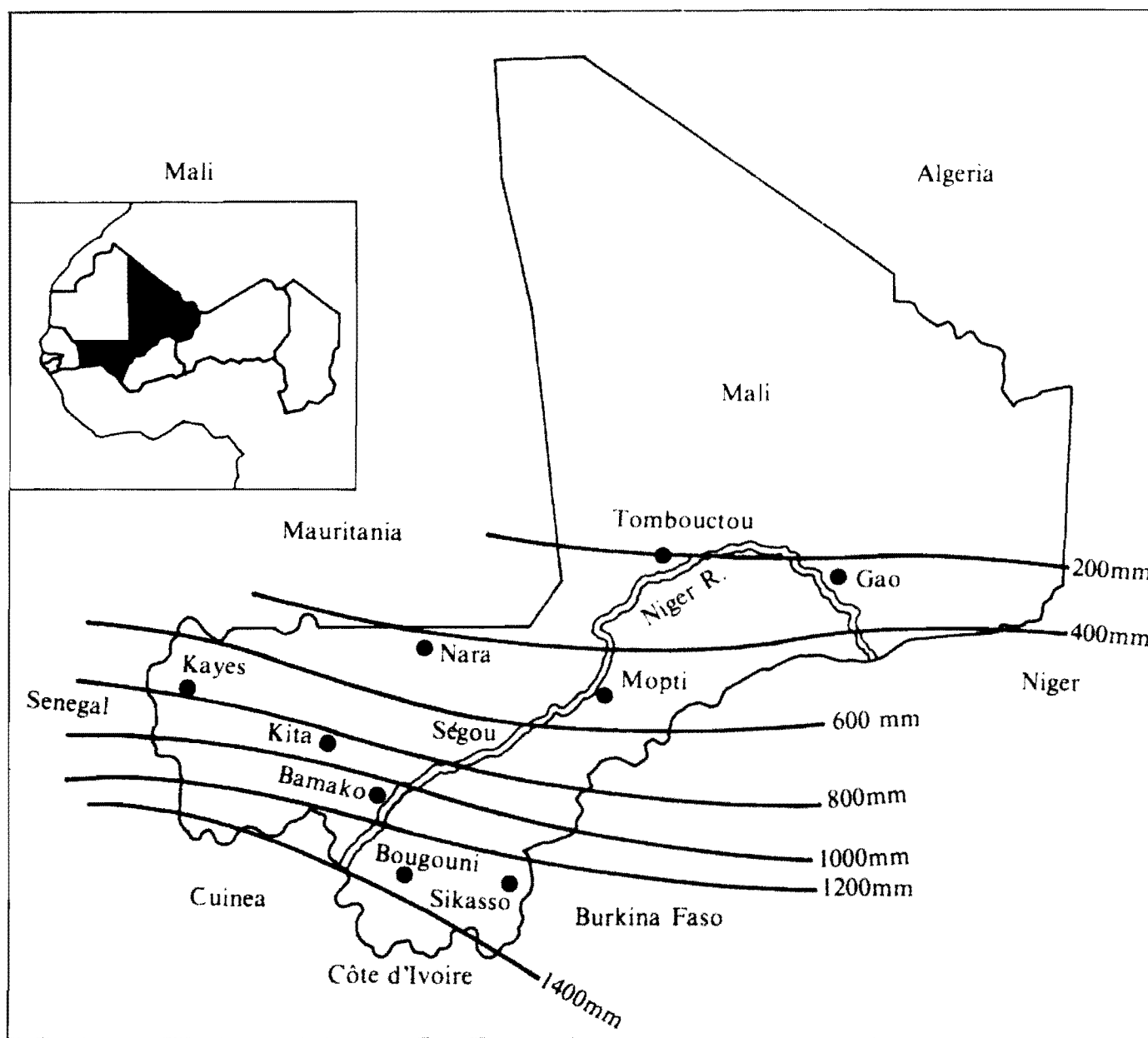

Figure 1. Rainfall isohyts in Mali (Source: IFDC 1976; TAMS 1983).

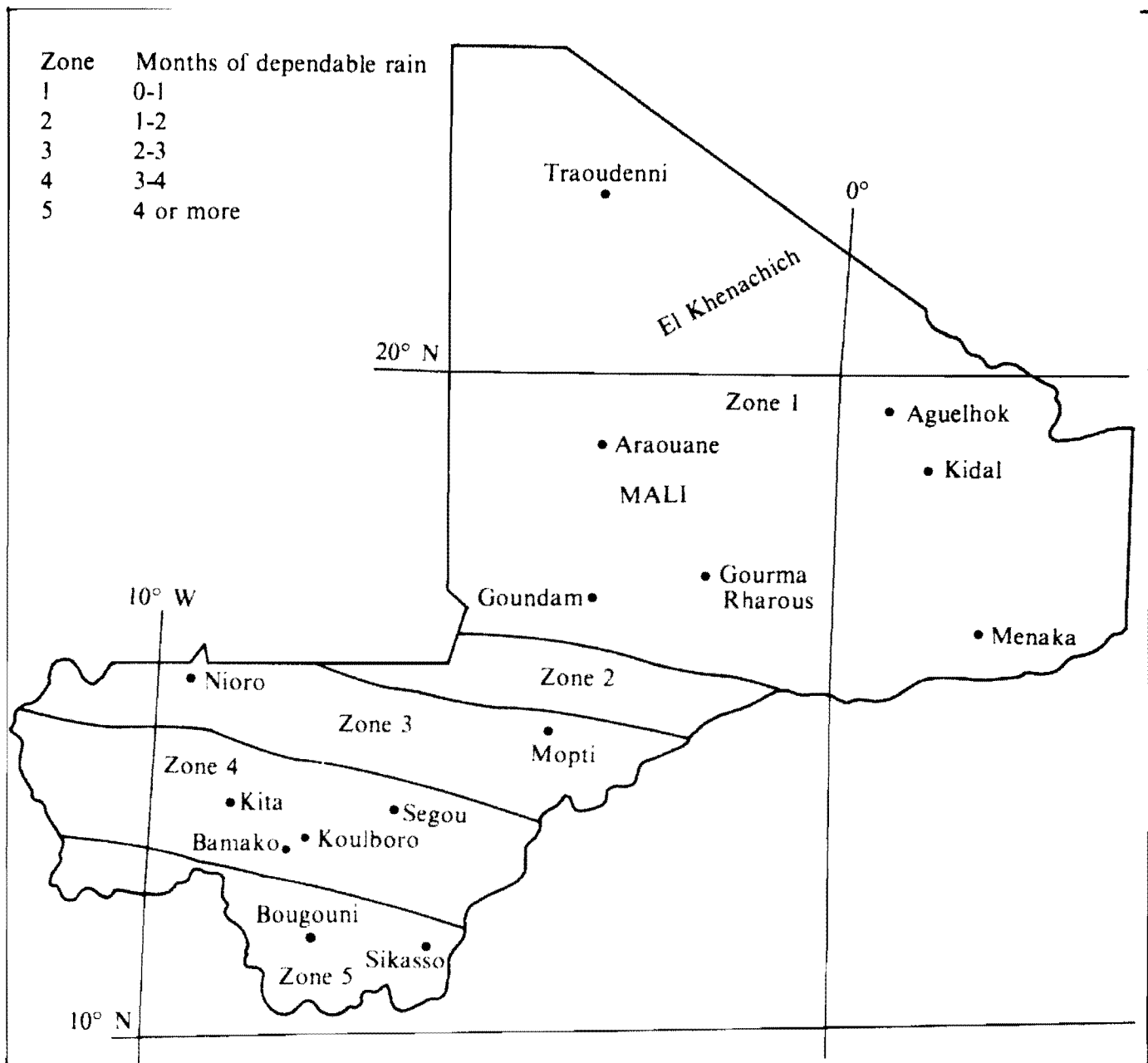

Figure 2. Zones showing the length of the dependable rainy season in Mali (Source: Hargreaves and Samini 1986).

Moreover, the natural fertility of soils is low; organic matter is lacking, and soils are generally deficient in nitrogen, phosphorus, and sulfur. Clay soils tend to be neutral to alkaline, slowly permeable, susceptible to flooding and difficult to manage with traditional tillage practices. Sandy soils tend to be acidic. Gravelly and stoney soils are generally infertile due to intense leaching. Aluminium and manganese toxicity may also exist in Mali soils (Jaynes et al. 1988, TAMS 1983).

Mali's land resources have been classified into seven major categories: sand dunes 65%, plains

10.4%, laterite 10.2%, waterlogged plains and depressions 1.6%, flooded land 2.1%, rocky lands 3.6%, and special land types 2.8% of the total land surface (Table 1).

Table 2 indicates the distribution of land use in Mali, and shows that 85% of the cultivated land is planted with food grains. The primary cash crops, groundnuts and cotton, account for approximately 15% of the cultivated land. Irrigation, primarily rice, accounts for approximately 10% of the arable land.

From 1966 to 1983, the total food production

**Table 1. Land classification in Mali, 1983<sup>1</sup>.**

| Soil type   | Area (km <sup>2</sup> ) | Percentage |
|---|-------------------------|------------|
| Sand dunes  | 795 689                 | 65.2       |
| Plains  |                         |            |
| Clay  | 12 656                  | 1.1        |
| Silt-loam   | 92 140                  | 7.5        |
| Loam  | 21 410                  | 1.8        |
| Laterite  | 123 854                 | 10.2       |
| Plains/depressions  | 19 657                  | 1.6        |
| Waterlogged more than half the year   |                         |            |
| Flooded lands   | 26 203                  | 2.1        |
| Rocky lands   | 43 912                  | 3.6        |
| Special land types  | 34 259                  | 2.8        |
| Inclusion areas—areas too small to be accounted for separately at the 1:500 000 scale | 50 220                  | 4.1        |
| Total   | 1 220 000               | 100.0      |

1. Source: TAMS 1983.

declined at a rate of 0.5% per year (Shapouri et al. 1986). With a projected annual population growth rate of 3%, resulting in a doubling of the population in 25 years, the ability of Malian agriculture to feed its population in future is in question (Fig. 3).

Declining land fertility and productivity at both the intensive and extensive margins leading to resource degradation (Lallement 1986), coupled

**Table 2. Areas planted to various crops, Mali 1984.<sup>1</sup>**

| Crop                                      | Area (ha) |
|---|-----------|
| Pearl millet/sorghum, other coarse grains | 1 655 000 |
| Rice                                      | 170 000   |
| Cotton                                    | 128 000   |
| Maize                                     | 50 000    |
| Groundnut                                 | 50 000    |
| Total area cropped                        | 2 053 000 |

1. Source: FAO 1983 and RTI 1984.



Figure 3. Per capita food production in Mali, 1966-1983. (Source: Shapouri et al. 1986).

with the limited potential for major productivity increase or area expansion of irrigation (Eicher 1986), suggest that measures must be adopted at the farm level to enable low resource dryland farmers to improve management of available land and water resources (Stewart et al. 1986).

### Technological Options for Soil/Water Management

A number of recent studies have demonstrated the potential of practices such as animal traction for tillage operations, fertilization, tied ridging, and mulching to improve crop yields in dryland environments (Delgado and McIntire 1982, CRED 1976, Nicou and Charreau 1985, Sanders et al. 1985).

The studies point out that the new technologies may have certain negative effects that may restrict their adoption, e.g., animal-traction plowing may accelerate erosion and may conflict with labor requirements for planting; fertilization may not be effective without adequate water; tied ridges may increase labor requirements and are highly dependent on soil type for success.

It is also shown that interactive effects of these technologies may be substantially greater than their individual effects, e.g., the combination of tied ridges and fertilization (Roth and Sanders 1986, Sanders et al. 1985, Lallement 1986). However, the farmer's learning curve for "packages" of new technologies may be a significant factor in explaining slow widespread adoption.

Although a number of research projects dealing with improved farming practices have been conducted in Mali, little attention has been given to generating the economic information necessary for technology-feasibility studies. As a result, little is known about the costs and returns associated with new soil-water-management practices and equipment, specific crop-response relationships, and farm resource use adjustments that accompany technology adoption.

In the Mali context, therefore, the important research objectives are (1) to identify existing practices and/or new technologies that will fit the soil, rainfall, and other resource conditions of the dryland Mali farmer, and (2) to estimate technology cost ranges that the farmer may be able to absorb.

For improved soil- and water-management practices to be widely adopted, they must be compatible with the particular farm-level setting in which they are to operate (Matlon and Spencer 1984). From a technical perspective, management practices must be suitable to the particular soils, rainfall patterns, and biological conditions in which the farmer must work. Moreover, these practices must be effective in helping the farmer to increase his income and must satisfy other objectives given the available capital and labor resources.

Whole-farm modeling is widely recommended as a methodology for small-farm technology assessments (Ghodake and Hardaker 1981, Nagy et al. 1986). As one aspect of the United States Department of Agriculture (USDA)/United States Agency for International Development (USAID)/Technology for Soil Moisture Management (TSMM) project, a system of representative farm models are to be developed that give special consideration to soils, rainfall, and soil-moisture balance relationships that are so critical to improved dryland agricultural productivity.

Under the first phase of this activity, a farm programming model was designed, based on a typical farming operation in the Kita region of western Mali. This model has a number of features that should make it a useful prototype for various analyses in Mali as well as in other dryland production areas in the Sahel. The features of this model include crop technology options such as alternative planting schedules, fertilizer levels, intercropping, crop-residue management, and soil-moisture management practices. The water-balance component of the model incorporates data on rainfall, infiltration efficiency, soil moisture, and evapotranspiration (ET) requirements during crop growth stages, and generates yield reductions associated with moisture stress. Under subsequent phases of the project, risk is to be incorporated as an explicit component in the model, and the model data base is to be expanded and improved. Eventually, the representative farm models are to be aggregated for use in regional analyses.

In this analysis, we utilize our current representative Mali farm model to generate first approximations of the potential farm income changes with various levels of soil-moisture conservation.

## Infiltration, Evapotranspiration, and Crop Response

**Table 3. Representative farm (traditional)<sup>1</sup>.**

|                   |   |
|-------------------|---|
| Location:         | Kita region, Western Mali.                                  |
| Agroclimatic zone | : Sudano-Guinean  |
| Rainfall zone     | : 800-1000 mm   |
| Soils             | : Alfisols (32% of cultivable lands in Mali)                |
| Farm size         | : 8 ha  |
| Family size       | : 12 members  |
| Family labor pool | : 5 adults (FTE)  |
| Crops             | : Sorghum, pearl millet, groundnut, maize, rice, vegetables |
| Technology        | : Traditional, with no modern inputs                        |
| Prices            | : Official/market   |
| Home consumption  | : Minimum nutritional requirements for family.              |

1. Source : Flemming 1981.

### The Representative Mali Farm

Drawing upon farm-level surveys conducted in 9 villages and 55 farms in the Kita region during 1978 and 1979, the basic characteristics of traditional farms in the area were identified (Table 3).

### Rainfall Pattern

Data obtained from the Kita weather station was used as the basis for rainfall levels, probabilities, number of events per month, and other climatic information (FAO 1983, Hargreaves and Samini 1986). The rainfall patterns at 50 and 75% (approximately one standard deviation below the mean) are shown in Table 4.

Base infiltration estimates were generated from rainfall-runoff relationships reflecting soil characteristics, ground cover, and rainfall intensities (USDA/SCS 1986). Crop ET during each phase of crop growth was estimated using ET for a green cover crop and adjustment coefficients applicable to the representative farm crops (Doorenbos and Pruet 1975, Doorenbos and Kassam 1979). Crop yield response to moisture stress during growth stages was estimated using generalized crop-yield relationships developed by FAO through research literature review, empirical studies, and various water/crop-yield models (Doorenbos and Kassam 1979).

The relationship between ET and soil moisture which leads to soil-moisture deficits by crop growth stages, and hence crop yield reductions, is illustrated in Table 5 for one crop (sorghum/pearl millet), one alternative planting period (15 May-1 Jun), and one rainfall pattern (the 0.50 probability rainfall). The complete analysis involves one relationship for each combination of five crops, four planting periods, three infiltration efficiencies, and two rainfall scenarios.

### The Analysis

The analysis involves, first, estimating crop yields that might be expected with three alternative levels of infiltration efficiency and two levels of rainfall for each of several alternative planting dates. Infiltration levels chosen reflect low, medium, and high

**Table 4. Rainfall (mm) at Kita Station, during the cropping season, Mali.**

| 4-week period | Weeks | Probability Levels (%) |     |      |      |      | Mean |
|---------------|-------|------------------------|-----|------|------|------|------|
|               |       | 90                     | 75  | 50   | 25   | 10   |      |
| 23 Apr-20 May | 17-20 | 4                      | 9   | 21   | 39   | 62   | 27   |
| 21 May-17 Jun | 21-24 | 48                     | 75  | 104  | 135  | 162  | 104  |
| 18 Jun-15 Jul | 25-28 | 98                     | 135 | 175  | 216  | 253  | 175  |
| 16 Jul-12 Aug | 29-32 | 181                    | 224 | 271  | 320  | 364  | 271  |
| 13 Aug-9 Sep  | 33-36 | 198                    | 237 | 287  | 344  | 401  | 294  |
| 10 Sep-7 Oct  | 37-40 | 74                     | 103 | 145  | 195  | 250  | 154  |
| 8 Oct-4 Nov   | 41-44 | 10                     | 20  | 40   | 68   | 103  | 49   |
| Total         |       | 831                    | 941 | 1074 | 1219 | 1360 | 1080 |

1. Source: ICRISAT 1984.

**Table 5. Evapotranspiration requirements (ETm) and soil moisture by time periods in sorghum/pearl millet growth cycle, Kita area, Mali (40% rainfall infiltration rate).**

| Dates        | Growth stages   | ETm (mm) | Soil moisture (mm) |
|--------------|-----------------|----------|--------------------|
| 1 Jan-15 May | -               | 0        | 0                  |
| 15 May-1 Jun | -               | 0        | 15.0               |
| 1 Jun-15 Jun | -               | 0        | 20.0               |
| 15 Jun-1 Jul | Establishment   | 31.5     | 26.0               |
| 1 Jul-15 Jul | Vegetative      | 78.8     | 28.7               |
| 15 Jul-1 Aug | Vegetative      | 78.8     | 43.1               |
| 1 Aug-15 Aug | Flowering       | 105.0    | 39.7               |
| 15 Aug-1 Sep | Flowering       | 105.0    | 41.2               |
| 1 Sep-15 Sep | Yield formation | 78.8     | 43.7               |
| 15 Sep-1 Oct | Yield formation | 78.8     | 19.0               |
| 1 Oct-15 Oct | Yield formation | 78.8     | 17.5               |
| 15 Oct-1 Nov | Ripening        | 52.5     | 3.3                |
| 1 Nov-15 Nov | -               | 0        | 0                  |
| 15 Nov-1 Dec | -               | 0        | 0                  |
| 1 Dec-15 Dec | -               | 0        | 0                  |
| Total        |                 | 688.0    | 297.2              |

levels of efficiency (i.e., approximately 40, 60, and 80%). Then, using the whole-farm modeling technique, the optimal production plan associated with each infiltration rate and rainfall scenario was identified.

Information generated from each solution includes: crop production and sales, home consumption of food crops, resource use (land, labor, material inputs, capital), and planting schedules selected in response to the rainfall soil-moisture and plant-ET requirements. Disposable income after production expenses (excluding those for the soil-moisture conservation technology itself and any associated labor) was estimated.

Disposable income, less returns to management and other household costs represent an estimate of the upper bound on annual costs the farmer could afford to pay to improve moisture infiltration. By comparing the results with each rainfall/moisture infiltration scenario, we can assess the differing farm-level effects of the three levels of soil-moisture conservation. In this analysis, however, the possible price-decreasing effects of yield-increasing soil-moisture technology adopted by a large number of farmers was not considered. Utilizing the 50 and 75% rainfall probability estimates provides a picture of the rainfall patterns and optimal farm responses 5 years out of 10 vs 7 years out of 10.

## Conclusions

The principal results of the analysis are shown in Table 6 and Figure 4.

The analysis indicates that if farmers could increase their rainfall infiltration rate from, say, 40 to 60%, disposable income would be expected to rise by about 125 000 Mali Francs (MF), i.e., about U.S. \$278 based on the 1979 currency exchange

**Table 6. Infiltration efficiency, soil moisture level, and farm disposable income, by 0.5 and 0.75 rainfall probabilities, Kita representative farm, Mali, 1979.**

| Infiltration efficiency percentage | Soil moisture (mm) |                   | Disposable income <sup>1</sup> 1000 MF |                   |
|------------------------------------|--------------------|-------------------|--|-------------------|
|                                    | 0.5 <sup>2</sup>   | 0.75 <sup>2</sup> | 0.5 <sup>2</sup>                       | 0.75 <sup>2</sup> |
| 0.40                               | 380                | 297               | 70                                     | 27                |
| 0.60                               | 580                | 455               | 198                                    | 149               |
| 0.80                               | 784                | 612               | 296                                    | 246               |

1. Disposable income is defined as net income level associated with the optimal farm management plan, prior to deduction of the cost of soil-moisture conservation returns to management and miscellaneous household expenses.

2. Rainfall probabilities.

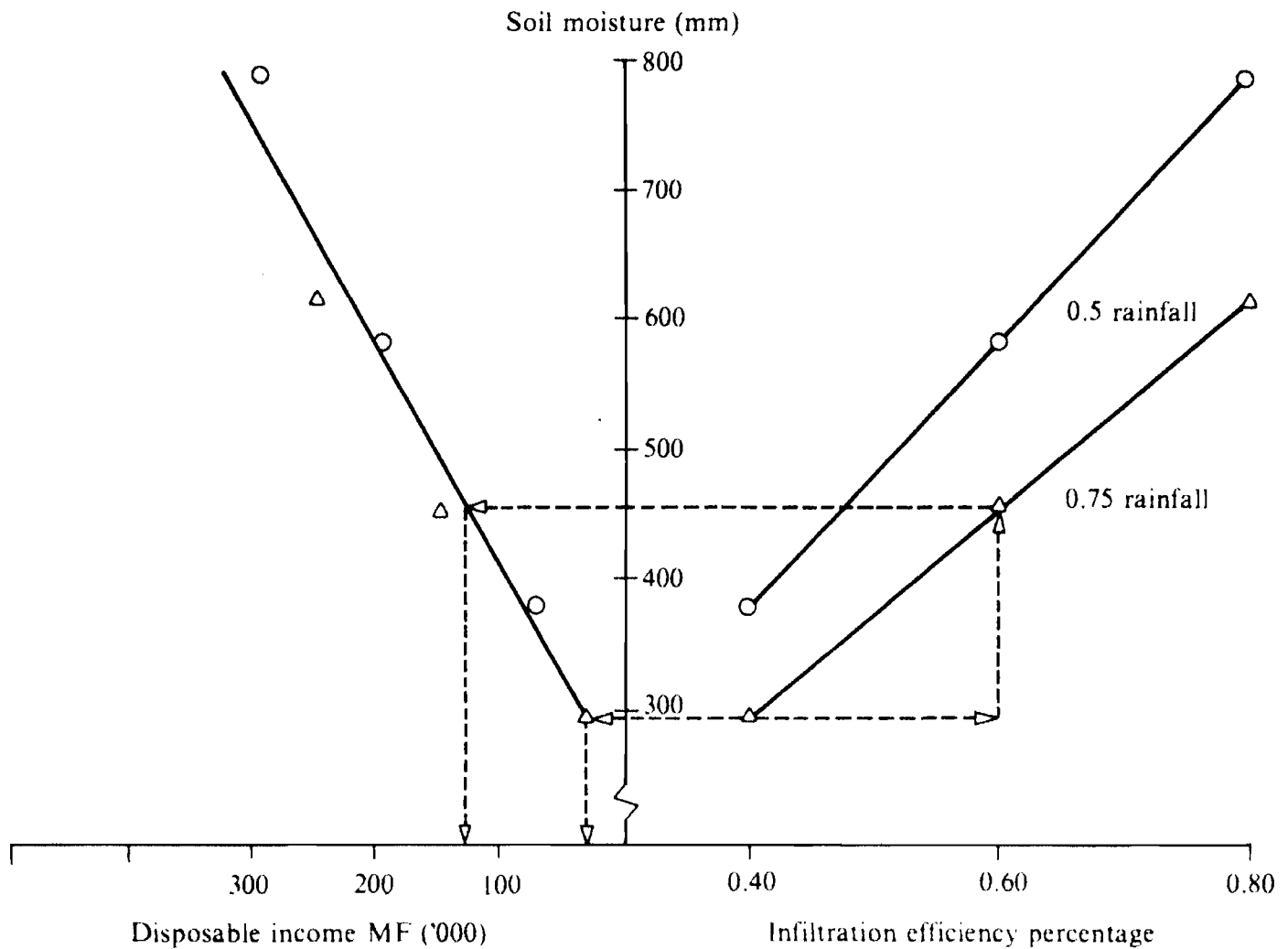

**Figure 4. Disposable income by infiltration efficiency, Kita representative farm.**

rate. Increasing efficiency from 60 to 80% would result in an additional income gain of slightly less than 100 000 MF.

If one assumes, for example, that 10% of total disposable income is necessary to cover the needed returns for management, then the amount of annual disposable income available for soil-moisture conservation technology expenses (capital, interest on loans, operation, maintenance, and repairs) is nearly 90 000-100 000 MF, i.e., the average gain in disposable income associated with improving infiltration from 0.4 to 0.6 and 0.6 to 0.8. When developing and distributing soil-moisture management equipment, the research and development community and the credit institutions must consider these figures as a first approximation of the on-farm cost range.

Figure 4 suggests that during the poor rainfall years, improvements in soil-moisture efficiency

can increase the amount of water available for plant uptake and in effect, move the farmer to equivalent soil moisture and income levels as those obtainable during the normal rainfall years. Tied ridges, bunding, small catchment basins, tillage practices that increase rainfall infiltration, and mulching are some of the techniques that offer the potential to achieve improved moisture conservation in this situation.

## References

**CRED** (Center for Research on Economic Development) 1976. *Mali Agricultural Sector Assessment*, University of Michigan. Ann Arbor, Michigan, USA: CRED.

- Delgado C., and McIntire, J.** 1982. Constraints on oxen cultivation in the Sahel. *American Journal of Agricultural Economics* 64: 188-196.
- Doorenbos, J., and Kassam, A.** 1979. Yield response to water. *FAO Irrigation and Drainage Paper no. 33*. Rome, Italy: FAO.
- Doorenbos, J., and Pruitt, W.O.** 1975. Guidelines for predicting crop water requirements. *FAO Irrigation and Drainage Paper no. 24*. Rome, Italy: FAO.
- Eicher, C.** 1986. Food security research priorities in Sub-Saharan Africa. Presented at the International Drought Symposium, 19-23 May 1986, Kenyatta Conference Centre, Nairobi, Kenya.
- FAO.** 1983. 1982 FAO Production Yearbook, Vol. 36. Rome, Italy: FAO.
- Flemming, A.** 1981. Agricultural productivity and the use of labor in alternative enterprises in the circle of Kita, Mali. M. Sc. thesis, Purdue University, West Lafayette, Indiana, USA.
- Ghodake, R., and Hardaker, J.** 1981. Whole-farm modelling for assessment of dryland technology. Economics Program Progress Report no. 29. Patancheru, A.P. 502 324, India: International Crops Research Institute for the Semi-Arid Tropics. (Limited distribution.)
- Hargreaves, G., and Samini, F.** 1986. Rainfall and water requirements manual for Mali. Utah, USA: Utah State University, International Irrigation Center.
- ICRISAT (International Crops Research Institute for the Semi-Arid Tropics).** 1984. Agroclimatology of West Africa: Mali. Information Bulletin no. 19. Patancheru, A.P. 502 324, India: ICRISAT.
- IFDC (International Fertilizer Development Center).** 1976. West Africa Fertilizer Study. Vol 3. Mali. Florence, Alabama, USA: IFDC.
- Jaynes, T., Day, J., and Dregne, H.** 1988. Technological change and agricultural productivity in dryland areas of the Sahel. Washington, D.C., USA: United States Department of Agriculture, Economic Research Service.
- Lallement, D.** 1986. Prospects for rainfed agriculture in arid and semi-arid areas of West Africa. Sixth Agricultural Sector Symposium, Development of rainfed agriculture under arid and semi-arid conditions. Washington, D.C., USA: World Bank.
- Matlon, P., and Spencer, D.** 1984. Increasing food production in Sub-Saharan Africa: environmental problems and inadequate technological solutions. *American Journal of Agricultural Economics* 66: 671-676.
- Nagy, J., Ames, L., and Ohm, H.** 1986. Technology evaluation, policy change and farmer adoption in Burkina Faso. Presented at the Farming Systems Research Symposium, Oct 1986, Manhattan, Kansas, USA.
- Nicou, R., and Charreau, C.** 1985. Soil tillage and water conservation in semi-arid West Africa. Pages 9-11 *in* Appropriate technologies for farmers in semi-arid West Africa. West Lafayette, Indiana, USA: Purdue University.
- Roth, M., and Sanders, J.** 1986. Economic evaluation of selected agricultural technologies with implications for development strategies in Burkina Faso. Presented at the Farming Systems Research Symposium, Oct 1986, Manhattan, Kansas, USA.
- RTI (Royal Tropical Institute).** 1984. Food strategies in four African countries. Amsterdam, Netherlands: RTI.
- Sanders, J., Nagy, J., and Shapiro, B.** 1985. Developing and evaluating new agricultural technology for the Sahel: case study in Burkina Faso. West Lafayette, Indiana, USA: Purdue University.
- Shapouri, S., Dommen, A., and Rosen, S.** 1986. Food aid and the African food crisis. Foreign Agricultural Research Report no. 221. Washington, D.C., USA: US Department of Agriculture.
- Stewart, R., Bertrand, A., Papendick, R., Steiner, J., Meyer, R., and Day, J.** 1986. Improving and sustaining productivity of dryland areas. Washington, D.C., USA: US Department of Agriculture.
- TAMS (Tippetts-Abbott-McCarthy-Stratton).** 1983. Mali land and water resources. New York, USA: TAMS.
- USDA (United States Department of Agriculture).** 1986. Hydrology for small watersheds. Technical Release f5. Washington, D.C., USA: USDA.





# Recommandations

Les recommandations suivantes ont été faites par les divers groupes de travail.

## **Groupe de travail sur les contraintes agroécologiques et systèmes de production**

1. Pour un développement futur de l'agriculture dans la zone soudano-sahélienne et pour une assistance aux institutions de recherche et de développement, toutes les publications disponibles sur les systèmes de production, le climat et les sols des différentes régions de la zone soudano-sahélienne doivent être rassemblées et fichées.
2. La zone soudano-sahélienne ne peut être considérée comme une zone homogène. La priorité doit être donnée à l'élaboration de cartes des systèmes culturels tels que la culture pure du mil, du sorgho et leurs associations.
3. Des synthèses sur les renseignements disponibles concernant le sol et le climat doivent faire ressortir l'utilité des analyses de risque et leur prise en compte.
4. Des études systématiques sur le bilan hydrique, la croissance et les rendements permettront une utilisation optimale des ressources du sol et du climat.
5. Les recherches de base doivent initialement être entreprises sur les contraintes critiques du climat qui retardent le développement des cultures.
6. Des études doivent être entreprises sur l'hétérogénéité et la distribution spatiale des sols à trois niveaux différents : champ, pays et région.
7. Des efforts pour l'élaboration de synthèses utiles des interactions entre les systèmes de production et les contraintes climatiques dans la zone soudano-sahélienne pourraient être grandement appuyées par des sites appropriés de stations expérimentales.
8. Des tests précoces sur les composantes des systèmes de production dans les champs des cultivateurs peuvent favoriser la recherche et le transfert de technologie.
9. Il est urgent d'utiliser des données agroclimatologiques et pédologiques dans l'interprétation des données issues du champ du paysan.
10. Les conséquences écologiques et économiques

de l'incorporation des cultures de rente et du cheptel dans les systèmes actuels de production doivent être étudiées.

11. Des études sur la récolte de l'eau de pluie et son utilisation pour l'irrigation complémentaire peuvent aider à assurer la stabilité des systèmes de production. D'autres recherches sont nécessaires pour répertorier l'intérêt récent des cultures de contre-saison dans la zone soudano-sahélienne.
12. Des études sur le rôle de la végétation naturelle et ses effets sur la croissance des cultures dans les systèmes de production existants nécessitent plus d'attention.
13. La modélisation est un outil efficace pour l'examen des options pour une optimisation des systèmes de production lorsqu'elle est appliquée aux contraintes climatiques. L'inventaire des modèles disponibles doit aider à identifier les besoins futurs en données et en recherche.

## **Groupe de travail sur l'aménagement des sols et des cultures pour l'utilisation efficace de l'eau**

1. La priorité devrait être donnée à l'étude des relations sol-eau-plante et plus particulièrement au travail du sol, l'amélioration de l'infiltration, et de la récolte de l'eau, le contrôle des mauvaises herbes et les systèmes d'exploitation des cultures, y compris les cultures associées.
2. De telles études devraient être réalisées selon une approche collaborative de type réseau de recherche dans laquelle un minimum commun de paramètres identiques serait évalué de telle sorte que l'on puisse recourir à la modélisation.
3. Le groupe a examiné les divers problèmes que rencontre l'agriculture pluviale et recommande d'étudier plus particulièrement :
  - Le travail du sol avec la prise en compte des effets à long terme sur les propriétés édaphiques, la matière organique et la structure;
  - Le billonnage cloisonné en relation avec les conditions édaphiques et climatiques qui prévalent là où ce système est appliqué. On fera particulièrement attention à l'utilisation de la traction animale et d'instruments adéquats;
  - L'effet de la densité des plantes, de l'espacement des rangs et des associations et de leur interaction sur les relations sol-eau-plante;
  - Le contrôle à l'aide d'herbicides dans cer-

taines situations et le désherbage mécanique avec traction animale.

### Groupe de travail sur l'aménagement de la fertilité du sol

La faible productivité des sols de la zone soudano-sahélienne est due à différents facteurs dont les principaux sont : les aléas climatiques; l'érosion éolienne et hydrique, le lessivage; la disparition progressive de la jachère; et le faible niveau de technologie des agriculteurs.

#### 1. La productivité des sols

L'amélioration de cette faible productivité consiste :

- à prendre en considération les facteurs physico-chimiques tels que la conservation de l'eau du sol, l'exploitation et la restauration des sols, l'amélioration de la fertilité, ainsi que les facteurs économiques liés à la fumure organique et minérale;
- à définir des stratégies adaptées à tous les différents niveaux d'intervention.

#### 2. Technologies transférées et transférables

En matière de technologies transférées et transférables, dans le domaine de l'amélioration de la fertilité des sols, il apparaît important de considérer les points principaux suivants :

**Fumures organiques.** Emploi des fumures organiques dans les associations culturales (céréales-légumineuses); l'intégration agriculture-élevage (fumier, parcage, cultures fourragères); les pratiques des engrais verts et paillage.

**Fumures minérales.** Emploi de la fumure minérale en tenant compte des doses, des types et formes d'engrais, des dates d'apport, des modalités d'application et de l'environnement physique et économique de l'agriculteur; emploi des amendements minéraux (correction du pH).

**Valorisation des ressources nationales.** En vue de limiter les importations et par conséquent favoriser l'économie de devises, il est important de valoriser au maximum les ressources naturelles disponibles telles que le phosphate naturel, le gypse, la dolomie.

**Gestion du sol.** L'amélioration de la fertilité des sols doit tenir compte des pratiques culturelles améliorées et des techniques de gestion des

sols telles que la conservation de l'eau, le drainage, la défense et la restauration des sols, et le travail du sol (dont le billonnage).

#### 3. Les besoins en recherche fondamentale

Par ordre prioritaire on retiendra :

- une approche intégrée multidisciplinaire pour les différents aspects de la fertilité des sols;
- une identification des carences et toxicité par éléments et par zone en vue d'aboutir à une cartographie de la fertilité des sols;
- une étude de l'utilisation de la fixation écologique de l'azote;
- une étude des effets des mycorhizes sur l'assimilation par les plantes du phosphore;
- un développement de variétés tolérantes à l'acidité et l'alcalinité et au déficit hydrique.

#### 4. Les besoins en recherche appliquée

La recherche appliquée doit être multidisciplinaire et conduite en priorité en champs d'agriculteurs. Elle doit porter sur :

- la définition de formules de fumure adaptées et économiques (les doses, les dates, et les modes d'application, les types d'engrais) par l'établissement de courbes de réponse, ceci prenant en considération les systèmes de culture;
- l'étude de l'utilisation des fumures organiques et des ressources locales;
- l'étude de fumures spéciales telles que les supergranules d'urée sur le riz;
- l'application mécanique des engrais.

#### 5. Collaboration entre institutions

Il est souhaitable que la collaboration entre institutions nationales et internationales soit renforcée par une meilleure diffusion des résultats de recherche, la préparation et l'exécution de programmes collaboratifs de manière à éviter une duplication des efforts et de renforcer les échanges entre institutions.

#### 6. Besoins prioritaires

Les besoins prioritaires ci-dessous doivent faire l'objet d'une attention particulière :

- recherche et formation à tous les niveaux;
- diffusion des résultats en milieu paysan (vulgarisation);
- amélioration des circuits de distribution (commercialisation, infrastructure, etc.);
- incitations à la production et disponibilité du crédit agricole pour les agriculteurs et les fournisseurs tels que prix suffisants des produits agricoles, subventions pour les intrants.

### **Groupe de travail sur l'aménagement des résidus de cultures pour le bétail et la conservation du sol et de l'eau**

Les paysans, intéressés par une rentabilité à court terme, négligent souvent les stratégies à long terme de conservation du sol. Le manque de temps et la main-d'oeuvre sont des contraintes majeures à l'utilisation de la jachère, alors que le manque de renseignement explique la sous-exploitation de cultures d'utilité multiple, tel le niébé précoce. Le groupe a discuté, entre autres, du parcage des animaux, afin de faciliter le ramassage du fumier et le compostage des résidus de récolte, et de l'utilisation des engrais verts.

1. Renforcer les contacts entre les chercheurs et les paysans à travers les projets de vulgarisation et de développement améliorés. Cela permettra une meilleure utilisation des méthodologies existantes et améliorées, ainsi qu'une meilleure connaissance des contraintes liées au milieu paysan et à l'utilisation des résidus de récolte.
2. Des études agronomiques et économiques doivent être entreprises pour optimiser les systèmes d'utilisation des résidus de récolte, pour une production intégrée agriculture/élevage et la conservation des sols et de l'eau. Ces études doivent être réalisées à un niveau régional (réseau).
3. Mettre au point des systèmes de gestion intégrée agriculture/élevage/pâturage pour maximiser la qualité, la quantité, et la gestion des résidus provenant des cultures et des terrains de parcours.
4. Augmenter la production de biomasse, en identifiant des espèces et des variétés végétales.
5. Déterminer les modalités d'application (quantité, fréquence) de la matière organique pour le maintien de la fertilité du sol, ralentir l'érosion et améliorer la conservation du sol et de l'eau.

### **Groupe de travail sur l'incidence socio-économique des technologies améliorées des systèmes d'exploitation**

Le groupe a décidé de se situer à trois niveaux : parcelle, exploitation, village. A ce jour, les paysans ont été réticents à adopter des technologies nouvelles pour des raisons diverses : risque finan-

cier, savoir-faire technique, manque d'argent et diverses contingences socio-économiques.

1. Les technologies nouvelles devraient être recommandées en concordance avec les problèmes identifiés en commun avec les paysans. Elles devraient être testées dans les champs paysans avant d'être diffusées, et le fait de rendement supérieur n'est pas le seul critère décisif.
2. On devrait faire un inventaire de toutes les technologies recommandées aux paysans, de même que des obstacles à leur adoption.
3. Les technologies doivent être appropriées au site et à d'autres contingences externes de l'exploitation. Cela est particulièrement important quand on met au point des solutions alternatives.
4. Une collaboration interdisciplinaire pour la solution de problèmes au niveau paysan est plus urgente que les études sectorielles en profondeur.
5. On doit étudier l'impact des technologies nouvelles à tous les niveaux, car une étude faite au niveau national ou régional peut masquer les problèmes au niveau de l'exploitation.
6. Un support institutionnel devrait être fourni au travers d'incitants qui protègent les paysans contre les risques socio-économiques qui leur échappent.

# Recommendations

Recommendations by the various working groups follow.

## Working Group on Agroecological Constraints and Production Systems

1. All available published information on production systems, climate, and soils from individual countries in the region should be compiled and computerized.
2. Mapping of adaptation zones for diverse cropping systems, pure and intercropped, should be prioritized.
3. Agronomically significant syntheses of available soil and climate data should be prepared for use in risk-analysis and risk-management.
4. Systematic studies should be made on water balance, growth, and yield to ensure optimal use of soil and climatic resources.
5. Basic research should begin with critical climatic constraints that delay the phasic development of crops.
6. Studies on the heterogeneity and spatial distribution of soils should be made at the field, national, and regional levels.
7. Experimental stations should be appropriately sited and minimum data sets collected to ensure greater compatibility between crops and climate.
8. Field surveys and on-farm tests should be made to provide the necessary feedback to research for effective technology transfer.
9. Agroclimatological and pedological data need to be collected and used in interpreting and reporting on-farm data.
10. A study should be made on the ecological and economic consequences of incorporating cash crops and livestock in the present production systems.
11. Studies are needed on rainwater collection and utilization for supplemental irrigation to help ensure the stability of production systems and to facilitate the production of off-season irrigated crops.
12. More studies should be made on the role of native vegetation and its effects on crop growth in the existing production systems.
13. Inventories of available models and data should be matched in an effort to identify

needs for additional data collection, validation and future research needs.

## Working Group on Soil and Crop Management for Efficient Use of Water

1. Priority should be given to the study of soil/water/plant relationships with particular emphasis to tillage, improving infiltration, water harvesting, weed control, and management systems including crop associations.
2. Such studies should adopt a collaborative research network approach with a minimum set of uniform parameters that can fit into a model.
3. More generally, the group took stock of problems facing rainfed agriculture and recommended that detailed studies be made on:
  - soil tillage with adequate consideration for long-term effects on soil properties, organic matter, and soil structure;
  - the soil and climatic conditions that lend themselves to the tied-ridging system with due attention to animal traction and adapted implements;
  - the effects of plant density, row spacing, and intercropping, and their interaction within the soil/water/plant system, and
  - chemical weed control for certain soils and crops, and mechanical weed control using animal traction.

## Working Group on Soil Fertility Management

The main causes of low soil fertility in the Sudano-Sahelian zone are: uncertain climate, wind and water erosion, leaching, decreasing fallows, and insufficient technical know-how at the farm level.

1. Soil Productivity
  - Proper attention must be given to physico-chemical factors such as soil-water conservation, the use and restoration of soils, improving soil fertility and economic factors linked to organic and mineral fertilization.
  - Strategies adapted to all input levels need to be designed.
2. Transferred and Transferable Technologies

- Organic and mineral fertilizers should be used in intercropping, mixed farming, mulching, and in correcting the pH of the soil with due respect for quantities, types, forms, application dates, and methods as well as the physical and economic environment.
- Maximum use should be made of local resources such as natural phosphate, gypsum, and dolomite to reduce spendings incurred in foreign currency.
- Soil fertility improvement measures must be related to farming practices and management techniques such as water conservation, drainage, proper use and restoration of the soil, land preparation, e.g., ridging.

### 3. Basic Research

- A multidisciplinary integrated approach should be used to study various aspects of soil fertility.
- Soil deficiencies and toxicities must be identified, in preparation of soil fertility maps.
- Studies are needed on ecological nitrogen fixation, the effects of mycorrhiza on the plant's uptake of phosphorus, development of varieties tolerant to acidity, alkalinity, and water stress.

### 4. Applied Research

- Multidisciplinary applied research should focus on economic fertilizer uses recorded on a response curve, organic fertilizers available locally, special fertilizers such as supergranule urea for rice, and mechanized application of fertilizers.

### 5. Cooperation

- National and international institutions should strengthen their cooperation through broader dissemination of the results of research, joint programs that avoid duplication and closer contacts.

### 6. Priorities

- There is an urgent need for (a) research and

training at all levels, (b) dissemination of research data to the farmers through extension services, (c) improving distribution circuits (marketing, infrastructure, etc.), (d) providing incentives for production through appropriate pricing policies, subsidies for inputs, and farm credit facilities for both farmers and suppliers.

### **Working Group on Crop Residue Management in Relation to Livestock and Soil and Water Conservation**

Farmers interested in short-term gain adopt management strategies that neglect long-term conservation activities. Time and labor are constraints to upgrading fallows through fodder plant production, while unawareness explains the absence of worthwhile multipurpose crops such as early cowpea. The group discussed the economic difficulties in building fences to confine the animals, composting, constraints to green manure, etc.

1. Researchers and farmers should work more closely together to improve technologies related to the use of crop residues.
2. Agroeconomic studies should be made on mixed farming, soil/water conservation, and optimal use of crop residue. A regional network could be established.
3. Improved integrated crop/livestock/pasture management systems should be developed to maximize on the quality, quantity, and management of crop/pasture residues and manures.
4. Species and varieties that provide increased biomass need to be identified.
5. Quantities, frequencies and modes of application of organic matter to maintain soil fertility, control erosion and improve soil/water conservation must be determined.

### **Working Group on the Socio-economic Impact of Improved Technologies for Farming Systems**

Three interrelated levels (plot, farm, village) were discussed. To date, farmers have been reticent about new technologies for reasons relating to

financial risk, technical know-how, shortage of cash, and various socioeconomic contingencies.

1. New technologies should be recommended in response to problems that have been well-defined together with the farmers. They should be tested in the farmer's field before being disseminated; increasing yields alone is not a decisive criterion.
2. An inventory should be made of all the technologies recommended to the farmers, together with obstacles to their being adopted.
3. Technologies must accommodate the site specificity and various outside contingencies of farms; this is especially important when designing alternative solutions.
4. Interdisciplinary cooperation for solving problems at the farm level is more urgent than in-depth sectoral studies.
5. Studies should be made on the impact of new technologies at all levels. A study designed at the national or regional level may dissimulate a problem at the farm level.
6. Institutions should provide support through incentive policies that protect farmers against socioeconomic risks beyond their control.

# Participants

## BURKINA FASO

**H. Eger**  
Programme Allemand-CILSS  
B.P. 4400  
Ouagadougou

**J.M. Chapotard**  
CIEH  
B.P. 369  
Ouagadougou

**L. Somé**  
Institut d'Etudes et de  
Recherches Agricoles  
B.P. 7192  
Ouagadougou

**M.S. Rodriguez**  
IITA/SAFGRAD  
B.P. 1783  
Ouagadougou

**S. Sori**  
Bureau National des Sols  
B.P. 7142  
Ouagadougou

**T. Bezuneh**  
OAU/STRC-SAFGRAD  
B.P. 1783  
Ouagadougou

## CAMEROON

**M.R. Rao**  
IITA/IRA  
B.P. 33  
Maroua

## CAP VERT

**José Brito**  
MURP  
B.P. 50  
Praia

## CHAD

**C. Daoussa Bichara**  
USAID  
s/c FAO  
B.P. 101  
N'Djaména

## CÔTE D'IVOIRE

**J.L. Chopart**  
IRAT-CIRAD  
04 B.P. 125  
Bouaké

## ETHIOPIA

**S. Sandford**  
ILCA  
P.O. Box 5689  
Addis Ababa

## FRANCE

**E. Roose**  
ORSTOM  
3191 route de Mende  
34040 Montpellier

**J.Vieira Da Silva**  
Université de Paris VII  
2 Place Jussieu  
75005 Paris

**R. Bertrand**  
IRAT-CIRAD  
B.P. 5035  
34032 Montpellier Cedex

## GHANA

**L. Sipkens**  
GTZ/Nyankpala Agricultural Experiment Station  
P.O. Box 9698  
Kotoka Airport  
Accra



**P. Nabila**  
Nyankpala Agricultural Experiment Station  
Box 483, Tamale

## ITALY

**M. Stigliano**  
Universite de Naples  
Viale Pinturicchio 214  
00196 Rome

## MALI

**A.V. David Kéré**  
Institut du Sahel (CILSS)  
B.P. 1530  
Bamako

**Boubacar Coulibaly**  
Institut d'Economie Rurale  
B.P. 9030  
Bamako

**Jens Bernt Aune**  
Aide de l'Eglise Norvégienne (NORAGRIC)  
B.P. 8031  
Badalabougou Est, Bamako

**Kounkandji Bitchibaly**  
Institut d'Economie Rurale  
B.P. 438  
Sotuba, Bamako

**Racine Ly**  
INRZFH  
B.P. 1704  
Bamako

**R.G. Chase**  
Projet FSR/E, USAID  
B.P. 34  
Bamako

**Sanath K. Reddy**  
USAID  
B.P. 34  
Bamako

**Tiécouradié Diarra**  
Institut d'Economie Rurale  
B.P. 9030  
Bamako

**Zoumana Kouyaté**  
IER/SRCVO  
B.P. 438  
Sotuba, Bamako

## THE NETHERLANDS

**Berry Lekanne**  
Department of Rural Sociology  
Agricultural University of Wageningen  
Hollandseweg 1  
Wageningen

**J. Bouma**  
Department of Soil Science and Geology  
Agricultural University of Wageningen  
Box 37  
6700 AA Wageningen

## NIGER

**Abdel Berrada**  
CNRA/PARA  
B.P. 240  
Maradi

**Aboubacar Issa**  
INRAN/DRF  
B.P. 225  
Niamey

**Adam Abdoulaye**  
INRAN  
B.P. 429  
Niamey

**Adi Habou**  
Journaliste  
ORTN  
Niamey

**Akilou Ali**  
Direction Départementale de l'Agriculture  
B.P. 149  
Zinder

**Amadou Sallaou**  
Direction Départementale de l'Agriculture  
B.P. 84  
Tahoua

**Aminou Tassiou**  
Projet de Développement Rural  
B.P. 243  
Maradi

**Atchabi Abdou**  
Direction Départementale de l'Agriculture  
Niamey

**Bako Karamba**  
Projet de Développement  
Rural Intégré  
B.P. 626  
Zinder

**Baoua Assoumane**  
Projet Productivité Niamey  
Ministère de l'Agriculture  
B.P. 11807  
Niamey

**C. Dancette**  
AGRHYMET  
B.P. 11011  
Niamey

**Chipkao Idrissa**  
Direction Départementale de l'Agriculture  
Maradi

**F. Fuller**  
USAID  
Niamey

**M. Gaoh Goubé**  
INRAN/MAG  
B.P. 429  
Niamey

**Hama Diallo**  
USAID  
Niamey

**Hama Saidi Bakkah**  
Projet de Développement  
des Vallées de l'Air  
Ministère de l'Agriculture  
Agadez

**Hamidou Souley**  
Projet Keita  
Tahoua

**H. Josserand**  
B.P. 11201  
Niamey

**I. Mahamadou Magah**  
INRAN  
B.P. 429  
Niamey

**Issaka Hassane**  
Direction Départementale de l'Agriculture  
B.P. 17  
Dosso

**J.D. Rainey**  
TROP SOILS  
B.P. 136  
Niamey

**Kadi Maliki**  
INRAN/CNRA/DECOR  
B.P. 240  
Maradi

**M. Garba Annou**  
INRAN/DRE  
B.P. 429  
Niamey

**M. Krause**  
INRAN/CNRA/DECOR  
B.P. 240  
Maradi

**M. Moussa Chétima**  
INRAN  
Kolo

**Mohamed Abba**  
Direction Départementale de l'Agriculture  
B.P. 01  
Diffa

**M. O'Neill**  
PPN  
B.P. 872  
Niamey

**Moussa Salou**  
INRAN/DRE  
B.P. 429  
Niamey

**Moussa Oumarou**  
INRAN  
B.P. 429  
Niamey

**Naraine Persaud**  
TROPISOILS/INRAN/Texas A&M University  
B.P. 136  
Niamey

**R. Deuson**  
Projet Appui à la Recherche Agricole  
B.P. 429  
Niamey

**R. Nygard**  
Projet GAO/UNSO  
B.P. 102  
Dosso

**Rulfo Mazzeranghi**  
FAO, Projet de Développement  
Intégré de Keita  
B.P. 49  
Keita

**Sarki Assoumane**  
Projet Productivité  
B.P. 139  
Tahoua

**Soumana Idrissa**  
Directeur Général  
INRAN  
B.P. 429  
Niamey

**T. Amani**  
Service Départemental de l'Agriculture  
B.P. 84  
Tahoua

**Viateur Buzizi**  
INRAN/DRE  
B.P. 429  
Niamey

**Wagé Saidou**  
Direction Départementale de l'Agriculture  
B.P. 105  
Agadez

## **NORWAY**

**Halvor J. Kolshus**  
Noragric/ Agricultural University of Norway  
Box 2, 1342 AS-NLH,

**Kare Ringlund**  
Department of Crop Science  
Agricultural University of Norway  
Box 41  
1432 AS-NLH

**Sigurd K. Bjortuft**  
Noragric/ Agricultural University of Norway  
Blasbortveien 14B  
N-0873 Oslo 8

**Yngvar Gjessing**  
University of Bergen  
Alle'gt. 70  
Bergen

## **SENEGAL**

**Saidou Koala**  
CRDI/CANADA  
B.P. 11007 CD Annexe  
Dakar

## **SUDAN**

**B.A. Ibrahim**  
WSARP  
El Obeid Research Station  
Box 429  
El Obeid

**Mahmoud M. Gadelkarim**  
WSARP  
El Obeid Research Station  
Box 429  
El Obeid

## UNITED KINGDOM

### **P. J. Gregory**

Department of Soil Science  
University of Reading  
London Road,  
Reading, England RG1 5AQ

## USA

### **A.B. Onken**

Texas Agricultural Experiment Station  
Texas A&M University  
RT 3, Box 219  
Lubbock, TX 79401

### **B.A. Stewart**

USDA-Agricultural Research Service  
Conservation and Production  
Research Laboratory  
P.O. Drawer 10  
Bushland, TX 79012

### **D.J. Mulla**

Department of Agronomy and Soils  
Washington State University  
Pullman, WA 99164-6420

### **D.W. Fryrear**

USDA/ARS  
RT 1 Box 319  
Big Spring, TX 79720

### **I.J. Stewart**

Wharf, USDA/USAID  
P.O. Box 1158  
Davis, CA 95617

### **J.C. Day**

USDA/ERS  
1301 New York Avenue  
Washington D.C.

### **J.F. Parr**

USDA/ARS/USAID  
Barc-W, Beltsville Agriculture  
Research Center  
Beltsville, MD.

### **J.L. Steiner**

U.S. Department of Agriculture  
P.O. Drawer 10  
Bushland, TX 79012

### **L. Hossner**

Soil and Crop Sciences Department  
Texas A & M University  
College Station, TX 77843

### **R.E. Meyer**

USAID, SIT/AGR/AID  
Washington D.C. 20523

### **R.I. Papendick**

USDA/ARS/USAID  
Land & Water Conservation  
Research Unit  
c/o Washington State University  
Pullman, WA.

### **Uzo Mokwunye**

IFDC, P.O. Box 2040  
Muscle Shoals, AL 35662

## ZAIRE

### **C. Joly**

FAO Fertilizer Programme  
c/o PNUD B.P. 7248  
Kinshasa I

### **ICRISAT Center**

(Patancheru A.P. 502 324, India)

### **C.K. Ong**

R.J. Van Den Beldt

### **ICRISAT/Mali**

(c/o Ambassade des Etats-Unis  
B.P. 34, Bamako)

### **S.V.R. Shetty**

**ICRISAT Sahelian Center**  
(B.P. 12404 Niamey, Niger)

Abderahmane Tekete  
B.R. Ntare  
C. Renard  
J. Kaziende  
L.K. Fussell  
Maimouna Garba  
M.C. Klaij  
M. Manzo Mahaman  
M.V.K. Sivakumar  
P.G. Serafini  
P. Ouedraogo  
R.W. Gibbons

**Interpreters**

**A. Byll-Wright**  
B.P. 10964  
Niamey, Niger

**E. Benamar**  
26, rue Malivert  
01630 Saint Genis, France

**T. Gaillard**  
25, Av. du Mal. de Lattre  
92210 Saint-Cloud, France

# Discours de clôture

**Illo Katché**

**Secrétaire Général du Ministère de l'Agriculture du Niger**

Messieurs les séminaristes, Honorables invités, Mesdames et Messieurs,

Au moment où s'achève les travaux de l'Atelier international sur les systèmes d'aménagement des sols, de l'eau et des cultures pour l'agriculture pluviale dans la zone soudano-sahélienne", il m'est agréable de vous adresser mes vives félicitations pour l'effort tant physique qu'intellectuel accompli par chacun de vous tout au long de ces cinq jours qu'ont duré vos assises.

Nous déplorons bien sincèrement que les conditions matérielles dans lesquelles vous avez eu à travailler n'aient pas été aussi idéales que nous l'aurions souhaité et que votre visite de terrain se soit déroulée sous une journée chaude bien que l'on soit en période froide.

Malgré ces handicaps, vous avez pu, et c'est tout à votre honneur, épuiser les différents points inscrits à votre ordre du jour. Sans vouloir porter atteinte à votre modestie de techniciens, chercheurs et hommes de terrain, habitués donc à évoluer sous des conditions sévères, nous voulons louer ici publiquement le haut niveau de compétence dont vous avez fait preuve.

Comme je le disais à l'ouverture de cet atelier, vos travaux ont porté sur des sujets de brûlante actualité. En effet après vos plénières, vous avez constitué des groupes de travail pour réfléchir sur cinq grands thèmes, à savoir :

- les contraintes agro-écologiques et les systèmes de production,
- l'aménagement des sols et des cultures pour l'utilisation efficace de l'eau,
- l'aménagement de la fertilité du sol,
- l'aménagement des résidus de culture pour le bétail et la conservation du sol et de l'eau,
- l'impact socio-économique des technologies améliorées des systèmes d'exploitation.

Au terme de vos travaux, vous avez su traiter des sujets assez divers qui ont tous trait au développement du monde rural et vous avez suggéré des propositions et des recommandations pertinentes. Notre pays prendra en compte toutes ces recommandations et cherchera les voies et moyens pour mettre notre production agricole à l'abri des aléas climatiques et autres.

Je ne m'étalerai pas plus sur vos travaux car vous les avez discutés en long et en large.

Je ne terminerai pas sans réitérer nos vifs remerciements aux Organisations internationales et particulièrement aux bailleurs de fonds notamment l'USAID qui a permis la tenue de cet atelier. L'ICRISAT, l'INRAN et les autres organismes qui ont organisé cet atelier, souhaiteraient que de telles rencontres soient régulières car elles permettent non seulement de faire le point sur des thèmes bien précis mais aussi c'est l'occasion d'échanges fructueux entre d'éminents scientifiques.

A vous tous, Messieurs les Délégués, je dois dire combien nous avons été honorés de votre présence parmi nous, et, en vous souhaitant un bon retour dans vos foyers respectifs, je déclare clos l'atelier sur les Systèmes d'aménagements des sols, de l'eau et des cultures pour l'agriculture pluviale dans la zone soudano-sahélienne.

Vive la coopération internationale !

Je vous remercie.





**ICRISAT**

**International Crops Research Institute for the Semi-Arid Tropics  
Patancheru, Andhra Pradesh 502 324, India**