

Genetic variants of EPO and EPOR influence cognitive core features of schizophrenia

Dissertation

for the award of the degree
"Doctor rerum naturalium"

Division of Mathematics and Natural Science
of the Georg-August-Universität Göttingen

submitted by

Heidi Friedrichs
from Remscheid

Göttingen 2011

Doctoral thesis committee: Prof. Dr. Dr. Hannelore Ehrenreich (Advisor, First Referee)
Division Klinische Neurowissenschaften
Max-Planck-Institut für Experimentelle Medizin
Hermann-Rein-Str. 3
37073 Göttingen

PD Dr. Henning Gibbons (Second Referee)
Juniorprofessor für Biopsychologie
Georg-Elias-Müller-Institute für Psychologie
Goßlerstr. 14
37073 Göttingen

Prof. Dr. Klaus-Armin Nave
Abteilung Neurogenetik
Max-Planck-Institut für Experimentelle Medizin
Hermann-Rein-Str. 3
37073 Göttingen

Date of submission of thesis: January 18, 2011

I hereby declare that this thesis has been written independently with no other sources or aids than quoted.

Göttingen, January 18, 2011

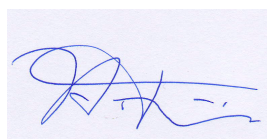
A handwritten signature in blue ink, appearing to read 'Heidi Friedrichs', is displayed on a light blue rectangular background.

Heidi Friedrichs

Acknowledgments

I would like to thank Hannelore Ehrenreich for giving me the possibility to work in her division and to study under her supervision. I am very grateful for the help, guidance and numerous opportunities offered during the course of the years. Henning Gibbons and Klaus-Armin Nave, both members of my PhD committee, have always offered valuable input and constructive criticism.

For the genetics' section of this work, I would like to thank Sabrina Grube, and Sergi Papiol for all their work and expertise regarding genetic analyses. A special note of gratitude goes to Martin Begemann for frequent help and caring for the patients as well as their follow ups. Also I would like to thank Ahmed El-Kordi for his work in the behaviour unit including provision of the data on the cEPOR mice.

I am grateful to Anne Kästner for productive discussions and all her help, and to Erin Choi for proofreading. I would like to specially thank Katja Ribbe who not only provided intellectual and emotional support but also created a wonderful working atmosphere.

And last but not least I would like to thank my family and friends for their continuous motivation, encouragement and support.

Contents

Summary	10
1 Introduction.....	11
2 Theoretical background.....	13
2.1 EPO.....	13
2.1.1 Erythropoietin.....	13
2.1.2 Epo treatment	14
2.1.3 Genes of the Epo system.....	15
2.1.4 Transgenic mouse model.....	24
2.2 Schizophrenia.....	24
2.2.1 Symptoms of schizophrenia.....	24
2.2.2 Göttingen Research Association for Schizophrenia (GRAS)	28
3 Hypotheses	32
4 Materials and methods	34
4.1 Ethics.....	34
4.2 Sample	34
4.3 Healthy controls.....	36
4.4 Neuropsychological tests.....	37
4.5 Control variables and covariates	38
4.6 Measure for impulsivity in humans	38
4.7 Genetics	38
4.8 Analysis of PBMCs.....	39
4.9 Statistics	40
5 Results	42
5.1 Genetic analyses.....	42
5.2 PGAS approach	45
5.3 Control variables.....	51
5.4 Further analyses of STR(GA) _n	51
5.4.1 Sum of allelic repeat lengths.....	51
5.4.2 Heterogeneity of allelic repeat lengths.....	54
5.5 Exploration of genetic influence on blood levels.....	54
5.6 Impulsivity in humans	55
5.7 Effects of genetic markers on mRNA.....	57

6	Discussion	59
7	Literature	64
	Supplement A	70
	Supplement B	71
	Supplement C	72
	Supplement D	94

Figures

Figure 1: Schemes of EPO and EPOR genes	15
Figure 2: Collaborating centers, visited by the traveling team from the Max Planck Institute of Experimental Medicine.....	29
Figure 3: Overview of the most important domains, in which phenotype information of every patient were collected	30
Figure 4: Flow chart of patients from whom blood indices were collected	36
Figure 5: Distribution of genotypes for SNP rs1617640 of EPO gene	42
Figure 6: Distribution of genotypes for SNP rs564449 of EPO gene	43
Figure 7: Distribution of sum of allelic repeat lengths of EPOR STR among cases and controls.....	44
Figure 8: Distribution of difference between allelic repeat lengths of EPOR STR among cases and controls.....	44
Figure 9: Main effects of EPO SNP and EPOR STR on Cognitive Composite Score	47
Figure 10: Display of the interaction effect of both genetic markers on Cognitive Composite Score	48
Figure 11: Influence of EPO SNP and EPOR STR on Speed of Processing	48
Figure 12: Interaction effect of EPO SNP and EPOR STR on Speed of Processing	49
Figure 13: Main effects of EPO and EPOR markers on Verbal Learning and Memory	50
Figure 14: Interaction effect of EPO and EPOR on Verbal Learning and Memory ...	50
Figure 15: Effect of EPOR STR split up in four repeat length sum groups on Speed of Processing and Verbal Learning and Memory.....	51
Figure 16: Effect of EPOR four sum groups on the Cognitive Composite Score	52
Figure 17: Interaction of the three EPO SNP genotype groups with four EPOR repeat lengths sum groups	53
Figure 18: Heterogeneity of the four EPOR repeat lengths groups	54
Figure 19: Effect of EPOR repeat separated in high and low sum on impulsivity	56
Figure 20: Association of EPOR STR(GA) _n with impulsivity	57
Figure 21: Effect of EPOR repeat separated in high and low sum on EPO mRNA... ..	58
Figure 22: Effect of EPOR repeat separated in four different sum groups on EPO mRNA.....	58

Tables

Table 1: Studies on EPO gene variants.....	17
Table 2: Studies on EPOR gene variants	20
Table 3: Criteria for the diagnosis of schizophrenia (F.20) according to DSM-IV, slightly modified	25
Table 4: GRAS sample description.....	35
Table 5: Obtained raw data of EPO and EPOR genotype groups in cognitive tests, including percentile rank in relation to normative sample	45
Table 6: Associations of EPO SNP and EPOR STR with target and control variables (n=841–945)	46
Table 7: Mean values and standard deviations for blood indices per genotype group	55

Abbreviations

5CSRTT – Five Choice Serial Reaction Time Tasks

CPZ – chlorpromazine

cEPOR – constitutively active EPOR

Epo – erythropoietin

EPO – erythropoietin gene

EPOR – erythropoietin receptor gene

GRAS – Göttingen Research Association for Schizophrenia

GWAS – genome-wide association study

mRNA – messenger ribonucleic acid

PANSS – Positive and Negative Syndrome Scale

PBMCs – peripheral blood mononuclear cells

PFCP – primary familial and congenital polycythemia

PGAS – phenotype-based genetic association study

rhEpo – recombinant human erythropoietin

SNP – single nucleotide polymorphism

STR – short tandem repeat

Summary

Introduction: Erythropoietin (Epo), a hematopoietic growth factor, has long been observed to improve cognition but this effect was attributed to the increase in hemoglobin levels. Even after the discovery of Epo and Epo receptor (EpoR) in brain, it lasted for years until potential direct Epo effects on the brain were explored by in vivo experiments. A large number of preclinical studies followed, essentially devoted to employment of Epo as a neuroprotective agent. Ultimately, clinical trials on patients with schizophrenia or chronic progressive multiple sclerosis as well as on extremely preterm infants, all demonstrating improved cognitive outcome upon Epo treatment, particularly of speed of processing/short-term memory, strongly suggested to consider this growth factor as an important player in neuroplasticity and higher cognition. It was thus hypothesized that a respective relevance of the Epo/EpoR system would also be reflected by genetic variations within the encoding genes (EPO and EPOR). **Methods:** For addressing this hypothesis, the GRAS (Göttingen Research Association for Schizophrenia) data collection was used, providing a thus far unique ground for phenotype-based genetic association studies (PGAS). GRAS comprises >1000 patients diagnosed with schizophrenia or schizoaffective disorder according to DSM-IV. DNA samples of GRAS patients were genotyped for genetic polymorphisms of the EPO and EPOR genes. For all subsequent statistical analyses, age, antipsychotic medication, negative symptoms, and duration of disease were used as covariates. Also, since in a transgenic mouse model with a constitutively active form of EPOR (cEPOR) in the postnatal mouse forebrain, a superior cognitive performance came with a price of enhanced impulsivity, it should be explored whether or not genetic markers of EPO/EPOR are associated with impulsivity in humans. **Results:** Genotype-phenotype analyses in schizophrenic patients, targeting higher cognition, revealed significant associations of EPO/EPOR variants with processing speed/verbal learning and memory. Interestingly, an interaction effect of the 2 markers was also detected. In humans, like before already seen in a transgenic mouse model, EPOR-related improved cognition comes at the price of higher impulsivity. **Conclusions:** The data show that genetic variants of the EPO/EPOR system influence the cognitive and behavioral phenotype of schizophrenic individuals. The interaction effect of these genetic variants may be a useful tool to provide mechanistic insight into the molecular interplay between EPO and EPOR regarding higher cognition and impulsive behavior.

1 Introduction

Schizophrenia is a devastating disease, affecting approximately 1% of the population. The most popular symptoms of this disease fall under the category of *positive symptoms*, such as delusions, and hallucinations. For a long time it was thought, that curing these symptoms would cure the disease as a whole. Nowadays it is known that in most cases, the more persistent *negative symptoms* such as lack of drive and affect, as well as anhedonia are more fatal than positive symptoms. A third major class of symptoms was neglected for a long time: cognitive symptoms. But a recent review in 1996 (Green, 1996) caught the focus of researchers on cognitive decline in schizophrenia. Green showed that the cognitive performance of schizophrenic patients was the best predictor for their functional outcome. Today, cognitive decline is accepted as a core symptom of the disease, which is not influenced by positive symptoms.

In 2004 the Göttingen Research Association for Schizophrenia (GRAS) was established and initiated a huge data collection of schizophrenic patients all over Germany. Patients were interviewed, neuropsychologically tested, examined and gave blood samples for DNA and serum analyses. This data collection gives a great overview and perspective of the disease. It builds the foundation to further understand the mechanisms and associations between the symptoms and features of the disease, also in combination with genetic analyses (see Chapter 2.2).

Since the impact of cognitive decline in schizophrenia on functional outcome measures is known, and therefore its costs for the health care system (Knapp, Mangalore, & Simon, 2004; Patel, et al., 2006), the search for a treatment in regard to cognition began. So far this search was not thoroughly successful, except for one trial with recombinant human erythropoietin (rhEpo) as an add-on treatment which gave promising results (Ehrenreich, Hinze-Selch, et al., 2007; Wüstenberg, et al., 2010). Erythropoietin (Epo) is a hematopoietic growth factor, named after its role on stimulating erythrocyte progenitor cells to develop. However, in several preclinical studies it could be shown that Epo not only carries beneficial effects on many different symptoms/conditions in animal disease models through its antiapoptotic, anti-inflammatory, angiogenetic, and neuroprotective properties while stimulating neurogenesis, but it is also enhanced cognitive performance in many animal models (Chapter 2.1).

Since in a treatment trial with chronic schizophrenics Epo enhanced cognitive performance significantly, the idea aroused that genes for EPO and EPO receptor (EPOR) might be disease modifier by influencing cognitive performance. Identifying genes which modify cognition could help to understand the mechanism behind the decline and find a way to delay or even stop this process.

2 Theoretical background

The following chapter will give an introduction into the field of erythropoietin, a hematopoietic growth factor which - as an add-on treatment in brain diseases - improved cognitive performance (2.1) and to schizophrenia, one of the most severe psychiatric diseases (2.2).

2.1 EPO

The following paragraph will shed light on erythropoietin by first describing the hormone and some of its pathways (2.1.1), then briefly summarizing results of Epo treatment regarding cognitive performance (2.1.2) and afterwards reporting previous findings of the genes for Epo and its receptor (2.1.3) and of a transgenic approach to model a constitutively active Epo receptor in the mouse brain (2.1.4).

2.1.1 Erythropoietin

Erythropoietin (Epo) is a circulating glycoprotein hormone named after its regulating function in erythropoiesis. Epo prevents apoptosis and promotes proliferation and differentiation of erythroid progenitor cells in the bone marrow after binding to its receptor. Epo receptor belongs to the cytokine receptor family; upon ligand binding, the receptor dimerizes, Janus kinase 2 (JAK2) is phosphorylated, thereby activating secondary signalling molecules such as signal transducer and activator of transcription 5 (STAT5), the mitogen-activated protein kinases (MAPK) ERK-1/-2, PI3K/Akt, and the activation/nuclear translocation of nuclear factor- κ B (NF- κ B) (for reviews see (Rabie & Marti, 2008; Tilbrook & Klinken, 1999).

Postnatal, Epo is mainly expressed in kidney; additionally liver cells synthesize up to 20% of the circulating Epo (M. J. Koury, Bondurant, Graber, & Sawyer, 1988; S. T. Koury, Bondurant, Koury, & Semenza, 1991). Interestingly, both proteins are also synthesized in the nervous system with a peak in neuronal expression during development (Juul, Yachnis, Rojani, & Christensen, 1999) and an upregulation in the adult brain under hypoxic conditions and after injury (Siren, et al., 2001).

2.1.2 Epo treatment

Epo has been clinically used for more than 20 years and has been proven to be well tolerated and safe. Although Epo is originally used to treat anemia, it is more and more considered as an add-on treatment in human brain diseases due to its neuroprotective properties (for reviews see Ehrenreich, Bartels, Sargin, Stawicki, & Krampe, 2008; Siren, Fasshauer, Bartels, & Ehrenreich, 2009). In several preclinical studies during the last decade, Epo's potential as treatment of neurological diseases was revealed (for review see Sargin, Friedrichs, El-Kordi, & Ehrenreich, 2010; attached as Supplement C of the thesis on hand). In cerebrovascular disease models, neuroinflammatory disease models, neurodegenerative disease models, and in models of traumatic brain and spinal cord injury, Epo treatment led in the majority of the studies to an improvement in clinical as well as in neuroprotective/neuroregenerative outcome parameters. Additionally it was shown in several models of cerebrovascular diseases and traumatic brain injury that Epo treatment improved cognition (Sargin, et al., 2010). This effect was for a long time explained as a result of improved tissue oxygenation (Ehrenreich, et al., 2008; Grimm, et al., 1990; Hengemihle, et al., 1996) but cumulated evidence points to an independent Epo effect on the brain (Ehrenreich, et al., 2008).

In addition, clinical studies with Epo could already prove its beneficial effect as neuroprotective and cognitive enhancing agent. In a follow-up study with preterm born infants, Neubauer and colleagues could show a major effect of Epo treatment on cognitive development (Neubauer, Voss, Wachtendorf, & Jungmann, 2010). Those children who received Epo to stimulate erythropoiesis were more likely to develop cognitively within a normal range than those who did not receive Epo. This cognitive enhancing effect of Epo was also shown in treatment studies with adults, e.g. in patients with multiple sclerosis and patients with chronic schizophrenia (Ehrenreich, Fischer, et al., 2007; Ehrenreich, Hinze-Selch, et al., 2007; Siren, et al., 2009). In the MS exploratory study, it could be shown that cognitive improvement was independent of hemoglobin raise; a clue against the oxygenation hypothesis and towards a separated action of Epo on the brain (Siren, et al., 2009). In the randomized double-blind placebo-controlled study, in which chronic schizophrenics were treated either with placebo or Epo over a twelve week period and tested neuropsychologically, patients who received Epo improved significantly more regarding their cognitive performance than patients who received placebo

(Ehrenreich, et al., 2007). Most striking results were reached on the subscale of attention, comprising a test for speed of processing. Follow-up MRI measures during this treatment trial in schizophrenia have proven that Epo slowed down the process of grey matter atrophy and even reversed it in some areas (Wüstenberg, et al., 2010). This increase in grey matter volume was correlated with cognitive improvement (especially in regard to speed of processing, immediate memory and working memory), but both beneficial effects were independent of psychopathological symptoms in these patients.

2.1.3 Genes of the Epo system

Human genes for EPO and EPOR are located on different chromosomes. The EPO gene lies on chromosome 7q21 and is stretched over a 2.9 kb region which contains five exons. The EPOR gene is located on chromosome 19p13.2 and comprises eight exons over a stretch of 6.5 kb. Figure 1 gives a schematic impression of the two genes.

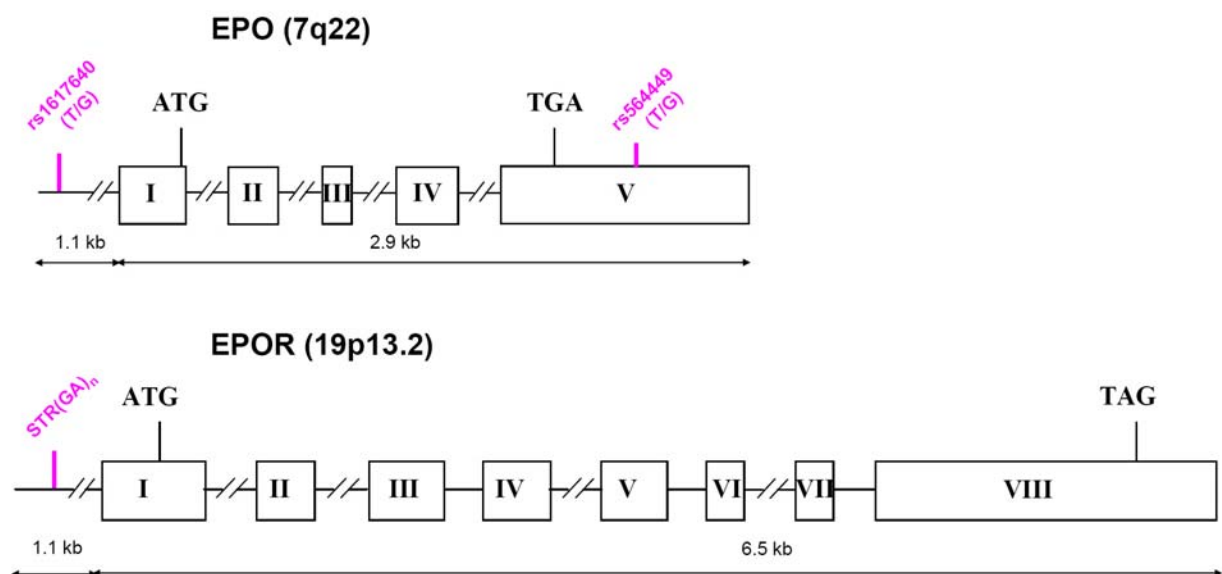

Figure 1: Schemes of EPO and EPOR genes
(marked and labeled polymorphisms are evaluated in the present work)

The EPO gene is highly conserved between species. It was cloned by Jacobs and co-workers in 1985 (Jacobs, et al., 1985). Since then, several association studies attempted to associate the gene with different readouts, of which Table 1 gives an overview. Genetic markers of EPO have been significantly associated with response to high altitude (Jedlickova, et al., 2003), myelodysplastic syndrome (Ma, et al., 2010)

and proliferative diabetic retinopathy and end stage renal disease (Abhary, et al., 2010; Tong, et al., 2008). The results for diabetic retinopathy are contradictory concerning a single nucleotide polymorphism (SNP) in the promoter region of EPO, rs1617640, and the direction of risk alleles (T or G allele associated with higher risk for diabetic retinopathy) whilst in an Indian sample, no association with that SNP and diabetic retinopathy was found at all (Balasubbu, et al., 2010).

In addition to the revealed association of SNP rs1617640 with diabetic retinopathy, the group of Tong and colleagues could show that this SNP rs1617640 in the EPO gene has an influence on Epo protein level in vitreous body with T homozygotes having a 7.5-fold higher Epo concentration (Tong, et al., 2008). Luciferase reporter expression was even enhanced by 25-fold with T allele compared to G allele. However, in peripheral blood mononuclear cells (PBMCs) no effect of the base pair substitution on Epo mRNA expression could be found (Tong, et al., 2008).

Studies which looked for associations of EPO gene with e.g. erythrocytosis, chronic mountain sickness, hemoglobin E- β -thalassemia, or amyotrophic lateral sclerosis were not successful so far (Ghezzi, et al., 2009; Mejia, Prchal, Leon-Velarde, Hurtado, & Stockton, 2005; Percy, McMullin, & Lappin, 1997; Sripichai, et al., 2005).

Table 1: Studies on EPO gene variants

Authors	Year	Population	Genetic marker(s)	Association/Target	Result	Remarks
Percy et al.	1997	12 erythrocytosis patients, 4 healthy controls	sequencing of a 256bp region 3' to EPO gene	erythrocytosis	4 polymorphisms in cases & controls, no association with erythrocytosis	
Zeng et al.	2001	247 healthy blood donors from Iowa	STR (CACT) in the third intron (position 2153) of the EPO gene	differences between gender or hematocrit levels or both (interaction effect)	no differences; marker explained neither gender differences nor differences in hematocrit level	
Jedlickova, et al.	2003	48 athletes, 10% Hispanic origin, 4% African-American origin, 86% Caucasian origin	4 dinucleotide polymorphic markers in EPO gene; 1 SNP in 3'HRE of EPO 3434	erythropoietin response to high altitude	D7S477 repeat 0.70Mbp 3' showed allelic association with Epo hypoxic response phenotype	D7S477 not in congruence with Hardy-Weinberg equilibrium
Lin et al.	2005	1702 subjects of 330 families from Massachusetts	genome-wide scan for quantitative trait loci (QTL)	hematocrit levels	no association with EPO gene	genome-wide association scan
Mejia et al.	2005	104 males from Peru (Andean)	4 microsatellites D7S515, D7S518, D7S2480, D7S477	chronic mountain sickness (CMS), polycythemia	no association with analysed EPO markers	
Sripichai et al.	2005	1060 Hb E- β -thalassemia patients of Asian origin	SNPs rs1617640*, rs4729606, rs576237	hemoglobin E- β -thalassemia	no linkage to EPO gene	rs576237 not polymorphic in this Thai population
Iliadou et al.	2007	391 pairs of dizygotic twins from UK	genome-wide scan for associations	red cell indices	no linkage to EPO gene	genome-wide association scan
Tong et al.	2008	374 patients & 239 matched controls with European-American origin; 2 replica samples with same origin	rs1617640* in the promoter of the EPO gene	proliferative diabetic retinopathy (PDR) & end stage renal disease (ESRD) in diabetes mellitus	the TT genotype of rs1617640* was associated with PDR and ESRD	luciferase reporter expression 25-fold higher with T-allele than with G-allele

Ganesh et al.	2009	24,167 European individuals + independent replica set of 9,456 European individuals	rs2075671, 7q22.1, within 60kb span around EPO gene	6 erythrocyte traits	associations for Hct, MCV and RBC with rs2075671 near the EPO gene	genome-wide analyses, no direct association with EPO gene
Ghezzi et al.	2009	222 Italian patients, 204 healthy controls matched for ethnicity & age	sequence analysis of 3' untranslated region with two polymorphisms C3434T and G3544T	sporadic amyotrophic lateral sclerosis (SALS)	no potentially causative differences between cases and controls were found	G3544T associated with age of onset of ALS: TT having later age of onset
Abhary et al.	2010	518 subjects with diabetes mellitus; 93% Europeans, 7% of Asian and Middle Eastern	3 SNPS from EPO gene: rs507392, rs1617640*, and rs551238	diabetic retinopathy (DR)	all SNPs associated with DR status; identification of disease haplotype	opposite to Tong (2008): G allele of rs1617640* associated with DR status
Balasubbu et al.	2010	345 patients with diabetic retinopathy & 356 diabetic controls all of Indian origin	SNP rs1617640*	diabetic retinopathy (DR)	no association with DR found in this population	
Ma et al.	2010	187 patients with myelodysplastic syndromes (MDS) compared to 813 patients with other types of leukemia and 95 healthy controls, ethnicity unknown	SNP rs1617640*	myelodysplastic syndromes (MDS) in comparison to other types of leukemia	association found with MDS	GG genotype of rs1617640* associated with higher risk for MDS (OR 4.98)

*genetic marker evaluated in the present work

The EPOR gene was cloned in 1989 from murine erythroleukemia cells (D'Andrea, Lodish, & Wong, 1989). In Table 2, recent findings from association studies for EPOR gene markers are summarized. No associations of EPOR gene were found so far with Diamond-Blackfan anemia, myeloproliferative disorders, hemoglobin E- β -thalassemia, chronic mountain sickness or erythropoietin response to high altitude (Dianzani, et al., 1996; Jedlickova, et al., 2003; Mejia, et al., 2005; Mittelman, et al., 1996; Sripichai, et al., 2005). Instead, in many studies polymorphisms and rare mutations of the EPOR gene were associated with primary familiar and congenital polycythemia (PFCP) as well as secondary polycythemia / erythrocytosis (Arcasoy, Degar, Harris, & Forget, 1997; de la Chapelle, Sistonen, Lehvaslaiho, Ikkala, & Juvonen, 1993; Furukawa, et al., 1997; Kralovics, Sokol, Broxson, & Prchal, 1997; Percy, et al., 1998; Petersen, Hokland, Petersen, & Nyvold, 2004; Sokol, Prchal, & Prchal, 1993; Watowich, et al., 1999). Regardless, some studies failed to show that association (Bourantas, et al., 2006; Emanuel, et al., 1992; Hess, et al., 1994) or found associations only in some studied cases or families, but not in all (Kralovics, Sokol, & Prchal, 1998; Sokol, et al., 1995).

Also, several studies explored whether genetic variants of EPO and/or EPOR have an influence on hematocrit, erythrocytes or other blood cell measures (Ganesh, et al., 2009; Iliadou, et al., 2007; Lin, O'Donnell, Levy, & Cupples, 2005; Zeng, Yankowitz, Widness, & Strauss, 2001) but failed to show an association. Some studies simply found allele-wise associations with blood cell measures which would not remain after correction for multiple testing (Zeng, et al., 2001) or only found associations with markers close to the EPO gene (Ganesh, et al., 2009). So far there is no evidence for suspecting EPO or EPOR genes to be risk genes for schizophrenia due to its lack of any hit with genome-wide association studies (Duan, Sanders, & Gejman, 2010; O'Donovan, et al., 2008).

Surprisingly, even though many preclinical studies have shown neuroprotective and neuroregenerative effects of Epo (see Chapter 2.1.2), only one study investigated the effect of EPO/EPOR genes on a disease of the central nervous system, in this case ALS (Ghezzi, et al., 2009). With regard to the cognitive enhancing effect of Epo which was not only in many preclinical studies but also in a few clinical treatment studies found, it is even more remarkable that no one looked for an association of EPO and EPOR genes with cognition until now.

Table 2: Studies on EPOR gene variants

Authors	Year	Population	Genetic marker(s)	Association/Target	Result	Remarks
Emanuel et al.	1992	3 unrelated families with primary familiar and congenital polycythemia (PFCP)	search for DNA changes in EPOR and its 3' untranslated region	primary familiar and congenital polycythemia (PFCP)	no chromosomal rearrangements or gene amplification in PFCP patients found	
de la Chapelle et al.	1993	family (n=58) from Finland	182-196bp products from nucleotides -618 to -420 upstream of transcription initiation site of EPOR gene, STR(GA) _n *	familial erythrocytosis	STR(GA) _n * upstream of the EPOR gene was in high linkage with the disease	
Sokol et al.	1993	3 families with primary familiar and congenital polycythemia (PFCP)	search for abnormalities in structure of EPOR gene	primary familiar and congenital polycythemia (PFCP)	STR(GA) _n * upstream of the EPOR gene was associated with the disease	same marker found like de la Chapelle 1993
Hess et al.	1994	24 patients with polycythemia vera (PV)	search for abnormalities in structure and expression of EPOR gene	polycythemia vera (PV)	no structural changes of EPOR gene in PV	
Sokol et al.	1995	9 families with primary familiar and congenital polycythemia (PFCP)	2 microsatellites STR(GA) _n * & STR(GGAA) _n in 5'-untranslated region	primary familiar and congenital polycythemia (PFCP)	linkage with selected genetic markers in 2 families found	
Dianzani et al.	1996	23 patients with Diamond-Blackfan anemia (DBA), 21 white, 1 black, 1 of East Indian origin; 13 of Italian origin, 8 Canadians	screening its coding sequence for mutations	Diamond-Blackfan anemia (DBA)	no causal mutations were identified, DBA is not commonly associated with EPOR gene mutations	

Mittelman et al.	1996	7 healthy controls, 20 MPD patients, 11 MDS patients; examined in Israel	search for differences in genetic structure via DNA digestion with four different enzymes	myeloproliferative disorders (MPD) [with/without polycythemia vera (PV)] and myelodysplastic syndrome (MDS)	EPOR is intact in MPD and most patients with MDS; only one patient with MDS had a different restriction pattern than the controls with one enzyme	
Arcasoy et al.	1997	3-generation Caucasian family (n=8)	heterozygosity for a deletion of 7 nucleotides between positions 5985 and 5991 in exon 8 of the EPOR gene	dominantly inherited familial erythrocytosis	heterozygosity for this mutation was associated with inherited familial erythrocytosis	cells expressing mutant EPOR displayed 5 to 10-fold increased sensitivity to Epo
Furukawa et al.	1997	Japanese family	screening for mutations in exons VII and VIII	primary familiar and congenital polycythemia (PFCP)	heterozygosity for C & T at position 5986 (point mutation C-T on one allele) associated with PFCP	
Kralovics et al.	1997	27 unrelated subjects with (primary) polycythemia of Caucasian origin	screening for mutations in exons VII and VIII	primary familiar and congenital polycythemia (PFCP)	mutations in association with PFCP found; 7bp-deletion (del5985-5991) in one family, 5967insT in a second family	
Kralovics et al.	1998	3-generation family (n=8)	screening for mutations; found C5964G mutation in exon VIII, resulting in a truncated EPOR protein	primary familiar and congenital polycythemia (PFCP)	C5964G mutation induces increased proliferative response to EPO	no clear linkage between mutation and PFCP, unaffected family member also carries mutation
Percy et al.	1998	1 English boy	<i>de novo</i> transition mutation of G to A at nucleotide 6002, leading to a loss of 70 amino acids from the carboxy terminus	erythrocytosis	associated with erythrocytosis in this single case	same mutation (G6002A) was found and linked to erythrocytosis in a Finnish family (de la Chapelle et al., 1993)

Watowich et al.	1999	Swedish family	tandem duplication of nucleotides 5968-5975, leading to a truncation of 79 amino acids from the C-terminus	familial erythrocytosis (FE)	association with dominant familial erythrocytosis (FE)	FE caused by hyper-responsiveness of receptor-mediated signalling pathways; dominant with respect to normal EPOR signalling
Zeng et al.	2001	247 healthy blood donors from Iowa	STR(GGAA) _n at -548bp from the ATG start codon	differences between gender or hematocrit (Hct) levels or both (interaction effect)	alleles of STR(GGAA) _n associated with Hct based on gender and/or Hct level	results would not remain after correction for multiple testing
Jedlickova, et al.	2003	48 athletes, 10% Hispanic origin, 4% African-American origin, 86% Caucasian origin	microsatellite STR(GA) _n * in 5' untranslated region	erythropoietin response to high altitude	no association	
Petersen et al.	2004	6 members of a Danish family and 1 unrelated healthy control subject	screening exon VIII of EPOR gene for changes	primary familiar and congenital polycythemia (PFCP)	3 affected members had deletion of 5938-5941 bp resulting in truncation of 58 amino acids of the C-terminal part of the protein	the found deletion introduced the same stop codon as seen in another PFCP family (Kralovics et al. 1997)
Lin et al.	2005	1702 subjects of 330 families from Massachusetts	genome-wide scan to search for quantitative trait loci (QTL)	hematocrit levels	no association with EPOR gene	genome-wide association scan
Mejia et al.	2005	104 males from Peru (Andean)	microsatellite STR(GA) _n * in 5' untranslated region	chronic mountain sickness (CMS), variant of acquired polycythemia	no association with analysed EPOR marker	
Sripichai et al.	2006	1060 Hb E-β-thalassemia patients of Asian origin	SNPs rs2291516, rs316500	Hemoglobin E-β-thalassemia	no association with disease	rs316500 not polymorphic in this Asian population

Bourantas et al.	2006	8 families with familiar polycythemia of Greek origin	search for mutations in the exon VIII	familiar polycythemia	no point mutation in exon VIII of the EPOR gene	
Iliadou et al.	2007	391 pairs of dizygotic twins from UK	genome-wide scan for associations	red cell indices	no linkage to EPOR gene	genome-wide association scan

*genetic marker evaluated in the present work

2.1.4 Transgenic mouse model

In a transgenic mouse model it could be shown that Epo has an effect on cognition independent of its role in the hematopoietic system: Transgenic mice expressing constitutively active EPOR (cEPOR) in pyramidal neurons of cortex and hippocampus show a superior cognitive phenotype compared to wildtypes (Sargin, et al., submitted). Thus, this mouse model delivers the proof that increased Epo levels in the periphery are not required for the cognitive improvement after Epo treatment as suggested by some authors (see Chapter 2.1.2). There is however an erythropoiesis independent effect of Epo in the brain. Having Epo receptors in pyramidal neurons of the cortex and hippocampus which can dimerize and activate their downstream cascade without binding of Epo, resulted in better performance of the mice in almost all cognitive tests. The only exception was found in the Five Choice Serial Reaction Time Tasks (5CSRTT), where – under high cognitive challenge – cEPOR mice made more premature responses, which were rated as mistakes. To put it in other words, these animals paid for their cognitive advantage with enhanced impulsivity. This behavioural finding was confirmed in the marble burying test, a simpler test for impulsivity. Also in this test cEPOR mice showed higher levels of impulsivity by burying significantly more marbles compared to wildtype mice.

2.2 Schizophrenia

In the following passage, the psychopathology of schizophrenia is introduced with a focus on cognitive decline (2.2.1). Further on, the Göttingen Research Association for Schizophrenia (GRAS) is presented with its unique multicenter cross-sectional sample of schizophrenic patients and its scientific approach (2.2.2).

2.2.1 Symptoms of schizophrenia

To receive the diagnosis of schizophrenia, at least two out of five characteristic symptoms must be prominent for a given period of time (see Table 1). All possible combinations of characteristic symptoms which lead to one and the same diagnosis already give an impression, how multifaceted this disease really is (criterion A).

Table 3: Criteria for the diagnosis of schizophrenia (F.20) according to DSM-IV, slightly modified

- A. **Characteristic symptoms:** Two of the following, each present for a significant portion of time during a 1-month period:
 - 1. delusions
 - 2. hallucinations
 - 3. disorganized speech
 - 4. grossly disorganized or catatonic behavior
 - 5. negative symptoms

 - B. **Social/occupational dysfunction:** For a significant portion of the time, one or more major areas of functioning (e.g. work, interpersonal relations, or self-care) are markedly below the level achieved prior to the onset

 - C. **Duration:** Continuous signs of the disturbance persist for at least 6 months. This 6-month period must include at least 1 month of symptoms that meet criterion A and may include periods of prodromal or residual symptoms

 - D. Schizoaffective and mood disorder exclusion

 - E. **Substance/general medical condition exclusion:** The disturbance is not due to the direct physiological effects of a substance (e.g., a drug of abuse, a medication) or a general medical condition

 - F. Relationship to a pervasive developmental disorder
-

Even though, cognitive decline in schizophrenia was one of the first reported features in this disease (“dementia praecox”; Kraepelin, 1893), it is not (yet) integrated in recent diagnostic criteria of DSM-IV and ICD-10 (American Psychiatric Association, 1994; World Health Organization, 1992; Keefe & Fenton, 2007; Barch & Keefe, 2010). The most important problem may potentially be to identify the decline, since one needs the comparison between the cognitive level prior to and after the onset of the disease and it is rare that a comprehensive cognitive test battery was carried out before the disease onset.

Palmer and colleagues approached that topic when writing their paper entitled “Is it possible to be schizophrenic yet neuropsychologically normal?” (Palmer, et al.,

1997). They tried to find the answer by allowing two blinded raters judge the performance in schizophrenics as well as in healthy controls. Impairments in five or more tested domains were considered not to be “neuropsychologically normal” anymore. According to that definition, only 28% of the examined patients with schizophrenia fell into the normal range which led the authors to consider the potential existence of a biological subgroup of patients. Later, Keefe and colleagues showed convincingly that being neuropsychologically normal did not mean that no cognitive decrement took place (Keefe, Eesley, & Poe, 2005). They had a closer look at predicted cognitive performance upon premorbid intelligence. If estimates of cognitive performance were based on premorbid intelligence and maternal education, nearly all (98.1%) of the patients did not fulfil the expected cognitive performance. Therefore, Palmers question finally got answered from Wilk and colleagues by publishing a paper with the title “No, it is not possible to be schizophrenic yet neuropsychologically normal” (Wilk, et al., 2005). In their own study they showed that Palmers proceeding did not take into account whether or not the patterns of performance in different cognitive domains differed between healthy controls and schizophrenics; in their own study they found significant differences between cases and controls concerning these cognitive “profiles” (Wilk, et al., 2005). Regarding the course of the cognitive decline in schizophrenia, a longitudinal neuropsychological follow-up study showed that is relatively stable (Hoff, et al., 1999). Only little evidence was found for a deterioration of cognitive abilities in the first few years of illness with an exception for verbal learning and memory, where significantly less improvement was shown (Hoff, et al., 1999).

Nowadays it is a widely accepted fact that cognitive impairments are a core feature of schizophrenia since they are longitudinally stable, specific for the diagnosis of schizophrenia, reliable as a predictor of functional outcome, already feasible in drug-naïve patients with a first episode of schizophrenia and they are independent of positive symptoms (Elvevag & Goldberg, 2000; Green, 1996, 2006; Heinrichs & Zakzanis, 1998; Saykin, et al., 1994). Findings of (1) cognitive impairments which already take place before the onset of psychotic symptoms (Reichenberg, et al., 2002) and (2) significant impairments in relatives of schizophrenic patients (Cannon, et al., 2000) undermined the idea of a genetic root/cause of the cognitive reduction.

Its impact on the functional outcome in schizophrenia, on community outcome, social problem solving, and skill acquisition (Bellack, Sayers, Mueser, & Bennett, 1994; Buchanan, Holstein, & Breier, 1994; Corrigan, Green, & Toomey, 1994), is especially of huge interest for clinicians and researchers since schizophrenia is an expensive disease and treating the positive symptoms did not help most of the patients to regain an acceptable functional level (Hegarty, Baldessarini, Tohen, Wateraux, & Oepen, 1994; Knapp, et al., 2004).

In his review Green could show that verbal memory was the strongest predictor for the functional outcome in schizophrenia (Green, 1996); it had an impact on all three previously mentioned categories of functioning (community outcome, social problem solving, and skill acquisition) whilst surprisingly, positive symptoms failed completely to have an effect on them. Therefore, Green calls verbal memory performance in schizophrenia as a “rate-limiting factor”, meaning it restricts the functioning of the patients. It was shown in further studies that differences in memory performance between healthy controls and schizophrenics result from problems in the encoding phase, measured by the total acquisition rate (Cirillo & Seidman, 2003; Gold, et al., 2000; Javitt, Strous, Grochowski, Ritter, & Cowan, 1997; Koh, Kayton, & Berry, 1973), therefore it is also a measure for the learning impairment in schizophrenia. Saykin and colleagues could show, that deficits in verbal memory are already present at an early stage of the disease and they account for most of the variance between patients and controls (Saykin, et al., 1994). In a meta-analysis about neuropsychological domains in schizophrenia, the effect size for “global verbal memory” including summary indices such as total acquisition rate, was the largest among all 22 analysed tests and domains reviewed (Heinrichs & Zakzanis, 1998). Therefore it is worthwhile to say that verbal declarative memory is “a core deficit in schizophrenia” (Cirillo & Seidman, 2003).

Brébion and colleagues found negative correlations between processing speed and the encoding performance in verbal memory tasks in schizophrenic patients (Brébion, Amador, Smith, & Gorman, 1998; Brébion, et al., 2000), meaning that slower speed of processing (measured with a digit symbol task) lead to deficits in organizing verbal stimuli. The idea of speed of processing as the cognitive core process determining a broader diversity of cognitive disturbances was further supported in a study in which - if used as a covariate - speed of processing neutralized differences between cases

and controls in tasks of verbal memory, attention and working memory (Rodriguez-Sanchez, Crespo-Facorro, Gonzalez-Blanch, Perez-Iglesias, & Vazquez-Barquero, 2007). It seems as if the two domains of verbal learning and memory and speed of processing are complementing one another, like they were two distinct parts of one system.

Additionally, speed of processing may be a critical component of neuropsychological vulnerability to schizophrenia since anomalies have been found in schizophrenic patients (psychotic and remitted) as well as in biological relatives (Nuechterlein, Dawson, & Green, 1994). In a recent meta-analysis a mean effect for digit symbol coding of -1.57 in case-control comparisons was revealed which was significantly larger than effects for all other, widely used cognitive measures (Dickinson, Ramsey, & Gold, 2007). This led Dickinson to the conclusion that “information processing inefficiency is a central feature of the cognitive deficit in schizophrenia” (Dickinson, et al., 2007).

2.2.2 Göttingen Research Association for Schizophrenia (GRAS)

GRAS data collection

The Göttingen Research Association for Schizophrenia (GRAS) was founded in 2004 with the aim to further explore and understand the disease, its roots and mechanisms. For this purpose, much information was collected from a huge cohort of schizophrenic/schizoaffective patients in 23 collaborating centers all over Germany (see Figure 2).

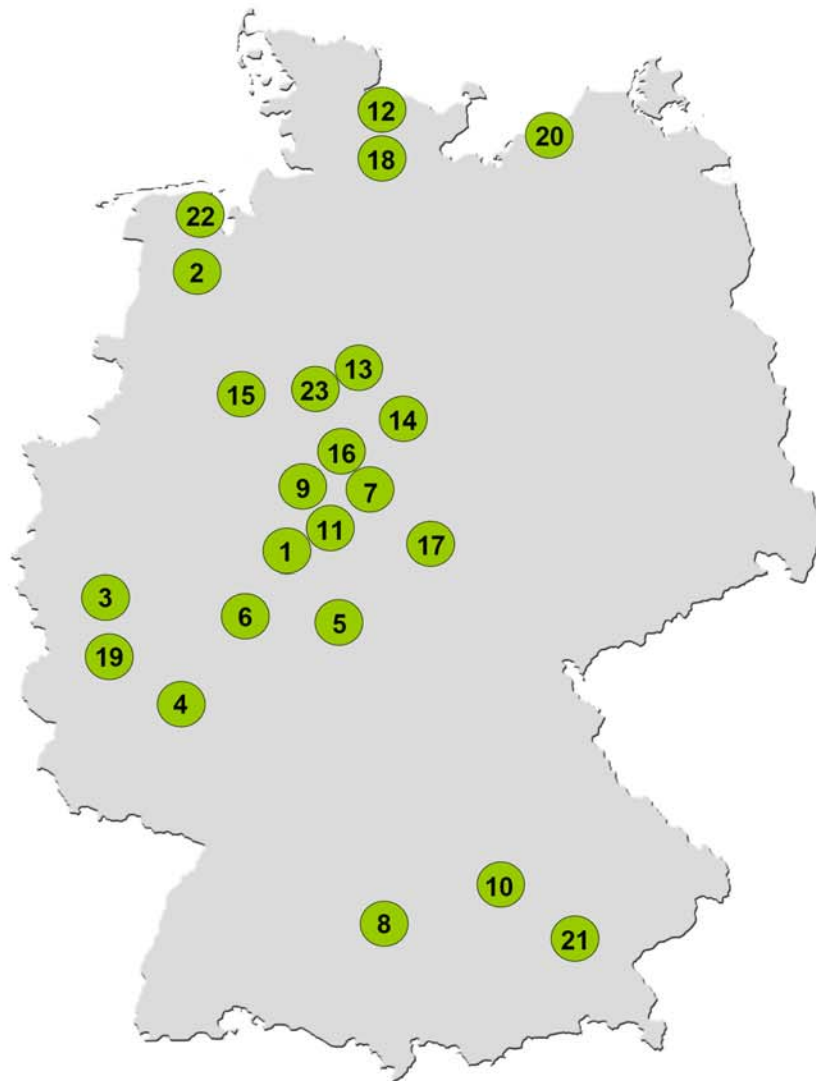

	center (city)	numbers of recruited patients
1.	Bad Emstal-Merxhausen	241 (22.2%)
2.	Bad Zwischenahn	40 (3.7%)
3.	Bonn	19 (1.8%)
4.	Eltville-Eichberg	20 (1.8%)
5.	Fulda	30 (2.8%)
6.	Giessen-Haina	36 (3.3%)
7.	Göttingen	114 (10.5%)
8.	Günzburg	31 (2.9%)
9.	Hofgeismar	10 (0.9%)
10.	Ingolstadt	27 (2.5%)
11.	Kassel	19 (1.8%)
12.	Kiel	26 (2.4%)
13.	Langenhagen	24 (2.2%)
14.	Liebenburg	27 (2.5%)
15.	Lübbecke	30 (2.8%)
16.	Moringen	4 (0.4%)
17.	Mühlhausen	53 (4.9%)
18.	Rickling	56 (5.2%)
19.	Rieden	91 (8.4%)
20.	Rostock	80 (7.4%)
21.	Taufkirchen	32 (2.9%)
22.	Wilhelmshaven	27 (2.5%)
23.	Wunstorf	48 (4.4%)
total number of patients		1085

Figure 2: Collaborating centers, visited by the traveling team from the Max Planck Institute of Experimental Medicine.

Between the years 2005 and 2008, 1071 patients with an ex ante diagnosis of their health care providers of schizophrenia or schizoaffective disorder were introduced to an invariant team of traveling investigators from the Max Planck Institute of Experimental Medicine in Göttingen. Patients with the respective diagnosis who were willing to voluntarily take part in the investigation, and gave written informed consent after detailed information, were then interviewed, tested, examined and gave a blood sample for DNA and serum analyses (detailed description of carried out investigations see Ribbe, Friedrichs, et al., 2010; attached as Supplement D). Since the end of the travelling period in 2008, steady-state recruitment is being pursued in Göttingen and yielded so far in a total number of 1085 examined patients. Since the ex ante diagnosis of schizophrenia or schizoaffective disorder was in some cases not confirmed by the GRAS team of investigators, as to this time point information about 1037 patients with approved diagnoses of schizophrenia or schizoaffective disorder have been carefully explored, double-checked and entered. The total amount of collected information resulted ultimately in a most comprehensive data bank with a unique accumulation of more than 3000 data points per patient. Figure 3 gives an impression of the different domains the GRAS collection possesses information about.

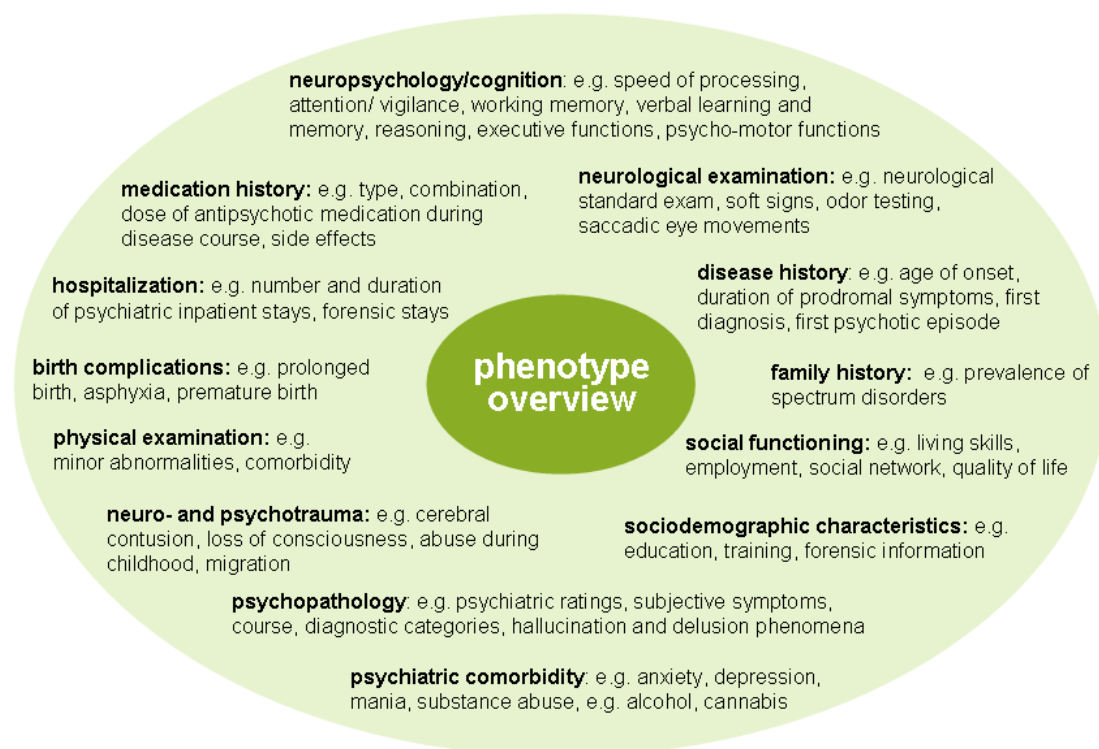

Figure 3: Overview of the most important domains, in which phenotype information of every patient were collected

In addition to carrying out interviews and examinations, all discharge letters from every inpatient stay in psychiatry of every participating patient were collected. These charts were an important instrument to (1) confirm all the patients' statements and (2) to allow judgement about longitudinal information about the patients' disease, e.g. age at prodromal onset, age at onset of psychotic symptoms, lifetime substance abuse, treatment history, frequency and duration of psychiatric inpatient stays. For more detailed information about the high quality of collected data, their internal consistency and the power of this study see (Ribbe, Friedrichs, et al., 2010). To conclude, the collected data gives a most comprehensive overview of the state of schizophrenia in Germany and provides the ground for phenotype-based genetic association studies.

GRAS scientific approach

In contrast to recent GWAS studies, which search genome-wide for differences in genetic markers between case and control populations (Hardy & Singleton, 2009), the GRAS approach focuses much more on the specific contribution of a single gene to the disease phenotype. Therefore it is named phenotype-based genetic association study (PGAS) to underline that instead of comparing samples only in regard to end-point diagnosis, PGAS studies search hypothesis-driven for phenotypes within a population (in the thesis on hand the schizophrenic GRAS population) which are modulated by selected genetic markers. Already first publications were able to demonstrate proof-of-concept of the PGAS approach (Begemann, et al., 2010; Papiol, et al., 2011; Grube, et al., submitted; Ribbe, et al., submitted).

3 Hypotheses

As a result of careful literature research and reasonable conclusions made of previous findings, five hypotheses were derived to be checked in the thesis on hand.

(1) In recent GWAS studies, regions of EPO gene and EPOR gene were never characterized as being associated with schizophrenia (see Chapter 2.1.3), therefore it is also assumed that there is no difference in allelic distribution of chosen markers for both genes between schizophrenics and healthy controls.

Hypothesis 1: EPO/EPOR genes are not associated with schizophrenia (no disease genes)

(2) In treatment studies with Epo compounds it was shown that they improve cognitive performance in rodent disease models and human brain diseases (Chapter 2.1.2). Furthermore, in a transgenic approach it could be found that transgenic mice expressing constitutively active Epo Receptors in pyramidal neurons in the hippocampus and cortex revealed superior cognitive results compared to wildtype mice. It was assumed that genetic variants of the EPO system are associated with the cognitive performance in a schizophrenic sample. Based on previous work it was assumed that in schizophrenic patients, particularly the cognitive domains of speed of processing and immediate memory are sensitive towards changes in the EPO system (Ehrenreich, Hinze-Selch, et al., 2007; Wüstenberg, et al., 2010). Therefore, it is supposed that genetic polymorphisms of the EPO system are modulating the performance in both domains in the GRAS population.

Hypothesis 2: Common genetic variants of EPO/EPOR genes are associated with the cognitive domains of 'speed of processing' and 'verbal learning and memory' in schizophrenic patients

(3) Since Epo is a hormone which - after binding to its receptor - stimulates erythrocyte precursor cells in the bone marrow to differentiate, it can not be excluded that genetic variants in this gene or in its receptor gene may influence levels of hemoglobin, hematocrit, erythrocytes, and/or thrombocytes. Even though, researchers failed to detect an association of EPO and EPOR genes with different

blood indices so far (see Chapter 2.1.3), such an association cannot be excluded without testing it in the GRAS population.

Hypothesis 3: There might be an association between these genetic variants and certain blood indices (hemoglobin, hematocrit, erythrocytes, and thrombocytes)

(4) One finding from the above and in chapter 2.1.4 mentioned transgenic mouse model was that these mice with constitutively active Epo receptors in pyramidal neurons have to pay for their cognitive superiority with an enhanced impulsivity under cognitive challenge. This finding presumes that there is also a possible association between genetic variants of EPO or EPOR genes with impulsivity in humans.

Hypothesis 4: Genetic variants of the EPO system which influence cognition should also have an influence on impulsivity

(5) Tong and colleagues showed an influence of a polymorphism in EPO gene on EPO mRNA in vitreous body (Tong, et al., 2008). Since in treatment studies, patients improved cognitively after receiving externally high doses of rhEpo, it seems reasonable that polymorphisms of EPO/EPOR genes which presumably influence cognitive performance might do that by affecting mRNA levels.

Hypothesis 5: There might be an association between genetic variants of the EPO system and their mRNA levels in periphery

4 Materials and methods

In this chapter, all used materials and methods for the thesis on hand are described in detail, such as ethical approval (4.1), sample characteristics (4.2), information about healthy controls (4.3), neuropsychological tests (4.4), control variables and covariates (4.5), measure for impulsivity (4.6), genetics (4.7), analyses of PBMCs (4.8) and information about used statistics (4.9).

4.1 Ethics

The GRAS data collection has been approved by the ethical committee of the Georg-August-University of Göttingen (master committee) as well as by the respective local regulatory/ethical committees of all collaborating centers.

4.2 Sample

Of the 1085 patients recruited for the GRAS study up to this point (see chapter 2.2.2), only those with confirmed diagnosis of schizophrenia or schizoaffective disorder were included. Table 4 gives an overview of the sample, of some socio-demographic characteristics as well as obtained values in the below mentioned variables of interest.

Table 4: GRAS sample description

	n (%)	mean (sd)
Total sample	1037 (100%)	
Males	693 (66.8%)	
Females	344 (33.2%)	
Diagnosis		
Schizophrenia	852 (82.2%)	
Schizoaffective disorder	185 (17.8%)	
Ethnicity		
Caucasian	992 (95.6%)	
African	7 (0.7%)	
Mixed	10 (1.0%)	
Unknown	28 (2.7%)	
Age		39.52 (12.56)
Duration of disease (years)		13.23 (10.71)
PANSS		
Positive Symtoms		13.76 (6.32)
Negative Symptoms		18.23 (7.85)
General Psychopathology		33.73 (11.83)
PANSS Total Score		65.64 (23.40)
Global Assessment of Functioning (GAF)		45.76 (17.25)
Number of siblings		1.91 (1.75)
Premorbid Intelligence¹		26.04 (6.20)
Cognitive target measures		
Speed of Processing		37.83 (13.12)
Verbal Learning and Memory ¹		41.66 (12.78)

¹for all analyses with speech-dependent readouts, non-German speakers (n=89) were excluded

From a subsample of the GRAS cohort, samples of peripheral blood mononuclear cells (PBMCs) were taken to further analyse mRNA status of respective genes of interest (n=35). Also, from every GRAS patient who had stayed as an inpatient in the department of psychiatry in the University Medical Center of Göttingen (n=102),

results of every blood test which was taken between January 2000 and June 2010 were collected. Five had to be excluded due to medical conditions (see Figure 4), and for the remaining 97 patients, mean values of hemoglobin, hematocrit, erythrocytes and thrombocytes were calculated from all collected results (between one and 48 per patient), outliers and extreme values within individual patients (both lying more than 1.5 interquartile ranges [middle 50% of scores] from the normal range) were excluded.

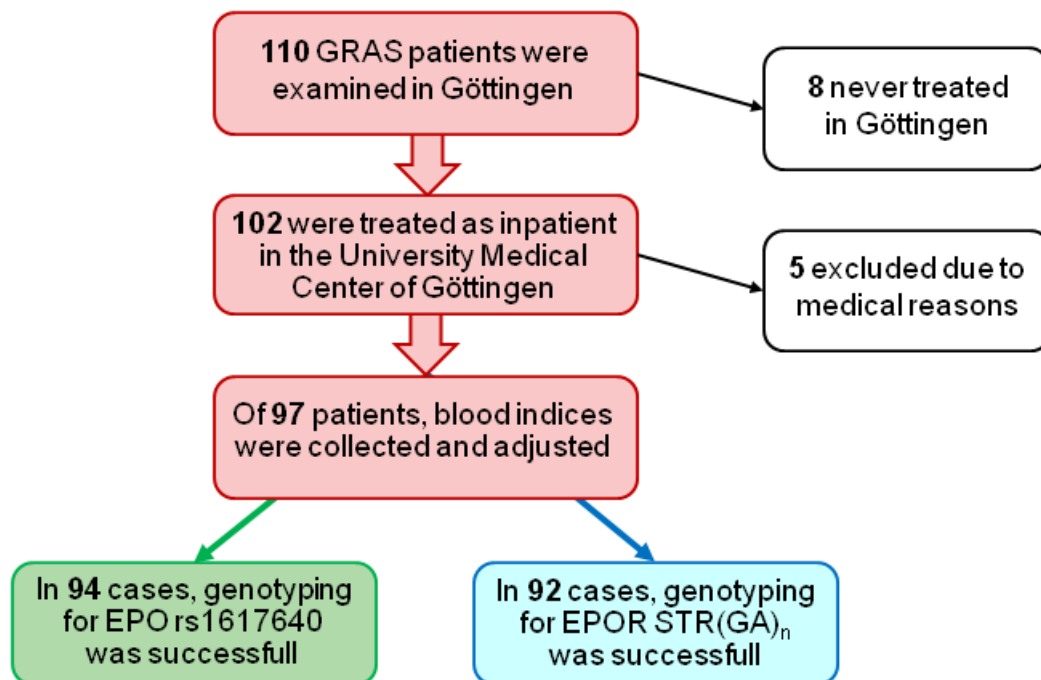

Figure 4: Flow chart of patients from whom blood indices were collected

4.3 Healthy controls

For reassessment of whether or not the selected genetic markers are associated with schizophrenia, blood samples from 1143 healthy subjects who gave written informed consent, were used. The sample consists of 673 male (58.9%) and 470 female (41.1%) blood donors with an average age of 34.6 ± 12.3 years (range from 18 to 69 years). Participation as healthy controls for the GRAS sample was anonymous, with information restricting to age, gender, blood donor health state and ethnicity. Comparable to the patient population, almost all control subjects were of European Caucasian descent (Caucasian 97.8%; other ethnicities 2%; unknown 0.2%).

4.4 Neuropsychological tests

From the most comprehensive neuropsychological test battery used in the GRAS study, the most appropriate conducted test from each domain of interest was chosen: The Digit-Symbol Test (ZST, subtest of HAWIE-R, Tewes, 1991; German version of WAIS-III, Wechsler, 1997) was applied to measure the speed of processing and ability to concentrate. The task is to translate lines of digits into symbols according to a displayed digit-symbol-code, where every digit has a different symbol. The task stops after 90 seconds, and the readout is the number of correct translations (test sheet attached as Supplement A). Reliability of the Digit-Symbol Test was measured via test time bisection with Spearman-Brown correction and revealed a Cronbach's alpha of .95 (Tewes, 1991); also test-retests reliability tends to run high with correlation coefficients in a range of .82 - .88 (Matarazzo & Herman, 1984; Wechsler, 1981). In comparison to a healthy control population used to obtain normalized data for this test, mean values of the GRAS population obtain a percentile rank of 16, indicating a considerably worse performance in schizophrenics (for more details see Ribbe, Friedrichs, et al., 2010).

To measure the encoding part in a verbal learning and memory task, the general learning score from the Verbal Learning and Memory Test (VLMT, Helmstaedter, Lendt, & Lux, 2001; German version of the Auditory-Verbal Learning Test, Rey, 1958) was used. In this task a list of 15 words is read five times to the proband, who should say which words he can remember after every run. The number of correct answers from the five runs is summed up and used as readout for the "total acquisition" or encoding performance (test evaluation sheet attached as Supplement B). Reliability of the total acquisition rate was measured with alternate forms of the VLMT with a mean retest interval of eight to twelve months and lies in a range of $r_{tt}=.81$ to .82 (Helmstaedter, et al., 2001). Obtained mean values from the GRAS population reach a percentile rank of 10 compared to the normalizing sample of healthy controls, again implying poorer performance in schizophrenia (again, for more details see Ribbe, Friedrichs, et al., 2010)).

4.5 Control variables and covariates

In addition to the two cognitive target variables, three carefully chosen variables are used as control target variables, on which an influence of the analysed genetic markers is not expected. For the cognitive control variable a measure for premorbid intelligence (MWTB, Lehrl, 1999) was chosen, for a disease-related control variable the clinical rating of global functioning (GAF, American Psychiatric Association, 1994) and lastly as disease-unrelated control variable the number of siblings was used.

Age as an important influencing factor of cognitive performance (Kern, et al., 2008) is used as a covariate. Additionally, neuroleptic medication measured in chlorpromazine equivalents (Davis, 1976), duration of disease in years and negative symptoms (measured with the Positive and Negative Syndrome Scale (PANSS): Negative symptoms subscale, Kay, Fiszbein, & Opler, 1987) which were shown to have an influence on cognition in schizophrenic patients (Ribbe, Friedrichs, et al., 2010) are applied as covariates.

4.6 Measure for impulsivity in humans

Impulsivity in the GRAS human population was operationalized with item number 14 “Poor impulse control” of the PANSS General Psychopathology Scale, which was rated by the examiners of the GRAS team of investigators, trained in psychopathological ratings. This item is described as to measure “disordered regulation and control of action on inner urges, resulting in sudden, unmodulated, arbitrary, or misdirected discharge of tension and emotions without concern about consequences” (Kay, et al., 1987). It was rated on a scale from one to seven, with one for the lowest and seven for the highest degree in impulsivity.

4.7 Genetics

Two selected SNPs rs1617640 and rs564449 of the human EPO gene (hEPO) were analysed using Simple Probes (TIB Molbiol, Berlin, Germany) and using the LightCycler® 480 Genotyping Software implemented in the LightCycler® 480 system (Roche, Mannheim, Germany). The reaction mixture (10µl) was prepared with 20ng of DNA in 384 well plates according to standard protocols (Roche). In each run, 8

positive controls (hgDNA, Bioline, Luckenwalde, Germany) and negative water blanks were included for quality and internal control purposes. Overall, successfully genotyped markers amounted to 99.7-99.9%.

The polymorphic GA repeat in the promoter region of human EPOR gene (hEPOR) was amplified from genomic DNA by PCR. Primers were chosen according to the paper of de la Chapelle and colleagues (de la Chapelle, et al., 1993):

*hEPOR*_(GA)_n forward: 5'- FAM GGT GAC AGA GCA ACA CCC TG-3'

*hEPOR*_(GA)_n reverse: 5'- ATC AGC ATC TCT TCC CAG CC -3'

resulting in a PCR fragment of ~ 186 bp. For each sample, the reaction mixture (20µL) was prepared in 384 well plates, each containing 20ng of human genomic DNA, 125µM dNTPs each, 200nM FAM-labeled forward primer and the reverse primer and 1U Phire polymerase (Finnzymes, Espoo, Finland). The amplicons were separated using size electrophoresis on the ABI 3730 XL DNA Analyzer (Applied Biosystems, Foster City, USA). For this, samples were diluted 1:50 with 0.3mM EDTA and 4µl were mixed with 6µl LIZ-500 Size Standard (Applied Biosystems). Raw data were processed using the Gene Mapper Software 4.0 (Applied Biosystems).

4.8 Analysis of PBMCs

Blood was collected in CPDA tubes from schizophrenic patients with different genotypes in the promoter region of EPO/EPOR. PBMCs were isolated applying the standard Ficoll-Paque Plus isolation procedure (GE Healthcare, München, Germany). RNA was prepared using Qiagen miRNeasy Mini Kit (Qiagen, Hilden, Germany). The RNA samples were used to synthesize cDNAs (SuperScriptIII, Invitrogen, Karlsruhe, Germany). The qRT-PCR was performed with the aid of SYBR Green detection on the LightCycler® 480 system (Roche). CT (cycle threshold) values were standardized to CT values of GAPDH.

*hEPO*_qRT-PCR forward: 5'- TCCCAGACACCAAAGTTAATTTCTA-3'

*hEPO*_qRT-PCR reverse: 5'- CCCTGCCAGACTTCTACGG-3'

*hEPOR*_qRT-PCR forward: 5'- TTGGAGGACTTGGTGTGTTTC -3'

*hEPOR*_qRT-PCR reverse: 5'- AGCTTCCATGGCTCATCCT -3'

*hGAPDH*_qRT-PCR forward: 5'- CTGACTTCAACAGCGACACC -3'

*hGAPDH*_qRT-PCR reverse: 5'- TGCTGTAGCCAAATTCGTTGT -3'

4.9 Statistics

For all statistical analyses of the data, SPSS for Windows version 17.0 ("SPSS Inc.") was used. For case control comparison, allelic distribution for both EPO SNPs and the possible genotype combinations were tested via χ^2 -test. Comparisons between cases and controls concerning EPOR STR(GA)_n were made via χ^2 -test of the allelic sum of repeat lengths and separately of the allelic difference between repeat lengths (as a measure of allelic heterogeneity). For testing the influence of genetic markers on cognition, target and control variables had to be Blom transformed (Blom, 1958) since they were not normally distributed. Blom transformed values for speed of processing and verbal learning and memory were used to build a composite score by taking the mean value. Non-native German speakers (n=89) were excluded for all analyses of tests where speech ability may influence the result (verbal learning and memory, premorbid intelligence). Analyses of covariance for target and control variables were carried out, adjusting for age, medication, duration of disease and negative symptoms (measured with PANSS). Independent measures were EPO SNP rs1617640, split up in three groups (TT, TG and GG) and EPOR STR(GA)_n, split up in two groups (high vs. low sum of repeat lengths). Covariates for control variables: For the cognitive control variable premorbid intelligence, and for GAF as disease-related control variable, analyses of covariance with the same covariates as the target variables were performed. For number of siblings as disease-unrelated control variable, only age was used as covariate. Prior to all phenotype-genotype analyses, gender distribution was controlled using χ^2 -tests. For assessing the effect of EPO and EPOR genotypes on impulsivity, analyses of covariance with age, duration of disease and medication as covariates were used. To test the effect of the genetic markers on mean values of hemoglobin, hematocrit, erythrocytes, and thrombocytes, analyses of variance as well as student's *t*-tests were carried out for a subsample of

the GRAS patients (n=92 - 94). Due to small sample sizes, impact of EPO and EPOR genotypes on mRNA levels had to be tested non-parametrically using Kruskal-Wallis tests and Mann-Whitney-U tests in the subsample of patients of whom PBMCs were available (n=35).

5 Results

This chapter summarizes the results of statistical analyses, in the order of assembled hypotheses, starting with the case-control study (5.1). This is followed by the PGAS approach on cognitive target variables (5.2) as well as on control variables (5.3), further analyses of STR(GA)_n (5.4), the influence of genetic markers on blood levels (5.5), effects on impulsivity (5.7), as well as on mRNA levels (5.8).

5.1 Genetic analyses

For the case-control study, the allelic distribution of both EPO SNPs, did not yield any differences between the groups (rs1617640: $\chi^2=.019$, $p=.890$; rs564449: $\chi^2=.002$, $p=.964$), both markers fulfilled the Hardy-Weinberg equilibrium criteria. Also, when the distribution of genotypes (GG, GT, TT) for both SNPs were compared, no group differences were found between cases and controls (rs1617640: $\chi^2=1.099$, $p=.580$; rs564449: $\chi^2=.035$, $p>.999$; see Figures 3 and 4).

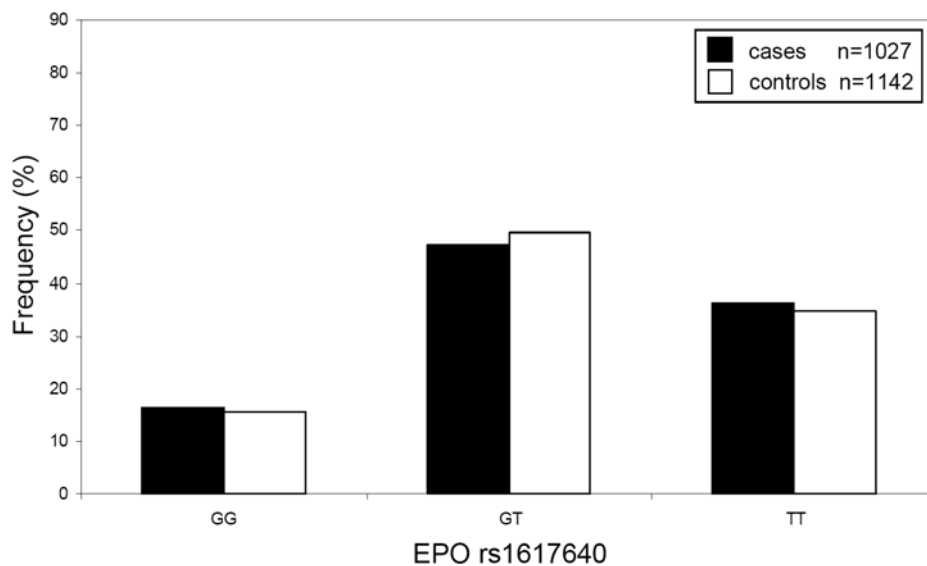

Figure 5: Distribution of genotypes for SNP rs1617640 of EPO gene

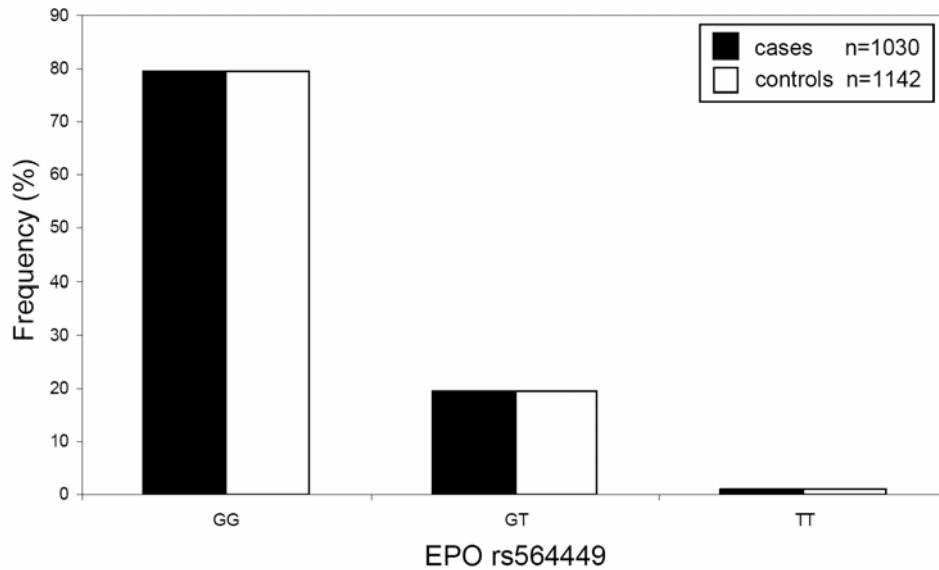

Figure 6: Distribution of genotypes for SNP rs564449 of EPO gene

Additional analyses exclusively with patients who fulfilled criteria for classical schizophrenia (n=852) did not yield different results (rs1617640: $\chi^2=1.204$, $p=.548$; rs564449: $\chi^2=.130$, $p=.937$). Since the allelic frequency of rs564449 was not well distributed (TT genotype only in 1% of the cases), this SNP was excluded from further analyses.

For comparison of the EPOR marker STR(GA)_n, sum of allelic repeat lengths (Sum, Figure 7) as well as difference between allelic repeat lengths (Difference, Figure 8) were compared between cases and controls and did not show any differences (Sum: $\chi^2=24.817$, $p=.846$; Difference: $\chi^2=7.091$, $p=.982$).

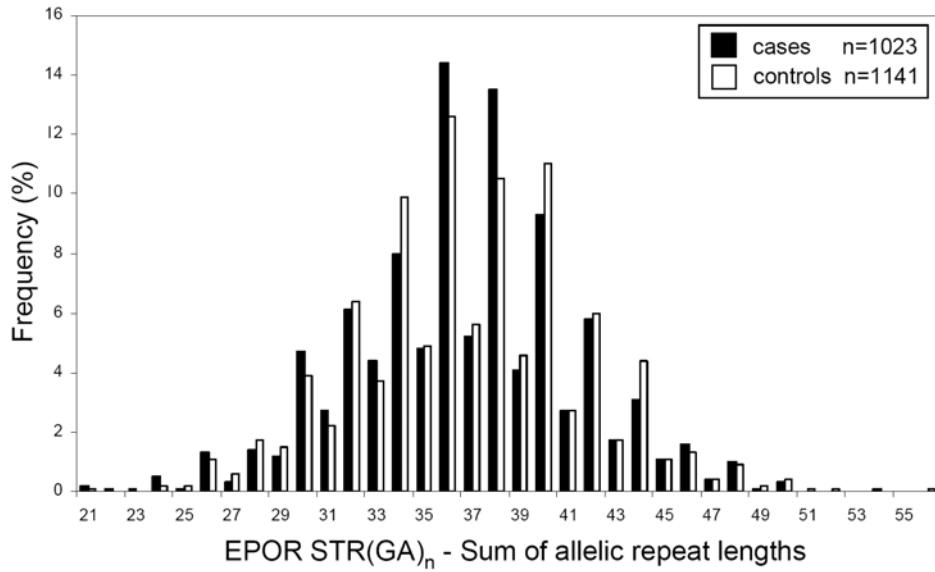

Figure 7: Distribution of sum of allelic repeat lengths of EPOR STR among cases and controls

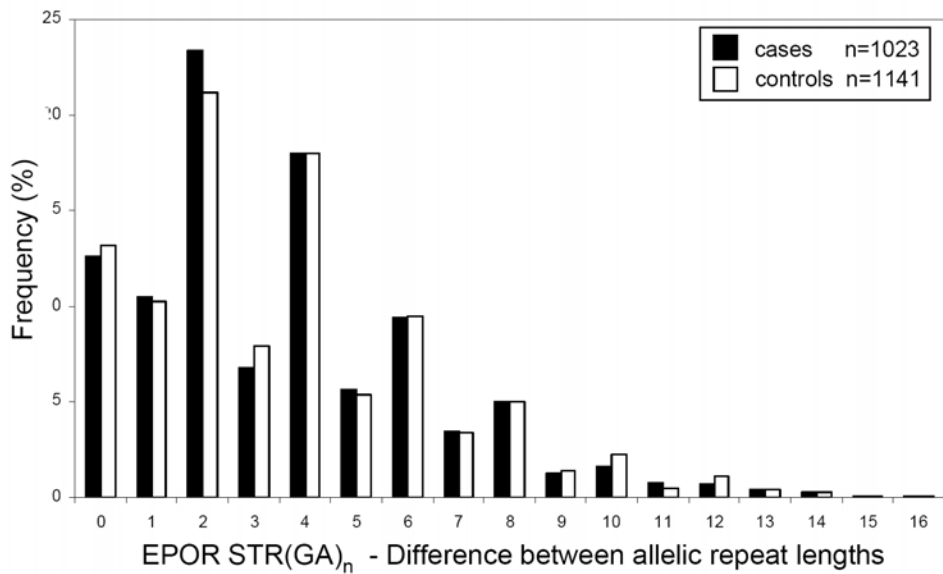

Figure 8: Distribution of difference between allelic repeat lengths of EPOR STR among cases and controls

As in the case of both EPO markers, these results hold true even upon restriction of analyses to the subsample of GRAS patients who carry the diagnosis of classical schizophrenia (Sum: $\chi^2=26.143$, $p=.796$; Difference: $\chi^2=10.003$, $p=.903$).

5.2 PGAS approach

Before testing for genotype-phenotype associations, distribution of gender was analysed and there was no significant difference between genetic groups (EPO rs1617640: $\chi^2=1.623$, $p=.448$; EPOR STR(GA)_n: $\chi^2=.070$, $p=.842$). Thus, no further correction for gender was needed.

As shown in Table 5, raw data of the cognitive tests as well as the Blom-transformed but still uncorrected data for the cognitive composite score give already a hint for the direction of possible genetic effects. For premorbid intelligence, speed of processing, verbal learning and memory, and the cognitive composite score, GG genotypes of EPO SNP reached higher test values, reflecting superior cognitive performance than GT and TT genotypes, whilst patients with low sum of repeat lengths in EPOR marker yielded better values in premorbid intelligence, verbal learning and memory and on the cognitive composite score than patients with high sum of repeat lengths. Still, compared to the healthy normative population provided from each test manual (Helmstaedter, et al., 2001; Lehrl, Triebig, & Fischer, 1995; Tewes, 1991), mean performance of the GRAS patients on speed of processing and verbal learning and memory lies in the lower normal range (PR=16 for ZST) or even below it (PR=10 for VLMT 1-5). Only results for premorbid intelligence fell in the mean range of the healthy normative population (PR=42).

Table 5: Obtained raw data of EPO and EPOR genotype groups in cognitive tests, including percentile rank in relation to normative sample

	EPO rs1617640			EPOR STR(GA) _n ¹		Percentile Rank
	GG	GT	TT	low sum	high sum	
Cognitive – Composite Score ²	0.13 ±0.94	0.03 ±0.85	-0.06 ±0.87	0.04 ±0.87	-0.02 ±0.89	-
Speed of Processing (ZST)	40.12 ±14.22	37.57 ±12.57	36.97 ±13.10	37.91 ±13.05	37.67 ±13.24	PR 16
Verbal Learning and Memory ² (VLMT 1-5)	42.64 ±13.20	42.22 ±12.75	40.39 ±12.54	42.28 ±12.91	40.90 ±12.66	PR 10
Premorbid Intelligence ² (MWTB)	26.53 ±5.93	26.08 ±6.22	25.67 ±6.30	26.23 ±6.09	25.76 ±6.32	PR 42

Analyses of covariance correcting for age, duration of disease, medication and negative symptoms yielded significant differences between genetic groups concerning the target variables. Table 3 gives an overview of all results on the cognitive composite score, the single target variables as well as the control variables.

Table 6: Associations of EPO SNP and EPOR STR with target and control variables (n=841–945)

	EPO	EPOR	Interaction
	rs1617640	STR (GA)_n¹	EPOxEPOR
	F	F	F
	(p)	(p)	(p)
Target Variables			
Combined			
Cognitive Composite Score ²	3.708 (.025)	5.997 (.015)	4.101 (.017)
Single Targets			
Speed of Processing (ZST)	5.230 (.006)	2.226 (.136)	1.579 (.207)
Verbal Learning and Memory (VLMT 1-5) ²	2.511 (.082)	6.210 (.013)	4.327 (.014)
Control Variables			
Cognitive Control Variable			
Premorbid Intelligence (MWTB) ²	.735 (.480)	2.567 (.109)	.608 (.498)
Disease-related Control Variable			
Global Assessment of Functioning (GAF)	.271 (.762)	2.804 (.094)	.520 (.594)
Disease-unrelated Control Variable			
Number of Siblings	2.052 (.129)	1.202 (.273)	.255 (.775)

¹EPOR repeat lengths sum (split into 2 groups [21-36] & [37-54])

²for all analyses with speech-dependent readouts, non-German speakers were excluded

For the cognitive composite score, main effects of the EPO SNP rs1617640 and of EPOR STR(GA)_n were found (rs1617640: $F_{2,847}=3.708$, $p=.025$; STR(GA)_n: $F_{1,843}=5.997$, $p=.015$). Bonferroni corrected post-hoc comparison for the three groups of EPO rs1617640 showing a significant difference between T-homozygotes and G-homozygotes ($p=.016$), with G-homozygotes having much better results in the cognitive composite score than T-homozygotes, whilst the heterozygotes lie in between both groups (Figure 9). For EPOR STR(GA)_n, low sums of repeat lengths yielded significantly better results than high sums of repeat lengths (Figure 9).

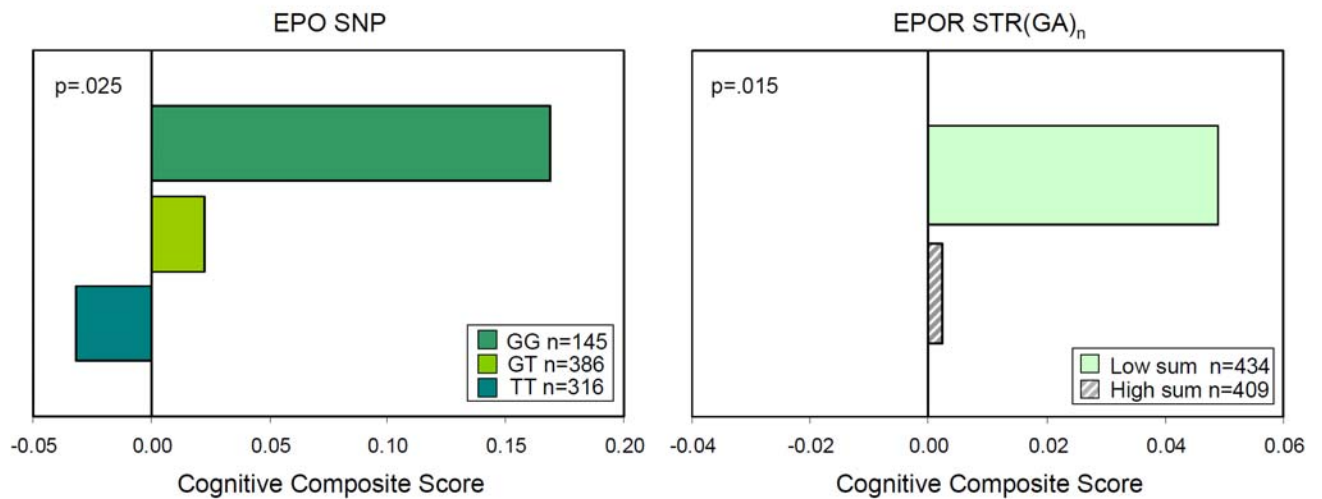

Figure 9: Main effects of EPO SNP and EPOR STR on Cognitive Composite Score

Also, an additional analysis of covariance revealed an interaction effect of both markers concerning the cognitive composite score ($F_{2,841}=4.101$, $p=.017$), as displayed in Figure 10. GG homozygotes in EPO SNP with a low sum of allelic repeat lengths in EPOR repeat are much better than all other groups, whilst GG homozygotes with a high sum of allelic repeat lengths are much worse. For the heterozygotes in EPO SNP, effect of EPOR repeat goes in the opposite direction: a high sum of allelic repeat lengths is associated with a better performance in cognitive composite score, and a low sum of allelic repeat lengths is associated with a worse performance.

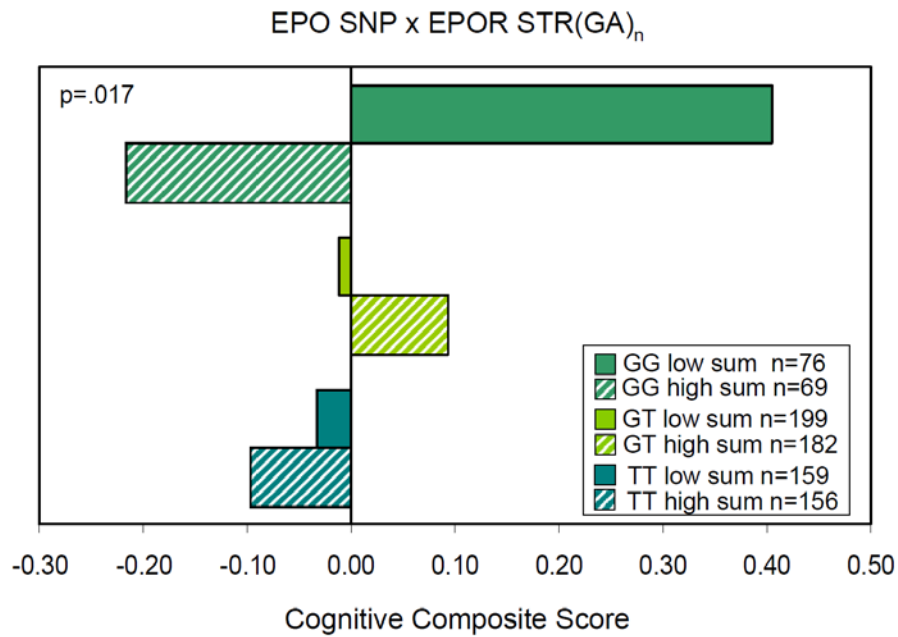

Figure 10: Display of the interaction effect of both genetic markers on Cognitive Composite Score

For speed of processing as single target variable, EPO SNP rs1617640 yielded significant differences between groups ($F_{2,945}=5.230$, $p=.006$). Post-hoc analyses showed a significant difference between T-homozygotes and G-homozygotes even after Bonferroni correction ($p=.004$) as well as a difference between G-homozygotes and the heterozygous group ($p=.024$). Again, G-homozygotes have better results in speed of processing than T-homozygotes, whilst the heterozygotes lie in between both groups (Figure 11).

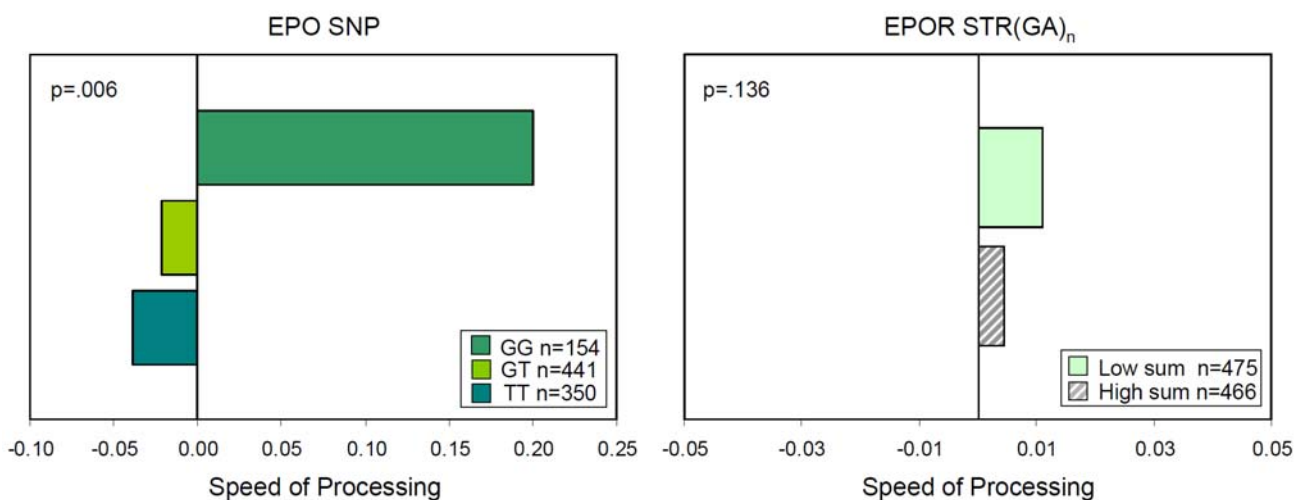

Figure 11: Influence of EPO SNP and EPOR STR on Speed of Processing

The EPOR STR did not have a significant effect on speed of processing (also Figure 11), neither did the two markers significantly interact on this cognitive domain (Figure 12). Even though it does not reach the significance level at all, the interaction pattern of both markers together on that domain looks very similar compared to the pattern found on the cognitive composite score.

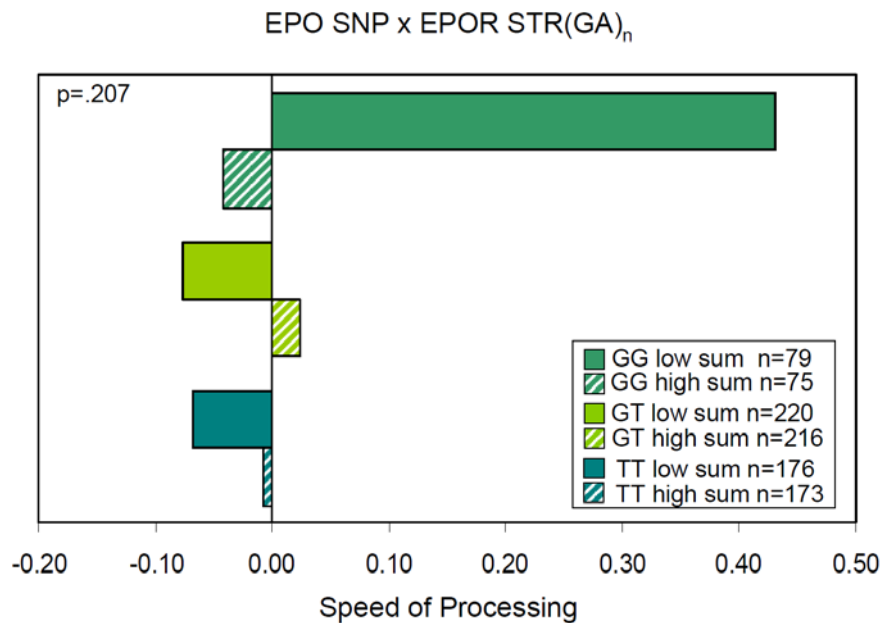

Figure 12: Interaction effect of EPO SNP and EPOR STR on Speed of Processing

EPOR STR(GA)_n on the other hand seems to have more influence on verbal learning and memory as single target variable ($F_{1,846}=6.210$, $p=.013$). Patients having a low sum of repeat length learning the word list better than patients with a high sum of repeat length (Figure 13). Results for EPO SNP rs1617640 are close to significance ($F_{1,850}=2.511$, $p=.082$), again with GG genotypes yielding the best results and TT genotypes the worst.

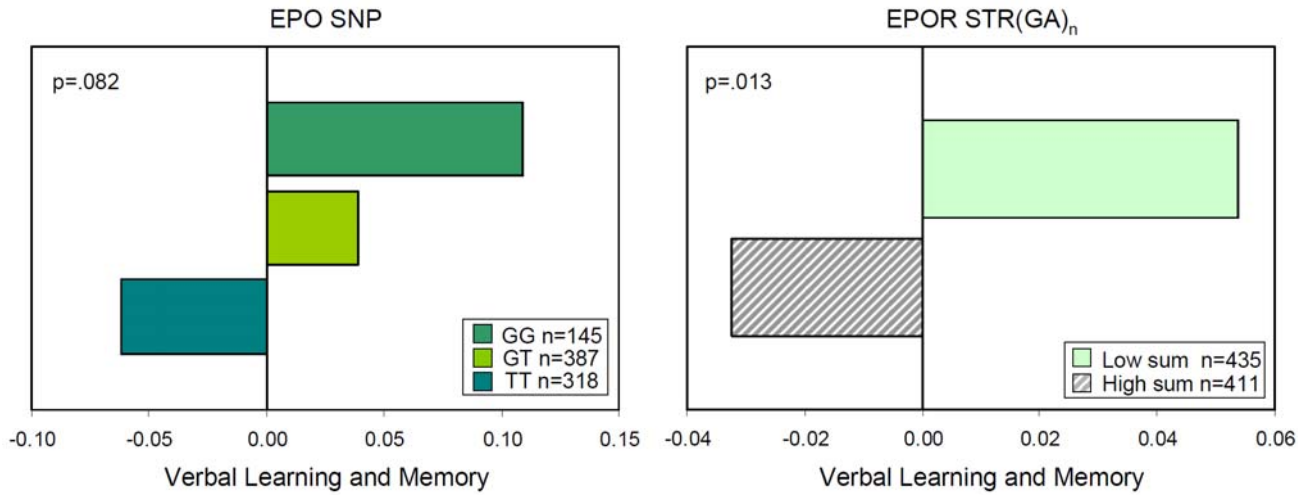

Figure 13: Main effects of EPO and EPOR markers on Verbal Learning and Memory

Also, an interaction effect between both genetic markers and the verbal learning and memory task was detected ($F_{2,844}=4.327$, $p=.014$), illustrating the same interaction pattern as in the composite score (Figure 14).

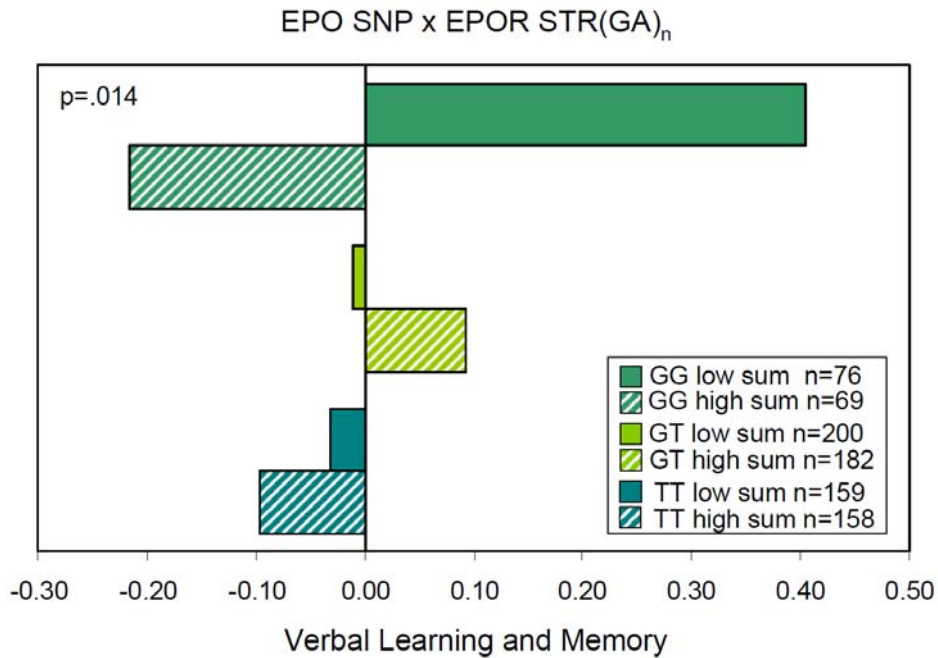

Figure 14: Interaction effect of EPO and EPOR on Verbal Learning and Memory

5.3 Control variables

EPO SNP and EPOR STR each had no effect on the control variables, neither on the cognitive control variable premorbid intelligence, nor on the disease-related control variable global assessment of functioning or the disease-unrelated control variable number of siblings. Also no interaction effect of the genetic markers on the control variables was found. Table 5 summarizes the presented results.

5.4 Further analyses of STR(GA)_n

It was an attempt to analyse the EPOR marker split up in high and low allelic sum of repeat lengths. This decision was made in order to not allow the number of subjects per group get too small to lose all statistical power. To discover what may lie behind the pattern of different allelic sum of repeat lengths, the EPOR genotype effect on the cognitive target variables was further explored.

5.4.1 Sum of allelic repeat lengths

One attempt was to split up the sum of allelic repeat lengths in four rather than in two groups. Significant main effects of EPOR on the cognitive composite score ($F_{3,843}=3.896$, $p=.009$; Figure 16) and on verbal learning and memory ($F_{3,846}=3.706$, $p=.011$) were found but not on speed of processing ($F_{3,941}=1.692$, $p=.167$; Figure 15).

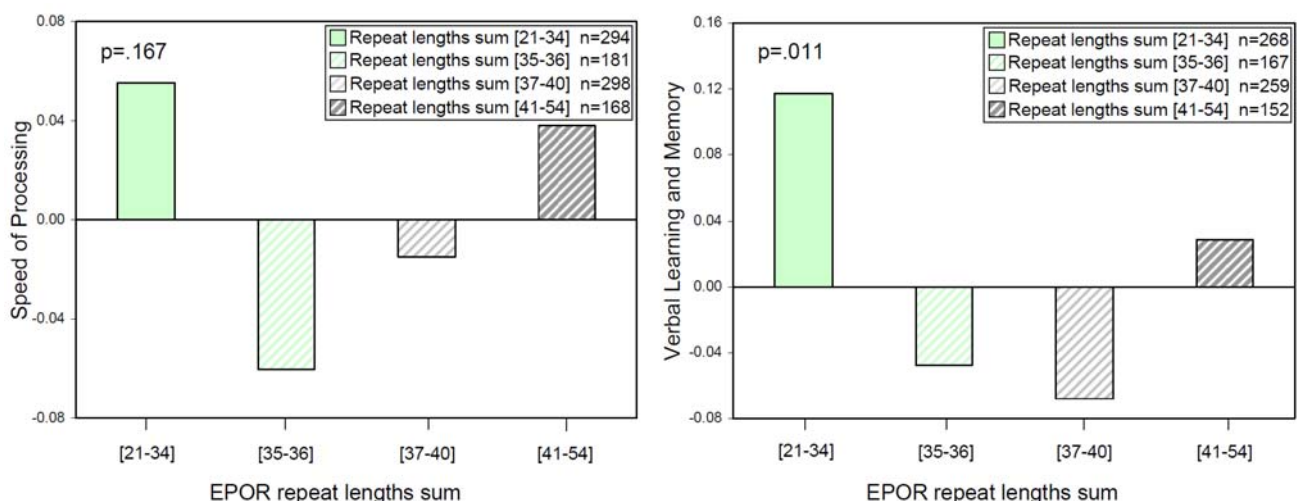

Figure 15: Effect of EPOR STR split up in four repeat length sum groups on Speed of Processing and Verbal Learning and Memory

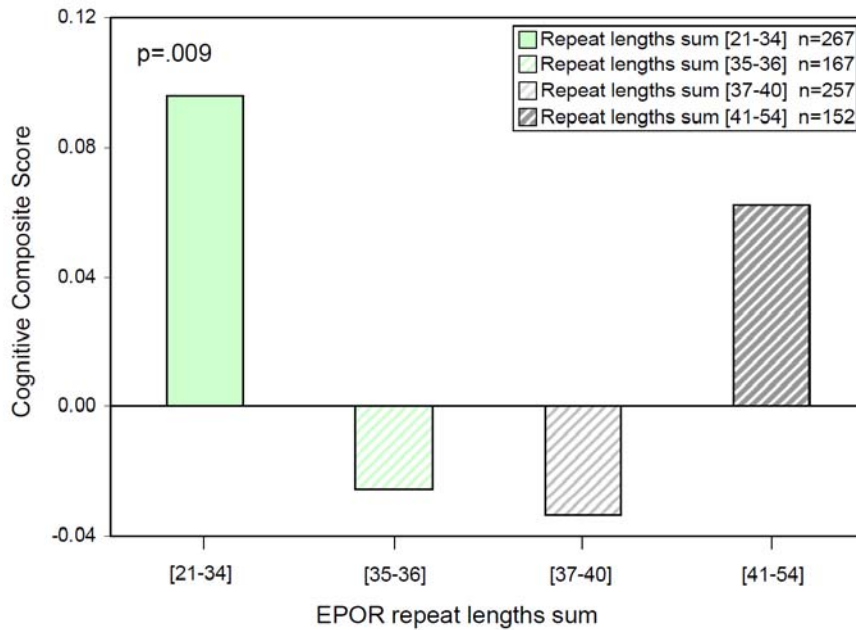

Figure 16: Effect of EPOR four sum groups on the Cognitive Composite Score

Post-hoc analyses revealed that in cases of cognitive composite score (Figure 16) and verbal learning and memory, significant effects after Bonferroni correction remain between group 1 (lowest sums of repeat length, 21-34) and group 3 (second to highest sums of repeat length, 37-40) with $p=.006$ for cognitive composite score and $p=.008$ for verbal learning and memory, with group 1 showing the best test results of all groups and group 3 showing the worst ones.

However, statistical power gets too low by splitting up in four EPOR sum groups to reveal a significant interaction effect with the EPO SNP rs1617640 (composite score: $F_{6,841}=1.753$, $p=.106$; speed of processing: $F_{6,939}=.790$, $p=.578$; verbal learning and memory: $F_{6,844}=1.844$, $p=.088$). But the graphical demonstration of this analysis gives a clue for how the interaction between the three EPO rs1617640 genotype groups (GG, GT, TT) and the four EPOR sum groups is taking place (see Figure 17; data shown in relation to the best performing group with GG genotype in EPO SNP and shortest sum of repeat lengths in EPOR STR [21-34]). With a larger number of subjects, even further partitioning of the EPOR groups might be useful.

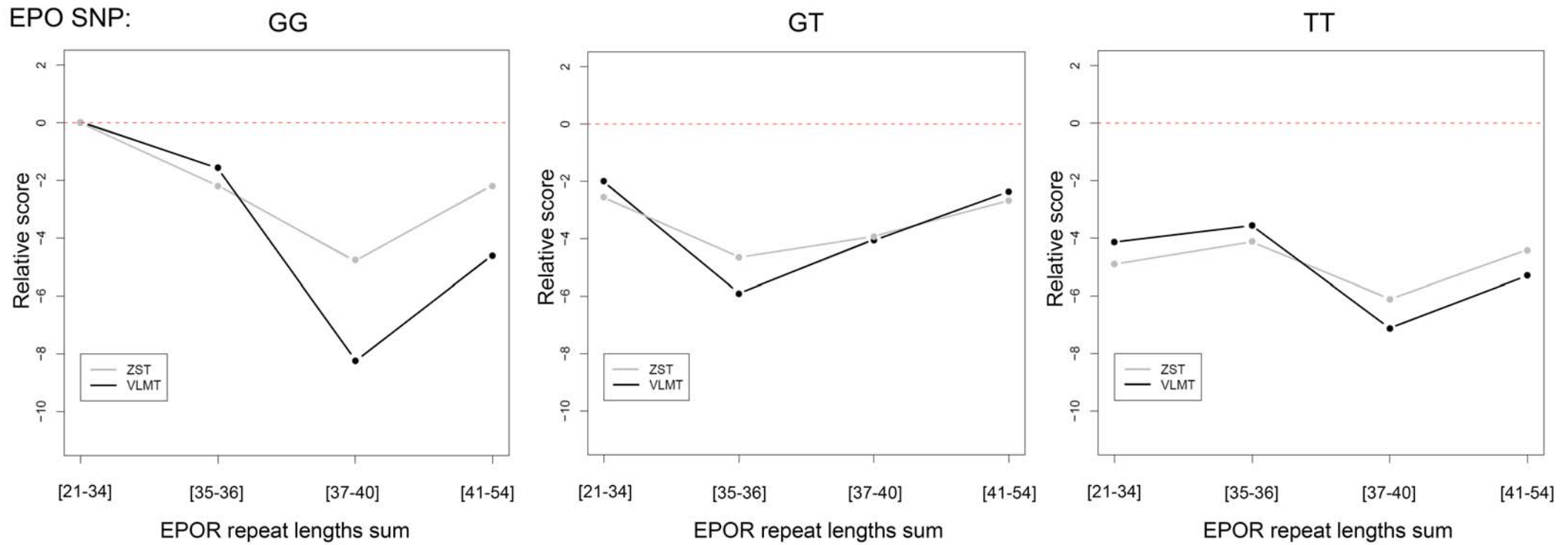

Figure 17: Interaction of the three EPO SNP genotype groups with four EPOR repeat lengths sum groups

5.4.2 Heterogeneity of allelic repeat lengths

The difference between allelic repeat lengths (as a measure for the heterogeneity of alleles) differed significantly between the four EPOR sum of allelic repeat lengths groups ($F_{3,1022}=13.506$, $p<.001$). Bonferroni corrected post-hoc tests revealed that significant effects can be found between the first [21-34] and second [35-36] group ($p<.001$), between the first and third [37-40] group ($p<.001$), between the second and fourth [41-54] group ($p=.005$), and between the third and fourth group of EPOR allelic repeat lengths sum ($p=.002$).

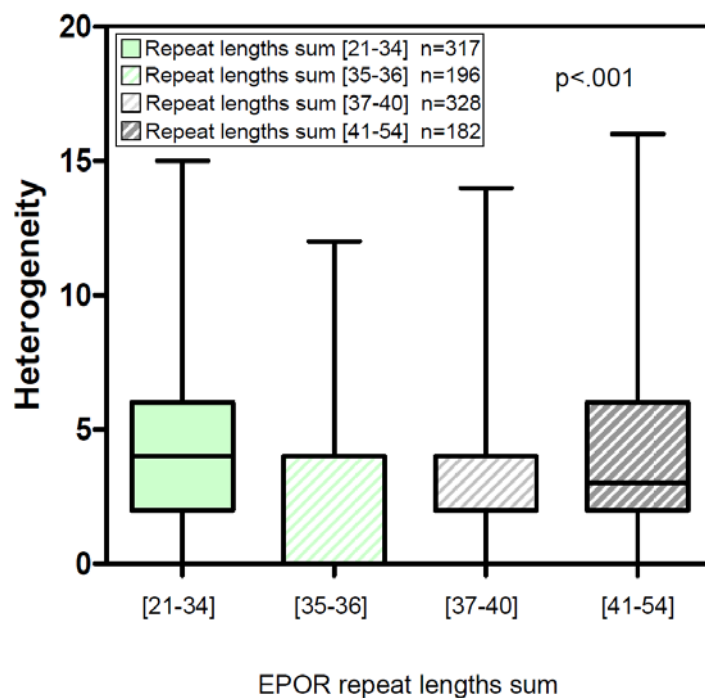

Figure 18: Heterogeneity of the four EPOR repeat lengths groups

5.5 Exploration of genetic influence on blood levels

In the subsample of GRAS patients from whom blood values were available ($n=92-94$), gender distribution was checked and showed no differences between genotype groups (EPO rs1617640: $\chi^2=.532$, $p=.787$; EPOR STR(GA)_n: $\chi^2=.038$, $p>.999$). No effect was found for neither genetic marker on levels of hemoglobin (EPO rs1617640: $F_{2,94}=.063$, $p=.939$; EPOR STR(GA)_n: $t=.256$, $df=92$, $p=.799$), hematocrit (EPO rs1617640: $F_{2,94}=.146$, $p=.864$; EPOR STR(GA)_n: $t=.569$, $df=92$, $p=.571$), erythrocytes (EPO rs1617640: $F_{2,94}=.223$, $p=.800$; EPOR STR(GA)_n: $t=.394$, $df=92$, $p=.695$) or thrombocytes (EPO rs1617640: $F_{2,94}=1.261$, $p=.288$; EPOR STR(GA)_n:

$t=.201$, $df= 92$, $p=.841$). Table 7 demonstrates the equal distribution of blood values among genotypes. A further subdivision of EPOR STR(GA)_n sum of allelic repeat lengths in four groups did not yield different results.

Table 7: Mean values and standard deviations for blood indices per genotype group

	EPO rs1617640			EPOR STR(GA) _n	
	GG	GT	TT	low sum	high sum
	n=13	n=46	n=35	n=50	n=42
hemoglobin	14.751 ± 1.317	14.710 ±0.930	14.650 ±1.311	14.748 ±1.112	14.645 ±1.181
hematocrit	43.765 ±3.877	43.480 ±2.625	43.264 ±3.837	43.661 ±3.187	43.226 ±3.453
erythrocytes	4.860 ±0.439	4.908 ±0.394	4.832 ±0.481	4.894 ±0.442	4.850 ±0.432
thrombocytes	271.166 ±54.047	250.669 ±42.291	271.683 ±70.701	261.442 ±59.959	261.870 ±52.927

5.6 Impulsivity in humans

No main effect of EPO rs161760 ($F_{2,962}=1.188$, $p=.829$) or interaction effect of both markers together ($F_{2,956}=1.141$, $p=.320$) was found on impulsivity, but a significant main effect of EPOR STR(GA)_n, when analyzing two groups (high/low: $F_{1,958}=4.804$, $p=.029$) with the low repeat sum group being more impulsive than the high repeat sum group (Figure 19; data shown as mean values + standard error of mean).

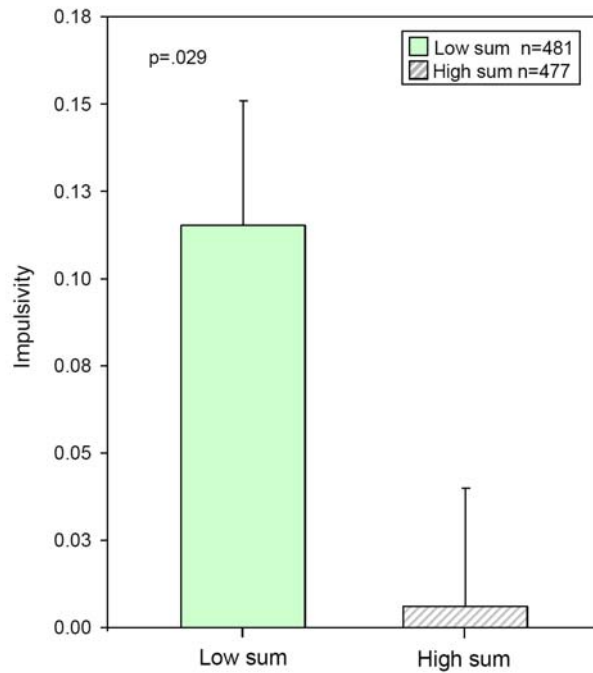

Figure 19: Effect of EPOR repeat separated in high and low sum on impulsivity

By analyzing four groups of EPOR STR(GA)_n allelic sum of repeat lengths, results were no longer significant (four groups: $F_{3,958}=1.958$, $p=.119$). Nevertheless, Figure 20 clearly shows that the influence of the EPOR genetic variant STR(GA)_n on impulsivity is on the “same line” as its influence on the cognitive readout (data shown in relation to the best performing group [21-34]). As in the mouse model, humans who reveal the best results on speed of processing and verbal learning and memory tasks, are most impulsive.

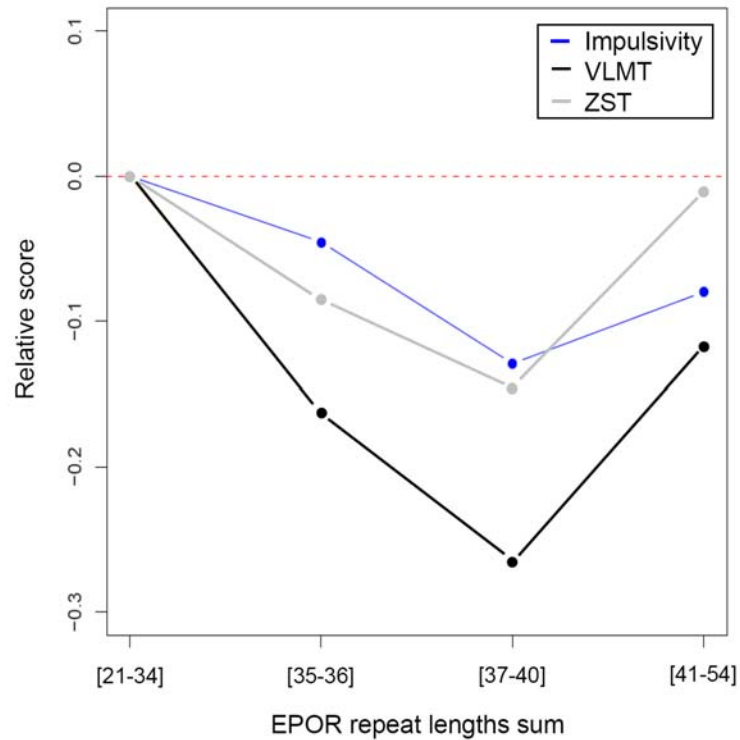

Figure 20: Association of EPOR STR(GA)_n with impulsivity

5.7 Effects of genetic markers on mRNA

It was tested before, whether gender distributions were different between genotype groups (EPO rs1617640: $\chi^2=2.804$, $p=.268$; EPOR STR(GA)_n: $\chi^2=.224$, $p=.712$), but no differences were found.

Genotypes of the analysed markers did not have a significant influence on their own mRNA level in PBMCs (EPO: $\chi^2=.350$, $p=.840$; EPOR: $Z=-.202$, $p=.855$). Interestingly, EPOR STR(GA)_n had an influence on the level of EPO mRNA (high/low grouping: $Z=-2.088$, $p=.037$, with the low repeat sum group having less EPO mRNA concentration in the peripheral blood (Figure 21).

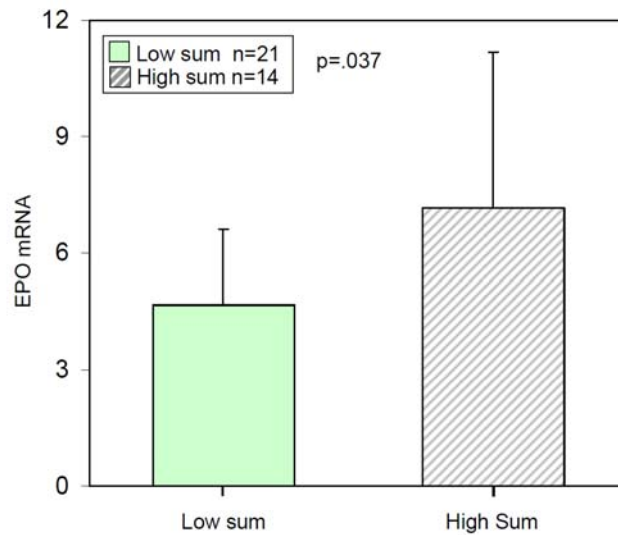

Figure 21: Effect of EPOR repeat separated in high and low sum on EPO mRNA

Concerning the four group approach, an even more interesting finding was revealed as shown in Figure 22: Again, like in the results concerning cognition, the first and third group had the most extreme values. But group one - which was cognitively the best group – has the least EPO mRNA whilst group three – concerning cognition the worst group - has the highest EPO mRNA concentration of the four groups ($\chi^2=6.767$, $p=.080$). Due to small n numbers this result does not reach significance level.

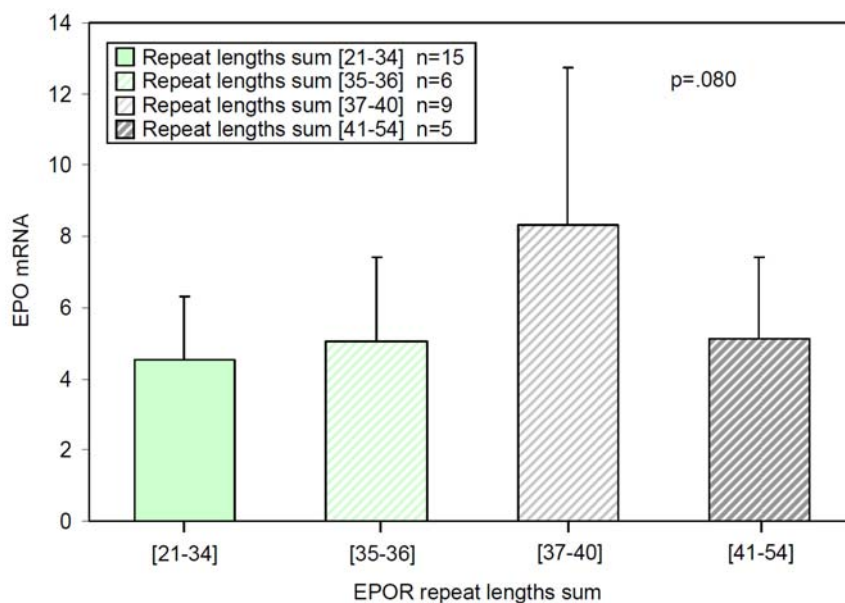

Figure 22: Effect of EPOR repeat separated in four different sum groups on EPO mRNA

6 Discussion

The present thesis explored whether common genetic variants of the EPO system (EPO/EPOR) have an influence on cognitive core features in schizophrenia, e.g. speed of processing and verbal learning and memory. Like hypothesized a simple case control association study, based on endpoint diagnosis and single markers, did not yield significant differences between cases and controls regarding genotypic or allelic frequencies. Therefore neither EPO nor EPOR are qualified for the label “disease gene”.

Instead, it could be shown that both genes are modifying cognition in schizophrenia and by that, have a considerable impact on the functional outcome of the disease (Green, 1996). Both were significantly associated with the cognitive composite score after correcting for age, medication, negative symptoms and duration of disease – independent of each other, but also in interaction, even though the genes are located on different chromosomes. Concerning the single domains, the EPO SNP was not significantly associated with verbal learning and memory, but the trend pointed to that direction ($p=.082$). For the EPOR marker, there was no single effect with speed of processing found. This might indicate that EPOR has more influence on a higher cognitive level.

In general, it is difficult to analyse short tandem repeats if they contain a large amount of allelic variants such as the STR(GA)_n in the promoter region of EPOR with 23 alleles in the GRAS sample. The used approach was to add up both alleles with the idea that lower sums indicate lower repeat frequencies on both alleles and vice versa. Still, further analyses by splitting up the sum groups not only in high and low, but into four categories showed, that the influence of the repeat sum is not a continuing one but of a far more complex nature. One approach to further shed light on this strategy was to compare the four sum groups concerning their heterogeneity. Interestingly, the first of the four sum groups was the most heterogeneous group and cognitively the best group, followed by the fourth sum group with second-best cognitive results and second-high heterogeneity rates. Both sum groups in between had a worse outcome in cognitive tests and had comparably low levels of heterogeneity. To conclude, it seems to be most beneficial to have one allele with very few repeats and a medium quantity of repeats on the second allele, which might imply an influence of the EPOR STR(GA)_n on transcriptional processes. To identify

number of repeats in EPOR, especially in interaction with EPO, a much bigger sample would be needed, which might even allow allele-wise analyses.

To control for random associations which might only occur by chance due to the distribution of subjects among the genetic groups, three different types of control variables were used (cognitive, disease-related and disease-unrelated) and revealed no significant association, indeed. Therefore it might be justified saying that the genes of the EPO system are specifically modulating cognitive performance.

For all shown analyses, correction for multiple testing was abandoned, since they were carried out strictly hypothesis-driven and in an exploratory fashion and are in many ways not independent of each other: Both cognitive domains are not independent of each others, the composite score comprises results of the single domains and also the interaction effect is not to be handled as a third genetic marker since it depends on the group distributions of the single markers.

For a long time, changes in cognitive performance after administration of rhEpo have been attributed to stimulation of erythrocytosis which in turn enhanced tissue oxygenation (for review see Ehrenreich, et al., 2008), therefore it was necessary to evaluate whether the influence of EPO and EPOR markers on cognition goes along with an effect on basic blood parameters, e.g. hemoglobin, hematocrit, erythrocytes or thrombocytes. Values were collected from a 10 year time span and individual means were calculated most carefully with an exclusion of outliers and extreme values; neither EPO nor EPOR had a significant effect on any of the obtained blood values. Thus, it underlines the assumption that the effect of Epo on higher cognitive functions is independent of its role in erythropoiesis. The independence of the amount of red blood cells was also confirmed in transgenic cEPOR mice, which have constitutively active EPO receptors in the postnatal mouse forebrain. Their superior cognitive phenotype compared with wildtype mice (Sargin, et al., submitted) came along with an enhanced impulsivity. A translational approach was taken by testing the impulsivity in humans, and as expected an association with STR(GA)_n of EPOR, but not with EPO or the interaction of both genes was found. Since the animal phenotype was also only due to a modification of the EPO receptor, this finding was an additional validation of the obtained results.

From a psychological point of view it was to some degree surprising that the influence of EPOR STR on cognition and on impulsivity was on the same line, (e.g. good results in cognitive tests went along with high impulsivity rates and vice versa), since the majority of studies about the link between cognition and impulsivity found inverse relations in humans (Corr & Kumari, 1998; Lynam, Moffitt, & Stouthamer-Loeber, 1993; Schweizer, 2002; Whitney, Jameson, & Hinson, 2004). While speculating about the reason for this seemingly contradictory finding, one has to keep in mind that impulsivity is a very complex construct which has been defined in many different ways (e.g. Buss & Plomin, 1975; Cloninger, 1987; Eysenck & Eysenck, 1985; Schalling, Asberg, Edman, & Oreland, 1987). For a deeper understanding of the connection between different dimensions of impulsivity and cognition, special measurements of impulsivity have to be applied, such as the Dickman's Impulsivity Inventory (Dickman, 1990). The idea behind Dickman's inventory is that two forms of impulsivity exist: Functional impulsivity, which is characterized by quick and inaccurate responding in situations where it is rewarded, and dysfunctional impulsivity, which is described as a lack of inhibiting fast and thoughtless reactions in situations where they do not pay off. In his own studies he could show that high functional impulsives were faster and therefore gained better results than low functional impulsives in a task measuring the speed and accuracy of basic perceptual processes (Dickman, 1990). By subdividing the rough concept of impulsivity and furthermore introducing for the first time a useful variant of impulsivity, he shed new light on that field of research. The variety of concepts developed since in human as well as in rodent studies made clear: Impulsivity is a multifactor concept and several neurochemical mechanisms can influence different facets of impulsivity (Evenden, 1999). Therefore, one can conclude that measuring impulsivity with one item of the PANSS may have led to a rating of a functional form of impulsivity in the thesis on hand. The found association with the biologically meaningful subgroups of EPOR STR(GA)_n suggests that the mechanism of action of EPOR repeat on cognition goes via neurochemical pathways involving among others a functional form of impulsivity, whilst the analysed EPO marker does not share this mechanism of action.

Concerning the mRNA findings, there is neither an influence of EPOR STR(GA)_n on EPOR mRNA level nor of EPO SNP rs1617640 on its mRNA expression in PBMCs. The latter is in accordance with findings of Tong and co-workers (Tong, et al., 2008).

Surprisingly, sum groups of EPOR STR(GA)_n were significantly associated with EPO mRNA level in PBMCs in a subsample of 35 GRAS patients. Unfortunately, due to the small sample size (n=35) the data could not be analyzed with respect to an interaction of both genotypes. For a better biological understanding this would be worthwhile. If this interaction can be replicated in bigger samples and as well allele-wise, it would be a first step to understand the mechanism behind the interaction effect of both genes on cognition. The interaction seen on biological level mirrors exactly what was found in the cognitive test results – only in the opposite direction. In the light of the clinical studies where EPO treatment improves cognition (e.g. Ehrenreich, Fischer, et al., 2007; Ehrenreich, Hinze-Selch, et al., 2007; Neubauer, et al., 2010; Siren, et al., 2009) it is at first view unexpected, that higher levels of EPO lead to worse cognitive performance. The fact that in the vitreous body of diabetic patients as well as in luciferase reporter gene experiments the T allele shows higher expression of EPO compared to the G allele also points into that direction; accordingly, in the GRAS sample T homozygotes have the worst cognitive results. Assuming a feedback regulation of EPO and EPOR, however, higher EPO mRNA levels may well point to a relative insufficiency (and thus compensatory upregulation) of the system.

The exact molecular mechanisms behind the EPO/EPOR system are still unknown. The fact that the analysed repeat in EPOR seems to have an influence only on the corresponding mRNA of EPO but not on its own mRNA, indicates that there is a complex regulation present in this system. Two possible scenarios might help to explain the mRNA findings, first regarding the quantity and second regarding quality of EPO/EPOR.

Having in mind that the STR in the EPOR gene is located in the 5' flanking region and is neither transcribed nor translated, the regulation has to take place on DNA level. A real regulation at this stage has not been described so far, thus all further attempts to explain how EPOR STR might influence the mRNA of its ligand are speculative. The EPOR STR might lead to a differential binding of common transcription factors. In line with this speculation, the promoter regions of EPO and its receptor share some common binding sites (Chin, Oda, Shen, & Noguchi, 1995; Fandrey, 2004). This could result in a competition of the mRNAs for specific transcription factors leading to differential expression. A further possibility is the

existence of another variation in linkage to the analysed STR that affects the EPOR function and therefore leads to an upregulation of the ligand. It is well known, that single mutations in the EPOR gene can have a tremendous impact on the system. In PFCP it has been shown that modifications of a single amino acid can induce a hypersensitive phenotype (Arcasoy, et al., 1997). To prove this hypothesis in the GRAS study, homozygous carriers for different allele lengths would need to be analyzed in their expression and on the sequence level.

To conclude, it is hard to predict how common genetic variations such as STRs and SNPs influence expression or later the function of a gene. There is a variety of possibilities how single base pair exchanges or repeats in intronic regions or putative promoter regions can influence a phenotype. The found interaction effect between the analysed markers of EPO and EPOR genes is definitely worthwhile studying further.

7 Literature

- Abhary, S., Burdon, K. P., Casson, R. J., Goggin, M., Petrovsky, N. P., & Craig, J. E. (2010). Association between erythropoietin gene polymorphisms and diabetic retinopathy. *Arch Ophthalmol*, *128*(1), 102-106.
- American Psychiatric Association. (1994). *Diagnostic and statistical manual of mental disorders, 4th edition (DSM-IV)*. Washington, DC: American Psychiatric Press.
- Arcasoy, M. O., Degar, B. A., Harris, K. W., & Forget, B. G. (1997). Familial erythrocytosis associated with a short deletion in the erythropoietin receptor gene. *Blood*, *89*(12), 4628-4635.
- Balasubbu, S., Sundaresan, P., Rajendran, A., Ramasamy, K., Govindarajan, G., Perumalsamy, N., et al. (2010). Association Analysis of Nine Candidate Gene Polymorphisms in Indian Patients with Type 2 Diabetic Retinopathy. *BMC Med Genet*, *11*(1), 158.
- Barch, D. M., & Keefe, R. S. (2010). Anticipating DSM-V: opportunities and challenges for cognition and psychosis. *Schizophr Bull*, *36*(1), 43-47.
- Begemann, M., Grube, S., Papiol, S., Malzahn, D., Krampe, H., Ribbe, K., et al. (2010). Modification of cognitive performance in schizophrenia by complexin 2 gene polymorphisms. *Arch Gen Psychiatry*, *67*(9), 879-888.
- Bellack, A. S., Sayers, M., Mueser, K. T., & Bennett, M. (1994). Evaluation of social problem solving in schizophrenia. *J Abnorm Psychol*, *103*(2), 371-378.
- Blom, G. (1958). *Statistical Estimates and Transformed Beta Variables*. New York: John Wiley and Sons, Inc.
- Bourantas, L. K., Chatzikyriakidou, A., Dasoula, A., Syrrou, M., Bournatas, K. L., & Georgiou, I. (2006). Absence of mutations of the EPO-receptor gene in Greek patients with familial polycythemia. *Eur J Haematol*, *76*(6), 537-538.
- Brébion, G., Amador, X., Smith, M. J., & Gorman, J. M. (1998). Memory impairment and schizophrenia: the role of processing speed. *Schizophr Res*, *30*(1), 31-39.
- Brébion, G., Smith, M. J., Gorman, J. M., Malaspina, D., Sharif, Z., & Amador, X. (2000). Memory and schizophrenia: differential link of processing speed and selective attention with two levels of encoding. *J Psychiatr Res*, *34*(2), 121-127.
- Buchanan, R. W., Holstein, C., & Breier, A. (1994). The comparative efficacy and long-term effect of clozapine treatment on neuropsychological test performance. *Biol Psychiatry*, *36*(11), 717-725.
- Buss, A. H., & Plomin, R. (1975). *A temperament theory of personality development*. New York: Wiley.
- Cannon, T. D., Huttunen, M. O., Lonnqvist, J., Tuulio-Henriksson, A., Pirkola, T., Glahn, D., et al. (2000). The inheritance of neuropsychological dysfunction in twins discordant for schizophrenia. *Am J Hum Genet*, *67*(2), 369-382.
- Chin, K., Oda, N., Shen, K., & Noguchi, C. T. (1995). Regulation of transcription of the human erythropoietin receptor gene by proteins binding to GATA-1 and Sp1 motifs. *Nucleic Acids Res*, *23*(15), 3041-3049.
- Cirillo, M. A., & Seidman, L. J. (2003). Verbal declarative memory dysfunction in schizophrenia: from clinical assessment to genetics and brain mechanisms. *Neuropsychol Rev*, *13*(2), 43-77.
- Cloninger, C. R. (1987). A systematic method for clinical description and classification of personality variants. A proposal. *Arch Gen Psychiatry*, *44*(6), 573-588.
- Corr, P. J., & Kumari, V. (1998). Impulsivity, Time of Day, and Stress: Effects on Intelligence Test Performance. *Journal of Research in Personality*, *32*, 1-12.
- Corrigan, P. W., Green, M. F., & Toomey, R. (1994). Cognitive correlates to social cue perception in schizophrenia. *Psychiatry Res*, *53*(2), 141-151.

- D'Andrea, A. D., Lodish, H. F., & Wong, G. G. (1989). Expression cloning of the murine erythropoietin receptor. *Cell*, *57*(2), 277-285.
- Davis, J. M. (1976). Comparative doses and costs of antipsychotic medication. *Arch Gen Psychiatry*, *33*(7), 858-861.
- de la Chapelle, A., Sistonen, P., Lehvaslaiho, H., Ikkala, E., & Juvonen, E. (1993). Familial erythrocytosis genetically linked to erythropoietin receptor gene. *Lancet*, *341*(8837), 82-84.
- Dianzani, I., Garelli, E., Dompe, C., Crescenzo, N., Locatelli, F., Schiliro, G., et al. (1996). Mutations in the erythropoietin receptor gene are not a common cause of Diamond-Blackfan anemia. *Blood*, *87*(6), 2568-2572.
- Dickinson, D., Ramsey, M. E., & Gold, J. M. (2007). Overlooking the obvious: a meta-analytic comparison of digit symbol coding tasks and other cognitive measures in schizophrenia. *Arch Gen Psychiatry*, *64*(5), 532-542.
- Dickman, S. J. (1990). Functional and dysfunctional impulsivity: personality and cognitive correlates. *J Pers Soc Psychol*, *58*(1), 95-102.
- Duan, J., Sanders, A. R., & Gejman, P. V. (2010). Genome-wide approaches to schizophrenia. [doi: DOI: 10.1016/j.brainresbull.2010.04.009]. *Brain Research Bulletin*, *83*(3-4), 93-102.
- Ehrenreich, H., Bartels, C., Sargin, D., Stawicki, S., & Krampe, H. (2008). Recombinant human erythropoietin in the treatment of human brain disease: focus on cognition. *J Ren Nutr*, *18*(1), 146-153.
- Ehrenreich, H., Fischer, B., Norra, C., Schellenberger, F., Stender, N., Stiefel, M., et al. (2007). Exploring recombinant human erythropoietin in chronic progressive multiple sclerosis. *Brain*, *130*(Pt 10), 2577-2588.
- Ehrenreich, H., Hinze-Selch, D., Stawicki, S., Aust, C., Knolle-Veentjer, S., Wilms, S., et al. (2007). Improvement of cognitive functions in chronic schizophrenic patients by recombinant human erythropoietin. *Mol Psychiatry*, *12*(2), 206-220.
- Elvevag, B., & Goldberg, T. E. (2000). Cognitive impairment in schizophrenia is the core of the disorder. *Crit Rev Neurobiol*, *14*(1), 1-21.
- Emanuel, P. D., Eaves, C. J., Broudy, V. C., Papayannopoulou, T., Moore, M. R., D'Andrea, A. D., et al. (1992). Familial and congenital polycythemia in three unrelated families. *Blood*, *79*(11), 3019-3030.
- Evenden, J. L. (1999). Varieties of impulsivity. *Psychopharmacology*, *146*(4), 348-361.
- Eysenck, H. J., & Eysenck, M. W. (1985). *Personality and individual differences: a natural science approach*. New York: Plenum Press.
- Fandrey, J. (2004). Oxygen-dependent and tissue-specific regulation of erythropoietin gene expression. *Am J Physiol Regul Integr Comp Physiol*, *286*(6), R977-988.
- Furukawa, T., Narita, M., Sakaue, M., Otsuka, T., Kuroha, T., Masuko, M., et al. (1997). Primary familial polycythaemia associated with a novel point mutation in the erythropoietin receptor. *Br J Haematol*, *99*(1), 222-227.
- Ganesh, S. K., Zakai, N. A., van Rooij, F. J., Soranzo, N., Smith, A. V., Nalls, M. A., et al. (2009). Multiple loci influence erythrocyte phenotypes in the CHARGE Consortium. *Nat Genet*, *41*(11), 1191-1198.
- Ghezzi, S., Del Bo, R., Scarlato, M., Nardini, M., Carlesi, C., Prella, A., et al. (2009). Is erythropoietin gene a modifier factor in amyotrophic lateral sclerosis? [doi: DOI: 10.1016/j.neurobiolaging.2007.08.008]. *Neurobiology of Aging*, *30*(5), 842-844.
- Gold, J. M., Rehkemper, G., Binks, S. W., 3rd, Carpenter, C. J., Fleming, K., Goldberg, T. E., et al. (2000). Learning and forgetting in schizophrenia. *J Abnorm Psychol*, *109*(3), 534-538.
- Green, M. F. (1996). What are the functional consequences of neurocognitive deficits in schizophrenia? *Am J Psychiatry*, *153*(3), 321-330.

- Green, M. F. (2006). Cognitive impairment and functional outcome in schizophrenia and bipolar disorder. *J Clin Psychiatry*, 67 Suppl 9, 3-8; discussion 36-42.
- Grimm, G., Stockenhuber, F., Schneeweiss, B., Madl, C., Zeitlhofer, J., & Schneider, B. (1990). Improvement of brain function in hemodialysis patients treated with erythropoietin. *Kidney Int*, 38(3), 480-486.
- Grube, S., Gerchen, M. F., Adamcio, B., Pardo, L. A., Martin, S., Mahlzahl, D., et al. (submitted). Calcium-activated potassium channels as regulators of cognitive performance in schizophrenia.
- Hardy, J., & Singleton, A. (2009). Genomewide Association Studies and Human Disease. *New England Journal of Medicine*, 360(17), 1759-1768.
- Hegarty, J., Baldessarini, R., Tohen, M., Wateraux, C., & Oepen, G. (1994). One hundred years of schizophrenia: a meta-analysis of the outcome literature. *Am J Psychiatry*, 151(10), 1409-1416.
- Heinrichs, R. W., & Zakzanis, K. K. (1998). Neurocognitive deficit in schizophrenia: a quantitative review of the evidence. *Neuropsychology*, 12(3), 426-445.
- Helmstaedter, C., Lendt, M., & Lux, S. (2001). *Verbaler Lern- und Merkfähigkeitstest (VLMT)*. Goettingen: Beltz.
- Hengemihle, J. M., Abugo, O., Rifkind, J., Spangler, E., Danon, D., & Ingram, D. K. (1996). Chronic treatment with human recombinant erythropoietin increases hematocrit and improves water maze performance in mice. *Physiol Behav*, 59(1), 153-156.
- Hess, G., Rose, P., Gamm, H., Papadileris, S., Huber, C., & Seliger, B. (1994). Molecular analysis of the erythropoietin receptor system in patients with polycythaemia vera. *Br J Haematol*, 88(4), 794-802.
- Hoff, A. L., Sakuma, M., Wieneke, M., Horon, R., Kushner, M., & DeLisi, L. E. (1999). Longitudinal neuropsychological follow-up study of patients with first-episode schizophrenia. *Am J Psychiatry*, 156(9), 1336-1341.
- Iliadou, A., Evans, D. M., Zhu, G., Duffy, D. L., Frazer, I. H., Montgomery, G. W., et al. (2007). Genomewide scans of red cell indices suggest linkage on chromosome 6q23. *J Med Genet*, 44(1), 24-30.
- Jacobs, K., Shoemaker, C., Rudersdorf, R., Neill, S. D., Kaufman, R. J., Mufson, A., et al. (1985). Isolation and characterization of genomic and cDNA clones of human erythropoietin. *Nature*, 313(6005), 806-810.
- Javitt, D. C., Strous, R. D., Grochowski, S., Ritter, W., & Cowan, N. (1997). Impaired precision, but normal retention, of auditory sensory ("echoic") memory information in schizophrenia. *J Abnorm Psychol*, 106(2), 315-324.
- Jedlickova, K., Stockton, D. W., Chen, H., Stray-Gundersen, J., Witkowski, S., Ri-Li, G., et al. (2003). Search for genetic determinants of individual variability of the erythropoietin response to high altitude. *Blood Cells Mol Dis*, 31(2), 175-182.
- Juul, S. E., Yachnis, A. T., Rojiani, A. M., & Christensen, R. D. (1999). Immunohistochemical localization of erythropoietin and its receptor in the developing human brain. *Pediatr Dev Pathol*, 2(2), 148-158.
- Kay, S. R., Fiszbein, A., & Opler, L. A. (1987). The positive and negative syndrome scale (PANSS) for schizophrenia. *Schizophr Bull*, 13(2), 261-276.
- Keefe, R. S., Eesley, C. E., & Poe, M. P. (2005). Defining a cognitive function decrement in schizophrenia. *Biol Psychiatry*, 57(6), 688-691.
- Keefe, R. S., & Fenton, W. S. (2007). How should DSM-V criteria for schizophrenia include cognitive impairment? *Schizophr Bull*, 33(4), 912-920.
- Kern, R. S., Nuechterlein, K. H., Green, M. F., Baade, L. E., Fenton, W. S., Gold, J. M., et al. (2008). The MATRICS Consensus Cognitive Battery, part 2: co-norming and standardization. *Am J Psychiatry*, 165(2), 214-220.

- Knapp, M., Mangalore, R., & Simon, J. (2004). The global costs of schizophrenia. *Schizophr Bull*, 30(2), 279-293.
- Koh, S. D., Kayton, L., & Berry, R. (1973). Mnemonic organization in young nonpsychotic schizophrenics. *J Abnorm Psychol*, 81(3), 299-310.
- Koury, M. J., Bondurant, M. C., Graber, S. E., & Sawyer, S. T. (1988). Erythropoietin messenger RNA levels in developing mice and transfer of 125I-erythropoietin by the placenta. *J Clin Invest*, 82(1), 154-159.
- Koury, S. T., Bondurant, M. C., Koury, M. J., & Semenza, G. L. (1991). Localization of cells producing erythropoietin in murine liver by in situ hybridization. *Blood*, 77(11), 2497-2503.
- Kraepelin, E. (1893). *Psychiatrie*. Leipzig: J. A. Barth.
- Kralovics, R., Sokol, L., Broxson, E. H., Jr., & Prchal, J. T. (1997). The erythropoietin receptor gene is not linked with the polycythemia phenotype in a family with autosomal dominant primary polycythemia. *Proc Assoc Am Physicians*, 109(6), 580-585.
- Kralovics, R., Sokol, L., & Prchal, J. T. (1998). Absence of polycythemia in a child with a unique erythropoietin receptor mutation in a family with autosomal dominant primary polycythemia. *J Clin Invest*, 102(1), 124-129.
- Lehrl, S. (1999). *Mehrfach-Wortschatz-Intelligenztest MWT-B*. Balingen: Spitta Verlag.
- Lehrl, S., Triebig, G., & Fischer, B. (1995). Multiple choice vocabulary test MWT as a valid and short test to estimate premorbid intelligence. *Acta Neurol Scand*, 91(5), 335-345.
- Lin, J. P., O'Donnell, C. J., Levy, D., & Cupples, L. A. (2005). Evidence for a gene influencing haematocrit on chromosome 6q23-24: genomewide scan in the Framingham Heart Study. *J Med Genet*, 42(1), 75-79.
- Lynam, D., Moffitt, T., & Stouthamer-Loeber, M. (1993). Explaining the relation between IQ and delinquency: class, race, test motivation, school failure, or self-control? *J Abnorm Psychol*, 102(2), 187-196.
- Ma, W., Kantarjian, H., Zhang, K., Zhang, X., Wang, X., Chen, C., et al. (2010). Significant association between polymorphism of the erythropoietin gene promoter and myelodysplastic syndrome. *BMC Med Genet*, 11(1), 163.
- Matarazzo, J. D., & Herman, D. O. (1984). Base rate data for the WAIS-R: test-retest stability and VIQ-PIQ differences. *J Clin Neuropsychol*, 6(4), 351-366.
- Mejia, O. M., Prchal, J. T., Leon-Velarde, F., Hurtado, A., & Stockton, D. W. (2005). Genetic association analysis of chronic mountain sickness in an Andean high-altitude population. *Haematologica*, 90(1), 13-19.
- Mittelman, M., Gardyn, J., Carmel, M., Malovani, H., Barak, Y., & Nir, U. (1996). Analysis of the erythropoietin receptor gene in patients with myeloproliferative and myelodysplastic syndromes. *Leuk Res*, 20(6), 459-466.
- Neubauer, A. P., Voss, W., Wachtendorf, M., & Jungmann, T. (2010). Erythropoietin improves neurodevelopmental outcome of extremely preterm infants. *Ann Neurol*, 67(5), 657-666.
- Nuechterlein, K. H., Dawson, M. E., & Green, M. F. (1994). Information-processing abnormalities as neuropsychological vulnerability indicators for schizophrenia. *Acta Psychiatr Scand Suppl*, 384, 71-79.
- O'Donovan, M. C., Craddock, N., Norton, N., Williams, H., Peirce, T., Moskvina, V., et al. (2008). Identification of loci associated with schizophrenia by genome-wide association and follow-up. *Nat Genet*, 40(9), 1053-1055.
- Palmer, B. W., Heaton, R. K., Paulsen, J. S., Kuck, J., Braff, D., Harris, M. J., et al. (1997). Is it possible to be schizophrenic yet neuropsychologically normal? *Neuropsychology*, 11(3), 437-446.

- Papiol, S., Begemann, M., Rosenberger, A., Friedrichs, H., Ribbe, K., Grube, S., et al. (2011). A phenotype-based genetic association study reveals the contribution of neuregulin1 gene variants to age of onset and positive symptom severity in schizophrenia. *American Journal of Medical Genetics Part B: Neuropsychiatric Genetics*, Epub ahead of print.
- Patel, A., Everitt, B., Knapp, M., Reeder, C., Grant, D., Ecker, C., et al. (2006). Schizophrenia patients with cognitive deficits: factors associated with costs. *Schizophr Bull*, 32(4), 776-785.
- Percy, M. J., McMullin, M. F., & Lappin, T. R. (1997). Sequence analysis of the 3' hypoxia-responsive element of the human erythropoietin gene in patients with erythrocytosis. *Biochem Mol Med*, 62(1), 132-134.
- Percy, M. J., McMullin, M. F., Roques, A. W., Westwood, N. B., Acharya, J., Hughes, A. E., et al. (1998). Erythrocytosis due to a mutation in the erythropoietin receptor gene. *Br J Haematol*, 100(2), 407-410.
- Petersen, K. B., Hokland, P., Petersen, G. B., & Nyvold, C. G. (2004). Erythropoietin receptor defect: a cause of primary polycythaemia. *Br J Haematol*, 125(4), 537-538.
- Rabie, T., & Marti, H. H. (2008). Brain protection by erythropoietin: a manifold task. *Physiology (Bethesda)*, 23, 263-274.
- Reichenberg, A., Weiser, M., Rabinowitz, J., Caspi, A., Schmeidler, J., Mark, M., et al. (2002). A population-based cohort study of premorbid intellectual, language, and behavioral functioning in patients with schizophrenia, schizoaffective disorder, and nonpsychotic bipolar disorder. *Am J Psychiatry*, 159(12), 2027-2035.
- Rey, A. (1958). *L'Examen Clinique en Psychologie*. Paris: Press Universitaire de France.
- Ribbe, K., Ackermann, V., Schwitulla, J., Begemann, M., Papiol, S., Grube, S., et al. (submitted). Interaction of common genetic variants in the corticotropin releasing factor system predicts the risk of comorbid alcoholism.
- Ribbe, K., Friedrichs, H., Begemann, M., Grube, S., Papiol, S., Kästner, A., et al. (2010). The cross-sectional GRAS sample: A comprehensive phenotypical data collection of schizophrenic patients. *BMC Psychiatry*, in press.
- Rodriguez-Sanchez, J. M., Crespo-Facorro, B., Gonzalez-Blanch, C., Perez-Iglesias, R., & Vazquez-Barquero, J. L. (2007). Cognitive dysfunction in first-episode psychosis: the processing speed hypothesis. *Br J Psychiatry Suppl*, 51, s107-110.
- Sargin, D., El-Kordi, A., Agarwal, A., Müller, M., Wojcik, S. M., Hassouna, I., et al. (submitted). Expression of constitutively active erythropoietin receptor in cortical neurons boosts higher cognitive functions in mice.
- Sargin, D., Friedrichs, H., El-Kordi, A., & Ehrenreich, H. (2010). Erythropoietin as neuroprotective and neuroregenerative treatment strategy: Comprehensive overview of 12 years of preclinical and clinical research. *Best Practice & Research Clinical Anaesthesiology*, 24, 573-594.
- Saykin, A. J., Shtasel, D. L., Gur, R. E., Kester, D. B., Mozley, L. H., Stafiniak, P., et al. (1994). Neuropsychological deficits in neuroleptic naive patients with first-episode schizophrenia. *Arch Gen Psychiatry*, 51(2), 124-131.
- Schalling, D., Asberg, M., Edman, G., & Oreland, L. (1987). Markers for vulnerability to psychopathology: temperament traits associated with platelet MAO activity. *Acta Psychiatr Scand*, 76(2), 172-182.
- Schweizer, K. (2002). Does impulsivity influence performance in reasoning? [doi: DOI: 10.1016/S0191-8869(01)00209-4]. *Personality and Individual Differences*, 33(7), 1031-1043.
- Siren, A. L., Fasshauer, T., Bartels, C., & Ehrenreich, H. (2009). Therapeutic potential of erythropoietin and its structural or functional variants in the nervous system. *Neurotherapeutics*, 6(1), 108-127.

- Siren, A. L., Knerlich, F., Poser, W., Gleiter, C. H., Bruck, W., & Ehrenreich, H. (2001). Erythropoietin and erythropoietin receptor in human ischemic/hypoxic brain. *Acta Neuropathol*, *101*(3), 271-276.
- Sokol, L., Luhovy, M., Guan, Y., Prchal, J. F., Semenza, G. L., & Prchal, J. T. (1995). Primary familial polycythemia: a frameshift mutation in the erythropoietin receptor gene and increased sensitivity of erythroid progenitors to erythropoietin. *Blood*, *86*(1), 15-22.
- Sokol, L., Prchal, J., & Prchal, J. T. (1993). Primary familial and congenital polycythaemia. *Lancet*, *342*(8863), 115-116.
- SPSS Inc. from <http://www.spss.com/>
- Sripichai, O., Whitacre, J., Munkongdee, T., Kumkhaek, C., Makarasara, W., Winichagoon, P., et al. (2005). Genetic analysis of candidate modifier polymorphisms in Hb E-beta 0-thalassemia patients. *Ann N Y Acad Sci*, *1054*, 433-438.
- Tewes, U. (1991). *Hamburg-Wechsler Intelligenztest fuer Erwachsene (HAWIE-R)*. Bern: Huber.
- Tilbrook, P. A., & Klinken, S. P. (1999). Erythropoietin and erythropoietin receptor. *Growth Factors*, *17*(1), 25-35.
- Tong, Z., Yang, Z., Patel, S., Chen, H., Gibbs, D., Yang, X., et al. (2008). Promoter polymorphism of the erythropoietin gene in severe diabetic eye and kidney complications. *Proc Natl Acad Sci U S A*, *105*(19), 6998-7003.
- Watowich, S. S., Xie, X., Klingmuller, U., Kere, J., Lindlof, M., Berglund, S., et al. (1999). Erythropoietin receptor mutations associated with familial erythrocytosis cause hypersensitivity to erythropoietin in the heterozygous state. *Blood*, *94*(7), 2530-2532.
- Wechsler, D. (1981). *Manual for the Wechsler Adult Intelligence Scale-Revised*. New York: The Psychological Corp.
- Wechsler, D. (1997). *Wechsler Adult Intelligence Scale (WAIS-III)* (3 ed.). San Antonio, TX: The Psychological Corporation.
- Whitney, P., Jameson, T., & Hinson, J. M. (2004). Impulsiveness and executive control of working memory. [doi: DOI: 10.1016/j.paid.2003.09.013]. *Personality and Individual Differences*, *37*(2), 417-428.
- Wilk, C. M., Gold, J. M., McMahon, R. P., Humber, K., Iannone, V. N., & Buchanan, R. W. (2005). No, it is not possible to be schizophrenic yet neuropsychologically normal. *Neuropsychology*, *19*(6), 778-786.
- WorldHealthOrganization. (1992). *The ICD-10 classification of mental and behavioural disorders: Clinical descriptions and diagnostic guidelines*. Geneva: WHO.
- Wüstenberg, T., Begemann, M., Bartels, C., Gefeller, O., Stawicki, S., Hinze-Selch, D., et al. (2010). Recombinant human erythropoietin delays loss of gray matter in chronic schizophrenia. *Mol Psychiatry*.
- Zeng, S. M., Yankowitz, J., Widness, J. A., & Strauss, R. G. (2001). Etiology of differences in hematocrit between males and females: sequence-based polymorphisms in erythropoietin and its receptor. *J Gend Specif Med*, *4*(1), 35-40.

Supplement A

ZAHLEN-SYMBOL-TEST (HAWIE-R)

90 Sekunden Bearbeitungszeit

1	2	3	4	5	6	7	8	9	Punkte
—	⊥	⊏	L	U	O	^	X	=	<input type="text"/>
									90"

Beispiel																								
2	1	3	7	2	4	8	2	1	3	2	1	4	2	3	5	2	3	1	4	5	6	3	1	4
1	5	4	2	7	6	3	5	7	2	8	5	4	6	3	7	2	8	1	9	5	8	4	7	3
6	2	5	1	9	2	8	3	7	4	6	5	9	4	8	3	7	2	6	1	5	4	6	3	7
9	2	8	1	7	9	4	6	8	5	9	7	1	8	5	2	9	4	8	6	3	7	9	8	6

Supplement B

VLMT - FORM A										
Liste A	Dg1	Dg2	Dg3	Dg4	Dg5	Liste B	I	Dg6	Dg7	
Trommel						Tisch				Trommel
Vorhang						Förster				Vorhang
Glocke						Vogel				Glocke
Kaffee						Schuh				Kaffee
Schule						Ofen				Schule
Eltern						Berg				Eltern
Mond						Handtuch				Mond
Garten						Brille				Garten
Hut						Wolke				Hut
Bauer						Boot				Bauer
Nase						Lamm				Nase
Truthahn						Gewehr				Truthahn
Farbe						Bleistift				Farbe
Haus						Kirsche				Haus
Fluß						Arm				Fluß
<i>Weitere Nennungen:</i>										

Auswertung:

Richtige						Richtige				
FP						FP				
PS						PS				
						In				
Leistungs- scores	Σ DG1-5 = _____					Dg5-Dg6 = _____		Dg5-Dg7 = _____		
Fehler- scores	Σ FP (Dg1-5) = _____			Σ PS (Dg1-5) = _____			Σ In (Dg6 u. Dg7) = _____			

Anmerkung zu den Fehlertypen:

FP= Falsch Positive: Wörter, die weder in der Lern- noch in der Interferenzliste vorkommen.

PS = Perseverationen: Mehrfachnennungen derselben Wörter während eines Lerndurchgangs

(unabhängig davon, ob sie den dargebotenen Listen entstammen).

In = Interferenzen: Wörter aus der gerade nicht relevanten Wortliste (Lern- oder Interferenzliste).



ELSEVIER

Contents lists available at ScienceDirect

Best Practice & Research Clinical Anaesthesiology

journal homepage: www.elsevier.com/locate/bean



8

Erythropoietin as neuroprotective and neuroregenerative treatment strategy: Comprehensive overview of 12 years of preclinical and clinical research

Derya Sargin, PhD^{a,b}, Heidi Friedrichs, MSc^{a,b}, Ahmed El-Kordi, PhD^{a,b},
Hannelore Ehrenreich, MD, DVM^{a,b,*}

^aDivision of Clinical Neuroscience, Max Planck Institute of Experimental Medicine, Hermann-Rein Str. 3, 37075 Göttingen, Germany

^bDFG Research Center for Molecular Physiology of the Brain, Göttingen, Germany

Keywords:

erythropoietin receptor
EPO variants
stroke
traumatic brain injury
traumatic spinal cord injury
neurodegeneration
multiple sclerosis
schizophrenia

Erythropoietin (EPO), originally discovered as hematopoietic growth factor, has direct effects on cells of the nervous system that make it a highly attractive candidate drug for neuroprotection/neuroregeneration. Hardly any other compound has led to so much preclinical work in the field of translational neuroscience than EPO. Almost all of the >180 preclinical studies performed by many independent research groups from all over the world in the last 12 years have yielded positive results on EPO as a neuroprotective drug. The fact that EPO was approved for the treatment of anemia >20 years ago and found to be well tolerated and safe, facilitated the first steps of translation from preclinical findings to the clinic. On the other hand, the same fact, naturally associated with loss of patent protection, hindered to develop EPO as a highly promising therapeutic strategy for application in human brain disease. Therefore, only few clinical neuroprotection studies have been concluded, all with essentially positive and stimulating results, but no further development towards the clinic has occurred thus far. This article reviews the preclinical and clinical work on EPO for the indications neuroprotection/neuroregeneration and cognition, and hopefully will stimulate new endeavours promoting development of EPO for the treatment of human brain diseases.

© 2010 Elsevier Ltd. All rights reserved.

* Corresponding author. Division of Clinical Neuroscience, Max Planck Institute of Experimental Medicine, Hermann-Rein Str. 3, 37075 Göttingen, Germany. Tel.: +49 551 3899628; Fax: +49 551 3899670.

E-mail address: ehrenreich@em.mpg.de (H. Ehrenreich).

Introduction

Undoubtedly, there would be a tremendous need for effective neuroprotective and neuroregenerative treatment strategies. Most diseases of the nervous system are etiologically unclear, extremely heterogeneous, and non-curable, with chances being very low that within the next decades a cure will be available for any of them. Facing this disillusioning reality, and considering the enormous human and socio-economic burden to be expected with an increasingly aging society in industrialized countries, the urgent demand of neuroprotective/neuroregenerative treatment approaches becomes even more plausible. Neuroprotective treatments aim at an enduring improvement of symptoms and/or slowing of an ongoing disease process. Essentially all compounds that have been associated with a potential neuroprotective/neuroregenerative capacity target determinants of the final common pathway of many different diseases of the nervous system, e.g. apoptosis, oxidative stress, inflammation, metabolic dysfunction or compromised neuroplasticity.

Hardly any other compound has now over more than a decade attracted so much attention as candidate for neuroprotection/neuroregeneration than erythropoietin (EPO). Not many other drug candidates have triggered so many preclinical studies on entirely different disease models, investigated by multiple independent research groups worldwide, than EPO. This overwhelming amount of data on EPO, showing mostly positive results regarding neuroprotection and neuroregeneration, has also stimulated clinical research as reflected by a substantial number of ongoing clinical trials on EPO in nervous system indications (for review see¹). The few thus far published clinical studies all yielded positive results or at least positive signals to be further pursued.^{2–6}

Astonishingly, despite this large number of positive data, no adequate continuous support for translation of these findings into the clinic has been provided. This stagnation of further development may be the result of a number of unfortunate coincidences: (1) The EPO industry strongly protects their lucrative anemia market that, for individual producers, has already been subject to shrinkage due to expired patents and popping-up of more and more biosimilar products. (2) Recent clinical trials in the anemia/oncology field have raised concerns regarding previously established indications. (3) In the absence of sufficient patent protection, new indications are not welcome since they bear the risk of as yet undetected additional side-effects of EPO that might further endanger the presently still highly profitable business. (4) Finally, there is an absurd reluctance of public funding agencies to support trials for new indications on compounds that are already approved and in their eyes should be supported by industry. This makes investigator-initiated trial designers going in time-, money-, and energy-consuming circles that ultimately lead nowhere. Therefore, even though EPO might be the most promising agent so far to provide neuroprotection/neuroregeneration in a broad field of neurological and psychiatric diseases, less effective and less well tolerated compounds are much more likely to be developed. Hopefully, the present review, summarizing the overall positive outcomes of preclinical as well as of clinical work, will stimulate novel attempts to conduct clinical trials on EPO treatment of brain diseases.

With this review, we provide a comprehensive but compacted overview of the more than 180 preclinical studies performed since 1998. In an especially designed master table (Table 1), the main results are briefly summarized. Five extensive supplementary tables encompass all available preclinical studies, with their main contents recapitulated shortly and commented on. In addition, we present in this article a brief synopsis of the few published clinical studies dealing with EPO treatment of neuropsychiatric diseases as well as an overview of work on healthy individuals, rodents and humans, set up to gain more mechanistic insight into the potent effects of EPO on cognitive performance. These positive effects on cognition have not sufficiently been explored yet for potential application in diseases characterized by cognitive decline. Ultimately, we will give an outlook regarding the most important next steps required to move the field towards clinical development.

Biology of the EPO system

Since the present review deals predominantly with neuroprotection/neuroregeneration in preclinical and clinical models, the molecular and cellular effects of EPO cannot be comprehensively covered. For deeper insight into these fields, the reader is politely referred to some excellent recent reviews e.g.^{7–10}

Table 1
Summary of EPO^a treatment effects in preclinical disease models (as of April 2010).

Category	Disease model	Years	# Studies	Species	Improvement in clinical outcomes	Improvement in other outcomes	No effects/deterioration in clinical outcomes	No effects/deterioration in other outcomes
Cerebrovascular disease	Focal cerebral ischemia	1998–2010	49	Mice, gerbils, rats, rabbits	1× increased survival rates 6× improved cognition 1× improved cognition upon EPO combined with MSCs 17× improved neurology 2× improved neurology when combined with IGF-1/GCSF	26× reduced lesion volume 2× reduced infarct volume when combined with IGF-1/GCSF 3× reduced brain edema 4× reduced brain atrophy 6× reduced inflammation 2× reduced BBB leakage 2× increased CBF (±GCSF) 1× reduced oxidative stress 15× increased cell survival/decreased apoptosis 2× decreased apoptosis when combined with DFO/GCSF 4× increased antiapoptotic protein 5× increased neurogenesis 2× increased neurogenesis when combined with MSCs/GCSF 4× increased angiogenesis/VEGF	1× no effect on mortality 1× no effect on neurology	5× no effect on lesion volume 1× no effect on brain edema 1× no effect on brain edema when combined with rtPA 1× no effect on CBF 1× no effect on cell survival 1× increased apoptosis when combined with rtPA 1× no protection against gray or white matter damage 1× no effect on neurogenesis 1× no effect on angiogenesis
	Global ischemia	1998–2010	8	Gerbils, rats	2× increased survival rates 3× improved cognition	1× reduced lesion volume 1× reduced brain edema 1× reduced BBB leakage 5× increased cell survival/decreased apoptosis 3× reduced oxidative stress 1× increased antiapoptotic protein	1× increased mortality on EPO pretreatment	1× no reduction in oxidative stress with EPO pretreatment

(continued on next page)

Table 1 (continued)

Category	Disease model	Years	# Studies	Species	Improvement in clinical outcomes	Improvement in other outcomes	No effects/deterioration in clinical outcomes	No effects/deterioration in other outcomes
	Cerebral hemorrhage	2000–2009	11	Mice, rats, rabbits	2× increased survival rates 5× improved neurological outcome	3× reduced lesion volume 2× reduced brain edema 1× reduced brain atrophy 1× reduced inflammation 1× reduced BBB leakage 2× increased CBF 6× increased cell survival/ decreased apoptosis 1× increased antiapoptotic protein 2× decreased vasospasm 1× decreased vasospasm upon viral <i>EPO</i> gene expression 1× increased neurogenesis 1× increased synapse formation		
Neuroinflammatory disease	Multiple sclerosis, optic neuritis	2000–2009	11	Mice, rats	8× reduction of clinical symptoms 2× reduction of clinical symptoms when combined with MPred 1× improved neurology 4× improved disease course (later onset/shorter duration)	6× reduced inflammation 1× decreased inflammation when combined with MPred 2× decreased demyelination 1× decreased demyelination when combined with MPred 1× reduced axonal injury 1× reduced axonal injury when combined with MPred 1× reduced BBB leakage 2× increased cell survival 1× increased cell survival when combined with MPred	2× no change in clinical symptoms 1× no relapse prevention	1× no effect on inflammation 2× no effect on myelination 2× no effect on axonal density
	Cerebral malaria	2006–2008	3	Mice	2× increased survival rates 1× increased survival and accelerated recovery when combined with artesunate	2× reduced inflammation 1× increased cell survival	2× no effect on disease course	1× no effect on cell survival 1× no effect on oxidative stress

	Others	2007–2010	3	Rats, rabbits, fetal sheep	1× reduced inflammation 1× increased myelination 1× increased cell survival 1× reduced brain injury	1× no effect on survival 1× no effect on disease course	1× no effect on inflammation 1× no effect MBP reduction 1× no effect on cell survival
Neurodegeneration	Status epilepticus	2000–2009	13	Mice, rats	2× increased survival rates 1× improved neurology 6× ameliorated seizures (duration/severity/latency) 1× improved cognition 1× antidepressant-like effect	1× reduced inflammation 2× reduced BBB leakage 8× increased cell survival/decreased apoptosis 1× decreased apoptosis (hypoxia) 2× increased antiapoptotic protein 1× increased neurogenesis	
	Parkinson's disease	2001–2010	7	Mice, rats	5× improved neurology 2× improved neurology upon viral <i>EPO</i> gene expression	1× reduced inflammation 4× increased cell survival/decreased apoptosis 2× increased cell survival upon viral <i>EPO</i> gene expression 3× increased TH-IR dopaminergic fibers - 1× upon viral <i>EPO</i> gene expression 1× increased neurogenesis 1× increased angiogenesis	1× no effect on cell survival upon systemic <i>EPO</i> injection
	Retinal degeneration	2002–2009	11	Mice, rats	10× increased cell survival/decreased apoptosis 2× improved function of photoreceptor cells 1× increased cell survival and function upon viral <i>EPO</i> gene expression		1× no effect on photoreceptor cell degeneration and function

(continued on next page)

Table 1 (continued)

Category	Disease model	Years	# Studies	Species	Improvement in clinical outcomes	Improvement in other outcomes	No effects/deterioration in clinical outcomes	No effects/deterioration in other outcomes
Neurodegeneration	Peripheral neuropathy	2003–2009	10	Mice, rats	3× recovery from mechanical allodynia/erectile dysfunction 2× reduced hyperalgesia 2× improved neurology 2× increased body weight 1× improved compound muscle action potential	1× reduced inflammation 2× increased cell survival/decreased apoptosis 2× increased myelination 3× increased nerve fiber density 3× decreased axonal degeneration 1× increased mitochondria number		
	Diabetic neuropathy	2004–2009	4	Mice, rats	2× improved neurology 1× improved compound muscle action potential 1× improved neurology and sensory nerve amplitude after viral <i>EPO</i> gene expression	1× increased nerve fiber density 1× reduction in the number of dystrophic neurites		
	Sciatic nerve injury	2005–2010	6	Mice, rats	5× enhanced neurorecovery 1× improved compound muscle action potential	1× reduced inflammation 2× decreased demyelination 3× reduced axonal degeneration		
	Amyotrophic lateral sclerosis	2006–2007	4	Mice	1× improved neurology 3× delay in disease onset	2× reduced inflammation 3× increased cell survival/decreased apoptosis	1× no effect on survival 1× no effect on neurological outcome in males	1× no effect on cell survival

	Other neurodegenerative models	2004–2006	6	Mice, rats	1× improved neurology	4× increased cell survival 1× reduced oxidative stress	1× no effect on neurology 1× no effect on weight loss	1× no effect on cell survival
Traumatic brain injury		2000–2010	30	Mice, rats	13× improved cognition 7× improved sensory-motor functions 1× reduced lesion-induced hyperactivity	7× lesion volume/brain injury 6× reduced brain edema 1× reduced brain atrophy 6× reduced inflammation 2× reduced BBB leakage 1× increased CBF (+L-arginine) 4× reduced oxidative stress 14× increased cell survival/decreased apoptosis 3× increased antiapoptotic protein 7× increased neurogenesis 2× reduced axonal degeneration 3× increased angiogenesis 1× improved mitochondrial function	1× no effect on mortality 1× no neurological improvement upon EPO plus L-arginine/D-arginine	2× no effect on lesion volume/brain injury 1× increased brain edema 1× no effect on brain edema 1× no effect on BBB leakage 1× no effect on cell survival 2× no effect on vascular density
Spinal cord injury	Compression, contusion, ischemia	2002–2009	16	Rats, rabbits	13× improved motor functions 2× (almost) full recovery of motor functions	4× reduced lesion volume 2× reduced inflammation 2× preservation of white matter 1× reduced oxidative stress 6× increased cell survival 1× increased angiogenesis	3× no motor improvement	1× no effect on inflammation 2× no effect on gray or white matter integrity

^a EPO treatment comprises recombinant human (rh)EPO, but also EPO variants: asialo-EPO, CEPO, rMoEPO, darbepoetin alfa; BBB – blood–brain barrier; CBF – cerebral blood flow; DFO – deferoxamine; GCSF – granulocyte colony stimulating factor; IGF-1 – insulin-like growth factor-1; MBP – myelin basic protein; MPred – methylprednisolone; MSCs – mesenchymal stem cells; rtPA – recombinant tissue plasminogen activator; TH-IR – tyrosine hydroxylase-immunoreactive.

Human EPO is an acidic glycoprotein with a molecular mass of about 30.4 kDa. It consists of 165 amino acids which form 2 disulphide bridges. The carbohydrate portion amounts to approximately 40% of the molecule and comprises 3 N-linked and 1 O-linked glycan. The N-glycans are essential for the *in vivo* biological activity of EPO, including its half-life. EPO exists in several glycosylation isoforms.⁸ EPO acts via binding to a specific transmembrane receptor, EPOR, belonging to the cytokine type 1 receptor subfamily. Homodimerization of 2 transmembrane EPOR molecules leads to binding of a single EPO molecule and induces a conformational change which initiates EPOR-associated JAK2 transphosphorylation. Downstream signaling molecules are subsequently activated including signal transducers and activators of transcription (STATs), phosphatidylinositol-3 kinase (PI3K)/AKT, RAS/extracellular signal-regulated kinase (ERK1/2), nuclear factor kappa B (NF-kappa B) and calcium. Activation of these signaling cascades leads, cell-type and situation-dependent, to further activation of antiapoptotic factors/pathways, stimulation of cell differentiation, including induction of cellular shape-change and growth, or modulation of plasticity e.g.^{7,10–17}

EPO is not only expressed in the adult kidney and fetal liver but also in many other organs in the body. In general, its expression can be upregulated via hypoxia inducible factor (HIF) which in turn is stimulated predominantly by low oxygen levels e.g.^{8,18–21} In addition, other mechanisms might tissue-dependently be involved in regulation of EPO gene expression.²² For more details, the reader is again referred to respective review articles.^{23,24} The EPO/EPOR system in the brain apparently plays an important role during fetal development and displays a strong reduction of expression levels towards postnatal life and adulthood.^{25–27} In the event of hypoxia/ischemia, inflammation or neurodegenerative processes, an upregulation of the endogenous EPO/EPOR system is observed.^{28–37} Experimental reduction of the available EPO molecules in such situations by e.g. application of soluble EPOR, leads to a dramatic increase in the model-specific tissue damage.^{38–42} Reduced concentrations of EPO in the cerebrospinal fluid in amyotrophic lateral sclerosis may point to a relative deficiency of endogenous EPO versus EPOR production in neurodegenerative disease. A more efficient extraction of any free molecule of EPO by brain tissue due to high reactive EPOR expression would explain this phenomenon.⁴³

There is an ongoing debate as to whether EPOR in brain tissue consists of a molecule identical or similar to the EPOR in hematopoietic tissue or whether other EPO receptive structures might at least partially explain the neuroprotective/neuroregenerative effects of this molecule. Further work is needed to clarify this issue.^{44–50} Another important aspect of EPO biology, and perhaps of future pharmacological developments building on the EPO system, is the existence of 'brain specific' EPO variants - both endogenous molecules and exogenously modified compounds - potentially devoid of hematopoietic and other peripheral effects.^{7,10,51–57}

Preclinical studies

EPO treatment effects reported in publications on preclinical disease models from 1998 up to April 2010 are summarized in Table 1. Diseases are presented in respective categories, ranging from cerebrovascular conditions to neuroinflammatory, neurodegenerative and traumatic brain/spinal cord diseases. The categories are further subdivided into disease models, with the main outcomes of clinical and non-clinical readouts listed. For each disease model, the number of studies, range of years when studies were published, and species used are given. Next to the positive outcomes, negative outcomes are presented wherever applicable. For more detailed information on the work underlying this master table, the reader is referred to the comprehensive supplementary material which provides in extensive tables, organized by disease category, overviews of all relevant publications from 1998 up to April 2010 (see Supplementary Tables 1–5). The supplementary material contains also work on mice with genetic modifications of EPO or EPOR that indirectly support EPO effects on neuroprotection/neuroregeneration but do not use treatment approaches.^{15,42,45,58} The numbers shown in the small chapters below always refer to the master table (Table 1).

Cerebrovascular disease models

Cerebrovascular conditions were the first disease models carefully and comprehensively analyzed regarding potential neuroprotective/neuroregenerative effects of EPO treatment (Table 1 and

Supplementary Table 1). A total of 68 studies, most of them using focal cerebral ischemia models, were published.^{13,38,48,52,53,59–121} The overwhelming number of publications point to an amelioration of clinical outcomes, particularly improved neurological symptoms and cognition. As other 'non-clinical' outcomes, the studies show a remarkable reduction in lesion volume, blood–brain barrier leakage and degree of brain edema, inflammation, and brain atrophy. These findings are underlined by reduced oxidative stress, enhanced cell survival/decreased apoptosis, associated with increased antiapoptotic protein expression, neurogenesis and angiogenesis. Only few studies failed to show effects on some of the readouts, like neurological symptoms, lesion volume and/or other of the above mentioned outcome parameters. Similarly to focal ischemia, global ischemia models^{38,104–110} as well as cerebral hemorrhage models^{111–121} demonstrate better survival rates, improved cognition, reduction in apoptosis and oxidative stress. Only one report shows inefficiency of EPO upon pretreatment.¹⁰⁴ To summarize, most publications on cerebrovascular disease models report clear beneficial outcomes of EPO treatment.

Neuroinflammatory disease models

Between the years 2000 and 2010, 17 preclinical studies have been published regarding EPO as potential treatment of neuroinflammatory conditions, mainly models of multiple sclerosis and cerebral malaria, most of them showing a dwindling of clinical symptoms, combined with reduced inflammation, increased cell survival and less prominent demyelination and/or axonal injury.^{53,61,122–136} Again, not all studies unequivocally confirm all of these findings. Some authors failed to find effects on inflammation, others on demyelination or axonal integrity/density (Table 1; Supplementary Table 2). Taken together, however, the preclinical models of neuroinflammatory brain disease strongly encourage further work on EPO in these indications, where essentially no neuroprotective/neuroregenerative treatment option is available.

Neurodegenerative disease models

In the category neurodegeneration, models of epilepsy, Parkinson's disease, retinal degeneration, peripheral neuropathy in general and diabetic neuropathy in particular, sciatic nerve injury, amyotrophic lateral sclerosis, and other, rarer conditions are listed. Over 60 studies have been published in this field.^{14,39,40,53,58,61,79,137–191} Again, many of them report increased/prolonged survival rates, improved neurological outcome, and amelioration of specific symptoms or even recovery, coupled with reduction in inflammation, blood–brain barrier leakage, apoptosis and demyelination/nerve fiber loss. In this particular category, essentially no study completely failed to show benefit (Table 1; Supplementary Table 3). Perhaps the least convincing findings come from amyotrophic lateral sclerosis models.^{182–185} Taken together, also for the large area of neurodegenerative conditions, preclinical studies strongly encourage further development of EPO towards application for human diseases.

Models of traumatic brain and spinal cord injury

Nearly 50 preclinical studies deal with EPO treatment of traumatic brain^{50,61,192–220} and/or spinal cord injury^{52,53,221–234} - conditions that up to now are devoid of efficient therapeutic options (Table 1; Supplementary Tables 4 and 5). Even in this disastrous field, EPO leads to improvement in cognitive outcome as well as in (sensory-) motor functions, together with a diminution of lesion volume, brain edema, inflammation and apoptosis. Moreover, augmented neurogenesis and angiogenesis have been noted by different research groups. Reports on treatment failure are rare and mostly restricted to certain aspects like blood–brain barrier leakage or brain edema.^{197,229,230}

Concluding remarks on preclinical studies

Knowing that it is by far more difficult to publish a negative as compared to a positive study, the considerable amount of papers on beneficial effects of EPO regarding neuroprotection/neuroregeneration in contrast to the few negative studies has to be perceived with some caution. Several

negative studies may have ended up in the investigators' drawer and not been presented to the public. Nevertheless, the overwhelming amount of positive outcome preclinical work on EPO of independent research groups from all over the world should encourage further development along these lines.

Clinical studies

Published clinical studies on EPO in neurological and psychiatric indications are still rare even though many studies are ongoing worldwide (for review see¹). In the following part of the review, we will provide a short overview of the published work.

Cerebrovascular diseases

The first study investigating the potential neuroprotective/neuroregenerative capacities of EPO in humans was the Göttingen EPO Stroke Study, started as early as 1998. This double-blind placebo-controlled monocentric study yielded a positive clinical outcome of EPO as compared to placebo treated patients, together with promising results on evolution of lesion size and levels of the circulating damage marker S100B.²³⁵ Encouraged by these findings, a German multicenter study on EPO in stroke patients was started in 2003 and concluded in 2008. From the first to the second EPO study, the 'stroke landscape' had considerably changed with the regulatory approval of thrombolytic treatment using rtPA (recombinant tissue plasminogen activator) for stroke.²³⁶ Predictions by advising stroke experts at study start regarding percentage of rtPA treatments ranged between 3% and maximally 10%. Unexpectedly, an incredible number of nearly 64% of the 522 patients included in this study received thrombolysis. This unforeseen development certainly explains the overall failure of the second EPO stroke study which formally ended up as a negative trial. Whereas the subpopulation of per-protocol treated patients non-qualifying for rtPA treatment (the actual comparator of the first study) again benefited from EPO treatment with respect to clinical recovery, the rtPA patients did not have any clear profit from EPO treatment. Those patients who had received thrombolysis despite contraindications to rtPA even showed a deterioration of their outcome upon combination of rtPA and EPO.^{237,238} Regarding a potential interaction of the two compounds in acute ischemic stroke, a recent paper may provide a first hint,¹⁰³ and more basic research will have to be performed before follow-up studies on EPO in stroke can include rtPA patients. At this point, EPO should only be considered for further development in ischemic stroke patients non-qualifying for rtPA. For these patients, however, it may ultimately provide a true alternative.²³⁷ Hopefully, the overall results of the German multicenter EPO stroke trial, forcing to call it a formally negative study, will not discourage researchers and funding agencies from further pursuing EPO/EPO variants for this indication. It should be emphasized that at present, there is no better neuroprotective/neuroregenerative compound available anywhere for treatment of ischemic stroke. This indication is additionally supported by recent clinical studies showing beneficial effects of EPO in patients after subarachnoid hemorrhage where ischemia is a frequent consequence⁴ as well as in patients suffering from cardiac arrest.⁵

Even though cerebrovascular events in neonates are certainly different from cerebrovascular events in adults, a just published study on late neurodevelopmental parameters of extremely pre-term infants with cerebral hemorrhage shows a dramatic improvement of the intellectual outcome of former high risk infants at the age of ten years.⁶ Recent trials on asphyctic newborns support the protective effect of EPO against hypoxic-ischemic encephalopathy.^{239,240} In addition, several trials on neonates underline the safety of EPO in this population.^{241,242}

In the context of cerebrovascular disease and EPO, it is important to mention that a recent clinical trial testing the effect of the EPO variant darbepoetin in patients with diabetes, chronic kidney disease, and moderate anemia who were not undergoing dialysis did not reduce the risk of death or a cardiovascular or renal event, and was associated with an increased risk of stroke.²⁴³ Even though the causes of this increased risk may be manifold and not directly related to the protective effect of EPO on cerebral hypoxia/ischemia, the expression 'double-edged sword' may come to mind and requests careful follow-up observation of patients under EPO/EPO variant treatment for potential chronic risk factors of stroke and/or interfering routine medication.

Chronic brain diseases

In addition to acute cerebrovascular brain diseases, chronic, degenerative and inflammatory brain diseases may be an interesting field for EPO application in humans. These certainly also include the regenerative/rehabilitative phase post stroke where EPO can be expected to promote and consolidate functional recovery and should be tested in a clinical study.

In a double-blind, placebo-controlled multicenter trial, chronic schizophrenic patients showed upon high-dose weekly EPO add-on treatment over 12 weeks a significant improvement of higher cognitive functions and a reduction of cortical gray matter loss in discrete disease-relevant brain areas (Fig. 1).^{3,244} The basis of their scattered distribution, including the lateralized (left-sided) preference of EPO-mediated gray matter protection, is still unclear but likely indicates areas with most progressive neurodegeneration inherent to the disease process. Also patients suffering from chronic-progressive multiple sclerosis displayed improvement in motor functions and cognitive performance upon high-dose EPO treatment without considerable increase in hemoglobin.^{2,245} Since no treatment options are available for patients with chronic-progressive multiple sclerosis or chronic schizophrenia that effectively target motor functions and/or cognition, EPO and EPO variants should be considered as candidate drugs to address these severely disabling symptoms. Fig. 2 exemplifies the improvement in attention/concentration upon high-dose EPO treatment in a patient suffering from multiple sclerosis.

Another indication for EPO might lie in the large field of affective diseases. Fig. 3 illustrates the clinical course before and during a 16-week placebo/EPO treatment period of a patient suffering over years from severe, therapy-resistant depression. This patient was unaware of the time point of EPO or placebo infusions (single-blind design). He did not improve upon placebo but clearly responded to EPO injection with reduced depressive symptoms, as evaluated by a trained clinician using the Hamilton rating scale for depression. Similarly to the multiple sclerosis case, this patient displayed an only weak reaction of hemoglobin to EPO. Just towards the end of his treatment period (in the 10th week), blood-letting (450 ml) was necessary. A potential new EPO indication 'major depression' is further supported by a functional magnetic resonance imaging study on depressed patients responding to EPO in a fashion comparable to that observed upon antidepressive medication.^{246,247} Based on these grounds, a clinical trial has been started in Denmark, testing the effect of high-dose EPO treatment on affective

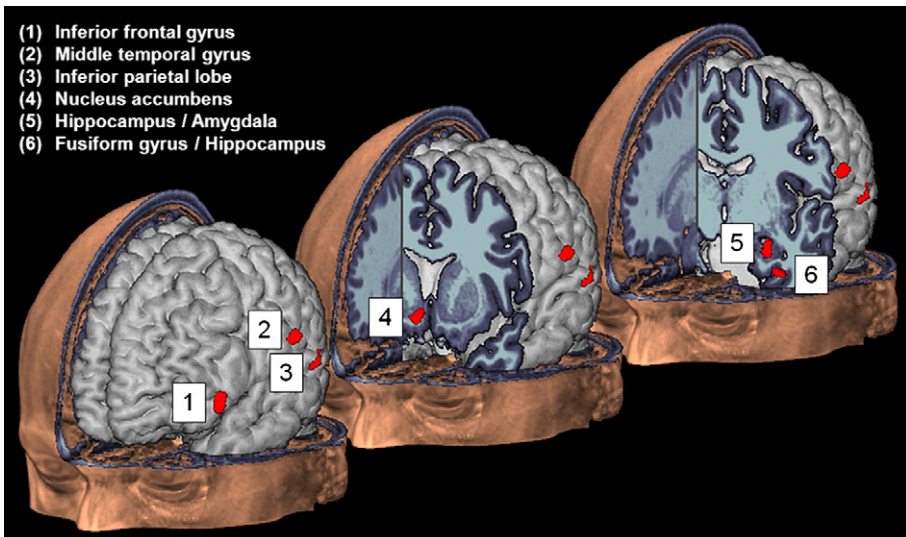

Fig. 1. EPO delays cortical gray matter loss in chronic schizophrenic patients. A computerized reconstruction of the brain delineates schizophrenia-relevant gray matter regions (marked in red) where highly significant EPO treatment effects were measured. Note the predominantly left hemispheric distribution. Overview based on.²⁴⁴

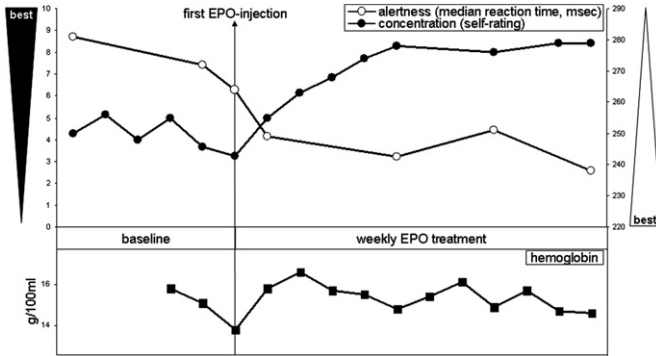

Fig. 2. Illustrating case - multiple sclerosis. A 42-year old male physician, suffering from multiple sclerosis and complaining about severe problems concentrating, was treated weekly with 48,000 IU of EPO intravenously over a 12-week period. During 5 weeks of baseline observation and 12 weeks of treatment, the patient was asked to regularly self-rate his concentration on a scale ranging from 1 to 10. In parallel, his concentration (“alertness”) was measured on a computerized test several times during this period. The data nicely show a corresponding improvement in both measures. During the EPO treatment phase, the hemoglobin level - after an initially slight increase - stayed relatively constant. No blood-letting was necessary.

and cognitive symptoms of major depression.²⁴⁸ Several other clinical studies targeting chronic diseases have been initiated and are running worldwide e.g.^{242,249–252} Unfortunately, the number is much lower than needed and funding of most of these trials is difficult.

EPO and cognition

Effects of EPO on cognition have been observed as early as around the time of its introduction to the clinic for the treatment of anemia in chronic kidney disease (for review see e.g.^{245,253}). At that time, improvement of cognitive performance was attributed to the EPO-induced increase in red blood cells/hemoglobin with subsequently enhanced tissue oxygenation. In fact, artificial reduction of circulating red blood cells in human volunteers to anemic levels leads to compromised cognitive performance, which can be corrected again by re-transfusion of the blood.²⁵⁴ The first animal study testing cognitive functions in healthy mice upon chronic EPO treatment was also conducted on these grounds.²⁵⁵ This

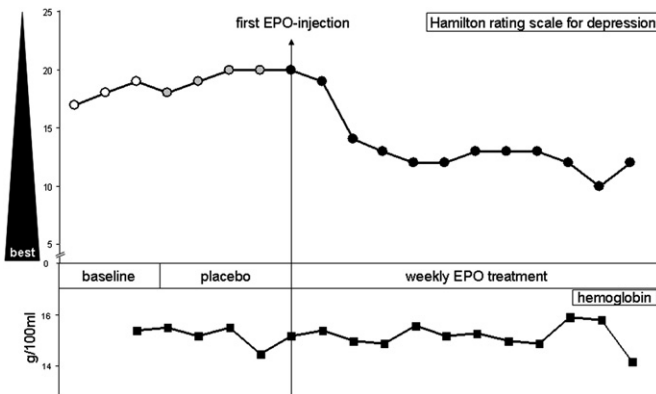

Fig. 3. Illustrating case - major depression. A 24-year old male law student suffering from chronic, therapy-resistant depression was treated, after a baseline observation of 3 weeks, weekly with placebo over 4 weeks, followed by 48,000 IU of EPO over another 12 weeks. At the third injection of EPO, a clear reduction in depressive symptoms, evaluated by the Hamilton rating scale, becomes evident. Again, the hemoglobin level stayed relatively stable. Only after the 10th injection of EPO, blood-letting was performed.

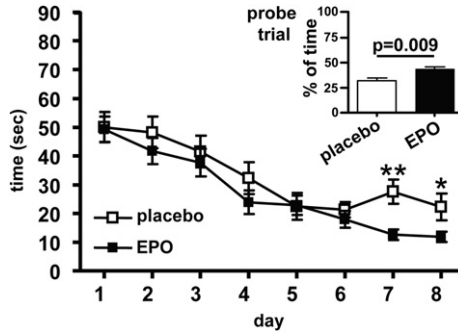

Fig. 4. Effect of chronic EPO administration on hippocampal learning and memory performance of healthy mice. Chronic EPO treatment (5000 IU/kg body weight i.p. every other day over 3 weeks) of healthy male C57Bl/6N mice (started at the age of 28 days) was followed by testing the animals in Morris water maze. EPO leads to better learning and memory, reflected by shorter escape latencies during the last training days in the hidden platform paradigm. Moreover, EPO treated mice spent more time in the previous platform position during the probe trial (inset). EL-Kordi et al, unpublished data.

study found a slight improvement in hippocampal learning and memory of mice, as measured using Morris water maze, following chronic EPO treatment, and attributed it to the increase in hemoglobin. We obtained similar findings in healthy mice following chronic high-dose EPO treatment over a period of 3 weeks (Fig. 4). Particularly the last days of the learning curve in the hidden platform task reveal superiority of the EPO treated group, underlined by the results of the probe trial.

The fact that EPO acts in the nervous system, has specific binding sites in neurons, and crosses even an intact blood–brain barrier^{33,61,256–258} makes it very likely that at least some of these effects on cognition are direct effects on the brain. In fact, human studies demonstrating improvements in cognitive performance failed to show a correlation between changes of blood values and cognitive enhancement.^{3,244} An even more convincing argument for direct cognitive effects of EPO is the observation that non-hematopoietic EPO variants (e.g. CEPO = carbamoylated erythropoietin) were found to exert specific actions on the nervous system.⁵³ Therefore, we tried to gain better mechanistic insight into how EPO might influence cognitive performance. We showed that high-dose EPO treatment of young mice every other day for 3 weeks leads not only to an improvement in hippocampus-associated learning and memory processes, but also to a highly significant enhancement of long-term potentiation in the hippocampus.²⁵⁹ The same treatment schedule lastingly enhances higher brain functions in mice, ranging from various types of learning and memory processes to attentional performance.²⁶⁰ Interestingly, after only one single high intravenous dose of EPO, before any change in hematological readouts, healthy human subjects display alterations in functional MRI studies investigating the hippocampal response.^{261–263} Inspired by all these findings, we created a mouse model, overexpressing continuously active EPOR (i.e. an EPOR not requiring endogenous ligand) under the α -calcium/calmodulin-dependent protein kinase II (α -CaMKII) promoter. In this model, we found a highly significant improvement of hippocampus-associated higher cognitive performance (manuscript in preparation).

EPO effects on cognition, as delineated in the chapters above, are also evident in human disease states like schizophrenia and multiple sclerosis.^{2,3,33,244} Moreover, they have been demonstrated in 23 of the >180 preclinical studies. To facilitate the screening of cognition-relevant publications, the respective references in all [supplementary Tables 1–5](#) are labeled with stars.

Taken together, in the nervous system, EPO targets cellular/molecular mechanisms involved in cognitive functions. These mechanisms apparently range from fast responding actions, e.g.,^{246–248,261–263} to more delayed and longer lasting effects that persist despite discontinuation of EPO treatment, both in human brain disease^{1,2,245} as well as in mouse models, and most likely influence readouts of neuroplasticity, e.g. synapse formation.^{215,259,260} In light of the fact that decline in cognitive function is one of the leading symptoms of diseases in an aging society, strategies employing EPO as a cognition improving compound have to be further pursued.

Outlook

Based on the above outlined multiple positive findings of EPO as a neuroprotective/neuro-regenerative agent for the treatment of human brain diseases, it appears mandatory to further pursue these indications. This more so since alternative treatments are completely lacking. As the critical next steps for further clinical development of EPO or EPO variants, the doses, application routes and treatment schedules would have to be varied and (re-)tested in different clinical studies for the most promising indications ischemic stroke, neurotrauma, schizophrenia and multiple sclerosis. Among others, nasal application might be worthwhile testing.^{12,77,95,264,265} In parallel, more basic research should be performed to investigate potential pharmacological interactions of EPO with drugs used routinely for treatment of the above listed conditions in order to predict potential beneficial or detrimental interactions.^{103,125,237,238}

Altogether, EPO may be regarded as a strong weapon fighting deterioration in brain diseases but certainly not as a miracle drug. Comparing it e.g. to corticosteroids, it becomes clear that strong positive effects, life-saving at times, are often paralleled by potentially severe side-effects, and the risk-benefit ratio has to be carefully considered at all times in all new indications. The attitude of dealing with a 'life style drug', as indirectly advertised by some EPO producers, has to disappear completely. The essential step for the future, however, will be to convince funding agencies and industry to support the development of EPO or EPO variants for the treatment of neurological and psychiatric diseases.

Conflict of interest

Hannelore Ehrenreich holds/has submitted user patents for EPO in stroke, schizophrenia and multiple sclerosis.

Acknowledgement

The work on EPO performed by the Division of Clinical Neuroscience over the last 14 years has had continuous support by the Max Planck Society and the DFG Center for Molecular Physiology of the Brain (CMPB).

Appendix. Supplementary material

Supplementary material associated with this article can be found in the online version, at [doi:10.1016/j.bpa.2010.10.005](https://doi.org/10.1016/j.bpa.2010.10.005).

References

- *1. Siren AL, Fasshauer T, Bartels C & Ehrenreich H. Therapeutic potential of erythropoietin and its structural or functional variants in the nervous system. *Neurotherapeutics* 2009; **6**: 108–127.
2. Ehrenreich H, Fischer B, Norra C et al. Exploring recombinant human erythropoietin in chronic progressive multiple sclerosis. *Brain* 2007; **130**: 2577–2588.
- *3. Ehrenreich H, Hinze-Selch D, Stawicki S et al. Improvement of cognitive functions in chronic schizophrenic patients by recombinant human erythropoietin. *Molecular Psychiatry* 2007; **12**: 206–220.
4. Tseng MY, Hutchinson PJ, Richards HK et al. Acute systemic erythropoietin therapy to reduce delayed ischemic deficits following aneurysmal subarachnoid hemorrhage: a phase II randomized, double-blind, placebo-controlled trial. Clinical article. *Journal of Neurosurgery* 2009; **111**: 171–180.
5. Grmec S, Strnad M, Kupnik D et al. Erythropoietin facilitates the return of spontaneous circulation and survival in victims of out-of-hospital cardiac arrest. *Resuscitation* 2009; **80**: 631–637.
6. Neubauer AP, Voss W, Wachtendorf M & Jungmann T. Erythropoietin improves neurodevelopmental outcome of extremely preterm infants. *Annals of Neurology* 2010; **67**: 657–666.
- *7. Brines M & Cerami A. Emerging biological roles for erythropoietin in the nervous system. *Nature Reviews. Neuroscience* 2005; **6**: 484–494.
8. Jelkmann W. Erythropoietin after a century of research: younger than ever. *European Journal of Haematology* 2007; **78**: 183–205.
9. Noguchi CT, Asavaritkrai P, Teng R & Jia Y. Role of erythropoietin in the brain. *Critical Reviews in Oncology/Hematology* 2007; **64**: 159–171.
10. Arcasoy MO. The non-haematopoietic biological effects of erythropoietin. *British Journal of Haematology* 2008; **141**: 14–31.

11. Yousoufian H, Longmore G, Neumann D et al. Structure, function, and activation of the erythropoietin receptor. *Blood* 1993; **81**: 2223–2236.
12. Digicaylioglu M & Lipton SA. Erythropoietin-mediated neuroprotection involves cross-talk between Jak2 and NF-kappaB signalling cascades. *Nature* 2001; **412**: 641–647.
- *13. Siren AL, Fratelli M, Brines M et al. Erythropoietin prevents neuronal apoptosis after cerebral ischemia and metabolic stress. *Proceedings of the National Academy of Sciences of the United States of America* 2001; **98**: 4044–4049.
14. Weishaupt JH, Rohde G, Polking E et al. Effect of erythropoietin axotomy-induced apoptosis in rat retinal ganglion cells. *Investigative Ophthalmology and Visual Science* 2004; **45**: 1514–1522.
15. Kilic E, Kilic U, Soliz J et al. Brain-derived erythropoietin protects from focal cerebral ischemia by dual activation of ERK1/-2 and Akt pathways. *FASEB Journal* 2005; **19**: 2026–2028.
16. Park MH, Lee SM, Lee JW et al. ERK-mediated production of neurotrophic factors by astrocytes promotes neuronal stem cell differentiation by erythropoietin. *Biochem Biophys Res Commun* 2006; **339**: 1021–1028.
17. Byts N, Samoylenko A, Fasshauer T et al. Essential role for Stat5 in the neurotrophic but not in the neuroprotective effect of erythropoietin. *Cell Death and Differentiation* 2008; **15**: 783–792.
18. Bauer C & Kurtz A. Oxygen sensing in the kidney and its relation to erythropoietin production. *Annual Review of Physiology* 1989; **51**: 845–856.
19. Semenza GL. HIF-1: mediator of physiological and pathophysiological responses to hypoxia. *Journal of Applied Physiology* 2000; **88**: 1474–1480.
20. Semenza GL. Hydroxylation of HIF-1: oxygen sensing at the molecular level. *Physiology (Bethesda)* 2004; **19**: 176–182.
21. Sharp FR & Beraudaudin M. HIF1 and oxygen sensing in the brain. *Nature Reviews. Neuroscience* 2004; **5**: 437–448.
22. Chikuma M, Masuda S, Kobayashi T et al. Tissue-specific regulation of erythropoietin production in the murine kidney, brain, and uterus. *American Journal of Physiology. Endocrinology and Metabolism* 2000; **279**: E1242–E1248.
23. Sasaki R, Masuda S & Nagao M. Erythropoietin: multiple physiological functions and regulation of biosynthesis. *Bioscience, Biotechnology, and Biochemistry* 2000; **64**: 1775–1793.
24. Fandrey J. Oxygen-dependent and tissue-specific regulation of erythropoietin gene expression. *American Journal of Physiology. Regulatory, Integrative and Comparative Physiology* 2004; **286**: R977–R988.
25. Juul SE, Anderson DK, Li Y & Christensen RD. Erythropoietin and erythropoietin receptor in the developing human central nervous system. *Pediatric Research* 1998; **43**: 40–49.
26. Knabe W, Knerlich F, Washausen S et al. Expression patterns of erythropoietin and its receptor in the developing midbrain. *Anatomy and Embryology* 2004; **207**: 503–512.
27. Ehrenreich H, Hasselblatt M, Knerlich F et al. A hematopoietic growth factor, thrombopoietin, has a proapoptotic role in the brain. *Proceedings of the National Academy of Sciences of the United States of America* 2005; **102**: 862–867.
28. Marti HH, Gassmann M, Wenger RH et al. Detection of erythropoietin in human liquor: intrinsic erythropoietin production in the brain. *Kidney International* 1997; **51**: 416–418.
29. Juul SE, Stallings SA & Christensen RD. Erythropoietin in the cerebrospinal fluid of neonates who sustained CNS injury. *Pediatric Research* 1999; **46**: 543–547.
30. Siren AL, Knerlich F, Poser W et al. Erythropoietin and erythropoietin receptor in human ischemic/hypoxic brain. *Acta Neuropathologica* 2001; **101**: 271–276.
31. Koehne P, Hochhaus F, Felderhoff-Mueser U et al. Vascular endothelial growth factor and erythropoietin concentrations in cerebrospinal fluid of children with hydrocephalus. *Child's Nervous System* 2002; **18**: 137–141.
32. Springborg JB, Sonne B, Frederiksen HJ et al. Erythropoietin in the cerebrospinal fluid of patients with aneurysmal subarachnoid haemorrhage originates from the brain. *Brain Research* 2003; **984**: 143–148.
33. Ehrenreich H, Degner D, Meller J et al. Erythropoietin: a candidate compound for neuroprotection in schizophrenia. *Molecular Psychiatry* 2004; **9**: 42–54.
34. Eid T, Brines ML, Cerami A et al. Increased expression of erythropoietin receptor on blood vessels in the human epileptogenic hippocampus with sclerosis. *Journal of Neuropathology and Experimental Neurology* 2004; **63**: 73–83.
35. Marti HH. Erythropoietin and the hypoxic brain. *Journal of Experimental Biology* 2004; **207**: 3233–3242.
36. Sairanen T, Karjalainen-Lindsberg ML, Paetau A et al. Apoptosis dominant in the periinfarct area of human ischaemic stroke—a possible target of antiapoptotic treatments. *Brain* 2006; **129**: 189–199.
37. Assaraf MI, Diaz Z, Liberman A et al. Brain erythropoietin receptor expression in Alzheimer disease and mild cognitive impairment. *Journal of Neuropathology and Experimental Neurology* 2007; **66**: 389–398.
- *38. Sakanaka M, Wen TC, Matsuda S et al. In vivo evidence that erythropoietin protects neurons from ischemic damage. *Proceedings of the National Academy of Sciences of the United States of America* 1998; **95**: 4635–4640.
39. Junk AK, Mammis A, Savitz SI et al. Erythropoietin administration protects retinal neurons from acute ischemia-reperfusion injury. *Proceedings of the National Academy of Sciences of the United States of America* 2002; **99**: 10659–10664.
40. Fu QL, Wu W, Wang H et al. Up-regulated endogenous erythropoietin/erythropoietin receptor system and exogenous erythropoietin rescue retinal ganglion cells after chronic ocular hypertension. *Cellular and Molecular Neurobiology* 2008; **28**: 317–329.
41. Dreixler JC, Hagevik S, Hemmert JW et al. Involvement of erythropoietin in retinal ischemic preconditioning. *Anesthesiology* 2009; **110**: 774–780.
42. Xiong SQ, Xia XB, Xu HZ & Jiang J. Suppression of retinal neovascularization by small-interference RNA targeting erythropoietin. *Ophthalmologica* 2009; **223**: 306–312.
43. Bretschneider J, Widl K, Ehrenreich H et al. Erythropoietin in the cerebrospinal fluid in neurodegenerative diseases. *Neuroscience Letter* 2006; **404**: 347–351.
44. Brines M, Grasso G, Fiordaliso F et al. Erythropoietin mediates tissue protection through an erythropoietin and common beta-subunit heteroreceptor. *Proceedings of the National Academy of Sciences of the United States of America* 2004; **101**: 14907–14912.
45. Tsai PT, Ohab JJ, Kertesz N et al. A critical role of erythropoietin receptor in neurogenesis and post-stroke recovery. *Journal of Neuroscience* 2006; **26**: 1269–1274.

46. Chen ZY, Asavaritikrai P, Prchal JT & Noguchi CT. Endogenous erythropoietin signaling is required for normal neural progenitor cell proliferation. *Journal of Biological Chemistry* 2007; **282**: 25875–25883.
47. Um M, Gross AW & Lodish HF. A “classical” homodimeric erythropoietin receptor is essential for the antiapoptotic effects of erythropoietin on differentiated neuroblastoma SH-SY5Y and pheochromocytoma PC-12 cells. *Cell Signal* 2007; **19**: 634–645.
48. Wang Y, Zhang ZG, Rhodes K et al. Post-ischemic treatment with erythropoietin or carbamylated erythropoietin reduces infarction and improves neurological outcome in a rat model of focal cerebral ischemia. *British Journal of Pharmacology* 2007; **151**: 1377–1384.
49. Sanchez PE, Navarro FP, Fares RP et al. Erythropoietin receptor expression is concordant with erythropoietin but not with common beta chain expression in the rat brain throughout the life span. *Journal of Comparative Neurology* 2009; **514**: 403–414.
50. Xiong Y, Mahmood A, Qu C et al. Erythropoietin improves histological and functional outcomes after traumatic brain injury in mice in the absence of the neural erythropoietin receptor. *Journal of Neurotrauma* 2010; **27**: 205–215.
51. Campana WM, Misasi R & O'Brien JS. Identification of a neurotrophic sequence in erythropoietin. *International Journal of Molecular Medicine* 1998; **1**: 235–241.
52. Erbayraktar S, Grasso G, Sfacteria A et al. Asialoerythropoietin is a nonerythropoietic cytokine with broad neuroprotective activity in vivo. *Proceedings of the National Academy of Sciences of the United States of America* 2003; **100**: 6741–6746.
- *53. Leist M, Ghezzi P, Grasso G et al. Derivatives of erythropoietin that are tissue protective but not erythropoietic. *Science* 2004; **305**: 239–242.
54. Villa P, van Beek J, Larsen AK et al. Reduced functional deficits, neuroinflammation, and secondary tissue damage after treatment of stroke by nonerythropoietic erythropoietin derivatives. *Journal of Cerebral Blood Flow and Metabolism* 2007; **27**: 552–563.
55. Brines M, Patel NS, Villa P et al. Nonerythropoietic, tissue-protective peptides derived from the tertiary structure of erythropoietin. *Proceedings of the National Academy of Sciences of the United States of America* 2008; **105**: 10925–10930.
56. Kirkeby A, Torup L, Bochsens L et al. High-dose erythropoietin alters platelet reactivity and bleeding time in rodents in contrast to the neuroprotective variant carbamyl-erythropoietin (CEPO). *Thrombosis and Haemostasis* 2008; **99**: 720–728.
57. Pankratova S, Kiryushko D, Sonn K et al. Neuroprotective properties of a novel, non-haematopoietic agonist of the erythropoietin receptor. *Brain* 2010.
58. Kilic U, Kilic E, Soliz J et al. Erythropoietin protects from axotomy-induced degeneration of retinal ganglion cells by activating ERK-1/-2. *FASEB Journal* 2005; **19**: 249–251.
59. Sadamoto Y, Igase K, Sakanaka M et al. Erythropoietin prevents place navigation disability and cortical infarction in rats with permanent occlusion of the middle cerebral artery. *Biochemical and Biophysical Research Communications* 1998; **253**: 26–32.
60. Bernaudin M, Marti HH, Roussel S et al. A potential role for erythropoietin in focal permanent cerebral ischemia in mice. *Journal of Cerebral Blood Flow and Metabolism* 1999; **19**: 643–651.
- *61. Brines ML, Ghezzi P, Keenan S et al. Erythropoietin crosses the blood–brain barrier to protect against experimental brain injury. *Proceedings of the National Academy of Sciences of the United States of America* 2000; **97**: 10526–10531.
62. Wen TC, Sadamoto Y, Tanaka J et al. Erythropoietin protects neurons against chemical hypoxia and cerebral ischemic injury by up-regulating Bcl-xL expression. *Journal of Neuroscience Research* 2002; **67**: 795–803.
63. Aydin A, Genc K, Akhisaroglu M et al. Erythropoietin exerts neuroprotective effect in neonatal rat model of hypoxic-ischemic brain injury. *Brain and Development* 2003; **25**: 494–498.
64. Kumral A, Ozer E, Yilmaz O et al. Neuroprotective effect of erythropoietin on hypoxic-ischemic brain injury in neonatal rats. *Biology of the Neonate* 2003; **83**: 224–228.
65. Kumral A, Uysal N, Tugyan K et al. Erythropoietin improves long-term spatial memory deficits and brain injury following neonatal hypoxia–ischemia in rats. *Behavioural Brain Research* 2004; **153**: 77–86.
66. Kumral A, Tugyan K, Gonenc S et al. Protective effects of erythropoietin against ethanol-induced apoptotic neurodegeneration and oxidative stress in the developing C57BL/6 mouse brain. *Brain Research. Developmental Brain Research* 2005; **160**: 146–156.
67. Matsushita H, Johnston MV, Lange MS & Wilson MA. Protective effect of erythropoietin in neonatal hypoxic ischemia in mice. *Neuroreport* 2003; **14**: 1757–1761.
68. Villa P, Bigini P, Mennini T et al. Erythropoietin selectively attenuates cytokine production and inflammation in cerebral ischemia by targeting neuronal apoptosis. *Journal of Experimental Medicine* 2003; **198**: 971–975.
69. Sun Y, Zhou C, Polk P et al. Mechanisms of erythropoietin-induced brain protection in neonatal hypoxia–ischemia rat model. *Journal of Cerebral Blood Flow and Metabolism* 2004; **24**: 259–270.
70. Wang L, Zhang Z, Wang Y et al. Treatment of stroke with erythropoietin enhances neurogenesis and angiogenesis and improves neurological function in rats. *Stroke* 2004; **35**: 1732–1737.
71. Belayev L, Khoutorova L, Zhao W et al. Neuroprotective effect of darbepoetin alfa, a novel recombinant erythropoietic protein, in focal cerebral ischemia in rats. *Stroke* 2005; **36**: 1071–1076.
72. Chang YS, Mu D, Wendland M et al. Erythropoietin improves functional and histological outcome in neonatal stroke. *Pediatric Research* 2005; **58**: 106–111.
73. Demers EJ, McPherson RJ & Juul SE. Erythropoietin protects dopaminergic neurons and improves neurobehavioral outcomes in juvenile rats after neonatal hypoxia–ischemia. *Pediatric Research* 2005; **58**: 297–301.
74. Sola A, Rogido M, Lee BH et al. Erythropoietin after focal cerebral ischemia activates the Janus kinase-signal transducer and activator of transcription signaling pathway and improves brain injury in postnatal day 7 rats. *Pediatric Research* 2005; **57**: 481–487.
75. Spandou E, Papadopoulou Z, Soubasi V et al. Erythropoietin prevents long-term sensorimotor deficits and brain injury following neonatal hypoxia–ischemia in rats. *Brain Research* 2005; **1045**: 22–30.

76. Sun Y, Calvert JW & Zhang JH. Neonatal hypoxia/ischemia is associated with decreased inflammatory mediators after erythropoietin administration. *Stroke* 2005; **36**: 1672–1678.
77. Yu YP, Xu QQ, Zhang Q et al. Intranasal recombinant human erythropoietin protects rats against focal cerebral ischemia. *Neuroscience Letter* 2005; **387**: 5–10.
78. McClure MM, Threlkeld SW & Fitch RH. The effects of erythropoietin on auditory processing following neonatal hypoxic-ischemic injury. *Brain Research* 2006; **1087**: 190–195.
79. Wen TC, Rogido M, Peng H et al. Gender differences in long-term beneficial effects of erythropoietin given after neonatal stroke in postnatal day-7 rats. *Neuroscience* 2006; **139**: 803–811.
80. Gonzalez FF, McQuillen P, Mu D et al. Erythropoietin enhances long-term neuroprotection and neurogenesis in neonatal stroke. *Developmental Neuroscience* 2007; **29**: 321–330.
81. Iwai M, Cao G, Yin W et al. Erythropoietin promotes neuronal replacement through revascularization and neurogenesis after neonatal hypoxia/ischemia in rats. *Stroke* 2007; **38**: 2795–2803.
82. Kellert BA, McPherson RJ & Juul SE. A comparison of high-dose recombinant erythropoietin treatment regimens in brain-injured neonatal rats. *Pediatric Research* 2007; **61**: 451–455.
83. Li Y, Lu ZY, Ogle M & Wei L. Erythropoietin prevents blood brain barrier damage induced by focal cerebral ischemia in mice. *Neurochemical Research* 2007; **32**: 2132–2141.
84. McClure MM, Threlkeld SW & Fitch RH. Auditory processing and learning/memory following erythropoietin administration in neonatally hypoxic-ischemic injured rats. *Brain Research* 2007; **1132**: 203–209.
85. McPherson RJ, Demers EJ & Juul SE. Safety of high-dose recombinant erythropoietin in a neonatal rat model. *Neonatology* 2007; **91**: 36–43.
86. Taguchi A, Wen Z, Myojin K et al. Granulocyte colony-stimulating factor has a negative effect on stroke outcome in a murine model. *European Journal of Neuroscience* 2007; **26**: 126–133.
87. Chi OZ, Hunter C, Liu X & Weiss HR. Effects of erythropoietin on blood–brain barrier disruption in focal cerebral ischemia. *Pharmacology* 2008; **82**: 38–42.
88. Esneault E, Pacary E, Eddi D et al. Combined therapeutic strategy using erythropoietin and mesenchymal stem cells potentiates neurogenesis after transient focal cerebral ischemia in rats. *Journal of Cerebral Blood Flow and Metabolism* 2008; **28**: 1552–1563.
89. Juul SE, McPherson RJ, Bammler TK et al. Recombinant erythropoietin is neuroprotective in a novel mouse oxidative injury model. *Developmental Neuroscience* 2008; **30**: 231–242.
90. Kaindl AM, Sifringer M, Koppelstaetter A et al. Erythropoietin protects the developing brain from hyperoxia-induced cell death and proteome changes. *Annals of Neurology* 2008; **64**: 523–534.
91. Kim SS, Lee KH, Sung DK et al. Erythropoietin attenuates brain injury, subventricular zone expansion, and sensorimotor deficits in hypoxic-ischemic neonatal rats. *Journal of Korean Medical Science* 2008; **23**: 484–491.
92. Lapchak PA, Kirkeby A, Zivin JA & Sager TN. Therapeutic window for nonerythropoietic carbamylated-erythropoietin to improve motor function following multiple infarct ischemic strokes in New Zealand white rabbits. *Brain Research* 2008; **1238**: 208–214.
93. Mizuno K, Hida H, Masuda T et al. Pretreatment with low doses of erythropoietin ameliorates brain damage in periventricular leukomalacia by targeting late oligodendrocyte progenitors: a rat model. *Neonatology* 2008; **94**: 255–266.
94. Yis U, Kurul SH, Kumral A et al. Effect of erythropoietin on oxygen-induced brain injury in the newborn rat. *Neuroscience Letter* 2008; **448**: 245–249.
95. Fletcher L, Kohli S, Sprague SM et al. Intranasal delivery of erythropoietin plus insulin-like growth factor-I for acute neuroprotection in stroke. Laboratory investigation. *Journal of Neurosurgery* 2009; **111**: 164–170.
96. Gonzalez FF, Abel R, Almi CR et al. Erythropoietin sustains cognitive function and brain volume after neonatal stroke. *Developmental Neuroscience* 2009; **31**: 403–411.
97. Juul SE, Beyer RP, Bammler TK et al. Microarray analysis of high-dose recombinant erythropoietin treatment of unilateral brain injury in neonatal mouse hippocampus. *Pediatric Research* 2009; **65**: 485–492.
98. van der Kooij MA, Groenendaal F, Kavelaars A et al. Combination of deferoxamine and erythropoietin: therapy for hypoxia–ischemia-induced brain injury in the neonatal rat? *Neuroscience Letter* 2009; **451**: 109–113.
99. Li L, Jiang Q, Ding G et al. MRI identification of white matter reorganization enhanced by erythropoietin treatment in a rat model of focal ischemia. *Stroke* 2009; **40**: 936–941.
100. Iwai M, Stetler RA, Xing J et al. Enhanced oligodendrogenesis and recovery of neurological function by erythropoietin after neonatal hypoxic/ischemic brain injury. *Stroke* 2010; **41**: 1032–1037.
101. Liu SP, Lee SD, Lee HT et al. Granulocyte colony-stimulating factor activating HIF-1 α acts synergistically with erythropoietin to promote tissue plasticity. *PLoS One* 2010; **5**: e10093.
102. Price CD, Yang Z, Karlnoski R et al. Effect of continuous infusion of asialoerythropoietin on short-term changes in infarct volume, penumbra apoptosis and behaviour following middle cerebral artery occlusion in rats. *Clinical and Experimental Pharmacology and Physiology* 2010; **37**: 185–192.
103. Zechariah A, Elali A & Hermann DM. Combination of tissue-plasminogen activator with erythropoietin induces blood–brain barrier permeability, extracellular matrix disaggregation, and DNA fragmentation after focal cerebral ischemia in mice. *Stroke* 2010; **41**: 1008–1012.
104. Calapai G, Marciano MC, Corica F et al. Erythropoietin protects against brain ischemic injury by inhibition of nitric oxide formation. *European Journal of Pharmacology* 2000; **401**: 349–356.
105. Catania MA, Marciano MC, Parisi A et al. Erythropoietin prevents cognition impairment induced by transient brain ischemia in gerbils. *European Journal of Pharmacology* 2002; **437**: 147–150.
106. Solaroglu I, Solaroglu A, Kaptanoglu E et al. Erythropoietin prevents ischemia-reperfusion from inducing oxidative damage in fetal rat brain. *Child's Nervous System* 2003; **19**: 19–22.
107. Zhang F, Signore AP, Zhou Z et al. Erythropoietin protects CA1 neurons against global cerebral ischemia in rat: potential signaling mechanisms. *Journal of Neuroscience Research* 2006; **83**: 1241–1251.

108. Zhang F, Wang S, Cao G et al. Signal transducers and activators of transcription 5 contributes to erythropoietin-mediated neuroprotection against hippocampal neuronal death after transient global cerebral ischemia. *Neurobiology of Disease* 2007; **25**: 45–53.
109. Bahcekapili N, Uzum G, Gokkusu C et al. The relationship between erythropoietin pretreatment with blood–brain barrier and lipid peroxidation after ischemia/reperfusion in rats. *Life Science* 2007; **80**: 1245–1251.
110. Samson ML, Kajitani K & Robertson GS. Nitric-oxide synthase mediates the ability of darbepoetin alfa to attenuate pre-existing spatial working memory deficits in rats subjected to transient global ischemia. *Journal of Pharmacology and Experimental Therapeutics* 2010; **333**: 437–444.
111. Alafaci C, Salpietro F, Grasso G et al. Effect of recombinant human erythropoietin on cerebral ischemia following experimental subarachnoid hemorrhage. *European Journal of Pharmacology* 2000; **406**: 219–225.
112. Buemi M, Grasso G, Corica F et al. In vivo evidence that erythropoietin has a neuroprotective effect during subarachnoid hemorrhage. *European Journal of Pharmacology* 2000; **392**: 31–34.
113. Grasso G, Buemi M, Alafaci C et al. Beneficial effects of systemic administration of recombinant human erythropoietin in rabbits subjected to subarachnoid hemorrhage. *Proceedings of the National Academy of Sciences of the United States of America* 2002; **99**: 5627–5631.
114. Springborg JB, Ma X, Rochat P et al. A single subcutaneous bolus of erythropoietin normalizes cerebral blood flow autoregulation after subarachnoid haemorrhage in rats. *British Journal of Pharmacology* 2002; **135**: 823–829.
115. Santhanam AV, Smith LA, Akiyama M et al. Role of endothelial NO synthase phosphorylation in cerebrovascular protective effect of recombinant erythropoietin during subarachnoid hemorrhage-induced cerebral vasospasm. *Stroke* 2005; **36**: 2731–2737.
116. Lee ST, Chu K, Sinn DI et al. Erythropoietin reduces perihematoma inflammation and cell death with eNOS and STAT3 activations in experimental intracerebral hemorrhage. *Journal of Neurochemistry* 2006; **96**: 1728–1739.
117. Li Y, Ogle ME, Wallace 4th GC et al. Erythropoietin attenuates intracerebral hemorrhage by diminishing matrix metalloproteinases and maintaining blood–brain barrier integrity in mice. *Acta Neurochirurgica. Supplement* 2008; **105**: 105–112.
118. Murphy AM, Xenocostas A, Pakkiri P & Lee TY. Hemodynamic effects of recombinant human erythropoietin on the central nervous system after subarachnoid hemorrhage: reduction of microcirculatory impairment and functional deficits in a rabbit model. *Journal of Neurosurgery* 2008; **109**: 1155–1164.
119. Chen G, Zhang S, Shi J et al. Effects of recombinant human erythropoietin (rhEPO) on JAK2/STAT3 pathway and endothelial apoptosis in the rabbit basilar artery after subarachnoid hemorrhage. *Cytokine* 2009; **45**: 162–168.
120. Grasso G, Graziano F, Sfacteria A et al. Neuroprotective effect of erythropoietin and darbepoetin alfa after experimental intracerebral hemorrhage. *Neurosurgery* 2009; **65**: 763–769 [discussion 9–70].
121. Seyfried DM, Han Y, Yang D et al. Erythropoietin promotes neurological recovery after intracerebral haemorrhage in rats. *International Journal of Stroke* 2009; **4**: 250–256.
122. Agnello D, Bigini P, Villa P et al. Erythropoietin exerts an anti-inflammatory effect on the CNS in a model of experimental autoimmune encephalomyelitis. *Brain Research* 2002; **952**: 128–134.
123. Li W, Maeda Y, Yuan RR et al. Beneficial effect of erythropoietin on experimental allergic encephalomyelitis. *Annals of Neurology* 2004; **56**: 767–777.
124. Sattler MB, Merkler D, Maier K et al. Neuroprotective effects and intracellular signaling pathways of erythropoietin in a rat model of multiple sclerosis. *Cell Death and Differentiation* 2004; **11**(Suppl. 2): S181–S192.
125. Diem R, Sattler MB, Merkler D et al. Combined therapy with methylprednisolone and erythropoietin in a model of multiple sclerosis. *Brain* 2005; **128**: 375–385.
126. Zhang J, Li Y, Cui Y et al. Erythropoietin treatment improves neurological functional recovery in EAE mice. *Brain Research* 2005; **1034**: 34–39.
127. Savino C, Pedotti R, Baggi F et al. Delayed administration of erythropoietin and its non-erythropoietic derivatives ameliorates chronic murine autoimmune encephalomyelitis. *Journal of Neuroimmunology* 2006; **172**: 27–37.
128. Yuan R, Maeda Y, Li W et al. Erythropoietin: a potent inducer of peripheral immuno/inflammatory modulation in autoimmune EAE. *PLoS One* 2008; **3**: e1924.
129. Kang SY, Kang JH, Choi JC et al. Expression of erythropoietin in the spinal cord of lewis rats with experimental autoimmune encephalomyelitis. *Journal of Clinical Neurology* 2009; **5**: 39–45.
130. Thorne M, Moore CS & Robertson GS. Lack of TIMP-1 increases severity of experimental autoimmune encephalomyelitis: effects of darbepoetin alfa on TIMP-1 null and wild-type mice. *Journal of Neuroimmunology* 2009; **211**: 92–100.
131. Kaiser K, Texier A, Ferrandiz J et al. Recombinant human erythropoietin prevents the death of mice during cerebral malaria. *Journal of Infectious Diseases* 2006; **193**: 987–995.
132. Bienvenu AL, Ferrandiz J, Kaiser K et al. Artesunate–erythropoietin combination for murine cerebral malaria treatment. *Acta Tropica* 2008; **106**: 104–108.
133. Wiese L, Hempel C, Penkova M et al. Recombinant human erythropoietin increases survival and reduces neuronal apoptosis in a murine model of cerebral malaria. *Malaria Journal* 2008; **7**: 3.
134. Kumral A, Baskin H, Yesilirmak DC et al. Erythropoietin attenuates lipopolysaccharide-induced white matter injury in the neonatal rat brain. *Neonatology* 2007; **92**: 269–278.
135. Spreer A, Gerber J, Hanssen M & Nau R. No neuroprotective effect of erythropoietin under clinical treatment conditions in a rabbit model of *Escherichia coli* meningitis. *Pediatric Research* 2007; **62**: 680–683.
136. Rees S, Hale N, De Matteo R et al. Erythropoietin is neuroprotective in a preterm ovine model of endotoxin-induced brain injury. *Journal of Neuro pathology and Experimental Neurology* 2010; **69**: 306–319.
137. Uzum G, Sarper Diler A, Bahcekapili N & Ziya Ziyilan Y. Erythropoietin prevents the increase in blood–brain barrier permeability during pentylentetrazol induced seizures. *Life Science* 2006; **78**: 2571–2576.
138. Mikati MA, El Hokayem JA & El Sabban ME. Effects of a single dose of erythropoietin on subsequent seizure susceptibility in rats exposed to acute hypoxia at P10. *Epilepsia* 2007; **48**: 175–181.
139. Nadam J, Navarro F, Sanchez P et al. Neuroprotective effects of erythropoietin in the rat hippocampus after pilocarpine-induced status epilepticus. *Neurobiology of Disease* 2007; **25**: 412–426.

140. Yang J, Huang Y, Yu X et al. Erythropoietin preconditioning suppresses neuronal death following status epilepticus in rats. *Acta Neurobiologiae Experimentalis* 2007; **67**: 141–148.
141. Chu K, Jung KH, Lee ST et al. Erythropoietin reduces epileptogenic processes following status epilepticus. *Epilepsia* 2008; **49**: 1723–1732.
142. Taoufik E, Petit E, Divoux D et al. TNF receptor 1 sensitizes neurons to erythropoietin- and VEGF-mediated neuroprotection after ischemic and excitotoxic injury. *Proceedings of the National Academy of Sciences of the United States of America* 2008; **105**: 6185–6190.
143. Girenti MJ, Hunsberger J, Duman CH et al. Erythropoietin induction by electroconvulsive seizure, gene regulation, and antidepressant-like behavioral effects. *Biological Psychiatry* 2009; **66**: 267–274.
144. Jing M, Shingo T, Yasuhara T et al. The combined therapy of intrahippocampal transplantation of adult neural stem cells and intraventricular erythropoietin-infusion ameliorates spontaneous recurrent seizures by suppression of abnormal mossy fiber sprouting. *Brain Research* 2009; **1295**: 203–217.
145. Jun Y, Jiang Tao X, YuanGui H et al. Erythropoietin pre-treatment prevents cognitive impairments following status epilepticus in rats. *Brain Research* 2009; **1282**: 57–66.
146. Kondo A, Shingo T, Yasuhara T et al. Erythropoietin exerts anti-epileptic effects with the suppression of aberrant new cell formation in the dentate gyrus and upregulation of neuropeptide Y in seizure model of rats. *Brain Research* 2009; **1296**: 127–136.
147. Sanchez PE, Fares RP, Rizzo JJ et al. Optimal neuroprotection by erythropoietin requires elevated expression of its receptor in neurons. *Proceedings of the National Academy of Sciences of the United States of America* 2009; **106**: 9848–9853.
148. Genc S, Kuralay F, Genc K et al. Erythropoietin exerts neuroprotection in 1-methyl-4-phenyl-1,2,3,6-tetrahydropyridine-treated C57/BL mice via increasing nitric oxide production. *Neuroscience Letter* 2001; **298**: 139–141.
149. Kanaan NM, Collier TJ, Marchionini DM et al. Exogenous erythropoietin provides neuroprotection of grafted dopamine neurons in a rodent model of Parkinson's disease. *Brain Research* 2006; **1068**: 221–229.
150. Puskovic V, Wolfe D, Wechuck J et al. HSV-mediated delivery of erythropoietin restores dopaminergic function in MPTP-treated mice. *Molecular Therapy* 2006; **14**: 710–715.
151. McLeod M, Hong M, Mukhida K et al. Erythropoietin and GDNF enhance ventral mesencephalic fiber outgrowth and capillary proliferation following neural transplantation in a rodent model of Parkinson's disease. *European Journal of Neuroscience* 2006; **24**: 361–370.
152. Xue YQ, Zhao LR, Guo WP & Duan WM. Intrastratial administration of erythropoietin protects dopaminergic neurons and improves neurobehavioral outcome in a rat model of Parkinson's disease. *Neuroscience* 2007; **146**: 1245–1258.
153. Kadota T, Shingo T, Yasuhara T et al. Continuous intraventricular infusion of erythropoietin exerts neuroprotective/rescue effects upon Parkinson's disease model of rats with enhanced neurogenesis. *Brain Research* 2009; **1254**: 120–127.
154. Xue YQ, Ma BF, Zhao LR et al. AAV9-mediated erythropoietin gene delivery into the brain protects nigral dopaminergic neurons in a rat model of Parkinson's disease. *Gene Therapy* 2010; **17**: 83–94.
155. Grimm C, Wenzel A, Groszer M et al. HIF-1-induced erythropoietin in the hypoxic retina protects against light-induced retinal degeneration. *Nature Medicine* 2002; **8**: 718–724.
156. Grimm C, Wenzel A, Stanescu D et al. Constitutive overexpression of human erythropoietin protects the mouse retina against induced but not inherited retinal degeneration. *Journal of Neuroscience* 2004; **24**: 5651–5658.
157. Rex TS, Allocca M, Domenici L et al. Systemic but not intraocular Epo gene transfer protects the retina from light-and genetic-induced degeneration. *Molecular Therapy* 2004; **10**: 855–861.
158. Tsai JC, Wu L, Worgul B et al. Intravitreal administration of erythropoietin and preservation of retinal ganglion cells in an experimental rat model of glaucoma. *Current Eye Research* 2005; **30**: 1025–1031.
159. King CE, Rodger J, Bartlett C et al. Erythropoietin is both neuroprotective and neuroregenerative following optic nerve transection. *Experimental Neurology* 2007; **205**: 48–55.
160. Rancho Cole I, Bonhomme B & Doly M. Pre-treatment of adult rats with high doses of erythropoietin induces caspase-9 but prevents light-induced retinal injury. *Experimental Eye Research* 2007; **85**: 782–789.
161. Zhong L, Bradley J, Schubert W et al. Erythropoietin promotes survival of retinal ganglion cells in DBA/2J glaucoma mice. *Investigative Ophthalmology and Visual Science* 2007; **48**: 1212–1218.
162. Rex TS, Wong Y, Kodali K & Merry S. Neuroprotection of photoreceptors by direct delivery of erythropoietin to the retina of the retinal degeneration slow mouse. *Experimental Eye Research* 2009; **89**: 735–740.
163. Campana WM & Myers RR. Exogenous erythropoietin protects against dorsal root ganglion apoptosis and pain following peripheral nerve injury. *European Journal of Neuroscience* 2003; **18**: 1497–1506.
164. Sekiguchi Y, Kikuchi S, Myers RR & Campana WM. ISSLS prize winner: erythropoietin inhibits spinal neuronal apoptosis and pain following nerve root crush. *Spine (Phila Pa 1976)* 2003; **28**: 2577–2584.
165. Keswani SC, Buldanlioglu U, Fischer A et al. A novel endogenous erythropoietin mediated pathway prevents axonal degeneration. *Annals of Neurology* 2004; **56**: 815–826.
166. Orhan B, Yalcin S, Nurlu G et al. Erythropoietin against cisplatin-induced peripheral neurotoxicity in rats. *Medical Oncology* 2004; **21**: 197–203.
167. Allaf ME, Hoke A & Burnett AL. Erythropoietin promotes the recovery of erectile function following cavernous nerve injury. *Journal of Urology* 2005; **174**: 2060–2064.
168. Bianchi R, Brines M, Lauria G et al. Protective effect of erythropoietin and its carbamylated derivative in experimental cisplatin peripheral neurotoxicity. *Clinical Cancer Research* 2006; **12**: 2607–2612.
169. Melli G, Jack C, Lambrinos GL et al. Erythropoietin protects sensory axons against paclitaxel-induced distal degeneration. *Neurobiology of Disease* 2006; **24**: 525–530.
170. Bianchi R, Gilardini A, Rodriguez-Menendez V et al. Cisplatin-induced peripheral neuropathy: neuroprotection by erythropoietin without affecting tumour growth. *European Journal of Cancer* 2007; **43**: 710–717.
171. Cervellini I, Bello E, Frapolli R et al. The neuroprotective effect of erythropoietin in docetaxel-induced peripheral neuropathy causes no reduction of antitumor activity in 13762 adenocarcinoma-bearing rats. *Neurotoxicity Research* 2009.

172. Yoon MS, Katsarava Z, Obermann M et al. Erythropoietin overrides the triggering effect of DNA platination products in a mouse model of cisplatin-induced neuropathy. *BMC Neuroscience* 2009; **10**: 77.
173. Bianchi R, Buyukakilli B, Brines M et al. Erythropoietin both protects from and reverses experimental diabetic neuropathy. *Proceedings of the National Academy of Sciences of the United States of America* 2004; **101**: 823–828.
174. Schmidt RE, Green KG, Feng D et al. Erythropoietin and its carbamylated derivative prevent the development of experimental diabetic autonomic neuropathy in STZ-induced diabetic NOD-SCID mice. *Experimental Neurology* 2008; **209**: 161–170.
175. Chattopadhyay M, Walter C, Mata M & Fink DJ. Neuroprotective effect of herpes simplex virus-mediated gene transfer of erythropoietin in hyperglycemic dorsal root ganglion neurons. *Brain* 2009; **132**: 879–888.
176. Li X, Goniais SL & Campana WM. Schwann cells express erythropoietin receptor and represent a major target for Epo in peripheral nerve injury. *Glia* 2005; **51**: 254–265.
177. Campana WM, Li X, Shubayev VI et al. Erythropoietin reduces Schwann cell TNF-alpha, Wallerian degeneration and pain-related behaviors after peripheral nerve injury. *European Journal of Neuroscience* 2006; **23**: 617–626.
178. Grasso G, Meli F, Fodale V et al. Neuroprotective potential of erythropoietin and darbepoetin alfa in an experimental model of sciatic nerve injury. Laboratory investigation. *Journal of Neurosurgery Spine* 2007; **7**: 645–651.
179. Elfar JC, Jacobson JA, Puzas JE et al. Erythropoietin accelerates functional recovery after peripheral nerve injury. *Journal of Bone and Joint Surgery* 2008; **90**: 1644–1653.
180. Toth C, Martinez JA, Liu WQ et al. Local erythropoietin signaling enhances regeneration in peripheral axons. *Neuroscience* 2008; **154**: 767–783.
181. Yin ZS, Zhang H & Gao W. Erythropoietin promotes functional recovery and enhances nerve regeneration after peripheral nerve injury in rats. *AJNR. American Journal of Neuroradiology* 2010; **31**: 509–515.
182. Mennini T, De Paola M, Bigini P et al. Nonhematopoietic erythropoietin derivatives prevent motoneuron degeneration in vitro and in vivo. *Molecular Medicine* 2006; **12**: 153–160.
183. Grignaschi G, Zennaro E, Tortorolo M et al. Erythropoietin does not preserve motor neurons in a mouse model of familial ALS. *Amyotrophic Lateral Sclerosis* 2007; **8**: 31–35.
184. Grunfeld JF, Barhum Y, Blondheim N et al. Erythropoietin delays disease onset in an amyotrophic lateral sclerosis model. *Experimental Neurology* 2007; **204**: 260–263.
185. Koh SH, Kim Y, Kim HY et al. Recombinant human erythropoietin suppresses symptom onset and progression of G93A-SOD1 mouse model of ALS by preventing motor neuron death and inflammation. *European Journal of Neuroscience* 2007; **25**: 1923–1930.
186. Dziejko M, Felderhoff-Mueser U, Sifringer M et al. Erythropoietin protects the developing brain against N-methyl-D-aspartate receptor antagonist neurotoxicity. *Neurobiology of Disease* 2004; **15**: 177–187.
187. Fukuda H, Fukuda A, Zhu C et al. Irradiation-induced progenitor cell death in the developing brain is resistant to erythropoietin treatment and caspase inhibition. *Cell Death and Differentiation* 2004; **11**: 1166–1178.
188. Gil JM, Leist M, Popov N et al. Asialoerythropoietin is not effective in the R6/2 line of Huntington's disease mice. *BMC Neuroscience* 2004; **5**: 17.
189. Kumral A, Gonenc S, Acikgoz O et al. Erythropoietin increases glutathione peroxidase enzyme activity and decreases lipid peroxidation levels in hypoxic-ischemic brain injury in neonatal rats. *Biology of the Neonate* 2005; **87**: 15–18.
190. Erbayraktar S, de Lanerolle N, de Lotbiniere A et al. Carbamylated erythropoietin reduces radiosurgically-induced brain injury. *Molecular Medicine* 2006; **12**: 74–80.
191. Keller M, Yang J, Griesmaier E et al. Erythropoietin is neuroprotective against NMDA-receptor-mediated excitotoxic brain injury in newborn mice. *Neurobiology of Disease* 2006; **24**: 357–366.
192. Lu D, Mahmood A, Qu C et al. Erythropoietin enhances neurogenesis and restores spatial memory in rats after traumatic brain injury. *Journal of Neurotrauma* 2005; **22**: 1011–1017.
193. Mala H, Alsina CG, Madsen KS et al. Erythropoietin improves place learning in an 8-arm radial maze in fimbria–fornix transected rats. *Neural Plasticity* 2005; **12**: 329–340.
194. Mala H, Rodriguez Castro M, Dall Jorgensen K & Mogensen J. Effects of erythropoietin on posttraumatic place learning in fimbria–fornix transected rats after a 30-day postoperative pause. *Journal of Neurotrauma* 2007; **24**: 1647–1657.
195. Ozturk E, Demirbilek S, Kadir But A et al. Antioxidant properties of propofol and erythropoietin after closed head injury in rats. *Progress in Neuro-psychopharmacology and Biological Psychiatry* 2005; **29**: 922–927.
196. Yatsiv I, Grigoriadis N, Simeonidou C et al. Erythropoietin is neuroprotective, improves functional recovery, and reduces neuronal apoptosis and inflammation in a rodent model of experimental closed head injury. *FASEB Journal* 2005; **19**: 1701–1703.
197. Matchett G, Hahn J, Obenaus A & Zhang J. Surgically induced brain injury in rats: the effect of erythropoietin. *Journal of Neuroscience Methods* 2006; **158**: 234–241.
198. Siren AL, Radyushkin K, Boretius S et al. Global brain atrophy after unilateral parietal lesion and its prevention by erythropoietin. *Brain* 2006; **129**: 480–489.
199. Akdemir Ozisik P, Oruckaptan H, Ozdemir Geyik P et al. Effect of erythropoietin on brain tissue after experimental head trauma in rats. *Surgical Neurology* 2007; **68**: 547–555 [discussion 55].
200. Chen G, Shi JX, Hang CH et al. Inhibitory effect on cerebral inflammatory agents that accompany traumatic brain injury in a rat model: a potential neuroprotective mechanism of recombinant human erythropoietin (rhEPO). *Neuroscience Letter* 2007; **425**: 177–182.
201. Cherian L, Goodman JC & Robertson C. Neuroprotection with erythropoietin administration following controlled cortical impact injury in rats. *Journal of Pharmacology and Experimental Therapeutics* 2007; **322**: 789–794.
202. Grasso G, Sfacteria A, Meli F et al. Neuroprotection by erythropoietin administration after experimental traumatic brain injury. *Brain Research* 2007; **1182**: 99–105.
203. Mahmood A, Lu D, Qu C et al. Treatment of traumatic brain injury in rats with erythropoietin and carbamylated erythropoietin. *Journal of Neurosurgery* 2007; **107**: 392–397.
204. Verdonck O, Lahrech H, Francois G et al. Erythropoietin protects from post-traumatic edema in the rat brain. *Journal of Cerebral Blood Flow and Metabolism* 2007; **27**: 1369–1376.

205. Xiong Y, Mahmood A, Lu D et al. Role of gender in outcome after traumatic brain injury and therapeutic effect of erythropoietin in mice. *Brain Research* 2007; **1185**: 301–312.
206. Hartley CE, Varma M, Fischer JP et al. Neuroprotective effects of erythropoietin on acute metabolic and pathological changes in experimentally induced neurotrauma. *Journal of Neurosurgery* 2008; **109**: 708–714.
207. Liao ZB, Zhi XG, Shi QH & He ZH. Recombinant human erythropoietin administration protects cortical neurons from traumatic brain injury in rats. *European Journal of Neurology* 2008; **15**: 140–149.
208. Lieutaud T, Andrews PJ, Rhodes JK & Williamson R. Characterization of the pharmacokinetics of human recombinant erythropoietin in blood and brain when administered immediately after lateral fluid percussion brain injury and its pharmacodynamic effects on IL-1beta and MIP-2 in rats. *Journal of Neurotrauma* 2008; **25**: 1179–1185.
209. Mogensen J, Boyd MH, Nielsen MD et al. Erythropoietin improves spatial delayed alternation in a T-maze in rats subjected to ablation of the prefrontal cortex. *Brain Research Bulletin* 2008; **77**: 1–7.
210. Okutan O, Turkoglu OF, Gok HB & Beskonakli E. Neuroprotective effect of erythropoietin after experimental cold injury-induced vasogenic brain edema in rats. *Surgical Neurology* 2008; **70**: 498–502.
211. Shein NA, Grigoriadis N, Alexandrovich AG et al. Differential neuroprotective properties of endogenous and exogenous erythropoietin in a mouse model of traumatic brain injury. *Journal of Neurotrauma* 2008; **25**: 112–123.
212. Xiong Y, Lu D, Qu C et al. Effects of erythropoietin on reducing brain damage and improving functional outcome after traumatic brain injury in mice. *Journal of Neurosurgery* 2008; **109**: 510–521.
213. Xiong Y, Mahmood A, Lu D et al. Histological and functional outcomes after traumatic brain injury in mice null for the erythropoietin receptor in the central nervous system. *Brain Research* 2008; **1230**: 247–257.
214. Liao ZB, Jiang YG, Tang ZH et al. Erythropoietin can promote survival of cerebral cells by downregulating Bax gene after traumatic brain injury in rats. *Neurology India* 2009; **57**: 722–728.
215. Sargin D, Hassouna I, Sperling S & Taskin Y. Uncoupling of neurodegeneration and gliosis in a murine model of juvenile cortical lesion. *Glia* 2009; **57**: 693–702.
216. Xiong Y, Chopp M & Lee CP. Erythropoietin improves brain mitochondrial function in rats after traumatic brain injury. *Neurological Research* 2009; **31**: 496–502.
217. Xiong Y, Mahmood A, Meng Y et al. Delayed administration of erythropoietin reducing hippocampal cell loss, enhancing angiogenesis and neurogenesis, and improving functional outcome following traumatic brain injury in rats: comparison of treatment with single and triple dose. *Journal of Neurosurgery* 2009.
218. Zhang Y, Xiong Y, Mahmood A et al. Therapeutic effects of erythropoietin on histological and functional outcomes following traumatic brain injury in rats are independent of hematocrit. *Brain Research* 2009; **1294**: 153–164.
219. Zhu L, Wang HD, Yu XG et al. Erythropoietin prevents zinc accumulation and neuronal death after traumatic brain injury in rat hippocampus: in vitro and in vivo studies. *Brain Research* 2009; **1289**: 96–105.
220. Valable S, Francony G, Bouzat P et al. The impact of erythropoietin on short-term changes in phosphorylation of brain protein kinases in a rat model of traumatic brain injury. *Journal of Cerebral Blood Flow and Metabolism* 2010; **30**: 361–369.
221. Celik M, Gokmen N, Erbayraktar S et al. Erythropoietin prevents motor neuron apoptosis and neurologic disability in experimental spinal cord ischemic injury. *Proceedings of the National Academy of Sciences of the United States of America* 2002; **99**: 2258–2263.
222. Gorio A, Gokmen N, Erbayraktar S et al. Recombinant human erythropoietin counteracts secondary injury and markedly enhances neurological recovery from experimental spinal cord trauma. *Proceedings of the National Academy of Sciences of the United States of America* 2002; **99**: 9450–9455.
223. Grasso G, Sfacteria A, Erbayraktar S et al. Amelioration of spinal cord compressive injury by pharmacological preconditioning with erythropoietin and a nonerythropoietic erythropoietin derivative. *Journal of Neurosurgery. Spine* 2006; **4**: 310–318.
224. King VR, Averill SA, Hewazy D et al. Erythropoietin and carbamylated erythropoietin are neuroprotective following spinal cord hemisection in the rat. *European Journal of Neuroscience* 2007; **26**: 90–100.
225. Okutan O, Solaroglu I, Beskonakli E et al. Recombinant human erythropoietin decreases myeloperoxidase and caspase-3 activity and improves early functional results after spinal cord injury in rats. *Journal of Clinical Neuroscience* 2007; **14**: 364–368.
226. Sonmez A, Kabakci B, Vardar E et al. Erythropoietin attenuates neuronal injury and potentiates the expression of pCREB in anterior horn after transient spinal cord ischemia in rats. *Surgical Neurology* 2007; **68**: 297–303 [discussion].
227. Vitellaro-Zuccarello L, Mazzetti S, Madaschi L et al. Erythropoietin-mediated preservation of the white matter in rat spinal cord injury. *Neuroscience* 2007; **144**: 865–877.
228. Fumagalli F, Madaschi L, Brenna P et al. Single exposure to erythropoietin modulates nerve growth factor expression in the spinal cord following traumatic injury: comparison with methylprednisolone. *European Journal of Pharmacology* 2008; **578**: 19–27.
229. Mann C, Lee JH, Liu J et al. Delayed treatment of spinal cord injury with erythropoietin or darbepoetin – a lack of neuroprotective efficacy in a contusion model of cord injury. *Experimental Neurology* 2008; **211**: 34–40.
230. Pinzon A, Marcillo A, Pabon D et al. A re-assessment of erythropoietin as a neuroprotective agent following rat spinal cord compression or contusion injury. *Experimental Neurology* 2008; **213**: 129–136.
231. Vitellaro-Zuccarello L, Mazzetti S, Madaschi L et al. Chronic erythropoietin-mediated effects on the expression of astrocyte markers in a rat model of contusive spinal cord injury. *Neuroscience* 2008; **151**: 452–466.
232. Yazihan N, Uzuner K, Salman B et al. Erythropoietin improves oxidative stress following spinal cord trauma in rats. *Injury* 2008; **39**: 1408–1413.
233. Fang XQ, Fang M, Fan SW & Gu CL. Protection of erythropoietin on experimental spinal cord injury by reducing the expression of thrombospondin-1 and transforming growth factor-beta. *Chinese Medical Journal* 2009; **122**: 1631–1635.
234. Huang H, Fan S, Ji X et al. Recombinant human erythropoietin protects against experimental spinal cord trauma injury by regulating expression of the proteins MKP-1 and p-ERK. *Journal of International Medical Research* 2009; **37**: 511–519.
235. Ehrenreich H, Hasselblatt M, Dembowski C et al. Erythropoietin therapy for acute stroke is both safe and beneficial. *Molecular Medicine* 2002; **8**: 495–505.

236. Weimar C, Kraywinkel K, Maschke M & Diener HC. Intravenous thrombolysis in German stroke units before and after regulatory approval of recombinant tissue plasminogen activator. *Cerebrovascular Diseases* 2006; **22**: 429–431.
237. Ehrenreich H, Weissenborn K, Prange H et al. Recombinant human erythropoietin in the treatment of acute ischemic stroke. *Stroke* 2009; **40**: e647–e656.
238. Dame C. Back to the ground. *Stroke* 2010; **41**: e166 [author reply 7–8].
239. Zhu C, Kang W, Xu F et al. Erythropoietin improved neurologic outcomes in newborns with hypoxic-ischemic encephalopathy. *Pediatrics* 2009; **124**: e218–e226.
240. Elmahdy H, El-Mashad AR, El-Bahrawy H et al. Human recombinant erythropoietin in asphyxia neonatorum: pilot trial. *Pediatrics* 2010; **125**: e1135–e1142.
241. Fauchere JC, Dame C, Vonthein R et al. An approach to using recombinant erythropoietin for neuroprotection in very preterm infants. *Pediatrics* 2008; **122**: 375–382.
242. Juul SE, McPherson RJ, Bauer LA et al. A phase I/II trial of high-dose erythropoietin in extremely low birth weight infants: pharmacokinetics and safety. *Pediatrics* 2008; **122**: 383–391.
243. Pfeffer MA, Burdmann EA, Chen CY et al. A trial of darbepoetin alfa in type 2 diabetes and chronic kidney disease. *New England Journal of Medicine* 2009; **361**: 2019–2032.
- *244. Wuestenberg T, Begemann M, Bartels C et al. Recombinant human erythropoietin delays loss of gray matter in chronic schizophrenia. *Molecular Psychiatry* 2010.
245. Ehrenreich H, Bartels C, Sargin D et al. Recombinant human erythropoietin in the treatment of human brain disease: focus on cognition. *Journal of Renal Nutrition* 2008; **18**: 146–153.
246. Miskowiak KW, Favaron E, Hafizi S et al. Effects of erythropoietin on emotional processing biases in patients with major depression: an exploratory fMRI study. *Psychopharmacology (Berl)* 2009; **207**: 133–142.
247. Miskowiak KW, Favaron E, Hafizi S et al. Erythropoietin modulates neural and cognitive processing of emotional information in biomarker models of antidepressant drug action in depressed patients. *Psychopharmacology (Berl)* 2010.
248. Miskowiak K, Vinberg M, Harmer C et al. Effects of erythropoietin on depressive symptoms and neurocognitive deficits in depression and bipolar disorder. *Trials* 2010; **11**: 97.
249. Georgopoulos D, Matamis D, Routsis C et al. Recombinant human erythropoietin therapy in critically ill patients: a dose-response study [ISRCTN48523317]. *Critical Care* 2005; **9**: R508–R515.
250. Boesch S, Sturm B, Hering S et al. Friedreich's ataxia: clinical pilot trial with recombinant human erythropoietin. *Annals of Neurology* 2007; **62**: 521–524.
251. Cramer SC, Fitzpatrick C, Warren M et al. The beta-hCG + erythropoietin in acute stroke (BETAS) study: a 3-center, single-dose, open-label, noncontrolled, phase IIa safety trial. *Stroke* 2010; **41**: 927–931.
252. Loblaw DA, Holden L, Xenocostas A et al. Functional and pharmacokinetic outcomes after a single intravenous infusion of recombinant human erythropoietin in patients with malignant extradural spinal cord compression. *Clinical Oncology (Royal College of Radiologists)* 2007; **19**: 63–70.
253. Jelkmann W. Erythropoietin: structure, control of production, and function. *Physiological Review* 1992; **72**: 449–489.
254. Weiskopf RB, Feiner J, Hopf H et al. Fresh blood and aged stored blood are equally efficacious in immediately reversing anemia-induced brain oxygenation deficits in humans. *Anesthesiology* 2006; **104**: 911–920.
255. Hengemihle JM, Abugo O, Rifkind J et al. Chronic treatment with human recombinant erythropoietin increases hematocrit and improves water maze performance in mice. *Physiology and Behavior* 1996; **59**: 153–156.
256. Martinez-Estrada OM, Rodriguez-Millan E, Gonzalez-De Vicente E et al. Erythropoietin protects the in vitro blood–brain barrier against VEGF-induced permeability. *European Journal of Neuroscience* 2003; **18**: 2538–2544.
257. Banks WA, Jumbe NL, Farrell CL et al. Passage of erythropoietic agents across the blood–brain barrier: a comparison of human and murine erythropoietin and the analog darbepoetin alfa. *European Journal of Pharmacology* 2004; **505**: 93–101.
258. Xenocostas A, Cheung WK, Farrell F et al. The pharmacokinetics of erythropoietin in the cerebrospinal fluid after intravenous administration of recombinant human erythropoietin. *European Journal of Clinical Pharmacology* 2005; **61**: 189–195.
- *259. Adamcio B, Sargin D, Stradomska A et al. Erythropoietin enhances hippocampal long-term potentiation and memory. *BMC Biology* 2008; **6**: 37.
260. El-Kordi A, Radyushkin K & Ehrenreich H. Erythropoietin improves operant conditioning and stability of cognitive performance in mice. *BMC Biology* 2009; **7**: 37.
- *261. Miskowiak K, O'Sullivan U & Harmer CJ. Erythropoietin enhances hippocampal response during memory retrieval in humans. *Journal of Neuroscience* 2007; **27**: 2788–2792.
262. Miskowiak K, O'Sullivan U & Harmer CJ. Erythropoietin reduces neural and cognitive processing of fear in human models of antidepressant drug action. *Biological Psychiatry* 2007; **62**: 1244–1250.
263. Miskowiak K, Inkster B, O'Sullivan U et al. Differential effects of erythropoietin on neural and cognitive measures of executive function 3 and 7 days post-administration. *Experimental Brain Research* 2008; **184**: 313–321.
264. Garcia-Rodriguez JC & Sosa-Teste I. The nasal route as a potential pathway for delivery of erythropoietin in the treatment of acute ischemic stroke in humans. *Scientific World Journal* 2009; **9**: 970–981.
265. Digicaylioglu M. Erythropoietin in stroke: quo vadis. *Expert Opinion on Biological Therapy* 2010; **10**: 937–949.

RESEARCH ARTICLE

Open Access

The cross-sectional GRAS sample: A comprehensive phenotypical data collection of schizophrenic patients

Katja Ribbe^{1†}, Heidi Friedrichs^{1†}, Martin Begemann^{1†}, Sabrina Grube¹, Sergi Papiol^{1,30}, Anne Kästner¹, Martin F Gerchen¹, Verena Ackermann¹, Asieh Tarami¹, Annika Treitz¹, Marlene Flögel¹, Lothar Adler², Josef B Aldenhoff³, Marianne Becker-Emner⁴, Thomas Becker⁵, Adelheid Czernik⁶, Matthias Dose⁷, Here Folkerts⁸, Roland Freese⁹, Rolf Günther¹⁰, Sabine Herpertz¹¹, Dirk Hesse¹², Gunther Kruse¹³, Heinrich Kunze¹⁴, Michael Franz¹⁴, Frank Löhner¹⁵, Wolfgang Maier¹⁶, Andreas Mielke¹⁷, Rüdiger Müller-Isberner¹⁸, Cornelia Oestereich¹⁹, Frank-Gerald Pajonk²⁰, Thomas Pollmächer²¹, Udo Schneider²², Hans-Joachim Schwarz²³, Birgit Kröner-Herwig²⁴, Ursula Havemann-Reinecke^{25,30}, Jens Frahm^{26,30,31}, Walter Stühmer^{27,30,31}, Peter Falkai^{25,30,31}, Nils Brose^{28,30,31}, Klaus-Armin Nave^{29,30,31}, Hannelore Ehrenreich^{1,30,31*}

Abstract

Background: Schizophrenia is the collective term for an exclusively clinically diagnosed, heterogeneous group of mental disorders with still obscure biological roots. Based on the assumption that valuable information about relevant genetic and environmental disease mechanisms can be obtained by association studies on patient cohorts of ≥ 1000 patients, if performed on detailed clinical datasets and quantifiable biological readouts, we generated a new schizophrenia data base, the GRAS (Göttingen Research Association for Schizophrenia) data collection. GRAS is the necessary ground to study genetic causes of the schizophrenic phenotype in a 'phenotype-based genetic association study' (PGAS). This approach is different from and complementary to the genome-wide association studies (GWAS) on schizophrenia.

Methods: For this purpose, 1085 patients were recruited between 2005 and 2010 by an invariable team of traveling investigators in a cross-sectional field study that comprised 23 German psychiatric hospitals. Additionally, chart records and discharge letters of all patients were collected.

Results: The corresponding dataset extracted and presented in form of an overview here, comprises biographic information, disease history, medication including side effects, and results of comprehensive cross-sectional psychopathological, neuropsychological, and neurological examinations. With >3000 data points per schizophrenic subject, this data base of living patients, who are also accessible for follow-up studies, provides a wide-ranging and standardized phenotype characterization of as yet unprecedented detail.

Conclusions: The GRAS data base will serve as prerequisite for PGAS, a novel approach to better understanding 'the schizophrenias' through exploring the contribution of genetic variation to the schizophrenic phenotypes.

Background

Schizophrenia is a devastating brain disease that affects approximately 1% of the population across cultures [1]. The diagnosis of schizophrenia or - perhaps more correctly - of 'the schizophrenias' is still purely clinical, requiring the

coincident presence of symptoms as listed in the leading classification systems, DSM-IV and ICD-10 [2,3].

Notably, one of the core symptoms of schizophrenia, namely cognitive deficits, from mild impairments to full-blown dementia, has not yet been considered in these classifications. Biologically, schizophrenia is a 'mixed bag' of diseases that undoubtedly have a strong genetic root. Family studies exploring relative risk of schizophrenia have led to estimates of heritability of about 64-88% [4,5]. Monozygotic twin studies showing

* Correspondence: ehrenreich@em.mpg.de

† Contributed equally

¹Division of Clinical Neuroscience, Max Planck Institute of Experimental Medicine, Göttingen, Germany

Full list of author information is available at the end of the article

concordance rates of 41-65% [6,7] indicate a considerable amount of non-genetic causes, in the following referred to as 'environmental factors'. Already in the middle of the twentieth century, schizophrenia was seen as a 'poly-genetic' disease [8] and, indeed, in numerous genetic studies since, ranging from segregation or linkage analyses, genome scans and large association studies, no major 'schizophrenia gene' has been identified [9]. Even recent genome-wide association studies (GWAS) on schizophrenia confirm that several distinct loci are associated with the disease. These studies concentrated on endpoint diagnosis and found odds ratios for single markers in different genomic regions ranging from 0.68 to 6.01 [10], essentially underlining the fact that - across ethnicities - in most cases these genotypes do not contribute more to the disease than a slightly increased probability.

We hypothesize that an interplay of multiple causative factors, perhaps thousands of potential combinations of genes/genetic markers and an array of different environmental risks, leads to the development of 'the schizophrenias', as schematically illustrated in Figure 1. There

may be cases with a critical genetic load already present without need of additional external co-factors, however, in most individuals, an interaction of a certain genetic predisposition with environmental co-factors is apparently required for disease onset. In fact, not too much of an overlap may exist between genetic risk factors from one schizophrenic patient to an unrelated other schizophrenic individual, explaining why it is basically impossible to find common risk genes of schizophrenia with appreciable odds ratios. One GRAS working hypothesis is that in the overwhelming majority of cases, schizophrenia is the result of a 'combination of unfortunate genotypes'.

If along the lines of traditional human genetics all attempts to define schizophrenia as a 'classical' genetic disease have largely failed, how can we learn more about the contribution of genes/genotypes to the disease phenotype? Rather than searching by GWAS for yet other schizophrenia risk genes, we designed an alternative and widely complementary approach, termed PGAS (phenotype-based genetic association study), in order to

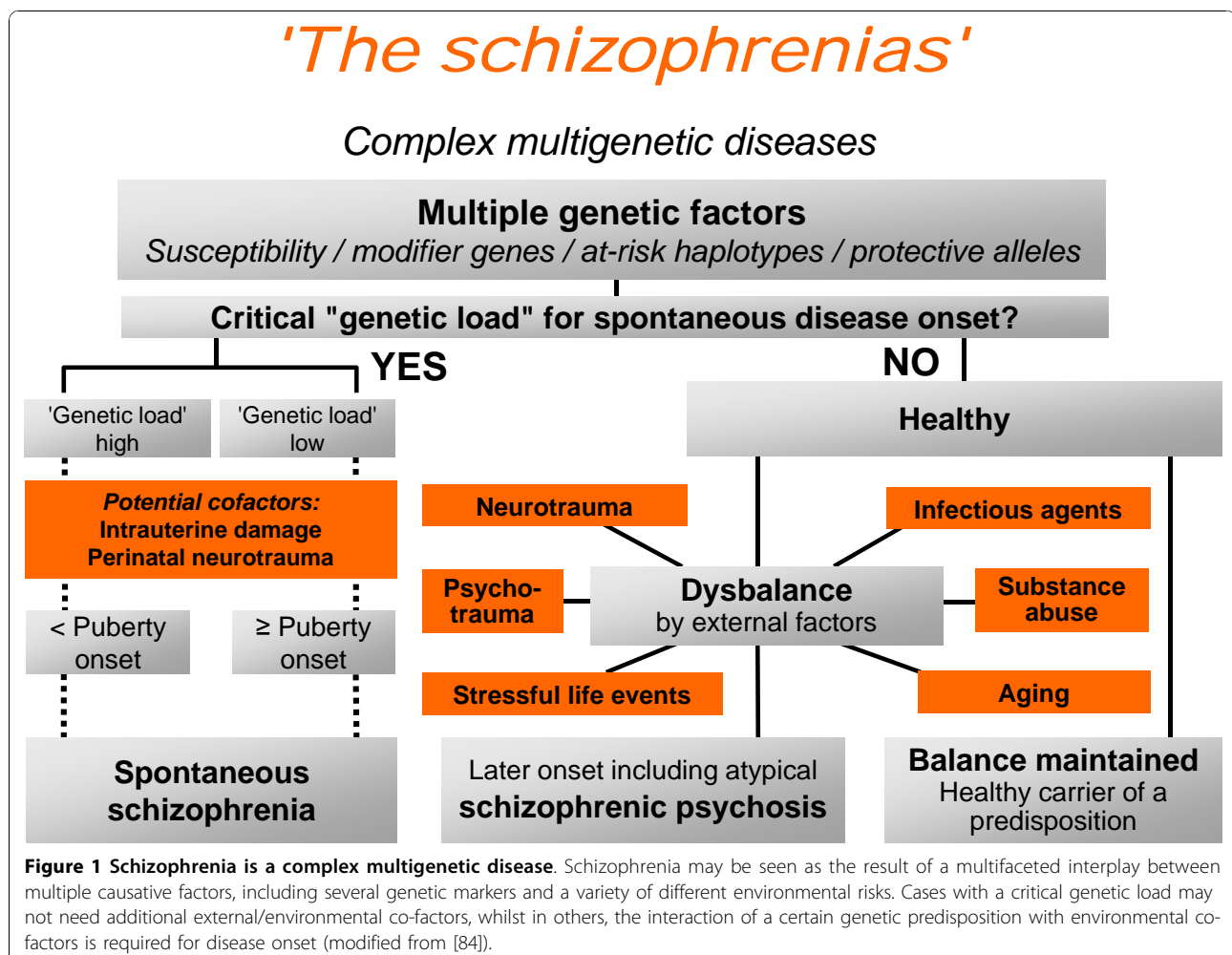

explore the contribution of certain genes/genetic markers to the schizophrenic phenotype. To launch PGAS, we had to establish a comprehensive phenotypical data base of schizophrenic patients, the GRAS (Göttingen Research Association for Schizophrenia) data collection. Very recently, we have been able to demonstrate proof-of-concept for the PGAS approach [[11], and Grube et al: Calcium-activated potassium channels as regulators of cognitive performance in schizophrenia, submitted].

Large data bases of schizophrenic patients have been instigated for decades to perform linkage/family studies, treatment trials, genetic or epidemiological studies applying either a cross-sectional or a longitudinal design (e.g. [12-20]). However, for the above introduced PGAS approach, another type of data base is required, and only few of the existing data banks are suited for phenotypical analyses. An example is the 'Clinical Antipsychotic Trial of Intervention Effectiveness (CATIE)', originally set up as a treatment study comparing a first generation antipsychotic drug with several second generation antipsychotics in a multisite randomized double-blind trial [17,21]. The huge amount of data accumulated in the frame of this trial serves now also for GWAS and genotype-phenotype association studies [22-25]. Disadvantages may be that the CATIE data were collected by different examiners in 57 US sites and that comprehensive data for phenotypical analyses are only available for subsamples of the originally included 1493 patients. Another example of a large data base with considerable phenotypical power is the 'Australian Schizophrenia Research Bank (ASRB)' [26]. ASRB operates to collect, store and distribute linked clinical, cognitive, neuroimaging and genetic data from a large sample of patients with schizophrenia (at present nearly 500) and healthy controls (almost 300) [27,28].

The present paper has been designed (1) to introduce the GRAS data collection, set up as prerequisite and platform for PGAS; (2) to exemplify on some selected areas of interest the potential of phenotypical readouts derived from the GRAS data collection and their internal consistency; (3) to provide a first panel of epidemiological data as a 'side harvest' of this data base; and (4) to enable interested researchers worldwide to initiate scientific collaborations based on this data base.

Methods

Ethics

The GRAS data collection has been approved by the ethical committee of the Georg-August-University of Göttingen (master committee) as well as by the respective local regulatory/ethical committees of all collaborating centers (Table 1). The distribution of the centers over Germany together with information on the numbers of recruited patients per center is presented in Figure 2.

GRAS patients

From September 2005 to July 2008, a total of 1071 patients were examined by the GRAS team of traveling investigators after giving written informed consent, own and/or authorized legal representatives. Since then, low-rate steady state recruitment has been ongoing, among others to build up a new cohort for replicate analyses of genotype-phenotype associations. As of July 2010, 1085 patients have been entered into the data base. They were examined in different settings: 348 (32.1%) as outpatients, 474 (43.7%) as inpatients in psychiatric hospitals, 189 (17.4%) as residents in sheltered homes, 54 (5%) as patients in specific forensic units, and 20 (1.8%) as day clinic patients. Inclusion criteria were (1) confirmed or suspected diagnosis of schizophrenia or schizoaffective disorder according to DSM-IV and (2) at least some ability to cooperate. Recruitment efficiency over the core travel/field study time from 2005 to 2008 and patient flow are shown in Figures 3a and 3b. Of the 1085 patients entered into the data base, a total of 1037 fulfilled the diagnosis of schizophrenia or schizoaffective disorder. For 48 patients the diagnosis of schizophrenia could not be ultimately confirmed upon careful re-check and follow-up. Of the schizophrenic patients, 96% completed the GRAS assessment whereas about 4% dropped out during the examination. Almost all patients agreed to be re-contacted for potential follow-up studies, only 1.5% were either lost to follow-up (present address unknown or deceased) or did not give consent to be contacted again.

Healthy control subjects

(1) For genetic analyses, control subjects, who gave written informed consent, were voluntary blood donors, recruited by the Department of Transfusion Medicine at the Georg-August-University of Göttingen according to national guidelines for blood donation. As such, they widely fulfill health criteria, ensured by a broad pre-donation screening process containing standardized questionnaires, interviews, hemoglobin, blood pressure, pulse, and body temperature determinations. Of the total of 2265 subjects, 57.5% are male ($n = 1303$) and 42.5% female ($n = 962$). The average age is 33.8 ± 12.2 years, with a range from 18 to 69 years. Participation as healthy controls for the GRAS sample was anonymous, with information restricted to age, gender, blood donor health state and ethnicity. Comparable to the patient population (Table 2), almost all control subjects were of European Caucasian descent (Caucasian 97.8%; other ethnicities 2%; unknown 0.2%). (2) For selected cognitive measures and olfactory testing, 103 additional healthy volunteers were recruited as control subjects (matched with respect to age, gender, and smoking habits). These healthy controls include 67.0% male ($n = 69$) and 33.0%

Table 1 GRAS data collection manual: Table of contents

category	content	reference in the paper
legal documents/ethical requirements	patient information, informed consent form, confidentiality form, and others...	
patient history	general information (age, sex, ethnicity,...)	→ table 2
	education/employment	→ table 2
	living situation	→ table 2
	legal history	
	medication including side effects	→ table 4
	medical history	
	family history	
	global quality of life ^a	→ table 2 and figure 6
	birth history/traumatic brain injury	
	stressful life events	
	suicidal thoughts/suicide attempts	
	hospitalization history	→ table 2 and figure 6
clinical interviews/ratings	parts of SCID-I: addiction, anxiety, affective disorders, psychotic disorders* ^b	
	Positive and Negative Syndrome Scale* (PANSS) ^c	→ table 2 and figure 6
	Clinical Global Impression* (CGI) ^d	→ table 2 and figure 6
	Global Assessment of Functioning* (GAF) ^e	→ table 2 and figure 6
questionnaires	State-Trait-Anxiety-Inventory* (STAI) ^f	→ table 2 and figure 6
	Brief Symptom Inventory* (BSI) ^g	→ table 2 and figure 6
	Toronto Alexithymia Scale* (TAS) ^h	→ table 2
cognitive tests	premorbid IQ (MWT-B) ^{i, j}	→ table 3 and figure 7
	reasoning (LPS-3) ^k	→ table 3 and figure 7
	letter-number-span (BZT) ^l	→ table 3 and figure 7
	finger dotting and tapping ^m	→ table 3 and figure 7
	trail making tests (TMT-A and TMT-B) ⁿ	→ table 3 and figure 7
	verbal fluency (DT/RWT) ^{o, p}	
	digit-symbol test (ZST) ^q	→ table 3 and figure 7
	verbal memory* (VLMT) ^r	→ table 3 and figure 7
physical examination	Testbatterie zur Aufmerksamkeitsprüfung (TAP) ^s	→ table 3 and figure 7
	general physical examination	
	Cambridge Neurological Inventory (CNI) ^t	→ table 5 and figure 8
	Contralateral Co-Movement Test (COMO) ^u	
	Barnes Akathisia Rating Scale (BARS) ^v	→ figure 8
	Simpson-Angus Scale (SAS) ^w	→ figure 8
	Tardive Dyskinesia Rating Scale (TDRS) ^x	→ figure 8
	Abnormal Involuntary Movement Scale (AIMS) ^y	→ figure 8
	odor testing (ORNI Test) ^z	
	blood sampling (DNA, serum)	

*questionnaires and cognitive tests in respective German versions

^a Based on a visual analogue scale (Krampe H, Bartels C, Victorson D, Enders CK, Beaumont J, Cella D, Ehrenreich H: The influence of personality factors on disease progression and health-related quality of life in people with ALS. *Amyotroph Lateral Scler* 2008, 9:99-107). ^b Wittchen H-U, Zaudig, M. and Fydrich, T.: SKID-I (Strukturiertes Klinisches Interview für DSM-IV; Achse I: Psychische Störungen). Göttingen: Hogrefe; 1997. ^c Kay SR, Fiszbein A, Opler LA: The positive and negative syndrome scale (PANSS) for schizophrenia. *Schizophr Bull* 1987, 13(2):261-276. ^d Guy W: Clinical Global Impression (CGI). In ECDEU Assessment manual for psychopharmacology, revised National Institute of Mental Health. Rockville, MD; 1976. ^e American Psychiatric Association: Diagnostic and statistical manual of mental disorders, 4th edition (DSM-IV). Washington, DC: American Psychiatric Press; 1994. ^f Laux L, Glanzmann P, Schaffner P, Spielberger CD: Das State-Trait-Angstinventar (STAI). Weinheim: Beltz; 1981. ^g Franke GH: Brief Symptom Inventory (BSI). Göttingen: Beltz; 2000. ^h Kupfer J, Brosig B, Braehler E: Toronto Alexithymie-Skala-26 (TAS-26). Göttingen: Hogrefe; 2001. ⁱ Lehrl S, Triebig G, Fischer B: Multiple choice vocabulary test MWT as a valid and short test to estimate premorbid intelligence. *Acta Neurol Scand* 1995, 91(5):335-345. ^j Lehrl S: Mehrfach-Wortschatz-Intelligenztest MWT-B. Balingen: Spitta Verlag; 1999. ^k Horn W: Leistungsprüfsystem (LPS). 2 edition. Göttingen: Hogrefe; 1983. ^l Gold JM, Carpenter C, Randolph C, Goldberg TE, Weinberger DR: Auditory working memory and Wisconsin Card Sorting Test performance in schizophrenia. *Arch Gen Psychiatry* 1997, 54(2):159-165. ^m Chapman RL: The MacQuarrie test for mechanical ability. *Psychometrika* 1948, 13(3):175-179. ⁿ War-Department: Army Individual Test Battery. Manual of directions and scoring. Washington, D.C.: War Department, Adjutant General's Office; 1944. ^o Kessler J, Denzler P, Markowitsch HJ: Demenz-Test (DT). Göttingen: Hogrefe; 1999. ^p Aschenbrenner S, Tucha O, Lange KW: Der Regensburger Wortflüssigkeitstest (RWT). Göttingen: Hogrefe; 2000. ^q Tewes U: Hamburg-Wechsler Intelligenztest fuer Erwachsene (HAWIE-R). Bern: Huber; 1991. ^r Helmstaedter C, Lendt M, Lux S: Verbaler Lern- und Merkfähigkeitstest (VLMT). Göttingen: Beltz; 2001. ^s Zimmermann P, Fimm B: Testbatterie zur Aufmerksamkeitsprüfung (TAP). Version 1.02c. Herzogenrath: PSYTEST; 1993. ^t Chen EY, Shapleske J, Luque R, McKenna PJ, Hodges JR, Calloway SP, Hymas NF, Denning TR, Berrios GE: The Cambridge Neurological Inventory: a clinical instrument for assessment of soft neurological signs in psychiatric patients. *Psychiatry Res* 1995, 56(2):183-204. ^u Bartels C, Mertens N, Hofer S, Merboldt KD, Dietrich J, Frahm J, Ehrenreich H: Callosal dysfunction in amyotrophic lateral sclerosis correlates with diffusion tensor imaging of the central motor system. *Neuromuscul Disord* 2008, 18(5):398-407. ^v Barnes TR: The Barnes Akathisia Rating Scale - revisited. *J Psychopharmacol* 2003, 17(4):365-370. ^w Simpson GM, Angus JW: A rating scale for extrapyramidal side effects. *Acta Psychiatr Scand Suppl* 1970, 212:11-19. ^x Simpson GM, Lee JH, Zoubok B, Gardos G: A rating scale for tardive dyskinesia. *Psychopharmacology (Berl)* 1979, 64(2):171-179. ^y Guy W: Abnormal involuntary movement scale (AIMS). In ECDEU Assessment manual for psychopharmacology, revised National Institute of Mental Health. Rockville, MD; 1976. ^z ORNI Test (Odor Recognition, Naming and Interpretation Test; developed for the purpose of odor testing in schizophrenics; manuscript in preparation)

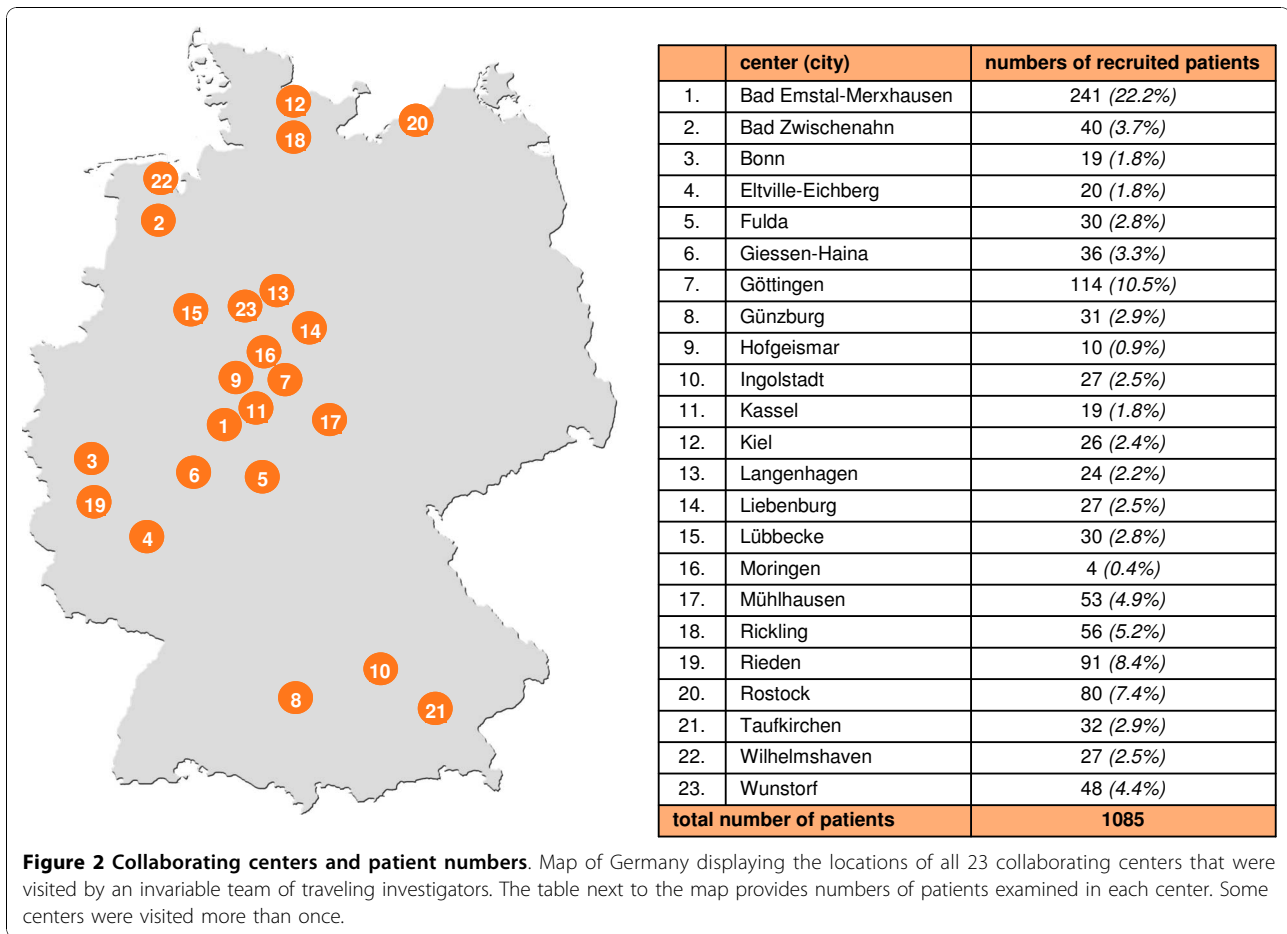

(n = 34) female subjects with an average age of 39.02 ± 13.87 years, ranging from 18 to 71 years.

Traveling team

The GRAS team of traveling investigators consisted of 1 trained psychiatrist and neurologist, 3 psychologists and 4 medical doctors/last year medical students. All investigators had continuous training and calibration sessions to ensure the highest possible agreement on diagnoses and other judgments as well as a low interrater variability regarding the instruments applied. Patient contacts were usually prepared by colleagues/personnel in the respective collaborating psychiatric centers (Figure 2) to make the work of the travel team as efficient as possible.

The GRAS manual

A standardized procedure for examination of the patients has been arranged with the GRAS manual, composed for the purpose of the GRAS data collection. Table 1 presents its contents, including established instruments, such as clinical interviews/ratings, questionnaires, cognitive and neurological tests [2,29-53].

GRAS operating procedure

The GRAS data base operating procedure leading from the large set of raw data provided by the travel team to the data bank with its several-fold controlled and verified data points is illustrated in Figure 4. Already during the time when the travel team examined patients all over Germany, a team of psychologists started to work on the development of the GRAS data base, integrating the raw data to ultimately result in over 3000 phenotypic data points per patient (total of over 3.000 000 data points at present in the data collection) (Figure 5). Most importantly, the chart records/medical reports of all patients were carefully screened, missing records identified and, in numerous, sometimes extensive and repeated, telephone and written conversations, missing psychiatric discharge letters of every single patient organized. After careful study and pre-processing of raw data and chart records, the confirmation of the diagnoses, determination of age of onset of the disease and prodrome as well as other essential readouts were achieved by meticulous consensus decisions.

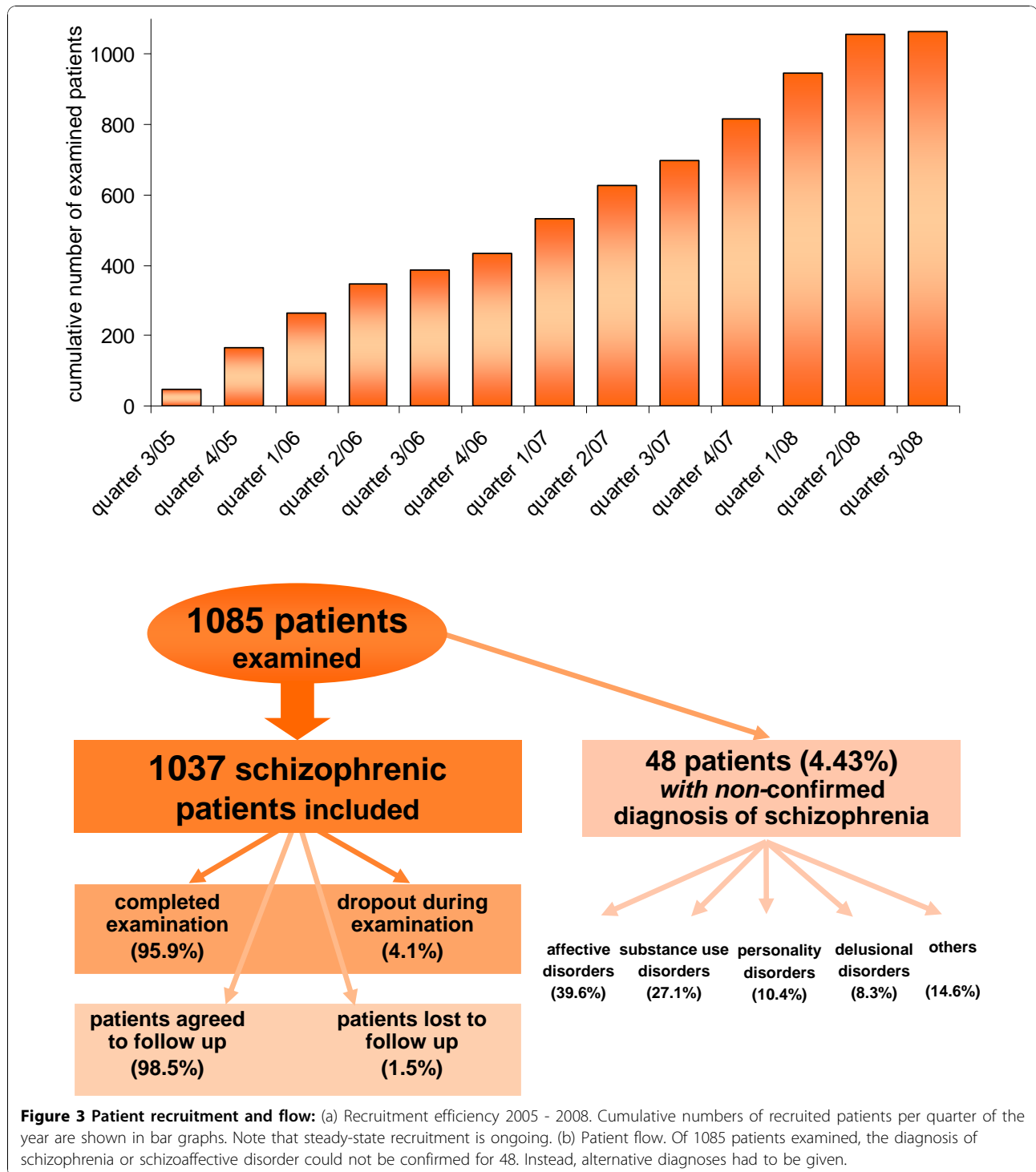

Figure 3 Patient recruitment and flow: (a) Recruitment efficiency 2005 - 2008. Cumulative numbers of recruited patients per quarter of the year are shown in bar graphs. Note that steady-state recruitment is ongoing. (b) Patient flow. Of 1085 patients examined, the diagnosis of schizophrenia or schizoaffective disorder could not be confirmed for 48. Instead, alternative diagnoses had to be given.

Statistical analyses

For the establishment of the data base and for basic statistical analyses of the data, SPSS for Windows version 17.0 [54] was used. Comparisons of men and women in terms of sociodemographic and clinical picture as well as neurological examination were assessed using either

Mann-Whitney-U or Chi-square test. Prior to correlation and regression analyses, selected metric phenotypic variables were standardized by Blom transformation [55]. The Blom transformation is a probate transformation into ranks and the resulting standardized values are normally distributed with zero mean and variance one.

Table 2 GRAS sample description

	total				men				women				statistics	
	N	%	mean (sd)	median	N	%	mean (sd)	median	N	%	mean (sd)	median	χ^2/Z	P
sociodemographics														
total n	1037	100			693	100			344	100				
age (in years)			39.52 (12.56)	39.05			37.57 (11.97)	36.67			43.46 (12.80)	42.85	Z = -6.980	< 0.001*
education (in years)			11.94 (3.37)	12.00			11.71 (3.34)	12.00			12.42 (3.39)	12.00	Z = -2.714	0.007*
ethnicity:														
	caucasian	992 95.66		661 95.38				331 96.20						
	african	7 0.68		6 0.87				1 0.30						
	mixed	10 0.96		7 1.01				3 0.90					$\chi^2 = 1.202$	0.753
	unknown	28 2.70		19 2.74				9 2.60						
native tongue:	German	902 86.98		591 85.71				311 90.67						
	bi-lingual German	46 4.44		38 4.33				8 1.46					$\chi^2 = 6.899$	0.032*
	other	89 8.58		64 9.96				25 7.87						
marital status:	single	748 72.13		575 82.97				173 50.44						
	married	129 12.44		48 6.93				81 23.32						
	divorced	124 11.96		57 8.23				67 19.53					$\chi^2 = 121.516$	< 0.001*
	widowed	13 1.25		3 0.43				10 2.92						
	unknown	23 2.22		10 1.44				13 3.79						
living situation:	alone	292 28.16		201 29.00				91 26.45						
	alone with children	17 1.64		0 0				17 4.94						
	with partner (\pm children)	137 13.20		50 7.22				87 25.29						
	With parents	157 15.14		121 17.46				36 10.47						
	with others (family members, friends)	71 6.85		53 7.65				18 5.23					$\chi^2 = 116.823$	< 0.001*
	sheltered home	282 27.19		212 30.59				70 20.35						
	forensic hospital	54 5.21		43 6.20				11 3.20						
	homeless	4 0.39		4 0.58				0 0						
	unknown	23 2.22		9 1.30				14 4.07						
clinical picture														
diagnosis:	classical schizophrenias	852 82.16		615 88.74				237 68.90					$\chi^2 = 61.794$	< 0.001*
	schizoaffective disorders	185 17.84		78 11.26				107 31.10						
age of onset of first psychotic episode			25.75 (8.81)	23.00			24.49 (7.71)	22.00			28.28 (10.23)	26.00	Z = -5.705	< 0.001*
duration of disease (in years)			13.23 (10.71)	10.87			12.57 (10.38)	10.16			14.54 (11.24)	13.02	Z = -2.600	0.009*
hospitalization (number of inpatient stays)			8.60 (9.76)	6.00			8.49 (9.95)	5.00			8.83 (9.38)	6.00	Z = -0.727	0.467

Table 2: GRAS sample description (Continued)

chlorpromazine equivalents		687.36 (696.85)	499.98	706.67 (668.43)	520.00	648.35 (750.50)	450.00	Z = -2.428	0.015*
PANSS ^a :	positive symptoms	13.76 (6.32)	12.00	13.94 (6.16)	12.00	13.92 (6.64)	12.00	Z = -0.130	0.990
	negative symptoms	18.23 (7.85)	17.00	18.14 (7.57)	17.00	18.11 (8.44)	17.00	0.886	0.376
	general psychiatric symptoms	33.73 (11.83)	32.00	33.37 (11.31)	32.00	34.50 (12.81)	33.00	-0.886	0.376
	total score	65.64 (23.40)	63.00	65.32 (22.41)	63.00	66.31 (25.37)	62.00	-0.025	0.980
Clinical Global Impression scale ^b		5.57	6.00	5.57 (1.03)	6.00	5.57 (1.18)	6.00	Z = -0.121	0.894
Global Assessment of Functioning ^c		45.76 (0.68)	45.00	45.60 (16.30)	45.00	46.09 (19.11)	45.00	Z = -0.323	0.747
global quality of life ^d		5.41 (2.37)	5.00	5.43 (2.31)	5.00	5.38 (2.49)	5.00	Z = -0.378	0.705
Brief Symptom Inventory ^e :	general severity index	0.88 (0.68)	0.71	0.87 (0.66)	0.71	0.92 (0.72)	0.71	Z = -0.687	0.492
State-Trait-Anxiety Inventory ^f :	state anxiety	43.54 (10.89)	43.00	43.48 (10.45)	43.00	43.65 (11.79)	43.00	Z = -0.121	0.904
	trait anxiety	44.96 (11.34)	45.00	44.67 (11.09)	45.00	45.56 (11.82)	46.00	-0.983	0.326
Toronto Alexithymia Scale ^g		2.59 (0.56)	2.61	2.58 (0.54)	2.55	2.60 (0.60)	2.66	Z = -0.607	0.544

^aKay SR, Fiszbein A, Opler LA: The positive and negative syndrome scale (PANSS) for schizophrenia. *Schizophr Bull* 1987,13(2):261-276. ^bGuy W: Clinical Global Impressions (CGI). In ECDEU Assessment manual for psychopharmacology, revised National Institute of Mental Health. Rockville, MD; 1976. ^cAmerican Psychiatric Association: Diagnostic and statistical manual of mental disorders, 4th edition (DSM-IV). Washington, DC: American Psychiatric Press; 1994. ^dBased on a visual analogue scale (Krampe H, Bartels C, Victorson D, Enders CK, Beaumont J, Cella D, Ehrenreich H: The influence of personality factors on disease progression and health-related quality of life in people with ALS. *Amyotroph Lateral Scler* 2008, 9:99-107). ^eFranke GH: Brief Symptom Inventory (BSI). Goettingen: Beltz; 2000. ^fLaux L, Glanzmann P, Schaffner P, Spielberger CD: Das State-Trait-Angstinventar (STAI). Weinheim: Beltz; 1981. ^gKupfer J, Brosig B, Braehler E: Toronto Alexithymie-Skala-26 (TAS-26). Goettingen: Hogrefe; 2001.

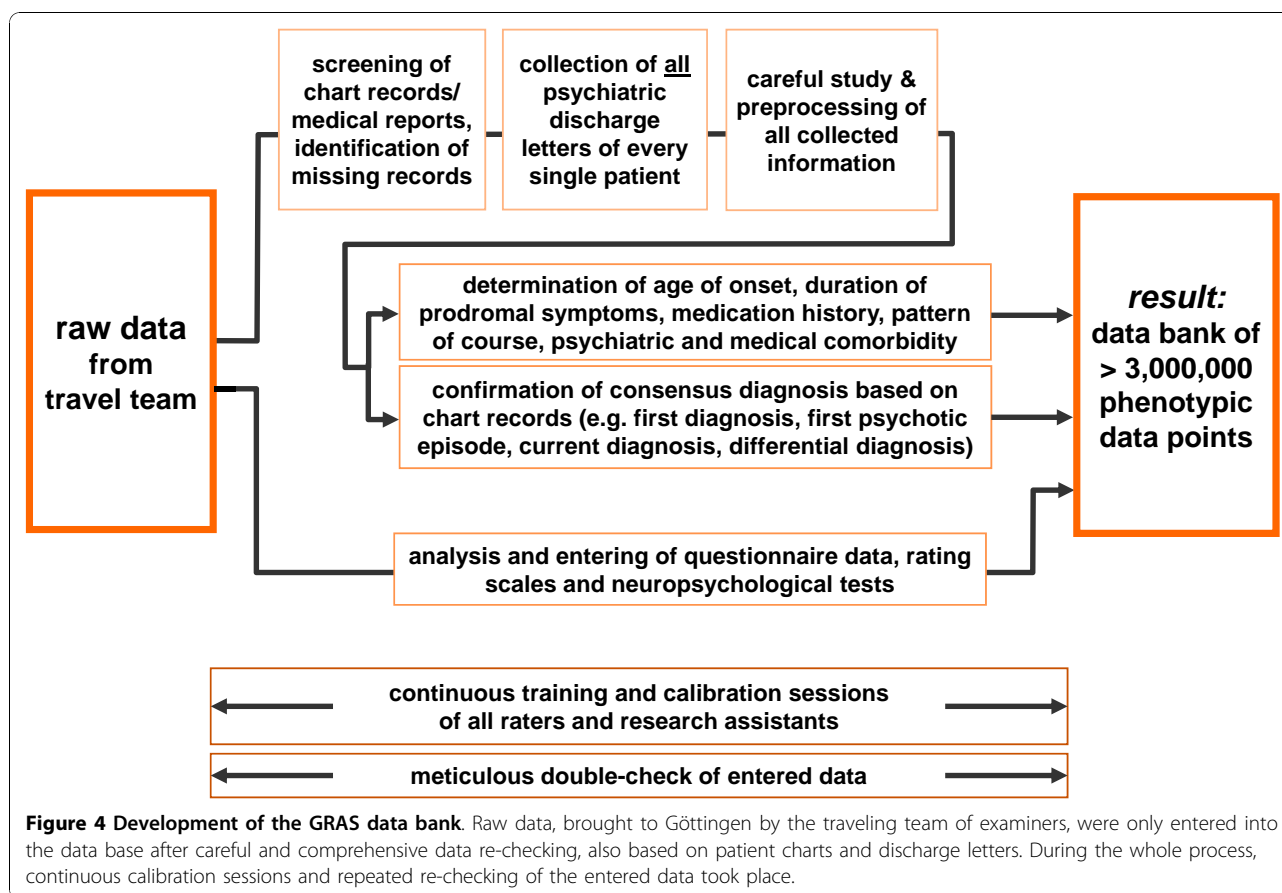

Comparisons of men and women in terms of cognitive performance were assessed by analyses of covariance, using age, duration of disease, years of education and chlorpromazine equivalents as covariates. For all inter-correlation patterns, correlations of the particular target variables were assessed using Pearson product-moment correlation. Cronbach's alpha coefficient was determined for estimation of internal consistency of the target variables within a defined intercorrelation pattern. Multiple regression analyses using the enter method were conducted to evaluate the contribution of selected disease related variables (duration of disease, positive symptoms, negative symptoms, catatonic signs and chlorpromazine equivalents) to 3 dependent variables: basic cognition/fine motor functions, cognitive functions and global functioning (GAF) [2]. The dependent variables basic cognition/fine motor functions and cognitive functions are both composite score variables. The basic cognition/fine motor function score comprises alertness (TAP), dotting and tapping (Cronbach's alpha = .801) [39,46] and the cognition score consists of reasoning (LPS3), 2 processing speed measures (TMT-A and digit-symbol test, ZST), executive functions (TMT-B), working memory (BZT), verbal learning & memory (VLMT) and

divided attention (TAP) [37,38,41,44-46] (Cronbach's alpha = .869). For both scores, a Cronbach's alpha >.80 indicates a high internal consistency as prerequisite for integrating several distinct items into one score. Multiple regression analyses were conducted for the total sample and separated for men and women.

Results

Biographic and clinical data

The GRAS data collection comprises presently (as of August 2010) 1037 patients with confirmed diagnosis of schizophrenia (82.2%) or schizoaffective disorder (17.8%). A total of 693 men and 344 women fulfilled the respective diagnostic requirements of DSM-IV. Table 2 provides a sample description, both total and separated for male and female patients, with respect to sociodemographic data and clinical picture. There are some differences between genders in the GRAS sample: Women are older, less single, have more years of education, more diagnoses of schizoaffective disorders, longer duration of disease, later age of onset of first psychotic episode and lower doses of antipsychotics. However, regarding determinants of the clinical picture, e.g. PANSS scores [30], genders do not differ significantly.

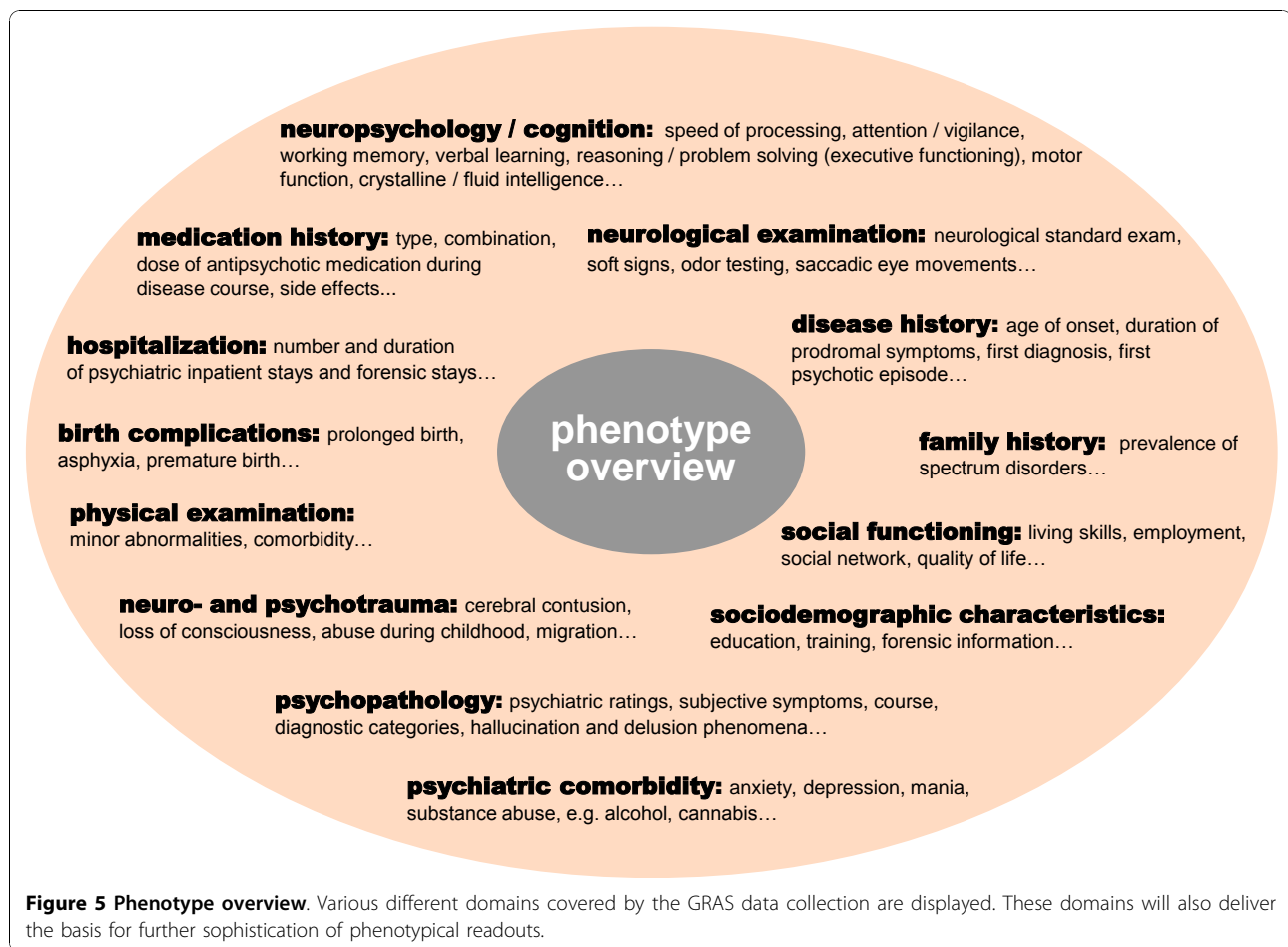

An intercorrelation pattern of selected clinical readouts, obtained by (1) clinical ratings and (2) self-ratings of the patients and complemented by (3) 'objective data', in this case medication and hospitalization, is presented in Figure 6. The Cronbach's alpha of .753 suggests that items derived from the 3 different perspectives harmonize well. Whereas patient ratings of quality of life and state anxiety (STAI) [32] are only weakly correlated with professional clinical ratings and objective data, the patients' self-estimated symptom burden as measured with the BSI [33] shows moderate to good correlation.

Cognition

For the ongoing/planned genetic analyses, not only the clinical picture with its schizophrenia-typical positive and negative symptoms, but particularly cognition plays an important role. The cognitive tests applied in the GRAS data collection show an intercorrelation pattern that further underlines quality and internal consistency of the data obtained by the invariable team of investigators (Figure 7). Table 3 represents the cognitive performance data of the complete GRAS sample in the respective domains. In addition, the performance level

of men and women is given as well as - for comparison - available normative data of healthy individuals. Since for dotting and tapping [39], no normative data were available in the literature, the values shown in Table 3 were obtained from the healthy GRAS control population for cognitive measures (n = 103; see patients and methods).

Comparing cognitive performance of schizophrenic men and women, analyses of covariance have been conducted, with age, duration of disease, years of education and chlorpromazine equivalents as covariates, which revealed significant gender differences in discrete cognitive domains. Men performed better in reasoning (F = 17.62, p <.001), alertness (F = 28.30, p <.001 for reaction time and F = 10.39, p = .001 for lapses), and divided attention (F = 14.07 p <.001 for reaction time and F = 22.12, p <.001 for lapses). In contrast, female schizophrenic patients were superior in verbal memory tasks (F = 12.38, p <.001) and digit symbol test (F = 19.24, p <.001). With respect to normative data obtained from healthy controls, cognitive data of all schizophrenic patients are in the lower normal range (percentile rank = 16 for digit symbol test) or even below (percentile

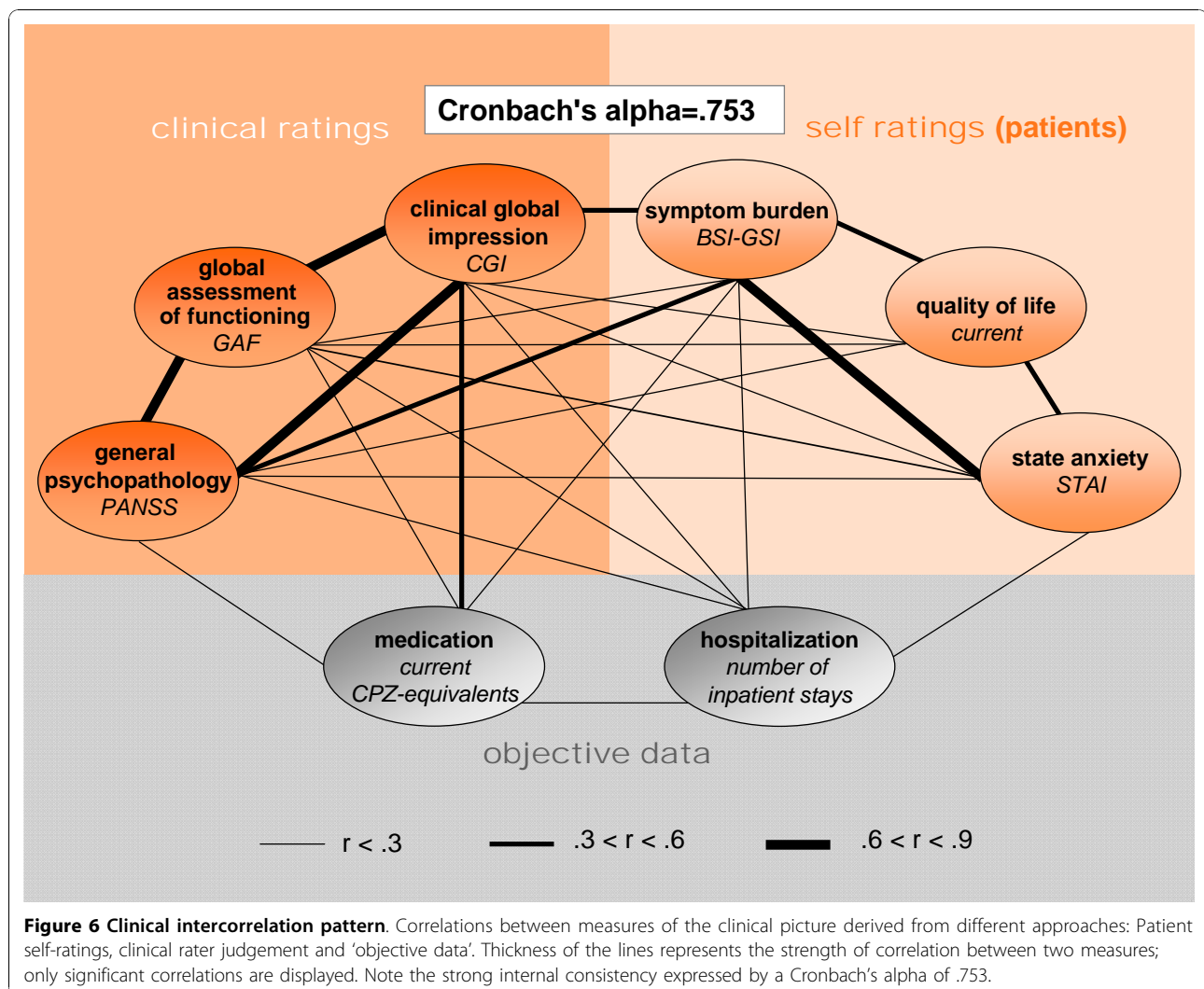

ranks 10 for verbal memory, TMT-A, TMT-B, alertness and divided attention). Only for reasoning (LPS) [37] and premorbid intelligence (MWT-B) [36], schizophrenic subjects lie in the average range (percentile ranks of 31 and 43.5 respectively).

Antipsychotic medication and side effects

Another important feature of schizophrenic patients that may influence their every-day functioning and performance, and result in a considerable number of side effects, is their antipsychotic medication. The GRAS data collection contains information on type, dose, duration of medication and drugs prescribed over the years. The mean dose of present antipsychotic medication of the whole GRAS population, expressed as chlorpromazine equivalents [56] amounts to 687.36 (\pm 696.85). Chlorpromazine equivalents in male are significantly higher as compared to female patients (Table 2). An overview of self-reported side effects of current antipsychotic medication in the

GRAS sample, again sorted by gender, is given in Table 4. Of the 1037 patients with confirmed diagnosis of schizophrenia/schizoaffective disorder, 24 were presently not on antipsychotic drugs, whilst for 1 patient the current medication was unknown. Of the remaining 1012 patients who currently receive antipsychotic medication (16.5% first generation antipsychotics, 54.1% second generation antipsychotics and 29.4% mixed) and were all explicitly interviewed regarding medication side effects, only 423 reported any. The discrepancy between side effects measured versus side effects based on patients' reports becomes obvious when considering for instance the number of patients with clear extrapyramidal symptoms: A total of 335 subjects measured by Simpson-Angus Scale (mean score $>.3$) [50] contrasts only 117 patients self-reporting extrapyramidal complaints. External rating of extrapyramidal side effects in the GRAS population was comprehensively performed, utilizing a number of respective instruments which all showed significant

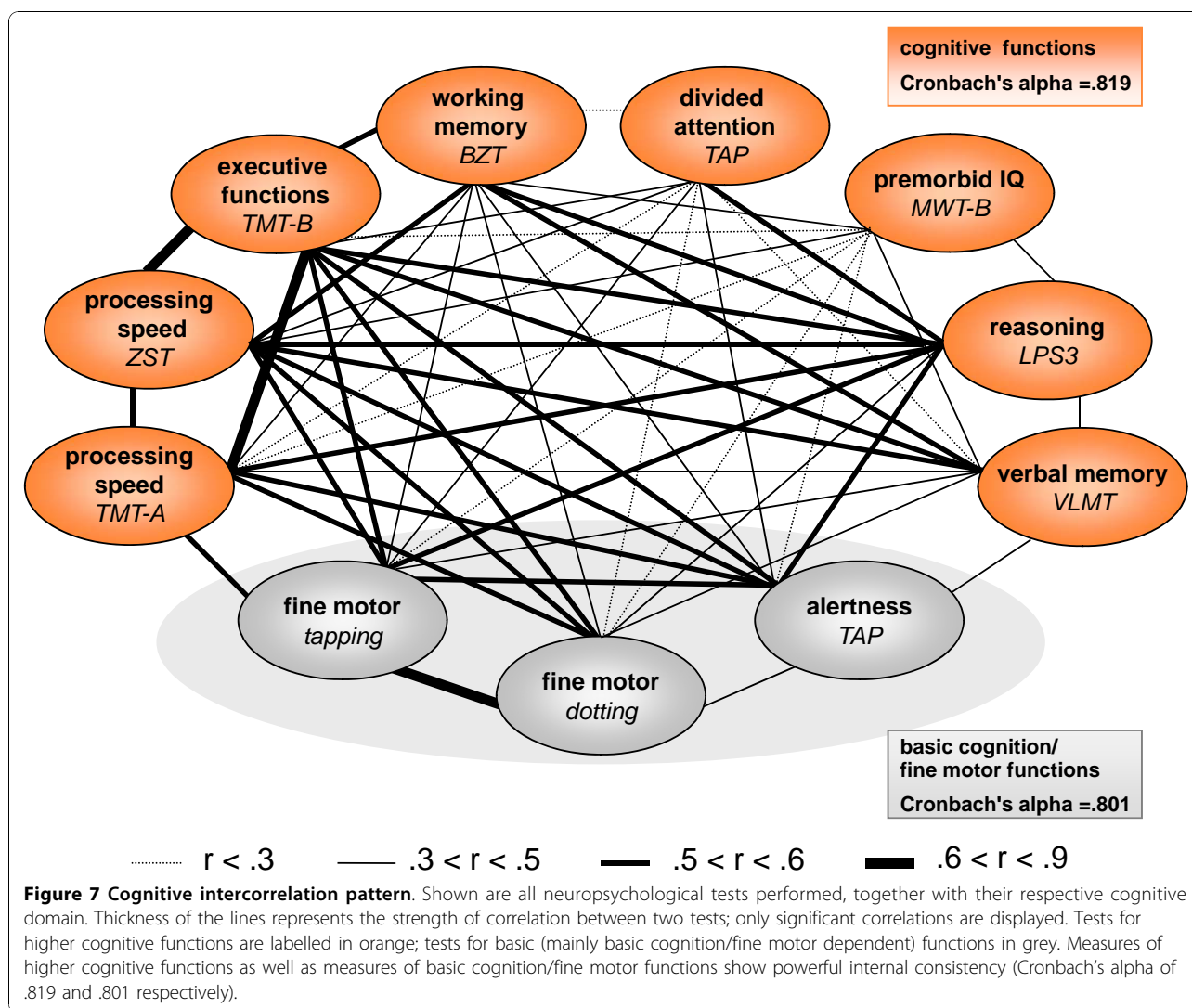

intercorrelation (Figure 8) [47,49-52,57]. A composite score of the 6 Blom transformed scales, used for testing potential gender effects, yielded no significant differences in extrapyramidal symptoms in men versus women ($Z = -0.022$, $p = 0.982$).

Neurological symptoms

Similar to cognitive readouts, evaluation of inherent neurological symptoms in the schizophrenic patient population are of tremendous interest, not only for understanding the contribution of particular genes/genetic markers and/or environmental factors to the schizophrenic phenotype but also for estimating the impact of potential neurological comorbidities. Table 5 provides an overview of neurological symptoms based on the Cambridge Neurological Inventory (CNI) [47]. Only in the subscale 'Failure to suppress inappropriate response', significant differences between men and

women ($Z = -3.175$, $p = 0.001$) became evident. Women were less able to hold respective responses back, e.g. to blink with one eye, leaving the other eye open, or to perform saccadic eye movements without moving the head.

Prediction of functioning

In order to delineate the influence of disease on functioning in the GRAS sample, multiple regression analyses have been employed. These procedures assessed the contribution of 5 disease-related variables, i.e. duration of disease, PANSS positive and negative scores [30], catatonic signs [47], and dose of antipsychotic medication, to 3 dependent performance variables: (a) basic cognition/fine motor functions, (b) cognitive performance and (c) global functioning (Table 6). Regarding basic cognition/fine motor function, multiple regression analysis revealed a significant model accounting for

Table 3 Cognitive performance of GRAS patients. For comparison, normative data are presented wherever available².

	men			women			ANCOVA		total			normative data (PR) or mean sample values of healthy controls		
	N	mean (sd)	median	N	mean (sd)	median	F	p	N	mean (sd)	median	N	PR (Percentile Rank)	mean (sd)
reasoning (LPS)	663	21.26 (6.70)	22.00	324	18.79 (6.31)	18.00	17.62	< .001*	987	20.45 (6.67)	21.00	1556 ^a	31	-
working memory (BZT)	627	13.24 (3.79)	14.00	312	12.62 (3.91)	13.00	1.20	.274	939	13.03 (3.84)	13.00	30 ^b	-	15.70 (2.6)
executive functions (TMT-B) ^o	631	131.42 (104.21)	99.00	307	147.65 (121.09)	108.00	0.00	.956	938	136.73 (110.22)	100.00	24 ^c	10	71.5 (31.07)
verbal memory ¹⁾ (VLMT)	602	41.15 (12.63)	41.00	302	42.68 (13.02)	42.00	12.38	< .001*	904	41.66 (12.78)	42.00	89 ^d	10	52.39 (7.87)
premorbid IQ ¹⁾ (MWT-B)	613	25.96 (6.22)	27.00	311	26.21 (6.13)	27.00	0.69	.405	924	26.04 (6.19)	27.00	1952 ^e	43.5	-
divided attention (TAP) ^o														
<i>reaction time</i>	651	759.67 (114.25)	743.43	308	805.16 (150.99)	780.04	14.07	< .001*	959	774.28 (128.89)	755.05	200 ^f	8	-
<i>lapses</i>		3.35 (7.15)	1.00		6.41 (13.18)	2.00	22.12	< .001*		4.33 (9.62)	1.00			
processing speed														
<i>trail making test A</i> (TMT-A) ^o	676	49.18 (35.22)	40.00	332	55.32 (42.22)	43.00	0.17	.683	1008	51.20 (37.76)	41.00	24 ^c	< 5	33.04 (7.89)
<i>digit-symbol test</i> (ZST)	674	37.46 (12.58)	37.00	329	38.58 (14.14)	39.00	19.24	< .001*	1003	37.83 (13.12)	38.00	200 ^g	16	-
basic cognition/fine motor function														
alertness (TAP) ^o														
<i>reaction time</i>	665	319.62 (116.13)	284.08	326	379.11 (161.80)	328.04	28.30	< .001*	991	339.19 (135.73)	298.41	200 ^f	10	-
<i>lapses</i>		0.52 (2.04)	0.00		1.18 (3.57)	0.00	10.39	.001*		0.73 (2.66)	0.00			
<i>dotting</i>	673	46.10 (13.08)	46.00	320	45.36 (14.96)	46.00	1.62	.203	993	45.86 (13.71)	46.00	103 ^h	-	63.24 (11.03)
<i>tapping</i>	671	29.01 (8.57)	29.00	319	27.58 (9.00)	27.00	0.76	.783	990	28.55 (8.73)	28.00	103 ^h	-	37.63 (7.04)

^o Higher scores reflect better performance, except for TMT-A, TMT-B, Alertness and Divided Attention (TAP)

* For statistical comparison (ANCOVA) between men and women values are corrected for age, duration of disease, chlorpromazine equivalents and years of education (except MWT-B).

¹⁾ Non-native and non-bilingual German speaking patients are excluded (n = 89).

²⁾ Percentile ranks (PR) < 15 indicate that the mean or the median of the total sample is below average in comparison to a normative sample.

^aHorn W: Leistungsprüfsystem (LPS). 2 edition. Goettingen: Hogrefe; 1983. ^bGold JM, Carpenter C, Randolph C, Goldberg TE, Weinberger DR: Auditory working memory and Wisconsin Card Sorting Test performance in schizophrenia. *Arch Gen Psychiatry* 1997, 54(2):159-165. ^cPerianez JA, Rios-Lago M, Rodriguez-Sanchez JM, Adrover-Roig D, Sanchez-Cubillo I, Crespo-Facorro B, Quemada JI, Barcelo F: Trail Making Test in traumatic brain injury, schizophrenia, and normal ageing: sample comparisons and normative data. *Arch Clin Neuropsychol* 2007, 22(4):433-447. ^dHelmstaedter C, Lendt M, Lux S: Verbaler Lern- und Merkfähigkeitstest (VLMT). Goettingen: Beltz; 2001. ^eLehrl S: Mehrfach-Wortschatz-Intelligenztest MWT-B. Balingen: Spitta Verlag; 1999. ^fZimmermann P, Fimm B: Testbatterie zur Aufmerksamkeitsprüfung (TAP). Version 1.02c. Herzogenrath: PSYTEST; 1993. ^gTewes U: Hamburg-Wechsler Intelligenztest fuer Erwachsene (HAWIE-R). Bern: Huber; 1991. ^hHealthy controls recruited for selected cognitive and olfactory testing (unpublished data).

32.4% of variance in the total sample. In fact, duration of disease, negative symptoms, catatonic signs, and medication (chlorpromazine equivalents) contributed significantly to basic cognition/fine motor function, whereas positive symptoms did not ($\beta = -.006$, $p = .856$). According to the standardized regression coefficients, duration of disease and negative symptoms are the best

predictors of basic cognition/fine motor function ($\beta = -.346$, $p < .001$ and $\beta = -.334$, $p < .001$). For higher cognitive functions, the set of disease-related variables explained 33% of variance in the total sample. Again, duration of disease and negative symptoms are the best predictors of higher cognitive functions ($\beta = -.335$, $p < .001$ and $\beta = -.351$, $p < .001$). Positive symptoms did not

Table 4 Self-reported medication side effects of patients (N = 423)* according to treatment type

	FGA ¹		SGA ²	
	men	women	men	women
Parkinson symptoms	17%	15.6%	3.8%	11.6%
dyskinetic/dystonic symptoms	35.8%	31.3%	9.4%	9.7%
akathisia	22.6%	12.5%	6%	6.8%
hyperprolactinaemia	-	-	-	1.9%
hormonal dysfunctions (gynecomastia, absence/changes of menorrhea)	-	9.4%	-	5.8%
sexual dysfunction	7.5%	-	10.3%	-
vertigo (incl. hypotonia)	5.7%	12.5%	5.1%	8.7%
weight gain	9.4%	18.7%	38.3%	39.8%
diabetes mellitus	-	-	0.4%	-
sialorrhea ('drooling')	-	-	20.4%	6.8%
skin abnormalities, loss of hair	1.9%	-	1.7%	5.8%
gastrointestinal symptoms	1.9%	6.3%	5.9%	7.8%
hyperhidrosis	-	-	2.6%	-
psychological symptoms (loss of concentration, no drive, tiredness)	33.9%	28.1%	44.2%	31.1%
cardiovascular symptoms (tachycardia, hypertension)	-	-	1.3%	1.9%
impaired vision	-	-	1.7%	3.9%
dry mouth	5.7%	9.4%	5.1%	4.9%
urinary retention	-	3.1%	1.3%	-
number of patients who reported side effects	53	32	235	103

¹FGA - first generation antipsychotics, typical antipsychotics

²SGA - second generation antipsychotics, atypical antipsychotics

*Only N = 423 patients (out of 1012 patients who were on antipsychotic medication) reported side effects (see text for details).

reach significance ($\beta = -.015$, $p = .658$). With respect to global functioning, all chosen disease-related factors accounted for 59.6% of variance in the total sample. Only duration of disease *per se* did not reach significance ($\beta = -.028$, $p = .198$). Positive and negative symptoms were the strongest predictors of global functioning ($\beta = -.441$, $p < .001$ and $\beta = -.380$, $p < .001$).

Discussion

The present paper provides an overview of the GRAS data collection, including (1) study logistics and procedures, (2) sample description regarding sociodemographic data, disease-related variables, cognitive performance and neurological symptoms, paying particular attention to gender differences, and (3) a first presentation of intercorrelation patterns for selected areas of interest to phenotype studies. (4) In addition, disease-related factors influencing important criteria of daily functioning are evaluated in the >1000 GRAS patients. Overall, the GRAS sample represents a typical schizophrenic population in contact with the health system and is - last not least due to its homogeneous data acquisition - ideally suited for the ongoing and planned phenotype-based genetic association studies (PGAS) (e.g. [[11], and Grube et al: Calcium-activated potassium channels as regulators of cognitive performance in schizophrenia, submitted]).

The GRAS data collection has several remarkable advantages, two of which are of major importance for its ultimate goal, PGAS: (i) Different from other studies dealing with the establishment of a schizophrenia data base, *all* data for GRAS were collected by one and the same traveling team of examiners, who frequently performed calibrating sessions and rater trainings. This effort has clearly paid off in terms of reliability and quality of the data, considering the internal consistencies of the GRAS phenotypes, as exemplified in the displayed correlation patterns. (ii) Even though the GRAS study has been implemented as a cross-sectional investigation, the GRAS data collection also includes solid longitudinal information derived from the almost complete psychiatric chart records/discharge letters of all schizophrenic patients. This longitudinal set of data has been essential to e.g. reliably estimate prodrome versus disease onset, i. e. occurrence of the first psychotic episode.

Comparable to other schizophrenia samples, the GRAS sample comprises around two thirds of male and one third of female patients [17,58]. Assuming that the gender ratio in schizophrenia were 1:1 as claimed in text books, but recently also questioned [59,60], then two principal reasons may account for the gender distribution observed here: (1) Schizophrenic women generally seem to have less contact with the health system due to being better socially settled (later age of onset of

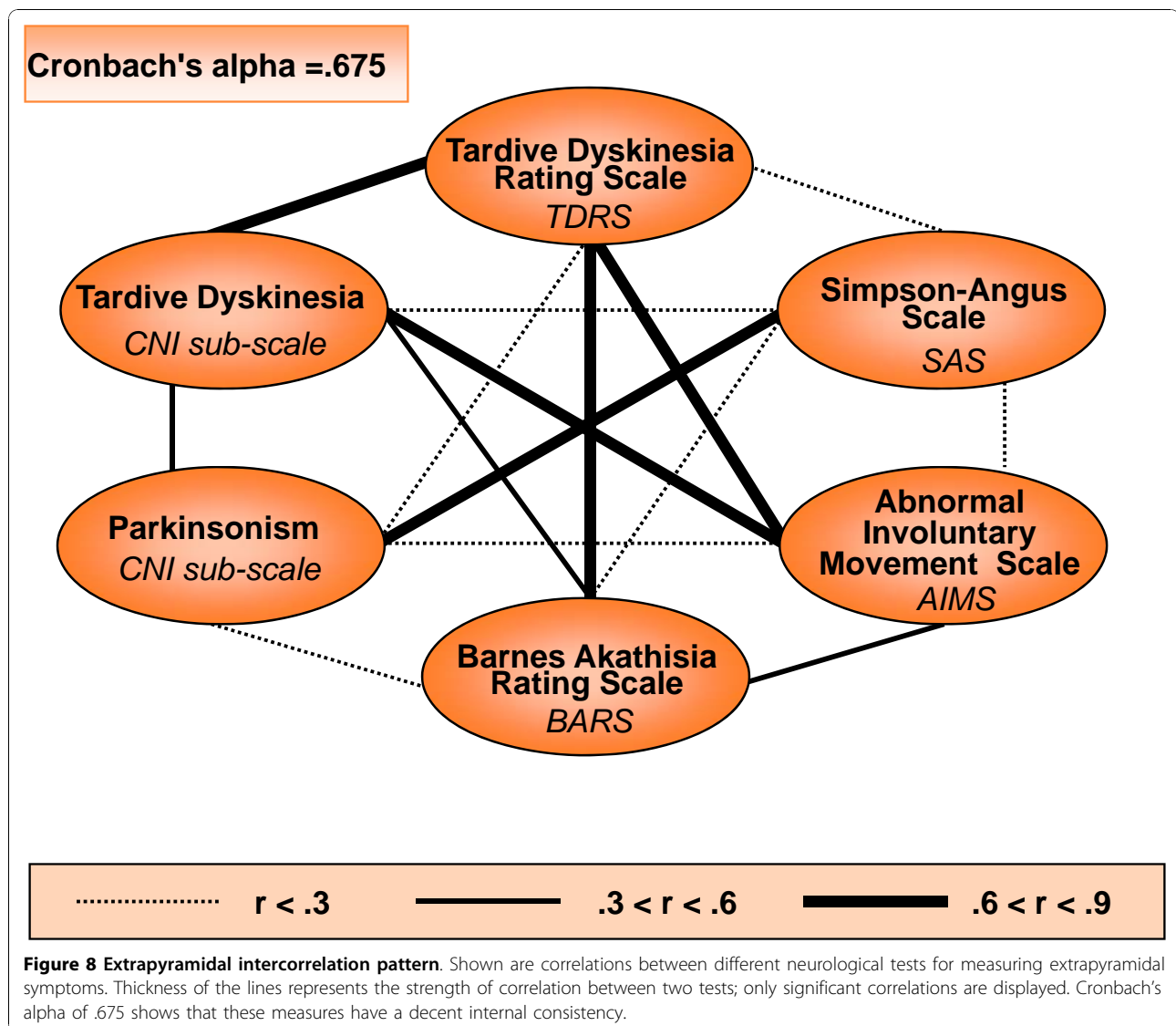

disease) and protected within their families [61]; (2) A certain (smaller) recruitment bias may be explained by the fact that the traveling team of examiners visited some institutions with an overrepresentation of males, e. g. specialized forensic units or a hospital for psychotic patients with co-morbid substance use disorders.

With the purposeful strategy to visit several different facilities of psychiatric health care covering inpatients, outpatients, residents of sheltered homes and forensic patients, the GRAS approach tried to avoid biases inherent to pure inpatient samples [58]. Nevertheless, patients who are not in contact with the health care system are unlikely to be integrated in any comparable data bases. For instance, only 4 of the 1085 examined patients are currently homeless, whereas among homeless people a considerable proportion suffers from schizophrenia [62]. To reach them as well, different and more cost intensive

recruitment strategies would be required [13]. On the other hand, the schizophrenic phenotype required for the GRAS-PGAS studies pursued here, might be veiled in this severely affected subsample of patients that is additionally characterized by other specific problems, e. g. a highly elevated incidence of multiple substance use disorders and severe downstream medical comorbidities [63,64].

Gender differences in schizophrenia as obvious from the present data collection have been known for a long time [65]. In agreement with the literature, men and women in the GRAS sample differ by diagnosis, with women having a higher rate of schizoaffective disorders [66,67]. With respect to age of onset, education, indicators of social integration (e.g. marital status, living situation) and medication, the present results are also in perfect agreement with previous findings: Male patients

Table 5 Cambridge Neurological Inventory (CNI)a subscale sum scores (N = 893-942)

sub scales	total		men		women		statistics	
	Mean (sd)	Median (range)	Mean (sd)	Median (range)	Mean (sd)	Median (range)	Z	p
<i>Hard neurological signs</i>								
plantar reflexes (le/ri*), power in upper and lower limb (le/ri), and reflexes (hyper- and hyporeflexia) in upper and lower limb (le/ri)	1.12 (1.70)	0.0 (0 - 10)	1.07 (1.66)	0.0 (0-8)	1.22 (1.78)	0.0 (0- 10)	-1.467	n.s
<i>Motor coordination</i>								
finger-nose test (le/ri), finger-thumb tapping (le/ri), finger-thumb opposition (le/ri), pronation-supination (le/ri); fist-edge-palm test (le/ri), Oseretsky test	4.11 (4.27)	3.0 (0- 20)	3.95 (4.17)	2.0 (0- 20)	4.44 (4.45)	3.0 (0- 20)	-1.629	n.s
<i>Sensory integration</i>								
extinction, finger agnosia (le/ri), stereoagnosia (le/ri), agraphesthesia (le/ri), left-right disorientation	3.66 (3.32)	3.0 (0- 15)	3.63 (3.32)	3.0 (0- 15)	3.73 (3.31)	3.0 (0- 14)	-0.521	n.s
<i>Primitive reflexes</i>								
snout reflex, grasp reflex, palmo-mental reflex (le/ri)	0.84 (1.14)	0.0 (0-5)	0.80 (1.11)	0.0 (0-5)	0.91 (1.19)	0.0 (0-5)	-1.363	n.s
<i>Tardive dyskinesia</i>								
dyskinetic, sustained or manneristic face and head movement, simple or complex abnormal posture, dyskinetic, dystonic or manneristic trunk/limb movement	0.55 (1.17)	0.0 (0-9)	0.58 (1.25)	0.0 (0-9)	0.49 (0.98)	0.0 (0-7)	-0.132	n.s
<i>Catatonic signs</i>								
gait mannerism, gegenhalten, mitgehen, imposed posture, exaggerated or iterative movement, automatic obedience, echopraxia	0.43 (0.96)	0.0 (0-8)	0.45 (0.98)	0.0 (0-8)	0.38 (0.91)	0.0 (0-7)	-1.717	n.s
<i>Parkinsonism</i>								
increased tone in upper and lower limb (le/ri), decreased associated movements in walking, shuffling gait, arm dropping, tremor postural or resting, rigidity in neck	1.76 (2.90)	0.0 (0- 15)	1.70 (2.85)	0.0 (0- 15)	1.89 (3.02)	0.5 (0- 15)	-1.172	n.s
<i>Failure to suppress inappropriate response</i>								
blinking or head movement in saccadic eye movement, winking with one eye	1.23 (1.49)	1.0 (0-6)	1.12 (1.42)	1.0 (0-6)	1.48 (1.62)	1.0 (0-6)	-3.175	.001*

*le/ri - left and right

^aChen EY, Shapleske J, Luque R, McKenna PJ, Hodges JR, Calloway SP, Hymas NF, Denning TR, Berrios GE: The Cambridge Neurological Inventory: a clinical instrument for assessment of soft neurological signs in psychiatric patients. *Psychiatry Res* 1995, **56**(2):183-204.

are younger when the first psychotic episode occurs, are more frequently single, more often dependent on supported living conditions (e.g. residential homes) and show lower educational status [61,67,68]. Among the explanations for the observed gender differences in schizophrenia are the protective role of female hormones [69] and social aspects like earlier marriage of young women leading to a more protected environment at disease onset [13]. In line with these considerations is the work of Häfner and colleagues [12]. In a prospective design he could show that 'the social course (of schizophrenia) is determined by individual stage at illness onset and by early illness course' [70].

With respect to psychopathology and premorbid functioning, the GRAS sample may be slightly different from other schizophrenia samples reported in the literature [67]. Several studies published in this area show that men exhibit more negative symptoms, even in a geriatric sample [71,72], and that females have poorer premorbid cognitive functioning than males [73]. In the GRAS patients, there are no gender differences regarding psychopathology and premorbid cognition. Importantly, clear support for a

comparable severity of psychopathology in men and women of the GRAS sample is provided by the lack of gender differences in numbers of hospitalizations, clinical severity ratings, including global functioning (CGI, GAF [2,31]), and self-ratings of symptom severity and anxiety. One potential explanation for the discrepancies between the GRAS sample and other studies regarding psychopathology may be that patient numbers in some of the other studies have been too low to give conclusive results. In the assessment of premorbid cognitive functioning of the GRAS sample, a methodological limitation could be the retrospective determination of premorbid intelligence using a so-called 'hold' measure, i.e. a multiple choice vocabulary test [35]. Even though this is an accepted and valid instrument to retrospectively estimate premorbid intelligence [74], a prospective procedure might be more accurate. In fact, Weiser and colleagues had the opportunity to base their assessments on cognitive testing performed on adolescents before starting their military service [73], potentially explaining the deviating results.

Gender differences regarding current cognitive performance are similar within the GRAS sample (even though

Table 6 Multiple regression analyses predicting a) basic cognition/fine motor functions, b) cognitive performance, c) global functioning

	total			male			female		
	β	t	p	β	t	p	β	t	p
a) basic cognition/fine motor functions¹									
duration of disease (years)	-0.346	-11.92	< .001	-0.353	-9.68	< .001	-0.318	-6.59	< .001
positive symptoms (PANSS)	-0.006	-0.18	.856	-0.028	-0.69	.489	.065	1.08	.283
negative symptoms (PANSS)	-0.334	-10.05	< .001	-0.293	-7.32	< .001	-0.415	-7.01	< .001
catatonic signs (CNI)	-0.126	-4.26	< .001	-0.128	-3.45	.001	-0.161	-3.27	.001
medication (CPZ-equivalents)	-0.080	-2.70	.007	-0.066	-1.83	.068	-0.147	-2.84	.005
regression model		$r^2 = .324$ $p < .001$			$r^2 = .306$ $p < .001$			$r^2 = .383$ $p < .001$	
b) cognitive performance²									
duration of disease (years)	-0.335	-11.54	< .001	-0.356	-9.72	< .001	-0.294	-6.12	< .001
positive symptoms (PANSS)	-0.015	-0.44	.658	-0.033	-0.80	.427	.023	0.38	.704
negative symptoms (PANSS)	-0.351	-10.47	< .001	-0.320	-7.92	< .001	-0.396	-6.56	< .001
catatonic signs (CNI)	-0.132	-4.46	< .001	-0.103	-2.76	.006	-0.204	-4.16	< .001
medication (CPZ-equivalents)	-0.082	-2.74	.006	-0.060	-1.62	.105	-0.140	-2.70	.007
regression model		$r^2 = .330$ $p < .001$			$r^2 = .305$ $p < .001$			$r^2 = .394$ $p < .001$	
c) global functioning³									
duration of disease (years)	-0.028	-1.29	.198	-0.008	-0.28	.780	-0.062	-1.78	.076
positive symptoms (PANSS)	-0.441	-17.33	< .001	-0.458	-14.45	< .001	-0.415	-9.60	< .001
negative symptoms (PANSS)	-0.380	-15.02	< .001	-0.345	-10.97	< .001	-0.430	-10.0	< .001
catatonic signs (CNI)	-0.060	-2.67	.008	-0.050	-1.71	.088	-0.093	-2.58	.011
medication (CPZ-equivalents)	-0.106	-4.71	< .001	-0.122	-4.29	< .001	-0.078	-2.07	.040
regression model		$r^2 = .596$ $p < .001$			$r^2 = .559$ $p < .001$			$r^2 = .662$ $p < .001$	

¹A basic cognition/fine motor composite score was used as a dependent variable comprising alertness (TAP), tapping, and dotting (Chronbachs alpha = .801).

²A cognitive composite score was used as a dependent variable consisting of reasoning (LPS3), 2 processing speed measures (TMT -A and digit-symbol test, ZST), executive functions (TMT-B), working memory (BZT), verbal memory (VLMT) and divided attention (TAP) (Chronbachs alpha = .869).

³Global assessment of functioning (GAF) was used as a dependent variable.

at a lower functioning level [75]) compared to healthy controls [76] after considering age of onset, duration of disease, education and medication as covariates. Men perform better in reasoning, alertness and divided attention but worse in verbal memory, confirming reports on first-episode as well as chronically ill schizophrenic patients [77].

Women in the GRAS study receive significantly lower doses of chlorpromazine equivalents, confirming that they require less medication to achieve a reasonable treatment effect [78]. Importantly, regarding medication side effects, there were no gender differences in extrapyramidal symptoms. There were also no differences in the overall proportion of men and women who self-reported side effects, but the pattern of complaints was slightly different. For instance, women mentioned more often hormonal dysfunction and vertigo (or related symptoms like hypotonia), whilst men complained mainly about sexual dysfunction. Altogether, it is worth pointing out that the percentage of patients self-reporting side effects is low when compared to that with

objectively measured side effects, e.g. extrapyramidal symptoms (11.3% versus 32.3%).

Explicit studies on gender differences in antipsychotic medication side effects found a somewhat different distribution of complaints, e.g. more weight gain, diabetes and specific cardiovascular diseases in females [78,79]. Here, one reason is certainly the still preliminary data set of the GRAS collection evaluated, based at this point exclusively on cross-sectional patient reports. For a more appropriate coverage of medication side effects, all charts/discharge letters of every GRAS patient (also of those patients who did/could not report them), will have to be screened and entered into the data base. Comprehensive information on antipsychotic (and other) drugs and their side effects in the GRAS sample has been collected and is waiting for analyses to support e.g. future pharmacogenomic approaches, perhaps also in collaboration with industry partners.

In line with the findings of a recent meta-analysis [80], positive symptoms of the GRAS patients do not influence higher cognitive function or basic cognition/fine

motor performance, whilst negative symptoms, catatonic signs, duration of disease and antipsychotic medication have a significant effect on both. The clinical ratings of global functioning, however, strongly rely on positive as well as negative symptoms, medication and catatonic signs [81-83].

Conclusion

GRAS enables a novel phenotype-based approach to understand the molecular-genetic architecture of schizophrenia. The GRAS data collection encompasses a large sample of comprehensively phenotyped, moderately to severely affected schizophrenic patients. Proof-of-principle for the suitability of the GRAS data collection for PGAS has already been demonstrated [[11], and Grube et al: Calcium-activated potassium channels as regulators of cognitive performance in schizophrenia, submitted]. Further extensive analyses of the accumulated information on every single patient are ongoing.

Abbreviations

GRAS: Göttingen Research Association for Schizophrenia; GWAS: genome-wide association study; PGAS: phenotype-based genetic association study; CATIE: clinical antipsychotic trials of intervention effectiveness; CNL: Cambridge Neurological Inventory; ASRB: Australian Schizophrenia Research Bank; FGA: first generation antipsychotics; SGA: second generation antipsychotics; CPZ: chlorpromazine.

Acknowledgements

This study was supported by the Max Planck Society and the DFG-Research Center for Molecular Physiology of the Brain (CMBP). We are indebted to all patients for their participation in the GRAS (Göttingen Research Association for Schizophrenia) study and to all colleagues in the collaborating centers who contributed to the GRAS data collection.

Author details

¹Division of Clinical Neuroscience, Max Planck Institute of Experimental Medicine, Göttingen, Germany. ²Department of Psychiatry and Psychotherapy, Ecumenical Hospital Hainich, Germany. ³Hospital of Psychiatry and Psychotherapy, Center for Integrative Psychiatry, Kiel, Germany. ⁴Karl-Jaspers-Hospital, Psychiatric Federation Oldenburger Land, Bad Zwischenahn, Germany. ⁵Department of Psychiatry II, Ulm University, District Hospital Günzburg, Germany. ⁶Department of Psychiatry and Psychotherapy, Hospital Fulda, Germany. ⁷Department of Psychiatry and Psychotherapy, Isar-Amper-Hospital, Taufkirchen (Vils), Germany. ⁸Department of Psychiatry and Psychotherapy, Reinhard-Nieter Hospital, Wilhelmshaven, Germany. ⁹Vitos Hospital of Forensic Psychiatry Eltville, Eltville, Germany. ¹⁰Vitos Hospital of Psychiatry and Psychotherapy Merxhausen, Kassel, Germany. ¹¹Department of Psychiatry and Psychotherapy, University of Rostock, Germany. ¹²Hospital of Forensic Psychiatry, Moringen, Germany. ¹³Hospital of Psychiatry and Psychotherapy Langenhagen, Regional Hospitals Hannover, Germany. ¹⁴Vitos Hospital of Psychiatry and Psychotherapy, Bad Emstal-Merxhausen, Germany. ¹⁵Addiction Hospital "Am Waldsee", Rieden, Germany. ¹⁶Department of Psychiatry and Psychotherapy, University Medical Center of Bonn, Germany. ¹⁷Vitos Hospital of Psychiatry and Psychotherapy Merxhausen, Hofgeismar, Germany. ¹⁸Vitos Haina Forensic Psychiatric Hospital, Haina, Germany. ¹⁹Department of Psychiatry and Psychotherapy, Regional Hospitals Hannover, Wunstorf, Germany. ²⁰Dr. K. Fontheim's Hospital for Mental Health, Liebenburg, Germany. ²¹Department of Psychiatry and Psychotherapy, Hospital Ingolstadt, Germany. ²²Department of Psychiatry and Psychotherapy, Hospital Lübbecke, Germany. ²³Hospital of Psychiatry and Psychotherapy, Rickling, Germany. ²⁴Georg-Elias-Müller-Institute for Psychology, University of Göttingen, Germany. ²⁵Department of Psychiatry and Psychotherapy, University Medical Center of Göttingen, Germany.

²⁶Biomedical NMR Research GmbH, Max Planck Institute of Biophysical Chemistry, Göttingen, Germany. ²⁷Department of Molecular Biology of Neuronal Signals, Max Planck Institute of Experimental Medicine, Göttingen, Germany. ²⁸Department of Molecular Neurobiology, Max Planck Institute of Experimental Medicine, Göttingen, Germany. ²⁹Department of Neurogenetics, Max Planck Institute of Experimental Medicine, Göttingen, Germany. ³⁰DFG Research Center for Molecular Physiology of the Brain (CMBP), Germany. ³¹Founders of the GRAS Initiative.

Authors' contributions

MB coordinated and supervised the traveling team of investigators and had a considerable impact on design and establishment of the data collection. KR and HFr were part of the traveling team of investigators, conducted statistical analyses of the clinical data, assisted in manuscript writing, and supervised data entry, substantially performed by SG, SP, AK, MFG, VA, ATa, ATr, and MF. Of the collaborating centers, LA, JBA, MBE, TB, AC, MD, HFO, RF, RG, SH, DH, GK, HK, MFr, FL, WM, AM, RMI, CO, FGP, TP, US, HJS and UHR enabled the work of the traveling team of examiners, by pre-selecting and preparing patients and organizing respective facilities and working conditions. HE, KAN, NB, PF, WS, and JF developed the concept of GRAS (Göttingen Research Association for Schizophrenia, founded in 2004), and guided the project, data analysis, and paper writing, hereby supported by BKH. All authors discussed the results, commented on the paper draft and approved the final version of the manuscript.

Competing interests

The authors declare that they have no competing interests.

Received: 24 August 2010 Accepted: 10 November 2010

Published: 10 November 2010

References

- Jablensky A, Sartorius N, Ernberg G, Anker M, Korten A, Cooper JE, Day R, Bertelsen A: **Schizophrenia: manifestations, incidence and course in different cultures. A World Health Organization ten-country study.** *Psychol Med Monogr Suppl* 1992, **20**:1-97.
- American Psychiatric Association: *Diagnostic and statistical manual of mental disorders, (DSM-IV)*. 4 edition. Washington, DC: American Psychiatric Press; 1994.
- World Health Organization: *The ICD-10 classification of mental and behavioural disorders: Clinical descriptions and diagnostic guidelines* Geneva: WHO; 1992.
- Cardno AG, Gottesman II: **Twin studies of schizophrenia: from bow-and-arrow concordances to starwars Mx and functional genomics.** *Am J Med Genet* 2000, **97**(1):12-17.
- Lichtenstein P, Yip BH, Björk C, Pawitan Y, Cannon TD, Sullivan PF, Hultman CM: **Common genetic determinants of schizophrenia and bipolar disorder in Swedish families: a population-based study.** *The Lancet* 2009, **373**(9659):234-239.
- Franzek E, Beckmann H: **Different Genetic Background of Schizophrenia Spectrum Psychoses: A Twin Study.** *Am J Psychiatry* 1998, **155**(1):76-83.
- Cardno AG, Marshall EJ, Coid B, Macdonald AM, Ribchester TR, Davies NJ, Venturi P, Jones LA, Lewis SW, Sham PC, Gottesman II, Farmer AE, McGuffin P, Reveley AM, Murray RM: **Heritability Estimates for Psychotic Disorders: The Maudsley Twin Psychosis Series.** *Arch Gen Psychiatry* 1999, **56**(2):162-168.
- Gottesman I I, Shields J: **A polygenic theory of schizophrenia.** *Proc Natl Acad Sci USA* 1967, **58**(1):199-205.
- Riley B, Asherson PJ, McGuffin P: **Genetics and schizophrenia.** In *Schizophrenia*. Edited by: Hirsch SR, Weinberger DR. Massachusetts: Blackwell Publishing; 2003.
- Duan J, Sanders AR, Gejman PV: **Genome-wide approaches to schizophrenia.** *Brain Research Bulletin* .
- Begemann M, Grube S, Papiol S, Malzahn D, Krampe H, Ribbe K, Friedrichs H, Radyushkin KA, El-Kordi A, Bensele F, Hannke K, Sperling S, Schwerdtfeger D, Thanhauser I, Gerchen MF, Ghorbani M, Gutwinski S, Hilmes C, Leppert R, Ronnenberg A, Sowislo J, Stawicki S, Stodtke M, Szuzies C, Reim K, Riggert J, Eckstein F, Falkai P, Bickeboller H, Nave KA, et al: **Modification of cognitive performance in schizophrenia by complexin 2 gene polymorphisms.** *Arch Gen Psychiatry* 2010, **67**(9):879-888.

12. Häfner H, Maurer K, Löffler W, an der Heiden W, Munk-Jørgensen P, Hambrecht M, Riecher-Rössler A: **The ABC schizophrenia study: a preliminary overview of the results.** *Social Psychiatry and Psychiatric Epidemiology* 1998, **33**(8):380-386.
13. Jablensky A, McGrath J, Herrman H, Castle D, Gureje O, Evans M, Carr V, Morgan V, Korten A, Harvey C: **Psychotic disorders in urban areas: an overview of the Study on Low Prevalence Disorders.** *Aust N Z J Psychiatry* 2000, **34**(2):221-236.
14. Haro JM, Edgell ET, Jones PB, Alonso J, Gavart S, Gregor KJ, Wright P, Knapp M: **The European Schizophrenia Outpatient Health Outcomes (SOHO) study: rationale, methods and recruitment.** *Acta Psychiatr Scand* 2003, **107**(3):222-232.
15. Karayiorgou M, Torrington M, Abecasis GR, Pretorius H, Robertson B, Kaliski S, Lay S, Sobin C, Möller N, Lundy SL, Blundell ML, Gogos JA, Roos JL: **Phenotypic characterization and genealogical tracing in an Afrikaner schizophrenia database.** *American Journal of Medical Genetics Part B: Neuropsychiatric Genetics* 2004, **124B**(1):20-28.
16. Fleischhacker WW, Keet IP, Kahn RS: **The European First Episode Schizophrenia Trial (EUFEST): rationale and de sign of the trial.** *Schizophr Res* 2005, **78**(2-3):147-156.
17. Lieberman JA, Stroup TS, McEvoy JP, Swartz MS, Rosenheck RA, Perkins DO, Keefe RS, Davis SM, Davis CE, Lebowitz BD, Severe J, Hsiao JK: **Effectiveness of antipsychotic drugs in patients with chronic schizophrenia.** *N Engl J Med* 2005, **353**(12):1209-1223.
18. Price GW, Michie PT, Johnston J, Innes-Brown H, Kent A, Clissa P, Jablensky AV: **A Multivariate Electrophysiological Endophenotype, from a Unitary Cohort, Shows Greater Research Utility than Any Single Feature in the Western Australian Family Study of Schizophrenia.** *Biological Psychiatry* 2006, **60**(1):1-10.
19. Calkins ME, Dobie DJ, Cadenhead KS, Olincy A, Freedman R, Green MF, Greenwood TA, Gur RE, Gur RC, Light GA, Mintz J, Nuechterlein KH, Radant AD, Schork NJ, Seidman LJ, Siever LJ, Silverman JM, Stone WS, Swerdlow NR, Tsuang DW, Tsuang MT, Turetsky BI, Braff DL: **The Consortium on the Genetics of Endophenotypes in Schizophrenia: Model Recruitment, Assessment, and Endophenotyping Methods for a Multisite Collaboration.** *Schizophr Bull* 2007, **33**(1):33-48.
20. Allen NC, Bagade S, McQueen MB, Ioannidis JPA, Kavvoura FK, Khoury MJ, Tanzi RE, Bertram L: **Systematic meta-analysis and field synopsis of genetic association studies in schizophrenia: the SzGene database.** *Nat Genet* 2008, **40**(7):827-834.
21. Stroup TS, McEvoy JP, Swartz MS, Byerly MJ, Glick ID, Canive JM, McGee MF, Simpson GM, Stevens MC, Lieberman JA: **The National Institute of Mental Health Clinical Antipsychotic Trials of Intervention Effectiveness (CATIE) project: schizophrenia trial design and protocol development.** *Schizophr Bull* 2003, **29**(1):15-31.
22. Poyastro Pinheiro A, Keefe RSE, Skelly T, Orlate M, Leviel K, Lange LA, Lange EM, Scott Stroup T, Lieberman J, Sullivan PF: **AKT1 and neurocognition in schizophrenia.** *Australian and New Zealand Journal of Psychiatry* 2009, **41**(2):169-177.
23. Sullivan PF, Keefe RSE, Lange LA, Lange EM, Stroup TS, Lieberman J, Maness PF: **NCAM1 and Neurocognition in Schizophrenia.** *Biological Psychiatry* 2007, **61**(7):902-910.
24. Crowley JJ, Keefe RSE, Perkins DO, Stroup TS, Lieberman JA, Sullivan PF: **The neuregulin 1 promoter polymorphism rs6994992 is not associated with chronic schizophrenia or neurocognition.** *American Journal of Medical Genetics Part B: Neuropsychiatric Genetics* 2008, **147B**(7):1298-1300.
25. Sullivan PF, Lin D, Tzeng JY, van den Oord E, Perkins D, Stroup TS, Wagner M, Lee S, Wright FA, Zou F, Liu W, Downing AM, Lieberman J, Close SL: **Genomewide association for schizophrenia in the CATIE study: results of stage 1.** *Mol Psychiatry* 2008, **13**(6):570-584.
26. **Australian Schizophrenia Research Bank.** [http://www.schizophreniaresearch.org.au/bank/index.php].
27. Loughland CM, Carr VJ, Lewin TJ: **The NISAD Schizophrenia Research Register: why do we need a database of schizophrenia volunteers?** *Aust N Z J Psychiatry* 2001, **35**(5):660-667.
28. Loughland C, Draganic D, McCabe K, Richards J, Nasir A, Allen J, Catts S, Jablensky A, Henskens F, Michie P, Mowry B, Pantelis C, Schall U, Rodney S, Tooney P, Carr V: **The Australian Schizophrenia Research Bank: A database of comprehensive clinical, endophenotypic and genetic data for etiological studies of schizophrenia.** *Australian and New Zealand Journal of Psychiatry* .
29. Wittchen H-U, Zaudig M, Fydrich T: **SKID-I (Strukturiertes Klinisches Interview für DSM-IV; Achse I: Psychische Störungen)** Göttingen: Hogrefe; 1997.
30. Kay SR, Fiszbein A, Opler LA: **The positive and negative syndrome scale (PANSS) for schizophrenia.** *Schizophr Bull* 1987, **13**(2):261-276.
31. Guy W: **Clinical Global Impression (CGI).** *ECDEU Assessment manual for psychopharmacology, revised National Institute of Mental Health.* Rockville, MD 1976.
32. Laux L, Glanzmann P, Schaffner P, Spielberger CD: **Das State-Trait-Angstinventar (STAI)** Weinheim: Beltz; 1981.
33. Franke GH: **Brief Symptom Inventory (BSI)** Göttingen: Beltz; 2000.
34. Kupfer J, Brosig B, Braehler E: **Toronto Alexithymie-Skala-26 (TAS-26)** Göttingen: Hogrefe; 2001.
35. Lehrl S, Triebig G, Fischer B: **Multiple choice vocabulary test MWT as a valid and short test to estimate premorbid intelligence.** *Acta Neurol Scand* 1995, **91**(5):335-345.
36. Lehrl S: **Mehrfach-Wortschatz-Intelligenztest MWT-B** Balingen: Spitta Verlag; 1999.
37. Horn W: **Leistungsprüfsystem (LPS).** 2. edition. Göttingen: Hogrefe; 1983.
38. Gold JM, Carpenter C, Randolph C, Goldberg TE, Weinberger DR: **Auditory working memory and Wisconsin Card Sorting Test performance in schizophrenia.** *Arch Gen Psychiatry* 1997, **54**(2):159-165.
39. Chapman RL: **The MacQuarrie test for mechanical ability.** *Psychometrika* 1948, **13**(3):175-179.
40. War-Department: **Army Individual Test Battery. Manual of directions and scoring** Washington, D.C.: War Department, Adjutant General's Office; 1944.
41. Perianez JA, Rios-Lago M, Rodriguez-Sanchez JM, Adrover-Roig D, Sanchez-Cubillo I, Crespo-Facorro B, Quemada JI, Barcelo F: **Trail Making Test in traumatic brain injury, schizophrenia, and normal ageing: sample comparisons and normative data.** *Arch Clin Neuropsychol* 2007, **22**(4):433-447.
42. Kessler J, Denzler P, Markowitsch HJ: **Demenz-Test (DT)** Göttingen: Hogrefe; 1999.
43. Aschenbrenner S, Tucha O, Lange KW: **Der Regensburger Wortflüssigkeits-Test (RWfT)** Göttingen: Hogrefe; 2000.
44. Tewes U: **Hamburg-Wechsler Intelligenztest fuer Erwachsene (HAWIE-R)** Bern: Huber; 1991.
45. Helmstaedter C, Lendt M, Lux S: **Verbaler Lern- und Merkfähigkeitstest (VLMT)** Göttingen: Beltz; 2001.
46. Zimmermann P, Fimm B: **Testbatterie zur Aufmerksamkeitsprüfung (TAP). Version 1.02c** Herzogenrath: PSYTEST; 1993.
47. Chen EY, Shapleske J, Luque R, McKenna PJ, Hodges JR, Calloway SP, Hymas NF, Denning TR, Berrios GE: **The Cambridge Neurological Inventory: a clinical instrument for assessment of soft neurological signs in psychiatric patients.** *Psychiatry Res* 1995, **56**(2):183-204.
48. Bartels C, Mertens N, Hofer S, Merboldt KD, Dietrich J, Frahm J, Ehrenreich H: **Callosal dysfunction in amyotrophic lateral sclerosis correlates with diffusion tensor imaging of the central motor system.** *Neuromuscul Disord* 2008, **18**(5):398-407.
49. Barnes TR: **The Barnes Akathisia Rating Scale - revisited.** *J Psychopharmacol* 2003, **17**(4):365-370.
50. Simpson GM, Angus JW: **A rating scale for extrapyramidal side effects.** *Acta Psychiatr Scand Suppl* 1970, **212**:11-19.
51. Simpson GM, Lee JH, Zoubok B, Gardos G: **A rating scale for tardive dyskinesia.** *Psychopharmacology (Berl)* 1979, **64**(2):171-179.
52. Guy W: **Abnormal involuntary movement scale (AIMS).** *ECDEU Assessment manual for psychopharmacology, revised National Institute of Mental Health.* Rockville, MD 1976.
53. Krampe H, Bartels C, Victorson D, Enders CK, Beaumont J, Cella D, Ehrenreich H: **The influence of personality factors on disease progression and health-related quality of life in people with ALS.** *Amyotroph Lateral Scler* 2008, **9**(2):99-107.
54. **SPSS Inc.** [http://www.spss.com/].
55. Blom G: **Statistical Estimates and Transformed Beta Variables** New York: John Wiley and Sons, Inc; 1958.
56. Davis JM: **Comparative doses and costs of antipsychotic medication.** *Arch Gen Psychiatry* 1976, **33**(7):858-861.
57. Barnes TR: **A rating scale for drug-induced akathisia.** *Br J Psychiatry* 1989, **154**:672-676.
58. Loughland CM, Carr VJ, Lewin TJ, Barnard RE, Chapman JL, Walton JM: **Potential sampling and recruitment source impacts in schizophrenia research.** *Psychiatry Res* 2004, **125**(2):117-127.

59. Aleman A, Kahn RS, Selten J-P: **Sex differences in the risk of schizophrenia: evidence from meta-analysis.** *Arch Gen Psychiatry* 2003, **60(6)**:565-571.
60. McGrath J, Saha S, Chant D, Welham J: **Schizophrenia: a concise overview of incidence, prevalence, and mortality.** *Epidemiol Rev* 2008, **30**:67-76.
61. Riecher-Rossler A, Hafner H: **Gender aspects in schizophrenia: bridging the border between social and biological psychiatry.** *Acta Psychiatr Scand Suppl* 2000, **407**: 58-62.
62. Henry J-M, Boyer L, Belzeaux R, Baumstarck-Barrau K, Samuelian J-C: **Mental Disorders Among Homeless People Admitted to a French Psychiatric Emergency Service.** *Psychiatr Serv* 2010, **61(3)**:264-271.
63. Toro PA, Bellavia CW, Daeschler CV, Owens BJ, Wall DD, Passero JM, Thomas DM: **Distinguishing homelessness from poverty: A comparative study.** *Journal of Consulting and Clinical Psychology* 1995, **63(2)**:280-289.
64. Israel N, Toro P, Ouellette N: **Changes in the Composition of the Homeless Population: 1992-2002.** *American Journal of Community Psychology* 2010, **46(1-2)**:49-59.
65. Kraepelin E: *Psychiatrie. Ein Lehrbuch für Studierende und Ärzte. Sechste, vollständig umgearbeitete Auflage* Leipzig: Johann Ambrosius Barth; 1899.
66. Castle DJ, Sham PC, Wessely S, Murray RM: **The subtyping of schizophrenia in men and women: a latent class analysis.** *Psychol Med* 1994, **24(1)**:41-51.
67. Leung A, Chue P: **Sex differences in schizophrenia, a review of the literature.** *Acta Psychiatr Scand Suppl* 2000, **401**:3-38.
68. Larsen TK, McGlashan TH, Johannessen JO, Vibe-Hansen L: **First-episode schizophrenia: II. Premorbid patterns by gender.** *Schizophr Bull* 1996, **22(2)**:257-269.
69. Seeman MV, Lang M: **The role of estrogens in schizophrenia gender differences.** *Schizophr Bull* 1990, **16(2)**:185-194.
70. Häfner H: **Onset and early course as determinants of the further course of schizophrenia.** *Acta Psychiatr Scand Suppl* 2000, **407**: 44-48.
71. Moriarty PJ, Lieber D, Bennett A, White L, Parrella M, Harvey PD, Davis KL: **Gender differences in poor outcome patients with lifelong schizophrenia.** *Schizophr Bull* 2001, **27(1)**:103-113.
72. Thorup A, Petersen L, Jeppesen P, Ohlenschlaeger J, Christensen T, Krarup G, Jorgensen P, Nordentoft M: **Gender differences in young adults with first-episode schizophrenia spectrum disorders at baseline in the Danish OPUS study.** *Nerv Ment Dis* 2007, **195(5)**:396-405.
73. Weiser M, Reichenberg A, Rabinowitz J, Kaplan Z, Mark M, Nahon D, Davidson M: **Gender differences in premorbid cognitive performance in a national cohort of schizophrenic patients.** *Schizophr Res* 2000, **45(3)**:185-190.
74. Green RE, Melo B, Christensen B, Ngo LA, Monette G, Bradbury C: **Measuring premorbid IQ in traumatic brain injury: an examination of the validity of the Wechsler Test of Adult Reading (WTAR).** *J Clin Exp Neuropsychol* 2008, **30(2)**:163-172.
75. Aylward E, Walker E, Bettes B: **Intelligence in schizophrenia: meta-analysis of the research.** *Schizophr Bull* 1984, **10(3)**:430-459.
76. Kern RS, Nuechterlein KH, Green MF, Baade LE, Fenton WS, Gold JM, Keefe RS, Mesholam-Gately R, Mintz J, Seidman LJ, Stover E, Marder SR: **The MATRICS Consensus Cognitive Battery, part 2: co-norming and standardization.** *Am J Psychiatry* 2008, **165(2)**:214-220.
77. Hoff AL, Wieneke M, Faustman WO, Horon R, Sakuma M, Blankfeld H, Espinoza S, DeLisi LE: **Sex differences in neuropsychological functioning of first-episode and chronically ill schizophrenic patients.** *Am J Psychiatry* 1998, **155(10)**:1437-1439.
78. Seeman MV: **Gender differences in the prescribing of antipsychotic drugs.** *Am J Psychiatry* 2004, **161(8)**:1324-1333.
79. Seeman MV: **Secondary effects of antipsychotics: women at greater risk than men.** *Schizophr Bull* 2009, **35(5)**:937-948.
80. Dominguez Mde G, Viechtbauer W, Simons CJ, van Os J, Krabbendam L: **Are psychotic psychopathology and neurocognition orthogonal? A systematic review of their associations.** *Psychol Bull* 2009, **135(1)**:157-171.
81. Puig O, Penades R, Gasto C, Catalan R, Torres A, Salameo M: **Verbal memory, negative symptomatology and prediction psychosocial functioning in schizophrenia.** *Psychiatry Res* 2008, **158(1)**:11-17.
82. Schennach-Wolff R, Jager M, Seemüller F, Obermeier M, Messer T, Laux G, Pfeiffer H, Naber D, Schmidt LG, Gaebel W, Huff W, Heuser I, Maier W, Lemke MR, Ruther E, Buchkremer G, Gastpar M, Moller HJ, Riedel M: **Defining and predicting functional outcome in schizophrenia and schizophrenia spectrum disorders.** *Schizophr Res* 2009, **113(2-3)**:210-217.
83. Gaité L, Vazquez-Barquero JL, Herran A, Thornicroft G, Becker T, Sierra-Biddle D, Ruggeri M, Schene A, Knapp M, Vazquez-Bourgon J: **Main determinants of Global Assessment of Functioning score in schizophrenia: a European multicenter study.** *Compr Psychiatry* 2005, **46(6)**:440-446.
84. Ehrenreich H, Siren AL: **Neuroprotection—what does it mean?—What means do we have?** *Eur Arch Psychiatry Clin Neurosci* 2001, **251(4)**:149-151.

Pre-publication history

The pre-publication history for this paper can be accessed here:
<http://www.biomedcentral.com/1471-244X/10/91/prepub>

doi:10.1186/1471-244X-10-91

Cite this article as: Ribbe et al.: The cross-sectional GRAS sample: A comprehensive phenotypical data collection of schizophrenic patients. *BMC Psychiatry* 2010 **10**:91.

Submit your next manuscript to BioMed Central and take full advantage of:

- Convenient online submission
- Thorough peer review
- No space constraints or color figure charges
- Immediate publication on acceptance
- Inclusion in PubMed, CAS, Scopus and Google Scholar
- Research which is freely available for redistribution

Submit your manuscript at
www.biomedcentral.com/submit



Curriculum Vitae

Heidi Friedrichs

Max Planck Institute of Experimental Medicine
Division of Clinical Neuroscience
Hermann-Rein-Str. 3
37075 Göttingen
Germany

Phone: +49 (551) 3899-586
Fax: +49 (551) 3899-670
E-mail: Heidi_Friedrichs@gmx.de

Education

- since Nov 2007 PhD student - Center for Systems Neuroscience, Graduate School for Neuroscience and Molecular Biosciences, Göttingen, Germany
working under Professor Hannelore Ehrenreich at the Max Planck Institute for Experimental Medicine, Göttingen, Germany
- Feb 2007 Diploma in Psychology, Friedrichs-Wilhelms-University, Bonn, Germany
- June 2001 German "Abitur" at the Ernst-Moritz-Arndt Gymnasium, Remscheid, Germany

Work and practical experience

- Aug – Nov 2006 working as tutor for 'InWEnt – Internationale Weiterbildung und Entwicklung gGmbH', Bonn, Germany
- Oct – Dec 2005 Internship at the 'Institut für Psychologische Unfallnachsorge' (ipu), Köln, Germany
- Oct – Dec 2004 Internship at a practice for psychological assessments, Dohrenbusch & Meise GbR, Bonn, Germany
- March – April 2004 Internship at the psychological counselling service of the Diakonie Wuppertal-Elberfeld, Germany

Publications

Ribbe, K.*, **Friedrichs, H.***, Begemann, M.*, et al. The cross-sectional GRAS sample: A comprehensive phenotypical data collection of schizophrenic patients. *BMC Psychiatry*, Nov 10; **10** (1):91. Epub ahead of print (2010).

* equally contributing first authors

Sargin, D., **Friedrichs, H.**, El-Kordi, A. & Ehrenreich, H. Erythropoietin as neuroprotective and neuroregenerative treatment strategy: Comprehensive overview of 12 years of preclinical clinical research. *Best Pract Res Clin Anaesthesiol.* **24**, 573-594 (2010).

Begemann, M., Klaus, S., Papiol, S., Malzahn, D., Krampe, H., Ribbe, K., **Friedrichs, H.**, et al. Complexin2 gene polymorphisms modify cognitive performance in schizophrenia. *Arch Gen Psychiatry*, **67**(9), 879-888 (2010).

Papiol, S., Begemann, M., Rosenberger, A., **Friedrichs, H.** et al. A phenotype-based genetic association study reveals the contribution of neuregulin1 gene variants to age of onset and positive symptom severity in schizophrenia. *Am J Med Genet B Neuropsychiatr Genet*, Epub ahead of print (2011).

Grube, S., Gerchen, M.F., Adamcio, B., Pardo, L.A., Martin, S., Malzahn, D., Papiol, S., Begemann, M., Ribbe, K., **Friedrichs, H.**, et al. A CAG repeat polymorphism of KCNN3 predicts SK3 channel function and cognitive performance in schizophrenia. *In revision.*

Ribbe, K., Ackermann, V., Schwitulla, J., Begemann, M., Papiol, S., Grube, S., Sperling, S., **Friedrichs, H.**, et al. Interaction of common genetic variants in the corticotropin releasing factor system predicts the risk of comorbid alcoholism. *Submitted.*

Conference Abstracts

Ribbe, K., **Friedrichs, H.**, Hilmes, C., Begemann, M., Gerchen, M. F., Ghorbani, M., et al. (2008). *The Data Collection of GRAS (Göttingen Research Association for Schizophrenia): Multi-Center Cross-Sectional Schizophrenia Study.* Poster presented at the Robert Sommer Award Symposium, Giessen.

Friedrichs, H., Grube, S., El-Kordi, A., Schwitulla, J., Sargin, D., Begemann, M., et al. (2010). *Genetic variants of EPO and EPOR influence cognitive core features of schizophrenia.* Poster presented at the Annual Congress of the German Association for Psychiatry and Psychotherapy, Berlin.

