

HIV and STI among women in Uganda, Zimbabwe and Thailand:
Associations with male circumcision and changes in condom use

Abigail Norris Turner

A dissertation submitted to the faculty of the University of North Carolina at Chapel Hill in partial fulfillment of the requirements for the degree of Doctor of Philosophy in the Department of Epidemiology, School of Public Health.

Chapel Hill
2007

Approved by:

William C. Miller, MD, PhD

Frieda M. Behets, PhD

Jay S. Kaufman, PhD

Charles S. Morrison, PhD

Nancy S. Padian, PhD

© 2007
Abigail Norris Turner
ALL RIGHTS RESERVED

ABSTRACT

Abigail Norris Turner

HIV and STI among women in Uganda, Zimbabwe and Thailand:
Associations with male circumcision and changes in condom use

(Under the direction of William C. Miller)

The results of most HIV-prevention programs over the 25-year history of the AIDS epidemic have been disappointing. Two interventions have been notable exceptions in the string of prevention failures: in 1983, researchers reported that consistent use of male condoms reduced risk of HIV transmission, and much more recently, in February 2007, large-scale randomized trials determined that circumcision reduced men's risk of HIV acquisition by 40-65%. These separate interventions - male circumcision and condom use - are the focus of these dissertation analyses.

We examined whether the circumcision status of women's primary sexual partner was associated with her risk of HIV and three sexually transmitted infections (STIs): *Chlamydia trachomatis* (Ct), *Neisseria gonorrhoeae* (GC), and *Trichomonas vaginalis* (Tv). We used data from a prospective cohort study on hormonal contraception and incident HIV and STI (HC-HIV study) among women from Uganda, Zimbabwe and Thailand (HIV analyses included 4,417 Ugandan and Zimbabwean women; STI analyses included 5,925 women from Uganda, Zimbabwe and Thailand). After adjustment, women with circumcised partners had similar risk to

women with uncircumcised partners for HIV (hazard ratio (HR): 1.03, 95% confidence interval (CI): 0.69-1.53), Ct (HR: 1.22, 95% CI: 0.94-1.59), GC (HR: 0.93, 95% CI: 0.70-1.24), and Tv (HR: 1.05, 95% CI: 0.81-1.37).

Among women who became HIV-infected during HC-HIV, we also examined whether HIV diagnosis, together with counseling and free condoms, was sufficient to induce changes in women's condom use over both short (2-6 months) and longer time periods (12-16 months). After diagnosis, the number of HIV-infected women reporting any unprotected acts in a typical month declined significantly (short-term: from 72% to 56%; long-term: from 74% to 56%). After adjustment, among women reporting any unprotected acts, HIV-infected women also reduced the number of unprotected acts by 29% (short term) and 38% (long term). When assessing the *proportion* of acts where male condoms were used, however, women had no reduction over time.

Circumcision was not associated with women's risk of HIV, Ct, Tv or GC among most participants. HIV-infected women reduced their overall number of unprotected sex acts, but the proportion of unprotected acts was unchanged from pre-infection behavior.

For Charlotte Ellertson and Charlotte Marie Norris Turner

ACKNOWLEDGEMENTS

This dissertation would not have been possible without the contributions and support of many individuals.

I thank my advisor and committee chair, William Miller, for his insightful analytic guidance and gentle encouragement, both always delivered with twinkling eyes and a kind smile. I remain indebted to Nancy Padian, who introduced me to the very concept of public health as a career; her guidance and support have been important in truly every professional decision I have made in the last ten years. Frieda Behets has treated me like a valued colleague from our first meeting, and I look forward to many years of fruitful collaboration with her. Jay Kaufman is the most energetic, committed, and humorous teacher I have ever had the pleasure of learning from. He is never too busy to explain a new concept, and he always seems to know the answer, even when I am not sure what the question is. Charles Morrison, the Principal Investigator of the study that generated the data for these analyses, gave speedy responses to virtually every question I ever asked. Without Charlie's support of my use of his data, this dissertation would not have been possible.

I remain grateful to the Graduate School at the University of North Carolina at Chapel Hill (UNC) for awarding me the Joseph E. Pogue Fellowship upon my

matriculation in 2002. The University Center for International Studies, the UNC Center for Women's Health Research, and *Providing Educational Opportunities for Women* (PEO), Chapel Hill Chapter AG, also gave me substantial and much-appreciated financial support during my time as a graduate student.

Many friends and colleagues both inside and outside the Department of Epidemiology provided essential help along the way. Thank you to my wonderful dissertation support group, Alia Al-Tayyib and Danielle Rentz, who led the way for me; to Sarah Landis and Maria Khan, who always made time to read drafts and give feedback; to Daniel Westreich, for critical help with SAS programming as well as general enthusiasm for my project; and to Rich MacLehose, Steve Marshall, Kathy Roggencamp, Marcia Hobbs, and Ron Gray, who each answered important questions at critical points in the analysis process, and without whose help I would not have been able to move forward.

Finally, I cannot adequately express my gratitude to my family, particularly my husband and partner in all things, Piers Turner, who provided both honest critiques and unflagging encouragement throughout the dissertation process. My parents, Bob and Peg Norris, and my siblings (Alison, Dan and Joe Norris), as well as my in-laws (David, Nancy, and Christian Turner, Dodie McDow and Jessica Norris) were each perfectly confident in my ability to complete this project, even when my own doubts felt insurmountable. Thank you to all of you.

TABLE OF CONTENTS

LIST OF TABLES.....	xi
LIST OF FIGURES	xiii
LIST OF ABBREVIATIONS	xiv
Chapter	
I. SPECIFIC AIMS	1
Specific Aim 1	3
Specific Aim 2	4
II. INTRODUCTION	5
Male circumcision and women’s risk of HIV/STI acquisition (Aim 1).....	6
Notification of HIV status and condom use among women (Aim 2).....	15
III. METHODS	26
Data sources	26
Aim 1 analyses	37
Aim 2 analyses	54
IV. MALE CIRCUMCISION AND WOMEN’S RISK OF HIV IN UGANDA AND ZIMBABWE	71
Abstract	71
Introduction	73
Methods	74

Results	79
Discussion	85
V. MALE CIRCUMCISION AND WOMEN'S RISK OF CHLAMYDIAL, GONOCOCCAL AND TRICHOMONAL INFECTION	95
Abstract	95
Introduction	97
Methods	98
Results	104
Discussion	109
VI. UNPROTECTED SEX IN HIV-INFECTED WOMEN IN UGANDA AND ZIMBABWE: SHORT- AND LONG-TERM COMPARISONS WITH PRE-INFECTED BEHAVIOR	120
Abstract	120
Introduction	123
Methods	124
Results.....	134
Discussion	141
VII. DISCUSSION	154
Male circumcision and women's HIV/STI risk	155
Summary of findings	155
Interpretation	156
Public health significance	157
Future research directions	157
HIV diagnosis and changes in condom use	159

Summary of findings	159
Interpretation	160
Public health significance	161
Future research directions	162
REFERENCES	165

LIST OF TABLES

Table

2.1. Women’s HIV/STI risk according to partner’s circumcision status	22
2.2. Misclassification of male circumcision status	24
3.1. Sample incident infection coding.....	66
4.1. Selected characteristics of participants at enrollment, Uganda and Zimbabwe, HC-HIV, 1999-2004	92
4.2. Unadjusted and adjusted hazard ratios and 95% confidence intervals for HIV acquisition, comparing women with circumcised partners to women with uncircumcised partners, Uganda and Zimbabwe, HC-HIV, 1999-2004	93
4.3. Sensitivity analysis: corrected HRs for HIV acquisition following three adjustment scenarios for misclassification of male circumcision, Uganda and Zimbabwe, HC-HIV, 1999-2004	94
5.1. Selected characteristics of women at enrollment, Uganda, Zimbabwe and Thailand, HC-HIV, 1999-2004	116
5.2. Unadjusted incidence rates and 95% confidence intervals for Ct, GC and Tv, Uganda, Zimbabwe and Thailand, HC-HIV, 1999-2004	118
5.3. Unadjusted and adjusted hazard ratios and 95% confidence intervals for Ct, GC and Tv, Uganda, Zimbabwe and Thailand, HC-HIV, 1999-2004.....	119
6.1. Selected participant characteristics reported two to six months before HIV diagnosis (HIV-infected women) or anchor visit (uninfected women), Uganda and Zimbabwe, HC-HIV and GS studies, 1999-2006	148
6.2. Coital frequency and condom use by HIV-infected and uninfected participants, Uganda and Zimbabwe, HC-HIV and GS studies, 1999-2006	150

6.3. Zero-inflated negative binomial models assessing changes in number of unprotected sex acts in a typical month following notification of HIV-positive status (HIV-infected participants) or randomly-assigned anchor visit (uninfected participants), Uganda and Zimbabwe, HC-HIV and GS studies, 1999-2006	152
6.4. Zero-inflated negative binomial models assessing changes in proportion of unprotected sex acts in a typical month following notification of HIV-positive status (HIV-infected participants) or randomly-assigned anchor visit (uninfected participants), Uganda and Zimbabwe, HC-HIV and GS studies, 1999-2006	153

LIST OF FIGURES

Figure

2.1. Relationship between HIV prevalence and MC prevalence in Sub-Saharan Africa	25
3.1. Causal model for male circumcision and women's risk of acquisition of HIV/STI (Aim 1).....	67
3.2. Short- and long-term comparisons of unprotected sex acts for HIV-infected and uninfected women, HC-HIV and GS studies, Uganda and Zimbabwe, 1999-2006	68
3.3. Causal model for notification of HIV-positive status and changes in condom use (Aim 2).....	69
3.4. Comparison of fits of regression models using Poisson, zero-inflated Poisson, negative binomial, and zero-inflated negative binomial distributions	70
4.1. Unadjusted Kaplan-Meier curve comparing HIV-free survival time for women partnered with circumcised men to women partnered with uncircumcised men, Zimbabwe and Uganda, HC-HIV, 1999-2004	90
4.2. Unadjusted Kaplan-Meier curves, by population subgroup, comparing HIV-free survival time for women partnered with circumcised men to women partnered with uncircumcised men, Zimbabwe and Uganda, HC-HIV, 1999-2004	91
5.1. Unadjusted Kaplan-Meier curve comparing women's STI-free survival time by baseline circumcision status of the primary partner, Zimbabwe, Uganda and Thailand, HC-HIV, 1999-2004	115

LIST OF ABBREVIATIONS

AAP	American Academy of Pediatrics
AIDS	acquired immunodeficiency syndrome
ACASI	audio computer-assisted self-interview
BV	bacterial vaginosis
Ct	<i>Chlamydia trachomatis</i>
CI	confidence interval
COC	combined oral contraceptive pills
DAG	directed acyclic graph
DMPA	depot medroxyprogesterone acetate
DSMB	data safety monitoring board
ELISA	enzyme-linked immuno-sorbent assay
EMM	effect measure modifier
FHI	Family Health International
FP	family planning clinics
GC	Gonorrhea/ <i>Neisseria gonorrhoeae</i>
GS	Effect of Hormonal Contraception on HIV Genital Shedding and Disease Progression among Women with Primary HIV Infection Study
HC	hormonal contraception
HC-HIV	Hormonal Contraception and Risk of HIV Acquisition Study
HCV	hepatitis C virus
HIV	human immunodeficiency virus
HIVNET	HIV Network for Prevention Trials
HPV	human papillomavirus
HR	hazard ratio

HSV	herpes simplex virus
IR	incidence rate
IRR	incidence rate ratio
MC	male circumcision
MCH	maternal-child health clinics
NB	negative binomial
OD	optical density
OR	odds ratio
PHA	proportional hazards assumption
PCR	polymerase chain reaction
POR	prevalence odds ratio
RCT	randomized controlled trial
QC	quality control
RR	risk ratio
RTI	reproductive tract infection
SAS®	Statistical Analysis System (Cary, NC)
SCHARP	Statistical Center for HIV/AIDS Research & Prevention
SIV	simian immunodeficiency virus
STI/STD	sexually transmitted infection/sexually transmitted disease
TV	Trichomoniasis/ <i>trichomonas vaginalis</i>
UNAIDS	Joint United Nations Program on HIV/AIDS
UNC	University of North Carolina at Chapel Hill
UPS	unprotected sex
WHO	World Health Organization
ZINB	zero-inflated negative binomial

CHAPTER 1: SPECIFIC AIMS

Overview

The World Health Organization (WHO) estimates that over 340 million new cases of curable sexually transmitted infections (STIs) occur among adults worldwide each year. In addition, as of December 2006, nearly 40 million people were living with human immunodeficiency virus (HIV). The vast majority of both STI and HIV infections occur in developing countries, and within these resource-poor settings, women suffer a disproportionate disease burden. Prevention strategies that may lower women's risk of acquiring HIV/STI are therefore an important research priority worldwide. We explored two research areas that may ultimately lead to interventions to reduce women's risk of STI and HIV, thereby reducing the serious morbidities (and in the case of HIV, mortality) associated with these infections.

In a prospective cohort of 6,109 Ugandan, Zimbabwean and Thai women, we examined the role of male circumcision (MC) on women's risk of acquiring HIV/STI. In a subgroup of Ugandan and Zimbabwean women, we compared women's condom use from the period several months prior to HIV diagnosis with that reported in the months and year following notification of HIV-positive status.

MC and female partners' risk of acquisition of HIV/STI

Associations between MC and men's risk of HIV/STI have been well studied; circumcised men appear to have significantly lower risk of HIV acquisition compared to uncircumcised men. The subsequent risk to men's female sex partners, however, is not known. The inner layer of the foreskin is a repository for shed cells and a hospitable environment for growth of bacteria and other microorganisms, possibly resulting in a higher burden of infectious organisms in uncircumcised men and therefore a greater risk of transmission to women. In addition, when the inner layer of the foreskin becomes exteriorized during intercourse, uncircumcised men may expose a greater infectious "surface area" to their partners, increasing the likelihood that women will be exposed to sexually-transmitted pathogens. Finally, MC may have no direct effect on the transmissibility of HIV or STIs from infected men to susceptible women, but if circumcision reduces men's disease risk, women partnered with circumcised men may be less likely to be exposed to sexually transmitted pathogens.

Changes in self-reported condom use following notification of HIV-positive status

Although male condoms are the most effective method currently available to prevent HIV transmission, condom use remains low in many populations. Much of the counseling delivered through HIV prevention programs encourages individuals to increase their use of male condoms. Few studies, however, actually measure behaviors before and after infection; they assume instead that pre-counseling behavior was sufficiently risky to lead to infection, and that self-reported increases in

condom use, or lower rates of subsequent STI or pregnancy, are evidence of a successful counseling intervention. When the behavior of recently HIV-infected individuals has been examined, the results are mixed: some individuals continue to engage in risky sexual behavior, while others report a period of sexual abstinence following infection. Our analysis compares reported condom use in the period prior to infection with condom use several months and one year after notification of HIV-positive status.

Specific Aim 1

To examine primary partner's circumcision status, as reported by their female sex partners, as a risk factor for women's acquisition of HIV and three treatable STIs: *Chlamydia trachomatis* (Ct), *Neisseria gonorrhoeae* (GC), and *Trichomonas vaginalis* (Tv) (each outcome modeled separately).

Aim 1 hypotheses:

We hypothesized that time to HIV infection, and time to first infection with Ct, GC, or Tv, would be shorter for women whose primary partners were uncircumcised than for women whose primary partners were circumcised.

(Analyses addressing Specific Aim 1 are presented in two chapters. Chapter 4 examines the effect of MC on women's risk of HIV acquisition, and Chapter 5 examines the effect of MC on women's risk of chlamydial, gonococcal and trichomonal infection.)

Specific Aim 2

To examine the association between notification of HIV-positive status and changes in women's self-reported use of male condoms.

Aim 2 hypotheses:

1. We hypothesized that women who were notified of HIV-positive status two to six months previously would report *higher* condom use than they had in the pre-diagnosis period, and that HIV-negative participants' condom use over the same period would be unchanged.
2. We hypothesized that women who were notified of HIV-positive status twelve to sixteen months previously would report *similar* condom use as they had reported in the pre-diagnosis period, and that HIV-negative participants' condom use over the same period would also be unchanged.

CHAPTER 2: INTRODUCTION

HIV/STI in women

Women face disproportionately high HIV/STI prevalence. WHO estimates that over 340 million new cases of curable STIs occur among adults worldwide each year.¹ In addition, as of December 2006, nearly 40 million people were living with HIV.² The vast majority of both STI and HIV infections occur in developing countries, and within these resource-poor settings, women suffer a disproportionate disease burden. For example, 57% of HIV infections in sub-Saharan Africa, the region experiencing the most severe HIV epidemic, occur in women and girls.² Cultural, socioeconomic and biologic factors all contribute to women's greater STI vulnerability. Poor health infrastructure, limited economic resources and cultural stigma may restrict women's access to treatment, and some women may also fail to seek out timely medical care because their infections are asymptomatic. When they are treated, security and cultural considerations may make women unable or unwilling to deliver partner treatment, consequently leaving them vulnerable to re-exposure and re-infection.³⁻⁵ In addition, because of a number of physiological factors, women are biologically at higher risk than men when exposed to STI and HIV.⁶ Development of prevention strategies that may lower women's risk of acquiring HIV/STI is an important research priority worldwide.

Male circumcision and women's risk of HIV/STI acquisition (Aim 1)

Male circumcision: history and prevalence

MC is a simple surgery in which the foreskin (prepuce) is removed. The prepuce is the fold of skin over the glans of the penis, composed of an outer keratinized layer and an inner mucosal layer; this inner layer lines a preputial sac. The prepuce is thought to protect the glans from drying out and keratinizing.

MC took place throughout the ancient world. Historians hypothesize that circumcision was performed for a variety of reasons, including hygiene, for infection prevention, in ceremonial sacrifice, to emasculate enemies after battle defeat, as cultural identity (similar to a tattoo), and to cure countless medical and social problems, including epilepsy, headache, rectal prolapse, asthma, gout, clubfoot and alcoholism.^{7,8}

Approximately 25% of the male population worldwide is circumcised,⁹ although MC is substantially more common in the US (in 1999, 1.2 million infant boys in the US (65% of newborn males) were circumcised).⁷ In many parts of the world, only particular religions (including Islam and Judaism) prescribe the surgery. In Europe circumcision is fairly rare outside these religious groups,¹⁰ whereas in the United States, circumcision is often performed at birth regardless of religious affiliation. In 1999 the American Academy of Pediatrics (AAP) revised their policy on circumcision: "Scientific studies show some medical benefits of circumcision.

However, these benefits are not sufficient for the AAP to recommend that all infant boys be circumcised.”¹¹ In some regions (including sub-Saharan Africa), circumcision may be performed in infancy or at puberty as a rite of passage into manhood.¹²

Because of intense media attention given to the results of recent randomized trials documenting MC’s protective effect against HIV acquisition by men (see below), uncircumcised adult men in parts of Africa are reportedly now requesting circumcision from providers.^{13,14} The recent swell in requests for circumcision surgeries may alter typical circumcision practices across the African continent; until now, prevalence of male circumcision has varied by region from close to 0% to close to 100%.¹⁵ Generally, countries in West and Central Africa have higher circumcision prevalence (more than 60% of men circumcised), whereas those in Southern Africa have lower circumcision prevalence (fewer than 40% circumcised), although exceptions exist (Figure 2.1, published in reference 15, data from references 16 and 17). Circumcision correlates in part with the presence of Islam: men in largely Muslim countries are typically circumcised.¹⁸ In other regions, however, cultural and traditional practices prescribe circumcision regardless of religious creed.¹⁸ An inverse, ecologic relationship between circumcision prevalence and HIV prevalence has been noted (Figure 2.1).^{15,18}

MC and men's risk of HIV acquisition

Male circumcision appears protective against HIV acquisition. Three randomized clinical trials (RCTs) evaluating the association between MC and men's HIV risk, conducted in South Africa,¹⁹ Uganda²⁰ and Kenya,²¹ were independently stopped early by their respective data safety monitoring boards when interim analyses showed that circumcised men had 40-65% reduced risk of incident HIV infection compared to uncircumcised men.

Prior to the recent RCTs, more than 50 studies of various designs, including several meta-analyses and systematic reviews,²²⁻²⁶ had evaluated the MC-HIV association in men. The large majority suggested that circumcised men have lower HIV risk than their uncircumcised peers. One 2005 modeling analysis concluded that the per-act risk of transmission from an HIV-infected woman to an uninfected, uncircumcised man is more than twice that for a circumcised man.²⁷

MC and men's risk of STI acquisition

Lack of MC is also a hypothesized risk factor for acquisition of various STIs, including possible links with herpes simplex virus (HSV), gonorrhea, syphilis, chancroid, chlamydia and genital warts.^{28,29} Evidence of the influence of MC on men's risk of gonococcal, chlamydial and trichomonal infection is inconclusive. Uncircumcised men had higher risk of gonorrhea in several studies,³⁰⁻³⁵ but other analyses report no substantial association between circumcision status and GC.^{18,32,36-40} A preponderance of evidence suggests that circumcision status does

not affect men's risk of chlamydial infection. Although three studies found increased risk of Ct infection among uncircumcised men,^{34,41,42} many others^{18,30-32,38-40,43-47} found no association. Many of these analyses were conducted on very small sample sizes or included small numbers of Ct cases. Insufficient data exist to examine the association between male circumcision and trichomoniasis. Two studies (cross-sectional³⁹ and ecologic⁴⁸) both noted no association, but additional research is needed to evaluate any causal link.

Several biologic mechanisms may explain uncircumcised men's increased HIV/STI risk:⁴⁹⁻⁵¹ 1) the nonkeratinized, inner layer of the prepuce may be more susceptible to traumatic epithelial disruptions during intercourse, permitting STI pathogens to move through microscopic abrasions;^{7,52,53} 2) the preputial sac may act as an incubating microclimate, promoting survival of STI microorganisms; 3) the presence of the foreskin may decrease STI detection, thereby increasing the likelihood both of complications and further transmission;⁶ 4) (for HIV acquisition) the highly vascularised prepuce contains high densities of HIV target cells (CD4 T cells, Langerhans cells, and macrophages), which bear the CCR5 and CXCR5 chemokine receptors involved in HIV acquisition. The concentration of these cells in the prepuce is higher than in cervical, vaginal or rectal mucosa,^{43,54} and 5) (for HIV acquisition) uncircumcised men appear to be at higher risk of genital ulceration and balanitis, which facilitates HIV acquisition.^{54,55}

The foreskin also has several protective functions, complicating disease prevention efforts related to MC. Some researchers postulate that the foreskin has numerous immunological functions that confer protection against HIV/STI. The prepuce contains apocrine glands, which secrete cathepsin B, lysozyme, chymotrypsin, neutrophil elastase, cytokine, and pheromones such as androsterone.⁵⁶⁻⁵⁹ Lysozyme destroys bacterial cell walls and attacks HIV.^{56,60,61} Animal studies also suggest that hydrogen peroxide and halide or pseudohalides are present in the prepuce,^{56,62} and this combination forms a powerful antimicrobial system that is effective against a variety of microorganisms.⁶³ Additionally, circumcision opponents argue that there may be no meaningful difference in the keratin layer covering the glans of the penis between circumcised and uncircumcised men (thereby refuting the argument that circumcision is protective because of this keratonization). They cite a study of 13 cadavers in which no substantial difference in keratonization was seen between circumcised and uncircumcised men.⁵¹

Men's circumcision status and women's HIV/STI risk

Almost all existing literature assesses the change in disease risk for men due to MC, without further evaluating how such changes may affect the risk of HIV/STIs to their female sex partners. It is this effect, men's circumcision status on women's risk of acquiring HIV and other STIs, which we address.

Circumcision may have a protective effect on women's HIV risk. Although only a handful of studies have been published, available evidence suggests that women

partnered with uncircumcised men are at higher risk of HIV acquisition than women partnered with circumcised men (Table 2.1).

Prospective studies from two groups suggest that women with uncircumcised partners have higher HIV risk than women partnered with circumcised men. In 1998, urban Tanzanian women with uncircumcised husbands had significantly increased HIV risk compared to women with circumcised husbands (adjusted RR=3.4).⁶⁴ A couples study in rural Uganda (the Rakai Project) published in 2000 among HIV-positive men and HIV-negative women found that the women who were partnered with uncircumcised men had significantly higher HIV risk compared to those partnered with circumcised men (adjusted RR=2.4; authors report inverse RR=0.4).^{65,66} A third report in 2006, also from the discordant couples in the Rakai Project in Uganda, reported that women with uncircumcised partners had an elevated, though non-significant, rate of HIV acquisition compared to women whose partners were circumcised (unadjusted incidence rate ratio=1.6, authors report inverse IRR=0.64).⁶⁷

Cross-sectional studies generated some mixed results, but the bulk of the evidence again suggests that male circumcision is protective against HIV acquisition by female partners. Women in Kenya partnered with uncircumcised men were significantly more likely to be HIV-infected than women whose partners were circumcised (adjusted OR=2.9).⁶⁸ A couples study in Uganda reported that women in HIV-concordant couples were more likely to have an uncircumcised partner than

women in HIV-discordant couples (adjusted OR=6.5).⁶⁹ Women in Brazil who were partnered with uncircumcised HIV-infected men had a higher prevalence of HIV than women whose partners were circumcised (unadjusted OR=2.5; authors report inverse OR=0.4).⁷⁰ Contrary to the other literature, a study of Rwandan women found that having an uncircumcised partner was not significantly associated with HIV prevalence (HIV prevalence=29% in women with circumcised husbands and 31% in women with uncircumcised husbands),⁷¹ and a separate study of pregnant Rwandan women found that those with uncircumcised partners had a *decreased* prevalence of HIV compared to women with circumcised partners (unadjusted POR=0.3, authors report inverse POR=3.5).⁷²

Circumcision has an unknown effect on women's risk of STIs (Table 2.1). Two studies have explored circumcision as a risk factor for women's Ct acquisition.^{67,73} The first, a case-control study of 305 couples, found that lack of MC was strongly associated with increased odds of Ct seropositivity in female partners (OR of 5.56; authors report inverse OR of 0.18).⁷³ The second, described above,⁶⁷ was designed to explore the association between MC and women's risk of incident HIV, but the investigators also examined prevalent Ct, GC and Tv infections in women:⁶⁷ comparing women with uncircumcised partners to those with circumcised partners, for Ct, the PRR was 0.94 (authors report inverse PRR=1.06); for GC, PRR=0.84 (authors report inverse PRR=1.19); and for Tv, PRR=1.54 (authors report inverse PRR=0.65).⁶⁷ Only the association with Tv was significant (MC was protective).

Proposed biologic mechanisms linking MC with women's HIV/STI risk

If uncircumcised men have a higher efficiency of transmitting STI pathogens, including HIV, their partners may have increased risk of acquisition of these infections. When the inner layer of the foreskin becomes exteriorized during intercourse, uncircumcised men may expose a greater infectious “surface area” to their partners, increasing the likelihood that women will come into contact with HIV/STI organisms. In addition, the inner layer of the foreskin is a repository for shed cells and a hospitable environment for the growth of microorganisms, possibly leading to a higher burden of infectious organisms in uncircumcised men and therefore a greater risk of passage of these pathogens to women. HIV/STI-infected uncircumcised men may be more infectious than HIV/STI-infected circumcised men. When male foreskins and female ectocervices from HIV-positive individuals were cultured, foreskins contained nine times the amount of HIV DNA than that found in cervical tissue. In contrast, HIV DNA from the outer surface of the foreskin, which is keratonized like that of a circumcised penis, was below the limits of detection.^{7,74} A study of tissue samples from macaques with simian immunodeficiency virus (SIV) reported SIV-infected cells in the dermis, epidermis, and mucosal epithelium of the penile foreskin.^{75,76} Lastly, uncircumcised men who are coinfectd with ulcerative STIs may shed HIV and other bacterial STIs more prolifically than circumcised men.

Misclassification of MC

Because MC in our analyses was self-reported by female partners, we also explored the role of misclassification of men's circumcision status. In the 1950s, a large US

study reported extremely low sensitivity (44%) and less-than-stellar specificity (83%) for men's reporting of their own circumcision status.⁷⁷ If such misclassification exists but goes undetected, and the misclassification is nondifferential with respect to disease status, the true effect of MC would be more extreme than what is reported in many studies.^{43,78}

In response to threats to validity from misclassification of circumcision status, several studies have quantified the accuracy of circumcision measures by comparing to the "gold standard" of clinician verification (Table 2.2). Of particular relevance, four studies examined the accuracy of women's classification of their partner's circumcision status.⁷⁹⁻⁸¹ (and R. Gray, unpublished) Compared to clinician-recorded circumcision, Rwandan women's reports in one study were 94% sensitive and 89% specific.⁷⁹ A decades-old US study of cervical cancer reported that women assessed their husband's circumcision status with 70% sensitivity and 79% specificity compared to clinician examination.⁸¹ Of note, 19-27% did not know whether their husbands were circumcised.⁸¹ A third study, also conducted in the US, queried men and women separately about the circumcision status of the male partner. The authors reported that both partners had fairly high sensitivity (92%) and specificity (94%) in identifying the male's circumcision status.⁸⁰ The fourth report, unpublished, is from a couples study in Rakai, Uganda, compared women's reports about their partners to the men's reports and found that women classified MC with 92% sensitivity and 97% specificity (Ron Gray, unpublished data).

Notification of HIV status and condom use among women (Aim 2)

Women in resource-poor regions have higher HIV/STI rates and face greater morbidities as a result of HIV/STI infection than their male counterparts. This disparity has many causes, and solutions involve both individual behavioral modification and societal changes to traditional sexual norms. Our analysis examined one behavioral change – increased male condom use – and the role that HIV diagnosis plays in inducing and sustaining this change.

Public health interventions are often targeted to reach individuals at the moment of disease diagnosis, since those affected may initially have increased motivation to respond to the intervention. In the case of HIV diagnosis, since results are usually given in clinical settings, the availability of immediate counseling may make women more open to the training and tools (e.g. condoms) provided to facilitate change.

Nevertheless, a positive HIV diagnosis may lead to at least three disparate outcomes: it may be an incentive for behavior change to avoid future transmission, and therefore risk-taking may decrease; it may lead to no change in risky behaviors, if the infection is not associated with sufficient worry to the individual or she lacks skills to avoid future transmission; or it may lead to increased risky behavior, since “the worst” has now happened and the individual has no incentive to limit risk-taking.⁸²

Changes in many types of behavior are possible following HIV diagnosis, such as reducing the number of new and existing sexual partners, or eliminating concurrent partnerships. Because our cohort enrolled largely married, monogamous women – most of whom already avoided these risky behaviors – we focused instead on changes in use of male condoms.

Male condoms and HIV/STI prevention

Although the subject of some political debate in recent years,^{83,84} latex male condoms, when used consistently and correctly, are effective against sexual transmission of HIV and most STIs.⁸⁵⁻⁸⁸ Analyses considering manufacturer failure rates, user failure rates, pathogen characteristics and other factors found effectiveness statistics ranging from 69%-95% against HIV.^{89,90} It is generally accepted that intact latex condoms provide an effective barrier to HIV-sized particles, though transmission is possible when condoms break or slip.⁹¹

Condoms are also important for population-level control of STIs, including HIV. Simulation models suggest that condom use can significantly alter population disease prevalence. For STIs with high transmission rates (e.g., gonorrhea), consistent condom use can adequately control disease spread.⁹² For low-transmission STIs (e.g. HIV), even inconsistent condom use has some benefit.^{93,94} Nevertheless, condom use remains low in many regions and in populations similar to ours.

Condom counseling following notification of HIV-positive status

Condom counseling is a common component of HIV post-test counseling, but the format varies. Whether it occurs in the context of a public health intervention or routine clinical care, counseling is often required following an HIV test (whether the test is positive or negative). The format, content, length and setting of counseling varies widely: sessions may be delivered individually or in groups, be didactic or interactive, and include demonstrations or role-playing.⁹⁵

The goal of increasing condom use, for individuals who have been recently infected, is to prevent subsequent transmission to partners. However, counseling is not always effective at increasing condom use. Although sustained increases in condom use in individuals receiving “enhanced” counseling (compared to more abbreviated programs) have been reported,⁹⁶⁻⁹⁹ other programs see initial success followed by subsequent regression to baseline levels,¹⁰⁰⁻¹⁰² and still others find little or no effect of counseling interventions.¹⁰³⁻¹⁰⁵

No available studies have prospectively measured condom use before and after HIV/STI diagnosis. Most condom counseling programs are conducted at the moment of HIV diagnosis, and all participants have just been given their positive result. When comparing condom use before and after the intervention, therefore, the “pre-intervention” measure of condom use is recorded *after* participants learn they are HIV-infected. Such condom use measures may be biased down (*i.e.*, individuals report lower than true condom use) or up (individuals report higher than true

condom use) because of participants' new knowledge of their infection status. An alternative design is to compare behaviors of HIV-infected individuals to a similar HIV-negative population to detect any differences that might be due to notification of HIV-positive status. Measures of condom use for these individuals may be similarly biased. Existing research suffers from another limitation: it has been conducted largely among specialized, high-risk populations (for example in the US, in adolescents or gay men; in international settings, in sex workers or truckers) and is not generalizable to the general population women in our study. Nevertheless, in the absence of relevant studies comparing behavior before and after notification of HIV positive status, below we review the existing literature on behavior change following STI or HIV diagnosis.

Behavior change following STI infection

Self-reported past STI in men is correlated with future risky behavior. Men generally report equivalent or increased risky behavior in the period following STI diagnosis. In a US study 25% of men had sex while infected with an STI (85% of those men claimed to have told their partner before sex) and 29% did not modify their behavior in any way following STI (e.g., no changes in condom use behavior or number of sex partners).¹⁰⁶ French men with past STI history had significantly increased likelihood of engaging in high-risk unprotected sex than men who did not have a prior STI.¹⁰⁷ In a cohort of high-risk, heterosexual, Indian men, among 56% with an STI history at baseline, the likelihood of visiting a sex worker increased during the

follow-up period. However this group also reported more consistent condom use with both sex workers and other partners.¹⁰⁸

Past STI in US adolescents is associated with increased STI prevention knowledge and temporary abstinence, but also high rates of multiple partnerships and repeat STI. Adolescents with prior STI initially report reduced risky behaviors, but over time, sexual risk taking resumes to or increases beyond baseline levels. Although they may temporarily abstain from sex and, when initially resuming sexual activity, report higher condom use than uninfected peers,¹⁰⁹⁻¹¹¹ adolescents previously infected with STIs also report higher rates of multiple partnerships and subsequent infections.^{82,109,110,112-115} Condom use rates that were higher early in follow-up are typically not sustained,^{102,110,114} and other high risk behaviors, such as sex while intoxicated and unprotected sex with multiple partners, are higher among those with a previous STI.¹¹⁴ Of interest, participants with past STI often report better STI prevention knowledge than those without prior STI.¹¹⁴

Adult women with past STI have increased condom use but also increased risk of subsequent STI. As with men and adolescents, self-reported STI history in women is associated with higher future condom use.^{99,107,116,117} Women with prior STI also experience higher rates of subsequent STI,^{118,119} although STI rates were lower in women receiving a specialized condom promotion intervention compared to the standard counseling program.⁹⁹ In one of few studies in international settings, South

African women recruited from STI clinics reported continuing sexual activity, 92% without condoms, despite knowledge of current infection.¹²⁰

Behavior change following HIV infection

Risky behavior in HIV-positive people is more difficult to characterize generally than behavior in STI-positive individuals. While many continue to engage in high-risk behavior, others adopt higher levels of condom use. No study has prospectively measured condom use before and after HIV acquisition.

A meta-analysis of HIV counseling covering studies conducted between 1985 and 1997 found that the benefits of counseling were more apparent in those testing HIV-positive than those testing negative.¹²¹ HIV-positive people (and HIV serodiscordant couples) generally increased their condom use, whereas HIV-negative people generally did not change condom use behavior. HIV-positive people generally had lower STI rates following counseling, whereas HIV-negative individuals had STI rates similar to uncounseled populations.¹²¹ Another review found a significant increase in condom use and abstinence over time in HIV-positive women receiving counseling, particularly when a woman's partner was also counseled. In general, the authors report that HIV-positive individuals are more likely to use condoms than HIV-negative individuals.¹²²

Some HIV-positive women reduce risk behaviors, but others become pregnant and acquire STIs after HIV seroconversion. Several studies from international settings

characterized the risk behaviors of HIV-positive women, with varying results. In some areas (Democratic Republic of Congo and Kenya), HIV counseling and testing had little impact on fertility rates in HIV-positive women,^{123,124} whereas HIV-positive Ugandan women had lower pregnancy rates than their HIV-negative peers.^{125,126} HIV-positive Rwandan women were more likely to use condoms, and had lower GC prevalence, than HIV-negative women.¹²⁷ In the US, substantial numbers of HIV-positive women become pregnant and experience STIs after HIV diagnosis.^{128,129}

In the US, many HIV-positive individuals continue to engage in high-risk behavior. Both adolescents and adults continued to engage in risky behavior following HIV diagnosis,¹³⁰ with high proportions experiencing STI in the period after seroconverting to HIV.^{131,132} Although HIV-positive people receiving counseling may have higher rates of condom self-efficacy and report fewer acts of unprotected sex, they do not report changes in their number of sex partners.¹³³

TABLE 2.1. Women's HIV/STI risk according to partner's circumcision status

Citation	N	Design	Population & location	Outcome	Finding	Adjusted for:
73	305 couples	Case-control	Case women with cervical carcinoma <i>in situ</i> or invasive cervical cancer and their partners; frequency matched control women and their partners, in Spain, Colombia, Brazil, Thailand, Philippines	Ct	OR=0.18 95% CI: 0.05-0.58 (MC protective)	Site, male and female age, male and female lifetime # sexual partners
				Ct	PRR=1.06 95% CI: 0.61-1.84 (MC had no effect)	Not adjusted
67	343 couples	Prospective	HIV serodiscordant couples (male HIV-positive, female HIV-negative) from rural communities in Rakai, Uganda	GC	PRR=1.19 95% CI: 0.51-2.79 (MC had no effect)	Not adjusted
				Tv	PRR=0.65 95% CI: 0.55-0.77 (MC protective)	Not adjusted
64	2,471 women	Prospective	FP clinic attendees in Dar es Salaam, Tanzania	HIV	RR=3.41 95% CI: 1.03-11.29 (MC protective)	Age, marital status, # sex partners in last year, gonorrhoea, candidiasis, history of alcohol consumption in follow-up period
65,66	228 couples	Prospective	HIV serodiscordant couples (male HIV-positive, female HIV-negative) from rural communities in Rakai, Uganda	HIV	RR=0.41 95% CI: 0.10-1.14 (MC protective against HIV transmission from men with viral loads <50,000 copies/ml)	Viral load, age, number of sex partners, GUD, genital discharge, dysuria, syphilis, gonorrhoea, chlamydia, trichomonas, BV
67	343 couples	Prospective	HIV serodiscordant couples (male HIV-positive, female HIV-negative) from rural communities in Rakai,	HIV	IRR = 0.64 95% CI 0.27-1.32 (MC protective)	Not adjusted

Citation	N	Design	Population & location	Outcome	Finding	Adjusted for:
			Uganda			
68	4,404 women	Cross-sectional	FP clinic attendees in Nairobi, Kenya	HIV	OR =2.9 95% CI: 2.0-4.2 (MC protective)	Age, marital status, education, gravidity, age at coital debut, gravidity, # lifetime sex partners, transactional sex, sex during menstruation, history of injections, blood transfusions, positive syphilis, positive Tv, history of GC, positive GC
69	49 HIV concordant & 126 discordant couples	Cross-sectional	Couples receiving voluntary HIV counseling and testing in Kampala, Uganda	HIV	OR=6.5 95% CI: 1.6-26.4 (MC protective)	Living together, STI history in last 6 months, log increase in HIV viral load
70	109 couples	Cross-sectional	Female partners of HIV-infected men in Brazil	HIV	OR=0.4 95% CI: 0.1-1.1 (MC protective)	Not adjusted
71	1,458 women	Cross-sectional	Representative sample of childbearing women recruited from outpatient prenatal and pediatric clinics in Kigali, Rwanda	HIV	29% with circumcised husbands & 31% with uncircumcised husbands were HIV-positive (MC had no effect)	Not adjusted
72	5,690 women	Cross-sectional	Pregnant women seeking antenatal care in Butare, Rwanda	HIV	POR=3.5 95% CI: 2.7-4.7 (MC harmful)	Not adjusted

TABLE 2.2. Misclassification of male circumcision status.

Reference	Sensitivity	Specificity	Study location
<i>Classification by men*</i>			
77	44%	83%	United States
134	51%	96%	United States
135	66%	79%	United States
32,136	88%	99%	Spain, Colombia, Brazil, Thailand, Philippines
137	89%	84%	Panama, Costa Rica, Colombia, Mexico
78	92%	68%	United States
138	94%	72%	Tanzania
139	96%	94%	Kenya
30	98%	99%	Australia
31	98%	99%	United States
45	~100%	~100%	Kenya
140	47%	93%	United States
<i>Classification by women about their partners*</i>			
79	86%	94%	Rwanda
81	70% [†]	79% [†]	United States
80	92%	94%	United States
Gray R	92%	97%	Uganda

* All reports except Gray R (unpublished) compare to clinician exam as the gold standard. The Gray report compares women's reports to men's reports.

† Clinician classification of "uncircumcised" - glans 2/3 to completely covered by foreskin; "circumcised" - foreskin completely absent or foreskin covered up to 2/3 of glans.

FIGURE 2.1. Relationship between HIV prevalence¹⁴¹ and MC prevalence^{16,17} in Sub-Saharan Africa.¹⁵

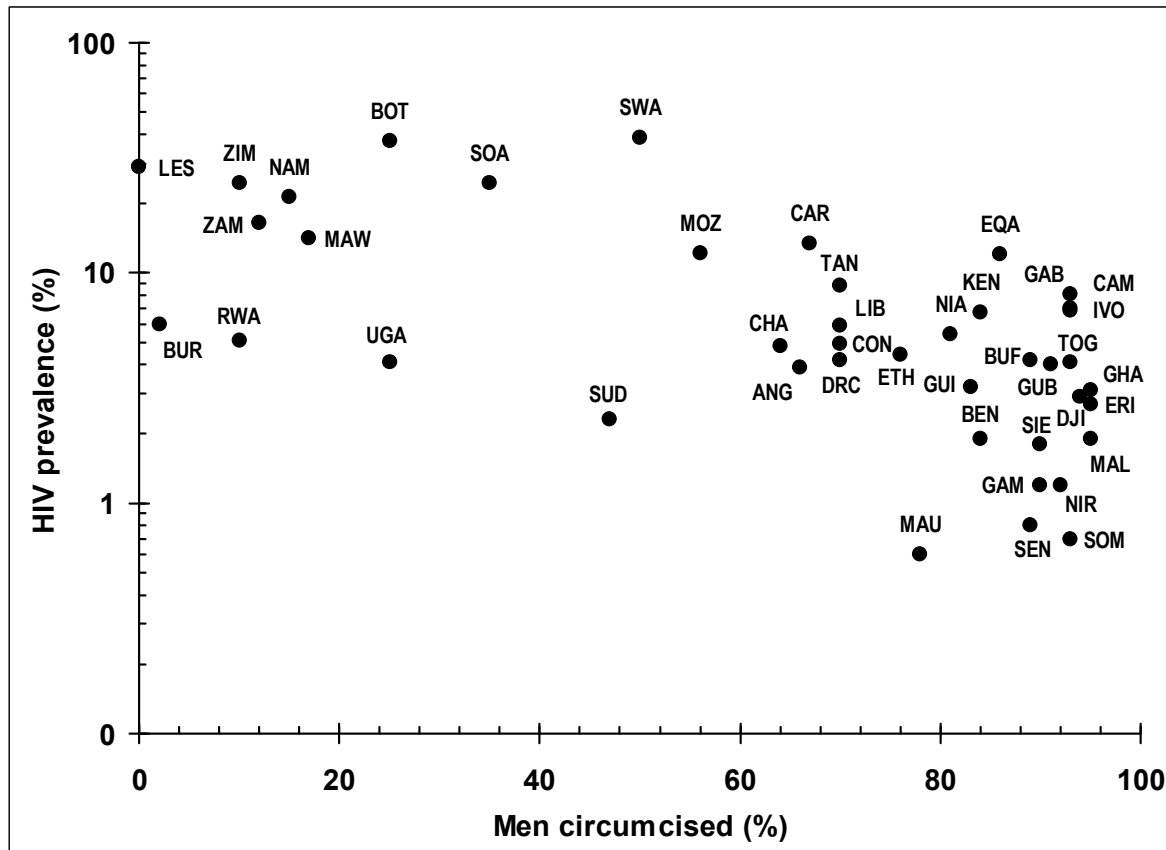

LEGEND

- | | |
|---------------------------------------|-------------------|
| ANG: Angola | LES: Lesotho |
| BEN: Benin | LIB: Liberia |
| BOT: Botswana | MAL: Mali |
| BUF: Burkina Faso | MAU: Mauritania |
| BUR: Burundi | MAW: Malawi |
| CAM: Cameroon | MOZ: Mozambique |
| CAR: Central African Republic | NAM: Namibia |
| CHA: Chad | NIA: Nigeria |
| CON: The Congo | NIR: Niger |
| DJI: Djibouti | RWA: Rwanda |
| DRC: Democratic Republic of the Congo | SEN: Senegal |
| EQA: Equatorial Guinea | SIE: Sierra Leone |
| ERI: Eritrea | SOA: South Africa |
| ETH: Ethiopia | SOM: Somalia |
| GAB: Gabon | SUD: Sudan |
| GAM: Gambia | SWA: Swaziland |
| GHA: Ghana | TAN: Tanzania |
| GUB: Guinea Bissau | TOG: Togo |
| GUI: Guinea | UGA: Uganda |
| IVO: Cote d'Ivoire | ZAM: Zambia |
| KEN: Kenya | ZIM: Zimbabwe |

CHAPTER 3: METHODS

We conducted these secondary analyses using data from the “Hormonal Contraception and the Risk of HIV Acquisition” (HC-HIV) study (formerly HIVNET protocol 021). HC-HIV was a multi-center, prospective cohort study conducted in Uganda, Zimbabwe and Thailand, with a primary aim to evaluate the effect of low-dose combined hormonal contraceptive pills (COCs) and injectable depot medroxyprogesterone acetate (DMPA) on women’s risk of HIV acquisition. Additional data for Aim 2 analyses came from an ancillary study of HC-HIV, the “Effect of Hormonal Contraception on HIV Genital Shedding and Disease Progression among Women with Primary HIV Infection” (GS) study. The purpose of GS is to examine the effect of hormonal contraception on HIV genital shedding and disease progression among women who became HIV-infected during HC-HIV.

Data sources

HC-HIV study

Study population

HIV-seronegative women (n=6,109) were recruited over a 34-month period from November 1999 through September 2002. To answer the primary study aim, users

of COCs and DMPA and women not using hormonal contraception (HC) were recruited in approximately equal numbers in each country.

Study setting

Women were enrolled from three sites in Kampala, Uganda; four sites in Harare and Chitungwiza, Zimbabwe; and seven sites in Chiang Mai, Khon Kaen, Hat Yai, and Bangkok, Thailand. Initially, women were recruited from family planning (FP) and maternal-child health (MCH) clinics; however, owing to low initial HIV incidence rates in the family planning population in Uganda, and especially in Thailand, recruitment was expanded to include higher-risk populations (see below). These participants were referred through STI clinics or primary health care clinics when women presented with STI symptoms. They included military wives and those referred through sex worker networks. These women met all study eligibility criteria.

Eligibility criteria

To enroll in HC-HIV, women had to be 18 to 35 years of age; sexually active (at least three sex acts in the past three months); if parous, at least 4.5 months post-partum; HIV seronegative; and using a) low dose COCs for at least three months with intention to continue for the next 12 months, or, b) DMPA for at least three months with intention to continue for the next 12 months, or, c) a non-hormonal method or no contraceptive method.

Exclusion criteria

Women were excluded who were pregnant or intending to become pregnant in the next 12 months; used an intrauterine device (IUD) in the last month; used any HC besides COCs or DMPA in the previous three months; used COCs in the last three months or DMPA in the previous six months (and no longer using that method); injected illicit drugs within the previous three months; received a blood transfusion within the previous three months; had a hysterectomy; had an abortion (spontaneous or induced) within the previous month; or was participating or had previously participated in an HIV vaccine trial.

Procedures

At screening, women were assessed for study eligibility, consented, and specimens were collected for HIV, syphilis and HSV-2 testing. Women returned within 15 days for their test results, and if HIV-negative and otherwise eligible, were invited to join the study. At the baseline visit they were re-consented, interviewed about their reproductive, contraceptive and sexual behavior, and examined. Specimens were collected to diagnose vaginal and cervical infections.

Follow-up clinic procedures were similar to those conducted at baseline, and visits were conducted approximately every three months for up to two years.

Recruitment and retention

Most participants (n=5,223; 85%) were recruited during routine visits to FP or MCH clinics. Women were approached by staff in the waiting room and given information about the study. A prescreening instrument of six questions was used to determine preliminary eligibility, including questions about age and contraceptive method.

Interested women were then invited to participate in formal screening for the study.

Some higher risk participants (n=886; 15%) were referred through STI clinics, primary health care clinics if they presented with STI symptoms, or sex worker networks. Staff attended these clinics and spoke to potentially eligible women as they waited to be seen by clinicians. Staff invited these women to return to a FP or MCH clinic routinely used for HC-HIV study procedures.

If a participant failed to appear for a scheduled visit, staff attempted to contact her by telephone, mail and through home visits. Overall retention was 92% at 24 months and was very similar across contraceptive groups.

Data collection

All behavioral data were recorded on paper forms during face-to-face interviews conducted by trained interviewers with individual participants. All clinical exam data were recorded on paper forms by trained clinicians during and following physical exams. Testing for some reproductive tract infections (including trichomonal infection, bacterial vaginosis (BV) and candidiasis) was performed at the clinic using

microscopy. In Uganda and Thailand, study clinicians carried out this testing and recorded the results on paper forms. In Zimbabwe, microscopy was performed by on-site laboratory technicians. Other diagnostic assays were performed off-site by laboratory personnel; clinicians then transcribed biomedical data from laboratory source documents onto paper forms.

At screening for HC-HIV, the short Screening Eligibility form was administered by staff to each potential participant to determine her eligibility. This form assessed inclusion and exclusion criteria, and also recorded demographic data to enable investigators to accurately characterize the screened population. At screening women provided blood samples for HIV, HSV-2 and syphilis testing, and the results were recorded on the Screening Laboratory Results form.

Women returned to the clinic within 15 days for their enrollment visit. At this visit, staff administered the Baseline Questionnaire form, which collected demographic information, current and past contraceptive use, and current and past sexual behavior. Participants underwent a pelvic exam, and clinicians recorded their observations and the results of on-site diagnostic procedures for Tv, candidiasis and bacterial vaginosis on the Physical Exam form. Cervical swabs were collected to test for chlamydial and gonococcal infection, and the results of the laboratory assays that identified these infections were later recorded on the Laboratory Results form.

Women were followed every 12 weeks for approximately two years (median follow-up was 22 months). At follow-up visits, participants were interviewed using the Follow-up Questionnaire form, which again captured information on contraceptive use, sexual behavior, partner's sexual behavior, and STI symptoms. They underwent a physical exam, and clinicians again recorded their observations and diagnoses for Tv, candidiasis and bacterial vaginosis on the Physical Exam form. Serum and cervical samples for testing for HIV, Ct and GC were collected, and the results of these assays were recorded on the Laboratory Results form.

HIV/STI diagnosis

HIV

At screening and each follow-up visit, 10-15 cubic centimeters of blood was collected from each woman for HIV testing. Serum was separated and stored in 2 ml aliquots. Aliquots not used for immediate serologic testing were stored at -80°C. A participant was considered HIV-positive if she was positive on a combination of two enzyme-linked immunosorbent assays (ELISA) and/or rapid tests and Western blot positive, or, polymerase chain reaction (PCR) positive. If the initial ELISA was positive, a rapid test was used for confirmation testing. Negative or indeterminate results were resolved by using a second rapid test. Western Blots were performed on women who had two positive results on ELISA or rapid tests. In the case of continued indeterminate results, HIV PCR testing was performed as the final arbiter of HIV status.

When an incident HIV infection was identified, the participant was called back for a retest to rule out labeling errors. If she had a positive ELISA or rapid test at that visit she was considered HIV-positive. Serial testing with HIV PCR using stored specimens from prior visits was conducted to accurately date incident HIV infections.

Serum specimens were processed and stored at the local site laboratory. Diagnostic testing was performed at the local site laboratory or at a certified laboratory within each country.

Neisseria gonorrhoeae and *Chlamydia trachomatis*

Endocervical specimens were collected at enrollment and at all follow-up visits for diagnosis of both gonococcal and chlamydial infection. After collection, swabs were vigorously agitated in a collection tube for up to 15 seconds and then discarded. Samples were processed using PCR (AMPLICOR® Ct/NG Test, Roche Diagnostics, Somerville, NJ, USA). This assay detects both Ct and GC infections using a single swab. For Ct, optical density (OD) >0.8 was positive, and for GC, OD>2.5 was positive. Negative results were indicated for OD <0.2 for Ct, and OD <0.2 for GC. Testing was repeated for results in the “gray zone” (for Ct: OD of 0.2–0.8; for GC, OD of 0.2–2.5).

As with serum samples, cervical specimens were processed and stored at the local laboratory for each site. Diagnostic testing was also performed at the local site laboratory or at a certified laboratory within each country.

Trichomonas vaginalis

At enrollment and each follow-up visit, clinicians touched a cotton swab to the lateral vaginal wall and then suspended it in 1-2 ml sterile saline to make a wet mount. The fluid was examined under low (10x) and high (40-45x) magnification for the presence of motile flagellated trichomonads. Identification of trichomonads indicated positive Tv infection.

HIV/STI diagnosis and partner notification

At HC-HIV screening, women who tested positive for HIV were ineligible for the study. They were given intensive post-test counseling and referred both to a support group for HIV-positive women and for additional counseling services. Women were told that their partners could receive free HIV testing and counseling at the clinic. All HIV-positive women were made aware of relevant research studies for which they might be eligible.

If an enrolled participant tested positive for HIV during the HC-HIV study, she was called back for a redraw visit (10-21 days after the initial test) to rule out labeling errors. At the redraw visit, counselors informed the woman that her HIV test appeared positive, but that further confirmatory tests were needed. A definitive

result was given to the participant 1-2 weeks after the redraw visit. Women were told that their partners could receive free HIV testing and counseling at the clinic.

Women who were confirmed HIV-positive were told they were no longer eligible to participate in HC-HIV, but they were invited to join GS (in Uganda and Zimbabwe) (see below).

Testing for curable STIs was not performed at screening. If participants tested positive for curable STIs at enrollment or during HC-HIV follow-up, they were given treatment and told that their partners could also receive STI testing and treatment from the study. Women were again counseled about STIs and condom use, and participants were given condoms to take home if desired.

Treatment of curable STIs varied across study sites and during the follow-up period. Data were not collected on whether women's partners were tested or treated.

Data management

Data entry for HC-HIV was completed using the DataFax data management system. DataFax breaks up each fax into individual pages, corrects any misalignment problems, flips pages faxed upside down, identifies which participant each page belongs to, reads the data, enters the data into the study database, and stores all pages as electronic images. DataFax generally reduces the amount of data cleaning required after study termination, since it automates much of the clerical work involved in data entry and speeds necessary corrections to incorrect data.

At the end of each day, all forms completed by study staff were sent to the Project Office at each site. Each site faxed completed paper forms over ordinary phone lines. Data management staff used DataFax validation tools (such as logic and range checks) to review all pages received, complete data entry and flag any problems (e.g., missing or potentially incorrect data). At least two people viewed every form received to ensure accuracy and data quality. On a pre-established schedule, a quality control (QC) report was generated and faxed back to each site. The QC reports showed the follow-up status of all screened and enrolled participants at that site and identified any problems flagged during the data review. Sites were asked to correct any problems and refax the corrected form pages. When received, the data management staff reviewed them again and updated the study database.

The data were managed by the Statistical Center for HIV/AIDS Research & Prevention (SCHARP), part of the Public Health Sciences Division of the Fred Hutchinson Cancer Research Center in Seattle, WA. SCHARP personnel provided a complete copy of the HC-HIV dataset for these analyses.

Main findings

HC-HIV's main findings have been reported previously.¹⁴² Neither COCs nor DMPA was associated with increased risk of HIV acquisition among women (HR for COCs: 0.99, 95% CI: 0.69 to 1.42; HR for DMPA: 1.25, 95% CI: 0.89 to 1.78).

GS study

Eligibility criteria for GS were similar to those for HC-HIV. In addition, all GS participants were HIV-infected, and women who were pregnant or using an IUD were permitted to enroll.

Procedures

All women at the Zimbabwe and Uganda HC-HIV sites, who experienced HIV infection during follow-up, were invited to enroll in GS. GS participants who joined soon after HIV diagnosis had multiple early follow-up visits (at 2, 4 and 8 weeks after GS study entry); follow-up visits then took place, as in HC-HIV, approximately every three months. At each GS visit the standard HC-HIV questionnaires were administered to collect information on reproductive variables, contraceptive exposure and recent sexual behavior. A pelvic exam was performed, and blood, cervical and vaginal specimens collected for STI diagnosis. Study participants continued to receive their chosen contraceptive method.

Unless otherwise specified, procedures for GS were the same as described above for HC-HIV.

Data management

Data management for GS was conducted by SCHARP through July 2003; Family Health International (FHI) subsequently assumed management of the GS data.

Following each visit, questionnaire, physical exam and laboratory forms were checked at the site for accuracy and completeness. They were then transmitted to the Data Management division at FHI, where data were entered and QC and data management procedures were conducted using the ClinTrials software system (Clintrials Research Inc., Cary, NC). FHI personnel provided a complete copy of all relevant GS data for these analyses.

Analytic overview

Our analyses answered two secondary research questions: 1) is primary partner's circumcision status associated with women's risk of acquiring HIV or three treatable STIs (Ct, GC or Tv)? and 2) is notification of HIV-positive status associated with changes in participants' self-reported condom use over the short- or longer-term?

Aim 1 analyses

Using the HC-HIV data, Aim 1 examined MC as a risk factor for women's acquisition of HIV, Ct, GC, and Tv.

Analysis population

Aim 1 analyses were performed on enrolled women:

- 1) completing at least one follow-up visit with valid HIV/STI results (depending on the outcome under investigation)
- 2) reporting a primary partner and subsequently answering questions about that partner's circumcision status

- 3) returning for follow-up within 28 months of enrollment
- 4) using one or more contraceptive methods (COCs, DMPA or non-hormonal methods) under study for the primary objective of HC-HIV (women using exclusively non-study methods were excluded).

For the analysis of MC and HIV, women were censored after becoming infected with HIV. Only four HIV infections occurred in the Thai cohort during follow-up, so Thai women (n=1,578) were excluded from HIV analyses but not from STI analyses. For the STI analyses, women were censored after their first infection with the individual STI under investigation.

Outcome assessments

Each model for Aim 1 used a dichotomous outcome coded as 0 (no incident infection) and 1 (incident infection). Infections were diagnosed as described above.

HIV: Incident HIV infection was defined as the first positive HIV result in a previously HIV-negative woman.

Chlamydia trachomatis: Initial incident Ct infection was defined as the first positive Ct result at a follow-up visit in a woman who was Ct-negative at all previous visits; or, the first positive Ct result in a woman who previously had missing or indeterminate Ct results at a follow-up visit, followed by a confirmed negative result, prior to her first positive Ct (see example in Table 3.1).

Neisseria gonorrhoeae: Initial incident GC infection was defined as the first positive GC result at a follow-up visit in a woman who was GC-negative at all previous visits; or, the first positive GC result in a woman who previously had missing or indeterminate GC results at a follow-up visit, followed by a confirmed negative result, prior to her first positive GC (Table 3.1).

Trichomonas vaginalis: Initial incident Tv infection was defined as the first positive Tv result at a follow-up visit in a woman who was Tv-negative at all previous visits; or, the first positive Tv result in a woman who previously had missing or indeterminate Tv results at a follow-up visit, followed by a confirmed negative result, prior to the first positive Tv (Table 3.1).

Any STI: Initial incident STI infection was defined as the first positive STI result (Ct, GC or Tv) at a follow-up visit in a woman who was STI-negative at all previous visits; or, the first positive STI result in a woman who previously had missing or indeterminate STI results at a follow-up visit, followed by confirmed negative results for all three infections, prior to the positive STI.

Time: Person-time was calculated as the number of months from the baseline visit to either a) the date of HIV or STI diagnosis in those experiencing infection, or b) the date of last study contact for women lost to follow-up (censored), or c) the date of the last study visit for participants remaining infection-free for their full study duration. A small group of women had extended follow-up, however, because follow-

up officially ended at the visit following 24 months, we censored follow-up time from all participants after 28 months.

Exposure

All five analyses (for outcomes HIV, Ct, GC, Tv, and any STI) for Aim 1 used the same exposure variable: primary partner's circumcision status as reported by women. In preliminary univariable and bivariable analyses, MC was treated as a three-level variable coded 0 (not circumcised), 1 (circumcised) and 2 (women does not know partner's circumcision status). In multivariable models for HIV, follow-up intervals where women reported they did not know their partner's circumcision status were excluded, and MC was treated dichotomously: 0 (not circumcised) and 1 (circumcised). In multivariable models for the STI outcomes, MC was modeled as a three-level variable: not circumcised, circumcised, and of unknown circumcision status (coded as two indicator variables with uncircumcised partners as the common referent group).

At baseline and each follow-up visit, women were asked first "In the last three months, have you had a primary partner? By primary partner, we mean your husband, someone with whom you live, or your boyfriend..." Those women who answered yes were later asked, "Is this partner circumcised?" This question was repeated at each follow-up visit. If women's primary partner changed, the circumcision status of the new partner was recorded; MC was therefore permitted to vary over the follow-up period.

Covariables

A large number of covariables were assessed through preliminary univariable, bivariable and simple multivariable analyses prior to the modeling phase of the analysis.

Covariables fell into several categories: demographic (age, marital status, education, occupation, ethnicity, other socioeconomic (SES) factors), reproductive characteristics (contraceptive history, age at coital debut, gravidity, use of vaginal drying products), risk behavior (alcohol use, number of sex partners, new sex partners, sex work, STI history during the study, sexual concurrency, condom use), and risk characteristics (reported by women) of the primary partner (his age, HIV/STI status, STI symptoms, occupation, time spent away from home, concurrency).

Variables considered for inclusion in multivariable models are shown in Figure 3.1, depicting a Directed Acyclic Graph (DAG).¹⁴³ To simplify the graphic, only relationships between the exposure, outcome and each covariable have been drawn; additional relationships between covariables are present but not depicted. Of note, using DAG methodology, only religion (unmeasured), ethnicity (measured) and SES could confound the main association. Nevertheless, each covariable in the DAG was evaluated in turn since they had been included in previous analyses of this and similar research questions.

Unmeasured variables

Some variables identified as confounders in previous studies of circumcision and HIV/STI (in men) were not measured in this study and so were not included in our analyses. These include:

1. men's age at circumcision: some evidence suggests that the age at which circumcision is performed changes its possible protective effect against HIV^{144,145}
2. "degree" of circumcision in partners¹⁴⁶
3. men's hygiene practices¹⁴⁷⁻¹⁴⁹
4. urbanicity, mobility,²² and other unmeasured socioeconomic factors¹⁵⁰
5. religion¹⁵¹⁻¹⁵⁴
6. male partner's ethnicity¹⁵³

Univariable analyses

For all variables, we first evaluated the frequency of missing data and identified outliers. We assessed the mean, median, standard deviation and overall distribution of each continuous variable using graphical data displays. We considered various categorization schemes for continuous variables, and developed meaningful cut-points using previous literature, critical percentiles, and based on the distribution of the data. We inspected the frequencies of all dichotomous and categorical variables.

Bivariable analyses

The relationships between each variable and the main exposure, and between each variable and each outcome, were evaluated using unadjusted Cox proportional hazards models.¹⁵⁵

Multivariable analyses

Preliminary assessments of effect measure modification and confounding

We hypothesized that HC use, pregnancy, age, country, and source population (e.g., recruitment from FP/MCH clinics vs. higher-risk settings) could modify the circumcision-HIV/STI association (the “main association”). To evaluate them as possible effect measure modifiers (EMMs), we compared the magnitude and precision of the main association within each level of each possible modifying covariable in turn;¹⁵⁶ we also made qualitative assessments about the importance of presenting stratified estimates of effect for each variable. For each potential EMM, we ran a simple Cox model containing partner’s circumcision status, HIV/STI, the potential EMM, and an interaction term between MC and the possible EMM. We examined the p-value for the interaction term, and interpreted values lower than $\alpha=0.10$ as evidence of substantial heterogeneity in the stratum-specific measures of effect.¹⁵⁷ For variables that appeared to be strong EMMs, we included in the starting multivariable model interaction terms between MC and these variables (see below).

Variables that were not important EMMs were assessed as potential confounders. For each possible confounder, we ran two simple Cox models: the first model containing MC, HIV/STI, and the potential confounder, and the second containing just MC and HIV/STI. We compared the HRs generated by the two models by taking the natural log of the ratio of the two estimates [$\ln(\text{HR}_{\text{model with confounder}}/\text{HR}_{\text{model without confounder}})$]. A result >0.05 (representing $>5\%$ change between the HRs of the two models) was interpreted as sufficient evidence to include the variable under consideration in the starting multivariable model (see below). We did not include variables that, based on our causal model (see Figure 3.1) we expected to be on the causal pathway between MC and women's risk of HIV/STI. ¹⁴³

Multivariable modeling

We used five separate extended Cox proportional hazards models^{155,158} to estimate adjusted hazard ratios (HRs) describing the effect of MC on:

1. time to HIV infection
2. time to first infection with Ct
3. time to first infection with GC
4. time to first infection with Tv
5. time to first infection with any STI

The data were structured in the “counting process” format, one record per visit and multiple records per woman. Proportional hazards models can accommodate

multiple records per person, and the counting process format permits proper analysis of both time-independent and time-varying covariates.¹⁵⁹ Extended Cox models use a robust variance estimator to adjust for non-independence resulting from multiple visits per participant.¹⁶⁰

Before beginning the model-building phase of the analysis, we created a preliminary dataset with one record per woman to assess the proportional hazards assumption (PHA) required for Cox regression models. Each woman's record contained her values for those variables that do not vary with time, and aggregate, over-time summary values for time-dependent variables (mean, summary, or median, depending on the variable). We created interactions between each variable (both time-independent and time-dependent) and continuous or categorical follow-up time, and examined $\log(-\log(s(t)))$ plots and $\log h(t)$ to determine if strata of the covariable were proportional over time. We used Cox tests¹⁶¹ to evaluate the significance of the coefficient of the interaction term. If the interaction was not statistically significant at $\alpha=0.05$, we concluded that that the PHA was not violated for that variable. If the coefficient was significant, the interaction between the covariable and continuous time was included in the full model. A covariable \times time interaction term permits the influence of the covariable to vary with time, thereby relaxing the PHA. Ties were accommodated using the Efron method.¹⁶²

The full model for each outcome consisted of the dichotomized exposure (MC), interaction terms between MC and variables determined to be EMMs, interaction

terms for covariables with time for covariables that violated the PHA, and all covariables that confounded or modified the MC association.

We presented unadjusted and adjusted HRs for the effect of MC on women's risk of HIV and STIs, and Kaplan-Meier curves¹⁶³ depicting HIV and STI-free survival time by the MC status of women's primary partner.

In general terms, the full model for HIV is represented by the following equation:

$$h_x(t) = h_0(t) \times e^{\beta_1(\text{MC}) + \beta_2(\text{covariableK}) + \beta_3(\text{covariableK} \times \text{time}) + \beta_4(\text{MC} \times \text{covariableK})}$$

where

t = continuous time (*i.e.*, $h_x(t)$ is the hazard at time t when $X=x$)

$h_0(t)$ = baseline hazard function

MC = MC status of women's primary partner, coded 0 (uncircumcised) or 1 (circumcised)

covariableK^a = representing all covariables (time-varying or time-independent) that were confounders or EMMs as determined in preliminary multivariable analysis

covariableK^a × time = interaction term between covariableK and time, for any covariableK that violated the PHA; time coded continuously

^a The term CovariableK stands in for the set of individual terms, one for each variable that may modify or confound the main measure of effect, that were included in the full model.

MC × covariable^a = representing all interaction terms between covariables and the main exposure

To assess EMM using multivariable models, we examined the significance of each MC × covariable interaction term in the starting, full model. Because of difficulty interpreting multiple interaction terms, we specified *a priori* that the final model could have a maximum of one interaction term; multiple HRs for the effect of MC (one for each stratum of the interacting variable) were presented in the final estimates.

We then used a manual backward elimination approach with a 10% change-in-estimate criterion to identify which covariables confounded the main association and which could be removed from the model.¹⁶⁴ The potential confounder with the weakest confounding effect in preliminary assessments was dropped first. The HR for the main association in the new model (excluding the dropped covariable) was compared quantitatively to the HR for the main association in the previous model (including the dropped covariable) by taking the natural log of the ratio of the unadjusted and adjusted estimates ($\ln(\text{HR}_{\text{unadjusted}}/\text{HR}_{\text{adjusted}})$). The impact of confounding was measured within strata of EMMs.

A threshold of >0.10 (a higher threshold than the 0.05 used in preliminary analyses) constituted substantial confounding, and the covariable under consideration was retained as a confounder for subsequent modeling steps. If the change in the main association was ≤ 0.10 , the covariable continued to be excluded from the model.

The covariable with the next smallest change-in-estimate in preliminary assessments was then dropped, and the process continued until all covariables had been assessed in this way. When all variables had been evaluated and those not substantially affecting the main association had been dropped, we arrived at the final model.

Certain covariables were retained in all models based on prior literature and precedent, regardless of their confounding influence. These included women's current contraceptive method and age.

Before generating estimates of effect from the final model, we assessed the linearity of the log hazard for each continuous and ordinal categorical variable. Continuous or ordinal categorical variables that were not linear in the log hazard were recategorized and/or recoded and included as indicator variables.

Missing data

We did not impute missing values but proceeded with a complete-case analysis.

Sensitivity analysis for Aim 1: HIV outcome

For analyses of MC and women's risk of incident HIV (but not other STIs), we conducted sensitivity analyses to evaluate the robustness of the association to potential misclassification of MC.¹⁵⁶ Extending the methods outlined by Greenland¹⁶⁵ and Lash¹⁶⁶ to Cox proportional hazards models, we "corrected" our estimates for

potential misclassification of MC. We used three reports of the sensitivity and specificity with which women classify MC (Table 2.2): two of these compared women's reports of their partner's MC status to a clinician exam,^{79,80} and the third compared women's reports to men's reports (R. Gray, unpublished data). Intervals where women reported that they did not know their partners' circumcision status were excluded from sensitivity analyses. We carried out the corrections in two steps, separately for each sensitivity-specificity pair.

First, using the circumcision prevalences (in our cohort) from Zimbabwe (9.4%) and Uganda (35.9%), and the reported sensitivity and specificity of women's classification from the three reports (described above and in Table 2.2), we computed the two probabilities that a participant's report about her partner was inaccurate: either, that a man was truly circumcised, although his partner reported he was uncircumcised, or that a man was truly uncircumcised, although his partner reported he was circumcised. These probabilities were computed separately for the Ugandan and Zimbabwean cohorts, because the prevalence of circumcision (and presumably the likelihood of misclassification) varied by country. Second, using these derived probabilities, we randomly reclassified participants' partner's circumcision status 2,500 times to create 2,500 corrected datasets. From each reclassified dataset, we computed corrected unadjusted and adjusted HRs. For each sensitivity-specificity pair, we reported the median, 2.5th and 97.5th percentiles of the 2,500 simulations.

Sensitivity analysis for Aim 1: STI outcomes

Our analyses evaluated the effect of circumcision status of the primary partner only on women's risk of acquisition of HIV and three STIs. Since some women reported multiple sexual partnerships during follow-up, our observed associations may reflect a mixture of the effects of primary and non-primary partners' circumcision status. For the STI analyses only, we conducted a simple sensitivity analysis by removing from the analysis all follow-up time where women reported multiple sexual partners. We then refit the unadjusted and adjusted models (using the same set of adjustment variables as in the main analysis) to determine whether the associations between MC and women's STI risk changed.

Limitations of analysis of Aim 1

Aim 1 analyses had several limitations. First, as noted above, the use of women's reports of their partners' MC status likely introduced misclassification in the MC measure. We attempted to characterize the extent and influence of the misclassification through sensitivity analysis. Second, a criticism of previous circumcision studies was that they suffered from unmeasured confounding by religion. We also lacked data on religion, although we used ethnicity as a proxy for religion (three categories in Zimbabwe and seven in Uganda),^b and adjusting for these variables had no substantial effect on the parameter estimates. In addition, because religion and ethnicity do not affect HIV risk directly but are themselves

^b Shona, Ndebele, and other in Zimbabwe; Muganda, Munyankole, Mukiga, Munyoro, Mutoro, Munyarwanda, and other in Uganda.

proxies for behavioral characteristics related to disease acquisition, and we measured these behaviors directly, we expect this bias to be minimized.

Fourth, as with any laboratory procedure, methods to diagnose HIV, Ct, GC and Tv are not 100% sensitive and 100% specific. Because HIV acquisition was the primary endpoint for HC-HIV, a variety of assays were used to detect infection (depending on the study visit and result of initial testing): 1) enzyme-linked immunosorbent assays (ELISA) [Recombigen HIV-1/HIV-2 (Cambridge Biotech, Galway, Ireland), Organon Vironostika (Organon Teknika, Durham, North Carolina, USA), Abbott Murex (Abbott Park, Illinois, USA), Sanofi (Sanofi Diagnostics Pasteur, Redmond, Washington, USA)]; 2) HIV rapid tests [HIV SAV1 or SAV2 (Savyon Diagnostics, Ashdod, Israel), Capillus HIV-1/HIV-2 (Trinity Biotech USA, Jamestown, New York, USA) or Determine (Abbott)]; 3) PCR (Amplicor HIV-1 DNA test, version 1.5, Roche Diagnostics, Branchburg, New Jersey, USA); and 4) Western blot (BioRad, Hercules, California, USA). All positive HIV results were checked and confirmed to rule out errors, and we expect misclassification of HIV status to be negligible. The AMPLICOR Ct/NG test, which has published sensitivity and specificity of 91.7% and 99.7%, respectively, for Ct¹⁶⁷ and 92.4% and 99.5%, respectively, for GC,¹⁶⁸ has been criticized for cross-reactivity with nonpathogenic *neisseriae* strains,¹⁶⁹⁻¹⁷¹ leading to higher false-positive rates for GC than test characteristics suggest. Microscopy (wet mount), the diagnostic method for trichomonas, has poor sensitivity (49%-67%) but nearly perfect specificity (often cited as 100%) compared to PCR.¹⁷²⁻
¹⁷⁵ We anticipate that misclassification of Tv status is nondifferential with respect to

the exposure, suggesting the that observed effect estimates for Tv may be biased toward the null.¹⁵⁶

Although not a limitation in our analytic techniques, we note that male circumcision is not a woman-controlled method of infection prevention. Ultimately, for women to better control their risk of HIV/STI acquisition, they need tools directly within their own control that do not require negotiation with a male partner. MC has many advantages: a one-time surgery may confer lifetime benefit, it may be administered in infancy, the surgery is simple and inexpensive, and it is not coitally-dependent. Nevertheless, women cannot insist that their partners be circumcised. Many women will remain in a vulnerable situation parallel to what they now experience when their partners refuse to use male condoms.

Finally, we note that we were unable to distinguish whether any association between MC and women's risk of HIV or STIs represents a change in risk of transmission to women (*i.e.*, MC affects male infectivity) *or* a change in the likelihood of the male partner being infected initially due to his circumcision status (followed by subsequent transmission to a susceptible female partner). Although a quantification of these two distinct effects of MC would be ideal, we believe our analysis, capturing the *total* effect of MC on women's HIV/STI risk, makes a valuable contribution to understanding this exposure.

Halloran and Struchiner¹⁷⁶ describe three measurable effects for exposure-disease scenarios where the likelihood of experiencing an outcome is dependent on the prevalence of people who have already experienced it: the direct effect, indirect effect, and overall effect. Our analysis captured the overall effect of MC circumcision on women's HIV/STI risk. As with a vaccine, male circumcision may permit a man to avoid initial infection (primary transmission; Halloran and Struchiner's "direct effect"), thereby breaking a link in the disease transmission chain, and subsequently reducing or eliminating the risk of infection in his sex partners (secondary transmission; Halloran and Struchiner's "indirect effect"). The total effect, a lower population prevalence of infection (Halloran and Struchiner's "overall effect"), is the combination of the direct and indirect effects.

Strengths of analysis of Aim 1

Despite the limitations described above, HC-HIV provided an excellent opportunity to characterize women's risk of HIV/STI associated with partner's circumcision status. HC-HIV was a very large, prospective, multicenter study. It was conducted in a population of largely monogamous women, making the findings widely generalizable. The investigators collected prospective data on multiple outcomes, permitting extensive investigation of the influence of men's circumcision status on women's disease risk. Unlike many studies in which similar analyses have been done, we were able to adjust for many potential confounders. Precise dating of incident HIV infections (by PCR, using previously-collected and stored specimens) to pinpoint the timing of HIV acquisition allowed more accurate time-to-event

analyses. Measurement of hormonal contraception variables is believed to be highly accurate, since methods were provided by the study (with all details recorded on study forms when dispensed), and self-reported DMPA injection history could be compared to clinician documentation.

Aim 2 analyses

Aim 2 seeks to examine changes in women's self-reported condom use a short and longer time period after notification of HIV-positive status (Figure 3.2). We merged data collected during HC-HIV with data collected during GS.

Short-term comparison

Our first analysis examined short term changes in participants' self-reported condom use. For women who experienced HIV infection during HC-HIV, we selected one HC-HIV visit two to six months prior to notification of HIV-positive status and one GS visit two to six months after HIV diagnosis. To capture any secular changes in condom use that may have taken place over the follow-up period, we also included visits from women who did not become HIV-infected during HC-HIV. From all HC-HIV visits contributed by uninfected women, we randomly selected one "anchor" visit (see below), then chose corresponding visits two to six months before and two to six months after the anchor visit. From all uninfected women with visits within the specified timeframe, we randomly selected a sample in an approximate 4:1 ratio with HIV-infected women.

Long-term comparison

Second, we examined changes in self-reported condom use over a longer time period. For women who experienced HIV infection during HC-HIV, we again selected one HC-HIV visit two to six months prior to notification of HIV-positive status, but we paired it with one GS visit twelve to sixteen months after HIV diagnosis. For women remaining uninfected, we chose corresponding visits two to six months before the randomly-selected anchor visit and twelve to sixteen months after the anchor visit. We again randomly selected a sample of uninfected women in an approximate 4:1 ratio with HIV-infected participants. Although the same number of uninfected women were selected for short- and long-term analyses (n=650 for each analysis), because of the random selection process, uninfected participants included in the long-term analysis were not necessarily the same uninfected women as in the short-term analysis.

Visit selection

The goal of visit selection for each analysis was to have a pair of observations for each participant, with one “before” and one “after” measure. To be included in these analyses, HIV-infected women had to have GS visits within the specified timeframes (within six months of the redraw visit (see below) for the short-term analysis and at least 12 months after the redraw visit for the long-term analysis); uninfected women had to participate in HC-HIV long enough for comparison measures to be captured (at least two months after their randomly-assigned anchor visit for the short-term

analysis and at least 12 months after their anchor visit for the long-term analysis). When participants (HIV-infected or HIV-uninfected) contributed more than one visit within the specified timeframe, we chose the visit with non-missing data on condom use that was closest to the beginning of the window (e.g. closer to two months than six months, or closer to twelve months than sixteen months).

As described earlier, because of low HIV incidence in Thailand, Thai women (n=1,578) were excluded from Aim 2 analyses.

Random selection of anchor visits for uninfected participants

Uninfected comparison participants for the short- and long-term analyses were randomly selected from the 4,226 HC-HIV participants who did not become HIV infected during HC-HIV. Using SAS's random number generator, we assigned each visit contributed by uninfected women a random number *RAND*. We sorted the dataset by participant ID and then *RAND*, so that all observations were ordered in truly random order within participant-specific clusters. We then assigned the first visit for each woman to be her "anchor" visit. We confirmed that for the full cohort of uninfected women, the duration of study participation prior to the anchor visit was roughly uniform. We then selected an HC-HIV visit two to six months prior to the anchor visit, two to six months after the anchor visit (for the short-term analysis), and 12 to 16 months after the anchor visit (for the long-term analysis). For the subset of participants who had "before" and "after" visits within the specified time frames, we

used the *RAND* value of the anchor visit to randomly select 650 uninfected participants for each analysis.

Outcome measure: Number of sex acts not protected by male condoms in a typical month in the last three months

At each follow-up visit, during both the HC-HIV and GS studies, participants were asked: “In the last three months, in a typical month, how many times did you have sex?” and “In the last three months, in a typical month, how many times did your partner use a male condom during sex with you?” Women answered these questions about all partners, separately for primary and other partners. The number of sex acts not protected by male condoms in a typical month was calculated as the total number of sex acts with all partners minus the total number of sex acts where male condoms were used.

Exposure measure: notification of HIV-positive status

Participants received HIV tests at every follow-up visit in HC-HIV using a combination of two enzyme-linked immunosorbent assays or rapid tests. Positive results were confirmed by Western Blot or HIV polymerase chain reaction tests. Following a positive result, the participant was called back for a redraw visit (typically 10-21 days after the initial test) to rule out labeling errors. At the redraw visit, counselors informed the woman that her HIV test appeared positive, but that further confirmatory tests were needed. A definitive result was given to the participant 1-2 weeks after the redraw visit. For this analysis, we used the date of the redraw visit,

when women were first told they were likely infected with HIV, as the date of notification of HIV-positive status.

Covariables

Figure 3.3 depict the variables evaluated as confounders for Aim 2.

Data analysis for Aim 2

Univariable analyses

Univariable analyses were conducted as described above for Aim 1.

Bivariable analyses

Bivariable analyses were conducted in a similar manner to that described above for Aim 1, using unadjusted zero-inflated negative binomial (ZINB) models (see below) rather than Cox models.

Multivariable models

Because our outcome (number of unprotected sex acts) was a count, we considered and compared the fit of regression models using the Poisson, negative binomial, zero-inflated Poisson and ZINB distributions (Figure 3.4).¹⁷⁷⁻¹⁷⁹ ZINB provided the best fit, and we subsequently used ZINB models to examine the change, with 95% CIs, in the number of unprotected sex acts in a typical month.

ZINB models follow a two-step process. The first is a logistic model that predicts a binary outcome: zero vs. more than zero in the value of the count. The second process is a negative binomial model including those observations with a count value more than zero; it predicts the value of the non-zero count. Parameter estimates are produced for both model steps. The logistic and negative binomial processes can have the same or different sets of predictor variables.

For these data, effect estimates from the logistic procedure can be interpreted as an odds ratio (OR) comparing the odds of having no unprotected sex acts in a typical month after HIV diagnosis (for women experiencing HIV infection) or anchor visit (for uninfected women), with the odds of having no unprotected sex acts in a typical month beforehand. A measure less than 1.0 indicates that the odds of having no unprotected acts in a typical month have declined after HIV diagnosis or anchor visit, compared to the odds of having no unprotected acts in a typical month beforehand; a measure greater than 1.0 indicates that the odds of having no unprotected acts have increased.

Interpretation of effect estimates from the negative binomial portion of the model change depending on whether an offset variable is included (inclusion of the offset does not affect interpretation of the logistic portion of the model). We ran each ZINB model without and then with an offset variable capturing the total number of sex acts in a typical month. Without an offset, effect estimates from the negative binomial portion of the model represent the relative change in the *number* of unprotected acts

in a typical month after HIV diagnosis or anchor visit, compared to number of unprotected acts in a typical month beforehand. A measure less than 1.0 indicates that the number of unprotected sex acts in a typical month has declined; a measure greater than 1.0 indicates that the number of unprotected acts has increased.

With the offset variable, the measure of effect from the negative binomial portion of the model can be interpreted as a relative change in the *proportion* of unprotected acts in a typical month. Interpretation is otherwise similar: a measure less than 1.0 indicates that the proportion of all acts where male condoms were not used in a typical month has declined; a measure greater than 1.0 indicates that the proportion of acts where male condoms were not used has increased.

We used a robust variance estimator to account for non-independence resulting from repeated measures on individual participants.¹⁶⁰

We examined participants' demographic characteristics, reproductive factors and sexual behavior for their confounding influence on the association between notification of HIV-positive status and condom use (see Figure 3.3). We included in each starting multivariable model all factors that were associated with HIV-positive status or condom use.

Because each model already produced four important interpretable measures of effect (logistic process for HIV-infected women, logistic process for uninfected

participants, negative binomial process for HIV-infected women, negative binomial process for uninfected participants), we did not consider any variables as EMMs for Aim 2.

To construct final models, we used a manual, backward elimination, change-in-estimate strategy.¹⁶⁴ One at a time, we removed covariates from the starting model; if removal changed the association with number of unprotected sex acts by less than 10%, a given covariate was not retained. We designated models as “final” when the remaining covariates confounded the main association or were retained for *a priori* considerations (age).

Any covariable that confounded the estimate for HIV-infected participants or for uninfected women, in short- or long-term analyses, in the logistic or negative binomial portions of the model, in a model with or without the offset variable, was included in the final adjustment set for all other analyses.

To generate separate effect estimates for HIV-infected and uninfected participants, we used three independent variables in both the logistic and negative binomial portions of the ZINB model: *HIV*, coded 0 for women who remained HIV-negative throughout HC-HIV and 1 for women who became HIV-infected while participating in HC-HIV; *TIMEPOINT*, coded 0 for visits prior to HIV diagnosis or anchor visit and 1 for visits after; and a product interaction term between *TIMEPOINT* and *HIV*.

The full models for Aim 2 are represented by the following equations (models fit simultaneously):

Logistic process

$$\text{logit}(\text{unprotect}=0) = \alpha_0 + \alpha_1(\text{timepoint}) + \alpha_2(\text{HIV}) + \alpha_3(\text{timepoint} \times \text{HIV}) + \alpha_4(\text{covariableK})$$

Negative binomial process

$$\log(\text{unprotect}=X|X>0) = \beta_0 + \beta_1(\text{timepoint}) + \beta_2(\text{HIV}) + \beta_3(\text{timepoint} \times \text{HIV}) + \beta_4(\text{covariableK}) \text{ [offset} = \log(\text{sexfreq})]$$

where

unprotect: number of sex acts in a typical month in the last three months where condoms were not used, coded continuously

timepoint: dichotomous variable coded 0 at the pre-diagnosis visit and 1 at the post-diagnosis visit

HIV: dichotomous variable distinguishing women who experienced HIV during the study (coded 1) from women who did not (coded 0)

timepoint × HIV: interaction term between TIMEPOINT and HIV, coded 1 for subjects who experienced HIV and for the post-diagnosis visit, 0 otherwise

covariableK^c: represents all covariables (time-varying or static) that were confounders in preliminary analysis

sexfreq: total number of sex acts in a typical month in the last three months, coded continuously, used as the offset variable

Two example interpretations of the models above:

- $e^{(\alpha_1 + \alpha_3)}$: the odds of HIV-infected women reporting no unprotected acts in a typical month post-infection compared to the odds of HIV-infected women reporting no unprotected acts in a typical month pre-infection.
- e^{β_1} : the number of unprotected acts in a typical month reported by uninfected women after the anchor visit, compared to the number of unprotected acts reported by uninfected women before the anchor visit. [This interpretation is for the model without an offset variable; with offset variable, the comparison is about the *proportion*, rather than absolute *number*, of sex acts in a typical month where condoms were not used].

Missing data

Missing data was addressed as described for Aim 1. We again conducted a complete case analysis.

c The term CovariableK represents the set of individual terms, one for each variable that may modify or confound the main measure of effect, that will be included in the full model; for example, age, education, ethnicity, employment, etc.

Limitations of Aim 2 analyses

This analysis has several limitations. First, several authors have noted potential methodologic flaws in using self-reported behavioral data, rather than biomarkers, to evaluate changes in risky sexual behavior.^{180,181} Although self-reported sexual behavior is generally believed to be accurate,^{182,183} we could not validate women's self-reports of condom use.

Additional biases may operate that could reduce the validity of condom use measures. Particularly in the short-term comparison, women who have recently experienced HIV may feel embarrassed or guilty about their recent infection. This may prompt them to report higher or lower condom use than is accurate. In addition, although all women received condom counseling during follow-up, counselors delivering positive HIV test results may give those participants more directed or intensive condom counseling than they deliver to women testing negative. As a result, women with recent infection may have greater behavior change not because of HIV diagnosis itself, but due to the more intensive counseling they receive from counselors.

Although we captured data about the frequency of condom use in several ways, we lacked an evaluation of the *correctness* of use. Correctness is necessarily correlated with the degree of protection that condoms can provide, and matters of proper timing, placement, and other procedural issues of condom use will also influence their efficacy.¹⁸¹

Similar to the limitation of Aim 1 described above, we note that women are not the final decision-makers in matters concerning use of male condoms. Even if women are motivated after HIV diagnosis to increase condom use, they may face resistance from male partners.

Strengths of analysis of Aim 2

No studies in the existing literature have used a prospective design to evaluate changes in risky behavior following HIV or STI diagnosis. Women in HC-HIV were asked identical questions both before and after HIV infection, allowing directly comparable condom use information from periods months prior to diagnosis with periods months, and more than one year, following diagnosis. Most previous prospective studies had short follow-up periods, many of three months or less. In HC-HIV, median follow-up time was 22 months. Cohort retention was also high, with 92% of Ugandan and Zimbabwean participants retained for 24 months. As with the analysis in Aim 1, findings from the women in our cohort are widely generalizable to women living in high-HIV prevalence regions in sub-Saharan Africa.

TABLE 3.1. Sample incident infection coding.

Visit	Result	Incident Infection?
Baseline	Positive	N/A
2	Positive	Not counted
3	Negative	No
4	Negative	No
5	Positive	Yes
6	Negative	No
7	Positive	Yes
8	Positive	Not counted
9	Positive	Not counted
10	Indeterminate or missing	Not counted
11	Negative	No
12	Indeterminate or missing	Not counted
13	Positive	Not counted

FIGURE 3.1. Causal model for male circumcision and women’s risk of acquisition of HIV/STI (Aim 1).

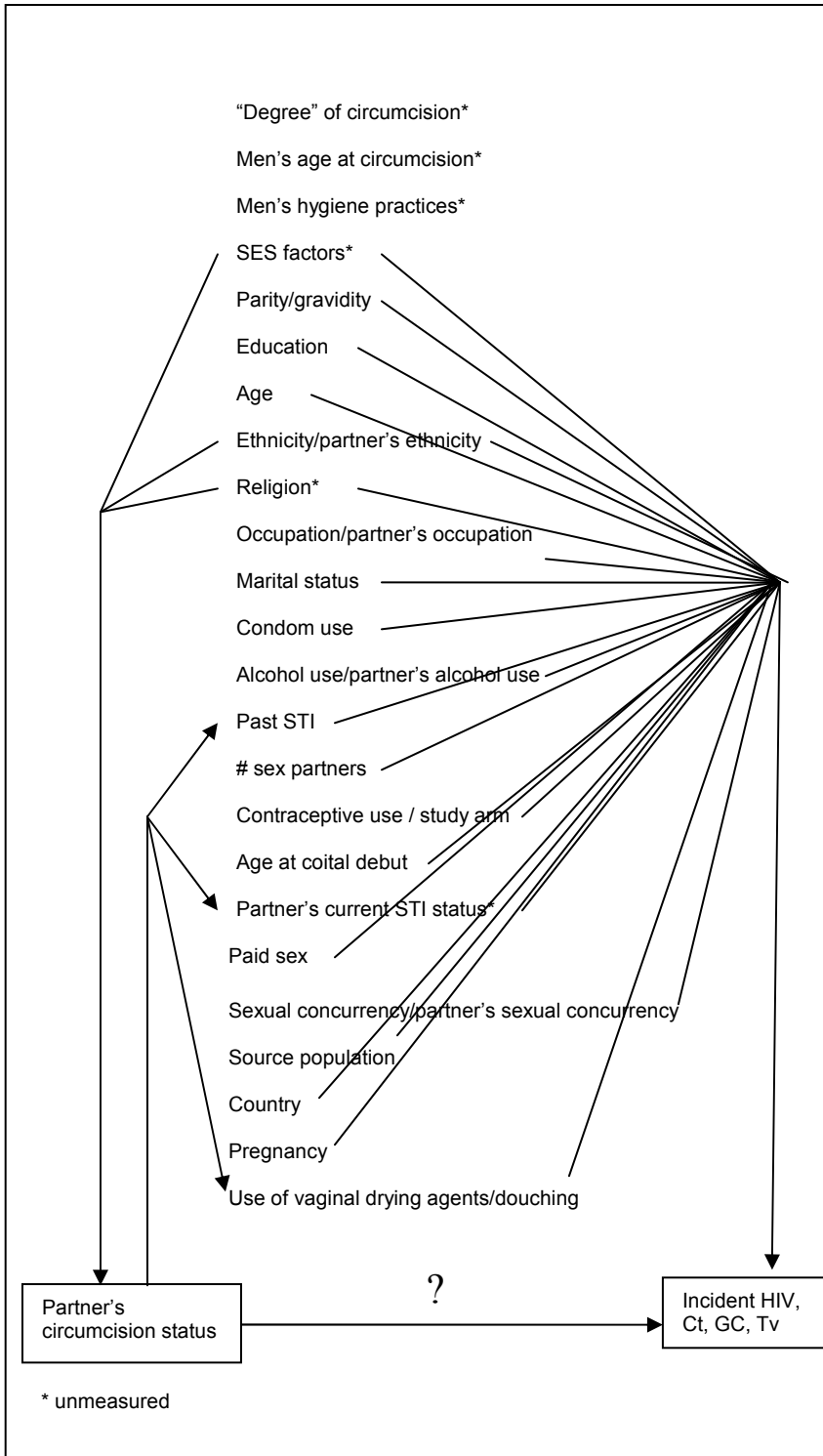

FIGURE 3.2. Short- and long-term comparisons of unprotected sex acts for HIV-infected and uninfected women, HC-HIV and GS studies, Uganda and Zimbabwe, 1999-2006.

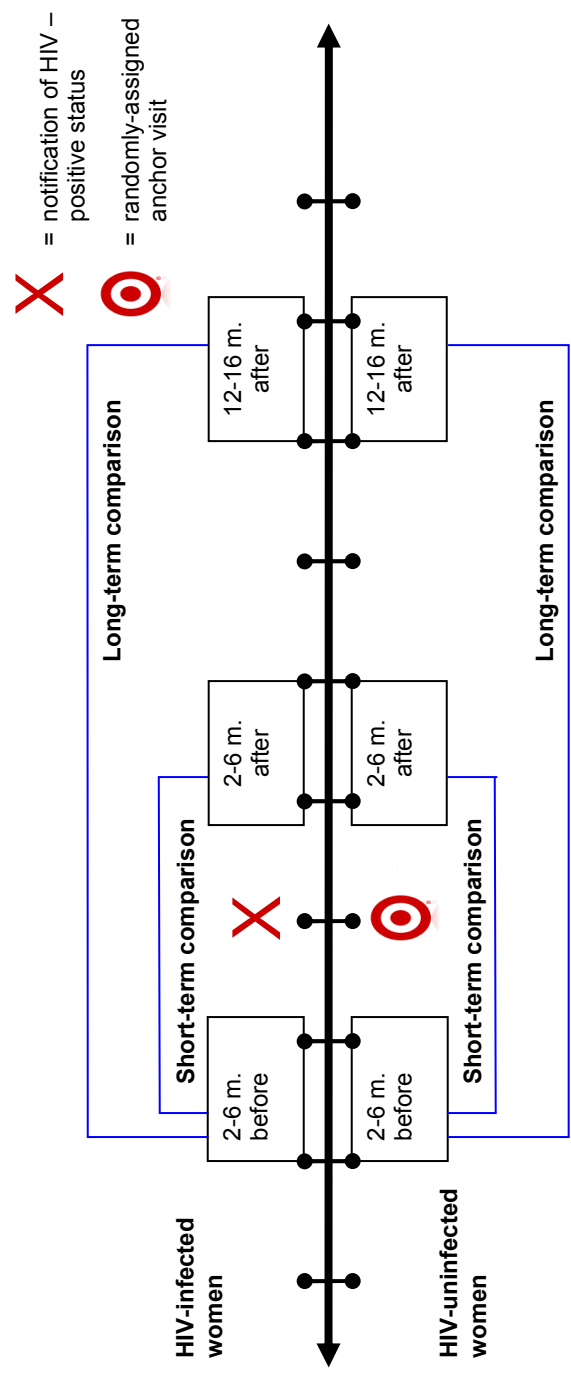

FIGURE 3.3. Causal model for notification of HIV-positive status and changes in condom use (Aim 2).

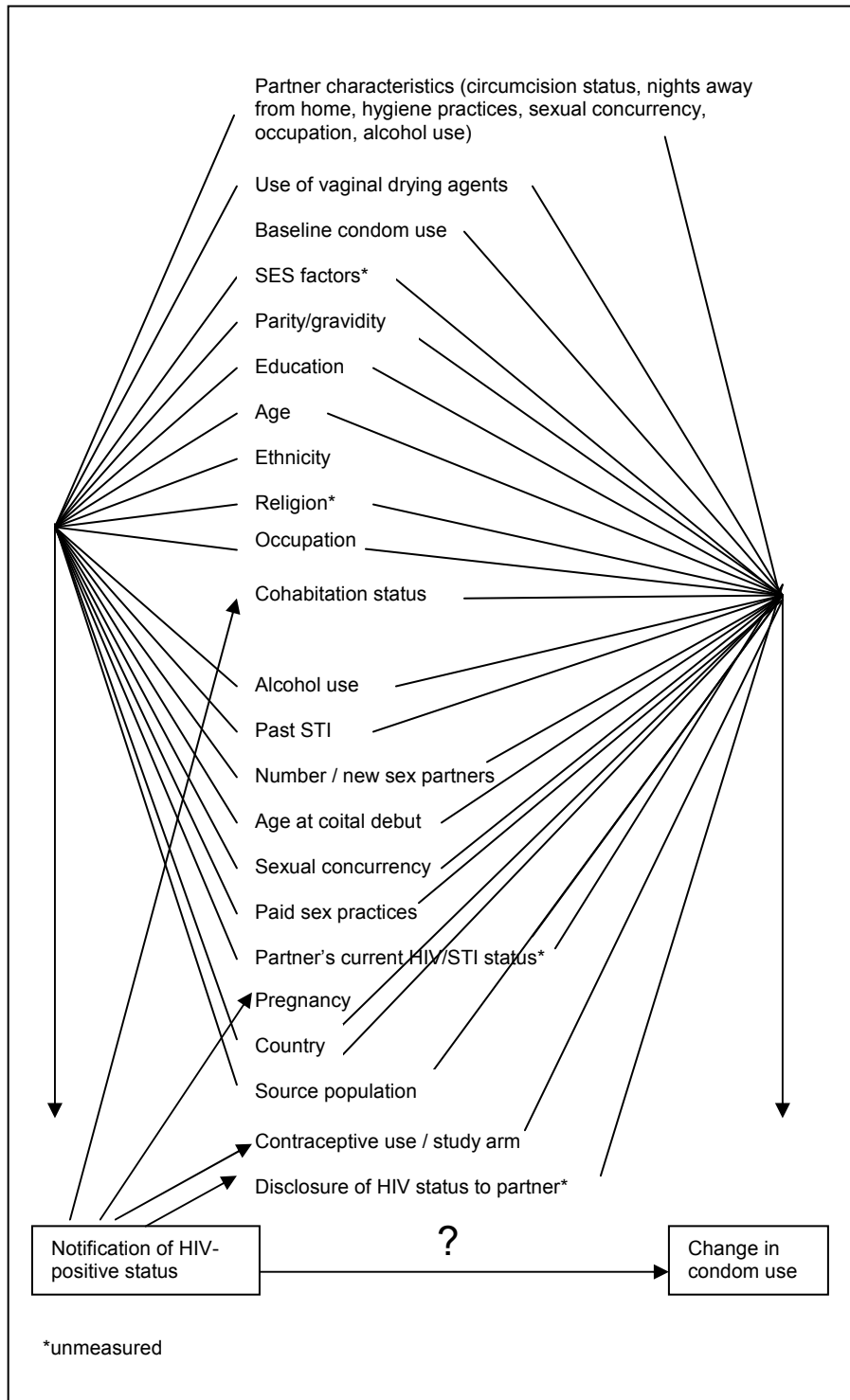
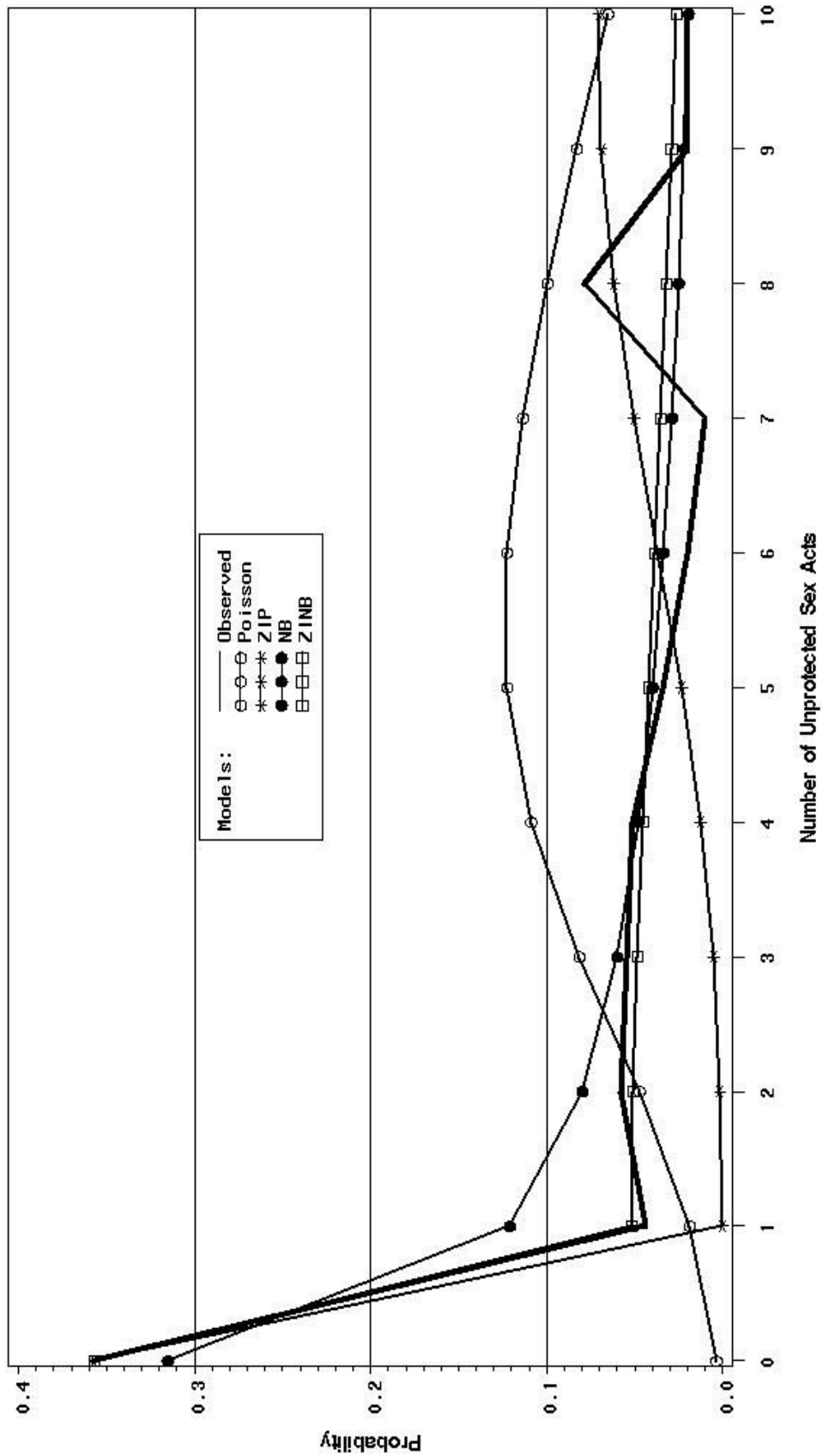

FIGURE 3.4. Comparison of fits of regression models using Poisson, zero-inflated Poisson, negative binomial, and zero-inflated negative binomial distributions.



CHAPTER 4: MEN'S CIRCUMCISION STATUS AND WOMEN'S RISK OF HIV ACQUISITION IN ZIMBABWE AND UGANDA

ABSTRACT

Objective: To assess whether male circumcision (MC) of the primary sex partner is associated with women's risk of HIV acquisition.

Design: Data were analyzed from 4,417 Ugandan and Zimbabwean women who participated in a prospective cohort study of hormonal contraception and HIV acquisition. Most participants were recruited from family planning clinics, although some in Uganda were referred from higher-risk settings such as sexually transmitted disease clinics.

Methods: Using Cox proportional hazards models, time to HIV infection was compared for women with circumcised vs. uncircumcised primary partners. Possible misclassification of MC was assessed using sensitivity analyses.

Results: Most women (73.8%) reported an uncircumcised primary partner at baseline, whereas 22.5% had circumcised partners and 3.8% had partners with unknown circumcision status. During follow-up, 210 women acquired HIV (167, 34, and 9 women whose primary partners were uncircumcised, circumcised, or of

unknown circumcision status, respectively). The unadjusted hazard ratio (HR) comparing women with circumcised partners to those with uncircumcised partners was 0.69 (95% CI: 0.48-0.99). After stratification by referral population and adjustment for other factors, any suggested protection offered by MC was limited to “high-risk” Ugandans (HR: 0.16 (95% CI: 0.02-1.25), whereas MC had little effect on HIV acquisition in “low-risk” Ugandans (HR: 1.33, 95% CI: 0.72-2.47) or Zimbabweans (HR: 1.12, 95% CI: 0.65-1.91). Results were largely unchanged after sensitivity analyses evaluating possible misclassification of reported MC.

Conclusions: Although MC appeared protective against women’s HIV acquisition in unadjusted analyses, after adjustment male circumcision was not associated with women’s HIV risk among most participants.

INTRODUCTION

Male circumcision (MC), a surgical procedure involving cutting and removal of the foreskin, has received increased attention in recent years due to its potential to reduce men's risk of HIV acquisition. Although a preponderance of evidence suggests that circumcised men have lower risk of acquiring HIV than uncircumcised men,^{19-22,24,25} the subsequent HIV risk in their female sex partners is not known. When compared to women with uncircumcised partners, women with circumcised partners have been found to have lower,^{64,66-70} higher,⁷² and approximately equal risk of HIV acquisition.⁷¹

Several biologic mechanisms have been proposed through which a woman's HIV risk may be altered by her partner's circumcision status. Uncircumcised men may have a higher efficiency of transmitting HIV (and possibly other sexually transmitted pathogens), because the foreskin is a repository for shed cells and a hospitable environment for microorganism growth.⁷ In HIV-infected individuals, male foreskins have substantially higher levels of HIV DNA than female ectocervices; in contrast, HIV DNA from the keratinized outer surface of the foreskin is below the limits of detection.⁷⁴ When the inner layer of the foreskin becomes exteriorized during intercourse, uncircumcised men may expose their partners to both a greater infectious "surface area" and an increased number of infectious organisms, thereby increasing the risk of transmission.¹⁸⁴ Finally, MC may have no direct effect on the transmissibility of HIV from infected men to susceptible women, but if circumcision

reduces men's HIV risk, women partnered with circumcised men may be less likely to be exposed to HIV.

Using data from a multi-site, prospective cohort study of incident HIV infection in Uganda and Zimbabwe, we examined the effect of MC on women's risk of HIV acquisition.

METHODS

We conducted a secondary analysis using data from the Hormonal Contraception and Risk of HIV Acquisition (HC-HIV) Study, a multi-site, prospective cohort study assessing the effect of hormonal contraception on HIV acquisition among women. The methods are described briefly below and have been published elsewhere.¹⁴²

Study setting and population

HC-HIV recruited women from Uganda, Zimbabwe, and Thailand. Thai women were excluded from this analysis because of very low HIV incidence.

From November 1999 through September 2002, women were enrolled from three sites in Uganda and four sites in Zimbabwe. Eligible women were 18-35 years of age; HIV-seronegative; sexually active (\geq three sex acts in the past three months); and users of either combined oral contraceptive pills (COCs), injectable depot medroxyprogesterone acetate (DMPA), or a non-hormonal or no contraceptive

method. Contraceptive group was not randomly assigned; women were already using their chosen contraceptive method at enrollment. All Zimbabwean and most Ugandan participants were recruited from family planning and maternal-child health clinics. Owing to low initial HIV incidence rates among Ugandan participants, recruitment in Uganda was expanded to include referrals from “high-risk” populations, such as sexually transmitted disease clinic patients, sex workers and military wives.

Data collection

We restricted the analysis to women in Zimbabwe and Uganda who completed at least one follow-up visit with valid HIV results and answered a question about their primary partner’s circumcision status (see below). Follow-up officially ended at the first visit following 24 months. We censored follow-up time after 28 months for a small number of women with extended follow-up.

At enrollment and each follow-up visit, women received structured, face-to-face interviews about their reproductive, contraceptive and sexual behavior and physical exams with specimen collection. Visits were conducted approximately every three months.

At enrollment, participants were asked whether they had a primary sexual partner (“In the last three months, have you had a primary partner? By primary partner, I mean your husband, someone with whom you live, or your boyfriend.”). They

answered several questions about that partner, including his circumcision status. At subsequent visits, women were asked whether their primary partner had changed. Participants with a new primary partner were asked about that partner's circumcision status, and therefore partner's circumcision status was time-varying in our analysis. We did not collect MC data for non-primary partners.

Women were considered HIV-infected if positive on a combination of two enzyme-linked immunosorbent assays or rapid tests. Positive HIV results were confirmed by Western Blot or HIV polymerase chain reaction (PCR) tests. We conducted serial testing on stored specimens using PCR to accurately date incident HIV infections.

Statistical analyses

All statistical analyses were performed using SAS (Version 9.1.3, SAS Institute, Cary, NC).

Using extended Cox proportional hazards models, we estimated unadjusted and adjusted hazard ratios (HRs) and 95% confidence intervals (CIs) to describe the effect of primary partner's circumcision status on women's time to HIV infection. Person-time was calculated as time from enrollment to either the date of HIV infection or the date of the last study visit for women remaining uninfected.

We hypothesized that the association between MC and women's HIV risk could vary by four factors previously associated with incident HIV in women: age, pregnancy,

contraceptive group, and population (a composite variable capturing both country and referral population, and representing recruitment from family planning clinics in Uganda vs. higher-risk settings in Uganda vs. family planning clinics in Zimbabwe). Product-interaction terms were constructed between MC and each of these variables; interaction terms with $p < 0.10$ were included in the preliminary multivariable model.¹⁵⁷ We also examined participants' demographic characteristics, reproductive factors, sexual behavior, and partner characteristics (as reported by women) for their confounding influence on the MC effect measure. We included in the preliminary multivariate model those variables that were associated with MC or HIV acquisition in simple Cox models. To assess the proportional hazards assumption, we created interactions between each variable and continuous time; we used survival plots and Cox tests for statistical evaluation.¹⁶¹ For variables violating this assumption, we included the time-interaction variables in the preliminary multivariate model.

We then used a manual, change-in-estimate backward elimination strategy to remove one at a time those variables which did not confound the association between MC and women's HIV risk.¹⁶¹ Covariates were not retained if their removal changed the main association by less than 10% overall or in any stratum of any interacting variable.^{164,185}

Sensitivity analysis

We examined the robustness of the observed association between MC and women's risk of HIV acquisition using sensitivity analysis (comparable to the methods of Lash and Silliman¹⁶⁶). Because MC status was reported by women, we assessed the influence of misclassification of men's circumcision status on the observed HRs.

Using three reports of the sensitivity and specificity with which women classify MC, we corrected our estimates of the association between MC and women's HIV risk. Two of these compare women's reports of their partner's circumcision status to a clinician exam,^{79,80} and the third compares women's reports to men's reports (R. Gray, unpublished data). Women who did not know their partners' circumcision status were excluded. We carried out these corrections in two steps, separately for each sensitivity-specificity pair.

First, using the circumcision prevalences in these data from Zimbabwe (9.4%) and Uganda (35.9%), and the reported sensitivity and specificity of women's classification, we computed the two probabilities that a participant's report about her partner was inaccurate: either, that a man was truly circumcised, although his partner reported he was uncircumcised, or that a man was truly uncircumcised, although his partner reported he was circumcised. These probabilities were computed separately for the Ugandan and Zimbabwean cohorts, because the prevalence of circumcision (and presumably the likelihood of misclassification)

varied by country. Second, using these derived probabilities, we randomly reclassified participants' partner's circumcision status 2,500 times to create 2,500 corrected datasets. From each reclassified dataset, we computed corrected unadjusted and adjusted HRs. For each sensitivity-specificity pair, we report the median, 2.5th and 97.5th percentiles of the 2,500 simulations.

Ethical approval

All participants provided written informed consent prior to study entry. HC-HIV was approved by ethics committees of collaborating institutions. This secondary analysis received ethical approval from the University of North Carolina at Chapel Hill.

RESULTS

HC-HIV enrolled 4,531 participants from Uganda and Zimbabwe. We excluded 114 women: 80 who did not return for follow-up; 14 who returned for the first time more than 28 months after enrollment, and were therefore censored; 12 who used exclusively non-study contraceptive methods, and 8 with missing data on circumcision status at every follow-up visit. (Thirteen women missing the MC status of their primary partner at baseline, but with valid MC data later in follow-up, were excluded from Table 4.1 but included in longitudinal analyses). This analysis includes 4,417 women (393 “high-risk” Ugandans (8.9%), 1,793 “low-risk” Ugandans (40.6%), and 2,231 Zimbabweans (50.5%)) who together contributed 7,559 person-

years (PY) of follow-up. The mean interval between follow-up visits was 0.24 years (2.9 months).

Baseline population characteristics (Table 4.1)

Among 4,404 women providing MC status of their primary partner at baseline, most (n=3,249, 73.8%) had uncircumcised partners, whereas 22.5% (n= 989) had circumcised partners and 3.8% (n=166) did not know their partner's circumcision status. Circumcision was more common among partners of Ugandan (35.9%) than Zimbabwean women (9.4%). Nearly all women (98.2%) who did not know whether their partner was circumcised came from Zimbabwe.

Users of COCs, DMPA, and non-hormonal methods were roughly balanced among circumcised and uncircumcised groups ($p=0.65$). Women with circumcised partners had somewhat less education than those with uncircumcised partners (8.6 vs. 9.3 years, $p<0.01$), a lower mean age at coital debut (16.8 vs. 17.7 years, $p<0.01$), a higher mean number of lifetime sex partners (4.8 vs. 2.7 partners, $p<0.01$), and a higher mean number of nights the primary partner was away from home in the last month (9.1 vs. 6.1 nights, $p<0.01$).

Follow-up

Over the follow-up period, participants with circumcised partners contributed 1,672 PY in 6,942 (22.4%) follow-up intervals; women with uncircumcised partners contributed 5,631 PY in 22,977 (74.1%) follow-up intervals; and those who did not

know their partner's circumcision status contributed 256 PY in 1,076 (3.5%) follow-up intervals. Changes in partnerships where the new partner had a different circumcision status than the previous partner were relatively rare, reported by 243 women (5.5%) at some point over the follow-up period. Partnership changes were more common among women in Uganda than those in Zimbabwe: 8.7% of high-risk Ugandans and 9.1% of low-risk Ugandans reported at least one partnership change over follow-up, compared to 2.0% of Zimbabweans.

Similar to the baseline findings, women partnered with circumcised men reported somewhat riskier sexual behavior during follow-up visits. Women with circumcised partners were more likely to self-report a sexually transmitted infection (STI) (6.4% vs. 4.4% of follow-up intervals, $p < 0.01$) or STI symptoms (25.6% vs. 19.6% of follow-up intervals, $p < 0.01$), and to have a risky sexual partner – a man with STI symptoms, other sex partners, or who was HIV-positive – (23.1% vs. 13.6% of follow-up intervals, $p < 0.01$). Although more women with circumcised partners reported never using condoms since the last visit (64.1% vs. 50.2% of follow-up intervals, $p < 0.01$), they had a lower mean number of unprotected acts per month (8.6 vs. 9.3, $P < 0.01$) than women with uncircumcised partners.

At enrollment and throughout follow-up, observed differences in risk behavior between women with circumcised partners and uncircumcised partners are largely due to the reported differences in risk behavior between women in Uganda and Zimbabwe. Women in Uganda both reported generally riskier behavior and were

more likely to report a circumcised primary partner (36%), whereas women in Zimbabwe generally reported less risky behavior, and fewer had circumcised primary partners (9%).

HIV acquisition

HIV infection occurred in 210 women during the follow-up period (34, 167 and 9 HIV seroconversions in women with partners who were circumcised, uncircumcised, and of unknown circumcision status, respectively). Unadjusted HIV incidence rates were 2.03 per 100 PY (95% CI: 1.35-2.72) among those with circumcised partners, 2.97 per 100 PY (95% CI: 2.52-3.42) in women with uncircumcised partners, and 3.51 per 100 PY (95% CI: 1.22-5.81) in women who did not know their partner's circumcision status.

Unadjusted and adjusted multivariate models

The unadjusted Cox proportional hazard model for time to HIV seroconversion indicated that women with circumcised partners had a reduced HIV risk compared to women with uncircumcised partners (HR: 0.69, 95% CI: 0.48-0.99) (Table 4.2). The Kaplan-Meier plot shows similar results (log-rank $p=0.06$, Figure 4.1). After adjustment for age, age at coital debut, contraceptive method, husband's employment status, education level, and number of sex partners in the previous three months, the protective effect of male circumcision weakened (HR: 0.78, 95% CI: 0.53-1.14 (Table 4.2)). After further adjustment for population (high-risk Ugandans, low-risk Ugandans, and Zimbabweans), the association disappeared

(HR: 1.03, 95% CI: 0.69, 1.53 (Table 4.2)). We saw no evidence of confounding by other demographic factors, including ethnicity, or other sexual behavior variables, including STI coinfection (capturing infection with *Chlamydia trachomatis* (Ct), *Neisseria gonorrhoeae* (GC), *Trichomonas vaginalis* (Tv), or herpes simplex virus type 2 (HSV-2)).

Because we detected substantial heterogeneity of the effect of MC on women's HIV risk by population in preliminary analyses ($p=0.08$), we also examined Kaplan-Meier curves for each population subgroup (Figure 4.2). HIV-free survival time for women with circumcised and uncircumcised partners was similar for both the low-risk Ugandan and Zimbabwean subgroups (log-rank $p=0.62$ and 0.39 , respectively). For the high-risk Ugandan cohort, women with circumcised partners had better HIV-free survival than women with uncircumcised partners (log-rank $p=0.05$). When we refit our unadjusted and adjusted models with a product-interaction term between MC and population, MC status was not significantly associated with women's risk of HIV acquisition in any subgroup (high-risk Ugandans, low-risk Ugandans or Zimbabweans), although the point estimates varied widely (Table 4.2). The unadjusted estimate for high-risk Ugandans suggested protection, but was not statistically significant (HR: 0.26, 95% CI: 0.06-1.16), whereas there was little to no association between MC and women's HIV risk in Zimbabweans (HR: 1.10, 95% CI: 0.64-1.87) or low-risk Ugandans (HR: 1.28, 95% CI: 0.69-2.35). All estimates were similar following adjustment (Table 4.2).

Sensitivity analyses: summary estimates

Under three sensitivity-specificity scenarios (94% sensitivity with 89% specificity,⁷⁹ 95% sensitivity with 92% specificity,⁸⁰ and 92% sensitivity with 97% specificity (Ron Gray, unpublished data)), the overall association between MC and women's HIV risk was robust to misclassification of MC status (Table 4.3). After randomly reclassifying circumcision status in 2,500 simulations, we saw little change in observed measures of effect. In all scenarios, the original point estimate fell within the 2.5th and 97.5th percentiles of the corrected HRs.

Sensitivity analyses: stratum-specific estimates

Potential misclassification of MC was not influential for low-risk Ugandans or Zimbabweans, for whom the original estimates fell within the 2.5th and 97.5th percentiles of the corrected HRs under all three misclassification scenarios (Table 4.3). Possible misclassification of MC was more influential among high-risk Ugandan women. Under all three sensitivity-specificity scenarios, the median corrected HR for this group weakened considerably (though remained protective). In unadjusted analyses, the original point estimate for high-risk Ugandans fell within the 2.5th and 97.5th percentiles of corrected HRs, but in the adjusted analyses for all three misclassification scenarios, the original estimate was not contained within the 2.5th to 97.5th percentiles of the corrected HRs.

DISCUSSION

Recent findings¹⁹⁻²¹ about the possible protective effect of MC against HIV acquisition in men have been greeted with both excitement and caution.¹⁸⁶⁻¹⁸⁸ Because information about the effect of MC on women's HIV risk could influence plans for MC-associated interventions, we undertook these analyses to determine whether MC was also associated with risk of HIV acquisition in men's female sex partners.

Although our unadjusted analysis agreed with two earlier prospective studies reporting a significant protective effect of MC on women's risk of HIV acquisition,^{64,66} after adjusting for demographic and behavioral factors, we did not observe a protective effect of MC for most women in our cohort. For a small group referred through high-risk settings, we found a non-significant suggestion of lower HIV risk for women with circumcised partners compared to those with uncircumcised partners.

Population-level factors – for example, HIV prevalence, the pervasiveness of large sexual networks or concurrent sexual partnerships, the prevalence of genital ulcer disease, the availability of antiretroviral medications for treatment of infected individuals, and many other factors – play essential contextual roles in individual-level risk of exposure and consequent infection with HIV. In this cohort, population (high-risk Ugandans vs. low-risk Ugandans vs. Zimbabweans) was influential in

characterizing the association between MC and women's HIV risk, suggesting that this composite variable captured otherwise unmeasured differences in participants' risk of HIV.

Population had a strong confounding influence. The unadjusted model indicated that MC was protective against women's acquisition of HIV; when population was included in the multivariate models, the protective effect of MC disappeared. This is because Zimbabwean women, comprising the largest segment of the full cohort, were less likely to have circumcised partners but more likely to become HIV-infected during follow-up;¹⁴² thus the apparent protective effect of MC in the unadjusted estimate was actually due to the confounding influence of population.

We also saw substantial heterogeneity of the MC effect according to population. After adjustment for sexual behavior and demographic factors, the suggested protective effect of MC was limited to the subgroup of women assumed to be at higher risk of HIV exposure (those in Uganda referred from higher risk settings), whereas women in both countries from family planning clinic populations saw no benefit from having a circumcised partner. The protection granted by MC to men is also hypothesized to be more pronounced for those with riskier sexual behavior.^{24,25,189,190}

Sensitivity analysis indicated that the unadjusted and adjusted associations between MC and women's HIV risk in this cohort were largely robust to misclassification of

reported MC status. In almost all analyses, the original estimates fell within the 2.5th and 97.5th percentiles of the corrected HRs, and the magnitude of the corrected associations was similar to the original estimates. The exception to this trend was the corrected estimates for high-risk Ugandans, which remained protective but weakened considerably; the original adjusted estimate for high-risk Ugandans did not fall within the 2.5th and 97.5th percentiles of the adjusted, corrected HR. This finding may indicate that the suggested protective effect of MC in this group was due in part to MC misclassification, or perhaps results from the small number of cases in that stratum (only 17 incident HIV infections overall, and only two infections among women with circumcised partners). In any case, possible misclassification of MC was more influential for high-risk Ugandans.

Some women became infected with STIs (Ct, GC, Tv, or HSV-2) during the follow-up period (data not shown). Because STI status may be affected by partner's circumcision status (*i.e.*, may lie on the causal pathway between MC and women's HIV risk), we did not adjust for confounding by STI in the final multivariate model. Nevertheless, in preliminary analyses we assessed changes to the estimates when STI status (both individual STIs and a combined indicator of "any STI") was included; the magnitude of the association between MC and women's HIV risk was largely unchanged. Due to missing data, the precision of the estimate was affected, reinforcing our decision not to include STI status in our final multivariate models.

Our analysis has a number of limitations. HC-HIV was not designed to evaluate the role of MC on women's HIV risk, and therefore we did not have some information that could have strengthened the analysis. For example, we did not ask about women's or partners' religion, hypothesized to be an unmeasured confounder in previous circumcision studies.⁴³ However, adjustment for ethnicity, a proxy for religion (three categories in Zimbabwe and seven in Uganda),^d had no substantial effect on the parameter estimates. In addition, because religion and ethnicity do not affect HIV risk directly but are themselves proxies for behavioral characteristics related to disease acquisition, and we measured these behaviors directly, we expect this bias to be minimized.

Women's sexual behavior, as well as MC, were self-reported, and may suffer from recall and courtesy biases. We attempted to account for misclassification of MC using sensitivity analyses, although our sensitivity analyses corrected the HRs only for MC misclassification of the primary partner. Some women, particularly those referred from higher-risk settings, may have been exposed to other men with unknown circumcision status. However, women reported multiple sex partners at only 2.0% visits (2.8% of visits contributed by low-risk Ugandan women, 7.2% of visits by high-risk Ugandan women, and 0.3% of visits from Zimbabwean women). If this is an accurate report, bias resulting from exposure to other partners is likely to be minimal. Alternatively, if 2.0% is a substantial underreport, the observed HR may

d Shona, Ndebele, and other in Zimbabwe; Muganda, Munyankole, Mukiga, Munyoro, Mutoro, Munyarwanda, and other in Uganda.

reflect a mixture of the effects of primary and non-primary partners' circumcision status on women's HIV risk.

As with an effective vaccine, MC could affect the population prevalence of HIV in two ways. It may permit a man to avoid initial infection, breaking a link in the disease transmission chain, and thereby reduce or eliminate the risk of infection in his sex partners. It may also reduce the transmissibility of HIV from infected men to susceptible women. Our analysis captures the summary effects of these pathways. Ultimately a quantification of the distinct components of any effect of MC on women's HIV risk is needed, and a prospective, HIV-serodiscordant couples study (HIV-positive men and HIV-negative women) is a superior design to parse out these effects (such a study is currently underway in Rakai, Uganda). We asked women about the HIV status of their partners, and attempted to conduct a subanalysis of the effect of MC on women's HIV risk just among women with HIV-positive partners, but we had insufficient sample size to characterize this association (data not shown).

Excitement about the possible protective benefits of MC may be appropriate. However, while MC may significantly reduce men's risk of HIV acquisition, we saw little difference in HIV risk according to male circumcision status for most women in our cohort.

FIGURE 4.1. Unadjusted Kaplan-Meier curves comparing HIV-free survival time for women partnered with circumcised men to women partnered with uncircumcised men, Zimbabwe and Uganda, HC-HIV, 1999-2004.

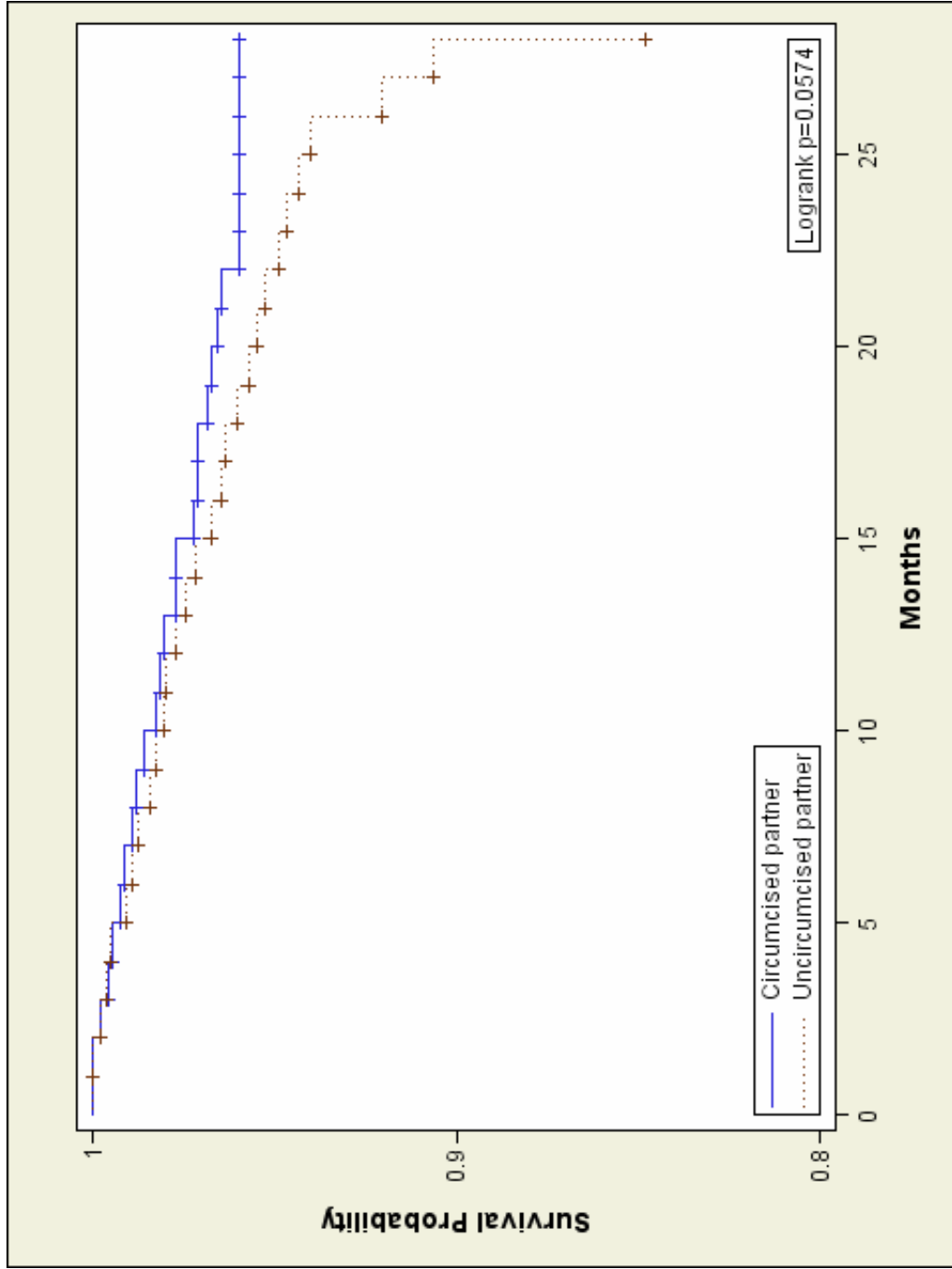

FIGURE 4.2. Unadjusted Kaplan-Meier curves, by population subgroup, comparing HIV-free survival time for women partnered with circumcised men to women partnered with uncircumcised men, Zimbabwe and Uganda, HC-HIV, 1999-2004.

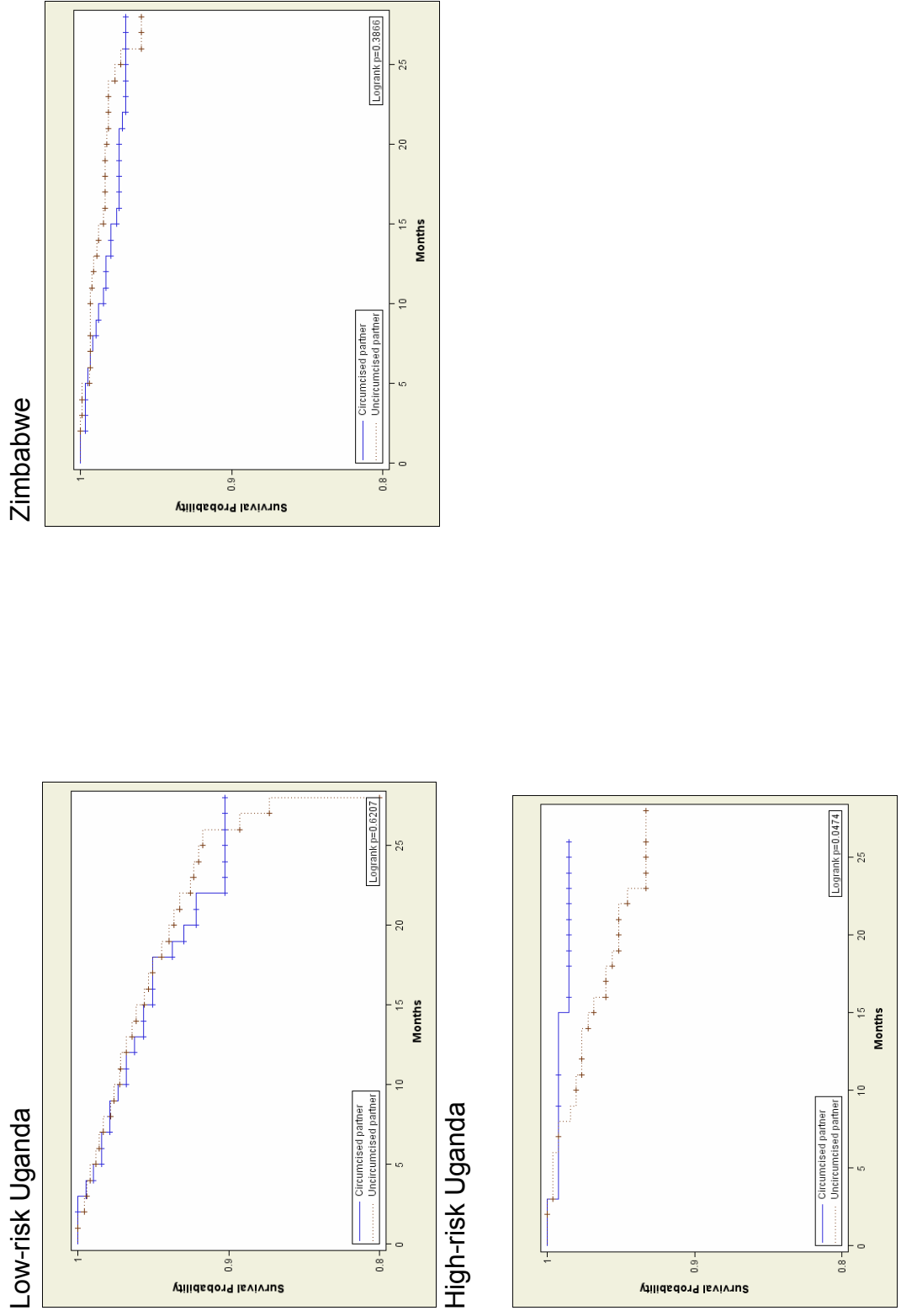

TABLE 4.1. Selected characteristics of participants at enrollment, Uganda and Zimbabwe, HC-HIV, 1999-2004.

Characteristic	Primary partner circumcision status				Total N=4,404 (%)
	Circumcised		Don't know		
	N=989 (%)	N=3,249 (%)	N=166 (%)	N=4,404 (%)	
Country and referral population					
Uganda					
Low risk: Family planning/maternal-child health clinics	639 (64.6)	1151 (35.4)	1 (0.6)	1791 (40.7)	
High risk: sexually transmitted disease clinics	141 (14.3)	241 (7.4)	2 (1.2)	384 (8.7)	
Zimbabwe					
Contraceptive group	209 (21.1)	1857 (57.2)	163 (98.2)	2229 (50.6)	
Low-dose combined oral contraceptive pills	348 (35.2)	1128 (34.7)	57 (34.3)	1533 (34.8)	
Injectable depot medroxyprogesterone acetate (DMPA)	310 (31.3)	1149 (35.4)	49 (29.5)	1508 (34.2)	
Non-hormonal or no contraceptive method	331 (33.5)	972 (29.9)	60 (36.1)	1363 (30.9)	
Currently cohabitate with primary partner					
Yes	773 (78.2)	2770 (85.3)	140 (84.3)	3683 (83.6)	
No	216 (21.8)	479 (14.7)	26 (15.7)	721 (16.4)	
Currently employed					
Yes	543 (54.9)	1637 (50.4)	70 (42.2)	2250 (51.1)	
No	446 (45.1)	1612 (49.6)	96 (57.8)	2154 (48.9)	
Male condom use ever					
Yes	795 (80.4)	2559 (78.8)	137 (82.5)	3491 (79.3)	
No	194 (19.6)	689 (21.2)	29 (17.5)	912 (20.7)	
Ever traded sex for goods or money					
Yes	13 (1.3)	27 (0.8)	2 (1.2)	42 (1.0)	
No	976 (98.7)	3222 (99.2)	164 (98.8)	4362 (99.0)	
	Mean (SD) [†]	Mean (SD)	Mean (SD)	Mean (SD)	
Age (years)	25.2 (4.5)	25.6 (4.5)	24.8 (4.3)	25.4 (4.5)	
Education (years)	8.6 (3.3)	9.3 (2.9)	9.7 (2.1)	9.1 (3.0)	
Age at coital debut (years)	16.8 (2.4)	17.7 (2.6)	18.4 (2.3)	17.5 (2.6)	
Number of pregnancies	2.7 (1.8)	2.4 (1.5)	1.9 (1.1)	2.5 (1.6)	
Number of sex partners, lifetime	4.8 (31.9)	2.7 (18.0)	1.7 (1.7)	3.1 (21.7)	
Number sex acts in last 30 days with primary partner	11.2 (9.6)	13.9 (11.2)	16.5 (14.4)	13.4 (11.0)	
Number of nights primary partner away in last 30 days	9.1 (12.2)	6.1 (10.3)	5.0 (8.6)	6.7 (10.8)	

* Because of missing data, not all categories total 100%.

† SD=standard deviation.

TABLE 4.2. Unadjusted and adjusted hazard ratios and 95% confidence intervals for HIV acquisition, comparing women with circumcised partners to women with uncircumcised partners, Uganda and Zimbabwe, HC-HIV, 1999-2004.

	Events	HR*	95% CI*
Summary estimates			
Unadjusted	201	0.69	0.48, 0.99
Adjusted (Model 1) [†]	197	0.78	0.53, 1.14
Adjusted (Model 2) [‡]	197	1.03	0.69, 1.53
Estimates by country and referral population			
Unadjusted			
High-risk Ugandans	17	0.26	0.06, 1.16
Low-risk Ugandans	43	1.28	0.69, 2.35
Zimbabweans	141	1.10	0.64, 1.87
Adjusted (Model 1) [†]			
High-risk Ugandans	14	0.16	0.02, 1.25
Low-risk Ugandans	43	1.33	0.72, 2.47
Zimbabweans	140	1.12	0.65, 1.91

* HR = hazard ratio; CI = confidence interval.

[†] Adjusted for age, age at coital debut, contraceptive method, husband's employment status, education, number of partners in the last three months, and including a product-interaction term between time and number of partners in the last three months (to relax the proportional hazards assumption).

[‡] Adjusted for the same covariates as Model 1, and in addition, population and a product-interaction term between time and population (to relax the proportional hazards assumption). Model 2 is not relevant for the population-specific estimates, because these estimates were generated using a product-interaction term between circumcision and population.

TABLE 4.3. Sensitivity analysis: corrected HRs following three adjustment scenarios for misclassification of MC, Uganda and Zimbabwe, HC-HIV, 1999-2004.

Corrected HRs*†	94% sensitivity, 89% specificity ⁷⁹			95% sensitivity, 92% specificity ⁸⁰			92% sensitivity, 97% specificity (Gray, unpublished data)		
	Median HR	2.5 th percentile	97.5 th percentile	Median HR	2.5 th percentile	97.5 th percentile	Median HR	2.5 th percentile	97.5 th percentile
Summary estimates									
Unadjusted	0.58	0.42	0.74	0.58	0.44	0.73	0.60	0.49	0.72
Adjusted (Model 1) [‡]	0.66	0.49	0.85	0.67	0.50	0.84	0.67	0.51	0.84
Adjusted (Model 2) [§]	0.92	0.67	1.21	0.92	0.68	1.20	0.92	0.69	1.18
Stratum-specific estimates									
Unadjusted									
High-risk Ugandans	0.52	0.15	1.03	0.50	0.15	0.98	0.45	0.26	0.90
Low-risk Ugandans	1.04	0.68	1.48	1.05	0.72	1.43	1.03	0.80	1.36
Zimbabweans	0.96	0.47	1.56	0.97	0.48	1.50	0.96	0.62	1.31
Adjusted (Model 1) [‡]									
High-risk Ugandans	0.65	0.19	1.32	0.64	0.19	1.16	0.57	0.32	1.15
Low-risk Ugandans	1.01	0.67	1.43	1.03	0.71	1.37	1.01	0.76	1.32
Zimbabweans	0.92	0.44	1.52	0.93	0.48	1.45	0.93	0.61	1.28

* Following 2,500 simulations for each sensitivity-specificity scenario.

† HR=hazard ratio.

‡ Adjusted for age, age at coital debut, contraceptive method, husband's employment status, education, number of partners in the last three months, and including a product-interaction term between time and number of partners in the last three months (to relax the proportional hazards assumption).

§ Adjusted for the same covariates as Model 1, and in addition, population and a product-interaction term between time and population (to relax the proportional hazards assumption).

CHAPTER 5: MEN'S CIRCUMCISION STATUS AND WOMEN'S RISK OF INCIDENT CHLAMYDIAL, GONOCOCCAL AND TRICHOMONAL INFECTIONS

ABSTRACT

Objectives: We examined associations between male circumcision (MC) and women's risk of acquisition of three curable sexually transmitted infections (STIs): *Chlamydia trachomatis* (Ct), *Neisseria gonorrhoeae* (GC), and *Trichomonas vaginalis* (Tv).

Methods: We analyzed data from a prospective cohort study on hormonal contraception and incident HIV and STI (HC-HIV study) among women from Uganda, Zimbabwe and Thailand. At enrollment and each follow-up, we collected endocervical swabs for polymerase chain reaction identification of gonococcal and chlamydial infection; trichomonal infection was diagnosed by wet mount. Women self-reported the circumcision status of their primary partner. Using Cox proportional hazards models, we compared time to STI acquisition for women according to their partner's MC status.

Results: Among 5,925 women (2,180 from Uganda, 2,228 from Zimbabwe, and 1,517 from Thailand), 18.6% reported a circumcised primary partner at baseline,

70.8% reported an uncircumcised partner, and 9.7% did not know their partner's circumcision status. During follow-up, 411, 307 and 373 participants had a first incident chlamydial, gonococcal or trichomonal infection, respectively. In multivariate analysis, after controlling for contraceptive method, age, age at coital debut, and country, the adjusted hazard ratios (HR) comparing women with circumcised partners to those with uncircumcised partners were: for Ct, HR: 1.22 (95% CI: 0.94 to 1.59); for GC, HR: 0.93 (95% CI: 0.70 to 1.24); for Tv, HR: 1.05 (95% CI: 0.81 to 1.37), and for the three STIs combined, HR: 1.02 (95% CI: 0.86 to 1.22).

Conclusions: MC was not associated with women's risk of acquisition of chlamydial, gonococcal or trichomonal infections in this cohort.

INTRODUCTION

Circumcised men appear to have lower risk of HIV acquisition than uncircumcised men in three randomized trials and dozens of observational studies,^{19-21,24,25} and prevention interventions focusing on male circumcision (MC) may soon be introduced worldwide. Whether MC is associated with *women's* risk of acquisition of HIV or other sexually transmitted infections (STIs), however, has not been well-studied. We found only two studies describing the association between MC and women's STI risk. In a large community cohort study in Rakai, Uganda, women with circumcised partners had reduced risk of *Trichomonas vaginalis* (Tv), but equal risks of *Neisseria gonorrhoeae* (GC) and *Chlamydia trachomatis* (Ct) when compared to women with uncircumcised partners.⁶⁷ MC was strongly associated with decreased odds of Ct infection in female partners in one case-control couples' study.⁷³

MC could affect STI risk in women if it reduced men's risk of initial STI acquisition, and subsequently decreased the probability of future STI transmission to susceptible female partners. However, epidemiologic evidence regarding the association between MC and men's risk of GC, Ct and Tv is mixed, and findings in several studies have been compromised by small sample sizes, poor study designs, selection bias, uncontrolled confounding and other validity concerns. For gonococcal infection, many studies found no association between MC and men's GC risk,^{18,32,36-40} although circumcised men had lower GC risk in some.^{30,31,33-35} A preponderance of evidence suggests no association between MC and men's

infection with Ct^{18,30-32,38-40,44-47} with few exceptions.^{34,41,42} MC and Tv infection in men has not been investigated thoroughly. The two existing studies (one cross-sectional⁴⁸ and one ecologic³⁹) both noted no association.

Because interest is growing in MC as a promising disease prevention strategy, we analyzed whether MC was associated with women's STI risk. Using data from a multi-site, prospective cohort study conducted in Uganda, Zimbabwe and Thailand, we examined the effect of MC on women's risk of acquisition of Ct, GC and Tv.

METHODS

The Hormonal Contraception and Risk of HIV Acquisition (HC-HIV) study is a prospective cohort study with a primary objective to assess the effect of hormonal contraception on women's risk of HIV acquisition. Detailed methods and main findings have been described elsewhere.¹⁴² We used the HC-HIV data to evaluate the association between MC and women's STI risk.

Study setting and population

HC-HIV enrolled and followed women from 1999-2004. Eligible women were 18-35 years of age; HIV-negative; sexually active; not pregnant or planning a pregnancy; and using oral contraceptive pills, injectable depot medroxyprogesterone acetate, or a non-hormonal or no contraceptive method.

All Zimbabwean and most Ugandan and Thai participants were recruited from family planning and maternal-child health (FP/MCH) clinics. Owing to low initial HIV incidence rates among Ugandan and Thai women, recruitment in these countries was expanded to include referrals from “higher-risk” populations, such as sexually transmitted disease clinics, sex workers and military wives.

Data collection

Participants reported their reproductive and sexual behavior during face-to-face interviews conducted at enrollment and during follow-up visits (every 3 months for approximately 24 months). Women also reported the circumcision status and other characteristics of their primary partner. Each participant was asked at every visit whether she had the same primary partner as at her previous visit; the circumcision status of any new primary partner was recorded.

At each visit we collected a single endocervical swab for polymerase chain reaction (PCR) identification of both gonococcal and chlamydial infection (AMPLICOR® Ct/NG Test, Roche Diagnostics, Somerville, NJ, USA). For Ct, optical density (OD) >0.8 was considered positive, and for GC, OD>2.5 was positive. Negative results were indicated for OD <0.2 for both Ct and GC. Testing was repeated if the results fell in the “gray zone” (for Ct: OD of 0.2–0.8; for GC, OD of 0.2–2.5). *Trichomonas vaginalis* was diagnosed using wet mount with examination under low (10x) and high

(40-45x) magnification. Identification of motile flagellated trichomonads indicated positive Tv infection.

Statistical analyses

All statistical analyses were performed using SAS (Version 9.1.3, SAS Institute, Cary, NC).

We estimated unadjusted and adjusted hazard ratios (HRs) and 95% confidence intervals (CIs) for the effect of primary partner's circumcision status on women's time to first incident infection with 1) Ct; 2) GC; 3) Tv; and 4) any STI (Ct, GC or Tv). We used extended Cox proportional hazards models to account for both time-independent and time-varying covariates.¹⁵⁹

We restricted the analysis to women who completed at least one follow-up visit with valid STI results and MC status of the primary sexual partner. Because of HC-HIV's primary objective, women's follow-up time was censored at the visit they were found to be HIV-infected. For women remaining HIV-negative, follow-up ended at the first visit after 24 months of participation; a small group of women (n=101) had extended follow-up, and we censored their follow-up time after 28 months.

HC-HIV enrolled 6,109 participants. For these analyses, we excluded 184 women: 149 never returned after enrollment; 9 returned for the first time after 28 months; 12

were missing the circumcision status of their primary partner at every follow-up visit; and 14 were missing results for Ct, GC and Tv at every follow-up visit. We separately analyzed each outcome from the remaining 5,925 women. Person-time contributed by women remaining infection-free for the full study duration was calculated as the number of months from enrollment to the last study visit. For women who acquired an STI during follow-up, person-time was calculated as the time from enrollment to first infection with the specific STI under investigation. For the combined analysis of all three STIs, women were censored after their first incident diagnosis with any one of the three infections.

Women's STI susceptibility is a function of a number of physiological factors (type of epithelium in the genital tract, resident flora and vaginal pH, cervical mucous, menstrual cycle phase, immunological repertoire of the individual, *etc.*)⁶ and behavioral factors (number of partners, frequency of coitus, condom use, *etc.*). Because hormonal contraception, pregnancy and age may each affect these factors, we hypothesized *a priori* that the association between MC and women's STI risk could vary by these three variables. We also explored variation in the circumcision effect by a fourth variable, referral population (*i.e.*, recruitment from FP/MCH clinics vs. higher-risk settings). We constructed product-interaction terms between MC and each of these variables, and included in the starting model interaction terms with *p*-values less than $\alpha=0.10$.¹⁵⁷

Multivariable models were constructed as described elsewhere (see Chapter 4). Briefly, we examined participants' demographic characteristics, reproductive factors and sexual behavior; we included in preliminary multivariable models all variables associated with MC or incident STI. We evaluated the proportional hazards assumption (PHA) using Cox tests and through visual inspection of log -log plots.¹⁶¹ For any variable violating the PHA, we created product-interaction variables with time to include in preliminary multivariable models.

To construct final models, we used a manual, backward elimination, change-in-estimate strategy.¹⁶⁴ One at a time, we removed covariates from the preliminary, full model; if removal changed the MC-STI association by less than 10% overall or in any stratum of any interacting variable, a given covariate was not retained. We designated models as "final" when the remaining covariates confounded the MC-STI association or were retained for *a priori* considerations (age and contraceptive method).

Any covariate surviving the manual backward elimination procedure for at least one of the four MC-STI associations was included in the adjustment set for all other analyses.

Missing data

Fifty-six women (0.9%) were missing the circumcision status of their primary partners at baseline, but subsequently provided this information during follow-up.

These women are excluded from descriptions of participant characteristics by baseline male circumcision status but included in multivariate models, which permit partner circumcision status to change if women change primary partners.

At any follow-up visit, women missing Ct, GC or Tv results were coded as missing for the “any STI” analysis. Therefore, more women and more follow-up time are included in analyses of individual STIs than in the analysis of the three infections combined.

Sensitivity analysis

Our main analyses evaluated the effect of circumcision status of the primary partner only on women’s risk of acquisition of three STIs. Since some women reported multiple sexual partnerships during follow-up, our observed associations may reflect a mixture of the effects of primary and non-primary partners’ circumcision status. We conducted a simple sensitivity analysis by removing from the analysis all follow-up time where women reported multiple sexual partners. We then refit the unadjusted and adjusted models (using the same set of adjustment variables as in the main analysis) to determine whether the associations between MC and women’s STI risk changed.

Ethical approval

All women enrolled in HC-HIV gave written informed consent prior to participating, and local ethics committees at collaborating institutions gave approval for the study.

The Institutional Review Board at the University of North Carolina at Chapel Hill approved this analysis.

RESULTS

Baseline characteristics

The study population was comprised of women from Uganda (36.8%), Zimbabwe (37.6%) and Thailand (25.6%). High-risk participants from Uganda and Thailand made up 14.2% of the overall cohort (Table 5.1).

At baseline, 18.6% of participants reported a circumcised primary partner, 70.8% had an uncircumcised partner, and 9.7% said they did not know whether their partner was circumcised (Table 5.1). Circumcision was more common among partners of Ugandan women (35.7%) than among partners of women from Zimbabwe (9.4%) or Thailand (7.4%). Although the circumcision prevalence varied substantially by country, it did not vary by referral population within Uganda or Thailand. Participants' had similar median age (25 years for women with circumcised and uncircumcised partners, and 26 years among women who did not know whether their partners were circumcised). The median level of education for all women, regardless of circumcision status of the primary partner, was 9 years. Most women (87.2%) cohabitated with their primary partner.

Women with circumcised partners reported somewhat riskier sexual behavior at baseline than women with uncircumcised partners or those who did not know whether their partners were circumcised. Participants with circumcised partners had a lower median age at coital debut (17 years vs. 18 for women with uncircumcised partners and 19 for women who did not know their partners' circumcision status). Although the median number of sex partners in the last 3 months was the same for all groups (1 partner), women with circumcised partners had a higher mean number of partners (1.9 vs. 1.3 and 1.5 partners for women with uncircumcised partners and partners of unknown circumcision status, respectively). Similarly, each group reported a median of 0 nights that the primary partner was away from home in the last month, but women with circumcised partners had a higher mean number of nights when the partner was away (mean: 8.7 nights vs. 5.4 nights for women with uncircumcised partners and 3.8 nights for women who did not know whether their partner was circumcised). The majority of women (71.7% overall) reported ever using male condoms, including a higher proportion of women with circumcised partners (78.0%) than uncircumcised partners (71.5%). Fewer women who did not know whether their partner was circumcised reported ever using male condoms (58.2%).

Prevalent STI at baseline was relatively rare (Table 5.1), and did not vary substantially by baseline MC status of the primary partner. At the enrollment visit, 3.5% of participants were diagnosed with Ct (3.7%, 3.2% and 5.4% of women with partners that were circumcised, uncircumcised, and of unknown circumcision status,

respectively), 1.6% with GC (2.3%, 1.5% and 1.2%, respectively), and 2.6% with Tv (2.5%, 2.7% and 2.1%, respectively).

During follow-up, 288 women reported a new primary partner with a different circumcision status than the previous partner: 198 partnership changes were reported by Ugandan women, 45 by Zimbabwean women, and 45 by Thai women.

Unadjusted and adjusted multivariable models

Chlamydial infection

Infection with Ct was the most common incident STI in this cohort, with 411 women acquiring a new Ct infection during follow-up: 80 infections occurred in women with circumcised partners (unadjusted incidence rate (IR): 4.5 per 100 PY, 95% CI: 3.5 to 5.5); 282 among participants with uncircumcised partners (IR: 3.9 per 100 PY, 95% CI: 3.5 to 4.4); and 49 among women who did not know whether their partner was circumcised (IR: 5.2 per 100 PY, 95% CI: 3.7 to 6.6) (Table 5.2).

Time to Ct infection was similar for women with circumcised vs. uncircumcised partners (unadjusted HR: 1.13, 95% CI: 0.89 to 1.45). After adjustment for confounding variables that were retained in the manual backward elimination procedure (contraceptive method, age, age at coital debut, and country), the HR increased slightly to 1.22 (95% CI: 0.94 to 1.59) (Table 5.3).

Gonococcal infection

Incident GC was detected in 307 participants: 66 with a circumcised primary partner (IR: 3.7 per 100 PY, 95% CI: 2.8 to 4.5); 224 with an uncircumcised partner (IR: 3.1 per 100 PY, 95% CI: 2.7 to 3.5); and 17 who did not know whether their partner was circumcised (IR: 1.7 per 100 PY, 95% CI: 0.9-2.6) (Table 5.2).

The unadjusted HR comparing time to initial GC for women with circumcised partners to those with uncircumcised partners was 1.18 (95% CI: 0.90 to 1.56); the adjusted HR was 0.93 (95% CI: 0.70 to 1.24) (Table 5.3).

Trichomonal infection

T. vaginalis occurred in 373 women during follow-up: 83 women reported circumcised primary partners (IR: 4.7 per 100 PY, 95% CI: 3.6 to 5.7); 278 participants had uncircumcised partners (IR: 3.9 per 100 PY, 95% CI: 3.4 to 4.4); and 12 women did not know whether their partner was circumcised (IR: 1.2 per 100 PY, 95% CI: 0.5 to 1.9) (Table 5.2).

The unadjusted HR comparing time to initial Tv for women with circumcised partners to those with uncircumcised partners was 1.20 (95% CI: 0.94 to 1.54). After adjustment the HR weakened to 1.05 (95% CI: 0.81 to 1.37) (Table 5.3).

Any STI: Ct, GC or Tv

Ct, GC or Tv was diagnosed in 895 women over the follow-up period: 180 women with circumcised partners (IR: 10.5 per 100 PY, 95% CI: 9.0 to 12.1); 648 participants with uncircumcised partners (IR: 9.5 per 100 PY, 95% CI: 8.8 to 10.2); and 67 among women who did not know whether their partner was circumcised (IR: 7.2 per 100 PY, 95% CI: 5.5 to 8.9) (Table 5.2).

The unadjusted HR comparing time to initial incident STI (Ct, GC or Tv) for women with circumcised partners to those with uncircumcised partners was 1.12 (95% CI: 0.95 to 1.32); the adjusted HR was 1.02 (95% CI: 0.86 to 1.22) (Table 5.3). The Kaplan-Meier curve of time to first incident STI (also unadjusted) shows similar findings: women with circumcised partners had similar time to STI as women with uncircumcised partners. Those who did not know their partner's circumcision status appeared to have reduced risk of acquisition of any STI (log-rank $p < 0.01$, see Figure 5.1).

Modeling results were largely unchanged when examining baseline (rather than time-varying) partner circumcision status. Because baseline condom use and baseline prevalence of GC and Tv were lower among Thai participants, we also examined whether restricting the analysis population to only African women affected our results; effect estimates were largely unchanged (data not shown).

Sensitivity analysis

When we excluded follow-up time where women reported multiple partnerships, our restricted datasets contained 2.5%-2.7% fewer person-years of follow-up, depending on the outcome. For example, the main analysis of any STI included 9455 PYs, whereas the restricted analysis included 9222 PYs, a 2.5% reduction. After restriction, nearly all effect estimates were unchanged (data not shown). The HRs for Ct, however, strengthened somewhat in both the unadjusted (restricted HR for women with circumcised vs. uncircumcised partners: 1.23, 95% CI: 0.95 to 1.59) and adjusted models (restricted HR: 1.33, 95% CI: 1.01 to 1.75).

DISCUSSION

In both unadjusted and adjusted analyses, women with circumcised partners were at similar risk of chlamydial, gonococcal and trichomonal infections compared to women with uncircumcised partners. Women who did not know their partner's circumcision status were at significantly lower risk of GC and Tv than women with uncircumcised partners in unadjusted analyses, but after controlling for other risk factors, these associations largely disappeared.

Our findings largely agree with prior studies on MC and *men's* risk of these STIs. The literature on men's risk of Ct and Tv suggests no protective effect of circumcision (although the few studies of MC and Tv make overall conclusions

difficult). Although the literature on MC and men's risk of GC is mixed, many reports also suggest MC is not associated with men's GC risk.

Chlamydial, gonococcal and trichomonal infections in women, though easily cured, are often asymptomatic. Ct and GC particularly can have serious morbidities if left untreated, including pelvic inflammatory disease, ectopic pregnancy and infertility.¹⁹¹ Since women's access to STI treatment and care is limited in many regions, identifying prevention interventions that reduce the incidence of these infections is an important research priority worldwide.

At least two mechanisms exist by which MC could affect women's STI risk. First, MC may change *men's* STI risk, and subsequently alter the probability that women will be exposed to infected men. However, as described above, no strong evidence supports a conclusively protective role for MC against men's acquisition of the three STIs evaluated here. Second, MC may change the probability of transmission from infected men to susceptible women - the absence of a foreskin may alter the efficiency of pathogen transmission. Although Ct, GC and Tv infections in men occur nearly exclusively in the urethra,¹⁹² the foreskin is a repository for shed cells and secretions, and a moist, hospitable environment for pathogen growth. STI-infected, uncircumcised men may therefore expose their female partners to a higher pathogen burden than STI-infected circumcised men. Transient infectious organisms that do not ultimately adhere and infect exposed men may also have

longer viability in uncircumcised men. We found no reports comparing pathogen burdens in circumcised vs. uncircumcised men.

Three clinical trials evaluating whether MC is protective against men's risk of HIV acquisition have been stopped early because the intervention was found to have a strong protective effect (40-65% reductions in HIV incidence in circumcised men compared to uncircumcised men).¹⁹⁻²¹ More than 50 cohort and cross-sectional studies found largely similar results. Few prospective evaluations have characterized the effect of MC on women's HIV risk, and the small number of existing studies have had mixed findings: an analysis of these HC-HIV data found no effect of MC on women's HIV risk in women from FP/MCH populations (see Chapter 4) whereas three other prospective studies determined that women with circumcised partners had lower HIV risk than women partnered with uncircumcised men (in Tanzania⁶⁴ and Uganda^{65,66}). A more recent evaluation of women in Rakai, Uganda found lower, but non-significant, HIV risk for women with circumcised partners.⁶⁷

Our analysis has a number of limitations. First, HC-HIV was not designed to evaluate the role of MC on women's STI risk, and so some data that may have strengthened this analysis was not collected. For example, we did not ask about women's or partners' religion, hypothesized to be an unmeasured confounder in previous circumcision studies.⁴³ In addition, an evaluation of MC and women's risk of syphilis or chancroid might have been informative, since MC has been associated

with reduced risk of these two infections in men.²⁹ Unfortunately, we did not have incidence data on syphilis or chancroid in our cohort. Second, women's sexual behavior, as well as MC, were self-reported, and may suffer from recall and social desirability biases. In a previous analysis using these data to examine the effect of MC on women's risk of HIV acquisition (see Chapter 4), we conducted extensive sensitivity analyses of potential misclassification of MC and observed little change in our estimates. Although not included here, we expect bias resulting from misclassification of MC to be similarly minimal. Finally, we did not know the STI status of women's partners, which would have permitted us to characterize separately the effect of MC on men's initial STI risk and the effect of MC on the STI transmissibility from infected men to susceptible women. Instead, our measures of effect capture the overall, combined effect of these two pathways.

As with any laboratory procedure, methods to diagnose Ct, GC and Tv are not always accurate. Microscopy (wet mount), the diagnostic method for trichomonas, has poor sensitivity (49%-67%) but nearly perfect specificity (often cited as 100%) compared to PCR.¹⁷²⁻¹⁷⁵ A substudy comparing wet mount with PCR for Tv diagnosis, conducted among Zimbabwean and Ugandan participants at selected visits, found sensitivities and specificities for microscopy similar to published reports (B. Van der Pol, unpublished data). We anticipate that misclassification of Tv status would be nondifferential with respect to the exposure (*i.e.*, not associated with MC), suggesting the that observed effect estimates may be biased toward the null. The AMPLICOR® Ct/NG test, which has published sensitivity and specificity of 91.7%

and 99.7%, respectively, for Ct¹⁶⁷ and 92.4% and 99.5%, respectively, for GC,¹⁶⁸ has been criticized for cross-reactivity with nonpathogenic *neisseriae* strains,¹⁶⁹⁻¹⁷¹ leading to higher false-positive rates for GC than test characteristics would indicate. False-positive results are an issue of particular importance in a low-prevalence setting such as ours. In light of this problem, our outcome classification used the adjusted optical density parameters described in the methods (B. Van der Pol, personal communication), but some women diagnosed with GC during follow-up may have been misclassified.

Because our main analysis evaluated only MC status of women's *primary* partner, for women with multiple partners, the observed associations mix the effect of MC status of primary and non-primary partners. To address this limitation we included a sensitivity analysis that excluded follow-up time where women reported multiple partnerships; this analysis confirmed a lack of association between MC and GC or Tv. However, in adjusted models, monogamous women with circumcised partners appeared to have a significantly increased risk of incident chlamydial infection compared to women with uncircumcised partners. This finding disagrees with both existing analyses of MC and women's Ct risk: one previous study found significant protection against Ct seropositivity for women with circumcised partners,⁷³ and the other found no association between MC and women's Ct risk.⁶⁷

MC has the potential to reduce HIV risk among millions of men, and intervention programs are being planned worldwide. The effect of MC on men's STI risk is not

yet clear, and further research is warranted to determine whether MC also has direct or indirect effects on women's STI risk.

FIGURE 5.1. Unadjusted Kaplan-Meier curve comparing women's STI-free survival time by baseline circumcision status of the primary partner, Zimbabwe, Uganda and Thailand, HC-HIV, 1999-2004.

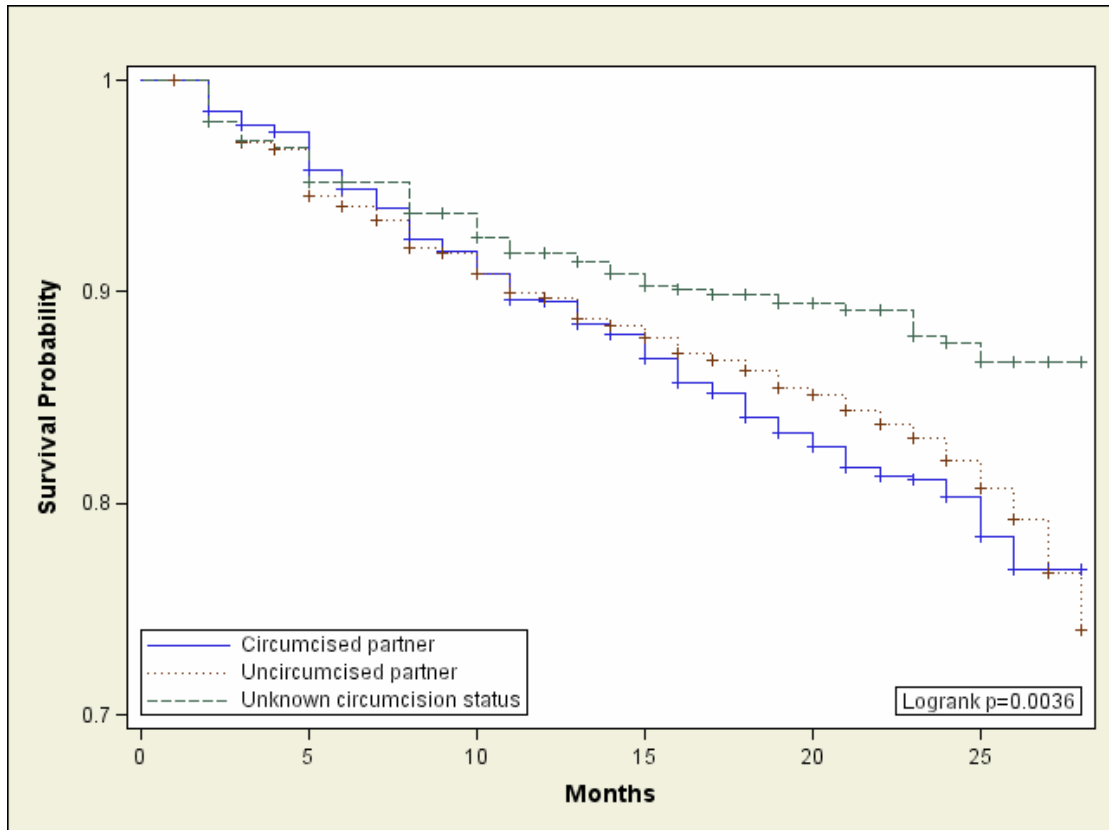

TABLE 5.1. Selected characteristics of women at enrollment, Uganda, Zimbabwe and Thailand, HC-HIV, 1999-2004.

Characteristic	n	%
Country and referral population		
Uganda		
Family planning/maternal-child health clinics	1790	30.2
STD clinics, military wives, sex worker networks	390	6.6
Thailand		
Family planning/maternal-child health clinics	1065	18.0
STD clinics, military wives, sex worker networks	452	7.6
Zimbabwe	2228	37.6
Baseline circumcision status of the primary partner		
Circumcised	1100	18.6
Uncircumcised	4195	70.8
Don't know	574	9.7
Missing	56	1.0
Baseline contraceptive method		
Combined oral contraceptive pills	2002	33.8
Injectable depot medroxyprogesterone acetate	2075	35.0
Non-hormonal or no contraceptive method	1848	31.2
Prevalent STI at enrollment		
Ct	208	3.5
GC	96	1.6
Tv	152	2.6
Currently cohabituate with primary partner		
Yes	5169	87.2
No	756	12.8
Currently employed		
Yes	3382	57.1
No	2543	42.9
Husband currently employed		
Yes	5671	95.7
No	201	3.4
Missing	53	0.9
Male condom use ever		
Yes	4247	71.7
No	1677	28.3
Don't know	1	0.02
Sex with men other than primary partner in last 3 months		
Yes	275	4.6
No	5649	95.3
Missing	1	0.02
Sex while intoxicated in last 3 months		
Yes	523	8.8
No	5401	91.2
Don't know	1	0.02
Ever exchanged sex for money or goods		
Yes	181	3.0
No	5744	97.0

Characteristic	Median	IQR*
Age (years)	25	22 to 29
Education (years)	9	7 to 11
Age at coital debut (years)	18	16 to 19
Age of primary partner (years)	30	27 to 35
Number of pregnancies	2	1 to 3
Number of sex partners, last three months	1	1 to 1
Number sex acts in last 30 days with primary partner	9	4 to 16
Nights primary partner away in last 30 days	0	0 to 7

* IQR = interquartile range

TABLE 5.2. Unadjusted incidence rates and 95% confidence intervals for CT, GC and TV, Uganda, Zimbabwe and Thailand, HC-HIV, 1999-2004.

Outcome	Circumcision status of primary partner			Circumcised			Uncircumcised			Unknown		
	Total events	Total PY*	Events	IR* per 100 PY*	95% CI*	Events	IR per 100 PY	95% CI	Events	IR per 100 PY	95% CI	
CT	411	9,892	80	4.47	3.49, 5.45	282	3.94	3.48, 4.40	49	5.18	3.73, 6.63	
GC	307	10,009	66	3.65	2.77, 4.54	224	3.10	2.69, 3.51	17	1.73	0.91, 2.56	
TV	373	9,891	83	4.65	3.64, 5.65	278	3.90	3.44, 4.36	12	1.23	0.53, 1.92	
Any STI [†]	895	9,455	180	10.53	8.99, 12.06	648	9.51	8.77, 10.24	67	7.21	5.48, 8.94	

* PY = person-years; IR = incidence rate; CI = confidence interval

[†] If women were missing outcomes for any individual STI at a given visit, she received a missing value for 'any STI.'

Consequently there are more missing outcomes for "any STI" than for individual STIs, and therefore the individual STIs do not sum to the "any STI" total of 895 cases.

TABLE 5.3. Unadjusted and adjusted hazard ratios and 95% confidence intervals for CT, GC and TV, Uganda, Zimbabwe and Thailand, HC-HIV, 1999-2004.

Outcome	Events	circumcised v. uncircumcised partners		partners of unknown circumcision status v. uncircumcised	
		HR	(95% CI)	HR	95% CI
Ct					
Unadjusted	411	1.13	(0.89, 1.45)	1.29	(0.95, 1.74)
Adjusted*	411	1.22	(0.94, 1.59)	0.94	(0.68, 1.30)
GC					
Unadjusted	307	1.18	(0.90, 1.56)	0.55	(0.34, 0.90)
Adjusted*	307	0.93	(0.70, 1.24)	0.95	(0.56, 1.60)
Tv					
Unadjusted	373	1.20	(0.94, 1.54)	0.31	(0.17, 0.55)
Adjusted*	368	1.05	(0.81, 1.37)	0.69	(0.38, 1.25)
Any STI					
Unadjusted	895	1.12	(0.95, 1.32)	0.74	(0.58, 0.95)
Adjusted*	890	1.02	(0.86, 1.22)	0.87	(0.67, 1.14)

* All adjusted models control for contraceptive method, age, age at coital debut, and country

CHAPTER 6: UNPROTECTED SEX IN HIV-INFECTED WOMEN IN UGANDA AND ZIMBABWE: SHORT- AND LONG-TERM COMPARISONS WITH PRE-INFECTION BEHAVIOR

ABSTRACT

Background: Recent HIV prevention initiatives focus on “positive prevention” – targeting and supporting HIV-infected individuals to modify their behavior and consequently reduce future transmission. However, despite the widespread promotion of male condoms to those living with HIV, no studies have systematically, prospectively measured condom use before and after HIV diagnosis. In a longitudinal cohort study that provided repeat HIV testing, counseling, and free condoms, we examined whether women decreased their unprotected sexual activity following notification of HIV-positive status.

Methods: We analyzed data collected during a multi-site, prospective study among women in Zimbabwe and Uganda (Hormonal Contraception and HIV Acquisition (HC-HIV)). We used zero-inflated negative binomial models to examine changes in the number and proportion of unprotected sex acts in a typical month. We selected one visit two to six months before HIV diagnosis and paired it with a visit two to six months after diagnosis (short-term analysis) or 12-16 months after diagnosis (long-term analysis). To track secular changes in condom use, we also included visits

spanning the same timeframes from a subset of randomly-selected uninfected women.

Results: Short- and long-term findings were similar. We therefore present only long-term results, conducted among 151 HIV-positive women and 650 uninfected comparison participants. After diagnosis, the number of HIV-infected women who reported *any* sex acts in a typical month decreased slightly (from 95% to 91%, $p=0.14$). The proportion of HIV-infected women reporting any *unprotected* acts declined more substantially (from 74% to 56%, $p<0.01$). In adjusted multivariable models, HIV-infected women were twice as likely to report no unprotected sex after diagnosis compared to pre-diagnosis behavior (odds ratio (OR): 1.99, 95% confidence interval (CI): 1.12 to 3.53); uninfected participants were somewhat less likely to report no unprotected sex (OR: 0.82, 95% CI: 0.64 to 1.04). Among those reporting any unprotected acts, HIV-infected women significantly reduced the *number* of unprotected sex acts in a typical month by 38% (95% CI: -16% to -55%) compared to pre-diagnosis behavior. However, HIV-positive women reported virtually no reduction in the *proportion* of unprotected acts in a typical month (7% reduction, 95% CI: -18% to +6%) after HIV diagnosis. Uninfected women reported little change in the number (2% increase, 95% CI: -8% to +12%) or proportion of unprotected acts (5% increase, 95% CI: +1% to +9%) over the same time period.

Conclusions: Reductions in the absolute number of sex acts and the number of unprotected acts reported by HIV-infected women are encouraging, because for

those in serodiscordant couples, each protected act is a potential transmission averted. However, more than half of HIV-positive women still engaged in unprotected sex more than a year after HIV diagnosis, and despite the lower absolute number of unprotected acts, women did not improve the proportion of acts in which they used male condoms. In addition, the lack of change in condom use among uninfected women, despite repeated risk reduction counseling and provision of free condoms, suggests that alternative prevention interventions are needed for this population.

INTRODUCTION

Recent HIV prevention initiatives focus on “positive prevention” – targeting and supporting HIV-infected individuals to modify their behavior and consequently reduce future transmission.¹⁹³⁻¹⁹⁶ Many randomized trials of positive prevention interventions measure changes in condom use to assess the efficacy of the intervention.¹⁹⁵ When used consistently and correctly, latex male condoms are effective against sexual transmission of HIV and most STIs.⁸⁵⁻⁸⁸

Despite the recent emphasis on positive prevention and the widespread promotion of male condoms to HIV-positive individuals, no studies have systematically and prospectively measured condom use before and after notification of HIV-positive status. Instead, some studies characterize risk behaviors (including condom use) of HIV-positive people after HIV diagnosis and compare them to behaviors reported at the time of notification of HIV-positive results;^{195,197,198} others make comparisons to a similar HIV-negative population to detect differences that might be due to awareness of HIV status. For example, HIV-positive Rwandan women were more likely to use condoms, and had a lower prevalence of gonococcal infection, than their HIV-negative peers.¹²⁷ In the Democratic Republic of Congo and Kenya, HIV counseling and testing had little impact on fertility rates in HIV-positive women,^{123,124} whereas HIV-positive Ugandan women had lower pregnancy rates than their HIV-negative peers.^{125,126} In longitudinal studies of HIV-infected US women, enrolled after HIV diagnosis, substantial numbers of HIV-positive participants experienced

STIs during follow-up.^{128,129} Many HIV-positive US adolescents and adults continue to engage in high-risk behavior,¹³⁰ with high proportions experiencing STI after HIV seroconversion.^{131,132} None of these studies captured condom use prior to individuals' notification of their HIV-positive status, so direct, prospective measurements of changes in condom use were not possible.

Is notification of HIV-positive status, together with risk reduction counseling, sufficient to induce and maintain increased condom use from pre-diagnosis behavior? We aimed to assess the effect of HIV diagnosis on women's use of male condoms over shorter (two to six months after diagnosis) and longer (12 to 16 months after diagnosis) time periods.

METHODS

This analysis draws data from the "Hormonal Contraception and Risk of HIV Acquisition" (HC-HIV) study, a prospective cohort study conducted in Uganda, Zimbabwe and Thailand, as well as an ancillary study involving the same participants called the "Effect of Hormonal Contraception on HIV Genital Shedding and Disease Progression among Women with Primary HIV Infection" (GS) study. HC-HIV had a primary objective to assess the effect of hormonal contraception on women's risk of HIV acquisition, whereas GS enrolled and followed Ugandan and Zimbabwean women who became HIV infected during HC-HIV, with a primary

objective to examine the role of hormonal contraception use on HIV genital shedding and disease progression.

Detailed methods and main findings for HC-HIV have been published elsewhere.¹⁴²

Study setting and population

HC-HIV enrolled and followed women from 1999-2004. Eligible women were 18-35 years of age; HIV-negative; sexually active and using either oral contraceptive pills (COCs), injectable depot medroxyprogesterone acetate (DMPA), or a non-hormonal or no contraceptive method.

Starting in March 2001, all women in Zimbabwe and Uganda who became HIV-infected during follow-up in HC-HIV were invited to enroll in GS. Because few incident HIV infections occurred in Thailand, the Thai site was not included in GS nor in the current analysis.

All Zimbabwean and most Ugandan participants were recruited from family planning and maternal-child health clinics. Owing to low initial HIV incidence rates among Ugandan women, recruitment there was expanded to include referrals from “higher-risk” populations, such as sexually transmitted disease clinics, sex workers and military wives.

Study procedures

HC-HIV study

At enrollment and each follow-up visit, women received structured, face-to-face interviews about their reproductive, contraceptive and sexual behavior, including use of male condoms. They also received physical exams with biological specimen collection for HIV and STI testing. Standard counseling on use of male condoms accompanied all HIV pre- and post-test counseling sessions. Follow-up visits took place approximately every three months for up to two years or until HIV seroconversion.

GS study

Women who became HIV-infected during HC-HIV were told about GS; interested women returned to the clinic for GS enrollment. GS participants who joined soon after HIV diagnosis had multiple early follow-up visits (at 2, 4 and 8 weeks after GS study entry); follow-up visits then took place, as in HC-HIV, approximately every three months. At each GS visit the same face-to-face HC-HIV questionnaires were administered to collect reproductive and sexual behavior information; women also underwent a physical examination with specimen collection. At every GS visit, participants received counseling and condom use instructions as well as a supply of free condoms.

Statistical analyses

Statistical analyses were performed using SAS (Version 9.1.3, SAS Institute, Cary, NC) and Stata (Version 9.2, Statacorp, College Station, TX).

Exposure measure: notification of HIV-positive status

Participants received HIV tests at every HC-HIV follow-up visit using a combination of two enzyme-linked immunosorbent assays or rapid tests. Positive results were confirmed by Western Blot or HIV polymerase chain reaction tests. Following a positive result, the participant was called back for a redraw visit (10-21 days after the initial test) to rule out labeling errors. At the redraw visit, counselors informed the woman that her HIV test appeared positive, but that further confirmatory tests were needed. A result was typically given to the participant within 1-2 weeks of the redraw visit. For this analysis, we used the date of the redraw visit, when women were first told they were likely infected with HIV, as the date of HIV diagnosis.

Outcome measure: Number of unprotected sex acts in a typical month

At each follow-up visit, during both HC-HIV and GS, participants were asked: “In the last three months, in a typical month, how many times did you have sex?” and “In the last three months, in a typical month, how many times did your partner use a male condom during sex with you?” Women answered these questions about all partners, separately for primary and other partners. The number of unprotected sex

acts in a typical month was calculated as the total number of sex acts with all partners minus the total number of sex acts where male condoms were used.

Analytic procedures

We examined condom use in two analyses, merging data collected during HC-HIV with data collected during GS (Figure 3.2).

Short-term comparison

Our first analysis examined short-term changes in participants' self-reported condom use. For women who experienced HIV infection during HC-HIV, we selected one HC-HIV visit two to six months prior to notification of HIV-positive status (the "before" visit) and one GS visit two to six months after HIV diagnosis ("after" visit). To capture any secular changes in condom use that may have taken place over the follow-up period, and to consider whether condom use was associated with HIV acquisition, we also included visits from women who did not become HIV-infected during HC-HIV. From all HC-HIV visits contributed by uninfected women, using SAS's random number generator, we randomly selected one "anchor" visit, then chose corresponding visits two to six months before and two to six months after the anchor visit. From all uninfected women with visits within the specified timeframe, we randomly selected a sample in an approximate 4:1 ratio with HIV-infected women.

Long-term comparison

Second, we examined changes in self-reported condom use over a longer time period. For women who became HIV-infected, we again selected one HC-HIV visit two to six months prior to notification of HIV-positive status, but we paired it with one GS visit 12-16 months after HIV diagnosis. For women remaining uninfected, we chose corresponding visits two to six months before the randomly-selected anchor visit and 12-16 months after the anchor visit. We again randomly selected a sample of uninfected women in an approximate 4:1 ratio with HIV-infected participants.

Although the same number of uninfected women were selected for short- and long-term analyses (n=650 for each), because of the random selection process and the timeframe requirements, uninfected participants included in the long-term analysis were not necessarily the same uninfected women as in the short-term analysis.

Visit selection

The goal of visit selection for each analysis was to have a pair of observations for each participant, with one “before” and one “after” measure. To be included in these analyses, HIV-infected women had to have GS visits within the specified timeframes (within six months of the redraw visit for the short-term analysis and at least 12 months after the redraw visit for the long-term analysis). Some HIV-infected women joined GS in sufficient time to be included in the short-term analysis but did not continue follow-up in GS long enough to be included in the long-term analysis. Similarly, uninfected women had to participate in HC-HIV long enough for

comparison measures to be captured (at least two months after their randomly-assigned anchor visit for the short-term analysis and at least 12 months after their anchor visit for the long-term analysis). When participants (HIV-infected or uninfected) contributed more than one visit within the specified timeframe, we chose the visit with non-missing data on condom use that was closest to the beginning of the window (e.g. closer to two months than six months, or closer to 12 months than 16 months).

Comparisons of coital frequency and unprotected sex

Using McNemar's test,¹⁹⁹ we examined whether the number of women reporting any sex acts in a typical month, or the number reporting any unprotected acts, changed a short and longer period after HIV diagnosis (for HIV-infected women) or anchor visit (for uninfected women). Using Student's t-test, we compared the mean number and proportion of unprotected acts among women who ultimately became HIV-infected and participants who remained HIV negative.²⁰⁰

Multivariable models

Because our outcome (number of unprotected sex acts) was a count, we considered and compared the fit of regression models using the Poisson, negative binomial, zero-inflated Poisson and zero-inflated negative binomial (ZINB) distributions.¹⁷⁷⁻¹⁷⁹ ZINB provided the best fit, and we subsequently used ZINB models to examine the change, with 95% confidence intervals (CIs), in the number of unprotected sex acts in a typical month.

Many condom use studies explore the *proportion* of sex acts where male condoms were used (or not used). However, because risk of sexual HIV transmission is more directly correlated with the *number* of unprotected sexual exposures, we were also interested in the absolute number of sex acts where condoms were not used. We ran each ZINB multivariable model without and then with an offset variable capturing the total number of sex acts in a typical month. Without the offset, the model predicted the number of unprotected acts in a typical month; with the offset, the model predicted the proportion of unprotected acts in a typical month.

ZINB models follow a two-step process. The first is a logistic model that predicts a binary outcome: zero vs. more than zero in the value of the count. The second process is a negative binomial model including those observations with a count value more than zero; it predicts the value of the non-zero count. Parameter estimates are produced for both model steps.

Effect estimates from the logistic procedure can be interpreted as an odds ratio (OR) comparing the odds of having no unprotected acts in a typical month after HIV diagnosis (for HIV-positive women) or anchor visit (for uninfected women), with the odds of having no unprotected acts in a typical month beforehand. A measure greater than 1.0 indicates that the odds of having no unprotected acts in a typical month after HIV diagnosis or anchor visit has increased compared to the odds of

having no unprotected acts in a typical month beforehand (in other words, that the odds of having any unprotected acts has decreased).

Interpretation of effect estimates from the negative binomial portion of the model changes depending on whether an offset variable is included (inclusion of the offset does not affect interpretation of the logistic portion of the model). Without an offset, effect estimates from the negative binomial portion of the model represent the relative change in the number of unprotected acts in a typical month after HIV diagnosis or anchor visit, compared to the number of unprotected acts in a typical month beforehand. A measure less than 1.0 indicates that the number of unprotected sex acts in a typical month has declined.

When including an offset variable for the total number of sex acts in a typical month, the measure of effect from the negative binomial portion of the model can be interpreted as a relative change in the *proportion* of acts in a typical month where male condoms were not used. Interpretation is otherwise similar: a measure less than 1.0 indicates that the proportion of all acts where male condoms were not used has declined.

To generate separate effect estimates for HIV-infected and uninfected participants, we used three independent variables in both the logistic and negative binomial portions of the ZINB model: *HIV*, coded 0 for women who remained HIV-negative throughout HC-HIV and 1 for women who became HIV-infected; *timepoint*, coded 0 for visits prior to HIV diagnosis (for women experiencing HIV infection) or anchor

visit (for women remaining HIV-negative) and 1 for visits after; and a product interaction term between *timepoint* and *HIV*.

We used robust variance estimation to account for non-independence resulting from repeated measures on individual participants.¹⁶⁰

We examined participants' demographic characteristics, reproductive factors and sexual behavior for their confounding influence on the association between HIV diagnosis and condom use. We included in each starting multivariable model all factors that were associated with HIV-positive status or condom use. We did not include in models variables which could be affected by notification of HIV-positive status.¹⁵⁶

To construct final models, we used a manual, backward elimination, change-in-estimate strategy.¹⁶⁴ One at a time, we removed covariates from the starting model; if removal changed the condom use association by less than 10%, a given covariate was not retained. We designated models as "final" when the remaining covariates confounded the main association or were retained for *a priori* considerations (age).

Any covariate that confounded the estimate for HIV-infected participants or for uninfected women, in short- or long-term analyses, in the logistic or negative binomial portions of the model, in a model with or without the offset variable, was included in the final adjustment set for all other analyses.

Ethical approval

All women enrolled in HC-HIV and GS gave written informed consent prior to participating, and local ethics committees at collaborating institutions gave approval for the studies.

RESULTS

Short-term changes in self-reported condom use

Selection of HIV-infected and uninfected participants

Of 213 Ugandan and Zimbabwean women who became HIV-infected during HC-HIV, 189 (89%) eventually participated in GS. A smaller proportion, 74% (n=158) had a GS visit within the specified window of two to six months after HIV diagnosis and are included in the short-term comparison. For these 158 participants, the median time between the “before” visit and the redraw visit was 3.3 months (interquartile range (IQR): 2.8-3.9 months), and the median time between the redraw visit and the “after” visit was 2.7 months (IQR: 2.3-3.7 months).

From 4,226 HC-HIV participants who remained HIV-uninfected, 650 women were randomly selected for the short-term analysis. For these uninfected women, the median time between the “before” visit and the anchor visit was 2.7 months (IQR:

2.6-2.8 months), and the median time between the anchor visit and the “after” visit was also 2.7 months (IQR: 2.6-2.9 months).

Because participant characteristics (Table 6.1), changes in coital frequency and frequency of unprotected sex (Table 6.2), and results of multivariable models (Table 6.3 and Table 6.4) for short-term comparisons were similar to the long-term analyses, due to space considerations we describe only the long-term findings in detail (see below).

Long-term changes in self-reported condom use

Selection of HIV-infected and uninfected participants

Of 189 HIV-infected women who joined GS, 151 participants (80%) had a GS visit 12-16 months after HIV diagnosis. For these 151 women, the median time between the “before” visit and the redraw visit was 3.2 months (IQR: 2.7-3.7 months), and the median time between the redraw visit and the “after” visit was 13.8 months (IQR: 13.1-14.3 months). Uninfected women (n=650) for the long-term comparison were selected from the 4,226 HC-HIV participants who remained HIV-uninfected; these participants were selected independent of inclusion in the short-term analysis. The median time between the “before” visit and the anchor visit for uninfected women in the long-term comparison was 2.7 months (IQR: 2.6-2.9 months), and the median time between the anchor visit and “after” visit was 13.5 months (IQR: 13.1-14.0 months).

Most HIV-infected women in the long-term analysis (91%, n=137) were also included in the short-term analysis. Approximately one-third of uninfected participants (35%, n=225) were common to both the short- and long-term analyses.

Participant characteristics (Table 6.1)

At the visit two to six months before HIV diagnosis, women who ultimately became HIV-infected were less likely than women remaining HIV-negative to be from Uganda (36% vs. 56%), although the proportion recruited from high-risk settings in Uganda was similar (11% vs. 10%) (Table 6.1). Half of all participants were employed, and most (76%-83%) lived with their primary partner. Mean age (25.0 vs. 25.5 years), mean age at coital debut (17.5 years in both groups) and mean years of education (9.1 for both groups) was similar between participants who ultimately became HIV-infected and those remaining uninfected. Alcohol or drug use during sex in the last three months was rare (3%-4%), and commercial sex was also uncommon (1% in both groups). Women who became HIV-infected were more likely than women remaining uninfected to report multiple partnerships in the last three months (7% vs. 3%) and to have a higher mean number of nights in the last month that the partner spent away from home (8.0 vs. 6.7 nights).

Changes in coital frequency and frequency of unprotected sex

We first examined changes in the number of HIV-infected and uninfected participants who reported any sex acts in a typical month (Table 6.2). The number of

women engaging in sex declined somewhat over the long term. Two to six months before HIV diagnosis, 144 participants (95%) who ultimately became HIV-infected reported at least one sex act in a typical month; 12-16 months after notification of HIV-positive status, 137 women (91%) reported at least one sex act in a typical month ($p=0.14$). Of uninfected women, 642 (99%) reported at least one sex act two to six months before the anchor visit, compared to 623 women (96%) who reported at least one sex act 12-16 months after the anchor visit ($p<0.01$) (Table 6.2).

We next examined whether the number of women reporting any *unprotected sex* acts changed over the long-term. Among HIV-infected women reporting at least one sex act, the number who had at least one unprotected act in a typical month declined significantly after diagnosis: two to six months before notification of HIV-positive status, 107 participants (74%) who ultimately became HIV-infected reported at least one unprotected act in a typical month; two to six months after notification of HIV-positive status, 77 women (56%) reported at least one unprotected act in a typical month ($p<0.01$). Uninfected women showed almost no change: among those with at least one sex act, 486 (75%) two to six months before the anchor visit, compared to 489 women (79%) 12-16 months after the anchor visit ($p=0.87$), reported at least one unprotected act in a typical month (Table 6.2).

Among women reporting at least one unprotected act in a typical month, we also examined changes to the mean total number of sex acts, the mean number of unprotected acts, and the proportion of sex acts where condoms were not used in a

typical month (Table 6.2). Among this subgroup, HIV-infected women showed significant declines in their overall mean coital frequency, but less substantial changes in the mean number of unprotected acts and virtually no change in the proportion of sex acts where condoms were used. Two to six months prior to notification of HIV-positive status, among those with at least one unprotected act, women who ultimately became HIV-infected reported a mean of 19.9 total sex acts and 11.2 unprotected acts in a typical month; they reported that condoms were not used in 79% of sex acts. After diagnosis, HIV-infected participants with at least one unprotected act reported means of 9.5 total sex acts and 7.0 unprotected acts in a typical month; the proportion of sex acts where condoms were not used was again 79%. In contrast, uninfected women with at least one unprotected act reported a mean of 14.9 total sex acts and 11.8 unprotected acts in a typical month before the anchor visit, very similar to the 14.2 mean total sex acts and 11.0 mean unprotected acts reported after the anchor visit (Table 6.2). The proportion of sex acts where condoms were not used among uninfected women was 84% prior to the anchor visit and 87% afterwards.

Of note, among women reporting at least one unprotected act in a typical month at the “before” visit, women who ultimately became HIV-infected did not differ significantly from women who remained uninfected in their mean number of unprotected acts (11.2 acts vs. 11.8 acts, $p=0.62$) or the mean proportion of unprotected acts (79% vs. 84% unprotected, $p=0.09$).

Multivariable long-term models

Because women who reported zero sex acts in a typical month were not at risk of the outcome (number of unprotected acts), these observations were excluded from multivariable models.

Long-term changes in the number of unprotected sex acts (Table 6.3)

In unadjusted analyses, women who experienced HIV infection were approximately twice as likely to report no unprotected sex in a typical month after notification of HIV-positive status compared to their pre-diagnosis visit (OR: 2.19, 95% CI: 1.28 to 3.74). Uninfected women had somewhat lower odds of reporting no unprotected acts in a typical month (in other words, higher odds of having any unprotected acts) 12-16 months after their anchor visit (OR: 0.84, 95% CI: 0.67 to 1.05) compared to two to six months before the anchor visit (Table 6.3).

Among those who reported any unprotected acts, 12-16 months after notification of HIV-positive status, HIV-infected women had a 40% reduction (95% CI: -19% to -56%) in the number of unprotected sex acts in a typical month compared to the pre-diagnosis period. Uninfected women did not substantially change their number of unprotected acts in a typical month (1% increase, 95% CI: -8% to +12%) following their anchor visit.

We refit our models after adjusting for variables that confounded associations with condom use (age, country, recruitment population, prior STI during study, and

partner symptomatic of STI in past three months). Adjusted measures of effect were similar to unadjusted estimates (Table 6.3): HIV-infected women were twice as likely to report no unprotected sex after HIV diagnosis (OR: 1.99, 95% CI: 1.12 to 3.53), and uninfected women had somewhat lower odds of no unprotected acts after their anchor visit (OR: 0.82, 95% CI: 0.64 to 1.04). Among those who reported any unprotected acts, 12-16 months after diagnosis, HIV-positive women had an adjusted decline in sex acts of 38% (95% CI: -16% to -55%). Uninfected women did not substantially change their number of unprotected acts in a typical month (2% adjusted increase, 95% CI: -8% to +12%) following their anchor visit.

Long-term changes in the proportion of unprotected sex acts (Table 6.4)

Inclusion of an offset variable for the total number of sex acts did not have a large influence on the logistic portion of the unadjusted model. HIV-infected women still had increased odds of reporting no unprotected sex acts 12-16 months after diagnosis, and uninfected women continued to have decreased odds of reporting no unprotected sex acts after the anchor visit (Table 6.4). Effect estimates did not meaningfully change for either group following multivariable adjustment (Table 6.4).

Accounting for the total number of sex acts, however, had a strong influence on the negative binomial portion of the long-term model compared to the model without the offset. After diagnosis, HIV-infected women had virtually no reduction in the *proportion* of sex acts where male condoms were not used (4% reduction (unadjusted), 95% CI: -15% to +10%). Uninfected women similarly had no

meaningful change (4% increase (unadjusted), 95% CI: -0% to +8%). Adjustment for confounding variables did not substantially alter the proportion of total sex acts where male condoms were not used for HIV-infected or uninfected women (Table 6.4).

Restricting the analysis datasets to include only participants contributing complete pairs of “before” and “after” visits did not meaningfully change the short- or long-term effect estimates (data not shown).

DISCUSSION

In this prospective analysis, women who were made aware of their HIV infection modified their behavior in several ways that protected their partners from exposure. Although most did not abstain altogether from coitus, HIV-infected participants were less likely to report any unprotected sex acts, and among those with at least one unprotected act, they reduced the absolute number of unprotected acts in a typical month. Although these results are encouraging, the proportion of HIV-positive women reporting some unprotected sex remained fairly high (56%) more than a year after diagnosis. In addition, although HIV-infected women modified the number of unprotected acts, the proportion of unprotected acts was nearly unchanged from pre-infection behavior. These results contrast with women who remained HIV-negative, who exhibited few substantive changes over equivalent follow-up periods.

Reductions in risky behavior were evident both through a decline in the number of women reporting any unprotected sex and, among those who continued to have unprotected sex, through the decreased number of unprotected acts that they engaged in. However, those HIV-infected participants that continued to have some unprotected sex did not increase the proportion of acts in which condoms were used, suggesting that condom promotion messages delivered through HIV post-test counseling were not sufficient to change condom use behaviors among these participants and their partners.

From a public health perspective, a reduction in the number of unprotected acts is more important than a change in the proportion of acts where male condoms were used. Sexual transmission of HIV occurs through an act of unprotected sex. Whether that act is a large or small proportion of all sex acts is less relevant. Because HIV-infected women in this cohort significantly reduced their number of unprotected acts, susceptible partners of HIV-infected women likely faced reduced HIV risk. For example, a woman who has 20 total sex acts, with 10 acts unprotected, before notification of HIV-positive status and 10 total sex acts, with 5 acts unprotected, afterwards has used condoms in an equivalent proportion of acts (50% in each case). After diagnosis, however, her partner is exposed to HIV fewer times, and is therefore at lower risk of acquisition.

The lack of change in condom use among uninfected women, who also received risk reduction counseling and free male condoms throughout the study, suggests

that counseling and supplies alone are not sufficient to reduce unprotected sex. Importantly, most women in this cohort were in monogamous relationships, and they cohabitated with their partner; condom use in primary partnerships among both general population and higher-risk developing country cohorts has consistently been found to be low.²⁰¹⁻²⁰⁴ At HC-HIV baseline, 4% of COC users, 7% of DMPA users, and 63% of users of non-hormonal methods reported always using condoms, whereas 76% of COC users, 77% of DMPA users, and 17% of users of non-hormonal methods reported never using condoms.²⁰⁵ Given that the probability of HIV transmission from infected men to susceptible women may be higher than from infected women to susceptible men,^{206,207} an improvement in condom use among uninfected women may be more important from a public health perspective than improvements by HIV-positive women.

The decline in number of unprotected acts among HIV-infected women may be due to factors other than intentional risk-reduction behavior change. At the visit two to six months prior to HIV diagnosis, a woman may have reported riskier behavior than is typical for her – for most participants, the “before” visit occurred around the time of HIV acquisition – and so reductions in risk following notification of HIV infection may simply be a return to more typical behavior. Women who disclosed HIV status to their partners may have experienced relationship dissolution and consequent reductions in overall coital frequency and numbers of unprotected acts (we unfortunately did not collect data on disclosure to partners). Decreased sexual activity could also be due to depression following diagnosis, or (particularly for long-

term analyses) to HIV-related illness in a woman's partner, resulting in decreased sexual drive.

Our analysis addresses a number of gaps in the previous literature on this topic. First, no published study has compared women's reported condom use from the period prior to HIV diagnosis with condom use both a short and longer time after notification of infection status. Because we systematically captured women's condom use prior to diagnosis, our measure was not biased by women's knowledge of their status or the presence of symptoms that may have prompted them to modify condom use. Second, much of the research examining risk behavior after HIV acquisition has been conducted among specialized, high-risk populations (in the US, in adolescents or gay men; in international settings, in sex workers or truckers) and is not readily generalizable to the large proportion of general population women in our cohort. Finally, earlier studies that tracked changes in condom use after infection typically did so for a limited period of time, often for three months or less. Our long-term analysis demonstrates that behavior changes may be sustained over many months, and that a regression to baseline behavior may be avoidable.

In preliminary analyses, we examined changes to condom use associations when multivariable models were adjusted for contraceptive method, cohabitation with the primary partner, and recent pregnancy. Because each of these variables may be associated with condom use, we initially evaluated them as possible confounders. However, they may also be affected by notification of HIV positive status,¹⁵⁶ and lie

on the causal pathway between HIV diagnosis and behavior change. We ultimately decided to exclude all three variables from final models for this reason. Of note, the magnitude of modeling estimates did not change meaningfully when these variables were included (data not shown). We also initially included women's time since enrollment in HC-HIV as an adjustment variable in the modeling analyses, to account for participants' varying exposure to condom counseling messages. Due to substantial collinearity with several other covariates, the precision of our effect estimates declined considerably when this variable was included. Removing it from the models had very little influence on validity (since the magnitude of the measures of effect changed very little), and we ultimately chose to exclude it because of precision concerns.²⁰⁸

Our analyses also suffer from a number of limitations. Most importantly, the number of unprotected sex acts was self-reported by women and may have been influenced by recall and social desirability biases. For example, notification of HIV-positive status may affect women's *reports* of condom use, rather than affecting actual condom use. Because such misreporting could be differential by HIV status, the resulting bias is unpredictable and could lead to inflated or attenuated effect estimates. Second, we do not know which participants had HIV-infected partners. If a woman knew that her sex partner was already HIV-positive, she would likely lack incentive to reduce unprotected sex upon learning of her own positive status. Our estimates therefore reflect a combination of women who did and did not need to "protect" their sex partners from subsequent infection.

Third, we made two simplifying assumptions that could have influenced our findings: we computed the number of unprotected acts as the total number of acts minus acts where male condoms were used, without taking account of women's use of female condoms. Female condoms are not widely available in Zimbabwe and Uganda and are expensive where they can be purchased, so we do not expect that this assumption will lead to substantial bias. Of women included in short-term analyses, for example, at HC-HIV baseline, only 9 women (5%) who ultimately seroconverted and 10 women (2%) remaining uninfected reported *ever* using a female condom. In addition, we collapsed sexual behavior with primary and non-primary sexual partners. Most women did not have multiple partners – at the “before” visit, 6-7% of women ultimately becoming HIV-infected and 1-3% of participants remaining uninfected reported more than one sexual partner in the last three months – and we expect any bias to be minimal. Finally, we acknowledge that women may make different decisions upon discovering they are HIV-infected, and a change in condom use is only one; changes in multiple partnerships, concurrent partnerships, commercial sex work or other risky behavior among HIV-infected women are also possible. Although we examined these behaviors in preliminary analyses (data not shown), because they were not commonly reported by participants at any visit regardless of HIV status, we did not have adequate power to detect changes over the follow-up period.

We undertook these analyses to explore a fundamental assumption in HIV prevention interventions – that proper information and adequate supplies can induce HIV-infected individuals to reduce their risk behavior and prevent subsequent transmission to vulnerable partners. Due to both reductions in the number of women engaging in unprotected sex and through declines in overall coital frequency, HIV-infected Ugandan and Zimbabwean women in this cohort reduced the risk of HIV transmission to susceptible partners and sustained these behavior changes more than a year after HIV diagnosis.

TABLE 6.1. Selected participant characteristics reported two to six months before HIV diagnosis (HIV-infected women) or anchor visit (uninfected women).

Characteristic	Short-term analysis				Long-term analysis			
	HIV-infected		HIV-uninfected		HIV-infected		HIV-uninfected	
	N=158*	%	N=650†	%	n=151*	%	N=650†	%
Country/referral population								
Uganda								
Family planning and MCH clinic	36	22.8	291	44.8	38	25.2	299	46.0
STD clinics, sex worker networks, military wives	18	11.4	59	9.1	16	10.6	62	9.5
Zimbabwe	104	65.8	300	46.2	97	64.2	289	44.5
Employed								
Yes	80	50.6	325	50.0	75	49.7	326	50.2
No	78	49.4	325	50.0	76	50.3	324	49.9
Cohabitate with primary partner								
Yes	122	77.2	534	82.2	115	76.2	538	82.8
No	36	22.8	116	17.9	36	23.8	112	17.2
Alcohol or drug use during sex in last 3 months								
Yes	6	3.8	15	2.3	6	4.0	19	2.9
No	152	96.2	635	97.7	145	96.0	631	97.1
Current contraceptive method								
Combined oral contraceptive pills (COCs)	43	27.2	234	36.0	45	29.8	218	33.5
DMPA	65	41.1	239	36.8	64	42.4	258	39.7
COCs and DMPA	1	0.6	2	0.3	0	0.0	3	0.5
Non-hormonal method	49	31.0	175	26.9	42	27.8	171	26.3
Commercial sex in last 3 months								
Yes	2	1.3	5	0.8	2	1.3	5	0.8
No	156	98.7	645	99.2	149	98.7	645	99.2
Number of sex partners in last 3 months								
0 partners	6	3.8	12	1.9	7	4.6	4	0.6
1 partner	142	89.9	629	96.8	134	88.7	628	96.6
2 or more partners	10	6.3	9	1.4	10	6.6	18	2.8

	Short-term analysis				Long-term analysis			
	HIV-infected		HIV-uninfected		HIV-infected		HIV-uninfected	
	mean	SD	mean	SD	mean	SD	mean	SD
Age, years	24.9	4.1	25.6	4.4	25.0	4.2	25.5	4.5
Age at coital debut, years	17.6	2.2	17.5	2.5	17.5	2.2	17.5	2.7
Education, years	9.2	2.5	9.2	3.0	9.1	2.5	9.1	3.1
Partner nights away in last 30 days	8.3	11.1	6.8	10.7	8.0	10.9	6.7	10.7

* 137 HIV-infected women are common to the short- and long-term analyses.

† 225 HIV-uninfected women are common to both the short- and long-term analyses.

TABLE 6.2. Coital frequency of and condom use by HIV-infected and HIV-uninfected participants, Uganda and Zimbabwe, HC-HIV and GS studies, 1999-2006.

Sexual behavior	Short-term analysis				Long-term analysis			
	HIV-positive		HIV-negative		HIV-positive		HIV-negative	
	n	%	n	%	n	%	n	%
All women								
No sex acts*								
Before ^S	7	4.4	13	2.0	7	4.6	8	1.2
After ^S	15	9.5	20	3.1	14	9.3	27	4.2
≥ 1 sex act*								
Before	151	95.6	637	98.0	144	95.4	642	98.8
After	143	90.5	630	96.9	137	90.7	623	95.8
p-value	0.10		0.23		0.14		<0.01	
Among women with ≥ 1 sex act*†								
No unprotected acts*								
Before	42	27.8	142	22.3	37	25.7	156	24.3
After	63	44.1	117	18.6	60	43.8	134	21.5
≥ 1 unprotected act*								
Before	109	72.2	495	77.7	107	74.3	486	74.8
After	80	55.9	513	81.4	77	56.2	489	78.5
p-value	<0.01		0.08		<0.01		0.87	
Among women with ≥1 unprotected act*	mean	SD†	mean	SD	mean	SD	mean	SD
Total acts*	20.8	58.7	14.0	10.2	19.9	59.2	14.9	12.3
Before	13.9	21.1	13.8	9.6	9.5	7.2	14.2	11.9
Unprotected acts*								
Before	11.9	12.5	11.7	8.8	11.2	11.7	11.8	10.4
After	8.7	6.8	11.5	8.7	7.0	6.0	12.0	11.0
% of acts that are unprotected								
Before	77.0	30.4	86.5	25.2	78.9	29.5	84.1	27.7
After	78.4	31.7	86.5	25.5	78.5	29.8	87.1	25.0

- * In a typical month in the last three months
- † Denominator for percentages is women with ≥ 1 sex act
- ‡ SD = standard deviation
- § Before and after notification of HIV positive status (HIV-infected women) or anchor visit (uninfected participants)

TABLE 6.3. Zero-inflated negative binomial models assessing changes in number of unprotected sex acts in a typical month following notification of HIV-positive status (HIV-infected participants) or randomly-assigned anchor visit (uninfected participants), Uganda and Zimbabwe, HC-HIV and GS studies, 1999-2006.

Analysis	Population	Unadjusted			Adjusted [†]			
		ZI* OR*: odds of zero UPS* acts	95% CI*	Relative change in number of UPS acts	ZI OR: odds of zero UPS acts	95% CI	Relative change in number of UPS acts	
Short-term	HIV-positive	2.03	1.29, 3.20	0.72	1.55	0.91, 2.66	0.71	0.55, 0.91
	HIV-negative	0.77	0.63, 0.94	0.98	0.77	0.63, 0.95	0.98	0.91, 1.06
Long-term	HIV-positive	2.19	1.28, 3.74	0.60	1.99	1.12, 3.53	0.62	0.45, 0.84
	HIV-negative	0.84	0.67, 1.05	1.01	0.82	0.64, 1.04	1.02	0.92, 1.12

* ZI = zero-inflated; OR = odds ratio; UPS= unprotected sex; CI = confidence interval

† All adjusted models control for age, country, recruitment population, prior STI during study, and partner symptomatic of STI in past three months

TABLE 6.4. Zero-inflated negative binomial models assessing changes in proportion of unprotected sex acts in a typical month following notification of HIV-positive status (HIV-infected participants) or randomly-assigned anchor visit (uninfected participants), Uganda and Zimbabwe, HC-HIV and GS studies, 1999-2006.

Analysis	Population	Unadjusted			Adjusted [†]				
		ZI* OR*: odds of zero UPS* acts	95% CI*	Relative change in proportion of UPS acts	ZI OR: odds of zero UPS acts	95% CI	Relative change in proportion of UPS acts		
Short-term	HIV-positive	2.11	1.31, 3.39	0.98	0.86, 1.12	1.66	0.95, 2.91	0.96	0.83, 1.12
	HIV-negative	0.74	0.60, 0.90	0.99	0.96, 1.02	0.73	0.59, 0.90	1.00	0.97, 1.03
Long-term	HIV-positive	2.32	1.38, 3.90	0.96	0.85, 1.10	2.17	1.23, 3.83	0.93	0.82, 1.06
	HIV-negative	0.83	0.67, 1.04	1.04	1.00, 1.08	0.82	0.65, 1.04	1.05	1.01, 1.09

* ZI = zero-inflated; OR = odds ratio; UPS = unprotected sex CI = confidence interval

† All adjusted models control for age, country, recruitment population, prior STI during study, and partner symptomatic of STI in past three months

CHAPTER 7: DISCUSSION

As of January 6 [1986], the C.D.C. reported a cumulative total of 16,138 cases of AIDS, resulting in 8,220 deaths so far. ... “I fear it will get worse before it gets better,” said Dr. Ward Cates, head of the sexually transmitted disease division at the Federal centers. ...”

-*New York Times*, Philip M. Boffey, 14 January 1986

More than 25 years have passed since the perplexing immunodeficiency syndrome, later characterized as AIDS, was first noted among five previously healthy gay men in Los Angeles.²⁰⁹ As the outbreak grew from local clusters within marginalized communities to a worldwide pandemic affecting people of all ages and demographics – by December 2006, 40 million people worldwide were estimated to be infected with HIV² – efforts to prevent transmission of the virus have also seen exponential growth in scope and intensity. The results of most HIV-prevention programs, however, have been disappointing. Two interventions have been notable exceptions to this dismal history: by 1983, researchers had noted that consistent use of male condoms appeared to reduce the probability of transmission of disease from infected individuals to their susceptible sex partners.²¹⁰⁻²¹² Much more recently, in November 2005 and February 2007, large-scale randomized trials determined that men who were circumcised had 40-65% reduced risk of HIV acquisition compared to their uncircumcised peers.¹⁹⁻²¹ These “bookend” interventions – one at

the very start of the epidemic, and one just definitively confirmed in recent weeks – are the focus of these dissertation analyses.

Male circumcision and women's risk of HIV and STI

Summary of findings

Our analyses focused on the impact of these two interventions specifically among women. Few previous studies had investigated the influence of MC on women's HIV risk; the three published prospective reports all indicated that women with circumcised partners had lower HIV risk than those with uncircumcised partners.⁶⁴⁻⁶⁷ For most women in our cohort, however, MC was not associated with decreased risk of HIV. For a small subgroup of participants recruited from high-risk settings, there was a non-significant suggestion of reduced HIV risk among women with circumcised partners compared to those with uncircumcised partners. Our Ct results, which suggest little effect of MC on women's Ct risk, agrees with one of two previous analyses of MC and chlamydial risk among women.⁶⁷ The second study on MC and Ct reported that women whose partners were circumcised were strongly protected against Ct acquisition.⁷³ The direction of our observed association is the opposite of this second study, as women in our cohort who reported uncircumcised partners appeared to have somewhat lower Ct risk, particularly when the analysis was restricted to women with only one sexual partner. The one previous study that evaluated MC and women's risk of GC found no association,⁶⁷ and the same study

reported that MC was protective against women's infection with prevalent Tv.⁶⁷ We found no association between MC and these infections in our cohort.

Interpretation

Despite the great promise of MC to reduce HIV risk among men, we did not find substantial protection for most women in our cohort. We note that because we had HIV/STI incidence measures on women only and not their sexual partners, we were unable to separately assess the two mechanisms through which women's disease-acquisition risk could be altered: if circumcision allowed a man to avoid initial infection, and thereby reduced or eliminated the risk of infection in his sex partners, or, if circumcision reduced the transmissibility of HIV from infected men to susceptible women. Given that the recent MC-HIV trials are being interpreted as definitive confirmation that circumcised men have lower HIV risk, it is somewhat surprising that we did not see more of an impact of MC among women in our study through the first mechanism, even if the second proposed mechanism had no effect.

MC is only one factor that may raise or lower men's risk of HIV acquisition. Although we attempted to assess and control for men's behavior (as reported by their female partners), risky sexual practices by men (such as multiple and concurrent partnerships, prevalent STI, and other factors) may have "overwhelmed" the protective effect of MC for the male partners of women in our study. (We did not observe confounding by those partner-level risk behaviors that were measured). If circumcised partners of women in our study were HIV-infected in similar proportions

as uncircumcised partners, and circumcision is not associated with a direct reduction in risk of HIV transmission to susceptible women, it follows that HIV risk to women in our cohort would not differ by circumcision status of women's sex partners. In addition, the protection conferred to men by MC is not complete. If the circumcised primary partner of a woman in our cohort was previously partnered with an HIV-infected woman, over time the cumulative probability of HIV transmission to that man due to repeated HIV exposure may well have been greater than the protection provided by his circumcised status.

Public health significance

Male circumcision may “provide a degree of protection ... equivalent to what a vaccine of high efficacy [could] achieve.”¹⁹ Recent trials showing significant declines in HIV risk for circumcised men compared to uncircumcised men have been met with great enthusiasm and optimism, and intervention programs are being planned worldwide. Modeling simulations, accounting for changes in HIV prevalence to men directly and to their female sex partners indirectly, found that MC could avert two million new HIV infections and 300,000 deaths in sub-Saharan Africa in the first ten years of an MC intervention with full coverage. In the ten years after that, it could avert a further 3.7 million new HIV infections and 2.7 million deaths.¹⁵

Future research directions

Although MC interventions are currently being planned worldwide, significant questions remain about the efficacy of this intervention for non-HIV STIs and for

women. None of these outstanding questions will (or should) delay the planned interventions, but monitoring and follow-up analyses should be conducted alongside the prevention programs to answer unknown questions about efficacy of MC for other outcomes and populations. For example, previous observational research suggests that MC lowers men's risk of acquisition of syphilis and chancroid.²⁹ We could not assess the associations between MC and these infections in women because we did not have data on incident chancroid or syphilis among female participants in our cohort. Because transmission mechanisms for ulcerative STIs differ from those for HIV or bacterial STIs, a quantification of the association between MC and women's risk of chancroid and syphilis would be helpful.

In addition, as noted above, we were unable to determine whether associations between MC and women's HIV risk were due to men's reduced risk of initial HIV acquisition and subsequent reductions in women's exposure to HIV-infected men, or whether MC directly altered the probability of HIV transmission from infected men to susceptible women. Ultimately a quantification of these distinct components is needed. A prospective, HIV-serodiscordant couples' study (HIV-positive men and HIV-negative women) is a superior design to parse these effects, and such a study is currently underway in Rakai, Uganda. Better control of confounding factors related to men's sexual behavior is a second advantage of a couples' study, since male partners are study participants in their own right and provide information about their own behavior, rather than women guessing about their partners' risk factors. We note that in the HC-HIV study, however, women's HIV risk was correlated with

reported risk behavior of the primary partners,¹⁴² indicating that these women had accurate perceptions about partner behavior.

HIV diagnosis and changes in condom use

Summary of findings

Our second analysis aimed to explore a fundamental assumption of post-diagnosis counseling efforts directed at HIV-positive individuals. With comprehensive counseling and unlimited condom supplies, do HIV-positive women actually change their condom use after diagnosis? Women who became HIV-infected did modify their behavior in several ways that protected their partners from exposure to HIV. Although most did not abstain altogether from coitus, HIV-infected participants had lower sexual frequency, were less likely to report *any* unprotected sex acts, and had a reduced mean number of unprotected acts in a typical month both a short and longer period after notification of HIV-positive status. Although these results are encouraging, the proportion of HIV-positive women reporting at least one unprotected act remained fairly high (56%) more than a year after diagnosis. In addition, although HIV-infected women modified the number of unprotected acts, after adjustment for confounding factors, the proportion of unprotected acts was nearly unchanged from pre-infection behavior. These results contrast with women who remained HIV-negative, who exhibited few substantive changes over equivalent follow-up periods.

Reductions in risky behavior were evident both through a decline in the number of women reporting any unprotected sex and, among those who continued to have unprotected sex, through the decreased number of unprotected acts that they engaged in. However, those HIV-infected participants that continued to have some unprotected sex did not increase the proportion of acts in which condoms were used, suggesting that condom promotion messages delivered through HIV post-test counseling were not sufficient to change condom use behaviors among these participants and their partners.

Interpretation

The results of our analysis of condom use behavior among HIV-positive women differ somewhat from other studies on this topic. Although no previous published paper has prospectively, systematically compared condom use before and after HIV acquisition, studies attempting to answer a similar research question generally found that changes in risky behavior were short-lived.^{102,110,114}

We note that the decline in the number of unprotected acts among HIV-infected women could be due to factors other than an intentional choice to reduce risky behavior. For example, at the visit two to six months prior to HIV diagnosis, a woman may have reported riskier behavior than is typical for her – for most participants, the “before” comparison visit occurred around the time of HIV acquisition – and so reductions in risk following notification of HIV infection may simply be a return to her more typical behavior. Alternatively, women’s decreased

sexual activity could be a result of depression after learning their serostatus. Of course, coital frequency and condom use also depend on the behavior of women's primary partner. Women who disclosed HIV status to their partners may have experienced relationship dissolution and consequent reductions in overall coital frequency and numbers of unprotected acts. We unfortunately did not collect data on serostatus disclosure to partners. However, 91 HIV-positive women (58% of included HIV-infected women) in the short-term analysis and 92 women (61% in the long-term analysis reported either no primary partner or a different primary partner at some point over GS follow-up (not necessarily at the "after" comparison visit). Whether these partnership changes were the direct result of HIV serostatus disclosure is unknown. Finally, even for women whose relationships remained intact, participants (or more likely, their partners) may have become symptomatic and experienced decreased sexual drive.

Public health significance

Women's use of male condoms with partners is an inherently difficult topic. Since, as a physical reality, women do not "wear" the condom, they often lack control over decisions related to its use. Despite this (very large) limitation in the promotion of male condoms for HIV prevention, aside from abstinence, condoms are the most widely-promoted method to reduce the probability of disease transmission.

Our analysis explored changes in condom use in a very particular setting – HIV diagnosis accompanied by comprehensive counseling and unlimited condom

supplies. The substantial reductions in risky behavior observed among these participants, evident both through a decline in the number of women reporting any unprotected sex and, among those who continued to have unprotected sex, through the decreased number of unprotected acts that they engaged in, may therefore not be generalizable to populations where condoms and counseling are not so readily available to HIV-infected individuals.

The lack of change in condom use among uninfected women, who also received risk reduction counseling and free male condoms throughout the study, suggests that counseling and supplies alone are not sufficient to reduce unprotected sex. Importantly, most women in this cohort were in monogamous relationships, and they cohabitated with their partner; condom use in primary partnerships among both general population and higher-risk developing country cohorts has consistently been found to be low.²⁰¹⁻²⁰⁴ Given that the probability of HIV transmission from infected men to susceptible women may be higher than from infected women to susceptible men,^{206,207} an improvement in condom use among uninfected women may be more important from a public health perspective than improvements by HIV-positive women.

Future research directions

Little is known about women's decisions related to condom use following HIV diagnosis. Such decisions are tied to the type of partner (e.g., husband or boyfriend vs. casual partner), his interest in and willingness to use condoms, his serostatus,

and the level of communication between partners about these topics. Many studies have shown that condom promotion counseling is more successful when both members of the partnership receive counseling,¹²¹ but once again, prospective comparisons are lacking. An analysis of short- and long-term changes in condom use behavior within couples, particularly serodiscordant couples, would be informative.

A significant limitation of these analyses is reliance on self-reported condom use behavior. If biological assays could measure sexual frequency and condom use, reliance on self-reported measures would no longer be necessary, and potential social desirability and recall biases could be reduced. However, no sufficiently sensitive and specific assay exists for such measurements. Current detection methods that identify presence of Y chromosome or prostate specific antigen differ substantially with self-reported behavior; whether this is due to misreporting or mismeasurement of the biological outcome is not known.²¹³⁻²¹⁷ Future techniques will likely also have limitations related to half-life (for example, the decay of their ability to detect unprotected sex over time). Repetition of these analyses over shorter and longer time periods, and using different outcome classifications (for example, use of condoms at the last sex act rather than in a typical month) to determine whether findings are similar would be worthwhile to evaluate the robustness of our findings.

A further research goal is to prospectively explore changes in other risky behaviors following HIV diagnosis. We focused only on changes in male condom use in our analyses, when in fact women could chose to modify other aspects of their behavior in response to HIV diagnosis. In some populations, other types of behavior change may be more common and have greater impact in reducing subsequent HIV transmission.

REFERENCES

1. World Health Organization (WHO). Global prevalence and incidence of select curable sexually transmitted infections: overview and estimates. Department of Communicable Disease Surveillance and Response, Geneva: 2001.
2. UNAIDS/WHO. AIDS epidemic update: December 2006. Report number UNAIDS/06.29E. Geneva: 2006.
3. Mabey D. Sexually transmitted diseases in developing countries. *Trans R Soc Trop Med Hyg* 1996;90(2):97-9.
4. Mayaud P, Mabey D. Approaches to the control of sexually transmitted infections in developing countries: old problems and modern challenges. *Sex Transm Infect* 2004;80(3):174-82.
5. Glasier A, Gulmezoglu AM, Schmid GP, Moreno CG, Van Look PF. Sexual and reproductive health: a matter of life and death. *Lancet* 2006;368(9547):1595-607.
6. Bolan G, Ehrhardt AA, Wasserheit JN. Gender perspectives and STDs (Chapter 8). In: Holmes KK, Sparling PF, Mardh P, et al., eds. Sexually transmitted diseases. 3rd ed. New York: McGraw-Hill, Health Professions Division, 1999: xxiii, 1454, 1-62 p.
7. Alanis MC, Lucidi RS. Neonatal circumcision: a review of the world's oldest and most controversial operation. *Obstet Gynecol Surv* 2004;59(5):379-95.
8. Updegrave KK. An evidence-based approach to male circumcision: what do we know? *J Midwifery Womens Health* 2001;46(6):415-22.
9. Inungu J, MaloneBeach E, Betts J. Male circumcision and the risk of HIV infection. *AIDS Read* 2005;15(3):130-1, 135, 138.
10. Schoen EJ. Benefits of newborn circumcision: is Europe ignoring medical evidence? *Arch Dis Child* 1997;77(3):258-60.
11. American Academy of Pediatrics. Circumcision Information for Parents. URL: http://www.aap.org/pubed/ZZZJZMEMH4C.htm?&sub_cat=1. Accessed 6 March 2007.
12. Magoha GA. Circumcision in various Nigerian and Kenyan hospitals. *East Afr Med J* 1999;76(10):583-6.
13. Swazi men queue for circumcision to fight AIDS. Sydney Morning Herald. August 30, 2006.
14. Uganda: Braving the Knife. The Monitor. January 13, 2007.

15. Williams BG, Lloyd-Smith JO, Gouws E, et al. The potential impact of male circumcision on HIV in Sub-Saharan Africa. *PLoS Med* 2006;3(7):e262.
16. Wendell B, Werker E. Male circumcision and the impact of AIDS in Africa. Cambridge: Harvard University Department of Economics, 2004.
17. Measure DHS. Demographic and health surveys 2005. URL: <http://www.measuredhs.com>. Accessed 25 May 2006.
18. Auvert B, Buve A, Ferry B, et al. Ecological and individual level analysis of risk factors for HIV infection in four urban populations in sub-Saharan Africa with different levels of HIV infection. *Aids* 2001;15 Suppl 4:S15-30.
19. Auvert B, Taljaard D, Lagarde E, Sobngwi-Tambekou J, Sitta R, Puren A. Randomized, controlled intervention trial of male circumcision for reduction of HIV infection risk: the ANRS 1265 Trial. *PLoS Med* 2005;2(11):e298.
20. Gray RH, Kigozi G, Serwadda D, et al. Male circumcision for HIV prevention in men in Rakai, Uganda: a randomised trial. *Lancet* 2007;369(9562):657–66.
21. Bailey RC, Moses S, Parker CP, et al. Male circumcision for HIV prevention in young men in Kisumu, Kenya: a randomised controlled trial. *Lancet* 2007;369(9562):643–56.
22. O'Farrell N, Egger M. Circumcision in men and the prevention of HIV infection: a 'meta-analysis' revisited. *Int J STD AIDS* 2000;11(3):137-42.
23. Moses S, Nagelkerke NJ, Blanchard J. Analysis of the scientific literature on male circumcision and risk for HIV infection. *Int J STD AIDS* 1999;10(9):626-8.
24. Weiss HA, Quigley MA, Hayes RJ. Male circumcision and risk of HIV infection in sub-Saharan Africa: a systematic review and meta-analysis. *Aids* 2000;14(15):2361-70.
25. Siegfried N, Muller M, Deeks J, et al. HIV and male circumcision--a systematic review with assessment of the quality of studies. *Lancet Infect Dis* 2005;5(3):165-73.
26. Van Howe RS. Circumcision and HIV infection: review of the literature and meta-analysis. *Int J STD AIDS* 1999;10(1):8-16.
27. Baeten JM, Richardson BA, Lavreys L, et al. Female-to-male infectivity of HIV-1 among circumcised and uncircumcised Kenyan men. *J Infect Dis* 2005;191(4):546-53.
28. Moses S, Bailey RC, Ronald AR. Male circumcision: assessment of health benefits and risks. *Sex Transm Infect* 1998;74(5):368-73.

29. Weiss HA, Thomas SL, Munabi SK, Hayes RJ. Male circumcision and risk of syphilis, chancroid, and genital herpes: a systematic review and meta-analysis. *Sex Transm Infect* 2006;82(2):101-9; discussion 110.
30. Parker SW, Stewart AJ, Wren MN, Gollow MM, Straton JA. Circumcision and sexually transmissible disease. *Med J Aust* 1983;2(6):288-90.
31. Cook LS, Koutsky LA, Holmes KK. Circumcision and sexually transmitted diseases. *Am J Public Health* 1994;84(2):197-201.
32. Diseker RA, 3rd, Peterman TA, Kamb ML, et al. Circumcision and STD in the United States: cross sectional and cohort analyses. *Sex Transm Infect* 2000;76(6):474-9.
33. Hooper RR, Reynolds GH, Jones OG, et al. Cohort study of venereal disease. I: the risk of gonorrhea transmission from infected women to men. *Am J Epidemiol* 1978;108(2):136-44.
34. Hart G. Factors associated with genital chlamydial and gonococcal infection in males. *Genitourin Med* 1993;69(5):393-6.
35. Reynolds SJ, Shepherd ME, Risbud AR, et al. Male circumcision and risk of HIV-1 and other sexually transmitted infections in India. *Lancet* 2004;363(9414):1039-40.
36. Donovan B, Bassett I, Bodsworth NJ. Male circumcision and common sexually transmissible diseases in a developed nation setting. *Genitourin Med* 1994;70(5):317-20.
37. Smith GL, Greenup R, Takafuji ET. Circumcision as a risk factor for urethritis in racial groups. *Am J Public Health* 1987;77(4):452-4.
38. Gray R, Azire J, Serwadda D, et al. Male circumcision and the risk of sexually transmitted infections and HIV in Rakai, Uganda. *Aids* 2004;18(18):2428-30.
39. Jansen HA, Morison L, Mosha F, et al. Geographical variations in the prevalence of HIV and other sexually transmitted infections in rural Tanzania. *Int J STD AIDS* 2003;14(4):274-80.
40. Oliver JC, Oliver RT, Ballard RC. Influence of circumcision and sexual behaviour on PSA levels in patients attending a sexually transmitted disease (STD) clinic. *Prostate Cancer Prostatic Dis* 2001;4(4):228-231.
41. Aynaud O, Piron D, Bijaoui G, Casanova JM. Developmental factors of urethral human papillomavirus lesions: correlation with circumcision. *BJU Int* 1999;84(1):57-60.

42. Fergusson DM, Boden JM, Horwood LJ. Circumcision status and risk of sexually transmitted infection in young adult males: an analysis of a longitudinal birth cohort. *Pediatrics* 2006;118(5):1971-7.
43. Bailey RC, Plummer FA, Moses S. Male circumcision and HIV prevention: current knowledge and future research directions. *Lancet Infect Dis* 2001;1(4):223-31.
44. Laumann EO, Masi CM, Zuckerman EW. Circumcision in the United States. Prevalence, prophylactic effects, and sexual practice. *Jama* 1997;277(13):1052-7.
45. Lavreys L, Rakwar JP, Thompson ML, et al. Effect of circumcision on incidence of human immunodeficiency virus type 1 and other sexually transmitted diseases: a prospective cohort study of trucking company employees in Kenya. *J Infect Dis* 1999;180(2):330-6.
46. Serour F, Samra Z, Kushel Z, Gorenstein A, Dan M. Comparative periurethral bacteriology of uncircumcised and circumcised males. *Genitourin Med* 1997;73(4):288-90.
47. Spach DH, Stapleton AE, Stamm WE. Lack of circumcision increases the risk of urinary tract infection in young men. *Jama* 1992;267(5):679-81.
48. Krieger JN, Verdon M, Siegel N, Critchlow C, Holmes KK. Risk assessment and laboratory diagnosis of trichomoniasis in men. *J Infect Dis* 1992;166(6):1362-6.
49. Jessamine PG, Plummer FA, Ndinya Achola JO, et al. Human immunodeficiency virus, genital ulcers and the male foreskin: synergism in HIV-1 transmission. *Scand J Infect Dis Suppl* 1990;69:181-6.
50. de Vincenzi I, Mertens T. Male circumcision: a role in HIV prevention? *Aids* 1994;8(2):153-60.
51. Szabo R, Short RV. How does male circumcision protect against HIV infection? *Bmj* 2000;320(7249):1592-4.
52. Corey L, Wald A. Genital herpes (Chapter 21). In: Holmes KK, Sparling PF, Mardh P, et al., eds. Sexually transmitted diseases. 3rd ed. New York: McGraw-Hill, Health Professions Division, 1999: xxiii, 1454, 1-62 p.
53. Halperin DT, Bailey RC. Male circumcision and HIV infection: 10 years and counting. *Lancet* 1999;354(9192):1813-5.
54. Hussain LA, Lehner T. Comparative investigation of Langerhans' cells and potential receptors for HIV in oral, genitourinary and rectal epithelia. *Immunology* 1995;85(3):475-84.

55. Nasio JM, Nagelkerke NJ, Mwatha A, Moses S, Ndinya-Achola JO, Plummer FA. Genital ulcer disease among STD clinic attenders in Nairobi: association with HIV-1 and circumcision status. *Int J STD AIDS* 1996;7(6):410-4.
56. Fleiss PM, Hodges FM, Van Howe RS. Immunological functions of the human prepuce. *Sex Transm Infect* 1998;74(5):364-7.
57. Ahmed AA, Nordlind K, Schultzberg M, Liden S. Immunohistochemical localization of IL-1 alpha-, IL-1 beta-, IL-6- and TNF-alpha-like immunoreactivities in human apocrine glands. *Arch Dermatol Res* 1995;287(8):764-6.
58. Ahmed A, Jones AW. Apocrine cystadenoma. A report of two cases occurring on the prepuce. *Br J Dermatol* 1969;81(12):899-901.
59. Frohlich E, Schaumburg-Lever G, Klessen C. Immunelectron microscopic localization of cathepsin B in human exocrine glands. *J Cutan Pathol* 1993;20(1):54-60.
60. Denniston GC, Hill G. Male circumcision and HIV. *Epidemiology* 2004;15(5):647; author reply 647-8.
61. Siegfried N, Muller M, Volmink J, et al. Male circumcision for prevention of heterosexual acquisition of HIV in men. *Cochrane Database Syst Rev* 2003(3):CD003362.
62. De PK. Tissue distribution of constitutive and induced soluble peroxidase in rat. Purification and characterization from lacrimal gland. *Eur J Biochem* 1992;206(1):59-67.
63. Klebanoff SJ, Coombs RW. Viricidal effect of *Lactobacillus acidophilus* on human immunodeficiency virus type 1: possible role in heterosexual transmission. *J Exp Med* 1991;174(1):289-92.
64. Kapiga SH, Lyamuya EF, Lwihula GK, Hunter DJ. The incidence of HIV infection among women using family planning methods in Dar es Salaam, Tanzania. *Aids* 1998;12(1):75-84.
65. Quinn TC, Wawer MJ, Sewankambo N, et al. Viral load and heterosexual transmission of human immunodeficiency virus type 1. Rakai Project Study Group. *N Engl J Med* 2000;342(13):921-9.
66. Gray RH, Kiwanuka N, Quinn TC, et al. Male circumcision and HIV acquisition and transmission: cohort studies in Rakai, Uganda. Rakai Project Team. *Aids* 2000;14(15):2371-81.
67. Gray R, Wawer M, Thoma M, et al. Male circumcision and the risks of female HIV and sexually transmitted infections acquisition in Rakai, Uganda (abstract

- #128). 13th Conference on Retroviruses and Opportunistic Infections, Denver, 2006.
68. Hunter DJ, Maggwa BN, Mati JK, Tukei PM, Mbugua S. Sexual behavior, sexually transmitted diseases, male circumcision and risk of HIV infection among women in Nairobi, Kenya. *Aids* 1994;8(1):93-9.
 69. Malamba SS, Mermin JH, Bunnell R, et al. Couples at risk: HIV-1 concordance and discordance among sexual partners receiving voluntary counseling and testing in Uganda. *J Acquir Immune Defic Syndr* 2005;39(5):576-80.
 70. Guimaraes M, Castilho E, Ramos Filho C, al. e. Heterosexual transmission of HIV-1 : a multicenter study in Rio de Janeiro, Brazil (abstract #ThC573). VII International Conference on AIDS, Florence, 1991.
 71. Allen S, Lindan C, Serufilira A, et al. Human immunodeficiency virus infection in urban Rwanda. Demographic and behavioral correlates in a representative sample of childbearing women. *Jama* 1991;266(12):1657-63.
 72. Chao A, Bulterys M, Musanganire F, et al. Risk factors associated with prevalent HIV-1 infection among pregnant women in Rwanda. National University of Rwanda-Johns Hopkins University AIDS Research Team. *Int J Epidemiol* 1994;23(2):371-80.
 73. Castellsague X, Peeling RW, Franceschi S, et al. Chlamydia trachomatis infection in female partners of circumcised and uncircumcised adult men. *Am J Epidemiol* 2005;162(9):907-16.
 74. Patterson BK, Landay A, Siegel JN, et al. Susceptibility to human immunodeficiency virus-1 infection of human foreskin and cervical tissue grown in explant culture. *Am J Pathol* 2002;161(3):867-73.
 75. Miller CJ, Vogel P, Alexander NJ, Dandekar S, Hendrickx AG, Marx PA. Pathology and localization of simian immunodeficiency virus in the reproductive tract of chronically infected male rhesus macaques. *Lab Invest* 1994;70(2):255-62.
 76. Miller CJ. Localization of Simian immunodeficiency virus-infected cells in the genital tract of male and female Rhesus macaques. *J Reprod Immunol* 1998;41(1-2):331-9.
 77. Lilienfeld AM, Graham S. Validity of determining circumcision status by questionnaire as related to epidemiological studies of cancer of the cervix. *J Natl Cancer Inst* 1958;21(4):713-20.

78. Diseker RA, 3rd, Lin LS, Kamb ML, et al. Fleeting foreskins: the misclassification of male circumcision status. *Sex Transm Dis* 2001;28(6):330-5.
79. Seed J, Allen S, Mertens T, et al. Male circumcision, sexually transmitted disease, and risk of HIV. *J Acquir Immune Defic Syndr Hum Retrovirol* 1995;8(1):83-90.
80. Stern E, Lachenbruch PA. Circumcision information in a cancer detection center population. *J Chronic Dis* 1968;21(2):117-24.
81. Terris M, Wilson F, Nelson JH, Jr. Relation of circumcision to cancer of the cervix. *Am J Obstet Gynecol* 1973;117(8):1056-66.
82. Kershaw TS, Ickovics JR, Lewis JB, Niccolai LM, Milan S, Ethier KA. Sexual risk following a sexually transmitted disease diagnosis: the more things change the more they stay the same. *J Behav Med* 2004;27(5):445-61.
83. National Institute of Allergy and Infectious Diseases (NIAID). Workshop summary: scientific evidence on condom effectiveness for sexually transmitted disease (STD) prevention. 20 July 2001.
84. Draft guidance for industry and FDA staff. Class II special controls guidance document: labeling for male condoms made of natural rubber latex: United States Food and Drug Administration (FDA), 2005.
85. Holmes KK, Levine R, Weaver M. Effectiveness of condoms in preventing sexually transmitted infections. *Bull World Health Organ* 2004;82(6):454-61.
86. Wald A, Langenberg AG, Krantz E, et al. The relationship between condom use and herpes simplex virus acquisition. *Ann Intern Med* 2005;143(10):707-13.
87. Wald A, Langenberg AG, Link K, et al. Effect of condoms on reducing the transmission of herpes simplex virus type 2 from men to women. *Jama* 2001;285(24):3100-6.
88. Warner L, Newman DR, Austin HD, et al. Condom effectiveness for reducing transmission of gonorrhea and chlamydia: the importance of assessing partner infection status. *Am J Epidemiol* 2004;159(3):242-51.
89. Pinkerton SD, Abramson PR. Effectiveness of condoms in preventing HIV transmission. *Soc Sci Med* 1997;44(9):1303-12.
90. Weller SC. A meta-analysis of condom effectiveness in reducing sexually transmitted HIV. *Soc Sci Med* 1993;36(12):1635-44.

91. Spruyt A, Steiner MJ, Joanis C, et al. Identifying condom users at risk for breakage and slippage: findings from three international sites. *Am J Public Health* 1998;88(2):239-44.
92. Pinkerton SD, Chesson HW, Layde PM. Utility of behavioral changes as markers of sexually transmitted disease risk reduction in sexually transmitted disease/HIV prevention trials. *J Acquir Immune Defic Syndr* 2002;31(1):71-9.
93. Pinkerton SD, Layde PM, DiFranceisco W, Chesson HW. All STDs are not created equal: an analysis of the differential effects of sexual behaviour changes on different STDs. *Int J STD AIDS* 2003;14(5):320-8.
94. Pinkerton SD, Abramson PR. Occasional condom use and HIV risk reduction. *J Acquir Immune Defic Syndr Hum Retrovirol* 1996;13(5):456-60.
95. Centers for Disease Control and Prevention (CDC). Revised Guidelines for HIV Counseling, Testing, and Referral and Revised Recommendations for HIV Screening of Pregnant Women. *MMWR* 2001;50(RR-19).
96. Belcher L, Kalichman S, Topping M, et al. A randomized trial of a brief HIV risk reduction counseling intervention for women. *J Consult Clin Psychol* 1998;66(5):856-61.
97. Kamb ML, Fishbein M, Douglas JM, Jr., et al. Efficacy of risk-reduction counseling to prevent human immunodeficiency virus and sexually transmitted diseases: a randomized controlled trial. Project RESPECT Study Group. *Jama* 1998;280(13):1161-7.
98. Laga M, Alary M, Nzila N, et al. Condom promotion, sexually transmitted diseases treatment, and declining incidence of HIV-1 infection in female Zairian sex workers. *Lancet* 1994;344(8917):246-8.
99. Shain RN, Piper JM, Newton ER, et al. A randomized, controlled trial of a behavioral intervention to prevent sexually transmitted disease among minority women. *N Engl J Med* 1999;340(2):93-100.
100. Jenkins PR, Jenkins RA, Nannis ED, McKee KT, Jr., Temoshok LR. Reducing risk of sexually transmitted disease (STD) and human immunodeficiency virus infection in a military STD clinic: evaluation of a randomized preventive intervention trial. *Clin Infect Dis* 2000;30(4):730-5.
101. Kalichman SC, Cain D, Ketch J, Hill J. Patterns of sexual risk behavior change among sexually transmitted infection clinic patients. *Arch Sex Behav* 2005;34(3):307-19.
102. Shrier LA, Ancheta R, Goodman E, Chiou VM, Lyden MR, Emans SJ. Randomized controlled trial of a safer sex intervention for high-risk adolescent girls. *Arch Pediatr Adolesc Med* 2001;155(1):73-9.

103. Metcalf CA, Malotte CK, Douglas JM, Jr., et al. Efficacy of a booster counseling session 6 months after HIV testing and counseling: a randomized, controlled trial (RESPECT-2). *Sex Transm Dis* 2005;32(2):123-9.
104. Metcalf CA, Douglas JM, Jr., Malotte CK, et al. Relative efficacy of prevention counseling with rapid and standard HIV testing: a randomized, controlled trial (RESPECT-2). *Sex Transm Dis* 2005;32(2):130-8.
105. Orr DP, Langefeld CD, Katz BP, Caine VA. Behavioral intervention to increase condom use among high-risk female adolescents. *J Pediatr* 1996;128(2):288-95.
106. Payn B, Tanfer K, Billy JO, Grady WR. Men's behavior change following infection with a sexually transmitted disease. *Fam Plann Perspect* 1997;29(4):152-7.
107. Warszawski J, Meyer L. Gender difference in persistent at-risk sexual behavior after a diagnosed sexually transmitted disease. ACSF-Investigators. *Sex Transm Dis* 1998;25(8):437-42.
108. Bentley ME, Spratt K, Shepherd ME, et al. HIV testing and counseling among men attending sexually transmitted disease clinics in Pune, India: changes in condom use and sexual behavior over time. *Aids* 1998;12(14):1869-77.
109. Fortenberry JD. Health care seeking behaviors related to sexually transmitted diseases among adolescents. *Am J Public Health* 1997;87(3):417-20.
110. Fortenberry JD, Brizendine EJ, Katz BP, Orr DP. Post-treatment sexual and prevention behaviours of adolescents with sexually transmitted infections. *Sex Transm Infect* 2002;78(5):365-8.
111. Crosby RA, DiClemente RJ, Wingood GM, et al. Associations between sexually transmitted disease diagnosis and subsequent sexual risk and sexually transmitted disease incidence among adolescents. *Sex Transm Dis* 2004;31(4):205-8.
112. Fortenberry JD, Brizendine EJ, Katz BP, Wools KK, Blythe MJ, Orr DP. Subsequent sexually transmitted infections among adolescent women with genital infection due to *Chlamydia trachomatis*, *Neisseria gonorrhoeae*, or *Trichomonas vaginalis*. *Sex Transm Dis* 1999;26(1):26-32.
113. Blythe MJ, Katz BP, Batteiger BE, Ganser JA, Jones RB. Recurrent genitourinary chlamydial infections in sexually active female adolescents. *J Pediatr* 1992;121(3):487-93.
114. Diclemente RJ, Wingood GM, Sionean C, et al. Association of adolescents' history of sexually transmitted disease (STD) and their current high-risk

- behavior and STD status: a case for intensifying clinic-based prevention efforts. *Sex Transm Dis* 2002;29(9):503-9.
115. Crosby R, Leichliter JS, Brackbill R. Longitudinal prediction of sexually transmitted diseases among adolescents: results from a national survey. *Am J Prev Med* 2000;18(4):312-7.
 116. Godin G, Gagnon H, Lambert LD. Factors associated with maintenance of regular condom use among single heterosexual adults: a longitudinal study. *Can J Public Health* 2003;94(4):287-91.
 117. Fleisher JM, Senie RT, Minkoff H, Jaccard J. Condom use relative to knowledge of sexually transmitted disease prevention, method of birth control, and past or present infection. *J Community Health* 1994;19(6):395-407.
 118. Capps L, Peng G, Doyle M, El-Sadr W, Neaton JD. Sexually transmitted infections in women infected with the human immunodeficiency virus. Terry Bein Community Programs for Clinical Research on AIDS (CPCRA). *Sex Transm Dis* 1998;25(8):443-7.
 119. Hillis SD, Nakashima A, Marchbanks PA, Addiss DG, Davis JP. Risk factors for recurrent Chlamydia trachomatis infections in women. *Am J Obstet Gynecol* 1994;170(3):801-6.
 120. McCoy D. Active STDs at rural community clinics in KwaZulu. *S Afr Med J* 1995;85(1):57.
 121. Weinhardt LS, Carey MP, Johnson BT, Bickham NL. Effects of HIV counseling and testing on sexual risk behavior: a meta-analytic review of published research, 1985-1997. *Am J Public Health* 1999;89(9):1397-405.
 122. Wolitski RJ, MacGowan RJ, Higgins DL, Jorgensen CM. The effects of HIV counseling and testing on risk-related practices and help-seeking behavior. *AIDS Educ Prev* 1997;9(3 Suppl):52-67.
 123. Ryder RW, Batter VL, Nsuami M, et al. Fertility rates in 238 HIV-1-seropositive women in Zaire followed for 3 years post-partum. *Aids* 1991;5(12):1521-7.
 124. Temmerman M, Moses S, Kiragu D, Fusallah S, Wamola IA, Piot P. Impact of single session post-partum counselling of HIV infected women on their subsequent reproductive behaviour. *AIDS Care* 1990;2(3):247-52.
 125. Campbell CH, Jr., Marum ME, Alwano-Edyegu M, Dillon BA, Moore M, Gumisiriza E. The role of HIV counseling and testing in the developing world. *AIDS Educ Prev* 1997;9(3 Suppl):92-104.

126. De Zoysa I, Phillips KA, Kamenga MC, et al. Role of HIV counseling and testing in changing risk behavior in developing countries. *Aids* 1995;9 Suppl A:S95-101.
127. Allen S, Serufilira A, Bogaerts J, et al. Confidential HIV testing and condom promotion in Africa. Impact on HIV and gonorrhea rates. *Jama* 1992;268(23):3338-43.
128. Kissinger P, Clark R, Dumestre J, Bessinger R. Incidence of three sexually transmitted diseases during a safer sex promotion program for HIV-infected women. *J Gen Intern Med* 1996;11(12):750-2.
129. Bersoff-Matcha SJ, Horgan MM, Fraser VJ, Mundy LM, Stoner BP. Sexually transmitted disease acquisition among women infected with human immunodeficiency virus type 1. *J Infect Dis* 1998;178(4):1174-7.
130. Diamond C, Buskin S. Continued risky behavior in HIV-infected youth. *Am J Public Health* 2000;90(1):115-8.
131. Erbeding EJ, Chung SE, Kamb ML, Irwin KL, Rompalo AM. New sexually transmitted diseases in HIV-infected patients: markers for ongoing HIV transmission behavior. *J Acquir Immune Defic Syndr* 2003;33(2):247-52.
132. Belongia EA, Danila RN, Angamuthu V, et al. A population-based study of sexually transmitted disease incidence and risk factors in human immunodeficiency virus-infected people. *Sex Transm Dis* 1997;24(5):251-6.
133. Kalichman SC, Rompa D, Cage M, et al. Effectiveness of an intervention to reduce HIV transmission risks in HIV-positive people. *Am J Prev Med* 2001;21(2):84-92.
134. Wynder EL, Licklider SD. The question of circumcision. *Cancer* 1960;13:442-5.
135. Schlossberger NM, Turner RA, Irwin CE, Jr. Early adolescent knowledge and attitudes about circumcision: methods and implications for research. *J Adolesc Health* 1992;13(4):293-7.
136. Castellsague X, Bosch FX, Munoz N, et al. Male circumcision, penile human papillomavirus infection, and cervical cancer in female partners. *N Engl J Med* 2002;346(15):1105-12.
137. Brinton LA, Reeves WC, Brenes MM, et al. The male factor in the etiology of cervical cancer among sexually monogamous women. *Int J Cancer* 1989;44(2):199-203.

138. Urassa M, Todd J, Boerma JT, Hayes R, Isingo R. Male circumcision and susceptibility to HIV infection among men in Tanzania. *Aids* 1997;11(3):73-80.
139. Agot KE, Ndinya-Achola JO, Kreiss JK, Weiss NS. Risk of HIV-1 in rural Kenya: a comparison of circumcised and uncircumcised men. *Epidemiology* 2004;15(2):157-63.
140. Dunn JE, Jr., Buell P. Association of cervical cancer with circumcision of sexual partner. *J Natl Cancer Inst* 1959;22(4):749-64.
141. UNAIDS/WHO. Report on the global AIDS epidemic: December 2004. Geneva, 2004.
142. Morrison CS, Richardson BA, Mmiro F, et al. Hormonal contraception and the risk of HIV acquisition. *Aids* 2007;21(1):85-95.
143. Greenland S, Pearl J, Robins JM. Causal diagrams for epidemiologic research. *Epidemiology* 1999;10(1):37-48.
144. Kelly R, Kiwanuka N, Wawer MJ, et al. Age of male circumcision and risk of prevalent HIV infection in rural Uganda. *Aids* 1999;13(3):399-405.
145. Quigley M, Munguti K, Grosskurth H, et al. Sexual behaviour patterns and other risk factors for HIV infection in rural Tanzania: a case-control study. *Aids* 1997;11(2):237-48.
146. Brown JE, Micheni KD, Grant EM, Mwenda JM, Muthiri FM, Grant AR. Varieties of male circumcision: a study from Kenya. *Sex Transm Dis* 2001;28(10):608-12.
147. Meier AS, Bukusi EA, Cohen CR, Holmes KK. Independent association of hygiene, socioeconomic status, and circumcision with reduced risk of HIV infection among Kenyan men. *J Acquir Immune Defic Syndr* 2006;43(1):117-8.
148. O'Farrell N, Quigley M, Fox P. Association between the intact foreskin and inferior standards of male genital hygiene behaviour: a cross-sectional study. *Int J STD AIDS* 2005;16(8):556-9.
149. O'Farrell N, Morison L, Moodley P, et al. Association between HIV and subpreputial penile wetness in uncircumcised men in South Africa. *J Acquir Immune Defic Syndr* 2006;43(1):69-77.
150. Hargreaves JR. Socioeconomic status and risk of HIV infection in an urban population in Kenya. *Trop Med Int Health* 2002;7(9):793-802.

151. Gray PB. HIV and Islam: is HIV prevalence lower among Muslims? *Soc Sci Med* 2004;58(9):1751-6.
152. Drain PK, Halperin DT, Hughes JP, Klausner JD, Bailey RC. Male circumcision, religion, and infectious diseases: an ecologic analysis of 118 developing countries. *BMC Infect Dis* 2006;6:172.
153. Drain PK, Smith JS, Hughes JP, Halperin DT, Holmes KK. Correlates of national HIV seroprevalence: an ecologic analysis of 122 developing countries. *J Acquir Immune Defic Syndr* 2004;35(4):407-20.
154. Malamba SS, Wagner HU, Maude G, et al. Risk factors for HIV-1 infection in adults in a rural Ugandan community: a case-control study. *Aids* 1994;8(2):253-7.
155. Cox DR. Regression models and life-tables. *Journal of the Royal Statistical Society, Series B* 1972;34(2):187-220.
156. Rothman KJ, Greenland S, eds. *Modern epidemiology*. 2nd ed. Philadelphia, PA: Lippincott-Raven, 1998.
157. Selvin S. *Statistical analysis of epidemiologic data*. 3rd ed. Oxford ; New York: Oxford University Press, 2004.
158. Allison PD. *Survival analysis using the SAS system : a practical guide*. Cary, N.C.: SAS Institute, Inc., 2003.
159. Hosmer DW, Lemeshow S. *Applied survival analysis : regression modeling of time to event data*. New York: Wiley, 1999.
160. Lin DY, Wei LJ. The robust inference for the Cox proportional hazards model. *J Am Stat Assoc* 1989.
161. Kleinbaum DG, Klein M. *Survival analysis : a self-learning text*. 2nd ed. New York, N.Y.: Springer, 2005.
162. Efron B. The efficiency of Cox's likelihood function for censored data. *J Am Stat Assoc* 1977;72:557-62.
163. Kaplan EL, Meier P. Nonparametric estimation from incomplete observations. *J Am Stat Assoc* 1958;53:457-81.
164. Maldonado G, Greenland S. Simulation study of confounder-selection strategies. *Am J Epidemiol* 1993;138(11):923-36.
165. Greenland S. Basic methods for sensitivity analysis and external adjustment (Chapter 19). In: Rothman KJ, Greenland S, eds. *Modern epidemiology*. 2nd ed. Philadelphia, PA: Lippincott-Raven, 1998: 343-57.

166. Lash TL, Silliman RA. A sensitivity analysis to separate bias due to confounding from bias due to predicting misclassification by a variable that does both. *Epidemiology* 2000;11(5):544-9.
167. Livengood CH, 3rd, Wrenn JW. Evaluation of COBAS AMPLICOR (Roche): accuracy in detection of Chlamydia trachomatis and Neisseria gonorrhoeae by coamplification of endocervical specimens. *J Clin Microbiol* 2001;39(8):2928-32.
168. Martin DH, Cammarata C, Van Der Pol B, et al. Multicenter evaluation of AMPLICOR and automated COBAS AMPLICOR CT/NG tests for Neisseria gonorrhoeae. *J Clin Microbiol* 2000;38(10):3544-9.
169. Van Der Pol B, Martin DH, Schachter J, et al. Enhancing the specificity of the COBAS AMPLICOR CT/NG test for Neisseria gonorrhoeae by retesting specimens with equivocal results. *J Clin Microbiol* 2001;39(9):3092-8.
170. Tabrizi SN, Chen S, Cohenford MA, et al. Evaluation of real time polymerase chain reaction assays for confirmation of Neisseria gonorrhoeae in clinical samples tested positive in the Roche Cobas Amplicor assay. *Sex Transm Infect* 2004;80(1):68-71.
171. Farrell DJ. Evaluation of AMPLICOR Neisseria gonorrhoeae PCR using cppB nested PCR and 16S rRNA PCR. *J Clin Microbiol* 1999;37(2):386-90.
172. Radonjic IV, Dzamic AM, Mitrovic SM, Arsic Arsenijevic VS, Popadic DM, Kranjcic Zec IF. Diagnosis of Trichomonas vaginalis infection: The sensitivities and specificities of microscopy, culture and PCR assay. *Eur J Obstet Gynecol Reprod Biol* 2006;126(1):116-20.
173. Madico G, Quinn TC, Rompalo A, McKee KT, Jr., Gaydos CA. Diagnosis of Trichomonas vaginalis infection by PCR using vaginal swab samples. *J Clin Microbiol* 1998;36(11):3205-10.
174. Van Der Pol B, Kraft CS, Williams JA. Use of an adaptation of a commercially available PCR assay aimed at diagnosis of chlamydia and gonorrhea to detect Trichomonas vaginalis in urogenital specimens. *J Clin Microbiol* 2006;44(2):366-73.
175. Wendel KA, Erbeding EJ, Gaydos CA, Rompalo AM. Trichomonas vaginalis polymerase chain reaction compared with standard diagnostic and therapeutic protocols for detection and treatment of vaginal trichomoniasis. *Clin Infect Dis* 2002;35(5):576-80.
176. Halloran ME, Struchiner CJ. Study designs for dependent happenings. *Epidemiology* 1991;2(5):331-8.

177. Mullahy J. Specification and testing of some modified count data models. *Journal of Econometrics* 1986;33:341-65.
178. Cameron AC, Trivedi PK. Econometric models based on count data: comparisons and applications of some estimators and some tests. *Journal of Applied Econometrics* 1986;1:29-53.
179. Cameron AC, Trivedi PK. Regression analysis of count data. Cambridge, UK; New York, NY, USA: Cambridge University Press, 1998: xvii, 411 p.
180. Aral SO, Peterman TA. Measuring outcomes of behavioural interventions for STD/HIV prevention. *Int J STD AIDS* 1996;7 Suppl 2:30-8.
181. Fishbein M, Pequegnat W. Evaluating AIDS prevention interventions using behavioral and biological outcome measures. *Sex Transm Dis* 2000;27(2):101-10.
182. Okamoto K, Ohsuka K, Shiraishi T, Hukazawa E, Wakasugi S, Furuta K. Comparability of epidemiological information between self- and interviewer-administered questionnaires. *J Clin Epidemiol* 2002;55(5):505-11.
183. Dare OO, Cleland JG. Reliability and validity of survey data on sexual behaviour. *Health Transit Rev* 1994;4 Suppl:93-110.
184. McCoombe SG, Short RV. Potential HIV-1 target cells in the human penis. *Aids* 2006;20(11):1491-5.
185. Mickey RM, Greenland S. The impact of confounder selection criteria on effect estimation. *Am J Epidemiol* 1989;129(1):125-37.
186. Clark J. Male circumcision is not a panacea for HIV prevention. *Bmj* 2006;333(7565):409.
187. Kuehn BM. Routine male circumcision could prevent millions of HIV infections in Africa. *Jama* 2006;296(7):755.
188. Wise J. Demand for male circumcision rises in a bid to prevent HIV. *Bull World Health Organ* 2006;84(7):509-11.
189. Hayes R. Confounding, effect modification and attributable fractions: epidemiological issues in interpreting circumcision effects. *Int J STD AIDS* 2001;12(Supplement 2):6.
190. Wawer MJ, Reynolds SJ, Serwadda D, Kigozi G, Kiwanuka N, Gray RH. Might male circumcision be more protective against HIV in the highly exposed? An immunological hypothesis. *Aids* 2005;19(18):2181-2.

191. Cates W, Jr., Wasserheit JN. Genital chlamydial infections: epidemiology and reproductive sequelae. *Am J Obstet Gynecol* 1991;164(6 Pt 2):1771-81.
192. Holmes KK, Sparling PF, Mardh P, et al., eds. Sexually transmitted diseases. 3rd ed. New York: McGraw-Hill, Health Professions Division, 1999.
193. UNAIDS. Intensifying HIV prevention: a UNAIDS policy position paper. Geneva, 2005.
194. Bunnell R, Mermin J, De Cock KM. HIV prevention for a threatened continent: implementing positive prevention in Africa. *Jama* 2006;296(7):855-8.
195. Crepaz N, Lyles CM, Wolitski RJ, et al. Do prevention interventions reduce HIV risk behaviours among people living with HIV? A meta-analytic review of controlled trials. *Aids* 2006;20(2):143-57.
196. Mermin J, Bunnell R, Lule J, et al. Developing an evidence-based, preventive care package for persons with HIV in Africa. *Trop Med Int Health* 2005;10(10):961-70.
197. Farquhar C, Kiarie JN, Richardson BA, et al. Antenatal couple counseling increases uptake of interventions to prevent HIV-1 transmission. *J Acquir Immune Defic Syndr* 2004;37(5):1620-6.
198. Gordon CM, Forsyth AD, Stall R, Cheever LW. Prevention interventions with persons living with HIV/AIDS: state of the science and future directions. *AIDS Educ Prev* 2005;17(1 Suppl A):6-20.
199. McNemar Q. Note on the sampling error of the difference between correlated proportions or percentages. *Psychometrika* 1947;12:153-7.
200. Gosset WS. The Probable Error of a Mean. *Biometrika* 1908;6:1-25.
201. Chimbiri AM. The condom is an 'intruder' in marriage: Evidence from rural Malawi. *Soc Sci Med* 2007;64(5):1102-15.
202. Kapadia F, Latka MH, Hudson SM, et al. Correlates of consistent condom use with main partners by partnership patterns among young adult male injection drug users from five US cities. *Drug Alcohol Depend* 2007.
203. Wellings K, Collumbien M, Slaymaker E, et al. Sexual behaviour in context: a global perspective. *Lancet* 2006;368(9548):1706-28.
204. Kankasa C, Siwale M, Kasolo F, Nishiyama A, Terunuma H, Wakasugi N. Socioeconomic and reproductive factors associated with condom use within and outside of marriage among urban pregnant women in Zambia. *Afr J Reprod Health* 2005;9(3):128-36.

205. Liku J, McLoughlin K, Broomhall L, Williamson NE, Nakayima F, Nyamongo IK. Consistent condom use among Ugandan couples in primary relationships: Family Health International, 2005.
206. Downs AM, De Vincenzi I. Probability of heterosexual transmission of HIV: relationship to the number of unprotected sexual contacts. European Study Group in Heterosexual Transmission of HIV. *J Acquir Immune Defic Syndr Hum Retrovirol* 1996;11(4):388-95.
207. Leynaert B, Downs AM, de Vincenzi I. Heterosexual transmission of human immunodeficiency virus: variability of infectivity throughout the course of infection. European Study Group on Heterosexual Transmission of HIV. *Am J Epidemiol* 1998;148(1):88-96.
208. Greenland S. Principles of multilevel modelling. *Int J Epidemiol* 2000;29(1):158-67.
209. Gottlieb MS, Schroff R, Schanker HM, et al. Pneumocystis carinii pneumonia and mucosal candidiasis in previously healthy homosexual men: evidence of a new acquired cellular immunodeficiency. *N Engl J Med* 1981;305(24):1425-31.
210. Des Jarlais DC, Chamberland ME, Yancovitz SR, Weinberg P, Friedman SR. Heterosexual partners: a large risk group for AIDS. *Lancet* 1984;2(8415):1346-7.
211. William DC. The prevention of AIDS by modifying sexual behavior. *Ann N Y Acad Sci* 1984;437:283-5.
212. Centers for Disease Control and Prevention (CDC). Immunodeficiency among female sexual partners of males with acquired immune deficiency syndrome (AIDS) - New York. *MMWR* 1983;31(52):697-8.
213. Gallo MF, Behets FM, Steiner MJ, et al. Prostate-specific antigen to ascertain reliability of self-reported coital exposure to semen. *Sex Transm Dis* 2006;33(8):476-9.
214. Gallo MF, Behets FM, Steiner MJ, et al. Validity of self-reported 'safe sex' among female sex workers in Mombasa, Kenya--PSA analysis. *Int J STD AIDS* 2007;18(1):33-8.
215. Ghanem KG, Melendez JH, McNeil-Solis C, et al. Condom Use and Vaginal Y-Chromosome Detection: The Specificity of a Potential Biomarker. *Sex Transm Dis* 2007.
216. Thomsen SC, Gallo MF, Ombidi W, et al. Randomized controlled trial on whether advance knowledge of prostate-specific antigen testing improves participant reporting of unprotected sex. *Sex Transm Infect* 29 Nov 2006.

217. Zenilman JM, Yuenger J, Galai N, Turner CF, Rogers SM. Polymerase chain reaction detection of Y chromosome sequences in vaginal fluid: preliminary studies of a potential biomarker for sexual behavior. *Sex Transm Dis* 2005;32(2):90-4.