



Citation for published version:

Sadhukhan, J, Martinez-Hernandez, E, Murphy, RJ, Ng, DKS, Hassim, MH, Siew Ng, K, Yoke Kin, W, Jaye, IFM, Leung Pah Hang, MY & Andiappan, V 2018, 'Role of bioenergy, biorefinery and bioeconomy in sustainable development: Strategic pathways for Malaysia', *Renewable and Sustainable Energy Reviews*, vol. 81, no. 2, pp. 1966-1987. <https://doi.org/10.1016/j.rser.2017.06.007>

DOI:

[10.1016/j.rser.2017.06.007](https://doi.org/10.1016/j.rser.2017.06.007)

Publication date:

2018

Document Version

Peer reviewed version

[Link to publication](#)

Publisher Rights

CC BY-NC-ND

University of Bath

General rights

Copyright and moral rights for the publications made accessible in the public portal are retained by the authors and/or other copyright owners and it is a condition of accessing publications that users recognise and abide by the legal requirements associated with these rights.

Take down policy

If you believe that this document breaches copyright please contact us providing details, and we will remove access to the work immediately and investigate your claim.



Contents lists available at ScienceDirect

Renewable and Sustainable Energy Reviews

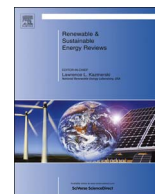
journal homepage: www.elsevier.com/locate/rser

Role of bioenergy, biorefinery and bioeconomy in sustainable development: Strategic pathways for Malaysia

Jhuma Sadhukhan^{a,*}, Elias Martinez-Hernandez^b, Richard J. Murphy^a, Denny K.S. Ng^c, Mimi H. Hassim^d, Kok Siew Ng^a, Wan Yoke Kin^e, Ida Fahani Md Jaye^a, Melissa Y. Leung Pah Hang^a, Viknesh Andiappan^e

^a Centre for Environment and Sustainability, University of Surrey, Guildford, Surrey GU2 7XH, UK

^b Department of Chemical Engineering, University of Bath, Bath BA2 7AY, UK

^c Department of Chemical & Environmental Engineering/Centre for Sustainable Palm Oil Research (CESPOR), University of Nottingham, Malaysia, Broga Road, 43500 Semenyih, Selangor, Malaysia

^d Centre of Hydrogen Energy/Department of Chemical Engineering, Universiti Teknologi Malaysia, 81310 UTM Johor Bahru, Malaysia

^e School of Engineering, Taylor's University, Lakeside Campus, No. 1 Jalan Taylor's, 47500 Subang Jaya, Selangor, Malaysia

ARTICLE INFO

Keywords:

Lignocellulosic biorefinery
Resource recovery from waste (RRfW)
Circular economy
Climate change mitigation
Adaptation and resilience
Malaysia development plan
Sustainable development goals

ABSTRACT

Malaysia has a plethora of biomass that can be utilized in a sustainable manner to produce bio-products for circular green economy. At the 15th Conference of Parties in Copenhagen, Malaysia stated to voluntarily reduce its emissions intensity of gross domestic product by upto 40% by 2020 from 2005 level. Natural resources e.g. forestry and agricultural resources will attribute in achieving these goals. This paper investigates optimum bio-based systems, such as bioenergy and biorefinery, and their prospects in sustainable development in Malaysia, while analyzing comparable cases globally. Palm oil industry will continue to play a major role in deriving products and contributing to gross national income in Malaysia. Based on the current processing capacity, one tonne of crude palm oil (CPO) production is associated with nine tonnes of biomass generation. Local businesses tend to focus on products with low-risk that enjoy subsidies, e.g. Feed-in-Tariff, such as bioenergy, biogas, etc. CPO biomass is utilized to produce biogas, pellets, dried long fibre and bio-fertilizer and recycle water. It is envisaged that co-production of bio-based products, food and pharmaceutical ingredients, fine, specialty and platform chemicals, polymers, alongside biofuel and bioenergy from biomass is possible to achieve overall sustainability by the replacement of fossil resources. Inception of process integration gives prominent innovative biorefinery configurations, an example demonstrated recently, via extraction of recyclable, metal, high value chemical (levulinic acid), fuel, electricity and bio-fertilizer from municipal solid waste or urban waste. Levulinic acid yield by only 5 wt% of waste feedstock gives 1.5 fold increase in profitability and eliminates the need for subsidies such as gate fees paid by local authority to waste processor. Unsustainable practices include consumable food wastage, end-of-pipe cleaning and linear economy that must be replaced by sustainable production and consumption, source segregation and process integration, and product longevity and circular economy.

1. Introduction

In the Eleventh Malaysia Plan 2016–2020 (11MP), green economy has been identified to play a fundamental role in socio-economic growth of the country [1]. Malaysia has abundant biomass available, which can be sustainably reused to produce bio-based products. Bio-based products include food and pharmaceutical ingredients, fine, specialty and platform chemicals, polymers, biofuel and bioenergy, which can be coproduced in an advanced multi-process industrial

plant, known as biorefinery [2]. Biorefinery has a potential to offer sustainability by trading off between triple-bottom-line criteria: environmental, social and economic. Biorefinery ultimately needs to be adopted for greening the economy [3].

Although biorefinery offers environmental benefits, it is important to consider prevention of biodiversity loss during the conception of a biorefinery. The international leaders and stakeholders became concerned about sustainable biomass development post 21st Conference of Parties (COP21) [4] and agreed on the global

* Corresponding author.

E-mail address: jhumasadhukhan@gmail.com (J. Sadhukhan).

<http://dx.doi.org/10.1016/j.rser.2017.06.007>

Received 9 August 2016; Received in revised form 6 April 2017; Accepted 1 June 2017
1364-0321/ © 2017 Elsevier Ltd. All rights reserved.

temperature rise in this century to well below 2 °C. Furthermore, three most important activities for reversing environmental degradation have been identified [5]:

1. Restoration of carbon by forestation and biodiversity
2. Sustainable production and consumption, especially with respect to food
3. Biorefinery for a circular economy

Sustainable resourcing and consumptions of biomass are essential, so that there is no negative impact on the ecosystem and the environment across value chains. Many researchers believe that it is possible to decouple human prosperity from environmental footprint. Human prosperity without economic growth is recommended for developed nations [6] recognizing the fact that human consumptions are continuously exceeding the planetary boundaries [7]. Sustainable production and consumption is an attractive but challenging proposition. This is because developing nations are yet to attain the minimum threshold Gross National Income (GNI) to get the status of the developed nations. The 11MP anchors on socio-economic growth to achieve the targeted GNI per capita of US\$15,690 (RM54,100) and thereby exceed the US\$15,000 minimum threshold of a high-income economy, by 2020 [1]. This paper reviews examples of bio-based economic activities for green inclusive growth and intensification of sustainable production and consumption pathways, in Malaysia. Short through medium to long term bio-based technologies have been reviewed from critical perspectives of the Sustainable Development Goals (SDGs) [8].

1.1. Role of bioenergy, biorefinery and bioeconomy in meeting the SDGs

The SDGs built upon the Millennium Development Goals (MDGs) with 17 goals, 169 targets and a high number of indicators, work around elimination of poverty in all its forms; ending maternal and child mortality; ending gender inequalities; building sustainable cities and communities, reversing environmental degradation, achieving education for all, reducing inequalities, promoting peace and justice and strong institutions amongst others [8]. The SDGs are targeted to be met in 15 years, the onus is on every country to create an enabling national environment that can facilitate effective implementation of the SDGs. The SDGs have been highly recommended for adoption into the development of bioenergy, biorefinery and bioeconomy, in a UK-Malaysia cooperation event [9].

As well as delivering socio-economic growth of the nation by the development of bioenergy, biorefinery and bioeconomy, it is vitally important for Malaysia to also contribute to global climate change mitigation agenda, as suggested in COP21. Bioenergy, biorefinery and bioeconomy have an important role to play in the following four focus areas in the 11MP, which can be related to the SDGs [1].

1. Strengthening resilience against climate change and natural disasters
2. Strengthening the enabling environment for green growth
3. Adopting the sustainable production and consumption concept
4. Conserving natural resources for present and future generations

For all the above goals, natural resource and environment conservation is of utmost importance responsible for success or failure of the goals. If the natural resource and environment are conserved, global warming potential over 100 years (GWP) and risks of natural disasters will be reduced, green growth will be strengthened, humans will live in harmony with the nature, and resource security will be ensured for future generations [10]. Biomass can help in mitigating the impact by replacing fossil fuels, because embedded carbon released from biomass combustion is sequestered during biomass growth.

Exhaust gas from biomass combustion may contain other pollutants for the environment, causing acidification, urban smog, etc. Energy-from-waste should be the option of last resort after all valuable materials have been salvaged [11]. It is possible to live in harmony with the nature by the adoption of high resource efficiency biorefinery and resource recovery from waste (RRfW) system. The society will be only allowed to reuse sustainably resourced materials after their all uses have been exhausted leaving least or no waste or emission to the environment. Concerns over health and environment, and for the developed economy, rising landfill tax and high cost of waste disposal are the drivers for transforming wastes into resources, which can lead to a circular economy future [11]. This is a radically different perspective compared to a linear take-make-dispose economy. Presently, waste and recycling supports a global market worth more than \$1 trillion [11]. To pursue sustainable consumption and production, Malaysia must as well ensure security of local resource supply and build their green economy based on locally available resources. The 11MP encompasses agenda for inclusive economic growth and social welfare [1]. Indigenous biomass can play a key role in practical implementation of the Plan, because it offers an opportunity to channel the cash flow to much needed low income populations.

1.2. Malaysia's bio resources: status quo and perspectives

Natural and sustainable bio-resources include [2]:

- Forestry and agricultural residues
- Palm oil mill and pulp and paper industrial residues
- Grass silage, empty fruit bunch
- Oily wastes and residues
- Aquatic: algae and seaweed
- Organic residues: municipal solid waste (MSW), manure, sewage and wastewaters

A database of globally important biomass has been created [12]. Amongst these aforementioned avenues, oil palm industry is the main provider of bio-based products and is the main business in Malaysia that can support sustainable bioeconomy. Fig. 1 illustrates the main products: crude palm oil (CPO) and crude palm kernel oil (CPKO) and biomass from oil palm industry in Malaysia [13,14]. Table 1 shows oil palm planted areas in main states in Malaysia [15].

The monthly CPO production in 2014 and 2015 is shown in Table 2 [16]. The total productions were 19.67 and 19.96 million tonnes in 2014 and 2015, respectively. The resulting fresh fruit bunch (FFB) was 92.33 million tonnes in 2014 [17]. The production rates of empty fruit bunch (EFB), palm mesocarp fibre (PMF), palm kernel shell (PKS) and palm oil mill effluent (POME) with respect to the production rate of FFB are shown in Table 3. Their total production rate is 94.18 million tonne, 4.8 times greater than CPO. Taking account of the production rates of oil palm frond (OPF) and oil palm trunk (OPT), the quantity of the total biomass generated is 9 times greater than the quantity of CPO. For a calorific value of 20 GJ/t and 40% efficiency in electricity generation, 34% of the national electricity demand can be met by this biomass generated from FFB processing in palm oil mill. If the residual biomass is used to produce 34% of the electricity consumption (which in 2014 was 128,330 GWh [18]) and using an average avoided burden of 0.12 kg CO₂ equivalent per kWh of grid electricity displacement, around 19 million tonnes CO₂ equivalent can be avoided. With an expected 3.4% annual growth in electricity consumption [19], avoided GWP can be up to 23 million tonnes CO₂ equivalent by 2020, which is 13.5% of the total CO₂ equivalent impact in year 2000 and 8% of the total CO₂ equivalent impact estimated in year 2020, respectively [20].

Industrial, manufacturing and agricultural sectors can be interconnected by symbiotic flows. For example, residues generated from the agricultural sector could be the inputs to the industrial and manufacturing sectors, fertilizer outputs from which could become

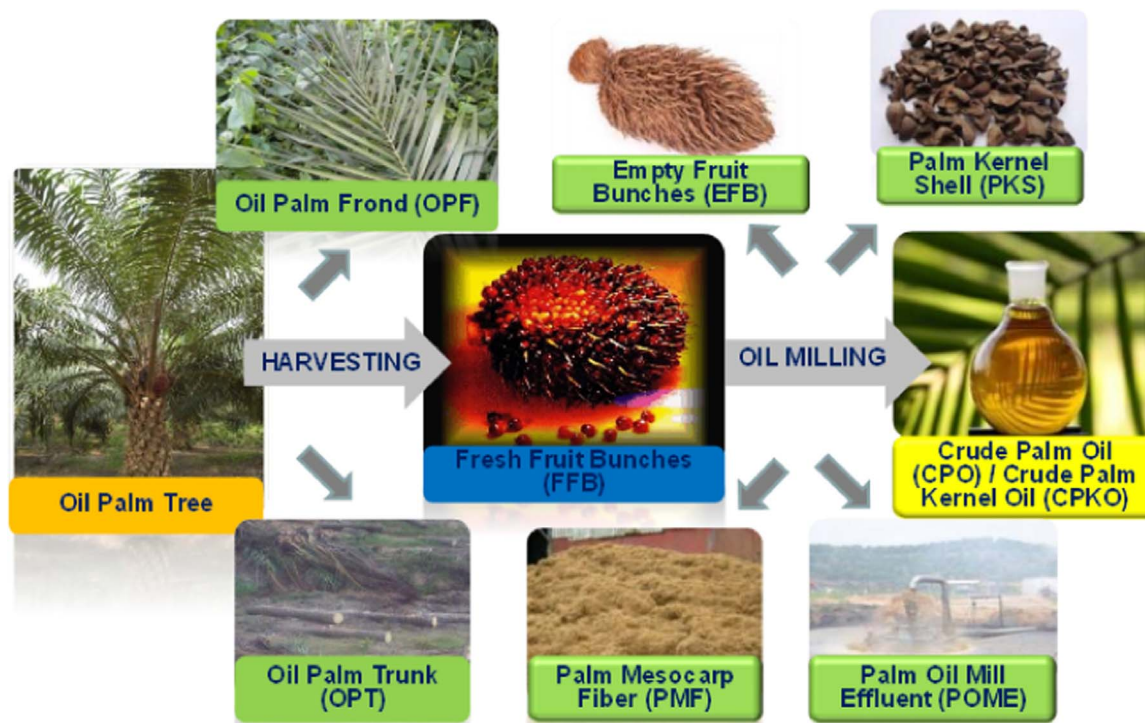

Fig. 1. Main biomass from oil palm industry.

Table 1

Oil palm planted areas (in ha) in main states in Malaysia, 2013 [15].

State	Mature	%	Immature	%	Total	%
Johore	651,242	88.8	82,225	11.2	733,467	13.6
Kedah	80,767	93.7	5415	6.3	86,182	1.6
Kelantan	99,783	68.9	44,979	31.1	144,762	2.7
Malacca	49,501	93.7	3348	6.3	52,849	1.0
Negeri Sembilan	142,503	84.1	26,865	15.9	169,368	3.1
Pahang	623,269	86.6	96,344	13.4	719,613	13.3
Perak	348,794	89.6	40,370	10.4	389,164	7.2
Perlis	189	64.1	106	35.9	295	0.0
Penang	13,309	93.7	895	6.3	14,204	0.3
Selangor	126,805	91.6	11,677	8.4	138,482	2.6
Terengganu	139,410	82.5	29,538	17.5	168,948	3.1
Peninsular Malaysia	2,275,572	91.6	341,762	8.4	2,617,334	48.5
Sabah	1,355,541	89.7	155,969	10.3	1,511,510	28.0
Sarawak	1,058,208	83.8	205,183	16.2	1,263,391	23.5
Sabah & Sarawak	2,413,749	87.0	361,152	13.0	2,774,901	51.5
MALAYSIA	4,689,321	87.0	702,914	13.0	5,392,235	100.0

the inputs to the agricultural sector [21]. This interconnectedness must be optimized simultaneously for an inclusive people growth. Bioeconomy is expected to create 1.5 million jobs by 2020, enabled by coherent sectorial developments between agriculture, industry and manufacturing. In addition, sustainable design of integrated biorefinery to attain desired environmental, inherent safety, health and economic performances [22] is much needed. To facilitate cooperation between sectors, industrial symbiosis concept [23,24] needs to be applied.

A critical issue is to determine the amount of residues available for bioenergy production [25]. There are alternative renewable energy systems, for example hydropower as the most prominent one in Malaysia, for energy services, while for products other than energy, biomass is the only renewable carbon source. Depending upon availability of these resources, choices of locally available renewable resources can be made for locally producing products of demand.

The main stress should be on local availability of natural resources and how to make sustainable use of them for greening the economy [2,26].

The priorities should be in the order of meeting energy demands by alternative renewable systems, meeting product demands by biorefinery systems and meeting the balance of energy demands by bioenergy systems, respectively. Renewable energy supply is intermittent in nature. The intermittency can be resolved by hybrid renewable and bio energy systems. For example, photocatalytic reactors have been developed to store and transform solar energy effectively into bioenergy [27,28]. Largely, the renewable energy supply intermittency is addressed by fossil (coal, crude oil) based power plants. Globally, a third of oil reserves, half of gas reserves and over 80 per cent of current coal reserves should remain unused from 2010 to 2050 in order to meet the target of well below 2 °C temperature rise in this century. Hence, biomass utilization for bioenergy especially for peak demands is an obvious choice to mitigate GWP and limit the temperature rise to below 2 °C in this century [29,30]. Furthermore, bioenergy can bring opportunities along the supply chain for economic development as illustrated in the bioenergy economic cycle in Fig. 2.

Many researchers stress on a rapid turn-over in biomass, for which bioenergy is a perfect option, in order to be able to meet increasing demand due to growing population and support growth of lower income nations from the equity point of view. Biotechnology is the key to efficient biomass resourcing and rapid turnover [31]. Focused literatures show improved agricultural efficiency by the incorporation of biotechnical research breakthrough [32,33].

1.3. Biorefinery: a way to bio-based circular economy

A sustainable biorefinery configuration must produce bio-products in conjunction with bioenergy and biofuel [2]. The key question is what other sustainable bio-based products can be generated in conjunction with bioenergy that give highest resource efficiency [34]. This gives rise to the conception of a biorefinery. In the most advanced sense, a biorefinery is a facility with integrated, efficient and flexible conversion of biomass feedstocks, through a combination of physical, chemical, biochemical and thermochemical processes, into multiple products [2].

Table 2
Quantities of CPO produced in 2014 and 2015, on monthly basis, in tonne [16].

States	Jan		Feb		Mar		Apr		May		Jun		Jan – Jun (Total)	
	2014	2015	2014	2015	2014	2015	2014	2015	2014	2015	2014	2015	2014	2015
Johor	235,748	171,725	194,587	188,325	223,268	247,856	225,776	282,791	248,045	291,057	257,604	287,502	1,385,028	1,469,256
Kedah	23,643	15,066	21,523	20,527	22,103	31,839	22,969	33,341	24,570	35,627	21,205	31,725	136,013	168,125
Kelantan	16,682	11,181	12,963	11,847	19,670	18,858	25,032	26,044	28,244	28,614	26,157	25,287	128,748	121,831
Negeri Sembilan	50,360	37,505	41,698	46,682	46,025	59,585	43,621	62,262	46,646	62,583	47,649	64,351	275,999	332,968
Pahang	213,875	141,442	171,071	158,471	218,266	218,187	230,387	247,363	242,591	261,187	230,621	254,275	1,306,811	1,280,925
Perak	153,947	116,186	133,417	119,968	152,754	179,758	154,848	178,342	162,630	178,521	163,046	188,938	920,642	961,713
Selangor	40,061	27,384	35,560	30,431	40,482	42,946	40,571	47,675	45,256	49,005	46,012	48,012	247,942	245,453
Terengganu	28,068	19,382	22,086	17,106	30,307	25,482	40,378	36,875	42,320	45,604	42,189	44,455	205,348	188,905
Other States	17,365	11,284	15,064	12,275	16,643	18,321	14,918	18,376	18,504	20,378	18,180	19,050	100,674	99,684
Peninsular Malaysia	779,749	551,155	647,969	605,632	769,518	842,832	798,500	933,069	858,806	972,577	852,663	963,595	4,707,205	4,868,860
Sabah	481,341	401,299	415,250	325,830	475,637	405,830	494,911	475,838	526,124	530,644	472,000	489,764	2,865,263	2,629,205
Sarawak	247,890	208,233	212,593	190,166	251,987	246,489	262,366	284,518	272,027	307,309	245,021	310,308	1,491,884	1,547,023
Sabah and Sarawak	729,231	609,532	627,843	515,996	727,624	652,319	757,277	760,356	798,151	837,952	717,021	800,072	4,357,147	4,176,228
MALAYSIA	1,508,980	1,160,687	1,275,812	1,121,628	1,497,142	1,495,151	1,555,777	1,693,425	1,656,957	1,810,530	1,569,684	1,763,667	9,064,352	9,045,088
Johor	278,807	288,086	329,385	313,321	295,433	299,337	294,130	300,383	263,147	246,005	201,019	201,231	3,047,049	3,117,619
Kedah	22,666	31,029	24,069	30,409	19,287	25,729	17,441	26,683	14,432	17,901	11,044	15,773	244,952	315,649
Kelantan	26,548	26,879	33,295	30,795	28,856	26,413	29,297	29,595	25,753	25,744	12,147	20,155	284,644	281,412
Negeri Sembilan	52,801	66,546	64,071	71,019	62,446	65,643	64,895	63,665	54,826	45,974	37,742	34,470	612,780	680,285
Pahang	248,100	279,108	307,877	323,407	290,297	305,767	295,789	306,181	275,286	257,504	165,183	197,408	2,889,343	2,950,300
Perak	181,287	202,149	204,425	217,863	182,071	185,200	159,711	171,914	141,462	124,848	118,113	125,598	1,907,711	1,989,285
Selangor	49,681	51,113	54,612	53,709	48,347	48,352	42,926	44,306	37,206	31,623	28,952	29,322	509,666	503,878
Terengganu	42,504	47,799	59,799	59,111	53,147	52,581	50,462	60,737	45,320	50,408	24,447	36,988	481,027	496,529
Other States	18,182	19,558	19,068	19,211	16,694	18,663	16,686	19,564	13,610	13,120	10,022	11,710	194,936	201,510
Peninsular Malaysia	920,576	1,012,267	1,096,701	1,118,845	996,578	1,027,685	971,337	1,023,028	871,042	813,127	608,669	672,655	10,172,108	10,536,467
Sabah	456,459	476,371	556,614	540,882	544,375	533,540	573,601	593,579	569,465	517,102	489,792	432,888	6,055,569	5,722,967
Sarawak	288,626	326,996	378,362	391,273	355,948	397,839	348,056	420,859	310,060	323,717	266,403	294,440	3,439,339	3,702,147
Sabah and Sarawak	745,085	803,367	934,976	821,155	900,323	931,379	921,657	1,014,438	879,525	840,819	756,195	726,728	9,494,908	9,425,114
MALAYSIA	1,665,661	1,815,634	2,031,677	2,051,000	1,896,901	1,959,064	1,892,994	2,037,466	1,750,567	1,653,946	1,364,864	1,399,383	19,667,016	19,961,581

Table 3
Production rates of EFB, PMF, PKS and POME with respect to FFB [18].

Biomass available from Palm Oil Industry	% from FFB	Quantity million tonnes
EFB	23	21.24
PMF	13	12.00
PKS	6	5.54
POME	60	55.40

The concept was developed by an analogy to the complex crude oil refineries adopting the process engineering principles applied in their designs, such as feedstock fractionation, multiple value-added productions, process flexibility and integration. This definition of biorefinery evolved from the earlier works of the National Renewable Energy Laboratory (NREL) [35] and the Department of Energy (DOE) of the USA [36]. The products to target from lignocellulosic materials are the main question for a biorefinery system. Biorefineries are often ambiguously inferred to bioethanol or biodiesel or biogas production plants. However, biofuel plants are not economically feasible without subsidies or government support, which are short term and change with change in ruling party. High value materials are essential to become independent of policy and regulatory framework for businesses [37]. Chemical and material products in a sustainable biorefinery system can have a niche market and act as a carbon sink. Any public spending saved by self-sustaining integrated biorefinery systems can be made available for education and socio-economic growth of much needed vulnerable and poor populations of the society.

Which products should be generated and what those flexible processes are that can uptake the mixture of locally available biomass and achieve desired product slate of demand invoke optimization based decision making tools. There are numerous possibilities, amongst which the niche areas need to be carefully selected based on macro-economic or socio-economic drivers within geographical and policy constraints. The application principles encompass integrated feedstock management, conversion, use of end products and reuse in cyclical and synergistic loop [2]. Renewable feedstocks from a range of local activities can be converted to products of local needs [2]. With co-optimization of anthropogenic activities (agricultural, forestry, residential, industrial and commercial), impacts on land, soil, water and

atmosphere will be reduced. A truly sustainable biorefinery design calls for such a challenging solution for “whole systems” [2]. However, the complete fusion of industrial symbiosis framework is a gradual process, requires decades to stabilize from one state to another: e.g. from fossil based economy to bio- renewable economy [38].

This paper critically reviews bioenergy, biorefinery and bioeconomy potentials in Malaysia in the following sections. Processes to recover resources from waste such that the recovered resources can be put back into value chains have been identified and prioritised for delivering a more circular economy. The final sections also review unsustainable pathways and recommends strategies for sustainable production and consumption pathways for Malaysia, before drawing on overall conclusions. The sustainable technological pathways discussed in this paper can be replicated in other emerging economies, such as South-East Asian, African and Latin American countries.

2. Lignocellulosic biomass: challenges and opportunities for the bioeconomy

Lignocellulosic biomass is the only workable biomass to avoid any potential competition with food [2]. Lignocelluloses are made up of three main polymer types: cellulose, hemicellulose and lignin. Celluloses and hemicelluloses are polysaccharides of C6 and C5 monomers, respectively, connected by β -(1-4)-glycosidic linkages [2]. The main lignin compounds are polymers of para-hydroxyphenyl (H lignin), guaiacyl (G lignin) and syringyl (S lignin) alcohol [2]. Lignocellulose structure is illustrated in Fig. 3.

Pretreatment for decomposition of biomass into cellulose, hemicellulose and lignin is needed for lignocellulosic or second generation feedstock due to its heterogeneous nature [39]. The various methods of pretreatment broadly fall into two categories: addition of extraneous agent and application of energy for the decomposition of lignocellulose. The former incurs higher cost of chemical and downstream separation and purification and the latter incurs higher cost of energy and capital cost of pretreatment. Hydrolysis (acid or alkali) [40], organosolv (extraction using organic solvent) [41] and ionic liquid extraction [42,43] use extraneous agents for biomass decomposition, while ultrasonication [44] and microwave irradiation [45,46] technologies make use of energy for biomass decomposition. Steam explosion and supercritical water extraction technologies (also known as pulping or

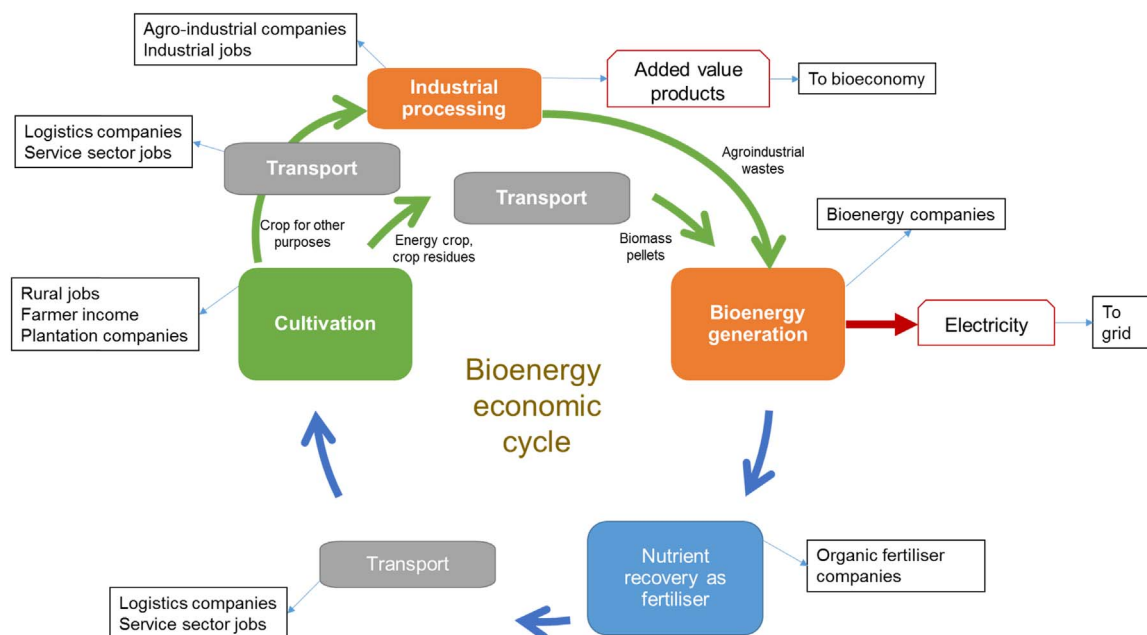

Fig. 2. A conceptual diagram of bioenergy economic cycle.

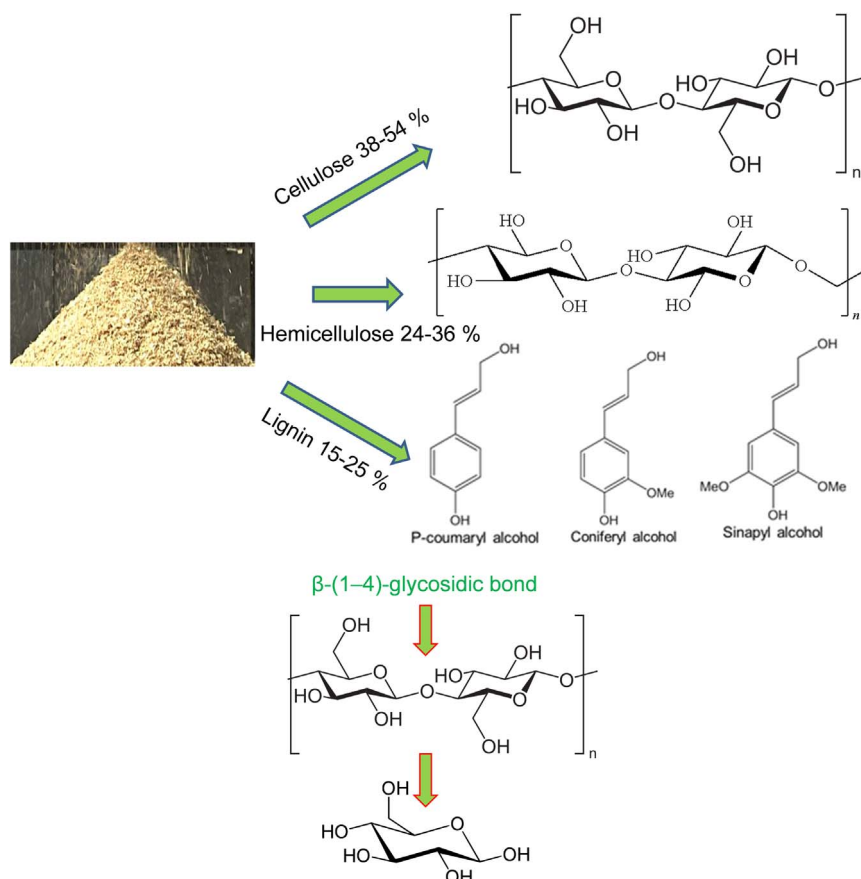

Fig. 3. Lignocellulose structure and constituents (top); β (1-4)-glycosidic bond breakage by pretreatment, liberating glucose from celluloses (bottom).

hydrothermal liquefaction, operated upto 450 °C temperature and 250 bar pressure) [47,48] are a flexible method for biomass decomposition, because moisture is naturally present in biomass reducing the amount of steam requirement. Pretreatment liberates hemicelluloses first because these are hydrolyzed at a faster rate. Liberation of hemicellulose is needed and usually the first step to separate lignin and cellulose. β (1-4)-glycosidic linkages are broken down by pretreatment, liberating glucose from celluloses. The mechanism is also illustrated in Fig. 3.

3. A framework approach for the creation of technology readiness level (TRL)

Lignocellulosic biorefineries are developing – with mature technologies focused on bioenergy, biogas and biofuels; developed technologies on platforms or intermediate products, e.g. syngas and bio-oil; and developing technologies on RRfW [49], carbon dioxide reduction (CDR) and carbon capture and reuse (CCR) to produce chemicals,

biofuels, materials, etc. These technologies across the TRL are illustrated in Fig. 4. High efficiency RRfW, CDR and CCR technologies integrated within biorefineries [49] are beginning to be seen as an effective way in realizing a circular green economy in Malaysia [1].

The creation of the TRL is a result of an effective stakeholders' engagement approach through a week long Researcher Links workshop between UK and Malaysia [9]. Fig. 5 shows the main steps in the approach and interactions between various stakeholders. The core scientific and management committee consisting of specialists in biorefinery design configuration, synthesis, integration and optimization for sustainability that has organized the fully funded workshop under Newton funding, has also been responsible to synthesize outputs from the workshop. The committee has fully engaged with all participant stakeholders in order to synthesize the outputs, one of which is the work reported here. Early career researchers, 20 from each nation, were offered fully funded places on a competitive basis using the format for the Newton funded Researcher Links workshop application, to present

Mature	Developed	Developing
<ul style="list-style-type: none"> Bioenergy Fermentation-Bioethanol Transesterification-Biodiesel Anaerobic digestion- Biogas 	<ul style="list-style-type: none"> Pyrolysis- Bio-oil Gasification-Syngas Hydrothermal liquefaction- Fuel Algae- Biofuel 	<ul style="list-style-type: none"> Catalytic (hydro)processing-Chemical and Fuel CO₂ reduction or reuse- Fuel and Chemical Resource recovery from waste- Functional products

Fig. 4. Lignocellulosic biorefinery development across the technology readiness level (TRL).

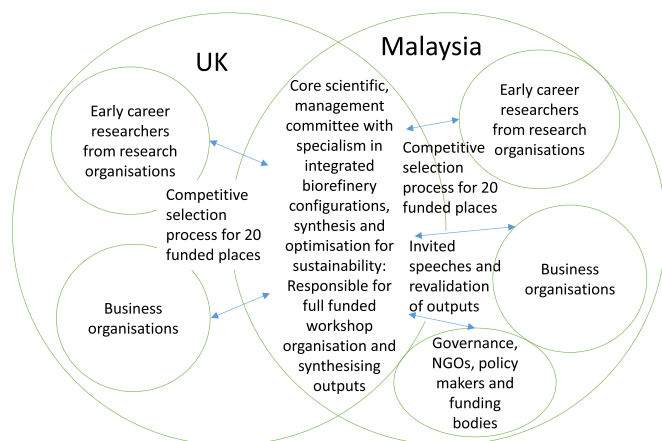

Fig. 5. Framework for stakeholders' engagement for output synthesis via a Newton funded UK-Malaysia Researcher Links workshop.

their research in the workshop and contribute in follow-on discussions for the synthesis of outputs. The governance, NGOs and policy and decision makers in the area in Malaysia were invited to give speeches and fully engaged after the workshop for revalidation of the outputs synthesized. The output synthesis process has been iterative involving stakeholders' inputs throughout. The stakeholders that represented the workshop have been research and business organizations in the UK and research, business, governmental, non-governmental and funding organization in Malaysia.

The following sections discuss the systems' status quo and perspectives, across the TRL, shown in Fig. 4.

4. Overview of mature technologies: bioenergy and biofuel productions

4.1. Bioenergy production

Bioenergy technologies are the oldest amongst all possible biomass exploitation technologies. The simplest form consists of a biomass boiler integrated with steam drum for steam generation from boiler feed water (BFW) and steam superheater. Exhaust gas leaving the biomass boiler is heat recovered into steam generation in steam drum and steam superheating in superheater. Adsorbent such as activated carbon should be in place to entrap particulates and un-combusted volatile organic compounds, which can be recycled back to the boiler for complete combustion. Thus, the exhaust gas is free from pollutants other than carbon dioxide and moisture. CO₂ released is from renewable carbon constituent of the biomass. Ash content in the biomass is collected by a rotating cone configuration at the bottom of the boiler. Ash has various uses e.g. in construction sector. The superheated steam is expanded through back pressure and condensing steam turbines, generating electricity through generator, into BFW, returned to the boiler. An effective biomass based combined heat and power (CHP) system using boiler technology has been designed for bioenergy generation [50]. The optimum CHP system designed under Malaysian economic scenario generates 472 kW of net electricity from sago barks (10.2 odt/d) (odt: oven dry tonne) with a payback period of 3.51 years, and a GWP saving of 8487 kg CO₂ equivalent/d [50]. In order to achieve the highest economic performance, labor from sago starch extraction process (SSEP) with the starch production capacity of 12 t/d, and off-site pre-treatment have been utilized. Besides, sensitivity analysis based on the existence of pre-treatment, variations in feedstock cost, boiler efficiency, and biomass feedstock has also been conducted [50].

4.2. Bioethanol production

Fermentation is the process of decomposing an organic substrate into products (e.g. bioethanol) by bacteria, yeast, fungi and other microorganisms usually present in gut. The reaction of bioethanol production from glucose fermentation is as follows (1 mol glucose is decomposed into 2 mol ethanol and 2 mol carbon dioxide):

$$C_6H_{12}O_6 \rightarrow 2CH_3CH_2OH + 2CO_2$$

The process of both sequential and simultaneous saccharification and fermentation (SSF) of biomass can be carried out in parallel to on-site enzyme production using some cellulose from saccharification [51]. Based on the study in NREL/TP-5100-47764, cellulase enzyme can be produced by *Trichoderma asperellum* and *Aspergillus fumigates* [52]. A total cellulase loading of 20 mg enzyme protein / g cellulose is required to achieve > 90% conversion of glucose into bioethanol. How much cellulose should therefore be diverted for highest glucose yield at least enzyme cost can be determined based on biomass variability [51]. In the fermentation process, recombinant co-fermenting bacterium (*Zymomonas mobilis*) can be used to ferment C5, C6 sugars simultaneously to bioethanol [52]. After the fermentation process, a beer column and a rectification column are operated to recover bioethanol-rich stream, which can further be dehydrated to drop-in bioethanol via a molecular sieve adsorption process. The bottom stream from the beer column is dewatered by filter press. The solid-rich stream can be used for CHP generation. The filtrate can be treated for recycling water, while the sludge can be anaerobically digested to recover nutrients and generate biogas. Upon process integration, more flexibility to product recovery can be incorporated, e.g. biogas for gas grid or engine for electricity generation, etc.

Majority of the bioethanol plants are still operating on first generation food crops. For second generation non-food lignocelluloses, pretreatment, e.g. dilute acid / alkali hydrolysis is necessary, to extract C5, C6 sugars for fermentation to bioethanol production; this pretreatment extraction process helps to separate lignin from the sugars. Lignin is known to interfere or inhibit microbial fermentation of sugars, hence, its separation from hydrolysate or sugar solutions is needed by pretreatment for maximization of fermentation product yield, in this case bioethanol. The other difference between first and second generation feedstocks is that a greater amount of lignin is available for valorization into bio-based products, in the latter scenario, thus the former scenario gives higher yield of bioethanol based on the feedstock flowrate, compared to the latter. However, yield of bioethanol with respect to sugars enzymatically fermented is very much the same at the mark of 95% by mass of C6 sugars and 85% by mass of C5 sugars [51]. For more developed TRL, lignin is utilized to produce CHP, more likely in a boiler system, as shown in [51]. In the case of CHP generation from second generation bioethanol plant, excess electricity generated after fulfilling on-site energy demand can be distributed locally in rural areas without connection to grid or otherwise added to national grid [51]. Alternatively, where there is cheaper heat and electricity available in surrounding areas for the use by the site, lignin can be valorized into high value products, benzene, toluene, xylene, phenol, guaiacol, vanillin, syringol, dimeric structures, etc. [51], replacing petrochemicals.

In an integrated sago-based bioethanol plant (SBP) in Malaysia, a total of 4.75 t/d of bioethanol and 35.3 kW of electricity for export has been produced from 20.8 t (wet basis) or 10.2 t (dry basis) of sago barks; and 16.9 t (wet basis) or 6.5 t (dry basis) of sago fibres generated from the SSEP operating at a starch production capacity of 12 t/d [51]. The process is associated with a GWP saving of 16.32 t CO₂ equivalent / d. The payback period of the integrated SBP with on-site enzyme production and using available labor from SSEP is estimated to be 6.6 years. Based on the analysis, it is noted that enzyme and labor costs are the main cost contributors in the development of a new integrated SBP and hence a sensitivity analysis of such parameters on sustainability performance has been performed, which can be found in [51].

4.3. Biodiesel production

Biodiesel is a state-of-the-art renewable fuel produced by reacting vegetable oils, refined oils and animal fats, containing triglycerides and free fatty acids as the main constituents, with methanol. The three main reactions steps in transesterification of triglyceride with methanol are triglyceride (*T*), diglyceride (*D*), and monoglyceride (*M*) reactions with methanol (CH_3OH) to form *D*, *M* and glycerol (*G*) respectively along with methyl oleate (*MeOl*), or longer chained methyl ester – depending on glyceride chain length [53]. Fatty acid methyl esters such as *MeOl* are known as biodiesel.

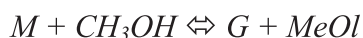

The multiphase transesterification reaction suffers from mass transfer limitations. Various researchers have investigated intensification of biodiesel reactor for increasing area to volume ratio and overcoming mass transfer limitations, such as heterogeneously catalyzed reactor [54], oscillatory baffled reactor [55–57], micro-structured reactor [58], membrane reactor [59,60] and simulated moving bed reactor (SMBR) [61]. Dynamic multi-scale simulation and computational fluid dynamics methods have been used to optimize process and product performances.

Heterogeneously catalyzed transesterification reactions that include alkali oxides, alkaline earth oxides, zeolites, and hydrotalcites, are preferred over homogeneous reactions due to soap formation, catalyst loss, and greater number of separation steps in homogeneous reaction mixture. An effective SMBR process has been designed for 90% conversion of fatty acids via esterification reaction for high purity biodiesel production with the following operating conditions: switching time of 900 s, length of 0.25 m, and feed, raffinate, and eluent flow rate ratios of 0.41, 0.49, and 0.75, for a given velocity of 2.4×10^{-4} m/s in the reaction zone [61].

Biohydrogen for renewable electricity for electric vehicles is an attractive proposition. Biohydrogen can be derived from biomass via fermentation or gasification. Food and agriculture wastes have been examined in continuous tubular fermenter using *E.coli* bacteria with a view of industrial scalability [62,63].

4.4. Future bioethanol producing systems

Pretreatment by mechanical separation extracts hemicellulose from celluloses. Enzymatic hydrolysis of C5 sugars can then give rise to various valuable chemicals, xylose, arabinose, while C6 sugars to bioethanol. Co-production of arabinoxylan as food ingredient by roller milling / debranner operations as pretreatment prior to SSF producing bioethanol has been assessed for optimal operation and economic value generation [64–67]. Bioethanol yield is 34% by mass of feedstock and arabinoxylan's yield is 3.5% by mass of bioethanol, respectively. Arabinoxylan's selling price is £6 per kg compared to bioethanol's (£0.3–0.6 per kg). In the integrated configuration between bioethanol and arabinoxylan productions, bioethanol can be internally used for arabinoxylan extraction and purification, in a cyclical loop, which can be optimized using bioethanol pinch analysis methodology [68]. Furthermore, economic value and environmental impact (EVEI) analysis has been applied to graphically visualize environmental impact savings vs economic value generation in a step-wise improvement of a biofuel plant to a biorefinery system [69,70]. Fig. 6 shows the integration strategy between bioethanol production, CHP, effluent treatment plant (ETP) and anaerobic digestion (AD) systems [52]. Life cycle assessment (LCA) is a standardized method of evaluating environmental impact of a system across all associated supply chains and from raw material acquisition through manufacturing and opera-

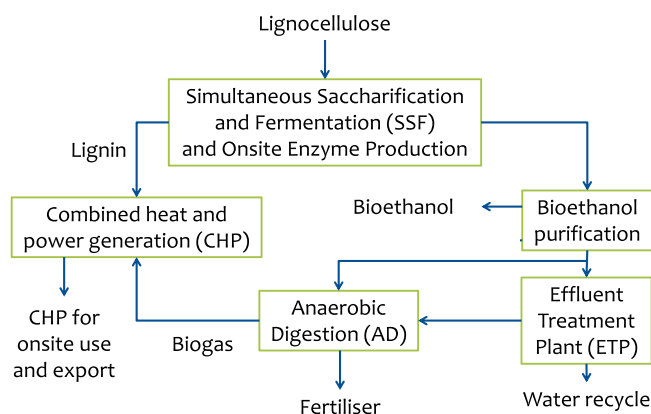

Fig. 6. Integrated system of bioethanol production, CHP, effluent treatment plant (ETP) and anaerobic digestion (AD) systems.

tions to end use, reuse, recycling and recovery [2,71]. LCA tool has been applied to demonstrate that an integrated bioethanol, ETP, AD and CHP system gives more than 85% greenhouse gas (GHG) emission reduction and 97% fossil resource saving, compared to a stand-alone bioethanol plant, barely giving 50% GHG emission reduction potential [72].

4.5. Future biodiesel producing systems

Novozymes© have their own enzymatic cocktail to make biodiesel from oils, in Malaysia. Their enzymatic, yeast and nutrition recipe enables palm kernel cake (PKC) (e.g. 1000 kg) conversion into palm kernel oil (PKO) (35 kg), bioethanol (237 kg) and palm kernel protein (PKP) (555 kg), respectively [73].

Malaysia has a biodiesel policy which required the fuel producers to blend palm oil & petroleum derived diesel for diesel fuel to be used in transport. Current global output of 65 million tonne palm oil requires cultivation of 15 million ha which are dramatically less than the 194 million ha needed to produce just 87 million tonne oil from oilseed crops such as soybean, rapeseed and canola [74]. Therefore, in terms of total oil yield per hectare, oil palm is more than 6.5-fold more efficient than the average combined yields of other crops. If oil palm is not taken into account, about 130 million ha more land will be needed to produce the same volume of oil [74]. Oil palm is the most productive source and cheapest of vegetable oil for biodiesel.

It has been seen that oil palm grows in a region of high poverty, illustrated in Fig. 7 [74]. Thus, palm oil for blending into petroleum derived diesel should be seen as an opportunity for socio-economic growth of world's high poverty regions. However, negative campaigns have prevented wide-spread take up of palm oil as a viable transportation fuel. This led to the creation of the Roundtable of Sustainable Palm Oil (RSPO) for certifying sustainable palm oil production and use [75]. RSPO enabled more than 13 million tonnes of RSPO Certified Sustainable Palm Oil produced from more than 3 million hectares production area around the world. This figure translates to 20% of the global CPO production certification to date [74]. The palm oil industry in Malaysia today grows oil palm plantation in brownfields and low carbon stock areas and free from claims by other stakeholders. The sustainable palm oil producers operate within the boundary of the law, particularly with regard to land ownership, labor rights and environmental conservation.

The RSPO standard was developed by stakeholders from around the world, which allowed the criteria to cover from legal, economic, social to environmental aspects of oil palm production, yet keeping in mind that the standard is to promote continuous improvement of the current practices, and not meant to shut down the industry. The standard gives room for producers embark on the learning process thus supporting

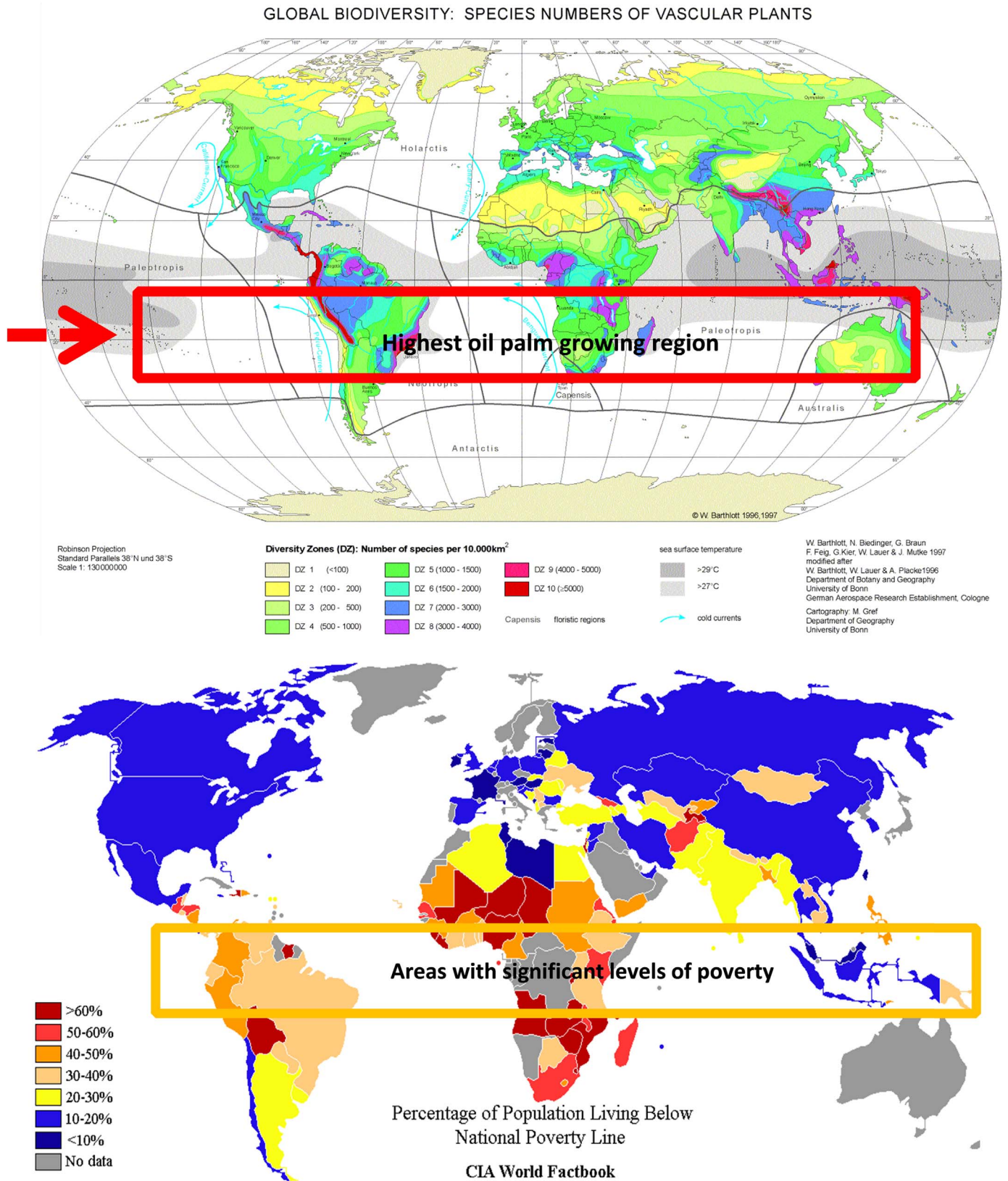

Fig. 7. Highest oil palm growing region is also the region of extreme poverty. Palm oil should therefore be seen as an opportunity for elimination of poverty in this region [74].

the theory on factors contributing to the effective voluntary approach. The standard should form the basis for acceptability of palm oil as biofuel in other countries not producing it, in order to channel the economic flow to the countries producing it in the regions of extreme poverty. The European Union mandates the use of only those biofuels

that give an emission cut by at least 60% across the supply chain and limits the use of first generation biofuels up to 7%. Thus, the GHG emission sources in the supply chain of palm oil production, as shown in Fig. 8, must be optimized for least GHG emissions [74]. Some global companies have already uptaken certified products, but not particularly

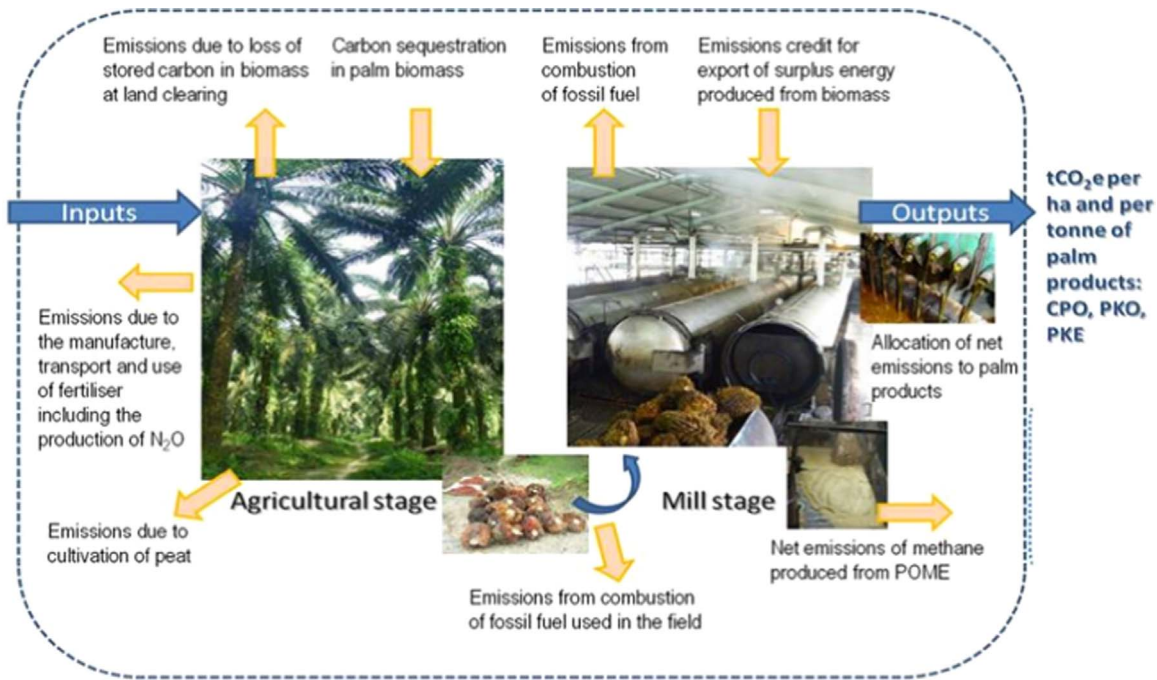

Fig. 8. GHG emission sources in the palm oil production value chain [74].

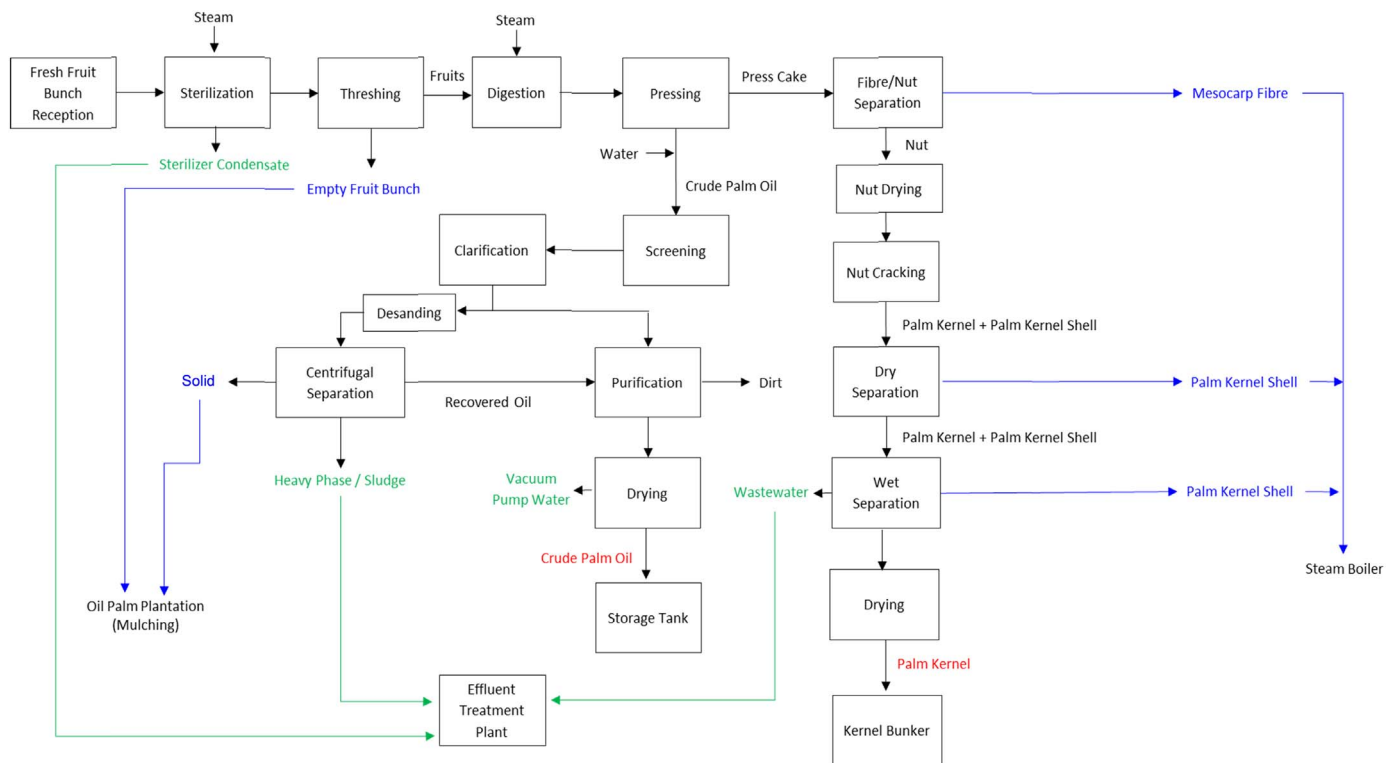

Fig. 9. State-of-the-art biogas plant in Malaysia [73].

as biofuel, for which the demand is higher and so is the socio-economic growth potential of poorer.

A recent report from the International Energy Agency reveals that fossil fuel usage has stepped up again [76]. Much of the middle income families in developing world are just beginning to experience the comfort of driving their own petroleum-driven cars. Electrical vehicles are developing, but the infrastructure is not quite ready yet to support the wide-spread adoption of vehicles run on renewable electricity. Thus, biofuels can provide an interim solution for developing economies.

Though renewable electricity generation has gone up and is expected to double up to 22% share of electricity mix by 2040, the quantity generated is not enough to support developing economy. It is the transition period, when the use of biofuel is desirable to help the developing nations reach the developed economy, as long as biomass to produce biofuel does not compete with food crops land. Up to 20% palm oil can be blended into petro-diesel using existing engines [74]. 100% palm oil usage calls for engine modifications yet to be seen. In June 2016, 10% biofuel blend in transport sector has been mandated in Malaysia [74].

Table 4
Quality of effluent and clean water generated [79].

Parameter	Treated Effluent	Recovered water	Drinking Water Std.	Unit
pH	6.8–7	7–8	6.5–9	
BOD	15–22	< 6	6	mg/L
COD	200–250	< 10	10	mg/L
TSS (Total suspended solid)	50–100			mg/L
Turbidity	Nil	< 5	5	mg/L
TDS (Total dissolved solid)			1000	mg/L

Table 5
Production rates from integrated multi-process / multi-product facility utilizing biomass from 60 t/h – capacity CPO mill [79].

Product	Projected Annual Production Capacity
Dried Long Fibre	4800 t
Pellet	24,000 t
Bio-fertilizer	24,000 t
Power from Biogas (3MWh)	21,600 MWh
Treated Water	103,000 t

The implications of energy consumption in the modern world go beyond these boundaries, for e.g. environmental pollution, in particular important in urban environment [88,89], which must be mitigated using RRfW concept [90]. The following section thus reviews emerging biorefinery, RRfW, CCR and CDR technologies exploiting polygeneration concepts [90].

5. Overview of developed systems: platform or intermediate products

Thermochemical conversion is an important process for converting biomass into a platform product, syngas via gasification and bio-oil via pyrolysis, etc. Syngas and bio-oil can be precursors to a range of transportation fuels, gasoline, jet fuel and diesel as well as chemicals.

5.1. Bio-oil based biorefineries

Thermochemical conversion at a temperature 400–500 °C in the absence of oxygen results into a liquid called bio-oil. The widely applied Waterloo's kinetic model assumes that the pyrolysis reactions proceed in a two-stage mechanism [2]. The primary reactions involve the formation of gas, oil and char. The secondary reactions involve the conversion of oil into further products in the forms of gas, oil and char. The rate of the secondary reactions is much lower than the primary reactions. The secondary conversion of oil into char is negligible. Typical yields of gas, bio-oil and char are 45%, 45% and 5% by mass from dry lignocellulose. Bio-oil can be gasified into syngas generation followed by methanol or Fischer-Tropsch synthesis [90]. Bio-oil is a cleaner form than biomass and has higher energy density, which makes it an easy to transport commodity. Hence, bio-oil can be produced from locally available biomass at small scale, collated from various distributed locations and transported to a centralized plant for fuel (e.g. Fischer-Tropsch liquid) or chemical (e.g. methanol) synthesis. An energy efficiency of 61.5% from bio-oil to methanol production or 58% from bio-oil to Fischer-Tropsch liquid synthesis (based on bio-oil low heating value) has been demonstrated. Out of these, the main product, heat, and electricity contribute by 54%, 33%, and 13% of the output energy generated from the centralized plant, respectively. The GWP savings by the centralized plants are 0.75 kg CO₂ equivalent / kg bio-oil.

Microwave pyrolysis is a technically and energetically viable and effective method to recover useful products from biomass, e.g. used cooking oil, MSW, forestry and agricultural residues. It shows advantages in providing fast heating, extensive cracking and a reducing reaction environment [46,47]. The pyrolysis produces biofuel and syngas that can be utilized as a fuel or precursor of petrochemicals or equivalent functional chemicals and the char produced can also be used as a precursor to produce activated carbon and catalyst. The biofuel is diesel-like, low in oxygen, free of sulphur, carboxylic acid and triglycerides.

Steam explosion and supercritical water extraction technologies (also known as pulping as well as hydrothermal liquefaction, up to 450 °C and 250 bar) [48] can be used to extract bio-oil with lower oxygen and moisture contents and higher calorific value (34 MJ/kg compared to the bio-oil from pyrolysis process, 17 MJ/kg) [2]. The process provides higher functionality, but incurs higher capital cost than pyrolysis.

Bio-oil hydrotreating and hydrocracking also called upgrading are suitable for simultaneous production of gasoline and diesel and include cracking to olefins and hydrogenation to high octane isoparaffins (mainly in gasoline), ring separation and opening into smaller aromatic compounds and cycloparaffin (mainly in diesel) and side chain hydrocracking and isomerization, which can be regulated to have better control over biofuel product and process performance [2,91,92]. Hydro-de-oxygenation refers to water removal by hydrogen. Decarboxylation indicates carbon dioxide and or carbon monoxide removal for the generation of olefins, isoparaffins, smaller aromatics and cycloparaffins, etc. [2,91]. 40 step reactions have been targeted on bio-oil to produce drop-in straight run gasoline and diesel from side columns, followed from the bio-oil reactor. Drop-in qualities diesel and gasoline yields of 40% and 3% by mass of bio-oil are obtained from bio-oil hydrotreating and hydrocracking. Up to 60% blending of these fuels to the crude oil derived gasoline and diesel are possible, without affecting the resulting transportation fuel qualities, giving a GWP saving of 85%. [2,91]. Furthermore, it is possible to add bio-oil as hydrocracker feedstock in petroleum refinery, which can produce the final quality renewable diesel. This can lower the capital cost of the bio-oil upgrader by 38% and operating cost by 15%.

Driven by the need to develop a wide variety of products with low environmental impact, biorefineries need to emerge as highly integrated facilities [93]. This becomes effective when overall mass and energy integration through a centralized utility system design is undertaken. A whole *Jatropha* biorefinery design includes green diesel production via hydrotreatment of *Jatropha* oil [94]. The process is coupled with gasification of husk to produce syngas. Syngas is converted into end products, heat, power and hydrogen for the green diesel production reaction. Anaerobic digestion of *Jatropha* by-products such as fruit shell and cake has been considered to produce biogas for power generation. The integrated biorefinery system achieves 57% energy efficiency and greater than 90% GHG emission cut, compared to petroleum derived diesel system [94]. The green diesel yield is 90% by mass of *Jatropha* oil. For whole *Jatropha* fruit utilization, the net electricity export is 0.7 GJ/kg *Jatropha* fruit.

5.2. Syngas based biorefineries

Gasification, on the other hand, provides a cleaner and higher efficiency process at 950 °C for partially oxidizing carbonaceous fuels into a gas product that upon clean-up and purification has mainly CO and H₂, known as syngas (synthetic gas). The valuable energy is retained in the syngas, which is a versatile platform to produce chemicals, fuels, heat and power. Biomass gasification combined cycle (BGCC) builds upon utilization of syngas in power generation via gas turbine, shown in Fig. 11 [2,82]. The exhaust gas from the gas turbine

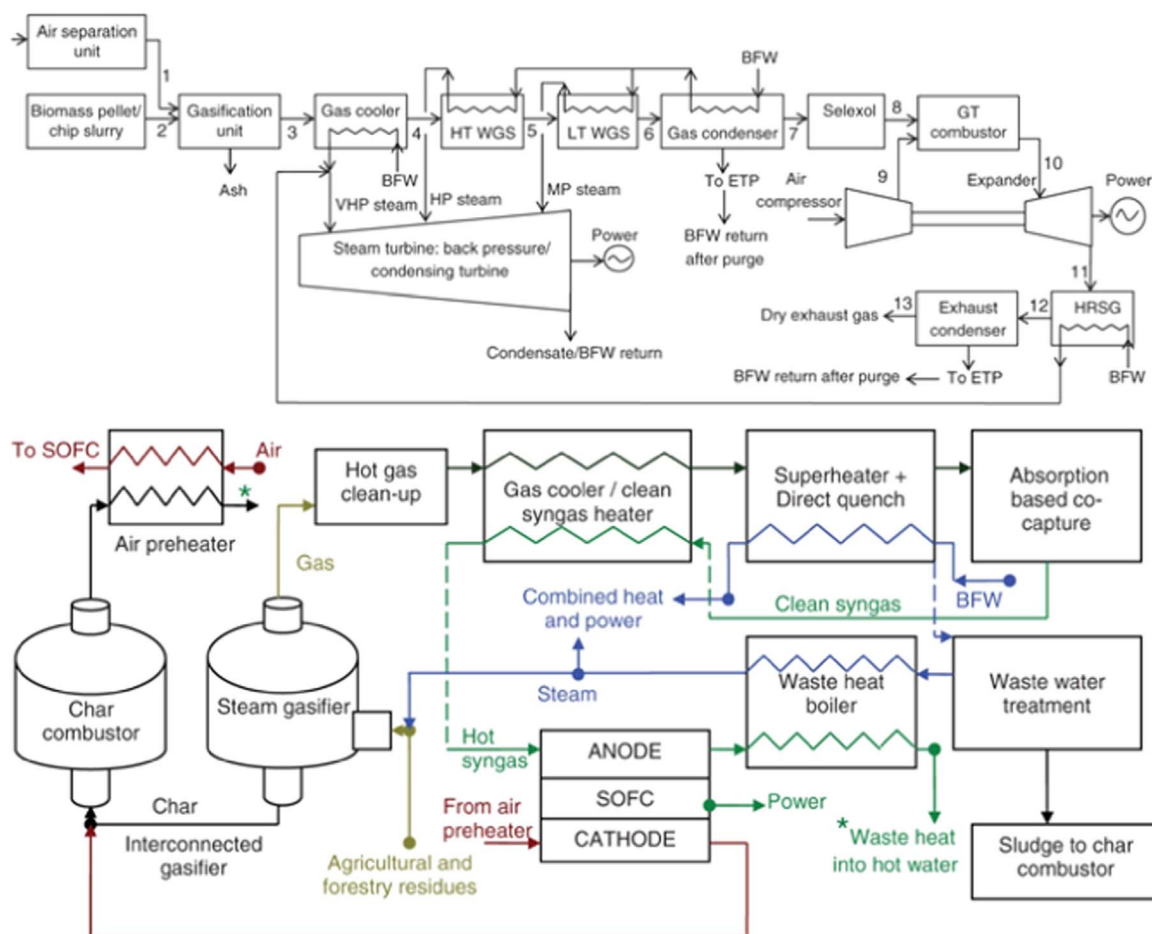

Fig. 11. BGCC: BFW: Boiler feed water, ETP: Effluent treatment plant, GT: Gas turbine, HT: High temperature, LT: Low temperature, VHP: Very high pressure, HP: High pressure, MP: Medium pressure (top); BGFC: SOFC: solid oxide fuel cell (bottom) [2]. Copyright© 2014 Society of Chemical Industry and John Wiley & Sons, Ltd.

is heat recovered into steam generation, in heat recovery steam generator (HRSG), before being released to the environment. Generated steam is superheated in gas cooler and then expanded through back pressure and condensing turbines for electricity generation. The product gas from gasification undergoes cooling for heat recovery into steam superheating, and clean-up including Selexol™ or Rectisol™ process for removal of contaminants including sulphur compounds to ppmv level and quench for particulate removal, before combustion in the combustor of the gas turbine. If other usages of syngas is targeted, e.g. methanol [85] or Fischer-Tropsch [84] synthesis, water gas shift reaction is incorporated after gas cooling and clean-up, for meeting hydrogen to carbon monoxide molar ratio of 2:1 required by those synthesis processes.

Biomass gasification fuel cell (BGFC) shown in Fig. 11 gives a much higher energy efficiency of ~ 80% [2,81]. The proven concept exploits extensive heat and water recoveries to achieve close to theoretical energy efficiency [81].

Entrainment of tar, ash and particulates in the product gas in the gasifier is the greatest problem to solve [95]. Heterogeneously catalyzed gasification shows promises of selective production of clean gas with higher hydrogen to carbon monoxide molar ratio that can be directly used in product synthesis, methanol or Fischer-Tropsch liquid. For BGCC or BGFC, though hydrogen to carbon monoxide molar ratio is not crucial for combustion in gasifier or solid oxide fuel cell, but removal of contaminants to ppm level is essential for catalytic product synthesis downstream. Successful gasification catalysts and along with enhanced gasifier performance

in terms of hydrogen to carbon monoxide molar ratio are shown in Table 6 [96–102].

6. Overview of developing systems: future biorefinery systems

It has been observed that Malaysia's local businesses go for low risk – low value products, bioenergy, pellets, biogas, fibre, particle board, etc. [78,79,103]. But the economic profitability lies with the chemical products [39,104–108]. Fig. 12 shows the economic values of bio-based products with respect to time scale of their development, in Malaysia. There are economic drivers for chemical synthesis, especially succinic acid (£3990–5985 per tonne), levulinic acid (£5000–8000 per tonne) and biobutanol (£630–815 per tonne, compared to bioethanol £300–590 per tonne) – these three priority chemicals appear in the various National reports and have attracted market investments [109–112]. GWP saving by these when used as chemical is also not far off from biofuels or bioenergy, e.g. 0.7 kg CO₂ equivalent / kg, compared to fossil-derived equivalent products. Better functional or quality product and faster marketability, greener and sustainable production and consumption, and least production cost are the main targets to tap into chemical market that can attract the Government's investment.

Even though a niche bio-based product would have much higher market price, listed in Fig. 12, compared to energy products, which are dependent on policy and legal framework and actions by the Government, supportive policy regulations will still be essential for sustainable bio-businesses.

Table 6
Catalytic gasification options and performances against non-catalytic gasification.

Catalyst	Ni/Al ₂ O ₃	Ni/Ce/Al ₂ O ₃	Ni/Mn/Al ₂ O ₃	Fe/Al ₂ O ₃	Fe/Ca/Al ₂ O ₃	Fe/Mn/Al ₂ O ₃	Cu/Al ₂ O ₃	Co/Al ₂ O ₃	Ni/Cu/Al ₂ O ₃	Ni/Fe/Al ₂ O ₃
Water injection (g/h)	2.85	2.85	2.85	2.85	2.85	2.85	2.85	2.85	2.85	2.85
Gas yield (wt%)	42.63	63.19	77.19	60.76	59.59	56.59	54.49	42.92	49.79	56.75
Mass balance (wt%)	95.42	95.29	103.20	99.59	98.06	93.09	95.23	97.37	89.90	96.78
Hydrogen Production (mmol/g)	4.92	14.48	24.32	13.44	12.28	12.18	11.90	5.87	9.15	11.31
Gas Composition (vol%)										
CO	36.74	23.83	23.41	18.61	16.81	15.28	15.59	33.62	24.81	24.98
H ₂	25.12	42.88	52.88	44.00	42.31	43.89	44.24	30.04	37.66	39.76
CO ₂	15.06	20.40	19.07	27.10	29.31	29.74	29.85	19.91	22.95	22.38
CH ₄	18.16	11.86	4.47	8.55	9.86	8.34	8.61	12.33	11.90	11.13
C ₂ – C ₄	4.91	1.03	0.17	1.73	1.71	2.74	1.70	4.11	2.68	1.75
H ₂ /CO	0.68	1.80	2.26	2.36	2.52	2.87	2.84	0.89	1.52	1.59
H ₂ /CO ₂	1.67	2.10	2.77	1.62	1.44	1.48	1.48	1.51	1.64	1.78
CO + H ₂	61.86	66.71	76.28	62.61	59.13	59.18	59.84	63.65	62.47	64.74

6.1. Supportive policy regulations for advanced biorefinery system and bioeconomy development

Three main policies shown in Fig. 13 will drive the bioenergy, biorefinery and bioeconomy development in Malaysia: Renewable Energy Policy & Act; National Biotechnology Policy; and Green Technology Policy.

The Feed-in-Tariff (FiT) scheme gives leverage on biomass-derived / renewable electricity price applicable to biogas to electricity and biomass to electricity generation schemes. The FiT rates in RM-Sen/kWh valid for following 16 years after operation, are dependent on installed capacity, up to 4 MW, 4–10 MW, 10–30 MW; and gas engine performance: e.g. above 40% efficiency, locally manufactured or assembled gas engine technology, additional FiT for landfill or sewage

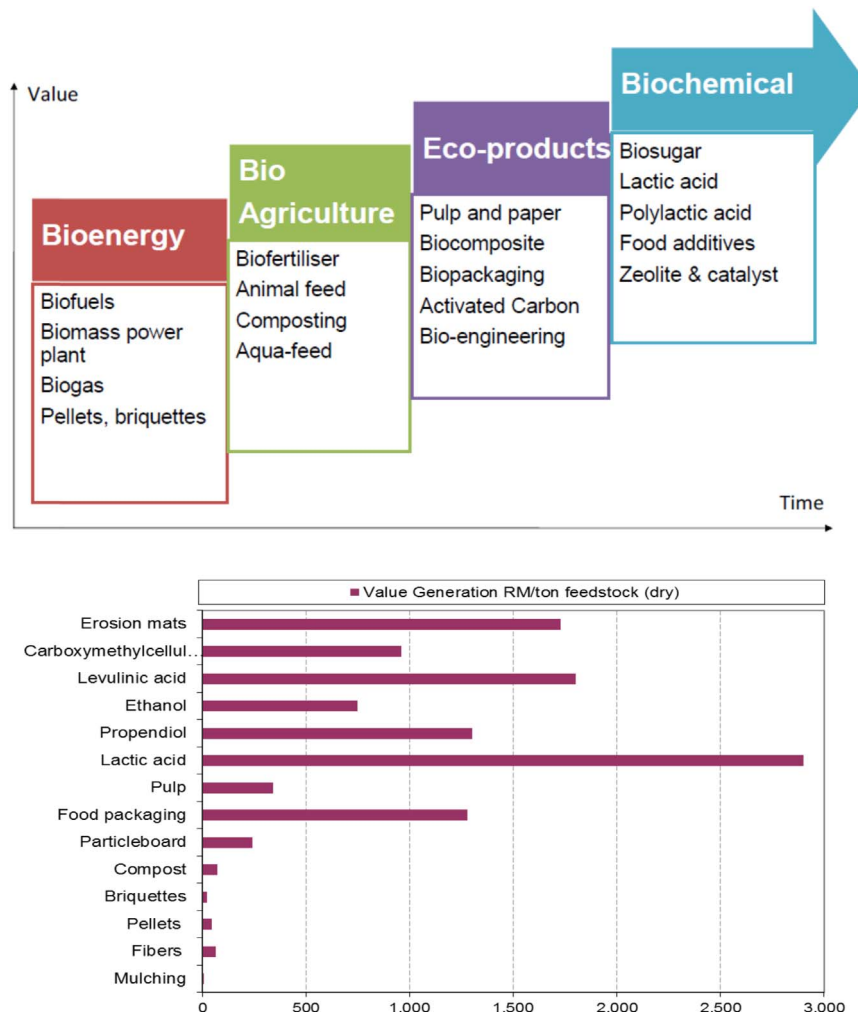

Fig. 12. Economic values of bio-based products with respect to time scale of their development (top); Value generation in Malaysian Ringgit (RM) per tonne for bio-based products (bottom) [124].

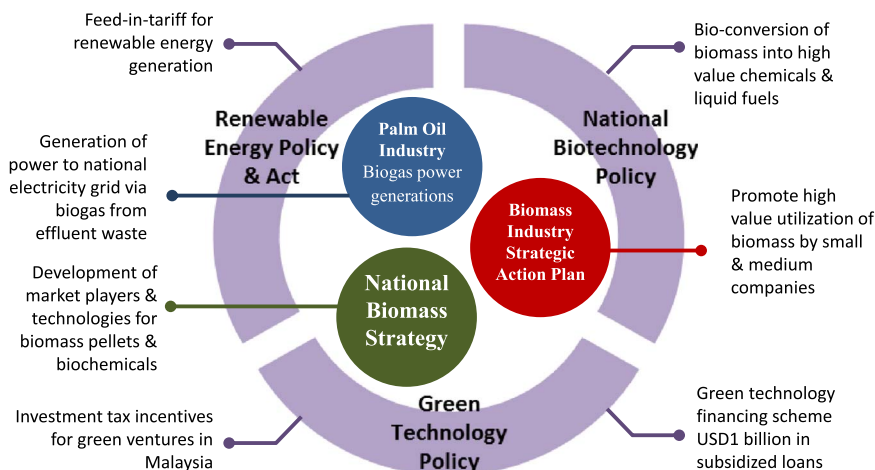

Fig. 13. Policy and legal frameworks and actions by the Malaysian Government [124].

gas usage [113,114]. Main renewable energy sources identified are biomass: CPO biomass, wood / forestry / sawmill, MSW, rice husk and straws and sugarcane bagasse and molasses; hydro-power, and solar thermal and photovoltaic [115–118]. Animal wastes / livestock though were not explicitly mentioned as a source of biogas, a recent study shows that 4589.49 million m³ annual production of biogas are possible from animal waste in Malaysia that could provide an electricity generation of 8.27 TWh [119]. However, the quality of the biogas generated will not be suitable for engine usage. Another promising application of biogas is seen as compressed natural gas (CNG) as a fuel in vehicles. This application particularly needs ultra-pure quality methane. The composition of methane should be more than 97% and CO₂ less than 3% by volume, H₂S less than 10 ppmv and water content should be less than 32 mg/Nm³ [120]. Thus, the Selexol™ or Rectisol™ absorption process that also absorbs CO₂ is needed for biogas purification before injection to gas grid or being used as CNG [2,81,82].

Under the Renewable Energy fund by Pusat Tenaga Malaysia (PTM), consumers who utilize electricity more than the set minimum point must contribute 1% of their bill towards the fund. The collected fund will then be used to equalize the price between non-renewable and renewable sources of energy administered by the Sustainable Energy Development Authority (SEDA), under the Ministry of Energy, Green Technology and Water (KeTTHA) [121,122].

The National Biotechnology Policy is meant to protect interest of high value chemicals from biomass. Application sectors include agricultural biotech, healthcare biotech, industrial biotech and bio-informatics. The development is seen in phases, first by capacity building, followed by science to business and finally global presence of Malaysian business [123].

Green technologies are defined based on the following criteria: that minimizes degradation of the environment; has zero or low GHG emission; is safe for use and promotes healthy and improved environment for all forms of life; conserves the use of energy and natural resources; and promotes the use of renewable resources [125]. The green technology has a sizable fund, 1.5 billion RM in 2009–2010 for promoting sustainable production and consumption pathways. A producer company can get 50 million RM loan for a tenure of 15 years and a user company can get 10 million RM loan for a tenure of 10 years. During the tenure period, no payment is needed, even if the company makes a profit margin. On top of these, there is an interest subsidy of 2% and 60% guarantee on the amount borrowed from the Government. Flexibility can also be recognized by the way eligibility criteria are set, 51% for the producer and 70% for the user Malaysia based share-hold.

However, clear policies are not in place for mitigation of environmental emissions. Majority of biomasses are disposed to local streams, which cause severe pollution to the environment. As a result,

majority of biomasses have remained unutilized at present. In order to develop a bioeconomy and a circular economy, environmental emissions must be mitigated by recovering apparently pollutants as resources from biomass, thereby remedying environmental impact and closing the loop. Of particular interest is the SDG 12, “sustainable consumption and production”, that recognizes the important role of resource efficient technologies and there is a clear policy gap to turn SDG 12 into practices.

6.2. RRfW integrated biorefinery systems

RRfW is a cross-cutting theme can be supported by the three governing policies shown in Fig. 13. RRfW includes recovery of metal, element, material, inorganic and organic from rejects from any sector, industrial, agricultural, forestry, manufacturing, commercial, construction, transport and residential. MSW is an example of heterogeneous mixture, which can give numerous resources that need to be conserved, such as metals and elements as well as added value products, chemical, materials, etc. [2,39]. Despite the sharp economic development in Malaysia, solid waste management is relatively poor [126]. It is projected that MSW production can reach 30,000 t by 2020 [127]. MSW constitutes of domestic (49%), industrial (24%), commercial (16%), construction (9%) and miscellaneous (2%) by mass, respectively [128]. Malaysia generated 5.5 MW of electricity from MSW in August 2009 and it is expected that, with the policies adopted by the Government, the total installations will rise to 360 MW by 2022 [129,130]. However, source segregation strategies have to be enforced to ensure that the non-combustible constituents exist in various streams of MSW, post-combustion, do not end up as emissions to the environment. Source segregation is necessary for clean technology and processing for remedying environmental pollution, albeit at a higher capital investment, which needs either subsidies or process integration for unlocking the value of organic waste via added value bio-based productions and a total site utility system design [39].

The main state-of-the-art MSW management strategies are recycling, composting and incineration, before landfilling [131]. Mechanical biological treatment (MBT) is regarded as pretreatment for valorization of MSW [39]. The state-of-the-art MBT is configured to recover recyclables, metals and refuse derived fuel (RDF) from MSW. MBT consists of mechanical unit operations: screening, magnetic separator, Eddy current separator, manual, induction and automated sorting, near infrared sensor, X-ray sensor, etc. Individual mechanical unit operations needed for resource recovery from various streams of urban waste are illustrated in [39]. In a desired advanced scenario: MSW is first separated into recyclables and MSW free of recyclables; the latter is further recovered into RDF, metal stream, chemical and AD sections' feedstocks [39]. Usually, source separated MSW consists of

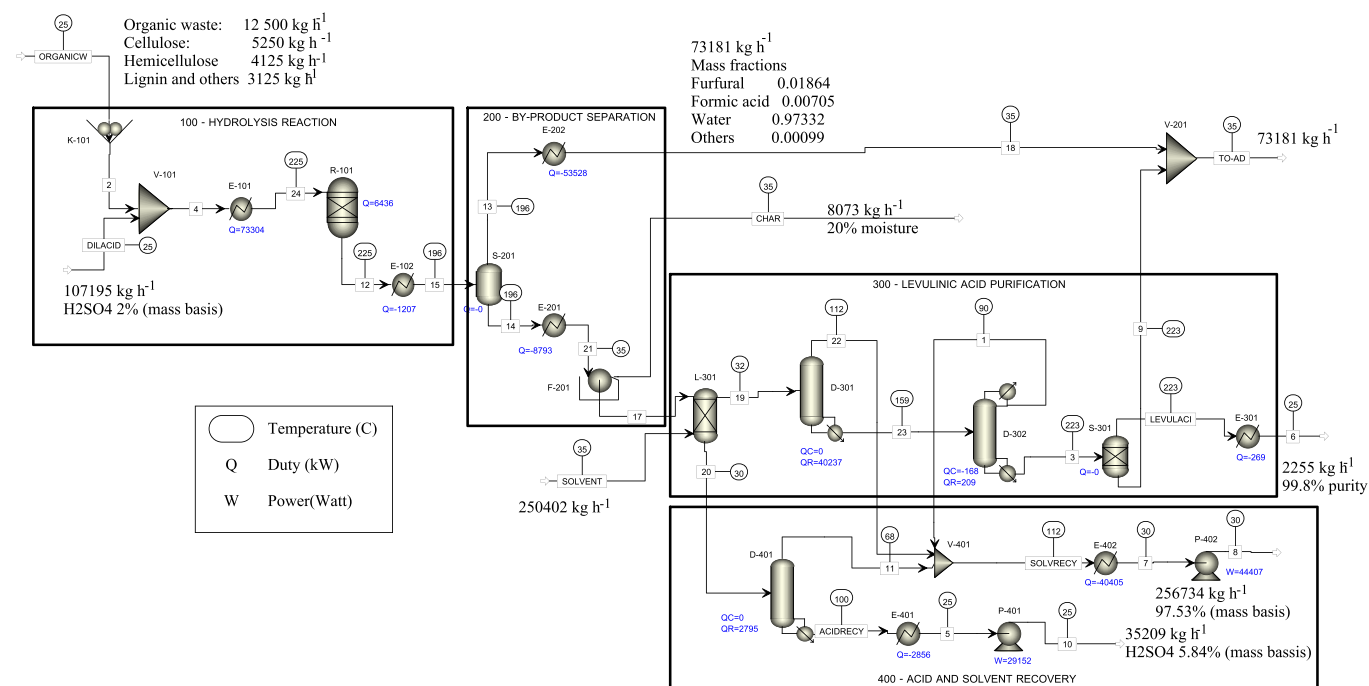

Stream name	ORGANICW	DILACID	15	18	21	17	19	23	3	LEVULACI	20	ACIDRECY	SOLVRECY	CHAR	SOLVENT
To unit	K-101	V-101	S-201		F-201	L-301	D-301	D-302	S-301	E-301	D-401	E-401	E-402	V-401	V-201
From unit			E-102	E-202	E-201	F-201	L-301	D-301	D-302	S-301	L-301	D-401	V-401	V-201	
Mass Flow kg/hr															
CELLULOS	5250.0	0.0	0.0	0.0	0.0	0.0	0.0	0.0	0.0	0.0	0.0	0.0	0.0	0.0	0.0
HEMICELL	4125.0	0.0	0.0	0.0	0.0	0.0	0.0	0.0	0.0	0.0	0.0	0.0	0.0	0.0	0.0
LIGNIN	3125.0	0.0	0.0	0.0	0.0	0.0	0.0	0.0	0.0	0.0	0.0	0.0	0.0	0.0	0.0
H2SO4	0.0	2143.9	2143.9	12.2	2131.7	2055.9	0.0	0.0	0.0	0.0	2055.9	2055.9	0.0	75.8	0.0
LEVULINA	0.0	0.0	2415.0	60.8	2354.2	2270.5	2263.0	2257.5	2253.0	2253.0	7.5	7.5	10.0	83.7	0.0
FORMICAC	0.0	0.0	945.0	515.7	429.3	414.1	412.7	0.0	0.0	0.0	1.4	1.4	412.7	15.3	0.0
FURFURAL	0.0	0.0	1650.0	1364.0	286.0	275.8	275.8	202.9	2.4	2.4	0.0	0.0	273.4	10.2	0.0
CHAR	0.0	0.0	6458.7	0.0	6458.7	0.0	0.0	0.0	0.0	0.0	0.0	0.0	0.0	6458.7	0.0
SOLVENT	0.0	0.0	0.0	0.0	0.0	0.0	249646.0	998.6	0.1	0.1	755.9	15.1	250387.0	0.0	250402.0
WATER	5357.1	105051.0	111439.0	71228.4	40210.7	38780.9	5603.9	0.0	0.0	0.0	33177.0	33124.9	5656.0	1429.8	0.0
Total Flow kmol/hr	297.4	5853.1	6266.2	3979.8	2286.3	2205.1	2834.8	31.5	19.4	19.4	1870.2	1859.9	2825.7	81.3	2500.0
Total Flow kg/hr	17857.1	107195.0	125052.0	73181.1	51870.6	43797.2	258201.0	3458.9	2255.5	2255.5	35997.7	35204.8	256739.0	8073.4	250402.0
Temperature C	25.0	25.0	196.0	35.0	35.0	35.0	31.7	159.3	223.5	223.5	30.4	99.6	112.1	35.1	35.0
Pressure bar	1.0	1.0	14.0	1.0	5.0	4.8	3.0	1.0	0.4	0.4	3.0	1.0	1.0	1.0	5.0

Fig. 14. Detailed mass and energy analyses of the levulinic acid production process [39]. Copyright© Elsevier 2016.

the following streams diverted into various lines for recycling: paper and cardboard packaging; glass; dense plastic and plastic films (container, plastic packaging); wood, garden and food waste; textiles; WEEE (waste electrical and electronic equipment). Other than these, metals and unidentified wastes are present in these streams. Also, the source segregation is not perfect; hence, MBT is essential for recycling these materials back to value chains. To introduce source segregation in Malaysia, collection trucks, caddies, and communication campaigns have to be introduced, alongside budget commitment from the Malaysian Government to support initial capital investment for creating a resource-efficient infrastructure.

In MBT, paper and cardboard packaging are separated after conveying by air classifier fitted with a digital camera and a weighing machine; the air flowrate is adjusted to separate paper and cardboard packaging according to their images and weights, into two separate compartments and bailed for transporting to milling sites. Alternatively, paper and cardboard packaging may not need to be separated, but can be used as mixed substrates in a pulping process for recovering organic fraction for conversion into a chemical, e.g. levulinic acid [39]. The latter option has been evaluated to demonstrate 1.5 fold increase in profitability by an extraction of the chemical by only 5 wt% of recycle free MSW [39].

The stream containing dense plastic and plastic films (container, plastic packaging) after conveyance is separated by automated sorting system employing various types of sensing systems into

three streams: Al cartons with HDPE (high density polyethylene) (according to the numbering of plastic, it is numbered as 2), PET (polyethylene terephthalate numbered as 1) and mixed plastic waste (MPW numbered as 3–7). Magnetic and Eddy current separators are used downstream to Al cartons with HDPE stream to first isolate ferrous and non-ferrous streams and then to separate Al cans from the non-ferrous stream. Other streams if manually or automatically detected to be containing Al are also diverted to the Eddy current separator. An ‘Eddy current’ occurs when a conductor is exposed to a changing magnetic field. It is an electromagnetic way of dividing ferrous and non-ferrous metals. This stream with low PVC (poly vinyl chloride) can be further screened to remove traces of metals and recover polymer in purer form to give rise to RDF. RDF is used as an alternative to fossil fuel, specifically coal. It uses materials which are not otherwise possible to recycle. To make RDF useful in industrial incineration and energy generating plant, it is important to ensure the quality of RDF, when it comes to heating values, ingredients, and contaminants like metals, stones and chemicals. Therefore, in some plants, induction sorting systems and x-ray sorting systems are installed to detect and remove these components [39]. In induction sorting, material is sent along a conveyor belt with a series of sensors underneath. These sensors locate different types of metal which are then separated by a system of fast air jets which are linked to the sensors. X-rays can be used to distinguish between different types of materials based on their density.

Wood, garden and food wastes are the primary source of organics. The mixed stream can be treated by steam explosion or supercritical hot water extraction, called pulping process that separates the curbside-type recyclables from the lignocellulosic fraction of MSW. The lignocellulosic fraction of MSW goes through a primary wash for ash removal and cellular disruption for yield maximization combined with a sterilization stage – fractionation of this lignocellulosic stream of MSW is then carried out by the controlled acid hydrolysis process for eventually producing levulinic acid in the chemical conversion section, comprising hydrolysis in 2 wt% dilute H₂SO₄ catalyst producing levulinic acid, furfural, formic acid, via C₅/C₆ sugar extraction, in plug flow (210–230 °C, 25 bar, 12 s) and continuous stirred tank (195–215 °C, 14 bar, 20 min) reactors; char separation and levulinic acid extraction/purification by methyl isobutyl ketone solvent; acid / solvent and by-product recovery. The by-product and pulping effluents are anaerobically digested into biogas and bio-fertilizer [77]. Produced biogas (6.4 MWh/t), RDF (5.4 MWh/t), char (4.5 MWh/t) are combusted, heat recovered into steam generation in boiler (efficiency: 80%); on-site heat/steam demand is met; balance of steam is expanded into electricity in steam turbines (efficiency: 35%) [39]. A yield of Levulinic acid by only 5 wt% of recycle free MSW gives 1.5 fold increase in profitability and eliminates the need for subsidies such as gate fees paid by local authority to waste treatment plant owner [39]. Fig. 14 gives detailed mass and energy analyses of the chemical section producing levulinic acid and char [39].

For more advanced and intense valorization, emerging technologies such as microbial electrosynthesis (MES) can be applied for further recovery of organics from the effluent. The process is versatile in terms of the ability to process mixed stillage streams, containing metals, organics, inorganics, e.g. stillage streams from MBT, into the recovery of metals, bioplastics, biofuel and biochemical [90,132].

An MBT integrated with chemical conversion plant, recently coined as mechanical biological chemical treatment (MBCT), can unlock the value of organics in wastes through the production of a high value chemical, such as levulinic acid [39]. Its extraction as low as by 5 wt% of MSW can increase the economic margin by 150% and eliminate the need for gate fees that are paid from the Government or tax payers to the waste treatment company for treating the waste [39]. Composting, AD and incineration are unsustainable solution, due to public spending, environmental emissions due to lack of clean-up and RRfW technologies and exploitation of process integration. Process integration and process engineering are vital for demonstrating the benefits of core technologies at the right scale.

Levulinic acid is a platform or building block chemical is a precursor to many added value products. Ethyl valerate, an ester derived from levulinic acid, is a drop-in biofuel, which can be blended up to 45% by volume [133] and have a demand as high as 22 million barrel a day [105]. Derivatives of levulinic acid have applications as pharmaceutical, specialty chemical, agricultural, solvent, platform chemical and fuel additive products. Levulinic acid is one of few molecules referred as ‘sleeping giants’ owing to their vast potentials in the emerging bio-based economy due to their key positions in the production of biomass-derived intermediates and transition from fossil based economy to bio- renewable- based circular economy [39]. GF Biochemicals to date is the main producer of levulinic acid at their plant in Caserta, Italy [134]. Levulinic acid has emerged as a niche platform chemical in production of pharmaceutical: δ -aminolevulinic acid, specialty chemical: γ -valerolactone, agricultural: diphenolic acid, platform chemical: pyrrolidones, succinic acid and fuel additive: levulinate esters, 2-methyltetrahydrofuran with addressable petrochemical replacement potential of over 25 million tonne by 2020 [39,134].

Commercial bio-based butanol production also came a step closer with Green Biologics beginning the retrofit of their Minnesota ethanol plant for *n*-butanol and acetone production [135,136]. Butanol is a drop-in fuel that can replace petrol. Existing bioethanol production

facilities can be easily retrofitted to produce biobutanol, which is a much better quality fuel than bioethanol. Cellulosic biorefinery followed from dilute acid / alkali hydrolysis or pretreatment of lignocellulose is thus becoming a key to effectively replace petroleum refinery and petrochemical industry [137].

Succinic acid is an important building block chemical with an annual potential demand 140–400 kg tonne and main producer companies: BioAmber along with Reverdia and Succinity [136]. Glycerol is an example of a precursor to succinic acid [2]. Glycerol is a byproduct of biodiesel production via transesterification process [53,54]. Glycerol is also produced in oleochemical industry during soap production and synthetically from propene. The low, stable prices of glycerol will allow emerging uses, including succinic acid.

6.3. Computer aided process engineering (CAPE) tools for sustainable biorefinery system design

There are CAPE tools to enable design of resource efficient biorefinery systems for developing an optimal proof of concept before experimental investigation [138–143]. However, the incorporation of safety and health aspects into CAPE is not strongly emphasised in many design problems. Because of this, many chemical substances available in the market may lead to unwanted accidents as well as adverse health impacts following prolonged and repeated exposure. For newer systems and systems utilizing wastes safety and health aspects are vital at the preliminary conceptual design phase, because it is possible to manipulate the designs at the early stage of R & D. At earlier stage of process life cycle, there are higher degrees of freedom to make any changes on the process – the associated costs as well are relatively much lower. Therefore, the integration of safety and health aspects as design criteria in the CAPE methods is of paramount importance. This is to ensure that the synthesized product does not bring harm and health-related hazards to the consumers. Many do not realize that few fundamental decisions made at the early process development stage will have major impact on the latter performance of the process, especially those related to safety and health features of the process. A CAPE framework has been developed not only to consider safety and health aspects in process designs, but also to target physicochemical properties of products and optimal process performances in terms of highest economic profitability and least environmental footprint, simultaneously [144,145]. The assessment of safety and health parameters is based on fundamental molecular properties that also influence the product quality, functionality and process performance.

6.4. CCR and CDR for chemical and biofuel production

Earlier works have considered reuse of CO₂ rich streams in chemical reactions to produce syngas, hydrogen, formic acid, methane, ethylene, methanol, dimethyl ether, urea, Fischer-Tropsch liquid, succinic acid, etc. as well as materials, such as epoxides acetals and orthoesters as important precursors to many polymers and carbonates through mineralisation reactions for construction applications [83,146–148]. CO₂ as a reactant in Sabatier's reaction for methane formation, in reactions to produce calcite and succinic acid and CO₂ reuse for the growth of algae to produce biofuels, e.g. bioethanol and biodiesel have been analyzed for techno-economic feasibility [2,83]. MES works on reverse principles of microbial fuel cell, which utilises microbial decomposition of organic waste substrate to generate electricity [149]. In MES, renewable electricity is invested to make bio-based products sourced from organic substrates decomposed by microbes. Microbial oxidation of organic wastes, wastewaters, lignocellulosic hydrolysates and organic streams from industrial systems as anode substrates using biotic anode harvests electron, releases proton and produces hydrogen, carbon dioxide, pyruvate, formate and fatty acids, as species, which can be subjected to reduction reaction in cathode for chemical, bioplastic and biofuel productions. In the

cathode chamber, carbon dioxide in the form of carbonic acid is reduced into products. The cathode can be biotic or abiotic. The process is versatile in terms of the ability to process mixed stillage streams, containing metals, organics, inorganics, e.g. wastewaters from metal and mineral industries and hydrolysate streams from dilute acid / alkali hydrolysis or pretreatment of lignocellulose, into the recovery of metals, bioplastics, biofuel and biochemical [90,150].

For CDR reactions using MES, the relevant anode and cathode reactions, their Gibbs free energies and the Gibbs free energy of formations of the species participating in these reactions, along with the calculations of the Gibbs free energies of reactions have been considered [90]. 63 anodic and 72 cathodic reactions of metabolism and 9 metabolic pathways have been collated for assessing technical feasibility / thermodynamic spontaneity of resource recovery from waste substrates and combinations of anodic and cathodic reactions using MES. Some CDR occur in biocathode of MES are shown here:

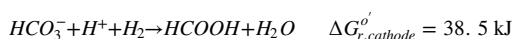
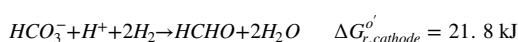
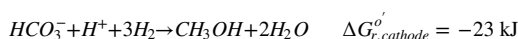
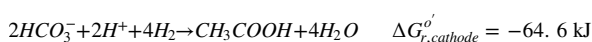
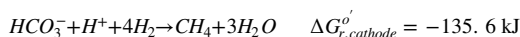

$\Delta G_{r,cathode}^{\circ}$ is the Gibbs free energy for the cathode side reaction under standard conditions (25 °C temperature and 1 atm pressure) and pH 7.

Recently, medium chain fatty acids such as caproate and caprylate have been produced from acetate at a biocathode using mixed microbial cultures (where *Clostridium kluyveri* was the predominant microorganism). The cathode reactions to caproate and butyrate are as follows:

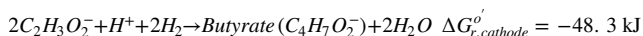
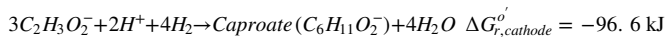

These compounds are liquid at room temperature which makes the product recovery relatively easy. Broadly, homoacetogenesis by *Clostridium thermoaceticum* converting hydrogen and carbon dioxide into acetate; succinate formation from glycerol by *Actinobacillus succinogenes*; reverse β oxidation for chain elongation of ethanol and acetate to *n*-butyrate; and ethanol and *n*-butyrate to *n*-caproate by *Clostridium kluyveri* are proven cathode carboxylation reactions [90]. Their productions are also demand driven, i.e., there is a prominent market for these molecules as drop-in fuels replacing petrol.

6.5. Integration between algae biorefinery, and ecosystem

A synergetic integration lies between algae based-biorefineries, and wastewaters / renewable energy systems. Renewable resources include, for example, wind and solar irradiation which can be used to supply energy for algae production [2]. Algae cultivation within photobioreactors (PBRs) or raceway ponds is used as part of the treatment process of residential wastewater. The energy for the paddle wheels in raceway ponds or the illumination lamps in PBRs is provided by electricity generated by solar panels, and wind turbines. The residual biomass after oil extraction is digested to produce biogas. The biogas is used in a CHP plant to provide energy for households. Nutrients, and water are recycled from the anaerobic digestion plant while CO₂ from biogas combustion in CHP plant is used for algae growth. Water regeneration can be achieved by process integration. The energy production from the residual algae biomass via anaerobic digestion offers flexibility to cope with the intermittency in renewable energy supply.

Algae are also a source of proteins, carbohydrates, nucleic acids, and other important molecules such as vitamins, aminoacids, antioxidants, and pigments. This is one of the key motivations in considering integrated algae biorefineries as a waste management strategy to fulfil the local / regional market demands. The polygeneration potential can be realized by symbiotic integration within and between sites and the ecosystem thus forming a locally integrated production system [19,151]. Algae biomass can be fractionated by solvent or supercritical fluid extraction into high value added extractives, oil, protein, sugars, and substrate for anaerobic digestion. The interesting feature is the possibility of capture of CO₂ by algae cultivation resulted from energy production or fermentation. There is also recycle of nutrients, water, and energy by using anaerobic digestion of biorefinery waste streams [2].

7. Sustainable production and consumption

Foods, especially meat and dairy products have the highest carbon footprint. Food waste must be avoided, from both environmental and ethical considerations. Globally, about 1.3 billion tonnes of food valued at RM4.4 trillion are lost or wasted yearly, causing a carbon footprint of 3.3 billion tonnes CO₂ equivalent. Eliminating the food waste thus can slash the GWP by 13%. In Malaysia, 15,000 t of food are wasted daily, including 3000 t still fit for consumption [152]. This amount is equivalent to 1.5 million bags of 10 kg rice and enough to feed 7.5 million people daily [153]. At the current rate of consumption and disposal pattern of food, global food production has to be increased by at least 70% by 2050 [154]. Broadly, developing economies have been suppliers of food and resource intensive developed economies have been consumer of the same, or there is a net flow of resources from developing to developed economies. To enable resource efficient agriculture in order to feed the world population that is expected to increase by 34% by 2050, an annual investment of \$83 billion in developing countries agriculture is needed from now through to 2050. This needs a strong focus on policy for financing resource efficient technologies for developing countries economy. Food waste, its environmental footprint and recommendation on good healthy lifestyle by adopting to sustainable resourcing and consumption of food should be part of the National Plan. Modern economies may see the food waste as an opportunity of biorefining into added value products including food and feed ingredients. However, any material transformation by physical, mechanical, physicochemical, chemical and biochemical process into another form of material causes energy and environmental footprints. Thus, sustainable lifestyle must embark upon reduction and elimination of food waste, and SDG 3: “good health and wellbeing”. Prevention is the best option for managing waste. Once this is fulfilled, a biorefinery can be built upon non-consumable rejects from harvesting, processing, distribution and consumption. As discussed earlier, biorefinery must build upon the SDG 12: sustainable consumption and production.

The transport sector has the highest GWP impact in Malaysia, which can be slowed down by biofuel blending. As Malaysia's economy is booming, and electric vehicle is not the main stream yet, biofuel R & D needs support in the interim period to slow down GWP impact. The recommended routes are CPO upgrading to produce drop-in biofuel compliant with the RSPO standard, retrofitting existing fermentation to obtain butanol, which has a higher efficiency than bioethanol and can be used 100% in existing engine and CNG production by incorporation of gas clean-up technology in existing AD system. Eventually, the focus needs to be on RRfW, CDR and CCR integrated biorefineries for added value resource extractions, until no more waste can be salvaged into valuable resources. High resource efficiency technology R & D must be done in close concert with fundamental process integration and CAPE R & D to enable high tech resource efficient technology off the ground.

Palm plantation will remain as an important economic driver for the development of poor and vulnerable populations, in spite of

controversies around transboundary haze pollution from palm plantation. The serious transboundary air pollution incident since 1997 due to widespread burning of forest gave bad reputation of the palm oil industries [155]. However, this criticism is rather delusive and wrong because there are many other external contributing factor to this problem e.g. logging, subsistence and semi subsistence cultivators, etc. [156]. The oil palm plantations often rather restore previously degraded land, implementation of which can be made under jurisdiction of reclassification of some state forest reserves. This reclassification allows a conversion of this forest reserve to more productive plantations. Further to add to this debate, with the establishment of various agencies at national and regional levels, the distinction of palm oil industry has been attained and enhanced. In fact, the external pressure from the European country to only allow the products from sustainable palm oil industries assures that the palm oil cultivation and supply chain are run in more organized, rigorous and sustainable manners. Continuous technological development and research activities as well as better management of the plantation activities have been found to be able to increase the average oil yield, which could potentially reduce the needs of land to be cleared for new plantation area for the oil palm.

Techno-economic and business modeling systems for monitoring socio-economic growth of poor populations for ensuring money flow to much needed populations are seen to be as important as the regulatory framework for incentivizing bio-based product development, which is usually driven by climate change mitigation goals. Studies have shown acceptable payback of 3–6 years without the consideration of labor costs. However, skillsets must be developed, employment opportunities must be provided to boom economy for the low-income families. There is a clear knowledge gap between engineers and scientists that can lead to many unnecessary experimental efforts. Resolving this knowledge gap by advancing cross-disciplinary knowledge and education in biorefinery engineering will require continued support and commitment from the Government.

A key proposition here is to decouple demand from waste generation via the circular economy principle of transforming what would otherwise have been ‘waste’ into resources for reuse/redeployment. By 2020, the OECD estimates that the Europe could be generating 45% more waste than in 1995. To reverse the trend, the European Union's Sixth Environment Action Programme identifies waste prevention, and management as one of the four top priorities. Its primary objective is to decouple waste generation from economic activity, so that EU growth will no longer lead to more, and more wastes.

RRfW, CDR and CCR technologies such as MES are in an important stage of development between TRL 1–3; it is therefore timely to strengthen indigenous R&D capability in the area, in Malaysia. Better functional or quality product and faster marketability, sustainable production and consumption throughout life cycle, and least production cost are the main drivers for bio-based products that can be produced by biorefineries integrated with RRfW, CDR and CCR technologies, R&D of which needs financing, e.g. via the National Biotechnology Policy and Green Technology Policy. Technologies and products have niche markets, for which support from the government will be highly needed.

8. Conclusions

This paper discusses the status quo and perspectives of a whole range of bioenergy and biorefinery technologies and systems relevant for Malaysia and developing countries in creating a bio-based circular economy and their roles in meeting SDGs. An effective stakeholders' engagement approach has been adopted through a participatory workshop to organize the systems across the TRL. The technologies from mature through developed to emerging include bioethanol / biodiesel / AD, through syngas / bio-oil upgrading to biofuel to RRfW, CDR and CCR integrated biorefinery systems, respectively. Techno-economics

and LCA based sustainability must be analyzed considering whole system to make sure that the system / product is greener and sustainable with respect to the state-of-the-art in triple bottom line criteria, economic, social and environmental. This paper recommends such indicators both quantitative and qualitative for relevant systems for Malaysia.

Continuous improvement is imperative to achieve SDGs and also to be at the forefront of R&D. Indigenous industries tend to target products of low-risk and high demand (low hanging fruit), such as bioenergy and biofuel, which primarily rely on policy and regulatory incentives, while economic proposition is to produce chemical and material, with niche market, still serving substantial human needs, in conjunction with bioenergy and biofuel generation, replacing petrochemicals and petroleum. Better functional or quality product and faster marketability, greener and sustainable production and consumption, and least production cost are the main targets to tap into the chemical market that can attract the Malaysian Government's investment. Co-production of bio-based products, food and pharmaceutical ingredients, fine, specialty and platform chemicals, polymers, alongside biofuel and bioenergy can achieve overall sustainability by the replacement of fossil resources.

Oil palm will remain to be the main resource for socio-economic and bioeconomy development in Malaysia. CPO as drop-in biofuel is needed for poverty alleviation. It has been seen that oil palm grows in a region of high poverty. Thus, palm oil for blending into petroleum derived diesel should be seen as an opportunity for socio-economic growth of world's high poverty regions. Utilization of this mid-term option, along with other options, such as pyrolysis and upgrading to drop-in biofuel and purification of biogas to serve as CNG can bring livelihood and socio-economic welfare of poor populations. Better safety and health regime must be promoted at the earliest design phase. Explicit and intrinsic accounting of safety and health indicators is recommended for the newer systems. Overall sustainability lies in integrated biorefinery systems with RRfW such as MBCT, and MES, CDR and CCR technologies for bio-based product generation. Ultimately, source segregation is imperative for clean technology and processing for remedying environmental pollution, albeit at a higher capital investment, which needs process integration for unlocking the value of organic waste via added value bio-based productions and a total site utility system design. An example demonstrated recently, via polygeneration in conjunction with recyclable, metal, levulinic acid and bio-fertilizer recoveries. Wood, garden and non-consumable food wastes are the primary sources of organics. The mixed stream can be treated by steam explosion or supercritical hot water extraction, called pulping process that separates the curbside-type recyclables from the lignocellulosic fraction of MSW. The lignocellulosic fraction goes through a primary wash for ash removal and cellular disruption for yield maximization combined with a sterilization stage – fractionation of this lignocellulosic stream is then carried out by the controlled acid hydrolysis process for eventually producing levulinic acid in the chemical conversion section; char separation and levulinic acid extraction/purification by methyl isobutyl ketone solvent; acid / solvent and by-product recovery. The by-product and pulping effluents can be anaerobically digested into biogas and bio-fertilizer. Produced biogas, RDF, char can be combusted, heat recovered into steam generation in boiler; on-site heat/steam demand is met; balance of steam is expanded into electricity in steam turbines. A yield of levulinic acid by only 5 wt% of biomass gives 1.5 fold increase in profitability that can eliminate the need for subsidies such as gate fees paid by local authority to waste processor, where relevant. The system is versatile in terms of the ability to process mixed biomass into the recovery of resources: metals, bioplastics, biofuel, biochemical and bioenergy. Unsustainable practices include consumable food wastage, end-of-pipe cleaning and linear economy that must be eliminated by sustainable biorefineries aimed at source segregation, process integration, product longevity and circular economy.

Acknowledgement

The authors gratefully acknowledge the financial support of the British Council and Akademi Sains Malaysia for supporting this work followed from the UK-Malaysia British Council Researcher Links Workshop, “Bioenergy, Biorefinery and Bioeconomy: Promoting Innovation, Multidisciplinary Collaboration and Sustainability”, Kuala Lumpur, 30 May – 3 June 2016. < <http://www.theibest.org/malaysia-workshop-material> >. The authors also gratefully acknowledge contributions of the participants of the workshop to the body of the knowledge presented in this paper.

References

- [1] Eleventh Malaysia Plan 2016–2020 Anchoring growth on people. (<http://www.micci.com/downloads/11MP.pdf>) [Accessed 5 April 2017].
- [2] Sadhukhan J, Ng KS, Hernandez EM. Biorefineries and chemical processes: design, integration and sustainability analysis. John Wiley & Sons Ltd; 2014.
- [3] Ed Jong, Higson A, Walsh P, Wellisch M. IEA Bioenergy – task 42 biorefinery: biobased chemicals – value added products from biorefineries; 2012 (<http://www.ieabioenergy.com/publications/bio-based-chemicals-value-added-products-from-biorefineries/>) [Accessed 5 April 2017].
- [4] United Nations Climate Change Conference, COP21. Paris, France; 2015. (<http://www.cop21.paris.org/>) [Accessed 5 April 2017].
- [5] (<http://www.theibest.org/apps/blog/show/44027981-biorefinery-becomes-bioenergy-with-carbon-capture-and-storage-and-bio-chemicals-are-going-to-be-the-focus-areas-for-large-scale-demonstrations-of-sustainable-biomass-resourcing-eubce-2016-thursday-9-june-closing-remark>). [Accessed 5 April 2017].
- [6] Jackson T. Prosperity without growth: economics for a finite planet. Routledge; 2011.
- [7] Rockstrom J, Steffen W, Noone K, Persson A, Chapin FS, Lambin EF, et al. A safe operating space for humanity. *Nature* 2009;461:472–5.
- [8] Vision 2030's medium term plan as a framework for implementation of the sustainable development goals, SDGs Kenya Forum for Sustainable Development. (<http://www.developlocal.org/wp-content/uploads/2016/04/ImplementingTheSDGs.pdf>) [Accessed 5 April 2017].
- [9] UK-Malaysia British Council Researcher Links Workshop, bioenergy, biorefinery and bioeconomy: promoting innovation, multidisciplinary collaboration and sustainability, Kuala Lumpur; 30 May – 3 June 2016 (<http://www.theibest.org/malaysia-workshop-material>).
- [10] (http://www.wwf.org.my/about_wwf/what_we_do/) [Accessed 5 April 2017].
- [11] Innovation opportunities from industrial waste. Knowledge Transfer Network; 2016. (<https://connect.innovateuk.org/documents/2832130/32795723/Innovation+Opportunities+from+Industrial+Waste/e150620e-4007-4b7c-8730-93f98378739a>) [Accessed 5 April 2017].
- [12] Black MJ, Sadhukhan J, Day K, Drage G, Murphy RJ. Developing database criteria for the assessment of biomass supply chains for biorefinery development. *Chem Eng Res Des* 2016;107:253–62.
- [13] Kasivisvanathan H, Ng RTL, Tay DHS, Ng DKS. Fuzzy optimisation for retrofitting a palm oil mill into a sustainable palm oil-based integrated biorefinery. *Chem Eng J* 2012;200–202:694–709.
- [14] Liew WH, Hassim MH, Ng DKS. Review of evolution, technology and sustainability assessments of biofuel production. *J Clean Prod* 2014;71:11–29.
- [15] MPOB Oil Palm Planted Area by States. Malaysian Palm Oil Board. (<http://cpofutures.blogspot.co.uk/2015/01/mpob-oil-palm-planted-area-by-states.html>). [Accessed 5 April 2017].
- [16] Production of Crude Palm Oil for the Month of December 2015. Malaysia Palm Oil Board. (<http://bepi.mpob.gov.my/index.php/statistics/production/135-production-2015/736-production-of-crude-oil-palm-2015.html>). [Accessed 5 April 2017].
- [17] Bakar NA. Country presentation on status of bioenergy development in Malaysia; 2014. (<https://www.iea.org/media/technologyplatform/workshops/southeastasiabioenergy2014/Malaysia.pdf>) [Accessed 5 April 2017].
- [18] Energy Commission, Malaysia Energy Statistics Handbook; 2016. (<http://www.st.gov.my/index.php/en/all-publications/item/735-malaysia-energy-statistics-handbook-2016>) [Accessed 5 April 2017].
- [19] Energy Commission, Peninsular Malaysia Electricity Supply Industry Outlook; 2016. (<http://www.st.gov.my/index.php/en/download-page/category/106-outlook.html?Download=591:peninsular-malaysia-electricity-supply-industry-outlook-2016>) [Accessed 5 April 2017].
- [20] Safaai NSM, Noor ZZ, Hashim H, Ujang Z, Talib J. Projection of CO₂ emissions in Malaysia. *Environ Progress Sustain Energy* 2011;30:658–65.
- [21] Leung MYPH, Martinez-Hernandez E, Leach M, Yang A. Designing integrated local production systems: a study on the food-energy-water nexus. *J Clean Prod* 2016;135:1065–84.
- [22] Ng RTL, Hassim MH, Ng DKS. Process synthesis and optimization of a sustainable integrated biorefinery via fuzzy optimization. *AIChE J* 2013;59:4212–27.
- [23] Ng RTL, Ng DKS, Tan RR. Systematic approach for synthesis of integrated palm oil processing complex. Part 2: multiple owners. *Ind Eng Chem Res* 2013;52:10221–35.
- [24] Ng RTL, Ng DKS, Tan RR, El-Halwagi MM. Disjunctive fuzzy optimisation for planning and synthesis of bioenergy-based industrial symbiosis system. *J Environ Chem Eng* 2014;2:652–64.
- [25] Tock JY, Lai CL, Lee KT, Tan KT, Bhatia S. Banana biomass as potential renewable energy resource: a Malaysian case study. *Renew Sustain Energy Rev* 2010;14:798–805.
- [26] Martinez-Hernandez E, Leach M, Yang A. Impact of bioenergy production on ecosystem dynamics and services – a case study on U.K. Heathlands. *Environ Sci Technol* 2015;49:5805–12.
- [27] McCullagh C, Skillen N, Adams M, Robertson PKJ. Photocatalytic reactors for environmental remediation: a review. *J Chem Technol Biotechnol* 2011;86:1002–17.
- [28] Skillen N, Adams M, McCullagh C, Ryu SY, Fina F, Hoffmann MR, et al. The application of a novel fluidised photo reactor under UV-Visible and natural solar irradiation in the photocatalytic generation of hydrogen. *Chem Eng J* 2016;286:610–21.
- [29] McGlade C, Ekins P. The geographical distribution of fossil fuels unused when limiting global warming to 2 °C. *Nature* 2015;517:187–90.
- [30] Sadhukhan J, Martinez-Hernandez E, Ng KS. Biorefinery value chain creation. *Chem Eng Res Des* 2016;107:1–280.
- [31] BiotechCorp. Bioeconomy transformation programme. enriching the nation, securing the future. Annual Report. BioEconomy Malaysia; 2015 (http://www.biotechcorp.com.my/wp-content/uploads/2011/11/publications/BTP_AR_2015.pdf) [Accessed 5 April 2017].
- [32] Lim S, Teong LK. Recent trends, opportunities and challenges of biodiesel in Malaysia: an overview. *Renew Sustain Energy Rev* 2010;14:938–54.
- [33] Tye YY, Lee KT, Wan Abdullah WN, Leh CP. Second-generation bioethanol as a sustainable energy source in Malaysia transportation sector: status, potential and future prospects. *Renew Sustain Energy Rev* 2011;15:4521–36.
- [34] Gerssen-Gondelach SJ, Saygin D, Wicke B, Patel MK, Faaij APC. Competing uses of biomass: assessment and comparison of the performance of bio-based heat, power, fuels and materials. *Renew Sustain Energy Rev* 2014;40:964–98.
- [35] (<http://www.nrel.gov/biomass/biorefinery.html>) [Accessed 5 April 2017].
- [36] US Department of Energy. Energy, environmental and economics (E3) handbook – a resource tool to aid the office of industrial technologies. 1st ed: US Department of Energy (DOE); 1997.
- [37] Parajuli R, Dalgaard T, Jørgensen U, Adamsen APS, Knudsen MT, Birkved M, et al. Biorefining in the prevailing energy and materials crisis: a review of sustainable pathways for biorefinery value chains and sustainability assessment methodologies. *Renew Sustain Energy Rev* 2015;43:244–63.
- [38] Foo KY, Hameed BH. Insight into the applications of palm oil mill effluent: a renewable utilization of the industrial agricultural waste. *Renew Sustain Energy Rev* 2010;14:1445–52.
- [39] Sadhukhan J, Ng KS, Martinez-Hernandez E. Novel integrated mechanical biological chemical treatment (MBCT) systems for the production of levulinic acid from fraction of municipal solid waste: a comprehensive techno-economic analysis. *Bioresour Technol* 2016;215:131–43.
- [40] Faba L, Díaz E, Ordóñez S. Recent developments on the catalytic technologies for the transformation of biomass into biofuels: a patent survey. *Renew Sustain Energy Rev* 2015;51:273–87.
- [41] Ruiz HA, Rodríguez-Jasso RM, Fernandes BD, Vicente AA, Teixeira JA. Hydrothermal processing, as an alternative for upgrading agriculture residues and marine biomass according to the biorefinery concept: a review. *Renew Sustain Energy Rev* 2013;21:35–51.
- [42] Sivapragasam M, Moniruzzaman M, Goto M. Recent advances in exploiting ionic liquids for biomolecules: solubility, stability and applications. *Biotechnol J* 2016.
- [43] Man Z, Muhammad N, Sarwono A, Bustam MA, Vignesh Kumar M, Rafiq S. Preparation of cellulose nanocrystals using an ionic liquid. *J Polym Environ* 2011;19:726–31.
- [44] Cho S, Park S, Seon J, Yu J, Lee T. Evaluation of thermal, ultrasonic and alkali pretreatments on mixed-microalgal biomass to enhance anaerobic methane production. *Bioresour Technol* 2013;143:330–6.
- [45] Mašek O, Budarin V, Gronnow M, Crombie K, Brownsort P, Fitzpatrick E, et al. Microwave and slow pyrolysis biochar—comparison of physical and functional properties. *J Anal Appl Pyrolysis* 2013;100:41–8.
- [46] Lam SS, Chase HA. A review on waste to energy processes using microwave pyrolysis. *Energies* 2012;5:4209.
- [47] Reina TR, Yeletsky P, Bermúdez JM, Arcelus-Arrillaga P, Yakovlev VA, Millan M. Anthracene aquacacking using NiMo/SiO₂ catalysts in supercritical water conditions. *Fuel* 2016;182:740–8.
- [48] Yim SC, Quitain AT, Yusup S, Sasaki M, Uemura Y, Kida T. Metal oxide-catalyzed hydrothermal liquefaction of Malaysian oil palm biomass to bio-oil under supercritical condition. *J Supercrit Fluids*.
- [49] Natural Environment Research Council (NERC). (<http://www.nerc.ac.uk/research/funded/programmes/waste/>) [Accessed 5 April 2017].
- [50] Wan YK, Sadhukhan J, Ng KS, Ng DKS. Techno-economic evaluations for feasibility of sago-based biorefinery, Part 1: alternative energy systems. *Chem Eng Res Des* 2016;107:263–79.
- [51] Humbird D, Davis R, Tao L, Kinchin C, Hsu D, Aden A, et al. Process design and economics for biochemical conversion of lignocellulosic biomass to ethanol: dilute-acid pre-treatment and enzymatic hydrolysis of corn stover. *Natl Renew Energy (NREL)* 2011, NREL/TP-5100-47764. [Accessed 5 April 2017].
- [52] Wan YK, Sadhukhan J, Ng DKS. Techno-economic evaluations for feasibility of sago-based biorefinery, Part 2: integrated bioethanol production and energy systems. *Chem Eng Res Des* 2016;107:102–16.
- [53] Kapil A, Wilson K, Lee AF, Sadhukhan J. Kinetic modeling studies of hetero-

- geneously catalyzed biodiesel synthesis reactions. *Ind Eng Chem Res* 2011;50:4818–30.
- [54] Davison TJ, Okoli C, Wilson K, Lee AF, Harvey A, Woodford J, et al. Multiscale modelling of heterogeneously catalysed transesterification reaction process: an overview. *RSC Adv* 2013;3:6226–40.
- [55] Kasim FH, Harvey AP, Zakaria R. Biodiesel production by in situ transesterification. *Biofuels* 2010;1:355–65.
- [56] Phan AN, Harvey A. Development and evaluation of novel designs of continuous mesoscale oscillatory baffled reactors. *Chem Eng J* 2010;159:212–9.
- [57] Masngut N, Harvey AP, Ikwebe J. Potential uses of oscillatory baffled reactors for biofuel production. *Biofuels* 2010;1:605–19.
- [58] Laziz AM. Continuous production of biodiesel production in a micro-structured reactor. UK-Malaysia British Council Researcher Links Workshop, bioenergy, biorefinery and bioeconomy: promoting innovation, multidisciplinary collaboration and sustainability, Kuala Lumpur; 30 May – 3 June 2016 (<http://www.theibest.org/malaysia-workshop-material>).
- [59] Oh PP, Chong MF, Lau HLN, Choo YM, Chen J. Modeling of a membrane reactor system for crude palm oil transesterification. Part I: chemical and phase equilibrium. *AIChE J* 2015;61:1968–80.
- [60] Oh PP, Chong MF, Lau HLN, Choo YM, Chen J. Modeling of a membrane reactor system for crude palm oil transesterification. Part II: transport phenomena. *AIChE J* 2015;61:1981–96.
- [61] Kapil A, Bhat SA, Sadhukhan J. Dynamic simulation of sorption enhanced reaction processes for biodiesel production. *Ind Eng Chem Res* 2010;49:2326–35.
- [62] Ren N, Li J, Li B, Wang Y, Liu S. Biohydrogen production from molasses by anaerobic fermentation with a pilot-scale bioreactor system. *Int J Hydrog Energy* 2006;31:2147–57.
- [63] Asli UA, Abdullahi IN, Hamid HA, Zakaria ZA. Enzymatic hydrolysis of palm biomass for fermentable sugars using polyethylene glycol immobilized cellulase. In: Proceedings of the seventh annual conference on the challenges in environmental science and engineering (CESE, 2014), Johor Bahru, Johor; 12–16 October 2014.
- [64] Mustafa MA, Misailidis N, Mateos-Salvador F, Du C, Sadhukhan J, Campbell GM. Integrated exploitation of wheat for non-food products: An integration and assessment framework. Report submitted to Home-Grown Cereals Authority of the UK. RD-2005-3186; 2007.
- [65] Du C, Campbell GM, Misailidis N, Mateos-Salvador F, Sadhukhan J, Mustafa M, et al. Evaluating the feasibility of commercial arabinoxylan production in the context of a wheat biorefinery principally producing ethanol. Part 1. Experimental studies of arabinoxylan extraction from wheat bran. *Chem Eng Res Des* 2009;87:1232–8.
- [66] Misailidis N, Campbell GM, Du C, Sadhukhan J, Mustafa M, Mateos-Salvador F, et al. Evaluating the feasibility of commercial arabinoxylan production in the context of a wheat biorefinery principally producing ethanol: Part 2. process simulation and economic analysis. *Chem Eng Res Des* 2009;87:1239–50.
- [67] Sadhukhan J, Mustafa MA, Misailidis N, Mateos-Salvador F, Du C, Campbell GM. Value analysis tool for feasibility studies of biorefineries integrated with value added production. *Chem Eng Sci* 2008;63:503–19.
- [68] Martinez-Hernandez E, Sadhukhan J, Campbell GM. Integration of bioethanol as an in-process material in biorefineries using mass pinch analysis. *Appl Energy* 2013;104:517–26.
- [69] Martinez-Hernandez E, Campbell GM, Sadhukhan J. Economic and environmental impact marginal analysis of biorefinery products for policy targets. *J Clean Prod* 2014;74:74–85.
- [70] Martinez-Hernandez E, Campbell G, Sadhukhan J. Economic value and environmental impact (EVEI) analysis of biorefinery systems. *Chem Eng Res Des* 2013;91:1418–26.
- [71] Gallego A, Hospido A, Moreira MT, Feijoo G. Environmental assessment of dehydrated alfalfa production in Spain. *Resour Conserv Recycl* 2011;55:1005–12.
- [72] Martinez-Hernandez E, Ibrahim MH, Leach M, Sinclair P, Campbell GM, Sadhukhan J. Environmental sustainability analysis of UK whole-wheat bioethanol and CHP systems. *Biomass Bioenergy* 2013;50:52–64.
- [73] Hong WO. Palm oil processing – role towards a sustainable bioeconomy. UK-Malaysia British Council Researcher Links Workshop, bioenergy, biorefinery and bioeconomy: promoting innovation, multidisciplinary collaboration and sustainability, Kuala Lumpur; 30 May – 3 June 2016 (<http://www.theibest.org/malaysia-workshop-material>).
- [74] Yaacob S. The roundtable on sustainable palm oil (RSPO) – current status and how it influenced the industry. UK-Malaysia British Council Researcher Links Workshop, bioenergy, biorefinery and bioeconomy: promoting innovation, multidisciplinary collaboration and sustainability, Kuala Lumpur; 30 May – 3 June 2016 (<http://www.theibest.org/malaysia-workshop-material>).
- [75] Roundtable on Sustainable Palm Oil (RSPO). (<http://www.rspo.org/certification>). [Accessed 5 April 2017].
- [76] The Nation. (<https://www.thenation.com/article/bad-news-were-actually-using-more-fossil-fuels-than-ever/>). [Accessed 5 April 2017].
- [77] Sadhukhan J. Distributed and micro-generation from biogas and agricultural application of sewage sludge: comparative environmental performance analysis using life cycle approaches. *Appl Energy* 2014;122:196–206.
- [78] Chan YJ, Chong MF, Law CL. An integrated anaerobic–aerobic bioreactor (IAAB) for the treatment of palm oil mill effluent (POME): start-up and steady state performance. *Process Biochem* 2012;47:485–95.
- [79] Ng DKS. Systematic synthesis and design of sustainable palm based integrated biorefinery. UK-Malaysia British Council Researcher Links Workshop, bioenergy, biorefinery and bioeconomy: promoting innovation, multidisciplinary collaboration and sustainability, Kuala Lumpur; 30 May – 3 June 2016 (<http://www.theibest.org/malaysia-workshop-material>).
- [80] Ng DKS, Ng WPQ, Chong MF, Lim DLK. Waste recovery and regeneration (REGEN) system for palm oil industry. *Energy* 2015; p. 1315–20.
- [81] Sadhukhan J, Zhao Y, Shah N, Brandon NP. Performance analysis of integrated biomass gasification fuel cell (BGFC) and biomass gasification combined cycle (BGCC) systems. *Chem Eng Sci* 2010;65:1942–54.
- [82] Sadhukhan J, Ng KS, Shah N, Simons HJ. Heat integration strategy for economic production of combined heat and power from biomass waste. *Energy Fuels* 2009;23:5106–20.
- [83] Ng KS, Zhang N, Sadhukhan J. Techno-economic analysis of polygeneration systems with carbon capture and storage and CO₂ reuse. *Chem Eng J* 2013;219:96–108.
- [84] Ng KS, Sadhukhan J. Techno-economic performance analysis of bio-oil based Fischer-Tropsch and CHP synthesis platform. *Biomass Bioenergy* 2011;35:3218–34.
- [85] Ng KS, Sadhukhan J. Process integration and economic analysis of bio-oil platform for the production of methanol and combined heat and power. *Biomass Bioenergy* 2011;35:1153–69.
- [86] Chua SC, Oh TH. Review on Malaysia's national energy developments: key policies, agencies, programmes and international involvements. *Renew Sustain Energy Rev* 2010;14:2916–25.
- [87] Thematic debate – sustainable development and climate change: practical solutions in the energy-water Nexus. UN General Assembly. (http://www.un.org/en/ga/president/67/programme_and_guide_water.pdf) [Accessed 5 April 2017].
- [88] Lam HL, Ng WPQ, Ng RTL, Ng EH, Aziz MKA, Ng DKS. Green strategy for sustainable waste-to-energy supply chain. *Energy* 2013;57:4–16.
- [89] Kumar P, Saroj DP. Water–energy–pollution nexus for growing cities. *Urban Clim* 2014;10(Part 5):846–53.
- [90] Sadhukhan J, Lloyd JR, Scott K, Premier GC, Yu EH, Curtis T, et al. A critical review of integration analysis of microbial electrosynthesis (MES) systems with waste biorefineries for the production of biofuel and chemical from reuse of CO₂. *Renew Sustain Energy Rev* 2016;56:116–32.
- [91] Sadhukhan J, Ng KS. Economic and European union environmental sustainability criteria assessment of bio-oil-based biofuel systems: refinery integration cases. *Ind Eng Chem Res* 2011;50:6794–808.
- [92] Arcelus-Arrillaga P. Hydrothermal and/or hydrotreating processes for the production of transportation fuel from bio-oil. UK-Malaysia British Council Researcher Links Workshop, bioenergy, biorefinery and bioeconomy: promoting innovation, multidisciplinary collaboration and sustainability, Kuala Lumpur; 30 May – 3 June 2016 (<http://www.theibest.org/malaysia-workshop-material>).
- [93] Mofijur M, Masjuki HH, Kalam MA, Hazrat MA, Liaquat AM, Shahabuddin M, et al. Prospects of biodiesel from *Jatropha* in Malaysia. *Renew Sustain Energy Rev* 2012;16:5007–20.
- [94] Martinez-Hernandez E, Martinez-Herrera J, Campbell GM, Sadhukhan J. Process integration, energy and GHG emission analyses of *Jatropha*-based biorefinery systems. *Biomass Convers Biorefin* 2014;4:105–24.
- [95] Ahmed AMA, Salmiaton A, Choong TSY, Wan Azlina WAKG. Review of kinetic and equilibrium concepts for biomass tar modeling by using Aspen Plus. *Renew Sustain Energy Rev* 2015;52:1623–44.
- [96] Chen F, Wu C, Dong L, Vassallo A, Williams PT, Huang J. Characteristics and catalytic properties of Ni/CaAlOx catalyst for hydrogen-enriched syngas production from pyrolysis-steam reforming of biomass sawdust. *Appl Catal B: Environ* 2016;183:168–75.
- [97] Chen F, Wu C, Dong L, Jin F, Williams PT, Huang J. Catalytic steam reforming of volatiles released via pyrolysis of wood sawdust for hydrogen-rich gas production on Fe–Zn/Al₂O₃ nanocatalysts. *Fuel* 2015;158:999–1005.
- [98] Yao D, Wu C, Yang H, Hu Q, Nahil MA, Chen H, et al. Hydrogen production from catalytic reforming of the aqueous fraction of pyrolysis bio-oil with modified Ni–Al catalysts. *Int J Hydrog Energy* 2014;39:14642–52.
- [99] Wu C, Wang Z, Wang L, Huang J, Williams PT. Catalytic steam gasification of biomass for a sustainable hydrogen future: influence of catalyst composition. *Waste Biomass Valoriz* 2014;5:175–80.
- [100] Wu C, Wang Z, Huang J, Williams PT. Pyrolysis/gasification of cellulose, hemicellulose and lignin for hydrogen production in the presence of various nickel-based catalysts. *Fuel* 2013;106:697–706.
- [101] Wu C, Wang Z, Dupont V, Huang J, Williams PT. Nickel-catalysed pyrolysis/gasification of biomass components. *J Anal Appl Pyrolysis* 2013;99:143–8.
- [102] Wu C, Wang L, Williams PT, Shi J, Huang J. Hydrogen production from biomass gasification with Ni/MCM-41 catalysts: influence of Ni content. *Appl Catal B: Environ* 2011;108–109:6–13.
- [103] Hashim R, Nadhari WNAW, Sulaiman O, Kawamura F, Hizirolu S, Sato M, et al. Characterization of raw materials and manufactured binderless particleboard from oil palm biomass. *Mater Des* 2011;32:246–54.
- [104] Mohamad Ibrahim MN, Zakaria N, Sipaut CS, Sulaiman O, Hashim R. Chemical and thermal properties of lignins from oil palm biomass as a substitute for phenol in a phenol formaldehyde resin production. *Carbohydr Polym* 2011;86:112–9.
- [105] Hurst P. Biorenewables from gram to kilo: optimising feedstocks, improving processes and valorising by-products. UK-Malaysia British Council Researcher Links Workshop, Bioenergy, biorefinery and bioeconomy: promoting innovation, multidisciplinary collaboration and sustainability, Kuala Lumpur; 30 May – 3 June 2016 (<http://www.theibest.org/malaysia-workshop-material>).
- [106] Martinez-Hernandez E, Sadhukhan J, Ng KS. Technological approach for strategic bioeconomy development between Malaysia and the UK. UK-Malaysia British Council Researcher Links Workshop, Bioenergy, biorefinery and bioeconomy: promoting innovation, multidisciplinary collaboration and sustainability, Kuala Lumpur; 30 May – 3 June 2016 (<http://www.theibest.org/malaysia-workshop-material>).

- [107] Sadhukhan J Bioenergy, biorefinery and bioeconomy – an overview. UK-Malaysia British Council Researcher Links Workshop, Bioenergy, biorefinery and bioeconomy: promoting innovation, multidisciplinary collaboration and sustainability, Kuala Lumpur; 30 May – 3 June 2016 (<http://www.theibest.org/malaysia-workshop-material>).
- [108] Ragauskas AJ, Williams CK, Davison BH, Britovsek G, Cairney J, Eckert CA, et al. The path forward for biofuels and biomaterials. *Science* 2006;311:484–9.
- [109] Biddy MJ, Scarlata C, Kinchin C. Chemicals from Biomass: A Market Assessment of Bioproducts with Near-Term Potential National Renewable Energy Laboratory (NREL). NREL/TP-5100-65509; 2016.
- [110] Bozell JJ, Petersen GR. Technology development for the production of biobased products from biorefinery carbohydrates—the US Department of Energy's "Top 10" revisited. *Green Chem* 2010;12:539–54.
- [111] Patel M, Crank M, Dornburg V, Hermann B, Roes L, Hüsing B, et al. Medium and Long-term Opportunities and Risks of the Biotechnological Production of Bulk Chemicals from Renewable Resources. Department of Science, Technology and Society (STS) / Copernicus Institute, Utrecht University; 2006.
- [112] Weryp T, Petersen G, Aden A, Bozell J, Holladay J, White J, et al. Top value added chemicals from biomass, volume 1 – results of screening for potential candidates from sugars and Synthesis gas. Natl Renew Energy (NREL) Pac Northwest Natl Lab (PNNL) 2004.
- [113] Wong SL, Ngadi N, Abdullah TAT, Inuwa IM. Recent advances of feed-in tariff in Malaysia. *Renew Sustain Energy Rev* 2015;41:42–52.
- [114] Chua SC, Oh TH, Goh WW. Feed-in tariff outlook in Malaysia. *Renew Sustain Energy Rev* 2011;15:705–12.
- [115] Petinrin JO, Shaaban M. Renewable energy for continuous energy sustainability in Malaysia. *Renew Sustain Energy Rev* 2015;50:967–81.
- [116] Jaye IFM, Sadhukhan J, Murphy RJ. Renewable, local electricity generation from palm oil mills: a case study from Peninsular Malaysia. *Int J Smart Grid Clean Energy* 2016;5:106–11.
- [117] Hashim H, Ho WS. Renewable energy policies and initiatives for a sustainable energy future in Malaysia. *Renew Sustain Energy Rev* 2011;15:4780–7.
- [118] Lim CH, Salleh E, Jones P. Renewable energy policy and initiatives in Malaysia. *ALAM CIPITA Int J Sustain Trop Des Res Pract* 2006;1:33–40.
- [119] Abdeslahian P, Lim JS, Ho WS, Hashim H, Lee CT. Potential of biogas production from farm animal waste in Malaysia. *Renew Sustain Energy Rev* 2016;60:714–23.
- [120] Najafpour GD, Zinatizadeh AAL, Mohamed AR, Hasnain Isa M, Nasrollahzadeh H. High-rate anaerobic digestion of palm oil mill effluent in an upflow anaerobic sludge-fixed film bioreactor. *Process Biochem* 2006;41:370–9.
- [121] Mekhilef S, Saidur R, Safari A, Mustafa WESB. Biomass energy in Malaysia: current state and prospects. *Renew Sustain Energy Rev* 2011;15:3360–70.
- [122] Siwar C. Solid waste management: recycling, green jobs and challenges in Malaysia. ILO Research Conference on Green Jobs for Asia & Pacific. Nigata, Japan; 2008. p. 21–23.
- [123] (http://www.ita.doc.gov/td/health/malaysia_biotech05.pdf) [Accessed 5 April 2017].
- [124] Leong KM Legal framework and policies on bioenergy, biorefinery and bioeconomy in Malaysia. UK-Malaysia British Council Researcher Links Workshop, Bioenergy, biorefinery and bioeconomy: promoting innovation, multidisciplinary collaboration and sustainability, Kuala Lumpur; 30 May – 3 June 2016. (<http://www.theibest.org/malaysia-workshop-material>).
- [125] (http://portal.ppi.gov.my/c/document_library/get_file?P_l_id=17335&folderId=27605&name=DLFE-4709.pdf) [Accessed 5 April 2017].
- [126] Status HashimM Present and Problems of Biomass Energy Utilization in Malaysia. APECATC–Workshop on Biomass Utilization, Tokyo; 19–21 January 2005.
- [127] Mekhilef S, Barimani M, Safari A, Salam Z. Malaysia's renewable energy policies and programs with green aspects. *Renew Sustain Energy Rev* 2014;40:497–504.
- [128] Ahmad S, MZAA Kadir, Shafie . S. current perspective of the renewable energy development in Malaysia. *Renew Sustain Energy Rev* 2011;15:897–904.
- [129] Lam MK, Lee KT. Renewable and sustainable bioenergies production from palm oil mill effluent (POME): win–win strategies toward better environmental protection. *Biotechnol Adv* 2011;29:124–41.
- [130] Mukherjee I, Sovacool BK. Palm oil-based biofuels and sustainability in southeast Asia: a review of Indonesia, Malaysia, and Thailand. *Renew Sustain Energy Rev* 2014;37:1–12.
- [131] (http://ec.europa.eu/eurostat/statistics-explained/index.php/Municipal_waste_statistics) [Accessed 5 April 2017].
- [132] Ng KS, Head I, Premier GC, Scott K, Yu E, Lloyd J, et al. A multilevel sustainability analysis of zinc recovery from wastes. *Resour Conserv Recycl* 2016;113:88–105.
- [133] Lei T, Wang Z, Chang X, Lin L, Yan X, Sun Y, et al. Performance and emission characteristics of a diesel engine running on optimized ethyl levulinate–biodiesel–diesel blends. *Energy* 2016;95:29–40.
- [134] (<http://www.gfbiochemicals.com/products/>) [Accessed 5 April 2017].
- [135] Saqib A Navigating a path toward renewable chemical production. UK-Malaysia British Council Researcher Links Workshop, Bioenergy, biorefinery and bioeconomy: promoting innovation, multidisciplinary collaboration and sustainability, Kuala Lumpur; 30 May – 3 June 2016. (<http://www.theibest.org/malaysia-workshop-material>).
- [136] (<http://www.nnfcc.co.uk/news/that-was-the-bio-based-year-that-was>). [Accessed 5 April 2017].
- [137] Loow Y-L, Wu TY, Md. Jahim J, Mohammad AW, Teoh WH. Typical conversion of lignocellulosic biomass into reducing sugars using dilute acid hydrolysis and alkaline pretreatment. *Cellulose* 2016;23:1491–520.
- [138] Chong KJ, Bridgwater AV. A methodology to generate, analyse and compare biorefinery process chains. In: Bridgwater AV, editor. Proceedings of the bioten conference on biomass bioenergy and biofuels 2010. Birmingham UK.: CPL Press; 2011.
- [139] Andiappan V, Ko ASY, Lau VW, Ng LY, Ng RTL, Chemmangattuvalappil NG, et al. Synthesis of sustainable integrated biorefinery via reaction pathway synthesis: economic, incremental environmental burden and energy assessment with multiobjective optimization. *AIChE J* 2015;61:132–46.
- [140] Ng LY, Andiappan V, Chemmangattuvalappil NG, Ng DKS. Novel Methodology for the synthesis of optimal biochemicals in integrated biorefineries via inverse design techniques. *Ind Eng Chem Res* 2015;54:5722–35.
- [141] Xenos DP, Ciciotti M, Kopanos GM, Bouaswaig AEF, Kahrs O, Martinez-Botas R, et al. optimization of a network of compressors in parallel: real time optimization (RTO) of compressors in chemical plants – an industrial case study. *Appl Energy* 2015;144:51–63.
- [142] Andiappan V, Tan RR, Aviso KB, Ng DKS. Synthesis and optimisation of biomass-based tri-generation systems with reliability aspects. *Energy* 2015;89:803–18.
- [143] Liew WH, Hassim MH, Ng DKS. Sustainability assessment for biodiesel production via fuzzy optimisation during research and development (R & D) stage. *Clean Technol Environ* 2014;16:1431–44.
- [144] Ten JY, Hassim MH, Ng DKS, Chemmangattuvalappil NG. A molecular design methodology by the simultaneous optimisation of performance, safety and health aspects. *Chem Eng Sci*; 2016.
- [145] Othman MR, Idris R, Hassim MH, Ibrahim WHW. Prioritizing HAZOP analysis using analytic hierarchy process (AHP). *Clean Technol Environ* 2016;1–16.
- [146] Ng KS, Zhang N, Sadhukhan J. A graphical CO₂ emission treatment intensity assessment for energy and economic analyses of integrated decarbonised production systems. *Comput Chem Eng* 2012;45:1–14.
- [147] Ng KS, Zhang N, Sadhukhan J. Decarbonised coal energy system advancement through CO₂ utilisation and polygeneration. *Clean Technol Environ* 2012;14:443–51.
- [148] Sadhukhan J, Ng KS, Martinez-Hernandez E. Process systems engineering tools for biomass polygeneration systems with carbon capture and reuse. In: Ng DKS, Tan RR, Foo DCY, El-Halwagi MM, editors. Process design strategies for biomass conversion systems. Wiley; 2015. p. 217–45.
- [149] Nor MHM, Mubarak MFM, Elmi HSA, Ibrahim N, Wahab MFA, Ibrahim Z. Bioelectricity generation in microbial fuel cell using natural microflora and isolated pure culture bacteria from anaerobic palm oil mill effluent sludge. *Bioresour Technol* 2015;190:458–65.
- [150] Nancharaiyah YV, Venkata Mohan S, Lens PNL. Metals removal and recovery in bioelectrochemical systems: a review. *Bioresour Technol* 2015;195:102–14.
- [151] Martinez-Hernandez E, Leung MYPH, Leach M, Yang A. A framework for modeling local production systems with techno-ecological interactions. *J Ind Ecol* 2016.
- [152] (<http://www.thestar.com.my/news/nation/2016/05/24/malaysians-waste-15000-tonnes-of-food-daily/>) [Accessed 5 April 2017].
- [153] (<http://www.theheatmalaysia.com/Main/The-bigger-battle-against-food-wastage>) [Accessed 5 April 2017].
- [154] How to Feed the World in 2050. Food and Agriculture Organization of the United Nations (FAO). (http://www.fao.org/fileadmin/templates/wsfs/docs/expert_paper/How_to_Feed_the_World_in_2050.pdf) [Accessed 5 April 2017].
- [155] Jones DS. ASEAN and transboundary haze pollution in Southeast Asia. *Asia Eur J* 2006;4:431–46.
- [156] Wicke B, Sikkema R, Dornburg V, Faaij A. Exploring land use changes and the role of palm oil production in Indonesia and Malaysia. *Land Use Policy* 2011;28:193, [–06].