



## Durham E-Theses

---

### *System reliability when components can be swapped upon failure*

NAJEM, AESHA,MOHAMMAD,M

#### How to cite:

---

NAJEM, AESHA,MOHAMMAD,M (2019) *System reliability when components can be swapped upon failure*, Durham theses, Durham University. Available at Durham E-Theses Online:  
<http://etheses.dur.ac.uk/13110/>

#### Use policy

---

The full-text may be used and/or reproduced, and given to third parties in any format or medium, without prior permission or charge, for personal research or study, educational, or not-for-profit purposes provided that:

- a full bibliographic reference is made to the original source
- a [link](#) is made to the metadata record in Durham E-Theses
- the full-text is not changed in any way

The full-text must not be sold in any format or medium without the formal permission of the copyright holders.

Please consult the [full Durham E-Theses policy](#) for further details.

---

Academic Support Office, Durham University, University Office, Old Elvet, Durham DH1 3HP  
e-mail: [e-theses.admin@dur.ac.uk](mailto:e-theses.admin@dur.ac.uk) Tel: +44 0191 334 6107  
<http://etheses.dur.ac.uk>

# System reliability when components can be swapped upon failure

Aesha M. Najem

A Thesis presented for the degree of  
Doctor of Philosophy



Department of Mathematical Sciences  
University of Durham  
England

2019

*Dedicated to*

My dear parents, my beloved husband and my lovely children.

# System reliability when components can be swapped upon failure

Aesha M. Najem

Submitted for the degree of Doctor of Philosophy  
April 2019

## Abstract

Resilience of systems to failures during functioning is of great practical importance. One of the strategies that might be considered to enhance reliability and resilience of a system is swapping components when a component fails, thus replacing it by another component from the system that is still functioning. This thesis studies this scenario, particularly with the use of the survival signature concept to quantify system reliability, where it is assumed that such a swap of components requires these components to be of the same type. We examine the effect of swapping components on a reliability importance measure for the specific components, and we also consider the joint reliability importance of two components. Such swapping of components may be an attractive means toward more resilient systems and could be an alternative to adding more components to achieve redundancy of repair and replacement activities.

Swapping components, if possible, is likely to incur some costs, for example for the actual swap or to prepare components to be able to take over functionality of another component. In this thesis we also consider the cost effectiveness of component swapping over a fixed period of time. It is assumed that a system needs to function for a given period of time, where failure to achieve this incurs a penalty cost. The expected costs when the different swap scenarios are applicable are compared with the option not to enable swaps. We also study the cost effectiveness of component swapping over an unlimited time horizon from the perspective of renewal theory. We assume that the system is entirely renewed upon failure, at a known cost, and

we compare different swapping scenarios. The effect of components swapping on preventive replacement actions is also considered.

In addition, we extend the approach of component swapping and the cost effectiveness analysis of component swapping to phased mission system. We consider two scenarios of swapping possibilities, namely, assuming that the possibilities of component swapping can occur at any time during the mission or only at transition of phases.

# Declaration

The work in this thesis is based on research carried out at the Department of Mathematical Sciences, Durham University, UK. No part of this thesis has been submitted elsewhere for any other degree or qualification and it is all my own work unless referenced to the contrary in the text.

**Copyright © 2019 Aesha M. Najem.**

“The copyright of this thesis rests with the author. No quotations from it should be published without the author’s prior written consent and information derived from it should be acknowledged”.

# Acknowledgements

All praise due to the Almighty Allah, without His great help, this work could not have been done.

I am speechless and cannot express my deep thanks and gratitude to my supervisor Professor Frank Coolen. He was very supportive and kind. I will never forget how much time he gave me. Without his patience, insightful comments and guidance, I could not have overcome many obstacles I faced and my thesis could not have been completed. So, thank you so much for everything you have done for me during your invaluable supervision period on my research.

My parents were my source of strength, thank you my beloved mother Khadija and my great father Muhammad. Without you both and your countless support, I could not reach this happy ending today.

My dearest gratitude to my family, my dear husband Amin, who was very supportive for many years, not only during my PhD study, but in all my life aspects. I really cannot find the words to thank him. My beloved children: Ahmed, Ibtihal, Omar and Ibrahim, who are my life, always empowered me in my hard times. Thank you all for your endless support, patience and understanding. I can tell you now, your mum finally has finished.

My thanks also to my sponsor, the Saudi Electronic University for facilitating my scholarship and continually supporting me.

My thanks and gratitude are extended to Durham University Mathematics Department for the help and support they offered me. I cannot forget to thank my classmates at the Department for their kindness and great time we had together.



# Contents

<b>Abstract</b>	<b>iii</b>
<b>Declaration</b>	<b>v</b>
<b>Acknowledgements</b>	<b>vi</b>
<b>1 Introduction</b>	<b>2</b>
1.1 Resilience . . . . .	5
1.2 System reliability . . . . .	5
1.2.1 Structure function . . . . .	6
1.2.2 Reliability measurement . . . . .	9
1.3 Reliability importance . . . . .	11
1.4 The survival signature . . . . .	14
1.5 Research aim and objectives . . . . .	18
1.6 Outline of the thesis . . . . .	19
<b>2 System reliability and component importance when components can be swapped upon failure</b>	<b>21</b>
2.1 Introduction . . . . .	21
2.2 Swapping components . . . . .	22
2.2.1 Alternative approach . . . . .	27
2.3 Component reliability importance . . . . .	37
2.4 Joint reliability importance (JRI) . . . . .	47
2.5 Concluding remarks . . . . .	50

---

<b>3</b>	<b>Cost effective component swapping to increase system reliability</b>	<b>54</b>
3.1	Introduction . . . . .	54
3.2	Penalty costs for system failure with component swapping . . . . .	55
3.2.1	Time independent penalty costs . . . . .	55
3.2.2	Time dependent penalty costs . . . . .	56
3.3	Optimal swapping based on renewal theory . . . . .	60
3.3.1	Preventive Replacement . . . . .	62
3.4	Concluding remarks . . . . .	66
<b>4</b>	<b>Phased mission systems with components swapping</b>	<b>68</b>
4.1	Introduction . . . . .	68
4.2	Phased mission systems . . . . .	71
4.3	Swapping components upon failure . . . . .	72
4.3.1	PMS with single type of components . . . . .	72
4.3.2	PMS with multiple types of components . . . . .	78
4.4	Swapping components according to structure importance . . . . .	85
4.5	Cost analysis of PMS with component swapping . . . . .	93
4.5.1	Time independent penalty costs . . . . .	94
4.5.2	Time dependent penalty costs . . . . .	95
4.6	Concluding remarks . . . . .	105
<b>5</b>	<b>Concluding Remarks</b>	<b>107</b>
	<b>Bibliography</b>	<b>111</b>

# Chapter 1

## Introduction

With the need for highly reliable systems, there are many possibilities to make a basic system more reliable or more resilient to possible faults. It may be possible to add component redundancy or make individual components more reliable. In addition, one may be able to repair failed components or replace them with new ones. In this thesis, we consider a quite straightforward way in which some systems may become more reliable and resilient to component failure, namely, the possibility to replace a failed component by another component in the system that has not yet failed, in effect swapping components. This is logically restricted to components which are of the same type, hence it is likely that only some swapping opportunities exist in a system. It seems that the increase in system reliability through such component swapping has not received much attention in the literature, yet in some scenarios it can be an attractive opportunity to prevent a system from failing. In practice, this could enable preparation of substantial repair activities, or it may be deemed to leave the system reliable enough to complete its mission.

Scenarios where swapping of components may be an option can include the following examples. Aerospace systems with multiple computers on board, where some computers tasked with minor functions can be prepared to take over crucial functions in case another computer fails. Lighting systems, where multiple locations must be provided with light under contract but where partial lighting at any location may be sufficient to meet the contractual requirements. Transport systems, where parts of one mode of transport can be used to keep another one running. Organizations,

where employees can be trained to take over some functioning of others in case of unexpected absence.

It should be emphasized that swapping a component, upon failure, with another component from the system, differs from the well-studied scenarios of using cold or warm standby components or adding components in parallel to achieve increased reliability [25, 33, 61, 71]. When we replace a failed component with a functioning component that was already in the system, the subsystem, in which the later component was originally placed, becomes less reliable. One can also compare the kind of component swapping studied in this thesis to a minimal repair [60], in that the failure time distribution of the component does not change, but this is combined with a change in the overall structure of the system due to the functioning component being removed elsewhere.

In this thesis we consider the effect of defined component swap possibilities on the total system reliability. We also consider the importance of individual components, which can be strongly affected by opportunities to swap them and the joint reliability importance (JRI) of two components. The survival signature concept is used to derive the corresponding system reliability [18].

A system is usually designed and installed for completing a specific function. If a system fails, it can cause losses such as loss of lives, damage to health, release of hazardous materials, or economic losses including repair or replacement of any damaged structures. These losses incur costs. It would be attractive if the cost that is associated with system failure could be reduced by increasing system reliability through component swapping. The operation of swapping components is likely to incur some costs, for example for the actual swap or to prepare components to be able to take over functionality of another component. This thesis also consider the cost effectiveness of component swapping to increase system reliability. The cost aspects is studied under the assumption that a system would need to function for a given period of time, where failure to achieve this incurs a penalty cost. We compare different swap scenarios with the option not to enable swaps, focusing on minimum expected costs over the given period. We also consider the cost effectiveness of component swapping from the perspective of renewal theory, so effectively over an

unlimited time horizon. We assume that the system is entirely renewed upon failure, at a known cost, and we compare different swapping scenarios. The effect of components swapping on preventive replacement actions is also considered [64].

A phased mission system (PMS) is one that performs several different tasks or functions in sequence. In order to accomplish the mission successfully, the system in every phase has to be completed without failure. Therefore, it is often difficult for a PMS to work with high reliability. Generally, there are mainly two approaches that can be used to improve the reliability of the PMS. The first way is increasing the component reliability (reliability allocation), and the other way is using redundant components in parallel (redundancy allocation) e.g. [3, 23, 43, 50]. As an alternative to these approaches, in this thesis we introduce the approach of component swapping to enhance the reliability of phased mission system and to make it more resilient to component failure. This approach is attractive since the reliability and the number of the components do not need to be increased to improve the system reliability as the other approaches. We consider two strategies of components swapping to improve the reliability of PMS, namely, swapping components upon failure and swapping components according to structure importance. The effect of both strategies on the reliability of the PMS is studied under two scenarios of swapping possibilities. First, it is assumed that the swap between components can be done at any time during the mission. Second, it is assumed that the swap between components can be done only at transition of phases. In this thesis we also study the effectiveness of the cost of component swapping in reducing the expected costs of the failure of the PMS. The expected costs when the two different scenarios of swapping possibilities are applicable are compared with the option not to enable swaps, focusing on minimum expected costs over the given period.

This introductory chapter is organized as follows. Section 1.1 introduces the concept of resilience. Section 1.2 briefly reviews the concepts related to system reliability and its measurement. Section 1.3 provides a brief introduction to reliability importance. Section 1.4 introduces the concept of survival signature. Section 1.5 illustrates the aim and objectives of this research. A detailed outline of this thesis is given in Section 1.6, with details of related publications.

## 1.1 Resilience

The concept of resilience originated in the field of ecology. It is defined in this field as the speed with which an ecosystem returns to the equilibrium state after a perturbation [24]. After it emerged in the field of ecology, this concept is gradually developed into different research fields. Despite an increase in the usage of the term resilience, there is no universal agreement on its definition. It is defined variously in different research fields such as social [1], organizational [30] and economical [56] fields. In each research field the term has taken more specific meaning depending on the field that it is introduced in. Although the concept of resilience has been around for a long time, this concept is relatively new in the field of systems engineering [39]. Various definitions of the term resilience in the field of systems engineering have been reviewed by [36]. In this thesis, resilience is defined to be the ability of systems to recover quickly from failures.

In engineering systems redundancy is embedded in system design in order to make the system resilient to possible faults. This strategy causes increase in the cost of the system and does not always yield competitive results [69]. As an alternative to this strategy, component swapping that is introduced in this thesis could be embedded in system design, precisely, systems could be designed to be resilient through allowing its components to be swapped. This would ensure that the system returns to function quickly. In a more resilient system, the design of the system would allow for component swaps to be beneficial in practice.

## 1.2 System reliability

In this thesis we assume that the term *system* is used to describe the collection of components when connected to each other in some way to create the whole system. We might consider any electronic devices as an example of a system. In this section we briefly introduce the notation and concepts related to system reliability and its measurement. In Section 1.2.1, we present the theory of structure function and we briefly discuss related concepts. In Section 1.2.2, we discuss reliability measurement based on the structure function.

### 1.2.1 Structure function

The main characteristic of any systems in this thesis is that the functioning state of the whole system is dependent on the functioning states of its components. To quantify if the system is functioning or failed, it is assumed that the system and each component are binary, which means that they are only in one of two possible states: functioning or failed. We use the indicator 1 to denote the system or component functions, and 0 to denote that the system or component fails.

**Definition 1.2.1** For a system with  $m$  components, the **state vector** is a vector  $\underline{x} = (x_1, x_2, \dots, x_m) \in \{0, 1\}^m$ , where  $x_i$  is a binary variable indicating the functioning state of the component  $i$ , for each  $i$ , so  $x_i = 1$  if the  $i^{th}$  component functions and  $x_i = 0$  if the  $i^{th}$  component fails [42]. The labelling of the components is arbitrary but must be fixed to define  $\underline{x}$ .

It is assumed that the state of the system is completely determined by the states of its components. A mapping called the structure function determines whether or not the system is functioning when its components are in specific states.

**Definition 1.2.2** Consider the space  $\{0, 1\}^m$  of all possible state vectors for an  $m$ -component system [42]. The **structure function**  $\phi : \{0, 1\}^m \rightarrow \{0, 1\}$  is a mapping that associates those state vectors  $\underline{x}$  for which the system functions with the value 1 and those state vectors  $\underline{x}$  for which the system does not function with the value 0.

The quantification of the structure function  $\phi$  is dependent on the structure of a system. The structure of a system shows how its components are connected to each other. The connection between components represents how functioning of the components influences the functioning of the system. A system is called coherent, if its structural function is non-decreasing and each its component is relevant [42]. In this thesis we consider only coherent systems. The following examples demonstrate the structure of some simple systems and their structure functions  $\phi$ .

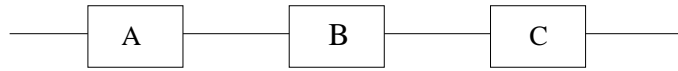

Figure 1.1: A series system with three components

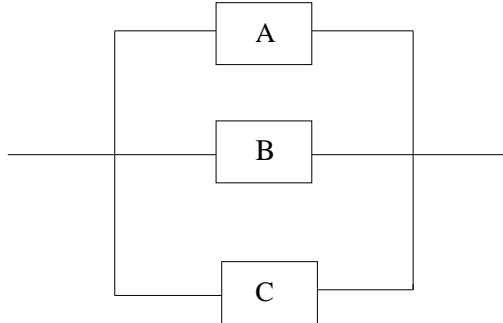

Figure 1.2: A parallel system with three components

**Example 1.2.1** (Series systems)

In a series system the components are connected to each other in series [2]. All the components in a series system must function for the system to function. Figure 1.1 shows an example of a series system consisting of 3 components. The structure function of a series system consisting of  $m$  components is

$$\phi(\underline{x}) = \prod_{i=1}^m x_i \quad (1.2.1)$$

**Example 1.2.2** (Parallel systems) In a parallel system, the components are connected to each other in parallel [2]. A parallel system functions, if at least one of its components functions. For the system to be failed, all of its components must be failed. Figure 1.2 shows an example of a parallel system consisting of 3 components. The structure function of a parallel system consisting of  $m$  components is

$$\phi(\underline{x}) = 1 - \prod_{i=1}^m (1 - x_i) \quad (1.2.2)$$

**Example 1.2.3** (Series-parallel and parallel-series systems) Series-parallel and parallel-series systems consist of only combinations of subsystems in series or parallel configuration [2]. A series-parallel system consists of parallel subsystems which are connected to each other in series. A parallel-series systems consists of series subsystems which are connected to each other in parallel. The structure functions of these



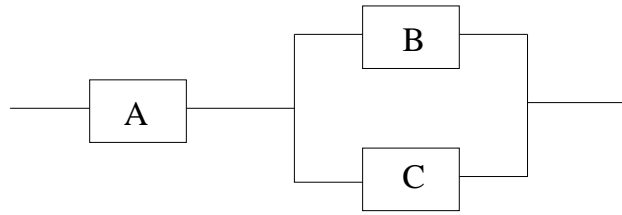

Figure 1.3: A series-parallel system with three components

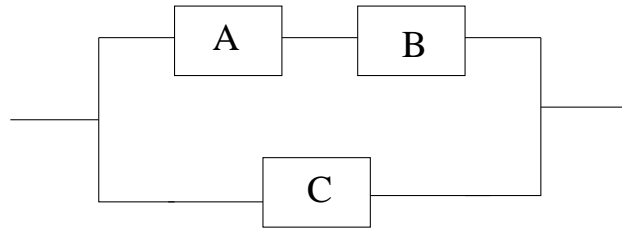

Figure 1.4: A parallel-series system with three components

types of systems can be calculated using a combination of Formula (1.2.1) for series systems and (1.2.2) for parallel systems. Figure 1.3 shows a series-parallel system consisting of 3 components. The structure function  $\phi$  for this system is given by

$$\phi(\underline{x}) = x_1(1 - (1 - x_2)(1 - x_3)) \quad (1.2.3)$$

Figure 1.4 shows a parallel-series system consisting of 3 components. The first series subsystems consists of the components A and B, and the second one consists of the component C. The structure function  $\phi$  for the overall system is

$$\phi(\underline{x}) = 1 - (1 - x_1x_2)(1 - x_3) \quad (1.2.4)$$

**Example 1.2.4** (*k-out-of-m* systems) A system with  $m$  components which functions if and only if at least  $k$  of the  $m$  components function, for  $1 \leq k \leq m$ , is called a *k-out-of-m*:G system [72]. The structure function for a *k-out-of-m*:G system is

$$\phi(\underline{x}) = \begin{cases} 1 & \text{if } \sum_{i=1}^m x_i \geq k \\ 0 & \text{if } \sum_{i=1}^m x_i < k \end{cases} \quad (1.2.5)$$

A system with  $m$  components that fails if and only if at least  $k$  of the  $m$  components fail, for  $1 \leq k \leq m$ , is called a *k-out-of-m*:F system [72]. Based on the definitions of a *k-out-of-m*:G system and a *k-out-of-m*:F system, a *k-out-of-m*:G

system is equivalent to an  $(m - k + 1)$ -out-of- $m$ :F system. The structure function of a  $k$ -out-of- $m$ :F system is

$$\phi(\underline{x}) = \begin{cases} 1 & \text{if } \sum_{i=1}^m x_i \geq m - k + 1 \\ 0 & \text{if } \sum_{i=1}^m x_i < m - k + 1 \end{cases} \quad (1.2.6)$$

The term  $k$ -out-of- $m$  system is often used to refer to either a G system or a F system or both. Series systems and parallel systems are special cases of  $k$ -out-of- $m$  systems. A series system is equivalent to an  $m$ -out-of- $m$ :G system, and to a 1-out-of- $m$ :F system. A parallel system is equivalent to a 1-out-of- $m$ :G and to an  $m$ -out-of- $m$ :F system.

### 1.2.2 Reliability measurement

The reliability of a system is defined as the probability that the system functions properly at a time  $t$ , and is denoted by  $R$ . To calculate the system reliability at a fixed time  $t$ , we consider a system with  $m$  components. Let  $X_i$  be a random variable, and

$$X_i = \begin{cases} 1 & \text{if component } i \text{ functions} \\ 0 & \text{if component } i \text{ fails} \end{cases} \quad (1.2.7)$$

Let  $p_i = P(X_i = 1)$  be the probability that component  $i$  functions. Assuming that  $X_i$ ,  $i = 1, 2, \dots, m$  are mutually statistically independent, and introducing notation  $\underline{X} = (X_1, X_2, \dots, X_m)$  and  $\underline{p} = (p_1, p_2, \dots, p_m)$ , the reliability of a system is a function of the reliability of its components and can be computed from the structure function of the system [42],

$$R = P(\phi(\underline{X}) = 1) = R(\underline{p}) \quad (1.2.8)$$

The following example demonstrates reliability of some simple systems based on their structure functions [42].

**Example 1.2.5** The reliability of a series system consisting of  $m$  components, so with structure function  $\phi(\underline{x}) = \prod_{i=1}^m x_i$ , is given by

$$R(\underline{p}) = \prod_{i=1}^m p_i \quad (1.2.9)$$

The reliability of a parallel system consisting of  $m$  components, with structure function  $\phi(\underline{x}) = 1 - \prod_{i=1}^m (1 - x_i)$ , is given by

$$R(\underline{p}) = 1 - \prod_{i=1}^m (1 - p_i) \quad (1.2.10)$$

If we assume that the random quantities  $X_i$  which represent the function of the system components, are independent and identically distributed (i.i.d.), so if  $p_1 = p_2 = \dots = p_m = p$ , then the reliability of a  $k$ -out-of- $m$ :G systems with structure function  $\phi(\underline{x}) = 1$  if  $\sum_{i=1}^m x_i \geq k$ , is given by

$$R(\underline{p}) = \sum_{i=k}^m \binom{m}{i} p^i (1-p)^{m-i} \quad (1.2.11)$$

In the i.i.d. case, the reliability of  $m$ -component series and parallel systems are given by  $R(\underline{p}) = p^m$  and  $R(\underline{p}) = 1 - (1-p)^m$ , respectively.

The reliability measure defined above deals with time as implicit and fixed because of this the time  $t$  doesn't appear in the previous reliability equations. For example, in the case of a 3-component series system, the system reliability is given by  $R(\underline{p}) = p_1 p_2 p_3$ . The values of  $p_1, p_2$  and  $p_3$  are given for a common time and the reliability of the system is calculated for that time. However, in many real life applications no specific time is specified in advance. In this situation, the time could be considered as a variable in the reliability measure [42]. Let

$$X_i(t) = \begin{cases} 1 & \text{if component } i \text{ functions at time } t \\ 0 & \text{if component } i \text{ fails at time } t \end{cases} \quad (1.2.12)$$

Let random variable  $T_i \geq 0$  be the failure time of component  $i$ ,  $i = 1, 2, \dots, m$ . The component failure characteristics can be described by probability distributions. Assuming that component  $i$  has an absolutely continuous failure time distribution with cumulative distribution function (CDF)  $F_i(t)$  and with probability density function (pdf)  $f_i(t)$ , then  $F_i(t)$  represents the probability that component  $i$  fails before or at time  $t$ ,

$$F_i(t) = P(T_i \leq t) \quad (1.2.13)$$

The reliability function of component  $i$  at time  $t$  is the probability that a component  $i$  still functions at time  $t$ ,  $R(t) = P(T_i > t)$ . Since a component  $i$  either fails

by time  $t$ , or survives at time  $t$ , we have

$$1 - F_i(t) = P(T_i > t) = P(X_i(t) = 1) \quad (1.2.14)$$

If we consider the 3-components series system in Figure 1.2.1, the reliability of the system can be rewritten as  $P(T_S > t) = [1 - F_1(t)][1 - F_2(t)][1 - F_3(t)]$ . In the case that if the system components are i.i.d.,  $F_i(t) = F(t)$  for  $i = 1, 2, 3$ , the reliability of the system is given by  $P(T_S > t) = [1 - F(t)]^3$ . What is important and needs to be emphasized is that, in this thesis, both the system and its components are assumed to be non-repairable, so if a component is failed, it cannot work again, so there are no repair activities.

### 1.3 Reliability importance

One of the important purposes of a reliability and risk analysis is to study the component importance. Component importance measures are frequently used as tools to evaluate and rank the impact of components on the system reliability [52]. The most important (critical) component for the system reliability should be given priority with respect to improvements or maintenance. There are many applications of importance measures in probabilistic risk analysis [12, 29, 34].

The first importance measure concept is introduced by Birnbaum in 1969 [11]. Birnbaum categorises the importance measures into three categories based on the knowledge needed for determining them, namely, structure importance measures, reliability importance measures and lifetime importance measures [11]. Structure importance measures assume that the system structure is known and it measures the relative importance of various components with respect to their positions in a system. It is relevant to system design when several components with different reliabilities can be arbitrarily assigned to several locations in the system. One would like to assign more reliable components to positions with higher structure importance. Reliability importance measures depend on both the structure of the system and reliability of components. It measures the change in the system reliability with respect to the change in reliability of a specific component. The lifetime importance

measures, depends on both the structure of the system and component lifetime distribution [4].

Birnbaum reliability importance measure is defined as the rate at which the system reliability changes with respect to changes in the reliability of a given component. It is also defined as marginal reliability importance [32,38]. It is obtained for a binary coherent system, by partial differentiation of the system reliability with respect to the given component reliability. The reliability importance of component  $i$  when the mission time of a system is implicit and fixed is given by

$$RI_i = \frac{\partial R(\underline{p})}{\partial p_i} \quad (1.3.15)$$

where  $p_i$  is the reliability of the  $i^{th}$  component,  $\underline{p} = (p_1, p_2, \dots, p_m)$  is the vector of components reliability and  $R$  is the reliability of the system. The Birnbaum reliability importance of component  $i$  can be rewritten in the form

$$RI_i = R(1_i, \underline{p}^i) - R(0_i, \underline{p}^i) \quad (1.3.16)$$

where  $\underline{p}^i$  represents the vector of components reliability with  $p_i$  removed,  $(1_i, \underline{p}^i)$  and  $(0_i, \underline{p}^i)$  represents the component reliability vector when component  $i$  is in state 1 and 0, respectively.

In the case that the mission time of a system is not fixed, the reliability importance of component  $i$  is defined as

$$RI_i(t) = P(T_S > t | T_i > t) - P(T_S > t | T_i \leq t) \quad (1.3.17)$$

where  $T_S$  is the random system failure time and  $T_i$  the random failure time of component  $i$ ,  $i = 1, 2, \dots, m$ .

If it is assumed that all components are equally reliable and the reliability of each component  $p_j = 1/2$ , for all  $j \neq i$ , the Birnbaum reliability importance measure reduces to Birnbaum structural importance measure, denoted by  $SI_i$ ,

$$SI_i = SI_i(i, 1/2, \dots, 1/2) = \frac{1}{2^{m-1}} \sum_{\underline{x}^i} [\phi(1_i, \underline{x}^i) - \phi(0_i, \underline{x}^i)] \quad (1.3.18)$$

where  $\underline{x}^i$  represents the component state vector with  $x_i$  removed,  $(1_i, \underline{x}^i)$  and  $(0_i, \underline{x}^i)$  represents the component vector when component  $i$  is in state 1 and 0,

respectively,  $\phi$  is the structure function of the system and  $2^{m-1}$  represents the total number of different state vectors with  $m - 1$  in it [11].

Since Birnbaum reliability importance measure is introduced, there have been quite many different importance measures introduced in the literature. Some of them are based on the three categories defined by Birnbaum such as Fussell-Vesely measure of importance [65] and the criticality importance measure [41], and there are others which are apart from the three categories, such as the risk achievement worth and the risk reduction worth [15, 16]. Feng et al [31] introduce component importance measure based on survival signature to analyse systems with multiple types of components.

The joint importance of two components for the system reliability has attracted considerable attention in the reliability literature. Hong and Lie [35] defined the the joint reliability importance (JRI) as a measure of how two components in a system interact in contributing to system reliability. For a system with statistically independent component reliabilities, the JRI of component  $i$  and  $j$  is defined as

$$JRI_{i,j} = \frac{\partial^2 R(\underline{p})}{\partial p_i \partial p_j} \quad (1.3.19)$$

This can be simplified as [8],

$$JRI_{i,j} = R(1_i, 1_j, \underline{p}^{i,j}) - R(1_i, 0_j, \underline{p}^{i,j}) - R(0_i, 1_j, \underline{p}^{i,j}) + R(0_i, 0_j, \underline{p}^{i,j}) \quad (1.3.20)$$

where  $\underline{p}^{i,j}$  represents the vector of components reliability with  $p_i$  and  $p_j$  removed,  $1_i$  and  $0_i$  represents the state when component  $i$  functions and doesn't function, respectively, and  $1_j$  and  $0_j$  represents the state when component  $j$  functions and doesn't function, respectively.

In the case that the mission time of a system is not fixed, the JRI of component  $i$  and  $j$  is given by

$$\begin{aligned} JRI_{i,j}(t) &= P(T_S > t | T_i > t, T_j > t) - P(T_S > t | T_i > t, T_j \leq t) \\ &\quad - P(T_S > t | T_i \leq t, T_j > t) + P(T_S > t | T_i \leq t, T_j \leq t) \end{aligned} \quad (1.3.21)$$

where  $T_S$  is the random system failure time,  $T_i$  the random failure time of component  $i$ ,  $T_j$  the random failure time of component  $j$ . This definition was extended

in several ways. For example, Armstrong [8] presents a joint importance measure for dealing with the statistical dependence between components and Wu [67] generalized JRI to multistate systems. Recently, Eryilmaz et al [27] have presented general results on marginal and JRI for components with dependent failure time distributions; they also used the concept of survival function.

The importance of a component and the joint importance of two components are defined through their functions in a system, hence, we can expect that the ability to swap components can have a strong effect on them. In Chapter 2 we examine the effect of swapping components on the importance of individual components and on the joint reliability importance (JRI) of two components.

In this thesis we introduce the strategy of swapping components according to the structural importance. In this strategy the structural importance is used to measure the importance level of the components of the same type in contributing to system reliability. After the components are prioritized by structural importance, the swapping rules are defined upon this prioritization. This is explained in more detail in Chapter 4.

## 1.4 The survival signature

Quantification of system reliability has traditionally been based on the structure function [5, 72]. Samaniego [57] introduced the system signature as a tool for reliability assessment for systems consisting of components of a single type, which means that their failure time distributions are exchangeable [44, 48]. Samaniego's signature can be regarded as a summary of the structure function that is sufficient to derive the system reliability function if the failure times of all the system's components are exchangeable, so in the case that all the system's components are of one type.

Consider a coherent system of  $m$  components with independent identically distributed failure times. Let  $T_S$  be the random failure time for the system, and  $T_i$  be the random failure time of component  $i$ ,  $i = 1, 2, \dots, m$ .  $T_{j:m}$  is the  $j^{\text{th}}$  order statistic of the  $m$  random component failure times giving the  $j^{\text{th}}$  smallest component lifetime, which is the time of the  $j^{\text{th}}$  component failure, for  $j = 1, 2, \dots, m$ . The

**system's signature** is defined to be the  $m$ -dimensional probability vector  $\mathbf{s}$ , where its  $j^{\text{th}}$  element  $s_j$  is the probability that the  $j^{\text{th}}$  component failure causes system failure [58],

$$s_j = P(T_S = T_{j:m}) \quad (1.4.22)$$

The value of an element  $s_j$  of the system signature for  $j = 1, 2, \dots, m$  can be computed by implementing combinatorics and order statistic. The signature  $\mathbf{s}$  is a probability vector, so,  $\sum_{j=1}^m s_j = 1$  and  $s_j \geq 0$  for all  $j$ . The reliability of the system  $R(t) = P(T_S > t)$  is

$$R(t) = \sum_{j=1}^m s_j P(T_{j:m} > t) \quad (1.4.23)$$

If the failure time distribution for the components is known and has cumulative distribution function (CDF)  $F(t)$ , then

$$R(t) = \sum_{j=1}^m s_j \sum_{i=0}^{j-1} \binom{m}{i} [F(t)]^i [1 - F(t)]^{m-i} \quad (1.4.24)$$

In the previous equation the reliability of the system is expressed as a function of  $\mathbf{s}$  and  $F(t)$  alone. It is clear that the main attraction of this signature is that it enables separation of aspects of the system structure and the components failure times distribution, which simplifies a range of reliability related problems such as stochastic comparison of different system structures and inference on the system reliability from component failure data.

The major drawback of Samaniego's signature is that it can only be applied to systems with single type of components, which is quite rare for real-world systems and prevents the method to be used for analysis of networks [7]. To overcome this limitation, Coolen and Coolen-Maturi [18] introduced the survival signature as an alternative tool for system reliability quantification. This is also a summary of the system structure function that is sufficient for a range of reliability computations and inferences, including derivation of the system reliability function, and crucially, it can be used for systems with multiple types of components. The only requirement is that failure times of components of the same type are exchangeable. Components of different types can be dependent. Of course, any such dependence must be modeled, for example, through the use of copulas [47] or the use of multivariate failure



time models including dependence [27, 28]. In this thesis, to present the swapping opportunities without further complications, we throughout assume that the random failure time of components of different types have independent failure times, and in addition, we assume that the random failure times of components of the same type are conditionally independent and identically distributed. These assumptions can be relaxed without difficulty, such relaxation can of course alter the effect of enabled swaps on the overall system reliability.

For a coherent system consisting of  $m$  components that are all of the same type, the **survival signature**, denoted by  $\Phi(l)$ , for  $l = 1, \dots, m$ , is defined as the probability that the system functions, given that precisely  $l$  of its components function [18]. Since in this thesis we considered only a coherent system  $\Phi(l)$  is an increasing function of  $l$ , with  $\Phi(0) = 0$  and  $\Phi(m) = 1$ . If exactly  $l$  of the components function, this means that there are  $\binom{m}{l}$  state vectors  $\underline{x}$  with precisely  $l$  components  $x_i = 1$ , so with  $\sum_{i=1}^m x_i = l$ , and all remaining  $x_i = 0$ . Let  $S_l$  denote the set of these state vectors, so  $|S_l| = \binom{m}{l}$ . Since we assume that all of the components are of the same type, which means that they have exchangeable failure times, these state vectors are equally likely to occur, hence

$$\Phi(l) = \binom{m}{l}^{-1} \sum_{\underline{x} \in S_l} \phi(\underline{x}) \quad (1.4.25)$$

Let  $C_t \in \{0, 1, \dots, m\}$  denote the number of components in the system that function at time  $t > 0$ . Let the probability distribution of the component failure time to have CDF  $F(t)$ .  $F(t)$  gives the probability that a component is not functioning at time  $t$ . If we assume that there are exactly  $l$  components functioning, then the remaining  $m - l$  components must not function. Thus, for  $l \in \{0, 1, \dots, m\}$

$$P(C(t) = l) = \binom{m}{l} [F(t)]^{m-l} [1 - F(t)]^l \quad (1.4.26)$$

By using the partition theorem, the probability that the system functions at time  $t$  can be derived easily by

$$P(T_S > t) = \sum_{l=0}^m \Phi(l) P(C(t) = l) \quad (1.4.27)$$

It is clear from Equation (1.4.27) that the system structure is taken into account

through the survival signature  $\Phi(l)$ , while the term  $P(C(t) = l)$  takes the random failure times of the components into account.

Generalization of the signature to multiple types of components is quite complicated [18]. However, the survival signature can be easily generalized for systems with multiple types of components. Consider a system that consists of  $m$  components of  $K \geq 2$  types, with  $m_k$  components of type  $k \in \{1, 2, \dots, K\}$  and  $\sum_{k=1}^K m_k = m$  [18]. Assume that the random failure times of components of the same type are exchangeable, while full independence is assumed for the random failure times of components of different types. Let the state vector  $\underline{x}^k = (x_1^k, x_2^k, \dots, x_{m_k}^k) \in \{0, 1\}^{m_k}$  be the state vector representing the state of the system components of type  $k$ , with  $x_i^k = 1$  if the  $i^{\text{th}}$  component of type  $k$  functions and  $x_i^k = 0$  if not. The labeling of the components is arbitrary but must be fixed to define  $\underline{x}^k$ . Let  $\underline{x} = (\underline{x}^1, \underline{x}^2, \dots, \underline{x}^K) \in \{0, 1\}^m$  be the state vector for the overall system. The structure function  $\phi : \{0, 1\}^m \rightarrow \{0, 1\}$ , defined for all possible  $\underline{x}$ , takes the value 1 for a particular state vector  $\underline{x}$  if the system functions and 0 if the system does not function for the state vector  $\underline{x}$ . The survival signature is denoted by  $\Phi(l_1, l_2, \dots, l_K)$  and represents the probability that the system functions, given that exactly  $l_k$  of type  $k$  components function, for  $l_k = 0, 1, \dots, m_k$ , for each  $k = 1, 2, \dots, K$ .

There are  $\binom{m_k}{l_k}$  state vectors  $\underline{x}^k$  with exactly  $l_k$  of its  $m_k$  components  $x_i^k = 1$ , so with  $\sum_{i=1}^{m_k} x_i^k = l_k$ . We denote the set of these state vectors for components of type  $k$  by  $S_l^k$ . Let  $S_{l_1, \dots, l_K}$  denote the set of all state vectors for the whole system for which  $\sum_{i=1}^{m_k} x_i^k = l_k$ , for  $k = 1, 2, \dots, K$ . Because of the assumption that the failure times of  $m_k$  components of type  $k$  are exchangeable, all the state vectors  $\underline{x}^k \in S_l^k$  are equally likely to occur, Thus,  $\Phi(l_1, l_2, \dots, l_K)$  can be calculated by

$$\Phi(l_1, l_2, \dots, l_K) = \left( \prod_{k=1}^K \binom{m_k}{l_k}^{-1} \right) \times \sum_{\underline{x} \in S_{l_1, \dots, l_K}} \phi(\underline{x}) \quad (1.4.28)$$

Let  $C_t^k \in \{0, 1, \dots, m_k\}$  denote the number of type  $k$  components in the system that function at time  $t > 0$ . Using the assumed independence of failure times of components of different types, the reliability of the system  $R(t) = P(T_S > t)$  is

$$R(t) = \sum_{l_1=0}^{m_1} \dots \sum_{l_K=0}^{m_K} \left[ \Phi(l_1, \dots, l_K) \prod_{k=1}^K P(C_t^k = l_k) \right] \quad (1.4.29)$$

Note that if one would not assume independence of the failure times of components of different types, then the product of the marginal probabilities for individual events  $C_t^k = l_k$  in this formula would be replaced by the joint probability of these events, from which point a model must be assumed for this joint probability. Henceforth we assume, in addition to exchangeability of failure times of components of the same type, that these failure times are conditionally independent and identically distributed, with the probability distribution for the failure time of components of type  $k$  specified by the cumulative distribution function (CDF)  $F_k(t)$ . This leads to

$$R(t) = \sum_{l_1=0}^{m_1} \dots \sum_{l_K=0}^{m_K} \left[ \Phi(l_1, \dots, l_K) \prod_{k=1}^K \left( \binom{m_k}{l_k} [F_k(t)]^{m_k-l_k} [1 - F_k(t)]^{l_k} \right) \right] \quad (1.4.30)$$

The survival signature is closely linked to Samaniego's system signature for systems with a single type of components, and it is particularly useful for larger systems with only a few different types of components. Recently, the survival signature has attracted considerable interest from researchers in reliability, who have considered both mathematical properties and aspects of application, including statistical inference [7, 19], comparison of different systems [59], and fast simulation methods [49]. Feng et al. [31] demonstrates a methodology to include explicitly the imprecision, which leads to upper and lower bounds of the survival function of the system. An efficient algorithm for computing exact system and survival signatures has been introduced by [54, 55]. Aslett [6] has created a function in the statistical software R to compute the survival signature, given a graphical presentation of the system structure.

## 1.5 Research aim and objectives

The possibility to replace a failed component by another component in the system that has not yet failed, swapping components, could be considered as a new approach to enhance reliability and resilience of a system. In this thesis we aim to introduce and study this approach.

The research objectives are:

1. Quantifying the reliability of a system if its components can be swapped.

2. Examining the effect of swapping components on the total system reliability and reliability importance.
3. Analysing the cost effectiveness of component swapping.
4. Extending the approach of component swapping and the cost effectiveness analysis of component swapping to phased mission systems.

## 1.6 Outline of the thesis

This thesis is organized as follows. In Chapter 2, the survival signature concept is implemented to study the effect of component swapping on the total system reliability. We also consider the effect of component swapping on the importance of individual components and the joint reliability importance of two components. A paper presenting the results of Chapter 2 has already been published in *Applied Stochastic Models in Business and Industry* [46]. Some results in this chapter have been presented at Research Students Conference in Probability and Statistics in Durham in April 2017 and at the training school for Uncertainty Treatment and Optimisation in Aerospace Engineering in 2018 at Durham University. It also been presented at several seminars.

In Chapter 3, we study the cost effectiveness of component swapping to increase system reliability over a fixed period of time. We also study the cost effectiveness of component swapping over an unlimited time horizon from the perspective of renewal theory. The effect of components swapping on preventive replacement actions is also studied in this chapter. Some results in this chapter have been presented at 10th IMA International Conference on Modelling in Industrial Maintenance and Reliability in Manchester in June 2018 and a short paper has appeared in the conference proceeding [45]. A paper based on this chapter has been submitted to the 29th edition European Safety and Reliability Conference (ESREL 2019) in Hannover that will be held in September 2019. This chapter has also been presented at several seminars.

In Chapter 4, we extend the strategy of swapping components upon failure that is

---

introduced in Chapter 2, to improve the reliability of phased mission system (PMS) and to make it more resilient to component failure. We also in this chapter introduce another strategy that could be used to improve the reliability of PMS which is swapping components according to the structural importance. In this chapter we also extend the cost effectiveness analysis of component swapping that is introduced in Chapter 3 to PMS. The strategy of swapping components according to the structural importance and the analysis related to it has been done in the collaboration with Professor Xianzhen Huang (School of Mechanical Engineering and Automation, Northeastern University, China) during his research visit to Durham University. A paper based on this chapter is being prepared for submission to an international peer-reviewed journal. We summarize our results with some concluding remarks in Chapter 5. Part of this thesis will also be presented at 1st UK Reliability Meeting in Durham in April 2019. All figures in this thesis were obtained using R. The R codes are available from the author upon request.

# Chapter 2

## System reliability and component importance when components can be swapped upon failure

### 2.1 Introduction

In Chapter 1, we introduced an attractive strategy in which some systems may become more reliable and resilient to component failure, namely, swapping components. In this chapter we aim to use the survival signature concept that was introduced in Section 1.4 to examine the effect of resilience through components swapping on the reliability of systems with multiple types of components. Actually, throughout this thesis we assume that there are fixed swapping rules, which prescribe upon failure of a component precisely which other component takes over its role in the system, if possible and if the other component is still functioning. The objective of component swapping in this chapter is to increase the system reliability by making the system more resilient to possible fault, so we further assume here that such a swap of components can be done only when the system cannot function with the existing components in place. Also, we assume that such a swap of components takes neglectable time and does not affect the functioning of the component that changes its role in the system nor its remaining time until failure. Under these assumptions, in this chapter we analyse the effect of swapping components upon fail-

ure on the total system reliability and reliability importance. Section 2.2, considers the effect of swapping components on the total system reliability. We consider the impact of possible component swapping on a reliability importance measure for an individual component in Section 2.3, followed in Section 2.4 by attention to joint reliability importance of two components. In each section, we illustrate our approach via examples. We end the chapter with some concluding remarks.

## 2.2 Swapping components

As we introduced in Section 1.4, the reliability of a system with  $m$  components of  $K$  different types can be obtained by the use of the partition theorem involving the survival signature of the system  $\Phi(l_1, l_2, \dots, l_K)$  and the probabilities that given the numbers of components of each type will be functioning as given in Equation (1.4.29). The survival signature takes into account the structure of the system, and this information is separated from the failure time distributions of the system components. We are able to quantify the reliability of the system if some components can be swapped by two approaches. The effect of a regime of specified swaps can be reflected through the system structure function, and hence, it can be taken into account for computation of the system reliability through the survival signature. Alternatively, the component can be defined based on its location, then, the effect of the regime of specified swaps can be taken into account for computation of the system reliability through the failure times of specific locations. The time at which a specific location in the system will contain a failed component, might depend on whether other specific locations contain a failed or functioning component. We explain this approach in more detail later in Section 2.2.1, after we introduce the first approach.

For a regime of specified swaps that will occur if specific components fail, let  $\phi^w(\underline{x})$  denote the system structure function given the defined swap in place. Compared to the system's structure function without swapping opportunities,  $\phi(\underline{x})$ ,  $\phi^w$  will typically be equal to 1 for some  $\underline{x}$  for which  $\phi$  was equal to 0, reflecting the benefit from swapping components upon failure, so  $\phi^w(\underline{x}) \geq \phi(\underline{x})$ . Let  $\Phi^w(l_1, l_2, \dots, l_K)$

denote the survival signature given the defined swapping regime is in place, so

$$\Phi^w(l_1, l_2, \dots, l_K) = \left( \prod_{k=1}^K \binom{m_k}{l_k}^{-1} \right) \times \sum_{\underline{x} \in S_{l_1, \dots, l_K}} \phi^w(\underline{x}). \quad (2.2.1)$$

Let  $T^w$  denote the random system failure time with the specified swapping regime in place. Therefore, the reliability of the system with the specified swapping regime in place  $R^w(t) = P(T^w > t)$  is

$$R^w(t) = \sum_{l_1=0}^{m_1} \dots \sum_{l_K=0}^{m_K} \left[ \Phi^w(l_1, \dots, l_K) \prod_{k=1}^K \left( \binom{m_k}{l_k} [F_k(t)]^{m_k-l_k} [1 - F_k(t)]^{l_k} \right) \right] \quad (2.2.2)$$

It is important to notice here that the swapping regime is entirely reflected in the system survival signature. Crucially, the components have kept the same failure time distributions and the same assumptions apply, that is failure times of components of the same type remain independent and identically distributed, and failure times of components of different types remain independent. The increase in reliability caused by the swapping regime, when compared to the system without possible swapping, is given by

$$R^w(t) - R(t) = \sum_{l_1=0}^{m_1} \dots \sum_{l_K=0}^{m_K} \left[ \{ \Phi^w(l_1, \dots, l_K) - \Phi(l_1, \dots, l_K) \} \prod_{k=1}^K \left( \binom{m_k}{l_k} [F_k(t)]^{m_k-l_k} [1 - F_k(t)]^{l_k} \right) \right] \quad (2.2.3)$$

Hence, as long as a swapping regime leads to an increase of the survival signature, for at least one of its values, it will be of benefit for the overall system reliability. It is also obvious that a series system can never benefit from such swapping, simply because it only functions if all of its components function. This is reflected by the fact that for a series system, the two survival signatures considered here are always equal. The above result for the difference of the reliability of the system with and without possible swapping, ensures that some relevant computations, for example, for importance measures as presented in Sections 2.3 and 2.4, are quite straightforward. To illustrate the above way to reflect the effect of a component swapping regime, we present the following two examples.

**Example 2.2.1** Consider the system in Figure 2.1, which consists of four components of two types, so  $m_1 = m_2 = 2$ . We want to examine the reliability of this system in the case that components A and B can be swapped. Of course, this



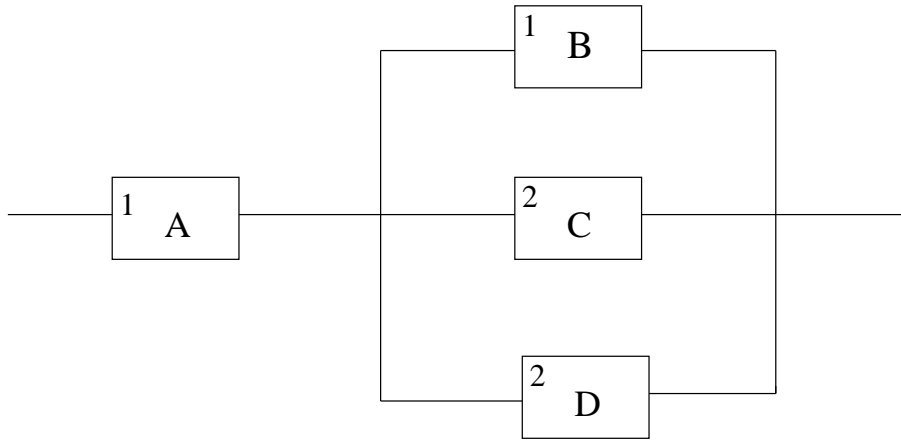

Figure 2.1: System with four components of two types

$l_1$	$l_2$	$\Phi$	$\Phi^w$
0	0	0	0
0	1	0	0
0	2	0	0
1	0	0	0
1	1	1/2	1
1	2	1/2	1
2	0	1	1
2	1	1	1
2	2	1	1

Table 2.1: Survival signatures for the system in Figure 2.1

swap only has a positive effect on the system reliability if component A fails while component B still functions and at least one of components C or D also still functions. So, the system's structure function with this swap applied if needed, changes from value 0 to 1 for three values of the state vector  $\underline{x}$  (with entries alphabetically ordered):  $(0, 1, 0, 1)$ ,  $(0, 1, 1, 0)$ ,  $(0, 1, 1, 1)$ , as in these cases the failed component A will be replaced by component B which is functioning, and indeed at least one more component functions. The corresponding survival signatures,  $\Phi(l_1, l_2)$  for the system without the swap, and  $\Phi^w(l_1, l_2)$  with this specific swap applied if needed, are given in Table 2.2 for all  $l_1, l_2 \in \{0, 1, 2\}$ .

The reliability of the system without the swap being possible, and the reliability of the system with the swap applied if needed, is obtained by multiplying  $\Phi(l_1, l_2)$

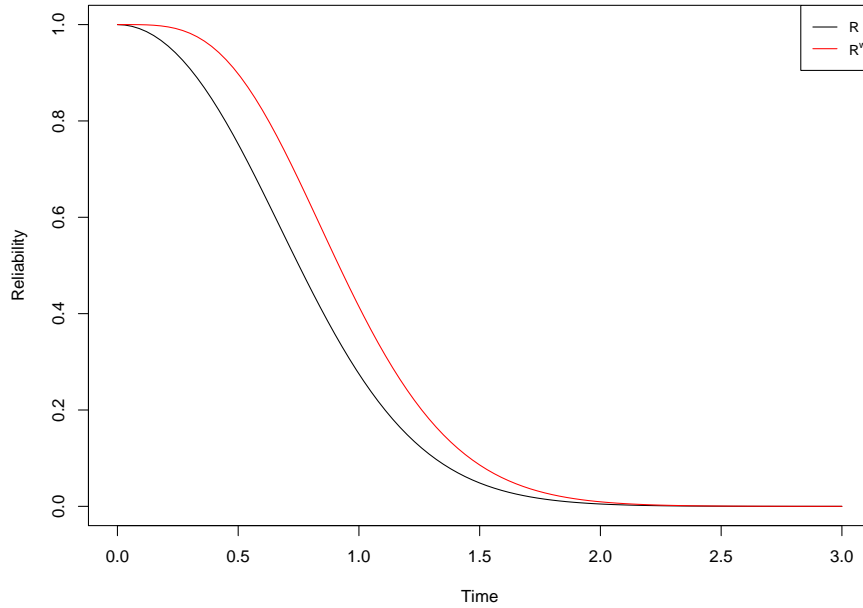

Figure 2.2: Reliability of system in Figure 2.1

and  $\Phi^w(l_1, l_2)$  by the probability that the number of components of each type will be functioning, assuming independence of failure time of components of different types. Let the CDFs of the failure times of the Type 1 and Type 2 components be  $F_1(t)$  and  $F_2(t)$ , respectively. Then the reliability  $R(t)$  of the system without the swap being possible, and the reliability  $R^w(t)$  of the system with the swap applied if needed are

$$R(t) = [F_1(t)][1 - F_1(t)][1 - [F_2(t)]^2] + [1 - F_1(t)]^2$$

$$R^w(t) = 2[F_1(t)][1 - F_1(t)][1 - [F_2(t)]^2] + [1 - F_1(t)]^2 \quad (2.2.4)$$

Figure 2.2 presents  $R(t)$  and  $R^w(t)$  if the failure times of Type 1 components have a Weibull distribution with shape parameter 2 and scale parameter 1, that is with CDF  $F_1(t) = 1 - e^{-t^2}$ , and the failure times of Type 2 components have an Exponential distribution with expected value 1, so with CDF  $F_2(t) = 1 - e^{-t}$ . This figure clearly presents the gain in reliability of the system due to the possible component swap.

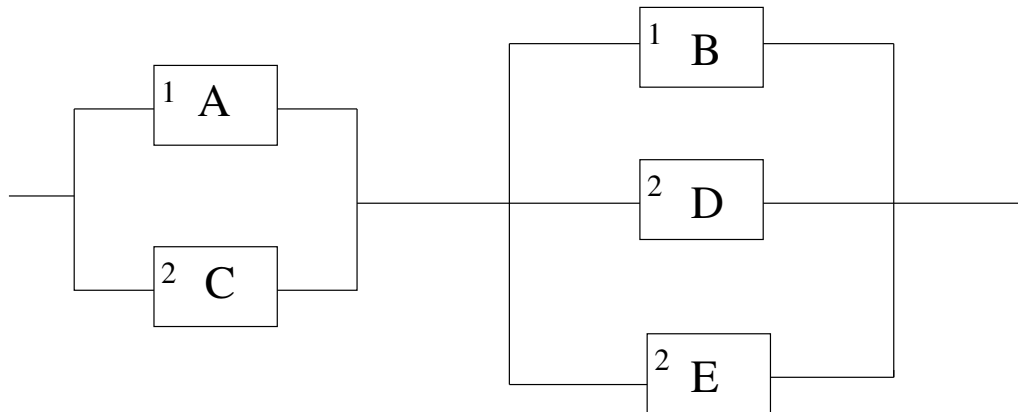

Figure 2.3: System with five components of two types

**Example 2.2.2** Consider the system in Figure 2.3, which consists of five components  $m = 5$  with two types  $K = 2$ , so  $m_1 = 2$  and  $m_2 = 3$ . We want to examine the reliability of this system in the case that components A and B can be swapped. The system can benefit from this swap if components A and C are functioning while components B, D and E are failed and if components A and C are failed while component B and at least one of components D and E are functioning. So, the system's structure function with this swap applied, changes from value 0 to 1 for four values of the state vector  $\underline{x}$  (with entries alphabetically ordered):  $(1, 0, 1, 0, 0)$ ,  $(0, 1, 0, 1, 0)$ ,  $(0, 1, 0, 0, 1)$ ,  $(0, 1, 0, 1, 1)$ . The survival signature,  $\Phi(l_1, l_2)$  for the system without the swap, and  $\Phi^w(l_1, l_2)$  with the swap applied, are given in Table 2.2 for all  $l_1 \in \{0, 1, 2\}$  and  $l_2 \in \{0, 1, 2, 3\}$ .

Let the probability distribution of the Type 1 components failure time have CDF  $F_1(t)$  and the probability distribution of the Type 2 components failure time have CDF  $F_2(t)$ . Then the reliability of the system  $R(t)$  without the swap being possible, and the reliability  $R^w(t)$  of the system with the swap applied if needed are

$$\begin{aligned}
 R(t) &= [F_1(t)]^2 \left[ 2[F_2(t)][1 - F_2(t)]^2 + [1 - F_2(t)]^3 \right] + [F_1(t)][1 - F_1(t)] \\
 &\quad \left[ 3[F_2(t)]^2[1 - F_2(t)] + 5[F_2(t)][1 - F_2(t)]^2 + 2[1 - F_2(t)]^3 \right] + [1 - F_1(t)]^2. \\
 R^w(t) &= [F_1(t)]^2 \left[ 2[F_2(t)][1 - F_2(t)]^2 + [1 - F_2(t)]^3 \right] + 2[F_1(t)][1 - F_1(t)] \\
 &\quad \left[ 1 - [F_2(t)]^3 \right] + [1 - F_1(t)]^2.
 \end{aligned} \tag{2.2.5}$$

$l_1$	$l_2$	$\Phi$	$\Phi^w$
0	0	0	0
0	1	0	0
0	2	2/3	2/3
0	3	1	1
1	0	0	0
1	1	1/2	1
1	2	5/6	1
1	3	1	1
2	0	1	1
2	1	1	1
2	2	1	1
2	3	1	1

Table 2.2: Survival signatures for the system in Figure 2.3

If we keep the same scenario for the failure times of Type 1 and Type 2 components as in Example 2.2.1, we can see in Figure 2.4 how the system's reliability change over time before and after the possible component swaps. It is clear that there would be a good improvement in the system's reliability if the system is designed in the way that we could implement the defined swap.

It is clear from the previous example that the effect the swap between components A and B is fully taken into account through the system structure function, and hence the survival signature. This has the important advantage that each components remains of the same type when compared to the system without swaps being possible. This is not the case in the alternative approach as we will see.

### 2.2.1 Alternative approach

In this approach we consider the change that might happen in reliability of a system if its components can be swapped upon failure in the failure times of the specific locations that the system's components fixed on. For example, for the system in Figure 2.1, let us assume that  $L_A$ ,  $L_B$ ,  $L_C$  and  $L_D$  denote the locations in the system that components A, B, C and D are fixed on, respectively. If a swap could take place as considered in Example 2.2.1, then location  $L_A$  would have as failure

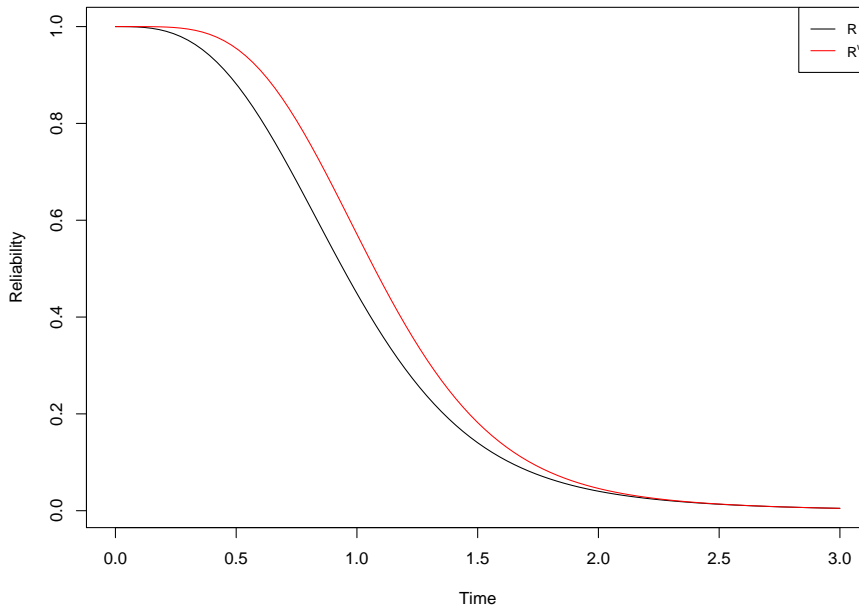

Figure 2.4: Reliability of the system in Figure 2.3

time the maximum of the failure times of components A and B, and location  $L_B$  would have as failure time the minimum of the failure times of components A and B. Hence,  $L_A$  and  $L_B$  would not have exchangeable failure times anymore, and hence they would not be of the same type, so the swap breaks down these locations into two different types.

In order to consider the change that might happen in reliability in the failure times of the specific locations, we define the survival signature according to the specific locations. Consider a system with  $m$  components. Let  $L_1, L_2, \dots, L_m$  represent different locations in the system that the components might be fixed on.  $T_{L_j}$  denote the failure time of location  $L_j, j \in \{1, 2, \dots, m\}$  and it represents the time at which this location will contain a failed component. The survival signature of specific locations gives the probability that system functions if there is exactly  $Y_b$  of type  $b$  locations functioning. Assuming that the random failure times of locations of the same type are exchangeable, while full independence is assumed for the random failure times of locations of different types. If we have  $B \geq 2$  types of locations with  $m_b$  locations of type  $b \in \{1, 2, \dots, B\}$  and  $\sum_{b=1}^B m_b = m$ ,  $a_j^b$  is used to donate the

functioning states of the  $j$  location of type  $b$ .  $a_j^b = 1$  if  $j^{\text{th}}$  location of type  $b$  function and  $a_j^b = 0$  if it fails.  $\underline{a}^b = (a_1^b, a_2^b, \dots, a_{m_b}^b)$  is a state vector that represents the state of type  $b$  locations and  $\underline{a} = (\underline{a}^1, \underline{a}^2, \dots, \underline{a}^B)$  is the state vector for the overall system. The structure function that gives the overall state of the system according to the functioning status of specific locations is denoted by  $\phi_L(\underline{a})$ .

There are  $\binom{m_b}{Y_b}$  state vectors  $\underline{a}^b$  with exactly  $Y_b$  of its  $m_b$  locations  $a_j^b = 1$ , so with  $\sum_{j=1}^{m_b} a_j^b = Y_b$ . We denote the set of these state vectors for locations of type  $b$  by  $S_Y^b$ . Let  $S_{Y_1, \dots, Y_B}$  denote the set of all state vectors for the whole system for which  $\sum_{j=1}^{m_b} a_j^b = Y_b$ , for  $b = 1, 2, \dots, B$ . Because of the assumption that the failure times of  $m_b$  locations of type  $b$  are exchangeable, all the state vectors  $\underline{a}^b \in S_Y^b$  are equally likely to occur. The survival signature of specific locations is denoted by  $\Phi_L(Y_1, Y_2, \dots, Y_B)$ , and is given as follows:

$$\Phi_L(Y_1, Y_2, \dots, Y_B) = \left( \prod_{b=1}^B \binom{m_b}{Y_b}^{-1} \right) \times \sum_{\underline{a} \in S_{Y_1, \dots, Y_B}} \phi(\underline{a}). \quad (2.2.6)$$

To find the reliability of the system  $R^w(t)$  that considers a defined swap, we find  $\Phi_L(Y_1, Y_2, \dots, Y_B)$ , then we multiply it by the probability that the number of specific locations of each type will be functioning, taking into account the defined swap in the failure time of specific locations. Let  $N_t^b \in \{0, 1, \dots, m_b\}$  denote the number of type  $b$  locations in the system that function at time  $t > 0$ . To find  $P(N_t^1 = Y_1, N_t^2 = Y_2, \dots, N_t^B = Y_B)$ , we need to find the joint probability that consider the dependency that occurred between specific locations as a result of the defined swap.

$$R^w(t) = \sum_{Y_1=0}^{m_1} \dots \sum_{Y_B=0}^{m_B} [\Phi_L(Y_1, Y_2, \dots, Y_B) P(N_t^1 = Y_1, N_t^2 = Y_2, \dots, N_t^B = Y_B)] \quad (2.2.7)$$

This approach is illustrated in more detail through the following two examples.

**Example 2.2.3** Consider the same system in Figure 2.1 and the same swapping possibility between components A and B as discussed in Example 2.2.1. The time at which location  $L_A$  fails,  $T_{L_A}$ , is dependent on the time at which location  $L_B$  fails,  $T_{L_B}$ .  $T_{L_A} = \max(T_A, T_B)$  and  $T_{L_B} = \min(T_A, T_B)$  where  $T_A$  is the failure time of component A with disregard to its location and  $T_B$  is the failure time of component

$Y_1$	$Y_2$	$Y_3$	$\Phi_L$	$Y_1$	$Y_2$	$Y_3$	$\Phi_L$
0	0	0	0	1	0	0	0
0	0	1	0	1	0	1	1
0	0	2	0	1	0	2	1
0	1	0	0	1	1	0	1
0	1	1	0	1	1	1	1
0	1	2	0	1	1	2	1

Table 2.3: Survival signature  $\Phi_L$  of system in Figure 2.1

B with disregard to its location. It is clear that under the defined swap,  $L_A$  and  $L_B$  represent two different types of locations. We have  $Y_1 \in \{0, 1\}$  corresponding to location  $L_A$  and we have  $Y_2 \in \{0, 1\}$  corresponding to location  $L_B$ . The defined swap does not change the locations of Type 2 components, so all of the locations of Type 2 components still have the same type as its components we denote this Type 3 and we have  $Y_3 \in \{0, 1, 2\}$ .

In order to find the reliability of the system, we calculate  $\Phi_L(Y_1, Y_2, Y_3)$  with disregard to the structure of components in the system. For example, in the situation that if location  $L_A$  fails while locations  $L_B$ ,  $L_C$  and  $L_D$  are still functioning, the structure function in this situation is  $\phi_L(a_1^1 = 0, a_1^2 = 1, a_1^3 = 1, a_2^3 = 1) = 0$ , comparing to the structure function  $\phi(x_1^1 = 0, x_2^1 = 1, x_1^2 = 1, x_2^2 = 1) = 0$  for the original system,  $\phi_L$  breaks down the system locations to different types according to the change that happens in their failure times as a result of the defined swap. Table 2.3 demonstrates  $\Phi_L$  for all  $Y_1, Y_2 \in \{0, 1\}$  and  $Y_3 \in \{0, 1, 2\}$ .

To find  $P(N_t^1 = Y_1, N_t^2 = Y_2, N_t^3 = Y_3)$  for all  $Y_1, Y_2 \in \{0, 1\}$  and  $Y_3 \in \{0, 1, 2\}$ . We need to find the joint probability of  $P(N_t^1 = Y_1, N_t^2 = Y_2)$  for all  $Y_1, Y_2 \in \{0, 1\}$  then multiply it by the probability that the number of locations of type 3 will be functioning  $P(N_t^3 = Y_3)$  because under the defined swap,  $N_t^3$  is still independent of  $N_t^1$  and  $N_t^2$ .

Components A and B are of the same type. So,  $T_A$  and  $T_B$  are identically distributed  $T_A, T_B \sim F_1(t)$  where  $F_1(t)$  is CDF of the failure time of Type 1 component. Under the defined swap, the probability that the two locations  $L_A$  and

$L_B$  are functioning together at time  $t > 0$  is  $P(N_t^1 = 1, N_t^2 = 1) = [1 - F_1(t)]^2$  and the probability that these two locations are not functioning at time  $t > 0$  is  $P(N_t^1 = 0, N_t^2 = 0) = [F_1(t)]^2$ . The event that location  $L_A$  functions while location  $L_B$  is failed will occur when location  $L_A$  contains functioning component A and location  $L_B$  contains a failed component B or when component A fails at location  $L_A$  and it was swapped with functioning component B. The probability of this event is  $P(N_t^1 = 1, N_t^2 = 0) = 2[F_1(t)][1 - F_1(t)]$ . Also, it is impossible that location  $L_B$  functions while location  $L_A$  fails. So,  $P(N_t^1 = 0, N_t^2 = 1) = 0$ . If we substitute the values of  $\Phi_L$  and the joint probability in Equation (2.2.7), we can find that

$$R^w(t) = 2[F_1(t)][1 - F_1(t)][1 - [F_2(t)]^2] + [1 - F_1(t)]^2 \quad (2.2.8)$$

Comparing the results in Equations (2.2.4) and (2.2.8), we can clearly see that we arrived at the same result by implementing the two different approaches.

**Example 2.2.4** Consider again the system in Figure 2.3 and the same swapping possibility between the components A and B as discussed in Example 2.2.5. The defined swap will only change the failure time of locations  $L_A$  and  $L_B$  in the situations when the location  $L_C$  functions while the locations  $L_D$  and  $L_E$  fail,  $T_{L_A} = \min(T_A, T_B)$  and  $T_{L_B} = \max(T_A, T_B)$ , and in the situation that the location  $L_C$  fails while at least one of the locations  $L_D$  and  $L_E$  function,  $T_{L_A} = \max(T_A, T_B)$  and  $T_{L_B} = \min(T_A, T_B)$ . In the situation that the location  $L_C$ ,  $L_D$  and  $L_E$  are functioning together or failed together, the swap will not influence the failure time of locations  $L_A$  and  $L_B$ . Thus, they still have their original failure times in this situation,  $T_{L_A} = T_A$  and  $T_{L_B} = T_B$ . It clear that the failure time  $T_{L_A}$  is not exchangeable with the failure time  $T_{L_B}$ . So, the locations  $L_A$  and  $L_B$  represent two different types namely Type 1 and Type 2 locations and we have  $Y_1 \in \{0, 1\}$  corresponding to the number of Type 1 locations functioning and we have  $Y_2 \in \{0, 1\}$  corresponding to the number of Type 2 locations functioning. Since  $T_{L_A}$  and  $T_{L_B}$  dependent on  $T_{L_C}$  and either one of  $T_{L_D}$  and  $T_{L_E}$ , we breakdown the location of Type 3 components into two types, namely Type 3 location represents the location  $L_C$  and Type 4 represents the location  $L_D$  and  $L_E$ . So, we have  $Y_3 \in \{0, 1\}$  and  $Y_4 \in \{0, 1, 2\}$ . Table 2.4 demonstrates  $\Phi_L(Y_1, Y_2, Y_3, Y_4)$  for all  $Y_1, Y_2, Y_3 \in \{0, 1\}$  and  $Y_4 \in \{0, 1, 2\}$ .



$Y_1$	$Y_2$	$Y_3$	$Y_4$	$\Phi_L$	$Y_1$	$Y_2$	$Y_3$	$Y_4$	$\Phi_L$
0	0	0	0	0	1	0	0	0	0
0	0	0	1	0	1	0	0	1	1
0	0	0	2	0	1	0	0	2	1
0	1	0	0	0	1	1	0	0	1
0	1	0	1	0	1	1	0	1	1
0	1	0	2	0	1	1	0	2	1
0	0	1	0	0	1	0	1	0	0
0	0	1	1	1	1	0	1	1	1
0	0	1	2	1	1	0	1	2	1
0	1	1	0	1	1	1	1	0	1
0	1	1	1	1	1	1	1	1	1
0	1	1	2	1	1	1	1	2	1

Table 2.4: Survival signature  $\Phi_L$  of system in Figure 2.3

Components A and B are of the same type. So,  $T_A$  and  $T_B$  are identically distributed  $T_A, T_B \sim F_1(t)$  where  $F_1(t)$  is CDF of the failure time of Type 1 components. Components C, D and E are of the same type. So,  $T_C, T_D$  and  $T_E$  are identically distributed  $T_C, T_D, T_E \sim F_2(t)$  where  $F_2(t)$  is CDF of the failure time of Type 2 components. It is clear that the joint probability  $P(N_t^1 = Y_1, N_t^2 = Y_2, N_t^3 = Y_3, N_t^4 = Y_4)$  would be different than the joint probability for the original system only in the situations when  $N_t^1 = 1$  and  $N_t^2 = 0$  or when  $N_t^1 = 0$  and  $N_t^2 = 1$ . For example,  $P(N_t^1 = 1, N_t^2 = 0, N_t^3 = 0, N_t^4 = 1) = 4[1 - F_1(t)][F_1(t)][1 - F_2(t)][F_2(t)]^2$  because the event that  $L_A$  and one of  $L_D$  or  $L_E$  function while  $L_B$  and  $L_C$  are failed will occur in 4 situations namely, when  $L_A$  contains functioning component A and  $L_D$  contains functioning component D and  $L_B, L_C$  and  $L_E$  contain failed components, or when  $L_A$  contains functioning component A and  $L_E$  contains functioning component E and  $L_B, L_C$  and  $L_D$  contain failed components, or when component A fails at  $L_A$  and it is swapped by the functioning component B and  $L_D$  contains functioning component D and  $L_B, L_C$  and  $L_E$  contain failed components, or when component A fails at location  $L_A$  and it is swapped by the functioning component B and  $L_E$

$Y_1$	$Y_2$	$Y_3$	$Y_4$	$P(N_t^1 = Y_1, N_t^2 = Y_2, N_t^3 = Y_3, N_t^4 = Y_4)$
1	0	0	0	$[1 - F_1(t)][F_1(t)][F_2(t)]^3$
1	0	0	1	$4[1 - F_1(t)][F_1(t)][1 - F_2(t)][F_2(t)]^2$
1	0	0	2	$2[1 - F_1(t)][F_1(t)][1 - F_2(t)]^2[F_2(t)]$
1	0	1	0	0
1	0	1	1	$2[1 - F_1(t)][F_1(t)][1 - F_2(t)]^2[F_2(t)]$
1	0	1	2	$[1 - F_1(t)][F_1(t)][F_2(t)]^3$
0	1	0	0	$[1 - F_1(t)][F_1(t)][F_2(t)]^3$
0	1	0	1	0
0	1	0	2	0
0	1	1	0	$2[1 - F_1(t)][F_1(t)][1 - F_2(t)][F_2(t)]^2$
0	1	1	1	$2[1 - F_1(t)][F_1(t)][1 - F_2(t)]^2[F_2(t)]$
0	1	1	2	$[1 - F_1(t)][F_1(t)][F_2(t)]^3$

Table 2.5: The probability in the cases when  $N_t^1 = 1$  and  $N_t^2 = 0$  and in the cases when  $N_t^1 = 0$  and  $N_t^2 = 1$  in Example 2.2.4

contains functioning component C and  $L_B$ ,  $L_C$  and  $L_D$  contain failed component. Table 2.5 shows  $P(N_t^1 = Y_1, N_t^2 = Y_2, N_t^3 = Y_3, N_t^4 = Y_4)$  in the cases when  $N_t^1 = 1$  and  $N_t^2 = 0$  and in the cases when  $N_t^1 = 0$  and  $N_t^2 = 1$ , for all  $Y_3 \in \{0, 1\}$  and  $Y_4 \in \{0, 1, 2\}$ .

By substituting the values of  $\Phi_L(Y_1, Y_2, Y_3, Y_4)$  and  $P(N_t^1 = Y_1, N_t^2 = Y_2, N_t^3 = Y_3, N_t^4 = Y_4)$  for all  $Y_1, Y_2, Y_3 \in \{0, 1\}$  and  $Y_4 \in \{0, 1, 2\}$  in Equation(2.2.7), we can find that

$$R^w(t) = [F_1(t)]^2 \left[ 2[F_2(t)][1 - F_2(t)]^2 + [1 - F_2(t)]^3 \right] + 2[F_1(t)][1 - F_1(t)] \left[ 1 - [F_2(t)]^3 \right] + [1 - F_1(t)]^2. \quad (2.2.9)$$

Therefore, we arrived at the same result as in Example 2.2.2. It clear from the previous examples that while we arrived at the same result by implementing the two different approaches. The first approach in which the effect of a defined swapping regime is fully taken into account through the system structure function,

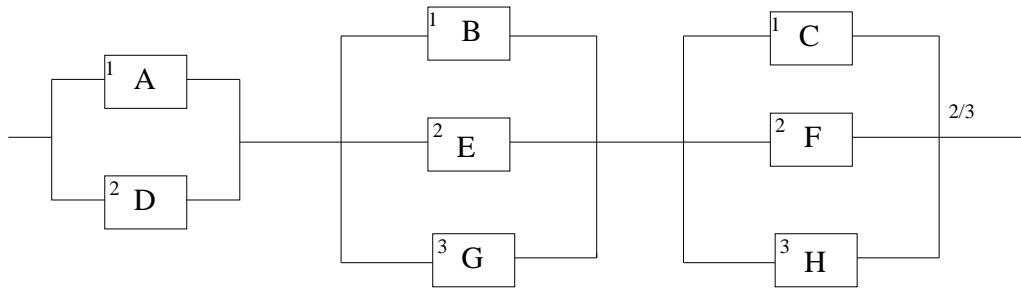

Figure 2.5: System with 8 components of 3 types; C,F,H form a 2-out-of-3 subsystem

and hence the survival signature is more attractive than the second one, since it has continued with the same advantage of survival signature by modeling the structure of systems and separating it from the random failure time of components. However, in the second approach in which the effect of such a component swap is taken into account through the failure times of specific locations, the lifetime distributions become extremely complex and may not be feasible if one has a variety of swapping opportunities. This thesis considers only the first approach for reliability assessment when system components can be swapped.

The following extensive example is comparing the change that might happen in the reliability as a result of different swapping opportunities. We can see through this example how the reliability of the system can be obtained easily by considering the first approach, however it would be quite difficult to obtain it by the second approach.

**Example 2.2.5** The system in Figure 2.5 consists of 8 components of 3 types,  $m = 8$  and  $K = 3$ ,  $m_1 = 3$ ,  $m_2 = 3$  and  $m_3 = 2$ . The letters A to H represent the specific components, the numbers 1 to 3 represent the component types. This system consist of three subsystems in series configuration. The first subsystem is a parallel system consisting of components A and D, the second subsystem is a parallel system consisting of components B, E and G, and the third subsystem is a 2-out-of-3 system consisting of components C, F and H.

The reliability of this system might be enhanced by a variety of swapping opportunities, we compare 7 swapping cases. In Case 1, we assume that we are able to swap only Type 1 components, in Case 2, we assume that we are able to swap

only Type 2 components, in Case 3, we assume that we are able to swap only Type 3 components, in Case 4, we assume that we are able to swap both Type 1 and Type 2 components, in Case 5, we assume that we are able to swap both Type 1 and Type 3 components, in Case 6, we assume that we are able to swap both Type 2 and Type 3 components, in Case 7, we assume that we are able to swap Type 1, Type 2 and Type 3 components. In each case the swap can be done in any way when needed to keep the system functioning.

The survival signatures are given in Table 2.6, where  $\Phi$  is the survival signature for the original system and  $\Phi^w, w \in \{1, 2, 3, 4, 5, 6, 7\}$  are the survival signatures in Cases 1, 2, 3, 4, 5, 6 and 7. In this table we present only nonzero values. The zero values represent the situations when the system has only 3 functioning components or less, because the system needs at least 4 components to function. In Case 7, all nonzero values are equal to 1, because in this case we can swap components of all types, so the system just needs four functioning components of any type in order to function.

In order to see the change to the system's reliability as a result of each of swapping case, we assume that the failure times of Type 1 components have a Weibull distribution with shape parameter 2 and scale parameter 1, the failure times of Type 2 components have an Exponential distribution with expected value 1 and the failure times of Type 3 components have an Exponential distribution with expected value 2, so  $F_1(t) = 1 - e^{-t^2}$ ,  $F_2(t) = 1 - e^{-t}$  and  $F_3(t) = 1 - e^{-t/2}$ . The reliability functions of the system in Cases 1, 2, 3, 4, 5, 6 and 7 are given in Figure 2.6. Case 0 in this figure represents the reliability function for the original system. Clearly, while all swap cases would enhance the system reliability, Cases 7 and 4 provide the best improvement, which is mainly due to the fact that in Case 7 all the components are involved in the swaps and in Case 4, six components are involved in the swaps, including the two components in the first subsystem.

$l_1$	$l_2$	$l_3$	$\Phi$	$\Phi^1$	$\Phi^2$	$\Phi^3$	$\Phi^4$	$\Phi^5$	$\Phi^6$	$\Phi^7$
0	2	2	1/3	1/3	1	1/3	1	1/3	1	1
0	3	1	1/2	1/2	1/2	1	1/2	1	1	1
0	3	2	1	1	1	1	1	1	1	1
1	1	2	2/9	2/3	2/3	2/9	1	2/3	2/3	1
1	2	1	2/9	2/3	2/3	4/9	1	1	1	1
1	2	2	5/9	1	1	5/9	1	1	1	1
1	3	0	1/3	1	1/3	1/3	1	1	1/3	1
1	3	1	2/3	1	2/3	1	1	1	1	1
1	3	2	1	1	1	1	1	1	1	1
2	0	2	1/3	1	1/3	1/3	1	1	1/3	1
2	1	1	2/9	2/3	2/3	4/9	1	1	1	1
2	1	2	5/9	1	1	5/9	1	1	1	1
2	2	0	1/3	2/3	2/3	1/3	1	2/3	2/3	1
2	2	1	1/2	5/6	5/6	7/9	1	1	1	1
2	2	2	7/9	1	1	7/9	1	1	1	1
2	3	0	2/3	1	2/3	2/3	1	1	2/3	1
2	3	1	5/6	1	5/6	1	1	1	1	1
2	3	2	1	1	1	1	1	1	1	1
3	0	1	1/2	1/2	1/2	1	1/2	1	1	1
3	0	2	1	1	1	1	1	1	1	1
3	1	0	1/3	1/3	1	1/3	1	1/3	1	1
3	1	1	2/3	2/3	1	1	1	1	1	1
3	1	2	1	1	1	1	1	1	1	1
3	2	0	2/3	2/3	1	2/3	1	2/3	1	1
3	2	1	5/6	5/6	1	1	1	1	1	1
3	2	2	1	1	1	1	1	1	1	1
3	3	0	1	1	1	1	1	1	1	1
3	3	1	1	1	1	1	1	1	1	1
3	3	2	1	1	1	1	1	1	1	1

Table 2.6: The survival signatures of system in Figure 2.5

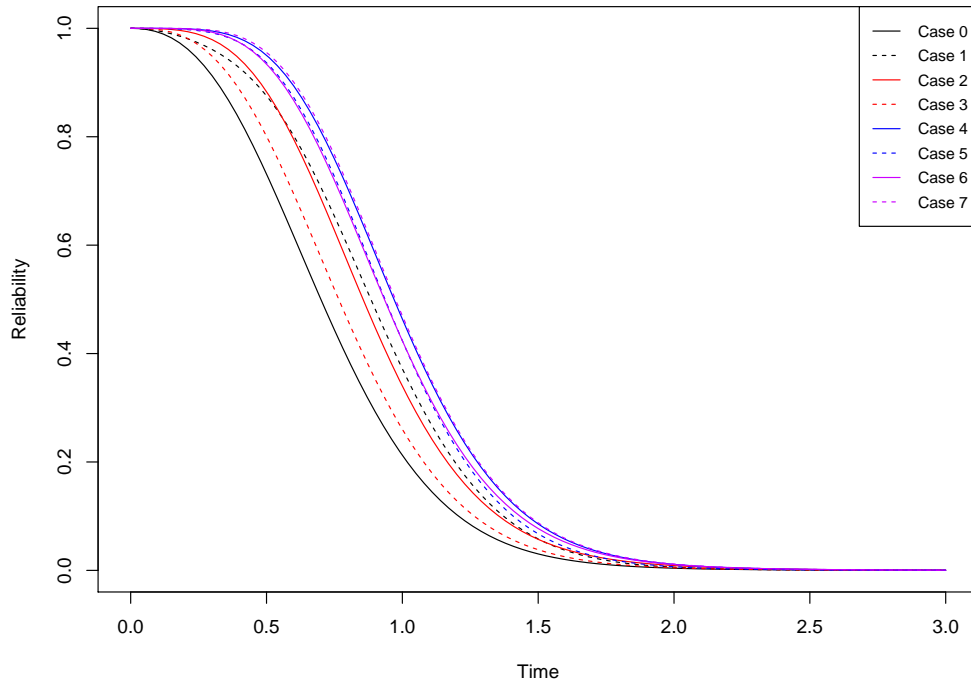

Figure 2.6: Reliability of the system in Figure 2.5

## 2.3 Component reliability importance

We examine the reliability importance of a specific component if we assume that some components in the system can be swapped. We consider the relative importance index  $RI_i(t)$  as introduced by [31], which is the difference between the probability that the system functions at time  $t$  given that component  $i$  functions at time  $t$ , and the probability that the system functions at time  $t$  given that component  $i$  is not functioning at time  $t$ , so

$$RI_i(t) = P(T_S > t | T_i > t) - P(T_S > t | T_i < t)$$

The conditional survival functions  $P(T_S > t | T_i > t)$  and  $P(T_S > t | T_i < t)$  can be obtained quite easily by deriving the survival signatures corresponding to the two possible states of component  $i$ . We can compute this for the system without swapping being possible as well as for specific swapping regimes, and it is of interest to consider the change in importance of specific components resulting from the swapping possibilities. We illustrate this using the same systems and swapping

		A		B		C, D			
$l_1$	$l_2$	$\tilde{\Phi}_1$	$\tilde{\Phi}_0$	$\tilde{\Phi}_1$	$\tilde{\Phi}_0$	$l_1$	$l_2$	$\tilde{\Phi}_1$	$\tilde{\Phi}_0$
0	0	0	0	0	0	0	0	0	0
0	1	1	0	0	0	0	1	0	0
0	2	1	0	0	0	1	0	1/2	0
1	0	1	0	1	0	1	1	1/2	1/2
1	1	1	0	1	1	2	0	1	1
1	2	1	0	1	1	2	1	1	1

Table 2.7:  $\tilde{\Phi}_1$  and  $\tilde{\Phi}_0$  for components A, B, C, D

regimes considered in Examples 2.2.1 and 2.2.5.

**Example 2.3.1** Consider again the system in Figure 2.1 and the same swapping possibility as discussed in Example 2.2.1. We refer to the original case of the system when there is no swapping possible between components as Case 0. We refer to the case when components A and B can be swapped as Case 1. To calculate the relative importance indices in Case 0, we first calculate the survival signature of the system conditional on the component of interest functioning, which we denote by  $\tilde{\Phi}_1(l_1, l_2)$ , where it should be noted that either  $l_1$  or  $l_2$  (corresponding to the type of the component of interest) now only takes values in  $\{0, \dots, m_k - 1\}$  for  $k = 1$  or  $k = 2$ , as it only reflects the number of the other components of the same type that are functioning. Similarly, we calculate the survival signature of the system conditional on the component of interest not functioning, which we denote by  $\tilde{\Phi}_0(l_1, l_2)$ . The survival signatures  $\tilde{\Phi}_1(l_1, l_2)$  and  $\tilde{\Phi}_0(l_1, l_2)$  are given in Table 2.7 for all components, note of course that these are identical for components C and D.

The relative importance index for component A,  $RI_A(t)$ , is derived by

$$RI_A(t) = \sum_{l_1=0}^1 \sum_{l_2=0}^2 \left[ \tilde{\Phi}_1(l_1, l_2) - \tilde{\Phi}_0(l_1, l_2) \right] \prod_{k=1}^2 P(C_t^k = l_k)$$

leading to

$$RI_A(t) = [F_1(t)] [1 - [F_2(t)]^2] + [1 - F_1(t)]$$

		A		B		C, D			
$l_1$	$l_2$	$\tilde{\Phi}_1^1$	$\tilde{\Phi}_0^1$	$\tilde{\Phi}_1^1$	$\tilde{\Phi}_0^1$	$l_1$	$l_2$	$\tilde{\Phi}_1^1$	$\tilde{\Phi}_0^1$
0	0	0	0	0	0	0	0	0	0
0	1	1	0	1	0	0	1	0	0
0	2	1	0	1	0	1	0	1	0
1	0	1	0	1	0	1	1	1	1
1	1	1	1	1	1	2	0	1	1
1	2	1	1	1	1	2	1	1	1

Table 2.8:  $\tilde{\Phi}_1^1$  and  $\tilde{\Phi}_0^1$  for components A, B, C, D

Similarly, we derive

$$RI_B(t) = [1 - F_1(t)][F_2(t)]^2$$

$$RI_C(t) = RI_D(t) = [F_1(t)][1 - F_1(t)][F_2(t)]$$

We aim to determine the differences that might occur in  $RI_A(t)$ ,  $RI_B(t)$ ,  $RI_C(t)$  and  $RI_D(t)$  in Case 1, in which we assume that components A and B can be swapped. To calculate the relative importance indices in Case 1,  $\tilde{\Phi}_1^1(l_1, l_2)$  represents the survival signature with the swap enabled, if the component of interest functions, and  $\tilde{\Phi}_0^1(l_1, l_2)$  if the component does not function. We denote the relative importance index of component  $i$  if the Case 1 swap is possible by  $RI_i^1(t)$ . Table 2.8 presents  $\tilde{\Phi}_1^1$  and  $\tilde{\Phi}_0^1$  for all the components in Case 1.

The relative importance index for component A,  $RI_A^1(t)$ , is derived by

$$RI_A^1(t) = \sum_{l_1=0}^1 \sum_{l_2=0}^2 \left[ \tilde{\Phi}_1^1(l_1, l_2) - \tilde{\Phi}_0^1(l_1, l_2) \right] \prod_{k=1}^2 P(C_t^k = l_k)$$

leading to

$$RI_A^1(t) = [F_1(t)] [1 - [F_2(t)]^2] + [1 - F_1(t)][F_2(t)]^2$$

Similarly we derive

$$RI_B^1(t) = [F_1(t)] [1 - [F_2(t)]^2] + [1 - F_1(t)][F_2(t)]^2$$

$$RI_C^1(t) = RI_D^1(t) = 2[F_1(t)][1 - F_1(t)][F_2(t)]$$



To compare the relative importance indices of the system's components in Cases 0 and 1, we use the same failure time distributions for Type 1 and Type 2 components as in Example 2.2.1. Figure 2.7 (a) and (b) show the relative importance indices of the system's components in Cases 0 and 1, respectively. These figures show that in Case 0, component A is clearly the most important, yet with the swapping possible between components A and B in Case 1 these two components become equally important.

**Example 2.3.2** We consider the component importance for the system in Figure 2.5, under the same swapping possibilities that we introduced in Example 2.2.5, namely in Case 1, we assume that we are able to swap only Type 1 components, in Case 2, we assume that we are able to swap only Type 2 components, in Case 3, we assume that we are able to swap only Type 3 components, in Case 4, we assume that we are able to swap both Type 1 and Type 2 components, in Case 5, we assume that we are able to swap both Type 1 and Type 3 components, in Case 6, we assume that we are able to swap both Type 2 and Type 3 components, in Case 7, we assume that we are able to swap Type 1, Type 2 and Type 3 components. We refer to the original Case, in which there is no swap option as Case 0. We also assume the same component failure time distributions as in Example 2.2.5.

The survival signatures for all components of Type 1 are given in Table 2.9, the survival signatures for all components of Type 2 are given in Table 2.10 and the survival signatures for all components of Type 3 are given in Table 2.11. In these tables  $\tilde{\Phi}_1$  and  $\tilde{\Phi}_0$  are the survival signatures for the components in Case 0 and  $\tilde{\Phi}_1^w$  and  $\tilde{\Phi}_0^w$ ,  $w \in \{1, 2, 3, 4, 5, 6, 7\}$  are the survival signatures for the components in Cases 1, 2, 3, 4, 5, 6 and 7. In these tables we present only non zero values.

Figures 2.8(a)-(h) show the relative importance indices of the components in these cases. These figures show that due to the ability of swapping between components, in Case 1, the components of Type 1 become equally important and, in Case 2, the components of Type 2 become equally important and, in Case 3, the components of Type 3 become equally important, in Case 4, the components of Type 1 become equally important and the components of Type 2 become equally important, in Case 5, the components of Type 1 become equally important and the components

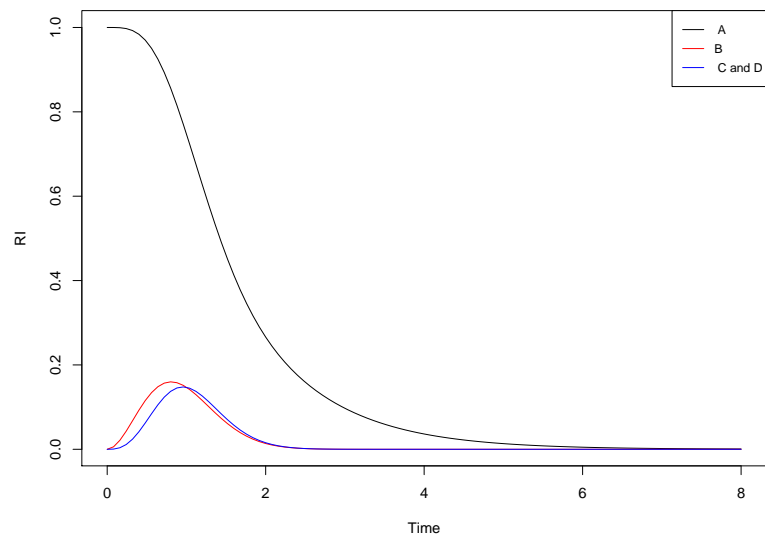

(a) Case 0

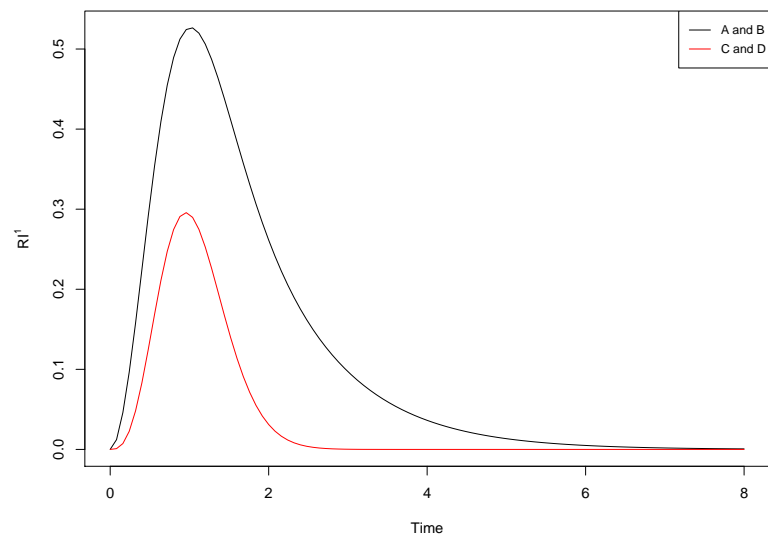

(b) Case 1

Figure 2.7: The relative importance indices of components in Figure 2.1

of Type 3 become equally important, in Case 6, the components of Type 2 become equally important and the components of Type 3 become equally important and in Case 7, the components of Type 1 become equally important, the components of Type 2 become equally important and the components of Type 3 become equally important for system reliability.

The importance of specific components depends on the swapping cases that would be allowed as well as the component failure time distributions. If we consider only the period of time from  $t = 0$  to  $t = 0.4$ , for example, then we can see that in this period, in Cases 0, 1 and 4, component H is the most important component, in Case 2 and 6, component C is the most important component, in Case 3, component A is the most important component, in Case 5, components G and H are the most important components, and in Case 7, components A, B and C are the most important components for system reliability.

$l_1$	$l_2$	$l_3$	A		B		C		A, B, C		A		B		C		A	
$l_1$	$l_2$	$l_3$	$\tilde{\Phi}_1$	$\tilde{\Phi}_0$	$\tilde{\Phi}_1$	$\tilde{\Phi}_0$	$\tilde{\Phi}_1$	$\tilde{\Phi}_0$	$\tilde{\Phi}_1$	$\tilde{\Phi}_0$	$\tilde{\Phi}_1$	$\tilde{\Phi}_0$	$\tilde{\Phi}_1$	$\tilde{\Phi}_0$	$\tilde{\Phi}_1$	$\tilde{\Phi}_0$	$\tilde{\Phi}_1$	$\tilde{\Phi}_0$
0	1	2	1/3	0	0	0	1/3	0	2/3	0	1	0	0	0	1	0	1/3	0
0	2	1	1/6	0	1/6	0	1/3	0	2/3	0	1/3	0	1/2	0	1	0	1/3	0
0	2	2	2/3	1/3	1/3	1/3	2/3	1/3	1	1/3	1	1	1	1	1	1	2/3	1/3
0	3	0	0	0	0	0	0	0	1	0	0	0	0	0	1	0	0	0
0	3	1	1/2	1/2	1/2	1/2	1	1/2	1	1/2	1/2	1/2	1/2	1/2	1	1/2	1	1
0	3	2	1	1	1	1	1	1	1	1	1	1	1	1	1	1	1	1
1	0	2	1/2	0	1/2	0	1/2	0	1	0	1/2	0	1/2	0	1/2	0	1/2	0
1	1	1	1/6	0	1/6	0	1/3	0	2/3	0	3/4	0	1/2	0	3/4	0	1/2	0
1	1	2	2/3	1/6	1/3	1/3	2/3	1/3	1	2/3	1	1/2	1	1	1	1/2	2/3	1/6
1	2	0	1/6	0	1/6	0	1/6	0	2/3	0	1/2	0	1/2	0	1	0	1/6	0
1	2	1	1/2	1/4	5/12	1/3	7/12	1/6	5/6	2/3	3/4	3/4	3/4	3/4	1	1/2	5/6	1/2
1	2	2	5/6	1/2	2/3	2/3	5/6	1/2	1	1	1	1	1	1	1	1	5/6	1/2
1	3	0	1/2	1/2	1/2	1/2	1	0	1	1	1/2	1/2	1/2	1/2	1	0	1/2	1/2
1	3	1	3/4	3/4	3/4	3/4	1	2/4	1	1	3/4	3/4	3/4	3/4	1	1/2	1	1
1	3	2	1	1	1	1	1	1	1	1	1	1	1	1	1	1	1	1
2	0	1	1/2	0	1/2	0	1/2	0	1/2	0	1/2	0	1/2	0	1/2	0	1	0
2	0	2	1	0	1	1	1	0	1	1	1	0	1	1	1	0	1	0
2	1	0	1/3	0	1/3	0	1/3	0	1/3	0	1	0	1	0	1	0	1/3	0
2	1	1	5/6	1/2	2/3	1/3	2/3	1/3	5/6	2/3	1	1/2	1	1	1	1/2	1	1/3
2	1	2	1	1/3	1	1	1	1	1	1	1	1	1	1	1	1	1	1/3
2	2	0	2/3	1/3	2/3	1/3	2/3	0	2/3	2/3	1	1	1	1	1	0	2/3	1/3
2	2	1	5/6	1/2	5/6	2/3	5/6	1/3	5/6	5/6	1	1	1	1	1	1/2	1	2/3
2	2	2	1	2/3	1	1	1	1	1	1	1	1	1	1	1	1	1	2/3
2	3	0	1	1	1	1	1	0	1	1	1	1	1	1	1	0	1	1
2	3	1	1	1	1	1	1	1/2	1	1	1	1	1	1	1	1/2	1	1
2	3	2	1	1	1	1	1	1	1	1	1	1	1	1	1	1	1	1

$l_1$	$l_2$	$l_3$	B		C		A, B, C		A, B, C		A		B		C		A, B, C	
$l_1$	$l_2$	$l_3$	$\tilde{\Phi}_1^3$	$\tilde{\Phi}_0^3$	$\tilde{\Phi}_1^3$	$\tilde{\Phi}_0^3$	$\tilde{\Phi}_1^4$	$\tilde{\Phi}_0^4$	$\tilde{\Phi}_1^5$	$\tilde{\Phi}_0^5$	$\tilde{\Phi}_1^5$	$\tilde{\Phi}_0^5$	$\tilde{\Phi}_1^5$	$\tilde{\Phi}_0^5$	$\tilde{\Phi}_1^6$	$\tilde{\Phi}_0^6$	$\tilde{\Phi}_1^7$	$\tilde{\Phi}_0^7$
0	1	2	0	0	1/3	0	1	0	2/3	0	1	0	0	0	1	0	1	0
0	2	1	1/3	0	2/3	0	1	0	1	0	1	0	1	0	1	0	1	0
0	2	2	1/3	1/3	2/3	1/3	1	1	1	1/3	1	1	1	1	1	1	1	1
0	3	0	0	0	1	0	1	0	1	0	0	0	0	0	1	0	1	0
0	3	1	1	1	1	1	1	1/2	1	1	1	1	1	1	1	1	1	1
0	3	2	1	1	1	1	1	1	1	1	1	1	1	1	1	1	1	1
1	0	2	1/2	0	1/2	0	1	0	1	0	1/2	0	1/2	0	1/2	0	1	0
1	1	1	1/3	0	1/2	0	1	0	1	0	1	0	1	0	1	0	1	0
1	1	2	1/3	1/3	2/3	1/3	1	1	1	2/3	1	1/2	1	1	1	1/2	1	1
1	2	0	1/6	0	1/6	0	1	0	2/3	0	1/2	0	1/2	0	1	0	1	0
1	2	1	2/3	1/2	5/6	1/3	1	1	1	1	1	1	1	1	1	1	1	1
1	2	2	2/3	2/3	5/6	1/2	1	1	1	1	1	1	1	1	1	1	1	1
1	3	0	1/2	1/2	1	0	1	1	1	1	1/2	1/2	1/2	1/2	1	0	1	1
1	3	1	1	1	1	1	1	1	1	1	1	1	1	1	1	1	1	1
1	3	2	1	1	1	1	1	1	1	1	1	1	1	1	1	1	1	1
2	0	1	1	0	1	0	1/2	0	1	0	1	0	1	0	1	0	1	0
2	0	2	1	1	1	0	1	1	1	1	1	0	1	1	1	0	1	1
2	1	0	1/3	0	1/3	0	1	0	1/3	0	1	0	1	0	1	0	1	0
2	1	1	1	2/3	1	1/3	1	1	1	1	1	1	1	1	1	1	1	1
2	1	2	1	1	1	1	1	1	1	1	1	1	1	1	1	1	1	1
2	2	0	2/3	1/3	2/3	1/3	1	1	2/3	2/3	1	1	1	1	1	0	1	1
2	2	1	1	1	1	2/3	1	1	1	1	1	1	1	1	1	1	1	1
2	2	2	1	1	1	1	1	1	1	1	1	1	1	1	1	1	1	1
2	3	0	1	1	1	0	1	1	1	1	1	1	1	1	1	0	1	1
2	3	1	1	1	1	1	1	1	1	1	1	1	1	1	1	1	1	1
2	3	2	1	1	1	1	1	1	1	1	1	1	1	1	1	1	1	1

Table 2.9: The survival signatures of component of Type 1 in Case 0, 1, 2, 3, 4, 5, 6 and 7

			D		E		F		D		E		F		D, E, F		D	
$l_1$	$l_2$	$l_3$	$\tilde{\Phi}_1$	$\tilde{\Phi}_0$	$\tilde{\Phi}_1$	$\tilde{\Phi}_0$	$\tilde{\Phi}_1$	$\tilde{\Phi}_0$	$\tilde{\Phi}_1^1$	$\tilde{\Phi}_0^1$	$\tilde{\Phi}_1^1$	$\tilde{\Phi}_0^1$	$\tilde{\Phi}_1^1$	$\tilde{\Phi}_0^1$	$\tilde{\Phi}_1^2$	$\tilde{\Phi}_0^2$	$\tilde{\Phi}_1^3$	$\tilde{\Phi}_0^3$
0	1	2	1/2	0	1/2	0	1/2	0	1/2	0	1/2	0	1/2	0	1	0	1/2	0
0	2	1	1/2	0	1/2	0	1/2	0	1/2	0	1/2	0	1/2	0	1/2	0	1	0
0	2	2	1	0	1	1	1	0	1	0	1	1	1	0	1	1	1	0
1	0	2	1/3	0	0	0	1/3	0	1	0	0	0	1	0	2/3	0	1/3	0
1	1	1	1/6	0	1/6	0	1/3	0	3/4	0	1/2	0	3/4	0	2/3	0	1/2	0
1	1	2	4/6	1/6	1/3	1/3	2/3	1/3	1	1/2	1	1	1	1/2	1	2/3	2/3	1/6
1	2	0	1/3	0	1/3	0	1/3	0	1	0	1	0	1	0	1/3	0	1/3	0
1	2	1	5/6	3/6	2/3	1/3	2/3	1/3	1	1/2	1	1	1	1/2	5/6	2/3	1	1/3
1	2	2	1	1/3	1	1	1	1	1	1	1	1	1	1	1	1	1	1/3
2	0	1	1/6	0	1/6	0	1/3	0	1/3	0	1/2	0	1	0	2/3	0	1/3	0
2	0	2	2/3	1/3	1/3	1/3	2/3	1/3	1	1	1	1	1	1	1	1/3	2/3	1/3
2	1	0	1/6	0	1/6	0	1/6	0	1/2	0	1/2	0	1	0	2/3	0	1/6	0
2	1	1	6/12	3/12	5/12	4/12	7/12	2/12	3/4	3/4	3/4	3/4	1	1/2	5/6	2/3	5/6	1/2
2	1	2	5/6	3/6	4/6	4/6	5/6	3/6	1	1	1	1	1	1	1	1	5/6	3/6
2	2	0	2/3	1/3	2/3	1/3	2/3	1/3	1	1	1	1	1	0	2/3	2/3	2/3	1/3
2	2	1	5/6	3/6	5/6	4/6	5/6	2/6	1	1	1	1	1	1/2	5/6	5/6	1	2/3
2	2	2	1	2/3	1	1	1	1	1	1	1	1	1	1	1	1	1	2/3
3	0	0	0	0	0	0	1	0	0	0	0	0	1	0	1	0	0	0
3	0	1	1/2	1/2	1/2	1/2	1	1/2	1/2	1/2	1/2	1/2	1	1/2	1	1/2	1	1
3	0	2	1	1	1	1	1	1	1	1	1	1	1	1	1	1	1	1
3	1	0	1/2	1/2	1/2	1/2	1	0	1/2	1/2	1/2	1/2	1	0	1	1	1/2	1/2
3	1	1	3/4	3/4	3/4	3/4	1	2/4	3/4	3/4	3/4	3/4	1	2/4	1	1	1	1
3	1	2	1	1	1	1	1	1	1	1	1	1	1	1	1	1	1	1
3	2	0	1	1	1	1	1	0	1	1	1	1	1	0	1	1	1	1
3	2	1	1	1	1	1	1	1/2	1	1	1	1	1	1/2	1	1	1	1
3	2	2	1	1	1	1	1	1	1	1	1	1	1	1	1	1	1	1

			E		F		D, E, F		D		E		F		D, E, F		D, E, F	
$l_1$	$l_2$	$l_3$	$\tilde{\Phi}_1^3$	$\tilde{\Phi}_0^3$	$\tilde{\Phi}_1^3$	$\tilde{\Phi}_0^3$	$\tilde{\Phi}_1^4$	$\tilde{\Phi}_0^4$	$\tilde{\Phi}_1^5$	$\tilde{\Phi}_0^5$	$\tilde{\Phi}_1^5$	$\tilde{\Phi}_0^5$	$\tilde{\Phi}_1^5$	$\tilde{\Phi}_0^5$	$\tilde{\Phi}_1^6$	$\tilde{\Phi}_0^6$	$\tilde{\Phi}_1^7$	$\tilde{\Phi}_0^7$
0	1	2	1/2	0	1/2	0	1	0	1/2	0	1/2	0	1/2	0	1	0	1	0
0	2	1	1	0	1	0	1/2	0	1	0	1	0	1	0	1	0	1	0
0	2	2	1	1	1	0	1	1	1	0	1	1	1	0	1	1	1	1
1	0	2	0	0	1/3	0	1	0	1	0	0	0	1	0	2/3	0	1	0
1	1	1	1/3	0	1/2	0	1	0	1	0	1	0	1	0	1	0	1	0
1	1	2	1/3	1/3	2/3	1/3	1	1	1	1/2	1	1	1	1/2	1	2/3	1	1
1	2	0	1/3	0	1/3	0	1	0	1	0	1	0	1	0	1/3	0	1	0
1	2	1	1	2/3	1	1/3	1	1	1	1	1	1	1	1	1	1	1	1
1	2	2	1	1	1	1	1	1	1	1	1	1	1	1	1	1	1	1
2	0	1	1/3	0	2/3	0	1	0	1	0	1	0	1	0	1	0	1	0
2	0	2	1/3	1/3	2/3	1/3	1	1	1	1	1	1	1	1	1	1/3	1	1
2	1	0	1/6	0	1/6	0	1	0	1/2	0	1/2	0	1	0	2/3	0	1	0
2	1	1	2/3	1/2	5/6	1/3	1	1	1	1	1	1	1	1	1	1	1	1
2	1	2	4/6	4/6	5/6	3/6	1	1	1	1	1	1	1	1	1	1	1	1
2	2	0	2/3	1/3	2/3	1/3	1	1	1	1	1	1	1	0	2/3	2/3	1	1
2	2	1	1	1	1	2/3	1	1	1	1	1	1	1	1	1	1	1	1
2	2	2	1	1	1	1	1	1	1	1	1	1	1	1	1	1	1	1
3	0	0	0	0	1	0	1	0	0	0	0	0	1	0	1	0	1	0
3	0	1	1	1	1	1	1	1/2	1	1	1	1	1	1	1	1	1	1
3	0	2	1	1	1	1	1	1	1	1	1	1	1	1	1	1	1	1
3	1	0	1/2	1/2	1	0	1	1	1/2	1/2	1/2	1/2	1	0	1	1	1	1
3	1	1	1	1	1	1	1	1	1	1	1	1	1	1	1	1	1	1
3	1	2	1	1	1	1	1	1	1	1	1	1	1	1	1	1	1	1
3	2	0	1	1	1	0	1	1	1	1	1	1	1	0	1	1	1	1
3	2	1	1	1	1	1	1	1	1	1	1	1	1	1	1	1	1	1
3	2	2	1	1	1	1	1	1	1	1	1	1	1	1	1	1	1	1

Table 2.10: The survival signatures of component of Type 2 in Case 0, 1, 2, 3, 4, 5, 6 and 7

$l_1$	$l_2$	$l_3$	G		H		G		H		G		H	
			$\tilde{\Phi}_1$	$\tilde{\Phi}_0$	$\tilde{\Phi}_1$	$\tilde{\Phi}_0$	$\tilde{\Phi}_1^1$	$\tilde{\Phi}_0^1$	$\tilde{\Phi}_1^1$	$\tilde{\Phi}_0^1$	$\tilde{\Phi}_1^2$	$\tilde{\Phi}_0^2$	$\tilde{\Phi}_1^2$	$\tilde{\Phi}_0^2$
0	2	1	1/3	0	1/3	0	1/3	0	1/3	0	1	0	1	0
0	3	0	0	0	1	0	0	0	1	0	0	0	1	0
0	3	1	1	1	1	0	1	1	1	0	1	1	1	0
1	1	1	2/9	0	2/9	0	2/3	0	2/3	0	2/3	0	2/3	0
1	2	0	1/9	0	1/9	0	1/3	0	1	0	1/3	0	1	0
1	2	1	5/9	3/9	5/9	1/9	1	1	1	1/3	1	1	1	1/3
1	3	0	1/3	1/3	1	1/3	1	1	1	1	1/3	1/3	1	1/3
1	3	1	1	1	1	1/3	1	1	1	1	1	1	1	1/3
2	0	1	1/3	0	1/3	0	1	0	1	0	1/3	0	1/3	0
2	1	0	1/9	0	1/9	0	1/3	0	1	0	1/3	0	1	0
2	1	1	5/9	3/9	5/9	1/9	1	1	1	1/3	1	1	1	1/3
2	2	0	3/9	2/9	6/9	2/9	2/3	2/3	1	2/3	2/3	2/3	1	2/3
2	2	1	7/9	6/9	7/9	3/9	1	1	1	2/3	1	1	1	2/3
2	3	0	2/3	2/3	1	2/3	1	1	1	1	2/3	2/3	1	2/3
2	3	1	1	1	1	2/3	1	1	1	1	1	1	1	2/3
3	0	0	0	0	1	0	0	0	1	0	0	0	1	0
3	0	1	1	1	1	0	1	1	1	0	1	1	1	0
3	1	0	1/3	1/3	1	1/3	1/3	1/3	1	1/3	1	1	1	1
3	1	1	1	1	1	1/3	1	1	1	1/3	1	1	1	1
3	2	0	2/3	2/3	1	2/3	2/3	2/3	1	2/3	1	1	1	1
3	2	1	1	1	1	2/3	1	1	1	2/3	1	1	1	1
3	3	0	1	1	1	1	1	1	1	1	1	1	1	1
3	3	1	1	1	1	1	1	1	1	1	1	1	1	1

$l_1$	$l_2$	$l_3$	G, H		G		H		G, H		G, H		G, H	
			$\tilde{\Phi}_1^3$	$\tilde{\Phi}_0^3$	$\tilde{\Phi}_1^4$	$\tilde{\Phi}_0^4$	$\tilde{\Phi}_1^4$	$\tilde{\Phi}_0^4$	$\tilde{\Phi}_1^5$	$\tilde{\Phi}_0^5$	$\tilde{\Phi}_1^6$	$\tilde{\Phi}_0^6$	$\tilde{\Phi}_1^7$	$\tilde{\Phi}_0^7$
0	2	1	1/3	0	1	0	1	0	1/3	0	1	0	1	0
0	3	0	1	0	0	0	1	0	1	0	1	0	1	0
0	3	1	1	1	1	1	1	0	1	1	1	1	1	1
1	1	1	2/9	0	1	0	1	0	2/3	0	2/3	0	1	0
1	2	0	4/9	0	1	0	1	0	1	0	1	0	1	0
1	2	1	5/9	4/9	1	1	1	1	1	1	1	1	1	1
1	3	0	1	1/3	1	1	1	1	1	1	1	1/3	1	1
1	3	1	1	1	1	1	1	1	1	1	1	1	1	1
2	0	1	1/3	0	1	0	1	0	1	0	1/3	0	1	0
2	1	0	4/9	0	1	0	1	0	1	0	1	0	1	0
2	1	1	5/9	4/9	1	1	1	1	1	1	1	1	1	1
2	2	0	7/9	2/9	1	1	1	1	1	2/3	1	2/3	1	1
2	2	1	7/9	7/9	1	1	1	1	1	1	1	1	1	1
2	3	0	1	2/3	1	1	1	1	1	1	1	2/3	1	1
2	3	1	1	1	1	1	1	1	1	1	1	1	1	1
3	0	0	1	0	0	0	1	0	1	0	1	0	1	0
3	0	1	1	1	1	1	1	0	1	1	1	1	1	1
3	1	0	1	1/3	1	1	1	1	1	1/3	1	1	1	1
3	1	1	1	1	1	1	1	1	1	1	1	1	1	1
3	2	0	1	2/3	1	1	1	1	1	2/3	1	1	1	1
3	2	1	1	1	1	1	1	1	1	1	1	1	1	1
3	3	0	1	1	1	1	1	1	1	1	1	1	1	1
3	3	1	1	1	1	1	1	1	1	1	1	1	1	1

Table 2.11: The survival signatures of component of Type 3 in Case 0, 1, 2, 3, 4, 5, 6 and 7

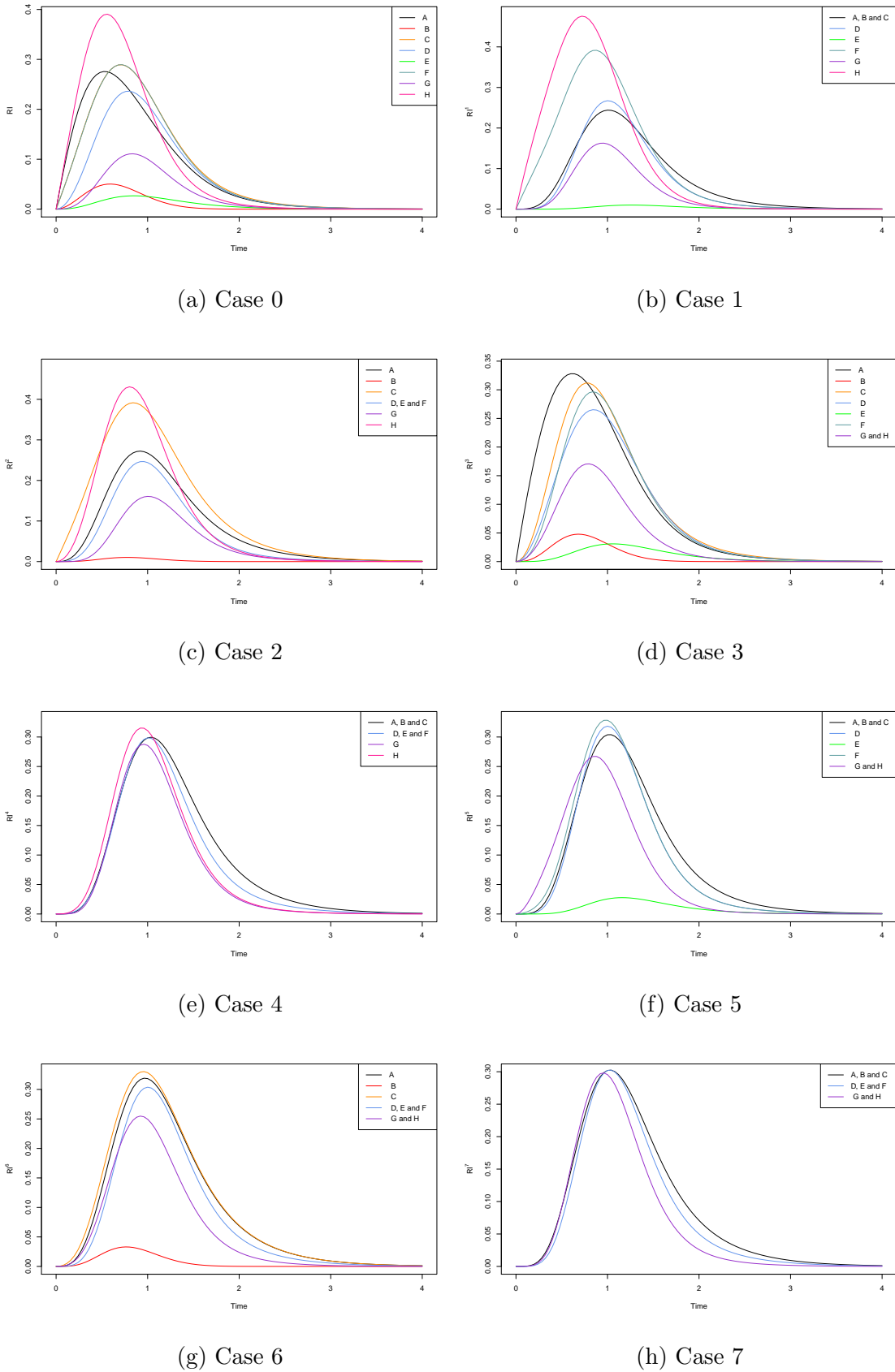

Figure 2.8: The relative importance indices of components in Figure 2.5

## 2.4 Joint reliability importance (JRI)

We consider the joint reliability importance index  $JRI$  of components  $i$  and  $j$ , given by the following equation:

$$\begin{aligned} JRI_{i,j}(t) = & P(T_S > t | T_i > t, T_j > t) - P(T_S > t | T_i > t, T_j \leq t) \\ & - P(T_S > t | T_i \leq t, T_j > t) + P(T_S > t | T_i \leq t, T_j \leq t) \end{aligned}$$

for  $t > 0$  [8]. The joint reliability importance  $JRI$  is a measure of interaction of the two components in a system with regard to their contribution to the system reliability. The value of  $JRI$  indicates that one component is more or less important, or has the same importance, when the other is functioning. If  $JRI > 0$  then one component becomes more important when the other is functioning (so they can be regarded as ‘complements’). If  $JRI < 0$  then one component becomes less important when the other is functioning (‘substitutes’), while if  $JRI = 0$  then one component’s importance is unchanged by the functioning of the other [8]. We consider again the influence of possible swaps on the joint reliability importance of components. The importance measure and the approach considered in this section can be generalized quite straightforwardly to joint importance of more than two components, but this tends to be of less practical relevance. Computing the conditional survival functions given the states of two components is again quite straightforward, and requires the computation of the corresponding survival signatures. We illustrate this using the same two systems and scenarios considered in Examples 2.2.1 and 2.2.5, and also in Examples 2.3.1 and 2.3.2.

**Example 2.4.1** We consider the  $JRI$  of each pair of components in Figure 2.1 for the same swapping case introduced in Example 2.2.1. The joint reliability importance of components A and B in Case 0, in which there is no swapping possible, is denoted by  $JRI_{A,B}$ . Note that, given the states of these two components, the only variable left is the number of functioning components of Type 2, so components C and D, hence we can represent the survival signatures given the states of components A and B as a function of only  $l_2$ , the number of functioning components of Type 2. Table 2.12 presents the survival signatures  $\tilde{\Phi}_{1,1}(l_2)$ ,  $\tilde{\Phi}_{1,0}(l_2)$ ,  $\tilde{\Phi}_{0,1}(l_2)$  and  $\tilde{\Phi}_{0,0}(l_2)$



$l_2$	$\tilde{\Phi}_{1,1}$	$\tilde{\Phi}_{1,0}$	$\tilde{\Phi}_{0,1}$	$\tilde{\Phi}_{0,0}$
0	1	0	0	0
1	1	1	0	0
2	1	1	0	0

Table 2.12: Survival signatures given states of components A and B

in Case 0, where the first subscript represents the state of component A and the second the state of component B.

The *JRI* for components A and B can be derived by

$$JRI_{A,B}(t) = \sum_{l_2=0}^2 \left[ \Phi_{1,1}(l_2) - \tilde{\Phi}_{1,0}(l_2) - \tilde{\Phi}_{0,1}(l_2) + \tilde{\Phi}_{0,0}(l_2) \right] P(C_t^2 = l_2)$$

leading to

$$JRI_{A,B}(t) = [F_2(t)]^2$$

By the same method we derive

$$JRI_{A,C}(t) = JRI_{A,D}(t) = [F_1(t)][F_2(t)]$$

$$JRI_{B,C}(t) = JRI_{B,D}(t) = -[1 - F_1(t)][F_2(t)]$$

$$JRI_{D,C}(t) = -[F_1(t)][1 - F_1(t)]$$

These joint reliability indices are presented in Figure 2.9(a), where the same component failure time distributions have been assumed as in Example 2.2.1. These joint reliability indices will be compared to the similar indices in the case of component swaps being possible later in this example.

We now consider the same possible component swap as in Example 2.2.1, that is component B can take over the role of component A if needed. Let  $JRI_{i,j}^1(t)$  denote the joint reliability importance of components  $i$  and  $j$  in Case 1, so with this swap being possible. To calculate  $JRI_{i,j}^1(t)$ , we first compute the four survival signatures corresponding to this swap in Case 1 and conditioned on the respective states for

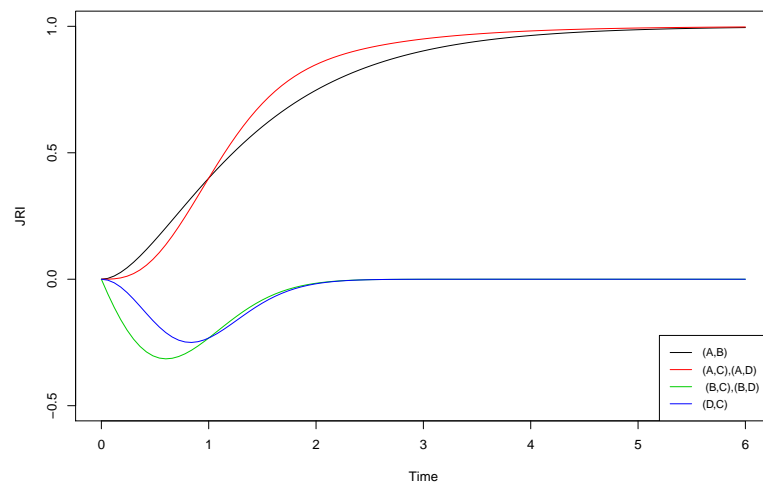

(a) Case 0

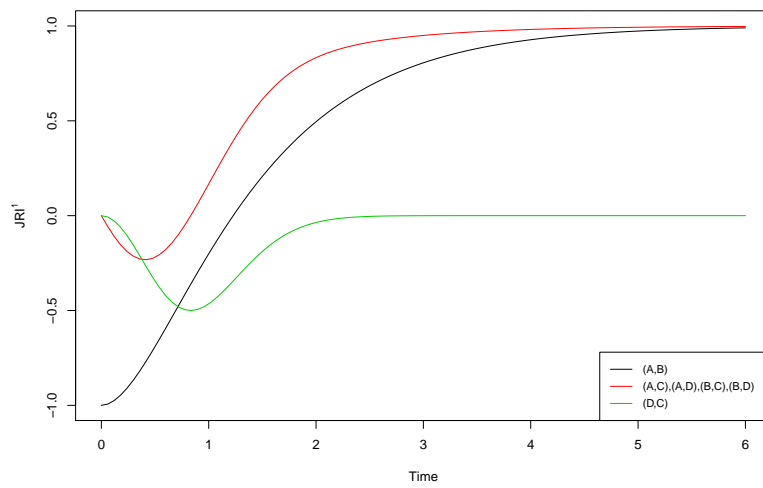

(b) Case 1

Figure 2.9: JRI of each pair of components in Figure 2.1

components  $i, j$ . This leads to the following results

$$JRI_{A,B}^1(t) = [2[F_2(t)]^2] - 1$$

$$JRI_{A,C}^1(t) = JRI_{A,D}^1(t) = JRI_{B,C}^1(t) = JRI_{B,D}^1(t) = [2F_1(t) - 1][F_2(t)]$$

$$JRI_{D,C}^1(t) = -2[F_1(t)][1 - F_1(t)]$$

Figure 2.9(b) illustrate the JRI in Case 1. We can see that in Case 0, the pairs of components  $(A, B)$ ,  $(A, C)$  and  $(A, D)$  are each complementary, while  $(B, C)$ ,  $(B, D)$  and  $(D, C)$  are substitutes. It is clear by comparing these figures that the interaction of each pair of components with regard to their contribution to the system reliability is impacted by component swapping being possible. In particular, not all pairs are complements or substitutes for all  $t$  anymore, where particularly the joint reliability importance of the pair  $(A, B)$  is much affected by the swapping opportunity.

**Example 2.4.2** For the system in Figure 2.5, discussed in Examples 2.2.5 and 2.3.2, there are 28 pairs of components. We only briefly illustrate joint reliability importance for this system, by considering the JRI for components G and H in Cases 0, 2 and 3 considered before, namely Case 0 of no swaps being possible, Case 2 where components D, E, F (Type 2) can be swapped, and Case 3 where components G and H (Type 3) can be swapped. With the same component failure time distributions assumed as in Example 2.2.5, Figure 2.10 presents these three JRIs. In Case 0 the components  $G$  and  $H$  are complementary. The possible swapping in Case 2 has the effect that components  $G$  and  $H$  become reliability substitutes. In Case 3, in which we can swap these two components with each other, they become reliability complements until a specific time point and they become reliability substitutes after that time, of course the precise times involved depends on the failure time distributions of all components.

## 2.5 Concluding remarks

In this chapter, we have considered quantification of system reliability if some components can be swapped upon failure. Based on the survival signature concept that

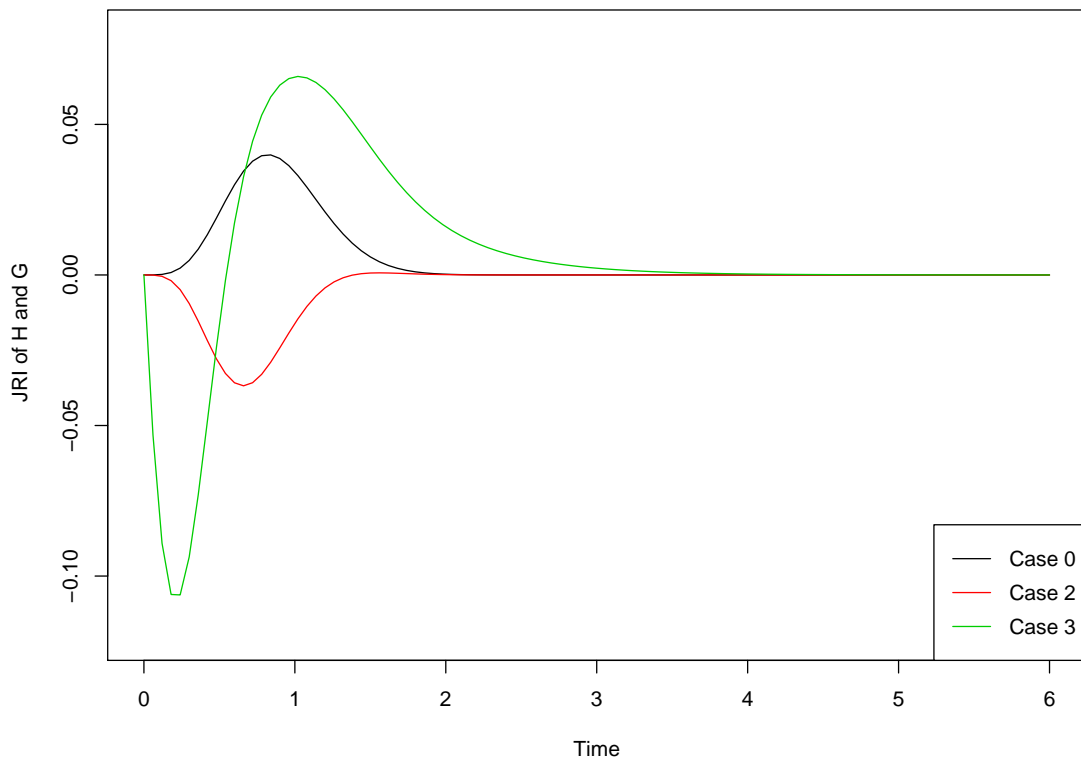

Figure 2.10: JRI for components G and H in Figure 2.5

was introduced by [18], we introduced two different approaches to quantify the reliability of the system if its components can be swapped upon failure. In the first approach the effect of a defined swapping regime is fully taken into account through the system structure function, and hence the survival signature. In the second approach, the effect of such a component swap is taken into account through the failure times of specific locations. While the same reliability information can be obtained by both approaches, the first one is more attractive than the second one, since it has continued with the same advantage of survival signature by modeling the structure of systems and separating it from the random failure time of components. However, in the second approach the lifetime distributions become extremely complex and may not be feasible if one has a variety of swapping opportunities. This thesis considers only the first approach for reliability assessment if some components can be swapped. We considered component importance, which was particularly simplified

by the use of the survival signature.

The approach of increasing system reliability through swapping components upon failure that is proposed in this chapter is quite interesting since it makes the system resilient to possible faults and it will not increase the weight and volume of the system. This approach can be used in the systems that are not easily accessible for repair and replacements and it could enable preparation of substantial repair activities. What is more important and needs to be emphasized is that, in the proposed approach, the reliability and number of the components don't need to be increased to improve the reliability of the system.

A further interesting topic for future research is the possibility to swap components when they are all still functioning. This could be attractive if one has the opportunity to swap components of different types where a critical component may, while still functioning, be swapped with another component at a certain time if they have different hazard rates over time. For example, a component with increasing hazard rate may be best to use in a critical part of the system in early stages, to then be swapped by a component with decreasing hazard rate to improve system reliability at later stages. Further research also is to study the contribution that swaps can make to system resilience in comparison to other activities, including more in-built redundancy, standby components, or maintenance and replacement activities. It could also consider other importance measures.

The effect of the swapping of components is entirely reflected through the change in the survival signature. It may be of interest to investigate whether or not this change can also be reflected by a distortion of the component reliabilities [59], which may provide a further tool for comparison of different systems and different swapping routines. It has been shown that very efficient simulation methods can be based on the survival signature [49]. The same simulation method can perhaps also be used to only learn about difference in reliability for two swapping regimes.

The approach presented in this thesis requires repeated calculation of survival signatures. Aslett [6] has created a function in the statistical software R to compute the survival signature, given a graphical presentation of the system structure. This will be necessary for our work for systems that are not very small, and it will

be of interest to create a tool that can automatically compute all the survival signatures required in case of a substantial system with many component swapping opportunities.

# Chapter 3

## Cost effective component swapping to increase system reliability

### 3.1 Introduction

In Chapter 2, we have used the concept of survival signature to quantify the reliability of systems when there is a possibility to swap components upon failure. Swapping components, if possible, is likely to incur some costs, for example for the actual swap or to prepare components to be able to take over functionality of another component. In this chapter, we consider the cost effectiveness of component swapping over a fixed period of time, and also over an unlimited time horizon from the perspective of renewal theory [64]. In Section 3.2, we consider the cost effectiveness of component swapping under the assumption that a system would need to function for a given period of time, where failure to achieve this incurs a penalty cost. The expected penalty costs of system failure when the different swap scenarios are applicable are compared with the option not to enable swaps. In Section 3.3, we study the cost effectiveness of component swapping from the perspective of renewal theory. We assume that the system is entirely renewed upon failure, at a known cost, and we compare different swapping scenarios. We also study the effect of components swapping on possible preventive replacement actions. We end this

chapter with some concluding remarks in Section 3.4.

## 3.2 Penalty costs for system failure with component swapping

In this section, we consider the cost effectiveness of component swapping over a fixed period of time under the assumption that a system would need to function for a given period of time, where failure to achieve this incurs a penalty cost. We consider time independent penalty costs in Section 3.2.1 and time dependent penalty cost in Section 3.2.2.

### 3.2.1 Time independent penalty costs

Suppose that we have a system which needs to function for a fixed period of time  $[0, \tau]$ . If the system fails at any time  $t$  before the fixed time  $\tau$ , a penalty cost needs to be paid. This penalty cost is fixed, independent of the failure time, and denoted by  $c_p$ . Let  $T_S$  denote the random failure time of the system, so  $R(\tau) = P(T_S \geq \tau)$ , is the probability that the system functions, and  $1 - R(\tau) = P(T_S < \tau)$  is the probability that the system fails before  $\tau$ . We refer to the situation in which there is no swapping opportunity as Case 0. Let  $C(\tau)$  denote the expected cost of failure of system in Case 0, then

$$C(\tau) = c_p(1 - R(\tau)) \quad (3.2.1)$$

We assume that the system can benefit from different swapping opportunities if it fails before  $\tau$ . An upfront cost may need to be paid out to enable each swapping opportunity. Let  $c_w$  denote the cost to enable swap Case  $w$ . We need to consider up front which opportunity of swapping cases will minimize the expected cost. The probability that the system survives until  $\tau$  if a specified swapping regime is applicable defined by  $R^w(\tau)$ . Let  $C^w(\tau)$  denote the expected cost if the specified swapping regime is applicable, then

$$C^w(\tau) = c_w + c_p(1 - R^w(\tau)) \quad (3.2.2)$$



### 3.2.2 Time dependent penalty costs

In this section we assume that the penalty costs that need to be paid if the system fails before a fixed time  $\tau$  is dependent on the failure time. Let  $c_u$  represents the cost per unit of time if the system does not function in the period  $[0, \tau]$ . If the system fails at time  $T_S \in [0, \tau]$ , then the downtime is  $\tau - T_S$  and the downtime cost is equal to  $c_u(\tau - T_S)$ . Let  $C(\tau)$  denote the expected cost in Case 0, so,  $C(\tau) = c_u E(\tau - T_S)$ . We assume that  $F(0) = 0$ , so the system functions at  $t = 0$ . We have

$$E(\tau - T_S) = \int_0^\tau (\tau - t)f(t)dt = \tau[F(\tau) - F(0)] - \int_0^\tau tf(t)dt \quad (3.2.3)$$

To find  $\int_0^\tau tf(t)dt$ , let us substitute  $t = \int_0^t du$ , so,

$$\begin{aligned} \int_0^\tau tf(t)dt &= \int_0^\tau \int_0^t f(t)dudt = \int_0^\tau \int_u^\tau f(t)dtdu = \\ &= \int_0^\tau F(\tau) - F(u)du = \int_0^\tau (F(\tau) - 1)du + \int_0^\tau (1 - F(u))du = \\ &= \tau F(\tau) - \tau + \int_0^\tau R(u)du \end{aligned} \quad (3.2.4)$$

Substituting the result from Equation (3.2.4) to Equation (3.2.3), we get

$$E(\tau - T_S) = \tau - \int_0^\tau R(u)du$$

Therefore, the expected cost in Case 0 is

$$C(\tau) = c_u \left[ \tau - \int_0^\tau R(t)dt \right] \quad (3.2.5)$$

If the system can benefit from different swapping cases if it fails at any time before  $\tau$ , with an upfront cost  $c_w$  to enable the specified swaps, the expected cost with the specified swaps in place,  $C^w(\tau)$ , is equal to

$$C^w(\tau) = c_w + c_u \left[ \tau - \int_0^\tau R^w(t)dt \right] \quad (3.2.6)$$

where  $R^w(\tau)$  is the reliability of the system if the specified swaps is applicable.

**Example 3.2.1** Consider again the system in Figure 2.1 and the same swapping possibility as discussed in Example 2.2.1. We refer to the original case of the system

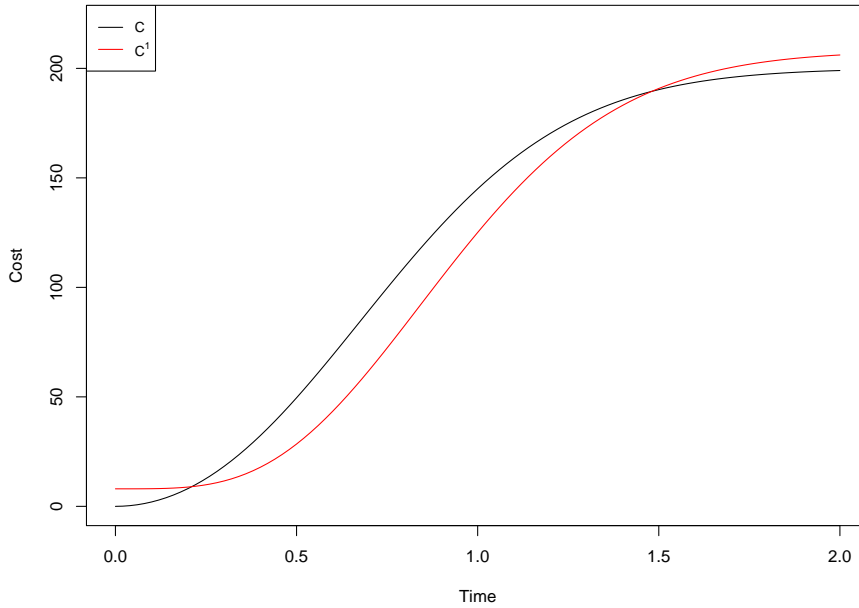

Figure 3.1: Cost with fixed penalty for the system in Figure 2.1

when there is no swapping possible between components as in Case 0. We refer to the case when components A and B can be swapped as Case 1. We use the same failure time distributions for Type 1 and Type 2 components as in Example 2.2.1, so the system has the same reliability in Cases 0 and 1 as in Example 2.2.1. Assume that the system needs to continue functioning for the period of time  $[0, 0.5]$ , if the system fails in this period, a fixed penalty cost  $c_p = 200$  needs to be paid. Let the cost to enable the swap in Case 1 be  $c_1 = 8$ . We want to compare the expected cost in Cases 0 and 1. The expected cost in Case 0 is  $C(0.5) = 49.57$  and the expected cost in Case 1 is  $C^1(0.5) = 28.45$ , which means that when  $\tau = 0.5$ , it is good to take the opportunity of the swap in Case 1. Figure 3.1 illustrates how the expected cost in Cases 0 and 1, change depending on the value of  $\tau$ . The opportunity of the swap in Case 1, minimizes the expected cost only if  $0.21 < \tau < 1.48$ , because if  $\tau$  is small, failure is unlikely and if  $\tau$  is large, failure is very likely even with the swap in Case 1.

Now assume that the penalty cost depends on the system failure time, and the cost per unit of time is  $c_u = 100$ . In this case, the cost in Case 0 is  $C(0.5) = 4.20$ ,

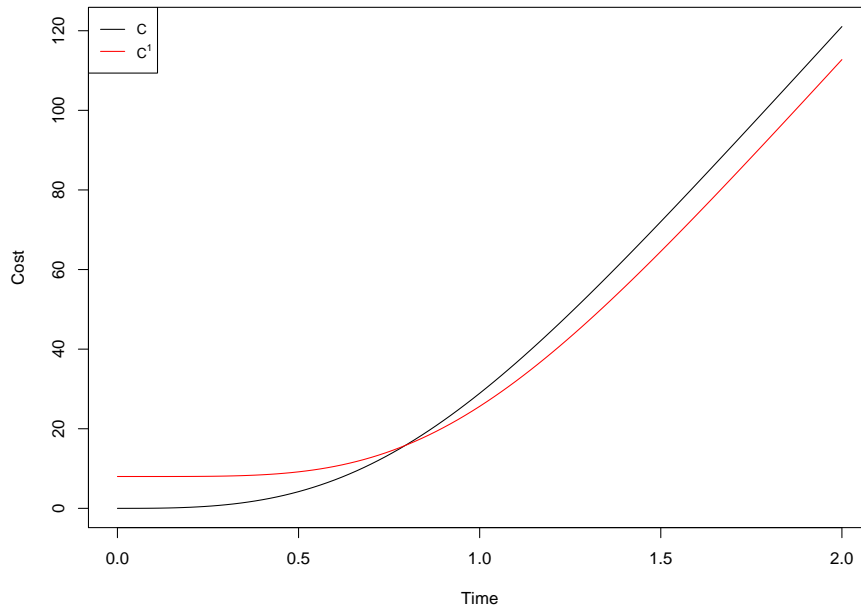

Figure 3.2: Cost with time dependent penalty for the system in Figure 2.1

and the cost in Case 1 is  $C^1(0.5) = 9.17$ , which means that when  $\tau = 0.5$ , the opportunity of the swap in Case 1 will increase the expected cost. However, when  $\tau = 1$ , we have  $C(1) = 28.91$  and  $C^1(1) = 25.63$ , which means that the expected cost has decreased with the opportunity of the swap, so it is good to enable the swap. Figure 3.2 illustrates how the expected cost in Cases 0 and 1 changes, depending on the value of  $\tau$ . It clear that if  $\tau$  is small, the system is unlikely to fail, while for large  $\tau$  the system is likely to fail but the swapping case delayed the failure time, leading to lower penalty costs.

**Example 3.2.2** For the system in Figure 2.5, 7 possible swap cases are discussed in Example 2.2.5. In this example, we only consider the swap Cases 0, 2, 3 and 5, namely Case 0 of no swaps being possible, Case 2 where components D, E, F (Type 2) can be swapped, Case 3 where components G and H (Type 3) can be swapped, and in Case 5 where both Type 2 and Type 3 components can be swapped. In each case the swap can be done only between components of the same type. With the same component failure time distributions assumed as in Example 2.2.5, the system reliability in Cases 0, 2, 3 and 5 are given in Example 2.2.5.

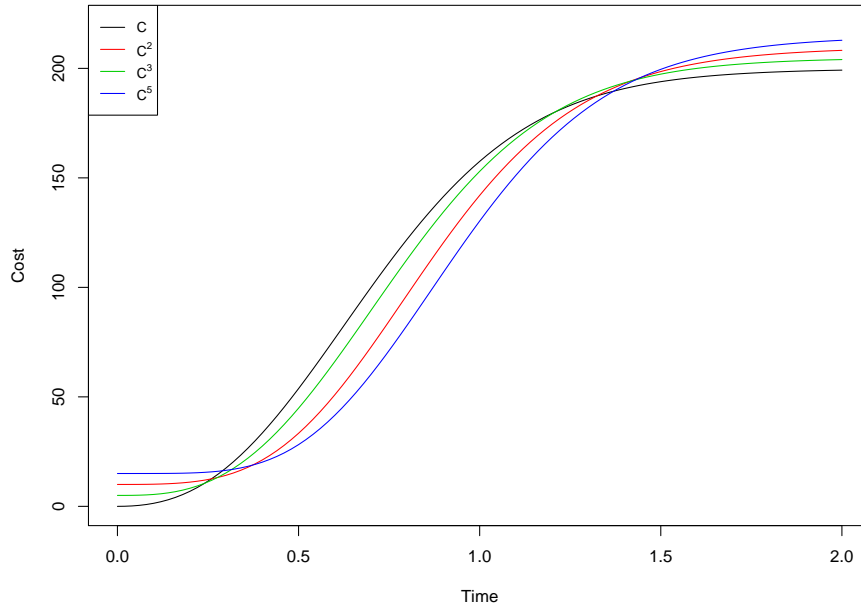

Figure 3.3: Cost with fixed penalty for the system in Figure 2.5

Assume that, if the system fails before the fixed time  $\tau = 1$ , the penalty cost is fixed and is  $c_p = 200$ . The costs to enable swapping Cases 2, 3 and 5 are  $c_2 = 10$ ,  $c_3 = 5$  and  $c_5 = 15$ , respectively. The expected cost in Case 0 is  $C(1) = 157.53$ , and the expected cost in Cases 2, 3 and 5 are  $C^2(1) = 142.00$ ,  $C^3(1) = 152.98$  and  $C^5(1) = 130.30$ , respectively, which means that the opportunity of swapping Case 5 should be taken to minimize the expected cost. We plot  $C(\tau)$ ,  $C^2(\tau)$ ,  $C^3(\tau)$  and  $C^5(\tau)$  as functions of  $\tau$  in Figure 3.3. It is clear from this figure that for values of  $\tau$  it is either optimal not to prepare for any swaps ( $\tau < 0.24$  or  $\tau > 1.37$ ), or to prepare for swap Case 5 ( $0.29 < \tau < 1.37$ ), this is explained by the same reason as discussed in Example 3.2.1.

Let  $c_u = 100$ . If  $\tau = 1$ , the expected costs in Cases 0, 2, 3 and 5 are  $C(1) = 31.54$ ,  $C^2(1) = 30.24$ ,  $C^3(1) = 31.59$ , and  $C^5(1) = 30.37$ , respectively. Thus, to minimize the expected cost is better to take the opportunity of the swap Case 2. If  $\tau = 2$ , the expected cost in Case 0 is  $C(2) = 126.06$ , and the expected cost in Cases 2, 3 and 5 are  $C^2(2) = 120.72$ ,  $C^3(2) = 124.77$  and  $C^5(2) = 117.96$ , respectively, so to minimize the expected cost in this case we should prepare for swapping Case 5.

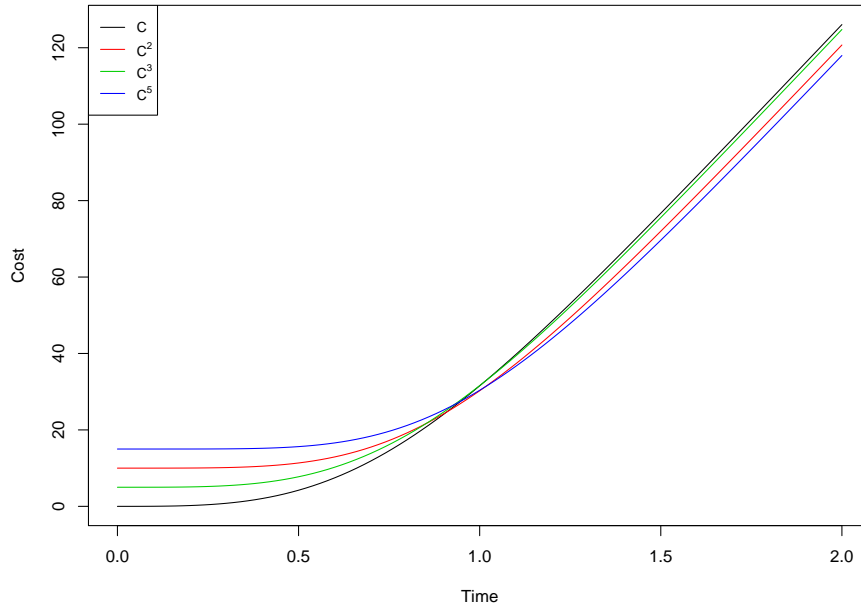

Figure 3.4: Cost with time dependent penalty for the system in Figure 2.5

Figure 3.4 illustrates how the expected cost in cases 0, 2, 3 and 5 would change depending on the value of  $\tau$ .

### 3.3 Optimal swapping based on renewal theory

In the previous section we considered the cost effectiveness of component swapping over a fixed period of time. In this section we consider the cost effectiveness of component swapping over an unlimited time horizon from the perspective of renewal theory.

Renewal theory is a well-known theory that has a wide application in the literature of Operational Research and Reliability see e.g. [20–22, 51, 66]. Renewal theory deals with successive occurrences of events in terms of random variables. A typical application of renewal theory is in failure or maintenance models. A system is installed at time 0. If it failed at some random time  $T_1 > 0$ , it is replaced by a new system. The new system lasts for a second random time  $T_2$ , with the same distribution as  $T_1 > 0$ . The same process goes on for an undefined length of time. This replacement process might be considered in general either because the system

is not accessible for repair or the cost of repairs are higher than the cost of replacement. An example of the system may be something simple like a light-bulb, or it may be something more complicated like a hard disk for an internet server or a GPS satellite.

Many applications of renewal theory involve rewards or cost. The optimal reward or cost per unit of time over a very long period of time is derived by renewal reward theory [9], assuming that the same process goes on for infinity or undefined length of time. In practice, although one acknowledges the fact that assuming such a long period for the same process may not be realistic, renewal reward theory is still often considered attractive and reasonable since it provides a mathematically convenient way to compute the optimal costs per unit of time.

Here are some mathematical definitions. Suppose that the same process goes on for infinity or undefined length of time. This process is assumed to consist of consecutive cycles which are stochastic copies of each other.  $T_1, T_2, T_3, \dots$  is a sequence of independently and identically distributed random variable representing the length of the cycles.  $T_i$  represents the length of the cycle  $i$ ,  $0 \leq T_i \leq \infty$  and it indicates the time between the occurrence of the  $(i-1)^{th}$  and the  $i^{th}$  events (renewals). It is assumed that these random variables have a known probability distribution, with CDF  $F(t) = P(T_i \leq t)$ ,  $t \geq 0$ ,  $i = 1, 2, \dots$ , probability density function (pdf)  $f(t)$ , reliability function  $R(t) = P(T_i > t)$  and expected value  $0 < E(T_i) < \infty$ . The time to the  $i^{th}$  renewal, denoted by  $S_i$ , is  $S_i = \sum_{k=1}^i T_k$ . The number of renewals up to time  $t$  is denoted by the random variable  $N(t)$  and is equal to the largest integer  $i \geq 0$  for which  $S_i \leq t$ .  $N(t)$  is called a renewal counting process [64].

Let  $W_i$  be a random cost associated with  $i$  cycle. It is assumed that the sequence of random variable  $W_1, W_2, \dots$  are *i.i.d.*, but dependence of  $W_i$  on  $T_i$  is possible. The accumulative costs up to time  $t$  are denoted by  $W(t)$ , so  $W(t) = \sum_{i=1}^{N(t)} W_i$  and  $W(t)$  is called a renewal reward process. The long run average reward cost per unit of time,  $g$ , for a renewal reward process is given by the reward reward theory [64],

$$g = \lim_{t \rightarrow \infty} \frac{W(t)}{t} = \frac{E[W_i]}{E[T_i]} \quad (3.3.7)$$

Assume that we have a system that is entirely renewed upon failure for a long period of time. The reliability of this system might be enhanced by component swapping. Some components that are tasked with minor functions can be prepared to take over crucial functions in case another component fails. Let  $T$  denote the system random failure time. If the system is entirely renewed upon failure, the length between renewals is equal to the random failure time of the system  $T$ .  $R(t) = P(T > t)$  is the reliability of the system. The expected failure time of the system is  $E[T] = \int_0^\infty tf(t)dt = \int_0^\infty R(t)dt$ . If this system is entirely renewed upon failure at a known cost  $c_f$ , then the expected renewal cost is  $E[W] = c_f$ . Therefore, the long run average cost per unit of time,  $g$ , for the renewal system, is given by

$$g = \frac{c_f}{\int_0^\infty R(t)dt} \quad (3.3.8)$$

If we assume that the system can benefit upon failure of its components from a defined component swap.  $T^w$  is the random failure time of the system when the defined swap is applicable.  $T^w$  represents the length of time between renewals when the defined swap is applicable. The reliability of the system if the defined swap is applicable is  $R^w(t) = P(T^w > t)$ . Let  $c_w$  be an upfront cost needed to be paid to enable the defined swap. The long run average cost per unit of time for the renewal system if the defined swap is applicable is denoted by  $g^w$ , and is given by

$$g^w = \frac{c_f + c_w}{\int_0^\infty R^w(t)dt} \quad (3.3.9)$$

### 3.3.1 Preventive Replacement

A well known application of renewal reward theory is age replacement [64]. Age replacement requires a system to be renewed when it reaches a specified age  $A_r > 0$  (preventive replacement) or if it fails prior the specified age  $A_r$  (corrective replacement), in a manner that is most cost-effective. The optimal preventive replacement age is the one that leads to the minimum expected costs per unit of time and is derived from applying the renewal reward theory [9].

Assume that the system is entirely renewed upon reaching a specified age  $A_r$  at a known cost  $c_r > 0$ , or upon failure at a known cost  $c_f > c_r$ . The cost per renewal

is  $c_r$  with probability  $R(A_r)$  and  $c_f$  with probability  $[1 - R(A_r)]$ , so the expected renewal cost  $E[W] = c_r R(A_r) + c_f [1 - R(A_r)]$ . The length between renewals is equal to  $\min(T_S, A_r)$ . Thus, the expected length between renewal is  $E[\min(T_S, A_r)] = \int_0^\infty \min(t, A_r) f(t) dt = \int_0^{A_r} t f(t) dt + A_r \int_{A_r}^\infty f(t) dt = \int_0^{A_r} R(t) dt$ . Thus, the long run average cost per unit of time,  $g(A_r)$ , is given by

$$g(A_r) = \frac{c_r R(A_r) + c_f [1 - R(A_r)]}{\int_0^{A_r} R(t) dt} \quad (3.3.10)$$

If we assume that upon failure the system components can be swapped, then the expected length between renewals is  $E[\min(T^w, A_r)] = \int_0^{A_r} R^w(t) dt$  and the expected renewal costs are  $E[W] = c_r R^w(A_r) + c_f [1 - R^w(A_r)]$ . If the cost to enable a defined swap is  $c_w$  per cycle, then the long run average cost per unit of time for strategy  $A_r$  if the defined swap is applicable,  $g^w(A_r)$ , is given by

$$g^w(A_r) = \frac{c_r R^w(A_r) + c_f [1 - R^w(A_r)] + c_w}{\int_0^{A_r} R^w(t) dt} \quad (3.3.11)$$

It is clear from Equations (3.3.10) and (3.3.11) that the expected costs per unit of time depend on the renewal time, so we can find the optimal renewal time for the system in case there is no swap possible by setting  $\frac{dg(A_r)}{dA_r} = 0$ , and in the case of possible swap by setting  $\frac{dg^w(A_r)}{dA_r} = 0$ .

**Example 3.3.1** Consider again the system in Figure 2.1 and the same swapping possibility as discussed in Example 2.2.1. We refer to original case of the system when there is no swapping possible between components as Case 0. We refer to the case when components A and B can be swapped as Case 1. We use the same failure time distributions for Type 1 and Type 2 components as in Example 2.2.1, so the system has the same reliability in Cases 0 and 1 as Example 2.2.1. We assume that the system is entirely renewed upon failure at the cost  $c_f = 200$ . The long run average cost per unit of time of the original system is  $g = 253.01$ , and in Case 1 is  $g^1 = 217.96$ . Therefore, taking the opportunity of Case 1 swapping will minimize the expected cost per unit of time for the renewal system. In Figure 3.7, we plot the long run average cost per unit of time as a function of renewal cost,  $c_f$ . It is clear



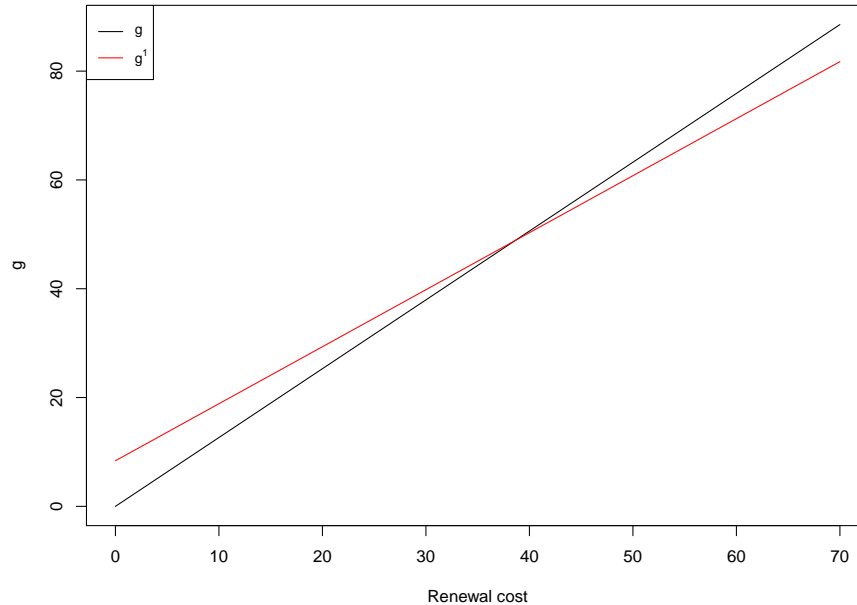

Figure 3.5: The long run average cost for the system in Figure 2.1

from this figure that if  $c_f > 38.60$ , it is good to take the opportunity of the swap but if  $c_f \leq 38.60$ , it is good not to take the swap opportunity.

Assume that preventive replacement is possible on this system when it is reaching a specified age  $A_r$  at cost  $c_r = 30$ , and if the system fails before  $A_r$  then the renewal cost upon failure is  $c_f = 200$ . Figure 3.8 presents the expected costs per unit of time in Cases 0 and 1, depending on the value of  $A_r$ . The points in this figure show the optimal renewal times. The optimal renewal time in Case 0 is  $A_r = 0.38$  with corresponding minimum cost  $g = 151.70$ . In Case 1 the optimal renewal time is  $A_r = 0.48$  with corresponding minimum cost  $g^1 = 113.31$ . It clear that enabling this swap delays the optimal renewal time and reduces the costs.

**Example 3.3.2** For the system in Figure 2.5, we again, consider as in Example 3.2.2 consider only the swap Cases 0, 2, 3 and 5 which we discussed in Example 2.2.5. Assume the same component failure time distributions as in Example 2.2.5, so the system reliabilities in Cases 0, 2, 3 and 5 are the same as in Example 2.2.5. Assume that the system is entirely renewed upon failure at the cost  $c_f = 200$ . The long run average cost per unit of time in Cases 0, 2, 3, and 5 are  $g = 270.06$ ,

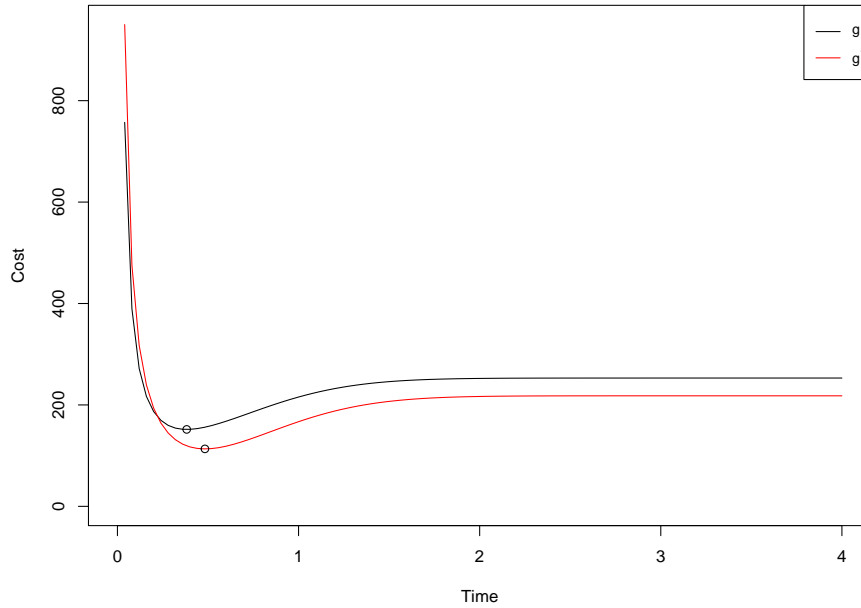

Figure 3.6: The cost with the preventive replacement for the system in Figure 2.1

$g^2 = 234.50$ ,  $g^3 = 255.09$ , and  $g^5 = 220.85$ , respectively. It is clear that if  $c_f = 200$ , taking the opportunity of any of the swap cases would minimize the cost, however, the maximum reduction in the cost is obtained by swap Case 5 followed by Case 2 then Case 3. In Figure 3.7, we present the long run average cost per unit of time as a function of  $c_f$ . We can see that if  $c_f \leq 47.69$ , is better not to prepare for any swaps, but if  $c_f > 47.69$  is good to prepare for the swap Case 5.

Assume now that the preventive replacement cost is  $c_r = 30$  and the corrective replacement cost  $c_f = 200$ . Figure 3.8 illustrates how the expected costs per unit of time in Cases 0, 2, 3 and 5 depends on the value of  $A_r$ . The points in this figure show the optimal renewal times. The optimal renewal times in Cases 0, 2, 3 and 5 are  $A_r = 0.3443592$ ,  $A_r = 0.4660438$ ,  $A_r = 0.3952356$  and  $A_r = 0.529294$ , respectively, and the minimum costs associated with these renewal times are  $g = 151.9113$ ,  $g^2 = 122.3783$ ,  $g^3 = 139.5121$  and  $g^5 = 113.3712$ . Thus, enabling swapping Case 5 minimizes the expected costs and delays the optimal replacement time.

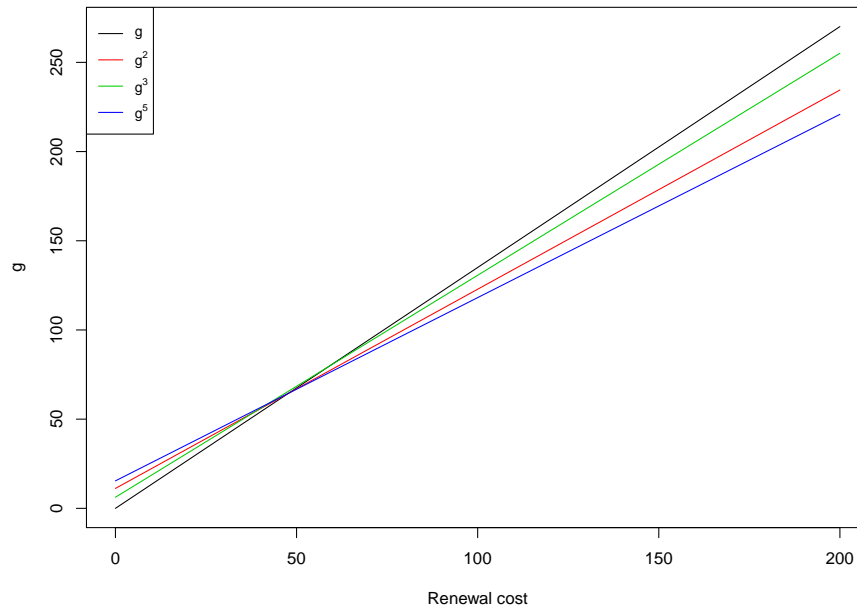

Figure 3.7: The long run average cost for the system in Figure 2.5

### 3.4 Concluding remarks

In this chapter we have discussed the cost effectiveness of component swapping over a fixed period of time. We derive two models (time independent and time dependent) of penalty costs of a system, in order to compare the expected costs for the system when there is a possibility to swap components with the option not to enable swaps.

The cost effectiveness of component swapping over an unlimited time horizon is also discussed from the perspective of renewal theory. It is assumed that the system is entirely renewed upon failure, at a known cost. The expected cost per unit of time for the renewal system when there are different swapping scenarios are compared with the option not to enable swaps, focusing on minimum expected costs. In addition, we discussed the meaningful effect that component swapping might have on the preventive replacement actions.

The results in this chapter show that although an upfront cost might need to be paid to enable each swapping scenario, the operation of component swapping might contribute significantly in reducing the expected cost of the system. The indicators in this chapter are useful in security assessment and risk management under the

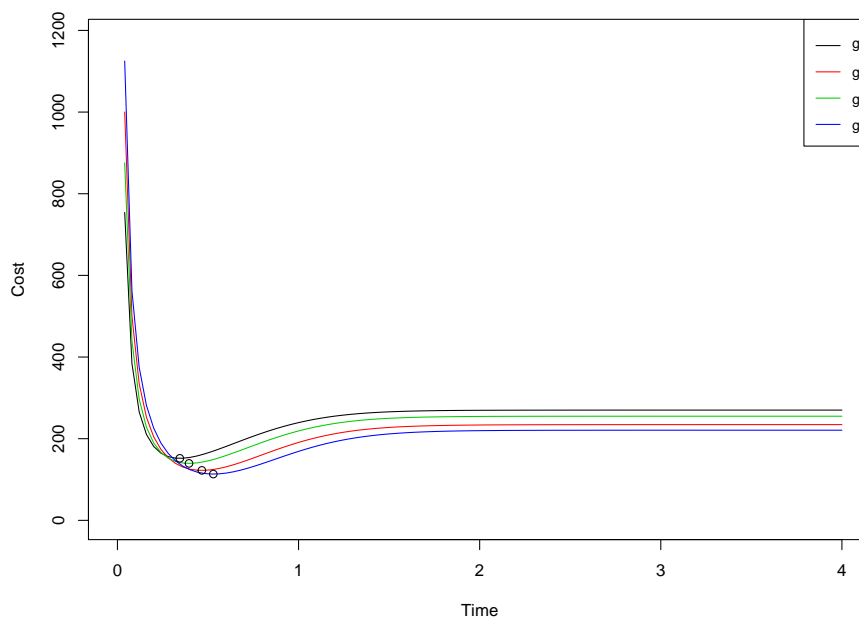

Figure 3.8: The cost with the preventive replacement for the system in Figure 2.5

constraint of cost.

Further interesting topics for future research are different cost structures and consideration of choice between swapping components, standby, spares and maintenance activities based on corresponding costs. It may also consider the possibility to combine components swapping with inspection models [10].

# Chapter 4

## Phased mission systems with components swapping

### 4.1 Introduction

A phased mission system (PMS) is defined as a system which performs a series of tasks in consecutive and non-overlapping periods (phases). In order for this system to accomplish its mission successfully, each phase has to be completed without any failure [68]. Therefore, the reliability of a PMS is the probability that the system functions in all phases.

An example of such a system is an aircraft flight which can be divided into three phases, namely take-off phase, cruise phase and landing phase. Each of these phases has completely different reliability requirements and behaviour. A distinct feature of a PMS is that the system configuration varies between phases while the component failures in different phases are mutually dependent. This feature makes the reliability analysis of PMS more complex than the reliability analysis of a single phase system.

Over the past few decades, there has been extensive research to analyse the reliability of a PMS. Some researchers focus on modelling the dependence among system components using state-based approaches, which are based on Markov models or Petri nets [13, 17, 26, 40]. Other approaches are based on combinatorial methods, such as binary decision diagram (BDD) or multi-valued decision diagram (MDD)

based models [53, 62, 63, 70]. Recently, a new combinatorial analytical approach providing a new survival signature methodology for reliability analysis of PMSs has been introduced [37]. This method has similar computational complexity to BDD methods, but for the first time brings all the advantages associated with the compact representation of a system provided by the survival signature to PMS. This method shows that the survival signature can be used for reliability analysis of PMS with similar types of components in each phase. It keeps the attractive survival signature property of separating the system structure from the component lifetime distributions, simplifying computation of insight into, and inference for system reliability.

It is often difficult for a PMS to work with high reliability. Generally, there are mainly two approaches that can be used to improve the reliability of the PMS and to prevent them from failure. The first way is increasing the component reliability (reliability allocation), and the other way is using redundant components in parallel (redundancy allocation) e.g. [3, 23, 43, 50]. Unfortunately, these two approaches will increase the cost of the PMS and do not always yield competitive results.

In this chapter, we extend the strategy of swapping components upon failure that was introduced in Chapter 2, to improve the reliability of PMS and to make them more resilient to component failure. We assume that if a component fails, it can be swapped by another one which is still functioning in order to prevent the PMS from failing. In addition, in this chapter we discuss another strategy that could be used to improve the reliability of PMS, which is swapping components according to structure importance. The structure importance is first used to measure the importance level of the components in contributing to system reliability, then when a component with high importance fails, it is swapped by another component in the system with lower importance which has not yet failed. In the strategy where if the components are swapped according to the structure importance, the swap will take place with disregard to whether the system can continue to function with the existing components in place or not, depending on the level of the importance of the component that is failed. However, in the strategy that if the components are swapped upon failure, the swap between component is done to prevent the PMS from the failure, so the swap takes place only when the PMS cannot continue

functioning with the existing components in place. The swap between components in both strategies is logically restricted to components of the same type.

It is attractive if we can consider the possibility of swapping components at any time during the mission. However, this cannot be realized in some PMSs, in which the swap between components can be done only at transitions of phases. In this chapter, we use the survival signature methodology as introduced by [37] to study the effect of swapping components in both strategies, that is swapping components upon failure and swapping component according to reliability importance, on the PMS reliability when the components can be swapped at any time during the mission or only at transitions of phases.

In this chapter we also extend the established cost models, presented in Chapter 3, to evaluate the expected costs of the failure of the PMS if there is a possibility to swap components at any time during the mission or only at transitions of phases, under the assumption that each phase of the system would need to complete its mission successfully, where failure to achieve this incurs a penalty cost allocated to each phase of not performing its mission. We consider two types of penalty costs, namely, time independent and time dependent costs. The expected costs when the two different scenarios of swapping possibilities are applicable are compared with the option not to enable swaps.

This chapter is organized as follows: Section 4.2 presents a brief background on phased mission systems. Section 4.3 considers the effect of swapping components upon failure on the PMS reliability under the two scenarios of swapping possibilities. Section 4.4 presents the effect of swapping components according to reliability importance on the PMS reliability, considering the two scenarios of swapping possibilities. Section 4.5 demonstrates two cost models to analyse the expected costs of the failure of the PMS if the components can be swapped at any time during the mission or only at transitions of phases. In each section, we illustrate the proposed strategies through numerical examples. We end this chapter with some concluding remarks.

## 4.2 Phased mission systems

A PMS performing a sequence of functions or tasks during consecutive phases to accomplish a specific mission. Generally, in a PMS, each phase corresponds to one configuration and the configuration changes from phase to phase. The states of the same component in different phases are mutually dependent. The PMS might have the same components in each phase or the components might vary from phase to phase. In this chapter we consider only PMSs with the same components used in each phase. What is important and needs to be emphasized is that, in this thesis, both the system and its components are assumed to be non-repairable during the mission, so if a component fails to function at the end of a certain phase, then it cannot work again in subsequent phases.

Consider a PMS with  $n$  components in each phase, with  $N \geq 2$  phases. The state of component  $j \in \{1, 2, \dots, n\}$  in phase  $i, i \in \{1, 2, \dots, N\}$  can be represented as a binary variable  $X_{i,j}$

$$X_{i,j} = \begin{cases} 1 & \text{component } j \text{ is functioning in phase } i \\ 0 & \text{component } j \text{ is failed in phase } i \end{cases} \quad (4.2.1)$$

The state of the system in phase  $i$  can then be described by a binary function

$$\phi_i = \phi_i(X_i) = \phi_i(X_{i,1}, \dots, X_{i,n}) \quad (4.2.2)$$

where  $\phi_i = 1$  represents that the system successfully works for the entire phase  $i$  and  $\phi_i = 0$  represents failure to do so. The vector  $X_i = (X_{i,1}, \dots, X_{i,n})$  represents the states of all components at the end of phase  $i$ .

Similarly, the structure function of the PMS is also a binary variable which is completely determined by the states of all the components during the mission

$$\phi_s = \phi_s(X) = \phi_s(X_{1,1}, \dots, X_{1,n}, \dots, X_{N,1}, \dots, X_{N,n}) \quad (4.2.3)$$

where  $X = (X_1, \dots, X_N) = (X_{1,1}, \dots, X_{1,n}, \dots, X_{N,1}, \dots, X_{N,n})$  is the state vector of the components during the entire phased mission. Because a PMS is functioning if and only if all its phases are completed without failure, the structure function of the PMS can be written as

$$\phi_s = \prod_{i=1}^N \phi_i(X_{i,1}, \dots, X_{i,n}) \quad (4.2.4)$$



When  $\phi_s = 1$ , this would provide a logical expression for the functioning of the system, while  $\phi_s = 0$  provides an expression for the failure of the system.

### 4.3 Swapping components upon failure

In this section, we consider the strategy of swapping components upon failure to increase PMS reliability under two scenarios of possibilities. First, we assume that if a component fails at any time during the mission, it can be swapped by another one which is still functioning. Secondly, we assume that the possibilities of component swapping can occur only at transitions of phases, which means that when a PMS fails during a certain phase, then no immediate swapping opportunities exist, so the system fails. The swap between components is logically restricted to components of the same type. We further assume here that such a swap of components can be done only when the system cannot function with the existing components in place. Section 4.3.1 considers the effect of swapping components upon failure on PMS with single type of components. Section 4.3.2 considers the effect of swapping components upon failure on PMS with multiple types of components.

#### 4.3.1 PMS with single type of components

In this section we consider the simplest case in which a system with  $n$  components of the same type that performs a  $N \geq 2$  phase mission. Phase  $i \in \{1, 2, \dots, N\}$  runs from time  $\tau_{i-1}$  to time  $\tau_i$  with  $\tau_0 = 0$  and  $\tau_{i-1} < \tau_i \forall i$ . The survival signature  $\Phi_S(l_1, l_2, \dots, l_N)$  denotes the probability that the PMS functions by the end of the mission given that precisely  $l_i$ ,  $i \in \{1, 2, \dots, N\}$ , of its components functioned in phase  $i$ . It is assumed that the random failure times of components in the same phase are fully independent and exchangeable [37]. If  $N(t) \leq N$  is the phase that the system is in at time  $t$ , the survival signature of the first  $N(t)$  phases  $\Phi_S(l_1, l_2, \dots, l_{N(t)})$  is equal to

$$\Phi_S(l_1, l_2, \dots, l_{N(t)}) = \left( \prod_{i=1}^{N(t)} \binom{m_i}{l_i}^{-1} \right) \times \sum_{X \in S} \phi_s(X) \quad (4.3.1)$$

where  $S$  denotes the set of all possible state vectors for which  $l_i$  components function in phase  $i$ , and  $m_i$  is the number of components that function at the beginning of phase  $i$ . Because both the system and its components are non-repairable during the mission, the number of components that function at the beginning of phase  $i$  should be equal to the number of components that function at the end of phase  $i - 1$ . So,  $m_i = l_{i-1}$  while  $m_1 = n$  [37]. The reliability of the PMS at time  $t$  is given by

$$R(t) = \sum_{l_1=0}^{m_1} \dots \sum_{l_{N(t)}=0}^{m_{N(t)}} \left[ \Phi_S(l_1, \dots, l_{N(t)}) P \left( \bigcap_{i=1}^{N(t)} \{C_i(t) = l_i\} \right) \right] \quad (4.3.2)$$

where  $C_i(t)$  denotes the number of components that function in phase  $i$  at time  $t \in [\tau_{i-1}, \tau_i)$  [37].

In this chapter we consider only PMS with the same components in each phase, which means that all components appear in all phases and they age together. If the components have a common CDF  $F(t)$ , its conditional CDF in phase  $i$  is  $F_i(t)$  at time  $t \in [\tau_{i-1}, \tau_i)$ , conditioned on the system working at the beginning of phase  $i$ , this is conditional CDF

$$\begin{aligned} F_i(t) &= P(T < t | \tau_{i-1}, \tau_i, T > \tau_{i-1}) \\ &= \frac{1}{1 - F(\tau_{i-1})} \int_{\tau_{i-1}}^{\min\{t, \tau_i\}} dF(z) \\ &= \frac{F(\min\{t, \tau_i\}) - F(\tau_{i-1})}{1 - F(\tau_{i-1})} \end{aligned} \quad (4.3.3)$$

where  $\tau_{i-1}$  is the start time of phase  $i$ ,  $\tau_0 \equiv 0$ , and  $T$  is the random variable represents the component lifetime. From Equation (4.3.3), the last part of Equation (4.3.2) can be simplified as

$$P \left( \bigcap_{i=1}^{N(t)} \{C_i(t) = l_i\} \right) = \prod_{i=1}^{N(t)} P(C_i(t) = l_i) = \prod_{i=1}^{N(t)} \left( \binom{m_i}{l_i} [1 - F_i(t)]^{l_i} [F_i(t)]^{m_i - l_i} \right) \quad (4.3.4)$$

Thus, the reliability of the PMS at time  $t$  can be rewritten as

$$R(t) = \sum_{l_1=0}^{m_1} \dots \sum_{l_{N(t)}=0}^{m_{N(t)}} \left[ \Phi_S(l_1, \dots, l_{N(t)}) \prod_{i=1}^{N(t)} \left( \binom{m_i}{l_i} [1 - F_i(t)]^{l_i} [F_i(t)]^{m_i - l_i} \right) \right] \quad (4.3.5)$$

where

$$F_i(t) = \frac{F(\min\{t, \tau_i\}) - F(\tau_{i-1})}{1 - F(\tau_{i-1})} \quad (4.3.6)$$

is the conditional CDF of the components at time  $t \in [\tau_{i-1}, \tau_i)$  in phase  $i$  for  $i = 1, 2, \dots, N(t)$  [37]. It is conditioning on the component having worked at the beginning of phase  $i$ .

From Equation (4.3.5), we can see that the survival signature of the PMS has the same advantage as the survival signature of a single phased mission, that is it takes into account the structure of the PMS and separates it from the conditional failure time distributions of the components.

As in Section 2.2, we assume that there are fixed swapping rules, which prescribe upon failure of a component precisely which other component takes over its role in the system, if possible and if the other component is still functioning, in order to prevent system from the failure, and we further assume that such a swap of components takes neglectable time and does not affect the functioning of the component that changes its role in the PMS nor its remaining time until failure. We can take the effect of the defined swaps if they are applicable at any time during the mission or only at transitions of phases, into account through the PMS structure function, and hence, it can be taken into account for computation of the system reliability through the PMS survival signature. Let  $\Phi_S^{(W)}(l_1, l_2, \dots, l_{N(t)})$  denote the PMS survival signature if the defined swaps are applicable at any time during the mission and  $\Phi_S^{(E)}(l_1, l_2, \dots, l_{N(t)})$  denote the PMS survival signature if the defined swaps are applicable only at transitions of phases,

$$\Phi_S^{(W)}(l_1, l_2, \dots, l_{N(t)}) = \left( \prod_{i=1}^{N(t)} \binom{m_i}{l_i}^{-1} \right) \times \sum_{X \in S} \phi_s^{(W)}(X) \quad (4.3.7)$$

$$\Phi_S^{(E)}(l_1, l_2, \dots, l_{N(t)}) = \left( \prod_{i=1}^{N(t)} \binom{m_i}{l_i}^{-1} \right) \times \sum_{X \in S} \phi_s^{(E)}(X) \quad (4.3.8)$$

where  $\phi_s^{(W)}(X)$  is the structure function of the PMS considering the defined swaps at any time during the mission and  $\phi_s^{(E)}(X)$  is the structure function of the PMS considering the the defined swaps only at transitions of phases,  $\phi_s^{(E)}$  will be typically equal to 1 for some  $X$  for which  $\phi_s$  was equal to 0 and  $\phi_s^{(W)}$  will typically be equal

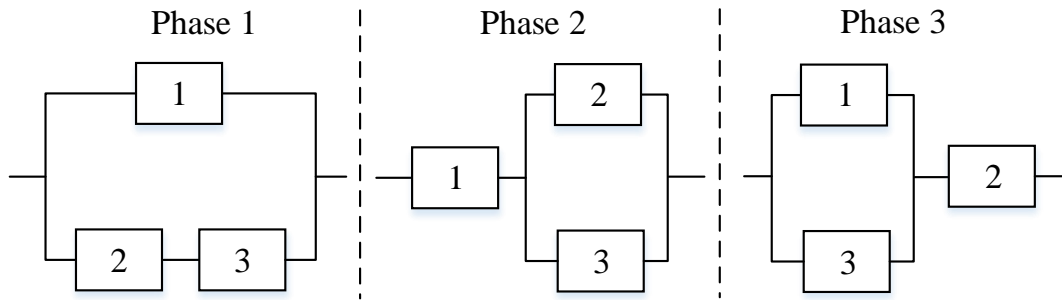

Figure 4.1: A PMS with single type of components

to 1 for some  $X$  for which  $\phi_s^{(E)}$  was equal to 0, so  $\phi_s^{(W)} \geq \phi_s^{(E)} \geq \phi_s$ . The reliability of PMS can be calculated straightforwardly in both scenarios by substituting the survival signature of the original PMS in (Equation 4.3.5) by the survival signatures that consider the swapping scenarios in Equations (4.3.7) and (4.3.8).

$$R^{(W)}(t) = \sum_{l_1=0}^{m_1} \dots \sum_{l_{N(t)}=0}^{m_{N(t)}} \left[ \Phi_S^{(W)}(l_1, \dots, l_{N(t)}) \prod_{i=1}^{N(t)} \binom{m_i}{l_i} [1 - F_i(t)]^{l_i} [F_i(t)]^{m_i - l_i} \right] \quad (4.3.9)$$

$$R^{(E)}(t) = \sum_{l_1=0}^{m_1} \dots \sum_{l_{N(t)}=0}^{m_{N(t)}} \left[ \Phi_S^{(E)}(l_1, \dots, l_{N(t)}) \prod_{i=1}^{N(t)} \binom{m_i}{l_i} [1 - F_i(t)]^{l_i} [F_i(t)]^{m_i - l_i} \right] \quad (4.3.10)$$

where  $R^{(W)}(t)$  is the reliability of the PMS if the defined swaps are applicable at any during the mission and  $R^{(E)}(t)$  is the reliability of the PMS at time  $t$  if the defined swaps are applicable only at transitions of phases. The conditional CDF of the components,  $F_i(t)$ , at time  $t \in [\tau_{i-1}, \tau_i)$  in phase  $i$  for  $i = 1, 2, \dots, N(t)$ , is given by Equation (4.3.6). This CDF is conditioning on the component having worked at the beginning of phase  $i$ .

It is important to notice here that the swap in both scenarios is entirely reflected in the PMS survival signature, and the conditional failure time of the components remains the same as for the original system. The following example explains this approach in more detail.

**Example 4.3.1** Consider the PMS in Figure 4.1 that consists of three components performing a three-phase mission. All the components are of the same type and work independently from one another in each phase. The duration of all three phases are

The first phase				The first two phases				The PMS						
$0 \leq t \leq 10^-$				$10^+ \leq t \leq 20^-$				$20^+ \leq t \leq 30$						
$l_1$	$\Phi_1$	$\Phi_1^{(W)}$	$\Phi_1^{(E)}$	$l_1$	$l_2$	$\Phi_{1,2}$	$\Phi_{1,2}^{(W)}$	$\Phi_{1,2}^{(E)}$	$l_1$	$l_2$	$l_3$	$\Phi_S$	$\Phi_S^{(W)}$	$\Phi_S^{(E)}$
1	1/3	2/3	1/3	2	2	2/3	1	1	2	2	2	1/3	1	1
2	1	1	1	3	2	2/3	1	2/3	3	2	2	1/3	1	2/3
3	1	1	1	3	3	1	1	1	3	3	2	2/3	1	2/3
									3	3	3	1	1	1

Table 4.1: Survival signatures of PMS shown in Example 4.3.1

10 hours each. All components in each phase are of the same type and the lifetime distribution of the components in each phase follows an Exponential distribution and the failure rates of phases 1, 2 and 3 are  $2 \times 10^{-3}$ /hour,  $1 \times 10^{-4}$ /hour and  $2 \times 10^{-4}$ /hour, respectively.

We want to examine the reliability of this PMS if components 1 and 2 can be swapped upon failure at any time during the mission or only at transitions of phases. The survival signature for the original PMS is calculated by Equation(4.3.1) and the survival signature if components 1 and 2 are swappable upon failure at any time during the mission or only at transitions of phases are calculated by Equation(4.3.7) and Equation(4.3.8), respectively. In both scenarios, the opportunity of the swap is taken into account through the structure functions. For example, the state vector  $(0, 1, 0)$  represents the situation when components 1 and 3 fail during phase 1, but component 2 is still functioning, in this case,  $\phi_1(0, 1, 0) = \phi_1^{(E)}(0, 1, 0) = 0$ , however,  $\phi_1^{(W)}(0, 1, 0) = 1$ , because in this scenario component 2 would be swapped by component 1 during phase 1. The state vector  $(0, 1, 1, 0, 1, 1)$  represents the situation when component 1 fails during phase 1, but components 2 and 3 continue to function until the end of phase 2. In this case  $\phi_{1,2}(0, 1, 1, 0, 1, 1) = 0$ , however,  $\phi_{1,2}^{(W)}(0, 1, 1, 0, 1, 1) = \phi_{1,2}^{(E)}(0, 1, 1, 0, 1, 1) = 1$ , because component 1 would be swapped by component 2 at the time of transition to phase 2 in order to continue the mission of phase 2.

Table 4.10 shows the results of the survival signatures for the original PMS and for both scenarios. The first group of results are the survival signatures of

phase 1, where  $\Phi_1$ ,  $\Phi_1^{(W)}$ ,  $\Phi_1^{(E)}$  are the survival signatures for the original PMS and for both scenarios, respectively. The second group of results contain the survival signatures of the first two phases, where  $\Phi_{1,2}$ ,  $\Phi_{1,2}^{(W)}$ ,  $\Phi_{1,2}^{(E)}$  are the survival signatures for the original PMS and for both scenarios, respectively. The last group of results represents the survival signatures of the whole PMS, where  $\Phi_S$ ,  $\Phi_S^{(W)}$ ,  $\Phi_S^{(E)}$  are the survival signatures for the original PMS and for both scenarios, respectively. Entries for which the survival signatures are 0 are omitted. From the results, we can see clearly that the survival signature of the PMS is significantly improved in the case that the swap can be performed at any time during the mission. The survival signature in the case when the swap can be performed only at the transitions is improved to some extent, but this improvement is not so large as in the case that we can swap the components at any time.

Moreover, an interesting and unusual phenomenon of the value of the survival signature is observed in the case that the swap is only applicable at the transitions. In this case, the survival signature is not monotonically increasing with the increase of the number of components that function, for example,  $\Phi_{1,2}^{(E)}(2, 2) = 1 > \Phi_{1,2}^{(E)}(3, 2) = 2/3$ . That has not happened in the system without the operation of component swapping. We want to briefly discuss the reason for that here.  $l_1 = 2$ ,  $l_2 = 2$ , indicates that one component failed during phase 1 and if this component is component 1, then we can swap it by component 2 at transitions to complete the mission of phase 2, however,  $l_1 = 3$ ,  $l_2 = 2$  indicates that there is one component failed during phase 2 and if this component is component 1, the system would fail in phase 2 since in this scenario the swap is not applicable.

We can obtain the conditional CDF of the components by using the failure rate of the component in each phase in Equation (4.3.6). Then the reliability of the original PMS can be obtained by substituting the survival signatures and the conditional CDF into Equation (4.3.5). The results are shown in the second row of Table 4.2 and the solid line in Figure 4.2. As shown in Table 4.2 and Figure 4.2, there are reliability jumps at  $t = 10$  and  $t = 20$ . The reason is that if component 1 has failed in phase 1, the PMS may still function in phase 1, however, the PMS will fail immediately when it steps into phase 2. Therefore, there is a reliability jump

$t$	0	$10^-$	$10^+$	$20^-$	$20^+$	30
$R$	1	0.99922	0.97981	0.97880	0.95887	0.95691
$R^{(W)}$	1	0.99961	0.99884	0.99872	0.99872	0.99847
$R^{(E)}$	1	0.99922	0.99884	0.99778	0.99778	0.99567

Table 4.2: Reliability of the PMS in Example 4.3.1

between phases 1 and 2. Similarly, if component 2 has failed in phase 2, the system can still function in phase 2 when component 3 is functioning, however, the system will fail immediately when it steps into phase 3. Therefore, there is a reliability jump between phases 2 and 3.

The reliability of the PMS when the swap is applicable at any time during the mission or only at transition of phases can be obtained by Equation (4.3.9) and Equation (4.3.10), respectively. The values of the reliability in both scenarios are given in the third and fourth rows in Table 4.2 and are presented in Figure 4.2. In Table 4.2,  $\tau_{i-1}^+$  represents the first moment in phase  $i$ , and  $\tau_i^-$  represents the last moment in phase  $i$ . In Figure 4.2,  $R_i$ ,  $R_i^{(W)}$  and  $R_i^{(E)}$ ,  $i \in \{1, 2, 3\}$ , are the reliability of the original PMS and the reliability of both scenarios in phase  $i$ , respectively. The results show that the reliability jumps at  $t = 10$  and  $t = 20$  are greatly reduced (or even eliminated). The reason is that if component 1 has failed in phase 2, we can replace it with component 2 if it still functions. Similarly, if component 2 has failed in phase 3, it can be swapped by component 1 if it still functions. These measures can greatly improve the reliability of the system. Moreover, these results illustrate that the reliability of the PMS with the possibility of component swapping at any time is higher than if can only swap components at the transitions of phases.

### 4.3.2 PMS with multiple types of components

Most practical PMSs for which the reliability is investigated consist of multiple types of components. Therefore, a more interesting challenge is to develop the theory of survival signature to such kind of PMSs.

Consider a system with  $N \geq 2$  phases, and there are  $K$  types of components in

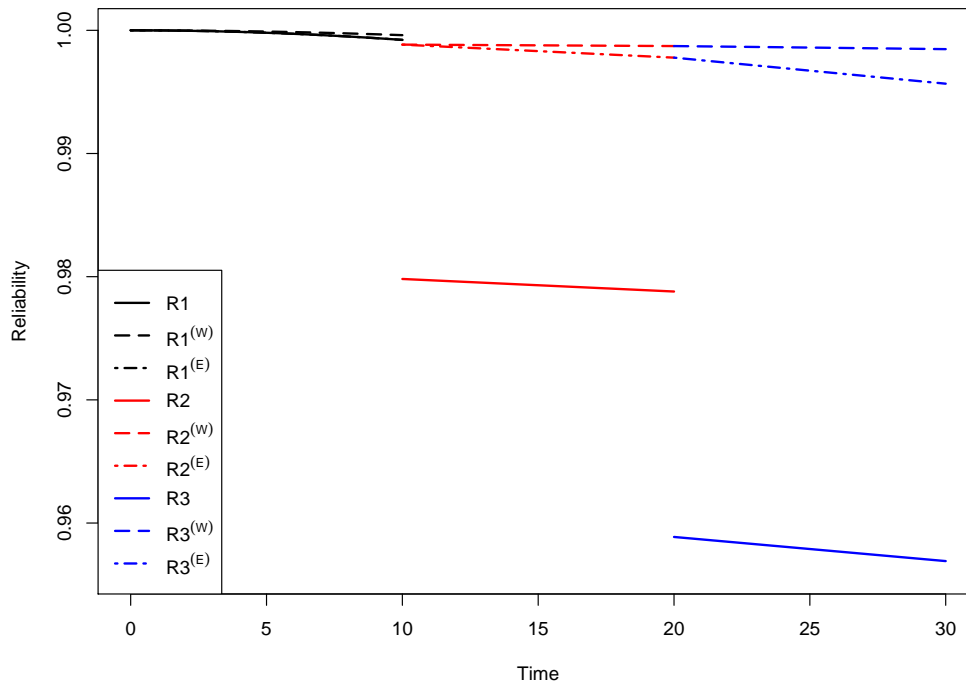

Figure 4.2: Reliability of the PMS in Example 4.3.1

each phase. Let phase  $i$  run from time  $\tau_{i-1}$  to time  $\tau_i$  with  $\tau_0 = 0$  and  $\tau_{i-1} < \tau_i, \forall i$ . Let  $\Phi_S(l_{1,1}, \dots, l_{1,K}, \dots, l_{N,1}, \dots, l_{N,K})$  denote the probability that the PMS functions given that precisely  $l_{i,k}$ ,  $i \in \{1, 2, \dots, N\}$  and  $k \in \{1, 2, \dots, K\}$ , components of type  $k$  function at the end of phase  $i$ . Because the failure times of the components in the same phase are considered to be exchangeable, the survival signature of the first  $N(t)$  phases is

$$\Phi_S(l_{1,1}, \dots, l_{1,K}, \dots, l_{N(t),1}, \dots, l_{N(t),K}) = \left( \prod_{i=1}^{N(t)} \prod_{k=1}^K \binom{m_{i,k}}{l_{i,k}}^{-1} \right) \times \sum_{X \in S} \phi_s(X) \quad (4.3.11)$$

where  $N(t) \leq N$  is the phase that the system is in at time  $t$  and  $S$  denotes the set of all possible state vectors for which there are precisely  $l_{i,k}$  components of type  $k$  functioning at the end of phase  $i$ . The number of components of type  $k$  that function at the beginning of phase  $i$  is  $m_{i,k}$ . As pointed out in Section 4.3.1, because both the system and its components are non-repairable during the mission, the number of components of type  $k$  that function at the beginning of phase  $i$  is equal to the number



of components of type  $k$  that function at the end of phase  $i - 1$ . So,  $m_{i,k} = l_{i-1,k}$  while  $m_{1,k} = n_k$ , is the number of components of type  $k$  in the system.

A PMS functions if and only if all its phases are completed without failure, therefore the reliability of the PMS can be expressed as:

$$R(t) = \sum_{l_{1,1}=0}^{m_{1,1}} \dots \sum_{l_{N(t),K}=0}^{m_{N(t),K}} \left[ \Phi_S(l_{1,1}, \dots, l_{1,K}, \dots, l_{N(t),1}, \dots, l_{N(t),K}) \times P \left( \bigcap_{i=1}^{N(t)} \bigcap_{k=1}^K \{C_{i,k}(t) = l_{i,k}\} \right) \right] \quad (4.3.12)$$

where  $C_{i,k}(t)$  is the number of components of type  $k$  that function in phase  $i$  at time  $t \in [\tau_{i-1}, \tau_i)$  and  $K$  is the number of types of components.

As we mentioned in Section 4.3.1, in this chapter we consider only the PMSs with the same components in each phase, which means that all components appear in all phases. If the components of type  $k$  in phase  $i$  have common CDF  $F_k(t)$ , its conditional CDF in phase  $i$  is  $F_{i,k}(t)$  at time  $t \in [\tau_{i-1}, \tau_i)$  conditioned on that the system is working at the beginning of phase  $i$ , and it is equal to

$$F_{i,k}(t) = \frac{F_k(\min\{t, \tau_i\}) - F_k(\tau_{i-1})}{1 - F_k(\tau_{i-1})} \quad (4.3.13)$$

Equation (4.3.12) can be simplified as

$$R(t) = \sum_{l_{1,1}=0}^{m_{1,1}} \dots \sum_{l_{N(t),K}=0}^{m_{N(t),K}} \left[ \Phi_S(l_{1,1}, \dots, l_{1,K}, \dots, l_{N(t),1}, \dots, l_{N(t),K}) \times \prod_{i=1}^{N(t)} \prod_{k=1}^K \left( \binom{m_{i,k}}{l_{i,k}} [1 - F_{i,k}(t)]^{l_{i,k}} [F_{i,k}(t)]^{m_{i,k} - l_{i,k}} \right) \right] \quad (4.3.14)$$

As in Section 4.3.1, if it is assumed that there are fixed swapping rules and that such a swap of a component takes neglectable time, then we can study the effect of the defined swaps if they are applicable at any time during the mission or only at transitions of phases through the PMS survival signatures. The PMS survival signatures if the defined swaps are applicable at any time during the mission or only at transitions of phases are given, respectively, by

$$\Phi_S^{(W)}(l_{1,1}, \dots, l_{1,K}, \dots, l_{N,1}, \dots, l_{N,K}) = \left( \prod_{i=1}^N \prod_{k=1}^K \binom{m_{i,k}}{l_{i,k}}^{-1} \right) \times \sum_{X \in S} \phi_s^{(W)}(X) \quad (4.3.15)$$

$$\Phi_S^{(E)}(l_{1,1}, \dots, l_{1,K}, \dots, l_{N,1}, \dots, l_{N,K}) = \left( \prod_{i=1}^N \prod_{k=1}^K \binom{m_{i,k}}{l_{i,k}}^{-1} \right) \times \sum_{X \in S} \phi_s^{(E)}(X) \quad (4.3.16)$$

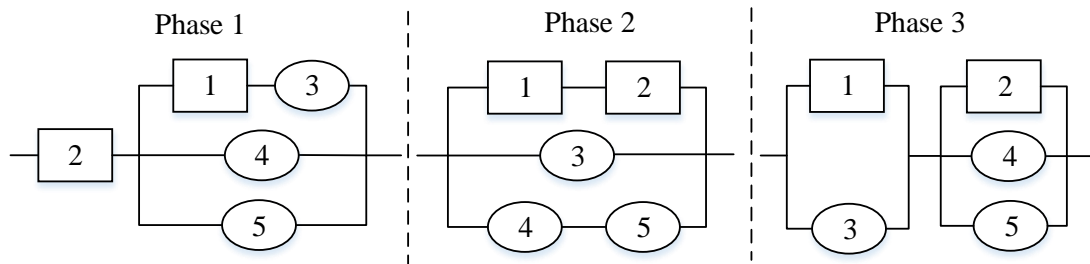

Figure 4.3: A PMS with multiple types of components

Type	Component	Distribution	Phase 1	Phase 2	Phase 3
1	1,2	Weibull	$\alpha = 180, \beta = 2.2$	$\alpha = 400, \beta = 3.2$	$\alpha = 200, \beta = 2.4$
2	3,4,5	Exponential	$\lambda = 1 \times 10^{-3}$	$\lambda = 1 \times 10^{-4}$	$\lambda = 2 \times 10^{-4}$

Table 4.3: The distribution information of the components in Figure 4.3

where  $\phi_s^{(W)}(X)$  and  $\phi_s^{(E)}(X)$  are the structure functions of the PMS considering the defined swaps at any time during the mission or only at transition of phases, respectively, so  $\phi_s^{(W)} \geq \phi_s^{(E)} \geq \phi_s$ . The reliability of PMS in both scenarios can be calculated straightforward by substituting the survival signature of the original PMS in Equation (4.3.14) by the survival signatures in Equation (4.3.15) and Equation (4.3.16) that consider these scenarios. This approach is illustrated and explained in more detail in the next example.

**Example 4.3.2** For the PMS shown in Figure 4.3, assume that phases 1, 2 and 3 last for 10, 270 and 20 hours, respectively. The components follow Weibull and Exponential distributions and can be divided into two types according to the distribution of the lifetime. Table 4.3 summarizes the distribution information of the components in each phase. For the Weibull distribution,  $F(t) = 1 - e^{-(t/\beta)^\alpha}$ ,  $\alpha$  and  $\beta$  are the scale parameter and shape parameter, respectively. For Exponential distribution,  $F(t) = 1 - e^{-\lambda t}$ ,  $\lambda$  is the failure rate. We want to examine the reliability of this PMS if components 1 and 2 are swappable, and components 3 and 4 are swappable upon failure at any time during the mission or only at transition of phases. For example, in phase 1, if the swap is applicable only at transition of phases, then no swapping opportunity exists, but if the swap is applicable at any time during the mission, then we can swap component 1 by 2 when component 2

fails but component 1 still functions, and we can swap component 3 by 4 when component 1, 4 and 5 fail but component 3 still functions. Note that if any of the components 1 or 5 still function, component 4 cannot be swapped by component 3 because the swap is just applicable upon failure, which means that if the system cannot continue to function with the existing components in place. The survival signature for the original PMS is calculated by Equation (4.3.11) and the survival signatures if the defined swaps are applicable at any time during the mission or only at transition of phases, are calculated by Equation (4.3.15) and Equation (4.3.16), respectively. Table 4.4 shows the survival signatures of phase 1, where  $\Phi_1$ ,  $\Phi_1^{(W)}$ ,  $\Phi_1^{(E)}$  are the survival signatures for the original PMS and for both scenarios, respectively. Table 4.5 shows the survival signatures of the first two phases, where  $\Phi_{1,2}$ ,  $\Phi_{1,2}^{(W)}$ ,  $\Phi_{1,2}^{(E)}$  are the survival signatures for the original PMS and for both scenarios, respectively. Table 4.6 shows the survival signatures of the whole PMS, where  $\Phi_S$ ,  $\Phi_S^{(W)}$ ,  $\Phi_S^{(E)}$  are the survival signatures for the original PMS and for both scenarios, respectively. Entries for which the survival signatures are 0 are omitted.

The reliability of the PMS is shown in Table 4.7 and Figure 4.4. In Figure 4.4,  $R_i$ ,  $R_i^{(W)}$  and  $R_i^{(E)}$ ,  $i \in \{1, 2, 3\}$ , are the reliability of the PMS in phase  $i$ . Specially,  $R_i^{(W)}$  is for the case that we can swap the components at any time and  $R_i^{(E)}$  is for the case that the components can only be swapped at the switches of phases. The results show that there is a reliability jump at the transition of phases 2 and 3 in the original PMS. The reason is that if components 1 and 3 or components 2, 4 and 5 have all failed simultaneously in phase 2, then the PMS still has to be functioning, however, the PMS will fail immediately when it steps into phase 3. Therefore, there is a reliability jump between phases 2 and 3. The operation of component swap upon failure nearly eliminates the reliability jump between these phases. The reason for this is that, if components 1 and 3 both failed in phase 2, then component 1 can be swapped by 2 and component 3 can be swapped by 4. Also, if the components 2, 4 and 5 all failed in phase 2, then components 2 and 4 can be swapped by 1 and 3, respectively. The results show that the reliability of PMS is significantly improved as a result of possible swapping components upon failure.

The first phase				
$0 \leq t \leq 10^-$				
$l_{1,1}$	$l_{1,2}$	$\Phi_1$	$\Phi_1^{(W)}$	$\Phi_1^{(E)}$
1	1	1/3	1	1/3
1	2	1/2	1	1/2
1	3	1/2	1	1/2
2	1	1	1	1
2	2	1	1	1
2	3	1	1	1

Table 4.4:  $\Phi_1$ ,  $\Phi_1^{(W)}$  and  $\Phi_1^{(E)}$  of PMS shown in Example 4.3.2

The first two phases													
$10^+ \leq t \leq 280^-$													
$l_{1,1}$	$l_{1,2}$	$l_{2,1}$	$l_{2,2}$	$\Phi_{1,2}$	$\Phi_{1,2}^{(W)}$	$\Phi_{1,2}^{(E)}$	$l_{1,1}$	$l_{1,2}$	$l_{2,1}$	$l_{2,2}$	$\Phi_{1,2}$	$\Phi_{1,2}^{(W)}$	$\Phi_{1,2}^{(E)}$
1	1	0	1	0	2/3	1/6	2	2	0	2	1	1	1
1	1	1	1	0	2/3	1/6	2	2	1	1	1/3	2/3	1/2
1	2	0	1	1/6	2/3	1/4	2	2	1	2	1	1	1
1	2	0	2	1/2	1	1/2	2	2	2	0	1	1	1
1	2	1	1	1/6	2/3	1/4	2	2	2	1	1	1	1
1	2	1	2	1/2	1	1/2	2	2	2	2	1	1	1
1	3	0	1	1/6	2/3	1/6	2	3	0	1	1/3	2/3	1/3
1	3	0	2	1/2	1	1/2	2	3	0	2	1	1	1
1	3	0	3	1/2	1	1/2	2	3	0	3	1	1	1
1	3	1	1	1/6	2/3	1/6	2	3	1	1	1/3	2/3	1/3
1	3	1	2	1/2	1	1/2	2	3	1	2	1	1	1
1	3	1	3	1/2	1	1/2	2	3	1	3	1	1	1
2	1	0	1	1/3	2/3	2/3	2	3	2	0	1	1	1
2	1	1	1	1/3	2/3	2/3	2	3	2	1	1	1	1
2	1	2	0	1	1	1	2	3	2	2	1	1	1
2	1	2	1	1	1	1	2	3	2	3	1	1	1
2	2	0	1	1/3	2/3	1/2							

Table 4.5:  $\Phi_{1,2}$ ,  $\Phi_{1,2}^{(W)}$  and  $\Phi_{1,2}^{(E)}$  of PMS shown in Example 4.3.2

The PMS																	
$280^+ \leq t \leq 300$																	
$l_{1,1}$	$l_{1,2}$	$l_{2,1}$	$l_{2,2}$	$l_{3,1}$	$l_{3,3}$	$\Phi_S$	$\Phi_S^{(W)}$	$\Phi_S^{(E)}$	$l_{1,1}$	$l_{1,2}$	$l_{2,1}$	$l_{2,2}$	$l_{3,1}$	$l_{3,3}$	$\Phi_S$	$\Phi_S^{(W)}$	$\Phi_S^{(E)}$
1	1	1	1	1	1	0	2/3	1/6	2	2	2	2	2	0	1	1	1
1	2	0	2	0	2	1/3	1	1/2	2	2	2	2	2	1	1	1	1
1	2	1	1	1	1	1/6	2/3	1/6	2	2	2	2	2	2	1	1	1
1	2	1	2	0	2	1/3	1	1/2	2	3	0	2	0	2	2/3	1	1
1	2	1	2	1	1	1/6	1	1/3	2	3	0	3	0	2	2/3	1	2/3
1	2	1	2	1	2	1/3	1	1/2	2	3	0	3	0	3	1	1	1
1	3	0	2	0	2	1/3	1	1/2	2	3	1	1	1	1	1/6	2/3	1/3
1	3	0	3	0	2	1/3	1	1/3	2	3	1	2	0	2	2/3	1	2/3
1	3	0	3	0	3	1/2	1	1/2	2	3	1	2	1	1	1/2	1	2/3
1	3	1	1	1	1	1/6	2/3	1/6	2	3	1	2	1	2	5/6	1	1
1	3	1	2	0	2	1/3	1	1/2	2	3	1	3	0	2	2/3	1	2/3
1	3	1	2	1	1	1/6	1	1/3	2	3	1	3	0	3	1	1	1
1	3	1	2	1	2	1/3	1	1/2	2	3	1	3	1	1	1/2	1	1/2
1	3	1	3	0	2	1/3	1	1/3	2	3	1	3	1	2	5/6	1	5/6
1	3	1	3	0	3	1/2	1	1/2	2	3	1	3	1	3	1	1	1
1	3	1	3	1	1	1/6	1	1/6	2	3	2	0	2	0	1	1	1
1	3	1	3	1	2	1/3	1	1/2	2	3	2	1	1	1	1/2	1	1/2
1	3	1	3	1	3	1/2	1	1/2	2	3	2	1	2	0	1	1	1
2	1	1	1	1	1	1/6	2/3	1/3	2	3	2	1	2	1	1	1	1
2	1	2	0	2	0	1	1	1	2	3	2	2	0	2	2/3	1	2/3
2	1	2	1	1	1	1/2	1	1/2	2	3	2	2	1	1	1/2	1	1/2
2	1	2	1	2	0	1	1	1	2	3	2	2	1	2	5/6	1	5/6
2	1	2	1	2	1	1	1	1	2	3	2	2	2	0	1	1	1
2	2	0	2	0	2	2/3	1	1	2	3	2	2	2	1	1	1	1
2	2	1	1	1	1	1/6	2/3	1/3	2	3	2	2	2	2	1	1	1
2	2	1	2	0	2	2/3	1	2/3	2	3	2	3	0	2	2/3	1	2/3
2	2	1	2	1	1	1/2	1	2/3	2	3	2	3	0	3	1	1	1
2	2	1	2	1	2	5/6	1	1	2	3	2	3	1	1	1/2	1	1/2
2	2	2	0	2	0	1	1	1	2	3	2	3	1	2	5/6	1	5/6
2	2	2	1	1	1	1/2	1	1/2	2	3	2	3	1	3	1	1	1
2	2	2	1	2	0	1	1	1	2	3	2	3	2	0	1	1	1
2	2	2	1	2	1	1	1	1	2	3	2	3	2	1	1	1	1
2	2	2	2	0	2	2/3	1	2/3	2	3	2	3	2	2	1	1	1
2	2	2	2	1	1	1/2	1	1/2	2	3	2	3	2	3	1	1	1
2	2	2	2	1	2	5/6	1	5/6									

Table 4.6:  $\Phi_S$ ,  $\Phi_S^{(W)}$  and  $\Phi_S^{(E)}$  of PMS shown in Example 4.3.2

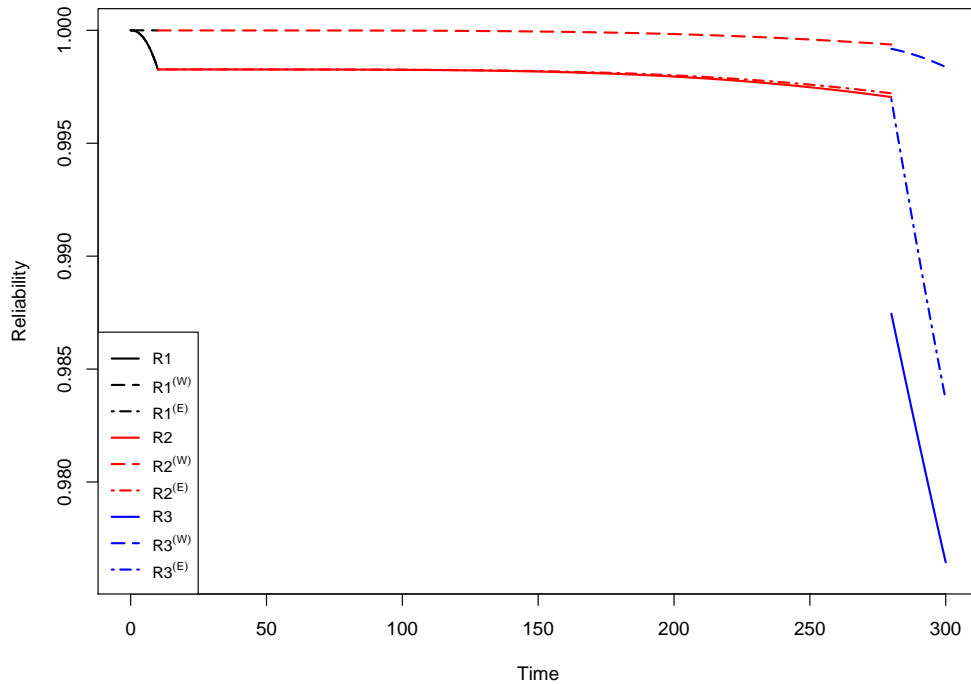

Figure 4.4: Reliability of the PMS in Example 4.3.2

$t$	0	$10^-$	$10^+$	$280^-$	$280^+$	300
$R$	1	0.998269	0.998269	0.997046	0.987450	0.976445
$R^{(W)}$	1	0.999996	0.999996	0.999371	0.999179	0.998375
$R^{(E)}$	1	0.998269	0.998269	0.997211	0.996951	0.983626

Table 4.7: Reliability of the PMS in Example 4.3.2

## 4.4 Swapping components according to structure importance

In Section 4.3, the reliability of the PMS is improved by swapping components upon failure. In this section, we consider another swapping strategy to improve the reliability of PMSs, which is having swapping of components according to structure importance. In this strategy, the structure importance is used to measure the importance level of the components in contributing to system reliability, then when a component with high importance fails, it is swapped by another component with

lower importance from the system which has not yet failed. If the component is swapped according to the structure importance criterion, the swap will take place with disregard of whether or not the system can continue to function with the existing components in place, depending on the level of the importance of the component that has failed. However, if the component is swapped upon failure, the swap takes place only if the PMS cannot continue to function with the existing components in place.

As introduced in Chapter 1, since it is assumed that only components of the same type are swappable, the structural importance which measures the relative importance of components with respect to their positions is sufficient to prioritize the components in each phase [11]. The structural importance of component  $j \in \{1, 2, \dots, n\}$  for the configuration in phase  $i \in \{1, 2, \dots, N\}$  denoted by  $SI_j^{(i)}$ , is defined as

$$SI_j^{(i)} = \frac{1}{2^{n-1}} \sum_{x^j} [\phi_i(1_j, x^j) - \phi_i(0_j, x^j)] \quad (4.4.1)$$

where  $\phi_i(\cdot)$  is the structure function of the system in phase  $i$ ;  $x^j$  represents the component state vector with  $x_j$  removed,  $(1_j, x^j)$  and  $(0_j, x^j)$  represent the component vector when component  $j$  in phase  $i$  is in state 1 or 0, respectively and  $2^{n-1}$  represents the total number of different state vector with  $n - 1$  in it.

After the components are prioritized by structural importance, the swapping rules are defined upon this prioritization, so it is assumed that when a component with high importance fails, it is swapped by another component of the same type with lower importance which has not yet failed. It is assumed further that the swap between components takes neglectable time and does not affect the functioning state of the component that changes its role in the PMS nor its remaining time until failure.

We can calculate the reliability of a PMS after we define the swapping rules according to the structural importance, in the same way as in Section 4.3. We take the effect of the defined swaps either if they are applicable at any time during the mission or only at transitions of phases, into account through the PMS structure function, and hence, it can be taken into account for computation of the system reliability through the PMS survival signature. The survival signatures, if the defined

Phase 1			Phase 2			Phase 3		
$SI_1^{(1)}$	$SI_2^{(1)}$	$SI_3^{(1)}$	$SI_1^{(2)}$	$SI_2^{(2)}$	$SI_3^{(2)}$	$SI_1^{(3)}$	$SI_2^{(3)}$	$SI_3^{(3)}$
0.75	0.25	0.25	0.75	0.25	0.25	0.25	0.75	0.25

Table 4.8: Structure importance for the configuration in Figure 4.1

swaps according to the structure importance are applicable at any time during the mission or only at transitions of phases, can be calculated using Equation (4.3.15) and Equation (4.3.16) respectively and the reliability can be obtained as in Section 4.3 by substituting the survival signature of the original PMS in Equation (4.3.14) by these survival signatures. This approach is illustrated and explained in more detail in the following two examples.

**Example 4.4.1** Consider again the system in Figure 4.1 and the same scenario for the phases duration and the conditional lifetime distribution of the components in each phase as in Example 4.3.1. We want to examine the reliability of this PMS if the components are swapped according to structural importance. Table 4.10 listed structural importance of each component for the configuration in each phase of the PMS shown in Figure 4.1.

The results show that, for the first two phases, the structural importance of component 2 is equal to that of component 3, and both are lower than the structural importance of component 1 so  $SI_1^{(1)} > SI_2^{(1)} = SI_3^{(1)}, SI_1^{(2)} > SI_2^{(2)} = SI_3^{(2)}$ . In phase 3, the structural importance of component 1 is equal to that of component 3, and the importance of components 1 and 3 is lower than that of component 2 so  $SI_2^{(3)} > SI_1^{(3)} = SI_3^{(3)}$ . Therefore, we would enable to swap component 2 or 3 into the place of component 1, if that fails in the first two phases. In phase 3, it is better to swap component 1 or 3 into the place of component 2 if that component fails.

Let us assume that components 1 and 2 are swappable according to their structural importance. Therefore, if components 1 and 2 are swappable at any time during the mission, we can swap component 2 by 1 in phases 1 and 2 if component 1 fails but component 2 is still functioning. Similarly, component 1 can take over the role of component 2 in phase 3, if component 2 fails but component 1 is still



functioning. If components 1 and 2 are swappable only at switches of phases, we can swap component 2 by 1 at the switch of phases 1 and 2 when component 1 fails but component 2 is still functioning. Similarly, component 2 can take over the role of component 1 at the switch of phases 2 and 3, if component 2 fails but component 1 is still functioning. Therefore, the cases of the swap that we have if components 1 and 2 are swappable according to its structural importance in this example are the same as the cases of the swap that we have in Example 4.3.1 when components 1 and 2 are swappable upon failure, but this is not usually the case as we will see in the next example. So, the results of the survival signatures are the same as in Table 4.10 and the results of the reliability are the same as that are shown in Table 4.2 and Figure 4.2.

**Example 4.4.2** Consider the system in Figure 4.3 and we keep the same scenario for the phases duration and the conditional lifetime distribution of the components in each phase as in Example 4.3.2. Structural importance analysis is conducted to measure the importance of the components in contributing to system reliability in each phase, the results are shown in Table 4.9. The results show the orders of structure importances are  $SI_2^{(1)} > SI_1^{(1)}$ ,  $SI_4^{(1)} = SI_5^{(1)} > SI_3^{(1)}$ ,  $SI_1^{(2)} = SI_2^{(2)}$ ,  $SI_3^{(2)} > SI_4^{(2)} = SI_5^{(2)}$ ,  $SI_1^{(3)} > SI_2^{(3)}$ ,  $SI_3^{(3)} > SI_4^{(3)} = SI_5^{(3)}$ . Therefore, for the components of type 1, if components 1 and 2 are swappable, we can swap component 1 by 2 in phases 1 when component 2 fails but component 1 still functions. And we can swap component 2 by 1 in phase 3. Similarly, for the components of type 2, if components 3 and 4 are swappable, we can swap component 3 by 4 in phase 1 when component 4 fails but component 2 still functions. Moreover, component 4 can take over the role of component 3 in phases 2 and 3 when component 3 fails but component 4 still functions. Table 4.10, Table 4.11 and Table 4.12 show The resulting survival signatures of phase 1, the survival signatures of the first two phases and the survival signatures of the whole PMS, respectively. Entries for which the survival signatures are 0 are omitted. The resulting reliability function are shown in Figure 4.5 with the specific values around transition times given in Table 4.13.

Phase 1				
$SI_1^{(1)}$	$SI_2^{(1)}$	$SI_3^{(1)}$	$SI_4^{(1)}$	$SI_5^{(1)}$
0.06	0.81	0.06	0.19	0.19
Phase 2				
$SI_1^{(2)}$	$SI_2^{(2)}$	$SI_3^{(2)}$	$SI_4^{(2)}$	$SI_5^{(2)}$
0.19	0.19	0.56	0.19	0.19
Phase 3				
$SI_1^{(3)}$	$SI_2^{(3)}$	$SI_3^{(3)}$	$SI_4^{(3)}$	$SI_5^{(3)}$
0.44	0.19	0.44	0.19	0.19

Table 4.9: Structure importance for the configuration in each phase in Figure 4.3

The first phase				
$0 \leq t \leq 10^-$				
$l_{1,1}$	$l_{1,2}$	$\Phi_1$	$\Phi_1^{(W)}$	$\Phi_1^{(E)}$
1	1	1/3	1	1/3
1	2	1/2	1	1/2
1	3	1/2	1	1/2
2	1	1	1	1
2	2	1	1	1
2	3	1	1	1

Table 4.10:  $\Phi_1$ ,  $\Phi_1^{(W)}$  and  $\Phi_1^{(E)}$  of PMS shown in Example 4.4.2

The first two phases													
$10^+ \leq t \leq 280^-$													
$l_{1,1}$	$l_{1,2}$	$l_{2,1}$	$l_{2,2}$	$\Phi_{1,2}$	$\Phi_{1,2}^{(W)}$	$\Phi_{1,2}^{(E)}$	$l_{1,1}$	$l_{1,2}$	$l_{2,1}$	$l_{2,2}$	$\Phi_{1,2}$	$\Phi_{1,2}^{(W)}$	$\Phi_{1,2}^{(E)}$
1	1	0	1	0	2/3	1/6	2	2	0	2	1	1	1
1	1	1	1	0	2/3	1/6	2	2	1	1	1/3	2/3	1/2
1	2	0	1	1/6	2/3	1/4	2	2	1	2	1	1	1
1	2	0	2	1/2	1	1/2	2	2	2	0	1	1	1
1	2	1	1	1/6	2/3	1/4	2	2	2	1	1	1	1
1	2	1	2	1/2	1	1/2	2	2	2	2	1	1	1
1	3	0	1	1/6	2/3	1/6	2	3	0	1	1/3	2/3	1/3
1	3	0	2	1/2	1	1/2	2	3	0	2	1	1	1
1	3	0	3	1/2	1	1/2	2	3	0	3	1	1	1
1	3	1	1	1/6	2/3	1/6	2	3	1	1	1/3	2/3	1/3
1	3	1	2	1/2	1	1/2	2	3	1	2	1	1	1
1	3	1	3	1/2	1	1/2	2	3	1	3	1	1	1
2	1	0	1	1/3	2/3	2/3	2	3	2	0	1	1	1
2	1	1	1	1/3	2/3	2/3	2	3	2	1	1	1	1
2	1	2	0	1	1	1	2	3	2	2	1	1	1
2	1	2	1	1	1	1	2	3	2	3	1	1	1
2	2	0	1	1/3	2/3	1/2							

Table 4.11:  $\Phi_{1,2}$ ,  $\Phi_{1,2}^{(W)}$  and  $\Phi_{1,2}^{(E)}$  of PMS shown in Example 4.4.2

The PMS																	
$280^+ \leq t \leq 300$																	
$l_{1,1}$	$l_{1,2}$	$l_{2,1}$	$l_{2,2}$	$l_{3,1}$	$l_{3,3}$	$\Phi_S$	$\Phi_S^{(W)}$	$\Phi_S^{(E)}$	$l_{1,1}$	$l_{1,2}$	$l_{2,1}$	$l_{2,2}$	$l_{3,1}$	$l_{3,3}$	$\Phi_S$	$\Phi_S^{(W)}$	$\Phi_S^{(E)}$
1	1	1	1	1	1	0	0	0	2	2	2	2	2	0	1	1	1
1	2	0	2	0	2	1/3	1	1/2	2	2	2	2	2	1	1	1	1
1	2	1	1	1	1	1/6	0	0	2	2	2	2	2	2	1	1	1
1	2	1	2	0	2	1/3	1	1/2	2	3	0	2	0	2	2/3	1	1
1	2	1	2	1	1	1/6	1/3	1/4	2	3	0	3	0	2	2/3	1	2/3
1	2	1	2	1	2	1/3	1	1/2	2	3	0	3	0	3	1	1	1
1	3	0	2	0	2	1/3	1	1/2	2	3	1	1	1	1	1/6	0	0
1	3	0	3	0	2	1/3	1	1/3	2	3	1	2	0	2	2/3	1	1
1	3	0	3	0	3	1/2	1	1/2	2	3	1	2	1	1	1/2	1/3	1/2
1	3	1	1	1	1	1/6	0	0	2	3	1	2	1	2	5/6	1	1
1	3	1	2	0	2	1/3	1	1/2	2	3	1	3	0	2	2/3	1	2/3
1	3	1	2	1	1	1/6	1/3	1/4	2	3	1	3	0	3	1	1	1
1	3	1	2	1	2	1/3	1	1/2	2	3	1	3	1	1	1/2	1/3	2/3
1	3	1	3	0	2	1/3	1	1/3	2	3	1	3	1	2	5/6	1	1
1	3	1	3	0	3	1/2	1	1/2	2	3	1	3	1	3	1	1	1
1	3	1	3	1	1	1/6	1/3	1/3	2	3	2	0	2	0	1	1	1
1	3	1	3	1	2	1/3	1	1/2	2	3	2	1	1	1	1/2	1/3	1/2
1	3	1	3	1	3	1/2	1	1/2	2	3	2	1	2	0	1	1	1
2	1	1	1	1	1	1/6	0	0	2	3	2	1	2	1	1	1	1
2	1	2	0	2	0	1	1	1	2	3	2	2	0	2	2/3	1	1
2	1	2	1	1	1	1/2	1/6	1/2	2	3	2	2	1	1	1/2	2/3	1/2
2	1	2	1	2	0	1	1	1	2	3	2	2	1	2	5/6	1	1
2	1	2	1	2	1	1	1	1	2	3	2	2	2	0	1	1	1
2	2	0	2	0	2	2/3	1	1	2	3	2	2	2	1	1	1	1
2	2	1	1	1	1	1/6	0	0	2	3	2	2	2	2	1	1	1
2	2	1	2	0	2	2/3	1	1	2	3	2	3	0	2	2/3	1	2/3
2	2	1	2	1	1	1/2	1/3	1/2	2	3	2	3	0	3	1	1	1
2	2	1	2	1	2	5/6	1	1	2	3	2	3	1	1	1/2	1/2	1/3
2	2	2	0	2	0	1	1	1	2	3	2	3	1	2	5/6	5/6	1
2	2	2	1	1	1	1/2	1/3	1/2	2	3	2	3	1	3	1	1	1
2	2	2	1	2	0	1	1	1	2	3	2	3	2	0	1	1	1
2	2	2	1	2	1	1	1	1	2	3	2	3	2	1	1	1	1
2	2	2	2	0	2	2/3	1	1	2	3	2	3	2	2	1	1	1
2	2	2	2	1	1	1/2	1/3	1/2	2	3	2	3	2	3	1	1	1
2	2	2	2	1	2	5/6	1	1	2	3	2	3	2	3	1	1	1

Table 4.12:  $\Phi_S$ ,  $\Phi_S^{(W)}$  and  $\Phi_S^{(E)}$  of PMS shown in Example 4.4.2

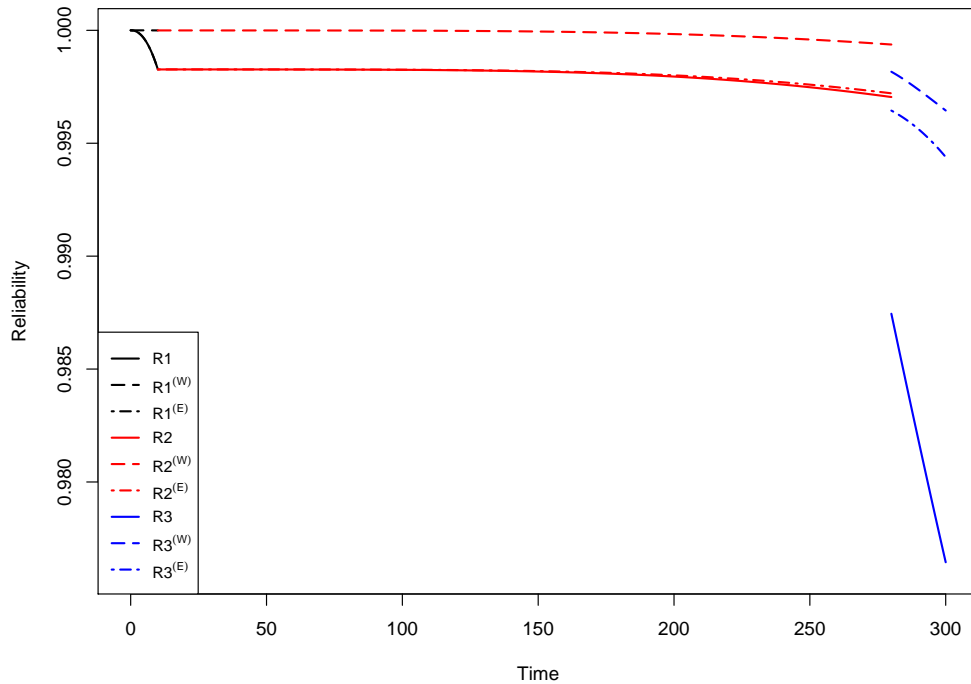

Figure 4.5: Reliability of the PMS in Example 4.4.2

$t$	0	$10^-$	$10^+$	$280^-$	$280^+$	300
$R_S$	1	0.998269	0.998269	0.997046	0.987450	0.976445
$R_S^{(w)}$	1	0.999996	0.999996	0.999371	0.998166	0.996450
$R_S^{(E)}$	1	0.998269	0.998269	0.997211	0.996446	0.994388

Table 4.13: Reliability of the PMS in Example 4.4.2

Comparing these results with the results in Example 4.3.2 in which the components are swapped upon failure, we find that the survival signatures and the reliability in phases 1 and 2, if the components 1 and 2 are swappable, and the components 3 and 4 are swappable according to their structural importances are exactly the same as if these components are swapped upon failure, however, in phase 3, the results are different. The reason is that there is some cases of the swaps that happen when the components are swapped upon failure but not happen when the components swapped according to their structural importance, and vice versa. For example, if the swaps are applicable at any time during the mission, when the com-

ponents 1 and 4 function and components 2, 3 and 5 are failed in phase 3, the PMS continue to function when the components are swapped upon failure, since there is no need for component swapping in this case, however, when the components are swapped according to their structural importances, the system will have failed since in this case component 4 has taken over the role of component 3, because component 4 is classified as less importance than 3.

The results also show that the reliability jump at the transition of phases 2 and 3 in the original PMS is reduced when the components are swapped according to its structural importance. However, the amount of reduction that is gained if the component are swapped upon failure, is more than if they are swapped according to their structural importance. The reason for this is that in the case when the components are swapped according to their structure importances, if the components 2, 4 and 5 all failed during phase 2, then components 2 and 4 cannot be swapped by 1 and 3 respectively when is needed, as in the case when the components swapped upon failure.

## 4.5 Cost analysis of PMS with component swapping

In Chapter 3, we have analyzed the cost effectiveness of component swapping over a fixed period of time. In this section, we aim to extend the cost effectiveness analysis of component swapping to phased mission system under the assumption that each phase of the system would need to complete its mission successfully, where failure to achieve this incurs a penalty cost allocated to each phase of not performing its mission. We consider time independent penalty costs in Section 4.5.1 and time dependent penalty cost in Section 4.5.2. In each section the expected costs when the components swapping (either upon failure or according to reliability importance) is applicable at any time during the mission, are compared with the option when it is applicable only at transitions, and also with the option not to enable swaps.

### 4.5.1 Time independent penalty costs

Suppose that we have a PMS which needs to perform a sequence of missions in a certain period of time  $[\tau_0, \tau_N)$ . The system must function during all the phases. If the system fails at any time during phase  $i$  before  $N$ , then a fixed penalty cost must be paid. Let this cost be

$$P(i) = \sum_{j=i}^N p_j \quad (4.5.1)$$

where  $p_j$ ,  $j = i, \dots, N$ , is a specific cost resulting for phase  $j$  not being completed. We assume that  $p_j$  is independent of the failure time during phase  $j$ . Let  $T_s$  denote the random failure time of the PMS. We need to derive the probability that the system fails during phase  $i$ , so  $P(T_s \in [\tau_{i-1}, \tau_i))$ . Let  $A_i$  denote the event that the PMS fails at any time during phase  $i$ ,  $i \in \{1, 2, \dots, N\}$ , so  $A_i^c$  denotes the event that the PMS survives during phase  $i$ .

$$\begin{aligned} P(T_s \in [\tau_{i-1}, \tau_i)) &= P(A_1^c, A_2^c, \dots, A_{i-1}^c, A_i) = \\ &= P(A_1^c, A_2^c, \dots, A_{i-1}^c) - P(A_1^c, A_2^c, \dots, A_{i-1}^c, A_i^c) \end{aligned}$$

Let  $R(\tau_{i-1}^-) = P(A_1^c, A_2^c, \dots, A_{i-1}^c)$  be the probability that the system survives phase  $i-1$ , and  $R(\tau_i^-) = P(A_1^c, A_2^c, \dots, A_{i-1}^c, A_i^c)$  is the probability that the system survives phase  $i$ , then, the probability that the system fail during phase  $i$  is

$$P(T_s \in [\tau_{i-1}, \tau_i)) = R(\tau_{i-1}^-) - R(\tau_i^-)$$

Let  $C_S$  denote the expected cost of failure of the PMS,

$$C_S = \sum_{i=1}^N P(i) (R(\tau_{i-1}^-) - R(\tau_i^-)) \quad (4.5.2)$$

where  $\tau_i^-$  represents the last moment in phase  $i$ .

As described in Sections 4.3 and 4.4, the reliability of PMSs can be improved by swapping components either at any time during the mission or only at the transition of phases. An upfront cost may need to be paid to enable each swapping scenario. Let  $b$  denote the cost to enable a regime of specified swaps at any time during the mission and  $e$  denote the cost to enable a regime of specified swaps only at the

transition of phases. Let  $C_S^{(W)}$  and  $C_S^{(E)}$  denote the expected costs of the system in both scenarios, respectively. These expected costs are derived as follows:

$$C_S^{(W)} = b + \sum_{i=1}^N \left[ P(i) (R^{(W)}(\tau_{i-1}^-) - R^{(W)}(\tau_i^-)) \right] \quad (4.5.3)$$

$$C_S^{(E)} = e + \sum_{i=1}^N \left[ P(i) (R^{(E)}(\tau_{i-1}^-) - R^{(E)}(\tau_i^-)) \right] \quad (4.5.4)$$

where  $R^{(W)}(t)$  is the reliability of the system at time  $t \in [\tau_{i-1}, \tau_i)$  if the specified swaps are applicable at any time during the mission, and  $R^{(E)}(t)$  is the reliability of the system the specified swaps are applicable only at the transitions of phases.

### 4.5.2 Time dependent penalty costs

In practical engineering, the cost penalty for failure of a PMS may be time dependent. Similar as in Section 3.2.2, we consider the case where the costs are based on the system downtime, let the penalty cost per unit of time in phase  $i$  be  $u_i$ . If the system fails at time  $T_S \in [\tau_{i-1}, \tau_i)$ , then the down time is  $(\tau_i - T_S) + \sum_{k=i+1}^N (\tau_k - \tau_{k-1})$  for  $i \in \{1, 2, \dots, N\}$ ,  $k \in \{2, 3, \dots, N-1\}$ . If the system fails during phase  $i$ , the expected penalty costs that need to be paid are

$$C_{S_i} = \int_{\tau_{i-1}^+}^{\tau_i^-} f(t) \left( u_i(\tau_i - t) + \sum_{k=i+1}^N u_k(\tau_k - \tau_{k-1}) \right) dt.$$

where  $\tau_{i-1}^+$  represents the first moment in phase  $i$  and  $\tau_i^-$  represents the last moment in phase  $i$  and  $f(t)$  is the PDF of the failure time of the PMS. If the system fails at  $\tau_i$ , the expected penalty cost are

$$C_{S_{\tau_i}} = P(T_S = \tau_i) \left( \sum_{k=i+1}^N u_k(\tau_k - \tau_{k-1}) \right)$$

Let  $C_S$  denote the expected cost of a PMS, then

$$C_S = \sum_{i=1}^N \left[ \int_{\tau_{i-1}^+}^{\tau_i^-} f(t) \left( u_i(\tau_i - t) + \sum_{k=i+1}^N u_k(\tau_k - \tau_{k-1}) \right) dt + P(T_S = \tau_i) \left( \sum_{k=i+1}^N u_k(\tau_k - \tau_{k-1}) \right) \right]$$



$$\begin{aligned}
&= \sum_{i=1}^N \left[ u_i \int_{\tau_{i-1}^+}^{\tau_i^-} (\tau_i - t) f(t) dt + \left( F(\tau_i^-) - F(\tau_{i-1}^+) \right) \sum_{k=i+1}^N u_k (\tau_k - \tau_{k-1}) + \right. \\
&\quad \left. \left( F(\tau_i^+) - F(\tau_i^-) \right) \left( \sum_{k=i+1}^N u_k (\tau_k - \tau_{k-1}) \right) \right] \\
&= \sum_{i=1}^N \left[ u_i \int_{\tau_{i-1}^+}^{\tau_i^-} (\tau_i - t) f(t) dt + \left( R(\tau_{i-1}^+) - R(\tau_i^+) \right) \sum_{k=i+1}^N u_k (\tau_k - \tau_{k-1}) \right] \quad (4.5.5)
\end{aligned}$$

We derive  $\int_{\tau_{i-1}^+}^{\tau_i^-} (\tau_i - t) f(t) dt$  as follows,

$$\int_{\tau_{i-1}^+}^{\tau_i^-} (\tau_i - t) f(t) dt = \tau_i [F(\tau_i^-) - F(\tau_{i-1}^+)] - \int_{\tau_{i-1}^+}^{\tau_i^-} t f(t) dt \quad (4.5.6)$$

and

$$\int_{\tau_{i-1}^+}^{\tau_i^-} t f(t) dt = \int_0^{\tau_i^-} t f(t) dt - \int_0^{\tau_{i-1}^+} t f(t) dt \quad (4.5.7)$$

We derive  $\int_0^{\tau_i^-} t f(t) dt$  for any  $i = 1, 2, \dots, N$  as follows,

$$\begin{aligned}
\int_0^{\tau_i^-} t f(t) dt &= \int_0^{\tau_i^-} \int_0^t f(t) du dt = \int_0^{\tau_i^-} \int_u^{\tau_i^-} f(t) dt du = \int_0^{\tau_i^-} F(\tau_i^-) - F(u) du = \\
\int_0^{\tau_i^-} (F(\tau_i^-) - 1) + (1 - F(u)) du &= -\tau_i R(\tau_i^-) + \int_0^{\tau_i^-} R(u) du \quad (4.5.8)
\end{aligned}$$

Substituting the result from Equation (4.5.8) to Equation (4.5.7), gives

$$\int_{\tau_{i-1}^+}^{\tau_i^-} t f(t) dt = -\tau_i R(\tau_i^-) + \int_0^{\tau_i^-} R(u) du - \left[ -\tau_{i-1} R(\tau_{i-1}^+) + \int_0^{\tau_{i-1}^+} R(u) du \right] \quad (4.5.9)$$

Substituting the result from Equation (4.5.9) to Equation (4.5.6), gives

$$\int_{\tau_{i-1}^+}^{\tau_i^-} (\tau_i - t) f(t) dt = (\tau_i - \tau_{i-1}) R(\tau_{i-1}^+) - \int_{\tau_{i-1}^+}^{\tau_i^-} R(t) dt \quad (4.5.10)$$

From Equations (4.5.9) and (4.5.5), the expected cost of failure of a PMS is given by the following equation:

$$\begin{aligned}
C_S &= \sum_{i=1}^N \left[ u_i \left( (\tau_i - \tau_{i-1}) R(\tau_{i-1}^+) - \int_{\tau_{i-1}^+}^{\tau_i^-} R(t) dt \right) + \right. \\
&\quad \left. \left( R(\tau_{i-1}^+) - R(\tau_i^+) \right) \sum_{k=i+1}^N u_k (\tau_k - \tau_{k-1}) \right] \quad (4.5.11)
\end{aligned}$$

Similarly, as shown above with time independent penalty costs, if  $b$  is the upfront cost needed to be paid to enable a regime of specified swaps at any time during the mission, and  $e$  is the upfront cost needed to be paid to enable a regime of specified swaps at only at the transitions of phases, the expected costs in both scenarios are given by the following equations

$$C_S^{(W)} = b + \sum_{i=1}^N \left[ u_i \left( (\tau_i - \tau_{i-1}) R^{(W)}(\tau_{i-1}^+) - \int_{\tau_{i-1}^+}^{\tau_i^-} R^{(W)}(t) dt \right) + \left( R^{(W)}(\tau_{i-1}^+) - R^{(W)}(\tau_i^+) \right) \sum_{k=i+1}^N u_k (\tau_k - \tau_{k-1}) \right] \quad (4.5.12)$$

$$C_S^{(E)} = e + \sum_{i=1}^N \left[ u_i \left( (\tau_i - \tau_{i-1}) R^{(E)}(\tau_{i-1}^+) - \int_{\tau_{i-1}^+}^{\tau_i^-} R^{(E)}(t) dt \right) + \left( R^{(E)}(\tau_{i-1}^+) - R^{(E)}(\tau_i^+) \right) \sum_{k=i+1}^N u_k (\tau_k - \tau_{k-1}) \right] \quad (4.5.13)$$

The following two examples illustrate the effect of swapping components in both scenarios on the expected costs for a PMS when the components are swapped upon failure, while the case when the components are swapped according to structure importance will be illustrated in Example 4.5.3.

**Example 4.5.1** In this example, we consider again the PMS with single type of components as in Figure 4.1 and we keep the same scenario for the duration of all the three phases and for the conditional lifetime distribution of the components in each phase as in Example 4.3.1. We also consider the same scenario for the swapping opportunity as in Example 4.3.1, namely components 1 and 2 can be swapped upon failure. We want to compare the expected cost of the original PMS with the expected cost when components 1 and 2 are swappable at any time during the mission or only at switches of phases.

Assume that the penalty costs allocated to each phase of not performing its mission are  $1 \times 10^3$ ,  $8 \times 10^2$  and  $5 \times 10^2$ , respectively, for phase 1, 2, and 3. If these penalty costs are independent of the failure time during or before the phases, the

expected cost for the original PMS are given by Equation (4.5.2) and equal to

$$C_S = \left[ 23 \times 10^2 \left( 1 - R(10^-) \right) \right] + \left[ 13 \times 10^2 \left( R(10^-) - R(20^-) \right) \right] + \left[ 5 \times 10^2 \left( R(20^-) - R(30) \right) \right] = 39.28$$

Assume that the cost to enable the swap at any time during the mission is  $b = 50$ , and the cost to enable the swap only at the transitions of phases is  $e = 3$ . The expected cost of failure in both swapping scenarios are as follows:

$$C_S^{(W)} = 50 + \left[ 23 \times 10^2 \left( 1 - R^{(W)}(10^-) \right) \right] + \left[ 13 \times 10^2 \left( R^{(W)}(10^-) - R^{(W)}(20^-) \right) \right] + \left[ 5 \times 10^2 \left( R^{(W)}(20^-) - R^{(W)}(30) \right) \right] = 52.1$$

$$C_S^{(E)} = 3 + \left[ 23 \times 10^2 \left( 1 - R^{(E)}(10^-) \right) \right] + \left[ 13 \times 10^2 \left( R^{(E)}(10^-) - R^{(E)}(20^-) \right) \right] + \left[ 5 \times 10^2 \left( R^{(E)}(20^-) - R^{(E)}(30) \right) \right] = 7.72$$

It can be clearly seen that, while taking the opportunity of both swapping scenarios would reduce the expected costs, the maximum reduction is obtained when the swap is applicable only at the switches of phases. In Figure 4.6(a), we plot the expected cost as a function of the swap costs. We can clearly see that  $C_S \leq C_S^{(W)}$  when  $b \geq 37.11$  and  $C_S \leq C_S^{(E)}$  when  $e \geq 34.58$ . Also,  $C_S^{(W)} = C_S^{(E)}$  when  $b = e + 2.54$ . Therefore, in the case that  $b \leq e + 2.54$  and  $b < 37.11$  it is better to take the option that enable the swap at any time during the mission, and in the case that  $b > e + 2.54$  and  $e < 34.58$  it is better to take the option to enable the swap only at the transitions of phases. In the other cases is better not to take the option of any swap scenarios.

Now assume that the penalty cost is time dependent where  $1 \times 10^3$ ,  $8 \times 10^2$  and  $5 \times 10^2$  are the costs per unit of time in phases 1, 2 and 3, respectively, and the swap costs at any time during the mission and at the transitions of phases are  $b = 50$  and  $e = 3$ , respectively. The expected cost of the original PMS and the expected costs in the both scenarios are calculated as follows:

$$\begin{aligned}
C_S = & \left[ 1 \times 10^3 \left( 10 - \int_0^{10^-} R(t) dt \right) + \left( 1 - R(10^+) \right) \left( (8 + 5) \times 10^2(10) \right) \right] + \\
& \left[ 8 \times 10^2 \left( (10)R(10^+) - \int_{10^+}^{20^-} R(t) dt \right) + \left( R(10^+) - R(20^+) \right) \left( 5 \times 10^2(10) \right) \right] \\
& + \left[ 5 \times 10^2 \left( (10)R(20^+) - \int_{20^+}^{30} R(t) dt \right) \right] = 378.71
\end{aligned}$$

$$\begin{aligned}
C_S^{(W)} = & 50 + \left[ 1 \times 10^3 \left( 10 - \int_0^{10^-} R^{(W)}(t) dt \right) + \left( 1 - R^{(W)}(10^+) \right) \left( (8 + 5) \times 10^2(10) \right) \right] + \\
& \left[ 8 \times 10^2 \left( (10)R^{(W)}(10^+) - \int_{10^+}^{20^-} R^{(W)}(t) dt \right) + \left( R^{(W)}(10^+) - R^{(W)}(20^+) \right) \left( 5 \times 10^2(10) \right) \right] \\
& + \left[ 5 \times 10^2 \left( (10)R^{(W)}(20^+) - \int_{20^+}^{30} R^{(W)}(t) dt \right) \right] = 68.07
\end{aligned}$$

$$\begin{aligned}
C_S^{(E)} = & 3 + \left[ 1 \times 10^3 \left( 10 - \int_0^{10^-} R^{(E)}(t) dt \right) + \left( 1 - R^{(E)}(10^+) \right) \left( (8 + 5) \times 10^2(10) \right) \right] + \\
& \left[ 8 \times 10^2 \left( (10)R^{(E)}(10^+) - \int_{10^+}^{20^-} R^{(E)}(t) dt \right) + \left( R^{(E)}(10^+) - R^{(E)}(20^+) \right) \left( 5 \times 10^2(10) \right) \right] \\
& + \left[ 5 \times 10^2 \left( (10)R^{(E)}(20^+) - \int_{20^+}^{30} R^{(E)}(t) dt \right) \right] = 35.49
\end{aligned}$$

It can be clearly seen that the best option is to take the opportunity to enable the swap only at the switches of phases. The expected costs are plotted as a function of the swap costs in Figure 4.6(b). We can see that  $C_S \leq C_S^{(W)}$  when  $b \geq 360.65$  and  $C_S \leq C_S^{(E)}$  when  $e \geq 346.22$ . Also,  $C_S^{(W)} = C_S^{(E)}$  when  $b = e + 14.42$ . Therefore, if  $b \leq e + 14.42$  and  $b < 360.65$  it is better to take the opportunity to enable the swap at any time during the mission, and if  $b > e + 14.42$  and  $e < 346.22$  it is better to take the opportunity to enable the swap only at the transitions of phases. In all other cases it is better not to take the option of any swap scenarios.

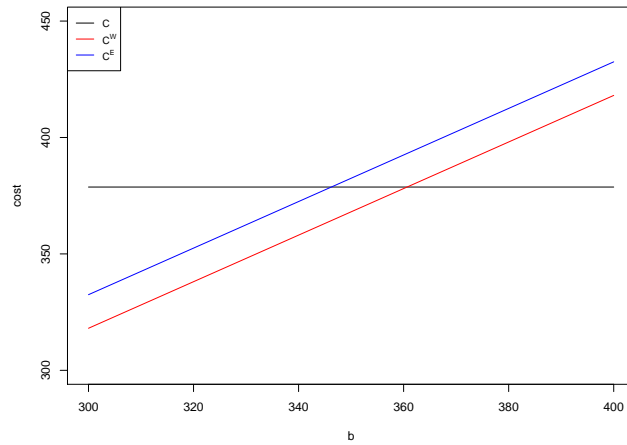

(a) Time independent penalty

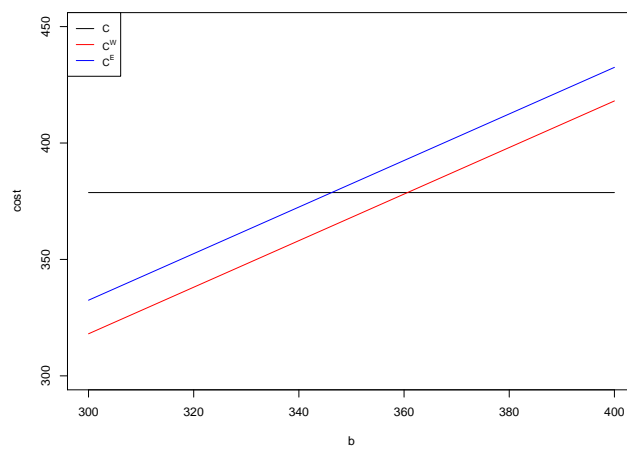

(b) Time dependent penalty

Figure 4.6: Cost for the PMS in Example 4.3.1

**Example 4.5.2** In this example, we consider the same PMS with multiple types of components as in Figure 4.3, and we keep the same scenario for the duration of all the three phases and for the conditional lifetime distributions of the components in each phase as in Example 4.3.2 and Example 4.4.2. Also, we consider the same scenario for the swapping case as in Example 4.3.2, namely that components 1 and 2 are swappable, and components 3 and 4 are swappable, upon failure. We want to compare the expected costs of the original PMS with the expected costs when the components are swapped at any time during the mission or only at transitions of phases.

Assume that the penalty costs allocated to phases 1, 2 and 3 are  $1 \times 10^3$ ,  $8 \times 10^2$  and  $5 \times 10^2$ , respectively, and the swap cost at any time during the mission and at the transitions of phases are  $b = 50$  and  $e = 3$ . If the penalty costs are independent of the failure time during the phases, the expected cost for the original PMS is  $C_S = 15.87$  and the expected cost in both scenarios are  $C_S^{(W)} = 51.32$  and  $C_S^{(E)} = 15.15$ . Therefore, the least cost is obtained when the swap is enabled only at the transitions of phases, followed by the option of not to enable any swaps, and the maximum cost is when the swap is enabled at any time during the mission.

We plot the expected costs as functions of the swap costs in Figure 4.7(a). From this figure we can see that  $C_S \leq C_S^{(W)}$  when  $b \geq 14.55$ ,  $C_S \leq C_S^{(E)}$  when  $e \geq 3.72$  and  $C_S^{(W)} = C_S^{(E)}$  when  $b = e + 10.83$ . Therefore, it is better to take the opportunity to enable the swap at any time during the mission if  $b \leq e + 10.83$  and  $b < 14.55$ , it is better to take the opportunity to enable the swap only at the transitions of phases if  $b > e + 10.83$  and  $e < 3.72$ , and in the other cases it is better to not take the option of any swaps.

If the penalty costs are dependent on the failure time during the phases, the expected cost of the original PMS and the expected costs in both scenarios are  $C_S = 615.38$ ,  $C_S^{(W)} = 90.63$  and  $C_S^{(E)} = 526.99$ . Figure 4.7(b) shows the expected cost as a function of the swap costs.  $C_S \leq C_S^{(W)}$  when  $b \geq 574.75$ ,  $C_S \leq C_S^{(E)}$  when  $e \geq 91.39$ , and  $C_S^{(W)} = C_S^{(E)}$  when  $b = e + 483.36$ , so, if  $b \leq e + 483.36$  and  $b < 574.75$  is good to take the opportunity that enable the swap at any time during the mission, if  $b > e + 483.36$  and  $e < 91.39$  it is better to take the opportunity to

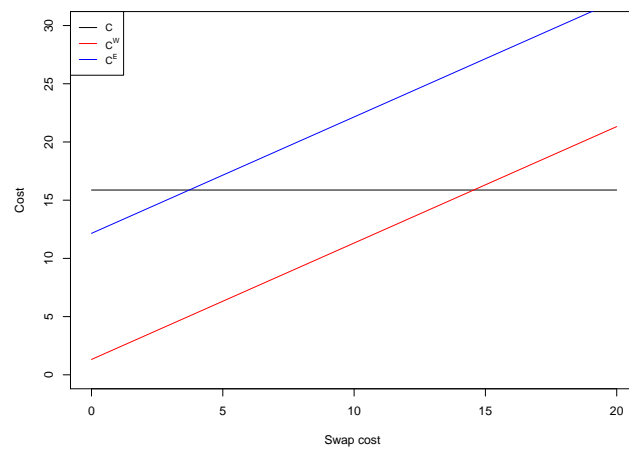

(a) Time independent penalty

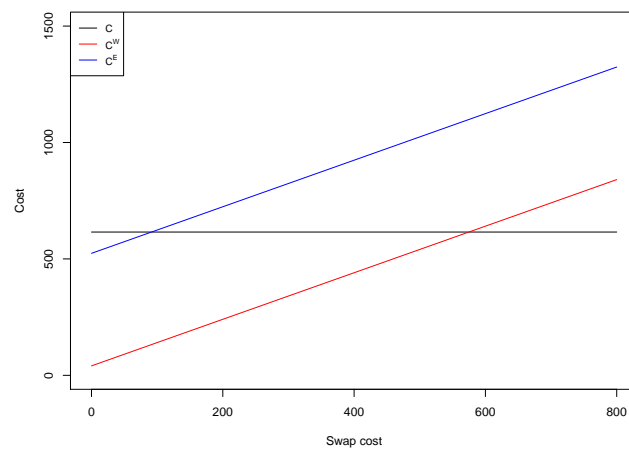

(b) Time dependent penalty

Figure 4.7: Cost for the PMS in Example 4.4.1

enable the swap only at the transitions of phases, and in the other cases it is better to not take the option of any swaps scenarios.

**Example 4.5.3** In this example, we consider again the same system in Figure 4.3, and we want to analyse the cost of this system if the component swapped according to the structure importance as Example 4.4.2, we also keep the same scenario for the duration of all three phases and for conditional lifetime distribution of the components in each phase as in Example 4.3.2, and Example 4.4.2. If the penalty costs of failure and the swap costs are the same as Example 4.5.2, the expected costs when the penalty costs are independent of the failure time during the phase is  $C_S = 15.87$  for the original system and are  $C_S^{(W)} = 52.28$   $C_S^{(E)} = 16.77$  for the both swap scenarios. Comparing these results with the results when the components swapped upon failure in Example 4.5.2, we find that in this example it is better to not take the option of any swap scenarios, but in the previous example is good to take the the opportunity to enable the swap only at the transitions of phases. This because the improvement that is gained in the reliability when the components are swapped upon failure is more than if they are swapped according to the structure importance.

Figure 4.8(a) shows how the expected costs would change depending on the cost of the swap. We can see in this figure that if  $b \leq e + 4.48$  and  $b < 13.59$  is good to take the opportunity that enable the swap at any time during the mission, if  $e < 9.10$  and  $b > e + 4.48$  is good to take the opportunity to enable the swap only at the switches of phases, and in the other cases is good to not take the option of any swap scenarios.

If the penalty costs of failure is time dependent, the expected cost for the original system is  $C_S = 615.38$  and for the both swap scenarios are  $C_S^{(W)} = 105.41$  and  $C_S^{(E)} = 473.02$ . Comparing these results with the results in Example 4.5.2, it clear that although the best option in both results is to take the the opportunity to enable the swap only at the transitions of phases, the expected cost when the components are swapped upon failure is less than if they are swapped according to the structure importance.

If we plot the expected costs against the swap cost, we can see in Figure 4.8(b) that, if  $b \leq e + 414.60$  and  $b < 559.96$  it is better to take the opportunity to enable the swap at any time during the mission, if  $e < 145.35$  and  $b > e + 414.60$  it is better



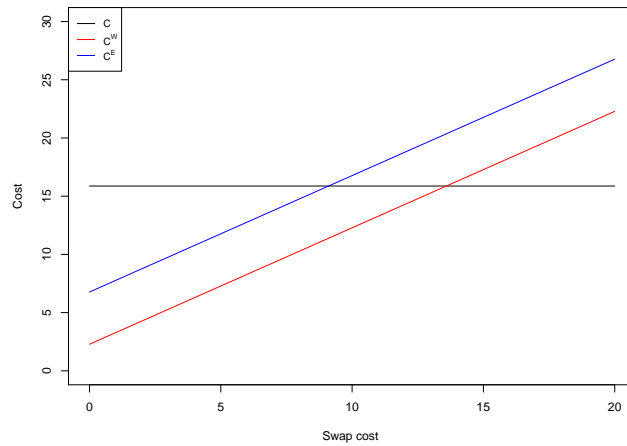

(a) Time independent penalty

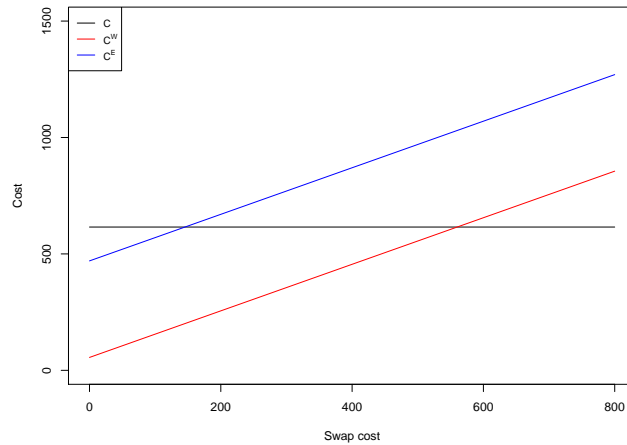

(b) Time dependent penalty

Figure 4.8: Cost for the PMS in Example 4.4.2

to take the opportunity to enable the swap only at the transitions of phases, and in the other cases it is better to not take the option of any swap scenarios.

The analyses in the previous examples show that the operation of component swapping either at any time during the mission or only at the transitions of phases might contribute significantly to reducing the expected costs of the PMS. The amount of this contribution depends on the gain in the reliability that due to these swap scenarios and on the swap costs.

## 4.6 Concluding remarks

A phased mission system (PMS) is one that performs several different tasks or functions in sequence. In order to accomplish the mission successfully, the system has to complete every phase without failure. Therefore, it is often difficult for a PMS to work with high reliability. We extended the new interesting strategy of swapping components upon failure as introduced in Chapter 2 of this thesis, to improve the reliability of PMSs. It is assumed that when a component fails, it can be swapped by another one which is still functioning in order to prevent the PMS from failure. In addition, in this chapter we discussed the strategy of swapping components according to structure importance. The structure importance is used to measure the importance level of the components in contributing to system reliability, then when a component with high importance fails, it is swapped by another component with lower importance from the system which has not yet failed, in order to improve the system reliability.

The survival signature methodology that is introduced by [37] is used to analyse the effect of component swapping according to both strategies on the reliability of the PMS, comparing the scenario when the swap between components is applicable at any time during the mission with the scenario when it is applicable only at transitions of phases. The analysis shows the effectiveness of component swapping in both scenarios in improving the reliability of the system. Considering component swapping strategy in increasing the reliability of the PMS is attractive since it will not increase the weight and volume of the system. What is more important and need to be emphasized is that, in the proposed approaches, the reliability and number of components do not need to be increased to improve the system reliability. A topic for further research could be to study the contribution that swapping components can make to PMS resilience in comparison to other activities, including more in-built redundancy, standby components, or maintenance and replacement activities. Moreover, a further interesting topic is the possibility to swap PMS components when they are all still functioning. This could be attractive if one has the opportunity to swap components of different types, where for example, a critical component may, while still functioning, be swapped with another of different type component

at a certain time if they have different hazard rates over time, for example, a component with increasing hazard rate may be best to use in a critical part of the system in early stages, to then be swapped by a component with decreasing hazard rate to improve system reliability at later stages.

In this chapter, we derive two models (time independent and time dependent) of penalty costs of PMSs, in order to compare the expected costs for the PMS when there is a possibility to swap components with the option not to enable swaps. This shows that although an upfront cost might need to be paid to enable each swapping opportunity, the operation of component swapping either at any time during the mission or only at the switches of phases might contribute significantly in reducing the expected cost of the PMS. The amount of this contribution is depend on the amount of the reliability that is gained in these swap scenarios and on the swap cost. The amount of reliability gained by component swapping could be used to determine which swap cost options is good in reducing the expected cost. These indicators are useful in security assessment and risk management under the constraint of cost. Further interesting topics for future research are different cost structures and consideration of swapping, component standby, spares and maintenance activities.

# Chapter 5

## Concluding Remarks

In this thesis, we introduced the strategy of components swapping to enhance system reliability and to make it more resilient to component failure. It is crucial that this is a different activity than popular and well-studied approaches such as the use of additional components to provide increased redundancy, the use of standby components, maintenance activities, or increased component reliability [25, 33, 61, 71]. It is assumed that when a component fails, it can be swapped by another one which is still functioning in order to enhance the reliability of the system. It is further assumed that such a swap of components can be done only when the system cannot function with the existing components in place. The quantification of system reliability if some components can be swapped is introduced based on the survival signature concept [18]. We considered component importance, which was particularly simplified by the use of the survival signature.

It is likely to be attractive to consider a component swap, upon failure if this activity can be done at low cost. In this thesis we also studied the cost effectiveness of component swapping over a fixed period of time. The cost aspects is studied under the assumption that a system would need to function for a given period of time, where failure to achieve this incurs a penalty cost. The different swap scenarios are compared with the option not to enable swaps, focusing on minimum expected costs over the given period. We also examined the cost effectiveness of component swapping over an unlimited time horizon from the perspective of renewal theory. It is assumed that the system is entirely renewed upon failure, at a known cost.

The expected cost per unit of time for the renewal system when there are different swapping scenarios are compared with the option not to enable swaps, focusing on minimum expected costs. We also discussed the meaningful effect that component swapping might have on the preventive replacement actions.

A phased mission system (PMS) is one that performs several different tasks or functions in sequence. In order to accomplish the mission successfully, the system in every phase has to be completed without failure. Therefore, it is often difficult for a PMS to work with high reliability. We extended the strategy of swapping components upon failure that is introduced in Chapter 2 to improve the reliability of PMS. In addition, we discussed another strategy of swapping components which is swapping components according to structure importance. The survival signature methodology that is introduced by [37] is used to analyse the effect of component swapping according to both strategies on the reliability of the PMS. The scenario when the swap between components is applicable at any time during the mission is compared with the scenario when it is applicable only at transition of phases. In this thesis we also studied the effectiveness of the cost of component swapping in reducing the expected costs of the failure of PMS. The expected costs when the two different scenarios of swapping possibilities are applicable are compared with the option not to enable swaps, focusing on minimum expected costs over the given period.

The increase in system reliability through such component swapping is new and has not received much attention in the literature. The results show that the strategy of swapping components upon failure can contribute significantly in improving the reliability of a system and makes it resilient to possible faults. This strategy is quite interesting since it will not increase the weight and volume of the system, it can be used in the systems that are not easily accessible for repair and replacements, it could enable preparation of substantial repair activities. In addition, in this strategy the reliability and number of the components don't need to be increased to improve the reliability of the system. Although an upfront cost needs to be paid to enable each swapping opportunity, this cost can contribute effectively in reducing the cost associated with system failure. The cost modules that are derived in this thesis are

useful in security assessment and risk management under the constraint of cost.

The approach of component swapping can be applied to improve the reliability of many real systems. Real applications can include the following examples. Aerospace systems with multiple computers on board, where some computers tasked with minor functions can be prepared to take over crucial functions in case another computer fails. Lighting systems, where multiple locations must be provided with light under contract but where partial lighting at any location may be sufficient to meet the contractual requirements. Transport systems, where parts of one mode of transport can be used to keep another one running. Organizations, where employees can be trained to take over some functioning of others in case of unexpected absence.

A further interesting topic for future research is the possibility to swap components of different types and the possibility to swap components when they are all still functioning. This could be attractive if one has the opportunity to swap components of different types where a critical component may, while still functioning, be swapped with another component at a certain time if they have different hazard rates over time. For example, a component with increasing hazard rate may be best to use in a critical part of the system in early stages, to then be swapped by a component with decreasing hazard rate to improve system reliability at later stages. Further research also is to study the contribution that swaps can make to system resilience in comparison to other activities, including more in-built redundancy, standby components, or maintenance and replacement activities [64]. It could also consider other importance measures. All the introduced research topics might be considered for PMS.

The effect of the swapping of components in this thesis is entirely reflected through the change in the survival signature. It may be of interest to investigate whether or not this change can also be reflected by a distortion of the component reliabilities [59], which may provide a further tool for comparison of different systems and different swapping routines. It has been shown that very efficient simulation methods can be based on the survival signature [49]. The same simulation method can perhaps also be used to only learn about difference in reliability for two swapping regimes.

It may be of interest also for future research to investigate different cost structures and consideration of choice between swapping components, standby, spares and maintenance activities based on corresponding costs. It may also consider the possibility to combine components swapping with inspection models [10].

The approach presented in this thesis requires repeated calculation of survival signatures. Aslett [6] has created a function in the statistical software R to compute the survival signature, given a graphical presentation of the system structure. This will be necessary for our work for systems that are not very small, and it will be of interest to create a tool that can automatically compute all the survival signatures required in case of a substantial system with many component swapping opportunities. It will be of interest also if this could be created for PMS in which the calculation of survival signatures is more complicated.

# Bibliography

- [1] Adger, W.N. (2000). Social ecological resilience: are they related? *Progress in Human Geography*, 24, 347-364.
- [2] Andrews, J. D. and Moss T. R. (1993). *Reliability and Risk Assessment*. Longman, Wiley.
- [3] Amari, S., Wang, C., Xing, L. and Mohammad, R. (2018). An efficient phased-mission reliability model considering dynamic k-out-of-n subsystem redundancy. *IISE Transactions*, 50, 868-877.
- [4] Amrutkar, K. and Kamalja, K. (2017). An Overview of Various Importance Measures of Reliability System. *International Journal of Mathematical, Engineering and Management Sciences*, 2, 150-171.
- [5] Andrews, J. and Moss, T. (2002). *Reliability and risk assessment*. London: Professional Engineering Pub.
- [6] Aslett, L. J. M. (2012), ReliabilityTheory: Tools for structural reliability analysis. R package, URL <http://www.louisaslett.com/>.
- [7] Aslett, L. J. M., Coolen, F.P.A and Wilson, S. P. (2014). Bayesian Inference for Reliability of Systems and Networks Using the Survival Signature. *Risk Analysis*, 35, 1640-1651.
- [8] Armstrong, M. (1995). Joint reliability-importance of components. *IEEE Transactions on Reliability*, 44, 408-412.
- [9] Barlow, R. E. and Proschan, F. (1965). *Mathematical Theory of Reliability*. Wiley: New York.



- [10] Berrade, M., Scarf, P., Cavalcante, C. and Dwight, R. (2013). Imperfect inspection and replacement of a system with a defective state: A cost and reliability analysis. *Reliability Engineering and System Safety*, 120, 80-87.
- [11] Birnbaum, Z.W. (1969). On the importance of different components in a multi-component system. *Multivariate AnalysisII*, P.R. Krishnaiah (Editor), Academic, New York, 581-592.
- [12] Bisanovic, S., Samardzic, M. and Aganovic, D. (2016). Application of Component Criticality Importance Measures in Design Scheme of Power Plants. *International Journal of Electrical and Computer Engineering (IJECE)*, 6, 63.
- [13] Bondavalli, A., Chiaradonna, S., Di Giandomenico, F. and Mura, I. (2004). Dependability Modeling and Evaluation of Multiple-Phased Systems Using DEEM. *Transactions on Reliability*, 53, 509-522.
- [14] Butler, D. (1979). A complete importance ranking for components of binary coherent systems, with extensions to multi-state systems. *Naval Research Logistics Quarterly*, 26, 565-578.
- [15] Cheok, M., Parry, G. and Sherry, R. (1998). Response to Supplemental viewpoints on the use of importance measures in risk-informed regulatory applications. *Reliability Engineering and System Safety*, 60, 261.
- [16] Cheok, M., Parry, G. and Sherry, R. (1998). Use of importance measures in risk-informed regulatory applications. *Reliability Engineering and System Safety*, 60, 213-226.
- [17] Chew, S., Dunnett, S. and Andrews, J. (2008). Phased mission modelling of systems with maintenance-free operating periods using simulated Petri nets. *Reliability Engineering and System Safety*, 93, 980-994.
- [18] Coolen, F.P.A. and Coolen-Maturi, T. (2012) Generalizing the signature to systems with multiple types of components. *in Complex systems and depend-*

- ability*. Berlin: Springer, Advances in intelligent and soft computing., 170, 115-130.
- [19] Coolen, F.P.A., Coolen-Maturi, T. and Al-nefaiee, A. (2014). Nonparametric predictive inference for system reliability using the survival signature. Proceedings of the Institution of Mechanical Engineers, Part O: *Journal of Risk and Reliability*, 228, 437-448.
- [20] Coolen-Schrijner, P. and Coolen, F.P.A. (2006). On Optimality Criteria for Age Replacement. Proceedings of the Institution of Mechanical Engineers, Part O: *Journal of Risk and Reliability*, 220, 21-29.
- [21] Coolen-Schrijner, P. and Coolen, F.P.A. (2007). Nonparametric adaptive age replacement with a one-cycle criterion. *Reliability Engineering and System Safety*, 92, 74-84.
- [22] Coolen-Schrijner, P., Coolen, F.P.A. and Shaw, S.C. (2006). Nonparametric adaptive opportunity-based age replacement strategies. *Journal of the Operational Research Society*, 57, 63-81.
- [23] Dai, Y., Levitin, G. and Xing, L. (2014). Structure Optimization of Nonreparable Phased Mission Systems. *IEEE Transactions on Systems, Man, and Cybernetics: Systems*, 44, 121-129.
- [24] DeAngelis, D. (1980). Energy Flow, Nutrient Cycling, and Ecosystem Resilience. *Ecology*, 61, 764-771.
- [25] Dhingra, A. (1992). Optimal apportionment of reliability and redundancy in series systems under multiple objectives. *IEEE Transactions on Reliability*, 41, 576-582.
- [26] Dugan, J. (1991). Automated analysis of phased-mission reliability. *IEEE Transactions on Reliability*, 40, 45-52.
- [27] Eryilmaz, S., Coolen, F.P.A and Coolen-Maturi, T. (2018). Marginal and joint reliability importance based on survival signature. *Reliability Engineering and System Safety*, 172, 118-128.

- [28] Eryilmaz, S., Coolen, F.P.A and Coolen-Maturi, T. (2018). Mean residual life of coherent systems consisting of multiple types of dependent components. *Naval Research Logistics (NRL)*, 65, 86-97.
- [29] Lin, Y., Li, Y. and Zio, E. (2016). Component Importance Measures for Components With Multiple Dependent Competing Degradation Processes and Subject to Maintenance. *IEEE Transactions on Reliability*, 65, 547-557.
- [30] Linnenluecke, M. (2013). The Concept of Organizational Resilience: Towards a Research Agenda. *Academy of Management Proceedings*, 2013, Academy of Management, Orlando, FL, USA, 73<sup>rd</sup> Annual Meeting of the Academy of Management, <https://doi.org/10.5465/ambpp.2013.15010abstract>.
- [31] Feng, G., Patelli, E., Beer, M. and Coolen, F.P.A (2016). Imprecise system reliability and component importance based on survival signature. *Reliability Engineering and System Safety*, 150, 116-125.
- [32] Gao, X., Cui, L. and Li, J. (2007). Analysis for joint importance of components in a coherent system. *European Journal of Operational Research*, 182, 282-299.
- [33] Hadipour, H., Amiri, M. and Sharifi, M. (2018). Redundancy allocation in series-parallel systems under warm standby and active components in repairable subsystems. *Reliability Engineering and System Safety*, <https://doi.org/10.1016/j.ress.2018.01.007>.
- [34] Hajian-Hoseinabadi, H. (2013). Reliability and component importance analysis of substation automation systems. *International Journal of Electrical Power and Energy Systems*, 49, 455-463.
- [35] Hong, J. S. and Lie, C. H. (1993). Joint reliability-importance of two edges in an undirected network. *IEEE Transactions on Reliability*, 42, 17-23.
- [36] Hosseini, S., Barker, K. and Ramirez-Marquez, J. (2016). A review of definitions and measures of system resilience. *Reliability Engineering and System Safety*, 145, 47-61.

- [37] Huang, X., Aslett, L.J.M. and Coolen, F.P.A. (2018). Reliability analysis of general phased mission systems with a new survival signature. *Reliability Engineering and System Safety*, 189, 416-422.
- [38] Hsu, S. and Yuang, M. (2001). Efficient computation of marginal reliability importance for reducible networks. *IEEE Transactions on Reliability*, 50, 98-106.
- [39] Jackson, S. and Brtis, J. (2015) Overview of the Resilience of Engineered Systems. INCOSE Insight.
- [40] Kim, K. and Park, K. (1994). Phased-mission system reliability under Markov environment. *IEEE Transactions on Reliability*, 43, 301-309.
- [41] Kuo, W., and Zuo, M.J. (2003). Optimal reliability modelling: Principles and Applications. *John Wiley and Sons*, New Jersey.
- [42] Kuo, W. and Zhu, X. (2012). *Importance measures in reliability, risk, and optimization: principles and applications*. Wiley.
- [43] Levitin, G., Xing, L. and Dai, Y. (2014). Minimum Mission Cost Cold-Standby Sequencing in Non-Repairable Multi-Phase Systems. *IEEE Transactions on Reliability*, 63, 251-258.
- [44] Marichal, J., Mathonet, P., Navarro, J. and Paroissin, C. (2017). Joint signature of two or more systems with applications to multistate systems made up of two-state components. *European Journal of Operational Research*, 263, 559-570.
- [45] Najem, A. and Coolen, F.P.A. (2018). Cost Effective Component Swapping To Increase System Reliability. In 10<sup>th</sup> IMA International Conference On Modelling In Industrial Maintenance And Reliability. <https://doi.org/10.19124/ima.2018.001.17>.
- [46] Najem, A. and Coolen, F.P.A (2018). System reliability and component importance when components can be swapped upon failure. *Applied Stochastic Models in Business and Industry*, <https://doi.org/10.1002/asmb.2420>.

- [47] Navarro, J. and Durante, F. (2017). Copula-based representations for the reliability of the residual lifetimes of coherent systems with dependent components. *Journal of Multivariate Analysis*, 158, 87-102.
- [48] Navarro, J., Samaniego, F., Balakrishnan, N. and Bhattacharya, D. (2008). On the application and extension of system signatures in engineering reliability. *Naval Research Logistics*, 55, 313-327.
- [49] Patelli, E., Feng, G., Coolen, F.P.A and Coolen-Maturi, T. (2017). Simulation methods for system reliability using the survival signature. *Reliability Engineering and System Safety*, 167, 327-337.
- [50] Peng, R., Zhai, Q., Xing, L. and Yang, J. (2016). Reliability analysis and optimal structure of series-parallel phased-mission systems subject to fault-level coverage. *IIE Transactions*, 48, 736-746.
- [51] Popova, E. and Wu, H. (1999). Renewal reward processes with fuzzy rewards and their applications to T-age replacement policies. *European Journal of Operational Research*, 117, 606-617.
- [52] Ramirez-Marquez, J. and Coit, D. (2007). Multi-state component criticality analysis for reliability improvement in multi-state systems. *Reliability Engineering and System Safety*, 92, 1608-1619.
- [53] Reed, S., Andrews, J. and Dunnett, S. (2011). Improved Efficiency in the Analysis of Phased Mission Systems With Multiple Failure Mode Components. *IEEE Transactions on Reliability*, 60, 70-79.
- [54] Reed, S. (2017). An efficient algorithm for exact computation of system and survival signatures using binary decision diagrams. *Reliability Engineering and System Safety*, 165, 257-267.
- [55] Reed, S., Lofstrand, M. and Andrews, J. (2019). An efficient algorithm for computing exact system and survival signatures of K-terminal network reliability. *Reliability Engineering and System Safety*, 185, 429-439.

- [56] Rose, A. and Liao, S. (2005). Modeling Regional Economic Resilience to Disasters: A Computable General Equilibrium Analysis of Water Service Disruptions. *Journal of Regional Science*, 45, 75-112.
- [57] Samaniego, F. (1985). On Closure of the IFR Class Under Formation of Coherent Systems. *IEEE Transactions on Reliability*, 34, 69-72.
- [58] Samaniego, F. J. (2007). *System Signatures and their Applications in Engineering Reliability*. Springer.
- [59] Samaniego, F. and Navarro, J. (2016). On comparing coherent systems with heterogeneous components. *Advances in Applied Probability*, 48, 88-111.
- [60] Shaked, M. and Shanthikumar, J. (1992). Optimal allocation of resources to nodes of parallel and series systems. *Advances in Applied Probability*, 24, 894-914.
- [61] Shen, K. and Xie, M. (1990). On the increase of system reliability by parallel redundancy. *IEEE Transactions on Reliability*, 39, 607-611.
- [62] Somani, A. and Trivedi, K. (1994). Phased-mission system analysis using Boolean algebraic methods. *ACM SIGMETRICS Performance Evaluation Review*, 22, 98-107.
- [63] Tang, Z. and Dugan, J. (2006). BDD-Based Reliability Analysis of Phased-Mission Systems With Multimode Failures. *IEEE Transactions on Reliability*, 55, 350-360.
- [64] Tijms, H. (1990). *Stochastic Modelling and Analysis*. Chichester: Wiley.
- [65] van der Borst, M. and Schoonakker, H. (2001). An overview of PSA importance measures. *Reliability Engineering and System Safety*, 72, 241-245.
- [66] Venkat, D., Coolen, F.P.A. and Coolen-Schrijner, P. (2010). Extended opportunity-based age replacement with a one-cycle criterion. Proceedings of the Institution of Mechanical Engineers, Part O: *Journal of Risk and Reliability*, 224, 55-62.

- [67] Wu, S. (2005). Joint importance of multistate systems. *Computers and Industrial Engineering*, 49, 63-75.
- [68] Xing, L. and Dugan, J.B. (2002). Analysis of generalized phased-mission system reliability, performance, and sensitivity. *IEEE Transactions on Reliability*, 51, 199-211.
- [69] Youn, B., Hu, C., Wang, P. and Yoon, J. (2011). Resilience Allocation for Resilient Engineered System Design. *Journal of Institute of Control, Robotics and Systems*, 17, 1082-1089.
- [70] Zang, X., Sun, H. and Trivedi, K. S. (1999). A BDD-based algorithm for reliability analysis of phased-mission systems. *IEEE Transactions on Reliability*, 48, 50-60.
- [71] Zhang, T., Xie, M. and Horigome, M. (2006). Availability and reliability of k-out-of-(M+N):G warm standby systems. *Reliability Engineering and System Safety*, 91, 381-387.
- [72] Zuo, M. J., Huang J. , and Kuo W. (2003). *Multi-state k-out-of-n systems*. In: Pham H (ed) *Handbook of Reliability Engineering*, Springer, 3-17.