

## Research Article

# Kaybob Revisited: What We Have Learned about Compressor Stability from Self-Excited Whirling

Edgar J. Gunter<sup>1,2</sup> and Brian K. Weaver<sup>3</sup>

<sup>1</sup>*RODYN Vibration Analysis, Inc., Charlottesville, VA, USA*

<sup>2</sup>*Rotor Dynamics Laboratory, Mechanical and Aerospace Engineering Department, University of Virginia, Charlottesville, VA, USA*

<sup>3</sup>*Rotating Machinery and Controls Laboratory, Mechanical and Aerospace Engineering Department, University of Virginia, Charlottesville, VA, USA*

Correspondence should be addressed to Brian K. Weaver; [bkw3q@virginia.edu](mailto:bkw3q@virginia.edu)

Received 11 July 2016; Accepted 14 November 2016

Academic Editor: Lars Hakansson

Copyright © 2016 E. J. Gunter and B. K. Weaver. This is an open access article distributed under the Creative Commons Attribution License, which permits unrestricted use, distribution, and reproduction in any medium, provided the original work is properly cited.

The Kaybob compressor failure of 1971 was an excellent historic example of rotordynamic instability and the design factors that affect this phenomenon. In the case of Kaybob, the use of poorly designed bearings produced unstable whirling in both the low and high pressure compressors. This required over five months of vibration troubleshooting and redesign along with over 100 million modern U.S. dollars in total costs and lost revenue. In this paper, the history of the Kaybob compressor failure is discussed in detail including a discussion of the ineffective bearing designs that were considered. Modern bearing and rotordynamic analysis tools are then employed to study both designs that were considered along with new designs for the bearings that could have ultimately restored stability to the machine. These designs include four-pad, load-between-pad bearings and squeeze film dampers with a central groove. Simple relationships based on the physics of the system are also used to show how the bearings could be tuned to produce optimum bearing stiffness and damping of the rotor vibration, producing insights which can inform the designers as they perform more comprehensive analyses of these systems.

## 1. Introduction

The rotordynamic stability of high-speed compressors and turbines has been a critical element of their design for decades. With the ever-increasing demand for greater output through an increased number of stages, higher speeds, and higher pressures, these machines are continuously being pushed to the design limits of the previous generation of machines. As they are being pushed to these new extremes of operation the designs must also adapt to accommodate the consequences of these extremes including increased rotor flexibility and an increased likelihood of subsynchronous whirl. This whirl can be excited by a number of sources in turbomachinery including seals and even the bearings supporting the rotor. The stability of that whirl can then be reduced by destabilizing cross-coupled stiffness forces from the bearings, interstage seals, balance pistons, and Alford-type aerodynamic cross-coupled forces around blades.

The increasing use of tilting pad journal bearings in the 1960s and 70s brought about new opportunities for compressor design as these bearings eliminated the self-exciting oil whirl commonly found in fixed geometry bearings. They also essentially eliminated the destabilizing cross-coupled stiffness forces produced by these bearings. However, despite the fact that a number of important papers were being published on these topics by Lund [2] and others, it was not until 1974 that Lund published his landmark paper on damped eigenvalue solutions for stability analysis [3]. It was because of this lack of accurate design and analysis tools that a significant number of high-speed machines were not designed appropriately for the conditions in which they were intended to operate.

The Kaybob compressor failure of 1971 was a historic case of rotordynamic instability from self-excited, subsynchronous whirl. The many months of troubleshooting that followed this failure served as a valuable lesson to the team

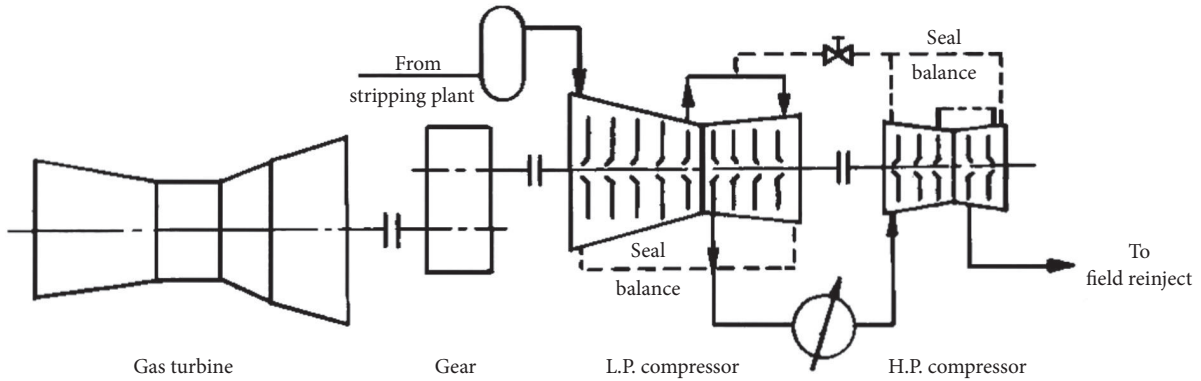

FIGURE 1: Kaybob compressor train schematic from Smith [1].

involved but even to this day this classic example serves as an important motivator for understanding the underlying principles that govern the design of these machines, many of which that were developed after the incident and troubleshooting took place. With the advent of advanced bearing and rotordynamic analysis tools, designers now have the ability to fine tune their designs to avoid these failures; however it is critically important that the underlying principles and physical insights gained from the analysis of these machines are properly considered as even modern bearing technologies can contribute to stability problems when not implemented correctly.

In this study, modern bearing and rotordynamic analysis tools are applied to the Kaybob compressor instability case to highlight the effects of the design choices made with this machine and how they contributed to its ultimate failure. By combining useful design principles with these analysis tools it also showed not only why the costly solution to this failure worked at the time, but also how a number of alternative and much simpler design changes to the support structure could have restored stability to the machine including the use of properly designed tilting pad journal bearings and squeeze film dampers. It is the goal of this study to provide practical information and design approaches that designers can then use to avoid costly failures like the one experienced in Kaybob.

## 2. Stage Case History: Kaybob Plant, Alberta

The case of the Kaybob compressor instability began in November of 1971, a detailed summary of which is provided by Smith of Cooper-Bessemer [1]. Three natural gas reinjection trains were being commissioned at the Kaybob South Beaverhill Lake plant in Fox Creek, Alberta, operated by Chevron-Standard.

These duplicate trains (Figure 1) consist of a gas turbine drive, a speed-increasing gearbox, a 9-stage low pressure compressor, and a 5-stage high pressure compressor. Both compressors have back-to-back impeller arrangements with centrally located balance pistons to control thrust and are supported by tilting pad thrust and radial bearings.

The tilting pad journal bearings were designed as five-pad, load-on-pad bearings, a design that has been commonly employed in compressors over the years. Floating oil film ring seals were employed in both compressor casings. The trains were designed for a rated speed of 10,200 rpm with a maximum continuous operating speed of 11,400 rpm.

As site testing began, a significant vibration problem became apparent in the low pressure compressor. A first train was operated at speeds up to 10,000 rpm with inlet pressures of 700–750 psi and discharge pressures of 1,300–1,500 psi. Under these conditions a significant vibration was present at a frequency of approximately 4,250 cpm, producing 3 to 4 mil peak-to-peak amplitudes in one of the bearings which had a 6 mil clearance.

A second train was then tested to rule out possible unexplained sources of resonance from the first train. This machine was ran up to its maximum speed of 11,440 rpm, followed by increases to the inlet and discharge pressures to 1,120 psi and 3,300 psi.

At this point the machine became highly unstable, resulting in a violent 5,100 cpm whirl of 9+ mils peak-to-peak amplitude. Figure 2 shows the 20-second time lapse of the instability onset in the thru-drive end bearing along with the orbit shape. Smith [1] notes that “the rotor assembly and internal labyrinths were severely damaged as a result of this violent, high-energy motion” and that the “vibration could be heard and felt in the control room some 50 feet away from the unit.”

The five months that followed included a thorough investigation into the causes of this instability as well as tests of various potential solutions to the problem including investigations into both seals and journal bearings. The seal investigation involved the consideration of four different seal configurations to determine whether seal lockup or effective damping had any significant effects on the instability. It was concluded, though, that the seals were in fact floating and their configuration overall had little effect on the problem.

A number of design modifications were considered for the tilting pad journal bearings as well. These modifications included increasing the specific load of the bearing, introducing asymmetry to the bearing design, different pad load

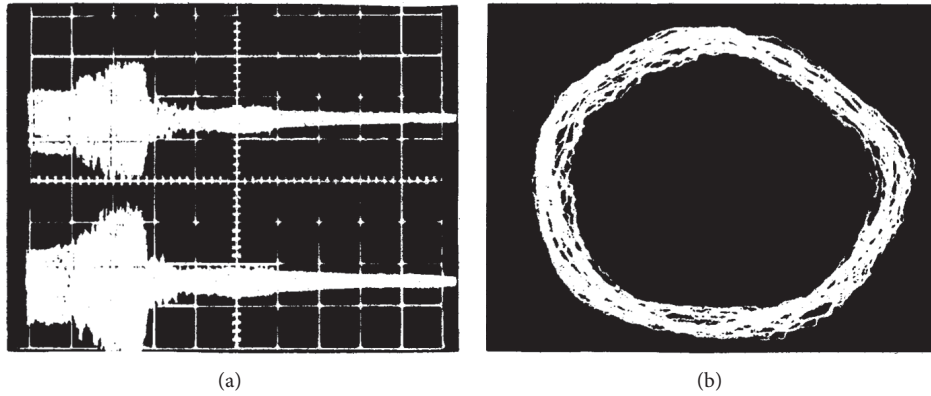

FIGURE 2: (a) Time lapse and (b) orbit of the instability onset. From Smith [1].

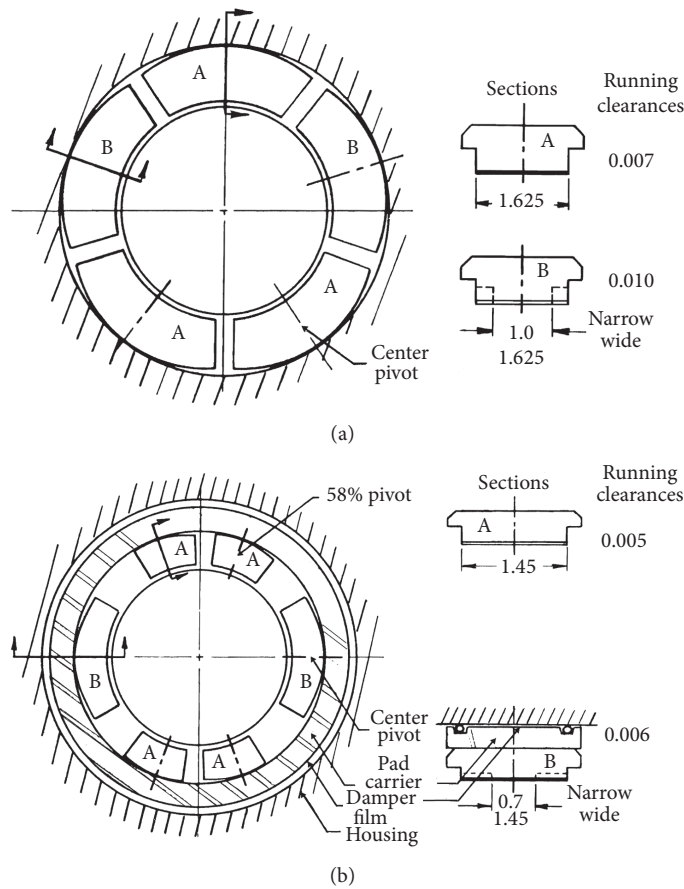

FIGURE 3: (a) Asymmetric tilt pad bearing from Smith [1]. (b) Squeeze film damper design from Smith [1].

configurations, offset pads, variable preloads, the introduction of squeeze film dampers, and combinations thereof. Two of the configurations tested are shown in Figure 3. Overall it was found that all of these bearing design-based solutions produced marginal improvements in rotordynamic stability. Additional analysis and discussion of these and other bearing designs is presented in the following sections.

Note that, in Figure 3(a), the side pads, B, are reduced in width in an attempt to incorporate some bearing asymmetry.

This modification had a negligible influence on stability. In Figure 3(b), the A pads are reduced in arc length and a squeeze film damper was added without a central groove. This design results in a damper with excessive damping and stiffness.

The ultimate solution to this vibration problem was a redesign of the rotor to a shorter, stiffer configuration with increased diameters beneath the impellers. This stiffer shaft would thereby accommodate the stiff bearing designs that

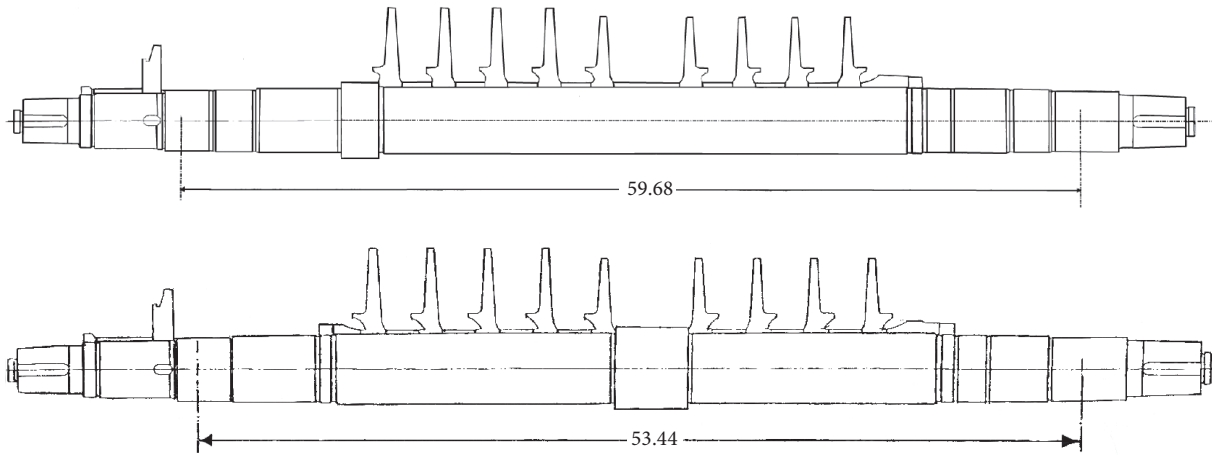

FIGURE 4: Rotor redesign from Smith [1].

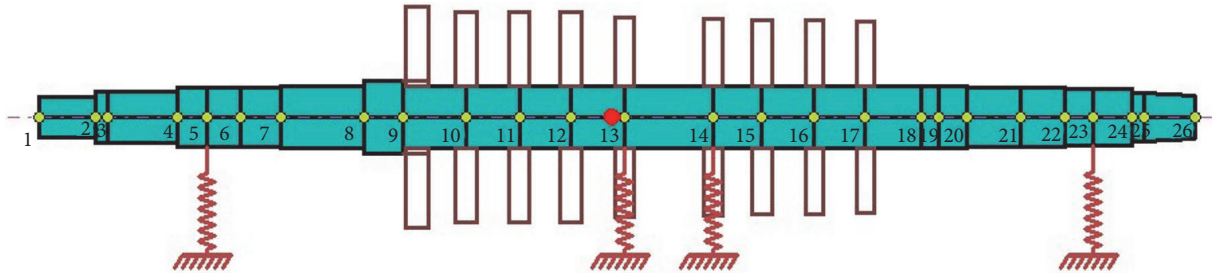

FIGURE 5: Kaybob 9-stage compressor model with aerodynamic cross-coupling at stations 13 and 14.

were used and that will be demonstrated in Section 9. Figure 4 shows the initial and final shaft designs. Overall, these significant changes resulted in a redesign of most of the primary machine components, a process which would cost the plant over 100 million modern U.S. dollars.

In the original design of the Kaybob rotor, the bearing span was 59.688 inches. A modal analysis of the rotor indicated that the shaft first critical speed modal stiffness was approximately 115,000 lb/in. This fundamental shaft modal stiffness is extremely important for the proper tuning of the bearings to the shaft. From previous research studies of the optimum bearing stiffness, it has been determined that the optimum bearing stiffness is approximately one half the rotor shaft stiffness. When the bearing stiffness greatly exceeds this fundamental design value, the first mode damping is drastically reduced causing the rotor to be very susceptible to self-excited whirl effects.

The fundamental stiffness of a uniform team is given by the following equation:

$$K_{\text{shaft}} = 48 \frac{EI}{L^3} \text{ lb/in.} \quad (1)$$

In the final redesign as shown in the lower rotor of Figure 4, the bearing span has been reduced to 53.438 inches. In addition to the reduced bearing span, the center section diameter has also been increased. This then leads to an improved shaft modal stiffness of 200,000 lb/in.

### 3. Rotordynamic Characteristics

In revisiting the design and troubleshooting of the Kaybob compressor, the first step was to establish the overall rotordynamic characteristics of the system. A finite element model of the compressor was first developed in the Dyrobes software suite used for this analysis and is presented to scale in Figure 5. The rotor spans 78 inches in total length with a bearing span of 60 inches. The model consists of 25 elements and 26 nodes with 9 rigid disks representing the mass and inertial properties of the 9 compressor stages, the details of which are provided in Table 1. The total rotor weight is 400 lbs. The bearings are represented as linear stiffness and damping coefficients at nodes 5 and 23.

After building the shaft model, the analysis began with an assessment of the rotor critical speeds in the operating range of the compressor (Figure 6). Two modes were found in the operating range: a first bending mode at approximately 4,600 rpm (Figure 7) which proved to be the unstable mode for the machine and a well-damped conical mode at approximately 8,500 rpm. Overlaying the critical speed map is the vertical stiffness  $K_{yy}$  of the original 5-pad load-on-pad tilting pad bearings supporting the rotor. Its position on the curve for the first bending mode provides an early indication of a relatively stiff support structure for the compressor.

In order to evaluate the stability characteristics of this compressor, a nominal amount of cross-coupled stiffness of 25,000 lb/in was assumed acting at stations 13 and 14. This

TABLE I: Kaybob compressor model disk properties.

Disk #	Station	Mass (lbm)	Transverse inertia (lbm·in <sup>2</sup> )	Polar inertia (lbm·in <sup>2</sup> )	Length (in)	Inner diameter (in)	Outer diameter (in)
1	9	15	760	1400	1.5	4.36	15.0
2	10	15	760	1400	1.5	4.36	14.3
3	11	15	760	1400	1.4	4.36	14.3
4	12	15	760	1400	1.4	4.36	14.3
5	13	5	760	1400	1.3	4.36	13.6
6	14	5	400	750	1.3	4.36	13.3
7	15	5	400	750	1.3	4.36	13.1
8	16	5	400	750	1.2	4.36	13.1
9	17	5	400	750	1.2	4.36	13.0

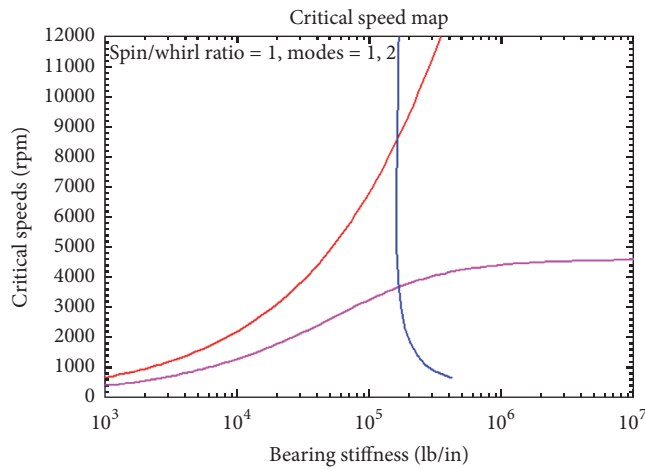

FIGURE 6: Compressor critical speed map.

Critical speed mode shape, mode number = 1  
 Spin/whirl ratio = 1, stiffness:  $K_{xx}$   
 Critical speed = 4612 rpm = 76.86 Hz

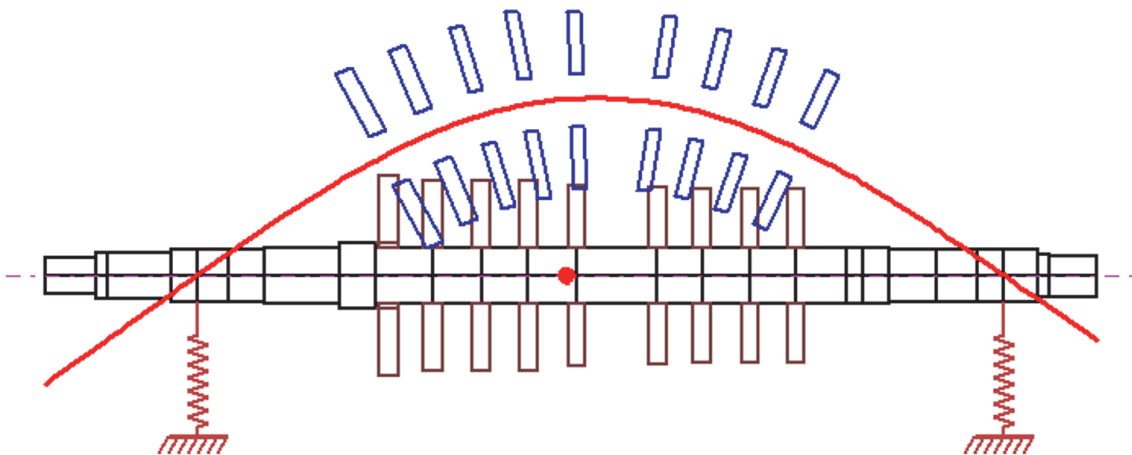

FIGURE 7: First bending mode of the compressor.

value was estimated based on experience and the description of the stability characteristics of the machine. These cross-coupling effects are known as the Alford effect [4] and can occur in all gas turbines and high pressure compressors. These effects are often not observed on a test stand when the

unit is operated under low pressure ratios. When operated in the field under high pressure conditions, the Alford effects become apparent resulting in self-excited whirling which can then lead to damage of seals and labyrinths. Due to a lack of information on the design of the seals these were not modeled

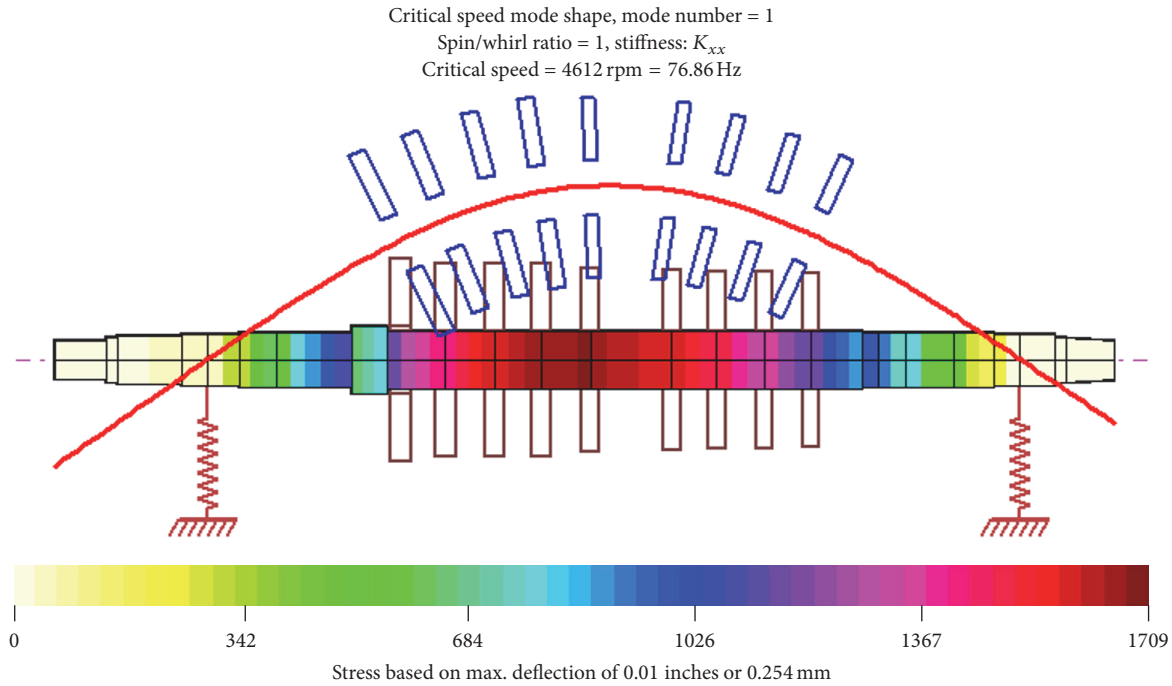

FIGURE 8: Shaft modal stresses of the first bending mode.

separately, with their contribution to the destabilization of the compressor being included in the cross-coupled stiffness applied.

The shaft modal stresses and stiffness were also assessed for the first bending mode assuming rigid bearings with a stiffness of  $10^8$  lb/in (Figure 8). Peak stresses of 1,709 psi were predicted along with a shaft modal stiffness of 115,850 lb/in. This magnitude of stiffness will prove to be very important to the stability of the machine as it is compared to the stiffness of the bearings in the following sections. It was presented by Barrett et al. [5] that the optimum ratio of twice the bearing stiffness to the shaft modal stiffness for maximizing modal stability is one.

To further support this important relationship in rotor dynamics, a plot was created showing the amplification factors of the first bending mode under various sets of bearing stiffness and damping (Figure 9). It is shown that the amplification factors are reduced as the bearing stiffness approaches this ideal ratio. The plot also highlights the importance of designing the bearings in such a manner that underdamped and overdamped conditions can also be avoided through proper design. The following sections on various bearing designs for the compressor will further show how various design variables affect these bearing properties and the stability of the compressor.

Figure 9 shows the importance of tuning the bearing stiffness to the rotor shaft stiffness. For example, with the original rotor design, it is seen that, with a vertical bearing stiffness of 100,000 lb/in, the optimum damping is about 250 lb-sec/in with an amplification factor of two. As the bearing stiffness increases, the required optimum damping increases

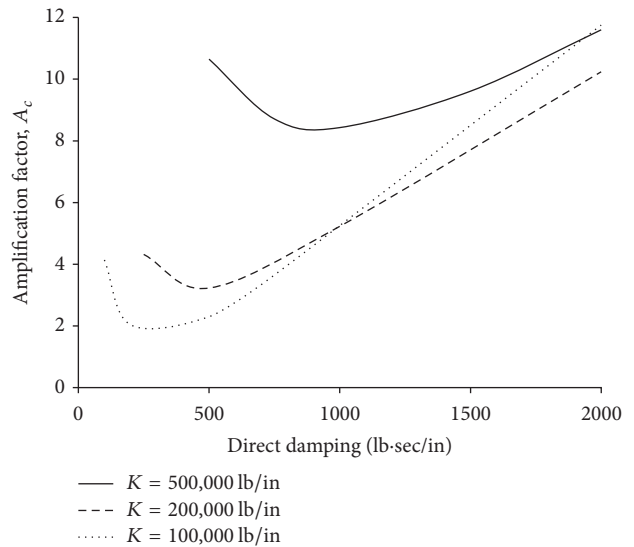

FIGURE 9: Amplification factors of the first bending mode.

to 500 lb-sec/in and the minimum amplification factor is over three.

For the case of very high stiffness bearing of 500,000 lb/in, it is seen that the optimum bearing damping is over 800 lb-sec/in and the amplification factor is now over eight. Therefore it is very apparent that it is critical to select the bearing stiffness in relationship to the predicted first modal shaft stiffness. This concept will often lead to the requirement of an extended width bearing in order to have a reduced vertical



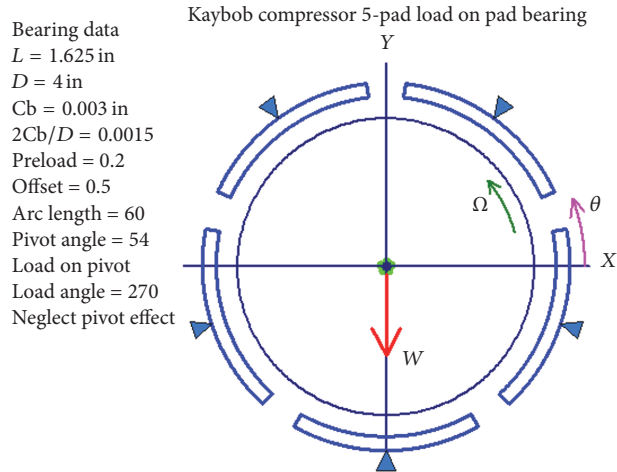

FIGURE 10: Original compressor bearing design.

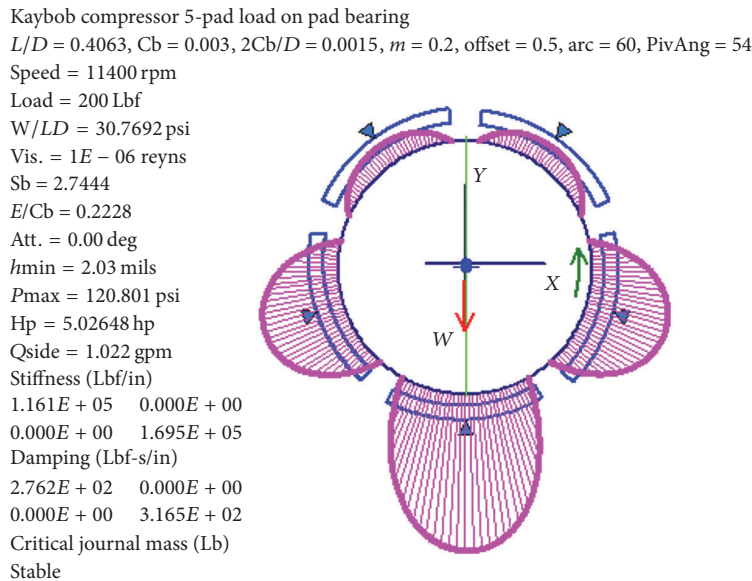

FIGURE 11: Original compressor bearing analysis results.

bearing stiffness in order to properly tune the bearings to the fundamental shaft stiffness.

#### 4. Original Bearing Design

The analysis of the Kaybob compressor continued with the development of various bearing models to better understand how the design of the bearings would impact the stability of the machine. The original design of the compressor bearings was a 5-pad load-on-pad configuration with an  $L/D$  of approximately 0.4, depicted in Figure 10. This model utilizes a two-dimensional Reynolds equation solver that for the current analysis neglects thermal effects and deformation for simplicity. All bearing analyses were performed at the maximum continuous operating speed of 11,400 rpm.

The results of this initial bearing analysis are shown in Figure 11. It was found that for this configuration the tight

clearance, preload, and load-on-pad configuration together produced a relatively stiff bearing, resulting in a vertical bearing stiffness of 169,500 lb/in. Recall from the previous section that the ideal ratio of twice the bearing stiffness to the shaft modal stiffness is unity. When comparing twice the vertical stiffness of the original compressor bearing to the calculated shaft modal stiffness, this results in a ratio of over 2.9. These results alone are indicative of an overly stiff support structure for the compressor that could contribute to an unstable whirl motion.

The next step in analyzing the original rotor-bearing system was to perform a stability analysis of the compressor with the original bearings. The results of the damped eigenvalue analysis are presented in Figure 12. It is shown that the poor choices made in the bearing design process resulted in an unstable forward bending mode in the operating range. The combination of high stiffness and damping in the bearings

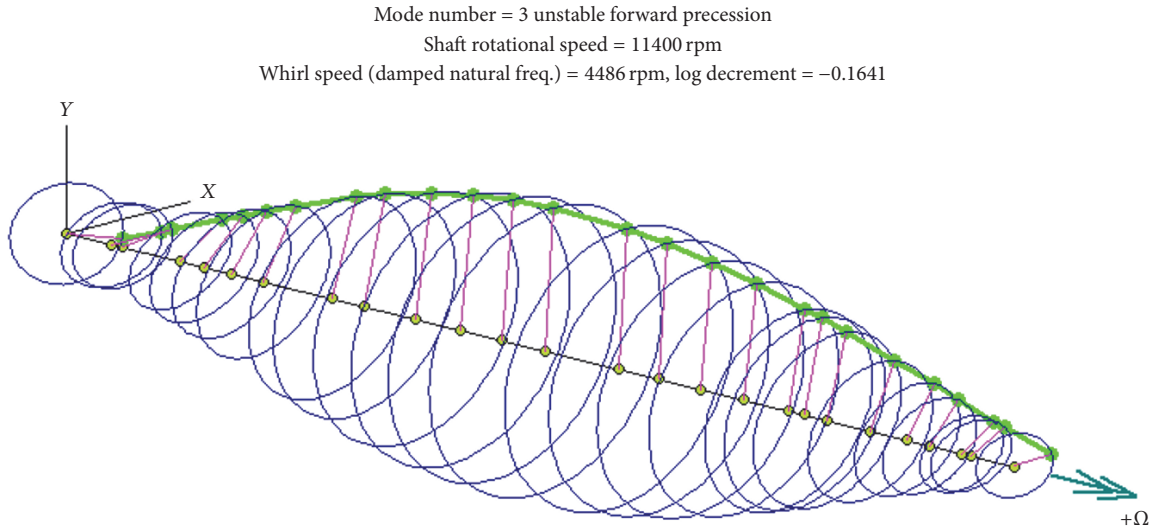

FIGURE 12: Stability results for the original bearing design.

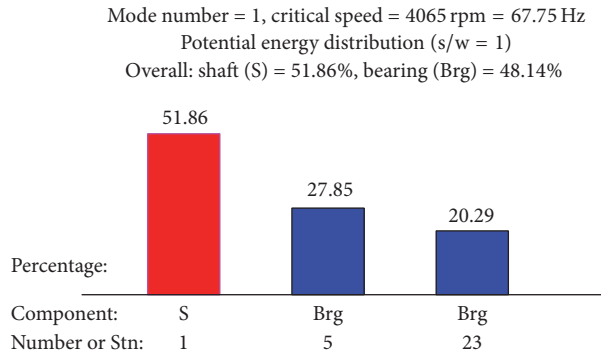

FIGURE 13: First mode shaft and bearings energy distribution with the original bearing design.

resulted in less shaft motion at the bearings and therefore a greater distribution of the system energy into the shaft, resulting in the unstable mode. A critical speed analysis using the bearing vertical stiffness reveals the relative energy distribution in the shaft and bearings (Figure 13).

### 5. A Lesson in Bearing Asymmetry

A second bearing design considered when troubleshooting the Kaybob compressor was an asymmetric bearing. Smith [1] cited two papers by Gunter [6, 7] as evidence that introducing bearing asymmetry could lead to an improvement in rotor stability. However, this evidence was misinterpreted as asymmetry has little effect in cases of high bearing stiffness and large quantities of aerodynamic cross-coupling [8]. This is demonstrated in the below analysis of an asymmetric bearing design similar to that considered by the team at Cooper-Bessemer.

The model (Figure 14) shows how the bearing was clocked to a load-between-pad position. The bearing clearance was also increased in the upper-left and upper-right pads from a 3.5 mil radial clearance to 5 mils. These two pads were also

narrowed from an axial length of 1.625'' to a length of 1'', though this modification is not captured by the model. This proves to have little effect, however, as shown in the results (Figure 15). The pads with the increased clearance show no participation in controlling the shaft motion, resulting in predicted vertical stiffness values that are still quite large when compared to the shaft stiffness. A significant drop in damping is also produced as a result of this design.

A stability analysis of the bearing-rotor system (Figure 16) in fact shows a decrease in the log decrement of the first bending mode when compared to the original bearing design. This is due to the fact that not only is the bearing stiffness still too large, but now the system is also likely underdamped with this bearing design.

The team at Cooper-Bessemer tried multiple bearing designs that utilized bearing asymmetry, but with such high levels of bearing stiffness and aerodynamic cross-coupling they were unable to achieve any significant increases in modal stability.

Figure 16 represents the damped eigenvalue analysis of the nine-stage Kaybob compressor with the aerodynamic cross-coupling included at stations 13 and 14. It has also been



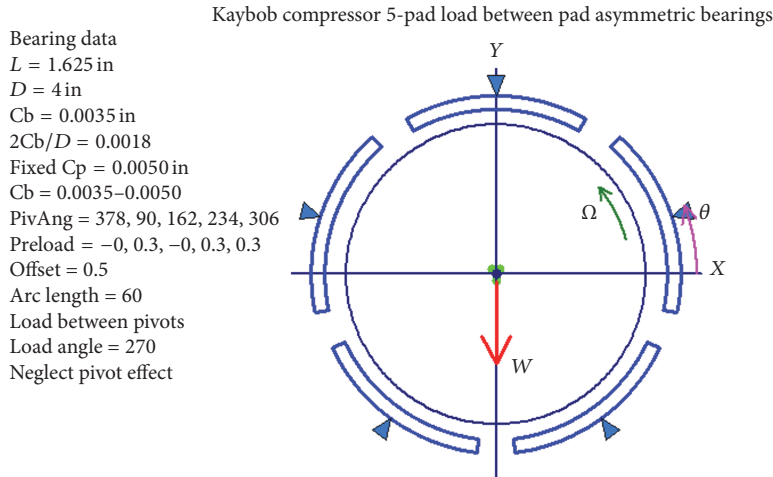

FIGURE 14: Asymmetric bearing model.

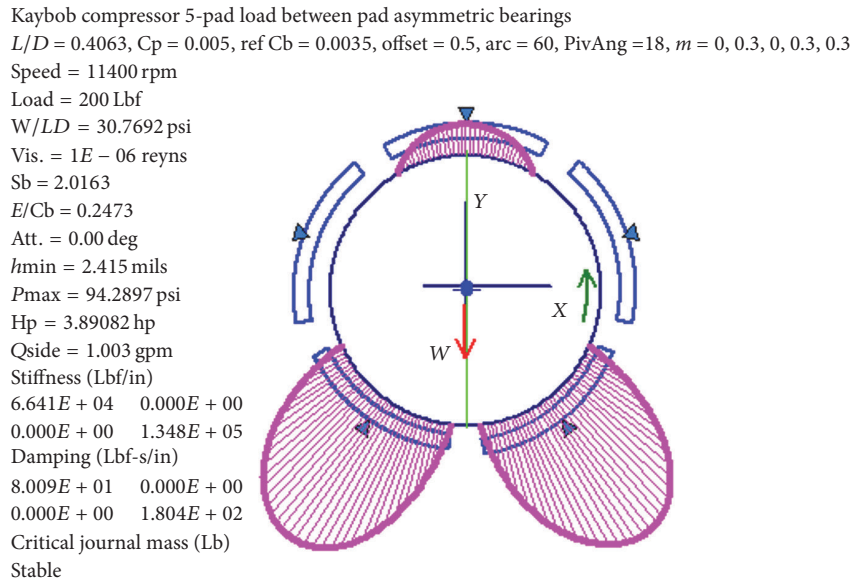

FIGURE 15: Results for the asymmetric bearing.

shown that, in addition to turbines and compressors developing aerodynamic cross-coupling, a center span balance piston can also create aerodynamic cross-coupling effects. Therefore small values of aerodynamic cross-coupling of 25,000 lb/in were placed at the center stations 13 and 14 at the balance piston location.

It is seen that, at the operating speed of 11,400 rpm, there now occurs a self-excited whirl component at 3733 cpm. The log decrement shows a value of  $-0.51$  which represents a highly unstable system. Noncontact probes are often placed at the bearings to observe the rotor motion. The motion observed at the bearing locations is often quite small as compared to the large orbital motion occurring at the rotor center due to the added whirl component. This large motion occurring at the center causes extensive rubbing and seals to be extensively damaged.

## 6. 4-Pad Bearing Design

A design not considered by the team at Cooper-Bessemer was a 4-pad tilting pad bearing. These bearings, particularly when oriented in a load-between-pad position, are known to be beneficial from a rotordynamic standpoint due to their ability to more evenly distribute stiffness forces in the vertical and horizontal directions. To see how this design might impact the Kaybob compressor, an initial 4-pad load-between-pad bearing design was analyzed with other design parameters that were kept constant from the original 5-pad bearing including the axial length, bearing clearance, and preload as shown in Figure 17.

The results of the bearing analysis (Figure 18) show that the 4-pad design does produce equal values of vertical and horizontal stiffness. When compared to the original 5-pad

Mode number = 2 unstable forward precession  
 Shaft rotational speed = 11400 rpm  
 Whirl speed (damped natural freq.) = 3733 rpm, log decrement = -0.5112

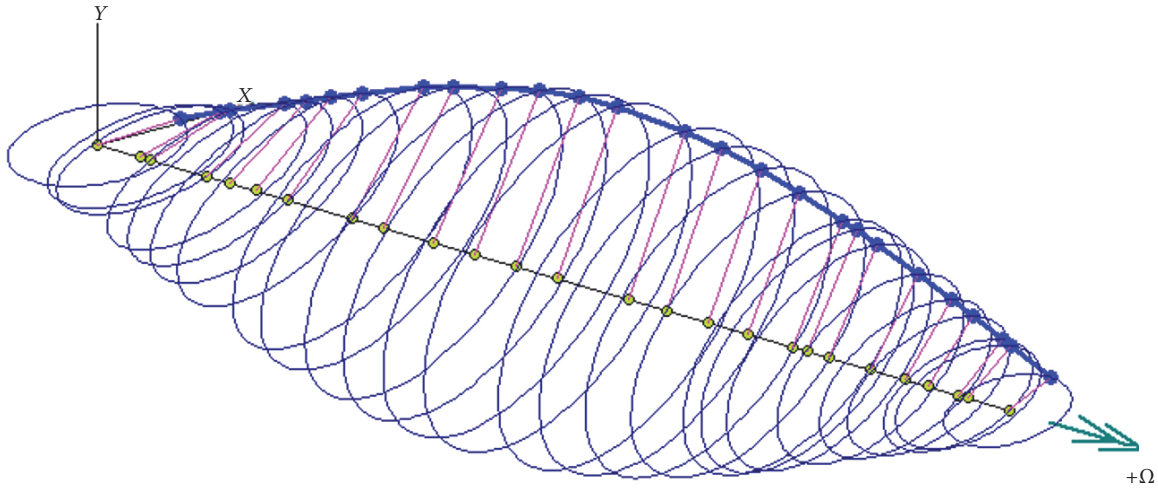

FIGURE 16: Stability results for the asymmetric bearing.

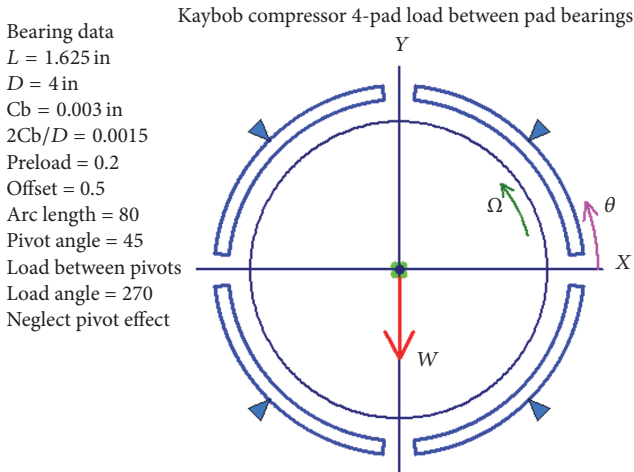

FIGURE 17: Initial four-pad bearing design.

bearing, the vertical stiffness is slightly lower along with an increase in direct damping. However, in general this design is still very stiff for this machine.

A stability analysis (Figure 19) reveals a reduction in the log decrement of the first bending mode when compared to the original design, likely due to increases in damping and horizontal stiffness preventing the bearings from absorbing the shaft vibrational energy. These results indicate that more drastic changes to the bearing design are necessary in order to restore stability to the system.

The design for the 4-pad bearing is superior to the asymmetric 5-pad bearing in that the log decrement has improved. However the dynamic analysis of the compressor with the 4-pad design as shown in Figure 19 is still unstable. The system has been improved over the asymmetric 5-pad

design with a reduction of the log decrement from -0.51 for the 5-pad case as compared to -0.233 with the 4-pad design.

In order to improve the rotor dynamics with the 4-pad bearings, it will be necessary to further reduce the vertical bearing stiffness in order to bring the values more in line with the fundamental shaft stiffness value. This requires a longer pad with a reduced bearing preload.

The paradox of this type of design is that the noncontact probes monitoring the bearing motion indicate higher amplitudes of motion, although the shaft center motion has been reduced. This phenomenon led one chief engineer of a compressor company to remove the redesigned 4-pad bearings and replace them with the original 5-pad design because of the increased motion observed at the bearings. Total rotor failure occurred shortly after the 5-pad bearings were installed!

### 7. Improved 4-Pad Bearing

In an effort to determine what bearing design choices were necessary in order to restore stability to Kaybob compressor, a number of modifications were made to the previously analyzed 4-pad bearing. Because it has been revealed that all of the designs considered thus far have produced bearings that are overly stiff, a number of design parameters must be considered to reduce the stiffness of the bearing while maintaining damping so that the bearings can better absorb the energy of the first bending mode.

Design parameters including the bearing clearance, pad preload, load orientation, and lubricant properties have all been shown by many authors [9–11] to affect the bearing stiffness. Therefore, for this design (Figure 20), it was decided to increase the bearing clearance from 3 mils radial to 6 mils and reduce the pad preload from 0.2 to 0.1 while maintaining the load-between-pad orientation to reduce the stiffness of

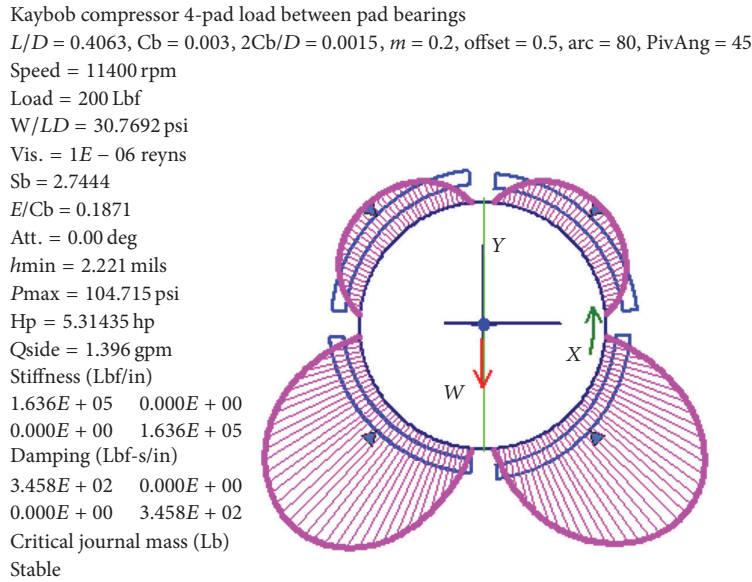

FIGURE 18: Results of the four-pad bearing analysis.

Mode number = 4 unstable forward precession  
 Shaft rotational speed = 11400 rpm  
 Whirl speed (damped natural freq.) = 4652 rpm, log decrement = -0.2329

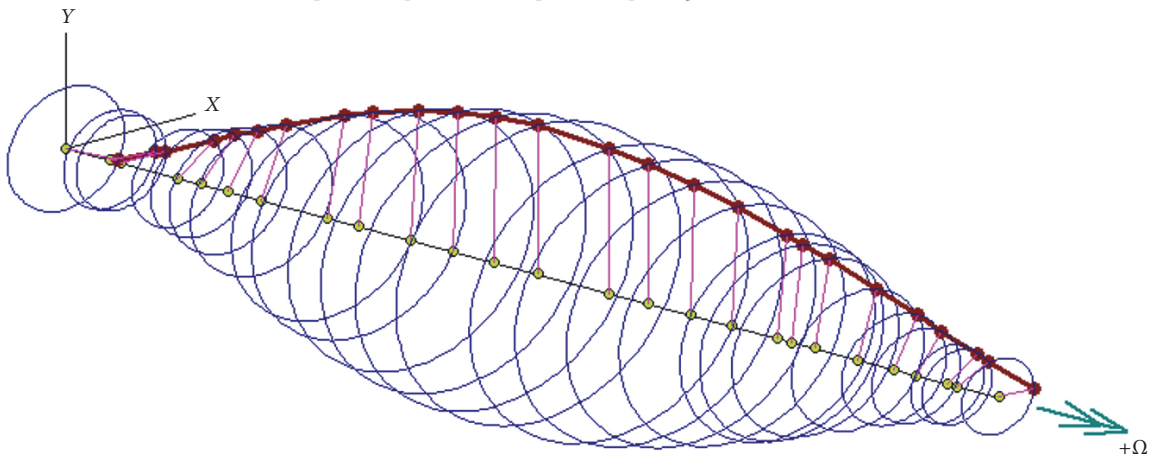

FIGURE 19: Stability results for a four-pad bearing design.

the bearing. In order to maintain adequate damping the bearing axial length was also increased from 1.625 inches to 4 inches, resulting in an increase in the  $L/D$  ratio from 0.4 to 1.

The results from the bearing analysis show a significant change in bearing performance when compared to the previous designs (Figure 21). The bearing stiffness has now been reduced to 48,960 lb/in. When comparing twice the bearing stiffness to the shaft modal stiffness this now results in a ratio of 0.85, much closer to the desired value of unity. The increase in bearing axial length also results in reasonable levels of damping. A stability analysis of this system shows a drastic increase in the log decrement of the first bending mode (Figure 22), resulting in a fully stable mode for the compressor. An energy distribution plot

(Figure 23) shows how the improved bearing design does a much better job of allowing the bearings to absorb the vibrational energy, resulting in an increase of 32% of the energy being transmitted to the bearings when compared to the original 5-pad design.

### 8. Squeeze Film Dampers

Another solution considered by the team at Cooper-Bessemer was a squeeze film damper. Smith [1] describes the overall design as a long damper surrounding a number of different bearing designs that were considered including a unique design that involved six tilting pads with asymmetries in the pad clearance, axial length, and arc length. However,

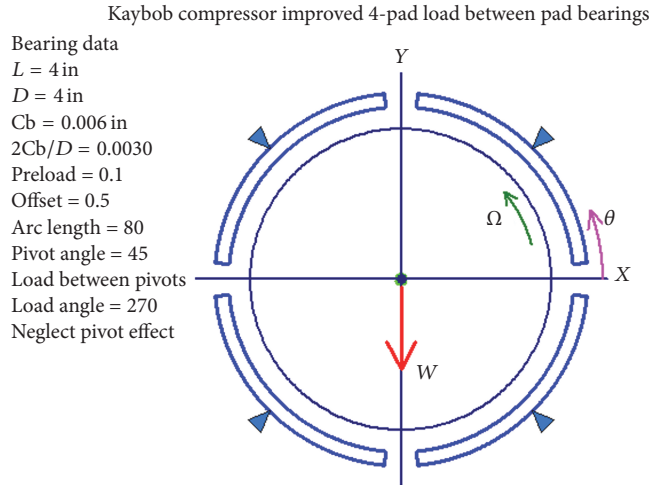

FIGURE 20: Improved four-pad bearing design.

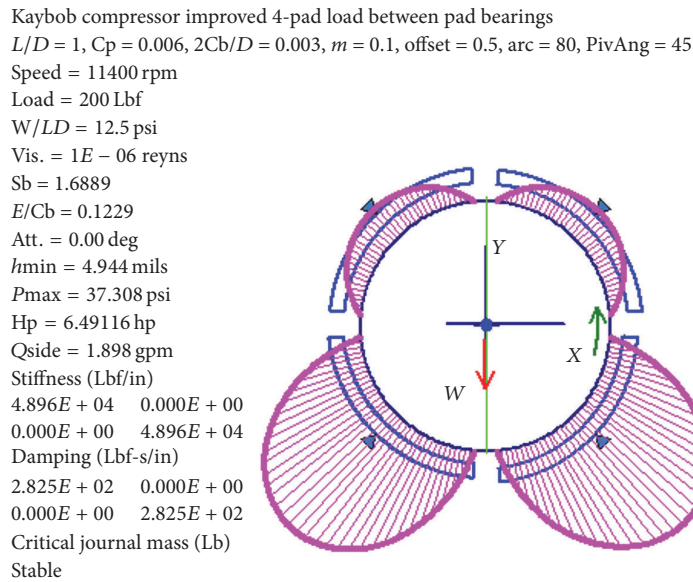

FIGURE 21: Analysis of the improved four-pad bearing.

none of these designs produced an ultimately stable solution for the machine and the use of a long squeeze film damper was likely a key factor in this.

To further make this point, the analysis was performed on two damper designs surrounding the original 5-pad bearing (Figure 24): a long damper design and a damper with a central groove of 0.15 inches in axial length. The nongrooved damper is treated as a long bearing, but because an added groove to the damper results in a different pressure distribution within the damper the grooved damper is modeled as a short bearing.

With all other inputs equal it can be seen that the groove has a significant effect on the predicted stiffness and damping of the damper. The longer damper design—similar to the

one used by Cooper-Bessemer—produces very high levels of stiffness and damping while the grooved design produces much more reasonable values.

Stability analyses of these two support scenarios also reveal the significant effect of the central groove (Figures 25 and 26). It is shown that the nongrooved damper produces only a very slight increase in the log decrement of the unstable mode when compared to the original bearing design.

The grooved damper, however, provides a substantial increase in the log decrement, resulting in a marginally stable system. Had the team at Cooper-Bessemer considered adding a central groove to their squeeze film damper design they may have actually avoided the costly rotor redesign discussed in Section 9.

Mode number = 5 stable forward precession  
 Shaft rotational speed = 11400 rpm  
 Whirl speed (damped natural freq.) = 4061 rpm, log decrement = 1.7522

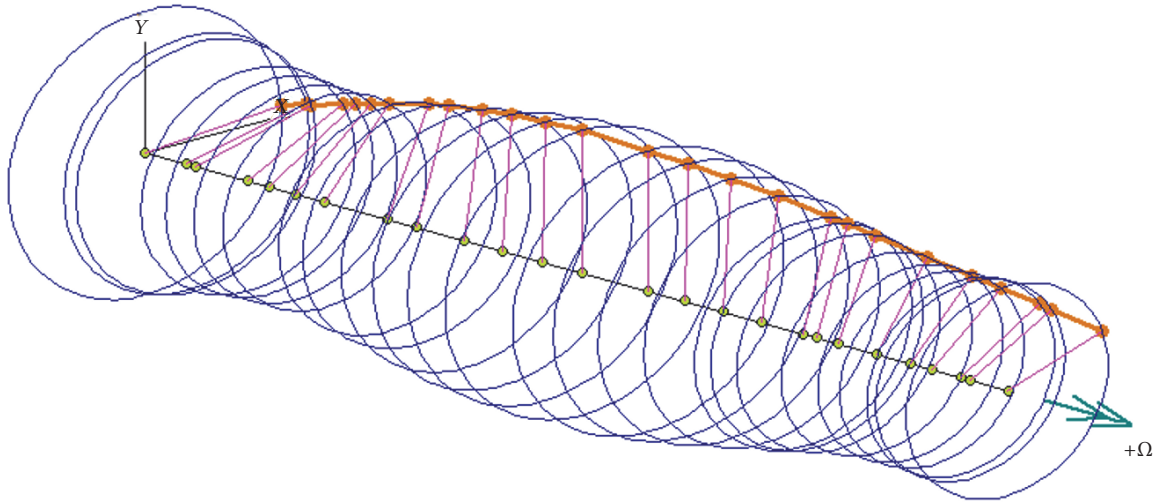

FIGURE 22: Stability analysis of the improved four-pad bearing.

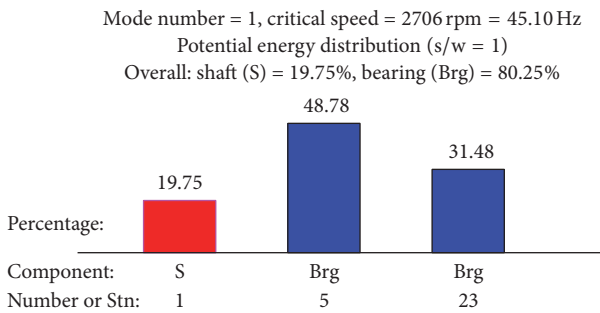

FIGURE 23: Energy distribution in the shaft and bearings for the improved four-pad bearing design.

### 9. Rotor Redesign

To produce a stable operating environment the team at Cooper-Bessemer ultimately had to redesign the rotor. This involved multiple design iterations that resulted in a final shaft design with a bearing span reduced from about 60 inches to approximately 53 inches, modified shrink fits, an integral center seal section, and an increased shaft diameter under the impellers (Figure 4). This design, along with either a squeeze film damper or a 5-pad tilting pad bearing with no preload, was enough to restore the full operational capabilities of the compressor.

To show how these shaft design modifications made such a difference in the performance of the machine a shaft model was developed to analyze with the original bearing design and the original design with a long squeeze film damper (Figure 27). A critical speed analysis assuming rigid bearings with a stiffness of  $10^8$  lb/in predicted shaft stresses at the first bending mode of 2,371 psi (Figure 28), an increase of 39% when compared to the original rotor.

The shaft modal stiffness was calculated to be 201,780 lb/in, a 74% increase when compared to the original rotor. This significant increase in shaft modal stiffness made the new rotor design much more suited to the high stiffness bearings utilized.

A stability analysis of the original bearing design with the new shaft design (Figure 29) demonstrates how the new rotor accommodates the stiffer bearing design, resulting in a stable first bending mode. Note that the ratio of twice the bearing stiffness to the shaft modal stiffness in this case is 1.7, a significant improvement from the original design.

Since the long squeeze film damper was also considered along with the new rotor design, this case was analyzed for stability as well (Figure 30). Similar to before, however, the

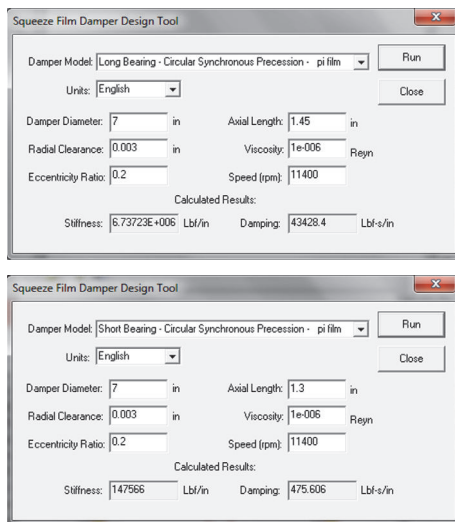

FIGURE 24: Nongrooved and grooved squeeze film damper analysis.



Mode number = 3 unstable forward precession  
 Shaft rotational speed = 11400 rpm  
 Whirl speed (damped natural freq.) = 4477 rpm, log decrement = -0.1537

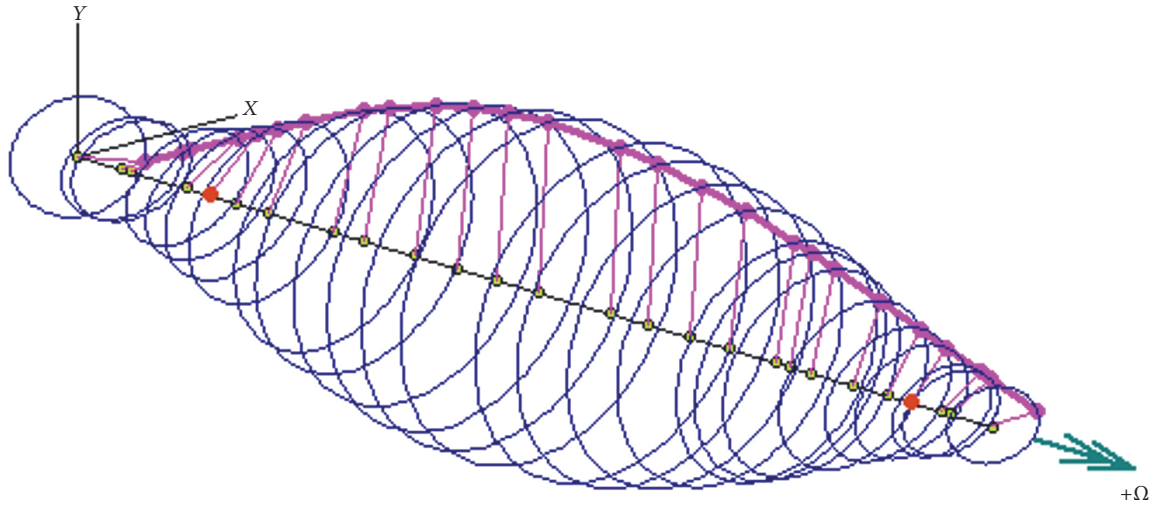

FIGURE 25: Stability analysis of the nongrooved squeeze film damper supported system.

Mode number = 3 stable forward precession  
 Shaft rotational speed = 11400 rpm  
 Whirl speed (damped natural freq.) = 3651 rpm, log decrement = 0.0669

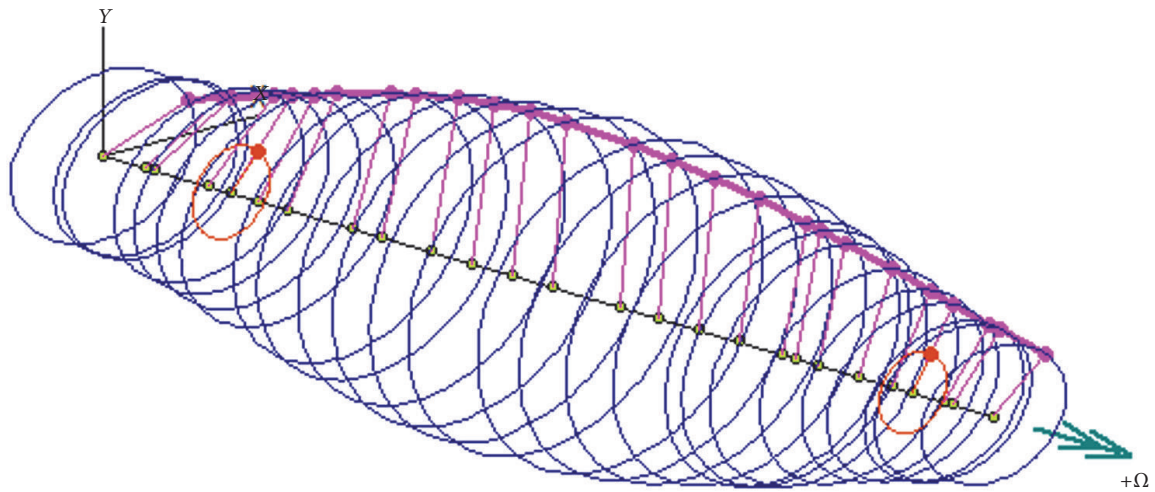

FIGURE 26: Stability analysis of the grooved squeeze film damper supported system.

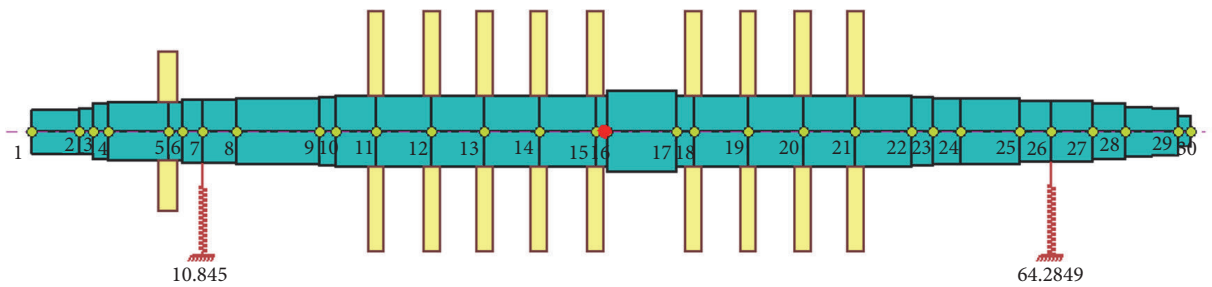

FIGURE 27: Reduced bearing span shaft model.



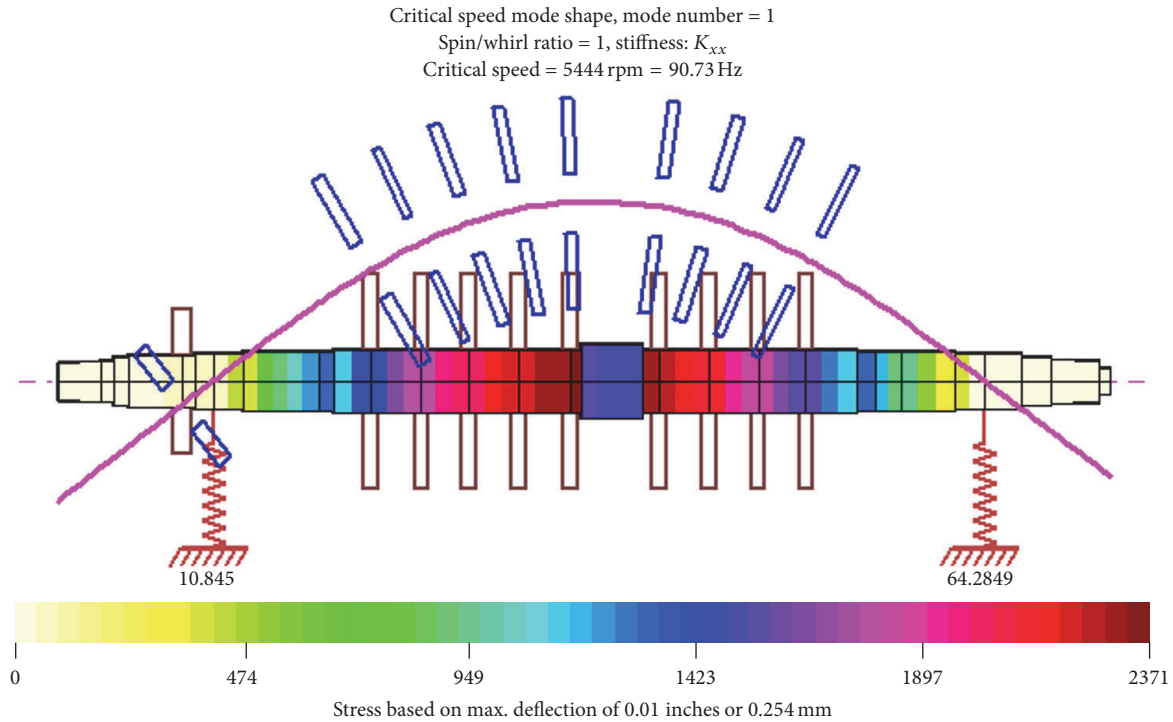

FIGURE 28: Shaft modal stresses of the first bending mode.

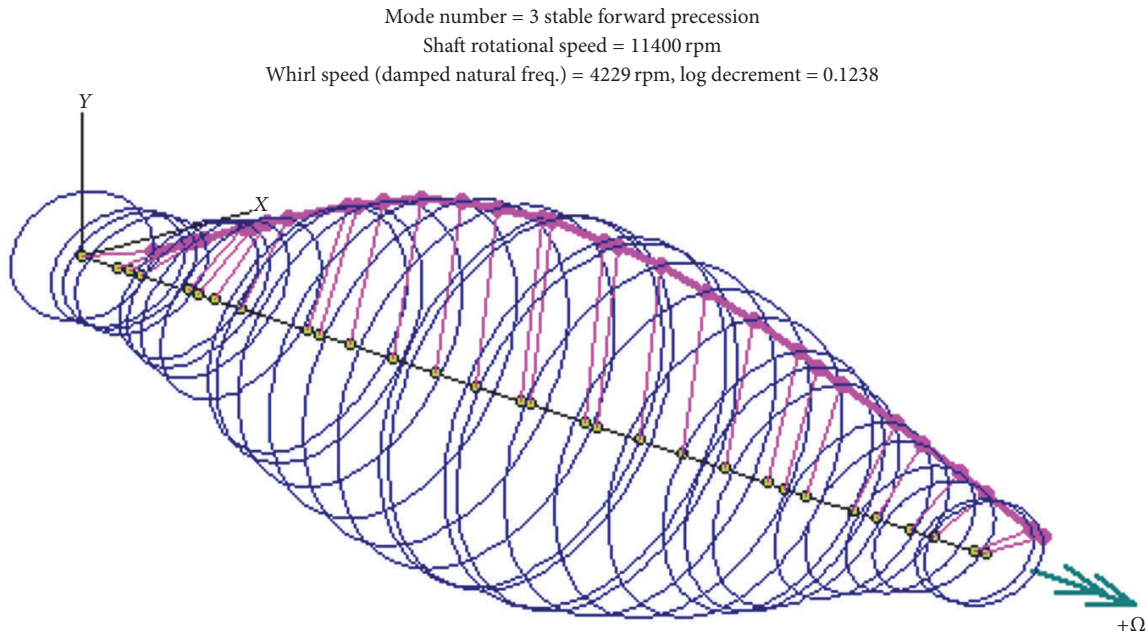

FIGURE 29: Stability analysis of the new rotor design with the original five-pad LOP bearings.

addition of the damper without a central groove proves to have little effect on the stability of the system.

**10. Conclusions**

The Kaybob compressor failure of 1971 was a historic case of rotordynamic instability and has taught us many things about

the design of these machines. Tilting pad journal bearings have become a new normal in compressor stabilization due to their innate capacity for avoiding self-excited oil whirl; however great care must be taken in the design of these bearings for both ensuring a stable machine and meeting API specifications. Many have been tempted to try and avoid critical speeds and reduce motion at the bearings by

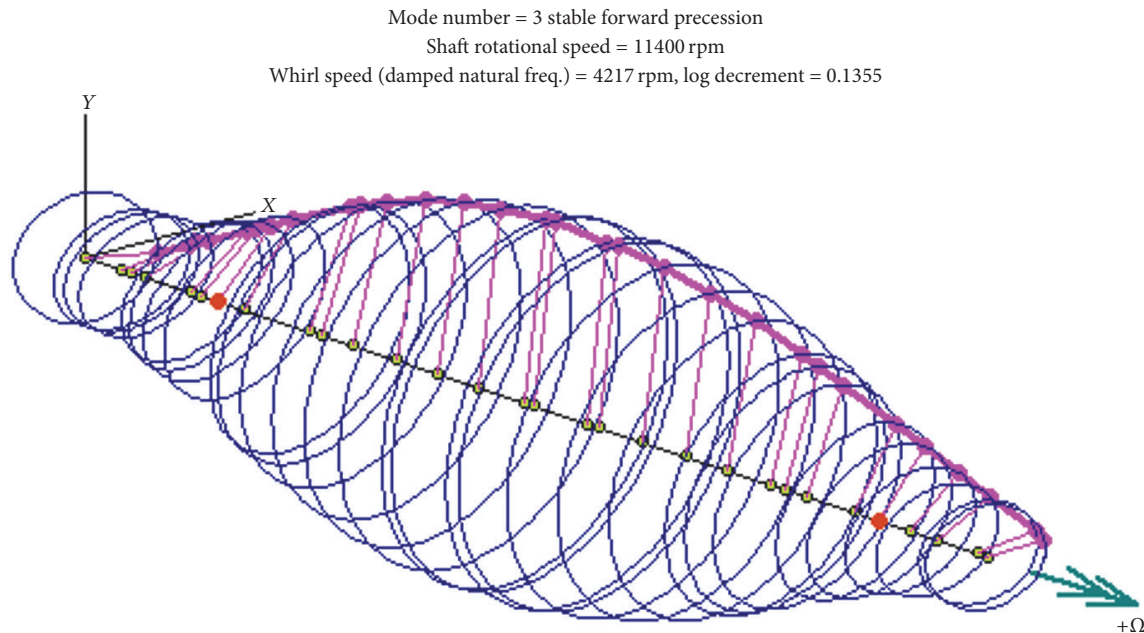

FIGURE 30: Stability analysis of the new rotor design with the original bearing and a long squeeze film damper.

increasing bearing stiffness; however this approach can and has often created a stability disaster as demonstrated by the Kaybob case. By designing for stability, however, these modes can also be eliminated from the operating range to the extent that they are not even detected because they are so well-damped.

In particular the Kaybob case has revealed the importance of designing bearings such that the bearing stiffness is tuned in to be in proper proportion to the shaft modal stiffness. By using this simple relationship and designing for proper damping as well, the bearings can properly absorb shaft vibrational energy and produce highly stable modes. While bearing asymmetry has been shown in past cases to produce some increases in stability—particularly in the presence of internal shaft friction or moderate levels of aerodynamic cross-coupling—the bearing stiffness must still be considered as a primary design variable as asymmetry will not benefit a system with a large bearing to shaft modal stiffness ratio. The presented design cases for 5- and 4-pad bearings demonstrate the importance of these concepts.

Squeeze film dampers have also been a significant source of compressor stabilization in decades past and will continue to do so when properly designed. It was shown in the context of the Kaybob failure that important features such as central grooves can make a large difference in the stiffness and damping characteristics of the damper, which can ultimately have as large an effect on compressor stability as the design of the bearing itself. While the redesign of the compressor rotor also produced a stable machine, this solution was far more costly than the simple use of a properly designed bearing or squeeze film damper. However, the team at Cooper-Bessemer cannot be faulted for these errors as they did not have the luxury of high-speed analysis tools that are available to designers today. Overall, the failure of the Kaybob

compressor and their work to investigate the instability has helped create the knowledge and methods necessary to avoid these kinds of failures in the future.

### Competing Interests

The authors declare that they have no competing interests.

### Acknowledgments

This work was supported by the Rotating Machinery and Controls Laboratory and industrial consortium at the University of Virginia and Rodyn Vibration Analysis, Inc.

### References

- [1] K. J. Smith, "An operation history of fractional frequency whirl," in *Proceedings of the 4th Turbomachinery Symposium*, pp. 115–125, Texas A&M University, 1975.
- [2] J. W. Lund, "Spring and damping coefficients for the tilting-pad journal bearing," *ASLE Transactions*, vol. 7, no. 4, pp. 342–352, 1964.
- [3] J. W. Lund, "Stability and damped critical speeds of a flexible rotor in fluid-film bearings," *Journal of Engineering for Industry*, vol. 96, no. 2, pp. 509–517, 1974.
- [4] J. S. Alford, "Protecting turbomachinery from self-excited rotor whirl," *Journal of Engineering for Power*, vol. 87, no. 4, pp. 333–334, 1965.
- [5] L. E. Barrett, E. J. Gunter, and P. E. Allaire, "Optimum bearing and support damping for unbalance response and stability of rotating machinery," *Journal of Engineering for Power*, vol. 100, no. 1, pp. 89–94, 1978.
- [6] E. J. Gunter, "Dynamic stability of rotor-bearing systems," NASA SP-113, 1966.

- [7] E. J. Gunter and P. R. Trumpler, "The influence of internal friction on the stability of high speed rotors with anisotropic supports," *Journal of Engineering for Industry*, vol. 91, no. 4, pp. 1105–1113, 1969.
- [8] E. J. Gunter, "The influence of bearing asymmetry on rotor stability," in *Proceedings of the Vibration Institute Training Conference*, pp. 1–28, Williamsburg, Va, USA, June 2012.
- [9] J. C. Nicholas and R. G. Kirk, "Selection and design of tilting pad and fixed lobe journal bearings for optimum turborotor dynamics," in *Proceedings of the 8th Turbomachinery Symposium*, pp. 43–57, Texas A&M University, College Station, Tex, USA, 1979.
- [10] J. C. Nicholas and R. G. Kirk, "Four pad tilting pad bearing design and application for multistage axial compressors," *Journal of Lubrication Technology*, vol. 104, no. 4, pp. 523–529, 1982.
- [11] B. K. Weaver, Y. Zhang, A. F. Clarens, and A. Untaroiu, "Non-linear analysis of rub impact in a three-disk rotor and correction via bearing and lubricant adjustment," *Journal of Engineering for Gas Turbines and Power*, vol. 137, no. 9, Article ID 092504, 2015.



**Hindawi**

Submit your manuscripts at  
<http://www.hindawi.com>

