

## Research Article

# Multifrequency Oscillator-Type Active Printed Antenna Using Chaotic Colpitts Oscillator

**Bibha Kumari and Nisha Gupta**

*Department of Electronics and Communication Engineering, Birla Institute of Technology, Mesra, Ranchi 835215, India*

Correspondence should be addressed to Bibha Kumari; bibhakumari3@gmail.com

Received 26 August 2014; Revised 3 November 2014; Accepted 10 November 2014; Published 30 November 2014

Academic Editor: Chien-Jen Wang

Copyright © 2014 B. Kumari and N. Gupta. This is an open access article distributed under the Creative Commons Attribution License, which permits unrestricted use, distribution, and reproduction in any medium, provided the original work is properly cited.

This paper presents a new concept to realize a multifrequency Oscillator-type active printed monopole antenna. The concept of period doubling route to chaos is exploited to generate the multiple frequencies. The chaotic Colpitts oscillator is integrated with the printed monopole antenna (PMA) on the same side of the substrate to realize an Oscillator-type active antenna where the PMA acts as a load and radiator to the chaotic oscillator. By changing the bias voltage of the oscillator, the antenna can be made to operate at single or multiple frequencies. To test the characteristics of the antenna at single and multiple frequencies of operation, two similar prototype models of printed monopole broadband antennas are developed. One of these antennas used at transmit side is fed by the chaotic Colpitts oscillator while the other is used as the receive antenna. It is observed that the antenna receives single or multiple frequencies simultaneously for particular values of the bias voltage of the oscillator at the transmit end.

## 1. Introduction

During the last decades, tremendous attention has been devoted to the design and applications of active antennas and chaotic circuits. The active antenna is an active microwave circuit in which the output or input port is free space instead of a conventional  $50\text{-}\Omega$  interface [1]. The integration of active devices with a radiating element forms an active antenna. The integration of active devices directly in the antenna structure is known as active integrated antenna (AIA). Depending on the functions of active devices used in the structure the active antennas are classified into three categories; amplifier type active antenna, Oscillator-type active antenna, and frequency conversion type active antenna [2]. The present work deals with the Oscillator-type active antenna employing a nonlinear device.

Most of the nonlinear devices exhibit chaotic modes of operation under certain parametric conditions. There are different routes to chaos. To achieve the multifrequency operation the concept of deterministic chaos exhibited by the chaotic Colpitts oscillator is used. Colpitts oscillator exhibits bifurcation phenomena for certain values of the circuit parameter and in this way it exhibits periodic, multiperiodic,

and chaotic motion [3]. The applications of chaotic circuits have been already reported in the past in chaotic communication, spread spectrum communication, low power communication, and so forth. In [4] a robust assessment for the Colpitts oscillator and the application of chaotic circuit in encrypted data transmission are presented. Over the last three decades different techniques have been used to analyze the behavior of an antenna with a nonlinear load. However, little work has been reported in the literature where such circuits are integrated with the antenna. Overfelt [5] has studied the effect of chaos on an electrically small dipole antenna operating at low frequency loaded with the nonlinear circuit known as a Chua's oscillator by assuming that the dipole could be modeled as a pure capacitance and an equivalent circuit of the combined antenna/load system is determined. However, the characteristic of the chaotic oscillators for multifrequency operation is unexploited. When this chaotic oscillator is integrated with the printed patch antenna on the same substrate, it can be viewed as an active integrated antenna [2]. An active antenna (Oscillator-type) consists of two terminal nonlinear devices such as Tunnel diode, Gunn diode, or three terminal devices such as BJT or FET loaded with printed patch antenna. Under certain parametric

conditions these oscillators may exhibit chaotic phenomena due to presence of nonlinear elements in the circuit. The output of such oscillators exhibits sinusoidal oscillations initially and by changing a single parameter of the system the output period bifurcates. This process of bifurcation continues further if the parameter value is changed. As the parameter value changes, due to bifurcation, the period of the output signal becomes 2, 4, 8, 16, and so forth, and it continues till no more stable state is obtained and the system goes into the chaotic mode of operation. Chaotic oscillators have wide spectrum properties and this property can be used to design a multifrequency antenna. Multifrequency antennas are antennas which can operate at several frequencies at a particular instant of time. In this paper, for the first time the chaotic mode of operation of these nonlinear oscillators is exploited in generating multiple frequencies in the GHz range to be used in printed patch antennas for multifrequency operation. The designed Oscillator-type active antenna can be made to operate on single, dual, quadruple, octal frequencies, and so forth, or in the chaotic mode of operation by changing the bias voltage of the oscillator. When the oscillator operates in multiple frequency modes, it can be used in realizing multifrequency antennas; otherwise in the chaotic mode of operation it can be used in secure communication [4].

The paper is organized as follows. Section 2 presents the simulation and experimental study of the microwave chaotic Colpitts oscillator and its route to chaos. Section 3 presents the design of a printed rectangular monopole antenna along with the simulation and experimental results. Section 4 presents the design of an Oscillator-type active antenna by integrating the chaotic Colpitts oscillator with printed monopole antenna (PMA) to realize the antenna in multifrequency mode of operation. Conclusions are discussed in Section 5.

## 2. Microwave Colpitts Oscillator

The classical Colpitts oscillator is commonly used to generate sinusoidal signals. However with a certain set of circuit parameters one can generate chaotic waveform across the capacitors. Chaos in the Colpitts oscillator has been first reported by Kennedy [6] and, subsequently, various types of chaotic Colpitts oscillator circuits operating at both low and microwave frequencies have been realized [7–12]. The active device used in the oscillator is the BFG425W NPN bipolar transistor in CB configuration. The resonance loop has three energy storing elements: an inductor  $L$  and two capacitors  $C_1$  and  $C_2$ . The parametric values are  $C_1 = 3.3$  pF,  $C_2 = 3.3$  pF,  $R = 391$   $\Omega$ ,  $C_3 = 10$  pF, and  $L = 3.3$  nH. Here  $C_3$  is the coupling capacitor. The fundamental frequency of oscillation of the designed oscillator is 2.2 GHz. The fundamental frequency of oscillation of the circuit can be estimated by [8]

$$f_0 = \frac{1}{2\pi} \sqrt{\frac{C_1 + C_2}{C_1 C_2 L}}. \quad (1)$$

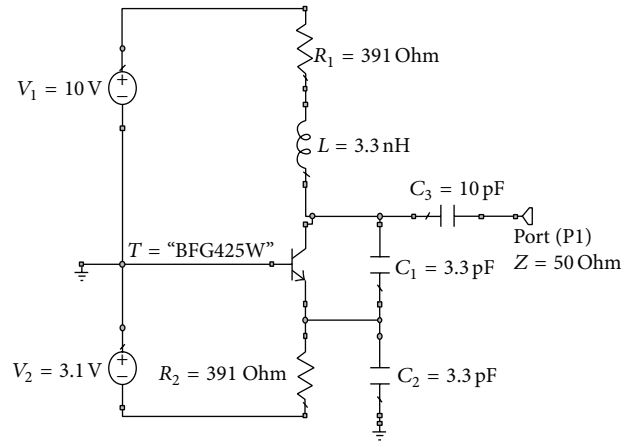

FIGURE 1: Schematic of microwave Colpitts oscillator.

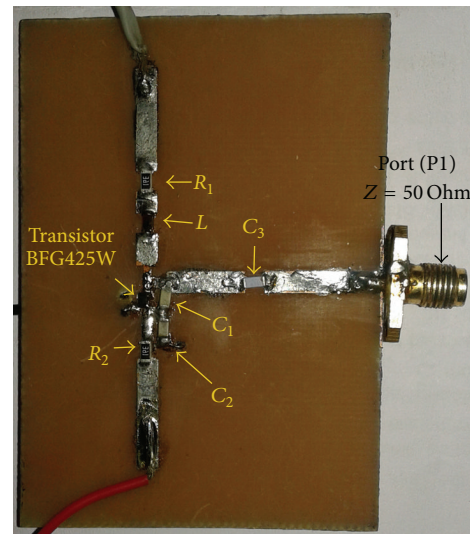

FIGURE 2: Microwave Colpitts oscillator fabricated on FR4 substrate.

The schematic of microwave Colpitts oscillator [12] is shown in Figure 1. The fabricated structure of microwave chaotic Colpitts oscillators on FR4 substrate is shown in Figure 2.

The chaotic Colpitts oscillator shown in Figure 2 exhibits different dynamical behavior for different values of emitter bias voltage  $V_2$ . In the circuit all parameters have been kept constant and the supply voltage  $V_2$  is varied to observe the different dynamical behavior under periodic mode, period-doubled mode, and chaotic mode of operations. The simulation and experimental results for these modes of operation of the microwave chaotic Colpitts oscillator are shown in Figures 3 and 4.

2.1. *Simulation Results.* See Figure 3.

2.2. *Experimental Results.* The experimental results showing the behavior of microwave chaotic Colpitts oscillator are also presented for various modes of operations (see Figure 4).

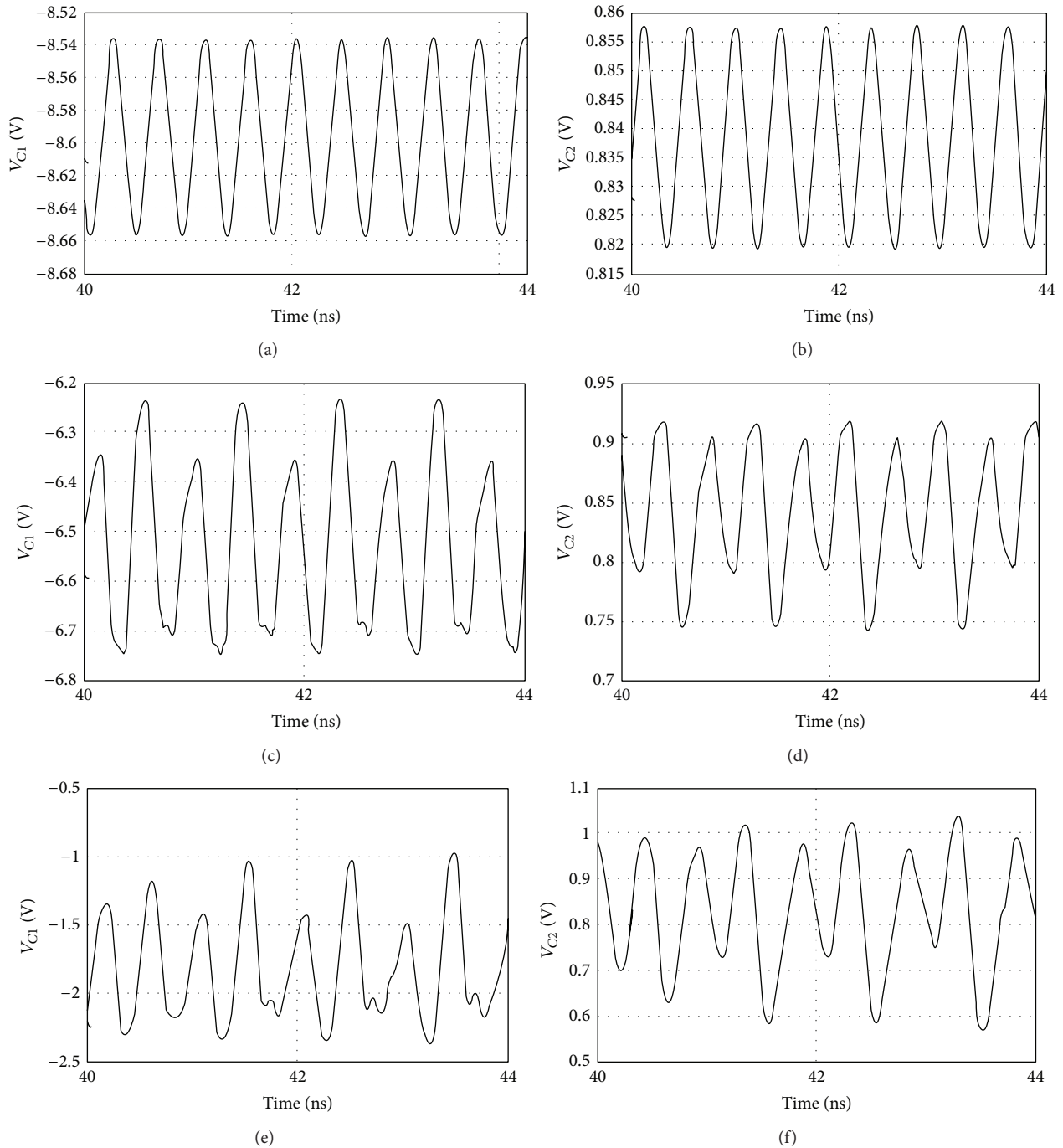

FIGURE 3: Time series plot of  $V_{C1}$  and  $V_{C2}$  with respect to emitter bias voltage  $V_2$  of chaotic Colpitts oscillator: (a) and (b) periodic mode for  $V_2 = 3.1$  V, (c) and (d) period-doubled mode for  $V_2 = 5.2$  V, and (e) and (f) chaotic mode for  $V_2 = 7$  V.

### 3. Printed Monopole Antenna

The selection of antenna is of prime importance in the active integrated approach. Planar type antennas such as the patch or slot are considered good for minimizing interconnects, as they are suitable for direct integration with microstrip or coplanar waveguide (CPW). The microwave Colpitts oscillator is designed at 2.2 GHz. This oscillator can generate several

frequencies following the route to chaos by varying the emitter bias voltage  $V_2$ . Further to transmit these frequencies a wide band antenna is required. Hence, a printed rectangular monopole antenna is selected and designed to achieve the broadband characteristics. The antenna parameters for the desired band of frequency are obtained as [13]. The patch dimensions are selected as follows: length of patch ( $L$ ) = 11.33 mm, width of patch ( $W$ ) = 15.21 mm, width of the feed

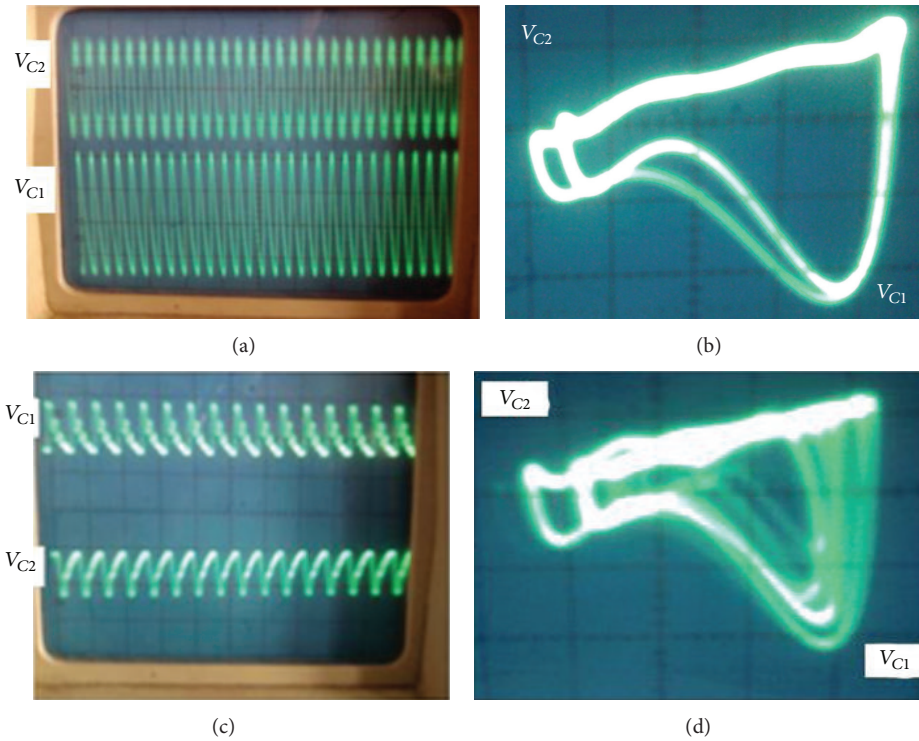

FIGURE 4: Oscilloscope display of time series plot of  $V_{C1}$  and  $V_{C2}$  and phase portrait of  $V_{C2}$  versus  $V_{C1}$ . (a) Periodic mode for  $V_2 = 3.1$  V, (b) period-doubled mode, X-Y mode: two loops can be seen for  $V_2 = 5.2$  V, and (c) and (d) chaotic mode for  $V_2 = 7$  V.

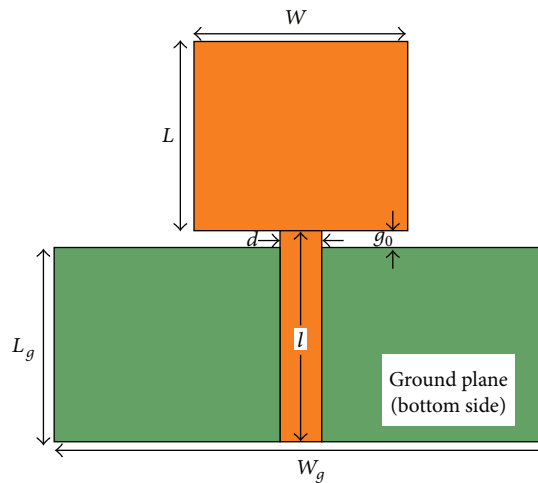

FIGURE 5: A rectangular monopole antenna structure.

line ( $d$ ) = 3 mm, distance between patch and the ground plane ( $g_0$ ) = 1 mm, length of the feed line ( $l$ ) = 12.5 mm, length of the ground plane ( $L_g$ ) = 11.5 mm, and width of the ground plane ( $W_g$ ) = 35.21 mm. Figure 5 shows the geometry of printed rectangular monopole antenna structure. The antenna uses FR4 substrate of thickness 1.6 mm, relative dielectric constant as 4.4, and the loss tangent as 0.002. The designed printed rectangular monopole antenna is simulated using the IE3D electromagnetic simulator from Zeland, Inc., USA. The lumped equivalent circuit of the proposed printed

rectangular monopole antenna is obtained as presented in [14, 15]. The lumped equivalent circuit model is simulated in the advanced design system (ADS) software. The prototype model and the lumped equivalent of the proposed printed rectangular monopole antenna are shown in Figures 6 and 7. A comparison of the reflection coefficient ( $S_{11}$ ) parameter of simulation result obtained from IE3D EM simulator, experimental result, and simulation result of lumped equivalent of proposed antenna obtained in ADS is shown in Figure 8.

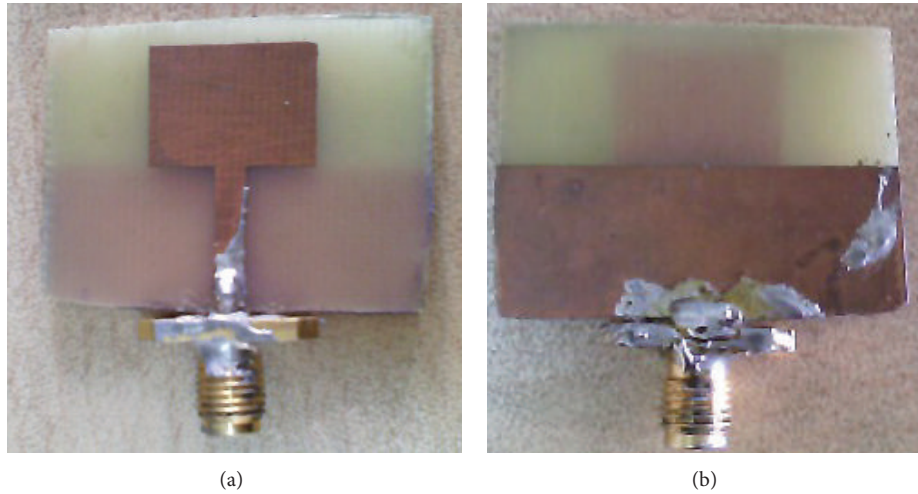

FIGURE 6: Prototype model of printed monopole antenna (a) top view and (b) bottom view.

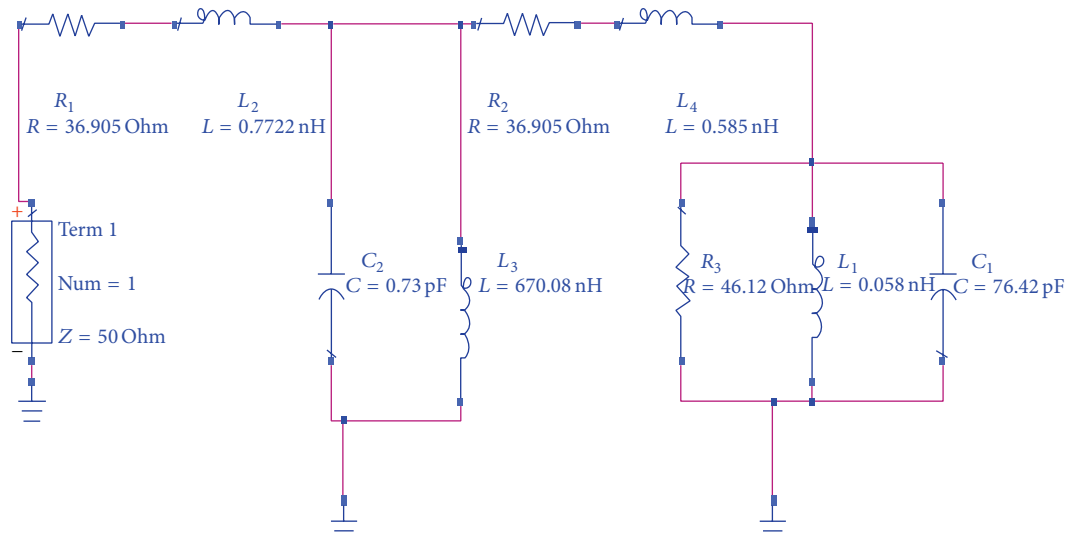

FIGURE 7: Lumped equivalent circuit model of the proposed printed monopole antenna.

#### 4. Design of Oscillator-Type Active Antenna

Active devices can easily be integrated with printed antenna on a common substrate. Several different microwave oscillator circuits integrated with printed antenna have been reported in the literature where active nonlinear devices such as Gunn diode and IMPATT diode [16–26] have been used. Haskins et al. [26] have designed an active antenna using the Schottky diode as a tuning device and it is shown that the oscillation frequency can be varied by means of a bias voltage applied to the tuning device. In the present work, the concept of the oscillator loaded antenna is first demonstrated using the AWR Microwave Office simulation tool. Here a microstrip antenna (MSA) represented by a lumped equivalent circuit is loaded with a Colpitts oscillator and is shown in Figure 9.

From the simulation study carried out in this section, it is observed that for certain values of bias voltage, various types of periodic, intermittent, and chaotic state of operation occur across the lumped equivalent of MSA since the antenna is fed by a chaotic Colpitts oscillator. However, the narrow band characteristics of the MSA restrict the depiction of all the intermittent states of route to chaos, and only the few frequency components falling within the bandwidth of the MSA can be observed. Therefore to accommodate all the frequencies generated by the chaotic oscillator in chaotic mode of operation, a broadband printed monopole antenna [27] is preferred. Next, the chaotic Colpitts oscillator is integrated with the printed monopole antenna on the same side of the FR4 substrate. The prototype model of the Oscillator-type active printed antenna where the chaotic Colpitts oscillator and printed monopole



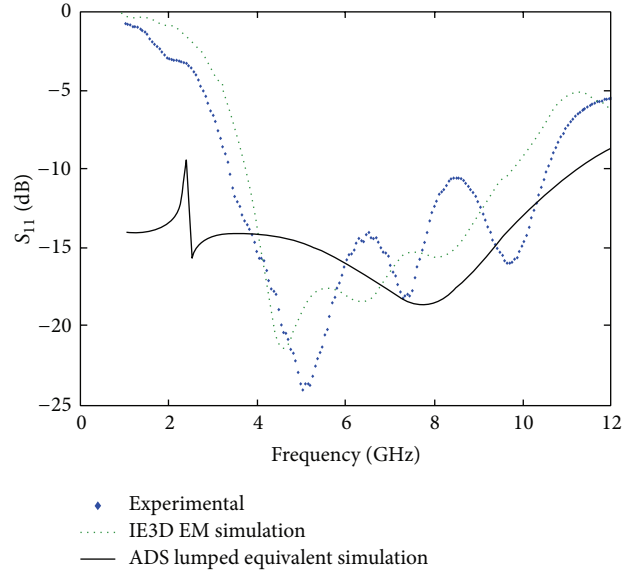

FIGURE 8: Comparison of results.

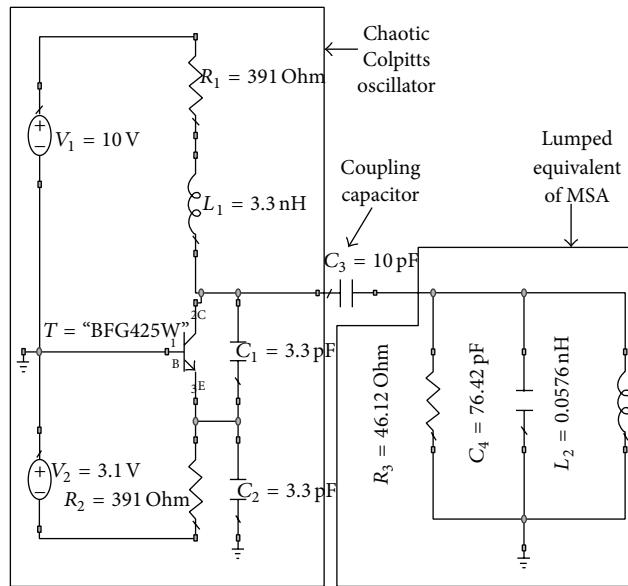

FIGURE 9: Schematic showing the integration of chaotic Colpitts oscillator and the lumped equivalent of MSA.

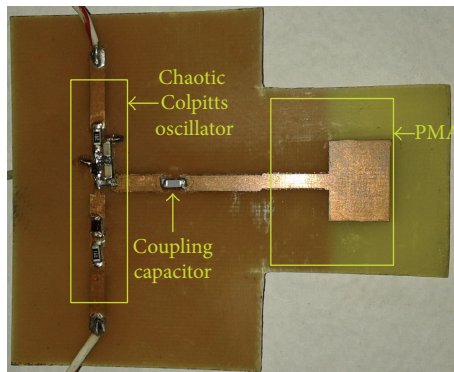

FIGURE 10: Prototype model of Oscillator-type active antenna fabricated on FR4 substrate.

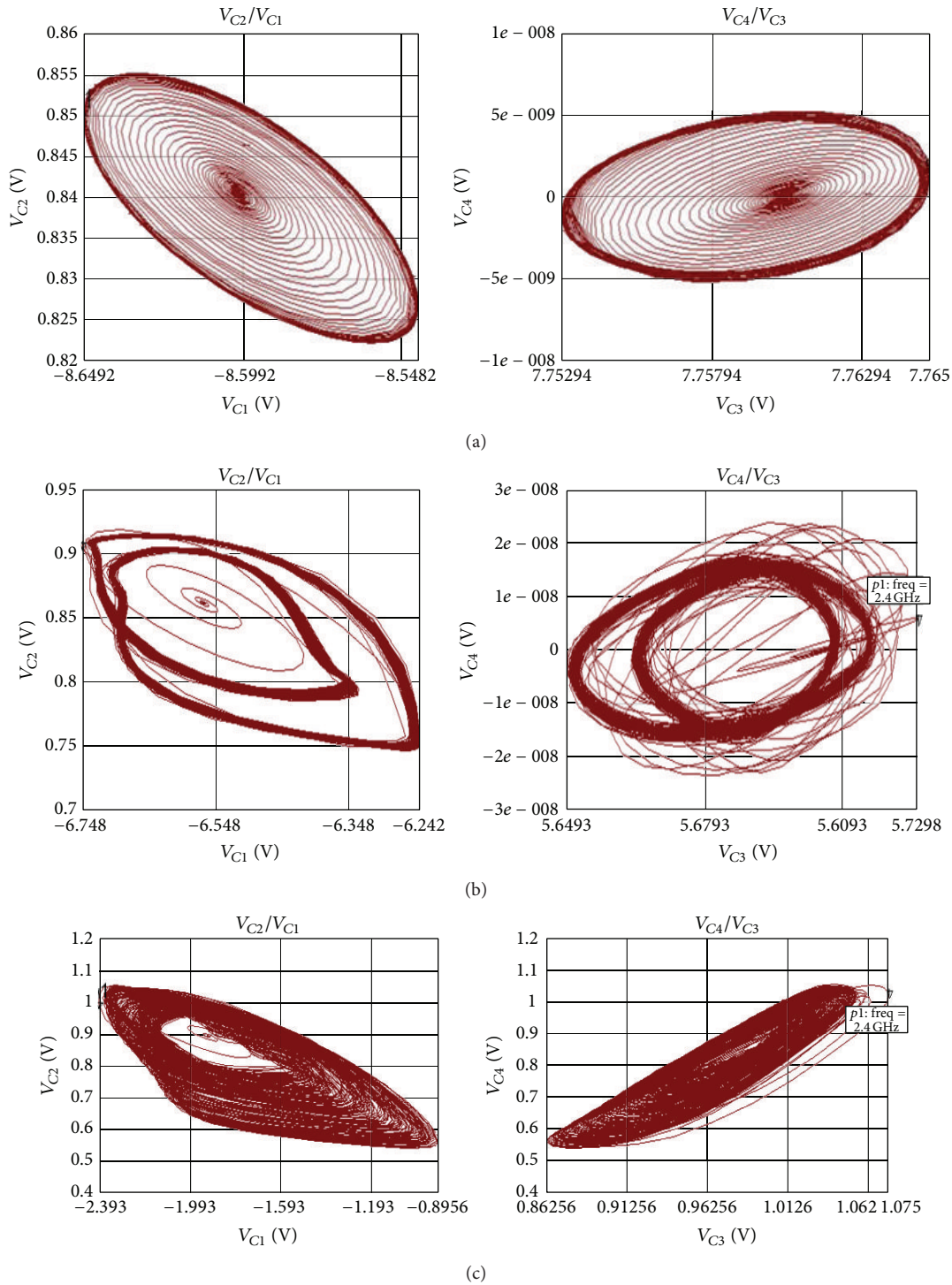

FIGURE 11: Phase portrait of  $V_{C2}$  versus  $V_{C1}$  and  $V_{C4}$  versus  $V_{C3}$  by changing the emitter biasing voltage  $V_2$  of chaotic Colpitts oscillator (a) periodic mode for  $V_2 = 3.1$  V, (b) intermittent state for  $V_2 = 5.2$  v, and (c) chaotic mode for  $V_2 = 7$  V.

antenna are integrated over a single substrate is shown in Figure 10.

**4.1. Simulation Results.** The phase portraits obtained in the simulation are shown in Figure 11. The phase portrait shows the graph of  $V_{C2}$  versus  $V_{C1}$  and  $V_{C4}$  versus  $V_{C3}$ . Here  $V_{C1}$ ,

$V_{C2}$ ,  $V_{C3}$ , and  $V_{C4}$  are the voltages across capacitor  $C_1$ ,  $C_2$ ,  $C_3$ , and  $C_4$ . Capacitors  $C_1$  and  $C_2$  are the frequency determining components of the Colpitts oscillator;  $C_3$  is the coupling capacitor and the capacitor  $C_4$  is one of the lumped equivalent components of MSA. The bifurcation parameter is the voltage source  $V_2$ . Figure 11(a) shows the periodic mode of operation

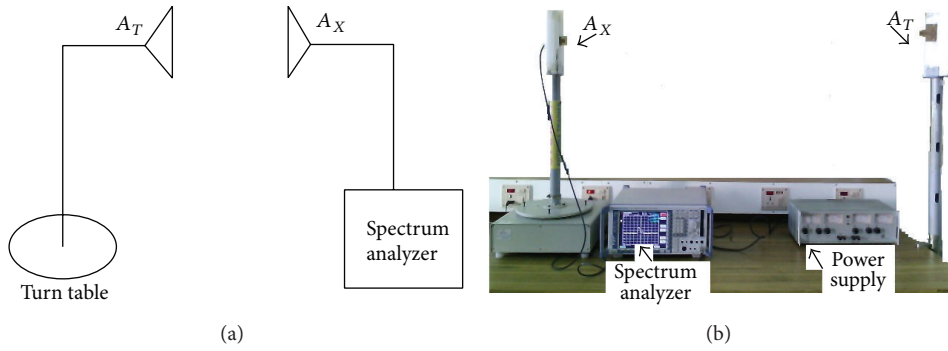

FIGURE 12: Experimental setup.

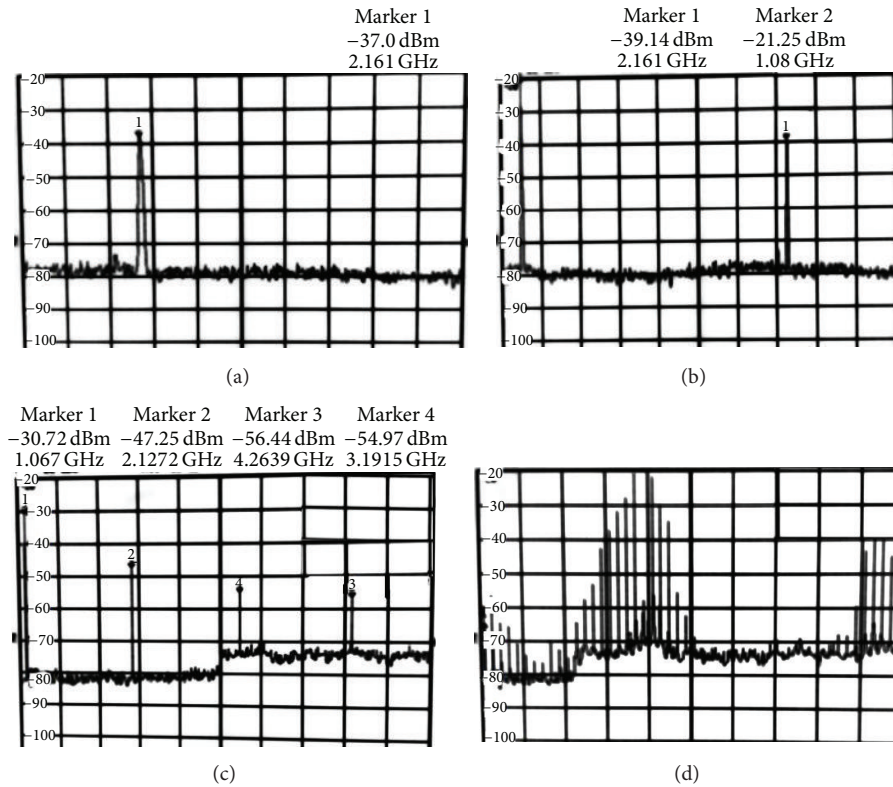

FIGURE 13: Spectrum analyzer display of Oscillator-type active antenna (a) periodic mode, (b) period-doubled mode, (c) period-four mode, and (d) chaotic mode.

for  $V_2 = 3.1$  V as single loop can be seen. Figure 11(b) shows an intermittent state of operation for  $V_2 = 5.2$  V as two loops falling within the BW of MSA can be seen. Figure 11(c) shows the chaotic mode of operation for  $V_2$  ranges from 7 to 10 V, where a large number of frequency components falling within the BW of MSA are observed.

**4.2. Experimental Results.** By changing the bias voltage of the oscillator the antenna can be made to operate at single or multiple frequencies. Here the bifurcation parameter is the emitter bias voltage source  $V_2$  of the chaotic Colpitts oscillator. Figure 12 shows the experimental setup for the

measurement of different frequencies. In Figure 12  $A_T$  is the Oscillator-type active antenna which is the integration of chaotic Colpitts oscillator and PMA.  $A_X$  is the PMA only. To accommodate all the frequencies transmitted by this active antenna, a similar broadband PMA is used at the receiving side which is connected to the spectrum analyzer. The spectrum analyzer display is shown in Figure 13. Figure 13(a) shows the periodic mode of operation for  $V_2 = 3.1$  as the single frequency component at 2.161 GHz can be seen. Figure 13(b) shows the period-doubled mode of operation for  $V_2 = 5.2$  V as the two frequency components at 1.08 GHz and 2.161 GHz can be seen. Figure 13(c) shows the period-four mode of operation for  $V_2 = 8.9$  V as the four



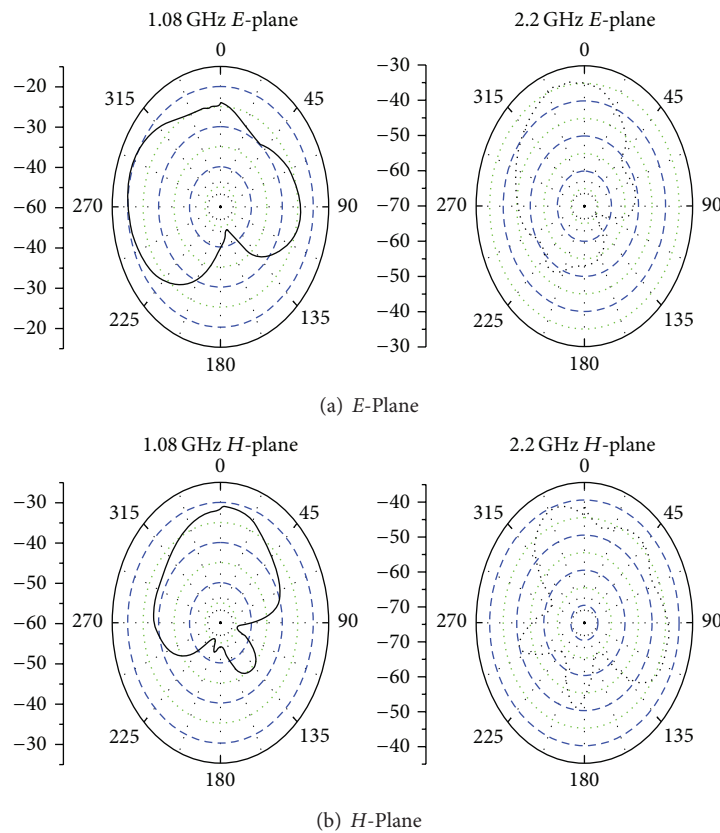

FIGURE 14: Experimental results: showing the measured radiation pattern.

frequency components at 1.067 GHz, 2.1272 GHz, 3.1915 GHz, and 4.2639 GHz can be seen. Figure 13(d) shows the chaotic mode of operation for  $V_2 = 10$  V. The measured radiation pattern in *E*-plane and *H*-plane for frequencies 1.08 GHz and 2.2 GHz is shown in Figure 14.

## 5. Conclusion

The Oscillator-type active antenna has been designed by using the chaotic Colpitts oscillator. The multifrequency operation of the antenna is exploited based on the theory of route to chaos. Both simulated and experimental results confirm the validity of the proposed technique. It is evident that the antenna can be made to transmit multiple frequencies simultaneously by setting the bias voltage of the chaotic oscillator to a certain value. The proposed technique is found to be suitable for wireless devices.

## Conflict of Interests

The authors declare that there is no conflict of interests regarding the publication of this paper.

## Acknowledgment

The authors wish to acknowledge the financial support received from University Grant commission, New Delhi,

India, for carrying out this research under SAP II programme.

## References

- [1] K. Chang, R. A. York, P. S. Hall, and T. Itoh, "Active integrated antennas," *IEEE Transactions on Microwave Theory and Techniques*, vol. 50, no. 3, pp. 937–944, 2002.
- [2] I. Bahl and P. Bhartia, *Microstrip Antennas*, Artech House, 1980.
- [3] D. F. Osker and G. M. Maggio, "Bifurcation phenomena in the colpitts oscillator: robustness analysis," in *Proceedings of the IEEE International Symposium on Circuits and Systems (ISCAS '00)*, vol. 2, pp. 469–472, Geneva, Switzerland, 2000.
- [4] G. Lombardo, G. Lullo, and R. Zangara, "Experiments on chaotic circuits and crypted data transmission," in *Proceedings of the 8th IEEE International Conference on Electronics, Circuits and Systems (ICECS '01)*, vol. 1, pp. 461–464, September 2001.
- [5] P. L. Overfelt, "An electrically small dipole antenna loaded with Chua's oscillator: time-retarded chaos," in *Proceedings of the IEEE Antennas and Propagation Society International Symposium*, vol. 4, pp. 2872–2875, Orlando, Fla, USA, 1999.
- [6] M. P. Kennedy, "Chaos in the Colpitts oscillator," *IEEE Transactions on Circuits and Systems I: Fundamental Theory and Applications*, vol. 41, no. 11, pp. 771–774, 1994.
- [7] G. Mykolaitis, A. Tamaševičius, and S. Bumeliene, "Experimental demonstration of chaos from Colpitts oscillator in VHF and UHF ranges," *Electronics Letters*, vol. 40, no. 2, pp. 91–92, 2004.

- [8] S. Zhigno, R. Lixin, and C. Kangsheng, "Simulation and experimental study of chaos generation in microwave band using colpitts circuits," *Journal of Electronics (China)*, vol. 23, no. 3, pp. 433–436, 2006.
- [9] S. Wei and S. Donglin, "Microwave chaotic colpitts circuit design," in *Proceedings of the 8th International Symposium on Antennas, Propagation and EM Theory (ISAPE '08)*, pp. 1127–1130, Kunming, China, November 2008.
- [10] B. E. Kyarginsky and N. A. Maxico, "Wideband microwave chaotic oscillators," in *Proceedings of the IEEE 1st International Conference on Circuits & Systems for Communications (ICCS '02)*, pp. 296–299, 2002.
- [11] A. Panas, B. Kyarginsky, and N. Maximov, "Single-transistor microwave chaotic oscillator," in *Proceedings of International Symposium on Nonlinear Theory & Its Applications*, vol. 2, pp. 445–448, 2000.
- [12] B. Kumari and N. Gupta, "Effect of radiated electromagnetic interference on colpitts oscillators," *Proceedings of the 29th Annual Review of Progress in Applied Computational Electromagnetics*, March 2013.
- [13] C. A. Balanis, *Antenna Theory: Analysis and Design*, John Wiley & Sons, New York, NY, USA, 1996.
- [14] M. H. Badjian, C. K. Chakrabarty, and S. Devkumar, "Circuit modeling of an UWB patch antenna," in *Proceedings of the IEEE International RF and Microwave Conference (RFM '08)*, Kuala Lumpur, Malaysia, December 2008.
- [15] S. Jangid and M. Kumar, "An equivalent circuit of UWB patch antenna with band notched characteristics," *International Journal of Engineering and Technology*, vol. 3, no. 2, 2013.
- [16] N. Wang, S. E. Schwarz, and T. Hierl, "Monolithically integrated Gunn oscillator at 35 GHz," *Electronics Letters*, vol. 20, no. 14, pp. 603–604, 1984.
- [17] Z. Ding, L. Fan, and K. Chang, "New type of active antenna for coupled Gunn oscillator driven spatial power combining arrays," *IEEE Microwave and Guided Wave Letters*, vol. 5, no. 8, pp. 264–266, 1995.
- [18] R. A. York and R. C. Compton, "Dual-device active patch antenna with improved radiation characteristics," *Electronics Letters*, vol. 28, no. 11, pp. 1019–1021, 1992.
- [19] W. W. Lam, Y. C. Ngan, and Y. Saito, "Millimeter-wave active patch antenna," in *Proceedings of the Antennas and Propagation Society International Symposium*, vol. 2, pp. 791–794, 1990.
- [20] C.-C. Huang and T.-H. Chu, "Radiating and scattering analyses of a slot-coupled patch antenna loaded with a MESFET oscillator," *IEEE Transactions on Antennas and Propagation*, vol. 43, no. 3, pp. 291–298, 1995.
- [21] J. Bartolic, D. Bonefacic, and Z. Sipus, "Modified rectangular patches for self-oscillating active-antenna applications," *IEEE Antennas and Propagation Magazine*, vol. 38, no. 4, pp. 13–21, 1996.
- [22] G.-J. Chou and C.-K. C. Tzuang, "Oscillator-type active-integrated antenna: the leaky-mode approach," *IEEE Transactions on Microwave Theory and Techniques*, vol. 44, no. 12, pp. 2265–2272, 1996.
- [23] A. Bhattacharya and P. Lahiri, "New design philosophy of active microstrip patch antenna," in *Proceedings of the Antennas and Propagation Society International Symposium*, vol. 3, pp. 1284–1287, 2000.
- [24] P. S. Hall, "Analysis of radiation from active microstrip antennas," *Electronics Letters*, vol. 29, no. 1, pp. 127–129, 1993.
- [25] F. Giuppi, A. Georgiadis, M. Bozzi, S. Via, A. Collado, and L. Perregrini, "Hybrid electromagnetic and non-linear modeling and design of SIW cavity-backed active antennas," *Applied Computational Electromagnetics Society Journal*, vol. 25, no. 8, pp. 682–689, 2010.
- [26] P. M. Haskins, P. S. Hall, and J. S. Dahele, "Active patch antenna element with diode tuning," *Electronics Letters*, vol. 27, no. 20, pp. 1846–1848, 1991.
- [27] R. S. Kshetrimayum, "Printed monopole antennas for multi-band applications," *International Journal of Microwave and Optical Technology*, vol. 3, no. 4, 2008.

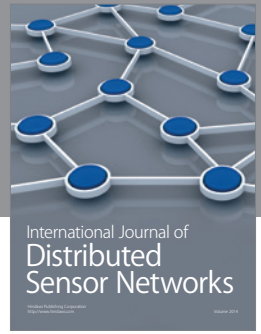
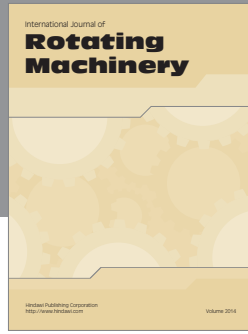

**Hindawi**

Submit your manuscripts at  
<http://www.hindawi.com>

