

## Wind energy courses in the virtual classroom

**Badger, Merete**

*Published in:*  
Department of Wind Energy Annual Report 2013

*Publication date:*  
2014

*Document Version*  
Publisher's PDF, also known as Version of record

[Link back to DTU Orbit](#)

*Citation (APA):*  
Badger, M. (2014). Wind energy courses in the virtual classroom. In B. C. Larsen, J. C. Hansen, & T. Cronin (Eds.), Department of Wind Energy Annual Report 2013 (pp. 25). DTU Wind Energy.

## DTU Library

Technical Information Center of Denmark

---

### General rights

Copyright and moral rights for the publications made accessible in the public portal are retained by the authors and/or other copyright owners and it is a condition of accessing publications that users recognise and abide by the legal requirements associated with these rights.

- Users may download and print one copy of any publication from the public portal for the purpose of private study or research.
- You may not further distribute the material or use it for any profit-making activity or commercial gain
- You may freely distribute the URL identifying the publication in the public portal

If you believe that this document breaches copyright please contact us providing details, and we will remove access to the work immediately and investigate your claim.

# Department of Wind Energy Annual Report 2013



**Annual Report 2013**

ISBN: 978-87-92896-79-7

**DTU Wind Energy**

Technical University of Denmark

DTU Risø Campus

Building 118

Frederiksborgvej 399

DK-4000 Roskilde

[www.vindenergi.dtu.dk](http://www.vindenergi.dtu.dk)

**Editor in Chief**

Berit C. Larsen

**Editing:**

Berit C. Larsen, Jens Carsten Hansen og Tom Cronin

**Layout:**

Karina Bredahl Petersen, SvendborgTryk

**Photos:**

Colourbox

Siemens press Photo

Berit C. Larsen

Thomas Buhl

etc.

**Printed in Denmark by SvendborgTryk**

**Frontpage photo:**

Colourbox

# CONTENTS

Foreword by Head of Department	4
HIGHLIGHTS 2013	6
<b>Cross-sectional projects</b>	
Development of smart blade technology – trailing edge flaps	12
Center for Computational Wind Turbine Aerodynamics and Atmospheric Turbulence	14
<b>Research activities</b>	
Measurements on full scale megawatt turbines	16
Micro-macro understanding of fatigue in unidirectional composites	17
Wind Turbine Improvements by Wind-lidar-based Preview and Control	18
Fatigue damage of steel components	19
Wave loads on offshore wind turbines: Accurate tools and structural response	20
Jacket substructure fatigue mitigation through active control	21
Fuga - a fast flow model for offshore wind farms	22
TWENTIES - 20% energy from renewables in Europe in 2020	23
<b>Public Consultancy</b>	
Technical certification scheme for design, manufacture, installation, maintenance and service of wind turbines	24
<b>Education</b>	
Wind energy courses in the virtual classroom	25
New educational initiatives to comply with the need from the growing wind energy sector	26
PhD Projects	27
PhDs in 2013	34
<b>Publications</b>	35
<b>Organisation</b>	42
Team descriptions	45

# HEAD OF DEPARTMENT

## VALUE CREATION IN THE WIND ENERGY SECTOR

DTU Wind Energy is a department of the Technical University of Denmark specifically focusing on wind energy and with a globally unique combination of research, education, innovation and public sector consultancy.



*Peter Hauge, Head of Department*

The creation of value for the benefit of society using the natural and technical sciences goes hand in hand with the development of these disciplines as the two key elements in DTU's mission. The development of the sciences is directly associated with research, which by means of dissemination in journal papers, conference proceedings and reports indirectly benefits society's ability to create value. On the other hand, the direct and targeted contribution to value creation is to be found in a variety of means at DTU grouped together within education, innovation and consultancy to authorities and related sectors.

The Department of Wind Energy focuses on the needs of the sector and for technology development. As such, the department contributes to value creation through a large number of activities within education, innovation and consultancy. The development and deployment of wind energy is global, and industry based in Denmark operates on an international scale. Hence the department's activities, too, have an international dimension that is based on international cooperation, not only in our research projects, but also through our education, innovation and consultancy undertakings.

Research is, nonetheless, our core activity and 2013 saw many exciting developments as can be seen by this annual report. The research is cross-disciplinary and takes its lead in the critical challenges, the needs for development and application of the technology. The department leads the Danish Consortium for Wind Energy and is an active participant in MegaVind, a public-private partnership to

maintain and develop Denmark as a leading research and development centre for wind energy. Similarly, the department heads up the Wind Energy Program and the European Energy Research Alliance (EERA). It also is a major contributor to the Technology Platform for Wind Energy (TPWind), where in 2013 there was a special focus on the development of a new European Strategic Research Agenda. In addition, experts from the department are often called upon to review and provide advice on national research programs.

In Europe, the department now coordinates six EU projects and participates in 42 projects in total with seven new projects added in 2013. One of the new projects, coordinated by DTU Wind Energy, is the Integrated Research Program on Wind Energy (IRPWIND), where the ambition is to create a joint European Wind Energy Research Program complete with a strategy and action plan, including a secretariat to support the implementation. This will make it possible to continue the proactive approach towards European collaboration and funding of research in Horizon 2020.

The operation and development of research and test infrastructure is a central element in the department's research programs, but it also plays a major role in the interaction with industry and our contribution to technology development and innovation. As examples, in 2013, the department has worked with both the development of a national wind tunnel and a grid test facility for wind turbines. Together with DTU IT and DTU Mechanical Engineering the department has

### **Vision:**

- DTU Wind Energy is a globally leading department for wind energy with technical-scientific competences in the international front and with a unique integration of research, education, innovation and public/private sector consulting
- DTU Wind Energy is a key contributor to the realization of the vision of Denmark as a "Wind Power Hub" and the activities support and develop the global wind energy sector with a special effort on national industrial development and innovation

### **Mission:**

- To develop new opportunities and technology for global and Danish exploitation of wind energy and improve the competitiveness compared to other energy sources
- To develop technical-scientific knowledge and competencies in key fields, which are central for the development and use of wind energy and provide the basis for advanced education at DTU
- To facilitate the implementation and exploitation of research results through research-based consultancy and services to industry and the public sector, innovation and education comprising training courses at DTU



also invested in the first PC cluster of its kind in Denmark, which is now ready for use in the beginning of 2014. It is the second largest cluster in Denmark opening up new opportunities for advanced modelling, complex simulations and scientific computing. At the National Test Centre for Large Wind Turbines in Østerild, Vestas began the assembly and erection of a new 8 megawatt wind turbine. It will be the largest wind turbine in the world once fully erected with a rotor diameter of 164 meters and a tip height of 222 meters. To date, this is the fourth wind turbine to be erected at Østerild Test Centre.

Within education, DTU Wind Energy offers a complete two-year master programme in wind energy, which was accredited in 2013. The accreditation for the MSc in Wind Energy was given with the highest mark in all categories and is valid for the next six years. Furthermore, DTU Wind Energy participates in the Erasmus Mundus European Wind Energy Master (EWEM), a two year double degree programme in cooperation with NTNU, University of Delft and University of Oldenburg. The majority of students in the master programmes and the PhD school are international.

Continued education and training of industry staff in wind energy topics has for many years been a significant activity, particularly associated with software developed by the department. Clients have traditionally come from all over the world and travel has been a limiting factor. E-learning is solution to this challenge and in 2013 DTU Wind Energy held, for the first time, an online WAsP wind resource assessment course with participants from all over the world. More e-learning courses are being developed and will be used in our master programmes in the future.

At DTU Wind Energy we define innovation as the implementation of new research-based knowledge with an external party in a product, a technology or a process aiming to create value in the wind energy industry and society. Our primary contribution to innovation is direct collaboration with industry partners, either through co-financed research projects, commissioned research and development projects or research-based consulting and testing. Another important route for innovation is embedding our research in

software products for example within wind resource assessment, wind loads, fluid dynamics, structural blade analysis and aero-elastic modelling. Our software is sold internationally and the income finances continued development and supporting research. In 2013 a new version of WAsP, the industry standard for wind resource assessment, was released. WAsP 11 combines the WAsP approach with the option of using the CFD solver EllipSys for wind resource assessments in complex terrain. The CFD analysis is run on a server operated by our partner, the Danish company EMD A/S.

As innovation is our primary means for value creation with industry, this topic is constantly being discussed with our Advisory Board and our industrial partners. Internally, 2013 has seen a strategy development for the following specific innovation areas: Commissioned R&D, Test and Measurements, Software and Inventions, and Patents. Our challenge for the latter is to strengthen and develop the field into an advantage rather than a potential barrier for industrial collaboration.

Finally, we continue our efforts on research-based consultancy to authorities and the wind energy sector. In Denmark DTU Wind Energy manages the Energy Agency's Secretariat for the Danish Wind Turbine Certification Scheme and leads the wind turbine technical committee for wind turbines. We also lead, and contribute to, several international standards groups under CENELEC and IEC, and also participate in the IEA wind activities. We have many projects and global collaboration activities with public institutions, for example in South Africa, China and India. In 2013 DTU Wind Energy was pre-qualified as one of three international institutions for wind resource mapping as part of the World Bank's ESMAP programme and won the very first contract for such services in Vietnam.

Overall 2013 was a good year and we are proud of our achievements in both our research and value creation. In the following pages you can read about some of the key activities, cooperation and achievements that have helped make 2013 a success.



# HIGHLIGHTS 2013



## January

### New Year's reception at Risø Campus

2013 started with a New Year's reception at Risø Campus where Head of Department Peter Hauge Madsen said: "The solid and satisfying international research results of which DTU Wind Energy contributes with a grand majority gives us the opportunity to contribute where needed as Denmark has an important role to play. We have an obligation to continue to take on leading roles within a European and global context".

## January

### Department day at Lyngby Campus

DTU Wind Energy held the yearly Department day at Lyngby Campus. All employees were invited to come and listen to the interesting presentations of research and projects that among others included 'A new 3D viscous-inviscid interactive code for rotor aerodynamics', 'Status of the new Wind Tunnel', 'PC Cluster' etc. It was a good and interesting morning including time to be social with colleagues.

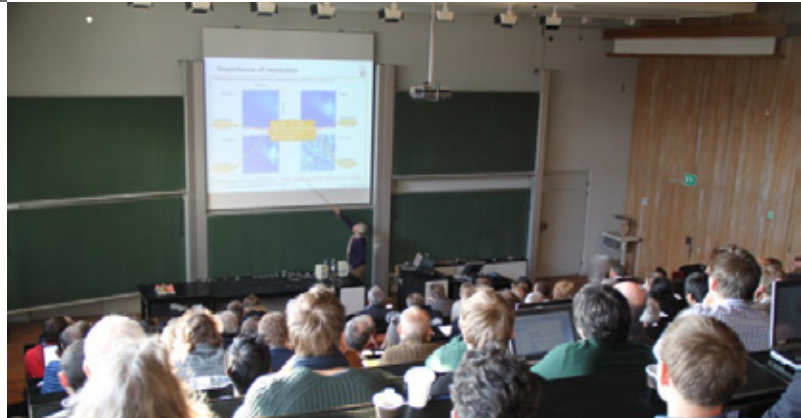

## January

### Inaugural lecture by professor Jakob Mann

1 February 2012 Jakob Mann was appointed Professor in Wind Energy Meteorology and Turbulence at DTU Wind Energy. 25 January 2013 he held his inaugural lecture entitled "Atmospheric flow and turbulence for wind energy" at Lyngby Campus. After the lecture a reception was held.

## January

### Ioanna Karagali got a fund from the European Space Agency

Ioanna Karagali was granted a fund from the European Space Agency (ESA) to pursue a 2-year postdoctoral research project within the framework of ESA's Support to Science Element (STSE). A total of 83K Euro is granted to Ioanna's project, entitled "Sea Surface Temperature Diurnal Variability: Regional Extent - Implications in Atmospheric Modelling (SSTDV: REX-IMAM)". The aim is to investigate the regional extent of the daily variability of the sea surface temperature and its impact on the forecasts from the mesoscale model WRF which is operationally available at DTU Wind Energy.



## February

### DTU Wind Energy stand at EWEA 2013

DTU Wind Energy was present at the EWEA Conference which took place in Vienna from 4-7 February 2013. The stand in Hall A was very good positioned and many well-known and new people passed by to ask questions, talk, listen and network. Tuesday afternoon Andreas Bechmann and Brian O. Hansen had a session where they explained WASP CFD and many interested in the topic came and listened. Colleagues from department were active participants as speakers or chairmen in different conference sessions. The department was also presented with posters which could be seen outside the conference rooms.

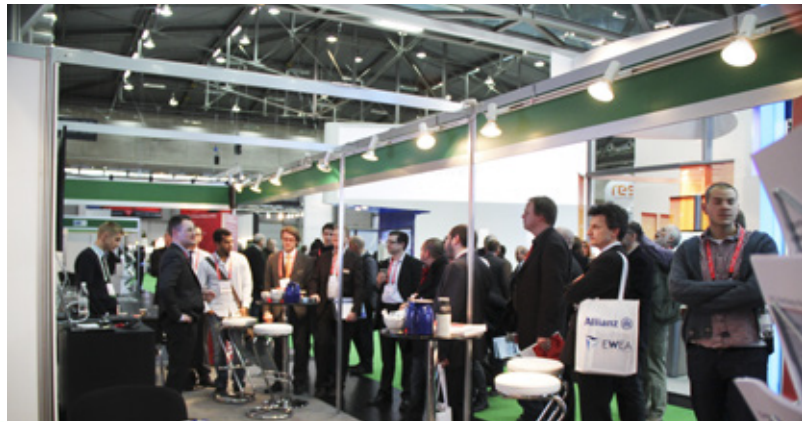

## February

### Accreditation of the Master's programme in wind energy (MSc in Wind Energy)

21 February 2013 culminated several months work to get the graduate programme in Wind Energy accredited. It was accredited last time in 2007 and accreditation must be renewed every 6 years. At the accreditation meeting with the Accreditation Agency ACE Denmark, various groups were invited to share their experiences concerning the education and the interviews in conjunction with the submitted report of more than 300 pages. The accreditation for MSc in Wind Energy was given with the highest mark in all categories and lasts for the next 6 years.



## April

### The Ingeborg and Leo Dannin award went to Professor Jakob Mann

5 April 2013 the Ingeborg and Leo Dannin award went to Professor Jakob Mann from DTU Wind Energy. On this occasion the Department of Wind Energy invited all interested to a lecture held by Jakob Mann with the title: "Atmospheric turbulence for wind energy". After the award ceremony all were invited to the reception.

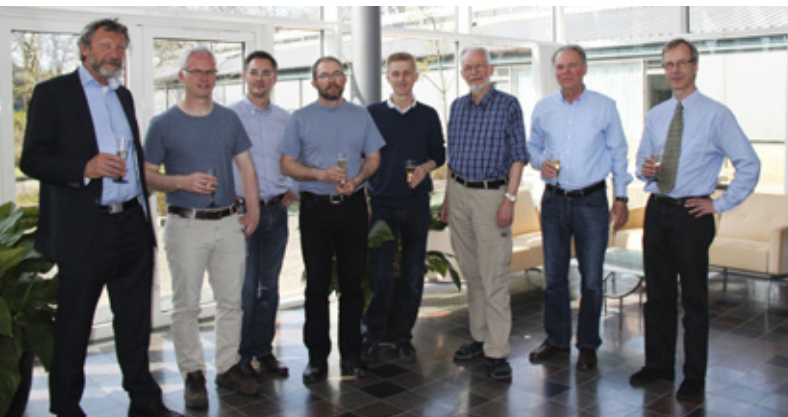

## May

### DTU Wind Energy signed a contract with EMD A/S

DTU Wind Energy has in co-operation with the energy- and environment data company EMD A/S launched a new version of WASP which solves a vital challenge. The launching was marked in May when both parts signed the contract. The new program makes it possible to make very accurate calculations in foreign areas dominated by forests, cliffs and mountains with steep slopes – also called 'complex terrain'.

*From the left: EMD A/S Per Nielsen, DTU: Hans E. Jørgensen, Brian O. Hansen, Niels Sørensen, Andreas Bechmann, Ole Rathmann, Flemming Rasmussen and Peter Hauge Madsen*





## June

### ICOWES 2013

In June the 3-day International Conference on aerodynamics of Offshore Wind Energy Systems and Wakes (ICOWES2013) took place at Lyngby Campus. Many academic or industrial scientists from 16 different countries attended the conference, with 70% from Europe and the rest from Asia or America. The main subject of the Conference was the aerodynamic aspect of offshore wind energy and wakes. There were 13 sessions with oral presentations, 7 sessions dealt with wake aerodynamics and wind farm aerodynamics.

## June

### PhD Summer School held at Risø Campus

Once again DTU Wind Energy arranged the PhD Summer School: Remote Sensing for Wind Energy 2013 which took place at Risø Campus. Remote sensing lectures, demonstrations and exercises on remote sensing observations and data analysis were part of the week. 21 participants were gathered and besides Denmark, they came from many different countries including Bulgaria, France, Germany, India, Japan, the Netherlands, Norway, Sweden, Switzerland and Taiwan.

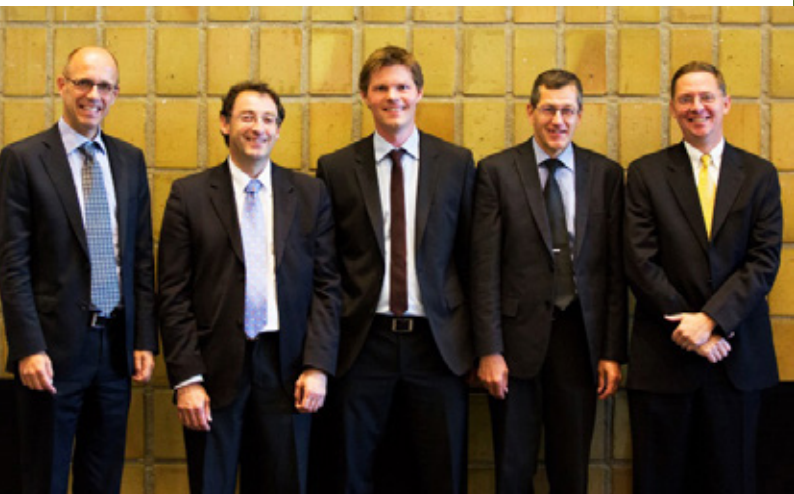

## August

### Doctorate in new methods of optimal design

In August senior researcher at DTU Wind Energy Mathias Stolpe defended his doctoral thesis in "Models and Methods for Structural Topology Optimization with Discrete Design Variables". He has developed computer methods that help determine the choice of material, the quantity and finally the distribution of holes with the structure. After the defence all present were invited to the reception.

*From the left: Provost Henrik Caspar Wegener, Professor Pierre Duysinx, Mathias Stolpe, Professor Mads Peter Sørensen, Professor Jeffrey T. Linderoth*

# HIGHLIGHTS 2013 CONTINUED

## September

### 34<sup>th</sup> Risø International Symposium on Materials Science

The symposium lasted a week from 2-5 September 2013 and took place at Risø Campus. The symposium focused on the links between fundamental science and more practically oriented developments of processing techniques, in order to further the understanding of relationships between processing conditions and engineering properties of the final composites.



34<sup>th</sup> Risø International Symposium on Materials Science  
2-5 September 2013



## September

### Inaugural lecture by Professor Poul Ejnar Sørensen.

1 January 2013 Poul Ejnar Sørensen was appointed Professor in Wind Power Integration and Control at DTU Wind Energy. 6 September 2013 he held his inaugural lecture entitled "Integration and Control of Wind Power" and earlier that year he held his 25<sup>th</sup> state jubilee.

*From the left: Peter Hauge Madsen, Poul Ejnar Sørensen*

## September

### Academy Scientific Award of the European Academy of Wind Energy

Jakob Mann, professor at DTU Wind Energy, won the Academy Scientific Award of the European Academy of Wind Energy. The award was given to Jakob "for his extraordinary efforts and achievements in turbulence research and for his significant contributions in the field of atmospheric turbulence".

*On the photo from the left: Gijs van Kuik, professor at TU Delft and director for DUWind, Professor at DTU Wind Energy Jakob Mann, Michael Muskulus, president of EAWE, Assoc. Professor at NTNU Trondheim, Norway, Joachim Peinke, past president of EAWE, Professor at University of Oldenburg, Germany, Gerard van Bussel, Professor at TU Delft, The Netherlands.*





Minister of Energy, Mr. Dikobe Ben Martins



## September

### Unusual recognition from South Africa at the Wind Energy Conference Windaba 2013

It was an unusual recognition of “sterling work” that sounded from the Minister of Energy Mr. Dikobe Ben Martins as he held his ministerial speech at the annual wind conference Windaba 2013. He said: “Your contribution both financially and technically has contributed immensely to the transfer of skills and knowledge and has put South Africa on a firm footing to support the global wind atlas project. I also want to extend the Department’s gratitude to the participating institutions, namely; SANEDI, UCT, CSIR, SAWS, and Riso DTU for the sterling work that has been done thus far. We trust that your positive collaboration will continue for the remainder of this project.”

## October

### DTU Wind Energy signed a spectacular cluster contract with HP.

In October DTU Wind Energy invested in the first cluster of its kind in Denmark, based on the newest Intel Ivy Bridge processor technology. DTU Wind Energy’s new cluster will be ready for use in the beginning of 2014.

*Photo: HP’s Managing Director Jakob Schou Meding and Head of Department at DTU Wind Energy Peter Hauge Madsen. (Photo Thomas Buhl)*



## November

### DTU Wind Energy participates in EWEA Offshore

For the first time the department decided to participate at the EWEA Offshore Conference. It was held in Frankfurt and the department participated with a stand through the Danish Export Association. It was a very positive experience and many people came and visited the stand.

*Photo: HP’s Managing Director Jakob Schou Meding and Head of Department at DTU Wind Energy Peter Hauge Madsen. (Photo Thomas Buhl)*



## November

### Online E-learning course

For the first time DTU Wind Energy held an online WAsP course with participants from all over the world. The course began 16 September and ended 18 November. It was a very successful experience for all involved. The participants expressed satisfaction with the length of the course, the content and the way the course was designed.



# HIGHLIGHTS 2013 CONTINUED

## November

### Successful celebration of 'Wind Turbine Improvements by Wind-lidar-based Preview and Control'

Representatives of the project took part in the celebration that The Danish National Advanced Technology Foundation Thursday 7 November held. The participants received a fine award for the successful completion of project. The award describes the whole project cycle from the start in 2009 to the end of 2013.

*From the left: Professor and Vice chairman Klaus Bock, Professor, DTU Wind Energy Torben Mikkelsen, Project manager, NKT Photonics Lasse Leick and CEO Danfoss and Chairman Jørgen Mads Clausen.*



## December

### DTU Wind Energy coordinates IRPWIND

The EC decided in December 2013 to fund the Integrated Research Programme on Wind Energy (IRPWIND) which was one of the final projects allocated in FP7. The project is coordinated by DTU Wind Energy (Peter Hauge Madsen) and addressed coordination and networking elements as well as normal research activities. The ambition is to create a joint, European Wind Energy Research Programme with strategy and planning including a secretariat to support this. DTU will lead this work. The budget is 10M EURO for 4 years. A Kickoff meeting will take place at the EWEA Conference 2014 in Barcelona in March.

## December

### Equation competition

DTU Wind Energy held the yearly Christmas lunch at Scandic Hotel in Roskilde. During the lunch the winner of the department's equation competition was announced. Marisciel Litong-Palima won for having made the shortest and most accurate presentation of wind energy.

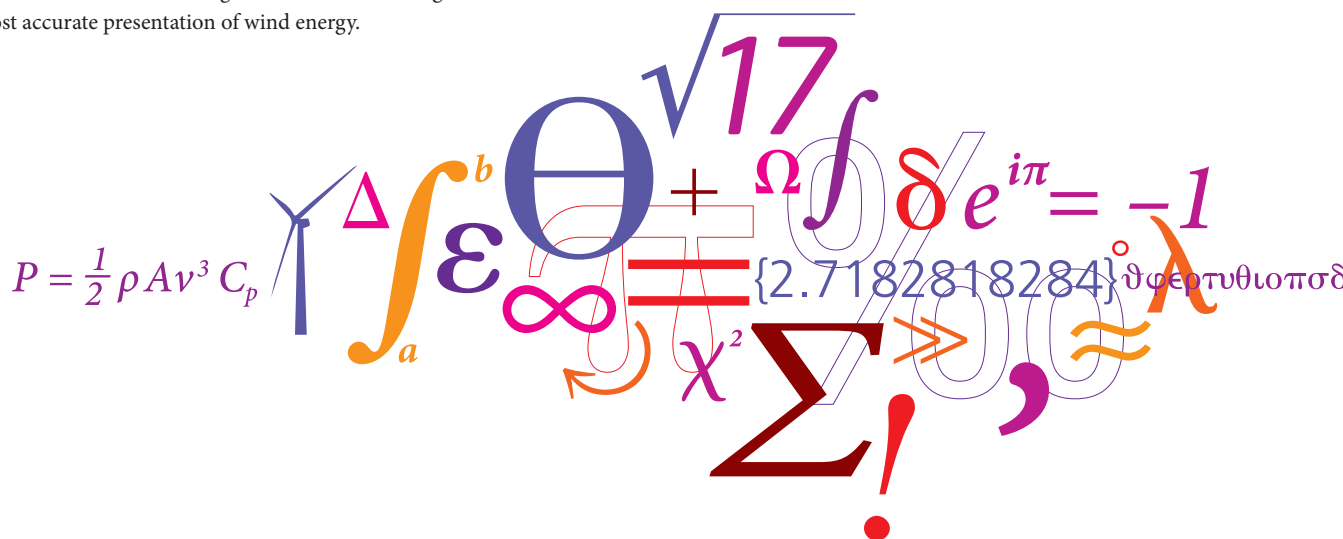



Fig. 1. Manufacturing the flap prototypes



## DEVELOPMENT OF SMART BLADE TECHNOLOGY - TRAILING EDGE FLAPS

With blade lengths presently up to 80+ m there is a need for a supplement to the standard pitch system for control of power and loads. Distributed load control along the blade span with trailing edge flaps is a promising concept where numerical simulations have shown considerable load alleviation potential. However, the technology still has not been developed, but in the INDUFLAP project the overall goal is to transfer a trailing edge flap system tested in the laboratory to full-scale industrial application.

If we can reduce the unsteady loads on the blades caused by the turbulence in the inflow to a wind turbine, the rotor diameter can be increased and more power can be produced without changing the turbine platform. This is the vision by the smart

blade technology where the cross section geometry of the blade is adjusted continuously to counteract the changes in loads that otherwise would occur due to the fluctuating wind. It is the same technique that birds use to control their flight. Simulation of the flow over airfoils has shown that the most efficient load control is obtained by modifying the geometry either at the leading edge or at the trailing edge of the airfoil. The technology we are working with is the concept of a morphing trailing edge region of the airfoil as shown in figure 3 on page 13 where a deflection down and up, respectively, is shown.

The deflection of the flap as we call the morphing trailing edge region in figure 3 is simply obtained by pressurizing the upper voids with air or a fluid if a downward deflection is wanted and opposite if an upward deflection is the goal. In order to obtain the deflection with a reasonable low pressure, the flap is manufactured in a suitable rubber or polymer material. Thus, it is basically a simple mechanism to control the loads as there are no mechanical parts and it is also what the wind turbine manufacturers want. Such a new system should not introduce additional maintenance requirements or reduce the availability of the turbine. To prove that such new smart blade technology is robust and



Fig. 2. Manufacturing the flap prototypes

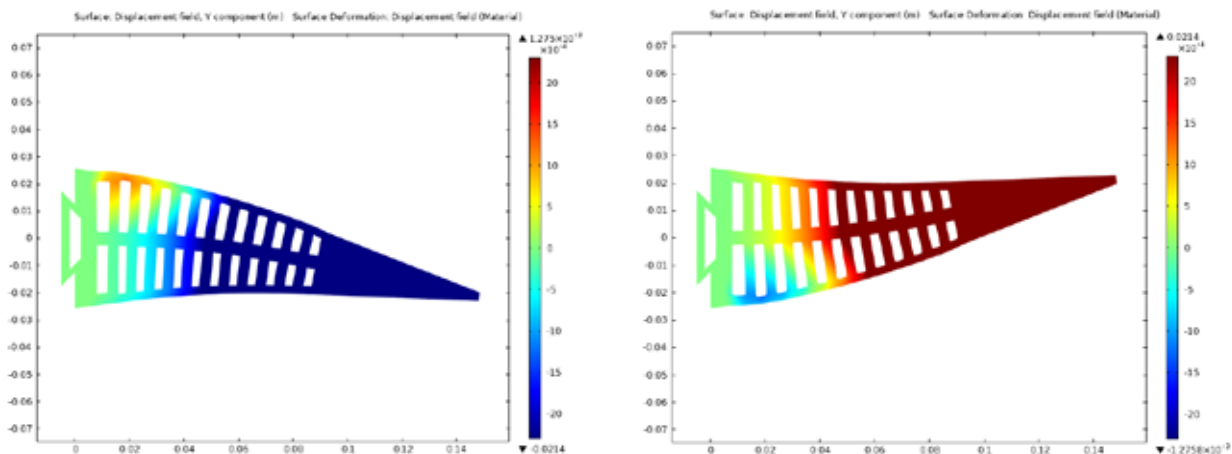

Fig. 3. The concept of a morphing trailing edge of an airfoil is the technology used in the INDUFLAP project.

can be manufactured in an industrial manufacturing process, is the main objective of the INDUFLAP project that was initiated in the beginning of 2011 and will end in the summer 2014. The project is funded by EUDP and it is a corporation between three industrial partners: Rehau, Hydratech Industries, Dansk Gummi Industri and DTU Wind with three sections Composites and Materials Mechanics Section, the Test and Measurement Section and the Aeroelastic Design Section. The DTU workshop is also participating and so is DTU Elektro where a PhD project on lightning of wind turbine blades is carried out. It is a project that spans over several engineering disciplines and thus profits from the presence of the necessary competences within the Department of Wind Energy. As an example the development of the flap design has involved stress computations with the software COMSOL in the Aeroelastic Design Section. Exploring suitable materials and manufacturing techniques of prototypes have taken place in the Composites and Materials Mechanics Section and the manufacturing of the molds for the prototypes have been carried out in the workshop. Finally setting up the prototype testing system was done by the Test and Measurement Section. This progressive work has been carried out in close cooperation with the industrial partners.



Fig. 4 and 5. The flap system will be tested on a blade 2m x1m blade section mounted on a 10m long boom replacing the standard rotor on the 100kW Tellus turbine at Risø Campus. In this way almost similar working conditions as a full scale turbine are obtained.

Besides manufacturing flap prototypes, the testing of the smart blade technology is another main part of the INDUFLAP project. Wind tunnel testing of the present flap technology was done back in 2009 and proved that the concept works.



Photo: Members of the team behind the project are from the left: Johnny Egtved Jørgensen (DTU), Karen Enevoldsen (DTU), Martin Heisterberg (Rehau), Peter Michels (Rehau), Mads Brinch Christensen (Hydratech Industries), Helge Aagaard Madsen (DTU), Tom Løgstrup Andersen (DTU), Hanne Thomassen (Energistyrelsen), Michael Schoebel (Rehau), Leonardo Bergami (DTU), Michael Nimb (DTU)

However, there is big step from wind tunnel testing to full scale turbine application and therefore a so-called rotating test rig has been developed in the project. The idea is that the testing should be as close as possible to the rotating test environment on a real turbine and have the same unsteady inflow conditions and a size of the flap almost matching a full scale. Manufacturing a blade section with a 1m chord and 2m span has been produced, and it has been mounted on a 10m long boom as shown in figure 4 and 5. The boom will be mounted on the 100kW Tellus turbine in the spring 2014 instead of the normal three bladed rotor that was taken down in February 2013.

At the end of the INDUFLAP project in the summer 2014 it is expected that the robustness and the performance of the system has been proven in order to take the next step and testing it on a MW turbine. This could be done by integrating the flap system on an existing blade.

By Helge Aagaard Madsen



# CENTER FOR COMPUTATIONAL WIND TURBINE AERODYNAMICS AND ATMOSPHERIC TURBULENCE

In order to design and operate a wind farm optimally it is necessary to know in detail how the wind behaves and interacts with the turbines in a farm. This not only requires knowledge about meteorology, turbulence and aerodynamics, but it also requires access to powerful computers and efficient software. Center for Computational Wind Turbine Aerodynamics and Atmospheric Turbulence was established in 2010 in order to create a world-leading cross-disciplinary flow center that covers all relevant disciplines within wind farm meteorology and aerodynamics.

The center was established with the aim of dealing with the mutual interaction between wind turbine aerodynamics, turbine wakes, terrain affected flow and atmospheric turbulence. This interaction is normally not accounted for in state of the art models. The aerodynamics of wind turbines is highly complex in that the length scales that govern the performance of a wind turbine range from the thickness of the very thin boundary layer developing on the rotor blades to the height of the atmospheric boundary layer, which can be several kilometers. A main effort of the center is to develop approaches for dealing with all relevant length and time scales and parameterize this into engineering models and operational computational tools. These tools are subsequently employed to derive better wind input for the aerodynamic models as well as providing a better representation of wind turbines into meteorological models. The results from the center has enabled a much more precise description of all relevant physical properties in wind turbine aerodynamics and atmosphere turbulence, and made it possible to derive simple en-

gineering models of practical use for designers of wind turbines and wind farms.

Highlights of results achieved from the center:  
Comparison with Rotor loads measured in real atmospheric conditions

Much effort has been devoted to extracting and analyzing data from the DANAERO experiment. Based on the selected data sets, full rotor computations have been performed, and the results have been compared with the detailed pressure and load data from the experiment. The agreement between computations and measurements are encouraging, even though still preliminary, and indicate that the study can be used to clarify the necessary requirements for rotor computations of wind turbine rotors operating in the atmospheric boundary layer.

Wake behind a model rotor

The wake behind a model of a 3-bladed wind turbine rotor has been investigated both experimentally in a water flume and numerically using a Navier-Stokes solver. The motivation for the analysis is to verify existing tools for wind farm performance predictions and for understanding how various disturbances of the wake influences the turbine efficiency. The investigation has revealed a rather complex flow development including a transi-



Fig. 2. Høvsøre, Siemens press@photo

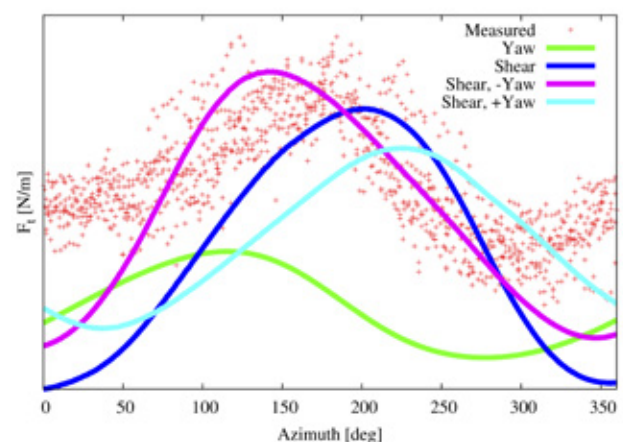

Fig. 1. Computational evaluation of the relative importance of yaw and shear for a turbine operating in the atmosphere, including comparison with actual turbine operating in yaw and negative shear.

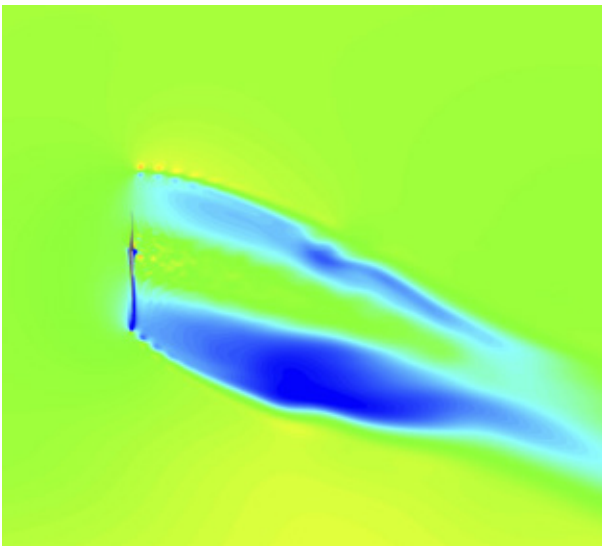

Fig. 3. Birds view of the wake behind a turbine operating in yaw, and shear with wind direction from top left to bottom right. The difference in colours illustrate the large difference of the wake velocity caused by the yaw and shear effects.

tional regime developed from an initial disturbance of the tip and root vortices through a vortex paring process to a fully turbulent wake state.

Fuga – A new fast Navier-Stokes based wind farm solver  
 Fuga is a new wake model for offshore wind resource estimation. Key features are prediction of shadowing from neighbouring farms and effects of variable atmospheric stability. Fuga can be characterized as a linearized CFD model. It is based on the same equations as a traditional CFD model, but only the linear response to turbine drag forces is calculated. Fuga is of the order of hundred thousand to one million times

faster than a traditional CFD model and is therefore ideal for optimization of wind farm layout. Fuga has been tested by many critical users in the offshore wind industry with data from offshore wind farms. Model results were in good general agreement with data.

Siting in Forested and Complex Terrain

Turbines are more and more often erected in forested and complex terrain. The blind comparison of fifty-seven flow model calculations based on the complex terrain Bolund experiment was conducted by scientists from the center. The comparison showed good agreement except from the very critical region close to the surface. Flow over forest has been investigated and a forest module has been implemented in a Navier-Stokes solver and tested over homogeneous forest and close to a forest edge.

Center for Computational Wind Turbine Aerodynamics and Atmospheric Turbulence is sponsored by the Danish Council for Strategic Research, DTU Wind Energy, including industrial partners from Vestas Wind Power, Siemens Wind Systems, LM Wind Power and Vattenfall Group Wind R&D plus a number of international research institutions and universities.

By Jens Nørkær Sørensen

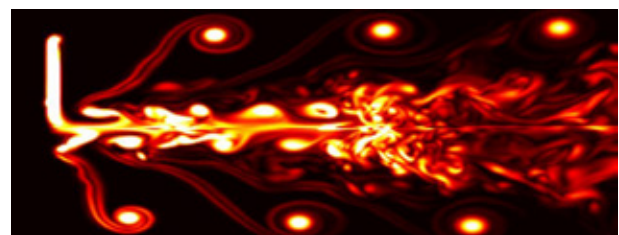

Fig. 4. Iso-vorticity contour showing the cross section of the near wake behind a highly loaded wind turbine

Navier-Stokes solver

A Navier-Stokes solver is a popular designation of a computer software developed to solve the Navier-Stokes equation. These equations, which were developed independently by Claude-Louis Navier (1820) and George Gabriel Stokes (1843), describe the motion of fluid substances. The equations arise from applying Newton's second law to fluid motion, together with the assumption that the stress in the fluid is the sum of a diffusing viscous term and a pressure term. The equations are very general and may be used to model as different phenomena as the weather, ocean currents, water flow in a pipe and air flow around wings. In wind energy the Navier-Stokes equations are used to solve the wind field in the atmospheric boundary layer as well as the flow around wind turbines and the internal flow in wind farms.

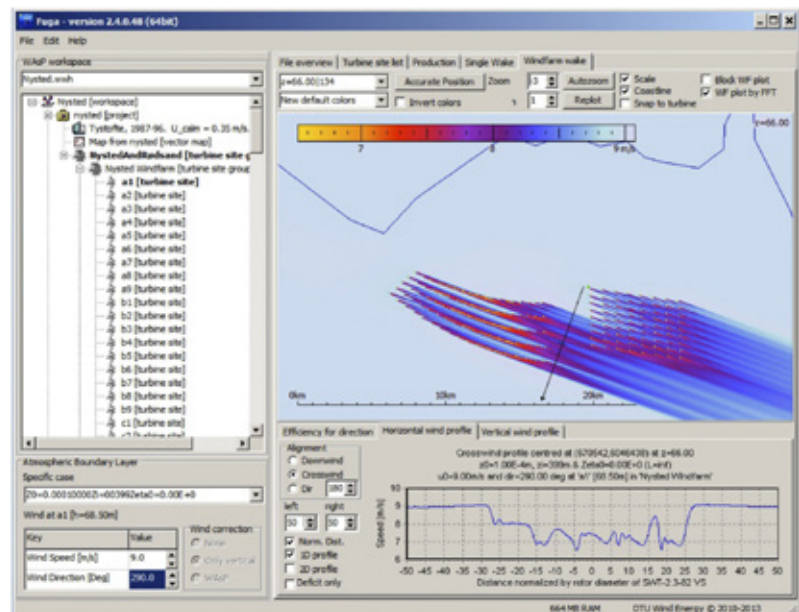

Fig. 5. The graphical user interface of Fuga showing a calculation of the wakes behind two wind farms in the Baltic: Nysted and Rødsand II. The software has been partly integrated with the wind resource program WAsP.



# MEASUREMENTS ON FULL SCALE MEGAWATT TURBINES

In the DANAERO MW project measurements on full scale megawatt wind turbines were carried out. The result of the measurements is a valuable database supporting the validation and further development of simulation models for design of new wind turbines.



*Fig. 1. The NM80 wind turbine in sun set with a crane is lifting two persons up to the blade. The turbine was fully equipped with 450 sensors.*

Precise predictions of power and loads for wind turbines are increasingly important for further optimization and up-scaling. Therefore, validations of simulation models are very important. Thus, from 1985 to 2006 tests were carried out both in the field and in wind tunnels on wind turbines with rotor diameters between 4.5m and 25m. However, modern wind turbines have rotor diameters of 80m+ with a flow around the blades that is different from that around the smaller blades, caused by the differences in shape and size. Even though the knowledge about wind turbine performance is high, there are still a lot of unanswered questions. If we are able to answer these questions, we can design even more efficient and silent wind turbines, thus reduce the cost of energy.

The DANAERO MW project initiated on this experience and detailed tests could for the first time be carried out on full scale megawatt wind turbines. The project included two projects

starting in 2007 and ended in 2013. In the first project, EFP-2007, there were mainly three activities: Airfoil tests in wind tunnels, test of inflow on a Siemens 3.6MW wind turbine and detailed measurements on an NM80 2MW wind turbine. In the second project, EUDP-2009-II, organization of a database and calibration and analysis of the data were carried out. They were carried out in cooperation with DTU Wind Energy, Vestas, Siemens, LM Wind Power and DONG. With these unique and strong partners it was possible to carry out this ambitious project both technically and financially. Both projects were partly funded by the Danish Energy Agency. The analysis resulted in many important and interesting findings. Below only a few findings are described. However, a detailed overview is found in the final project report<sup>1</sup>.

Exact copies of selected airfoils of the blade were tested in wind tunnels. Comparisons of the aerodynamic airfoil characteristics measured in a so-called 2D wind tunnel with the corresponding characteristics measured in 3D full scale and atmospheric conditions revealed that for angles of attack just larger than maximum lift, a lower negative slope of the lift curve was measured on the blade sections on the turbine than on the corresponding airfoils in the wind tunnel. Whether the lower negative slope is a result of centrifugal forces or the lack of walls around the flow is not clear. However, the result indicates that the risk of vibrations due to low aerodynamic damping is smaller on real turbines than predictions based on wind tunnel measurements.

Based on microphones flush mounted at the blade surface, an analysis of the sound pressure on the NM80 wind turbine was carried out. In general there were good agreement between the models and measured data. However, some discrepancies between models and measurements were observed, probably due to the presence of turbulent inflow impacting the turbine blade. Also, for the turbulent inflow noise models, the use of a Von Karman spectrum describing the inflow turbulence characteristics may be a source of error at low frequencies. Finally, new important insight into amplitude modulation of wind turbine noise was extracted from the data.

The outcome of the project is a valuable database with measurements that are accessible for the partners in the project in order for future comparisons between models and measurements to be carried out. Also, selected measurements are available for other institutions in new future research projects like AVATAR.

*By Christian Bak*

<sup>1</sup> N.Troldborg, C. Bak, H.A. Madsen, W. Skrzypinski, "DANAERO MW: Final Report", DTU Wind Energy E-0027, April 2013, Technical University of Denmark, Risø Campus Department of Wind Energy, Roskilde, Denmark

# MICRO-MACRO UNDERSTANDING OF FATIGUE OF FIBRE COMPOSITES

Degradation of composite materials during cyclic loading is being better understood. Better understanding enables better material models and the development of more durable composite materials that have longer life for e.g. wind turbine rotor blades.

During their 20-year service life, wind turbine rotor blades are subjected to varying loads caused by fluctuating wind loads and varying direction relative to the gravitation force. Cyclic loads can induce fatigue damage in the load-carrying parts of the blade, which are usually made of polymer composite materials consisting of long fibers (usually glass or carbon) oriented almost exclusively in the length direction of the blade. Therefore, the fatigue properties of composite materials are of great importance. Understanding of fatigue damage evolution can lead to the development of new composite materials with improved resistance to fatigue, increasing the durability of wind turbine rotor blades. Recent investigations, e.g. by microscopy and 3D X-ray tomography have shown that the presence of backing fibres (a small amount of fibres oriented off-axis, e.g. 90 degrees to the principal load-direction) can have a decremental effect on the fatigue life of the composites. The sequence of damage mechanisms seems to be the formation of cracks in the backing layers, extending into the layers consisting of 0-degree fibres, causing fibre failure. With an increasing number of load cycles the amount of fibre failure increases eventually leading to complete failure. The transverse crack in the backing layers is likely to start from debond cracks forming along fibre/matrix interfaces, kinking out of the fibre/matrix interface into the surrounding matrix and linking up. Thus, fibre/matrix debonding and crack kinking are important phenomena that should be understood mechanically.

Moving mechanics to the microscale also raises the experimental challenge of determine microscale mechanical properties of the fibre/matrix interface. We have developed methods for mechanical characterization of the fibre/matrix interface. The approaches involve both the development of methods for specimen manufacturing and preparation, special testing fixtures to introduce loads and the use of image acquisition during the mechanical testing using either camera, optical microscopy (since the matrix is semi-transparent) or 3D X-ray tomography (for 3D data) and scanning electron microscopy (high resolution 2D data). Finally, experimental results are analyzed using micromechanical models enabling the determination of microscale mechanical properties.

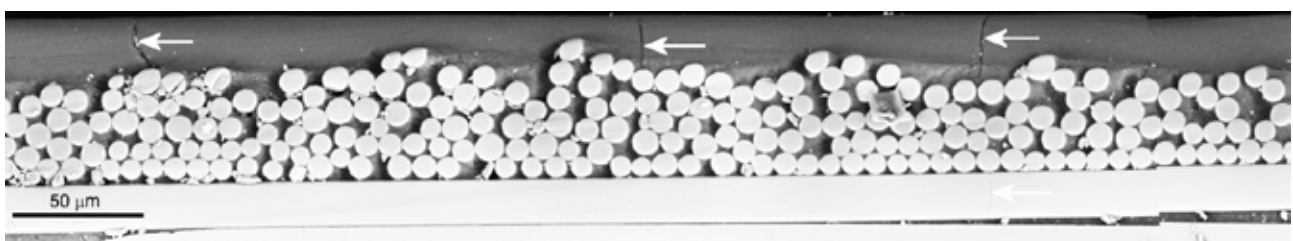

Fig. 1. Micrograph of polished edge showing cracks (indicated by arrows) and broken fibre.

Fig. 3. Debonding and crack kinking observed during transverse tensile testing in scanning electron microscope.



Future research will be towards the use of microscale testing methods under cyclic loading and the use of advanced micromechanical models to investigate whether experiments conducted on single fibres embedded in matrix can be used as a basic tool to characterize the mechanical response of the fibre/matrix interface. This would enable fast tests of e.g. new fibre coatings (protective layers on fibres). The use of 3D X-ray tomography for the characterization of internal damage evolution in composites is expected to be strengthened significantly in 2014 by the planned acquisition of new 3D X-ray tomography equipment as a result of a donation from the Villum Foundation to DTU which will be integrated with the mechanical testing laboratory.

By Bent F. Sørensen

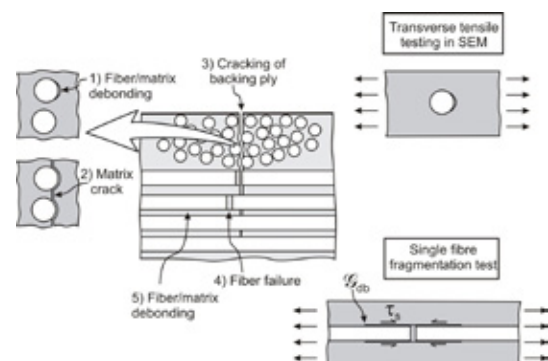

Fig. 2. Schematics of fatigue damage evolution in fibre composites (left) and appropriate microscale testing methods (right).

# WIND TURBINE IMPROVEMENTS BY WIND-LIDAR-BASED PREVIEW AND CONTROL

Wind turbines equipped with laser prevision hold potential for up to 6+ years lifetime extension. Forward looking wind lidars integrated within operational wind turbines providing feed-forward control can reduce the daily operation loads. The turbine lifetime may in this way be extended by up to 30 percent.

The new laser-based wind measuring equipment “SpinnerLidar” installed in wind turbines help the reduction of the cost of renewable energy production via extending its expected lifetime. By use of a patented DTU Wind Energy invented wind lidar scanning system integrated directly into the wind turbine’s rotating spinner turbine, load reduction and improved power performance have addressed this proof-of-concept lidar-integration study based on measured inflow in front of an operating 2.3 MWatt turbine 100 meters upwind of the turbines rotor plane. In combination with fast feed-forward control strategies the SpinnerLidar measured inflow can in combination with turbine feed-forward control be combined to optimize the turbine cyclic blade pitch and rotor speed to alleviate fatigue effects on the tower, gear and blades coming from wind gusts and wind shear during daily operation. During the demonstration phase the SpinnerLidar based preview measurements of the approaching inflow in front of the test turbine which have recorded upwind in front of operating turbines. In combination with features of feed-forward controllers, preview wind measurements have earlier shown the ability to prolong the expected lifetime of wind turbines. By providing an advanced feed-forward controller with on-line real-time inflow wind measurements from a forward-looking wind lidar, mounted in the rotating spinner, or on top of the nacelle, or even directly into the rotating blades, turbine yaw can be improved

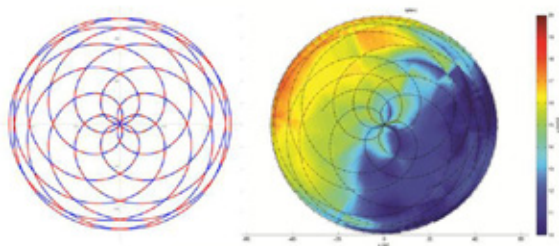

Fig. 2. SpinnerLidar scan pattern with 400 measurement points sampled once per second (left). Example of measured rotor plane inflow at an upwind distance of 100 meters in front of the turbine.



Fig. 1. Research technicians installing the SpinnerLidar in the rotating tip of the NM80 2.3 MW test turbine spinner.

at the same time as the turbine torque, hence its rotor speed can be adjusted in anticipation of incoming wind gusts and wind shear measured over the turbines entire rotor plane.

The newly designed 2D rotor-plane scanning “Spinner-lidar” is demonstrated to monitor the incoming wind gusts, turbulence and wakes from other turbines at distances 100+ meters or more in front of the turbines. In addition extreme wind loads and wind shear effects can also be alleviated by lidar. Wind turbines power production has also been addressed and can seemingly also be enhanced by wind lidar prevision, but marginally only (+1 %), and at the cost of increased fatigue loads.

The research has shown the potential of advanced wind measurement technology in helping energy production from renewable energy sources to be cheaper and more competitive, hence lowering the cost of energy (LCOE).

By demonstrating that we can integrate forward looking wind lidars into an operating MW turbine we have shown that wind turbine control can be improved to help reduction of both operation and extreme loads. Consequently, wind turbine lifetime can be prolonged. Partners: LM Wind Power A/S, NKT Photonics A/S, DTU Wind Energy; IPU Lyngby; ZephIRLidar, Malvern UK.

Sponsor: HTF

By Torben Mikkelsen



Fig. 3. The NM80 2.3 MW test turbine at Tjæreborg Enge (Courtesy Dong Energy)



# FATIGUE DAMAGE OF STEEL COMPONENTS

Railway rails and the inner ring in roller bearings in wind turbines are both experiencing steel-to-steel contact in small areas with huge loads resulting in extremely high stresses in the base materials.

Rolling contact fatigue is a problem that is shared between wind turbine bearings and railway rails. Fatigue failure is generated by stressing the material with cycles of high and low forces, and Rolling Contact Fatigue (RCF) is said to appear when a crack is initiated. Thus in rails the most typical damage mode is the appearance of fatigue cracks in the run way where the wheel is in contact with the rail. If the fatigue cycle continues then in most RCF modes the crack will continue to grow until a piece of the rail is detached. The missing parts of the rail make passing trains noisier and this phenomenon is known as “roaring rails”. Although annoying, these noisy rails do not normally evolve critical failures. However there are RCF failure modes that lead to severe cracking of rails. To prevent these dangerous types of failures from developing they are routinely grinded to remove surface damage on the rails (Fig. 1).

The steel for rails is chosen with care to achieve a balance between fatigue life and wear resistance. Very hard steels will develop cracks on the surface but in slightly softer steels the wear will remove enough material so starting cracks are removed before they have time to develop. Rail steel is so to speak designed to wear away very slowly to avoid surface cracking. The rails don't wear evenly and this often produces an incorrect rail to wheel geometry. This uneven profile accelerates the wearing process. The problem is overcome by regular grinding to restore the optimum rail profile.

White etched layers which are regions of nanocrystalline materials play an important role with respect to failures in rails. White etched layers are formed on the surface (fig. 2) and often consist of martensite (fig. 3). Martensite is generated when heating the steel to temperatures above 727°C followed by a rapid cooling.

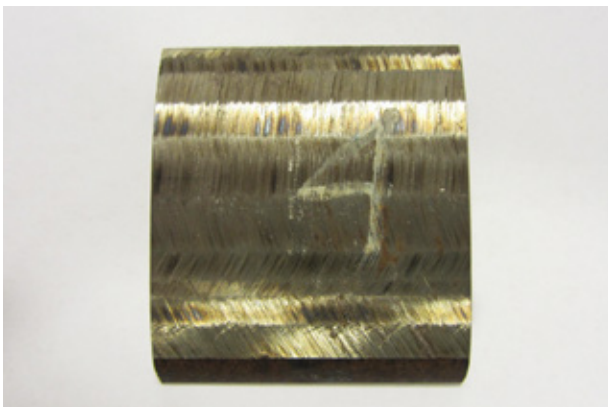

Fig. 1. Top surface of a rail that have been preventively grinded to remove surface cracks and to obtain the correct shape of the rail. The facets and the grinding marks indicate the roughness of the grinding process.

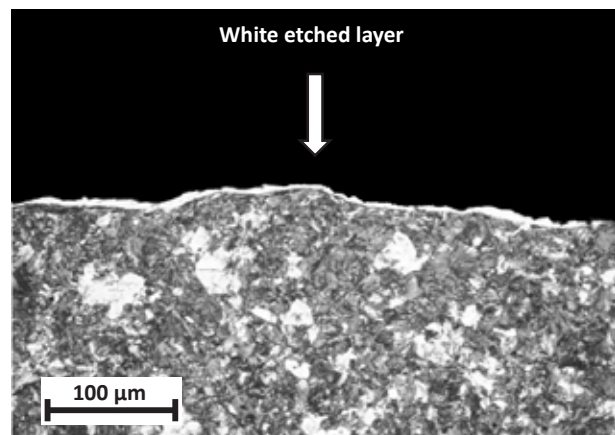

Fig. 2. Optical microscopy image. The pearlitic rail has a white etched layer at the surface which is marked by an arrow.

The heat is produced when the train wheel is spinning during train acceleration or sliding during braking. The heating affects the surface of the rail and the bulk of the rail absorb the heat very quickly resulting in a rapid cooling of the affected layer. Untempered martensite is very hard but also very brittle. Cracks are therefore very likely to develop from these martensitic regions. A workshop was held in June 2013 at DTU Wind Energy where rail experts from Banedanmark, Chalmers University of Technology, University of Leoben and Delft University of Technology discussed rail from a materials science perspective. It is planned to engage in further collaboration with leading experts in rails. This work may be extended in order to further the understanding of subsurface damage evolution of wind turbine bearings.

By Soren Faester, Xiaodan Zhang, Xiaoxu Huang and Dorte Juul Jensen

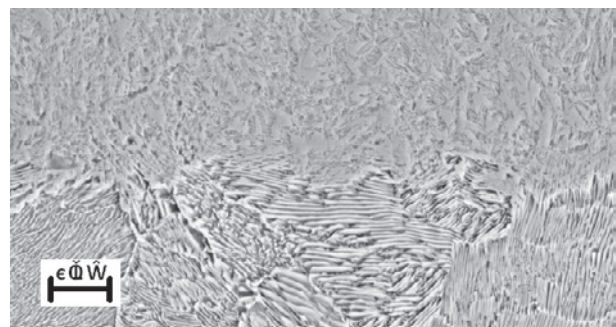

Fig. 3. SEM image of the Interface between the pearlitic (lower) and martensitic (upper) phases in a rail. The martensitic layers is produced when the surface of the rail is heated to more than 727 °C and rapidly cooled.



# WAVE LOADS ON OFFSHORE WIND TURBINES: ACCURATE TOOLS AND STRUCTURAL RESPONSE

Can the design models for offshore wind turbine wave loads be improved? And how will that change the overall load picture? Core questions of the Wave Loads project which was finalised in 2013 with two PhD theses, response calculations for jackets and monopiles, a detailed set of experiments and a 3D coupled CFD wave solver.

Reducing the Cost of Energy is vital for offshore wind energy. The substructure and foundations hold a key potential for this. As the wave loads can be dimensioning for these, accurate load prediction is a must for a safe, yet economic design.

This is the outset for the Wave Loads project (2010-2013), carried out by DTU Wind Energy, DHI and DTU Mechanical Engineering. During the last 10 years, a new generation of wave models has been developed at DTU Mechanical Engineering and DTU Compute that allows direct computation of 3D fully nonlinear waves. In Wave Loads this has been exploited in order to calculate loads and response of monopile and jacket offshore wind turbines. "The non-linear description of large waves leads to larger loads and a stronger response. The effect is most pronounced during stand-still, where the aerodynamic rotor damping is absent", says Henrik Bredmose, project leader.

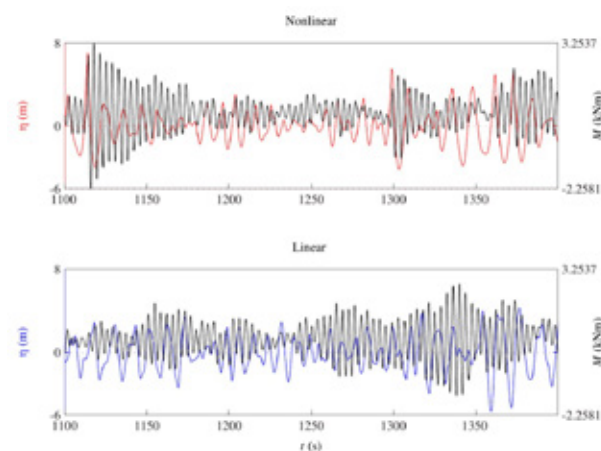

Fig. 1. Response plot for nonlinear waves (upper) and linear waves (lower) for a monopile wind turbine at stand still. Black curves are sectional force in tower bottom. Red/blue lines are the free surface elevation.

The topic of 'ringing', where large waves excite the natural frequencies of a structure has received increased attention over the last three years. This phenomenon can be predicted by the advanced wave load models developed. This was utilized to quantify the lifetime fatigue effects of wave nonlinearity. An aspect that makes this even more important is the increase of nonlinearity at intermediate and shallow depths where wind farms are often placed. A central part of the project was a detailed set of experiments in 2D and 3D waves carried out at DHI. Some of the tests concerned a flexible cylinder. "We built the model such that the first two natural frequencies matched those of a typical monopile wind turbine", explains Henrik Bredmose. "We have measured ringing responses and also impulsive excitations from breaking waves."

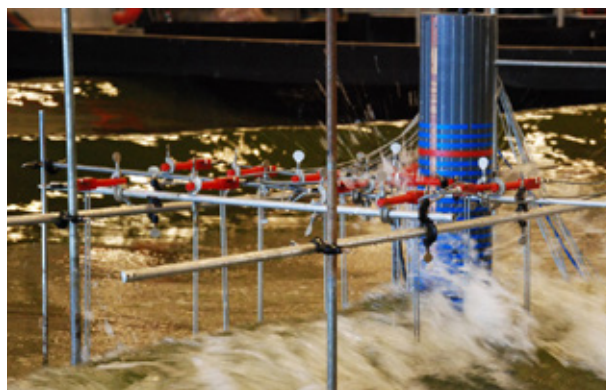

Fig. 2. Model test at DHI with a monopile exposed to breaking waves.

To allow computation of detailed loads and the flow around the structure, a coupled CFD solver was developed. Here an inner CFD model around the structure is driven by an outer wave model to allow direct computation of breaking wave impacts for realistic 3D irregular wave fields. This way we achieved a simple, yet accurate solver that can be used for detailed calculations and benchmarking of simpler models. One topic here is 3D load effects that need quantification with respect to extreme wave loads.

"Wave Loads have given the three partners a fantastic opportunity to work together. There has been a great interest and collaboration from DONG, Statkraft and our research partners. The next challenge is to apply the models to reduce the risk and uncertainty associated with today's design loads. The Wave Loads project provides a solid outset for this," Says Henrik Bredmose.

By Henrik Bredmose

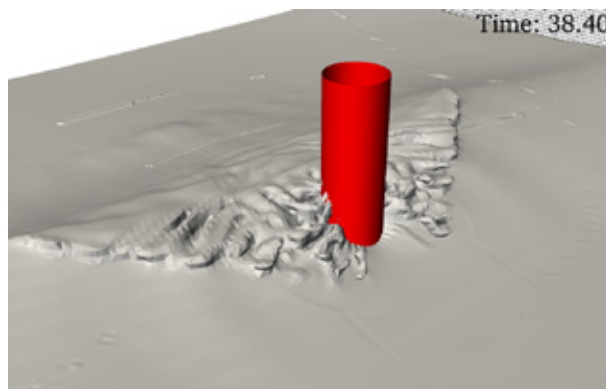

Fig. 3. A 3D focused wave that hits a monopile. Computed by the coupled CFD solver.

# JACKET SUBSTRUCTURE FATIGUE MITIGATION THROUGH ACTIVE CONTROL

Active fatigue control system developed within DTU Wind Energy is used to enhance structural design by increasing lifetime or possible mass reduction.

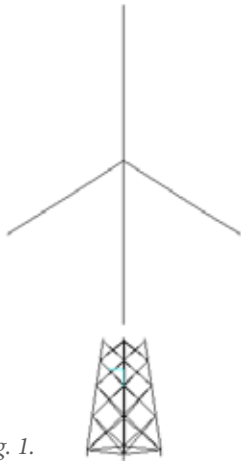

Fig. 1.

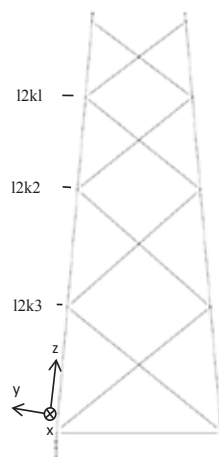
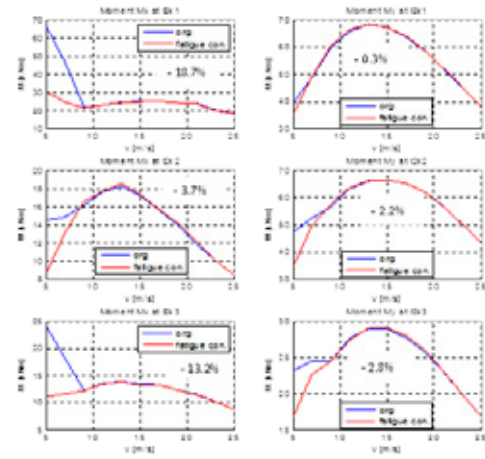

Fig. 3 and 4.



The modern trend in wind power production is to install wind farms further offshore using new, larger and more sophisticated marine foundation substructures, see Figure 1.

The ambition is installation locations at transient offshore areas with water depth of up to 50 meters. This gives rise to foundation substructures comparable to a wind turbine both in size and, more importantly, in cost. The most significant cost-determining factors of the foundation substructure are its mass and lifetime. Regardless of the usage of advance structural optimization tools even the best structural design has its limits. Modal frequencies of such large structures approach  $3p$  and modal frequencies of the turbine itself, which leads to modal coupling and even resonances. Therefore, it is essential to develop an active control system providing a sufficient structural damping and consequently a fatigue reduction of the foundation substructure and of the wind turbine structure itself.

The developed control system consists of a power production controller and structural dampers. The power controller is based on

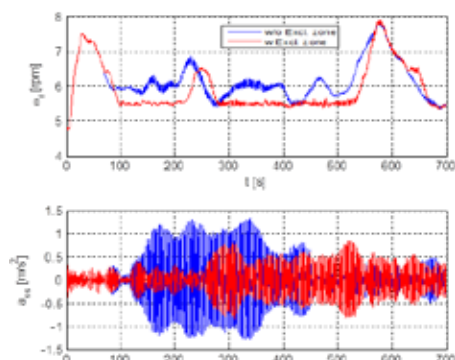

Fig. 2.

conventional collective pitch and generator torque PID controllers sensing 'just' the generator angular velocity. Such control provides both the maximization of power production (an optimal  $C_p$  tracking) in the variable speed regime and the rotor speed stabilization in the constant speed regime. On top of that, structural damper functionalities are introduced to mitigate the extreme and fatigue structural loads while preserving power the production performance. An example of such a structural controller is exclusion zone, avoiding the side-to-side excitation of the tower top, as seen in Figure 2.

The evaluation of the fatigue loads on the foundation substructure, in this case namely at the K-braces (see Figure 3), demonstrates the features and performance of structural control.

A significant overall fatigue reduction of up to 19% for side-to-side motion ( $M_x$  moments), reaching even higher values for low wind speeds, is demonstrated in Figure 4 above. The presented hierarchical control system is developed using very basic control techniques, but exhibit a significant fatigue reduction nonetheless. In the next step, a fully integrated (MIMO) robust control system will be developed, using advanced optimization techniques. Model uncertainties and other robustness requirements, together with multi-objective performance requirements, can be then a priori taken into account during the process of the control system design.

This active fatigue mitigation control system was developed by DTU Wind Energy during the 'INNOVATIVE WIND CONVERSION SYSTEMS (10-20MW) FOR OFFSHORE APPLICATIONS' EU project. Further information can be found at [www.innwind.eu](http://www.innwind.eu).

By Tomas Hanis and Anand Natarajan

# FUGA - A FAST FLOW MODEL FOR OFFSHORE WIND FARMS

The Fuga is a fast, yet surprisingly accurate tool that estimates wake losses in offshore wind farms. The Fuga model will be made commercially available in 2014.

The annual energy production (AEP) is a key factor in wind farm design. The more energy you can harvest, the more profitable your wind farm will get, therefore it is important to be able to make accurate estimates of the AEP for a given design. The AEP is mainly determined by the local wind climate which the designer can do little about, but a clever positioning of the turbines inside the farm is something that can improve the AEP. The clever layout minimizes loss of production due to turbines standing in the wakes of each other, and since any improvement of the AEP made in this way is profitable, even an AEP increase of just a fraction of a percent should be taken seriously.

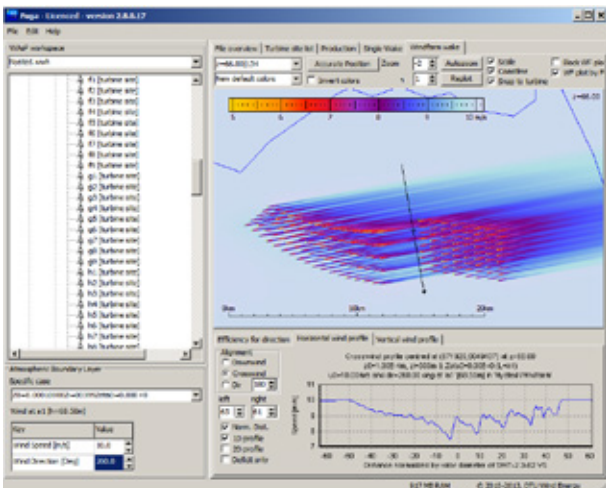

Fig. 1. Fuga as it appears on at computer screen.

Fuga is a tool for estimating wake losses and AEP for offshore wind farms and works as an add-on to the software WAsP. The version that will be made commercially available is the result of two projects sponsored by Carbon Trust Offshore Wind Accelerator, a joint industry project counting nine offshore wind developers. The development of the code and the graphical user interface was made in close contact with the industry. The flow model is the central component. Technically speaking it is a linearized CFD model. It predicts the whole 3D velocity field including the turbine wakes just like any 'normal' CFD model does, but the equations have been simplified. The trick is to treat the drag force exerted on the air as it passes by the rotor as a small perturbation. This works surprisingly well despite the fact that the drag is a fairly large perturbation. A very fast solver has been developed for the resulting set of linear equations. There has been made several different versions based on linearized versions of different CFD models including the k- model, a mixing length model and the simplest, most primitive CFD model we could think

of. Much to our surprise the most primitive one gave the best results.

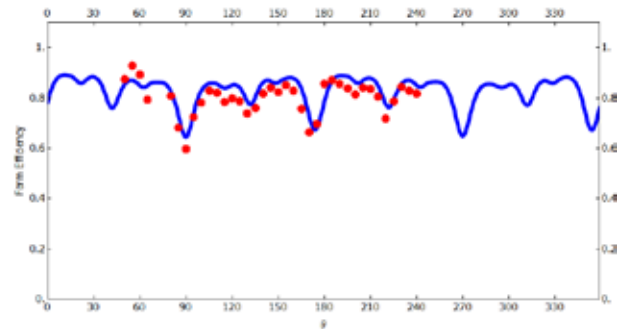

Fig. 2. Predicted (blue line) and observed farm efficiency for Horns Rev 1 as a function ten minutes average wind direction. The hub height wind speed is  $9 \pm 1$  m/s with neutral stability. The dips correspond to wind directions aligned with turbine rows. Measured data only covers directions where the met mast is outside the farm wake.

Fuga can handle atmospheric stability except for very stable cases. A meandering model is also included as well as a model for the effect of non-stationary of the wind direction which turns out to have an important impact on model validations.

Optimizing a wind farm involves AEP estimates for a large number of different layouts, and computational speed therefore becomes an issue. Depending on the problem Fuga is about  $10^5$  to  $10^6$  times faster than conventional CFD and about  $10^8$  to  $10^{10}$  times faster than LES models. One of the reasons for Fuga being so tremendously fast is that the most cumbersome calculations are the same for every flow case. Instead of repeating these calculations they are done once and for all and the results are stored in look-up tables. Carbon Trust partners comparing Fuga results with CFD models find that the large gain of computational speed is achieved without much sacrifice in terms of accuracy.

By Søren Ott

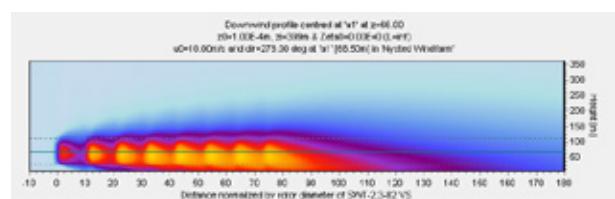

Fig. 3. The accumulated velocity deficit for a wind direction aligned with a row of turbines.



# TWENTIES - 20% ENERGY FROM RENEWABLES IN EUROPE IN 2020

The behavior of wind turbines during storm passages is becoming a challenge in the operation of future power systems because offshore wind power is developing massively in relatively small areas, and because storms are more frequent offshore than onshore.

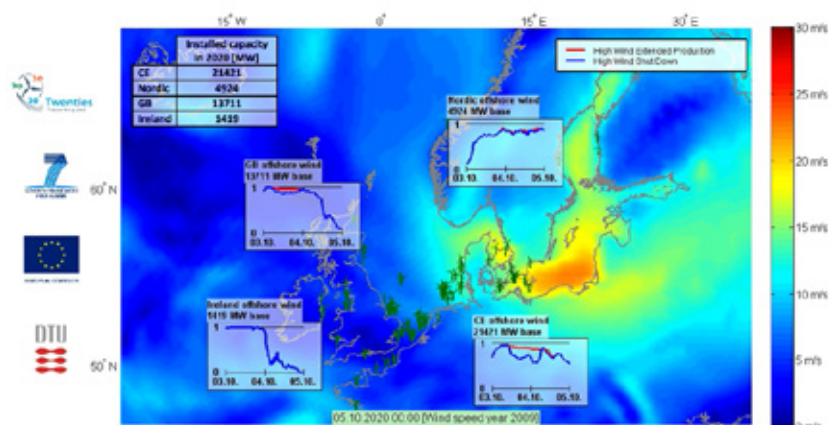

Fig. 1. Simulated offshore wind power production with High Wind Shut Down and High Wind Extended Production controls. The simulated wind power production is shown in the Continental Europe (CE), Nordic, Great Britten and Ireland because the fast power system reserves are shared in those areas.

20% reduction of greenhouse gas emission compared to 1990, 20% of the total energy consumption from renewables and 20% reduction in the total energy consumption. Those EU targets for 2020 are the drivers behind the EU TWENTIES project, which was finalized in September 2013.

The research contribution from DTU Wind Energy was focused on how the targets for massive development of offshore wind power will affect the need for fast responding reserves in the power systems. The technical challenge lies in the strict requirement that the power system must balance production with consumption at any time in order to stay stable. In order to ensure a reliable electricity supply, sufficient reserves must be available to replace any unforeseen changes in production or consumption. On the other hand, the amount of reserves should be kept to a minimum because there is a cost associated with reserves.

Wind power contributes to the need for reserves because the wind power production cannot be perfectly forecasted. Therefore, the available reserves must be sufficient to replace the possible wind power forecast errors. The TWENTIES Storm Demonstration, led by the Danish TSO Energinet.dk, showed that the wind power forecast error can get very large when a storm passes an offshore wind power plant if the wind turbines use the conventional High Wind Shut Down control. With this control, the wind turbines shut down if the mean wind speed or the wind gust exceeds certain values. This causes shut down of the whole wind power plant, which was verified by measurements on the Horns Rev 2 wind power plant in cooperation with the owner DONG Energy and the wind turbine manufacturer Siemens Wind Power. The next step in the Storm Demonstration was that Siemens developed a High Wind Ride Through™ controller and uploaded that to the wind turbines in Horns Rev 2. Even though the wind power forecast system was not modified, the new controller resulted in a significant reduction of the forecast error, simply because the wind

power production was not reduced as fast as with the High Wind Shut Down controller.

The power system has fully adequate reserves to handle a situation where the 209 MW Horns Rev 2 wind power plant shuts down due to a storm passage. But the amount of new offshore wind power is currently growing very fast, resulting in an expected massive concentration of offshore wind power capacity in relatively small areas already in 2020. With this scenario for offshore wind power development, a storm passage can cause significant loss of wind power production in a short period if the wind turbines use the conventional High Wind Shut Down control.

In order to quantify the value of a High Wind Extended Production control like the SIEMENS High Wind Ride Through™, DTU Wind Energy has developed a methodology to simulate the wind power production during storms. This is a relatively complex task, because the simulations must span over a large spectrum of temporal and spatial wind speed variations to capture the effect of the large front system passages and the wind gusts.

By Poul E. Sørensen and Jens Carsten Hansen

The TWENTIES project was led by Red Eléctrica de España which is the Transmission System Operator (TSO) who operates the power transmission system in Spain. TWENTIES performed six demonstrations which were led by TSOs and power production companies. The project was funded by the EU FP7 program. The total budget was with 56.8m Euro, and DTU was the largest R&D contributor with a budget of 1.6m Euro. DTU Wind Energy led the work with 11 partners who analyzed the impact of the six demonstrations on the European power systems in 2020 and 2030.





# TECHNICAL CERTIFICATION SCHEME FOR DESIGN, MANUFACTURE, INSTALLATION, MAINTENANCE AND SERVICE OF WIND TURBINES

Wind energy plays an important role in the Danish electricity supply and consumption. Today the wind power generation account for more than 30% of the electricity generation. In order to secure the reliability of the wind turbines and the power supply The Energy Agency's Secretariat for the Danish Wind Turbine Certification Scheme is managed by DTU Wind Energy for administration and supervision of compliance with the provisions of the Executive Order on a technical certification scheme for wind turbines.

Denmark is in the middle of a historic transition to a renewable energy system

- Wind power must constitute 50% of the total electricity generation by 2020
- Electricity and heat must be fossil-free by 2035
- Denmark must be 100% fossil-free by 2050

One of the instruments that support transfer to renewables is the technical certification scheme for design, manufacture, installation, maintenance and service of wind turbines based upon the Act of Promotion of Renewable Energy and outlined in the Executive Order no. 73 of 25 January 2013, on a technical certification scheme for wind turbines.

The Secretariat is responsible for the technical certification basis, including coordination of standardisation work and acts as the Danish Energy Agency's information and knowledge centre. All wind turbines and wind turbine projects installed, maintained and serviced in Denmark onshore as well as offshore must be certified according to the requirements in the Danish Certification Scheme. Prior to erection the wind turbines must have a type or proto-

type certificate in compliance with Danish and international standards. Before commissioning a wind farm the owner must present a project certificate. Also type certification is required in connection with modification, conversion into testing and demonstration, relocation and use after testing and demonstration, or following expiry of a prototype certificate. The secretariat carry out ongoing supervision of the approvals issued pursuant to the conditions.

The Technical Certification Scheme also provides rules and regulations of wind turbine maintenance, service and in the event of major damage or damage affecting safety. This includes verification and supervision of the performance of maintenance and service for the individual wind turbines, but also of the companies or private owners performing these services. In the event of major damage or damage affecting safety, the owner of the wind turbine is to submit information about the event to the Secretariat.

*By Peggy Friis*

Read more about the technical certification scheme here:  
[www.wt-certification.dk](http://www.wt-certification.dk).

# WIND ENERGY COURSES IN THE VIRTUAL CLASSROOM

The Virtual Campus Hub project has kick-started a development of online training courses. DTU Wind Energy now offers three E-learning courses to participants all over the world.



Fig. 1. The Virtual Campus Hub project team from four technical universities in Europe: DTU in Denmark, KTH in Sweden, TU/e in the Netherlands, and Polito in Italy.

DTU Wind Energy has been active in training and education for many years and the department can now invite learners into the virtual classroom. Three new online courses allow us to reach out to new and global learner segments – both from universities and the industry – and the benefits of online teaching are many. Some learners from abroad find it difficult or costly to travel to Denmark to take a course. They can now follow from home and the expenses are limited. Others prefer the flexible learning style online over more traditional classroom teaching, as it fits better into a busy work schedule.

The development of E-learning courses was kick-started in 2011 when DTU Wind Energy became coordinator of the EU-funded project Virtual Campus Hub. The project demonstrated for the first time how universities can share virtual learning material securely with each other via the European E-infrastructure Géant/eduGAIN. DTU's contribution was an E-learning course in WAsP

– the Wind Atlas analysis and Application Programme. The feedback from participants and teachers of the first course runs was very positive and the portfolio of E-learning courses was quickly expanded with courses in the software tools WAsP Engineering and HAWC2.

All three E-learning courses follow a common format and are built upon the same pedagogical model. The course material is organized in bite-sized E-lessons which follow a fixed structure. This makes it easy to navigate so participants can focus on the content. The learning material is varied and consists of recorded lectures, screen demonstrations, hands-on exercises, and group discussions.

A continuous dialogue is fundamental in DTU Wind Energy's E-learning courses because help and support from the teachers and fellow course participants keeps the motivation high. The target is that all participants complete the E-learning courses. The teacher's impression is that participants learn more from the interactive online courses than from courses in the classroom where the communication is mostly one-way. The teachers also enjoy the flexibility of teaching anywhere and anytime.

The E-learning courses in WAsP and WAsP Engineering are offered twice per year and the HAWC2 courses are given on-demand. In addition to these specialized courses, a series of E-learning courses about more general wind energy topics are planned with university teaching at the global scale in mind. The Virtual Campus Hub project (2011-13) is partially funded by the European Commission under the 7th Framework Programme.

By Merete Badger

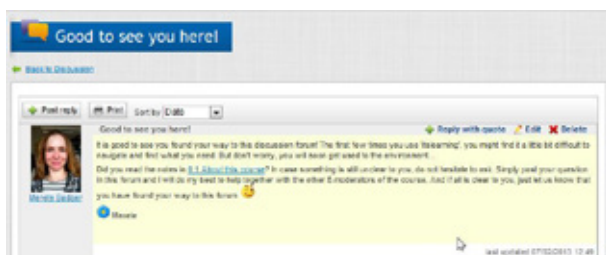

Fig. 2. Course teachers act as E-moderators who support participants in their learning process. Here is an example of a teacher's message in a forum for group discussions.

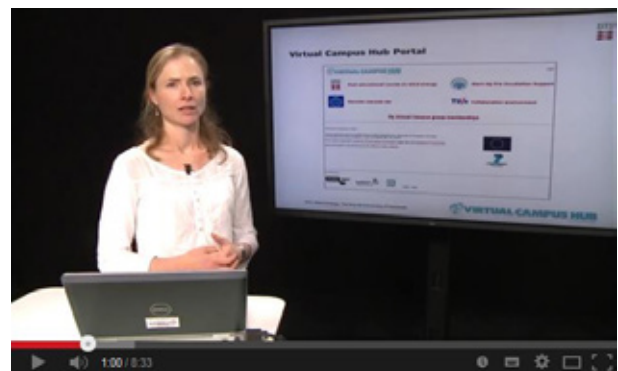

Fig. 3. E-learning courses in wind energy have been used to inspire others at DTU. This video lecture has been made for DTU's site Scholarship of Teaching and Learning.



# NEW EDUCATIONAL INITIATIVES TO COMPLY WITH THE NEED FROM THE GROWING WIND ENERGY SECTOR

As a part of the educational strategy at DTU Wind Energy several new masters' programmes and wind energy specializations have been launched in 2013.

The aim of the various MSc programmes in Wind Energy is to give the students a general understanding of wind energy systems and an in-depth knowledge of aerodynamics, aero-elasticity, mechanics, grid connection and power systems that qualifies them to analyse, design, develop and operate wind energy systems. In order to attract international students interested in wind energy, DTU Wind Energy has since its start in 2012 launched three new masters' programmes in wind energy with different international partners.

In 2012 the European Erasmus Mundus master's programme (EWEM) started with 38 students. In 2013 about 40 new students were matriculated. The EWEM programme consists of 4 tracks: Rotor Design, Wind Physics, Offshore Engineering and Electrical Power Systems. DTU offers candidates to graduate with a wind energy diploma in Rotor Design and Wind Physics. The partners in the programme are DTU, TU Delft, NTNU and University of Oldenburg.

An agreement between the Korean elite university KAIST and DTU was made in 2013 to initiate a common Offshore Wind Energy master's programme. This programme enables a closer cooperation between Korea and Denmark in wind energy, exploiting the offshore and ocean engineering expertise in Korea with the Danish know-how in utilization of wind power technology.

A new study line with specific specialisation in 'Wind Energy' has been established recently as part of DTU's master programme in Sustainable Energy. The students following this study line achieve a general understanding of wind energy and knowledge in the various technologies related to the field that enables them to analyse, design, develop and operate wind energy systems. The study line combines socio-economic aspects of sustainable energy with relevant technical disciplines, such as measurement techniques, design of wind turbines, offshore wind energy, net integration, planning and development of wind farms.

DTU Wind Energy now offers various recommended study tracks covering all main aspects of wind power exploitation, ranging from aerodynamics and structural mechanics to materials and electrical power systems. As an outcome of a discussion with different stakeholders, including the main Danish wind turbine manufacturers, a new recommended study line in test and measurements was launched in 2013. A test engineer graduating with this specialization has besides a general knowledge about wind technology also gained in-depth experience in test and verification of wind turbine components as well as practical knowledge from field experience.

It is the aim of DTU Wind Energy that students, achieving a degree from one of the Wind Energy study lines, are trained to become the internationally best qualified candidates for jobs in the rapidly expanding wind energy sector.

*By Jens Nørkær Sørensen*





DTU Wind Energy has during the years attracted many PhD students from all over the world for whom the main interest have been research with the wind energy area. The Department has about 60 PhD Students. Presented is the students that finished in 2013 and the department's 3<sup>rd</sup> year PhD students who are about to finish in 2014.

**Name**

Abdul Basit

**PhD title**

Wind Power Plant System Services

**Section**

Wind Energy Systems

**Supervisor**

Anca D. Hansen

**Funding**

Sino-Danish Center for Education and Research (SDC)

**Start-end**

December 2011 - December 2014

**Contact**

abdl@dtu.dk

**Project Description:** To develop and analyze generation control strategies which increase the capability of wind farms to provide system services with respect to power/frequency control. A generic model is designed for the Danish power system considering generation and power exchange capacities as in 2020 & 2030.

**Perspective:** Different case studies and operational conditions will be considered in order to assess the effectiveness of developed strategies for optimized power system balancing incorporating wind farms. Wind power system services will be investigated and their impact on the power system operation will be quantified in a trustworthy manner.

**Name**

Carlo Tibaldi

**PhD title**

Concurrent aero-servo-elastic design

**Section**

Aeroelastic Design

**Supervisor**

Christian Bak

**Funding**

DTU

**Start-end**

November 2011-October 2014

**Contact**

tibl@dtu.dk

**Project Description:** The project is expected to contribute with new knowledge of the potentials and methods for integration of the aeroelastic design and control design in one concurrent aero-servo-elastic design process for wind turbines.

**Perspective:** The PhD project is a success when a new systematic method for concurrent aero-servo-elastic design of wind turbines has been developed and its potential of reducing the cost of energy has been documented by comparisons to a reference design obtained by the traditional design methodology.

**Name**

Christina Koukoura

**PhD title**

Validated loads prediction models for offshore wind turbines for enhanced component reliability

**Section**

Wind Turbine Structures

**Supervisor**

Anand Natarajan

**Funding**

Danish EUDP project titled: "Offshore wind turbine reliability through complete loads measurements".

**Start-end**

September 2011- September 2014

**Contact**

kouk@dtu.dk

**Project Description:** The project focuses on the investigation of foundation and tower dynamics of offshore wind turbines and the understanding of sudden high loads under various operational conditions. Damping estimation is a main target that will lead to better understanding of the system's response.

**Perspective:** This work will demonstrate turbine load dependencies, thus reducing the uncertainties and leading to enhanced component reliability. The result will provide a good reference for validation of the state-of-the-art models and will probably lead to update of the current simulations.

**Name**

Hamid Sarlak Chivaee

**PhD title**

Large eddy simulation of turbulent flows in wind energy

**Section**

Fluid Mechanics

**Supervisor**

Jens Nørkær Sørensen

**Funding**

Statkraft - COMWIND Flow Center

**Start-end**

January 2011- January 2014

**Contact**

hsar@dtu.dk

**Project Description:** The overall goal of this research is to seek a better understanding of the role of SGS modeling in a wide range of applications within wind energy. To this end, a conclusive survey of the LES with special focus on the finite volume methods has been performed.

**Perspective:** Implementation of the new SGS eddy viscosity and SGS eddy diffusivity models and running LES cases with thermally stratified flows, evaluation of the LES in atmospheric boundary layer studies, airfoil and wind turbine wake studies and wind tunnel measurements of the airfoils at low Reynolds numbers.

**Name**

Zhenbo Zhang

**PhD title**

Nanostructuring of oxide dispersion strengthened ferritic steels by plastic deformation

**Section**

Materials Science and Characterisation

**Supervisor**

Dr. Wolfgang Pantleon, DTU MEK

**Funding**

Sino-Danish Center for Education and Research

**Start-end**

October 2011 - October 2014

**Contact**

zzhe@dtu.dk

**Project Description:** Nanostructuring is thought to be a promising approach to improve the mechanical properties and irradiation tolerance of structural materials for fusion reactors. The aim of the project is to explore the potential of specific processing techniques for introducing nanostructures in oxide dispersion strengthened steels, to characterize the obtained microstructure and to evaluate the mechanical properties and thermal stability.

**Perspective:** Establish a grain structure on nanoscale, and validate the achieved improvement in performance. Characterize the evolution of microstructure, features of the oxide dispersoids, and oxide/ferrite interfaces during plastic deformation and annealing, which is expected to shine light on how to enhance the properties of these steels.

**Name**

Georg Raimund Pirrung

**PhD title**

Aeroelastic modeling and stability of wind turbine blades

**Section**

Aeroelastic Design

**Supervisor**

Helge Aagaard Madsen

**Funding**

Basic Funding/DTU

**Start-end**

November 2011 - October 2014

**Contact**

gepir@dtu.dk

**Project Description:** The main research areas are fast engineering models for wind turbine aerodynamics that are used in aeroelastic codes for time domain or frequency domain analysis, mainly a model that couples the induced velocity from trailed vorticity in the near wake with blade element momentum theory.

**Perspective:** New and improved models are available in the commercial aeroelastic codes HAWC2 and HAWCStab2. The effect of these models on stability analysis is investigated to reduce the uncertainty of for example flutter speed predictions.

**Name**

Nikola Vasiljevic

**PhD title**

3D measurements of wind velocity fields by a time-space synchronization of coherent Doppler scanning lidars

**Section**

Test and Measurements

**Supervisor**

Michael Courtney

**Funding**

Marie Curie FP7-ITN- WAUDIT Project and WindScanner.dk project

**Start-end**

June 2010 - January 2014

**Contact**

niva@dtu.dk

**Project Description:** The PhD project focuses on the development of a system of coherent Doppler scanning lidars known as a long-range WindScanner, for three-dimensional measurements of fluctuating wind velocity fields within a large volume of the atmospheric boundary layer.

**Perspective:** To continue having possibilities to do research that aims at finding a solution for an immediate problem facing a society or an industrial/business organization.

**Name**

Patrick J.H. Volker

**PhD title**

Wake effects of large offshore wind farms - a study of the mesoscale atmosphere

**Section**

Meteorology

**Supervisor**

Andrea H. Hahmann

**Funding**

WAUDIT, Marie Curie ESR-FP7

**Start-end**

October 2010 - March 2014

**Contact**

pvol@dtu.dk

**Project Description:** Development of a wind farm parametrization, which is evaluated against measurements from a large offshore wind farm. The influence of the wind farm to the marine atmosphere is analyzed and also it is investigated how different lower tropospheric conditions affect the wind farm efficiency.

**Perspective:** A new wind farm parametrization that, compared to previous approaches, allow for more realistic flow simulations is used to estimate the wind farm power production under different atmospheric conditions and to investigate the influence of upstream wind farms to those downstream.

**Name**

M. Paul van der Laan

**PhD title**

Development of Efficient Turbulence Models for CFD Wake Simulations

**Section**

Aeroelastic Design

**Supervisor**

Niels N. Sørensen

**Funding**

Center for Computational Wind Turbine Aerodynamics and Atmospheric Turbulence funded by the Danish Council for Strategic Research

**Start-end**

December 2011 - December 2014

**Contact**

plaa@dtu.dk

**Project Description:** The modelling of wind turbine wakes in Computational Fluid Dynamics (CFD) is dominated by the chosen turbulence model. The present PhD project is dedicated to develop a new computational efficient turbulence model that performs as good as expensive turbulence models as Large-Eddy Simulations.

**Perspective:** A new turbulence model, dedicated for CFD wind turbine wake simulations.



**Name**  
Louis-Etienne Boudreault

**PhD title**  
Flow over complex forested terrain

**Section**  
Meteorology

**Supervisor**  
Ebba Dellwik, DTU Wind Energy

**Funding**  
DSF Flowcenter/Vattenfall

**Start-end**  
October 2011 - October 2014

**Contact**  
lbou@dtu.dk

**Project Description:** The project Addresses the prediction of the atmospheric boundary layer over forested terrains using computational fluid dynamics methods. The research areas are wind power predictions, wind turbine siting and forest modeling.

**Perspective:** So far, a descriptive method of the canopy structure using aerial lidar scans was developed and coupled to a CFD approach. This method proved to provide highly accurate flow field predictions and is a significant step in modeling the airflow over heterogeneous forests.

**Name**  
Ewan Machefaux

**PhD title**  
Multiple turbine wakes

**Section**  
Aeroelastic Design

**Supervisor**  
Gunner Chr. Larsen

**Funding**  
This project is funded by the Danish Council of Strategic Research

**Start-end**  
November 2011 - October 2014

**Contact**  
ewma@dtu.dk

**Project Description:** This PhD project focuses on characterization and modeling of interacting wind turbine wakes. The scientific approach is based on detailed EllipSys3D CFD studies combined with analysis of dedicated full-scale recordings using cutting-edge technologies in wind energy remote sensing such as LIDARs.

**Perspective:** The results from experiments and numerical studies are condensed into a computationally efficient engineering model capturing the essential physics of merged wake. This model extends the application of the existing Dynamic Wake Meandering model from solitary turbines to wind farms.

**Name**  
Neil Davis

**PhD title**  
Forecasting Wind Turbine Icing Conditions

**Section**  
Meteorology

**Supervisor**  
Andrea Hahmann

**Funding**  
Icewind Project

**Start-end**  
June 2011 - May 2014

**Contact**  
neda@dtu.dk

**Project Description:** This study investigates the predictability of icing conditions and their impact on wind turbine production. This involves using a meteorological model to forecast wind, temperature and cloud parameters and then tie them to the production loss on wind turbines.

**Perspective:** The goal of this study is to provide an enhanced power production forecast system for use in both siting and pricing of wind energy. By including the expected loss due to icing, operators can better select where to install their turbines, and better estimate their production

**Name**

Martin de Maré

**PhD title**

The impact of non-neutral atmosphere on offshore wind turbines

**Section**

Meteorology

**Supervisor**

Jakob Mann

**Funding**

DONG Energy A/S and Forskings- og Innovationsstyrelsen through the Industrial PhD program

**Start-end**

March 2011 - March 2014

**Contact**

martin.demare@gmail.com

**Project Description:** The core assumption of the project is that the loads and power production of wind turbines in offshore wind farms increasingly depend on a quantity known as atmospheric stability, as the dimensions of the wind farms increase. The research is therefore focused on improving the performance of relevant engineering models to quantify the effect of this quantity.

**Perspective:** The main contribution of the project is the quantification of longitudinal coherence of shear generated turbulence and its application in the so called meandering of a wind turbine wake. Getting the opportunity to spend 3 years diving deep into a problem statement has been somewhat of a personal journey.

**Name**

Lorenzo Zeni

**PhD title**

Communication and control in clusters of wind power plants connected to HVDC offshore grids

**Section**

Wind Energy Systems

**Supervisor**

Poul E. Sørensen

**Funding**

60% DONG Energy Wind Power, 40% Nordic Energy Research

**Start-end**

October 2011 - December 2014

**Contact**

lorze@dongenergy.dk, lzen@dtu.dk

**Project Description:** New communication and control issues arise when offshore wind power plants are connected to the land grid with an HVDC transmission system. From an industrial perspective, the project aims at addressing such challenges in terms of reliable delivery of wind power as well as power system services.

**Perspective:** The project will facilitate the understanding of static and dynamic control phenomena related to HVDC and wind power. Due to the industrial nature of the project, the proposed analysis, solutions and tools must be robust and realistically applicable for wind power plants currently being built.

**Name**

Konstantinos Marmaras

**PhD title**

Optimal Design of Composite Structures under Manufacturing Constraints

**Section**

Composites and Material Mechanics

**Supervisor**

Mathias Stolpe

**Funding**

The Danish Council for Independent Research | Technology and Production Sciences (FTP) under the grant "Optimal Design of Composite Structures under Manufacturing Constraints".

**Start-end**

August 2011 - July 2014

**Contact**

komar@dtu.dk

**Project Description:** In this PhD project we have developed parameterizations and numerical optimization methods such that manufacturing constraints and manufacturing cost can be taken into account when designing composite structures.

**Perspective:** If manufacturing constraints are included together with structural considerations in the early design phase, the result will be structures with better structural performance and lower cost. The inclusion of manufacturing constraints will significantly reduce the need for manual post-processing of the found designs compared to classical optimal design without manufacturing constraints

**Name**

Martin Haubjerg Rosgaard

**PhD title**Limited-Area Numerical Weather Prediction for Day-Ahead  
Wind Energy Planning**Section**

Meteorology and Wind Energy Systems

**Supervisor**

Andrea Noemí Hahmann

**Project Description:** The project aims to quantify value added to wind energy forecasts in the 12-48 hour lead time by downscaling global numerical weather prediction (NWP) data using a limited-area NWP model. Basis of comparison is wind farm data from offshore and coastal sites in Denmark, and an inland site in Sweden.

**Perspective:** Based on data for yearlong time periods two experiments – one covering southwest Denmark, the other focusing on central Sweden – will quantify strengths and weaknesses for each NWP model resolution in terms of wind energy forecast value, depending on metrics used in the comparison to observations.

**Funding**

PSO 10464

**Start-end**

October 2011 - December 2014

**Contact**

mhros@dtu.dk

**Name**

Farzad Cyrus Foroughi Abari

**PhD title**An improved opto-electronic front-end design for coherent  
detection in coherent optical light detection and ranging  
(lidar) instruments**Section**

Test and Measurements

**Supervisor**

Jakob Mann

**Funding**

DTU Wind Energy

**Start-end**

December 2011 - December 2014

**Contact**

fzfa@dtu.dk

**Project Description:** The objective is to improve the quality of measurements carried out by continuous wave and pulsed coherent lidars. In the first stage, an IQ detection scheme with additional signal processing capability was suggested to replace the existing technology used in short range Windscanners. The second stage is designing and prototyping a new long range (pulsed) coherent lidar which has additional capabilities as compared to the existing technology.

**Perspective:** The study will contribute to my knowledge of coherent lidars on the whole, and more insight into the operation of the system and its various building blocks. It provides the opportunity to dig deeper into the opto-electronic front-end design where I could improve the performance of the system by modifying the existing technology.

**Name**

Sanita Zike

**PhD title**

Micro-Scale Experiments and Models for Composite Materials

**Section**

Composites and Materials Mechanics Section

**Supervisor**

Lars P. Mikkelsen

**Funding**Supported by the Danish Centre for Composite Structure and  
Materials for Wind Turbines (DCCSM), grant no. 09-067212,  
from the Danish Strategic Research Council (DSF).**Start-end**

January 2012 - December 2014

**Contact**

zike@dtu.dk

**Project Description:** The PhD project is divided into two parts: First part is related to strain measurement device – strain gauge – accuracy evaluation in polymer composite testing. Second part involves experimental determination of ‘real’ mechanical properties of polymer used in composite materials and an appropriate material model for numerical analysis.

**Perspective:** The outcome of the first part of the PhD research project is improved strain gauge design, what is expected to be patented. The outcome of the second part includes determination of material mechanical properties at micro-scale, which can be further introduced in numerical analysis as actual material properties. It also includes determination of material model, which can be used to predict the performance of composite material structures.



**Name**

Adriána Hudecz

**PhD title**

Icing Problems of Wind Turbines in Cold Climate

**Section**

Fluid Mechanics

**Supervisor**

Martin O.L. Hansen

**Funding**

DTU Wind Energy

**Start-end**

November 2010 - January 2014

**Contact**

ahud@dtu.dk

**Project Description:** Operation of wind turbines is challenging at cold climate (CC) sites (e.g. Nordic countries or Canada) because they may be exposed to icing conditions. CC plays a major role in power production and safety hazards of a wind turbine as well. The main part of the PhD contained experimental and numerical study of the impact of the different ice accretion types on an airfoil section with different angles of attack.

**Perspective:** It was seen that even one hour of ice accretion can cause significant changes of the aerodynamic characteristic of the studied airfoil and the flow pattern is highly disturbed. This also implies that a small amount of ice build-up can have significant influence on the power production and therefore it has to be taken into account. Both the ice accretion and the changes of the aerodynamic coefficients over time showed a nearly linear trend.

**Name**

Alemseged Gebrehiwot Weldeyesus

**PhD title**

Free Material Optimization of Wind Turbine Blades

**Section**

Wind Turbines Structures

**Supervisor**

Mathias Stolpe

**Funding**

Danish Center for Composite Structures and Materials (DCCSM)

**Start-end**

December 2010-

**Contact**

alwel@dtu.dk

**Project Description:** The project is to develop new models and methods of Free Material Optimization (FMO) of load carrying structures which are suitable for optimal design of wind turbine blades. The models are based on the recently developed models for FMO of plates and shells in linear elasticity and include design criteria based on stiffness, weight, and local stress properties.

**Perspective:** The development of FMO models for laminated plates and shells. The development of efficient and robust optimization method for FMO and a conceptual design of wind turbine blades (or wind turbine blade sections).

# PHDS IN 2013

Name of PhD	Contact	Project title	Start-End	Section	Supervisor
Signe Schløer	sigs@dtu.dk	Fatigue and extreme wave loads on bottom fixed offshore wind turbines. Effects from fully nonlinear wave forcing on the structural dynamics	May 2010 - June 2013	FLU	Associate Professor Henrik Bredmose/Senior Researcher Robert F. Mikkelsen
Søren Juhl Andersen	sjan@dtu.dk	Simulation and Prediction of Wakes and Wake Interaction in Wind Farms.	June 2010 - September 2013	FLU	Jens Nørkær Sørensen, Robert Mikkelsen, Wen Zhong Shen
Rolf-Erik Keck	rolf.keck@gmail.com	Dynamic wake model for load calculations of wind turbines	October 2009 - January 2013	AED	Helge Aagaard Madsen, Gunner Larsen, Dick Veldkamp, Jens-Jacob Wedel-Heinen & Jan Forsberg
Tilman Koblitz	tiko@dtu.dk	CFD Modelling of non-Neutral ABL Conditions	June 2010 - June 2013	AED	Niels Sørensen/ Andreas Bechmann, Andrey Sogachev
Srinivas K. Guntur	srgu@dtu.dk	A Detailed study of the rotational augmentation and dynamic stall phenomena for wind turbines.	September 2010 - September 2013	AED	Niels N. Sørensen
Rogier Floors	rofl@dtu.dk	Measuring and modelling of the wind on the scale of tall wind turbines	September 2010 - September 2013	MET	Sven-Erik Gryning and Alfredo Peña
Leonardo Bergami	leob@dtu.dk	Adaptive Trailing Edge Flaps for Active Load Alleviation in a Smart Rotor Configuration	January 2010 - March 2013	AED	Mac Gaunaa, Thomas Buhl, Niels K. Poulsen (DTU Compute)
Jens Zangenberg Hansen	jzan@lmwind-power.com	The effects of fibre architecture on fatigue life-time of composite materials	April 2010 - September 2013	KOM	Povl Brøndsted, DTU, Rasmus Østergaard, LM Wind Power
Karolina Martyniuk	karm@dtu.dk	Microscale Fracture of Composite Materials for Wind Turbine Blades	April 2010 - October 2013	KOM	Bent F. Sørensen, Erik M. Lauridsen
Joakim Refslund Blakstad	jref@dtu.dk	Representing vegetation processes in hydrometeorological simulations using the WRF model	October 2009 - August 2013	MET	Ebba Dellwik, Andrea N. Hahmann, Eva Bøgh
David R.S. Verelst	dave@dtu.dk	Numerical and Experimental Results of a Passive Free Yawing Downwind Wind Turbine	April 2010 - May 2013	AED	Torben J. Larsen, Helge Aa. Madsen, Jan-Willem Van Wingerden (TU Delft, Netherlands)
Ivan Bergquist Sønderby	ivson@vestas.com	Low-order aeroelastic models of wind turbines for controller design	September 2009 - May 2013	AED	Morten H. Hansen
Abhijit Chougule		Influence of atmospheric stability on the spatial structure of turbulence	April 2010 - May 2013	MET	Jakob Mann, Mark Kelly
Lonnie Andersen		Biodegradable Polymers used in Mechanically Loaded Implants	September 2009 - August 2013	KOM	Povl Brøndsted and Jes Bruun Lauritzen
Joachim Christian Heinz	jhei@dtu.dk	Partitioned Fluid - Structure Interaction for Full Rotor Computations Using CFD	October 2009 - February 2013	AED	Niels N. Sørensen, Frederik Zahle and John M. Hansen
Nikolay Krasimirov Dimitrov	nkdi@dtu.dk	Structural reliability of Wind	September 2009 - February 2013	FLU	Christian Berggren, Peter Friis Hansen, DNV and Jesper Stær-dahl, Siemens Wind Power A/S
Jesper Grønnegaard Pedersen	jegp@dtu.dk	Large-eddy simulation of the atmospheric boundary layer: Influence of unsteady forcing, baroclinicity, inversion strength and stability on the wind profile	October 2010 - November 2013	MET	Sven-Erik Gryning, Mark Kelly

# PUBLICATIONS

## SCIENTIFIC ARTICLES WITH REFEREE IN ISI-INDEXED JOURNALS

**3D in situ observations of glass fibre/matrix interfacial debonding.** / Martyniuk, Karolina; Sørensen, Bent F.; Modregger, Peter; Lauridsen, Erik Mejdal.

In: Composites Part A: Applied Science and Manufacturing, Vol. 55, 2013, p. 63-73.

**A 3D ductile constitutive mixed-mode model of cohesive elements for the finite element analysis of adhesive joints.** / Anyfantis, Konstantinos; Tsouvalis, Nicholas G.

In: Journal of Adhesion Science and Technology, Vol. 27, No. 10, 2013, p. 1146-1178.

**A data-driven analysis of energy balance closure across FLUXNET research sites: The role of landscape scale heterogeneity.** / Stoy, Paul C.; Mauder, Matthias; Foken, Thomas; Marcolla, Barbara; Bøgh, Eva; Ibrom, Andreas; Arain, M. Altaf; Arneth, Almut; Aurela, Mika; Bernhofer, Christian; Cescatti, Alessandro; Dellwik, Ebba; Duce, Pierpaolo; Gianelle, Damiano; van Gorsel, Eva; Kiely, Gerard; Knohl, Alexander; Margolis, Hank; McCaughey, Harry; Merbold, Lutz; Montagnani, Leonardo; Papale, Dario; Reichstein, Markus; Saunders, Matthew; Serrano-Ortiz, Penelope; Sottocornola, Matteo; Spano, Donatella; Vaccari, Francesco; Varlagin, Andrej.

In: Agricultural and Forest Meteorology, Vol. 171-172, 2013, p. 137-152.

**Adhesion improvement of glass-fibre-reinforced polyester composites by gliding arc discharge treatment.** / Kusano, Yukihiko; Sørensen, Bent F.; Løgstrup Andersen, Tom; Leipold, Frank.

In: Journal of Adhesion, Vol. 89, 2013, p. 433-459.

**Advanced materials characterization and modeling using synchrotron, neutron, TEM, and novel micro-mechanical techniques - A European effort to accelerate fusion materials development.** /

Linsmeier, Ch.; Fu, C.-C.; Kaprolat, A.; Fæster, Søren; Mergia, K.; Schäublin, R.; Lindau, R.; Bolt, H.; Buffière, J.-Y.; Caturia, M.J.; Décamps, B.; Ferrero, C.; Greuner, H.; Hébert, C.; Höschel, T.; Hofmann, M.; Huginschmidt, C.; Jourdan, T.; Köppen, M.; Plocinski, T.; Riesch, J.; Scheel, M.; Schillinger, B.; Vollmer, A.; Weitkamp, T.; Yao, W.; You, J.-H.; Zivelonghi, A.

In: Journal of Nuclear Materials, Vol. 442, 2013, p. S834-S845.

**A fractional derivative approach to full creep regions in salt rock.** / Zhou, H. W.; Wang, C. P.; Mishnaevsky, Leon; Duan, Z. Q.; Ding, J. Y.

In: Mechanics of Time Dependent Materials, Vol. 17, No. 3, 2013, p. 413-425.

**A Loss-of-Function Screen for Phosphatases that Regulate Neurite Outgrowth Identifies PTPN12 as a Negative Regulator of TrkB Tyrosine Phosphorylation.** / Ambjørn, Malene;

Dubreuil, Véronique; Miozzo, Federico; Nigon, Fabienne; Møller, Bente; Issazadeh-Navikas, Shohreh; Berg, Jacob; Lees, Michael; Sap, Jan.

In: PloS one., Vol. 8, No. 6, e65371, 2013.

**Analysis of an adhesively bonded single lap joint subjected to eccentric loading.** / Anyfantis, Konstantinos; Tsouvalis, N. G.

In: International Journal of Adhesion and Adhesives, Vol. 41, 2013, p. 41-49.

**A new theoretical model of the quasistatic single-fiber pullout problem: Analysis of stress field.** / Qing, Hai.

In: Mechanics of Materials, Vol. 60, 2013, p. 66-79.

**Annealing behaviour of a nanostructured Cu-45 at.%Ni alloy.** / Tian, Hui; Suo, H. L.; Mishin, Oleg; Zhang, Yubin; Juul Jensen, Dorte; Grivel, Jean-Claude.

In: Journal of Materials Science, Vol. 48, No. 12, 2013, p. 4183-4190.

**A Novel Wind Turbine Concept Based on an Electromagnetic Coupler and the Study of Its Fault Ride-through Capability.** / Cutululis,

Nicolaos Antonio.

In: Energies, Vol. 6, 2013, p. 6120-6136.

**A practical approach to fracture analysis at the trailing edge of wind turbine rotor blades.** / Eder, Martin Alexander; Bitsche, Robert;

Nielsen, Magda; Branner, Kim.

In: Wind Energy, 2013.

**Are local wind power resources well estimated?** / Lundtang Petersen, Erik; Troen, Ib; Ejlsing Jørgensen, Hans; Mann, Jakob.

In: Environmental Research Letters, Vol. 8, 2013, p. 011005.

**A review of turbulence measurements using ground-based wind lidars.** / Sathe, Ameya;

Mann, Jakob.

In: Atmospheric Measurement Techniques, Vol. 6, 2013, p. 3147-3167.

**A simple atmospheric boundary layer model applied to large eddy simulations of wind turbine wakes.** / Troldborg, Niels; Sørensen, Jens Nørkær; Mikkelsen, Robert Flemming; Sørensen,

Niels N.

In: Wind Energy, 2013.

**A simplified dynamic inflow model and its effect on the performance of free mean wind speed estimation.** / Henriksen, Lars Christian;

Hansen, Morten Hartvig; Poulsen, Niels Kjølstad.

In: Wind Energy, Vol. 16, No. 8, 2013, p. 1213-1224.

**A strong viscous-inviscid interaction model for rotating airfoils.** / Ramos García, Néstor;

Sørensen, Jens Nørkær; Shen, Wen Zhong.

In: Wind Energy, 2013.



## SCIENTIFIC ARTICLES WITH REFEREE IN ISI-INDEXED JOURNALS

**A Study on the Effect of Nudging on Long-Term Boundary Layer Profiles of Wind and Weibull Distribution Parameters in a Rural Coastal Area.** / Gryning, Sven-Erik; Batchvarova, Ekaterina; Floors, Rogier.

In: Journal of Applied Meteorology and Climatology, Vol. 52, No. 5, 2013, p. 1201-1207.

**Atmospheric stability-dependent infinite wind-farm models and the wake-decay coefficient.** / Peña, Alfredo; Rathmann, Ole.

In: Wind Energy, 2013.

**Calculation of alternating current losses in stacks and coils made of second generation high temperature superconducting tapes for large scale applications.** / Zermeno, Victor M. R.; Abrahamsen, Asger Bech; Mijatovic, Nenad; Jensen, Bogi Bech; Sørensen, Mads Peter.

In: Journal of Applied Physics, Vol. 114, No. 17, 2013, p. 173901.

**Characterization of a strongly textured non-ferromagnetic Cu-33 at%Ni substrate coated with a CeO<sub>2</sub> buffer layer.** / Tian, Hui; Suo, H.L.; Yue, Zhao; Grivel, J.-C.; Mishin, Oleg; Grivel, Jean-Claude.

In: Materials Letters, Vol. 108, 2013, p. 142-144.

**Comments on the research article by Gross et al. (2012).** / Guntur, Srinivas; Sørensen, Niels N.

In: Wind Energy, 2013.

**Comparison of coupled and uncoupled load simulations on a jacket support structure.** / Haselbach, Philipp Ulrich; Natarajan, Anand; Jiwinangun, Randi Gusto; Branner, Kim.

In: Energy Procedia, Vol. 35, 2013, p. 244 - 252.

**Compressive damage mechanism of GFRP composites under off-axis loading: Experimental and numerical investigations.** / Zhou, H.W.; Li, H.Y.; Gui, L.L.; Dai, Gaoming; Peng, R.D.; Wang, H.W.; Mishnaevsky, Leon.

In: Composites Part B: Engineering, Vol. 55, 2013, p. 119-127.

**Computational Fluid Dynamics model of stratified atmospheric boundary-layer flow.**

/ Koblitz, Tilman; Bechmann, Andreas; Sogachev, Andrey; Sørensen, Niels N.; Réthoré, Pierre-Elouan.

In: Wind Energy, 2013.

**Coupling of local texture and microstructure evolution during restoration processes in aluminum deformed to large strains.** / Hansen, Niels; Yu, Tianbo; Mishin, Oleg; Huang, Xiaoxu.

In: Materials Science Forum, Vol. 753, 2013, p. 251-256.

**Cross-spectra over the sea from observations and mesoscale modelling.** / Vincent, Claire Louise; Larsén, Xiaoli Guo; Larsen, Søren Ejling; Sørensen, Poul Ejnar.

In: Boundary-Layer Meteorology, Vol. 146, 2013, p. 297-318.

**Crystal plasticity modeling of through-thickness texture heterogeneity in heavily rolled aluminum.** / Delannay, Laurent; Mishin, Oleg V.

In: Key Engineering Materials, Vol. 554-557, 2013, p. 1189-1194.

**Damage evolution in nanoclay-reinforced polymers: A three-dimensional computational study.** / Dai, Gaoming; Mishnaevsky, Leon.

In: Composites Science and Technology, Vol. 74, 2013, p. 67-77.

**Deposition of matrix-free fullerene films with improved morphology by matrix-assisted pulsed laser evaporation (MAPLE).** / Canulescu, Stela; Schou, Jørgen; Fæster, Søren; Hansen, Karin Vels; Conseil, Helene.

In: Chemical Physics Letters, Vol. 588, 2013, p. 119-123.

**Design and validation of the high performance and low noise CQU-DTU-LN1 airfoils.** / Cheng, Jiangtao; Zhu, Wei Jun; Fischer, Andreas; Ramos García, Néstor; Madsen, Jesper .

In: Wind Energy, 2013.

**Determination of the minimum size of a statistical representative volume element from a fibre-reinforced composite based on point pattern statistics.** / Hansen, Jens Zangenberg; Brøndsted, Povl.

In: Scripta Materialia, Vol. 68, 2013, p. 503-505.

**De-trending of wind speed variance based on first-order and second-order statistical moments only.** / Larsen, Gunner Chr.; Hansen, Kurt Schaldemose.

In: Wind Energy, 2013.

**Development of an anisotropic beam finite element for composite wind turbine blades in multibody system.** / Kim, Taeseong; Hansen, Anders Melchior; Branner, Kim.

In: Renewable Energy, Vol. 59, 2013, p. 172-183.

**Development of satellite green vegetation fraction time series for use in mesoscale modeling: application to the European heat wave 2006.** / Nielsen, Joakim Refslund; Dellwik, Ebba; Hahmann, Andrea N.; Barlage, Michael J.; Boegh, Eva .

In: Theoretical and Applied Climatology, 2013.

**Development of superconducting wind turbine generators.** / Jensen, Bogi Bech; Mijatovic, Nenad; Abrahamsen, Asger Bech.

In: Journal of Renewable and Sustainable Energy, Vol. 5, No. 2, 023137, 2013.

**Dislocation content of geometrically necessary boundaries aligned with slip planes in rolled aluminium.** / Hong, Chuanshi; Huang, Xiaoxu; Winther, Grethe.

In: Philosophical Magazine (London, 2003), Vol. 93, No. 23, 2013, p. 3118-3141 .

**Dynamic Stall on Rotating Airfoils: A Look at the N-Sequence Data from the NREL Phase VI Experiment.** / Guntur, Srinivas; Sørensen, Niels N.; Schreck, Scott.

In: Key Engineering Materials, Vol. 569-570, 2013, p. 611-619.

**Editorial: Selected Publications of the EU FP7 project VIRTUAL NANOTITANIUM.**

/ Mishnaevsky, Leon; Levashov, Evgeny .  
In: Computational Materials Science, Vol. 76, 2013, p. 1-2.

**Effectiveness of WRF wind direction for retrieving coastal sea surface wind from synthetic aperture radar.**

/ Takeyama, Yuko; Ohsawa, Teruo; Kozai, Katsutoshi; Hasager, Charlotte Bay; Badger, Merete.  
In: Wind Energy, Vol. 16, No. 6, 2013, p. 865-878.

**Effect of consolidation pressure on volumetric composition and stiffness of unidirectional flax fibre composites.**

/ Aslan, Mustafa ; Mehmood, S.; Madsen, Bo.  
In: Journal of Materials Science, Vol. 48, 2013, p. 3812-3824.

**Effect of non-uniform mean flow field on acoustic propagation problems in computational aeroacoustics.**

/ Si, Haiqing; Shen, Wen Zhong; Zhu, Wei Jun.  
In: Aerospace Science and Technology, Vol. 28, No. 1, 2013, p. 145-153.

**Effect of Polymer Form and its Consolidation on Mechanical Properties and Quality of Glass/PBT Composites.**

/ Raghavulu Thirumalai, Durai Prabhakaran; Pillai, Saju ; Charca, Samuel ; Ataollahi, Simin ; Knudsen, Hans ; Løgstrup Andersen, Tom; Bech, Jakob Ilsted; Thybo Thomsen, Ole ; Lilholt, Hans.  
In: Applied Composite Materials, 2013.

**Effects of extreme wind shear on aeroelastic modal damping of wind turbines.**

/ Skjoldan, P.F.; Hansen, Morten Hartvig.  
In: Wind Energy, Vol. 16, 2013, p. 401-415.

**Effects of widening during rolling on the subsequent recrystallization kinetics of copper.**

/ Lin, Fengxiang; Leffers, Torben; Juul Jensen, Dorte; Pantleon, Wolfgang.  
In: Materials Science Forum, Vol. 753, 2013, p. 285-288.

**Environmental impact of wind energy:**

**Synthesis and Review.** / Mann, Jakob; Teilmann, Jonas.  
In: Environmental Research Letters, Vol. 8, No. 3, 035001, 2013.

**Evaluating winds and vertical wind shear from Weather Research and Forecasting model forecasts using seven planetary boundary layer schemes.**

/ Draxl, Caroline; Hahmann, Andrea N.; Pena Diaz, Alfredo; Giebel, Gregor.  
In: Wind Energy, 2013.

**Evaluation of the wind direction uncertainty and its impact on wake modeling at the Horns Rev offshore wind farm.**

/ Gaumont, M.; Réthoré, Pierre-Elouan; Ott, Søren; Peña, Alfredo; Bechmann, Andreas; Hansen, Kurt Schaldemose.  
In: Wind Energy, 2013.

**Fatigue damage propagation in unidirectional glass fibre reinforced composites made of a non-crimp fabric.**

/ Hansen, Jens Zangenberg; Brøndsted, Povl; Gillespie Jr., John W.  
In: Journal of Composite Materials, 2013.

**Flow over Hills: A Large-Eddy Simulation of the Bolund Case.**

/ Diebold, Marc; Higgins, Chad; Fang, Jiannong; Bechmann, Andreas; Parlange, Marc B.  
In: Boundary-Layer Meteorology, Vol. 148, No. 1, 2013, p. 177-194.

**Formation of a random recrystallization texture in heavily cold rolled and annealed Al-1%Si alloy.**

/ Chen, Y.L.; Huang, T.L.; Gong, X.; Wu, G.L.; Liu, Q.; Huang, Xiaoxu.  
In: Materials Science Forum, Vol. 753, 2013, p. 243-246.

**Frequency-Weighted Model Predictive Control of Trailing Edge Flaps on a Wind Turbine Blade.**

/ Castaignet, Damien; Couchman, Ian; Poulsen, Niels Kjølstad; Buhl, Thomas; Wedel-Heinen, Jens Jakob.  
In: IEEE Transactions on Control Systems Technology, Vol. 21, No. 4, 2013, p. 1105-1116.

**Full-scale test of trailing edge flaps on a Vestas V27 wind turbine: active load reduction and system identification.**

/ Castaignet, Damien ; Barlas, Thanasis K.; Buhl, Thomas; Poulsen, Niels Kjølstad; Wedel-Heinen, Jens Jakob ; Olesen, Niels A.; Bak, Christian; Kim, Taeseong.  
In: Wind Energy, 2013.

**Growth limit of carbon onions - A continuum mechanical study.**

/ Todt, Melanie; Bitsche, Robert; Hartmann, Markus A.; Fischer, Franz D.; Rammerstorfer, Franz G. .  
In: International Journal of Solids and Structures, Vol. 51, No. 3-4, 2014, p. 706-715.

**Hierarchical structures in cold-drawn pearlitic steel wire.**

/ Zhang, Xiaodan; Godfrey, Andrew ; Hansen, Niels; Huang, Xiaoxu.  
In: Acta Materialia, Vol. 61, 2013, p. 4898-4909.

**Hybrid immersed boundary method for airfoils with a trailing-edge flap.**

/ Zhu, Wei Jun; Behrens, Tim; Shen, Wen Zhong; Sørensen, Jens Nørkær.  
In: AIAA Journal, Vol. 51, No. 1, 2013, p. 30-41.

**Implementation of a Model Output Statistics based on meteorological variable screening for short-term wind power forecast.**

/ Ranaboldo, Matteo; Giebel, Gregor; Codina, Bernat.  
In: Wind Energy, Vol. 16, No. 6, 2013, p. 811-826.

**Importance of Local Structural Variations on Recrystallization.**

/ Juul Jensen, Dorte; Lin, Fengxiang; Zhang, Yubin; Zhang, Y.H.  
In: Materials Science Forum, Vol. 753, 2013, p. 37-41.

**Increased Power Capture by Rotor Speed-Dependent Yaw Control of Wind Turbines.**

/ Kragh, Knud Abildgaard; Fleming, Paul A.; Scholbrock, Andrew K.  
In: Journal of Solar Energy Engineering, Vol. 135, 031018, 2013.

## SCIENTIFIC ARTICLES WITH REFEREE IN ISI-INDEXED JOURNALS

**Indicial lift response function: an empirical relation for finite thickness airfoils, and effects on aeroelastic simulations.** / Bergami, Leonardo; Gaunaa, Mac; Heinz, Joachim Christian. In: *Wind Energy*, Vol. 16, No. 5, 2013, p. 681-693.

**Influence of grain size in the near-micrometre regime on the deformation microstructure in aluminium.** / Le, G.M.; Godfrey, A.; Hansen, Niels; Liu, W.; Winther, Grethe; Huang, Xiaoxu. In: *Acta Materialia*, Vol. 61, No. 19, 2013, p. 7072-7086.

**Interface debond crack growth in tension-tension cyclic loading of single fiber polymer composites.** / Pupurs, Andrejs; Goutianos, Stergios; Brøndsted, Povl; Varna, Janis. In: *Composites Part A: Applied Science and Manufacturing*, Vol. 44, 2013, p. 86-94.

**Interface debond crack growth in tension-tension cyclic loading of single fiber polymer composites.** / Pupurs, Andrejs; Goutianos, Stergios; Brøndsted, Povl; Varna, Janis. In: *Composites Part A: Applied Science and Manufacturing*, Vol. 44, 2013, p. 86-94.

**Interface fatigue crack propagation in sandwich X-joints - Part I: Experiments.** / Moslemian, Ramin; Berggreen, Christian. In: *Journal of Sandwich Structures and Materials*, Vol. 15, No. 4, 2013, p. 429-450.

**Interface fatigue crack propagation in sandwich X-joints - Part II: Finite element modeling.** / Moslemian, Ramin; Berggreen, Christian. In: *Journal of Sandwich Structures and Materials*, Vol. 15, No. 4, 2013, p. 451-463.

**Isolation and cultivation of microalgae select for low growth rate and tolerance to high pH.** / Berge, Terje; Daugbjerg, Niels; Hansen, Per Juel. In: *Harmful Algae*, Vol. 20, 2012, p. 101-110.

**Kinetics of thermal grooving during low temperature recrystallization of pure aluminum.** / Zhang, Yubin; Godfrey, Andy; Juul Jensen, Dorte. In: *Materials Science Forum*, Vol. 753, 2013, p. 117-120.

**Lidar-Observed Stress Vectors and Veer in the Atmospheric Boundary Layer.** / Berg, Jakob; Mann, Jakob; Patton, Edward G. In: *Journal of Atmospheric and Oceanic Technology*, Vol. 30, No. 9, 2013, p. 1961-1969.

**Life cycle strain monitoring in glass fibre reinforced polymer laminates using embedded fibre Bragg grating sensors from manufacturing to failure.** / Nielsen, Michael Wenani; Schmidt, Jacob Witttrup; Høgh, Jacob Herold; Waldbjørn, Jacob Paamand; Hattel, Jesper Henri; Løgstrup Andersen, Tom; Markussen, Christen Malte. In: *Journal of Composite Materials*, 2013, p. 1-17.

**Linking recovery and recrystallization through triple junction motion in aluminum cold rolled to a large strain.** / Yu, Tianbo; Hansen, Niels; Huang, Xiaoxu. In: *Acta Materialia*, Vol. 61, No. 17, 2013, p. 6577-6586.

Load alleviation of wind turbines by yaw misalignment. / Kragh, Knud Abildgaard; Hansen, Morten Hartvig. In: *Wind Energy*, 2013.

**Loading and fracture response of CFRP-to-steel adhesively bonded joints with thick adherents - Part I: Experiments.** / Anyfantis, Konstantinos; Tsouvalis, Nicholas G. In: *Composite Structures*, Vol. 96, 2013, p. 850-857.

**Loading and fracture response of CFRP-to-steel adhesively bonded joints with thick adherents - Part II: Numerical simulation.** / Anyfantis, Konstantinos; Tsouvalis, Nicholas G. In: *Composite Structures*, Vol. 96, 2013, p. 858-868.

**Long-Term Profiles of Wind and Weibull Distribution Parameters up to 600 m in a Rural Coastal and an Inland Suburban Area.** / Gryning, Sven-Erik; Batchvarova, Ekaterina; Floors, Rogier Ralph; Peña, Alfredo; Brümmer, Burghard; Hahmann, Andrea N.; Mikkelsen, Torben. In: *Boundary-Layer Meteorology*, 2013.

**Martensitic transformations in nanostructured nitinol: Finite element modeling of grain size and distribution effects.** / Liu, Hong-Sheng; Mishnaevsky, Leon. In: *Computational Materials Science*, Vol. 76, 2013, p. 27-36.

**Microscale damage mechanisms and degradation of fiber-reinforced composites for wind energy applications: results of Danish-Chinese collaborative investigations.** / Mishnaevsky, Leon; Zhou, H.W.; Yi, H.Y.; Peng, R.D.; Wang, H.W.; Dai, Gaoming; Gui, L.L.; Zhang, X. In: *Journal of Composite Materials*, 2013.

**Microstructure and mechanical properties of nickel processed by accumulative roll bonding.** / Zhang, Yubin; Mishin, Oleg; Kamikawa, N.; Godfrey, A.; Liu, W.; Liu, Q. In: *Materials Science and Engineering A: Structural Materials: Properties, Microstructures and Processing*, Vol. 576, 2013, p. 160-166.

**Microstructure, texture and magnetic properties of Ni-Cu-W substrates for coated conductors.** / Wulff, Anders Christian; Mishin, Oleg; Andersen, Niels Hessel; Yue, Zhao; Grivel, Jean-Claude. In: *Materials Letters*, Vol. 92, 2013, p. 386-388.

**Multi-material topology optimization of laminated composite beams with eigenfrequency constraints.** / Blasques, José Pedro Albergaria Amaral. In: *Composite Structures*, 2013.

**Multi-site testing and evaluation of remote sensing instruments for wind energy applications.** / Sanz Rodrigo, J.; Borbon Guillen, F.; Gomez Arranz, P.; Courtney, Michael; Wagner, Rozenn; Dupont, E. In: *Renewable Energy*, Vol. 53, 2013, p. 200-210.



**Multivariate data-driven modelling and pattern recognition for damage detection and identification for acoustic emission and acousto-ultrasonics.** / Torres-Arredondo, M.A.;

Tibaduiza, D.-A.; McGugan, Malcolm; Toftegaard, Helmuth Langmaack; Borum, Kaj Kvisgaard; Mujica, L.E.; Rodellar, J.; Fritzen, C.-P.

In: Smart Materials and Structures, Vol. 22, 105023, 2013.

**Observations and modeling of the diurnal SST cycle in the North and Baltic Seas.** / Karagali,

Ioanna; Høyer, J.L.

In: Journal of Geophysical Research - Oceans, Vol. 118, No. 9, 2013, p. 4488-4503.

**Observations of orientation dependence of surface morphology in tungsten implanted by low energy and high flux D plasma.** / Xu, H.Y.;

Zhang, Yubin; Yuan, Y.; Fu, B.Q.; Godfrey, A.; De Temmerman, G.; Liu, W.; Huang, Xiaoxu.

In: Journal of Nuclear Materials, Vol. 443, No. 1-3, 2013, p. 452-457.

**On atmospheric stability in the dynamic wake meandering model.** / Keck, Rolf-Erik; de Mare,

Martin Tobias; Churchfield, Matthew J.; Lee, Sang; Larsen, Gunner Chr.; Aagaard Madsen, Helge.

In: Wind Energy, 2013.

**On the lattice rotations accompanying slip.** /

Wronski, M.; Wierzbanski, K.; Leffers, Torben.

In: Materials Science and Technology, Vol. 29, No. 2, 2013, p. 129-133.

**Open-loop frequency response analysis of a wind turbine using a high-order linear aeroelastic model.** / Sønderby, Ivan Bergquist;

Hansen, Morten Hartvig.

In: Wind Energy, 2013.

**Optical diagnostics of a gliding arc.** / Sun, Z.W.;

Zhu, J.J.; Li, Z.S.; Aldén, M.; Leipold, Frank; Salewski, Mirko; Kusano, Yukihiko.

In: Optics Express, Vol. 21, No. 5, 2013, p. 6028-6044.

**Phase-field simulation study of the migration of recrystallization boundaries.** / Moelans,

Nele; Godfrey, Andy; Zhang, Yubin; Juul Jensen, Dorte.

In: Physical Review B (Condensed Matter and Materials Physics), Vol. 88, No. 5, 054103, 2013.

**PIV study of the effect of piston position on the in-cylinder swirling flow during the scavenging process in large two-stroke marine diesel engines.** / Haider, Sajjad; Schnipper, Teis;

Obeidat, Anas; Meyer, Knud Erik; Okulov, Valery; Walther, Jens Honore; Mayer, S.

In: Journal of Marine Science and Technology, Vol. 18, No. 1, 2013, p. 133-143.

**Power curve measurement with a nacelle mounted lidar.** / Wagner, Rozenn; Friis Pedersen,

Troels; Courtney, Michael; Antoniou, Ioannis; Davoust, S.; Rivera, R.L.

In: Wind Energy, 2013.

**Pretreatment of the macroalgae Chaetomorpha linum for the production of bioethanol - Comparison of five pretreatment technologies.** / Schultz-Jensen, Nadja; Thygesen, Anders;

Thomsen, Sune Tjalfe; Leipold, Frank; Roslander, Christian; Lilholt, Hans; Bjerre, Anne Belinda.

In: Bioresource Technology, Vol. 140, 2013, p. 36-42.

**Promoting new links between energy and meteorology. Meeting summaries.** / Troccoli,

Alberto; Coppin, Peter; Gunasekera, Don; Audinet, Pierre; Ebinger, Jane; Bonelli, Paolo; Boulahya,

Mohammed S.; Buontempo, Carlo; Dubus, Laurent; Dutton, John A.; Griggs, David; Gryning, Sven-Erik;

Harrison, Mike; Haupt, Sue Ellen; Lee, Trevor; Mailier, Pascal; Mathieu, Pierre-Philippe; Schaeffer,

Roberto; Schroedter-Homscheidt, Marion; Zhu, Rong; Zillman, John.

In: American Meteorological Society. Bulletin, Vol. 94, No. 4, 2013, p. ES36-ES40.

**Quantitative study on the statistical properties of fibre architecture of genuine and numerical composite microstructures.** / Hansen,

Jens Zangenberg; Brøndsted, Povl.

In: Composites Part A: Applied Science and Manufacturing, Vol. 47, 2013, p. 124-134.

**RANS-based simulation of turbulent wave boundary layer and sheet-flow sediment transport processes.** / Fuhrman, David R.;

Schløer, Signe; Sterner, Johanna.

In: Coastal Engineering, Vol. 73, 2013, p. 151-166.

**Recovery and recrystallization in commercial purity aluminum cold rolled to an ultrahigh strain.** / Mishin, Oleg; Godfrey, A.; Juul Jensen,

Dorte; Hansen, Niels.

In: Acta Materialia, Vol. 61, No. 14, 2013, p. 5354-5364.

**Reducing Conductor Usage in Superconducting Machines by Multiple Power Supplies.** /

Jensen, Bogi Bech; Mijatovic, Nenad; Abrahamsen, Asger Bech.

In: IEEE Transactions on Applied Superconductivity, Vol. 23, No. 5, 2013, p. 5202708.

**Reliability Analysis of a Composite Wind Turbine Blade Section Using the Model Correction Factor Method: Numerical Study and Validation.** / Dimitrov, Nikolay; Friis-Hansen,

Peter; Berggreen, Christian.

In: Applied Composite Materials, Vol. 20, No. 1, 2013, p. 17-39.

**Retrieving wind statistics from average spectrum of continuous-wave lidar.** / Branlard,

Emmanuel Simon Pierre; Pedersen, Anders Tegtmeier; Mann, Jakob; Angelou, Nikolas; Fischer,

Andreas; Mikkelsen, Torben; Harris, M.; Slinger, C.; Montes, B. F.

In: Atmospheric Measurement Techniques, Vol. 6, 2013, p. 1673-1683.

**Self-induced vibrations of a DU96-W-180 airfoil in stall.** / Skrzypinski, Witold Robert; Gaunaa,

Mac; Sørensen, Niels N.; Zahle, Frederik; Heinz, Joachim Christian.

In: Wind Energy, 2013.

**Sensor comparison study for load alleviating wind turbine pitch control.** / Kragh, Knud

Abildgaard; Hansen, Morten Hartvig; Henriksen, Lars Christian.

In: Wind Energy, 2013.

## SCIENTIFIC ARTICLES WITH REFEREE IN ISI-INDEXED JOURNALS

**Simulation of the inherent turbulence and wake interaction inside an infinitely long row of wind turbines.** / Andersen, Søren Juhl; Sørensen, Jens Nørkær; Mikkelsen, Robert Flemming.

In: Journal of Turbulence, Vol. 14, No. 4, 2013, p. 1-24.

**Smart dynamic rotor control using active flaps on a small-scale wind turbine: aero-elastic modeling and comparison with wind tunnel measurements.** / Barlas, Thanasis K.; van Wingerden, W.; Hulskamp, A.W.; Van Kuik, G.A.M.; Bersee, H.E.N.

In: Wind Energy, Vol. 16, 2013, p. 1287-1301.

**Spatial and temporal variability of winds in the Northern European Seas.** / Karagali, Ioanna; Badger, Merete; Hahmann, Andrea N.; Pena Diaz, Alfredo; Hasager, Charlotte Bay; Sempreviva, Anna Maria.

In: Renewable Energy, Vol. 57, 2013, p. 200-210.

**Structural and mechanism design of an active trailing-edge flap blade.** / Lee, Jae Hwan; Natarajan, Balakumaran; Eun, Won Jong; Viswamurthy, S. R.; Park, Jae-Sang; Kim, Taeseong; Shin, Sang Joon.

In: Journal of Mechanical Science and Technology, Vol. 27, No. 9, 2013, p. 2605-2617.

**Structural Design Optimization of a Tiltrotor Aircraft Composite Wing to Enhance Whirl Flutter Stability.** / Kim, Taeseong; Kim, Jaehoon; Shin, Sang Joon; Kom, Do-Hyung.

In: Composite Structures, Vol. 95, 2013, p. 283-294.

**Structural optimization study of composite wind turbine blade.** / Chen, Jin; Shen, Wen Zhong; Wang, Quan; Pang, Xiaoping; Li, Songlin; Guo, Xiaofeng.

In: Materials & Design, Vol. 46, 2013, p. 247-255.

**Synthetic atmospheric turbulence and wind shear in large eddy simulations of wind turbine wakes.** / Keck, Rolf-Erik; Mikkelsen, Robert Flemming; Troldborg, Niels; de Maré, Martin; Hansen, Kurt Schaldemose.

In: Wind Energy, 2013.

**The Høvsøre Tall Wind-Profile Experiment: A Description of Wind Profile Observations in the Atmospheric Boundary Layer.** / Peña, Alfredo; Floors, Rogier Ralph; Gryning, Sven-Erik.

In: Boundary-Layer Meteorology, 2013.

**The OML-SprayDrift model for predicting pesticide drift and deposition from ground boom sprayers.** / Løfstrøm, Per; Bruus, Marianne; Andersen, Helle Vibeke; Kjær, Christian; Nuytens, David; Astrup, Poul.

In: Journal of Pesticide Science, Vol. 38, No. 3, 2013, p. 129-138.

**The Wind Profile in the Coastal Boundary Layer: Wind Lidar Measurements and Numerical Modelling.** / Floors, Rogier; Vincent, Claire Louise; Gryning, Sven-Erik; Peña, Alfredo; Batchvarova, Ekaterina.

In: Boundary-Layer Meteorology, Vol. 147, 2013, p. 469-491.

**TOPFARM: Multi-fidelity optimization of wind farms.** / Réthoré, Pierre-Elouan; Fuglsang, Peter; Larsen, Gunner Chr.; Buhl, Thomas; Larsen, Torben J.; Aagaard Madsen, Helge.

In: Wind Energy, 2013.

**Transmission of wave energy through an offshore wind turbine farm.** / Christensen, Erik Damgaard; Johnson, Martin; Sørensen, Ole Rene; Hasager, Charlotte Bay; Badger, Merete; Larsen, Søren Ejling.

In: Coastal Engineering, Vol. 82, 2013, p. 25-46.

**Triple junction motion - A new recovery mechanism in metals deformed to large strains.** / Yu, Tianbo; Hansen, Niels; Huang, Xiaoxu.

In: Materials Science Forum, Vol. 753, 2013, p. 485-488.

**Two improvements to the dynamic wake meandering model: including the effects of atmospheric shear on wake turbulence and incorporating turbulence build-up in a row of wind turbines.** / Keck, Rolf-Erik; de Mare, Martin Tobias; Churchfield, Matthew J.; Lee, Sang; Larsen, Gunner Chr.; Aagaard Madsen, Helge.

In: Wind Energy, 2013.

**Unbalanced voltage faults: the impact on structural loads of doubly fed asynchronous generator wind turbines.** / Barahona Garzón, Braulio; Cutululis, Nicolaos Antonio; Hansen, Anca Daniela; Sørensen, Poul Ejnar.

In: Wind Energy, 2013.

**Uncertainties of the 50-year wind from short time series using generalized extreme value distribution and generalized Pareto distribution.** / Larsén, Xiaoli Guo; Mann, Jakob; Rathmann, Ole; Ejsing Jørgensen, Hans.

In: Wind Energy, 2013.

**Uncertainty modelling and code calibration for composite materials.** / Toft, Henrik Stensgaard; Branner, Kim; Mishnaevsky, Leon, Jr; Sørensen, John Dalsgaard.

In: Journal of Composite Materials, Vol. 47, No. 14, 2013, p. 1729-1747.

**Verification and validation of an actuator disc model.** / Réthoré, Pierre-Elouan; Laan, van der, Paul Maarten; Troldborg, Niels; Zahle, Frederik; Sørensen, Niels N.

In: Wind Energy, 2013.

**Verification of aero-elastic offshore wind turbine design codes under IEA Wind Task XXIII.** / Vorpahl, Fabian; Strobel, Michael; Jonkman, Jason M.; Larsen, Torben J.; Passon, Patrik.

In: Wind Energy, 2013.

**Vortex methods to answer the need for improved understanding and modelling of tip-loss factors.** / Branlard, Emmanuel Simon Pierre; Dixon, Kristian; Gaunaa, Mac.

In: I E T Renewable Power Generation, Vol. 7, No. 4, 2013, p. 311-320.

**Water-cooled non-thermal gliding arc for adhesion improvement of glass-fibre-reinforced polyester.** / Kusano, Yukihiro; Sørensen, Bent F.; Løgstrup Andersen, Tom; Toftegaard, Helmuth Langmaack; Leipold, Frank; Salewski, Mirko; Sun, Zhiwei; Zhu, Jijian; Li, Zhongshan; Alden, Marcus.

In: Journal of Physics D: Applied Physics, Vol. 46, No. 13, 2013, p. 135203.

**Weather radars - the new eyes for offshore wind farms?.**

/ Trombe, Pierre-Julien ; Pinson, Pierre; Vincent, Claire Louise; Bøvith, Thomas; Cutululis, Nicolaos Antonio; Draxl, Caroline; Giebel, Gregor; Hahmann, Andrea N.; Jensen, Niels E.; Jensen, Bo P.; Le, Nina F.; Madsen, Henrik; Pedersen, Lisbeth B.; Sommer, Anders.

In: Wind Energy, 2013.

**Wind characteristics in the North and Baltic Seas from the QuikSCAT satellite.**

/ Karagali, Ioanna; Pena Diaz, Alfredo; Badger, Merete; Hasager, Charlotte Bay.

In: Wind Energy, Vol. 17, No. 1, 2014, p. 123-140.

**Wind Energy literature survey no. 26.**

/ Henriksen, Lars Christian.

In: Wind Energy, Vol. 15, 2012, p. 945-949.

**Wind Energy literature survey no. 27.**

/ Henriksen, Lars Christian.

In: Wind Energy, Vol. 16, 2013, p. 159-161.

**Wind Energy literature survey no. 28.**

/ Henriksen, Lars Christian.

In: Wind Energy, Vol. 16, No. 3, 2013, p. 475-477.

**Wind Energy literature survey no. 29.**

/ Henriksen, Lars Christian.

In: Wind Energy, Vol. 16, No. 5, 2013, p. 804-809.

**Wind Energy literature survey no. 30.**

/ Henriksen, Lars Christian.

In: Wind Energy, Vol. 16, No. 8, 2013, p. 1303-1308.

**Wind Farm Wake: The Horns Rev Photo Case.**

/ Hasager, Charlotte Bay; Rasmussen, Leif; Peña, Alfredo; Jensen, Leo E.; Réthoré, Pierre-Elouan.

In: Energies, Vol. 6, 2013, p. 696-716.

**Wind gust parametrizations at heights relevant for wind energy: a study based on mast observations.**

/ Suomi, I.; Vihma, T.; Gryning, Sven-Erik; Fortelius, C.

In: Quarterly Journal of the Royal Meteorological Society, Vol. 139, No. 674, 2013, p. 1298-1310.



# ORGANISATION

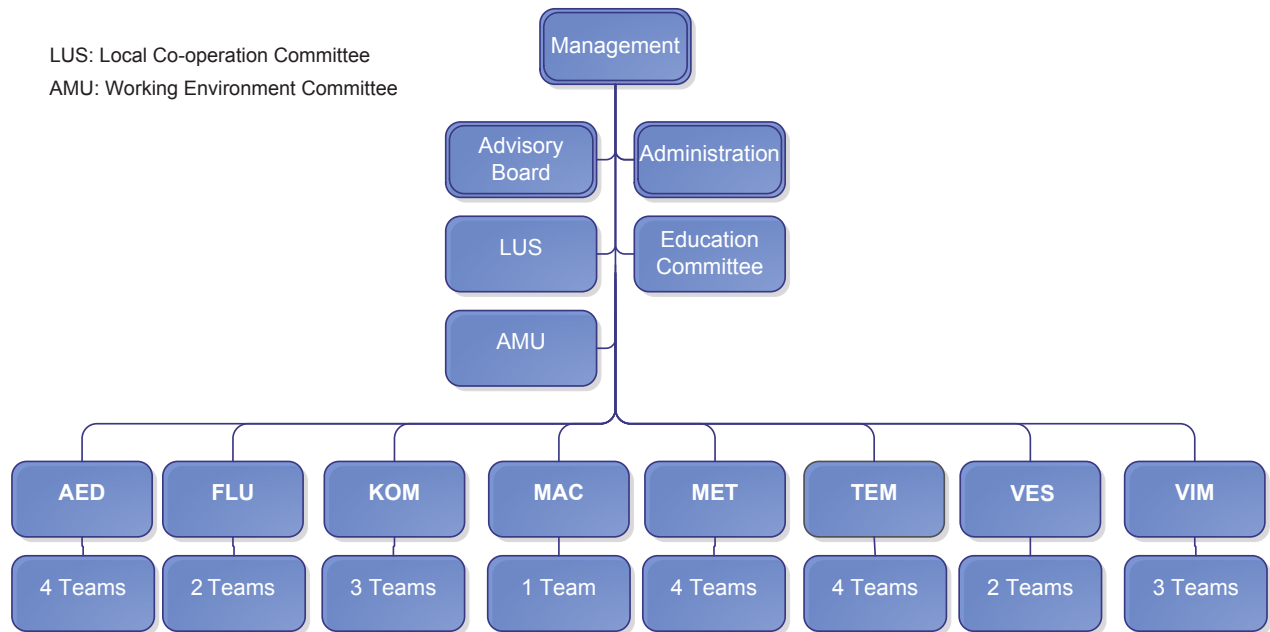

The management of the department consists of the Head of Department and the Deputy Head of Department. The management structure of the department is organized with a single management team with the Head of Department as chairman and the Deputy Head of Department and the 8 head of sections as members. The organization of DTU Wind Energy is shown in the organizational chart above.

## **AED:**

Aerodynamics, aeroacoustics, airfoil and blade design team  
CFD for wind turbine design team  
Aeroelastic stability and control team  
Aero-hydro-elastics and loads team

## **FLU:**

Aerodynamics and Fundamental Fluid Mechanics team  
Computational Aerodynamics and Aero-acoustics team

## **KOM:**

Processing and microstructural characterization team  
Modelling of materials mechanics team  
Mechanical characterization and damage detection team  
Mechanical characterization and damage detection team

## **MAC:**

Materials Science and Characterization team (Section).

## **MET:**

WAsP team  
MesoWind team  
Boundary-Layer Meteorology team  
Offshore wind power meteorology team

## **TEM:**

Applied Measurement Technique team  
WindScanner Research and Innovation team  
Experimental Research and Development team  
Wind Turbine Testing team

## **VES:**

Wind Energy Systems and Development team  
Wind Power Integration and Control team

## **VIM:**

Loads and Component Design team  
Structural Design and Testing team  
Structural and Multidisciplinary Optimization team



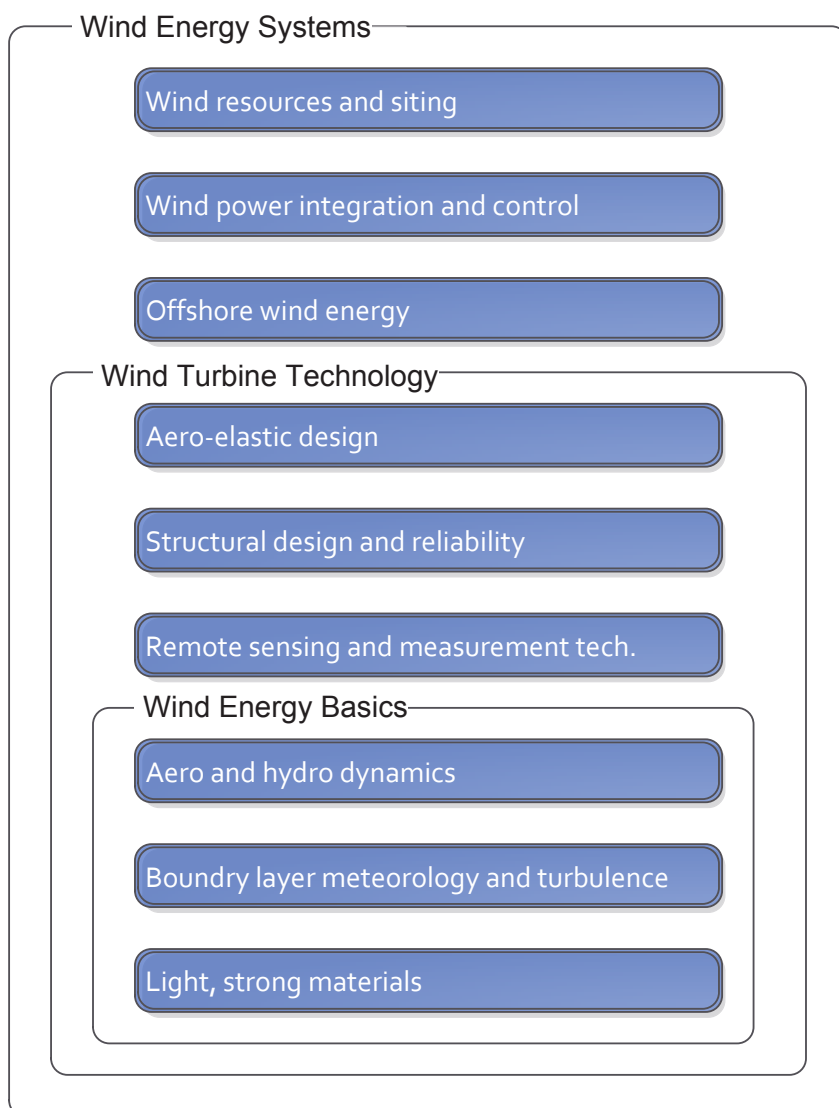

The technical/scientific competences within the department are embedded in the eight sections. The research is organized in 9 research programmes within three main research themes: Wind energy systems, where the turbine enters as a component, wind turbine technology and wind energy basics. Each strategic research programme typically has contributions from other sections from the department and cooperation with other DTU departments.

## Advisory Board:



Tove Feld, Senior Director, Deputy Wind Power Engineering, Dong Energy



Michael Høgedal, Senior Vice President, Product Integration, Vestas Turbines R&D



Henrik Stiesdal, CTO, Chief Technology Officer of the Wind Power Business Unit, Siemens Energy, Siemens AG

## Department Management:

### Head of Department:



Peter Hauge Madsen

### Deputy Head of Department:



Peter Hjuler Jensen

## Sections:



Aeroelastic Design (AED), Flemming Rasmussen, Head of Section



Composites and Materials Mechanics (KOM), Professor Bent F. Sørensen, Head of Section



Fluid Mechanics (FLU), Professor Jens Nørkær Sørensen, Head of Section



Materials Science and Characterisation (MAC), Professor Dorte Juul Jensen, Head of Section



Meteorology section (MET), Dr. Hans E. Jørgensen, Head of Section



Test and Measurements (TEM), Dr. Poul Hummelshøj, Head of Section



Wind Energy Systems (VES), Jens Carsten Hansen, Head of Section



Wind Turbine Structures (VIM), Dr. Thomas Buhl, Head of Section

## Study Programmes:



Study Committee, Dr. Niels-Erik Clausen, chairman



Erasmus Mundus European Wind Energy Master, Professor Jens Nørkær Sørensen



Master Programme in Wind Energy, Ass. Professor Martin L. Hansen

# TEAM DESCRIPTIONS

After the first year as a department comprising 250 employees divided into 8 sections and an administration, the management decided to further divide the sections into smaller and unique teams in order to support the scientific and staff development taking place in a department characterized by cross-disciplinary research.

The teams have different technical or scientific areas:

## Aeroelastic Design Section is divided into four teams:

### **Aerodynamics, aeroacoustics, airfoil and blade design team:**

The team works with aerodynamic and aeroacoustic research for airfoil and blade design and optimization - modeling and experiments.

### **CFD for wind turbine design team:**

The team addresses CFD for aeroelastic design of wind turbines in wind farms including wakes and terrain.

### **Aeroelastic stability and control team:**

The team works with modeling and analysis of aeroelastic stability and multi-variable control of wind turbines including distributed blade censoring and control.

### **Aero-hydro-elasticity and loads team:**

The team addresses aero-hydro-servoelastic modeling, analysis and optimization of wind turbine response and loads under real operational conditions for different concepts.

## The Fluids Mechanics Section is divided into three teams:

### **Aerodynamics and Fundamental Fluid Mechanics team:**

The research focuses on a broad spectrum from applied aeroelasticity to fundamental study of various flows e.g. wakes behind wind turbines including stability and devices for controlling the boundary layer on blades. Further, advanced numerical methods are used for wake flow and large databases are used for wind farm analysis.

### **Computational Aerodynamics and Aero-acoustics team:**

The team works with numerical simulation tools which are developed for analysis, control and design of wind turbines, including codes for generation and emission of noise from wind turbines and wind farms.

## The Composites and Materials Mechanics Section is divided into three teams:

### **Processing and microstructural characterization team:**

The team addresses manufacturing of new types of composite materials, test specimens and prototype by vacuum infusion, autoclave consolidation or hot pressing. Preparation of test specimen by cutting, grinding, polishing and adhesive bonding. Process control by process modelling, microscopy, embedded sensors.

### **Modelling of materials mechanics team:**

The team works with numerical and analytical modelling to describe or predict the mechanical properties of materials by phenomenological or micromechanical models. Modelling of stress-strain laws, cohesive laws and fatigue life laws using solid mechanics, damage mechanics and fracture mechanics concepts.

### **Mechanical characterization and damage detection team:**

The team addresses experimental characterization of mechanical properties of fiber composites, measurement of deformation, stiffness, strength, cohesive laws and fatigue lifetime. Development of improved mechanical testing methods and test specimen design, damage detection and non-destructive evaluation.

## Materials Science and Characterization Section

The Materials Science and Characterization Section is organized into one large team. The Section focuses on structural characterization of materials – mostly metals- and relating the structural observations to the processing and the properties as well as the performance of the materials. The work encompasses both experimental characterizations and theoretical modelling.

## The Meteorology Section is divided into four teams:

### The WASP team

The WASP Team carries out research, innovation, software development, education and public sector consultancy within the field of wind flow modelling over terrain for wind resource assessment and site assessment for wind turbines and wind farms.

### The MesoWind team:

The team addresses the application of mesoscale modelling in the field of wind energy. Emphasis is on developing methods to accurately calculate wind conditions, apply the results in microscale models, and validate.

### Boundary-Layer Meteorology team:

The team carries out basic and applied research on the structure and turbulent dynamics of the lower part of the atmosphere. Topics of current particular interest are wind profiles, wind turbine inflow and wake dynamics, flow in complex terrain, air-sea interactions, flows in and over canopies, effects of stratification on turbulence and wind profiles, turbulent exchanges of energy and gases such as carbon dioxide, turbulence statistics in the atmospheric boundary layer, and coupling of local flow with the meso scale.

### Offshore wind power meteorology team:

The team addresses research on offshore wind power meteorology including observation, data analysis and modeling of the marine atmospheric boundary layer relevant for assessment of offshore wind resources and wind farm siting, lay-out, operation, optimization and design.

## Wind Energy System Section is divided into two teams:

### Wind Energy Systems and Development team:

The team addresses wind farm project planning and development, integrating knowledge for development of wind energy technology and sector development as well as application of advanced active materials in wind turbine generators, short-term prediction, wind power in cold climates and in isolated power systems.

### Wind Power Integration and Control team:

The team addresses integration and control of wind energy into power systems. Focus are wind power variability, control and ancillary services from wind power plants, grid connection, integration of large scale offshore wind power and integrated analysis of power systems and wind turbine loading.

## The Test and Measurement Section is divided into four teams:

### Applied Measurement Technology team:

The team focuses on moving new, wind related measuring technologies out to the industry and is currently engaged in work with spinner anemometers, kinematic measurements with stereo-vision, ground-based lidars, nacelle-mounted lidars and scanning lidars.

### WindScanner Research and Innovation team:

The team focuses on WindScanners space and time synchronized scanning wind lidars deployed and operated for measurement of the 3D wind and turbulence structures in the atmospheric boundary layer, and upwind scanning wind lidars installed on the turbine nacelle and in the rotating turbine.

### Experimental Research & Development team:

The team provides the technical expertise needed to perform experimental wind energy research. This means to develop and maintain the needed hardware and software to perform large field experiments, long-term meteorological measurements and measurements on and around wind turbines.

### Wind Turbine Testing team:

The team focuses on the activities taking place at the two test stations in Høvsøre and Østerild. The team performs accredited power curve and loads measurements at the prototype wind turbines installed at the test stations. Also DANAK accredited-calibration of ground-based lidars is a part of the team activity.

## Wind Turbine Structures Section is divided into three teams:

### Loads and Component Design team:

The team focuses on reducing model uncertainties in design loads evaluation by improving computational methods, prediction models, wind and wave field characterization, and reducing design loads, and robust techniques, probabilistic design involving lifetime prediction etc.

### Structural Design & Testing team:

The team does research in the areas of experimental, numerical and analytical design theory in order to develop more reliable and precise methods for structural design of wind turbine blades and other large composite and metal structures. Also research in understanding failure mechanisms and progressive damage under both static and dynamic loading is done.

### Structural and Multidisciplinary Optimization team:

The team focuses on development of mathematical models and numerical optimization methods for structural optimization of load carrying structures within wind energy. The research includes optimal design of composite structures such as wind turbine blades.



**Main address:**

DTU Wind Energy  
Campus Risø  
Building 118  
Frederiksborgvej 399  
DK- 4000 Roskilde

Phone: 4677 5085

**Other locations:**

DTU Wind Energy  
Campus Lyngby  
Building 403  
Nils Koppels Alle  
DK-2800 Lyngby

DTU Wind Energy  
Campus Risø  
Building 228  
Frederiksborgvej 399  
DK- 4000 Roskilde

DTU Wind Energy  
Test Station for Large Wind Turbines at Høvsøre  
Bøvlingvej 41B  
DK-7650 Bøvlingbjerg

DTU Wind Energy  
Test Centre Østerild  
Damsgård  
Blovsgårdsvej 17  
DK-7741 Frøstrup

