

NANO EXPRESS

Open Access

On the direct insulator-quantum Hall transition in two-dimensional electron systems in the vicinity of nanoscaled scatterers

Chi-Te Liang^{1*}, Li-Hung Lin², Kuang Yao Chen¹, Shun-Tsung Lo¹, Yi-Ting Wang¹, Dong-Sheng Lou³, Gil-Ho Kim⁴, Yuan-Huei Chang¹, Yuichi Ochiai⁵, Nobuyuki Aoki⁵, Jeng-Chung Chen³, Yiping Lin³, Chun-Feng Huang⁶, Sheng-Di Lin⁷, David A Ritchie⁸

Abstract

A direct insulator-quantum Hall (I-QH) transition corresponds to a crossover/transition from the insulating regime to a high Landau level filling factor $\nu > 2$ QH state. Such a transition has been attracting a great deal of both experimental and theoretical interests. In this study, we present three different two-dimensional electron systems (2DESs) which are in the vicinity of nanoscaled scatterers. All these three devices exhibit a direct I-QH transition, and the transport properties under different nanoscaled scatterers are discussed.

Introduction

The simultaneous presence of disorder and a strong enough magnetic field B can lead to a wide variety of interesting physical phenomena. For example, the integer quantum Hall effect is one of the most exciting effects in two-dimensional electron systems (2DES), in which the electrons are usually confined in layers of the nanoscale [1]. In an integer quantum Hall (QH) state, the current is carried by the one-dimensional edge channels because of the localization effects. It has been shown that with sufficient amount of disorder, a 2DES can undergo a B -induced insulator to quantum Hall transition [2-5]. Experimental evidence for such an insulator-quantum Hall (I-QH) transition is an approximately temperature (T)-independent point in the measured longitudinal resistivity of a 2DES [3-5]. The I-QH transition continues to attract a great deal of interest both experimentally and theoretically as it may shed light on the fate of extended states [6-10], the true ground state of a non-interacting 2DES [2], and a possible metal-insulator transition in 2D [11,12].

It is worth pointing out that in order to observe an I-QH transition separating the zero-field insulator from the QH liquid, one needs to deliberately introduce

strong disorder within a 2DES. The reason for this is that the localization length needs to be shorter than the sample size. In the study by Jiang and co-workers [2], a 2DES without a spacer layer in which strong Coulomb scattering exists was used. Wang et al. utilized a 30-nm-thick heavily doped GaAs layer so as to allow the positively charged Si atoms to introduce long-range random potential in the 2DES [3]. Hughes et al. have shown that when a Si-doped plane was incorporated into a 550-nm-thick GaAs film, a deep potential well can form in which the 2DES is confined close to the ionized donors and is therefore highly disordered [4]. It has been shown that by deliberately introducing nanoscaled InAs quantum dots [13] in the vicinity of a modulation-doped GaAs/AlGaAs heterostructure, a strongly disordered 2DES which shows an I-QH transition can be experimentally realized [14,15].

The transition/crossover from an insulator to a QH state of the filling factor $\nu > 2$ in an ideal spinless 2DES can be denoted as the direct I-QH transition [16-19]. Such a transition has been attracting a great deal of interest and remains an unsettled issue. Experimental [16-19] and theoretical results [9,10] suggest that such a direct transition can occur, and it is a quantum phase transition. However, Huckestein [20] has argued that such a direct transition is not a quantum phase

* Correspondence: ctliang@phys.ntu.edu.tw

¹Department of Physics, National Taiwan University, Taipei 106, Taiwan
Full list of author information is available at the end of the article

transition, but a narrow crossover in B due to weak localization to Landau quantization.

In this study, the authors compare three different electron systems containing nanoscaled scatterers which all show a direct I-QH transition. The first sample is a GaAs 2DES containing self-assembled nanoscaled InAs quantum dots [13,14,21-23].

The second one is a 2DES in a nominally undoped AlGaN/GaN heterostructure [24-33] grown on Si substrate [33,34]. Such a GaN-based electron system can be affected by nanoscaled dislocation and impurities [35]. Finally, experimental results on the third sample, a delta-doped GaAs/AlGaAs quantum well with additional modulation doping [36,37], will be presented. All the

experimental results on the three completely different samples show that the direct I-QH transition does not occur with the onset of strong localization due to Landau quantization [20,38]. Therefore, in order to obtain a thorough understanding of the direct I-QH transition, further studies are required.

Experimental details

Figure 1a,b,c show the structures of the three devices, Sample A, Sample B, and Sample C, considered in this study. Sample A is a GaAs/AlGaAs 2DES containing self-assembled InAs quantum dots. Sample B is an AlGaN/GaN heterostructure grown on Si. Such a system is fully compatible with Si CMOS technology and is thus

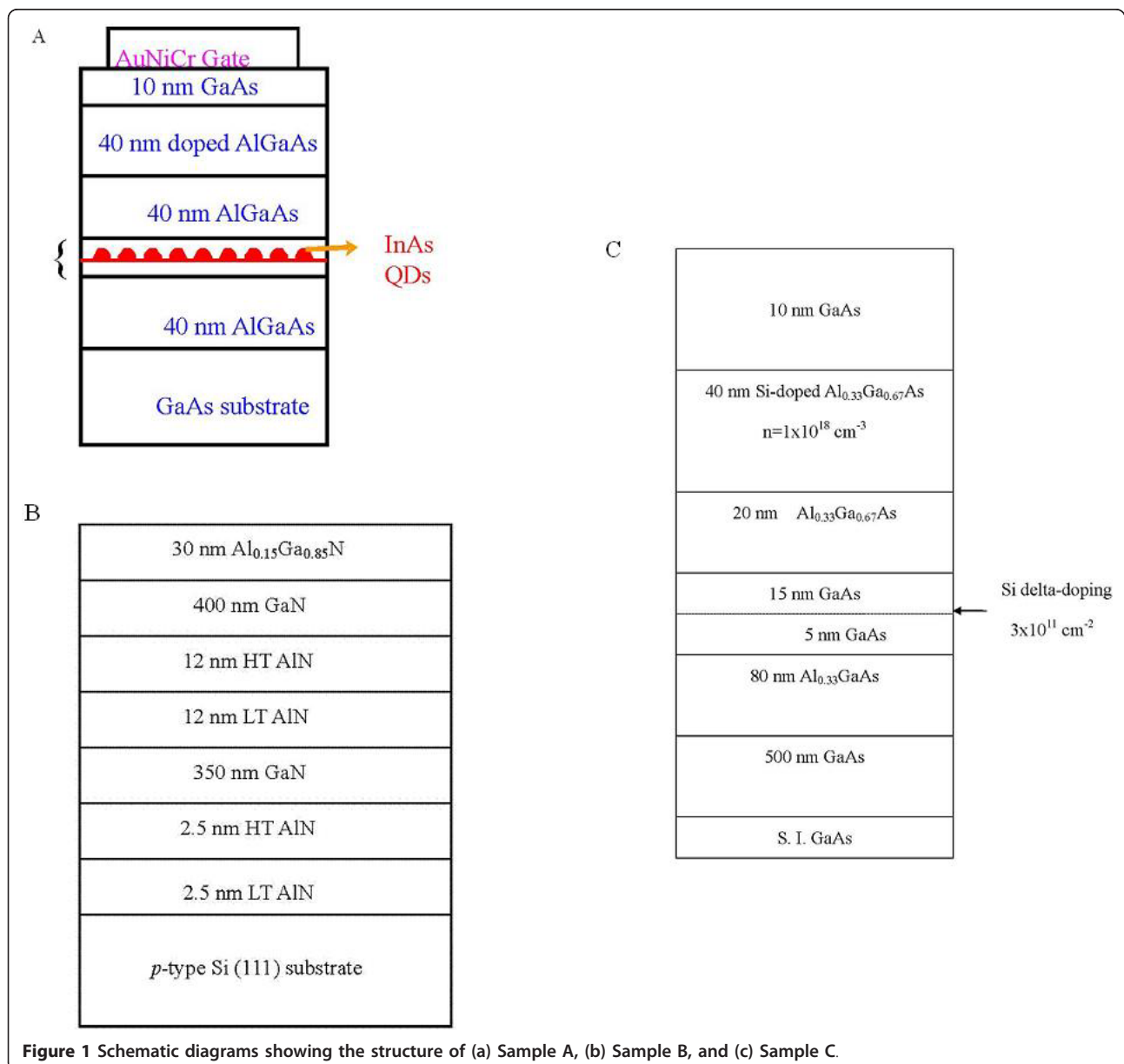

of great potential applications. Sample C is a delta-doped quantum well with additional delta-doping. Since the electrons in the quantum well in sample B are in close proximity of nanoscaled dislocation and impurities, the 2DES is strongly influenced by these nanoscaled scatterers. In fact, these scatterers provide scattering which is required for observing the I-QH transition [16]. On the other hand, the scatterings in samples A and C are mainly due to the self-assembled quantum dots and the delta-doping in the quantum well, respectively. Recent studies focussing on alloy disorder in $\text{Al}_x\text{Ga}_{1-x}\text{As}/\text{GaAs}$ heterostructure [39-41] have shown that 2DESs influenced by short-range disorder provides an excellent opportunity to connect the Anderson localization theory with real experimental systems [41]. Moreover, the nature of disorder may affect scaling behavior in the plateau-plateau (P-P) transition at high B [39-41], and the P-P and I-QH transitions may be considered as the same universality class [42]. Therefore, it may be interesting to investigate the direct I-QH transitions under different scattering types at low magnetic fields. In this article, such low-field direct transitions in samples A, B, and C are compared.

Figure 2 shows a TEM image of the wafer for fabricating Sample A. Very uniform nanoscaled InAs quantum dots can be seen. These nano-scattering centers provide strong scattering in the vicinity of the 2DES in the GaAs. The dimensions of the quantum dot are estimated to be 20 nm in diameter and 4 nm in height. Experiments were performed in a top-loading He3 cryostat equipped with a superconductor magnet. Four-terminal resistance measurements were performed using standard phase-sensitive lock-in techniques.

Results and discussions

Figure 3 shows the longitudinal magnetoresistivity measurements on Sample A as a function of B at various temperatures. It can be seen that at a crossing field $B_c = 0.9$ T, ρ_{xx} is approximately T -independent. For $B < B_c$, ρ_{xx} decreases with increasing temperature, characteristics of an insulating regime [16]. For $B > B_c$, ρ_{xx} increases with increasing temperature, and therefore the 2DES is in the quantum Hall regime. As the 2DES enters the $\nu = 4$ QH state from the insulating regime, a direct 0-4 transition where the symbol 0 corresponds to the insulator has been observed. It is worth pointing out that before the 2DES enters the $\nu = 4$ QH state, resistance oscillations due to Landau quantization in the insulating regime have already been observed [15,19,21]. Therefore, the experimental results of this study clearly demonstrate that the crossover from localization from Landau quantization actually covers a wide range of magnetic

field, in sharp contrast to Huckestein's argument [19-21].

As mentioned earlier, a GaN-based electron system can be affected by nanoscaled dislocation and impurities. It is therefore interesting to study such a system. Figure 4 shows magnetoresistance measurements on Sample B as a function of magnetic field at different temperatures. The data deviate slightly from the expected symmetric behavior, i.e., $R(B) = R(-B)$. The reason for this could be due to slight misalignment of the voltage probes. Nevertheless, it can be seen that at $B_c = 11$ T and $-B_c = -11$ T, the measured resistances are approximately temperature independent. The corresponding Landau level filling factor is about 50 in this case. Therefore, a direct 0-50 transition has been observed. Note that even at the highest attainable field of approximately 15 T, there is no sign of resistance oscillations due to the moderate mobility of our GaN system. Therefore, the experimental results of this study clearly demonstrate that the observed direct I-QH transition is irrelevant to Landau quantization. Therefore, the onset of Landau quantization does not necessarily accompany the direct I-QH transition, inconsistent with Huckestein's model [20].

Figure 5 shows magnetoresistance measurements on Sample C as a function of magnetic field at various temperatures. It can be seen that the 2DES undergoes a 0-8 transition characterized by an approximately temperature-independent point in ρ_{xx} at the crossing field B_c . Near the crossing field, ρ_{xx} is very close to ρ_{xy} though ρ_{xy} shows a weak T dependence. For $B < B_c$, no resistance oscillation is observed. At first glance, our experimental results are consistent with Huckestein's model. However, it is noted that Landau quantization should be linked with quantum mobility, not classical Drude mobility [36]. Moreover, the observed oscillations for $B > B_c$ do not always correspond to formation of quantum Hall states. As mentioned in our previous study [36], the observed oscillations can be well approximated by conventional Shubnikov-de Haas (SdH) formalism. It is noted that the SdH formula is derived without considering quantum localization effects which give rise to formation of quantum Hall state. Therefore, quantum localization effects are not significant in the system under this study. Actually, as shown in Figure 6, the crossing point in σ_{xy} at around 7.9 T may correspond to the extended states due to the onset of the strong localization effects. Therefore, in this study, the onset of strong localization actually occurs at a magnetic field approximately 4 T higher than the crossing point.

It has been suggested that by converting the measured resistivities into longitudinal and Hall conductivities, it is possible to shed more light on the observed I-QH

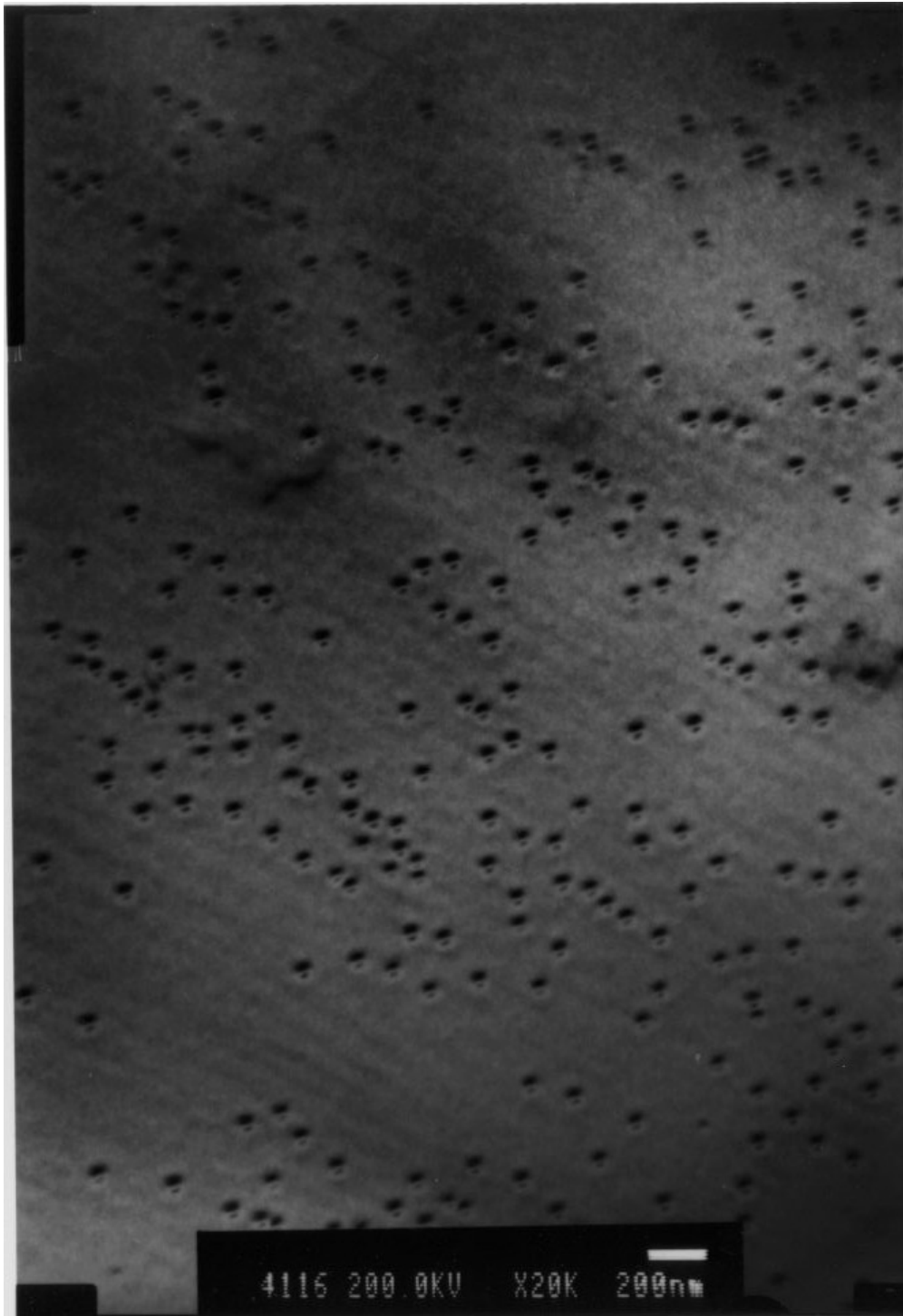
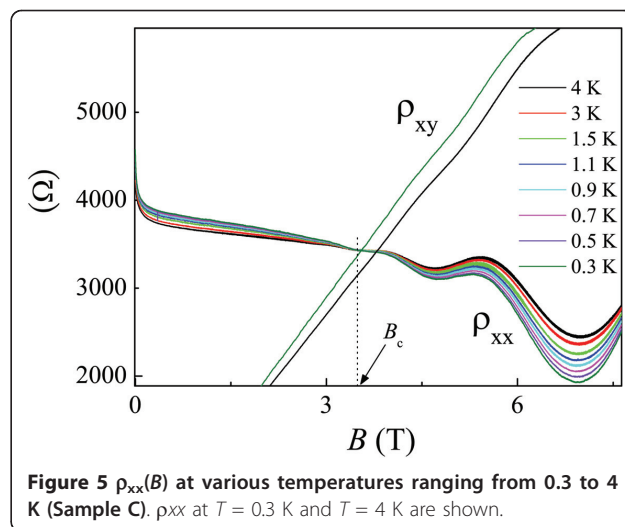
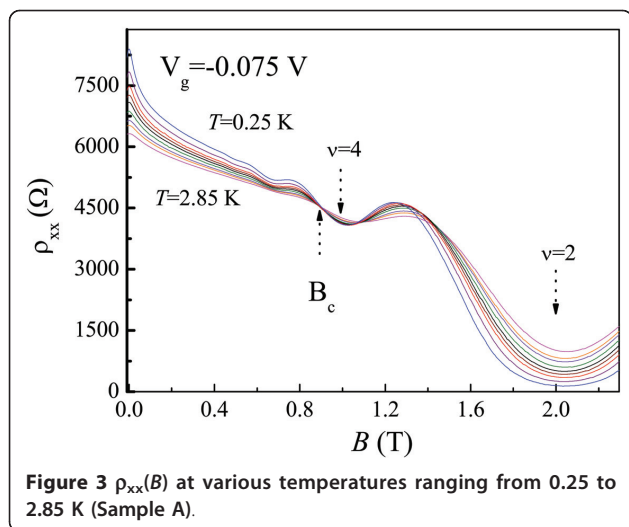

Figure 2 A plane-view of TEM image of the wafer which was cut to fabricate sample A.

transition [5]. Figure 6 shows such results at various temperatures. Interestingly, for $B < 5$ T, σ_{xy} is nominally T independent. Such data are consistent with electron-electron interaction effects. Over the whole measurement range, σ_{xx} decreases with increasing T , consistent with

electron-electron interaction effects. Unlike σ_{xy} , σ_{xx} shows a significant T dependence.

By inspecting the conductivities, previously the authors have studied the renormalized mobility [43] of a GaN-based 2DES at high temperatures (Sample B) [44]. It is



therefore interesting to study such a mobility for both Sample A and Sample C. It has been suggested the electron-electron interaction effects can renormalize the mobility μ' given by

$$\sigma_{xy} = \frac{ne\mu'^2 B}{1 + (\mu' B)^2}, \quad (1)$$

$$\sigma_{xx} = \frac{ne\mu' B}{1 + (\mu' B)^2} + \Delta\sigma_{ee}^d. \quad (2)$$

Figure 7 and the inset to Figure 7 show σ_{xy} and σ_{xx} , together with fits to Equations 1 and 2 over limited ranges for Sample C, respectively. From the fits, it is possible to determine the respective renormalized mobilities as a function of temperature as shown in Figure 8a for Sample C and in Figure 8b for Sample A. The

renormalized mobility calculated using Equation 1 is only slightly larger than that using Equation 2. It may be possible that different mobilities should be taken into account to understand the direct I-QH transition [37,43,45].

Conclusions

In conclusion, the authors have presented studies on three completely different electron systems. In these three samples, the nanoscaled scatterers, in close proximity of the 2DES, provide necessary disorder for observing the direct I-QH transition. In these studies, it has been shown that the crossover from localization to Landau quantization actually covers a wide range of magnetic field. Moreover, the observed direct I-QH transition is not necessarily linked with Landau quantization as no resistance oscillations are observed even up to a magnetic field 4 T higher than the crossing

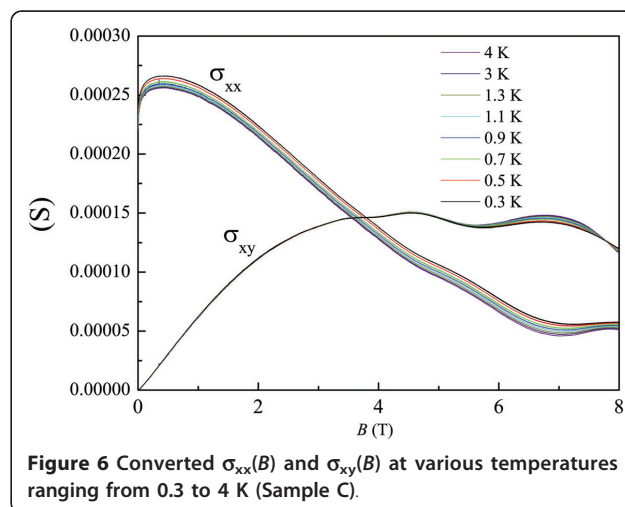
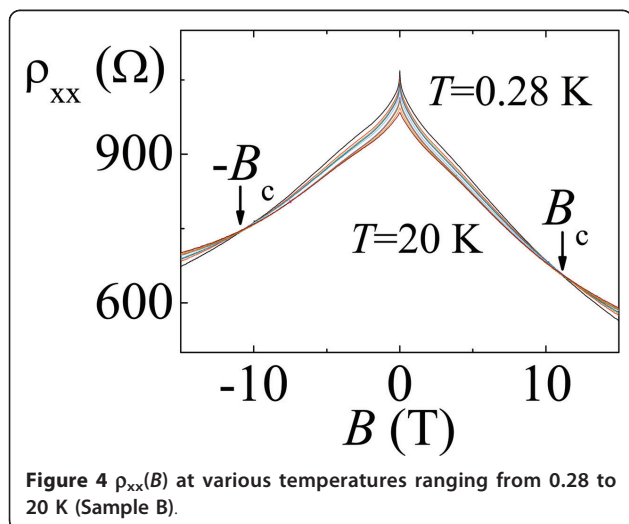

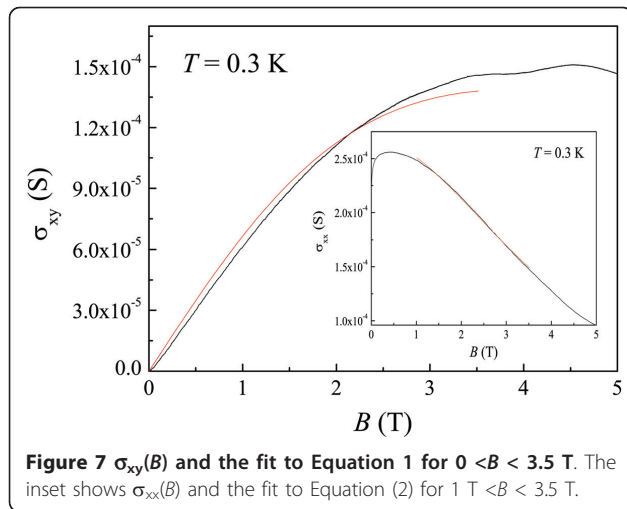

Figure 7 $\sigma_{xy}(B)$ and the fit to Equation 1 for $0 < B < 3.5$ T. The inset shows $\sigma_{xx}(B)$ and the fit to Equation (2) for $1 \text{ T} < B < 3.5$ T.

field. Most importantly, the onset of strong localization which gives rise to the formation of quantum Hall state does not correspond to the direct I-QH transition. All these three pieces of experimental evidence show that a 2DES in the vicinity of nanoscaled scatterers is an ideal playground for studying the direct I-QH transition. Furthermore, in order to obtain a thorough understanding of the underlying physics of the direct I-QH transition, modifications of Hückelstein's model [20] must be made.

Abbreviations

I-QH: insulator-quantum Hall; Sdh: Shubnikov-de Haas; 2DESs: two-dimensional electron systems.

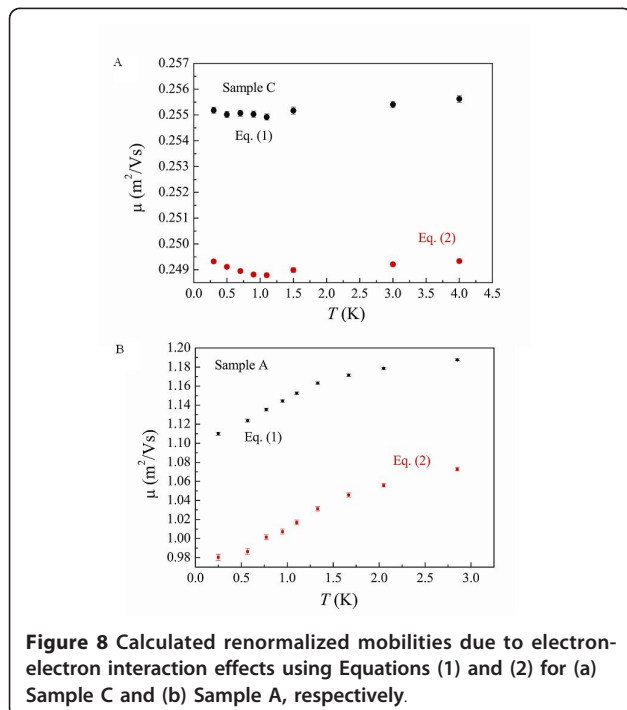

Figure 8 Calculated renormalized mobilities due to electron-electron interaction effects using Equations (1) and (2) for (a) Sample C and (b) Sample A, respectively.

Acknowledgements

This research was supported by the WCU (World Class University) program through the National Research Foundation of Korea (NRF) funded by the Ministry of Education, Science and Technology (Grant No. R32-2008-000-10204-0). C.T.L. acknowledges financial support from the NSC (Grant no: NSC 99-2119-M-002-018-MY3). The authors would like to thank Yi-Chun Su and Jau-Yang Wu for providing help in the experiments.

Author details

¹Department of Physics, National Taiwan University, Taipei 106, Taiwan
²Department of Applied Physics, National Chiayi University, Chiayi 600, Taiwan
³Department of Physics, National Tsinghua University, Hsinchu 300, Taiwan
⁴Department of Electronic and Electrical Engineering and SAINT, Sungkyunkwan University, Suwon 440-746, Korea
⁵Graduate School of Advanced Integration Science, Chiba University, Chiba 263-8522, Japan
⁶National Measurement Laboratory, Centre for Measurement Standards, Industrial Technology Research Institute, Hsinchu 300, Taiwan
⁷Department of Electronics Engineering, National Chiao Tung University, Hsinchu 300, Taiwan
⁸Cavendish Laboratory, JJ. Thomson Avenue, Cambridge CB3 0HE, UK

Authors' contributions

CTL, GHK and YHC coordinated the measurements on Sample A. CTL coordinated the measurements on Sample B. KYC performed the measurements on Sample B. JCC and YL coordinated the measurements on Sample C undertaken in Taiwan. YO and NA coordinated early measurements on Sample C in Japan. CTL, STL and CFH drafted the manuscript. LHL, YTW and DLS performed measurements on Sample C. SDL and DAR grew the MBE wafers. All authors read and approved the final manuscript.

Competing interests

The authors declare that they have no competing interests.

Received: 14 August 2010 Accepted: 11 February 2011

Published: 11 February 2011

References

- von Klitzing K, Dorda G, Pepper M: **New Method for High-Accuracy Determination of the Fine-Structure Constant Based on Quantized Hall Resistance.** *Phys Rev Lett* 1980, **45**:494.
- Kivelson S, Lee DH, Zhang SC: **Global phase diagram in the quantum Hall effect.** *Phys Rev B* 1992, **46**:2223.
- Jiang HW, Johnson CE, Wang KL, Hannah ST: **Observation of magnetic-field-induced delocalization: Transition from Anderson insulator to quantum Hall conductor.** *Phys Rev Lett* 1993, **71**:1439.
- Wang T, Clark KP, Spencer GF, Mack AM, Kirk WP: **Magnetic-field-induced metal-insulator transition in two dimensions.** *Phys Rev Lett* 1994, **72**:709.
- Hughes RJF, Nicholls JT, Frost JEF, Linfield EH, Pepper M, Ford CJB, Ritchie DA, Jones GAC, Kogan E, Kaveh M: **Magnetic-field-induced insulator-quantum Hall-insulator transition in a disordered two-dimensional electron gas.** *J Phys Condens Matter* 1994, **6**:4763.
- Laughlin RB: **Levitation of Extended-State Bands in a Strong Magnetic Field.** *Phys Rev Lett* 1984, **52**:2304.
- Khmelnitskii D: **Quantum hall effect and additional oscillations of conductivity in weak magnetic fields.** *Phys Lett* 1984, **106A**:182.
- Liu DZ, Xie XC, Niu Q: **Weak Field Phase Diagram for an Integer Quantum Hall Liquid.** *Phys Rev Lett* 1996, **76**:975.
- Sheng DN, Weng ZY: **Disappearance of Integer Quantum Hall Effect.** *Phys Rev Lett* 1997, **78**:318.
- Sheng DN, Weng ZY: **Phase diagram of the integer quantum Hall effect.** *Phys Rev B* 2000, **62**:15363.
- Kravchenko SV, Kravchenko GV, Furneaux JE, Pudalov VM, D'orio M: **Possible metal-insulator transition at $B = 0$ in two dimensions.** *Phys Rev B* 1994, **50**:8039.
- Dobrosavljevic V, Abrahams E, Miranda E, Chakravarty S: **Scaling Theory of Two-Dimensional Metal-Insulator Transitions.** *Phys Rev Lett* 1997, **79**:455.
- Chang WH, Lin CH, Fu YJ, Lin TC, Lin H, Cheng SJ, Lin SD, Lee CP: **Impacts of Coulomb Interactions on the magnetic response of excitonic complexes in single semiconductor nanostructures.** *Nanoscale Res Lett* 2010, **5**:680.

14. Kim GH, Nicholls JT, Khondaker SI, Farrer I, Ritchie DA: **Tuning the insulator-quantum Hall liquid transitions in a two-dimensional electron gas using self-assembled InAs.** *Phys Rev B* 2000, **61**:10910.
15. Kim GH, Liang CT, Huang CF, Nicholls JT, Ritchie DA, Kim PS, Oh CH, Juang JR, Chang YH: **From localization to Landau quantization in a two-dimensional GaAs electron system containing self-assembled InAs quantum dots.** *Phys Rev B* 2004, **69**:073311.
16. Song SH, Shahar D, Tsui DC, Xie YH, Monroe D: **New Universality at the Magnetic Field Driven Insulator to Integer Quantum Hall Effect Transitions.** *Phys Rev Lett* 1997, **78**:2200.
17. Lee CH, Chang YH, Suen YW, Lin HH: **Magnetic-field-induced delocalization in center-doped GaAs/Al_xGa_{1-x}As multiple quantum wells.** *Phys Rev B* 1998, **58**:10629.
18. Huang CF, Chang YH, Lee CH, Chuo HT, Yeh HD, Liang CT, Lin HH, Cheng HH, Hwang GJ: **Insulator-quantum Hall conductor transitions at low magnetic field.** *Phys Rev B* 2002, **65**:045303.
19. Huang TY, Juang JR, Huang CF, Kim GH, Huang CP, Liang CT, Chang YH, Chen YF, Lee Y, Ritchie DA: **On the low-field insulator-quantum Hall conductor transition.** *Physica E* 2004, **22**:240.
20. Huckestein B: **Quantum Hall Effect at Low Magnetic Fields.** *Phys Rev Lett* 2000, **84**:3141.
21. Huang TY, Liang CT, Kim GH, Huang CF, Huang CP, Lin JY, Goan HS, Ritchie DA: **From insulator to quantum Hall liquid at low magnetic fields.** *Phys Rev B* 2008, **78**:113305.
22. Huang TY, Huang CF, Kim GH, Huang CP, Liang CT, Ritchie DA: **An Experimental Study on the Hall Insulators.** *Chin J Phys* 2009, **47**:401.
23. Huang TY, Liang CT, Kim GH, Huang CF, Huang CP, Ritchie DA: **Probing two-dimensional metallic-like and localization effects at low magnetic fields.** *Physica E* 2010, **42**:1142.
24. Nakamura S, Senoh M, Iwasa N, Hagehama S, Yamada Y, Mukai Y: **Superbright Green InGaN Single-Quantum-Well-Structure Light-Emitting Diodes.** *Jpn J Appl Phys* 2 1995, **34**:L1332.
25. Wu Y, Keller B, Keller S, Kapolnek D, Kozodoy P, DenBaars S, Mishra U: **Very high breakdown voltage and large transconductance realized on GaN heterojunction field effect transistors.** *Appl Phys Lett* 1996, **69**:1438.
26. Bulman GE, Doverspike K, Sheppard ST, Weeks TW, Kong HS, Dieringer HM, Edmond JA, Brown JD, Swindell JT, Schetzina JF: **Pulsed operation lasing in a cleaved-facet InGaN/GaN MQW SCH laser grown on 6H-SiC.** *Electron Lett* 1997, **33**:1556.
27. Mack MP, Abare A, Aizcorbe M, Kozodoy P, Keller S, Mishra UK, Coldren L, Denbaars S: **Characteristics of indium-gallium-nitride multiple-quantum-well blue laser diodes grown by MOCVD.** *MRS Internet J Nitride Semicond Res* 1997, **2**:41.
28. Hang DR, Liang CT, Juang JR, Huang TY, Hung WK, Chen YF, Kim GH, Lee JH, Lee JH: **Electrically detected and microwave-modulated Shubnikov-de Haas oscillations in an Al_{0.4}Ga_{0.6}N/GaN heterostructure.** *J Appl Phys* 2003, **93**:2055.
29. Juang JR, Huang TY, Chen TM, Lin MG, Lee Y, Liang CT, Hang DR, Chen YF, Chyi Ji: **Transport in a gated Al_{0.18}Ga_{0.82}N/GaN electron system.** *J Appl Phys* 2003, **94**:3181.
30. Cho KS, Huang TY, Huang CP, Chiu YH, Liang CT, Chen YF, Lo I: **Exchange-enhanced g-factors in an Al_{0.25}Ga_{0.75}N/GaN two-dimensional electron system.** *J Appl Phys* 1996, **96**:7370.
31. Chen JH, Lin JY, Tsai JK, Park H, Kim GH, Youn D, Cho HI, Lee EJ, Lee JH, Liang CT, Chen YF: **Experimental evidence for Drude-Boltzmann-like transport in a two-dimensional electron gas in an AlGaIn/GaN heterostructure.** *J Korean Phys Soc* 2006, **48**:1539.
32. Lin JY, Chen JH, Kim GH, Park H, Youn DH, Jeon CM, Baik JM, Lee JL, Liang CT, Chen YF: **Magnetotransport measurements on an AlGaIn/GaN two-dimensional electron system.** *J Korean Phys Soc* 2006, **49**:1130.
33. Hang DR, Chou MMC, Hsieh MH, Heuken M: **Influence of an Advanced Buffer Layer on the Optical Properties of an InGaIn/GaN MQW Grown on a (111) Silicon Substrate.** *J Korean Phys Soc* 2007, **50**:797.
34. Chen KY, Liang CT, Chen NC, Chang PH, Chang CA: **Weak Localization and electron-electron interaction effects in Al_{0.15}Ga_{0.85}N/GaN High Electron Mobility Transistor Structure.** *Chin J Phys* 2007, **45**:616.
35. Schremer AT, Smart JA, Wang Y, Ambacher O, MacDonald NC, Shealy JR: **High electron mobility AlGaIn/GaN heterostructure on (111) Si.** *Appl Phys Lett* 2000, **76**:736.
36. Chen KY, Chang YH, Liang CT, Aoki N, Ochiai Y, Huang CF, Lin LH, Cheng KA, Cheng HH, Lin HH, Wu JY, Lin SD: **Probing Landau quantization with the presence of insulator-quantum Hall transition in a GaAs two-dimensional electron system.** *J Phys Condens Matter* 2008, **20**:295223.
37. Chen KY, Liang CT, Aoki N, Ochiai Y, Cheng KA, Lin LH, Huang CF, Li Y-R, Tseng YS, Yang CK, Lin PT, Wu JY, Lin SD: **Probing insulator-quantum Hall transitions by current heating.** *J Korean Phys Soc* 2009, **55**:64.
38. Kannan ES, Kim G-Ho, Lin JY, Chen JH, Chen KY, Zhang ZY, Liang CT, Lin LH, Youn DH, Kang KY, Chen NC: **Experimental Evidence for Weak Insulator-Quantum Hall Transitions in GaN/AlGaIn Two-Dimensional Electron Systems.** *J Korean Phys Soc* 2007, **50**:1643.
39. Li W, Csathy GA, Tsui DC, Pfeiffer LN, West KW: **Direct observation of alloy scattering of two-dimensional electrons in Al_xGa_{1-x}As.** *Appl Phys Lett* 2003, **83**:2832.
40. Li W, Csathy GA, Tsui DC, Pfeiffer LN, West KW: **Scaling and Universality of Integer Quantum Hall Plateau-to-Plateau Transitions.** *Phys Rev Lett* 2005, **94**:206807.
41. Li W, Vicente CL, Xia JS, Pan W, Tsui DC, Pfeiffer LN, West KW: **Scaling in Plateau-to-Plateau Transition: A Direct Connection of Quantum Hall Systems with the Anderson Localization Model.** *Phys Rev Lett* 2009, **102**:216801.
42. Shahar D, Tsui DC, Shayegan M, Shimshoni E, Sondhi SL: **A Different View of the Quantum Hall Plateau-to-Plateau Transitions.** *Phys Rev Lett* 1997, **79**:479.
43. Minkov GM, Germanenko AV, Rut OE, Sherstobitov AA, Larionova VA, Bakarov AK, Zvonkov BN: **Diffusion and ballistic contributions of the interaction correction to the conductivity of a two-dimensional electron gas.** *Phys Rev B* 2006, **74**:045314.
44. Liang CT, Lin LH, Huang JZ, Zhang ZY, Sun ZH, Chen KY, Chen NC, Chang PH, Chang CA: **Electron-electron interactions in Al_{0.15}Ga_{0.85}N/GaN high electron mobility transistor structures grown on Si substrates.** *Appl Phys Lett* 2007, **90**:022107.
45. Murzin SS: **On the phase boundaries of the integer quantum Hall effect. Part II.** *JETP Lett* 2010, **91**:155.

doi:10.1186/1556-276X-6-131

Cite this article as: Liang et al.: On the direct insulator-quantum Hall transition in two-dimensional electron systems in the vicinity of nanoscaled scatterers. *Nanoscale Research Letters* 2011 **6**:131.

Submit your manuscript to a SpringerOpen® journal and benefit from:

- Convenient online submission
- Rigorous peer review
- Immediate publication on acceptance
- Open access: articles freely available online
- High visibility within the field
- Retaining the copyright to your article

Submit your next manuscript at ► springeropen.com