

S. RUSZ*, L. CIZEK*, M. SALAJKA*, S. TYLSAR*, J.KEDRON*, V. MICHENKA**, T. DONIC***, E. HADASIK****, M. KLOS*

ULTRAFINE GRAIN REFINEMENT OF AlMn1Cu AND AZ 31 ALLOYS BY SPD PROCESS

ROZDROBNIENIE ZIARN STOPÓW AlMn1Cu I AZ 31 DO ROZMIARÓW ULTRAMETRYCZNYCH Z ZASTOSOWANIEM PROCESU SPD

One of the ways to the more effective use of metallic materials is their processing by forming. At present in this the area the use of the process of severe plastic deformation (SPD process), leading to a refinement of the structure (materials with UFG structure) and thus to achievement of higher level of their utility value, is expanding. AlMn1Cu alloy is commercially produced aluminum alloy by the company Al Invest Bridlicna (the cast strip with a mild reduction by rolling up to 10% to the thickness of 10 and 15 mm, which has its uses especially in engineering. AZ31 alloy is commercially produced aluminum alloy after casting and extrusion at 400°C on final rod with 20 mm diameter. For experimental purposes from the belts of alloys the test samples of the underlying dimensions of 10×10 mm length 40 mm (geometry with channel deflection 20°) and 15×15 mm length 60 mm (geometry with helix matrix) in the direction of rolling were made. All three instruments are made of high tool steel - HOTVAR. For compare the influence of geometry ECAP tool on structure refining was used AlMn1Cu and AZ31 alloys were used three specially made tools ECAP, differing mainly in the construction design.

Keywords: severe plastic deformation, ECAP method, hardness, microstructure

Jednym ze sposobów bardziej efektywnego kształtowania plastycznego metali jest metoda dużych odkształceń plastycznych. Aktualnie do tego celu wykorzystywany jest proces SPD, w wyniku którego osiąga się wysokie wartości odkształcenia materiału z ultra drobnoziarnistą strukturą. Prowadzi to do wzrostu właściwości wytrzymałościowych, przy nieznacznym obniżeniu plastyczności. W artykule przedstawiono wyniki badań dwóch stopów – stop aluminium AlMn1Cu, który jest produkowany w formie blachy grubości 10 lub 15 mm z zastosowaniem w przemyśle maszynowym oraz stop magnezu AZ31, który po odlaniu jest wyciskany w temperaturze 400°C z pręta o średnicy 60 mm na średnicę 20 mm. Do eksperymentów użyto próbek o rozmiarach 10×10-40 mm z odchyleniem kanału narzędzia ECAP o 20° od kierunku poziomego oraz próbki o rozmiarach 15×15-60 mm z nową geometrią kanału narzędzia ECAP (część kanału w kształcie śruby) dla zwiększenia odkształcenia w poszczególnych przejściach próbki narzędziem ECAP. Uzyskane wyniki twardości oraz struktury, przy użyciu wyżej podanych geometrii narzędzia ECAP, były porównywane oddzielnie u obu stopów.

1. Introduction

The process of plastic deformation, which leads to a refinement of the structure, depends on several factors. The most important mechanism of cold and hot plastic deformation is dislocation slip, which is the most evident under the shear stress load. It is one of the main pre-requisites at designing the methods based on the use of the SPD process. The effect was observed mainly in metals and alloys with cubic face-centred lattice, characterised by a high number of slip systems (Al, Cu, Ni) [1,4,5,6].

In addition to the mentioned lattice structure the following factors are involved: the structure before deformation (grain size, microstructure), the second phase particles, strain rate and temperature of deformation, magnitude of deformation,

the route of deformation. Mechanisms of grain refinement vary depending on the magnitude of deformation divided the influence of the magnitude of an increase of deformation into four areas [2,3]. This concerns evaluation of results achieved during deformation of metals with cubic face-centred lattice ECAP (ECAP-principle – see below at description of the proposed project), using the deformation route B_C : small strain intensity ($\epsilon_{VM} < 2$), small to moderate strain intensity ($\epsilon_{VM} = 2 - 4$), moderate to high strain intensity ($\epsilon_{VM} = 4 - 6$), extreme strain intensity – SPD ($\epsilon_{VM} > 6$) [5].

Ultra fine-grained materials (UFG) are defined as poly-crystals with average grain size in the range from 100 nm - 1000 nm, i.e. less than 1 μ m. UFG materials include also nano-materials with grain sizes ranging from 10 nm - 100 nm. Growing interest in UFG materials arises mainly for two rea-

* VSB – TECHNICAL UNIVERSITY OF OSTRAVA, FACULTY OF MECHANICAL ENGINEERING, CZ 708 33 OSTRAVA PORUBA, CZECH REPUBLIC

** RESEARCH INSTITUTE OF IRON AND METALLURGY DOBRA, CZ 738 01 DOBRA, CZECH REPUBLIC

*** TECHNICAL UNIVERSITY OF ZILINA, 010 26 ZILINA, SLOVAKIA

**** SILESIAN UNIVERSITY OF TECHNOLOGY KATOWICE, FACULTY OF MATERIALS ENGINEERING AND METALLURGY, KATOWICE, POLAND

sons. Firstly, it is known that in all the alloys the Hall-Petch mechanism [4] contributes to strengthening of the material at room temperature according.

The basic methods of production of UFG materials are the following [3,7]:

- ECAP** – Equal Channel Angular Pressing
- DCAP** – Dissimilar Channel Angular Pressing
- HPT** – High Pressure Torsion
- CCDC** – Cyclic Channel Die Compression
- CEC** – Cyclic Extrusion Compression
- CONFORM** – Continuous Extrusion Forming
- ARB** – Accumulative Roll Bonding
- CGP** – Constrained Groove Pressing
- TE** – Twist Extrusion

Designing a new concept of geometry tool

The ECAP method is based on extrusion of the sample through the tool with an internal L-shaped channel, without any change of cross-section of the sample, as it is evident from Figure 1. The sample is inserted from above into the vertical channel and then extruded through the tool [7,14]. This operation is then repeated in order to achieve the required degree of deformation of the material leading to a refinement of the structure. It is possible to use in the process various types of changes of the route of deformation [11].

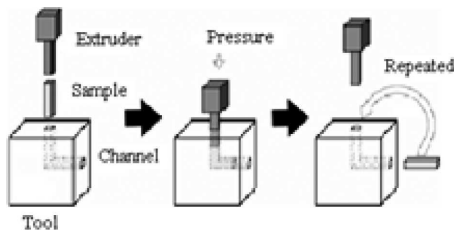

Fig. 1. The principle of the ECAP method [7]

New concept – method ECAP with twist extrusion

TE is based on extrusion of the sample of prismatic cross-section through the tool with the profile consisting of two prismatic parts separated by a helical part (Fig. 2). Cross-section at TE remains unchanged. This feature makes it possible to extrude the sample repeatedly in order to accumulate the strain needed to change the micro-structure and mechanical properties of the sample material.

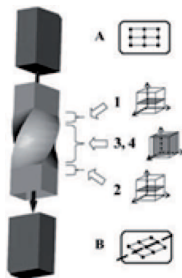

Fig. 2. Principle of the Twist Extrusion Process [10,12]

Technological possibilities of the TE method compared with the ECAP method [12]. Magnitude of termination of the deformed area of the sample at the input and output part of the sample is much lower in TE than in ECAP. This is a feature, which is very important for repeating of passes. Change of the

sample profile occurs at the central part of the axial channel TE can be easily installed on the standard equipment of the press by replacement of traditional tools by the tool with rotary channel (helix). Tool (TE) does not change the direction of movement of the sample, which enables its simple inclusion into the existing tools on the presses and thus integration of this equipment into a production line [6,13]. The proposed project will verify the totally new concept of the forming tool – called ECAP + TE (ECAP tool with built-helix in the horizontal channel – Fig. 3). This new approach will make it possible to significantly increase the efficiency of the process of severe plastic deformation (SPD). The material will be strengthened very intensely, allowing us to achieve a high degree of deformation of material at a lower number of passes through the forming tool [8]. At the same time high homogeneity of the structure will be achieved.

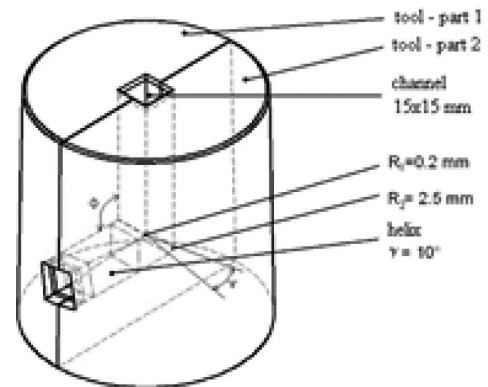

Fig. 3. Insert of the ECAP tool with built-in helix

2. Experimental materials

AlMn1Cu alloy is commercially produced aluminum alloy by the company Al Invest (the cast strip with a mild reduction by rolling up to 10% to the thickness of 10 and 15 mm, which has its uses especially in engineering. Chemical composition of the AlMn1Cu alloy is given in Tab.1. AZ31 alloy is commercially produced aluminum alloy after casting and extrusion at 400°C on final rod with 20 mm diameter. Chemical composition of the AZ31 alloy is given in Tab.2. For experimental purposes from the belts of alloys the test samples of the underlying dimensions of 10×10 mm length 40 mm (geometry with channel deflection 20°) and 15×15 mm length 60 mm (geometry with helix matrix) in the direction of rolling were made.

TABLE 1
Chemical composition of AlMn1Cu alloy (weight %)

Si	Fe	Cu	Mn	Other	Al
00.55	00.45	00.15	11.1	00.15	Rest

TABLE 2
Chemical composition of the AZ31 alloy (weight %)

Al	Zn	Cu	Mn	Other	Mg
33.07	00.765	00.0016	00.246	00.15	Rest

3. ECAP design tools used in the experiments

For compare the influence of geometry ECAP tool on structure refining was used AlMn1Cu and AZ31 alloys were used three specially made tools ECAP, differing mainly in the construction design. All three instruments are made of high tool steel – H0TVAR. The first tool used in the experiment is a classic tool of ECAP with vertical and horizontal channel connections at an angle $\varphi = 90^\circ$, outer radius $R1 = 2.5$ mm, inner radius $R2 = 0.2$ mm and 10×10 mm cross-section of the channel (Fig. 1). The second tool is based on geometry from the first type [9]. To the modification of instruments occurred in the horizontal part of channel – deflection of the horizontal channel with 20° around axis "z" (Fig. 4). The third modification of tool used in the experiment is a new tool of ECAP with helix part in the horizontal part of channel (Fig. 5). The helix angle is 10° and 30° . Value of the outer channel radius is $R1 = 2.5$ mm, inner radius $R2 = 0.5$ mm and the angles of the channel have values $\varphi = 90^\circ$, $\psi = 90^\circ$. The main benefit of the new geometry is arising of the backpressure and the increasing degree of deformation. The tools used are shown in Fig. 4,5,6 and 7.

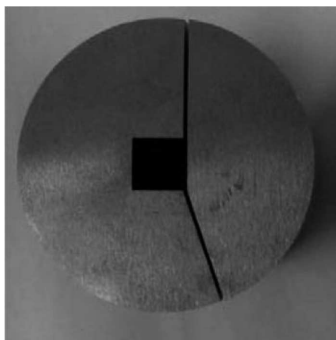

Fig. 4. The horizontal channel with 20° around axis



Fig. 5. ECAP tool with helix matrix

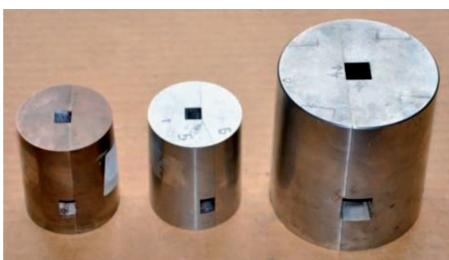

Fig. 6. General view on used ECAP tools



Fig. 7. Shape of punches

4. Influence of the number of passes on the stress –strain curves

The results of experiments conducted on hydraulic press DP 1600 kN, was shown a significant effect modification of the geometry tools ECAE curves deformable resistance and thus hardening the AlMn1Cu and magnesium AZ31 alloys each channel passes. According to the assumptions underlying the increase deformable resistance occurs in all the instruments of ECAP with increasing number of passes. Fig. 8 shows selected readings stress-strain curves after selected passes through the channel for AlMn1Cu alloy. Very good results were achieved in both alloys using geometry tools with embedded helix after 1st and 5th passes through the ECAP tool. Fig. 9 show selected readings stress-strain curves after selected passes through the channel for magnesium alloy AZ31[8,9].

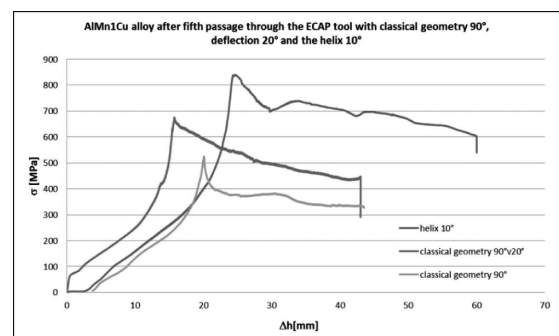

a)

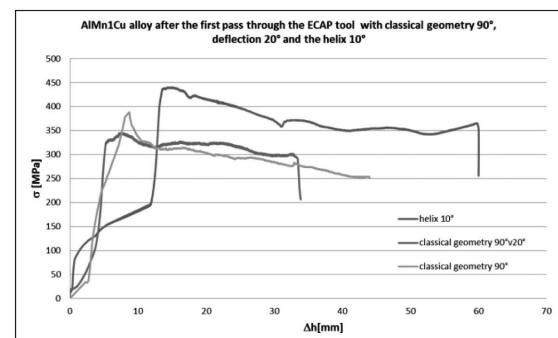

b)

Fig. 8. Stress-strain curves a) after the first and b) after the fifth pass through ECAP

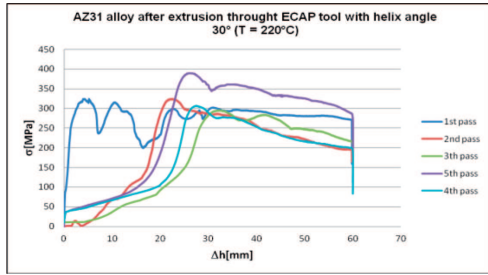

Fig. 9. Stress-strain curves ECAP with helix matrix

5. Metallographic analysis

For metallographic analyses a series of samples after passes were prepared by the cutting perpendicular to forming direct. Metallographic analysis of the final structure of the AlMn1Cu alloy was performed methods of light microscopy, TEM and SAED. For the AZ31 alloy the metallographic analysis by light microscopy was carried out. Metallographic analysis on light microscopy NEOPHOT 2 was performed. After the usual metallographic preparation the AlMn1Cu alloy underwent the electrolytic etching and magnesium alloy AZ31 was etched. Results of metallographic analysis of samples AlMn1Cu alloy are shown in Fig. 10 and 11 (results of light microscopy). As it is seen from Fig. 10 and 11 the step of grain size arises with number of passes. Metallographic analysis TEM and SAED of AlMn1Cu alloy shows Fig. 12 and 13: a) initial state; b) after 5th pass classical ECAP tool; c) after 5th pass ECAP tool with deflection 20°; d) after 5th pass ECAP tool with helix 10° [8,9].

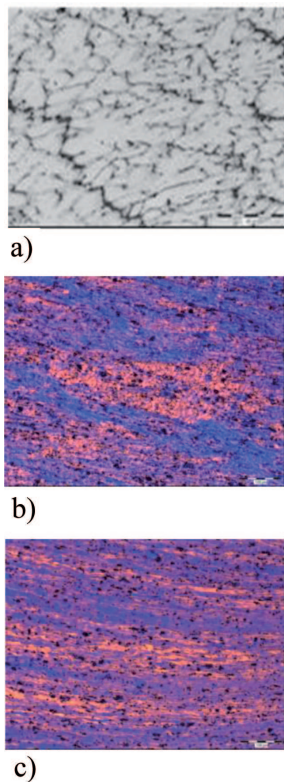

Fig. 10. Results of metallographic analysis of the AlMn1Cu alloy a) initial state, b) 3rd pass, c) 5th pass

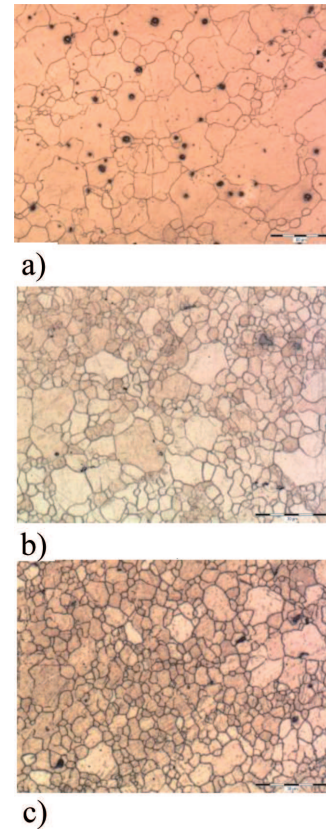

Fig. 11. Results of metallographic analysis of the magnesium alloy AZ31, a) initial state, b) 3rd pass, c) 5th pass

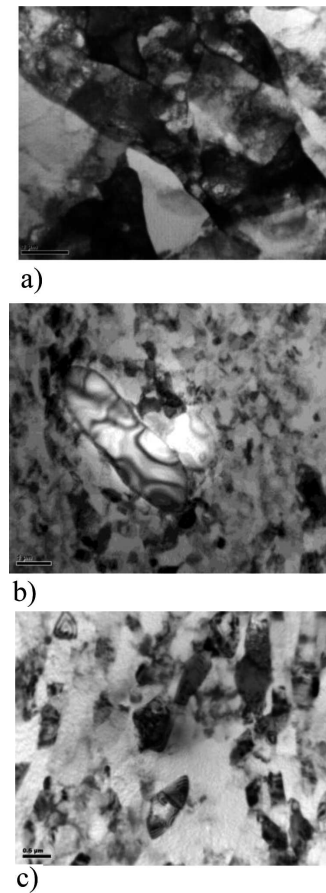

Fig. 12. Structure of the AlMn1Cu alloy (performed methods of TEM), a) initial state, b) 5th pass, channel without deflection, c) 5th pass, with 10° helix

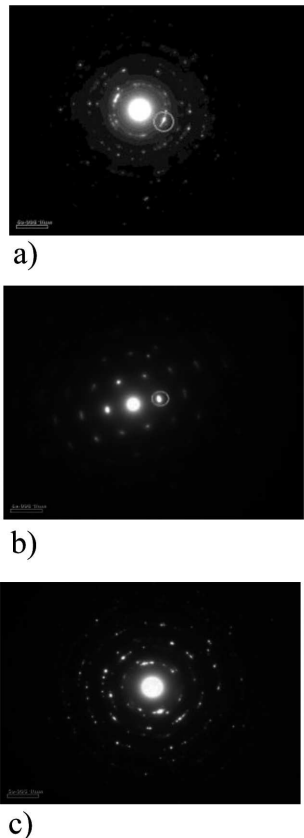

Fig. 13. Structure of the AIMn1Cu alloy (performed methods of SAED), a) initial state, b) 5th pass, channel without deflection, c) 5th pass, with 10° helix

6. Discussion

Testing plates with a thickness of 3 mm were used from samples after 5th pass. The plates were then cut and polished to a final thickness of 0.13-0.15 mm. AIMn1Cu alloy structure consists of grains of approximately the same size [8,9]. These grains contain crystals of Mn and Cu and in Fig. 12a are colored gray or black. The basic matrix of Al acting like precipitates, which reinforce the material and prevent secondary grain growth. The existence of precipitates is very important, because pure aluminum has a tendency to ECAP process, grain coarsening and loss of mechanical properties achieved. Initial grain size reached values of the order of 150-200 μm . The fifth classic extrusion tool without deflection formed small grains with large disorientation of the median size of 0,5 μm to 0,7 μm (Fig. 12 b) [8,9]. Originated here many intermetallic inclusions in the vicinity of small grains. Due to the partial recrystallization of small defects formed within the grains and showed the heterogeneity of the structure here. shows a fine-grained structure with mean grain size of 0,3 μm to 0,6 μm and high disorientation between the grains. Are there a lot of iron-containing intermetallic inclusions of up to 5 μm . The experimental verification of the ECAP tools with 10° helix in the horizontal part of the channel was achieved even with the largest increase deformable resistance during testing, refinement of large structures AIMn1Cu alloy (see Fig. 12 c). Calling back pressure by rotation the horizontal channel of 10° was to soften the material in grain size 250 nm [8,9].

Results of TEM analysis are verified using by SAED method (see Fig. 13 a,b,c).

7. Hardness

For the evaluation of hardness of formed material was used by Vickers hardness test, when investigated in the sample were carried out five stitches on the surface and central portions of the sample. Initial hardness of the alloy AIMn1Cu already achieved a significant increase after from 1st to 3rd pass all of the instruments used ECAP methods. When you make these measurements there was a gradual increase in hardness with increasing number of passages. After 5th resp. 6th passes occurs in all three tools to increase hardness of the alloy to almost 100% from baseline in both alloys (see Fig. 14 a,b)

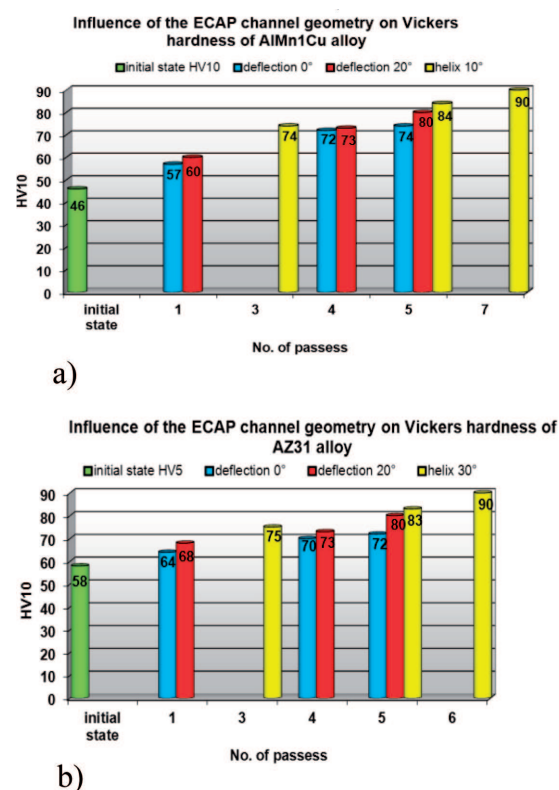

Fig. 14. Results of hardness, a) AIMn1Cu alloy, b) AZ 31 alloy

8. Conclusion

The main aim of the experiments is a refinement of the structure of alloys AIMn1Cu using the minimum number of ECAP passes with special tools [8,9]. To increase the degree of distortion, thereby achieving the desired structure is an important factor in appropriate modification tool geometry. Geometric adjustment of instruments is particularly evident in the new instrument ECAP helix is located 10° and 30° in the horizontal part of the channel, which shows an overall increase in efficiency of the SPD process and obtain significantly better mechanical properties of AIMn1Cu and AZ31 alloys [8,9]. The experimental results confirmed the achievement of very good grain refinement of the structure in both alloys. Structural design tools ECAP with inserted helix (pitch angle of 10 and 30°) substantially increases the efficiency of the production

UFG structure. Especially for AZ31 Mg alloy is given very important finding. It is well-known that grain refinement in Mg alloys is difficult to achieve at lower temperatures (about 200°C) [15]. The knowledge achieved in alloy AZ31 also want to check for other types of magnesium alloys used in aerospace and military industries.

Acknowledgements

The research work sponsored by project of Ministry of Industry and Trade No. 2A-1TP1/124 and the project of Ministry of Education, Youth and sports of Czech Republic, project Nanoteam VSB-TU Ostrava, CZ.1.07/2.3.00/20.0038 and the project Financial support of Structural Funds in the Operational Programme – Innovative Economy (IE OP) financed from the European Regional Development Fund – Project "Modern material technologies in aerospace industry", No POIG.01.01.02-00-015/08-00.



REFERENCES

- [1] M.Y. Gutkin, Ovidko and al. Theoretical models of plastic deformation processes in nano-crystalline materials. *Rev. Adv. Mater. Sci.*, 2, 80-102 (2001).
- [2] R. Song, D. Ponge, D. Raabe, Grain Boundary Characterization and Grain Size Measurement in an Ultrafine Grained Steel, Max-Planck Institut for Eisenforschung, Düsseldorf, Germany, *Z. Metallkd* **95**, 6, 513-517 (2004).
- [3] M. Berta, D. Orlov, P. Prangnell, *International Journal of Materials Research* **98**, 200-204 (2007).
- [4] N.J. Petch, *J. Iron Steel Inst.* **174**, 25 (1953).
- [5] A.H. Cottrell, *Trans. TMS-AIME* **212**, 192 (1958).
- [6] M.A. Meyers, D.J. Benson, H.H. Fu, in: *Advanced Materials for the 21st Century*, (Y. W. Chung, D. C. Dunand, P. K. Liaw, and G. B. Olson, eds.), The Minerals, Metals, and Materials Society, Warrendale, PA (1999), p. 499.
- [7] R.Z. Valiev, Recent Developments of Severe Plastic Deformation Techniques for Processing Bulk Nano-structured Materials, *Materials Science Forum* **579**, 1-14 (2008).
- [8] S. Rusz, L. Cizek, J. Kedron, S. Tylsar, M. Salajka, J. Dutkiewicz, M. Klos, E. Hadasik, Structure of AZ31 Magnesium alloy after ECAP processing. In *Journal of Trends in the Development of Machinery and Associated Technology* **16**, 1, 51-54 (2012), ISSN 2303-4009.
- [9] S. Rusz, V. Michenka, K. Malanik, M. Salajka, S. Tylsar, J. Kedron, Investigation of extreme deformation conditions on metals submicrostructure and testing methods to diagnostic their technological properties, Final Project Report No. Well. 2A 1TP1/124, p. 1-117 (2011).
- [10] V. Varyukhin, Y. Beygelzimer, B. Efros, Nanostructured Materials by Twist Extrusion and High Pressure Torsion. *Materials Science Forum* **A584-586**, 102-107 (2008).
- [11] A.V. Nagasekhar, S.C. Yoon, Y. Tick-Hon, H.S. Kim, An experimental verification of the finite element modeling of equal channel angular pressing, *Computational Materials Science* **46**, 347-351 (2009).
- [12] V. Varyukhin, Y. Beygelzimer, R. Kulagin, O. Prokof'eva, A. Reshetov, Twist Extrusion: Fundamentals and Applications, *Materials Science Forum* 2-vol. Set **667-669**, 31-38 (2011), ISSN 0255-5476.
- [13] F.Z. Utyashev, Strain Compatibility and Nanostructuring of Bulk Metallic Materials via Severe Plastic Deformation, *Materials Science Forum* 2-vol. Set **667-669**, 45-50 (2011), ISSN 0255-5476.
- [14] Z.C. Duan, T.G. Langdon, Effect of a Special ECAP Die Configuration on Microhardness Distributions in Pure Aluminum, *Materials Science Forum* 2-vol. Set **667-669**, 69-74 (2011), ISSN 0255-5476.
- [15] D. Kuc, E. Hadasik, I. Schindler, P. Kawulok, R. Śliwa, Characteristics of plasticity and microstructure of hot forming magnesium alloys Mg Al-Zn type. *Archives of Metallurgy and Materials* **58**, 1, 151-156 (2013).

Received: 10 May 2013.