

## **Economic impact analysis of the demonstrations in task-forces TF1 and TF3 - Deliverable D15.1**

WP15. Economic impacts of the demonstrations, barriers towards scaling up and solutions

**García-González, Javier ; Contreras, Alejandro ; Formozo, Camila ; Vallés, Mercedes ; Rivero, Enrique ; Lobato, Enrique ; Ramos, Andrés ; Frías, Pablo ; Egido, Ignacio ; Sánchez, Pedro ; Altiparmakis, Argyrios ; Litong-Palima, Marisciel ; Cutululis, Nicolaos Antonio ; Sørensen, Poul Ejnar ; Stryg, Morten ; Hansen, Jan ; Detlefsen, Nina ; Villumsen, Jonas Christoffer ; Andersen, Jeanne ; Wöllner, Stephan ; Lyck Falk, Kirsten ; Ostos, Plácido ; Rivier, Juan ; Azpiri, Iñigo**

*Publication date:*  
2014

*Document Version*  
Publisher's PDF, also known as Version of record

[Link back to DTU Orbit](#)

### *Citation (APA):*

García-González, J., Contreras, A., Formozo, C., Vallés, M., Rivero, E., Lobato, E., ... Azpiri, Í. (2014). Economic impact analysis of the demonstrations in task-forces TF1 and TF3 - Deliverable D15.1: WP15. Economic impacts of the demonstrations, barriers towards scaling up and solutions.

## **DTU Library** Technical Information Center of Denmark

---

### **General rights**

Copyright and moral rights for the publications made accessible in the public portal are retained by the authors and/or other copyright owners and it is a condition of accessing publications that users recognise and abide by the legal requirements associated with these rights.

- Users may download and print one copy of any publication from the public portal for the purpose of private study or research.
- You may not further distribute the material or use it for any profit-making activity or commercial gain
- You may freely distribute the URL identifying the publication in the public portal

If you believe that this document breaches copyright please contact us providing details, and we will remove access to the work immediately and investigate your claim.



# Economic impact analysis of the demonstrations in task-forces TF1 and TF3

Deliverable: D15.1



EC-GA n° 249812

**Project full title:** Transmission system operation with large penetration of Wind and other renewable Electricity sources in Networks by means of innovative Tools and Integrated Energy Solutions





## Disclaimer

This document has been prepared by TWENTIES project partners as an account of work carried out within the framework of the EC-GA contract n° 249812.

Neither Project Coordinator, nor any signatory party of TWENTIES Project Consortium Agreement, nor any person acting on behalf of any of them:

- (a) makes any warranty or representation whatsoever, express or implied,
  - (i) with respect to the use of any information, apparatus, method, process, or similar item disclosed in this document, including merchantability and fitness for a particular purpose, or
  - (ii) that such use does not infringe on or interfere with privately owned rights, including any party's intellectual property, or
  - (iii) that this document is suitable to any particular user's circumstance; or
- (b) assumes responsibility for any damages or other liability whatsoever (including any consequential damages, even if Project Coordinator or any representative of a signatory party of the TWENTIES Project Consortium Agreement, has been advised of the possibility of such damages) resulting from your selection or use of this document or any information, apparatus, method, process, or similar item disclosed in this document.

## TABLE OF CONTENTS

<b>DOCUMENT INFO</b> .....	<b>2</b>
<b>DISCLAIMER</b> .....	<b>4</b>
<b>LIST OF FIGURES</b> .....	<b>8</b>
<b>LIST OF TABLES</b> .....	<b>13</b>
<b>EXECUTIVE SUMMARY</b> .....	<b>16</b>
1.1.    IMPACT ASSESSMENT OF THE DEMOS BELONGING TO TF1: NEW SYSTEM SERVICES .....	17
1.2.    IMPACT ASSESSMENT OF THE DEMOS BELONGING TO TF3: NETWORK FLEXIBILITY.....	19
<b>1. INTRODUCTION</b> .....	<b>21</b>
<b>2. ECONOMIC IMPACT OF ACTIVE-POWER CONTROL PROVIDED BY WIND FARMS IN THE SPANISH SYSTEM</b> .....	<b>22</b>
2.1.    EXPECTED OUTCOMES OF THIS ANALYSIS .....	22
2.2.    MAIN FINDINGS OF THE DEMO .....	25
2.3.    DESCRIPTION OF THE ASSESSMENT METHODOLOGY AND PROBLEM SETTING .....	26
2.3.1. <i>Assessment methodology for a system perspective</i> .....	26
2.3.2. <i>Description of the model ROM</i> .....	26
2.3.3. <i>Description of the optimization stage</i> .....	28
2.3.4. <i>Description of the simulation stage</i> .....	33
2.3.5. <i>About the upward and downward requirements</i> .....	34
2.3.6. <i>Illustrative case in a mock-up example case</i> .....	35
2.3.7. <i>Description of input-data: scenarios for 2013 and 2020</i> .....	40
2.4.    RESULTS UNDER A SYSTEM PERSPECTIVE.....	42
2.4.1. <i>Results under a system perspective for the 2020 scenario: costs, emissions and impact on the generation shares</i> .....	42
2.4.2. <i>Sensitivity analysis for the 2020 scenario</i> .....	45
2.4.3. <i>Results under a system perspective for the 2013 scenario: costs, emissions and impact on the generation shares</i> .....	51
2.4.4. <i>Impact for a hypothetical scenario of larger wind penetration</i> .....	52
2.4.5. <i>Up-scaling of the required costs</i> .....	53
2.5.    THE AGENT PERSPECTIVE .....	54
2.6.    CONCLUSIONS .....	56
<b>3. ECONOMIC IMPACT OF VOLTAGE-CONTROL PROVIDED BY WIND FARMS IN THE SPANISH SYSTEM</b> <b>58</b>	
3.1.    EXPECTED OUTCOMES OF THIS ANALYSIS .....	58
3.2.    WIND FARM HARVESTING NETWORKS .....	59
3.3.    WIND POWER PENETRATION STUDY .....	59
3.3.1. <i>Introduction</i> .....	60
3.3.2. <i>Overview of the methodology</i> .....	61
3.3.3. <i>Simplified model of both, transmission and harvesting networks</i> .....	66
3.3.4. <i>Simplified model of TNet and detailed model of harvesting network</i> .....	77
3.3.5. <i>Simplified model of harvesting network and detailed model of TNet</i> .....	81
3.3.6. <i>Conclusions</i> .....	83
3.4.    ACTIVE POWER LOSSES STUDY.....	83
3.4.1. <i>Economic value of the active power losses in both grids (sub-transmission and wind farms grid)</i> .....	83
3.4.2. <i>Methodology</i> .....	84
3.4.3. <i>Illustrative test result</i> .....	87

3.4.4.	<i>Conclusions</i> .....	96
3.5.	CONCLUSIONS OF THE ECONOMIC ASSESSMENT OF THE VOLTAGE CONTROL.....	97
<b>4.</b>	<b>ECONOMIC IMPACT OF UP-SCALING THE VPP MODEL IN DENMARK .....</b>	<b>98</b>
4.1.	EXPECTED OUTCOMES OF THE ANALYSIS.....	98
4.2.	MAIN FINDINGS OF THE DEMO .....	99
4.2.1.	<i>Main findings of the demonstration of VPP technology: Power Hub</i> .....	99
4.2.2.	<i>Findings directly used in the VPP upscaling modelling</i> .....	99
4.2.3.	<i>Findings not used in the VPP up-scaling modelling</i> .....	102
4.2.4.	<i>Findings that justify the up-scaling of the VPP technology</i> .....	103
4.3.	DESCRIPTION OF THE ASSESSMENT METHODOLOGY AND PROBLEM SETTING .....	104
4.3.1.	<i>Methodology for assessing the impact of the VPP for a system</i> .....	104
4.3.2.	<i>Description of the tools and models used in the assessment</i> .....	105
4.3.3.	<i>Cold storage model</i> .....	107
4.3.4.	<i>Electric vehicle model</i> .....	109
4.3.5.	<i>Description of input-data: scenarios for 2020 and 2030</i> .....	110
4.4.	RESULTS.....	113
4.4.1.	<i>Day-ahead unit commitment results (WILMAR)</i> .....	113
4.4.2.	<i>Hour-ahead balancing results (SIMBA)</i> .....	125
4.5.	DESCRIPTION OF THE ASSESSMENT FOR THE SPANISH SYSTEM .....	126
4.5.1.	<i>Methodology for VPP-System Interaction</i> .....	126
4.5.2.	<i>VPP Performance Modeling in ROM</i> .....	127
4.5.3.	<i>Assessment of the VPP Impact on the System Costs</i> .....	128
4.5.4.	<i>The Generalized VPP Unit Model</i> .....	129
4.5.5.	<i>Description of Scenarios for the Spanish Case 2020</i> .....	131
4.5.6.	<i>Regulatory scheme: Remuneration and incentives</i> .....	132
4.5.7.	<i>Results</i> .....	133
4.6.	CONCLUSIONS .....	137
<b>5.</b>	<b>ECONOMIC IMPACT ASSESSMENT OF ENHANCED NETWORK FLEXIBILITY IN CORESO .....</b>	<b>138</b>
5.1.	EXPECTED OUTCOMES OF THIS ANALYSIS .....	138
5.2.	MAIN FINDINGS OF THE DEMO .....	140
5.3.	DESCRIPTION OF THE ASSESSMENT METHODOLOGY AND OF THE PROBLEM.....	142
5.3.1.	<i>Methodology for assessing the economic impact of the NETFLEX demo in Belgium</i> .....	142
5.3.2.	<i>Description of CONTINENTAL</i> .....	146
5.3.3.	<i>Description of input-data: scenarios for 2020</i> .....	148
5.4.	RESULTS OF THE TESTED DEMO .....	151
5.5.	RESULTS UNDER A SYSTEM PERSPECTIVE (CWE).....	151
5.5.1.	<i>KPI.15.TF3.2: Increase in exchanges</i> .....	151
5.5.2.	<i>KPI.15.TF3.3: Wind curtailment</i> .....	153
5.5.3.	<i>KPI.15.TF3.4: Cost Benefit Analysis</i> .....	154
5.5.4.	<i>KPI.15.TF3.5: Generation shares</i> .....	156
5.5.5.	<i>KPI.15.TF3.6: CO2 emissions</i> .....	157
5.6.	CONCLUSIONS .....	157
<b>6.</b>	<b>ECONOMIC IMPACT ASSESSMENT OF RTTR AND FACTS IN SPAIN.....</b>	<b>160</b>
6.1.	DESCRIPTION OF THE ASSESSMENT METHODOLOGY AND PROBLEM SETTING .....	160
6.1.1.	<i>Selection of potential locations for the placement of FACTS and DLR</i> .....	162
6.1.2.	<i>Impact of FACTS and DLR in the network</i> .....	163
6.1.3.	<i>Computation of the economic benefits of the enhanced network flexibility provided by FACTS and DLR technologies in Spain</i> .....	165
6.2.	ECONOMIC IMPACT ASSESSMENT OF THE TESTED DEMONSTRATION .....	168
6.2.1.	<i>Avoided conventional generation redispatch</i> .....	169

---

6.2.2.	<i>Additional wind hosting capacity</i> .....	171
6.2.3.	<i>Investment deferral</i> .....	172
6.3.	SCALING-UP THE ECONOMIC IMPACT ASSESSMENT TO OTHER AREAS WITHIN THE SPANISH TRANSMISSION SYSTEM 173	
6.3.1.	<i>Results of the economic assessment for the selected areas of study</i> .....	174
6.4.	CONCLUSIONS .....	183
<b>7.</b>	<b>ANNEX 1: THE ROM MODEL</b> .....	<b>186</b>
7.1.	INTRODUCTION TO THE ROM MODEL .....	186
7.2.	DESCRIPTION OF THE ROM MODEL .....	187
7.3.	FORMULATION OF THE DAY-AHEAD MARKET OPERATION.....	187
7.4.	OBJECTIVE FUNCTION.....	189
7.5.	DEMAND CONSTRAINT .....	190
7.6.	THERMAL UNITS CONSTRAINTS.....	190
7.7.	HYDRO PLANTS CONSTRAINTS.....	190
7.8.	CSP PLANTS CONSTRAINTS.....	191
7.9.	REAL TIME SIMULATION.....	191
<b>8.</b>	<b>ANNEX 2: ESTIMATION OF COSTS FOR AMPACIMONS</b> .....	<b>193</b>
<b>9.</b>	<b>REFERENCES</b> .....	<b>196</b>



## LIST OF FIGURES

Figure 0.1: Four cases where DLR and PFC devices are deployed in the CWE region .....	19
Figure 1.1: General description of Work Package 15.....	21
Figure 2.1: Qualitative load frequency fundamentals and loops.....	23
Figure 2.2: ROM model overview.....	28
Figure 2.3: Wind farms do not provide active power control.....	30
Figure 2.4: Wind farms are allowed to provide active power control .....	33
Figure 2.5: Generating output in case A .....	38
Figure 2.6: Generating output in case B.....	38
Figure 2.7: Share of installed capacities for mainland Spain in 2013 .....	40
Figure 2.8: Hourly time series of system demand (blue) and wind forecast (red), and share of installed capacities for mainland Spain in 2020.....	41
Figure 2.9: Share of the down reserve requirements of the system for case B .....	43
Figure 2.10: Share of the up reserve requirements of the system for case B .....	44
Figure 2.11: Effect of the down reserve requirements of the system on the economic impact of active power control by wind farms .....	45
Figure 2.12: Effect of the up reserve requirements of the system on the economic impact of active power control by wind farms .....	46
Figure 2.13: Effect of pumped storage hydro on the economic impact of active power control by wind farms.....	47
Figure 2.14: Effect of the level of demand on the economic impact of active power control by wind farms.....	48
Figure 2.15: Effect of installed wind generation capacity on the economic impact of active power control by wind farms.....	49
Figure 2.16: Supply of the down reserve requirements demanded by the system for case B... 50	
Figure 2.17: Supply of the up reserve requirements demanded by the system for case B..... 51	
Figure 2.18: Resulting KPI's for mainland Spain in 2013. ....	51
Figure 2.19: Hypothetical scenario where the wind forecast (in red) has been multiplied by a factor of 2 .....	52
Figure 2.20: Hypothetical scenario where the wind forecast (in red) has been multiplied by a factor of 4.....	52
Figure 2.21: Remuneration of wind energy in accordance with RD 661/2007.....	54
Figure 2.22: Three main factors considered to assess the probability of providing the requested reserve.....	55
Figure 3.1: Diagram of the networks involved in the assessment .....	59
Figure 3.2: Voltage collapse curve taking into account the voltage rise effect .....	60

---

Figure 3.3: Spanish demand versus wind power production 7/02/2012. Source: REE.....	61
Figure 3.4: Simplified model for obtaining qualitative results.....	62
Figure 3.5: VTNet impact on the PV curve .....	62
Figure 3.6: x/r ratio impact on the PV curve .....	63
Figure 3.7: Wind farm power factor impact on the PV curve .....	63
Figure 3.8: Short-circuit power (Scc) impact on the PV curve .....	64
Figure 3.9: Short-circuit power (Scc) and x/r ratio impact on the PV curve .....	65
Figure 3.10: Simplified model of the transmission network, detailed model of the wind farm harvesting network .....	66
Figure 3.11: Detail model of the transmission network, simplified model of the wind farm harvesting network .....	66
Figure 3.12: Short-circuit power (Scc) and x/r ratio impact on the PV curve with and without voltage control .....	67
Figure 3.13: Reactive power and voltage for a ratio equal to 2 and different Scc when the wind farm provides voltage control.....	68
Figure 3.14: Extrapolated PQ curves.....	68
Figure 3.15: Reactive power and voltage for two different ratios maintaining fix the short-circuit power (Scc=4000 MVA) in two situation, with and without voltage control.....	69
Figure 3.16: Reactive power and voltage for two different VTNet (1.00 p.u. and 1.04 p.u.) maintaining fix the short-circuit power (Scc=4000 MVA) and the ratio (x/r=6) .....	70
Figure 3.17: Mean, maximum and minimum short circuit power in 220kV .....	71
Figure 3.18: Mean, maximum and minimum short circuit power in 400kV .....	71
Figure 3.19: Maximum and minimum x/r ratio in 220kV.....	72
Figure 3.20: Mean, maximum and minimum x/r ratio in 400kV.....	72
Figure 3.21: Correlation between the mean short-circuit bus power and the mean bus x/r ratio .....	73
Figure 3.22: Wind penetration increment when VTNet is 0.97 p.u. ....	74
Figure 3.23: Wind penetration increment when VTNet is 1.00 p.u. ....	75
Figure 3.24: Wind penetration increment when VTNet is 1.03 p.u. ....	75
Figure 3.25: Cumulative probability of mean x/r ratios.....	76
Figure 3.26: Cumulative probability of mean Scc .....	76
Figure 3.27: Lose of reactive capabilities because of topology configuration.....	77
Figure 3.28: Harvesting network.....	78
Figure 3.29: PQ curves of the harvesting network. Taking into account the detail model of the wind farms.....	78
Figure 3.30: PQ curves of the harvesting network. Assuming ideal Wind farms PQ curves.....	79

---

Figure 3.31: PQ curves of the harvesting network.....	79
Figure 3.32: Real and ideal PQ curve .....	80
Figure 3.33: Distribution of the voltage values.....	81
Figure 3.34: Wind power limitation in different 220 kV buses taking into account the detail model of the transmission network.....	82
Figure 3.35: Wind power limitations with and without control .....	82
Figure 3.36: Reactive power required in order to provide voltage control in accordance with Spanish Operational Procedure .....	85
Figure 3.37: Wind speed modeling using Weibull density functions.....	86
Figure 3.38: Process of building the hourly wind power scenarios representative of the annual behaviour .....	87
Figure 3.39: Diagram of network 1 (aggregated model of each wind farm) .....	88
Figure 3.40: Diagram of network 2 (aggregated model of each wind farm) .....	89
Figure 3.41: Power losses for the five cases under study in all the scenarios evaluated, providing a zoom analysis of the first scenario, network 1. ....	90
Figure 3.42: Power losses for the five cases under study in all the scenarios evaluated, providing a zoom analysis of the first scenario, network 2. ....	90
Figure 3.43: Reactive power at CB for the cases evaluated, network 1 .....	91
Figure 3.44: Reactive power at CB for the cases evaluated, network 2 .....	91
Figure 3.45: Voltage at CB for all the controllers, network 1.....	92
Figure 3.46: Voltage at CB for all the controllers, network 2.....	92
Figure 3.47: Comparison between losses of base case and proportional control in MWh (Proportional control – base case).....	93
Figure 3.48: Comparison between base case and optimal in MWh. (Optimal – Base case).....	94
Figure 3.49: Evolution of the mean daily market price and mean wind power remuneration in the four year period under study.....	95
Figure 3.50: Evolution of the prices with the production of a wind agent. Real data year 200896	
Figure 4.1: Power Hub can include a variety of different units (both production and consumption units) and different technologies.....	99
Figure 4.2: Overview of Power Hub integrations and capacity etc. ultimo 2012. ....	101
Figure 4.3: Estimated potential for flexible power consumption assessed as power (MW) available for shift en time (hours and days). It is based on yearly average power. Source: <i>Kortlægning af potentialet for fleksibelt elforbrug i industri, handel og service</i> (composed by Ea Energianalyse for Energinet.dk). ....	102
Figure 4.4: The VPP operator and the legal asset owner have a direct business relationship. ....	103

---

Figure 4.5: The VPP operator has a direct business relationship with both the integrator and the legal asset owner. The relationship between the integrator and the legal asset owner is not relevant seen with from the VPP perspective (indicated with grey color). .....	104
Figure 4.6: The VPP operator has a direct business relationship with the aggregator. The relationship between the aggregator and the asset owner is not relevant from a VPP perspective (indicated with grey color). .....	104
Figure 4.7: Overview of methodology for economic and environmental assessment. ....	104
Figure 4.8: Cold Storage Model.....	109
Figure 4.9: System demand (load) and realized cold storage consumption (VPP Contribution) .....	115
Figure 4.10: Fuel usage difference between Base and VPP scenario, 2020 .....	116
Figure 4.11: Change in CO <sub>2</sub> emissions after the VPP introduction for 2020, ktons .....	116
Figure 4.12: Wind shedding reduction after the VPP introduction, 2020 .....	117
Figure 4.13: Evolution VPP cost reduction across N. Europe.....	120
Figure 4.14: Change in production of electricity categorized by fuel in Denmark post-VPP, 2030 .....	120
Figure 4.15: Breakdown of cost reduction source for selected countries .....	121
Figure 4.16: Fuel usage changes after VPP introduction .....	122
Figure 4.17: Cost change of different VPP scenarios compared to Base case one .....	124
Figure 4.18: Total system costs for each case (mil. €).....	124
Figure 4.19: Wind shedding in Base case and VPP scenarios, 2030.....	125
Figure 4.20: Interactions VPP area and Electric System in Day Ahead Market.....	127
Figure 4.21: Global Objective Function of the Unit Commitment including VPP performance	127
Figure 4.22: Generalized model of the VPP unit.....	130
Figure 4.23: Pure Consumption Unit Model .....	130
Figure 4.24: Pure Generation Unit Model.....	131
Figure 4.25: Generation and Consumptions Units with Energy Reservoir.....	131
Figure 4.26: Thermal Cost Variation.....	135
Figure 4.27: Technology contribution for the average day using the Smart execution mode .	135
Figure 4.28: Technology contribution for the average day using the Non-Smart execution mode .....	136
Figure 4.29: Wind Generation Spillage for 500 MW, 1 GW and 2 GW VPP scenarios.....	136
Figure 4.30: RES Generation Spillage for 500 MW, 1 GW and 2 GW VPP scenarios.....	137
Figure 5.1: Plan, Monitor and Control.....	139
Figure 5.2: From CWE grid to CWE market .....	140

---

Figure 5.3: Transmission capacity of an overhead line equipped with Ampacimons and a PST .....	143
Figure 5.4: Distribution of the D-2 ampacity forecast.....	144
Figure 5.5: Illustration of the network effect (aka PTDF effect) .....	145
Figure 5.6: NTC increase cases used in the study .....	148
Figure 5.7: Relative NTC increase giving wind load factors thanks to DLR and PFC .....	148
Figure 5.8: RES installed capacity by 2020 .....	149
Figure 5.9: Comparison of the thermal installed capacity by 2020 .....	150
Figure 5.10: Example of hourly NTC in Case 3.....	152
Figure 5.11: Average NTC Increase over the year.....	152
Figure 5.12: Energy exchanged over CWE by case.....	153
Figure 5.13: Decrease in wind curtailment by case .....	154
Figure 5.14: Cost-Benefits analysis.....	155
Figure 5.15: Cost-Benefits distributions in case 1 et 2.....	156
Figure 5.16: Cost-Benefits distributions in case 3 et 4.....	156
Figure 5.17: CO2 emissions avoided .....	157
Figure 6.1: Python routine .....	164
Figure 6.2: Aragon area of study.....	169
Figure 6.3: Estimated annual avoided conventional generation redispatch in the area of study of Aragon.....	170
Figure 6.4: Estimated additional wind hosting capacity in the area of study of Aragon .....	171
Figure 6.5: Annual avoided CO2 emissions cost in the area of study of Aragón .....	172
Figure 6.6: Basque Country area of study .....	175
Figure 6.7: Estimated annual avoided redispatch in the Basque Country area of study .....	176
Figure 6.8: Catalonia area of study .....	178
Figure 6.9: Estimated annual avoided redispatch in the Catalonia area of study .....	178
Figure 6.10: Andalusia area of study.....	179
Figure 6.11: Estimated annual avoided redispatch in the Andalusia area of study.....	180
Figure 6.12: Madrid area of study.....	181
Figure 6.13: Estimated annual avoided redispatch in the Madrid area of study.....	182
Figure 6.14: Estimated annual redispatch savings in Spain using either FACTS or DLR technologies.....	184
Figure 7.1: Time division in the ROM model.....	187

## LIST OF TABLES

Table 0.1: Resulting KPI'S for mainland Spain in nominal scenario 2020 .....	17
Table 0.2: Comparison of wind output for an installed wind power capacity of 38302 MW .....	18
Table 0.3: Summary of results of economic assessment of demo 6 in Spain .....	20
Table 2.1: KPIs of the economic assessment .....	24
Table 2.2: Critical Success Factor and Key Performance Indicators.....	25
Table 2.3: Sets used in the ROM model .....	28
Table 2.4: Parameters used in the ROM model .....	29
Table 2.5: Additional variables used in ROM to model the provision of wind reserves.....	29
Table 2.6: Data of the thermal units .....	36
Table 2.7: Data of the hydro plant .....	36
Table 2.8: Day-ahead forecasts of wind power and hydro inflows.....	36
Table 2.9: Demand and reserve requirements. ....	36
Table 2.10: Wind power management for case A and case B.....	39
Table 2.11: Input data for the 2013 and 2020 scenarios for mainland Spain.....	42
Table 2.12: Resulting KPI'S for mainland Spain in 2020.....	42
Table 2.13: Resulting output of each technology for mainland Spain in 2020 .....	43
Table 2.14: Comparison of up reserve requirements of the system. ....	44
Table 2.15: Comparison of wind output for an installed wind power capacity of 38302 MW for the Spanish electricity system in the 2020 scenario .....	49
Table 2.16: Amount of power that needs to be spilled to ensure a regulation band of +/-200 MW.....	55
Table 3.1: KPIs of the voltage control economic assessment .....	58
Table 3.2: Wind power limitation because of voltage reason, VTNet = 1.03 p.u. ....	73
Table 3.3: Wind power limitation because of voltage reason, VTNet = 1.00 p.u. ....	74
Table 3.4: Wind power limitation because of voltage reason, VTNet = 0.97 p.u. ....	74
Table 3.5: Increment of wind power penetration.....	76
Table 3.6: Wind power increment thanks to provide voltage control taking into account the ideal and real PQ curve VTNet=1.00 p.u .....	81
Table 3.7: Installed active power of each wind farm within network 1.....	88
Table 3.8: Installed active power of each wind farm within network 2.....	89
Table 3.9: Summary of the economic impact .....	95
Table 3.10: Summary of the economic impact taking into account the evolution of the prices with the wind production.....	96

---

Table 4.1: List of technologies capable in Power Hub portfolio. ....	101
Table 4.2: Description of VPP cases .....	105
Table 4.3: Cold Storage model parameters.....	108
Table 4.4: Electric Vehicle model parameters.....	110
Table 4.5: Fuel and CO <sub>2</sub> prices. Source: TradeWind project .....	111
Table 4.6: Aggregated Generation Capacity (MW) of model regions, 2020.....	111
Table 4.7: Aggregated Generation Capacity (MW) of model regions, 2030.....	112
Table 4.8: Aggregated Yearly Load demand (GWh) of model regions, 2020&2030.....	112
Table 4.9: System Marginal Price for Base and VPP cases in 2020 .....	113
Table 4.10: Total System Costs for Base and VPP cases in 2020.....	114
Table 4.11: Revenues, costs and profits for 2020 .....	115
Table 4.12: Marginal System Price in 2030 .....	118
Table 4.13: System costs (Mil. €) by category for base and VPP cases, 2030.....	119
Table 4.14: Revenues, Costs and Profits for 2030.....	119
Table 4.15: System Marginal Price for all 2030 scenarios.....	123
Table 4.16: Hour-ahead balancing in Denmark with the 2030 scenarios .....	125
Table 4.17: Differences in balancing costs comparing VPP scenarios and base scenarios. ....	126
Table 4.18: Difference in balancing costs, comparing VPP scenarios and base scenarios.....	126
Table 4.19: Capacity for each VPP Technology of the Base Case.....	133
Table 5.1: Main technical benefits of NETFLEX.....	142
Table 5.2: Qualitative assessments of benefits.....	146
Table 5.3: Time series and granularity for each data type used in the study .....	147
Table 6.1: FACTS steps .....	164
Table 6.2: Estimated annualized investment of the devices tested in demo 6 .....	168
Table 6.3: Estimated annual net benefit of avoiding redispatch in the area of study of Aragon .....	170
Table 6.4: Estimated net benefit of deferring network investments in the area of study of Aragon.....	173
Table 6.5: Potential locations for the placement of FACTS and DLR devices.....	174
Table 6.6: Estimated annual net benefit of avoiding redispatch in the Basque Country area of study.....	177
Table 6.7: Estimated annual net benefit of avoiding redispatch in the Catalonia area of study .....	179
Table 6.8: Estimated annual net benefit of avoiding redispatch in the Andalusia area of study .....	181

Table 6.9: Estimated annual net benefit of avoiding redispatch in the Madrid area of study .	183
Table 6.10: Economic impact assessment of FACTS and DLR devices in other areas of Spain .	185
Table 7.1: Sets of the ROM model .....	188
Table 7.2: Parameters of the ROM model .....	188
Table 7.3: Variables of the ROM model .....	189
Table 7.4: Daily Operation chronological resume.....	192
Table 8.1: Cases used in the study .....	195



---

## Executive summary

This deliverable D15.1 is one of the outcomes of Work Package WP15 entitled “Economic impacts of the demonstrations, barriers towards scaling up and solutions”. In particular, this deliverable presents the economic impact analysis of the demonstrations performed in task-forces TF1 and TF3. The main findings of the analysis carried out can be summarized as follows:

### Task force 1:

- TWENTIES has overcome a major technical barrier preventing better use of wind generation (WG). The capability of providing frequency and voltage control by wind farms makes it possible to reduce system operation costs and carbon emissions.
- The analysis of the 2020 scenario for Spain shows that the active power control by wind farms could reduce 1.1% of system operation costs thanks to 1) the substitution of expensive thermal downward reserve by wind generation reserve during off-peak hours, and 2) the need of lower up-reserve requirements during peak hours. This impact would increase under certain conditions: higher levels of WG, higher prediction errors, higher requirements of downward reserve, and reduced installed power of flexible generation (as pumped-storage units).
- The analysis performed about the impact in the Spanish system of the voltage control by wind farms shows that wind penetration will not be limited notably because of voltage reasons. Nevertheless, in buses that present a low  $x/r$  ratio or in buses with low short circuit power, the voltage control capability of wind farms would help to accommodate higher levels of WG.
- Virtual power plants (VPP) in the Danish system can decrease overall system costs. With the considered VPP scenario in 2030 consisting of 400 MW cold storage and 300,000 electrical vehicles (2,800 MW) in Denmark, the benefit for the whole European System was estimated to 27 M€/y cost savings in the day-ahead based on the performed simulations. Moreover, the net balancing costs of the hour-ahead balancing performed by the Danish TSO is estimated to be reduced by 3.4 M€/y. Regarding wind curtailment, the total reduction in wind curtailment due to the VPP is estimated to 18 GWh/y.

### Task force 3:

- Adequate coordination mechanisms between Dynamic Line Rating (DLR), Power Flow Controlling (PFC) devices and Wide Area Monitoring Systems (WAMS) make the electric system more flexible within affordable capital and operational costs. They enable the system to be operated more efficiently, bring down the costs of electricity supply by reducing the need for ‘out-of-merit generation’, and avoid or reduce wind curtailment, contributing to a better and more efficient integration of wind power.
- The analysis performed in the Central Western Europe (CWE) area shows that PFC and DLR bring benefits for the system with lower implementation costs and time than conventional assets. Smart-controller of PFC in Belgium borders could reduce system costs by 50 M€

(250 M€ if fully deployed in CWE). Broad DLR deployment in CWE would reduce system operational costs in 125 M€.

- Regarding of the analysis in the Spanish system, the FACTS devices could avoid the redispatch of more than 550 GWh per year, which represents 4.5% of the total energy that is currently redispatched in Spain. For the tested DLR system, the potential avoided redispatch would be approximately 650 GWh.

The methodology followed to perform the assessments, and the main results obtained for both tasks-forces (TF1: new system services, and TF3: network flexibility) are summarized hereafter.

### 1.1. Impact assessment of the demos belonging to TF1: new system services

The methodology followed in order to assess the economic impact of the provision of active power control by wind farms in Spain in 2020 is based on the comparison of system operational costs in two cases: A) wind farms do not provide active power control, and B) wind farms are allowed to provide active power control. To simulate both cases, an updated version of the model ROM has been used in TWENTIES. This model reproduces the usual decision process of the system operator. In the first stage, an optimal unit-commitment is obtained with the objective of minimizing system operational costs. Then an hourly simulation is run for the same day revising the previous schedule to account for wind production deviations with respect forecasts, demand prediction errors and units failure. The new boundary conditions are transferred to the initial hour of the following day, and the process is repeated sequentially for all 365 days of the year.

The obtained results show that the provision of active power control by wind generators in Spain would reduce the need for committing extra conventional generation in order to comply with reserve requirements, avoiding wind curtailments and reducing slightly system operation costs. Table 0.1 shows the main outcomes for the nominal scenario. Note that the provision of active power control by wind farms accounts for 1.1% of reduction in the operating costs of the system. However, for this scenario, the market share of wind generation and the CO2 emissions are barely impacted. It is important to highlight that this cost reduction cannot be interpreted as renewable energy integration costs.

2020 results (nominal scenario)		CASE A	CASE B	Difference (A-B)	Difference [%]
<b>Operating Costs</b>	[M€]	7444,4	7361,4	83,0	1,11%
<b>CO2 emissions</b>	[MtCO2]	48,9	49,0	-0,1	-0,21%
<b>Wind generation</b>	[TWh]	72,9	72,80	0,14	0,19%

Table 0.1: Resulting KPI'S for mainland Spain in nominal scenario 2020

Most of the obtained cost savings are explained by the usage of wind generation to provide downward reserve instead of conventional thermal generation. In case B, wind down reserve accounts for 11.8% of total down reserve requirements. These reserves are provided during

off-peak hours, where thermal units are operated close to their minimum stable loads and hydro plants close to the run of river output.

The advantage of being able to provide active power control by wind farms is more remarkable in situations with higher wind generation spillages. In the nominal scenario wind generation capacity is 34820 MW. Assuming an increase of 20% of wind generation capacity (38302 MW) the provision of active power control by wind farms has a higher impact on cost savings (6.45%), reducing notably wind generation spillages and carbon emissions as shown in next table.

2020 results (+20% extra WG)		CASE A	CASE B	Difference [%]
<b>Wind output</b>	%	92,8%	94,9%	-2,1%
<b>Wind spillage</b>	%	7,2%	5,1%	2,1%
<b>CO<sub>2</sub> emissions</b>	MtCO <sub>2</sub>	43,3	42,2	2.4%

**Table 0.2: Comparison of wind output for an installed wind power capacity of 38302 MW**

A sensibility analysis has also been performed in this study, and the main conclusion is that the economic impact is higher on systems with a high share of wind power capacity, low share of flexible pumping-storage facilities, and where reserve's constraints highly influence the resulting generation scheduling.

Regarding the provision of voltage control by wind generators, the study demonstrated that in most cases wind penetration will not be limited due to voltage reasons. This voltage control by wind farms originates a slightly increment of active power losses in the wind farm grid that could be reduced in case of developing an optimal voltage control strategy.

The methodology used to perform the economic impact assessment of the VPP in Denmark is based on the model WILMAR (used to estimate the day ahead unit commitment and dispatch in the North European power system), and the model SIMBA (used to simulate the hour-ahead balancing). The unit commitment and balancing simulations use a set of consistent wind power simulations as inputs, and data for the generation system in Denmark, Norway, Sweden, UK, Germany, Holland, Belgium and France.

One important conclusion drawn from the simulations is that even when treated solely as a demand-response unit, the VPP technologies have managed to decrease overall system costs and increase revenues. With the VPP scenario for VPPs in 2030 consisting of 400 MW cold storage and 300,000 electrical vehicles (2,800 MW), the benefit of the VPP was estimated to 27 M€/y cost savings in the day-ahead based on the WILMAR simulations. On top of that, the net balancing costs of the hour-ahead balancing performed by the Danish TSO is estimated to be reduced by 3.4 M€/y, so the total calculated savings are approximately 30 M€/y. Other benefits of the VPP, like savings in the real time balancing and voltage control may render the VPP even more profitable

Another important finding from the WILMAR simulation is the mixed results of the VPP when it comes to assess its impact on CO<sub>2</sub> emissions, as they depend on the base-load fuel type. If coal and lignite are dominant in base-load production and wind penetration is not too high, the VPP

might have unfavourable effects for CO<sub>2</sub> emissions, which was the result of the 2020 scenario simulations. Contrary to that, in 2030, higher wind penetration and more base-load facilities of other kinds changed the result. The total reduction in CO<sub>2</sub> emission in 2030 due to the VPP is estimated to 280,000 tons/y. Finally, it was found that the wind shedding was reduced because of the VPP. This was expected, as the VPP was acting as a demand-response system. The total reduction in wind curtailment due to the VPP is estimated to 18 GWh/y.

### 1.2. Impact assessment of the demos belonging to TF3: network flexibility

The most significant economic benefit of FACTS and DLR technologies tested demos 5 & 6 is the relief of transmission congestions, which enables a more efficient operation of the system. While demo 5 focused on the increase Net Transfer Capacities provided by the tested devices, demo 6 focused on local network effects. The economic impact assessment performed for each demo demonstrated that FACTS and DLR devices reduces the need for dispatching of out-of-merit generation in both cases, decreasing electricity supply costs. In areas with high wind potentials these technologies avoid or reduce wind curtailment, contributing to a higher and more efficient integration of wind generation.

Regarding the assessment of network-enhanced flexibility demo in CORESO, the main objective was to compute the benefits resulting from increased Net Transfer Capacities (NTC) achieved with the installation of DLR and PFC devices in the CWE region. For this purpose, a bottom-up electricity market model that simulates the hourly economic dispatch of generation units and considers cross-border transmission capacity constraints was used to compute system operation costs.

In order to compute the economic benefits from the installation of DLR and PFC devices in the CWE region four cases where DLR and PFC devices are deployed in the CWE region (see Figure 0.1) were compared to a business-as-usual case without DLR or PFC implementation. According to the results of the study, the deployment of smart-controller of PFC and DLR devices could reduce system operation costs from 50 M€ (if deployed in Belgium borders) up to 250 M€ (if fully deployed in the CWE region).

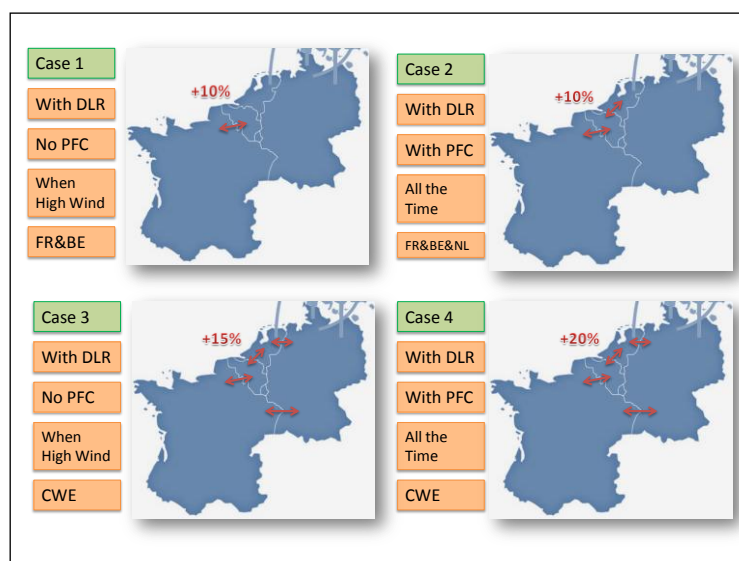

Figure 0.1: Four cases where DLR and PFC devices are deployed in the CWE region

Regarding the assessment of demo 6 FLEXGRID in Spain, the main objective was to compute the benefits of FACTS and DLR devices in the Spanish transmission network in terms of avoided out-of-merit generation costs. With this purpose, a detailed technical analysis using PSS/E was performed to simulate the impact of these devices in four areas of the Spanish transmission grid during real congestion cases when the TSO had to redispatch out-of-merit generation.

According to the results of this analysis, the installation of the FACTS device in the studied areas could avoid the redispatch of more than 550 GWh per year, which represents 4.5% of the total energy that is currently redispatched in Spain. For the tested DLR system, the potential avoided redispatch would be approximately 650 GWh. The total estimated cost savings that would result from avoiding the redispatch of conventional generation amounts to almost 20 M€ with the installation of FACTS devices and 25 M€ if DLR systems are used. These values correspond to 3.7% and 4.5%, respectively, of the total redispatch cost in Spain. The table below presents these results in detail.

			Spain	North	East	Center	South
<b>Avoided redispatch (GWh/year)</b>	FACTS		<b>563</b>	12	154	259	138
	DLR		<b>649</b>	15	225	265	144
<b>Redispatch cost savings (k€/year)</b>	FACTS		<b>21 957</b>	451	6 014	10 092	5 400
	DLR		<b>25 322</b>	604	8 771	10 327	5 620
<b>Net benefit (k€/year)</b>	FACTS		<b>20 235</b>	21	5 584	9 661	4 969
	DLR		<b>25 082</b>	495	8 713	10 277	5 597

**Table 0.3: Summary of results of economic assessment of demo 6 in Spain**

## 1. Introduction

WP15 “Economic impacts of the demonstrations, barriers towards scaling up and solutions” is one of the transversal work-packages within TWENTIES project. Its final goals are to assess the local economic and/or technological impact of each demo, to perform an analysis of the joint impact for all the demos in the same task-force, to identify the barriers to scale-up the results, to propose solutions to overcome the identified barriers, and to perform a transversal analysis to provide a reference point to WP16. WP15 involves the participation of 12 out of 26 partners and it has been led by Comillas-IIT. Next figure summarizes the main activities developed in WP15

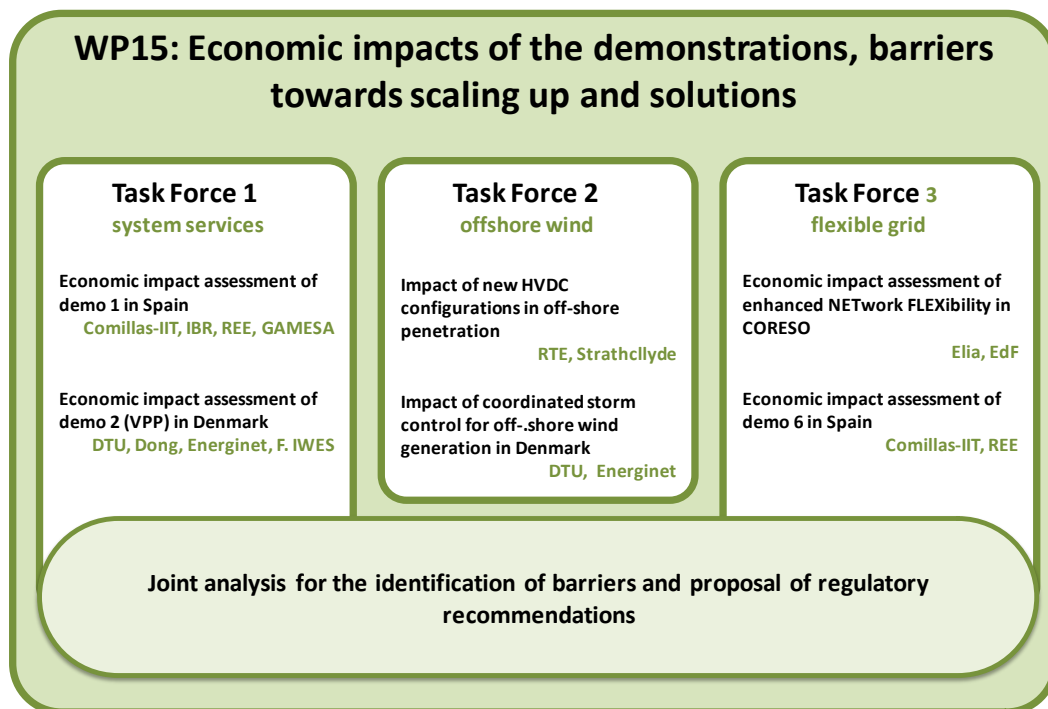

Figure 1.1: General description of Work Package 15

This document presents the deliverable D15.1 and it contains the economic impact analysis of the demonstrations performed in task-forces TF1 and TF3. The scope of the analysis is limited to the countries/systems where the demos have taken place, with the objective of performing the assessment under a system perspective in order to evaluate the potential scaling-up of the demos. This document could be divided in two main differentiated parts:

- Impact assessment of the demos belonging to TF1: new system services. This assessment is presented in chapters 3, 4, and 5.
- Impact assessment of the demos belonging to TF3: network flexibility. This analysis is presented in chapters 6 and 7.

## 2. Economic impact of ACTIVE-POWER control provided by wind farms in the Spanish system

Once that the demonstration SYSERWIND has proven that it is technically feasible to provide active-power control by an aggregation of wind farms, it is necessary to assess up to what extent it would be economically efficient to scale-up this technology to the whole system. In order to avoid being biased by the current market design and regulation, the assessment will be carried out by comparing system operational costs and by assuming that available generation resources (both in terms of energy and reserves) can be allocated optimally under a system perspective. By comparing the expected operational costs obtained when wind generators are able and not able to provide active-power control, it would be possible to identify potential costs savings for the whole system. In case these potential cost savings were significant, it would mean that an additional social welfare could be gained if wind farms were able to provide the tested system services, and this could require an adaptation of current market rules as discussed in deliverable D15.3.

This chapter is organized as follows. Section 2.1 summarizes the expected outcomes of this analysis that are presented as a subset of the family of Key Performance Indicators (KPIs) included in the deliverable D2.1. Section 2.2 summarizes the main findings of the demo. Section 2.3 explains the main features of the methodology that has been followed to perform the assessment. Section 2.4 is the core of this chapter as it contains the main results of economic impact assessment under a system perspective. Section 2.5 presents the analysis from the perspective of the agent, and main conclusions are summarized in section 2.6.

### 2.1. Expected outcomes of this analysis

Active power control has always played an essential role in guaranteeing the secure and reliable operation of a power system, and its objective is to re-establish the necessary equilibrium between generation and demand in order to keep the frequency of the power system within admissible bands. Figure 2.1 presents the different loops of the frequency control in a qualitative way, where reserve provision is divided into primary, secondary and tertiary regulation. The secondary frequency control is a centralized automatic control that adjusts the active power production of generating units to restore the frequency and the interchanges. In contrast, the tertiary frequency control consists of manual changes in the dispatching and commitment of generating units. In the figure, it can be seen that the secondary regulation starts after 30 seconds and it must be totally deployed within a period of 12-15 minutes. Once the secondary reserve is exhausted the tertiary reserve is activated manually.

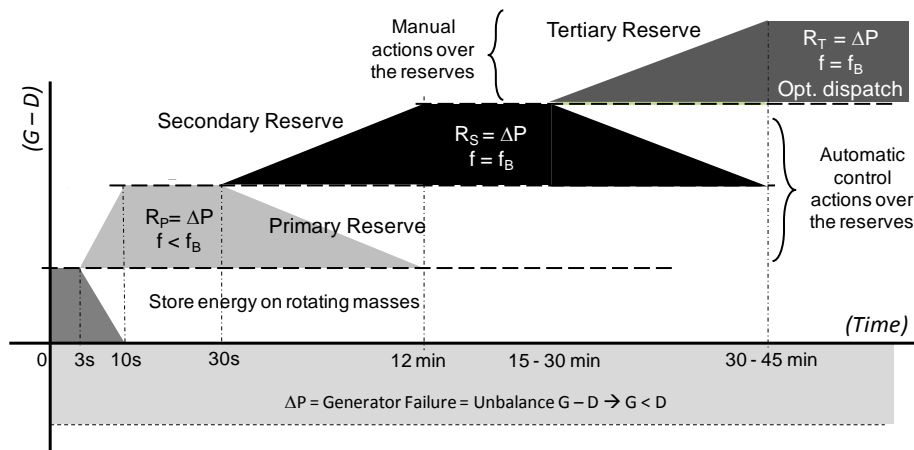

**Figure 2.1: Qualitative load frequency fundamentals and loops**

An important concept to fully understand the remaining part of this chapter is the concept of upward and downward reserve requirements. The Transmission System Operator (TSO) establishes the hourly requirements of upward and downward reserves that are needed in the system in order to ensure that in case the demand is higher/lower than the scheduled generation, there is some available upward/downward reserve that could be deployed in order to ensure the balance by increasing/decreasing the output level of the generators providing reserve. Therefore, the total upward and downward reserve requirements established by the TSO need to be provided jointly by all the generators that are able to regulate its output power. In the case of Spain, this is managed by means of market mechanisms, as besides the energy market, there are markets to trade ancillary services such as secondary and tertiary regulation reserves.

Traditionally, upward and downward reserves in the Spanish system have been provided by hydroelectric and thermal units, enabling the TSO to operate the system with an adequate level of reliability. In order to provide upward regulation, the generating unit needs to leave a certain margin between the scheduled output power, and the maximum power that could be generated if it were required. In order to provide downward regulation, the unit should be able to decrease its power, and in the case of thermal units, the existence of minimum stable loads could compromise such available margin.

Given that TWENTIES project has proven that it is technically feasible that wind generation provide upward and downward regulation, it is necessary to assess whether it is economically efficient that wind reserve substitute the reserves traditionally provided by hydro-thermal units. In theory, the provision of active power control by wind farms could relieve reserve requirements and decrease the operating costs of the system as explained hereafter:

On the one hand, the provision of wind downward reserve could be useful during off-peak hours, where hydro plants and thermal units are operated close to their minimum output values and have low downward reserve capabilities. Furthermore, the provision of wind downward reserve is also expected to reduce wind spillage by preventing the system from



increasing hydrothermal generation and spill wind generation to meet system downward reserve needs.

On the other hand, the provision of wind upward reserve entails a reduction of the wind generation, leaving a certain margin from the output power to the maximum available wind generation that could be achieved. This would be the same mechanism as in other generation technologies. However, when a thermal unit decides to reduce its power to provide upward reserve, it is incurring in lower generation costs as it is generating less power, and thus, consuming less fuel. In the case of a hydro plant, the power that has not been produced could be generated afterwards assuming that the water can be stored in the reservoir and therefore could be released in the future if necessary. However, in the case of wind generation, in order to be able to increase the power, it will be necessary to spill some of the available generation that has a null variable cost, and it will not be possible to recover it afterwards. This is why in principle it is not very likely to expect that providing upward reserve with wind generation will be economically interesting. However, in case of having wind spillages, i.e. when there is an excess of generation that requires curtailing part of the available wind production, it could happen that some of the thermal units have been started-up just for providing upward regulation. In that case, it could be profitable to provide upward reserve with the wind generators reducing their spillages by substituting the thermal generation of such units and therefore, converting “useless” spillages into actual generation and “useful” spillage in the form of upward reserve. Therefore, wind upward reserve could theoretically help to prevent the system from committing thermal units just to meet the upward reserve requirements of the system. In any case, due to the fact that hydro-thermal generators are subject to many technical constraints that link their hourly operation, and given that the structure of generation cost is not simple (non convex cost, discrete decisions, etc.), in order to assess properly the impact of the demo, it will be necessary to perform a detailed modelling of the generation system and its realistic characteristics, in order to capture the interaction between all the involved variables.

Based on such preliminary ideas, the current assessment will try to quantify the economic impact, and it will be measured by means of the KPIs presented in the next table:

<b>KPI.15.TF1.1:</b> Cost savings in the Spanish system where wind power generators are able to control their active power and to provide frequency control: [Euro/year] for installed wind generation capacity in 2013 and prospective analysis for future scenarios up to 2020.
<b>KPI.15.TF1.2:</b> Additional economic benefit, compared with the default case, for a wind power producer participating in the Spanish secondary reserve market: [Euro/year/Installed MW]
<b>KPI.15.TF1.5:</b> CO2 emissions avoided in the Spanish system with respect the default case due to the new services provided by wind power generators: [tonne CO2/year] for installed wind generation capacity in 2013 and prospective analysis for future scenarios up to 2020.
<b>KPI.15.TF1.6:</b> Additional wind energy that could be generated in the Spanish system thanks to the new capabilities tested in Demo 1. [GWh/year]

**Table 2.1: KPIs of the economic assessment**

## 2.2. Main findings of the Demo

A detailed description of the demo can be found in deliverable D.9.1. entitled “Test results, with their technical impact and validation, regarding the secondary frequency control demonstration & voltage control demonstration”. The Main findings of the demo can be summarized as follows:

- Grouped wind farms are able to control their active power, in real time and in a coordinated way, according to the REE’s secondary frequency control requirements (RCP).
- In the demonstration a +/- 20 MW regulation band was provided, with its central point in 100 MW. This was achieved with only 7 out of 15 wind farms being able to take part in the regulation, due to the fact that wind conditions at the time of the demo were not good enough in one of the clusters.
- The regulators are able to change their response time in the same way as conventional generation units do.
- The secondary frequency control test has shown a good behavior with high capacity factors, it would be necessary to study deeper how the results would be affected by machines stopping due to low capacity factors.
- A high amount of energy has to be curtailed for providing the upward power reserve service.
- The required energy curtailment is lower the more wind farms are grouped to provide the service, and the shorter term the forecast calculation is. However, the amount of energy to be curtailed is still quite representative.
- The current secondary reserve market is a day-ahead one, and wind energy would need a short term market -almost in real time-, or to offer these upward reserves only once wind generation has been curtailed due to technical constraints, or being able just to offer downward reserve.

Critical Success Factor (CSF)	Key Performance Indicator (KPI)	
Availability of the offer for upward and downward secondary power reserve	Percentage of achievement of the active power set point request	100%
Dynamic response of the wind energy AGC regulator	Achievement of the dynamic requirements to participate in the Spanish secondary frequency control of the system	98.34%
	Constant time of the AGC regulator	<100 seconds
	Active power increase/reduction according to the set point requested	Yes

Table 2.2: Critical Success Factor and Key Performance Indicators

## 2.3. Description of the assessment methodology and problem setting

### 2.3.1. Assessment methodology for a system perspective

The methodology followed in order to capture the economic impact of the provision of active power control by wind farms in Spain in 2013 and 2020 is based on the comparison of two cases:

- In the first one (case A), wind farms do not provide active power control. This case stands for the current situation of wind power in the Spanish electricity market.
- In the second one (case B), wind farms are allowed to provide active power control.

The comparison of both cases will be based on the resulting operational cost (mainly fuel cost and variable operation & maintenance costs), and therefore, the effect on investment decisions will be out of the scope of this analysis. The term OPEX (Operating Expense) will be used in the assessment to characterize the annual generation cost incurred to supply the system demand at minimum cost, while satisfying all the technical constraints of the system.

In order to perform the numerical analysis, it is necessary to make use of an advanced model of the power system. In this case, the ROM model has been the tool used and updated to obtain the numerical results for both cases and to carry out the economic assessment. The main features of model ROM are described below.

### 2.3.2. Description of the model ROM

The ROM model<sup>1</sup> consists of a daily operation model that allows obtaining the optimal hourly scheduling of all the generating units of the system. The model scheme is based on a daily sequence of planning and simulation, which is similar to an open-loop feedback control used in control theory. For each one of the 365 days of the year the model takes the results of the optimal hourly scheduling, simulates the corrective actions in order to respond to the deviation of the random variables with respect their forecasted values (demand, renewable, etc.), and sends the resulting boundary conditions to the first hour of the next day. Therefore, two main stages can be differentiated in the model:

- The first stage consists of an optimization of operation decisions (daily unit commitment and economic dispatch) with demand and wind power generation (WG) forecasted one day in advance. Although ROM model is prepared to solve this first stage as a stochastic optimization problem, a deterministic and single-node approach was used due to the complexity of its practical implementation to model the Spanish system.
- The second stage deals with a simulation of the unknown events: hourly simulation of unit failures, adapting and correcting previous decisions to real WG and demand (forecasting error) and deployment of the corresponding corrective actions.

---

<sup>1</sup> ROM Model (Reliability and Operation Model for Renewable Energy Sources)

Regarding the first stage, the unit commitment and hourly dispatch of all thermal and hydro units, as well as the assignment of up and down reserves to these units, are decided. The unit commitment problem is described in detail in [1]. Operation costs for the whole system are minimized in the objective function. These costs include fixed and variable costs of thermal units (no-load, start-up, fuel, operation & maintenance costs, and CO<sub>2</sub> emissions), penalty for shortcoming of up and down reserve, and non-supplied energy costs.

Detailed operation constraints are also taken into account in the unit commitment model:

- Demand and generation balance and, supply of operating reserves. Up and down reserve requirements are input data of the model and include two main components: the first is related to wind forecasting errors, and the second is related to unit outages. These reserve requirements can be compared to the supply of secondary and tertiary reserves in the Spanish ancillary services market.
- For thermal units: start-up/shutdown time, bound on power reserve and power output, up and down ramps and exponential start-up costs.
- For hydro units: bound on pumped storage up and down reserves, water inventory in hydro reservoirs and pumped storage, bounds on hydro power output and daily hydro output target. Decisions above the daily scope, as the weekly scheduling of pumped storage hydro plants, are done internally by the model respecting economic criteria. Yearly hydro scheduling of storage hydro plants is done by a longer term model (hydrothermal coordination) [2] and has to be provided as input data to the operation model.

Regarding the second stage, the model revises the previous schedule and redispatches generators at 12 pm of “D-1” taking into account unit outages occurred after generation dispatch (2 pm of “D-1”). Monte Carlo simulation is run to simulate unit outages. Regarding wind forecasting errors, two series are used in the model. The first one corresponds to the estimation of wind generation at the time of generation dispatch. The second stage is divided in two parts:

- a) At midnight, unit commitment is modified to account for unit outages (Monte Carlo simulation) occurred after generation dispatch is decided. This is assumed to be the last hour at which a thermal unit can be committed to reach the morning demand ramp. The objective is to reduce the difference between generation and demand to a safe margin (approximately, 1 GW).
- b) Subsequently, the model simulates unit outages and corrective actions are applied for production deviations due to these outages. The order in which these actions are applied follows economic criteria: (1) hydro reserve deployment; (2) pumping units reserve deployment; (3) thermal reserve deployment and (4) commitment of gas turbines in real time. If generation and load balance is not achieved after reserve is deployed, two operating situations can happen: (i) non-supplied energy, if generation is not able to cover demand and (ii) wind curtailment.

The main outcomes of the operation model are hourly generation by technology, use of reserves, energy spillage (excess of production at a single node), CO<sub>2</sub> emissions, and system marginal cost.

Figure 2.2 presents an overview of the model for a single day. The process represented in the figure is repeated 365 times (for each day of the year).

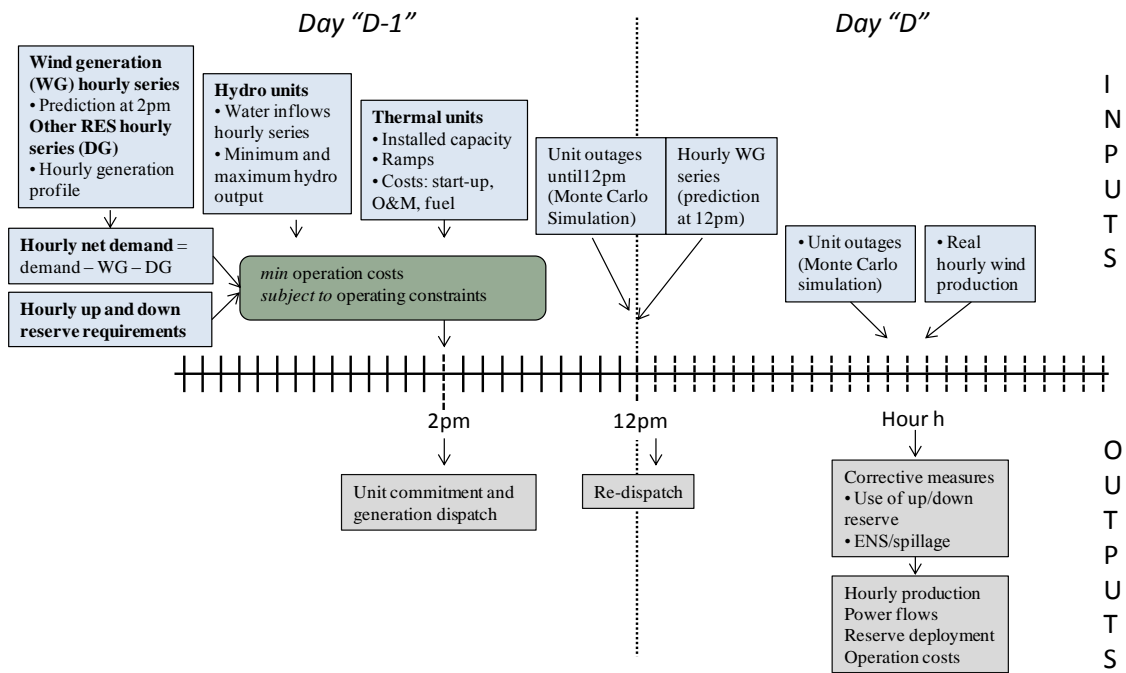

Figure 2.2: ROM model overview

In this section, the main changes required by TWENTIES that have been introduced in the ROM model in order to include the active power control by wind farms are highlighted. A more comprehensive description of the model can be found in the Anexes.

### 2.3.3. Description of the optimization stage

Case A and case B have been modeled differently in the optimization stage as case A would be the “business as usual” case, while case B requires to model the capability of wind farms to provide reserve. The tables below show the main indexes, parameters and variables used in the mathematical formulation:

Name	Meaning
$p$	Periods (hours)
$g$	Generators
$w$	Wind farms
$t$	Thermal units ( $\{t\} \subset \{g\}$ )
$h$	Hydro plants (reservoirs) ( $\{h\} \subset \{g\}$ )
$b$	Pumped storage hydro plants (reservoirs) ( $\{b\} \subset \{h\}$ )

Table 2.3: Sets used in the ROM model

Name	Meaning	Unit
$D_p$	Day-ahead demand forecast in period $p$	MW
$WF_p^w$	Day-ahead wind power forecast of wind farm $w$ in period $p$	MW
$UR_p^{case A}$	Upward reserve requirements for case A in period $p$	MW
$DR_p$	Downward reserve requirements in period $p$	MW

**Table 2.4: Parameters used in the ROM model**

Name	Meaning	Unit
$tur_p^t, tdr_p^t$	Upward and downward reserve of thermal unit $t$ in period $p$	MW
$hur_p^h, hdr_p^h$	Upward and downward reserve of hydro plant $h$ in period $p$	MW
$bur_p^b, bdr_p^b$	Upward and downward reserve of pumped storage hydro plant $p$ in period $p$	MW
$gwind_p^w$	Generation of wind farm $w$ in period $p$	MW
$sp_p^w$	Energy spillage of wind farm $w$ in period $p$	MW
$wur_p^w, wdr_p^w$	Upward and downward reserve of wind farm $w$ in period $p$	MW
$conswur_p^w$	Up reserve consumed due to wind generation of wind farm $w$ in period $p$	MW
$ur_p^{case B}$	Upward reserve requirements for case B in period $p$	MW
$urdef_p, drdef_p$	Upward and downward reserve deficit in period $p$	MW

**Table 2.5: Additional variables used in ROM to model the provision of wind reserves.**

- **Case A: wind farms do not provide active power control**

In this case, wind farms are not able to provide active power control. Therefore, all the available wind power forecast  $WF_p^w$  that has been forecasted the day-ahead, will be scheduled as wind generation ( $gwind_p^w$ ) or spilled ( $sp_p^w$ ), as shown in next equation:

$$E.1 \quad gwind_p^w + sp_p^w = WF_p^w \quad \forall p, w$$

A graphical description can be seen in Figure 2.3, where the existence of such expected spillages could be motivated by an excess of committed generation:

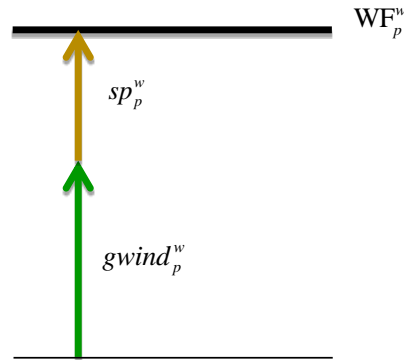

**Figure 2.3: Wind farms do not provide active power control**

The optimization stage tries to model the day-ahead market clearing in which all available resources are scheduled optimally in order to supply the system demand subject to all system constraints and based on forecasted values of demand, wind generation, inflows, etc. that are subject to uncertainty. For that reason, the TSO establishes some requirements of upward and downward reserves that will enable the system to be protected against such uncertainty. In this case, only thermal, hydro and pumped storage units are able to provide these reserves. It must be also noted that pumped storage plants provide active power control when just when producing but not when pumping, since that is the current situation in the Spanish electricity system, although it could be possible in the near future update this technologies by means of variable speed pumping units <sup>2</sup>.

The constraints that allow modeling such system requirements are the next ones, where it can be seen that the system upward and downward reserve requirements ( $UR_p^{case A}$  and  $DR_p$ ) are satisfied by the sum of the individual reserve provisions of all thermal, hydro, and pumping storage units. Notice that in case there is not enough reserve in the system, in order to avoid an unfeasibility, two auxiliary variables ( $urdef_p, drdef_p$ ) have been introduced although they will only take values different to zero when such deficit of reserves cannot be physically avoided

$$\begin{aligned}
 \text{E. 2} \quad & \sum_t tur_p^t + \sum_h hur_p^t + \sum_b bur_p^b + urdef_p \geq UR_p^{case A} \\
 & \sum_t tdr_p^t + \sum_h hdr_p^h + \sum_b bdr_p^b + drdef_p \geq DR_p \quad \forall p
 \end{aligned}$$

Given that one of the sources of uncertainty is the wind generation, the amount of these reserve requirements should reflect that wind generation could deviate from its forecasted value.

In the Spanish electricity market, as in any other power system, between the day-ahead market clearing and the real time power delivery, there exist a number of mechanisms that

<sup>2</sup> Variable speed technology offers additional network flexibility to conventional pumped-storage plants by enabling power regulation in pumping mode as well as in generation mode.

allow the operators to correct their schedules and to adapt them to the real demand, wind generation, etc. In the particular case of Spain, six intra-day markets are run each day so that demand and generation agents may carry out adjustments before the energy is delivered, in order to correct unfeasible schedules and correct deviations from the forecast, as prediction errors are lower under these shorter temporal scopes. Moreover, the TSO establishes the requirements of secondary reserve one day in advance, and makes use of the tertiary reserve market to re-establish the secondary energy in use, so it is only called and cleared if the secondary reserve is exhausted or it has to be replaced in real time operation.

As in the ROM model all these intermediate stages between the day-ahead and the real time are not modelled, the reserve requirements in equation E.2. should represent something else than just the secondary and tertiary reserves managed by the TSO. They should also include the equivalent reserve that the system has implicitly one day in advance thanks to the existence of the intraday markets that are not being modelled in ROM. In order to determine how much this extra-reserve requirement should be, an analysis of historical data has been carried out. The time series used in the analysis were:

- Hourly wind generation forecasted by the TSO one day in advance
- Real hourly wind generation

The comparison of both series shows that 95% of the hours, the real generation measured the day after was higher than 60% of the forecasted value the day ahead. This can be interpreted as having a 95% of probability that wind generation is not going to be lower than such 60% of the forecasted value. Therefore, the remaining 40% is subject to uncertainty, and to be protected against it, the upward requirements used in equation E.2. will include a term for the 40% of the forecasted wind generation as shown in section 2.3.5.

- **Case B: wind farms are able to provide active power control**

In this case, wind farms are allowed to provide active power control. The next constraint ensures that wind generation that is scheduled the day ahead does not exceed the wind generation forecast:

$$\text{E. 3} \quad gwind_p^w \leq WF_p^w \quad \forall p, w$$

Given that the optimization stage in the ROM model is formulated as a deterministic problem, assuming that the difference between the wind forecast and the scheduled wind generation is going to be available reserve, could be too optimistic. As explained before, the analysis of historical data of the Spanish system shows that with a 95% probability, the real wind generation is going to be higher than 60% of the forecasted value. This fact has a twofold effect from the modeling point of view:

1. If wind generation is scheduled the day-ahead below such 60% of the forecasted value, it would not be necessary to include the term of the wind error forecast in the upward reserve requirements. In other words, such scheduled wind generation can be considered as certain, and therefore there is no need to deploy reserves for it. However, if wind generation is scheduled above such 60% of the forecasted value, all



the wind power scheduled exceeding it, will be subject to uncertainty, and thus, it should be included as an extra term in the upward reserve requirements.

2. When computing the amount of upward reserve that wind generators can provide, it is necessary to take into account that it can only be ensured a 60% of the wind forecasted value.

In order to model these dependences, the formulation that has been necessary to design and to implement in ROM is the following one:

On the one hand, if wind generation scheduled the day-ahead is lower than the 60% of the wind power forecast, no up reserve requirements related to the uncertainty of the wind power forecast are going to be demanded to the system. Moreover, wind farms are allowed to provide wind up reserve. However, wind up reserve is only allowed to be provided till the sum of wind generation and wind up reserve reaches the 60% of the wind forecast due to the possibility that a further value may not be entirely supplied. In the next equation it can be seen that upward reserve provided by wind generation ( $wur_p^w$ ) is the difference between the wind generation that can be ensured ( $60\% WF_p^w$ ) and the wind generation ( $gwind_p^w$ ):

$$\text{E. 4} \quad gwind_p^w + wur_p^w = 60\% WF_p^w \quad \forall p, w$$

On the other hand, if wind generation exceeds the 60% of the day-ahead wind power forecast, the difference between the wind generation committed and the 60% of the day-ahead wind power forecast value is going to constitute an extra up-reserve requirement to the system. The variable  $conswur_p^w$  represents such concept, and it could be interpreted as the consumption of up-reserve due to scheduling wind generation above the level that can be guaranteed. Furthermore, wind farms are not allowed to provide wind up reserve in this case. Note that if wind generation committed is equal to the day-ahead wind power forecast, the consumed band up demanded to the system ( $conswur_p^w$ ) matches with the up reserve requirement in case A (40% of the day-ahead wind power forecast).

$$\text{E. 5} \quad \begin{aligned} gwind_p^w - conswur_p^w &= 60\% WF_p^w \\ wur_p^w &= 0 \end{aligned} \quad \forall p, w$$

A graphical description of previous equations can be seen in Figure 2.4:

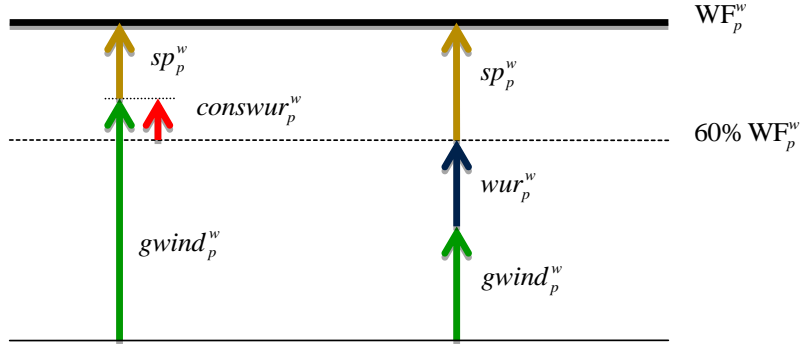

**Figure 2.4: Wind farms are allowed to provide active power control**

Therefore, active power control by wind farms allows optimizing the wind generation committed relating this amount to the corresponding up reserve requirements of the system. This is expected to relieve the up reserve constraint of the system and reduce operating costs.

Finally, wind farms are also allowed to provide wind down reserve. The amount of wind down reserve provided must exceed neither wind generation nor the 60% of the day-ahead wind power forecast value due to the possibility that a further value may not be entirely available:

$$\begin{aligned}
 \text{E. 6} \quad & wdr_p^w \leq gwind_p^w \quad \forall p, w \\
 & wdr_p^w \leq 60\%WF_p^w \quad \forall p, w
 \end{aligned}$$

Reserve constraints when introducing active power control by wind farms are shown in equation E.7. Once again, pumped storage hydro plants provide active power control when producing but not when pumping, since that is the current situation in the Spanish electricity system.

$$\begin{aligned}
 \text{E. 7} \quad & \sum_t tur_p^t + \sum_h hur_p^t + \sum_b bur_p^b + \sum_w wur_p^w + urdef_p \geq ur_p^{case B} \\
 & \sum_t tdr_p^t + \sum_h hdr_p^h + \sum_b bdr_p^b + \sum_w wdr_p^w + drdef_p \geq DR_p \quad \forall p
 \end{aligned}$$

Notice that the main differences of this formulation with respect the one shown in equation E.2. is the inclusion of the sum of the reserves provided by wind generators, and the right hand side of the upward reserve inequality, which instead of a fixed parameter it is a variable of the problem, as the amount of reserve requirement depends on the final schedule of wind generation.

#### 2.3.4. Description of the simulation stage

The adjustments of the generating units due to the realization of the random variables and unexpected events are computed by a simulation module. This module is divided in two steps:

- In the first step, the simulation module performs corrections to the commitment specified by the daily optimization module, applying them in the 24 h of the day before the operation day (D-1). The Midnight is assumed to be the last time where the commitment decision of a group would allow this group to reach the ramping hours in the morning (7-12 am). These deviations could be produced by an error in the forecast of the intermittent generation or the failure of the generation units. The corresponding corrective actions are the commitment of new generation units or the shutting down of others, whose objective is to reduce the deviation into safe margins that can later be handled by the use of reserve (for instance reducing error to less than 1 GW).
- The second step deals with the monitoring of each hour of the interest day and it takes the adequate decisions in order to correct the error in the forecasting of the wind production, the demand or failure of the thermal units. At this point, all available wind power is aimed to be produced for both cases A and B, regardless of the wind generation and the wind up reserve committed in the optimization stage. The corresponding corrective actions cannot be the commitment or shutting down of any unit (except the fast peaking units) but the use of reserves.

### 2.3.5. About the upward and downward requirements

Reserve requirements in the Spanish electricity system are established as follows:

1. Primary reserve requirement consists of a mandatory non-remunerable service from conventional units: generating units must be capable of modifying 1.5% of their rated output power in less than 15 seconds, for frequency variations less than 100 mHz and linearly up to 30 seconds for frequency deviations up to 200mHz [3].
- Regarding secondary regulation, the ENTSO-E system proposes the following minimum up reserve level [4]:

$$\text{E. 8} \quad USR = \sqrt{(a \cdot L_{max} + b^2)} - b$$

Where  $USR$  is the level of secondary up reserve demanded by the ENSTO-E system,  $L_{max}$  is the forecasted demand for a certain period and  $a$  and  $b$  have been empirically determined as 10 MW and 150 MW, respectively. On the other hand, the ENTSO-E system establishes that down reserve level represents between 40% and 100% of the up reserve one. Additionally, ENTSO-E imposes 500 MW and 400 MW as the minimum values for up and down reserve levels, respectively [4].

- The Spanish SO determines the minimum amount of tertiary regulation computed as the rated power of the largest unit within the system plus 2% of the forecasted load for each hour [5].

The ROM model does not consider all the intermediate stages between the day-ahead scheduling and the real time power delivery. Therefore, the reserve requirements in the optimization stage will include an extra term than just the secondary and tertiary reserves managed by the TSO. As it was explained before, such requirements will include the equivalent reserve that the system has implicitly one day in advance thanks to the existence of the intraday markets, and for the particular case of wind generation it has been decided to consider that only 60% of wind generation forecast can be considered certain. Therefore, the formulation included is the next one:

Reserve requirements for case A are:

$$\begin{aligned} \text{E. 9} \quad UR_p^{case A} &= 2\% D_p + \text{capacity of the largest unit} + 40\% \sum_w WF_p^w \quad \forall p \\ DR_p &= 2\% D_p \quad \forall p \end{aligned}$$

Reserve requirements for case B are:

$$\begin{aligned} \text{E. 10} \quad ur_p^{case B} &= 2\% D_p + \text{capacity of the largest unit} + \sum_w conswur_p^w \quad \forall p \\ DR_p &= 2\% D_p \quad \forall p \end{aligned}$$

Reserve requirements for case A and B coincide if the wind generation committed in case B is equal to the day-ahead wind power forecast. Besides this, in both cases the term “capacity of the largest unit” means that the reserve is able to cope with the failure of the largest unit that is already committed in the system.

### 2.3.6. Illustrative case in a mock-up example case

This section shows a mock-up example case to illustrate the main benefits of the provision active power control by wind farms from system’s perspective. After introducing the input data describe below, case A and case B were solved using the deterministic stage of the ROM model. Both results were compared in order to determine the impact of the active power control by wind farms.

- **Input data**

The time scope of the case study was considered to be made up of only three periods to simplify the illustration: off-peak, intermediate and peak hours.

Thermal generation considered is made up of a nuclear unit of mandatory commitment and three more units ordered in increasing costs. Table 2.6 shows the main technical data of the thermal units considered, Table 2.7 shows the main characteristics of the only hydro plant considered, and Table 2.8 shows the day-ahead forecasts of wind power and hydro inflows for the three periods.

Finally, the demand and reserve requirements to be met by generation are shown in Table 2.9<sup>3</sup>. Note that the up reserve requirement of case B does not include the uncertainty of the day-ahead wind power forecast; that amount of up reserve requirement ( $consur_p^w$ ) is a variable that will be decided depending on the amount of wind generation committed.

Thermal Unit	Fixed cost [k€/h]	Variable cost [€/MWh]	Min stable load [MW]	Max output [MW]
Nuclear	0	3.5	400	400
Unit 1	0.10	20.7	100	200
Unit 2	0.25	25.5	40	200
Unit 3	0.80	66	20	320

Table 2.6: Data of the thermal units

	Run of river [MW]	Max output [MW]
Hydro plant	200	250

Table 2.7: Data of the hydro plant

	P=1	P=2	P=3
$WF_p$ [MW]	600	700	400
Inflows [MWh]	250	250	250

Table 2.8: Day-ahead forecasts of wind power and hydro inflows

	P=1	P=2	P=3
$D_p$ [MW]	900	1200	1500
$DR_p$ [MW]	45	50	55
$UR_p^{case A}$ [MW]	300	350	240
$ur_p^{case B}$ [MW] (uncertainty of wind power not included)	60	70	80

Table 2.9: Demand and reserve requirements.

<sup>3</sup> The values for the reserve requirements in this mock-up example have been selected just for illustrative purposes, and therefore they do not correspond to the expressions in E.9 and E.10 that are the ones used for the real analysis.

- **Results**

Figure 2.5 and Figure 2.6 show the generating output for cases A and B, respectively. Table 2.10 compares the wind power management for both cases. The main differences between both cases for each period are:

- For the first period, note that the most expensive unit (unit 3) needs to be committed in case A in order to provide the up reserve requirement demanded by the system. Moreover, the hydro plant is producing above the run of river output in order to meet the down reserve constraint. Both decisions increase the amount of wind spillage.

On the other hand, note that only nuclear, run of river and wind generation are necessary to meet both demand and reserve constraints in the first period of case B. The reason behind it is that, the up and down reserves provided by wind farms are enough to meet the reserve requirements of the system during that period. Finally, also note that less wind is spilled in case B thanks to the provision of active power control by wind power.

- Similarly to the first period, note that the most expensive unit (unit 3) needs to be on in order to provide the up reserve requirements demanded by the system during the second period in case A. Moreover, the hydro plant is producing above the run of river output in order to meet the down reserve requirement of the system.

On the other hand, note that wind output is decreased in case B to consume lower up reserve requirements and commit the cheapest thermal unit (unit 1) instead of the most expensive one (unit 3). Therefore, in spite of wind output is reduced and thermal output is increased in case B, this solution entails lower thermal costs; the reason behind it is that the lower up reserve requirement allows the scheduling of unit commitment that entails lower thermal costs. Moreover, the provision of wind down reserve also relieves down reserve constraint and prevents the system from increasing hydro output above the run of river outcome.

- Finally, note that the provision of active power control was not necessary during the third hour (peak hour).

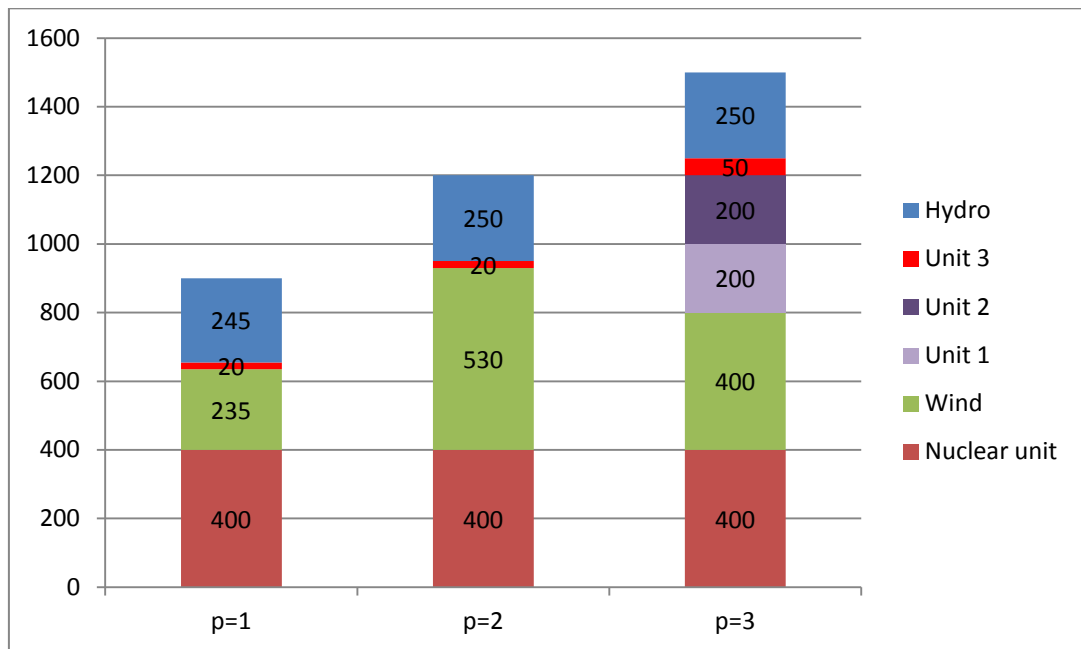

Figure 2.5: Generating output in case A

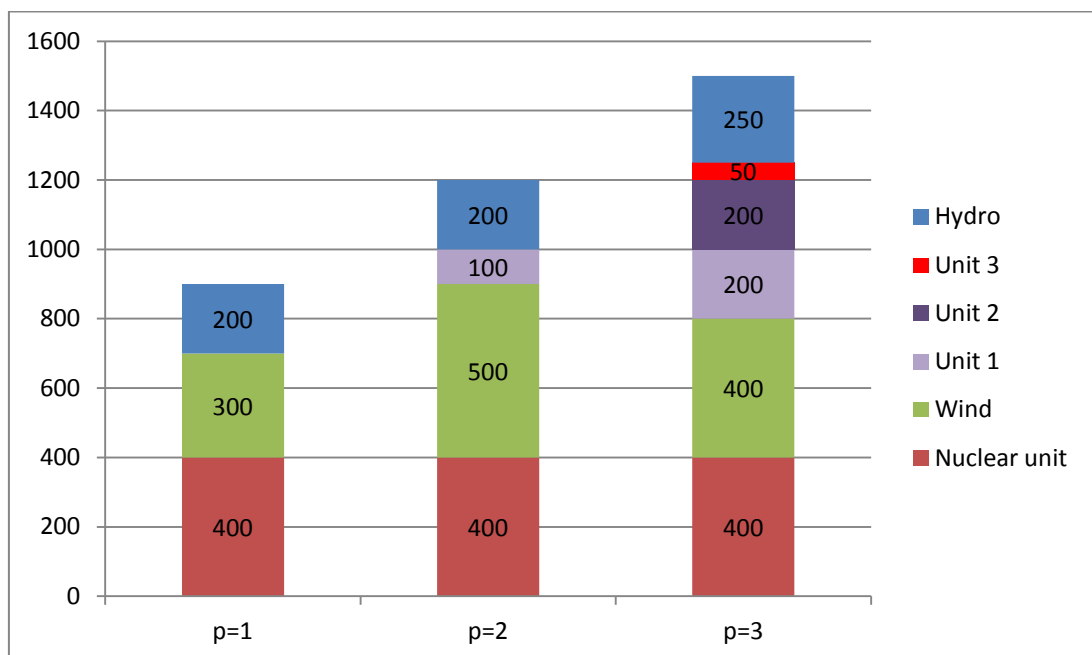

Figure 2.6: Generating output in case B

Wind power management	Case A			Case B		
	P=1	P=2	P=3	P=1	P=2	P=3
$WF_p$ [MW]	600	700	400	600	700	400
$gwind_p$ [MW]	235	530	400	300	500	400
$sp_p^w$ [MW]	365	170		240	200	
$wur_p^w$ [MW]	X	X	X	60		
$wdr_p^w$ [MW]	X	X	X	45	50	
Up reserve requirement due to WG uncertainty [MW]	240	280	160	0	80	160
$UR_p^{case A}, ur_p^{case B}$ [MW]	300	350	240	60	150	240

Table 2.10: Wind power management for case A and case B

- **Conclusions**

The conclusions that can be derived from the analysis of the mock-up example case, are the following ones:

- Wind down reserve may be a useful tool to relieve the down reserve constraint of the system and decrease the operating costs. In particular, the provision of wind down reserve is expected to gain importance during off-peak hours, where hydro plants and thermal units are operated close to their minimum output values and therefore, have very low down reserve capabilities. The provision of wind down reserve is also expected to reduce wind spillage since it prevents the system from increasing hydrothermal generation and spill wind generation in order to meet system down reserve needs. Therefore, the provision of wind down reserve may be beneficial for reducing the operating costs of the system, permitting additional wind power to be produced and reducing CO2 emissions. The more the down reserve constraint conditions the generating scheduling, the more economic impact is expected to be obtained from the provision of this service.
- The provision of wind up reserve may be a useful tool to relieve the up reserve constraint of the system and reduce the operating costs. However, the fact that more than 40% of the day-ahead wind power forecast needs to be spilled so that wind farms may provide wind up reserve limits its provision to very extreme off-peak hours. The provision of wind up reserve may come from a substitution of wind spillage or from a reduction of wind output. As shown in this case example, when substituting wind spillage, the provision of wind up reserve may permit additional wind generation to be produced. However, the provision of wind up reserve may also entail a decrease of wind output and increase of thermal generation due to the scheduling of a new unit commitment that entails lower operating costs. Consequently, the provision of active



power control by wind farms may lead to lower operating costs but also higher CO2 emissions.

- Similarly to the provision of wind up reserve, the consumption of lower values of upward reserve requirements may also be a useful tool to relieve up reserve constraint of the system and decrease the operating costs. The consumption of lower up reserve requirements may also come from wind that would be spilled anyway (which may permit additional wind output to be produced) or from a reduction of wind generation. Moreover, the provision of this service is expected to gain importance during off-peak hours too, in which wind spillage arises and the reduction of wind output entails the increase of cheap thermal generation. However, the provision of this service may also be provided during intermediate or even peak hours, in which there barely is wind spillage but the reduction of wind output may be economically preferred since it may bring a UC that entails lower operating costs.

### 2.3.7. Description of input-data: scenarios for 2013 and 2020

Input data were obtained in collaboration with Red Eléctrica de España and were used to develop the 2020 and a 2013 scenarios for mainland Spain. These data are summarised in Table 2.11. Furthermore, the shares of installed capacities for the 2013 and the 2020 scenarios are plotted in Figure 2.7 and Figure 2.8, respectively, where it has been included the demand and wind generation hourly time series of the nominal case for 2020. CO2 emission price has been estimated as 30 €/Tn, and it will be considered as part of the operational cost together with fuel and O&M costs of thermal units. A sensitivity analysis of the main input parameters that condition the economic impact for the year 2020 is performed in section 2.4.2.

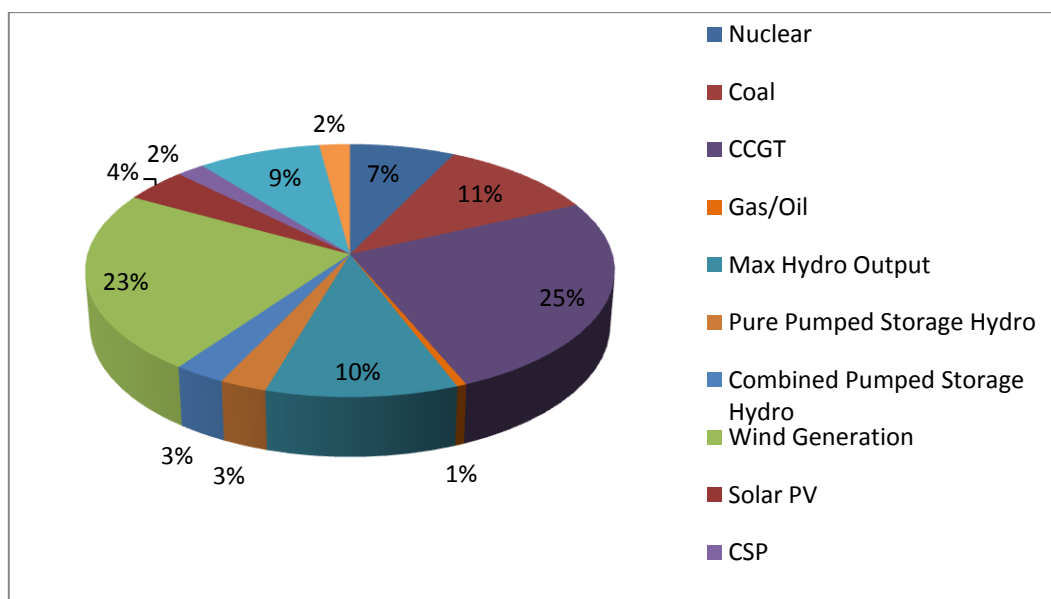

Figure 2.7: Share of installed capacities for mainland Spain in 2013

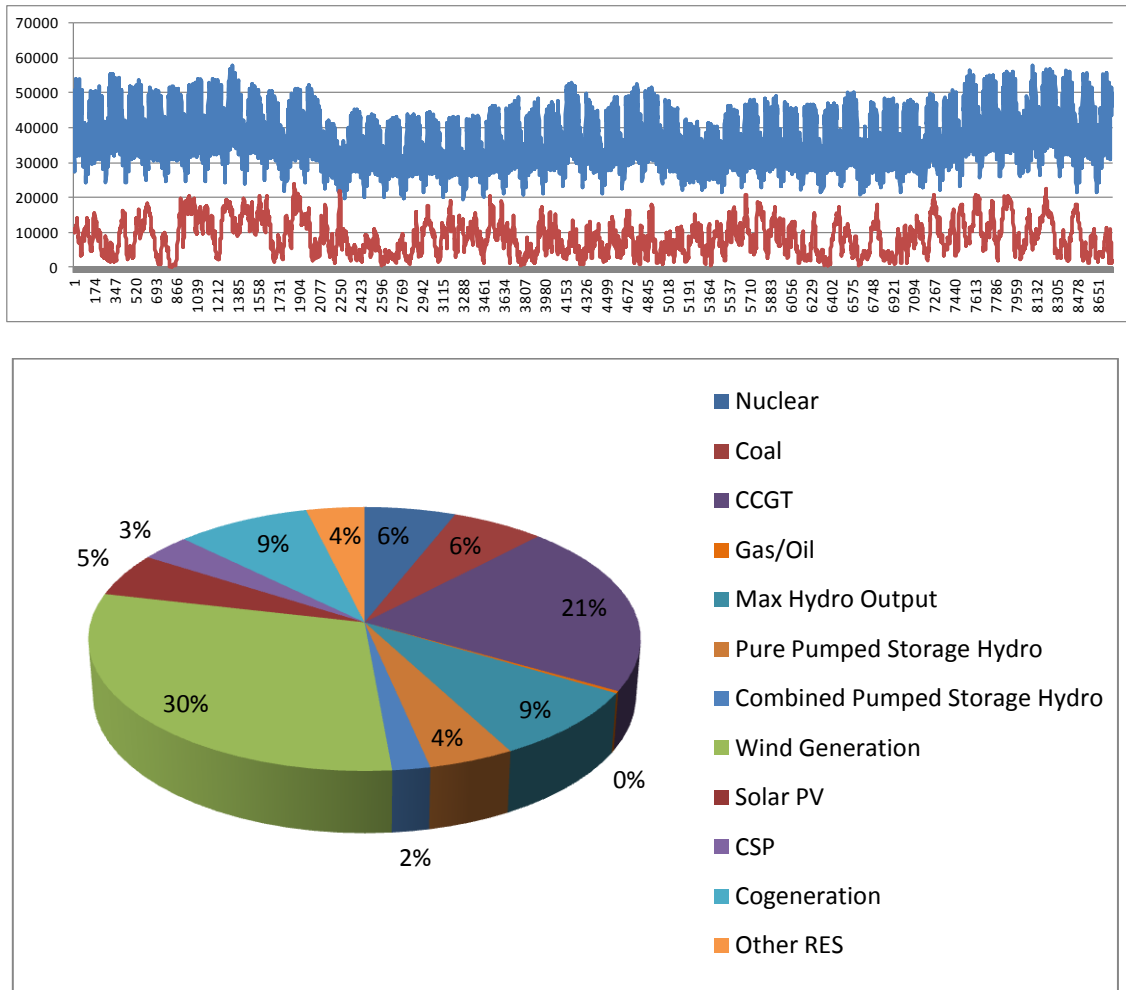

Figure 2.8: Hourly time series of system demand (blue) and wind forecast (red), and share of installed capacities for mainland Spain in 2020

		2013 scenario	2020 scenario
Energy	[TWh]	251	331
Winter Peak	[MW]	40636	58000
Summer Peak	[MW]	39953	53000
Min Load	[MW]	17000	19246
Peak/OffPeak Ratio	[p.u.]	2.4	3.0
Nuclear	[MW]	7000	7000
Coal	[MW]	10434	7113
CCGT	[MW]	24491	24491
Gas/Oil	[MW]	506	301
Max Hydro Output	[MW]	10000	10000
Pure Pumped Storage Hydro	[MW]	2451	5185
Combined Pumped Storage Hydro	[MW]	2712	2284
Wind Generation	[MW]	22213	34820
Solar PV	[MW]	4186	6250
CSP	[MW]	1878	3810
Cogeneration	[MW]	8192	10310
Other RES	[MW]	2041	4460
Natural Hydro Inflows	[TWh]	28	28
Natural Gas Price	[€/MWh]	26	27,5
CO2 Price	[€/t CO2]	15	30

Table 2.11: Input data for the 2013 and 2020 scenarios for mainland Spain.

## 2.4. Results under a system perspective

### 2.4.1. Results under a system perspective for the 2020 scenario: costs, emissions and impact on the generation shares

Table 2.12 shows the main results of the assessment: operating costs, emissions and wind output for both cases. Note that the provision of active power control by wind farms accounts for 1.1% of reduction in the operating costs of the system. However, the share of wind generation and the CO2 emissions are barely impacted.

2020 results		CASE A	CASE B	Difference	Difference [%]
Operating Costs	[M€]	7444,4	7361,4	83,0	1,11%
CO2 emissions	[MTCO2]	48,9	49,0	-0,1	-0,21%
Wind generation	[TWh]	72,9	72,80	0,14	0,19%

Table 2.12: Resulting KPI'S for mainland Spain in 2020

Table 2.13 shows the resulting output of the different technologies for both cases. Note that pumped storage hydro output is the only technology impacted by the provision of active

power control by wind farms. In particular, the provision of active power control by wind farms reduces pumped storage hydro production and consumption; the reason behind it is that the resulting lower operating costs obtained thanks to the provision of active power control reduce the need for using pumped storage hydro plants.

Generation Technology		CASE A	CASE B	Difference	Difference[%]
Thermal	[TWh]	142,7	142,4	0,3	0,2%
Hydro	[TWh]	27,5	27,5	0,0	0,0%
Pumped Storage Hydro	[TWh]	3,4	2,4	1,0	28,6%
Wind	[TWh]	72,9	72,8	0,1	0,2%
Other Renewable Energy Sources	[TWh]	89,3	89,3	0,0	0,0%
Energy non-served	[TWh]	0,0	0,0	0,0	0,3%
Pumped Storage Hydro Consumption	[TWh]	4,9	3,5	1,4	28,0%

Table 2.13: Resulting output of each technology for mainland Spain in 2020

Figure 2.9 illustrates the share of down reserve requirements demanded by the system. Note that wind down reserve accounts for 11.8% of total down reserve requirements. The total wind down reserves that are finally used after running the simulation stage amount to 191 GWh. Wind down reserve is provided during off-peak hours, where thermal units are operated close to their minimum stable loads and hydro plants close to the run of river output.

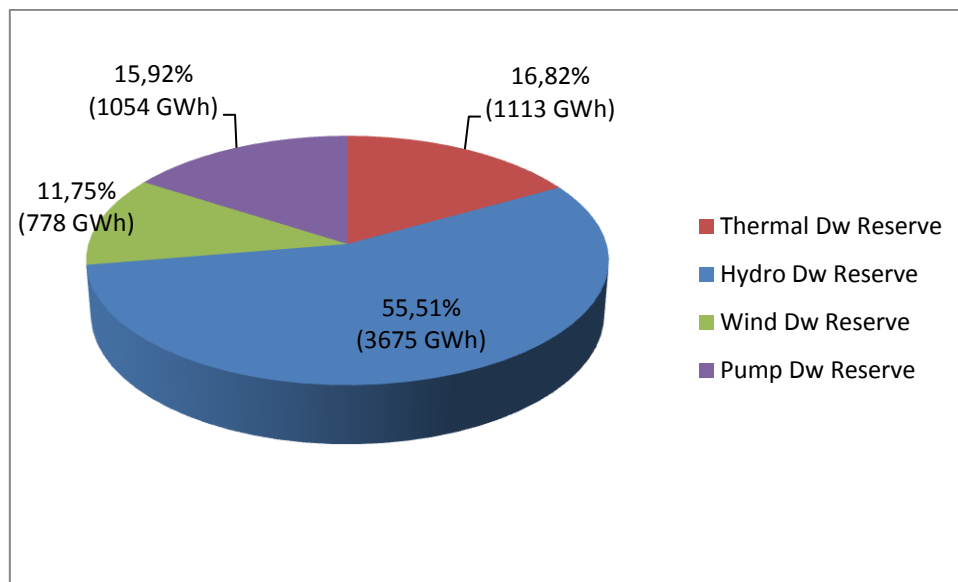

Figure 2.9: Share of the down reserve requirements of the system for case B

Table 2.14 shows how the up reserve requirements of the system are covered for both cases and Figure 2.10 illustrates the share of the up reserve requirements for case B. Note that the up reserve requirements of the system are reduced by 8.8% in case B thanks to the lower up reserve requirements consumed by wind generation. Furthermore, note that the effect of wind up reserve is negligible due to two reasons:

- More than 40% of the day-ahead wind power forecast needs to be spilled so that wind power may provide up reserve. This limits the provision of wind up reserve to a very small number of off-peak hours.
- When wind power provides up reserve, the up reserve requirements of the system are low since the uncertainty of the wind power forecast is not included in them (E. 10). Moreover, hydro plants, which are operated close to the run of river output during these hours, have enough up reserve capabilities to meet the up reserve requirements of the system.

Generating Technology		CASE A	CASE B	Difference	Difference[%]
Thermal Up Reserve	TWh	16,9	17,4	-0,5	-3,1%
Hydro Up Reserve	TWh	25,3	24,3	1,1	4,2%
Wind Up Reserve	TWh		0,1	-0,1	
Pump Storage Up Reserve	TWh	4,4	0,8	3,6	82,6%
Up Reserve Req. not due to WG uncertainty	TWh	16,0	16,0	0,0	0%
Up Reserve Requirement due to WG uncertainty	TWh	30,6	26,5	4,1	13,4%
Total Up Reserve Req.	TWh	46,6	42,5	4,10	8,8%

Table 2.14: Comparison of up reserve requirements of the system.

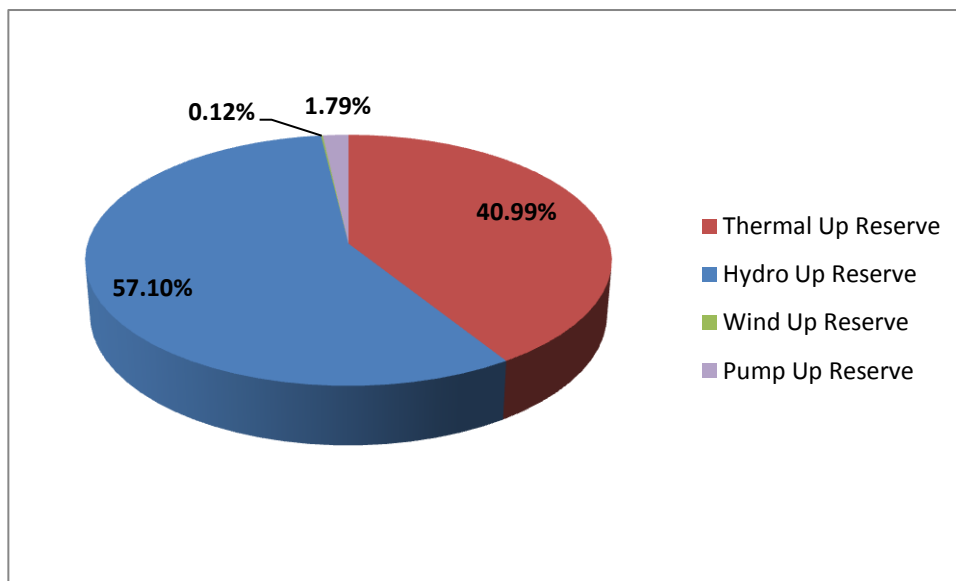

Figure 2.10: Share of the up reserve requirements of the system for case B

It may be concluded that the impact of the active power control by wind farms for Spain 2020 consists of a 1.1% reduction of the operating costs of the system that comes from the provision of wind down reserve and the consumption of lower up reserve requirements. However **it is important to highlight that this cost reduction cannot be interpreted as renewable energy integration cost**, and that the resulting savings could depend on the cost

parameters of generating units considered in the analysis, and on the methodology followed in the assessment.

#### 2.4.2. Sensitivity analysis for the 2020 scenario

A sensitivity analysis of the main input parameters that affect the economic impact obtained was performed for the 2020 scenario. The sensitivity analysis was conducted changing unilaterally each of the following input data:

- System down reserve requirements.

The higher the down reserve requirements demanded by the system are (E. 9 and E. 10), the higher the need for wind down reserve is expected to be. Therefore, the economic impact of the provision of active power control by wind farms is expected to be increased if down reserve requirements are higher.

This is illustrated in Figure 2.10, where the economic impact of the provision of active power control by wind farms increases up to 3.9% of the operating costs of the system if down reserve requirements are increased from 2% to 4% of demand:

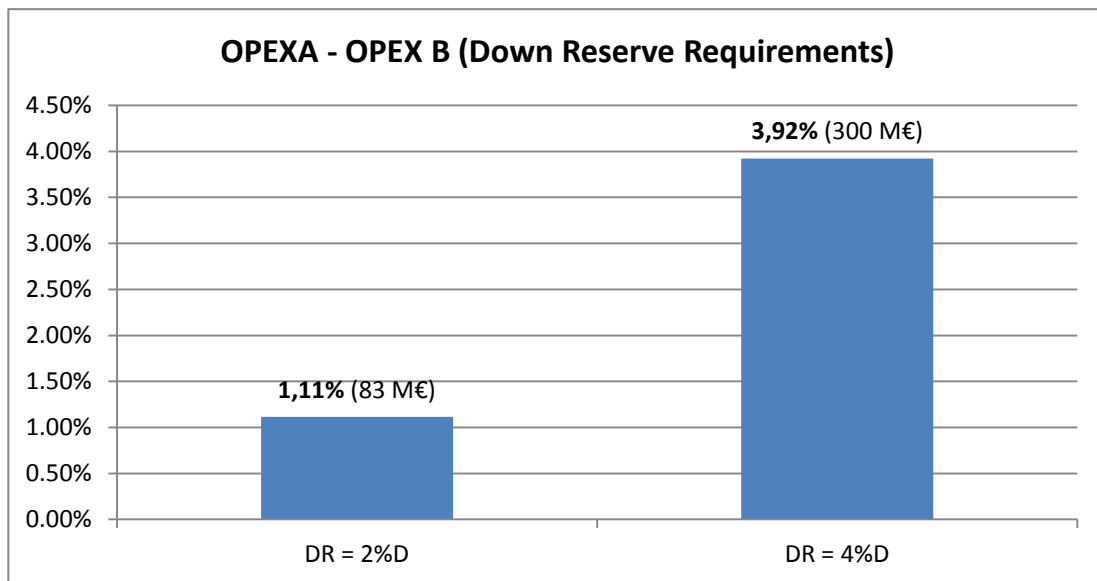

Figure 2.11: Effect of the down reserve requirements of the system on the economic impact of active power control by wind farms

- Up reserve requirements: uncertainty of the day-ahead wind power forecast.

The economic impact of the active power control by wind farms increases with increasing up reserve requirements. The reason behind it is that the flexibility provided by the active power control of wind farms to the up reserve requirement of the system is more demanded with higher up reserve requirements.

This is illustrated in Figure 2.11 where the economic impact of the provision of active power control by wind farms with respect to different levels of up reserve requirements is plotted. In particular, the different levels of up reserve requirements were obtained depending on the amount of up reserve requirements related to the uncertainty of the wind power forecast:

- A scenario in which 30% of the day-ahead wind power forecast is demanded to the system as up reserve requirement.
- The base case, in which 40% of the day-ahead wind power forecast is demanded to the system as up reserve requirement.
- A scenario in which 50% of the day-ahead wind power forecast is demanded to the system as up reserve requirement.

Note that if wind power forecasting techniques improve significantly, the amount of up reserves demanded to the system and therefore, the economic impact of the active power control by wind farms, would considerably decrease.

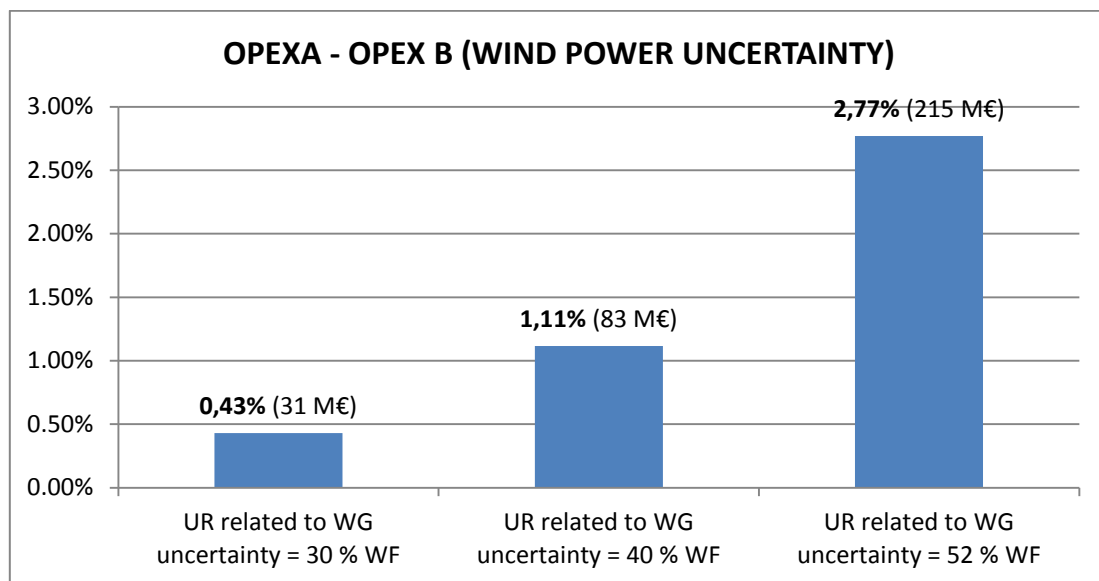

**Figure 2.12: Effect of the up reserve requirements of the system on the economic impact of active power control by wind farms**

- [Installed Pumped Storage Capacity.](#)

Pumped storage hydro mitigates the economic impact of the active power control by wind farms. The reasons behind it are related to the fact that water is pumped during off-peak hours, where the main impact of the provision of active power control by wind farms is also obtained:

- On the one hand, the more water is pumped during off-peak hours, the less wind is expected to be spilled. Consequently, the amount of wind up reserve or the consumption of lower up reserves requirements coming from wind that would be spilled anyway is expected to be reduced when the capacity of pumped storage hydro plants is increased.
- On the other hand, if the water pumped during off-peak hours is replaced by an increase of conventional generation (instead of a decrease of wind spillage), the downward reserve of conventional generation increases. Therefore, the need for wind down reserve is lower when pumped storage hydro capacity is increased.

This is illustrated in Figure 2.12, where the economic impact of the active power control by wind farms in a scenario where no pumped storage hydro is installed is compared to the economic impact in the base scenario:

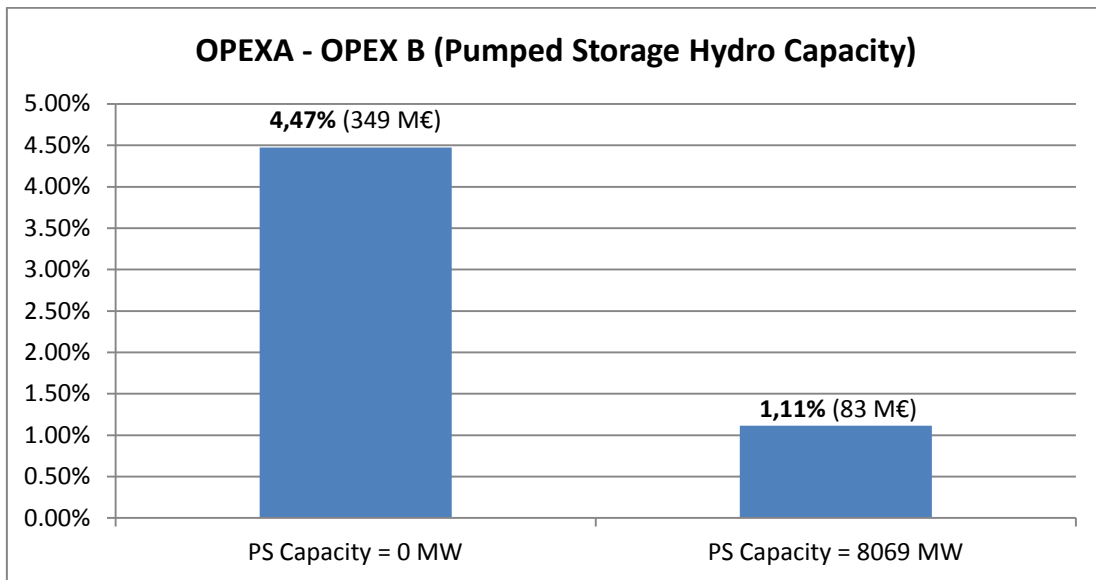

Figure 2.13: Effect of pumped storage hydro on the economic impact of active power control by wind farms

- Demand.

For the generation mix considered, the lower demand the higher the economic impact of the provision of active power control is expected to be. The reason behind it is that the impact of active power control by wind farms is mainly produced during off-peak hours; consequently, for lower demand scenarios, the need for active power control by wind farms is expected to be higher. This is illustrated in Figure 2.13, where the economic impact of the active power control by wind farms is plotted with respect to different levels of demand: the base one (331 TWh), 90% of the base one (298 TWh) and 110% of the base one (364 TWh).



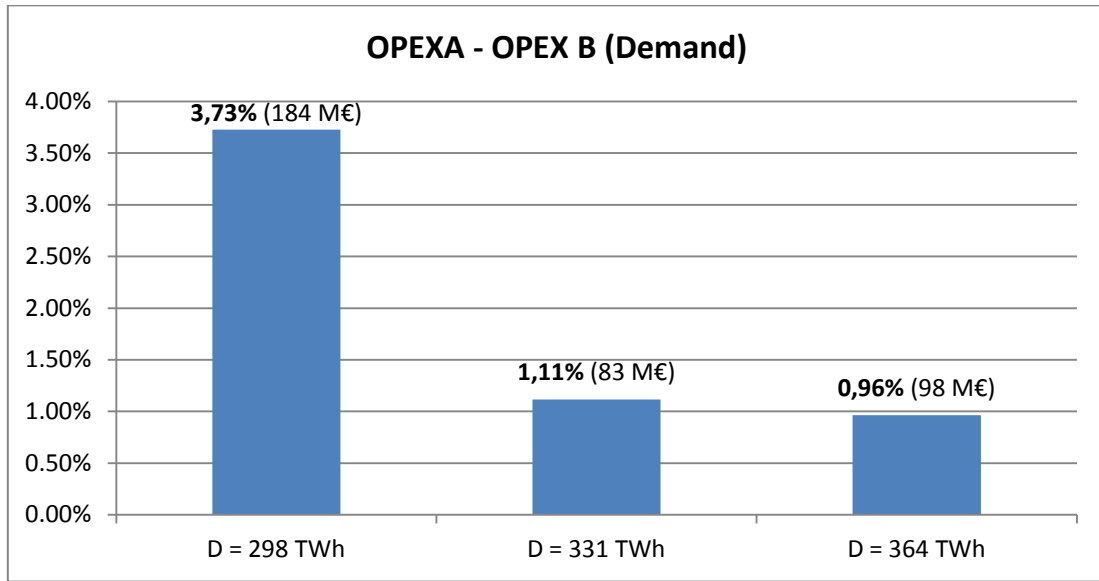

Figure 2.14: Effect of the level of demand on the economic impact of active power control by wind farms

- [Installed Wind Power Capacity.](#)

For this sensitivity analysis, it was assumed that wind error increases or decreases proportionally with respect to the installed wind power capacity.

The main conclusion is that higher installed wind power capacities than the one used in the base case increase the economic impact of the active power control by wind farms. The main reason behind it is that the up reserve requirements of the system also increase and consequently, the flexibility provided by the active power control by wind farms is more demanded. Moreover, wind down reserve provision is also more demanded with higher installed wind power capacities, since the number of hours in which demand could be entirely satisfied by just nuclear, wind, run of river and other renewable energy sources increases if wind power provides down reserve.

This is illustrated in Figure 2.14 where the economic impact of the active power control by wind farms with respect to different levels of installed wind power capacity is shown. The levels of installed power capacity are 80% of the base one (27856 MW), the base one (34820 MW), and 120% of the base one (34820 MW).

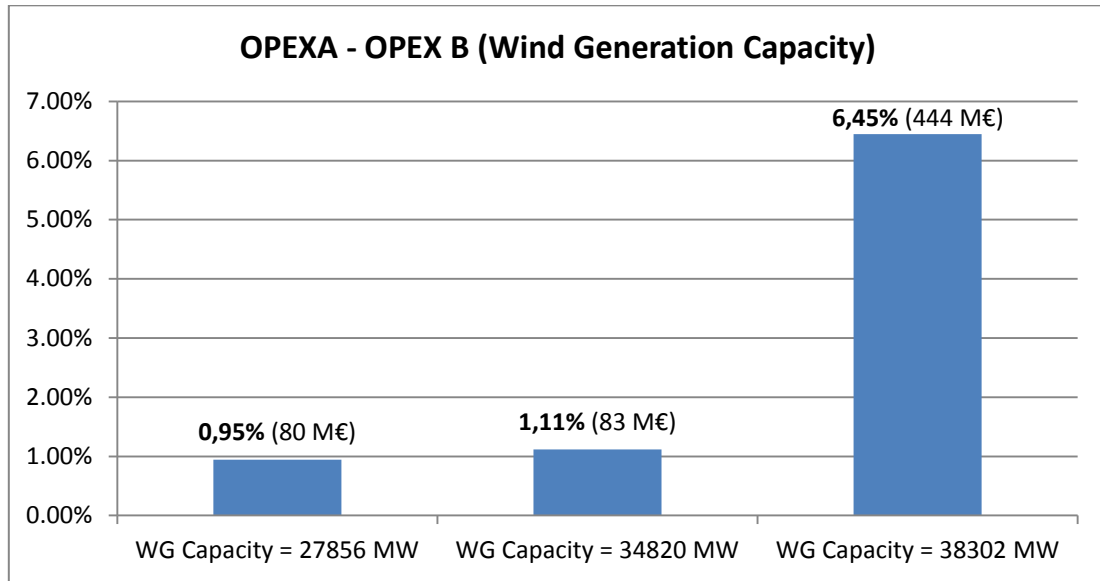

**Figure 2.15: Effect of installed wind generation capacity on the economic impact of active power control by wind farms**

Moreover, the increasing up reserve requirements related to high installed wind power capacities may limit the amount of wind power generation in the system. This situation was detected for the scenario where wind generation capacity is 38302 MW, in which the high up reserve requirements of the system require many units to be on and entail a lot of wind spillage for case A. The provision of active power control by wind farms for the same installed wind power capacity allows a relevant amount of additional wind output that can be generated in case B. This is effect illustrated in Table 2.15 and is expected to increase with even higher shares of installed wind power capacity and up reserve requirements. Note that the CO2 emissions are also considerably reduced under this scenario.

		CASE A	CASE B	Difference [%]
Wind output	%	92,8%	94,9%	-2,1%
Wind spillage	%	7,2%	5,1%	2,1%
CO2 emissions	MtCO2	43,3	42,2	2.4%

**Table 2.15: Comparison of wind output for an installed wind power capacity of 38302 MW for the Spanish electricity system in the 2020 scenario**

- Pumped storage hydro provides active power control when producing and consuming

As introduced in section 2.3.2., the ROM model takes into account that pumped storage hydro plants provide active power control when producing but not when consuming energy, since that is the current situation in the Spanish electricity system. Nevertheless, the case where pumped storage hydro units provide active power control both when producing and consuming is assessed here. The conclusion under that situation is that the impact of the

active power control by wind farms in the Spanish electricity system in 2020 is negligible due to the following reasons:

- Pumped storage hydro plants may also now provide wind down reserve by increasing the amount of consumption. Therefore, the need for wind down reserve is limited to hydro plants and thermal units operating close their minimum output values and pumping storage hydro plants operating close to their maximum consumption values. The high capacity of pumped storage hydro in the Spanish electricity system in 2020 (8069 MW) limits the provision of wind down reserve to a 0.03% out of the total down reserve requirements. Its impact is then negligible (see Figure 2.15).

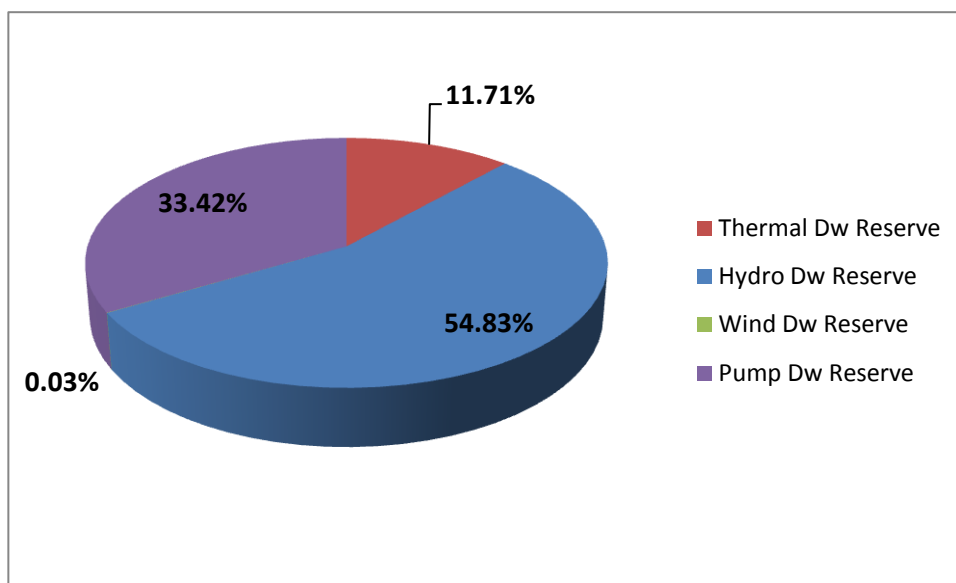

**Figure 2.16: Supply of the down reserve requirements demanded by the system for case B**

- In a similar way for wind down reserve, the impact of reducing wind generation to consume less up reserve requirements is expected to gain importance during off-peak hours. However, the provision of up reserve by pumped storage hydro plants (that may reduce consumption and even produce) is enough in most of those periods in order to commit wind generation regardless of the up reserve requirements consumed. Its impact is also negligible.
- Finally, more than 40% of the wind power forecast needs to be spilled so that wind power may provide up reserve. This limits the provision of wind up reserve to a very small number of off-peak hours. Moreover, when wind power provides up reserve, the up reserve requirements of the system are low since the uncertainty of the wind power forecast is not demanded as up reserve requirement. In this situation, hydro units and pumping storage hydro up reserve capabilities are enough to meet the up reserve requirement. Therefore, the provision wind up reserve has no economic

impact on the operating costs of the system and it only represents a 0.15% of the total up reserve needs (see Figure 2.16). Its impact is also negligible.

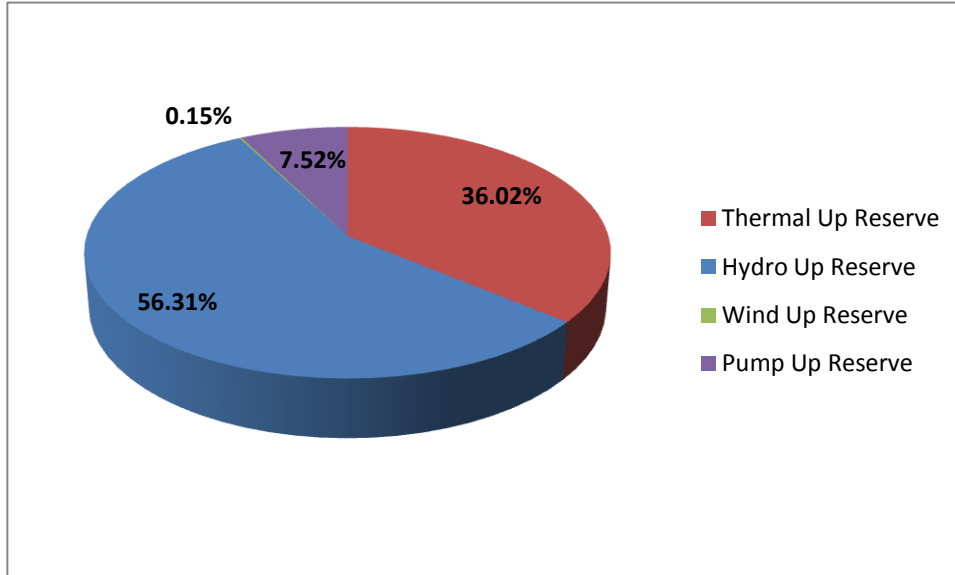

Figure 2.17: Supply of the up reserve requirements demanded by the system for case B

Therefore, the provision of active power control by wind farms has a negligible impact in the Spanish electricity system in 2020 if pumped storage hydro units provide active power control when producing and consuming.

#### 2.4.3. Results under a system perspective for the 2013 scenario: costs, emissions and impact on the generation shares

The economic impact of the active power control by wind farms for the 2013 scenario is almost negligible. The reason is the relatively smaller amount of installed wind power capacity in the system in the 2013 scenario than in the 2020 scenario:

- The amount of up reserves required by the system to deal with the wind power uncertainty for the 2013 scenario is lower than in the 2020. Therefore the flexibility provided by the active power control by wind farms to the reserve requirement is not so useful.
- The need for wind down reserve is also much smaller since the relatively smaller amount of wind and other renewable sources in the system reduces the number of hours in which thermal units and hydro plants could be operated close to their minimum output values.

2013 results		CASE A	CASE B	Difference	Difference [%]
Operating Costs	[M€]	4096,0	4095,5	0,5	0,01%
CO2 emissions	[MTCO2]	46,7	46,6	0,1	0,12%
Wind generation	[TWh]	47,8	47,74	0,02	0,04%

Figure 2.18: Resulting KPI's for mainland Spain in 2013.

#### 2.4.4. Impact for a hypothetical scenario of larger wind penetration

TWENTIES project, and in particular, the demo SYSERWIND has overcome a major technical barrier preventing better use of wind generation, although other barriers remain to be addressed in the future (such as primary regulation or inertia).

Consider the case of a particular day in which there is enough wind generation to cover all the demand through the different hours. If wind farms are not able to provide secondary regulation, i.e. to receive the set points of the AGC system in order to increase/decrease its output power under the required dynamic conditions to deal with the load variability, some conventional generators would need to be committed just to provide such service. Therefore, even in case of having enough wind resource to supply all the system demand, some thermal or hydro units would still be required to be committed, increasing therefore the level of wind curtailments and the CO<sub>2</sub> emissions in case such units were fossil fuel thermal plants.

As it was shown earlier in the sensibility analysis, for scenarios of higher wind penetration, the economic impact is more notable. In this section, two extreme scenarios are going to be analyzed just to assess what could be the benefit (from the operational costs point of view) in case the 2020 considered wind scenario were multiplied by a factor of 2 and 4.

In case of multiplying the wind scenario by 2, (Figure 2.19), the results of the model show that the operation cost of the system would be 2902 M€, with 20 Mt emissions of CO<sub>2</sub>.

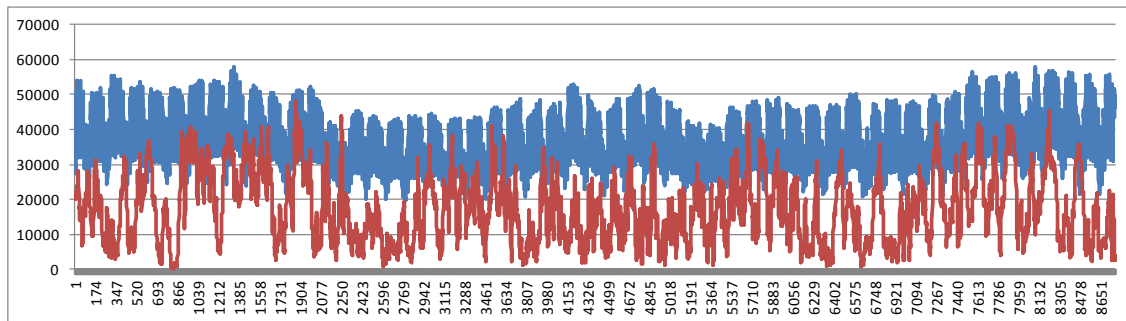

Figure 2.19: Hypothetical scenario where the wind forecast (in red) has been multiplied by a factor of 2

In case of multiplying the wind scenario by 4, (Figure 2.20), the operational cost of the system would be 671 M€, with 3.1 Mt emissions of CO<sub>2</sub>.

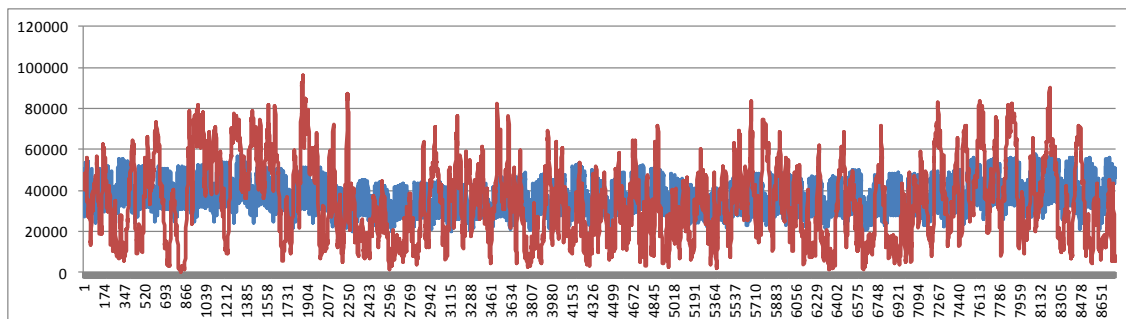

Figure 2.20: Hypothetical scenario where the wind forecast (in red) has been multiplied by a factor of 4

In terms of annual operational costs, savings would be 4542 M€ and 6773 M€ respectively, Obviously, this would require a great investment in wind generation that might not be realistic

for different reasons, but what should be emphasized here, is that this kind of hypothetical scenarios relying mostly on renewable energy sources, will only be achievable in the future if wind generation is able to provide the services demonstrated in this project.

#### 2.4.5. Up-scaling of the required costs

In the previous analysis, it has been shown that the active-power control of wind generation could have a positive economic impact in terms of the operational cost of the system. However this needs to be compared with the extra cost required to up-scale this technology to all the wind farms of the system.

In the Deliverable 9.2 entitled “Technical and economic impact on assets of the services provided by the wind farms”, it is presented the assessment of the economic impact of the demo SYSERWIND. The selected wind farms for the demonstrations are located in southern Spain, being grouped in 3 clusters with a total installed nominal power of 488 MW distributed as follows:

- Hueneja Cluster (6 wind farms): 127 G87 2 MW wind turbines
- Arcos de la Frontera Cluster (6 wind farms): 56 G87 2 MW wind turbines
- Tajo de la Encantada Cluster (3 wind farms): 61 G87 and G90 2 MW nominal power wind turbines.

The impact on CAPEX for making it possible to provide active-power control was assessed as 1 412 790 €, with no relevant impact on OPEX. Therefore, the unitary cost per MW of wind power installed would be  $1\,412\,790\text{€}/488\text{MW} = 2943.31\text{€}/\text{MW}$ . Assuming an installed capacity of wind generation of 34820 MW in 2020, the scaling-up cost would be 102.5 M€, that assuming a 20 year life span and neglecting the discount rate, it could be annualized as 5.1 M€/year. As in the nominal case the cost savings per year were estimated as 83 M€, this results in a positive cost-benefit analysis.

Moreover, in the previous analysis the up-scaling cost have been notably overestimated, given that the presented figures correspond to the cost incurred during the demo, and it is likely that the effect of economies of scale would diminish such costs. In particular, the impact study has been carried out in three complementary areas: Wind Turbine Area, Wind Farm Area, and Cluster Area in such a way that the total cost could be distributed as follows:

- Low impact (23% of total cost) at the WTG level (spending only on adaptation and control software update).
- Very low impact (11%) at the WF level (Parameterization of control and communications with the superior regulator).
- The greatest impact (66%) corresponds to the Zone level (equipment and superior control software and weather forecasting system).

For the particular case of Iberdrola, most of the cost has been incurred at the Zone level, and therefore it would not be necessary to incur on it again in case of scaling-up this technology to all the wind farms operated by them. Assuming an estimated value of 150 000€ for a wind farm of 100 MW, the upscaling cost for the whole system would be 52.3 €, that could be roughly annualized as 2.6 M€/year. This figure represents just 3.1% of the expected savings of operational costs.

## 2.5. The agent perspective

Currently in Spain wind installed power technology is remunerated according to Royal Decree RD661/2007 [6]. RD 661/2007 provides two different options to be selected by the wind owner. The first one remunerates the wind energy at a constant regulated price independently of the daily market price. However, within the second option the wind owner participates sending the wind energy forecast as an offer to the daily market. The remuneration in this second option is computed adding a premium to the daily market price. In both cases the parameters (the constant regulated price for the first case and the premium, the floor and the cap for the second case) change every year in accordance with the RPI. Figure 2.21 depicts the remuneration of wind energy ( $P_{Wind}$ ) according to RD 661/2007.

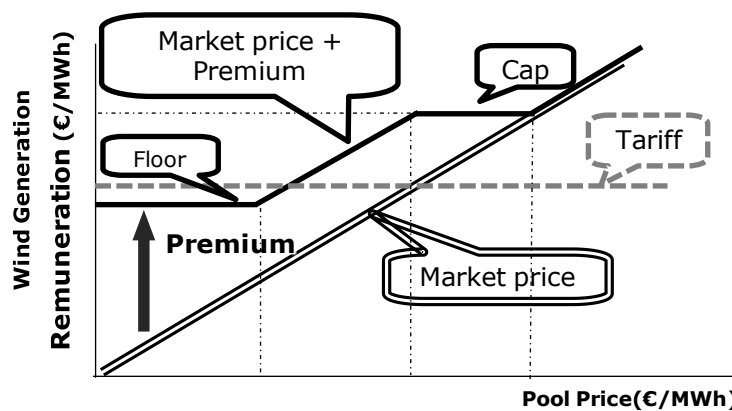

Figure 2.21: Remuneration of wind energy in accordance with RD 661/2007

It should be noted that from 31st January 2012, the premiums for the new installed wind farms have been removed, and given that the pricing mechanisms for renewable energy sources are currently being under study, this section will not be focused on the economic impact from the agent perspective, but on the amount of generation that is needed to be spilled in order to ensure the deployment of the reserves.

In order to evaluate the amount of wind power that has to be curtailed to deliver the active-power control, a statistical analysis has been performed. There are three main factors that must be studied in this case.

The first one is the short-term forecast error, which deals with the inaccuracies when predicting 15 and 75 minutes ahead the power output that the wind farms will provide during the demonstration. According to the studies, this forecast error follows a Gaussian distribution and the more wind farms are aggregated, the smaller it is, although the errors for different wind farms, even for those sitting next to each other, are not completely independent.

The second factor is the high frequency variability. The forecast model provides an average power for a 15 minute period, but within this period the power output value can vary in a quick way, deviating notably from the average value. This effect has also been modeled taking 1 Hz samples.





If the wind forecast was to be provided 15 minute in advance, 733 MW of 5270 MW would have to be curtailed to make sure that 100% of the setpoints received from the TSO are fulfilled. If wind generators are allowed to fail 10% of the setpoints, only 186 MW would have to be curtailed. The amount of power to be curtailed increases notably if the forecast is provided 75 minutes in advance.

## 2.6. Conclusions

The provision of active power control by wind farms may be a useful tool to relieve the reserve constraints of the system and reduce the operating costs:

- In particular, the provision of wind down reserve is expected to gain importance during off-peak hours, where hydro plants and thermal units are operated close to their minimum output values and therefore, have very low down reserve capabilities. The provision of wind down reserve is also expected to reduce wind spillage since it prevents the system from increasing hydrothermal generation and spill wind generation to meet system down reserve needs. The more the down reserve constraint of the system conditions the generating scheduling, the more economic impact is expected to be obtained from the provision of this service.
- The fact that more than a significant amount of the day-ahead wind power forecast perfect needs to be spilled so that wind farms may provide wind up reserve limits its provision to very extreme off-peak hours. Moreover, when wind power provides up reserve, the up reserve requirements of the system are low since the uncertainty of the wind power forecast is not included in them; therefore, the up reserve provided by hydro plants, which are operated close to the run of river output during these hours, is enough to meet the up reserve requirements of the system.
- Similarly to the provision of wind up reserve, the consumption of lower up reserve requirements may also be a useful tool to relieve up reserve constraint and decrease the operating costs of the system. The consumption of lower up reserve requirements may come from wind that would be spilled anyway (this may permit an increase in wind generation) or from a reduction of wind output. Moreover, the provision of this service is expected to gain importance during off-peak hours too, in which wind spillage arises and the reduction of wind output entails the increase of cheap thermal generation. However, the provision of this service may also be provided during intermediate or even peak hours, in which there barely is wind spillage but the reduction of wind output may be economically preferred since it may bring a cheaper UC.

Results show that the impact of the provision of active power control by wind farms in the Spanish electricity system is negligible for the 2013 scenario and consists of a 1.1% reduction of the operating costs for 2020, but barely impacts the share of wind output and the emissions

of CO<sub>2</sub>. The reasons under the economic impact are the provision of wind down reserve and the consumption of lower up reserve requirements by wind generation. However, the economic impact would be negligible if pumped storage hydro plants were allowed to provide active power control in 2020.

The sensitivity analysis performed indicates that the conditions for a high economic impact of the provision of active power control by wind farms are:

- Systems with a high share of wind power capacity and other technologies that do not provide active power control such as nuclear or other renewable energy sources. It was assumed that the error of wind power forecast also increases with a higher share of installed wind power capacity.
- Systems with a low share of installed capacity of flexible generating sources, such as pumped storage hydro plants.
- In general, systems in which up and down reserve constraints highly condition the resulting generation scheduling.

Under this situation, it may be expected a higher economic impact of the active power control by wind farms in the Spanish electricity system in a longer term perspective, where the share of wind output is expected to be even higher.

### 3. Economic impact of VOLTAGE-control provided by wind farms in the Spanish system

Deliverable 9.1 showed the good performance of the voltage control in the three clusters that participate in the demo SYSERWIND. Therefore, given that there are no technical barriers that prevent wind turbine generators to provide voltage control, this section focuses on the economic impact of the voltage control provision by wind farms on the wind farm owner’s results. The economic impact can be divided into two independent effects. On one hand, the increment of wind power penetration that could be achieved maintaining the system within an adequate voltage profile and remaining far away from voltage collapse thanks to the wind voltage control provision. On the other hand, the possible increase or decrease of revenues due to the new profile of active power losses in the wind farms harvesting networks.

In this section the results of the two studies, increment of wind penetration and new active power losses profile, are presented. This section is structured as follows. Firstly in subsection 3.1 the expected outcomes of the two studies are outlined. Then, the topology of the networks involved in the analysis is explained in subsection 3.2. Once that the scope of the analysis has been presented and their main characteristics are clear, in the following subsection the two studies are explained (the wind penetration increment study is explained in 3.3 and the active power losses study is presented in 3.4. Finally, the conclusions of this section are drawn in 3.5

#### 3.1. Expected outcomes of this analysis

The provision of voltage control by wind farms is expected to have a twofold effect:

- On one hand, thanks to the voltage control provision the wind penetration could be increased. This is the most important effect because currently could be the bottleneck for the wind penetration increment.
- On the other hand, the provision of this service changes the active power losses profile and thus, their economic value. Nevertheless, as it will be explained in this document this effect is not as significant as the first effect.

In order to quantify these effects several KPI, which are summarized in Table 3.1, were defined. This document presents the studies that have been developed in order to obtain these KPI. However, because of the local nature of the voltage control and the dependence of the impact (wind penetration increment and power losses profile) on the network, the prospective analysis for future scenarios up to 2020 has not been included. On the contrary, statistical data and the analysis of two networks with different characteristics are provided.

KPI.15.TF1.6: Additional wind energy that could be generated in the Spanish system thanks to the new capabilities tested in Demo 1. [GWh/year]
KPI.15.TF1.3: Energy losses avoided thanks to the voltage control in wind farms (and clusters): [GWh/year] for installed wind generation capacity in 2013 and prospective analysis for future scenarios up to 2020.
KPI.15.TF1.4: Economic value of the losses avoided thanks to the voltage control in wind farms (and clusters): [Euro/year] for installed wind generation capacity in 2013 and prospective analysis for future scenarios up to 2020.

**Table 3.1: KPIs of the voltage control economic assessment**

### 3.2. Wind farm harvesting networks

The aim of this subsection is to clarify the different networks that are involved in the economic assessment. For this purpose, Figure 3.1 shows a simple example of the different grid infrastructures built to evacuate wind power of 4 wind farms embedded within 2 harvesting networks. The harvesting network is divided into the sub-transmission grid and the wind farm grid, that it is represented with dotted lines in Figure 3.1. The sub-transmission grid corresponds to the common infrastructure of the wind farms harvesting network where the different wind farms inject their power. On the other hand, the wind farm grid corresponds to the internal infrastructure of each wind farm. The sub-transmission portion of a harvesting network may be radial or partially meshed (as the case example of Figure 3.1) whereas the wind farm portion typically presents a radial nature.

In Spain, commonly different wind farm owners or other distributed generation owners make an arrangement and build a harvesting network in order to evacuate the power. Thus, no demands are located in these networks. The wind generation that is located in these harvesting networks is estimated to represent the 85% whereas the 15% is embedded in a distribution network. In fact, harvesting grids are also starting to be the standard option in other systems with high wind penetration such as Ireland [7], [8]. This document focuses on the Spanish situation, in which the wind generation is commonly located in harvesting networks. However, this fact does not invalidate the study because the conclusion drawn in this document could be extrapolated to other systems.

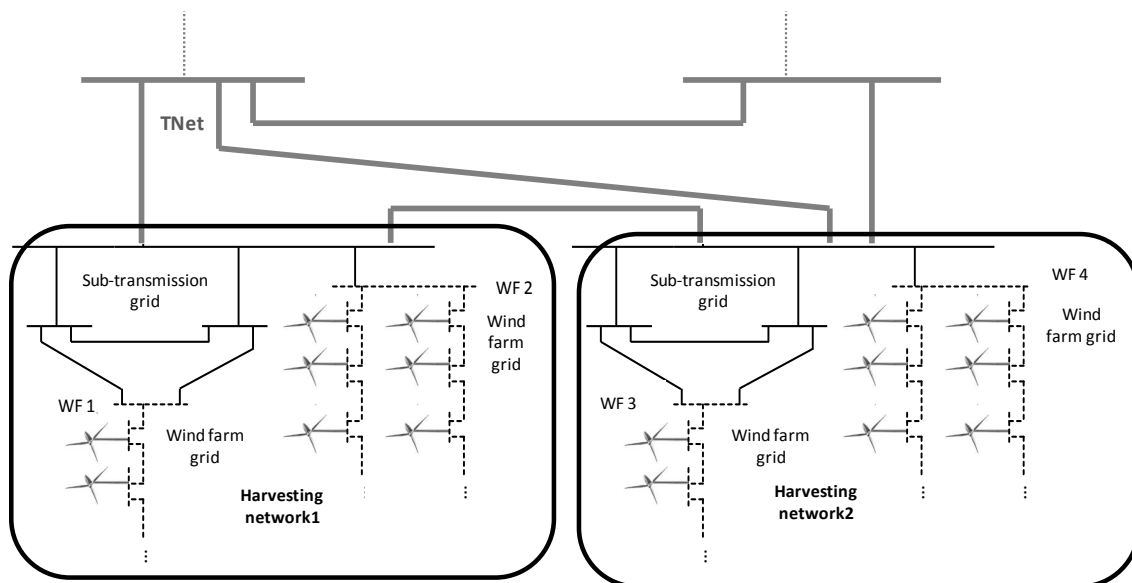

Figure 3.1: Diagram of the networks involved in the assessment

### 3.3. Wind power penetration study

This subsection explains in detail the methodology and then, the results, for the first study. The aim of this study is to assess the economic value of the increment of wind penetration thanks to the voltage control provision by this technology. This subsection is structured as follows. Firstly, in 3.3.1 a short introduction about the reasons that currently originate the wind power limitation are presented. Then, an overview of the methodology that has been used in order to carry out this study is explained. As it will be explained in more detail, the

methodology has been applied to three different network models. The first one is a simplified model, the second one takes into account the detailed model of the harvesting network but the transmission network is represented with its simplified model. The last model evaluated, takes into account the detailed model of the transmission network. The results of the analysis of these three network models will be presented and the conclusions of this study will be outlined in 3.3.6.

### 3.3.1. Introduction

Due to the lack of voltage control provision by wind turbine generators, the wind penetration into the transmission network (TNet) could be limited. This limitation could be due to over-voltages or because the voltages are under their minimum value. In Figure 3.2 it is presented the possible limits that could appear in case that the active power is increased without any control evaluating the P-V curve for the off-peak and peak scenario. This document tries to assess both limits of the wind penetration (voltage rise or voltage collapse). Moreover in order to investigate the profits that the voltage control provides, the wind penetration limits in case that this technology contributes with voltage control will be computed. Thus, the increment of wind penetration thanks to the voltage control provision is evaluated.

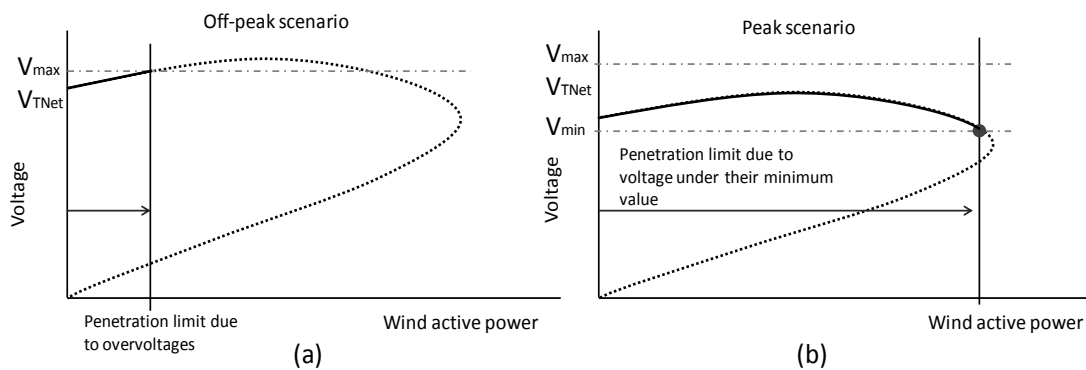

**Figure 3.2: Voltage collapse curve taking into account the voltage rise effect**

The first situation (figure (a) in Figure 3.2) may happen in the off-peak hours, where the initial TNet voltage is high and there are high levels of wind penetration when a big share of the generation that supplies the demand does not provide any type of control. The additional increase of wind penetration will stress this situation if wind power production is contrary to the demand as commonly happens. As an example, in Figure 3.3 the Spanish system demand and the wind power production of 7<sup>th</sup> February 2011 is depicted, where it can be seen that wind production increases as demand decreases.

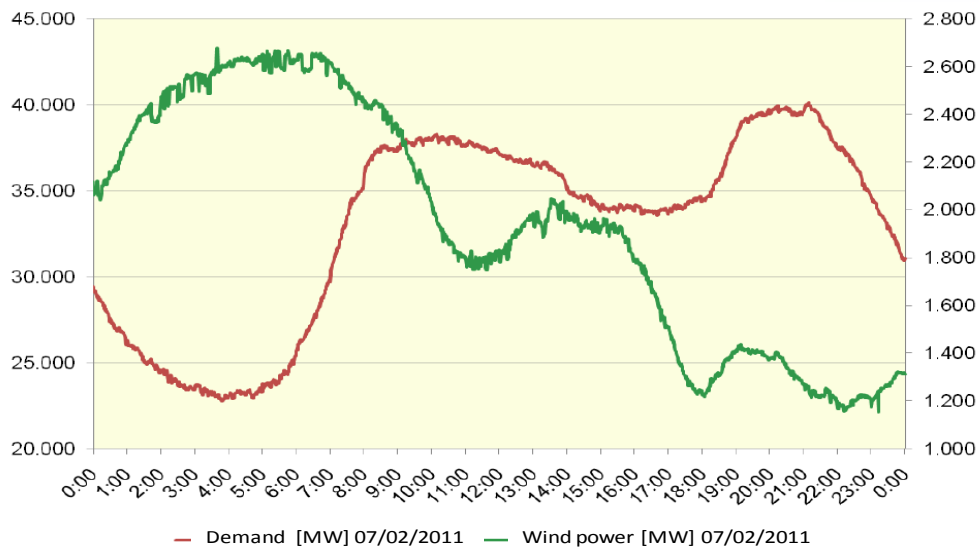

**Figure 3.3: Spanish demand versus wind power production 7/02/2012. Source: REE**

For analyzing the increase of the voltage in the valley hours, reactance/resistant ratio of the TNet equivalent ( $x/r$  ratio) and the power factor of the wind production may play an important role.

The second situation (figure (b) in Figure 3.2) could happen in peak hours where the initial TNet voltage is small. As wind penetration increases, the critical operational point corresponds to the minimum voltage limits.

### 3.3.2. Overview of the methodology

In order to carry out this study, the main factors that influence the wind power penetration, the methodology followed, and the network models that have been evaluated are presented in this subsection.

- **Wind power penetration limitation factors**

There are different factors that could affect the wind power penetration limitation:

- Transmission network bus voltage (VNet)
- $x/r$  ratio
- Wind farms power factor
- Short circuit power ( $S_{cc}$ )

In order to understand which factors are the most relevant, a simplified model is analyzed. This first simplified model, depicted in Figure 3.4, considers that several wind farms are coupled directly to the transmission network (modeled with the Thevenin equivalent) without considering the harvesting network.

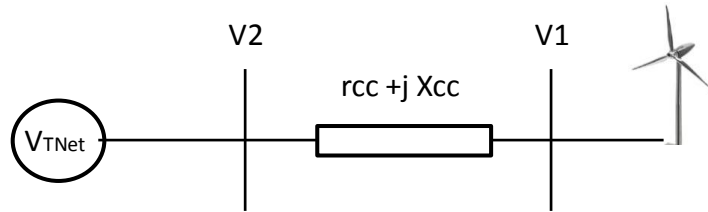

Figure 3.4: Simplified model for obtaining qualitative results

Using this simplified model the impact of different factors have been studied in order to acquire knowledge of how these factors could influence the wind penetration limitation. First of all, the impact of the  $V_{TNet}$  on the PV curves is evaluated, the other parameters remain constant (an example is provided with the following values:  $x/r$  ratio=10, Power factor=1 and  $S_{cc}$ =6592MVA). In Figure 3.5 it can be appreciated that the shape of the curve is the same in the three cases evaluated. Nevertheless, the initial point of the  $V_{TNet}$  changes.

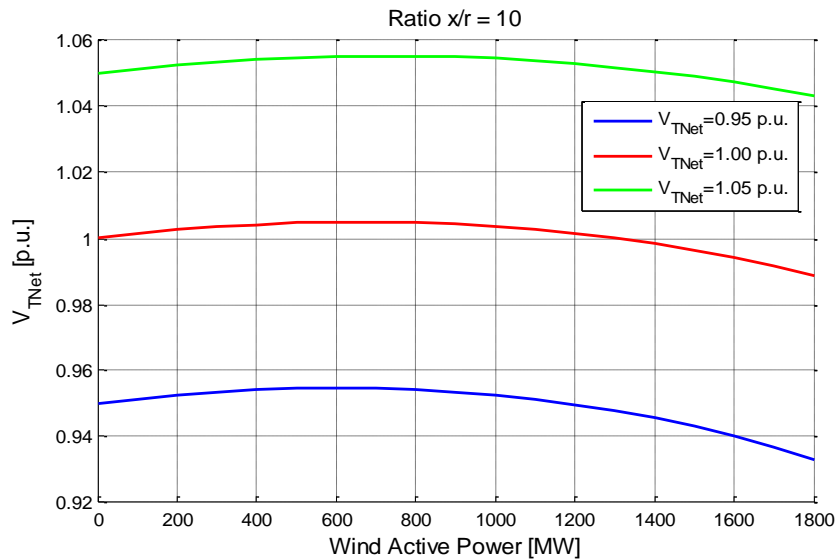

Figure 3.5:  $V_{TNet}$  impact on the PV curve

Next, the impact of the  $x/r$  ratio on the PV curves is evaluated. This parameter has a significant variability within the Spanish power system. The lower value of this parameter has been detected in Cantales 220 kV bus ( $x/r$  ratio=2) whereas the bus presenting the highest ratio detected is Puerto de la Cruz 220 kV bus (mean  $x/r$  ratio = 50). The most common  $x/r$  ratios are between 6 and 15. In Figure 3.6 it is depicted the PV curve for different  $x/r$  ratios while the other parameters remain constant ( $V_{TNet}$ =1.00 p.u., Power factor=1 and  $S_{cc}$ =6592MVA). It can be appreciated that the voltage increase is significant for low ratios. Nevertheless the voltage rise for the common values of this ratio is small. Thus, the voltage rise will be mainly originated by the  $V_{TNet}$  increase.

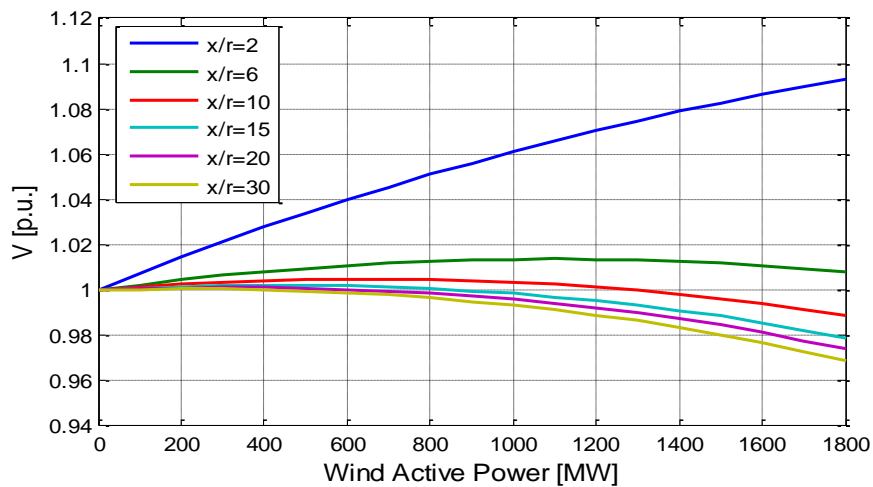

Figure 3.6:  $x/r$  ratio impact on the PV curve

Moreover, the wind farms power factor influence in the PV curve is studied. Thus, PV curves are obtained for different power factors whereas the other parameters remain constant ( $V_{TNet}=1.00$  p.u.,  $x/r$  ratio =10 and  $S_{cc}=6592$ MVA). In Figure 3.7 it can be appreciated how if the wind farms are operated at a lagging power factor (consuming reactive power) the voltage will decrease rapidly. On the contrary, if the wind farms are operated at a leading power factor (generating reactive power) the voltage rise could limit the wind penetration.

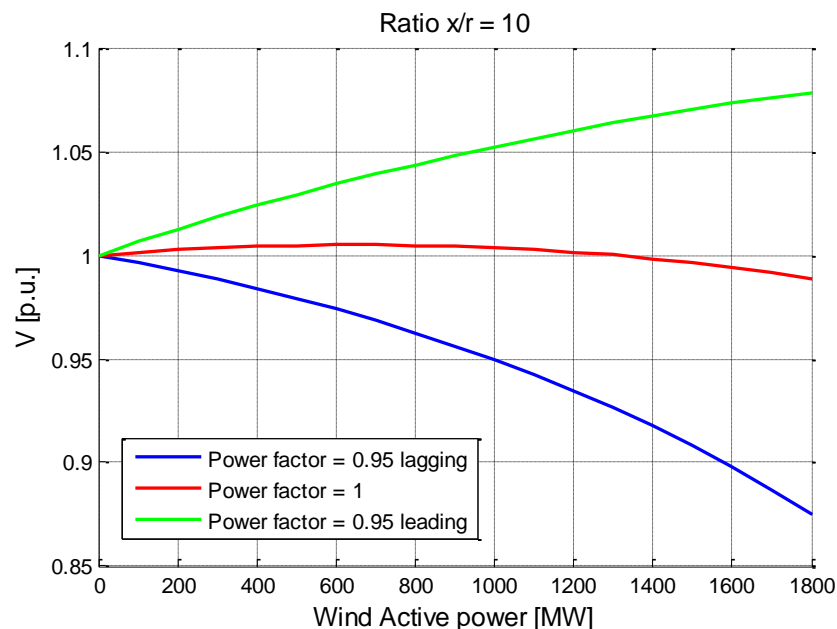

Figure 3.7: Wind farm power factor impact on the PV curve

Finally, the impact of the short-circuit power on the PV curve is presented. In order to perform this study the PV curves are obtained for different values of short-circuit power whereas the other parameters remain constant ( $V_{TNet}=1.00$  p.u.,  $x/r$  ratio =10 and wind farm power factor



equal to 1). Within the Spanish power system typical values of 400kV bus short-circuit power are between 4000 MVA and 20000 MVA whereas the typical values of short-circuit power for 220 kV bus are between 2000MVA and 12000 MVA In Figure 3.8 it can be appreciated that the voltage rise effect is similar for all the short-circuit powers analyzed. Nevertheless, when the short-circuit power is low the voltage collapse point is achieved earlier. This is due to the fact that the transmission network is not able to supply more reactive power in order to maintain an adequate voltage profile.

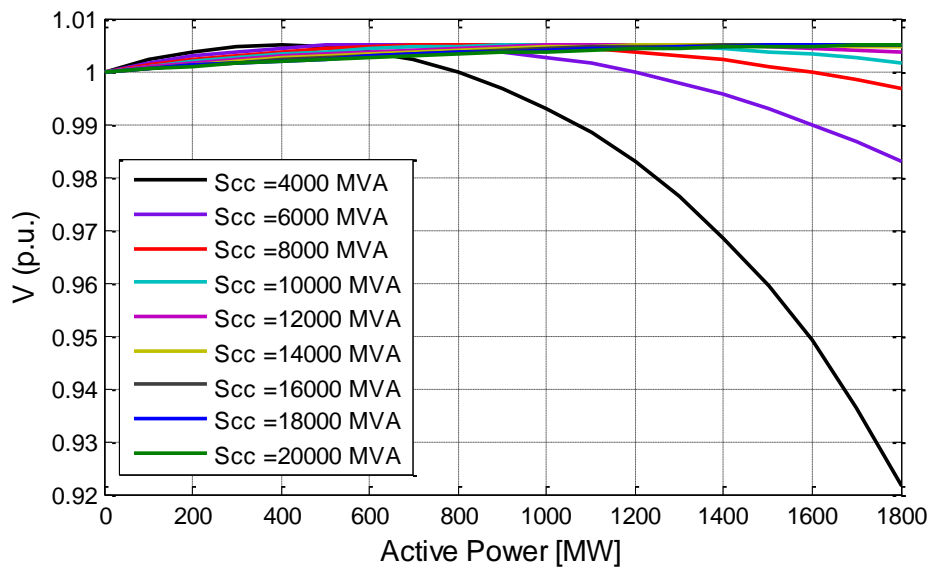

Figure 3.8: Short-circuit power (Scc) impact on the PV curve

In addition, for a fixed power factor and transmission network voltage (Power factor = 1 and VTNet=1.00 p.u.) different combinations of short-circuit power and x/r ratio are analyzed in Figure 3.9, as will be seen in Figure 3.21 there is no a significant correlation between these two variables. It can be appreciated how when the short-circuit power is high (dotted lines) the impact of the power delivered on the voltage is significantly lower than for a small short-circuit power (continuous lines).

As can be seen, the wind power penetration could be limited because of over-voltages or under-voltages, being the most restrictive limitation the first one. Hence, the most restrictive operation condition is a high VTNet, a low x/r ratio and a low short-circuit power. On the other hand, concerning the second possible limitation, voltage under admissible values, the most unfavourable operation condition correspond to a low VTNet, a high x/r ratio and a low short-circuit power.

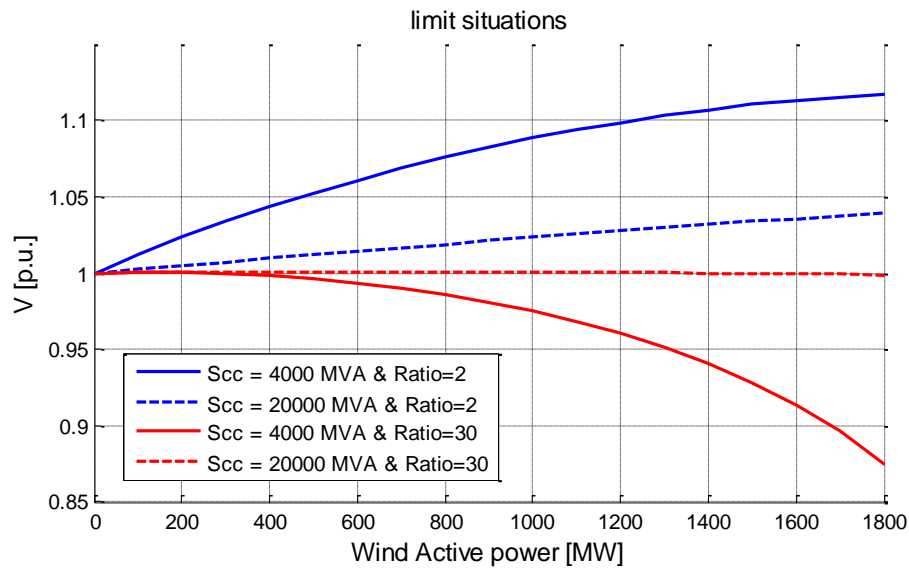
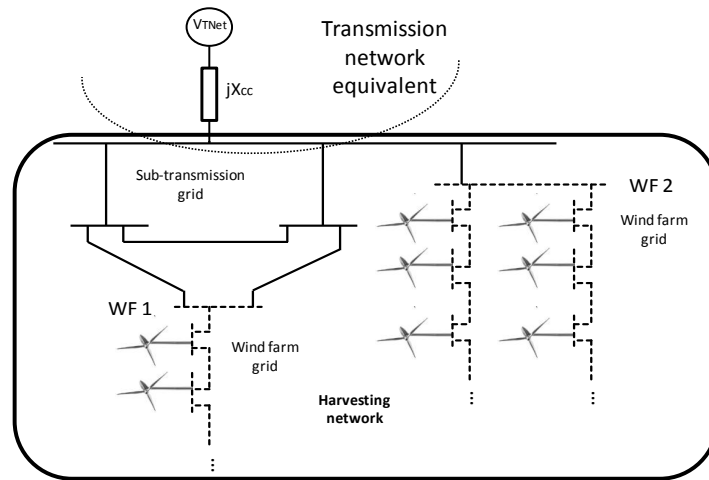

Figure 3.9: Short-circuit power (Sc) and x/r ratio impact on the PV curve

- Methodology of the assessment

For assessing the increment of wind penetration, the wind power generation has been increased until the voltage values are inadmissible in case of providing and not providing voltage control. This analysis has been performed in three networks models, with the intention of evaluating the impact of the different networks involved (wind farm grid, harvesting network, transmission network) on the wind penetration.

The first model studied is a simplified one, (Figure 3.4) in order to analyze the influence of different factors on the wind penetration. The reason of this model is that its simplicity facilitates the comprehension of the problem and allows obtaining important qualitative results. Secondly, in order to assess the real reactive capabilities of the harvesting network and how this network influences the wind penetration, the network model presented in Figure 3.10 has been studied. In order to study the influence of the wind farm grid and the sub-transmission grid two hypotheses have been evaluated. The first hypothesis, evaluates the detailed model of the harvesting network (sub-transmission and wind farm grids). On the other hand, the second hypothesis considers that thanks to the addition of capacitances and reactances, the PQ curve of the wind farm is equal to the number of wind turbines multiplied by the PQ curve of one wind turbine generator. This means that just the sub-transmission grid is considered.



**Figure 3.10: Simplified model of the transmission network, detailed model of the wind farm harvesting network**

The last network model, considers the detailed model of the transmission network whereas the harvesting network is represented with its Thevenin equivalent and its real PQ curve. The diagram of this model is next depicted in Figure 3.11.

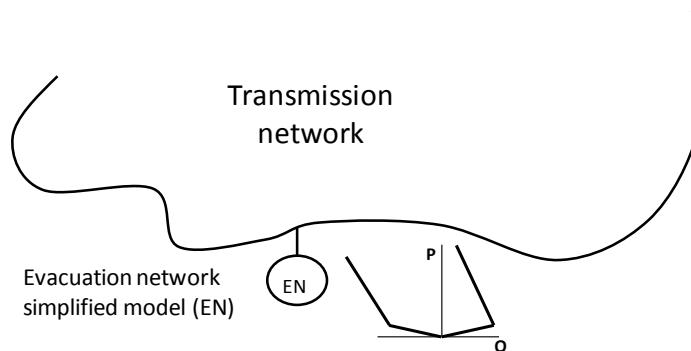
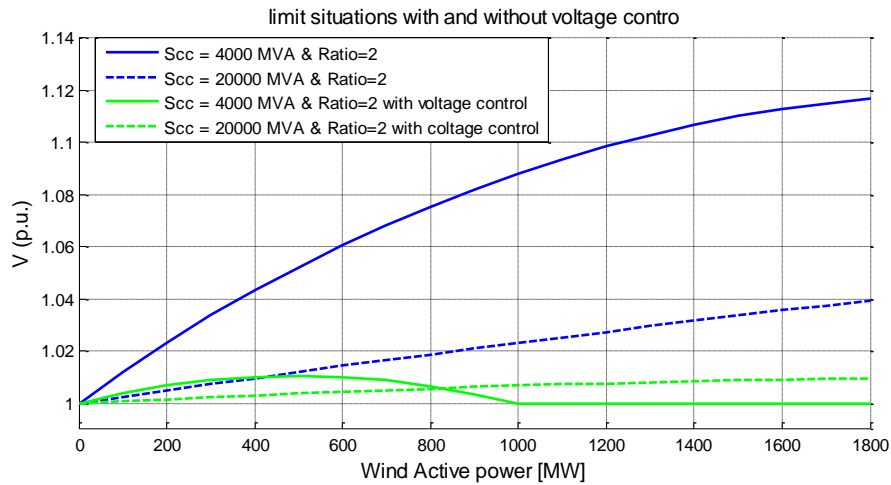

**Figure 3.11: Detail model of the transmission network, simplified model of the wind farm harvesting network**

### 3.3.3. Simplified model of both, transmission and harvesting networks

- **Impact of the different factors**

In order to analyze how the reactive capabilities of the wind farms will improve the voltage profile and the influence of the different factors, Figure 3.12 is depicted. This analysis has been done for a fixed ratio ( $x/r=2$ ) and two different short-circuit powers of 4000 MVA (continuous lines) and 20000 MVA (dotted lines). It can be appreciated that when the wind farms provide reactive support (green lines) the voltage rise is significantly lower. This voltage rise happens when the reactive capacity is not enough for maintaining the voltage set-point (1.00 p.u).



**Figure 3.12: Short-circuit power (Scc) and x/r ratio impact on the PV curve with and without voltage control**

For a better comprehension of the voltage control effect Figure 3.13 is presented. In this figure the reactive power and the voltage are depicted for several short-circuit powers maintaining the ratio  $x/r$  fixed to 2. It could be appreciated how the maximum values of the voltage are the same for all the different short-circuit powers analyzed. The mathematical demonstration of this fact is provided for the simplified model in the appendix. These maximum values have been obtained considering that the maximum reactive capability of the wind farms (black dotted lines in the reactive power sub-plot) correspond to  $\pm 0.33$  of the total installed active power. In this document, it has been assumed that the wind farms produce their maximum power. Thus, the increment of wind active power means an increment of the installed capacity. Therefore, this is the most unfavorable case. In order to clarify the reactive capabilities that have been considered in this case, Figure 3.14 is provided. In this figure, three PQ curves are depicted, for 1 wind turbine, 2 wind turbines and finally for 3 wind turbines, in order to show how the reactive capabilities increase with the active power penetration. In addition, in green is presented the reactive capability in case of considering that the wind active power increment means an increment on the installed capacity.

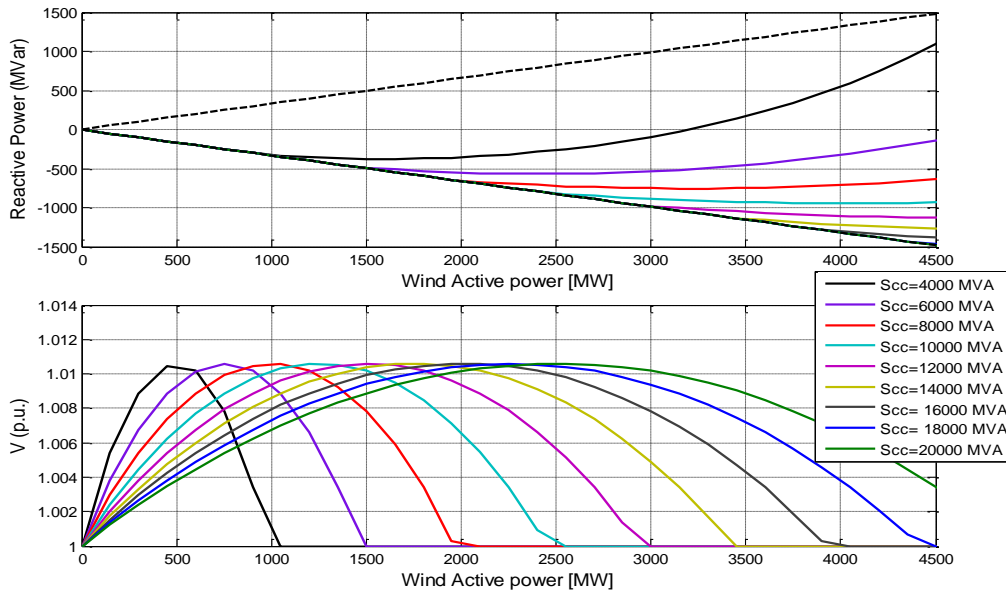

Figure 3.13: Reactive power and voltage for a ratio equal to 2 and different Scc when the wind farm provides voltage control

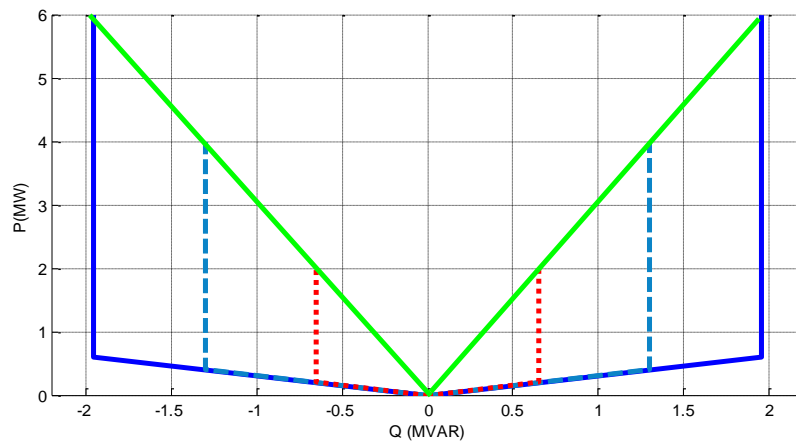
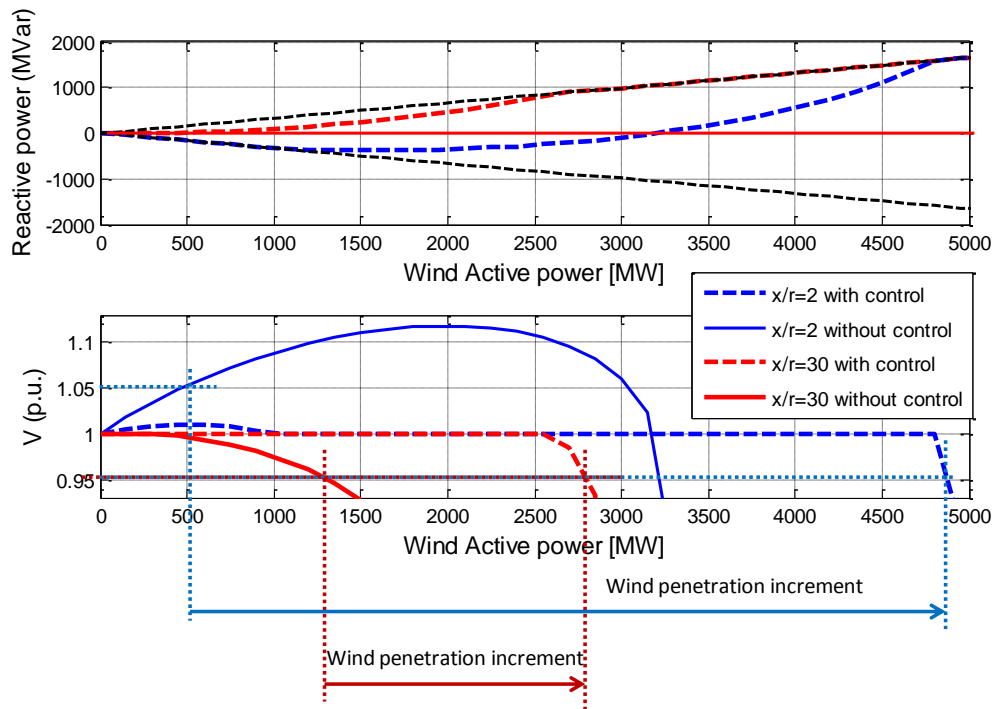

Figure 3.14: Extrapolated PQ curves

With the intention of analyzing the wind penetration increment thanks to the voltage control provision, Figure 3.15 is presented. In this case the short-circuit power is fixed to 4000 MVA (which is the lowest short-circuit power and thus, the most unfavorable). In this case the PV curves have been obtained for a small (2) and a considerable big (30)  $x/r$  ratio in two situations. The first situation considers that the wind farms maintain a fixed power factor equal to one whereas the second situation takes into account the reactive capabilities of the wind farm in order to maintain an adequate voltage profile. As can be seen in this figure, when the ratio is small the voltage rise is significant and the wind power could be limited due to overvoltages (voltages over 1.05 p.u.). In case of providing voltage control the voltage rise decrease significantly and the wind penetration limit due to overvoltage disappears. Thus, the wind penetration increases significantly. On the contrary, when the ratio is big, the wind

penetration is limited because of voltage under the admissible value (0.95). In this case, thanks to the voltage control provision the wind penetration is increased. Nevertheless the wind penetration increment is significantly lower when the reason of the wind penetration limitation is that voltages are under the limit value than when the reason of the wind penetration limitation is overvoltage as can be observed in Figure 3.15.



**Figure 3.15: Reactive power and voltage for two different ratios maintaining fix the short-circuit power ( $S_{cc}=4000$  MVA) in two situation, with and without voltage control**

In addition, in Figure 3.16 the same curves are presented than in Figure 3.15. Nevertheless, in this figure the ratio has been fixed ( $x/r=6$ ) whereas two different values of VTNet have been considered (1.00 p.u. and 1.04 p.u.). In this figure it can be seen that if the initial value of VTNet is high and wind farms do not provide voltage control, the wind penetration could be limited due to overvoltage. However, if the wind farms provide voltage control the wind penetration is limited because of voltage under the admissible value (0.95), obtaining a wind penetration increment of 3200 MW. On the other hand, for the initial value of VTNet = 1.00 p.u. the wind power penetration is limited because of voltage under the admissible value in both situation (with and without voltage control). Thus, the wind penetration increment is significantly lower than in the previous case.

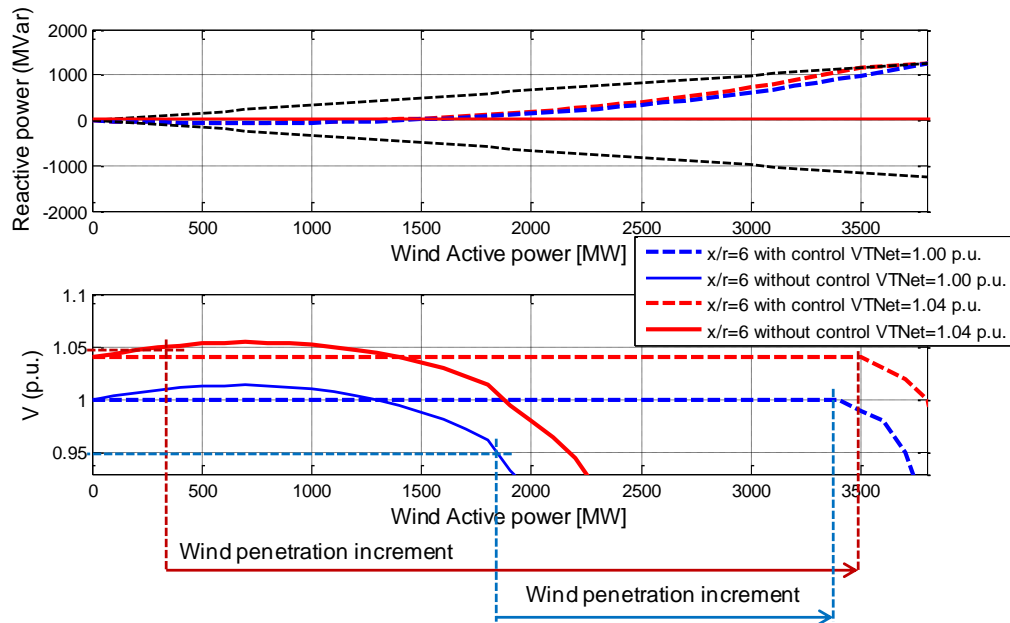
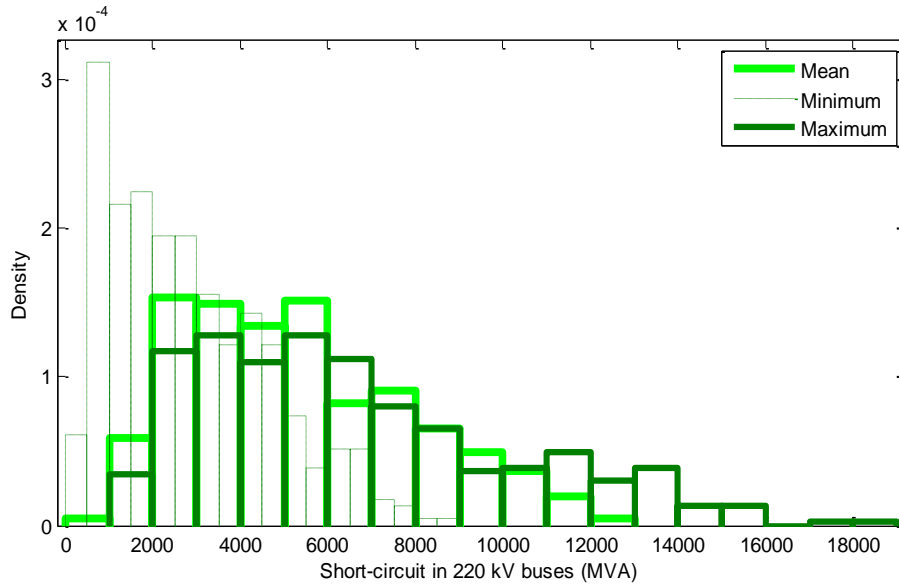

Figure 3.16: Reactive power and voltage for two different VTNet (1.00 p.u. and 1.04 p.u.) maintaining fix the short-circuit power ( $S_{cc}=4000$  MVA) and the ratio ( $x/r=6$ )

- [Statistical analysis of Spanish System](#)

Next a parametric analysis is presented for determining the increment of the wind power penetration in a certain bus. With this analysis, it could be possible to evaluate which is the increment of the wind penetration (in case of providing voltage control with the wind farms) in a certain bus knowing the characteristic (short-circuit power and the  $x/r$  ratio) of that bus. In this document this analysis is presented for the Spanish network. Thus, a statistical analysis of the short-circuit power and the  $x/r$  ratio of all the 220 and 400 kV buses within the Spanish network has been done (data of year 2010). In Figure 3.17 the mean, maximum and minimum short-circuit power of the 220kV buses are presented respectively. In these figures it can be appreciated that the majority of the buses have a mean short-circuit power between 2000 MVA and 6000 MVA. On the other hand, in Figure 3.18 the mean, maximum and minimum short-circuit powers of the 400kV buses are presented respectively. In this case, the majority of the buses have a mean short-circuit power between 7000 MVA and 13000 MVA. Focusing on Figure 3.17 and Figure 3.18, it can be said that the spread in 400kV buses is significantly higher than in 220kV buses.



**Figure 3.17: Mean, maximum and minimum short circuit power in 220kV**

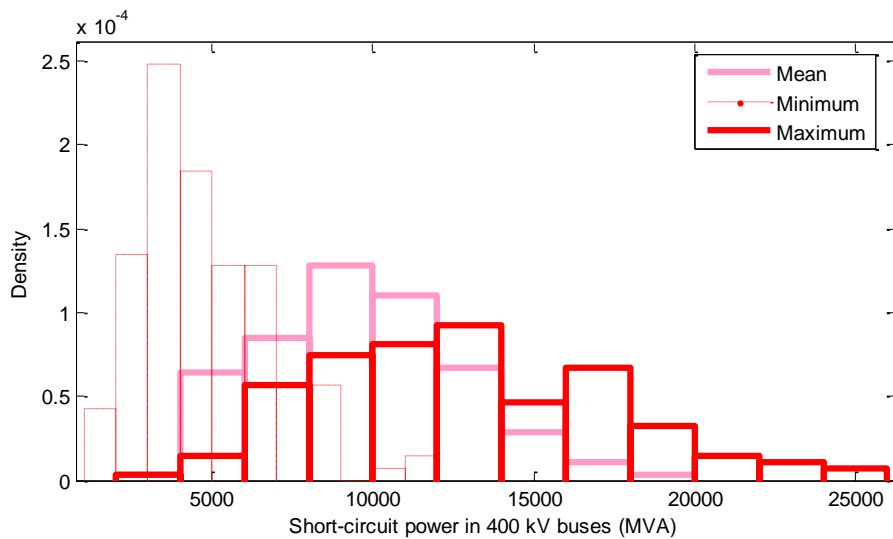

**Figure 3.18: Mean, maximum and minimum short circuit power in 400kV**

In Figure 3.19 the mean, the maximum and minimum  $x/r$  ratio of the 220kV buses is presented respectively. In these figures, it can be appreciated that the majority of the buses have a  $x/r$  ratio between 5 and 15. On the other hand, in Figure 3.20 the mean, the maximum and minimum  $x/r$  ratio of the 400kV buses is presented respectively. In this case, the majority of the buses have a  $x/r$  ratio between 10 and 14. Focusing on Figure 3.19 and Figure 3.20, it can be said that the spread in 400kV buses is significantly lower than in 220kV buses (the opposite effect than for the short-circuit power).



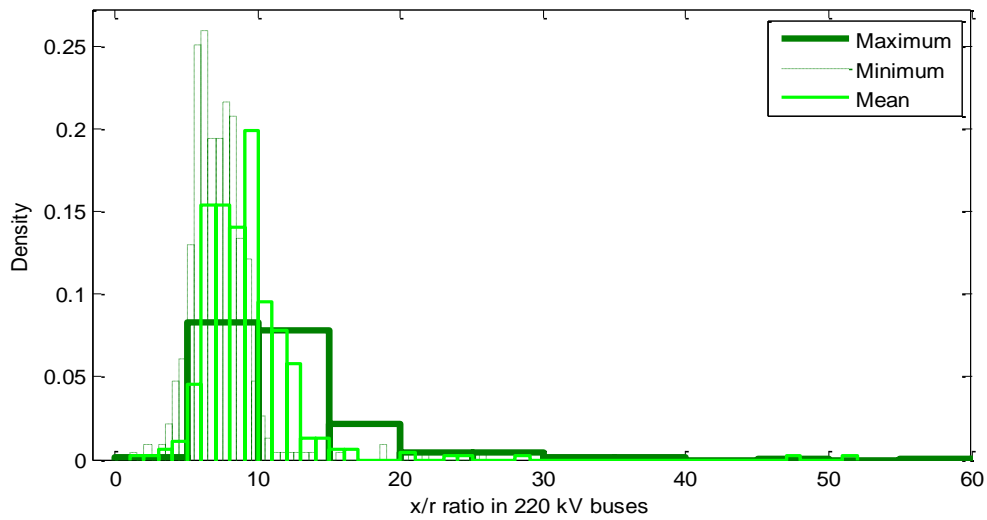

**Figure 3.19: Maximum and minimum x/r ratio in 220kV**

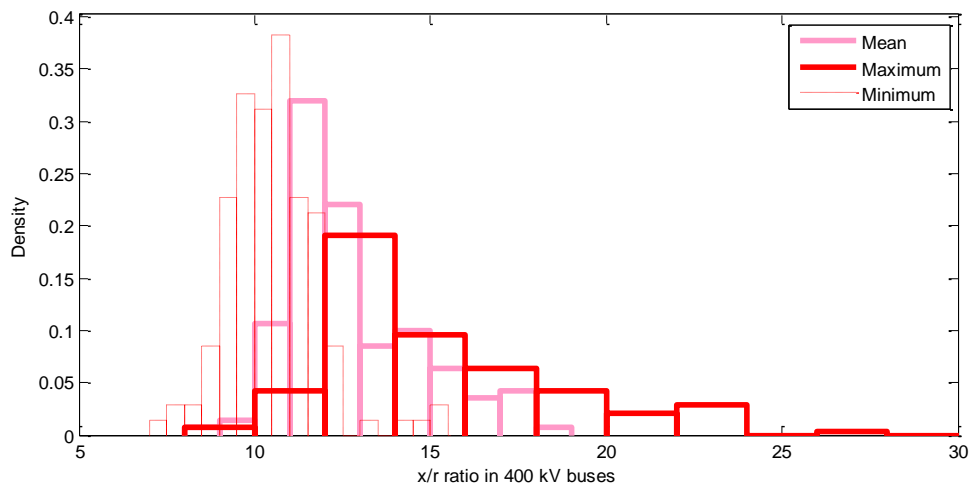

**Figure 3.20: Mean, maximum and minimum x/r ratio in 400kV**

In order to identify if the mean x/r ratio and the mean short-circuit power are correlated Figure 3.21 is presented. In this figure it can be appreciated that the ratios increase when the short-circuit power increases. However, in 220 kV the higher values of the ratio have been obtained in buses with low short-circuit power.

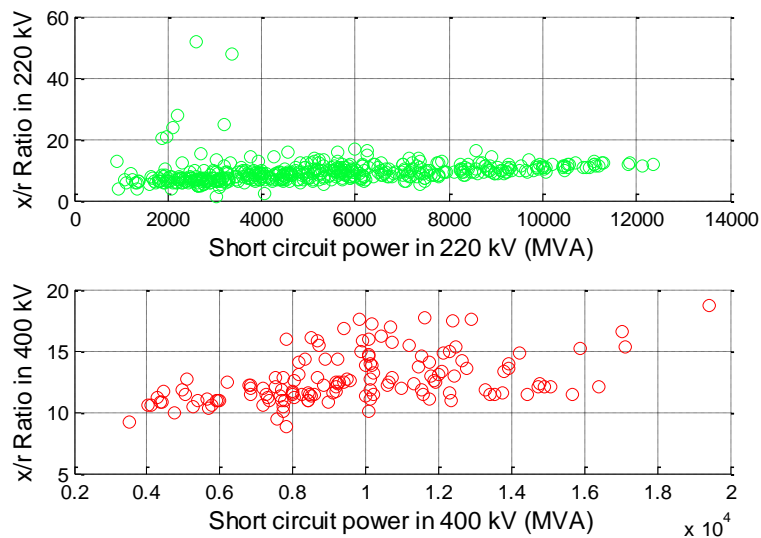

Figure 3.21: Correlation between the mean short-circuit bus power and the mean bus x/r ratio

- Increase of wind penetration in the Spanish System

For each pair of x/r ratio and short-circuit power, the wind penetration limit without control has been evaluated for different voltage values of VTNet. This data is presented in the following tables: (Table 3.2 for VTNet=1.03, Table 3.3 for VTNet=1.00 and Table 3.4 for VTNet=0.97). In these tables, when the wind power limitation is less than 2000MW the values are outline in red. The other values, although theoretical are not realistic due to the fact that it is not probable to install more than 2000 MW in a single bus. Evaluating the results provided in these tables, it can be concluded that in the majority of the buses the wind penetration will not be limited because of voltage reasons. In these cases the wind penetration will be limited because of transmission capacity constraints.

		Scc								
		4000	6000	8000	10000	12000	14000	16000	18000	20000
Ratio	2	182,58	264,96	352,35	440,80	527,40	613,42	702,08	789,58	875,90
	6	2163,07	3279,55	4362,69	5461,86	6562,96	7653,15	8747,85	9843,29	10934,33
	10	1884,24	2843,16	3799,32	4756,54	5713,42	6662,98	7611,58	8564,95	9517,53
	15	1760,07	2645,49	3528,52	4412,73	5299,13	6183,69	7065,38	7950,40	8833,83
	20	1684,78	2540,44	3394,06	4248,73	5105,29	5954,10	6800,93	7652,21	8502,79
	30	1618,61	2448,45	3270,11	4084,67	4905,93	5728,23	6543,43	7361,11	8179,71

Table 3.2: Wind power limitation because of voltage reason, VTNet = 1.03 p.u.

		Scc								
		4000	6000	8000	10000	12000	14000	16000	18000	20000
Ratio	2	474,70	711,70	948,04	1184,24	1421,96	1658,28	1894,75	2131,55	2368,12
	6	1884,21	2837,83	3787,00	4731,69	5681,24	6630,33	7575,18	8522,03	9468,47
	10	1589,56	2386,14	3180,64	3976,18	4773,70	5569,54	6362,79	7159,05	7953,86
	15	1443,61	2169,25	2893,22	3618,05	4344,10	5067,52	5789,05	6513,54	7236,96
	20	1376,34	2067,09	2755,43	3446,64	4136,43	4826,74	5514,11	6203,98	6893,44
	30	1309,30	1968,11	2622,26	3279,65	3937,04	4593,31	5248,65	5904,49	6560,18

Table 3.3: Wind power limitation because of voltage reason, VNet = 1.00 p.u.

		Scc (MVA)								
		4000	6000	8000	10000	12000	14000	16000	18000	20000
Ratio	2	856,08	1281,99	1706,94	2132,43	2558,95	2984,62	3409,43	3836,34	4262,32
	6	2273,95	3422,93	4568,98	5716,30	6861,78	8004,33	9144,57	10289,92	11433,85
	10	1174,59	1765,92	2355,45	2945,73	3537,49	4127,97	4716,47	5307,21	5896,90
	15	1002,31	1526,58	2034,15	2542,99	3057,94	3570,51	4076,47	4588,10	5101,30
	20	936,33	1407,86	1882,66	2359,66	2830,59	3309,04	3776,38	4251,60	4723,36
	30	867,15	1300,11	1742,42	2179,17	2618,31	3057,09	3491,93	3932,07	4366,62

Table 3.4: Wind power limitation because of voltage reason, VNet = 0.97 p.u.

Moreover, the increment that can be achieved in case of providing voltage control has been evaluated. In Figure 3.22, Figure 3.23 and Figure 3.24 these values are presented for different VNet (0.97, 1.00 and 1.03p.u. respectively). In all these figures the pair (short-circuit power, x/r ratio) most common in 220 kV (green circle) and 400 kV (red circle) is outlined. Analyzing the three figures it can be seen that the highest increment of wind penetration is achieved in the three situations for a low ratio and a high short-circuit power. Moreover, it is important to note that for low VNet the increment obtained for the majority of the ratios ( $x/r > 2$ ) is slightly higher. However, the opposite effect happens for low ratios ( $x/r \leq 2$ ). This fact happens because in this case the wind penetration is limited due to over-voltages.

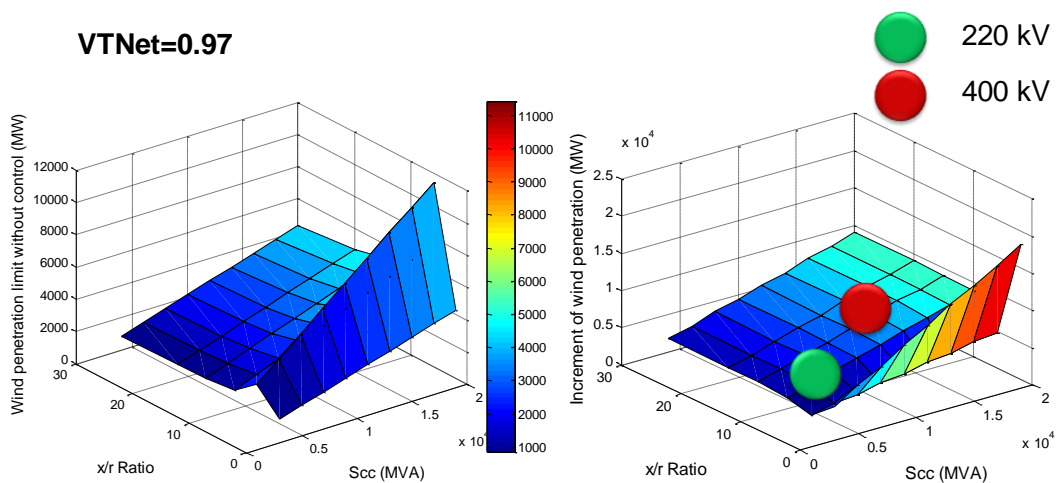
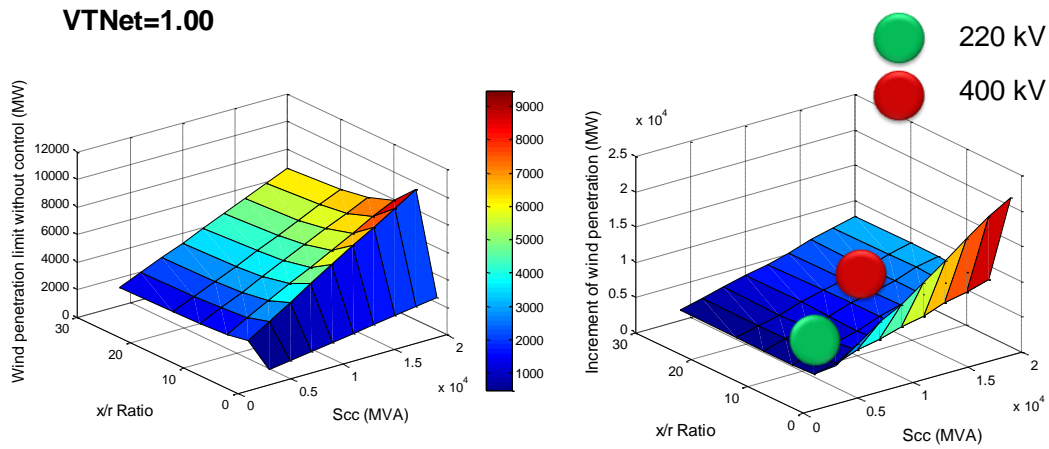
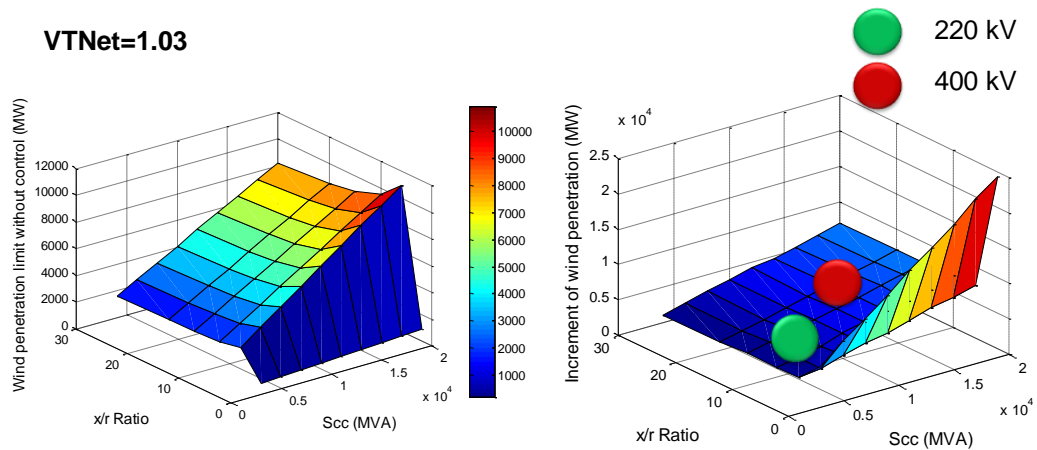

Figure 3.22: Wind penetration increment when VNet is 0.97 p.u.



**Figure 3.23: Wind penetration increment when VTNet is 1.00 p.u.**



**Figure 3.24: Wind penetration increment when VTNet is 1.03 p.u.**

The information of Figure 3.22, Figure 3.23, and Figure 3.24 are numerically summarized in Table 3.5 for the mean values of x/r ratio and short circuit powers. The cumulative probability of the distribution of the mean x/r ratio and mean short circuit powers in 220kV and 400 kV is evaluated in order to obtain the values that correspond to the percentiles 25%, 50% and 75%.

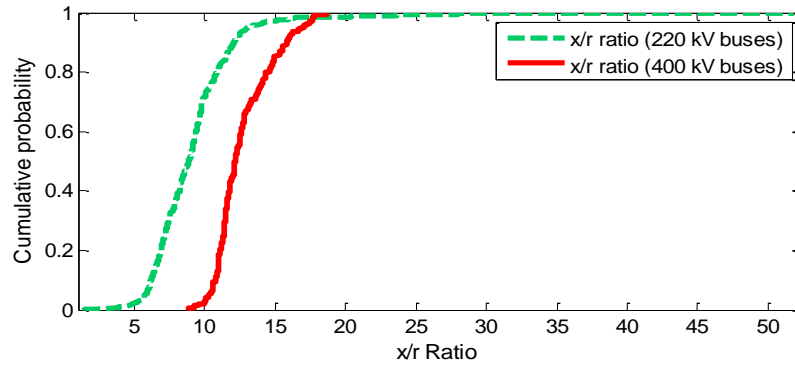

Figure 3.25: Cumulative probability of mean x/r ratios

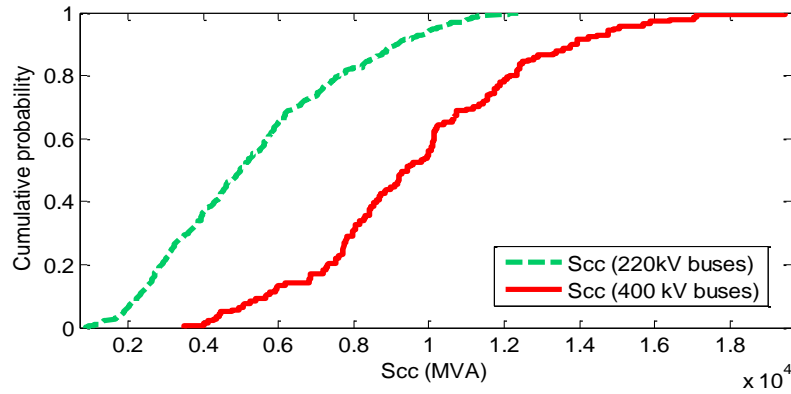

Figure 3.26: Cumulative probability of mean Scc

			Low VTNet 0,97 p.u.	Nominal VTNet 1,00 p.u.	High VTNet 1,03 p.u.	
<b>220 kV buses</b>	High x/r ratio 9	High Scc	7015 MVA	2561,28	2527,79	2309,13
		Mean Scc	5136 MVA	1805,11	1839,02	1687,81
		Low Scc	4000 MVA	1325,57	1461,78	1346,05
	Mean x/r ratio 8	High Scc	7015 MVA	2226,42	2583,68	2334,67
		Mean Scc	5136 MVA	1568,68	1868,06	1695,73
		Low Scc	4000 MVA	1125,73	1513,12	1376,34
	Low x/r ratio 7	High Scc	7015 MVA	1891,56	2639,57	2360,22
		Mean Scc	5136 MVA	1332,26	1897,10	1703,65
		Low Scc	4000 MVA	925,89	1564,45	1406,63
<b>400 kV buses</b>	High x/r ratio 14	High Scc	11742 MVA	5181,06	4613,28	4207,77
		Mean Scc	9669 MVA	4214,84	3577,62	3469,22
		Low Scc	7596 MVA	3404,43	2871,55	2675,45
	Mean x/r ratio 12	High Scc	11742 MVA	5113,20	4592,23	4205,69
		Mean Scc	9669 MVA	4159,28	3492,43	3470,05
		Low Scc	7596 MVA	3282,54	2774,20	2573,04
	Low x/r ratio 11	High Scc	11742 MVA	5079,27	4581,71	4204,66
		Mean Scc	9669 MVA	4131,50	3449,83	3470,46
		Low Scc	7596 MVA	3221,59	2725,53	2521,83

Table 3.5: Increment of wind power penetration

### 3.3.4. Simplified model of TNet and detailed model of harvesting network

As has been explained previously this model allows determining the impact of the wind farm grid and sub-transmission grid on the wind penetration increment. In order to assess this influence the real PQ curves at the transmission network bus have been obtained. Once that these curves are obtained the increment of the wind power penetration is quantified.

- **Determination of PQ curves**

In the previous subsection it has been assumed that the reactive capability of the wind farm is equal to the number of wind turbine generators multiplied by the PQ curve of one wind turbine generator. However, in the real operation, the wind turbine generators could lose their reactive capabilities if the voltage is not within the range  $0.95 < V < 1.05$ . This fact is outlined in Figure 3.27. In this figure it can be seen how in a wind farm feeder although the voltage at the beginning is within their limits, this fact does not happen at the end of the feeder. Thus, the wind turbine generators located at the end of the feeder will lose their reactive capabilities. Moreover, the lines contribute generating or consuming reactive power.

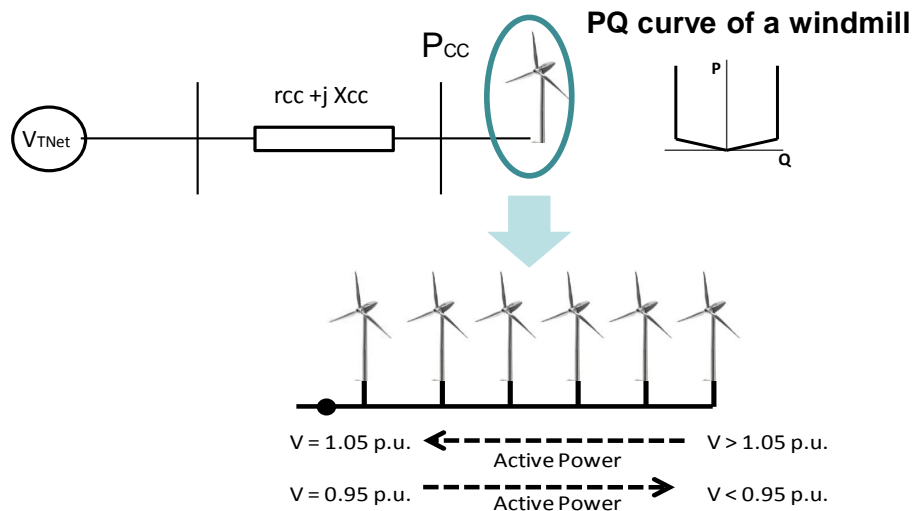
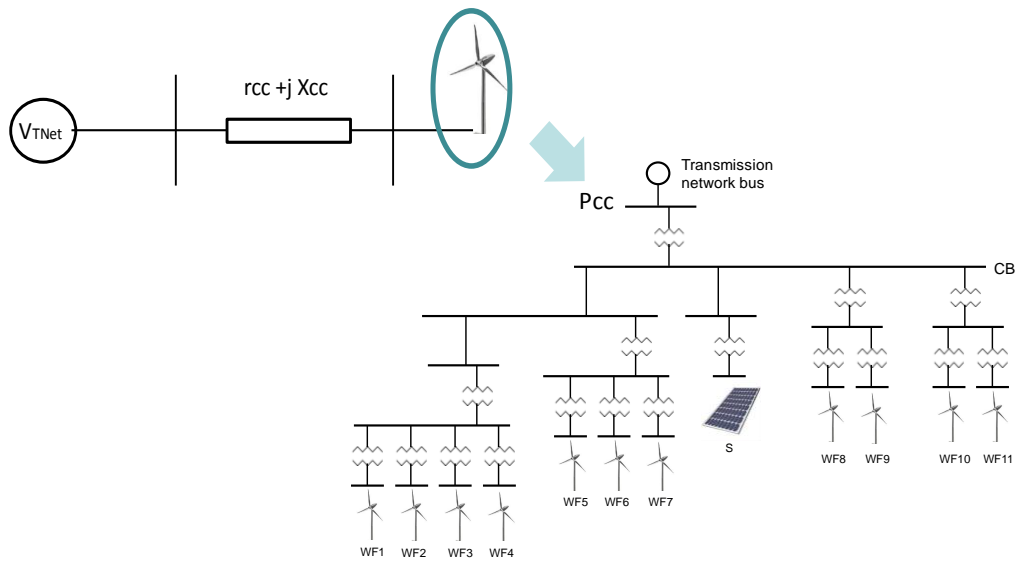

Figure 3.27: Lose of reactive capabilities because of topology configuration.

In this paragraph the real PQ curves of a harvesting network will be considered taking into account two hypotheses. The first hypothesis, evaluates the detailed model of the harvesting network (sub-transmission grid + wind farm grid). On the other hand, the second hypothesis considers that thanks to the addition of capacitances and reactances at the wind farm the PQ curve of the wind farm is equal to the number of wind turbine multiplied by the PQ curve of one wind turbine generator. Thus, only the sub-transmission grid is taken into account. Next, in Figure 3.28 one of the networks of the demo which belongs to the demo leader has been evaluated. In this network there are 11 wind farms. In addition, a solar-thermal plant is connected in this network)



**Figure 3.28: Harvesting network.**

In Figure 3.29 the optimistic PQ curve (the real wind turbine generator curve extrapolated to the transmission network) and the real PQ curves are depicted for  $V_{TNet}=1.00p.u.$  In this figure it can be appreciated that when the wind farms do not supply power, the harvesting network generates a little reactive power. This happens because when the lines are unloaded they generate reactive power. On the contrary, when the lines are very loaded they consume reactive power. Moreover, it is important to note that whereas from the reactive consumption point of view the real PQ curve is bigger than the ideal one; from the reactive generation point of view the real PQ curve is smaller than the ideal one. This means, that this harvesting network will be able to reduce the voltage at the Pcc bus. However, its ability for increasing the voltage at this bus is much smaller.

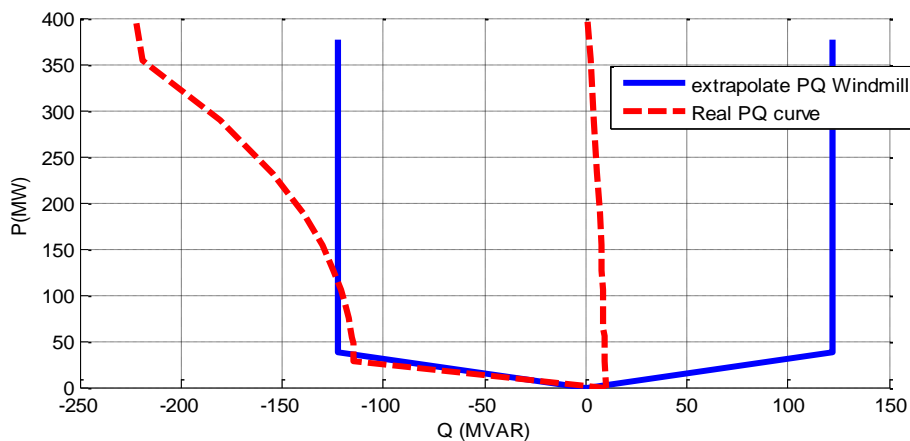

**Figure 3.29: PQ curves of the harvesting network. Taking into account the detail model of the wind farms**

In the second hypothesis it has been assumed that thanks to the addition of capacitances and reactance the PQ curve of the wind farm is equal to the number of wind turbine generators multiplied by the PQ curve of one wind turbine generator. Thus, just the sub-transmission grid is evaluated. In Figure 3.30 the optimistic PQ curve and the real PQ curves are depicted for  $V_{TNet}=1.00p.u.$

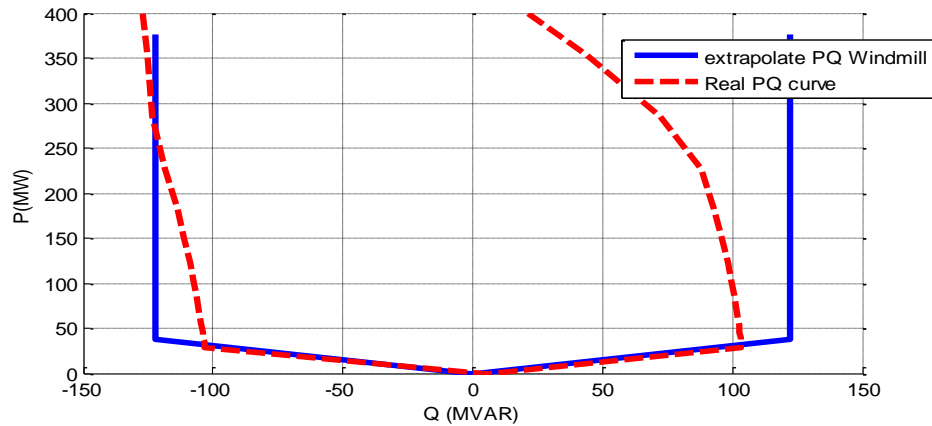

Figure 3.30: PQ curves of the harvesting network. Assuming ideal Wind farms PQ curves

In order to compare these results with the ones obtained under the first hypothesis, Figure 3.31 depicts the PQ curves obtained under the two hypothesis (hypothesis 1 = Detail model and hypothesis 2 = Assuming ideal wind farm PQ curve). In this figure, it can be appreciated how thanks to the addition of capacitances, the PQ curve at  $P_{CC}$  is closer to the ideal one. In addition, is important to note that the detail model takes into account the wind farms infrastructure whereas in the second hypothesis the aggregate model of the wind farm has been assumed. This fact can be seen in Figure 3.31 for high power scenarios, where the reactive consumption of the lines is considerable. In addition, in this figure the real PQ curve is depicted in yellow, this curve is the surrounding of the two previous PQ curves calculated (using the detail model, assuming ideal wind farms PQ curve)

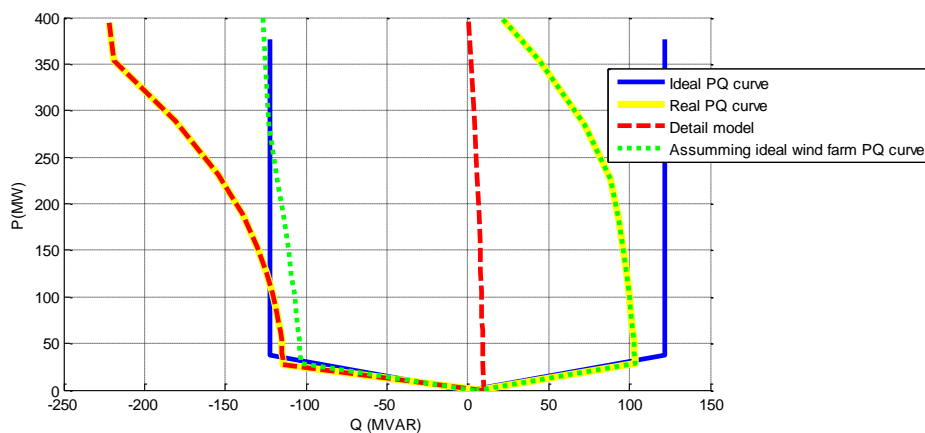
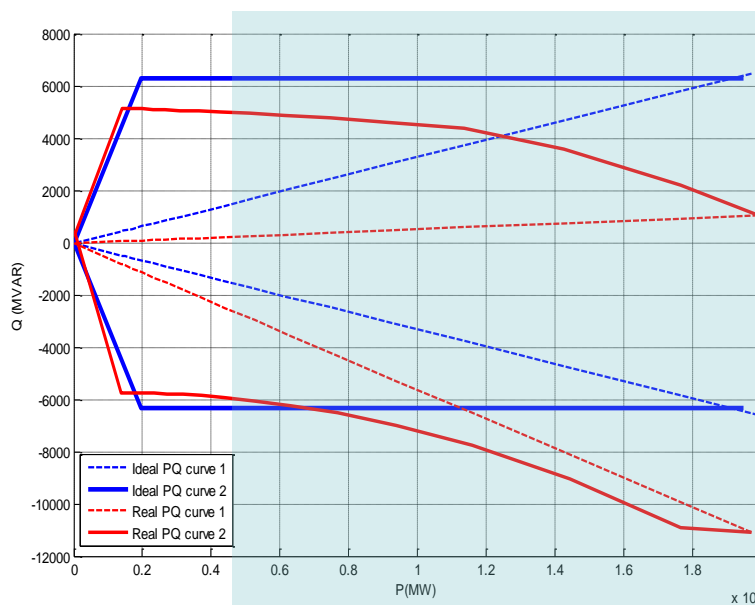

Figure 3.31: PQ curves of the harvesting network



- Wind power penetration increment using real PQ curves

In this paragraph the wind power penetration increment is computed taking into account the real PQ curve that was obtained in the previous paragraph. In Figure 3.32, four PQ curves are depicted. In blue are presented the ideal PQ curves whereas in red are presented the real ones. Moreover, the difference between two different curves (1 and 2) has been made as explained in paragraph 3.5.3. The curve1, depicted in dotted lines, considers that the active power increases by adding wind farms which generate their maximum power. On the other hand, the curve2 considers just one wind farm. For this study only the first curve will be considered. In addition in this figure the part of the curve that is theoretical but not practical has been shaded.



**Figure 3.32: Real and ideal PQ curve**

Taking into account curve1, the wind power increment thanks to the reactive power capabilities utilization are evaluated. In Table 3.6 the wind power limitation in case of using the ideal (in the event that the harvesting network is negligible) PQ is provided. It can be seen how, in case of providing voltage control, the wind power limitation will increase dramatically (in this table, in red are depicted those cases in which a realistic limitation was identified, less than 2000 MW, see Table 3.3). Thus, in most of the buses the limitations will appear because of transmission constraints. In Table 3.6 the wind power increment thanks to voltage control provision is also evaluated taking into account the real PQ curve. Comparing both tables, it can be seen how the wind power limitation is reduced significantly. This reduction increases when the short-circuit increases. This fact happens because the difference between the PQ curves is higher when the active power is high (see Figure 3.32).

		Scc (MVA)								
		4000	6000	8000	10000	12000	14000	16000	18000	20000
		<b>Wind power penetration increment using ideal PQ curve</b>								
<b>x/r Ratio</b>	2	4325,30	6588,30	8851,96	10315,76	12578,04	14841,72	17105,25	19368,45	21131,88
	6	1615,79	2162,17	3213,00	3768,31	4818,76	5369,67	6424,82	6977,97	8031,53
	10	1410,44	2113,86	2819,36	3523,82	4726,30	5430,46	6137,21	6840,95	7546,14
	15	1356,39	2380,75	3056,78	3731,95	4755,90	5432,48	6110,95	7136,46	7813,04
	20	1423,66	2132,91	2844,57	3903,36	4613,57	5323,26	6035,89	7096,02	7806,56
	30	1490,70	2231,89	2977,74	3720,35	4462,96	5206,69	6301,35	7045,51	7789,82
		<b>Wind power penetration increment using real PQ curve</b>								
<b>x/r Ratio</b>	2	2956,51	4313,82	5983,16	7029,55	9000,87	10083,04	11130,75	13347,88	14345,67
	6	203,96	370,78	525,66	685,11	834,46	961,22	1096,38	1238,03	1381,37
	10	207,16	347,35	486,76	626,26	765,34	896,49	1018,37	1144,64	1273,31
	15	194,55	356,98	466,36	585,16	718,56	840,57	956,67	1083,43	1208,10
	20	199,69	334,02	444,61	580,64	689,11	808,37	932,95	1043,27	1166,46
	30	214,26	307,26	440,66	547,34	666,56	780,75	891,87	1010,19	1119,24

**Table 3.6: Wind power increment thanks to provide voltage control taking into account the ideal and real PQ curve VTNet=1.00 p.u**

### 3.3.5. Simplified model of harvesting network and detailed model of TNet

In this paragraph the wind power limitation has been computed taking into account the detail model of TNet, which corresponds to the expected network for the summer peak of 2014. Before computing the wind power limitation, the voltage of the base case has been analyzed. In Figure 3.33 the distribution of the voltage values is presented.

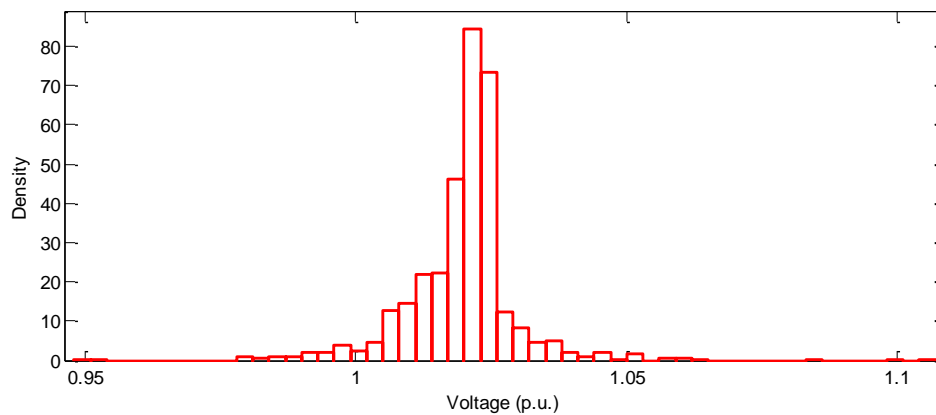

**Figure 3.33: Distribution of the voltage values**

Once checked that the majority of the voltages are within limits, the wind power limitations are computed, in case of not providing voltage control (blue) and in case of providing voltage control (red). In Figure 3.34 the wind power limitations are depicted for several 220 kV buses. In order to evaluate these limitations the active power is incremented in one bus and proportional decremented in the other generators.

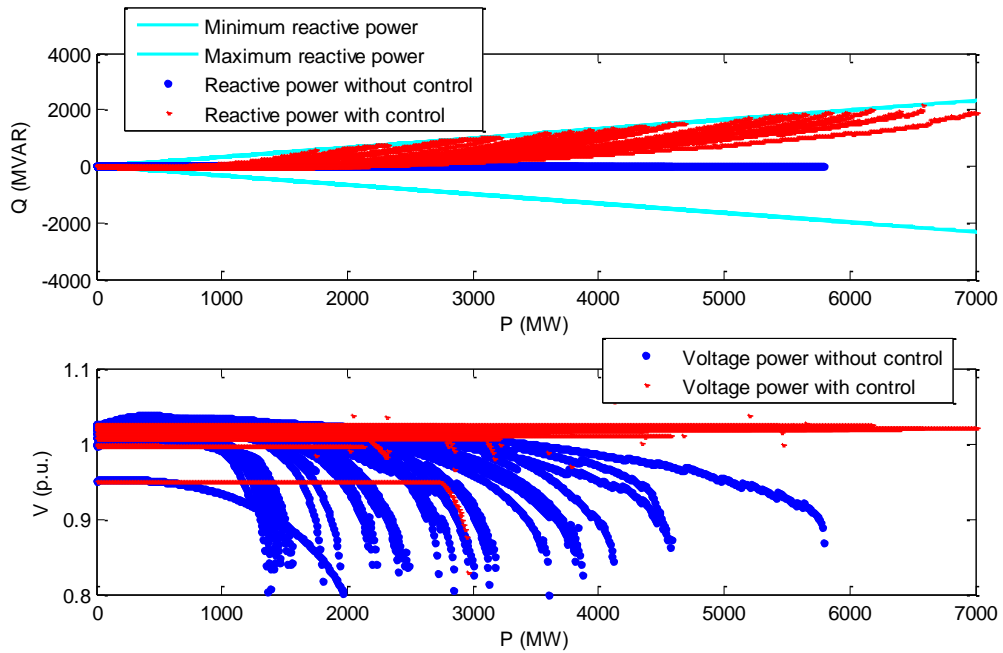

**Figure 3.34: Wind power limitation in different 220 kV buses taking into account the detail model of the transmission network**

In order to analyze the accuracy of the simplified model, the next figures are presented. In order to determine the wind power increment thanks to the voltage control provision, in Figure 3.35 the wind power limitation with and without providing voltage control are presented in the same figure. In these figures it can be appreciated how the results obtained with the simplified model are quite similar to the results obtained with the detail model in most of the cases. However, it is important to note that when the short circuit increases the wind power limitation saturates.

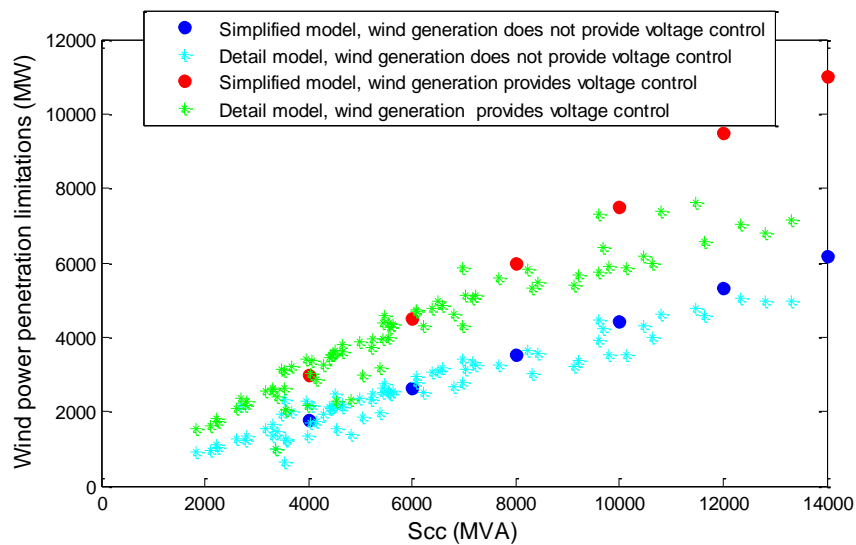

**Figure 3.35: Wind power limitations with and without control**

### 3.3.6. Conclusions

A detailed analysis of the wind penetration limits from the voltage point of view has been presented. In this analysis statistical data of the Spanish system has been used. After this analysis, it can be concluded that in the majority of the buses the wind penetration will not be limited because of voltage reasons. As can be seen in Table 3.2 in most of the buses the wind limitation appears for active injections of more than 2000 MW, which although is the theoretical limit is not the practical one. This fact is due to more than 2000MW of wind power probably will not be connected in just one bus, in these cases the wind penetration will be limited because of transmission capacity constraints but not because of voltage reasons. Nevertheless, in buses that present a low  $x/r$  ratio the wind penetration could be limited for low penetration levels because of voltage rise problems. In these cases the voltage control allows significant increments in the wind penetration. In addition, it must be remembered that the real reactive power that can be absorbed is higher than in case of taking into account the ideal PQ curve. Moreover, the wind penetration could also be limited in buses with low short circuit power. In these cases, it will be very important to compensate the absorption of reactive power; otherwise the increment of wind penetration thanks to the voltage control provision will not be significant.

### 3.4. Active power losses study

This subsection explains in detail the methodology and then, the results, for the second study. The aim of this study is to assess how the active power losses change because of the voltage control provision by wind farms. This subsection is structured as follows. Firstly, in paragraph 3.4.1, the economic value of the active power losses of the two grids previously presented (sub-transmission and wind farm grid) is explained. Then, the methodology used to assess this study is presented in 3.4.2. Next, in 3.4.3 the results are evaluated for a real representative network within the Spanish system. Finally the conclusions of this study are outlined in paragraph 3.4.4.

#### 3.4.1. Economic value of the active power losses in both grids (sub-transmission and wind farms grid)

In this subsection the economic value of the active power losses in the wind farms grid and in the sub-transmission grid is evaluated. The losses in the wind farm grid ( $Loss_{Windfarm\_grid}$ ) are evaluated for the second option (daily market price plus a premium which is the most favorable one) and also considering that the wind farms are remunerated as any conventional generator (daily market price). Thus, the economic value of the losses ( $\$Wind\ farm\ grid$ ) on the wind farms owner caused by  $Loss_{Windfarm\_grid}$  is computed as:

$$\$Wind\ farm\ grid = Loss_{Windfarm\_grid} \cdot P_{Wind} \quad (1)$$

On the other hand, the sub-transmission grid losses must be quantified and allocated. In Spain the generators usually do not pay the costs originated by power losses because the consumers absorb this cost. In addition, in order to increase the efficiency of the system and reduce the cost for the consumers, the regulator establishes a distribution network losses goal for each Distribution System Operator (DSO) in order to foster the power losses minimization. In case that the real losses are lower than this goal the DSO receives an incentive. However, if the real losses are higher, the DSO is penalized. Nevertheless, in Spain most of the wind generation is located in a network that has been built in order to evacuate power. Thus, no demands are located in this network and the wind farms owners must assume these power losses. In order

to allocate power losses from the common infrastructure to wind owners, the loss factor of each wind farm ( $f_{WF}$ ) is determined. This factor represents how the power losses in the common infrastructure depend on the gross power delivered by a certain wind farm. Thus, the economic value of the common infrastructure losses for a certain wind farm ( $\$Sub-transmission$ ) is computed as:

$$\$Sub-transmission_{WF} = f_{WF} \cdot P_{gross_{WF}} \cdot P_{Wind} \quad (2)$$

where ( $f_{WF} \cdot P_{gross_{WF}}$ ) represents the power losses allocated to the wind farm. Currently,  $f_{WF}$  is calculated assuming that all wind farms deliver 80% of their maximum power and do not provide reactive power to the sub-transmission grid. Due to the fact that  $f_{WF}$  is fixed, the cost of the losses in the common infrastructure is the same irrespective of the voltage controller installed on the wind farms. However, this regulation may be replaced by one which will be more efficient as it will take into account the specific scenario. Hence, the influence of wind power voltage control on common infrastructure losses will be reported.

### 3.4.2. Methodology

This section presents the methodology followed in this document for the quantification of the economic impact of wind voltage control on active power losses in the harvesting network. First an overview of the methodology is presented. Then, the development of scenarios is outlined.

- [Overview of the methodology](#)

The economic impact will be assessed by comparing five cases for each scenario of wind power and transmission bus voltage.

- The first case (BASE CASE) considers that wind turbines have reactive capabilities, but the wind farm is operated at a constant unity power factor ( $\cos\phi = 1$ ) which corresponds to the actual operation of Spanish wind farms. In this case, wind turbines could contribute to the internal voltage control of the wind farm grid, but they do not supply any help in controlling the external voltage corresponding to the sub-transmission grid. This means that the reactive consumption or generation of the wind farm grid is managed by the wind turbines, and the reactive consumption or production of sub-transmission lines and transformers is provided by the transmission network.
- The second and third cases consider that the wind farms maintain a constant power factor as the previous case and FACTS devices (STATCOM in the second case and switched shunt in the third case) are used to maintain an adequate voltage profile.
- The fourth case considers that the wind farms provide voltage control in accordance with a proportional controller (implemented in the SYSERWIND demo). This option considers a proportional controller for each wind farm, as is depicted in Figure 3.36, in order to achieve a certain set-point of the control bus (CB) which connects the harvesting network with the transmission network. As can be appreciated in this figure, there is a dead band where the control does nothing. The normal value of this dead band is around 0.0025 p.u. In the event that the voltage deviation (the difference between the set-point and the measured value of the voltage both at CB) is higher than the dead band the wind farms should

generate or consume reactive power (generate when the real controlled voltage is lower than the set-point and consume when it is higher). The amount of reactive power that should be generated for a certain voltage deviation is determined by parameter K, which represents the slope of the curve. The typical value of the slope is 25. In Figure 3.36 P<sub>nom</sub> represents installed wind power capacity and V<sub>nom</sub>, the nominal TNet voltage value.

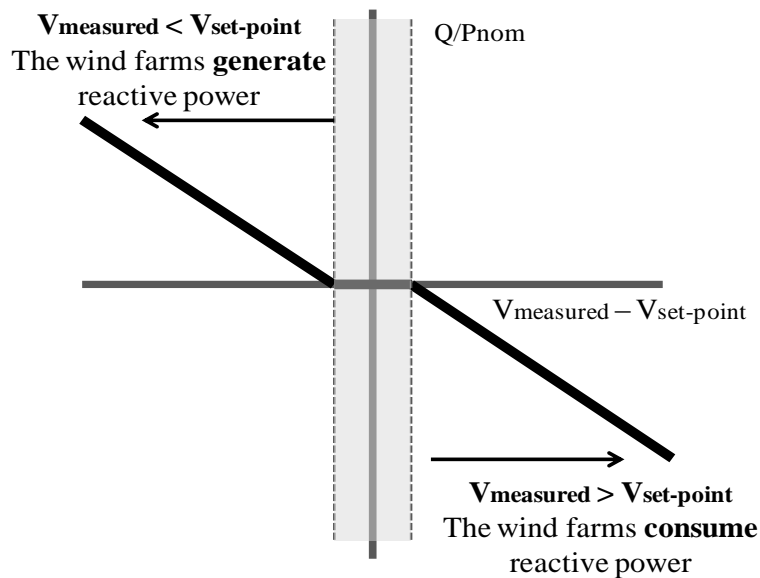

Figure 3.36: Reactive power required in order to provide voltage control in accordance with Spanish Operational Procedure

- Finally, the fifth case corresponds to the optimal situation in which the wind farms provide optimal reactive power in order to reduce the global power losses (including the common infrastructure). In this optimal case, wind turbines contribute to the internal voltage control of the wind farm grid, and also supply help in controlling the external voltage corresponding to the sub-transmission network.

In all the cases evaluated, a commercial optimal power flow OPF is used to give the optimal adjustment of control variables (wind turbines reactive outputs, position of transformer taps, and reactive injection of the FACTS device for the second and third case) within the grid in order to minimize the total losses while keeping the voltage profile within limits. In all cases the wind turbines are modeled as PV buses and additional constraints (for all the cases except the optimal one) are added in order to provide the adequate reactive power depending on the case evaluated.

- **Development of scenarios**

To model the wind farms production the cumulative Weibull density function of the wind speed over one year is used:

$$S_{Wind} = \beta \log (h/8760)^{1/\alpha} \quad (3)$$

where,  $S_{Wind}$  is the wind speed for a certain hour,  $h$  is the hour in which the wind speed is determined,  $\alpha$  is the shape factor of the distribution and  $\beta$  is the mean wind speed of the Weibull distribution with parameters ( $\alpha=2, \beta=6$ ) shows the cumulative Weibull density function. As an example of interpretation, the probability of a wind speed higher than 3.691 m/s is 68.5% (6000/8760) in Figure 3.37.

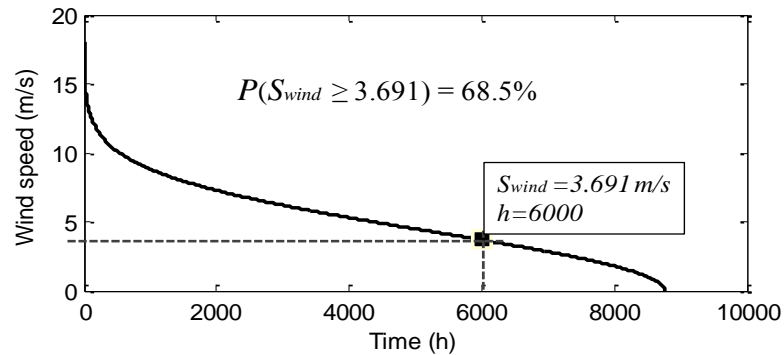

Figure 3.37: Wind speed modeling using Weibull density functions

In this study, the wind farms of each owner are modeled taking into account the actual values of the Weibull density function of its wind farms. In the Spanish case, wind power is embedded in harvesting networks which do not contain consumer’s loads. It should be noted that the methodology proposed could be used in other systems that contains demands (fixed mean annual consumption could be used or different demand scenarios could be developed).

Once the Weibull density function of wind turbines has been determined, a selected number of wind power scenarios must be developed. The cumulative density function is divided into twenty wind speed scenarios of 438 hours. Using the power curve provided by the wind turbine generator manufacturer, the power scenarios are obtained for each wind turbine generator. These scenarios represent the hourly power production of one wind turbine generator that occurs 438 hours a year. It is assumed in this document that all wind turbine generators on all wind farms are close to each other since it is likewise assumed that the geographical area where they are installed is small. Therefore, given this proximity, each wind turbine generator is operated at the same value of wind speed. However, each wind turbine generator has its own cumulative Weibull density function. Figure 3.38 summarizes the development of scenarios. It shows 20 hourly scenarios which are representative of the annual performance. Each scenario will be used for 438 hours.

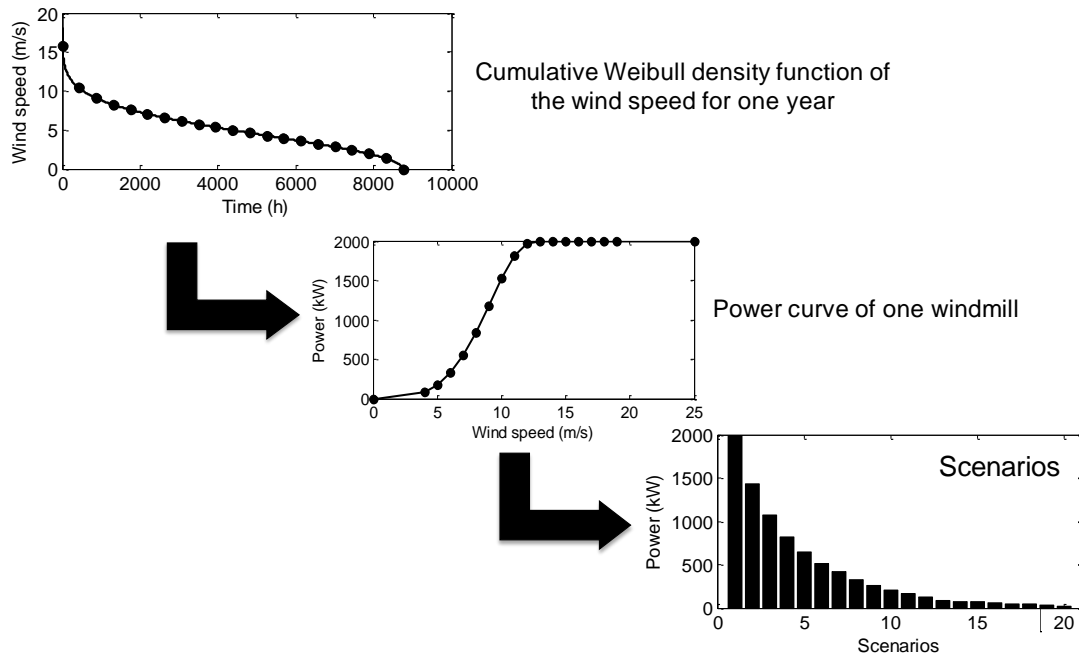

Figure 3.38: Process of building the hourly wind power scenarios representative of the annual behaviour

### 3.4.3. Illustrative test result

This section presents the economic impact of the wind voltage control for a Spanish representative network. The section is structured as follows. First, the network that has been used for performing the analysis is presented. Next, a losses comparison is presented. In (A) a global analysis of the five cases evaluated is presented. Then in (B) a detailed analysis of the cases in which the reactive capabilities of the wind farms are involved is explained. Finally, the economic impact is evaluated for the cases analyzed in (B) taking into account current Spanish regulations (an increase in losses on the sub-transmission grid does not affect the wind owners as is explained in 3.4.1).

- [Description of the network](#)

The methodology proposed in this document has been applied in a case example to two actual wind farm harvesting networks within the Spanish power system. In this section the main features of the two networks are analyzed. In Figure 3.39 the sub-transmission portion of the network is presented. It consists of 13 wind farms. The network is partially meshed (indicated in dotted lines in Figure 3.39) and, since it contains long feeders wind turbine generators will be more prone to reach saturation in providing reactive power.



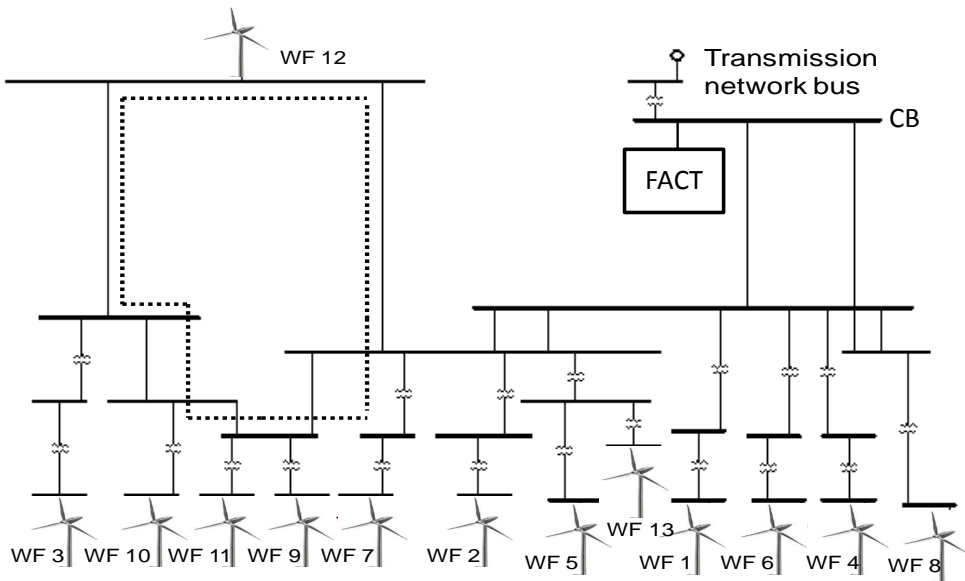

Figure 3.39: Diagram of network 1 (aggregated model of each wind farm)

The total installed power of each wind farm in network 1 is presented in Table 3.7.

Wind farms	1	2	3	4	5	6	7	8	9	10	11	12	13
Power [MW]	30	48	40	38	12	18	32	16	25	40	35	150	30

Table 3.7: Installed active power of each wind farm within network 1

On the other hand, in order to evaluate how the results obtained depend on the network evaluated another network has been evaluated. This second network is radial and has short feeders and which is most important; the wind farm grid is more significant than the sub-transmission grid. Its diagram is depicted in Figure 3.40, showing the 11 wind farms and the solar plant embedded inside. It is important to note that the reactive capability of the solar plant has not been considered in the analysis. In all the cases, the solar plant is operated at a fix unity power factor

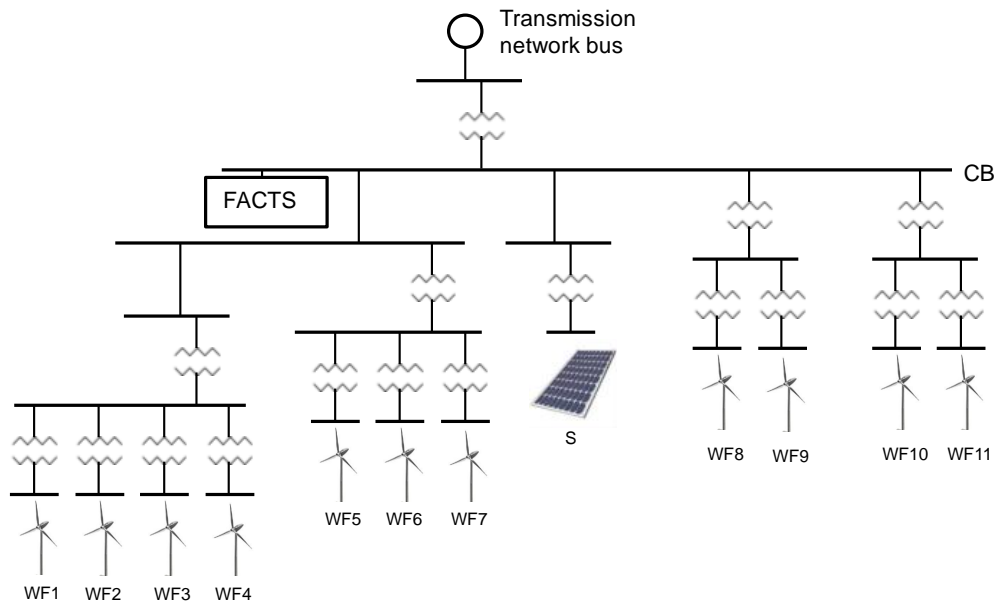

Figure 3.40: Diagram of network 2 (aggregated model of each wind farm)

The total installed power of each wind farm in network 2 is next presented in Table 3.8.

	Wind farms												Solar
	1	2	3	4	5	6	7	8	9	10	11	12	
<b>Power [MW]</b>	28	12	16	26	24	20	50	100	50	50	50	50	100

Table 3.8: Installed active power of each wind farm within network 2

In addition, it can be appreciated that in both networks a FACTS device is connected to the transmission network bus (only in the second and third cases). In the second case, the FACTS device connected is a STATCOM with unlimited capacity. This means that this device injects or absorbs the necessary reactive power in order to maintain the voltage of the CB fixed at 1.00 p.u. In the third case, there a switched shunt (two steps of 50 MVAR adding to a total reactive capacity of 100 MVAR, which could be injected in order to maintain the desired voltage) is connected.

- **Comparison of losses**

In this subsection, a comparison of losses is provided. Firstly, the five cases under study (Base, STATCOM, switched shunt, proportional control and optimal control) are compared. Secondly, a detailed analysis of the increase in losses of the proportional and optimal control with respect to the base case is presented. This second analysis evaluates the impact that the provision of voltage control in wind farms could have on the losses in the harvesting network.

**A) Comparison of global losses**

In order to compare all the controllers the power losses, the reactive power and the voltage at CB are presented in Figure 3.41, Figure 3.43 and Figure 3.45 respectively for network 1 and in Figure 3.42, Figure 3.44 and Figure 3.46 for network 2. As can

be seen in Figure 3.41 for network 1 and in Figure 3.42 for network 2, power losses depend greatly on the active power scenario. However, the difference between the different cases evaluated is not significant. Comparing the five cases for the first scenario, it can be seen that the proportional control increases the losses in both networks. On the other hand, the optimal control permits a considerable reduction in total losses (2.5 MW less than in the case of the proportional control) in network 1 whereas no reduction is obtained for network 2. This fact is due to the sub-transmission grid is more significant in network 1. The other two cases (STATCOM and switched shunt) maintain the same losses as the base case for both networks.

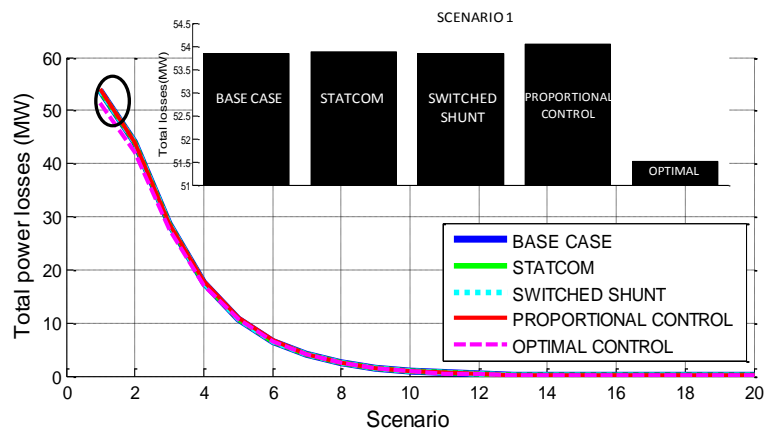

Figure 3.41: Power losses for the five cases under study in all the scenarios evaluated, providing a zoom analysis of the first scenario, network 1.

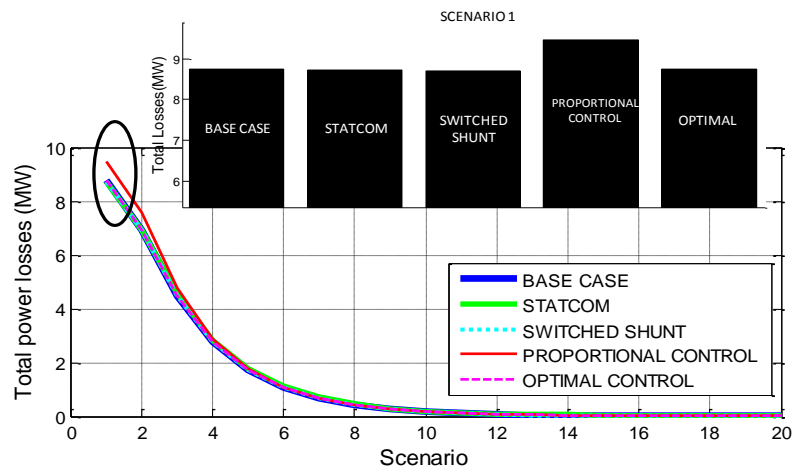

Figure 3.42: Power losses for the five cases under study in all the scenarios evaluated, providing a zoom analysis of the first scenario, network 2.

Figure 3.43 shows the reactive consumption from the grid for the five cases for network 1 and Figure 3.44 for network 2. As can be seen, in strong wind scenarios the reactive consumption of the STATCOM case falls significantly compared to that

of the base case (250 MVAR for network 1 and 80 MVAR for network2). In addition, for network1 the reactive consumption reduces 50 MVAR for the switched shunt. On the other hand, in network2 it can be seen how the switched shunt for the two first scenarios is 100 MVAR, 50 MVAR for the third and 0 MVAR for the rest of scenarios. Concerning the proportional control, it can be seen that in network 1 allows to reduce 50 MVAR the reactive consumption in high windy scenarios, as the switched shunt case. On the other hand, for network2 it allows to nearly avoid the consumption of reactive power from the grid. Finally in both networks it can be seen how the reactive consumption is quite similar to that of the base case.

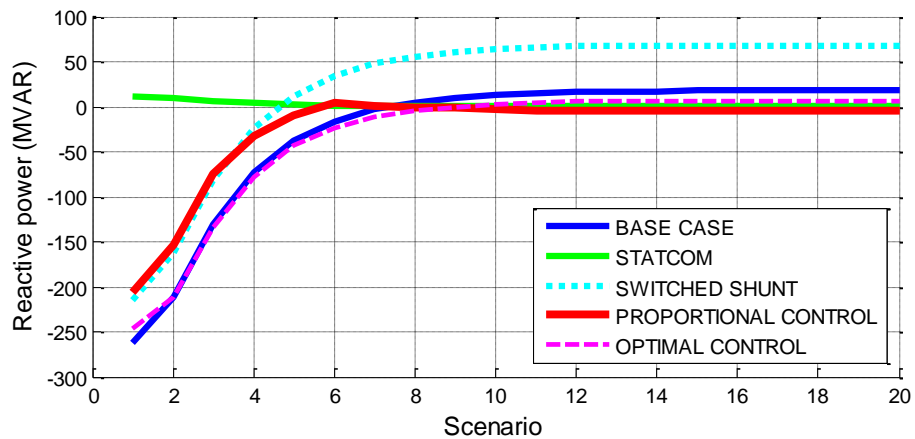

Figure 3.43: Reactive power at CB for the cases evaluated, network 1

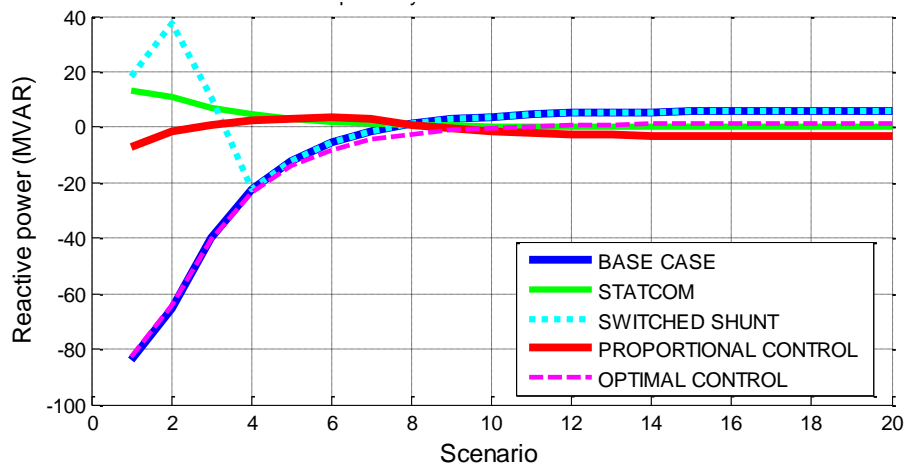

Figure 3.44: Reactive power at CB for the cases evaluated, network 2

Finally, the voltage profile at CB is depicted in Figure 3.45 for network1 and Figure 3.46 for network2 showing a similar profile to the reactive consumption. As can be seen in Figure 3.45 and in Figure 3.46 the CB voltage for the STATCOM case is fixed at 1.00 p.u.. Hence, the reactive power necessary to achieve this goal could be obtained. From an evaluation of all the figures, it can be concluded that with respect to voltage, the STATCOM case performs better than the others.

Nevertheless, the reactive injection is much higher than in the other cases. On the other hand, the switched shunt, and the proportional controllers do slightly better than optimal control at maintaining voltage at the CB. This better performance is more significant in networks with a small sub-transmission grid (as happens in network2). On the contrary, the optimal control achieves a better reduction in losses than the remaining cases in the event of having a big sub-transmission grid (as happens in network1).

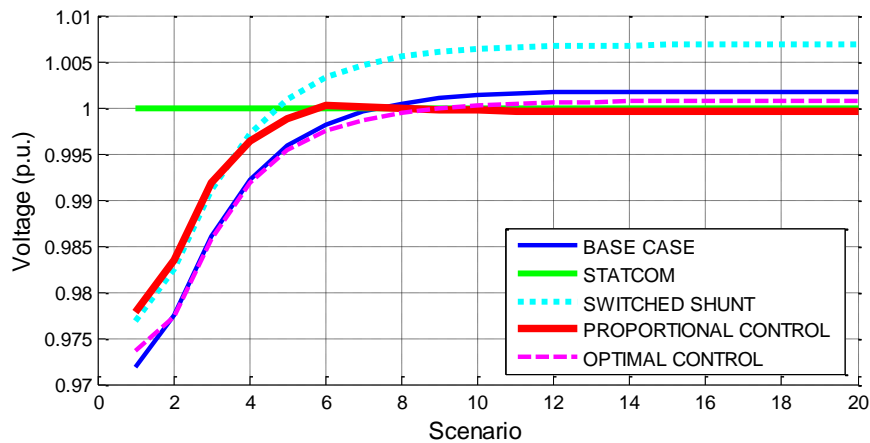

Figure 3.45: Voltage at CB for all the controllers, network 1

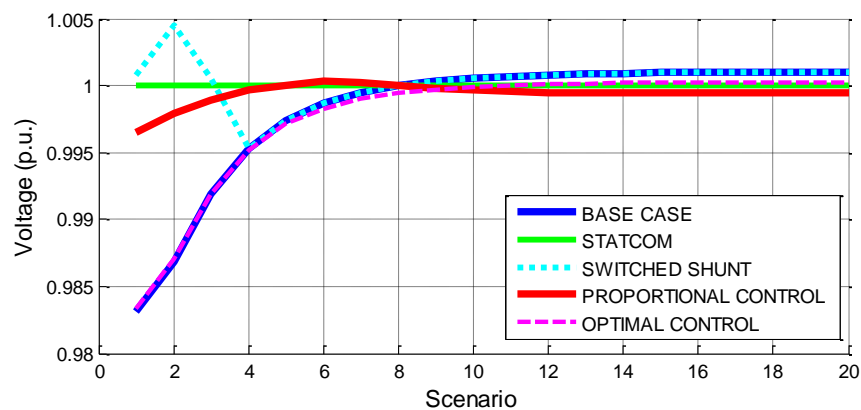
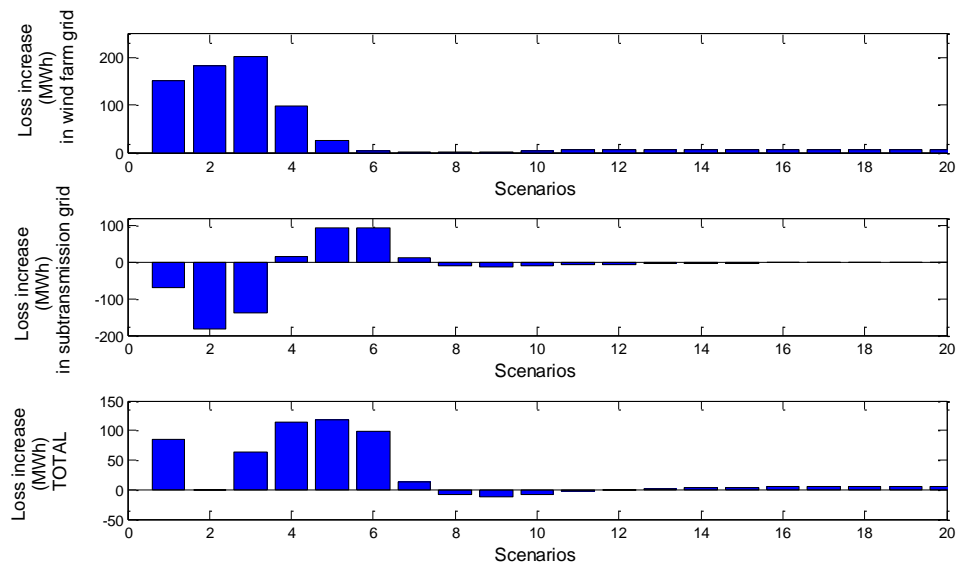

Figure 3.46: Voltage at CB for all the controllers, network 2

### B) Detailed comparison of losses

The two cases that analyze the reactive capabilities of wind farms (Proportional and Optimal control) are now compared in more detail with respect to the base case. The detail model is just explained for network1 because it is where the losses reduction is more significant. Moreover, it is important to note that the cases that included FACTS devices are not presented here because the losses are the same as in the base case. The first comparison (proportional control – base case) gives the

impact on the losses profile of providing voltage control in accordance with a proportional controller. In Figure 3.47 the difference between base case losses and proportional control losses is presented in MWh (each scenario is evaluated in 438h see subsection 3.2), for the twenty representative annual scenarios and a voltage transmission network bus of 1.00 p.u. In this figure the comparison is also separated for the sub-grids. It can be seen that the proportional voltage control increases the losses of the wind farm grid, while those of the sub-transmission grid increase or decrease depending on the scenario, resulting in an increase in total power losses.



**Figure 3.47: Comparison between losses of base case and proportional control in MWh (Proportional control – base case)**

In the second case, a comparison between the base case and optimal control indicates the impact on the losses profile of using the reactive capabilities of wind turbines in an optimal way to contribute to both the wind farm and sub-transmission electric losses. In Figure 3.48 the difference between base case losses and the optimal control losses is presented in MWh. It can be observed that when the wind farms provide reactive power in an optimal way, active power losses in the wind farm grid losses increase whereas in the sub-transmission grid losses decreases significantly. Due to the fact that the decrease in the sub-transmission grid is significantly higher than the increase in the wind farm grid, the total losses falls sharply. Nevertheless, with the actual regulations there is no incentive to provide this optimal control since the loss reduction in the sub-transmission grid is not allocated to wind owners. On the other hand, it is important to note that optimal control reduces the increase in losses in the wind farm grid compared to proportional control and considerably reduce the sub-transmission grid losses. Thus, whereas the proportional control will stress the network compared to the base case increasing the losses, the optimal control permits a reduction in total losses.

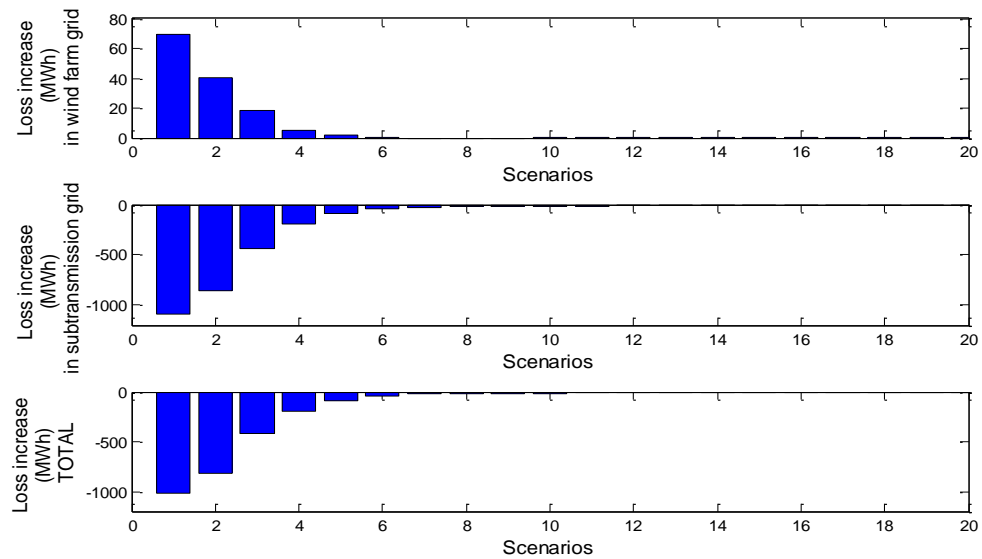
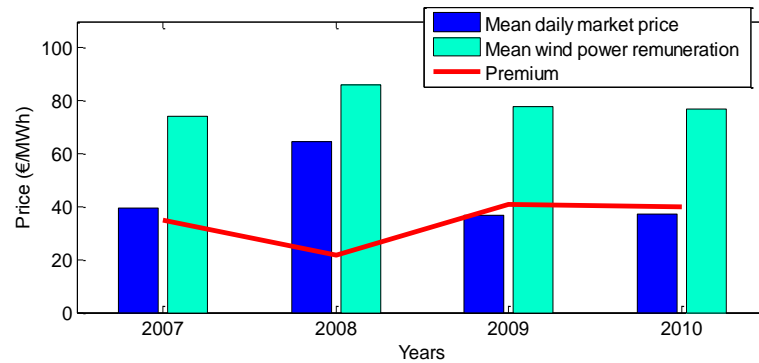

Figure 3.48: Comparison between base case and optimal in MWh. (Optimal – Base case)

- Economic impact with the current regulation

The economic impact must be evaluated from the wind farm owner standpoint. The economic impact is quantified at daily market price plus a premium (which is the most favorable one) and also considering that the wind farms are remunerated as any conventional generator (daily market price)<sup>4</sup>. Adding together the twenty scenarios, each one repeated over 438 hours, the annual loss reduction is obtained. Thus, the annual economic impact of providing voltage control is obtained by multiplying the annual loss reduction by the corresponding price. This document evaluates the economic impact for years 2007-2010. The cases that have been evaluated are those in which the reactive capabilities of the wind farms are used (proportional control, optimal control). These scenarios will be compared with the base case. Figure 3.49 depicts the evolution of the mean daily market price and the mean wind power remuneration in the years under study. It can be observed that whereas the mean daily market price is subject to significant variability, the mean wind remuneration remains stable. This is due to the “floor” of the wind remuneration, which represents the minimum wind remuneration.

<sup>4</sup> The regulatory changes in the Spanish market regarding the remuneration of wind generation is subject to changes that could affect the results obtained in this assessment.



**Figure 3.49: Evolution of the mean daily market price and mean wind power remuneration in the four year period under study**

In Table 3.9 a summary of the improvement in economic performance that could have been achieved by providing voltage control is presented for the years under study. It can be seen that in both cases providing voltage control means a cost for the wind owner but a significant reduction in sub-transmission grid losses. The cost to the wind owner remains relatively stable due to the stability of the mean wind remuneration (around €60,000 per year with proportional control and around €11,000 per year with optimal control). The economic impact has also been evaluated assuming that no premium is delivered to wind. The absence of premiums reduces the economic cost as expected (in Figure 3.49, the premium represents approximately 50% of the total wind economic impact for years 2007, 2009 and 2010).

		Wind farm sub-grid			Sub-transmission grid
		Loss increase (MWh)	Economic impact with premium(€/year)	Economic impact without premium(€/year)	Loss increase (MWh)
<i>PROPORTIONAL CONTROL - BASE CASE</i>	2007	736,66	54.603,36 €	28.987,56 €	-242,47
	2008	736,66	63.342,14 €	47.462,99 €	-242,47
	2009	736,66	57.459,47 €	27.226,95 €	-242,47
	2010	736,66	56.646,19 €	27.263,78 €	-242,47
<i>OPTIMAL CONTROL- BASE CASE</i>	2007	136,54	10.121,11 €	5.373,04 €	-2890,52
	2008	136,54	11.740,90 €	8.797,59 €	-2890,52
	2009	136,54	10.650,51 €	5.046,70 €	-2890,52
	2010	136,54	10.499,76 €	5.053,53 €	-2890,52

**Table 3.9: Summary of the economic impact**

An evaluation of whether wind power production affects prices is also presented in this section. In order to perform this study real hourly data for production, daily market price and wind power remuneration for 2008 have been used. Figure 3.50 presents the real production of a wind agent and prices (daily market and wind power remuneration). The wind production has been sorted and divided into twenty scenarios computing the mean price in each one of the twenty scenarios. It can be seen that when wind power production is high prices fall. This effect is less significant in the case of wind remuneration due to the “floor” established in the RD 661/2007. However, in both cases the difference between the first and the last scenario is not significant.



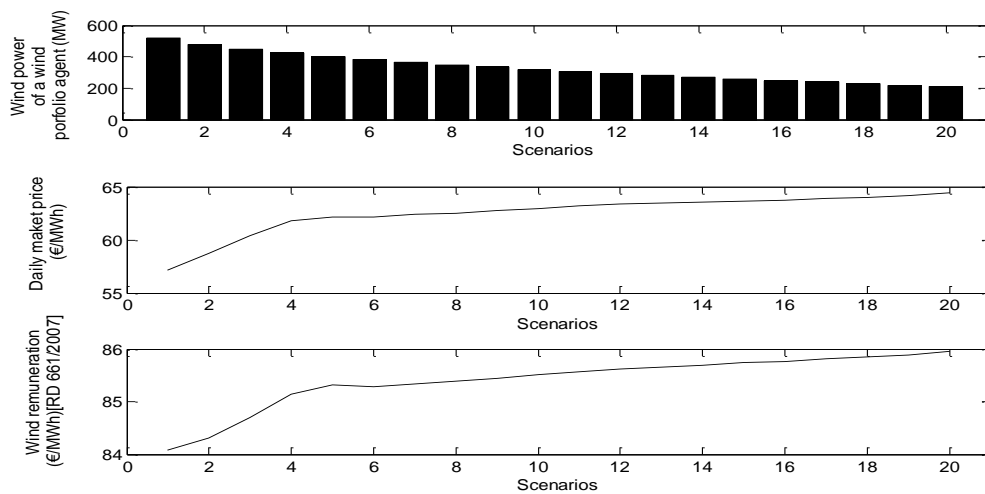

**Figure 3.50: Evolution of the prices with the production of a wind agent. Real data year 2008**

In order to verify if it is accurate enough evaluating the economic impact using the annual mean prices, Table 3.10 is presented. This table shows the economic impact for each of the twenty scenarios for year 2008. It can be appreciated that the total result (adding the twenty scenarios) are quite similar to the results presented in Table 3.9 for this year (using mean daily prices).

<i>PROPORTIONAL CONTROL - BASE CASE</i>						
Scenario	Wind from grid				Sub-transmission grid	
	Loss increase (MWh)	Price (€/MWh)		Economic impact (€/year)		Loss increase (MWh)
		with premium	without premium	with premium	without premium	
1	152,71	84,08	57,19	12.839,34 €	8.733,10 €	-68,34
2	183,93	84,30	58,69	15.505,72 €	10.794,57 €	-184,10
3	202,62	84,70	60,42	17.162,45 €	12.242,00 €	-139,16
4	97,93	85,15	61,79	8.338,59 €	6.051,20 €	16,03
5	24,88	85,32	62,19	2.123,06 €	1.547,41 €	93,09
6	4,49	85,28	62,15	383,25 €	279,29 €	94,56
7	0,10	85,33	62,37	8,93 €	6,53 €	13,21
8	0,55	85,38	62,49	47,00 €	34,40 €	-8,97
9	2,08	85,44	62,73	177,49 €	130,30 €	-13,59
10	3,47	85,51	62,97	296,52 €	218,34 €	-11,73
11	5,20	85,57	63,19	444,53 €	328,30 €	-7,84
12	5,91	85,62	63,35	506,00 €	374,38 €	-5,67
13	6,30	85,66	63,46	539,73 €	399,86 €	-4,29
14	6,49	85,69	63,59	555,87 €	412,47 €	-3,12
15	6,61	85,74	63,66	566,92 €	420,87 €	-2,39
16	6,67	85,76	63,74	571,85 €	425,03 €	-2,07
17	6,68	85,81	63,89	573,22 €	426,84 €	-2,02
18	6,68	85,85	64,01	573,50 €	427,63 €	-2,02
19	6,68	85,89	64,15	573,81 €	428,56 €	-2,02
20	6,68	85,95	64,42	574,20 €	430,35 €	-2,02
TOTAL	736,66			62.361,96 €	44.111,43 €	-242,47
using mean daily prices	736,66			63.342,14 €	47.462,99 €	-242,47

**Table 3.10: Summary of the economic impact taking into account the evolution of the prices with the wind production**

### 3.4.4. Conclusions

This document has provided a methodology for assessing and comparing different types of voltage controls (STATCOM, switched shunt and wind farm reactive capabilities) on wind

harvesting networks. Results have been illustrated for two actual wind harvesting grid to the transmission network. Even though quantitative results might depend on the specific harvesting grid, important qualitative results are derived from the case example presented in the document. Voltage control provision by wind farms leads to an increase in active power losses in the wind farm grid. On the other hand, it contributes to a reduction in sub-transmission grid losses. Furthermore, optimal control performs better in terms of loss reduction, in case of minimizing the power losses; whereas proportional control performs better in terms of how well it controls the bus that connects the harvesting network with the transmission network. Nevertheless, it appears that, to control voltage, a STATCOM or a switched shunt device could be more adequate. Finally, in the event that voltage control is imposed to wind farms owners, the associated cost computed in this document should be allocated to them. This economic cost is reduced by 50% with the removal of the wind premium.

### **3.5. Conclusions of the economic assessment of the voltage control**

In this section of the document, an economic assessment of the voltage control provision by wind generation has been provided. In order to present this assessment two different studies have been presented. In the first one, the analysis of how the power losses are affected by the voltage control has been evaluated. In this analysis, results have been illustrated for two actual wind harvesting grids to the transmission network. Even though quantitative results might depend on the specific harvesting grid, important qualitative results are derived from the case example presented in the document. The voltage control provision by wind farms originates an increment of active power losses in their own network. On the other hand the provision of this control contributes to reduce the sub-transmission grid losses. Optimal control performs better in loss reduction. This reduction is higher in case of having a significant sub-transmission grid as has been presented for network1 .On the contrary, the proportional control performs better in controlling TNet control bus. In addition it is important to note that the proportional control could be optimal if an OPF is used.

On the other hand, in the second study the wind penetration increment thanks to the voltage control provision has been computed. The results of this analysis show how in the majority of the buses the wind penetration will not be limited because of voltage reasons. Nevertheless, it has been identified that buses with low  $x/r$  ratio or low short circuit power could present problems for achieving high wind penetration levels.

## 4. Economic impact of up-scaling the VPP model in Denmark

### 4.1. Expected outcomes of the analysis

The Key Performance Indicators of the TWENTIES project are defined in [9]. The following 3 KPI's are directly related to the up scaling of the VPP in Denmark:

- KPI.15.TF1.7: Marginal (operating) costs for use and provision of the services, as defined in the Demo 2 DERINT KPIs, from the VPP within each demand/technical/regulation/market scenario in Denmark [€/ [MW], [MWh], [MVA], [MVA<sub>r</sub>], [tonne] range
- KPI.15.TF1.8: Existing approaches for providing the services, as defined in the Demo 2 DERINT KPIs, In Denmark. Marginal (operating) cost for each demand/technical/regulation/market scenario for providing these services. For each existing approach the following measurements/calculations will be made: [€/ [MW], [MWh], [MVA],[MVA<sub>r</sub>], [tonne] range
- KPI.15.TF1.9: Marginal (operating) cost-benefit rate of the VPP when providing the services for each demand/technical/regulation/market scenario in comparison with the existing approaches in Denmark. This will be measured in [€] and [tons of CO<sub>2</sub>] reduction/increase for each of the services provided.

The overall idea of these KPIs is to estimate volume and economic / environmental benefit of the services which the VPP under study can provide in future cases (2020 and 2030) within Danish power system context. This is done by comparing key numbers for system performance between cases with VPP services (KPI.15.TF1.7) to base cases without VPP services (KPI.15.TF1.8), and quantify the difference (KPI.15.TF1.9).

The original KPIs include active power [MW], [MWh], as well as reactive power related services [MVA], [MVA<sub>r</sub>] and the economic [€] and environmental [tonne] impact. The present assessment will exclude the reactive power services, which is justified by the lack of a market for reactive power services in Denmark, given the lack of experience with reactive power services from the demonstration, and because the value of reactive power and voltage control services are highly dependent on the local grid, a general assessment is not very precise.

Focusing on the active power services and their impact, and on sensitivity analysis, the actual expected outcome is modified as follows:

- Reduction in day-ahead market prices [€/MW]
- Reduction in total operation costs per year [€/year]
- Reduction in CO<sub>2</sub> emission [tonnes/year]
- Reduction in curtailed wind power [MW/year]
- Reduction in net balancing costs for TSO hour-ahead balancing [€/year]

## 4.2. Main findings of the Demo

### 4.2.1. Main findings of the demonstration of VPP technology: Power Hub

This section strives to present the findings related to the Power Hub demonstrations covering the economic assessment based on upscaling the VPP technology currently deployed in Denmark. In this relation the findings can be divided into three areas:

1. Findings that are *directly* used in the VPP upscaling modelling.
2. Findings that are *not* used in the VPP upscaling modelling, but qualitatively qualify to be used in a development of the modelling.
3. Findings that *justify* the upscaling of the VPP technology in Denmark.

#### *Introduction to Power Hub*

Power Hub is a VPP that is unique because of the high versatility; it can collect flexibility from a variety of units (both consumption and production), optimize the use of its flexibility across different markets, and create value to all the stakeholders by allocating the flexibility based on the optimisation. Today several consumption and production units interact at commercial level with Power Hub (seen Figure 4.1).

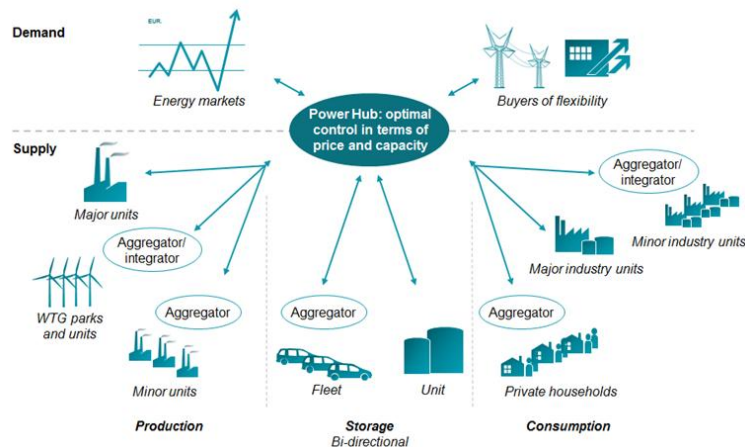

**Figure 4.1: Power Hub can include a variety of different units (both production and consumption units) and different technologies.**

To demonstrate the value and capabilities of Power Hub in the Twenties project, several demonstrations have been conducted, e.g. integration and control of wind in ancillary services portfolio etc. These demonstrations are subject to further presentation and discussion in the following subsections.

### 4.2.2. Findings directly used in the VPP upscaling modelling

The goal for the VPP is to aggregate large numbers of LUs, each with stochastic behaviour, in such a way that the portfolio of units obtains deterministic properties. The operation of the individual LUs is planned and optimized with respect to an aggregated objective.

The ability of the VPP of providing ancillary services from the integrated units (consumption and production), have been a key objective in the demonstration. The VPP have shown the following capabilities:

- Commercial capabilities:
  - Day-ahead optimisation (according to expected spot prices)
  - Primary regulation
- Technical capabilities
  - Day-ahead optimisation (price depending bidding)
  - Secondary regulation
  - Tertiary regulation
  - New services (fast frequency demand response, integration and control of wind to deliver ancillary services and reactive power control)

VPP's are very suitable as an aggregator of assets. A VPP eases the operator's burden of forecasting, supervising, activating and evaluating the performance of the portfolio, especially when suppliers are numerous and relatively small in size.

It has been shown in the demonstrations that the units are willing to operate according to the Power Hub control, given that the primary function of the operation is not compromised – which is secured by operating the unit within the comfort zone in the process energy buffer (i.e. temperature limit of a cold storage etc.).

- The consumption units have a potential for shifting the energy several hours by use of the energy buffer and to provide ancillary services.
- Small/medium scale power production unit found in industry and district heating also have unexploited potential to provide ancillary services to the grid.
- Wind power is technical capable of delivering ancillary services.

#### *Technologies in Power Hub*

The demonstration of Power Hub has successfully mobilised units within different industries that possesses flexible power capability. A list of available technologies in Power Hub is listed in Table 4.1.

Technology	Explanation
<b>Cold Storage</b>	Plant or process utilizing a refrigerating engine
<b>Diesel Genset</b>	Diesel engine with power generator
<b>Drain Pump Station</b>	Water pumps to drain land below sealevel
<b>Drinking Water Pump(s)</b>	Pumps used for the supply of drinking water
<b>Feeder</b>	Part of a grid distribution system supplying a radial with power. For Power Hub it is equivalent with the circuit breaker
<b>Gas Turbine Generator</b>	Gas turbine with power generator

<b>Greenhouse Growth Light</b>	Assembly of light sources used for growth light in a greenhouse
<b>Heating Ventilation Air Cooling</b>	Equipment for heating/cooling the air for building ventilation
<b>Heat Pump</b>	A device that transfers heat energy from a heat source to a heat sink by use of the vapor compression cycle
<b>Hydro Turbine Generator</b>	Hydro turbine with power generator
<b>Metal Foundry</b>	Broad concept covering all kind of metal founding or surface treatment
<b>Photovoltaic Panel(s)</b>	A packaged, connected assembly of photovoltaic cells
<b>Wind Turbine Generator</b>	Wind turbine with power generator

Table 4.1: List of technologies capable in Power Hub portfolio.

A list of units on Power Hub can be seen in Figure 4.2.

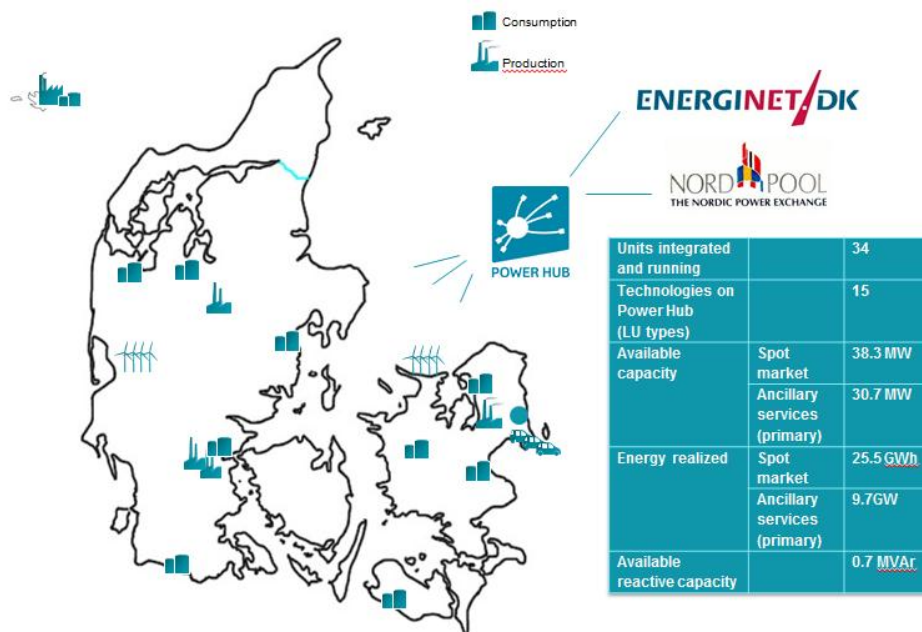
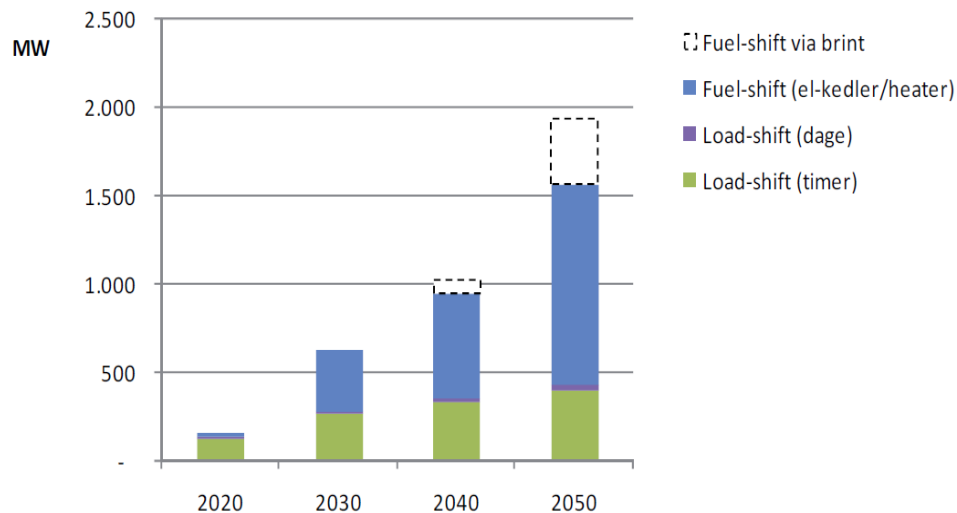

Figure 4.2: Overview of Power Hub integrations and capacity etc. ultimo 2012.

The common characteristic across the different technologies is that energy storage is present, e.g. water reservoir (potential energy) and heat reservoir (thermal energy). The flexibility of the different technologies differ based on the boundaries set by the operational pattern, e.g. a greenhouse must supply light to the growth process at least 16 hours a day or how much the cold storage can vary in temperature without jeopardizing the production etc.

### Potential of flexible consumption in Denmark

The potential flexible power consumption in Denmark in a scenario based on extensive build out of wind power can be seen in Figure 4.3. The analysis supports the theoretical work about upscaling of a VPP based on flexible power.



**Figure 4.3: Estimated potential for flexible power consumption assessed as power (MW) available for shift en time (hours and days). It is based on yearly average power.**

**Source: Kortlægning af potentialet for fleksibelt elforbrug i industri, handel og service (composed by Ea Energianalyse for Energinet.dk).**

#### 4.2.3. Findings not used in the VPP up-scaling modelling

Additional findings from the demonstrations of Power Hub have not been used in the upscaling modelling as these have not been able to include in the scope. This is mainly because the modelling tools have not been adequate to model these findings. The common characteristics of these findings are that they represent an unknown value created by the VPP in addition to the outcome of the analysis.

**Fast frequency demand response** has been demonstrated at the Faroe Islands where Power Hub has demonstrated the ability to stabilize the grid in case of fallout of a power plant etc. The result is that a controlled and limited blackout replaces a bigger and uncontrolled blackout. The value at the Faroe Islands is especially in the industry where production is easily jeopardized, e.g. at a fish farm where cooling is a crucial factor in the production and a lack of energy might cause major economic losses.

**Integration and control of wind power** is crucial as more wind power is integrated into the system and the base load is dependent on wind power production. Power Hub has demonstrated the capability to integrate wind power in the portfolio and to control the production to follow a set point and deliver ancillary services. In addition Power Hub has demonstrated that it is possible to integrate an energy storage unit in addition to optimizing the flexibility, i.e. to integrate a battery. The value is directly created by a VPP when the market based WTGs with no subsidies is economic optimized.

**Reactive power control** becomes more crucial as (de)central power plants are taken out of production and more wind power is build, as the WTGs are not capable of delivering reactive power in times of no wind. The DSOs might want to build out compensating units to deliver reactive power, but an alternative to this is that DERs deliver reactive power through a VPP as Power Hub. In the demonstration work Power Hub has shown capabilities to deliver reactive power control from DERs.

**Primary ancillary services** is a core competence of the Power Hub which has demonstrated the ability to deliver primary ancillary services from both consumption and production units. The Ancillary services market represent a high value and will be more crucial to a stabilized system as more intermittent power production is integrated into the grid.

#### 4.2.4. Findings that justify the up-scaling of the VPP technology

Additional demonstrations of Power Hub have been conducted to show that it is realistic to create a VPP that is based on a solution that is scalable.

A VPP based on a **scalable, portable and secure IT platform** is crucial to be able to adopt the benefits in relation to economy of scale. Power Hub has been assessed by an external consultancy with expertise in relation to IT platforms within the energy industry. Their findings are that Power Hub is highly scalable to integrate sufficient units, highly portable to other markets and countries and that the security is state-of-the-art.

Power Hub has been demonstrated to **maximize the value of a variety of assets across different markets**, which is crucial in the value creation to all stakeholders. The ability of optimizing across several types of units (consumption Vs production units and different technologies with different characteristics) together with the adaption to different markets is crucial to the marginal value created.

The generic structure of Power Hub has also demonstrated agility in relation to **adapt to developing and new markets**. This is demonstrated by Power Hub by handling rolling gate closures with a parameterised market setup.

Through the Twenties project different **mobilization strategies of units** have been tested and demonstrated. Overall three types have been tested: Single unit, integrator and aggregator. Single unit is where Power Hub mobilizes the unit 1:1 (Figure 4.4). The integrator is where Power Hub utilizes existing communication channels to mobilize single units, e.g. through water pump suppliers (Figure 4.5). The aggregator is where Power Hub sees the aggregation of several units as one entity, i.e. the flexibility can be utilized through one entity (Figure 4.6).

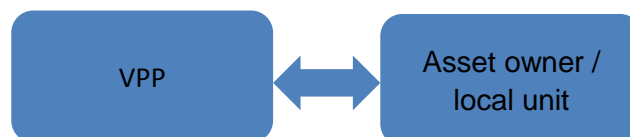

Figure 4.4: The VPP operator and the legal asset owner have a direct business relationship.



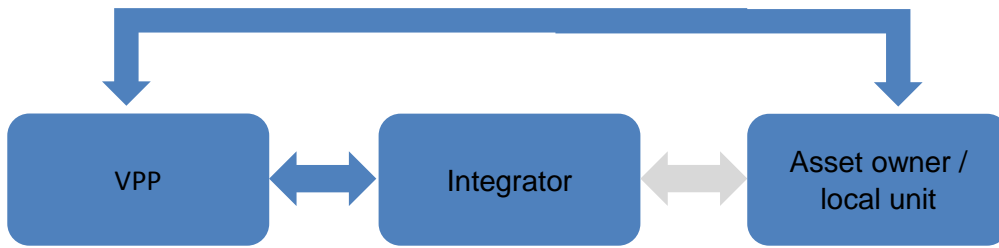

Figure 4.5: The VPP operator has a direct business relationship with both the integrator and the legal asset owner. The relationship between the integrator and the legal asset owner is not relevant seen with from the VPP perspective (indicated with grey color).

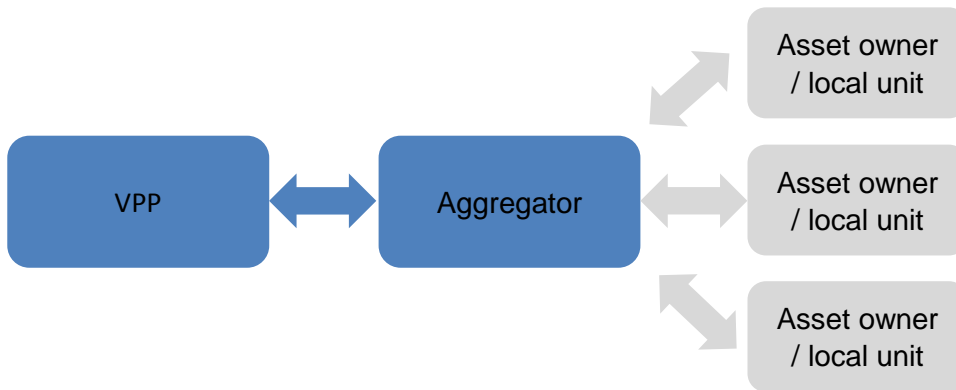

Figure 4.6: The VPP operator has a direct business relationship with the aggregator. The relationship between the aggregator and the asset owner is not relevant from a VPP perspective (indicated with grey color).

### 4.3. Description of the assessment methodology and problem setting

#### 4.3.1. Methodology for assessing the impact of the VPP for a system

An overview of the methodology for economic and environmental assessment is illustrated in the block diagram Figure 4.7. It includes simulation of the day-ahead unit commitment and dispatch using WILMAR Joint Market Model (JMM), and simulation of hour-ahead balancing using SIMBA. The unit commitment and balancing simulations uses a set of consistent wind power simulations as inputs.

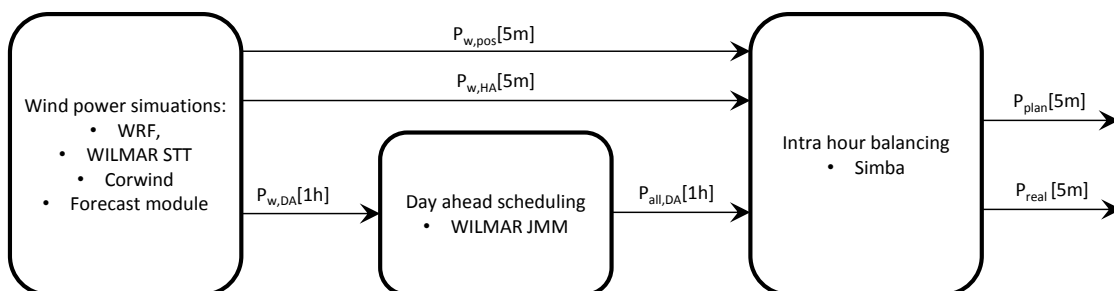

Figure 4.7: Overview of methodology for economic and environmental assessment.

In the present assessment, WILMAR is used to simulate the day ahead unit commitment and dispatch in the North European power system (Denmark, Norway, Sweden, UK, Germany, Holland, Belgium, France) with 1 hour time resolution. Thus, WILMAR uses the day-ahead wind power forecast  $P_{w,DA}[1h]$  as input, and outputs the day ahead generation and consumption schedule  $P_{all,DA}[1h]$ .

In the present assessment, SIMBA simulates the hour ahead balancing in Denmark. As inputs, SIMBA uses day ahead generation schedule  $P_{all,DA}[1h]$  as input, together with wind power hour ahead forecasts  $P_{w,HA}[5m]$  and the real time possible wind power  $P_{w,pos}[5m]$ . The output results from SIMBA are 5 minute hour-ahead generation power plan  $P_{plan}[5m]$  for the in the Danish system and the real time generated and consumed power  $P_{real}[5m]$ .

#### *VPP scenarios in the model*

The VPP cases that will be used in WILMAR and SIMBA are described below. The VPP technologies examined are cold storage and electric vehicles.

In the 2020 VPP case, Denmark will have 200 MW of cold storage installed and 75,000 electric vehicles introduced, while these numbers will increase to 400 MW cold storage and 300,000 vehicles in 2030. This increase reflects the expected rapid integration of these technologies, particularly electric vehicles, into power systems, especially as wind power increase requires more demand response solutions. Concurrently, it assures that some estimate of the effect of the scale of the VPP system can be measured.

<i>Flexible electric power</i>	<i>VPP model in WILMAR</i>	<i>2020 Scenario</i>	<i>2030 Scenario</i>
<b>Flexible consumption</b>	Cold storage	200 MW	400 MW
<b>Transportation</b>	EV's	#75,000 (600 MW)	#300,000 (2,800 MW)

**Table 4.2: Description of VPP cases**

#### 4.3.2. Description of the tools and models used in the assessment

This clause provides a short description of the 3 main tools applied in the methodology: WILMAR, SIMBA and the wind power simulation complex.

##### *WILMAR*

The WILMAR (Wind Power Integration in Liberalised Electricity Markets) model (reference) consists of two modules: the Scenario Tree Tool (STT) and the Joint Market Model (JMM). The STT is a tool for generating scenario trees for wind and demand. The scenario trees are subsequently used by the JMM to find the hourly economic unit commitment and dispatch of electricity generation with respect to uncertainty in wind and demand. In Wilmar, uncertainty is disregarded in the unit commitment and dispatch problem solution, and scenario trees are not needed for the JMM simulations. Therefore only the JMM is used in WILMAR.

The Joint Market Model (JMM) forms the economic dispatch of power generation, flows, and consumption given generation unit data, trading capacities, loads, fuel and emission prices, as well as, information on wind, hydro etc. JMM operates with a dynamic planning horizon of up

to 36 hours and an hourly time resolution. JMM includes integrated optimisation of electricity storages over the planning horizon (up to 36 hours). This makes it possible to model e.g. cold storages as described in section 4.3.3 and electric vehicles in section 4.3.4. Three modes are available: Perfect forecast, deterministic with forecast error, and stochastic. The three modes differ in the way stochasticity in wind and demand is treated. In this project JMM is run in perfect forecast mode, which assumes perfect information throughout the entire planning horizon.

Due to the nature of the wind forecasts used in this project, the hourly dispatch values can be interpreted as “Day-ahead” or “Spot-market” solution and serves as input to the SIMBA model.

### *Simba*

SIMBA requires hourly energy values for scheduled production, consumption and exchange as input. In the operational set-up the values are expected to be the scheduled hourly values shortly before the power planning of the operating hour. This is usually seen as the output from a traditional Unit Commitment model (UC model) and therefore the output from an UC model is used as input to SIMBA. In the present setup, the UC model (WILMAR JMM) simulates the day-ahead spot market and returns time series for production, consumption, prices etc. in an hourly time resolution. Then SIMBA transforms these time series into a more detailed (5 minutes) time resolution and thus simulating hour-ahead operational schedules for production, exchanges etc. In the operational setup the sum of the day-ahead energy schedules will always be zero whereas the sum of all hour-ahead power schedules might not be zero for all detailed time steps. Market players will pay for deviations from energy schedules as well as deviations from their power schedules. The generation of power schedules in SIMBA differs for the different types of production, consumption and exchanges.

Hour-ahead power schedules for consumption are generated by smoothing the hourly energy values. In this first version of the model it is assumed that the consumption is perfectly forecasted which also can be interpreted as if the consumption were known one hour in advance.

Power schedules for exchanges via interconnectors are generated so that they respect ramping conditions. In the West Danish area transit from Nordic countries to Germany causes imbalance due to different ramping speeds.

Power schedules for traditional power plants are based on ramping from one hourly energy to the next using the ramping characteristics the user has given in the user interface.

Power schedules for wind production are based on wind power forecasts. The hourly wind power values from the UC model are not used by SIMBA, but replaced by simulations of the wind power forecast one hour prior to the operating hour with the detailed time resolution. Based on these values detailed power schedules are generated, including the intra-hour variability that is not modeled by most wind power forecast systems. In addition, detailed power time series are generated to model the actual wind power production.

Based on these detailed power schedules, a resulting system balance can be calculated. The schedules can be interpreted as the power schedules available to the operators prior to the operating hour.

SIMBA also calculates the available capacity in the system. This is based on knowledge about the technical characteristics of the units in the model. Based on this and the marginal costs of

the units a merit order list of upward and downward regulation capacity is created. This simulates the NOIS list in the Nordic system.

Finally, when activating regulating power in the model, the rules applying to activation are obeyed. In this version of the model, the balancing is rather simple but obeys the existing rules for balancing in the Danish system. For each half hour the mean imbalance is calculated and this amount is activated. This simulates real-life operations at Energinet.dk although Energinet.dk continuously updates schedules and activates regulating power in real time. The results from SIMBA will therefore be able to provide an estimate of the amount of activated regulating power as well as a residual imbalance that needs to be balanced with real time schedule updates and automatic reserves.

#### *Wind power simulations*

The wind power simulations provide a set of consistent time series for possible wind power production, day ahead and hour-ahead forecasts of wind power. The methodology for the wind power simulations are described in detail in TWENTIES deliverable 15.2 [10]. The following tools are used:

- CorWind a tool for simulating time series of possible wind power for large wind farms or power system areas, taking into account the correlation between wind speeds at the different geographical locations of the wind power plants. CorWind is based on wind speeds from mesoscale reanalysis with WRF and adds a stochastic (random) contribution to the wind speeds ensuring simulation of realistic wind power variability.
- The day-ahead wind speed forecast errors are simulated using WILMAR STT.
- The hour-ahead wind power forecast error is simulated using an ARMA(1,1) model to emulate the meteorological forecast error and an adjustment procedure to adjust the meteorologically based forecast to the real time possible power at the time of online forecast.

#### 4.3.3. Cold storage model

A cold-storage plant is controlled to keep the temperature  $T(t)$  at time  $t$  close to a fixed temperature  $T_{ideal}$ . For simplicity, we can assume that the hourly average temperature  $T_{normal}(t)$  is kept constant at  $T_{ideal}$  if the cold-storage is normally operated, i.e.

$$T_{normal}(t) = T_{ideal}$$

In the VPP mode, we allow the temperature to be lower than  $T_{ideal}$ , but not lower than  $T_{min}$ , i.e.

$$T_{min} \leq T_{VPP}(t) \leq T_{ideal}$$

In the VPP mode, the stored energy, or the “state of charge”  $S_{VPP}(h)$  can be determined as

$$S_{VPP}(t) = C_{heat}(T_{ideal} - T_{VPP}(t))$$

We will also assume that we have a normal operation profile for the power  $P_{normal}(t)$  which ensures that the temperature is kept ideal. The normal power profile  $P_{normal}(t)$  then varies because the stored items are changed and the ambient temperature is changing.

The VPP operated cold-storage uses the normal power plus extra dissipation power because the temperature is below  $T_{ideal}$  plus/minus power to change the temperature:

$$P_{VPP}(t) = P_{normal}(t) + C_{diss}(T_{ideal} - T_{VPP}(t)) - C_{heat} \frac{dT_{VPP}(t)}{dt}$$

The dissipation factor  $C_{diss}$  [MW/deg] probably increases for lower temperatures, but since the temperature interval is relatively small, it is reasonable to assume that it is constant.

In principle, the heat capacity  $C_{heat}$  [MWh/deg] will vary with time, but if the volume of stored items is relatively stable, then we can assume that the heat capacity is constant.

The cold storage has a maximum power capacity  $P_N$ , meaning that the power in normal operation is restricted to

$$0 \leq P_{normal}(t) \leq P_N$$

and likewise the power in VPP operation is restricted to

$$0 \leq P_{VPP}(t) \leq P_N$$

Using hourly time steps  $\Delta t = 1\text{h}$ , the VPP model can also be expressed as

$$P_{VPP}(h) = P_{normal}(h) + c_{diss}S_{VPP}(h) + \frac{S_{VPP}(h) - S_{VPP}(h-1)}{\Delta t}$$

$$0 \leq P_{VPP}(h) \leq P_N$$

$$0 \leq S_{VPP}(h) \leq E_N$$

with the following parameters as shown in Table 4.3 :

Symbol	Description	Unit
$P_{normal}(h)$	power profile of the cold-storage if it is operated	MW
$P_N$	Rated power of cold storage, i.e. maximum continuous (electrical) power that the unit can consume (this number can probably be read from the name plate.	MW
$E_N$	Rated energy of cold storage, i.e. maximum energy that can be stored. $E_N$ should be calculated according to $E_N = C_{heat}(T_{ideal} - T_{min})$ where $C_{heat}$ is the heat capacity [MWh/deg] of the cold storage, $T_{ideal}$ is the ideal (normal) operation temperature and $T_{min}$ is the minimum temperature for VPP operation.	MWh
$c_{diss}$	Relative dissipation factor. $c_{diss} = \frac{C_{diss}}{C_{heat}}$ where $C_{diss}$ is the dissipation factor [MW/deg] of the cold storage	MW/ MWh

Table 4.3: Cold Storage model parameters

This formulation of the model is illustrated in Figure 4.8.

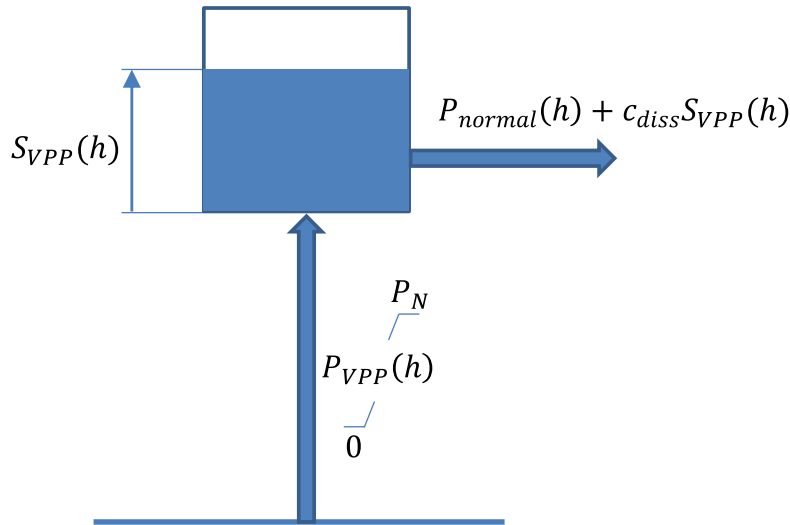

Figure 4.8: Cold Storage Model

With this formulation, we should remember to subtract  $P_{normal}(h)$  from the fixed demand profile in the relevant WILMAR region, because the cold-storage is there, even if it is not operated as a VPP.

#### 4.3.4. Electric vehicle model

An electric vehicle is operated, so that it charges its battery from the grid when it is not driving and consumes energy from the battery when it is driving. We disregard vehicle-to-grid technologies, so the battery never discharges to the grid. Hence, the periods of charging and consumption are temporally exclusive.

Let  $\alpha'$  denote the time periods a single vehicle is parked and available for charging. That is, for all time periods  $t$

$$\alpha'(t) = \begin{cases} 1, & \text{if the vehicle is available for charging in time period } t \\ 0, & \text{otherwise} \end{cases}$$

The vehicle power consumption  $d'$  on the other hand must adhere to,

$$d'(t) \begin{cases} > 0, & \text{if the vehicle is driving in time period } t \\ = 0, & \text{otherwise} \end{cases}$$

Now, for a single vehicle the variable charging pattern  $p'$  is bounded by

$$p'(t) \leq P'_N \alpha(t), \quad \forall t$$

where  $P'_N$  is the rated charging capacity of the battery.

We now consider an aggregated model where a single energy storage represents all available EV-battery capacity and let  $p(t)$  be the total power charged to the aggregated energy storage in time period  $t$ . This assumes a large number of electric vehicles in the VPP. Now,  $\alpha(t)$  is the share of vehicles available for charging at time  $t$  and  $P_N$  is the total charging capacity of all EV-batteries. Analogous to the single vehicle model, we then have

$$p(t) \leq P_N \alpha(t), \quad \forall t$$

The state of charge  $S_{EV}$  of the aggregated energy storage is determined by

$$S_{EV}(t) = S_{EV}(t - 1) + p(t) - d(t), \quad \forall t$$

where  $d(t)$  is the vehicle power consumption (provided by the battery) in time period  $t$ . Also, we have energy storage limitation of the battery:

$$E_{min}\alpha(t) \leq S_{EV}(t) \leq E_N\alpha(t), \quad \forall t$$

Parameters of the aggregated model can be found in Table 4.4 below.

Symbol	Description	Unit
$d(t)$	Profile of vehicle power consumption (when driving).	MW
$\alpha(t)$	Share of vehicles available for charging. $0 \leq \alpha(t) \leq 1$	-
$P_N$	Rated power of battery (charging capacity), i.e. maximum continuous (electrical) power that the battery can consume (this number can probably be read from the name plate).	MW
$E_N$	Rated energy of battery, i.e. maximum energy that can be stored.	MWh
$E_{min}$	Minimum storage level of the aggregated battery.	MWh

**Table 4.4: Electric Vehicle model parameters**

#### 4.3.5. Description of input-data: scenarios for 2020 and 2030

WILMAR's main input data are fuel prices, generation capacities, electricity demand, transmission capacities and wind profiles for all modelled regions. To contain calculation times for such a large system as the North European one, each country included was modelled as a separate region. Overall, the ten following countries were included: Germany, Denmark, Sweden, Norway, Finland, Poland, Belgium, Netherlands, the UK and France.

Fuel prices were taken from the TradeWind project [11] which was completed in 2008 and are shown in Table 4.5. Prices were not assumed to change between 2020 and 2030 so that other aspects that might influence the VPP could be more clearly examined.

Fuel	Coal	Oil	Natural gas	Nuclear	Lignite	CO <sub>2</sub> price
Year	(€2005/GJ)	(€2005/GJ)	(€2005/GJ)	(€2005/GJ)	(€2005/GJ)	(€2005/ton)
2020/2030	2.2	8.4	6.4	0.57	1.17	25

**Table 4.5: Fuel and CO<sub>2</sub> prices. Source: TradeWind project**

DTU WIND has gathered the aggregated generation capacities and wind capacities respectively for each country.

The wind power capacities are based on the baseline offshore wind power capacity scenarios published in TWENTIES deliverable 16.1 [10].

The main developments were the increase of installed wind power across all countries modelled and the proliferation of solar power in Germany particularly. As far as thermal power plants are concerned, the main development is the prediction that nuclear power plants will be slowly decommissioned in Germany and replaced by a mix of renewable, coal and natural gas. Table 4.6 and Table 4.7 below show the aggregated generation capacities for 2020 and 2030.

Country	Water	Wind offshore	Wind onshore	Sun	Nuclear	Sum Thermal (coal, oil, gas, bio)
Germany, N	0	7704	35874	4,920	432	83,070
Germany, S	12,780	1101	5125	44,280	3,888	9,230
Germany	12,780	8805	40999	49,200	4,320	92,300
Holland	40	5298	3500	0	480	25,668
Sweden	16,600	2239	5999	0	10,100	8,774
Norway	31,000	415	3180	0	0	1,200
Finland	3,200	846	1500	0	5,100	11,150
UK	3,870	13711	13000	0	4,000	60,085
Poland	2,365	500	10000	0	0	31,845
France	25,200	3275	18999	0	65,845	27,858
Belgium	1,448	2156	2100	0	5,488	10,578
Denmark	0	2811	3700	0	0	6,875

**Table 4.6: Aggregated Generation Capacity (MW) of model regions, 2020**



Country	Water	Wind offshore	Wind onshore	Sun	Nuclear	Sum Thermal (coal, oil, gas, bio)
Germany, N	0	21055	47204	6,500	0	80,370
Germany, S	13,900	3008	6743	58,500	0	8,930
Germany	13,900	24063	53947	65,000	0	89,300
Holland	40	12794	4605	0	2,000	26,909
Sweden	16,600	6025	7894	0	10,100	6,824
Norway	32,000	3215	4183	0	0	1,200
Finland	3,300	3605	1973	0	6,000	9,900
UK	3,870	33601	17106	0	9,450	59,380
Poland	2,390	5300	13158	0	3,040	30,745
France	25,200	4990	25000	0	64,830	13,961
Belgium	1,448	3956	2763	0	0	12,667
Denmark	0	4611	4869	0	0	6,875

Table 4.7: Aggregated Generation Capacity (MW) of model regions, 2030

Finally, load demand for all those regions was also provided by Energinet.dk according to their projections of the growth in electricity demand for the following years. The assumptions for yearly electricity demand are shown in Table 4.8 for each country.

Country	Reference 2018	Reference 2030
	Total Demand	Total Demand
Denmark	37	39
Germany	562	562
Netherlands	131	141
Sweden	153	155
Norway	137	143
Finland	100	102
UK	350	363
Poland	158	155
Belgium	96	105
France	528	554

Table 4.8: Aggregated Yearly Load demand (GWh) of model regions, 2020&2030

## 4.4. Results

### 4.4.1. Day-ahead unit commitment results (WILMAR)

The WILMAR model was utilized to assess the impact of the VPP on the day-ahead market under the assumptions of perfect forecast for wind and load demand. The WILMAR results show that the VPP's effect on socio-economic costs depends heavily on the make-up of the system and particularly the VPP's scale as well as the VPP technology under discussion. To capture all those elements, different scenarios were produced for 2020 and 2030 to assess the impact of the production mix, VPP size and the impact of each VPP technology separately and in combination.

WILMAR run both 2020 and 2030 scenarios and run 2030 scenarios with both VPP technologies (cold storage and EVs) and separately with only one of them activated. The results that will be presented below show that there is an overall decrease in costs from the VPP introduction in both cases, even if the effect is much more significant in 2030. There is also clearly an increase in revenues after the VPP introduction, as marginal prices follow different trajectories in different countries, raising the question over the distributional effects of the VPP. It will be seen that the VPP's effect depends on a variety of factors, most prominent of which seem to be its size, the amount of wind power in the system and the fuel mix present in the conventional power plants. Even if its effect is relatively small, it should be remembered that it is a relatively inexpensive technology and furthermore than several of its benefits are not included in the WILMAR model which treats the VPP as a one-dimensional demand response unit.

#### 2020

The first variables examined were the day-ahead prices for all WILMAR regions before and after the introduction of VPP technologies in 2020. Results are shown in Table 4.9 below.

Region	System Average Marginal Price- Base Case (€/MWh)	System Average Marginal Price – VPP (€/MWh)	Difference (€/MWh)
Germany	41.719	41.730	0.011
Denmark, East	37.301	37.327	0.026
Denmark, West	39.907	39.843	-0.064
Belgium	42.836	42.849	0.013
Finland	41.095	41.053	-0.042
France	25.464	25.476	0.012
Netherlands	41.507	41.525	0.018
Norway	37.212	37.283	0.071
Poland	40.391	40.394	0.003
Sweden	35.663	35.800	0.137
UK	45.223	45.228	0.005

Table 4.9: System Marginal Price for Base and VPP cases in 2020

This scenario corresponds to the case where both EVs and cold storage have been introduced in moderate amounts, i.e. there are 100 MW of cold storage each connected to eastern and western Denmark and 75,000 electric vehicles. As can be seen, the VPP effects are ambiguous and small. The VPP's modest size means that its effect is relatively small, as in the most extreme case of Sweden, prices are changed by 0.1 €/MWh and in Western Denmark by 0.06 €/MWh, which is nevertheless not a trivial sum over the whole year. The main reason for this is that in 2020 the VPP has little effect on the marginal system price as there is spare capacity to be activated in the Northern system at the same cost as the last MW used, leaving the marginal system cost unchanged. Nevertheless it should be noted that most changes are positive, i.e. the VPP is increasing the marginal system price. This however does not mean that the VPP is increasing the overall system costs, as shown in Table 4.10 and the reasons for changes in marginal prices are connected to relocation of production among areas due to the introduction of the VPP. For Denmark the prices in Eastern and Western Denmark are seen to converge by the introduction of the VPP.

Regions & Costs (€)	CO <sub>2</sub> cost	CO <sub>2</sub> cost-VPP	Fuel cost	Fuel cost-VPP	OMV cost	OMV cost - VPP	Total energy cost	Total energy cost - VPP	Difference
Germany	6000	5998	7191	7189	742	742	13934	13929	-5
DK West	159	159	282	282	17	17	459	458	0
DK East	125	123	186	184	9	9	320	316	-4
Belgium	141	139	1274	1271	357	357	1772	1767	-5
Finland	145	146	977	974	454	454	1576	1573	-3
France	468	466	4099	4096	4351	4351	8918	8912	-6
Netherlands	1038	1036	1717	1708	118	118	2873	2863	-10
Norway	14	14	60	60	483	483	558	557	0
Poland	2664	2673	2072	2077	173	173	4909	4923	14
Sweden	87	87	1493	1497	980	980	2560	2564	4
UK	2828	2832	5155	5160	808	808	8791	8800	9
<b>Total</b>	13670	13673	24507	24498	8492	8492	46669	46663	-6

Table 4.10: Total System Costs for Base and VPP cases in 2020

As it can be seen, the system costs change only modestly after the introduction of the VPP; In total, only 6 mil. € are saved due to the introduction of the VPP in N. European. Most of the savings come due to the temporal displacement of part of the electricity production. Some of the wind and hydropower generated at times of low demand is able to be used by the VPP at a later point in time. This is shown in Figure 4.9 below, where the contribution of the cold storage to demand response is shown. The VPP's contribution in this case is the demand allocated from the cold storage when it is operated by the VPP. As indicated in the figure, the cold storage demand takes place generally during off-peak times. This happens since cold storage is regulated to downsize its energy demand at times of peak load. As such, the VPP acts similar to an electricity storage unit.

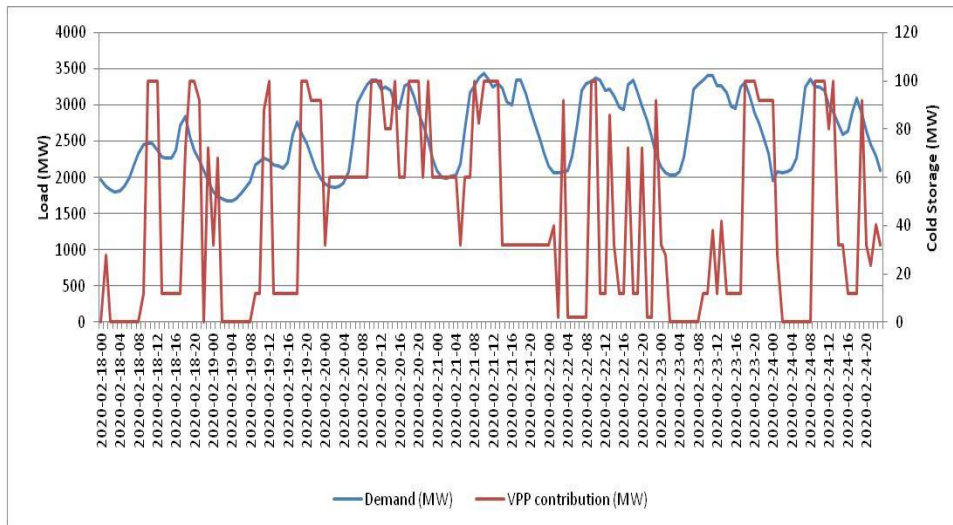

**Figure 4.9: System demand (load) and realized cold storage consumption (VPP Contribution)**

This power displacement of the VPP reduces costs modestly, but also increases average marginal prices as previously seen. The conjuncture of those two developments is the rise of profits, as marginal prices rise in most countries while costs go down. As shown in Table 4.11, while costs decrease by 6 mil. Euros only, profits across the N. European system increase by 50 million euros.

	BASE Scenario	VPP Scenario	Difference (VPP-Base)
<b>Revenues (M€)</b>	84580	84624	44
<b>Cost reduction (M€)</b>	46669	46663	-6
<b>Profits (M€)</b>	37911	37961	50

**Table 4.11: Revenues, costs and profits for 2020**

This can be seen in the new fuel mix shown in Figure 4.10, after the introduction of the VPP which has shifted only slightly over the year. VPP demand response has allowed the optimization routine to occasionally shut down marginal amounts of natural gas power plants and replace them with biomass, coal and lignite power plants or simply displace that production towards another time. However, results for 2020 appear to be small and it is difficult to extract definite judgments about the VPP’s usefulness.

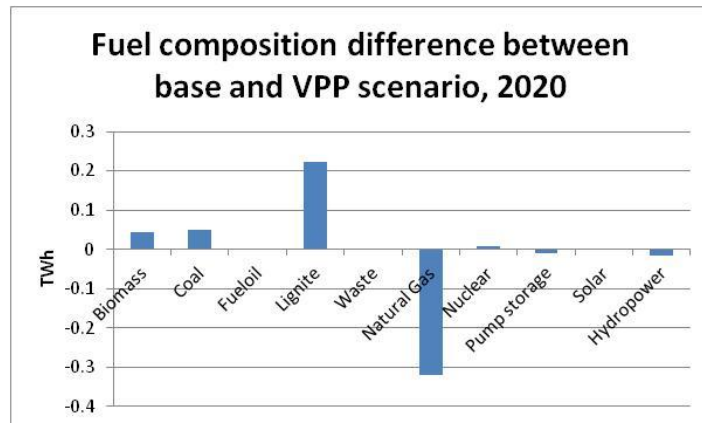

Figure 4.10: Fuel usage difference between Base and VPP scenario, 2020

The displacement of natural gas in favor of lignite and coal mostly as shown in Figure 4.10 is what is causing slightly higher CO<sub>2</sub> costs for the VPP scenario compared to the base case one. The reason for this is that despite the increased CO<sub>2</sub> costs, the fuel cost savings from operating coal and lignite are large enough to allow for the displacement of natural gas. The result is the increase of overall emissions as can be seen in Figure 4.11 below.

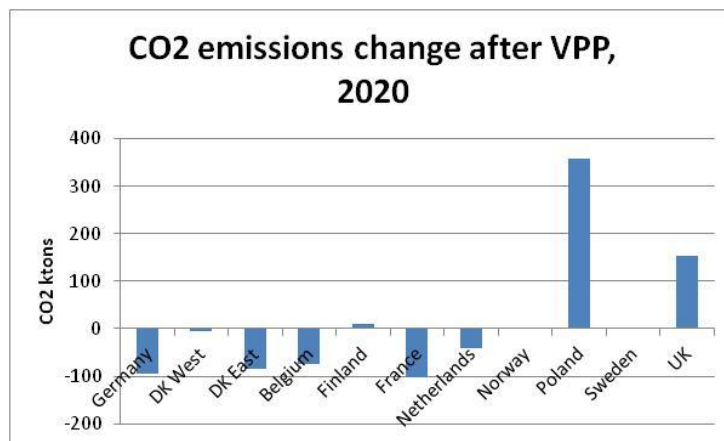

Figure 4.11: Change in CO<sub>2</sub> emissions after the VPP introduction for 2020, ktons

It can be seen that CO<sub>2</sub> emissions have decreased for most countries, apart from those where the bulk of new coal and lignite production is taking place, namely Poland and the UK. This happens as those countries which are net importers of electricity reduce their balance deficit and turn slightly more towards domestic production after the introduction of the VPP. As such, it seems the benefits of the VPP smoothening demand in Denmark reverberate across the European system and produce benefits far and wide. However, those benefits come at the cost of slightly increasing CO<sub>2</sub> emissions; however caution is required as this result relies on the assumption that transmission of electricity throughout Europe is much more seamless and smooth than current physical line constraints and regulatory divergences allow. As will be seen for the 2030 case, the CO<sub>2</sub> results rely a lot as well on the kind of system configuration. The introduction of the VPP shifts load from peak-load to base-load plants and it is the wide use of

coal and lignite as base load in 2020 that causes the rise of CO<sub>2</sub> emissions. If other fuels were used or wind penetration was higher, as in 2030, results may not be similar.

Another benefit that the VPP provides is reduced wind shedding. As Figure 4.12 shows below, wind shedding is decreased by approximately 7 GWh in 2020 after the introduction of the VPP, the difference being particularly concentrated in the UK.

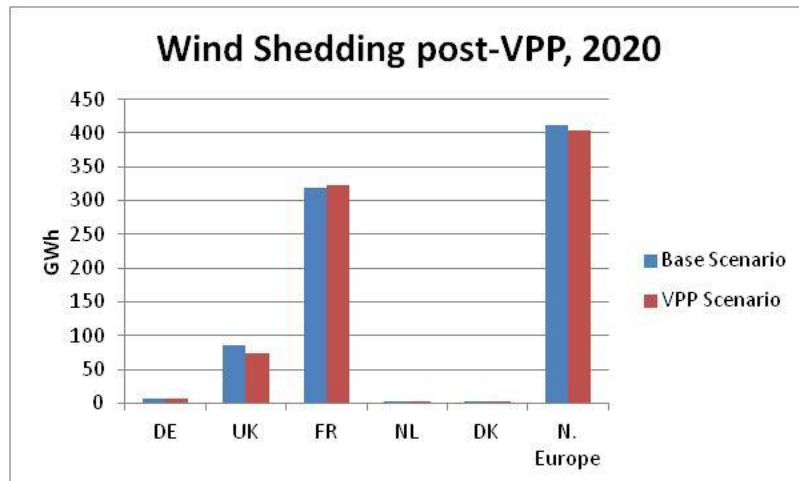

Figure 4.12: Wind shedding reduction after the VPP introduction, 2020

Additionally, it should be noted that the WILMAR model does not fully capture the VPP benefits; however they might be higher than the ones portrayed here. Specifically, in WILMAR only the day-ahead market was examined, which meant that potential benefits of the VPP on ancillary and reserve markets was largely left unexplored. Furthermore, the VPP was essentially treated as a demand response unit that allowed for higher flexibility of load delivery, so the WILMAR implementation is not incorporating all of the VPP characteristics as outlined in section 4.2, but is an abstraction that focuses on the few, most important characteristics from a socio-economic perspective.

### 2030

In any case though, results for 2030 are much more significant. Overall, the assumptions for 2030 depart from 2020 in three major points; Wind production is significantly higher, thermal total power capacity is lower by 12 GW and cheap nuclear power plants in Germany are closed. Additionally, the VPP has been scaled up significantly, doubled in size for the cold storage and quadrupled the amount of electric cars, allowing up-scaling of the provided flexibility. The system marginal price for 2030 is shown in Table 4.12.

Region	System Average Marginal Price- Base Case (€/MWh)	System Average Marginal Price- VPP Case (€/MWh)	Difference after VPP
Germany	38.258	38.287	0.030
Denmark, East	29.997	29.611	-0.386
Denmark, West	33.072	32.731	-0.341
Belgium	40.912	40.967	0.055
Finland	29.455	29.506	0.050
France	20.860	20.863	0.003
Netherlands	36.458	36.481	0.023
Norway	27.266	27.350	0.084
Poland	33.763	33.820	0.056
Sweden	26.261	26.384	0.123
UK	34.402	34.407	0.005

**Table 4.12: Marginal System Price in 2030**

As it can be seen, the VPP is having a much more significant and local impact in this case due to all the aforementioned reasons. Particularly, most of the effects are concentrated in and around Denmark rather than being split throughout the N. European system like in the 2020 cases. The difference in the Danish (and Swedish) marginal prices is one magnitude higher than the rest of the results, with Denmark East showing a significant system marginal price decrease of 0.386 €/MWh. The impact of the VPP on all other countries is marginal and probably has a small negative effect on the marginal price of those countries as base load there is utilized in the place of peak load in Denmark, changing their marginal price slightly upwards while having the opposite effect for Denmark. Furthermore, the proliferation of wind has led to lower marginal prices across the block and higher power transfers compared to 2020.

Table 4.13 below shows how these marginal price differences translate into overall changes in system costs across the different countries:

As can be seen, the results now show that the VPP clearly reduces system costs by 27 M€ and additionally has a positive impact in most countries. Furthermore, unlike the 2020 case, overall system cost reduction is accompanied by cost reduction across all categories described, including CO<sub>2</sub> emissions, which was not the case for 2020 where CO<sub>2</sub> costs rose after the VPP introduction. The 7 M€ CO<sub>2</sub> cost reduction in Table 4.13 corresponds to 280,000 tons CO<sub>2</sub>.

Regions & Costs (mil. €)	CO <sub>2</sub> cost	CO <sub>2</sub> cost-VPP	Fuel cost	Fuel cost-VPP	OMV cost	OMV cost - VPP	Total energy cost	Total energy cost - VPP	Difference
Germany	3671	3673	5682	5681	251	251	9604	9605	1
DK West	118	116	225	224	13	13	356	353	-3
DK East	94	89	147	142	7	6	248	238	-10
Belgium	188	187	1321	1317	17	17	1526	1522	-4
Finland	54	54	827	834	483	482	1365	1370	5
France	237	237	3604	3603	4615	4614	8457	8454	-3
Nethe.	1269	1270	1726	1719	245	245	3240	3236	-7
Norway	0	0	0	0	491	492	491	492	1
Poland	1722	1721	1550	1550	326	326	3598	3597	-1
Sweden	68	68	920	913	937	937	1924	1917	-7
UK	1138	1138	3872	3872	708	709	5717	5717	1
<b>Total</b>	<b>8561</b>	<b>8554</b>	<b>19874</b>	<b>19854</b>	<b>8092</b>	<b>8092</b>	<b>36527</b>	<b>36500</b>	<b>-27</b>

Table 4.13: System costs (Mil. €) by category for base and VPP cases, 2030

Furthermore, the balance between revenue increases due to increased marginal prices in certain regions and cost reductions is much more balanced in the 2030 case. While the profits remain at the same magnitude as in the 2020 case, they are now equally split between revenue and cost effects as shown in Table 4.14.

	Base case Scenario	VPP Scenario	Difference (VPP-Base)
Revenues (mil. €)	72784	72808	24
Cost reduction (mil. €)	36527	36500	-27
Profits (mil. €)	36257	36307	51

Table 4.14: Revenues, Costs and Profits for 2030

Figure 4.13 below presents graphically the VPP impact on system costs for each country in Europe. It can be seen that the bulk of the benefit comes from Denmark, which reduces its costs by 13 million Euros if both west and east areas are combined. There are still a few individual countries whose overall costs are increased after the introduction of the VPP, like Finland and Norway. This is due to increased use of base load with higher operation and maintenance cost like nuclear and hydropower which is nevertheless cheaper overall than the sources of electricity it is displacing in Denmark and elsewhere.



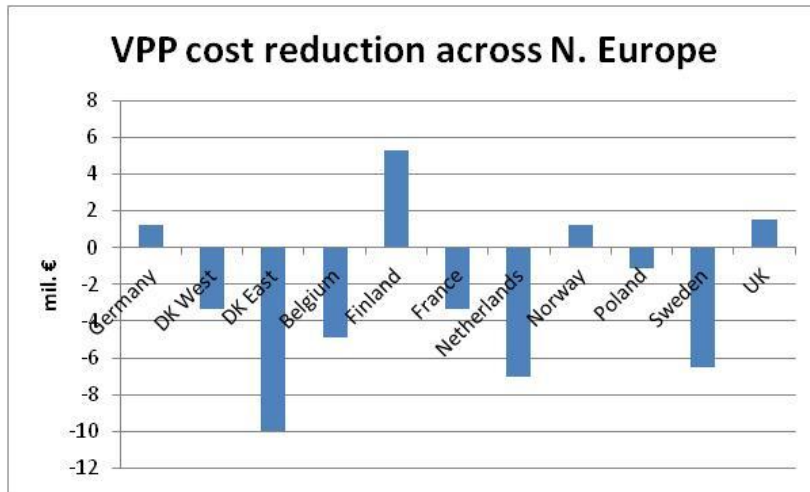

Figure 4.13: Evolution VPP cost reduction across N. Europe

For Denmark specifically, most of the cost reduction comes from using the demand response characteristics of the VPP to lower production from conventional thermal power plants, particularly coal and therefore concurrently reduce CO<sub>2</sub> emissions and fuel costs. Essentially the VPP is allowing the temporal reallocation of load and the arrangement of imports from Sweden, Norway and Finland which have lower cost base load power in the place of consuming coal and natural gas, as the new, post-VPP production composition of Denmark shows in Figure 4.14.

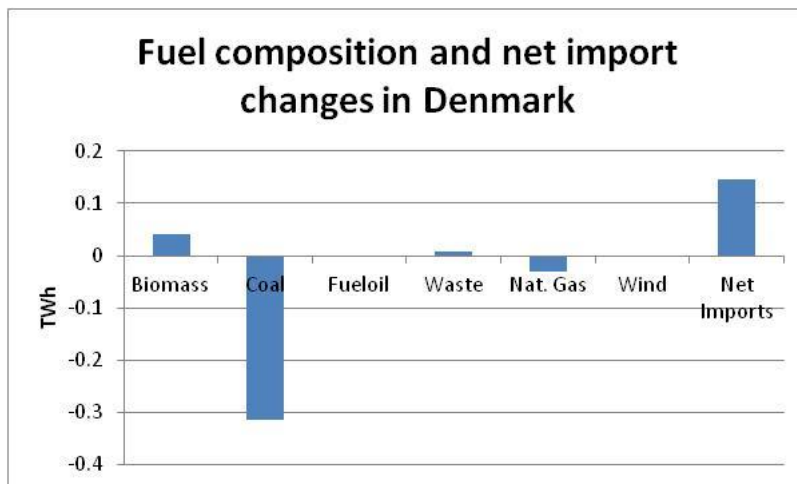

Figure 4.14: Change in production of electricity categorized by fuel in Denmark post-VPP, 2030

The breakdown of cost reductions can explain where the benefits come from. Specifically, most of the cost reduction (73%) is due to foregone fuel costs, while approximately 27% is reduced CO<sub>2</sub> costs. Operation and maintenance variable costs are actually increasing after the VPP's introduction across the N. European system, even if they decrease for Denmark where the VPP is installed. There are two main reasons for the cost reduction distribution, mainly the smoothing of demand which means that power plants can be used more efficiently and

secondarily, that peak load power plant usage is displaced by base load power plant usage like nuclear/hydro that has lower CO<sub>2</sub> costs.

Figure 4.15 below shows how the cost reduction breakdown occurs in several countries. It can be seen that each one follows a different pattern, but the overall trend is towards the major cost reduction being borne out of fuel cost reduction. Large operation and maintenance cost reductions are present in areas with large nuclear and hydropower capacities where o&m costs are significant, whereas large CO<sub>2</sub> cost reductions are prominent in Denmark where the VPP is having the most impact.

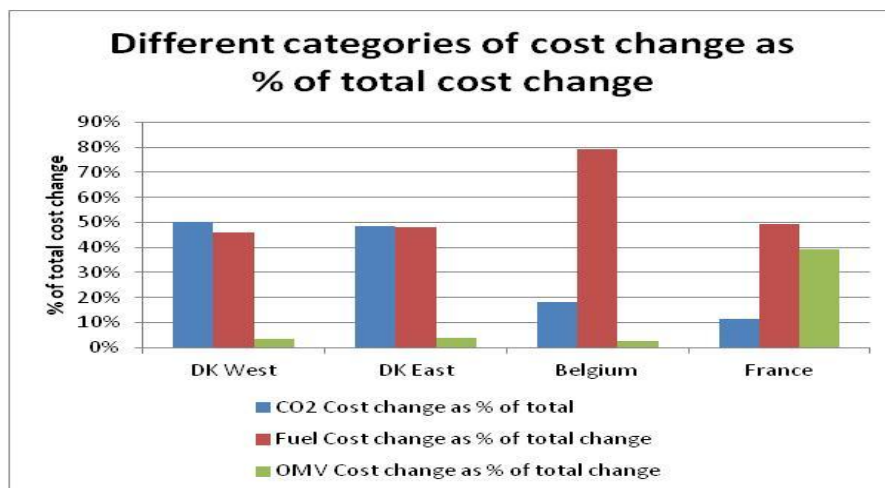

Figure 4.15: Breakdown of cost reduction source for selected countries

Few exceptions exist. For example, Norway and Germany increase their total system costs after the VPP introduction. Instead, what is happening is that the combination of the VPP and extensive power transfer networks allows for the displacement of natural gas thermal power plants by hydropower/coal ones that operate on lower fuel and CO<sub>2</sub> costs but higher maintenance costs for hydropower and lower maintenance and fuel costs but higher CO<sub>2</sub> ones for coal. This produces cheaper electricity, but the benefit is mostly spread to other countries in the N. European grid rather than Finland or Germany which witness an increase in maintenance/CO<sub>2</sub> costs respectively.

The effect of the VPP can be seen more clearly in the new production mix established after its introduction. Figure 4.16 below shows the changes in fuel usage when going from the Base case scenario to the VPP case scenario.

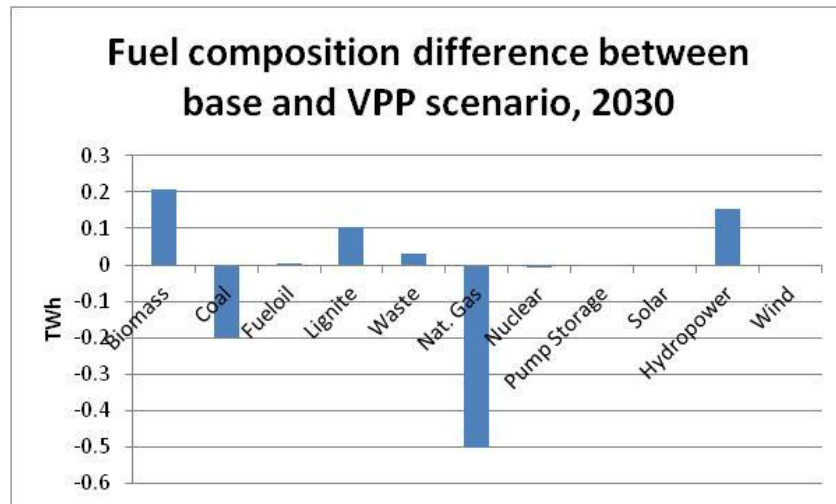

Figure 4.16: Fuel usage changes after VPP introduction

It can be seen that once the VPP is introduced, natural gas, but also coal power production is displaced by biomass and hydropower. What is taking place then is that the VPP is enhancing system efficiency; it can store energy transferred from hydropower regions when demand is low there and store it for future usage, displacing power plants that have either high fuel costs (natural gas power plants) or high CO<sub>2</sub> costs (coal power plants).

It should be noted that unlike the 2020 scenario, it is biomass and hydropower whose output share is growing rather than coal. This is explained by the shutting down of nuclear capacity and the opening of new biofuel plants in the 2030 scenario. Along with those, lignite and waste incineration are filling in the missing output of natural gas and coal power plants, as they are both cheaper fuels. Finally, it should be noted that nuclear has expanded its output share in a way as well, as capacity has shifted from Germany and Belgium to France and has been somewhat shrunk compared to the 2020 case. As such, nuclear retaining its share of output means that its utilization has increased relative to its capacity.

Due to all the aforementioned changes, the overall benefits of the VPP approximate 25 million euros at 2030. A question that emerges is what is causing this discrepancy with the 2020 scenario where the effect was much smaller. While some of the main factors, like tighter thermal power production and increased wind penetration were already mentioned and factored into the model, it is interesting to explore the issue of the VPP size and characteristics. To understand this better, two model runs for 2030 were done where only one of the two VPP technologies was used successively, to assess whether a specific technology was causing most of the VPP benefits. As such, some of the previous results comparing the base and VPP cases will be reproduced for these scenarios. The two scenarios are ones where only cold storage is available (CS) and one where only EVs are available (EV) at the same volume as they are in the VPP 2030 scenario.

First, the marginal system price changes for all four scenarios for 2030 are now depicted below in Table 4.15:

Region	BASE(€/MWh)	CS(€/MWh)	EV(€/MWh)	VPP(€/MWh)
<b>Germany</b>	38.258	38.260	38.277	38.287
<b>DK West</b>	33.072	32.928	29.612	29.611
<b>DK East</b>	29.997	29.840	32.763	32.731
<b>Belgium</b>	40.912	40.915	40.928	40.967
<b>Finland</b>	29.455	29.463	29.470	29.506
<b>France</b>	20.860	20.850	20.857	20.863
<b>Netherlands</b>	36.458	36.452	36.445	36.481
<b>Norway</b>	27.266	27.105	27.119	27.350
<b>Poland</b>	33.764	33.768	33.791	33.820
<b>Sweden</b>	26.261	26.139	26.157	26.384
<b>UK</b>	34.402	34.399	34.398	34.407

**Table 4.15: System Marginal Price for all 2030 scenarios**

The table shows main differences among Denmark's regions, where predictably, the installation of only one VPP technology raised the price considerably, but not back to the levels before the introduction of the VPP. The other regions fluctuate in small quantities towards a positive or negative direction compared to the VPP case. The direction mostly depends on whether a region tends to export more energy than it imports, in which case the VPP's size reduction might have marginal positive effects on its own marginal electricity price. The effects tend to be in the same direction of the VPP, but smaller. Furthermore, the EV scenario is much closer to the VPP impact than the CS scenario. As the EV is considerably larger than the CS system in storage and consumption potential, this is to be expected but it can show that the VPP's effect does scale up with size.

This can also be seen by comparing the total cost differences in each case compared to the base scenario, as shown in Figure 4.17, where it is shown that the bulk cost decreases happens in the EV scenario, even if there are some changes on the distribution of production across Europe, especially in the Northern countries that is due to a change in the marginal unit as less storage is available than in the VPP scenario.

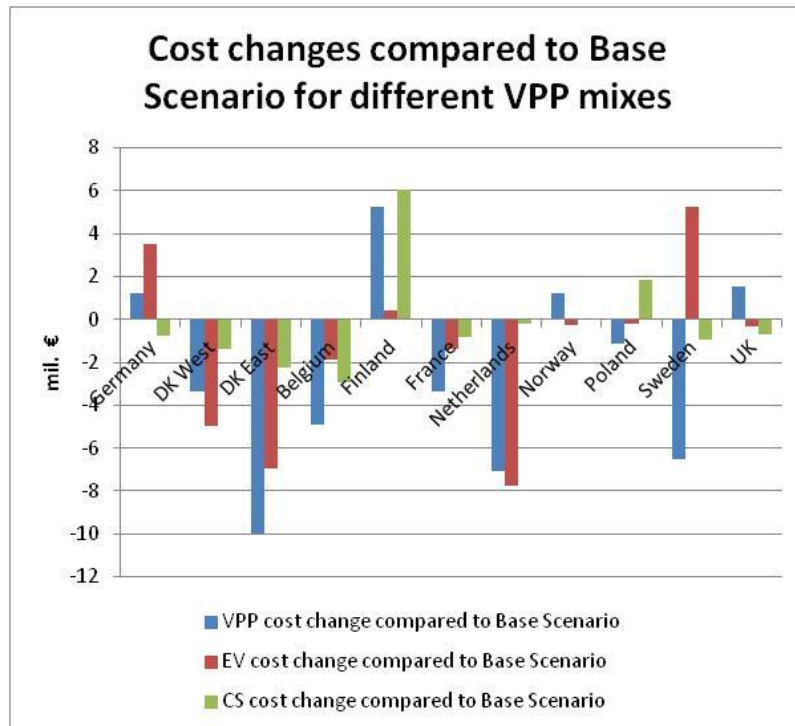

Figure 4.17: Cost change of different VPP scenarios compared to Base case one

It is clear from Figure 4.17 that while other VPP mixes tend to follow the main VPP scenario trends, some of them are more accentuated or diminished, signaling that the type of VPP chosen as well as its scale matter to the distribution of the results. However, they do not equally matter for the trend of the overall results, which as shown in Figure 4.18 are clearly improved with higher capacities of VPP, leaving open the question however of whether there are diminishing returns to scale after a certain point of VPP capacity.

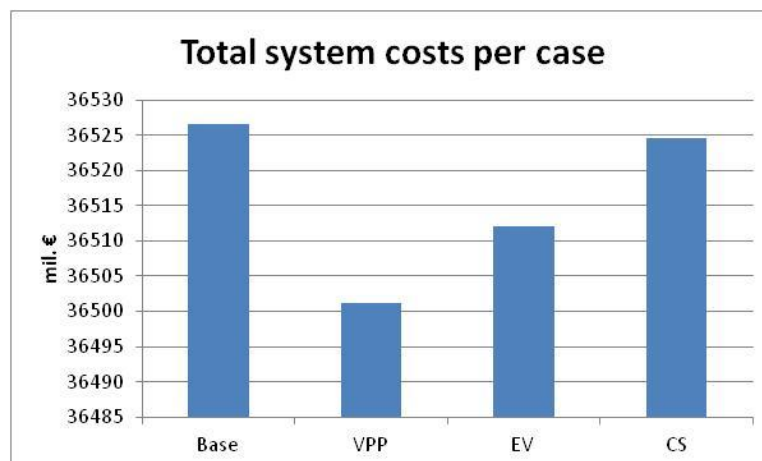

Figure 4.18: Total system costs for each case (mil. €)

Finally, wind shedding reduction is another benefit of the VPP that has been particularly enhanced in 2030. This was expected, as wind capacity increased significantly in the 2030 scenario. As can be seen below in Figure 4.19, approximately 21 GWh of wind power shedding

have been avoided due to the VPP introduction. However, it is useful to note that this is approximately 2.2% of the total wind shedding that is being avoided and this percentage has not changed significantly since 2020 when it was 1.7%.

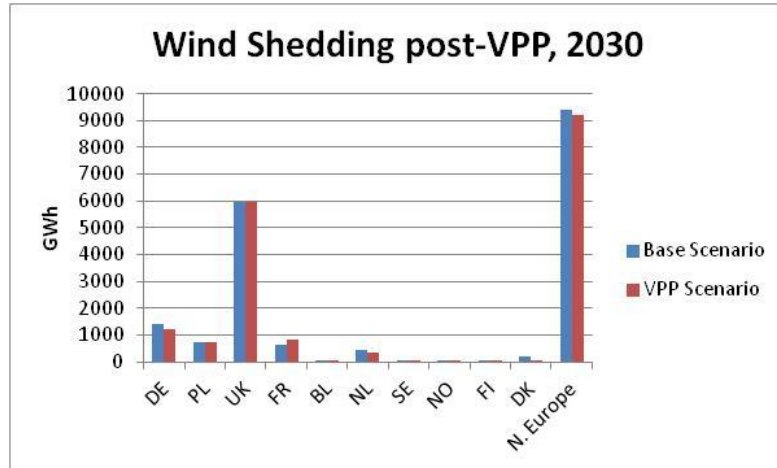

Figure 4.19: Wind shedding in Base case and VPP scenarios, 2030

#### 4.4.2.Hour-ahead balancing results (SIMBA)

The hour-ahead balancing only includes results from Denmark. The clearest results are obtained with the 2030 VPP scenario. Those results are summarised in Table 4.16 below.

Year 2030	base	VPP	VPP-base
Up regulation volume [GWh]	1783	1850	67
Down regulation volume [GWh]	-2659	-2743	-84
Up regulation expenses [k€]	8520	7966	-555
Down regulation earnings [k€]	2236	5044	2807
Net balancing costs [k€]	6284	2922	-3362

Table 4.16: Hour-ahead balancing in Denmark with the 2030 scenarios

The first observation is that the up regulation volumes and the down regulation volumes are very similar comparing the base scenario and the VPP scenario. This is as expected, because the need for hour-ahead balancing volume is primarily determined by the difference between the day-ahead wind power forecast  $P_{w,DA}$  and hour-ahead wind power forecasts  $P_{w,HA}$ , which are the same in the VPP and base scenarios.

Still, the TSO's up regulation expenses decreases and the down regulation earnings increase significantly. This is because the prices are quite different in the two scenarios, because the additional competition caused by the VPP generally decreases the up regulation prices and decreases the down regulation prices.

Table 4.17 shows a comparison between the balancing costs with the 2020 and 2030 VPP and base scenarios. It is observed from these results that the impact of the VPP is less distinct in 2020 than in 2030. The reason for this difference is that the 2020 scenario for VPP development described in Table 4.2 is very moderate.

VPP - base difference	2020	2030
Up regulation expenses [k€]	1064	-555
Down regulation earnings [k€]	1886	2807
Net balancing costs [k€]	-822	-3362

Table 4.17: Differences in balancing costs comparing VPP scenarios and base scenarios.

Finally, Table 4.18 shows a comparison between the balancing cost reductions with the complete 2030 VPP scenarios and the EV and Cold storage scenarios. It is observed from these results that EV is making the main contribution to the savings in net balancing costs. This is because the nominal power of EVs 2.8 GW, while CS is only 0.4 GW according to Table 4.2.

VPP - base difference	VPP	EV	CS
Up regulation expenses [k€]	-555	-373	-810
Down regulation earnings [k€]	2807	2703	970
Net balancing costs [k€]	-3362	-3075	-1780

Table 4.18: Difference in balancing costs, comparing VPP scenarios and base scenarios.

## 4.5. Description of the assessment for the Spanish System

### 4.5.1. Methodology for VPP-System Interaction

The VPP can choose to participate in different markets offering the power and flexibility of the integrated unit to the market and at the same time providing the opportunity to the integrated parts of taking advantage of the other integrated units characteristics for optimal effort (or more profitable). VPPs are integrated in the model as generic units which can reflect the different characteristics of each VPP unit. Each unit looks for the more optimal use of the internal resources (minimization of Variable Cost), and the VPP aggregator balances with the day ahead market either an energy supply or consumption offer according to the net energy balance of all its VPP units, taking advantage of the internal flexibility characteristics of them.

The VPP assessment for the Spanish System is focused mainly on the day ahead market. Methodologically, the VPP management model combines optimization and simulation techniques. The Unit Commitment optimization is executed for each week of the year, and afterwards a simulation process manages the energy balance of the electric System taking into account generation unit failures, wind production variation and demand uncertainties. The optimization tool used for the assessment of the Spanish case is the ROM model, an internal tool developed by the Institute for Research in Technology (detailed in the appendix). This model contains a unit commitment optimization model, which objective function minimizes the cost of energy of the electric System and at the same time the variable cost of the VPP. To model the VPP structure and its flexibility performance, input data is included in the ROM model according to the nature of the technology modeled, e.g. an Electric vehicle will specify the energy that can be consumed in a 24 hours framework, and for each hour during the day

minimal and maximal consumption limits will be specified to provide the flexibility of power profile to the Unit Commitment which will assign the most optimal consumption profile.

#### 4.5.2.VPP Performance Modeling in ROM

A general description of ROM can be found in section 2.3.2, and a more detailed formulation, can be found in Annex 2 (pag 186). This section presents how the model ROM has been updated in order to be able to model the VPP concept.

Figure 4.20 represents the interaction between the different VPP units (VPP Area) and the “Market Operator (MO) or System Units. This figure shows that VPP Area will interact and has a net energy balance that could be either energy supply ( $gm_h$ ) or consumption ( $cm_h$ ) for each hour.

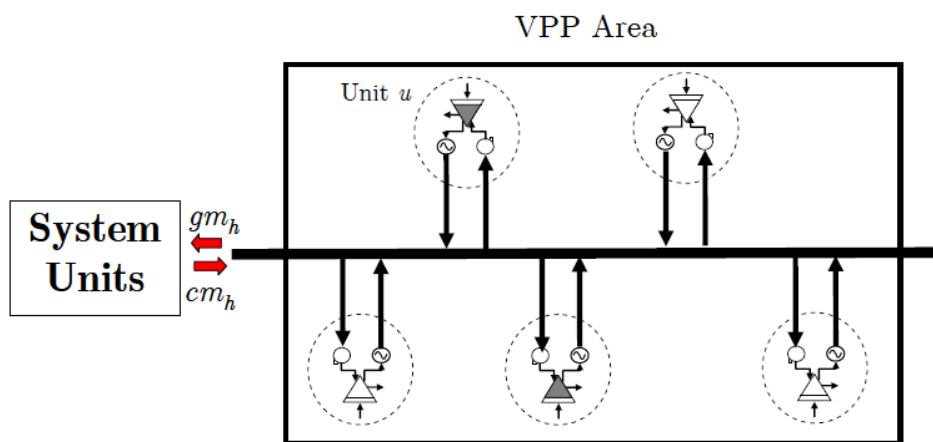

Figure 4.20: Interactions VPP area and Electric System in Day Ahead Market

To include the optimization of the VPP performance in a global Unit Commitment of the Electric System, the VPP variable cost is incorporated as another component of its objective function as Figure 4.21 shows.

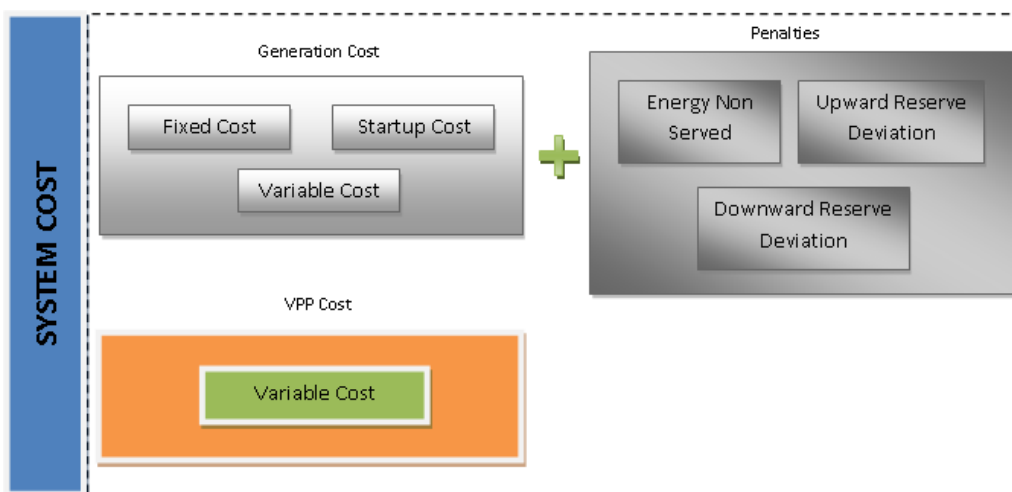

Figure 4.21: Global Objective Function of the Unit Commitment including VPP performance

The mathematical formulation of the objective function in the Unit Commitment follows:



$$\min \sum_h System\ Cost_h + \sum_h VC^u g_h^u$$

The VPP Energy Balance for each unit  $u$  at hour  $h$  establish that the sum of energy produced and energy consumed within the VPP should match the energy produced minus the energy consumed from the VPP to the System. This constraint assumes that units are connected to a single bus with specific transmission efficiency rate per unit of the VPP,  $\rho^u$ . In case that transmission operator does not take in account loss effect at the VPP energy exchange among units, value is assumed to be 1.

$$\sum_u \rho^u g_h^u - \sum_u c_h^u = gm_h - cm_h \quad \forall h$$

The Energy Storage level of the unit  $u$  at hour  $h$  defines that the energy stored at hour  $h$ ,  $e_h^u$  is computed subtracting the energy stored at hour  $h-1$  and  $e_{h-1}^u$ , the generation of the unit  $g_h^u$  and the output of the energy at hour  $h$   $o_h^u$  from the energy storage and adding the input energy at hour  $h$  to the energy storage,  $i_h^u$ , and also adding the consumption of the unit  $c_h^u$  affected by the conversion efficiency rate of the unit,  $\mu^u$ . A general expression of this balance is given, and some terms can become zero in case of modeling pure generation, consumption units, and inclusion or exclusion of energy storage as next section explains.

$$e_h^u = e_{h-1}^u - g_h^u - o_h^u + i_h^u + \mu^u c_h^u \quad \forall u, h$$

#### 4.5.3. Assessment of the VPP Impact on the System Costs

The use of the ROM model is very useful to compare the impact of VPP performance on the System Operation: Cost, CO<sub>2</sub> emissions and generation profile. This model is run twice: the first one consists of including daily flexibility on the generation and/or consumption needs for each unit, and the second one has on the flexibility of the generation and/or consumption profile of the VPP units. The first execution mode is named “smart” and the second one is named “non-smart”. The way to set the VPP execution mode in the ROM model is based on relaxing or fixing Generation and Consumption limits for each unit  $u$  at hour  $h$ .

For the “smart” execution model, the consumed energy required by the unit  $u$  along the day,  $c_h^u$  should be equal to the expected daily outflows,  $o_h^u$ . So, there exists flexibility on the distribution of energy to be consumed along the day.

$$\sum_{h=1}^{h=24} c_h^u = \sum_{h=1}^{h=24} o_h^u \quad \forall u$$

Analogously for the “smart” execution model, the generated energy supplied by the unit  $u$ ,  $g_h^u$  along the day should be equal to the expected daily inflows,  $I_h^u$ . So, there exists flexibility on the distribution of energy to be supplied along the day by the VPP unit.

$$\sum_{h=1}^{h=24} g_h^u = \sum_{h=1}^{h=24} I_h^u \quad \forall u$$

Additionally, bounds of the energy storage level may change during the day; those are defined for  $u$  unit at  $h$  hour by the next equation.

$$\underline{E}^u \leq e_h^u \leq \overline{E}^u \quad \forall u, h$$

Technical bounds on generation and consumption for each VPP unit are included into the ROM model. These bounds are those ones that limit generation and consumption values for each hour. Next lower and upper bounds on variables set the maximum capacity values for generation,  $\overline{G}_h^u$ , and consumption,  $\overline{C}_h^u$ , and also hourly limits on these technical capacities for generation,  $\underline{HG}_h^u$  and  $\overline{HG}_h^u$ , and consumption,  $\underline{HC}_h^u$  and  $\overline{HC}_h^u$ . These limits are included into the “smart” execution mode.

$$0 \leq g_u^h \leq \overline{G}_h^u$$

$$0 \leq c_u^h \leq \overline{C}_h^u$$

$$\underline{HG}_h^u \leq g_u^h \leq \overline{HG}_h^u$$

$$\underline{HC}_h^u \leq c_u^h \leq \overline{HC}_h^u$$

Next, lower and upper bounds are included into the “non-smart” execution mode as they fix generation and consumption values of the VPP units.

$$FG_h^u \leq g_u^h \leq FG_h^u$$

$$FC_h^u \leq c_u^h \leq FC_h^u$$

#### 4.5.4. The Generalized VPP Unit Model

This section shows the VPP generalized model that has been included into the Unit Commitment. Figure 4.22 shows a generic representation of the performance of the VPP unit during the  $h$  hour, where the Inflows,  $i_h^u$ , and the outflows,  $o_h^u$ , correspond to energy to be generated and/or consumed by the unit. The storage level,  $e_h^u$ , is the level of energy that is stored in the energy reservoir at the beginning of the hour  $h$ ; finally the generation  $g_h^u$  and consumption  $c_h^u$  are the energy supplied by the Unit or consumed. Flexibility profile is defined by these technical capacities for generation,  $\underline{HG}_h^u$  and  $\overline{HG}_h^u$ , and consumption,  $\underline{HC}_h^u$  and  $\overline{HC}_h^u$ . The generation and consumption of the generic VPP unit is balanced first with the rest of units in the VPP System as it is shown in Figure 4.22 as the Single Bus. The final net energy balance with the System is represented in the figure with the supply and consumption variables,  $gm_h$  and  $cm_h$ .

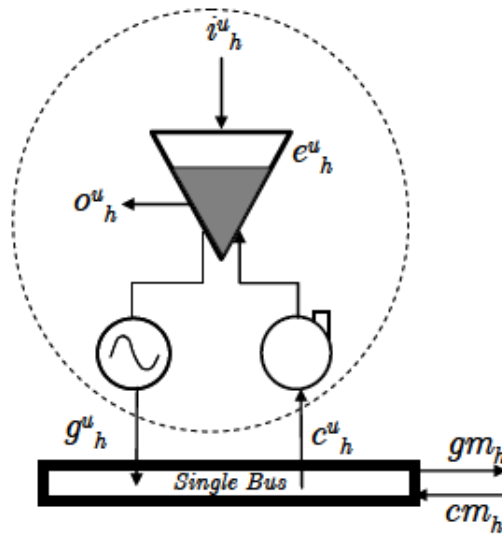

Figure 4.22: Generalized model of the VPP unit.

The different parameters that define the VPP model can be limited in different ways to closely simulate the specific characteristics of the VPP to the real operation. Each technology sets the parameters that fit better its functional characteristics.

Pure consumption unit, such as a heat pump, can be modeled as the outflow energy will consume from the single bus, flexibility profile will be set by the limitation of its consumption capacity each hour.

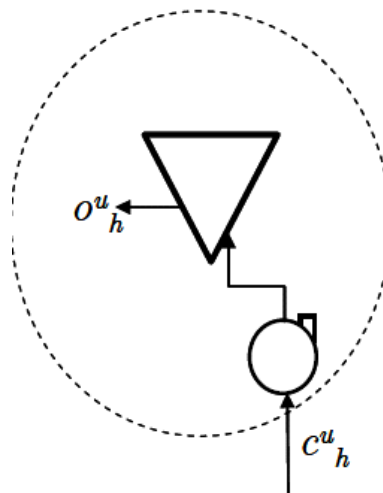

Figure 4.23: Pure Consumption Unit Model

A pure Generation unit, such as a Combined Heat and Power (CHP) or CCGT, WGT or Cogeneration units, can be equally modeled by setting the level of inflow as the energy it can provide while the generation unit is supplying energy restricted to the flexibility profile. This type of unit can or cannot include an energy reservoir.

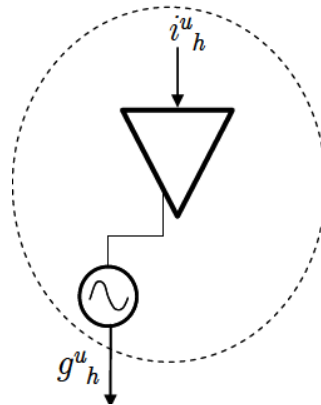

Figure 4.24: Pure Generation Unit Model

Generation unit with energy storage, such as small hydro, and also consumption unit with energy reservoir that could represent an EV. These two are represented in the next two figures.

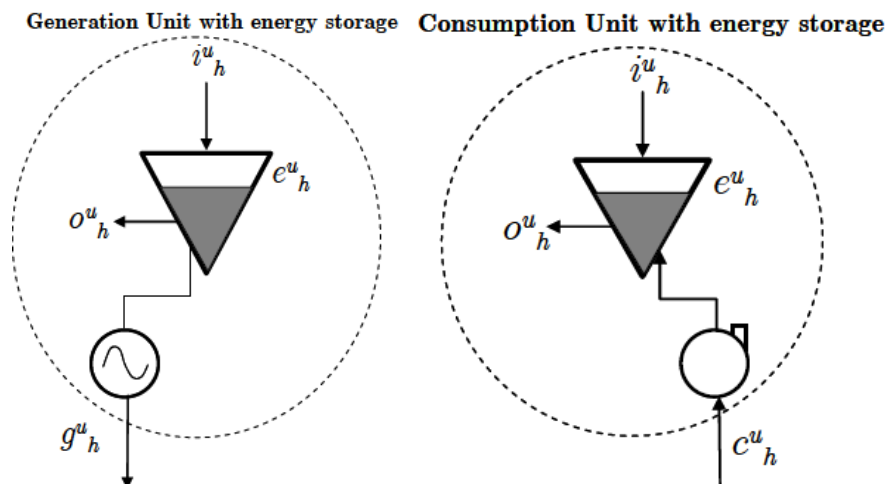

Figure 4.25: Generation and Consumption Units with Energy Reservoir

#### 4.5.5. Description of Scenarios for the Spanish Case 2020

Spain, among the European member states, has set very aggressive objectives above the ones set by European Union for emission reductions, relying mainly in RES. Current situation of the electricity markets of Spain, driven by crisis and the tariff deficit, had forced the government to change the regulatory scheme and affecting in different degree utilities, changing not only the tax level payment but in many cases the remuneration scheme based in Feed-in premiums to less profitable levels.

Next subsection will analyze the remuneration and incentive regulatory scheme from 2007 to the last change in 2013 for RES and cogeneration technologies, paying special attention in expected technology growth and flexibility of demand measures. Following subsection will describe different scenarios first of technology additions in the system and then of possible change of remuneration scheme to a VPP framework.

---

#### 4.5.6. Regulatory scheme: Remuneration and incentives

Spain has implemented in previous years an incentive scheme to promote the RES penetration towards fulfilling European targets reduction of emissions.

The case of the Renewable Energy Sources (RES) development took place after 2007 regulation changes, setting the remuneration scheme with a double approach, for one side offering the option of receiving a Feed-in Tariff or in other hand the chance of selling in the market with a Premium on top of the price. In general the result was a great development of RES (mainly wind).

Cogeneration which is also under the special regime as well, has suffered also modifications on the Tariffs but the main change that affect them is the fact that the values are updated every three months but instead of using the IPC (Prices index) to a lower one at constant taxes and that does not include raw materials or fuels.

European economic crisis and Tariff deficit (growth in the debt to the utilities given the gap of price of energy and final tariff charged to consumers) lead the government to introduce major changes in the regulation in 2013, basically disappearing Premiums and changing the value where the tariffs were indexed used to update the tariff (now using a price index without including energetic or taxes).

- Possible VPP scenarios in the Spanish System

Spanish electricity market, from the utilities point of view now faces two main challenges: (1) ensuring an adequate remuneration for current installations and (2) find a way to make profitable future projects. VPP offers in some way a scheme that with the adequate business plan and specific operation can offer also the added value to the system of improving the system efficiency by Distributed Energy Resources (DER) either gathering disperse generation or implementing demand side management.

Analysis is done using 4 scenarios covering 4 technologies: Wind Generation, Cogeneration, Electric Vehicles and Heat Pump units.

The base case of the VPP Spanish Scenario for 2020 year has a gross demand of around 330.9 TWh with a maximum peak around 58 GW. The scenario models a VPP integrated by 1 GW of generation and 1 GW of consumption added on top of current load. The capacity for each VPP technology is given in the next table. This base case scenario assumes the installation of 500 MW capacity of each VPP technology of generation or consumption.

Base VPP Scenario	Characteristics			
	Average contribution (hour)	Energy Managed <sup>0</sup> (day)	Energy Managed (year)	Flexibility (year)
Wind	431 MWh	10.3 GWh	3.7 TWh	None
Cogeneration	541 MWh	4.3 GWh	1.31 TWh	2.2 TWh <sub>flex</sub>
EV	540 MWh	2.1 GWh <sup>b</sup>	0.79 TWh	1.3 TWh <sub>flex</sub>
Heat Pumps	496 MWh	3.9 GWh	1.04 TWh	1.4 TWh <sub>flex</sub>

**Table 4.19: Capacity for each VPP Technology of the Base Case**

<sup>a</sup> Refers to energy generated for wind and cogeneration and consumed by EV and heat pumps

<sup>b</sup> Consumption in a weekday

For the specific case of the wind generation, 5% of the 2020 forecast generating capacity of 1.403 GW with an average production of 431 MW and a total yearly generation around 3.7 TWh (1% of total demand). This technology has been modeled without generation flexibility. All its production should be dispatched inside the VPP System and its surplus should be injected into the Spanish System.

Cogeneration is modeled as 6000 hours a year generation unit (8 hours five days a week) providing 541 MWh target defined for 2013 contributing with 1.31 TWh during the year (less than 1%), typical consumption time period is considered from 9:00 to 16:00, offering a flexible consumption from 5:00 to 20:00; its marginal price considered is around 85 €/MWh.

The EV technology is modeled considering 150000 vehicles (batteries) with a 3.6 KW individual power consumption; total group consumption represents 540 MW per hour, 4 hours a day, adding up 0.8 TWh to the yearly consumption. Typical consumption time period is considered to take place from 0:00 to 4:00 hours with a extended flexibility profile from 0:00 to 9:00 hours.

Heat Pump units consider 40000 installations of units that operate between 3.52 and 16.54 KW. Global technology consumption represents 496.2 MWh 8 hours a day during weekdays, adding up 1.04 TWh to the yearly load. Typical consumption time period is considered to take place from 9:00 to 16:00, offering a flexible consumption from 8:00 to 17:00 at 100% of the maximum capacity and in hours 7:00 and 18:00 at 50% capacity.

Starting from the base case scenario other scenarios were built multiplying by 2 and by 4 the amount of generation and consumption capacities for each technology of the previous table. So, 1 GW and 2 GW contributions per technology are approximately taken into account for each technology naming 1 GW Scenario and 2 GW Scenario.

#### 4.5.7. Results

For the sake of comparison, each scenario is simulated in two execution modes: “Smart” and “Non-Smart” based on the existence or not of the generation and/or consumption flexibility.

---

Main VPP performance indicators include:

- Thermal cost variation of the Electric System
- Variation of Technology contribution
- Wind/RES spillages

The obtained results for the base case (around 500 MW for each technology) show that:

1. The combination of generation and flexible demand allows allocating better the resources during peak times.
2. Reduction of total system cost (thermal cost) 0.2 %: 18 M€
3. Reduction of the average marginal cost (0.1%) and the gap between maximum and minimum demand (0.03%)
4. Reduction in the CO<sub>2</sub> Emissions (0.11 million tons)
5. Reduction on the need of other supporting technologies such as Coal (0.3%), CCGT (3%) and Pump Storage Hydro (7% to 11%)
6. Reduction on the spillages (RES surplus) like wind generation (12%) and other RES (0.8%)

As a matter of comparison, other scenarios were built to compare the results. 1 GW and 2 GW scenarios reveal that:

1. The reduction of the thermal cost is consistent reductions reach 0.7% under proposed structure with 2GW contribution case.
2. Reductions on RES surplus are consistent for other scenarios reaching 2% reduction under proposed structure with 2GW contribution case.
3. Reduction on CO<sub>2</sub> exists but does not seem to be affected increasing the size of the VPP.

Next graph shows the comparison of savings provided by the VPP: difference of thermal cost of non-smart execution minus thermal cost using the smart execution mode. The green line shows the relative value in terms of MW flexible provided, which is the Euros that the VPP saves per MW flexible of the VPP. Although the trend is lowering the thermal cost, there is no linear relationship.

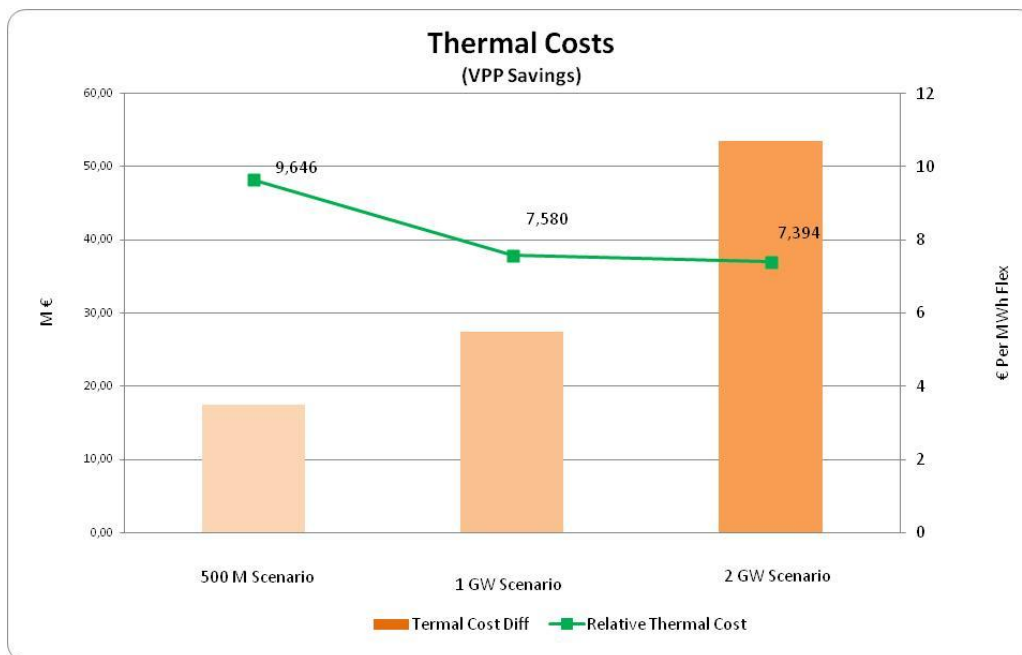

Figure 4.26: Thermal Cost Variation

Next graph shows the comparison of the contribution made by different technologies in the average weekday. Every hour data corresponds to the average of all the corresponding hours of the week days. Next figure shows the smart execution mode, with the “peak shaving”. The gray band shows how the contribution of the VPP covers more the peak periods than the next figure that corresponds to the “non-smart” execution mode.

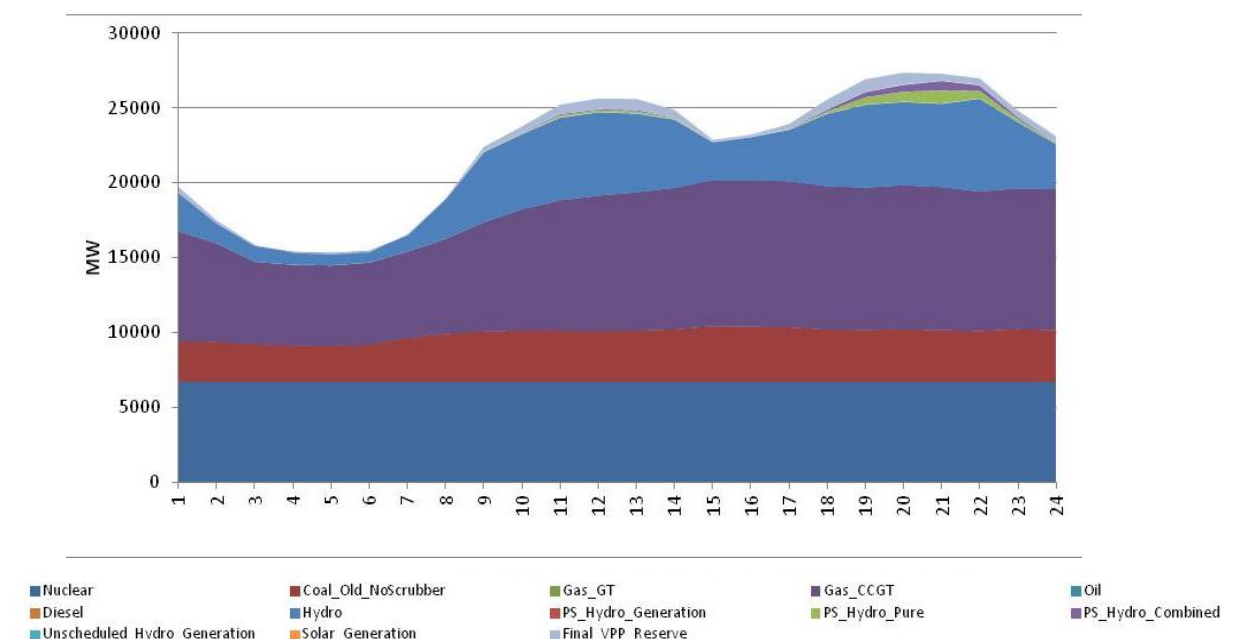
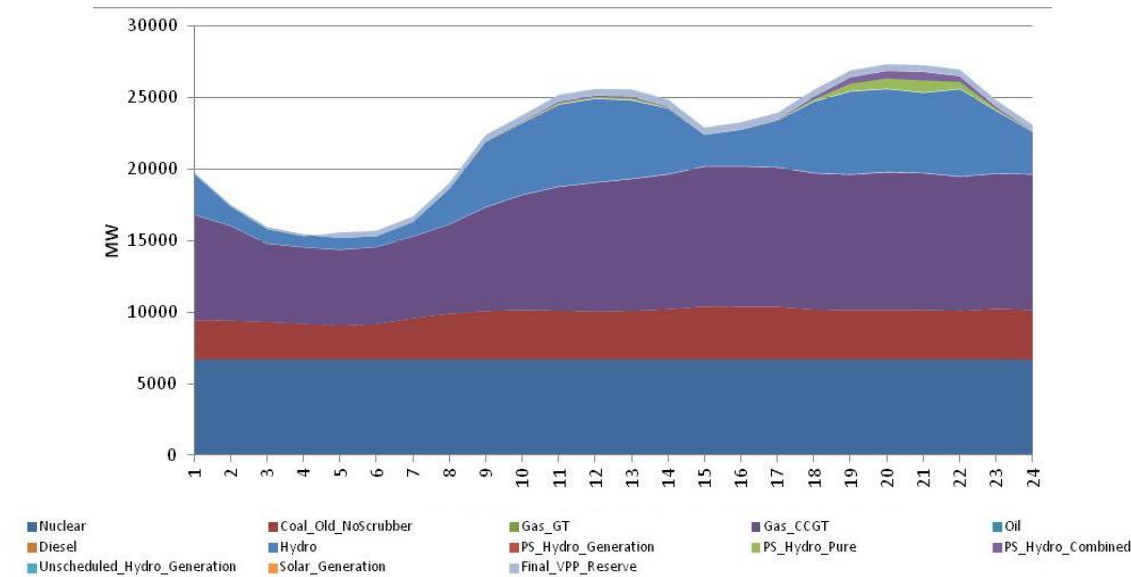

Figure 4.27: Technology contribution for the average day using the Smart execution mode





**Figure 4.28: Technology contribution for the average day using the Non-Smart execution mode**

The Wind and RES generation spillages or surplus is reduced when larger VPP are included. Although the gross effect is higher, the relative compared with the non smart execution decreases. Next figures represent the gross spillages of each scenario depicted in bars. Also these figures depict in lines the relative RES savings of using a VPP instead of executing the “non smart” mode. This means that VPP brings the benefit or reducing the level of spillages but it will reach a saturation level when this cannot be improved anymore by adding flexibility.

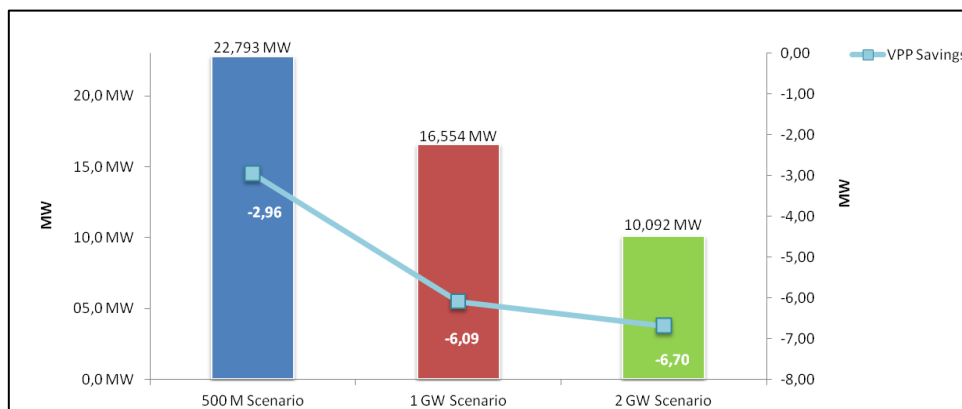

**Figure 4.29: Wind Generation Spillage for 500 MW, 1 GW and 2 GW VPP scenarios**

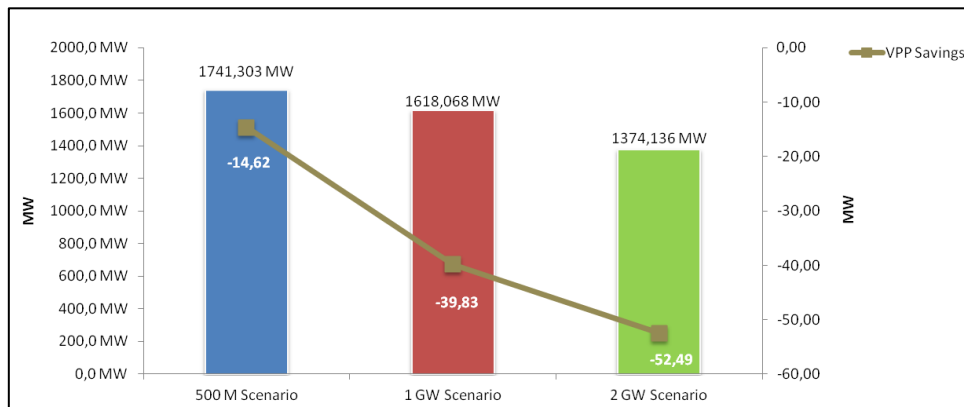

Figure 4.30: RES Generation Spillage for 500 MW, 1 GW and 2 GW VPP scenarios

#### 4.6. Conclusions

The important conclusion from the simulations is that even when treated solely as a demand-response unit, the VPP technologies have managed to decrease overall system costs and increase revenues. With the VPP scenario for VPPs in 2030 consisting of 400 MW cold storage and 300,000 electrical vehicles (2,800 MW), the benefit of the VPP was estimated to 27 M€/y cost savings in the day-ahead based on the WILMAR simulations. On top of that, the net balancing costs of the hour-ahead balancing performed by the Danish TSO is estimated to be reduced by 3.4 M€/y, so the total calculated savings are approximately 30 M€/y. Other benefits of the VPP, like savings in the real time balancing and voltage control may render the VPP even more profitable.

Another important finding from the WILMAR simulation is the mixed results of the VPP when it comes to reducing CO<sub>2</sub>, as it was that this depends on the base-load fuel type. If coal and lignite are dominant in base-load production and wind penetration is not too high, the VPP might have adverse effects for CO<sub>2</sub> emissions, which was the result of the 2020 scenario simulations. Contrary to that, in 2030, higher wind penetration and more base-load facilities of other kinds changed the result. The total reduction in CO<sub>2</sub> emission in 2030 due to the VPP is estimated to 280,000 tons/y.

Finally, it was found that the wind shedding was reduced because of the VPP. This was expected, as the VPP was acting as a demand-response system. The total reduction in wind curtailment due to the VPP is estimated to 18 GWh/y.

Assessing the VPP performance in the Spanish System, the combination of generation and flexible demand allows allocating better the resources during peak times. Some results are obtained including around 500 MW for each of the four VPP technologies of the base case: wind generation, cogeneration, CHP and EV consumptions. The annual reduction of total system cost is 18 M€ (0.2%) and also the average marginal is reduced a little bit into a 0.1%. Reductions on CO<sub>2</sub> emissions and on spillages from Wind and RES generation are relevant (12% wind spillage reduction and 0.8% RES spillage reduction).

These results for the Spanish System are consistent as other scenarios with more VPP capacity are analyzed. 1GW and 2 GW for each VPP technology are analyzed. For the 2 GW scenario, the thermal cost reduction reaches 63 M€ (0.7%) and also 2% of RES spillage reduction is obtained. Nevertheless, the reduction of CO<sub>2</sub> is not modified so much increasing the VPP installed capacity.

---

## 5. Economic impact assessment of enhanced NETWORK FLEXibility in CORESO

### 5.1. Expected outcomes of this analysis

TWENTIES aimed to remove multiple barriers that prevent the electric system from welcoming more wind electricity, and wind electricity from contributing more to the electric system. One of the barriers is the flexibility of the transmission grid in coping with the variable nature of wind power.

TASK FORCE 3 focused specifically on this, i.e. it demonstrated how to make the transmission grid more flexible. One question that immediately comes to mind is, “What is flexibility?” Some define it as the ability to increase the utilization of the system (which is usually computed as the average value of the ratio of the flow to the limit). This definition is imperfect, since getting more out of existing assets does not necessarily mean increasing and better distributing flows in the system. Our definition of flexibility is slightly different. From our perspective, *flexibility is the ability to provide capacity where it is needed when it is needed* with the same level of security of supply. The difference is that this definition is broader, as it embraces both capacity usage (higher flows) and capacity creation (higher limits).

NETFLEX focused on system level effects (demo no. 5), whereas GRIDFLEX focused on local effects (demo no. 6). Both are of the utmost importance for making the grid more flexible. GRIDFLEX aims to alleviate congestion by installing smart devices that have a local effect. NETFLEX aims to use what is left of these smart devices when the congestion they targeted has been fixed - for a greater common purpose. In particular, NETFLEX aimed to demonstrate that adequate coordination mechanisms between Dynamic Line Rating, Power Flow Controlling (PFC5) devices and Wide Area Monitoring Systems (WAMS) – smart devices – make the electric system more flexible within affordable capital and operational costs.

---

<sup>5</sup> Examples of PFC devices are a Phase Shifting Transformer (PST), a High Voltage Direct Current (HVDC) link, and a Flexible Alternate Current Transmission System (FACTS).

PST: specialized form of transformer used to control the flow of real power on three-phase electricity transmission networks. For an alternating current transmission line, power flow through the line is proportional to the sine of the difference in the phase angle of the voltage between the transmitting end and the receiving end of the line. Where parallel circuits of differing capacity exist between two points in a transmission grid (for example, an overhead line and an underground cable), direct manipulation of the phase angle makes it possible to control the division of power flow between the paths, preventing overload.

HVDC link: A high-voltage, direct current (HVDC) electric power transmission system uses direct current for the bulk transmission of electrical power, in contrast with the more common alternating current systems. For long-distance transmission, HVDC systems may be less expensive and suffer lower electrical losses. For underwater power cables, HVDC avoids the heavy currents required to charge and discharge the cable capacitance each cycle. For shorter distances, the higher cost of DC conversion equipment compared to an AC system may still be warranted, due to other benefits of direct current links, like controllability of the flows through the HVDC system.

FACTS: power electronic-based system and other static equipment that provide control of one or more AC transmission system parameters to enhance controllability and increase power transfer capability. A PST can be considered a FACTS even if a FACTS refers more to power electronic-based technologies.

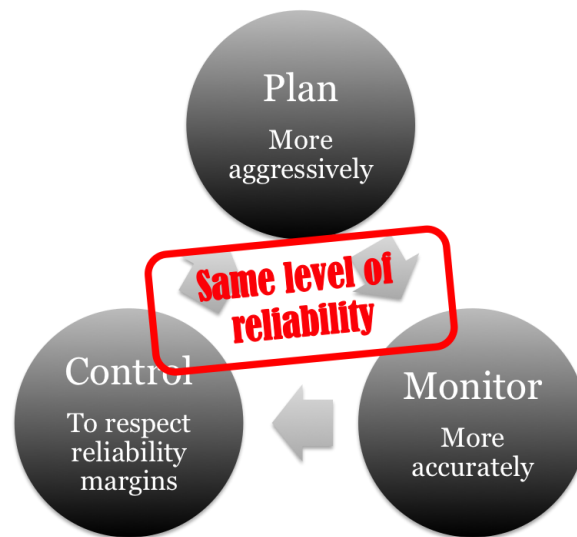

Figure 5.1: Plan, Monitor and Control

Thanks to this flexibility, TSOs can plan the network *more “aggressively”* by monitoring it *more accurately* and by controlling it *more tightly* while delivering the same level of reliability.

To demonstrate this, several technological advances were needed. In practice, we aimed to demonstrate that enhanced network flexibility results from:

1. Reliably forecasting overhead line ratings, i.e. plan capacities thanks to the accurate monitoring of real time capacities;
2. Enhancing the way actions pertaining to power flow controlling devices are planned, i.e. plan operations thanks to a tighter control over the grid;
3. Reliably forecasting system stability, i.e. plan capacities with due consideration for stability (damping);
4. Implementing a combination of the above to increase transmission capacity where and when it is needed (which includes all operational aspects from managing data and communicating to following procedures), i.e. plan capacities more aggressively while delivering the same level of reliability by using a more audacious policy in forecasting ratings because the enhanced controller makes it possible to compensate for over-estimations.

Enhanced network flexibility is expected to close the gap between the appearance of congestion and the actual commissioning of new pieces of network, which usually takes between 5 and 10 years.

Of course, the technologies we developed aimed to deliver flexibility while achieving the same level of security of supply. Another project was proposed in response to call ENERGY.2013.7.2.1, specifically to revisit reliability aspects with a stronger focus on benefits and to optimize the level of security of supply. But that was not the topic in TWENTIES. To measure flexibility while achieving today’s level of security of supply, multiple Key Performance Indicators (KPIs) were identified at the start of the project:

- The additional Net Transfer Capacity, i.e. how our technologies can create/free cross-border capacity for exchanging electricity between European countries (KPI.15.TF3.2)
- The additional amount of wind power that can be absorbed by the network, i.e. how much room is created by these technologies to accommodate wind generation (KPI.15.TF3.3), the resulting share of conventional generation (KPI.15.TF3.5), the resulting CO2 emissions (KPI.15.TF3.6), and the value created at European level (decrease in total operational costs) (KPI.15.TF3.4)

The additional capacity that NETFLEX technologies offer can seem less valuable than the capacity provided by conventional technologies like overhead lines and underground cables, whether AC or DC, as it is neither permanent nor firm. It is quite the opposite, i.e. it is more valuable, because it can be created – to some extent – where and when it is needed at a much lower cost. To be clear, however, it is a complement that makes existing physical capacities more valuable than a real substitute for conventional technologies.

## 5.2. Main findings of the Demo

The purpose of the demo was to demonstrate an effect within Central Western Europe (CWE). Hence, despite the fact that the Ampacimon sensors and the testing of the forecast were highly localized within the Belgian network, the focus was on how it could translate at cross-border level, not on one line but on many. Similarly for the PFC effect, the focus was on how together they affect the CWE grid in general, and cross-border capacities in particular.

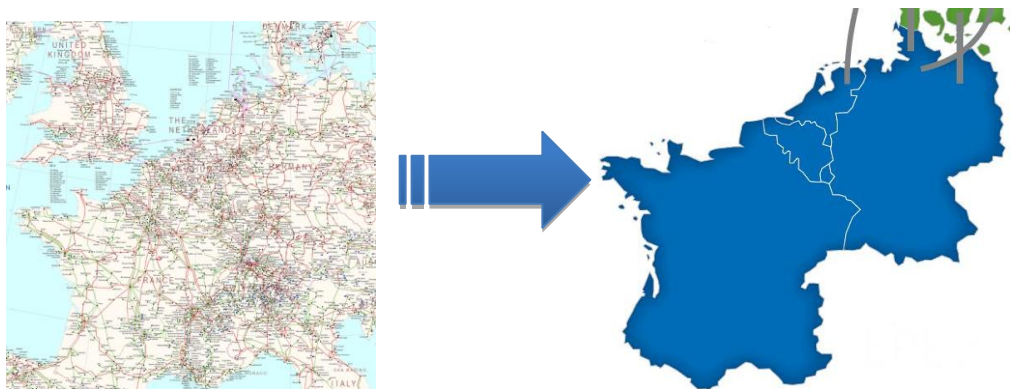

**Figure 5.2: From CWE grid to CWE market**

A quick look at the map of CWE (Figure 5.2) is enough to understand that, when Germany is exchanging electricity with France, part of this electricity is crossing Belgium and the Netherlands. Considering the number of wind turbines installed in Germany – with more yet to come – the challenge is obvious: the variability of wind power not only affects Germany and France, but also Belgium and the Netherlands.

The enhanced flexibility that NETFLEX aimed to deliver serves the specific purpose of better coping with this variability in order to facilitate exchanges across market areas.

#### NETFLEX as demonstration

- Overhead line ratings can be forecast reliably 1 and 2 days ahead, hence delivering additional transmission capacity. This requires the deployment of Dynamic Line Rating (e.g. via Ampacimons), coupled with local weather forecasts focused on low wind speeds. This combination delivers an average gain in usable transmission capacity of the overhead lines by approximately 10%. This is smaller than the average gain measured by the Ampacimons, which is above 50%. The difference comes from the inherent nature of wind, i.e. variability, which requires searching for a high confidence interval for capacity.
- Planning PFC-related actions in a coordinated way enables the better network utilization by shifting flows where and when capacities are needed. The demonstration showed that aside from the required security margin for dealing with outages and wind deviations, there is some extra margin left – not always though – that can be used to transfer more power (it could be RES or thermal).
- The influence of PSTs is not unlimited, i.e. the effect becomes very small on very distant lines. This can be an issue in optimization. When the influence factor of a PST on a very distant line is tiny, the optimizer still uses the PST to alleviate the congestion or create some margin on the line. Because the influence factor is tiny, the PST is overused, i.e. pushed to the limit, whereas the benefit is very limited. This does not make sense from an operational perspective. Therefore, an efficiency threshold on the influence factors of PFCs is used and critical branches to enforce are selected very carefully.
- There is an impact by the operating points, and indirectly, by wind power generation, on the damping of the dominant inter-area modes, though this impact is positive for some modes and negative for others. Moreover, there is a relationship between the operating point and the modes' damping ratio.
- Existing PFCs in CWE do not have a significant influence on the damping ratio. Further investigation is needed to assess if strategically placing new PFCs to influence the damping is an effective and efficient solution.

#### NETFLEX as lessons

- The initial plan was to focus on increasing commercial capacities. Ensuring security of supply is the critical mission of operators in the control room. The operational benefits to internal markets (balancing, operational expenditures for the TSO) are not assessed in this report since we focus on cross-border benefits (commercial capacities). We soon realized that we needed to take an oblique route to achieve increased commercial capacities. Therefore, we focused our efforts on developing an enhanced coordinated planning approach that reveals margins in the system by using DLR forecasters and smart controller of PFCs while adequately addressing security of supply issues. This remaining margin translates into additional cross-border transmission capacities.
- When defining KPIs for demonstrations, care must be taken not to mix what the technology does but with what the technology enables (e.g. Ampacimons measure the

real time ampacity<sup>6</sup> of an overhead line, but do not measure how much additional wind generation can be integrated at the end of the line).

#### NETFLEX as numbers

15%	Average day-2 gain in ampacity that the DLR forecaster delivered on Bruges-Slijkens from April 2011 to December 2012 with a 98% confidence interval, expressed as percentages of the seasonal rating.  This average gain is as high as 30% with a 90% confidence interval.
26%	Average day-1 gain in ability to deal with wind deviations that the Smart controller delivered from 1 January 2013 to 31 January 2013, expressed as percentages of the installed wind power.
0	Number of poorly damped situations.

**Table 5.1: Main technical benefits of NETFLEX**

#### NETFLEX as an innovative mindset

- The experience gained in developing NETFLEX helps to identify where to install Ampacimons, and possibly PFCs, in order to create more network flexibility. The approach requires an examination of sensitivities and correlations:
  - Sensitivities of flows to wind and to tap changes,
  - Correlations between congestion and wind.

Beyond Twenties, research and development continue for integrating this learning into long-term planning processes, from maintenance to grid development.

DLRs and PFCs complement conventional network assets by making it possible to increase their utilization. Even if DLRs retrieve some “hidden” capacities in the system and if PSTs and FACTS enable flow routing, they do not increase – strictly speaking – the physical capacity of the network. Moreover, increased losses are the price to pay for these. Conventional assets are needed in order to increase the network’s physical capacity to transfer electricity over long distances (e.g. from the North Sea to industrial zones where it can be consumed). HVDC links offer both physical capacity and flexibility but the costs are still very high compared to other solutions.

### 5.3. Description of the assessment methodology and of the problem

#### 5.3.1. Methodology for assessing the economic impact of the NETFLEX demo in Belgium

Here, the focus is on the EU energy strategy, known as Energy 2020 – A Strategy for Competitive, Sustainable and Secure Energy. NETFLEX contributes to developing a pan-European energy market (priority 2) by having a triple effect:

1. Enhanced EU Internal Energy Market (IEM) through higher cross-border capacities

<sup>6</sup> “Ampacity” is the capacity of an overhead line expressed in A. It is a contraction of “ampere” and “capacity”.



2. Faster integration of Renewable Energy Sources (RES) via better management of wind fluctuations
3. Maintaining the level of Security of Supply (SoS)

All three have multiple aspects. In this study, we provide an evaluation that encompasses only cross-border effects due to interconnections. As stated before, this report looks only at cross-border benefits and does not assess gains from the TSO's internal congestion management. Indeed, the main benefits in CWE (Benelux, France and Germany) will come from cross-border effects. We are able to provide an estimate of these benefits that may result from a better optimization of the cross-border dispatching.

Since the economic equilibrium of France and Belgium depends on exchanges with neighbouring countries, it is necessary to have a wide perimeter by means of a transnational model (as the CWE region involves Belgium, France, Germany and the Netherlands).

Moreover, since our assessment has been done for the years ahead, there is a need for a medium- to long-term model to capture the impact of the technologies tested (DLR, PST, etc.) in such a broad region on a yearly basis (2020).

To assess the KPIs, a case comparison has been made by EDF:

- Business-as-usual case without DLR or PFC implementation (called "REF")
- Four cases – which will be described later – where DLR or PFC devices are supposed to be widely deployed (in France and Belgium only, then in the whole CWE networks).

The added value of each case is to be found in the increase in NTC (Net Transfer Capacity) between neighbouring power systems. NTC is commercial capacity and represents the physical capacity left when the network and network security have been taken into consideration.

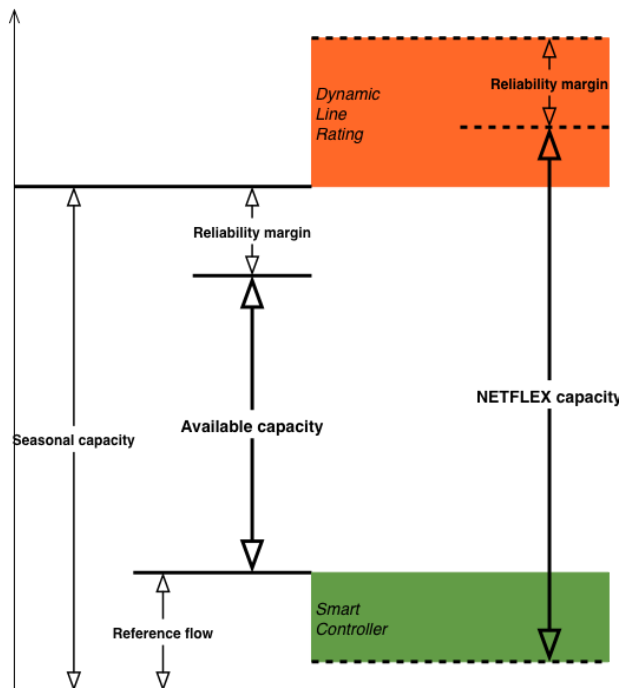

Figure 5.3: Transmission capacity of an overhead line equipped with Ampacimons and a PST



Based on the results of demo 5, it is expected that the transit capability of the existing transmission network will be enhanced through network flexibility. The above figure sketches out the impact of the DLR and Smart Controller on physical capacity, assuming the overhead line is fitted with both Ampacimons and a phase-shifting transformer (PST).

Because electricity follows Kirchoff's law (physics), overhead lines in a meshed grid carry more or less current depending on the situation. Power plants and factories in the vicinity of the line have a strong influence on flow through the line. However, distant power plants and factories, and the topology of the network, also have an influence on flow through the line. So the first important parameter to determine the available capacity is the "reference flow". It varies by nature, which means that available capacity also varies.

The effect of Ampacimons – as illustrated by the orange zone – does not represent permanent capacity. Instead, it corresponds to the distribution of a capacity that depends on wind conditions.

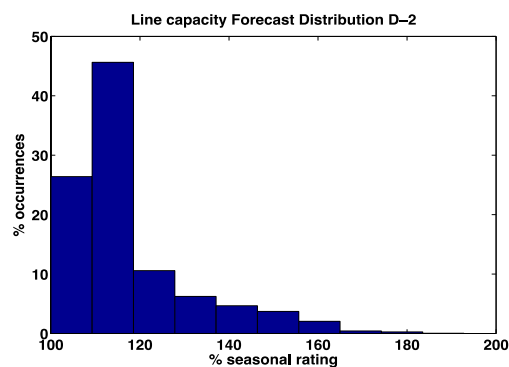

Figure 5.4: Distribution of the D-2 ampacity forecast

Locally, the relatively high variability of capacity is not without consequences:

- i. changes from one hour to the next have operational consequences and the means for dealing with large changes must be anticipated;
- ii. the automation of wind generation (downward) in case of change is critical for dealing with large numbers of equipped lines but has not yet been implemented.

In the case of an overhead line fitted with a PST, the second effect is only limited by the characteristics of the PST and its availability. In real time, the two effects add up. However in planning, as sudden changes in wind condition from one hour to the next are likely events, taps of the PST may be needed as countermeasures to forecast error of the ampacity (even with a 98% confidence interval).

For **commercial capacities** (the capacities used in CONTINENTAL for assessing benefits), this is more complicated. First, there is the so-called network effect as illustrated in Figure 5.5. Second, not all overhead lines are equipped with Ampacimons and PSTs. To circumvent the latter, assumptions have been made based on the experience of the TSOs.

In the case of commercial capacities, the orange zone also depends on whether or not the interconnections are equipped with Ampacimons. The correlation of local wind among different locations in Belgium has been studied. The correlation is such that a 3% gain in physical capacity on the interconnections between France and Belgium can be considered with high confidence when the wind blows in such a way that wind farms produce more than 20%

of their installed capacity. These 3% translate into approximately 10% commercial capacity through the network effect.

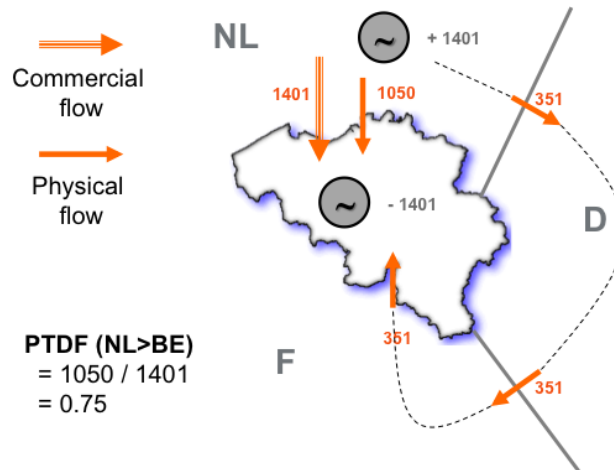

Figure 5.5: Illustration of the network effect (aka PTDf effect)

The green zone varies as well, since it depends on the combined effect of all PFCs on the congested line (which is not necessarily fitted with a PFC). And it varies much more in the case of commercial capacities because the congested line is not always the same.

The relatively high variability of capacity has local consequences as explained previously. But at regional level, variability can be either smaller when multiple local effects are not overly correlated or higher when they are highly correlated. The correlation across specific locations was not studied because the number of Ampacimons deployed in CWE is relatively small. But the correlation of wind across various areas in CWE was assessed at a relatively high level (lower than country level but much higher than line-section level) based on weather data. It is expected that variability at the border will be limited, but proof of this will still have to be produced when DLR is deployed wherever appropriate.

The correlation between the two distributions (orange zone and green zone) is assumed to be low, i.e. PFCs shift flows whether or not there is wind even if congestion is more likely to happen in high winds. This correlation will be properly assessed as soon as interconnections are fitted with Ampacimons.

To illustrate the benefits of this additional commercial capacity, we can imagine in the business-as-usual case a situation with high winds and where expensive oil-fired generation is needed in order to supply the country (the national price being thus high). If we are able to have a better monitoring and control (by means of DLR and PFC), then we could allow more exchanges (higher NTC) without changing the level of security of supply. These additional exchanges enable better dispatching of Europe's fleet of power plants: in this case, expensive oil-fired generation no longer produces and is replaced by CCGT unit in a neighbouring country (now accessible thanks to the higher NTC). The gains clearly come from:

- Integration of Energy Markets (IEM): cheaper and cleaner generation plant (CCGT or RES) replaces expensive and dirty generation (Oil Peaker).
- Security of Supply (SoS): In some situations, a country facing a tough security of supply situation (shortage) could be relieved by imports thanks to the extra-NTC.

- Renewable Energy Sources (RES): In some situations the flexibility provided can prevent curtailment of wind power and increase the use of RES.

In economic terms, for all the situations (hours) we assess the contributions that are linked to overall better dispatching, resulting in reduced supply costs and therefore gains for society (see [12]).

Below is a qualitative chart of the situations where the devices could provide benefits:

Qualitative assessment of benefits				
Demand supply situation (marginal price)	Wind pattern	IEM (economic exchanges)	SoS (security of supply)	RES (Increase use of RES)
No problem with the supply	Medium wind			
No problem with the supply	High wind			
Tough situation in <b>one</b> country	Medium wind			
Tough situation in <b>one</b> country	High wind			
Tough situation in <b>both</b> countries	Medium wind			
Tough situation in <b>both</b> countries	High wind			

Table 5.2: Qualitative assessments of benefits

The drawbacks of the market model used in this assessment is that it does not take into account national internal effects in the network (one country being one node and thus not modelling internal networks) and it does not allow for the controllability of PFCs since they are not modelled. A network model with detailed data (nodes, lines, PSTs, etc.) could catch and optimize the operation of PFCs but it has not been developed in this study. Thus, we are not able to assess either the impact of internal congestion or offshore wind curtailment due to grid weaknesses.

Thus, the aim of the study is to assess the economic gains (in terms of lower operational costs) on a cross-border scale (overall welfare for the 15 countries modelled including CWE), which will be function of the overall increase in NTC.

### 5.3.2. Description of CONTINENTAL

The model used in this study is called Continental and was developed at EDF [13]. Continental is a bottom-up electricity market model simulating the hourly matching between supply and demand by minimizing generation costs. Demand and supply are gathered in different zones, which can exchange power through commercial links. The maximum power that can be transmitted through these links is called Net Transfer Capacity (NTC).

Continental works in a two-step sequence. First, it considers scenarios of various demands, intermittent renewable generation, generation availabilities (by taking both contingencies and maintenance) and water inflows in order to compute the monthly value of water of each reservoir as a function of the stored water level, using dynamic programming.

Second, Continental performs hourly matching between supply and demand by minimizing generation costs using linear programming within conventional linear constraints. The price of each zone is thus defined as the dual variable relative to the zone demand constraint. Matching is performed across 96 equally likely scenarios over a complete year (8760 hours). Each scenario combines various time series related to important parameters, as shown below (taken from [13]):

NUMBER OF DIFFERENT TIME SERIES AND RELATED GRANULARITY FOR EACH DATA TYPE USED IN THIS STUDY		
Data type	Granularity used in this study	Number of different time series over the 81 scenarios
Fuel costs	monthly	1
Water inflows	daily	27
Pumping reference	daily	1
Generation maintenance	daily	1
Generation forced outage	daily	81
Run-of-river and wind	hourly	27
Cogeneration and biomass	weekly	1
Exchanges with countries outside the perimeter of study	weekly	1
Demand	hourly	27
Net transfer capacities (NTC)	monthly	1

**Table 5.3: Time series and granularity for each data type used in the study**

Commercial links connect the different zones, with monthly NTC as the maximum power that can be transmitted. Regarding DLR and PLC devices, we can modify monthly NTCs with the hourly input of wind for each hour:

$$\text{NTC}(\text{country A, country B}) = f(\text{NTC BaU, parameters: wind A, wind B, others})$$

Where:

- $f$  is the DLR function for the case that will enable calculation of a new NTC.
- NTC BaU= is the monthly NTC in the business-as-usual case (in line with ENTSO-e assumptions).
- A and B are the countries involving the NTC.
- 

Cases of study

Different cases have been identified. The benefits in terms of NTCs have been estimated based on the results of the demonstration itself, some of them being already considered by respective TSOs. These cases are illustrated in Figure 5.6.

The first 2 (two) cases focus on assessing the direct benefits from NETFLEX, i.e. real benefits coming from the demonstration. Cases 3 and 4 are meant for studying the benefits in Central Western Europe from some deployment of the technology. Replication over EU27+ falls outside the scope of this document.

For cases 2 and 4, the increase will be performed all the time (homothetic transformation of the initial NTC). As for case 3 and 1, the function has to be applied when the wind load factor is above 20%. Both functions are represented in Figure 5.7.

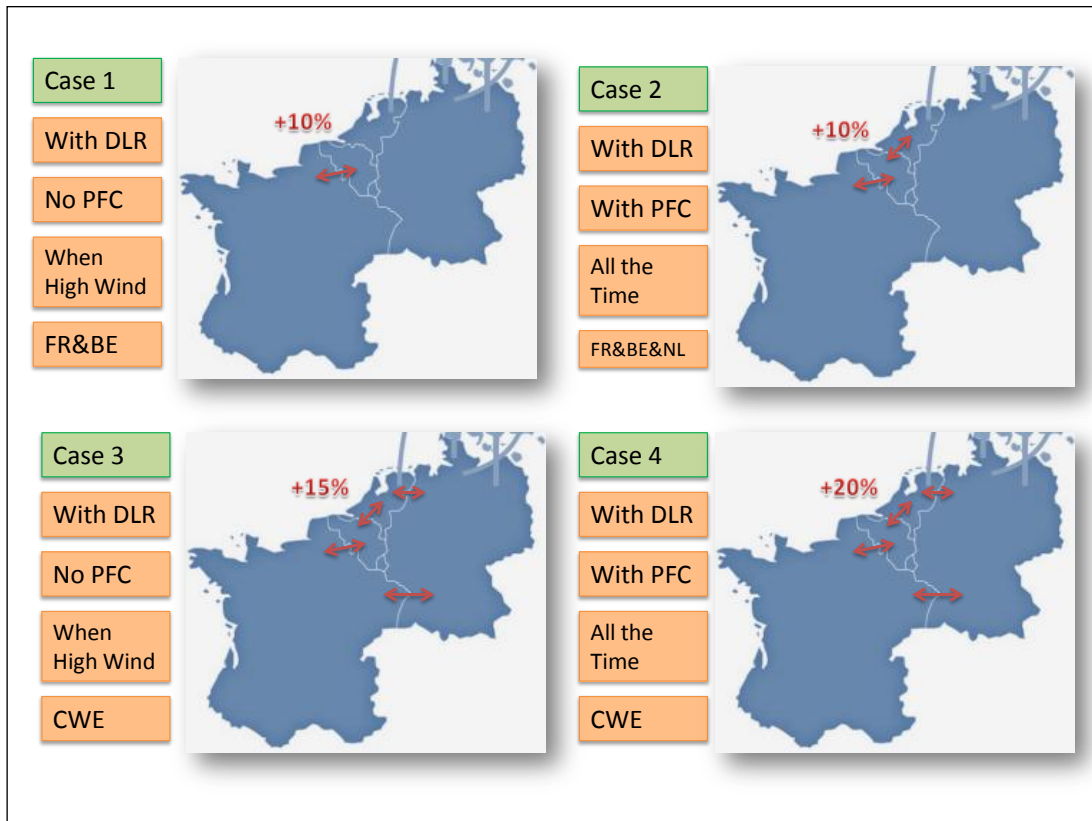

Figure 5.6: NTC increase cases used in the study

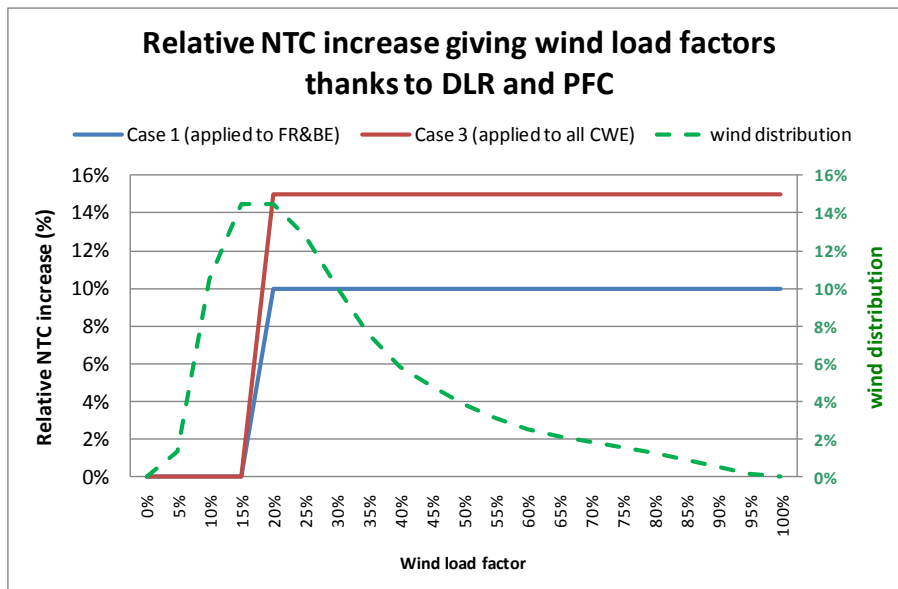

Figure 5.7: Relative NTC increase giving wind load factors thanks to DLR and PFC

### 5.3.3. Description of input-data: scenarios for 2020

As explained before, the Continental market model has to be supplied with structural inputs, namely:

- Fuel costs: Fuel costs are the same for the 81 Continental scenarios. The source is [14] and the numbers are given below.
- Demand: Demand is aggregated by area and 27 different time series are considered, as a function of historical temperature series over 50 years. Hence, each time series is represented three times in our 81 scenarios.
- Generation: Assumptions will be made in order to test a given set of hypotheses.
- Interconnection (Net Transfer Capacities): developed on the basis of recalculating actual capacities in Europe<sup>7</sup> which are then increased if any interconnection project is expected to come online by 2020<sup>8</sup>.
- Installed capacity for wind, which is in line with the national renewable energy action plans (NREAP) of the European countries.

Next Figure 5.8 shows installed capacity for renewables:

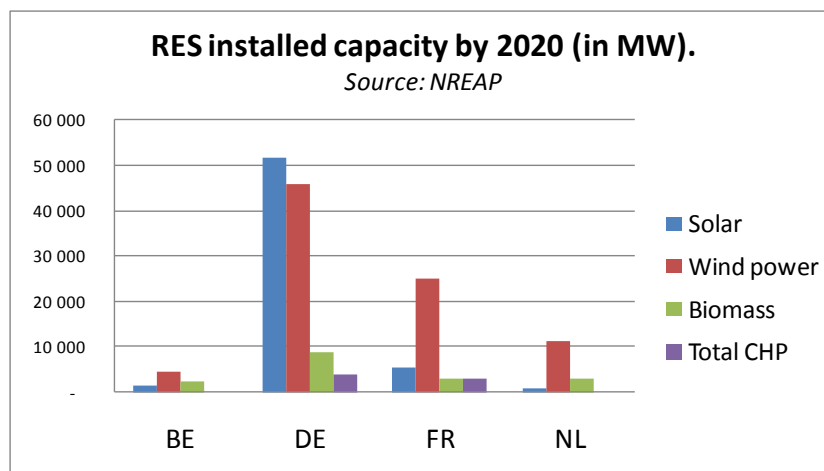

Figure 5.8: RES installed capacity by 2020

Since there is a high level of interdependency in the development of generation and transmission networks, a part of the generation portfolio (CCGs and peaking units) is modified as a function of the interconnection level<sup>9</sup>. This is an important point since the benefits come not only from short-term optimized dispatching but also from long-term economic equilibriums (generation adapts to commercial capacities).

In order to check consistency, we compare the generation fleet to public sources. So far, the more exhaustive and public source is [15], the ENTSO-e “System Outlook and Adequacy Forecast” (SO&AF) which provides the forecast aggregated installed capacity for each technology and for each ENTSO-e member.

Figure 5.9 shows the comparison of the thermal capacity for the 15 countries modelled by Continental. Six types are taken into account: Nuclear, Coal, Lignite, CCG, Gas Peaker and Oil Peaker.

<sup>7</sup> Available on ENTSO Vista: <http://www.entsoe.net>

<sup>8</sup> See TYNDP 2012, which outlines future projects and their Grid Transfer Capability.

<sup>9</sup> Indeed, investment in peaking units and number of hours at the VOLL (value of lost load, in €/MWh) are tightly linked.

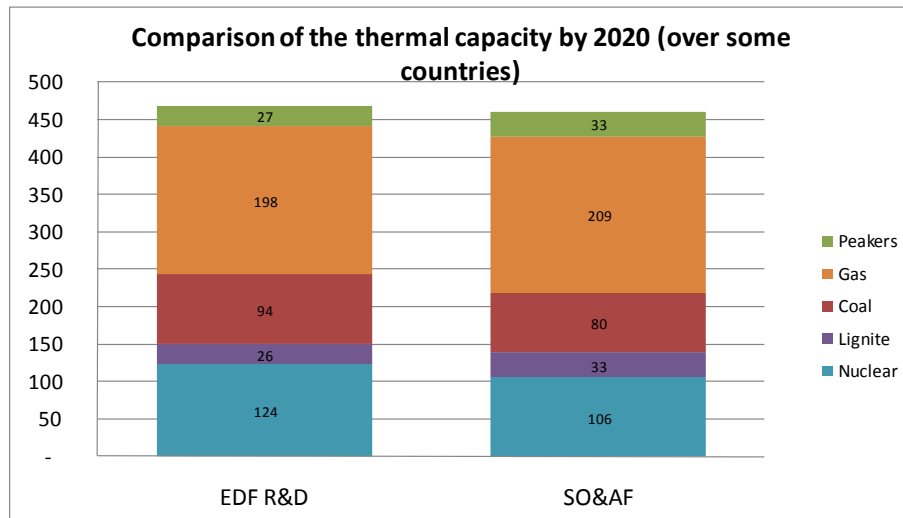

**Figure 5.9: Comparison of the thermal installed capacity by 2020**

In order to build a public set of variable costs, we need first to decide the structural prices of the commodities. For our study we have used the Energy Roadmap 2050 [14]:

- Fuel price: 88\$/bbl in 2020

“International fuel prices are projected to grow over the projection period with oil prices reaching 88\$/bbl in 2020, 106\$/bbl in 2030 and 127 \$/barrel in 2050 with 2% inflation (ECB target) this corresponds to some 300 \$ in 2050 in nominal terms”

- Gas price: 62\$/boe in 2020

“Gas prices follow a trajectory similar to oil prices reaching 62\$/boe in 2020, 77\$/boe in 2030 and 98 \$(08)/boe in 2050” [14].

Coal price: 26\$/boe in 2020

“Coal prices increase during the economic recovery period to reach almost 26\$/boe in 2020 and stabilize at around 34\$/boe in 2050” [14].

- CO<sub>2</sub> price: 25€ / tCO<sub>2</sub>

This number comes from [14].

- Exchange rate: 1.25\$/€

“The dollar exchange rate for current money changes over time; it starts at the value of 1.45\$/€ in 2009 and is assumed to decrease to 1.25 \$/€ by 2020 and to remain at that level for the remaining period.” [14].

These prices enable us to calculate the variable costs for each type of generation (CCGTs, Coal, Peak Units) which is made by means of assumptions of “regular” power plants (see [16]). The main assumptions needed are the energy efficiency of the plant (in terms of electric MWh produced / thermal MWh fed to the plant regardless of the fuel), calorific characteristics of the fuel (e.g. thermal MWh per MMBtu of gas) and CO<sub>2</sub> concentration of the fuel (in terms of tons of CO<sub>2</sub> per thermal MWh) which are taken from [17] and [18].

With these 3 terms, one can build “regular” plants in order to establish heat rates and emission factors. Thus, variable cost can be computed as:

Variable Cost (technology) = Fuel cost (commodity) + Carbon cost (CO<sub>2</sub>) + O&M cost

The commodity and CO<sub>2</sub> prices chosen will define the competitiveness of standard generation technologies (e.g. Classic Coal versus CCGT). Depending on the assumptions made, switching between expensive generation and cheaper generation could lead to a reduction or increase in CO<sub>2</sub>. As the structural inputs could be very sensitive, it has been chosen to keep the European Commission assumptions that are public.

In order to check consistency we compared the generation fleet to public sources. So far, the most exhaustive and public source [15] has been used, the ENTSO-e “System Outlook and Adequacy Forecast” (SO&AF), which provides the forecast aggregated installed capacity for each technology and for each ENTSO-e member.

#### 5.4. Results of the tested demo

Since the PSTs have been installed at the North border of Belgium, the internal congestion management costs significantly dropped but this benefit shouldn’t be allocated to the demonstration itself.

The installation of the 10 Ampacimons on the double 150kV circuit Brugges-Slijkens (lines that are absolutely not influenced by the PSTs) and the ability to forecast the ampacity of these 2 lines in a reliable way have dropped to congestion management costs in the vicinity of the line.

#### 5.5. Results under a system perspective (CWE)

##### 5.5.1. KPI.15.TF3.2: Increase in exchanges

Continental works with 96 scenarios (32 wind scenarios multiplied by 3 different outage scenarios). The aim is to compute a NTC for each case by increasing the NTC in the reference case (“REF”) by means of the functions.

For cases 2 and 4, the increase is trivial since we just increase the REF NTC of 10% and 20% across the board for CWE countries regardless of the wind scenario.

For cases 1 and 3, the increase takes place in the hours when the wind is higher than a load factor of 20% (10% and 15% respectively). As we have 96 wind scenarios, we compute 96 different NTCs from the reference case for cases 1 and 3.

The figure below shows NTC exports from Belgium to the Netherlands. As explained above, there is only one NTC for case 4 (which is +20% of the REF NTC) and 96 scenarios for case 3. Figure 5.10 shown below 3 scenarios of the case 3 during two days to illustrate the inputs.



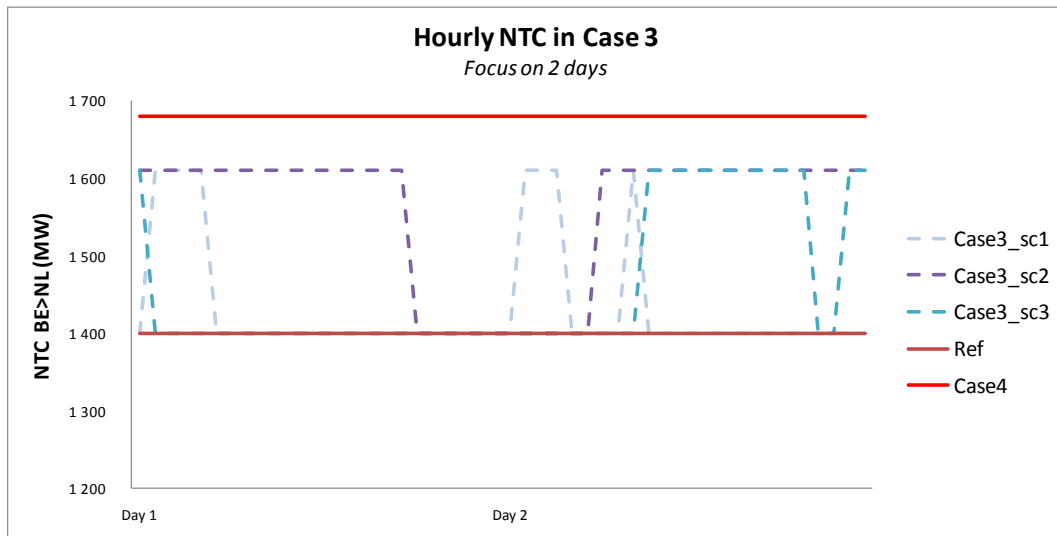

Figure 5.10: Example of hourly NTC in Case 3

The hourly modification of the initial NTC (from the “REF” scenario) gives rise to an average increase shown in Figure 5.11.

The average NTC increase in case 3 is around 10%: this number is explained by the fact that 70% of the time the CWE load factor is higher than 20% and the subsequent NTC increase is 15%. Thus, in average terms, the overall increase is of  $70\% \cdot 15\%$ , i.e. around 10%.

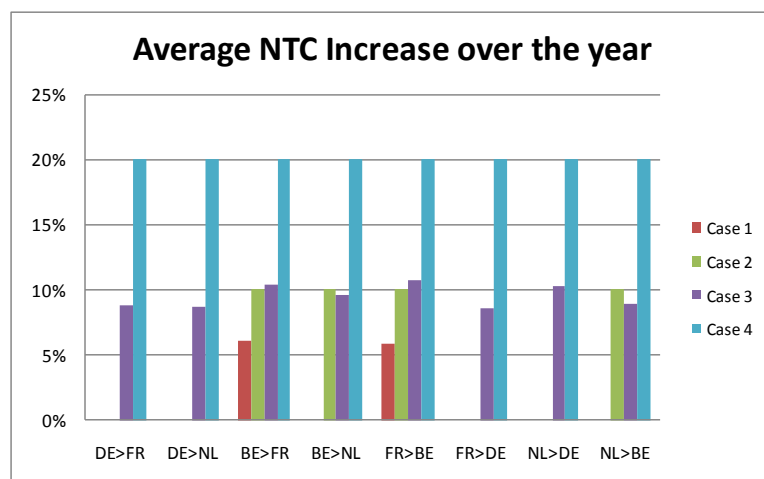

Figure 5.11: Average NTC Increase over the year

Concerning actual power flows exchanged, Figure 5.12 illustrates supplementary yearly energy exchanges:

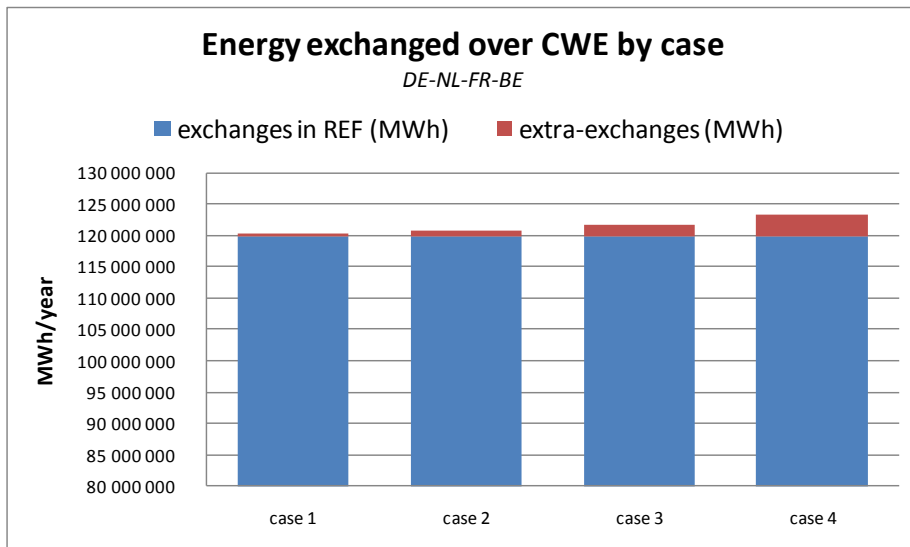

Figure 5.12: Energy exchanged over CWE by case

The amount increases from 0.5TWh in case 1 (0.42% of total CWE exchanges) to 3.3TWh in case 4 (2.8%). The effect is thus quite limited, taking into account our previous remark.

#### 5.5.2.KPI.15.TF3.3: Wind curtailment

As for the effects on wind power, curtailment can occur in the following situations (taken from the Spanish TSO<sup>10</sup>):

1. Excess generation that could not be integrated in the system: for example, when the production of inevitable generation<sup>11</sup> is higher than national demand (plus exports<sup>12</sup>).
2. Viability of the generation balance: for example, when the generation fleet is not flexible enough and cannot cope with a given increase in wind generation.
3. Congestion: when the local networks cannot transmit power through either the distribution or transmission networks: this can be seen in countries with high installed wind capacity such as Spain and Germany.
4. Other technical issues: voltage stability, short-circuit power and others.

From the four situations described above, we can compute only the first one with our market model. Indeed, since local networks are not modelled (one country = one node) then the local/national issues cannot be observed (a load flow model is needed).

Figure 5.13 represents the decrease in wind curtailment assessed with Continental.

<sup>10</sup> See [www.ree.es](http://www.ree.es).

<sup>11</sup> Including hydro run of river, solar, wind and also minimal generation for thermal.

<sup>12</sup> In that case, national demand is served by inevitable output and moreover the surplus of wind cannot be exported (interconnections congested: the surplus of wind is shed).

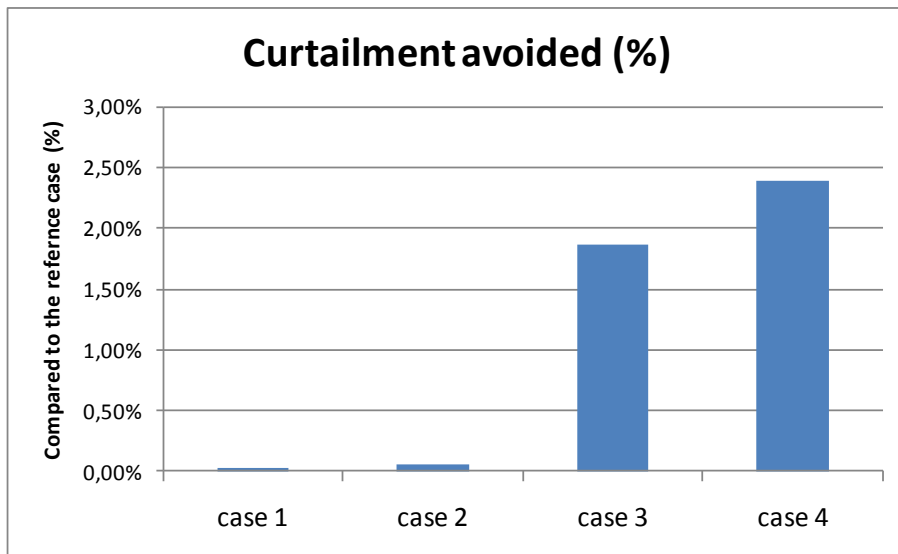

Figure 5.13: Decrease in wind curtailment by case

We can thus deduce the curtailment decrease but the amount is quite limited (around 4GWh for a whole year) as the model is not able to take into account network constraints as grid congestion. This value is to be compared to the 400GWh of wind curtailed in 2011 in the north of Germany to overcome congestion (grid bottlenecks<sup>13</sup>).

#### 5.5.3.KPI.15.TF3.4: Cost Benefit Analysis

As stated above, the Continental Model can be used to compute the economic equilibriums of the system as well as the costs needed to supply the energy. The difference in supply costs with the business-as-usual case makes it possible to deduce the gains for society. These gains have to be compared to the annualized costs (which have been provided by Elia): the methodology is in line with Entso-e practices [12] as well as previous EDF work [13]. Figure 5.14 shows the cost-benefit analysis for the cases.

<sup>13</sup> <http://www.germanenergyblog.de>

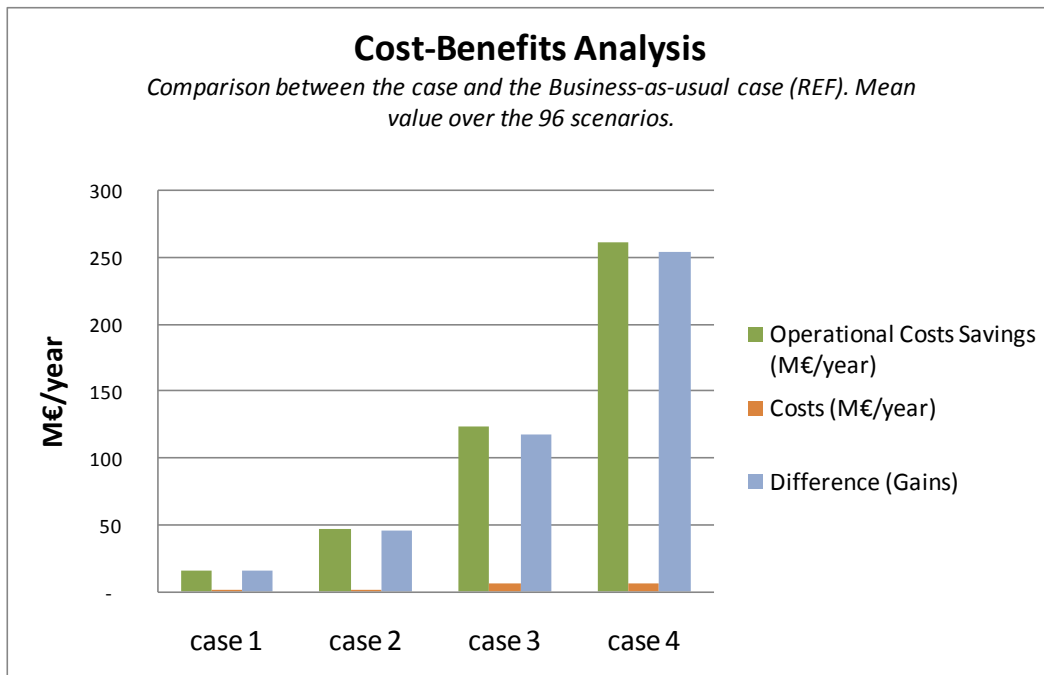

Figure 5.14: Cost-Benefits analysis

As explained before, the extra NTC provided by the devices enables better dispatching which in turn results in lower supply costs<sup>14</sup>, and therefore gains for society. The graph above shows the important gains assessed for each case studied. Taking into account the limited costs of deploying the devices (both in terms of capital expenditure and operational costs), the cost-benefit analysis shows very interesting results.

For case 3 and case 4 costs are linked to a CWE implementation, while the demonstration is directly linked to the French-Belgian border. Thus, Elia as demo leader made realistic assumptions concerning deployment across CWE. However, the results are likely to remain valid.

A benefit of around €250 million for case 4 is less than 1% of total thermal generation variable costs<sup>15</sup>. Compared to overall system costs, the share should be lower<sup>16</sup>.

The results represented in Figure 5.14 were calculated as an average of the 96 scenarios. Figure 5.15 and Figure 5.16 show the distribution of these results. Since all of the 96 scenarios have the same probability, we shall consider the cost-benefit expectancy calculated over 96 scenarios. Even for the worst scenario, the yearly operational cost savings are higher than the infrastructure costs incurred.

<sup>14</sup> As explained before, there is also an adjustment to the generation fleet, resulting in lower capital expenditure.

<sup>15</sup> We performed a rough calculation of thermal variable costs over 2012 (DE+FR+BE+NL): around 200TWh of gas generation (€65/MWh), 330TWh of coal (€45/MWh) and 14TWh of oil (€120/MWh) give rise to €30,000 million over 2012.

<sup>16</sup> System costs include not only thermal variable generation costs, but also all other variable costs (hydro, nuclear, network losses) and fixed costs linked to capital expenditure (thermal, renewable, network CAPEX, etc.)

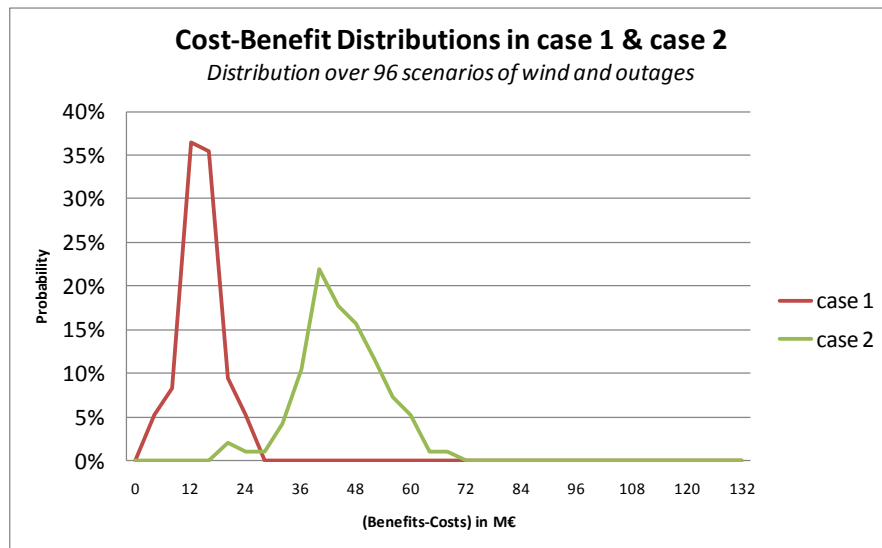

Figure 5.15: Cost-Benefits distributions in case 1 et 2

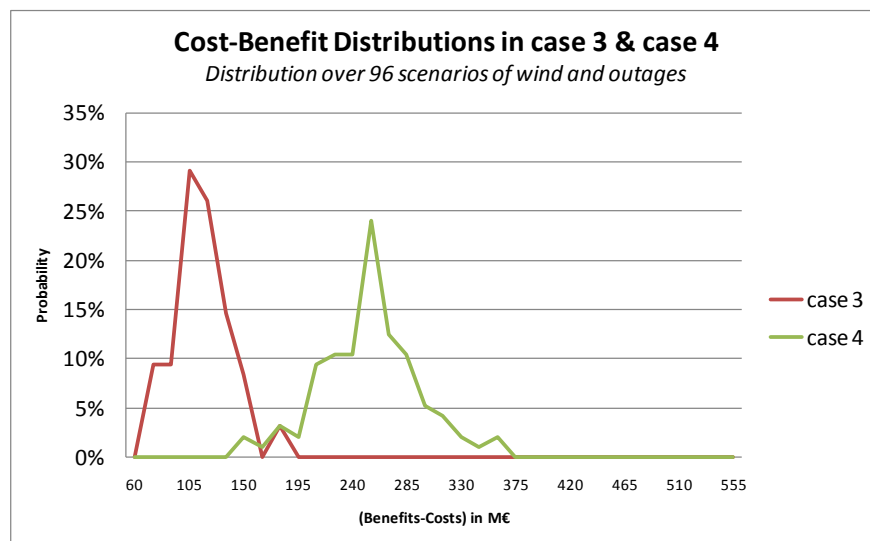

Figure 5.16: Cost-Benefits distributions in case 3 et 4

#### 5.5.4.KPI.15.TF3.5: Generation shares

The generation shares are almost the same as the reference point, since the share switched thanks to extra NTC is a very small share of total generation. In fact:

- The level of interconnections is usually around 10% of the installed capacity of each country.
- Of this 10%, the maximum effect studied here (DLR+PCF) is 20% for case 4.
- Thus, the overall effect of switching between generation technologies should be less than  $20\% \times 10\% = 2\%$ .

Taking into account these remarks, this indicator is not consistent. Indeed, in absolute terms (energy) the variations are of the same magnitude as the model's accuracy<sup>17</sup>.

#### 5.5.5.KPI.15.TF3.6: CO<sub>2</sub> emissions

We start by calculating the amount of energy produced by different type of thermal generation and we multiply by conventional emission factors [19]<sup>18</sup>. As stated above, from standard efficiency plants ratios and the standard CO<sub>2</sub> emissions by type of fuel (t CO<sub>2</sub> / TJ), we can deduce the amount of emissions for each type of technology [15].

Note that other plants do emit CO<sub>2</sub>, such as Combined Heat & Power (CHP) plants whose main fuel could be a fossil fuel. However, as we compare the cases (which each have the same CHP), we can compute the relative difference in terms of CO<sub>2</sub> despite the fact that we are not able to assess the CHP emissions themselves.

Figure 5.17 shows CO<sub>2</sub> emissions avoided:

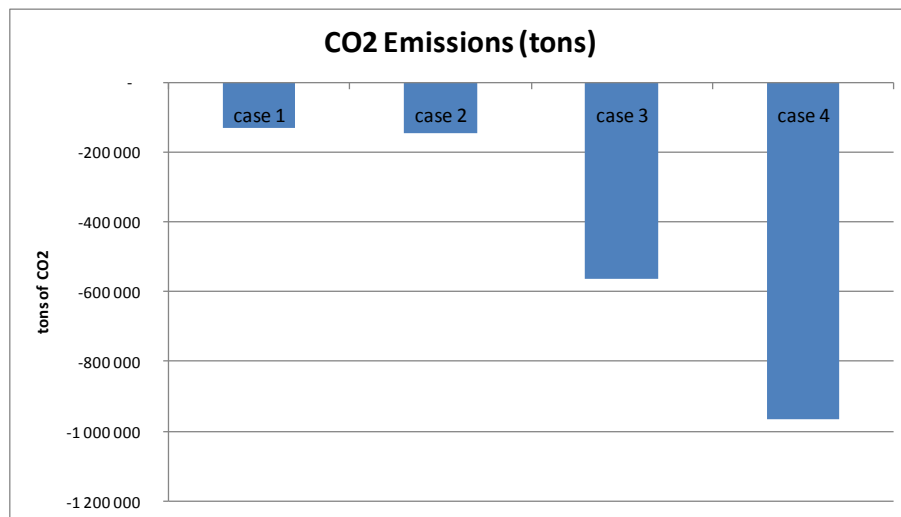

Figure 5.17: CO<sub>2</sub> emissions avoided

The graph above shows that thanks to the devices analysed, we are able to avoid CO<sub>2</sub> emissions and thus contribute to climate change objectives. However, the number of tonnes avoided is relatively low compared to total CO<sub>2</sub> emissions from the electric system<sup>19</sup> [19].

## 5.6. Conclusions

The average gain in physical capacity provided by the Dynamic Line Rating (DLR) forecaster is 10% with a high confidence interval. Thanks to the network effect, it could translate into a bigger average gain in Net Transfer Capacity (NTC). Note that not all lines are cooled in the

<sup>17</sup> In relative terms, we see a decrease in gas peakers, notably in case 3 and case 4 (around 20 hours less in case 3, and 50 hours in case 4).

<sup>18</sup> Emission factor is the amount of tons of CO<sub>2</sub> emitted in order to produce 1 MWh (energy). It varies from technology to technology.

<sup>19</sup> In our case, 1 million tonnes compared to around 55 million tonnes for the French electric system and 327 millions tonnes for Germany [19].

same way and some lines can be congested when the wind does not blow. The net benefit is lower operational costs for the overall system.

*By equipping two lines at the Belgian coast, by developing the DLR forecaster and by studying the correlations between wind locations, the NETFLEX partners expect to unlock approximately 10% wind-based NTC on the France-Belgium border, with the potential to reduce overall costs by more than €5 million per year.*

The smart controller developed for coordinating the action of multiple Power Flow Controlling devices (PFC) can be used to route flows where capacity remains and to better cope with wind variability. It uncovers a variable margin for more exchanges that complements the capacity delivered by the DLR forecaster and compensate for its potential overestimations.

*Combined and applied to the Belgian borders, it is expected to result in a potential decrease in the overall cost of the system by almost €50 million per year.*

The damping ratio of the system tends to decrease over time when there is an increasing volume of asynchronous generation, such as wind turbines, connected to the system.

*The potential effect of existing PFCs on the damping ratio has been demonstrated as insignificant. Hence, it has not been considered in this Cost-Benefit Analysis.*

Ampacimons have a remarkable advantage over most Real-Time Thermal Rating technologies: they can be installed very quickly and do not require long downtime for the overhead lines to be equipped.

*According to our assumption, broadly deploying DLRs in CWE would enable a large reduction in operational costs estimated at approximately €125 million.*

Fully deploying the smart controller is a promising solution, though a comparable challenge to all security and capacity data exchanges among TSOs. This will be eased in CWE once the Flow-Based Market Coupling is fully operational, as it is based on very similar information.

*The assumption is that full deployment in CWE would secure higher NTC through enhanced flexibility. The decrease in operational costs is estimated at a significant €250 million.*

There are important remarks to note. First, NTC as provided by NETFLEX technologies is more complex to incorporate in long-term market simulations. Further experience must be gained and data gathered to precisely define the NTC functions used for the current analyses.

Second, the gain depends on the combination of risk policies chosen for the different parts. So far, the risk policy of each part (DLR forecaster and smart controller) has been considered independently. But what really matters is the overall risk of the entire process. NETFLEX enables more aggressive planning, i.e. choosing more ambitious policies for each part while taking the same level of overall risk. This is only possible through the more accurate monitoring of network capacity and tighter control of flows via the PFCs.

Third, transmission assets – whose lifetime usually is more than 30 years – should be assessed by means of a cost-benefit analysis made on long-term forecasts of structural inputs. As set out in this report, the scope should encompass at least the countries directly involved as well as the immediate neighbours. It is also important to note the strong link between generation and transmission investment, something which is usually ignored. Generation adaptation makes it possible to have a more realistic view of the future than ex-ante generation fleet definition and to secure long-term benefits due to generation decisions.

Finally, existing market models, such as the one used in this report and others, have shortcomings that should be addressed in the future. In the case of flexibility, the most influential shortcoming is the lack of internal network description, which hampers the explicit integration of PFC controllability. Moreover, long-term market models usually do not model flow-based exchanges. They should soon follow recent developments (the implementation of flow-based market coupling). Anyway, further investigation is needed on how to implement a flow-based approach and get reliable data for developing a long-term perspective<sup>20</sup>.

The results presented in this report robustly demonstrate the main benefits. The potential value of NETFLEX technologies has been demonstrated since they would enable significant benefits compared to the costs incurred. In addition, deployment time is shorter than those of conventional assets such as new overhead lines and underground cables. This makes it possible to close the gap between investment decision and commissioning.

Ampacimons are particularly quick to install (< 6 months). However, the costs and time needed for integration into the TSO's tools and processes should not be underestimated. A tool has been developed to reliably predict the capacity 1 and 2 days ahead. An average gain of 10 to 15% on the seasonal limits can be expected on equipped overhead lines. It is important to note that this gain should not be compared as such to the gain provided by a new asset, as it is highly dependent on the local wind conditions (in extreme cases, no wind means no gain). Ampacimons are ideal where congestion is directly related to wind power injections.

Stability will become increasingly important. Damping, in particular, depends to a large extent on the status of certain large power plants. The more wind and solar generation, the less operation of large power plants. A tool has been developed for learning what observable variables/parameters influence damping and that tool can be used to reliably predict damping. The analyses have shown that existing Power Flow Controlling devices have a rather limited impact on damping. To control damping, further research is needed in order to identify adequate countermeasures for coping with very high shares of renewables.

In the future, Dynamic Line Rating and the smart control provided by Power Flow Controlling devices should be incorporated by TSOs in the long term planning process as a complement to conventional asset. Finally, from a market player perspective, the benefits of any asset, device or process newly introduced should be understandable and predictable. This is especially critical for long-term decisions across the entire electricity industry. Further research is needed for evolving market models and for efficiently integrating network flexibility in their decision-making process.

---

<sup>20</sup> The ideal tool would be an exhaustive network model that optimizes exchanges, hydro reservoirs and PFC controlling for every hour of the year and over a wide European perimeter. Such a tool does not exist and both network and market models have their strengths and weaknesses.



## 6. Economic impact assessment of RTTR and FACTS in Spain

The objective of Demo 6 performed by the Spanish TSO Red Eléctrica de España (REE) is to demonstrate that Flexible AC Transmission Systems (FACTS) and Dynamic Line Rating (DLR) technologies bring flexibility, enhance security and expand the capability of the network to evacuate more generation.

The FACTS device tested in Demo 6 is a mobile Overload Line Controller (OLC) which consists in three mechanically switched reactors connected in series with a reactance distribution of 2.6+5.2+10.3 ohm. This device allows for re-directing the power flow from a congested line to parallel corridors through the modification of the impedance introduced in that line, avoiding overloads and, consequently, conventional generation redispatch and/or wind power curtailment. The combination of the three reactor steps allows for seven different reactance settings. This device was installed in the 220 kV Magallón-Entrerriós line in Aragón, Spain. The detailed description of the OLC design can be found in [20].

On the other hand, the goal of testing DLR is to show that transmission lines can be operated considering dynamic thermal capacity ratios instead of static seasonal ratios. Since the thermal capacity of transmission lines depends on temperature conditions, actual line capacity limits can be higher than the pre-established static ratios. In this sense, one of the objectives of the demonstration is to show that there is a correlation between high wind production in a certain area and higher thermal capacity limits in that same area due to a refrigeration effect [21]. For this purpose, a Real-Time Thermal Rating (RTTR) system based on Distributed Temperature Sensing for overhead lines was implemented in the 220 kV Maria-Fuendetodos line in the Spanish autonomous community of Aragón. This system calculates the maximum current that can be carried along the whole overhead line taking into account real-time weather conditions. The detailed description of the RTTR system designed in Demo 6 can be found in [22].

The objective of this chapter is to present the economic impact assessment of the application of the technologies tested in Demo 6 in the Spanish transmission network. Apart from this introduction, Chapter 6 is divided in five sections. Section 6.1 explains the methodology used for the economic impact assessment of Demo 6. Section 6.2 presents the results of the economic impact for the area where the FACTS device and the DLR system were actually installed. Section 6.3 extends the study to other potential locations for the placement of FACTS and DLR devices in Spain. Finally, Section 6.4 presents the conclusions of the performed analyses.

### 6.1. Description of the assessment methodology and problem setting

The main objective of the economic impact assessment of Demo 6 is to obtain the economic Key Performance Indicators (KPIs) for this Demo. These KPIs are described in [9] and listed below:

- i) **KPI.15.TF3.7:** Potential wind power integration increase in the Spanish system obtained by identifying the latent capacity of the network using the RTTR system, and by operating the line at maximum capacity by using the OLC device (in GWh/year).
- ii) **KPI.15.TF3.8:** Economic impact (benefits and costs) of scaling-up the RTTR system and the OLC device to the Spanish power system (in EUR/year).

In order to obtain the economic KPIs of Demo 6, a comprehensive and scalable methodology to compute the benefits of the enhanced network flexibility provided by the technologies tested in Spain by REE was developed. This economic analysis is performed not only for the area where the real facilities are installed but also for other locations within the Spanish network that could benefit from these devices.

In order to avoid transmission congestions, once the day-ahead market is closed, the management of technical constraints procedure is performed by the Spanish TSO for each hour of the day ahead. In case the schedule resulting from the day-ahead market does not comply with transmission security criteria, the TSO may apply the following short-term measures [23]:

- a) First, if it is possible according to the configuration of the network, the TSO performs a topological maneuver (e.g. split/join substations' busbars) in order to avoid overloads;
- b) If it is not possible to perform the topological maneuver or the topological maneuver is not enough to relieve the transmission congestion, the TSO redispatches conventional generation in the congested area;
- c) If the above mentioned measures cannot be applied or are not enough to solve the transmission congestion, the TSO curtails wind power.

Among these short-term measures the cheapest solution to alleviate transmission congestions is the topological maneuver. Although there is no pre-defined cost associated to this measure, it may engender system security and increase maintenance costs. The redispatch of conventional generation is the measure with highest impact on system operation costs, while the curtailment of wind power is a last resort measure to avoid transmission congestions.

If transmission constraints in a specific area are recurrent, the TSO has to include the reinforcement of the network (i.e. upgrading an existing line or building a new one) in the network expansion plan. Building new lines requires large investment and long construction time, apart from facing strong public opposition. FACTS and DLR devices can be considered as a mid-term solution to avoid transmission congestions and for this reason the economic impact assessment of the devices tested in Demo 6 on the area where they were actually installed contemplates three different perspectives:

- i. **Avoided conventional generation redispatch:** the redispatch of out-of-merit generation to avoid transmission congestions brings an extra cost to the system, which correspond to the difference between the cost of the energy generated at the redispatched generator cost and the cost of the energy generated at the system marginal cost (day-ahead market price). In this analysis, it will be computed up to what extent the redispatch of conventional generation can be avoided due to the use of FACTS and DLR technologies and the resulting economic benefit, i.e. the avoided redispatch cost. This is the most relevant cost for the economic impact assessment of the application of these devices in the Spanish transmission network.
- ii. **Higher wind hosting capacity:** in areas with high wind penetration the TSO may ask wind power plants to reduce their production in order to alleviate transmission congestions. Although the level of wind curtailment due to transmission congestions is still low in Spain, it will be assessed whether FACTS and DLR technologies allow for a higher integration of wind power. The benefit of a higher penetration of wind generation will be assessed in terms of reduced CO<sub>2</sub> emissions costs.

- iii. **Investment deferral:** in case of recurrent transmission congestions, the TSO must reinforce the network (upgrading an existing line or building a new line). By increasing transmission capacity, FACTS and DLR technologies may defer this type of investment. The economic benefit of deferring investments is associated with the temporal value of money. Since estimating the time during which transmission investments could be delayed due to the use of FACTS and DLR technologies is out of the scope of this analysis, a more simplified study is performed. This analysis consists in computing the opportunity cost of investing in a new line instead of investing in FACTS or DLR devices.

Since the most relevant economic impact of these technologies in the Spanish case is the avoided redispatch cost, the potential economic benefits for other locations (i.e. up-scaling analysis) will be assessed under the perspective of avoided conventional generation redispatch.

The impact of FACTS and DLR technologies on the expansion of transmission capability largely depends on the network design (existence of alternative paths, maximum limits of network components, etc.), and on the system state (line loading, contingencies, etc.), and, consequently, must be analyzed at a local level. This analysis requires:

- A robust and exhaustive methodology in terms of compliance with the current operational practices and grid security criteria.
- Automation of the analyses (tool) in order to obtain aggregated results.
- A deep knowledge on the operation of the zones to be analyzed and data/scenarios to feed the tool, which include:
  - Detailed network modelling of the areas to be studied;
  - Grid Codes for maximum lines and transformers ratings;
  - Characteristics of the FACTS device (reactance steps) and RTTR system (capacity gain).

In order to take these aspects into account, the economic impact assessment of Demo 6 in Spain was divided into three steps. The first step is the selection of the potential areas within the Spanish transmission network that could benefit from the installation of FACTS and DLR technologies. The second step involves the study of the technical impact of those technologies in the transmission network. After the areas of study are selected and the technical impact of FACTS and DLR devices is analyzed, the potential economic benefits are assessed.

The main tools used to perform these analyses are the Power System Simulator for Engineering (PSS/E)<sup>21</sup> [24] and the ROM model (described in Annex 1). Real 2010 data for generation, demand, network characteristics and power flows are used to estimate future potential economic benefits of FACTS and DLR devices.

#### 6.1.1. Selection of potential locations for the placement of FACTS and DLR

The objective of the economic impact assessment of Demo 6 is to estimate potential benefits of FACTS and DLR devices not only in the area where they were actually installed by REE but also in other areas of the Spanish system that could benefit from those technologies. For this

---

<sup>21</sup>PSS/E is the tool used by several TSOs, including REE, to perform power flow analysis.

reason, an exhaustive analysis was performed by REE to identify potential locations for the placement of FACTS and DLR devices. The activities carried out by REE in this context can be summarized as follows:

- a) Identification of critical lines (areas of study): the critical lines are the ones where the installation of FACTS or DLR devices could avoid at least partially the costs of redispatching conventional generation to solve transmission congestions in a certain area of the Spanish transmission network.
- b) Selection of study cases: each study case is a real-time PSS/E saved case file that corresponds to a snapshot of the Spanish transmission system (i.e. nodes, generators, loads, power flows, etc.) representing one hour of operation of 2010. For each area of study, a set of study cases corresponding to hours during which conventional generation was redispatched or wind power was curtailed to alleviate congestions was selected.
- c) Delimitation the area of study:
  - Identification of nearby affected lines: The reduction of the congestion in the critical line affects the power flow of nearby lines. For this reason, the line loading of those lines must be also checked.
  - Identification of the most relevant nearby lines to be included in the contingency analysis (N-1).
  - Identification of the redispatched generator: this must be the generator or the group of generators with the highest sensitivity in relation to the flow through the studied line.

#### 6.1.2. Impact of FACTS and DLR in the network

Before computing the economic benefits of the installation of FACTS and DLR devices, a detailed analysis of the effects of those technologies in the transmission network must be performed. This analysis is essential due to the fact that the installation of these technologies will affect not only the power flow going through the line where the device is installed but also the power flow of nearby lines and transformers. In order to perform this analysis, an algorithm was developed in Python Programming Language [25] to automate PSS/E.

The Python routine is used for recalculating power flows of real PSS/E case files generated by the TSO when: a) the FACTS effect (different impedance levels) is introduced in the critical line; b) the DLR effect (capacity gain) is introduced in the critical line; c) the power output of a specific generator is modified. As explained in Section 6.2.1, each one of these case files contains the whole Spanish transmission network and represents a specific hour of operation of 2010.

The starting point of the analysis for each area of study selected by REE is the set of PSS/E case files which represent operation hours during which a redispatch or curtailment measure was taken by the TSO. In the former case (redispatch), this means that in each one of these hours a conventional generator had to increase its output in order to alleviate transmission congestions. It is important to emphasize that only redispatch measures that require generators to increase their output (up redispatch) are considered in the analysis since they

are the ones that impose an extra cost to the system. In the latter case (curtailment), a wind generator had to reduce its output.

In the original case files no congestions are detected since the redispatch or curtailment measure has already been taken by the TSO. The basic idea behind the algorithm is that once the effect of the FACTS device or the DLR system is applied in the critical line, a higher power flow can go through this line, and consequently, the redispatch or curtailment measure taken by the TSO can be, at least partially, reversed. This is done by the algorithm by decreasing the output of the redispatched generator or increasing the production of the curtailed wind power plant (i.e. reversing the action taken by the TSO). Figure 6.1 illustrates this routine.

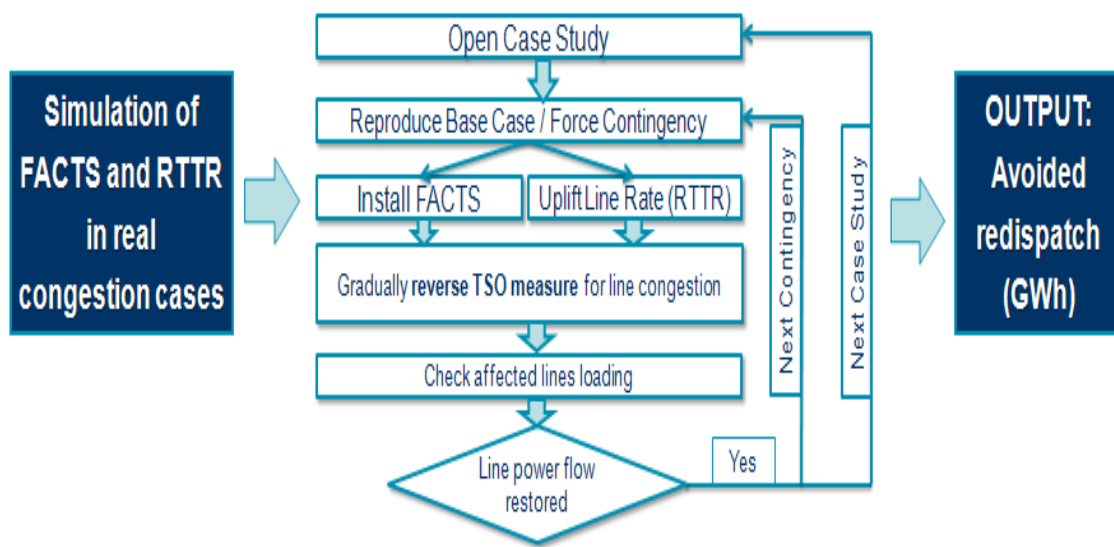

Figure 6.1: Python routine

Settings	X ( $\Omega$ )	Steps
Step 1	2.6	2.6
Step 2	5.5	5.5
Step 3	8.1	2.6 + 5.5
Step 4	10.3	10.3
Step 5	12.9	2.6 + 10.3
Step 6	15.8	5.5 + 10.3
Step 7	18.4	2.6 + 5.5 + 10.3

Table 6.1: FACTS steps

The effect of the FACTS device is simulated by changing the reactance of the line where it is placed (critical line) according to each one of the possible settings presented in Table 6.1. For each study case and each contingency, the results of all FACTS steps are analyzed.

The effect of the RTTR system, i.e. higher transmission capacity ratios due to short-term measurements, is modeled as an increment in the maximum evacuation capacity of the line set by the TSO for each season of the year. Three levels of transmission capacity gain are considered in this study: 10%, 20% and 30%.

### 6.1.3. Computation of the economic benefits of the enhanced network flexibility provided by FACTS and DLR technologies in Spain

- **Avoided conventional generation redispatch**

Under this perspective, the Python routine is performed to compute up to what extent the redispatch measure taken by the TSO could be avoided if a FACTS device or DLR system was installed in a certain line of the network. This analysis is performed separately for each area of study selected by REE as potential locations for the placement of FACTS and DLR devices.

The avoided conventional generation redispatch is computed by the algorithm in four steps:

- i) Starting from the original study case where the redispatch measure was applied by the TSO (i.e. the redispatched generator increased its power output to alleviate the congestion in a certain line of the studied area), the Python routine introduces the FACTS effect or the DLR effect in the critical line, reducing its loading level.
- ii) Once this effect has been taken into account, the algorithm decreases gradually the power output of the redispatched generator, reversing the redispatch action taken by the TSO. The algorithm will stop decreasing the generator's output when: a) the final power flow of the critical line is equal to its initial value, which means that the transmission capacity gain provided by the device is enough to avoid the redispatch action in that hour; b) an overload is detected, implying that the device can avoid only partially the redispatch action; c) the redispatched generator achieves its minimum operational limit, which indicates that the device could avoid more energy from being redispatched than it actually was.
- iii) The algorithm loops through all FACTS steps (Table 6.1) and through all study cases (redispatch hours) of a same area of study. The total redispatch that could have been avoided with the FACTS or the DLR device in that area of study is equal to the sum of the all cases' results.
- iv) The analysis is repeated for a series of specified contingencies (failure of line circuits or transformers) to ensure an N-1 secure state.

The economic benefit of FACTS and DLR devices in the Spanish system is assessed as the savings obtained in terms of redispatch costs and it is computed according to Equation 1:

$$ARC_a = \sum_{h=1}^n Pr_h \cdot (Cr - Cmg) \quad (1),$$

where  $ARC_a$  is the avoided redispatch cost in the area of study  $a$ ;  $h$  defines the study case and  $n$  is the number of study cases for area  $a$ ;  $Pr_h$  is the avoided redispatched power during hour  $h$ ;  $Cr$  is the cost of the redispatched generator; and  $Cmg$  is the day-ahead marginal price.

In order to estimate the cost savings that could be obtained with the installation of FACTS and DLR devices in Spain, the difference between the annual average marginal price resulting from the Spanish day-ahead market and the annual average cost of redispatched energy in Spain for the last six years (2006-2011) was analyzed. Three redispatch cost scenarios were selected: the low average redispatch cost scenario, which corresponds to the lowest price difference in the period 2006-2011 – 17€/MWh; the medium average redispatch cost scenario, which corresponds to the average price difference in the same period – 39 €/MWh; and the high average redispatch cost scenario, which corresponds to the highest price difference – 59 €/MWh in the period 2006-2011.

- **Computation of the additional wind hosting capacity**

Although the level of wind curtailment due to transmission congestions in Spain is still low and, consequently, it does not impose a significant extra cost to the system, an analysis will be performed in order to compute the additional wind power that could be integrated by FACTS and DLR technologies. This study is performed for the tested demonstration.

For this purpose, the Python routine is run to compute the additional wind power that could be injected in the area where the FACTS and DLR devices are actually installed. The study cases selected to carry out this analysis correspond to operation hours during which a topological maneuver was performed by the system operator in order to avoid congestions in the critical line. In order to not overestimate the results, it was considered that the system operator could not perform the maneuver and, therefore, this maneuver was undone in the original study cases, increasing the power flow of the critical line. The additional wind hosting capacity is then computed by the algorithm according to the following steps.

- i) Starting from the original study case where the power flow through the critical line is significantly high, the Python routine introduces the FACTS effect or the DLR effect in the critical line, reducing its loading level.
- ii) Once this effect has been taken into account, the algorithm increases gradually the power output of a fictitious wind generator. This generator is placed in the node where the wind generator with the highest influence on the critical line's flow is located. The algorithm will stop increasing the fictitious generator's output when:
  - a) the final loading level in the critical line reaches the line's capacity
  - b) an overload is detected;
  - c) the fictitious generator achieves its maximum operational limit.If the latter condition is met, the case is eliminated from the cases' sample since it does not represent a critical operation hour.
- iii) The algorithm loops through all FACTS steps (Table 6.1) and study cases.

It is assumed that the resulting additional wind capacity can be integrated into the system by 2020. The economic benefit of the integration of higher levels of wind generation will be assessed in terms of avoided CO<sub>2</sub> emissions costs. In this study, CO<sub>2</sub> emissions costs are computed by a unit commitment model (ROM model).

The ROM model is used as a tool in the economic impact assessment of Demo 6 to compute the annual cost of CO<sub>2</sub> emissions under two scenarios of wind penetration in specific area of the Spanish system. As it was explained in section 2.3.2, this tool is a mid-term unit commitment model that simulates power system operation during one year with daily periods and hourly time steps. In this model, the economic dispatch is decided in two stages: first, the unit commitment problem for each day of the year is solved minimizing system operation



costs; after that, the unit commitment is revised and generators are redispatched depending on unit outages occurred after the unit commitment is decided and on wind forecasting errors.

- **Investment deferral**

One of the reasons for building transmission lines is to reduce network congestions and, consequently, the costs of running out-of-merit generation. However, building new transmission lines generally requires large capital and long construction times, apart from facing strong public opposition due to environmental and health issues, among others [26]. Flexible devices such as FACTS may achieve (at least partially) this objective in a much shorter construction time and, in some cases, with smaller capital investment [27]. In this sense, FACTS devices may defer network investments. The value of the investment deferral depends on the investment required to undertake the network reinforcement and the time by which this investment is deferred. As computing the time during which FACTS and DLR devices could delay the construction of new transmission line is out of the scope of this analysis, a more simplified study is performed.

The benefit of deferring the investment in a new line is calculated as the opportunity cost of investing in this line instead of investing in FACTS or DLR devices and it is computed according Equation 2:

$$Benefit_{ID} = Deferred\_Invest. (1 + r)^n - Deferred\_Invest \quad (2),$$

where  $r$  is the annual interest rate;  $n$  is the number of years during which the investment was deferred; and  $Deferred\_Invest$  is calculated according to Equation 3:

$$Deferred\_Invest = Invest_{Line} - Invest_{Device} \quad (3),$$

where  $Invest_{Line}$  is the annualized investment cost of the new line; and  $Invest_{Device}$  is the annualized investment cost of the device.

- **Estimated device cost**

In order to estimate the net economic benefit of the FACTS and DLR technologies tested in Demo 6, the cost of each device must be subtracted from the benefits they bring to the system. Since there is no public available information on the real costs of the tested devices, these costs were estimated based on the costs of similar technologies. Based on FACTS devices' costs presented in [28], it was considered that the investment cost of the FACTS device tested in Demo 6 is equal to 50 €/kVar.

Regarding the DLR technology, the RTTR system tested by REE consists in based on an optical fiber cable that required its installation in a new line. According to information provided by REE, the extra cost incurred due the installation of the RTTR system (i.e. the difference between the cost of an overhead line equipped with RTTR and the cost of this line without the RTTR system) is estimated in 500,000 € for a 30 km-long 220 kV line. This includes cost of adding optic fiber in the wire and temperature and position sensors to estimate the actual line capacity limit.



Table 6.2 presents the estimated annualized investment cost of each device.

	<b>FACTS</b>	<b>DLR system</b>
Investment cost	50 €/kVar	17,000/km
Specification	84.5 Mvar	30 km line
Total cost	4,225,000 €	500,000 €
Lifetime	20 years	20 years
Interest	8%	8%
Annualized Investment cost	<b>430,325 €</b>	<b>50,926 €</b>

**Table 6.2: Estimated annualized investment of the devices tested in demo 6**

## 6.2. Economic impact assessment of the tested demonstration

This section presents the economic impact assessment for the devices actually installed by REE. The critical line considered in this analysis is the line where the FACTS device is placed, in Spanish autonomous community of Aragon: L-220 kV Magallón-Entrerríos. Since the DLR system was installed in a new line where transmission congestions are not detected so far, the L-220 kV Magallón-Entrerríos is also the critical line considered for the economic impact assessment of the DLR system. Transmission congestions are detected in this line when high wind power flows together with combined cycle generation is transmitted from the West to the East, i.e. from Magallón to Entrerríos. Overloads also occur due to contingencies in the area, especially in the L-400 kV Magallón - Peñaflor which is the alternative path for power flows coming from the West of Magallón. Figure 6.2 presents the area of study of the tested demo, where the nodes of the critical line are identified by blue circles.

In order to avoid transmission congestions during normal and contingency situations in this area the system operator performs a topological maneuver which consists in switching off the connection-breaker of the 220kV Magallón substation (i.e. splitting the 220kV Magallón substation busbars). Under high West-East flows, this maneuver may not be enough to avoid overloads in this line. In this case, conventional generation is redispatched. If it is not possible to redispatch conventional generation to alleviate congestion in this area, wind power is curtailed.

To assess the economic impact in this area of study PSS/E case files corresponding to winter, spring, summer and autumn operation hours during which the topological maneuver in the 220kV Magallón substation was performed to alleviate congestions in the critical line were selected. For the purpose of this analysis, it was assumed that the TSO cannot perform this topological maneuver. Therefore, the original real time cases files were changed to reverse the topological maneuver in the 220 kV Magallón substation (i.e. to join the substation busbars), increasing the power flow of the critical line.



Figure 6.2: Aragon area of study

#### 6.2.1. Avoided conventional generation redispatch

As previously mentioned, the conventional generation redispatch that could be avoided with the installation of the OLC device and the RTTR system tested in Demo 6 was estimated assuming that the TSO cannot perform the topological manoeuvre in the 220 kV Magallón substation. It is considered that the solution for the transmission congestions in the L-220 kV Magallón-Entrerriós is the redispatch of the combined cycle power plants located in the West of the studied area (e.g. Escatrón and Castel Nou). This solution consists in increasing the output of those generators to supply the demand in the West, reducing the power flow of the critical line.

Taking into account these assumptions, Figure 6.3 presents the estimated annual redispatch that could be avoided with the installation of the FACTS device in the 220 kV Magallón-Entrerriós line for each reactance step. According to the results of the Python routine, if the topological maneuver could not be performed by the TSO, the maximum total redispatch that could be avoided with the installation of the FACTS device in the L-220 kV Magallón-Entrerriós would be approximately 24 GWh, which corresponds to 0.24% of the total current electricity demand in Aragon. This value is 90% higher than the redispatch that could be avoided if the only possible reactance setting was Step 1.

Regarding these results is important to emphasize that, even though in this case the highest total avoided redispatch is achieved with Step 7 of the OLC device, the highest reactance step will not always be a feasible solution. This can be explained by the fact that the impedance introduced by the device in the critical line affects the power flow of nearby lines, i.e. depending on the network conditions a higher reactance step introduced in the critical line may provoke an overload in nearby lines, especially under N-1 cases.

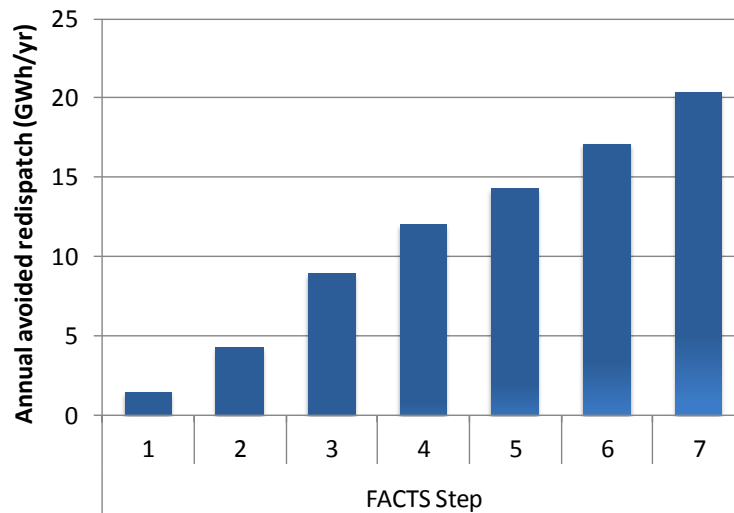

Figure 6.3: Estimated annual avoided conventional generation redispatch in the area of study of Aragon

As described in section 6.1.3, in order to estimate the cost savings that could be achieved with the installation of the FACTS and DLR devices in Spain, three redispatch cost scenarios (i.e. difference between the day-ahead market price and the cost of the redispatched generation) were considered: the low average redispatch cost scenario – 17 €/MWh; the medium average redispatch cost scenario – 39 €/MWh; and the high average redispatch cost scenario – 59 €/MWh. Table 6.3 presents the estimated annual net benefit that could be achieved considering the redispatch that could be avoided under Step 1 and Step 7 of the FACTS device. The net benefit is computed as the different between the annual cost savings that could be obtained with the FACTS device and its annualized investment cost.

Table 6.3: Estimated annual net benefit of avoiding redispatch in the area of study of Aragon

		Low average redispatch cost <b>17 €/MWh</b>	Medium average redispatch cost <b>39 €/MWh</b>	High average redispatch cost <b>59 €/MWh</b>
FACTS	Step 1	-214 k€	66 k€	320 k€
	Step 7	-15 k€	523 k€	1012 k€

According to the results, if the low average redispatch cost is realized the annual cost savings in terms of avoided redispatch cost that could be achieved with the installation of the device in the L-220 kV Magallón-Entrerríos would be lower than the annualized investment cost of the device. However if the medium or the high average redispatch cost scenario is considered, the annual cost savings that could be obtained with the device would be enough to compensate the estimated annualized investment cost.

### 6.2.2. Additional wind hosting capacity

In order to estimate the additional wind power that could be injected in the 220 kV Magallón bus due to the installation of the FACTS device, the Python routine was performed to gradually increase the power output of a fictitious wind generator placed in the 220 kV Magallón bus until the power flow of the critical line (L-220 kV Magallón-Entrerríos) reaches the line's maximum capacity for all selected study cases. Figure 6.4 presents the minimum, average and maximum additional wind power that could be injected in the 220kV Magallón bus for each setting of the FACTS device compared to the case in which the device is not installed.

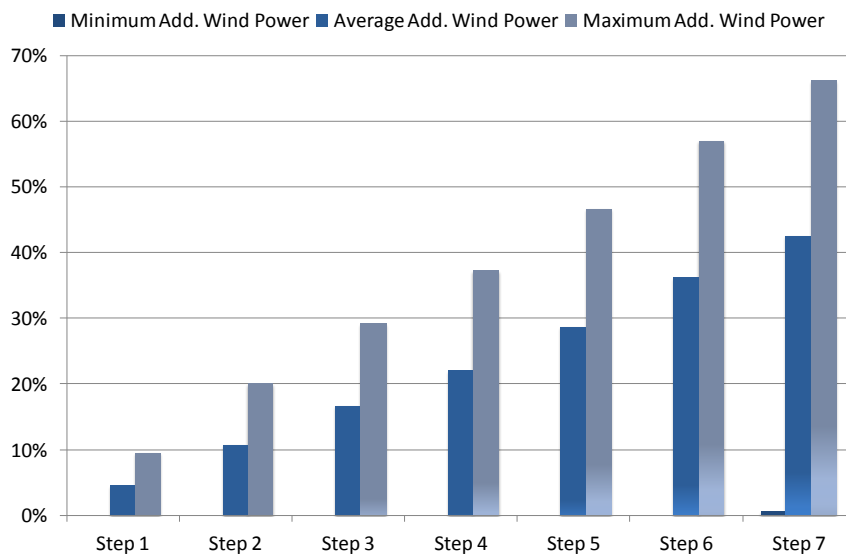

**Figure 6.4: Estimated additional wind hosting capacity in the area of study of Aragon**

Depending on the local network conditions, the additional wind power that could be evacuated during a specific hour due to the installation of the device varies from 1% to more than 65% in comparison to the situation in which the device is not installed. The average additional wind power integrated by the device could be 40% higher compared to the base case. These results can be considered a conservative estimation of the additional that could be integrated in the area since the fictitious generator was placed in the bus with the highest influence on the power flow of the critical line.

As explained in section 6.1.3, the economic benefit of integrating more wind generation is assessed in this analysis in terms of avoided CO<sub>2</sub> emissions cost. It is worth mentioning that it was not considered in this analysis that the additional wind generation that could be integrated by the technologies tested in Demo 6 could affect market prices (thus reducing total system costs) since the impact of the device is concentrated in a specific area of the network.

To compute the avoided CO<sub>2</sub> emissions cost the ROM unit commitment model was run for four scenarios of wind generation in Aragon: the base case scenario, the low additional wind scenario, the average additional wind scenario and the high additional wind scenario. In the base case scenario the hourly series of wind generation was estimated based on the current Spanish hourly wind generation series taking into account the wind power installed in Aragon. In each additional wind scenario, the hourly wind generation series was modified to increase the wind output during the hours corresponding to the study cases (i.e. hours with

transmission constraints) by the increment that could be achieved with the device (i.e. 1%, 40% and 65%, respectively).

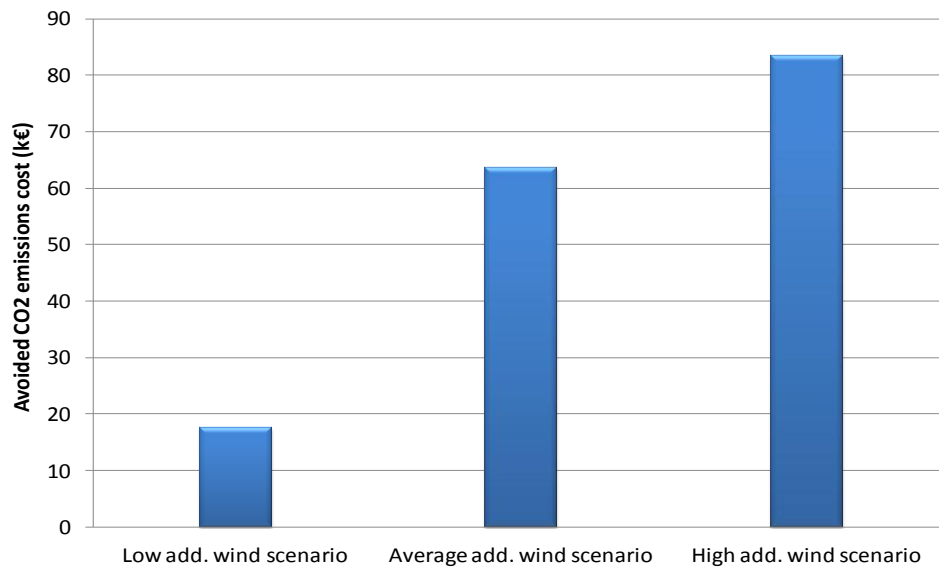

**Figure 6.5: Annual avoided CO2 emissions cost in the area of study of Aragón**

Figure 6.5 presents the annual savings in terms of CO2 emissions cost that could be obtained with the installation of the FACTS device in the low additional wind scenario, the average additional wind scenario, and the high additional wind scenario. It was considered that in 2020 the price of the CO2 emissions will be approximately 25€/ton of CO2. The CO2 emissions cost savings in each scenario of additional wind generation was computed subtracting the CO2 emission cost obtained in the base case from the cost results obtained in each of those scenarios. According to the results, the annual CO2 emissions cost savings that could be achieved with the integration of additional wind generation in the area where the FACTS device is installed varies between 0.12% and 1.5% of the total CO2 emissions cost estimated for Aragón.

### 6.2.3. Investment deferral

As explained in section 6.1.3, the economic benefit of deferring the construction of a new line depends on the investment required to undertake the network reinforcement and the time by which this investment is deferred. As computing the time during which FACTS and DLR devices could delay the construction of new transmission line is out of the scope of this analysis, a more simplified study is performed.

The construction of the new line L-220 kV Jalón-Los Vientos alleviates most of the transmission congestions in the critical line L-220 kV Magallón-Entrerríos since part of the area's West-East flows is evacuated through the new line. In order to assess the potential benefit of deferring this investment the estimated cost of this line is compared to the estimated cost of the FACTS device and the DLR system. Table 6.4 presents the estimated annualized investment cost of the three alternative investment options (i.e. FACTS device, DLR system and new line) as well

as the benefit in terms of investment deferral calculated according to Equation 1 of Section 6.2.3.3. As it can be seen in the table, the economic benefit of deferring the construction of a new line can vary considerably depending on the time during which the investment is deferred.

**Table 6.4: Estimated net benefit of deferring network investments in the area of study of Aragon**

	<b>DLR</b>	<b>FACTS</b>	<b>New line</b>
Investment cost	17,000 €/km	50 €/kVar	468,960 €/km
Specifications	26 km of line	84.5 Mvar	26 km of line
Total cost	500,000 €	4,225,000 €	12,192,960 €
Lifetime	20 years	20 years	40 years
Interest rate	8%	8%	8%
Annualized Investment cost	51,000 €	430,325 €	1,022,504 €
Benefit n = 1 year	<b>77,720 €</b>	<b>47,374 €</b>	
Benefit n = 5 years	<b>455,954 €</b>	<b>277,926 €</b>	

### 6.3. Scaling-up the economic impact assessment to other areas within the Spanish transmission system

Since the impact of the technologies tested in Demo 6 is local and depends greatly on the characteristics of the network, generation and demand in a certain area, to scale-up the results of Demo 6 to the Spanish system, other areas within the Spanish network were selected as potential locations for the installation of FACTS and DLR devices. Two types of areas were selected: i) areas where transmission congestions are highly influenced by wind power and where, in some cases, wind power is curtailed; ii) areas where congestions arise due to local transmission constraints. In order to identify areas where the devices tested in Demo 6 could facilitate the integration of wind generation, the 2012-2020 Spanish TSO network expansion plan was consulted [30]. In this plan, network reinforcements required to integrate of renewable generation (mostly wind) are identified.

It was also taken into account in the selection of those areas whether the devices tested in Demo 6 could be an economic solution for at least part of the transmission congestions occurred in those locations. This means that areas where transmission congestions could be relieved by a more economic solution were not included in the analysis. Table 6.5 presents the results of the selection of potential locations for the placement of FACTS and DLR devices within the Spanish transmission network. In the table it is shown the line where the device would be placed (critical line), the Spanish Autonomous Community where the area of study is located, and the main cause of transmission congestions.

Transmission congestions in the areas of study 1 and 2 are greatly influenced by high wind power flows due to the significant wind penetration in the nearby area. This means that avoiding transmission congestions in those areas contributes to a higher integration of wind power. Transmission congestions in the areas of study 3 and 4 are detected due to local transmission constraints. Nevertheless, since wind power installations are growing in the



South of Spain, avoiding transmission congestions in area of study 3 could prevent future wind curtailment in the nearby area.

**Table 6.5: Potential locations for the placement of FACTS and DLR devices**

Area of study	Critical line	Autonomous Community	Congestion cause
1	L-220 kV Itxaso - Orcoyen	Basque Country (North)	Influenced by wind power
2	L-220 kV Mequinenza -Torres del Segre	Catalonia (East)	Influenced by wind power
3	L-220 kV Aljarafe - Santiponce	Andalusia (South)	Local constraints
4	L-220 kV Arganda – Valdemoro	Madrid (Center)	Local constraints

### 6.3.1. Results of the economic assessment for the selected areas of study

In order to compute the avoided redispatch that could be obtained with the installation of FACTS devices in other areas within the Spanish network, the following sensitivity analyses were calculated for the selected study cases of each area of study:

- i) Sensitivity of the critical line power flow with respect to the impedance introduced in that line by each setting of the FACTS device.
- ii) Sensitivity of the critical line power flow with respect to the redispatched generator output. The generators with the highest influence on the power flow of the line were chosen as the redispatched generators. This can be considered a conservative assumption since the actually redispatched generators can be located farther from the congested area than the ones considered in this study.

For the DLR system, the three levels of capacity gain were used to compute the potential avoided redispatch with the installation of this technology: 10%, 20% and 30%. In this analysis also the generators with highest influence on the critical line flow were considered to be the redispatched generators.

- **Areas with transmission congestions influenced by wind generation**

#### **1) Basque Country (North)**

This area of study was selected as a potential location for the installation of FACTS and DLR technologies since transmission congestions in some lines within this area requires that the TSO redispatches conventional generation in order to avoid overloads. The critical line selected for this area of study is the L-220 kV Itxaso-Orcoyen, represented in Figure 6.6 by the blue circles. In these lines overloads are detected when high active power flows coming from the East (Orcoyen) are transmitted to the West (Itxaso) to feed the demand in the North of the studied area. The power flow of this line is greatly influenced by the wind power generated in the nearby area and in some cases wind curtailment is required to avoid overloads. According to operation procedures, a topological manoeuvre is performed in Itxaso substation (i.e. the substation busbar is split) to avoid overloads in lines of the analyzed area. If this topological manoeuvre is not enough to alleviate transmission congestion in this area, conventional generation is redispatched. For the purpose of this analysis, it is considered that the combined





the real thermal rate of the line, usually higher than the seasonal one. Therefore, a more reasonable capacity gain to be considered is 10%. If it is assumed that 10% additional capacity is available at every hour under consideration, the annual avoided redispatch would reach 15 GWh.

In this respect it is worth mentioning that the FACTS device reduces not only the flow of the critical line but also the flow of the lines in the downstream segment of a certain corridor, while the DLR system measurements may be valid only for the line where it is installed. On the other hand, in areas of the network where there are no alternative paths or where alternative lines are highly loaded the installation of the FACTS device tested in Demo 6 would not be a feasible solution to the transmission congestions detected in those areas. In this case, among these two alternatives, the DLR system should be chosen solution provided that the capacity gain of 10% would be guaranteed in the studied hours.

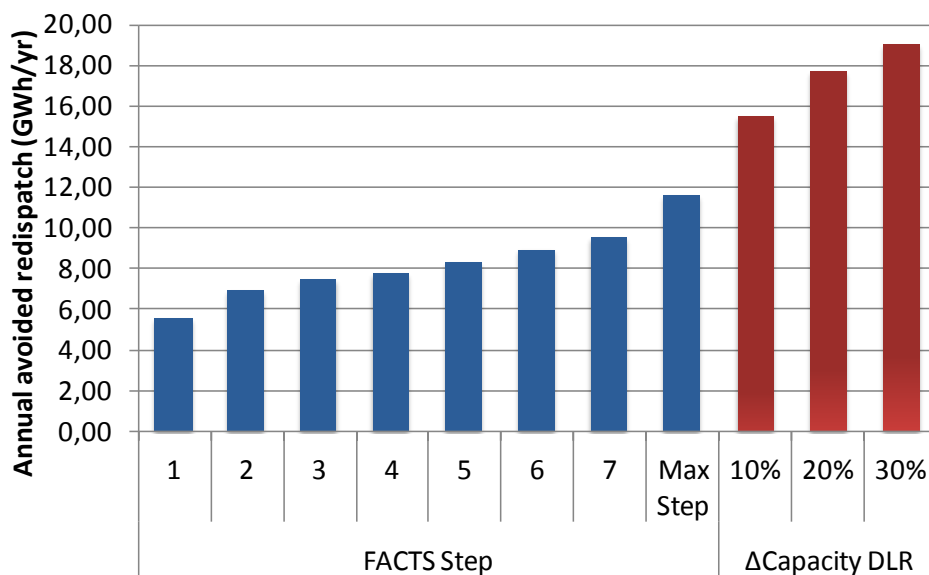

Figure 6.7: Estimated annual avoided redispatch in the Basque Country area of study

Table 6.6 presents the potential annual net benefits that could be obtained with the installation of the FACTS device and the DLR system in the L-220 kV Itxaso-Orcoyen. The annual net benefit is computed as the different between the annual cost savings that could be obtained with the FACTS device and the DLR system and the annualized investment cost of the respective technology.

According to the estimated results, the FACTS device could bring net benefits in the medium and the high redispatch cost scenarios, while the annual economic benefits that would be in the low redispatch cost scenario would not compensate the annualized cost of this device. In the high redispatch cost scenario, the estimated net benefit provided by the FACTS device would correspond to approximately 50% of the estimated annualized investment cost of the device. The potential annual savings that could be obtained in the Basque Country area of study with the DLR system would surpass the annualized investment costs even in the most

reasonable scenario (i.e. 10% capacity gain). Note that the costs of DLR technology are assumed to be proportional to the length of the line for every case analyzed here.

**Table 6.6: Estimated annual net benefit of avoiding redispatch in the Basque Country area of study**

		Low average redispatch cost <b>17 €/MWh</b>	Medium average redispatch cost <b>39 €/MWh</b>	High average redispatch cost <b>59 €/MWh</b>
FACTS	Max Step	-234	21	252
DLR	$\Delta$ Rate 10%	154	495	805

## 2) Catalonia (East)

This area of study was selected as a potential location for the installation of FACTS and DLR technologies since transmission congestions in some lines of the area are detected, requiring the redispatch of conventional generation in order to avoid overloads. The critical line selected for this area of study is the L-220 kV Mequinenza-Torres del Segre. In this line, overloads occur when high power flows are transmitted from the West (Mequineza) to the East (Torres del Segre) to supply the demand in located in the East. These power flows are influenced by the wind generation installed in Aragon (West) and, in some cases, wind curtailment is required in order to avoid overloads. To perform the economic assessment of this area of study, it was assumed that the generators that are redispatched to solve congestions in the critical line are the combined cycle power plants located in the West (Tarragona and Plana del Vent). By increasing the output of those power plants part of the demand in West is supplied by these generators, reducing the flow of the critical line. In Figure 6.8 the critical line is identified.

Figure 6.9 presents the potential annual avoided redispatch in the Catalonia area of study that could be achieved with the installation of the FACTS device and the DLR system in the L-220 kV Mequinenza-Torres del Segre. According to the results, when the most favorable reactance setting is considered the estimated annual avoided redispatch is around 150 GWh, and at least beyond 29 GWh. The maximum potential savings that could be achieved with the installation of the FACTS device would correspond to approximately 43% of the total estimated redispatch in this area.

According to the results for this area of study, the potential savings that could be achieved in terms of redispatched energy with the DLR system are higher than the maximum savings that could be achieved with the FACTS device. As well as for the Basque Country area of study, this can be explained by the fact that the potential savings that could be achieved with the FACTS device are limited due to congestion in parallel lines where the flows are redirected to. It can also be appreciated that the impact of increasing the capacity of the line 10% or 30% is practically the same. This is due to the fact that other lines within the same corridor may be congested.



Figure 6.8: Catalonia area of study

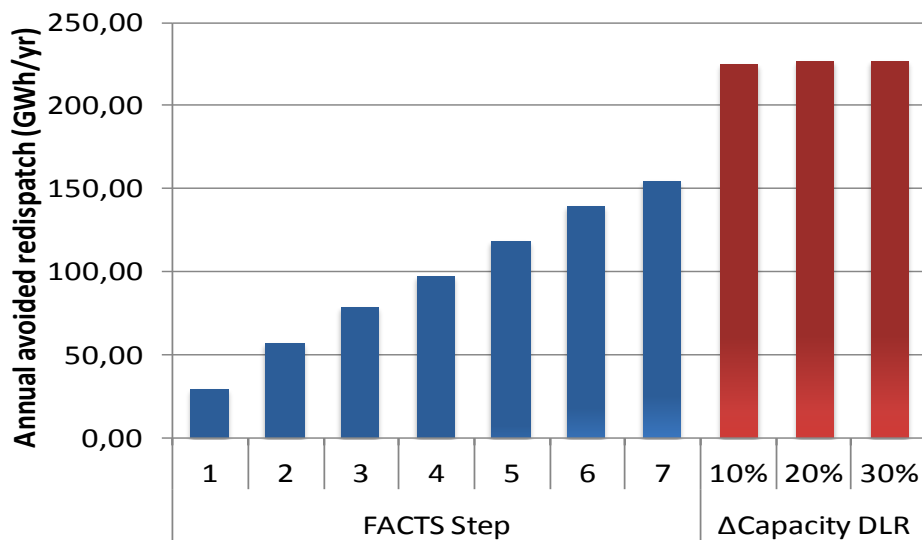

Figure 6.9: Estimated annual avoided redispatch in the Catalonia area of study

Table 6.7 presents the annual net benefit (i.e. cost savings subtracted from the respective device cost) that could be achieved with the installation of the FACTS device and the DLR system in the Catalonia area of study. According to the results obtained in this analysis, even considering the low average redispatch cost scenario and the minimum avoided redispatch that could be achieved with the FACTS device or the DLR system, the potential annual cost savings in this area of study would be enough to compensate the annualized investment cost

of the respective device. Under all redispatch cost scenarios considered, the annual cost savings would be enough to pay for the full investment of each device considered.

**Table 6.7: Estimated annual net benefit of avoiding redispatch in the Catalonia area of study**

		Low average redispatch cost <b>17 €/MWh</b>	Medium average redispatch cost <b>39 €/MWh</b>	High average redispatch cost <b>59 €/MWh</b>
FACTS	Max Step	2,191	5,584	8,668
DLR	ΔRate 10%	3,765	8,713	13,211

- Areas with transmission congestions due to local network constraints

### 1) Andalusia (South)

This area of study was selected as a potential location for the installation of FACTS and DLR technologies since local transmission constraints require the redispatch of conventional generation and can limit future wind generation evacuation in the South of Spain. The critical line selected for this area of study is the L-220 kV Aljarafe-Santiponce, shown in Figure 6.10. In this line, overloads occur when high power flows are transmitted from the North (Santiponce) to the South (Aljarafe) to supply the demand located in the South. For the purpose of this analysis, it was assumed the combined cycle power plants located in the South of Andalusia (e.g. Campo de Gibraltar and San Roque) are redispatched to supply the demand located in the area, reducing the power flow of the congested line.

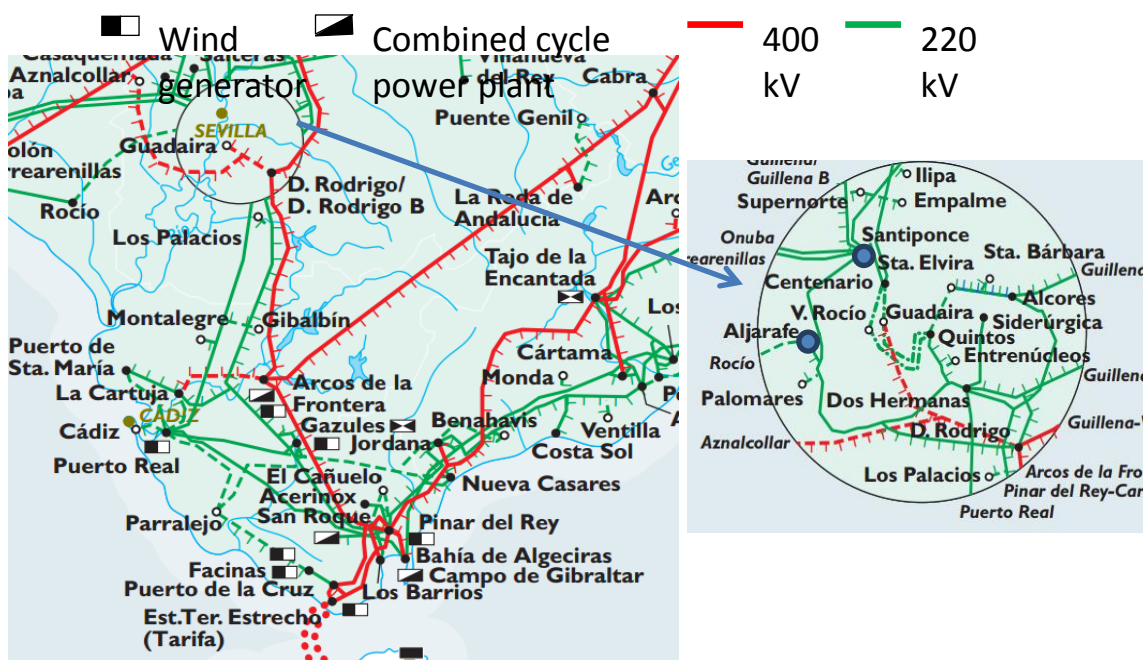

Figure 6.10: Andalusia area of study

Figure 6.11 shows the potential annual avoided redispatch in the Andalusia area of study that could be obtained with the installation of the FACTS device and the DLR system in the L-220 kV Aljarafe - Santiponce. According to the results, the maximum redispatch that could be avoided with the installation of the FACTS would be similar to the potential savings that could be achieved the 10% capacity gain estimated for the DLR system. This demonstrates that in this area of study lines nearby the critical line are less congested to the previous studied areas. In fact, this estimated avoided redispatch (around 140 GWh/year) would correspond to approximately 68% of the total estimated redispatch for this area of study. In spite of this, The pattern followed by the maximum avoided redispatch as the reactance step is increased presents a saturation effect due to the limits imposed by nearby constraints inasmuch as power flows are redirected from the critical line to adjacent ones.

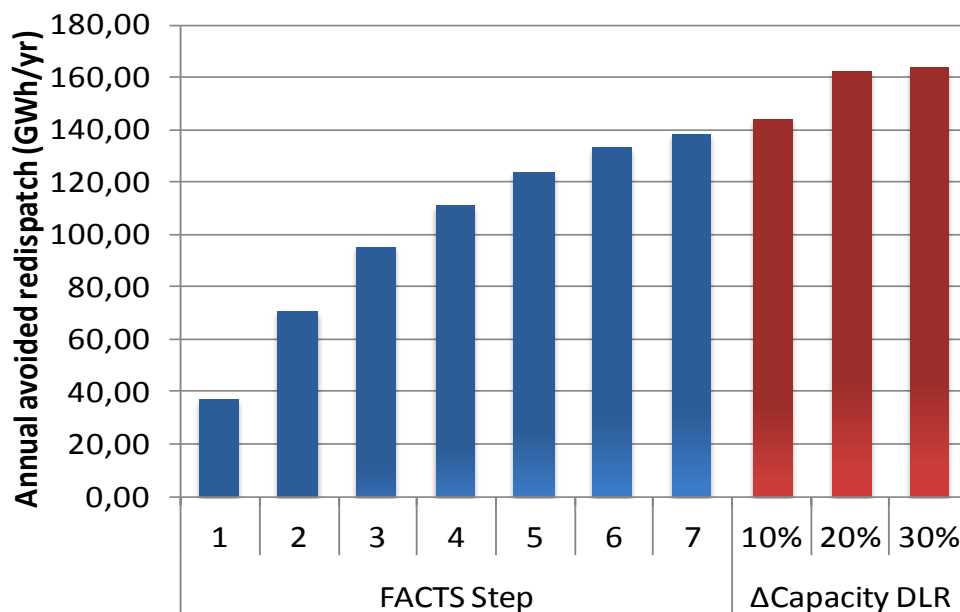

Figure 6.11: Estimated annual avoided redispatch in the Andalusia area of study

Table 6.8 shows the estimated annual net benefit that could be achieved with the installation of the devices tested in Demo 6 in the area of study of Andalusia. In this area of study the cost savings that could be achieved with FACTS and DLR devices are significant even if the most conservative scenarios, i.e. considering the scenarios with the lowest level of avoided redispatch and the lowest average redispatch cost. For instance, the avoided redispatch cost that could be obtained considering the first step of the FACTS device or the lowest DLR capacity gain would compensate the full estimated investment costs of the respective devices. Similarly to what happens to the Catalanian area, under a wide range of redispatch costs, the annual cost savings easily repay for the full investment of the devices.

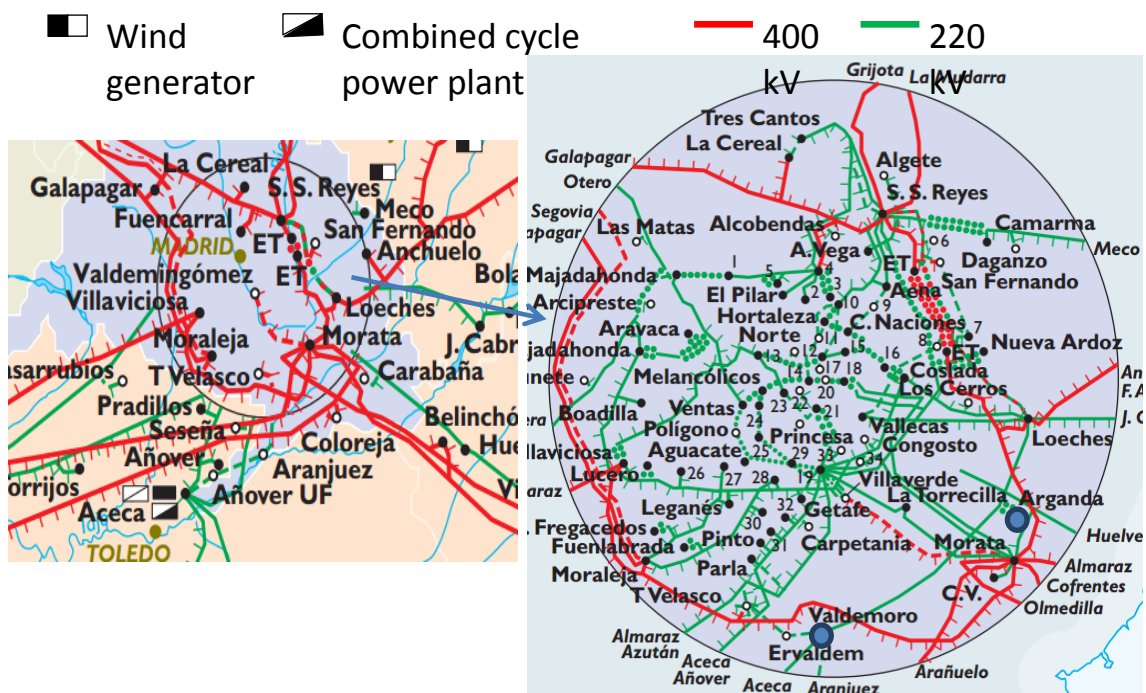

**Table 6.8: Estimated annual net benefit of avoiding redispatch in the Andalusia area of study**

		Low average redispatch cost <b>17 €/MWh</b>	Medium average redispatch cost <b>39 €/MWh</b>	High average redispatch cost <b>59 €/MWh</b>
FACTS	Max Step	1,923	4,969	7,738
DLR	ΔRate 10%	2,427	5,597	8,479

## 2) Madrid (Center)

This area of study was selected as a potential location for the installation of FACTS and DLR technologies due to the local transmission constraints in the network of the Spanish autonomous community of Madrid, which requires the redispatch of conventional generation to relieve transmission congestions in that area. The critical line selected for this area of study is the L-220 kV Arganda-Valdemoro. In this line, overloads occur when high power flows are transmitted from the North (Arganda) to the South (Valdemoro) to supply the demand located in the South. To alleviate transmission congestions in this area it was assumed that the combined cycle power plants located in the South (Aceca) are redispatched to supply the demand of the zone, reducing the flow of the critical line. Figure 6.12 shows the transmission network in the area of study of Madrid.



**Figure 6.12: Madrid area of study**

Figure 6.13 presents the potential annual avoided redispatch that could be achieved in the area of study of Madrid if the FACTS device and the DLR system were installed in the L-220 kV

Arganda-Valdemoro. In this area of study the estimated avoided redispatch with the installation of the FACTS device could vary between 43 GWh and 258 GWh per year. The maximum potential avoided redispatch corresponds to approximately 1% of the total current electricity demand in Madrid and to 40% of the total estimated redispatched energy in this area of study. If the most reasonable DLR capacity gain considered (10%) is realized, the potential avoided redispatch would be very similar to the avoided redispatch that could be obtained with the highest step of the FACTS device.

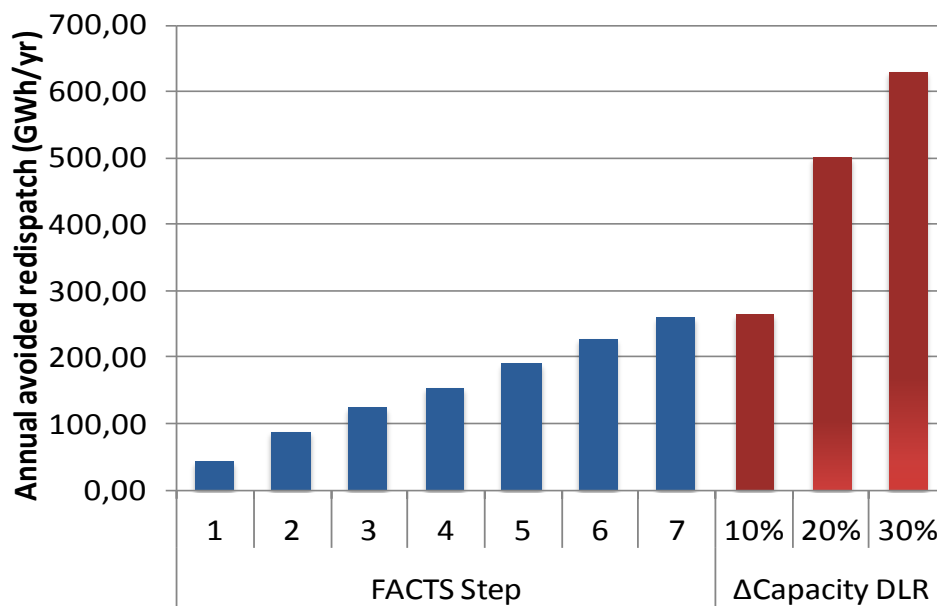

Figure 6.13: Estimated annual avoided redispatch in the Madrid area of study

Table 6.9 presents the estimated annual net benefit that could be obtained with the installation of the FACTS device and the DLR system in the area of study of Madrid. The installation of these devices in the area of study of Madrid could bring significant redispatch cost savings with a similar order of magnitude to those that could be obtained in the Eastern (Catalonia) and Southern (Andalusia) areas. Both in terms of energy and costs, the annual net benefit of using DLR or FACTS bear a great resemblance in the considered conditions, as shown in Table 6.9. The minimum cost savings that could be achieved either by the FACTS device or the DLR system would be enough to compensate the annualized investment cost of each device. In the most favorable scenario of avoided redispatch, even considering low average redispatch cost scenario, the potential cost savings obtained could compensate the full investment cost of the devices.

**Table 6.9: Estimated annual net benefit of avoiding redispatch in the Madrid area of study**

		Low average redispatch cost <b>17 €/MWh</b>	Medium average redispatch cost <b>39 €/MWh</b>	High average redispatch cost <b>59 €/MWh</b>
FACTS	Max Step	3,969	9,661	14,837
DLR	Δ Rate 10%	4,452	10,277	15,573
DLR	10%	2,335 k€	5,423 k€	8,230 k€
	30%	7,190 k€	16,560 k€	25,078 k€

#### 6.4. Conclusions

In the context of growing penetration of renewable generation in Europe and the consequent need to expand the transmission network, the Twenties project aims at demonstrating through real live demonstration projects the impact and the benefits of several alternative technologies that can improve the European transmission network and facilitate the integration of renewable generation. In Demo 6 a FACTS device and a DLR system were installed to increase transmission capacity without reinforcing the network. The objective of this chapter was to present the methodology and the results of the economic impact assessment of the installation of FACTS and DLR devices in the Spanish transmission network.

Since the impact of these technologies is localized in the area where they are installed and depends greatly on the characteristics of the network, load and generation patterns of the area, the approach followed to perform the economic impact assessment consisted in selecting different areas of the Spanish network that could be improved with the installation of the devices tested in Demo 6. In order to take into account the real network a deep analysis of real load and generation characteristics of each selected area of study has been carried out. In addition, an algorithm was developed to automate the tool used by the Spanish system operator to perform power flow analyses. This algorithm was developed to comply with transmission security criteria and operation procedures. The adopted methodology allowed a better understanding of the effect of the tested technologies in the network nearby the line where they are installed.

This methodology was applied to estimate the economic impact of the FACTS device and the DLR system in the area where they were actually installed by REE under three perspectives: avoided conventional generation redispatch, additional wind hosting capacity and investment deferral. The results of these analyses demonstrated that the FACTS and the DLR devices can effectively bring net economic benefits in terms of redispatch cost or investment deferral, apart from integrating more wind generation and, consequently, contributing to the achievement of the 2020 renewable targets.

The results obtained from the up-scaling study confirmed that the impact of FACTS and DLR devices can vary greatly from one area to another. In general it was observed that in some areas of the Spanish network those devices can bring significant benefits in terms of redispatch. In this respect, the areas where the highest economic benefits could be achieved do not always correspond to the most congested area. This can be explained by the fact that in some areas the transmission capacity gain provided by the tested technologies is limited due to a higher level of transmission constraints when compared to other areas. For those areas,



FACTS and DLR technologies can be a short-term solution for transmission congestions (i.e. until the network is reinforced). In less congested areas, FACTS and DLR solutions could be a longer term solution and economic alternative to the reinforcement of the network, especially taking into account the long construction times required to build a new line and the strong public opposition which can delay significantly the realization of these projects.

Table 6.10 and Figure 6.14 sum up the results of the economic impact assessment of FACTS and DLR devices in Spain. The average annual redispatch cost savings were computed based on the average redispatch cost of 39 €/MWh and the average annual net benefit was calculated as the difference between the annual cost savings and the annualized investment cost of each device. According to these results, the installation of the FACTS device in each one of the studied areas could avoid the redispatch of more than 550 GWh per year, which represents 4.5% of the total energy that is currently redispatched in Spain. For the DLR system, the potential avoided redispatch would be approximately 650 GWh, which corresponds to 5.2% of the energy redispatched in Spain, as can be seen in Figure 6.14.

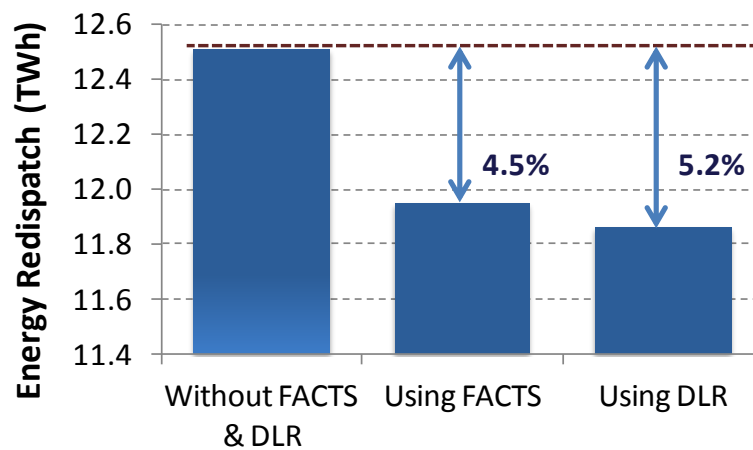

Figure 6.14: Estimated annual redispatch savings in Spain using either FACTS or DLR technologies

The total estimated cost savings that would result from avoiding the redispatch of conventional generation amounts to almost 20 M€ with the installation of FACTS devices and 25 M€ if DLR systems are used. These values correspond to 3.7% and 4.5% respectively, of the total redispatch cost in Spain.

Although the results obtained for the different areas of study were estimated based on recent past data, it can be considered they are valid for next future (up to 2020) since it is expected that the Spanish electricity demand will not change significantly within the next years, and also few network reinforcements will be built in the studied areas. Regarding the integration of wind generation, it was observed that by avoiding the redispatch of conventional generation in areas within Spain with high wind penetration the use of FACTS and DLR devices will contribute to avoid wind curtailment. In areas where wind generation is growing those devices will facilitate future wind evacuation and avoid wind curtailment.

**Table 6.10: Economic impact assessment of FACTS and DLR devices in other areas of Spain**

		Total	North	East	Center	South
Avoided redispatch (GWh/year)	FACTS	<b>563</b>	12	154	259	138
	DLR	<b>649</b>	15	225	265	144
Redispatch cost savings (k€/year)	FACTS	<b>21 957</b>	451	6 014	10 092	5 400
	DLR	<b>25 322</b>	604	8 771	10 327	5 620
Net benefit (k€/year)	FACTS	<b>20 235</b>	21	5 584	9 661	4 969
	DLR	<b>25 082</b>	495	8 713	10 277	5 597

Comparing the impact of the FACTS device tested in Demo 6 and the DLR system in the figures, in general it was observed that the latter avoid higher amounts of energy from being redispatched. However, this would only occur if the TSO can rely on a 10% capacity gain due to DLR with certainty on every redispatch hour. Furthermore, while the FACTS device could contribute to avoid the use preventive measures to manage transmission congestions, the RTTR system would mainly avoid the use of corrective measures for transmission congestions. On the other hand, it is relevant to point out that depending on the network configuration the FACTS device tested in Demo 6 is not a technically feasible solution (e.g. when there are no alternative paths to where the power flows could be redirected to or when the alternative lines are already highly loaded). In this case, the best solution among the two options would be the DLR system.

Regarding the tested FACTS device it was observed that the different reactance steps can be very useful in highly congested areas, especially under N-1 contingencies. Depending on the network state the highest impedance introduced in the line will be the best solution while in other cases a lower reactance step will have to be used in order to avoid overloads in nearby lines. Therefore, from an economic impact perspective, and as a result of the scenarios analyzed, few steps are justified (e.g. two or three), although from a technical point of view more steps may be required.

## 7. Annex 1: The ROM MODEL

The ROM model consists of a crucial tool in WP15 in TWENTIES. The ROM model has been developed at the Instituto de Investigación Tecnológica (IIT), Universidad Pontificia Comillas, and has already been used in the European projects MERGE (Mobile Energy Resources in Grids of Electricity) and SUSPLAN (Planning for Sustainability), as well as in the Spanish one CENIT-VERDE. This document is based on the ROM model description presented for the MERGE project [31].

### 7.1. Introduction to the ROM model.

The main challenges for facilitating the widespread integration of intermittent generation into the electricity system can be summarized as follows:

- Medium and long-term planning: reliability assessment.
  - Will there be enough generation to meet peak loads?
  - Need of complementary units.
- Short-term operation planning: unit commitment.
  - Strong **variability** of WG over the day. Opposite behavior with respect to the demand in certain periods.
  - Ramps, minimum load, startups and shutdowns.
  - Need of flexible units.
- Real time:
  - Limited predictability or **uncertainty**: errors increasing with forecasting horizon.
  - Critical time horizons are 24 or 36 hours in advance for D-1 reserve evaluation and 6 hours for real-time unit commitment.
  - Rapid dynamic adjustments to fix WG forecasting errors. Balancing mechanisms, operating reserves. Need of quick-start units.

In TWENTIES, the ROM tool is used in order to deal with the short-term and real time operation planning. Next there is a list of the main characteristics of the model:

- A daily stochastic optimization model [32] followed by a sequential hourly simulation [33]. This replicates the sequence of the markets and the decisions, reproducing the hierarchy and the chronology of the decision levels and allows representing that uncertainty is revealed over time (forecasting techniques become more accurate when the interest hour approaches). Detailed operation constraints such as minimum load, ramp-rate, minimum up-time and downtime of thermal units and power reserve provision are included into the daily stochastic unit commitment model. The hourly simulation is run for the same day to account for IG production errors and unit failure and therefore revising the previous schedule. This system modeling in two phases reproduces the usual decision mechanism of the system operator.
- A chronological approach to sequentially evaluate every day of a year. Decisions above this scope as the weekly scheduling of pumped storage hydro plants are done internally in the

model by heuristic criteria. Yearly hydro scheduling of storage hydro plants is done by higher hierarchy models, as for example, a hydrothermal coordination model.

- The model scheme based on a daily sequence of planning and simulation is similar to an open-loop feedback control used in control theory.

The scope of the model is one year, divided in periods of one day and sub-periods of one hour:

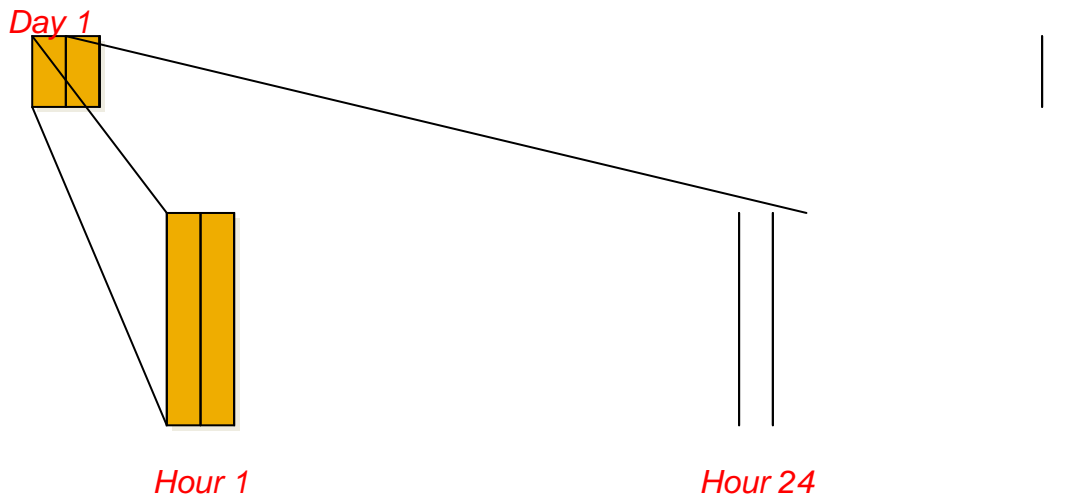

Figure 7.1: Time division in the ROM model

Results include generation output, including IG surplus, pumped storage and storage hydro usage, and adequacy reliability measures. The benefits of improving IG predictions can also be determined by changing forecasting error distributions and re-running the model.

## 7.2. Description of the ROM model.

A daily operation model is repeated the 365 days of the year and is composed of two stages:

- The first stage consists of a deterministic optimization of operation decisions: daily unit commitment and economic dispatch. A stochastic approach is not considered due to the complexity of its implementation in the Spanish system.
- The second stage deals with a simulation of the unknown events: hourly simulation of unit failures, adapting and correcting previous decisions to real WG (forecasting error) and deployment of corrective actions used in a predefined sequence (increase hydro production, use operating reserve, etc.).

This section has the description of the two fundamental parts (optimization and simulation) of the model.

## 7.3. Formulation of the day-ahead Market Operation

In this section, the optimization model that is responsible for determining the initial daily program for the generators production is going to be described. This model calculates the daily economic dispatch, considering the demand and wind power generation forecasted one day in advance. Subsequently, these estimates may be altered by changes in the values of the random variables (electricity demand, intermittent generation, availability of the generators,

etc.) that are taken into account by a simulation model that will be described in the next section. Actually, the formulation of the ROM model is more complex than the one presented here, since the number of variables and constraints is higher. Nevertheless, it must be pointed out that this annex aims to summarise the model and serve as a schematic description of it.

The tables below show the main elements of the model: indexes, parameters and variables.

Name	Meaning
$p$	Periods (hours)
$g$	Generators
$w$	Wind farms
$t$	Thermal units ( $\{t\} \subset \{g\}$ )
$h$	Hydro plants (reservoirs) ( $\{h\} \subset \{g\}$ )
$b$	Pumped storage hydro plants (reservoirs) ( $\{b\} \subset \{h\}$ )
$i$	Concentrated solar power (CSP) plants ( $\{i\} \subset \{g\}$ )

Table 7.1: Sets of the ROM model

Name	Meaning	Unit
$D_p$	Demand for period $p$	MW
$WF_p^w$	Forecasted wind power of wind farm $w$ for period $p$	MW
$RES_p$	Output of other renewable energy sources for period $p$	MW
$UR_p^{case A}$	Upward reserve requirements for case A in period $p$	MW
$DR_p$	Downward reserve requirements in period $p$	MW
$\overline{GP}_p^g$	Maximum output of generator $g$ in period $p$	MW
$RU^t, RD^t$	Ramp-up and ramp-down of thermal unit $t$	MW/h
$\overline{GC}_p^h$	Maximum consumption of pumped storage hydro plant $h \in b$ in period $p$	MW
$I_p^h$	Inflows in reservoir $h$ for period $p$	MWh
$In_p^i$	Irradiation in CSP plant $i$ for period $p$	MWh
$IRC^i, IRD^i$	Charging and discharging ramp of storage of CSP plant $i$	MWh/h
$URC, DRC$	Upward and downward reserve deficiency cost	€/MWh
$NSEC$	Non-supplied energy cost	€/MWh
$FC^t$	Fixed cost of thermal unit $t$	€/h
$VC^g$	Variable cost of thermal unit $g$ including fuel cost and O&M	€/MWh
$SC^t$	Start-up cost of thermal unit $t$	€

Table 7.2: Parameters of the ROM model

Name	Meaning	Unit
$opcost$	Total system operation cost	€
$nse_p$	Non-supplied energy in period $p$	MW
$urdef_p, drdef_p$	Upward and downward reserve deficiency in period $p$	MW
$st_p^t, sh_p^t$	Start-up and shut-down of thermal unit $t$ in period $p$	[0,1]
$c_p^t$	Commitment of thermal unit $t$ in period $p$	[0,1]
$ih_p^h$	Indicator of pumping or generation of hydro plant $h$ in period $p$	[0, 1]
$gp_p^g$	Output of generator $g$ in period $p$	MW
$gc_p^h$	Consumption of pumped storage hydro plant $h \in b$ in period $p$	MW
$r_p^h, s_p^h$	Reservoir level and spillage of hydro reservoir $h$ in period $p$	MWh
$gur_p^g, gdr_p^g$	Upward and downward power reserve of generator $g \notin b$ in period $p$	MW
$pur_p^h, pdr_p^h$	Upward and downward power reserve of pumped storage hydro plant $h \in b$ in period $p$	MW
$gwind_p^w$	Generation of wind farm $w$ for period $p$	MW
$wur_p^w, wdr_p^w$	Upward and downward power reserve of wind farm $w$ for period $p$	MW
$conswur_p^w$	Up reserve consumed due to the wind generation of wind farm $w$ for period $p$	MW
$ur_p^{case B}$	Upward reserve requirements for case B in period $p$	MW
$sp_p^w$	Energy spillage of wind farm $w$ for period $p$	MW
$ie_p^i, is_p^i$	Energy stored and spilled in CSP plant $i$ in period $p$	MWh
$ic_p^i, id_p^i$	Power output and power consumption of CSP plant $i$ in period $p$	MW

Table 7.3: Variables of the ROM model

#### 7.4. Objective function

The operations costs minimization of the electric system is expressed as follows:

$$E. 11 \quad opcost = \sum_p \left[ \sum_t (FC^t c_p^t + SC_t st_p^t + VC^g gp_p^g) + NSEC nse_p + URC urdef_p + DRC drdef_p \right]$$

Model constraints are described in the following sections. Note that the duration of all periods is one hour.

## 7.5. Demand constraint

The following equation controls the balance of generation and demand by the generation units for each period. The set of generators  $g$  includes thermal units, hydro plants and CSP plants.

$$\text{E. 12} \quad \sum_g gp_p^g + \sum_w gwind_p^w + RES_p + nse_p = D_p \quad \forall p$$

## 7.6. Thermal units constraints

- The commitment, start-up and shut-down of thermal units is controlled by these variables, with the following logical relation. Only commitment variable needs to be defined as binary.

$$\text{E. 13} \quad c_p^t - c_{p-1}^t = st_p^t - sh_p^t \quad \forall p, t$$

- The output plus the power reserve of each thermal unit is bounded by the maximum output of the unit, given by the parameter  $\overline{GP}_p^g$ .

$$\text{E. 14} \quad gp_p^g + gur_p^g \leq \overline{GP}_p^g \quad \forall p, g \in t$$

- The generators could have a minimum time that, once the generator has been switched on (respectively switched off), it must be kept running (respectively stopped). The up and down ramps limit the variation of the thermal unit output including the up and down power reserves in consecutive hours:

$$\text{E. 15} \quad \begin{aligned} (gp_p^g + gur_p^g) - (gp_{p-1}^g - gdr_{p-1}^g) &\leq RU^g \\ (gp_{p-1}^g + gur_{p-1}^g) - (gp_p^g - gdr_p^g) &\leq RD^g \end{aligned} \quad \forall p, g \in t$$

## 7.7. Hydro plants constraints

- The model considers an equation that ensures that if a unit is pumping, it cannot be generating at the same time.

$$\text{E. 16} \quad \begin{aligned} gp_p^h &\leq ih_p^h \overline{GP}_p^h \\ gc_p^h &\leq (1 - ih_p^h) \overline{GC}_p^h \end{aligned} \quad \forall p, h$$

- The maximum output (pumping) of the hydro units is bounded by technical limitations of the unit.

$$\text{E. 17} \quad gp_p^g + gur_p^g \leq \overline{GP}_p^g \quad \forall p, g \in h$$

- The account of the hydro reservoir is controlled by the following hourly constraint.

$$\text{E. 18} \quad r_p^h - r_{p-1}^h = -gp_p^h + gc_p^h - s_p^h + I_p^h \quad \forall p, h$$

### 7.8. CSP plants constraints

- The equation that controls the energy balance in the CSP plant:

$$\text{E. 19} \quad In_p^i - gp_p^i - ic_p^i + id_p^i = 0 \quad \forall p, i$$

- The balance of the CSP plant storage is given by the following equation:

$$\text{E. 20} \quad ie_p^i - ie_{p-1}^i = ic_p^i - id_p^i - is_p^i \quad \forall p, i$$

- The constraints in the charge and discharge of the CSP plants:

$$\text{E. 21} \quad \begin{aligned} ie_p^i - ie_{p-1}^i &\leq IRC^i \\ ie_{p-1}^i - ie_p^i &\leq IRD^i \end{aligned} \quad \forall p, i$$

### 7.9. Real time simulation

The correction of the deviations identified previous to the hour 14 (this is the hour when the daily programming is sent to the System Operator [34]) of the day before the operation has been modelled in the optimization module. After the 14 h, the adjustments that have to be done in the commitment of the units, the program of the units and the level of the different loads of the system are computed by a simulation module. This module is divided in two steps:

The adjustments of the generating units due to unexpected events after the 14h of the day before are computed by a simulation module. This module is divided in two steps:

- In the first step, the simulation module performs corrections to the commitment specified by the daily optimization module, applying them in the 24 h of the day before the operation (D-1). The Midnight is assumed to be the last time where the commitment decision of a group would allow this group to reach the ramping hours in the morning (7-12 am). These deviations could be produced by an error in the forecast of the intermittent generation or the failure of the generation units. The corresponding corrective actions are the commitment of new generation units or the shutting down of others, whose objective is to reduce the deviation into safe margins that can later be handled by the use of reserve (for instance reducing error to less than 1 GW).
- The second step deals with the monitoring of each hour of the interest day and it takes the adequate decisions in order to correct the error in the forecasting of the wind production, the demand or failure of the thermal units. At this point, all available wind power is aimed to be produced for both cases A and B, regardless of the wind generation and the wind up reserve committed in the optimization stage. The corresponding corrective actions cannot



be the commitment or shutting down of any unit (except the fast peaking units) but the use of reserves. Wind power is allowed to provide down reserve in case B.

<b>Time</b>	<b>Action</b>
Hour 14 of day D-1	Estimation of intermittent generation for each hour of day D (errors for 10 to 34 h in advance)
	Daily dispatch of day D using the optimization module
Hour 24 of day D-1	Estimation of the intermittent generation for each hour of day D (errors for 1 to 24 h in advance)
	Commitment (disconnection) correction of units related to the error estimation for peak (low consumption) periods
Each hour of day D	Knowledge of actual intermittent generation
	Selection of adequate decisions for forecast deviations correction according to priorities (as can be seen in Figure 7.1)
Last hour of day D	Data regarding the commitment of the different units, production and the reservoir level is stored to be used in the unit commitment of the next day

**Table 7.4: Daily Operation chronological resume**

## 8. Annex 2: Estimation of costs for Ampacimons

The following assumptions were made regarding Ampacimons for estimating the costs of the different cases:

- Lifetime: 10 years (for both hardware and software, whereas experience feedback is not currently available)
- CAPEX of approximately 12kEUR per km
- OPEX of approximately 0.5kEUR per km per year
- Annualized cost of 1.7kEUR per km

The following assumptions were made regarding PMU for estimating the costs of the different cases:

- Lifetime: 10 years (for both hardware and software)
- CAPEX of approximately 20kEUR per PMU
- OPEX (software maintenance) negligible
- Annualized cost of 2kEUR per PMU

The following assumptions were made regarding PST for estimating the costs of the different cases:

- 9 out of 10 are sunk costs
  - NETFLEX only enhances their utilization whereas they were installed for other reasons (fix local congestion).
- This additional utilization impacts on maintenance (50% higher maintenance costs): 3% of CAPEX (instead of 2%)
- Standard 380kV PST rated at 1400MVA
  - Lifetime: 40 years
  - CAPEX of approximately 12MEUR per PST
- OPEX of 360kEUR per PST per year
- Annualized cost ranging from 120kEUR (existing) to 760kEUR (new) per PST

The following assumptions were made regarding the deployment of the smart controller for estimating the costs of the different cases:

- Related to the implementation within each participating TSO (building upon existing processes like DACF, D-2CF, IDCF)
- CAPEX of approximately 250kEUR per TSO for implementing new tools/processes for delivering the data
- OPEX of approximately 25kEUR per TSO for maintaining and operating these tools/processes
- Annualized cost of 50kEUR per TSO

We assumed that future PFCs are installed for alleviating local congestion. Hence, this CBA does not directly consider any additional PST or HVDC link to achieve the capacity increases.

Case	NTCs	Costs	Explanation
1	10% more NTC on F2B and B2F <u>when</u> the wind injection in B and F is higher than 20% of the installed wind capacity	Installation and integration of 10 Ampacimons and 3 PMUs <b>+83.2kEUR</b>	When the wind is blowing beyond the 20% level, all overhead lines are sufficiently cooled to provide 3% more capacity with high confidence even if they are not equipped with DLR. (This depends on the correlation of wind speed between places.) This translates into 10% across the Belgium-France border due to the so-called network effect.
2	10% more NTC on F2B and B2F permanently <u>AND</u> 10% more NTC on B2NL and NL2B permanently as well	Existing PFCs are used to do more and hence only consider some additional OPEX <b>+510kEUR</b> (Belgian PSTS only and industrial deployment of the smart controller in Elia, RTE, Tennet [NL])	On the one hand, when the wind is blowing under the 20% level, smarter control over the Belgian PFCs delivers the capacity.  On the other hand, smarter control over the Belgian PFCs also delivers capacity on the Belgium-Netherlands border.
3	15% more NTC on all intra-CWE borders <u>when</u> the wind injection in B, D, F and NL is higher than 20% of the installed wind capacity	Installation and integration of 1000 Ampacimons (assuming 30 critical lines of 100km each) <b>+5100kEUR</b>	By installing Ampacimons, the average gain is approximately 10% (KPI.D5.DLR-3) per equipped overhead line. Again because of the so-called network effect, it translates into even higher NTCs. However, because new constraints are very likely to appear as a consequence of the change (possibly constraints that Ampacimons cannot alleviate), an overall 15% when the wind is blowing beyond the 20% level.
4	20% more NTC on all intra-CWE borders permanently	Existing PFCs and future PFCs) are used to do more and hence only consider add. OPEX	By controlling PFCs in a smarter manner across the whole CWE area, flows will be routed where capacity remains whether or not the wind is blowing. Our experience shows that congestion

Case	NTCs	Costs	Explanation
		<b>+900kEUR</b> (other existing CWE PSTs and industrial deployment in Tennet [DE], Amprion, EnBW, 50Hertz, swissgrid and NG)	taking place when the wind is not blowing is more manageable and that less margin must be kept on the PFCs for coping with wind deviations, which enable more benefits from the PFCs than when the wind is blowing.

**Table 8.1: Cases used in the study**

## 9. References

- [1] K. Dietrich, J. M. Latorre, L. Olmos, A. Ramos, "Demand response in an isolated system with high wind integration", IEEE Transactions on Power Systems, Vol. 27, nº. 1, pp. 20-29, 2012.
- [2] M. Ventosa, M. Rivier, A. Ramos, A. G. Alcade, "An MCP approach for hydrothermal coordination in deregulated power markets". In: IEEE power engineering society summer meeting, Washington, USA; 2000.
- [3] Ministerio de Industria y Energía, P.O. 7.1., *Servicio complementario de regulación primaria*, BOE., 1997/1998, 1998, p.28171.
- [4] Ministerio de Industria, Turismo y Comercio, Anexo P.O. 1.5, *Establecimiento de la reserva para la frecuencia-potencia*, BOE., 2006-13170, 2006, p. 27473-27474.
- [5] Ministerio de Industria y Energía, P.O. 7.3., *Servicio complementario de regulación terciaria*, BOE., 197/1998, 1998, p.28181.
- [6] "Real Decreto 661," 25 Mayo 2007, Available: <http://www.ree.es/seie/pdf/RD661.pdf>.
- [7] T. Arlaban, J. Peiró, Ó. Alonso, R. Rivas, D. Ortiz, G. Quiñonez-Varela, P. Lorenzo, "Experiences in Simulating and Testing Coordinated Voltage Control Provided by Multiple Wind Power Plants," 10th International Workshop on Large-Scale Integration of Wind Power into Power Systems as well as on Transmission Networks for Offshore Wind Power Plants. 25-26 October 2011, Aarhus, Denmark,
- [8] Thomas Ackermann, *Wind Power in Power System*. John Wiley & Sons, Ltd, July 2005.
- [9] R. Veguillas et al., "Project Objectives & KPI". D2.1 of the TWENTIES EU Project. Available at: [www.twenties-project.eu](http://www.twenties-project.eu), 2010.
- [10] Nicolaos Cutululis, Marisciel Litong–Palima, Lorenzo Zeni, Allan Gøttig, Nina Detlefsen, Poul Sørensen. TWENTIES D16.1. Offshore wind power data. April 2012.
- [11] M. Korpås, L. Warland, J. O. G. Tande, K. Uhlen. Tradewind D3.2 Grid modelling and power system data. February 2009.
- [12] ENTSO-E, Draft of Guideline for Cost Benefit Analysis of Grid Development Projects, September 2012. Available at: <https://www.entsoe.eu/>
- [13] Rebours Y et al., How Much Electric Interconnection Capacities are Needed within Western Europe?, EEM10 conference. 2010
- [14] European Commission (EC), Impact Assessment Accompanying the document COMMUNICATION FROM THE COMMISSION TO THE COUNCIL, THE EUROPEAN PARLIAMENT, THE EUROPEAN ECONOMIC AND SOCIAL COMMITTEE AND THE COMMITTEE OF THE REGIONS Energy Roadmap 2050, 2011.
- [15] ENTSO-E, SCENARIO OUTLOOK & ADEQUACY FORECAST 2012 – 2030. 2012.
- [16] AIE, Projected Costs of Generating Electricity, 2010 Edition.
- [17] ADEME, FACTEURS D'ÉMISSION DE DIOXYDE DE CARBONE POUR LES COMBUSTIBLES LES CHIFFRES ADEME À UTILISER, April 2005.
- [18] CREG, Etude sur les perspectives d'approvisionnement en électricité 2008-2017. October 2009.

- 
- [19] AIE, CO2 EMISSIONS FROM FUEL COMBUSTION Highlights, 2012 Edition.
- [20] I. Romero et al., "OLC Conceptual Design and Equipment Specification". D8.1 of the TWENTIES EU Project. Available at: [www.twenties-project.eu](http://www.twenties-project.eu), 2011.
- [21] G. Juberías et al., "RTTR analysis on wind power generation disaggregation on monitored lines". D8.2 of the TWENTIES EU Project. Available at: [www.twenties-project.eu](http://www.twenties-project.eu), 2011.
- [22] S. Fernandez et al., "RTTR system specifications". D14.1 of the TWENTIES EU Project. Available at: [www.twenties-project.eu](http://www.twenties-project.eu), 2011.
- [23] Red Eléctrica de España, "Operating Procedure 3.2: Management of technical constraints". (In Spanish). Available at: [http://www.ree.es/operacion/pdf/po/RES\\_PROOPE-SEIE\\_20120724\\_POs\\_Pen\\_3.1y2\\_9\\_14.4\\_Seie\\_1\\_2.2\\_3.1\\_7.1y2\\_8.2\\_9\\_2.3.pdf](http://www.ree.es/operacion/pdf/po/RES_PROOPE-SEIE_20120724_POs_Pen_3.1y2_9_14.4_Seie_1_2.2_3.1_7.1y2_8.2_9_2.3.pdf)
- [24] Siemens, 2009. PSSE 32.0 Application Program Interface (API).
- [25] Clear Grid Solutions, LLC, 2011. Resources for Automating PSSE with Python. Available at: <http://www.cleargridsolutions.com/developer.html>.
- [26] M. Klobasa, and I. Boie, "Infrastructure development Implementation strategies for decision makers", D5.3 of the SUSPLAN EU Project. Available at: [www.susplan.eu](http://www.susplan.eu), 2010.
- [27] J. Mutale, and G. Strbac, "Transmission Network Reinforcement versus FACTS: An Economic Assessment", IEEE Transactions on Power Systems, Vol. 15, nº. 3, 2000.
- [28] A. L'Abbate, G. Fulli, E. Handschin, Economics of FACTS integration into the liberalized European power system" 2007 IEEE PowerTech, Lausanne, Switzerland, 1-5 July 2007.
- [29] EPRI, "Estimating the costs and benefits of the Smart Grid: A Preliminary Estimate of the Investment Requirements and the Resultant Benefits of a Fully Functioning Smart Grid", 2011 Technical Report.
- [30] Ministerio de Industria, Turismo y Comercio, "2012-2020 Electricity and Gas Sectors Plan: development of transmission networks". (In Spanish).
- [31] F. Bañez, A. Ramos, J. M. Latorre, G Asimakopoulou, A. Dimeas and N. Hatziaargyriou. "Functional specification for tools to assess steady state and dynamic behavior impacts, impact on electricity markets and impact of high penetration of EV on the resources levels - Market Issues", Deliverable 2.2 of the MERGE EU Project. 2011, Available at <http://www.ev-merge.eu/>.
- [32] A. J. Wood y B. F. Wollenberg, "Power Generation, Operation, and Control", 2º ed. Wiley-Interscience, 1996.
- [33] A. M Law, W. D Kelton, y W. D Kelton, "Simulation modeling and analysis", vol. 2, McGraw-Hill New York, 1991.
- [34] "Reglas de Funcionamiento del Mercado de Producción de Energía Eléctrica". BOE 20/04/2001.

