

Experimental and Theoretical Analysis of a Combined Floating Wave and Wind Energy Conversion Platform

Yde, Anders; Pedersen, Mads Mølgaard; Bellew, Sarah Bellew; Køhler, Anders ; Clausen, Rasmus S. ; Wedel Nielsen, Anders

Publication date:
2014

Document Version
Publisher's PDF, also known as Version of record

[Link back to DTU Orbit](#)

Citation (APA):
Yde, A., Pedersen, M. M., Bellew, S. B., Køhler, A., Clausen, R. S., & Wedel Nielsen, A. (2014). Experimental and Theoretical Analysis of a Combined Floating Wave and Wind Energy Conversion Platform. DTU Wind Energy. (DTU Wind Energy E; No. 0044).

DTU Library

Technical Information Center of Denmark

General rights

Copyright and moral rights for the publications made accessible in the public portal are retained by the authors and/or other copyright owners and it is a condition of accessing publications that users recognise and abide by the legal requirements associated with these rights.

- Users may download and print one copy of any publication from the public portal for the purpose of private study or research.
- You may not further distribute the material or use it for any profit-making activity or commercial gain
- You may freely distribute the URL identifying the publication in the public portal

If you believe that this document breaches copyright please contact us providing details, and we will remove access to the work immediately and investigate your claim.

Experimental and Theoretical Analysis of a Combined Floating Wave and Wind Energy Conversion Platform

Department of Wind
Energy
E Report 2014

Anders Yde (DTU Wind Energy)

Mads M. Pedersen (DTU Wind Energy)

Sarah Bellew (Floating Power Plant)

Anders Køhler (Floating Power Plant)

Rasmus S. Clausen (Dong)

Anders Wedel Nielsen (DHI)

DTU Wind Energy-E-0044

February 2014

DTU Wind Energy
Department of Wind Energy



Authors: Anders Yde, Mads M. Pedersen, Sarah Bellew, Anders Køhler, Rasmus S. Clausen, Anders Wedel Nielsen (DHI)

Title: Experimental and Theoretical Analysis of a Combined Floating Wave and Wind Energy Conversion Platform Experimental and Theoretical Analysis of a Combined Floating Wave and Wind Energy Conversion Platform

Department: AED

Summary (max 2000 characters):

This report presents results from the PSO project 2011-1-10668 entitled Poseidon 2. The project is a continuation of the previous PSO project entitled Aero-Hydro-Elastic Simulation Platform for Wave Energy Systems and floating Wind Turbines. Floating Power Plant has developed the technology for a novel, floating, wave- and wind-energy hybrid device. To test the technology they have scaled the design to P37, a 37 m wide test platform that has been undergoing offshore testing for four complete test phases (totaling more than 2 years). The test platform provides electricity to the grid from both wind and wave energy, however its purpose is purely for research and development. The PSO project has equipped the platform with comprehensive measurements equipment for measuring platform motion, wave and wind conditions and turbine loads. Data from the test periods has been used for evaluating the design and verifying numerical models.

DTU Wind Energy-E-0044 DTU Wind Energy-E-0044 February 20144

ISBN 978-87-92896-75-9

Contract no.:
PSO- 2011-1-10668

Pages: 45
Tables: 6
References: 14

Technical University of Denmark
Department of Wind Energy
Frederiksborgvej 399
Building 118
4000 Roskilde
Denmark
Phone 23652958
anyd@dtu.dk
www.vindenergi.dtu.dk

1. INTRODUCTION	1
2. GENERAL INTRODUCTION	2
2.1 Development history	3
2.2 Off-Shore tests - operational experiences	5
2.3 PTO system development	7
3. RESULTS FROM TEST PHASE 3 AND 4	7
3.1 Test site	8
3.2 Measurement system and upgrades	10
3.3 Test phase 3 and 4	11
3.4 Directional and Dynamic stability of platform	13
3.4.1 Determining if turbines and absorbers are active	13
3.4.2 Platform vanning in relation to wind-waves and current	14
3.4.3 Platform pitch and roll	21
3.5 Summary	23
4. AERO-HYDRO-ELASTIC NUMERICAL SIMULATIONS	24
4.1 Panel model of P-37 in WAMIT	24
4.2 WAMSIM simulations of the platform	26
4.2.1 Description of WAMSIM	26
4.2.2 WAMSIM Model Set-up and Input Data	26
4.2.3 WAMSIM simulations of the P-37	27
4.2.4 Results of the simulation	28
4.2.5 Forces in anchor chains	33
4.2.6 Notes on more advanced modelling of the P-37	33
4.3 Summary	33
5. OUTLOOK TO MW SIZE TURBINES ON WIND AND WAVE ENERGY PLATFORM	34
5.1 Wave energy upscaling	35
5.1.1 The Reasons of Upscaling Wave Energy Devices	35
5.1.2 How to scale FPP's technology	36
5.2 Wind energy upscaling	37
5.3 Combined wind and wave upscaling	43
6. REFERENCES	45

1. Introduction

This report presents results from the PSO project entitled Poseidon 2. The project is a continuation of the previous PSO project entitled Aero-Hydro-Elastic Simulation Platform for Wave Energy Systems and floating Wind Turbines [1].

The concept of Poseidon combines both wind and wave energy. The technology is owned by Floating Power Plant A/S (FFP) and is based on a semi submerged structure that works both as a floating platform for a patented wave energy concept and wind turbines. The wave energy concept is a multi-absorber system, where the wave energy is extracted by dynamically ballasted floaters that move up and down. The floaters are connected to a PTO (Power Take Off) system that converts the mechanical energy into electricity. The wind energy utilized by wind turbines mounted on the stable platform. The present version of Poseidon, P37, is a 37 meter wide off-shore test plant with ten 3 KW (5 KW peak) wave energy absorbers/floaters and three 11 kW wind turbines (Figure 1).

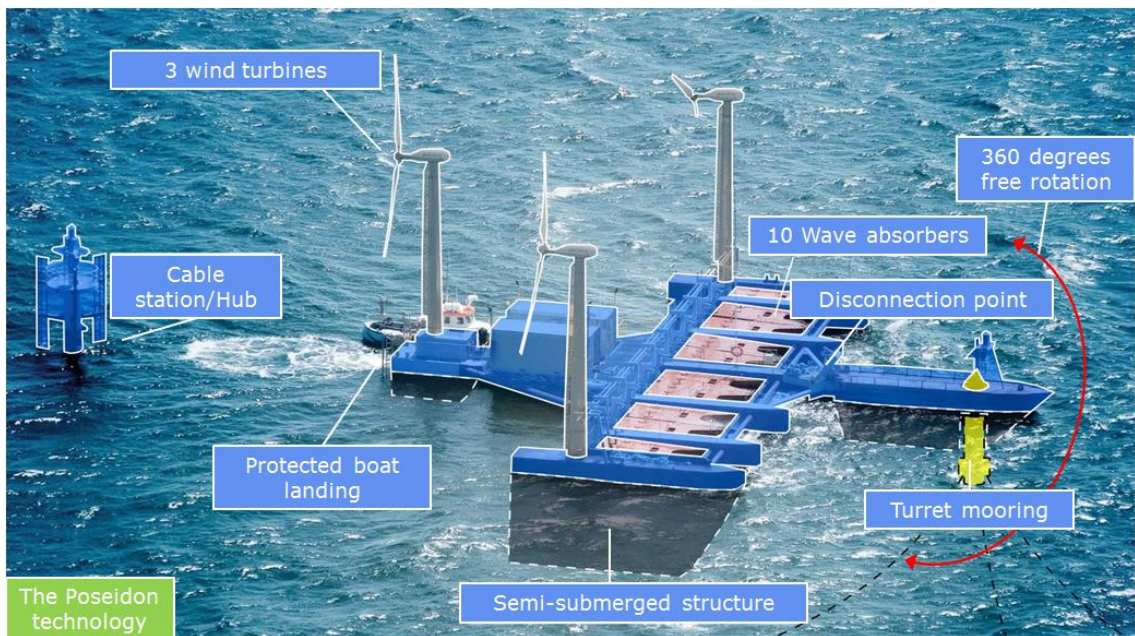

Figure 1. P-37 demonstration platform

In the previous PSO project, the Poseidon test platform P37 was instrumented to measure platform motion, wave and wind condition as well as turbine loads. The platform was tested for two periods; in the first period the platform was tested as a wave energy conversion platform only and in the second period it was tested as a combined wind and wave energy conversion platform. The result of the measurements and data analysis showed that the floating platform could be equipped with wind turbines with the following consequences; turbine tower loads will increase with increased platform motion, and blade loads are not affected by the platform motion. The fact that the blade loads was not affected by the platform motions could be because of the special turbine concept of a two bladed stall regulated turbine with a teeter hinge in the rotor. The analysis also indicated that the wind turbines would reduce the platform pitch motion, because of the large aerodynamic damping for longitudinal rotor motion of the wind turbines [1]. After analyzing the data it was clear that due to lack of sensors on the platform it was difficult to get an overview of the operational status of the platform in the test periods. Therefore it was decided to upgrade the measurement system and extend the test with two more periods in the new PSO project.

This paper presents the result from the third and fourth test phase of P37 conducted in 2012-2013. Chapter two describes the general experience with the platform in terms of operation and development. Chapter three deals with the results from test phase three and four. Chapter four presents the numerical aspect of development and validation of simulation tools to model the concept. Chapter five gives an outlook to the challenges of up-scaling the concept into the next step of a commercial multi MW wind-wave energy platform and finally chapter six conclude the work.

2. General introduction

Floating Power Plant are the developers of a novel, floating, wave- and wind-energy hybrid device. The concept of Poseidon was established back in 1998. In 2004 the development process was speeded up and the concept has during the last decade undergone tests in scales of 8 and 17 meters concurrently with great focus on the engineering design.

The Poseidon concept consists of different technologies that are combined in one device:

- The semi submerged platform is a stable floating platform
- This stability is obtained through a combination of following passive elements:
 - Submerged multiple dampening elements front and aft
 - Energy absorption from the wave energy device
 - A passive orientation of the platform (wave vaning)
- The platform is anchored by using standard turret mooring system
- The anchoring system is the grid connection point (hub) and the platform can be disconnected and towed away.
- The wave absorbers consists of a front pivot hinged absorber (float) with a unique shape and size and can be ballasted for different wave conditions
- The special wave absorber creates a system that is unique and can absorb both the push and lift of the wave into one mechanical movement.
- Safety system that locks the absorbers in storm position.
- PTO (Power Take Off) system is an oil based multi cylinder hydraulic system that is connected directly on the hinge axis of the absorbers.

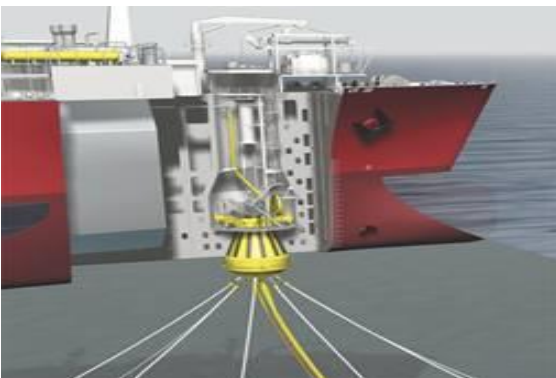

Figure 2. Turret mooring system

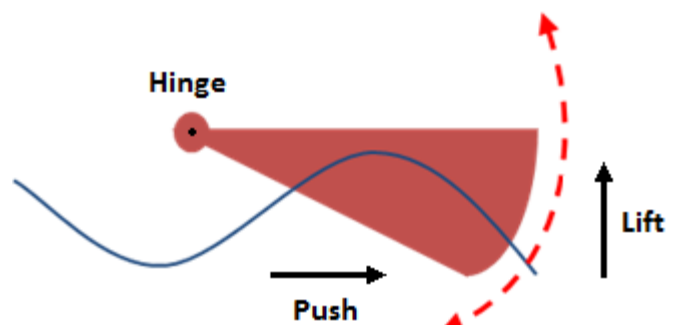





Figure 3. Hinged wave absorber

2.1 Development history

Since the initial conception of the invention, Floating Power Plant have performed hydrodynamic tests on their device at 1:16 and 1:14,5 scale in wave flumes and 1:33 and 1:9,5 scale in wave basins, with the purpose of design development and optimization. Further to this, P37, a 37 m wide test platform (see Figure 1) has been submitted to offshore testing for four complete test phases (totaling more than 2 years). The test platform provides electricity to the grid from both wind and wave energy, however its purpose is purely for research, development and demonstration – not for commercial power production. The PTO for the WECs (Wave Energy Converter) has undergone rigorous testing as well as regular optimization through both dry and offshore testing. The development and testing phases are shown in Figure 4.

Floating Power Plant’s first commercial platform will be the P80, which is 80 m in width. This platform is likely to be deployed in a more energetic and deeper test site than the P37 platform. Design modifications are, therefore, required for the P80 platform to optimize it for the larger scale and more energetic conditions.

It is essential for FPP to analyze the data obtained during the P37 test phases to aid in the development of numerical models. Once validated, these numerical models will be used to optimize the design of the platform and better predict the annual power production for specific site locations.

Year	PSO	Nr.	Test activity	
1998	No	P1	Conceptual design and test in 3D basins of a 2,4 meter (wave front) floating power plant at AAU.	
2000	No	P2	Two empirical wave flume tests phases of different floats designs at DHI.	
2002	No	P3	Test of a 8,4 meter (wave front) model with wind turbines was tested in a 3D basin at DHI.	
2008/ 20 09	Yes	P4.1	Off-shore test phase 1. Off-shore test of a 37 meter (wave front) floating power plant was initiated (P37). The first test was performed without the wind turbines installed.	





2010	Yes	P4.2	Off-shore test phase 2. Further off-shore test of a P37. This second test was performed with 3 grid connected wind turbines installed.	
2010	No	P5	Wave flume test of an improved PTO system for the wave energy device.	
2012-2013	Yes	P4.3	Off-shore test phase 3. Further off-shore test of P37. This second test was performed with 3 grid connected wind turbines and a grid connected PTO system from the wave energy device. (and further measurements)	
2013	Yes	P4.4	<i>Off-shore test phase 4.</i> Further off-shore test of P37. This second test was performed with 3 grid connected wind turbines and a grid connected PTO system from the wave energy device. (and further measurement)	
2013	no	P5	<i>3D basin test in cork</i> 1:50 scale hydrodynamic testing of the commercial design. This to validate commercial design options and secure data for modeling and engineering	

Figure 4. Table showing Poseidon's development history.

FPP is currently In the process of upscaling and re-engineering its design to commercial sites.

Based on data and experiences from offshore tests, wave flume tests, dry tests, basin and test and modeling – FPP is currently in the design process towards the commercial design. This work is done in cooperation with key technical partners and end users.

This will continually be coupled with further experimental testing, currently test are planed/Undergoing:

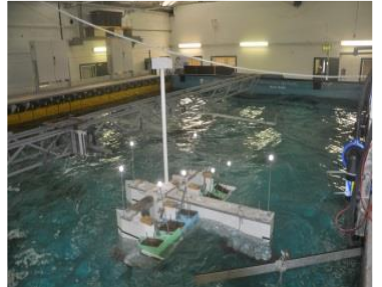
- PTO dry tests in Denmark and UK
- A 3D basin wave and wind test in Nantes (1:50 scale)
- A 75 KW dry test of a single PTO in under planning in cooperation with Belgium and Danish partners.

2.2 Off-Shore tests - operational experiences

Operating P37 for four offshore tests has, besides crucial data, provided FPP with significant amounts of highly valuable operational experiences. Even though P37 is an autonomous unit, a lot of offshore hours have been spent on board the platform. Experiences range in form of:

- Installation operations
- Operation and maintenance
- Measurement and data acquisition
- Insurance, approvals, environmental impacts
- Design principles and loads

Installation principle

The P37 installation principle is based on an oil and gas principle called a disconnectable turret mooring systems. This means P37 could be constructed and tested in harbor and then installed with small tug boats, no special purpose vehicle are needed and the P37 can be disconnected and taken back in harbor for upgrades, maintenance and evaluation. FPP has executed the operations 8 times (4 out, 4 in), and proved at significant asset. This will be integrated into the commercial design. The Turret mooring rotation bearing will however be optimized to an integrated version based on roller bearings, since O&M (Operation and Maintenance) and lubrication has proven difficult on the Thordon (Thordon is a nylon based material, that can function with only water as a lubricant) sea water lubricated bearing used on P37.

Fatigue caused by pressure differences

FPPs wave absorbers work in enclosed chambers trapping the wave energy for optimizing the absorption. This has proven highly efficient, also in the offshore environment with average absorption rates well over 50%. Meaning more than 50% of the wave energy is converted to rotational energy. The highly efficient absorber is driven by large differences in pressure. The high number of cycles (~7 million per year) have imposed fatigue in some of the thin plate sections in absorption chambers. This has led to a critical design change in the structure that have been tested offshore and compared with the previous solution.

O&M concept and vaning

The FPP device vanes passively into the primary wave direction (same as wind turbine turns into the wind). This has proven a key asset in the O&M, since this creates a safe harbor with smooth water for transfer to the platform. This is also clearly seen in  Figure 5. The principle has successfully been demonstrated but a better understanding of this effect is needed. FPPs are working on this and was one of the key elements in Cork testing. The boat-landing/quay design needs to be more flexible to fit to more vessels.



Figure 5. P37 demonstration platform in operation

Mooring loads

Mooring design and models for a rotating combined wave, wind device have never been done before. Thus designing this at a shallow water site (7 meter water depth) was a significant design problem. The commercial operation zone is over 50 meter water depth, so this limitation to this test site was a challenge and therefore highly monitored. FPP has seen movement in the anchor position twice during the offshore tests. This was due to ice and the weather impact from the “Allan 2013” storm. The picture below is from that storm, with 50 m/s wind gusts, 30 m/s mean wind and the highest wave and currents measurement at the test site.



Figure 6. P37 during the storm "Allan" 28th of October 2013.

Calibration of measurement equipment

P37 is extremely heavily monitored and measured. Calibrating and monitoring all these data channels have proved difficult. But has provided a key learning experiences and focus for such a device.

Condition monitoring

Continues supervision of key components, e.g. mooring, turbines, PTO systems, etc. is a challenge and the need for structural health monitoring for O&M and operations have become obvious. Turning the many measurements into a decision making tool has been a key focus for FPP and two separate projects have developed based on this. These experiences will be a central part of the commercial design and O&M concepts

2.3 PTO system development

A key part of offshore test phase 3 and 4 has been the testing of a new developed PTO system in cooperation with Siemens Industry, Fritz Schur Energy and Contech Automatic.

THIS IS NOT A PART OF THIS PSO PROJECT.

This has been done via iterative approach were a dry test unit of the PTO system initially was build and tested. This PTO module was then put offshore for testing (test phase 3), then on shore for further dry testing, then offshore again (test phase 4) and is currently undergoing further dry testing.



Figure 7. PTO system

The result from the new PTO system has been impressive and the wave energy part of the technology has now exceeded a 30% average wave to wire efficiency. This calculated as the total amount of energy produced on the generator divided by the total amount of energy that hit the platform over the entire test phase. This including, service, O&M, storms etc. The power produced by the PTO system was conditioned to be grid compliant, and was fed into the grid.

This means FPP is now the only developer in the world that successfully has provided power to the grid from wave and wind at the same time in an offshore environment.

3. Results from test Phase 3 and 4

Offshore test phase 3 and 4 were executed for the following primary reasons:

- Data for engineering and numerical model development and validation
- Test and demonstration of new PTO unit
- General operating experiences and reliability data
- Pr./demonstration of platform

Test phase 3 was executed in the fall of 2012 and test phase 4 was executed in the fall off 2013. The fall is chosen due to better / more extreme testing conditions.

3.1 Test site

This section deals with the environmental conditions at the test site during the two test periods. The location of the test site is the same as in the previous tests of P37 which is the confined Danish waters north of the island of Lolland see Figure 8. The position of the grid connection of P37 is located just the west of Vindeby wind turbine park which is close enough to have impact on the wind condition of the site.



Figure 8. Location of P-37 just north of Lolland.

The wind rose during the test period 3 and 4 is shown in Figure 9. It compares quite well with the wind conditions measured in the previous test periods 1 and 2 with dominating wind directions from north-east and south-west but it seems that there is more wind coming from east. This could be due to operational conditions at the nearby wind farm or seasonal changes. It should also be noted that the directions are calculated based on the wind direction measured at the platform and corrected according to the platform vaning that is measured by GPS. The wave direction shows a similar pattern with similarity of the measurement in the periods 1 and 2 however a bit more wave are coming from north-west as shown in Figure 10. Additionally the current rose is also shown in Figure 11. This shows a very distinct pattern of current coming in from north-east or south-west.

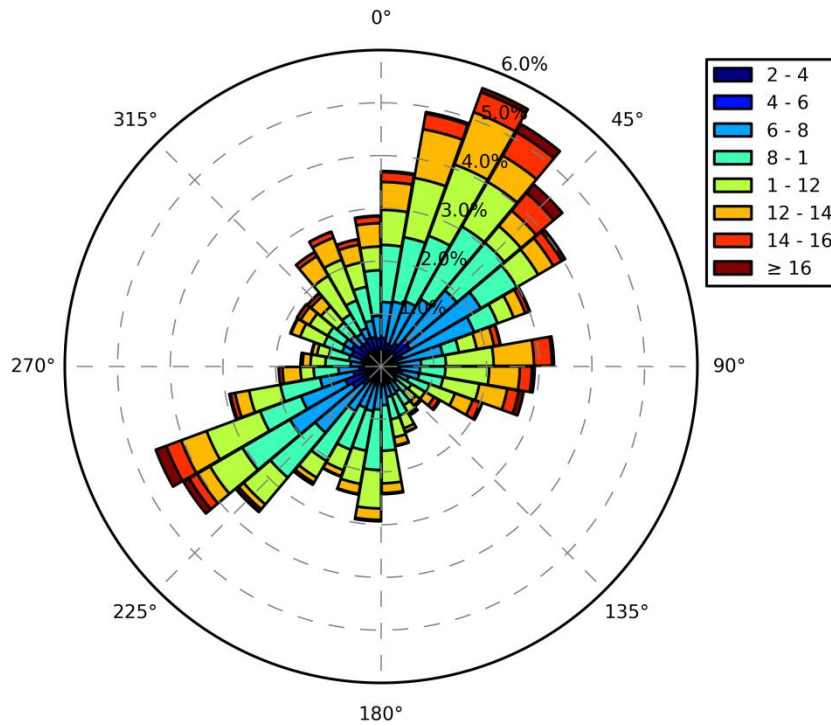

Figure 9. Wind rose and distribution for the Poseidon site, measured during measurement campaigns 3 and 4. North is located at 0° and the wind speed is in m/s.

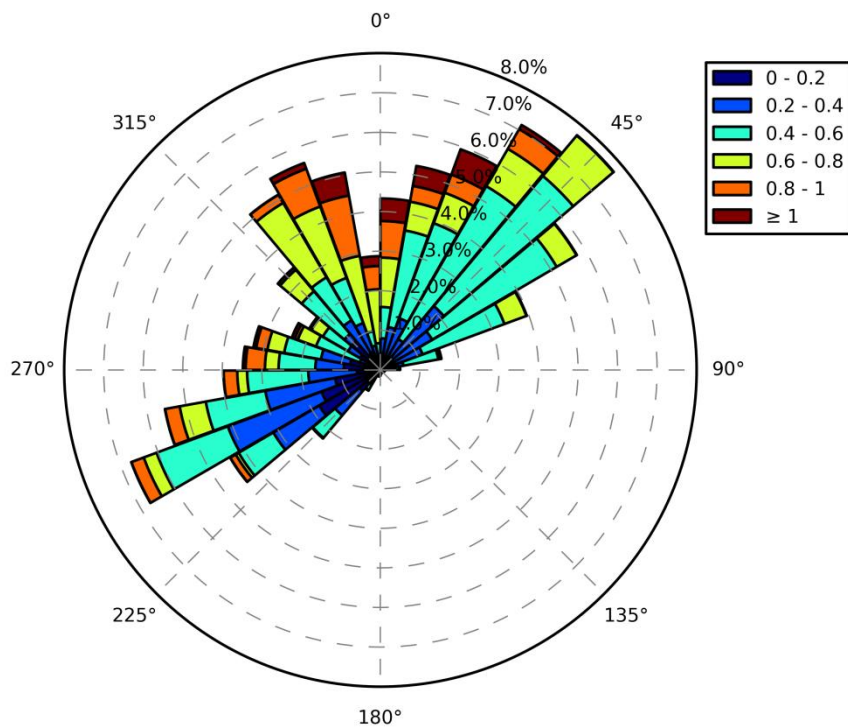

Figure 10. Wave rose and distribution for the Poseidon site, measured during measurement campaigns 3 and 4. North is located at 0° and the significant wave height is in m.

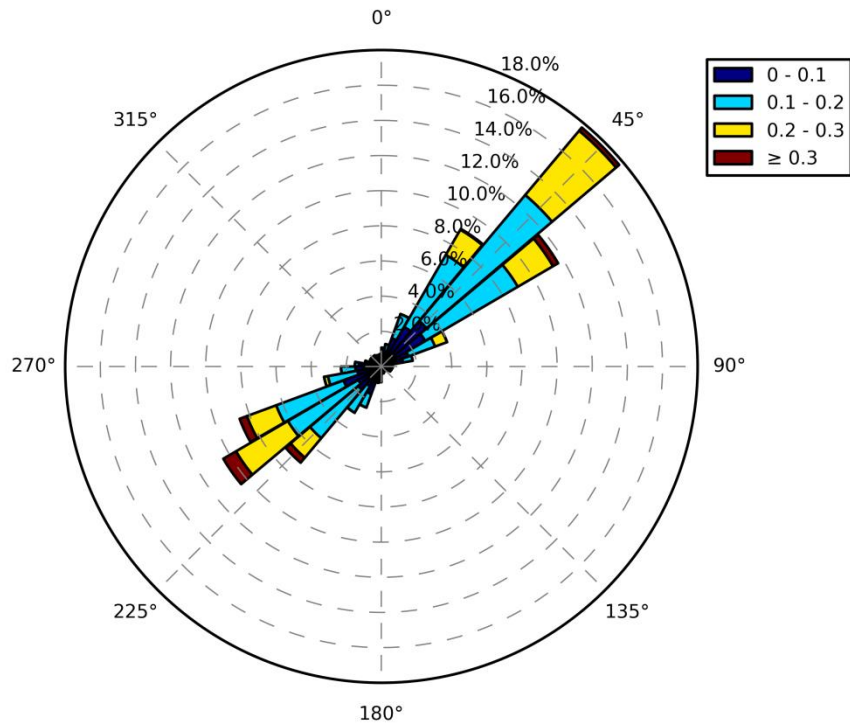

Figure 11. Current rose and distribution for the Poseidon site, measured during measurement campaigns 3 and 4. North is located at 0° and the current speed is in m/s.

3.2 Measurement system and upgrades

The measurement system on the platform was upgraded after the offshore test phase 1 and 2. The equipment was renovated and additional sensors was installed which includes inclinometers on all of the ten wave absorbers, 3 axis accelerometers on several locations on the platform. The inspection of the measurement system showed that the sensors in the nacelle of wind turbine 2 were critically damaged, and unfortunately there was not enough room in the budget for replacing them all.

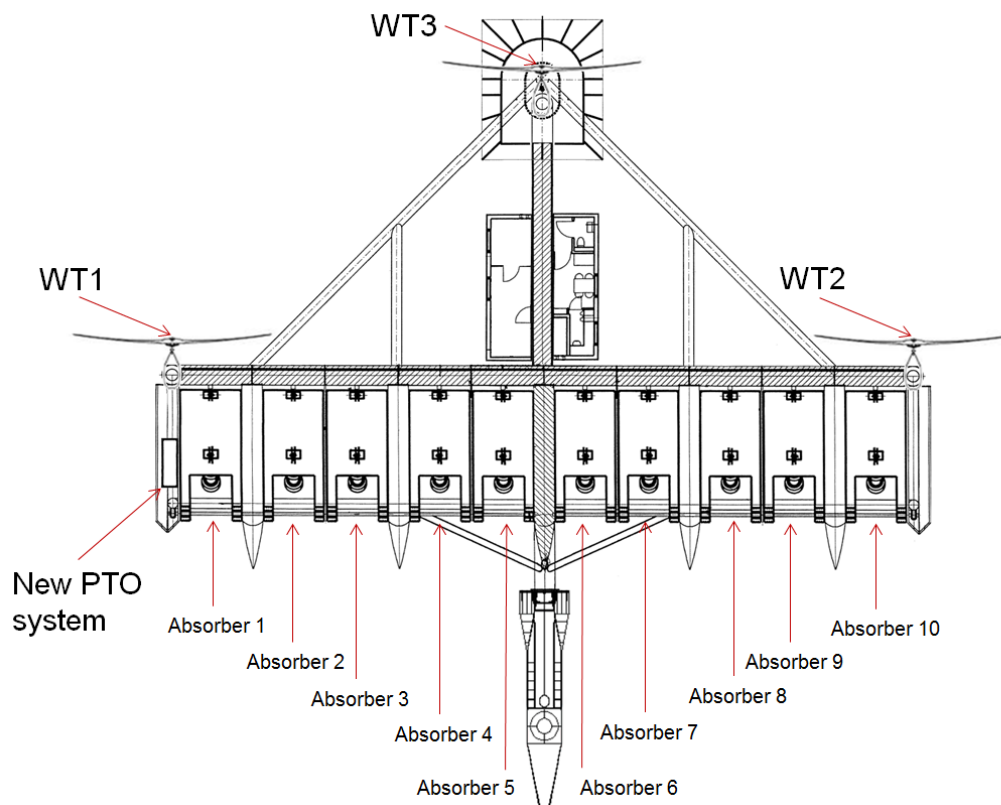

Figure 12. Overview of P-37 and components.

It was decided that more documentation on the measurement set up was needed and therefore a detailed measurement report has been written [2]. The report contains a full list of sensors including sensor type, location, calibration, sample rate, etc. for both the DTU Wind Energy and the DHI measurement system.

After all the data was collected, a comprehensive post processing routine was set up to get the recalibrated data, filter away measurement errors and implement calculated sensors. Detail of the data post processing is described in a separate report [3]. Initially the intention was to estimate platform displacement by integrating the accelerometer signals. However this proved to be impossible due to a significant drift in the accelerometer offsets so it was not possible to distinguish acceleration from drift and accelerations from platform motion in roll and pitch. The conclusions were made after an isolated test of an accelerometer. The test and more detail on the findings are described in a separate report [4].

3.3 Test phase 3 and 4

The original plan was to have only one more test phase but due to FFPs development in other projects they acquired the funds to split the test phase into two phases and thereby extending the total duration of the measurement campaign. The demonstration platform has been at sea for approximately four months in the two periods:

- **Test period 3**, 15 Nov 2012 to 13 Jan 2013. 7101 10 min files
- **Test period 4**, 25 Sep 2013 to 28 Oct 2013. 4807 10 min files

During the two test periods there have been some issues with the oceanography data measured by an Acoustic Doppler Current Profiler (ADCP). Some periods has been without any data collected form the ADCP and in test period 3 all data measured by the turbine control system was lost (generated power, cup anemometer wind speed etc.).

Storm event 28th October 2013

P37 has undergone four offshore tests totaling close to 2 years of operation time. This with a device initially built to last only one test phase.

The last test phase was terminated due to movement in the anchors during the storm, Allan. The storm Allan hit P37 straight on the 28th of October. Peak measurements were:

~ 50 m/s wind gusts

~ 30 m/s mean wind speed

~ 0,65 m/s current

Last 20 minute average wave measurement (before connection to ADCP was lost) was $H_s \sim 2$ m and still rising. See Figure 13 from an onboard camera during Allan.



Figure 13. Picture taken from the storm "Allan" at P-37.

P37 was deployed in a very shallow area of approximately 7 meters water depth. This was, from a design point of view, a significant challenge due to the difficulty of securing enough elasticity in the mooring system.

FPP's 3-spread mooring system is designed for a 15 ton peak load based on numerical models and model testing. The chain design is shown in Figure 14.

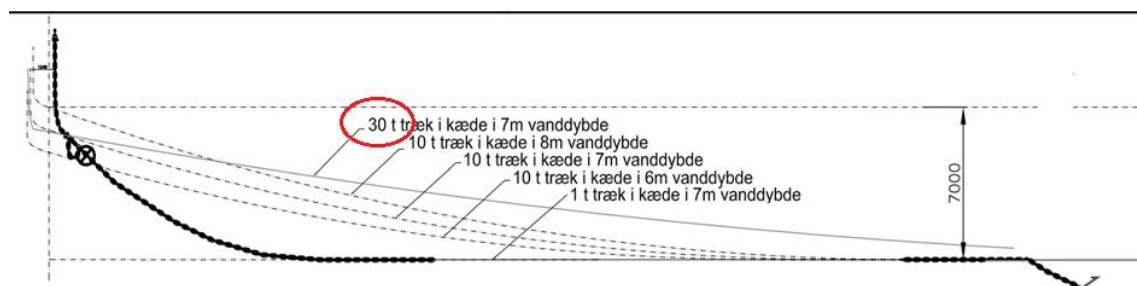

Figure 14. Mooring system design.

The mooring system is designed for the anchors to move first before component breakages. The holding capacities are given below.

- **Anchor chains:**
Working Load 180 tonnes, Break Load 260 tonnes (uncertified)

- **Shackles:**
(35 Working Load tonnes, Peak Load 72 tonnes, Break Load 175 tonnes)
- **Anchors:**
(Deep penetrating): maximum 40 tonnes holding capacity

FPPs mooring system is pretensioned to 1.5 tonnes per mooring chain to secure the correct platform yawing/rotation and safety for the electrical cable.

During the storm a 35 tonnes peak load was measured in the mooring system, which led to movement in the anchors. This led to the termination of the 4th test phase.

As this was the last test phase with P37, FPP has chosen not to reposition the anchors and reinitiate the test phase. The cost compared to the potential data was not adequate.

3.4 Directional and Dynamic stability of platform

This chapter contains analysis of the global movements of the Poseidon 37 platform (P37).

The analysis is based on the 10 min average data that has been collected on the platform. The data used in the analysis is based on the results from phase 3 and 4

In total around 2000 hours of data has been recorded.

The primary measurements used are:

- Sonic anemometer
 - Wind speed and wind direction is measured by a sonic anemometer placed on a small mast in the middle of the P37 platform. Because the anemometer is on the platform the wind direction measured is relative to the platform. In order to get the wind direction with north = 0 the actual direction of the platform has been subtracted in each data point.
- Wave height and direction
 - Wave height H_{M0} and wave direction
- Current speed and direction
- Platform direction
 - Platform direction is measured by GPS and is also used to get the general wind directions
- Pitch and roll
 - Pitch and roll measured by two inclinometers, in the starboard turbine foundation.

3.4.1 Determining if turbines and absorbers are active

In order to investigate how the platform behaviour is affected by the turbines and the wave absorbers it is necessary to analyse whether the wind turbines are in operation or not and if the wave absorbers are in operation or not.

It turns out that quality of the data and the limited number of datasets collected makes it difficult to determine if the turbines and absorbers are active. For the first period there is no power production signal from the wind turbines, and therefore the state of the turbines must be determined from other measurements. Instead shaft speed, shaft torque and rotor position is used to determine if the turbines are active. For the second period a power signal from the turbines is available.

Criteria used to see if the turbines are operational:

- **Shaft speed**
 - Shaft speed above 50 RPM
- **Shaft torque**
 - Torque above 0.5
- **Rotor position max and min**
 - Rotor position minimum less than 0.5 degrees
 - Rotor position maximum larger than 355.5 degrees
- **Power production**
 - Power larger than 100w

Even with all these criteria it can in some situations be difficult to get a definite measure of weather the turbines are running or not. In the analysis it is assumed that all the turbines are running when two turbines are running.

Criteria used to see if the absorbers are operational:

The absorber activity is determined from the angle between the absorber and the platform. The absorbers are set to inactive when the mean angle is fixed above 10 degrees.

Because of the test campaigns carried out on the platform the distribution of data in the different situation are not evenly distributed.

case	Absorbers	WTGs	Number of 10 min samples
A	on	on	4164
B	on	off	2567
C	off	on	952
D	off	off	476

Table 1. Different operational cases

In case A and B there are a lot of data samples and it is possible to get some information on how the platform behaves. For the C and D cases there are not so many data points. This makes it hard to make any conclusions about the platforms behaviour in these cases. As the two first cases are the most important cases from an energy production point of view, the focus has been put on these two situations.

3.4.2 Platform vaning in relation to wind-waves and current

The P37 platform is anchored to the seabed with three anchors in a way so that the entire structure can turn freely around the anchoring point. As the anchoring point is on the front part of the structure the platform should in general turn to have the wind and waves in from the front.

There are three main effects acting on the platform. That is wind, waves and current. In order for the wave absorbers to be as efficient as possible, it is important that the platform is aligned with the wave direction. The wind turbines are free yaw turbines meaning that they will always be aligned with the wind direction.

The wind turbines will lose production (wake losses) if the wind is coming from the side so that the wind turbines are shadowing each other. The platform will be vaning with the wind and wave direction. In cases where there is a large misalignment between wind and waves and the platform is aligned with the waves there will be strong wake effects on the wind turbines. However this situation is very unlikely to happen. A small misalignment between the platform and the wind will not have a significant impact on the output from the wind turbines.

As the wave power output are more sensitive to the alignment with the waves it is important to investigate the platform alignment with the waves and if this is affected by the wind turbines.

The current in the water below the platform is coming primarily from two directions presumably because of the tides in the area. The current does not seem to have any significant impact on the platform.

The actual direction of the platform will be a result of the combination of the forces coming from waves, wind and current.

Platform orientation vs general wind direction

On the plot below the platforms orientation is plotted against the general wind direction. It is clear to see that the platform aligns with the wind very nicely most of the time. The colours of the data points in the plot shows HMO in the 10 min time interval based on the colour bar on the right.

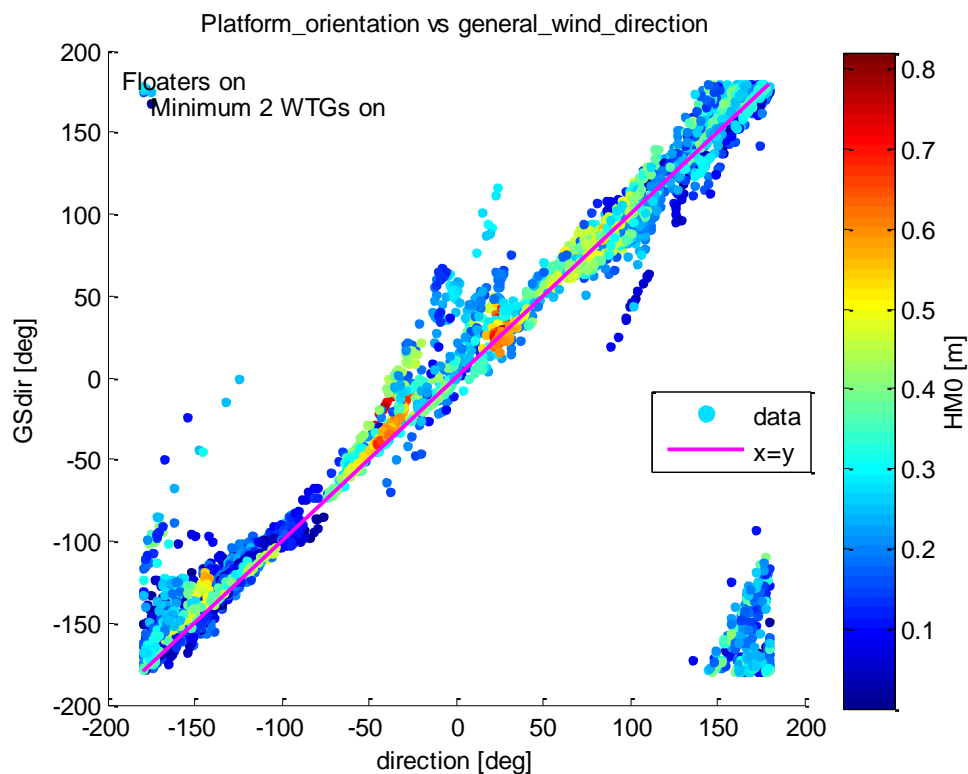

Figure 15. Platform orientation (direction) vs general Wind direction (GSdir) with the WTGs on. Wind speed above 2 m/s

In the plot below the same plot is shown with the turbines off. Because the wind turbines are now off more cases with low wind speeds (and also low wave height) is included. This can be seen as there is a lot of points that are not on the x=y line.

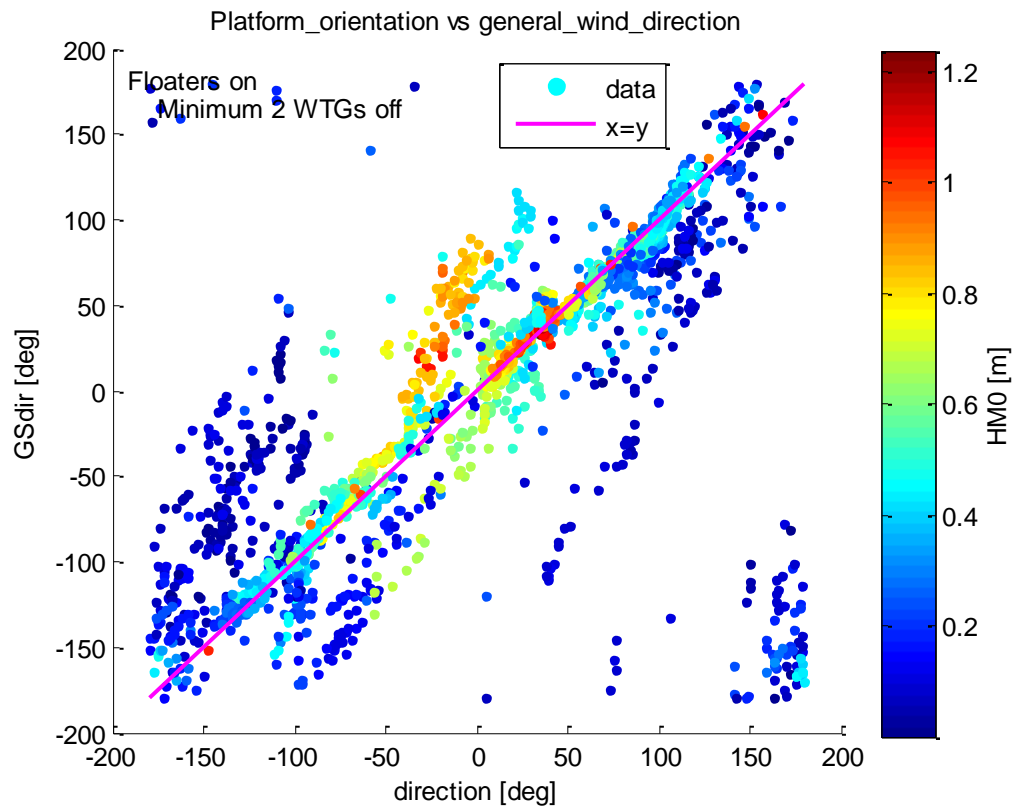

Figure 16. Platform orientation (direction) vs general Wind direction (GSdir) with the WTGs off

Platform orientation vs general wave direction

Below the platform direction is plotted in relation to the wave direction. In this case the alignment is not as clear as in the wind direction case shown above. Only situations with HMO above 0.2 m are plotted.

There is a clear trend that the platform is following the wave direction but the scatter is higher than for the wind direction.

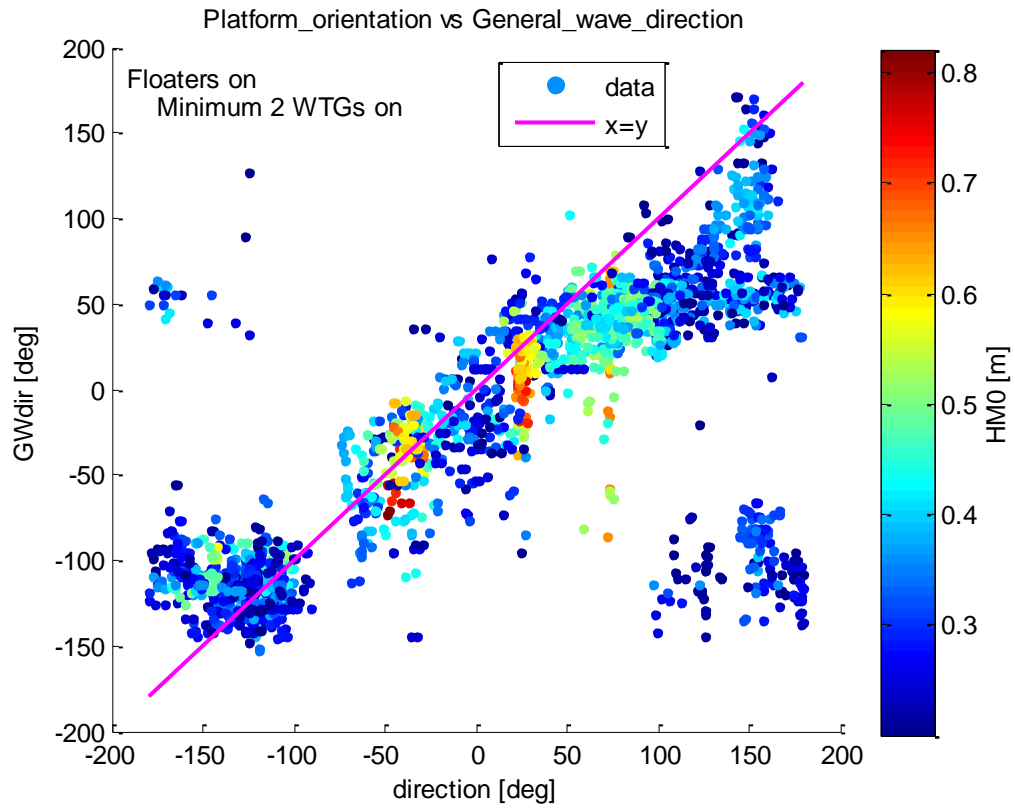

Figure 17. Platform orientation vs wave direction WTGs on and minimum 0.2m wave height (HMO)

Wind and wave misalignment

To further investigate the platforms behavior when both the wind turbines and the absorbers are active the wind-wave misalignment has been compared to the platform wave misalignment and the platform wind misalignment.

Basically the wind-wave misalignment is a property of the wind climate on the site. On the figure below the wind-wave misalignment is plotted against the platform wind misalignment. Generally there is no trend in the data as a large wind-wave misalignment does not lead to platform wind misalignment. There are some outliers that cannot be explained but most of them occurs at low wind speeds.

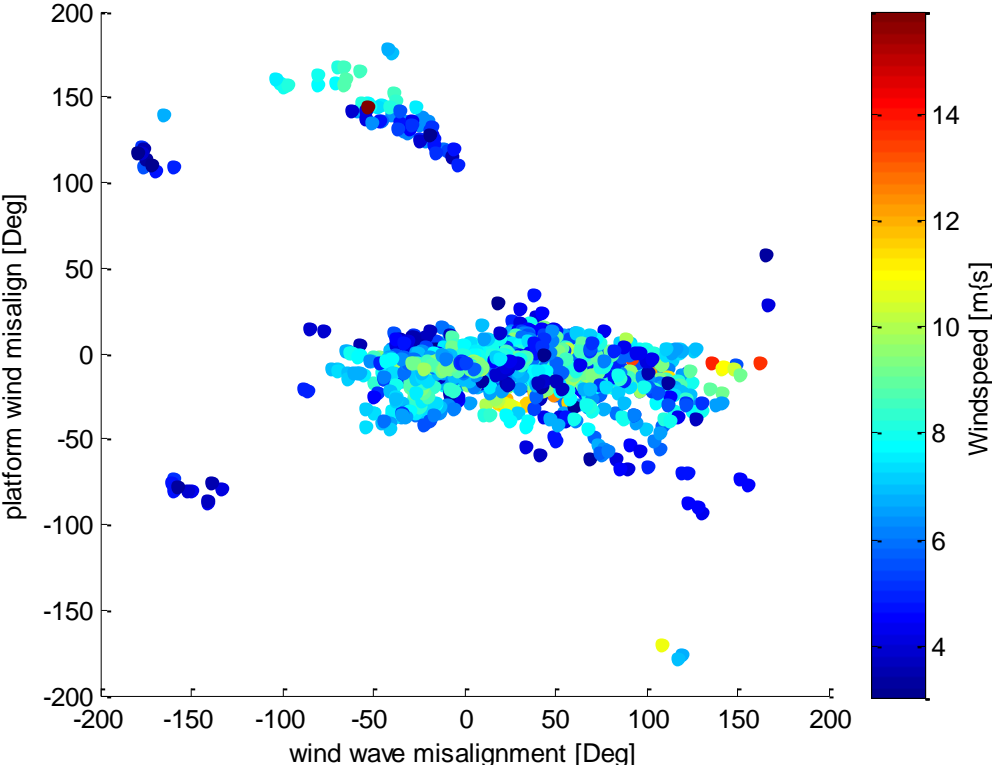

Figure 18. Platform-Wind misalignment as function of Wind-Wave misalignment WTGs on

When looking at platform-wave vs. wind-wave misalignment there seems to be a more strong connection between the two.

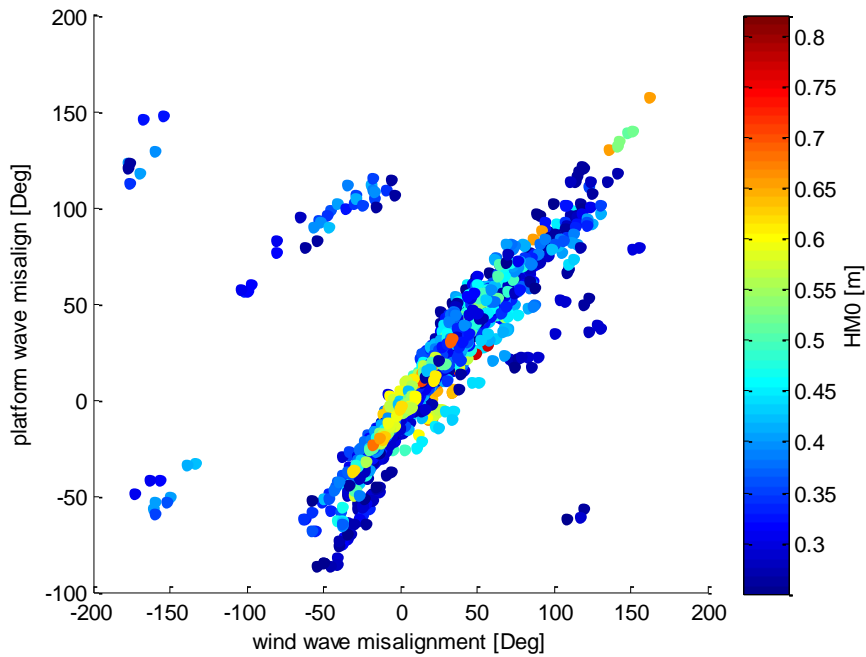

Figure 19. Platform-Wave misalignment as function of Wind-Wave misalignment WTGs on

In Figure 20 and Figure 21, the same situation as in Figure 18 and Figure 19, are plotted but only in situations when the wind turbines are not operating. Now it looks like that there is a misalignment with both wind and waves.

In the situations where the wind turbines are off, it is expected that the platform is aligned with the waves only, but that does not seem to be the case. Exactly what the reason for this, is hard to say from the data. One reason could be that the wind forces on the platform even with the wind turbines off have an impact on the platform direction. It could also be an issue with the data.

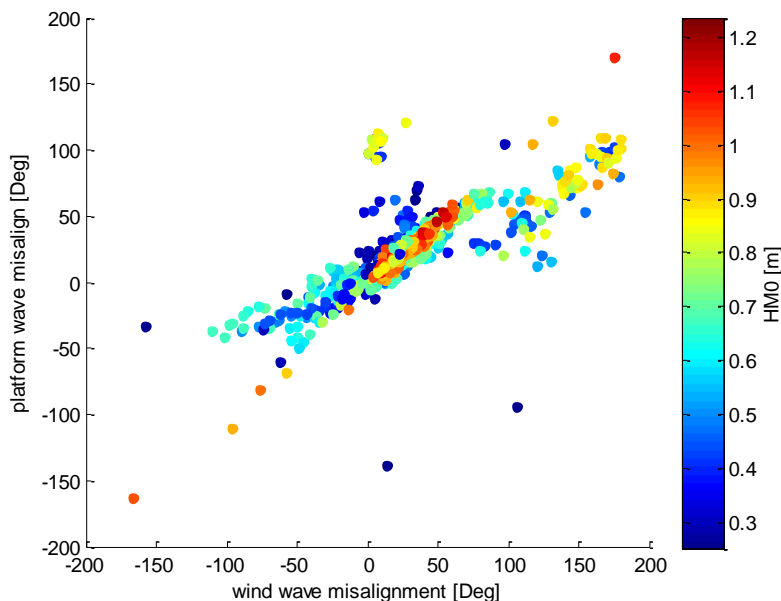

Figure 20. Platform-Wave misalignment as function of Wind-Wave misalignment WTGs off

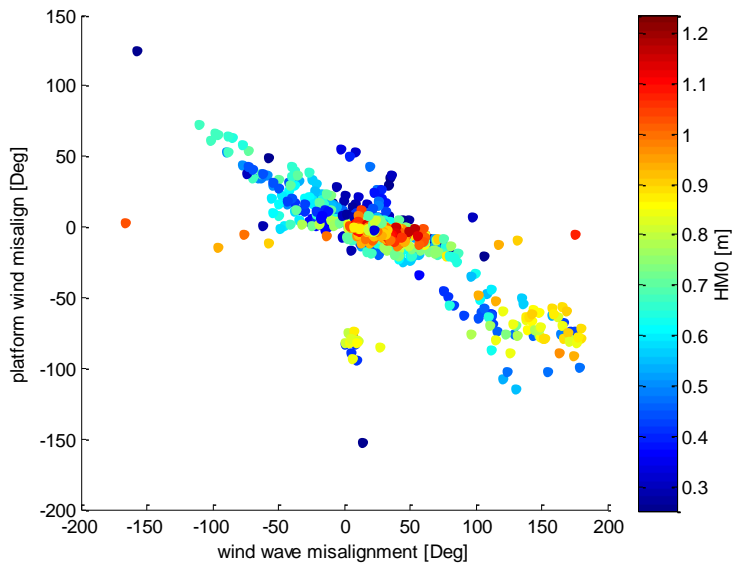

Figure 21. Platform-Wind misalignment as function of Wind-Wave misalignment WTGs off

Platform orientation vs general current direction

It does not appear from the data that the current direction and speed has any significant impact on the platform movement. It should also be noted that the measured current velocities in general is quite low at the site with typical mean values of 0.1 m/s and max values of 0.4 m/s.

3.4.3 Platform pitch and roll

As wind and waves becomes stronger the platform will start rolling and pitching. To investigate this behavior as function of wave height the measurements from two inclinometers placed at the bottom of turbine 1 is investigated. On Figure 22 and Figure 23 the max min and mean 10 min pitch and roll data are shown as a function of wave height. Both figures include situations with the WTGs on and off. The absorbers are active.

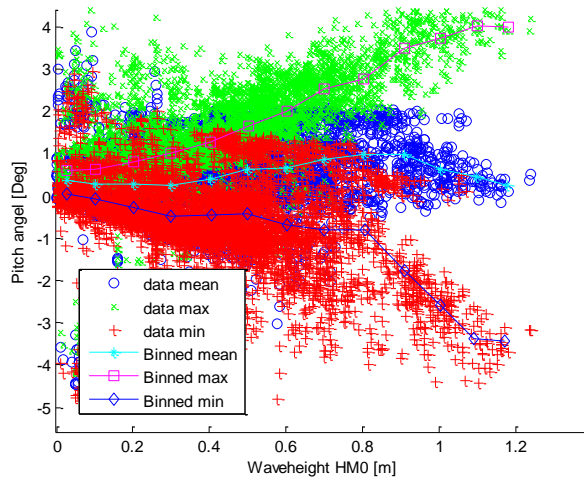

Figure 22 Pitch angle data WTGs on and off

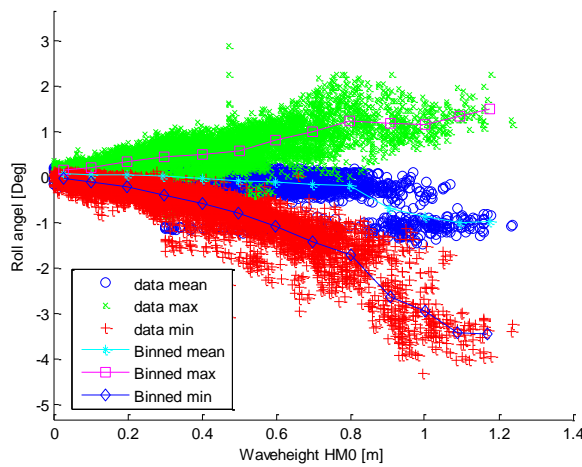

Figure 23 Roll angle data WTGs on and off

From the spread between max and min it can be seen that the platform is pitching a little more than it is rolling. It also looks like there is some change in behavior as the wave height increases. However for large wave heights, the amount of data is reduced so the result is less certain.

In Figure 24 and Figure 25 the binned data is shown in situations with the turbine on and with the turbines off. It shows that there is a shift in the data when the turbines are active but the general magnitude of the pitch and roll is not increasing.

It is expected that the thrust from the turbines will affect the pitch and the torque from the wind turbines will affect the roll. But it does not seem to be the case that the turbines have a negative impact on the stability of the platform. The forces from the turbines means that the platform finds a new equilibrium position that is actually closer to zero in both pitch and roll direction. This is probably because the platform is trimmed to be level when the wind turbines are operating.

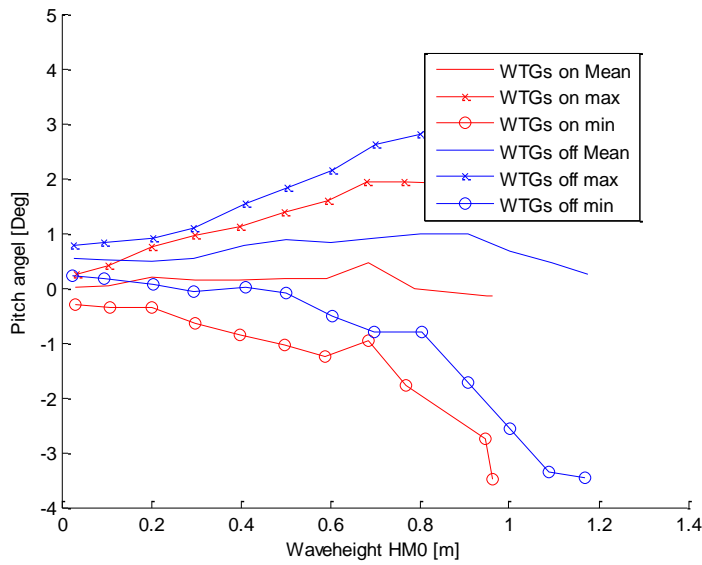

Figure 24 Pitch binned

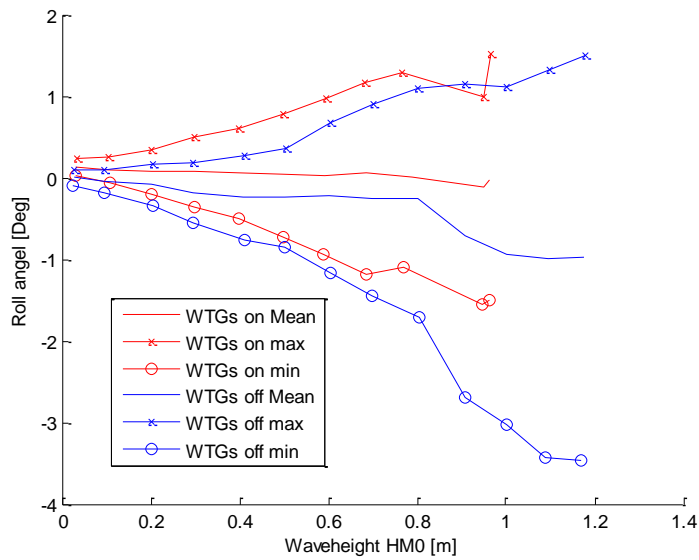

Figure 25 Roll binned

3.5 Summary

In conclusion this chapter shows that the platform is following the wind and wave directions and that the platform has a tendency to follow the wind more than the waves.

The stronger alignment with the wind direction seems more apparent when the wind turbines are operating. A possible reason for this is, that the tree wind turbines on P37 are all placed far aft of the rotation axis of the mooring system and further aft than the wave absorbers . This gives the wind forces acting on the turbines more moment arm. More research on the relation between the wave- and wind generated turning moment is needed to design the optimum wind turbine location. But the location of the wind turbines on the platform seems to affect the platforms ability to align to the waves.

The roll of the platform seems rather high with a tendency to lean at one side (almost -1 degree in mean value seen in Figure 23 and Figure 25) when looking at the statistical data compared to the values obtained in [1]. The reason for this is issues with a ballast tank in the last test period which has not been filtered away in the post processed data. The episode is clearly seen mean platform roll in the statistical data of the platform in the last test period shown in Figure 27.

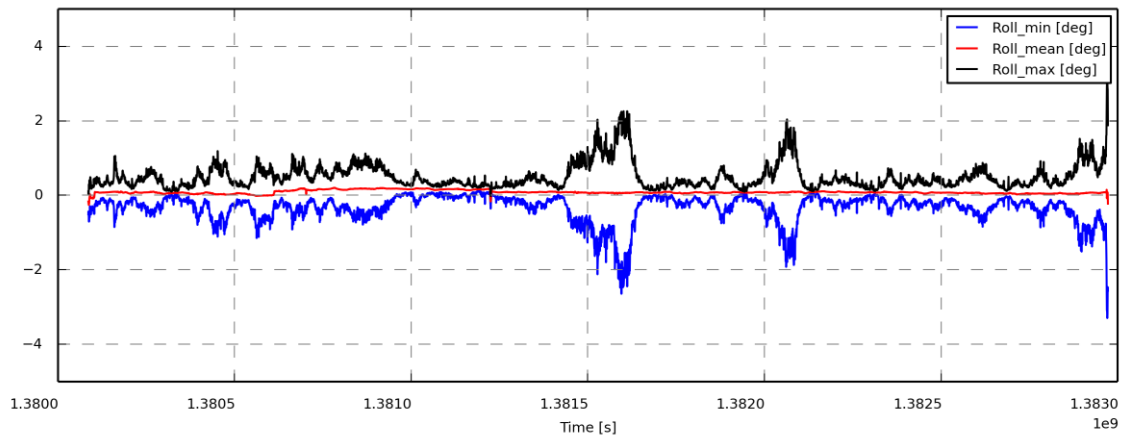

Figure 26. Platform roll, statistical data test period 3.

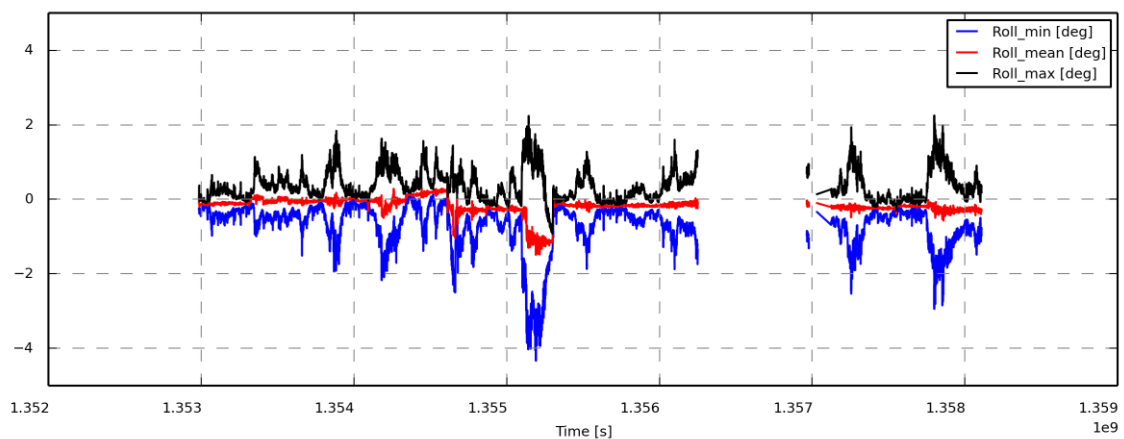

Figure 27. Platform roll, statistical data test period 4.

4. Aero-Hydro-Elastic numerical simulations

One of the challenges of developing a floating platform concept like Poseidon with wind turbines, wave absorbers and mooring lines on a floating platform is that it is close to the limit of what numerical tool can handle. Different tools have been developed to calculate the response of advanced turbine concepts [5] but the complex substructure of the floating platform of Poseidon requires a different approach compared to other methods e.g. for handling the hydrodynamic response of cylindrical members. Currently the challenge of modelling active absorbers (using FPPs principle) is beyond the current capabilities of existing numerical tools and therefore the focus will be on representing the hydrodynamics of a platform with inactive wave absorbers locked in storm position (which means that they effectively are raised out of the water). The aeroelastic response of the wind turbines can be handled by the aero-elastic-code, HAWC2 [6],[7],[8], developed by DTU Wind Energy and coupled to the response output of WAMIT [9] that models the radiation/diffraction of the floating foundation. The following section does only describe the work to model and validate the hydrodynamic response of the platform. Future work will focus on validation of the coupled simulations once the validation of the hydrodynamic response platform has been established. A coupling between HAWC2 and DHI's radiation/diffraction floating body analysis tool, WAMSIM [1] which is based on WAMIT has previously been established and verified [1].

4.1 Panel model of P-37 in WAMIT

The original drawings of P-37 made by the naval architect exist as a 3D CAD model, see Figure 28. The 3D model has been converted into a panel model and further adjusted.

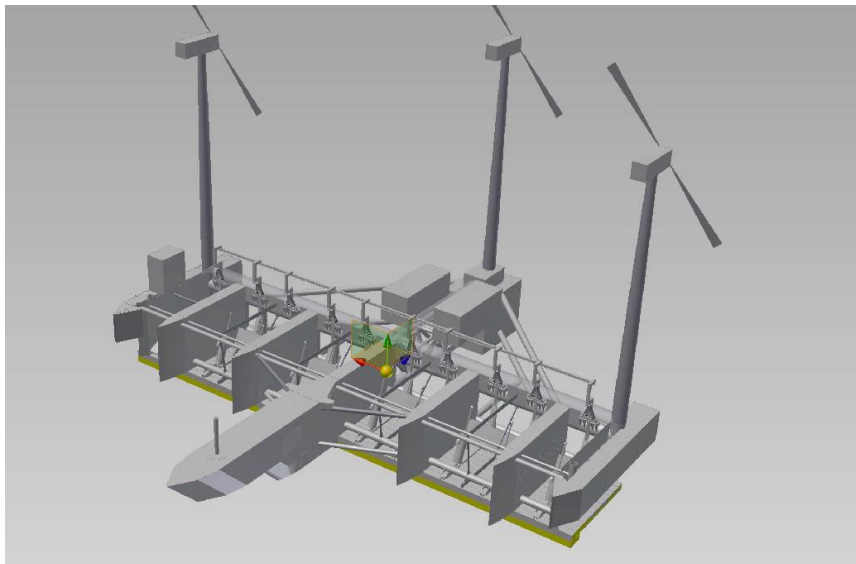

Figure 28. 3D drawing of the P-37

Some beams were removed from the model to prevent any errors resulting from their small size and only the submerged body was included. Surfaces for all of the water-plane areas were created as panels using Matlab (see black dots on below figures) and concatenated with the submerged body pane, see Figure 29. Some adjustments were also made to convert the model so that the reference coordinate system was located in the center of gravity.

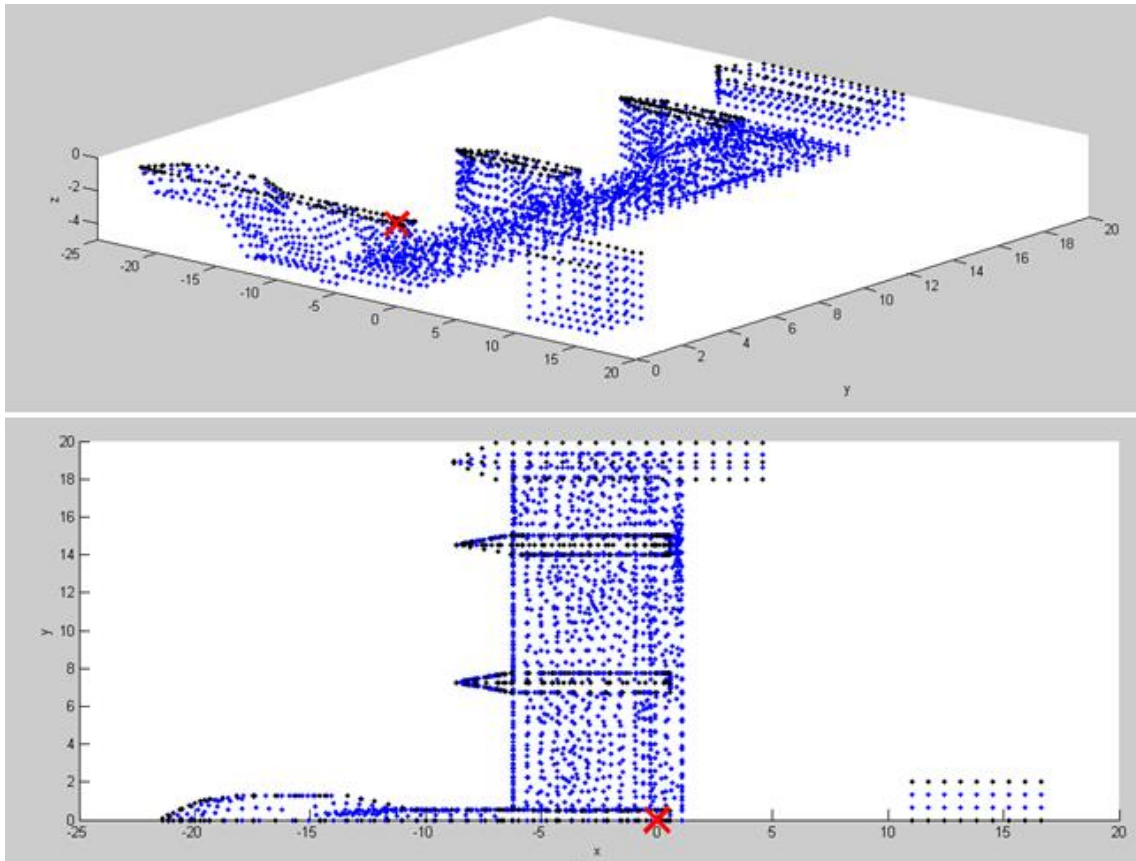

Figure 29. Panel model of P-37

The centre of gravity and mass moments of inertia are dependent on the amount of mass from the floaters that is carried by the platform. In the extreme case where the floaters are completely neutrally buoyant, their masses are not carried by the platform at all. The other extreme case would be where the floaters are locked in their storm-safety mode, in which case the mass of all of the floaters must be included in the platform calculations. In operational mode, control systems are used to apply variable amounts of damping to the floaters, hence the mass of the floaters which must be included in platform calculations is also variable.

As an approximation to operational mode, the mass of the empty floaters was included in the platform calculations, but not their ballast water.

4.2 WAMSIM simulations of the platform

4.2.1 Description of WAMSIM

The moored ship simulation package, WAMSIM, is DHI's state-of-the-art tool for the analysis of coastal and offshore structures subjected to wave forcing. The package relies on the WAMIT model to provide the frequency-domain hydrodynamic characteristics (the frequency-response functions, FRFs) of the body. WAMIT is recognized to be an industry standard for the analysis of floating structures.

WAMSIM takes a Fourier transform of the FRFs to get the body's impulse-response functions (or IRFs), which are then combined with incident wave, hydrostatic, mooring system, wind, current and viscous damping forces to solve the equations of motion for the body in six degrees of freedom.

The incident wave forcing may be input in several ways:

- a superposition of long-crested incident surface elevation (waves) at one point in space
- an incident wave pressure and velocity at each panel of the ship body
- the water depth and horizontal flux components from a MIKE 21 BW wave simulation over a rectangle of grid points enclosing the body linearized by assuming that, in the vicinity of the structure, the wave can be described by a superposition of linear free waves. The linearized velocity and pressure field are then used to obtain the exciting forces on the ship

Certain non-linear external forces on the body can also be included in the simulation:

- restoring forces due to mooring lines, fenders, and/or posts; each of which may vary in any pre-defined way as a function of extension (or compression, or flexure and/or any derivatives of these motions) of the device
- linear frictional damping in the surge and roll modes, due to scraping along fenders
- viscous surge and sway damping
- constant wind and/or current forces based on empirical coefficients
- slowly varying drift force calculated by Newman's approximation

4.2.2 WAMSIM Model Set-up and Input Data

The set-up of WAMSIM relies on detailed information on the vessels, the position at the berths and the mooring systems. The following type of data is specified in the model set-up:

- Layout of ships given as line drawings in digital form
- Mass distribution given either as body inertia matrix, or as body radii of gyration
- Centre of gravity
- Anchor chain attachment points on ship and seabed (x, y, z in well-defined coordinate system)
- Pre-tension in mooring lines, or non-stretched length

4.2.3 WAMSIM simulations of the P-37

The movements and forces on the P-37 were modelled using WAMSIM with the WAMIT panel model described in Section 4.1. The actual model includes the effects of waves and anchor chain forces. The wave absorbers and wind turbines as well as wind and current forces on the platform are not included. A sketch of the platform, including anchor positions as applied in the model, is shown in Figure 30.

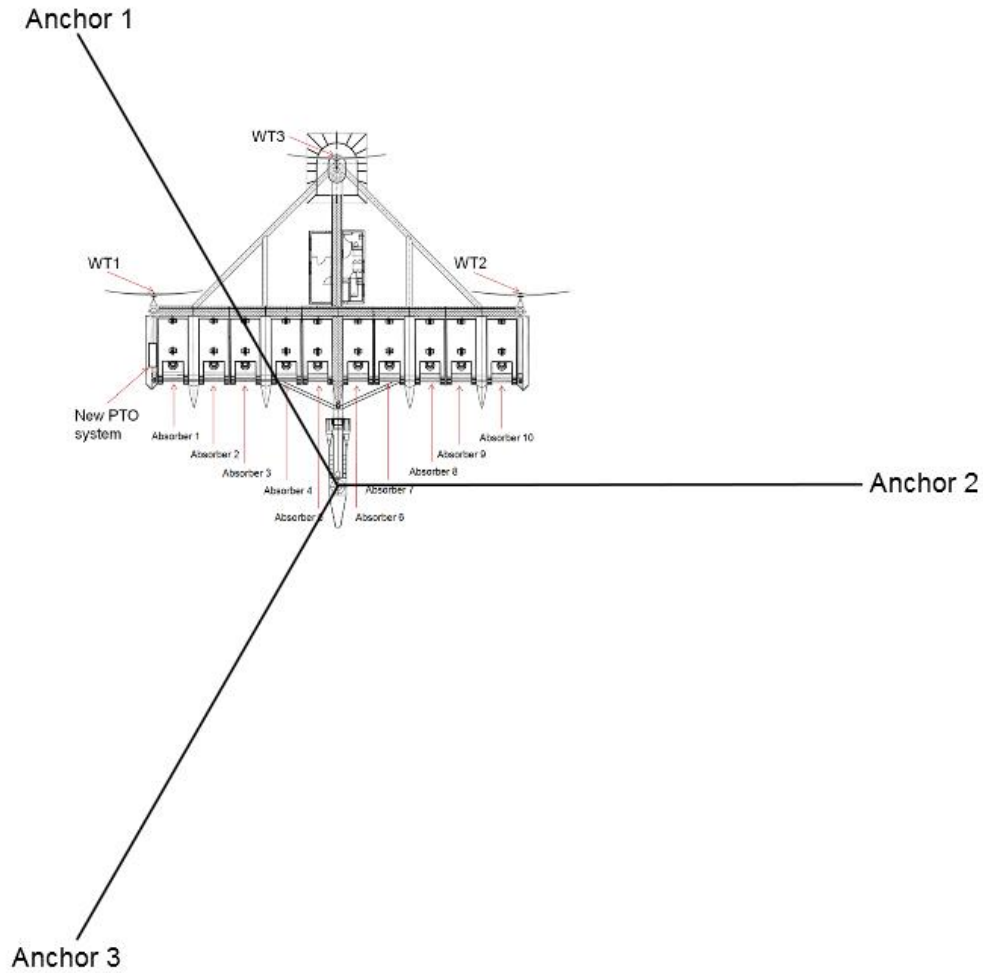

Figure 30. Sketch of the P-37 including anchor positions applied in the model. Not to scale.

The measurements and model simulation data were compared for the conditions present at the 2012-12-05 11:40 to 12:40. The following mean conditions was measured at the platform and applied in the model:

- $H_{m0}=0.61$ m
- $T_p=3.4$ s
- Misalignment between waves and platform= 15°

During the period used for comparison of the WAMSIM model and the measurements of the P-37, the wave absorbers were locked in storm position (except absorber 6) and no turbines were running.

A wave spreading is assumed: 73.7% of the wave energy is assumed to travel in the wave direction while the remaining wave energy (equally divided) is assumed to travel $\pm 30^\circ$ relative to the main direction; this corresponds to a typical directional wave spreading in a wind generated sea [10], where the spreading is defined as $\cos(\theta)^{2s}$ and $s=6$. The wave spectrum is assumed to be a JONSWAP and the water depth is kept constant to 7 m.

Wind and current forces are not included in the actual model, but are given here for completeness. The mean wind speed was 9.7 m/s, which is a considerable wind speed that will have had some effect on the total forces on the platform due to drag. On the other hand, the mean current was low, only 0.04 m/s, and would probably not have influenced the forces on the platform.

4.2.4 Results of the simulation

The roll and pitch of the P37 has been simulated and compared with measurements by inclinometers. The frequency spectrum of the roll motion is shown in Figure 31 and shows that the peak frequencies of the measured and modelled data are almost identical (0.27 Hz and 0.28 Hz, respectively). However, the magnitude of the roll is too small in case of the modelled data.

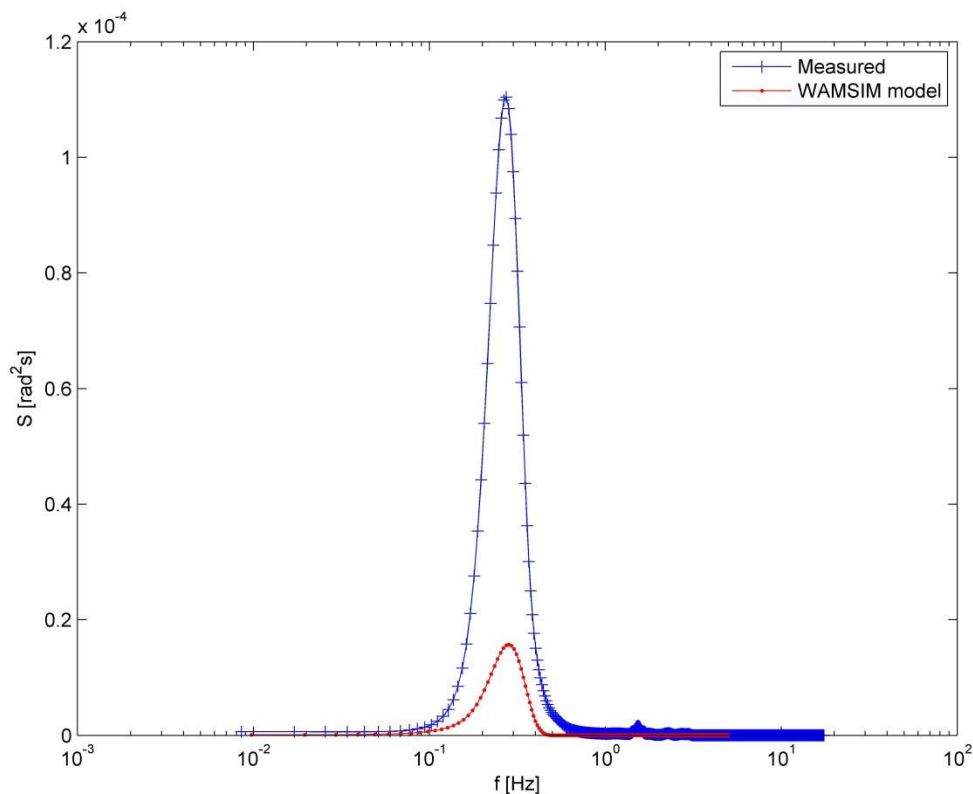

Figure 31. Frequency spectrum of the measured and modelled roll of the P-37.

The key parameters for the roll motion are listed in Table 2. As expected, based on Figure 31, both maximum, minimum and the standard deviation of the modelled roll are smaller than the measured. The measured parameters are between 2.7 to 3.3 times higher than the modelled results, taking the different mean roll into account. This is a relative large difference, but it is not possible to give a single explanation. Possible reasons for the difference could be: slightly different stiffness system in prototype and model, effects of wind forces on the turbine (not included in the model), and effects of the one active wave absorber (not included in the model). It should also be noted that the modelled time series was only around 10 minutes compared to one hour for the measurements which can also explain some of the difference. The difference in sample frequency (10 Hz for the model and 35 for measurements) has the same effect. Furthermore, the applied wave spectrum has an influence.

Table 2. Key parameters for the measured and modelled roll motion of P-37 in degrees.

Parameter	Measured	Modelled
Max roll	0.62	0.30
Min roll	-1.26	-0.30
Mean roll	-0.28	0.00
Standard deviation of roll	0.24	0.09

The frequency spectrum of the pitch is shown in Figure 32. The figure shows a better correlation between the measured and modelled results compared to case of roll; nevertheless, the difference in peak frequencies is slightly – but still insignificant – larger: 0.26 Hz and 0.28 Hz for measured and modelled data, respectively.

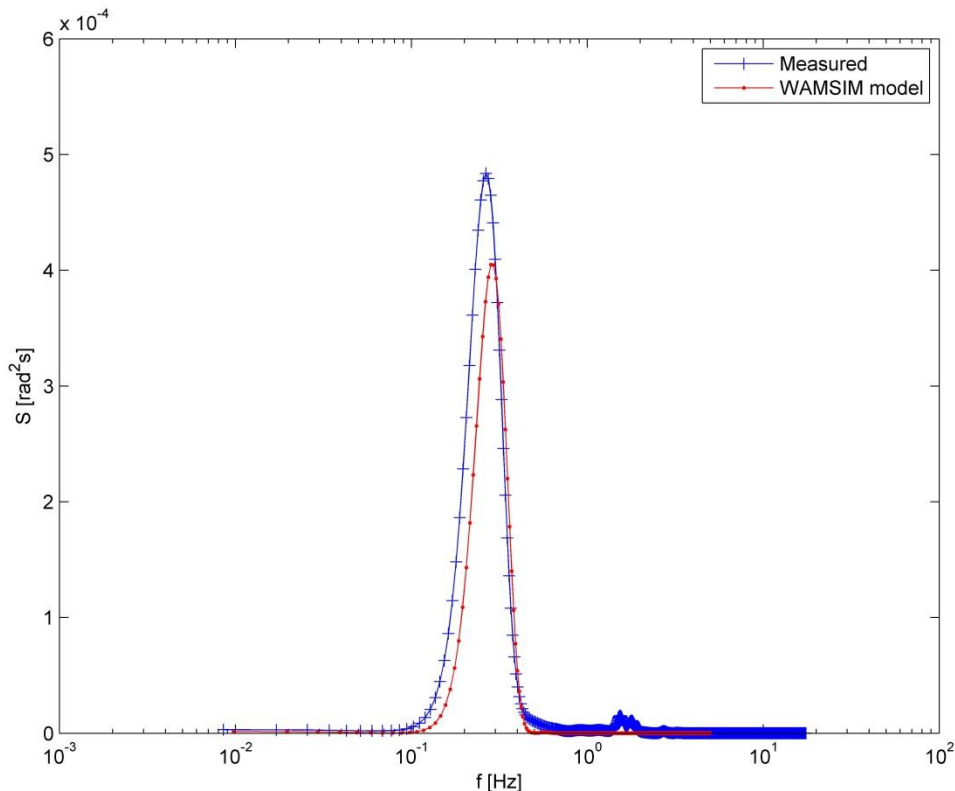

Figure 32. Frequency spectrum of the measured and modelled pitch of the P-37.

The key parameters for the pitch motion are listed in Table 3. As expected, based on Figure 32, there is a better correlation between the measured and modelled data, although the measured values are still larger than the modelled. The measured values are 1.2 to 1.4 times larger than the modelled, taking the different mean pith into account. The possible reasons for this small difference are found to be the same as in case of roll.

Table 3. Key parameters for the measured and modelled roll motion of P-37 in degrees.

Parameter	Measured	Modelled
Max pitch	2.67	1.24
Min pitch	-1.34	-1.85
Mean pitch	0.53	-0.31
Standard deviation of pitch	0.51	0.44

The influence of the wave spreading in the model has been investigated and the pitch and roll for $s=0.5$ to 10 are plotted in Figure 33 and Figure 34. As seen in the figures the influence is small.

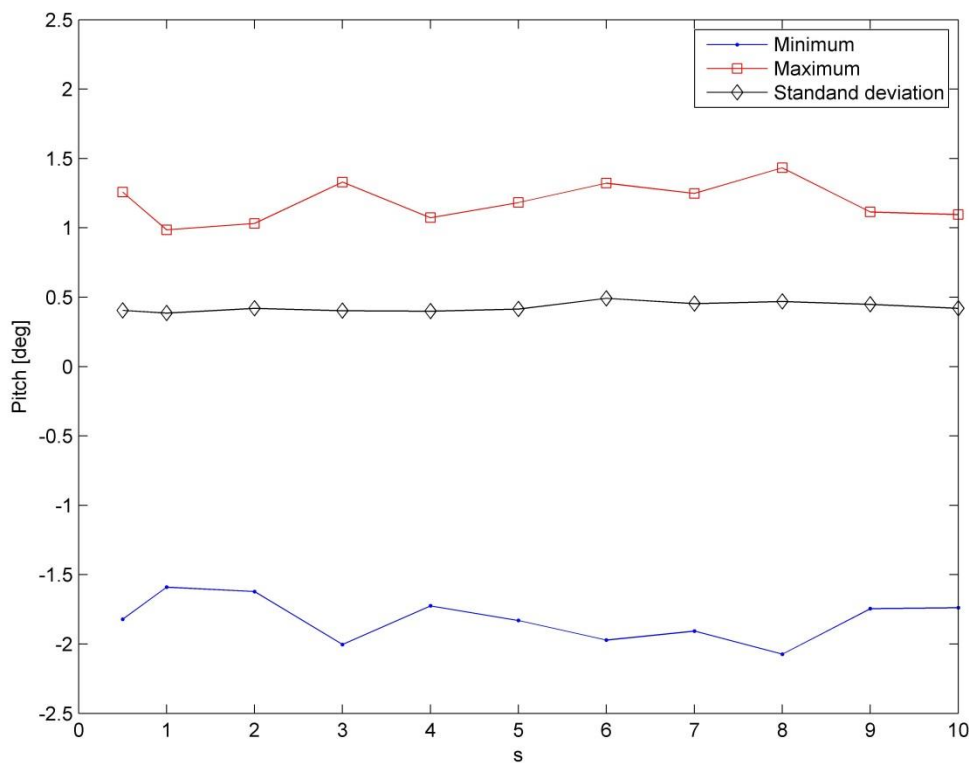

Figure 33. Influence of wave spreading on the pitch in the model.

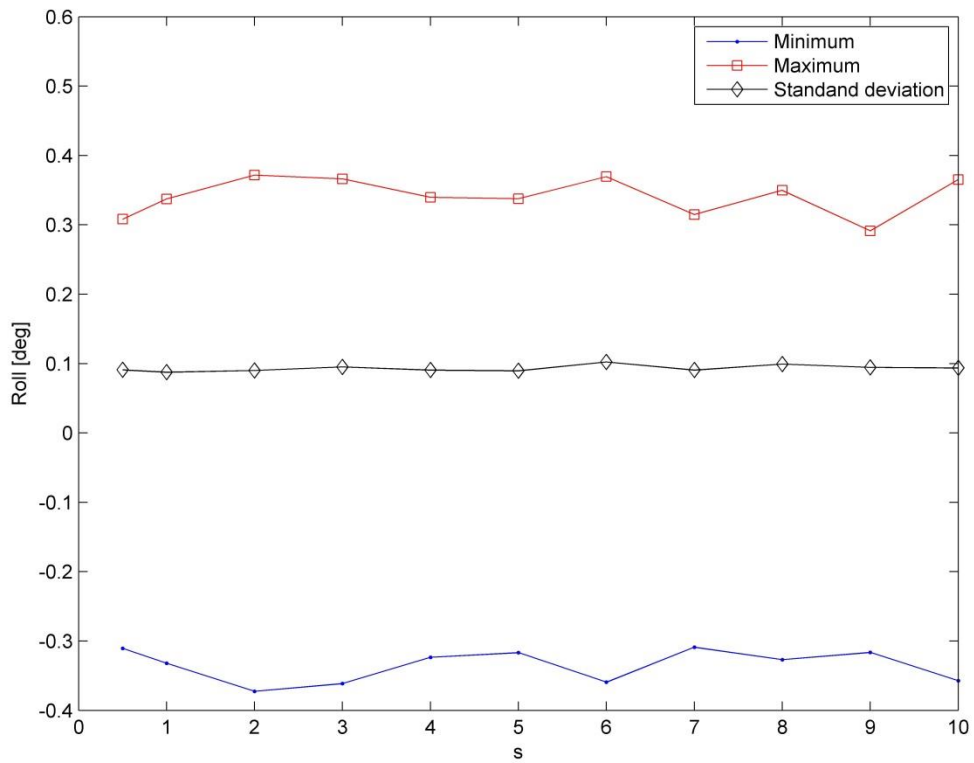

Figure 34. Influence of wave spreading on the roll in the model.

The effect of the mean wave direction was tested as well, and the results are shown in Figure 35 and Figure 36. All conditions – including wave spreading ($s=6$) – are kept constant except the mean wave direction. The effect of the changed mean wave direction is larger than in the case of varied wave spreading, but it is still not very pronounced. Both roll and pitch remains almost constant except for wave directions close to 0° and 90° , where roll and pitch reduces, respectively. It is likely that the effect of the changed mean direction of the wave would be larger with less wave spreading, however, this is not realistic given the location of P-37

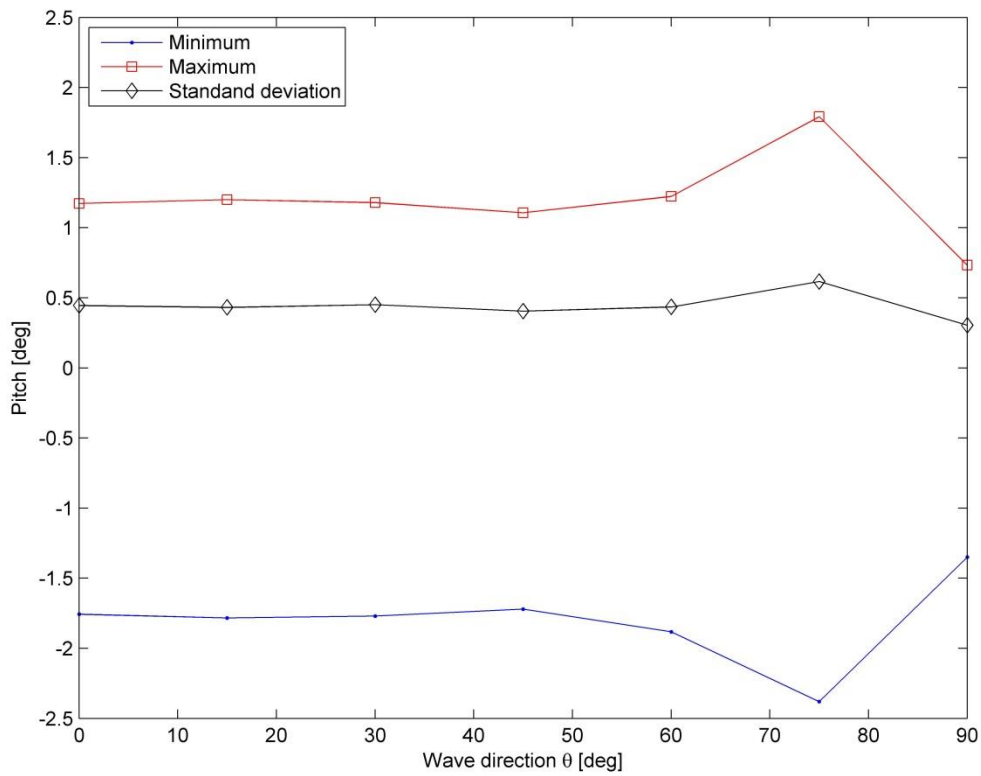

Figure 35. Influence of the mean wave direction on the pitch in the model.

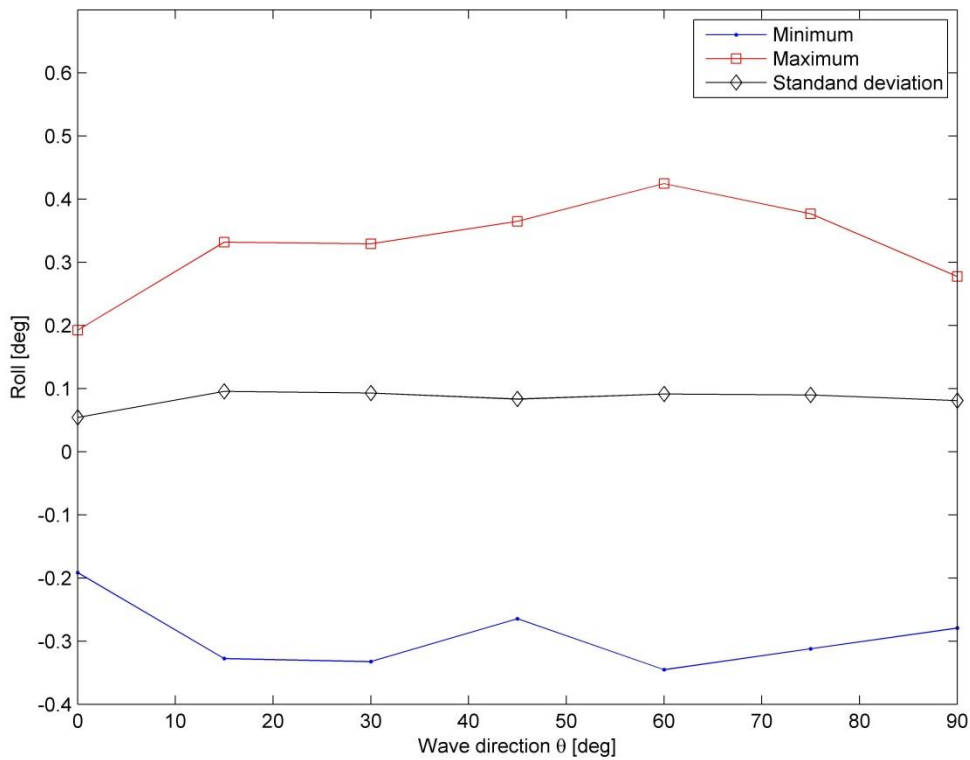

Figure 36. Influence of the mean wave direction on the roll in the model.

4.2.5 Forces in anchor chains

The forces in the anchor chains have also been measured; unfortunately, the sensors on two of the three chains were not working at the time of interest. However, it can still be useful to compare the results to see if the modelled results are the right order of magnitude. Table 4 lists the most important results of the anchor chain analysis. The three modelled forces are almost equal; the forces are only half of the measured (the standard deviation is only 20% to 30%). There can be several reasons for this; the most likely are that the pretension in the anchor chain is higher than in the model. This is supported by the high mean force. Another reason could be that the forces are not equally distributed in the prototype and a much larger part of the force was carried by one anchor (the one which measured). However, the prototype forces should be larger than the forces obtained by the model as the movement is larger.

Table 4. Forces in anchor chains for measured and modelled data.

Anchor	Measured	Modelled 1	Modelled 2	Modelled 3
Max force [kN]	45.0	16.7	17.1	16.7
Min force [kN]	20.4	12.2	11.3	12.0
Mean force [kN]	29.6	14.4	14.3	14.2
Standard deviation of force [kN]	3.4	0.6	1.0	0.7

4.2.6 Notes on more advanced modelling of the P-37

During the project it has been tried to model the P37 including active wave absorbers; it has so far not been successful. WAMIT has a feature that allows one or more parts of a body, e.g. wave absorbers, to move relative to the main body by predefined functions (generalized modes). However, the present case is very complex primarily due to the power-take-off system; that must be included to obtain a realistic result. The power-take-off varies as function of wave height and period, but the generalized modes in WAMIT can only take the size of the motion into account, while it is assumed to be independent of the frequency. Different methods have been suggested, within this and other parallel projects, to overcome this problem; however, so far without success, even for simpler cases

4.3 Summary

The movements and anchor forces of the P-37 platform have been modelled using WAMIT and WAMSIM. The results of the simulations show a reasonable good agreement between the measured and modelled data, although the modelled data is smaller than the measured data in absolute values; this is especially the case for the roll motion. The simulations show that the effect of wave spreading on the movements is small. This is also the case for different mean wave directions applied with a realistic wave spreading, but in this case a small effect are seen around a wave direction of 0° and 90°.

The anchor forces seems to be underestimated by the model, but it has not been possible to make a detailed comparison as the anchor forces was only measured in one out of the three anchor chains.

5. Outlook to MW size turbines on wind and wave energy platform

FPPs market segment is high energy (wave and wind) sites with water depth of more than 45 meter water depth. This is where traditional fixed foundation becomes non-financial viable.

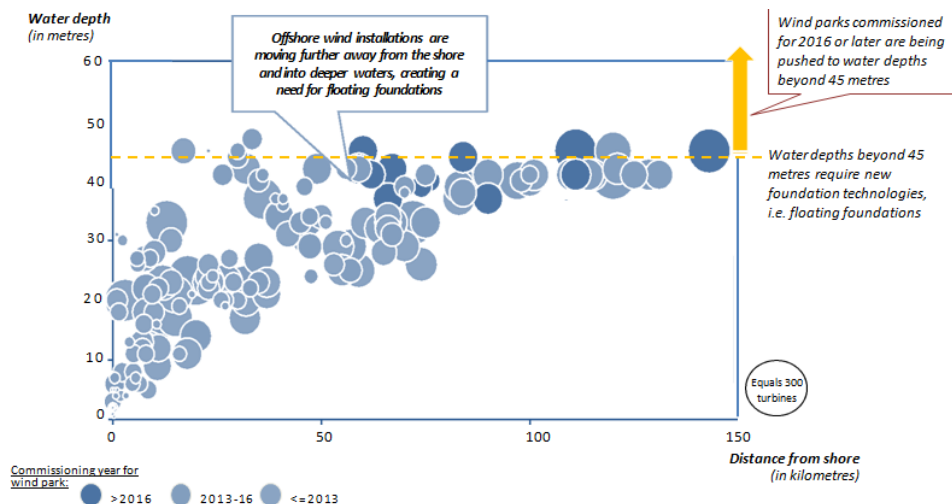

The number of shallow water sites is rapidly becoming reduced, many countries only have plus 50 meter and view sheed is becoming an increasingly barrier for close shore and on shore development.

Going offshore provides many positive aspects e.g. better energy sources, more space, being out of sight etc. But it also imposes significant cost drivers e.g. grid, survivability, device cost, increased environmental impacts, complex O&M, consenting, etc.

The key market competition parameters for renewable energy are:

- The Levelised Cost of Energy (LCOE), meaning the cost of energy seen over the entire project lifecycle incl. capital costs.
- Used space
- Power quality (predictability and dispatchability)

The offshore wind on fixed foundation industry in currently investing heavily in reducing the LCOE to 100€/MWh ~ 125€/MWh including a 10% *weighted average cost of capital (WACC)*.

FPPs value proposition is built around addressing the challenges in the deep water market segment on the generic terms for renewable energy, this by:

- 1) Combining wave and wind on the same platform, hereby increasing the total power output
- 2) Using the same platform for 2 energy resources reduces the capital cost for the devices
- 3) Combining the two energy resources secures a better power profile and predictability. Wave have significant better based load and predictability characteristics than wind

- 4) The wave energy conversion uses patented floats to extract directly grid-transferable energy from the waves. This in addition secures the platform vanes passively into the primary wave direction and creates calm waters at the aft for safe access to the foundation for Operation and Maintenance.

For the technology to be cost competitive the devices must be large and in arrays. This is to carry the significant indirect cost of consenting, installing and working offshore in deep waters.

Below are generic cost curves coupled with FPP's cost modeling.

Power generation costs based on P80
(in €/kWh)

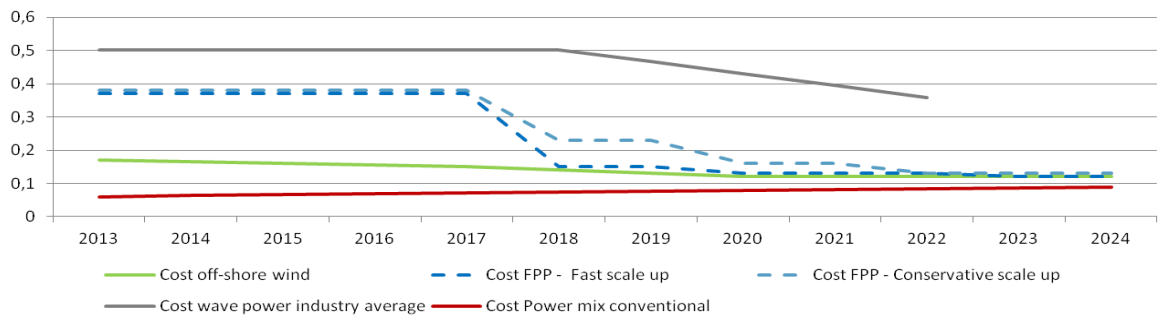

Note: FPP has based its method of LCOE calculations on the framework applied by The Crown Estate, which is similar to the general offshore wind industry. The method includes cost of capital (WACC) which the Crown Estate fixes at 10% for offshore wind, however FPP applies a WACC of 12%. The wave energy cost curve and wind energy cost curve source is renewable UK. Cost Power mix conventional: Fraunhofer, ISE

FPPs first commercial device will not be cost competitive with offshore wind, this due to

- Is being one off build
- Is a single unit
- Is fitted with a smaller turbine for safety and put at a more benign wave site meaning lower wave power production.

The significant drop cost for FPPs technology is not due to a significant reduction in the device prices but due to large power output (large WT and larges waves) and the synergies of developing arrays.

5.1 Wave energy upscaling

5.1.1 The reasons of upscaling wave energy devices

Wave energy is still an early-stage industry, with several device designs on their way to full-scale commercialization. The devices must be designed to achieve maximum power, whilst surviving the harsh offshore environments and minimizing costs. To minimize risk, it is advisable to take a systematic approach to development, where the size and complexity of the test devices are increased for each development stage. Common development steps include small scale (1:50 to 1:100) in a controlled environment, medium-scaled device (1:4 to 1:2) at a benign ocean test site and full-scale device in a commercial-level ocean site. Once confidence has been gained with the technology, from, amongst others, a safety, survivability, power production and maintenance perspective, the device must be upscaled to get the maximum from the site (if the first commercial prototype was not already), then arrays of devices must be deployed. It is only through the upscaling process that wave energy devices can become financially feasible and competitive with alternative technologies.

The exact method of upscaling is dependent on the specific device. The following section describes this upscaling process for FPP's device.

5.1.2 How to upscale FPP's technology

Wave scatter diagrams indicating the annual distribution of wave height and energy wave period must first be acquired for the proposed deployment site, together with the bathymetry/depth across the site. Using this site data, an iterative optimization procedure is used to scale the platform to the site.

According to the requirements of the project, the dimensions of the platform must be determined, with a view to achieving the maximum power for the lowest cost. From both a performance and cost perspective, there are upper limits to the platform size, above which it is more economically viable to deploy multiple devices, each of an optimized size. The optimization procedure used to determine the upscaled device characteristics is iterative, and is described briefly in this section.

The length of the platform is designed for pitch stability, and the draught designed according to the water depth (at low tide) and the depth of nearby service harbors. A water depth of 40 to 100 m is ideal for the current design. At greater water depths, the mooring system would need further optimization to keep costs low. The width of the platform must be determined from stability and cost perspectives as well as the available manufacturing and assembly capabilities close to the site. Once the platform width is determined, the maximum power that will be available to the platform at the site can be approximated for each wave regime using the definition of Energy Period together with the annual distribution of the waves at the site.

In house design parameters are applied to determine the efficiency of specific floater heights and lengths in each of the wave regimes considered. Using these calculated efficiencies together with the calculated maximum available annual energy from that wave regime at that site, the maximum annual energy from the floater can be determined, allowing for reductions in energy due to downtime and power losses.

The number of floaters is determined by the width of the platform and the optimum width of an individual floater, under the restriction that the platform must be balanced, hence the number of floaters even. The individual floater width is selected according to an optimization procedure. The optimization accounts for the torque on the hinge, whose upper limit is dictated by the associated increase in cost of materials, the generator, which must be between 400 and 600 Kw to minimize the use of bespoke components and efficiency, where the upper limit is dictated by the potential wave regimes at the site. Research has indicated an optimal floater width of between 12 and 20 m.

For many EU sites, the P80 is close to the optimal design according to the above criteria. The P80 has a platform width of 80 m, and four floaters. The length and height of the floaters, as well as the generator size, must be finely optimized using the above outlined design process according to the specific site characteristics.

5.2 Wind energy upscaling

This section deals with the challenges of upscaling the Poseidon concept when it comes to the wind energy. In order to achieve a higher potential for capturing more wind energy from an up scaled platform there are two ways of doing this: increasing the size of the turbine or increase the numbers of turbines.

The following study is based on the technology of Poseidon with a large triangular floating platform connected to a turret mooring system and equipped with an array of WEC's. The purpose of this investigation is to look at the advantages and disadvantages of installing a total capacity of 10 MW wind energy on a platform in one of the following configurations:

1. One 10 MW turbine
2. Two 5 MW turbines
3. Three 3.3 MW turbines

The platform has the dimension of 300 meters for the sides in an equilateral triangle of the main floating support frame and 30 meters in the connecting frame to the turret mooring point see Figure 37. The turbines used in this study is the DTU 10MW Reference Wind Turbine [11], the NREL 5MW reference turbine [12] and a downscaled 3.3 MW turbine based on the NREL 5MW reference turbine (scaling rules described in [13]).

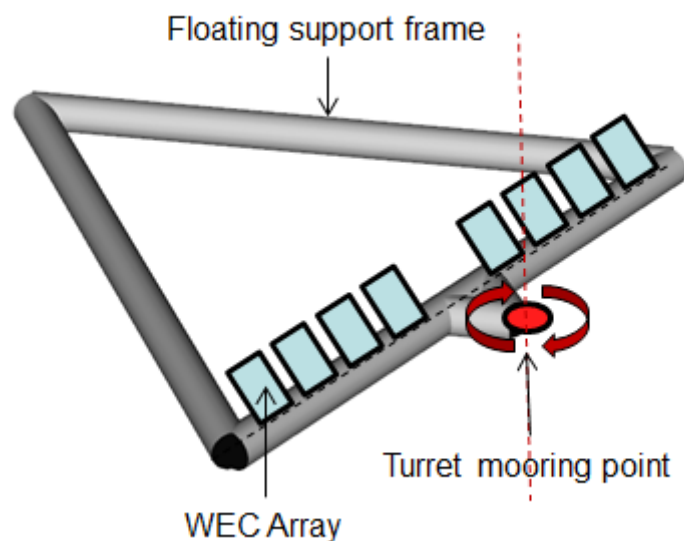

Figure 37. Illustration of the floating platform

The basic properties of the three turbines are summarized in Table 5. All turbines are virtual turbines but have very similar characteristics as real manufactured turbines and are considered to be representative. All turbine configurations are maintained even though the tower height of the different configuration could potentially be adjusted to keep the same tip to platform clearance.

Parameter	DTU 10-MW	NREL 5MW	Scaled 3.3 MW
Wind Regime	IEC Class 1A	IEC Class 1B	IEC Class 1B
Rotor Orientation	Clockwise rotation - Upwind	Clockwise rotation - Upwind	Clockwise rotation - Upwind
Control	Variable Speed Collective Pitch	Variable Speed Collective Pitch	Variable Speed Collective Pitch
Cut in wind speed	4 m/s	4 m/s	4 m/s
Cut out wind speed	25 m/s	25 m/s	25 m/s
Rated wind speed	11.4 m/s	11.4 m/s	11.4 m/s
Rated power	10 MW	5 MW	3.3 MW
Number of blades	3	3	3
Rotor Diameter	178.3 m	126 m	102.4 m
Hub Diameter	5.6 m	3 m	2.4 m
Hub Height	119.0 m	90.0 m	73.1 m
Drivetrain	Medium Speed, Multiple -Stage Gearbox	High Speed, Multiple -Stage Gearbox	High Speed, Multiple -Stage Gearbox
Maximum Rotor Speed	9.6 rpm	12.1 rpm	14.9 rpm
Maximum Generator Speed	480.0 rpm	1173.3 rpm	1173.3 rpm
Gearbox Ratio	50	97	78.8
Maximum Tip Speed	90.0 m/s	80.0 m/s	80.0 m/s
Hub Overhang	7.1 m	5.0 m	4.06 m
Shaft Tilt Angle	5.0 deg.	5.0 deg.	5.0 deg.
Rotor Precone Angle	-2.5 deg.	-2.5 deg.	-2.5 deg.
Blade Prebend	3.332 m	0 m	0 m
Rotor Mass	227,960 kg	110,000 kg	58,980 kg
Nacelle Mass	446,040 kg	240,000 kg	128,690 kg
Tower Mass	628,440 kg	347,460 kg	186,300 kg
Total Turbine Mass	1,302,440 kg	697,460 kg	373,970 kg
Total Turbine Mass for 10 MW	1,302,440 kg	1,394,920 kg	1,121,910 kg

Table 5. Key parameters of the DTU 10 MW Reference Wind Turbine compared to the NREL 5 MW Reference Wind Turbine and a downscaled 3.3 MW Wind Turbine

The setup of the three configurations are shown Figure 38 where a DTU 10 MW RWT, two NREL 5 MW RWT's and three downscaled 3.3 MW RWT's are placed on the same platform. The DTU 10 MW RWT is placed central close to the turret mooring point, the two NREL 5 MW RWT's are placed in the first two corners of the platform and the three downscaled 3.3 MW RWT's are placed in every corner of the triangular platform. No further investigations have been made in order to optimize turbine position for all the configurations.



Figure 38 Illustration of three different configurations of installing 10 MW wind power on a floating platform: one 10 MW turbine, two 5 MW turbines or three 3.3 MW turbines.

In order to investigate the potential advantages and disadvantages of the three different configurations the following key points have been chosen for evaluation in a MCDA (Multi Criteria Decision Analysis):

- Wind Power production
- Wave power production
- Turbine cost (including installation)
- Maintenance cost
- Impact on platform stability
- Turbine Loads

Wind Power production

The turbines should always be able to produce power even though there is a wind/wave misalignment as the turbines are able to yaw into the wind. However a wind/wave misalignment might cause the turbines to be operating in each others wake and thereby reducing the power produced by the wind turbines. The first configuration with one turbine will be unaffected by this whereas the two other concepts of having two or three turbines on the platform can potentially be operating in wake. The case with two turbines is less sensitive compared to the case with three turbines as wake situation could occur with a wind/wave misalignment of 30 degree compared to 90 degree due to the platform geometry and assuming that the platform will align with the wave direction due to second order drift effects see Figure 39 and Figure 40. It might even occur less than 30 degree due to wake expansion and wake meandering effects. Additionally larger turbines will operate slightly higher up in the lower part of the atmosphere and due to wind shear will potentially produce more power. In conclusion one large turbine gets the highest score and the configuration with three turbines gets the lowest score due to the highest risk of power loss in wake situations.

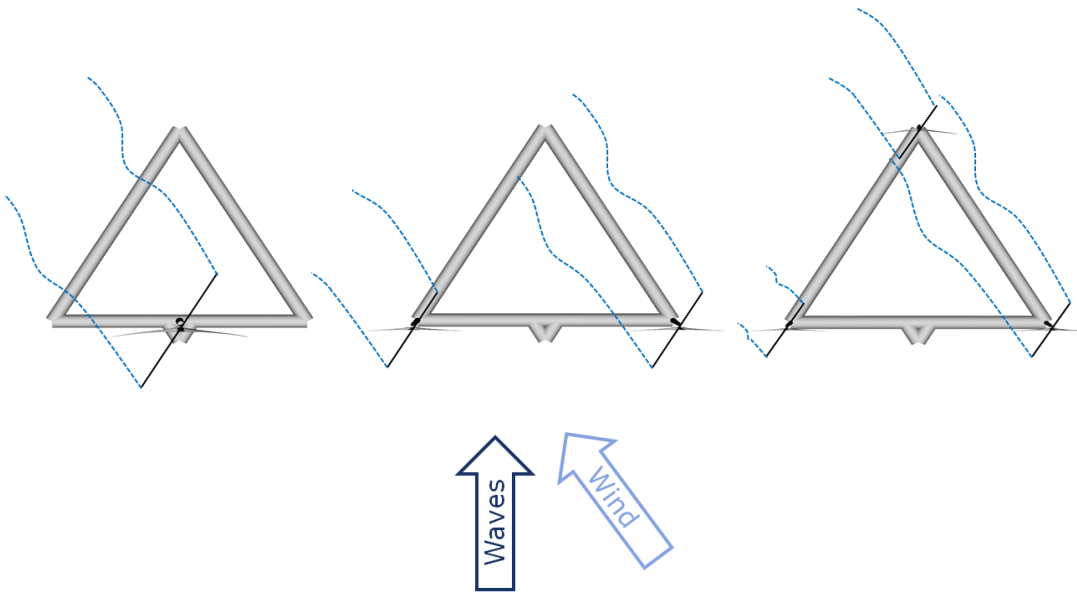

Figure 39. Situation of 30 degree wind/wave misalignment and potential wake situations for the different configurations.

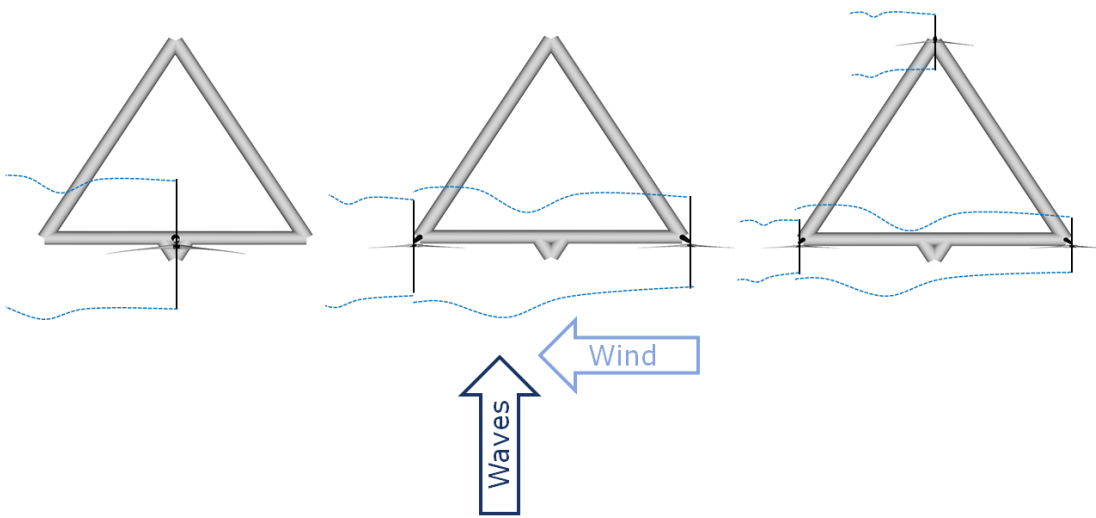

Figure 40. Situation of 90 degree wind/wave misalignment and potential wake situations for the different configurations.

Wave power production

Wave power is included in this section because that the wind turbines potentially can force the platform out of the waves in situations with wind/wave misalignment and thereby reducing the wave power produced. One large wind turbine can be placed very close or even on top of the turret mooring system and thereby applying a little or even no moment to turn the platform from the thrust force going into the platform. The worst case is have three turbines as the thrust force from the turbine located furthest away from the turret mooring system will generate a large moment due to the thrust offset distance as seen in Figure 41. Another scenario where a significant moment will try to turn the platform is with no wind/wave misalignment and in the case of having one out of two or three stopped turbine turbine. In conclusion one large turbine gets the highest score and the configuration with three turbines gets the lowest score due to the highest risk of wave power loss because of a platform misalignment with the wave direction.

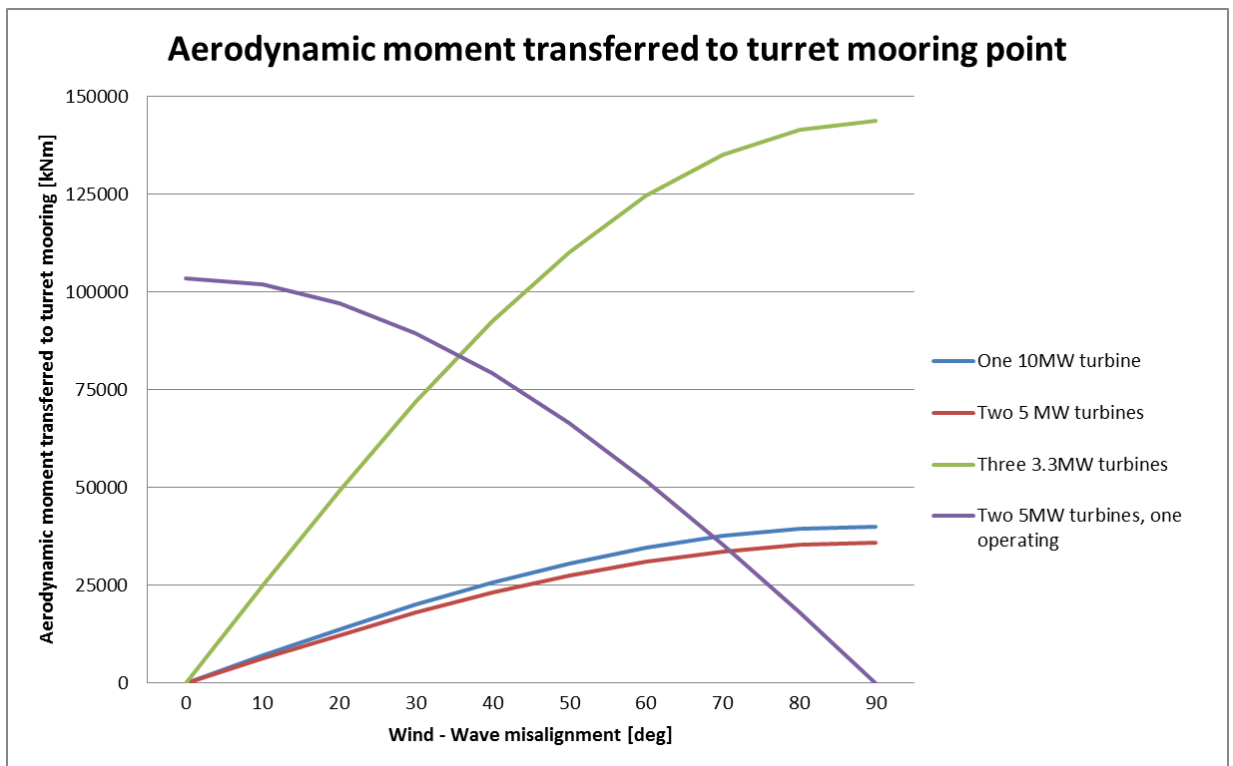

Figure 41. Aerodynamic moment transferred to turret mooring point in different platform configurations. The forces are calculated based on the aerodynamic thrust force and distance to the turret mooring point. Thrust reduction due to wake effects is not included.

Turbine cost (including installation)

Generally the upscaling is associated with the challenge of beating the square-cube law saying that power and energy increases with dimensions squared while weight increases with dimensions cubed. This means that weight become relatively heavier with size. However technology development seems to be able to beat this trend which is also seen in the total weight of 10 MW wind power as shown in Table 5. According to [14] where a wind farm project is evaluated for the same rated capacity with 4MW, 6MW and 8MW turbines the price of the turbine increases as the size increases. It also shows that the installation cost drops for using larger turbines in the case of offshore bottom fixed turbines. It is expected that turbines on a floating platform can be installed in harbor and therefore the cost savings compared to bottom fixed turbines might not be as significant when it comes to increasing the turbine size. Technology development might show that future turbines will cost less due to production optimization and potential modular construction of large tower and blades. In conclusion one large turbine gets the lowest score but it is evaluated that the cost including installation is similar for the three concepts as smaller turbines might be cheaper but has a higher installation cost.

Maintenance cost

Due to fewer components in one big turbine it is estimated that one large turbine will have a lower maintenance cost compared to more and smaller wind turbines with more components in total. In case of a component failure one of the turbines, there might be a need to ship the entire platform in harbor and thereby losing a significant amount of power generated from both wind and waves. This will also be a costly operation and therefore it is valued higher than e.g. turbine cost.

Impact on platform stability

The large turbine has its rotor center where the entire thrust force will be applied higher up than the other configurations. Therefore one turbine will induce a larger pith moment to the platform motions but at the same time a larger aerodynamic damping. The configuration with two or three turbines has the disadvantage of turning the platform in a situation with wind/wave misalignment.

Turbine Loads

One large turbine might experience the relatively highest tower bottom loads as it has a heavier turbine located on a high tower. This means that even small pitch motions will attribute relatively more to the tower loads of larger turbines. On the other hand one large turbine is subjected to lesser fatigue loads due to the fact that will not operate in wake.

	Wind Power production	Wave power production	Turbine cost (including installation)	Maintenance cost	Impact on platform stability	Turbine Loads	Concept score
Concept/Weight	5	4	3.5	4	3	3	
One DTU 10 MW RWT	5	5	3.5	5	3	5	118
Two NREL 5 MW RWT's	4	4	4	4	4	4	116
Three scaled 3.3 MW RWT's	3	3	4.5	3	5	3	114

Table 6. Result of the MCDA (Multi Criteria Decision Analysis) for the three different concepts.

Only one type of turbine has been evaluated in this study as the majority of large multi MW turbines are horizontal, up-wind, pitch-regulated wind turbines. There is no commercial stall regulated turbines above 2.3 MW and no large vertical axis wind turbines (VAWT). Recently a large interest from both industry and research has been focusing more on development of VAWT and in a case of a floating platform a VAWT might have some benefits like having a lower center of gravity and no yaw mechanism. From the previous arguments and the results from the MCDA shown in Table 6 it is expected that it is preferable to have one large turbine on floating concept like Poseidon.

5.3 Combined wind and wave upscaling

The combination of wave and wind poses several challenges. The key driver must be that the combination makes the combined solution more financial feasible. Combining the two technologies increases risk and capital cost.

There are several designs present for combined solution, FPP however being the only one with offshore operation and test to support the principle.

FPPs value proposition is (as stated before) built around addressing the challenges in the deep water market segment on the generic terms for renewable energy, this by:

- 1) Combining wave and wind on the same platform, hereby increasing the total power output
- 2) Using the same platform for 2 energy resources reduces the capital cost for the devices
- 3) Combining the two energy resources secures a better power profile and predictability. Wave have significant better based load and predictability characteristics than wind



Figure 42.FFP deep water technology

- 4) The wave energy conversion uses patented floats to extract directly grid-transferable energy from the waves. This, in addition, secures that the platform vanes passively into the primary wave direction and creates calm waters at the aft for safe access to the foundation for Operation and Maintenance.

A key challenge for other designs looks to be extracting enough wave power to make it feasible or to have other synergies present to support the investment.

This does remove the challenges of increased technology risk and higher capital cost for FPP (even if this leads to a significantly reduced LCOE)

Scaling to commercial size, as stated above, will lead to very large structures with a single turbine:

- This to support the development in wind turbine industry moving to larger and larger MW wind turbines.
- Wave energy is only commercial viable in high wave energy conditions.

This is a complex optimization exercise containing several parameters including:

- Cost
- Structural strength
- Must support a single multi MW turbine
- Must be placed in a high wave energy areas
- Stability
- Survivability
- Maintainability
- Buildability
- Etc.

FPP's cost and engineering models looks to lead to a commercial P80 device with a 5 MW wind turbine and up to 2.6 MW wave power. These optimization calculations have not been included (due to confidentially and out of project scope)

6. References

- [1]. B. S. Kallesøe (2011). "Aero-Hydro-Elastic Simulation Platform for Wave Energy Systems and floating Wind Turbines". Roskilde: Danmarks Tekniske Universitet, Risø Nationallaboratoriet for Bæredygtig Energi. (Denmark. Forskningscenter Risoe. Risoe-R; No. 1767(EN))
- [2]. A. Yde (2014) "Poseidon 2 - Measurement System Report", Roskilde, DTU Wind Energy. (DTU Wind Energy I; No. 0192(EN)).
- [3]. M. M. Pedersen; A. Yde (2014) "Poseidon 2 - Measurement Data Post Processing & Calibration", Roskilde, DTU Wind Energy. (DTU Wind Energy I; No. 0194(EN)).
- [4]. A. Yde; M. M. Pedersen (2014) "Poseidon 2 - Accelerometer Test Report", Roskilde, DTU Wind Energy. (DTU Wind Energy I; No. 0193(EN)).
- [5]. A. Robertson, J. Jonkman, W. Musial, F. Vorpah, W. Popko (2013) "Offshore Code Comparison Collaboration, Continuation: Phase II Results of a Floating Semisubmersible Wind System", EWEA Offshore 2013 Frankfurt, Germany
- [6]. T. J. Larsen, A. M. Hansen (2012) "How to HAWC2, the user's manual". Tech. Rep. Risø-R-1597(ver.4-3) (EN), DTU Wind Energy, Roskilde, Denmark .
- [7]. T. J. Larsen, H. Aa. Madsen, G. Larsen, K. S. Hansen (2012). "Validation of the Dynamic Wake Meander Model for Loads and Power Production in the Egmond aan Zee Wind Farm", Accepted for Wind Energy
- [8]. T. Kim, A. M. Hansen, K. Branner (2013) "Development of an anisotropic beam finite element for composite wind turbine blades in multibody system", Renewable Energy, Volume 59, November 2013, Pages 172-183, ISSN 0960-1481.
- [9]. Lee, C.-H. (1995) "WAMIT Theory Manual". Massachusetts Institute of Technology.
- [10]. Det Norske Veritas (DNV); "Environmental conditions and environmental loads, DNV-RP-C205" Recommended Practice, October 2010.
- [11]. C. Bak, F. Zahle, R. Bitsche, T. Kim, A. Yde, L.C. Henriksen, P.B. Andersen, A. Natarajan, M.H. Hansen, "Design and performance of a 10 MW wind turbine", J. Wind Energy, To be accepted.
- [12]. J. Jonkman, S. Butterfield, W. Musial, G. Scott (2009) "Definition of a 5-MW reference wind turbine for offshore system development". Technical Report NREL/TP-500-38060, NREL.
- [13]. Chaviaropoulos, P.K. (2006) "Similarity rules for wind turbine up-scaling". Online Documentation.
- [14]. The Crown Estate, BVG Associates (2012) "Offshore Wind Cost Reduction Pathways", May 2012.

DTU Wind Energy is a department of the Technical University of Denmark with a unique integration of research, education, innovation and public/private sector consulting in the field of wind energy. Our activities develop new opportunities and technology for the global and Danish exploitation of wind energy. Research focuses on key technical-scientific fields, which are central for the development, innovation and use of wind energy and provides the basis for advanced education at the education.

We have more than 240 staff members of which approximately 60 are PhD students. Research is conducted within nine research programmes organized into three main topics: Wind energy systems, Wind turbine technology and Basics for wind energy.
