

Technical University of Denmark



## Investigations of Intelligent Solar Heating Systems for Single Family House

**Andersen, Elsa; Chen, Ziqian; Fan, Jianhua; Furbo, Simon; Perers, Bengt**

*Published in:*  
Energy Procedia

*Link to article, DOI:*  
[10.1016/j.egypro.2014.02.002](https://doi.org/10.1016/j.egypro.2014.02.002)

*Publication date:*  
2014

*Document Version*  
Publisher's PDF, also known as Version of record

[Link back to DTU Orbit](#)

*Citation (APA):*  
Andersen, E., Chen, Z., Fan, J., Furbo, S., & Perers, B. (2014). Investigations of Intelligent Solar Heating Systems for Single Family House. *Energy Procedia*, 48, 1-8. DOI: 10.1016/j.egypro.2014.02.002

## DTU Library

Technical Information Center of Denmark

---

### General rights

Copyright and moral rights for the publications made accessible in the public portal are retained by the authors and/or other copyright owners and it is a condition of accessing publications that users recognise and abide by the legal requirements associated with these rights.

- Users may download and print one copy of any publication from the public portal for the purpose of private study or research.
- You may not further distribute the material or use it for any profit-making activity or commercial gain
- You may freely distribute the URL identifying the publication in the public portal

If you believe that this document breaches copyright please contact us providing details, and we will remove access to the work immediately and investigate your claim.



SHC 2013, International Conference on Solar Heating and Cooling for Buildings and Industry  
September 23-25, 2013, Freiburg, Germany

## Investigations of intelligent solar heating systems for single family house

Elsa Andersen<sup>a</sup>, Ziqian Chen<sup>a</sup>, Jianhua Fan<sup>a</sup>, Simon Furbo<sup>a</sup>, Bengt Perers<sup>a</sup>

<sup>a</sup>Department of Civil Engineering, Technical University of Denmark, Brovej, DK-2800 Kgs. Lyngby, Denmark

---

### Abstract

Three differently designed intelligent solar heating systems are investigated experimentally in a test facility. The systems provide all the needed yearly heating demand in single family houses. The systems are based on highly stratified tanks with variable auxiliary heated volumes. The tank is a tank in tank heat storage with domestic hot water in the inner tank and space heating water in the outer tank. The total tank volume is 750 liters and the solar collector area is 9 m<sup>2</sup>. The auxiliary energy supply system is based on electrical heating element(s)/heat pump and is different for all three systems.

The system will be equipped with an intelligent control system where the control of the electrical heating element(s)/heat pump is based on forecasts of the variable electricity price, the heating demand and the solar energy production.

By means of numerical models of the systems made in Trnsys, the control strategy of intelligent solar heating systems is investigated and the yearly auxiliary energy use of the systems and the electricity price for supplying the consumers with domestic hot water and space heating are calculated.

© 2014 The Authors. Published by Elsevier Ltd. Open access under [CC BY-NC-ND license](https://creativecommons.org/licenses/by-nc-nd/4.0/).

Selection and peer review by the scientific conference committee of SHC 2013 under responsibility of PSE AG

*Keywords:* stratification; variable auxiliary heated volume; solar heating system; smart control

---

### 1. Background

The project “Solar/electric heating systems in the future energy system” is carried out in the period 2008-2012. The aim of the project is to elucidate how individual intelligent solar heating systems for single family houses are best designed in order to fit into the future energy system [1].

The suitability of heating units based on solar collectors, electric heating elements or heat pump and a smart heat storage will be determined, both for home owners and for our future energy system. It is expected that the heating

unit will be more attractive than traditional solar heating systems and that the heating unit can contribute to an improved utilization of the energy production from wind farms in windy periods. In this way the heating units, if used in large numbers, can facilitate the access of wind energy in the energy system, improve the cost efficiency of wind energy and increase the share of our energy consumption covered by renewable energy sources

In short: The aim is to establish the basis for development of a future safe energy system based on the two most powerful renewable energy sources: Solar and wind energy.

## 2. Ongoing experimental investigations

Three systems with differently designed intelligent tanks with variable auxiliary heated volumes are being investigated experimentally [2]. Each system has a solar collector area of 9 m<sup>2</sup>, and a tank which is a tank in tank heat storage with a total volume of 750 liters. The solar heating systems are identical, except for the auxiliary heating systems which are based on a large electrical heating element of 9 kW, a heat pump of 9 kW and three smaller electrical heating elements of 3 kW respectively.

The tanks are designed as shown in Fig. 1 where principal drawings are shown of : a) the tank in tank heat storage with the solar energy supply system, the space heating system and the domestic hot water system, b) the auxiliary heating system based on an electrical heating element build into a thermo siphoning loop, c) the auxiliary heating system based on an air/water heat pump build into a pumped loop with inlet through a stratification inlet device and c) the auxiliary heating system with three electrical heating elements build into the tank in three different levels. In Fig. 2 photos of the three tanks are shown.

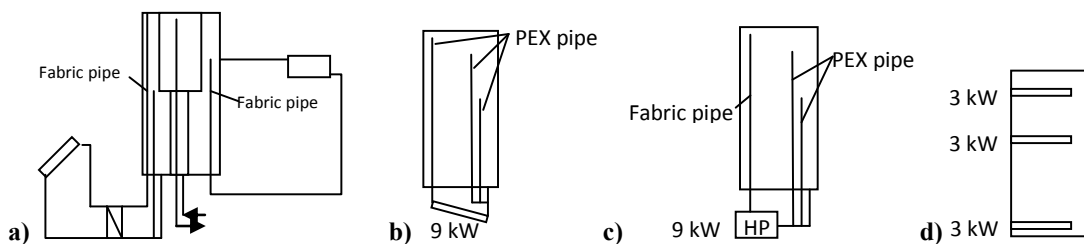

Fig. 1: Principal drawing of: a) The tank in tank heat storage with the solar energy supply system, the space heating system and the domestic hot water system, b) auxiliary heating system based on a heating element build into a thermosiphoning loop, c) auxiliary heating system based on an air/water heat pump build into a pumped loop and d) auxiliary heating system based on three heating elements in three different levels.

The electrical heating element(s)/heat pump will if possible, only be in operation in periods where the energy demand cannot be covered by solar energy and where the variable electricity price is low, e.g. due to large electricity production by wind farms [3]. The control of the electrical heating element/heat pump is based on forecasts of the electricity price, the heating demand and the solar energy production [4]. Consequently, the control system is based on weather forecasts.

Solar energy is transferred to the tank by water circulating from the tank through an external heat exchanger and back to the tank through a stratification inlet device, a fabric inlet stratifier. Water can either be transported to the heat exchanger from the bottom or from the middle of the tank. In this way, beneficial thermal stratification is built up during solar collector operation. Space heating is transferred from the upper part of the tank and the return inlet to the tank is through another fabric inlet stratifier.

The three intelligent solar heating systems are experimentally investigated side by side in a laboratory test facility. Temperatures are measured in the hydraulic loops and in the tanks, both the inner domestic hot water tanks

and the outer space heating tanks. And the flows in the hydraulic loops and the weather conditions are measured. The detailed measurements will allow for a detailed study of the thermal performance of the systems.

The measurements are ongoing and some of the measurements are described and analyzed in [5].



Fig. 2: The heat storages of the three solar heating systems which are being tested.

### 3. Investigation of control strategy

The control strategy is investigated for three smart (solar) heating systems with storage volumes of 750 litres and solar collector areas of 0 m<sup>2</sup>, 9 m<sup>2</sup> and 18 m<sup>2</sup>. The auxiliary volume can be 240 litres or 390 litres or 750 litres. Auxiliary heating is restricted to the night time from 2 am until 5 am where the electricity price is low. The size of the auxiliary volume and the set point temperature of the auxiliary volume are determined month by month in such a way that the energy demand is fully covered at the lowest electricity price. The smart (solar) heating systems are referred to as S-0m2, S-9m2 and S-18m2.

Further calculations are made for a semi smart solar heating system with a storage volume of 750 litres and 9 m<sup>2</sup> solar collector area and a fixed auxiliary volume of 750 litres and a fixed set point temperature of 90 °C in such a way that the energy demand is fully covered when the auxiliary heating is restricted to the night time from 2 am until 5 am. The semi smart solar heating system is referred to as SS-9m2.

Finally, calculations are made for three traditional (solar) heating systems with storage volumes of 750 litres and solar collector areas of 0 m<sup>2</sup>, 9 m<sup>2</sup> and 18 m<sup>2</sup>. The auxiliary volumes and the set point temperatures are fixed to 240 litres and 50 °C, respectively and auxiliary heating can take place during all hours whenever it is needed in order to fully cover the energy demand. The traditional (solar) heating systems are referred to as T-0m2, T-9m2 and T-18m2.

All the calculations are made with a real highly variable electricity price hour by hour and with a fixed electricity price of 1.8 DKK/kWh.

The control strategy is investigated with a Trnsys model of a solar heating system. The Trnsys model used is worked out in the solar heating and cooling program Task 32 within the International Energy Agency [6]. Fig. 3 shows a schematically illustration of the solar heating system used in the calculation. The variable auxiliary volume is facilitated by varying the position of the outlet for the auxiliary loop.

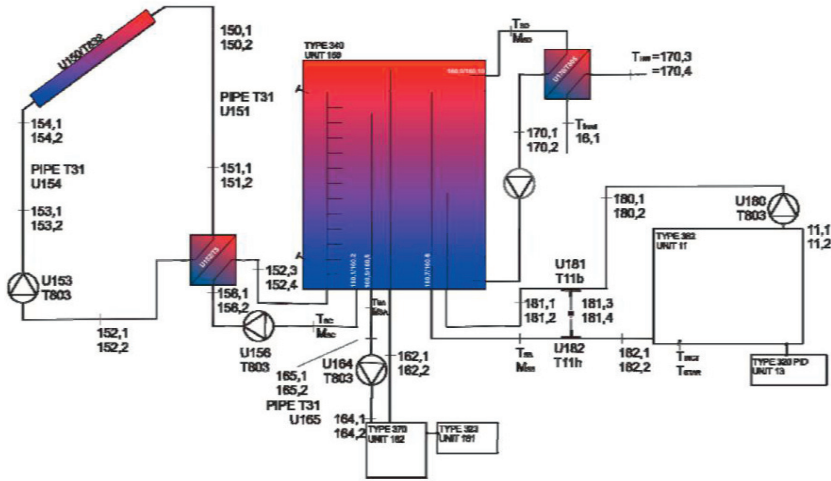

Fig. 3: Schematically illustration the solar heating system used in the calculations. Picture from [6].

The weather data used in the calculations are measured at the solar radiation measurement station at the Technical University of Denmark in 2009 [7]. Fig. 4 shows the ambient temperature, the beam irradiance on horizontal and the diffuse irradiance on horizontal.

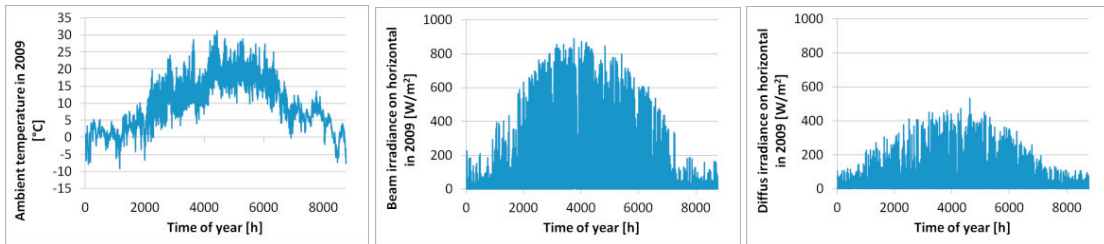

Fig. 4: Left: The ambient temperature. Middle: The beam irradiance on horizontal. Right: The diffuse irradiance on horizontal.

The electricity price used in the calculations is also from 2009. The electricity price is shown in Fig. 5 as the variable electricity price hour by hour. It can be seen that there are large variations in the electricity price during the year. Detailed study of the electricity price shows that the price most often is lowest in the night in the hours from 2 am to 5 am.

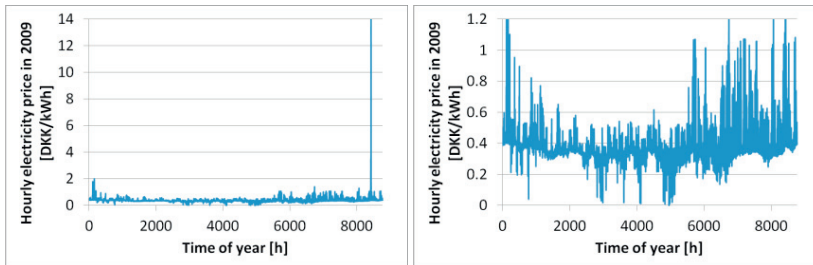

Fig. 5: The hourly electricity price during 2009. The two graphs show the same with different resolution on the y-axis.

The calculations are made for a single family house with a yearly energy consumption of about 4700 kWh and a daily hot water consumption of 100 litres heated from a varying cold water temperature to 45 °C, corresponding to a yearly energy consumption of about 1500 kWh. The cold water temperature varies between 3.4 °C and 16.0 °C throughout the year. Hot water for domestic hot water is taken from the top of the tank and lead through an external plate heat exchanger and back to the bottom of the tank. The domestic hot water is heated in the plate heat exchanger. Domestic hot water is tapped three times per day at 7 am, noon and 7 pm in three equal portions with a low volume flow rate.

Fig. 6 shows the monthly space heating consumption and domestic hot water consumption, respectively. The data of the solar heating system used in the calculations are listed in Table 1.

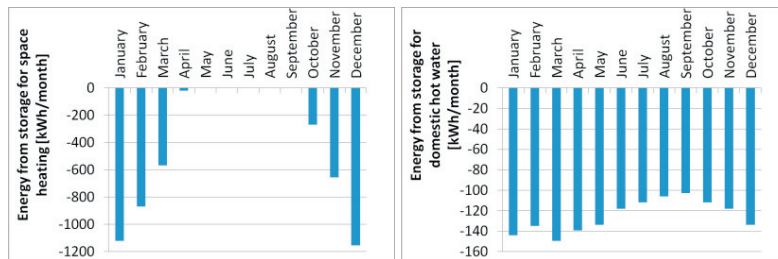

Fig. 6: Left: Energy from the storage used for space heating. Right: Energy from the storage used for domestic hot water.

Table 1 shows data of the solar heating system used in the calculations. The heat loss coefficient of the sidearm and the external heat exchanger for domestic hot water preparation are not taken into calculation.

Table 1: Data used in the calculations.

|   |  |
|---|--|
| Solar collector area  | 9 m <sup>2</sup> / 18 m <sup>2</sup>                                     |
| Optical efficiency of incident radiation, $\eta_0$  | 0.756  |
| Heat loss coefficients, $a_1$ / $a_2$   | 4.37 W/m <sup>2</sup> /K / 0.01 W/m <sup>2</sup> /K <sup>2</sup>         |
| Efficiency for all incidence angles, $\eta$   | $\eta_0 \cdot k_0 - a_1 \cdot (T_m - T_a)/E - a_2 \cdot (T_m - T_a)^2/E$ |
| Incidence angle modifier for beam radiation, $k_0$  | $1 - \tan^{4.2}(\theta/2)$   |
| Collector tilt / Orientation  | 45° / South  |
| Solar collector fluid   | 40% (weight) propylene glycol/water mixture                              |
| Volume flow rate in solar collector loop  | 0.20 l/min/m <sup>2</sup>  |
| Storage volume / auxiliary volume   | 750 l / 240 l, 390 l, 750 l  |
| Height/diameter   | 1.89 / 0.71 m  |
| Tank insulation top / side / bottom   | 200 mm / 200 mm / 20 mm  |
| Heat transfer coefficient of external heat exchanger in solar collector loop                                | 125 W/K per m <sup>2</sup> collector                                     |
| Relative inlet/outlet height of domestic hot water loop   | 0 / 1  |
| Relative outlet height of space heating system  | 0.84   |
| Relative inlet/outlet height in solar collector loop  | Stratifier / 0.06  |
| Auxiliary power   | 30 kW  |
| Control system – Differential thermostat control with one sensor in the solar collector and one in the tank |  |
| Relative height of temperature sensor in solar collector loop   | 0.1  |
| Maximum/Minimum temperature differential  | 7 K / 0.5 K  |

In Fig. 7 the solar energy and the auxiliary energy transferred to the storage tanks in the different calculated solar heating systems are shown. It can be seen that the smart solar heating systems and the semi smart solar heating system get less solar energy and more auxiliary energy to the storage tank than the traditional solar heating systems. The reason is that the auxiliary volume in the smart systems often is higher than the auxiliary volume in the traditional systems. As expected, the figure also shows that the difference between the auxiliary energy for solar heating systems with 9 m<sup>2</sup> and 18 m<sup>2</sup> solar collector areas is not very large, because the used storage volume is too small for a solar collector area of 18 m<sup>2</sup>.

In Fig. 8 the electricity price for operating the smart, semi smart and traditional solar heating systems can be seen. The figure shows that the yearly electricity price is lower for the traditional solar heating systems than for the smart solar heating systems when a fixed electricity price is used. If the variable electricity price is used, the yearly electricity price is lowest for the smart solar heating systems and there is no difference in the yearly electricity price between the traditional and the semi smart solar heating system. Consequently, the use of cheap electricity plays a large role for the yearly auxiliary energy price.

The most attractive system for the home owner is a system resulting in the lowest energy costs. Therefore the cost of the system as well as the yearly electricity costs must be considered. In order to elucidate which collector areas and tank volumes will result in the most attractive systems, more calculations are needed. Most likely, the optimal system size will depend on the heat demand of the house.

In Fig. 9 the needed size of the auxiliary volume and the needed set point temperature of the auxiliary volume in the smart solar heating system with 9 m<sup>2</sup> solar collector area are shown. Also the sensitivity of the monthly electricity price as function of the needed size of the auxiliary volume and the needed set point temperature of the auxiliary volume that can fully cover the energy demand in October is shown. It can be seen that the electricity price can be reduced further by 5 % by using a stepless auxiliary volume instead of the three auxiliary volume sizes used in this investigation.

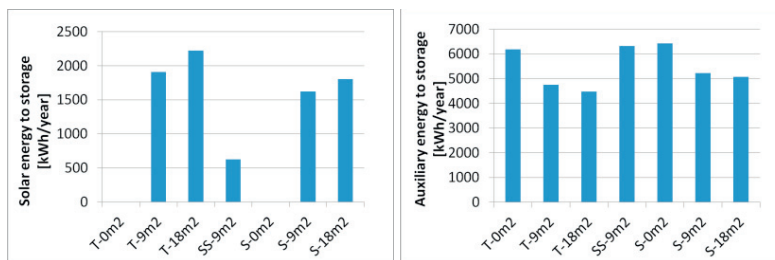

Fig. 7: Left: Solar energy to the storage. Right: Auxiliary energy to the storage.

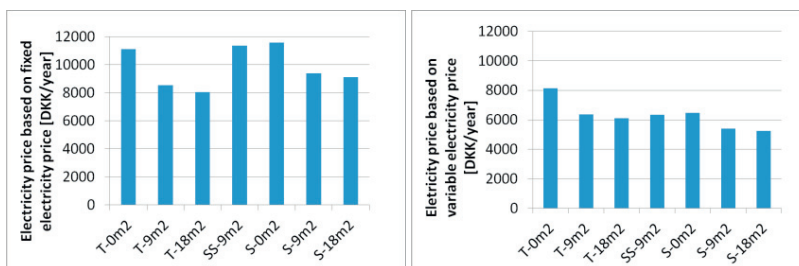

Fig. 8: Left: Electricity price based on fixed electricity price of 1.8 DKK/kWh. Right: Electricity price based on variable electricity price.

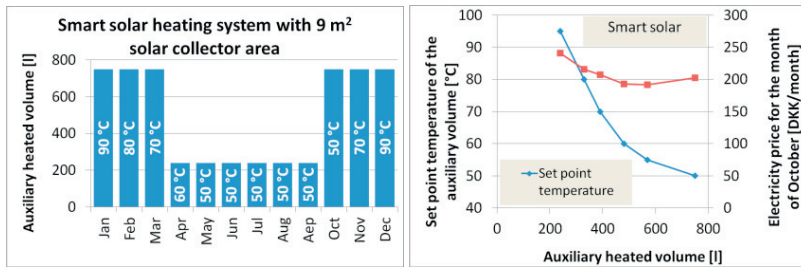

Fig. 9: Left: Needed auxiliary heated volume and set point temperature of auxiliary heated volume if auxiliary heating takes place from 2 am to 5 am. Right: Electricity price in October as function of the auxiliary heated volume and the set point temperature of the auxiliary heated volume with variable electricity price.

#### 4. Discussion and conclusions and outlook

The investigation shows that it is possible to reduce the yearly energy price with around 25 % by using a simple control strategy, a smart solar heating system and cheap electricity even if the thermal performance in terms of solar and auxiliary energy transferred to the tank is worse for the smart solar heating system than for the similar traditional solar heating system.

For each month the energy demand is covered by the smart solar heating with one auxiliary volume with a fixed set point temperature resulting in the lowest monthly electricity price. The auxiliary volume and the set point temperature can be different from month to month.

Therefore it is expected that the yearly energy price can be reduced even further by only using the exact needed auxiliary volume size and set point temperature for all periods. This can be achieved by a smart control system that makes use of weather forecast.

The concept can be further improved by making use of a control system which is also based on forecasts of the solar heat production and on prognoses for electricity costs and a larger tank volume.

The power used in the calculations, 30 kW is unrealistic high for a normal electricity installation in a single family house. It is used in order to be able to supply the needed energy during the allowed heating period of 3 hours during the night time with known cheap electricity. The electricity will be cheap in other periods during the day and a real smart control system will be able to utilize all periods with cheap electricity and consequently, lower power consumption is needed. If large power consumption is needed, this can be achieved by a heat pump.

In the future a high part of our electricity will be covered by wind energy. For instance in Denmark wind energy today covers 23 % of the yearly electricity consumption and the plan is that in 2020 50 % of the electricity consumption will be covered by wind energy. It is therefore expected that in the future the electricity price will vary stronger than today. Consequently it is also expected that the smart solar heating system concept will be more attractive in the future.

Future work should elucidate economical optimal solar collector areas and tank volumes for houses with different heat demands.

#### References

- [1] Perers B, Furbo S, Andersen E, Fan J. *Solar/electric heating systems for the future energy system*. ISES Solar World 2009 Congress proceedings, Johannesburg, South Africa (2009).
- [2] Fan J, Andersen E, Furbo S, Chen Z, Perers B. *Charging behaviour of differently designed smart solar tanks*. ISES Solar World 2011 Congress proceedings, Kassel, Germany (2011).
- [3] Perers B, Furbo S, Andersen E, Fan F. *Solar/electric heating systems using smart solar tanks and variable electricity costs*. EuroSun 2010 Congress proceedings, Graz, Austria (2010).
- [4] Perers B, Furbo S, Fan J, Andersen E, Chen Z. *Solar Combisystems with forecast control to increase the solar fraction and lower the auxiliary energy costs*. ISES Solar World 2011 Congress proceedings, Kassel, Germany (2011).



- [5] Halvgaard R, Bacher P, Perers B, Andersen E, Jørgensen JB, Poulsen NK, Madsen H. *Model predictive control for a smart solar tank based on weather and consumption forecasts*. SHC Conference 2012 Proceedings, San Francisco, USA (2012).
- [6] Heimrath R, Haller M. *The Reference Heating System, the Template Solar System*. Project Report A2 of Subtask A, IEA SHC Task 32 (2007).
- [7] Skalík L, Lulkovičová O, Furbo S, Perers B, Dragsted J, Nielsen KP, Scharling M, Carlund T. *Evaluation of long-term global radiation measurements in Denmark and Sweden*. European Solar Energy Conference, EuroSun 2012 Proceedings, Rijeka, Croatia (2012).