

DOI: 10.18372/2306-1472.73.12176

Mykhailo Matiychyk¹
Natalya Suvorova²
Dmytro Tereshchenko³
Ievgen Plakhotniuk⁴
Kateryna Trachuk⁵

INFLUENCE OF ICING ON AIRCRAFT PERFORMANCE OF UNMANNED AERIAL VEHICLE M-10-2 "OKO"

National aviation university
Kosmonavta Komarova ave., 1, 03680, Kyiv, Ukraine
E-mails: ¹nvcha@nau.edu.ua; ²suv_nat@bigmir.net; ³tedmiv@gmail.com;
⁴iesp@i.ua; ⁵kate.trachuk@ukr.net

Abstract

Purpose: Carry out the analysis of lifting surface area of unmanned aerial aircraft. Icing appeared during test flights of unmanned aerial aircraft. **Methods:** Analysis of flight results in icing conditions using design flight characteristics of unmanned aerial vehicle and data from flight recorder was conducted. The largest ice formations observed on along whole length leading edge of the wing and whole length leading edge of winglets. **Results:** Under certain meteorological conditions ice deposits forms on parts of small unmanned aerial vehicle similar to how it is formed on a large-sized aircraft was found in practice. Ice formation distorted wing leading edge and front part and bottom and top wing curves. Analogically way tail unit was distorted by ice formations. In addition icing of front surface of telemetry and video antennas, and front part of airspeed sensor tube was found. Formation belongs to pike-shaped type was specified. **Discussion:** Icing of lifting surface area of aircraft during flight can cause undesirable consequences both in manned and unmanned aviation. Real test flights of unmanned aerial vehicles of SPCUA "Virazh" of National Aviation University in the winter period showed, that ignorance of icing problem could decrease flight safety level up to aviation accident. Fact of icing was discovered after unmanned aerial vehicle landing.

Key words: aircraft performance; icing; lift surface; pitch; unmanned aerial vehicle; wing profile.

1. Introduction

It is known that icing of aircraft (AC) lift surfaces has a negative influence on aircraft performance and can lead to an aviation accident. Deposits of ice on the earth are well considered in the works [1, 2]. Ice deposition on surfaces is assisted by coincidence of meteorological and other factors, among which the most import are dimensions and drops concentration, AC speed of flight, and air temperature [3-5].

2. Problem statement

Primary source analysis shows that attention is usually given to "regular" AC of general aviation [6]. However, information about UAVs is almost absent and icing influence is not considered.

Practical test flights of UAVs in winter period executed by specialists of SPCUA "Virazh" of National Aviation University shown, that ignorance of problem consideration can decrease the flight safety level up to preconditions of aviation accident.

As example we will take day flights of UAV M-10-2 "Oko" under next meteorological conditions (MC): air temperature: from 0°C to -5°C; speed of surface wind – up to 4 m/s; wind speed at altitude: – up to 10 m/s; clouds bottom limit – 400 m [7].

Cruising speed of UAV on the route amounted 20 m/s; no precipitation. Before flight, during before flight tests there were no icing revealed. AC launch performed in automatic mode without shortcomings. Planned and achieved flight altitude – 600 m; maximum distance – around 15,5 km. All ground

and board systems operated in regular mode. The battery capacity installed in UAV was 16 Ah; its charge at the launch moment was 95 %.

3. Flight results

Above the mission area (15 km away from control station) UAV got into conditions, which led to icing. Ice formed at leading edge of wing and tail unit, frontal surfaces of video antennas and on pitot static tube (PST).

Icing fact was investigated after UAV landing. During flight recorded via telemetry, that at the altitude 600 m UAV stall started. Autopilot managed to level off UAV without operators assistance, however UAV lost altitude and descended at 400 m, but after leveling off returned to assigned altitude of flight and continued flight on planned route. After mission completed UAV returned to the launch position and performed parachute landing.

4. Solution

During study of consequences of UAV M-10-2 "Oko" icing scheme of ice deposits location on the surfaces was defined (Fig.1).

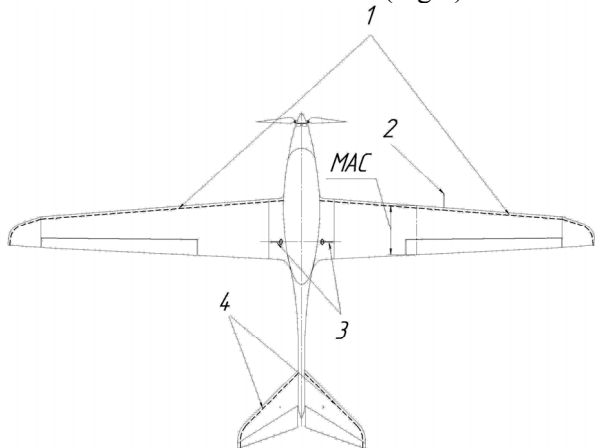

Fig. 1. Scheme of ice deposits location on the surfaces of unmanned aerial vehicle M-10-2 "Oko" (top view): 1– on the wing leading edge; 2 – on the front part of the pitot static tube; 3– on the front surfaces of the video antennas; 4– on the leading edge of the tail unit; mean aerodynamic chord (MAC) – projections location of the MAC to the horizontal

The biggest ice formations observed on leading edge of the wing almost along all its length; ice formations also covered whole leading edge of winglets. Ice formations on wing were loose, without “gloss” signs. Formation binding is not strong, because during parachute landing part of them loosed of wing. Character and dimensions (mm) of wing leading edge icing are shown on Fig.2 (formations on top view) and on Fig.3 (formations on bottom view).

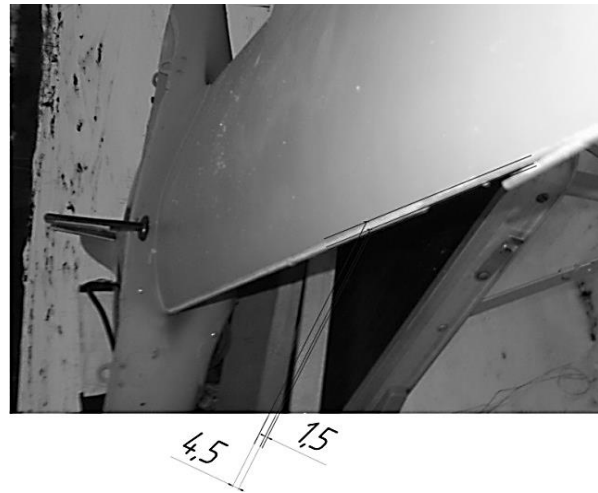

Fig. 2. Icing of the leading edge of the wing (top view)

Tail unit surfaces covered with ice had character similar to wing formation: formation width from top view – 2 mm, bottom view 3,5 mm.

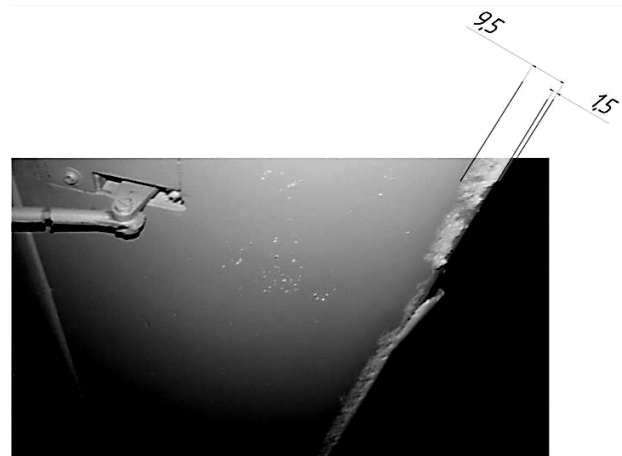

Fig. 3. Icing of wing leading edge (bottom view)

Scheme of distortion of original wing profile Wortmann FX61-184 was developed with ice deposits of specified dimensions (Fig.4 a and Fig.4 b).

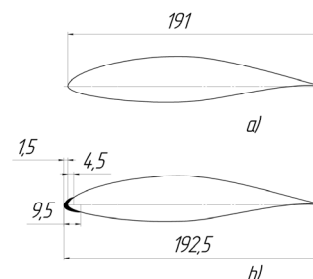

Fig. 4. Scheme of distortion and changes of geometrical dimensions of original wing profile Wortmann FX61-184: a) original profile contour along mean aerodynamic chord; b) distorted profile contour along mean aerodynamic chord

Specified that formation is related to icing type “pike-shape formation”, which is characterized with opacity, dimness and looseness; ice contains a significant amount of small drops and ice crystals or their mix. Such type of ice is formed on relatively narrow section of profile [8, 9].

Icing of the PST inlet had gloss surface of grey color; formations closed measuring hole of dynamic pressure, and static pressure holes continued to be non-iced and passable. Formation binding with metal of PST is strong. Character and dimensions (mm) of PST icing is shown on Fig. 5.

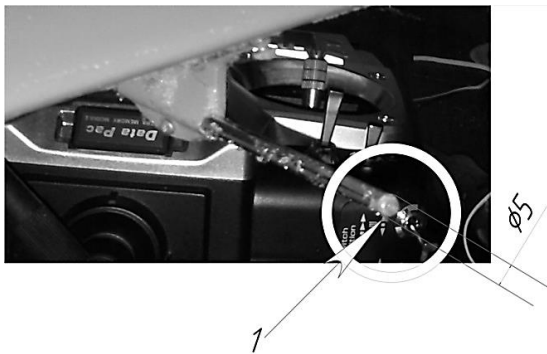

Fig. 5. Character and dimensions (mm) of PST icing:
1– icing of tube cap (inlet) of PST

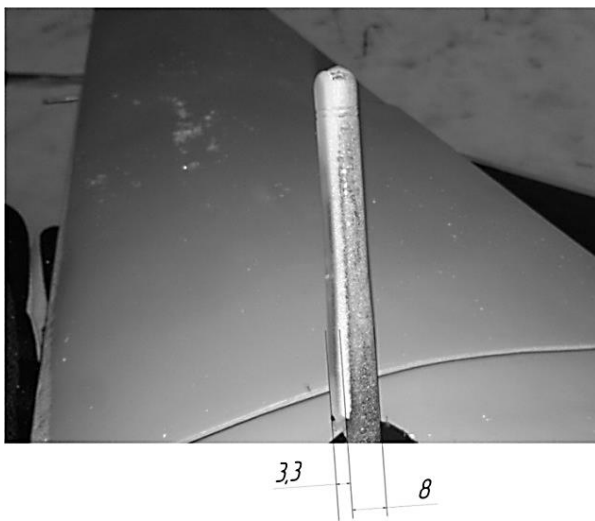

Fig. 6. Icing of the video channel antennas

Antennas have been iced from the front side; formation surface has been solid on the top and gloss, and under the solid top there was a loose layer. Character and dimensions (mm) of video channel antennas icing is shown on Fig. 6.

5. Results analysis

Analysis of flight results in conditions of icing conducted using the design aircraft performance of

the UAV and data obtained from mode of flight recorder (MFR). The hypothesis was that UAV in icing conditions successfully performs flight mission, but that achieved by significant excess of its energy consumption.

Input data for calculation:

1. Autopilot controlled cruising speed of flight of UAV– 20 m/s;
2. Maximum take-off weight (MTOW) – 5 kg (50N);
3. Wing area of UAV, $S_w – 0,38 \text{ m}^2$;
4. Air density (for ISA) – $1,225 \text{ kg/m}^3$;
5. $C_{y_{m.b.i}}$ – lift force coefficient for cruising mode before icing;
6. $C_{y_{m.a.i}}$ – lift force coefficient for cruising mode after icing;
7. Wing setting angle of UAV +0,5 degrees.

The basis of calculation was estimation of increment of drag force as the result of icing.

It is known, that at the cruising mode of operation next condition must be fulfilled:

$$MTOW = Y$$

During calculation known formulas were applied for lift and drag force estimation, also for lift force coefficient:

$$Y = \frac{\rho V^2}{2} C_y S_w,$$

$$X = \frac{\rho V^2}{2} C_x S_w$$

Drag force coefficient was determined from next relation:

$$C_y = \frac{Y}{\frac{\rho V^2}{2} S_w}$$

During results generation drag force before and after icing used a combined data array, taken from MFR and from UAV aerodynamic characteristics, obtained on design stage. Calculation algorithm was next.

Using data of MFR and input data: cruising speed, MTOW and air density defined in-flight value of $C_{y_{m.b.i}}$.

$$C_{y_{m.b.i.calc.}} = 50 / (1,225 \cdot 324 / 2) \cdot 0,38 = 50 / 198,45 \cdot 0,38 = 50 / 75,4 = 0,66$$

From dependence $C_y f(\alpha)$ for UAV M-10-2 «Oko» (wing profile Wortmann FX61-184) was found respective values of angle of attack and drag force coefficient (Fig. 7).

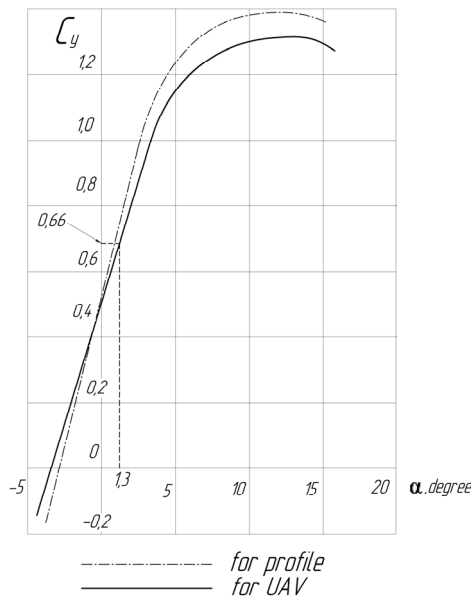

Fig. 7. Dependence of lift coefficient of UAV on an angle of attack

Upon respective value of angle of attack from polar curve defined coefficient $C_{x_{m.b.i.}}$ for UAV.

Respectively calculated value of drag force before icing was:

$$X_{b.i} = \frac{\rho V^2}{2} C_x S_w = \frac{1,225 \cdot 20^2}{2} \cdot 0,06 \cdot 0,38 = 5,58N$$

Calculation results are presented in Table 1.

Table 1

Calculation results of drag force on UAV icing

№	Parameter	Value
1	$C_{y_{m.b.i.calc.}}$	0,66
2	Angle of attack α , degree	1,3°
3	$C_{x_{pc.}}$ (from UAV polar curve)	0,06
4	Drag force value $X_{b.i.}$	5,58N
5	Current aerodynamic quality, K	11 units

Similarly calculated drag force of UAV after icing. The difference was that current value of angle of attack at cruising mode we take from MFR through current value of pitch angle. Calculated value of drag force after icing equal:

$$X_{a.i} = \frac{\rho V^2}{2} C_x S_w = \frac{1,225 \cdot 20^2}{2} \cdot 0,095 \cdot 0,38 = 8,84N$$

Calculation results are presented in Table 2.

Table 2

Calculation results of drag force after UAV icing

№	Parameter	Value
1	$C_{y_{m.a.i.calc.}}$	0,74
2	Angle of attack α , degree	2,4°
3	C_{x_a} (polar curve of UAV)	0,095
4	Drag force value $X_{calc.}$	8,84N
5	Current aerodynamic quality, K	7,8 units

Upon the data from Table 1 and Table 2 it is apparent that before icing UAV had aerodynamic quality about 11 units. Wing surfaces, antennas etc. were not distorted by ice, so UAV performance was in design range. The aircraft was influenced by aerodynamic drag force 5,58N at flight speed 20 m/s.

After icing UAV automatics independently taken into account deterioration of its aerodynamics from icing, to maintain cruising speed at level 20 m/s, that lead to setting new angle of attack, current wing angle of attack 2,4°, so as consequence, to increase of coefficient of aerodynamic drag C_{x_a} to value 0,095. Respectively drag force increased to value 8,84N, that in comparison to drag force before icing is 40 % more. The result is correlated with the conclusions of the authors in the work [10].

For the actual proof of danger presence from icing of air frame surface of UAV were analyzed flight data, obtained from MFR at two segments during flight. First segment was taken during steady horizontal flight till the icing moment, second segment after icing.

Data comparison shows, that for maintaining given flight parameters autopilot had to increase thrust level on an average 10 % (Fig. 8 a, 8 b).

Average value of current from battery increased respectively from 25,5A to 35A (Fig. 9 a, 9 b).

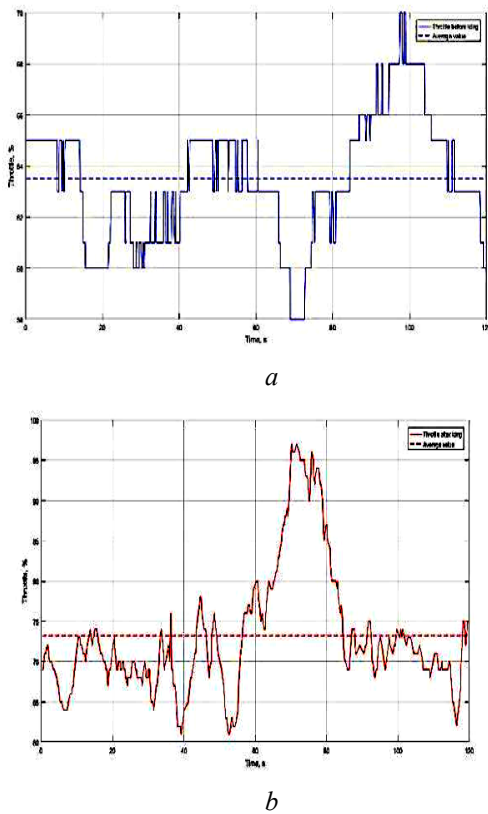

Fig.8. Dependence of engine throttle level on time; *a*– before icing; *b*– after icing

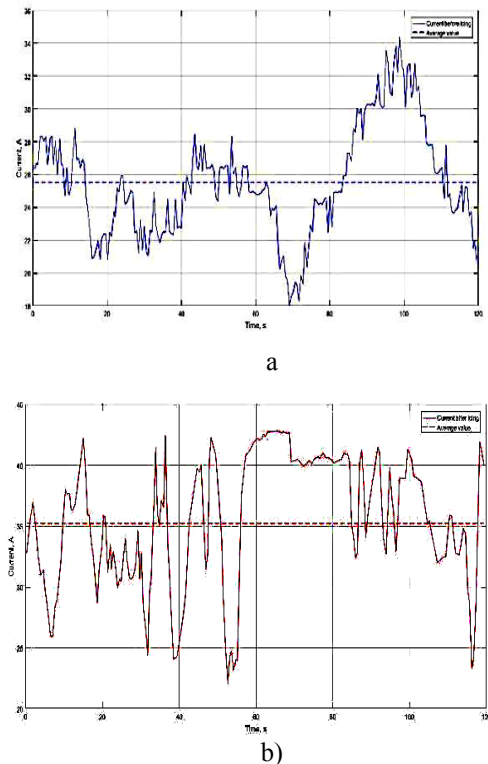

Fig.9. Electrical energy consumption depending on time: *a*– before icing; *b*– after icing

The reason for these indices increase in general is increase of UAV control surface deflection to maintain given flight parameters. This can be clearly seen on Fig. 10 a and Fig. 10 b, apparent, that average angle of positive pitch increased from $1,3^{\circ}$ before icing to almost 3° after icing.

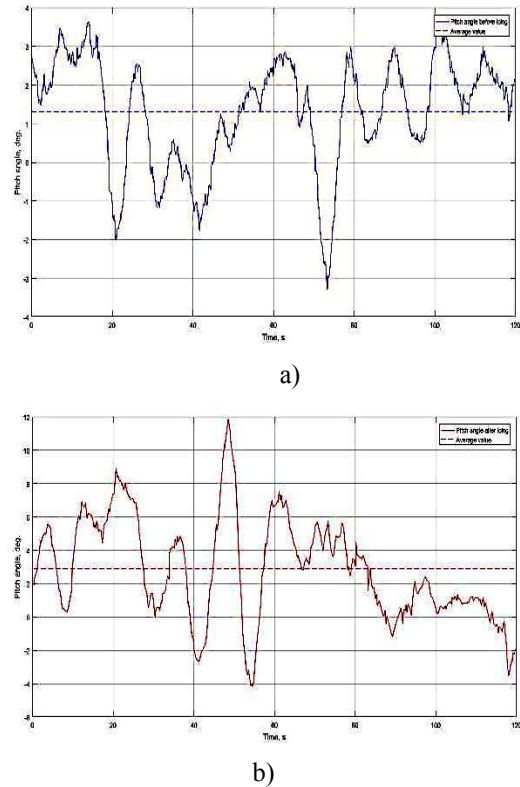

Fig. 10. Dependence of pitch level on time: *a*–before icing; *b*–after icing

Sharp increase of pitch has caused the wing to set a greater angle of attack, that has caused increase of C_x coefficient, aerodynamic quality of UAV has decreased, increased level of engine throttle and consequently greater electrical energy consumption.

6. Conclusions

1. In practice identified, that upon certain meteorological conditions ice formations are formed on parts of small UAVs, by the similar scheme, as they form on large AC.
2. Distortion from ice formation take place on the leading edge of the wing and front part of bottom and upper airfoil sections; similarly iced tail unit of the AC. In addition, icing formed at frontal surfaces of telemetry and video antennas, and inlet of PST.
3. Maximum linear dimensions of formations on the wing amounted up to 9,5 mm, their thickness reached 1,5 mm.

4. In wing section through MAC chord of distorted profile increased from 191 mm to 192,5 mm.
5. Force of aerodynamic drag before and after icing increased from 5,58N to 8,84N, increased by more than 40%.
6. UAV icing lead to significant decrease of UAV performance, namely: thrust level increased on an average 10 %; average index of battery current increased respectively from 25,5A to 35A; pitch angle on cruising mode increased from 1,3⁰ before icing to 2,8⁰ after icing.
7. Identified calculated angle of attack 2,4⁰ that differs from recorded by the MFR 2,8⁰ on 0,4⁰, that can be explained by errors in calculation and current value of angle of attack, measured by the MFR at given moment of time.

References

- [1] Storozhuk M.V. (2015) *Ground icing, of aircraft: measures to prevent accidents*. Moscow, Scientific Bulletin MGTU GA, no. 219, pp. 93-98
- [2] Simonenkova R.V., Vmnogradova L.M., and others (1982) *Protection of aircraft from ground icing* [The aviation industry], no. 8. Available at: <http://www.viam.ru>
- [3] Mazin I.P. (1957) *Fizicheskiye osnovy obledeneniya samoletov*, Moscow
- [4] Borovikov A.M. i dr. (1961) *Fizika oblakov*. Gidrometizd. L-d, 435 p.
- [5] Astapenko P.D., Baranov A.M., Shvarev I.M. (1980) *Pogoda i polety samoletov i vertoletov*. Gidrometizd. L-d, 186 p.
- [6] *Mobile unmanned complex M-10 "Oko 2"* (2017) NAU. Available at: <http://uav.nau.edu.ua>
- [7] Klemenkov G.P., Prikhod'ko YU.M. i dr. (2008) [Modelirovaniye protsessov obledeneniya letatel'nykh apparatov v aeroklimaticheskikh trubakh]. *Trudy Instituta teoreticheskoy i prikladnoy mekhaniki im. S.A. Khristianovicha* [Teplofizika i aeromekhanika]. T.15, no. 4, pp. 563-572
- [8] Thomas P. Ratvasky, Billy P. Barnhart Bihrlle, Sam Lee (2008) *Current Methods for Modeling and Simulating Icing Effects on Aircraft Performance, Stability and Control*. National Aeronautics and Space Administration Glenn Research Center Cleveland, Ohio 44135, pp. 4-13
- [9] Grzegorz Kowaleczko, Michał Wachłaczko (2012) *Aircraft dynamics during dynamics flight in icing conditions*. Warsaw, Journal of Theoretical and Applied Mechanics, 50, 1, pp. 269-284
- [10] Xuan Zhang, Jingchun Min, Xiaomin Wu (2016) *Model for aircraft icing with consideration of property-variable rime ice*. International Journal of Heat and Mass Transfer. Available at: <http://www.elsevier.com/locate/ijhmt>

М.П. Матійчик¹, Н.О. Суворова², Д.І. Терещенко³, Є.С. Плахотнюк⁴, К.В. Трачук⁵

Вплив зледеніння на льотно-технічні характеристики безпілотного повітряного судна М-10-2 «Око»

Національний авіаційний університет, просп. Космонавта Комарова, 1, Київ, Україна, 03680

E-mails: ¹nvcba@nau.edu.ua; ²suv_nat@bigmir.net; ³tedmiv@gmail.com; ⁴iesp@i.ua; ⁵kate.trachuk@ukr.net

Мета: Проведення аналізу зледеніння несучих поверхонь безпілотного повітряного судна. Зледеніння відбулося при випробувальних польотах безпілотного повітряного судна. **Методи дослідження:** Аналіз результатів польоту в умовах зледеніння проводився із використанням проектних льотно-технічних характеристик безпілотного повітряного судна, а також даних, отриманих із бортового самописця. Найбільші льодові формування було зафіксовано на поверхні передньої кромки крила практично по всій її довжині; відкладення накрили також всю передню кромку вінглетів. **Результати:** Практично встановлено, що за відповідних метеоумов на частинах малорозмірних безпілотних повітряних суднах утворюються відкладення льоду, за схемою подібною, як вони утворюються на великорозмірних повітряних суднах. Спотворення від утвореного льоду відбулось по передній кромці крила та передній частині нижньої та верхньої дужок крила; аналогічним чином обмерзло хвостове оперення. Крім того обмерзанню піддалися фронтальні поверхні телеметричної та відеоантен, а також передня частина трубки приймача повітряного тиску. **Обговорення:** Зледеніння

несучих поверхонь повітряного судна під час польоту може мати небажані наслідки як для великої авіації, так і для малих безпілотних повітряних суден. Практичні випробувальні польоти безпілотних повітряних суден НВЦБА "Віраж" Національного авіаційного університету в зимовий період показали, що ігнорування розгляду проблеми може знижувати рівень безпеки польотів аж до виникнення передумов до авіаційних подій. Факт зледеніння був виявлений після посадки безпілотного повітряного судна.

Ключові слова: безпілотне повітряне судно; зледеніння; льотно-технічні характеристики; несучі поверхні; профіль крила; тангаж.

М.П. Матийчик¹, Н.А. Суворова², Д.И. Терешенко³, Е.С. Плахотнюк⁴, Е.В. Трачук⁵
Влияние обледенения на летно-технические характеристики беспилотного воздушного судна М-10-2 «Око»

Национальный авиационный университет, просп. Космонавта Комарова, 1, Киев, Украина, 03680
E-mails: ¹nvcba@nau.edu.ua; ²suv_nat@bigmir.net; ³tedmiv@gmail.com; ⁴iesp@i.ua; ⁵kate.trachuk@ukr.net

Цель: Проведение анализа обледенения несущих поверхностей беспилотного воздушного судна. Обледенение произошло во время испытательных полетов беспилотного воздушного судна. **Методы исследования:** Анализ результатов полета в условиях обледенения проводился с использованием проектных летно-технических характеристик беспилотного воздушного судна, а также данных, полученных с бортового самописца. Наибольшие ледовые формирования были зафиксированы на поверхности передней кромки крыла практически по всей ее длине; отложения накрыли также всю переднюю кромку винглетов. **Результаты:** Практически установлено, что при соответствующих метеоусловиях на частях малоразмерных беспилотных воздушных судов образуются отложения льда, по схеме подобной, как они образуются на крупноразмерных воздушных судах. Искажение от образованного льда произошло по передней кромке крыла и передней части нижнего и верхнего обвода крыла; аналогичным образом обледенело хвостовое оперение. Кроме того, обледенению подверглись передние поверхности телеметрической и видеоантен, а также передняя часть трубки приемника воздушного давления. **Обсуждение:** Обледенение несущих поверхностей воздушного судна во время полета может иметь нежелательные последствия, как для большой авиации, так и для малых беспилотных воздушных судов. Практические испытательные полеты беспилотных воздушных судов НВЦБА "Вираж" Национального авиационного университета в зимний период показали, что игнорирование рассмотрения проблемы может снижать уровень безопасности полетов включительно с предпосылками к авиационным происшествиям. Факт обледенения был обнаружен после посадки беспилотного воздушного судна.

Ключевые слова: беспилотное воздушное судно; летно-технические характеристики; несущие поверхности; обледенение; профиль крыла; тангаж.

Mykhailo Matiychyk (1960). Ph.D., Associate Professor, Docent.
Chief designer of Unmanned Aircraft Systems Scientific and Production Center of Unmanned Aviation "Virazh", Kyiv, Ukraine.

Education: Ternopil National University, General Engineering and Technology Faculty, Ternopil, Ukraine (1985).

Research area: mechanics, aerodynamics and concepts of unmanned aircraft.

Publications: 82.

E-mail: a04misha8@meta.ua

Natalya Suvorova (1974). Lecturer.

Department of Aviation Operations and Services, National Aviation University, Kyiv, Ukraine.

Education: National Aviation University, Kyiv, Ukraine (2002).

Research area: Unmanned Aerial Systems.

E-mail: suv_nat@bigmir.net

Dmytro Tereshchenko (1987).

Aviation engineer, LLC 'Ukrspesystems', Kyiv, Ukraine.

Education: National Aviation University, Kyiv, Ukraine (2011).

Research area: air navigation systems, communication systems, unmanned aerial systems.

Publications: 15.

E-mail: tedmiv@gmail.com

Ievgen Plakhotniuk (1988). Researcher.

Scientific and Research part of National Aviation University, Kyiv, Ukraine.

Education: National Aviation University, Kyiv, Ukraine (2010).

Research area: Unmanned Aerial Systems.

Publications: 6.

E-mail: iesp@i.ua

Kateryna Trachuk (1991). Junior researcher.

Scientific and Research part of National Aviation University, Kyiv, Ukraine.

Education: National Aviation University, Kyiv, Ukraine (2013).

Research area: Unmanned Aerial Systems.

E-mail: kate.trachuk@ukr.net