

Energy Aware Power Save Mode Management in Wireless Mesh Networks

S.P. Shiva Prakash
 Research Scholar,
 JSS Research Foundation,
 JSS Technical Institutions Campus,
 Mysore, Karnataka, India
 shivasp26@gmail.com

T.N. Nagabhushan
 JSS Academy of Technical Education,
 Noida, Uttar Pradesh, India
 tnnagabhushan@gmail.com

Kirill Krinkin
 Open Source and Linux Lab,
 Saint-Petersburg State
 Electrotechnical University LETI,
 St.Petersburg, Russia
 kirill.krinkin@fruct.org

Abstract—In recent times Wireless Mesh Networks (WMN) have evolved as powerful networks for most commercial applications. Many contributions have been made to enhance the performance of WMN of which the enhancement of the network lifetime remains as one of the challenging area for research. IEEE standard proposed an amendment which introduced Power Save Mode (PSM) in order to increase the lifetime of WMN. It has three modes such as Active, Light Sleep and Deep Sleep. There exist a lot of literature on increasing energy efficiency by keeping node in Deep Sleep mode when it is not involved in transmission. But current Power Save Mode has some deficiency in low Packet Delivery Ratio (PDR). This paper presents Energy Aware Power Save Mode (EAPSM) which attempt to overcome the deficiency of low PDR by triggering PSM. EAPSM consist of three modules namely, remaining energy calculator, transmission mode identifier and PSM scheduler. EAPSM schedules PSM based on the constraints such as remaining energy of a node and its participation in transmission. The proposed method includes mathematical model and algorithms which gives improved performance over conventional PSM.

Keywords—Power Save Mode, Battery, Remaining Energy, Transmission, Wireless Mesh Networks.

I. INTRODUCTION

In wireless mesh networks, battery plays a major role in deciding the efficiency of routing protocols. Since battery is a limited resource of energy, we must be very careful in the design of energy efficient routing protocols. Any node in a WMN can be in the state of transmission, reception or relaying of packet during transmission. It is known that the battery energy draining rate is higher during transmission state compared to idle state. Hence IEEE 802.11s standard introduced a mechanism called Power Save Mode (PSM) in which mesh station (STA) acts in three different modes such as active, light sleep and deep sleep mode. A STA must change its mode to active from light sleep mode before involving in transmission. Otherwise it has to be in the sleep mode. This mechanism reduces energy consumption of STA and increases network life time.

In conventional PSM, mesh nodes change their state from light sleep mode to active mode whenever there is a request from beacon mesh node to transmit or receive or relay a packet. Fig. 1 shows switching of modes for three different mesh stations A, B and C. A mesh STA creates a link and maintains a link specific power mode towards each peer STA. It also tracks the

power mode of each peer and only exchanges data frames with its peer. A link consists of two mesh STAs and both STAs have their own independent power mode for each other. A STA can operate in any of the three power modes for a link. A single mesh STA can serve its various peers in different power modes at the same time. In Fig. 1, STA A is in active mode for both link-X and link-Y. STA C is in deep sleep mode for link-Y and link-Z where as STA B is in light sleep mode for link-X and in deep sleep mode for link-Z. In light sleep mode for a link, a PSM STA wakes up periodically to listen to all the beacons of the peer STA. On the other hand, in deep sleep mode for a link, a PSM STA may not wake up to listen to all the beacons. In active mode operation, a STA remains in awake state all the time. If a STA works in either light sleep or deep sleep mode for any of its peer links, STA will alternate between awake and doze states for that link, as determined by the frame transmission and reception rules [17]. A Peer Service Period (PSP), which is an agreed contiguous time period is used to exchange buffered frame in a link if the receiver STA operates in PSM.

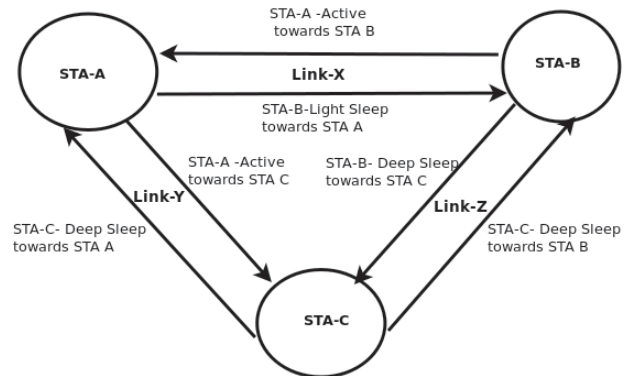

Fig. 1. An example of mesh power mode usage

Lot of works have been carried out to reduce energy consumption while maintaining quality of service (QoS) for several applications [3], [5], [6]. The latest amendment does not mention about the triggering of power save mode. It has been stated that "triggering of peer specific mesh power save modes is out of scope" in the IEEE 802.11s standard [17]. The conventional PSM does not consider battery energy resource while alternating from Doze state to active state.

This may lead to unsuccessful delivery of packets due to non availability of sufficient energy to transmit/receive/relaying of packets during transmission. Hence in this paper, we propose a method called Energy Aware Power Save Mode (EAPSM) to trigger PSM maintaining QoS and considering two important characteristics namely remaining energy of a node and node's involvement in transmission mode. The remaining energy of a node at a particular instant time is calculated and compared with the energy threshold required for transmission. Depending on the remaining energy status, we change the state of STA from light sleep to active mode. This will ensure the successful delivery of packets and increase the QoS for various applications running over wireless mesh networks.

The rest of the paper is organized as follows: Section II define the problem statement and Section III discuss related previous works. Section IV presents the proposed model and Section V define the mathematical model while Section VI depict the state diagram of the proposed model. Algorithms and their analysis are discussed in Section VII and VIII. Section IX presents the Conclusion and scope for future work.

II. PROBLEM STATEMENT

In WMN installed with PSM, the Announcement Traffic Indication Message (ATIM) window gets activated whenever peer station STA sends request to transmit data. In conventional PSM, the STA changes its state from Idle to Active when it listens to a request from beacon STA. It will remain in Active state until all the frames in the buffer gets transmitted within Peer Specific Period (PSP) time. Since STA has already received packet and stored in buffer, all the packets have to be transferred to the next STA to which PSP agreed upon. In this situation STA is unaware about its energy resource availability to transmit/receive packet during transmission. This results in packet loss and leads to low Packet Delivery Ratio (PDR). Hence, there is a need to define a model which schedules the PSM based on remaining energy constraints at each STA by considering the nature of node such as STA involved in transmitting/receiving/relaying of packet. Hence this research attempts to develop a mathematical model that enhance the efficiency of WMN by increasing the PDR.

III. RELATED WORKS

This section presents the previous works on the optimization of energy efficiency in PSM.

To address resource management S. Balandin, A. Heiner [4] have proposed a model to increase throughput and decrease delay in network called Dynamic Localized Load Balancing (DLLB). They have compared their proposed model with standard Open Shortest Path First (OSPF) routing protocol by considering two main factors such as DLLB uses several paths that create possibility of more efficient traffic distribution and traffic distribution prevents global synchronization of the TCP flows as flows are distributed over multiple paths. Their results shows that DLLB is more efficient than standard OSPF. To address the need of energy efficiency in network C. M. Chao, J. P. Sheu, I. C. Chou [9] and H. Memarzadeh, M. Dehghan, S. Jabbehdari [15] have proposed a quorum based energy conserving protocol for a single hop mobile adhoc

network. A quorum set is a set of time frames wherein a node must wake up. Any two nodes can wake up and meet each other at some time frame defined in the set. During the non quorum time frames, nodes are allowed to remain in sleep state to save their energy. S. Andreev, P. Gonchukov, N. Himayat, Y. Koucheryavy, A. Turlikov [18] have proposed energy-aware cross layer power-bandwidth optimization approaches to improve energy consumption at the client in a cellular network. They have conducted performance evaluation in the context of uplink orthogonal frequency division multiple access (OFDMA) systems and suggested that significant gains in client power efficiency are possible with such techniques. They have considered the important relationship between inter-cell interference and power reduction and compared the performance of energy efficient schemes with power-control based interference management schemes. Their results shows both advantages and disadvantages associated with the apply of power-bandwidth optimization approaches for improving client energy efficiency. Addressing network installed with PSM, H. Woesner, J.P. Ebert, M. Schlager and A. Wolisz [1] have suggested the optimal ratio of the ATIM window size to the beacon interval which is used as an important parameter for ATIM. Y.C. Tseng, C.S. Hsu and T.Y. Hsieh [2] have addressed the problems caused by in-synchronization and proposed the notion of asynchronous wakeup which resulted in improving energy efficiency. H. Zhu and G. Cao [7] have proposed an algorithm in which streaming traffic is scheduled based on the traffic rate by Access Point (AP). M.J. Miller and N.H. Vaidya [8] have showed a method to calculate a time value (Tvalue) when an empty frame is received during the contention slot indicating there are data frames to be transferred. H. Lei and A. A. Nilsson [10] have proposed a model that predicts the system performance by considering the known parameters of the configuration in a queue for infrastructure mode. S. Baek and D. C. Bong [11] have come up with an exact average of exact average value of the percentage of time a station stays in the doze state when it is in PSM. They considered that polling message from a STA has minimum impact and AP is responsible for transmitting a finite packets in one beacon interval. C. H. Gan and Y. B. Lin [13] have proposed a scheme to reduce the contention called power conservation scheme which schedules the awake time of STA optimally. Lee and S. Kim [14] have used the Kalman filter to predict the best ATIM window size to increase the time spent in doze state. V. Gorodetsky et al. [12] have shown an approach to programming architecture for communication by proposing Virtual P2P Emulation Environment (P2P VEE) specifically designed for running of implemented distributed P2P agent systems.

The importance of ATIM field scheduling, data frame exchange between STAs and minimizing energy in link specific power save modes in IEEE 802.11 PSM is addressed in existing power saving schemes. Most of the reported works have focused on improving energy efficiency by keeping the node in sleep mode. It has been found that no work has been carried out till date to trigger PSM mode while considering battery energy of node and improving QoS of a network. In this paper we propose a method which triggers power save mode considering remaining energy of a STA and its involvement in transmission mode.

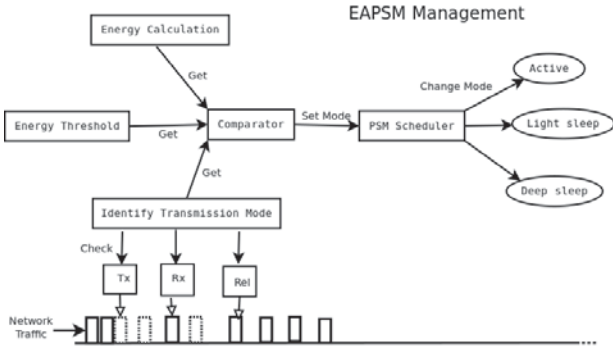

Fig. 2. Proposed model for EAPSM management

IV. PROPOSED EAPSM MODEL

In this section, we present our proposed model called EAPSM that schedules the PSM based on energy constraints and transmission mode of a STA.

Fig. 2 shows the proposed model that comprises of

- 1) Energy consumption calculator
- 2) Transmission mode identifier
- 3) PSM scheduler.

The energy consumption calculator module calculates the remaining energy of a node at a regular interval of time. The transmission mode identifier module identifies the nodes involvement in transmission such as receiving or transmitting or relaying packets. The calculated remaining energy and identified transmission mode is given as input to PSM scheduler. The scheduler compares the remaining energy of a node with the energy threshold required by the node to be involved in transmission. If the remaining energy of a node is greater than the minimum energy threshold required by node to be involved in transmission, the scheduler changes node's current PSM state from light sleep mode to Active mode otherwise PSM of a node remains in Light Sleep mode. If the remaining energy of a node gets drained completely and reaches NULL or value 0, then scheduler changes the current PSM state of node to Deep Sleep mode. This proposed EAPSM method assures the successful delivery of packets and increases QoS of routing in wireless mesh network.

V. MATHEMATICAL MODEL

In this section, we define mathematical model to represent the energy consumption of a node that is involved in transmission. We propose a mathematical model that schedules PSM considering remaining energy and transmission mode of a node.

A. Energy consumption model

1) *Considering data rate and packet size:* Energy required to transmit a packet is given by

$$E_c = I * V * t_p \quad (1)$$

where E_c = Energy consumed, I = Current, V = Voltage, t_p = time taken to transmit a packet.

TABLE I. ENERGY CONSUMED AT VARIOUS DATA RATE AND PACKET SIZE

Data Rate	Packet Size		
	256 bytes	512 bytes	1024 bytes
1 Mbps	0.42 J	0.84 J	1.69 J
5 Mbps	0.08 J	0.17 J	0.34 J
10 Mbps	0.04 J	0.08 J	0.17 J

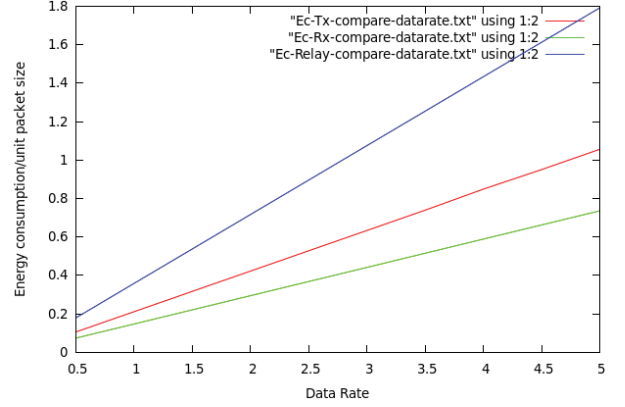

Fig. 3. Transmit, Receive and Relaying comparison

We conducted experiment with simulation time of 50s and calculated energy consumed using equation (1) by varying data rate and packet size of a node. It is as shown in Table I.

Fig. 3 shows the energy consumed by a node with varying data rate and packet size. The initial energy was set to 10 J.

From the Fig. 3, we can notice that energy consumption is directly proportional to Packet Size and inversely proportional data rate. So we can represent the energy consumption E_c as

$$E_c = \frac{Packetsize}{datarate} \quad (2)$$

using equation (2) in equation (1), we can rewrite the energy consumption equation considering the data rate dr and packet size ps of a node $E_c(ps, dr)$ as,

$$E_c(ps, dr) = \frac{I * V * T_p * P_s}{d_r} \quad (3)$$

2) *Considering node transmission mode:* Consider a single node n in a set of N nodes $n_i \in \{N\}$ Where i is the number of nodes. We have $n_{ik} \in \{N\}$ where ik is the traffic from $n_i \rightarrow n_k$ there exists n_j as a relay node. Energy consumed to Transmit packet from node n_i to node n_j can be given by,

$$E_{c(i \rightarrow j)}^{TX}(ps, dr) = T_p * E_c(ps, dr) \quad (4)$$

where T_p = transmit power in mA.

Energy consumed to Receive packet from node n_k to node n_i can be given by,

$$E_{c(k \leftarrow i)}^{RX}(ps, dr) = R_p * E_c(ps, dr) \quad (5)$$

where R_p = receive power in mA.

Energy consumed to Relay packet from node n_i to node n_k can be given by,

$$E_{c(i \rightarrow j \rightarrow k)}^{REL}(ps, dr) = E_{c(i \rightarrow j)}^{RX}(ps, dr) + E_{c(i \rightarrow j)}^{TX}(ps, dr) \quad (6)$$

Therefore Total energy consumed by node which involve in transmission can be represented as

$$E_c^{tot}(ps, dr) = E_c^{TX}(ps, dr) + E_c^{RX}(ps, dr) + E_c^{REL}(ps, dr) \quad (7)$$

In general,

$$E_c^{tot}(ps, dr) = N \sum_{i=1}^n (E_c^{TX}, E_c^{RX}, E_c^{REL}) \quad (8)$$

where N= total no of transmission occurred.

3) *Calculating remaining energy model:* The remaining energy of a node can be calculated by using the below equation

$$R_E = I_E - E_c^{tot} \quad (9)$$

where R_E = Remaining Energy, I_E = Initial Energy, E_c^{tot} = total energy consumed by the node at time t_n given n is the simulation time.

4) *Fixing minimum energy required (threshold) by node during transmission :* Using equations 4, 5 and 6, we define the minimum energy required by node considering node's transmission from node n_i to node n_k via n_j when it is:

a. Transmitting a packet size of ps bytes and data rate of dr Mbps from node n_i node n_j .

$$R_{ET}^{TX}(ps, dr) = E_{c(i \rightarrow j)}^{TX}(ps, dr)J \quad (10)$$

where R_{ET}^{TX} = Minimum energy required by a node to transmit a one packet from node n_i node n_j .

b. Receiving packet size of ps bytes and data rate of dr Mbps by a node n_k from node n_i .

$$R_{ET}^{RX}(ps, dr) = E_{c(k \leftarrow i)}^{RX}(ps, dr)J \quad (11)$$

where R_{ET}^{RX} =Minimum energy required by a node n_k to receive a one packet from node n_i .

c. Relay packet size of ps bytes and data rate of dr Mbps by node n_j to relay a packet n_i to node n_k .

$$R_{ET}^{REL}(ps, dr) = E_{c(i \rightarrow j \rightarrow k)}^{REL}(ps, dr)J \quad (12)$$

where R_{ET}^{REL} = Minimum energy required by node n_j to relay a one packet n_i to node n_k .

B. Set power save mode base on energy constraints and transmission mode :

In order to set the power save mode, we propose to consider two constraints : Remaining Energy of a node and its Transmission Mode. Variables AE and TM are used to denote available energy and transmission mode of a node respectively. The following equation defines the state of AE and TM .

$$TransmissionMode(TM) = \begin{cases} 1, & \text{if } n = \{T_X, R_X, R_{EL}\} \\ 0, & \text{if } n = \text{no transmission} \end{cases} \quad (13)$$

The equation 13 indicates that TM will be set to 1 when node is involved in transmission such as receiving or transmitting or relaying packet. TM will be set to 0 when node is not involved in packet transmission. and

$$AvailableEnergy(AE) = \begin{cases} 1, & \text{if } R_E \geq R_{ET} \\ 0, & \text{if } R_E \leq R_{ET} \end{cases} \quad (14)$$

where R_{ET} = Remaining Energy Threshold and R_E = Remaining Energy of a node.

Equation 14 indicates that AE will be set to 1 when node's remaining energy is greater than remaining energy threshold fixed during receiving or transmitting or relaying of a packet. AE will be set to 0 when node's remaining energy is less than remaining energy threshold.

Based on the above notations, Table II summarizes the PSM mode of a node considering its involvement in transmission mode and remaining energy. We can notice that node will be in Active mode whenever it has high available energy (ie, remaining energy of a node is greater than the threshold) and is involved in transmission mode otherwise it will be in Deep Sleep mode or in Light Sleep mode.

TABLE II. PSM STATES

Transmission Mode \ Available Energy	TM=1			TM=0
	R_X	T_X	R_{EL}	
AE=1	A	A	A	LS
AE=0	DS	DS	DS	DS

A= Active, LS= Light Sleep and DS= Deep Sleep.

Considering available energy of a node and node's involvement in transmission we can define PSM state as,

$$PSM(S) = \begin{cases} A, & \forall n = \{TM == 1 \& \& AE == 1\} \\ LS, & \forall n = \{TM == 1 \& \& AE == 0\} \\ DS, & \forall n = \{TM == 0/1 \& \& AE == 0\} \end{cases} \quad (15)$$

where A= Active mode, LS=Light Sleep mode and DS=Deep Sleep mode

The above equation 15 is a proposed EAPSM mathematical model which schedules PSM of a node.

C. Packet Delivery Ratio

In conventional PSM, the PDR of a network can be defined as

$$PDR(i, j) = \frac{\sum_{n=i}^j \left(\frac{\sum P_{rec}}{\sum P_{sen}} \right)}{N} \quad (16)$$

where P_{rec} is number of packets received by node, P_{sen} is number of packets sent by node and N is the number of node involved in transmission.

PDR considering packet size and data rate can be given as

$$PDR(i, j, ps, dr) = \frac{\sum_{n=i}^j \left(\frac{\sum P_{rec}}{\sum P_{sen}} \right) (ps, dr)}{N} \quad (17)$$

where i is the source node, j is the destinations node, ps is packet size, dr is the data rate, P_{rec} is number of packets received by node, P_{sen} is number of packets sent by node and N is the number of node involved in transmission.

The conventional PSM does not consider the energy resource of node and hence it results in low PDR. The Proposed EAPSM model for PDR can be given by considering energy constraints

$$PDR(i, j, ps, dr, s) = \frac{\sum_{n=i}^j psm(s) \left(\frac{\sum P_{rec}}{\sum P_{sen}} \right) (ps, dr)}{N} \quad (18)$$

where ps is packet size, dr is the data rate, P_{rec} is number of packets received by node, P_{sen} is number of packets sent by node and N is the number of node involved in transmission. $psm(s)$ is determined by equations 15, 13 and 14. This will ensure that STA changes its state from Light sleep only when it has sufficient energy to be involved in transmission. This will result in high PDR and increases QoS of network.

VI. STATE DIAGRAM OF PROPOSED MODEL

In this section we present the state diagram of proposed EAPSM model.

Consider a set of states
 $P = \{Active, LightSleep, DeepSleep\}$
 $TM = \{R_X, T_X, R_{EL}, Null\}$
 $AE = \{High, Low\}$

Where P is an outcome PSM state based on two observations: Transmission Mode (TM) and Available Energy (RE) of a node. The probability of change in state of PSM is as shown in below state diagram.

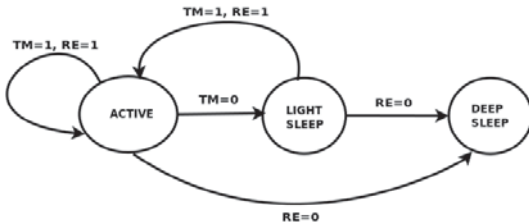

Fig. 4. State diagram of EAPSM

Fig. 4 shows the state diagram of proposed model EAPSM. The node changes its state from Active to Light Sleep only when it has high remaining energy and not involved in packet

transmission. Whenever the remaining energy of node becomes Null or zero it will go to Deep Sleep mode otherwise it will remain in Active state. This will result in increase in energy saving of a node. The probability of node being in Active state can be defined by using Baye's conditional probability theorem as shown in below equation 19.

$$P(S = A | (TM == 1 \cap AE == 1)) = \frac{P((TM == 1 \cap AE == 1) | S = A) P(S = A)}{P(TM == 1 \cap AE == 1)} \quad (19)$$

where,

- $P(S = A)$ is the probability of PSM state in Active.
- $P(TM == 1 \cap AE == 1)$ is the probability of node being in Transmission Mode and High Available Energy.
- $P((TM == 1 \cap AE == 1) | S = A)$ is the probability of node being in Transmission Mode and High Available Energy given PSM state is Active.
- $P(S = A | (TM == 1 \cap AE == 1))$ is the probability of node being in Active PSM state given node being in Transmission Mode and High Remaining Energy.

VII. ALGORITHMS

In this section we present the algorithm used to schedule PSM of a node by considering its remaining energy and involvement in transmission.

Algorithm 1 Schedule Power Save Mode

```

    set  $I_E = 10J$ 
    set  $R_E = 10J$ 
    set  $R_{ET}^{RX} = 0.1472J$ 
    set  $R_{ET}^{TX} = 0.212J$ 
    set  $R_{ET}^{REL} = 0.3584J$ 
    set  $TM == 1, AE == 1$ 
    for each  $n$  in  $N$  do
        Calculate Available Energy (AE)
        Identify Transmission Mode (TM)
        if  $(TM \neq 0 \& \& AE \neq 0)$  then
            if  $((TM == R_X) \& \& (R_E^{RX} \geq R_{ET}^{RX})) \parallel (TM == T_X) \& \& (R_E^{TX} \geq R_{ET}^{TX}) \parallel (TM == R_{EL}) \& \& (R_E^{REL} \geq R_{ET}^{REL})$  then
                PSM(S) == Active
            else
                PSM(S) == Light Sleep
            end if
        else
            PSM(S) == Deep Sleep
        end if
    end for
    
```

The algorithm 1 is used to schedule PSM in proposed EAPSM model. The initial energy, remaining energy, remaining energy threshold of a node involved in transmission such as transmitting, receiving and relaying a packet are calculated and initialized using the equations defined in mathematical model. For all the nodes in a network installed with EAPSM, each node will calculate its remaining energy as shown in algorithm

2. Whenever a request is made by peer node to transmit or receive or relay packet, the node will identify its transmission mode as shown in 3. Node's remaining energy and its remaining energy threshold with respect to its transmission mode is compared to define the PSM state of a node. If node is involved in transmission and its remaining energy is greater than the remaining energy threshold then node changes its PSM state to Active mode otherwise PSM state of a node is set to Light Sleep mode. If the remaining energy of a node becomes NULL or value 0 then its PSM state is set to Deep Sleep mode. The node accepts requests to perform transmission operation if the state of a node is in Active mode otherwise node rejects request from peer node to be involved in transmission.

Algorithm 2 Calculate Available Energy

```

set  $I_E = 10$ 
set  $C_E = 0$ 
 $E_{i+1} = E_i + V^*(t_{i+1}t_i) * I_i$ 
 $R_E = I_E - E_c^{tot}$ 
    
```

The algorithm 2 is used to calculate the remaining energy of each node in a network. It subtracts the current energy with the total energy consumed earlier as defined in equation 8.

Algorithm 3 Identify Transmission Mode

```

set  $R_X = 0$ 
set  $T_X = 0$ 
set  $R_{EL} = 0$ 
for each  $n$  in  $N$  do
  if ( $n == R_X \parallel n == T_X \parallel n == R_{EL}$ ) then
     $TM == 1$ 
  else
     $TM == 0$ 
  end if
end for
    
```

The algorithm 3 is used to identify the transmission mode of a node. If a node is involved in transmission such as receiving, transmitting and relaying packet, then transmission mode (TM) is set to 1 otherwise it is set to 0 as defined in equation 13.

VIII. ANALYSIS OF PROPOSED ALGORITHM

In this section we present about the analysis of proposed algorithm.

To analyse the proposed algorithm, we considered a simple routing that takes place in WMN. We fixed values for the network parameters as shown in Table III.

A. Working of conventional PSM

Let us consider an example of routing with conventional PSM installed to each node in WMN as shown in Fig. 5 Fig. 5 consists of 7 nodes each in different PSM state. Node-1, node-2, node-4, node-5 and node-7 are in Light Sleep mode. Node-3 and node-6 are in Deep Sleep Mode. The initial PSM state of each node is as shown in Table IV.

Let us consider a traffic from node-1 to node-4 where node-1 is source and node-4 is destination. To identify the

TABLE III. ALGORITHM ANALYSIS PARAMETERS

Parameters	Values
No. of Nodes	7
Packet Size	256 bytes
Data Rate	2 Mbps
No. of Packets	40
Initial Energy	10 J
Initial PSM Mode	Light Sleep
Initial Transmission Mode	0
Transmission Power	330 mA
Reception Power	230 mA
Energy threshold-Tx	0.21 J
Energy threshold-Rx	0.14 J
Energy threshold-Rel	0.35 J

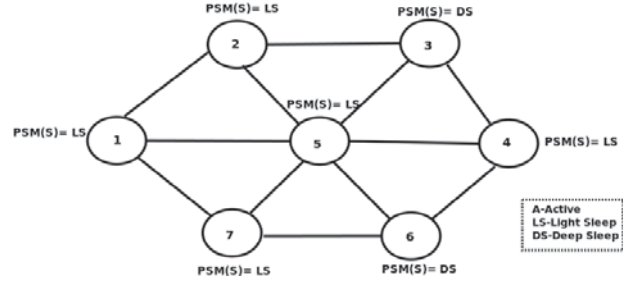

Fig. 5. Example of Routing with conventional PSM installed in WMN

relay node, let us consider a simple minimum hop routing protocol. In our example to transmit a packet from node 1 to node 4, there are several paths. The minimum hop path is node-1→node-5→node-4. So node 5 acts as a relay node to receive and forward packet from node 1 to node 4.

During transmission, node changes its initial PSM state to new PSM state. Hence node-1, node-4 and node-5 changes its initial state from Light Sleep mode to new PSM state Active mode as shown in Table V.

Fig. 6 shows that packets are transmitted from node-1 to node-4 successfully via node-5.

Fig. 7 shows that, packet will be transmitted from node-1 but gets dropped at node-5 due to unavailability of sufficient energy to forward packet to node-4 even though it has sufficient energy to receive packet from node-1 at some interval of time. This is due to change in the state of node from Light Sleep mode to Active mode without without the awareness of its available energy status. This results in low PDR for network.

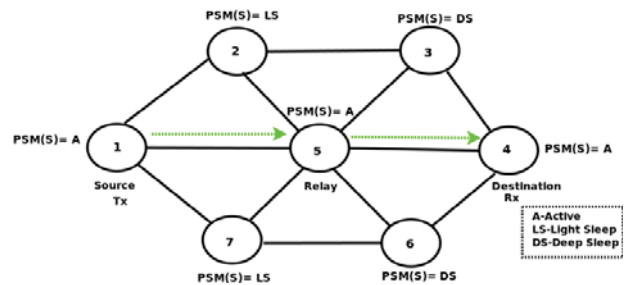

Fig. 6. Example of Routing with PSM conventional installed Packet transmission

TABLE IV. EAPSM-NODE'S STATUS WITHOUT TRANSMISSION

Node	Initial-PSM(S)
1	Light Sleep
2	Light Sleep
3	Deep Sleep
4	Light Sleep
5	Light Sleep
6	Deep Sleep
7	Light Sleep

TABLE V. PSM-NODE'S STATUS WITH TRANSMISSION

Node	Initial-PSM(S)	New-PSM(S)
1	Light Sleep	Active
2	Light Sleep	Light Sleep
3	Deep Sleep	Deep Sleep
4	Light Sleep	Active
5	Light Sleep	Active
6	Deep Sleep	Deep Sleep
7	Light Sleep	Light Sleep

B. Working of proposed EAPSM

Considering the same example that is used in conventional PSM, let us assume that proposed EAPSM is installed instead of conventional PSM to all the nodes as shown in Fig. 8. Two important constraint such as remaining energy and transmission mode of a node is used to schedule PSM in proposed EAPSM.

Initially each node has remaining energy 10J and it is not involved in transmission of packet. It is as shown in Table VI. It shows the initial PSM state of each node. Node-1, node-2, node-4, node-5 and node-7 are in Light Sleep mode. Node-3 and 6 are in Deep Sleep Mode. Available energy of all node is 10J. Since nodes are not involved in transmission initially, Energy consumption is 0J. The PSM state of node is determined using equation 15.

Let us consider a traffic from node-1 to node-4 where

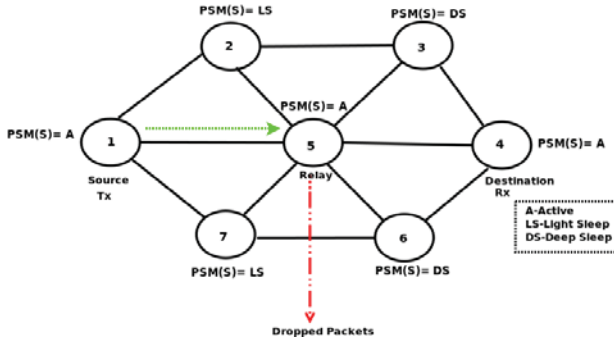

Fig. 7. Example of Routing with conventional PSM installed showing Packets dropped

TABLE VI. EAPSM-NODE'S STATUS WITHOUT TRANSMISSION

Node	Transmission Mode			E_c^{tot}	R_E	Init-PSM(s)
	RX	TX	Rel			
1	×	×	×	0	10	LS
2	×	×	×	0	10	LS
3	×	×	×	0	10	DS
4	×	×	×	0	10	LS
5	×	×	×	0	10	LS
6	×	×	×	0	10	DS
7	×	×	×	0	10	LS

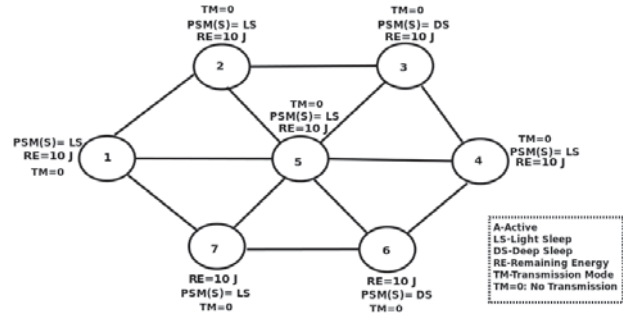

Fig. 8. Example of Routing with proposed EAPSM installed

node-1 is source and node-4 is destination. To identify the relay node, let us consider a simple minimum hop routing protocol. In our example to transmit a packet from node-1 to node-4, there are several paths. The minimum hop path is node-1→node-5→node-4. So node-5 acts as a relay node to receive and forward packet from node-1 to node-4.

1) Fixing minimum energy (threshold) required by node during transmission to transmit one packet: Using equations 10, 11 and 12, we calculate the minimum energy required by node when it is:

a. Transmitting packet size of 256 bytes and data rate of 2 Mbps

$$R_{ET}^{TX}(256, 1) = 0.212J \quad (20)$$

where R_{ET}^{TX} = Minimum energy required by node-1 to transmit packet-1 to node-5

b. Receiving packet size of 256 bytes and data rate of 2 Mbps

$$R_{ET}^{RX}(256, 1) = 0.1472J \quad (21)$$

where R_{ET}^{RX} = Minimum energy required by node-4 to receive a packet-1 from node-5

c. Relay packet size of 256 bytes and data rate of 2 Mbps

$$R_{ET}^{REL}(256, 1) = 0.3584J \quad (22)$$

where R_{ET}^{REL} = Minimum energy required by node-5 to relay a packet-1 from node-1 to node-4.

During transmission, node changes its initial PSM state to new PSM state. Hence to transmit packet-1 from node-1 to node-4, node-1, node-4 and node-5 changes its initial state from Light Sleep mode to new PSM state Active mode as shown in Table VII. Since packets are not transmitted yet, All node's available energy is 10J. AE is set to 1 for the nodes involved in transmission and if its $R_E \geq R_{ET}$ else it is set to 0 otherwise AE is not calculated. If AE is set to 1, then node will accept request from peer node to be involved in transmission. If AE is set to 0, then node will reject request from peer node to be involved in transmission.

Fig. 9 shows that one packet is transmitted from node-1 to node-4 successfully via node-5. Since node-1, node-5

TABLE VII. EAPSM-NODE'S STATUS WITH TRANSMISSION OF PACKET

Node	Transmission Mode			E_c^{Tot}	R_E	AE	Init-PSM(s)	New-PSM(s)
	RX	TX	Rel					
1	×	×	×	0	10	1	LS	A
2	×	×	×	0	10	×	LS	LS
3	×	×	×	0	10	×	DS	DS
4	×	×	×	0	10	1	LS	A
5	×	×	×	0	10	1	LS	A
6	×	×	×	0	10	×	DS	DS
7	×	×	×	0	10	×	LS	LS

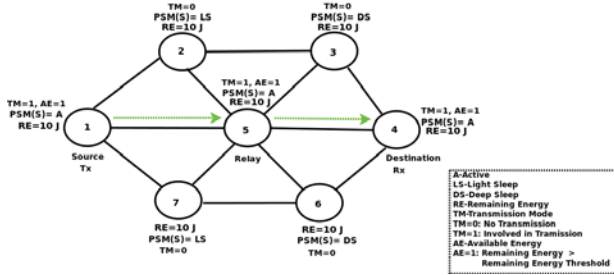

Fig. 9. Example of Routing with proposed EAPSM installed showing Packet transmission

and node-4 are transmitting, relaying and receiving one packet respectively, It consumes energy as defined in equations 4, 5 and 6. The remaining energy of each node involved in transmission is calculated as defined in equation 9.

2) *Calculating energy consumed by node during transmission to transmit packet-1:* Using equations 4, 5 and 6, we calculate the energy consumed by node when it is:

a. Transmitting packet size of 256 bytes and data rate of 2 Mbps

$$E_{c(1 \rightarrow 5)}^{TX}(256, 1) = 0.21J \quad (23)$$

where $E_{c(1 \rightarrow 5)}^{TX}(256, 1)$ = Energy consumed by node-1 to transmit packet-2 to node-5

b. Receiving packet size of 256 bytes and data rate of 2 Mbps

$$E_{c(4 \leftarrow 1)}^{RX}(256, 1) = 0.14J \quad (24)$$

where $E_{c(4 \leftarrow 1)}^{RX}(256, 1)$ =Energy consumed by node-4 to receive a packet-2 from node-5

c. Relay packet size of 256 bytes and data rate of 2 Mbps

$$E_{c(1 \rightarrow 5 \rightarrow 4)}^{REL}(256, 1) = 0.35J \quad (25)$$

where $E_{c(1 \rightarrow 5 \rightarrow 4)}^{REL}(256, 1)$ = Energy consumed by node-5 to relay a packet-1 from node-1 to node-4.

Table VIII shows remaining energy of each node involved in transmission and Available energy of each node. The minimum energy required by node to be involved in transmission is calculated as shown in equations 24, 23, 25. For nodes node-1, node-4 and node-5, AE is set to 1 as these nodes are involved in transmission and its $R_E \geq R_{ET}$. For nodes node-2, node-3,

TABLE VIII. EAPSM-NODE'S STATUS WITH TRANSMISSION OF PACKET-1

Node	Transmission Mode			E_c^{Tot}	R_E	AE	Init-PSM(s)	New-PSM(s)
	RX	TX	Rel					
1	×	✓	×	0.21	9.79	1	LS	A
2	×	×	×	0	10	×	LS	LS
3	×	×	×	0	10	×	DS	DS
4	✓	×	×	0.14	9.86	1	LS	A
5	×	×	✓	0.35	9.65	1	LS	A
6	×	×	×	0	10	×	DS	DS
7	×	×	×	0	10	×	LS	LS

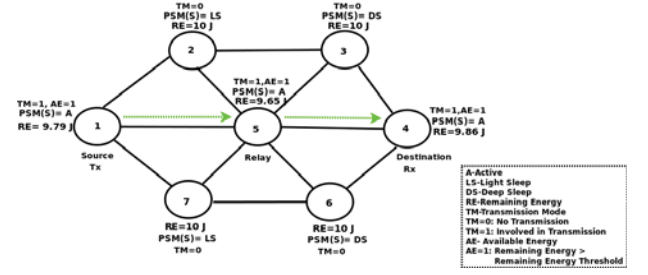

Fig. 10. Example of Routing with proposed EAPSM installed showing Packet transmission and Decrease in Remaining Energy

node-6 and node-7, AE is not calculated as it is not involved in transmission.

Fig. 10 shows that packets are transmitted from node-1 to node-4 successfully via node-5. Since node-1, node-5 and node-4 are transmitting, relaying and receiving packet respectively. It consumes energy as defined in equations 4, 5 and 6. The remaining energy of each node involved in transmission is calculated as defined in 9.

3) *Calculating energy consumed by node during transmission to transmit packet-2:* Using equations 4, 5 and 6, we calculate the energy consumed by node when it is:

a. Transmitting packet size of 256 bytes and data rate of 2 Mbps

$$E_{c(1 \rightarrow 5)}^{TX}(256, 1) = 0.42J \quad (26)$$

where $E_{c(1 \rightarrow 5)}^{TX}(256, 1)$ = Energy consumed by node-1 to transmit packet-2 to node-5

b. Receiving packet size of 256 bytes and data rate of 2 Mbps

$$E_{c(4 \leftarrow 1)}^{RX}(256, 1) = 0.28J \quad (27)$$

where $E_{c(4 \leftarrow 1)}^{RX}(256, 1)$ =Energy consumed by node-4 to receive a packet-2 from node-5

c. Relay packet size of 256 bytes and data rate of 2 Mbps

$$E_{c(1 \rightarrow 5 \rightarrow 4)}^{REL}(256, 1) = 0.70J \quad (28)$$

where $E_{c(1 \rightarrow 5 \rightarrow 4)}^{REL}(256, 1)$ = Energy consumed by node-5 to relay a packet-1 from node-1 to node-4.

Table IX shows remaining energy of each node involved in transmission and Available energy of each node. The minimum

TABLE IX. EAPSM-NODE'S STATUS WITH TRANSMISSION OF PACKET-2

Node	Transmission Mode			E_c^{Tot}	R_E	AE	Init-PSM(s)	New-PSM(s)
	RX	TX	Rel					
1	×	✓	×	0.42	9.68	1	LS	A
2	×	×	×	0	10	×	LS	LS
3	×	×	×	0	10	×	DS	DS
4	✓	×	×	0.28	9.72	1	LS	A
5	×	×	✓	0.70	9.30	1	LS	A
6	×	×	×	0	10	×	DS	DS
7	×	×	×	0	10	×	LS	LS

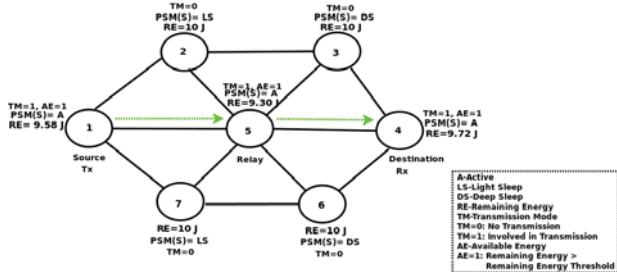

Fig. 11. Example of Routing with proposed EAPSM installed showing Packet transmission and Decrease in Remaining Energy

energy required by node to be involved in transmission is calculated as shown in equations 27, 26, 28. For nodes node-1, node-4 and node-5, AE is set to 1 as these nodes are involved in transmission and its $R_E > R_{ET}$. For nodes node-2, node-3, node-6 and node-7, AE is not calculated as it is not involved in transmission.

Fig. 11 shows that packets are transmitted from node-1 to node-4 successfully via node-5. Since node-1, node-5 and node-4 are transmitting, relaying and receiving packet respectively. It consumes energy as defined in equations 4, 5 and 6. The remaining energy of each node involved in transmission is calculated as defined in 9.

4) Calculating energy consumed by node during transmission to transmit packet-28: Using equations 4, 5 and 6, we calculate the energy consumed by node when it is:

a. Transmitting packet size of 256 bytes and data rate of 2 Mbps

$$E_{c(1 \rightarrow 5)}^{Tx}(256, 1) = 5.88J \quad (29)$$

where $E_{c(1 \rightarrow 5)}^{Tx}(256, 1)$ = Energy consumed by node-1 to transmit packet-2 to node-5

b. Receiving packet size of 256 bytes and data rate of 2 Mbps

$$E_{c(4 \leftarrow 1)}^{Rx}(256, 1) = 3.92J \quad (30)$$

where $E_{c(4 \leftarrow 1)}^{Rx}(256, 1)$ =Energy consumed by node-4 to receive a packet-2 from node-5

c. Relay packet size of 256 bytes and data rate of 2 Mbps

$$E_{c(1 \rightarrow 5 \rightarrow 4)}^{REL}(256, 1) = 9.8J \quad (31)$$

TABLE X. EAPSM-NODE'S STATUS WITH TRANSMISSION OF PACKET-28

Node	Transmission Mode			E_c^{Tot}	R_E	AE	Init-PSM(s)	New-PSM(s)
	RX	TX	Rel					
1	×	✓	×	5.88	4.12	1	LS	A
2	×	×	×	0	10	×	LS	LS
3	×	×	×	0	10	×	DS	DS
4	✓	×	×	3.92	6.08	1	LS	A
5	×	×	×	9.8	0.20	0	A	LS
6	×	×	✓	0.35	9.65	1	DS	A
7	×	×	✓	0.35	9.65	1	LS	A

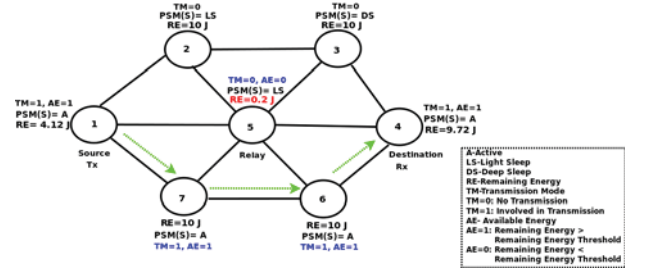

Fig. 12. Example of Routing with proposed EAPSM installed showing Packet reaching successfully to destination by changing PSM state

where $E_{c(1 \rightarrow 5 \rightarrow 4)}^{REL}(256, 1)$ = Energy consumed by node-5 to relay a packet-1 from node-1 to node-4.

Table X shows remaining energy of each node involved in transmission and available energy of each node. The minimum energy required by node to be involved in transmission is calculated as shown in equations 30, 29, 31. For nodes node-1, node-4, AE is set to 1 as these nodes are involved in transmission and its $R_E > R_{ET}$. For nodes node-2, node-3, node-6 and node-7, AE is not calculated as it is not involved in transmission. AE is changed from 1 to 0 for Node-5 as its $R_E < R_{ET}$. Since AE is set to 0, Node-5 has changed its PSM state from Active mode to Light Sleep mode. Node-6 has changed its PSM state from Deep Sleep mode to Active mode. Node-7 has changed its PSM state from Light Sleep mode to Active mode.

Fig. 12 shows that packets are transmitted from node-1 to node-4 successfully by choosing node-6 and node-7 as relay nodes rather node-5 as relay node. Node consumes energy as defined in equations 4, 5 and 6. The remaining energy of each node involved in transmission is calculated as defined in 9. Since node-5 $R_E < R_{ET}$, node-5 changes its PSM state from Active mode to Light Sleep mode and rejects node-1 request to relay packet to node-4. We can notice that, even though node-5 has minimum energy to receive packet, it rejects node-1 request as does not have minimum energy to forward packet to node-4. Hence, node-1 chooses another path node-1→node-6→node-7→node-4 to deliver packet successfully to node-4. This results in high PDR in network.

C. PDR calculation

In our example installed with conventional PSM, we have considered 40 packets to transmit from node-1 to node-4. The PDR was calculated by using equation 17 for conventional PSM. In conventional PSM, only 27 packets were successfully delivered to destination. The remaining 13 packets were dropped at node-5 as node was in Active mode to receive

packet but failed to forward to destination due to less energy. Since node-5 was in Active mode while forwarding packet 28, the other nodes were not allowed to choose as relay node in network to forward packet to destination.

$$PDR(1, 4, 256, 1) = \frac{1 \left(\frac{40}{40} + \frac{27}{40} + \frac{27}{40} \right)}{3} \quad (32)$$

$$= 0.79$$

Therefore conventional PSM results in 79% of PDR. Considering same example installed with EAPSM, the PDR was calculated by using equation 18 for proposed EAPSM. In EAPSM, All 40 packets were successfully delivered to destination. Since node-5 was in Active mode and was having less energy, the PSM state of node-5 is changed from Active mode to Light sleep mode in our proposed EAPSM. This allowed source node to choose another node as relay node in a network to forward packet to destination.

$$PDR(1, 4, 256, 1, s) = \frac{1 \left(\frac{40}{40} + \frac{27}{27} + \frac{13}{13} + \frac{13}{13} + \frac{40}{40} \right)}{5} \quad (33)$$

$$= 1$$

Therefore proposed EAPSM results in 100% of PDR.

The results from equations 32 and 33 shows that using our proposed EAPSM model results high PDR compared to conventional PSM.

IX. CONCLUSION AND FUTURE WORK

In this paper, we have proposed a mathematical model to trigger the PSM in WMN. The model has equations to compute remaining energy, energy consumption and conditions to trigger the PSM. We have shown the state diagram and analysed the probabilities of changing the PSM considering the constraints such as remaining energy and node's involvement in transmission. It has been found that the proposed model enhance the QoS by the increase of PDR when compared to conventional PSM. The future work includes the study of network behaviour under NS3.

X. ACKNOWLEDGEMENT

Authors would like to thank Mr. Suresh Chande, Nokia-India University Relations, Finland for supporting this project.

REFERENCES

- [1] H.Woesner, J.P. Ebert, M. Schlager and A. Wolisz, "Power saving mechanisms in emerging standards for wireless LANs: The MAC level perspective", *IEEE Personal Commun.*, vol 5, 1998, pp. 40-48.
- [2] Y.C.Tseng, C.S. Hsu and T.Y. Hsieh, "Power-saving protocols for IEEE 802.11-based multi-hop adhoc networks", *In Proc. CCS Conf.*, 2002, pp. 200-209.
- [3] J. Punde, N. Pissinou, and K. Makki, "On quality of service routing in ad-hoc networks," *In Proc. of LCN Conf.*, 2003, pp. 276278.
- [4] S. Balandin, A. Heiner, "Dynamic Localized Load Balancing", *SPIE Performance and Control of Next-Generation Communications Networks*, Boston, USA, Vol. 5244, 2003, pp. 164-175.
- [5] X. Zhong and C.-Z. Xu, "Delay-constrained energy-efficient wireless packet scheduling with QoS guarantees," *In IEEE Globecom Conf.*, 2005
- [6] A. Fallahi, E. Hossain, and A. S. Alfa, "QoS and energy trade off in distributed energy-limited mesh/relay/ networks: A queuing analysis," *IEEE Transactions on Parallel and Distributed Systems*, vol. 17, 2005, pp. 6.
- [7] H. Zhu and G. Cao, "On supporting power-efficient streaming applications in wireless environments", *IEEE Transactions on Mobile Computing*, vol. 4, no. 4, 2005, pp. 391-403.
- [8] M.J. Miller and N.H. Vaidya, "Improving power save protocols using carrier sensing for dynamic advertisement windows". *In Proc. ICMAS Conf.*, 2005, pp. 482-482.
- [9] C. M. Chao, J. P. Sheu, and I. C. Chou, "An adaptive quorum-based energy conserving protocol for IEEE 802.11 ad hoc networks", *IEEE Transactions on Mobile Computing*, vol. 5, no.5, 2006, pp. 560-570.
- [10] H. Lei and A. A. Nilsson, "Queuing analysis of power management in the IEEE 802.11 based wireless LANs", *IEEE Transactions on Wireless Communications*, vol. 6, no. 4, 2007, pp. 1286-1294.
- [11] S. Baek and D. C. Bong, Performance analysis of power save mode in IEEE 802.11 infrastructure WLAN", *In Proc. ICT Conf.*, Petersburg, Russia, 2008, pp. 14.
- [12] V. Gorodetsky, O. Karsaev, V. Samoylov, S. Serebryakov, S. Balandin, S. Leppanen, M. Turunen, "Virtual P2P Environment for Testing and Evaluation of Mobile P2P Agents Networks", *In Proc. UBICOMM*, Valencia, Spain, 2008, pp. 422-429.
- [13] C. H. Gan and Y. B. Lin, "An effective power conservation scheme for IEEE 802.11 wireless networks", *IEEE Transactions on Vehicular Technology*, vol. 58, no. 4, 2009, pp. 1920-1929.
- [14] J. Lee and S. Kim, "Mathematical system modeling and dynamic resource allocation through Kalman filter based prediction in IEEE 802.11 PSM", *In Proc. ICIT Conf.*, Australia, 2009.
- [15] H. Memarzadeh, M. Dehghan, and S. Jabbehdari, "A new quorum-based power saving protocol to maintain QoS for MANETs with burst traffics", *In Proc. WAINA Conf.*, Australia, 2010, pp. 674-679.
- [16] Y. H. Zhu and V. C. M. Leung, "Efficient power management for infrastructure IEEE 802.11 WLANs", *IEEE Transactions on Wireless Communications*, vol. 9, no. 7, 2010, pp. 2196-2205.
- [17] IEEE, "Draft amendment: ESS mesh networking," *IEEE P802.11s Draft 12.00*, Jun 2011.
- [18] S. Andreev, P. Gonchukov, N. Himayat, Y. Koucheryavy, A. Turlikov, "Energy efficient communications for future broadband cellular networks", *Elsvier journal on Computer Communications*, Vol. 35 (14), 2012, pp. 1662-1671.