

Utilization of 10 Gbps DWDM System with Duobinary Modulation into Passive Optical Network

Tomáš Huszaník, Ján Turán and Ľuboš Ovseník

Abstract—Passive optical networks are considered to be the most promising solution for future access networks. Growing demand for capability and high bit rate transmission has become an important part of metropolitan optical communication networks in recent years. Currently deployed 1 Gbps passive optical networks do not seem to be suitable for future demands. This paper deals with the utilization of 10 Gbps DWDM (Dense Wavelength Division Multiplex) in PON (Passive Optical Network) using simulation tool OptSim. The importance of advanced optical modulation is the key for the future high spectral efficiency DWDM passive optical networks. Optical duobinary modulation seems to be the main contender for the future DWDM-PON systems. Based on the real passive optical network we propose and demonstrate the novel 10 Gbps DWDM-PON solution implementing optical duobinary modulation as a future candidate for high speed passive optical networks. Performance of proposed 10 Gbps DWDM-PON with optical duobinary modulation and intensity modulation with direct detection is analyzed using BER (Bit Error Rate) and Q factor measurements.

Index Terms—BER, duobinary modulation, DWDM, intensity modulation, optical modulation, OptSim, PON, Q factor, WDM.

I. INTRODUCTION

During the last few years the demand for broadband multimedia services has grown rapidly. The number of internet customers increased massively. Perspective solution applied today is an introduction of a broadband access network based on passive optical networks technology. PONs have several advantages over active optical networks – higher reliability, simpler maintenance and reduced power consumption. The currently dominating technology is Gigabit-PON (G-PON), but 10G-PON is already in the market adaptation phase and can be deployed alongside with G-PON

Manuscript received October 19, 2018; revised December 2, 2018. Date of publication December 14, 2018. The associate editor Prof. Ivan Radoš has been coordinating the review of this manuscript and approved it for publication.

Authors are with the Department of Electronics and Multimedia Communication, Technical University of Košice, Košice, Slovakia. E-mails: (tomas.huszanik, jan.turan, lubos.ovsenik)@tuke.sk.

Digital Object Identifier (DOI): 10.24138/jcomss.v14i4.644

[1]. One way to keep up with the growing demand in metropolitan passive optical networks is to expand to DWDM systems. To increase the capacity of 10G-PON solution is to deploy dense wavelength division multiplexing – DWDM.

This paper focuses on utilization of 10 Gbps DWDM into passive optical network. The increased signal complexity in DWDM-PON sets the higher requirements for signal propagation. With the multichannel transmission we have to count with the risk of channel crosstalk and other fiber impairments due to fiber Kerr nonlinearities. The most of currently available optical systems use simple optical modulation techniques based on intensity modulation. For most of the situations, these modulations are fully sufficient. However, increasing demand for high bandwidth and high data rate services are slowly pushing out basic intensity modulation formats. The use of intensity modulation formats could be still beneficial, especially for short distances. The main problem is chromatic dispersion and non-linear effects which are the main impairments that cause signal degradation in optical fiber. Robustness of an optical system can be achieved by utilizing advanced optical modulation formats.

In this paper, we have designed and simulated an 8-channel 10 Gbps DWDM-PON with duobinary modulation. Duobinary modulation has shown the most promising results for deployment in WDM infrastructures. Moreover, the duobinary modulation is highly tolerant to chromatic dispersion, which means that longer transmission distances can be achieved. The common problem with DWDM transmission and potentially the big problem for DWDM based PON is four wave mixing (FWM), which is present when using narrow channel spacings. The negative effect of FWM can be eliminated by utilizing advanced modulation technique, e.g. duobinary modulation. Till now, this modulation format has been tested in active optical network infrastructures. Here, the implementation of DWDM-PON with duobinary modulation is presented and compared to the equal system with ordinary intensity modulation. In the present simulation study, a duobinary modulated system has been evaluated and compared to conventional intensity modulation using various channel spacing. The performance and the robustness of proposed optical system is indicated by BER and Q-factor.

The main aim is to increase the performance of the next generation DWDM-PON by implementing optical duobinary modulation as a future candidate for such networks.

In recent years, several articles about DWDM and PON have been published. In [2] we show how can be the performance of DWDM influenced through optical modulation. For example, Ivaniga et al. [3] provides an overview on passive optical network with G-652.B optical fiber. Authors not only analyze network with OTDR (Optical Time Domain Reflectometry), but they also run simulation of proposed optical network in OptSim. Another article on passive optical network with WDM has been published by Kurbatska et al. [4]. In this article authors evaluate various optical modulation formats as a future solution for high speed WDM based passive optical networks. The article by Ivaniga et al [5] shows the influence of four wave mixing (FWM) in high spectral DWDM system with arrayed waveguide grating (AWG) using different channel spacing to influence channel crosstalk. This paper is also part of a continuous research, part of which is an article [6] presented by authors at ICC 2018. In this article authors deal with the implementation of advanced optical modulation formats based on optical IQ modulator in high spectral efficiency DWDM system with transmission rate of 20 Gbps per channel. Authors show that by implementing advanced optical modulation into DWDM system we can significantly reduce fiber nonlinear impairments and thus increase efficiency of the whole communication system.

The structure of this paper is: In the second section we describe WDM-PON technology. The third section concerns about intensity modulation for direct detection (IMDD) and fourth section deals with optical duobinary modulation. Experimental simulation model is shown in section five and experimental results are in section six.

II. WDM PASSIVE OPTICAL NETWORK

Passive optical network (PON) is a set of technologies standardized both by International Telecommunication Union (ITU) and IEEE. PON provides a variety of broadband services to users through optical fiber access. Because it is passive, PON removes all active components between the source and receiver and uses passive network components instead. Its principal component is a passive optical splitter. Passive network architectures significantly reduce cost and are mainly used in FTTx (Fiber To The x services) networks. PON infrastructure can carry multiple services such as plain old telephone service (POTS), voice over IP (VoIP), data, video, telemetry or other network services. All these services are encapsulated in a single packet type for transmission over optical fiber.

PON architecture consists of the following equipment: optical line terminal (OLT), optical network units (ONUs) and optical network termination (ONT) [1], [2] and [3]. The basic architecture of PON is shown in Fig. 1.

Optical line terminal (OLT) is located at the service provider's central office. OLT controls the bidirectional data flow across the optical distribution network. Generally, OLT must be capable of transmission distance up to 60 km (Gigabit PON) without additional amplifying. The main function of OLT in the downstream is to broadcast data, video or voice to all ONT modules connected to distribution network. In the

upstream OLT distributes all the traffic from the network users [4].

Optical distribution network (ODN) connects OLT with ONUs by using optical fibers and optical splitters.

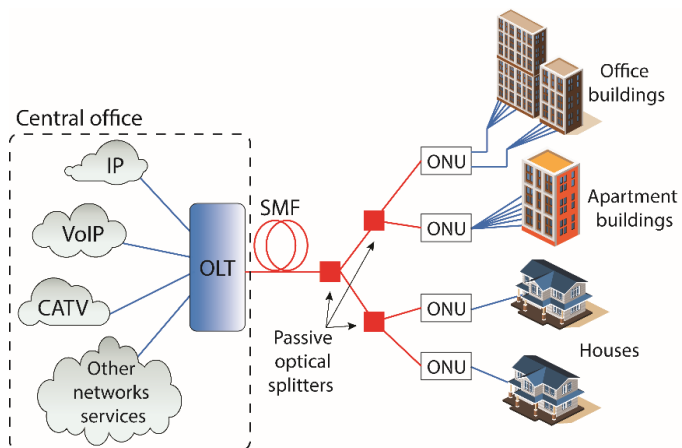

Fig. 1. Structure of passive optical network

ODN is usually formed to tree structure with OLT as the root of the tree and ONUs as the leaves of the tree. Optical fiber used for ODN is able to carry different wavelengths for each direction. PON wavelength range for data transmission is 1490 -1500 nm for downstream. Upstream is used mainly for voice services and works in the range of 1290-1310 nm wavelength. However, these ranges may vary depending on the specification of PON [4], [5], [6].

Optical network termination (ONT) is placed directly at customer's place. Its purpose is to provide an optical connection to the PON. ONT typically supports a mix of services including 10/100Base-TX (RJ45) (10/100 Gbps), 1000Base-T/SX/LX (1 Gbps), 10GBase-SR/LX4 (10 Gbps) and VoIP services. At high performance ONT can transport various types of information traffic coming from the user site and send it upstream over a single fiber PON infrastructure. ONT receives all the signals send by OLT and then filters the channels that are directed to itself [1], [4] and [5].

Essential part of PON infrastructure is a passive splitter. Splitters are passive dividers dedicated to split signals. Splitters are bidirectional optical distribution devices with one input and multiple output. Because these splitters are passive components, they can operate without external power source reducing cost and complexity of an optical network. Multiplexing is done by passive combiners or arrayed waveguide grating (AWG) multiplexers [4], [5].

Passive splitters introduce optical power loss on communication signals. In the ideal case, splitter with two outputs loses approximately 3 dB at each. Attenuation caused by passive splitter can be calculated as:

$$\alpha_{spl} = -10 \log \frac{1}{N}, \quad (1)$$

where N is number of outputs. Wavelength division multiplex (WDM) is a candidate solution for the next generation PON. One of the drawbacks of conventional PON is a lack of bandwidth. Conventional PON implement time division

multiplexing access (TDMA) which supplies each customer with shared wavelength but for a limited time period. Recent Giga bit optical networks deploy the combination of TDM (Time Division Multiplexing) and WDM to increase data rate. On the other hand, WDM supplies each customer with separate wavelength for unlimited time [1]. Structure of WDM-PON is shown in Fig. 2.

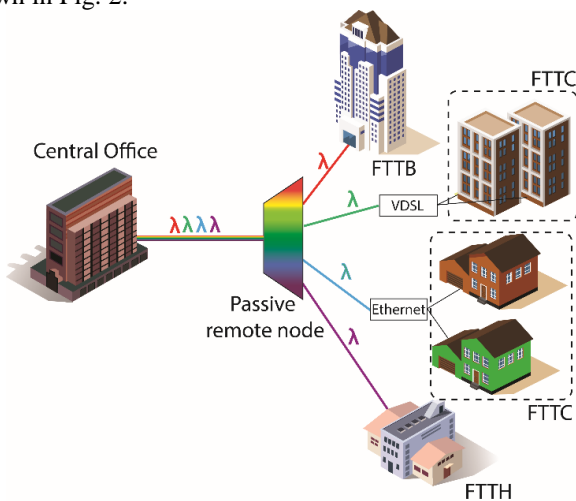

Fig. 2. Structure of WDM-PON

Typical for WDM-PON is the use of an arrayed waveguide grating (AWG) filter instead of a splitter. AWG separates the wavelengths for individual delivery to customer's ONT [2]. The typical attenuation of AWG is 5.5 - 10 dB depending on the number of outputs [1]. Advantage of WDM approach is that downstream channels are separated on different wavelengths which provides more bandwidth to each customer. The biggest disadvantage of WDM approach is high price compared to TDM-PON (Time Division Multiplex-PON). The reason is that each customer requires own transceiver at the OLT [1].

WDM-PON can also associate dense wavelength division multiplexing (DWDM – ITU-T G.694.1) and coarse division multiplexing (CWDM - ITU-T G.694.2) technology. DWDM is characterized by narrow channel spacing compared to CWDM. Channel transmitters employed with DWDM technology require a control mechanism to enable them to meet requirements on frequency stability. Recommendation G.694.1 defines a variety of fixed channel spacings – 12.5 GHz, 25 GHz, 50 GHz and 100 GHz as well as flexible spacing [3], [6]. CWDM defines 18 wavelength channels (1271 – 1611 nm) with channel spacing of 20 nm. CWDM systems can realize cost effective applications in transport networks and metropolitan areas.

III. INTENSITY MODULATION METHOD FOR DIRECT DETECTION

Majority of existing PONs facilitate intensity modulation for direct detection (IMDD). In fact, all IMDD links use laser diodes in two possible designs: Fabry-Perot (FP) or distributed feedback (DFB). To reduce cost, some low performance PONs use light-emitting diodes (LED). Intensity modulation is the simplest optical modulation method. There are two principal intensity modulation techniques - direct and external modulation [1], [7].

A typical example of direct intensity modulation is an optical modulation in which data are modulated by varying the intensity of a laser beam. However, this type of modulation is not suitable for long distance transmission since the power at which transmitter's laser emit should be kept at low level, its necessity to use optical amplifier or repeaters which significantly increase overall cost of network solution. For more sophisticated modulations are used devices called external optical modulators [7], [8] and [9].

OOK (On-Off Keying) is an intensity modulation performed with external modulator and can be used in IMDD systems. In this modulation, the baseband signal is multiplied by a carrier frequency. The logical 1 is transmitted via short light pulse with non-zero intensity. When logical 0 occurs, there is no light emitted. At receiver side, demodulation is performed using a simple photodetector which converts optical signal to electrical signal. Intensity modulation formats are characterized by simple implementation, simple signal regeneration and detection [8]. OOK modulation can be implemented as an external Mach-Zehnder modulator (MZM), as shown in Fig. 3. MZM can be operated in two modes – push-push and push-pull mode. In push-push mode ($u1(t)=u2(t)$), there is identical phase shift induced in both arms so that pure phase modulation is achieved. If one of the arms gets negative phase shift to the other arm we speak about push-pull mode ($u1(t) = -u2(t)$) and chirp-free amplitude modulation is achieved.

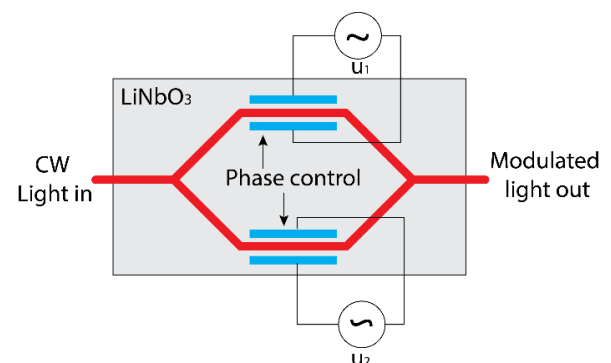

Fig. 3. Mach-Zehnder modulator

IV. OPTICAL DUOBINARY MODULATION

Transmission over optical fiber is always accompanied with signal loss and degradation. The main threat for long distance transmission over optical fiber are chromatic dispersion and non-linear effects, namely self-phase modulation (SPM), cross phase modulation (XPM) and four wave mixing (FWM). These degradation mechanisms are also current for PON and WDM-PON. There are several ways to deal with nonlinear degradation mechanisms [1]. Because majority of nonlinear fiber impairments are sensitive to certain signal waveforms and signal power level we can eliminate small fraction of nonlinear effects just by mitigating the light source or the whole transmitter [11], [12].

Duobinary optical modulation seems to be a perfect fit for WDM-PON networks. Compared to IMDD, duobinary modulation provides higher spectral efficiency and high tolerance to nonlinear fiber impairments and chromatic dispersion. Duobinary modulation is a modulation scheme for

transmitting R bits per second using less than $R/2$ Hz bandwidth [8]. Duobinary modulation can be described as a combination of traditional amplitude and phase modulations. The duobinary modulation is basically an amplitude modulation in which the bit stream is manipulated to reduce the bandwidth to overcome inter symbol interference (ISI) [13-17]. Let consider following transmitted signal:

$$x(t) = \sum_{k=-\infty}^{\infty} D_k q(t - kT), \quad D_k = 0,1 \quad (2)$$

where D_k is data bit sequence, $q(t)$ is transmitted impulse and $T=1/R$ is period of one bit [10]. Then duobinary modulation scheme affects transmitted pulses as follows:

$$q(kT) = \begin{cases} 1 & k = 0,1 \\ 0 & \text{otherwise} \end{cases} \quad (3)$$

Looking at equations (2) and (3) one can tell that the receiver does not recover data bits D_k but $D_{k-1}+D_k$. To recover data bits, receiver must perform the XOR operation of adjacent bits. This modulation scheme allows pulses with a smaller bandwidth which helps reducing ISI and distortion effect of the channel. Duobinary modulation is the simplest partial response coding method. Instead of transmitting $D_k=0, 1$ signal (in case of OOK) duobinary modulation transmits $D_{k-1}+D_k$ so the original two-level signal becomes a three-level signal with signal levels 0, 1 and 2 [18]. The structure of duobinary precoder is shown on Fig. 4.

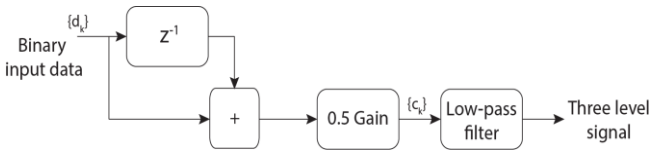

Fig. 4. Duobinary precoder

The advantage of optical duobinary modulation is the narrower bandwidth. This is significant for DWDM systems because the creation of four wave mixing (FWM) can be reduced. The other advantage of duobinary modulation is that receiver structure for duobinary modulation is identical to the basic OOK receiver, no modifications are required.

Duobinary modulation reduce the bandwidth by half compared to regular NRZ (Non Return to Zero) intensity modulation. The signal has the same probability in zero-level and non-zero level as the OOK modulation. The polarity of signal changes from negative to positive or in an opposite way if there is odd number of zero-level signal in between. If there is even number of zero-level signals in between, polarization remains the same polarity. The main disadvantage of optical duobinary modulation is polarization mode dispersion (PMD) which can strongly impair the performance of system, especially when working at high bit rates (40 Gbps and more) [18], [19].

V. EXPERIMENTAL SIMULATION OF 10 GBPS DWDM-PON

Simulation model of DWDM-PON was designed in OptSim simulation tool from the RSoft company. The complete

structure of proposed simulation model is shown in Fig. 5. The simulation model has tree structure and it is formed of four parts – central office (CO), optical distribution network (ODN), remote node (RN) and user section which are all described in following subsections. The aim of the simulation is to evaluate BER and Q factor of DWDM-PON using ordinary IMDD based on Mach-Zehnder modulator and optical duobinary modulation which should increase overall transmission quality and robustness of proposed DWDM-PON.

A. Central Office

Central office consists of eight transmitters which are generating data at 10 Gbps data rate. All the channels deploy frequency grid according to ITU-T G.694.1 recommendation for DWDM systems [21]. For this application we opted for 100 GHz channel spacing (from 193.0 THz to 193.7 THz), which is common channel spacing used in real optical communication systems.

In the first simulation setup, we used IMDD transmitters as shown in Fig. 6. IMDD transmitter is constructed using Mach-Zehnder modulator. Data are generated by pseudorandom binary sequence (PRBS). Data are then driven through NRZ driver and filtered with linear electrical low pass Bessel filter. Optical carrier signal is generated by CW laser (based on distributed feedback laser DFB laser [22],[23]), output power is 10 dBm (10 mW) and initial phase is set to 0 degrees.

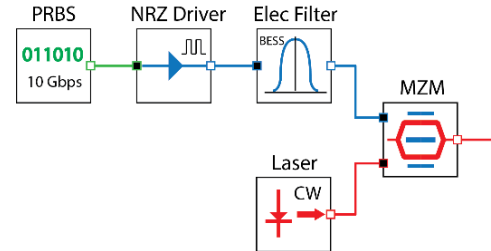

Fig. 6. IMDD transmitter

The second simulation setup uses already mentioned optical duobinary modulation. Transmitter with duobinary modulation is illustrated in Fig. 7.

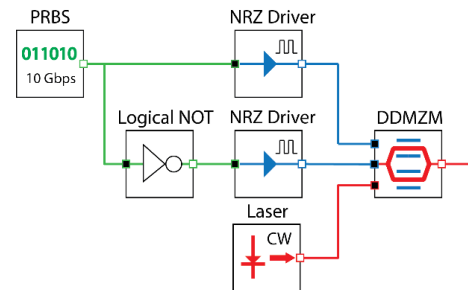

Fig. 7. Optical duobinary transmitter

Duobinary transmitter consists of PRBS generator, generating data at 10 Gbps data rate. Randomly generated data are split into two arms. The logical state of data in one of the two arms is inverted using Logical NOT component. Both data sequences are then driven by NRZ modulator and filtered with low pass Bessel filter. Data, in electrical domain are modulated

using dual drive Mach-Zehnder modulator (DDMZM). DDMZM is dual arm optical modulator and is important optical modulator used for high spectral efficiency DWDM systems.

Dual drive configuration of a Mach-Zehnder modulator modulates data by applying modulating voltages to both arms

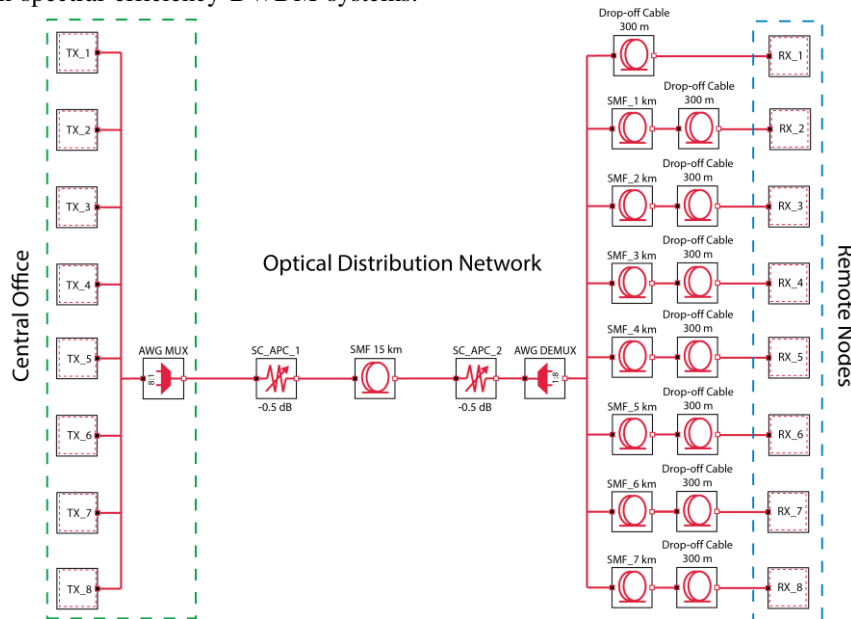

Fig. 5. Structure of proposed 10 Gbps DWDM-PON

of the interferometer. Phase change in the arms is $\pi/2$. On the other hand, single drive modulator applies modulating voltage to one of the arms of the interferometer and the phase change is π . Parameters of PRBS generator are same for both transmitter configurations – bit rate is 10 Gbps, Baud rate is 10 GBaud/s generating 156 samples per bit. Finally, all eight channels are multiplexed. Multiplexer is based on AWG.

B. Optical Distribution Network

To better approximate the real-life transmission, optical distribution network of the simulation model is based on the real optical distribution network operating in the city of Košice, Slovakia which was tested with OTDR. Total measured optical fiber loss of this optical distribution network was 9.832 dB. The reflection curve of this ODN is shown on Fig. 8. Attenuation characteristics of ODN are in Table I. The real optical distribution path is deployed as E-PON (Ethernet PON) that delivers maximum 1 Gbps symmetrical bandwidth. However this network should be capable to support data rates of G-PON and even 10G-PON.

Based on this measurement we set the simulation model: the length of SMF is 15 km with attenuation of 9 dB, we also added two 0.5 dB attenuation blocks to simulate SC/APC connectors. Next in the chain is 1:8 AWG demultiplexer with attenuation of 10 dB. Outputs of the AWG lead to remote nodes. Each remote node is placed 1 km further from other. Total set attenuations to the remote nodes (including drop-off cables) are provided in Table II. In order to perform the simulation in realistic conditions, we set non-linearity coefficient of a signlemode optical fiber to $10 \text{ W}^{-1}\text{km}^{-1}$ and chromatic dispersion to $16 \text{ ps}/(\text{nm}\cdot\text{km})$.

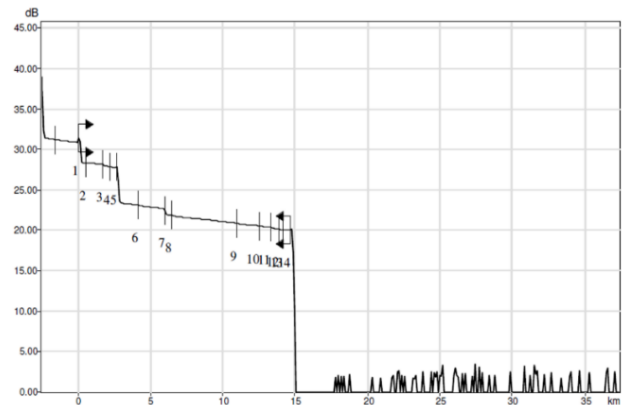

Fig. 8. The reflection curve of the real ODN

TABLE I
PROPERTIES OF THE REAL ODN

| Fiber length (km) | Fiber Atten. (dB) | Attenuation (dB) |
|-------------------|-------------------|-------------------|
| SMF_1 | 0.53 | SC_APC_1 0.500 |
| SMF_2 | 1.19 | 1_Weld 0.063 |
| SMF_3 | 0.46 | 2_Connector 0.192 |
| SMF_4 | 0.46 | 3_Weld 0.048 |
| SMF_5 | 1.75 | 4_Weld 0.065 |
| SMF_6 | 1.81 | Splitter 4.300 |
| SMF_7 | 0.52 | 5_Weld 0.083 |
| SMF_8 | 4.51 | 6_Weld 0.101 |
| SMF_9 | 1.55 | 7_Connector 0.676 |
| SMF_10 | 0.79 | 8_Weld 0.034 |
| SMF_11 | 0.54 | 9_Weld 0.068 |
| SMF_12 | 0.28 | 10_Weld 0.053 |
| SMF_13 | 0.55 | 11_Weld 0.071 |
| | | 12_Weld 0.072 |
| | | 13_Weld 0.081 |
| | | SC_APC_2 0.500 |
| Sum | 14.94 | Sum 6.907 |

C. User Section

Signal is demultiplexed to individual channels using AWG demultiplexer. Receiver is formed from Gauss optical bandpass filter and a simple PIN photodiode with sensitivity of -30 dBm which converts optical signal to electrical signal.

TABLE II
ATTENUATION CHARACTERISTICS OF REMOTE NODES

| Remote node | Fiber length (km) | Total attenuation (dB) | Reserve sensitivity (dB) |
|-------------|-------------------|------------------------|--------------------------|
| RN 1 | 15 | 20.0 | 20.0 |
| RN 2 | 16 | 21.5 | 18.5 |
| RN 3 | 17 | 23.0 | 17.0 |
| RN 4 | 18 | 24.5 | 15.5 |
| RN 5 | 19 | 26.0 | 14.0 |
| RN 6 | 20 | 27.5 | 12.5 |
| RN 7 | 21 | 29.0 | 11.0 |
| RN 8 | 22 | 30.5 | 9.5 |

Reference frequency of PIN is 193.0 THz, quantum efficiency is 0.63855 and responsivity is 0.8 A/W. If the PIN sensitivity is -30 dBm and launch power is 10 dBm, maximum power capacity of this network is 10 dBm - (-30 dBm) = 40 dBm. The structure of a receiver is identical for IMDD and duobinary modulation. The block diagram of a receiver is in Fig. 9. Received signal, in electrical domain, is analyzed using BER and Q factor measurements.

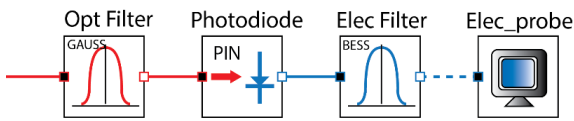

Fig. 9. Receiver for IMDD and duobinary modulation

Please note, that simulation results may vary from the real optical networks as Rsoft OptSim works in ideal conditions. The overall performance of the real optical system depends upon all network components, and is mainly determined by noise level including quantum and thermal noise. The overall performance of proposed system depends on how much impairments is included by designer. As default we include a 3 dB noise in each SMF section.

VI. RESULTS AND DISCUSSION

Input optical spectrums of proposed DWDM-PON with 100 GHz channel spacing using IMDD and duobinary transmitters are shown in Fig. 10.

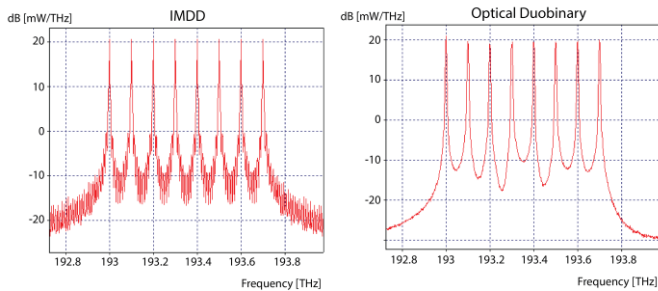

Fig. 10. Input optical spectrum for IMDD and duobinary modulation

Output optical spectrums before demultiplexing for IMDD and duobinary modulation are shown in Fig. 11. We can see the creation of new spectral components in sidebands of optical spectrum of duobinary modulation. The peak power of new sideband spectral components is approximately 10 dB. Channel central frequencies still remain well separated. Signal degradation in spectral domain is more obvious in case of IMDD.

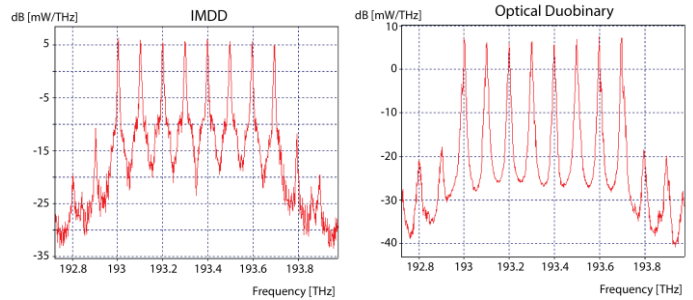

Fig. 11. Output optical spectrum for IMDD and duobinary modulation

Signal received in each remote note was analyzed in electrical domain. We used eye diagrams to evaluate the performance of IMDD and duobinary modulation in DWDM-PON system. From the eye diagram display, we can extract various parameters of received signal. The most used ones are bit error rate (BER), Q factor measurements measured in decibels and the eye opening. Eye opening signals how much is the analyzed eye diagram opened. The most open part means the best signal-to-noise ratio (SNR). Q factor is a function of SNR and provides a qualitative description of receiver performance. Eye diagrams for IMDD and duobinary modulation from remote nodes no. 3 and no. 7 are shown in Fig. 12 and Fig. 13. BER values are provided in Table III.

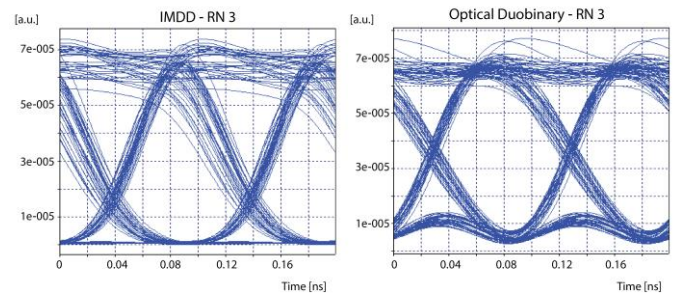

Fig. 12. Eye diagrams for RN no. 3

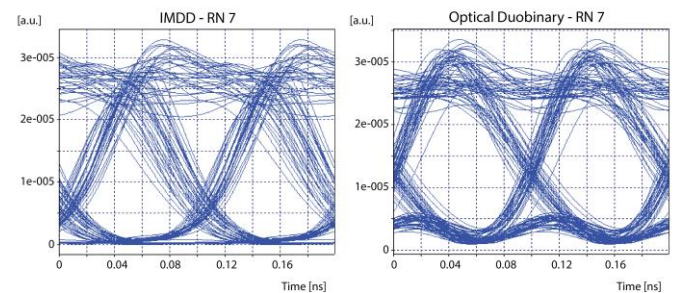

Fig. 13. Eye diagrams for RN no. 7

The most open eye diagrams were achieved for optical duobinary modulation at remote node no.1 (15 km), no.2 (17 km) and no. 3 (17 km). The eye opening of IMDD eye diagrams was considerably smaller for all remote nodes. Based on this display, the assumption is that duobinary modulation increase OSNR and decrease BER of DWDM-PON. The required bit error rate for today's optical networks is 1×10^{-9} which corresponds to 16.94 dB Q factor.

TABLE III
BER FOR IMDD AND DUOBINARY DWDM-PON

| Remote node / distance | IMDD BER | Duobinary BER |
|------------------------|------------------------|------------------------|
| 1 / 15 km | 7.97×10^{-25} | 1.33×10^{-34} |
| 2 / 16 km | 2.66×10^{-22} | 1.82×10^{-32} |
| 3 / 17 km | 1.60×10^{-21} | 8.11×10^{-31} |
| 4 / 18 km | 6.90×10^{-20} | 4.72×10^{-27} |
| 5 / 19 km | 5.27×10^{-19} | 3.06×10^{-22} |
| 6 / 20 km | 3.20×10^{-18} | 9.07×10^{-21} |
| 7 / 21 km | 2.42×10^{-17} | 1.30×10^{-19} |
| 8 / 22 km | 1.53×10^{-16} | 7.44×10^{-18} |

From the gives values we see that quality of transmission in DWDM-PON decreases as increasing transmission distance.

Bit error rate (BER) was calculated form eye diagram display. The other useful parameter is Q factor, which is in very close relationship to BER. Q-factor is a function of SNR and it represent the system tolerance in decibels. It can be calculated using following equation:

$$Q = \frac{I_1 - I_0}{\sigma_1 + \sigma_0} \quad (4)$$

where I_1 and σ_1 are mean values and variance output by Gaussian pulse "1" and I_0 and σ_0 are mean values and variance output by Gaussian pulse "0". Then the relationship between BER and Q factor can be described as:

$$BER = \frac{1}{2} \operatorname{erfc} \left(\frac{Q}{\sqrt{2}} \right) \approx \frac{1}{\sqrt{2\pi}Q} \exp \left(-\frac{Q^2}{2} \right), \quad (5)$$

In the last experiment we changed the channel spacing of proposed DWDM-PON according to ITU-T G.694.1 [10]. The benefit of choosing tighter channel spacing is that we can transmit larger number of channels in the same bandwidth. Downside is that with tighter margins between adjacent channels, the channel crosstalk is increased and the creation of new spectral components due to nonlinear effect called four wave mixing (FWM) is present. Our presumption is that the performance of the system with duobinary modulation will be better regarding to the more compact frequency bandwidth per channel compared to intensity modulation.

Channel frequencies in this run are (193.0 – 193.35) THz for 50 GHz spacing, (193.0 – 193.175) THz for 25 GHz spacing and (193.0 – 193.0875) THz for 12.5 GHz spacing. Following figures (Fig. 14, Fig. 15, Fig. 16) show the signal spectra before demultiplexing for 50, 25 and 12.5 GHz channel spacing.

As seen on Fig. 14 channels remain well separated for both optical modulations. Channel separation when using 25 GHz grid (Fig. 15) is still satisfactory. However, the Q factor show

that the performance of IMDD based DWDM-PON already suffers. Finally, the Fig. 16 shows the optical specar using 12.5GHz channel spacing. Yet channels of IMDD signal spectra seem to be well separated, the Q factor reveals that with this tight channel spacing IMDD is no more suitable for such system.

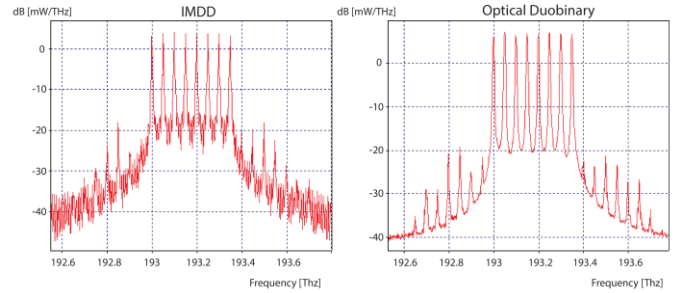

Fig. 14. Output optical spectrum for 50 GHz channel spacing

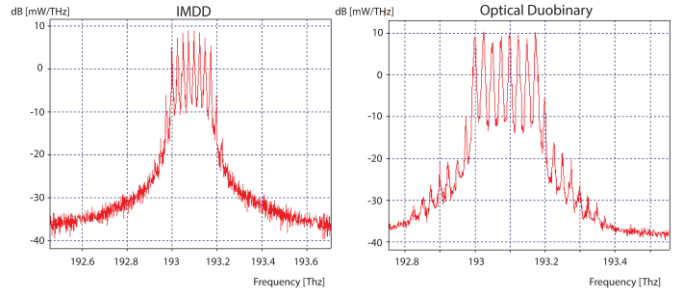

Fig. 15. Output optical spectrum for 25 GHz channel spacing

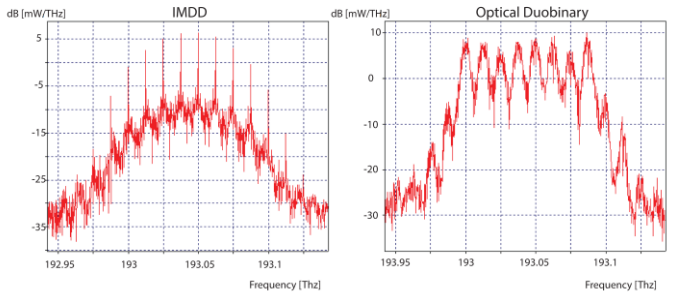

Fig. 16. Output optical spectrum for 12.5 GHz channel spacing

On the figures above, we can see, that signals are significantly distorted, mainly due to fiber nonlinear effects such as FWM and XPM. The phase shift induced by XPM ϕ_{nl}^i can be expressed by following equation (for eight channels):

$$\phi_{nl}^i = k_{nl} L_e \left(P_i + 2 \sum_{n=i+1}^8 P_n \right) \quad (6)$$

where k_{nl} is the nonlinear constant of spreading, L_e is effective length of optical fiber and P is the optical power. The first part of this equation represents the contribution of the SPM and the second part the contribution of the XPM. FWM results when transmitting multiple channels over single fiber and it is generally expressed as:

$$f_{ijk} = f_i + f_j - f_k \quad (i, j \neq k). \quad (7)$$

FWM occurs at the propagation of at least three signals with different wavelengths. Due to the FWM, there is an interaction between the three distributed signals of the frequency f_i , f_j and f_k , and a new frequency signal is generated. The performance of the signal with respect to the length of the optical fiber affected by the FWM is:

$$P_F(L) = \frac{1024\pi^6}{n^4 \lambda^2 c^2} (D_X) \cdot \frac{P_i(0)P_j(0)P_k(0)}{A_{ef}^2} e^{-\alpha L} \cdot \frac{(1 - e^{-\alpha L})^2}{\alpha^2} \eta. \quad (8)$$

In this relation P_i , P_j and P_k are the outputs of the optical signal bound to the optical fiber, P_F is the power of the newly generated filament frequency signal, n is the optical fiber refractive index, λ is the wavelength, c is the velocity of light in the vacuum, A_e is the effective region of the core optical fiber, α is the loss coefficient, L is the length of the optical fiber, D is the degradation factor, X is nonlinear susceptibility and η is the efficiency.

The graphical dependence of Q factor to transmission distance for all channel spacings is displayed on Fig. 17.

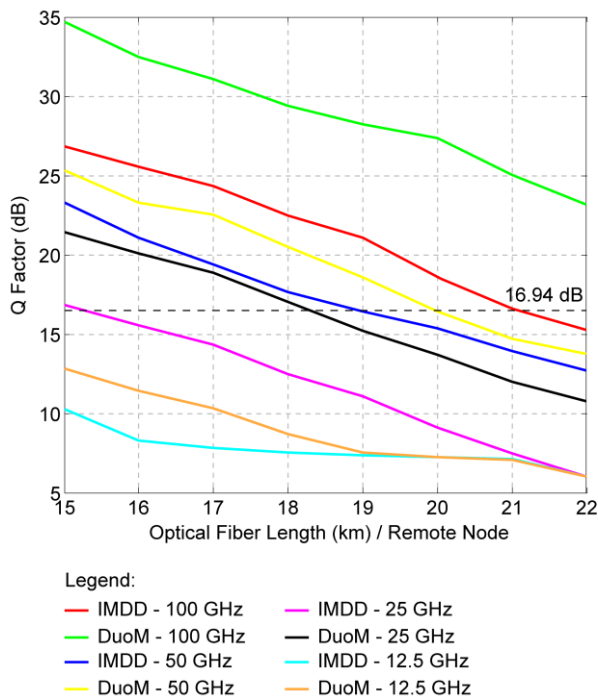

Fig. 17 Q factor vs optical fiber length for various channel spacings

VII. CONCLUSION

Simulation results declare that optical duobinary modulation significantly improves transmission quality in proposed DWDM-PON. Given that the reach of a real WDM-PON based network in up to 80 km we assume that BER at 80th km is no bigger than 1×10^{-9} which is the maximum allowable value of BER. Then, the simulation results are within the allowed range

of BER. IMDD system reach BER 7.97×10^{-25} and Q factor 27.26 dB at 15 km fiber length. By pushing fiber length to 20 km we reach 3.20×10^{-18} . Duobinary modulation reaches much lower BER than IMDD – from 1.33×10^{-34} at 15 km to 7.44×10^{-18} at 22 km. As we can see from Fig. 17 by narrowing channel spacing we also decrease the performance of proposed system. However, deployment of optical duobinary modulation into DWDM-PON allows more channels per bandwidth using tighter channel spacing as proved by the simulation results. At this stage the optical duobinary modulation is very beneficial as its narrower bandwidth keeps channel well separated and therefore is more resistant to ISI and FWM. It is also important to add, that the influence of fiber nonlinearities is increased on longer optical fiber links. Overall, optical duobinary modulation provides better performance of proposed DWDM-PON in term of resistance to non-linear fiber impairments, chromatic dispersion and ISI. This paper shows the possibility of using DWDM in existing optical infrastructure which is supported by simulation results. Based on the simulation results, optical duobinary modulation proves to be suitable candidate for future DWDM based passive optical networks.

ACKNOWLEDGEMENTS

This work was supported by following research grants: KEGA 023TUKE-4/2017 and the Slovak Research and Development Agency under the contract no. “APVV-17-0208 - Resilient mobile networks for content delivery”.

REFERENCES

- [1] V. Eržen, B. Batagelj, „NG-PON1: Technology presentation, implementation in practice and coexistence with the GPON system,” *Elektrotehnikski Vestnik/Electrotechnical Review*, vol. 79, no. 3, 2012, pp. 117-122.
- [2] R. Ramaswami, K. N. Sivarajan, G. H. Sasaki, *Optical Networks*, 928p. 2010. ISBN: 978-0-12-374092-2.
- [3] B. Batagelj, V. Janyani, S. Tomažič, „Research challenges in optical communications towards 2020 and beyond,” *Journal of Microelectronics, Electronic Components and Materials*, vol. 44, no. 3, 2014, pp. 177 – 184.
- [4] M. Vidmar, “Optical-fiber communications: components and systems,” *Informacije MIDEEM*, vol. 31, no. 4, 2001, pp. 246-251.
- [5] T. Horvath, J. Chlapek, P. Munster, J. Vojtech, M. Filka, „High Speed (100G) Access Networks,” *Journal of Communications Software and Systems*, vol. 14, no. 3, 2018, pp. 258 – 263. DOI: <http://dx.doi.org/10.24138/jcomss.v14i3.523>.
- [6] T. Horvath, P. Cymorek, P. Munster, V. Oujezsky, J. Vojtech, “Simulations of Grant Allocation in NG-PON2 Networks Using OPNET Modeler,” *Journal of Communications Software and Systems*, vol. 14, no. 4, 2018, pp. 281 – 289. DOI: <http://dx.doi.org/10.24138/jcomss.v14i4.525>.
- [7] T. Huszanik, L. Ovsenik, J. Turán, „Performance Analysis of Optical Modulation Formats for 10 Gbit/s DWDM System”, *Carpathian Journal of Electronic and Computer Engineering*, vol. 10, no. 2 pp. 3-8, 2017. ISSN: 1844-9689.
- [8] L. Ovsenik, J. Turán, T. Ivaniga, P. Ivaniga, “Deployment of the PON with an optical fibre G-652.B”, *IEEE 14th International Scientific Conference on Informatics, INFORMATICS 2017 - Proceedings*, 2018, pp. 289-292. DOI: 10.1109/INFORMATICS.2017.8327262
- [9] I. Kurbatska, S. Spolitis, V. Bobrovs, A. Alsevska, G. Ivanovs, „Performance Comparison of Modulation Formats for 10 Gbit/s WDM-PON Systems”, *Advances in Wireless and Optical Communications*, 2016. DOI: 10.1109/RTUWO.2016.7821854.
- [10] P. Ivaniga, T. Ivaniga, J. Turán, L. Ovsenik, M. Márton, D. Solus, J. Oravec, T. Huszanik, “The influence of FWM with AWG multiplexor in

- DWDM system”, *Przegląd Elektrotechniczny*, vol. 94, no. 4, pp. 113-117, 2018, DOI: 10.15199/48.2018.04.28.
- [11] T. Ivaniga, J. Turán, E. Ovseník, “Verification of the SPM Impact in DWDM System Using AWG Multiplexer Demultiplexer,” *Acta Electrotechnica et Informatica*, vol. 17, no. 1, 2017, pp. 17-22. DOI: 10.15546/aei-2017-0003.
- [12] T. Huszanik, J. Turán, E. Ovseník, „Comparative analysis of optical IQ modulation in four-channel DWDM system in the presence of fiber nonlinearities”, Proceedings of the 2018 19th International Carpathian Control Conference, ICCCC 2018, pp. 468-473, DOI: 10.1109/CarpathianCC.2018.8399675.
- [13] J. Oravec, J. Turán, E. Ovseník, “An Image Encryption Scheme Utilizing Harper’s Map,” *Acta Electrotechnica et Informatica*, vol. 18, no. 1, 2018, pp. 47-51. DOI: 10.15546/aei-2018-0007.
- [14] L. G. Kazovsky, W. T. Shaw, D. Gutierrez, N. Cheng, S. W. Wong, „Next-Generation Optical Access Networks”, *Journal of Lightwave Technology*, vol. 25, no. 11, 2017, DOI: 10.1109/JLT.2007.907748
- [15] A. Israr, M. Junaid, A. Israr, „Performance Analysis of Advance Optical Modulation Formats for GPON System”, *Frontiers of Information Technology*, 2015. DOI: 10.1109/FIT.2015.11.
- [16] P. Ivaniga, T. Ivaniga, “10 gbps optical line using EDFA for long distance lines”, *Przegląd Elektrotechniczny*, vol. 93, no. 3, pp. 193-196, 2017, DOI: 10.15199/48.2017.03.45
- [17] S. Jawla, R. K. Singh, „Different Modulation Formats Used In Optical Communication System”, *IOSR Journal of Electronics and Communication Engineering*, vol. 8, no. 4, pp. 15-18, 2013. ISSN: 2278-8735.
- [18] J. A. O’Down, S. K. Ibrahim, V. Bessler, A. D. Ellis, „Investigation of duobinary modulation implementations for use in wavelength switched networks”, *Transparent Optical Networks*, pp. 1-4, 2010. DOI: 10.1109/ICTON.2010.5549145.
- [19] R. Kaur, S. Dewra, „Duobinary Modulation Format for Optical System - A Review”, *International Journal of Advanced Research in Electrical, Electronics and Instrumentation Engineering*, vol. 3, no. 8, pp. 11039-11046, 2014, ISSN: 2278-8875.
- [20] T. Ivaniga, P. Ivaniga, “The development of DWDM using OADM to influence a non-linear effect SBS”, *ARPJ Journal of Engineering and Applied Sciences*, vol. 13, No. 13, pp. 4185-4194, 2018.
- [21] P. Liptai, B. Dolník, M. Pavlík, J. Zbojovský, M. Špes, “Check measurements of magnetic flux density: Equipment design and the determination of the confidence interval for EFA 300 measuring devices”, *Measurement: Journal of the International Measurement Confederation*, Vol. 111, 2017, pp. 51-59. DOI: 10.1016/j.measurement.2017.07.022
- [22] J. Ratkoceri and B. Batagelj, "Comparison of the frequency responses of free-running and injection-locked Fabry-Perot laser diodes up to 10 GHz," *2017 International Workshop on Fiber Optics in Access Network*, Munich, 2017, pp. 1-6. DOI: 10.1109/FOAN.2017.8215246.
- [23] ITU-T G.694.1. Series G: Transmission Systems and Media, Digital Systems and Networks: Transmission media and optical systems characteristics – Characteristics of optical systems. Spectral grids for WDM applications: DWDM frequency grid. 2012.



Tomáš Huszaník (Ing.) received Ing. (MSc.) degree in telecommunications with honours from Technical University of Košice at Department of Electronics and Multimedia Telecommunications, in 2017. Since September 2017 he has been at Technical University of Košice as PhD. student. His research interest is mainly focused on all optical fiber networks and mitigation and degradation mechanisms in all optical WDM systems.

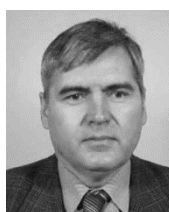

Ján Turán (Dr.h.c., prof., RNDr., Ing., DrSc.) received Ing. (MSc.) degree in physical engineering with honours from the Czech Technical University, Prague, Czech Republic, in 1974, and RNDr. (MSc.) degree in experimental physics with honours from Charles University, Prague, Czech Republic, in 1980. He received a CSc. (PhD.) and DrSc. degrees in radioelectronics from University of Technology, Košice, Slovakia, in 1983, and 1992, respectively. Since March 1979, he has been at the University of Technology, Košice as Professor for electronics and information technology. His research interests include digital signal processing and fiber optics, communication and sensing.



Ľuboš Ovseník (doc., Ing., PhD.) received Ing. (MSc.) degree in radioelectronics from the University of Technology, Košice, in 1990. He received PhD. degree in electronics from University of Technology, Košice, Slovakia, in 2002. Since February 1997, he has been at the University of Technology, Košice as Associate Professor for electronics and information technology. His general research interests include optoelectronic, digital signal processing, photonics, fiber optic communications and fiber optic sensors.