

A Cross-Layer Design Framework for Wireless Sensor Networks with Environmental Monitoring Applications

Kejie Lu, Yi Qian, Domingo Rodriguez, Wilson Rivera, and Manual Rodriguez

Abstract—In the past few years, wireless sensor networks (WSNs) are becoming more and more attractive because they can provide services that are not possible or not feasible before. In this paper, we address the design issues of an important type of WSNs, i.e., WSNs that enable environmental monitoring applications. We first provide an overview and analysis for our ongoing research project about a WSN for coastal-area acoustic monitoring. Based on the analysis, we then propose a cross-layer design framework for future WSNs that provide environmental monitoring services. The focus of the framework is the network layer design and the key idea of the framework is to fully understand and exploit both the physical layer characteristics and the requirements of upper layer applications and services. Particularly, for the physical layer characteristics, our framework 1) can enable advanced communication technologies such as cooperative communication and network coding; 2) can utilize the transmission characteristics for identifying/authenticating a sender; and 3) can exploit the communication pattern as a mean of sensing. For the requirements of applications and services, our framework 1) is service-oriented; 2) can enable distributed applications; 3) can utilize the fact that many applications do not have strict delay constraints. To illustrate the advantages of the framework, we also conduct a case study that may be a typical scenario in the near future. We believe that our study in this work can provide a guideline for future WSN design.

Index Terms—wireless sensor networks, environmental monitoring, application, service-oriented

I. INTRODUCTION

Wireless sensor networks (WSNs) have recently come into prominence because they hold the potential to revolutionize many segments of our economy and life [1]. In general, WSNs consist of battery-powered sensor devices with computing, data processing, and communication components. Energy conservation is typically a critical issue in WSNs since batteries are the only energy source to power the sensor nodes in many situations.

Although there have been extensive study in WSNs, addressing different aspects of the system design, we note that the design of WSN can be significantly different to one

another, depending on the application scenario. In this paper, we aim at the design issues of an important type of WSNs, i.e., WSNs that enable environmental monitoring applications.

Clearly, environmental monitoring is a crucial application that can improve our understanding with the physical world. With great advances in sensor technology, communications and networking technology, and computing and information processing technology, it is now feasible to develop WSNs for environmental monitoring.

Nevertheless, deploying such systems is not an easy task. To cope with the application scenarios and the features of the aforementioned technologies, new theories, methods, and techniques are necessary and can further improve our seamless understanding and interaction with our physical or sensory reality. For instance, better tools are needed for the tasks of storage, manipulation, representation, visualization, and rendering when dealing with very large amounts of signal-based content.

In this paper, we focus on how to design the future WSNs for environmental monitoring. We first provide an overview and analysis for our ongoing research project about a WSN for coastal-area acoustic monitoring. Based on the analysis, we then propose a cross-layer design framework for future WSNs that provide environmental monitoring services. The focus of the framework is the network layer design and the key idea of the framework is to fully understand and exploit both the physical layer characteristics and the requirements of upper layer applications and services. Particularly, for the physical layer characteristics, our framework 1) can enable advanced communication technologies such as cooperative communication and network coding; 2) can utilize the transmission characteristics for identifying/authenticating a sender; and 3) can exploit the communication pattern as a mean of sensing. For the requirements of applications and services, our framework 1) is service-oriented; 2) can enable distributed applications; 3) can utilize the fact that many applications do not have strict delay constraints. To illustrate the advantages of the framework, we also conduct a case study that may be a typical scenario in the near future. We believe that our study in this work can provide a guideline for future WSN design.

The remainder of this paper is organized as follows. In Section II, we will provide an overview and analysis of our ongoing research project on WSN, which is designed for providing environmental monitoring in coastal area. Based on the analysis, we then summarize key requirements for the

Manuscript received on May 1, 2007 and revised on September 15, 2007.

This work was supported in part by the US National Science Foundation (NSF) under Award Number 0424546.

Kejie Lu, Domingo Rodriguez, Wilson Rivera, and Manual Rodriguez are with the Department of Electrical and Computer Engineering, University of Puerto Rico at Mayagüez, Mayagüez, PR 00681, USA.

Yi Qian is with National Institute of Standards and Technology, Gaithersburg, MD 20899-8920, USA. He was with the Department of Electrical and Computer Engineering, University of Puerto Rico at Mayagüez, when the work was done.

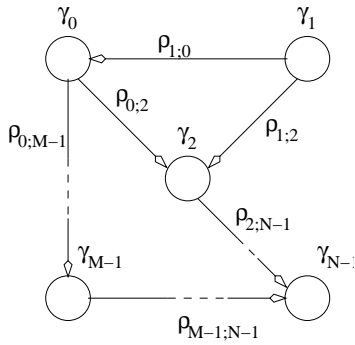

Fig. 1. An example of the SbDSP overlay model.

future WSN design in Section III. In Section IV, we elaborate the detail of the design framework. To illustrate the potential advantages of the framework, we conduct a case study in Section V. Finally, we conclude this paper and provide our future plan in Section VI.

II. A WSN DESIGN FOR ACOUSTIC MONITORING

A particular WSN testbed [2] is currently being developed at the Jobos Bay National Estuarine Research Reserve (JBNEER) environmental observatory situated in the southern part of the island of Puerto Rico. JBNERR encompasses a chain of 15 tear shape mangrove islets known as Cayos Caribe and the Mar Negro area in western Jobos Bay. The reserve is home to the endangered brown pelican, peregrine falcon, hawksbill sea turtle and West Indian manatee. It is managed by the US National Estuarine Research Reserve System of the National Oceanic and Atmospheric Administration.

The main objective of the testbed is to gather and process near real-time data from various sensor types to assist in the analysis and modeling of large scale environmental systems. Special attention is being given to the gathering and processing of acoustic information.

Our work addresses the development of a *sensor-based, distributed signal processing* (SbDSP) infrastructure as an overlay network on top of a WSN for the structural signal content analysis of acoustic waveforms gathered from the Jobos Bay environmental observatory testbed. WSNs have been demonstrated to be useful at integrating tasks such as signal sensing (acquisition), signal communication (conveying), and signal processing (treatment) when conducting physical observations in environmental observatories. The advantage of our design is the ability to processing large scale signals with space/time attributes such as acoustic waveforms. For example, the infrastructure will allow large scale space-time and time-frequency distributed signal processing tasks at the node level of a WSN, providing in this manner a framework for decentralized information processing and decision making.

An SbDSP overlay can be modeled as a directed graph where the vertices of the directed graph represent linear closed subspaces and the edges represent linear operators (Fig. 1). A linear operator $\rho_{m;n} : \gamma_m \rightarrow \gamma_n$, acting on an element of a closed subspace γ_m and producing an element for another closed subspace γ_n , becomes an element of a finite tree

computational structure, a computational orbit, or a multicast computational route, denoted by G_m . In certain cases, a closed subspace γ_m may be treated as a linear algebra over a finite field $GF(q)$. If in such cases the directed graph presented in Fig. 1 is also treated as a directed acyclic graph, then an SbDSP overlay can be treated as a generalized network system where theoretic methods of linear network coding may be applied. The computational structure G_m is characterized as a distributed signal processing algorithm. Examples of this type of algorithms being developed for this proposed infrastructure are acoustic beamforming algorithms for time delay compensation and matched filtering correlation operations which are very useful for sound source localization and *signal to noise ratio* (SNR) enhancements.

Structural content analysis of acoustical signals is a distributed signal processing task dealing with the formulation of computational tools for representing and analyzing inherent signal characteristics and attributes that are only indirectly observable in a combined temporal-spectral or spatial-temporal depiction in a time-frequency plane. Examples of these computational tools are the Wigner distribution, the Weyl-Brezin transform, the Zak transform, the short-time Fourier transform, and the cross-ambiguity function.

It has been demonstrated that the computational nature of these tools can be studied in a unified manner using the concept of Weyl-Heisenberg systems [3]. It has been also demonstrated that Kronecker products algebra, a branch of finite-dimensional multi-linear algebra, can be used as a tool to aid in the formulation of computational frameworks such as those utilized for unitary signal transforms [4]. The computational complexity of these tools is being studied using information-based complexity techniques presented in [5] and a modified approach to computer performance measures presented in [6].

To enable the proposed SbDSP infrastructure, we consider that pervasive storage and distributed database are two main services that shall be provided in WSN. The motivation is as the following. First, sensor nodes can gather a large amount of data in a certain period. And with the increase of the capability of sensor nodes, the amount of data will keep increasing in the near future. Secondly, in many scenarios, transmitting all the raw data to the sink node (which is common in existing WSN architecture) may not be cost-effective. This is because it requires the network to provide larger bandwidth capacity. Consequently, storing the data inside the WSN becomes a practical solution.

A. Pervasive Storage Service

To enable the functionality addressed above, we consider that pervasive storage is necessary in the design of the testbed. We note that, in WSN scenarios, fusion techniques that distill raw measurements for a specific purpose potentially lose data that may be important for future analysis. It may be helpful to scientists, for example, to analyze data in different ways and determine discrepancies. In this particular case raw data should be collected and persistently stored.

In our previous study [7], we have demonstrated how a replication schema based on the *Information Dispersal*

Algorithm (IDA) and its subsequent deployment as a grid service improves reliability in distributed storage. Preliminary results showed that the IDA-based replication provides better reliability and less storage spending than traditional replication methods. It makes good sense to utilize sensor network information to determine a priori an optimal set of resources to provide pervasive storage and respond to unsteady events.

In our study, we propose to deploy a set of low price storage servers integrated to the sensor network. Sensor nodes collect and transmit data to local storage units. Data files are then partitioned and blocks are replicated to other storage units. When blocks have the independent probability of failure p , the access reliability is determined by:

$$p(a) = \sum_{i=0}^{n-m} \binom{n}{i} p^i (1-p)^{n-i} \quad (1)$$

Let $F = \{b_1, b_2, b_3, \dots\}$ be a file, where b_i is an integer taken from a certain range $[0, (2B - 1)]$. If b_i is two bytes long, for example, then $0 \leq b_i \leq 65535$. Let c be a prime number greater than b_i . Each b_i is an element of the finite field Z_c where all arithmetic operations are done in mod c . Since $c > (2B - 1)$, this implies an excess of one bit per byte when integers greater than $(2B - 1)$ are obtained, which implies a storage space increment. In order to avoid the waste of space, all b_i values are represented as polynomials with binary coefficients $(b_B x^B + b_{B-1} x^{B-1} + \dots + b_1 x + b_0)$ and use a larger degree non-reducible polynomial $p(x)$ instead of the prime p . The polynomial must suffice $(p(x) \in Z_2[x])$ in such a way that all operations can be done in the finite Galois field $E = GF(2B)$. The total number of blocks, the size of each block, and redundancy are correlated to the sampling frequency and sensor mobility. The provision of this information must be considered as a network design requirement.

B. Database Service

As we have discussed in the previous subsection, we can store data in a distributed, pervasive manner. Now the next interesting and important issue is how to better utilize such data. In our project, we consider that WSNs and mobile database environments can be combined to create environmental monitoring applications that are deployed over wide-area environments [8].

Nevertheless, the combination of these technologies poses new challenges to the developers of distributed database applications. Traditionally, database designers have relied on data sources that are always on-line, with unlimited power sources, and generous amounts of computational resources such as CPU, memory and disk. In this type of system, replication has been widely used as a mechanism to increase the reliability and availability of these resources, particularly the data collections. By replicating a given data collection on multiple hosts, users can choose to access the data from the nearest or most convenient locations. Moreover, a failure at one site does not render the data unavailable, since the client can go to any other of the “mirror” sites to get a copy of the data.

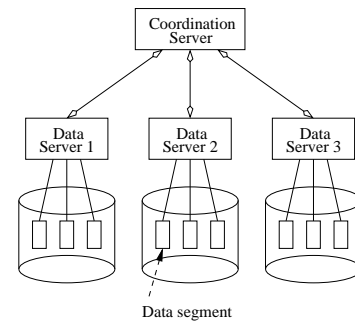

Fig. 2. Partitioned data processing.

In the realm of WSNs, these assumptions are no longer valid. Sensors generally have very limited power and computational capabilities. Likewise, mobile devices have limitations in computing power and network connectivity. Query optimization and processing frameworks must be re-designed with these constraints in mind. Optimization and processing schemes must now:

- 1) Choose query plans that target power rich data sources.
- 2) Choose sensor data sources based on their proximity to the phenomena to be studied.
- 3) Run queries in an energy efficient way.
- 4) Route queries based on the name of the data collection, and not the address of data sources.

The underlying infrastructure must support services that efficiently deliver statistics about sensor and mobile hosts. It must also provide communication primitives that make data and query broadcasting or multicasting easy to use. Sensor and mobile devices should have OS capable of running operation in various power-saving modes, to maximize the number of queries solved with the least waste of energy.

In this context, replication has an important use that has received little attention from the database research community. Replication can be used to efficiently solve distributed queries in a cooperative fashion by partitioning the query execution task among the replicas of a targeted data set. In our experiment, we have developed a mechanism to execute distributed queries by distributing the load of query processing among replication sites.

In our scheme, shown in Fig. 2, the application of a query operator α to a given relation R is broken down into the application of α to s_1, s_2, \dots, s_n segments of R . These segments form a partition of R , and each segment of R is taken from a given replica site, including the original (master) copy of R . Each participating replication site is instructed to apply query operator α to a given segment s_i of R and send back the results to a coordination site. This coordination site collects all results from the different replicas, and forms the result set delivered to the client. This scheme has the following advantages. First, it provides more reliability to the system since the data can be obtained from a multitude of sites in the system. Second, the system provides a higher level of availability for the data collections, since sharing the load of query processing among various sites reduces hot spots. Third, individual queries run faster because intra-operator parallel

processing can be used to reduce response time. Finally, error recovery during query processing is easier to implement since we only need to recover from the failure occurring at the executing environment producing a segment of data.

III. DESIGN REQUIREMENTS

Based on our study described in the previous section, we consider that there is a need to design a better network layer for WSN to improve the service of environmental monitoring. We believe that security and quality-of-service are two key components from the application perspective.

A. Security

In our design, we consider that security is a crucial issue that must be addressed [9]. In general, a secure WSN shall satisfy the following security concerns:

- **Confidentiality:** Confidentiality requirement is necessary to ensure that sensitive information is well protected and not revealed to unauthorized third parties. The confidentiality objective is required in WSN environment to protect information traveling between different sensor nodes and stations, since an adversary having the appropriate equipment may eavesdrop on the communication.
- **Authentication:** As in conventional systems, authentication techniques verify the identity of the participants in a communication, distinguishing in this way legitimate users from intruders.
- **Integrity:** From the integrity perspective, there is the danger that information could be altered when exchanged over insecure networks. Lack of integrity could result in many problems since the consequences of using inaccurate information could be disastrous. Integrity controls must be implemented to ensure that information will not be altered in any unexpected way.
- **Availability:** In WSNs, the availability can be a major security issue since adversary can launch *denial-of-service* (DoS) attack to block the legitimate communications.

B. Quality of Service (QoS)

QoS refers to control mechanisms that can provide different priority to different users or data flows, or guarantee a certain level of performance to a data flow in accordance with requests from the application program. QoS guarantees are important if the network capacity is limited, especially for real-time applications.

- 1) **Bandwidth:** Bandwidth is an important requirement in many applications. In wireless communications, for example, bandwidth is the range of frequencies occupied by a modulated carrier wave. According to the Shannon-Hartley theorem, the data rate of reliable communication is directly proportional to the frequency range of the signal used for the communication. In this context, the word bandwidth can refer to either the data rate or the frequency range of the communication system (or both).
- 2) **Delay:** Delay requirement is essential to real-time applications. It is one of the most important QoS parameters.

On the other hand, we also note that many important applications do not have strict delay requirement. Since these applications are generally delay-tolerant, we have noted that the concept of *delay tolerant networks* (DTNs) can be utilized.

In the past few years, DTN have been studied in communication scenarios, where the delay in certain parts of the network can be arbitrarily long, such as the interplanetary networking [10], [11]. According to [10], there are basically three design principles behind DTN:

- **A poster communication model:** Since the delay can be very long, the operation of network shall not based on schemes that rely on real-time information exchange. Instead, the data unit transmitted in the network shall be self-contained, and the communication shall be asynchronous.
- **Tiered functionalities:** The DTN design shall utilize existing network control as much as possible because these control approaches have been optimized for
- **Terseness:** In the design of DTN, the processing complexity can be afforded so as to save the bandwidth requirements.

Although DTN is not designed for WSNs previously, we believe that its philosophy can be applied to better support the applications that do not have strict delay requirement.

To enable DTN in WSNs, some nodes in the networks shall have the capability to temporarily store data information. Moreover, the connection management can be different to regular networks. For instance, the authors in [11] provided the fundamental formulations for unicast routing scheme; some recent studies also developed the routing framework for multicast routing in DTN.

C. Routing Requirements

In the above discussion, we have addressed the network design issue from the security and QoS perspective. Next, we analyze the routing requirement of different applications, since routing is the fundamental service that must be provided by the network layer.

- 1) **Basic Access:** To support the basic access, a straightforward method is to provide a unicast connection between the sink station and a sensor node.
- 2) **Group Communications:** To support group communication scenarios, multicast is a natural choice. In the past, Internet multicast is not successful because it is too complex, and more importantly, because Internet multicast requires a global deployment, which is virtually impossible. In WSNs, however, since all nodes are under control, implementing such group communication become a possible solution.
- 3) **Distributed Service:** With the deployment of WSNs, more and more services can be provided in a large area. To efficiently support a large number of applications, it is possible that distributed services can be enabled.
- 4) **Content-Based Distribution:** The content-based routing scheme [14] is a service-oriented communication model. In this scheme, the sender of a message does not need

to explicitly specify its destination(s). The network layer will automatically deliver the message to receivers that are interested in the content of the message. We note that the content-based distribution can be improved and applied to support the requirements from the applications we discussed in Section II.A and II.B.

In [14], the authors proposed to design an overlay network based on broadcast service of the existing network.

- 5) **Quality Guaranteed Applications:** For many applications, it is desirable that the network layer can provide sufficient QoS guarantee, usually in terms of bandwidth, data rate, delay, and delay jitter. However, wireless communications are naturally error-prone and thus it is difficult to provide such guarantee in wireless network. To address such an issue, in the literature, multipath routing has been studied in many previous works. In general, multi-path routing can provide better quality than that of a single path routing.

To summarize the discussion above, the application layer requirements must be addressed in the network layer design. In the next section, we provide a solution to satisfy the above applications while providing sufficient security.

IV. A FRAMEWORK FOR WSN DESIGN

In this section, we elaborate on the framework to address the requirements stated above. In our framework, we consider that 1) the future WSN shall be heterogeneous, 2) the network layer design shall better meet the requirements of applications and services, 3) the network layer design shall be able to utilize advanced wireless communication technologies, and 4) the network layer can provide the monitoring functionality.

A. Heterogeneity

In our framework, we consider that the WSN consists of different sensor nodes with various capabilities. Some sensors nodes, for instance, have the capability for storage and processing, and have extra power supply. In this manner, the data can be disseminated in the network and temporally stored. Such a behavior is significantly different to most existing assumption of WSNs, where sensor nodes are homogeneous and data collected by sensor nodes will be sent to sink nodes as soon as possible since sensor node cannot store them.

B. Physical-Layer Awareness

In our framework, we consider that the network layer shall be aware of the physical layer characteristics. More importantly, this framework shall be able to exploit the characteristics. In particular, we consider the following three important features in our framework:

- 1) The framework shall be able to exploit the communication pattern as a mean of sensing. Similar to the previous point, the communication pattern can also be used as a method for sensing. For instance, a group of nodes can cooperate and quickly identify a potential attacker that launches DoS attacks by jamming the signal transmission in a certain area. On the other hand, these

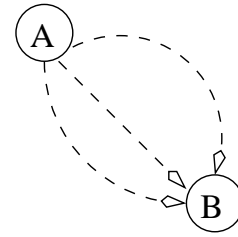

Fig. 3. An example of using transmission signature for authentication.

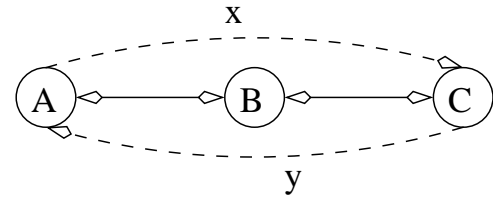

Fig. 4. An example of combing network coding and cooperative communications.

nodes can also use the communication pattern to tract a moving object.

- 2) The framework shall be able to exploit the transmission characteristics for identifying and authenticating a sender. As shown in Fig. 3, the transmitted signals from node A may have certain patterns (e.g., power, multipath), which can be recognized by neighboring nodes. Clearly, such a pattern can be utilized to identify or authenticate the sender. This feature is especially useful since it is easy for an adversary to send a message with spoofed source address in the data link and upper layers.
- 3) The framework shall be able to utilize and enable advanced communication technologies. Recently, many advanced communication technologies have been developed, such as cooperative communication [12] and network coding [13]. However, it is still an open issue how to enable such technologies in the network layer design. For instance, many existing cooperative communication schemes do not consider that overhead of coordination of nodes, which shall be considered in the design. To address this issue, traditional time-slot based, circuit switching network layer may be utilized, instead of packet-based network layer design. A potential advantage of such a scheme is that the two methods can be combined together to achieve an astonishing performance gain.

Fig. 4 shows a typical scenario in WSN, in which node A wants to transmit a packet, denoted as x , to node C via relay node B, and node C wants to transmitted a packet, denoted as y , to node A through node B. Using the traditional method, a total of four slots are necessary, i.e., A sends x to B in slot 1, C sends y to B in slot 2, B sends x to C in slot 3, and B sends y to A in slot 4. Using network coding scheme, such a communication demand can be performed in three slots, in which node B can broadcast $x+y$ to both node A and C in slot 3. Since node A has the information of x , it can decode y

if $x+y$ is received.

Now assuming all three nodes have been coordination by our framework, then node A and C can exchange two packets in only two slots. The main idea is that A and C can transmit x and y simultaneously in the first time slot. Consequently, node B will receive, generally speaking, the symbol of $x+y$. It can then broadcast this information in the second slot and node A and C can decode if they can successfully receive $x+y$. In addition to the improvement in terms of throughput, this cooperative network coding scheme can also improve the confidentiality of information because every intermediate node can only received the combined signals and does not have the transmitted information (i.e., x and y).

C. Service-Awareness

In our framework, we consider that the network layer shall be service aware. To facilitate the discussion, we first define the server and service in WSNs. In this paper, we consider that a sensor node can be a server and the data or functionality provided by the sensor nodes can be generalized as service. Consequently, the service can be either located in a single node in the network, or can be distributed in multiple locations in the network. Moreover, depending on the events that shall be reported, the location of services can be moved. For instance, if the task of WSN is to track a moving object, such as a bird, then the service will be moving based on the location of the object.

Clearly, to efficiently support different applications, the control platform for the network layer shall be aware of the availability of different services. To provide these services, the servers must register the type of service and the availability of service to the control framework. Notice that the availability information shall be updated periodically or based on predefined events. Upon receiving these messages, the control framework will also be responsible for distribute such message to nodes in the network.

D. Unified Routing

With the availability information of the service, a unified routing scheme shall be designed such that all the application scenarios discussed in the previous section can be supported. In addition, the packets of a certain flow will be forwarded based on the service requirements and the security requirements. Below we summarize the potential options in routing.

- 1) Basic Access: To support the basic access, a straightforward method is to provide a unicast connection between the sink station and a sensor node.
- 2) Group Communications: To support group communication scenarios, multicast is a natural choice. In the past, Internet multicast is not successful because it is too complex, and more importantly, because Internet multicast requires a global deployment, which is virtually impossible. In WSNs, however, since all nodes are under control, implementing such group communication becomes a possible solution.
- 3) Distributed Service: With the deployment of WSNs, more and more services can be provided in a large area. To efficiently support a large number of applications, it is possible that distributed services can be enabled.
- 4) Content-Based Distribution: The content-based routing scheme [14] is a service-oriented communication model. In this scheme, the sender of a message does not need to explicitly specify its destination(s). The network layer will automatically deliver the message to receivers that are interested in the content of the message. In [14], the authors proposed to design an overlay network based on broadcast service of the existing network. We note that the content-based distribution can be improved and applied to support the requirements from the applications we discussed in Section II.
- 5) Quality Guaranteed Applications: For many applications, it is desirable that the network layer can provide sufficient QoS guarantee, usually in terms of bandwidth, data rate, delay, and delay jitter. However, wireless communications are naturally error-prone and thus it is difficult to provide such guarantee in wireless network. To address such an issue, in the literature, multipath routing has been studied in many previous works. In general, multi-path routing can provide better quality than that of a single path routing.

V. A CASE STUDY

To illustrate the advantage of the new framework, we use a novel *medium access control* MAC scheme design as a case study. In this scheme, we focus on an important type of applications in WSN, namely, periodic monitoring. For such applications, we assume that we know the number of samples that must be taken in an interval of time and the specific instants when they are taken. Consequently, nodes can periodically wake up when a sample is taken. In this way, a lot of energy can be saved because of the avoidance of idle listening between two consecutive samples.

The key idea of the new scheme is to maintain a schedule in which nodes only wake up when a sample from environment is taken. Consequently, no periodic sleep/listen schedule will be necessary as it was proposed in most existing protocols [15].

An example of the proposed scheduling scheme is shown in Fig. 5. In the example, we stagger the schedule to lower the delay in the network, which is similar to the protocol proposed in [16]. Furthermore, we design our time schedule in such a way that all data gathered from sensor nodes be delivered to the sink in just one active period, i.e. a node would only wake up once in a period to receive and transmit packets destined to the sink.

Fig. 5 shows that, as a node approaches the sink, its receiving and transmitting intervals get larger. This happens because the closer a node is to the sink, the more data it receives from other nodes and the more packets it has to relay.

Fig. 6 compares the performance of our protocol with S-MAC [15]. In our simulation, the duty cycle of the S-MAC is set to 50% to obtain an acceptable network connectivity.

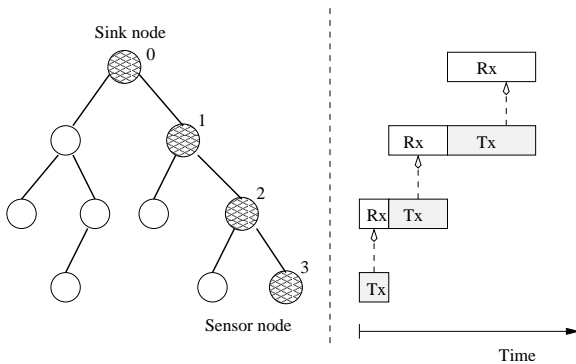
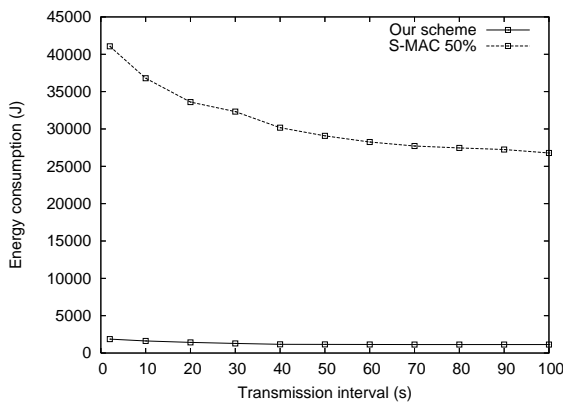
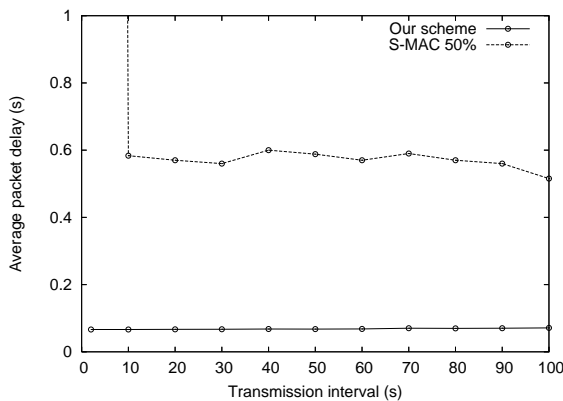

Fig. 5. An example of the proposed scheduling scheme.



(a) Energy consumption



(b) Delay

Fig. 6. Performance comparison.

In fact, a lower value of duty cycle may lead to excessive packets loss. The results show that our protocol significantly outperforms S-MAC, in terms of energy consumption and delay, which are major performance metrics in WSN. Note that, in Fig. 6(b), the delay of S-MAC is larger than 10 seconds when the transmission interval (period) is 2 second.

VI. CONCLUSION

In this paper, we have addressed the design issues of WSNs that enable environmental monitoring applications. We first provide an overview and analysis for our ongoing research project about a WSN for coastal-area acoustic monitoring.

Based on the analysis, we then propose a framework for the design of future WSNs that provide environmental monitoring services. The key idea of our framework is to fully understand and exploit both the physical layer characteristics and the requirements of applications and services. Particularly, our framework has the following features. For the physical layer characteristics, our framework 1) can enable advanced communication technologies such as cooperative communication and network coding; 2) can utilize the transmission characteristics for identifying/authenticating a sender; and 3) can exploit the communication pattern as a mean of sensing. For the requirements of applications and services, our framework 1) is service-oriented; 2) can enable distributed applications; 3) can utilize the fact that many applications do not have strict delay constraints. To illustrate the advantages of the framework, we have also presented a case study that may be a typical scenario in the near future. We believe that our study in this work can provide a guideline for future WSN design.

REFERENCES

- [1] I. Akyildiz, W. Su, Y. Sankarasubramanian, E. Cayirci, "A Survey on Sensor Networks", *IEEE Communications Magazines*, August 2002.
- [2] The WALSAIP Project, URL: <http://walsaip.uprm.edu/>.
- [3] R. Tolimieri and M. An, "Time-Frequency Representations," Birkhäuser, Boston, 1998.
- [4] R. Johnson, D. Rodriguez, R. Tolimieri, "A Methodology for Designing, Modifying, and Implementing Fourier Transform Algorithms on Various Architectures," *Journal of Circuits, Systems, and Signal Processing*, Birkhäuser, vol. 9, no. 4, 1990.
- [5] J. F. Traub, A. G. Werschulz, *Complexity and Information*, Oxford University Press, Oxford, UK, 1998.
- [6] N. G. Santiago, D. T. Rover, D. Rodriguez, "A Statistical Approach for the Analysis of the Relation between Low-Level Performance Information, the Code, and the Environment," *Journal of Information*, vol. 9, no. 3, pp. 503-518, May 2006.
- [7] D. Arias, J. Sanabria, and W. Rivera, "Grid Based Pervasive Distributed Storage," in *Proc. IEEE ISWPC 2007*, pp. 316-320, San Juan, Puerto Rico, Feb. 2007.
- [8] TinyDB, URL: <http://telegraph.cs.berkeley.edu/tinydb/>.
- [9] W. Stallings, *Cryptography and Network Security: Principles and Practices*, 4th ed. Upper Saddle River, NJ, USA: Prentice Hall, 2005.
- [10] S. Burleigh, A. Hooke, L. Torgerson, K. Fall, V. Cerf, B. Durst, K. Scott, H. Weiss, "Delay-tolerant networking: an approach to interplanetary Internet," *IEEE Communication Magazine*, Volume: 41, Issue: 6, On page(s): 128- 136, June 2003.
- [11] Kevin Fall, "A delay-tolerant network architecture for challenged internets," in *Proc. ACM SIGCOMM'03*, pp. 27-34, 2003, Karlsruhe, Germany.
- [12] A. Nosratinia, T. E. Hunter, A. Hedayat, "Cooperative communication in wireless networks," *IEEE Comm. Magazine*, vol. 42, no. 10, Oct. 2004.
- [13] D. S. Lun, N. Ratnakar, M. Medard, R. Koetter, D. R. Karger, T. Ho, E. Ahmed, and F. Zhao, "Minimum-cost multicast over coded packet networks," *IEEE Trans. Inform. Theory*, vol. 52, no. 6, pp. 2608-2623, June 2006.
- [14] A. Carzaniga, M. Rutherford, and A. Wolf, "A routing scheme for content-based networking," in *Proc. INFOCOM 2004*, vol. 2, pp. 918-928, 7-11 March 2004.
- [15] W. Ye, J. Heidemann, and D. Estrin, "Medium Access Control With Coordinated Adaptive Sleeping for Wireless Sensor Networks," *IEEE/ACM Transactions on Networking*, Vol. 12, no. 3, pp. 493-506, June 2004.
- [16] G. Lu, B. Krishnamachari, and C. S. Raghavendra, "An Adaptive Energy-Efficient and Low-Latency MAC for Data Gathering in Wireless Sensor Networks," in *Proc. of IPDPS'2004*, April 2004.



Kejie Lu received the B.S. and M.S. degrees in telecommunications engineering from Beijing University of Posts and Telecommunications, Beijing, China, in 1994 and 1997, respectively. He received the Ph.D. degree in electrical engineering from the University of Texas at Dallas in 2003.

In 2004 and 2005, he was a Postdoctoral Research Associate in the Department of Electrical and Computer Engineering, University of Florida. Since July 2005, he has been an Assistant Professor in the Department of Electrical and Computer Engineering, University of Puerto Rico at Mayagüez. His research interests include architecture and protocols design for computer and communication networks, performance analysis, network security, and wireless communications.



Manuel Rodriguez-Martinez received the Ph.D. degree in Computer Science from the University of Maryland, College Park (2001). He also holds a M.S. degree in Computer Science from the University of Maryland, College Park (1996) and a B.S. degree in Mathematics from the University of Puerto Rico, Rio Piedras. His research interests focus on Database Middleware Systems, Peer-to-Peer Database Architectures, Web-based Information Systems, and applications for Mobile Environments. He serves as Co-Principal Investigator for project Intelligent Power

Routers for Distributed Coordination in Electric Energy Processing Networks, an NSF/ONR funded initiative. He has published papers on prestigious international forums such as ACM SIGMOD, EDBT and IASTED. He has served as reviewer for research papers for several international conferences such as VLDB, ACM SIGMOD and IEEE ICDE. In addition, he has served as panelist for reviewing NSF SBIR proposals. He is a member of the ACM society and the SIGMOD special interest group.



Yi Qian joined National Institute of Standards and Technology in August 2007. He was an Assistant Professor in the Department of Electrical and Computer Engineering, University of Puerto Rico at Mayaguez (UPRM) between July 2003 and July 2007. At UPRM, Dr. Qian regularly teaches courses on wireless networks, network design, network management, and network performance analysis. Prior to joining UPRM in July 2003, he worked for several start-up companies and consulting firms, in the areas of voice over IP, fiber optical switching, internet

packet video, network optimizations, and network planning, as a Technical Advisor and a Senior Consultant. He had also worked several years for the Wireless Systems Engineering Department, Nortel Networks in Richardson, Texas, as a Senior Member of Scientific Staff and a Technical Advisor.

He received a Ph.D. degree in Electrical Engineering with a concentration in Telecommunication Networks from Clemson University. His current research interests include network security, network design, network modeling, simulations and performance analysis for next generation wireless networks, wireless sensor networks, broadband satellite networks, optical networks, high-speed networks and internet. He has publications and patents in all these areas.



Domingo Rodriguez is currently a professor of Communications Theory and Signal Processing at the Electrical and Computer Engineering Department of the University of Puerto Rico at Mayaguez (UPRM) and Director of the Institute for Computing and Informatics Studies located at the Research and Development Center of UPRM. He received his doctoral degree in Engineering from the Graduate Center of the City University of New York (CUNY) and conducted postdoctoral work at the CUNY Center for Large Scale Computation and the Bell

Laboratories. His areas of interests are Signal-based Information Processing and Communications Theory.



Wilson Rivera is an Associate Professor at the University of Puerto Rico Mayaguez Campus (UPRM). He leads the Parallel and Distributed Computing Laboratory (PDCLab) at UPRM. His current funded projects address fundamental research problems in the areas of Grid computing (automated Grid deployment, adaptive grid services, dynamic resource management and Grid performance) and workflow management (workflow modeling, metadata description and dynamic scheduling). Dr. Rivera is also executive director for the Institute for Computing

and Informatics Studies at UPRM and is faculty member of the NSF Center for Subsurface Sensing and Imaging Systems (CenSSIS) and the NSF Center for Collaborative Adaptive Sensing of the Atmosphere (CASA).