

Applications of Nanomaterials in Energetic Formulations: Classification, Production and Properties

M.K. Berner* and M.B. Talawar

The Organization for the Prohibition of Chemical Weapons (OPCW),
Johan de Wittlaan 32, 2517 JR - The Hague, The Netherlands

Abstract

In this article authors present a classification, description and competitive analyze of the main methods for production of nano scale and nanostructured materials for propellants application. Main advantages and difficulties concomitant with nanomaterials use in propellant formulations are mentioned in the beginning of the article. Specific issues related with high reactivity and pyrophoricity of nanomaterials and related risks are analyzed. Methods for nanomaterials' surface preservation and passivation are also classified and discussed. The focus is on those methods that are most widely used, and those that are considered promising today.

Introduction

The use of nanoparticles in the energetic formations is one of the prospective approaches that plays key role in the development of advanced propellants. Generally, when we reduce the scope of the disperse phase (increased degree of dispersion), the speed of burning goes up and in general – the process of burning becomes more stable. The understandable strive to enhance propellants' power characteristics have lead specialists to research the opportunity of introducing ultra fine particles in the propellants' composition. Research results have confirmed that although the burn rate does not increase to the initially expected levels, the idea of replacement of traditional components with such in nano-state has great potential. At the same time, researches have surfaced a number of specific technological difficulties that have, in the recent past, limited the use of nanoparticles in the mass production of propellants. The rapid development of nanotechnologies in the last two decades, and especially of the methods for large-scale and comparatively cheap production and synthesis of different materials in the form of nanopowder, has

given the opportunity to reveal the full potential of nanomaterials as a component of rocket propellants. Today many leading science centers conduct research in this promising field. Expectations are focused on the creation of fuels with unique power, high mechanical qualities and increased stability.

According to the definition [1] powder is a disperse system composed of hard particles in a disperse state distributed in a gas (usually air) medium. In other words, powders are a mixture of individual solid bodies, in contact with each other, and their agglomerates or aggregates. Usually, almost all dry materials could be qualified as powders, but the correct usage of the term is only with regard to highly-dispersed systems with particles of such a size that the forces of inter-particle interaction are either equal or smaller than their weight. This requirement is met by disperse systems with particle size between 0.001 μm and 1000 μm . Particles with sizes under 0.001 μm are usually called clusters, and those with size above 1000 μm – granules. In the following paragraphs the meaning of particle, agglomerate and aggregate, nanoparticles and clusters is given.

Particle – this is the morphological element of the powder which cannot be further fragmented in the course of regular separation processes. Particles may have a complicated structure.

*corresponding author. E-mail: drmaterialsscience@gmail.com

Agglomerate and aggregate – several particles, united in larger formations. Aggregates and agglomerates differ in the availability of internal pores.

Agglomerates have internal pores and aggregates do not have such pores (Fig. 1).

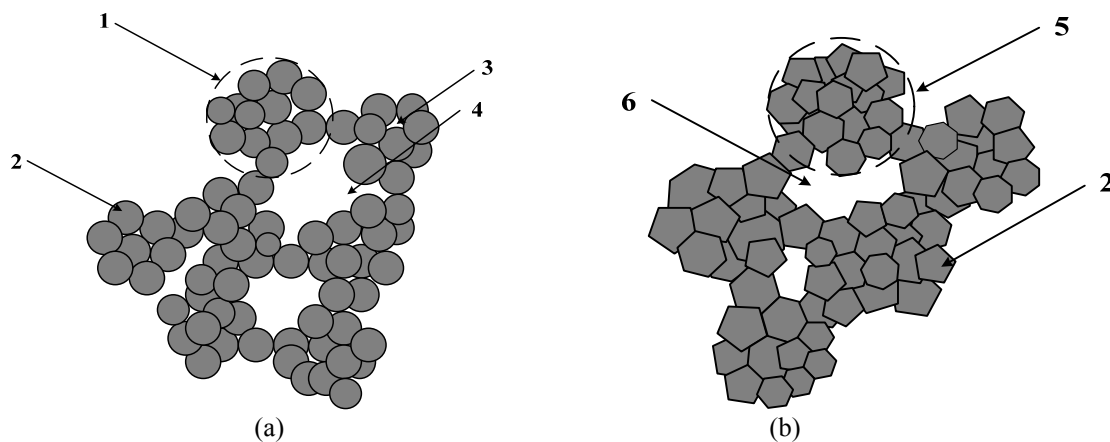

Fig. 1. Agglomerated (a) and aggregated (b) powders; 1 – agglomerate, 2 – primary particle, 3 – intra-agglomerate pore, 4 – inter-agglomerate pore, 5 – aggregate, 6 – inter-aggregate pore.

Nanoparticles – formations consisting of connected atoms and molecules with sizes under 100 nm. Nanoparticles are composed of several dozens up to about 10^6 atoms. This definition is not quite precise and could be viewed just as a working definition. It does not consider, for example, the differences between molecules and nanoparticles. As it is known, polymer molecules with a large number of atoms (including those of biological origin) are of a very large size and are within the nano-range. We cannot draw a clear line between them and nanoparticles. Nanoparticles are particularly inclined to agglomeration and aggregation.

Cluster – a group of atoms, molecules or ions closely located and connected to each other.

Currently we do not have available a well-developed, consistent and well-founded classification of disperse systems, including in the area of nanometric dimensions. Different industries use their own specific classifications, the so-called

branch classifications. For example, powders used in metallurgy are classified in the following way: ultra fine powder – diameter under 500 nm; very fine powder – from 500 nm to 10 μm ; fine powder – from 10 to 40 μm ; powder of average dimension – from 40 to 150 μm , and rough powder – from 150 to 500 μm .

With regard to powders synthesized in plasma, the following classification is used: nano-size (ultra dispersed) powders – from 1-30 to 50 nm; highly dispersed powders – from 30-50 to 100-500 nm; microns – 100-500 nm to 10 μm . This classification was done with consideration of the specifics of the granulometric composition of materials obtained through the plasma technology.

Scientists and researchers, on the other hand, use a slightly different classification: ultra dispersed (ultra fine) powders – from 1 to 100 nm; fine powders – 100 nm – 10 μm ; averagely dispersed – from 10 to 100 μm , roughly dispersed – from 200 to 1000 μm (Fig. 2) [2-4].

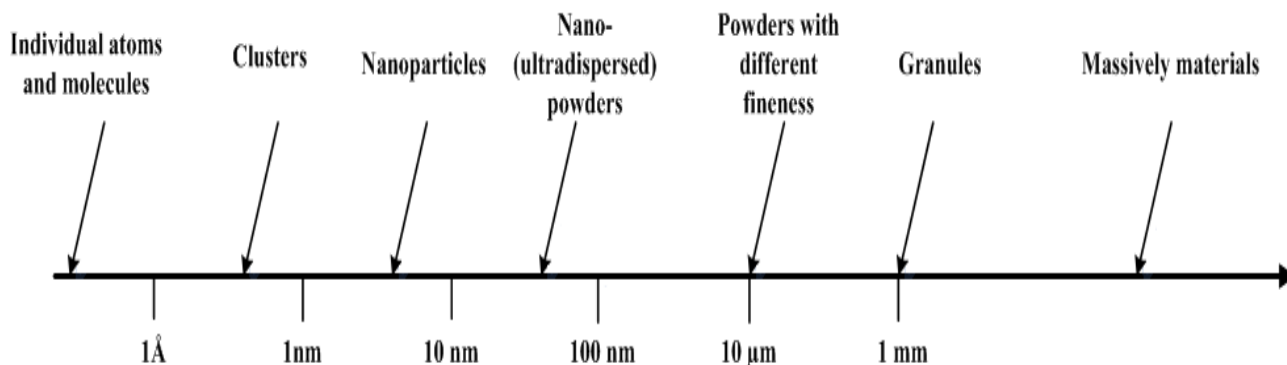

Fig. 2. Dispersive materials and size of the dispersed phase.

From a physics point of view, it is justified to include disperse systems in the category of nano-dimensional ones on the basis of change in the material qualities with the reduction of its linear dimensions. Many key physical and chemical qualities of materials, such as density, Jung's modality, conductivity, temperature of melting, ionization energy and many others, change drastically under a certain critical size dimension. Most often such effects occur with disperse phase sizes below 100 nm and they are most clearly observed with particles under 10 nm of size (Fig. 3). It is proven that temperature of beginning of intensive oxidation for aluminum particles with diameter 40 nm is about 500°C, which is well below melting temperature ($\approx 660^\circ\text{C}$). As a comparison, for Al particles with micrometric diameter, temperature of beginning of intensive oxidation is above 700°C [5].

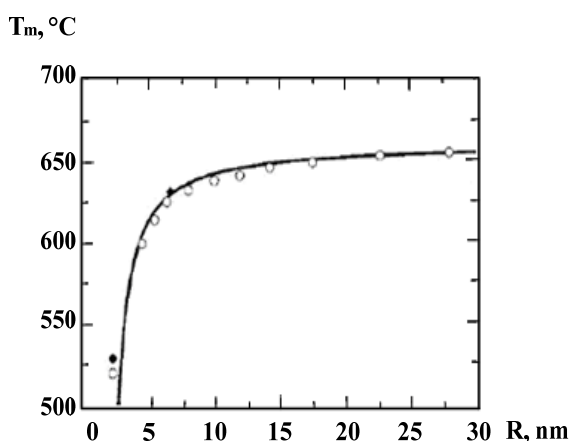

Fig. 3. Melting temperature of aluminium as a function of nano-Al particles diameter.

With regard to nanomaterials used in energetic materials, these are usually nanopowders of oxidizers, metal fuels and others. Even though research is being done on the use of nanopowders from different components, the major work is focused mainly on the inclusion of metal nanopowders in the composition of propellants, and more specifically – aluminum as the most widely used one. This, of course, does not exclude the usage of other materials in the form of nanopowders (magnesium, AM alloy, boron, zirconium, titanium, and others).

It is supposed that the replacement of metal powders, traditionally used in rocket technology, with metal nanopowders, could bring an increase in the speed of burning of composite rocket propellants to 5-10 times, with one and the same

content of components (other sources forecast a speed acceleration of up to 30 times) (Fig. 4) [6-12].

The accelerated speed of burning, caused by the introduction of nanopowders in the propellant composition, is mainly due to the following factors:

- Increased reaction ability of nanomaterials (nanoparticles) compared to voluminous materials (micro metric particles);
- Simplified diffusion of reagents in the usage of nanomaterials;
- A much shorter time for burning of nanoparticles leading to the emission of a much larger quantity of energy for a unit of time (Table 1);
- Lower thermodynamic heat capacity of nanoparticles compared to voluminous bodies [13, 14].

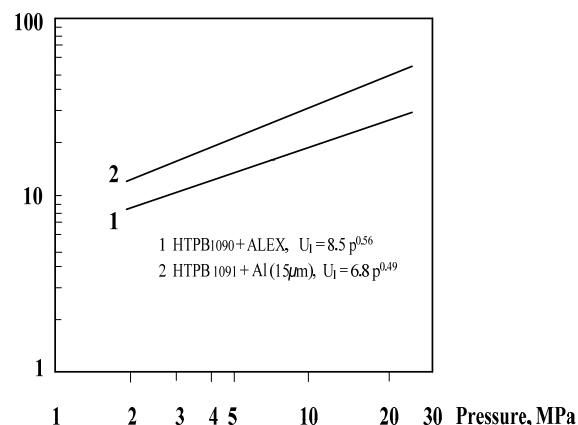

Fig. 4. Burning rates of modelling composite solid propellants measured in a strand burner [5].

Table 1

Relation between the size of aluminium particles and the time for their complete burning [5]

Particle size, mm	Burning time, ms
1	50.00
0.01	0.5
0.001	0.005
0.0001	0.00005

With the diminishing of particles diameter, the percentage of atoms, located at the surface and able to enter chemical reactions, goes up. (Fig. 5) The increased reactivity of nanoparticles is due precisely to their large surface. Surface atoms (or molecules) have a small number of close proximity neighbors and that is why they have free (unsaturated) links on the side of the surface [15].

Because of this effect, the surface atoms are subjected to forces that are directed towards the volume of the particles. As a result, the links between the surface and the sub-surface atoms (or molecules) are weaker compared to those in-between the atoms located in the volume. Atoms influence each other within five inter-atom distances. [16] In this way, we see the formation of a surface layer in which atoms find themselves in a more peculiar state. The thickness of this layer is about 5 atom layers or approximately 1 nm. If we assume that the particle has a spherical form, in that case:

$$R_{\text{surface layer}} = R_{\text{particles}} - 1 \text{ nm}$$

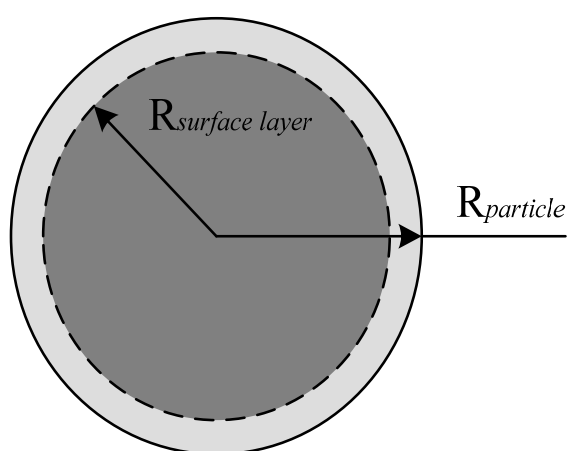

Fig. 5. Scheme of nano-particle and its surface layer.

Calculations show that nanoparticles with a diameter of 10 nm will have 50% of all atoms in the volume of their surface layer. It is obvious that with such dimensions of materials, the notions of surface and volume have, to a large extent, a conditional nature.

The use of nanoparticles gives opportunity for a more effective mixing of components and ensures a more intimate contact between them – a factor which also facilitates the diffusion of reagents to the surface.

Another effect, typical of metallic nanoparticles obtained through some synthesis technologies, is related to the availability of the so-called additional or excess energy. The reason for the appearance of this phenomenon is to be found in the extremely fast formation of particles during the condensation of metal vapors and the related formation of unbalanced, meta-stable, tense structures in the crystal grid. In normal circumstances these defects could exist for an almost indefinite length of time.

When heated, however meta-stable structures get relaxed in relation to the re-structuring of the crystal grid and release additional (excess) energy in the form of heat. These relaxation processes occur much below the melting temperature of voluminous material. Some particles, for example the ones obtained through the technology of electric explosion of metal wires (EEW), could concentrate a considerable amount of additional energy in meta-stable structures. In [18-19] are presented experimental data on particles obtained through the EEW method. Measuring levels of additional energy at 100-200 kJ/mol are quoted. It could be assumed that reduction of the nanoparticles diameter would cause an increase in values of additional energy. This energy causes combustion of particles and could even cause a melt down. When such metal nanopowders are included in the composition of rocket propellants, the additional relaxation energy is emitted in the chamber of the motor and becomes part of the overall temperature effect. These effects will be mentioned again when we consider the different methods of obtaining nanoparticles.

The effectiveness of solid fuel motors, when using metal nanopowders, is increased as a result of the elimination of the loss of energy associated with the completion of burning of particles outside the burning chamber (often observed in the use of traditional metal powders) and the practically full elimination of the biphasity of the gas flux passing through the nozzle. Additionally, the replacement of traditional metal powders with metal nanopowders opens up an opportunity for an extremely precise control of the propellant energy parameters. The highly increased speed of burning [20-23], on the other hand, allows for a significant simplification of the configuration of the burning block and the construction of the motor, in general.¹

¹ When using the classical composite propellants, in most cases it is necessary to build a burning block with a central opening (often with a complicated profile) that ensures radial burning and a large surface necessary for the generation of a sufficient quantity of gaseous products per one unit of time. With propellants containing nano-powders, because of their inherent high speed of burning, we could expect the elimination of the need for the building of burning blocks with a complicated configuration.

Nanopowders are used also for the obtaining of the so-called meta-stable intermolecular composites (MIC). These are mixtures of reagents in nano-state, stable in normal conditions and able to interact with each other by emitting a large quantity of energy after the transfer of a triggering impulse (heat, mechanical or electrical). An example of such MICs are the mixtures between some nanopowders, such as Al, Mg, Zr, Hf etc. and nanopowders of metal oxides – Fe₂O₃, MoO₃, Cr₂O₃, MnO₄, CuO, Bi₂O₃, WO₃. In essence, these are the familiar thermite compositions, with the only difference that in this case the reagents are to be found in nano-state and in intimate contact with one another (in some cases these mixtures are called super thermites). With classical thermites, the burning reaction is slow because of the more difficult process of diffusion. When reagents are in nano-state the diffusion path is much shorter and the reaction rate goes up several orders of magnitude compare to the reaction rate of conventional thermites. In certain conditions the reaction has a character of an explosion.

The interaction between Al and Fe₂O₃ could be presented with the following equation:

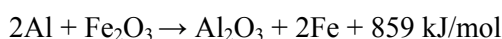

The reaction is accompanied by the emission of a large quantity of heat, but without the formation of gaseous products. The addition of polymeric materials or binders and gas generating agents to the metal-metal oxide MIC will provide the necessary working body during the process of burning. Supposedly, such mixtures could find application as rocket propellants or gas generating compositions. They could present a combination of high energy characteristics with unprecedented sustainability, safety and opportunity for precise regulation of the speed of burning within wide margins through the regulation of the granulometric composition and therefore – of the diffusion pathway. An area of particular interest is so called micro scale propulsion. This is related with production of thrust in micro scale (even 1 mm) and use of these energetic materials in microrockets and even in small space vehicles. RDX and HMX commonly used in conventional propulsion systems cannot be used in micro scale motors because of high energy losses in circumambient (including the chamber). In case with nano-thermites, energy losses in the chamber are negligible. For example MoO₃ – Al nano-thermite, prepared by simple mechanical mixing of 79 nm Al and 30x200 nm

MoO₃-flakes, has combustion rate as high as 790 m/s when confined in metal tube with diameter 0.5 mm. This composition is considered as very promising as a base for micro scale propellants [24].

Other possible applications of nano-scaled MICs are in ammunition primers and electric matches [25].

Three technological approaches for the obtaining of such MICs are currently being researched – mechanical mixing, arrested reactive mixing and sol gel technology. The first one is the simplest and most common method of production of nano-thermites. Nano-powders of the metal oxide and the fuel are mixed in a volatile inert liquid (for reduction of static charge) and the treated with ultrasound to guarantee even distribution of components and deagglomeration. After evaporation of the liquid, the thermite is ready to be used. This technology is applicable to practically all thermite systems. Its simplicity makes it widely used. The main disadvantage is related to the use of nano scale starting materials. Other two nano-thermite production methods will be discussed later in this paper.

Other area of application of nanoparticulate materials, currently under intensive research, is the use of nanosized catalysts in Composite Propellants. Since catalytic activity of heterogeneous catalysts is dependable of their specific surface, it is intuitively expectable that catalysts grain size reduction will lead to increased catalytic activity. And indeed, studies of many authors confirm that the activity of many heterogeneous catalysts increase greatly with the transition from micrometer to nanometer scale. Dave and Chaturvedi [26] summarized the results of many researchers of nanocatalysts for Composite Solid Rocket Propellants.

One classical catalyst used in ammonium perchlorate (AP)-based Propellants as Iron(III) Oxide added in nano scale form (3.5 nm α -Fe₂O₃) to AP in amount of 5% (wt.) lowering the high temperature decomposition with 77°C. Many other transition metal oxides also demonstrate increased catalytic activity in nano scale form compare with the bulk material (Table 2). It is obvious that with passing from micrometer to nanometer sizes and increasing of the specific surface, the number of active centres and oxygen vacancies on particles surfaces also dramatically increase. These morphological changes improve the catalytic action of above mentioned nanosized materials and enable them as excellent catalysts.

Table 2
Decomposition rate of AP, AP + nanometric catalyst
and AP + micrometric catalyst [26]

Sample	Decomposition rate, min ⁻¹ (25% decomposition)	
	nanometric catalyst (1% wt)	micrometric catalyst (1% wt)
AP	0.142	0.142
AP + CuO	0.819	0.167
AP + NiO	0.745	0.156
AP + Co ₂ O ₃	0.600	0.180
AP + MnO ₂	0.595	0.151

Other group of AP decomposition catalysts as ferros spinels also demonstrates increased catalytic activity with passing in nanosized form. Model AP/hydroxyl terminated polybutadiene (HTPB) based Composite Rocket Propellant shows many fold increase of burn rate in presence of ferros spinel nanoparticles in the composition. Relative efficiency of some nanosized catalysts of this type decreases in the following series:



In addition to above examples it is proven that nanosized Cu, Ni and Al powders added to AP decreases activation energy of it high temperature decomposition by 22 kJ/mol, 10 kJ/mol and 5 kJ/mol respectively.

Nanosized Cu reacts easy with nitrogen oxides by the scheme:

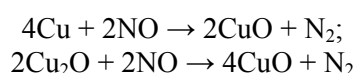

Cu nanoparticles concentrated many crystal lattice defects on the surface. Atoms on the defects tend to become steady by absorbing materials with surplus of electrons on the surface. N atoms of AP can provide surplus electrons and are attracted. The N-Cl bond become weaker and breaks easy. This facilitates the forming of NH₃.

Small amount of Mg nanoparticles also notably catalyzes AP decomposition by lowering the decomposition temperature.

Together with the many advantages and prospectives that open up, the exchange of traditional components with components in nano-state creates a series of challenges and has a number of drawbacks. These issues are again related to the huge specific surface of the

nanopowders and the raised reactive ability of the particles.

Nanoparticles interact quickly with the oxygen and the moisture of the air. In fact, metal nanoparticles (except when special measures are taken) are covered by a layer of oxide. It is proven that aluminum particles of size about 10 nm are covered with a layer of Al₂O₃ with thickness of 2.5-5 nm. This oxide layer reduces the reactivity of the particles during burning process and adds ballast mass in the composition. This naturally leads to energy losses. When aluminum is in the form of particles with micro-metric sizes, the mass of the oxide could be ignored. With aluminum nanoparticles, however, the oxide layer represents a considerable part of the overall mass of the particle – around 30-40% which requires the ballast mass to be taken into consideration when calculating the component composition of the propellant. The high reactive ability of the nanoparticles requires special measures for their protection. Some of protection techniques will be reviewed separately in the article.

Another serious technological problem in the use of nanopowders is caused by the increased viscosity of the un-hardened Composite Solid Rocket Propellant (CSRP) mass and the difficulties associated with its processing. With traditional nanomaterials, the specific surface S_{sp} (i.e. the sum surface that contains one gram of material), is within the 0.05-2 m²/g range. With metal nanopowders with pure surface, S_{sp} could vary in the range of 7 to 40 m²/g and even higher. The presence of oxide coating could raise this value up to 50-70 m²/g. The spheroidizing of the particles reduces the specific surface of powders and reversely, in particles with an irregular shape, and especially in those with an uneven and developed surface, S_{sp} could reach huge values. The enlarged

specific surface causes an increasing of the influence of surface effects (adhesion, friction, etc.). The study of rheological characteristics of the HTPB-based suspensions filled with aluminum nano-particles shows the following relationship for the relative viscosity as a function of solid additives volume concentration [4-5].

In addition to above listed problems it has to be mentioned that replacement of micrometric metal powders with nano-powders, leads to increasing of pressure dependence of the burn rate. Although the pressure exponent has still acceptable value, this effect should be taken under account [27-28].

Presently, a number of different methods are being used for the obtaining of nanoparticles. This, on the one hand, is due to the diverse qualities of the starting raw materials, and on the other – due to the different spheres of application of nanopowders and the specific requirements associated with them. We need to bear in mind that a series of important characteristics of nanomaterials, such as particles' form, size, average diameter, specific surface, purity and others, change within wide ranges depending on the selected production methodology. Thus, for example, by changing the synthesis technology and conditions we could obtain nanoparticles that are spherical, needle-like, or of irregular shape and with a highly developed surface. The disperse composition could also be controlled through a change in the process conditions. We could also say that today we can actually choose the method of synthesis of nanoparticles in light of their area of application,

The methods for obtaining nanopowders should meet the following general requirements:

- High level of productivity;
- Long-lasting stability, i.e. the surface of particles needs to be protected from oxidation and agglomeration of powder in the production and storage process;
- Guaranteed replication of qualities and obtaining of nanopowders with controlled composition;
- Guaranteed production of a product with a defined particle size and narrow size range (the granulometric composition needs to be controllable).

Usually, the methods for production of nano-size particles are classified according to the nature of the process resulting in the formation of particles, and therefore we speak about mechanical, physical and chemical methods. In this article, we will stick to this classification and will review the

methods that are used for the obtaining of nanomaterials for production of composite propellants.

Mechanical Methods for the Production of Nano Particles [4, 29, 30]

These methods are based on the applying of high deforming forces on the initial raw material (pressure, friction, bending, vibration and others). This group of methods includes mechanical fragmentation, intense plastic deformation, and mechanical impact of different media on the starting material. The methods for mechanical fragmentation are often called mechanical synthesis.

In fragmentation, the mechanical impact is impulsive – the pressure fields are not permanent, i.e. present throughout the whole duration of particle presence in the reactor, but occur only at the moments of particles collision and for a short time after it.

The mechanical fragmentation (mechanical synthesis) is carried out inside different equipment, such as: ball mills, planetary mills, vibration mills, jet mills, vortex mills and attritors.

The simplest of all, from construction point of view, is the ball mill. It is a steel drum containing grinding bodies – usually spherical, made of hard alloys or steel. The drum rotates and the grinding bodies rise up in the direction of movement till the moment when the power of gravity exceeds the sum of all other forces working on the bodies. After reaching the critical height point, the grinding body falls downward and breaks up the base raw material by hitting it and grinding it in the walls of the drum and the surface of the other grinding bodies.

The mechanism and intensity of fragmentation in ball mills depends on different technological parameters such as: rotation speed, mass and quantity of grinding bodies, process duration, base material mass, form of the grinding bodies, the medium in which the process takes place. Often, in order to minimize contamination of the resulting product with material of the equipment, grinding bodies are made from tungsten carbide and a process is lead in inert gas medium. The form of particles obtained in the ball mills is irregular, and their surface is smooth.

There are different types of ball mills. The vibration ball mills have an unbalanced arbor and the whole construction is mounted on a dempfying foundation (Fig. 6). Rotation causes circular

fluctuations of the drum with amplitude of 3-4 mm whose trajectory lies on a plane perpendicular to the plane of rotation of the vibrating axis. In comparison to the classic ball mills, the moment of the individual grinding body is lower, but the large number and high frequency of hits causes intense grinding the base material. Grinding bodies are made of steel or hard alloys and have a spherical or cylindrical form. Powders obtained in vibration mills have particles mostly with a round form which is due to the occlusion of the particles. The high frequency impact does not allow self-restoration of the cracks and the defects on the surface of the particles. As a result, the material gets high level of fatigue and the process of grinding goes much faster.

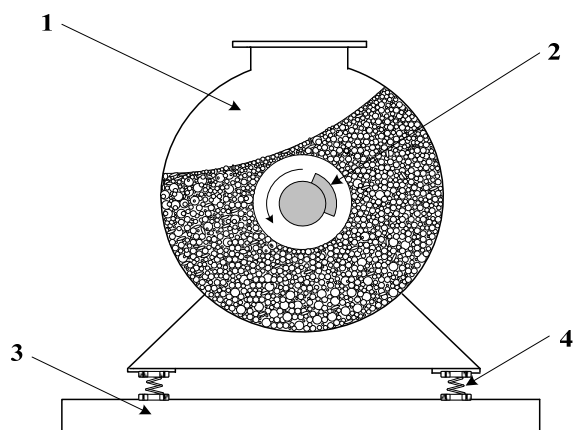

Fig. 6. Scheme of the vibratory mill: 1 – body (housing), 2 – unbalanced shaft, 3 – base, 4 – spring dampers.

Ball mills and vibrating ball mills can be used also for preparing of some MICs (nano-thermites) by technology of Arrested Reactive Milling (ARM). The essence of the method consists in co-milling of metal oxide and aluminum, as components particles may be or may not be nanosized. During the milling process components particles mix together and form nanocomposite particles in which fuel and oxidizer are contained in one and the same particle. The particles produced by ARM technology are in the range of 1-50 nm and are composed of layers of metal (e.g. Al) and oxidizer of about 10 nm. The particles size is function of the milling time, however due to the reactivity of the mixture, after a certain processing time (dependant of initial particles size, type of the components and milling media used), when particles are reduced below a certain size, the milling causes ignition of the mix. In order to avoid

accumulation of a static electricity, liquids such as hexane are usually added in the mill chamber. The term Arrested Reactive Milling comes from the fact that milling is stopped before the moment of ignition of the mix. Advantages of this method are: possibility use of micrometric starting particles; producing of nanocomposite particles with density approaching their theoretical density; highly reduced presence of metal oxide, because of the effect of encapsulation of the metal within the particle matrix; precise control of degree of intermixing and respectively reactivity, by varying the milling time. The main disadvantage is the facts that only few thermite mixtures can be prepared by ARM method as many other mixtures are too sensitive and ignites before sufficient mixing can occur.

Gyroscopic mills are yet another type of ball mills. Their grinding drum rotates around both its horizontal axis and its vertical axis. The grinding bodies perform complicated movements and as a result the material is subject to intense fragmentation.

With attritors (Fig. 7), the grinding bodies are situated in a vertical, immobile drum containing a vertical spade mixer rotating at a speed of above > 100 rotations/min. Attritors are simple to construct, convenient to use and allow for a continuous process. The fragmentation process produces particles with a narrow size range which attain dispersion much faster compared to the other types of ball mills. Attritors have the highest loading capacity with regard to the base material.

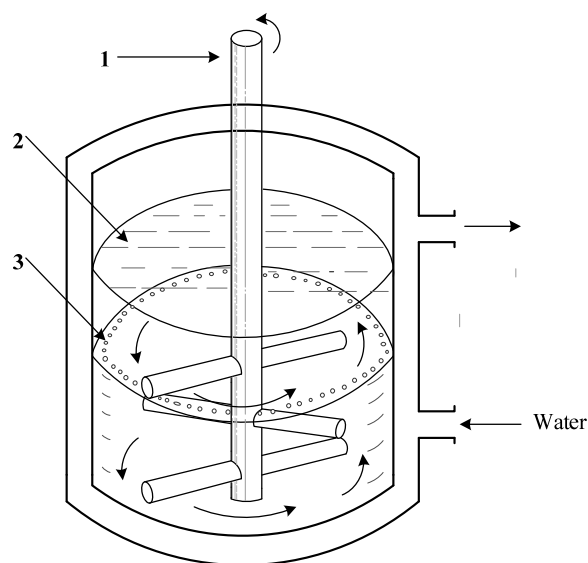

Fig. 7. Scheme of the attritor: 1 – shaft of the stirrer, 2 – grinded material, 3 – grinding bodies.

Jet mills [1] achieve fine defragmentation of the base material through a gas jet under pressure (air, nitrogen, inert gases) or a dry jet entering the work chamber through nozzles at the speed of sound or super-sound. In the chamber the particles swirl up, and as a result of the multiple mutual hits they disintegrate. Jet mills are highly efficient. Often they are used jointly with other methods. Additionally, as initial material they use larger-size powders obtained in the other types of equipment. In jet mills in example, a sponge metals obtained through electro-chemical methods can be defragmented. Usually, in order to prevent oxidation, we create inert atmosphere in the work chamber. Additionally, in order to increase the effectiveness of grinding, the process can take place in liquid organic media.

Vortex mills are used mostly for the obtaining of nanopowders from malleable metals. The milling occurs mainly through the collision of the milled material. The process chamber of the vortex mill has blades situated opposite each other and rotating in opposite directions at a high speed (≈ 3000 rotations/min – obligatorily at the same speed). The base material goes into the swirling streams of the blades where they bump into each other and disintegrate. With the help of a gas-carrier the disaggregated particles are transported outside the work chamber and directed to a receiving chamber. In the receiving chamber the large particles precipitate at the bottom and again come back for further processing in the work chamber. The small particles are carried away to a separate bunker which is periodically unloaded. Depending on the type of material, particles obtained in the vortex mills might have irregular shape, or be porous or spherical. The major advantage of the vortex mills is that the powder is not contaminated by material from the grinding bodies

For the obtaining of nanopowders from materials that are difficult to disintegrate we could use quite successfully planetary centrifugal mills.

With mechanical fragmentation the duration of the technological cycle depends on the type of the grinded material, the power of the equipment and the needed level of dispersion. It could last from few hours up to several days. So, for example, in the ball mills the process duration ranges from 1 hour to 100 hours, and in vibration mills it reaches up to 300 hours.

As it was already mentioned, mechanical grinding produces particles of different shapes. The size of the particles also depends on the process

conditions and the type of material used, and ranges from several to hundreds nanometers. Interdependency between the melting temperature of the metal and the reached minimum size of particles is proven. In the majority of cases, the higher the melting temperature, the smaller the minimal size of particles. During grinding, part of the mechanical energy is transformed into heat. As a result, some of the particles manage to merge. In the processing of metals of lower melting temperature, this effect is more strongly pronounced. Generally, in mechanical grinding of metal powders, the minimum size of particles depends on two competitive processes – merging of particles facilitated by the increase of temperature, and fragmentation of particles under the influence of the high mechanic deformation associated with the hits with the grinding bodies and the walls of the equipment, as well as collisions between particles. Apparently, the drop in melting temperature associated with the drop in particle size in the nanometric area (particularly strong below 10 nm), is yet another influencing factor. The quantity of fine particles could be increased through the application of a technology called cryogrinding. In this case, the process is conducted in an environment of liquid nitrogen or liquid inert gas. The liquid nitrogen controls the temperature in the equipment and the grinding process takes a shorter period of time. The liquid nitrogen interacts with metals and forms a fine nitride layer on the surface which impedes the merging (it acts as a dispersant). Additionally, it impedes the contamination of nanoparticles with material from the walls of the chamber or from the grinding bodies.

In general, with the method of mechanic grinding, the minimum size of particles varies between 5 and 22 nm. The minimum size aluminum particles obtained through mechanic grinding is between 20 and 24 nm.

The hydrodynamic cavitation method is included in the category of mechanical methods. It is based on a phenomenon called cavitation and its purpose is to produce a suspension of nanoparticles in different disperse environments.

Cavitation is a process in which as a result of local reduction of the liquid pressure, gas caverns form inside it. Cavitation may be caused by increase of liquid speed, by the passing of acoustic waves through the liquid, or the movement of solid bodies in the liquid. In the hydrodynamic cavitation method, ultra sound with frequency of 16 KHz is used for the obtaining of particles. In the half-

period of rarefaction, rapidly growing gas balloons are formed in the liquid. In the half-period of contraction the gas balloons contract and disintegrate. The contraction and the following destruction of the caverns in the liquid under the influence of the acoustic pressure occurs within a very short time frame – from 10^{-3} to 10^{-5} s. The instantaneous destruction of caverns causes the formation of shock waves at the front whose pressure reaches up to 1000 MPa and temperature up to ≈ 3000 K. These energies are completely sufficient for the destruction of the hard surfaces neighboring the micro explosion. In the defragmentation of particles, a definite role is played by their mutual collisions, as well as the friction with the liquid. The forming nanoparticles have a tendency to coagulate. Surface-active substances are used to prevent aggregation and to insure uniform concentration of the material throughout the chamber.

Mechanical methods have the following advantages:

- comparatively simple technology;
- opportunity to obtain nanopowders from alloys and compounds;
- universality.

The drawbacks of the mechanical methods include:

- difficult control of the shape and the granulometry of the nanoparticles;
- Inability to obtaining metal nanopowders with ultrahigh purity.

Physical Methods [1, 3, 4, 18, 29, 30-33]

The group of physical methods for the obtaining of nanomaterials includes methods based on evaporation and consequent condensation, on dispersion of melts and vacuum sublimation methods.

Methods Based on Evaporation and Condensation [34]

This method of obtaining of nanoparticles is based on the rapid change in the aggregate state of the material, i.e. as the result of state shifts – from vapor to solid state, and from vapor – to liquid – to solid state. In other words, the base material evaporates through intensive heating and then cools down rapidly.

There are different options for the implementation of this method. Evaporation can

take place in vacuum or in inert gas media. Heating could be achieved by laser, plasma, induction, electric arch discharge, ionization or other means. Cooling could be achieved by different methods too.

Plasma technology [35] has very wide application in the production of metal nanoparticles. Usually the parameters of the plasma are as follows: temperature 2000-10000 K (low-temperature plasma), and pressure 10^{-5} - 10^3 MPa, created in high frequency or ultra-high frequency and electric-arc plasmotrons. Stable plasma of low pressure could be obtained through the usage of inert gases with small quantities of hydrogen as an additive.

The material to be vaporized is introduced in the plasma zone in the form of powders or vaporizable anode. As a result, highly heated gas forms which is afterwards subjected to abrupt cooling. The cooling down of the dispersed material occurs within a stream of cooling gas and on cooled surfaces. In this way a temperature gradient of 10^5 °C/m is achieved that is sufficient for the obtaining of particles with a size of 5-100 nm, even from highly malleable metals. With cooling speed of 10^5 - 10^{80} C/s we could obtain aluminum powder with particles size of 0.5-50 nm and specific surface of 30 - $70 \cdot 10^3$ m²/kg. The form of particles obtained in plasma is spherical and often with uneven surface.

The advantage of the method is the opportunity for stable vaporization of metals of high melting temperature and of low vapor pressure. Its disadvantages are related with difficulties in focusing of the plasma jet at low pressure (under 25 kPa) and with the unreliable work of the plasmatron in prolonged heating regimes. This lowers, to a certain extent, the effectiveness of the technology.

When we use the method of combined plasma, the effectiveness of vaporization of the dispersed material is enhanced. A two-stage heating process takes place. Initially, the material heats up to high temperature through plasma obtained by direct current (DC); as a result the substance melts and evaporates from plasma obtained through high-frequency charges. The initial material is in the form of large sized powder or shavings. The particles obtained through this technology have spherical form and sizes over 50 nm [36].

The use of laser heating (laser ablation) allows for overcoming the drawbacks of the plasma methods in the preservation of working temperature levels. This technology produces powders from aluminum, titanium and magnesium with an

average particle size of several tens of nanometers. Laser heating allows for the obtaining of nanoparticles from multiple-component materials such as alloy Al/Mg.

Electric arc melting [37] allows the base material to evaporate through electric arc plasmatron working with direct current (DC). Originally the process was conducted in inert atmosphere, but later on it was proven to be much more effective in inert hydrogen media – usually Ar-H₂. In this case, an interaction between the metal and the nascent hydrogen takes place (solubility of nascent hydrogen is much higher than that of the molecular hydrogen). The melt is oversaturated with hydrogen and this causes speeded evaporation of the respective metal. The productivity of the process in the realization of this technology goes up 10 to 10⁴ times. The form of the obtained particles is close to spherical.

In recent years, there is wide application of the method called electric explosion of wires (EEW-method), which were mentioned already [38].

In essence this is a variation of the evaporation–condensation method. In this case, thin metal wires with a diameter of 0.1-1 mm are placed in a chamber and subjected to impulses of high-power electrical current (Fig. 8). The duration of the impulse is within the range of 10⁻⁵-10⁻⁷ s and the current density of 10⁴-10⁶ A/mm². In these conditions the metal wire is heated up instantaneously and it evaporates. The process has the character of an explosion. The electrical explosion of the wires is in fact an abrupt transformation of the metal as a result of the rapid emission of a large quantity of energy when it is subjected to impulses of high-density current. The

electrical explosion is accompanied by the generation of shock waves and the fast heating up of the metal to temperatures up to 10⁴ K with speed over 10⁷ K/s. In the initial stage of the electrical explosion, the heating up of the wire is accompanied by a linear expansion of not too high speed – 1 to 3 m/s. During the actual explosion, the metal is over heated above its melting temperature and the expansion of the material happens at a rate of up to 5.10³ m/s, so the over heated metal is dispersed explosively. The pressure and the temperature at the front of the rising shock wave reach several hundreds megapascals and around 10⁴ K respectively. Subsequently, in the rapidly expanding metal vapors a process of condensation and the formation of nanoparticles starts. When the process is conducted in inert media, metal powders or metal alloys powders are obtained; with the introduction in the reactor of additional reagents (air, mixture of O₂-Ar, nitrogen, water steam, paraffin and others) nanopowders of oxides, nitrides, carbides, etc are obtained. Through warring with the concentration of reagents, particles with passivation coating could be obtained. The pressure of the chamber usually is in the range of 0.1-60 MPa. In this way, through an electric explosion in air and nitrogen-argon media we obtain aluminum and titanium particles covered with a layer of Al₂O₃ or AlN and TiO₂ or TiN (Table 3). The particles obtained through electric explosion of wires have spherical shape. The particle size distribution is logarithmically-normal with $\sigma_g = 1.3-1.8$ and the maximum lies in the range of 10-500 nm. The average size of particles monotonously diminishes with the rise in current density and reducing of the impulse duration.

Table 3
Products obtained in different mediums in the chamber (EEW method)

Metal	Vacuum < 1.3×10 ⁻⁶ Pa	Air	Nitrogen	Water	Decan C ₁₀ H ₂₂	Paraffin oil
Al	n-Al	n-Al covered with oxide layer	n-AlN	n-Al(OH) ₃ or γ-Al ₂ O ₃	n-Al ₄ C ₃	Carbides
Ti	n-Ti	n-Ti covered with oxide layer	n-TiN _y	n-Ti ₂ O ₃	n-TiC _y	Mixture of Carbides
Fe	n-Fe	n-Fe covered with oxide layer		n-FeO	n-FeC	Mixture of Carbides

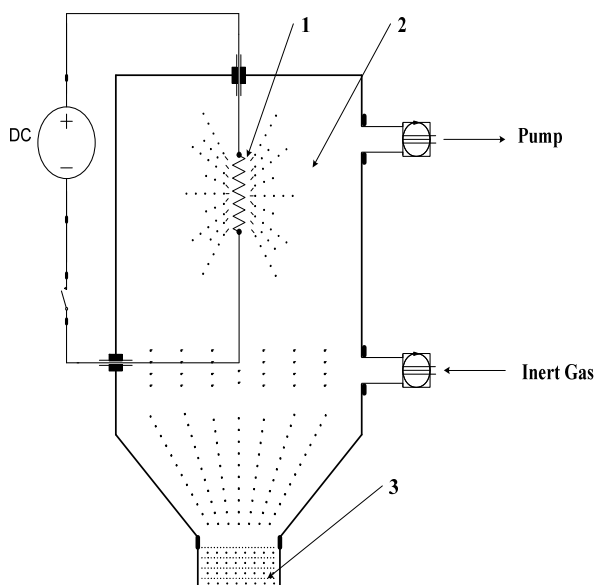

Fig. 8. Principle scheme of an installation for obtaining of nanoparticles by using of EEW method: 1 – exploding wire, 2 – chamber, 3 – nano particles collector.

As we mentioned in the beginning, the particles composing nanopowders obtained through EEW-technology, are characterized by multiple defects in the crystal grid. When such powders are heated in air medium we observe two distinct phases of ignition. The first happens at temperature of 400°-500°C and is in itself a physical process of regrouping and relaxing of the crystal grid associated with emission of heat (this phase could be accompanied by melting down and superficial burning). The second phase is a chemical process of oxidation of the metal. Through differential thermal analysis (DTA) of Al-nanopowders, synthesized by this technology, in air and nitrogen, a release of large amount of heat significantly below metal melting temperature (660, 35°C) is proven. In a contrast, in case of aluminum powders with micrometric particle size the interaction with oxygen starts at a temperature of about 1000°C. Relaxation processes in metal nanoparticles can be initiated also through irradiation with a stream of electrons. Such occurrences take effect when, for example, we observe samples of nanopowders through a transmission electronic microscope. We can see that under the action of the electronic beam, the surface of the particles, in the field of vision, becomes uneven as a result particles melt and coalesce into bigger ones.

The EEW-technology produces nanopowders of aluminum, titan, zirconium, magnesium, etc. with a

diameter of 40-100 nm. The method is used on a wide scale. Productivity reaches several hundred grams per hour. In this way, Argonide Corporation – Pittsburg, produces two types of nano-Al powders – with oxide coated particles and with ligand-stabilized particles (carboxylate ligands – palmitic acid, around 5%), with brand names ALEX™ and L-ALEX™ (from Aluminum Exploded). The specific surface is in the range of 10-20 m²/g. These nanopowders find application in the production of composite solid rocket propellants and pyrotechnics in general.

Cryogen melting of metals [39] is yet another method for obtaining of nanopowders of high efficiency. In this case, metal particles are formed as a result of spontaneous condensation of metal vapors in cryogen media. Metal vapors are obtained through abrupt inductive heating up of a metal rod by a powerful high-frequency generator. This method of metal heating allows for the formation of high vapor pressure in a very short period of time. The reactor is constantly fed with cryogen liquid and nanoparticles are formed through quick condensation of saturated metal vapors. The area of particle formation is characterized by a high temperature gradient of around 2200 K on the metal surface to 77 K in cryogen media. The low temperature of the media facilitates high speed of particle formation and rapid cooling, and places limitations on their growth. Liquid argon, instead of liquid nitrogen, is used for the production of aluminum nanopowders. In this way the formation of AlN is avoided. Aluminum particles are spherical with a diameter below 70 nm. The particle size distribution is logarithmically-normal. The yield is 75% of the mass of the base material, and productivity of around 60 g/h.

As we already noted in the beginning of the text, the evaporation-condensation methods differ by type of work media and by method of cooling.

The conducting of the process in vacuum allows for the production of powders with special qualities. It is suitable for the production of nanopowders from metals that are difficult to melt.

The equipment for condensation of vapors maintains pressure of the inert gas media at about 10⁻¹⁰ Pa (in some cases the pressure could be even several times higher). Helium, argon, xenon or nitrogen is used to provide inert media – they are inert with regard to many chemical elements and substances. In evaporation, atoms which have left the solid surface collide with atoms and molecules of the inert media. These collisions limit the free

route of the evaporating particles and slow down the diffusion. The slow diffusion gives an opportunity for the achievement of saturation of vapors over the solid surface. In the saturated vapors begins process of nucleation and formation of clusters, which growing rapidly. In different types of equipment particles are caught on a surface cooled by liquid nitrogen. In the condensation of vapors in inert gas medium, the particle size, shape and productivity depend on three factors: speed of atoms infusion in the area of saturation, intensity of energy transfer from the hot atoms to the atoms and the molecules of the inert medium, and the speed of evacuation of particles from the zone of saturation.

The following major regularities are observed in the production of nanoparticles through condensation in inert media:

- The lower the pressure of the chamber, the wider the zone of saturation (condensation). The inside boundary of the area is found immediately above the surface of evaporation and the external boundary, depending on the pressure, can be limited by the chamber walls. With pressure of several hundred pascals it has thickness of 250-350 mm;
- With the increase of pressure to several hundred pascals, the size of particles initially grows fast, and after that, above 2.5 KPa, continue grows slowly, approaches maximum size;
- With equal levels of gas pressure, the transition from helium to xenon, i.e. to denser inert gas, is accompanied by a multiple-time increase of the size of resulting particles.

Vacuum-sublimation Technology for the Production of Nanomaterials [40]

This technology is used for the obtaining of nanopowders from oxides, nitrides, salts, etc., as well as of their mixtures, used in the production of composite propellants.

The process of obtaining nanopowders involves three major stages. At the first stage, an initial solution of the processed substance is produced (water is used, as well as organic dissolvent) with concentration approximating the point of saturation. The second stage is related to the freezing of the reservoir with the purpose of achieving even distribution of components characteristic of real solutions and for the obtaining of particles of minimum size in solid state. The third stage involves sublimation of the solvent and formation of nanoparticles.

At the end of the process, after completion of all three technological stages, a porous body is produced formed by the crystals of the dissolved substance. The crystallites are loosely connected with each other through fragile "bridges". It is sufficient to apply just insignificant mechanical force to destroy this body, and nanopowder is produced from the respective substance or mixture of substances. The particles size is approximately equal to the size of particles of the dissolved salts that were formed at the stage of freezing.

The effectiveness of the process is determined above all by the parameters of conducting of the second stage, because precisely the freezing of the initial material solution defines the structure and the qualities of the product. Generally speaking, with the increase of the speed of freezing, the size of the structural elements decreases and the boundaries of size distribution narrow down.

Key freezing methods are the evaporation freezing (also called self-freezing), the dispersing of the solution or spreading of a thin solution film on the metal surface cooled by liquid nitrogen (also known as contact crystallization).

The evaporation freezing is done at the expense of intense sublimation of the frozen solvent in vacuum, at pressure considerably lower than the pressure corresponding to the triple point. In these conditions, self-freezing of particles occurs. The pressure of the chamber is usually about 6.5 Pa, and the temperature does not exceed - 40°C. From the mixing tank starting solution is input under pressure to the nozzle of the dispersion device, small drops are formed which freeze in flight. After their precipitation, the cryogranules find themselves in a receptor where sublimation of the solvent occurs. A product is obtained in the form of porous spherical granules from the dissolved substance. Careful milling of the obtained product at low mechanical stress follows. Usually the milling of the granules to nanopowder occurs immediately before the usage of the material. By this technology many oxidants, burn rate catalysts, regulators and others are produce.

The vacuum-sublimation technology has the following advantages:

- Granulation of the product, which facilitates its transportation and storage, and diminishes emission of powders;
- Hygienic and safety process (no explosion risk);
- Continuity of production.

At the same time, we should note that the limited solubility of some substances limits, to a certain degree, the usage of the method.

Nanomaterials Production via Dispersion of Melts [41]

This method uses a thin jet of melt from the respective material which is flows into the chamber and is dispersed in fine drops through a stream of inert gas or liquid under pressure. There are different modes of conducting the method. The most widely used is the option in which the jet is dispersed through a stream of gas or liquid directed to the axis of the melt jet under an angle of 90° . In

other realization of the process the breaking stream is directed to the axis of the jet of metal melt under angle below 90° . In this case, the jet of melt is usually broken by more than one stream. Another possible option is dispersion through a circumfluent gas stream, whose axis is parallel to the melt jet (Fig. 9).

This method uses working gases such as argon or nitrogen, and working liquids such as ethanol (and other alcohols), water, acetone, acetaldehyde.

The process of melt dispersion goes through a consecutive break down into primary, comparatively large drops, followed by their disintegration in the stream into secondary, finer particles.

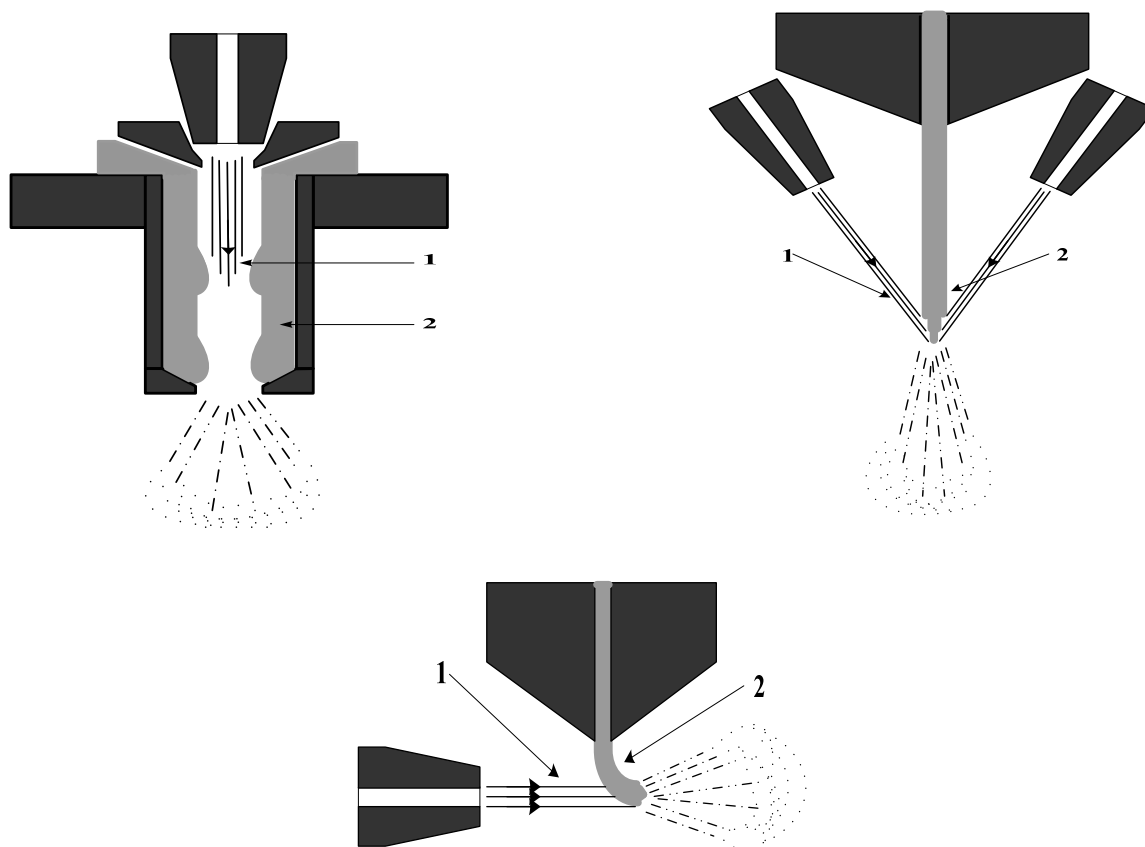

Fig. 9. Different variants for realisation of the method of metal melts atomisation: a – gaseous jet coincidental with the axle of flow of melted metal, b – gaseous (liquid) jet directed at an angle to the flow of melted metal, c – gaseous (liquid) jet directed perpendicular to the flow of melted metal; 1 – gaseous or liquid jet, 2 – flow of melted metal.

Process of dispersion through liquids, due to the higher density and kinetic energy of the stream, achieves higher speed of the stream which remains high even on big distances from the nozzle throat. This in itself gives opportunity for changing, within wide margins, the mutually related locations of the

jet and the stream. In fact, when the stream of liquid comes into contact with the melt, it starts to evaporate vigorously – both around the jet of melted material in general, as well as around every separate particle. In other words, process of dispersion is conducted not through a liquid, but

through a stream of overheated steam under pressure.

For the purpose of obtaining nanomaterials with particle size below 100 nm, the melt is dispersed by highly cooled gases or liquids, and an additional temperature gradient is created. This helps for cooling down of precipitation surface as well. The size and morphology of the particles depend on the work pressure of the dispersing stream, the temperature of the melt and its cross profile. Generally speaking, with the raising of the speed of the dispersing stream and the temperature of the melt, the size of the obtained particles goes down. With the diminishing of the cross-section dimension of the melt jet, the diameter of the particles also diminishes.

The described method can produce metal nanopowders with particle size from 50 to 100 nm. The form of the particles is usually spherical or drop-shaped, but when the speed of cooling is very high, particles with irregular forms can be formed too. The purity of the particles depends largely on the purity of the base material, but in the course of dispersion process, contamination by dispersing substances may occur (intrusions of nitrogen and inert gas or carbon, when organic substances are used). The use of water as dispersing liquid could lead to the obtaining of particles covered with oxide layer.

There are some improved modifications of the method of melt dispersion. For example, with the method of double dispersion of melts, the melt is saturated with soluble gas under high pressure and then the jet is dispersed by another insoluble gas. When the gas-saturated drops cool down, an explosive emission of the dissolved gas occurs and the semi-solid drops break down into smaller particles. Double dispersion of the material occurs. This technology allows production of powders with particles diameter of 1-10 nm.

The method of centrifugal dispersion from rotating electrode [42] (Fig. 10) produces nanopowders through the sprinkling of melted material in inert atmosphere through the action of a centrifugal power.

Melting occurs through the electric arc discharge (arc melting) or through melting in low-temperature plasma. The base substance is in the form of malleable electrode, rotating at high speed. Drops fly out from the melted surface of the rotating electrode, freeze in flight and form nanopowders. This method is suitable for the obtaining of nanopowders from high-melting. The

size of the particles obtained through centrifugal dispersion is about 100 nm. The basic advantage of this method is the opportunity for dispersion of the material in vacuum or in inert medium.

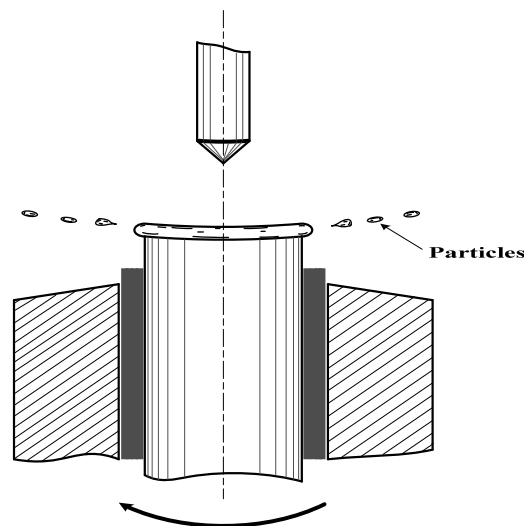

Fig. 10. Method of centrifugal pulverization of melt from rotating electrode.

In general, the advantages of the method of dispersion of melts could be summarized as follows:

- Universality, i.e. a wide spectrum of substances in nano form could be obtained;
- Use of relatively inexpensive equipment;
- High productivity and low energy expenses.

The major drawback of the method is the wide size range of particles in the obtained nanopowders.

Synthesis of Nanomaterials using Chemical Methods [43-45]

There are many chemical reactions which could be used for the obtaining of different nanomaterials. Generally they could be divided into two groups: methods in which the dispersion occurs immediately in the course of a certain chemical reaction (synthesis, decomposition, etc.) and electrochemical methods with different modes of realization.

Preparation of Nano Energetic Materials using Sol-gel Method

The sol-gel method is a chemical process where reactive Precursors (monomers) are mixed into solution in which polymerization occurs leading to

formation of highly cross linked three dimensional solid network resulting in a gel. The energetic materials can be incorporated during the formation of the solution or during the gel stage of the process. The composition pore and primary particle sizes, gel time, surface areas and density may be tailored and controlled by the solution chemistry. The gel is then dried using supercritical extraction to produce highly porous low density aero gel or by controlled slow evaporation to produce a highly porous low density aero gel or by controlled slow evaporation to produce xerogel. Applying stress during the extraction phase can result in high energy high density materials. Thus sol-gel method can be used for precision detonator explosive manufacturing as well as producing precision explosives, propellants and pyrotechnics along with high power composite energetic materials [46].

One of the areas where sol-gel method is very successfully applied is the synthesis of nanostructured metal oxides, which are used for obtaining of different MICs (mainly metal/metal oxide nanotermites).

Based on the nature of the precursor, two routs for synthesis of nanostructured metal oxide bodies are used, – a metal salt route and a metal alkoxide rout.

With metal salt route as precursors metal salts, dissolved in suitable solvent, are used (most often chlorides and nitrates). In order to destabilise the solution (the sol) and to induce the gelation, a proton scavengers are introduced. As such substances as propylene oxide, butadiene oxide 1, 2 epoxybutene, 1, 2 epoxybutane, cis-2,3 epoxybutane, cyclohexene oxide, trimethylene oxide, 2, 3 epoxy(propyl)benzene, epifluorohydrin, epichlorohydrin, epibromohydrin and glycidol are used.

The reaction scheme may be expressed as follows:

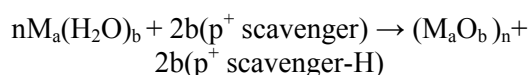
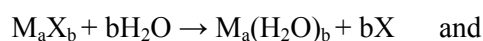

where: M is a metal kation and X is the salt anion.

When metal alkoxide route is applied a metal alkoxide is hydrolyzed and subsequently condensed, by introducing of base or acid catalysts into the sol, to induce the gelation.

The reaction in this case may be expressed as follows:

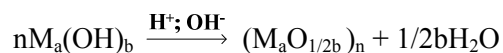
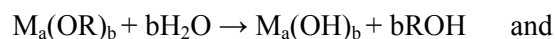

Once the gel is formed it is further processed to xerogel, by drying under ambient conditions or in vacuum oven at elevated temperature (+70-85°C), or processed to aerogel, in supercritical point dryer, where solvent is replaced with liquid CO₂. The process of obtaining of aerogel is slow. After saturation of the gel with liquid CO₂ under pressure (≈10 MPa), the temperature is elevated to 40-45°C, and then chamber is slowly depressurized. The water is not miscible with liquid CO₂ and drying process must pass through two stages. The water inside xerogels is first replaced by methanol or acetone (samples are placed in the organic solvent prior to drying), and then the organic solvent is displaced by liquid CO₂. Displacement of the solvent with liquid CO₂ lasts several days.

By using described sol-gel methods metal oxide nanostructures of many different metals and metalloids may be synthesized: Fe, Cr, Al, Ga, In, Hf, Sn, Zr, Mo, Ti, V, Co, Ni, Cu, Y, Ta, W, Pb, B, Nb, Ge, Pr, U, Ce, Er and Nb [47].

In [48] a method for preparation of Fe₂O₃ from Fe(III) salts is described. The precursor – 0.65 g Fe(NO₃)₃·9H₂O is dissolved in 3.5 ml 100% ethanol. Process of gelation is initiated by introducing in the solution of 1 g propylene oxide. In these conditions within 1 minute the sol change the color to dark red and later formation of monolithic dark red gel block is observed. The reaction is exothermic.

Properties of obtained nanostructured material depend on the type of the precursor, concentration of the reagents, temperature and pH of the solution, the type of the solvent and conditions of drying.

Type of the solvent is one of the most important factors. Gelation kinetic, gel structure and regime of drying depend of the nature of the solvent - its dielectric constant, dipole moment and surface tension. It is found that polar protic solvents are more suitable for the formation of monolithic Fe₂O₃ nanostructured blocks, than polar aprotic solvents. This can be explained bay hydroxyl bonding characteristics of protic solvents. The growth of the Fe₂O₃ may be facilitated by formation of hydrogen bonds between the solvent and hydroxyl groups on the surface of the primary particles (and cluster its elves). Water, methanol, ethanol, formamide and n-propanol are some of suitable solvents.

Diameter of clusters that make up the gel skeleton may vary in wide frames depending of the parameters of the process. Normally the clusters diameter is 5-10 nm, build up of primary particles with diameter of 1-3 nm. Diameter of pores in aerogels varies within 2-25 nm. Densities of Fe₂O₃ aerogels are in frames 0.04-0.2 g/cm³, respectively 0.9-2.00 g/cm³ for xerogels.

If necessary, the metal oxide aerogel may be further processed to nanoparticulate material by milling.

In order to obtain Metal Oxide/Metal energetic nanocomposite, the powder of the metal fuel have to be introduced into the sol just before the beginning of the gelation, when viscosity starts rapidly to increase. Thus, if under intensive mixing, aluminum powder is added to the Fe(III) salt solution, when liquid begin to change it viscosity, after introducing of propylene oxide, a metal oxide gel matrix with uniformly distributed Al particles will be obtained. Aluminum powder may be with micrometric or nanometric particles sizes. The increased viscosity and stirring prevent settling of the metal. By using the same drying technologies as described above, a xerogel or aerogel may be obtained. When nonaluminum is used as a fuel, an ultrasonication of the solution may be applied in order to prevent agglomeration of the particles.

When specific effect is targeted, together with the metal fuel, other modifying components may be incorporated to the Metal Oxide matrix (polymers, gas generators, inert metal oxides and etc.). Mixing with inert metal oxides (SiO₂, Al₂O₃ etc.), leads to reducing the sensitivity, burn rate and burn temperature of the thermite material.

Sol-gel chemistry may be used for the preparation of yet different type of nanostructured energetic materials, where the organic fuel forms a three dimensional skeleton, and the oxidizer is crystallized and fixed in the nanosized pores. For the obtaining of such nanostructure some reactions of aqueous polycondensation can be used. Because of the well known chemistry and technology, most often for this purpose resorcinol-formaldehyde clay is used. It can be processed through sol-gel transition. In theory many polyfunctional monomers can be polymerized in dilute solutions and to become base to produce aerogels.

The reaction of polycondensation between resorcinol and formaldehyde in molar ratio 1:2 mol proceeds under alkaline conditions, with using of Na₂CO₃ as a catalyst. Following reactions leads to the formation of resorcinol-formaldehyde nanosized clusters:

- the formation of hydroxymethyl (-CH₂OH) derivatives of resorcinol;
- the condensation of the hydroxymethyl derivatives to form methylene (-CH₂-) and methylene ether (-CH₂OCH₂-) bridged compounds;
- the disproportionation of methylene ether bridges to form methylene bridges and formaldehyde as a byproduct [49].

The reaction takes place in diluted aqueous solutions. The rate of formation of the gel depends of concentration of the reagents. Solutions containing less than 7% of reagents formed gels for 7 days at 95°C. More concentrated solutions give gels for 4 days (first day at 50°C and 3 days at 95°C). The size of the resorcinol-formaldehyde clusters and specific surface area depends strongly of the ratio [Rezorcinol]/[[Catalyst]]. When catalyst concentration is high (i.e. [Rezorcinol]/[[Catalyst] = 50), the particles are with size of 3-5 nm and are connected each other with thick necks [52]. Obtained aerogels are with very high specific surface. During the drying a significant shrinkage is observed. When catalyst concentration is low (i.e. [Rezorcinol]/[[Catalyst] = 200), particles size is 11-14 nm and they are connected with thin necks. Specific surface areas of respective aerogels are smaller and no effect of shrinkage is mentioned during the drying.

Gels are processed to aerogels by using supercritical extraction with CO₂, on the analogy of the technology used for obtaining of inorganic aerogels.

Chemical Reactions as a Method for Obtaining of Nanomaterials

The method of precipitation [50] consists of precipitation of metal hydroxides in their salt solutions. Alkaline solutions are used as precipitators – solutions of NaOH, KOH, NH₄OH):

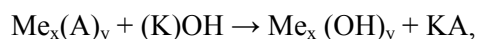

here: A – NO₃⁻, Cl⁻, SO₄²⁻, a K – Na⁺, NH₄⁺, K⁺.

When suitable conditions (pH, temperature and concentration) are created, we achieve high speed of precipitation and obtain a highly dispersed product. The obtained sediment is washed, dried, glowd and reduced. Metal nanopowders obtained through this method have particle size between 50 and 150 nm. The particle size could be regulated by changing the conditions of the process. The particle

shapes could be spherical, needle shaped or irregular and could also be subject to control through the change of conditions.

The method of sublimational drying [51] consists in dispersion of water solution of the metal salt in organic substance of low temperature. This causes rapid freezing of the water solution drops. From the received precipitation, at low temperatures and low pressure, the water is released. Metal salt particles with a highly developed surface are obtained in the process. Metal powders are produced after the thermal decomposition of the salt.

With the method of evaporative thermal decomposition [52] a solution of the metal salt is dispersed in the gas medium heated to a high temperature. In the process the solvent evaporates and thermal decomposition of the salt occurs. In order to use the heat of burning, alcohols as a solvent often are used. This method can produce metal powders of very small particle size – from 5 to 15 nm, but it requires sophisticated equipment and precise control of conditions.

The reduction method obtains nanomaterials through a process of reduction of oxygen containing compounds (oxides, hydroxides). Naturally, this method could also constitute the final stage of the process of obtaining nanometal powders through any of the other methods. As reducers we could use carbon monoxide, carbon, metals (Na, K), metal hydrides (usually CaH_2) and others. Boron and zirconium nanopowders are obtained with using of metal hydrides as reducer. The reaction could be presented as follows:

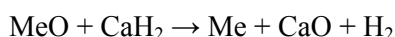

The purity of the final product depends on the level of purity of the base raw materials and of the reducers.

The method of gaseous chemical reactions [53] is based on chemical interaction taking place in vapors of volatile compounds. Metal halides are predominantly used as a raw material – normally chlorides and fluorides. Sometimes, but less frequently, reactions are conducted with alkoxides $\text{M}(\text{OR})_n$, oxychlorides, MO_nCl_m , alkyl compounds $\text{M}(\text{R})_m$ or with metal vapors.

The qualities of nanomaterials in this case depend largely on the construction of the reactor, the heating method, the temperature gradient of the system, the temperature of the reaction gas mixture, the speed of diffusion, etc. The reactors most

widely used so far have been the reactors with external heating of the reaction zone. The metal vapors go into the cooling chamber where they condense in the form of nanopowders. This method gives an opportunity for the obtaining of many metals and metal compounds used as components in CSRP. In this way magnesium, aluminum, and titanium are obtained from the respective volatile chlorides and fluorides in interaction with sodium vapors:

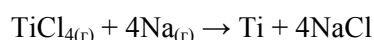
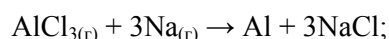
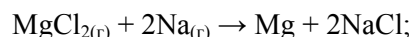

An interesting method for the obtaining of aluminum nanopowders with potential industrial application is the decomposition of $(\text{CH}_3)_2\text{C}_2\text{H}_3\text{NAIH}_3$ in toluene with subsequent two-hour heating at temperature of 105°C . Titanium or titanium isopropoxide is used as a catalyst. The catalyst affects the size of particles. When Ti is used, obtained nanopowders are with average size of 80 nm. In order to prevent agglomeration and aggregation of particles a surface active agents (surfactant) have to be added in the reaction mixture.

Electrochemical Methods for the Obtaining of Nanomaterials

In the method of electric precipitation [4, 54] an electric current is passed through water solutions of metal salts which lead to the precipitation of metal powder. The electrodes (cathode and anode) usually are grid-like or plate-like. It is preferably, when possible, the anode to be made from the same material as of the precipitated metal. Such approach guarantees purity of the obtained product. As a result of the ongoing electro-chemical reactions, metal is released on the cathode (depending on the electrolyte used). The product is periodically released from the cathode which is necessary in order to guarantee the desired granulometry. In the course of the reaction, the composition of the electrolyte constantly changes. This requires forced circulation of the electrolyte in the electrolyte vessel during the reaction.

After the metal powder is released from the cathode, it is purified through stirring and centrifugal discharge of the purification waters.

Drying is conducted in vacuum in order to avoid oxidation. The method of electric precipitation produces nanopowders of very high purity.

The process of electrolysis of the melt is conducted in melted salt of the respective metal as an electrolyte. This method is used for production of Ti, Zr, and Be-nanopowders.

A very convenient method for the obtaining of nanopowders is the electrolysis with mercury cathode. In this case, the metal powder is precipitated into the liquid mercury cathode. The electrolysis is conducted in solutions of non-organic acids. This method produces nanopowder of Zr. The particles have irregular form and their size varies between 10 to 20 nm [55].

Chemical methods have a number of advantages:

- Relatively narrow range of particle size distribution;
- High purity of the product;
- High productivity;
- Opportunity for effective influence on the powder quality.

The usage of expensive and constructively sophisticated equipment, the high price and the high value of energy expenses (predominantly associated with electrochemical methods) are some of the drawbacks of the chemical methods for synthesis of nanopowders.

Oxidation of Nanomaterials and Protection from External Influences [56]

The study of the air oxidation process of different nanomaterials and micrometric powders obtained from the same materials shows that nanomaterials start to oxidize with considerable speed at much lower temperatures. For example, aluminum nanopowders with particle size of 120 nm and S_{sp} 18.5 m²/g start to oxidize with a measurable speed at 420°C, while larger-size powders of particle size under 20 μm start to oxidize at 870°C.

The oxide coating forming when contact with air occurs, together with the adsorbed gases, provide a some level of stability to nanoparticles in the air up to a certain temperature. With further increase in temperature, a point is reached when quick desorption of the gas coating occurs, as well as emission of the excess energy accumulated during the formation of particles in the form of heat (the energy emitted during the relaxation of meta-stable, imbalanced structures) and reactivity of nanopowders sharply increase.

The phenomenon of pyrophoricity is related to the processes of oxidation in the atmosphere, especially typical of nanomaterials.

Pyrophoricity is in itself a spontaneous chemical ignition of certain materials when they come in contact with air, without heat impulse from an outside heat source.

Autogenous ignition, in itself is burning as a result of self-heating of solid combustible materials due to self-accelerating isothermal reactions. It occurs when the release of heat in the course of the reaction is higher than the heat loss in the environment. The Temperature of self-heating – T_{sh} presents the minimal temperature, in the specific circumstances, at which release of heat in the material begins. It marks the beginning of the process of Autogenous ignition. When certain temperature is reached in the course of self-heating, called Temperature of autoignition – T_{ig} , reacting of the material occurs in the form of smoldering or flaming up.

The main specific characteristic of pyrophoric materials is that their temperature of autoignition is lower than regular room temperature. Materials are not always pyrophoric. These properties depend on the chemical nature of the substances, their mass, granulometry, particle shape, morphology of the surface and the presence of protecting coatings.

From a physical point of view, the beginning of the self-heating process is defined by the balance of the heat fluxes, i.e. by the heat release in the system itself (and possibly the coming from outside) and heat losses in the environment. When mass of the nanopowder and speed of heating are sufficient, the strong self-heating leads to ignition. Usually, the increase of the mass of nanopowders to 100-200 g, leads to considerable release of heat and to reduce heat losses which causing autogenous ignition in the air.

Experimental data on the kinetics of oxidation of nanopowders (linear law of oxidation) give the opportunity to make an assessment on the critical temperatures (T_{sh} and T_{ig}) of the metals in nano-state. For aluminum nanopowders the temperature of self-heating is in the interval 415 to 445°C. Pyrophoricity is a dangerous and undesirable phenomenon that strongly impedes the obtaining and use of nanomaterials. For the purpose of preserving the qualities of the nanopowders and lowering the risks related to their pyrophoricity, it is necessary to take measures to protect them.

The main task for the protection of nanopowders from interaction with the environment is the prevention of the access of reaction-active

substances to them. This could be achieved through the preservation of nanopowders in suitable inert media or through passivation of the surface of nanoparticles. When nanopowders are preserved in inert media, the chemical composition, qualities of materials and the particles surface, do not change. Passivation, on the contrary, aims to foster a suitable chemical reaction with the purpose of lowering the chemical activity of the particles surface. The essence of passivation consists in the creation, around the particle, of a layer of molecules of another substance (a passivator) which compensate the chemical activity of the surface and in this way to protect the material from the unwanted influence of the environment

Protection of Nanopowders under Super-clean Inert Gas Media

For the protection [57] of nanopowders can be used gas, liquid, solid media or vacuum. It is most convenient to do the protection with the help of super-clean inert gases. The use of technical inert gases cannot ensure full protection because of the presence of different impurities in them. In a medium of technical argon, the speed of oxidation goes down by 2.5-3 times. In some cases, inert gases could be replaced by gaseous or liquid nitrogen, with heavy hydrocarbon vapors or silicone oil. As protective media, apart from the above listed, practically all moisture-free organic solvents can be use (ethers, alcohols, benzene, toluene, hexane and so on). It is also convenient to preserve nanopowders in a medium of dry ice (solid CO₂).

An effective protective technique is also the compaction of nanopowders in a media of inert gas to volume between 0.5-0.6 of their loos (bulk) volume and forming of briquettes Pressing causes filling up of the pores between the particles and in this way the access of oxygen to the inner layers of the briquettes is considerably limited. Oxidation occurs mainly on the external surface of the material. Pressing leads to lowering of the oxidation speed as much as 2 to 3 times.

The creation of inert media in the process of industrial production of nanopowders is quite a difficult task because the protection from reaction-active substances needs to be ensured during all production operations and during possible processing of the materials. This is related with work in dry boxes, isolated chambers, hermetic containers filed with inert media, etc. Additionally,

the processes of fragmentation, thermal treatment, chemical reactions and other operations related to the synthesis of nanomaterials needs to be conducted in equipment that guarantees a controlled inert media. If in the process of obtaining the material has been heated, then cooling down should be conducted in the same aggregate because during cooling, nanomaterials absorb gasses from the surrounding environment, including oxygen and moisture. The absorbed oxygen and moisture cause the formation of large and strong aggregates in the nanopowders.

Nanopowders need to be packed immediately after they have been obtained. Pyrophoric powders are usually packed in welded, vacuumed metal containers or in metal containers filled with inert media. Less active powders may be stored in glass or metal vessels, two-layer polyethylene bags, etc. In any particular case an assessment of the compatibility between the nano material and the packaging material should be made.

Protection Techniques used for the Nanopowders through Processing of the Particle Surface

These protection techniques can be divided in the following groups:

- Creation of a protective surface layer on the particles through a controlled interaction of the nano material in the reaction-active environment;
- Creation of a protective polymer layer;
- Laying a protective layer of organic compounds;
- Sorbing of a protective layer of gas on the particle surface.

Formation of a Protective Surface Layer on the Particles through Controlled Interaction of the Nano Material in a Reaction-Active Media

The protection is usually done through oxidation of the surface. The goal is to build a thick and even microcrystal oxide layer. This is achieved through the exposure of nanopowders to the influence of a medium of inert gas containing 10-1000 ppm oxygen. Argon is usually used as inert gas. The neutral atmosphere and the low content of oxidizing agent do not allow the reaction to run fast, controlling that way the increase of the oxide layer. Nanopowders are exposed to the influence of the gas mixture under atmospheric pressure for a period

of 1 to 2 days. The temperature of the media is maintained under 20°C. In the course of the process, the temperature slowly goes up, and because of that measures need to be taken for the cooling of the reaction system. During passivation the powder needs to be stirred in order to achieve even exposure of all layers to the influence of the passivation media. In these conditions, the processing of aluminum nanopowder causes the formation of a dense layer of α -Al₂O₃ on the particle surface with thickness of 1.5-5 nm. In this way, in case of ALEX-powders the protective layer consumes 10-12% of the mass of the particles and guarantees practically full protection for 40 days at a temperature of 45°C and relative humidity of 32% [58].

For passivation of the metal nanoparticles, it can be used also technical inert gasses because they always contain a certain quantity of oxygen. The passivation of particles in an atmosphere containing trace quantities of water vapors also leads to surface oxidation. In this case, however, an effect is observed which could have very positive influence on the usage of metal particles as a component of composite propellants. The interaction, for example, of aluminum nanopowders with water vapors, causes particles to cover with a layer of Al₂O₃ and Al(OH)₃ and in same time to release of hydrogen. Part of the formed hydrogen in nascent form occludes in the metal nucleus under the protective layer. Such particles included in the composition of the propellant enhance its energy characteristics significantly.

In some cases, for example with titanium nanopowders, it is justifiable to create a surface nitride layer. This could be done either in the course of synthesis (through conducting it in nitrogen media), or consequently, through the exposure of nanopowders to the influence of a passivation media.

The obtaining of nanopowders through the EEW technology in media of aliphatic hydrocarbons (or vapors of hydrocarbons – dekan, paraffins) causes surface carbidisation of the particles and formation of a layer of carbon which also ensures protection of nanopowders.

The drawback of this technology is the partial consumption of the particles material during the formation of the protective layer.

Coating with Protective Polymer Layer

Polymers could be laid on the surface of the particles in different ways. For example,

precipitation of the polymer from a solution through the replacement of the solvent, evaporation of the solvent, joint extrusion of the nanopowders with suitable film-forming material, in situ polymerization or polycondensation. For protective layers a wide range of polymers may be use – fluoropolymers, polystyrene, silanes, polyurethanes and others.

Glebov and co-workers [59] describes the deposition of polyvinyl fluoride on the aluminum nanoparticles when supercritical CO₂ is being used. The use of silane solutions with concentration of about 5% also achieves reliable protection of metal nanoparticles. There is wide usage of low-molecular chloro-fluor polymers with chain-end functional groups of opposite chemical nature – H and OH or Cl and CCl₃. An example for such a polymer is polychlorotrifluoroethylene (KEL-F) [60].

The majority of the mentioned techniques involve mechanical laying of polymer molecules on the surface of the nanoparticles which act as condensation nuclei. In this case, because of the tendency of nanoparticles to agglomerate, often the polymer layer covers not individual particles but large agglomerates. This leads to a change in the granulometry of the powders and to deterioration of their qualities. This problem can be avoided through the application of the so-called in situ polymerization or polycondensation, i.e. when polymers are formed directly on the surface of the particles.

A detailed description of the in situ technology for the obtaining of coatings from some polyolefins and polyurethanes is given in [61]. In both cases, a presence of hydroxyl groups on the surface of metal nanoparticles is used.

In the process of obtaining coatings from polyolefins, Ziegler-Natta polymerization is applied. Initially, the catalyst – a titanium tetrachloride is graft on the surface of the particles. Later on, triethylaluminum and monomer in gas form are added to the reaction mixture [62]. The reaction could be represented as follows:

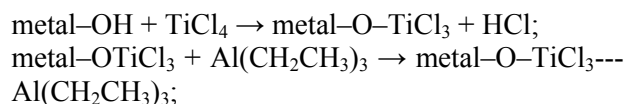

coordination complex

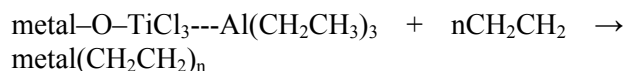

polymer coated particle

Polymerization is conducted in a glass reactor equipped with a water jacket, a mechanical mixer and an ultra sound head (transducer) for the obtaining of the suspension and for homogenization throughout the process. According to the described method, 20 g of preliminary dried Al-powder is dispersed in 800 ml of dry hexane for the duration of 30 minutes, through mechanical stirring. The temperature of the reactor is maintained around 60°C. After the obtaining of an even suspension, several microliters of $TiCl_4$ are injected in the reactor and the ultrasound generator is turned on. Ten minutes later, the co-catalyst $Al(CH_2CH_3)_3$ is introduced in the suspension. $TiCl_4$ and $Al(CH_2CH_3)_3$ form a complex on the particle surface in about three minutes and after that the monomer can be introduced in the system. The polymerization is conducted under low pressure (30 kPa for polyethylene and 300 kPa for polypropylene) for a period of 5 to 20 min (more time is needed for the obtaining of coatings from polypropylene). Polymerization is interrupted through injection in the reactor of 10 ml of ethanol which hydrolyzes the catalyst. Filtration follows, then washing with hexane and drying of the powder at 60°C. The thickness and the mass of the coating depend on the duration of the process and from the granulometric composition of the powder. For a period of 5-20 minutes, about 8-19% of polyethylene is deposited on the particles. With the increase of the polymer content, the degree of particle agglomeration goes up.

Researches prove the effectiveness of the coatings. Processed aluminum nanopowder (diameter 43 nm) retains about 55% of its initial active Al after 120 hours at 100% humidity and temperature of 60°C. In pure form, in the same conditions, the powder oxidizes practically completely in 20 hours.

The reaction of forming polyurethane coatings can be presented through the following graphic:

The reaction is conducted in dry acetonitrile at 60°C in nitrogen atmosphere at 1 atmospheric pressure. A sample of preliminary dried nonaluminum (20-40 g) is introduced and is dispersed in the solvent with the simultaneous usage of a mechanical mixer and ultrasound source. After the obtaining of an even suspension, a solution of the catalyst – dibutyl tin dilaurate in methylenchloride and diisocyanate (toluen diisocyanate) are introduced in the reactor. The concentration of the catalyst in the reactor needs to be 0,05M, and the diisocyanate needs to have a 30

– 50% of molar surplus. The time for interaction between the hydroxyl groups on the surface of the particles and the diisocyanate is about 3 hours. During this period, an intense stirring of the suspension need to guaranteed. Polyol is also introduced, with a 30-50% of molar surplus. The reaction with isocyanate chains implanted on the particle also takes about 3 hours. Filtration and washing of the powder follows, for the purpose of eliminating the remaining un-reacted, soluble oligomers. The described reaction is repeated which guaranties growth of the implanted polyurethane chains. As polyols a polybutadien with chain-end hydroxyl groups, difenilol propane (Bisphenol A) and fluorinated aliphatic oligomers with chain-end hydroxyl groups (Zonyl BA-L, $F-(CF_2CHF_2)_n-CH_2CH_2-OH$). The step-by-step conducting of the reaction prevents agglomeration of the particles. The particles remain separated even when the polymer coating is of considerably large quantity (around 12%).

Coating of a Protective Layer of Organic Compounds

In this case, the particles of the preliminary dried nanopowders are covered with a layer of suitable organic compounds. Usually, in the way of coatings, aliphatic carboxylic acids are used with a chain length from C10 to C19. With the extension of the chain, melting temperature, density of the acid and the protective qualities of the coating increase. In case of L-ALEX or P-Al(50), for the protection of the particles palmitic acid is used (around 5% for the powders with average particles diameter of 110 nm and 7-9% for particles with average diameter 77 nm P-Al(50)). Tests conducted at a temperature 45°C and relative humidity 75% show that the coating guarantees reliable protection of the metal even after 40 days.

The coatings are usually laid through the processing of powders with a solution of the compound in a suitable dry solvent (benzene, ethanol, methanol, etc.) which afterwards evaporates. The coating can be laid also through joint extrusion of the powders and the organic compound or through a different suitable technique for mechanical mixing and rolling.

As protective coating, also salts of organic acids could be used, their esters with mono- and polyvalent alcohols and others as well. A drawback of this protection method is the strong agglomeration of particles. [18, 63] Additionally,

the acid nature of the coating is incompatible with the other components of the propellant and in many cases it has to be removed before the introduction of powders in the mixture. This is a laborious and expensive process.

Protective Layer of Gas on the Surface of the Nano Particles [63]

Carbon dioxide, because of the strong adsorption on the surface of the particles, has a strong passivation effect. Sorbing could be realized through processing of the powders with a mixture of argon and carbon dioxide or through the mixing of nanopowders with grinded dry ice (CO₂). It is possible to use other gases too.

The processing with high-purified hydrogen at temperature up to 700°C also could be used for protection of metals in nano-state. This leads to a strongly reduced activity of the metals to the atmospheric oxygen.

The advantage of the method is the preservation of the granulometric composition and the morphology of the particles. During processing there is no change in the form or growth of the size of the particles. A drawback is the short protection period because of the desorption or chemical decomposition of the gas coating molecules [4]. It has to bear in mind that the long-lasting reliable protection of the surface of particles and the preservation of their properties could be guaranteed only through the combined application of protective surface coatings and the preservation of nanopowders in inert media.

Conclusions

The nano energetic materials area will continue to be the fore front runners in the research and development of novel energetic materials formulations. The use of nano energetic materials will offer an opportunity to develop new propellant formulations with very high specific impulse and tailored properties. Nano energetic materials incorporated propellant formulations will also offer less payload and higher range of systems in space and defence applications. The use of these novel materials in the propellant formulations will continue to pose challenges in terms of producing technology, based on rapidly increased market demand and high quality requirements. The emergence of nanoparticles application in the area of energetic materials can lead to revolution in the

energetic materials research area in order to gain higher performance.

References

1. K.J. Klabunde, "Nanoscale Materials in Chemistry," Wiley, 10 – 12; 41 – 50. (2001).
2. Ph. Knauth, J. Schoonman "Nanostructured Materials. Selected Synthesis Methods, Properties and Applications," Kluwer Academic Publishersp. 7 – 17, 23 – 52, (2004).
3. Jun Ren, Shouci Lu, Jian Shen, Chunhong Yu, Research on the composite dispersion of ultra fine powder in the air, *Materials Chemistry and Physics*, 69, 1-3 204-209, (2001).
4. A.N. Pivkina, D.B. Meerov, K.A. Monogarov, D.A. Ivanov, Yu.V. Frolov. "Nanoaluminum – Obtaining, Properties and Use in a Condensed Energetic Systems, Scientific Session" – MIFI, V.9, 2007.
5. U. Teipel. "Energetic Materials. Particle Processing and Characterization," Wiley & Sons, p. 7 – 27, 203 – 226, 450 – 457, 509 – 528 (2005).
6. Committee on advanced energetic materials and manufacturing technologies, National Research Council "Nanomixtures and Nanocomposites in Advanced Energetic Materials," National Academies Press, Washington, (www.nap.edu/openbook), 24-27, (2004).
7. Committee on Materials Research for Defense, National Materials Advisory Board, Division on Engineering and Physical Sciences "Materials Research to meet 21st - Century Defense Needs' (2003), National Academies Press.
8. R. Stanley, D. Hagler, "Elimination of Toxic Materials and Solvents from Solid Propellants Components" Strategic Environmental Research and Development Program, ADA363240, 32 – 36, (2001).
9. W.H. Wilson, M.P. Kramer, R.W. Armstrong, "In Symposium on Defense Applications of Nanomaterials" 21st ACS National Meeting, San Diego, CA, 1-5 April, (2001).
10. M.J. Chiaverini, N. Serin, D.K. Johnson, Y.C. Lu, K.K. Kuo "In Challenges in Propellants and Combustion 100 Years after Nobel" Kuo, K. K., Ed.; Begell House: NY, 7119, (1997).
11. L.T. DeLuca, M. Verri, F. Cozzi, A. Jalongo, G. Columbo "In Challenges in Propellant and Combustion 100 Years after Nobel" Kuo, K. K., Ed.; Begell House: NY, 493, (1997).

12. B. Baschung, D. Grune, H.H. Licht, M. Samirant "Combustion of Energetic Materials," Edited by Kuo, K. K., DeLuca, L. T., Eds.; Begell House: NY, 219, (2001).
13. M.M. Mench, C.L. Yeh, K.K. Kuo, "Propellant Burning. Rate Enhancement and Thermal Behavior of Ultra-Fine. Aluminum Powders (ALEX)," *Proceedings of the 29th International Annual Conference of Institute for Chemical Technology (ICT): Karlsruhe, Germany 30/1* (1998).
14. A. Peter, Psaras and H. Dale Langford, "Solid State Sciences Committee, National Research Council, Advancing Materials Research" ISBN: 0-309-56404-2, 408 pages, 6 x 9, (1987), <http://www.nap.edu/catalog/10291.html>
15. A.E.D.M. van der Heijden, R.H.B. Boumal, E. P. Carton, M. Martinez Pacheco, B.Meuken1, R. Webb and J.F. Zevenbergen, "Processing application and characterization of ultra fine aand nanomaterials in energetic compositions," *Shock compression and condensed Matter*, 1-7, (2005).
16. Poole C.P., Owens F.J., Introduction to Nanotechnology, Wiley & Sons, 2003 p. 26 – 28, 99 – 102.
17. Ballard, Stephen Gwyn, "Apparatus and methods for the production of powders" *US Patent US 6,972,115* (2005).
18. V.N. Simonenko, V.E. Zarko. Comparative Studying the Combustion Behavior of Fine Aluminum, *30th Int. Annual Conference of ICT*, 21/1, (1999).
19. Denis Spitzer, Marc Comet, Christian Baras, Vincent Pichot, Nelly Piazzon "Energetic nano-materials: Opportunities for enhanced performances" *Journal of Physics and Chemistry of Solids*, 71, February 2010, Pages 100-108.
20. Carole Rossi, Alain Estève, Priya Vashishta, "Nano scale energetic materials" *Journal of Physics and Chemistry of Solids*," 71, 2, 57-58, (2010).
21. K. Jayaraman, K.V. Anand, S.R. Chakravarthy, R. Sarathi "Effect of nano-aluminium in plateau-burning and catalyzed composite solid propellant combustion" *Combustion and Flame*, 156, 8, 1662-1673 (2009).
22. L. Meda, G. Marra, L. Galfetti, F. Severini, L. De Luca, "Nano-aluminum as energetic material for rocket propellants," *Materials Science and Engineering: C*, 27, 5-8, 1393-1396 (2007).
23. Klapötke, T.M. *Chemistry of High-Energy Materials*; Walter de Gruyter: Berlin, Germany, 2011.
24. TA. Gibson, L.D. Haws, J.H. Mohler, Integral low-energy thermite igniter, *US Patent 4,464,989*, (1984).
25. P. Dave, S. Chaturvedi, Nanocatalyst for composite solid rocket propellants: Nanocatalyst as potential burning rate modifier for composite solid rocket propellants, LAMBERT, 2010.
26. M.M. Mench, C.L. Yeh, and K.K. Kuo, "Propellant Burning Rate Enhancement and Thermal Behavior of Ultra-Fine Aluminum Powders (ALEX)," *29th Int. Annual Conference of ICT*, Karlsruhe, Germany. 30/1, 1998.
27. J.R. Luman, B. Wehrman, K.K. Kuo, R.A. Yetter, N.M. Masoud, T.G. Manning, L.E. Harris, H.A. Bruck, "Development and characterization of high performance solid propellants containing nano-sized energetic ingredients". *Proceedings of the Combustion Institute*, 31, January, 2089-2096 (2007).
28. Roya Dastjerdi, Majid Montazer, A review on the application of inorganic nano-structured materials in the modification of textiles: Focus on anti-microbial properties *Colloids and Surfaces B: Biointerfaces*, 79, 1, 5-18 (2010).
29. S.C. Tjong, H. Chen, "Nanocrystalline Materials and Coatings", *Material Science and Engineering*, 16 – 27, 34 – 38. (2004).
30. Alla Pivkina, D. Ivanov, Yu. Frolov, Svetlana Mudretsova, Anna Nickolskaya and J. Schoonman, "Plasma synthesized nano-aluminum powders Structure, thermal properties and combustion behavior," *Journal of Thermal Analysis and Calorimetry*, 86, 3, 733-738, (2006).
31. Yuri F. Ivanov, Mirswan N. Osmonoliev, and Valentin S. Sedoi Vladimir A. Arkhipov, Sergey S. Bondarchuk, Alexander B. Vorozhtsov, Alexander G. Korotkikh, and Valery T. Kuznetsov, "Productions of Ultra-Fine Powders and Their Use in High Energetic Compositions", *Propellants, Explosives, Pyrotechnics* 28, 6, 319-333 (2003).
32. Frolov, Yu., A. Pivkina, P. Ulyanova, S. Zavyalov, "Nanomaterials and nanostructures as components for high-energy condensed systems," 28th International Pyrotechnics Seminar, Adelaide, Australia, 311, (2001).
33. Guozhong Cao, Nanostructures & nanomaterials: Synthesis, properties &

- applications - London: Imperial College press. London. - cop. 2004.
34. C. Altavilla and E. Ciliberto, "Inorganic Nanoparticles: Synthesis, Applications, and Perspectives," 116, (2010).
 35. Dieter Vollath, "Nanomaterials: an introduction to synthesis, properties and applications", 83, (2008).
 36. Hideo Hosono, Yoshinao Mishima, Hideo Takezoe and Kenneth J.D. MacKenzie. "Nanomaterials: Research Towards Applications" 425, (2006).
 37. Mahi R. Singh, Robert H. Lipson, "Transport and Optical Properties of Nanomaterials" Proceedings of the International Conference Series: AIP Conference Proceedings - Materials Physics and Applications Series, 1147, (2009).
 38. C. Bréchnignac (Editor), P. Houdy (Editor), M. Lahmani (Editor), "Nanomaterials and Nanochemistry" 422, (2008).
 39. José A. Rodriguez and Marcos Fernández-García, "Synthesis, Properties, and Applications of Oxide Nanomaterials" 114, (2007).
 40. C. N. R. Rao, Achim Müller, Anthony K. Cheetham, "Nanomaterials Chemistry: Recent Developments and New Directions," 71, (2007).
 41. Ignac Capek, "Nanocomposite structures and dispersions," 23 (2006).
 42. M.B. Talawar, A.P. Agarwal, M. Anniyappan, G.M. Gore, S.N. Asthana, S. Venugopalan "Method for preparation of fine TATB (2–5 µm) and its evaluation in plastic bonded explosive (PBX) formulations" *Journal of Hazardous Materials*, 137, 1848-1852, (2006).
 43. M.B. Talawar, R. Sivabalan, M. Anniyappan, G. M. Gore, S. N. Asthana and B. R. Gandhe, "Emerging trends in advanced high energy materials," *Combustion, Explosion, and Shock Waves*, 43, 1, 62-72, (2009).
 44. Martinez Pacheco, M., Bouma, R.H.B., Carton, E.P., Stuivinga, M., and Katgerman, L., "Synthesis of electrical contact materials via combustion synthesis reactions", *NIMR Conference Building Bridges in Metallurgy*, 10-1, (2004).
 45. Alexander E. Gash, Randall L. Simpson, and Joe H. Satcher, Jr., Direct Preparation of Nanostructured Energetic Materials Using Sol-Gel Methods, *Defense Applications of Nanomaterials*, ACS Symposium Series, 891 198–210, (2005).
 46. T.M. Tillotson, R.L. Simpson, L.W. Hrubesh, Metal-oxide-based energetic materials and synthesis thereof, *US Patent* 6,986,819, (2006).
 47. Teipel U. Energetic Materials. Particle Processing and Characterization. Wiley & Sons, 2005 p. 7 – 27, 203 – 226, 450 – 457, 509 – 528.
 48. R.W. Pekala, C.T. Alviso, F.M. Kong, S.S. Hulse. Aerogel Derived from Multifunctional Organic Monomers, *Third International Symposium on Aerogels, Wurzburg*, September, 1991.
 49. C.N.R. Rao, Müller Achim, Anthony K. Cheetham. "The Chemistry of Nanomaterials: Synthesis, Properties and Applications," 2, 761 Wiley-VCH (2004).
 50. A.S. Edelstein, R.C. Cammaratra, "Nanomaterials: Synthesis, Properties and Applications," Taylor & Francis; 2 edition (1998)
 51. Kurt E. Geckeler, Hiroyuki Nishide, "Advanced Nanomaterials" Wiley-VCH; 2 Volumes edition (2010).
 52. Mel M. Schwartz, "New Materials, Processes, and Methods Technology" (2005) (CRC Press).
 53. J. Ping Liu, Eric Fullerton, Oliver Gutfleisch, D.J. Sellmyer, "Nano scale Magnetic Materials and Applications", Springer; 296 (2009).
 54. Johann Reithmaier, Plamen Petkov, Wilhelm Kulisch, Cyril Popov, "Nanostructured Materials for Advanced Technological Applications (NATO Science for Peace and Security Series B: Physics and Biophysics)," Springer; (2009).
 55. F.Le Guyadec, X. Génin, J.P. Bayle, O. Dugne, A. Duhart-Barone, C. Ablitzer, Pyrophoric behaviour of uranium hydride and uranium powders, *Journal of Nuclear Materials*, 396, 2-3, 294-302, (2010).
 56. M. Conte, P.P. Prosini and S. Passerini "Overview of energy/hydrogen storage: state-of-the-art of the technologies and prospects for nanomaterials," *Symposium C, Nano scale materials for Energy Storage. Materials Science and Engineering B*, 108, 1-2, (2004).
 57. Glebov E., Yuan L., Kishtopa L., Usov O, Krasnoperov L, "Coating of Metal Powders with Polymers in Supercritical Carbon Dioxide," *Industrial Chemistry Research*, 40, 19, 4057-4068, (2001).

58. Ballard; Stephen Gwyn Patent US US 6, 972, 115 / 2005.
59. Zhi-peng Cheng, Yi Yang, Feng-sheng LI, Zhen-hua PAN, "Synthesis and characterization of aluminum particles coated with uniform silica shell," *Transactions of Nonferrous Metals Society of China*, 18, 378-382 (2008).
60. Dubois C., Lafleur P., Roy C. Polymer-Grafted Metal Nanoparticles for Fuel Applications, *Journal of Propulsion and Power*, V. 23, № 4, 2007, p. 651-658.
61. L. Meda, G. Marra, L. Galfetti, S. Inchingalo, F. Severini and L. De Luca. "Nano-composites for rocket solid propellants," *Composites Science and Technology* 769-773, (2005).
62. Alba L. Ramaswamy, Pamela Kaste, Andrzej W. Miziolek, Barrie Homan, Sam Trevino, and Michael A. O'Keefe. "Nanoenergetics Weaponization and Characterization Technologies, Defense Applications of Nanomaterials," *ACS Symposium Series*, 891, 180-197, (2005).
63. Seied Mahdi Pourmortazavi, Seiedeh Somayyeh Hajimirsadeghi. "Application of supercritical carbon dioxide in energetic materials processes". *Industrial & Engineering chemistry research*. 2005, vol. 44, n 17, pp. 6523-6533.

Received 12 October 2011