

# Dissolved Oxygen Regulatory System Using Fuzzy Logic Method Based on Teensy Board Microcontroller

Fajar Budiman, Muhammad Rivai, Devy Kuswidiastuti, and Luthfi Riadhi

Department of Electrical Engineering  
Institut Teknologi Sepuluh Nopember (ITS)  
Surabaya, Indonesia

email: fajarbudiman@ee.its.ac.id, muhammad\_rivai@ee.its.ac.id, devy@ee.its.ac.id, luthfiriadhi95@gmail.com

**Abstract**— Dissolved oxygen in water becomes a critical factor in the cultivation of fish hatcheries that determines the success/failure rate in the process of improving the quality and quantity of fish hatcheries. Low dissolved oxygen levels cause deficient to the process of decomposition, reproduction, and growth of fish. In this study, a system that can regulate the levels of dissolved oxygen in water is designed and built by utilizing the Dissolved Oxygen Meter of AZ-8403 as a sensor. The percentage of oxygen in water is controlled by Fuzzy Logic implemented in the Teensy board microcontroller. When the oxygen level is below the setting point, the aerator is then activated to produce dissolved oxygen in the water. The test results conducted on the aquarium containing fish obtained error for the reading of dissolved oxygen sensor of 0.075%. The system response requires 1 minute to reach the setting point.

**Keywords**— Fuzzy Logic Control, Dissolved Oxygen, Teensy Board.

## I. INTRODUCTION

In fish cultivation, the success in the hatchery field is determined by several factors including: seed quality, water quality, hatchery process and so forth. Water quality factors include: water temperature, salinity, pH, and dissolved oxygen (DO). One of the problems in aquaculture is to know and to overcome the problem of oxygen level in aquatic ecosystem. There are some cases of fish mortality in fish cultivation such as in Wukisari subdistrict Cangkringan, Sleman, Yogyakarta in 2012. The target catfish fish produced is around 943,200 fishes, but only around 419,200 fishes are produced [1]. From the data, it can be concluded that the survival rate of catfish seeds of 34.22% or the mortality rate of 65.78% in one seeding cycle [2]. Water quality becomes the factor that determines the level of success of fish farming. One of the water quality factors that leads to high mortality of fish is dissolved oxygen level [3]. Deficient dissolved oxygen level causes the processes of decomposition, reproduction, and growth in the pond do not work well. The minimum value of dissolved oxygen level for fish cultivation is 3 ppm [4]. The need of dissolved oxygen for fish is affected by age, activity and aquatic conditions [5]. The oxygen content affects the oxidation process and the reduction of organic and inorganic materials [6]. Lack of oxygen will cause fish less appetite and the growths of bacteria that cause the death for fish. In this research, dissolved oxygen monitor and control system using fuzzy method based on Teensy board microcontroller is designed. The system is expected to be used as an effective, cheap, and

easy-to-use for dissolved oxygen level control, especially in Freshwater fish hatchery.

## II. THEORETICAL BACKGROUND

### A. Factors of Freshwater Pond Quality

In general, water quality is related to the content of dissolved material inside. Environmental suitability for each fish is different. If some circumstances do not match, then it can hamper its growth and life. Several factors in water quality that can affect the fish farming are dissolved oxygen, temperature, acidity (pH), and salinity. Table I summarizes the ideal requirement of freshwater fishes that are popular in Indonesia regarding to dissolved oxygen, temperature and acidity (pH).

Oxygen is indispensable for the respiration and metabolism of fish and microorganisms in the water. Insufficient oxygen level for fish and other biota can endanger the fish life. Water temperature is also very influential on the growth of fish. Unsuitable water temperatures, either too high or too low may cause the fish to not-grow properly. Temperatures suitable for growth of fish are ranged from 15°C – 30°C. Water temperature affects its density. The higher the water temperature, the lower the density (gr/cm<sup>3</sup>). The difference in water density in the upper layer and in the lower layer can cause stratification. The deadly temperature for almost all types of fish is 10 – 11 degrees Celsius for several days. Fish appetite decreases at temperatures below 16 degrees Celsius, while fish reproduction decreases at temperatures below 21 degrees Celsius.

The degree of acidity of water is divided into three categories, namely low pH, neutral pH and high pH. The degree of acidity of the water is influenced by Hydrogen ions (H<sup>+</sup>). Water becomes acidic when pH < 7 and is said to be alkaline if pH > 7. The degree of acidity of aquaculture that meets the requirements is 5 - 8.5. For the fish cultivation in freshwater, the suitable pH is 6.5 - 7.5. Another important requirement, the pH fluctuations in the morning and afternoon are no more than 1.

Salinity is the concentration of the total ions present in the water. Salinity has a close bond with the life of aquatic organisms including fish, where physiologically salinity is closely related to the adjustment of the osmotic pressure of the fish. If the osmotic environment (salinity) differs greatly from the osmotic pressure of body fluids (conditions are not ideal), then the osmotic system will become a burden on fish

TABEL I. IDEAL REQUIREMENT OF FRESHWATER FISH REGARDING TO DISSOLVED OXYGEN, TEMPERATURE AND ACIDITY

Freshwater Fish	Dissolved Oxygen (ppm)	Temperature (°C)	Acidity (pH)
Patin fish ( <i>Patin</i> )	4.5 – 6.5	28 – 32	25 – 30
parrot fish ( <i>ikan nila</i> )	4 - 6	25 – 30	6.5 – 8.5
Eel fish ( <i>ikan sidat</i> )	5 - 6	28 – 29	7 – 8
Cork fish ( <i>ikan gabus</i> )	4.2 - 5.6	25 – 30	6 – 7.5
Nilem fish ( <i>Ikan Nilem</i> )	5 - 7	18 – 28	6.5 – 7.5
Goldfish ( <i>Ikan Mas</i> )	4 - 5	20 – 25	7 – 8
Pomfret ( <i>Ikan Bawal</i> )	4 - 6	25 – 30	7 – 8
Catfish ( <i>Ikan Lele</i> )	3 - 5	25 – 30	6.5 – 8
Gurame fish ( <i>Ikan Gurame</i> )	4 - 6	24 – 28	6.5 – 8

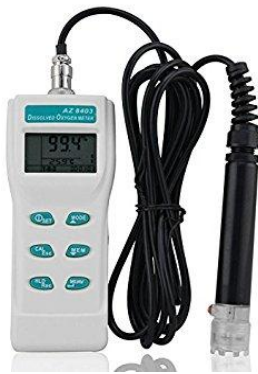

Fig. 1. Dissolved Oxygen AZ- 8403

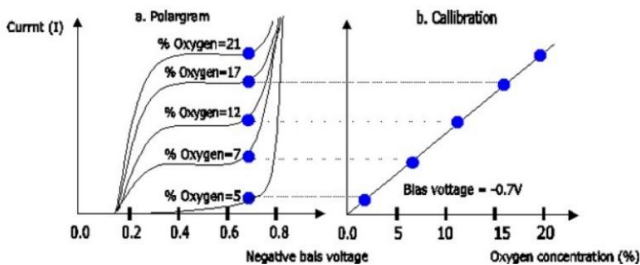

Fig. 2. Calibration Curve for Dissolved Oxygen [7]

so that relatively large energy is needed to maintain the osmotic of his body to remain in the ideal state. Energy expenditure for osmoregulation will affect the level of feed consumption and conversion into fish body weight. Salinity of freshwater is <0.5 while sea water (marine) is 30 – 40.

### B. Dissolved Oxygen Sensor AZ- 8403

The working principle of Dissolved Oxygen (DO) meter is based on the polarography phenomenon that occurs between two cathode electrodes and anode. Negative voltage is applied to the cathode electrode. The existence of this negative voltage will result in a rapid chemical reaction between water and dissolved oxygen on the cathode surface. Here is a chemical reaction that occurs at the cathode electrode:

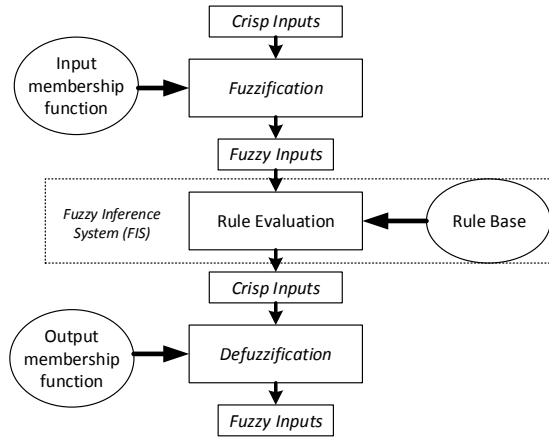
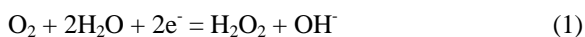

Fig. 3. Fuzzy Logic Diagram

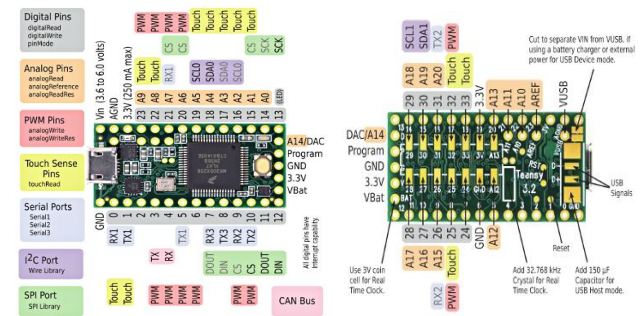

Fig. 4. Teensy Board Microcontroller [11]



The electric voltage will continue to rise to an equivalent saturation value that already reacts all dissolved oxygen to the cathode surface. This saturated electric voltage is characterized by an almost uptake of electric current readings, after a few moments of silence at one value even though the voltage value is raised. After passing this saturation voltage, the electric current keeps rising if the voltage continues to be added. This rising current value occurs because other chemical reactions have occurred, especially the reaction of the breakup of H<sub>2</sub>O water molecules into H<sup>+</sup> and OH<sup>-</sup> ions. Figure 1 shows an example of dissolved oxygen meter.

The reading of dissolved oxygen values is obtained from the value of electric current when all oxygen diffuses on the surface of the cathode electrode. In other words, the electric current is read when the system reaches a saturation voltage, equivalent to the amount of dissolved oxygen. The use of linear calibration method will obtain the value of dissolved oxygen, as shown in Fig. 2.

### C. Fuzzy Logic

Fuzzy Logic is a branch of science Artificial Intelligence, a knowledge that makes computers can imitate human intelligence. Fuzzy logic can solve problems in stored controllers and processing information that can be implemented on embedded systems on a microcontroller [8]. Fuzzy logic resembles human decision making with its ability to work from interpreted data and find appropriate solutions. Fuzzy logic is basically a multivalued logic that can define values between conventional states like yes or no.

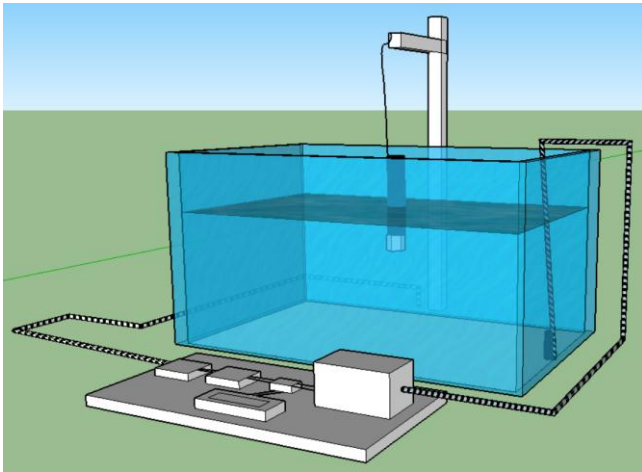

Fig. 5. System design with aquarium as experiment

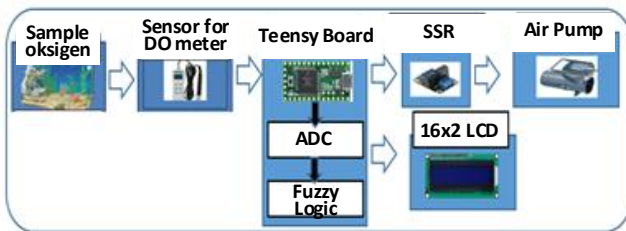

Fig. 6. Block Diagram of Proposed System

Fuzzy reasoning provides a way to understand the performance of the system by assessing the input and output system of observations. Figure 3 is a block diagram of Fuzzy Logic. Fuzzification is the process of converting a numerical variable into a fuzzy variable (linguistic variable). Rules specify the output condition rules according to the input conditions. Defuzzification is the process of converting the fuzzy data into numeric data that can be sent to the control device [10].

#### D. Teensy Board 3.2

Teensy 3.2 is a small-scale development board and can be mounted on a breadboard designed by Paul Stoffregen and PJRC, shown in Fig. 4. Teensy 3.2 carries the cheap 32-bit ARM Cortex-M4 using an adapted version of the Arduino IDE (Teensyduino) or programmed in directly in C language. Teensy 3.2 is utilized in this design due to signal processing needs that will take up huge resources but still considering the conciseness. It aims to be easily implemented on sensors and actuators of the proposed system.

The technical specification of Teensy 3.2, such as it is equipped with 32-bit ARM Cortex-M4 72MHz CPU with DSP extensions, 256K Flash Memory, 64K RAM, 2K EEPROM, 21 High Resolution Analog Inputs (13 bits usable, 16 bit hardware), 34 Digital I/O Pins (21 shared with analog), 12 buah PWM outputs, 1 buah 12-bit DAC output, 8 Timers for intervals/delays, separate from PWM, USB with dedicated DMA memory transfers, CAN bus, 3 buah UARTs (serial ports), SPI, I2C, I2S, IR modulator, I2S (for high quality audio interface), Real Time Clock (with user-added 32.768 crystal and battery), 16 general purpose DMA channels (separate from USB), Touch Sensor Inputs.

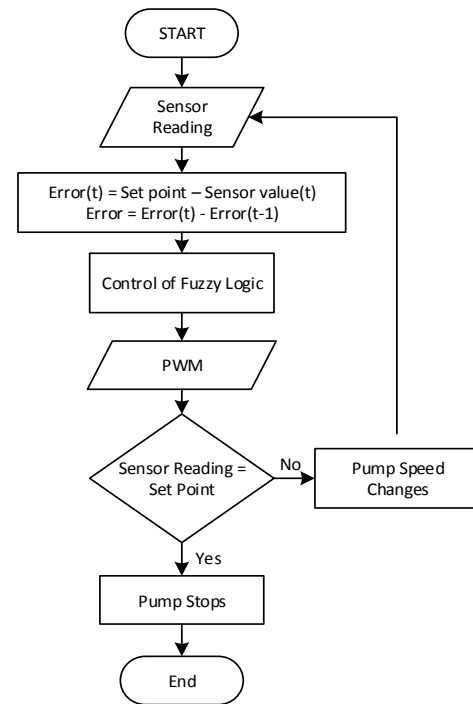

Fig. 7. Flowchart of the system

### III. DESIGN OF THE SYSTEM

The proposed system will control oxygen levels in the water to avoid the state of lack of oxygen in fish farming. Fig. 5 illustrated the design system for the purpose of lab experiment. The system will control oxygen levels by turning an actuator on that produces air bubbles in the water. The actuator used in this study is an air pump that is directly switch on/off by a relay. A relay module used in this study is an OMRON G3MB-202P with 2 channels. 1 channel drives one air pump.

Figure 6 shows the system block diagram of the proposed system. The system design can be divided into 3 parts, namely sensor, processor, and actuators. The sensor used is a DO-AZ8403 to measure oxygen levels in water. The processor is a teensy board microcontroller version 3.2 as a data processor, the A/D converter and fuzzy logic processes. Data output from the teensy board will give a PWM signal to the SSR module which is used to activate the air pump as an actuator to produce dissolved oxygen levels. Furthermore, is a 16x2 LCD is used as a monitor to display dissolved oxygen levels in the water. The input of the system is a setting point. When the dissolved oxygen level is below the setting point value, the aerator will be turned on to produce dissolved oxygen levels. When the oxygen level is above the setting point value, the aerator will be deactivated.

Figure 7 shows the system workflow. The initial step of the system is a process of reading dissolved oxygen levels, dissolved oxygen levels in analog data will be processed by an analog-to-digital (A/D) converter on the teensy board microcontroller which has a 10-bit resolution. The digital data produced by the A/D converter will enter the fuzzy process where errors and  $\Delta$ errors become input sets. Error is the value of the setting point minus the current sensor reading, and  $\Delta$ error is the current error value subtracted by the previous error as in (1) and (2) respectively. Error and  $\Delta$ error values will be assigned to the fuzzification process

TABEL II. FUZZY RULES OF THE SYSTEM

		Error			
		NB	Z	PK	PB
$\Delta$ Error	NEG	OFF	OFF	MED	HIGH
	NOL	OFF	OFF	HIGH	HIGH
	POS	OFF	OFF	HIGH	HIGH

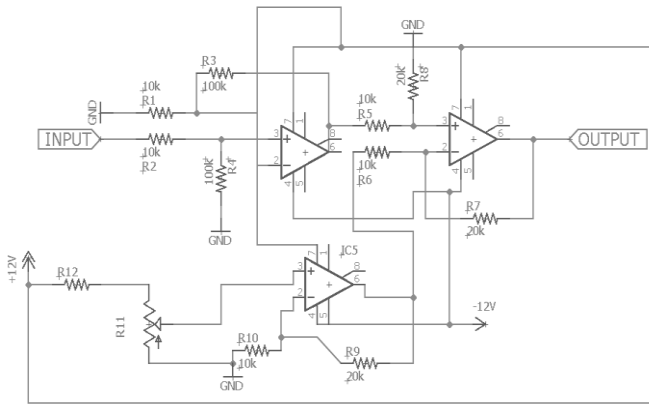

Fig. 8. Amplifier circuit

where the value of crisp is changed in the form of a fuzzy set, then the fuzzy set will be determined by the rule that has been created, and the final stage of fuzzy is the defuzzification process which is the output of the membership function.

$$Error = Set\ point - Sensor\ input \quad (1)$$

$$\Delta error = error - previous\ error \quad (2)$$

#### A. Design of Operational Amplifier and Clipper Circuit

Operational amplifier circuit is used to process the signal from the sensor of DO meter AZ-8403 in the form of a voltage of 0.6 volts with the increase in voltage of 1mV for every 0,01ppm. To enlarge the measurement range with a maximum output voltage of 3.3 volt, three operational amplifier circuits are used. The amplifier circuit is shown in Fig. 8. Furthermore, a diode clipper circuit is used that serves to ensure the safety of the circuit. This circuit consists of one resistor and two diodes, where resistors are used to limit the current, while the diode functions as a voltage limiter. If the input voltage is between the upper limit of 3.3volt and the lower limit is 0.7 volt, the signal will be passed. If the signal is above the upper limit, the positive diode becomes forward bias and the negative diode becomes reverse bias so that the current flows to the positive diode. Conversely, if the signal is at the lower limit, the positive diode becomes reverse bias and the negative diode becomes forward bias so that the current flows to the negative diode.

#### B. Fuzzy Logic Control

There are two fuzzy input sets in the form of crisp numbers, namely error and  $\Delta$ error. The input value in a crisp number will be converted into a fuzzy number with a fuzzification process. The fuzzy input values of error and  $\Delta$ error are a representation of the sensor readout error value from the specified set point value. Two fuzzy membership types are used in this study which are triangles and trapezoidal.

The error membership function is shown in Figure 9 which has 4 sets,

- NB (Large Negative) : -5 - -0.5
- Zero (Zero Value) : -1 - 0.25
- PK (Positive Small) : 0 - 0.5
- PB (Positive Big) : 0.25 - 5

While the  $\Delta$ error membership function is shown in Figure 10 which has 3 sets,

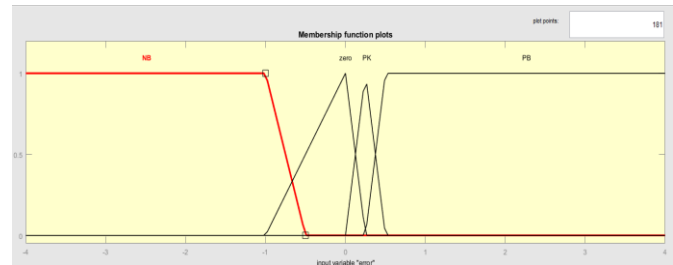

Fig. 9. Membership function of error

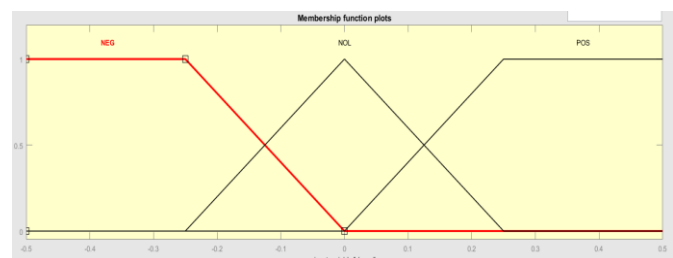

Fig. 10. Membership function of  $\Delta$ error

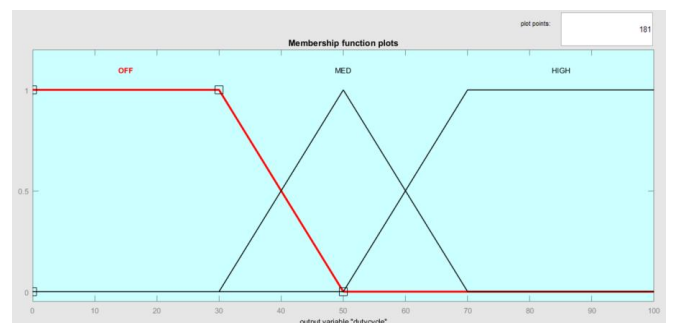

Fig. 11. Membership function of fuzzy output

- NEG : -0.5 - 0
- ZERO : -0.25 - 0.25
- POS : 0 - 0.5

Fuzzy output is water pump speed parameters obtained by the defuzzification process. Figure 11 shows the membership function of fuzzy output. Fuzzy output will be used by a microcontroller to activate an air pump as the actuator. Fuzzy output has 3 sets,

- Off
- Medium
- High

Fuzzy inference system (FIS) that uses fuzzy numbers to process input into output by using a table rule to map the relationship between input and output is used in this study. The inference system consists of 12 possible inputs in the *if-then statement* with two outputs that are independent of each other. Each output has a different table rule to map the output in the form of a pump PWM value. Table II shows the rules of fuzzy logic used to maintain dissolved oxygen levels. A Mamdani type with a defuzzification process using the centroid method is used in this study. Mamdani type

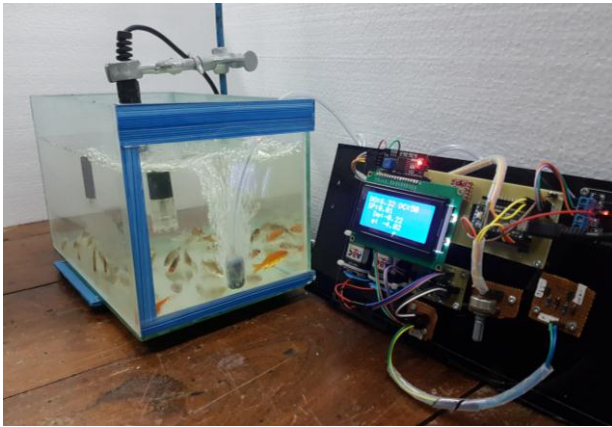

Fig. 12. The photograph of proposed system

TABEL III. FUZZY RULES OF THE SYSTEM

Oxygen DO Meter (ppm)	Oxygen System (ppm)	Error of Sensor (ppm)	output of sensor (volt)	output of amplifier (volt)
2.3	2.04	0.26	0.797	2.595
2.5	2.25	0.25	0.787	2.473
2.7	2.43	0.27	0.778	2.368
3	2.72	0.28	0.765	2.224
3.5	3.17	0.33	0.744	1.978
3.7	3.35	0.35	0.735	1.875
4	3.74	0.26	0.722	1.726
4.5	4.26	0.24	0.7	1.467
4.7	4.39	0.31	0.691	1.371
5	4.76	0.24	0.678	1.224
5.2	4.87	0.33	0.669	1.116
5.5	5.22	0.28	0.657	0.971
5.85	5.59	0.26	0.642	0.814

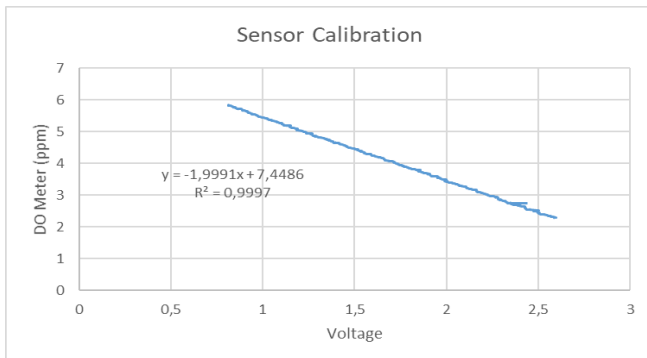

Fig. 13. Graph of testing result and calibration of dissolved oxygen sensor

inference is used since it is intuitive, easy to understand, and simple rule tables.

#### IV. TESTING AND RESULT

Figure 12 shows the realization of the system used in this study. An aquarium containing comets is used for experiment purpose. The aquarium has dimension of 27cm long, 16cm wide and 17cm tall. The system hardware is placed on the right side of the aquarium, namely teensy board 3.2, a 16x2 LCD, amplifier circuits, solid state relays, and air pumps. The setting point can be changed by the user

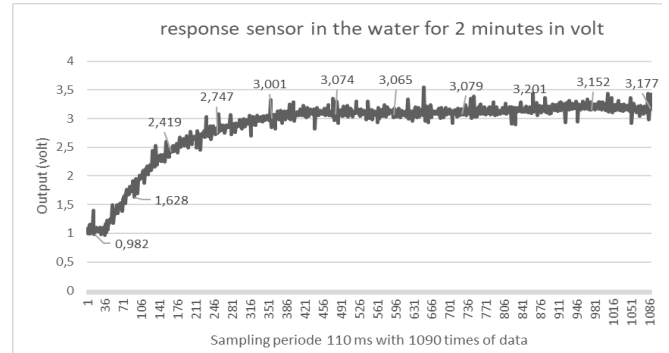

Fig. 14. Output data of the probe sensor in the air until it enters the water

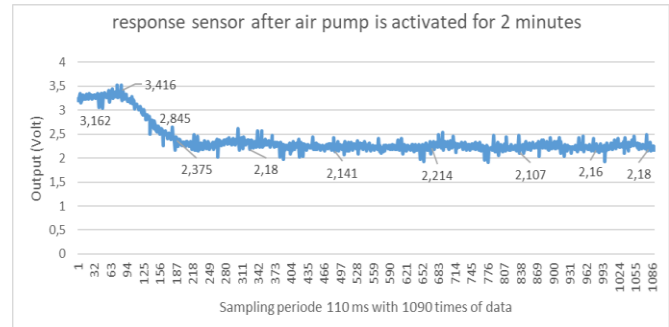

Fig. 15 Response output when the air pump is activated in 2 minutes

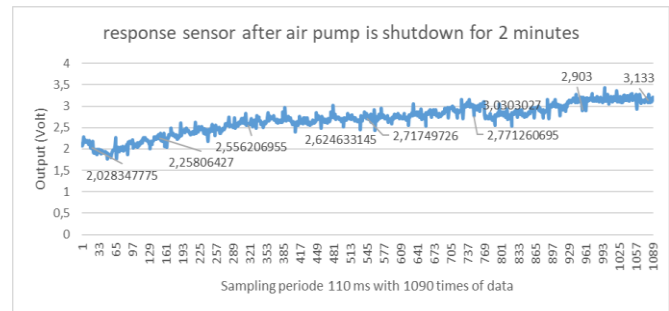

Fig. 16 Response output when the air pump is shutdown in 2 minutes

by rotating the potentiometer. This system has a variety of setting points starting from 2.3 ppm - 5.8ppm.

The initial test is conducted to the A/D converter test of Teensy board in order to know the accuracy of the on-board ADC. The test result shows an error of 1.461 bit or 0.0093 % which is considerably low. Then, testing of dissolved oxygen sensor probes is done to determine the characteristics of the sensor, and to find the sensor output value that will be acquired by the A/D converter. Table III shows the results of measurement of dissolved oxygen level using the DO-8403 DO sensor where the value ranges between 2.3 and 5.8 ppm with the mean error reading is 0.28ppm or 0.075%, and the maximum error is 0.39ppm.

From the test results, calibration of dissolved oxygen values can be done using linear regression from the data obtain from 2.3ppm to 5.8ppm. The sensor calibration formula is then obtained as shown in Fig. 13. Before the probe is drowned into the water, the sensor probe saturation value in the air must be found in order to calibrate. The probe of sensor requires 3 minutes to reach the saturation value. The percentage of dissolved oxygen is the value used for calibration on the sensor module, when reading the percentage value ranges from 90% - 100% with a stable output, the data acquisition is accurate.

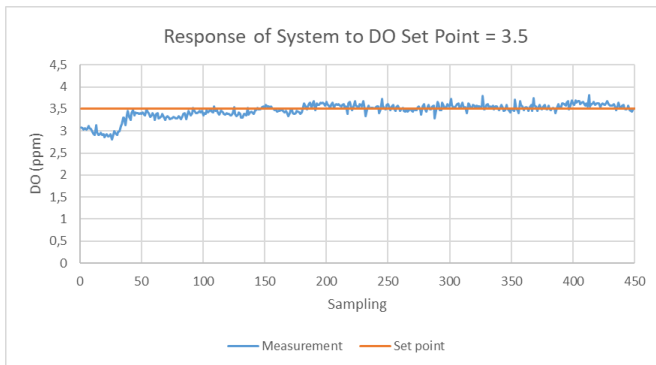

Fig. 17. Response of system in measuring DO to set point of 3.5ppm

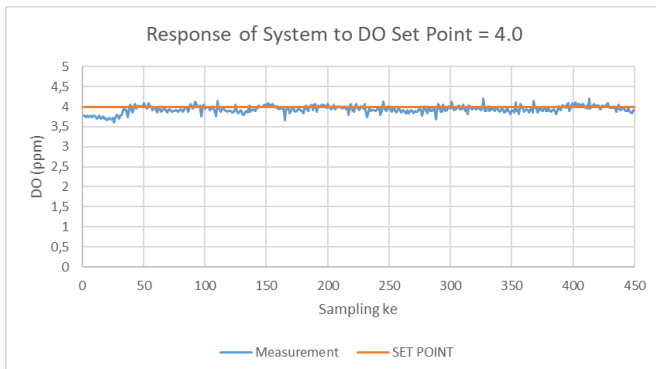

Fig. 18 Response of system in measuring DO to set point of 4.0ppm

Furthermore, testing of the sensor system in water is carried out to find out the sensor response of the probe Fig. 14 displays the sensor probe response for 2 minutes with a sampling period of 110ms. It can be seen that a stable reading is obtained for 2 minutes. The reading process is long enough because the diffusion process between oxygen and membrane requires time to ionize.

The test of response sensor toward air pump is also conducted for 2 minutes as seen in Fig. 15. As results, the dissolved oxygen is increased significantly in the opening minutes and experienced saturation at a voltage of 2.18 volts. The data to 204, the DO meter value reaches to the saturation. Then, when the air pump is shut down for 2 minutes from the initial 2 volt and saturation is 3.1 volt, it was found that the dissolved oxygen requires long time to decrease or vanish after being given an air pump as seen in Fig. 16.

Finally, the overall system test is performed to determine the performance of the dissolved oxygen control system that has been made. The values of dissolved oxygen readings are recorded for 4.5 minutes with set points of dissolved oxygen valued at 3.5, 4.00, 4.5, 5.00 ppm. Figure 17 shows the system response in achieving the setting point value of 3.5ppm, it can be seen that the dissolved oxygen value reaches the setting point at the 50<sup>th</sup> sampling (30 seconds) but not yet in the steady state due to the reading process of the device. The steady state occurs at sampling 100 or for 1 minute. The sampling period on this system experiment is 600ms. Figure 18 shows the system response in achieving the setting point value of 4.0ppm, it can be seen that the dissolved oxygen value reaches the setting point at the 50<sup>th</sup> sampling or for 30 seconds. In this experiment the system is faster in reaching the steady state. Figure 19 shows the system response in achieving the setting point value of

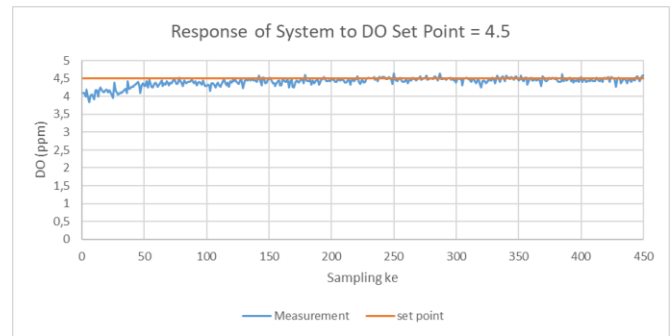

Fig. 19 Response of system in measuring DO to set point of 4.5ppm

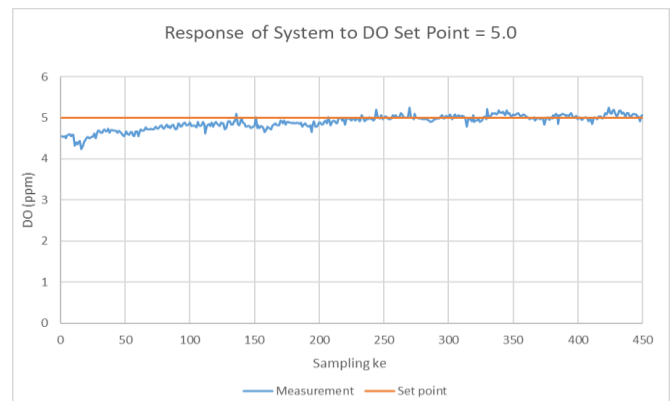

Fig. 20 Response of system in measuring DO to set point of 5.0ppm

4.5ppm, it can be seen that the dissolved oxygen value reaches the setting point at the 80<sup>th</sup> sampling or for 48 seconds but the steady state occurs at 72 seconds. Figure 20 shows the system response in achieving the setting point value of 5.0ppm, it can be seen that the dissolved oxygen value reaches the setting point at 150 sampling or for 84 seconds. The steady state response occurs at sampling 160 or for 96 seconds which is longer. because dissolved oxygen levels approach the saturation value of 5.8 ppm.

## V. CONCLUSION

In this research, a dissolved oxygen regulation system using fuzzy logic method based on teensy board microcontroller is designed. The result of measurement of the system shows that the measured oxygen value measured between 2.3 and 5.8 ppm with the average error reading is 0.075%. The longest system response requires 1 minute to reach the desired oxygen level according to the setting point.

## ACKNOWLEDGMENT

We thank to Lembaga Penelitian dan Pengabdian Kepada Masyarakat (LPPM) Institut Teknologi Sepuluh Nopember (ITS) Surabaya for the financial aid support, and thank to the Kementerian Riset, Teknologi dan Pendidikan Tinggi Republik Indonesia.

## REFERENCES

- [1] Wibisono, G.A., "Investment Feasibility Study Catfish Breeding Fisheries Development in the Perspective of Supply Chain Management (*Studi Kelayakan Investasi Pembuatan Perikanan Pembibitan Ikan Lele Dalam Perspektif Supply Chain Management*)", Fakultas Sains dan Teknologi Universitas Islam Negeri Sunan Kalijaga, Yogyakarta, 2012
- [2] Yosanto, R.A., "Hatchery and Enlargement of Sangkuriang Clarias catfish sp. in the Wonocatur Cangkringan Freshwater Cultivation

- Sleman Yogyakarta (*Pembenihan dan Pembesaran Ikan Lele Sangkuriang Clarias sp. Di Unit Kerja Budidaya Air Tawar Wonocatur Cangkringan Sleman Yogyakarta*), Institut Pertanian Bogor, Bogor, 2015
- [3] Yusvarina, M., Sumarna., "Design of Oxygen Level Control System in Water at Pearl Catfish Hatchery Pond in Freshwater Cultivation Work Unit (UKBAT) Wonocatur Cangkringan, Sleman, Yogyakarta (*Rancang Bangun Sistem Kontrol Kadar Oksigen di Dalam Air Pada Kolam Pembesaran Ikan Lele Mutiara di Unit Kerja Budidaya Air Tawar(UKBAT) Wonocatur Cangkringan, Sleman, Yogyakarta*)", Jurnal Universitas Negeri Yogyakarta, Vol 5, No.7, 2016
- [4] Urbasa, P.A., "Impact of Water Quality on Fish Cultivation with Tancap Nets in Toulimembet Village Lake Tondano (*Dampak Kualitas Air Pada Budi Daya Ikan Dengan Jaring Tancap di Desa Toulimembet Danau Tondano*)", Jurnal Budidaya Perairan, Vol. 3 No. 1: 59-67, jan 2015
- [5] Fujaya, Y., 2002. "Fish physiology: the basis for developing fisheries technology (*Fisiologi ikan: dasar pengembangan teknologi perikanan*)", Diterbitkan oleh Direktorat Jenderal Pendidikan Tinggi Depdiknas, Jakarta, 2002
- [6] Macqy, G., Pajarillo, J., Tenorio, J.E., Trambulo, E.M., Apsay, M.R.B., Chua, M.G., "Development of Dissolved Oxygen Monitoring System for Fish Ponds", IEEE 3rd International Conference on System Engineering and Technology, Malaysia, 19 - 20 Aug 2013
- [7] Zulkarnain, M.R., "River Water Quality Monitoring System Equipped with Data Loggers and Wireless Communication as A Liquid Waste Pollution Monitoring Media (*Sistem Monitoring Kualitas Air Sungai Yang Dilengkapi Dengan Data Logger Dan Komunikasi Wireless Sebagai Media Pengawasan Pencemaran Limbah Cair*)", Prosiding Undergraduate Theses of Electrical Engineering, RSE 621.384 Zul s, Surabaya, Juni 2015
- [8] Resmana, Ferdinando., Thiang, Widagdo A.S., "Fuzzy Logic Implementation in Microcontrollers for DC Motor Rotation Control (*Implementasi Fuzzy Logic Pada Microcontroller Untuk Kendali Putaran Motor DC*)", Proceedings, Industrial Electronic Seminar, Surabaya, Oktober 1999
- [9] Masri'an., "Control of Webcam Orientation as a Room Controller with Fuzzy Control Method (*Pengendalian Orientasi Webcam Sebagai Pengawas Ruangan Dengan Metode Kontrol Fuzzy*)", Prosiding Undergraduate Theses of Electrical Engineering, Semarang, Januari 2011
- [10] Hidayati, Q., Prasetyo, M.E., " DC Motor Setting by Using a Fuzzy-PID Based Microcontroller (*Pengaturan Motor DC dengan Menggunakan Mikrokontroler Berbasis Fuzzy-PID*)" Jurnal Teknologi Terpadu, No.1 Vol. 4, Balikpapan, 2016
- [11] PJRC Electronic Project Components Available Worldwide, "Teensy 3.2 New Features", <URL: <https://www.pjrc.com/teensy31.html>>, 2014