

REPORTS FROM OBSERVERS

The Deep Near-Infrared Southern Sky Survey (DENIS)

N. EPCHTEIN, B. DE BATZ, L. CAPOANI, L. CHEVALLIER, E. COPET, P. FOUQUÉ, F. LACOMBE, T. LE BERTRE, S. PAU, D. ROUAN, S. RUPHY, G. SIMON, D. TIPHÈNE, Paris Observatory, France
 W.B. BURTON, E. BERTIN, E. DEUL, H. HABING, Leiden Observatory, Netherlands
 J. BORSENBARGER, M. DENNEFELD, F. GUGLIELMO, C. LOUP, G. MAMON, Y. NG, A. OMONT, L. PROVOST, J.-C. RENAULT, F. TANGUY, Institut d'Astrophysique de Paris, France
 S. KIMESWENGER and C. KIENEL, University of Innsbruck, Austria
 F. GARZON, Instituto de Astrofísica de Canarias, Spain
 P. PERSI and M. FERRARI-TONIOLO, Istituto di Astrofisica Spaziale, Frascati, Italy
 A. ROBIN, Besançon Observatory, France
 G. PATUREL and I. VAUGLIN, Lyons Observatory, France
 T. FORVEILLE and X. DELFOSSE, Grenoble Observatory, France
 J. HRON and M. SCHULTHEIS, Vienna Observatory, Austria
 I. APPENZELLER AND S. WAGNER, Landessternwarte, Heidelberg, Germany
 L. BALAZS and A. HOLL, Konkoly Observatory, Budapest, Hungary
 J. LÉPINE, P. BOSCOLO, E. PICAZZIO, University of São Paulo, Brazil
 P.-A. DUC, European Southern Observatory, Garching, Germany
 M.-O. MENNESSIER, University of Montpellier, France

1. The DENIS Project

Since the middle of 1994, the ESO 1-metre telescope has been dedicated on a full-time basis to a long-term project whose main objective is to survey the entire southern sky in 3 bands of the near-infrared regime, namely I, J, and K_s. The routine observations of the DENIS project began in December 1995, after a long period of tests of the instruments and telescope optics, observational pilot programmes, and an unexpected delay due to the implementation of the new read-out electronics of the I channel.

Extensive catalogues of stars, galaxies, and other celestial objects constitute a fundamental tool of astronomy. Statistics of any class of objects requires data as complete and as well-calibrated as possible. Before making any deep investigation of a particular region, a large-scale map of the surrounding area is essential to establish the general context. For these simple reasons, the sky has been surveyed at almost all wavelengths accessible from the Earth's surface and for which the appropriate technology is available; and soon after man had escaped the Earth's atmosphere, or discovered new ways of detecting radiation thus unveiling new spectral ranges, explorations quickly commenced in quest of new

celestial objects and unknown physical processes.

The 2.2-micron window is of particular astrophysical interest. It is the longest wavelength window not much hampered by extinction in the Earth's atmosphere, and is also a band quite free of background thermal emission. The interstellar medium is quite transparent at 2.2 microns. The astrophysical importance of the band lies in the fact that this wavelength corresponds to the maximum in the emission spectrum of evolved stars.

At the end of the 1980's, it had become clear that an all-sky survey was technically possible which would yield an improvement by more than 4 orders of magnitude in the K band, at 2.2 microns, over what had been achieved by the extraordinarily valuable Two-Micron Sky Surveys (TMSS) (Neugebauer and Leighton, 1969). Obviously, crucial was the release from military classification of infrared detectors suitable for astronomical work; also important were the advances in computer technology which would allow the enormous amount of data to be processed and distributed in a feasible manner.

Two major efforts to map the infrared sky began more or less simultaneously. In Europe, several laboratories, under the leadership of the Paris Observatory in Meudon, started to consider pooling

efforts which led to a proposal for the DENIS project, aimed at covering the entire southern sky from the ESO site at La Silla, making full-time use of the ESO 1-metre telescope. In the US, following the initiatives of the University of Massachusetts, the 2MASS project was put forward, which proposed to use two custom-built telescopes to observe both hemispheres of the sky. Operating with somewhat different wavelength bands, and in particular without the CCD-camera coverage of the I band, the 2MASS project is in some ways complementary and in other ways competitive with the DENIS survey of the southern sky.

Although not originally designed for infrared observations, the ESO 1-metre telescope has been used successfully over a two-decade period to carry out photometric observations from 1 to 20 microns. In fact, many of the most well-known "infrared objects" populating the southern sky, including very young massive stars, extreme AGB stars, active galactic nuclei, and actively star-forming systems, were discovered with this instrument.

The DENIS efforts started in earnest in 1990 to generate the necessary funds and manpower. The French Education Ministry provided the initial funding which supported the preliminary feasibility studies. The *Département de Recherche Spatiale* of Paris Observatory at

Meudon had established expertise in building IR cameras during the CIRCUS and ISOCAM short-wavelength projects, and this allowed a prompt design of the two DENIS infrared cameras. At the same time, several European laboratories pooled their manpower resources and technical expertise to propose a project which was first granted funding within the context of the *Science* plan of the European Commission, then subsequently as a network in the *Human Capital and Mobility* programme.

The ambition of the DENIS project is to produce the first directly-digitised astronomical sky survey, and the largest infrared star catalogue ever produced. It is a long-range project that will extend over the full decade of the 1990's, from the initiation of the design studies to the final exploitation of the data. The basic DENIS objective is to explore the entire sky at $\delta < +2^\circ$ in three spectral bands of the near-infrared, namely the I, J, and K_s , bands centred at 0.85, 1.25, and 2.15 μm , respectively. DENIS will thus produce and deliver to the community a set of fundamental astronomical documents, including a point-source catalogue of almost 1 billion stars in the I band, an extended-source catalogue containing some 250,000 galaxies, and an atlas of 1 million elementary images of $12' \times 12'$ size, in three colours. This material, which will amount to some 4 Terabytes of data, will be of direct value and will also support statistical investigations (star and galaxy counts) in a newly explored spectral range; it will also support the preparation and subsequent exploration of the planned and on-going space missions such as the Infrared Space Observatory (ISO) mission of the European Space Agency, the Near-Infrared Camera and Multi-Object Spectrometer (NICMOS) project on the Hubble Space Telescope, and the Space Infrared Telescope Facility (SIRTF), as well as ground-based projects including in particular some of those to be carried out with the ESO Very Large Telescope.

The DENIS material will support a range of investigations in several important astronomical fields, including those dealing with the structure of our galaxy, specifically with the distribution of various stellar populations, the investigation of the missing mass in our galaxy, the formation and evolution of stars, and the local structure of the Universe.

The DENIS project incorporates state-of-the-art technologies in several different areas, including IR-array detectors, electronics, real-time computing, and data-base management, each of which require a different sort of expertise. For this reason, the design and implementation of the DENIS project has required the pooling of funding and human resources in a number of different European institutes. No less than 20 institutes, located in 8 coun-

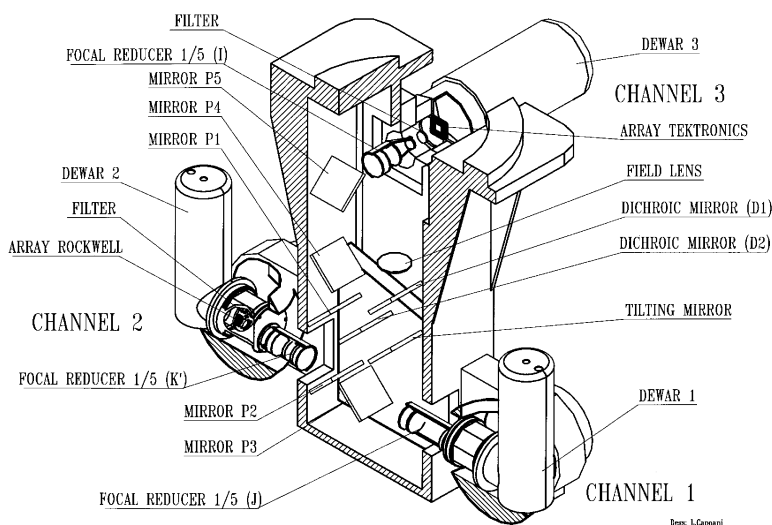

Figure 1: Sketch of the DENIS focal instrument (from L. Capozzi).

tries¹, are involved in the DENIS project, together with the European Southern Observatory (ESO). The technological requirements and the realities of the funding problems have led to a somewhat cumbersome organisational structure, but has had the advantage of stimulating new collaborations for the scientific exploitation of the data.

¹ Contributing countries and institutes are Austria (Universities of Innsbruck and Vienna) Brazil (University of São Paulo), France (Paris, Lyon, Grenoble and Besançon Observatories and Institut d'Astrophysique de Paris), Germany (Landessternwarte, Heidelberg), Hungary (Konkoly Observatory, Budapest), Netherlands (Leiden Observatory), Italy (Istituto di Astrofisica Spaziale, Frascati) and Spain (Instituto Astrofisica de Canarias).

2. The DENIS Instrument and the Observing Strategy

The DENIS focal instrument is a completely new and specially designed 3-channel camera including its dedicated data-handling system (Fig. 1, Fig. 2). It consists of 3 independent cameras attached to a main structure that is set up at the Cassegrain focus of the 1-metre telescope. The I-band camera is equipped with a Tektronix array of 1024×1024 pixels; the J- and K_s -band cameras are each outfitted with Rockwell NICMOS-3 detector arrays of 256×256 pixels. Installing such a substantial instrument at the focus of a relatively small

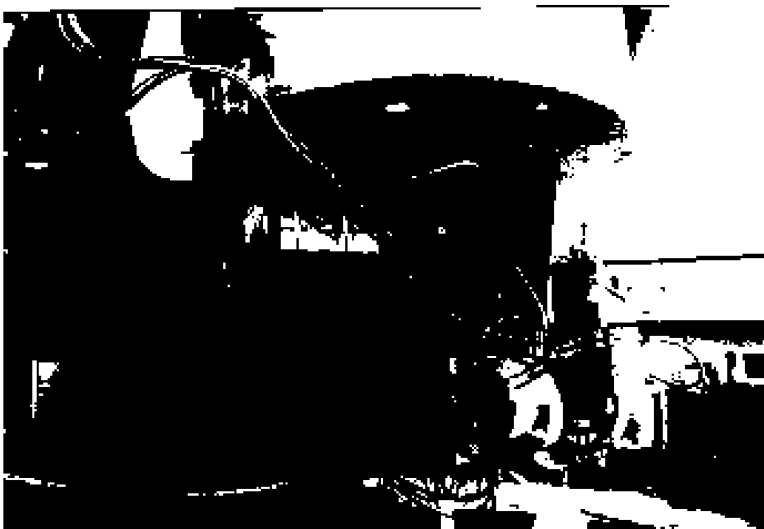

Figure 2: The DENIS focal instrument installed at the Cassegrain focus of the 1-metre telescope at La Silla. The stainless steel dewar seen on the left of the main structure contains the CCD array. The infrared NICMOS arrays are set up in 2 cryostats, one of which (K band) is seen on the right of the picture (blue vertical cylinder), the other is hidden by the structure. Part of the read-out electronics is hanging on the fork of the telescope.

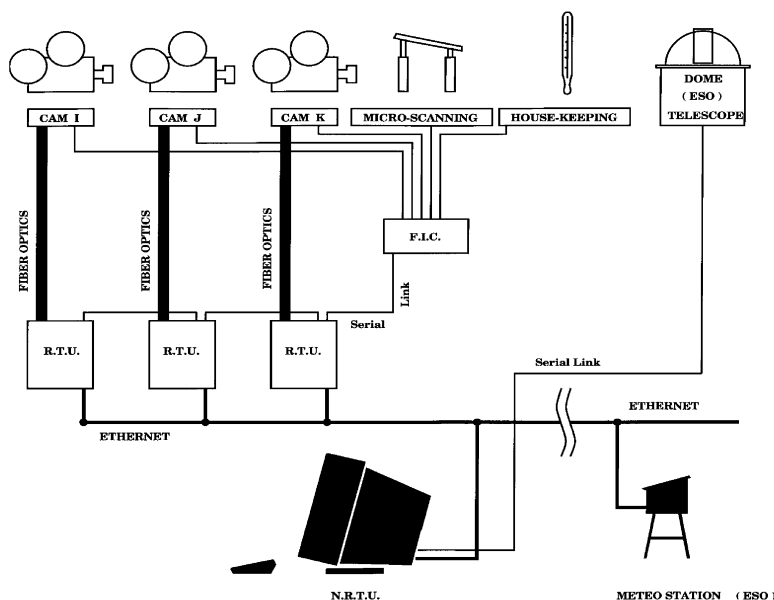

Figure 3: The DENIS computer network (from F. Lacombe).

telescope was quite challenging; for example, due to weight limitations, the main instrumental structure had to be made of magnesium. The $f/15$ beam coming from the telescope is split into three beams, corresponding to the three survey wavelengths, using dichroic beam splitters. Three focal reducers, each optimised for the respective wavelengths, transform the $f/15$ focal ratio to $f/3$. They provide a field of view of $12' \times 12'$ on the sky for the three arrays and a scale of $3''$ per pixel on the J and K_s channels and $1''$ on the I channel. A microscanning mirror is inserted in the infrared beams which can be tilted by piezoelectric actuators in the right ascension and declination directions in small steps corresponding to fractions of pixels.

The purpose of this microscanning mirror is to optimise the sampling of the J and K_s images and to minimise the effect of bad pixels on the NICMOS arrays. An elementary DENIS image in the J and K_s bands results from combining and interlacing 9 sub-images obtained by moving the microscanning mirror by $1/3$ of a pixel in α and $2^{1/3}$ pixels in δ , in both negative and positive directions. Because of this optimised sampling of the DENIS images, each of the three channels is characterised by similar astrometric accuracy, of the order of $1''$.

The DENIS project will survey the entire sky between $\delta = +2^\circ$ and -88° . The sky-coverage strategy involves dividing the sky into three zones, each covering 30° of declination; each zone is itself divided into narrow *strips*, $12'$ wide in α and $30'$ long in δ . Each strip is scanned by moving the telescope in the so-called *step and stare mode*. The

integration time on each position of the telescope is approximately 10 seconds; after this duration, the telescope is moved $10'$ in declination in order to allow for an overlap of $2'$ between two consecutive images. One strip contains 180 images of $12' \times 12'$ and takes approximately 1.5 hours to be completed. This includes the time spent on photometric and astrometric calibrations and the overhead delays required by the movement and stabilisation of the telescope, by the data read-out of the cameras, by data transfer between computers, as well as by the actions of shutters and filter wheels. Flat-fielding observations are performed in the three colours at dusk and at dawn.

The data handling at the telescope is controlled by three "Real-Time Units" (RTU), one per channel, each consisting of a pair of 68040 processors. A special processor (the Focal Instrument Con-

troller or FIC) controls the hardware (including filter-wheel rotation on the IR channels, the movement of the CCD shutter and microscanning mirror, etc.) as well as general housekeeping (including temperature probes, etc.) and the sequence of observations. Finally, an HP 9720 workstation (NRTU) is used as the observer interface; it manages the survey strategy automatically, by choosing the right strip to be observed at a given time, and displays all necessary information regarding telescope control and the status of the survey. This workstation is also interfaced with the HP 1000 of the Telescope Control System (TCS) (see Fig. 3).

The focal instrument was designed and constructed under the leadership of the *Département de Recherche Spatiale* of Paris Observatory at Meudon, where D. Rouan, D. Tiphène, F. Lacombe, B. de Batz, N. Epchtein, L. Capoani, S. Pau and E. Copet contributed to the design and implementation of the hardware and software, and in partnership with the *Institut d'Astrophysique* in Paris, where J.C. Renault served as project manager. The *Istituto di Astrofisica Spaziale* in Frascati, Italy, the *Instituto Astrofísica de Canarias* in Spain, and the Observatories of Lyon and Haute-Provence in France, each contributed optical and mechanical parts for the focal instrument. The real-time data-handling software was implemented by a collaboration between F. Lacombe at the Meudon Observatory, S. Kimeswenger at the University of Innsbruck, and T. Forveille at the Grenoble Observatory.

A preliminary version of the DENIS instrument, equipped only with the J and K_s channels, was mounted on the ESO telescope for the first time in December 1993. The I-band CCD channel was delivered to La Silla in July 1995, and put in full operation soon after. The performance characteristics (see Table 1) of the cameras are in agreement with the design specifications. During

TABLE 1: Characteristics of the DENIS Channels.

Channel	I	J	K_s
Central wavelength (μm)	0.80	1.25	2.15
Array manufacturer	Tektronix	Rockwell	Rockwell
Number of pixels	1024×1024	256×256	256×256
Array quantum efficiency	0.65	0.81	0.61
Pixel size (μm , arcsec)	24, 1	40, 3	40, 3
Number of bad pixels	a few	216	254
Largest defect (pixels)	none	16	73
Read-out noise (e^-)	6.7	38	39
Read-out time (second)	2.98	0.13	0.13
Exposure time (second)	9	8.8	8.8
Storage capacity (e^-)	1.510^5	2.010^5	2.010^5
Achieved limiting magnitude (point source 5σ)	18.0	16.0	13.5
Magnitude of saturation	10.3	8.0	6.5

DENIS DATA PROCESSING and ARCHIVING

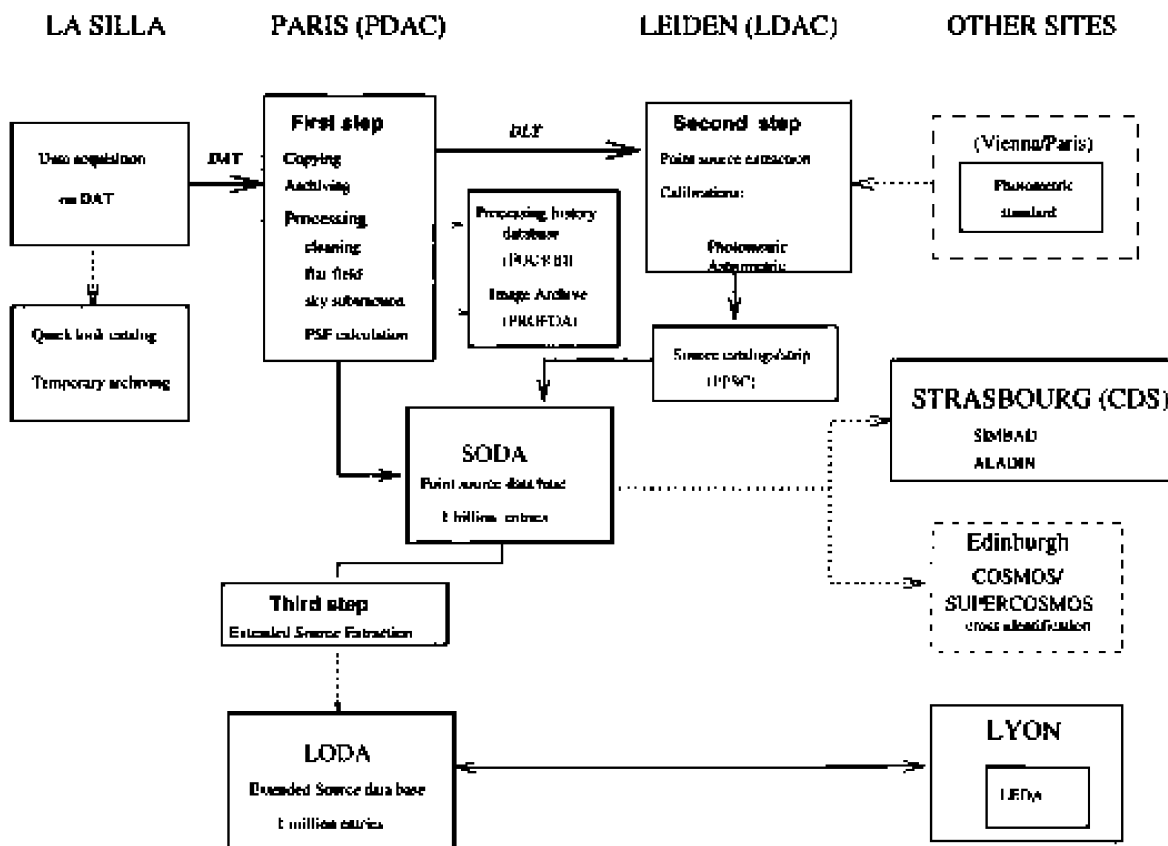

Figure 4: The DENIS data pipeline. Users will access the image archives (PROFIDA) that will be installed on a jukebox of DLTs at PDAC, and the source catalogues in the SODA and LODA databases. The FOURBI database already provides the consortium members with information on the current status of observations (observed areas). The connections with the CDS in Strasbourg and ROE are under discussion.

the commissioning phase, hardware subsystems and software were tested and improved in order to optimise the image quality, the data reduction procedures, and the survey strategy. Because no major change in the instrumental configuration nor in the survey strategy will be possible during the lifetime of the survey, in order to ensure homogeneity of the data, all the parameters that define this strategy were carefully reviewed during the commissioning phase of the project.

The series of pilot-programme observations (*protosurvey*) of selected areas of the sky chosen for specific scientific reasons, has been fully completed and has resulted in a sky coverage of about 2000 square degrees, in either two or three colours, depending on whether the pilot programme in question was completed before or after the CCD channel had been installed. Scientific analysis of these data is now underway (see section 5).

3. The Off-Site Data-Analysis Centres in Leiden and in Paris

The data processing and archiving is performed as a joint task between the Paris Data Analysis Centre (PDAC), operating out of the *Institut d'Astrophysique* and the Paris Observatory under the supervision of J. Borsenberger, and the Leiden Data Analysis Centre (LDAC) operating at the Leiden Observatory under the supervision of E. Deul. The data pipeline is schematised in Figure 4.

The PDAC is responsible for archiving and preprocessing the raw data in order to provide a homogeneous set of images suitable for the subsequent data-analysis streams in both Leiden and Paris. The LDAC is extracting objects, ranging from point sources to small extended sources, and then parameterising them and entering the results into an archive constituting a preliminary point source catalogue (PPSC). The PDAC also extracts and archives

images for those sources found to be extended, and will thus create a catalogue of galaxies. Both DAC's are working in close collaboration, supplementing each other, to perform a coherent and complete data reduction analysis task.

3.1 The Paris Data Analysis Centre (PDAC)

The PDAC performs a number of steps necessary to prepare the data for further processing and analysis. The steps involve the flat-fielding and sky-emission corrections of the strip images using flat-fields derived during the real-time processing on the mountain and through sunrise/sunset observations. Subsequently, a sorting of the frames is done to obtain colour-grouped sets of data for each pointing position. At PDAC, the incoming data stream is inspected thoroughly to assess the quality of each and every image of the strips.

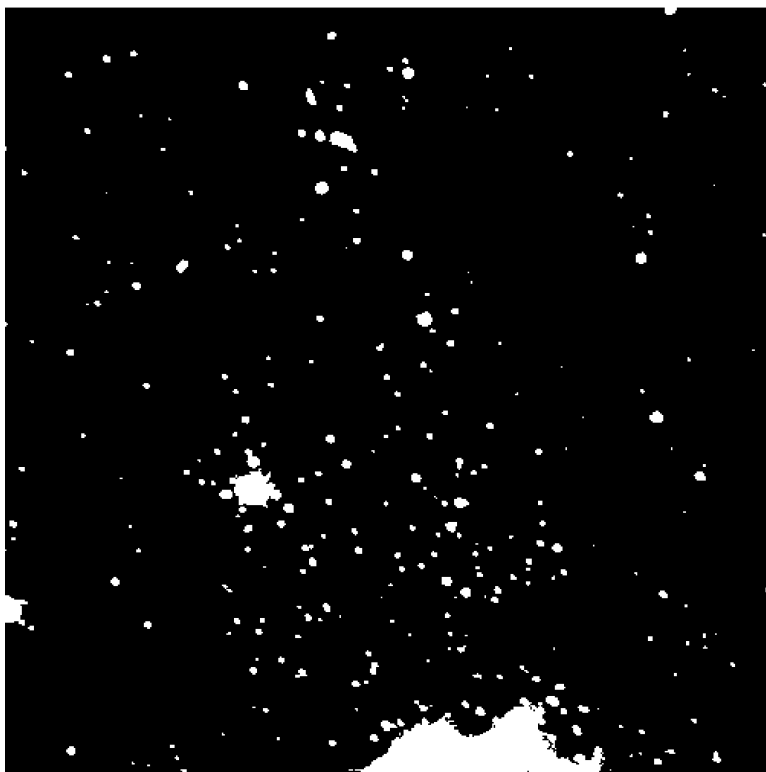

Figure 5: DENIS image of the molecular cloud OMC2 as seen in J and K_s (false colours, blue = J, red = K_s , processed by E. Copet).

This information is relayed back to La Silla to allow re-observations when necessary. This procedure ensures a homogeneous survey.

The processed frames (strips) are stored in the Processed Frame Database (PROFDA) and also sent to the LDAC for further processing. The PROFDA will allow mosaicking the individual images. Access to the PROFDA is provided through a database produced and maintained at the PDAC. This database allows verification of the observing strategy goals aimed at full mapping of the southern sky, and also keeps track of the data quality and storage administration.

Upon return of source and calibration information from LDAC, the PDAC examines the processed frames for extended objects. These non-stellar objects are parametrised and archived in the extended-source database. For each extended object a postage stamp image is extracted and stored.

3.2 The Leiden Data Analysis Centre (LDAC)

The LDAC concentrates on the extraction of "small objects" from the DENIS images, at all three wavelength bands. Production of a catalogue is done during the course of the survey data acquisition and should result in an

incremental first-order data product tracing the observations with a delay period of approximately one year. Access to the "protosurvey" data is open to the DENIS Science Working Groups.

The derivation of object parameters is based solely on image properties; no *a priori* astronomical information will enter this catalogue. Object parameters are corrected for instrumental effects in the final catalogue. Apart from the usual extraction parameters, information about the local image environment and extraction characteristics are also retained. All objects above the $5\text{-}\sigma$ noise level are extracted. The objects are de-blended and their positions calculated using the frame centres and plate parameters computed with the help of cross-identifications with the DENIS Input Catalogue sources. In order to improve the positional accuracy, strip wide astrometric solutions are computed utilising the overlap information inherent to the observing strategy. The small objects are photometrically calibrated using a set of DENIS standards widely distributed over the southern sky. The list of standard stars used for DENIS has been divided into two parts, one for the I band and the other for the J and K bands. The I-band standards come from the set of UBVRI standards used at ESO and at CTIO (Landolt, 1992). For the J and K bands, a list of standards has

been compiled from those in use at CTIO, ESO, MSSSO, SAAO, and UKIRT. At LDAC, a working database stores all the raw and derived extraction parameters along with the most recent calibration parameters. At regular intervals, the raw information is transformed into astronomically meaningful parameters using the best available calibration.

3.3 Quality estimates and final databases

The photometric accuracy of the DENIS data can be assessed using the photometric standard stars as a local reference frame. The standard deviation in the photometric parameter derived from the protosurvey data shows that high accuracy is achieved over a large range in magnitudes. The photometric accuracy of the object extraction (rms error) has been shown to be about 0.03 mag, just below the saturation limit, and 0.02 mag at the faint cut-off. The DENIS instrument has so far been very stable in time. As a result of the large amount of data produced by DENIS, we will define our own photometric system and provide transformation formulae to most other standard photometric systems. Our system, however, will increase in accuracy with time and can only be finalised at the end of the survey.

The positional accuracy is influenced mainly by the systematic errors of the GSC, which on average are about $1''$. In fact, the DENIS input catalogue used is a combination of several catalogues, the GSC v1.2, the PPM catalogue, the HIPPARCOS input catalogue and eventually also the Tycho catalogue, each appropriately weighted in the astrometric solution. The relative rms errors (within a DENIS frame) are of the order of $0.1''$. After the TYCHO catalogue becomes available (we expect one TYCHO star per DENIS frame), the positional errors can be reduced to a few tenths of arcseconds. Current positional errors are about $0.3''$. Once the data have passed the quality tests, they will be gathered into final databases, one containing the small sources (SODA) the other the extended sources (LODA). These databases will result from a collaboration between both DACs and the CDS in Strasbourg. Cross-identifications with the optical SUPERCOSMOS data are also envisaged to eventually provide 5-colour photometric catalogues.

4. DENIS Operations in Chile

The survey operations in Chile involve a major effort, requiring the presence of at least one person every night, all the year round, at the observing site for an expected total duration of ≈ 4.5 years. The project maintains a dedicated team, resident in Chile and now fully operational. The team involves a survey

astronomer, P. Fouqué, who supervises the observations; an operations engineer, formerly B. Jansson; and a young scientist, generally a French "coopérant", E. Bertin for the 1994–95 year, P.-A. Duc for the 1995–96 year, and presently R. Moliton. In addition, visiting astronomers and engineers come from Europe to reinforce the local staff, to make urgent hardware or software modifications, and to provide the necessary link between the operations in Chile and the data analysis centres in Paris and Leiden.

The mountain operations are conducted under the responsibility of the survey astronomer. All commissioning tests have been done under his supervision in close interaction, via daily e-mail connections, with the instrument team based in Meudon and with the two data analysis centres. The primary responsibilities of the operations engineer involve maintenance of all aspects of the instrumentation, mainly the electronics and hardware devices; as with any new and complex instrument, maintenance of the complete DENIS facility is an important and demanding task.

5. First Scientific Results from the DENIS Project

5.1 Organisation of the scientific data analysis

The scientific interpretation of the data obtained during the pilot-survey period has now started, under the responsibility of five dedicated Science Working Groups set up for this purpose. They involve astronomers from the different institutes of the consortium, including a number of graduate students and post-doctoral fellows, several of whom are supported by the European Community through a network of the *Human Capital and Mobility* programme, as well as through other individual and institutional fellowships. The five working groups are dedicated to the principal areas to which DENIS is expected to contribute: (i) late-type and AGB stars, chaired by H. Habing, Leiden; (ii) low-mass stars, chaired by T. Forveille, Grenoble; (iii) galactic structure, chaired by A. Robin, Besançon; (iv) star formation, chaired by P. Persi, Frascati; and (v) extragalactic systems and cosmology, chaired by G. Mamon, IAP, Paris.

A data-release policy group (DRPG) defines and regulates the access to the data and the authorship of the publications. The main rule is in accordance with ESO policy, that once the data have been processed and certified regarding quality, they are put at the disposal of the consortium members for the duration of one year after archival in the DACs; subsequently the data are released to the community at large. The first such general release of DENIS data is expected in spring 1997. The DENIS consor-

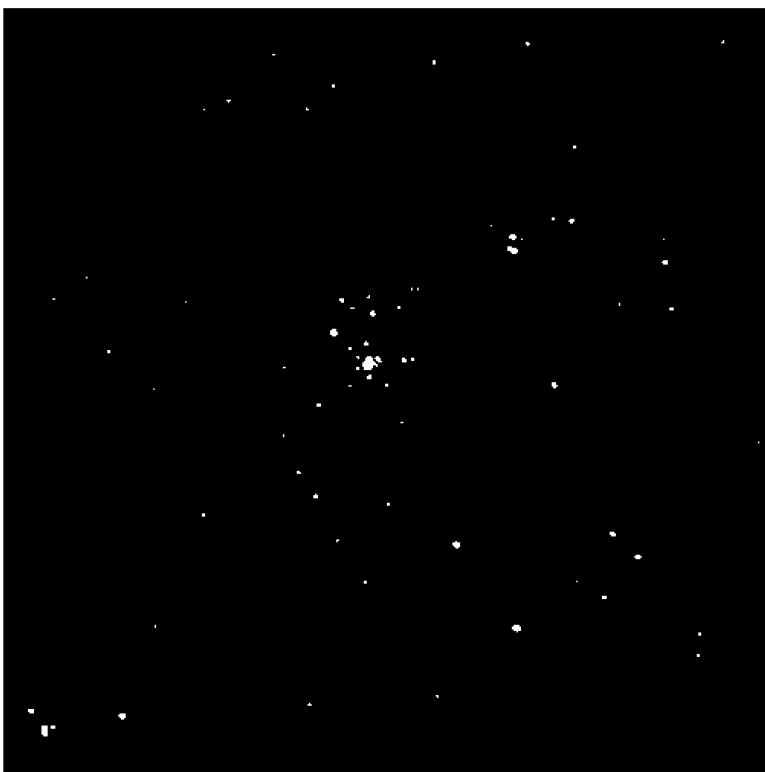

Figure 6: DENIS two-colour (J , K_s) image of the Tarantula Nebula in the Large Magellanic Cloud (false colours, blue = J , yellow = K_s , processed by E. Copet).

um has been actively pursuing its goals. Twice a year progress review meetings are held, involving the entire consortium and chaired by the PI. More frequently, in practice at least five times a year, the data processing specialists meet in Data Analysis Meetings, or DAMs, chaired by E. Deul, in order to discuss and optimise the data processing techniques and methods. The DENIS project has been the focus of several national and international conferences. A *Les Houches School* was held on the subject of Science with Astronomical Near-Infrared Surveys (Epchtein et al., 1994). Two Euroconferences, supported by a grant from the EC, have been dedicated to presenting and discussing the first scientific results from DENIS. The first of these was organised in Italy (Persi et al., 1995), and the second in Spain (Garzon et al., 1997). Several scientists from 2MASS and IPAC have participated in these workshops, thus maintaining contacts and collaborations between the two infrared survey projects.

A couple of DENIS images obtained during the now-routine period of observations are shown in Figure 5 and Figure 6. These images illustrate the quality of the data and the results of the reduction pipeline; the images involve the nominal integration times of 10 seconds, and each represents a field of $12' \times 12'$ area.

Several Ph.D. theses based on the exploitation of DENIS data acquired during the protosurvey period have been recently defended or are currently in progress. Eric Copet (Meudon, DESPA), the first graduate student involved in DENIS since its beginning, in addition to contributing to the implementation of parts of the real-time data handling software, studied the luminosity function of young stars in the Orion region based on the early DENIS observations. He investigated the nature of some 2000 objects detected in J and K_s in an area covering $2^\circ \times 0.5^\circ$ around the Trapezium (Copet, 1996). Most of them are likely to be associated with the Orion complex. Stephanie Ruphy (Meudon, DESPA), has performed large-scale DENIS star counts, mainly in J and K_s , in various directions of the Galaxy, and compared them with the predictions of currently available models of stellar populations synthesis. She is particularly involved in a study of the anticentre direction. In these directions, all current existing models disagree with DENIS star counts in the sense that there are fewer stars observed than the models predict. At low galactic latitudes, colour diagrams are successfully used to separate giant and dwarf stellar populations (Fig. 7) (Ruphy, 1996). New revised values of the scale length and of the cut-off distance of the

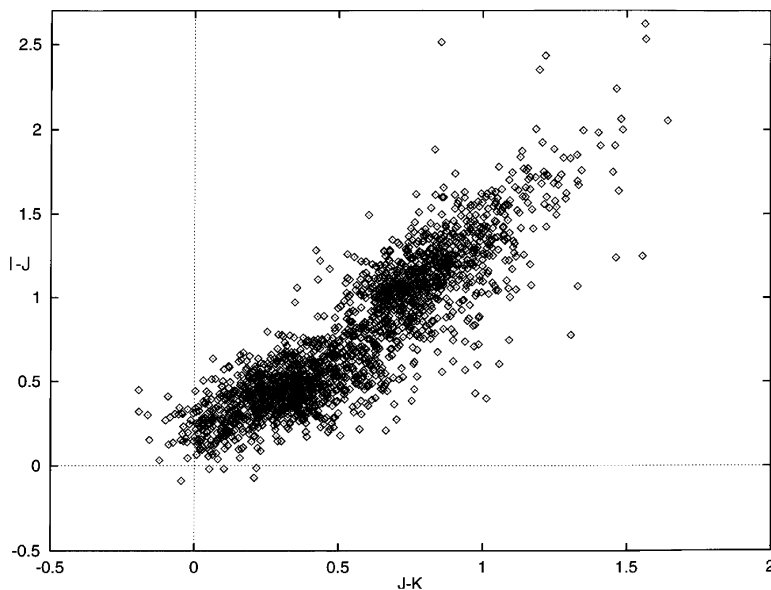

Figure 7: DENIS colour-colour diagram of ≈ 3800 point sources detected in an area of one half square degree at $b = 1^\circ$ and $l = 238^\circ$ at $K < 13.5$. This diagram shows two main concentrations of sources, the blue one corresponds mainly to dwarf stars and the redder one mainly to giants. At low latitude, the interstellar extinction efficiently separates the two populations.

stellar distribution in the Galaxy have been derived (Ruphy et al., 1996).

Another study in progress involves a search for low-mass stars at high galactic latitudes. Xavier Delfosse, at Grenoble, is preparing a Ph.D. thesis based on the analysis of DENIS images taken far from the galactic disk. A first analysis of several tens of strips at high galactic latitude resulted in the discovery of several very late (M8 to M10) red dwarfs. Other results have been already obtained by Y. Dabrowski who has combined DENIS images with optical data coming from Schmidt plates digitised with the COSMOS machine (Fig. 8). Most of the DENIS source extractions were done using the *sextractor* software developed by Emmanuel Bertin.

Extensive investigations involving the combination of DENIS and ISO images have already started. A. Omont (IAP, Paris) is leading a large-scale ISO open-time programme, entitled "ISOGAL" and aimed at probing the galactic bulge populations at 7 and 15 μm . Several areas located in the range $+45^\circ > l > -45^\circ$ and $|b| \leq 0.5^\circ$ are currently being observed by ISO and by DENIS almost simultaneously, giving a wide spectral coverage and allowing much easier population separation in colour-colour diagrams (Perault et al., 1996). Other DENIS and ISO collaborations have begun, aimed e.g. at exploring nearby star formation regions, and the evolved giant and supergiant populations of the Magellanic Clouds. P. Persi (IAS, Frascati) and collaborators are studying the star-formation rate in several nearby molecular clouds such as the Chameleon clouds. L. Cambresy

is drawing out a high spatial resolution and large-scale mapping of the extinction towards this nearby dust and molecular complex on the basis of star counts and $[I - K]$ reddening. C. Loup and collaborators are characterising the

DENIS colours of late-type giants (e.g., O-rich vs. C-rich) and identifying new such stars in the Magellanic Clouds.

Gary Mamon (IAP, Paris) and his collaborators have made simulations for star-galaxy separation and have estimated that the number of galaxies that will be detected by DENIS in the K_s band would be around 250,000, while in the I band, this number could be close to 1 million. As an illustration of the capability of detecting reddened galaxies in the Zone of Avoidance, an edge-on galaxy, IRAS 07395-2224, as seen by DENIS in its three bands is shown in Figure 9. Although the galaxy is barely seen on Schmidt plates (SRCJ) and is still rather faint in I, it appears prominently in K_s , where the density of field stars is much lower. A long-range programme to detect highly-obscured galaxies in the Zone of Avoidance is planned in collaboration with Renée Kraan-Korteweg (Meudon). G. Patrel and I. Vaugin from Lyon Observatory are currently cross-identifying DENIS sources with the galaxies of the Lyon-Meudon Extragalactic Data Base (LEDA) using the deep I images, and are drawing up a list of still uncatalogued galaxies detected by DENIS. Thousands of new galaxies have been already identified on the DENIS images.

Although DENIS has been operating in its routine mode only for one year, covering about one quarter of the southern sky, the project has already resulted

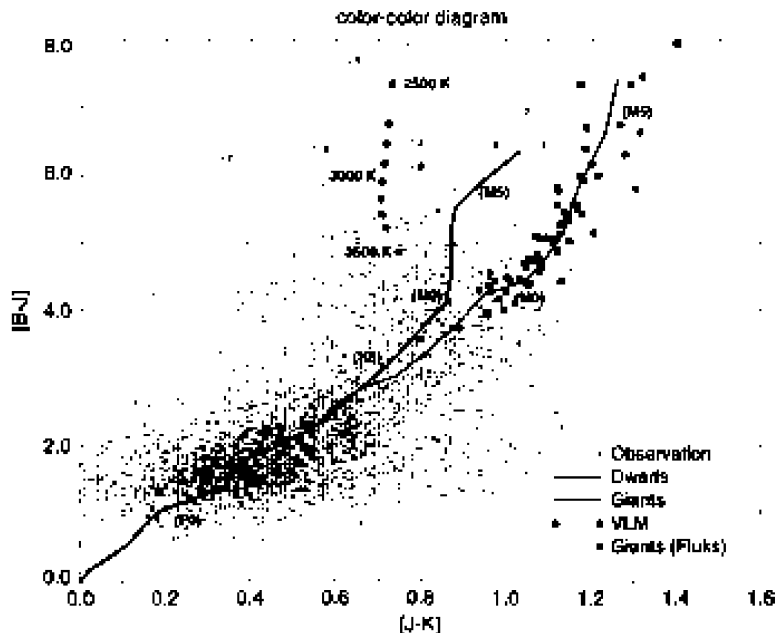

Figure 8: $[B-J]$ vs. $[J-K]$ colour diagram obtained by cross-identifying hundreds of objects detected by DENIS with optical sources extracted from a Schmidt SRCJ plate with the COSMOS machine at high galactic latitudes. This diagram illustrates the extremely promising breakthrough that the combination of optical and near-IR data at large scale will provide in the quest for very low mass stars. According to the recent models of VLM stars, (e.g. Allard and Hauschildt), they should appear much bluer in $[J-K]$ than the normal main-sequence dwarfs, and thus good candidates could be easily recognised in this diagram.



Figure 9: The galaxy IRAS 07395-2224, located at $b = 0.2^\circ$ as seen in the 3 DENIS bands from left to right: I, J, K_s . Notice that this edge-on spiral appears prominently in the K_s band. DENIS is expected to pick up many such galaxies in the zone of avoidance.

in a number of promising results. A small fraction of the archived data has been exploited, so far. Several fruitful collaborations have started within the consortium institutes and with ISO teams. Owing to the huge amount of data to analyse, we expect that the interest in DENIS products in the astronomical community at large, and in particular within the ESO community, will grow as the survey progresses; we also expect that the 2-micron point source catalogue will be available, at least partly, for the first light of the VLT.

Acknowledgements

The DENIS project is partly funded by the European Commission through *SCIENCE and Human Capital and Mobility* plan grants. It is also supported in France by the Institut National des Sciences de l'Univers, the Education Ministry and the Centre National de la Recherche Scientifique, in Germany by the State of

Baden-Württemberg, in Spain by the DGICYT, in Italy by the Consiglio Nazionale delle Ricerche, in Austria by the *Fonds zur Förderung der wissenschaftlichen Forschung und Bundesministerium für Wissenschaft und Forschung*, in Brazil by the Foundation for the development of Scientific Research of the State of São Paulo (FAPESP), and in Hungary by an OTKA grant and an ESO C&EE grant. The European Southern Observatory is greatly contributing to the success of the project by providing a long-term access and maintenance of the 1-metre telescope and free subsistence for the DENIS operations team at La Silla. We are also greatly indebted to the graduate and postdoctoral students who have contributed to the observations at La Silla, namely, L. Cambresy (Meudon), P. Le Sidaner (Paris), M. Lopez-Corredoia (IAC, Tenerife), P. Heraudeau (Lyon), M. J. Sartori (São Paulo), R. Alvarez (Montpellier), V. de Heijs (Leiden).

References

- Copet E., 1996, Thèse de Doctorat, Paris 6.
 Epchtein N., Omont A., Burton W.B., Persi P. (eds.), 1994, *Science with Astronomical Near-Infrared Sky Surveys*, Proc. Les Houches School, Sept. 1993, Kluwer Ac. Pub., (reprinted from *Astrophys. Sp. Sci.*, **217**).
 Garzon F., Epchtein N., Burton W.B., Omont A., Persi P. (eds.), 1996, Proc. of the 2nd Euroconference on *the impact of Near-Infrared Sky Surveys*, Puerto de la Cruz, Spain, April 1996, Kluwer Ac. Pub., in press.
 Landolt A.U., 1992, *AJ* **104**, 340.
 Neugebauer G., Leighton R.B., 1969, Two Micron Sky Survey, NASA SP 3047.
 Perault M., Omont A., Simon G., et al., 1996, *AA Lett.* **314**, L165.
 Persi P., Burton W.B., Epchtein N., Omont A. (eds.), 1995, Proc. of the *1st Euroconference on near-infrared sky surveys*, San Miniato, Italy, Jan. 1995, reprinted from *Mem. S. A. It.*, **66**.
 Ruphy S., Robin A.C., Epchtein N., Copet E., Bertin E., Fouqué P., Guglielmo F., 1996, *AA Lett.* **313**, L21.
 Ruphy S., 1996, Thèse de Doctorat, Paris 6.

R Doradus: the Biggest Star in the Sky

T.R. BEDDING, J. G. ROBERTSON and R.G. MARSON,
School of Physics, University of Sydney, Australia
 A.A. ZIJLSTRA and O. VON DER LÜHE, ESO

What is the biggest star in the sky? Here we are not speaking of absolute size in kilometres, but in apparent size as seen from the Earth. The obvious

answer is the Sun, which has an angular diameter of half a degree. But which star comes next? The answer has long been assumed to be Betelgeuse (alpha Ori-

onis), which appears to be about 35,000 times smaller than the Sun (depending on the wavelength at which you observe). In fact, Betelgeuse was the first