

Data Analytics in Maintenance Planning – DAIMP

Public report



Project within FFI – Sustainable Production

Authors Gopalakrishnan, M., Subramaniyan, S., Salonen, A., Asp, M., Archenti, A., and Skoogh, A.

Date 20190329

FFI Fordonsstrategisk
Forskning och
Innovation

VINNOVA

Energimyndigheten

TRAFIKVERKET

FKG

VOLVO

SCANIA

VOLVO

Content

1. Summary	1
2. Sammanfattning på svenska	3
3. Background	9
4. Purpose, research questions and method	11
5. Objective	15
6. Results and deliverables	17
6.1. WP1 results	17
6.2. WP2 results	21
6.3. WP3 results	26
6.4. WP4 results	31
6.5. WP5 results	32
6.6. WP6 results: International evaluation of DAIMP	42
6.7. Summary of the deliverables.....	44
7. Dissemination and publications	47
7.1 Dissemination.....	47
7.2 Publications.....	48
8. Conclusions and future research	51
9. Participating parties and contact persons	55
References	56

FFI in short

FFI is a partnership between the Swedish government and automotive industry for joint funding of research, innovation and development concentrating on Climate & Environment and Safety. FFI has R&D activities worth approx. €100 million per year, of which about €40 is governmental funding.

Currently there are five collaboration programs: Electronics, Software and Communication, Energy and Environment, Traffic Safety and Automated Vehicles, Sustainable Production, Efficient and Connected Transport systems.

For more information: www.vinnova.se/ffi

1. Summary

Manufacturing industry plays a vital role in the society, which is evident in current discussions on industrialization agendas. Digitalization, the Industrial Internet of Things and their connections to sustainable production are identified as key enablers for increasing the number of jobs in Swedish industry. To implement digitalized manufacturing achieving high maintenance performance becomes utmost necessity. A substantial increase in systems availability is crucial to enable the expected levels of automation and autonomy in future production. Maintenance organizations needs to go from experiences based decision making in maintenance planning to using fact based decision making using Big Data analysis and data-driven decision support. Currently, there is lack of maintenance-oriented research based on empirical data, which hinders the increased use of engineering methods within the area.

The DAIMP project addresses the problem with insufficient availability and robustness in Swedish production systems. The main challenges include limited productivity, challenges in capability of introducing new products, and challenges in implement digital production. The DAIMP project connects data collection from a detailed machine level to system level analysis. DAIMP project aimed at reaching a system level analytics to detect critical equipment, differentiate maintenance planning and prioritize the most important equipment in real-time. Furthermore, maintenance organizations will also be supported in moving from descriptive statistics of historical data to predictive and prescriptive analytics.

The main goals of the project are:

- Agreed data parameters and alarm structures for analyses and performance measures
- Increased back-office maintenance planning using predictive and prescriptive analysis
- Increased use of dynamic and data-driven criticality analysis
- Increased prioritization of maintenance activities

The goals were further divided into specific goals and six work packages were designed to execute the project.

WP1 focused on the purchase phase and getting data structures and collaboration with equipment vendors correct from start.

WP2 focused on the ramp-up phase of new products and production lines when predictive and prescriptive analytics are important to handle unknown disturbances.

WP3 focused on the operational phase and to provide data-driven decision support for directing maintenance efforts to the critical equipment from a systems perspective.

WP4 focused on designing maintenance packages for different equipment with inputs from WP3, including both reactive, preventive, and improving activities.

WP5 focused on the evaluation and demonstration for different project results

WP6 focused on coordination project management

In WP1, models were developed to understand the missing element for the capability assessment from initiation of the machine tool procurement to the end of lifecycle. The information exchange and process of machine tool procurement from the end-users perspective was assessed. Additionally, the alarm structure is created using the capability framework and the ability model. In WP2, diagnostic, predictive and prescriptive algorithms were developed and validated. The algorithms were developed using manufacturing execution system (MES) data to provide system level decision making using data analytics. Improved quality of decisions by data-driven algorithms. Moved from experienced based decision to algorithmic based decisions. Identified the required amount data sets for developing machine learning algorithm. In WP3, data-driven machine criticality assessment framework was developed and validated. MES and computerised maintenance management system (CMMS) data were used to assess criticality of machines. It serves as data-driven decision support for maintenance planning and prioritization. It provided guidelines to achieve systems perspective in maintenance organization. In WP4, a component classification was developed. It provides guidelines for designing preventive maintenance programs based on the machine criticality. It uses CMMS data for component classification. In WP6, three demonstrator cases were performed at (i) Volvo Cars focusing on system level decision support at ramp up phase, (ii) Volvo GTO focusing on global standardization and (iii) a test-bed demo of data-driven criticality assessment at Chalmers. Lastly, as part of WP6, an international evaluation was conducted by inviting two visiting professors.

The outcomes of the DAIMP project showed a strong contribution to research and manufacturing industry alike. Particularly, the project created a strong impact and awareness regarding the value maintenance possess in the manufacturing companies. It showed that maintenance will have a key role in enabling industrial digitalization. The project put the maintenance research back on the national agenda. For example, the project produced world-leading level in MES data analytics research; it showed how maintenance can contribute to productivity increase, thereby changing the mind-set from narrow-focused to having an enlarged-focus; showed how to work with component level problems to working with vendors and end-users.

2. Sammanfattning på svenska

Bakgrund

Digitalisering, Dina Industrial Internet och deras kopplingar till hållbar produktion identifieras som viktiga förutsättningar för att öka antalet jobb i den svenska industrin. För att genomföra digitaliserad tillverkning som uppnår hög underhållsbehov blir yttersta nödvändighet. En väsentlig ökning av systemtillgången är avgörande för att möjliggöra de förväntade nivåerna av automatisering och autonomi i framtida produktion. Underhållsorganisationer måste gå från erfarenhetsbaserad beslutsfattande i underhållsplanering för att använda faktabaserat beslutsfattande med hjälp av Big Data-analys och datastyrt beslutsstöd. För närvarande finns brist på underhållsinriktad forskning baserad på empiriska data, vilket hindrar ökad användning av teknikmetoder inom området.

Forskning och industriellt problem

DAIMP-projektet löser problemet med otillräcklig tillgänglighet och robusthet i svenska produktionssystem. De viktigaste utmaningarna är begränsad produktivitet, utmaningar med förmåga att introducera nya produkter och utmaningar när det gäller digitalproduktion. DAIMP-projektet förbinder datainsamling från en detaljerad maskinnivå till systemnivåanalys. DAIMP-projektet syftade till att nå en systemnivåanalys för att upptäcka kritisk utrustning, skilja underhållsplanering och prioritera den viktigaste utrustningen i realtid. Vidare stöds även underhållsorganisationer för att flytta från beskrivande statistik över historiska data till prediktiv och preskriptiv analys.

Syfte och mål

DAIMP-projektet behandlar specifikt högre produktivitet och minskad miljöpåverkan i produktionen som de två huvudsakliga målen för FFI Sustainable Production. Färre störningar leder till högre utnyttjande och reducerade förluster i nedåt och tomgångsmaskinstillstånd. Projektets huvudmål är:

- G1 – Avtalade dataparametrar och larmstrukturer för analyser och prestationsåtgärder
- G2 – Ökad underhållsplanering för kontorshantering med hjälp av prediktiv och preskriptiv analys
- G3 – Ökad användning av dynamisk och datadriven kritisk analys
- G4 – Ökad prioritering av underhållsaktiviteter

Projektledning

Målen delades vidare in i specifika mål och sex arbetspaket utformades för att genomföra projektet.

WP1 fokuserade på inköpsfasen och fick datastrukturer och samarbete med leverantörer av utrustning rätt från början.

WP2 fokuserade på rampfasen av nya produkter och produktionslinjer när prediktiv och prescriptiv analys är viktig för hantering av okända störningar.

WP3 fokuserade på operations fasen och tillhandahöll datastyrt beslutsstöd för att styra underhållsinsatser för den kritiska utrustningen ur ett systemperspektiv.

WP4 fokuserade på att utforma underhållspaket för olika utrustning med inmatningar från WP3, inklusive både reaktiva, förebyggande och förbättrade aktiviteter.

WP5 fokuserade på utvärdering och demonstration för olika projektresultat

WP6 fokuserade på samordningsprojektledning

Projekttimplerering

Projektets övergripande mål var indelade i specifika mål. 5 WPs utformades för att uppnå dessa specifika mål och WP6 lyckades hela projektet. Alla 5 WPs utfördes parallellt med akademiska partners som leder dem. Branschpartnerna bidrog till olika WPs under hela projektet. Förutom starkt individuell WP-fokus samarbetade några WPs för att maximera forskningspotentialen. Som en del av WP6 genomfördes en internationell utvärdering genom att inbjuda två besökande professorer.

Resultat och resultat

WP1

Modeller utvecklades för att förstå det saknade elementet för kapacitetsbedömningen från start av maskinverktygsupphandling till slutet av livscykeln. Informationsutbytet och processen för maskinverktygsupphandling från slutanvändarnas perspektiv bedömdes. Dessutom skapas larmstrukturen med hjälp av kapacitetsramen och förmåga modellen.

WP2

Diagnostiska, prediktiva och prescriptiva algoritmer utvecklades och validerades. Algoritmerna utvecklades med användning av tillverkningsexekveringssystem (MES) - data för att tillhandahålla systemnivåbeslutsfattande med hjälp av dataanalys. Förbättrad kvalitet på beslut av datastyrda algoritmer. Flyttade från erfaren baserat beslut till algoritmiska baserade beslut. Identifierade de nödvändiga datamängderna för att utveckla maskininlärningsalgoritmen.

WP3

Datastyrd maskinkritisk bedömningsram har utvecklats och validerats. MES och datasystem för underhållssystem (CMMS) användes för att bedöma kritik av maskiner. Det fungerar som datastyrt beslutsstöd för underhållsplanering och prioritering. Det gav riktlinjer för att uppnå systemperspektiv i underhållsorganisationen.

WP4

En komponentklassificering utvecklades. Det ger riktlinjer för att utforma förebyggande underhållsprogram baserat på maskinkritik. Det använder CMMS data för komponent klassificering.

WP6

Tre demonstrationsfall utfördes vid (i) Volvo Personvagnar med fokus på systemnivåbeslutsstöd vid rampfasen, (ii) Volvo GTO med inriktning på global standardisering och (iii) en testbäddsdemo av data-driven kritisk bedömning vid Chalmers.

WP6 - internationell utvärdering

En internationell utvärdering genomfördes genom att inbjuda två besökande professorer, Oliver Rose från Bundeswehr University Munich och Jayantha P. Liyanage från University of Stavanger. Denna halvtidsutvärdering sker i oktober 2017 på Chalmers i Göteborg. Besöksprofessorerna har fått projektansökan, resultat från varje WP och planen för resten av projektet i förväg. Besökande professorer gav kritisk information och konstruerade feedback på alla WPs. Den kritiska feedbacken och förbättringskommentarerna togs i beaktande och genomfördes ytterligare under andra halvåret av projektet.

Förväntat resultat	Hur uppnåddes det
R1. Validerad modell för kritisk klassificering av produktionsutrustning (G3)	I WP3 utvecklades och validerades data-driven maskinkritisk bedömningsram. MES- och CMMS-data användes för att bedöma kritik av maskiner. Det fungerar som datastyrt beslutsstöd för underhållsplanering och prioritering. Det gav riktlinjer för att uppnå systemperspektiv i underhållsorganisationen.
R2. Validerade algoritmer för prediktiv och prescriptiv analys (G2)	I WP2 utvecklades och validerades diagnostiska, prediktiva och förskrivande algoritmer. Algoritmerna utvecklades med hjälp av MES-data för att tillhandahålla systemnivåbeslutsfattande med hjälp av dataanalys. Förbättrad kvalitet på beslut av datastyrda algoritmer. Flyttade från erfaren baserat beslut till algoritmiska baserade beslut. Identifierade de nödvändiga datamängderna för att utveckla maskininlärningsalgoritmen.
R3. Riktlinjer för utformning av underhållsprogram på olika kritiska nivåer (G4)	I WP4 utvecklades en komponentklassificering. Det ger riktlinjer för att utforma förebyggande underhållsprogram baserat på maskinkritik. Det använder CMMS data för komponent klassificering.
R4. Specifikation av data och informationsstrukturer för förmåga analys och för delning av data mellan slutanvändare och utrustning leverantörer (G1)	I WP1 utvärderades informationsutbytet och processen för maskinverktygsupphandling från slutanvändarens perspektiv. Slutsatsen är att leverantörerna och slutanvändarna behöver mer öppenhet och stöd under olika faser av maskinverktygets livscykel. Detta kommer att förbättra produktkvaliteten genom att tillhandahålla återkopplingsdata från slutanvändaren till leverantörerna och högsta standardprodukten för kundens behov (win-win-situation).

fortsatte på nästa sida

R5. Standardiserade arbetsprocedurer och rollbeskrivningar för att säkerställa data och analyskvalitet (G1 & G2)	I WP1 skapas larmstrukturen med hjälp av kapacitetsramen och förmåga modellen. Valideringen av larmstrukturen är emellertid komplex utan korrekt data och förståelse av maskinverktyget på komponentnivån. Så är den modulära spindelenheten konstruerad och utvecklad som kommer att stödja för att validera larmstrukturen i framtiden. I WP2, algoritmen för att upptäcka flaskhalsen, diagnostisera flaskhalsarna, kluster underhållsalarmen, förutsäga framtida flaskhals, förutse de diagnostiska faktorerna för de framtida flaskhalsarna, har man utvecklat recept på nödvändiga underhållsåtgärder på flaskhalsar.
R6. Jämförelse av modeller för att kvantifiera kostnaden för förlorad produktion (G3)	I WP3, för att förstå relationerna mellan maskinerna i ett produktionsflöde, utfördes en aktuell tillståndskartläggning av kritikverktygsverktyget. Ett gemensamt tema över alla olika kritiskklassificeringsmodeller som användes var att realtidsdata inte användes för att kvantifiera relationerna. Kvantifiering av utnyttjandet (aktiva perioder) för varje maskin i systemet kan möjliggöra identifiering av flaskhalsmaskinen i produktionsflödet. En som prioriterar flaskhalsmaskinerna ökar genomströmningen av produktionssystemet. Kostnaden för förlorad produktion beräknades utifrån produktivitetstförlusterna.
R7. 3 3 demonstranter, 2 industriella och en i en laboratorieinställning (all Gs)	Två industridemonstratörer: VCC och Volvo GTO utvecklades. VCC-fall fokuserat på produktionsrampen. Flera algoritmer från Axxos-data utvecklades, vilket kommer att stödja underhållsbeslutsfattande under rampfasen. Volvo GTO fokuserade på global standardisering för planering av underhållsverksamhet. Workshops genomfördes på olika fabriker inom Volvo GTO. Laboratoriesättningsdemo utvecklades på SII-lab, Chalmers. En testbädd skapades för att visa datadriven maskinkritisk bedömning (resultat av WP3), inklusive datagenerering från testbädden, datainsamling, dataanalys och visualisering.
R8. Två akademiska avhandlingar, en doktorand och en licentiat (all Gs)	Doktorand avhandling: Datatryckt beslut Stöd för underhållsprioritering presenterades augusti 2018. Licentiatuppsats i Dataanalys för produktionsförbättring planeras sen 2018 med hjälp av resultaten från DAIMP-projektet
R9. Lärande moduler för kurser på MSc nivå (all Gs)	Underhållsprioritering, kritisk bedömning, förebyggande underhållsplanering, flaskhalsdetektering, datastyrd beslutsfattande ingår som moduler i produkt- och produktionsservice systemkurs på Chalmers på MSc-nivå. På samma sätt ingår design av förebyggande underhåll i MDH MSc-kursen och maskinens förmåga ingår i KTH MSc-kurser.

Påverkan och effekter

Resultatet av DAIMP-projektet visade ett starkt bidrag till både forsknings- och tillverkningsindustrin. Framför allt har projektet skapat en stark inverkan och medvetenhet om värdet underhållsinnehav i tillverkningsbolagen. Det visade att underhållet kommer att spela en nyckelroll för att möjliggöra industriell digitalisering. Projektet lade

underhållsforskningen tillbaka på den nationella agendan. Projektet producerade till exempel världsledande nivå i MES dataanalysforskning; Det visade hur underhåll kan bidra till ökad produktivitet och därigenom förändra sinnet från smalfokuserad till att ha en förstorad fokusering. Visade hur man arbetar med komponentnivåproblem för att arbeta med leverantörer och slutanvändare.

Framtida forskning

Forskning och utveckling i underhållsorganisationer har inte prioriterats under de senaste årtiondena. Innan projektet har de deltagande företagen några underhållsprojekt i sina nuvarande portföljer. Slutsatsen är att effekterna av projektet har ökat antalet underhållsprojekt, både inom företagen och på nationell nivå, inklusive stora projekt med stora budgetar som tilldelats dem.

3. Background

Digitalization, the industrial internet of things and their connections to sustainable production are identified as key enabler to ensure the productivity, robustness and resource efficiency in automated production. To achieve the key enabler, the information and knowledge about systems/ sub-systems/ components capability are becomes essential and core.

At the same time, the average overall effectiveness is around 55%, in other words, the maintenance work becomes important to keep up an overall effectiveness. However, this cost huge resources like investigation and solution identification time which means there are lack of necessary information in term of critical equipment's. Ultimately, the research on maintenance strategies and capability verifications during machine implementation process as well as machine reliability assessment throughout the lifecycle is vital to reach the industry 4.0 goals.

Machining and assembly systems are two of the most important units in production systems since their capability affects the overall productivity. To produce parts with required accuracy, the relationship between system characteristics and part accuracy/surface finish must be evaluated in order to control deviations within required tolerances. In order to increase pro-activeness to the maximum level possible, the early life-cycle phases such as acquisition, implementation and start-up of production systems/subsystems/ components are critical and the attempts so far described in state of the art lack the necessary links to these activities. An implemented closed loop between vendors and end-users together with the interchange of data and knowledge must be adapted to end-user functional and capability needs and data needed for maintenance and machine reliability assessment (work package 1).

Unplanned maintenance is a major problem in several asset-intensive industries such as manufacturing. This type of maintenance can be extremely costly as it often leads to extended production times or delayed deliveries of products to customers. Maintenance activities addressing unplanned maintenance stops is termed as reactive maintenance. Statistics show that this type of maintenance is 70% of the total maintenance tasks especially in discrete manufacturing industries (e.g. automotive manufacturing) [1]. On the other hand, proactive maintenance helps minimize unplanned maintenance in manufacturing. Majority of the manufacturing companies in the automotive sector aims to have proactive maintenance practices which have the possibility of predicting the disturbances in the machines beforehand. This way of predicting the disturbances gives maintenance engineers to act in advance to either prevent the disturbances in occurring or increase the response time when the disturbance happens.

Proactive maintenance can be achieved by using advanced data analytics by using machine data. However, today the Swedish manufacturing industries are limited in using data analytics to achieve proactive maintenance practices [2]. With this background, the purpose

of this work package 2 is to develop data-driven algorithms that can analyse the big sets of machine data and predict the disturbances in advance which enables proactive maintenance practices.

Generally, companies work toward higher availability, which has increased the discussions around zero-failure strategies. Predictive and prescriptive analysis (work package 2) helps identifying problems before they become disturbances. However, it is not a resource efficient or even a realistic approach to prevent all failures and disturbances. Therefore, companies are currently trying to find methods for identifying critical equipment from a systems perspective and move towards zero-failure on these operations. If disturbances still occur, they should be handled as quickly as possible with top priority relative other operations in the system.

Unfortunately, few companies prioritize maintenance effectively and tend to serve all equipment with equal priority [3]. It is understood that maintenance activities are often executed on a first-come-first-served basis or experience based. Current methods for criticality classification, e.g. the ABC classification [4], tend to use a very wide perspective and analyse machine per machine, i.e. a lack of systems perspective. The common result is that many stations get top priority and maintenance stays undifferentiated.

A powerful alternative solution would be to use modern bottleneck detection methods [5] for quantifying costs of lost production from a maintenance perspective. Adaption of these methods to a real-time data-driven approach holds great potential. Work package 3 will work towards the development of approaches from descriptive to predictive, enabling maintenance prioritization based on expected future states.

Proper preventive maintenance, differentiated and specific for each individual equipment, is a prerequisite in order to establish high availability and productivity in the production system. However, maintenance requirements are often neglected in order to prioritize organizational goals over the need of the equipment. Hence, preventive maintenance programs are also often generalized to fit all equipment. This results in that some equipment is over-maintained while others are under-maintained. Work package 4 will work towards the development of differentiated preventive maintenance programs.

4. Purpose, research questions and method

The project goals are,

- G1. Agreed data parameters and alarm structures for analyses and performance measures**
- G2. Increased back-office maintenance planning using predictive and prescriptive analysis**
- G3. Increased use of dynamic and data-driven criticality analysis**
- G4. Increased prioritization of maintenance activities**

The expected results of the project and its relation to the project goals are,

- R1. Validated model for criticality classification of production equipment (G3)**
- R2. Validated algorithms for predictive and prescriptive analysis (G2)**
- R3. Guidelines for designing maintenance programs at various criticality levels (G4)**
- R4. Specification of data and information structures for capability analysis and for sharing data between end-users and equipment vendors (G1)**
- R5. Standardized work procedures and role descriptions for ensuring data and analysis quality (G1 & G2)**
- R6. Comparison of models for quantifying the cost of lost production (G3)**
- R7. 3 demonstrators, 2 industrial and one in a laboratory setting (all Gs)**
- R8. Two academic theses, one PhD and one licentiate (all Gs)**
- R9. Learning modules for courses on MSc level (all Gs)**

In order to achieve these goals, four work packages (WP) were designed. The following section describes these WPs, their research questions (RQ) and overall method.

WP1 – Data specification with equipment vendors

The purpose is to assure data quality from machine capability, via condition assessment of critical parts for functions and performance to deviation monitoring, maintenance and improvements from initial life cycles to fully ramped-up operation by preparing machines for collecting and sharing necessary data.

The most critical problem while sourcing a machine would be about the verification of system, and defining the verification level of system condition. Currently, machine tool sourcing industries verify it's capability before procurement but despite, huge amount of critical problems occurring quite often and reason is uncertain and cost huge resource for the assessment. So, lack of proper information brings considerable difficulties in identifying the root cause of the problem whether the problem associated to the design of the machine tool or maintenance. Consequently, this leads to different question are followed below:

- Are the right methods used to investigate or enough information is available to verify the machine tool before commenced to the normal production?

- Does equipment vendors having/ providing enough information about machine tool reliability information at component level?
- Considering the information is available, is it an accuracy enough to define machine tool conditions?
- Does the capability determine the machine tool reliability in component/ part level?
- Do we have any concert method to use the identified errors to define the critical equipment?

The goal is accomplished using qualitative approach and following activities:

1. Investigation of OEMs (end-users) machine tool procurement process i.e. from project initiation (defining machine tool capability) to an implementation (fixing machine tool at the shop floor). The first part emphasis the importance of maintenance at all the stages from procurement of the machine till maintaining it to the end of lifecycle which lead to integrate the maintenance in the process. Here, the OEMs and machine tool supplier or vendors are deeply connected and involved in the process.
2. Developing the determination framework model for defining error sources in the machine tool through analyzing different phases using physical quantities. At this stage, the overall assessment of machine tool condition at the part level is outlined with the error source using machine tool capability and ability status.
3. Finally, the machine tool performance is characterized using an alarm structure using the differential functional deviations which significantly contributed to the machine tool failure.

WP2 – Predictive and prescriptive analysis

The purpose of this work package is to increase robustness by enabling a reduction of production disturbances using better failure prediction and prevention. Both preventive and reactive maintenance should be planned in real-time back-office.

This WP aimed to answer the following research questions,

RQ1: What are the various data-driven performance measures that are used to understand the production system behaviour?

RQ2: How can the disturbances in the MES can be followed and commented?

RQ3: How can MES data be used to create algorithms for predicting disturbances and propose actions in real-time?

The overall methodology followed in this work package is adapted from a standard data mining methodology called Cross Industry Standard Process for Data Mining (CRISP-DM) model [6]. Firstly a detailed literature review was conducted on the disturbance analysis to understand the previous works in this field and also on different types of machine learning algorithms focussed towards analysis of disturbances in production systems. In parallel with that, the real-world data from the partner companies was collected to understand the data structure. With the combined insights from the literature review and the study of real-world data set, the conceptual model for different algorithms was proposed. These proposed algorithms are then tested on the partner

company's data set and their performance was evaluated. Moreover, the proposed algorithms performance was benchmarked with that of the naive method, which is the standard process followed at the partner companies. This benchmarking procedure was done to assess if the proposed algorithms adds any value towards predicting disturbances and help engineers to make decisions.

WP3 – Data-driven criticality classification

The purpose of this work package is to enable differentiation of maintenance planning in terms of preventive, reactive as well as improving activities. A dynamic data-driven approach will serve as decision support for always prioritizing maintenance from a systems perspective with a focus improving productivity and resource efficiency.

The following research questions were framed to guide WP3 work,

RQ1: How to quantify relationship of machines in the production flow and how can it affect the productivity?

RQ2: What are the gaps between current industrial practices and research in maintenance prioritisation?

RQ3: How can maintenance prioritisation be supported to increase productivity?

A mixed-method research approach was used achieve the overall purpose of this WP. Literature study and simulation experiments were conducted initially to form the theory on machine classification, quantifying relationships and evaluate productivity through maintenance prioritization. Subsequently, in-depth studies were required to capture the industrial current state of method, uses and practices of machine classification. Hence, embedded multiple case study with qualitative was used. Lastly, the development and validation required industrial uses cases to maximize the learnings. Therefore, another multiple case study research approach was used. This study used a mixed method approach, i.e. both qualitative and quantitative approaches were used.

WP4 – Differentiated maintenance programs

The purpose of this work package is to develop a guideline that can be used by industrial companies in planning proper preventive maintenance activities in order to maximize maintenance effectiveness and system throughput based on data-driven benchmarking and criticality classification.

The following research questions were formulated to guide the work:

RQ1: What is the current state of practice in industry for PM design?

RQ2: On which data should PM programs be designed?

RQ3: What method should be used for PM design?

In order to answer RQ1, an embedded multiple case study was performed with four major production sites in Swedish automotive industry. Data was collected through focus groups and individual interviews with maintenance planners at the different sites. The data was structured and analysed through a pattern matching logic.

For RQ2 and RQ3, an iterative process was used, in which maintenance experts, engineers, and researchers participated in workshops, discussions and brainstorming, in order to design, test, and evaluate a method for assessing criticality of machine components, and design suitable, preventive maintenance.

WP5 – Evaluation cases and demonstrators

This work package will be central for the research in WP1-4 in terms of data and information collection. WP5 will use and implement the results from WP1-4 and serve as a validation of the applicability and usefulness as well as being a demonstration and learning platform.

Three cases were planned for this WP. They are,

1. Production ramp-up case at VCC
2. Global standardization case at AB Volvo
3. Smart industry demonstrator at Chalmers

Each of the three cases used different methods to achieve specific goals. The detailed explanation of each of the cases is presented in Chapter 6: Results, under WP5.

WP6 – Project management

The aim of this work package is to coordinate the other work packages and ensure that the project aims and deliverables are fulfilled. The management structure enables efficient collaboration between work packages and makes sure that project results are demonstrated in the WP5 cases and disseminated.

As part of WP6, a mid-term *international evaluation* of the project was planned and conducted. Two professors from international universities in Germany and Norway were chosen to evaluate the project mid-way. The evaluation criteria included results generated in each WP until that point, the research approach used, industrial implication, scientific implication and future plans of each WP in the project.

5. Objective

Based on the overall project goals and WP research questions, specific goals for each WP were drafted. The specific goal's contribution to the overall goal is specified in parenthesis.

Methods enabling zero defective parts and elimination of unplanned downtime in the production systems using sustainable developments which will provide a significant competitive edge for the Swedish automotive industry. The major activities are followed, G1.1: Identify capability (data) parameters needed for selected performance measures and analyses (G1)

G1.2: Standardize data and alarm structures (G1)

G1.3: More thorough requirements for purchase of critical equipment (G1)

The goals of WP2 were,

G2.1: Define data-driven performance measures accepted cross organizations (G1, G2)

G2.2: Develop methods for following-up and commenting disturbances data in MES (G1)

G2.3: Develop and evaluate data-driven algorithms for predicting disturbances and propose actions on the root cause in real-time (prescriptive analysis) (G2)

The goals of WP3 were,

G3.1: Quantify the relations between resources in a production flow (G3)

G3.2: Criticality classification models for various production layouts (G3)

G3.3: Develop and evaluate data-driven algorithms for identifying critical equipment (G3)

The goals of WP4 were,

G4.1: Reduce waste by differentiating maintenance efforts from a systems perspective (G4)

G4.2: Develop differentiated maintenance packages directed to specific criticality levels (G4)

G4.3: Find best-practices of maintenance planning through data analysis in CMMS (G4)

6. Results and deliverables

The results of this project is summarized on WP level in the following sections. Please note that only a summary of the most important results are presented here. In order to read the entire results, please read them through the publications. All the journal articles, conference articles, PhD thesis and Master thesis, which are published, have open access and can be found on the web. To identify the publications, see *Section 7.2. Publications*. The results presented also describes how the specific objectives/goals were fulfilled, thereby fulfilling the overall goals of the project.

6.1. WP1 results

The problem description of this work package is presented in figure below. It shows the overall awareness of lacking information in the process of new machine tool implementation and maintenance issues.

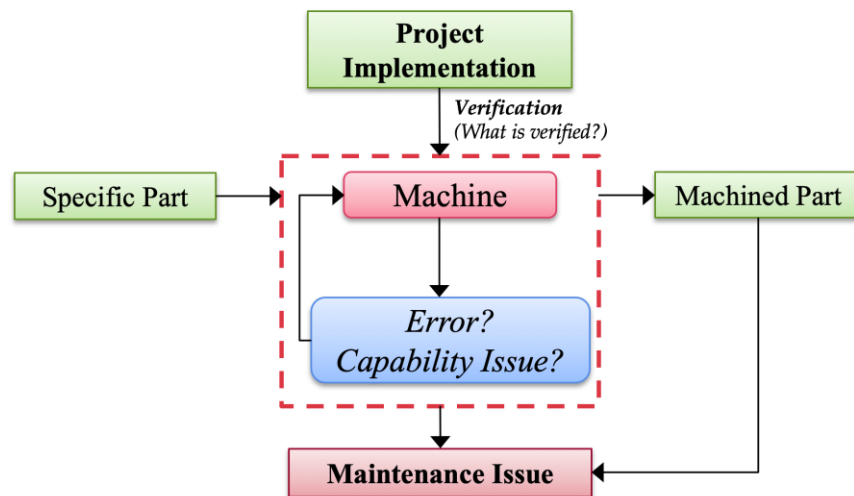

Representation of general machine tool implementation process

Integrating Maintenance

The integration of maintenance approach in the machine tool procurement process develops cooperation with the vendors to provide the most reliable input data for customer's maintenance system. It emphasizes data sharing and technology transfer between vendor's machine production system and customer implementation process.

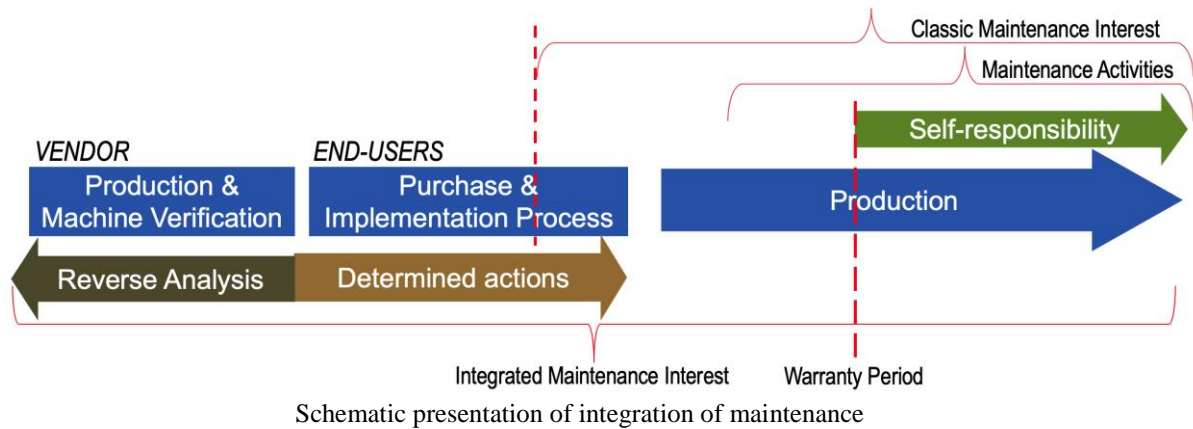

The figure above shows the linkage between the vendor and end-user as well as maintenance interest. In the overall perspective, the maintenance plays a major role to assess the information required for the machine acceptance tests. Within this approach, investigation of end-user's (OEMs) maintenance management system is performed to understand what input data it requires and how systems can benefit the most from the purchase process. This maintenance perspective looks further into the information exchange between the vendors and OEMs which supports to increase the understanding of the machine tool reliability status and its functions effectively for the future developments.

Customer - Vendor Cooperation

The information exchange is becoming crucial requirement for the better developments. In the future, relationship between vendor and customers need to be analysed as their quality is the major factor affecting the ability for performing valuable capability studies and maintenance integration. The impact should be considered for an analysis of the data transfer between machine vendor and customer during different stages of machine tool life cycle. The purchasing phase is just a section of complete relations, however, during this phase, relationships are established and well determined.

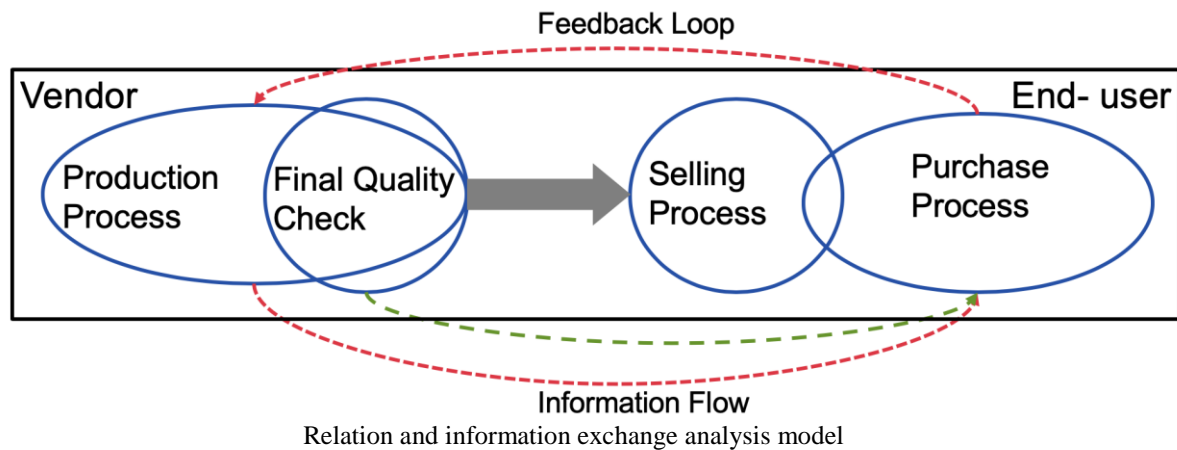

During the purchasing phase, Analysis of the purchase process should be compared with the selling process and final quality process from the vendor’s perspective (see figure above). A comparison of these processes will allow to identify similarities and differences in the organization and technical aspects. This information will be beneficial for both side for the improvements of their processes. In a long run, the information flow, machine final quality audit (FQA) and acceptance test needs to be revised and optimised to yield the highest level of outcomes (part of publication 1).

Deviation Investigation Pathway

The general investigation pathway is modelled to obtain the general method of establishing the source of error in the machine tool. The source of error in the machine tool examined through defining the linkage of deviation from the specification of the produced part to the component. The deviation source is identified through assessment of machine tool status which comprises of performance evaluation, investigation of operations and tools used to produce the part. The performance assessment includes physical properties which determine the influencing capabilities, data capturing instrument and data evaluation tool.

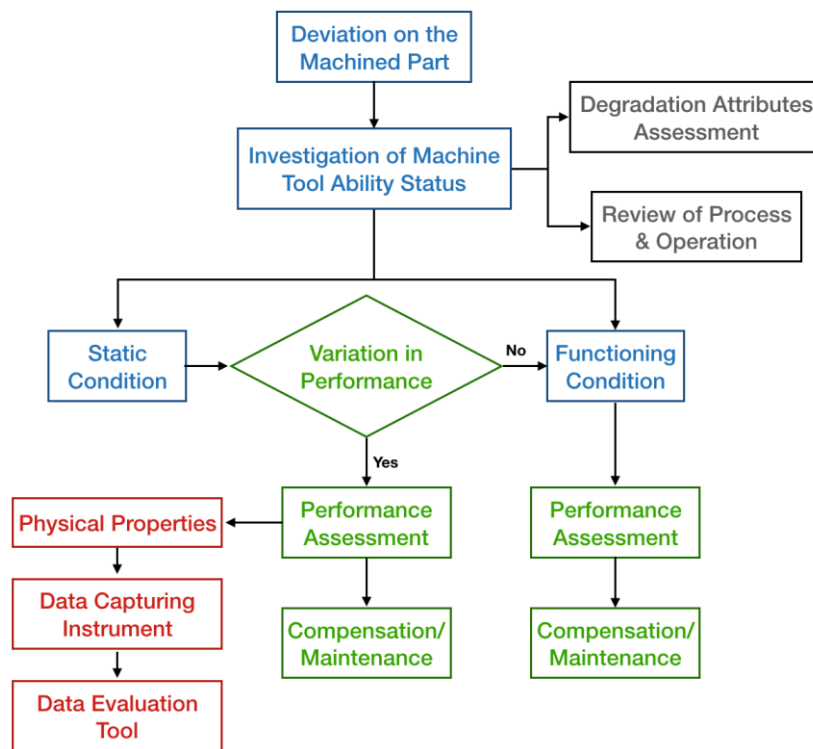

Deviation Investigation Pathway

The machine tool status investigated through two stages i.e. static and functioning condition (part of publication 2). In case of static condition, the performance variation is used to identify the source of an error. Otherwise, the functioning condition performance were assessed to identify the deviation source and determine the necessary maintenance activities.

Deviation Determination Framework

The deviation determination framework is developed to identify the deviation source through the reverse flow i.e. from production parts to the error source in the machine tool. This is possible through the study on possible error in the machine tool and impact of the error for the producing parts. In other words, determination of capability and ability status through defining the parameters for selected error source related to the functional status (performance).

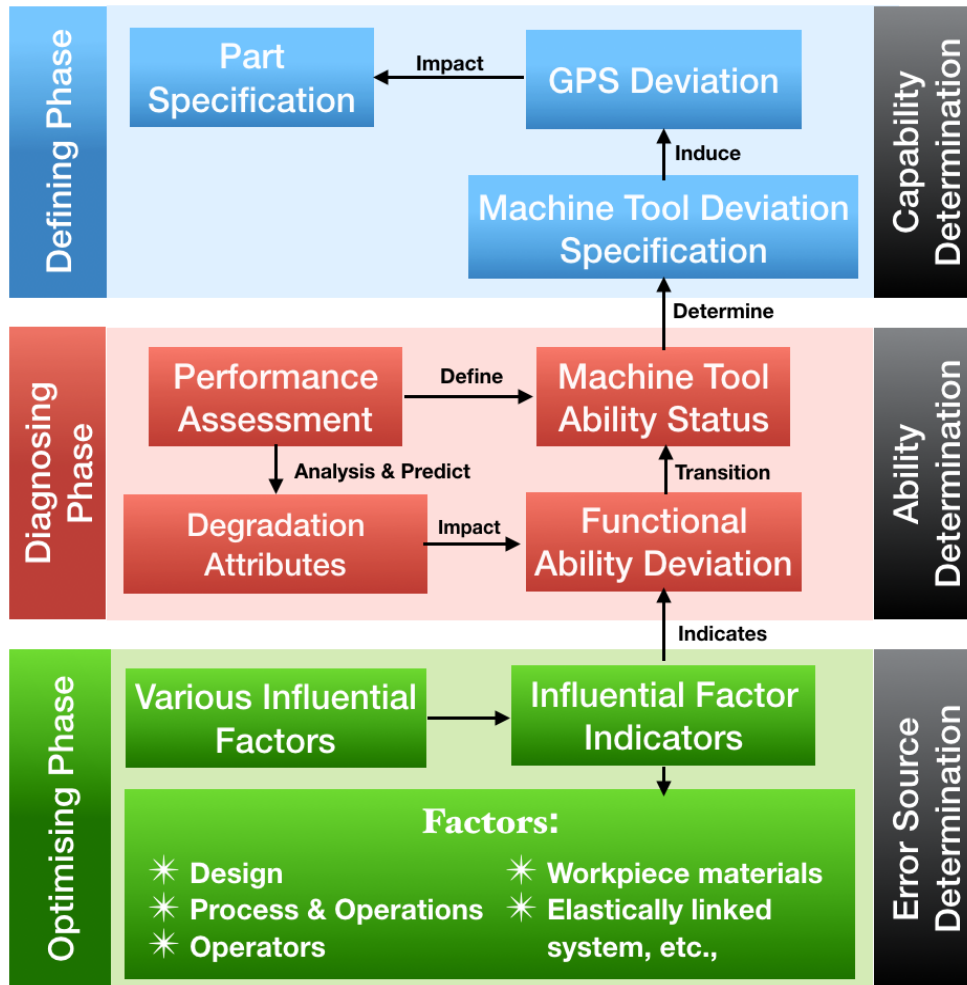

Deviation Determination Framework Model

The capability defines the condition of the machine tool in a bigger picture and the capability is determined using the performance of the machine tool in terms of number of parts produced with high accuracy. The first block of the framework model is considered to define the first phase of deviation on the workpiece level using geometric product specification (GPS). The reason behind the deviation in the workpiece which produced using the machine tool are varied to the level of investigation. At this stage, the machine tool ability plays a major role to identify and assess the deviation in component/ part level

using different physical quantities and degradation attributes to characterize the functional ability status (part of publication 3).

In the optimising phase, the identified deviation through the ability determination will be analysed and define the factor influence the error for each machine tool deviation. Through linking the machine tool deviation with the GPS deviations under certain factors will enables to identify the error at high accuracy level in the machine tool through the analysis of part specification.

In addition to the framework model, to critical components in the machine tool can be identified using the ability alarm structure and deviation significance status chart at figure 6. The ability alarm structure chart has the ability to provide the real-time status of functional deviation through the performance assessment and impact of combination of different deviations can be determined for every failure.

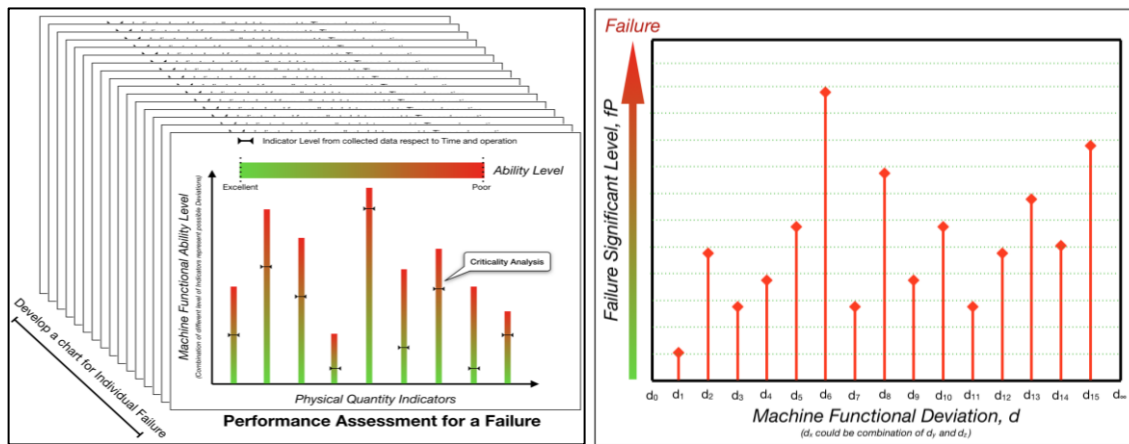

(a) Ability alarm structure, (b) Deviation significance status

This facilitates to establish the overall machine tool condition by determining the ability status for each function with possible deviations linked with the geometric product specification and its root causes. However, this can be achievable through extensive amount of data and information with advanced sensors and data analytics methods.

6.2. WP2 results

G2.1: Define data-driven performance measures accepted cross organizations

To support the proactive maintenance practices in the production system, first, the behaviour of the machines in the production system needs to be understood. The machine behaviour in the production system can be understood using various machine performance metrics such as active period, blockage and starvation metrics, utilization and inter-departure time variance. A detailed literature study revealed that, out of different machine performance metrics, the active period metric is considered a superior metric than others to understand the machine behaviour as it,

- Captures all relevant information affecting production flow efficiently and effectively
- An informative simple metric that would be easier to measure, comprehend and calculate
- Summarises the machine activities that affect the production
- Enables the opportunity to give diagnostic insights
- Stochastic nature of the metric enabling the use of time series prediction methods
- Comparison of this metric across all machines leads to bottleneck detection

The results of detailed literature study is presented in the Table below (publication 5)

Table 1. Different bottleneck detection methods and support tools used to develop them.

Method	Metric used to detect bottlenecks	References
(1) Using simulation model of production system		
Active period	Active durations	(Roser et al., 2001; Roser, Nakano, & Tanaka, 2002)
Queue time	Waiting time for parts before the machine	(Faget, Erkişon, & Herrmann, 2005)
Inactive period	Inactive periods (Blockage and starvation probabilities)	(Sengupta, Das, & VanTil, 2008)
Inter-departure time variance	Variance in arrival rate of parts at machines	(Betterton & Silver, 2012)
(2) Data-driven approaches		
Turning point	Total of blockage and starvation times	(Li et al., 2009)
(3) Hybrid approach: real-time data coupled with simulation model		
Sensitivity-based bottleneck detection	Throughput sensitivity of machine	(Chang, Ni, Bandyopadhyay, Biller, & Xiao, 2007)

Active period as a performance metric to understand the machine behaviour was accepted across the partner companies. Results presented in Publication 4.

G2.2: Develop methods for following-up and commenting disturbances data in MES

The major results accomplished under this goal are,

- Classified the disturbances in the Manufacturing Execution System (MES) of the partner companies into specific categories to get the machine active periods
- Classified the specific alarms to reflect the state of the machine: Producing, Part- Changing, Error, Blocked/Starved
- Identified the gaps in the MES data sets of the partner companies
 - Missing data
 - Duplicate data
 - Consistency issues (e.g. data from different stations were not the same format)
 - Accuracy issues (e.g. overlapping timestamps)
- Defined norms on data capturing to represent the active states of the machine
- Identified gaps were addressed through
 - Discussion with the respective production and maintenance experts in the field of the partner companies
 - Assumptions in cases where it is not possible to fully fill the gaps
- Recommended solutions on data accuracy to specific partner companies

An example of the MES data is shown below (from publication 5)

Table 2. Sample MES record.

Production area	Work area	Date and time	State of machine
Line 1	M1	01-09-2014 06:28:02	Not active
Line 1	M1	01-09-2014 06:28:25	Comlink up
Line 1	M1	01-09-2014 06:29:20	Not active
Line 1	M1	01-09-2014 06:29:34	Waiting
Line 1	M1	01-09-2014 06:29:34	Waiting
Line 1	M1	01-09-2014 06:42:46	Producing

Results are summarised in Publication 4, 6.

G2.3: Develop and evaluate data-driven algorithms for predicting disturbances and propose actions on the root cause in real-time (prescriptive analysis)

The disturbances to the production flow are often due to the disturbances in one or more machines called as throughput bottlenecks in a production system. Therefore, it is important that these bottleneck machines are prioritized for maintenance activities. The following are the results achieved to accomplish the goal,

- Developed active period-based statistical data-driven algorithm to
 - Detect the bottleneck location in the production line. An example (from publication 5) is presented below

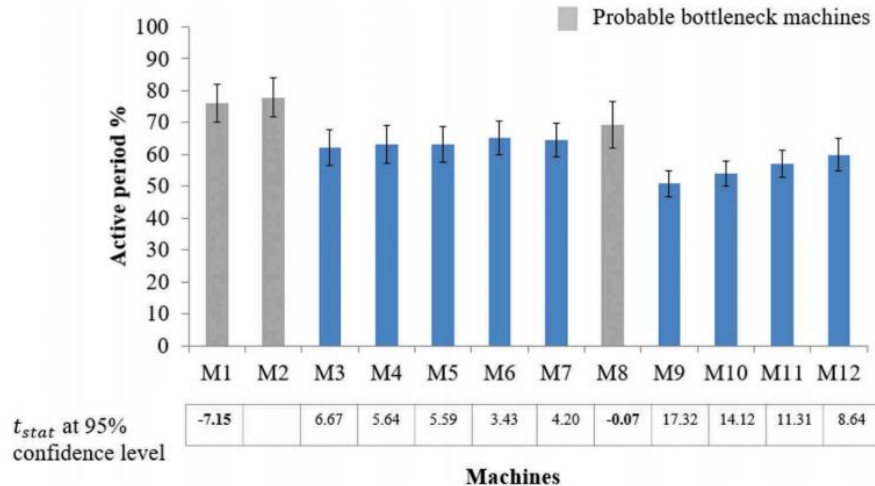

- Diagnose the bottlenecks. An example (from publication 5) is presented below

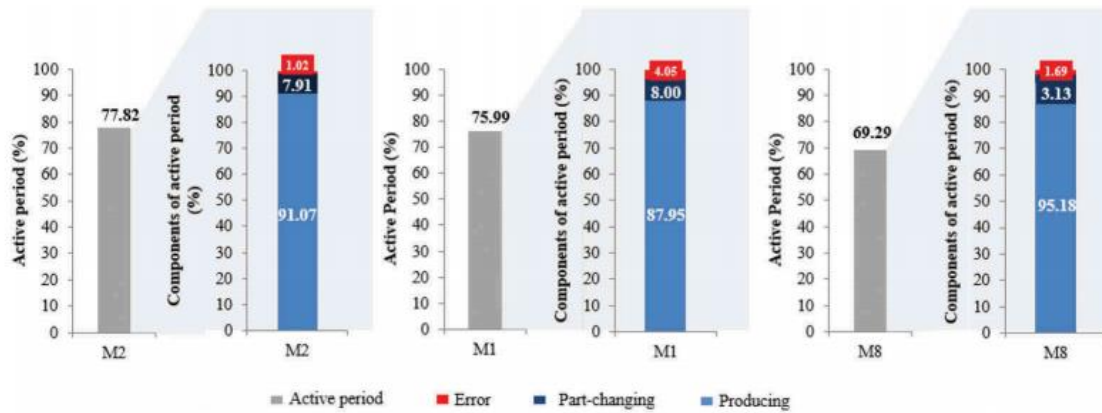

- Cluster the maintenance alarms on the bottleneck machines. An example (Result yet to be published – planned publication 10) is presented below

Descriptive Analytics on Alarms for Station 20 – Results ¹

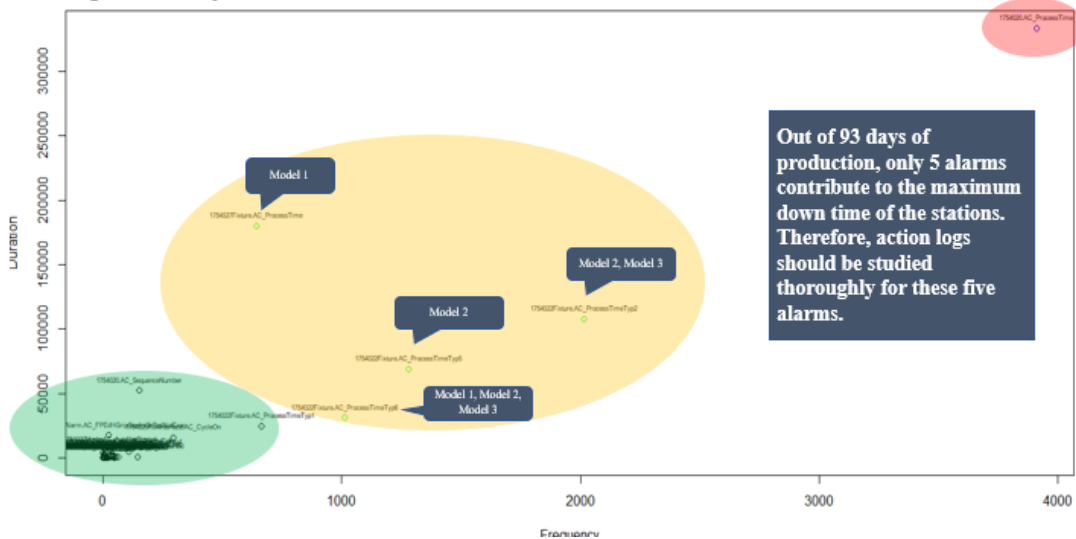

- Predict the future bottleneck location. An example (from publication 4) is presented below

Table 8

Forecasted active duration results for 13 machines.

Run	Machine	M1	M2	M3	M4	M5	M6	M7	M8	M9	M10	M11	M12	M13
190	ARIMA (p,d,q)	4,1,3	0,1,1	0,1,1	4,1,1	3,1,1	5,1,2	3,1,2	0,0,1	1,0,1	1,1,0	0,0,3	0,1,0	2,0,3
	Forecast (%)	84.08	76.43	77.22	75.93	74.50	83.08	82.08	79.41	79.72	75.71	72.63	63.94	60.87
	Standard error (%)	0.84	1.03	0.91	0.94	0.95	0.76	0.88	0.99	0.85	0.86	1.05	1.20	0.91
	t _{stat}	-	5.74	5.54	6.48	7.58	0.89	1.65	3.59	3.65	6.98	8.53	13.75	18.73
	Actual (%)	62.11	61.23	53.41	54.94	53.36	67.13	64.46	63.37	62.25	65.24	54.11	43.19	47.99
191	ARIMA (p,d,q)	1,1,1	2,1,1	0,1,1	4,1,2	4,1,1	3,1,1	3,1,1	3,1,1	4,1,4	0,0,0	2,0,2	0,1,0	1,0,3
	Forecast (%)	75.55	73.49	75.41	72.99	72.04	73.35	78.64	74.58	79.55	75.59	66.03	63.72	60.70
	Standard error (%)	0.87	1.04	0.94	0.92	0.97	0.78	0.84	0.94	0.87	0.86	1.02	1.22	0.92
	t _{stat}	3.26	4.47	3.25	5.19	5.79	5.32	0.75	3.88	-	3.24	10.09	10.60	14.93
	Actual (%)	83.04	82.98	82.41	78.07	79.82	83.65	83.77	83.75	80.03	76.52	71.12	66.12	53.30

- Predict the diagnostic factors of the future bottlenecks. An example (from publication 7) is presented below

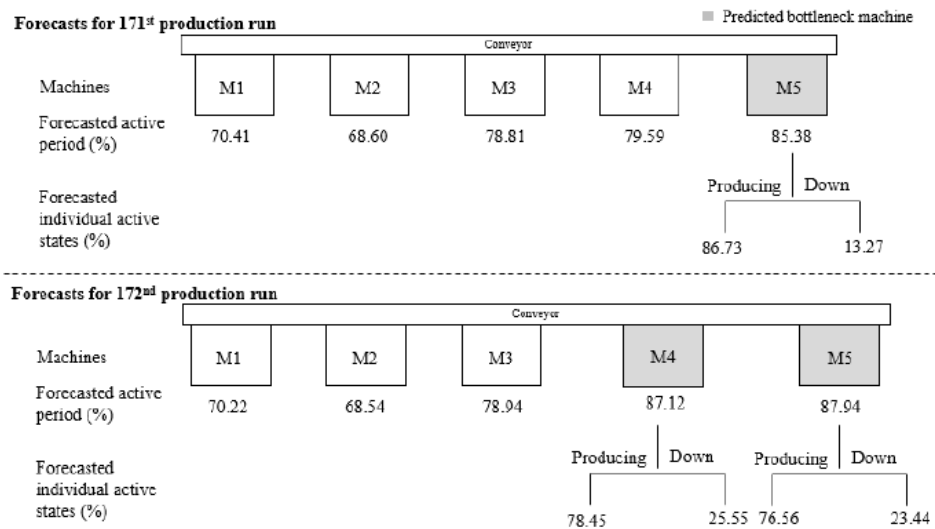

Figure 6. Diagram of prediction results for production runs 171 and 172.

- Prescribe necessary maintenance actions on bottlenecks in advance. An example (from publication 7) is presented below

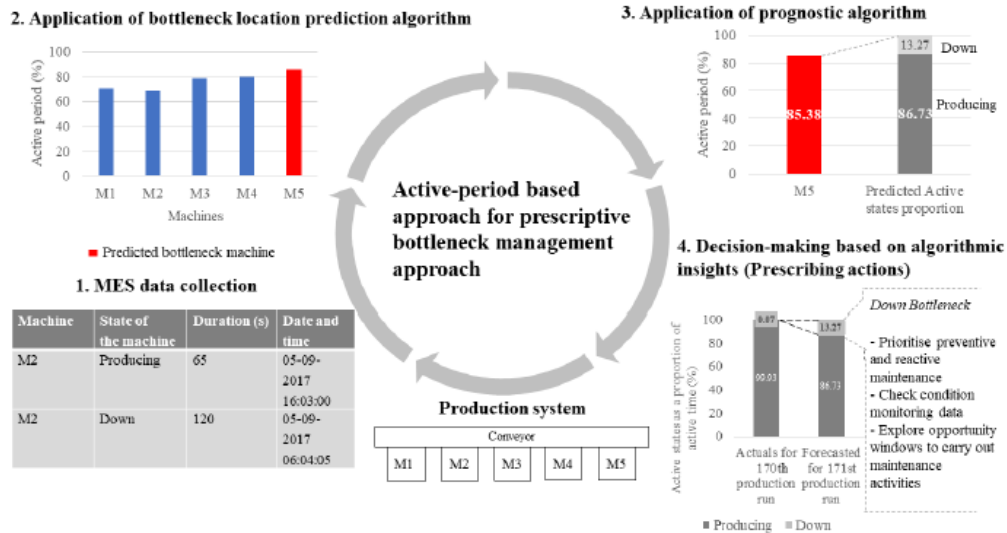

Figure 7. A Data-driven prescriptive approach for throughput bottleneck management using active-period theory for a 171st production run.

- Moreover, we also identified the amount of historical machine data to predict future bottlenecks. This is a novel result and suggests that more data is not always better for production systems. An example (from publication 4) is presented below.

Table 7
MAPE values of different window sizes.

Machines	Different window sizes and their MAPE values from ARIMA			
	50 (%)	100 (%)	150 (%)	185 (%)
M1	8.64	8.50	8.66	8.56
M2	12.45	12.36	12.91	12.98
M3	9.88	9.42	9.87	9.69
M4	10.35	10.50	10.70	10.60
M5	11.13	11.27	11.75	11.69
M6	8.44	8.25	8.83	8.74
M7	8.75	8.75	8.92	8.89
M8	10.01	9.89	10.62	10.07
M9	7.34	7.35	7.38	7.50
M10	8.54	8.43	8.55	8.53
M11	10.78	10.80	11.32	11.60
M12	17.30	17.21	17.28	17.43
M13	12.24	12.13	12.48	12.35
Average for the production line	10.45	10.37	10.71	10.66

- The developed data-driven algorithms were tested on the data sets received from partner companies. The framework (from publication 8)

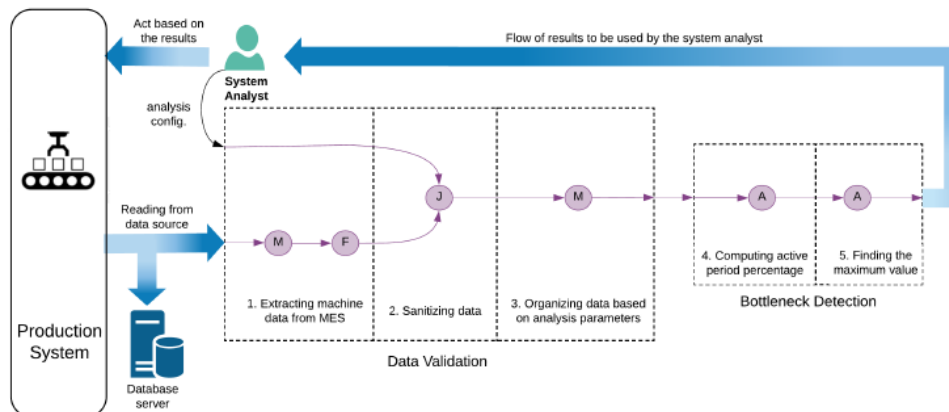

Results summarised in Publication 5, 7, 8, 9, 10 and 11.

6.3. WP3 results

G3.1: Quantify the relations between resources in a production flow (G3)

Criticality classification is a tool that intends to quantify the criticality of machines in a production flow in order to plan maintenance. In order to understand the relationships between the machines in a production flow, a current state mapping of the criticality

assessment tool was performed. The current state mapping was useful in understanding how different plants within companies as well as different companies use criticality classification for the purpose of quantifying the relationships between the resources in production flows. Some of the common ways used in manufacturing companies that were identified in this study are listed below,

- Cost deployment (CD) [7]
- ABC-type classification
- Priority scale for maintenance prioritization

A common theme across all the different criticality classification models used was that real-time data were not used for quantifying the relations. Predominantly, the quantification provided was static and updated thrice a year to once a year. The results are part of the publication 13 and 15. The results of this goal led towards a detailed understanding of criticality classification purpose, method and uses for various production layouts.

Furthermore, the quantification of the relations between the machines in the production flow can help prioritize the maintenance operations, for example repair maintenance work orders. Quantifying the utilization (active periods) of each machine in the system can enable identification of the bottleneck machine in the production flow. One prioritizing the bottleneck machines, the throughput of the production system increases. The figure below explains the potential of the throughput increment when compared to first-come-first-served basis of executing repair work orders. Naturally, dynamic prioritization has the potential to yield higher throughput increment than static bottleneck based prioritization because of the stochastic nature of the production system.

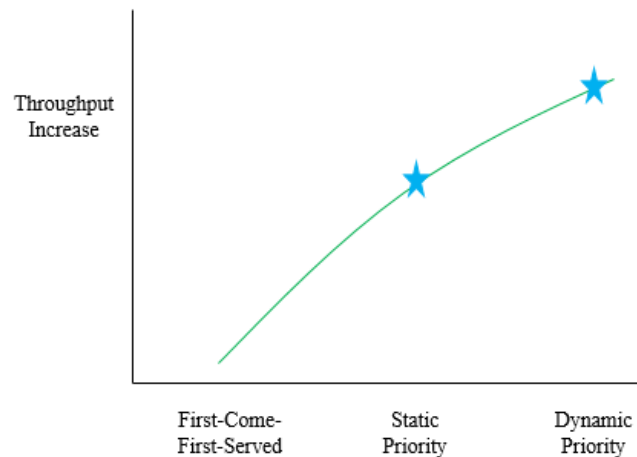

G3.2: Criticality classification models for various production layouts (G3)

An embedded multiple case study research design was performed. Six different cases were chosen from six different production sites operated by three multi-national manufacturing companies. The cases included different production layouts such as machining, assembly and foundry. The current state of industrial use of the classification tool can be summarized as,

- Main purpose in manufacturing companies with assessing criticality is to focus on machine availability
- Multiple criteria are generally used for assessment
- Several machines end by being classified as high critical
- Data usage are usually limited to MTTR and MTBF for analysis
- Qualitative approach was used
- Maintenance organizations were responsible for classification tool

On the maintenance planning and execution,

- Rarely the classification tool was used
- Maintenance execution such as prioritization was predominantly performed using the experience of the maintenance technicians or using the influence of the production operator

With respect to the different production layouts, the classification tool's usage was varied. It tends to work well for assembly and foundry production layouts, but not so well for machining lines. CD works particularly well on assembly and foundry lines. Furthermore, a generalized model (see Figure below) of the current state of the criticality classification in manufacturing company was developed using the multiple case study data. The results are published in publication 13 and 15. The results of this goal was directly used as in input to development and validation of data-driven machine criticality assessment in G3.3.

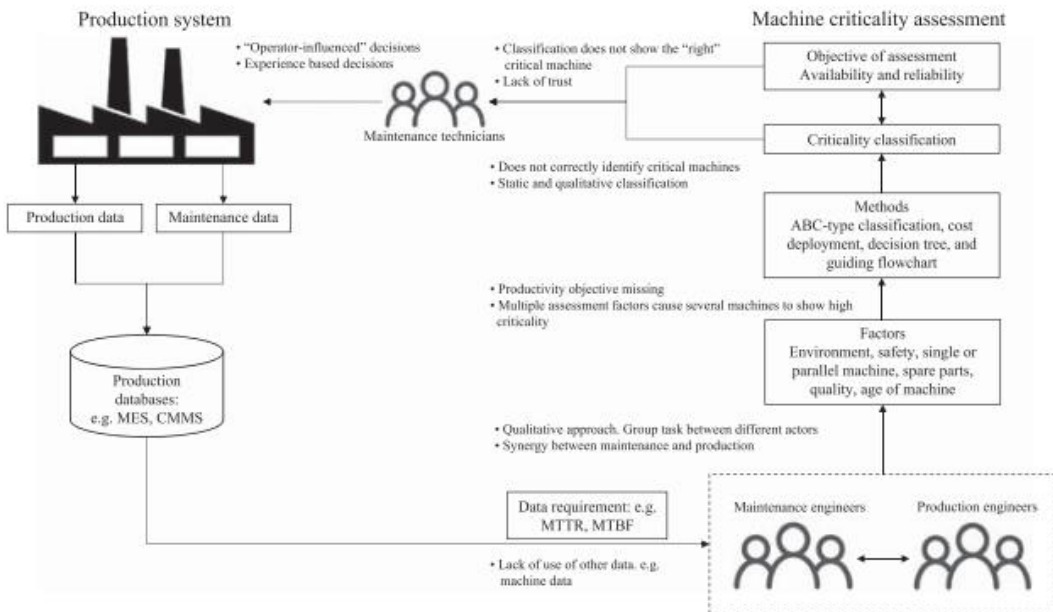

The model in the figure above shows the process of machine criticality assessment in manufacturing companies. It shows the data availability, the choice of data, different factors for assessment, multiple objectives, classification method, and lastly, the decision making process.

G3.3: Develop and evaluate data-driven algorithms for identifying critical equipment (G3)

Another multiple case study was performed to develop and validate data-driven machine criticality assessment. The main aim of data-driven machine criticality assessment is to connect maintenance to productivity, i.e. maintenance planning enabling throughput increase. Real-time data from MES system and CMMS system were collected to analyse machine criticality using data. The developed criticality assessment were further compared with existing machine classification to identify the differences. The developed data-driven machine criticality assessment framework consists of data analytics part and decision making part. The developed data-driven machine criticality framework is presented below,

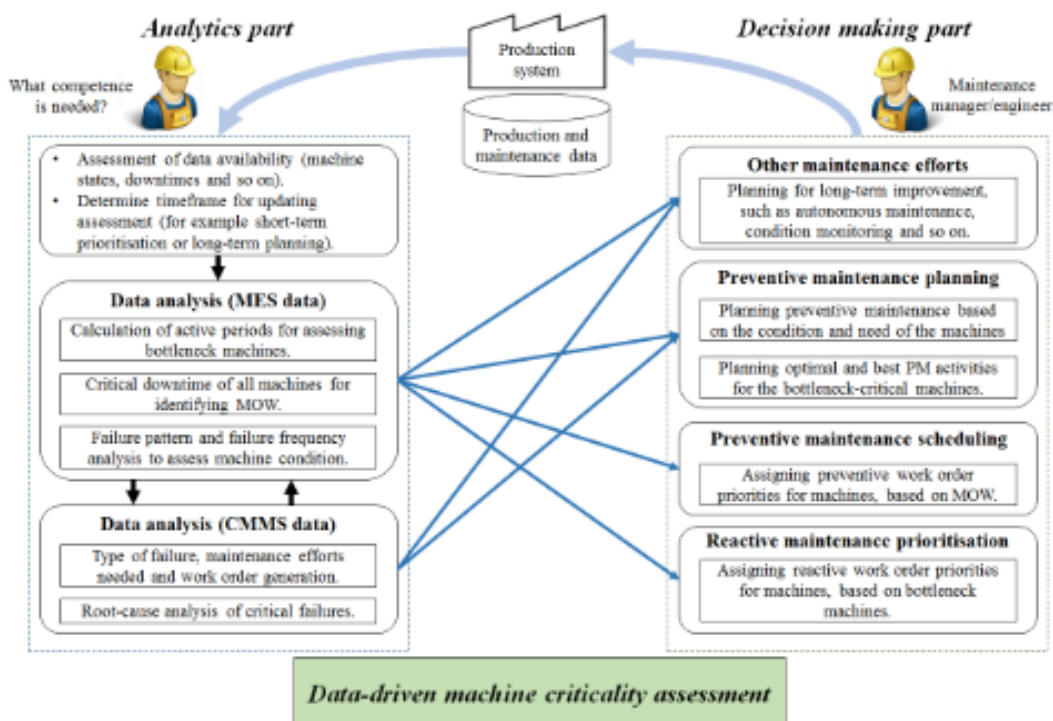

The data analytics part includes,

- Assessing data availability and time period for assessment
- MES data analysis: Bottleneck detection and maintenance opportunity window detection
- CMMS data analysis: failure type, personnel competence, root-cause analysis

Using the analytics part, different maintenance decision making can be performed. Such as,

- Prioritization of reactive maintenance
- Scheduling of preventive maintenance during production without compromising total available production time

- Plan preventive maintenance for machines based on the needs. It can be achieved through combining MES and CMMS data. Further, other maintenance efforts such as long-term improvements, decisions on condition monitoring can be performed

Upon development the data-driven framework was validated using simulation experiments. The experiments showed substantial throughput increment in comparison to first-come-first-served basis of maintenance prioritization as well as preventive maintenance scheduling by compromising the total available production time. Additionally, an interview study was performed within each of the selected case companies to evaluate the results. Major outcomes include, support for preventive and reactive maintenance planning, but also problems on data quality and competences needed for data analytics were raised. The results are part of the publication 14 and 15. The development and validation results show that the data-driven framework can enable the maintenance organizations to move from their current state, which is narrow focused to the desirable future state, which support systems perspective. The overall process is framed in the figure below. It shows the current state of maintenance organizations, guidelines drawn from the data-driven framework, the main principle of the framework and lastly, the desired future state.

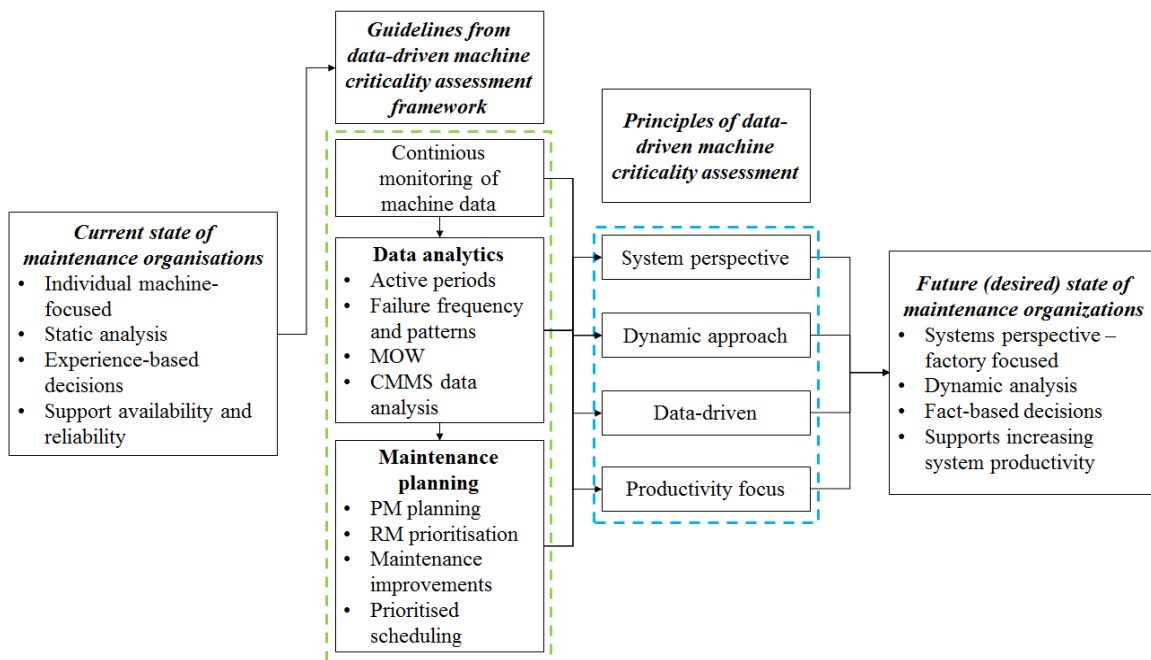

Furthermore, a study was performed to assess machine criticality for new production lines such as during design phase or complete change in product portfolio. This situation ensures lack of real-time data from the machines in the plant. Therefore, a fuzzy multi-criteria decision making model was used to perform machine classification by capturing the machine knowledge, maintenance personnel competence and key objectives of the maintenance organizations. The results are planned for publication 17.

6.4. WP4 results

WP4 has resulted in a model for classification of components in manufacturing equipment, and a method for designing diversified preventive maintenance. Further, this method has proved very effective as a tool to use in workshops, aiming at increasing the systems view on maintenance. The figure below shows the component classification which can be used for designing and planning preventive maintenance programs based the needs of the machines.

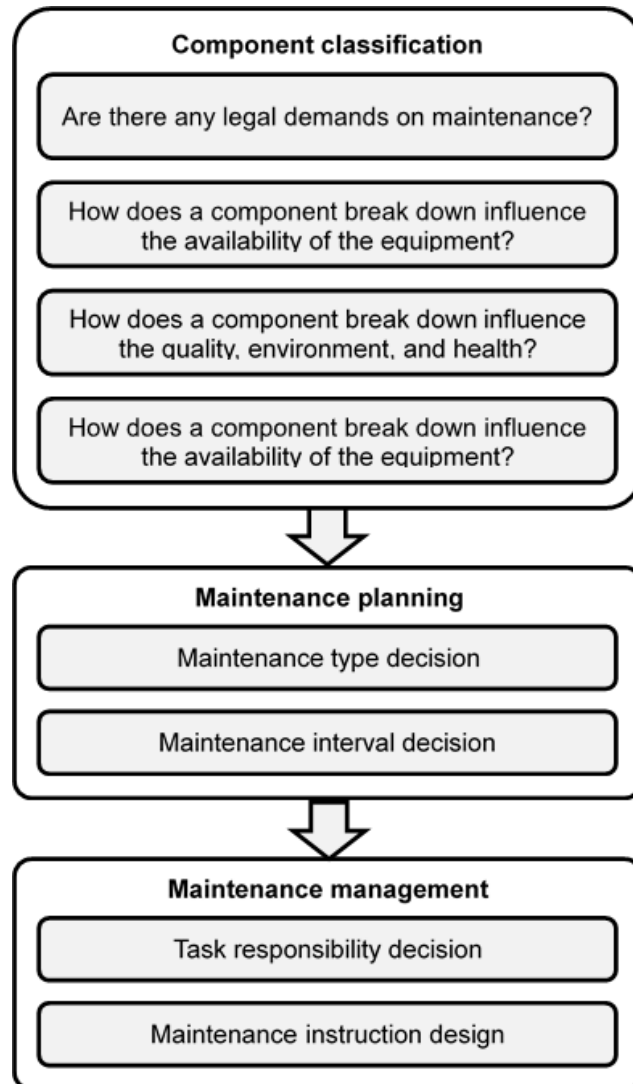

The classification model and the method for maintenance program design provide a basis for the fulfilment of goal G4.1, by identifying the true maintenance need of components from a systems perspective. Further, the method for maintenance design, build a basis that, combined with the equipment criticality classification from WP3, enable the design of differentiated maintenance packages, fulfilling the goal G4.2.

The goal G4.3 was partially fulfilled, mainly due to time constraints. However, conceptual model of the component classification model and the maintenance program design method were developed. The model take CMMS data into consideration. Further, in order to further the results for this goal, it should be noted that a thesis project was initiated within WP4. It showed that parts of the necessary CMMS data have rather poor quality, due to inconsistencies in the manual logging procedures. Further work will be carried out in this area to gather more results.

6.5. WP5 results

(i) Production ramp-up case at VCC

VCC often experiences major production disturbance issues, especially, during production ramp up phase, i.e. when new car models are rolled out from the VCC, Torslanda factory. Therefore, this demonstrator case aimed at showcasing how equipment and MES data can be used to identify production disturbances and how to prioritize them for effective planning of maintenance activities. Several results were gathered based on bottleneck detection and clustering of failure alarms. The production line case description and all major results are presented below.

Production Line Description

We took a body welding production line at Volvo cars to implement the different algorithms that were developed in WP2. The production line has 5 stations and the layout of the production line is shown below.

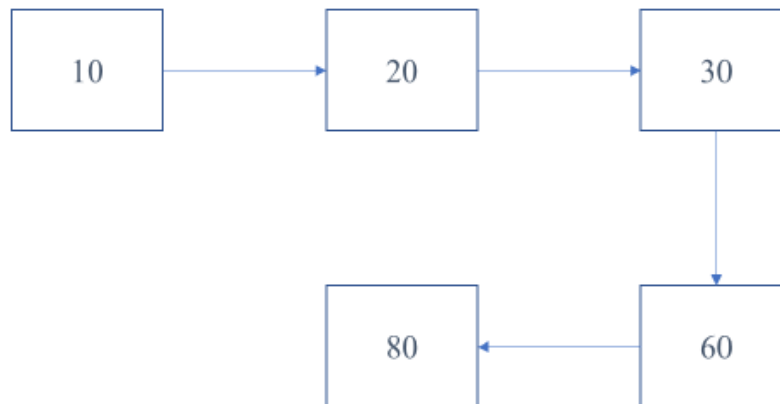

To demonstrate the algorithm, the data was collected from AXXOS IT system for a period of 6 months for every station. Thereafter, data cleaning exercise was performed to make the data suitable for applying different algorithms. The results of the data cleaning exercise are shown in the below Table:

	Stations				
	10	20	30	60	80
Number of days for which the data was given (02-Apr to 04-Sep)	133	133	133	136	134
Number of full days the production was not planned and was recorded in AXXOS ¹ as "Not Planned Production" in the Down time reason column	26	26	26	26	26
Number of days for which the data was missing for stations 10,20 and 30 (04-Jun, 05-Jun and 27-Aug) and that was present in station 60,80				3	3
Number of days for which the data was missing for station 80 (03-Sep, 04-Sep) and that was present for all remaining stations	2	2	2	2	2
Number of outliers in active period percentage ²	7	7	7	7	7
Total number of data points useful for system level analytics	98	98	98	98	98

Subtract from number of days to get the number of useful data points

Descriptive and Diagnostic Algorithm Results

Thereafter the descriptive and diagnostic algorithm which was developed in Publication 4 was applied to identify the bottlenecks and identify the potential root-causes of the bottlenecks. The results of the descriptive and diagnostic algorithm are shown below,

Descriptive and Diagnostic Bottleneck Analysis ¹ - Results

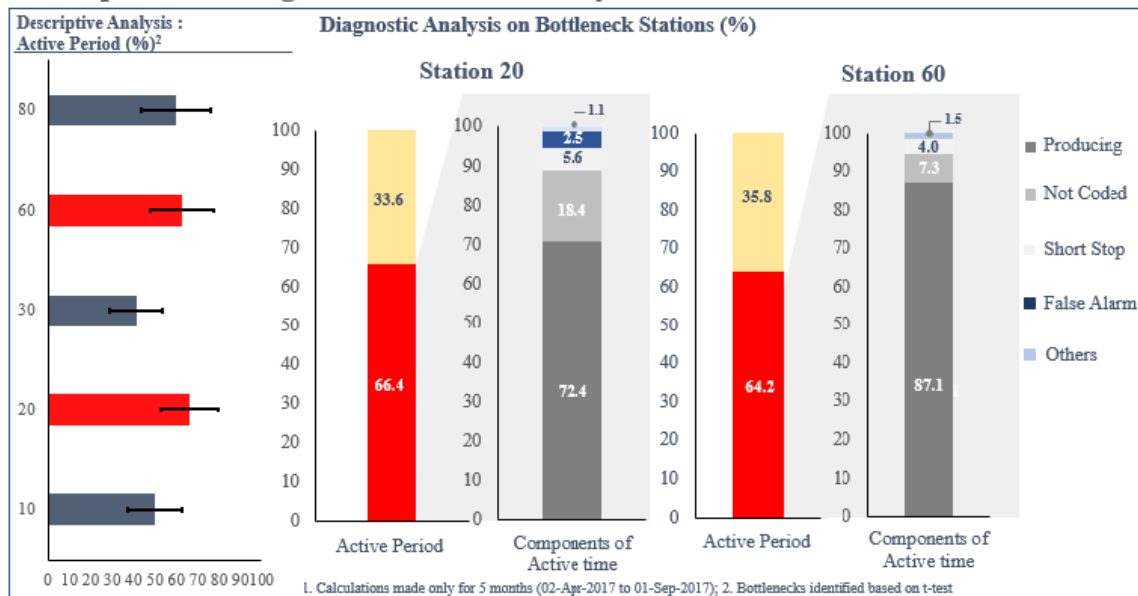

From the above figure station, 20 and station 60 are the potential bottlenecks. Station 20 is mainly downtime bottleneck and station 60 is mainly producing (i.e. cycle time) bottlenecks.

Clustering of alarms diagnostic insights

From the application of the descriptive and diagnostic algorithm, we found station 20 is a down type bottleneck and this indicates that maintenance teams need to focus this station for potential improvements. But the key question of what are the key elements maintenance

should focus? Answering this question will help maintenance teams to form actionable insights. The question can be answered by analysing the maintenance stops alarms. One way to analyse the maintenance stop alarms is to cluster them based on frequency and duration of the alarm. We applied the algorithm proposed in Publication 5 to cluster those alarms. The results are shown in the below figure,

Descriptive Analytics on Alarms for Station 20 – Results ¹

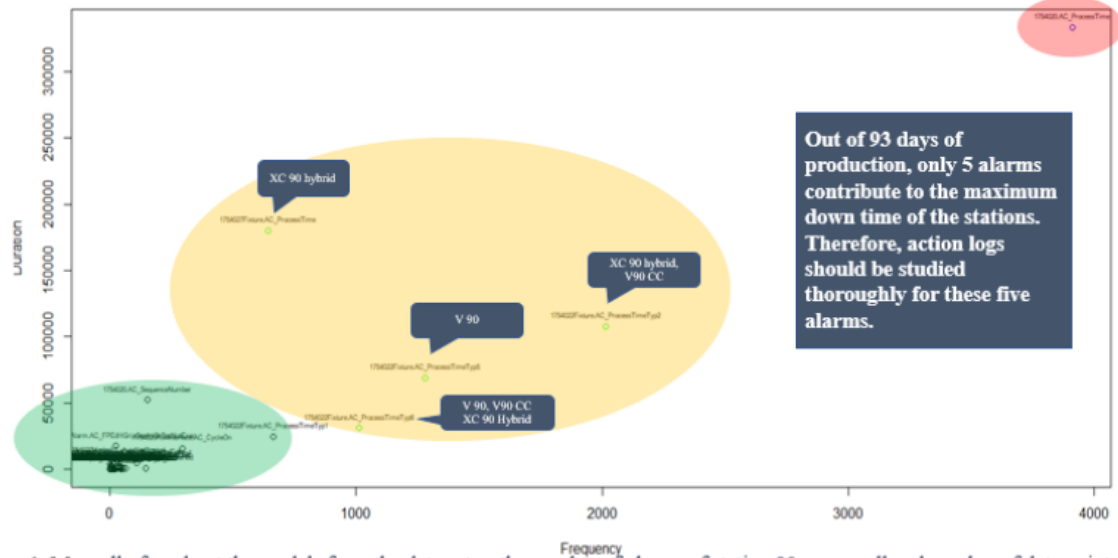

1. Manually found out the models from the data set as the number of alarms of station 20 was small and number of data points was small

Based on the above results, the maintenance teams can come up with improvement plans. An example of the improvement plans are shown in the below figure,

Prescriptive actions based on descriptive analytics¹

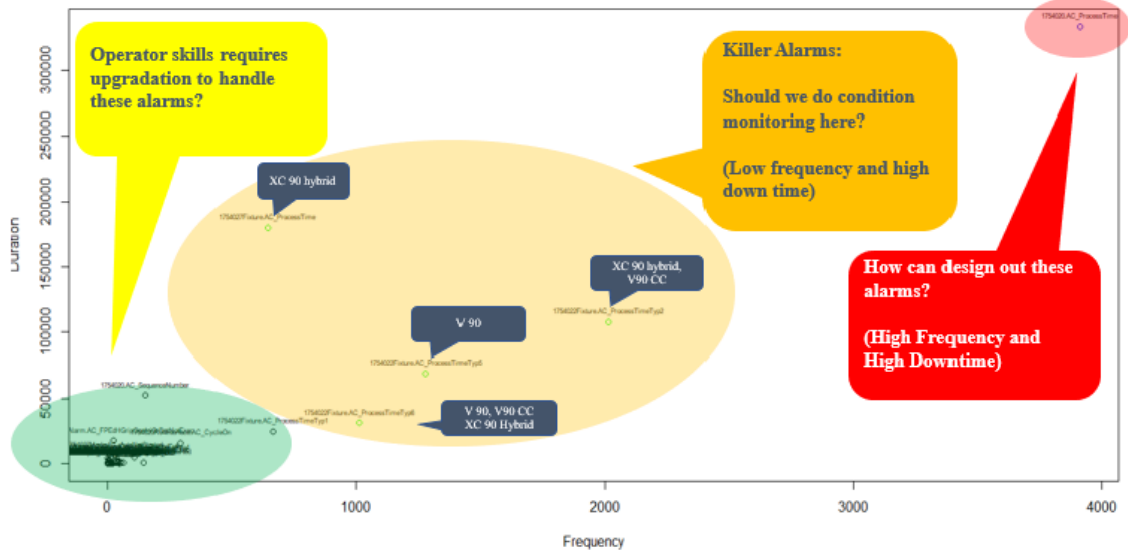

1. Based on the maintenance decision making grid proposed by A. W. Labib, A Decision Analysis model for maintenance policy selection using a CMMS. Journal of Quality in Maintenance Engineering. 2004

The above figure suggests that maintenance teams can form concrete action plans with the help of clustering algorithms that can cluster maintenance related alarms of the bottlenecks. Thus connecting the system level decision support to machine level decision support. Similarly, station 60 maintenance related alarms can also be clustered and the results are shown in the below figures,

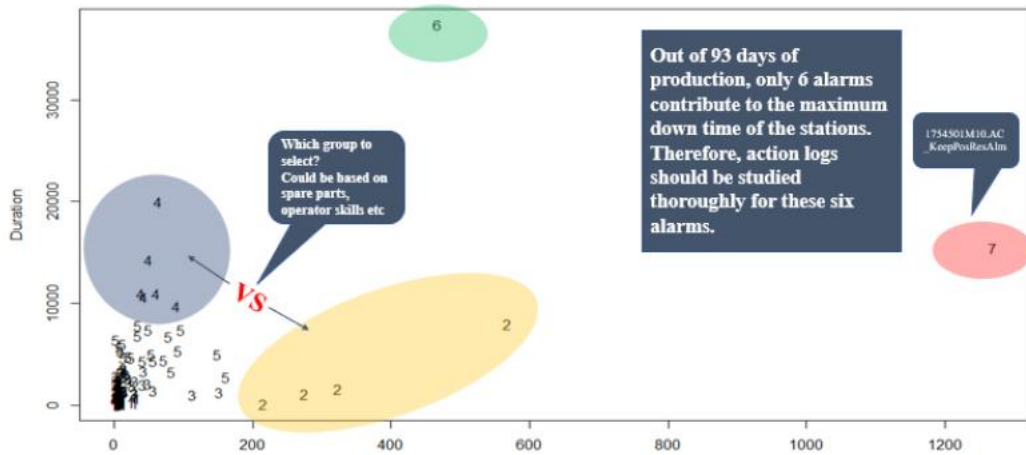
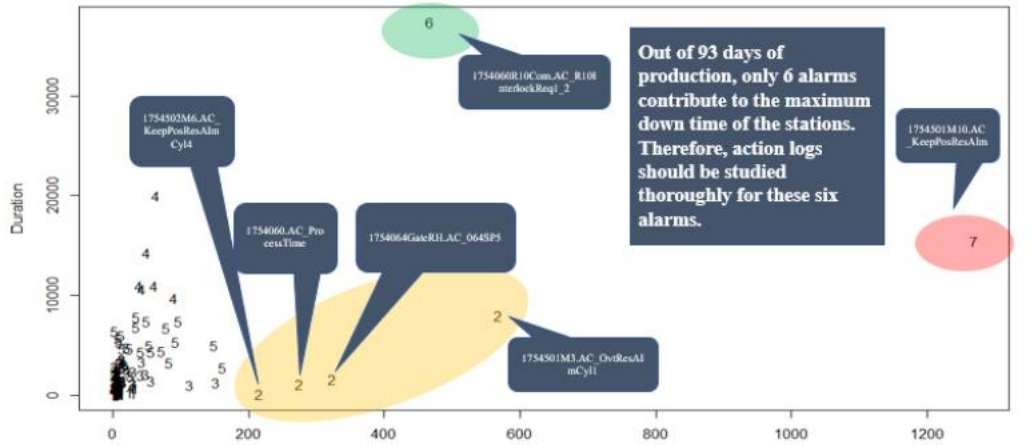

Prescriptive actions based on descriptive analytics¹

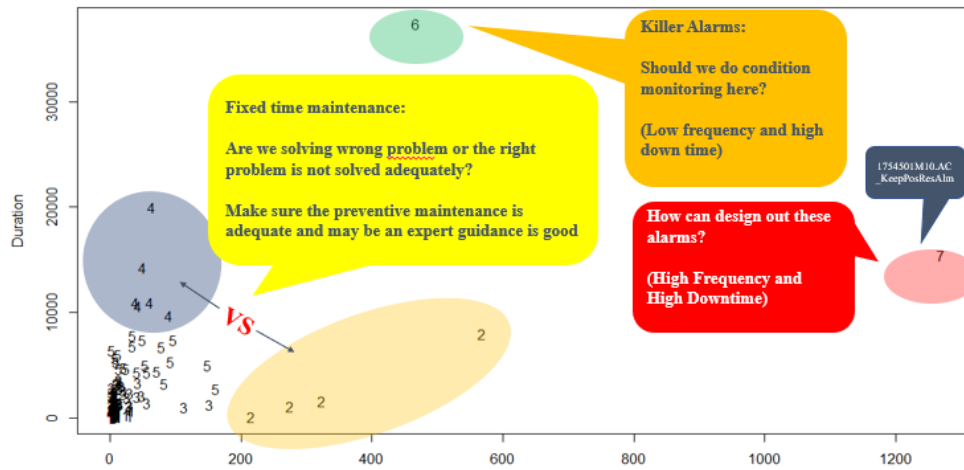

1. Based on the maintenance decision making grid proposed by A.W. Labib, A Decision Analysis model for maintenance policy selection using a CMMS. Journal of Quality in Maintenance Engineering, 2004

Validating the above insights with managers

The advantages of the algorithms compared to their existing approach are shown in the below Table:

Question	Volvo car approach	Our approach / recommendation	Comparison
Current bottlenecks in 1754 line?	Manual approach (Different for maintenance and production)	Data-driven approach	Data-driven approach also indicated the same bottlenecks pointed out by the maintenance teams. Station 60 and Station 20
Bottleneck shifts?	Don't know	Data-driven approach	Our approach shows that bottleneck shift mainly between stations 20,60 and 80.
Analysis of alarms?	Pareto based on frequency and based on experience	Clustering approach based on frequency, duration of stops and model types	Higher frequency doesn't necessary mean higher downtime. Our approach defines a methodology for the descriptive analytics on alarms based on different features selected and thus enabling predictive-prescriptive analytics approach
Product correlation with alarms thinking?	No. They don't look at the products when analysing the alarms.	Takes the product perspective into consideration	Our approach indicates that there are specific alarms on specific products. This diagnostic insight will lead to better understand the root causes. Product alarm correlation thinking is also novel in the research field.
Ideas on filling the inventory matrix with alarms?	Alarms that have longer spare parts lead supply lead time will be chosen	Take the alarms based on clustering	Alarms which have longer spare parts arrival lead time will may not be that frequent and will not have any impact on day-to day operations. Inventory matrix based on clustering of the alarms will have an operational impact

Predicting the bottlenecks

The bottlenecks shift day-to-day at this production line. This is illustrated in the below figure

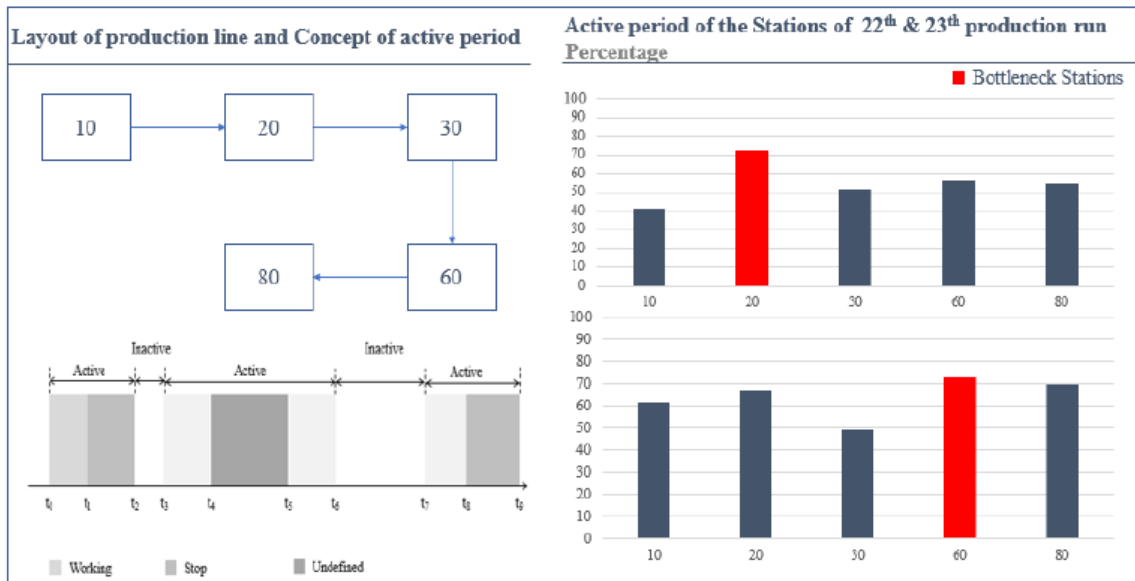

Therefore, if the future bottlenecks are known in advance, then it might lead to better management practices. The algorithm that we developed (as shown in publication 6) was applied to predict the future bottlenecks of the production system. In that process, the historical amount of data that is required to predict the future bottleneck is also found out. The results are summarised in the below figure,

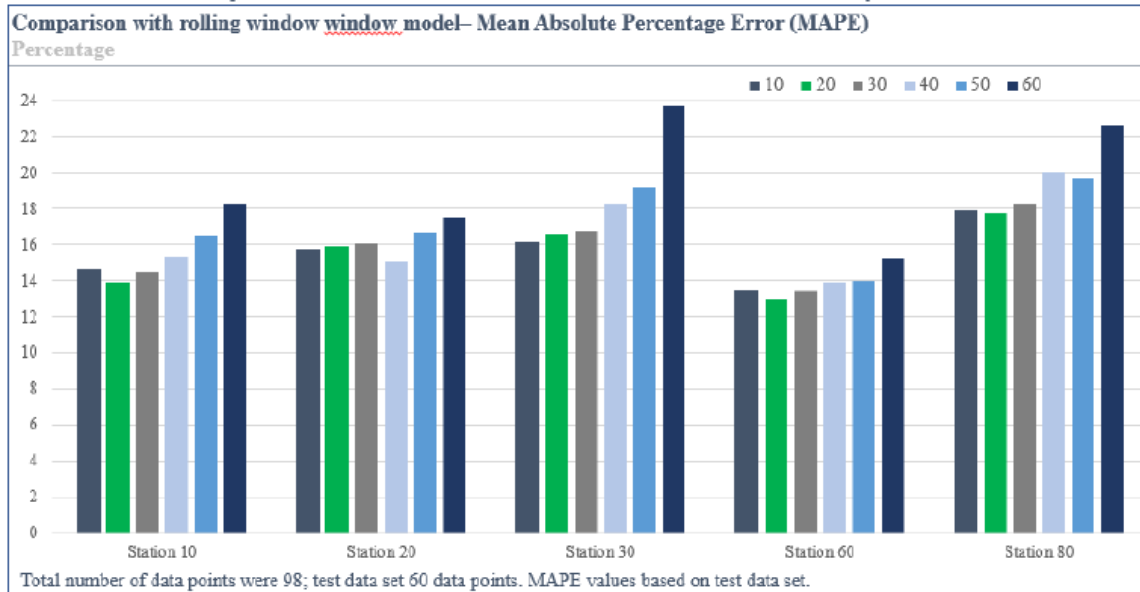

From the above figure, it can be seen that 20 historical production runs data is a better predictor of future bottlenecks. But we need to compare it with the naïve approach to assess this algorithm adds any value. This exercise was done and the results are shown in the below figure,

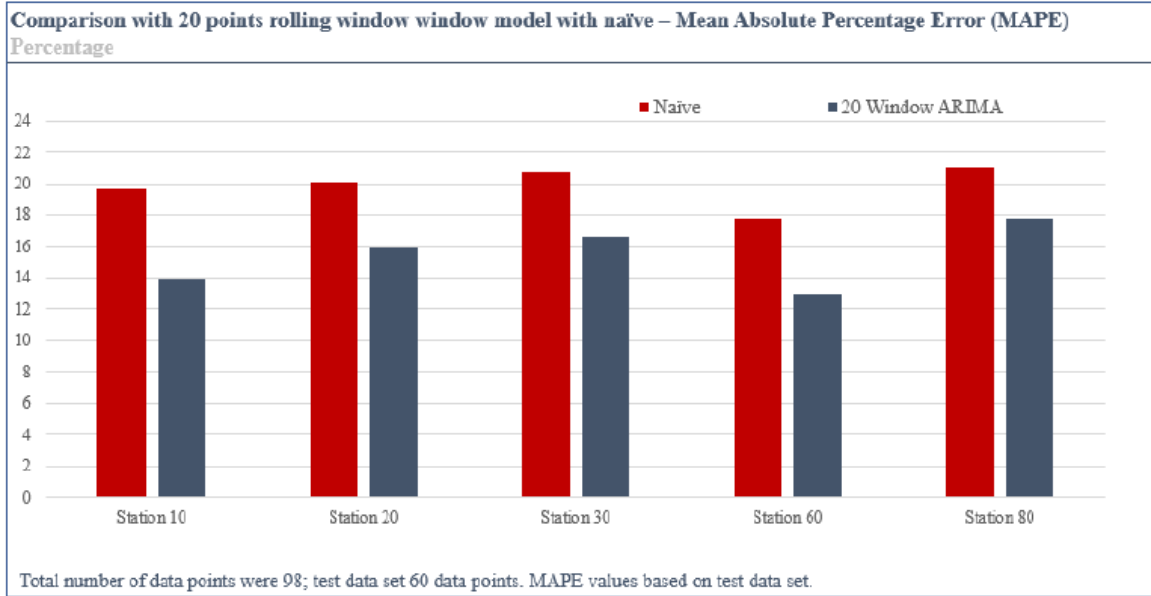

From the above figure, we see that the proposed algorithm error % is lower than that of naïve. This indicates that the algorithm adds value to the decision makers in terms of predicting the bottlenecks. An example of predicting the bottlenecks for the 23rd production run is shown below,

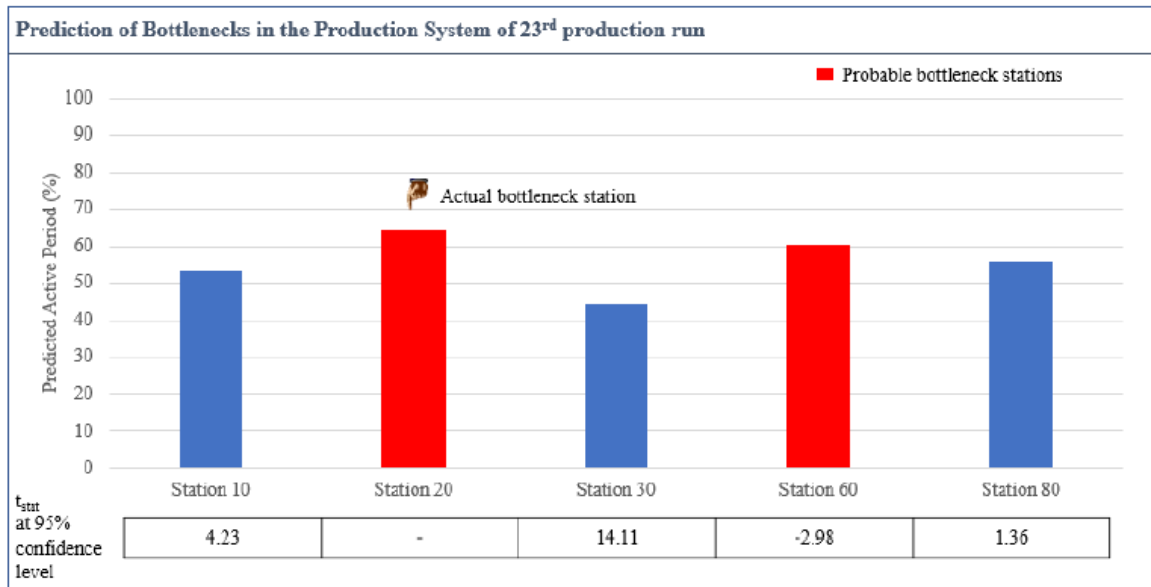

The proposed algorithm is evaluated by a method called Intersection of Union (IoU). The results comparing the performance of the proposed algorithm with that of the IoU is shown in below figure,

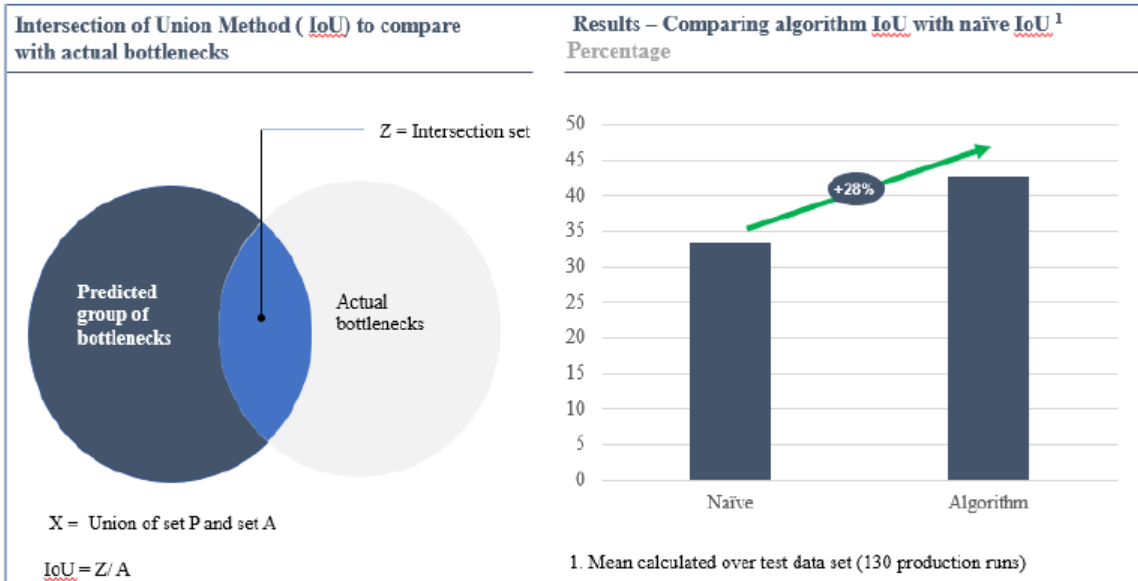

Predicting diagnostics insights on the bottlenecks

Predicting the bottlenecks doesn't yield to better management of bottlenecks. Further insights into the predicted bottlenecks are required in order to better manage it. We developed an algorithm in publication 4 that can predict the factors that make the stations to be bottlenecks and recommend actions. An example result is shown below,

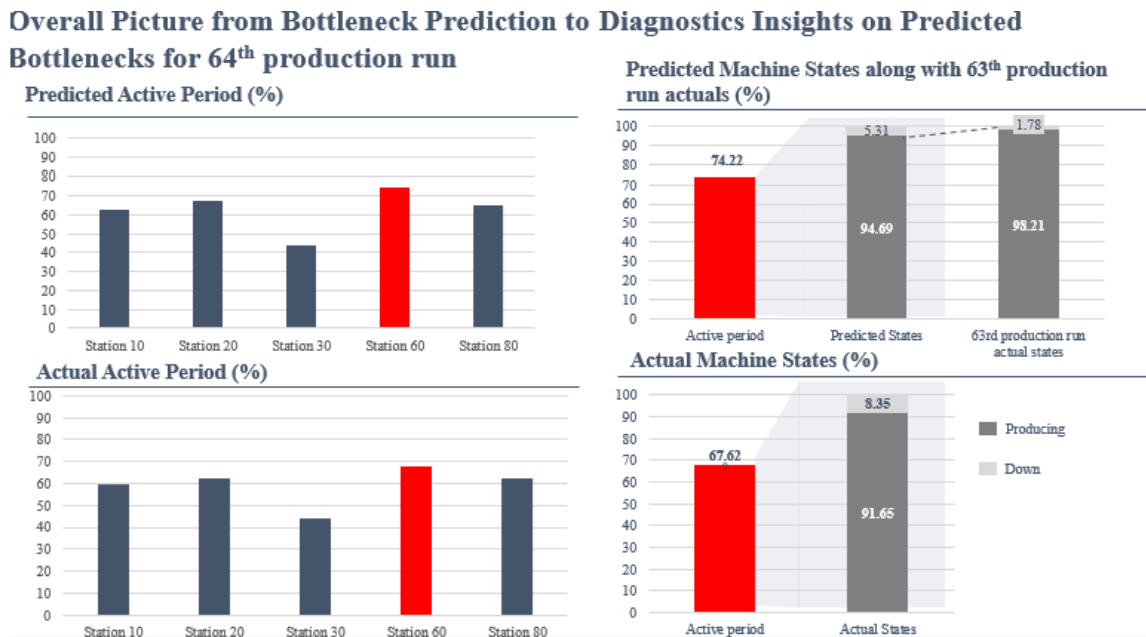

From the above figure, it can be seen that station 60 is predicted to be bottleneck station for a 64th production run. And station 60 is going to be mainly down time bottlenecks. Therefore, maintenance teams need to focus on this station and manage it better. Moreover,

we can see that station 60 which is a producing bottleneck in a 63rd production run is predicted to be shifting towards downtime bottleneck in the 64th production run.

(ii) Global standardization case at AB Volvo

As said in the description of the use case the focus has been on method the development connecting the OEE-system with the CMMS. During the project period, we have performed an investigation in three different sites of a machine supplier to check and understand how they handle both the professional and autonomous maintenance. The information from this investigation support the project to develop the methods and tools in all work packages. With the new demands for the future production, it will be even more important to use the opportunity windows in the production in order to optimize the maintenance activities that we need to perform on the machines. The DAIMP project will help us work in a more effective way both in short and long term planning of maintenance activities.

Considering the maintenance packages and how we can develop a more standardized way of working, this have been handled through one of the work packages and with the development of a component classification that we aim to implement in the maintenance method that we work with in all the Powertrain sites. This will also be used as an education tool to teach how to better understand what maintenance activities we should deploy on different components in the equipment. There is also an aim to use the global computerized maintenance management system to develop the tool to become data-driven in the future. During the project period we organized/ conducted numerous workshops among the sites both within and outside of Sweden. The workshops have also covered all areas of manufacturing for example foundry, machining and assembly. We have also included more functions than maintenance in the work for example manufacturing engineering and economy department.

In the workshops, we have covered purchasing, ramp-up and operations phase of an equipment looking from a maintenance perspective.

(iii) Smart industry demonstrator at Chalmers

Two demonstrators were developed in the form of test-beds in the Stena Industry Innovation (SII) lab. The test beds demonstrated various results developed in the WP3.

Demonstrator 1: Demonstration of real-time criticality assessment using a test-bed

A method for assessing dynamic criticality for different assets formulated. This is done using real-time system data and tested on a test-bed. The test-bed was designed and built at the SII lab for testing the dynamic criticality assessment. The test-bed demonstrator design is shown below.

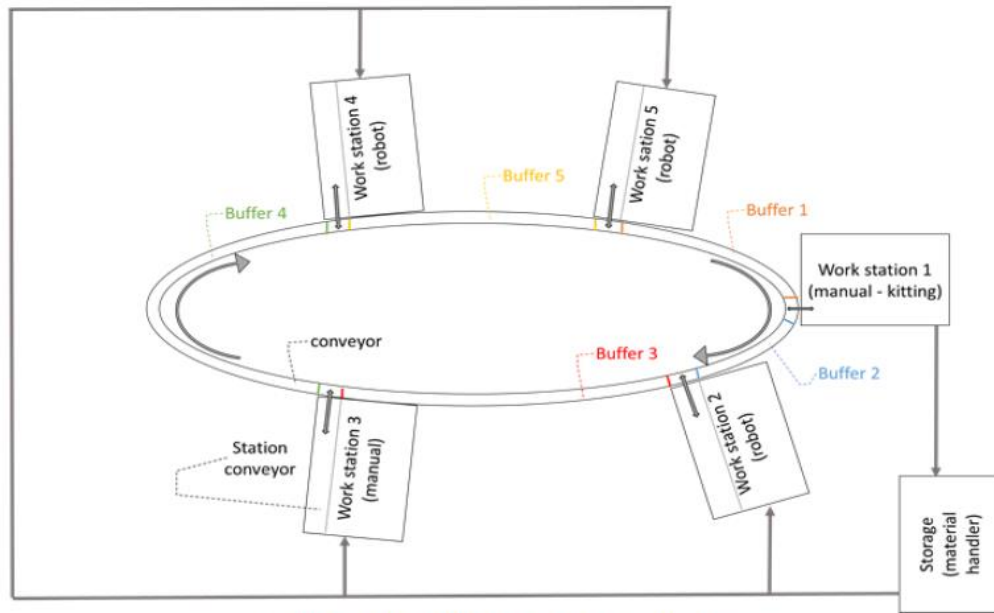
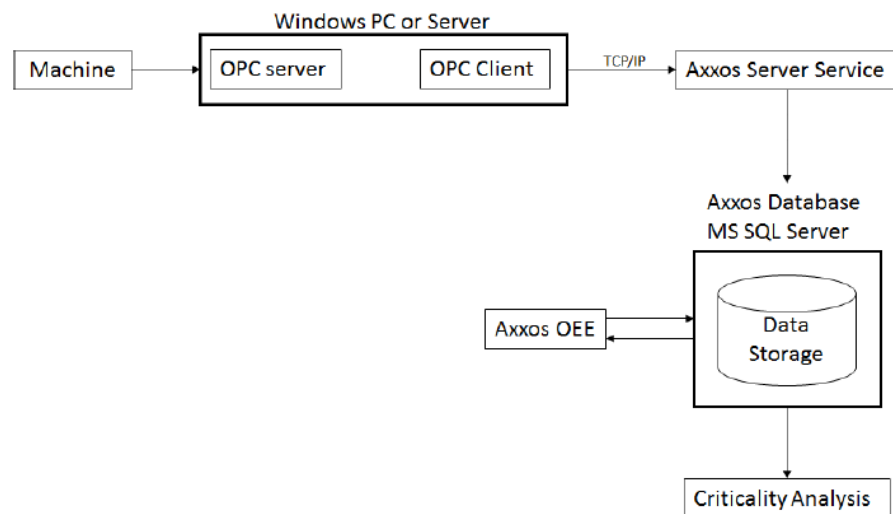

Figure 2: Description of demonstrator

Once the test-bed demonstrator was built, the data collection system and computerised maintenance management system (CMMS) software were installed. They were provided by Axxos and IFS respectively. The CMMS uses a dynamic criticality method based on a multi criteria decision making model. The data obtained from demonstration directly relates to the criteria for obtaining criticality and impacts the variation in criticality of assets. Moreover, using this data, maintenance activities can be planned accordingly. The functionality of Axxos system is shown below. Axxos collected the real-time data from the machines.



Subsequently, the Axxos data were transferred seamlessly to the IFS application software (see Figure below), which acted as the back office. It analysed the Axxos data to show the critical machine, i.e. to support maintenance planning in a data-driven manner.

Object ID:	Description:	Site:	Object Level:	Operational Status:																																				
ROBOT-1	ASSEMBLY ROBOT STATION	ACME	Sub Systems	In Operation																																				
<table border="1"> <tr> <td>Spare Parts</td> <td>Testpoints/Parameters</td> <td>Warranty</td> <td>Cost/Year</td> <td>Parties</td> <td>Notes</td> <td>Journal</td> <td>Requirements</td> <td>Maintenance Criticality</td> </tr> <tr> <td colspan="9">+</td> </tr> <tr> <td>Master Criticality</td> <td>Utilization</td> <td>Safety</td> <td>Maintainability</td> <td>Reliability</td> <td colspan="4"></td> </tr> <tr> <td></td> <td>36</td> <td>37,50 %</td> <td>12,50 %</td> <td>25,00 %</td> <td>25,00 %</td> <td colspan="3"></td> </tr> </table>					Spare Parts	Testpoints/Parameters	Warranty	Cost/Year	Parties	Notes	Journal	Requirements	Maintenance Criticality	+									Master Criticality	Utilization	Safety	Maintainability	Reliability						36	37,50 %	12,50 %	25,00 %	25,00 %			
Spare Parts	Testpoints/Parameters	Warranty	Cost/Year	Parties	Notes	Journal	Requirements	Maintenance Criticality																																
+																																								
Master Criticality	Utilization	Safety	Maintainability	Reliability																																				
	36	37,50 %	12,50 %	25,00 %	25,00 %																																			

To conclude, the use of real-time data as demonstrated in this test-bed can be used to have a clear information on status of system. The changing criticality of machines on dynamic level help maintenance organizations to focus maintenance resources on necessary assets, saving time and maintenance related costs. The results are published in a Master thesis (publication 12).

Demonstrator 2: Demonstration of ease in collecting data from any machine using affordable technology available in the market

The key setup of the test-bed demo is summarized below,

1. Demonstration on how to use a single device with multiple sensors for collecting data from Legacy machines.
2. Demonstration on how to log data in databases.
3. Visualization of the data for condition monitoring of machines can be tested
4. Demonstration of how to use Augmented Reality (AR) with tablet computers and smartphones for checking machine health in real time.
5. Demonstration of the use of Augmented Reality (AR) for providing visual assistance for maintenance operation using tablet computers.

This test-bed demonstration was performed as part of the DAIMP meeting final meeting during February 2019. All the industry and academic partners, including several colleagues from each partner participated in this final meeting. The results of all the WPs were disseminated via presentations and the test-bed demonstrator was performed. Chalmers, the project leaders, used this opportunity to disseminate the results and its impact to the larger audience by conducting interviews. Each WP responsible persons from academia and key respondents from each partnering companies were interviewed. The interviews were edited and published on the *Chalmers Production Area of Advance* YouTube channel. The interviews were structured to disseminate the main results from each WP in DAIMP and how the results had made/can make an impact in the manufacturing company.

The link to the video: <https://www.youtube.com/watch?v=HZOoaCoOml0&t=8s> (Please note the video has a mix of English and Swedish speakers)

6.6. WP6 results: International evaluation of DAIMP

Two international professors, Oliver Rose from Bundeswehr University Munich and Jayantha P. Liyanage from University of Stavanger were invited to evaluate the DAIMP project's progress. This mid-term evaluation happened during October 2017 at Chalmers in

Gothenburg, Sweden. The evaluation meeting was attended by all the academic and industrial project partners.

The visiting professors were provided with the project application, results from each WP and its plan for the rest of the project in advance. The visiting professors provided critical and constructive feedback on all the WPs. Some examples of the critical feedback are presented below.

- Professor Oliver Rose appreciated the current benchmarking methods proposed in WP2. He also raised questions for ARIMA modelling approach for the MES data, i.e. to check the statistical requirements of modelling. He also suggested the use of advanced algorithms for MES data. However, it was later understood that the main use from the MES data was to make data pre-processing in order to apply advanced algorithms. Further, it was demonstrated that how the MES data can be used for forecasting using ARIMA modelling. Also, the same data sets can be used for advanced forecasting techniques.
- Professor Jayantha P. Liyanage provided critical and valuable insights from his background of petroleum industry to WP3, which focused on discrete manufacturing. The technology driven approach to reduce maintenance costs was one of the major suggestion, particularly, the integration of machine data with maintenance data to provide reliable maintenance decisions. Specifically, in application of advanced algorithms. Subsequently, both type of data sets were used in the development of data-driven machine criticality assessment framework.

The critical feedback and the improvement comments were taken into account and further implemented in the second half of the project. For example, Prof. Oliver Rose's comments were used to improve parts of machine capabilities and application of advanced algorithms WP1 and WP2. Another example, Prof. Jayantha P. Liyanage were used to expand the scope of machine criticality assessment and design preventive maintenance programs in WP3 and WP4.

6.7. Summary of the deliverables

The expected results and how they were achieved are presented in the table below.

Expected results	How was it achieved
R1. Validated model for criticality classification of production equipment (G3)	In WP3, data-driven machine criticality assessment framework was developed and validated. MES and CMMS data were used to assess criticality of machines. It serves as data-driven decision support for maintenance planning and prioritization. It provided guidelines to achieve systems perspective in maintenance organization.
R2. Validated algorithms for predictive and prescriptive analysis (G2)	In WP2, diagnostic, predictive and prescriptive algorithms were developed and validated. The algorithms were developed using MES data to provide system level decision making using data analytics. Improved quality of decisions by data-driven algorithms. Moved from experienced based decision to algorithmic based decisions. Identified the required amount data sets for developing machine learning algorithm.
R3. Guidelines for designing maintenance programs at various criticality levels (G4)	In WP4, a component classification was developed. It provides guidelines for designing preventive maintenance programs based on the machine criticality. It uses CMMS data for component classification.
R4. Specification of data and information structures for capability analysis and for sharing data between end-users and equipment vendors (G1)	In WP1, the information exchange and process of machine tool procurement from the end- user’s perspective was assessed. The conclusion is that, the vendors and end-users need more transparency and support during different phase of machine tool life cycle. This will improve the product quality by providing feedback data from the end-user to the vendors and highest standard product for the customer need (win-win situation).
R5. Standardized work procedures and role descriptions for ensuring data and analysis quality (G1 & G2)	In WP1, The alarm structure is created using the capability framework and the ability model. However, the validation of the alarm structure is complex without proper data and understanding of the machine tool at the component level. So, the modular spindle unit is designed and developed which will support to validate the alarm structure in future. In WP2, algorithm to detect the bottleneck, diagnose the bottlenecks, cluster the maintenance alarms, predict the future bottleneck, predict the diagnostic factors of the future bottlenecks, prescription of necessary maintenance actions on bottlenecks were developed

The table continues on the next page

R6. Comparison of models for quantifying the cost of lost production (G3)	<p>In WP3, to understand the relationships between the machines in a production flow, a current state mapping of the criticality assessment tool was performed. A common theme across all the different criticality classification models used was that real-time data were not used for quantifying the relations. Quantifying the utilization (active periods) of each machine in the system can enable identification of the bottleneck machine in the production flow. One prioritizing the bottleneck machines, the throughput of the production system increases. The cost of lost production was calculated based on the losses in productivity</p>
R7. 3 demonstrators, 2 industrial and one in a laboratory setting (all Gs)	<p>Two industrial demonstrators: VCC and Volvo GTO were developed. VCC case focused on production ramp up case. Several algorithms from Axxos data were developed, which will support maintenance decision making during ramp up phase. Volvo GTO focused on global standardization for planning of maintenance activities. Workshops were conducted at different plants within Volvo GTO. The laboratory setting demo was developed at the SII lab, Chalmers. A test-bed was created to show data-driven machine criticality assessment (results of WP3), including data generation from test-bed, data collection, data analysis and visualization.</p>
R8. Two academic theses, one PhD and one licentiate (all Gs)	<p>Ph.D. thesis: Data-Driven Decision Support for Maintenance Prioritisation was presented August, 2018. Licentiate thesis in Data analytics for production improvement is planned for late 2018 using the results of DAIMP project</p>
R9. Learning modules for courses on MSc level (all Gs)	<p>Maintenance prioritization, criticality assessment, preventive maintenance planning, bottleneck detection, data-driven decision making are included as modules in Product and Production Service System course at Chalmers at MSc level. Similarly, design of preventive maintenance was included in MDH MSc course and machine capabilities are included in the KTH MSc courses.</p>

7. Dissemination and publications

7.1 Dissemination

How are the project results planned to be used and disseminated?	Mark with X	Comment
Increase knowledge in the field	X	<p>WP1: The results were published in scientific papers and results were integrated in courses</p> <p>WP2: The results from this work package contributed significantly from an academic research perspective and also to the industrial community. From an academic research perspective, there was clearly a research gap in different ways in which machine data can support system level maintenance decisions. The results from this work package contributed to addressing this gap by developing data-driven algorithms and testing its effectiveness on industrial data sets. From an industrial perspective, the data-driven algorithms clearly demonstrated how the machine data collected by the partner companies could support proactive maintenance practices.</p> <p>WP3: The results from WP3 contributed significantly in the field of machine criticality assessment. Data-driven criticality assessment is an entirely new approach in this field. Existing research are heuristics based or qualitative approaches. From the industrial perspective, the results provided guidelines to the maintenance organizations for making data-driven decision in maintenance planning. The approach supported decision making from a systems perspective focusing on the productivity of the production system.</p> <p>WP4: Scientific papers and courses</p> <p>Overall:</p> <ul style="list-style-type: none"> • Popular articles and industry presentations were performed. For example, an article was published in the business magazine “Automation”. Articles in similar magazines were published • The results of the WPs are integrated as teaching modules for Master students. For example, at Chalmers the results are taught in the <i>Product and Production Service System</i> course for masters students • Results are also used in teaching at <i>Chalmers Professional Education (CPE)</i> course, which is provided for industrial participants • Presentations and Demos were conducted at the Swedish Maintenance Fair (<i>Underhållsmässan 2018</i>)
Be passed on to other advanced technological development projects	X	<p>WP1, 2, 3 and 4: Future technical project ideas were developed from the WP results.</p>
Be passed on to product development projects		
Introduced on the market	X	<p>WP2: One of the algorithms (statistical bottleneck detection algorithm presented in publication 2) developed within this project been integrated into AXXOS IT system (AXXOS supplies IT systems to manufacturing companies). AXXOS implemented this algorithm at VCC and is considered as being implemented to other customers of AXXOS.</p>
Used in investigations / regulatory / licensing / political decisions		

7.2 Publications

The publications that sprang out the DAIMP project are listed below work package wise.

WP1

1. Baksza, P.A., First step towards integrating maintenance with machine capability – Identifying gaps, challenges and problem, *Master thesis*, KTH Royal Institute of Technology, March 2017
2. Sadasivam, L., Integration of machining system capability with maintenance activities, *Master thesis*, KTH Royal Institute of Technology, November 2017
3. Sadasivam, L., Archenti, A., Sandberg, U., Machine tool ability representation: A review, *Journal of Machine Engineering*, 2018, Vol 18, No. 2, 5-16

WP2

4. Subramaniyan, M., Skoogh, A., Salomonsson, H., Bangalore, P., & Bokrantz, J. (2018). A data-driven algorithm to predict throughput bottlenecks in a production system based on active periods of the machines. *Computers and Industrial Engineering*. <http://doi.org/10.1016/j.cie.2018.04.024>
5. Subramaniyan, M., Skoogh, A., Salomonsson, H., Bangalore, P., Gopalakrishnan, M., & Muhammad, A. S. (2018). Data-driven algorithm for throughput bottleneck analysis of production systems. *Production & Manufacturing Research*, 6(1), 225–246. <http://doi.org/10.1080/21693277.2018.1496491>
6. Baum, J., Laroque, C., Oeser, B., Skoogh, A., & Subramaniyan, M. (2018). Applications of Big Data analytics and Related Technologies in Maintenance—Literature-Based Research. *Machines* 6, no. 4: 54. <https://doi.org/10.3390/machines6040054>
7. Subramaniyan, M., Skoogh, A., Muhammad, A. S., Bokrantz, J., & Berkar, E.B. A prognostic algorithm to prescribe improvement measures on throughput bottlenecks. Submitted to the *Journal of Manufacturing Systems*
8. Nagdataei, H., Subramaniyan, M., Gulisano, V., Skoogh, A., & Papatriantafilou, M. Stream-IT: Continuous and dynamic processing of production systems data - throughput bottlenecks as a case-study. Submitted to *IEEE International Symposium of Industrial Electronics Conference*. Vancouver, Canada.
9. Clustering of throughput bottlenecks using unsupervised algorithms (*Planned*)
10. Clustering of alarms (*Planned*)
11. Streaming algorithms for shifting bottlenecks (*Planned*)
12. Eriksson, A. (2017). Bottleneck detection in manufacturing - A throughput case study at SCANIA CV. *Master Thesis*, Chalmers University of Technology, Gothenburg, Sweden

WP3

13. Gopalakrishnan, M., Skoogh, A., Salonen, A., & Asp, M. (2019). Machine criticality assessment for productivity improvement: Smart maintenance decision support. *International Journal of Productivity and Performance Management*, <https://doi.org/10.1108/IJPPM-03-2018-0091>

14. Gopalakrishnan, M., Subramaniyan, M., & Skoogh, A. (2018). Data-driven machine criticality assessment – Maintenance decision support for increased productivity. Submitted to *Production Planning and Control*.
15. Gopalakrishnan, M. (2018). Data-Driven Decision Support for Maintenance Prioritisation – Connecting Maintenance to Productivity. *Ph.D. Thesis*, Chalmers University of Technology, Gothenburg, Sweden.
16. Salunkhe, O. & Fumero, P. Q. (2017). Demonstration of real-time criticality assessment using a test-bed – Dynamic maintenance prioritisation based on criticality assessment of real-time production data with help of a Computerised Maintenance Management System. *Master Thesis*, Chalmers University of Technology, Gothenburg, Sweden.
17. Gopalakrishnan, M., Bekar, E. T. & Skoogh, A. (2019). Fuzzy logic based machine criticality assessment. (*Planned*)
18. Magnusson, J. & Savolainen, P. (2019). Data based planning & prioritization in maintenance. *Master Thesis*, Chalmers University of Technology, Gothenburg, Sweden.

WP4

19. Maintenance planning practices (Submitted to *Journal of Quality in Maintenance Engineering*)
20. Component classification and PM planning (Planned paper for *Journal of Quality in Maintenance Engineering*)
21. Maintenance improvement through CMMS analysis (*Master thesis*, currently under re-writing for journal paper)
22. Maintenance method development in co-production. (*Planned paper*)

Remark on the publications

The DAIMP project had high quality in the research work performed and created strong impact for the industrial partners. Naturally, it reflected in the number of publications that came out of this project. Most importantly, most of the articles were published in high quality peer-reviewed journals. Even though the project is completed now, there are a few papers that are planned/work-in-progress using the results of the DAIMP project.

8. Conclusions and future research

The conclusions and future research are presented work package wise. As a final remark, the overall conclusion and future opportunities are presented.

WP1

In general, the vendors and OEMs need to develop a strong cooperation which enables to share the advanced technical knowledge and information for the better development of machine tools. The developed determination framework model enhances the importance of defining an error at the component/ part level and connection to the part specification through the ability determination. However, the further research required in the area of defining the factors involved in the degradation of machine tool connected to the series of functions performed during machining operations. Also, the significance of each deviations level for an operation needs to be measured and analyzed with relation to the GPS. Obviously, this cannot be possible without the advance sensors and data analytical methods which emphasis the development of new sensors for the complex machine tools. In future studies, the modular component system e.g. spindle unit for a machine tool will be developed to validate the framework model which supports to map error related to the part deviation.

WP2

It turns out that maintenance engineers and managers have many difficult decisions to make on a day to day operations. Currently, the maintenance practices in many manufacturing companies are reactive and their vision is to become more proactive. Being proactive, for example, getting notifications of machine disturbances well in advance give enough time for maintenance engineers to plan specific strategies to either prevent or mitigate it. The results from this work package have contributed to the industrial vision of achieving proactive maintenance. This is done by developing algorithms that can take the machine data to predict the future disturbances in the machines of the production system and prescribes necessary actions to mitigate them. The algorithms developed are tested on different production systems on the partner companies and are proved to be effective. Overall, the results from this work package is a great example of cross disciplinary research bringing real value to the Swedish Industries and is a great example of industrial digitisation.

From an academic research point of view, the results from this work package push the boundaries of the research in the field of maintenance. The major contributions are demonstrating how machine data can be used in a novel way to support proactive maintenance activities on a production system level. The novelty of the developed algorithms includes the process of converting the machine data into a generic format thereby enabling different machine learning algorithms to be applied to support proactive maintenance planning. Yet another novelty is that the developed algorithms demonstrate that more data does not always lead to a better prediction of future disturbances. This

finding breaks the intuitive thought of using more data leads to better prediction. Moreover, we have created a generic benchmarking model to evaluate the predictive results with the naïve approach and argued that if the predictive accuracy is not beating the naïve, then it doesn't add value.

The results of this work package form a strong basis for future research. Some opportunities are,

- The results reported in this work package are based on the data from MES. Future research could focus on integrating data from several information systems such as MES, Computerised Maintenance Management Systems (CMMS), sensor data to better predict the production disturbances
- Usage of more advanced prediction algorithms to improve the accuracy of the disturbance predictions and also prescribe actions. Example of such algorithms is deep learning and collaborative filtering-based recommender systems

WP3

The purpose of this work package was to enable differentiation of maintenance planning in terms of preventive, reactive as well as improving activities through a dynamic data-driven approach for assessing machine criticality. The decision support framework helps in prioritizing maintenance from a systems perspective with the focus on improving productivity and resource efficiency. Currently, manufacturing companies use criticality classification tool for maintenance planning which are static, qualitative, narrow-focused (machine availability as the only aim) and uses multiple criteria. These problems in the classification tool causes maintenance decisions being made based on maintenance technician's experience or production operator's influence, i.e. not based on facts.

As a result, a dynamic data-driven machine criticality framework was developed and validated within WP3. It was done by using both MES and CMMS data. Using both data sources provided strengths in terms of capturing the current state of machines in the production flow, an accurate quantification of the relations between machines and factual insights on the machine's criticality. Furthermore, the framework provided guidelines for the maintenance organizations about how to approach the data analytics for the assessment as well as what type of maintenance decisions can be made based on those analyses. On validation, strong connection towards productivity improvement was demonstrated using simulation experiments. Further evaluations also showed strong support for industrial use and the factors for implementations were identified. It is concluded that a data-driven machine criticality assessment enables maintenance decision making from a systems perspective and enables productivity increase. It has strong scientific and industrial implications.

The results of the work package also provides interesting future research opportunities as well. Some of them are,

- The integration of system level decision support with the machine level decision support. For example, machine criticality assessment should be integrated with component level classification in order to obtain robust preventive maintenance programs for machines in a

- dynamic and optimized manner. This provides a top-down approach for design of preventive maintenance programs
- Further research is needed in terms of implementation of data-driven decision making tool in industrial setting. Several factors were already identified, for example, data quality. Further research of these factors such as identifying the necessary conditions will companies to develop road maps for implementing data-driven solutions in maintenance organizations.

WP4

Conclusions of WP4 are the following:

- The manufacturing industry rely more on experience than on scientific, data driven methods when designing programs for preventive maintenance.
- The manufacturing industry base the predetermined preventive maintenance on calendar time, of practical reasons, e.g. ease of production- and resource planning.
- Maintenance engineers realize the advantages of using dynamic PM planning, but believe the production- and resource planning will be too hard to manage.
- Traditional reliability engineering approaches are too rigid to use in the dynamic nature of discrete item manufacturing with mixed models, and varying work load.
- By adapting reliability engineering methods to the conditions of the manufacturing industry, it is possible to classify components from a criticality perspective, and thus, diversify the preventive maintenance due to contextual criticality.
- In order to base the preventive maintenance on CMMS data, the data quality need to be increased, mainly by better procedures for manual data input, e.g. free text, describing faults and cause of failures.

Further research:

- How can the preventive maintenance be packaged in diversified programs, based on dynamically assessed criticality of the equipment?
- How can preventive maintenance plan be optimized based on system criticality, production plans, and resource assignment?
- How can breakdowns, not related to poor maintenance be reduced?

Overall conclusion

The DAIMP project aimed to address the *higher productivity* and reduced *environmental impact* in production, which are the two main goals of FFI Sustainable Production. Improving them would reduce the disturbances and increase machine utilization. Subsequently, it addressed the problem of insufficient availability and robustness in Swedish production systems. The novelty of the project is the data-driven approach to solving these problems, which are traditionally experience driven and non-factual.

The outcomes of the DAIMP project showed a strong contribution to research and manufacturing industry alike. Particularly, the project created a strong impact and awareness regarding the value maintenance possess in the manufacturing companies. It showed that maintenance will have a key role in enabling industrial digitalization. The project put the maintenance research back on the national agenda. For example, the project

produced world-leading level in MES data analytics research; it showed how maintenance can contribute to productivity increase, thereby changing the mind-set from narrow-focused to having an enlarged-focus; showed how to work with component level problems to working with vendors and end-users.

In addition to the WPs of the project functioning individually and achieving the deliverables, there was also a strong collaboration between them. Individual contributions and collaboration presented themselves with plenty of spin-off ideas for future research within maintenance. Many of them are listed above as part of WP conclusions.

Research and development efforts in maintenance organizations have not been prioritized during the last decades. Before this project, the participating companies have few maintenance-related projects in their current portfolios. It is concluded that the impact of this project has increased the number of maintenance projects, both within the companies and on a national level, including big-sized projects with substantial budgets allocated to them.

9. Participating parties and contact persons

Academia	Contact persons	Role
Chalmers University of Technology	Anders Skoogh	Associate professor
KTH Royal Institute of Technology	Andreas Archenti	Associate professor
Mälardalen University	Antti Salonen	Senior lecturer
Companies		
Volvo Group Trucks Operations	Sven Wilhelmsson	Maintenance manager
Volvo Car Corporation	Peter Vänerfors	Maintenance manager
Volvo Construction Equipment	Marcus Bengtsson	Maintenance developer
IFS	Joakim Fransson	Consultant
Axxos	Johan Andersson	Product owner
Scania AB	Anders Ramström	Maintenance manager

CHALMERS
UNIVERSITY OF TECHNOLOGY



MÄLARDALENS HÖGSKOLA
ESKILSTUNA VÄSTERÅS



SCANIA



VOLVO
Construction Equipment

AXXOS

References

- [1] Andrén, A., A. Brusing. 2013. Invisible driving factors counteracting maintenance operations. MSc Thesis, Chalmers University of Technology.
- [2] Donovan, P., K. Leahy, K. Bruton, and T.J.Sullivan. 2015. Big data in manufacturing: a systematic mapping study. *Journal of Big Data*, 2(20).
- [3] Langer R, J. Li, S. Biller, Q. Chang, N. Huang, and G. Xiao. 2010. Simulation study of a bottleneck-based dispatching policy for a maintenance workforce, *International Journal of Production Research* 48(6):1745-1763.
- [4] Crespo Márquez, A., P. Moreu de León, J.F. Gómez Fernández, C. Parra Márquez, and M. López Campos. 2009. The maintenance management framework, *Journal of Quality in Maintenance Engineering* 15(2):167-178.
- [5] Li L., Q. Chang, J. Ni. 2009. Data Driven Bottleneck Detection of Manufacturing Systems. *International Journal of Production Research* 47(18):5019–5036.
- [6] Chapman, P., Clinton, J., Kerber, R., Khabaza, T., Reinartz, T., Shearer, C., and Wirth, R. 2000. Crisp-Dm 1.0. CRISP-DM Consortium, p.76.
- [7] Yamashina, H., and T. Kubo. 2002. Manufacturing Cost Deployment. *International Journal of Production Research* 40(16):4077-4091.