

Report from an International Nutrient Workshop focusing on Phosphate Analysis

**Royal Netherlands Institute for Sea Research
Texel, The Netherlands
12-15 November 2012**



PML

Plymouth Marine Laboratory



National Oceanography Centre, Southampton

UNIVERSITY OF SOUTHAMPTON AND NATURAL ENVIRONMENT RESEARCH COUNCIL



Report from an International Nutrient Workshop focusing on Phosphate analysis, Nov 2012.

Report authors:

M. Aoyama², K. Bakker^{4a}, J. van Ooijen^{4a}, S. Ossebaar^{4a}, E.M.S. Woodward¹²

Workshop Co-organisers:

The Royal NIOZ Laboratory, Texel, The Netherlands, and Plymouth Marine Laboratory, UK.

Workshop Participants:

C. Anstey¹, M. Aoyama², Y. Arii³, K. Bakker^{4a}, S. Becker⁵, S. Coverly⁶, A. Daniel⁷, P. Hughes⁸, M. Kimura⁹, A. Murao⁹, A. Murata¹⁰, J. van Ooijen^{4a}, S. Ossebaar^{4a}, K. Sato¹⁰, J. Sinke^{4b}, M. Stinchcombe¹¹, E.M.S. Woodward¹², J.Z. Zhang¹³

¹ Fisheries and Oceans Canada, Dartmouth, Canada

² Meteorological Research Institute (MRI), Ibaraki, Japan

³ Marine Works Japan Ltd., Yokohama, Japan

⁴ Royal Netherlands Institute for Sea Research (NIOZ), ^aTexel, ^bYerseke, The Netherlands

⁵ Scripps Institution of Oceanography (SIO), California, USA

⁶ SEAL Analytical GmbH, Norderstedt, Germany

⁷ French Research Institute for Exploitation of the Sea (IFREMER), Brest, France

⁸ CSIRO Marine and Atmospheric Research, Australia

⁹ The General Environmental Technos Co., Ltd., Kanso Technos, Katano, Osaka, Japan

¹⁰ Japan Agency for Marine-Earth Science and Technology (JAMSTEC), Japan

¹¹ National Oceanography Centre (NOC), Southampton, UK

¹² Plymouth Marine Laboratory (PML), Plymouth, UK

¹³ NOAA Atlantic Oceanographic & Meteorological Laboratory, Miami, USA

Abstract:

A practical analytical workshop at NIOZ (Royal Netherlands Institute for Sea Research), The Netherlands, was held on 12-15 November 2012. The aim of the workshop was to gain information from the global nutrient analytical community about general problems which arise when measuring nutrients, and then to attempt to investigate these problems in the laboratory, with a small select representative group of International nutrient analysts conducting the lab work. 18 experts were participated and worked simultaneously on four different PO₄ gas segmented CFA systems. This report documents the finding of the workshop and describes recommendations based on group consensus which can hopefully assist the larger community of labs worldwide participating in the Inter-Laboratory Comparison RMNS 2012 studies organized by MRI in Japan.

INSS Workshop at NIOZ, Texel 2012



This page left intentionally blank

Contents

1	Introduction.....	1
2	Practical Workshop.....	2
3	Methods.....	3
3.1	Applied Chemical Methodologies.....	4
3.2	Auto Sampler Set-up.....	4
3.3	Reference Material and Control.....	4
4	General Outline of Experiments.....	4
5	Results and Discussion.....	7
5.1	Control.....	7
5.2	Carryover effect.....	7
5.3	Coating Effect.....	10
5.4	Antimony/Phosphate (Sb/P) Ratio.....	13
5.5	Salinity Effects.....	15
5.6	Tubing and Glassware.....	16
5.7	Calibration.....	19
5.8	Sensitivity Drift.....	21
5.9	Silicate Ion Interference Effect.....	21
5.10	Baseline Background Determination.	22
6	Outcome of the Returned Questionnaires.....	23
6.1	Chemistry.....	24
6.2	Calibration.....	24
6.3	Flow Considerations.....	25
6.4	Questionnaire Figures	25
7	Other aspects not investigated during the workshop.....	32
7.1	Inter-Sample Air Compression (ISAC).....	32
7.2	Wetting Agents.....	32
7.3	Reaction Time, pH and Temperature.....	32
8	Conclusions & Recommendations.....	33
8.1	Phosphate Chemistry.....	33
8.2	Silicate Interference.....	34
8.3	Carryover.....	34
8.4	Calibration.....	34
8.5	Sample Tray Protocol.....	35
8.6	Sensitivity Drift.....	35
8.7	Tubing and Glassware.....	36
8.8	Literature for further guidance.....	36
9	References.....	37
10	Acknowledgements.....	39
11	Tables.....	40
12	Appendix.....	46
13	List of participants.....	64

This page left intentionally blank

1 Introduction

From discussions at the IOC/ICES Study Group on Nutrient Standards (SGONS) meeting held in San Diego in February 2012 (Aoyama et al, MRI, Japan, 2013), it was decided to organize a practical analytical workshop at the NIOZ (Royal Netherlands Institute for Sea Research), The Netherlands, in November 2012. The aim of the workshop would be initially to gain information from the global nutrient analytical community about general problems which arise when measuring nutrients, and then to attempt to investigate these problems in the laboratory, with a small representative group of international nutrient analysts conducting the lab work. The workshop findings would therefore result in recommendations for solving certain identified problems when carrying out high quality nutrient analysis.

The practical lab work mainly focused on the analysis of dissolved Phosphate (PO_4) as it was highlighted by the survey that this analyte exhibits most of the common problems encountered when running gas segmented Continuous Flow Analyzers (CFA). Such problems for example are the inter-sample air compression (ISAC) effects, sample peak carryover, and the linearity of the analyses, which can contribute to non-ideal performance of the PO_4 channel in gas segmented CFA's. We retain the designation 'Phosphate' (PO_4) throughout this report as the definition for the dissolved inorganic phosphorus pool, also referred to as orthophosphate or soluble reactive phosphorus (SRP), measured on gas segmented CFA.

A questionnaire was sent to all laboratories (See Appendix) who participated in the 2012 Inter Comparison Study of Reference Material for Nutrient Standards (IC RMNS) (Aoyama et al 2013, in press), with questions regarding general routine in the laboratory, CFA analysis, and specific issues found with the PO_4 chemistry. The outcome of the questionnaire made it possible to identify certain problem areas that would form the focus of the studies at the workshop which will benefit all the labs within the SGONS community, and beyond, in the future.

There were 10 labs that were representing the global nutrient community at this workshop, using four different PO_4 gas segmented CFA systems to test set-ups and various analytical options.

This report documents the finding of the workshop and describes recommendations based on group consensus which can assist the larger community of labs worldwide participating in the IC RMNS 2012 exercise.

It is recommended that analysts, however experienced, should investigate the various analytical set-ups and topics discussed in this document to check their analytical precision and procedures in the light of the results obtained in this workshop. Everyone can improve their analytical output quality and it is hoped that the issues discussed here will help analysts across the globe to move towards better quality, precision and inter-comparison of their data.

The analytical issues taken from the replies of the questionnaires and investigated at the workshop were as follows:

- a) Analytical set-up of calibration standards and measurement order of samples
- b) Distribution and concentrations of standard solutions during a calibration run
- c) Fitting of calibration curves: e.g. Slope only; Linear regression; and Quadratic
- d) Carry-over effects between samples for different flow set-ups
- e) Antimony/Phosphate ratios in the analytical methodology
- f) Comparing reducing agents: Ascorbic acid and Hydrazine
- g) Reaction temperature
- h) Matrix considerations for standards and baselines

Other practical issues considered during and after the workshop:

- a) Silicate interference
- b) Effects of glassware, tubing, connections and flow rates
- c) Detection wavelengths
- d) Salinity correction

2 Practical Workshop

The Workshop was held at the NIOZ for four days in November 2012. After a short welcome speech and introduction by Erica Koning (Marine Research Facilities Coordinator, representing NIOZ Directorate) on nutrient and sea going facilities of the NIOZ, Stephen Coverly of SEAL Analytical gave a presentation about the history of CFA and the design and technology changes through time. A presentation by Olga Lyashevskaya (NIOZ) followed, who discussed statistical issues concerning standards and calibrations, and where statistically, standard concentrations should be best situated over a calibration curve. Michio Aoyama then presented preliminary results from the last IC RMNS 2012 (Aoyama et al., 2013: in press), showing that although overall the results were better and with greater agreements than in 2008 (Aoyama et al, 2010), there were still improvements needed in order to reach any sort of global consensus. Karel Bakker then gave a brief overview regarding the workshop questionnaires, summarizing general trends, problems, and chemistries (See Figures 10a-m). Using the outcome of the questionnaire as a basis, the workshop program was presented by Jan van Ooijen discussing the main topics to be focused on during the practical sessions (See Appendix).

The first day practical session focused on getting acquainted with the laboratory, the analysers, and procedures for running different series of calibration curves.

The second day started off with another presentation by Stephen Coverly, covering segmentation bubbles and the use of slope-only calibration, and was followed by Anne

Daniel, who discussed salinity effects (Wurl 2009 and Coverly et al. 2012), and a method for calculating these within an analytical run using AACE software (SEAL Analytical).

The practical session continued on from that of the first day and covered the following;

- i) Calibration; Distribution, Order and Fit of standards.
- ii) Antimony (Sb) (as Potassium Antimonyl Tartrate solution); It's role as a catalyst, Antimony/Phosphate (Sb/P) ratios, and Carryover effects.
- iii) Carry-over effects from different analytical flow set-ups.
- iv) Glassware, tubing, connections and flow rates.
- v) Discussion of first and second day results.

The third day practical session began with Karel Bakker demonstrating a method for the determination of Low Nutrient Seawater (LNSW) concentration, which is discussed in section 5.10 and also covered the following topics:

- i) The coating effect on glassware due to the phospho-molybdenum blue complex formed in the reaction according to the Murphy and Riley (1962) method.
- ii) Silicate ion interference.
- iii) Types of transmission tubing.
- iv) Matrix Effects; comparing sea water (natural or artificial) and Ultra-Pure fresh water (18.2MΩ) baseline scenarios

A summary of the analytical runs for the entire workshop is shown in Table 1.

3 Methods.

The following gas segmented CFA's were used:

- SEAL Analytical QuAAtro
- Bran and Luebbe TrAAcs - 2 systems (TrAAcs 1 and TrAAcs 2)
- SEAL Analytical AA3HR

The standard concentration range used during the workshop on the QuAAtro and TrAAcs 2 was 0 - 1.5µM PO₄, while the AA3HR and TrAAcs 1 used a 0 - 3.0µM PO₄ range.

3.1 Applied Chemical Methodologies.

All of the Phosphate analytical chemistries used by participants were based on the methods of Murphy & Riley (1962) and Bernhardt & Wilhelms (1967).

In the workshop, the Murphy & Riley (1962) method was used for the QuAAtro and both TrAAcs. The AA3HR was set up with two channels, one according to Murphy & Riley (1962) and the other conforming to Bernhardt & Wilhelms (1967), which is carried out without the use of Antimony (Sb). Bernhardt & Wilhelms (1967) use hydrazine for the reduction of the yellow phospho-molybdenum complex to the detected blue complex, as opposed to Murphy & Riley (1962) who use ascorbic acid. However, an elevated reaction temperature is needed in combination with a lower pH to accelerate the reaction, when in the absence of an antimony catalyst, according to Bernhardt & Wilhelms (1967).

The flow diagrams and reagent protocols are described in the Appendix.

3.2 Auto-sampler Set-up.

The TrAAcs and QuAAtro systems were set-up using an initial sample to wash ratio of 3:1 with a sample throughput of 60 samples per hour. The AA3HR was set-up with a 4:1 sample to wash ratio and a 36 sample/hr sample throughput.

3.3 Reference Material and Control.

As a reference, Lot BT of the RMNS produced by Kanso Technos, Japan (www.kanso.co.jp), was measured during every run performed at the workshop, in order to keep track and monitor the effects on method performance during the different experiments, (BT is reported by Kanso as being $1.33\mu\text{M PO}_4$ ($1.296\mu\text{M/kg}$)).

4 General Outline of Experiments.

QuAAtro

Measuring range: 0 – $1.5\mu\text{M PO}_4$

Wavelength: 880nm

The QuAAtro did not show perfect PO_4 peak shapes during the workshop (the plateau slightly decreased with time), so, as a follow-up at the beginning of January 2013, a repeat

of these experiments was carried out, where ideal peak shapes were obtained and also similar results were found to those observed during the workshop. The experiments consisted of analysing samples ranging from both low to high and high to low concentrations. Variations in the standard distributions across the concentration range were also made.

TrAAcs 1

Measuring range; 0 – 3.0 μ M PO₄

Wavelength: 880nm

Calibration experiments using standards from low to high and high to low were performed to see if there was any effect on the results of samples subsequently analysed. It has been observed that often the very first analysed sample during a run will be lower than expected, so an experiment was carried out to determine how many samples should be run before a constant reading is obtained (see Figure 4a). Following the workshop, these experiments were repeated because samples were missed during the first practical session which influenced the results.

Antimony/Phosphate (Sb/P) molar ratio experiments were performed using different Antimony Potassium Tartrate concentrations in the reagent from a Sb/P of 1, up to a ratio of 96. Going and Eisenreich (1974) state that a Sb/P ratio of at least 2 is needed for a satisfactory result and at the higher Sb/P ratios, the more baseline drift was observed.

TrAAcs 2

Measuring range: 0 – 1.5 μ M PO₄.

Wavelength: 880nm

Two identical PO₄ channels were set-up on the TrAAcs 2: Channel 1 was used for the experiments, while Channel 2 was kept unchanged throughout as a reference.

As with the TrAAcs 1, calibration experiments were carried out using standards from low to high and high to low to see if there was an effect on the subsequent sample results. Tests were also carried out to see how many full-scale samples it took before a stable reading was obtained (See Figures 4b and 4c).

Channel 1 was used to show the effects that can occur when different glassware, coils, tubing and de-bubblers are either changed or used incorrectly. The effects could clearly be seen on peak shapes, carryover and noise (See Figures 7a-c). Runs were made to see the

effects of different glassware, one with a new and the other with an old 20 turn glass coil. In another run, the sample pump tube was replaced with a larger pump tube and the inter-sample air bubble was subsequently removed directly after the pump before it reached the manifold, while still maintaining the same flow conditions, and this showed extensive dispersion of the sample peaks. An old piece of transmission tubing between the sampler and the manifold was tested to investigate if there was any interference on the peak shape. (See Figures 7a-c).

Ultra-Pure water was used as the baseline to demonstrate the matrix effects on the system and the need in this scenario for longer sampling times and therefore a decreased sample throughput (See Figure 6).

During the workshop a demonstration was given on Channel 2 of TrAAcs 2 on the 'Baseline Background' procedure which determines the concentration of nutrient background in the LNSW when this is used as the baseline water, (See Section 5.10).

Following the workshop a couple of these experiments were repeated, again due to missing samples, and these repeats enabled us to gather more statistical information and allow accurate comparisons.

AA3HR

Measuring range; 0 – 3.0 μ M PO₄

Wavelength: Channel 1 (Murphy & Riley Method) 880nm

Wavelength: Channel 2 (Bernhardt & Wilhelms Method) 820nm

The AA3HR was set-up with two PO₄ channels, one conforming to Murphy and Riley (1962) (Channel 1), and the other to Bernhardt & Wilhelms (1967) (Channel 2). The Bernhardt & Wilhelms (1967) method did not initially perform as expected and took some time before an acceptable run could be achieved.

A clear demonstration was given on how to use the 'Slope Only' method for standard calculations which is the recommended procedure for those using Ultra-Pure water as the baseline for their analysis protocol. Carryover demonstrations were also performed to show the minimal coating effect when using the Bernhardt & Wilhelms (1967) method. Tests were also carried out to see how many full scale samples it took before a stable reading was obtained (See Figures 4d and 4e).

5 Results and Discussion.

5.1 Control Sample.

All working standards used for calibrations were made up in LNSW.

As a reference sample, Lot BT, (Kanso Technos), was measured during every run performed at the workshop. The following is a summary of the average BT value (μM) obtained per analytical system;

QuAAtro :	Ch1:	1.333 ± 0.007 (n=12)		
TrAAcs 1:	Ch1:	1.336 ± 0.022 (n=12)		
TrAAcs 2:	Ch1:	1.331 ± 0.014 (n=9)	Ch2:	1.329 ± 0.007 (n=10)
AA3HR:	Ch1:	1.334 ± 0.014 (n=5)	Ch2:	1.359 ± 0.028 (n=5)

It was observed on the AA3HR that the RMNS BT value was higher with the Bernhardt & Wilhelms (1967) method than all the results using the Murphy & Riley (1962) method determined during the workshop. The average value for the Murphy & Riley (1962) method was 1.333 whereas it was 1.359 for the Bernhardt & Wilhelms (1967) method, (See Table 2, pages 45-47, that show a complete overview of the average BT values measured in every run during the workshop).

5.2 Carryover effect.

Carryover is a phenomenon in which the analyte in a given sample is 'carried' by an analytical system 'over' to the following sample (Zhang 1997) and is also influenced by the formation and size of bubbles, glassware, tubing, chemistry, and other factors. Carryover is inherently unidirectional, i.e. each sample can affect the sample behind it, but never the one before. The magnitude of carryover depends on the concentration of the preceding sample, not the concentration of the measured sample or the difference between the preceding and measured sample. Carryover, where present, should be subtracted from the measured sample peak height to obtain a true value.

The carryover correction coefficient, 'k', is computed by measuring the difference between the absorbance of a high concentration standard, H, that is followed by two equal concentration low standards, L_1 and L_2 , expressed as a percentage from the higher standard. This term is often referred to as H2L (See Figure 1). Assuming the second low standard, L_2 , is the one without influence from the high standard, H, the carryover coefficient k is computed by the difference between the first and the second low standard

peak heights, divided by the high standard peak height, (H), minus the first low standard peak L_1 , and multiplied by 100 to express it as a percentage. The formula is given below:

$$k=100*(L_1-L_2)/(H-L_1) \quad (5-1)$$

where;

k is the carryover correction coefficient

H is the peak height of the high concentration standard

L_1 is the peak height of the first low concentration standard preceded by H

L_2 is the peak height of the second low concentration standard

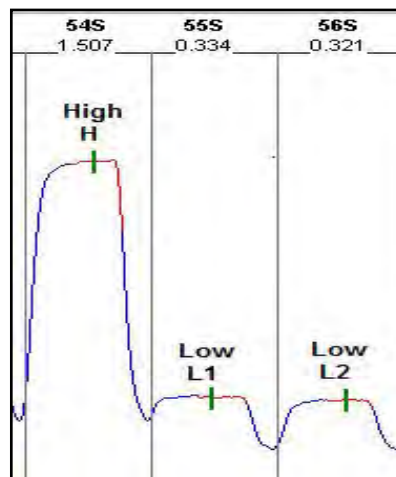

Figure 1. The H2L sequence for calculating the carryover coefficient. It is important that the L_1 peak should be of a concentration that results in a wash dip between H and L_1 , so as to avoid a shoulder peak.

In general, the computed carryover coefficient varied according to the analytical flow set-up and also to the type of CFA being used (macro- or micro-bore). Figure 2 and Tables 3a-d show the different carryover coefficients, in percentage terms, that can be calculated depending on the choice of the concentration used for the low peaks L_1 and L_2 that follow the high concentration peak H.

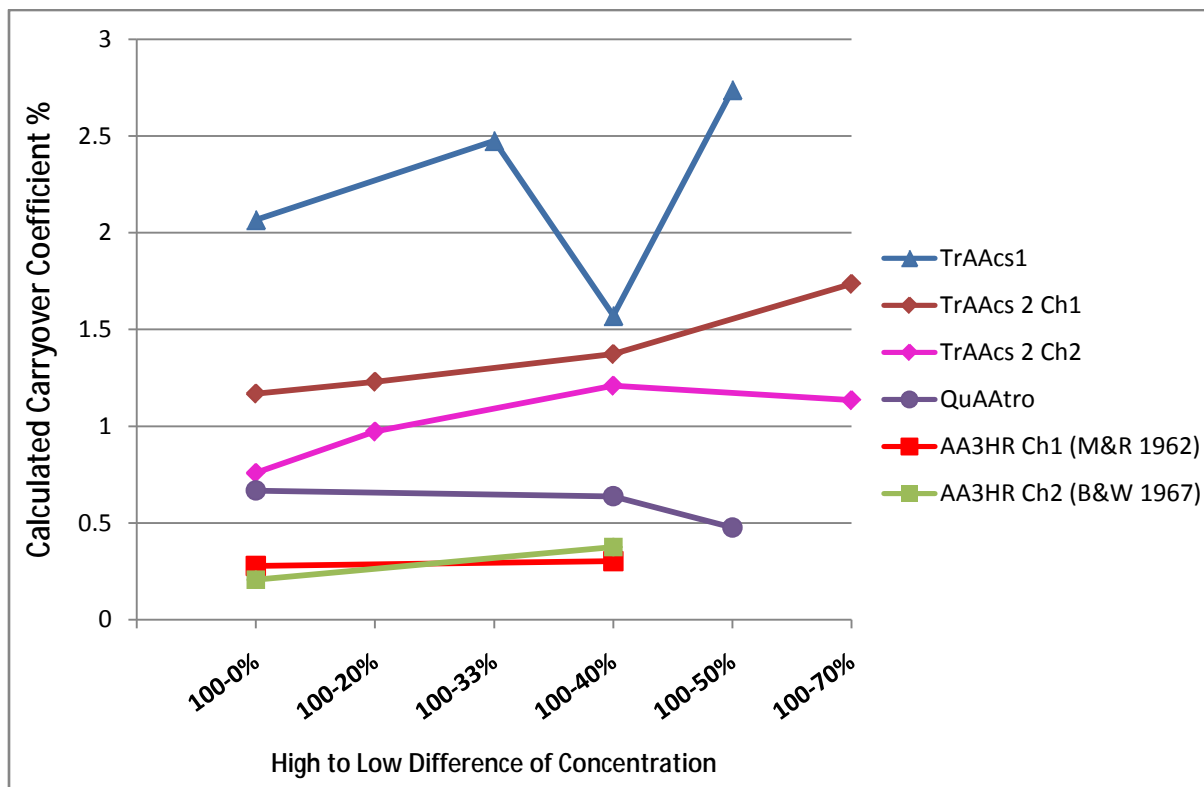

Figure 2 . The calculated carryover coefficients for the different H2L combinations on the systems that were used during the workshop.

The analytical response is very similar between the Bernhardt & Wilhelms (1967) method that uses a lower pH (pH = 0.1), compared to the Murphy & Riley (1962) method that uses Sb and a higher pH (pH = 0.7), and the computed carryover on the AA3HR is also very similar for both methods.

Generally, if samples are measured from surface to ocean bottom when working at sea, the sample concentrations generally increase with depth. However, with the presence of an oxygen minimum zone (OMZ) when measuring from surface to bottom, the concentrations increase from the surface to the OMZ then slightly decrease with depth thereafter (See Figure 3). The decrease in concentrations with depth after the OMZ is small and gradual, and therefore the carryover effect will be almost negligible. However, in comparison, if analysis is carried out from bottom to surface, then there will be an increased carryover effect especially towards the surface.

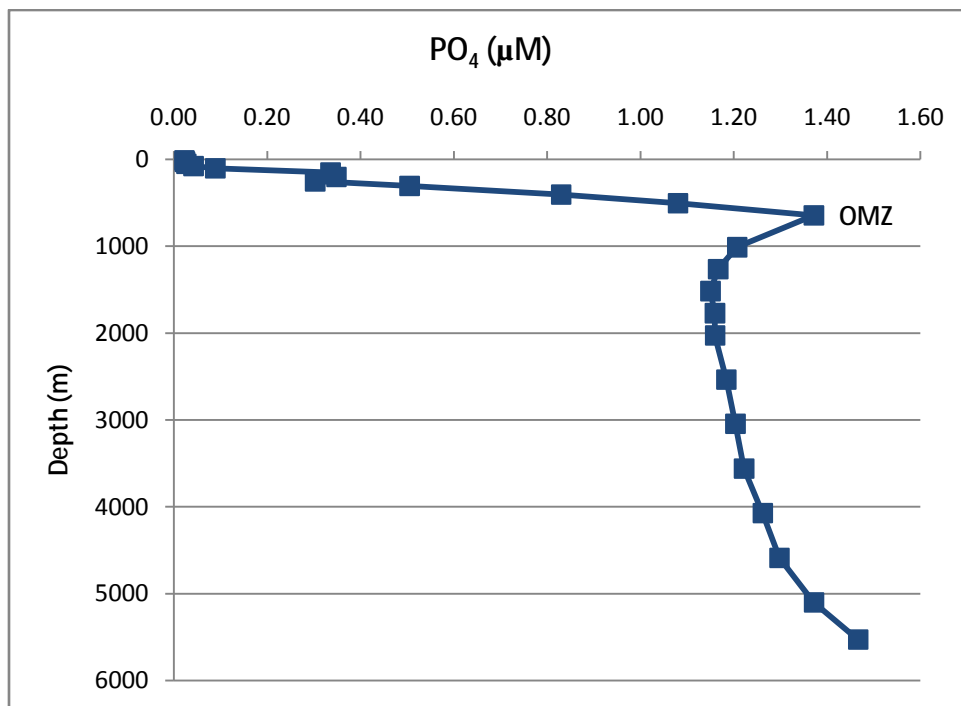

Figure 3: North Atlantic PO₄ depth profile, with the presence of an oxygen minimum zone (OMZ).

5.3 Coating Effect.

The coating of the flow cells and manifold glassware is a well-known drawback to the Murphy & Riley (1962) method for PO₄ analysis (Zhang et al. 1999) as Sb is present. The coating effect primarily results from the build-up of the molybdenum blue complex which is formed during the PO₄ analysis, as this readily adsorbs onto solid surfaces such as flow cells and glassware, and this is influenced by the pH of the reagents. Coating can cause asymmetrical peak shapes and excessive tailing, and the degree of coating is enhanced with increasing sampling time and concentration. An extended wash time is often used to minimize coating effects, but this is at the expense of sample throughput. Since no definitive correction factor is available for all situations, it is desirable to minimize coating effects through the optimization of the analytical procedure. This is important as the overall effect of coating can result in a decline in the precision and accuracy of analysis.

During the workshop, experiments were carried out to observe the effects of the coating and to see how many times it took a sample to reach a stable value, (See Figures 4a-e). The TrAAcs systems took on average three sample peaks to reach the same plateau height with a reproducible value, but the AA3HR system set up with the Bernhardt & Wilhelms (1967) method only needed two peaks to reach the same peak height and value. The Bernhardt & Wilhelms (1967) method is known to have less of a coating effect due to the absence of antimony, and our observation with this method on the AA3HR is also in agreement with a previous study on an Alpkem auto-analyser (Zhang et al., 2001).

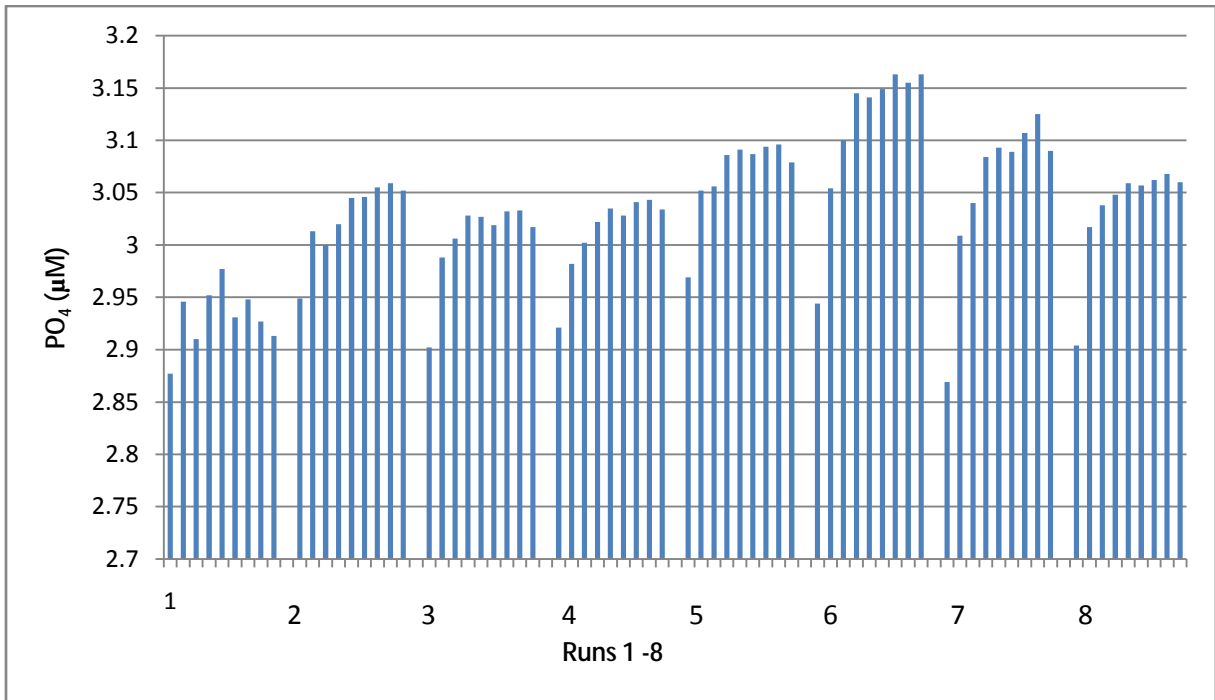

Figure 4a. Repeat sampling for 8 analytical runs to establish stable peak heights on the TrAAcs 1. A sample-wash ratio of 3:1 was used, with a sample and wash time of 45 and 15 seconds respectively with no carryover correction.

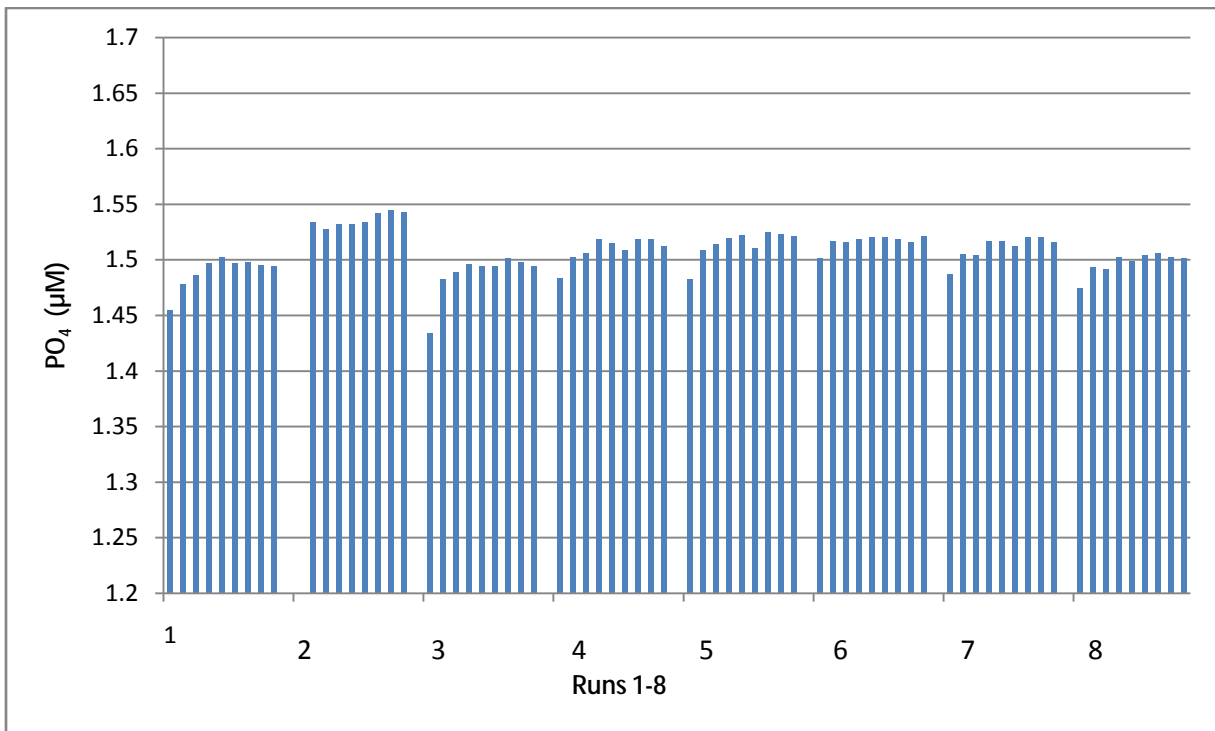

Figure 4b. Repeat sampling for 8 analytical runs to establish stable peak heights on Channel 1 of the TrAAcs 2. A sample-wash ratio of 3:1 was used, with a sample and wash time of 45 and 15 seconds respectively with no carryover correction.

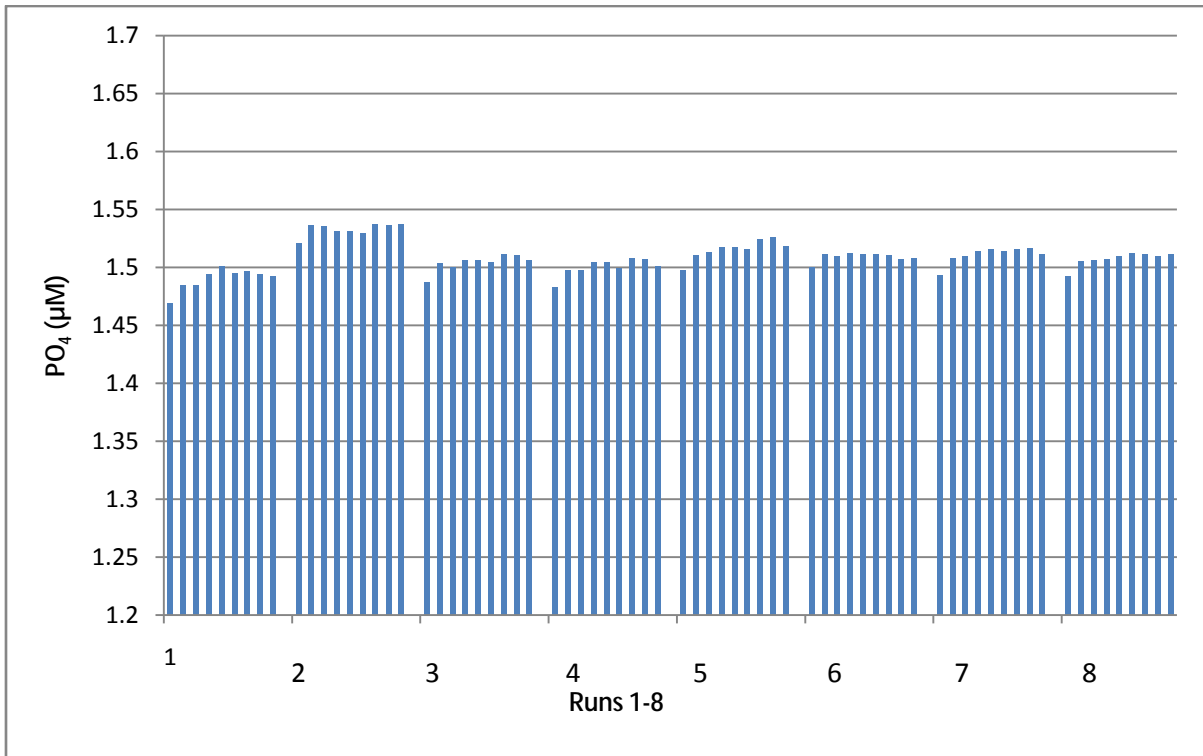

Figure 4c. Repeat sampling for 8 analytical runs to establish stable peak heights on Channel 2 of the TrAAcs 2. A sample-wash ratio of 3:1 was used, with a sample and wash time of 45 and 15 seconds respectively with no carryover correction.

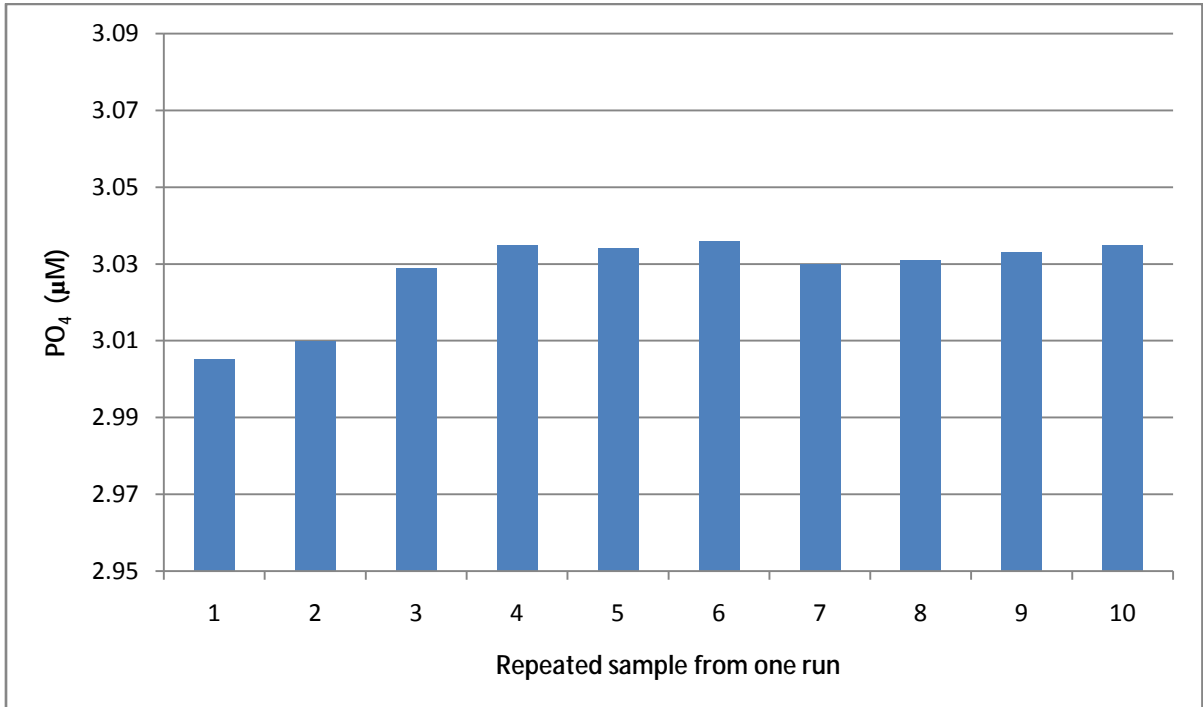

Figure 4d. Repeat sampling from 1 analytical run to establish stable peak heights on Channel 1 of the AA3HR. A sample-wash ratio of 4:1 was used, with a sample and wash time of 80 and 20 seconds respectively with no carryover correction. (Murphy & Riley 1962).

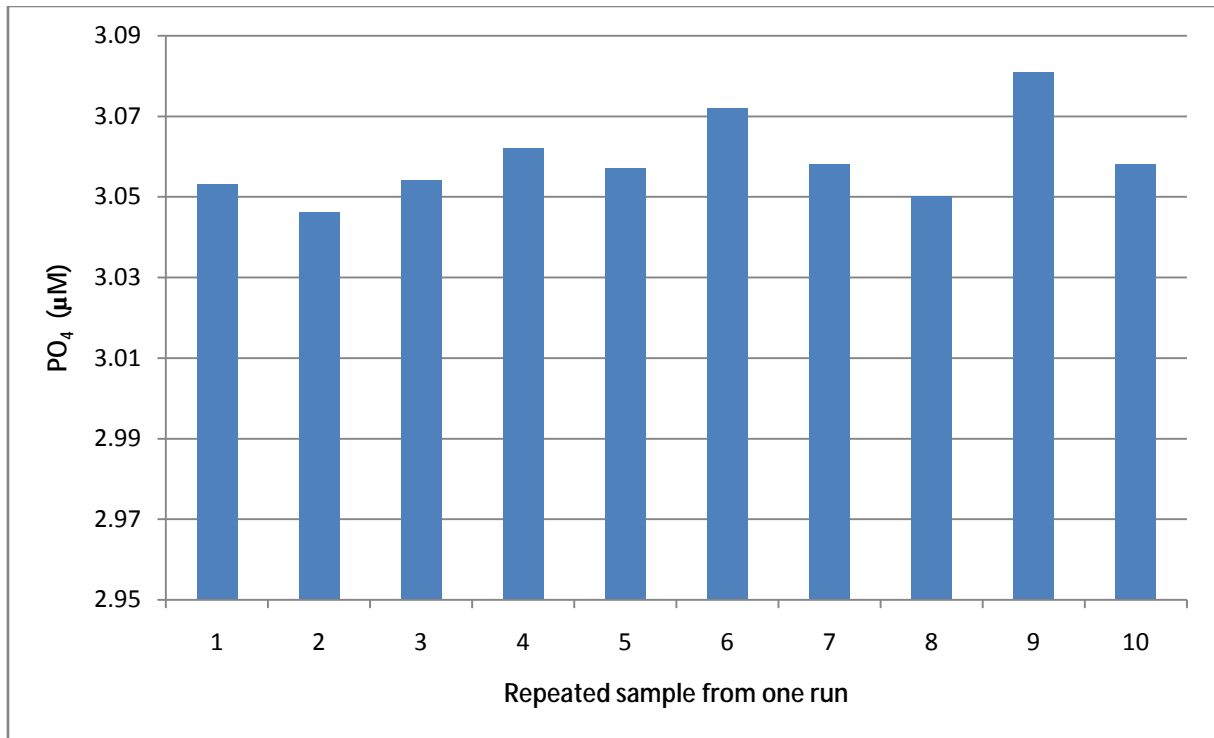

Figure 4e. Repeat sampling from 1 analytical run to establish stable peak heights on Channel 2 of the AA3HR. A sample-wash ratio of 4:1 was used, with a sample and wash time of 80 and 20 seconds respectively with no carryover correction. (Bernhardt & Wilhelms 1967)

Every system is susceptible to coating effects and this should be reduced by using the correct chemistry, tubing, glassware and adopting an analytical regime of good maintenance and regular cleaning, and good laboratory practice. Further findings suggest that where CFA flow speed decreases, there is an increased chance that the phosphate colloidal complex has more time to 'coat' the glassware, and hence potentially increasing the coating effects. The optimal condition for minimal coating is pH > 0.5 (Zhang et al. 1999), and frequent cleaning is recommended. Cleaning methods primarily use a NaOH/EDTA solution to wash through the whole system, (6g EDTA + 65g NaOH in 1 litre Ultra-Pure water) including the pump tubes and the entire segmented flow part of the manifold. Other methods consist of cleaning the whole PO₄ manifold with sodium hypochlorite solution for up to one hour. It has been noted that there is a possible risk of the flow cell being etched through using the NaOH/EDTA.

5.4 Sb/P Ratio.

The Sb/P ratio is required to be 2 or greater for PO₄ analysis (Going and Eisenreich 1974). At this ratio the colour attains its maximum intensity and higher concentrations of

antimony will not lead to any more rapid colour development or intensity. Different experiments were carried out on the TrAAcs 1 analyser, using different Sb/P ratios, in order to review this topic. The range of Sb/P ratios tested ranged from 1 to 96. With a lower Sb/P ratio of 1, the colour formation only achieved about 60% of the maximum sensitivity, and it was also shown that with increasing Sb/P ratio, the carryover increased as well. Figure 5a shows the calculated carryover coefficient in percentage terms, versus the Sb/P ratio used in the reagent make-up. Moreover, with a high Sb/P ratio of 96, the basic antimony salt started to precipitate in the reagent bottle and could not be used. The coating effect dramatically increased at higher Sb/P ratios and a substantial baseline drift was observed. Figure 5b shows the measurements of a replicated sample at different Sb/P ratios.

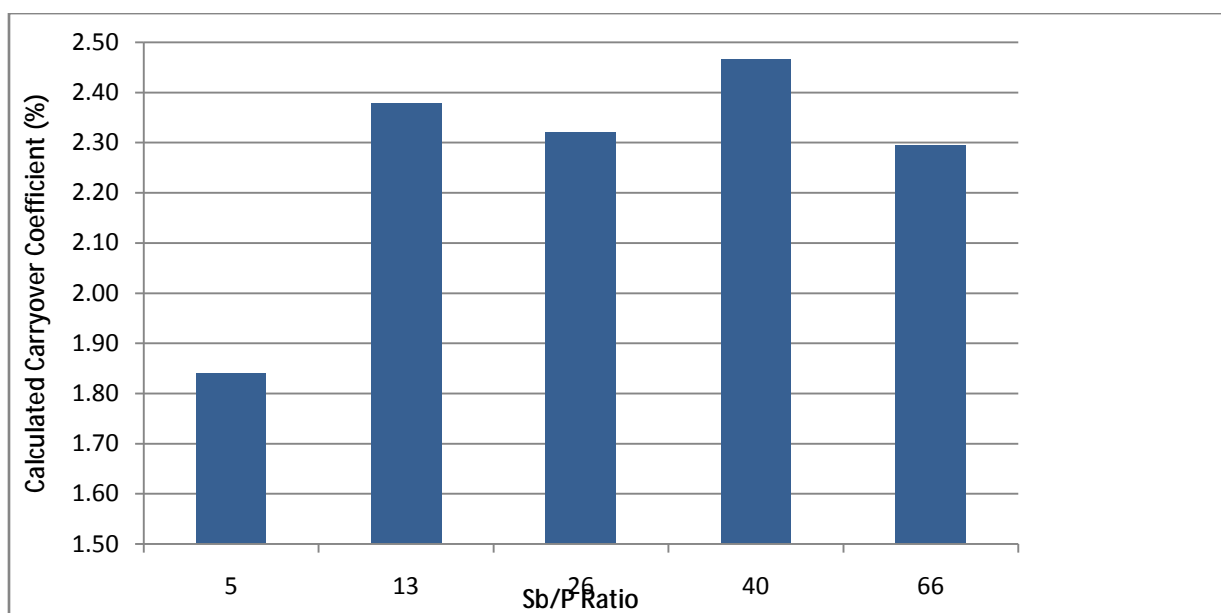

Figure 5a. The different carryover coefficient (%) calculated at different Sb/P ratios. The H2L carryover was calculated using PO_4 concentrations of $3.0\mu\text{M}$ (H) and $1.2\mu\text{M}$ (L).

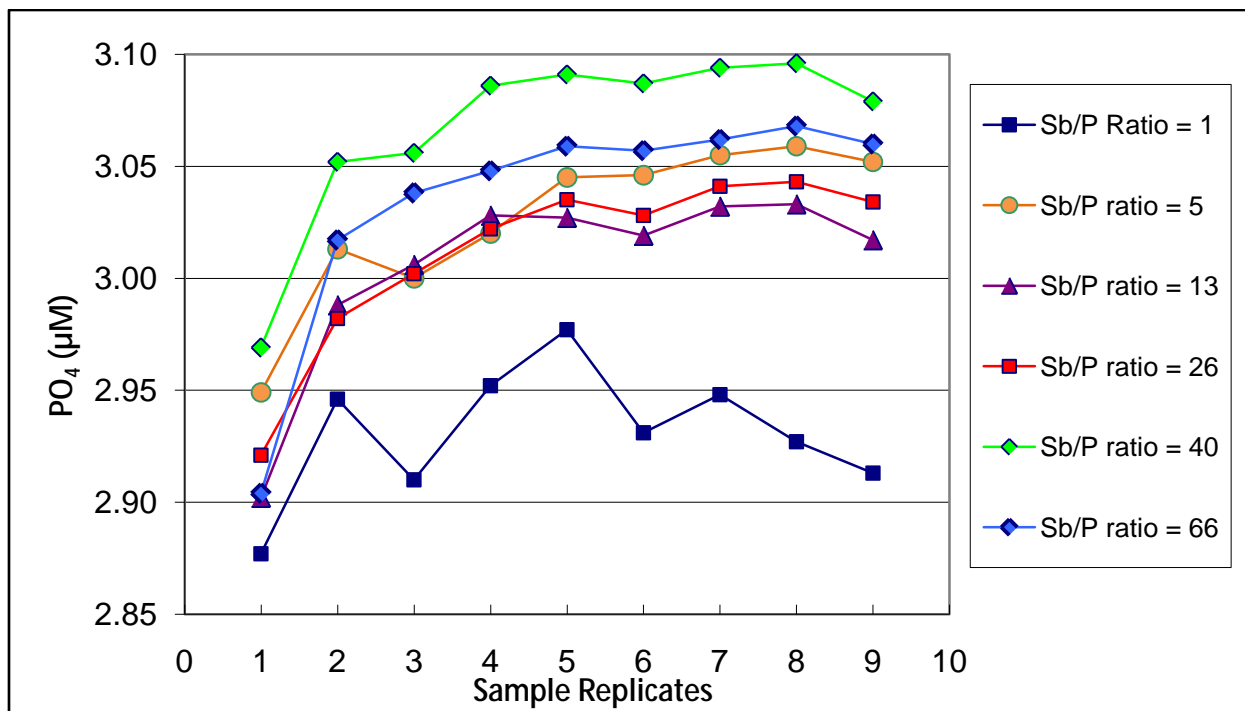

Figure 5b. Repeat sampling from 6 analytical runs with different Sb/P ratio's to establish stable peak heights of a sample with a PO_4 concentration of $3.01\mu\text{M}$ on TrAAcs1. A sample-wash ratio of 3:1 was used, with a sample and wash time of 45 and 15 seconds respectively, with no carryover correction.

5.5 Salinity Effects.

If the baseline is Ultra-Pure water and the samples are saline water, it is necessary to compensate for any optical contribution made to the sample peak heights due to the salinity or matrix effects of the solutions, (Woodward et al. 2010). Any contribution to peak height from refractive index differences between fresh and saline water is determined by removing one of the colour forming reagents for the analytical system and comparing the peak height differences between the solutions. For example, removing the ascorbic acid from PO_4 analysis stops any colour being formed so that any absorbance difference between Ultra-Pure water and seawater is due to the salinity differences between solutions. These matrix contributions are specific to a particular method and instrument, and in many cases are zero, but it is imperative that analysts carry out this procedure to ensure that they are reporting true nutrient concentrations from their samples.

Many laboratories favour using Ultra-Pure water as the baseline as this does not contain any nutrients, so is a reliable 'zero', and is also readily available to most labs, an advantage as not everyone can obtain sufficient regular quantities of LNSW, and many do not use or trust ASW either. When calculating the sample concentrations during an analytical run with an Ultra-Pure water baseline, one can use the 'Slope Only' software calculation (AACE Software, SEAL Analytical), which calculates the slope of the standard additions made to

saline waters but does not include the baseline water concentration in the calculation (Coverly et.al 2012). The AA3HR system was used to demonstrate the use of the Slope Only standard determination method when using Ultra-Pure water as the baseline. The optical effect observed at the interface between Ultra-Pure baseline water and a saline sample is known as the Schlieren effect, and can be seen in Figure 6, when measured by the TrAAcs2 analyser.

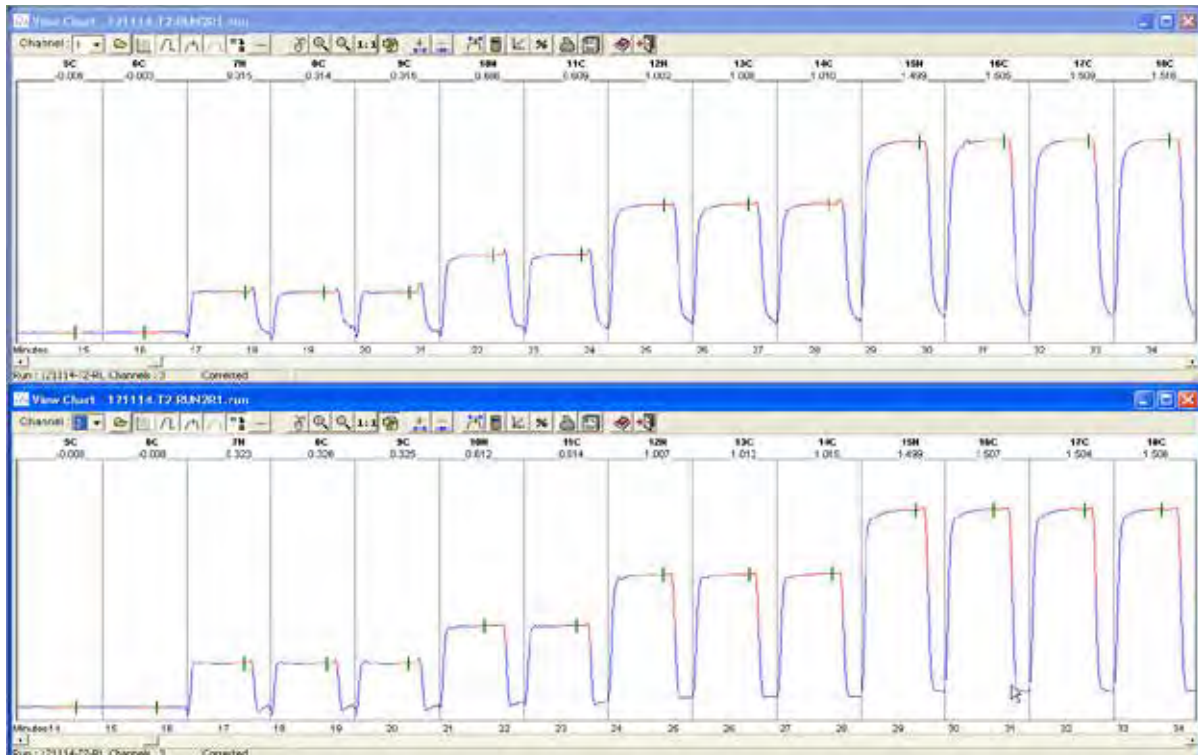

Figure 6. Ultra-Pure water as the baseline on TrAAcs2 for both channels running saline samples showing the Schlieren effect during the sample wash transition. A sample speed of 40 samples/hr was used during this experiment instead of the standard 60 samples/hr when using LNSW as baseline water. The sample to wash ratio is 3:1.

5.6 Tubing and Glassware.

Incorrect tubing or glassware can have a major impact on the flow characteristics of a CFA system. It is important that every instrument is checked and critically analyzed for optimal analysis in order to gain acceptable results. The formation and size of bubbles (which must always be consistent), the inside diameter of the tubing through which fluids flow, the peristaltic pumping action, connections of tubing and glassware, and other factors, can all influence effects such as carryover and coating. The size and type of sample probe and transmission tubing must also be selected to provide the correct conditions for the flow rates used. Here are some simple examples of these problems to be aware of;

- i) A sample probe or transmission tubing that is too wide, or where the bubbles are too small, or not touching the tube sides, will cause irregularities of the peak.
- ii) A sample probe or transmission tubing that is too narrow will affect the flow rate and will cause distortion or in the extreme, very noisy peaks.
- iii) A sample transmission tubing that is too long will affect the dispersion on the rise and fall of the peaks and will also cause irregularities on the plateau of the peak.
- iv) If the length of sample tubing from the peristaltic pump to the manifold is too long or too short, ISAC effects can be seen on the peaks. (See section 7.1).
- v) Connections of tubing and glassware that contain dead volume, can cause coating of the reagents and dispersion of the peaks; all glass to glass connections must be absolutely butt-jointed tightly by the sleeving tubing, even a gap of a couple millimetres will cause distortion of the bubble flow and poor output results. Regularly checking of all connections is recommended.

The TrAAcs 2 system was used to perform different experiments to show the effects of using old glassware, or incorrect tubing and manifold construction. See Figures 7a-c, for a clear view of the effects on the output peaks. Enhanced interference, dispersion and carryover were seen to be the results of these experiments. Most striking was the effect seen by completely removing the inter-sample bubble and then letting the sample travel through a small length of tubing before entering the manifold and then segmenting the flow afterwards, this showed considerable dispersion of the peaks, see Figure 7b. Larger sample (green/green) (0.635ml/min) and de-bubbler tubing (black/black) (0.151ml/min) were used to ensure the same flow rate and therefore the same chemistry was maintained as in the normal set-up. Therefore maintaining the inter-sample air bubble until after the peristaltic pump is essential to reduce the effect of dispersion.

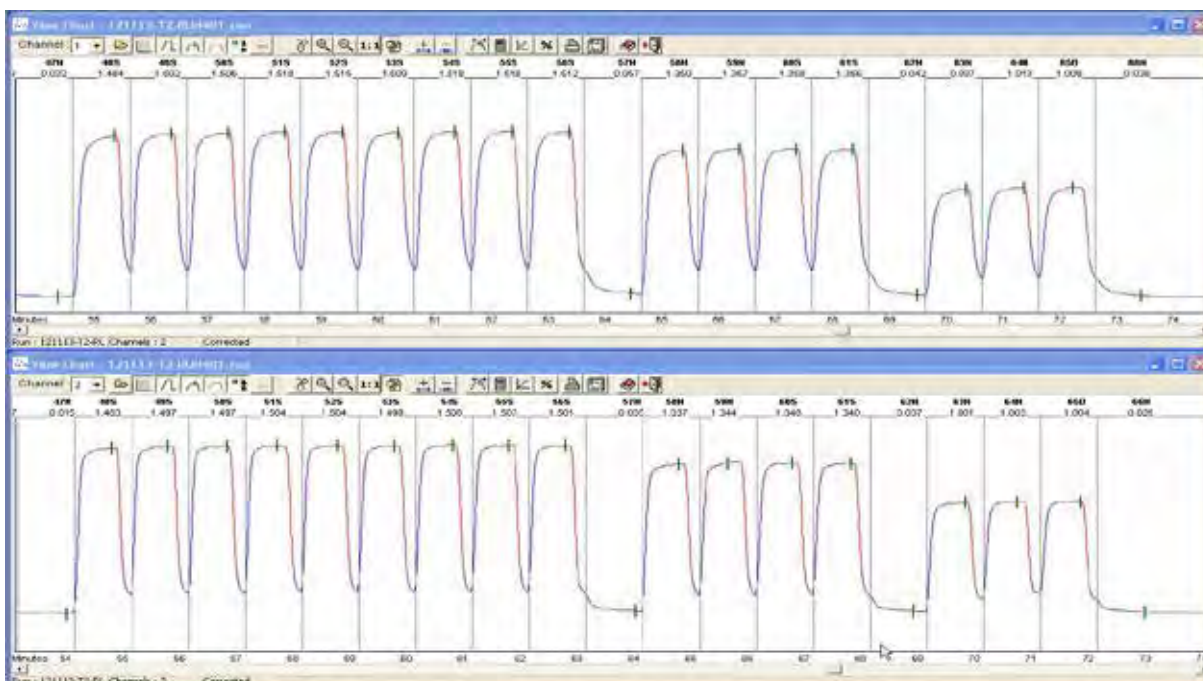

Figure 7a. Comparison of using old and new 20 turn glass coils: Top channel displays the original set up with a well used 20 turn glass coil and shows that the individual peaks take a longer time to reach a steady state than with a new 20 turn glass coil (bottom channel). The wash-out between the peaks is also more efficient using the new glass coil.

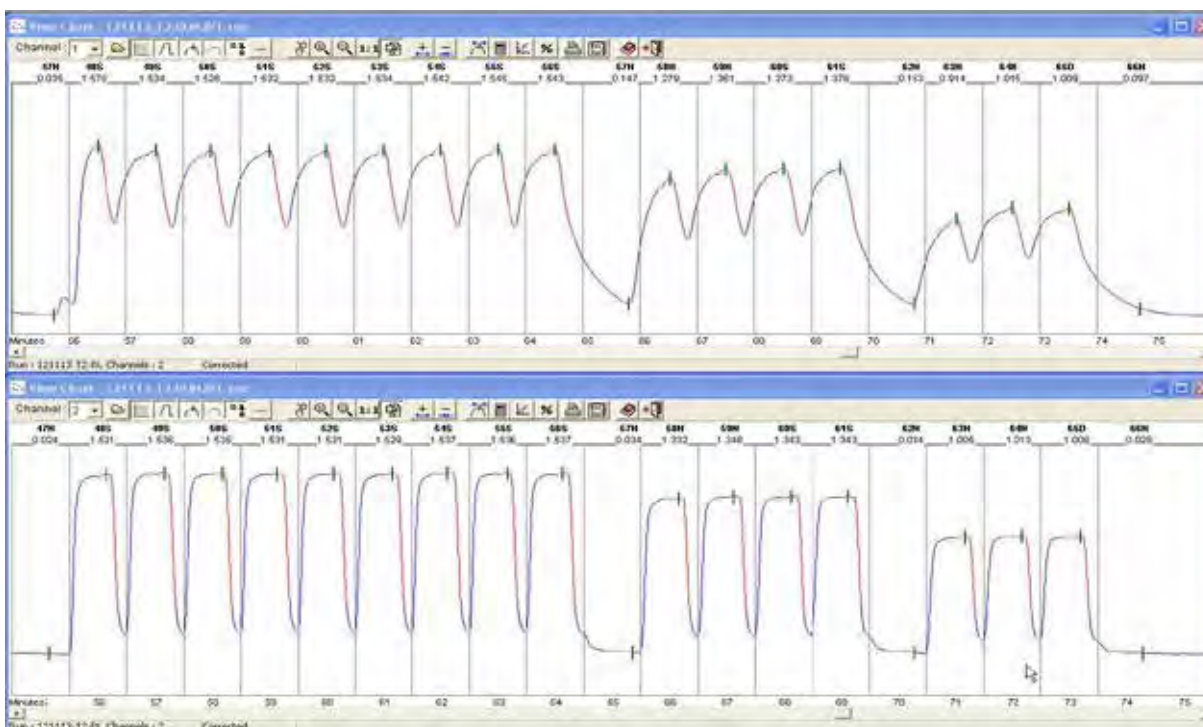

Figure 7b. Top Channel- Incorrect Tubing and Inter-sample bubble experiment: A green/green sample tube was used instead of yellow/blue tube (0.484 ml/min) and the inter-sample bubble was removed directly after the pump with a de-bubbler with black/black tubing so there was no inter-sample bubble for approximately 10cm before the sample entered the manifold. Extensive dispersion and poor peak shape was seen. The bottom channel shows a normal set-up response.

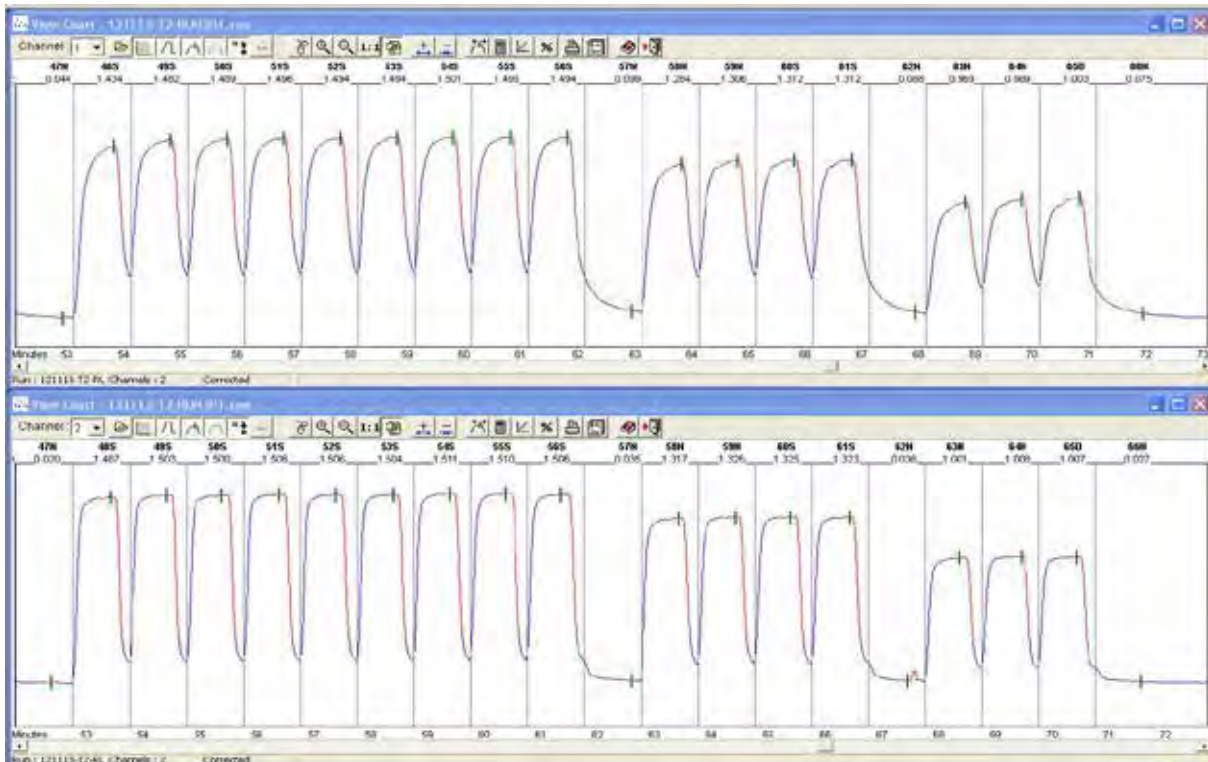

Figure 7c. Top Channel- Well used sample transmission tubing from the peristaltic pump to the manifold glassware shows that the peaks are rounded at the leading edge of the sample peak and continue to increase in height, not reaching a steady state. The bottom channel is a normal set-up.

5.7 Calibration.

There are many aspects to consider when deciding on the type of calibration curve to use and for making the calculations during an analytical run (Barwick 2003). The basic steps in avoiding the most common problems are as follow;

- i) Plan the calibration range so that the concentration of the samples is exceeded by this range.
- ii) Ensure that the concentration of the calibration standards are evenly distributed across the required range.
- iii) Always include a standard analyte blank which is the blank solution used to spike the standards into.
- iv) Ensure that appropriate materials and apparatus is used to prepare the calibration standards, and ensure all clean handling techniques are adhered to, e.g. wear non-contaminating gloves.
- v) Do not set the intercept to zero unless there is evidence that the intercept is not statistically different from zero. (This is not relevant for 'slope only').

vi) Plot and examine the results and residuals. (Residuals being the difference between the target and measured values).

Experiments were carried out on the QuAAtro using different calibration curve set-ups. These varied from low to high concentrations, high to low, and from two, and multiple spaced calibration points. The experiments calibrating the QuAAtro from low to high and high to low gave similar slopes. However, when looking in more detail at the lower concentration end of the calibration line e.g. the baseline point, higher carryover is seen when using a high to low calibration. When calibrating from low to high, this carryover problem is not present.

With both TrAAcs and the QuAAtro system, experiments using different calibration sample set-ups were carried out. This consisted of calibrating and measuring samples in the same order (either calibrating samples from low to high, or high to low concentrations), or measuring samples in opposing orders (calibrating low to high and measuring high to low, or calibrating high to low and measuring low to high). Figure 8 shows the sample residuals of the different calibration and sampling orders. When the calibrants and the samples are measured in the same order, both increasing or both decreasing concentrations, a better residual fit is seen.

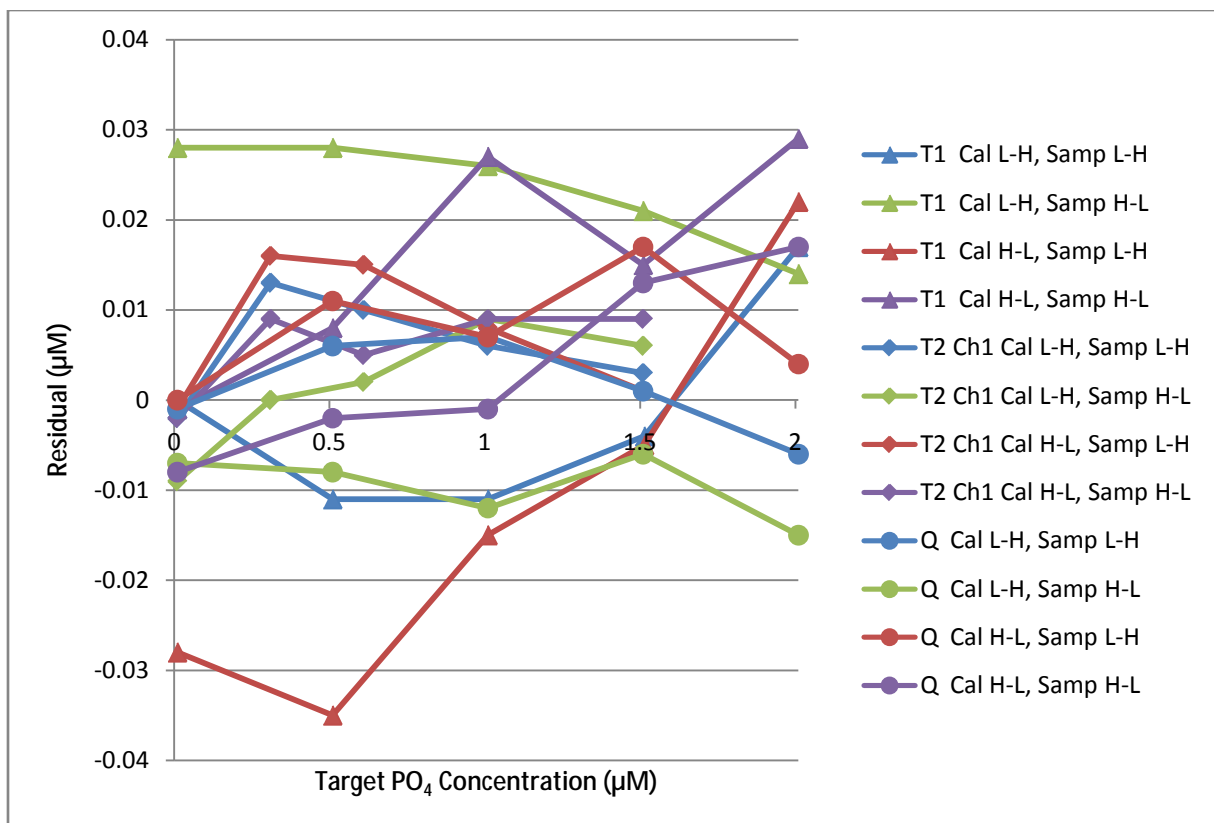

Figure 8. Sample residuals when using different combinations of calibration (Cal) and sampling (Samp) orders for both TrAAcs (T1 and T2) and QuAAtro (Q) systems. Values use the analytical systems calculated carryover coefficients.

5.8 Sensitivity Drift.

Ideally the response of an instrument should not change during a measurement cycle of any samples, however, in practice, this response does change and there is an observed drift, or change in magnitude of the output signal. A 'sensitivity drift standard' is a solution of a known concentration which is used to measure and correct sensitivity drift during a run. Usually this option can be selected in the software when creating a tray protocol. At least two drift peaks are needed during a run in order to apply this correction correctly. The software calculates for linear drift between two consecutive drift standards and applies a separate correction factor to each peak. It is therefore important that the sensitivity drift is not neglected as it can affect the measured results but will be at the expense of sample throughput.

Due to the chemical coating effect on the PO₄ channel, discussions were also held about the sensitivity drift standard; its position in the sample tray protocol and concentration to be used. Members of the international nutrient community reported several different positioning strategies for the sensitivity drift standards in the sample tray protocol, depending on the sample type and height that precedes the sensitivity drift standard peak. Theoretically, the highest full-scale calibration peak should be used for the sensitivity drift standard as you can assume that the best signal to noise ratio is obtained. Some users prefer a lower concentration if samples are at low level, or isolate the drift standard with a wash sample before or after. The positioning of the sensitivity drift sample should however always be consistent throughout the sample tray protocol.

5.9 Silicate Ion Interference Effect.

One problem that can be observed in PO₄ analysis is the competitive interference from silicate ions. The molybdenum blue PO₄ method can be subject to this if either arsenate or silicate are present in a sample, as both form similar blue complexes with molybdate. As arsenate concentrations are very much lower than phosphate in most natural waters, this interference can therefore be disregarded. However, the silicate concentration in natural waters can sometimes be up to sixty times higher than that of phosphate concentrations. Zhang et al. (1999), studied this topic in detail and suggested that when using a CFA, temperature, pH, [H⁺]/[Mo] ratios and the addition of Sb can all influence the interference effect.

At the workshop, samples containing high levels of Silicate were measured during a run to see the effects of the competitive interference and the silicate interference was observed to be less than 0.04 μM PO₄ on the AA3HR, and 0.01 μM PO₄ on both TrAAcs, when running a high 100 μM silicate sample.

After the workshop, additional experiments were performed to further check the Murphy & Riley (1962) method for its robustness concerning silicate interference and temperature dependence, in combination with two detection wavelengths. TrAAcs 1 was set-up with two PO₄ channels, one at 880nm and the other at 810nm. As the RMNS BT control sample contained a natural background of 42µM silicate it was used to see if any cross-over effects could be observed on either of the PO₄ channels. Additionally, a sample containing 100µM silicate was also used. In the first experiment, the reaction manifold was heated to 59°C for both channels, and a higher RMNS BT PO₄ value was observed, a 0.33µM increase on the 880nm channel and 0.80µM on the 810nm channel. The second experiment kept the 880nm channel at 30°C but the 810nm channel was again heated up to 59°C. The RMNS BT samples showed a 0.01µM increase in the 30°C 880nm channel and in the heated 810nm channel again an increase of 0.80µM was observed. With both channels at 30°C, again the 880nm wavelength channel showed an increase of 0.01µM, and the 810nm channel this time showed only an increase of 0.02µM. The increase in values that were found at 59°C for the RNMS BT sample are in good agreement with the calculated interference formula using temperature, silicate and pH described by Zhang et al.(1999). This suggests that if the Murphy & Riley (1962) method is used at temperatures above 37°C and with longer reaction times, then silicate interference will be observed.

5.10 Baseline Background Determination.

When labs are using a LNSW or ASW baseline, then it is imperative to make this following background determination for the concentration of nutrients in the baseline water being used. Labs using Ultra-Pure water baseline do not have to do this, but they will have to determine the salt correction due to the refractive index effect as described earlier in section 5.5. The TrAAcs 2 system was used to demonstrate a 'Baseline Background' procedure, running all reagents and using the LNSW to be determined as the baseline water. The gain was set on its most sensitive setting and a single LNSW solution added with a known amount of PO₄ standard (0.2 to 0.4µM) was measured, and its peak height recorded. Once a steady state baseline was observed, one of the colour reagent lines was placed into a solution which did not contain an essential colour reagent, e.g. ascorbic acid, and after establishing steady state, it was then placed back into the colour reagent. This procedure, with and without the colour reagent, was then repeated with fresh Ultra-Pure water being used as the baseline, (See Figure 9). Therefore, by using the peak height from the added PO₄ standard in LNSW, and the difference between the baselines with and without the colour reagent during LNSW and Ultra-Pure water baselines, the Phosphate concentration in the LNSW can be calculated;

$$\mu\text{M of PO}_4 \text{ in LNSW} = ([\text{PO}_4] \text{ peak}/y) * (\Delta\text{LNSW} - \Delta \text{Ultra-Pure Water}) \quad (5-2)$$

where,

$[PO_4]_{\text{peak}}$ is the concentration in μM of the low PO_4 standard solution

y is the peak height of the low PO_4 standard solution

ΔLNSW is the difference in baseline height that is seen with and without the colour reagent for LNSW baseline water

Δ Ultra-Pure Water is the difference in baseline height that is seen with and without the colour reagent for the Ultra-Pure water baseline

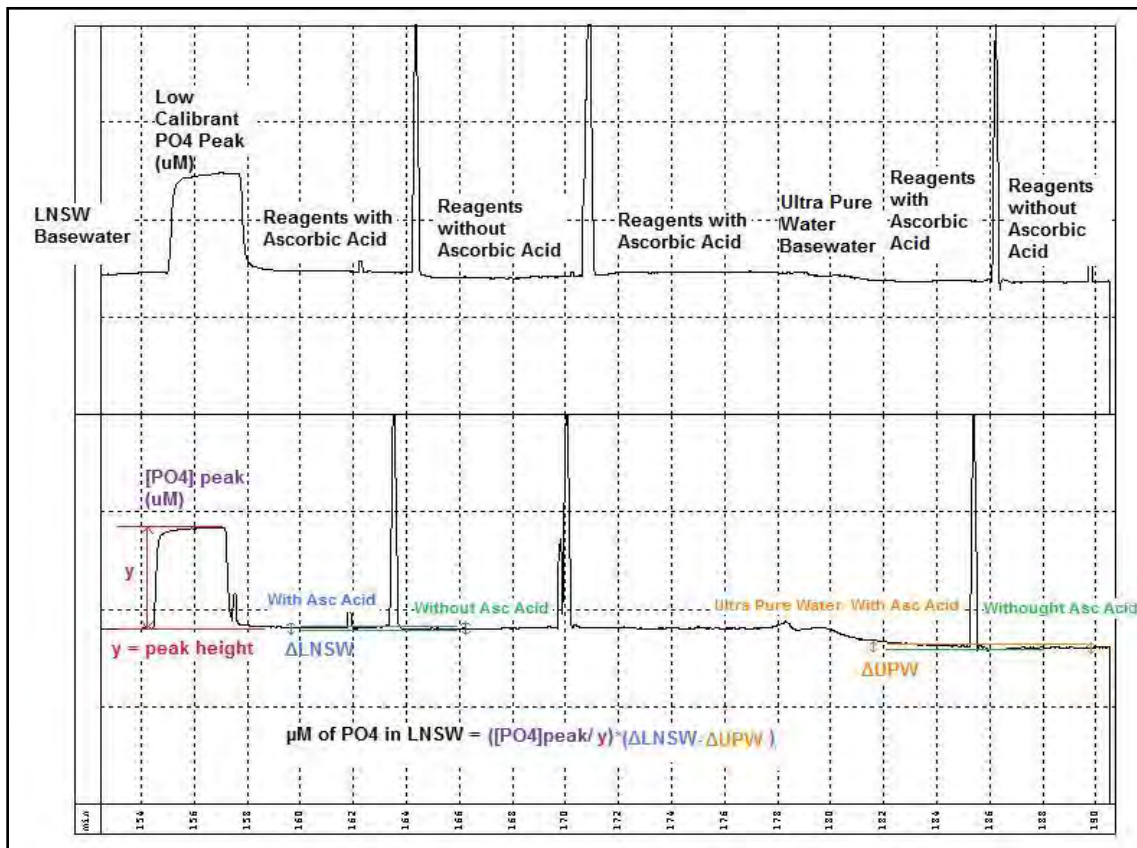

Figure 9: Determination of Phosphate concentration in low nutrient seawater using Ascorbic acid as the colour forming reagent.

6 Outcome of the Returned Questionnaires.

A questionnaire (see Appendix) was sent to the International SGONS community of 66 organisations, who participated in the IC RMNS study in 2012, of these 42 replied, and of these, 35 were used in the interpretations. The majority (31) of the participants carry out their PO_4 analyses based upon the Murphy & Riley (1962), and 4 use the Bernhardt & Wilhelms (1967) method.

6.1 Chemistry.

The reported molybdate concentrations ($[Mo]$) ranged from 0.1mM to 11mM Mo, and the acidity concentration ($[H^+]$) ranged from 79mM up to 750mM. The acidity concentration ($[H^+]$) is based on hydrogen ion concentrations calculated from known additions of standard sulfuric acid, and from this, the acid/molybdate ($[H^+]/[Mo]$) ratios can be determined. Calculated from the feedback provided in the questionnaires, the average $[H^+]/[Mo]$ ratio being used was 72, which is close to the recommended ratio value of 70 published by Murphy & Riley (1962), (See Figure 10c). However, the resulting pH ranged from 0.25 to 1.0, (See Table 5). The typical pH for the Bernhardt & Wilhelms (1967) method is lower than pH 0.3. At a lower pH, a higher acidity and a higher Mo content, a greater silicate competitive interference is caused when using longer reaction times (Zhang et al. 1999).

The findings of the questionnaire showed that the Sb/P ratio amongst the IC RMNS community ranged from 3 to 100, see Figure 10d. However, with increasing concentrations of Sb, the carryover effect will significantly increase, see again Figure 5.

6.2 Calibration.

19 of the questionnaire participants reported using an analytical calibration protocol of low to high, with the remainder (16) calibrating in the order of high to low. However, 23 respondents, measured their samples in the order of ocean surface waters down to deep waters (increasing values), as opposed to 9 who measured samples from deep waters to surface (decreasing values).

Nearly a third of those who replied used an equally weighted calibration line and the remainder calibrated with a bias towards the lower region of the calibration line. 31 participants from a total of 35 calibrated using a Linear fit (3 of these participants used a Slope Only calibration), 3 used a Quadratic fit and 1 user used a 2 standard Gordon et al. (1993) fit.

13 of the questionnaire participants reported calibrating and measuring samples in the same order (either calibrating and measuring samples both from low to high concentrations or from high to low concentrations) with 19 calibrating and measuring samples in the opposite order (i.e. calibrating from low to high and measuring from high to low concentrations or calibrating from high to low and measuring from low to high concentrations) (3 participants did not report on this).

6.3 Flow considerations.

The different analytical systems reported in the questionnaire clearly show that the macro-bore systems used (e.g. AAll, AAllI, AAllIHR, Skalar etc.) had a faster overall flow than the micro-bore systems (TrAAcs, QuAAtro etc.), See Figure 10k.

6.4 Questionnaire Figures; Using information supplied by the global nutrient community.

The following Figures show an overview of different parameters investigated from the information supplied.

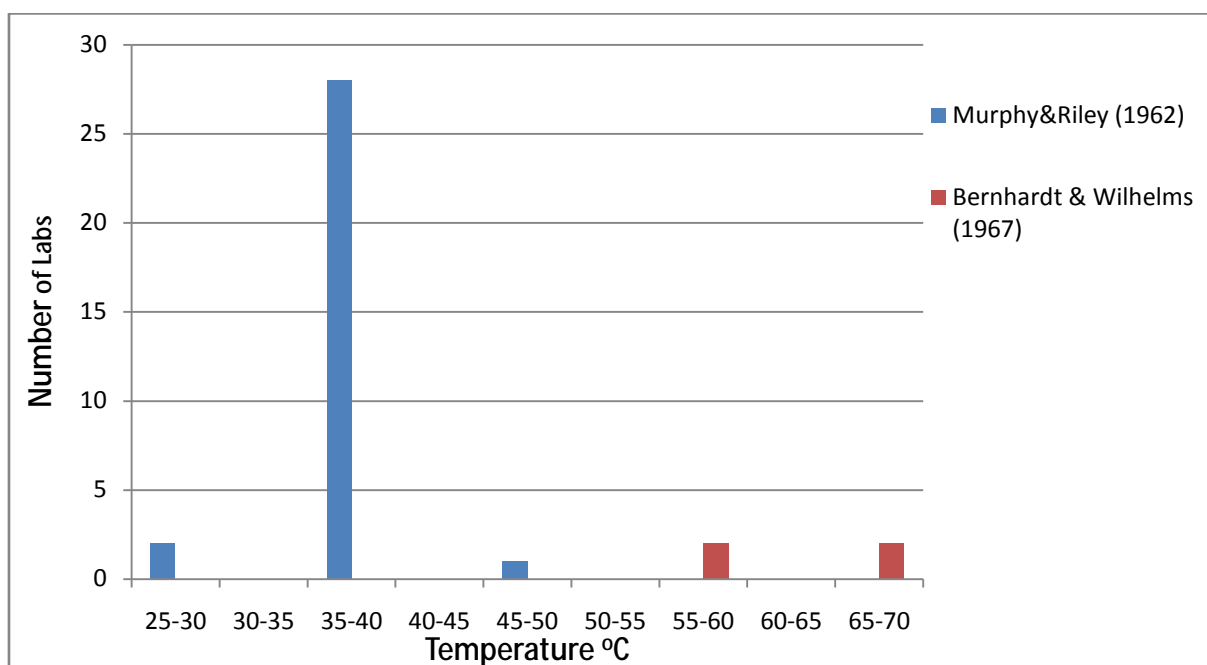

Figure 10a. Distribution of the reaction temperatures used for PO₄ analysis.

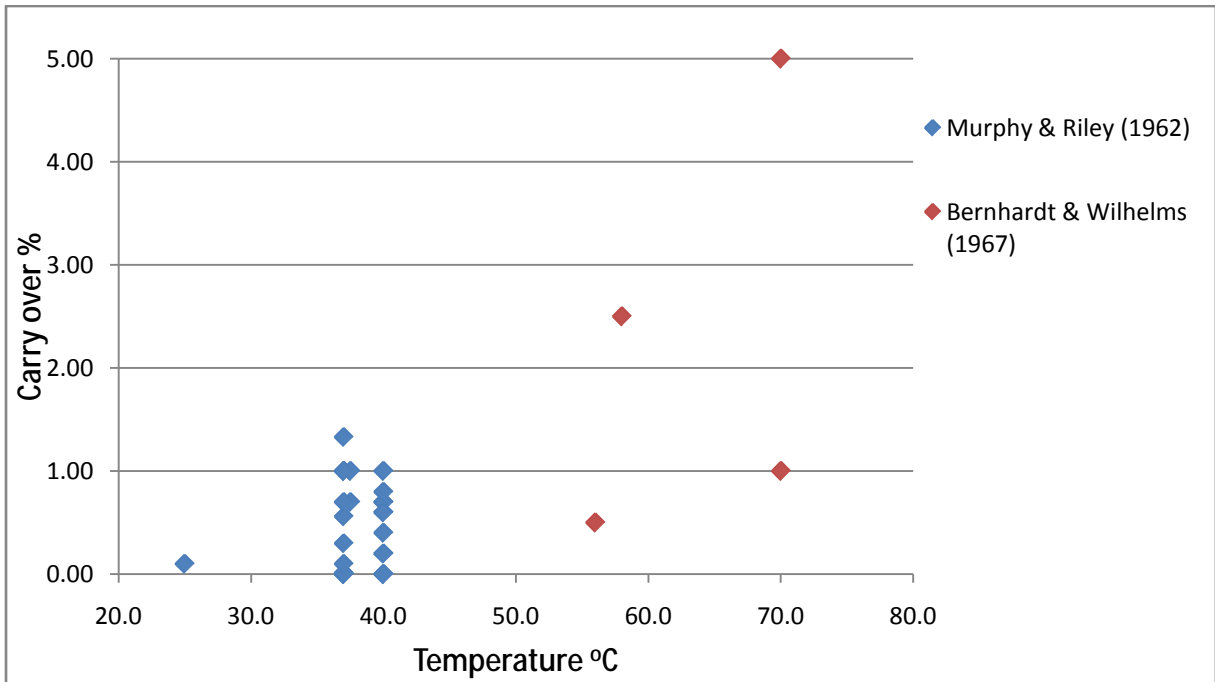

Figure 10b. Reported carryover coefficients at the temperatures used for PO₄ analysis.

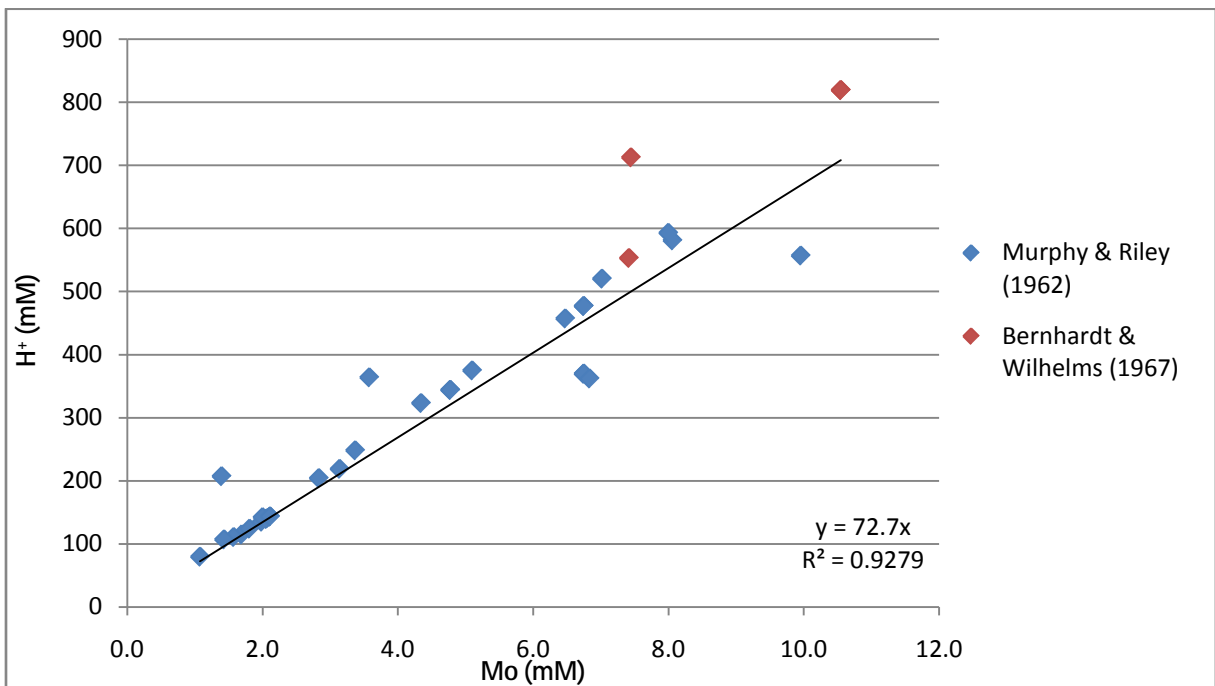

Figure 10c. Distribution of the [H⁺]/[Mo] ratio used by the labs, are in good agreement with the ratio of 70 found by Going and Eisenreich (1974).

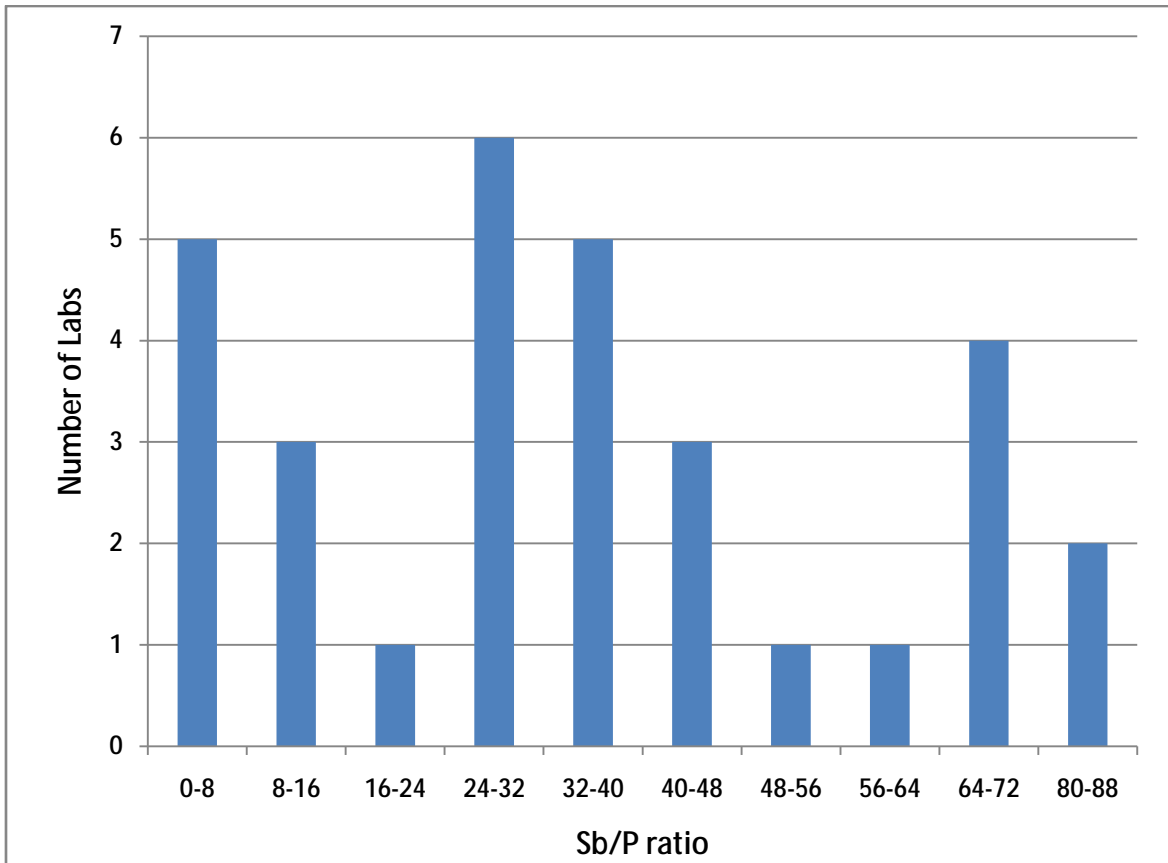

Figure 10d. Distribution of the calculated Sb/P ratios for the different labs at a PO_4 sample concentration of $3\mu\text{M}$.

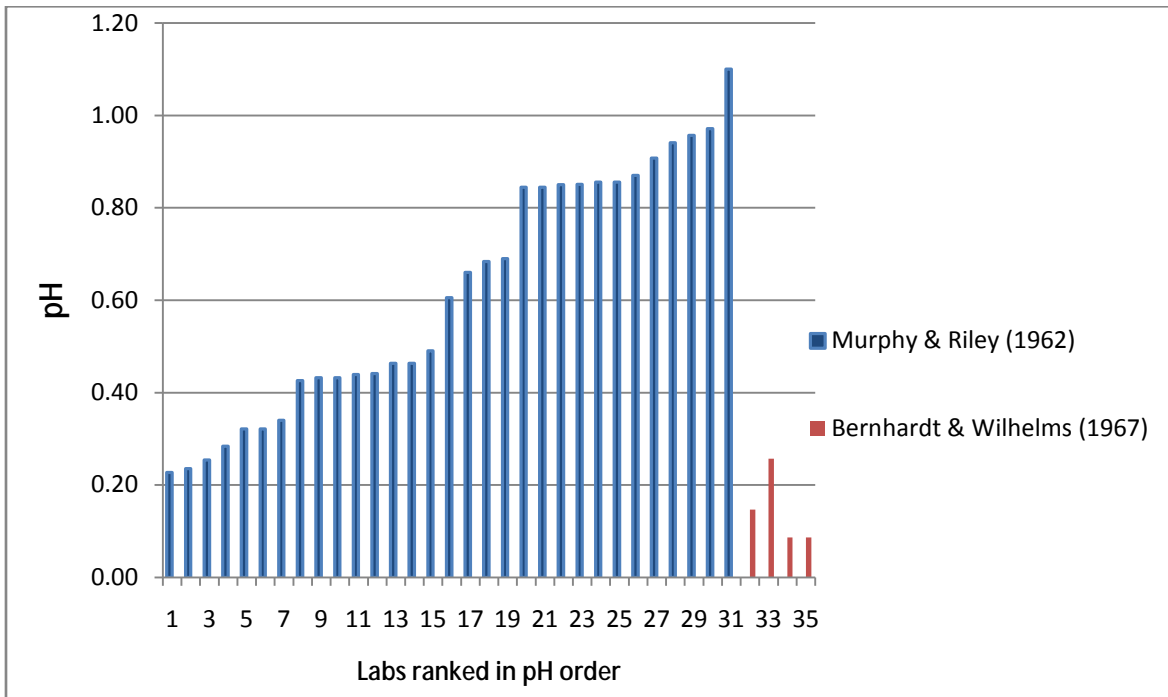

Figure 10e. Calculated pH-distribution of the final sample-reagent solution passing through the flow cell.

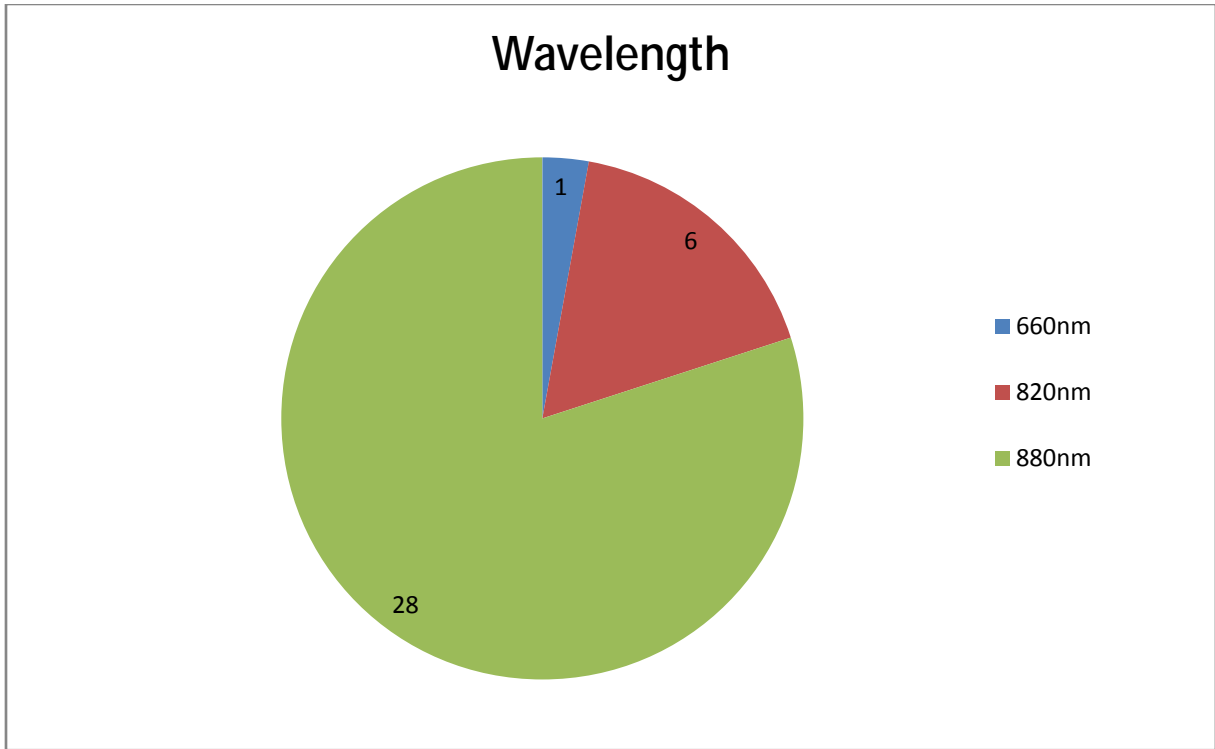

Figure 10f. The analytical wavelengths used by the different participants.

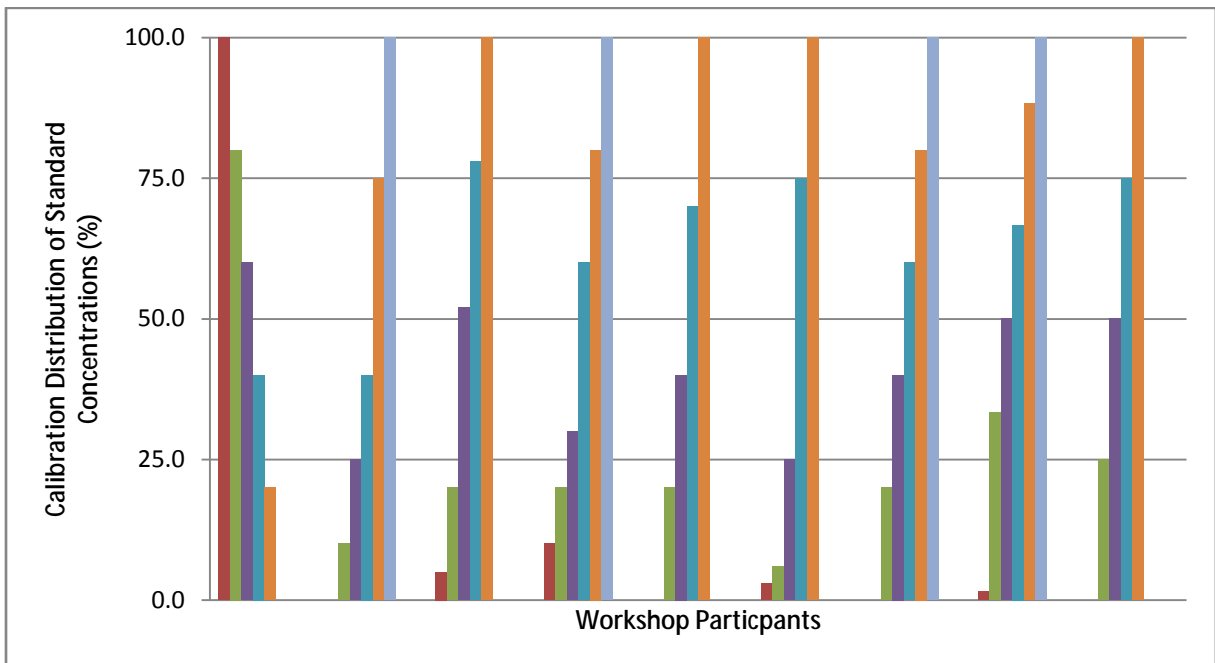

Figure 10g. An overview of the calibration distribution of the standards that were used by the workshop participants.

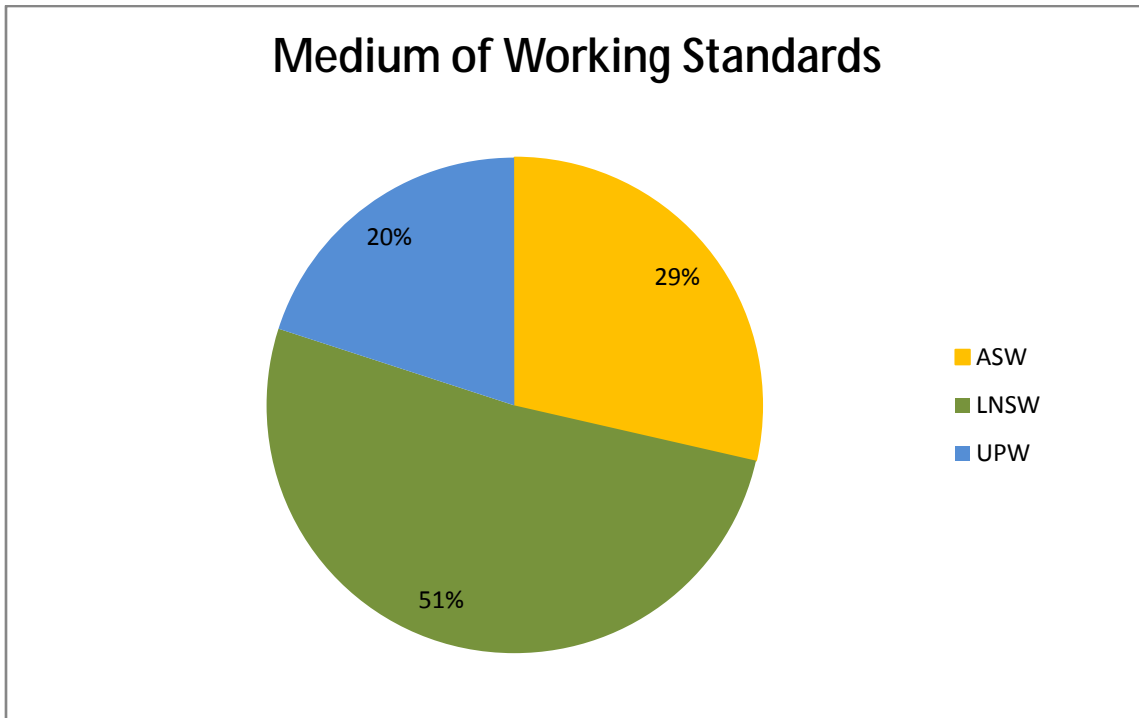

Figure 10h. Distribution of the medium used to make the working standard solutions.

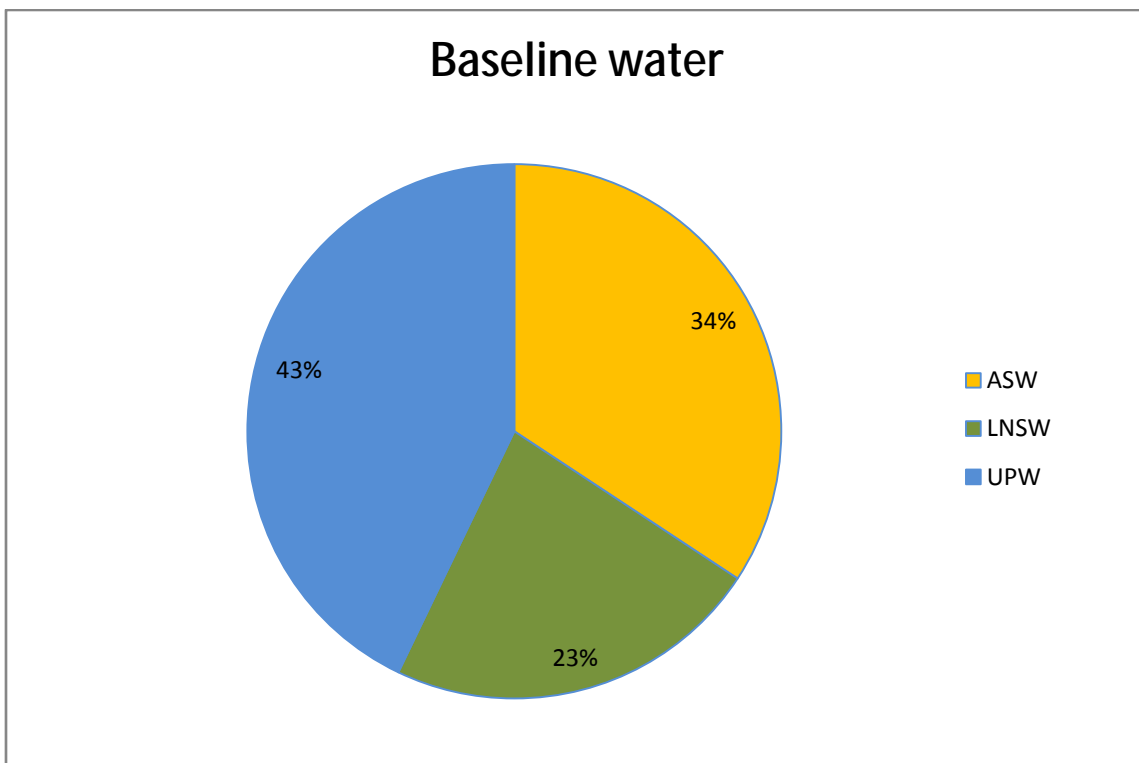

Figure 10i. Distribution of the baseline water used.

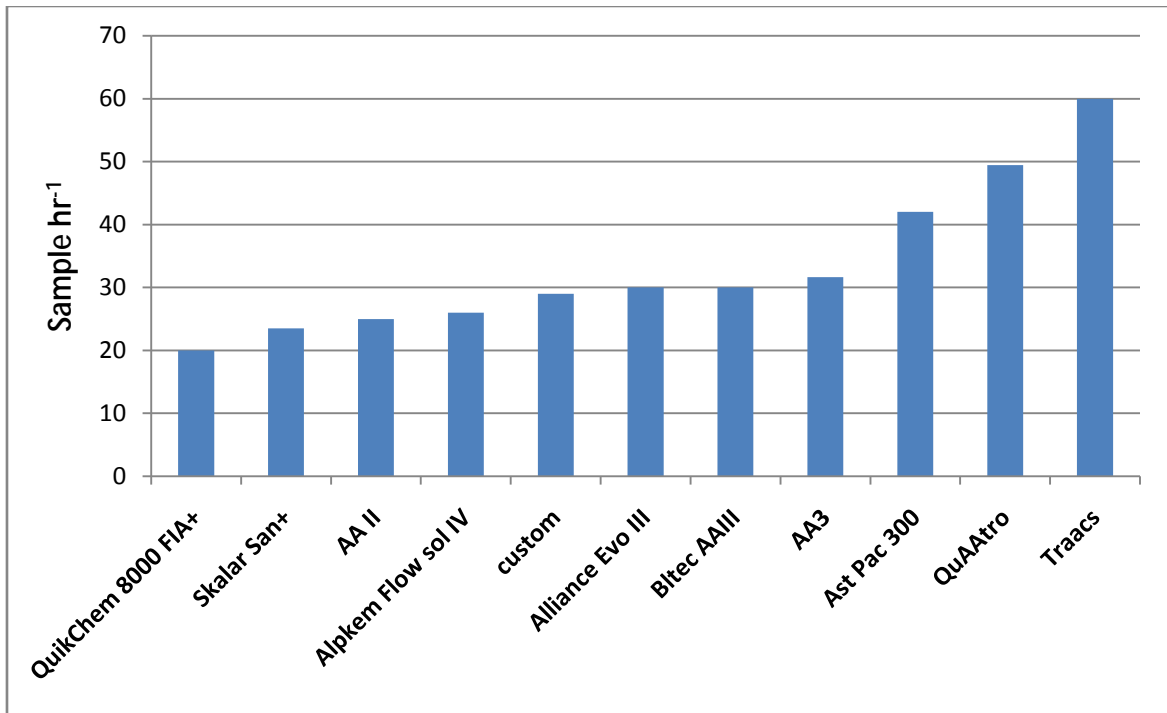

Figure 10j. An overview of the average sample throughput for the different analysers used.

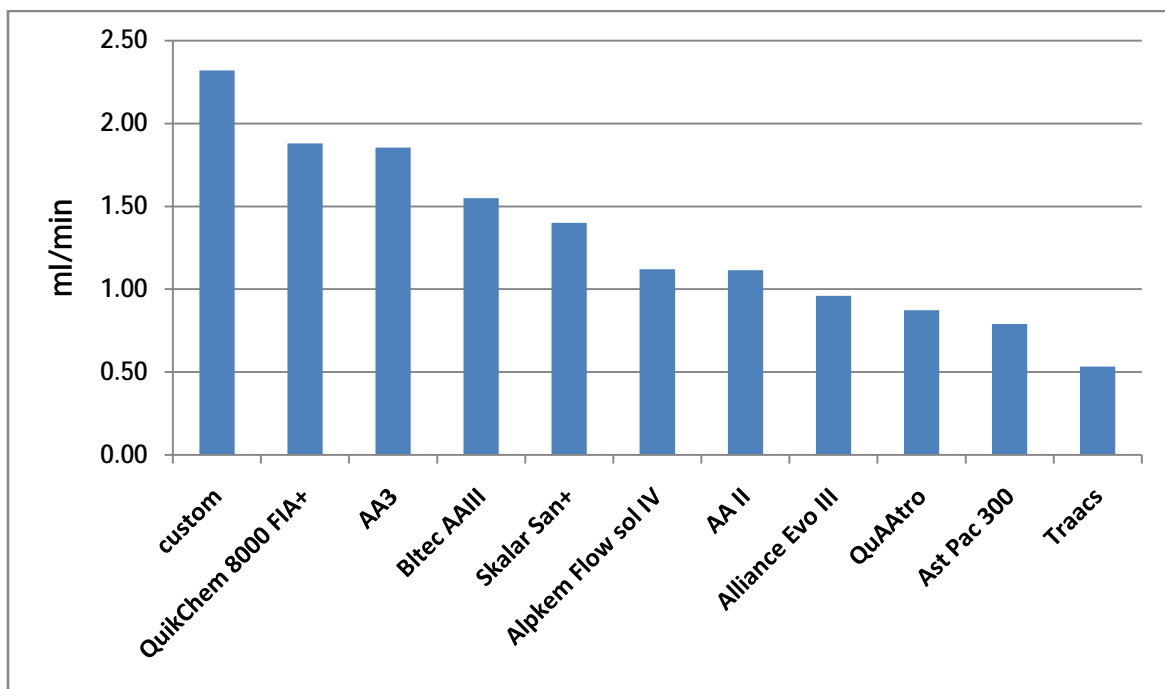

Figure 10k. An overview of the average total flow speed for PO₄ on the different analysers used.

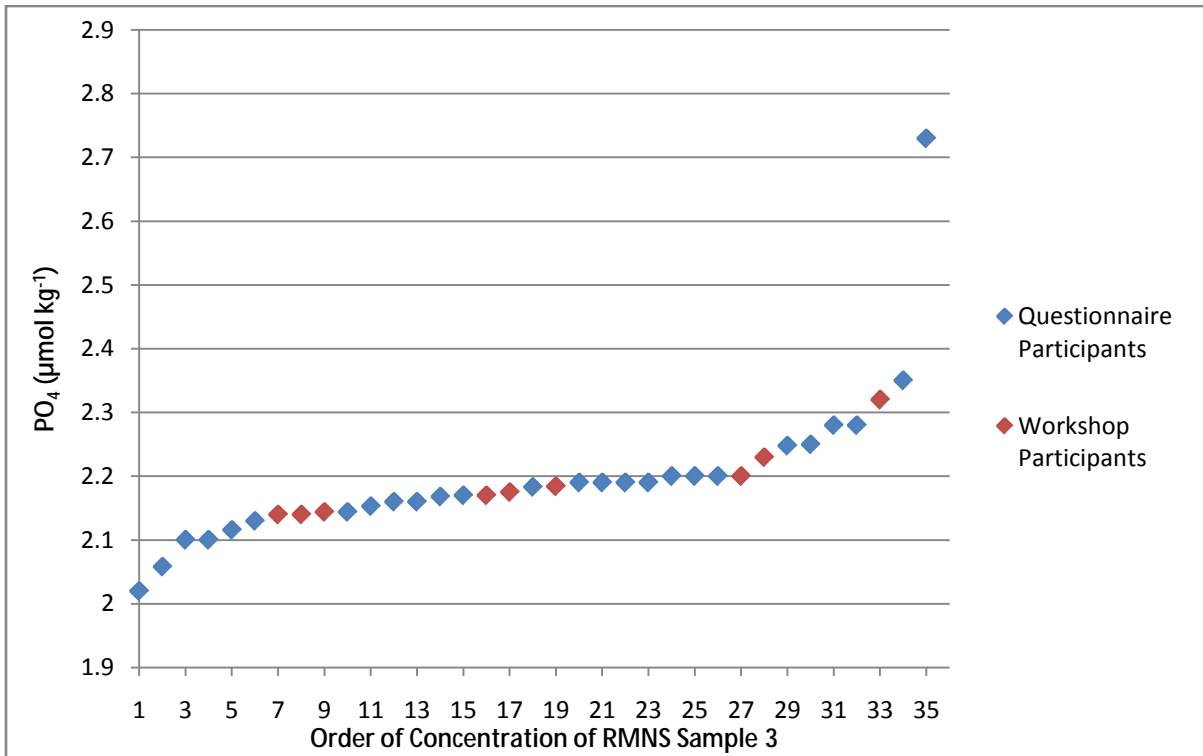

Figure 10l. Reported PO₄ concentrations from questionnaire respondents, with the NIOZ workshop participants highlighted in red. (The average value of the consensus mean was found to be 2.16µM PO₄/kg for sample 3 from the IC RMNS 2012 study, Aoyama et al. 2013).

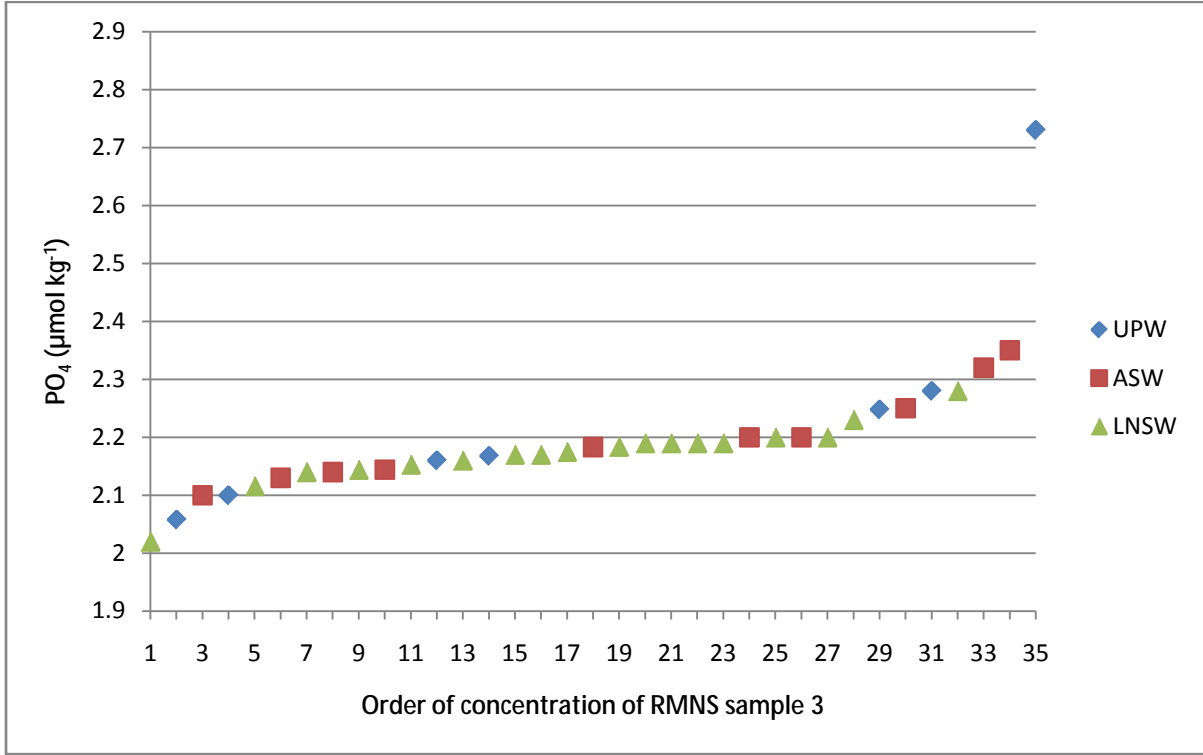

Figure 10m. Reported PO₄ concentrations from questionnaire respondents, for the medium used for the working calibration solutions. (The average value of the consensus mean was

found to be 2.16 μ M PO₄/kg for sample 3 from the IC RMNS 2012 study, Aoyama et al. 2013).

7 Other aspects of analysis that should be considered but were not investigated during the workshop.

7.1 Inter-Sample Air Compression (ISAC).

When inter-sample air bubbles are aspirated at the input side of the peristaltic pump, they are essentially at atmospheric pressure, or slightly below. After the air bubbles pass through the pump to positive pressure (output side), the pressure on the bubbles abruptly increases and they compress to occupy a smaller volume. As a result of the compression, there is a momentary interruption of the flow in the sample transmission tube and less sample is introduced into the diluent stream which can cause a dip in the peaks (See figure 11). Although this ISAC dip cannot be completely eliminated as it is a normally occurring phenomenon of CFA, its effect on the peak shape can be removed by shifting the dip into the wash phase. This issue can be overcome by changing the length of sample tubing between the pump and the manifold by making it longer or shorter, which can insure this occurs. Some manufacturers even supply an equation whereby the length of tubing from the pump to the injection point can be calculated using sample tube colour factors and sampling time.

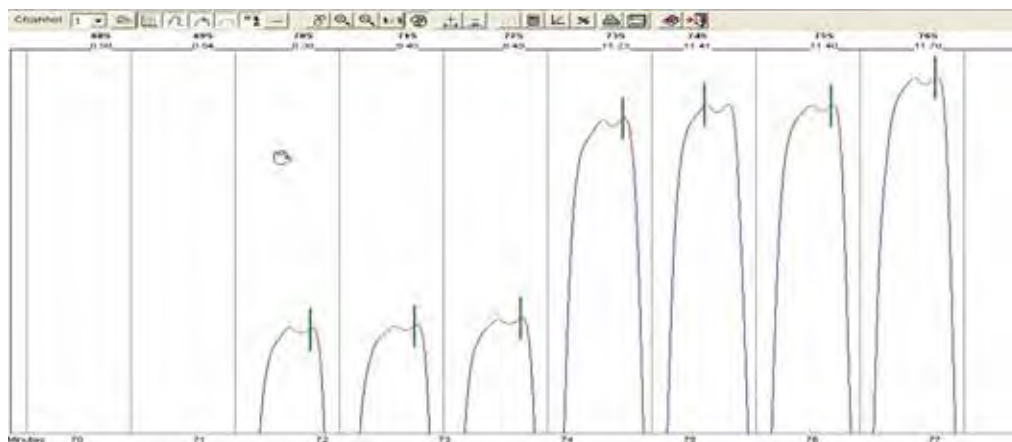

Figure 11. The ISAC effect causing a dip on the peak plateau.

7.2 Wetting Agents.

It is important that an optimal amount of wetting agent is used so as to ensure there is enough wetting to maintain optimal segmented flow in the system with a minimum of carryover. This is dependent on each individual system and should be tested by all users.

7.3 Reaction Time, pH and Temperature.

The critical length of the coil needed for the colour formation for PO_4 , optimal pH, and the required temperature were not further studied during the workshop. If the temperature were to be slightly lowered and the coil length shortened, the possible advantages could lead to less carryover and possibly less competitive interference from high silicate samples, for just a minor loss of sensitivity. It is therefore of interest for users to carry out such a test for the possible improvements and advantages to be gained on their own systems.

8 Conclusions & Recommendations.

8.1 Phosphate Chemistry.

There are 2 main analytical methods used for the analysis of Phosphate. One based on the Murphy & Riley (1962) method, using Sb as the catalyst for enhanced colour production and ascorbic acid as the reducing agent. The second method of Bernhardt & Wilhelms (1967) uses hydrazine as the reducing agent without the need for a catalyst, and therefore operates at a lower pH. Both methods produce the phospho-molybdenum blue complex after reduction.

Murphy & Riley (1962):

Sb/P Ratio

As Sb is being used in this method, it is advisable that each CFA should be specifically tested for the lowest optimum ratio that can be used. A Sb/P ratio of 3 is enough to achieve the highest possible sensitivity, as any excess Sb in the system only leads to more undesirable carryover effects, (Going and Eisenreich, 1974). Sb is a hazardous chemical, so this should also be considered (See Section 5.4).

Wavelength

It is important to consider the wavelength that is used to measure the PO_4 absorbance with reference to the reaction temperature, (see section 5.9). Going and Eisenreich (1974) clearly show that by using Sb in the reaction, the optimum absorbance for PO_4 shifts from 820nm to 880nm.

Bernhardt & Wilhelms (1967):

This method requires a higher analytical reaction temperature (55-58C) compared to Murphy & Riley (1962) which is 35-40°C; (See Figure 10a). It also operates at a lower pH, and while hazardous Sb is not used, toxic hydrazine is. Bernhardt & Wilhelms (1967) reported having no coating effect, no silicate interferences and minimum carryover, however, participants using this method reported relatively high carryover (See Figure 10b).

When lower concentrations of sulphuric acid and molybdate are used there are minimal coating effects and lower silicate interferences when compared to Murphy & Riley (1962), (Zhang et al. 2001). However, during the workshop, the Bernhardt & Wilhelms (1967) method was set-up using a heating bath temperature at 56°C and the silicate interference observed was similar to that seen with the Murphy & Riley (1962) method (37°C) (See Section 5.9) which is also in agreement with Zhang et al. (2001).

8.2 Silicate Interference.

A silicate interference test should also be carried out by measuring the influence of high silicate concentrations on the output of the PO₄ channel and analysts should ensure that their own analytical technique is robust and has no or at worst very minimal silicate interference. Labs need to establish their own best practice, and to consider the effects of temperature, reaction time in the glass coils, and the wavelengths being used for analysis. When using the Murphy & Riley (1962) method it is recommended to use temperatures below 40°C (Zhang et al. 1999) to minimise silicate interference (See Section 5.9).

8.3 Carryover.

It is advisable to use a standard carryover value that has been generated from many runs, and is specific to the system being used. This is to ensure that incorrect carryover values are not calculated from an individual analysis run where a single poor peak could have a disproportional large influence on this value, and more importantly, on the final results. It is essential that this standard carryover value is monitored on a regular basis as it can be sensitive to any system changes, See again Figures 7a-c.

8.4 Calibration.

Although it was shown that there is little difference if one calibrates from low to high or high to low (See Figure 8), it is more advisable that the sample order is also measured in the same way as the standards, either increasing concentrations for low to high calibrations or decreasing concentrations for high to low calibrations. A small difference in slope is seen depending on the calibration order and therefore it is advisable that the samples are also measured in the same way. The carryover coefficient should also be calculated accordingly as it will subsequently have an effect on the final results. It is also important to note that if one is calibrating or measuring from high to low, the lowest value closest to the baseline will be overestimated as the carryover for this situation can be higher than it is actually corrected for. As a consequence, it is therefore advisable to run samples from low to high so that the samples in the lower area are not influenced by any

carryover. See Tables 3a-d for an overview of the different systems and calculated carryover coefficients.

When using an unfamiliar system, it is vital that the calibration points are equally distributed over its range (e.g. 0, 25, 50, 75, 100% addition). However, if it is known that the calibration gives a linear response, then the analyst may choose to make more observations in the extremities of the calibration curve by taking more statistical observations to reduce the uncertainty in these areas and obtain a better calibration fit. It is therefore dependent on the system's performance if the analyst decides to put more weighting in certain areas of the calibration curve. Nevertheless, multiple measurements at each calibration level are still recommended.

8.5 Sample Tray Protocol.

Where sample throughput is not of paramount importance, and where there is carryover in the system, it is advantageous to sample the first peak of a series as a 'null' (non-counting) peak, whereby the second peak of the series is a duplicate of the first sample and becomes the true measured value. This is to ensure that the correct peak level is reached and is closer to the true concentration. For good laboratory practice, low concentration samples that are close to the detection limit should be preceded by a baseline so that the true values are more accurately measured and not influenced by preceding samples of higher concentrations.

8.6 Sensitivity Drift.

Although no practical tests were carried out, discussions were held about the sensitivity drift peak; its position, and the recommended concentration to be used. The degree of the coating effect increases with higher sample concentration and longer sampling time. Different protocols are used by different members of the global nutrient community depending on the peak height of the sample that precedes the sensitivity drift peak.

Depending on the precision of the CFA at the different concentration levels, it is of major importance to have optimal shaped drift peaks as this correction factor will influence the final results. Theoretically, the highest calibration peak level for the sensitivity drift peak will give the best signal to noise ratio. Therefore, in this scenario, the drift correction is based on the upper concentration end of the calibration curve. However, if high residuals are observed at the higher end of the calibration curve, than those seen at the other calibration level, then an overestimated drift correction could be calculated which will adversely affect the results.

The sensitivity drift can also be an issue with regard to sample throughput, when slow sample speeds are used. Since the sensitivity correction influences the results, the sampling regime of the sensitivity drift peak should be consistent throughout the run. It is advised that a 'null' (non-counting) peak is measured before the actual sensitivity drift.

8.7 Tubing and Glassware.

It was shown during the workshop that using, connecting, and the placing of the correct manifold tubing and glassware, is essential in order to reduce the effects of interference, coating, dispersion and carryover. As seen in Figure 7b, maintaining the inter-sample bubble through the peristaltic pump tubing is essential to minimise the effect of dispersion. It is important that a system is optimized throughout from sampler to after the colorimeter, and critically evaluated for any improvements that could be made with regards to the tubing, glassware, connections and their placement. It is also advisable to replace old glass coils used in the PO₄ method when it appears that the performance is deteriorating through interferences affecting the peak shape.

8.8 Recommended literature to consult for further guidance.

The GO-SHIP repeat hydrography manual for nutrient analyses, Hydes et al. (2010), should be consulted in detail as to best practice for analysis. Also 'Comparability of nutrients in the world's ocean', Aoyama et al. (2010), should be considered by the global nutrient community in order to encourage analysts to keep improving the analytical quality for the worldwide measurements of nutrients.

9 References

Aoyama M, Anning J, Barwell-Clarke J, Baurand F, Becker S, Blum M, S, Coverly , Czobik E, Damico F, Dahllöf I, Dai M H, Dobson J, Duval M, Engelke C, Gong G C, Gross O, Hirayama A, Hydes D, Inoue H, Ishida Y, Kasai H, Kerouel R, Knockaert M, Kress N, Kroglund K A, Kumagai M, Leterme S, Mahaffey Mitsuda H, Morin P, C, Moutin T, Munaron D, Murata A, Nausch G, Ogawa H, van Ooijen J, Pan J M, Paradis G, Payne C, Pierre-Duplessix O, Prove G, Raimbault P, Rose M, Saito H, Saito K, Sato K, Schmidt C, Schuett M, Shammon T M, Solveigo O, Sun J, Tanhua T, Weigelt-Krenz S, White L, Woodward E M S, Worsfold P J, Yoshimura T, Youenou A, Zhang J Z; 2008 Inter-laboratory Comparison Study for Reference Material for Nutrients in Seawater. Technical Reports of the Meteorological Research Institute of Japan, January 2010, Number 60, (2010), ISSN 0386-4049.

Aoyama M., Dickson A., Hydes D., Murata A., Roose P., Oh J. and Woodward E.M.S.; Comparability of nutrients in the world's ocean, INSS international workshop 10-12 Feb. 2009, Paris. ISBN978-4-9904863-0-3, (2010).

Aoyama M, Bakker K, Daniel A, Kamata M, Koyzr A, Becker S, Dickson A, Hydes D, Katagiri M, Mitsuda H, Sato K, Uchida H, Yoshimura T, Murata A, Schuller D, Woodward E.M.S. (2013); 2012 UCSD/SIO SGONS Meeting Report. The Joint IOC-ICES Study Group on Nutrient Standards (SGONS). Second Meeting, Scripps Institution of Oceanography, La Jolla, U.S.A. 27–29 February 2012. Published by MRI, Japan, (2013).

Aoyama M, Álvarez M, Anstey C, Ashraf M P, Barwell-Clarke J, Becker S, Bell S, Brand T, Blum M, Carignan M, Couceiro F, Crump M, Curless S, Dai M, Engelke C, Falconi C, Fayed N, Giani M, Grosso O, Henderson P, Hu Y, Jennings J, Jensen D, Kamata M, Kang D J, Kasai H, Kerouel R, Kim S H, Knockaert M, Kress N, Kroglund K, Larsen M, Ludwiczowski K-U, Mahaffey C, Márquez A, Miyao T, Molina D A, Monteiro I, Mordy C, Morin P, Murata A, Nausch G, Norris E, Ólafsdóttir S R, Olsen A, Ooijen J van, Paranhos R, Payne C, Prove G, Pierre-Duplessix O, Paradis G, Rabiller E, Raimbault P, Richardson W, Ruttenberg K, Saito H, Santis Brag E de, Sarma V, Schmidt C, Schütt M, Shulkin V, Sun J, Tanhua T, Taylor A, Terhell D, Tishchenko P, Torres-Valdés S, Waldron H, Weigelt-Krenz S, Woodward EMS, Yoshimura T, Zhang J-Z, Zhao Z; 2012 Inter-laboratory Comparison Study of a Reference material for Nutrients in Seawater, MRI, Japan, (2013), in press.

Barwick, V.; Preparation of Calibration Curves: A Guide to Best Practice, VAM, Sep 2003, LGC/VAM/2003/032

Benhardt H. and Wilhelms A.; The Continuous Determination of Low Level Iron, Soluble Phosphate, and Total Phosphate with the AutoAnalyzer; Automation in Analytical Chemistry, Technicon Symposium, "Automation in Analytical Chemistry," Oct. 3, 1967, New York, pp. 385-389.

Coverly S., K erouel R., Aminot A.; A re-examination of matrix effects in the segmented-flow analysis of nutrients in sea and estuarine waters; Anal. Chim. Acta, 712 (2012), pp.94-100.

Going, J.E., Eisenreich, S.J.; Spectrophotometric Studies of Reduced Molybdoantimonylphosphoric Acid; *Anal. Chim. Acta* 70 (1974) 95-106.

Gordon L.I., Jennings J.C., Ross A.A., Krest J.M.; WOCE Hydrographic Program Office, Methods Manual WHPO 91-1, (1993).

Hydes, D J, Aoyama M, Aminot A, Bakker K, Becker S, Coverly S, Daniel A, Dickson a G, Grosso O, Kerouel R, van Ooijen J, Sato K, Tanhua T, Woodward E M S, Zhang J.-Z.; Determination of dissolved nutrients (N,P,Si) in seawater with high precision and inter-comparability using gas-segmented continuous flow analysers. *The GO-SHIP Repeat Hydrography Manual: a collection of expert reports and guidelines; IOCCP report No.14, ICPO publication series No. 134, version 1, 2010*

Murphy J., Riley J.P.; A modified single solution method for the determination of Phosphate in natural waters; *Anal. Chim. Acta* 27 (1962) 31-36.

Woodward E.M.S., Coverly S., Kerouel R., Aminot A.; Some special analytical considerations for the Continuous Flow Analysis of Nutrients. (2010); pages 69-81. In: Comparability of nutrients in the world's ocean. INSS international workshop 10-12 Feb. 2009, Paris. Editors: M. Aoyama, A. Dickson, D. Hydes, A. Murata, P. Roose, J. Oh and E.M.S Woodward. ISBN978-4-9904863-0-3.

Wurl O.; Practical Guidelines for the Analysis of Seawater; CRC Press, 2009, p.408. ISBN: 9781420073065.

Zhang J.-Z.; Distinction and quantification of carry-over and sample interaction in gas segmented continuous flow analysis. *Journal of Automatic Chemistry*, Vol. 19, No. 6 (November-December 1997) pp. 205-212.

Zhang J.-Z., Fischer, C. J., Ortner, P. B.; Optimization of performance and minimization of silicate interference in continuous flow phosphate analysis, *Talanta* 49, 1999, 293–304.

Zhang, J.-Z., Fischer, C.J., Ortner P. B.; Continuous flow analysis of phosphate in natural waters using hydrazine as a reductant, *International Journal of Environmental Analytical Chemistry*, 2001, 80(1): 61-73.

10 Acknowledgements.

Thanks are given to all those who provided feedback and inspiration for the workshop by returning the questionnaire and for asking questions for practical consideration during the workshop.

Special thanks are also given to NIOZ for hosting the workshop in their laboratories on Texel, The Netherlands,

Funding support for the workshop was provided through Michio Aoyama by KAKENHI-KIBAN-S-23221003 of Ministry of Education, Culture, Sports, Science and Technology in Japan for which we are very grateful as this workshop would not have been able to take place without it. Additional funding, support and organisation was provided by NIOZ, The Netherlands, and Plymouth Marine Laboratory, UK.

Thanks to SEAL Analytical for providing an AA3HR analyser and to Stephen Coverly for providing guidance and technical support during the workshop.

11 TABLES

Table 1. Overview of the analysis runs performed during the workshop.

Autoanalyser	Date/Run	Description	
TrAAcs 1	121112-Run1	Calibration Low (L) to High (H)	
	121112-Run2	Calibration High (H) to Low (L)	
	121113-Run1	Calibration LH, Sb/P ratio = 1	
	121113-Run2	Calibration LH, Sb/P ratio = 5	
	121113-Run3	Calibration LH, Sb/P ratio = 13	
	121113-Run4	Calibration LH, Sb/P ratio = 26	
	121114-Run1	Calibration HL, Sb/P ratio = 40	
	121114-Run2	Calibration HL, Sb/P ratio = 40, slow flow	
	121114-Run3	Calibration HL, Sb/P ratio = 53, slow flow	
	121115-Run1	Calibration HL, Sb/P ratio = 66	
	121116-Run1	Low pH and No Sb used in ascorbic acid	
	130111-Run1	Calibration LH	
	130111-Run2	Calibration HL	
	130320-Run A	2 channels at 59°C, test for Si interference	
	130320-Run B,C	2 channels, channel 1 at 30°C, channel 2 at 59°C	
	130320-Run D	2 channels, both at 59°C	
TrAAcs 2	121112-Run1	Ch1 Calibration LH	Ch2 Calibration LH
	121112-Run2	Calibration HL	Calibration HL
	121113-Run1	New 20T glass coil	Calibration LH
	121113-Run2	green/green sample tube, No Inter-sample bubble	Calibration LH
	121113-Run3	Old 20 turn glass coil	Calibration LH

	121113-Run4	Old transmission tubing	Calibration LH
	121114-Run1	Sample Speed 60hr ⁻¹ , green/green sample tube, orange/white de-bubbler	Calibration LH
	121114-Run2	Ultra-Pure water baseline water, sample speed 40hr ⁻¹	Calibration LH
	121121-Run1	Calibration LH	Calibration LH
	121121-Run2	Calibration HL	Calibration HL
QuAAtro	121112-Run1	Calibration LH – Evenly distributed calibration	
	121112-Run2	Calibration LH – Two point calibration. Zero and High	
	121112-Run3	Calibration LH – Two point calibration. Zero and High	
	121113-Run1	Calibration LH – Three point calibration. Zero, Mid, High	
	121113-Run2	Calibration LH – Lower weighting calibration	
	121113-Run3	Calibration LH – Evenly distributed. Weighting on ends	
	121114-Run1	Calibration LH – Three point calibration	
	121120-Run1	Calibration LH – Two point calibration. Zero and High	
	130111-Run1	Calibration LH – Evenly distributed (Higher Concentration)	
	130111-Run2	Calibration HL – Evenly distributed. High to Low	
	130111-Run3	Calibration LH – Two point calibration	
	130111-Run4	Calibration LH – Three points. Weighting on midpoint	
AA3HR	121112-Run1	Ch1 & Ch2 Calibration LH	
	121113-Run1	Calibration LH, Slope Only, Base UPW	
	121113-Run1	Calibration LH, Slope Only, Base LNSW+0.1µMPO ₄	
	121114-Run1	Calibration LH, Slope Only, Base UPW	
	121115-Run1	Calibration LH, Base LNSW, Sb/P ratio 5, Both channels using ascorbic acid	

	121115-Run2	Calibration HL, Base LNSW Both Channels using ascorbic acid
	121116-Run1	Calibration LH, Base LNSW, Ch2 ascorbic acid and No Sb used.

Table 2. The values of RMNS lot BT obtained in every run performed.

Autoanalyser	Date - Run No.	Run average BT Value, PO ₄ (μM)
TrAAcs 1		Ch1
	121112-Run1	1.344
	121112-Run2	1.318
	121113-Run1	1.385
	121113-Run2	1.347
	121113-Run3	1.344
	121113-Run4	1.352
	121114-Run1	1.332
	121114-Run2	1.324
	121114-Run3	1.316
	121115-Run1	1.312
	130111-Run1	1.340
	130111-Run2	1.318
	Average BT value	1.336

TrAAcs 2	121112-Run1 121112-Run2 121113-Run1 121113-Run2 121113-Run3 121113-Run4 121114-Run1 121114-Run2 121121-Run1 121121-Run2 Average BT value	Ch1 1.338 1.330 1.326 1.367* 1.322 1.342 1.329 1.332 1.334 1.322 1.331	Ch2 1.336 1.323 1.324 1.335 1.326 1.335 1.328 1.322 1.332 1.326 1.329
QuAAtro	121112-Run1 121112-Run2 121112-Run3 121113-Run1 121113-Run2 121113-Run3 121114-Run1 121120-Run1 130111-Run1 130111-Run2 130111-Run3 130111-Run4 Average BT value	Ch1 1.341 1.336 1.340 1.332 1.334 1.333 1.345 1.333 1.332 1.326 1.314 1.325 1.333	

AA3HR		Ch1 (M&R 1962)	Ch2 (B&W 1967)
	121112-Run1**	1.297**	1.272**
	121113-Run1	1.343	1.362
	121113-Run2	1.317	1.331
	121114-Run1	1.326	1.359
	121115-Run1	1.340	1.371
	121116-Run1	1.346	1.373
	Average BT value	1.334	1.359

*TrAAcs 2; green/green sample tubing and inter-sample bubble removed showing very high carryover. This value was not used when calculating the mean BT value for TrAAcs 2 during the workshop.

**AA3HR had some flow problems during the first day. This value was not used when calculating the mean BT value for the AA3HR during the workshop.

Tables 3a-d. Carryover Calculations.

Table3a. Calculated Carryover (%) at different high to low combinations for the QuAAtro.

System	Average Calculated Carryover (%)	n
QuAAtro	Ch1	
High - Low		
100% - 0%	0.67	27
100% - 40%	0.64	3
100% - 50%	0.48	4

Table 3b. Calculated Carryover (%) at different high to low combinations for the TrAAcs 1.

System	Average Calculated Carryover (%)	n
TrAAcs 1	Ch1	
High - Low		
100% - 0%	2.07	4
100% - 33%	2.48	2
100% - 40%	1.57	2
100% - 50%	2.74	2

Table 3c. Calculated Carryover (%) at different high to low combinations for TrAAcs 2.

System	Average Calculated Carryover (%)	Average Calculated Carryover (%)	n
TrAAcs 2	Ch1	Ch2	
High - Low			
100% - 0%	1.17	0.76	19
100% - 20%	1.23	0.97	2
100% - 40%	1.37	1.21	6
100% - 70%	1.74	1.13	4

Table 3d. Calculated Carryover (%) at different high to low combinations for the AA3HR.

System	Average Calculated Carryover (%)	n	Average Calculated Carryover (%)	n
AA3HR	Ch1 (M&R 1962)	Ch1	Ch2 (B&W 1967)	Ch2
High - Low				
100% - 0%	0.07	2	0.002	2
100% - 40%	0.142	5	0.224	5

12 Appendix

Jan van Ooijen Workshop Welcome Presentation.

Welcome Presentation

SGONS/INSS Workshop

Overview:

Monday 12 Nov 2012

11:00 Stephen Coverly
11:30 Olga Lyashevskaya
11:45 Michio Aoyama
12:15 Lab tour followed by a lunch
13:30 Introduction Practical session
14:00 Practical Session 1
17:30 Practical Summary in Beril Room
18:00 Back to hotel
19:00 Group dinner

Tuesday 13 Nov 2012

09:00 Shuttle to NIOZ
09:15 Stephen Coverly
09:50 Anne Daniel
10:30 Practical session 2
12:30 Lunch
13:30 Practical session 3
17:30 Practical Summary
18:00 Shuttle to hotel

Wednesday 14 Nov 2012

09:00 Shuttle to NIOZ
09:15 Discussion on Topics for Practical's
10:30 Practical session 4
12:30 Lunch
13:30 Practical session 5
15:30 Practical summary
16:00 Departure to beer brewery
18:00 Shuttle from beer brewery to hotel
19:30 Group dinner

Thursday 15 Nov 2012

09:15 Check out hotel

09:00 Shuttle to NIOZ

09:15 Summary of Practical's 1-5 and workshop conclusions

12:30 Lunch

13:30 Presentation Michio to NIOZ in Ocean Room on the impact of radio-caesium released from Fukushima Dai-ichi NPP accident.

14:30 End of the workshop

15:00 Shuttle back to hotel (for those staying)

Practical Considerations

- Calibration high to low and low to high
- Distribution of calibration points
- Calibration using slope only
- Different tubing and glassware
- Carryover effects
- Influence of Antimony Potassium Tartrate
- Comparison of ascorbic acid and hydrazine channels
- Temperature effect on hydrazine channel
- Silicate interference effect
- Other discussed items

Gas Segmented Continuous Flow Analysers

QuAAtro (in container outside, 1 channel)

TrAAcs 1 (near lab door, channel)

TrAAcs 2 (near window, 2 channels)

AA3HR (2 channels, 2 methods)

Practical working groups

QuAAtro: Mark, Kenichiro, Yasuhiro / 1 channel

TrAAcs 1: Carol, Munehito, Asami, Jan Sinke / 1 channel

TrAAcs 2: Sharyn, Malcolm, Jia-Zhong / 2 channels

AA3HR: Peter, Susan, Anne / 2 channels

Michio, Eri, Akihiko may choose which group or walk around
Jan, Karel and Stephen walking around for assistance

Pre-made:

- Working standards made in LNSW.
- Baseline water : LNSW, except for AA3HR: Ultra-Pure water for baseline

-Rinse cups with Ultra-Pure water and working standard

-Run file and tray protocol

-Analysis file name:

Date-Machine-Run Number

e.g. '121113-Q-run1' for Run 1 on the QuAAtro on 13 Nov 2012.

Practical Session 1

QuAAtro (0-1.5 $\mu\text{M PO}_4$)

-Calibrant distribution 1.5 $\mu\text{M PO}_4$ full scale

First run: 0, 25%, 50%, 75%, 100%

Second run: 0,0,0,0,100,100,100,100%

Samples: Calibrants and BT

TrAAcs 1 (0-3 $\mu\text{M PO}_4$)

-Calibration Low-High and High-Low (2 runs)

-With samples Low-High and High-Low and BT

TrAAcs 2 (2-channels) (0-1.5 $\mu\text{M PO}_4$)

-Same as TrAAcs 1

AA3HR (2 channels) (0-3 $\mu\text{M PO}_4$) Ascorbic Acid and Hydrazine as reductant

-Calibration Low-High and High-Low (2 runs)

-With samples Low-High and High-Low and BT

Practical Session 2 and 3

QuAAtro

Continue calibrant distribution

Run1 to 4: Calibrations suggested by Olga

Samples: Calibrants and BT

TrAAcs1

Carryover by varying the Sb concentration

Sb/ PO_4 in flow-cell: 1, 5, 13, 26, 40, 66, 96

2 times H2L (100, 40,40), 2 times H2L (100,0,0), BT and 6 times 3rd calibrant
(total of 4 runs)

TrAAcs2

Effects of different glassware and transmission tubing
Channel 1 different setup, Channel 2 original setup
3 runs 4 times H2L (100,40,40) and BT

AA3HR

Slope only: UPW, LNSW with addition of 0.1 μM PO₄
Samples in LNSW, ASW and BT
run 1: UPW as wash
run 2: LNSW as wash

Practical Sessions 4 & 5

QuAAtro

Continuation of Calibration Distributions.

TrAAcs1

Continuation of varying Sb concentrations
Open for discussion
Suggested H-L / L-H
Different transmission tubing from sampler to manifold

TrAAcs2

Demonstration of LNSW background concentration (Karel)
LNSW spiked with 0.05 μM PO₄
Other topics open for discussion
Suggestion:
Replace flow cell channel 1 (differences of flow cells)
Change sample pump tube from yellow/blue to green/green
Ultra-Pure water as baseline wash looking for necessary plateau

AA3HR

Silicate interference effect, 1 run
Experiments suggested by Susan

SGONS Nutrient Workshop Questionnaire: Covering Letter

Workshop to be hosted at NIOZ, The Netherlands

To be held in November 2012

Organization: IOC/ICES SGONS

Dear SGONS Colleagues,

From discussions at the SGONS meeting held in San Diego in February 2012, it was decided that it would be useful to organize a practical analytical workshop at the NIOZ in November 2012. The aim of the workshop is to first gain information from the community about general problems which arise when measuring nutrients, and then to attempt to investigate these problems in the laboratory in order to come up with a consensus about how to help solve these problems when carrying out regular analysis. The practical lab work will mainly focus on the PO₄ analysis as this channel represents most of the common problems encountered when running gas segmented CFA. The outcome of the workshop will be reported and available for the whole SGONS community.

Due to obvious space limitations working in a lab, only a small group of laboratory analysts will be able to participate actively at this workshop. However, we would like written contributions from everyone within the SGONS community if possible please, so as to have an overall representation as many of the problems as possible that are encountered during nutrient analysis around the globe. Therefore, we are sending the attached questionnaire for you all to please fill in and send back before June 8th, this is to be able to properly focus the studies at the workshop and to make it as successful as possible. The outcome of the questionnaire and workshop will be of benefit to all labs and will be distributed to the whole SGONS community. We also wish to ensure all colleagues that all comments and shared problems will be kept confidential.

The questionnaire is set-up in the three parts. The first part concerns general information about the analytical system that you use and its calibration. The second part deals with general problems that are encountered with using a gas segmented CFA system. The third part is to gain specific information for the practical part of the workshop which focuses on the PO₄ analysis. The lab at the NIOZ will be set-up with at least four CFA systems set-up with PO₄ analytical method channels in order to be able to work on all the questions resulting from the outcome of the questionnaire, and to compare analytical techniques.

Please kindly return the questionnaire as soon as possible with your flow-diagram and reagent protocol by **Friday 8 June 2012**, or **preferably before this date**, so that we can start processing the information from the questionnaire for the workshop as soon as possible. Please send to: **nutslab@nioz.nl** or via the post to: Nutrient Lab, Royal NIOZ, Postbus 59, 1790 AB Den Burg, Texel, The Netherlands .

Kind Regards,

Workshop Lab Organization: Jan van Ooijen, Malcolm Woodward, Sharyn Ossebaar, Karel Bakker

SGONS Nutrient Workshop Questionnaire

Hosted at NIOZ, Texel, The Netherlands
To be held in November 2012

Organization: SGONS (Study Group on Nutrient Standards)
Workshop Lab Organization: Jan van Ooijen, Karel Bakker, Sharyn Ossebaar (NIOZ),
Malcolm Woodward (PML)

Please fill in as much of the following as possible and **Return before 8th June 2012** to
nutslab@nioz.nl

CFA Analyser Operators name:
Your Institute:
Address:
Country:
Email:

General Segmented Flow Analyser Information:

Analyser brand name:
Analyser Model:
Year of Purchase:
Number of operating channels:
For which nutrients:
Do you have bubble gating through the
flow cell: Yes No

What Light Source is used: Lamp LED

You Baseline water: LNSW, ASW or
DIW:
(DIW = eg: high purity 18.2Ωohm fresh
water, like Milli-Q) LNSW ASW DIW

Calibration: Stock Standards made up in
LNSW, ASW or DIW: LNSW ASW DIW

Working Standards made up in LNSW,
ASW or DIW: LNSW ASW DIW

Sample speed:
(eg. 30, 40, 60 samples per hour) samples per hour

Sample/Wash ratio
(eg. 45sec/15sec =3) Time in seconds:
Sample: Wash: Ratio:

Detection Limits for PO4µM/L
Detection Limits for SiµM/L

Detection Limits for NH4 μ M/L
 Detection Limits for NO3+NO2 μ M/L
 Detection Limits for NO2 μ M/L

General Question about Problems Encountered with your analysis system:

No Yes,
 Do you get any noise problems on the
 baseline or peaks: (if Yes, please give a
 detailed description)

No Yes
 Do your peaks reach a steady state
 plateau?

No Yes,
 Carryover higher than 1.0% ?
 (if Yes, with which analysis and value
 in %)

No Yes,
 Precision problems higher than 0.3%:
 (if Yes, which analysis and please state
 the amount in % and on what level of
 concentration)

Packed Cd Column Open Cd Tube Cu/Cd Wire
 What type of NO3 reduction reactor is
 used, Packed Cd Column, Open Cd
 Tube, or Cu/Cd wire?
 Other (please describe)

Reduction Efficiency%
 Reduction efficiency with Cadmium
 reactor: (Minimum acceptable value of
 NO3 reduction to NO2 in %) Minimum Acceptable Value%

.....
 How often is this checked on your
 analyser?

Yes No
 Do you run a separate Nitrite Channel as
 well as Nitrate+Nitrite?

.....
 Please state any of your own specific
 problems encountered with your
 analysis not mentioned in the questions
 above:

Specific Information related to your PO4 Analysis:

Concentrations of typical working standards C₁, C₂, C₃, C₄,... C_n for PO₄ in % of your highest used standard: (eg. 20%, 40%, 70%, 100%)

PO4 C₁.....%
PO4 C₂.....%
PO4 C₃.....%
PO4 C₄.....%
PO4 C₅.....%
PO4 C.....%
PO4 C_n 100 %

Calibration fit: using computer software: e.g. linear, quadratic etc.

.....

Calibration in LNSW, ASW or DIW:

LNSW ASW DIW

Calibration analysis carried out in order from low to high or high to low working standards:

Low to High High to Low

Baseline Wash-Water used: LNSW, ASW or DIW

LNSW ASW DIW

Sample-order for CTD analysis only: do you analyse the samples from surface to bottom water or bottom to surface water:

Surface to Bottom Bottom to Surface

Carryover % computed for PO₄:

.....%

Wavelength used at detection for PO₄

.....nm

What Light Source is used:

Lamp LED

Literature reference of PO₄ method used: e.g. Murphy, J. & Riley, J.P., 1962

.....
.....

Please state your own specific problems encountered with PO₄ analysis not mentioned above:

.....
.....
.....
.....
.....
.....
.....

Please Attach a **Flow-Diagram** of the PO4 channel with the return of the Questionnaire

Include the following in the **Flow Diagram**:

- Colour-Code of all Pump Tubing used
- Flow Rates in ml/min
- What material are your pump tubes made from?
- From which supplier do you purchase your pump tubes?
- Heating Bath (if used) and Temperature in °C

Please Attach a **Complete Reagent Protocol** with the return of the Questionnaire

Include the following with the **Reagent Protocol**:

- Reagent Composition including Wetting agents
- Names of manufacturers of your reagents

Please indicate the chemical, purity and manufacturer that you use for your Stock Standard:

Chemical Name:
Manufacturer:
Purity:

Please add any Additional Comments:

.....
.....
.....
.....
.....
.....
.....

Analytical Flow Diagrams used at the Workshop.

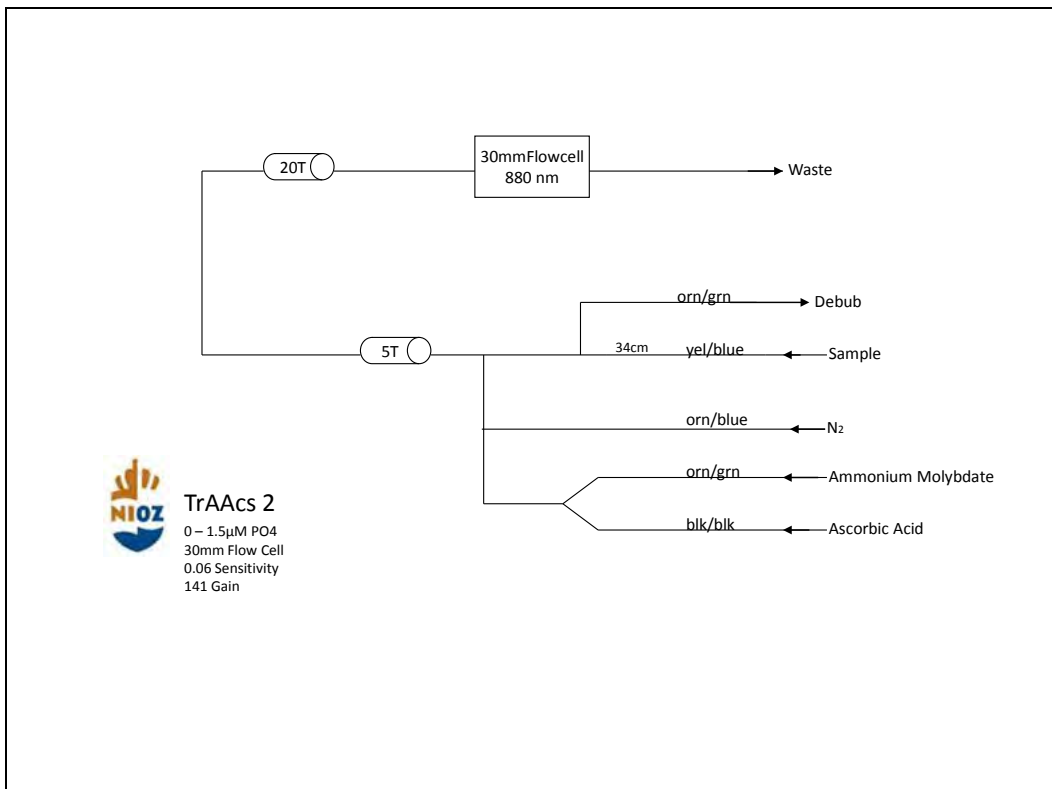
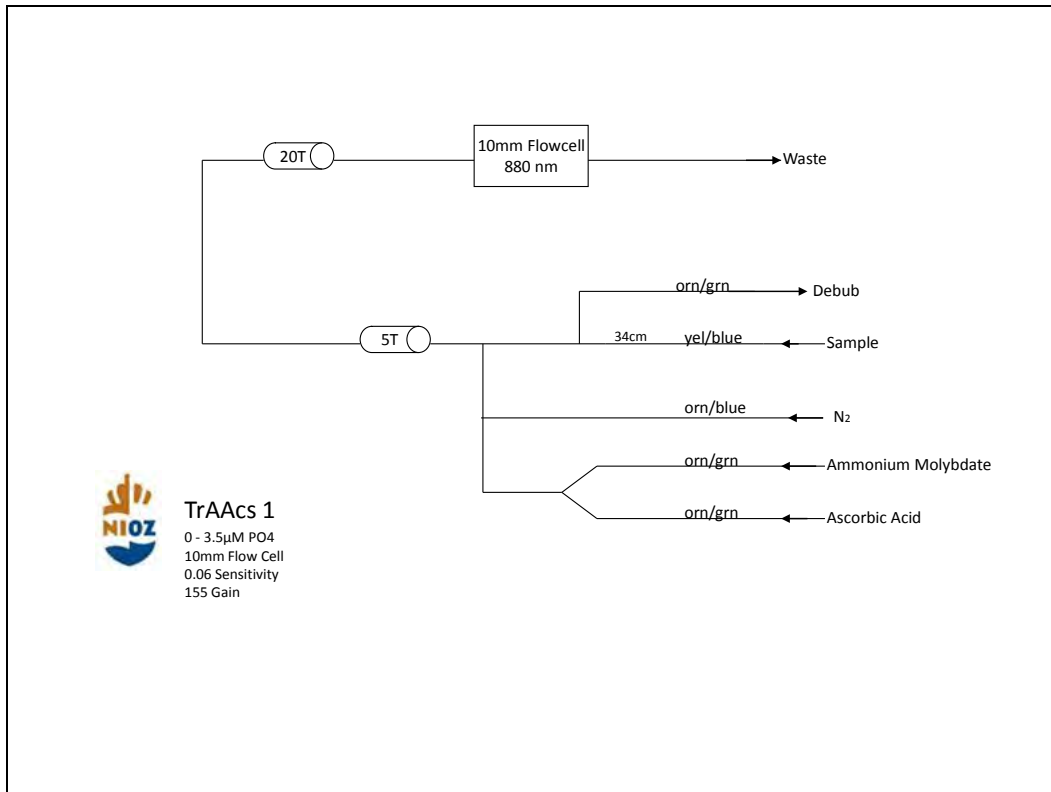

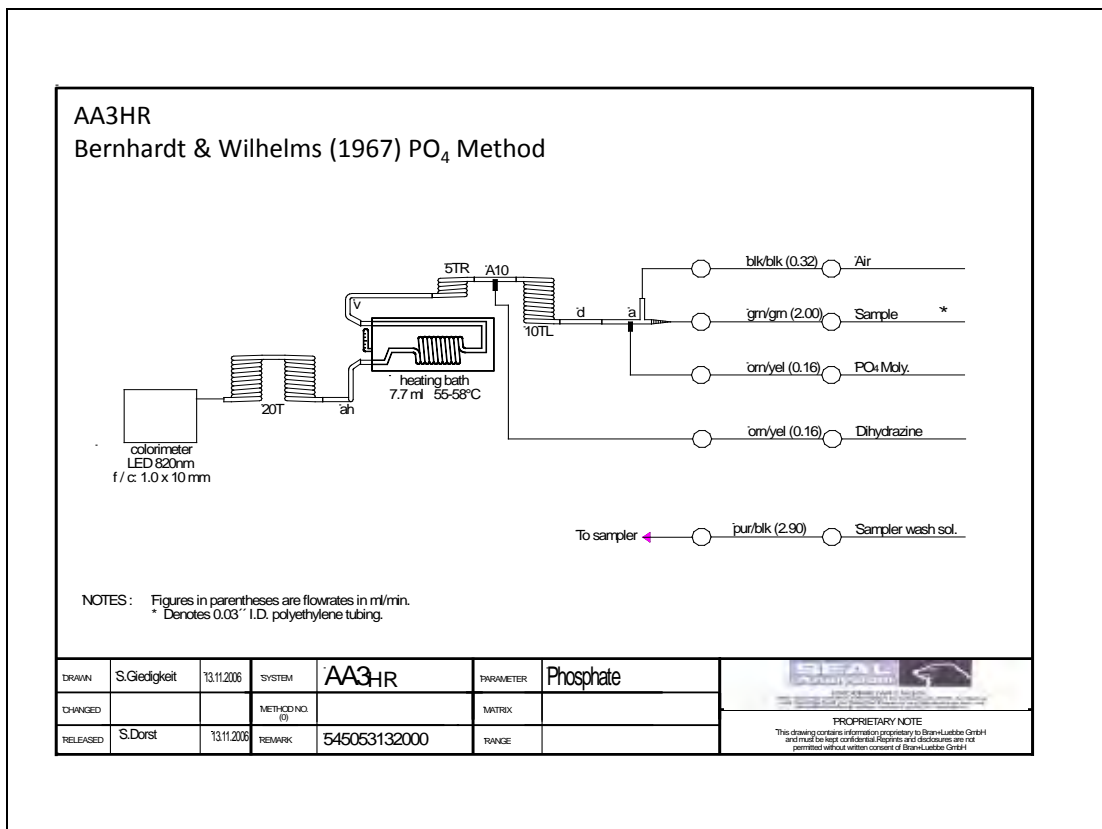
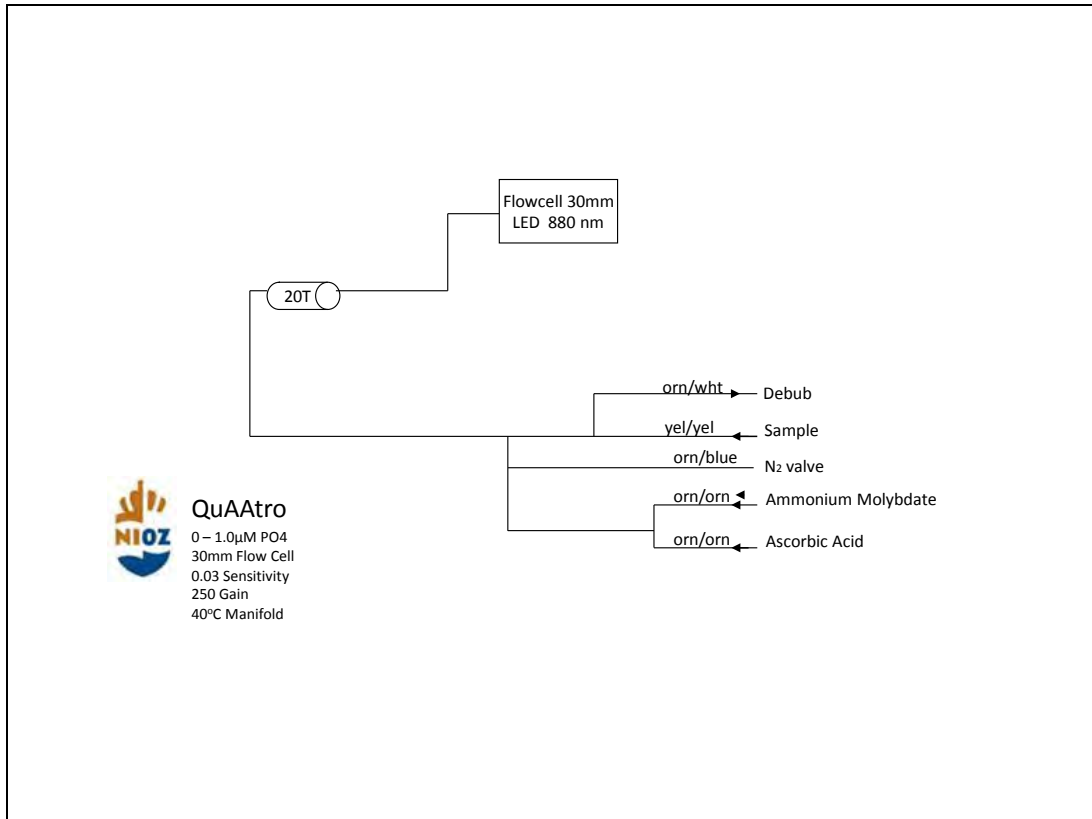

AA3HR
Murphy & Riley (1962) PO₄ Method

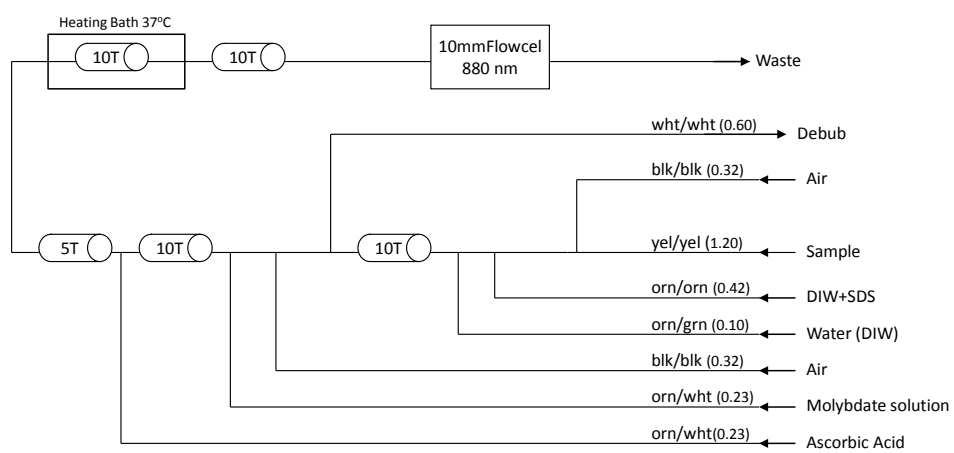

2012

Reagent Protocols used at the Workshop.

TrAAcs 1 - Murphy & Riley (1962) (10mm Flowcell)

Method

Stock Antimony Potassium Tartrate (2.3%)

Antimony Potassium Tartrate	23g
Ultra-Pure Water	to 1000ml

Stock Ammonium Molybdate (4%)

Ammonium Molybdate	40g
Ultra-Pure Water	to 1000ml

Stock 5N H₂SO₄ (2.5M)

H ₂ SO ₄ (conc.)	139ml
Ultra-Pure Water	to 1000ml

Caution: This solution gets very hot.

Stock Sodium Dodecyl Sulfate (10%)

Sodium dodecyl sulfate, SDS	100g
Ultra-Pure Water	to 1000ml

Ammonium Molybdate Working Reagent

Stock 4% Ammonium molybdate	83ml
5N H ₂ SO ₄ (2.5M)	262ml
Stock 2.3% Antimony potassium tartrate	1.5ml
10% SDS	50ml
Ultra-Pure Water	to 1000ml

Ascorbic Acid Working Reagent

Ascorbic Acid	13.7g
Acetone	75ml
10% Sodium dodecyl sulfate, SDS	17ml
Ultra-Pure Water	to 1000ml

TrAAcs 2 - Murphy & Riley (1962)
(30mm Flowcell)

Method

Stock Antimony Potassium Tartrate (2.3%)

Antimony Potassium Tartrate	23g
Ultra-Pure Water	to 1000ml

Stock Ammonium Molybdate (4%)

Ammonium Molybdate	40g
Ultra-Pure Water	to 1000ml

Stock 5N H₂SO₄ (2.5M)

H ₂ SO ₄ (conc.)	139ml
Ultra-Pure Water	to 1000ml

Caution: This solution gets very hot.

Stock Sodium Dodecyl Sulfate (10%)

Sodium dodecyl sulfate, SDS	100g
Ultra-Pure Water	to 1000ml

Ammonium Molybdate Working Reagent

Stock 4% Ammonium molybdate	70ml
5N H ₂ SO ₄ (2.5M)	225ml
Stock 2.3% Antimony potassium tartrate	0.75ml
10% SDS	17ml
Ultra-Pure Water	to 1000ml

Ascorbic Acid Working Reagent

Ascorbic Acid	8g
Acetone	40ml
10% Sodium dodecyl sulfate, SDS	10ml
Ultra-Pure Water	to 1000ml

QuAAtro - Murphy & Riley (1962)
(10mm Flowcell)

Method

Stock Antimony Potassium Tartrate (2.3%)

Antimony Potassium Tartrate	23g
Ultra-Pure Water	to 1000ml

Stock Ammonium Molybdate (4%)

Ammonium Molybdate	40g
Ultra-Pure Water	to 1000ml

Stock 5N H₂SO₄ (2.5M)

H ₂ SO ₄ (conc.)	139ml
Ultra-Pure Water	to 1000ml

Caution: This solution gets very hot.

Stock Sodium Dodecyl Sulfate (10%)

Sodium dodecyl sulfate, SDS	100g
Ultra-Pure Water	to 1000ml

Ammonium Molybdate Working Reagent

Stock 4% Ammonium molybdate	32.5ml
5N H ₂ SO ₄ (2.5M)	103ml
Stock 2.3% Antimony potassium tartrate	0.4ml
10% SDS	20ml
Ultra-Pure Water	to 1000ml

Ascorbic Acid Working Reagent

Ascorbic Acid	13.7g
Acetone	75ml
10% Sodium dodecyl sulfate, SDS	17ml
Ultra-Pure Water	to 1000ml

AA3HR - Channel 1, Murphy & Riley (1962):
(10mm flow cell)

Method

Stock Antimony Potassium Tartrate (2.3%)

Antimony Potassium Tartrate	23g
Ultra-Pure Water	to 1000ml

Stock Ammonium Molybdate (4%)

Ammonium Molybdate	40g
Ultra-Pure Water	to 1000ml

Stock 5N H₂SO₄ (2.5M)

H ₂ SO ₄ (conc.)	139ml
Ultra-Pure Water	to 1000ml

Caution: This solution gets very hot.

Ammonium Molybdate Working Reagent

4%w/v Ammonium Molybdate	73ml
5N H ₂ SO ₄ (2.5M)	230ml
Stock Antimony Potassium Tartrate	2.5ml
10%w/v SDS	27ml
Ultra-Pure Water	to 1000ml

Ascorbic Acid Working Reagent

Ascorbic Acid	12g
Acetone	50ml
10%w/v SDS	5ml
Ultra-Pure Water	to 1000ml

AA3HR - Channel 2, Bernhardt & Wilhelms (1967)
(10mm flow cell)

Method

Ammonium Molybdate Working Reagent

Ammonium Molybdate	27g
H ₂ SO ₄ (conc.)	330ml
Sodium dodecyl sulfate, SDS	3drops
Ultra-Pure Water	to 1000ml

Hydrazine Sulfate Working Reagent

Hydrazine sulfate	10g
Ultra-Pure Water	to 1000ml

OR

Dihydrazine sulfate	6.4g
Ultra-Pure Water	to 1000ml

AA3HR - Channel 2, Murphy & Riley (1962), After the workshop Experiment.
(10mm flow cell)

Method

Stock Antimony Potassium Tartrate (2.3%)

Antimony Potassium Tartrate 23g
Ultra-Pure Water to 1000ml

Stock Ammonium Molybdate (4%)

Ammonium Molybdate 40g
Ultra-Pure Water to 1000ml

Stock 5N H₂SO₄ (2.5M)

H₂SO₄ (conc.) 139ml
Ultra-Pure Water to 1000ml
Caution: This solution gets very hot.

Ammonium Molybdate Working Reagent

Stock Ammonium Molybdate 128ml
5N H₂SO₄ (2.5M) 410ml
Stock Antimony Potassium Tartrate 7ml
10% Sodium dodecyl sulfate, SDS 40ml
Ultra-Pure Water to 1000ml

Ascorbic Acid Working Reagent

Ascorbic Acid 21.5g
Acetone 40ml
10% Sodium dodecyl sulfate, SDS 20ml
Ultra-Pure Water to 1000ml

List of Participants

Ms. Carol Anstey
Ocean Research and Monitoring Section
Bedford Institute of Oceanography
I Challenger Dr., Dartmouth, Nova Scotia
B2Y 4A2
Canada

Dr. Michio Aoyama
Geochemical Research Department
Meteorological Research Institute
1-1 Nagamine, Tsukuba, Ibaraki, 305-0052
Japan

Mr. Yasuhiro Arii
Marine Works Japan Ltd.
Geochemical Oceanography
Department of Marine Science
2-15 Natsushimachou, Yokosuka 237-0061
Japan

Mr. Karel Bakker
Marine Chemistry Department
The Royal Netherlands Institute for Sea
Research, NIOZ
PO Box 59 1790 AB Den Burg
The Netherlands

Ms. Susan Becker
Scripps Institution of Oceanography
University of California, San Diego
UCSD 9500 Gilman Dr mc 0214
San Diego CA 92093
USA

Ms. Asami Murao
Laboratory for Instrumentation and Analysis
The General Environment Technos Co., LTD.
KANSO Technos
3-1-1 Higashikuraji, Katano, Osaka
576-0061
Japan

Dr. Akihiko Murata
Research Institute for Global Change
Japan Agency for Marine-Earth Science and
Technology
2-15 Natsushima, Yokosuka, Kanagawa
237-0061
Japan

Mr. Jan van Ooijen
Royal Dutch Institute for Sea Research
NIOZ
Landsdiep 4
1797 SZ Den Hoon (Texel)
The Netherlands

Ms. Sharyn Ossebaar
Royal Dutch Institute for Sea Research
NIOZ
Landsdiep 4
1797 SZ Den Hoon (Texel)
The Netherlands

Mr. Kenichiro Sato
Tokyo University of Marine Science and
Technology
Oceanographic Observation Center
Department of Marine Science
Marine Works Japan Ltd.
2-16-32 4F Kamariyahigashi, Kanazawa-ku,
Yokohama, Kanagawa, 236-0042
Japan

Mr. Stephen Coverly SEAL
Analytical GmbH Werkstrasse 4,
22844 Norderstedt Germany

Mr. Jan Sinke
Royal Dutch Institute for Sea Research
NIOZ Yerseke
Korringaweg 7, 4401 NT Yerseke
The Netherlands

Dr. Anne Daniel
DYNECO/PELAGOS
Institut français de recherche pour l'exploitation
de la mer
Technopole Brest Iroise BP 29280 Plouzané
France

Mr. Mark Stinchcombe
National Oceanography Center
University of Southampton Waterfront Campus
European Way
Southampton SO14 3ZH
United Kingdom

Mr. Peter Hughes
CSIRO Marine and Atmospheric Research
Underwood Avenue Floreat
Western Australia 6014
Australia

Dr. Malcolm Woodward
Plymouth Marine Laboratory
Prospect Place, The Hoe, Plymouth, PL1 3DH
United Kingdom

Mr. Munehito Kimura
Laboratory for Instrumentation and Analysis
The General Environment Technos Co., LTD
KANSO Technos
3-1-1 Higashikuraji, Katano, Osaka 576-0061
Japan

Dr. Jia-Zhong Zhang
Atlantic Oceanographic and Meteorological
Laboratory,
National Oceanic and Atmospheric
Administration
4301 Rickenbacker Causeway, Miami FL
33149
USA