

IMPACTS OF OTTER TRAWLING ON INFAUNAL
BIVALVES LIVING IN SANDY BOTTOM HABITATS
ON THE GRAND BANKS

CENTRE FOR NEWFOUNDLAND STUDIES

**TOTAL OF 10 PAGES ONLY
MAY BE XEROXED**

(Without Author's Permission)

KENT GILKINSON

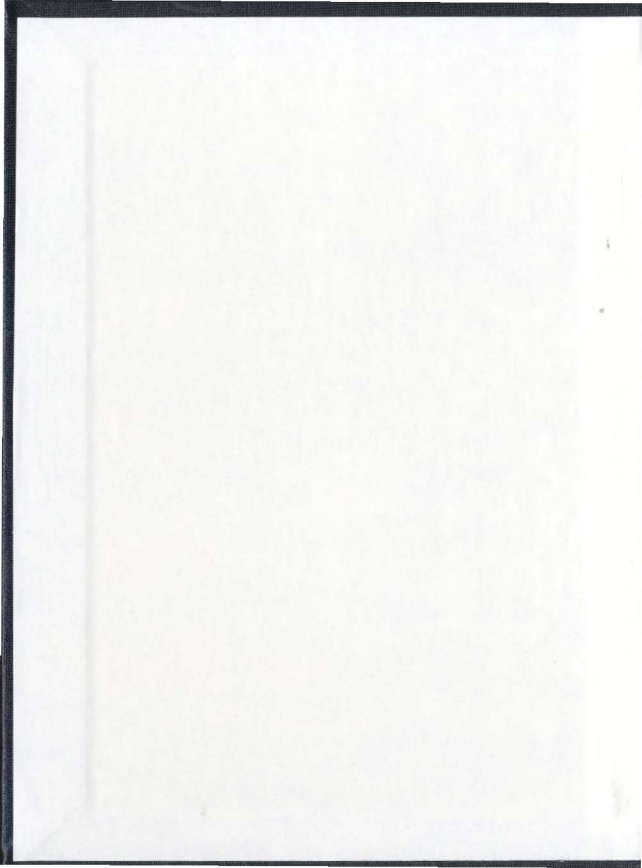





National Library
of Canada

Acquisitions and
Bibliographic Services

395 Wellington Street
Ottawa ON K1A 0N4
Canada

Bibliothèque nationale
du Canada

Acquisitions et
services bibliographiques

395, rue Wellington
Ottawa ON K1A 0N4
Canada

Your file Votre référence

Our file Notre référence

The author has granted a non-exclusive licence allowing the National Library of Canada to reproduce, loan, distribute or sell copies of this thesis in microform, paper or electronic formats.

The author retains ownership of the copyright in this thesis. Neither the thesis nor substantial extracts from it may be printed or otherwise reproduced without the author's permission.

L'auteur a accordé une licence non exclusive permettant à la Bibliothèque nationale du Canada de reproduire, prêter, distribuer ou vendre des copies de cette thèse sous la forme de microfiche/film, de reproduction sur papier ou sur format électronique.

L'auteur conserve la propriété du droit d'auteur qui protège cette thèse. Ni la thèse ni des extraits substantiels de celle-ci ne doivent être imprimés ou autrement reproduits sans son autorisation.

0-612-54847-3

Canada

**Impacts of Otter Trawling on Infaunal
Bivalves Living in Sandy Bottom Habitats
on the Grand Banks**

by

^oKent Gilkinson

A thesis submitted to the School of Graduate Studies in partial fulfilment of the requirements for the degree of Doctor of Philosophy

Department of Biology/Faculty of Science
Memorial University of Newfoundland
St. John's, Newfoundland

March 1999

St. John's

Newfoundland

Abstract

Otter trawling has been the prevalent method of ground fishing in Atlantic Canada. Despite this, little is known about associated impacts to benthic habitat and communities. This thesis examines the impacts of otter trawling on bivalves living in sand, a bottom type occurring widely over the Grand Banks. Bivalves are dominant members of sandy bottoms on continental shelves and are good indicators of physical disturbance. Two broad categories of impacts to benthos from mobile fishing gear are direct harvest and incidental damage. Bivalves have low susceptibility to capture by groundfish otter trawls; trawl capture efficiency is on the order of 10^{-5} . In order to investigate incidental impacts, a three-year otter trawling experiment was conducted on a fine to medium sand bottom on the northeastern Grand Bank. Each year a total of 12 trawl passes were made along the centre line of two 13 km by 200 m experimental corridors. Sampling was conducted inside experimental and adjacent reference corridors with a 0.5 m^2 hydraulic grab. No significant effects of trawling were detected on bivalve populations in any year. Shallow burrowing species showed no significant changes in density or biomass and recruitment of juveniles $\leq 3 \text{ mm}$ was apparent inside trawled corridors. The size structure of populations from trawled and reference areas were similar. Mean (\pm sd) percent major shell damage immediately after trawling was low, ranging from $2.8 \pm 6.1\%$ to $13.5 \pm 9.4\%$. Trawl doors are the most destructive gear component of otter trawls. A physical trawl door model was towed through an artificial sand testbed, constructed to resemble an offshore seabed. Although bivalves within the scour path were displaced, levels of damage were low (c. 5%), similar to levels of damage from the combined effects of all gear components recorded in the field experiment. The anomaly of displacement, accompanied by few instances of damage, is explained by sediment mechanics associated with scouring and size and life position of infaunal bivalves. Compared to natural

sediment-mediated disturbances, otter trawling can be manipulated over a wide range of frequencies. Individual and population-level adaptive traits probably confer considerable stability to sandy bottom bivalve populations exposed to typical patterns of trawling activity on the Grand Banks.

Acknowledgements

I dedicate my thesis to my family. I cannot adequately express my gratitude to my wife Linda for her unwavering support, encouragement and patience. I thank my daughters, Courtney and Kayla, for being so understanding about my many weekend absences. I apologize to my youngest for not picking a topic that involved sharks. I am forever grateful to my Mother and Father and Linda's parents for their constant support. I am indebted to Dr. Peter Schwinghamer for agreeing to supervise me and providing me with the opportunity to return to research and become involved in the Fisheries and Oceans fishing impact experiments. He was a constant source of encouragement and timely humour. His forced medical retirement in 1997 represented a great loss to our study team and to the field of benthic ecology. I am indebted to Dr. David Schneider for assuming the role of supervisor for me despite already having a full stable of graduate students. His door was always open and his advice and rapid turn-arounds of chapters were greatly appreciated. I am grateful to Dr. Ryan Phillips for providing guidance in the geophysical component of my thesis. I consider the trawl door model experiment one of the highlights of my thesis work. It gave me the opportunity to 'muck about' in vast quantities of sand and I had the pleasure of working with a group of dedicated engineers and technicians at C-CORE including Mike Paulin, Shawn Hurley, Steve Smyth, Karl Tuff and Don Cameron. Over the years there have been many people in the Groundfish Division, Fisheries and Oceans, St. John's, who have assisted me in various aspects of my research. I am grateful to all of them. I would like to thank Steve Walsh and Barry McCallum, Fisheries and Oceans, St. John's, for technical information on otter trawl gear. They gave me access to their extensive video library on otter trawling which proved invaluable. I thank David Kulka for providing me with bycatch data from the Fisheries and Oceans Observer Program. I thank my fellow study team members at the Bedford Institute of Oceanography. My ongoing association with these people is very

rewarding. I am grateful to Patrick Woo, Kevin McIsaac and Cynthia Bourbonnais for their meticulous extraction of bivalves from the samples. My thesis benefited from discussions with Pierre Pepin and Jens Prena. I would like to thank Janet Leawood, Fabian Hartery, Trevor Hoskins and Jonathan Walsh for their assistance in preparing the scour tank testbed. I am especially grateful to Mark Hawryluk for his companionship and assistance when we were laboratory roommates. I thank Dr. Don Gordon, project leader for the DFO fishing impact experiments, for involving me in ongoing investigations into impacts of mobile fishing gear in Atlantic Canada. He generously agreed to review my thesis at a very busy time for him.

Table of Contents

	Page
Abstract	ii
Acknowledgements	iv
List of Tables	xi
List of Figures	xv
Chapter 1	
Background and Study Approach	
1.1 Introduction	1
1.2 Mobile bottom fishing gears: physical aspects of gear-seabed interaction	4
1.2.1 Dredges	4
1.2.2 Beam trawls	6
1.2.3 Otter trawls	8
1.3 Otter trawl technology in Atlantic Canada	11
1.3.1 Otter boards	11
1.3.2 Footgear	12
1.3.3 Ground wires	12
1.3.4 Net	12
1.4 History of investigations into environmental impacts of mobile bottom fishing gears	13
1.5 Environmental concerns associated with otter trawling in Atlantic Canada ...	15
1.6 Thesis topic	16
1.6.1 Bivalves as indicators of physical disturbance	17
1.6.2 Thesis organization	18
1.7 Literature cited	20
Chapter 2	
Invertebrate Bycatch of Otter Trawls	
2.1 Introduction	36
2.1.1 Purpose of study	37
2.2 Literature review	37
2.3 Overview of spatial patterns of commercial otter trawling on the Grand Banks	40
2.4 Otter trawl gear-seabed interaction	43

2.5	Survey trawl descriptions	47
2.5.1	Engel 145 Hi-Lift trawl	48
2.5.2	Campelen 1800 trawl	48
2.6	Trawling stations	49
2.7	Quantification of bycatch	49
2.8	Grab sample collections	50
2.9	Results and discussion	50
2.9.1	Abundance and biomass of invertebrate bycatch	50
2.9.1.1	Campelen	50
2.9.1.2	Engel	51
2.9.2	Mollusc size frequency distributions: Campelen 1800	51
2.9.3	Factors determining the susceptibility of bivalves to capture by otter trawl	52
2.10	Literature cited	56
Appendix 2.1	Bycatch stations set details (Campelen 1800 trawl)	69
Appendix 2.2	Bycatch stations set details (Engel 145 trawl)	70

Chapter 3

Impacts of Otter Trawling on Infaunal Bivalves in a Sandy Bottom Ecosystem: Results of a Three-Year Trawling Experiment on the Grand Banks

3.1	Introduction	71
3.1.1	Study objectives	72
3.2	Newfoundland and Labrador region bivalve fauna	73
3.2.1	Densities and standing crops of Grand Banks bivalves	74
3.2.2	Bivalves inhabiting sandy ecosystems on the Grand Banks	76
3.3	Impacts of bottom trawling on bivalves: Literature review and hypotheses	77
3.3.1	Immediate trawling impacts (Hours-Days)	77
3.3.1.1	Densities and biomass of all bivalves	77
3.3.1.2	Juveniles	80
3.3.1.3	Physical damage	81
3.3.2	Long-term impacts	86
3.4	Methods	90
3.4.1	Experimental Trawling Study Area (OETSA) selection criteria	90
3.4.1.1	Site characterization	91
3.4.2	Experimental design	91
3.4.2.1	Trawling corridors	91
3.4.2.2	Trawling and navigation	92
3.4.3	Video-equipped hydraulic grab	94

3.4.4	Grab sampling	95
3.4.5	On-board treatment of samples	96
3.4.6	Laboratory treatment of samples	96
	3.4.6.1 Damage classification	97
	3.4.6.2 <i>Macoma calcaria</i>	97
3.4.7	Laboratory burrowing experiments	98
	3.4.7.1 Temperature regime	99
	3.4.7.2 Calculation of burrowing time and burrowing rate index	99
	3.4.7.3 Determination of burial depth and life orientation	101
3.4.8	Statistical analyses	103
3.5	Results	104
	3.5.1 Experimental trawling summary	104
	3.5.2 Spatial patterns of trawling disturbance	104
	3.5.3 Species summary	105
	3.5.4 Effects of location before trawling in 1993: reference and trawling corridors	106
	3.5.5 Biomass and densities	106
	3.5.6 Immediate post-trawl damage	109
	3.5.6.1 Shallow burrowing species	109
	3.5.6.2 Deep burrowing species (excluding <i>Macoma</i>)	110
	3.5.6.3 <i>Macoma calcaria</i>	110
	3.5.7 Index of species aggregation	110
	3.5.8 Size structure of OETSA bivalve populations	110
	3.5.8.1 Shallow burrowing species	110
	3.5.8.2 <i>Macoma calcaria</i>	111
	3.5.9 Ecology of OETSA bivalves	111
	3.5.9.1 Life positions	111
	3.5.9.2 Burrowing rates	112
3.6	Discussion	114
	3.6.1 Immediate effects of trawling	114
	3.6.2 Modification of bivalve habitat by trawling	119
	3.6.6 Long-term impacts of trawling	120
3.7	Literature cited	123
	Appendix 3.1 Mean wet weights (mg per 0.5 m ²) of bivalves by combination of treatments in the experimental trawling study area	180
	Appendix 3.2 Mean densities (per 0.5 m ²) of bivalves by combination of treatments in the experimental trawling study area	183

Chapter 4

Impacts of Otter Boards on Infaunal Bivalves: Results of a Laboratory Physical Trawl Door Model Scouring Experiment

4.1	Introduction	186
4.2	Materials and methods	188
4.2.1	Experimental tank and gantry	188
4.2.2	Trawl door model design	188
4.2.3	3-Dimensional positioning system	190
4.2.4	Data acquisition	191
4.2.5	Testbed preparation	191
4.2.6	Bivalve specimens	193
4.2.7	Measurement of bivalve displacement	194
4.2.8	Assessment of damage to bivalves	194
4.2.9	Testbed electronics and sediment displacement markers	195
4.2.10	Test procedure	196
4.2.11	Measurement of bivalve shell strengths	196
4.3	Results	197
4.3.1	Scour path profile	197
4.3.2	Displacement of testbed markers	197
4.3.3	Forces acting on the TDM	198
4.3.4	Pore pressures and total stresses recorded during scouring	199
4.3.5	Displacement of bivalves	199
4.3.6	Bivalve damage	200
4.3.7	Shell strength	201
4.4	Discussion	201
4.4.1	Scour profile	201
4.4.2	Description of trawl door scouring	202
4.4.2.1	Sediment deformation	202
4.4.2.2	Sediment failure and displacement	203
4.4.2.3	Effects of altering scouring parameters	204
4.4.3	Bivalve displacement	204
4.4.4	Physical damage to bivalves	205
4.4.5	A physical model for trawl door-bivalve interaction	205
4.5	Literature cited	211
	Appendix 4.1 Derivation of a velocity scaling factor used to convert TDM forces to field trawling forces	234

Chapter 5

Natural Physical Processes Affecting the Seabed on the Grand Banks

5.1	Introduction	239
5.2	Hydrodynamic disturbance agents	241
	5.2.1 Bedforms	241
	5.2.2 Probabilities of storm disturbances	243
	5.2.3 Sediment transport: impacts and predictabilities	244
5.3	Iceberg scouring	249
	5.3.1 Iceberg occurrences	249
	5.3.2 Disturbance processes	249
	5.3.3 Iceberg scour dimensions	250
	5.3.4 Spatial distribution of iceberg scours on the Grand Banks	250
	5.3.5 Iceberg scour probabilities	250
	5.3.6 Impacts of iceberg scouring on bivalves	251
	5.3.6.1 Mortality	251
	5.3.6.2 Habitat alteration	252
	5.3.7 Predictability of scouring events	253
5.4	Bioturbation	254
	5.4.1 Biological sediment displacement	254
	5.4.2 Impacts on bivalves	256
	5.4.3 Predictability of biological sediment displacement	256
5.5	Discussion	257
5.6	Literature cited	261
Chapter 6		
Summary and Conclusions		270
Literature cited		276

List of Tables

	Page
Table 1.1	Environmental impacts attributed to otter trawling in Atlantic Canada 31
Table 2.1	Mean shell length of bivalves captured by Campelen 1800 survey trawl 61
Table 2.2	Mean shell height of subsampled gastropods captured by Campelen 1800 survey trawl 61
Table 3.1	Life positions of deep water bivalve taxa recorded from the Newfoundland-Labrador continental shelf (including the Grand Banks) and Labrador Sea 135
Table 3.2	Dimensions of key gear components of the Engel 145 Hi-lift otter trawl used with the <i>Wilfred Templeman</i> in the experimental trawling study 137
Table 3.3	Summary of trawling events and grab sample collections 138
Table 3.4	Damage classification of bivalves collected by grab in the OETSA 139
Table 3.5	Laboratory burrowing trials test conditions 140
Table 3.6	Start and end times of trawling conducted by the <i>CSS Wilfred Templeman</i> in experimental corridors A and B, 1993-1995 141
Table 3.7	Life positions and burial depths of bivalve species collected by grab in the OETSA 142
Table 3.8	Two-way ANOVA of densities and biomass of all bivalves in July, 1993 for effects of location and corridor 143
Table 3.9	Mean biomass and densities of all bivalves by combination of treatment in the OETSA 144
Table 3.10	Two-way ANOVA of densities and biomass of all bivalves collected in the hydraulic grab in July 1993, for testing of main effects 145
Table 3.11	Two-way ANOVA of densities and biomass of all bivalves collected in the hydraulic grab in Sept. 1993, for testing of main effects 145
Table 3.12	Two-way ANOVA of densities and biomass of all bivalves collected in the hydraulic grab in July 1994, for testing of main effects 146
Table 3.13	Two-way ANOVA of densities and biomass of all bivalves collected in the hydraulic grab in July 1995, for testing of main effects 146
Table 3.14	Two-way ANOVA of densities and biomass <i>A. borealis</i> collected in the hydraulic grab in July 1993, for testing of main effects 147
Table 3.15	Two-way ANOVA of densities and biomass <i>A. borealis</i> collected in the hydraulic grab in July 1994, for testing of main effects 147
Table 3.16	Two-way ANOVA of densities and biomass <i>A. borealis</i> collected in the hydraulic grab in July 1995, for testing of main effects 147

Table 3.17	Two-way ANOVA of densities and biomass <i>C. ciliatum</i> collected in the hydraulic grab in July 1993, for testing of main effects	148
Table 3.18	Two-way ANOVA of densities and biomass <i>C. ciliatum</i> collected in the hydraulic grab in July 1994, for testing of main effects	148
Table 3.19	Two-way ANOVA of densities and biomass <i>C. ciliatum</i> collected in the hydraulic grab in July 1995, for testing of main effects	148
Table 3.20	Two-way ANOVA of densities and biomass <i>C. siliqua</i> collected in the hydraulic grab in July 1993, for testing of main effects	149
Table 3.21	Two-way ANOVA of densities and biomass <i>C. siliqua</i> collected in the hydraulic grab in July 1994, for testing of main effects	149
Table 3.22	Two-way ANOVA of densities and biomass <i>C. siliqua</i> collected in the hydraulic grab in July 1995, for testing of main effects	149
Table 3.23	Two-way ANOVA of densities and biomass <i>M. calcarea</i> collected in the hydraulic grab in July 1993, for testing of main effects	150
Table 3.24	Two-way ANOVA of densities and biomass <i>M. calcarea</i> collected in the hydraulic grab in July 1994, for testing of main effects	150
Table 3.25	Two-way ANOVA of densities and biomass <i>M. calcarea</i> collected in the hydraulic grab in July 1995, for testing of main effects	150
Table 3.26	Two-way ANOVA of densities and biomass <i>Thyasira</i> sp. <i>A</i> collected in the hydraulic grab in July 1993, for testing of main effects	151
Table 3.27	Two-way ANOVA of densities and biomass <i>Thyasira</i> sp. <i>A</i> collected in the hydraulic grab in July 1994, for testing of main effects	151
Table 3.28	Two-way ANOVA of densities and biomass <i>Thyasira</i> sp. <i>A</i> collected in the hydraulic grab in July 1995, for testing of main effects	151
Table 3.29	Two-way ANOVA of densities and biomass <i>A. borealis</i> collected in the hydraulic grab in Sept. 1993, for testing of main effects	152
Table 3.30	Two-way ANOVA of densities and biomass <i>C. ciliatum</i> collected in the hydraulic grab in Sept. 1993, for testing of main effects	152
Table 3.31	Two-way ANOVA of densities and biomass <i>C. siliqua</i> collected in the hydraulic grab in Sept. 1993, for testing of main effects	152
Table 3.32	Two-way ANOVA of densities and biomass <i>M. calcarea</i> collected in the hydraulic grab in Sept. 1993, for testing of main effects	153
Table 3.33	Two-way ANOVA of densities and biomass <i>Thyasira</i> sp. <i>A</i> collected in the hydraulic grab in Sept. 1993, for testing of main effects	153
Table 3.34	Mean densities of all juveniles (≤ 5 mm) per 0.5 m ² (excluding <i>M. calcarea</i>)	154
Table 3.35	Mean densities of juvenile <i>M. calcarea</i> (≤ 5 mm) per 0.5 m ²	154
Table 3.36	Two-way ANOVA of densities of juvenile (≤ 5 mm) bivalves (excluding <i>M. calcarea</i>) collected by grab in July 1993 for testing of main effects	155

Table 3.37	Two-way ANOVA of densities of juvenile (≤ 5 mm) bivalves (excluding <i>M. calcareo</i>) collected by grab in July 1994 for testing of main effects	155
Table 3.38	Two-way ANOVA of densities of juvenile (≤ 5 mm) bivalves (excluding <i>M. calcareo</i>) collected by grab in July 1995 for testing of main effects	155
Table 3.39	Two-way ANOVA of densities of juvenile (≤ 5 mm) <i>M. calcareo</i> collected by grab in July 1993, for testing of main effects	156
Table 3.40	Two-way ANOVA of densities of juvenile (≤ 5 mm) <i>M. calcareo</i> collected by grab in July 1994, for testing of main effects	156
Table 3.41	Two-way ANOVA of densities of juvenile (≤ 5 mm) <i>M. calcareo</i> collected by grab in 1995, for testing of main effects	156
Table 3.42	Mean densities of bivalves ≤ 3 mm shell length (per 0.5 m ²)	157
Table 3.43	Two-way ANOVA of densities of small juveniles (≤ 3 mm)(excluding <i>M. calcareo</i>) in 1993 for testing main effects	158
Table 3.44	Two-way ANOVA of densities of small juveniles (≤ 3 mm)(excluding <i>M. calcareo</i>) in 1994 for testing main effects	158
Table 3.45	Two-way ANOVA of densities of small juveniles (≤ 3 mm)(excluding <i>M. calcareo</i>) in 1995 for testing main effects	158
Table 3.46	Two-way ANOVA of densities of small juvenile (≤ 3 mm) <i>M. calcareo</i> in 1993 for testing main effects	159
Table 3.47	Two-way ANOVA of densities of small juvenile (≤ 3 mm) <i>M. calcareo</i> in 1994 for testing main effects	159
Table 3.48	Two-way ANOVA of densities of small juvenile (≤ 3 mm) <i>M. calcareo</i> in 1995 for testing main effects	159
Table 3.49	Two-way ANOVA of mean percent frequencies of damage in SBS in 1993 for testing of main effects	160
Table 3.50	Two-way ANOVA of mean percent frequencies of damage in SBS in 1994 for testing of main effects	160
Table 3.51	Two-way ANOVA of mean percent frequencies of damage in SBS in 1995 for testing of main effects	160
Table 3.52	Linear regressions of log-transformed means and standard deviations of the densities of bivalve species in each combination of the main effects of trawling and corridor	161
Table 3.53	Burrowing rate indices of bivalves occurring in the OETSA	162
Table 4.1	Comparison of selected geotechnical properties of experimental testbed sand and offshore experimental trawling study area (OETSA) sand	217
Table 4.2	Bivalve species and size classes placed in the experimental testbed	218
Table 4.3	Frequencies of damage to bivalves after TDM scouring in RB1	219

Table 4.4	Frequencies of damage to bivalves after TDM scouring in RB2	220
Table 4.5	Peak load and stress at shell failure for bivalve species used in the TDM test	221
Table 5.1.	Physical disturbances affecting sediments on the Grand Banks: impacts on bivalves and their habitat	269

List of Figures

	Page
Figure 1.1	Representative dry and hydraulic dredge designs 32
Figure 1.2	Variations of the Dutch beam trawl design 33
Figure 1.3	Otter trawl gear components that make contact with the seabed 34
Figure 1.4	Otter board designs used in Atlantic Canada 35
Figure 2.1	Areas of the Grand Banks referred to in the text 62
Figure 2.2	Otter board designs used on the Grand Banks 63
Figure 2.3	Footgear specifications for the DFO Engel survey trawl 64
Figure 2.4	Net mesh sizes (mm) of the DFO survey otter trawls 65
Figure 2.5	Footgear specifications for the Campelen 1800 survey trawl 66
Figure 2.6	DFO survey otter trawls invertebrate bycatch 67
Figure 2.7	Bivalve and gastropod size frequency distributions from Campelen trawl bycatch and OETSA grab samples (non-trawled) 68
Figure 3.1	Surficial geology of the Grand Banks 163
Figure 3.2	Location of the experimental trawling study area (OETSA) 164
Figure 3.3	Layout drawings of the main gear components of the Engel 145 otter trawl, used in the experimental trawling study 165
Figure 3.4	Operational characteristics of the video-hydraulic grab used to collect bivalves in the OETSA 166
Figure 3.5	Examples of minor and moderate damage in the bivalves <i>Astarte</i> <i>borealis</i> and <i>Macoma calcarea</i> 167
Figure 3.6	Examples of major damage in the bivalves <i>Cyrtodaria siliqua</i> , <i>M. calcarea</i> and <i>A. borealis</i> 168
Figure 3.7	Total number of species per corridor and mean number of species per station by corridor and treatment 169
Figure 3.8	Mean percent frequency of damage (by category) after trawling in shallow and deep burrowing species in 1993 170
Figure 3.9	Mean percent frequency of damage (by category) after trawling in shallow and deep burrowing species in 1994 171
Figure 3.10	Mean percent frequency of damage (by category) after trawling in shallow and deep burrowing species in 1995 172
Figure 3.11	Mean percent frequency of damage (by category) after trawling in <i>M. calcarea</i> , 1993-1995 173
Figure 3.12	Regressions of standard deviation and mean density of bivalve species by treatment, corridor and year 174
Figure 3.13	Size frequency distributions of pooled samples (n=10 stations) of shallow burrowing species in Corridor A, by treatment and year 175

Figure 3.14	Size frequency distributions of pooled samples (n=10 stations) of shallow burrowing species in Corridor B, by treatment and year	176
Figure 3.15	Size frequency distributions of pooled samples (n=10 stations) of shallow burrowing species in 1995, by corridor and treatment	177
Figure 3.16	Size frequency distributions of pooled samples (n=3 stations) of <i>M. calcareo</i> in Corridor A, by year and treatment	178
Figure 3.17	Size frequency distributions of pooled samples (n=3 stations) of <i>M. calcareo</i> in Corridor B, by year and treatment	179
Figure 4.1	Plan and profile views of the experimental tank used for the trawl door model (TDM) experiment	222
Figure 4.2	Trawl door model design and assembly	223
Figure 4.3	(a) Plan view of TDM assembly mounted on the gantry showing the 30° angle of attack. (b) Plan view of experimental testbed illustrating layout of experimental blocks for bivalves and instrumentation	224
Figure 4.4	Orientations of bivalve species in the testbed	225
Figure 4.5	Triaxial compression machine used to test bivalve shell strengths	226
Figure 4.6	Post-scour testbed profile	227
Figure 4.7	Plan view of the displacements of ball bearings by the scouring TDM	228
Figure 4.8	Vertical and lateral forces acting on the TDM as a function of shoe position as it scoured the testbed	229
Figure 4.9	Pore pressure and total stress recordings along the centre of the scour path as a function of shoe position (x coordinate) as it scoured the testbed.	230
Figure 4.10	(Top) Post-test displacement of bivalves at the sediment-water interface (z = 500) in RB1 and RB2.	231
Figure 4.11	Profile of physical model (1:2.5) of trawl door-bivalve interaction during scouring	232
Figure 4.12	Schematic plan diagram of sediment and bivalve displacement during scouring	233

Chapter 1

Background and Study Approach

1.1 Introduction

"And besides this, the great and long iron of the Wondyrchoun presses so hard on the ground when fishing that it destroys the living slime and the plants growing on the bottom under the water, and also the spat of oysters, mussels and of other fish, by which the large fish are accustomed to live and be nourished."

-excerpt from a 1366 petition put before Britain's Commons to ban the Wondyrchoun (from the Dutch Wonderkuil meaning "marvellous fishing trawl")(Crowley, 1996)

"What we've done is destroy the carrying capacity of the habitat to support those fisheries by removing the organisms that provide shelter for little fishes."

-Elliott A. Norse commenting on impacts to habitat from trawling (in Raloff, 1996)

Mobile, bottom fishing gears are used in all seas to harvest bottom-dwelling fish, invertebrates and algae. Variations in gear design reflect the type of fishery, habitat and preference. The earliest mobile gears were European dredges and beam trawls; the otter trawl is a further development of the beam trawl (Brandt, 1972).

Concerns over potential damage to marine habitat from mobile bottom fishing gears have been expressed since the advent of these fishing practices. Subsequent to the 14th Century petition, numerous attempts were made to suppress trawl fisheries in Europe because they were perceived to be destructive to young fish and to seabed life in general (Sahrage and

Lundbeck, 1992). In 1583, the Dutch banned shrimp trawling in Holland's estuaries while the trawl was banned in France the following year (Crowley, 1996). Early references to 'trawl' probably refer to dredge and beam trawl designs. More recently, groundfish and shrimp otter trawlers were banned from Bristol Bay, Alaska and South Carolina coastal waters based on perceived impacts to bottom habitat and impacts to non-target commercial species (Van Dolah, et al., 1991; Loshbaugh, 1996). Apparently, incentives for complying with gear restrictions were greater in earlier times as evidenced by the two fisherman in 16th Century Britain who were executed for daring to use metal chain on their beam trawls (Crowley, 1996).

The primary driving force behind conservation minded changes to trawl gear is gear selectivity, aimed at reducing various forms of bycatch. Public awareness and concern over impacts to benthic habitat has intensified in recent years (Martin, 1991; Anon., 1996; Crowley, 1996; Kaiser, 1996). The 1996 Greenpeace campaign, opposing the operations of factory trawlers in the Pacific Northwest, was based on damage to habitat and excessive bycatch attributed to this fishing technology (Berrill, 1997). Concerns have been expressed at various international fora regarding the clear signs of over-exploitation of fish stocks and damage to ecosystems. In addition, awareness of the environmental damage associated with current fishing practises is reflected in the many references to these elements in recent international treaties and agreements (FRCC, 1996). In 1991, the Food and Agriculture Organization (FAO) Committee on Fisheries recommended that FAO should develop the concept of responsible fisheries and elaborate a Code of Conduct to that end (FAO, 1995). In support of this, Canada hosted an Expert Consultation on Responsible Fishing Operations in 1994 (Stitt, 1994). A number of general principles were subsequently adopted for inclusion in the Code of Conduct. The Code stated that responsible fishing should ensure that: (i) the productive character of the environment is maintained; (ii) biodiversity of the

ecosystem is not threatened; (iii) mortalities in non-target species are minimized, and (iv) there are no undesirable environmental impacts of fisheries. Unfortunately, it has taken fisheries crises to focus attention on the environmental impacts of mobile fishing gears. Appraisal of fishing gear and harvesting technology in the wake of a fishery collapse is not unique to finfish resources. For instance, environmental assessment of Australian scallop dredge technology was undertaken only after the collapse of the southeast Australian commercial scallop fishery (Gorman, 1997). This stock collapse was the impetus to develop new scallop gear that would inflict minimal disturbance to the seabed, in addition to improving selectivity and harvesting efficiency. Another example of intense bottom fishing causing the collapse of a scallop stock is the Brazilian scallop (*Pecten ziczac*) fishery. Otter trawls modified with heavy tickler chains were used to harvest this species. The end result of sustained unregulated harvesting was the complete collapse of the resource (Pezzuto and Borzone, 1997). It is important to distinguish between the effects of fishing gear on the targeted stock (i.e. depletion through harvesting) and effects associated with physical disturbance to the seabed. Rarely has this been done.

Since 1992, Canada has been at the forefront of the debate over responsible fishing gears and harvesting practises. Much of the background work has been conducted through the Fisheries Resource Conservation Council (FRCC), which is an independent advisory body to Minister of the Department of Fisheries and Oceans. The Gear Technology Subcommittee of FRCC was commissioned to report on the state of knowledge of conservation implications of major fishing gears used throughout Atlantic Canada. These reports, in addition to DFO sponsored fishing industry workshops, have provided much of the necessary technical framework for future conservation strategies (Canadian Fishery Consultants Limited, 1994; Roache et al., 1995; FRCC 1994, 1996, 1997).

1.2 Mobile bottom fishing gears: physical aspects of gear-seabed interaction

Details of gear-seabed interaction vary considerably between the different gear types. The following sections summarize key features of gear design for the more common types of mobile bottom gears in use: beam trawls, shellfish dredges and otter trawls. Interactions with the seabed by specific gear components are highlighted.

1.2.1 Dredges

Dredges are used primarily to harvest molluscs. The two basic classes of dredge are hydraulic and 'dry' (i.e. no pumping of water). The most familiar type of dry dredge is the scallop dredge or rake. Basic dredge design has changed very little over the years. In common with most gear types however, there are many variations that reflect target species, size of vessel and bottom type. Gorman (1993) describes the European, North American, Japanese and Australian/New Zealand scallop dredge designs.

North American offshore dredges rank amongst the largest of dredges and can weigh up to four tonnes when full of scallops and rocks (Gorman, 1993). The Lunenburg (or New Bedford) style scallop dredge is used in the offshore scallop fisheries in Atlantic Canada. Basic components of this dredge include a rectangular steel frame fitted with a pressure plate on top and a cutting bar along the bottom (Fig 1.1). Attached to the frame is a bag (3-4 m in length) comprised primarily of steel rings linked together. The largest rings (9-10 mm thickness, 75 mm diameter) line the bottom of the net. The net terminates in a metal dumping bar. The dimensions of a typical offshore dredge are approximately 5 m wide by 0.3 m high. On hard bottom, dredge width does not normally exceed 4 m and the mouth may be fitted with rock chains. Usually one, or at most two, offshore dredges are towed at a time (F. Cahill, Fisheries and Oceans, St. John's, NF, pers. comm.).

Due to their heavy, unwieldy design, dry dredges cause considerable physical disturbance to the seabed and can inflict significant incidental damage to benthos. This, combined with the relatively low harvesting efficiency of most dry dredges (Medcof and Caddy, 1971; Brandt, 1972; Chapman et al., 1977; Messieh et al., 1991; Gorman, 1993, 1997) has led to the suggestion that such gear attributes would not be tolerated in other fisheries (Gorman, 1993). A particularly damaging component of many models of dredge is a toothed metal bar that runs along the bottom leading edge of the frame. For mussel and clam fisheries, the cutting bar or teeth dig into the sediment and excavate buried individuals. The rigid frame of some dredges (e.g. Australian box dredge) contributes to instability and significant digging action, particularly over uneven hard sand. Dredges that incorporate both flexible and rigid gear components, such as the Lunenburg model, travel more smoothly over the seabed. Nonetheless, physical disturbance can still be considerable.

Hydraulic dredges are used in Atlantic Canada to harvest Stimpson's surf clam *Mactromeris polynyma* (Fig. 1.1). Hydraulic dredges have an entirely rigid design due to the use of a steel cage as a collecting device. A New England style dredge has length, width and height dimensions of approximately 2 m, 1.5 m, and 42 cm, respectively (Lambert and Goudreau, 1996). The bottom of the cage consists of a series of metal rods spaced approximately 2.5 cm apart. An oblique, adjustable cutting blade digs deeply into the sediment and excavates and directs clams into the cage. The entire dredge travels over the seabed on a pair of flat runners. Hydraulic dredges used with factory freezer trawlers in offshore fisheries can be significantly larger.

A key component of the hydraulic dredge, lacking in the dry dredge, is a series of high pressure water jets that are directed downwards in front of the cutting blade. This serves to loosen the sediment so that infaunal clams can be collected more readily. The digging action can result in the suspension of significant quantities of sediment (Lambert and

Goudreau, 1996). In the early 1960s, clams and cockles were collected in a cage that was then retrieved and emptied on-board the towing vessel. Although this method is still used in some offshore clam fisheries, a recent innovation is a suction pipe (20-25 cm diam.) extending from the vessel to the top of the cage. The catch can then be continuously pumped aboard the vessel without the necessity of retrieving the cage.

Hydraulic dredging has the capacity to modify benthic topography to a greater extent than any other type of bottom fishing gear. It is not unusual for this gear to dig trenches in the sediment to depths ranging between 6 and 15 cm deep. Trench depths of 30 cm have been recorded (Lambert and Goudreau, 1996). There are also variations of hydraulic dredging in which fluidized sand and clams are sucked aboard using a hose or pipe. This method can leave holes in the seabed up to 3.5 m wide and 60 cm deep (Hall et al., 1990).

Since the early 1970s there has been a steady increase in the use of hydraulic methods for harvesting shellfish in intertidal and shallow subtidal areas in Europe (Hall et al., 1990). Offshore hydraulic dredging of surf clams and ocean quahogs has been a major industry along the U.S. northeast coast since 1985 (Serchuk and Murawski, 1997). Harvesting of Stimpson's surf clam has been ongoing on the Scotian Shelf for the past decade (Messieh et al., 1991) and for several years on the Grand Banks and at inshore locations in Quebec.

1.2.2 Beam trawls

The beam trawl is used extensively in Europe to harvest shrimp and flatfish (Polet et al., 1994). Holland is considered the centre of the beam trawl industry in Europe and the Dutch beam trawl design is widely used (Bates, 1993). The beam trawl is considered to be the simplest type of bottom trawl due to its fixed configuration. This is achieved by a cylindrical steel beam (approximately 10 cm in diameter) that spans the mouth of the trawl (Fig. 1.2). Attached to each end of the beam are wide, flat shoes (0.5 m x 1 m) upon which

most of the weight of the gear is borne. The largest 'beamers' are restricted to offshore areas and have a maximum beam length of 12 m. Vertical height of the trawl mouth is set by the height of the shoes and is about 80 cm.

Beam trawls cause considerable physical disturbance to the seabed for several reasons. They are very heavy gear with high drag. A fully rigged 12 m beam trawl can weigh 3,000 kg, excluding the chain mat (Polet et al., 1994). Unlike otter boards, the wide flat shoes of beam trawls are not considered to be the most destructive gear component. Rather, the various chains cause most of the physical disturbance. Beam trawls can be classified as either 'open' or 'closed'. In the case of closed or stone mat gear, the mouth of the trawl is protected by a mat of heavy chains that extends from the beam down to the footgear (Fig. 1.2). The mat is used on rough bottom to prevent large boulders from entering the trawl (Bates, 1993). The heaviest chain mats can weigh as much as seven tonnes. Possibly even more destructive are the series of heavy chains (14-22 mm diameter), known as 'ticklers', that are strung between the beam shoes, and the lighter chains, i.e. 'dusters', that span the trawl mouth from points along the footrope. All the various chains are rigged so that they will dig into the sediment and disturb flatfish which then swim upwards into the trawl. A 12 m beam trawl may have as many as 12 heavy tickler chains, in addition to numerous dusters. The heaviest tickler chains are used on hard, sandy bottoms. A series of new tickler chains can lose up to 15% of their original weight through wear, after just six weeks of fishing (Polet et al., 1994). In soft muddy sediments, tickler chains can penetrate to depths of 20 cm, but this is reduced to a few centimetres on hard sand (Kaiser, 1996). Although less common, tickler chains have also been used with otter trawls, particularly prawn trawls (Bridger, 1970; Pownall, 1979).

While Europe is the stronghold for large beam trawls, a smaller version is popular in shallow lagoons and inlets along the southern United States. The plumb-staff beam trawl

is used in Louisiana to harvest shrimps. This variation of the beam trawl is smaller and considerably lighter since it lacks shoes and tickler chains.

Similar to otter trawls, beam trawls have flexible footgear that is dragged over the seabed. A typical assembly consists of rubber disks ranging in size from approximately 15 to 25 cm (Gorman, 1992). The net of beam trawls is made of nylon or polyethylene.

1.2.3 Otter trawls

An otter trawl is a large net bag that is towed over the seabed (Fig. 1.3). Various types of otter trawl are used to harvest groundfish and shrimp and some species of scallop. A fundamental distinction of the beam trawl from the otter trawl is that the former has a fixed opening. The otter trawl derives its name from the pair of otter boards (doors) that are used to hold the net open. Otter boards are constructed of steel, wood, or polyvalent material. Attached to their base are steel or manganese shoes. The shoes provide ballast for the otter boards and protect the boards against wear. The otter board has undergone few changes, relative to the net and working gear components, since its introduction to trawl fisheries in Ireland around 1885 (Brandt, 1972). The otter board was not an invention of the trawl fishery, but rather it was first used in the hook and line fisheries in order to deploy gear in currents. In order to conserve fuel and to minimize wear and damage to gear, the doors and footgear of otter trawls should travel over the seabed with minimal penetration (Mounsey and Prado, 1997). This is in contrast to the cutting bars of dredges and the tickler chains of beam trawls, for which harvesting efficiency requires that these gear components dig into sediments. Considerable research has been directed at determining optimum otter board towing conditions (i.e. contact with the seabed and orientation) and trawl configurations (Crewe, 1964; Carrothers et al., 1969; Carrothers and Foulkes, 1972; FAO, 1974; Main and Sangster, 1979; Patterson and Watts, 1985; Anon., 1993a). Recent developments in both

footgear and otter board designs has permitted fishing over rough bottom, areas which have been traditionally non-accessible. While this is not particularly good news for fish stocks, it should serve to reduce physical disturbance to the seabed by otter boards. Rock hopper trawl doors are rigged to work 7-8 m above the seabed (Madden, 1990).

Otter board dimensions vary considerably depending on the fishery and size of trawl. They range from the relatively small doors (2-3 m² and 250 kg) used with prawn trawls (Pownall, 1979) to the massive doors (c. 17 m² and 4500 kg) used with the largest otter trawls. Cold water shrimp fisheries in northern regions of the western Atlantic and eastern Pacific are prosecuted with gear similar to that used for harvesting groundfish. In contrast, multi-rig otter trawls used in warm water prawn fisheries (e.g. Australia, Gulf of Mexico, South America), are usually fitted with lighter gear. While the size of doors used with prawn trawls varies, they are typically relatively light. Their basic design is rectangular, typically of wood construction.

Based on weight and towing action, otter boards transmit the highest forces, per unit area of seabed, of any trawl gear component. Due to towing characteristics, typically it is the heel of an otter board that is in contact with the seabed (Main and Sangster, 1979; Gibbs et al., 1980; van Dolah et al., 1991; Anon, 1993b). On sandy bottoms, otter boards create plumes of sediment that can extend several metres above the seabed. On smooth bottom, otter boards maintain their contact with the seabed. On rough or uneven bottom, they periodically leave the seabed after contacting boulders or sand waves. Main and Sangster (1979) describe the action of various designs of otter board over smooth and rough topography.

The footgear of most otter trawls consist of combinations of rubber discs or steel bobbins of varying size, number and alignment (Fig. 1.3). The purpose of the footgear is to protect the fishing line (to which the lower net panels are strung) and to ensure that the net

remains in close proximity to the seabed. Otter trawls used in warm water prawn fisheries employ light footgear, often consisting merely of small diameter (8 mm) wire cable. Otter trawls used to harvest groundfish and shrimp (*Pandalus* sp.) in the Newfoundland region employ heavier footgear, consisting of strings of individual steel bobbins or rubber discs that can reach diameters of 60 cm. Our understanding of the interaction of trawl gear components with the seabed is very limited. Groundfish trawls equipped with rockhopper footgear (rubber discs) have been observed to stir up clouds of sediment along the entire footrope (West, 1987). Rockhopper footgear has gained popularity in recent years by permitting trawling over rough bottom. It is just this attribute that has implicated rock hopper footgear as the chief cause of habitat destruction in boulder fields in the Gulf of Maine (Raloff, 1996).

Portions of the trawl rigging, i.e. ground-warps (sweeps) and bridles, also make contact with the seabed and may serve an important role by herding fish towards the mouth of the trawl (Loverich and West, 1988). Contact made with the seabed by the various trawl wires will depend upon rigging parameters and towing speed. There is evidence that the high aspect-ratio (i.e. large height/length ratio) trawl doors used in the Bering Sea commercial groundfisheries, results in minimal seabed contact by the ground-warps and bridle-wires (Goudey and Loverich, 1987; West, 1987). The low aspect-ratio doors used in the Atlantic region may result in a greater degree of rigging-seabed contact.

The net itself is generally regarded as the least destructive gear component. However, it is known that the last several metres of the cod end will drag on the bottom at least some of the time and that area of contact will increase as the catch accumulates (West, 1987).

1.3 Otter trawl technology in Atlantic Canada

An overview of otter trawl technology in Atlantic Canada is given by Canadian Fishery Consultants Limited (1994). Single-vessel, stern otter trawling is the prevalent method of bottom trawling in Atlantic Canada. Otter trawling has dominated groundfish landings in the Northwest Atlantic since the arrival of the distant water fleets in the 1960s (FRCC, 1997). Advantages of the otter trawl include high harvesting efficiency and suitability on most bottom types. The following sections summarize key technical aspects of otter trawl gear used in Atlantic Canada. The focus is on gear components that come into contact with the seabed during trawling: the net, footgear, otter boards and various ground wires.

1.3.1 Otter boards

A variety of otter board designs have been used in Atlantic Canada (Fig. 1.4). The oval door is the design of choice for trawling over rough bottom and is used by over 80% of trawlers in Atlantic Canada (Canadian Fishery Consultants Limited, 1994). Partly due to the environment and distant nature of fishing operations, trawlers operating on the Grand Banks have been large and powerful, with corresponding large trawls. Large trawls require large, heavy otter boards. Very little is known about the physical impact of otter boards in offshore benthic habitats. Side-scan sonar surveys on the Grand Banks and Scotian Shelf have revealed characteristic trawl door marks, in the form of furrows (Harrison et al., 1991; Jenner et al., 1991). Overall, a small proportion (< 10%) of the total area of the sonar tracks revealed signs of trawl marks. However, the true extent of scouring is obscured by hydrodynamic processes that re-distribute sediments and bioturbation, which leads to the infilling of furrows.

1.3.2 Footgear

Traditionally, large offshore trawls have been equipped with steel bobbin footgear. This type of footgear rolls easily over level bottoms. In recent years, there has been a gradual change to rockhopper footgear, primarily due to its suitability for fishing on rocky, uneven terrain. Rockhopper footgear consists of rubber disks assembled under tension. This allows the trawl to 'hop' over the bottom when contact is made with obstructions. Individual disks (up to 60 cm diam.) are connected to a chain strung through the entire assembly which prevents rotation of individual disks. This results in a ploughing kind of disturbance in unconsolidated sediments. Variations in footgear assembly reflect function. For instance, when flounder are the target species, footgear (i.e. small rubber discs) are often strung for a distance along the ground warp, in order to stir up the fish.

1.3.3 Ground wires

Otter boards are connected to the net by the ground warp and bridles. Collectively, these wires are referred to as the rigging. In Atlantic Canada, otter trawls have rigging that is constructed of 15 to 22 mm diameter galvanized steel cable (Carrothers, 1988; McCallum and Walsh, 1996). While the overall length of the rigging depends on the type of trawl, typically it is greater than 50 m. A series of three bridle wires (i.e. upper, central, lower) can also be adjusted (let in or out) in order to alter the vertical opening of the net. This may influence the degree of contact between the rigging and the seabed. Although the rigging is known to make contact with the seabed, very little is known about the extent of the interaction and the associated physical effects.

1.3.4 Net

Several different types of nets have been used in the Newfoundland-Labrador region.

The Western Trawl was popular in the mid-1960s. In the 1970s, the larger stern trawlers fishing the Grand Banks and the North Atlantic in general, favoured the Engel Hi-Lift and Granton otter trawls (McCallum and Walsh, 1996). The various types of otter trawl nets differ in terms of overall assembly (i.e. shape and numbers of net panels) and size. This is reflected by differences in headline and footrope lengths, weight of footgear and size of otter boards. Net mesh size and type (square or diamond) have also changed through the years and is primarily under regulatory control. Material used to make net twine has undergone a gradual sequence of change, progressing in the order- cotton, hemp, manila, nylon and synthetic 'poly' materials. Codends are currently constructed of hard polytwine, which minimizes escapement of smaller fish since the meshes are not very pliable. Chafing material is often added externally, over the codend, as protection against abrasion.

1.4 History of investigations into environmental impacts of mobile bottom fishing gears

Scientific investigations into the environmental impacts of mobile bottom fishing gears have been ongoing for the past 25 years although it has been most intense in recent years (see recent reviews by Dayton et al., 1995 and Jennings and Kaiser, 1998 and special issue of Conservation Biology vol. 12, no. 6, 1998: Effects of mobile fishing gear on marine benthos; also Dorsey and Pederson, 1998). The most extensive research on this issue has been conducted in Europe (see de Groot and Lindeboom, 1994 and Lindeboom and de Groot, 1998). Numerous short-term experiments, where the level of fishing has been controlled, have been conducted with beam trawls, scallop, and clam dredges. Relatively few experiments have been undertaken with otter trawls. Manipulative experiments must be conducted in areas that are closed to fishing and that have not had a recent history of

fishing activity. Several closed areas have been established in recent years in the Northwest Atlantic and in neighbouring seas of the eastern Atlantic (ICES, 1996). In addition, there have also been larger-scale investigations into impacts of mobile gear on benthic habitat (Auster et al., 1996; Collie et al., 1997; Service and Magorrian, 1997). These represent comparative surveys between areas with different fishing histories.

The ICES Working Group on Ecosystem Effects of Fishing Activities has convened on a regular basis since 1988, when it was formed by council resolution (ICES, 1991-1997). In addition to these meetings and those of the ICES Benthic Ecology Working Group, there have been recent workshops devoted to the impacts of mobile bottom fishing gear on marine benthic habitats and marine ecosystems in general (Dayton, 1995; Kaiser, 1995; Raloff, 1996; Anon., 1997). The attendance of both the scientific and trade press at these workshops, underscores the increasing profile of this topic (Kaiser, 1995).

The history of investigations into impacts of mobile fishing gears on marine benthic ecosystems in Atlantic Canada dates to 1990 with the initiation of collaborative research between the Maritimes and Newfoundland regions of Fisheries and Oceans Canada (DFO). A three-year otter trawling impact experiment was recently completed on the northeastern Grand Bank (DFO experimental trawling study area). This experiment was conducted on a level-bottom, dense sand seabed. In 1997, an otter trawling experiment was initiated on a rocky bottom on Western Bank, off Nova Scotia. Long-term objectives of these studies include: (i) the development of sampling gear specific to offshore environments (Rowell et al., 1997; McKeown and Gordon, 1997) and, (ii) quantitative information on impacts to benthic habitat (Prena et al., 1996, 1998; Gilkinson et al., 1998; Gordon et. al., 1998; Schwinghamer et al., 1996, 1998).

The DFO studies have been multidisciplinary, involving collaboration between the Habitat Ecology Section (Bedford Institute of Oceanography [BIO]), Ocean Ecology

Division (Northwest Atlantic Fisheries Centre), Ocean Science and Technical Services Divisions (BIO), Geological Survey of Canada, Atlantic Region (BIO) and numerous contractors in Nova Scotia and Newfoundland.

1.5 Environmental concerns associated with otter trawling in Atlantic Canada

Otter trawling has been condemned for its harvesting capacity and resource wastage, and for the destruction of habitat. Although evidence to support the former claim is compelling, impacts in specific benthic habitats as a function of fishing patterns are less clear. Nonetheless, there is considerable evidence for a variety of physical and biological disturbances to seabed habitat cause by otter trawling (Krost et al., 1990; Engel and Kvitek, 1998; Kaiser, 1998; Pilskaln et al., 1998; Tuck et al., 1998; Watling and Norse, 1998). The results of these studies as well as investigations with other gear types, show that it is not possible to make generalizations about impacts of mobile fishing gear on benthic habitat. The types of impacts and their magnitude will depend on a number of factors including habitat type (coarse or soft bottom, low energy vs. high energy), gear type and the resident biological community. In Atlantic Canada, much of the infamy surrounding otter trawl gear technology probably arises from its tremendous harvesting capability which has had a history of misuse. In Canada, controversy has surrounded otter trawling since at least 1928 when a Royal Commission on the Atlantic Fisheries recommended a ban on trawling (Canadian Fishery Consultants Limited, 1994). The issue of the nature of interaction of otter trawl gear with the seabed was prominent in 1947, a decade before this gear gained wide use in the Northwest Atlantic. Trawlermen contended that their gear glided along the ocean bottom like 'a skate on smooth ice'. Not to be outdone, fishermen from other gear sectors claimed that the otter trawl had the same general effect as a bulldozer (Ketchen, 1947). The current

debate over 'draggers' has pitted various user groups against each other, and in particular, fixed gear fishers and environmentalists against trawlermen. The prevailing opinion is that otter trawling invariably inflicts severe damage to the seabed, as evidenced by frequent use of the terms 'destroyed', 'devastated' and 'crushed' to describe impacts to the seafloor. Environmental concerns and impacts that have been attributed to otter trawling in Atlantic Canada are listed in Table 1. These have been compiled from various FRCC documents, fishing industry workshop proceedings and from the Canadian Report of the 1994 Consultation for the Code of Conduct for Responsible Fishing. As such, these views largely reflect the views of the fishing industry, special interest groups and their consultants. The results and conclusions of scientific research concerning impacts of otter trawling are presented in Chapters 2 through 5 (particularly 3 and 4).

The relatively fast-tracked assessments of current fishing methods and their impacts, without a sufficient database, has resulted in the dissemination of several unsubstantiated claims of impacts attributable to otter trawling. In addition, several of these claims are based on the results of experiments conducted with other types of gear. In the case of comparative studies, it is difficult to attribute habitat damage to otter trawling when fishing grounds have had histories of multiple gear use.

1.6 Thesis Topic

That otter trawling disturbs the seabed and impacts biological communities is not disputed. However, the nature of these impacts are poorly understood with respect to a variety of variables including habitat type, gear type, fishing patterns and resident benthic communities. This thesis focuses on the impacts of otter trawling on infaunal bivalves living in sandy bottom habitats on the Grand Banks and specifically, impacts associated with

capture rates (i.e. bycatch) and non-capture physical damage (i.e. incidental damage). A major component of this thesis is a three-year trawling experiment conducted in a sandy bottom ecosystem on northeast Grand Bank. This experiment investigated the physical and biological impacts of all gear components combined. It is stressed that results are only applicable to this bottom type. Large areas of the Grand Banks consist of this bottom type, on which the otter trawl is used to harvest groundfish. Both the spatial scale (13 km long trawling corridors) and pattern of experimental trawling were intended to mimic relatively high intensity commercial trawling. This study was initiated prior to the implementation of the 1992 cod fishery moratorium, when otter trawlers were still fishing over the entire Grand Banks. The role of otter trawling in future fisheries has not been decided.

In some cases, impacts from mobile bottom gear can be traced to the physical effects of specific gear components. Compared to other otter trawl gear components, otter boards are generally considered to inflict the greatest degree of disturbance to the seabed (Ketchen, 1947; Arntz and Weber, 1972; Krost et al., 1990; Rumohr and Krost, 1991; Anon., 1993b; Auster et al., 1995; Laevestu et al., 1996). Nonetheless, there is very little direct evidence of physical impacts of otter boards on benthic habitat. A second component of this thesis was a detailed study of the physical processes associated with trawl door scouring in dense sand. This was accomplished by conducting a trawl door scouring experiment in a scour tank facility (see below).

A third component was a comparison of temporal and spatial scales of natural and trawling disturbances.

1.6.1 Bivalves as indicators of physical disturbance

Bivalves were selected as the experimental subjects for trawling impacts for several reasons. Infaunal bivalves are dominant members of sandy bottom benthic communities on

the Grand Banks (Nesis, 1965; Hutcheson et al., 1981; Hutcheson and Stewart, 1994) and on continental shelves in general (Theroux and Wigley, 1983; Petersen, 1977; Brey et al., 1990; Steimle, 1990). Bivalves are good indicators of physical disturbance caused by mobile bottom gears. In particular, their shells record physical damage caused by contact with mobile gear (Rumohr and Krost, 1991; Shepard and Auster, 1991; Witbaard and Klein, 1994; Gaspar et al., 1998; Robinson and Richardson, 1998). Particularly relevant is the fact that populations of infaunal bivalves occur over a wide range of sediment depths. Patterns of damage and displacement can be used to assess the vertical extent of physical disturbance.

Increasingly, bivalves are being harvested on continental shelves for food. These are often large-scale operations conducted in offshore areas with a variety of mobile bottom gears including beam trawls, scallop and clam dredges and modified otter trawls. In many cases, these fisheries have been unregulated or have been managed with insufficient information on the stock status and as a result, the resources have either declined markedly or have collapsed. However, it is not known what the relative roles of over-harvesting and effects of gear-seabed interaction were on depletion of the resource. When assessing the impacts of any gear type or fishing pattern, it is important to distinguish between the effects of removal of the resource and other direct and indirect physical effects of the gear on the seabed. In areas such as the Grand Banks, which are exploited with a variety of mobile bottom gears, it is also important to determine the effects of the various types of gears on benthic habitat. Only then may informed decisions be made concerning conservation aspects of fishing gear.

1.6.2 Thesis Organization

The thesis consists of four main chapters. Chapter 2 deals with bivalve bycatch of the otter trawl. The analysis is based on the results of sampling the bycatch of two types of

groundfish otter trawls that differed in terms of type of footgear and net mesh size. Bycatch was recorded over a wide area of the Grand Banks from a range of bottom types and depths. These results were supplemented by limited bycatch statistics of Iceland scallops (*Chlamys islandica*), from commercial otter trawling (Fisheries and Oceans Observer Program). The results of a three-year field trawling experiment are presented in Chapter 3. The findings after the first year of experimental trawling were the impetus for a detailed study of the physical processes associated with trawl door scouring (Chapter 4). Given the relatively intense and localized pattern of the trawling, the very low rates of incidental damage to bivalves was a paradox. The physical interaction of gear with the seabed and bivalves could not be directly observed in the field experiment. A physical trawl door model scouring experiment was conducted in the ice scour research tank at the Faculty of Engineering and Applied Science, Memorial University. From this, a mechanism was developed for the physical processes associated with otter board-bivalve interaction on sandy bottoms. One limitation of all fishing impact experiments is the inability to study long-term and ecosystem level impacts. However, trawling impacts were placed in the context of natural sediment-mediated physical disturbances occurring on the Grand Banks (Chapter 5). An overall summary with conclusions is presented in Chapter 6.

1.7 Literature cited

- Anon. 1993a. Otterboard Performance and Behaviour. Commission of the European Communities (FAR). Contract No. TE 1 214. Prepared by Sea Fish Industry Authority, IFREMER and DIFTA.
- Anon. 1993b. Seabed disturbances from fishing activities. Project Summary. No. 41, May, 1993. Fisheries and Oceans, Industry Services and Native Fisheries, Scotia-Fundy Region, Halifax, N.S.
- Anon. 1996. Habitat must come first. Letters to the editor, Atlantic Fisherman, June 1996.
- Anon. 1997. Proceedings of the Conference on Effects of Fishing Gear on the Sea Floor of New England. Northeastern University, Ashland, MA. 30 May, 1997 (in press).
- Aquaprojects Inc. 1994. Responsible Harvesting Practises. A Discussion Paper: Supplement to the Canadian Report of the 1994 FAO International Expert Consultation for the Code of Conduct for Responsible Fishing. Sidney, British Columbia, June 6-11, 1994. Prepared for Fisheries and Oceans, Fishing Industry Services, Fisheries Operations, Ottawa.
- Arntz, W. and W. Weber. 1972. *Cyprina islandica* L. (Mollusca, Bivalvia) as food for cod and dab in Kiel Bay. Fisheries Research Board of Canada Translation Series No. 1985. Translated from Bericht der Deutschen Wissenschaftlichen Kommission für Meeresforschung 21(1-4): 193-209.
- Auster, P.J., R.J. Malatesta, R.W. Langton, L. Watling, P.C. Valentine, C-L.S. Donaldson, E.W. Langton, A.N. Shepard and I.G. Babb. 1996. The impacts of mobile fishing gear on seafloor habitats in the Gulf of Maine (Northwest Atlantic): Implications for conservation of fish populations. Reviews in Fisheries Science 4(2): 185-202.
- Bates, Q. 1993. Beam trawling in European waters. Fishing Boat World 5(9): 28-29.

- Berrill, M. 1997. *The Plundered Seas*. Douglas and MacIntyre, Vancouver.
- Brandt von, A. 1972. *Revised and Enlarged Fish Catching Methods of the World*. Fishing News (Books) Ltd., London.
- Brey, T., W.E. Arntz, D. Pauly and H. Rumohr. 1990. *Arctica (Cyprina) islandica* in Kiel Bay (Western Baltic): growth, production and ecological significance. *Journal of Experimental Marine Biology and Ecology* 136: 217-235.
- Bridger, J.P. 1970. Some effects of the passage of a trawl over the seabed. ICES C.M. 1970/B:10.
- Canadian Fishery Consultants Limited. 1994. *Review of Fishing Gear and Harvesting Technology in Atlantic Canada*. Fishing Gear and Harvesting Technology Assessment. Prepared for Fisheries and Oceans Canada, Fishing Industry Services Branch, Fisheries Operations, Ottawa. Project No. B519.
- Carrothers, P.J.G. 1988. Scotia-Fundy groundfish survey trawls. Canadian Technical Report of Fisheries and Aquatic Sciences 1609.
- Carrothers, P.J.G. and T.J. Foulkes. 1972. Trawl measurements: how Canadian east coast otter trawls behave. Fisheries Research Board of Canada General Circular Series No. 57.
- Carrothers, P.J.G., T.J. Foulkes and A.G. Walker. 1969. Data on the engineering performance of Canadian east coast groundfish otter trawls. Fisheries Research Board of Canada Technical Report No. 125.
- Chapman, C.J., J. Mason and J.A.M. Kinnear. 1977. Diving observations on the efficiency of dredges used in the Scottish fishery for the scallop, *Pecten maximus* (L.). Department of Agriculture and Fisheries for Scotland. Scottish Fisheries Research Report Number 10.
- Collie, J.S., G.A. Escanero and P.C. Valentine. 1997. Effects of bottom fishing on the

- benthic megafauna of Georges Bank. *Marine Ecology Progress Series* 155: 159-172.
- Crewe, P.R. 1964. Some of the general engineering principles of trawl gear design. In: *Modern Fishing Gear of the World 2: Part 2. Bulk Fishing*. Fishing News (Books) Ltd., London.
- Crowley, M. 1996. Does dragging harm the habitat? *National Fisherman* 76(12): 40.
- Dayton, P.K. 1995. Environmental impacts of fishing on marine communities: Working Group Report. Pp. 321-322. In: *Solving Bycatch: Considerations for Today and Tomorrow*. Alaska Sea Grant College Program Report No. 96-03, University of Alaska Fairbanks.
- Dayton, P.K., S.F. Thrush, M.T. Agardy and R.J. Hofman. 1995. Environmental effects of marine fishing. *Aquatic Conservation: Marine and Freshwater Ecosystems* 5: 205-232.
- de Groot, S.J. and H.J. Lindeboom (eds.). 1994. Environmental impact of bottom gears on benthic fauna in relation to natural resources management and protection of the North Sea. Reports of the Netherlands Institute for Sea Research, Texel, The Netherlands.
- Dorsey, E. and J. Pederson (eds.) 1998. Effects of fishing gear on the seafloor of New England. The Conservation Law Foundation, Boston, Massachusetts.
- Engel, J. and R. Kvitek. 1998. Effects of otter trawling on a benthic community in Monterey Bay National Marine Sanctuary. *Conservation Biology* 12: 1204-1214.
- FAO. 1974. *Otter Board Design and Performance*. FAO Fishing Manuals, Italy.
- FAO. 1995. *Code of Conduct for Responsible Fisheries*. Rome.
- FRCC. 1994. Conservation aspects of groundfish gear technologies in eastern Canada. A discussion paper prepared by the Gear Technology Subcommittee FRCC94.TD.4, December 1994, Ottawa.
- FRCC. 1996. Consultation paper on gear technology. A FCC discussion paper prepared by

- the Gear Technology Subcommittee FRCC96.TD.1, January 1996, Ottawa.
- FRCC. 1997. A report on gear technology in eastern Canada. Report of the Gear Technology Subcommittee. FCC.97.R.1, March, 1997, Ottawa.
- Gaspar, M.B., M. Castro and C.C. Monteiro. 1998. Influence of tow duration and tooth length on the number of damaged razor clams *Ensis siliqua*. Marine Ecology Progress Series 169: 303-305.
- Gibbs, P.J., A.J. Collins and L.C. Collett. 1980. Effect of otter prawn trawling on the macrobenthos of a sandy substratum in a New South Wales estuary. Australian Journal of Marine and Freshwater Research 31: 509-516.
- Gilkinson, K., M. Paulin, S. Hurley and P. Schwinghamer. 1998. Impacts of trawl door scouring on infaunal bivalves: results of a physical trawl door model/dense sand interaction. Journal of Experimental Marine Biology and Ecology 224(2): 291-312.
- Gordon, Jr., D.C., P. Schwinghamer, T.W. Rowell, J. Prena, K. Gilkinson, W.P. Vass and D.L. McKeown. 1998. Studies in eastern Canada on the impact of mobile fishing gear on benthic habitat and communities. Pp. 63-67. In: E.M. Dorsey and J. Pederson (eds.), Effects of Fishing Gear on the Sea Floor of New England. Conservation Law Foundation, Boston, Massachusetts.
- Gorman, T. 1992. Beam trawlers and beam trawling. Fishing Boat World 4(9): 24-25.
- Gorman, T. 1993. Scallops and other dredging boats. Fishing Boat World. 5(4): 31-35.
- Gorman, T. 1997. Fishing gear technology-scallop dredge appraisal. Fishing Boat World 8(11): 10-12.
- Goudey, C.A. and G. Loverich. 1987. Reducing the bottom impact of Alaskan groundfish trawls. Pp. 632-637. In: Oceans '87 Conference Proceedings, Marine Technology Society, IEEE Publishing Services, New York.
- Hall, S.J., D.J. Basford and M.R. Robertson. 1990. The impact of hydraulic dredging for

- razor clams *Ensis* sp. on an infaunal community. Netherlands Journal of Sea Research 27(1): 119-125.
- Harrison, P.H., K.W. Strong and K.A. Jenner, 1991. A review of fishing related seabed disturbance on the Grand Banks of Newfoundland. Maritime Testing (1985) Limited, Dartmouth, Nova Scotia.
- Hutcheson, M.S. and P.L. Stewart. 1994. A possible relict population of *Mesodesma deauratum* (Mesodesmatidae) from the Southeast Shoal, Grand Banks of Newfoundland. Canadian Journal of Fisheries and Aquatic Sciences 51: 1162-1168.
- Hutcheson, M.S., P.L. Stewart and J.M. Spry. 1981. Section VII- The Biology of Benthic Communities of the Grand Banks of Newfoundland (includes the Hibernia area). Grand Banks Oceanographic Studies Volume No. 3, Final Report. Prepared by MacLaren Plansearch. (Copy available at Bedford Institute of Oceanography library).
- ICES. 1991. Report of the Study Group on Ecosystem Effects of Fishing Activities, Lowestoft, 11-15 March, 1991. ICES CM 1991/G:7.
- ICES. 1992. Report of the Study Group on Ecosystem Effects of Fishing Activities, Copenhagen, Denmark, 7-14 April, 1992. Copenhagen, The Council.
- ICES. 1993. Report of the Working Group on Ecosystem Effects of Fishing Activities. Copenhagen: The Committee, 1993. ICES CM 1993/G:4.
- ICES. 1994. Report of the Working Group on Ecosystem Effects of Fishing Activities, Copenhagen, 20-27 April, 1994. ICES CM 1994/ASSESS/ENV:1.
- ICES. 1995. Report of the Working Group on Ecosystem Effects of Fishing Activities, May 1995. ICES CM 1995/ASSESS/ENV:1
- ICES. 1996. Report of the Working Group on Ecosystem Effects of Fishing Activities, 13-21 March, 1996. ICES CM 1996/ASSESS/ENV:1.
- ICES. 1997. Report of the Working Group on Ecosystem Effects of Fishing Activities, ICES

- Headquarters, Copenhagen, Denmark, 24 November-2 December 1997. ICES CM 1998/ACFMA/ACME:1 Ref.:E.
- Jenner, K.A., K.W. Strong and P. Pocklington. 1991. A review of fishing related seabed disturbance in the Scotia-Fundy region. Final report to Industry Services and Native Fisheries Branch. Fisheries and Habitat Management, Scotia-Fundy Region, Halifax, Nova Scotia.
- Jennings, S. and M.J. Kaiser. 1998. The effects of fishing on marine ecosystems. *Advances in Marine Biology* 34: 201-352.
- Kaiser, M.J. 1996a. Effects of trawling on marine ecosystems. A workshop held at the Darling Marine Centre, Walpole, Maine, USA, during 28-30 June 1996. *Environmental Conservation* 23 (4): 366-367.
- Kaiser, M.J. 1996b. Do beams cause damage to seabed life? *Fishing News*, 22 March 1996, pp. 12-13.
- Kaiser, M.J. 1998. Significance of bottom-fishing disturbance. *Conservation Biology* 12: 1230-1235.
- Ketchen, K.S. 1947. An investigation into the destruction of grounds by otter trawling gear. *Progress Report Fisheries Research Board of Canada* 73: 55-56.
- Krost, P., M. Bernhard, F. Werner and W. Hukriede. 1990. Otter trawl tracks in Kiel Bay (Western Baltic) mapped by side-scan sonar. *Meeresforsch* 32: 344-353.
- Laevastu, T., D.L. Alverson and R.J. Marasco. 1996. *Exploitable Marine Ecosystems: Their Behaviour and Management*. Fishing News Books, London.
- Lambert, J. and P. Goudreau. 1996. Performance of the New England hydraulic dredge for the harvest of Stimpson's surf clams (*Mactromeris polynyma*). *Canadian Industry Report of Fisheries and Aquatic Sciences* 235.
- Lindeboom, H.J. and S.J. de Groot (eds.) 1998. *IMPACT-II. The effects of different types*

- of fisheries on the North Sea and Irish Sea benthic ecosystems. Reports of the Netherlands Institute for Sea Research, Texel, The Netherlands.
- Loshbaugh, D. 1996. Trawlers out of the bay. *The Fisherman's News*, August 1996.
- Loveriche, G. and W. West. 1988. Performance and use of high aspect ratio bottom otter boards in the Bering Sea trawl fisheries. In: *Proceedings, World Symposium on Fishing Gear and Fishing Vessel Design*. Marine Institute, St. John's, NF.
- Madden, T. 1990. Trawl doors: meeting the needs of the industry. *Fishing Boat World* 2(2): 46.
- Main, J. and G.I. Sangster. 1979. A Study of Bottom Trawling Gear on both Sand and Hard Ground. *Scottish Fisheries Research Report Number 14*, Department of Agriculture and Fisheries for Scotland.
- Martin, C. 1991. Scientists voice fear for the barren seabed. *The Sunday Express*, May 19, 1991.
- McCallum, B.R. and S.J. Walsh. 1996. Groundfish survey trawls used at the Northwest Atlantic Fisheries Centre, 1971-Present. *NAFO SCR Doc. 96/50*.
- McKeown, D.L. and D.C. Gordon, Jr. 1997. Grand Banks otter trawling impact experiment: II. Navigation procedures and results. *Canadian Technical Report of Fisheries and Aquatic Sciences* 2159: xi + 79 p.
- Medcof, J.C. and J.F. Caddy. 1971. Underwater observations on performance of clam dredges of three types. *ICES C.M.* 1971/B:10.
- Mounsey, R.P. and J. Prado. 1997. Eco-friendly demersal fish trawling systems. *Fishing Technology* 34(2): 1-6.
- Nesis, K.I. 1965. Biocoenoses and biomass of benthos of the Newfoundland-Labrador region. *Fisheries Research Board of Canada Translation Series No. 1375*. Translated from *Trudy Vsesoyuznogo Nauchno-Issledovatel'skogo Instituta Morskogo Rybnogo*

- Khozyaistva I Okeanografii (VNIRO) 57: 453-489, 1965.
- Patterson, R.N. and K.C. Watts. 1985. The otter board as a low-aspect-ratio wing at high angles of attack; some theoretical aspects. *Fisheries Research* 3: 351-372.
- Pezzuto, P.R. and C. A. Borzone. 1997. The scallop *Pecten ziczac* (Linnaeus, 1758) fishery in Brazil. *Journal of Shellfish Research* 16(2): 527-532.
- Petersen, G.H. 1977. The density, biomass and origin of the bivalves of the central North Sea. *Meddelelser Fra Danmarks Fiskeri-og Havundersøgelser N.S. Vol. 7*, p. 221-273.
- Pilskaln, C., J.H. Churchill and L.M. Mayer. 1998. Resuspension of sediment by bottom trawling in the Gulf of Maine and potential geochemical consequences. *Conservation Biology* 12: 1223-1229.
- Polet, H., W. Blom and W. Thiele. 1994. An inventory of vessels and gear types in the Belgian, Dutch and German bottom trawling. Pp. 7-20. In: de Groot, S.J. and H.J. Lindeboom (eds.). *Environmental Impact of Bottom Gears on Benthic Fauna in Relation to Natural Resources Management and Protection of the North Sea*. NIOZ-Rapport 1994-11, RIVO-DLO Report C026/94, Netherlands Institute for Sea Research.
- Pownall, P. 1979. *Fisheries of Australia*. Fishing News Books Ltd., Farnham, Surrey, England.
- Prena, J., T.W. Rowell, P. Schwinghamer, K. Gilkinson and D.C. Gordon, Jr. 1996. Grand Banks otter trawling experiment: I. Site selection process, with a description of macrofaunal communities. *Canadian Technical Report of Fisheries and Aquatic Sciences* 2094: viii + 38 p.
- Prena, J., P. Schwinghamer, T.W. Rowell, D.C. Gordon, Jr., K.D. Gilkinson, W.P. Vass and D.L. McKeown. 1998. Experimental otter trawling on a sandy bottom ecosystem of

- the Grand Banks of Newfoundland: analysis of trawl bycatch and effects on epifauna. Marine Ecology Progress Series (in press).
- Roache, J., D. May and G. Mellano. 1995. Proceedings of the Workshop on the Review of Groundfish Gear and Harvesting Technology. St. John's, Nfld., Dec. 13-15, 1994. Published by Department of Fisheries and Oceans, Fisheries Management and Industry Services Directorate, Fishing Industry Services Branch, Ottawa.
- Raloff, J. 1996. Fishing for answers. Deep trawls leave destruction in their wake- but for how long? Science News 150: 268-271.
- Robinson, R.F. and C.A. Richardson. 1998. The direct and indirect effects of suction dredging on a razor clam (*Ensis arcuatus*) population. ICES Journal of Marine Science 55: 970-977.
- Rowell, T.W., P. Schwinghamer, M. Chin-Yee, K. Gilkinson, D.C. Gordon, Jr., E. Hartgers, M. Hawryluk, D.L. McKeown, J. Prena, D.P. Reimer, G. Sonnichsen, G. Steeves, W.P. Vass, R. Vine and P. Woo. 1997. Grand Banks otter trawling experiment: III. Sampling equipment, experimental design and methodology. Canadian Technical Report of Fisheries and Aquatic Sciences 2190: viii + 36 p.
- Rumohr, H., and P. Krost. 1991. Experimental evidence of damage to benthos by bottom trawling with special reference to *Arctica islandica*. Meeresforsch 33: 340-345.
- Sahrage, D. and J. Lundbeck. 1992. A History of Fishing. Springer-Verlag, Berlin.
- Schwinghamer, P., J.Y. Guigné and W.C. Siu. 1996. Quantifying the impact of trawling on benthic habitat structure using high resolution acoustics and chaos theory. Canadian Journal of Fisheries and Aquatic Sciences 53: 288-296.
- Schwinghamer, P., D.C. Gordon, Jr., T.W. Rowell, J. Prena, D.L. McKeown, G. Sonnichsen and J.Y. Guigné. 1998. Effect of experimental otter trawling on surficial sediment properties of a sandy bottom ecosystem on the Grand Banks of Newfoundland.

- Conservation Biology 12: 1215-1222.
- Serchuk, F.M. and S.A. Murawski. 1997. The offshore molluscan resources of the northeastern coast of the United States: Surf clams, Ocean quahogs, and sea scallops. Pp. 45-62. In: MacKenzie, Jr., C.L., V.G. Burrell, Jr., A. Rosenfield and W.L. Hobart (eds.). The History, Condition, and Future of the Molluscan Fisheries of North and Central America and Europe. Volume 1, Atlantic and Gulf Coasts. NOAA Technical Report NMFS 127, September 1997.
- Service, M. and B.H. Magorrian. 1997. The extent and temporal variation of disturbance to epibenthic communities in Strangford Lough, Northern Ireland. *Journal of the Marine Biological Association of the United Kingdom* 77: 1151-1164.
- Shepard, A.N. and P.J. Auster, 1991. Incidental (non-capture) damage to scallops caused by dragging on rock and sand substrates. Pp. 219-230. In: An international compendium of scallop biology and culture. Selected papers from the 7th International Pectinid Workshop, World Aquaculture Society, Baton Rouge, La.,
- Stitt, S. 1994. The Canadian Report of the 1994 International Consultation for the Code of Conduct for Responsible Fishing. June 6-11, 1994, Sidney, British Columbia. Prepared for Fishing Industry Services, Fisheries Operations, Ottawa.
- Steimle, F.W. 1990. Benthic macrofauna and habitat monitoring on the continental shelf of the northeastern United States. I. Biomass. NOAA Technical Report NMFS 86. U.S. Department of Commerce, Springfield, VA.
- Theroux, R.B. and R.L. Wigley. 1983. Distribution and abundance of east coast bivalve molluscs based on specimens in the National Marine Fisheries Service Woods Hole Collection. NOAA Technical Report NMFS SSRF-768.
- Tuck, I.D., S.J. Hall, M.R. Robertson, E. Armstrong and D.J. Basford. 1998. Effects of physical trawling disturbance in a previously unfished sheltered Scottish sea loch.

Marine Ecology Progress Series 162: 227-242.

- Van Dolah, R.F., P.H. Wendt and M.V. Levisen. 1991. A study of the effects of shrimp trawling on benthic communities in two South Carolina sounds. *Fisheries Research* 12: 139-156.
- Watling, L. and E.A. Norse. 1998. Disturbance of the seabed by mobile fishing gear: a comparison with forest clearcutting. *Conservation Biology* 12: 1180-1197.
- West, B. 1987. 1986 Bering Sea Trawling Impact Project. Pp. 626-631. In: *Oceans '87 Conference Proceedings*, Marine Technology Society, IEEE Publishing Services, New York.
- Witbaard R., and R. Klein, 1994. Long-term trends on the effects of the southern North Sea beam trawl fishery on the bivalve mollusc *Arctica islandica* L. (Mollusca, bivalvia). *ICES Journal of Marine Science* 51: 99-105.

Table 1.1. Environmental impacts attributed to otter trawling in Atlantic Canada.

Impact	Source
Organism/Population	
- incidental mortalities from otter boards and, to a lesser extent, groundgear ¹	Aquaprojects Inc., 1994 FRCC, 1994
- displacement of individuals from their habitats	FRCC, 1994
- loss of species that provide food or shelter	FRCC, 1994
Habitat	
- physical disturbance including:	
(i) marks on seabed after gear passage ¹	FRCC, 1994
(ii) door furrows:	
- to 8-10 cm depth on soft bottom	Aquaprojects Inc., 1994
- to 30 cm depth on soft bottom	Jenner <i>et al.</i> , 1991
- to 20 cm on gravel bottom	Canadian Fishery Consultants Ltd., 1994
(iii) resuspended sediment- adverse effects on some organisms? Beneficial effects through nutrient release?	FRCC, 1997; Canadian Fishery Consultants Ltd., 1994
(iv) changes in sediment grain size, texture, porosity, chemical exchanges and oxygen penetration	Aquaprojects Inc., 1994; FRCC, 1994; Harrison <i>et al.</i> , 1991

¹- confirmed impacts

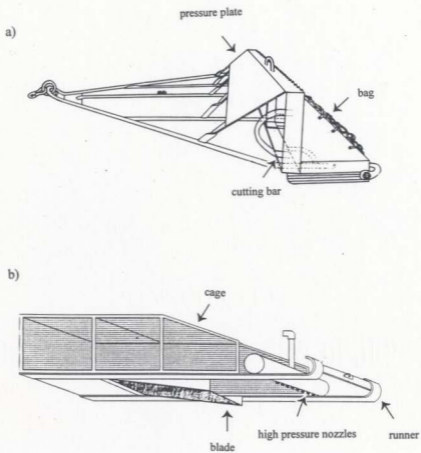

Figure 1.1. Representative dry and hydraulic dredge designs. a) Lunenburg style scallop dredge. b) Hydraulic clam dredge (taken from Messieh et al., 1991).

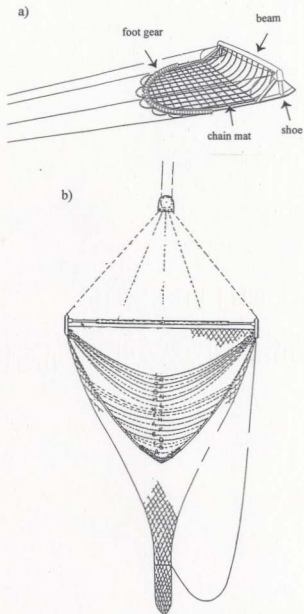

Figure 1.2. Variations of the Dutch beam trawl design. a) Closed or chain mat gear. b) Plan view of open gear, A-K=net tickler chains (14-20 mm diam.), L-S=tickler chains (18-22 mm diam.)(taken from Polet et al., 1994 and Gorman, 1992).

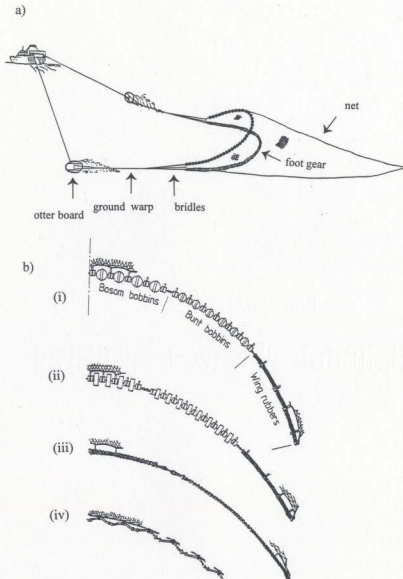

Figure 1.3. Otter trawl gear components that make contact with the seabed. a) Typical orientation of gear during fishing operations. b) Types of footgear used with otter trawls in Atlantic Canada (i) steel spherical bobbins on wire (ii) rubber bobbins on wire (iii) rope-rounded wire (iv) lead weight fibre rope (taken from Canadian Fishery Consultants Ltd., 1994).

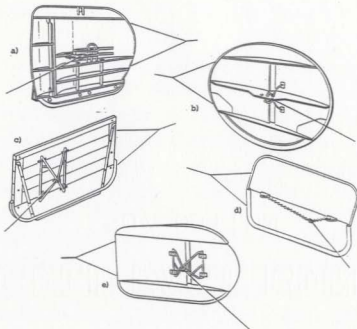

Figure 1.4. Otter board designs used in Atlantic Canada. a) Bison b) Oval c) Rectangular wood d) Vee e) Portuguese (taken from Canadian Fishery Consultants Ltd., 1994).

Chapter 2

Invertebrate Bycatch of Otter Trawls

2.1 Introduction

There are two broad categories of impacts on benthos caused by mobile bottom fishing gears: (i) capture and, (ii) collateral or incidental. Incidental impacts include all direct and indirect impacts to non-harvested organisms and habitat caused by passage of the gear over the seabed. This chapter deals with capture related impacts while Chapter 3 addresses incidental impacts. In its simplest form, bycatch is the capture of non-target organisms. Bycatch can be classified according to species, size and live or dead status of discards (Hall, 1996).

Debates over bycatch issues continue to focus on ways of reducing capture rates of commercial or recreational species, most often fish (Kennelly et al., 1997). In recent years, there has been increasing concern over the incidental capture of sea turtles, birds and marine mammals with a variety of gear types (Dayton et al., 1995; Baxter and Kaynor, 1997). Because of the high profile nature of this bycatch, bottom trawl fisheries have introduced bycatch reduction devices for these species (Robins, 1997; Rogers et al., 1997). Otter trawls used in groundfish, prawn and shrimp fisheries have the capacity to capture large quantities and a wide diversity of benthic invertebrates (Wassenberg and Hill, 1987, 1990; Hutchings, 1990; Andrew and Pepperell, 1992; Kennelly, 1995; Philppart, 1996). The invertebrate bycatch in these fisheries often is a large proportion (or significantly larger) of the total catch of the target organisms (Jennings and Kaiser, in press). For instance, in the North Sea sole fisheries prosecuted with beam trawls, every kg of marketable sole may yield up to 6 kg of discarded invertebrates (de Groot and Lindeboom, 1994). Most invertebrate bycatch is considered a nuisance or inconvenience by fishers.

Potential impacts related to removal of benthos in mobile bottom fisheries include:

(i) habitat modification through removal of large, emergent epifauna (e.g. sponges), (ii) changes to benthic community structure, (iii) changes in size and/or age distributions of benthic populations and, (iv) changes in ecosystem trophic relationships as a consequence of the capture and re-distribution (through discard) of large quantities of benthos.

Few studies have addressed any of the above impacts although the significance of discards (including benthos) in the diet and to the breeding success of seabirds has been studied (Blaber, 1995; Oro, 1995). Most of what is known concerning bycatch impacts associated with demersal fisheries relates to species-specific capture rates and mortalities.

2.1.1 Purpose of study

The primary objectives of the study were to quantify capture rates of benthic invertebrates by groundfish otter trawls and to determine the role of commercial otter trawling in the capture of bivalves on the Grand Banks. The invertebrate bycatch was quantified from two types of survey otter trawl that differed in footgear specifications and net mesh sizes. Survey trawls are representative of the types of trawls used in the commercial fisheries on the Grand Banks (see section 2.5). This was supplemented with limited data on commercial otter trawl capture rates of Iceland scallops (*Chlamys islandica*) collected in the Fisheries Observer Program.

2.2 Literature review

Much of the bycatch literature can be classified as 'bycatches of unknown level' since basic data on abundance and/or mortality is lacking (Hall, 1996). While the quantification of bycatch is the first step in assessing impacts, characterization of the bycatch in commercial fisheries is rare (Kennelly, 1995; Hall, 1996). Most of our understanding about invertebrate bycatch from mobile bottom gears comes from impact experiments and fisheries surveys,

primarily with beam trawls and shrimp (or prawn) otter trawls. There are few records of groundfish otter trawl invertebrate bycatch. Snow crabs (*Chionocetes opilio*), basket stars (*Gorgonocephalus arcticus*) and sea urchins (*Strongylocentrotus pallidus*) were the most common invertebrate bycatch in the otter trawl used in the Fisheries and Oceans otter trawling impact experiment (Prena et al., in press). The sampling protocol for Fisheries and Oceans groundfish surveys on the Grand Banks does not include the partitioning of the invertebrates by taxa. These are recorded as total pooled invertebrate biomass per trawl set. One reason for this is a time constraint for processing the fish catch, which has the highest priority. The Fisheries Observer Program is designed to monitor offshore commercial fishing activities. While there has been some characterization of a portion of the invertebrate bycatch of commercial otter trawls, levels of taxonomic identification depend on the invertebrate group (D. Kulka, Fisheries and Oceans, St. John's, pers. comm.).

Molluscs are captured incidentally in otter trawl fisheries. Allen (1965) compiled a record of capture of molluscs in the Northwest Atlantic, obtained from Canadian Fisheries Research vessels over the period 1946 to 1961. A total of 20 species of gastropods and 25 species of bivalves were collected using primarily commercial groundfish and shrimp otter trawls with an inserted small mesh (25 mm) liner. This qualitative data (there is no mention of capture rates) indicates those species that are susceptible to capture. Fariña and Pereiro (1995) captured 13 species of epibenthic gastropods (primarily buccinids) and no bivalves, using a Spanish 'Baca' bottom trawl.

A common feature of both otter and beam trawls is a tendency to capture primarily large epibenthic invertebrates, including echinoderms, crabs and large sessile, colonial organisms (Bridger, 1970; Creutzberg et al. 1987; Wassenberg and Hill, 1989, 1990; Hutchings, 1990; McAllister and Spiller, 1994; Fariña and Pereiro, 1995). The exception to this is beam trawls, which capture greater quantities of shallow burrowing bivalves due to the excavating action of the tickler chains (Fonds, 1994a). Based on long-term capture

records (1945-1983) in the southeastern North Sea, Philppart (1996) recorded ten-fold higher capture rates with a beam trawl compared to an otter trawl. The fact that otter trawls modified with tickler chains are used in the Brazilian scallop (*Pecten ziczac*) fishery (Pezzuto and Borzone, 1997) indicates that tickler chains make certain benthos more susceptible to capture by bottom trawls. Bridger (1970) recorded a ten-fold increase in the quantity of benthos in the bycatch of an otter trawl when a heavy tickler chain was used compared to a net without a chain. Otter trawls used in the Australian commercial prawn fisheries employ relatively light gear, often consisting of c. 8-mm wire footrope and flat otter boards approximately 0.6 to 1.5 m² in area. The efficiency of prawn trawling is enhanced by having the gear skim lightly over the surface of the seabed (Gibbs et al., 1980) and as a result, prawn trawl gear captures primarily large epibenthic invertebrates such as crabs and echinoderms (Wassenberg and Hill, 1989,1990).

There is limited information on invertebrate taxa that are likely to survive capture and discard from bottom trawls. Much of the work that has been done pertains to beam trawls and prawn trawls in European and Australian waters. In terms of molluscs, Fonds (1994b) recorded low mortalities for gastropods with round, strong shells, including *Buccinum*, *Neptunea* and *Natica* spp. In contrast, the large bivalves *Arctica islandica* and *Maetra corallina* showed high mortalities (85%), a result of shell breakage from tickler chains. Using similar gear, Kaiser and Spencer (1995) also recorded high survival (100%) for whelks and the thick-shelled scallop, *Pecten maximus*, whereas the thinner shelled queen scallop, *Aequipecten opercularis*, was slightly more susceptible (10% mortality). While comparative studies are lacking, it is probable that survival of invertebrates captured by otter trawl is higher than it is with beam trawls because the former use neither chain mats nor tickler chains (at least in the NW Atlantic). These gear components are implicated as the chief cause of most of the physical damage and associated mortalities in beam trawl fisheries (Fonds, 1994b; Kaiser and Spencer, 1995). A high proportion of gastropods captured by

groundfish otter trawls on the Grand Banks show little evidence of damage (pers. obs.).

One objective of bycatch management is to retain the basic structure and functioning of ecosystems, although in practice only the most obvious cases of habitat destruction or massive removal of species are usually considered as having an impact (Hall, 1996). Most, if not all demersal fisheries are conducted with unregulated removals of large quantities of benthic invertebrates. For instance, Warner (1977) cites an instance of a commercial otter trawl on the Grand Banks registering a bycatch of approximately 5 tons of sea cucumbers in a single tow. The removal or re-distribution of large quantities of benthos falls under the general category of 'cascading food web effects' on surface, midwater and benthic predators and scavengers (Kennelly, 1995).

One of the few studies to show a negative impact resulting from the removal of large epibenthos was Sainsbury's (1991) study of the relationship between (i) the northwest Australian Shelf trawl fishery, (ii) epibenthic habitats and (iii) a nearby fish trap fishery. Sainsbury concluded that changes in habitat, largely the result of removal of large epibenthos including sponges, alcyonarians and gorgonians, could be attributed to commercial bottom trawling activity, which in turn had a negative impact on two fish species targeted by a nearby commercial trap fishery. Based on underwater photography, commercial trap species were more likely to occur in habitat with large epibenthos that was largely absent on trawling grounds.

2.3 Overview of spatial patterns of commercial otter trawling on the Grand Banks

Otter trawling has had a long history on the Grand Banks dating back to its introduction by the French in 1907 (Blake, 1997). Up until the 1950s, otter trawling was conducted using side trawlers. In 1954 a new era was ushered in when the British introduced stern trawling and the first factory freezer trawler. Over the ensuing decades the 'distant

water fleets' of many nations harvested groundfish on the Grand Banks using otter trawlers (Warner, 1977; Blake, 1997). At the peak of world fish production in 1968, international fishing fleets were harvesting > 80% of the groundfish off Canada's east coast (Blake, 1997). On the Grand Banks, the three most important groundfish species have been: Atlantic cod (*Gadus morhua*), American plaice (*Hippoglossoides platessoides*) and Yellowtail flounder (*Limanda ferruginea*) (Kulka, 1991). A variety of sizes of side and stern trawlers prosecuted these fisheries including Newfoundland offshore stern trawlers (> 33 m in length) and larger trawlers (> 60 m) comprising the distant water fleets, primarily from the USSR, Poland, Portugal, Spain and Japan. In the early 1960's, factory freezer trawlers (> 90 m) from several nations (particularly Russia) made an appearance on the Grand Banks (Warner, 1977; Kingsley, 1972).

The main source of information used to extract patterns of commercial otter trawling activity on the Grand Banks has been Fishery Observer data (Newfoundland Observer Program). Beginning in 1980, and extending up to the time of the northern cod fishery moratorium in 1992, fisheries observers were stationed on a portion of the foreign and domestic fleets in order to record fishing operations. Kulka (1991) analysed spatial and temporal patterns of fishing intensity and consistency over an area of 100,000 km² encompassing potential oil fields on the northern Grand Banks. The minimum unit area used in the data analysis was 123 km². Several key findings of this analysis contribute to our understanding of recent patterns of trawling activity on the Grand Banks. Cod-directed otter trawling activity occurred over an area of 31,400 km². Within this area, high intensity trawling (i.e. high numbers of sets) occurred along the northeast slope and over an area of mixed species grounds (i.e. cod and plaice), which was centred at 50°W (Fig. 2.1). The mixed fishery area covered c. 1500 km². Fishing effort for cod was highly spatially variable between years. Approximately 22% of the entire cod grounds was fished in any given year.

In recent times, patterns of otter trawling activity have been governed by numerous

factors including patterns of movement of the key species, restricted access to fishing grounds for foreign fleets and quota allocations. After 1977, with the extension of the Canadian fishing exclusion zone to 200 miles, foreign trawlers were largely confined to areas outside the 200 mile limit. In terms of the above listed groundfish species this has meant intensive trawling in two main locations- the Tail and the Nose of the Bank. Even prior to the moratorium, the Tail of the Bank was a favoured flatfish fishing area of foreign trawlers although concentrations of the resource were known to be unpredictable (Kingsley, 1972).

Fisheries Observer Program trawl set location and duration data collected inside the 200 mile limit (1980-1991) were used to map patterns of 'trawl scouring' on the Grand Banks. The results of GIS SPANS™ analyses again revealed the spatial and temporal variability of trawling on the Grand Banks (Kulka and Schwinghamer, unpubl. data). A key finding was that since at least 1980, a very small proportion of the Grand Banks seabed has been scoured annually by commercial otter trawls. A large percentage of the Grand Banks seabed showed less than 8% disturbance (by area) on an annual basis. While the results provide an estimate of the proportion of the Grand Banks that is trawled annually, it does not provide information on frequency of trawling. Trawler operators have favoured locations which would lead to trawling consistency, however the spatial scales and intensities associated with these locations are unknown for the Grand Banks.

A secondary source of information on otter trawling activity is the practical experiences of trawler fishing captains. This information provides insight into favoured fishing locations, having high fishing consistency. Kingsley (1972) listed the northeast Grand Banks (probably upper slope depths), the Southeast Shoal to the Tail of the Bank, the southeast and southwest slopes of the Grand Banks and the area surrounding the Virgin Rocks, as fishing grounds particularly favoured by trawler captains (Fig. 2.1). As an example, Kingsley (1972) cites an aerial survey during which 80 foreign trawlers were

counted in the vicinity of the Virgin Rocks on one day. Prior to 1977 it was not unusual to observe up to 50 Russian factory freezer trawlers working the Tail of the Bank at any given time (Warner, 1977). However, the area of this trawling activity is not stated.

2.4 Otter trawl gear-seabed interaction

The composition of the invertebrate bycatch in bottom trawl fisheries is a function of the resident biological communities and their susceptibility to capture. Susceptibility to capture will be a function of gear configuration (e.g. type of footgear and height above-bottom of net opening), gear-seabed interaction, and net mesh size. The only direct evidence of gear components influencing bycatch originates from experiments performed with beam trawls equipped with tickler chains. The use of tickler chains, particularly increasing numbers of chains, results in increased catch rates of shallow burrowing species on sandy bottoms (Creutzberg et al., 1987). The components of an otter trawl that come into contact with the seabed for varying periods of time during trawling are: the otter boards, groundwarps or sweeps, lower bridles, footgear and portions of the net (Chap. 1, Fig. 1.3). The following sections focus on the role of various gear components in determining the invertebrate bycatch of otter trawls.

Otter boards

Otter board size is selected so as to be proportional to the size of the net. Trawlers operating on the Grand Banks tow large gear requiring large otter boards. The two most common otter boards used on the Grand Banks have been the rectangular and more recent oval designs (Fig. 2.2). Length and height of rectangular doors ranged from c. 2.7- 3.3 m and 1.2-1.5 m, respectively. The mass of individual doors ranged between 500 and 1000 kg. Rectangular boards were constructed of horizontal wood planking (ideally oak) reinforced

by a metal framework. Vertical stability was achieved by a steel keel (shoe) that was welded to the bottom of the door. Height and width of the shoe were approximately 5 cm by 12.5 cm. In order to correct for instability resulting from wear on the keel, it was common practice to weld additional strips of metal to the keel. This practice was also employed with oval doors and included the addition of lengths of iron reinforcing bar (rebar). Efforts to improve the efficiency of fishing gear led to the introduction of the oval shaped otter board in the late 1950's. Subsequently, these boards gained wide acceptance amongst fishing fleets. Early versions were constructed of wood-metal combinations, while more recent designs are made entirely of steel or polyvalent, the latter being a French innovation in the early 1970's. Due to their rounded edges, oval boards are less likely to dig into the sediment or snag projections or rocks. The steel shoes of large oval boards ($> 3.8 \text{ m}^2$) are typically ≥ 14 cm in width. Recent designs consist of sections (typically three) bolted to the trawl door proper, allowing for replacement of worn sections. Oval otter boards used with the largest trawls can be 17 m^2 and weight 4500 kg.

One other type of otter board used on the Grand Banks was favoured by the Japanese. These boards operated with the shortest edge in contact with the seabed (Fig. 2.2). This resulted in a very high aspect (i.e. high door height to door length ratio). The board was cambered and hydrofoil-like in appearance. This type of door was constructed of either wood/metal combinations or entirely steel. Dimensions of these boards ranged from 3 m to 4 m (height) and 1.5 m to 2.7 m (width) and they weighed between c. 800 kg and 3200 kg. The manganese steel shoes were typically in sections. The much larger Japanese trawl door was a reflection of the larger nets compared to North American trawls.

To maintain an optimum spread of the trawl, it is essential that there is maximum ground contact with the otter board (FAO, 1974). As an otter board moves over the seabed there is a resulting force that acts at right angles to the board. This otter board force is caused by both water flow (hydrodynamic force) and contact with the seabed (ground contact force).

While otter boards are generally regarded as the most destructive gear component of otter trawls (Arntz and Weber, 1972; Jenner et al., 1991; Aquaprojects, Inc., 1994), they probably play a minor role with respect to invertebrate bycatch. Most notably, the swept area of otter boards is small, relative to the net. Hydrodynamic forces, which should be able to resuspend smaller, lighter invertebrates, would have a larger sphere of influence. The small swept area is due to the length of the shoe in contact with the seabed combined with the angle of attack of the otter board (typically between 30-35°), which combines to produce a scour path width between c. 0.5 and 1.5 m. On sandy bottoms, spoil material is cast off on the inner edge of each otter board. This results in a linear concentration of excavated shallow infaunal organisms (Arntz and Weber, 1972; Rumohr and Krost, 1991). However, given that the door spread of large trawls is c. 60 m while wingspread is c. 20 m, these furrows lie outside the path of the net opening. However, this would not be the case when there are course changes, considerable lateral movement of the trawl, or repetitive trawling.

Ground warps and bridles

The various ground wires (i.e. ground warps, lower bridles) make occasional contact with the seabed. These wires or cables (c. 20-22 mm in diameter) vary in length according to trawl design. Very little is known about the interaction and behaviour of ground wires with the seabed. Based on trawl gear configuration and warp tension, it is likely that the primary action on sandy bottoms is surficial scouring. On soft mud however, the ground warps can dig deeply, to the point at which drag increases considerably (Wileman, 1980). Sections of ground wires close to the net may deflect larger epibenthos into the path of the trawl.

Footgear

The key gear components with respect to bycatch are the footgear and the net. The two main types of footgear used with otter trawls on the Grand Banks are rockhopper and bobbin. Bobbin footgear has had the longest history of use. Bobbins consist of a series of steel balls (35-53 cm diam.) separated by rubber and iron spacers. Bobbin size decreases progressing from the center or bosom section of the trawl to the sides. Centrally located bobbins roll freely over the seabed while those situated at the sides (i.e. on the arc) are dragged sideways. The fishing line connects the lower net panels (via the bolsh line) to the footgear by a series of toggle chains. Height of the fishing line above bottom, and therefore height of the net opening, can be adjusted to suit the target species. The height of the net opening above the seabed ranges between approximately 20 and 40 cm. When flatfish are the target species, the net opening is often adjusted closer to the bottom than it is for cod. Given this configuration, large epibenthic invertebrates should be most susceptible to capture. The spacing between bobbins (c. 40 cm) probably results in much of the benthos passing through the footgear and under the net.

Seabed topography plays an important role in bycatch. On level sand bottoms most captured invertebrates are relatively large and epifaunal, for instance sea urchins and basket stars. Occasionally, upon being directly hit by individual bobbins, certain non-attached invertebrates will be 'kicked-up' over the footgear into the net (pers. obs.). Based on observations of videos of otter trawls in operation, the elongate rubber spacers connecting bobbins may be primarily responsible for capturing benthos on seabeds sculpted with megaripples. On this type of bottom the spacers are observed to periodically scour the sediment along crests as bobbins cross over sand crests or travel along troughs (pers. obs.). The spacers can shear off sessile, stalked taxa or flip invertebrates into the mouth of the trawl where they land in the belly section of the net just behind the fishing line. Likely, here they remain until the trawl is hauled whereupon organisms larger than maximum mesh size end

up in the codend or become caught in the mesh along the sides.

In recent years, rockhopper footgear has gradually replaced bobbins on otter trawls due to better performance on rocky bottoms. Rockhopper footgear consists of sets of rubber discs (old tire material) (c. 35-45 cm diam.) separated by iron and rubber spacers. The rubber discs are compressed together providing spring upon impact with cobbles and boulders. Unlike bobbins, discs are dragged through unconsolidated sediments, as they are fixed in place by a chain that passes through the tops of the discs.

Net

The body of an otter trawl consists of a series of net panels connected by framing rope. The net is constructed from synthetic materials, typically polyethylene or polyamide twine. Net mesh size decreases progressing from the wings to the codend. The extent of the net that is in contact with the seabed is a function of net fullness (i.e. size of catch). Towing speed and details of gear configuration will also be factors. The section of net in contact with the seabed scours or scrapes the seabed surface (Bridger, 1970). Organisms smaller than the net mesh size may pass through the belly of the trawl as it scrapes the seabed, and become entrained with the rest of the catch.

2.5 Survey trawl descriptions

Otter trawls have been used by DFO since 1971 to collect information on the distribution and abundance of demersal fishes. Survey trawls were selected based on commercial trawls commonly used at the time (McCallum and Walsh, 1996). The main distinction between survey trawls and commercial trawls is the minimum mesh size. The minimum mesh size allowed in commercial trawls is 130 mm while survey trawls use codend liners of varying mesh sizes (12-30 mm) in order to sample juveniles. Commercial trawls

can also be larger, reflecting vessel size and horsepower.

In the present study, two types of DFO survey otter trawls in use at the time were the Campelen 1800 and the Engel 145. These two trawl types were selected for bycatch assessment because they differed in both type of footgear and net mesh size. Key technical aspects of these trawls are discussed below while detailed specifications can be found in McCallum and Walsh (1996).

2.5.1 Engel 145 Hi-Lift trawl

The Engel is a relatively old-style commercial otter trawl and until recently was the standard groundfish survey trawl in the Newfoundland region. The Engel trawl was equipped with steel bobbin footgear with individual bobbins ranging in diameter from 53 cm (bosom section) to 35 cm (Fig. 2.3). The total mass of the footgear was 2350 kg. Otter boards used with this trawl were oval, single slot, with a surface area and mass of 3.8 m² and 1250 kg. Otter boards used with the Engel trawl are slightly smaller than those used with the Campelen trawl, reflecting the smaller net relative to the Campelen. Lower net panel mesh size varied from 180 mm in the wing sections to 130 mm at the codend. A codend liner with a 30 mm mesh size distinguished this trawl from commercial otter trawls (Fig. 2.4a).

For both Engel and Campelen trawls, door spread (the distance between the two otter boards) ranges between 60 and 75 m. The extent of the seabed passed over by the mouth of the trawl corresponds more or less to net wingspread and ranges between 17 and 22 m.

2.5.2 Campelen 1800 trawl

The Campelen 1800 is a small mesh otter trawl that was adopted by DFO in 1992 specifically for juvenile fish surveys. In 1995 the Campelen trawl became the standard DFO groundfish survey trawl, replacing the Engel. The Campelen trawl is equipped with Rockhopper footgear, consisting of a series of 35 cm diameter rubber disks (Fig. 2.5). The

total mass of the footgear was 501 kg. At the time of the bycatch assessment in 1992, 4.3 m² (1400 kg) oval, polyvalent trawl doors were used. Net mesh size varied from 80 mm in the wings to 44 mm in the codend, with a 12.7 mm codend liner (Fig. 2.4b).

2.6 Trawling stations

Invertebrate bycatch was quantified during two routine DFO groundfish surveys conducted over large areas of the northeast Newfoundland shelf and Grand Banks with the 50 m stern trawler *Wilfred Templeman* (WT). Bycatch was quantified from the Campelen 1800 trawl during WT Trip 131, December 2-17, 1992. On this trip, the primary DFO objective was to survey the distribution and abundance of juvenile cod along transects extending from bays along the northeast Newfoundland coast to the edge of the continental shelf. Invertebrate bycatch was quantified from a total of 26 sets, representing a wide range of depths and geographic locations. Set details are given in Appendix 2.1.

Invertebrate bycatch was quantified for the Engel 145 from a total of 52 sets during WT Trip 138, May 24 -June 10, 1993. This trip was a routine offshore groundfish survey with trawl sets distributed randomly in strata throughout NAFO region 3L (i.e. north of 46°). Set details are given in Appendix 2.2.

2.7 Quantification of bycatch

Regardless of the type of trawl used, standard procedures are followed to process the catch. At the time when these bycatch assessments were conducted, individual tows (i.e. sets) were of 30 minutes duration at a vessel speed of approximately 3 knots. At the end of each tow, the trawl was hauled back and the entire catch dumped and washed down a chute to a conveyor belt in the wet lab below-decks. The following protocols were used to process

the invertebrates. All large and uncommon invertebrate taxa were enumerated and wet weighed. Typically, these included crabs, basket stars, sponges, anemones and tunicates. All molluscs were identified and enumerated for both Campelen and Engel trawls. Due to logistic constraints, wet weights were obtained for just the Engel trawl bycatch. Bivalve and gastropod shell lengths and heights, respectively, were recorded for the Campelen trawl bycatch.

Once all molluscs and large and uncommon invertebrates were removed, total numbers and weights of the remaining invertebrates were estimated by subsampling. Remaining invertebrates comprised a mix of the more abundant species including shrimp, sea urchins, brittlestars, and (for certain sets), mudstars. After dumping and washing, these taxa were judged to be fairly evenly mixed on the conveyor belt. A 1 kg subsample of this mix was randomly collected and all taxa enumerated and weighed. The entire mix was then weighed. Subsample weights and numbers were multiplied by the total weight of the invertebrate mix to obtain estimates of total set weights and numbers by taxa.

2.8 Grab sample collections

Populations of molluscs at the offshore study site were sampled using a 0.5 m² hydraulic grab sampler. The minimum size of bivalves retained was 1 mm based on a 1 mm mesh sieve size. Size frequency distributions of bivalves and gastropods collected by grab were compared with size frequency distributions of trawl caught molluscs in order to examine trawl capture size selectivity. Only those species captured by the trawls were used in the comparisons.

2.9 Results and discussion

2.9.1 Abundance and biomass of invertebrate bycatch

2.9.1.1 Campelen

A total of 18 bivalves, comprising 7 species, were captured over 26 sets (Table 2.1).

Mean (\pm sd) capture rate was 0.7 ± 1.7 bivalves per set (Fig. 2.6a). With one exception, all captured bivalves in the present study were either epifaunal or shallow burrowers. A large *Macoma calcareo* (34 mm) would normally be buried at a depth of several centimetres. The Iceland scallop, *Chlamys islandica*, comprised 61% of the total bivalve catch. This epifaunal species occurs on coarse substrata on the Grand Banks where it attaches by byssus to pebbles and cobble, (Gilkinson and Gagnon, 1991). Allen's (1965) data revealed that this was the most commonly caught mollusc with groundfish and shrimp trawls in the Northwest Atlantic.

2.9.1.2 Engel 145

A total of 53 bivalves were captured over 52 sets with a mean capture rate of 1.0 ± 2.4 bivalves per set (Fig. 2.6b). Bivalve species composition was *C. islandica* (49%), *A. crenata* (47%) and *C. ciliatum* (4%). Mean (\pm sd) bivalve biomass per set was 26.8 ± 126.1 g (Fig. 2.6c). In contrast, mean biomass per set of all other invertebrates combined was 4.7 ± 7.7 kg.

2.9.2 Mollusc size distributions: Campelen 1800

Size frequency distributions of captured molluscs are shown in Figure 2.7. Bivalves ranged in size from 7.5 mm (*Musculus niger*) to 77 mm (*C. islandica*) (Fig. 2.7a). Mean shell height of captured *C. islandica* was 47.9 ± 13.9 mm. A large size range of gastropods were captured, including a 122 mm *Colus islandicus* (Fig. 2.7b). Table 2.2 lists mean sizes, by species, of a subsample (105 out of 183 specimens) of the gastropod bycatch. Whelks (Buccinidae) comprised 50.5% of all captured gastropods. This is a diverse family of large epibenthic gastropods that are widespread on the Grand Banks. The relatively small (< 25 mm) top shell, *Margarites sordidus*, comprised 41% of the gastropod bycatch.

Size frequency distributions of populations of bivalves and gastropods, collected by

hydraulic grab (0.5 m²) at reference stations in the offshore experimental trawling study area (1993-1995), are shown in Figure 2.7c,d. The major difference between size frequency distributions of trawl-caught specimens and natural populations on the northeastern Grand Bank, was the absence of small (< 7.5 mm) specimens in the trawl bycatch even though this is the dominant size group for both bivalves and gastropods. It is not known whether the differences in size frequency distribution apply outside the experimental area.

2.9.3 Factors determining the susceptibility of bivalves to capture by otter trawl

The capture rates of bivalves (approximately one per set) for both types of otter trawl were very low. Similarly, low capture rates were recorded for Iceland scallops and several other bivalve species with the Engel 145 trawl in the DFO experimental trawling study (Prena et. al., in press.) which was conducted after the present study. When trawl swept area is factored in, it is evident that otter trawls equipped with large footgear are very inefficient at capturing bivalves. Swept area is the area of seabed which is passed over by the mouth of the trawl and is approximately equal to wingspread (m) x tow (i.e. set) distance (m). The swept area per trawl set was approximately 5.5×10^5 m² for both types of otter trawl. The average density of shallow burrowing bivalves on the Grand Banks, of a size greater than the minimum mesh size of either trawl (i.e. > 3 cm), is conservatively placed at 2 m⁻² (unpublished data). Multiplying this number by trawl set swept area translates to one bivalve captured for every 10^5 bivalves encountered (i.e. passed over) by the trawl. This translates to a capture or trawl net efficiency (*sensu* Dickson, 1988) of 10^{-5} . This efficiency might be expected to rise when the trawl is traversing scallop beds.

In terms of their efficiency in capturing benthos, otter trawls used for harvesting groundfish and shrimp in the Northwest Atlantic are probably intermediate between beam trawls (highest) and prawn trawls, the latter typically skimming the bottom with relatively light footgear. In contrast, beam trawls capture infaunal organisms as well as epibenthos.

With respect to bivalves, Fonds (1994a) recorded beam trawl capture rates of greater than 10 specimens per set for the bivalves *Arctica islandica* and *Acanthocardia echinata*, and as high as 25,300 specimens of *Spisula* after 7 sets with the latter figure based upon a total swept area of $7 \times 10^4 \text{ m}^2$. An explanation for such high capture rates for this species is not given.

Unlike the situation with fish, the majority of benthos have limited mobility and trawl avoidance is not a factor. Capture of benthos by otter trawls can occur in one of two ways: (i) entering the net over the footgear, or (ii) entering the net through the mesh of the belly of the trawl. In order for capture to occur, material must be retained after passing into the net proper. In all likelihood, the majority of invertebrates pass under or between the footgear and never enter the net. Although the estimated escape area between individual bobbins of the Engel is large (136- 500 cm^2) relative to the size of bivalves (Walsh, 1992), the critical factor is probably the vertical distance from the seabed to the net opening. This distance is determined by the height of the footgear. A general rule-of-thumb is that the distance above the seabed of the net opening is half the height of the footgear (D. Cranford, Fishing Skipper on the DFO MV *Teleost*, St. John's). For the trawls used in the present study, this distance is approximately 20-25 cm. Therefore, it is not surprising that benthos are poorly represented in the bycatch of these trawls.

Excluding shrimp, the most abundant taxa in the bycatch of the two types of otter trawl were relatively large epibenthos, particularly crabs and sea urchins. The greater representation of epifaunal species in the bycatch relative to infaunal species, was also seen with the molluscs. The proportions of gastropods to bivalves in the bycatch of the Campelen and Engel trawls were c. 10:1 and 3:1, respectively. A high proportion (50%) of the gastropod bycatch comprised epibenthic whelks while the majority of captured bivalves were the epibenthic Iceland scallop. The greater numbers of captured gastropods is a reflection of their widespread distribution, large-scale numerical dominance amongst epibenthic

molluscs on the Grand Banks, and their higher susceptibility to capture. With the exception of Iceland scallops, the great majority of bivalves on the Grand Banks are infaunal. Overall, it is seen that important criteria for capture by otter trawl are an epibenthic habit and large size. However, it is noted that many captured bivalves and gastropods were smaller than the minimum mesh size, with the exception of the codend liner. For instance, the relatively small trochid gastropod, *M. sordidus* (16 mm mean shell height), accounted for 41% of the subsample of gastropods. Possibly, this indicates that these small specimens are retained in the trawl after becoming mixed with the remainder of the catch. In the case of the relatively small bivalve, *Astarte crenata*, most captured specimens were < 20 mm shell length. The majority of these were associated with masses of polychaete tubes or were partially encased in sponges which effectively increased their overall dimensions.

Fisheries surveys do not strictly match commercial fleet operations. Nonetheless, the results of the present study are considered to be representative of capture rates of bivalves in the commercial groundfish and shrimp otter trawl fisheries in the Northwest Atlantic. Capture rates of bivalves recorded in the present study may be higher than those for commercial trawls considering that the latter are not equipped with codend liners. However, this might be offset by the significantly longer tows typical of commercial operations.

The bottom type on fishing grounds is a factor in capture rates and catch composition. The great majority of bivalves living on sandy bottoms on the Grand Banks are infaunal and are at low risk to capture by otter trawl. On coarse bottom, the relatively large epibenthic Iceland scallop (*C. islandica*) is captured at higher rates than infaunal species on sand bottoms. In certain cases, this represents individuals byssally attached to rocks that are caught up in the net. For instance, bycatch of Iceland scallops up to 5-6 kg per fishing set have been reported for commercial otter trawl fisheries (D. Kulka, unpub. data). However, these occurrences are relatively uncommon. Over the course of a set, lasting between c. 1-3 hours, tens of scallops may be captured. On cobble fields where Iceland scallops are most

dense (1-3 m⁻², Gilkinson and Gagnon, 1991), this nonetheless represents a very low harvesting efficiency. Of far more concern is incidental damage to scallops from the trawl gear and the effects of sustained trawling over many years on populations of these long lived species.

Considering that there has been close to 40 years of trawling on the Grand Banks prior to this study, the argument could be made that the original benthic communities on trawling grounds have been altered. If this is the case, then it is possible that effects, i.e. capture rates, recorded in the present study are significantly lower than occurred in earlier periods. Although it is plausible that capture rates of large epibenthos (e.g. echinoderms and crabs) may once have been higher, reflecting higher standing stocks at the time when trawling first started, it is doubtful that this applies to infaunal bivalves which, regardless of size or taxa, would have low probabilities of capture. Alteration of original bivalve communities through non-capture related impacts is a possibility (see Chapter 6).

The low capture rates of bivalves recorded for the otter trawls used in this study can be attributed to the large size of the footgear and therefore, height of the net opening above the seabed, combined with relatively small sizes and infaunal habits of most bivalve species on the Grand Banks. It is concluded that the removal of bivalves as bycatch in commercial otter trawl fisheries on the Grand Banks has been insignificant. Iceland scallops, which are restricted to coarse substrata, are most susceptible to capture and show the highest capture rates. Incidental impacts to bivalves are of greater interest, particularly in those areas that have been subjected to high levels of trawling consistency and intensity.

2.10 Literature cited

- Allen, J.A. 1965. Records of molluscs from the Northwest Atlantic obtained by Canadian fishery research vessels, 1946-1961. *Journal of the Fisheries Research Board of Canada* 22(4):977-997.
- Andrew, N.L. and J.G. Pepperell. 1992. The by-catch of shrimp trawl fisheries. *Oceanography and Marine Biology an Annual Review* 30: 527-565.
- Aquaprojects Inc. 1994. Responsible harvesting practises. A discussion paper: Supplement to the Canadian Report of the 1994 FAO International Expert Consultation for the Code of Conduct for Responsible Fishing. Sidney, B.C., June 6-11, 1994. Prepared for Fisheries Operations, Fishing Industry Services, Department of Fisheries and Oceans.
- Arntz, W. and W. Weber. 1972. *Cyprina islandica* L. (Mollusca, Bivalvia) as food for cod and dab in Kiel Bay. Fisheries Research Board of Canada Translation Series No. 1985. Translated from Bericht der Deutschen Wissenschaftlichen Kommission für Meeresforschung 21(1-4): 193-209. (Copy available from the Northwest Atlantic Fisheries Centre library, St. John's, NF.)
- Baxter, B. and C. Kaynor. 1997. Fisheries Bycatch: Consequences and Management. Proceedings of the Symposium on the Consequences and Management of Fisheries Bycatch. August 27-28, 1996, Dearborn, Michigan. Alaska Sea Grant College Program.
- Blaber, S.J.M. 1995. Trawl discards in the diets of tropical seabirds of the northern Great Barrier Reef, Australia. *Marine Ecology Progress Series* 95(127):1-13.
- Blake, R.B. 1997. The international fishery off Canada's east coast in the 20th Century. P. 207-222. In: J.E. Candow and C. Corbin (eds.), *How Deep is the Ocean? Historical Essays on Canada's Atlantic Fishery*. University College of Cape Breton Press,

Sydney, N.S.

- Bridger, J.P. 1970. Some effects of the passage of a trawl over the seabed. ICES C.M. 1970/B:10
- Creutzberg, F., G.C. A. Duineveld and G.J. van Noort. 1987. The effect of different numbers of tickler chains on beam-trawl catches. *International Journal for Exploration of the Sea* 43: 159-168.
- Dayton, P.K., S.F. Thrush, M.T. Agardy and R. J. Hofman. 1995. Environmental effects of marine fishing. *Aquatic Conservation: Marine and Freshwater Ecosystems* 5: 205-232.
- de Groot, S.J. and H.J. Lindeboom. 1994. Environmental impact of bottom gears on benthic fauna in relation to natural resources management and protection of the North Sea. NIOZ-Rapport 1994-11, RIVO-DLO Report C026/94, Netherlands Institute for Sea Research.
- Dickson, W. 1988. Size selectivity of trawl gear in Arctic surveys. ICES, C.M. 1988/B:30, Copenhagen.
- FAO, 1974. Otter board design and performance. FAO Fishing Manuals.
- Fariña, A.C. and F.J. Pereiro. 1995. Distributions and abundance of molluscs and decapod crustaceans in trawl samples from the Galician Shelf (NW Spain). ICES Marine Science Symposium 199: 189-199.
- Fonds, M. 1994a. Catch composition of 12-m beam trawl and 4-m beam trawl for sole fishing. P. 95-130. In: de Groot, S.J. and H.J. Lindeboom (eds.), Environmental impact of bottom gears on benthic fauna in relation to natural resources management and protection of the North Sea. NIOZ-Rapport 1994-11, RIVO-DLO Report C026/94, Netherlands Institute for Sea Research.
- Fonds, M. 1994b. Mortality of fish and invertebrates in beam trawl catches and the survival chances of discards. P. 131-146. In: de Groot, S.J. and H.J. Lindeboom (eds.),

- Environmental impact of bottom gears on benthic fauna in relation to natural resources management and protection of the North Sea. NIOZ-Rapport 1994-11, RIVO-DLO Report C026/94, Netherlands Institute for Sea Research.
- Gilkinson, K.D. and J.-M. Gagnon. 1991. Substratum associations of natural populations of Iceland scallops, *Chlamys islandica*, Müller, 1776, on the northeastern Grand Bank of Newfoundland. *American Malacological Bulletin* 9(1):59-67.
- Gibbs, P.J., A.J. Collins and L.C. Collett. 1980. Effect of otter prawn trawling on the macrobenthos of a sandy substratum in a New South Wales estuary. *Australian Journal of Marine and Freshwater Research* 31:509-516.
- Hall, M.A. 1996. On bycatches. *Reviews in Fish Biology and Fisheries* 6:319-352.
- Hutchings, P. 1990. Review of the effects of trawling on macrobenthic epifaunal communities. *Australian Journal of Marine and Freshwater Research* 41:111-120.
- Jenner, K., K.W. Strong and P. Pocklington. 1991. A review of fishery related seabed disturbance in the Scotia-Fundy region. Fisheries and Oceans Industry Services and Native Fisheries Branch. Halifax, N.S. Report No. 166.
- Jennings, S. and M.J. Kaiser. 1998. The effects of fishing on marine ecosystems. *Advances in Marine Biology* 34: 201-352.
- Kaiser, M.J. and B.E. Spencer. 1995. Survival of bycatch from a beam trawl. *Marine Ecology Progress Series* 126:31-38.
- Kennelly, S.J. 1995. The issue of bycatch in Australia's demersal trawl fisheries. *Reviews in Fish Biology and Fisheries*. 5:213-234.
- Kennelly, S.J., S.C. Drew and C.D. Delano Gagnon. 1997. Rates of retained and discarded catches from demersal fish trawling off the north-eastern United States. *Marine and Freshwater Research* 48: 185-199.
- Kingsley, R.G. 1972. Otter boards and trawlers on the Grand Banks of Newfoundland. Report prepared for Imperial Oil Ltd. and Amoco Canada Petroleum Company

- Limited. St. John's, Newfoundland.
- Kulka, D.W. 1991. A description of fisheries in the vicinity of significant oil discovery areas off Newfoundland. Canadian Technical Report of Fisheries and Aquatic Sciences 1787.
- McAllister, D.E. and G. Spiller. 1994. Trawling and dredging impacts on fish habitat and bycatch. P. 1709-1718. In: Wells, P.G. and P.J. Ricketts (eds.). Coastal Zone Canada '94, Cooperation in the Coastal Zone. Conference Proceedings Vol. 4. Coastal Zone Canada Association, Dartmouth, N.S.
- McCallum, B.R. and S.J. Walsh. 1996. Groundfish survey trawls used at the Northwest Atlantic Fisheries Centre, 1971-present. Northwest Atlantic Fishery Organization (NAFO) Scientific Council Research Document 96/50.
- Oro, D. 1995. Effects of a trawling moratorium on the breeding success of the yellow-legged gull *Larus cachinnus*. IBIS 137:547-549.
- Philppart, C.J.M. 1996. Long-term impact of bottom fisheries on several bycatch species of demersal fish and benthic invertebrates in the southeastern North Sea. ICES Annual Science Conference. Mini-symposium: Ecosystem Effects of Fisheries. C.M. 1996/Min:6.
- Prena, J., P. Schwinghamer, T.W. Rowell, D.C. Gordon Jr., K.D. Gilkinson, W. P. Vass and D. L. McKeown. 1998. Experimental otter trawling on a sandy bottom ecosystem of the Grand Banks of Newfoundland: analysis of trawl bycatch and effects on epifauna. Marine Ecology Progress Series (in press).
- Robins, J. 1997. The adoption of bycatch reduction gear technology: a cook's tour. Fishing Boat World 13: 12-16.
- Rumohr, H. and P. Krost. 1991. Experimental evidence of damage to benthos by bottom trawling with special reference to *Arctica islandica*. Meeresforsch 33:340-345.
- Sainsbury, K.J. 1991. Application of an experimental approach to management of a tropical

- multispecies fishery with highly uncertain dynamics. ICES Marine Science Symposium 193:301-320.
- Walsh, S.J. 1992. Size-dependent selection at the footgear of a groundfish survey trawl. North American Journal of Fisheries Management 12:625-633.
- Warner, W.W. 1977. Distant Water: The Fate of the North Atlantic Fisherman. Little, Brown and Company, Boston.
- Wassenberg, J.J. and B.J. Hill. 1987. Feeding by the sand crab *Portunus pelagicus* on material discarded from prawn trawlers in Moreton Bay, Australia. Marine Biology 95:387-393.
- Wassenberg, J.J. and B.J. Hill. 1989. The effect of trawling and subsequent handling on the survival rates of the bycatch of prawn trawlers in Moreton Bay, Australia. Fisheries Research 7:99-110.
- Wassenberg, J.J. and B.J. Hill. 1990. Partitioning of material discarded from prawn trawlers in Moreton Bay. Australian Journal of Marine and Freshwater Research 41:27-36.
- Wileman, D.A. 1980. Project "oilfish" investigation of the resistance of trawl gear. Danish Institute of Fisheries Technology Report (copy available at the Northwest Atlantic Fisheries Centre Library).

Table 2.1. Mean shell length of bivalves captured by Campelen 1800 survey trawl (n = 26 sets).

Family	Species	#	Shell length, mm (mean \pm sd)
Astartidae	<i>Astarte cf. crenata</i>	1	15.0
Pectenidae	<i>Chlamys islandica</i>	11	47.9 \pm 13.9
Cardiidae	<i>Clinocardium ciliatum</i>	1	23.0
	<i>Serripes groenlandicus</i>	1	30.0
Tellinidae	<i>Macoma calcarea</i>	1	34.0
Mytilidae	<i>Musculus niger</i>	1	33.0
	<i>Musculus discors</i>	2	8.8 \pm 1.8

Table 2.2. Mean shell height of subsampled gastropods captured by Campelen 1800 survey trawl (n = 26 sets).

Family	Species	#	Shell height, mm (mean \pm sd)
Buccinidae	<i>Buccinum sp. A</i>	1	24.0
	<i>Buccinum sp.</i>	22	54.0 \pm 16.8
	Buccinidae	2	38.0 \pm 18.4
	<i>Colus islandica</i>	9	101.7 \pm 15.6
	<i>Colus sp.</i>	12	50.8 \pm 16.9
	<i>Neptunea decemcostata</i>	2	70.3 \pm 26.4
	<i>Plicifusus kroeyeri</i>	2	56.0 \pm 1.4
	<i>Volutopsius norvegica</i>	3	72.7 \pm 19.1
Trochidae	<i>Margarites sordidus</i>	43	16.3 \pm 3.0
Naticidae	<i>Natica clausa</i>	5	20.4 \pm 2.5
	Unidentified	4	19.3 \pm 0.9

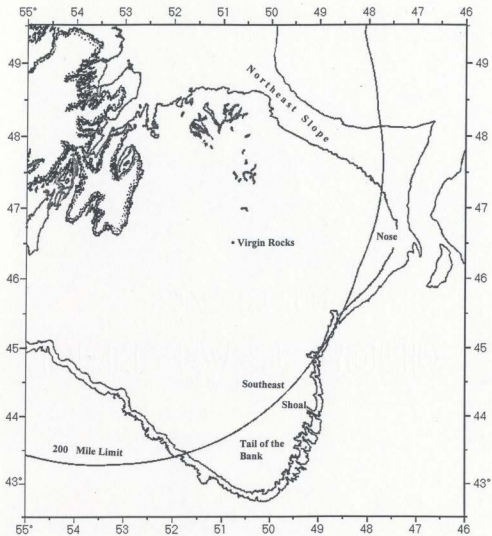

Figure 2.1. Areas of the Grand Banks referred to in the text.

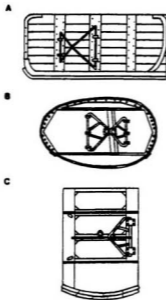

Figure 2.2. Otter board designs used on the Grand Banks. A- rectangular, B- oval, C- Japanese model.

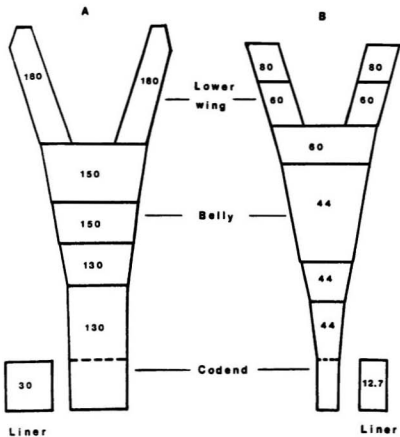

Figure 2.4. Net mesh sizes (mm) of the DFO survey otter trawls. A- Engel 145, B- Campelen 1800.

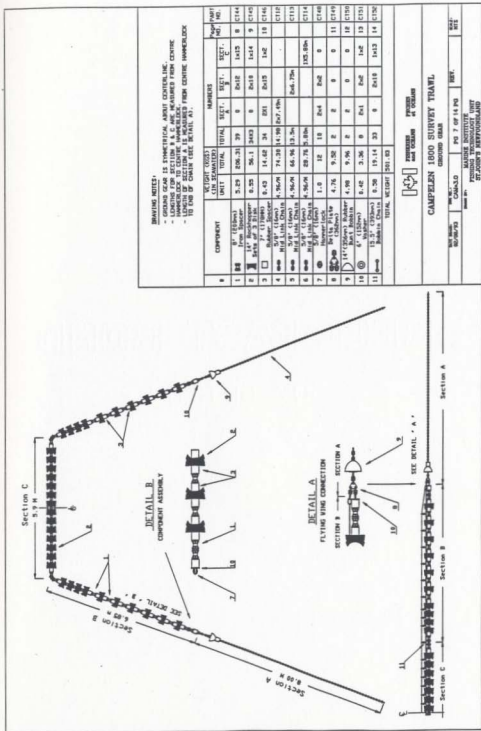

Figure 2.5. Footgear specifications for the Campelen 1800 survey trawl (from McCallum and Walsli, 1996).

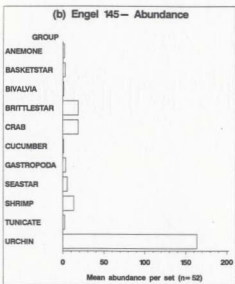
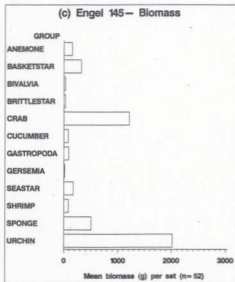
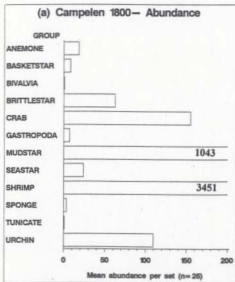

Figure 2.6 DFO survey otter trawls invertebrate bycatch.

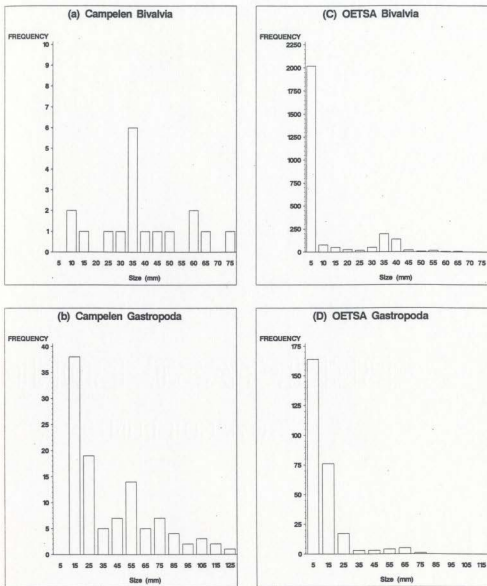

Figure 2.7. Size frequency distributions of Grand Banks molluscs. (a) Campelen trawl bivalve bycatch (b) Campelen trawl gastropod bycatch (c) bivalves collected at reference stations in the OETSA, 1993-95 (d) gastropods collected at reference stations in the OETSA, 1993-95.

Appendix 2.1. Bycatch stations set details: Campelen 1800 (WT 131)

Set #	Date m/d/yr	Depth (m)	Latitude	Longitude
5	03/12/92	97	47 30.0	49 35.8
7	03/12/92	209	47 43.3	48 34.5
8	04/12/92	181	47 43.7	52 52.2
9	04/12/92	76	47 31.2	53 04.5
10	04/12/92	94	47 47.5	53 05.9
12	05/12/92	325	48 11.7	52 58.5
15	05/12/92	133	48 28.2	51 27.5
16	05/12/92	207	48 37.8	50 50.0
17	06/12/92	116	47 59.5	53 32.8
19	06/12/92	127	47 40.5	53 38.9
21	07/12/92	144	48 18.8	53 20.0
22	07/12/92	105	48 38.2	52 53.5
25	08/12/92	366	49 26.5	51 03.8
26	08/12/92	347	49 40.1	50 21.8
28	08/12/92	405	50 11.8	50 37.9
32	09/12/92	428	49 37.6	52 47.5
33	09/12/92	280	49 01.8	53 16.0
34	09/12/92	324	48 54.1	53 12.1
37	10/12/92	60	49 31.8	54 06.0
38	10/12/92	315	50 13.6	53 29.8
42	11/12/92	261	51 19.7	50 44.6
54	13/12/92	189	50 28.8	56 03.7
55	13/12/92	161	50 02.4	56 40.1
59	14/12/92	376	49 47.1	55 15.6
60	14/12/92	200	49 34.6	55 03.7
65	15/12/92	637	48 50.5	49 55.9

Appendix 2.2. Bycatch stations set details: Engel 145 (WT 138)

Set #	Date m/d/yr	Depth (m)	Latitude	Longitude
32	28/05/93	94	45 50.5	53 24.4
33	28/05/93	134	46 05.7	53 13.9
34	28/05/93	156	46 18.4	52 53.1
35	28/05/93	83	46 11.4	52 24.5
42	29/05/93	103	46 58.0	51 18.0
43	29/05/93	91	46 49.3	51 04.0
44	29/05/93	101	46 54.8	50 58.7
54	30/05/93	78	46 56.4	49 08.1
56	30/05/93	86	47 06.6	49 01.0
57	30/05/93	115	47 10.4	48 54.5
58	30/05/93	131	47 14.6	48 32.4
66	31/05/93	64	46 19.9	48 55.0
67	31/05/93	86	46 01.1	48 35.1
68	31/05/93	97	46 08.1	48 25.2
72	01/06/93	120	46 22.0	47 55.1
73	01/06/93	122	46 16.2	47 55.3
74	01/06/93	201	46 09.7	47 41.8
75	01/06/93	214	46 14.9	47 34.4
76	01/06/93	629	46 12.2	47 19.2
84	02/06/93	196	46 57.2	47 36.3
85	02/06/93	176	47 01.1	47 45.9
86	02/06/93	172	47 06.1	47 50.9
87	02/06/93	405	47 02.5	47 17.3
88	02/06/93	317	47 12.3	47 18.8
94	03/06/93	321	47 44.4	47 33.7
95	03/06/93	322	47 40.2	47 28.6
106	04/06/93	241	47 46.6	48 14.3
107	04/06/93	255	47 51.5	48 25.9
108	04/06/93	212	47 51.3	48 51.2
109	04/06/93	175	47 40.3	48 50.2
110	04/06/93	139	47 26.7	48 51.3
117	05/06/93	106	47 35.4	50 01.4
118	05/06/93	116	47 30.0	50 21.5
119	05/06/93	120	47 41.0	50 22.5
120	05/06/93	117	47 43.3	50 30.7
127	06/06/93	163	48 21.1	50 31.7
128	06/06/93	162	48 06.5	50 16.9
129	06/06/93	211	48 11.7	49 49.0
130	06/06/93	213	48 07.3	49 30.1
137	07/06/93	225	48 28.0	49 57.4
138	07/06/93	237	48 35.1	49 58.9
139	07/06/93	443	48 46.8	49 56.2
140	07/06/93	680	48 49.3	49 52.2
141	07/06/93	317	48 44.9	49 59.9
149	08/06/93	660	49 09.1	50 00.3
150	08/06/93	330	49 13.8	50 35.8
152	08/06/93	289	48 56.3	50 57.1
158	09/06/93	302	49 12.3	52 39.7
159	09/06/93	358	48 52.3	52 20.0
160	09/06/93	250	48 41.5	52 24.7
161	09/06/93	240	48 36.5	52 17.9
162	09/06/93	301	48 43.4	52 06.3

Chapter 3

Effects of Experimental Otter Trawling on Infaunal Bivalves in a Sandy Bottom Ecosystem: Results of a Three-Year Field Trawling Experiment

3.1 Introduction

The otter trawl has been the primary mobile fishing gear used over the past 50 years on the continental shelf of Atlantic Canada (Messieh et al., 1991). Despite this, little is known about the environmental impacts associated with this type of gear. Messieh et al. (1991) reviewed current understanding of potential impacts while Churchill (1989) compared otter trawling and storm events as agents of sediment resuspension on continental shelves. Brylinsky et al. (1994) investigated the impacts of a small otter trawl on the intertidal habitat and communities in the Minas Basin of the Bay of Fundy. While observed impacts were minor, these results cannot be extrapolated to offshore fishing banks due to differences in environmental setting, benthic communities and size of gear. In the eastern Atlantic, there is evidence that otter trawls, and trawl doors specifically, damage infaunal bivalves and disturb surficial sediments (Arntz and Weber, 1972; Rumohr and Krost, 1991; Krost et al., 1990; Service and Magorrian, 1997; Tuck et al., 1998).

In 1990, the Department of Fisheries and Oceans (DFO), Newfoundland and Scotia-Fundy, initiated a multi-disciplinary investigation into the impacts of mobile bottom fishing gears on marine benthic habitat and communities of Atlantic Canada. Results presented in this chapter focus on impacts to infaunal bivalves and represents a component study of the overall investigation into impacts of otter trawling on the seabed at a site on the Grand Banks (1993-1995). Hereafter, this offshore site is referred to as the DFO offshore experimental trawling study area (OETSA). This study was initiated in 1992 as a collaborative effort between Newfoundland and Scotia-Fundy regions of DFO.

Bivalves are a dominant component of benthic invertebrate communities in the

Northwest Atlantic (Theroux and Wigley, 1983; Steimle, 1990). Many species are long-lived and therefore represent a significant sink for benthic biomass. Bivalves also play a role in nutrient recycling and have a direct role in benthic-pelagic coupling. Bivalves have long been exploited as fisheries resources on continental shelves (MacKenzie et al., 1997) and this has increased in certain areas including the Grand Banks. Bivalves in offshore regions are harvested by a variety of methods including scallop rakes and hydraulic dredges. In addition, bivalves are a bycatch and are damaged incidentally as non-target species by other mobile gear types such as beam trawls and otter trawls. These gear types inflict varying degrees of damage to benthos. Bivalves are particularly suitable as subjects to assess physical impacts of bottom fishing gears since they have limited mobility, occupy a wide depth range in the sediment and they leave records of physical damage on their shells.

Although generalizations about impacts from mobile fishing gear types are made, it becomes evident from the range of impacts reported for the various gear types, that it is important to consider impacts in the context of type of gear and sediment coarseness. The best way to determine the environmental impacts of mobile fishing gear is to conduct trawling experiments in areas that are closed to fishing with gear similar to that used in commercial fisheries. Until recently, partly due to a lack of adequate sampling gear and high resolution navigation, experiments in offshore deep water environments were not possible. In the present trawling experiment, sampling gear was developed specifically for offshore environments in the Northwest Atlantic. The experiment was conducted over a three-year period (1993-1995) with initial site selection and gear trials conducted in 1991 and 1992.

3.1.1 Study objectives

The overall objective of this study was to assess immediate (hours-days) and longer-term (weeks/two years) impacts of annual otter trawling on infaunal bivalves on a sandy seabed habitat on the northeastern Grand Banks. Specific objectives included tests of

hypotheses concerning impacts to bivalves (including equivocal impacts) that have been documented with other mobile gear types (see section 3.3).

3.2 Newfoundland and Labrador region bivalve fauna

The following discussion is restricted to the deeper water bivalve fauna of the continental shelf adjacent to Newfoundland and Labrador. This excludes species that are restricted to intertidal or shallow coastal waters. The discussion is restricted to key ecological factors that are pertinent to an analysis of susceptibility to trawling and is not a biogeographical treatment. The term 'offshore' is used in the context of areas fished with otter trawls and encompasses water depths generally > 50 m. The focus is on the southern portion of the Newfoundland shelf where the seabed topography is dominated by the Grand Banks (Fig. 3.1). The Grand Banks are the largest of three physiographic zones of the continental shelf off southern and eastern Newfoundland and represent an outer shelf archipelago of large, shallow banks that are interrupted by transverse saddles (Fader and Miller, 1986).

There have been few studies of the bivalve fauna of the Newfoundland-Labrador region. Species lists are lacking for much of the region. A species list of the bivalve fauna occurring in deep waters in the Newfoundland-Labrador region, including the Grand Banks, is given in Table 3.1. This list has been compiled from documented records or collections, and from presumed occurrence based on published species ranges. Out of a total of 76 species, 23 species (30% of the total bivalve fauna) are found in the OETSA, while 55% of the families have representatives in the OETSA. Marine benthos can be grossly classified according to life position: (i) epifaunal- living on the seabed (ii) infaunal- buried in the substratum and (iii) semi-infaunal- partly buried. A total of 55 species are classified as infaunal, 10 species are epifaunal and 11 species are considered capable of a variety of life

positions. After dividing these 11 species evenly between infaunal and epifaunal life positions (after Stanley, 1970), approximately 80% of the bivalve species in the Newfoundland-Labrador offshore region are infaunal while 20% are epifaunal. This conforms with Stanley's observation that regional bivalve faunas consist of between 75-85% infaunal and 15-25% epifaunal species, regardless of latitude.

Infaunal species can be classified according to burrowing depth, which is the distance from the sediment surface to the shallowest point of the shell of a buried bivalve. Species with burial depths (as adults) less than 2-3 cm are considered shallow burrowers while deep burrowers are those for which burial depth is greater than 3 cm (Stanley, 1970). Although species display characteristic burial regimes, burial depth is known to vary according to sediment type, size (i.e. age), feeding conditions and season (Trueman et al., 1966; Stanley, 1970; Zwarts and Wanink, 1989). Considering only those species for which burrowing depths are known, 69% of the Newfoundland region bivalve fauna can be classified as shallow burrowers. Given that juveniles (< 5 mm shell length) of both shallow and deep burrowing species are shallow burrowers, on a regional scale, a high percentage of the total bivalve fauna occupies the uppermost several centimetres of sediment.

3.2.1 Densities and standing crops of Grand Banks bivalves

There have been few surveys of the benthos on the Grand Banks. Reported densities, and in particular standing crops of bivalves, should be interpreted with caution since limitations of traditional mechanical grab samplers (e.g. van Veen) in terms of penetration of dense sediments can result in the underestimation of densities and biomass of deep burrowers.

Bivalves were sampled seasonally at several widespread locations on the Grand Banks in conjunction with baseline benthic invertebrate community analyses (Hutcheson et al., 1981; Hutcheson and Stewart, 1994). With the exception of the unique associations on

the Southeast Shoal, molluscs as a group averaged 96 g/m², representing 29% of mean standing crop. Molluscs and echinoderms were the dominant taxa in terms of biomass at all Grand Banks stations. In the Hibernia area (northeastern Grand Bank), the two infaunal bivalves *Liocyma fluctuosa* and *Cyrtodaria siliqua* were amongst the top 20 most abundant invertebrates. These two species occurred at mean densities of approximately 26 and 10 individuals/m², however they comprised < 2% of mean total density of all invertebrates (1083/m²). Bivalves are often dominant members of benthic communities in terms of biomass, however they comprise a minor fraction of densities of all invertebrates. However, there are exceptions to this that highlight the environmental complexity and the diverse nature of the fauna on the Grand Banks. On the Southeast Shoal (south eastern Grand Bank), very dense aggregations of the infaunal bivalve *Mesodesma deauratum* occur on a sand bottom at depths of 40-50 m. With maximum mean densities and standing crops of 5890 individuals/m² and 21.4 kg/m², respectively, these are amongst the densest populations of bivalves recorded anywhere (Hutcheson and Stewart, 1994). These populations probably represent relict populations from a Wisconsin low sea level stand that are now flourishing under conditions of high productivity (Carscadden et al., 1989; Hutcheson and Stewart, 1994). These populations would appear to be relatively stable considering that they were first documented by Nesis (1970) in 1959. Several small scale sampling programs conducted in the late 1980's-early 1990's, also in conjunction with offshore oil development on the northeastern Grand Banks, have yielded data on densities and biomass of bivalves. These are proprietary studies (Mobil, Petro-Canada Limited).

Patterns of distribution and abundance and substratum associations of epi-benthic megafauna, including bivalves, in the Hibernia region (northeastern Grand Bank) were analyzed from photographs (Schneider et al., 1987; Gilkinson and Gagnon, 1991). Over the past several decades, incidental collections of bivalves have been made during routine DFO groundfish surveys (Allen, 1965) although the great majority of these records are

unpublished.

3.2.2 Bivalves inhabiting sandy bottom ecosystems on the Grand Banks

With the exception of some members of the Pectinidae, the majority of bivalve species listed in Table 3.1 occur on sandy bottoms of varying coarseness grades. The general distribution of sediment types on the Grand Banks is shown in Figure 3.1. In their review of animal-sediment relationships, Snelgrove and Butman (1994) concluded that there is little evidence that sedimentary grain size alone is the primary determinant of infaunal species distributions. Other co-varying factors linked to patterns of distribution and abundance of bivalves include sediment organic content, water depth, temperature, salinity and primary production. Buchanan and Moore (1996) showed that a significant portion of inter-annual variation in the macrobenthos could be explained by phytoplankton abundance. The very high densities and biomass of *M. deauratum* on the South East Shoal has been attributed to localized high primary productivity (Hutcheson and Stewart, 1994). Hutcheson et al. (1981) stated that on the Grand Banks as a whole, the low organic content of sands make infaunal deposit feeding energetically uneconomical and the prevalence of suspension feeders and surface deposit feeders suggests a direct link between planktonic production systems and benthic communities on the Grand Banks.

Various invertebrate biocoenoses have been proposed for the Grand Banks (Nesis, 1965; Hutcheson et al., 1981). These species associations show varying degrees of correlation with sediment type and water depth. Several species of bivalves are dominant members of these communities. Nesis (1970) reported that *Astarte montagui* and *Macoma calcareo* typically occurred on sandy and stony-sand bottom types and more rarely on silty bottoms. Within the Hibernia sampling grid (400 km²), Hutcheson et al. (1981) considered spatial variability in bottom temperature, salinity and depth (ca. 80 m) to be negligible. They suggested that sediment characteristics were the variables controlling the distribution of

benthos within this area. A total of 9 coarseness grades were identified and the distribution of the bivalve *L. fluctuosa* was most strongly correlated ($r=0.5-0.6$) with fine and medium sand. However, this species is uncommon on a similar bottom type at depths of 120-140 m in the OETSA.

It is clear that the distribution and relative abundance of the majority of bivalve species cannot be predicted on the basis of sediment grain size alone. Exceptions to this are the relatively few instances of obligate association with sediment type. An example of this is the very strong association between the Iceland scallop, *Chlamys islandica*, and gravel-cobble clasts on the Grand Bank due to the propensity for byssal attachment (Gilkinson and Gagnon, 1991). Many species of infaunal bivalves appear to be capable of living in a wide range of sediment types (i.e. along a mud to sand grade). This was demonstrated for epifaunal invertebrates living on the northeastern Grand Bank (Schneider et al., 1987). Many species showed weak associations with substrata at small scales and strong ($r > 0.5$) association at larger scales. This indicated that individuals were capable of surviving on a range of sediment types, but that population density was not high in some habitats. Spatial patterns of density and biomass are influenced by a complex interplay of factors, including habitat-specific energetic/trophic relationships (Petersen, 1978; Hutcheson and Stewart, 1994) and variation in recruitment and mortality.

3.3 Impacts of bottom trawling on bivalves: Literature review and hypotheses

3.3.1 Immediate trawling impacts (Hours-Days)

3.3.1.1 Densities and biomass of all bivalves

Literature Review

Dramatic decreases in the densities and biomass of large epifauna have been linked to removals by most types of mobile fishing gears (Van Dolah et al., 1987; Sainsbury, 1988;

Langton and Robinson, 1990; Eleftheriou and Robertson, 1992; Dayton et al., 1995; Currie and Parry, 1996; Jennings and Kaiser, 1998). Changes in biomass and densities of infauna, directly attributable to mobile gears, are not well documented. Part of the difficulty with detecting change in the infauna is methodological. Sampling of the infauna is done with a wide variety of sampling devices, typically at much smaller sample scales compared to gear that has been used to document changes in populations of larger epifauna. Small-scale patchiness of infaunal bivalves often makes it difficult to detect change in this group (van Dolah et al., 1991; Eleftheriou and Robertson, 1992).

To date, no consistent changes have been recorded for infauna in terms of densities or species composition, after lighter prawn otter trawling (Gibbs et al., 1980; van Dolah et al., 1991). Decreases in densities of two infaunal bivalves (*Nucula nitidosa* and *Corbula gibba*) were recorded after repeated experimental otter trawl disturbance on a mud bottom over an 18 month period (Tuck et al., 1998). The trawl used in this experiment had modified rockhopper footgear and no net. Although this study, and Rumohr and Krost's (1991) experiment, demonstrate impacts on infaunal bivalves from heavier otter trawl gear on soft bottom, there is no direct evidence of an impact on infaunal bivalves in sandy bottoms from otter trawls. Changes in densities of infaunal bivalves have been recorded after experimental beam trawling and scallop dredging. Kaiser and Spencer (1996) recorded significantly lower densities of infaunal bivalves after experimental beam trawling while Curry and Parry (1996) observed a 53% decrease in mean density of infaunal bivalves over a 3.5 month period following intensive scallop dredging. Occurrence and densities of various bivalve species on Georges Bank appeared to reflect the different histories of frequencies of commercial scallop dredging and otter trawling (Collie et al., 1997). In another study, after a 9-day period of intensive scallop dredging, infaunal bivalves (*Venus* sp. and *Tellina* sp.) showed marked fluctuations in abundance, primarily due to vertical displacement and relocation within the dredging plots rather than elimination from the population (Eleftheriou and

Robertson, 1992).

Premise

Over the period of the experiment, mean densities of all infaunal bivalves in the OETSA will be a function of rate of recruitment, natural mortality and mortality from experimental trawling. Because groundfish otter trawls do not capture infaunal bivalves in significant quantities, trawling related mortality is primarily through physical damage and indirect effects. Documented decreases in densities of bivalves can be traced to more physically disruptive gears (e.g. beam trawls and scallop dredges). Given the results of the physical trawl door model experiment and the action of otter trawl gear on sand, high levels of fishing mortality (through damage) in bivalves are not expected. Mean densities of neither the total bivalve population (shallow and deep burrowers) nor shallow burrowers should decrease significantly after each annual trawling event over the three year period of the experiment. In terms of an alternative outcome, there is the possibility that rather than cause a decrease in densities, trawling might increase densities of bivalves due either to sediment-mediated enhancement of recruitment or increased survivorship of spat (i.e. due to favourable alteration of sediment characteristics).

The greatest contribution to sample biomass is from large bivalves. In the OETSA, these individuals generally reside at sediment depths greater than the trawling (penetration depth of trawl gear). As such, total mean bivalve biomass should not be significantly affected by trawling. Even in the case where densities of small bivalves (i.e. ≤ 3 mm) are reduced by trawling, this size class represents a very small proportion of total bivalve biomass.

Hypotheses

- (1) H_0 : Mean densities of all bivalves combined will not differ between trawled and reference corridors.
 H_A : Mean densities of all bivalves will differ between trawled and reference corridors.
- (2) H_0 : Mean biomass of all bivalves combined will not be greater in trawled than reference corridors.
 H_A : Mean biomass of all bivalves will be significantly lower in the trawled corridors.

3.3.1.2 Juveniles

Literature Review

Mortality in small juvenile bivalves, attributable to bottom fishing gears, has received relatively little attention. Santbrink and Bergman (1994) recorded a decrease in mean density of *Arctica islandica* in the 2-3 mm size range, 12 hours after two passes of a beam trawl equipped with tickler chains. There is also indirect evidence for negative impacts on small juveniles caused by mobile bottom gear. From their analysis of the size and age structures of populations of *A. islandica* in areas of the southeast North Sea, Witbaard and Klein (1994) noted that spat (1-2 mm) rarely occurred in areas subjected to intense commercial trawling activity. Bull (1986) reported that survival of seeded scallop spat after 9 months was higher in areas closed to trawling (20%) compared to trawled areas (0.8%). Naidu (1997) noted that scallop spat are particularly vulnerable to intense fishing pressure, an observation that has been stressed by Japanese scallop growers (Bull, 1986).

Premise

The relative fragility of small vs. large shells (Currey, 1988; Rumohr and Krost,

1991), combined with the position of juveniles in the uppermost several millimetres of the sediment, makes small juvenile bivalves susceptible to destruction (i.e. crushing) by trawling forces. Based on shell strength tests, one of the more fragile species in the OETSA is *Macoma calcarea* (see Chapter 4). For this reason, combined with the fact that this species is present at high densities ($> 400/m^2$) throughout the OETSA, the ability to detect trawling related mortality through decreases in densities, should be highest with this species. Although adults are deep burrowers, small *M. calcarea* (≤ 5 mm) reside within the uppermost several centimetres of the sediment, which exposes them to trawling forces.

Hypotheses

- (1) H_0 : Mean densities of small *M. calcarea* (≤ 5 mm) will not be greater in trawled than reference corridors.
 H_A : Mean densities of small *M. calcarea* will be significantly lower in trawled corridors.

3.3.1.3 Physical damage

Literature Review

There are two primary methods for estimating fishing mortality in bivalves. One method is to look for evidence of a significant reduction in density of living organisms immediately after trawling, while the second method is to assess shell damage. If lethal damage can be distinguished from non-lethal, this may be the only index of mortality if the time interval between trawling and post-trawl sampling is insufficient to result in changes in densities. Decreased densities inside trawled corridors could be the end result of consumption of damaged or excavated whole specimens by scavengers, or formation of empty shells in non-consumed damaged individuals. Analyses of rates of damage are therefore important. Unfortunately, while the term 'damage' is widely used, its meaning is

often ambiguous.

Most types of bottom fishing gears, including otter trawls, inflict incidental damage on near-surface infaunal bivalves. However, rates of damage vary widely (Arntz and Weber, 1972; Rumohr and Krost, 1991; Shepard and Auster, 1991; Bergman and Santbrink, 1994; Fonds, 1994; Santbrink and Bergman, 1994; Witbaard and Klein, 1994; Kaiser and Spencer, 1996).

Identification of damage caused by bottom fishing gear is not straightforward. This is because damage caused by fishing gear and sampling equipment (i.e. grabs, sleds) is often major (i.e. shell destruction including soft parts) and quite variable, with no unique distinguishing characteristics. Even in instances where the type of damage is distinct, such as in the case of severing of the siphon of the infaunal *Mya truncata*, this type of damage can be inflicted by both fishing gear (Kaiser and Spencer, 1996) and grab samplers (per. obs.). Non-destructive sampling techniques have been used to document damage caused by these gears. For instance, divers and observations from submersibles have been used to document damage to individual sea scallops, *Placopecten magellanicus*, caused by scallop dredges (Caddy, 1973; Shepard and Auster, 1991).

Typically, identification of fishing gear inflicted damage to bivalves in deep water experiments relies on the investigator being able to detect the signal (i.e. fishing gear damage) above the 'background noise' (i.e. damage from sampling gear). This is in contrast to the many visually distinct biological forms of shell damage such as traces of various types of predation on bivalves (Vermeij, 1987). Sublethal damage (i.e. represented by shell scars) to bivalves attributed to bottom fishing gear has been indirectly identified from correlations between frequencies of shell repair in populations and intensities or duration of exposure of these populations to commercial fishing activities (Gaspar et al., 1994; Witbaard and Klein, 1994).

There are numerous conflicting theories about rates of shell damage as a function of

shell size. Relationships are generally presented in terms of shell mechanical strength vs size. Rumohr and Krost (1991) provided direct evidence of size-specific damage to infaunal bivalves caused by otter boards. This was achieved by towing a collecting dredge immediately behind a small otter board. They compared rates of damage in several bivalve species between door tracks and non-trawled reference areas. Based on a limited number of samples, they recorded higher rates of damage with increasing shell size for several species. They proposed that large bivalves have relatively larger surface areas exposed to trawling forces, relative to small individuals, while their correspondingly greater shell strengths confer relatively little added protection against these forces. They estimated that *Arctica islandica* greater than 35 mm shell length are particularly susceptible. Arntz and Weber (1972) used divers to document damage to *A. islandica* caused by otter boards. They noted that cod were consuming disproportionate numbers of large *A. islandica* on trawling grounds. This was based on a high proportion of soft parts of *A. islandica* > 46 mm shell length in cod stomachs compared to a population mean length of 25 mm for this species. These observations led Brey et al. (1990) to conclude that rates of shell damage caused by otter boards increased with size (i.e. shell length) in this species. Fonds (1994) reported higher damage rates (85-90%) in large *Arctica islandica* compared to small infaunal bivalves (25%) captured by 12 m beam trawls. Tickler chains are suspected of inflicting most of the observed shell damage (Fonds, 1991). In contrast, based on bimodal age-frequency distributions of *A. islandica* in heavily fished areas of the southeast North Sea, combined with a relation of increasing shell strength with size, Witbaard and Klein (1994) concluded that large *A. islandica* (6-7 cm) could better resist beam trawling forces compared to smaller individuals. McLoughlin et al. (1991) and Shepard and Auster (1991) found no relationship between size of scallops and incidental damage after experimental scallop dredging. In the latter study, scallops over the size range 10-87+ mm were examined.

Shell strength is also correlated with shell thickness. Significant correlations have

been demonstrated for breaking load vs. shell thickness in addition to breaking load vs. size (Currey, 1988; Rumohr and Krost, 1991). Rumohr and Krost (1991) demonstrated a relationship of decreasing percent damage with increasing ratio of shell dry wt./total dry wt. for several species, which they interpreted to be an index of shell thickness. Bergman and Santbrink (1994) suggested that for bivalves living in soft bottoms non-catch mortality caused by beam trawling was related to the 'solidity of the shell'. However, this did not appear to hold for sandy bottoms as high mortalities were recorded for both fragile and 'solid shelled' bivalve species. Mortality estimates were based on differences in densities of live individuals before and after trawling with removals by the trawl factored in. The proportion of missing bivalves that were damaged is not known, although it was implied that this was a contributing factor in mortality.

Premise

Strength of molluscan shells is determined by the mechanical properties of the shell materials and by shell architecture (i.e. arrangement in space and thickness). For molluscs, a functional relationship exists between shell strength (breaking load or force) and shell mass (Currey, 1988), where:

$$\text{shell strength} \propto \text{shell mass}^b$$

where b ranges between approximately 1/3 and 2/3 depending on the species and population. This relationship holds both within and across taxa although more weakly in the latter case since shell form and sculpture also affects shell strength. Both shell size and thickness are good predictors of bivalve shell strength (Rumohr and Krost, 1991; Witbaard and Klein, 1994).

One benefit of shell mass is that larger shells are stronger and can provide protection

against predators. Another advantage of large shell mass is stability in shifting sediments, particularly for shallow burrowers, although shell sculpture is also important for stabilization (Stanley, 1970; Vermeij, 1978). From an evolutionary perspective, bivalves have only very recently been exposed to bottom trawling forces. Shell strengthening adaptations that confer resistance to predators or which maximize stability in sediments, would not necessarily pre-adapt bivalves to withstand the forces which can be generated by commercial otter trawlers. For instance, physical damage to concrete pipelines caused by otter trawl gear has been documented (Moshagen and Kjeldsen, 1980; Palmer et al., 1990). Rumohr and Krost (1991) concluded that greater shell size does not confer sufficient added protection against shell breakage from otter board forces. It is unlikely that a size refuge from trawling forces, based on shell strength alone, is achieved by any bivalve. Deep burrowing species achieve a size refuge from trawling forces based on life position. For these species, refuge is enhanced with increasing size since burrowing depth increases with size (Zaklan and Ydenberg, 1997).

The model for trawl door/bivalve interactions on sand bottoms (Chap. 4) does not incorporate shell strength, but rather size and burrowing depth. Based on increased probability of excavation by otter boards, the model predicts that small, near-surface bivalves (excluding small juveniles) will be least susceptible to damage. Based on the predominance of small bivalves at the sediment-water interface in the OETSA, it is expected that damage rates to infaunal bivalves (excluding small juveniles) after repetitive trawling in the OETSA will be low.

There are indications that some species of *Astarte* are resistant to physical forces of trawling (Rumohr and Krost, 1991; Collie et al., 1997). This mechanical resistance has been attributed to a thick shell in these species. No damage was recorded in *A. borealis* after passage of a trawl door through a muddy bottom (Rumohr and Krost, 1991). This species showed no damage after passage of the trawl door model through a sand testbed (this study). *Astarte borealis* is common and relatively abundant in the offshore study area. The

hypothesis of high mechanical resistance in this species was tested using the large field data set. It is expected that damage rates recorded immediately after trawling will not be significant in this species.

Hypotheses

- (1) H_0 : Mean percent damage (all categories) in shallow burrowing species (SBS) will not be higher in trawled than reference corridors.
 H_A : Mean percent damage (all categories) in shallow burrowing species (SBS) will be significantly higher in trawled corridors.
- (2) H_0 : Mean percent major damage in SBS will not be higher in trawled than reference corridors.
 H_A : Mean percent major damage in SBS will be significantly higher in trawled corridors.
- (3) H_0 : Mean percent major damage in *Astarte borealis* will not be higher in trawled than reference corridors.
 H_A : Mean percent major damage in *A. borealis* will be significantly higher in trawled corridors.

3.3.2 Long-term impacts

Literature Review

Long-term impacts on the benthos from trawling have yet to be demonstrated. There are several reasons for this. Multi-year trawling experiments have not been conducted. Such experiments require that areas be closed to all fishing for the duration of experiments. An associated problem concerns finding areas that have not had a history of fishing. An alternative to the experimental approach is retrospective examination of long-term changes

in populations. However, this is hindered by confounding factors, both anthropogenic and natural in origin.

A general prediction of ecological stress theory is a reduction in the mean size of individuals within stressed populations of animals over time (Odum, 1985; Rapport et al., 1985; Gray, 1989). This is because populations of larger, longer-lived species will be slower to recover from perturbations compared to fast growing, short-lived species. From a long time-series (1869-1981) of relative abundance data for benthic invertebrates in the Wadden Sea, changes in species composition were associated with multiple factors, including shrimp trawling and oyster dredging, combined with loss of major habitat types (Reise, 1982). There appeared to be a shift in species composition from a community characterized by mixed r and k life history strategists to one that was dominated by r -strategists, particularly polychaetes. The problem of confounding factors is further highlighted by a recent census of threatened marine species in the Wadden Sea (Petersen et al., 1996). In addition to fishing mortalities, it was concluded that factors that may have contributed to population declines in 93 species of macrofauna, including 14 bivalve species, were climate change, eutrophication, pollution and coastal habitat alteration.

Changes in the size and age structure of the benthos is generally regarded as a potential long-term consequence of sustained bottom fishing. It has been hypothesized that mean age and size in populations of long-lived species (e.g. *Arctica islandica*) will increase in fisheries exclusion areas relative to adjacent fished areas (ICES, 1996). To date, there is no conclusive evidence of any shifts in the size or age distributions of the benthos at the species or higher taxonomic levels attributable to bottom fishing. However, in the OETSAs there were indications of a smaller mean individual biomass in sand dollars after three years of experimental trawling (Prena et al., in prep.). Bimodal size distributions in populations of *A. islandica* in the southeast North Sea were interpreted as evidence of the susceptibility of intermediate sizes (1-4 cm) to the destructive forces of beam trawling (Witbaard and

Klein, 1994). In contrast, Rumohr and Krost (1991) reported that size distributions of *A. islandica* in heavily trawled areas of Kiel Bay, showed reductions in the larger size classes and Brey et al. (1990) noted that populations of this species in Kiel Bay had much lower modal ages (< 10 yr), compared to Middle Atlantic populations (65-100 yr). However, Brey et al. (1990) suggested that the younger ages of Kiel Bay populations could be the result of either higher fishing mortalities or periodic severe environmental conditions.

Collie et al. (1997) reported that sites on Georges Bank that had been subjected to both commercial otter trawling and scallop dredging were dominated by larger, hard-shelled molluscs (along with other species). Furthermore, they speculated that the absence or rarity of a group of small molluscs at a disturbed site was due to their sensitivity to the physical effects of dredging. Isolated, large bivalves have been found in heavily fished areas. Naidu et al. (1996) observed that in an area that was exposed to intense commercial dredging for Iceland scallops (*Chlamys islandica*), the stock was mostly composed of pockets of residual cohorts (i.e. year classes) consisting primarily of large scallops. This may have been a reflection of spatial variation in dredging effort.

In many respects, the scouring actions of icebergs are analogous to trawl door scouring, *albeit* at a larger scale. Iceberg scouring displaces sediments and infauna and causes mortalities in bivalves (Woodworth-Lynas et al., 1991; Peck and Bullough, 1993; Gutt et al., 1996; Ansell and Rhodes, 1997). Peck and Bullough (1993) compared the size structures of Antarctic populations of the infaunal bivalve *Yoldia eightsi* between areas subjected to different time intervals between iceberg scouring events. They speculated that iceberg scouring reduced the maximum size attained in this species while juveniles (< 10 mm) were numerically dominant (86% of population) in areas of scouring.

Overall, evidence for any long-term changes in the benthos due to bottom fishing is weak (Hall, 1994) although documented declines in certain large, slow growing epifauna (i.e. sponges) would appear to be a direct result of bottom fishing activities (Sainsbury, 1988;

Auster et al., 1996; Raloff, 1996).

Premise

Based on shell fragility and proximity to the surface, small juveniles should be most vulnerable to the cumulative, combined impacts of otter trawling. In keeping with the findings of others, the term 'small juveniles' refers to bivalves in the 1-3 mm shell length range. The lower limit is based on the 1 mm mesh sieve that was used to process samples in this study. Based on the ability of bivalve larvae to settle in physically stressed habitats, including trawled (Rice et al., 1989; Witbaard and Klein, 1994), ice scoured (Peck and Bullough, 1993) and polluted areas (Skog and Varmo, 1980), it is unlikely that significant, persistent changes in this size group would be observed over the three year period in the present study. Currie and Parry (1996) noted that scallop dredging impacts, reflected by decreased densities, became non-detectable for most benthic invertebrates following recruitment episodes. Peck and Bullough (1983) speculated that there was a cause-effect relationship in their observation of high densities of small bivalves co-occurring with low densities of adults. David et al. (1997) reviewed density-dependent and density-independent processes of recruitment in marine invertebrates. If adult bivalves inhibit recruitment, either by direct larval ingestion or competition, then high adult mortality would release settling larvae from this competition resulting in increased survivorship. Overall, spatial distributions of juveniles likely reflect variations in larval supply, passive transport of juveniles (including sediment bedload movements) or predation on recruits (David et al., 1997).

The results of the trawl door model experiment indicated vulnerability in the largest shallow burrowing species, *C. ciliatum*, at sizes ≥ 5 cm shell length. Given the low densities of large *C. ciliatum* in the OETSA, it is unlikely that significant changes will be detectable in size frequency distributions at the large end of the size spectrum.

Hypotheses

- (1) H_0 : Mean densities of small juveniles (1-3 mm) do not differ between trawled and reference corridors.

H_A : Mean densities of small juveniles (1-3 mm) in trawled and reference corridors differ.

- (2) H_0 : Mean densities of large, near-surface bivalves (> 25 mm) will not be lower in trawled than reference corridors.

H_A : Mean densities of large, near-surface bivalves (> 25 mm) are lower in trawled corridors.

3.4 Methods

3.4.1 Experimental Trawling Study Area (OETSA) selection criteria

As part of a site selection process, faunal surveys and gear trials were conducted in 1991 and 1992 at candidate sites on the Scotian Shelf and northeastern Grand Bank. A brief summary of site selection criteria follows, while a detailed account can be found in Prena et al. (1996).

Ideally, experiments designed to investigate impacts of mobile fishing gears on offshore benthic habitats should satisfy several criteria. The Grand Bank site was chosen based on the following:

- (i) DFO agreed to close this area in 1992 to all mobile fishing gear. Analysis of records of commercial fishing effort indicated that the candidate site had not been fished intensively since the early 1980s. The main reason for this was a marketing strategy that was adopted by the large fish processors. Rather than being limited to harvesting primarily plaice in the area that encompassed the OETSA, the fishing fleets targeted the mixed groundfish (cod/yellowtail/plaice) to the west of the study

area during this time period (Kulka, 1991).

(ii) The site is characterized by surficial sediments (Adolphus sand)(Fader and Miller, 1986) that are regionally representative;

(iii) The site is characterized by relatively high densities and biomass of invertebrates as well as a large number of abundant species. In addition, species composition was spatially homogeneous.

3.4.1.1 Site characterization

The OETSA is centered at 47°10'N, 48°17'W and encloses an area of approximately 340 km² (Fig. 3.2). The average water depth is 137 m. Surficial sediments are composed of Adolphus sand (0.17 mm mean grain size)(Fig. 3.1) which is a moderately to well-sorted fine- to medium grained sand occurring on the perimeter of the Grand Banks at depths below 110-120 m. This bathymetric boundary corresponds to the most recent post-glacial, low sea level stand (Dalrymple et al., 1992). Exploratory sampling of the benthos in 1992 revealed a community that was characterized by: (i) a high number of species (139 macrofaunal), including epibenthic species, (ii) high biomass (approximately 650 g wet wt/m²) and, (iii) relatively homogeneous species composition (Prena et al., 1996).

3.4.2 Experimental design

3.4.2.1 Trawling corridors

Within the 'closed' area, three experimental trawling corridors were established. Each corridor was 13 km long by 200 m wide. Adjacent, parallel reference corridors were established 300 m to one side of each experimental corridor (Fig. 3.2). All three corridors were trawled in each year (1993-1995), however due to logistic constraints only corridors

A and B could be sampled. Corridors A and B were subdivided into 260 sampling boxes (50 m long by 200 m wide) and boxes sampled on each cruise were randomly selected. Different boxes were sampled on each trip without replacement. In all instances, the box numbers of reference and experimental samples were the same (i.e. 300 m apart) in order to reduce variance due to increasing separation.

3.4.2.2 Trawling and navigation

Experimental trawling was conducted using the Engel 145 Hi-lift otter trawl (Fig. 3.3). Technical specifications and layout drawings for this trawl are given in McCallum and Walsh (1996) and are summarized in Table 3.2. The Engel 145 trawl is a two-panel 'balloon' design with a stretched mesh circumference of 60.5 m at the fishing circle. The Engel has been a popular commercial trawl in use throughout the North Atlantic (McCallum and Walsh, 1996). Since industry has moved to the use of 'rockhopper' footgear, experimental trawling was conducted using rockhopper footgear (45 cm discs) rather than the previous industry standard steel bobbin footgear. Unlike commercial trawls, and conforming to DFO survey trawls, a 30 mm square mesh liner was installed in the final 9 m of the 18.5 m long cod end in order to capture small invertebrates. Trawl 'behaviour' was monitored with a Scanmar net mensuration system. Trawling was conducted at a speed of 3.5 nM h^{-1} (6.5 km hr^{-1}) using the DFO research trawler *Wilfred Templeman*.

The experimental corridors were trawled annually, in early July, for three successive years (1993-1995) (Table 3.3). Each annual trawling event consisted of a total of 12 trawl passes along the centre line of each corridor with direction alternating on each set. The time required to trawl all 12 sets ranged between 31 and 34 hours. Each trawl pass started and ended 500 m from the ends of the corridor. This ensured that the trawl, having a layback of approximately 500 m, would be settled into its typical trawl configuration prior to entering the experimental corridor.

A high level of trawling intensity (i.e. 12 passes per event) was selected in order to investigate impacts associated with the upper end of the scale of realistic trawling intensity on the Grand Banks. Data on frequency of trawling per unit area of seabed is difficult to obtain. Usually an average is calculated based on estimates of total area of seabed swept per year and area of the fishing grounds. Based on trawl swept area data, Kulka and Schwinghamer (unpub. data) show that less than 8% of the seabed in the vicinity of the OETSA was scoured by otter trawls annually. Based on this, it has been suggested that the intensity level of experimental trawling is equivalent to more than 100 years of trawling effort. Areal coverage of trawling in this region has varied over the period 1980-1991. Certain areas of the Grand Banks (i.e. Nose and Tail) have likely experienced frequencies of short-term trawling similar to that incorporated into the experimental trawling design. Support for this comes from reports of trawlers lined up to trawl the same area of seabed (see Warner, 1977).

In the first year of the experiment, the *Wilfred Templeman* used Loran-C and non-differential GPS to navigate during trawling. In 1994 and 1995, dGPS (differential global positioning system) was used which gave ship position to an accuracy of 3-4 m. AGCNav, which is a PC-based navigation display and logging program, was used to display real-time data of ship position, heading and speed. The position of the trawl was determined using a Trackpoint II acoustic tracking system. A battery powered beacon (acoustic target) was attached to the headline of the trawl while the Trackpoint boom was mounted on the side of the *C.S.S. Parizeau*, extending into the water. From this, AGCNav calculated and displayed real-time positions of the trawl. The combined effects of positioning error in the dGPS and Trackpoint II systems, resulted in accuracies for trawl and grab positions on the seafloor of 4 m at the ship (i.e. grab position) and 20 m at a maximum working range of 600 m from the ship (i.e. trawl position). Each year, as time permitted, the *Parizeau* tracked the position of the otter trawl for some sets. The width of the disturbance zones (i.e. area between trawl

door tracks) was estimated from navigation data using procedures given in McKeown and Gordon (1997).

3.4.3 Video-equipped hydraulic grab

Complete details of the video grab used in this study can be found in Rowell et al. (1997) while an overview is presented below. Except for those assisting in lowering the gear (i.e. winch operators and handlers), the grab is remotely controlled from the ship's lab with the aid of monitors. A high resolution colour video camera, oriented to provide a downward directed view through the open grab, provides the operator with a view of the seafloor to be sampled. In addition to being able to select the area to be sampled, the operator can determine whether the grab attempt was successful prior to retrieval. The grab is opened and closed by a hydraulic actuator on the lab console.

The grab is housed in a heavy, galvanized steel frame that is approximately 2.5 m high (Fig. 3.4). The frame provides a stable platform as well as protecting the electro-hydraulically actuated clam-type bucket and video system. The grab is lowered by kevlar multi-conductor cable (max. 500 m) which is stored on a winch with a large diameter drum. Stability of the system is enhanced by large fins, which enables the grab to align with the current. The design incorporates minimal 'frontal' area so that as the grab is lowered to the seafloor there is minimal disturbance of surficial sediments and organisms caused by a 'bow wave' effect. Key technical specifications of the grab are:

Area sampled	0.5 m ²
Maximum sample volume	90-100 litres
Depth of penetration	to 25 cm
Penetration force	1000 kg (max.)
Maximum operating water depth	500 m

A 12 x 30 cm, 40-element acoustic array (DRUMS™) was installed on the frame of the grab in order to ensonify the seabed and collect acoustic images of the upper 4.5 cm of

sediment. The results of quantitative comparisons of acoustic microstructure of sediments in the experimental corridors are presented elsewhere (Schwinghamer et al., 1996).

3.4.4 Grab sampling

After experimental trawling was completed the *Parizeau* moved onto station inside the designated sample box. During grab sampling the *Parizeau* maintained position with the aid of bow thrusters. An acoustic beacon was attached to the grab and Trackpoint II was used to plot the on-bottom position of the grab. With the aid of ships positioning, grab samples were taken near the centre line of the sample boxes (McKeown and Gordon, 1997).

In July 1993, prior to the first trawling event, grab samples were collected in each experimental corridor (5 samples) and adjacent reference areas (5 samples) in order to test for differences in bivalve density and biomass with respect to experimental and reference locations. After trawling, the *Parizeau* moved back into the corridors to conduct post-trawl sampling. In September 1993, approximately 10 weeks after the first trawling event, the *Parizeau* returned to the OETSA to conduct sampling in the experimental and reference corridors. No trawling was conducted on this trip. In July of both 1994 and 1995, pre-trawl sampling was conducted inside experimental and reference corridors. This was followed immediately by trawling and post-trawl sampling. Due to time constraints and because of the relatively short time period (days) over which trawling and sampling was conducted, reference samples were collected prior to each trawling event in each corridor, but not after trawling.

For each combination of treatment, a total of 10 replicate grab samples were collected for a total of 200 samples over the duration of the three-year experiment (Table 3.3).

3.4.5 On-board treatment of samples

Upon retrieval the grab was opened and the contents dumped on a large wood tray. Sediment was then carefully transferred by shovel to a raised, fibreglass dumping table which emptied onto a sieve table fitted with 1 mm mesh screen. Sediment was washed by hose through a series of small ports at one end of the dumping table onto the sieve. A finer water spray was used to wash material through the sieve. Retained material (organisms and sediment) was then transferred from the sieve into plastic buckets and preserved in buffered 10% formalin in seawater solution. Borax was used as a buffering agent and was applied to concentrated formaldehyde to point of saturation (ca. 20 g l⁻¹).

3.4.6 Laboratory treatment of samples

All grab samples were initially processed at the Bedford Institute of Oceanography, Dartmouth, N.S. Although all macrofauna were processed, the following methodology refers to the Bivalvia. The preserved residue was screened through a 1 mm mesh sieve. Large specimens were removed while the remaining material was sorted under low magnification. All bivalves were identified to species, enumerated and wet weighed (formalin weights, shell and tissue) to a resolution of 0.1 mg. Taxonomic verification, size and damage classifications were conducted at the Northwest Atlantic Fisheries Centre, St. John's, NF. All specimens were measured individually and classified according to physical damage (see below). Specimens greater than approximately 5 mm shell length were measured to the nearest 0.1 mm using calipers. Smaller sizes were measured under low magnification (12x) using a graticule mounted in the ocular on a Wild M10 dissecting microscope. Specimens were measured in terms of shell length (anterior-posterior axis) except for pectinids which were measured for shell height (dorsal-ventral axis).

3.4.6.1 Damage classification

All bivalves were assessed for damage to the shell, ligament and exposed soft parts and assigned to a damage category according to a four point scale grading from no damage to major damage (Table 3.4)(Figs. 3.5 and 3.6). With the exception of *Cyrtodaria siliqua* and *Panomya arctica*, the valves of all species in the OETSA enclose the soft parts. *Cyrtodaria siliqua* and *Panomya arctica* possess a large soft tissue volume, including a large siphon and ventral region, which cannot be enclosed by the valves. For these species, damage classification also included visible soft tissue damage.

It is possible that the deep burrowing species *Macoma calcarea* and *Thyasira* sp. *A*, both of which possess long siphons, may have incurred damage to their siphons in the absence of any shell damage, after passage of the trawl. The soft parts of preserved specimens of these species were typically retracted between the valves. Given the difficulty of accurately identifying damage to these soft structures in the preserved state, only damage to the shell and ligament was assessed.

3.4.6.2 *Macoma calcarea*

Total sample density and biomass of *M. calcarea* were recorded. However, because this species occurred at high densities, random sub-samples of stations (3 out of 10) stratified by year, corridor and treatment were selected in order to obtain individual length measurements and damage classifications. A total of 15,667 *M. calcarea*, representing 66 stations, were individually measured and classified in terms of damage.

Three different methods were used to measure shell length. Specimens larger than 25 mm were measured to the nearest 0.1 mm with calipers. Specimens between 3 and 25 mm were measured automatically to the nearest 0.1 mm using Mocha™ Image Analysis Software. The setup consisted of a video camera linked to a monitor and a PC running MS Windows. For maximum contrast, *M. calcarea* (which are white) were measured against

a black felt cloth background. A Targa+ frame grabber was used to capture video images of *Macoma* into Mocha, whereupon contrast and resolution for each group of specimens was maximized. Shell length measurements were automatically taken on individual *Macoma* in groups of 25 specimens with each group taking approximately 30 seconds to complete. Measurement accuracy was determined for each group of specimens by comparing a Mocha-generated measurement versus a reading on the same specimen obtained by hand calipers. The minimum acceptable measurement accuracy was ± 0.5 mm otherwise calibrations and measurements were redone. Measurements were automatically stored in a data worksheet. After measurements were made on each group, damage classifications were entered. The minimum acceptable accuracy was not reached with specimens smaller than 3 mm. Measurements on this size class were performed to the nearest 0.1 mm under low magnification (12x) using a Wild M10 dissecting microscope with attached graticule.

3.4.7 Laboratory burrowing experiments

Burrowing rate is a risk factor for infaunal bivalves that are excavated to the sediment surface by bottom fishing gear. Bivalves that can quickly re-burrow are less vulnerable to scavengers that move into disturbed areas to feed. Burrowing rate decreases with increasing size (Stanley, 1970). Burrowing rate is also a function of shell sculpture and morphometric features.

Burrowing times, depths and orientations were determined for nine species of bivalves which are common in the OETSA (Table 3.5). These included both shallow and deep burrowing species. Live specimens were obtained from grab samples taken from the Grand Banks during routine groundfish surveys and from the OETSA. Bivalves were collected from the sieve table and immediately transferred to mesh bags and held in either 20 litre buckets or large fish tubs supplied with running seawater. Upon returning to St. John's, specimens were transferred to the aquarium facility at the Northwest Atlantic

Fisheries Centre where they were placed in either 19 or 30 litre glass aquaria and supplied with temperature controlled, non-filtered flowing seawater. Each aquarium had a 8-10 cm layer of sand. Wherever possible, the bivalves native sediment was used. When sufficient amounts of native sediment were not available, artificial sand (Grade 0 silica sand) was used. This is a medium grade sand and geotechnical parameters are given in Chapter 4 (Table 4.1). Over the period of the experiments bivalves were fed on a regular basis with concentrated batch culture *Isochrysis* sp.. Bivalves were acclimatized for a minimum period of 2 weeks prior to conducting experiments. While some mortalities were recorded during collecting and transfers, all specimens used in the experiments displayed normal burrowing activity and feeding behaviour.

3.4.7.1 Temperature regime

Water temperature was held constant in each aquarium using a NESLAB temperature controlling unit. Most of the burrowing experiments were conducted at a temperature of 5°C. This lower limit was selected based on concerns over the ability to maintain a lower temperature. During their lifespans, most of the species tested may experience temperatures approaching this in their natural habitats. However, average *in situ* temperature at the OETSA is probably in the 0-2°C range (Hutcheson et al., 1981). Since burrowing rate is correlated with temperature (Stanley, 1970), it is possible that rates recorded at 5°C might be somewhat higher than occur in natural populations.

3.4.7.2 Calculation of burrowing time and burrowing rate index

To simulate excavation from the sediment by trawl gear, bivalves were excavated by hand and placed on the sediment surface on one valve. Bivalves share a common set of behavioural patterns associated with the burrowing process (Trueman et al., 1966). The initial phase involves the foot making a major probe downward into the sediment. This

raises the shell from the horizontal into an upright position. In order for burrowing to proceed, the erected shell must be supported by the foot such that the shell does not fall again to a reclining position. Stanley (1970) defines burrowing time (BT) as the period of time from initial erection of the shell (foot-supported), to disappearance or virtual disappearance of the shell below the surface. In the present experiment there was one departure from this. *Cyrtodaria siliqua* has a large siphon and for adults, there is a significant time interval between shell and siphon disappearance. Therefore, for this species only, the point of disappearance of the siphon rather than the shell was used in the calculation of BT. While the siphon is exposed, the bivalve is vulnerable to predation. Certain other large infaunal species (e.g. *Mya truncata*), in which the siphon represents a large portion of total tissue mass, cannot regenerate the siphon if severed and will die (Welch and Martin-Bergmann, 1990).

Within a species there is a linear relationship between the cube root of body mass and burrowing time (Stanley, 1970). Based on this relationship Stanley (1970) defines a *burrowing rate index* (BRI). This is a means of comparing standardized burrowing rates between species. Essentially, it represents the time required for burial of a given mass, where:

$$\mathbf{BRI = [m^{0.333} / bt] [100]}$$

m = bivalve whole mass (g)

bt = burrowing time (sec.)

The BRI is relatively constant throughout the size range of a species and therefore permits species to be compared in terms of their relative burrowing speeds.

Stanley's descriptive terms for BRI values are as follows:

Very rapid burrower	≥ 6
Rapid	2 to 5
Moderately rapid	0.6 to 1
Slow	0.1 to 0.5
Very slow	≤ 0.09

Excavation burrowing time (EBT) was also recorded. This is the time interval from point of excavation to disappearance. Burrowing times were determined using a video camera directed at specimens just above the aquaria, linked to a time-lapse VCR.

3.4.7.3 Determination of burial depth and life position

The burial depth and orientation of a bivalve at the conclusion of the burrowing process defines *life position*. Life position is both species- and size-specific (Stanley 1970). Burial depth is also a key factor assessing a bivalve's risk of exposure to physical impacts from bottom fishing gear.

Details of test procedures are given below. Temperature regimes and sediment types used in the experiments are listed in Table 3.5.

Macoma calcarea

Due to the number of *M. calcarea* tested, specimens had to be distributed between several aquaria and 4 litre plastic buckets. Sediment depth in these containers ranged between 8 and 10 cm. Buckets were placed in a large tank that, along with the aquaria, were supplied with flowing seawater. After allowing time for the specimens to burrow (i.e. several days), the water was siphoned from the containers. The overlying sand was carefully scraped away by hand until the upper valve surface of the bivalve was exposed. Bivalves will normally burrow to their life positions without stopping, assuming their final position in a few hours (S.M. Stanley, pers. comm.). Once water is removed, infaunal bivalves will close their valves and remain in their original position (S. Stanley, pers. comm.). Burrowing

depth was measured with a ruler. The orientation of the specimens was then determined. This included noting which valve was uppermost (i.e. right or left), and estimating the angle of recline of the specimen with respect to the sediment surface.

Cyrtodaria siliqua

The aquaria were too shallow to determine burial depth in *C. siliqua*. Burrowing depths were recorded using a 95 x 76 x 66 cm plastic tub placed in a 2271 litre tank supplied with flowing seawater. Grade 0 silica sand (maximum grain size 1-2 mm) was added to the tub to a final depth of 45 cm. Burrowing depths were monitored for three large *C. siliqua* (6-9 cm shell length). Each specimen had a length of black thread attached to one shell valve, approximately 5 mm from the posterior margin. Threads were attached to the shell using T-88 structural epoxy adhesive. This is a two-part epoxy which can be applied to a damp surface and requires a curing time of approximately 1 week at a water temperature of 1.7°C. During the curing period specimens were held out of sediment in flowing seawater. A two-colour thread system was used with one specimen in order to monitor orientation in this species. On occasion, aquarium specimens had been observed with the posterior (i.e. siphon) end directed downwards. At the end of the curing period, the bivalves were placed on the sediment surface (spaced well apart) in the tub and monitored at intervals over a five month period. To record burial depth, water was partially drained from the large tank. Water was not drained from the small tub containing the sediment and bivalves. The length of thread above the sediment was then measured.

Shallow burrowers

Burrowing experiments on the shallow dwelling species *Astarte* spp., *Cyclocardia* spp., and *C. ciliatum* were conducted in aquaria. During the course of the experiments all individuals remained near the sediment-water interface. To record burial depth and

orientation, water was siphoned from the aquaria. Only minor excavation of the surrounding sediment was required in order to expose the specimens.

3.4.8 Statistical analyses

Two-way ANOVA was performed on density and biomass data for common species (*Astarte borealis*, *Clinocardium ciliatum*, *Cyrtodaria siliqua*, *Macoma calcarea*, *Thyasira* sp. A) to determine the statistical significance of the two main factors incorporated in the experimental design, namely trawling (comparing reference, pre-trawl and post-trawl) and corridor (comparing A and B). These species represent a range of life positions, and maximum adult size. Two-way ANOVA was performed on densities of shallow burrowing and deep burrowing bivalves (Table 3.6) to determine the statistical significance of the main factors listed above. Since small juveniles of all species are shallow burrowers, all bivalves ≤ 5 mm shell length were included in the shallow burrowing group.

In 1993, there were two trawling treatments: before trawling and after trawling. In both 1994 and 1995, there were three levels of the trawling factor: reference, pre-trawling and post-trawling. Although trawling intensity within experimental corridors was the same in each of the three years, there was a cumulative trawling effect since the same ground was re-trawled. Cumulative levels of trawling in each corridor after 1993, 1994 and 1995 were 12, 24 and 36 passes of the trawl, respectively. Because of this, each of the three years of the trawling experiment (1993-1995) was analyzed separately.

Comparisons of population size structures of bivalves between treatments were made using Kolmogorov-Smirnov two-sample comparisons of pooled size frequency distributions ($n = 10$ stations per sample).

The degree of variability in densities of species was examined by regression of mean and standard deviation of species densities within each combination of main effects. Taylor suggested that the slope of log-log regressions of means and standard deviations could

be used as an index to compare relative degree of variability between samples; an 'index of aggregation. Increased variability may be associated with increased variance relative to the mean, resulting in an altered slope. Using this relationship, Warwick and Clarke (1993) documented an increase in variance for estimates of mean density of meiobenthos and macrobenthos at sites that were anthropogenically stressed, relative to non-impacted sites. Eleftheriou and Robertson (1992) reported marked fluctuations in densities of infaunal bivalves after scallop dredging, which they attributed to the vertical and horizontal displacement and relocation of *Venus striatula* and *Tellina* spp.. Means and standard deviations were \log_{10} -transformed prior to performing regression in order to reduce the influence of the dominant *M. calcareo* on the regressions. Statistical analyses were performed using SAS® software (SAS Institute Inc.).

3.5 Results

3.5.1 Experimental trawling summary

The start and end times of annual trawling events within each experimental corridor are listed in Table 3.6. The time intervals between the last trawl pass and the collection of the first and last grab samples were quite variable. The time intervals were greatest in 1994- Corridor A (134 and 165 hrs.) and least in 1995- Corridor B (8 and 12 hrs.).

3.5.2 Spatial patterns of trawling disturbance

The following is a summary of patterns of trawling disturbance within the experimental corridors. Complete details can be found in McKeown and Gordon (1997). As determined by Scanmar, the trawl had wing and door spreads of 20 ± 2 m and 60 ± 5 m, respectively. Position of the trawl, relative to the stern of the vessel, was offset consistently to the port side a distance of 20-35 m, due to slight differences in warp lengths. Because of this offset, the most accurate positions for the trawl path were obtained from the Trackpoint

data, not the ship's position. These data were available for all 12 sets in Corridor A and 6 sets in Corridor B in 1993, 6 sets in Corridor B in 1994, and 4 sets and 3 sets in Corridors A and B respectively in 1995. The width of the disturbance zones created each year (i.e. after all 12 passes) was estimated by calculating the positions of the otter board tracks from either the Trackpoint data (when available for at least half the sets) or ship position (McKeown and Gordon, 1977).

Because the *Wilfred Templeman* was not equipped with dGPS in 1993, mean width of trawling disturbance was greatest in this year (> 200 m) and least concentrated around the centre line of the corridors. Mean width of disturbance decreased in both 1994 (120 m) and 1995 (< 200 m) with the use of dGPS. The greater width in 1995 was due to a deliberate sinusoidal trawling pattern that was made in an attempt to provide greater trawling coverage inside corridors. While cumulative trawling disturbance was greatest nearer the centre lines of the corridor compared to the edges, due to the inherently variable nature of the trawling, all areas within experimental corridors were not exposed to uniform levels of disturbance.

3.5.3 Species summary

A total of 23 species of bivalves, representing 16 families, were collected by grab in the OETSA (Table 3.7). Of these, 21 species are infaunal or at times semi-infaunal. Two species, *Hiatella arctica* and *Chlamys islandica*, are epifaunal, however both species were rare, occurring at only five and one station(s) respectively, out of a total of 200 stations. A total of 16 species are classified as shallow burrowers, residing in the upper several centimetres of sediment. Five species- *Macoma calcarea*, *Astarte borealis*, *Clinocardium ciliatum*, *Cyrtodaria siliqua* and *Thyasira sp. A*, were considered common, based on $\geq 80\%$ frequencies of occurrence over all stations. Only *M. calcarea* occurred at every station. Two species dominated in terms of density and biomass. *Macoma calcarea* had the highest densities, comprising 86% (247.7 ± 59.9 ind./0.5 m²) and 89% (244.9 ± 85.5 ind./0.5 m²)

of mean sample density (all bivalves) in corridors A and B, respectively. In contrast, this species comprised < 18% of mean sample biomass. The large, deep burrowing *C. siliqua*, contributed < 3% to mean sample total density. However, this species comprised 70.7% ($193.0 \pm 120.1 \text{ g}/0.5 \text{ m}^2$) and 68% ($187.4 \pm 135.4 \text{ g}/0.5 \text{ m}^2$) of mean sample biomass in Corridors A and B, respectively. The total number of bivalve species, by treatment, ranged between 15 and 19 and the mean number of species per station ranged from 7.9 ± 1.5 to 10.6 ± 1.6 (Fig. 3.7).

3.5.4 Effects of location before trawling in 1993: reference and trawling corridors

Two-way ANOVA on the five reference and five experimental samples in both corridors prior to trawling in 1993 (Table 3.8), revealed no significant differences in mean total density and biomass for the effects of corridor and location (i.e. inside vs. outside experimental trawl corridors).

3.5.5 Biomass and densities

All species combined

Mean sample biomass and densities of all bivalves, by combination of treatment, are shown in Table 3.9. Biomass ranged from approximately 175 to 339 g wet wt/0.5 m² while mean densities ranged from 252 to 329 individuals/0.5 m². Two-way ANOVA indicates there were no significant differences in biomass or densities of all bivalves for the effects of trawling in any year (Tables 3.10-3.13). In 1995, there was a significant difference in mean densities between corridors.

Common species

Mean biomass and densities, by combination of treatment, for each species collected in the OETSA, are given in Appendices 3.1 and 3.2. Two-way ANOVA indicates

there were no significant effects of trawling on biomass and densities for each of the five most common species in the OETSAs (Tables 3.14-3.33). There were instances of significant differences in densities or biomass between corridors for each of the common species (Tables 3.15, 3.16, 3.18, 3.21, 3.22 and 3.23). In particular, *Thyasira* sp. A displayed consistently lower densities and biomass in Corridor B in all years (Tables 3.26, 3.28, 3.33). No significant differences in mean densities or biomass, for the effects of trawling, were seen for any of the common species in Sept. 1993, 10 weeks after the first trawling event (Tables 3.29-3.33).

Shallow burrowing species- SBS (all sizes)

There were no significant differences in either mean densities or mean biomass of SBS, due to trawling effects, in any year (ANOVA, $p > 0.05$). Mean densities of SBS were significantly lower in Corridor B in 1994 ($F_{1,34} = 18.26, p=0.0001$).

Large, shallow burrowing bivalves

Astarte borealis and *C. ciliatum* are the only species of shallow burrowers in the OETSAs that attain a relatively large adult size (i.e. > 2.5 cm shell length). Maximum size of *A. borealis* was ca. 4 cm. Individuals of *C. ciliatum* > 6 cm were collected. Large *A. borealis* were common and large *C. ciliatum* were uncommon. A total of 23 *C. ciliatum* greater than 5 cm shell length were collected during the course of the three year study. Mean (\pm sd) densities of all large (> 2.5 cm) shallow burrowing bivalves ranged from 1.4 ± 0.9 to 5.9 ± 7.5 individuals/0.5 m². In 1993, mean densities of this size class were significantly lower post-trawl compared to before trawling ($F_{1,36} = 5.13, p = 0.03$) while densities were significantly lower in Corridor A in 1995 ($F_{1,34} = 4.78, p=0.033$).

Juveniles (< 5 mm)

Excluding *Macoma*, mean densities of all juveniles ≤ 5 mm of the remaining species combined (non-*Macoma* juveniles), and juveniles of *M. calcareea* alone, by combination of treatment, are given in Tables 3.34 and 3.35. In 1993 and 1994, mean densities of juvenile *Macoma* were roughly an order of magnitude higher than densities of all other species combined. Mean densities of juvenile *Macoma* were lower in 1995 compared with the previous two years. An exception to this were samples representing the pre-trawl treatment in Corridor B. There were no significant differences in densities of non-*Macoma* Juveniles for the effects of trawling in 1993 and 1994 (Tables 3.36 and 3.37). Densities were significantly lower in Corridor A in 1994 (Table 3.37). In 1995, there was a significant corridor-trawling interaction (Table 3.38).

In both 1993 and 1994, there were no significant differences in mean densities of *Macoma* due to trawling, while densities were significantly lower in Corridor B in 1993 (Tables 3.39, 3.40). In 1995, there was a corridor-trawling interaction (Table 3.41).

Recruitment in Species other than *M. calcareea*

Mean (\pm sd) densities of 'non-*Macoma* juveniles' ≤ 3 mm ranged from 7.0 ± 4.6 to 21.6 ± 12.2 individuals/0.5 m² (Table 3.42). This group was represented by a total of 17 species. Species having the highest proportion of small juveniles in Corridor A were *C. ciliatum* (26%), *C. siliqua* (18%) and *C. novangliae* (11%) and in Corridor B- *C. ciliatum* (21%), *C. siliqua* (21%) and *Y. myalis* (14%).

The highest mean densities were recorded in Sept. 1993, approximately 10 weeks after the first trawling event, and in the July 1994 Corridor A post-trawl treatment. There were no significant differences in mean densities of small juveniles for the effects of trawling in any year, while densities were significantly lower in Corridor B in 1994 (Tables 3.43-3.45).

Recruitment in *Macoma calcarea*

Mean (\pm sd) densities of *Macoma* ≤ 3 mm shell length ranged from 18.3 ± 11.2 to 69.7 ± 59.8 individuals per 0.5 m^2 (Table 3.42). There were no significant differences in mean densities in any year, for the effects of corridor and trawling (Tables 3.46-3.48).

3.5.6 Immediate post-trawl damage

3.5.6.1 Shallow burrowing species

Patterns of damage in shallow burrowing species (SBS) are shown in Figures 3.8-3.10. Low rates of damage were recorded for SBS in all treatments. Overall mean (\pm sd) percent frequency of SBS showing no signs of damage was $90.2 \pm 4.2\%$. Overall mean percent frequency of major damage was $9.7 \pm 4.7\%$. Each of the intermediate damage categories (minor, moderate) accounted for less than 5% of the total damage. There were no significant differences in mean percent frequencies of all damage (all categories combined) or major damage in SBS, for the effects of trawling (reference and post-trawl) or corridors, in any year (Tables 3.49-3.51).

Mean (\pm sd) percent frequencies of *A. borealis* collected post-trawl, showing no damage, ranged from $87.3 \pm 31.2\%$ to 100%. The large variation associated with the lower end of the range is attributed to one station that had only one specimen and it had major damage. If this station is excluded, coefficients of variation associated with mean percent 'no damage' averaged 2%. Percent frequencies of *A. borealis* displaying no damage did not differ significantly between post-trawl and reference treatments in any year (1993: $F_{1,35} = 1.73$, $p = 0.197$; 1994: $F_{1,35} = 0.01$, $p = 0.908$; 1995: $F_{1,35} = 2.21$, $p = 0.146$). *Clinocardium ciliatum* showed relatively high levels of major damage in both reference and post-trawl treatments. Mean (\pm SE) percent major damage in this species over all treatments was $21.9 \pm 8.0\%$ ($n = 104$ stations).

3.5.6.2 Deep burrowing species (excluding *Macoma*)

Mean (\pm sd) percent major damage in deep burrowing species ranged from 12.9 \pm 6.8% (trawl corridors) to 23.5 \pm 14.9% (reference corridors) (Figs. 3.8-3.10). The higher level of major damage recorded in this size group, relative to shallow burrowers, would appear to be a species effect. Two common and relatively abundant deep burrowers, *C. siliqua* and *Y. myalis*, sustained relatively high levels of major damage in all treatments (32.7 \pm 15.9% and 23.0 \pm 17.0 %, respectively).

3.5.6.3 *Macoma calcareo*

Patterns of damage in *M. calcareo* were similar to those recorded for all other deep burrowing species combined (Fig. 3.11). The wider confidence limits reflect fewer replicates used in the analysis of *M. calcareo* (n=3 stations) compared to the remaining deep burrowers (n=10).

3.5.7 Index of species aggregation

Summary statistics of linear regressions of standard deviation and mean species densities are given in Table 3.52. The slopes of the regression lines of the various trawling treatments were similar in all combinations of year and corridor (Table 3.52, Fig. 3.12).

3.5.8 Size structure of OETSA bivalve populations

3.5.8.1 Shallow burrowing species

Populations of SBS in the OETSA are dominated by small sizes, particularly \leq 7 mm shell length. In all treatments, bivalves \leq 7 mm comprised $>$ 60% of total abundance and in 13 out of 20 treatments \geq 75% (Figs. 3.13 and 3.14). A second mode at 30-40 mm comprised primarily large *A. borealis*. Large bivalves (i.e. $>$ 50 mm) occurred at low frequencies and were present in most treatments.

Size distributions of all SBS, at smaller class intervals, are shown for 1995 (Fig. 3.15). The results of Kolmogorov-Smirnov tests showed that in corridor A, distributions were significantly different between reference and post-trawl treatments ($n_1 = 126$, $n_2 = 179$, $Ks_a = 1.459$, $p = 0.029$) and pre-trawl and post-trawl treatments ($n_1 = 135$, $n_2 = 179$, $Ks_a = 1.408$, $p = 0.038$). In corridor B, reference and pre-trawl treatments were significantly different ($n_1 = 200$, $n_2 = 145$, $Ks_a = 1.823$, $p = 0.003$) and pre-trawl and post-trawl treatments were significantly different ($n_1 = 145$, $n_2 = 123$, $Ks_a = 1.594$, $p = 0.012$). In Corridor B, size distributions in reference and post-trawl treatments did not differ significantly, indicating that three years of experimental trawling in this corridor had not produced any major shift in the size distributions of shallow burrowing bivalves.

3.5.8.2 *Macoma calcarea*

Size frequency distributions of *M. calcarea* were dominated by small sizes (i.e. < 10 mm) in all treatments (Figs. 3.16 and 3.17). Individuals > 25 mm made a small contribution. In 1993 and 1994 the 3-5 mm size group dominated in all treatments (22%-46%). In 1995, the < 3 mm size class dominated in both reference and experimental corridors (Fig. 3.17).

Based on Kolmogorov-Smirnov two-sample comparisons between treatments for each corridor in 1995, with the exception of post-trawl and pre-trawl treatments in Corridor A, all size frequency distributions were significantly different.

3.5.9 Ecology of OETSA bivalves

3.5.9.1 Life positions

The laboratory observations on the life positions of *Astarte borealis*, *C. ciliatum*, *N. minuta*, *C. novangliae* and *C. sp. A*, confirmed their designations as shallow burrowers. The shell margins of these species were generally within 1-2 cm of the sediment surface.

Cyclocardia novangliae had 1-3 mm of shell margin (commissure) exposed and showed a highly variable orientation. All *Cyclocardia* sp. *A* remained on the sediment surface. Two of the smaller specimens were always in close proximity, and at times byssally attached to the larger specimen. On one occasion, a small specimen was observed attached to the glass side of the aquarium by its byssus, several centimetres above the sediment. *Astarte borealis* displayed a stereotyped orientation with the posterior margin directed vertically upwards. Typical orientations of these species are shown in Fig. 4.4 (Chapter 4). In addition to *Crenella decussata*, these were the most common and abundant shallow burrowing species in the OETSA.

Over the course of the 5 month observation period, the three large *C. siliqua* attained burial depths ranging from 11-12 cm, 15-27 cm, and 18-45 cm, with progressively deeper depths over time. Lateral movements were minimal. For the one individual for which measurements were taken, the siphon was oriented upwards.

All 16 *M. calcarea* were found lying on their left valve, oriented in a near horizontal position with the curved or bent posterior shell margin directed upwards. Such an orientation is typical of the bent-commissure condition in the Tellinidae, i.e., these species lie on their left valve with the long axis within 30° of the horizontal (Holme 1961). Mean (\pm sd) burial depths of small (14-17 mm), medium (20-29 mm) and large (30-41 mm) *Macoma* were 4.3 ± 1.2 cm (n=4), 5 ± 1.8 cm (n=6) and 6.3 ± 2.3 cm (n=6), respectively. Mean burial depth of large *Macoma* was likely underestimated because three out of six specimens had burrowed to the bottom of the tank.

3.5.9.2 Burrowing rates

The burrowing rate index (BRI) for *Cyrtodaria siliqua*, *Astarte* spp. and *C. ciliatum* was less than 0.2, placing them in the slow and very slow burrowers categories (Table 3.53). *Macoma calcarea* displayed slow to moderately rapid burrowing rates, with BRI values

ranging between 0.28 and 1.02. Characteristic of protobranchs, both *N. minuta* and *Y. myalis* were in the moderately rapid to rapid burrower categories.

Two measures of burrowing time allow the risks of predation to bivalves to be assessed. For shallow burrowers, total times to re-burrow (i.e. excavation burrowing time, EBT), ranged from 36 min. for a small *C. ciliatum* to 3.9 hrs. for an adult *A. borealis*. Mean (\pm sd) EBT in *A. borealis* and *C. siliqua* were 2.9 ± 1.4 hrs and 4.1 ± 2.6 hrs., respectively.

Times to initiate burrowing (EBT-BT) were variable for each species. Elapsed times were greater than one hour for 13 out of 17 specimens tested, while in the case of the fast burrower *N. minuta*, burrowing was initiated within 5 minutes of excavation. Although EBT was not recorded for *Macoma*, observations indicated approximate times ranging from several minutes to several hours.

It is possible that the lengthy time intervals recorded before burrowing was initiated were an experimental artifact. In nature these species may initiate burrowing much sooner. If this is true then BT (i.e. foot-supported burrowing time) is a more appropriate measure of the length of time that excavated bivalves are exposed at the sediment surface. Mean (\pm sd) BT for *A. borealis* and *C. siliqua* were 1.4 ± 0.6 hrs. and 1.9 ± 1.0 hrs., respectively. The small and large *Clinocardium* had BTs of 30 min. and 1.1 hrs., respectively. The fastest BT was recorded for *Y. myalis* (30 secs.). Mean BTs in large, medium and small *M. calcareo* were 8.2 min. \pm 3.6, 2.9 min. \pm 0.9 and 2.4 min. \pm 0.4, , respectively.

As predicted by Stanley (1970), BT for *M. calcareo* increased with shell length (SL) and body mass (M):

$$BT_{sec} = 16.2(SL) - 154.2, \quad r^2 = 0.71$$

$$BT_{sec} = 57.9(M) + 97.6, \quad r^2 = 0.86$$

Although there was a similar trend for *C. siliqua*, variation in BT at larger sizes obscured any relationship.

3.6 Discussion

3.6.1 Immediate effects of trawling

In this study, neither densities nor biomass of bivalves were significantly affected by trawling. It was predicted that juvenile bivalves (≤ 5 mm) would be vulnerable because they reside at the sediment-water interface and have relatively fragile shells. However, there was no evidence of a trawling impact on this size group. There were significant differences between corridors. In particular, both densities and biomass of *Thyasira* sp. *A* were significantly lower in Corridor B in all years. Results of three-way MANOVA on seven sediment size fractions (63-4000 μm) indicated that trawling had no effect on sediment grain size (Schwinghamer et al., in prep.). However, there were significant temporal changes over the three years of the experiment and there was a significant difference in grain size between Corridors A and B (MANOVA, $p = 0.004$). There was a higher proportion of fine sediment (< 125 μm) in Corridor B compared to A in all three years.

In the present study, trawling inflicted damage to bivalves was not significant. The percentage of bivalves comprising all shallow burrowing species in post-trawl treatments that showed no signs of damage was greater than 75% while in four out of six post-trawl treatments it was greater than 80%. Frequencies of major damage recorded for the shallow burrowers assemblage was low (3-14%). An exception to this was *C. ciliatum* which showed high mean (\pm sd) percent frequency major damage in both reference (36.9 ± 12.4) and immediate post-trawl (34.4 ± 29.4) samples. This species was dominated by the size range 1-3 mm. The types of damage observed in these fragile specimens were consistent with damage inflicted by handling and processing and were common to specimens from all treatments.

As previously stated, much of the damage associated with beam trawls can probably be traced to tickler chains. This is supported by the qualitative observations of divers which indicates only light damage to benthos after passage of a beam trawl lacking

tickler chains. Similarly, only minor damage was observed within the paths of the beam trawl shoes (Rumohr et al., 1994). The very low incidence of intermediate damage (minor and moderate) indicates that the underlying mechanism(s) generates forces considerably greater than the shell strengths of bivalves and act in an all or none fashion. Frequencies of moderate damage were also low for two types of scallop dredges, with minor chipping and major damage predominating (McLoughlin et al., 1991; Shepard and Auster, 1991). It is not possible to make direct comparisons of damage rates between otter trawls and beam trawls. Damage rates reported in the present study represent incidental damage. Damage and mortality rates recorded for beam trawls are based on captured individuals. Damage rates in these captured bivalves can range between 25 and 90% (Fonds, 1994), frequencies of incidental damage are not known.

The deep burrower assemblage, particularly *Cyrtodaria siliqua* and *Yoldia myalis* showed higher frequencies of damage than the shallow burrowers assemblage. These species normally reside deeper than the immediate scouring zone of trawl gear. Trends in major damage were similar between reference and trawl corridors suggesting that most damage was caused during sample collection and/or processing. Based on the types of major damage observed, it is believed that the primary cause was crushing caused by closure of the deep penetrating jaws of the grab.

The very low levels of damage recorded for *Astarte borealis* in the present study are of interest. This species resides near the sediment-water interface and attains a maximum size of approximately 40 mm in the OETSA. Rumohr and Krost (1991) reported that this species was not damaged by otter boards on soft bottom. On Georges Bank, *Astarte subequilatera* and *A. montagui* were numerous in areas that had been heavily scallop dredged; it was inferred that a thick shell afforded protection against physical disturbance (Collie et al., 1997). In Chapter 4 a model is proposed to explain the low rates of major damage in small to medium size shallow burrowing bivalves. The model is based on a

relationship between size and the probability of being excavated in front of trawl doors.

A limitation of remote sampling in offshore deepwater environments is the inability to accurately sample inside small scale features of interest, e.g. door furrows. Intense, repetitive trawling was conducted in this study. Sampling inside such features would only be worthwhile if it were known how many times a particular area of seabed had been trawled and with which gear components. There was a high degree of confidence that all grab samples had been taken from seabed that had been swept more than once by the trawl (i.e. some portion of the footgear at least). However, results must be interpreted in terms of the combined, cumulative effects of all trawl gear components.

Otter trawling may result in low rates of physical damage to infaunal bivalves. Conversely, damage rates may be higher and either relatively uniformly distributed or patchy (e.g. confined to trawl door furrows). In both cases a trawling effect could be confounded with damage caused by the sampling gear. If damaged bivalves were concentrated along narrow linear features (Arntz and Weber, 1972), grab sampling may miss these individuals.

In this study, the extent to which scavengers moved into trawled areas and consumed damaged or whole excavated bivalves was not measured. The time between trawling and sampling (hours to days) was within known rates for immigration of mobile predators (particularly crabs and groundfish) into disturbed areas (Caddy, 1973; Kaiser and Spencer, 1996). Trawl capture rates of snow crabs (*C. opilio*) increased within 6-12 hours of trawling in the present study (Prena et al., in prep.). Meyer et al. (1981) reported predators feeding on both damaged and non-damaged surf clams, *Spisula solidissima*, inside the tracks left by a hydraulic clam dredge. The lengthy burrowing times (hours) of most near-surface bivalves in the OETSA would make them susceptible to predation by fish in particular. However, trawl catch rates of groundfish were quite low throughout the course of the experiment. The response of scavengers to fishing disturbance is not always manifested as a large increase in their abundance (Ramsay et al., 1998).

Although significant differences in density and biomass were not detected between trawled and reference corridors, statistical power of the ANOVAs in this study was relatively low. As discussed previously, it was expected that juvenile (≤ 5 mm) *M. calcarea* would have lower mean densities inside the trawled corridors. However, the power for detecting true differences in densities due to trawling was in the 0.3 to 0.35 range. Therefore, in order to be 90% confident ($1-\beta$) that observed differences in population mean densities were due to a trawling effect, the minimum detectable difference between means ranges from 55% (1993) to 90% (1995) of the population mean. Low statistical power is typical of many benthic population level studies (Osenberg et al., 1994; Peterman and M'Gonigle, 1992). This is partly due to large sample variances for estimates of density and biomass (Vézina, 1988). Spatial variance is often considered a statistical annoyance, but increasingly it has come to be regarded as a biologically important, scale-dependent phenomenon (Horne and Schneider, 1995).

The act of trawling may increase the variance associated with mean densities of infaunal bivalves through spatial variation in mortality caused by trawling. In addition, the physical action of the trawl gear on the seabed may concentrate bivalves through displacement. For instance, Armtz and Weber (1972) showed that near-surface bivalves were concentrated along the berms left by trawl doors.

The slopes of regressions of means and standard deviations for densities of bivalves in post-trawl samples did not increase, indicating that trawling did not increase variability. However, based on a larger macrofaunal data set, increased variance was observed in species densities in the OETSA (Prena et al., in prep.). After fishing an experimental box (2000 m²) a total of 10 times with a 4-m beam trawl, Rumohr et al. (1994) showed using multi-dimensional scaling that the variation among post-trawl samples of the epibenthos was much lower than pre-trawl samples. They suggested that beam trawling reduces spatial variation within the community in the trawled area. Intuitively, the degree of homogenization should

be a function of both the intensity and consistency of trawling effort and spatial patterns of gear-inflicted damage.

A primary goal of the present study was to conduct experimental trawling at spatial scales consistent with commercial trawling. As such, there was a trade-off between this objective and sampling efficiency, i.e. numbers of replicates. Based on a pilot study, it was determined that a minimum number of 5 grab samples would be required in order to obtain high species similarity between replicate samples, which was important for planned benthic community analyses (Prena et al., 1996). While 10 replicate samples were taken per treatment, variances associated with estimates of densities and biomass were relatively large. In addition, small differences between treatment means resulted in a negligible trawling effect. In this study there was a high probability (65-70%) of committing a Type II error, that is, incorrectly stating that trawling had no significant effect on the densities and biomass of bivalves. As such, a precautionary approach would be warranted concerning impacts of trawling (Peterman and M'Gonigle, 1992). Using biomass and density data alone, the only conclusion that could be reached with confidence is that the experimental trawling regime did not cause catastrophic mortalities to infaunal bivalves. Possibly the only type of bottom gear known to cause dramatic changes in the benthos inside swept areas is the hydraulic clam dredge. Removal efficiencies of infaunal bivalves with this gear are often > 90% (Medcof and Caddy, 1971; Meyer et al., 1981; Lambert and Goudreau, 1996).

As D. Schneider has pointed out, because of problems with statistical power in field experiments, subtle or less than dramatic effects of bottom fishing may only come to light through the combined efforts of the scientific community involved in this research and not by any single study.

The empirical study of fishing effects is hampered by a lack of unfished control sites (Jennings and Kaiser, 1998). Given the long histories of bottom trawling on continental shelves, a more realistic goal is to identify reference areas which can be closed to fishing for

the duration of experiments and which have experienced low levels of fishing activity in recent times. These were selection criteria for the DFO offshore site. However, long term records (decadal) of fishing activities on the Grand Banks range from incomplete to non-existent. Given that otter trawling has been conducted on the Grand Banks for at least 40 years prior to the initiation of the field trawling experiment, there is the possibility that benthic communities at this site had already been fundamentally altered. For instance, biomass, densities and species composition of infauna could have changed due to direct physical effects of trawling. Given that the greatest rate of biological change (i.e. impact) in response to a sustained disturbance is to be expected at the onset of the disturbance (Jennings and Kaiser, 1998), effects may not be discernible in the case of a bivalve community that is already impervious to such impacts. Without baseline data for benthic communities on the Grand Banks (i.e. pre-trawling era, ca. 1940s-1950s) and historical records of fishing activity, it is not possible to address this question.

3.6.2 Modification of bivalve habitat by trawling

In the past, fisheries scientists and managers were pre-occupied with issues related to overfishing of commercially exploited fish stocks. It is now suspected that factors in addition to overfishing may contribute to the depletion of demersal fish stocks, including habitat impacts (Collie et al., 1997). The loss or degradation of fish habitat is now being regarded as a crucial issue in the conservation of fish stocks (Anon., 1996). In the present study, structural changes to the seabed after trawling were clearly seen (Schwinghamer et al., in prep). Both video imagery and acoustically measured bottom roughness (as measured by the RoxAnn™ system) indicated that surface roughness or topography was increased by repeated trawling. This may be the result of furrows and berms created by the doors. Sediment grain size did not change with trawling, however data collected with high resolution acoustic imagery (DRUMS™ - Dynamically Responding Underwater Matrix

Sonar) indicated that sediment structural complexity to depths of 4-5 cm had decreased, likely the result of the destruction of biogenic structures including mounds, tubes and burrows (Schwinghamer et al., 1996). However, there was evidence of recovery in intervening years between trawling, probably due to the combined effects of bioturbation and storms (Schwinghamer et al., in prep.).

From the foregoing, it is obvious that the habitat of infaunal bivalves was fundamentally altered by trawling. The re-distribution of surficial sediments should not be problematic in itself to infaunal bivalves. Although most suspension feeding bivalves are fairly stationary in their life position, they have the capacity to re-burrow when shifting sediments expose them (Stanley, 1975). Modification of habitat did not preclude recruitment of bivalves in any year. Although variances were relatively large, mean densities of shallow burrowing bivalves and *M. calcarea* ≤ 3 mm were similar between trawled and reference areas. This was true for immediate post-trawl samples as well as samples taken from areas trawled the year previous.

3.6.3 Long-term impacts of trawling

Due to the lack of long-term (multi-year) fishing impact experiments, combined with a relatively poor knowledge base of the systems being studied, predictions of long-term impacts from bottom fishing remain highly speculative. Increasingly, the need to consider marine ecosystem level impacts from fishing and other anthropogenic activities is being stressed (Gislason, 1994; Nilsson and Grelsson, 1995; Botsford et al., 1997; De Leo and Levin, 1997). However, there is confusion over the definition of the term ecosystem (Willis, 1997). The ecosystem concept is vague in its application because there are no readily definable temporal or spatial bounds, the key criteria being that there are continuous fluxes of matter and energy in an interactive open system (Willis, 1997). Odum (1964) advocated a holistic approach for the study of ecosystems rather than a reductionist approach, in which

'functional' attributes of the ecosystem are stressed. However, the cornerstone of most impact studies, reductionism and a structural approach (i.e. population or community structure), are contrary to this. Rather than focusing on an ambiguous term such as ecosystem, it may be more constructive to consider fishing impacts in terms of varying temporal and spatial scales (Thrush et al., 1995; Hall and Harding, 1997). At present the problem of scaling up from controlled experiments (necessarily at a small spatial scale) to questions of regional importance is perhaps the most pressing issue in ecology (Schneider et al., 1997). The design of the DFO field trawling experiment incorporated a realistic spatial scale for commercial trawling. With this design, practical considerations dictate that trawling be conducted within long corridors. The trawling experiment was carried out in two large areas, with treatment restricted to one contiguous section of each area (i.e. corridors). Reference stations were located in adjacent parallel corridors. Thus, trawling effects, if found could be due either to the treatment or to confounding effects at the scale of the corridors. However, no effects were detected so confounding effects need not be considered unless one hypothesizes a confounding effect, acting in the opposite direction of a trawling effect on density and biomass, and with the same linear configuration.

A considerable body of knowledge is accumulating on the immediate and short-term effects of various types of mobile gears on biological communities and habitat, yet we do not know the ecological significance of these effects. De Leo and Levin (1997) point out that the inherent dualism of the structural and functional organization of ecosystems has important practical implications concerning two different approaches to the study of the earth's biota. For instance, even when subject to high levels of disturbance (and, thereby, to substantial changes in their structure, e.g. population dynamics of species) a system may be able to preserve its macro-level functions, such as primary productivity. On the other hand, it has been suggested that because population-level responses are generally more sensitive indicators of stress than ecosystem responses (e.g. primary production), irreversible

damage may occur before significant changes become apparent in ecosystem processes (Carpenter et al., 1995).

The DFO offshore experimental trawling study has demonstrated the complexity of the effects of otter trawling in a sandy bottom habitat. While molluscs were a group that showed relatively minor effects (this study; Prena et al., in prep.), certain epifaunal and infaunal taxa showed reduced densities due to trawling (Prena et al., in prep.). While significant changes in the structure of the seabed were recorded after trawling there was evidence of recovery (Schwinghamer et al., 1996; Schwinghamer et al., in prep.). A more complex question about potential long-term effects of otter trawling, concerns the consequences of continuous disruption of the structure of benthic habitat. Schwinghamer et al. (1996) suggest that since ecosystem function depends upon the exchange of materials, the loss of fine-scale habitat complexity through the destruction of burrow walls, tubes and galleries of infauna, attacks the benthic environment in its primary functioning role, i.e. exchange processes. Reductions in the heterogeneity of benthic systems, through removal of epifauna and homogenization of sediment characteristics, have implications for the maintenance of diversity and stability at the population, community and ecosystem levels (Thrush et al., 1995).

Mobile bottom fishing gear cause both physical and biological changes to benthic habitat, however impacts vary considerably according to gear type, physical habitat, biological communities and fishing activity. Until we have improved understanding of the natural variability and functioning within marine ecosystems, combined with higher resolution data on patterns of commercial fishing activity, the precautionary approach as a guiding principle in the management of fisheries (Gislason, 1994; Anon., 1996) is advisable.

3.7 Literature cited

- Abbott, R.T. 1974. American Seashells. The Marine Molluska of the Atlantic and Pacific Coasts of North America. 2nd. Edition. Van Nostrand Reinhold, New York.
- Anon. 1996. The State of Canada's Environment. Government of Canada. Ottawa.
- Ansell, A.D. and M.C. Rhodes. 1997. Unusual capabilities for surface movement in a normally deep-burrowed Antarctic bivalve. *Journal of Molluscan Studies* 63:109-111.
- Arntz, W. and W. Weber. 1972. *Cyprina islandica* L. (Mollusca, Bivalvia) as food for cod and dab in Kiel Bay. Fisheries Research Board of Canada Translation Series No. 27. Translated from Bericht der Deutschen Wissenschaftlichen Kommission für Meeresforschung 21(1-4): 193-209.
- Auster, P.J., R.J. Malatesta, R.W. Langton, L. Watling, P.C. Valentine, C-L.S. Donaldson, E.W. Langton, A.N. Shepard and I.G. Babb. 1996. The impacts of mobile fishing gear on seafloor habitats in the Gulf of Maine (Northwest Atlantic): Implications for conservation of fish populations. *Reviews in Fisheries Science* 4(2): 185-202.
- Botsford, L.W., J.C. Castilla and C.H. Peterson. 1997. The management of fisheries and marine ecosystems. *Science* 277: 509-515.
- Brey, T., W.E. Arntz, D. Pauly and H. Rumohr. 1990. *Arctica (Cyprina) islandica* in Kiel Bay (Western Baltic): growth, production and ecological significance. *Journal of Experimental Marine Biology and Ecology* 136: 217-235.
- Brylinsky, M., J. Gibson and D.C. Gordon, Jr. 1994. Impacts of flounder trawls on the intertidal habitat and community of the Minas Basin, Bay of Fundy. *Canadian Journal of Fisheries and Aquatic Sciences* 51: 650-661.
- Buchanan, J.B. and J.J. Moore. 1996. A broad review of variability and persistence in the Northumberland benthic fauna 1971-1985. *Journal of the Marine Biological*

Association UK. 66: 641-657.

- Bull, M. 1986. Scallop enhancement programme approaches first harvesting. *Catch* (April): 10-12.
- Caddy, J.F. 1973. Underwater observations on tracks of dredges and trawls and some effects of dredging on a scallop ground. *Journal of the Fisheries Research Board of Canada* 30: 173-180.
- Carpenter, S.R., S.W. Chisholm, C.J. Krebs, D.W. Schindler and R.F. Wright. 1995. Ecosystem experiments. *Science* 269: 324-327.
- Carscadden, J.E., K.T. Frank and D.S. Miller. 1989. Capelin (*Mallotus villosus*) spawning on the Southeast Shoal: Influence of physical factors past and present. *Canadian Journal of Fisheries and Aquatic Sciences* 46(10): 1743-1754.
- Churchill, J.H. 1989. The effect of commercial trawling on sediment resuspension and transport over the Middle Atlantic Bight continental shelf. *Continental Shelf Research* 9: 841-864.
- Clarke, A.H. 1974. Molluscs from Baffin Bay and the northern North Atlantic ocean. National Museums of Canada Publications in Biological Oceanography, No. 7, Ottawa.
- Collie, J.S., G.A. Escanero and P.C. Valentine. 1997. Effects of bottom fishing on the benthic megafauna of Georges Bank. *Marine Ecology Progress Series* 155: 159-172.
- Currey, J.D. 1988. Shell form and strength. Pp. 183-211. In: Trueman and Clarke (eds.), *The Mollusca. Volume 11. Form and Function*. Academic Press, Inc., San Diego, California.
- Currie, D.R. and G.D. Parry. 1996. Effects of scallop dredging on a soft sediment community: a large-scale experimental study. *Marine Ecology Progress Series* 134: 131-150.
- Dalrymple, R.W., E.M. LeGresley, G.B.J. Fader and B.D. Petrie. 1992. The western Grand

- banks of Newfoundland: transgressive Holocene sedimentation under the combined influence of waves and currents. *Marine Geology* 105: 95-118.
- David, P., P. Berthou, P. Noel and P. Jarne. 1997. Patchy recruitment patterns in marine invertebrates: a spatial test of the density-dependent hypothesis in the bivalve *Spisula ovalis*. *Oecologia* 111: 331-340.
- Davidson, S.H. and A. Simms. 1997. Characterization of iceberg pits on the Grand Banks of Newfoundland. Environmental Studies Research Funds (ESRF) Report No. 13, Ottawa, Ontario.
- Dayton, P.K., S.F. Thrush, M.T. Agardy and R.J. Hofman. 1995. Environmental effects of marine fishing. *Aquatic Conservation: Marine and Freshwater Ecosystems* 5: 205-232.
- De Leo, G.A. and S. Levin. 1997. The multifaceted aspects of ecosystem integrity. *Conservation Ecology* [online] 1(1):3.
- Eleftheriou, A. and M.R. Robertson. 1992. The effects of experimental scallop dredging on the fauna and physical environment of a shallow sandy community. *Netherlands Journal of Sea Research* 30: 289-299.
- Fader, G.B.J. and K.O. Miller. 1986. Regional geological constraints to resource development- Grand banks of Newfoundland. Pp. 3-40. In: *Proceedings of the 3rd Canadian Conference on Marine Geotechnical Engineering*, St. John's, Newfoundland.
- Fonds, M. 1994. Mortality of fish and invertebrates in beam trawl catches and the survival chances of discards. Pp. 131-146. In: de Groot, S.J. de and H.J. Lindeboom (eds.). *Environmental Impact of Bottom Gears on Benthic Fauna in Relation to Natural Resources Management and Protection of the North Sea*. NIOZ-Rapport 1994-11, RIVO-DLO Report C026/94, Netherlands Institute for Sea Research.
- Gaspar, M.B., C.A. Richardson and C.C. Monteiro. 1994. The effects of dredging on shell

- formation in the razor clam *Ensis siliqua* from Barrinha, southern Portugal. *Journal of the Marine Biological Association UK* 74: 927-938.
- Gibbs, P.J., A.J. Collins and L.C. Collett. 1980. Effect of otter prawn trawling on the macrobenthos of a sandy substratum in a New South Wales Estuary. *Australian Journal of Marine and Freshwater Research* 31: 509-516.
- Gilkinson, K.D. 1986. Review and assessment of the literature on marine benthic molluscs (Amphineura, Bivalvia, Gastropoda) in Newfoundland and Labrador waters. *NAFO Scientific Council Studies* 10: 93-108.
- Gilkinson, K.D. and J-M. Gagnon. 1991. Substratum associations of natural populations of Iceland scallops, *Chlamys islandica* Müller 1776, on the northeastern Grand Bank of Newfoundland. *American Malacological Bulletin* 9(1): 59-67.
- Gislason, H. 1994. Ecosystem effects of fishing activities in the North Sea. *Marine Pollution Bulletin* 29: 520-527.
- Gordon, J. and T.E. Weeks. 1982. Seashells of the Northeast Coast from Cape Hatteras to Newfoundland. Hancock House Publishers Ltd., Surrey, B.C.
- Gray, J.S. 1989. Effects of environmental stress on species rich assemblages. *Biological Journal of the Linnean Society* 37: 19-32.
- Gutt, J., A. Starmans and G. Dieckmann. 1996. Impact of iceberg scouring on polar benthic habitats. *Marine Ecology Progress Series* 137: 311-316.
- Hall, S.J. 1994. Physical disturbance and marine benthic communities: life in unconsolidated sediments. *Oceanography and Marine Biology: an Annual Review* 32: 179-239.
- Hall, S.J. and M.J.C. Harding. 1997. Physical disturbance and marine benthic communities: the effects of mechanical harvesting of cockles on non-target benthic infauna. *Journal of Applied Ecology* 34: 497-517.
- Holme, N.A. 1961. Notes on the mode of life of the Tellinidae (Lamellibranchia). *Journal*

- of the Marine Biological Association UK. 41: 699-703.
- Horne, J.K. and D.C. Schneider. 1995. Spatial variance in ecology. *Oikos* 74: 18-26.
- Hutcheson, M.S. and P.L. Stewart. 1994. A possible relict population of *Mesodesma deauratum* (Mesodesmatidae) from the Southeast Shoal, Grand Banks of Newfoundland. *Canadian Journal of Fisheries and Aquatic Sciences* 51: 1162-1168.
- Hutcheson, M.S., P.L. Stewart and J.M. Spry. 1981. Section VII- The Biology of Benthic Communities of the Grand Banks of Newfoundland (includes the Hibernia area). Grand Banks Oceanographic Studies Volume No. 3, Final Report. Prepared by MacLaren Plansearch. (Copy available at Bedford Institute of Oceanography library).
- ICES, 1996. Report of the Working Group on Ecosystem Effects of Fishing Activities. ICES CM 1996/Assess/Env:1 Ref.:G, Copenhagen, Denmark.
- Jennings, S. and M.J. Kaiser. 1998. The effects of fishing on marine ecosystems. *Advances in Marine Biology* 34: 201-352.
- Johnson, C.W. 1934. List of marine mollusca of the Atlantic coast from Labrador to Texas. *Proceedings of the Boston Society of Natural History* 40: 1-204.
- Kaiser, M.J. and B.E. Spencer. 1996. The effects of beam-trawl disturbance on infaunal communities in different habitats. *Journal of Animal Ecology* 65: 348-358.
- Krost, P., M. Bernhard, F. Werner and W. Hukriede. 1990. Otter trawl tracks in Kiel Bay (Western Baltic) mapped by side-scan sonar. *Meeresforsch* 32: 344-353.
- Kulka, D.W. 1991. A description of fisheries in the vicinity of significant oil discovery areas off Newfoundland. *Canadian Technical Report of Fisheries and Aquatic Sciences* 1787.
- Lambert, J. and P. Goudreau. 1996. Performance of the New England hydraulic dredge for the harvest of Stimpson's surf clams (*Mactromeris polynyma*). *Canadian Industry Report of Fisheries and Aquatic Sciences* 235.

- Langton, R.W. and W.E. Robinson. 1990. Faunal associations on scallop grounds in the western Gulf of Maine. *Journal of Experimental Marine Biology and Ecology* 144: 157-171.
- Lubinsky, I. 1980. Marine bivalve molluscs of the Canadian central and eastern Arctic: faunal composition and zoogeography. *Canadian Bulletin of Fisheries and Aquatic Sciences* 207.
- MacKenzie, C.L., Jr., V.G. Burrell, Jr., A. Rosenfield and W.L. Hobart. 1997. The History, Present Condition, and Future of the Molluscan Fisheries of North and Central America and Europe. Vol.1-3. U.S. Department of Commerce.
- Mayhew, R. and F. Cole. Annotated list of marine benthic molluscs from the Arctic to Cape Hatteras (in prep.).
- McCallum, B.R. and S.J. Walsh. 1996. Groundfish survey trawls used at the Northwest Atlantic Fisheries Centre, 1971-Present. NAFO SCR Doc. 96/50.
- McKeown, D.L. and D.C. Gordon, Jr. 1997. Grand Banks otter trawling impact experiment: II. Navigation procedures and results. *Canadian Technical Report of Fisheries and Aquatic Sciences* 2159: xi + 79 p.
- McLoughlin, R.J., P.C. Young, R.B. Martin and J. Parslow. 1991. The Australian scallop dredge: estimates of catching efficiency and associated indirect fishing mortality. *Fisheries Research* 11: 1-24.
- Medcof, J.C. and J.F. Caddy. 1971. Underwater observations on performance of clam dredges of three types. *ICES C.M.* 1971/B:10.
- Messieh, S.N., T.W. Rowell, D.L. Peer and P.J. Cranford. 1991. The effects of trawling, dredging and ocean dumping on the eastern Canadian continental shelf seabed. *Continental Shelf Research* 11: 1237-1263.
- Meyer, T.L., R.A. Cooper and K.J. Pecci. 1981. The performance and environmental effects of a hydraulic clam dredge. *Marine Fisheries Review* 43: 14-22.

- Moshagen, H. and S.P. Kjeldsen. 1980. Fishing gear loads and effects on submarine pipelines. Pp. 383-393. In: Proceedings of the 12th Annual Offshore Technology Conference. Houston, Texas.
- Naidu, K.S. 1977. Stock status report Strait of Belle (NAFO Div. 4R) Iceland scallops. Pp. 68-69. In: Perry, G. (Ed.). Collected stock status reports for marine resources assessed by the Newfoundland region in 1996. Canadian Manuscript Report of Fisheries and Aquatic Sciences 2398.
- Naidu, K.S., F.M. Cahill and E.M. Seward. 1996. Abundance of Iceland scallops in NAFO Div. 4R (Strait of Belle Isle) declines further in 1995. DFO Atlantic Fisheries Research Document 96/49.
- Nesis, K. 1970. Biocoenoses and biomass of benthos of the Newfoundland-Labrador region. Fisheries Research Board of Canada Translation Series No. 1375.
- Nilsson, C. and G. Grelsson. 1995. The fragility of ecosystems: a review. *Journal of Applied Ecology* 32: 677-692.
- Odum, E.P. 1964. The new ecology. *BioScience* 14: 14-16.
- Odum, E.P. 1985. Trends expected in stressed ecosystems. *BioScience* 35(7): 419-422.
- Osenberg, C.W., R.J. Schmitt, S.J. Holbrook, K.E. Abu-Saba and A.R. Flegal. 1994. Detection of environmental impacts: Natural variability, effect size, and power analysis. *Ecological Applications* 4: 16-30.
- Palmer, A., I. Konuk, G. Comfort and K. Been. 1990. Ice gouging and the safety of marine pipelines. OTC 6371. Pp. 235-244. In: Proceedings of the 22nd Annual Offshore Technology Conference, Houston, Texas.
- Peck, L.S. and L.W. Bullough. 1993. Growth and population structure in the infaunal bivalve *Yoldia eightsi* in relation to iceberg activity at Signy Island, Antarctica. *Marine Biology* 117: 235-241.
- Peterman, R.M. and M. M'Gonigle. 1992. Statistical power analysis and the precautionary

- principle. *Marine Pollution Bulletin* 24(5): 231-234.
- Petersen, G.H. 1978. Life cycles and population dynamics of marine benthic bivalves from the Disko Bugt area of West Greenland. *Ophelia* 17(1): 95-120
- Petersen, G.H., P.B. Madsen, K.T. Jensen, K.H. van Bernem, J. Harms, W. Heiber, I. Kröncke, H. Michaelis, E. Rachor, K. Reise, R. Dekker, G.J.M. Visser and W.J. Wolff. 1996. V. Red list of macrofaunal benthic invertebrates of the Wadden Sea. *Helgoländer Meeresunters* 50, Suppl., 69-76.
- Prena, J., T.W. Rowell, P. Schwinghamer, K. Gilkinson, and D.C. Gordon, Jr. 1996. Grand Banks otter trawling impact experiment: I. Site selection process, with a description of macrofaunal communities. *Canadian Technical Report of Fisheries and Aquatic Sciences* 2094: viii + 38 p.
- Prena, J., P. Schwinghamer, T.W. Rowell, D.C. Gordon, Jr., K. Gilkinson, W.P. Vass, D.L. McKeown. 1998. Experimental otter trawling on a sandy bottom ecosystem of the Grand Banks of Newfoundland: analysis of trawl bycatch and effects on epifauna. *Marine Ecology Progress Series* (in press).
- Raloff, J. 1996. Fishing for answers. Deep trawls leave destruction in their wake- but for how long? *Science News* 150: 268-271.
- Ramsay, K., M.J. Kaiser and R.N. Hughes. 1998. Responses of benthic scavengers to fishing disturbance by towed gears in different habitats. *Journal of Experimental Marine Biology and Ecology* 224: 73-89.
- Rapport, D.J., H.A. Regier and T.C. Hutchinson. 1985. Ecosystem behaviour under stress. *The American Naturalist* 125(5): 617-640.
- Reise, K. 1982. Long-term changes in the macrobenthic invertebrate fauna of the Wadden Sea: are polychaetes about to take over? *Netherlands Journal of Sea Research* 16: 29-36.
- Rice, M.A., C. Hickox and I. Zehra. 1989. Effects of intensive fishing effort on the

- population structure of quahogs, *Mercenaria mercenaria* (Linnaeus, 1758), in Narragansett Bay. *Journal of Shellfish Research* 8: 345-354.
- Rowell, T.W., P. Schwinghamer, M. Chin-Yee, K. Gilkinson, D.C. Gordon, Jr., E. Hartgers, M. Hawryluk, D.L. McKeown, J. Prena, D.P. Reimer, G. Sonnichsen, G. Steeves, W.P. Vass, R. Vine and P. Woo. 1997. Grand Banks otter trawling experiment: III. Sampling equipment, experimental design and methodology. *Canadian Technical Report of Fisheries and Aquatic Sciences* 2190: viii + 36 p.
- Rumohr, H. and P. Krost. 1991. Experimental evidence of damage to benthos by bottom trawling with special reference to *Arctica islandica*. *Meeresforsch* 33: 340-345.
- Rumohr, H., Schomann, H. and T. Kujawski. 1994. Environmental impact of bottom gears on benthic fauna in the German Bight. Pp. 75-86. In: de Groot, S.J. de and H.J. Lindeboom (eds.). *Environmental Impact of Bottom Gears on Benthic Fauna in Relation to Natural Resources Management and Protection of the North Sea*. NIOZ-Rapport 1994-11, RIVO-DLO Report C026/94, Netherlands Institute for Sea Research.
- Santbrink, J.W. van and M.J.N. Bergman. 1994. Direct effects of beam trawling on macrofauna in a soft bottom area in the southern North Sea. Pp. 147-178. In: de Groot, S.J. de and H.J. Lindeboom (eds.). *Environmental Impact of Bottom Gears on Benthic Fauna in Relation to Natural Resources Management and Protection of the North Sea*. NIOZ-Rapport 1994-11, RIVO-DLO Report C026/94, Netherlands Institute for Sea Research.
- Sainsbury, K.J. 1988. The ecological basis of multispecies fisheries and management of a demersal fishery in tropical Australia. pp. 349-382. In: Gulland, J.A. (Ed.), *Fish Population Dynamics*, 2nd ed., John Wiley & Sons, London.
- Schneider, D.C., J.-M. Gagnon and K.D. Gilkinson. 1987. Patchiness of epibenthic megafauna on the outer Grand Banks of Newfoundland. *Marine Ecology Progress*

Series 39:1-13.

- Schneider, D.C., R. Walters, S. Thrush and P. Dayton. 1997. Scale-up of ecological experiments: Density variation in the mobile bivalve *Macomona liliana*. *Journal of Experimental Marine Biology and Ecology* 216: 129-152.
- Schwinghamer, P., J.Y. Guigné and W.C. Siu. 1996. Quantifying the impact of trawling on benthic habitat structure using high resolution acoustics and chaos theory. *Canadian Journal of Fisheries and Aquatic Sciences* 53: 288-296.
- Schwinghamer, P., D.C. Gordon, Jr., T.W. Rowell, J. Prena, D.L. McKeown, G. Sonnichsen and J.Y. Guigné. 1998. Effect of experimental otter trawling on surficial sediments of a sandy bottom ecosystem on the Grand banks of Newfoundland. *Conservation Biology* 12: 1215-1222.
- Service, M. and B.H. Magorrian. 1997. The extent and temporal variation of disturbance to epibenthic communities in Strangford Lough, Northern Ireland. *Journal of the Marine Biological Association U.K.* 77: 1151-1164.
- Shepard, A.N. and P.J. Auster. 1991. Incidental (non-capture) damage to scallops caused by dragging on rock and sand substrates. Pp. 219-230. In: *An International Compendium of Scallop Biology and Culture. Selected papers from the 7th International Pectinid Workshop*, World Aquaculture Society, Baton Rouge, La.
- Skog, S. And R. Varmo. 1980. Effects of pollution on the distribution of *Macoma baltica* (L.) in the sea area of Helsinki. *Finnish Marine Research* 247: 124-134.
- Snelgrove, P.V.R. and C.-A. Butman. 1994. Animal-sediment relationships revisited: cause versus effect. *Oceanography and Marine Biology: Annual Review* 32: 111-177.
- Stanley, S.M. 1970. Relation of Shell Form to Life Habits of the Bivalvia (Mollusca). The Geological Society of America, Inc., Boulder, Colorado.
- Stanley, S.M. 1975. Adaptive themes in the evolution of the Bivalvia (Mollusca). *Annual Review of Earth and Planetary Sciences* 3: 361-385.

- Steimle, F.W. 1990. Benthic macrofauna and habitat monitoring on the continental shelf of the northeastern United States. I. Biomass. NOAA Technical Report NMFS 86. U.S. Department of Commerce.
- Taylor, L.R. 1961. Aggregation, variance and the mean. *Nature* 189: 732-735.
- Taylor, L.R. 1965. A natural law for the spatial disposition of insects. Pp. 396-397. In: Proceedings of the 12th International Congress on Entomology
- Theroux, R.B. and R.L. Wigley. 1983. Distribution and abundance of east coast bivalve mollusks based on specimens in the National Marine Fisheries Service Woods Hole collection. NOAA Technical Report NMFS SSRF-768.
- Thrush, S.F., J.E. Hewitt, V.J. Cummings and P.K. Dayton. 1995. The impact of habitat disturbance by scallop dredging on marine benthic communities: what can be predicted from the results of experiments? *Marine Ecology Progress Series* 129: 141-150.
- Trueman, E.R., A.R. Brand and P. Davis. 1966. The effect of substrate and shell shape on the burrowing of some common bivalves. *Proceedings of the Malacological Society of London* 37: 97-109.
- Tuck, I.D., S.J. Hall, M.R. Robertson, E. Armstrong and D.J. Basford. 1998. Effects of physical trawling disturbance in a previously unfished sheltered Scottish sea loch. *Marine Ecology Progress Series* 162: 227-242.
- Van Dolah, R.F., P. H. Wendt and M.V. Levisen. 1991. A study of the effects of shrimp trawling on benthic communities in two South Carolina sounds. *Fisheries Research* 12: 139-156.
- Vermeij, G.J. 1978. Biogeography and adaptation. *Patterns of Marine Life*. Harvard University Press, Cambridge, Massachusetts.
- Vermeij, G.J. 1987. *Evolution and Escalation: An Ecological History of Life*. Princeton University Press, Princeton, N.J.

- Vézina, A.F. 1988. Sampling variance and the design of quantitative surveys of the marine benthos. *Marine Biology* 97: 151-155.
- Warner, W.W. 1977. *Distant Water. The Fate of the North Atlantic Fisherman*. Little, Brown and Company, Boston.
- Warwick, R.M. and K.R. Clarke. 1993. Increased variability as a symptom of stress in marine communities. *Journal of Experimental Marine Biology and Ecology* 172: 215-226.
- Welch, H.E. and K. Martin-Bergmann. 1990. Does the clam *Mya truncata* regenerate its siphon after predation by the walrus? An experimental approach. *Arctic* 43: 157-158.
- Willis, A.J. 1997. The ecosystem: an evolving concept viewed historically. *Functional Ecology* 11: 268-271.
- Witbaard R. and R. Klein. 1994. Long-term trends on the effects of the southern North Sea beamtrawl fishery on the bivalve mollusc *Arctica islandica* L. (Mollusca, bivalvia). *ICES Journal of Marine Science* 51: 99-105.
- Woodworth-Lynas, C.M.T., H.W. Josenhans, J.V. Barrie, C.F.M. Lewis and D.R. Parrott. 1991. The physical processes of seabed disturbance during iceberg grounding and scouring. *Continental Shelf Research* 11: 939-961.
- Zaklan, S. and R. Ydenberg. 1997. The body size-burial depth relationship in the infaunal clam *Mya arenaria*. *Journal of Experimental Marine Biology and Ecology* 215: 1-17.
- Zwarts, L. and J. Wanink. 1989. Siphon size and burying depth in deposit- and suspension-feeding bivalves. *Marine Biology* 100: 227-240.

Table 3.1 . Life positions¹ of deep water bivalve taxa recorded from the Newfoundland-Labrador continental shelf (including the Grand Banks) and Labrador Sea². Species collected by grab in the OETSA are in bold.

Nuculidae		Astartidae		
	<i>Ennucula tenuis</i>	i,s	<i>Astarte borealis</i>	i,s
	<i>N. proxima</i>	i,s	<i>A. castanea</i>	i,s
	<i>N. delphinodonta</i>	i,s	<i>A. crenata</i>	m,s
Nuculanidae	<i>Nuculana minuta</i>	i,s	<i>A. elliptica</i>	i,s
	<i>N. pernula</i>	i,d	<i>A. montague</i>	i,s
Yoldiidae			<i>A. undata</i>	i,s
	<i>Yoldia hyperborea</i>	i,d	<i>A. sp. A</i>	i,s
	<i>Y. limatula</i>	i,d	<i>A. sp. B</i>	i,s
	<i>Y. myalis</i>	i,d	Pectenidae	
	<i>Y. thraciaeformis</i>	i,d	<i>Chlamys islandica</i>	e,s
	<i>Y. solidula</i>	i,d	<i>Placopecten</i>	e,s
	<i>Y. expansa</i>	i,d	<i>magellanicus</i>	
	<i>Y. sapotilla</i>	i,d	<i>Palliolium striatum</i>	e,s
Arcidae			<i>Delectopecten</i>	e,s
	<i>Bathyarca</i> spp.	i,s	<i>vitreus</i>	
			<i>D. greenlandicus</i>	e,s
Mytilidae			Arcticidae	
	<i>Crenella decussata</i>	m,s	<i>Arctica islandica</i>	i,s
	<i>C. glandula</i>	m,s	Lyonsiidae	
	<i>Dacrydium vitreum</i>	m,s	<i>Lyonsia arenosa</i>	m,s
	<i>Modiolus modiolus</i>	m,s	<i>L. granulifer</i>	m,s
	<i>Musculus niger</i>	m,s	Thraciidae	
	<i>M. discors</i>	m,s	<i>Thracia septentrionalis</i>	i,?
	<i>Mytilus edulis</i>	m,s	<i>T. myopsis</i>	i,?
Limidae			<i>T. devesa</i>	i,?
	<i>Limea subovata</i>	e,s	<i>T. conradi</i>	i,?
	<i>Limatula</i>	e,s	Cuspidaridae	
	<i>subauriculatus</i>		<i>Cuspidaria obesa</i>	i,?
Periplomatidae			<i>C. arctica</i>	i,?
	<i>Periploma</i>	i,d	<i>C. striata</i>	i,?
	<i>abyssorum</i>		<i>C. rostrata</i>	i,?
Cardiidae			Limopsidae	
	<i>Cerastoderma</i>	i,s	<i>Limopsis minuta</i>	i,?
	<i>pinnulatum</i>		Veneridae	
	<i>Clinocardium</i>	i,s	<i>Liocyma fluctuosa</i>	i,s
	<i>ciliatum</i>		Myidae	
	<i>Serripes</i>	i,s	<i>Mya truncata</i>	i,d
	<i>groenlandicus</i>			

Table 3.1 (continued) . Life positions¹ of deep water bivalve taxa recorded from the Newfoundland-Labrador continental shelf (including the Grand Banks) and Labrador Sea². Species collected by grab in the OETSA are in bold.

Hiatellidae			
	<i>Cyrtodaria siliqua</i>	i,d	Thyasiridae
	<i>Hiatella arctica</i>	e,s	<i>Axinopsida orbiculata</i>
	<i>Panomya arctica</i>	i,d	<i>Thyasira gouldi</i>
Montacutiidae			<i>T. sp. A</i>
	<i>Montacuta dawsoni</i> ³	e,s	<i>T. flexuosa</i>
Pandoridae			<i>T. trisinuata</i>
	<i>Pandora gouldiana</i>	i,s	Corbulidae
	<i>P. glacialis</i>	i,s	<i>Corbula contracta</i>
Macluridae			Carditidae
	<i>Maclurina polynyma</i>	i,d	<i>Cyclocardia sp. A</i>
	<i>Spisula solidissima</i>	i,d	<i>C. borealis</i>
Mesodesmatidae			<i>C. novangliae</i>
	<i>Mesodesma arctatum</i>	i,s	
	<i>M. deauratum</i>	i,s	
Pharidae			
	<i>Siliqua costata</i>	i,d	
Turtonidae			
	<i>Turtonia minuta</i>	i,s	
Tellinidae			
	<i>Macoma calcarea</i>	i,d	
Anomiidae			
	<i>Anomia squamula</i>	e,s	

1- i-infaunal, e-epifaunal, m- multiple life positions possible; i,e infaunal, semi-infaunal or epifaunal; s=shallow burrower, d=deep burrower (see text). Source: Stanley (1970). nb-For species with unknown burrowing depth, probable burrowing depth has been determined based on characteristics of the pallial sinus and maximum adult size. 2- Sources: Johnson (1934), Abbott (1974), Clarke (1974), Lubinsky (1980), Gilkinson (1986), Hutcheson et al. (1981), Gordon and Weeks (1982), Mayhew and Cole (in prep.). 3- Living commensally on echinoderms (Abbott, 1974).

Table 3.2. Dimensions of key gear components of the Engel 145 Hi-lift otter trawl used with the *Wilfred Templeman* in the experimental trawling study.

Parameter	Standard
Trawl doors (otter boards)	3.8 m ² / 1250 kg (each)
Sweeps (ground warps)	15.2 m
Bridles	50 m
Buoyancy	283.5 kg
Headline length	29.2 m
Fishing line ¹ length	19.5 m
Footgear	
length	35.6 m
material	46 cm rubber discs
weight in air	501.3 kg
Net mesh size	
wings/square	180 mm
bellies	150/130 mm
codend	130 mm
liner	30 mm
material	polyethylene, nylon codend
Doorspread	60-75 m
Wing spread	17-22 m
Net vertical opening	4-6 m

1- wire to which lower net panels are strung; nb- all wires are 6x19 preformed, galvanized plow steel.

Table 3.3. Summary of trawling events and grab samples collected by combination of treatment.

C.S.S. Parizeau Trip #	Date	Trawling event ¹	Timing	Grab Samples			
				Corridor A ²		Corridor B ³	
				E	R	E	R
93-21	7/93	#1	Before trawling	5	5	5	5
			Post-trawl	10		10	
93-29 ¹	9/93			10	10	10	10
94-15	7/94	#2	Pre-trawl	10	10	10	10
			Post-trawl	10		10	
95-13	7/95	#3	Pre-trawl	10	10	10	10
			Post-trawl	10		10	

E- experimental trawling corridor, R- reference corridor; 1- each annual trawling event consisted of 12 passes down the center line of each corridor; cumulative passes for each corridor were: 1993 (12), 1994 (24), 1995 (36); 2- Corridor A stations mean depth and range (128.5 m, 120 m -140 m); 3- Corridor B stations mean depth and range (135.5 m, 122 m-146 m).

Table 3.4. Damage classification of bivalves collected by grab in the OETSA.

Category	Description
No damage	No visible signs of damage to the shell, ligament or soft parts.
Minor damage	Negligible shell breakage and no damage to ligament; inner soft parts not exposed and no damage to siphon or body in <i>Cyrtodaria</i> . <u>Example</u> : one or two very small chips missing from either valve along commissure.
Moderate damage	Larger area of reparable shell breakage; neither ligament nor soft parts damaged. <u>Example</u> : Larger chip or shell fragment missing from valve margin or hairline fracture extending partially across one valve.
Major damage	Destruction of shell or tissue damage. <u>Example</u> : (i) Shell: fragmentation of one or both valves or disarticulation of valves. (ii) Soft parts: gash(es) to ventral body or severing of siphon in <i>Cyrtodaria</i> , or severing of siphon.

Table 3.5. Laboratory burrowing trials test conditions.

Species	Sediment	Water Temp.(C)	Burrowing rate		Life position	
			SR	# tested	SR	# tested
<i>M. calcareea</i>	Grade 0 Silica sand	5	14-41	16	14-41	16
<i>C. siliqua</i>	native sediment (G.B. fine sand)	5*	41-71	12	60-90	3
<i>A. borealis</i>	native sediment (G.B. fine sand) & Grade 0 silica sand	5	28-36	4	25-40	11
<i>A. sp. A</i>	native sediment (G.B. fine sand)	5	12	1		
<i>C. ciliatum</i>	native sediment (G.B. fine sand)	5	32, 54	2	32, 54	2
<i>C. novangliae</i>	Grade 0 silica sand	5			15-20	10
<i>C. sp. A</i>	Grade 0 silica sand	5			17-25	5
<i>Y. myalis</i>	native sediment (G.B. fine sand)	5	14	1		
<i>N. minuta</i>	native sediment (G.B. fine sand)	5	14	1		

G.B.- Grand Banks; SR- size range in mm; * For the longer term (5 months) monitoring of life position for *Cyrtodaria*, water temperature underwent ambient changes, i.e. 0°C at the start, gradually increasing to ca. 5°C by the end of the experiment.

Table 3.6. Start and end times of trawling conducted by the *CSS Wilfred Templeman* in experimental corridors A and B, 1993-1995. Also listed are the range in time intervals between trawling and grab sample collections.

Year	Corridor	Trawling starts		Trawling ends		Time intervals between last trawl pass and first and last grabs (hours)	
		Date	GMT	Date	GMT	First	Last
1993	A	6 July	1130	7 July	2157	39	46
	B ¹	7 July	2316	10 July	0120	14	41
1994	A	9 July	1731	11 July	0024	134	165
	B	12 July	2320	14 July	0614	34	39
1995	A	30 June	1634	2 July	0007	16	20
	B	2 July	0043	3 July	0840	8	12

GMT- Greenwich meridian time; 1- due to equipment problems there was a 19 hr. delay between set numbers 6 and 7.

Table 3.7. Life positions and burial depths of bivalve species collected by grab in the OETSAs. I=infaunal- living entirely within sediment; S=semi-infaunal- partially exposed; E=epifaunal- living on the sediment surface.

Species	Position	Adult burial depth ^a
Astartidae		
<i>Astarte borealis</i>	I	shallow
<i>Astarte sp. A</i>	I	shallow
<i>Astarte sp. B</i>	I	shallow
Cardiidae		
<i>Clinocardium ciliatum</i>	I	shallow
<i>Serripes groenlandicus</i>	I	deep
Carditidae		
<i>Cyclocardia novangliae</i>	I,S	shallow
<i>Cyclocardia sp. A</i>	S,E	shallow
Corbulidae		
<i>Corbula contracta</i>	I	shallow
Hiatellidae		
<i>Cyrtodaria siliqua</i>	I	deep
<i>Hiatella arctica</i>	E	shallow
<i>Panomya arctica</i>	I	deep
Lyonsiidae		
<i>Lyonsia arenosa</i>	I,S	shallow
Mytilidae		
<i>Crenella decussata</i>	I,S	shallow
<i>Musculus discors</i>	I,S	shallow
Nuculanidae		
<i>Nuculana minuta</i>	I	shallow
Nuculidae		
<i>Ennucula tenuis</i>	I	shallow
Pandoriidae		
<i>Pandora gouldiana</i>	I	shallow
Pectenidae		
<i>Chlamys islandica</i>	E	shallow
Tellinidae		
<i>Macoma calcarea</i>	I	deep
Thraciidae		
<i>Thracia myopsis</i>	I	deep
Thyasiridae		
<i>Thyasira sp. A</i>	I	deep
Veneridae		
<i>Liocyma fluctuosa</i>	I	shallow
Yoldiidae		
<i>Yoldia myalis</i>	I	deep

^a depth of burial is the distance from the sediment surface to the shallowest point on a buried shell (typically, posterior margin).

Shallow burrowers are those species for which depth of burial, as adults, is less than approximately 2 to 3 cm; deep burrowers are those for which it is greater (Stanley, 1970).

Table 3.8. Two-way ANOVA of densities and biomass of all bivalves collected in the hydraulic grab prior to trawling in July 1993, for effects of location (inside experimental corridor vs adjacent reference area) and corridor.

Variable ¹	Source	DF	MS	F	P
Total Density	Corridor (C)	1	0.0362	2.10	0.166
	Location (L)	1	0.0108	0.63	0.440
	C x L	1	0.0041	0.24	0.633
	Error	19	0.0172		
Total Biomass	Corridor (C)	1	0.0175	0.73	0.405
	Location (L)	1	0.0047	0.20	0.663
	C x L	1	0.0028	0.12	0.738
	Error	19	0.0435		

1- logarithmic transformation applied

Table 3.9. Mean biomass and densities of all bivalves by combination of treatment in the OETSA. PT- immediate post-trawl; PT¹- 10 weeks post-trawl (i.e. July trawling event); PR- pre-trawl; R- reference.

Year	Corridor	Treatment (n = 10 stations)	Biomass (g/0.5 m ²)		Density (/0.5 m ²)	
			Mean	s.d.	Mean	s.d.
1993 (July)	A	Before	310.8	65.9	265.0	64.5
		PT	218.7	115.5	294.8	62.8
	B	Before	288.9	120.6	327.9	86.9
		PT	313.6	137.5	302.7	101.3
1993 (Sept.)	A	R	175.2	92.5	329.4	47.7
		PT ¹	193.7	101.6	252.1	78.4
	B	R	265.9	143.1	279.8	107.0
		PT ¹	219.4	154.2	274.3	95.1
1994	A	R	315.5	141.9	279.7	53.8
		PR	298.3	76.3	283.0	60.7
		PT	289.4	140.8	310.4	75.3
	B	R	259.4	96.9	283.6	84.2
		PR	289.3	181.2	254.4	58.6
		PT	239.3	104.9	258.2	62.5
1995	A	R	338.8	131.5	303.2	43.2
		PR	316.7	133.8	283.8	76.4
		PT	276.6	158.7	278.6	62.3
	B	R	286.5	133.1	255.2	115.9
		PR	288.8	136.2	285.1	51.3
		PT	305.7	64.4	228.4	58.4

Table 3.10. Two-way ANOVA of densities and biomass of all bivalves collected in the hydraulic grab in July 1993, for effects of corridor (A and B) and trawling (Before, After).

Variable ¹	Source	DF	MS	F	P
Total Density	Corridor (C)	1	0.0167	1.01	0.322
	Trawling (T)	1	0.0002	0.01	0.920
	C x T	1	0.0195	1.18	0.284
	Error	36	0.0166		
Total Biomass	Corridor (C)	1	0.0284	0.65	0.425
	Trawling (T)	1	0.0894	2.05	0.161
	C x T	1	0.1263	2.90	0.097
	Error	36	0.0435		

Table 3.11. Two-way ANOVA of densities and biomass of all bivalves collected in the hydraulic grab in Sept. 1993, for effects of corridor (A and B) and trawling¹ (Reference, Post-trawl).

Variable ¹	Source	DF	MS	F	P
Total Density	Corridor (C)	1	0.0096	0.49	0.489
	Trawling (T)	1	0.0457	2.33	0.136
	C x T	1	0.0417	2.12	0.154
	Error	36	0.0196		
Total Biomass	Corridor (C)	1	0.0459	0.45	0.506
	Trawling (T)	1	0.0469	0.46	0.501
	C x T	1	0.0865	0.85	0.362
	Error	36	0.1014		

1- logarithmic transformation applied.

nb- There was no trawling performed in Sept. 1993- post-trawl refers to 10 weeks post-trawl (i.e. from July trawling)

Table 3.12. Two-way ANOVA of densities and biomass of all bivalves collected in the hydraulic grab in 1994, for effects of corridor (A and B) and trawling (Reference, Pre-trawl, Post-trawl). Sources of variance in bold are statistically significant.

Variable ¹	Source	DF	MS	F	P
Total Density	Corridor (C)	1	0.0281	2.37	0.129
	Trawling (T)	2	0.0028	0.24	0.791
	C x T	2	0.0071	0.60	0.552
	Error	54	0.0118		
Total Biomass	Corridor (C)	1	0.0870	1.56	0.217
	Trawling (T)	2	0.0081	0.14	0.866
	C x T	2	0.0014	0.03	0.974
	Error	54	0.0558		

Table 3.13. Two-way ANOVA of densities and biomass of all bivalves collected in the hydraulic grab in 1995, for effects of corridor (A and B) and trawling (Reference, Pre-trawl, Post-trawl).

Variable ¹	Source	DF	MS	F	P
Total Density	Corridor (C)	1	0.0588	4.05	0.049
	Trawling (T)	2	0.0145	1.00	0.375
	C x T	2	0.0207	1.43	0.249
	Error	54	0.0145		
Total Biomass	Corridor (C)	1	0.0019	0.05	0.818
	Trawling (T)	2	0.0050	0.14	0.867
	C x T	2	0.0469	1.34	0.269
	Error	54	0.0349		

1- logarithmic transformation applied

Table 3.14. Two-way ANOVA of densities and biomass of *A. borealis* collected in the hydraulic grab in July 1993, for effects of corridor (A and B) and trawling (Before, After). Sources of variance in bold are statistically significant.

Variable ¹	Source	DF	MS	F	P
Density	Corridor (C)	1	0.0078	0.11	0.739
	Trawling (T)	1	0.1215	1.75	0.194
	C x T	1	0.0104	0.15	0.701
	Error	36	0.0694		
Biomass	Corridor (C)	1	4.6103	3.42	0.073
	Trawling (T)	1	0.0367	0.03	0.869
	C x T	1	0.3434	0.25	0.617
	Error	36	1.3474		

Table 3.15. Two-way ANOVA of densities and biomass of *A. borealis* collected in the hydraulic grab in 1994, for effects of corridor (A and B) and trawling (Reference, Pre-trawl, Post-trawl).

Variable ¹	Source	DF	MS	F	P
Density	Corridor (C)	1	0.1502	4.11	0.048
	Trawling (T)	2	0.0406	1.11	0.337
	C x T	2	0.0028	0.08	0.925
	Error	54	0.0366		
Biomass	Corridor (C)	1	0.5945	0.45	0.504
	Trawling (T)	2	3.4406	2.62	0.082
	C x T	2	0.7857	0.60	0.553
	Error	54	1.3135		

Table 3.16. Two-way ANOVA of densities and biomass of *A. borealis* collected in the hydraulic grab in 1995, for effects of corridor (A and B) and trawling (Reference, Pre-trawl, Post-trawl).

Variable ¹	Source	DF	MS	F	P
Density	Corridor (C)	1	0.4538	5.11	0.028
	Trawling (T)	2	0.0340	0.38	0.684
	C x T	2	0.0677	0.76	0.471
	Error	54	0.0888		
Biomass	Corridor (C)	1	3.1324	1.66	0.203
	Trawling (T)	2	2.1671	1.15	0.325
	C x T	2	0.7032	0.37	0.691
	Error	54	1.8877		

1 - logarithmic transformation applied

Table 3.17. Two-way ANOVA of densities and biomass of *C. ciliatum* collected in the hydraulic grab in July 1993, for effects of corridor (A and B) and trawling (Before, After).

Variable ¹	Source	DF	MS	F	P
Density	Corridor (C)	1	0.1929	3.04	0.089
	Trawling (T)	1	0.0619	0.97	0.330
	C x T	1	0.1246	1.96	0.170
	Error	36	0.0635		
Biomass	Corridor (C)	1	8.7326	2.85	0.099
	Trawling (T)	1	3.5174	1.15	0.291
	C x T	1	3.2954	1.08	0.306
	Error	36	3.0594		

Table 3.18. Two-way ANOVA of densities and biomass of *C. ciliatum* collected in the hydraulic grab in 1994, for effects of corridor (A and B) and trawling (Reference, Pre-trawl, Post-trawl). Sources of variance in bold are statistically significant.

Variable ¹	Source	DF	MS	F	P
Density	Corridor (C)	1	0.5952	6.09	0.017
	Trawling (T)	2	0.0482	0.49	0.613
	C x T	2	0.0854	0.87	0.423
	Error	54	0.0977		
Biomass	Corridor (C)	1	5.8306	2.21	0.143
	Trawling (T)	2	0.3447	0.13	0.878
	C x T	2	1.0419	0.39	0.676
	Error	54	2.6423		

Table 3.19. Two-way ANOVA of densities and biomass of *C. ciliatum* collected in the hydraulic grab in 1995, for effects of corridor (A and B) and trawling (Reference, Pre-trawl, Post-trawl).

Variable ¹	Source	DF	MS	F	P
Density	Corridor (C)	1	0.0148	0.20	0.659
	Trawling (T)	2	0.0165	0.22	0.803
	C x T	2	0.2899	3.86	0.027
	Error	54	0.0751		
Biomass	Corridor (C)	1	0.8700	0.26	0.615
	Trawling (T)	2	2.6411	0.78	0.466
	C x T	2	3.8440	1.13	0.331
	Error	54	3.4068		

¹- logarithmic transformation applied

Table 3.20. Two-way ANOVA of densities and biomass of *C. siliqua* collected in the hydraulic grab in July 1993, for effects of corridor (A and B) and trawling (Before, After).

Variable ¹	Source	DF	MS	F	P
Density	Corridor (C)	1	0.0931	1.21	0.279
	Trawling (T)	1	0.0139	0.18	0.673
	C x T	1	0.0039	0.05	0.823
	Error	36	0.0770		
Biomass	Corridor (C)	1	0.5653	0.71	0.406
	Trawling (T)	1	0.2751	0.34	0.561
	C x T	1	2.0129	2.52	0.121
	Error	36	0.7988		

Table 3.21. Two-way ANOVA of densities and biomass of *C. siliqua* collected in the hydraulic grab in 1994, for effects of corridor (A and B) and trawling (Reference, Pre-trawl, Post-trawl). Sources of variance in bold are statistically significant.

Variable ¹	Source	DF	MS	F	P
Density	Corridor (C)	1	0.7935	10.20	0.002
	Trawling (T)	2	0.0163	0.21	0.812
	C x T	2	0.0147	0.19	0.828
	Error	54	0.0778		
Biomass	Corridor (C)	1	2.8664	2.69	0.107
	Trawling (T)	2	0.1433	0.13	0.875
	C x T	2	0.4486	0.42	0.659
	Error	54	1.0667		

Table 3.22. Two-way ANOVA of densities and biomass of *C. siliqua* collected in the hydraulic grab in 1995, for effects of corridor (A and B) and trawling (Reference, Pre-trawl, Post-trawl). Sources of variance in bold are statistically significant.

Variable ¹	Source	DF	MS	F	P
Density	Corridor (C)	1	0.1848	4.58	0.037
	Trawling (T)	2	0.0114	0.28	0.755
	C x T	2	0.0038	0.10	0.910
	Error	54	0.0403		
Biomass	Corridor (C)	1	0.0219	0.32	0.576
	Trawling (T)	2	0.0163	0.23	0.792
	C x T	2	0.0045	0.07	0.936
	Error	54	0.0695		

1 - logarithmic transformation applied

Table 3.23. Two-way ANOVA of densities and biomass of *M. calcareea* collected in the hydraulic grab in July 1993, for effects of corridor (A and B) and trawling (Before, After). Sources of variance in bold are statistically significant.

Variable ¹	Source	DF	MS	F	P
Density	Corridor (C)	1	0.0210	0.78	0.382
	Trawling (T)	1	0.0016	0.06	0.809
	C x T	1	0.0131	0.49	0.489
	Error	36	0.0268		
Biomass	Corridor (C)	1	0.4165	4.36	0.044
	Trawling (T)	1	0.0075	0.08	0.780
	C x T	1	0.2354	2.46	0.125
	Error	36	0.0955		

Table 3.24. Two-way ANOVA of densities and biomass of *M. calcareea* collected in the hydraulic grab in 1994, for effects of corridor (A and B) and trawling (Reference, Pre-trawl, Post-trawl).

Variable ¹	Source	DF	MS	F	P
Density	Corridor (C)	1	0.0032	0.21	0.651
	Trawling (T)	2	0.0029	0.19	0.828
	C x T	2	0.0089	0.57	0.568
	Error	54	0.0156		
Biomass	Corridor (C)	1	0.0339	0.24	0.626
	Trawling (T)	2	0.0538	0.38	0.684
	C x T	2	0.0103	0.07	0.929
	Error	54	0.1408		

Table 3.25. Two-way ANOVA of densities and biomass of *M. calcareea* collected in the hydraulic grab in 1995, for effects of corridor (A and B) and trawling (Reference, Pre-trawl, Post-trawl).

Variable ¹	Source	DF	MS	F	P
Density	Corridor (C)	1	0.0624	3.47	0.068
	Trawling (T)	2	0.0204	1.13	0.330
	C x T	2	0.0313	1.74	0.186
	Error	54	0.0180		
Biomass	Corridor (C)	1	0.0219	0.32	0.576
	Trawling (T)	2	0.0163	0.23	0.792
	C x T	2	0.0046	0.07	0.936
	Error	54	0.0695		

1- logarithmic transformation applied

Table 3.26. Two-way ANOVA of densities and biomass of *Thyasira* sp. A collected in the hydraulic grab in July 1993, for effects of corridor (A and B) and trawling (Before, After). Sources of variance in bold are statistically significant.

Variable ¹	Source	DF	MS	F	P
Density	Corridor (C)	1	3.2047	45.82	0.0001
	Trawling (T)	1	0.0092	0.13	0.719
	C x T	1	0.0167	0.24	0.629
	Error	36	0.0699		
Biomass	Corridor (C)	1	14.8449	33.71	0.0001
	Trawling (T)	1	0.0014	0.00	0.955
	C x T	1	0.0749	0.17	0.683
	Error	36	0.4404		

Table 3.27. Two-way ANOVA of densities and biomass of *Thyasira* sp. A collected in the hydraulic grab in 1994, for effects of corridor (A and B) and trawling (Reference, Pre-trawl, Post-trawl). Sources of variance in bold are statistically significant.

Variable ¹	Source	DF	MS	F	P
Density	Corridor (C)	1	2.8049	30.15	0.0001
	Trawling (T)	2	0.0697	0.75	0.478
	C x T	2	0.0006	0.01	0.993
	Error	54	0.0930		
Biomass	Corridor (C)	1	7.7053	14.61	0.0003
	Trawling (T)	2	0.2305	0.44	0.648
	C x T	2	0.0852	0.16	0.851
	Error	54	0.5276		

Table 3.28. Two-way ANOVA of densities and biomass of *Thyasira* sp. A collected in the hydraulic grab in 1995, for effects of corridor (A and B) and trawling (Reference, Pre-trawl, Post-trawl). Sources of variance in bold are statistically significant.

Variable ¹	Source	DF	MS	F	P
Density	Corridor (C)	1	2.5953	39.51	0.0001
	Trawling (T)	2	0.0683	1.04	0.361
	C x T	2	0.0673	1.02	0.366
	Error	54	0.0657		
Biomass	Corridor (C)	1	6.5107	18.95	0.0001
	Trawling (T)	2	0.0915	0.27	0.767
	C x T	2	0.2911	0.85	0.434
	Error	54	0.3435		

1- logarithmic transformation applied

Table 3.29. Two-way ANOVA of densities and biomass of *A. borealis* collected in the hydraulic grab in Sept. 1993, for effects of corridor (A and B) and trawling (Reference, Post-trawl).

Variable ¹	Source	DF	MS	F	P
Density	Corridor (C)	1	0.0791	1.83	0.185
	Trawling (T)	1	0.0137	0.32	0.577
	C x T	1	0.0462	1.07	0.309
	Error	36	0.0433		
Biomass	Corridor (C)	1	0.4476	0.24	0.630
	Trawling (T)	1	0.8656	0.46	0.504
	C x T	1	3.3834	1.78	0.190
	Error	36	1.8977		

Table 3.30. Two-way ANOVA of densities and biomass of *C. ciliatum* collected in the hydraulic grab in Sept. 1993, for effects of corridor (A and B) and trawling (Reference, Post-trawl).

Variable ¹	Source	DF	MS	F	P
Density	Corridor (C)	1	0.2731	3.35	0.078
	Trawling (T)	1	0.0011	0.01	0.908
	C x T	1	0.0039	0.05	0.827
	Error	36	0.0815		
Biomass	Corridor (C)	1	1.1933	0.43	0.517
	Trawling (T)	1	0.7201	0.26	0.614
	C x T	1	0.1135	0.04	0.841
	Error	36	2.7793		

Table 3.31. Two-way ANOVA of densities and biomass of *C. siliqua* collected in the hydraulic grab in Sept. 1993, for effects of corridor (A and B) and trawling (Reference, Post-trawl).

Variable ¹	Source	DF	MS	F	P
Density	Corridor (C)	1	0.0335	0.18	0.677
	Trawling (T)	1	0.0008	0.00	0.948
	C x T	1	0.0879	0.46	0.499
	Error	36	0.1891		
Biomass	Corridor (C)	1	0.6596	0.16	0.690
	Trawling (T)	1	1.1527	0.28	0.599
	C x T	1	5.0110	1.23	0.276
	Error	36	4.0881		

1- logarithmic transformation applied

Table 3.32. Two-way ANOVA of densities and biomass of *M. calcarea* collected in the hydraulic grab in Sept. 1993, for effects of corridor (A and B) and trawling (Reference, Post-trawl).

Variable ¹	Source	DF	MS	F	P
Density	Corridor (C)	1	0.0070	0.32	0.577
	Trawling (T)	1	0.0438	1.99	0.167
	C x T	1	0.0691	3.13	0.085
	Error	36	0.0221		
Biomass	Corridor (C)	1	0.0128	0.11	0.737
	Trawling (T)	1	0.0011	0.01	0.922
	C x T	1	0.0031	0.03	0.869
	Error	36	0.1122		

Table 3.33. Two-way ANOVA of densities and biomass of *Thyasira* sp. A collected in the hydraulic grab in Sept. 1993, for effects of corridor (A and B) and trawling (Reference, Post-trawl). Sources of variance in bold are statistically significant.

Variable ¹	Source	DF	MS	F	P
Density	Corridor (C)	1	1.5294	12.07	0.001
	Trawling (T)	1	0.0357	0.28	0.599
	C x T	1	0.0644	0.51	0.481
	Error	36	0.1268		
Biomass	Corridor (C)	1	2.1509	3.18	0.083
	Trawling (T)	1	0.0504	0.07	0.786
	C x T	1	0.2488	0.37	0.548
	Error	36	0.6770		

¹ - logarithmic transformation applied

Table 3.34. Mean densities of all juveniles (≤ 5 mm) per 0.5 m² (excluding *M. calcaea*) (n=10 stations). R- reference; PR- pre-trawl; PT- post-trawl

Year	Corridor	Treatment	Mean	sd
1993 (July)	A	Before trawling	17.1	10.0
		PT	22.4	9.5
	B	Before trawling	14.1	11.5
		PT	14.7	5.1
1994	A	R	30.1	12.4
		PR	27.0	12.0
		PT	35.1	11.9
	B	R	14.3	6.6
		PR	14.7	6.5
		PT	15.4	6.7
1995	A	R	16.0	11.5
		PR	17.2	9.4
		PT	26.6	15.4
	B	R	18.6	7.2
		PR	17.0	7.1
		PT	12.2	5.5

Table 3.35. Mean densities of juvenile *M. calcaea* (≤ 5 mm) per 0.5 m² (n=10 stations). R- reference; PR- pre-trawl; PT- post-trawl

Year	Corridor	Treatment	Mean	s.d.
1993 (July)	A	Before trawling	232.9	62.2
		PT	239.5	75.8
	B	Before trawling	157.0	88.0
		PT	169.2	88.3
1994	A	R	90.3	50.1
		PR	121.8	43.5
		PT	136.3	59.6
	B	R	124.9	62.5
		PR	109.7	24.2
		PT	104.3	43.2
1995	A	R	78.7	41.5
		PR	64.9	45.6
		PT	48.3	26.5
	B	R	48.3	19.9
		PR	101.1	45.6
		PT	34.9	25.0

Table 3.36. Two-way ANOVA of densities¹ of juvenile (≤ 5 mm) bivalves (excluding *M. calcarea*) collected by grab in July 1993, for effects of corridor (A and B) and trawling (Before, Post-trawl). Sources of variance in bold are statistically significant.

Source	DF	MS	F	P
Corridor (C)	1	0.1834	3.62	0.065
Trawling (T)	1	0.1087	2.14	0.152
C x T	1	0.0033	0.06	0.801
Error	36	0.0507		

Table 3.37. Two-way ANOVA of densities¹ of juvenile (≤ 5 mm) bivalves (excluding *M. calcarea*) collected by grab in 1994, for effects of corridor (A and B) and trawling (Reference, Pre-trawl, Post-trawl). Sources of variance in bold are statistically significant.

Source	DF	MS	F	P
Corridor (C)	1	1.5487	31.74	0.0001
Trawling (T)	2	0.0308	0.63	0.536
C x T	2	0.0218	0.45	0.642
Error	54	0.0488		

Table 3.38. Two-way ANOVA of densities¹ of juvenile (≤ 5 mm) bivalves (excluding *M. calcarea*) collected by grab in 1995, for effects of corridor (A and B) and trawling (Reference, Pre-trawl, Post-trawl). Sources of variance in bold are statistically significant.

Source	DF	MS	F	P
Corridor (C)	1	0.0534	0.97	0.329
Trawling (T)	2	0.0045	0.08	0.921
C x T	2	0.2420	4.40	0.017
Error	54	0.0550		

1- logarithmic transformation applied

Table 3.39. Two-way ANOVA of densities¹ of juvenile (≤ 5 mm) *M. calcareo* collected by grab in July 1993, for effects of corridor (A and B) and trawling (Before, Post-trawl). Sources of variance in bold are statistically significant.

Source	DF	MS	F	P
Corridor (C)	1	0.7457	4.90	0.033
Trawling (T)	1	0.1069	0.70	0.408
C x T	1	0.1003	0.66	0.422
Error	36	0.1521		

Table 3.40. Two-way ANOVA of densities¹ of juvenile (≤ 5 mm) *M. calcareo* collected by grab in 1994, for effects of corridor (A and B) and trawling (Reference, Pre-trawl, Post-trawl).

Source	DF	MS	F	P
Corridor (C)	1	0.0034	0.08	0.781
Trawling (T)	2	0.0412	0.93	0.399
C x T	2	0.1149	2.61	0.0830
Error	54	0.0441		

Table 3.41. Two-way ANOVA of densities¹ of juvenile (≤ 5 mm) *M. calcareo* collected by grab in 1995, for effects of corridor (A and B) and trawling (Reference, Pre-trawl, Post-trawl). Sources of variance in bold are statistically significant.

Source	DF	MS	F	P
Corridor (C)	1	0.0241	0.17	0.679
Trawling (T)	2	0.4957	3.55	0.035
C x T	2	0.4476	3.21	0.048
Error	54	0.1396		

1- logarithmic transformation applied

Table 3.42. Mean (\pm sd) densities of bivalves ≤ 3 mm shell length (per 0.5 m²). R-reference; PR- pre-trawl; PT- post-trawl.

Year	Corridor	Treatment	All species excluding <i>Macoma</i> (n = 10 stations)	<i>Macoma</i> (n = 3 stations)
1993 (July)	A	Before trawling	9.1 (7.2)	46.7 (16.0)
		PT	11.0 (6.9)	42.3 (33.5)
	B	Before trawling	8.2 (7.7)	62.0 (13.0)
		PT	8.9 (4.5)	45.3 (12.2)
1993 (Sept.)	A	R	20.9 (12.1)	53.0 (19.1)
		PT ¹	21.6 (12.2)	36.3 (7.8)
	B	R	20.9 (8.9)	56.3 (54.7)
		PT ¹	15.6 (9.4)	18.3 (11.2)
1994	A	R	16.3 (6.6)	30.3 (10.0)
		PR	14.8 (8.4)	31.6 (31.5)
		PT	21.4 (7.5)	32.7 (16.6)
	B	R	9.1 (4.1)	22.0 (19.9)
		PR	9.8 (4.2)	38.3 (10.5)
		PT	9.0 (4.4)	34.7 (15.0)
1995	A	R	7.2 (5.4)	63.0 (60.0)
		PR	8.1 (6.9)	69.7 (59.8)
		PT	12.6 (9.6)	63.0 (48.1)
	B	R	10.1 (4.0)	38.0 (41.2)
		PR	9.8 (6.9)	83.7 (53.8)
		PT	7.0 (4.6)	41.7 (39.8)

¹ 10 weeks post-trawl (i.e. July trawling)

Table 3.43. Two-way ANOVA of densities¹ of small juveniles (≤ 3 mm)(excluding *M. calcareae*) collected by grab in July 1993, for effects of corridor (A and B) and trawling (Before, Post-trawl).

Source	DF	MS	F	P
Corridor (C)	1	0.0317	0.50	0.483
Trawling (T)	1	0.0681	1.08	0.306
C x T	1	0.0000	0.00	0.971
Error	36	0.0632		

Table 3.44. Two-way ANOVA of densities¹ of small juveniles (≤ 3 mm)(excluding *M. calcareae*) collected by grab in July 1994, for effects of corridor (A and B) and trawling (reference, pre-trawl, post-trawl). Sources of variance in bold are statistically significant.

Source	DF	MS	F	P
Corridor (C)	1	0.9629	19.4	< 0.001
Trawling (T)	2	0.0289	0.58	0.561
C x T	2	0.0846	1.71	0.191
Error	54	0.0495		

Table 3.45. Two-way ANOVA of densities¹ of small juveniles (≤ 3 mm)(excluding *M. calcareae*) collected by grab in July 1995, for effects of corridor (A and B) and trawling (Reference, Pre-trawl, Post-trawl). Sources of variance in bold are statistically significant.

Source	DF	MS	F	P
Corridor (C)	1	0.0050	0.05	0.826
Trawling (T)	2	0.0152	0.15	0.863
C x T	2	0.2178	2.12	0.130
Error	54	0.1026		

1- logarithmic transformation applied

Table 3.46. Two-way ANOVA of densities¹ of small juvenile (≤ 3 mm) *M. calcareo* collected by grab in July 1993, for effects of corridor (A and B) and trawling (Before, Post-trawl).

Source	DF	MS	F	P
Corridor (C)	1	0.0397	1.12	0.321
Trawling (T)	1	0.0442	1.25	0.297
C x T	1	0.0008	0.03	0.877
Error	8	0.0354		

Table 3.47. Two-way ANOVA of densities¹ of small juvenile (≤ 3 mm) *M. calcareo* collected by grab in July 1994, for effects of corridor (A and B) and trawling (reference, pre-trawl, post-trawl).

Source	DF	MS	F	P
Corridor (C)	1	0.0019	0.02	0.896
Trawling (T)	2	0.0347	0.32	0.734
C x T	2	0.1021	0.93	0.420
Error	12	0.1093		

Table 3.48. Two-way ANOVA of densities¹ of small juvenile (≤ 3 mm) *M. calcareo* collected by grab in July 1995, for effects of corridor (A and B) and trawling (Reference, Pre-trawl, Post-trawl).

Source	DF	MS	F	P
Corridor (C)	1	0.0047	0.01	0.918
Trawling (T)	2	0.0556	0.13	0.878
C x T	2	0.1995	0.47	0.636
Error	12	0.4246		

1- logarithmic transformation applied

Table 3.49. Two-way ANOVA of percent frequencies of damage in SBS in 1993, for effects of corridor (A and B) and trawling (Before, Post-trawl).

Variable ¹	Source	DF	MS	F	P
All damage	Corridor (C)	1	0.0013	0.03	0.863
	Trawling (T)	1	0.0130	0.31	0.582
	C x T	1	0.0087	0.21	0.652
	Error	36	0.0125		
Major damage	Corridor (C)	1	0.0075	0.21	0.653
	Trawling (T)	1	0.0077	0.21	0.649
	C x T	1	0.0075	0.21	0.653
	Error	36	0.0364		

Table 3.50. Two-way ANOVA of percent frequencies of damage in SBS in 1994, for effects of corridor (A and B) and trawling (reference, post-trawl).

Variable ¹	Source	DF	MS	F	P
All damage	Corridor (C)	1	0.0119	0.30	0.589
	Trawling (T)	1	0.0006	0.02	0.901
	C x T	1	0.0019	0.05	0.825
	Error	36	0.0401		
Major damage	Corridor (C)	1	0.0143	0.36	0.554
	Trawling (T)	1	0.0000	0.00	0.978
	C x T	1	0.0000	0.00	0.968
	Error	36	0.0401		

Table 3.51. Two-way ANOVA of percent frequencies of damage in SBS 1995, for effects of corridor (A and B) and trawling (reference, post-trawl).

Variable ¹	Source	DF	MS	F	P
All damage	Corridor (C)	1	0.0373	0.86	0.361
	Trawling (T)	1	0.0217	0.50	0.486
	C x T	1	0.00179	1.43	0.239
	Error	36	0.0127		
Major damage	Corridor (C)	1	0.0264	0.71	0.404
	Trawling (T)	1	0.0026	0.07	0.793
	C x T	1	0.0502	1.35	0.252
	Error	36	0.0371		

1- arcsin transformation applied

Table 3.52. Linear regressions of log-transformed means and standard deviations of the densities of bivalve species in each combination of the main effects of trawling and corridor. Each treatment consisted of 10 stations. N is the number of species used in the regressions and SE is the standard error.

Year	Corridor	Treatment	N	Slope (SE)	Intercept (SE)
1993 (July)	A	Before trawling	14	0.674 (0.041)	0.194 (0.040)
		Post-trawl	17	0.670 (0.022)	0.229 (0.020)
	B	Before trawling	16	0.711 (0.046)	0.235 (0.043)
		Post-trawl	18	0.697 (0.046)	0.181 (0.040)
1994	A	Reference	17	0.636 (0.037)	0.214 (0.036)
		Pre-trawl	19	0.645 (0.034)	0.211 (0.032)
		Post-trawl	19	0.647 (0.038)	0.221 (0.036)
	B	Reference	17	0.683 (0.034)	0.197 (0.030)
		Pre-trawl	17	0.675 (0.031)	0.211 (0.027)
		Post-trawl	18	0.675 (0.019)	0.203 (0.017)
1995	A	Reference	17	0.640 (0.040)	0.207 (0.036)
		Pre-trawl	19	0.660 (0.041)	0.203 (0.036)
		Post-trawl	15	0.692 (0.044)	0.201 (0.043)
	B	Reference	17	0.751 (0.037)	0.202 (0.033)
		Pre-trawl	18	0.624 (0.025)	0.236 (0.023)
		Post-trawl	15	0.663 (0.043)	0.199 (0.037)

Table 3.53. Burrowing rate indices of bivalves occurring in the OETSAs. **EBT**- total burrowing time from point of excavation to disappearance in sediment; **BT**- burrowing time from a foot-supported position to disappearance; **EBT-BT**- time to initiate burrowing; **BRI**- burrowing rate index.

Species	Shell length (mm)	Whole wet weight (g)	Excavation burrowing time (EBT) (sec.)	Burrowing time (BT) (sec.)	EBT-BT (hr.)	BRI
<i>C. siliqua</i>	41.0	11.0	8430	1849	1.8	0.12
	53.4	38.5	6600	2727	1.1	0.12
	54.0	41.4	7046	3208	1.1	0.11
	60.5	58.8	9930	8856	0.3	0.04
	62.2	58.8	14669	9716	1.4	0.04
	60.0	65.1	17918	13900	1.1	0.03
	65.7	68.5	14329	8635	1.6	0.05
	61.4	69.5	13139	8631	1.3	0.05
	70.6	76.3	16200	8824	2.0	0.05
	69.7	85.7	40527			
68.1	86.4	14459	5087	2.6	0.09	
<i>A. borealis</i>	28.6	4.7	3164	2729	0.12	0.06
	34.0	6.2	14007	4080	2.76	0.04
	33.4	6.3	13473	7536	1.65	0.02
	36.1	15.4	12423	6586	1.62	0.04
<i>Astarte sp. A</i>	12.0	0.6	4791	2823	0.55	0.03
<i>C. ciliatum</i>	32.0	10.1	2164	1767	0.11	0.12
	54.4	49.3	97802	4080	26.03	0.09
<i>N. minuta</i>	13.5	0.32		112	0.08	0.61
<i>Y. myalis</i>	14.0	0.15		30		1.77
<i>M. calcarea</i>	14.0	0.34		134		0.52
	15.0	0.41		138		0.54
	16.0	0.47		126		0.62
	16.0	0.49		179		0.44
	19.0	0.73		143		0.63
	19.0	0.78		118		0.78
	20.0	1.00		200		0.50
	20.0	1.02		190		0.53
	22.0	1.20		138		0.77
	22.0	1.20		172		0.60
	24.0	1.60		114		1.02
	22.0	2.04		187		0.68
	29.0	2.80		300		0.47
	37.0	6.10		327		0.56
	38.0	6.40		414		0.45
41.0	9.00		740		0.28	

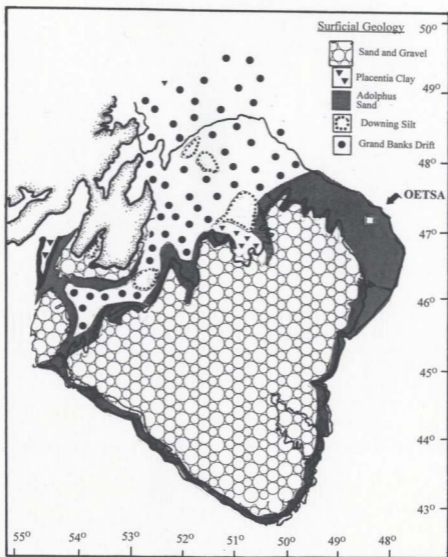

Figure 3.1 Surficial geology of the Grand Banks showing the location of the experimental trawling study area (OETSAS). Adapted from Davidson and Simms, 1997.

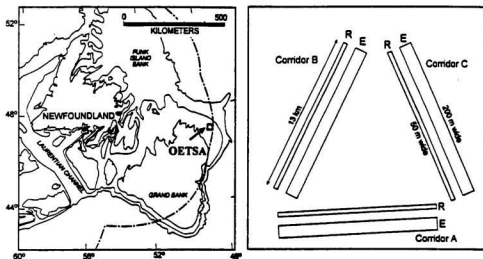

Figure 3.2 Location of the offshore experimental trawling study area (OETSA).

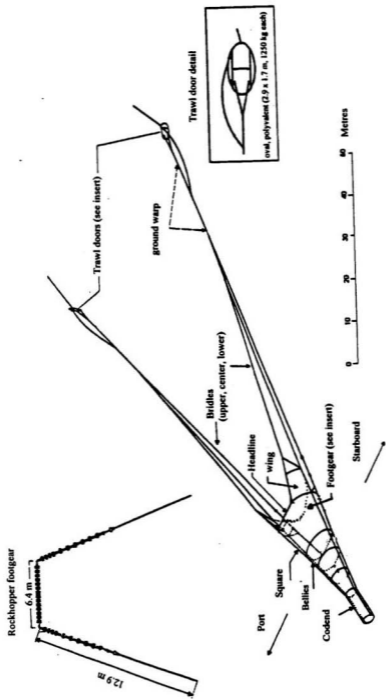

Figure 3.3 Layout drawings of the main gear components of the Engel 145 otter trawl, used in the experimental trawling study.

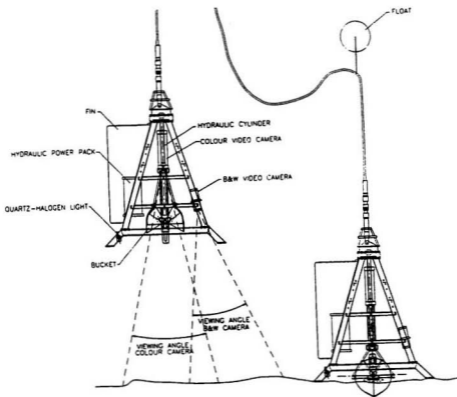

Figure 3.4 Operational characteristics of the video-hydraulic grab used to collect bivalves in the OETSA.

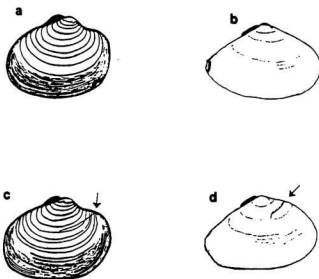

Figure 3.5 Examples of minor and moderate damage in the bivalves *Astarte borealis* and *Macoma calcareo*. a,c- *A. borealis*; b,d- *M. calcareo*; a,b- minor damage; c,d- moderate damage.



Figure 3.6 Examples of major damage in the bivalves *Cyrtodaria siliqua*, *M. calcarea* and *A. borealis*. a-c (*C. siliqua*); d,e (*M. calcarea*); f (*A. borealis*) a- specimen with severed siphon and gash in ventral body; b- large portions of tissue and shell missing; c- part of siphon; d- fragmented shell; e- disarticulated valves; f-fragmented shell.

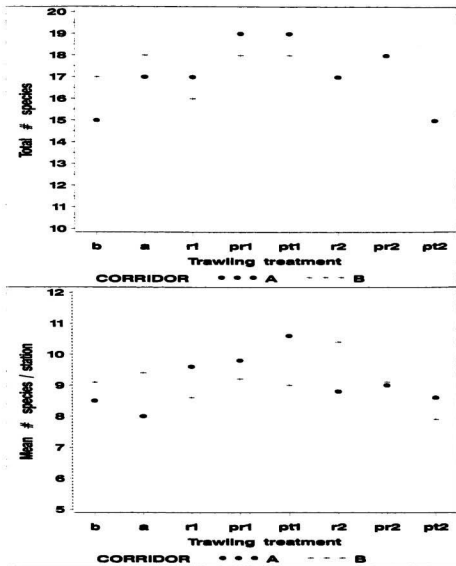

Figure 3.7 Total number of species per corridor and mean number of species per station by corridor and treatment. b-before trawling, a-after trawling (1993); r1 (reference 1994), r2 (reference 1995); pr1 (pre-trawl 1994) pr2 (pre-trawl 1995); pt1 (post-trawl 1994), pt2 (post-trawl 1995).

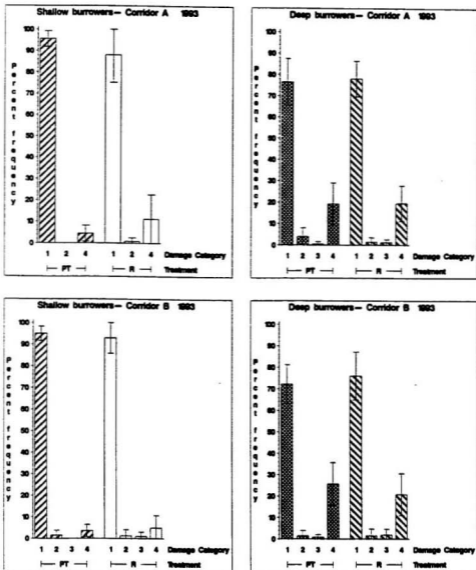

Figure 3.8 Mean percent frequency (95% confidence limits) of damage (by category) after trawling in shallow and deep burrowing species in 1993. Damage categories: 1-no damage 2-minor 3-moderate 4-major; PT-immediate post-trawl R- reference

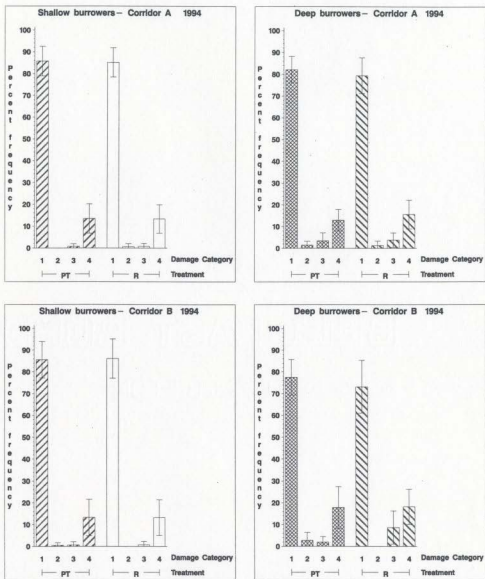

Figure 3.9 Mean percent frequency (95% confidence limits) of damage (by category) after trawling in shallow and deep burrowing species in 1994. Damage categories: 1-no damage 2-minor 3-moderate 4-major; PT-immediate post-trawl R- reference

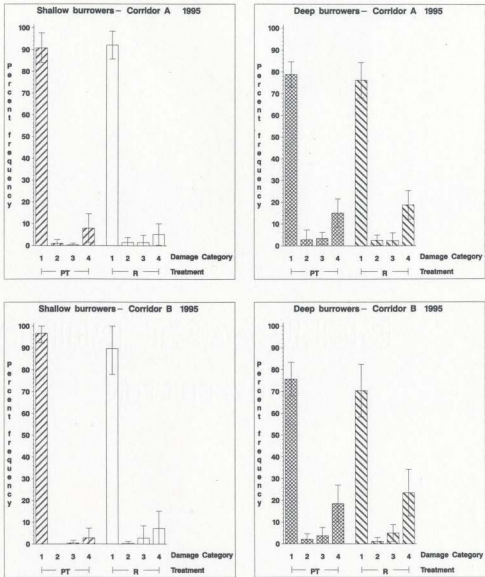

Figure 3.10 Mean percent frequency (95% confidence limits) of damage (by category) after trawling in shallow and deep burrowing species in 1995. Damage categories: 1-no damage 2-minor 3-moderate 4-major; PT-immediate post-trawl R- reference

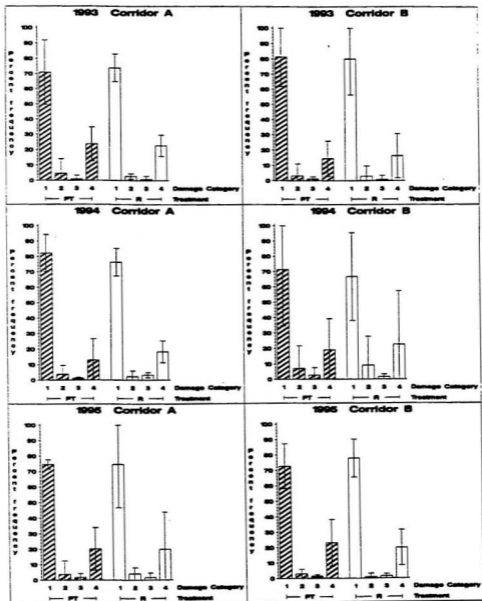

Figure 3.11 Mean percent frequency (95% confidence limits) of damage (by category) in *M. calcarea* after trawling, 1993-1995. Damage categories: 1-no damage 2-minor 3-moderate 4-major; PT-immediate post-trawl R- reference

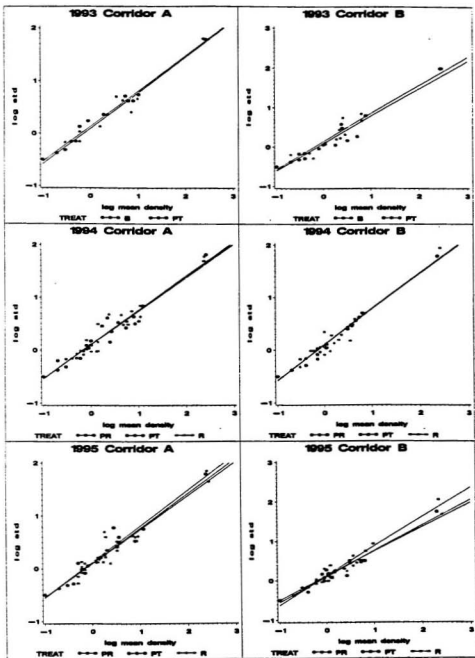

Figure 3.12 Linear regressions of \log_{10} (standard deviation) against \log_{10} (mean) densities of bivalve species by treatment, corridor and year. Symbols may represent more than one observation. B-before trawling, PT- post-trawling, PR-pre-trawling; R- reference

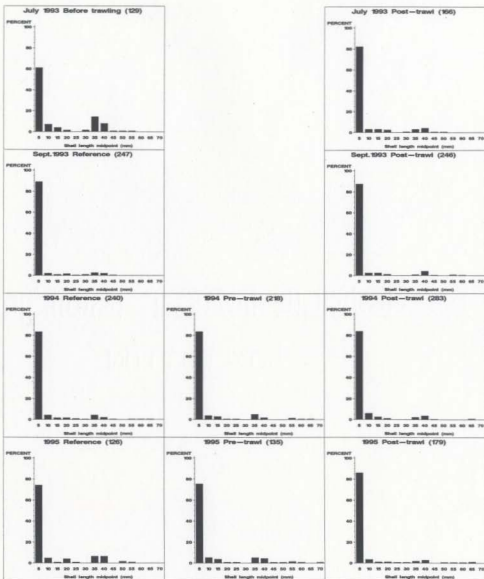

Figure 3.13 Size frequency distributions of pooled samples, n=10 stations, of shallow burrowing species in Corridor A, by treatment and year. Total # bivalves in parentheses.

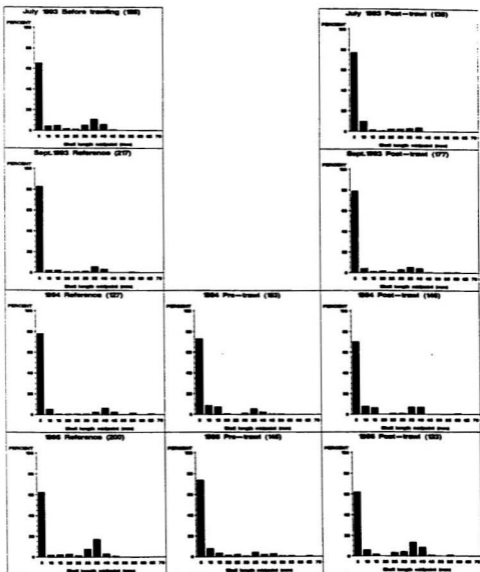

Figure 3.14 Size frequency distributions of pooled samples, n=10 stations, of shallow burrowing species in Corridor B, by treatment and year. Total # bivalves in parentheses.

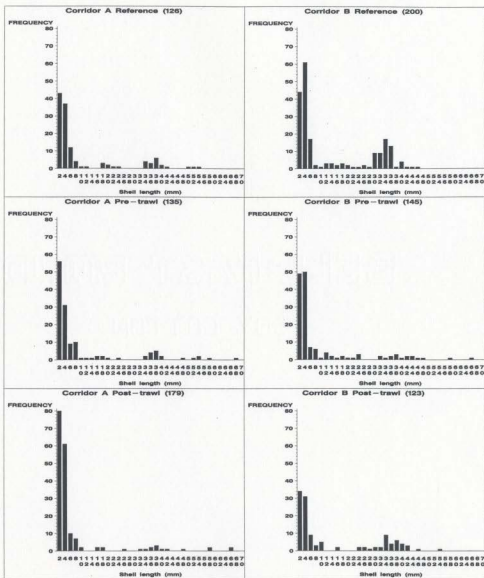

Figure 3.15 Size frequency distributions of pooled samples, n=10 stations, of shallow burrowing species in 1995, by corridor and treatment. Total # bivalves in parentheses.

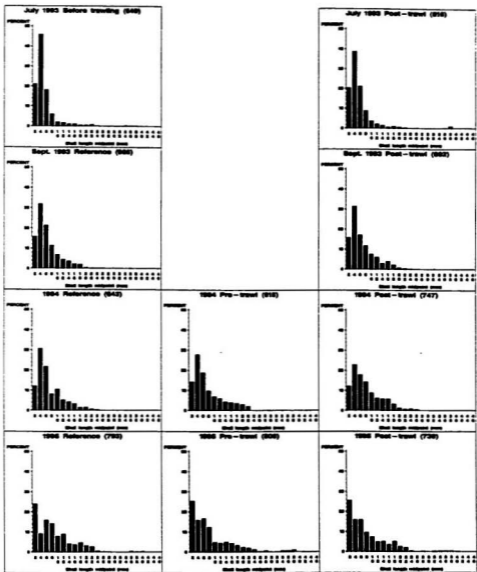

Figure 3.16 Size frequency distributions of pooled samples (n=3 stations) of *M. calcearia* in Corridor A, by year and treatment. Total # of bivalves in parentheses.

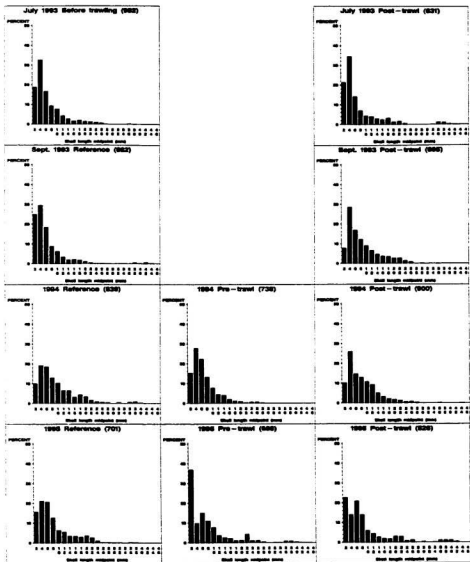

Figure 3.17 Size frequency distributions of pooled samples (n=3 stations) of *M. calcearia* in Corridor B, by year and treatment. Total # of bivalves in parentheses.

Appendix 3.1. Mean wet weights (mg per 0.5 m²) of bivalves by combination of treatments in the ETSA. Pre: pre-trawl; Post: post-trawl; C: control

Species	Effect	1993		1994		1995		1995		Corridor B	
		Mean	sd	Mean	sd	Mean	sd	Mean	sd	Mean	sd
<i>Anas borealis</i>	Pre	25432.9	19833.4	14941.2	20545.5	12189.9	17922.2	14683.9	16347.2	9778.8	12703.6
	Post	17188.7	11916.5	8717.4	22605.9	16903.2	24374.8	8092.5	11125.9	30757.6	20357.6
<i>Anas sp. A</i>	Pre	19.7	34.2	7.3	22.9	43.8	44.0	98.7	38.7	89.4	25.6
	Post	8.0	17.5	38.3	3.2	16.1	19.3	43.7	0.0	0.0	0.0
<i>Anas sp. B</i>	Pre	0.0	0.0	0.0	8.5	26.7	24.1	39.6	0.0	0.0	20.9
	Post	0.0	0.0	0.0	0.0	0.0	0.0	9.1	28.8	0.0	0.0
<i>Chionea ciliatum</i>	Pre	11135.7	17946.2	10318.4	11061.5	17983.0	8202.4	13574.2	15364.6	20554.1	18855.5
	Post	364.4	816.8	3386.4	24.2	16.0	18975.5	21143.2	11626.5	18088.2	8314.2
<i>Corbula constricta</i>	Pre	0.0	0.0	0.3	0.9	0.0	2.6	0.0	0.0	0.8	1.7
	Post	1.8	2.0	0.0	0.0	0.0	0.0	0.0	0.0	0.0	0.0
<i>Crexella decussata</i>	Pre	0.0	0.0	17.6	46.2	19.9	38.0	4.5	6.5	11.8	35.0
	Post	4.7	12.8	15.7	15.9	16.9	32.4	4.9	4.5	18.9	39.1
<i>Cyrcocardis noronhai</i>	Pre	1973.1	4238.9	314.3	632.8	858.7	313.5	719.6	874.2	1032.0	439.6
	Post	463.3	1035.1	4.8	58	507.1	806.0	133.2	464.5	252.1	436.9
<i>Cyrcocardis sp.</i>	Pre	3.9	8.8	7.9	25.1	0.1	0.2	0.0	0.0	0.9	1.4
	Post	0.0	0.0	1.8	5.6	2.9	3.0	0.0	0.0	1.2	1.6
<i>Cyrcocardis sp. A</i>	Pre	355.1	958.8	0.0	0.0	231.0	686.1	239.5	671.8	179.0	555.7
	Post	433.4	928.1	31.9	77.4	467.4	986.7	12.1	38.1	1776.2	3473.9
<i>Cyrcocardis siliqua</i>	Pre	22813.4	69175.8	18490.2	155056.9	218055.4	80451.8	21177.4	185483.9	212589.5	127869.8
	Post	158281.7	94581.1	239963.4	148123.1	206799.1	296799.1	152361.3	112340.8	89743.4	155473.3
C					244920.7	144023.9	160983.3	117779.4	250873.2	144378.5	157885.7

Appendix 3.1. Mean wet weights (mg per 0.5 m²) of bivalves by combination of treatments in the ETSA. Pre: pre-trawl; Post: post-trawl; C: control

Species	Effect	1993		1994		1995		1994		1995		Corridor B		Corridor A		Corridor B		
		Mean	sd	Mean	sd	Mean	sd	Mean	sd	Mean	sd	Mean	sd	Mean	sd	Mean	sd	
<i>Ilacilla arctica</i>	Pre	0.0	0.0	0.0	0.0	0.0	0.0	0.0	0.0	0.0	0.0	0.0	0.0	0.0	0.0	0.0	0.0	
	Post	0.0	0.0	0.4	0.8	0.0	0.0	0.0	0.0	0.0	0.0	0.0	0.0	0.0	0.0	0.0	0.0	0.0
	C	0.0	0.0	0.0	0.0	0.0	0.0	0.0	0.0	0.0	0.0	0.0	0.0	0.0	0.0	0.0	0.0	0.0
<i>Lycomya fluctuosa</i>	Pre	152.7	397.8	260.7	807.4	119.9	228.0	365.9	492.0	0.0	0.0	0.0	0.0	0.0	0.0	0.0	0.0	0.0
	Post	517.7	887.8	159.5	278.0	228.4	248.0	487.1	6.3	6.9	108.8	206.8	407.2	982.3	176.8	257.1	176.8	257.1
	C	0.0	0.0	286.1	555.4	171.6	245.2	304.0	634.4	176.8	257.1	176.8	257.1	176.8	257.1	176.8	257.1	176.8
<i>Lyomys arvensis</i>	Pre	0.0	0.0	0.0	0.0	0.0	0.0	0.0	0.0	0.0	0.0	0.0	0.0	0.0	0.0	0.0	0.0	0.0
	Post	55.2	174.5	0.6	1.8	0.0	0.0	0.1	0.3	0.0	0.0	0.0	0.0	0.0	0.0	0.0	0.0	0.0
	C	0.0	0.0	2.2	6.9	0.0	0.0	0.0	0.0	0.0	0.0	0.0	0.0	0.0	0.0	0.0	0.0	0.0
<i>Macoma calanora</i>	Pre	35605.5	23899.6	41298.7	26082.8	35795.0	25509.3	40732.5	31402.8	57767.4	29295.4	58363.7	35039.1	58363.7	35039.1	58363.7	35039.1	58363.7
	Post	38853.6	31882.1	58332.2	34331.8	42164.9	36932.1	43138.7	26128.4	52378.1	21616.5	57170.8	31474.9	57170.8	31474.9	57170.8	31474.9	57170.8
	C	0.0	0.0	36362.7	17479.9	37976.5	38132.6	37976.5	38132.6	37976.5	38132.6	37976.5	38132.6	37976.5	38132.6	37976.5	38132.6	37976.5
<i>Manicaris discors</i>	Pre	0.7	1.5	4.0	8.3	1.6	2.2	0.5	0.9	0.0	0.0	0.0	0.0	0.0	0.0	0.0	0.0	0.0
	Post	0.8	0.8	0.4	0.8	2.6	3.5	0.7	1.1	15.5	48.6	2.4	7.5	15.5	48.6	2.4	7.5	15.5
	C	0.0	0.0	84.5	256.3	1774.7	5606.2	0.3	0.7	86.6	265.2	0.3	0.7	86.6	265.2	0.3	0.7	86.6
<i>Nucula sinuata</i>	Pre	87.7	149.8	62.4	100.3	92.2	232.4	156.2	278.3	29.7	77.0	46.3	109.3	46.3	109.3	46.3	109.3	46.3
	Post	6.9	2.7	187.2	153.1	65.3	93.1	163.3	232.3	6.7	1.2	11.6	27.3	11.6	27.3	11.6	27.3	11.6
	C	0.0	0.0	46.3	128.3	25.9	54.6	54.6	7.5	14.3	31.2	93.0	31.2	93.0	31.2	93.0	31.2	93.0
<i>Panomya arctica</i>	Pre	6484.0	20594.2	4408.4	11547.8	5314.0	16804.4	17242.0	26884.8	4944.0	15634.3	7206.0	22787.4	15634.3	7206.0	22787.4	15634.3	7206.0
	Post	18918.0	23484.1	0.0	0.0	6786.0	21459.2	9823.8	30842.6	0.0	0.0	694.0	219.4	0.0	0.0	694.0	219.4	0.0
	C	0.0	0.0	86.4	273.1	55.6	175.9	14771.6	0.0	0.0	4621.0	14612.9	0.0	0.0	4621.0	14612.9	0.0	0.0
<i>Psudora goldiana</i>	Pre	0.0	0.0	0.0	0.0	0.0	0.0	0.0	0.0	0.0	0.0	0.0	0.0	0.0	0.0	0.0	0.0	0.0
	Post	0.0	0.0	0.0	0.0	0.0	0.0	0.0	0.0	0.0	0.0	0.0	0.0	0.0	0.0	0.0	0.0	0.0
	C	0.0	0.0	0.0	0.0	0.0	0.0	0.0	0.0	61.9	195.6	0.0	0.0	61.9	195.6	0.0	0.0	61.9
<i>Sericles granulicollis</i>	Pre	0.0	0.0	793.4	2509.0	11013.4	34826.1	0.0	0.0	9150.0	20102.6	4731.0	14960.8	9150.0	20102.6	4731.0	14960.8	9150.0
	Post	2075.0	6561.7	332.5	1819.7	5618.4	16502.9	0.0	0.0	18984.3	20856.4	0.0	0.0	18984.3	20856.4	0.0	0.0	18984.3
	C	0.0	0.0	9125.2	18376.8	687.0	2172.5	0.0	0.0	187.9	581.2	0.0	0.0	187.9	581.2	0.0	0.0	187.9
<i>Thracia myops</i>	Pre	13.3	41.5	90.9	148.6	151.7	238.7	79.6	230.6	113.1	353.7	74.4	234.3	113.1	353.7	74.4	234.3	113.1
	Post	23.3	55.5	155.5	488.1	130.3	394.9	54.3	171.8	61.9	130.4	78.7	178.9	61.9	130.4	78.7	178.9	61.9
	C	0.0	0.0	30.4	79.6	27.8	84.5	27.8	84.5	79.8	208.6	244.5	581.7	79.8	208.6	244.5	581.7	79.8

Appendix 3.1. Mean wet weights (mg per 0.5 m²) of bivalves by combination of treatments in the ETSA. Pre: pre-trawl; Post: post-trawl; C: control

Species	Effect	1993		1994		1994		1994		1995		1995	
		Mean	sd	Mean	sd	Mean	sd	Mean	sd	Mean	sd	Mean	sd
<i>Thyasira</i> sp. A	Pre	55.8	407.4	146.2	84.2	607.4	153.1	213.3	178.3	486.3	281.4	227.8	211.6
	Post	358.9	132.7	237.7	132.7	608.6	395.8	252.3	274.3	621.3	245.3	124.3	89.5
	C					55.3	354.8	150.2	118.3	304.1	177.9	229.4	232.7
<i>Yoldia myalis</i>	Pre	160.9	377.7	22674.5	65380.7	142.1	203.0	1517.9	1684.1	298.0	508.9	192.0	337.7
	Post	28.5	60.8	1287.9	1349.3	22874.5	65380.7	1874.4	2189.2	124.3	336.4	848.5	862.7
	C					496.7	872.8	1094.4	1261.7	123.9	251.0	772.7	1531.8
<i>Chameys Islandica</i>	Pre	0.0	0.0	0.0	0.0	0.0	0.0	9.7	30.6	0.0	0.0	0.0	0.0
	Post	0.0	0.0	0.0	0.0	0.0	0.0	0.0	0.0	0.0	0.0	0.0	0.0
	C					0.0	0.0	0.0	0.0	0.0	0.0	0.0	0.0

Appendix 3.2. Mean densities (per 0.5 m²) of bivalves by combination of treatments in the ETSa. Pre: pre-trawl; Post: post-trawl; C: control

Species	Effect	1993		1994		1995		1995		1995			
		Corridor A		Corridor B		Corridor A		Corridor B		Corridor A		Corridor B	
		Mean	sd	Mean	sd	Mean	sd	Mean	sd	Mean	sd	Mean	sd
<i>Astarte borealis</i>	Pre	4.8	4.3	7.0	3.5	5.9	3.5	4.5	2.9	5.6	2.9	6.5	3.2
	Post	6.3	4.2	5.8	8.1	2.8	6.5	3.9	4.8	3.4	6.5	3.2	
	C					6.8	3.9	4.9	2.5	4.6	4.4	10.9	9.1
<i>Astarte</i> sp. A	Pre	0.3	0.5	0.2	0.7	0.3	0.5	0.3	0.7	0.2	0.4	0.2	0.4
	Post	0.2	0.4	0.4	0.5	0.1	0.3	0.2	0.4	0.0	0.0	0.0	0.0
	C					0.1	0.3	0.4	0.7	0.0	0.0	0.3	0.7
<i>Astarte</i> sp. B	Pre	0.0	0.0	0.0	0.0	0.0	0.0	0.0	0.0	0.1	0.3	0.0	0.0
	Post	0.0	0.0	0.3	6.7	0.0	0.0	0.2	0.4	0.0	0.0	0.0	0.0
	C					0.0	0.0	0.2	0.4	0.0	0.0	0.0	0.0
<i>Chioneclione ciliatum</i>	Pre	1.6	1.4	1.9	1.6	4.8	3.1	4.4	3.9	1.9	1.7	2.7	1.8
	Post	0.9	1.7	1.8	1.2	7.9	4.4	3.8	2.9	3.8	3.2	1.1	1.4
	C					5.8	3.6	3.8	3.1	2.0	2.3	2.4	2.0
<i>Cardium contractus</i>	Pre	0.0	0.0	0.1	0.3	0.1	0.3	0.0	0.0	0.2	0.4	0.0	0.0
	Post	0.4	0.7	0.9	0.9	0.6	0.6	0.6	0.6	0.0	0.0	0.0	0.0
	C					0.1	0.3	0.0	0.0	0.2	0.4	0.1	0.3
<i>Comella acerosa</i>	Pre	0.0	0.0	2.6	5.6	2.4	4.8	0.8	1.2	1.8	5.0	0.9	2.0
	Post	0.8	1.4	2.6	3.1	2.2	4.1	6.7	0.8	2.8	6.1	0.9	1.2
	C					1.4	3.2	0.8	0.9	0.6	1.4	0.6	1.0
<i>Cyrcoides norvegicus</i>	Pre	3.5	5.1	2.2	2.8	4.3	4.7	0.8	0.9	2.4	1.3	1.5	1.7
	Post	6.4	6.2	6.4	6.5	3.4	6.7	1.1	3.8	4.0	3.8	4.0	4.0
	C					7.1	5.5	0.6	1.0	1.9	4.0	1.3	1.3
<i>Cyrcoides</i> sp.	Pre	0.3	0.7	0.1	0.3	0.1	0.3	0.0	0.0	0.6	0.9	0.0	0.0
	Post	0.9	0.9	0.1	0.3	1.0	1.5	0.6	0.6	0.8	1.2	0.4	0.7
	C					0.0	0.0	0.1	0.3	1.3	1.7	0.0	0.0
<i>Cyrcoides</i> sp. A	Pre	0.6	1.1	0.0	0.0	0.8	1.0	1.0	2.2	0.6	1.1	0.3	0.7
	Post	0.5	0.7	0.3	0.5	1.7	2.9	0.1	0.3	0.7	0.8	0.7	0.8
	C					0.8	1.1	0.0	0.0	0.5	0.7	0.8	0.9
<i>Cyrcoides elliptica</i>	Pre	7.2	2.6	6.6	4.7	9.9	3.6	0.2	5.1	7.9	4.0	5.8	3.2
	Post	6.0	4.2	7.9	6.3	8.4	3.2	6.5	6.0	7.8	3.4	7.8	3.4
	C					10.2	3.6	6.8	5.0	8.4	3.4	6.8	5.7

Appendix 3.2. Mean densities (per 0.5 m²) of bivalves by combination of treatments in the ETSA. Pre: pre-trawl; Post: post-trawl; C: control

Species	Effect	1993		1994		1995		1996	
		Mean	sd	Mean	sd	Mean	sd	Mean	sd
<i>Urosalpinx</i>	Pre	0.0	0.0	0.0	0.0	0.0	0.0	0.0	0.0
	Post	0.0	0.0	0.0	0.0	0.0	0.0	0.0	0.0
	C	0.0	0.0	0.0	0.0	0.0	0.0	0.0	0.0
<i>Lycaeus fluctans</i>	Pre	0.5	0.7	1.1	1.2	0.5	0.7	1.0	1.2
	Post	1.8	2.3	0.8	0.9	1.2	0.7	0.7	0.7
	C	0.0	0.0	1.0	1.0	1.0	0.8	0.5	1.1
<i>Lycaeus armatus</i>	Pre	0.0	0.0	0.0	0.0	0.0	0.0	0.0	0.0
	Post	0.1	0.3	0.1	0.3	0.0	0.0	0.0	0.0
	C	0.0	0.0	0.0	0.0	0.0	0.0	0.0	0.0
<i>Nacoma californica</i>	Pre	232.9	62.2	298.0	101.0	238.4	60.2	226.0	59.7
	Post	289.0	60.6	275.2	99.7	258.4	65.2	229.1	61.4
	C	0.0	0.0	0.0	0.0	232.7	49.6	258.7	87.8
<i>Maniculus discors</i>	Pre	0.3	0.5	0.5	0.7	0.7	1.0	0.3	0.5
	Post	0.0	0.0	0.2	0.4	1.0	1.3	0.4	0.5
	C	0.0	0.0	0.0	0.0	0.0	0.0	0.0	0.0
<i>Nuculae nitida</i>	Pre	0.6	0.7	1.1	1.3	0.5	0.9	1.6	1.4
	Post	0.2	0.4	1.0	1.2	0.9	1.1	1.1	1.3
	C	0.0	0.0	0.0	0.0	0.3	0.7	0.3	0.7
<i>Panopeus arcticus</i>	Pre	0.1	0.3	0.2	0.4	0.1	0.3	0.2	0.4
	Post	0.2	0.4	0.0	0.0	0.2	0.7	0.2	0.4
	C	0.0	0.0	0.0	0.0	0.0	0.0	0.0	0.0
<i>Pandora gouldiana</i>	Pre	0.0	0.0	0.0	0.0	0.1	0.3	0.1	0.3
	Post	0.0	0.0	0.0	0.0	0.0	0.0	0.1	0.3
	C	0.0	0.0	0.0	0.0	0.0	0.0	0.0	0.0
<i>Saxidomus nutalli</i>	Pre	0.0	0.0	0.2	0.7	0.3	0.7	0.1	0.3
	Post	0.1	0.3	0.1	0.3	0.5	0.6	0.0	0.0
	C	0.0	0.0	0.0	0.0	0.0	0.0	0.0	0.0
<i>Thracia myops</i>	Pre	0.2	0.4	0.6	0.5	0.7	0.8	0.4	0.7
	Post	0.3	0.5	0.4	0.7	0.5	0.7	0.1	0.3
	C	0.0	0.0	0.0	0.0	0.0	0.0	0.0	0.0

Appendix 3.2. Mean densities (per 0.5 m²) of bivalves by combination of treatments in the ETSA. Pre: pre-trawl; Post: post-trawl; C-control

Species	Effect	1993		1994		1994		1995		1995			
		Corridor A		Corridor B		Corridor A		Corridor B		Corridor A		Corridor B	
		Mean	sd	Mean	sd	Mean	sd	Mean	sd	Mean	sd	Mean	sd
<i>Thyasira</i> sp. A	Pre	9.6	4.6	2.3	1.7	10.9	4.4	4.0	3.1	9.1	4.1	3.7	4.3
	Post	10.3	5.5	2.4	3.9	12.3	8.9	4.6	3.7	11.8	5.7	2.7	1.4
	C					10.9	7.0	3.1	2.7	6.9	4.2	3.2	2.8
<i>Yoldia myalis</i>	Pre	2.3	2.3	2.9	2.1	1.3	1.0	1.3	1.0	1.7	1.4	3.7	2.4
	Post	6.4	6.7	3.2	1.5	2.5	1.5	3.1	2.5	1.8	1.9	3.1	3.2
	C					1.4	1.0	2.0	1.6	1.4	1.5	5.0	3.4
<i>Chamaea islandica</i>	Pre	0.0	0.0	0.0	0.0	0.0	0.0	0.1	0.3	0.0	0.0	0.0	0.0
	Post	0.0	0.0	0.0	0.0	0.1	0.3	0.0	0.0	0.0	0.0	0.0	0.0
	C					0.0	0.0	0.0	0.0	0.0	0.0	0.0	0.0

Chapter 4

Impacts of Otter Boards on Infaunal Bivalves: Results of a Laboratory Physical Trawl Door Model Scouring Experiment

4.1 Introduction

Large areas of the Grand Banks seabed consist of fine to medium sand on which the otter trawl is used to harvest flatfish and cod. Infaunal bivalves are among the dominant invertebrates living in this type of habitat. Bivalves are known to be good indicators of physical disturbance caused by mobile bottom fishing gear because many species are restricted in their movements and their shells record physical damage (Shepard and Auster, 1991; Witbaard and Klein, 1994). In addition, at any given location infaunal bivalve species cover a wide range of burrowing depths including near the sediment surface, which is the zone that is scoured by otter trawl gear.

Although the otter trawl has been the principal fishing gear used to harvest offshore groundfish in the Northwest Atlantic since post- World War II, little is known about its biological effects while specific details of physical disturbance and the mechanics of gear-seabed interaction are poorly understood. Advancements in fishing gear technology are primarily directed at decreasing the catch of small fish and by-catch of high profile species. However, concerns about effects on habitat are receiving increased attention including deliberation over "responsible" fishing gears and conservative fishing practises in general (Aquaprojects Inc., 1994; Canadian Fishery Consultants Limited, 1994; FRCC, 1994). In recent years, there has been increased attention given to the impacts to benthos and habitat from various mobile fishing gears (for reviews see Dayton, et al., 1995 and Jennings and Kaiser, 1998).

A generally held view is that trawl doors inflict more damage per unit area of seabed

than other gear components even though the footgear sweeps a larger area of seabed (Harrison et al., 1991; Gislason, 1994; Kenchington, 1995). This perception is reinforced by observations of greater penetration of the seabed by trawl doors compared to footgear based on the predominance of door scour marks visible on side scan sonar records on otter trawling grounds (Newton and Stefanon, 1975; Krost et al., 1990; Harrison et al., 1991).

Due to logistic constraints, most fishing impact experiments have assessed the cumulative effects of all gear components combined. It has proven difficult to quantify impacts attributable to specific gear components, particularly in deep water. However, damage to bivalves directly attributable to otter boards has been demonstrated (Arntz and Weber, 1972; Rumohr and Krost, 1991; Service and Magorrian, 1997).

In 1993, the Canadian Department of Fisheries and Oceans (DFO) initiated an experiment to investigate the impacts of trawling on a sandy seabed on the northeastern Grand Bank (see Rowell et al., 1997) for details of experimental design). Results of the first year (1993) of experimental trawling revealed little evidence of physical damage to megafauna after short-term intensive trawling. In order to examine more closely the physical disturbance and potential damage to infaunal bivalves caused specifically by scouring trawl doors, a physical trawl door model was constructed and tested in a simulated Grand Bank sand seabed. The primary objectives of the study were to describe the physical processes associated with trawl door scouring and quantify trawl door-specific damage and displacement of bivalves. A key product of this study is a mechanism that links the physical processes associated with trawl door scouring with observed impacts to bivalves living in sandy sediments on the Grand Banks.

4.2 Materials and methods

4.2.1 Experimental tank and gantry

The trawl door simulation was conducted in the ice scour research tank located in the Faculty of Engineering and Applied Science, Memorial University of Newfoundland. The watertight concrete tank was 14 m long, 6 m wide and 1.1 m deep and was divided equally into two long compartments by a centre wall. The experiment was conducted in the sand tank compartment (Fig. 4.1). The tank was flooded and drained through a series of perforated water pipes connected to an exterior faucet and drain and spanned the width of the tank base. The pipes were wrapped in geotextile to prevent plugging by the sand. A towing gantry, powered by a 7.5 hp electric motor, ran on tracks bolted to the tops of the two extreme scour tank walls. The two ballasted steel carriage beams of the gantry provided a base to which the trawl door model and a three-dimensional positioning system could be mounted. The tank coordinate system used for positioning the scour path and sensors, molluscs (etc.) in the test bed consisted of x (tank length), y (tank width) and z (vertical or depth component).

4.2.2 Trawl door model design

The trawl door model (TDM) was designed after the oval trawl doors used by offshore commercial trawlers and DFO groundfish survey trawlers on the Grand Banks. The main component of the TDM was the shoe, which was taken from an otter board used with the Engel 145 DFO survey trawl (Fig. 4.2). This type of otter board weighs 1250 kg and has a surface area of 3.8 m². The shoe consists of three sections, with each section attached to the trawl door proper with bolts which allows individual worn sections to be replaced. The forward and aft shoe sections are curved while the centre section is straight. An individual

shoe section weighs approximately 50 kg and is 7.5 cm high by 14 cm wide. It is the shoe which is in direct contact with the seabed. Due to door curvature, combined with towing characteristics, typically only the aft 50% of the shoe is in contact with the seabed at any given time. The TDM consisted of the centre and aft sections welded together with an attached metal plate to simulate the lower part of the trawl door proper where it was bolted to the shoe. The plate prevented sediment from spilling over the top of the shoe during scouring. The angle formed by the trawl door with respect to direction of travel is known as the angle of attack and was set at 30° (Fig. 4.3a). Trawl door angle of attack is variable, being dependent upon numerous towing and gear rigging factors. For optimum towing however, it is generally within the range of 30° to 45° (Anon., 1993). Total TDM shoe length was 165 cm but due to shoe curvature only a 106 cm section of the shoe was in contact with the testbed. With the angle of attack of the TDM set at 30°, a scour path width of 53 cm was established. This is close to the range of widths of trawl door scour marks (60-90 cm) estimated from side scan sonar records from the Grand Banks (R. Parrott GSCA, Bedford Institute of Oceanography, Dartmouth, N.S., pers. comm.).

Scouring depth is the maximum depth to which the bottom of the shoe penetrates the seabed. This was set at 2 cm. There are few empirical data for scouring depths for otter boards. Reported scouring depths in sand are in the 0 to 5 cm range (Rumohr, cited in Krost et al., 1990; Brylinsky et al., 1994). Krost et al., (1990) speculated that otter boards should have low penetration on sandy bottoms due to the relatively higher mechanical resistance of the sediment. Based on videos of trawl doors in operation on the Grand Banks, it appears that the action of a trawl door on level-bottom sand is one of surficial scouring with very little penetration. This was the type of action observed for otter trawl doors moving over a sandy seabed in Jervis Bay, Australia (Chopin et al., 1987). The TDM scouring depth of 2 cm was considered to be representative of the range of scouring depths possible on level

bottom dense sand. This scouring depth also ensured that the shoe passed through the depth zone that was occupied by shallowly placed bivalve specimens so that direct effects of interaction with the shoe could be studied.

The TDM was connected to a triangular aluminum mounting frame, that in turn was attached to an upper vertical support frame (Fig. 4.2). The entire assembly was bolted to the gantry beams. The gantry speed was limited to 0.87 knots (0.44 m/s) whereas a trawling speed of approximately 3 knots (1.52 m/s) is typical of trawling operations in the NW Atlantic. A correction factor was applied to forces generated by the TDM (see Appendix 4.1).

Various sensors were incorporated into the TDM in order to record testbed forces acting on the model during scouring. Two biaxial load cells connected opposite ends of the shoe to the mounting frame and recorded lateral forces in x and y directions. Three beam load cells connected the corners of the mounting frame to the vertical support frame and recorded uplift or vertical forces (Fig. 4.2). An underwater colour video camera, attached to the lower part of the steel plate at the leading end of the shoe, provided a close-up view of the entire scouring process.

4.2.3 3-Dimensional positioning system

A 3-D positioning system was used to record the position of bivalves and instruments placed in the testbed. This consisted of a 1.5 m long (12.5 mm diameter) aluminum rod with a machined point at one end (pointer) and a linear position transducer fixed to the other end. An aluminum rack was attached to the pointer and a hand-operated gear system raised and lowered the pointer in the z direction. The pointer was set up on a small truck which could be positioned by hand in the x direction along rails spanning the tank gantry. The entire positioning system assembly ran on a second set of rails bolted to the tank gantry to enable

positioning in the y-direction. The positioning system was connected to linear position transducers in the x, y, and z directions. Position transducers were excited at 10 volts and the output sent directly to the data acquisition system, which converted output voltages to positional values for real time display on a computer terminal that was secured to the gantry.

4.2.4 Data acquisition

Pre- and post-test positional data were acquired using a PC-based data acquisition system. The system was set up to acquire data from the displacement transducers with 16 bit resolution. A custom Basic program converted output voltages to positional (i.e. x,y and z coordinate) data. The pointer position was continuously updated and displayed on a screen. Once the pointer was positioned at a point of interest, the program was set up to store coordinates to disk along with an identifying label. A separate data acquisition system was used during the TDM scouring. This system was set up to acquire data over 16 channels with 16 bit resolution. Low level transducer signals were amplified and transmitted to the computer, situated remote to the scour tank. All amplified signals were filtered prior to digitization. An off-the-shelf operating system (Windows™) was used to control the acquisition and display of data.

4.2.5 Testbed preparation

The sand testbed was prepared to reproduce key geotechnical properties of a natural offshore seabed. In particular, it was important to simulate properties of shear strength since physical forces generated between the TDM and the testbed, as well as sediment displacement during scouring, would be a function of sediment shear strength. The mechanical behaviour of granular material is highly dependent on effective stresses and volumetric deformations that occur in the sediment mass during shearing. In a sediment mass, the total stress is carried by the sum of water pressure and effective stress. Effective

stress controls the mechanical aspects of sediment behaviour, notably compressibility and shear strength.

The most widely used index of cohesionless sediment shear strength is the angle of internal friction, ϕ . Given two granular materials with similar values of ϕ , subject to similar loading conditions and rates of shear, it can be expected that peak shearing forces will be similar. Values of ϕ reported from borehole locations on the Grand Banks range between 27° and 48° with most values greater than 35° (McClelland Engineers, 1971; Thompson et al., 1986; Thompson and Long, 1989). These values are associated with dense to very dense sediments on the northeastern Grand Bank as revealed by cone penetration test data. Reported relative densities are typically between 80% and 90% (Thompson and Long, 1989), where relative density, D_R , is expressed as,

$$D_R = [\gamma_d - \gamma_{d(\min)}] [\gamma_{d(\max)} - \gamma_{d(\min)}]^{-1} [(\gamma_{d(\max)}) (\gamma_d)^{-1}]$$

where $\gamma_{d(\min)}$ = dry unit weight in loosest state

γ_d = *in situ* dry unit weight

$\gamma_{d(\max)}$ = dry unit weight in densest state

The *in situ* relative density of the sand at the DFO offshore site was not known.

Based on the objectives of the experiment, it was decided to aim for an experimental testbed ϕ which was close to reported field values, rather than attempt to replicate grain size, relative density, grain angularity, dilatancy, etc. that would have produced a similar result. The testbed was prepared using commercial Grade No. 0 silica sand. Shearbox tests were conducted with this sand at different relative densities (D_R) in order to achieve a value for ϕ of 46°. The testbed was prepared at this angle of internal friction which corresponded to a mean (\pm sd) D_R of 73.2% \pm 7.7 based on 9 measurements taken at different points in the

testbed. This relative density resulted in a value for ϕ of. Samples of the testbed were collected using a stainless steel coring tube with inside diameter and length dimensions of 50 mm and 170 mm, respectively. Maximum and minimum sediment densities were determined following ASTM standard methods (ASTM 1993a,b) from which relative density was calculated. Key geotechnical properties of DFO offshore site sand and testbed sand are compared in Table 4.1.

The testbed was built up in 2 cm thick layers of wet sand, each layer being compacted in turn using 2 kg steel tampers with 200 mm square base plates. The final depth of the testbed was 500 mm. The base of the testbed (i.e. tank floor) was designated as $z = 0$, and the final prepared testbed surface was at $z = 500$ mm.

The testbed was subdivided into a series of experimental blocks for placement of bivalves and instrumentation (Fig. 4.3b) while the exact boundaries of the scour path were referenced on the positional system.

4.2.6 Bivalve specimens

A total of 200 bivalves representing six species were arranged in two replicate blocks (RB1=108, RB2=92) (Fig. 4.3b). These specimens had been collected from the DFO offshore experimental trawling study area (OETSA) and are common species in sandy sediments on the Grand Banks. The specimens had previously been fixed in buffered 10% formalin and stored in 70% ethanol. Prior to burial in the testbed, each specimen was engraved with an ID number using a Dremel tool equipped with a fine bit. The shells of small *Macoma calcaria* were too fragile for engraving so these were numbered with indelible ink. Because of their large soft tissue mass, prior to burial *Cyrtodaria siliqua* were injected with 10 ml of 10% formalin solution to retard decomposition. Bivalves were placed in the testbed at burrowing depths and in orientations typical of the species (cf. Fig. 4.4 and

Table 4.2). Specimens were arranged in single species transects oriented perpendicularly to the scour path at the following depths: $z=300, 400, 450, 480$ mm and at the sediment-water interface ($z=500$ mm). While the majority of specimens were placed inside the scour path, specimens of *A. borealis*, *C. novangliae*, *C. sp. A* and *M. calcarea* were also placed at distances of 10 cm and 20 cm outside the scour path boundaries.

4.2.7 Measurement of bivalve displacement

Pre-test positions of bivalves were recorded by lowering the pointer tip to the desired testbed depth (z coordinate) and location (x and y coordinates) followed by positioning the specimen beneath the pointer, generally after making a small excavation in the sand in order to seat the specimen. A position fix was then taken with the pointer touching the engraved reference point on the shell (Fig. 4.4). The testbed adjacent specimens was compacted and built-up through a combination of careful hand tamping and by using a small steel tamper. In order to confirm that the method was not causing damage, several specimens of the more fragile *Macoma calcarea* were disinterred. Examination of these specimens revealed no signs of damage. Subsequent to the test, and after the water had been drained from the tank, sand was carefully removed by hand around the pre-test position fixes. After partial excavation, the pointer was positioned at the appropriate point on the shell and the coordinates logged. Measurement accuracy for each coordinate was approximately 4 mm.

4.2.8 Assessment of damage to bivalves

After logging post-test position fixes, all bivalves were examined for signs of damage to the shell, ligament and exposed soft parts then assigned a damage category on a scale ranging from no damage to major damage. The classification scheme used was the same as that used for the field trawling study (Chapter 3, Table 3.4). With the exception of

Cyrtodaria siliqua, all species used in the test had their soft parts enclosed by the shell valves. The ventral part of the body and siphon of *C. siliqua* are exposed in both life and the preserved state.

4.2.9 Testbed electronics and sediment displacement markers

Total stress cells (TSC) and pore pressure transducers (PPT) were placed at testbed depths of $z = 350, 400$ and 450 mm along the centre line of the scour path in order to record total sediment stress (i.e. force per unit area) and interstitial pore water pressure, respectively, during scouring. Several types of sediment displacement markers were aligned in series across the width of the testbed, i.e. perpendicular to the scour path. These were designed to measure horizontal and vertical sediment displacement and to show the extent of sub-surface shearing beneath the scouring TDM. Five series of 11 stainless steel ball bearings (12.5 mm diam.) were placed at the following depths: $z = 500$ (on the surface), 460, 400, 360 and 300 mm relative to the base of the ball. Pliable, 0.9 mm diameter solder strands were placed at depths of $z = 470, 420, 370$ and 320 mm. Sand, which had been coloured by machinists liquid blue dye and dried, was laid at the following testbed depths: $z = 490, 470$ and 450 mm in approximately 1 cm wide by 5 mm thick bands using a funnel. A shop-vac, with flexible hose attached to the gantry, was used to shave narrow channels in the testbed for placement of instrumentation and coloured sand. In placing the instrument strings, personnel worked from large plywood boards to minimize disturbance to the testbed.

After placement of all subsurface instrumentation, the entire testbed surface was shaved to the final testbed height of 500 mm using the vacuum system. After this was completed, one series of ball bearings and five large *Cyclocardia sp. A* (RB1) were positioned on the prepared testbed surface.

As with the bivalves, the 3-D positioning system was used to record pre-test and post-

test positions of all instruments and displacement markers. The pointer tip was aligned on the top centre of individual ball bearings. Coordinates of the continuous solder strands and coloured sand bands were logged at approximately 10 points along their length. The post-test testbed was mapped by logging surface coordinates at 13-16 points along each of 7 equally spaced transects oriented perpendicularly to the scour path spanning the length of the testbed.

4.2.10 Test procedure

It took approximately 12 hours to flood the testbed at a rate of 960 litres per hour. The water level was raised to a height of approximately 20 cm above the prepared testbed surface which ensured immersion of the spoil build-up adjacent the scouring TDM shoe. The motorized gantry towing the TDM was remotely controlled and the test was completed in less than 20 seconds at a constant model speed of 0.44 m/s (0.87 knots). After the water was drained from the tank, the TDM assembly was removed from the gantry and replaced with the 3-D positioning system in preparation for post-test measurements.

4.2.11 Measurement of bivalve shell strengths

Compressive shell strength tests were performed on adults of the six species used in the TDM test. Specimens were collected by hydraulic grab from the OETSA and fixed in 10% buffered formalin and transferred to 70% ethanol. Because *Macoma calcarea* was considered to be the most fragile species, tests were performed over a size range for this species. Normally, shell strength tests are performed on empty shell valves; however, this ignores any potential counter-balancing effect of internal resistance provided by the soft tissues of the bivalve. Therefore, tests were performed using whole bivalves. Since drying may affect the strength of thin shells (Currey, 1979), all specimens were kept wet prior to

testing.

Shell strength index tests were performed using a triaxial compression machine (ELE Digital Tritest 50) equipped with a 250 lb. strain gauged proving ring (Fig. 4.5). The bivalve was laid on one valve in the centre of the triaxial platen and the proving ring was then lowered until it was just touching the specimen. The platen was raised at a loading rate of 1 mm/min. Typical loading rates (uniaxial, unconfined) for molluscs range between 1 and 5 mm/min. (Vermeij and Currey, 1980; Currey and Hughes, 1982; Blundon and Vermeij, 1983; Cook and Kenyon, 1993; Preston et al., 1996). During the test, proving ring signal voltage was continuously recorded. Failure was defined by a significant reduction in load. The load contact area was determined by measuring the dimensions of the disturbance of petroleum jelly which had been applied to the underside of the proving ring plate. The disturbance represented the surface area of shell in contact with the proving ring and was used to define peak stress at shell failure: $\text{Stress (kPa)} = \text{Load (kN)} / \text{Contact area (m}^2\text{)}$.

4.3 Results

4.3.1 Scour path profile

A mound of sediment (i.e. frontal spoil) formed adjacent the leading face of the TDM shoe as it scoured the testbed. Due to the angle of attack, most of this frontal spoil was shed off the trailing end of the shoe and formed a berm the length of the testbed. This resulted in a single, rounded berm with an adjacent shallow, U-shaped depression (i.e. furrow) representing the scour path (Fig. 4.6). Mean (\pm sd) berm height above the pre-test testbed surface was 55 ± 10 mm.

4.3.2 Displacement of testbed markers

The ball bearings laid on the testbed surface within the scour path were caught up in

the frontal spoil and deposited off the trailing edge of the shoe. Depending on point of contact along the shoe, forward displacements (+ x) ranged between 0.5 m and 1 m (Fig. 4.7). Outside the scour path, surface ball bearings on the side of the leading end of the shoe were displaced approximately 4 cm while those at the trailing end were not displaced. Several ball bearings at a testbed depth of 3 cm ($z = 460$) were displaced: 5 ball bearings placed in a line from the centre of the scour path to a point 10 cm outside the path on the leading edge side of the shoe, were displaced about 8 cm towards the berm with negligible forward displacement. The solder strands, all of which were sub-scour ($z = 320-470$), showed no signs of deformation. The band of coloured sand located at a depth of 1 cm ($z=490$) was obliterated within the scour path. The band located at a depth of 3 cm ($z = 470$), which was 1 cm subscour, was bowed slightly (1 cm) in the direction of travel of the TDM at the centre of the scour path while the band located at a depth of 5 cm ($z = 450$), 3 cm sub-scour, was intact and undeformed.

4.3.3 Forces acting on the TDM

The time record of total vertical force acting on the TDM during scouring showed a cyclic loading pattern with peak and mean uplift forces of 1548 N and 572 N, respectively (Fig. 4.8). The vectorial sum of the lateral forces (x and y directions) acting on the model also showed a cyclic pattern with peak and mean forces of 1231 N and 587 N, respectively (Fig. 4.8). Although peak forces were greatest in the x direction (1013 N) relative to y (757 N), the loading patterns were very similar. The forces acting on a plough are positively correlated with ploughing speed (Palmer, 1993). Using Palmer's (1993) regression data, and extrapolating to the scouring depth and speed used in the TDM experiment, a factor of 1.5 was calculated in order to convert TDM forces to approximate field trawling forces (see Appendix 4.1). This would result in peak field trawling vertical and lateral forces of 2322

N and 1846 N, respectively.

4.3.4 Pore pressures and total stresses recorded during scouring

There was a general trend of increasing pore water pressure with approach of the TDM to a point where the shoe was about 50-60 cm from the transducer (Fig. 4.9). At this point, there was a sharp drop in pore pressure ranging from -1.6 kPa at $z=400$ and 450 to -0.6 kPa at $z=350$. The initial response of PPT #3 ($z=350$) is suspect due to the drop in pore pressure when the TDM was still about 4 m away, however, the subsequent pattern is similar to that of the other transducers.

Total stress increased rapidly beginning at a point where the centre of the shoe was approximately 40-50 cm from the stress cell (Fig. 4.9). Maximum increase in total stress ranged from approximately 13.5 kPa at 3 cm ($z=450$) below the shoe to 5.5 kPa at 13 cm below the shoe ($z = 350$). Applying the scaling factor (1.5) produces a sediment stress of 20.2 kPa at the shallowest depth.

4.3.5 Displacement of bivalves

All bivalves within the scour path at the sediment-water interface ($z = 500$) were displaced and patterns of displacement were similar between the two blocks (Fig. 4.10). Specimens of *Cyclocardia sp. A*, *C. novangliae* and *A. borealis* located within the scour path were displaced forward and towards the developing berm a distance consistent with point of contact along the shoe. In general, forward displacement (Δx) increased as point of contact moved closer to the leading end of the shoe. In RB1, maximum forward displacement attributable to the TDM was approximately 2.5 m (*Cyclocardia sp. A*) although for most specimens it was less than 1 m in both +x and -y directions (Fig. 4.10). Specimens which were initially buried within 200 mm of either side of the scour path showed minor

displacement whereas two *Cyclocardia sp. A* (specimens #6 and 7) placed on the testbed surface immediately adjacent the scour path were displaced forward a maximum distance of 10 cm and towards the berm (-y) by 27 cm.

In RB2, displacement of bivalves ranged from approximately 58 cm to 1.1 m forward (Δx) and -29 to -41 cm laterally (Δy). There were several instances of atypical displacement. One small *M. calcarea* (specimen #8) and one small *C. ciliatum* (specimen #4) were displaced in a direction opposite to that of scouring (Fig. 4.10). In another instance, one large *C. ciliatum* (specimen # 19, length = 55 mm) in RB1 was displaced forward a distance of 6 m and was found lying adjacent the middle wall of the scour tank.

Considering only the displaced specimens, 7 out of 12 buried bivalves in RB1 were disinterred or partially exposed by the scouring process while specimens located adjacent the scour path on the trailing end of the shoe were covered by the berm. In RB2, all of the displaced specimens had originally been buried, and 7 out of 10 specimens within the scour path were either partially or entirely exposed on the berm. Two small *M. calcarea* and one *A. borealis* were buried in the berm. Displacement at a testbed depth of 2 cm ($z=480$ mm) was confined to bivalves within the scour path. In RB1, two small *M. calcarea* out of a total of 9 within the scour path were displaced a maximum distance of about 4 m. As a result of scouring, one medium and one large *M. calcarea* were partially exposed but not displaced. In RB2, one small *M. calcarea* was displaced forward by approximately 3.5 m. Specimens located deeper than 2 cm displayed no evidence of displacement attributable to the TDM with one possible exception. At a depth of 5 cm ($z=450$ mm) one small *M. calcarea* from within the scour path appeared to be rotated about 90° from its original position.

4.3.6 Bivalve damage

Out of a total of 42 recovered bivalves which had originally been placed in the scouring

zone (i.e. upper 2 cm of scour path), two specimens (5 %) in RB2 sustained major damage (Tables 4.3 and 4.4). In one instance, the TDM shoe had removed most of the dorsal portion of the shell of a large *C. ciliatum* while the ventral halves of the valves were intact, lying in their original pre-test position in the testbed. In the other instance, a medium *M. calcarea* originally located in the centre of the scour path at a depth of 2 cm was recovered with disarticulated valves. The only occurrences of minor damage (17 in total) were recorded with *M. calcarea* and were represented by a very small chip in one or both valves at the posterior margin. These occurred in both blocks and there was no discernible pattern, with occurrences both inside and outside the scour path and to testbed depths of 15 cm. We attribute minor damage to this relatively fragile species to handling effects during testbed preparation and excavation.

4.3.7 Shell strength

Peak load and stress at shell failure in specimens of the six species used in the TDM test are shown in Table 4.5. For *M. calcarea*, peak load at shell failure was positively correlated with shell length ($r^2 = 0.95$) and total mass ($r^2 = 0.88$). There was no correlation between either of these two size parameters and peak stress at shell failure. In general, the more fragile status of *M. calcarea* was confirmed.

4.4 Discussion

4.4.1 Scour profile

The scour profile consisted of a shallow furrow bordered by a single low berm. This type of profile would be observed on relatively level, sandy seabeds. Basic elements of trawl door scour profiles common to all types of otter trawls, include paired parallel door scour marks or grooves, i.e. scour furrows, and a single berm on the inner edge of each scour. The

width of scour marks, scouring depth, and berm height vary, depending on towing conditions, type of trawl gear and sediment type. Most reported widths of otter trawl door tracks are less than one metre (Arntz and Weber, 1972; Caddy, 1973; Krost et. al., 1990; Brylinsky et. al., 1994). In the TDM experiment, berm height was approximately 55 mm. In general, berm height will be correlated with scouring depth.

4.4.2 Description of trawl door scouring

The following description of trawl door scouring in sand is based on the TDM test results of sediment displacement and transmitted forces. Iceberg scouring theory, combined with published observations of cutting blades in sediment, provided a framework for the interpretation of the TDM data.

4.4.2.1 Sediment deformation

The leading face of a trawl door shoe represents essentially a vertical, blunt cutting blade ploughing horizontally through the seabed. In advance of a trawl door moving through the sediment is a zone of sediment deformation. Dense sand is dilatant and when it is sheared individual grains ride up over each other, which results in localized increases in the volume of the interstitial spaces. The suction which develops results in negative pore water pressure (van Os and van Leussen, 1987; Palmer et al., 1990). A drop in pore pressure was recorded during the TDM test at a distance of 0.5 to 0.6 m in front of the shoe. The magnitude of the pressure gradient decreased dramatically with depth, indicative of a vertically restricted zone of sediment deformation. Coincident with a drop in pore pressure was an increase in total stress within the deformed sediment mass, since the fluid suction resulting from the negative pore pressure presses individual sand grains more firmly together. The zone of increase in total stress within the sediment extended approximately 0.4 to 0.5 m in front of the shoe.

4.4.2.2 Sediment failure and displacement

Sediment failure (i.e. structural collapse) during scouring is characterized by a series of discrete failure surfaces or planes that extend from the bottom of the cutting device to the sediment surface (Selig and Nelson, 1964; Been, 1990). Sand is excavated forward and upward along failure planes, accumulating as surcharge (i.e. frontal spoil) adjacent to the leading face of the shoe. New failure planes are created due to a series of events of sediment surcharge build-up and shoe movement, which results in alternating episodes of resistance and sediment failure, several centimetres in advance of the scouring shoe. This process was identified from the cyclic nature of the TDM lateral and vertical load outputs, a pattern which has also been recorded in iceberg model scouring tests (Paulin, 1992; Hynes 1996). A steady state condition can be envisioned whereby newly excavated sand is added to the frontal spoil, while simultaneously, spoil is cast off at the trailing end of the angled shoe, forming a single, low berm. The mass of sediment that undergoes sediment deformation can be partitioned into three vertical zones (Palmer et al., 1989)(Fig. 4.11). In Zone 1, which extends from the surface to approximately the bottom of the shoe, sediment is excavated to the surface, becoming frontal spoil. Zones 2 and 3 are sub-scour. Zone 2 begins approximately at the base of the shoe and sediment in this zone is displaced forward by the shoe passing over it. This zone was identified in the testbed by the distortion of the coloured sand layer at a sub-scour depth of 1 cm. At the centre of the scour path the sand had been locally deformed forward a distance of approximately 1.8 cm. This zone of 'shear dragging' is vertically restricted in dense sand, and extended to a depth of less than 3 cm below the shoe. Based on results from the various displacement markers it is also apparent that sediment displacement is laterally restricted, being confined almost entirely to within the scour path.

Zone 3 is characterized by stresses that have been transmitted down through Zone 2.

Most of the resulting deformations are elastic, rebounding after release of load. Within the testbed, the lower boundary of Zone 3 extended to at least a subscour depth of 13 cm.

At the faster speeds characteristic of true trawling, transmitted stresses may extend deeper into the seabed. Because of the higher forces generated, Zones 2 and 3 would also be thicker, extending deeper below the surface.

4.4.2.3 Effects of altering scouring parameters

Because this was an experiment, key parameters such as scouring depth and speed were fixed. During normal trawling operations these factors will change, with corresponding effects on forces generated by trawl doors and stresses transmitted to the seabed. Door speed is an important variable. A factor of 1.5 was derived for converting TDM generated forces to field trawling forces. Higher forces and deeper penetration of sediment stresses (i.e. into Zone 3) will result from deeper scouring. Conversely, in the case of shallower scouring, forces generated by trawl doors will be lower and changes in vertical stresses would not extend quite as deeply into the sediment. Sediment density is also a variable. For example, trawling in areas with lower sediment density (i.e. at shallow depths), would result in lower generated forces relative to dense sediments while the depth of the shear dragging zone (i.e. Zone 2) would be expected to increase somewhat.

4.4.3 Bivalve displacement

There are two main effects of trawl door scouring with respect to bivalve displacement. Trawl door scouring causes shallow burrowed bivalves in the scour path to be re-distributed and concentrated along a berm (Arntz and Weber, 1972; this study). The second effect is to increase the risk of predation, by exposing or partially exposing bivalves on the surface. Kaiser and Spencer (1994, 1996a) documented scavengers feeding on damaged bivalves after

passage of a beam trawl. Many of the common, shallow-burrowing bivalves on the Grand Bank are slow burrowers with re-burrowing times after excavation in the laboratory, ranging from minutes to several hours. The extent of feeding by predators within recently trawled areas on the Grand Banks is unknown but evidence from our *in situ* trawling experiment (Prena et al., in press.) indicates that adult male snow crabs (*Chionocetes opilio*) move in to disturbed areas within 9-12 hours after trawling. This is supported by documentation of highly mobile scavengers such as fish and crabs moving into disturbed areas within hours (Caddy, 1973; Kaiser and Spencer, 1994; Ramsay et. al., 1996) while less mobile scavengers such as whelks and starfish move in within days (Kaiser and Spencer, 1996a).

4.4.4 Physical damage to bivalves

Only two out of 42 recovered bivalves which had originally been buried in the scour path at the sediment-water interface showed major damage, although all non-damaged specimens were displaced. This low incidence of damage to bivalves directly in the scour path was similar to the results of our *in situ* experimental trawling (OETSA), in which mean percent major damage to infaunal bivalves after intensive trawling was < 15%. However, the patterns of damage recorded in the OETSA represent cumulative effects of all gear components.

4.4.5 A physical model for trawl door-bivalve interaction

A model for the interaction of trawl doors with infaunal bivalves must combine elements of sediment mechanics with key biological/ecological parameters. Sensitivity of an organism to physical impacts of trawling can be defined as a measure of the organism's innate ability to withstand damage, for instance after a single trawl pass, whereas susceptibility combines both sensitivity and intensity of trawling (ICES, 1996). Intuitively,

one would expect that any bivalve fixed in place in the sediment coming into contact with a trawl door would be destroyed. This is based on the orders of magnitude higher forces which can be generated by a trawl door, relative to forces that break shells. While TDM forces can be scaled-up to true trawling forces, patterns of shell damage as a function of force are more complex, partly due to a shape factor (Currey, 1988). Although the TDM speed was lower than true trawling speeds, given the power of the gantry, if the TDM shoe had contacted an immovable bivalve its shell would have been destroyed. This was observed when a large *C. ciliatum* in the scour path was destroyed (i.e. sheared in half) while it remained in its original position. Likewise, the forces which can be generated by modern commercial trawlers are considerable as evidenced by damage to pipelines which come into contact with otter boards (Moshagen and Kjeldsen, 1980; Verley et. al., 1992). In the TDM test, with one exception, all shallow specimens in the scour path were displaced, yet they were not damaged. The following model is proposed in order to reconcile this paradox.

A novel visual aid, developed by Palmer et al., (1990) to assist in the interpretation of sediment deformation during ice scouring, is applied in the context of trawl door scouring, with an added biological component. If an observer moves at the same velocity as a trawl door then it will appear stationary relative to the observer. In steady-state scouring, sediment deformation relative to the trawl door is a steady flow of sediment past the shoe, represented by a displacement field (Fig. 4.11). Since the displacement field consists of particles (i.e. sediment grains), bivalves can be added to the displacement field as large particles. Sediment and small bivalves residing entirely or predominantly in Zone 1 will, at some critical distance from the shoe, be excavated into the frontal spoil. This mix of sediment and bivalves will flow along the length of the shoe, to be cast-off as a berm (Fig. 4.12). This accounts for bivalve displacement. The low incidence of damage can be attributed to a buffer effect. The two prerequisites for shell destruction- (i) fixed position and, (ii) direct

contact with the shoe, are precluded by the process in which bivalves are excavated and then entrained within the fluidized frontal spoil.

The test results indicate that with respect to damage to bivalves, key sensitivity parameters are burial depth and size. The proportion of a bivalve which extends below the scouring depth, may be a critical factor. For example, in typical life position, an *A. borealis* which is 4 cm in shell length would extend vertically into the sediment a distance of approximately 3 cm. Therefore, in the case of the TDM test setup, approximately 33% of the bivalve would extend below Zone 1 which was sufficient for excavation. In contrast, 57% of a 5-6 cm *C. ciliatum* extended below Zone 1, a proportion that afforded stability within the sediment during scouring. Large size notwithstanding, a spherical shape combined with well-defined radial ribs on the valves, provides infaunal stability in *C. ciliatum* (Stanley, 1970).

Trawling is a dynamic process and in reality, depth of scouring is not fixed. Scouring deeper than 2 cm should result in a greater number of excavated/displaced bivalves, including large individuals, within an overall higher berm. At shallower scouring depths (e.g. 1 cm), near-surface medium-size species such as *A. borealis* may not always be excavated, resulting in higher frequencies of damage. Overall, the effect of shallow scouring (i.e. < 2 cm) might be to further demarcate the susceptibility of relatively large, shallow burrowing bivalves to major shell damage.

The boundary between Zone 2 and Zone 3 is less precise and in the TDM test it lay somewhere between 1 cm and 3 cm sub-scour. Bivalves occupying Zone 3, while not at risk of direct shoe contact or exposure to shear dragging forces, will be exposed to vertical stresses transmitted down through Zone 2. However, it was seen that even juveniles (10-15 mm) of the more fragile *M. calcareo* have shell strengths which are an order of magnitude greater than maximum predicted sediment stresses in Zone 3.

A hydrodynamic force acts on a trawl door as it moves through the water column during bottom trawling (Crewe, 1964). As water flows around the ends of the door, a vortex is created behind the door. A small-scale vortex was observed at the water surface behind the TDM. Atypical displacements of bivalves in the TDM test were probably an artifact of a non-living condition (i.e. due to positive buoyancy after excavation) combined with a rebounding surface wave in the tank. Hydrodynamic forces generated by trawl doors probably play a role in displacement, over short distances, of small juveniles, in light of the frontal pressure wave and vortices which are created by trawl doors with their large surface areas.

Finally, the TDM test was performed on a level, smooth sand bed. While large areas of the Grand Banks are known to consist of relatively level bottom sand, at depths < 110 m the seabed displays wave-formed sand ripples and megaripples (Barrie et. al., 1984). Other features that create uneven surface macro-topography include iceberg scours and large rocks, and on these features, otter boards will be active, displaying periodic jumping action (Main and Sangster, 1979; Krost et. al., 1990). In these instances, the boards will momentarily leave and return to the seabed, imparting higher localized forces. Under these conditions, near-surface bivalves may suffer higher levels of damage compared to smooth bottom conditions.

Towing speed was a major difference between the TDM test and normal trawling operations. A primary objective of the test was to quantify the level of physical damage to infaunal bivalves directly attributable to a trawl door. It is necessary therefore, to examine the relationship between towing speed (i.e. speed of the trawl door through the sediment) and damage to bivalves. In the case of bivalves that are not excavated (i.e. those that are fixed in place), towing speed is irrelevant with respect to damage. Due to the high forces generated by a trawl door relative to shell strength, any bivalve that is directly contacted will be destroyed regardless of towing speed. Bivalves that are excavated and cast-off in the

frontal spoil escape damage. Although some of the parameters associated with sediment deformation and excavation will change with speed, the end result is essentially the same. The zone of excavation extends from the base of the shoe outwards and upwards to the surface, in the form of failure planes. Sediment and bivalves within this scouring zone will always be excavated in front of the shoe and a buffering zone will exist regardless of speed. In terms of major shell damage, scouring depth and bivalve size are the key determinants of damage.

This experiment was conducted in azoic sediment. As such, biological cohesion of sediment resulting from the activities and secretions of benthos was absent. Organisms have effects on physical properties of sediments that likely have consequent effects on patterns of sediment shear strength and natural transport processes (Hall, 1994). However, biological cohesion would break down under exposure to shear forces generated by trawling. Therefore, the fact that azoic sediment was used in the experiment should not affect the main results and conclusions.

The results of this experiment indicate the importance of linking the interaction between bottom fishing gear and the seabed in order to determine mechanisms of physical disturbance and damage to infaunal bivalves. The physical TDM was developed specifically for relatively level-bottom, dense sandy seabeds found on the northern Grand Banks. The other major surficial sediment type on the Grand Banks is gravel-cobble. Elsewhere, the influence of sediment coarseness on severity of damage caused by bottom fishing gears has been documented by the higher frequency of damage to scallops on a gravel-cobble substrata (25%) vs. sand (7%) caused by scallop dredging (Shepard and Auster, 1991). It is likely that otter boards would also inflict greater damage to bivalves associated with this bottom type, particularly the epifaunal Iceland scallop, *Chlamys islandica*.

Large near-surface bivalves such as *Clinocardium ciliatum* are less common on the

Grand Banks compared to small and medium size groups, and while results of the TDM experiment suggest greater sensitivity to physical damage in these large individuals, their low densities make it more difficult to field test this hypothesis. The focus of fishing gear impact experiments is generally on the directly observable shallow scouring zone, yet increased sediment stress is recorded to depths occupied by deep burrowers. The results of the TDM experiment indicate that these transient elevated stress levels are of insufficient magnitude to cause shell damage. Behavioural effects are unknown.

The results of the present study are only one aspect of the overall impacts to benthos from otter trawling. Habitat alteration, in the form of changes to the physical structure of surficial sediments, was clearly identified after repetitive trawling at the DFO OETSA (Schwinghamer et. al., 1996).

Considerable progress has been made in terms of understanding the immediate, direct impacts of various types of bottom fishing gears. Determining long-term impacts is a far more difficult task, particularly when often it can only be done retrospectively. In the short-term, benthic ecologists can make significant contributions by working with fishing gear technologists in order to design mobile bottom fishing gear that is less physically disruptive. Recent designs of lighter, more hydrodynamic footgear and trawl doors are 'benthos friendly' examples.

4.5 Literature cited

- Aquaprojects Inc. 1994. Responsible fishing gears and selectivity. A discussion paper: supplement to the Canadian report of the 1994 FAO International Expert Consultation for the Code of Conduct for Responsible Fishing. Sidney, B.C. June 6-11, 1994.
- Anon. 1993. Otter board performance and behaviour. Research project financed by The Commission of the European Communities within the frame of the EEC Research Program in the Fisheries Sector ("FAR"). Contract No. TE I 214.
- Arntz, W. and W. Weber. 1972. *Cyprina islandica* L. (Mollusca, Bivalvia) as food for cod and dab in Kiel Bay. Fisheries Research Board of Canada Translation Series No. 1985. 27 p. Translated from Bericht der Deutschen Wissenschaftlichen Kommission für Meeresforschung 21(1-4): 193-209.
- ASTM, 1993a. Standard test method for minimum index density and unit weight of soils and calculation of relative density. Pp. 674-681. In: Annual Book of ASTM Standards. Vol. 04.08.
- ASTM, 1993b. Standard test methods for maximum index density and unit weight of soils using a vibratory table. Pp. 661-673. In: Annual Book of ASTM Standards. Vol. 04.08.
- Barrie, J.V., C.F.M. Lewis, G.B. Fader and L.H. King. 1984. Seabed processes on the northeastern Grand Banks of Newfoundland: modern reworking of relict sediments. Marine Geology 57:209-227.
- Been, K. 1990. Mechanisms of failure and soil deformation during scouring. Pp. 179-189. In: Proceedings of Ice Scouring and the Design of Offshore Pipelines, Calgary, Alberta.
- Blundon, J.A. and G.J. Vermeij, 1983. Effect of shell repair on shell strength in the gastropod *Littorina irrorata*. Marine Biology 76: 41-45.
- Brylinsky, M., J. Gibson and D.C. Gordon, Jr., 1994. Impacts of flounder trawls on the intertidal habitat and community of the Minas Basin, Bay of Fundy. Canadian Journal

- of Fisheries and Aquatic Sciences 51: 650-661.
- Caddy, J.F. 1973. Underwater observations on tracks of dredges and trawls and some effects of dredging on a scallop ground. *Journal of the Fisheries Research Board of Canada* 30: 173-180.
- Canadian Fishery Consultants Limited. 1994. Review of fishing gear and harvesting technology in Atlantic Canada. Fishing gear and harvesting technology assessment. Prepared for Fisheries and Oceans Canada.
- Chopin, F., T.B. Gorman, K.J. Graham, K. Branden and J. Matthews. 1987. Underwater observations on commercial trawl nets and doors conducted in Jervis Bay during July 1985. Department of Agriculture New South Wales, Division of Fisheries, Miscellaneous Bulletin No. 6.
- Cook, L.M. and G. Kenyon. 1993. Shell strength of colour morphs of the mangrove snail *Littoraria pallescens*. *Journal of Molluscan Studies* 59: 29-34.
- Crewe, P.R. 1964. Some of the general engineering principles of trawl gear design. Part 2: bulk fish catching. Section 6, bottom trawling. Pp. 165-180. In: *Modern Fishing Gear of the World 2: Fishing News (Books) Ltd. London.*
- Currey, J.D. 1979. The effect of drying on the strength of mollusc shells. *Journal of Zoology (Lond.)* 188: 301-308.
- Currey, J.D. 1988. Shell form and strength. Pp. 183-210. In: Trueman, E.R., Clarke, M.R. (eds.), *The Mollusca: Volume 11, Form and Function*. Academic Press, Inc., San Diego, California.
- Currey, J.D. and R.N. Hughes. 1982. Strength of the dogwhelk *Nucella lapillus* and the wrinkle *Littorina littorea* from different habitats. *Journal of Animal Ecology* 51: 47-56.
- Dayton, P.K., S.F. Thrush, M.T. Agardy and R.J. Hofman. 1995. Environmental effects of marine fishing. *Aquatic Conservation: Marine and Freshwater Ecosystems* 5: 205-232.
- FRCC. 1994. Conservation aspects of groundfish gear technologies in eastern Canada. A

- Fisheries Resource Conservation Council Discussion Paper. Prepared by the Gear Technology Subcommittee. FRCC94.TD.4.
- Gislason, H. 1994. Ecosystem effects of fishing activities in the North Sea. *Marine Pollution Bulletin* 29: 520-527.
- Hall, S.J. 1994. Physical disturbance and marine benthic communities: life in unconsolidated sediments. *Oceanography and Marine Biology: an Annual Review* 32: 179-239.
- Harrison, P.H., K.W. Strong and K.A. Jenner. 1991. A review of fishing related seabed disturbance on the Grand Banks of Newfoundland. Maritime Testing (1985) Limited, Dartmouth, Nova Scotia.
- Hynes, F. 1996. Centrifuge modelling of ice scour in sand. M.Sc. Thesis. Faculty of Engineering and Applied Science, Memorial University of Newfoundland. St. John's, Newfoundland, 179 p.
- ICES. 1996. Report of the Working Group on Ecosystem Effects of Fishing Activities. ICES CM 1996/Assess/Env:1 Ref.:G.
- Jennings, S. and M.J. Kaiser. 1998. The effects of fishing on marine ecosystems. *Advances in Marine Biology* 34: 201-352.
- Kaiser, M.J. and B.E. Spencer. 1994. Fish scavenging behaviour in recently trawled areas. *Marine Ecology Progress Series* 112: 41-49.
- Kaiser, M.J. and B.E. Spencer. 1996a. The behavioural response of scavengers to beam trawl disturbance. Pp. 116-123. In: Greenstreet, S.P.R., Tasker, M.L. (eds.), *Aquatic Predators and Their Prey*. Blackwell Scientific Publications, Oxford.
- Kaiser, M.J. and B.E. Spencer. 1996b. The effects of beam-trawl disturbance on infaunal communities in different habitats. *Journal of Animal Ecology* 65: 348-358.
- Kaiser, M.J., A.S. Hill, K. Ramsay, B.E. Spencer, A.R. Brand, L.O. Veale, K. Prudden, E.I.S. Rees, B.W. Munday, B. Ball and S.J. Hawkins. 1996. Benthic disturbance by

- fishing gear in the Irish Sea: a comparison of beam trawling and scallop dredging. *Aquatic Conservation: Marine and Freshwater Ecosystems* 6: 269-285.
- Kenchington, T.J. 1995. A summary of the published evidence relating to habitat modification by fish draggers. Pp. 109-116. In: *The Canadian Maritimes Fishery: Let's Fix It: An Action Plan*. Southwest Nova Fixed Gear Association, Shelburne, N.S.
- Krost, P., M. Bernhard, F. Werner and W. Hukriede. 1990. Otter trawl tracks in Kiel Bay (Western Baltic) mapped by side-scan sonar. *Meeresforsch* 32: 344-353.
- Main, J. and G.I. Sangster. 1979. A study of bottom trawling gear on both sand and hard ground. *Scottish Fisheries Research Report Number 14*, Department of Agriculture and Fisheries for Scotland.
- McClelland Engineers. 1971. Soil borings-Grand Bank 1971. Report prepared by McClelland Engineers, Houston, Texas, for Auroco Canada Petroleum Company, Calgary, Alberta.
- Moshagen, H. and S.P. Kjeldsen. 1980. Fishing gear loads and effects on submarine pipelines. Pp. 383-393. In: *Proceedings of the 12th Annual Offshore Technology Conference*. Houston, Texas.
- Newton, R.S. and A. Stefanon. 1975. Application of side-scan sonar in marine biology. *Marine Biology* 31: 287-291.
- van Os, A.G. and W. van Leussen. 1987. Basic research on cutting forces in saturated sand. *Journal of Geotechnical Engineering* 113: 1501-1517.
- Palmer, A. 1993. The speed effect in seabed ploughing. Pp. 897-908. In: *Proceedings of the 4th Canadian Conference on Marine Geotechnical Engineering*, Vol. 3, St. John's, Newfoundland.
- Palmer, A., I. Konuk, G. Comfort and K. Been. 1990. Ice gouging and the safety of marine pipelines. OTC 6371. Pp. 235-244. In: *Proceedings of the 22nd Annual Offshore Technology Conference*, Houston, Texas.

- Palmer, A., I. Konuk, J. Love, K. Been and G. Comfort. 1989. Ice scour mechanisms. Pp. 123-132. In: POAC 89. Proceedings of the 10th International Conference on Port and Ocean Engineering under Arctic Conditions, edited by K.B.E. Axelsson and L.A. Fransson.
- Paulin, M.J. 1992. Physical model analysis of iceberg scour in dry and submerged sand. M.Sc. Thesis. Faculty of Engineering and Applied Science, Memorial University of Newfoundland. St. John's, Newfoundland, 324 pp.
- Prena, J., P. Schwinghamer, T.W. Rowell, D.C. Gordon, Jr., W.P. Vass, D.L. McKeown and K. Gilkinson. Experimental otter trawling on a sandy bottom ecosystem of the Grand Banks of Newfoundland: analysis of trawl bycatch and effects on epifauna. *Marine Ecology Progress Series* (in press).
- Preston, S.J., I.C. Revie, J.F. Orr and D. Roberts. 1996. A comparison of the strengths of gastropod shells with forces generated by potential crab predators. *Journal of Zoology (Lond.)* 238: 181-193.
- Ramsay, K., M.J. Kaiser and R.N. Hughes. 1996. Changes in hermit crab feeding patterns in response to trawling disturbance. *Marine Ecology Progress Series* 144: 63-72.
- Rowell, T.W., P. Schwinghamer, M. Chin-Yee, K. Gilkinson, D.C. Gordon, Jr., E. Hartgers, M. Hawryluk, D.L. McKeown, J. Prena, D.P. Reimer, G. Sonnichsen, G. Steeves, W.P. Vass, R. Vine and P. Woo. 1997. Grand Banks otter trawling experiment: III. Sampling equipment, experimental design and methodology. *Canadian Technical Report of Fisheries and Aquatic Sciences* 2190: viii + 36 p.
- Rumohr, H. and P. Krost. 1991. Experimental evidence of damage to benthos by bottom trawling with special reference to *Arctica islandica*. *Meeresforsch* 33: 340-345.
- Schwinghamer, P., J.Y. Guigné and W.C. Siu. 1996. Quantifying the impact of trawling on benthic habitat structure using high resolution acoustics and chaos theory. *Canadian Journal of Fisheries and Aquatic Sciences* 53: 288-296.

- Selig, E.T. and R.D. Nelson. 1964. Observations of soil cutting with blades. *Journal of Terramechanics* 1: 32-53.
- Service, M. and B.H. Magorrian. 1997. The extent and temporal variation of disturbance to epibenthic communities in Strangford Lough, Northern Ireland. *Journal of the Marine Biological Association U.K.* 77: 1151-1164.
- Shepard, A.N. and P.J. Auster. 1991. Incidental (non-capture) damage to scallops caused by dragging on rock and sand substrates. Pp. 219-230. *An International Compendium of Scallop Biology and Culture. Selected papers from the 7th International Pectinid Workshop*, World Aquaculture Society, Baton Rouge, La.
- Stanley, S.M. 1970. Relation of Shell Form to Life Habits of the Bivalvia (Mollusca). The Geological Society of America, Inc., Boulder, Colorado.
- Thompson, G.R. and L.G. Long. 1989. Hibernia geotechnical investigation and site characterization. *Canadian Geotechnical Journal* 26: 653-678.
- Thompson, G.R., S.H.C. Foo and H. Matlock. 1986. Hibernia GBS foundation behaviour. Pp. 141-164. In: *Proceedings of the 3rd Canadian Conference on Marine Geotechnical Engineering*, Vol. I, St. John's, Newfoundland.
- Verley, R.L.P., B.H. Moshagen, N.C. Moholdt and I. Nygaard. 1992. Trawl forces on free-spanning pipelines. *International Journal of Offshore and Polar Engineering* 2: 24-31.
- Vermeij, G.J. and J.D. Currey. 1980. Geographical variation in the strength of thaidid snail shells. *Biological Bulletin* 158: 383-389.
- Witbaard R. and R. Klein. 1994. Long-term trends on the effects of the southern North Sea beamtrawl fishery on the bivalve mollusc *Arctica islandica* L. (Mollusca, bivalvia). *ICES Journal of Marine Science* 51: 99-105.

Table 4.1. Comparison of selected geotechnical properties of experimental testbed sand and offshore experimental trawling study area (OETSA) sand.

Parameter	Testbed	OETSA
Sand type	Grade No. 0 silica-fine to medium	fine
Maximum grain size	2 mm	1.5 mm
D_{10}	0.26 mm	0.17 mm
C_u	2.154	1.618

D_{10} is **effective grain size** which is a sample parameter representing the grain size for which 10% of the grains are smaller than this diameter; C_u is the **coefficient of uniformity** which is an index of sediment uniformity with respect to grain size distribution defined as:

$C_u = D_{60}/D_{10}$; D_{60} is the diameter that 60% of the sample grains are smaller than this; if $C_u < 5$ then the sample is very homogeneous.

Table 4.2. Bivalve species and size classes placed in the experimental testbed.

Species	Size (mm)	Relative shell thickness	Natural burrowing depth
<i>Macoma calcareo</i> (Gmelin, 1791)	large (>30) medium (15-30) small (10-15)	intermediate thin thin	deep deep shallow to deep
<i>Cyrtodaria siliqua</i> (Spengler, 1793)	large (55-89)	thick	deep
<i>Astarte borealis</i> Schumacher, 1817	large (30-41)	thick	SWI ¹
<i>Clinocardium ciliatum</i> (Fabricius, 1780)	large (55) small (12-15)	intermediate thin	SWI SWI
<i>Cyclocardia novangliae</i> (Morse, 1869)	large (15-19)	intermediate	SWI
<i>Cyclocardia sp. A</i>	large (17-20) medium (12-15)	thick thick	SWI SWI

1- SWI = Sediment-water interface: the posterior margin of the valves extends to within millimetres, or at times just above the seabed surface.

Table 4.3. Frequencies of damage to bivalves after TDM scouring in RBI.

Testbed depth/z	Species	Scour path specimens				All specimens			
		#P	#R	ND	Minor	#P	#R	N	Minor
SWI/ 500	Cc _{large}	2	2	2		2	2		2
	Cc _{small}	2	2	2		2	2		2
	Cn _{large}	3	3	3		7	7		7
	Ca _{large}	4	3	3		6	5		5
	Ca _{medium}					2	2		2
	Ab _{large}	5	5	5		9	9		9
2 cm/ 480	Mc _{large}	3	3	2	1	7	7	6	1
	Mc _{medium}	3	3	3		7	7	6	1
	Mc _{small}	3	3	2	1	7	7	5	2
5 cm/ 450	Mc _{large}	3	3	3		7	7	7	
	Mc _{medium}	3	3	2	1	7	6	4	2
	Mc _{small}	3	3	2	1	7	5	4	1
	Cs _{large}	2	2	2		2	2	2	
10 cm/ 400	Mc _{large}	2	2	1	1	4	4	3	1
	Mc _{medium}	2	2	1	1	4	4	3	1
	Mc _{small}	2	2	2		4	4	4	
	Cs _{large}	4	4	4		4	4	4	
15 cm/ 350	Mc _{large}	4	4	4		4	4	4	
	Mc _{medium}	2	2	1	1	4	4	3	1
	Cs _{large}	2	2	2		4	4	4	
20 cm/ 300	Mc _{large}	2	2	2		4	4	4	
	Cs _{large}	2	2	2		4	4	4	
TOTALS		58	57	50	7	108	104	94	10

SWI- sediment-water interface; Cc- *Clinocardium ciliatum*, Cn- *Cyclocardia novangliae*, Ca- *Cyclocardia sp.A*, Ab- *Astarte borealis*, Mc- *Macoma calcareo*, Cs- *Cyrtodaria siliqua*; P- placed in testbed (pre-test) R- recovered (post-test); ND- no damage

Table 4.4. Frequencies of damage to bivalves after TDM scouring in RB2.

Testbed depth/z	Species	Scour path specimens					All specimens				
		#P	#R	ND	Minor	Major	#P	#R	ND	Minor	Major
SWI/ 500	C _{large}	2	2	1		1	2	2	1		1
	C _{small}	2	2	2			2	2	2		
	Mc _{small}	3	3	2	1		7	6	5	1	
	Ab _{large}	3	3	3			3	3	3		
2 cm/ 480	Mc _{large}	3	3	3			7	7	7		
	Mc _{medium}	3	2	1		1	7	6	3	2	1
	Mc _{small}	3	3	3			7	7	6	1	
5 cm/ 450	Mc _{large}	3	3	3			5	5	5		
	Mc _{medium}	3	3	3			7	7	5	2	
	Mc _{small}	3	3	3			7	7	7		
	C _{large}	2	2	2			2	2	2		
10 cm/ 400	Mc _{large}	2	2	2			4	4	4		
	Mc _{medium}	2	2	1	1		4	4	3	1	
	Mc _{small}	2	2	2			4	4	4		
	C _{large}	2	2	2			4	4	4		
15 cm/ 350	Mc _{large}	2	2	2			4	4	4		
	Mc _{medium}	2	2	2			4	4	4		
	C _{large}	2	2	2			4	4	4		
20 cm/ 300	Mc _{large}	2	2	2			4	4	4		
	C _{large}	2	2	2			4	4	4		
TOTALS		48	47	43	2	2	92	90	81	7	2

SWI- sediment-water interface; Cc- *Clinocardium ciliatum*, Ab- *Astarte borealis*, Mc- *Macoma calcarea*, Cs- *Cyrtodaria siliqua*; P- placed in testbed (pre-test); R- recovered (post-test); ND- no damage

Table 4.5. Peak load and stress at shell failure for bivalve species used in the TDM test.

Species	Shell length (mm)	Mass (g)	Peak load (N)	Contact area (m ²)	Peak stress (kPa)
<i>M. calcareo</i>	10.0	0.1	4.2	0.55*10 ⁻⁵	763.6
	15.3	0.3	7.9	3.957*10 ⁻⁵	199.6
	16.4	0.4	4.1	0.62*10 ⁻⁵	654.8
	21.8	0.7	13.1	2.873*10 ⁻⁵	456.0
	28.1	1.5	31.1	4.594*10 ⁻⁵	677.0
	42.0	7.6	56.2	1.276*10 ⁻⁴	440.4
<i>A. borealis</i>	35.4	8.3	205.7	5.343*10 ⁻⁵	3849.9
	41.2	14.8	253.0	8.055*10 ⁻⁵	3140.9
<i>C. sp. A</i>	23.4	6.8	162.9	7.2*10 ⁻⁵	2262.5
<i>C. novangliae</i>	15.1	1.1	30.0	1.734*10 ⁻⁵	1730.1
<i>C. ciliatum</i>	14.2	0.9	32.9	1.5*10 ⁻⁵	2193.3
	57.8	32.6	117.0	2.43*10 ⁻⁵	4814.8
<i>C. siliqua</i>	72.7	61.2	74.7	25.41*10 ⁻⁵	294.0

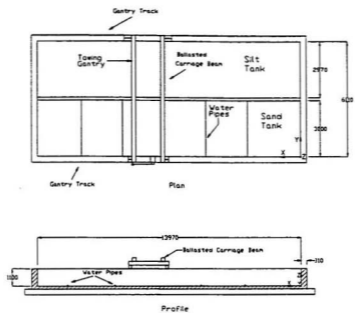

Figure 4.1. Plan and profile views of the experimental tank used for the trawl door model experiment (dimensions in mm).

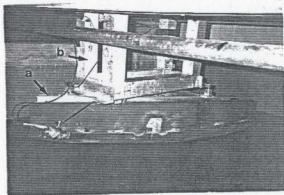
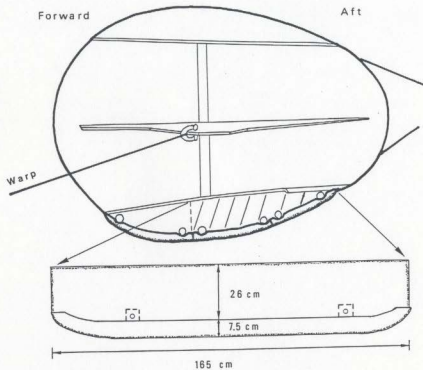

Figure 4.2. (Top) Portion of a trawl door that formed the main part of the TDM, consisting of the welded centre and aft shoe sections and plate. (Bottom) Assembled TDM connected to triangular mounting frame (a) that is connected to a vertical support frame (b) that attaches to the gantry. Also shown is the gantry axle and the underwater video camera mounted on the TDM steel plate. The total length of the model is 165 cm.

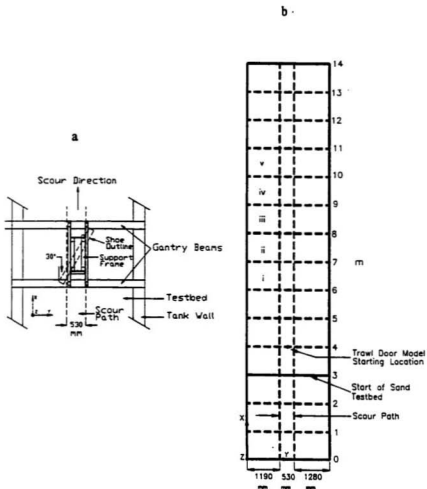

Figure 4.3. (a) Plan view of TDM assembly mounted on the gantry showing the 30° angle of attack. (b) Plan view of experimental testbed illustrating layout of experimental blocks for bivalves and instrumentation. (i) bivalves-RB1 (ii) ball bearings (iii) electronics and coloured sand (iv) bivalves-RB2 (v) solder strands.

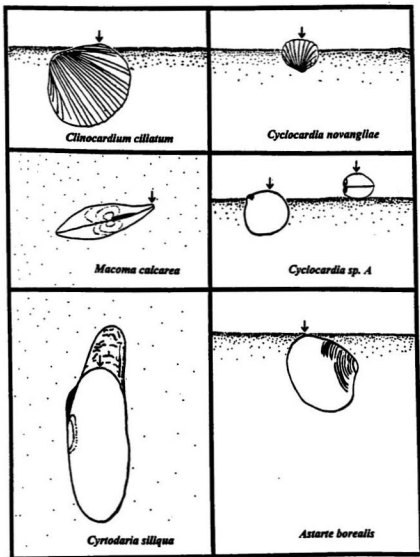

Figure 4.4. Orientations of bivalve species in the testbed. *Clinocardium ciliatum*, *Cyclocardia novangliae*, *Cyclocardia sp. A* and *Astarte borealis* occupy the sediment-water interface. Arrows show 3-D pointer position for logging coordinates.

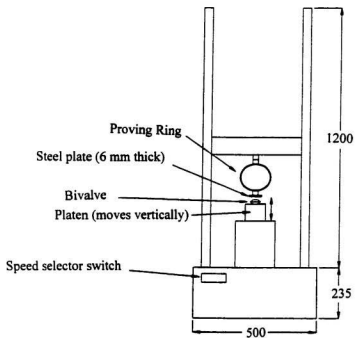

Figure 4.5. Triaxial compression machine used to test bivalve shell strengths (dimensions in mm).

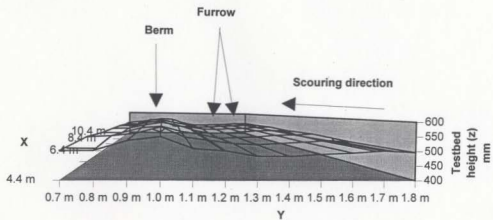

Figure 4.6. Post-scour testbed profile.

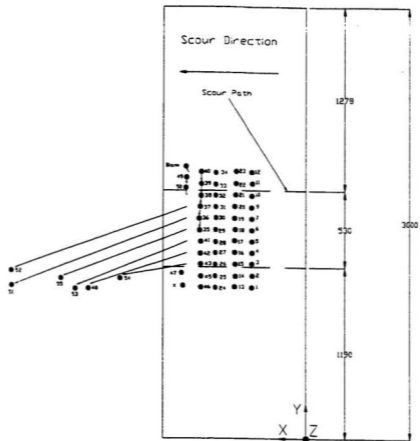

Figure 4.7. Plan view of the displacement of ball bearings by the scouring TDM. The five series were at the following depths (from left to right): $z = 500, 460, 400, 360$ and 300 mm. Dimensions in mm.

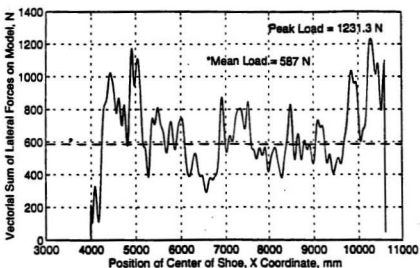
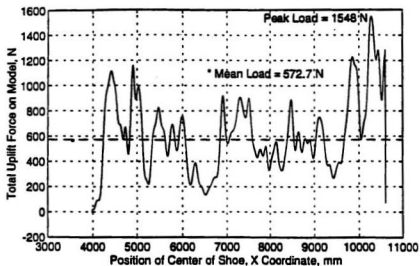

Figure 4.8. (Top) Total uplift (i.e. vertical) force acting on the TDM as a function of shoe position (x coordinate) as it scoured the testbed. (Bottom) Vectorial sum of lateral forces (x,y coordinates) acting on the TDM as a function of shoe position.

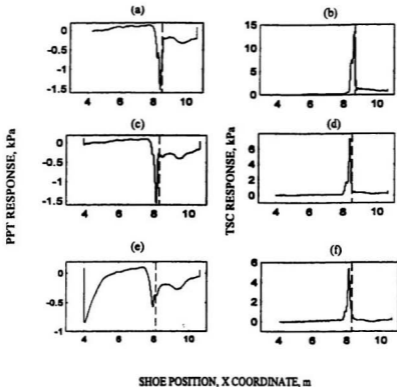

Figure 4.9. Pore water pressure and total sediment stress recordings along the centre line of the scour path as a function of shoe position (x coordinate) as it scoured the testbed. The depth of the pore pressure transducers (PPT) and total stress cells (TSC) in the testbed are indicated by the dashed vertical lines. (a),(b): $z = 450$ mm; (c),(d): $z = 400$ mm; (e),(f): $z = 350$ mm.

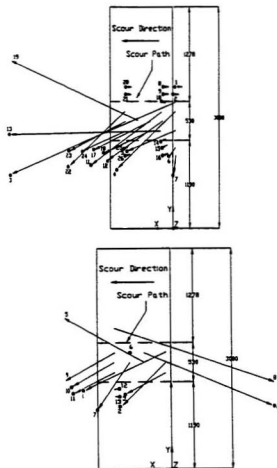

Figure 4.10. (Top) Post-test displacement of bivalves at the sediment/water interface ($z = 500$) in RB1. *Cyclocardia* sp. A: 1 (12.3 mm), 2 (13.3 mm), 3 (17.8 mm), 4 (23.4 mm), 5 (17.0 mm), 6 (21.4 mm), 7 (21.8 mm); *Astarte borealis*: 8 (37.5 mm), 9 (37.0 mm), 10 (35.8 mm), 11 (40.9 mm), 12 (40.0 mm), 13 (38.3 mm), 14 (34.7 mm), 15 (35.6 mm), 16 (37.0 mm); *Clinocardium ciliatum*: 17 (15.0 mm), 18 (14.4 mm), 19 (55.6 mm); *Cyclocardia novangliae*: 20 (15.6 mm), 21 (17.3 mm), 22 (17.8 mm), 23 (17.3 mm), 24 (17.5 mm), 25 (18.0 mm), 26 (19.3 mm). (Bottom) Post-test displacement of bivalves at the sediment/water interface ($z = 500$) in RB2. *Astarte borealis*: 1 (40.0 mm), 2 (36.1 mm), 3 (41.2 mm); *Clinocardium ciliatum*: 4 (14.0 mm), 5 (12.7 mm), 6 (55.0 mm), 7 (54.9 mm); *Macoma calcarea*: 8 (11.4 mm), 9 (12.7 mm), 10 (15.2 mm), 11 (13.0 mm), 12 (13.0 mm), 13 (15.1 mm).

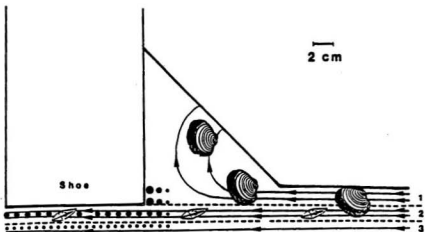

Figure 4.11. Profile of physical model (to scale) of trawl door-bivalve interaction during scouring. Large bivalve is *Astarte borealis* (40 mm) and small bivalve is *Macoma calcarea* (28 mm). Circles indicate relative magnitude of stress adjacent the shoe. # 1-3 are zones of sediment deformation referred to in the text; broken lines are zone boundaries.

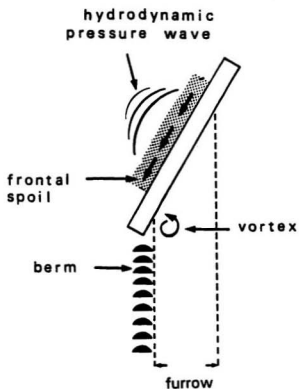

Figure 4.12. Schematic plan diagram of sediment and bivalve displacement during scouring. Arrows superimposed with frontal spoil indicate direction of movement of sediment and bivalves.

Appendix 4.1. Derivation of a velocity scaling factor used to convert TDM forces to field trawling forces.

For a trawl door cutting (i.e. scouring) through a level-bottom sandy seabed, the major force component is horizontal. This is also the force component of primary interest with respect to physical damage to bivalves. The velocity scaling factor used to convert TDM forces to field trawling forces was derived from Palmer's (1993) study into the relationships between horizontal forces generated by a plough and cutting (i.e. scouring) depth and speed. In sand, there is a strong positive, linear relationship between cutting force and cutting speed. Figure 1 has been reproduced from Palmer (1993). These results are based on a model plough being pulled through coarse beach sand (Cresswell sand, $D_{10} = 0.312$ mm). The degree of sorting of this sand is unknown but it appears to be somewhat coarser than the sand used for the TDM testbed ($D_{10} = 0.26$ mm). Because the model plough was towed or pulled, Palmer refers to the resulting horizontal force as horizontal pulling force. This force is analogous to the horizontal or lateral force that was recorded as the TDM scoured or cut the testbed. Pulling force increases with cutting speed and rate of change in force increases with cutting depth. Using the data from Figure 1, the rate of change in horizontal pulling force as a function of velocity (dP/dU) was plotted for each of the cutting depths ($h = 100, 200, 300$ and 400 mm). A best fit line was passed through the four points (Fig. 2). It is reasonable to assume that this linear trend would extend to a 20 mm cutting depth, the cutting depth used in the TDM test. Extrapolating to a cutting depth of 20 mm, $dP/dU = 1.48$ kN/(m/s). The y-intercepts of Palmer's best fit lines (from Fig. 1) were plotted against cutting depth and a best fit line was passed through the four points (Fig. 2). Extrapolating to a cutting depth of 20 mm, the value of the y-intercept is 2.39 kN. The derived equation, $y = 1.48x + 2.39$, where $y =$ pulling force and $x =$ cutting speed, was used to plot horizontal

pulling force vs. cutting speed for a cutting depth of 20 mm (Fig. 3). At the TDM cutting speed (0.44 m/s), the required horizontal pulling force is 3.05 kN. At a typical trawling speed of 1.54 m/s (3 knots), the horizontal force is 4.65 kN. Therefore, forces generated by the trawl door would increase by a factor of 1.5 due to the increase in cutting speed. The horizontal forces generated by the TDM, when increased by a factor of 1.5, give a reasonable estimate of full-scale (i.e. normal speed) trawling forces. Part of this increase in force would likely be transmitted downwards through the sediment, resulting in higher seabed stresses at depth, relative to recorded testbed stresses.

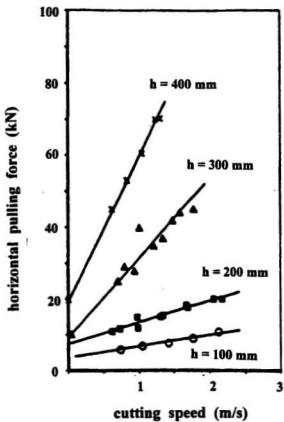

Figure. 1. Relationship between horizontal pulling force and cutting speed for a model plough pulled through coarse sand at four sediment depths (h) (from Palmer, 1993).

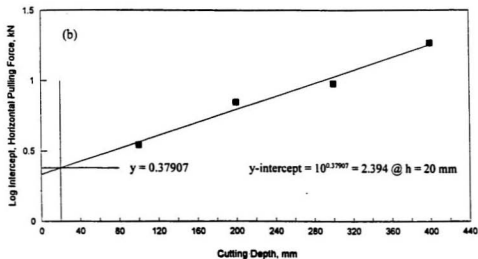
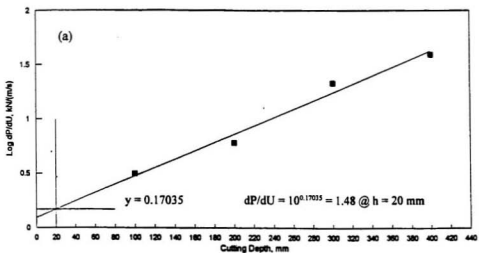

Figure. 2. Derivation of values for the slope and intercept for the linear equation relating horizontal pulling force to cutting speed for a cutting depth of 20 mm. (a) slope (kN/(m/s)) (b) y-intercept (horizontal pulling force, kN).

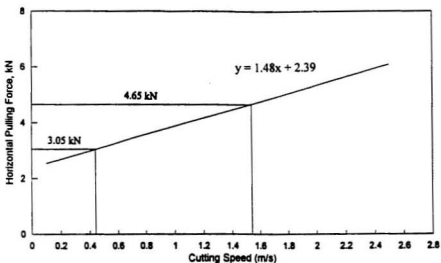

Figure 3. Calculation of a velocity scaling factor (1.5) derived from the ratio of horizontal pulling force at normal trawling speed (1.52 m/s) and horizontal pulling force at the TDM cutting speed (0.44 m/s).

Natural Physical Disturbances Affecting the Seabed on the Grand Banks

5.1 Introduction

It is important to place fishing related physical disturbances in the context of natural disturbances (Hall, 1994; Kaiser et al., 1996). The focus of this chapter is a comparison of disturbances caused by otter trawling with natural physical disturbances occurring on the Grand Banks. Much of the disturbance literature consists of chronic, small-scale, ubiquitous disturbances such as the creation of new space and food resources or impacts of biotic structures (e.g. tubes, casts, etc.). The various models of benthic disturbance focus on localized displacement or damage to resident organisms which directly or indirectly creates an opportunity for new individuals to colonize disturbed areas (Sousa, 1984). Because disturbance models emphasize adaptation, primarily in terms of colonizing ability, only those disturbances that have frequencies of occurrence within the lifetime of an individual within the community are considered. There is limited information on the recovery of benthic communities from natural disturbances of large magnitude. Reasons for this are that these types of disturbances are unpredictable and fall outside the experimental approach. Investigations of large-scale disturbances include opportunistic before-after surveys following the passage of storms (Dobbs and Vozarik, 1983; Posey et al., 1996).

Because of the low predictability of large-scale disturbances, ecologists consider it unlikely that species have evolved specific adaptations to exploit them (Thistle, 1981). However, Boero (1996) cautions against viewing episodic events (i.e. disturbances) strictly within an ahistorical context or within too narrow a time frame. Although severe, infrequent disturbances may not act as directional selective agents, but they can serve as sources of indiscriminant mortality and as initiators of successional processes (Posey et al., 1996). Ecological and evolutionary scale disturbance processes can be considered. Community ecologists consider predictability to be an important criterion for adaptive response to a

disturbance however, the experimental approach is really only feasible with small-scale disturbances that can be manipulated. On the other hand, paleobiologists consider catastrophic disturbances, which lie outside the adaptive framework of benthic communities, to be important over evolutionary time scales. For instance, changes following such catastrophes include physical modifications of the benthic system or release or introduction of some biotic interaction (Orensanz and Gallucci, 1982).

The following discussion focuses on natural physical disturbances and their effects on bivalves living in unconsolidated sediments on the Grand Banks. Because the primary goal is to compare these disturbances with physical disturbance associated with otter trawling, only sediment-mediated physical disturbances are considered. These are:

- (i) Secondary hydrodynamic forces: sediment resuspension and transport by waves and currents;
- (ii) Iceberg scouring;
- (iii) Bioturbation

There are numerous definitions of disturbance. For the purposes of the following discussion, the definition put forth by White and Pickett (1985) is appropriate:

'A disturbance is any discrete event in time that disrupts ecosystem, community or population structure and changes resources, substrate availability, or the physical environment.'

Due to a paucity of information on effects of these natural disturbances on benthic organisms, the discussion focuses on the physical environment. The first sections are devoted to assessment of disturbance regime descriptors and impacts for each natural

disturbance agent listed above. An historical (i.e. evolutionary scale) analysis is included because bivalves have co-evolved with natural disturbances while otter trawling is a very recent phenomenon. The final section is devoted to a comparison of the physical processes and main effects of natural disturbances with those of otter trawling. The term probability is used in the context of frequencies of occurrence of individual disturbance events while predictability refers to the probability of a bivalve experiencing a disturbance event during its lifespan.

5.2 Hydrodynamic disturbance agents

Sediment transport pathways on the eastern Canadian continental shelf have been determined from geological evidence, including grain size trends and bedform orientation (Amos and Judge, 1991). On continental shelves, processes of sediment transport vary with water depth, with distance from shore, and with latitude. Sediment transport along the coastline in the western Atlantic is wave dominated, particularly in association with winter storms (Barrie et al., 1984; Lyne et al., 1990; Amos and Judge, 1991; Harris and Wiberg, 1997).

5.2.1 Bedforms

In recent years, considerable progress has been made towards understanding sediment dynamics on the Grand Banks based on processes of bedform formation and differentiation of modern sediment reworking from relict features (Barrie et al., 1984; Fader and Miller, 1986; Amos and Judge, 1991; Dalrymple et al., 1992). The hydrodynamic regime shapes seabed geomorphology. On the Grand Banks, surficial sands and gravels are moulded by waves and currents into characteristic bedforms, extending to water depths representing the approximate wave base, i.e. 110-120 m (Barrie et al., 1984; Barrie and Collins, 1989;

Dalrymple 1992). Bedforms are classified by their height, width, length, morphology, and orientation. The largest bedforms are sand waves, ridges and ribbons. Sand ribbons greater than 30 km in length and 1 km in width have been observed on the Grand Banks (Amos, 1982). Sand ridges are larger scale, linear bedforms. Typically, they are 10-40 m high, 1-2 km wide and up to 60 km long. They often occur in groups, with inter-crest distances of 4-12 km. The term 'sand wave' refers to any rhythmic feature of sand. Sand waves typically have wave heights between 1.5 and 3 m and on the Grand Banks, waves up to 1 km in length have been observed (Amos, 1982). Ripples and megaripples are small-scale, flow-transverse bedforms. Wave and current-formed ripples are generally less than 25 cm in height and up to 2 m in length. Megaripples are formed at higher current speeds and display wavelengths ranging between 0.1 and 25 m and wave heights between 5 and 50 cm (Amos, 1982). The formation of sand waves, ripples and megaripples are associated with specific sand coarseness grades. Small-scale bedforms may be superimposed on the larger bedforms.

Surficial sediments over 80% of the Grand Banks may be mobilized by modern hydrodynamic processes (G. Fader, pers. comm.; cited in Amos and Judge, 1991, p. 1044). Storms are considered the main cause of sand transport on the Grand Banks at depths less than 120 m while at deeper depths the seabed is considered to be relatively stable based on lack of evidence of ripples. Side-scan sonograms typically reveal a smooth, continuous surface at deeper depths (Barrie et al., 1984; Dalrymple et al., 1992).

The spatial distribution and crestline-strike orientation of bedforms have been used to infer the direction of sediment transport on the Grand Banks. Overall, net movement of sediment on the Grand Banks is towards the south-southeast, parallel to the bathymetric contours, by suspended and bedload transport processes (Barrie and Collins, 1989; Dalrymple et al., 1992). Finer sediment fractions in particular are transported in suspension. Oscillatory water motion near the seabed at depths of 80 m (Hibernia area) is known to resuspend sediment (Barrie and Collins, 1989). These authors recorded from a submersible,

poor near-bottom visibility at Hibernia due to high concentrations of suspended sand and/or silt. At the time, there was a 3 m surface swell.

In bedload transport, particles may slide, roll or bounce along the sediment-water interface.

5.2.2 Probabilities of storm disturbances

The current speeds ($0.5\text{-}1\text{ m s}^{-1}$) required to generate sand waves and megaripples on the Grand Banks probably occur only during storms (Dalrymple et al., 1992). The Grand Banks experiences a large number of winter storms. Storm-wind conditions (wind speeds $> 88\text{ km h}^{-1}$) occur on average, for more than 40 hrs per month during December to January. Individual storms can cover large areas (up to 1000 km in diameter) and, as such, impact large areas as they track over the Grand Banks. By comparison, tidal currents and the inshore branch of the Labrador Current rarely exceed speeds of 0.1 m s^{-1} which is below the critical threshold of motion for medium sand. The prevailing flow of the Labrador Current may contribute to the overall southerly migration of bedforms (Dalrymple et al., 1992).

Model estimates of wind speeds required for sediment transport at specific depths on the eastern Canadian continental shelf have been applied to known periodicities of storms of varying intensity (e.g. wind speeds and significant wave heights) in order to predict storm-associated sediment mass transport (Amos and Judge, 1991). This type of analysis has been used to calculate the probabilities and consequences of major hydrodynamic disturbance events on the Grand Banks. Amos and Judge (1991) modelled storm transport of medium sand (0.35 mm) on the Grand Banks, as this particle size was considered a reasonable approximation of the mean bank-averaged particle diameter. Significant wave heights associated with storms of different intensity (i.e maximum wind speed) were considered. In order of decreasing intensity, the storms considered had return times of 32, 10 and 1 years. The 'Ocean Ranger Storm' was classified as a one-in-32-year (1:32) storm. For a storm of

this intensity, the projected direction of sediment transport was very similar to that derived from geological inference. The magnitude of sediment transport was strongly depth-dependent. Transport was predicted over most of the Grand Banks to depths of at least 200 m. Sediment transport versus particle size was predicted for Hibernia (c. 80 m depth) at the height of the storm. Transport rates for sediments finer than 30 mm diam. (pebbles) were estimated to range between 5×10^{-4} and $5 \times 10^{-3} \text{ kg m}^{-1} \text{ s}^{-1}$. A transport rate for very fine sand (0.062-0.125 mm) was estimated at $10^{-2} \text{ kg m}^{-1} \text{ s}^{-1}$. These rates of transport were associated with depth-averaged current speeds $\geq 0.8 \text{ m s}^{-1}$ inside the 100 m isobath. Predicted sand transport trajectories for the 1:10 year storm were similar to those for the 1:32 year return. Current speeds were highest at shallow depths (1.5 m s^{-1} over St. Pierre, Green and Whale Banks) while over central and northern Grand Bank they were 0.6 m s^{-1} . The maximum predicted particle size in motion at Hibernia was 20 mm and peak rate of transport of medium sand was $6 \times 10^{-4} \text{ kg m}^{-1} \text{ s}^{-1}$. Sediment transport approached zero between the 100 and 200 m isobaths. The 1:1 year storm was predicted to have depth-averaged current speeds of between 0.1 m s^{-1} and 1 m s^{-1} . Under these conditions, fine to coarse sand ($< 2 \text{ mm}$) were potentially transported at depths less than 100 m.

In summary, sediments on the Grand Banks are probably being reworked only during the winter months of higher wave activity. At water depths of 70 m, critical threshold velocities for sediment transport are exceeded greater than 30% of the time during the months of November to March. Wave action and steady low current flow, often in the same direction, are responsible for the formation and migration of bedforms (Barrie and Collins, 1989).

5.2.3 Sediment transport: impacts and predictabilities

Hall (1994) reviewed studies that examined the impacts of storms on benthos (also see Posey et al., 1996). Most investigations of storm-related disturbances on infauna are

from nearshore, shallow water habitats. Sources of mortality were associated with bedform movements and erosion and deposition of surficial sediments. In numerous studies, there were marked changes in densities of macrofauna caused by 'wash-out' of organisms from sediments. Storms in shallow water have been known to deposit new layers of sediment ranging from 1 to 10 cm thick (McCall, 1977; Rachor and Gerlach, 1978). Dynamic habitats are often dominated by opportunistic species that are able to quickly re-colonize disturbed areas and deep burrowing taxa that can tolerate shifting sediment. Macrobenthic communities in shallow water soft bottom habitats often display considerable resilience in the face of considerable wave-generated sediment disturbance and transport (Turner and Miller, 1995). It might be expected that biological communities in different habitats would differ in their resistance to physical disturbances based on relative frequencies of exposure to disturbances. Based on laboratory simulations of physical disturbances, Schratzberger and Warwick (1998) concluded that nematode assemblages from mobile sandy sediments were more resilient than those from sheltered muds. Adaptations to hydrodynamic disturbances include morphological adaptations that reduce the likelihood of washout (i.e. the concentric symmetric shell ridges in bivalves (Stanley, 1970, 1981), and life history traits that lead to rapid recovery of populations (Hall, 1994). Near-surface species and sedentary taxa may be more susceptible to sediment disturbance than deep, active burrowers (Posey et al., 1996). Posey et al. (1996) examined the effects of the passage of a severe storm on infauna inhabiting an artificial reef-sand habitat in an offshore, shallow water (13 m) environment. Mean densities of near-surface taxa, including juvenile bivalves, decreased after passage of the storm. The authors speculated however, that these changes may be less than background, annual variability. There is experimental evidence that juvenile bivalves, which reside at the sediment-water interface, may be particularly susceptible as a result of a synergistic effect of physical disturbance and increased availability to predators (Bonsdorff et al., 1995).

There is evidence that low levels of sediment disturbance can be beneficial to infaunal bivalves. Emerson (1990) reported that *Mercenaria mercenaria* displayed a higher than unexpected rate of growth when exposed to a near-bottom current velocity of 0.03 m s⁻¹. This was explained as a food subsidy from resuspended particulate matter.

Effects of storms on benthos are unknown at depths representing most of the Grand Banks (> 60 m). Based on the sediment transport model predictions, a certain degree of sediment displacement is expected to depths of at least 100 m. Based on data from the Hibernia area, bedload transport of sand at a depth of 80 m probably occurs at a low rate. The fastest migration rates are associated with ripples (4-6 cm crest heights) and megaripples (< 50 cm crest heights) while migration rates of larger features such as sand waves (2-3 m crest heights) probably occur only over long time periods (J.V. Barrie, pers. comm.). Given the longevity of bivalves, most species on the Grand Banks should, over the course of their life spans, be exposed to these shifting sediments.

Much of what is known concerning the effects of episodic burial on bivalves comes from laboratory estimates of mortality and burrowing behaviour associated with different thicknesses of overburden (Maurer et al., 1980; Appleby and Scarratt, 1989). These studies investigated questions associated with dumping dredge spoil at sea. Not unexpectedly, deep burrowers displayed higher survival rates from burial than shallow burrowers. The large, deep-burrowing *Panopea generosa* survived burial under 15 cm of spoil and could possibly tolerate overburden thicknesses as much as 50 cm (Goodwin, 1975; cited in Chang and Levings, 1978). Likewise, the deep-burrowing *Yoldia thraciaeformis* and *Macoma calcareo* were able to migrate vertically through 30 cm of sediment overburden. Relatively low mortalities (8.3%) were recorded for both species after this burial regime (Reid and Baumann, 1984). In contrast, shallow-burrowing species might be expected to be most adversely affected since, unlike deep-burrowers, they do not have a long, siphon in which to maintain contact with the surface. The shallow burrowing, relatively sedentary cockle,

Clinocardium nutallii, had marginal success escaping burial beneath 10 cm of sand. No individuals escaped from 20 cm burial over a 24 hour period (Chang and Levings, 1978). Ansell (1967) observed that three species of Cardiidae (*Laevicardium crassum*, *Cardium echinatum* and *C. edule*) readily burrowed upwards through an overburden of 5 cm of sand to re-establish their normal position at the sediment-water interface.

There is evidence that some deposit feeding species can migrate greater vertical distances after substantial burial compared to suspension feeders (see Reid and Baumann, 1984). Intuitively, this makes sense because obligate deposit feeders must be able to seek out new food sources. For a given species and size of individual, escape from burial will be a function of overburden stress, which is a measure that relates bulk sediment density and burial depth (Nichols et al., 1978). For bivalves, overburden stress reaches a critical point when the animal cannot open its valves to extend the foot (Reid and Baumann, 1984).

Relative to the maximum life spans of most species of bivalves (> 5 years), annual storms represent a highly predictable disturbance. Long-lived species (> 20 yrs) such as *Arctica islandica* and surf clams (*Spisula solidissima* and *Mactromeris polynyma*) would experience storms of greater intensity (i.e. 1:10 and 1:32 year storms) during their life spans. Many of the extant bivalve genera on the Grand Banks immigrated from the Northeast Pacific through the Arctic ocean into the Northwest Atlantic c. 3 mybp (Vermeij, 1991). Modern re-working of sediments on the Grand Banks has occurred over a very long period of time. Bivalves living on the Grand Banks have evolved in this type of shifting environment. The large-scale nature of sediment transport events during storms means that bivalves over large areas are potentially affected. Likely, it is a combination of adaptive traits at the individual level (burial survivorship) combined with life history characteristics (i.e. ability to re-colonize from non-impacted areas) that has ensured the success of bivalves on continental shelves.

Shallow offshore banks are subject to substantial resuspension of sediments during

storms (Appleby and Scarratt, 1989). Sediment resuspension due to currents below the wave base is also predicted for deep water areas of continental shelves (Churchill, 1989). Residence times in the water column of resuspended particles will be a function of particle size. Particle sizes that remain in suspension long enough to have potential biological impacts are the finer grained sands, silts and clays. Suspended solids can affect bivalves directly through injury as a result of mechanical or abrasive action of particles. They can also interrupt normal gonad development and feeding by suspension feeders. Experimental simulation of storm conditions (concentrations of suspended solids of 193 mg l^{-1}) did interrupt feeding in *M. mercenaria*, but effects were short-lived with normal resumption of growth after the disturbance (Turner and Miller, 1995). Concentrations of suspended solids that are lethal vary with species, exposure times and co-occurring environmental conditions (Appleby and Scarratt, 1989).

Churchill (1989) modelled sediment resuspension due to currents over the middle Atlantic Bight. The highest concentrations of resuspended sediment were observed over an area known as the 'Mud Patch' (south of Nantucket), characterized by sediments with a silt-clay fraction > 25%. Concentrations of resuspended sediment were greatest during winter months ($0.2\text{-}2.2 \text{ mg cm}^{-2}$ of seabed), coinciding with peak storm-induced bottom stress. Elsewhere on the shelf, at depths < 200 m, the silt-clay fraction was less than or equal to 5%. Over most of the Grand Banks, resuspended sediment due to storms would be expected to stay in suspension for shorter periods of time on the main part of the banks relative to slope depths where silt and clay fractions are higher. While poor visibility from an ROV at depths < 100 m indicate that wave-generated resuspended sand concentrations can be high on the Grand Banks (Barrie and Collins, 1989), video surveys at the DFO OETSA and Hibernia areas over the period 1992-1997, have generally shown excellent near-bottom visibility.

5.3 Iceberg scouring

5.3.1 Iceberg occurrences

Iceberg conditions on the Grand Banks represent the net effects of advection and accumulated deterioration of icebergs calved at least two years previously, primarily from west Greenland glaciers (Anon., 1997). Of the approximately 10,000 to 30,000 icebergs produced annually, on average, only 400 drift into the Grand Banks region each year (Paulin, 1992). The occurrence of icebergs is a seasonal phenomenon. Long-term records (1955-1985) show highest average monthly totals (120-130) in April and May (Anon., 1997). Most records of iceberg scours in the region have been obtained using sonograms, submersible observations of individual scours have also provided detailed information on specific physical and biological features. Critical to an understanding of iceberg scouring phenomena has been the ability to distinguish between relict and modern scours and seabed materials (Syvitski et al., 1983; Fader, 1989; Woodworth-Lynas et al., 1991).

5.3.2 Disturbance processes

When icebergs strike and move through the seabed, they create characteristic curvilinear scours. Scour dimensions average 1-2 m in depth, 30-40 m in width and range in length from hundreds of metres to several kilometres. The period of iceberg-seabed contact varies from minutes to months. The main features of a scour are a flat-bottomed trough bordered by two berms. Woodworth-Lynas et al., (1991) give a detailed description of the physical processes of seabed disturbance during iceberg grounding and scouring. Pits or craters are another scouring feature. Vertical oscillations of icebergs can produce a string of pits along the main scour line (Lewis et al., 1987).

5.3.3 Iceberg scour dimensions

There is an extensive database on scour statistics for the Newfoundland-Labrador region (see Goodwin et al., 1985; Davidson and Simms, 1997). Scours in the Terra Nova area (northeastern Grand Bank, 80-100 m depth), have mean (\pm sd) scour lengths, widths and depths of 566 ± 623 m, 24.8 ± 4 m and 0.6 ± 0.3 m, respectively. A maximum scour length and depth of 3.4 km and 1.5 m have been recorded (Anon., 1997). Scour berms can rise to 6 m above the seabed (Woodworth-Lynas et al., 1991). Iceberg pits up to 100 m in diameter and 6.5 m deep have been recorded (Lewis and Barrie, 1981). Median depth of these pits is about 2 m (Davidson and Simms, 1997).

5.3.4 Spatial distribution of iceberg scours on the Grand Banks

The majority of iceberg scours in the Newfoundland-Labrador region are found deeper than 100 m (Paulin, 1992). Lewis et al., (1987) mapped scour densities (both recent and relict) for the northern Grand Banks and northeast Newfoundland shelf from sidescan sonar records. Highest densities were recorded at depths greater than 200 m including the Avalon Channel ($500-4000$ scours/ 100 km^2). Observed scour densities on the northern Grand Bank at depths less than 100 m were 1 km^{-2} .

Paulin (1992) summarized the areal coverage of the seabed by iceberg scours, by geographic location. On the northeastern Grand Bank, scour densities in water depths < 100 m are very low. In deeper water, up to 95% of the seabed is disturbed. In relatively heavily scoured areas of the Labrador shelf (e.g. central Makkovik Bank), scours cover 30-40% of the seabed (Woodworth-Lynas and Barrie, 1985).

5.3.5 Iceberg scour probabilities

Iceberg scour statistics and probabilities have been calculated to assess risk of iceberg contact with offshore pipelines and seabed installations. A variety of methods have been

used to derive estimates of scouring rates on the Grand Banks (see Lewis et al., 1987 for a review). Regardless of the method employed, there is considerable uncertainty associated with estimates of scouring rates. Annual scouring rates for the northern margin of Grand Bank range from 0.08 to 1.05 scours/100 km², while those for the Hibernia area range from 0.04 to 0.35 (Lewis et al., 1987). Davidson and Simms (1997) mapped probability distributions for craters on the Grand Banks. The probability of observing 1 crater km⁻² inside the 100 m depth contour was < 10%, increasing to 40% between 100 and 200 m. Certain areas were characterized by high probabilities (80-90%). Supporting evidence from sedimentological studies which assume that ice-rafted sediment correlates with the presence of icebergs, suggests that the Grand Banks is a marginal iceberg zone and overall it would appear that modern iceberg scouring is a relatively infrequent occurrence on Grand Bank (Lewis and Parrott, 1987).

5.3.6 Impacts of iceberg scouring on bivalves

5.3.6.1 Mortality

Little is known about the ecological impacts of iceberg scouring, particularly in terms of recovery rates. Observations of physical disturbances caused by scouring icebergs are opportunistic. As such, studies are largely confined to records of species composition and densities inside and outside scour features. In the Newfoundland-Labrador region, most of the observations of biota from scour features are from deep water, based on videos or photographs taken from submersibles (Fader, 1989; Woodworth-Lynas et al., 1991). Divers have been used to study the benthos associated with scour features in shallow water habitats in Antarctica (Peck and Bullough, 1993; Gutt et al., 1996). Densities and biomass inside scours are reduced compared to adjacent undisturbed areas (Braun and Carey, 1985; Gutt et al., 1996; Sahade et al., 1998). In some shallow water environments, the destructive effects of iceberg scouring are believed to regulate benthic assemblages (Sahade et al., 1998). These

changes are known to persist for at least several years (Braun, 1985, cited in Carey, 1991). Over time, scoured areas of the seabed show signs of recovery through recolonization. Gutt et al., (1996) recorded the motile pectinid, *Arctinula greenlandica*, as the first pioneer organism on a iceberg-scoured sandy seabed off northeast Greenland.

Peck and Bullough (1993) studied size distributions and growth rates of the shallow burrowing bivalve, *Yoldia eightsi*, from habitats showing varying degrees of scouring. At a site where iceberg groundings were regularly observed, densities of large individuals were unusually low while densities of juveniles were high. The authors hypothesized that scouring may have caused both disproportionate mortalities in adults and enhanced recruitment of juveniles due to competitive release with adults.

5.3.6.2 Habitat alteration

In terms of magnitude of impact, there is no analogue to iceberg scouring. This is evident in photographs (Fader, 1989; Woodworth-Lynas et al., 1991; Gutt et al., 1996). Individual scouring events are localized, but the longevity of scour features can result in substantial cumulative impacts to benthic habitat over time. The shallow (several cm deep) trawl door furrows left on a sandy seabed in the experimental trawling study area (c. 137 m depth), were discernible for approximately one year. In contrast iceberg furrows can persist from years to centuries. The dimensions of scours impose a substantial relief to the seabed and in some cases may produce unique, localized hydrodynamic regimes (Fader, 1989). Iceberg pits modify seabed topography even more radically than scours. For instance, Barrie et al., (1986) investigated a pit in the Hibernia area that was 10 m deep with plan dimensions of 125 m by 80 m. Seabed recovery after ice scouring occurs gradually by the processes of scour infilling and degradation of berms.

Over time, icebergs can rework the seabed, altering the original sedimentary composition. Estimates of annual volumes of sediment re-worked on the highly scoured

Saglek Bank, Labrador, have been placed at $33.6 \times 10^6 \text{ m}^3$ (Woodworth-Lynas and Barrie, 1985). Annual rates of sediment re-working on the Grand Banks due to icebergs should be much lower. Through a combination of forces and ice-rafted material, icebergs can dramatically alter seabed properties (Woodworth-Lynas et al., 1991). Sediment texture in troughs is often different from that of adjacent berm material. The process of scouring often results in large boulders being pushed aside while large, irregular blocks of sediment form the margins of furrows on mud bottoms (Fader, 1989; Woodworth - Lynas, 1991; Gutt et al., 1996). Sediments inside troughs have been exposed to tremendous forces and as a result, troughs are often areas of more uniform sediments, possibly the result of sediment sorting by crushing of boulders into cobbles and gravel sizes (Fader, 1989). Comparisons of taxa from scour features and adjacent undisturbed areas would appear to support observations of small-scale sediment changes based on physical evidence (Carey, 1991). In areas with frequent scouring, spatial variability in sediment types from iceberg activity has a strong influence on benthic community structure. Along the northern Alaskan inner continental shelf, scouring produces a mosaic of long-lasting linear, sedimentary patches of differing ages and sediment type. Invertebrate species compositions in these areas exhibit a strong correlation with sediment characteristics (Braun and Carey, 1995).

5.3.7 Predictability of scouring events

Iceberg scouring has been a phenomenon on Canada's eastern continental shelf since at least the Wisconsinan glaciation (10,000 ybp) while modern scouring occurs primarily north of the Grand Banks (Woodworth-Lynas and Barrie, 1985). The current sea level was established approximately 10,000 ybp, but it has been suggested that the Labrador Current was not re-established in its current path until 5,000 to 2,500 ybp (Miller et al., in prep; cited in Davidson and Simms, 1997). As such, the modern population of iceberg scours is inferred to have a maximum age within this range of ages (Davidson and Simms, 1997).

Notwithstanding the long history of iceberg scouring in the region, estimates of scouring rates indicate very low predictability.

Through contact with the seabed, icebergs are sources of indiscriminant mortality leading to successional processes (Posey et al., 1996). Peck and Bullough (1993) propose that on evolutionary time scales, iceberg scouring in polar regions has been a powerful influence affecting populations of benthic invertebrates over large areas of the world's oceans. Furthermore, they suggest that population characteristics of many infaunal cold-water, continental shelf species may have been partly shaped by iceberg activity. Although adaptive responses of benthos to iceberg scouring have not been demonstrated, there is one possible example of individual-level adaptation in an infaunal bivalve species living in a highly ice scoured habitat. Ansell and Rhodes (1997) observed unusual capabilities for surface movement in the normally deep-burrowed bivalve *Laternula elliptica*. The retention of high mobility into adult life in such a deep-burrowing bivalve, combined with the capacity to re-burrow, suggests that this species is exposed to periodic excavation even at deep sediment depths. The small-scale patchiness of sediment types suitable for burrowing in this species, combined with relatively frequent excavation during the lifespan of this species, were suggested as the selective forces for high surface motility in this species.

5.4 Bioturbation

5.4.1 Biological sediment displacement

Disruption of sediments by benthic invertebrates and demersal fish by locomotion or feeding, may represent the smallest spatial scale at which sediment-mediated physical disturbance processes operate (Hall, 1994). Biological "bulldozing", attributable to the locomotory activities of mobile infauna and epifauna, is the most significant form of bioturbation with respect to sediment turnover (Thayer, 1983). Bulldozers are classified as sediment destabilizers (Woodin, 1983). On sandy bottoms on the Grand Banks, brittlestars

and sand dollars often occur at high densities. These species alone are capable of re-working the uppermost sediment layers. Based on submersible observations and photographs of an area of seabed taken at two different time periods, it was apparent that newly formed sand ripples (i.e. several cms in height) had been degraded within several weeks by mobile invertebrates and sand lance (Barrie et al., 1984). The infaunal brittlestar, *Amphiura filiformis*, often occurs at high densities on soft bottoms in the eastern Atlantic. Its movements destabilize the sediment and affects other infauna and larval settlement (Rosenberg et al., 1997).

Rates of sediment re-working by mobile fauna will be a function of the size of organisms, their densities, activity rates, and functional group status. Individual and population level sediment re-working rates have been estimated by a variety of techniques (reviewed by Thayer, 1983; Hall, 1994). There is a considerable range in magnitude of rates of sediment re-working. This partly reflects the different modes of disturbance, variation in densities of organisms, and method of rate calculation. Most estimates for rates of sediment re-working pertain to members of a single species. Some of the most effective displacement bulldozers are echinoderms. Thayer (1983) reports annual sediment re-working rates of approximately 900 l-m⁻² and 1100 l-m⁻² for the sand dollars *Dendraster excentricus* and *Encope grandis* occurring at densities of approximately 10 m⁻². These densities are within the range of densities of *Echinarachnius parma* on sand bottoms on the Grand Banks. Sediment re-working rates of 525 and 5,748 l-m⁻² were attributed to the burrowing activities of aggregations of *Macoma balthica*. Corresponding turnover times were greater than 139 days and 3.2 days, respectively. Densities within these populations were between 25 and 30 m⁻². In contrast, *M. calcarea* occurs at densities greater than 400 m⁻² on northeastern Grand Bank. Mobile, deep burrowers and dense concentrations of bivalves should have a significant effect on sediment properties over a large vertical range. The vertical extent of bioturbation by other organisms, such as amphipods, may be confined to the top 2 cm of the

sediment (Nedwell and Walker, 1995).

Physical disruption of surficial sediments by foraging predators is an important subset of the bioturbation process (Hall, 1994). Surficial sediments are also disturbed by the burrowing and concealment behaviours of certain demersal fishes, such as flatfish and sand lance. Presumably, on fine to medium sand bottoms on the Grand Banks, this form of disturbance can be significant based on collection of sand lance in grab samples at densities of dozens per 0.5 m² (pers. obs.).

5.4.2 Impacts on bivalves

Large mobile benthos should be capable of displacing small, near-surface bivalves. Early juvenile stages of invertebrates are particularly vulnerable to predation and ingestion or crushing by 'bulldozers' (Sloan and Robinson, 1983; Gosselin and Qian, 1997). However, instances of crushing of larger bivalves by bulldozers are probably rare considering the protection afforded by the bivalve shell. Infaunal bivalves are able to disrupt normal activities (e.g. feeding) of other bivalves through sediment disruption associated with movement (Levinton, 1977). Significant negative interactions leading to exclusions of taxa, i.e. mobility-group amensalism, have only been clearly demonstrated when the sizes of interacting organisms are disparate (Posey, 1987). Vertical advection of sediments, particularly resulting in the exposure of subsurface sediments, have been shown to delay or prevent settlement of bivalves although the age of the disturbance would appear to be a factor (Woodin et al., 1995).

5.4.3 Predictability of biological sediment displacement

Sediment disturbance by the movements of benthos is the most predictable type of physical disturbance occurring in unconsolidated sediments on continental shelves. It is a continuous process operating at small spatial scales over the entire seabed. Even short-lived

bivalve species that occupy the upper several centimetres of the sediment would be exposed to these disturbances within their life spans. Out of 161 values of sediment turnover time for populations of bivalves reported by Thayer (1983), 103 (64%) were less than or equal to 1 year. Furthermore, some of these species may have been dominant bioturbators within their communities, even though they represent only a portion of the total community of mobile fauna. The ecological-scale impacts of bioturbation are not well understood. However, bioturbation has likely influenced the course of bivalve evolution. Over geologic time, tidal and storm activity probably have not changed significantly, while bioturbation seems to have added to a more-or-less steady background of physical disturbance (Thayer, 1983). Estimates of cumulative population sediment re-working rates suggest a global increase in continental shelf bioturbation rates since the Paleozoic. With respect to the Bivalvia, patterns of change in generic diversity of different functional groups suggest that increased bioturbation rates have led to the decline of vulnerable, endobysate groups while numbers of mobile (i.e. free-burrowing) taxa have increased (Thayer, 1983).

5.5 Discussion

The effects of physical disturbances are manifested at the individual, population and community levels of biological organization. The nature and magnitude of the effects vary according to the type of disturbance (see Hall, 1994 for a review). The manner in which marine benthic communities respond to a disturbance determines their stability, typically defined in terms of persistence, resistance and resilience properties (see Boesch and Rosenberg, 1981).

Organisms respond to disturbances with mechanisms to cope with the physical variability in their environment. It has been suggested that most anthropogenic disturbances are similar to those which occur naturally, although they may differ in intensity (Boesch and

Rosenberg, 1981). For instance, Rees and Dare (1993) present the example of soft-bottom benthic communities in coastal areas that are subject to relatively frequent sediment-mediated storm disturbances. In order to persist, populations living in these habitats must survive re-distribution and light burial. They suggest that man-made disturbances (depending on frequency) may mimic these natural events. All sediment-mediated disturbances acting on the Grand Banks share some common features, including the capacity to displace sediment and resuspend particles. Churchill (1989) concluded that magnitudes of cross-shelf (mid-Atlantic) sediment resuspension by trawling activities and by storms were similar. However, examination of disturbance regime descriptors reveal widely varying spatial scales, rates and impacts associated with each type of disturbance (Table 5.1). For instance, the scouring action of trawl gear causes localized displacement of the top several centimetres of sediment. In contrast, storm-generated sediment movement can impact very large areas of the seabed. Likewise, while trawl door scouring and iceberg scouring are analogous in terms of the disturbance mechanism, they have vastly different severities of impact. A key distinction between natural and fishing related disturbances is that while natural disturbances will vary in frequency and intensity within an overall, long-term range of values, trawling disturbance regimes can be significantly altered and controlled. It has also been pointed out that human activities have had profound impacts on ecosystems through the alteration of the frequency and intensity of natural disturbances (Mack and D'Antonio, 1998). Although there are numerous examples of this from terrestrial ecosystems, it is not clear how important this may be in marine ecosystems.

At small scales there is no single disturbance event more destructive to the benthos than iceberg scouring. However, the low predictability and localized area of impact associated with iceberg scouring probably means that iceberg scouring has had a negligible effect on bivalve populations on the Grand Banks. In contrast, physical disturbances and associated biological interactions caused by mobile infauna occur at comparatively small

scales, with very low forces, yet the ubiquitous and continuous nature of bioturbation appears to have significantly shaped evolution of the benthos.

On sandy bottoms, the highly localized redistribution of surficial sediments and associated small-scale burial beneath berms left by trawl doors are unlikely to be a significant source of mortality in populations of infaunal bivalves. Unconsolidated sediments on the Grand Banks at depths less than 120 m (and probably deeper) are dynamic, *albeit* at low migratory rates. Therefore, infaunal bivalves have evolved within a shifting sedimentary regime. Storm-generated sediment movement and sediment resuspension may cause temporary cessation of activities. A similar behavioural response might be expected in bivalves that have been disturbed by shifting sediments due to trawling. On sandy substrata, the mechanism of otter trawl gear-seabed interaction would appear to preclude significant direct mortality in infaunal bivalves. This is certainly not the case on rocky bottoms where the compressive forces and scraping actions of bottom fishing gear inflict higher levels of mortality to the benthos than on sandy bottoms (Van Dolah et al., 1987; Shepard and Auster, 1991; Auster et al., 1996; Collie et al., 1996, 1997). Large, epifaunal bivalves such as sea scallops (*Placopecten magellanicus*) and horse mussels (*Modiolus modiolus*) are particularly vulnerable (Shepard and Auster, 1991; Service and Magorrian, 1997).

The functioning of an ecosystem is related to its history and to the history of its components (Boero, 1996). In contrast to sediment-mediated natural disturbances, otter trawling is a very recent disturbance within marine ecosystems. Nonetheless, bivalves living in sandy bottom ecosystems on the Grand Banks possess traits that reduce the effects of trawling. At the individual level, the small size of many near-surface species facilitates their excavation by otter trawl gear without being damaged. Over much of their lifespan, deep-burrowing species achieve a fortuitous spatial refuge from the direct effects of trawling. The resistance of shallow infaunal bivalves may break down under the effects of heavy, sustained trawling. Although in some areas trawling frequency may be high there will always be

interruptions, resulting in intervals where there is no trawling disturbance. In areas where there has been high trawling mortality to bivalves, or benthos in general, recovery will be most rapid in those species which have life-history and dispersal adaptations which facilitate rapid recolonization of disturbed areas (Boesch and Rosenberg, 1981). It has been suggested that the long-term abundance and dominance of most marine species is determined by larval recruitment (Jennings, 1997). At high levels of physical disturbance, a large proportion of the benthic landscape may be at some point on a successional trajectory (Hall, 1994).

Rees and Dare (1993) note that while anthropogenic activities, including fishing, can cause local extinction of benthic populations, most benthic species do not appear to be at risk over larger scales (i.e. North Sea/English Channel). Furthermore, they suggest that such changes are unlikely to be permanent, unless the habitat has been materially altered.

In summary, marine benthic bivalve communities found on the Grand Banks probably have considerable capacity to withstand the physical effects of trawling. This is founded in existing mechanisms, at different levels of biological organization, used to resist natural disturbances. The manifestation of severe impacts will occur in those habitats in which trawling disturbance processes differ markedly from natural disturbances.

5.6 Literature cited

- Amos, C.L. 1982. Bedforms on continental shelves/ their genesis and mobility. In: A short course on the sediment stability of Canadian shelves. Technical Report C-CORE publication No. 82-10.
- Amos, C.L. and J.T. Judge 1991. Sediment transport on the eastern Canadian continental shelf. *Continental Shelf Research* 11: 1037-1068.
- Anon. 1997. Development Application Terra Nova Development. Environmental Impact Statement. Prepared by Petro-Canada on behalf of the Terra Nova Proponents.
- Ansell, A.D. 1967. Leaping and other movements in some cardiid bivalves. *Animal Behaviour* 15: 421-426.
- Ansell, A.D. and M.C. Rhodes. 1997. Unusual capabilities for surface movement in a normally deep-burrowed Antarctic bivalve. *Journal of Molluscan Studies* 63: 109-111.
- Appleby, J. and D.J. Scarratt. 1989. Physical effects of suspended solids on marine and estuarine fish and shellfish, with special reference to ocean dumping: a literature review. *Canadian Technical Report of Fisheries and Aquatic Sciences* 1681.
- Auster, P.J., R.J. Malatesta, R.W. Langton, L. Watling, P.C. Valentine, C-L.S. Donaldson, E.W. Langton, A.N. Shepard and I.G. Babb. 1996. The impacts of mobile fishing gear on seafloor habitats in the Gulf of Maine (Northwest Atlantic): Implications for conservation of fish populations. *Reviews in Fisheries Science* 4(2): 185-202.
- Barrie, J.V. and M.B. Collins. 1989. Sediment transport on the shelf margin of the Grand Banks of Newfoundland. *Atlantic Geology* 25: 173-179.
- Barrie, J.V., C.F.M. Lewis, G.B. Fader and L.H. King. 1984. Seabed processes on the northeastern Grand Banks of Newfoundland; modern reworking of relict sediments. *Marine Geology* 57: 209-227.

- Barrie, J.V., W.T. Collins, J.I. Clark, C.F.M. Lewis and D.R. Parrot. 1986. Submersible observations and origin of an iceberg pit on the Grand Banks of Newfoundland. Current Research, Part A, Geological Survey of Canada, Paper 86-1A.
- Boero, F. 1996. Episodic events: their relevance to ecology and evolution. P.S.Z.N. I: Marine Ecology 17: 237-250.
- Boesch, D.F. and R. Rosenberg. 1981. Response to stress in marine benthic communities. Pp. 179-200. In: G.W. Barrett and R. Rosenberg (eds.), Stress Effects on Natural Ecosystems. John Wiley & Sons Ltd.
- Bonsdorff, E., A. Norkko and E. Sandberg. 1995. Structuring zoobenthos: the importance of predation, siphon cropping and physical disturbance. Journal of Experimental Marine Biology and Ecology 192: 125-144.
- Braun, G.M. and A.G. Carey, Jr. 1995. The structure of an Arctic shallow water benthic community: effects of ice gouging. In: Grassle, J.P., A. Kelsey, E. Oates and P.V. Snelgrove (eds.). Proceedings of the Twenty-third Benthic Ecology Meeting. Tetra-Tech Inc., Redmond, WA.
- Carey, Jr., A.G. 1991. Ecology of North American arctic continental shelf benthos: a review. Continental Shelf Research 11: 865-883.
- Chang, B.D. and C.D. Levings. 1978. Effects of burial on the heart cockle *Clinocardium nuttallii* and the Dungeness crab *Cancer magister*. Estuarine and Coastal Marine Science 7: 409-412.
- Churchill, J.H. 1989. The effect of commercial trawling on sediment resuspension and transport over the Middle Atlantic Bight continental shelf. Continental Shelf Research 9: 841-864.
- Collie, J.S., G.A. Escanero and L. Hunke. 1996. Scallop dredging on Georges Bank: photographic evaluation of effects on benthic epifauna. ICES C.M. 1996/Mini:9.
- Collie, J.S., G.A. Escarano and P.C. Valentine. 1997. Effects of bottom fishing on the

- benthic megafauna of Georges Bank. *Marine Ecology Progress Series* 155: 159-172.
- Dalrymple, R.W., E.M. LeGresley, G.B.J. Fader and B.D. Petrie. 1992. The western Grand Banks of Newfoundland: transgressive Holocene sedimentation under the combined influence of waves and currents. *Marine Geology* 105: 95-118.
- Davidson, S.H. and A. Simms. 1997. Characterization of iceberg pits on the Grand Banks of Newfoundland. *Environmental Studies Research Funds Report No. 133*. Calgary.
- Dobbs, F.C. and J.M. Vozarik. 1983. Immediate effects of a storm on coastal infauna. *Marine Ecology Progress Series* 11: 273-279.
- Emerson, C.W. 1990. Influence of sediment disturbance and water flow on the growth of the soft-shell clam, *Mya arenaria* L. *Canadian Journal of Fisheries and Aquatic Sciences* 47: 1655-1663.
- Fader, G.B.J. 1989. Submersible observations of iceberg furrows and sand ridges, Grand Banks of Newfoundland. Pp. 27-39. In: Piper, D.J.W. (ed.), *Submersible observations off the East Coast of Canada*. Geological Survey of Canada Paper 88-20.
- Fader, G.B.J. and R.O. Miller. 1986. A reconnaissance study of the surficial and shallow bedrock geology of the southeastern Grand Banks of Newfoundland. Pp. 591-604. In: *Current Research, Part B*, Geological Survey of Canada, Paper 86-1B.
- Goodwin, C.R., J.C. Finley and L.M. Howard (eds.). 1985. *Ice scour bibliography*. Environmental Studies Revolving Funds Report No. 010, Ottawa.
- Gosselin, L.A. and P.-Y., Qian. 1997. Juvenile mortality in benthic marine invertebrates. *Marine Ecology Progress Series* 146: 265-282.
- Gutt, J., A. Starmans and G. Dieckman. 1996. Impact of iceberg scouring on polar benthic habitats. *Marine Ecology Progress Series* 137: 311-316.
- Hall, S.J. 1994. Physical disturbance and marine benthic communities: life in unconsolidated sediments. *Oceanography and Marine Biology: an Annual Review*

- Harris, C.K. and P.L. Wiberg. 1997. Approaches to quantifying long-term continental shelf sediment transport with an example from the Northern California STRESS mid-shelf site. *Continental Shelf Research* 17(11): 1389-1418.
- Jennings, S. 1997. Aquatic life cycle strategies: survival in a variable environment. *Trends in Ecology and Evolution* 12(10): 384-385.
- Kaiser, M.J., A.S. Hill, K. Ramsay, B.E. Spencer, A.R. Brand, L.O. Veale, K. Prudden, E.I.S. Rees, B.W. Munday, B. Ball and S.J. Hawkins. 1996. Benthic disturbance by fishing gear in the Irish Sea: a comparison of beam trawling and scallop dredging. *Aquatic Conservation: Marine and Freshwater Ecosystems* 6: 269-285.
- Levinton, J.S. 1977. Ecology of shallow water deposit-feeding communities: Quissett Harbor, Massachusetts. Pp. 191-227. In: B.C. Coull (ed.). *Ecology of Marine Benthos*. University of South Carolina Press, Columbia.
- Lewis, C.F.M. and J.V. Barrie, 1981. Geological evidence of iceberg grounding and related seafloor processes in the Hibernia discovery area of Grand Bank, Newfoundland. Symposium on Production and Transportation Systems for the Hibernia Discovery, Newfoundland Petroleum Directorate, St. John's, Nfld.
- Lewis, C.F.M. and D.R. Parrott. 1987. Iceberg scouring rate studies, Grand Banks of Newfoundland. Pp. 825-833. In: *Current Research, Part A*, Geological Survey of Canada, Paper 87-1A.
- Lewis, C.F.M., D.R. Parrott, S.J. d'Apollonia, H.S. Gaskill and J.V. Barrie. 1987. Methods of estimating iceberg scouring rates on the Grand Banks of Newfoundland. Pp. 229-254. In: *Proceedings of the Ninth International Conference on Port and Ocean Engineering Under Arctic Conditions*, Fairbanks, Alaska.
- Lyne, V.D., B. Butman and W.D. Grant. 1990. Sediment movement along the U.S. east coast continental shelf- II. Modelling suspended sediment concentration and transport

- rate during storms. *Continental Shelf Research* 10: 429-460.
- Mack, M.C. and C.M. D'Antonio. 1998. Impacts of biological invasions on disturbance regimes. *Trends in Ecology and Evolution* 13: 195-198.
- Maurer, D., R.T. Keck, J.C. Tinsman and W.A. Leathem. 1980. Vertical migration and mortality of benthos in dredged material- Part I: Mollusca. *Marine Environmental Research* 4: 299-319.
- McCall, P.L. 1977. Community patterns and adaptive strategies of the infaunal benthos of Long Island Sound. *Journal of Marine Research* 35: 221-266.
- Nedwell, D.B. and T.R. Walker. 1995. Sediment-water fluxes of nutrients in an Antarctic coastal environment: influence of bioturbation. *Polar Biology* 15: 57-64.
- Nichols, J.A., G.T. Rowe, C.H. Clifford and R.A. Young. 1978. *In-situ* experiments on the burial of marine invertebrates. *Journal of Sedimentary Petrology* 48: 419-425.
- Orensanz, J.-M. and V.F. Gallucci. 1982. Post-catastrophic benthic recovery: Process and management implications. Pp. 181-198. In: Castilla, J.C. (ed.). *Second Workshop-Biological Basis for the Use and Management of Renewable Natural Resources: Marine Biological Resources*.
- Paulin, M.J., 1992. Physical model analysis of iceberg scour in dry and submerged sand. M.Sc. Thesis. Faculty of Engineering and Applied Science, Memorial University of Newfoundland. St. John's, Newfoundland, Canada.
- Peck, L.S. and L.W. Bullough. 1993. Growth and population structure in the infaunal bivalve, *Yoldia eightsi* in relation to iceberg activity at Signy Island, Antarctica. *Marine Biology* 117: 235-241.
- Posey, M. 1987. Influence of relative mobilities on the composition of benthic communities. *Marine Ecology Progress Series* 39: 99-104.
- Posey, M., W. Lindberg, T. Alphin and F. Vose. 1996. Influence of storm disturbance on an offshore benthic community. *Bulletin of Marine Science* 59: 523-529.

- Rachor, E. and S.A. Gerlach. 1978. Changes of macrobenthos in a sublittoral sand area of the German Bight, 1967 to 1975. *Conseil Permanent International pour l'Exploration de la Mer* 172: 418-431.
- Reid, B.J. and J. Baumann. 1984. Preliminary laboratory study of the effects of burial by AMAX/Kitsault mine tailings on marine invertebrates. Canadian Manuscript Report of Fisheries and Aquatic Sciences 1781.
- Rees, H.L. and P.J. Dare. 1993. Sources of mortality and associated life-cycle traits of selected benthic species: a review. MAFF, Directorate of Fisheries, Fisheries Research Data Report No. 33, Directorate of Fisheries Research, Lowestoft.
- Rosenberg, R., H.C. Nilsson, K. Hollertz and B. Hellman. 1997. Density-dependent migration in an *Amphiura filiformis* (Amphiuridae, Echinodermata) infaunal population. *Marine Ecology Progress Series* 159: 121-131.
- Sahade, R., M. Tatián, J. Kowalke, S. Kühne and G.B. Esnal. 1998. Benthic faunal associations on soft substrates at Potter Cove, King George Island, Antarctica. *Polar Biology* 19: 85-91.
- Service, M. and B.H. Magorrian. 1997. The extent and temporal variation of disturbance to epibenthic communities in Strangford Lough, Northern Ireland. *Journal of the Marine Biological Association U.K.* 77: 1151-1164.
- Shepard, A.N. and P.J. Auster, 1991. Incidental (non-capture) damage to scallops caused by dragging on rock and sand substrates. Pp. 219-230. *An International Compendium of Scallop Biology and Culture. Selected papers from the 7th International Pectinid Workshop*, World Aquaculture Society, Baton Rouge, La.
- Sloan, N.A. and S.M.C. Robinson. 1983. Winter feeding by asteroids on a subtidal sandbed in British Columbia. *Ophelia* 22(2): 125-140.
- Sousa, W.P. 1984. The role of disturbance in natural communities. *Annual Review of Ecology and Systematics* 15: 353-391.

- Stanley, S.M. 1970. Relation of Shell Form to Life Habits of the Bivalvia (Mollusca). The Geological Society of America, Inc., Memoir 125, Boulder, Co.
- Stanley, S.M. 1981. Infaunal survival: alternative functions of shell ornamentation in the Bivalvia (Mollusca). *Paleobiology* 7: 384-393.
- Syvitsky, J.P.M., G.B. Fader, H.W. Josenhans, B. MacLean and D.J.W. Piper. 1983. Seabed investigations of the Canadian east coast and arctic using Pisces IV. *Geoscience Canada* 10(2): 59-68.
- Thayer, C.W. 1983. Sediment-mediated biological disturbance and the evolution of marine benthos. Pp. 479-625. In: M.J.S. Tevesz and P.L. McCall (eds.), *Biotic Interactions in Recent and Fossil Benthic Communities*. Plenum Press, New York.
- Thistle, D. 1981. Natural physical disturbances and communities of marine soft bottoms. *Marine Ecology Progress Series* 6: 223-228.
- Turner, E.J. and D.C. Miller. 1995. Behaviour and growth of *Mercenaria mercenaria* during simulated storm events. *Marine Biology* 111: 55-64.
- Van Dolah, R.F., P.H. Wendt and N. Nicholson. 1987. Effects of a research trawl on a hard-bottom assemblage of sponges and corals. *Fisheries Research* 5: 39-54.
- Vermeij, G.J. 1991. Anatomy of an invasion: The trans-Arctic interchange. *Paleobiology* 17(3): 281-307.
- White, P.S. and S.T.A. Pickett. 1985. Natural disturbance and patch dynamics: an introduction. Pp. 1-13. In: S.T.A. Pickett and P.S. White (eds.), *Natural Disturbance and Patch Dynamics: An Introduction*. Academic Press, Orlando, Florida.
- Woodin, S.A. 1983. Biotic interactions in recent marine sedimentary environments. Pp. 1-38. In: M.J.S. Tevesz and P.L. McCall (eds.), *Biotic Interactions in Recent and Fossil Benthic Communities*. Plenum Press, New York.
- Woodworth-Lynas, C.M.T. and J.V. Barrie. 1985. Iceberg scouring frequencies and scour degradation on Canada's eastern shelf areas using sidescan mosaic remapping

techniques. Pp. 419-442. In: Proceedings of the 8th International Conference on Port and Ocean Engineering Under Arctic Conditions (POAC'85). Narssarsuaq, Greenland.

Woodworth-Lynas, C.M.T., H.W. Josenhans, J.V. Barrie, C.F.M. Lewis and D.R. Parrott. 1991. The physical processes of seabed disturbance during iceberg grounding and scouring. Continental Shelf Research 11: 939-961.

Table 5.1. Physical disturbances affecting sediments on the Grand Banks: impacts on bivalves and their habitat.

	Spatial scale ¹	Vertical scale	Probability (i.e. rates)	Return ² time	Predictability ³	Impacts
A. Natural/physical: iceberg scouring	localized (2x10 ⁴ m ²)	cm-m	very low-c. 1 scour/100 km ² /yr	decades-centuries	low	-high levels of mortality in shallow & deep burrowers; -excavation & burial of infauna; -temporary interruption of normal activities of survivors; -significant long-term modification of seabed topography & sediments.
Storm waves & currents	large (100s-1000s km ²)	cm-10s cm	annual-decadal	annual-decadal	high	-mortality (?) in shallow burrowers and juveniles -scouring/burial of infauna; -temporary interruption of normal activities; -sediment resuspension & bedload transport; -re-moulding of existing bedforms
B. Natural/bioturbation	small (mm-cm) ubiquitous	10s cm	relatively high	days-yr ⁴	high	-degradation of hydrodynamically-formed small-scale bedform features (i.e. ripples); -sediment resuspension at benthic boundary layer; -mobility interactions by large active burrowers and/or dense concentrations of burrowers
C. Otter trawling	1-2 km ²	cms	low-high	several x per year to decadal	low to high	-mortality in near-surface bivalves, particularly large sizes; -localized small-scale burial (5-10 cm overburden) and excavation of shallow burrowers; -interruption of normal activities; -short-term (c. 1 yr.) modifications of seabed topography, decreased biogenic structural complexity in uppermost 5 cm of sediment; -short-term sediment resuspension;

1. Individual disturbance events 2. Estimated time to re-disturb an area of seabed; 3. Probability of a disturbance event occurring in the lifespan of a bivalve; 4. Based on sediment re-working rates by infauna (Thayer, 1983).

Chapter 6

Summary and Conclusions

This thesis examined the impacts of otter trawling on infaunal bivalves living in sandy bottom habitats on the Grand Banks. Population level impacts associated with capture (i.e. bycatch) and immediate (hours-days) and short-term (months-3 years) incidental effects (i.e. non-capture) of experimental otter trawling were examined. A key component of this thesis was an examination of the physical interaction of otter trawl gear components with sediments and infaunal bivalves. The designs of the various trawling experiments permit conclusions to be expanded to include sandy bottom habitats throughout the Grand Banks.

Increasingly, bivalves worldwide are the target of a variety of mobile bottom fisheries and they have long been taken as bycatch in other demersal fisheries (Serchuk and Murawski, 1997). Otter trawls have been used on the Grand Banks since the 1950s in order to harvest various groundfish species. On the main part of the banks, otter trawling is conducted over sandy bottoms in order to harvest flatfish (*Limanda ferruginea* and *Hippoglossoides platessoides*) and cod (*Gadus morhua*). There is considerable speculation on the physical and biological impacts of otter trawling, however there is little data to evaluate effects. Fishing impact experiments conducted with a variety of bottom gear types show that impacts must be placed in the context of habitat type, in addition to gear type. Several components of otter trawl gear disturb the uppermost several centimetres (c. 0-5 cm) of sandy sediments (Krost et al., 1990). A large proportion of the bivalve fauna on the Grand Banks reside within the immediate disturbance zone of otter trawls. The bivalve fauna of the Grand Banks is dominated by infaunal species (80%) and of these, approximately 69% can be classified as shallow burrowers, i.e. residing in the uppermost 3 cm of sediment. These figures are representative of the DFO

OETSA, in which 91% and 70% of the bivalve fauna are infaunal and shallow burrowers, respectively.

Capture rates of infaunal bivalves on the Grand Banks by DFO groundfish survey trawls are very low. Otter trawl capture efficiencies for infaunal bivalves are on the order of 10^{-5} based on capture rates, densities of near-surface bivalves, and trawl swept areas. The reason that large groundfish and shrimp otter trawls are inefficient at capturing bivalves, or indeed most benthic invertebrates, is because the large footgear used with these trawls elevates the opening of the trawl considerably above the seabed (i.e. 200-250 cm) and the mechanics of gear-seabed interaction does not transfer relatively small, sedentary organisms over the footgear into the net. It is likely that historical capture rates of bivalves in commercial otter trawl fisheries have also been low considering similarity in design to survey trawls and the larger minimum mesh size of commercial trawls. The only large epifaunal bivalve on Grand Bank is the Iceland scallop, *Chlamys islandica*. This species displays a strong functional association with coarse bottom (Schneider et al., 1987; Gilkinson and Gagnon, 1991). Overall, the effects of trawl capture on populations of bivalves living on the Grand Banks are considered negligible, particularly on sand. The combined effects of harvesting (i.e. bycatch) and non-capture mortalities on *C. islandica* on rocky bottoms are not known.

Two independent lines of evidence point to negligible incidental impacts of otter trawling on populations of infaunal bivalves living in sand on the Grand Banks. After three years of intense, short-term experimental trawling at a site on the northeastern Grand Bank, there was no evidence that trawling had any large effect on biomass or densities of bivalves. Most notably, there was no detectable trawling effect on densities of juveniles (< 5 mm), the size group that was expected to be most vulnerable to the physical forces of trawling. There was no evidence of an immediate effect of trawling in

each of the years. Mean percent frequency of major shell damage in the shallow burrowers assemblage (SBS) was low (< 10%) and trawling inflicted damage could not be distinguished from damage caused by the sampling gear.

The experimental trawling did affect seabed habitat. There was an increase in surface roughness, due to the creation of trawl door furrows and berms, and a decrease in biogenic structural complexity likely through the destruction of burrows, tubes, etc., (Schwinghamer et al., 1996, 1998). There was evidence of recovery in the intervening years between trawling. These changes in sediment structure did not preclude recruitment in bivalves (≤ 3 mm) inside trawled corridors. Based on these data, a precautionary approach to incidental impacts is justified considering the low power of the statistical analyses due to limited sample size and high variance.

The field trawling experiment was designed to study cumulative, combined effects of all trawl gear components. The total swept area, and therefore area of impact, of the two doors (c. 2 m) was approximately 10% of the footgear swept area (20 m). As such, the probability of sampling within a door furrow is less than the probability of sampling within an area swept by the footgear, although this will increase after 12 concentrated trawl passes. Trawl doors are considered to be the most destructive component of the otter trawl. Frequencies of damage recorded in infaunal bivalves during a laboratory experiment were similar to the field trawling experimental results. In the laboratory, the trawl door model inflicted major shell damage to approximately 5% of shallowly placed bivalve specimens in the immediate scour path. The low rates of damage are explained by the plowing action of the door, which displaces bivalves to the side, undamaged, in advance of a scouring trawl door. The key factors are the processes of sediment deformation and displacement associated with the trawl door shoe plowing through sand, combined with the size of infaunal bivalves and the depth of scouring. A

widely quoted prediction of fishing disturbance is the gradual loss of long-lived, slow growing taxa from communities and replacement by small fast growing taxa. This is largely based on long-term changes in benthic community composition (all taxa) in the Wadden Sea, an area that has long been subjected to a variety of physical disturbances (Reise, 1982). Many bivalve species display considerable longevity. In general, bivalves are amongst the largest taxa in infaunal communities. On the Grand Banks large bivalves are more susceptible to bottom fishing mortality than smaller bivalves because they are not excavated and will therefore be directly hit by the trawl door or possibly the groundgear. The low densities of large species in the OETSA precluded a test of this hypothesis. There was no evidence in this study that trawling eliminates more fragile taxa due to physical damage (ICES, 1992). The most fragile and vulnerable members of the bivalve community, based on shell strength and proximity to the sediment surface, were not affected by trawling in the field experiment.

Bivalves living on the Grand Banks are exposed to a variety of sediment-mediated natural disturbances, including storms, icebergs and bioturbation. The adaptive capabilities of bivalves at the individual level will depend on the type of disturbance and its severity. Bivalve populations recover from periodic severe disturbances (e.g. severe storms, iceberg scouring) due to the ability of many species to recruit into disturbed habitat. Bivalves cannot withstand direct impacts with trawl doors, but the chances of direct contact with trawl doors for most species are greatly reduced by a combination of factors including sediment mechanics associated with trawl door scouring, life position and size.

Experimental trawling was purposefully conducted at a high intensity. Making the assumption that prior to the fishing moratorium (in 1992), most areas of the Grand Banks were trawled less than once per year, then the frequency of experimental trawling was

high for the Grand Banks as a whole. Based on commercial trawling activity in favoured fishing grounds on the Grand Banks, the frequency of experimental trawling likely falls within the range of frequencies for high intensity commercial trawling. A limitation in the interpretation of results of fishing impact experiments, is the lack of data on microscale frequencies of trawling disturbance. This information, rather than estimates based on total swept area of trawls and area of fishing grounds, is required in order to have a better understanding of the true extent of seabed disturbance. Microscale fishing effort has a bearing on the interpretation of experimental impacts, and management decisions pertaining to gear restrictions or closures (Rijnsdorp et al., 1996).

The results of this study apply only to sandy bottom habitats. Otter trawling in other more sensitive habitat such as cobble-boulder fields with abundant emergent epifauna, might be expected to have a much greater impact (Auster, 1998). This study investigated the impacts on a single faunal group. The results were interpreted in terms of the ecology of the component species and aspects of gear-seabed interaction. Benthic communities are typically comprised of many species representing diverse life histories, body structures and relative sensitivities to disturbance. As such, the results obtained for bivalves in this study cannot necessarily be expanded to include other faunal groups. This further emphasizes the importance of specifying gear types, habitat and biological communities when discussing the impacts of bottom fishing gears.

In conclusion, there was no evidence that the pattern of experimental trawling employed in this study had a large effect on bivalve populations found in sandy bottom habitats on the Grand Banks. Trawling does inflict damage to infaunal bivalves, but such occurrences are probably largely confined to trawl door tracks, and to large near-surface bivalves. This emphasizes the importance of considering the structure and size composition of bivalve communities when considering impacts. Despite independent

lines of evidence indicating no major effect of otter trawling, the low power of the field study does not preclude the possibility that more subtle effects of trawling on bivalves went undetected.

Literature cited

- Auster, P.J. 1998. A conceptual model of the impacts of fishing gear on the integrity of fish habitats. *Conservation Biology* 12: 1198-1203.
- Gilkinson, K.D. and J.-M. Gagnon. 1991. Substratum associations of natural populations of Iceland scallops, *Chlamys islandica* Müller 1776, on the northeastern Grand Bank of Newfoundland. *American Malacological Bulletin* 9(1): 59-67.
- ICES. 1992. Report of the Study Group on Ecosystem Effects of Fishing Activities. ICES C.M. 1992/G:11.
- Krost, P., M. Bernhard, F. Werner and W. Hukriede. 1990. Otter trawl tracks in Kiel Bay (Western Baltic) mapped by side-scan sonar. *Meeresforsch* 32: 344-353.
- Reise, K. 1982. Long-term changes in the macrobenthic invertebrate fauna of the Wadden Sea: are polychaetes about to take over? *Netherlands Journal of Sea Research* 16: 29-36.
- Rijnsdorp, A.D., A.M. Buijs, F. Storbeck and E. Visser. 1996. Micro-scale distribution of beam trawl effort in the southern North Sea between 1993 and 1996 in relation to the trawling frequency of the sea bed and the impact on benthic organisms. ICES C.M. 1996/Mini 11, Mini-Symposium Ecosystem Effects of Fisheries.
- Schwinghamer, P., J.Y. Guigné and W.C. Siu. 1996. Quantifying the impact of trawling on benthic habitat structure using high resolution acoustics and chaos theory. *Canadian Journal of Fisheries and Aquatic Sciences* 53: 288-296.
- Schwinghamer, P., D.C. Gordon, Jr., T.W. Rowell, J. Prena, D.L. McKeown, G. Sonnichsen and J.Y. Guigné. 1998. Effects of experimental otter trawling on surficial sediment properties of a sandy bottom ecosystem on the Grand banks of Newfoundland. *Conservation Biology* 12: 1215-1222.
- Schneider, D.C., J.-M. Gagnon and K.D. Gilkinson. 1987. Patchiness of epibenthic megafauna on the outer Grand Banks of Newfoundland. *Marine Ecology Progress*

Series 39:1-13.

