



This is a repository copy of *The effects of tribological factors and load sequence on surface pitting and cracks in bearing steel*.

White Rose Research Online URL for this paper:
<http://eprints.whiterose.ac.uk/139861/>

Version: Published Version

Proceedings Paper:

Al-Tameemi, H.A., Long, H. orcid.org/0000-0003-1673-1193 and Dwyer-Joyce, R.R. orcid.org/0000-0001-8481-2708 (2018) The effects of tribological factors and load sequence on surface pitting and cracks in bearing steel. In: Journal of Physics: Conference Series. Modern Practice in Stress and Vibration Analysis (MPSVA) 2018, 02-04 Jul 2018, Cambridge, UK. IOP .

<https://doi.org/10.1088/1742-6596/1106/1/012030>

Reuse

This article is distributed under the terms of the Creative Commons Attribution (CC BY) licence. This licence allows you to distribute, remix, tweak, and build upon the work, even commercially, as long as you credit the authors for the original work. More information and the full terms of the licence here:
<https://creativecommons.org/licenses/>

Takedown

If you consider content in White Rose Research Online to be in breach of UK law, please notify us by emailing eprints@whiterose.ac.uk including the URL of the record and the reason for the withdrawal request.



eprints@whiterose.ac.uk
<https://eprints.whiterose.ac.uk/>

PAPER • OPEN ACCESS

The effects of tribological factors and load sequence on surface pitting and cracks in bearing steel

To cite this article: Hamza A. Al-Tameemi *et al* 2018 *J. Phys.: Conf. Ser.* **1106** 012030

View the [article online](#) for updates and enhancements.

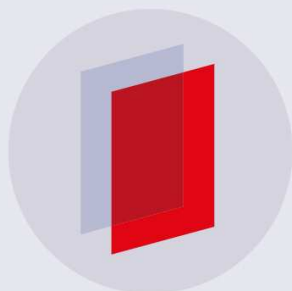

IOP | ebooks™

Bringing you innovative digital publishing with leading voices to create your essential collection of books in STEM research.

Start exploring the collection - download the first chapter of every title for free.

The effects of tribological factors and load sequence on surface pitting and cracks in bearing steel

Hamza A. Al-Tameemi^{1,2}, Hui Long¹ and Robert R. Dwyer-Joyce¹

¹ Department of Mechanical Engineering, The University of Sheffield, Sheffield, UK.

² Department of Mechanical Engineering, The University of Baghdad, Baghdad, Iraq

E-mail: hamza.al-tameemi@coeng.uobaghdad.edu.iq

Abstract. This paper presents an investigation of the influence of various tribological parameters on surface initiated damage through Rolling Sliding Tests (RSTs) using bearing steel specimens. The RSTs were conducted on a benchtop twin-disc machine, consisting of a tribometer and a rolling contact fatigue testing system. The parameters investigated were contact pressure, slipping ratio, rotational speed, lubricant viscosity and load sequence, with each of them varying between two values. The first step was an investigation of the Coefficient of Traction (COT) under different testing conditions, followed by a set of RSTs to investigate surface damage initiation. It was found that the COT increased significantly under certain conditions of opposite rotational direction. The RST results showed that cracks and spalls on the surface were severer when higher slip ratio, higher contact pressure and higher rotational speed were applied first than that when lower levels of these parameters were applied first.

1. Introduction

Premature bearing failures have been frequently observed in Wind Turbine Gearboxes (WTGs) which makes the improvement of their reliability a top priority among other components [1]. The most common premature failure was due to White Etching Cracks (WECs) which caused flaking of material from the surface termed as White Structure Flaking (WSF) [2][3]. The root causes of the premature failure for WTG bearings are not fully understood, and further investigation is necessary in order to achieve the design life in field operation. Bearing failures may initiate either on the surface or under the surface of contact in the bearing raceways. The surface initiation hypothesis suggested that cracks could be caused by surface flaws which became worsened under loading conditions [4][5]. Another cause of the premature failure was material defects such as non-metallic inclusions which could serve as WEC initiators by forming butterflies in subsurface of the contact according to the sub-surface damage initiation hypothesis [6][7].

Premature bearing failure had been investigated experimentally in previous studies with different machines under various test parameters. Most of these earlier studies were carried out using discs tested on bench-top machines to represent the non-conformal contact between the inner or outer raceways and the rollers in the bearings. Since the WSF was considered as the premature failure mode of WTG bearings, most of the tests focused on replicating this failure mode and the related damage to WECs and WEAs, observed in the form of butterflies. Others investigated micro-pitting and the surface initiation of spalling. Both surface and sub-surface initiated damage were important, since they were both observed in the examined bearings retrieved from the field [6]. High numbers of cycles



were commonly applied in testing, which reached tens to hundreds of millions [8]. Normally, to achieve this high number of cycles within a reasonable time, the tests were run at higher speeds, which may not be representative of those in-service operating conditions. The parameters investigated in the reported studies included the maximum contact pressure [9], the rolling-sliding ratio [10], lubricant additives [10], vibration and transient loading [11], sliding to an over-rolling direction [5], and the number of cycles [5][8]. It was found that the number of load cycles and friction between the contacted surface in a mixed lubrication affected the formation of WECs [8], in addition to the contact pressure and sliding ratio. One of the recent studies [10] found that a specific lubricant additive - metal sulphionate detergent - had a significant effect, triggering surface-initiation cracks that were similar to the WECs.

Despite a wide range of parameters were investigated under different testing levels of complexity, some issues still remained. For WTG planetary bearings the tangential speed is much lower than that tested in previous studies. Also, the values of the Coefficient of Traction (COT) have not been reported in some of the tests or lower values were reported, lower than that expected for roller bearings. Although the torque reversal is frequently reported in WTGs, no experimental investigation has been conducted to evaluate its effect due to the variation of the COT and reversed rotations. Some tests have investigated the effect of vibration or load variations, however the effect of the sequence in applying higher load levels or severe tribological conditions on damage initiation and propagation has not been investigated.

The paper reports the design of experimental tests to investigate the COT at three different operation conditions including dry and lubricated tests followed by nine RSTs conducted at different operational conditions. The research presented in this paper focuses on surface initiated damage by investigating the effect of surface traction and the loading sequence which may represent WTG operational conditions involving torque reversal and severe transient loading.

2. Experimental Testing

The machine used to perform rolling and sliding contact was the SUROS system (Sheffield University Rolling Sliding), shown in Figure 1 [12]. The instantaneous slip (S_i) between the specimens is calculated by Equation 1, where R is the radius of the specimens and N is the rotational speed in RPM. During the test, the data is logged including load, rotational speed, number of revolutions, torque and COT. The machine is designed to run a dry or lubricated contact in an oil bath. One of the tested specimens has a crowned contact surface and the other has a flat contact surface, as show in Figure 2.

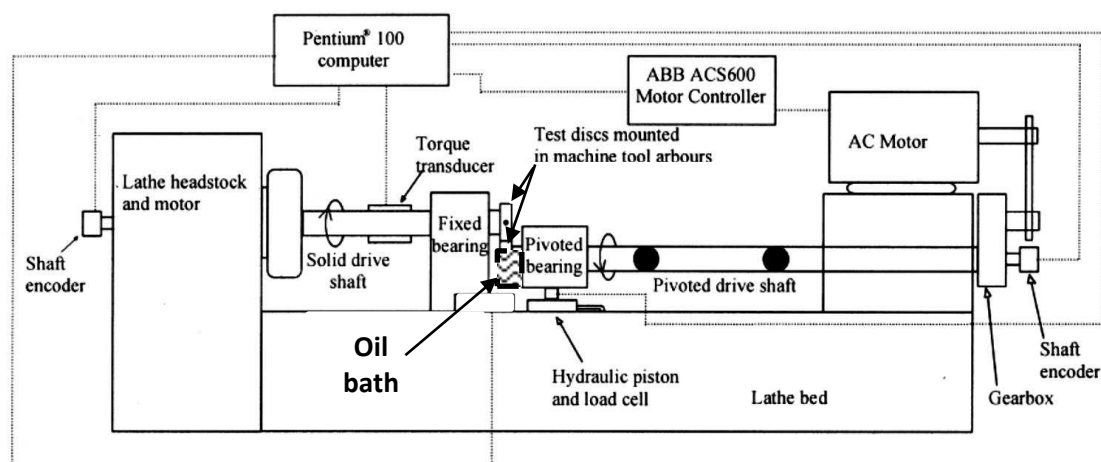

Figure 1: Schematic representation of SUROS machine adopted from [12]

$$S_i(\%) = 200 * \left(\frac{R_{Upper} * N_{Upper} - R_{Lower} * N_{Lower}}{R_{Upper} * N_{Upper} + R_{Lower} * N_{Lower}} \right)$$

1

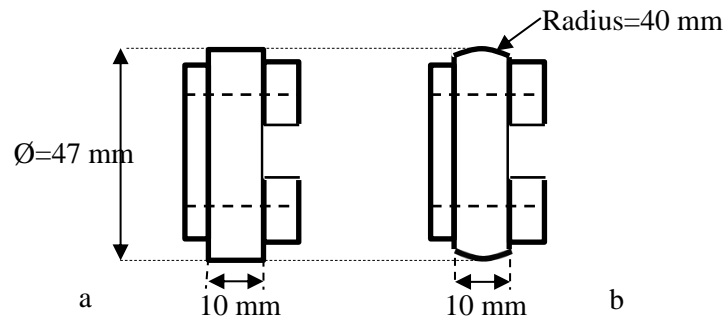

Figure 2: Specimens used for the tests (a) Flat (b) crowned surface of contact

The running track temperature close to the point of contact was measured using an Infrared thermocouple. The temperature was measured every 30 minutes during the tests and a record was made in which the average was applied for calculating the lubricant film thickness between the specimens at each test. In this research, two types of lubricants, Castrol Alpha SP 46 and 68, were used to investigate the effect of different lubricant viscosities. The average temperature measured close to the point of contact was considered for each RST to find the viscosity and calculate the minimum lubricant film thickness, according to Hamrock and Dowson in [13], and in turn to find the λ ratio, and thus the lubrication regime during the RSTs.

In each of the RSTs, two discs, crowned on a non-crowned, were rolling over each other under five controlled parameters. These were rotational speed of lower disc, contact pressure, slip ratio, lubricant viscosity and number of cycles. Since the surface traction, quantified by the COT, is one of the main test parameters to be investigated, a set of tests were conducted to gain an insight into the possible values of the COT under different operating conditions, as shown in Table 1. It was found that after a running in of 2000 cycles in a lubricated condition before the first measurement, the surface became very smooth and this reduced the effect of surface roughness.

Table 1: The settings for the COT measurement tests

Test	Lubrication	Load (kN)	P_{\max} (MPa)	Speed (rpm)	Slip %
COT1	Sp 68	4.6	3052	20	-1
COT2	Sp 68	6.5	3425	400	-10
COT3	Dry	3.5	2786	400	-1

To investigate the effect of different tribological conditions on surface initiated damage, nine RSTs were performed. The first test consisted of three steps, while each of the other eight tests consisted of two steps with different settings of operating parameters, as shown in Table 2. The first test ran longer than the other eight tests, and it was the only test with a step of reversed rotations, which was designated by the (–) sign of speed in Table 2. In these tests, with the exception of the number of cycles, the variation of all parameters was investigated as well as a change in the sequence of test steps. In each of the eight tests, there was a step which was called the *high speed step* where the testing parameters were set to a rotation speed of 400 rpm, maximum contact pressure of 3425 MPa, 250,000 cycles, -10% slip and using SP 68 lubrication oil. The other step was called *low speed step* where the number of cycles was 50,000 and other investigated parameters varied between two values. In Table 2, *sequence 1* refers to the first step, step (a), as the low speed step and the second step, step (b), as the high speed step. *Sequence 2* refers to the first step, step (a), as the high speed step and the second step, step (b), as the low speed step.

The tests in Table 2 were designed to investigate the effect of each of the studied parameters by comparing certain tests with each other. The features of the contact surface used to evaluate the effect of the investigated parameters were the variation of surface roughness, the weight loss, and the characteristics of surface. The surface roughness variation was examined using the non-contact

profilometer (INFINITEFOCUS Alicona). This system uses an optical focus variation method to create 3D measurements. The arithmetical mean roughness (Ra) was measured for the surface of each specimen outside and inside wear scars, in the axial and circumferential directions, with at least three lines at different locations. Then, the average and standard deviation were calculated to find the Ra inside and outside the wear scars in the axial and circumferential directions. The wear scar roughness for each RST was compared with the original roughness of the specimens in order to find the percentage difference.

Table 2: Specifications of RSTs

RSTs	Test step	Speed (rpm)	Slip %	Oil type SP	Sequence	Load (kN)	P_{max} (GPa)	Cycles	The radii of the elliptical contact area (mm)
1	1a	400	-10	68	-	6.5	3.42	900000	1.43 and 0.63
	1b	-20	0	68	-	1.5-3.5	2.1-2.78	36	(0.88 and 0.39) to (1.16 and 0.52)
	1c	400	-10	68		6.5	3.42	100000	1.43 and 0.63
2	2a	400	-10	68	2	6.5	3.42	250000	1.43 and 0.63
	2b	87	-10	68	2	6.5	3.42	50000	1.43 and 0.63
3	3a	87	-10	68	1	6.5	3.42	50000	1.43 and 0.63
	3b	400	-10	68	1	6.5	3.42	250000	1.43 and 0.63
4	4a	87	-20	46	1	6.5	3.42	50000	1.43 and 0.63
	4b	400	-10	68	1	6.5	3.42	250000	1.43 and 0.63
5	5a	48	-10	46	1	6.5	3.42	50000	1.43 and 0.63
	5b	400	-10	68	1	6.5	3.42	250000	1.43 and 0.63
6	6a	48	-20	68	1	6.5	3.42	50000	1.43 and 0.63
	6b	400	-10	68	1	6.5	3.42	250000	1.43 and 0.63
7	7a	87	-20	68	1	6.5	3.42	50000	1.43 and 0.63
	7b	400	-10	68	1	6.5	3.42	250000	1.43 and 0.63
8	8a	400	-10	68	2	6.5	3.42	250000	1.43 and 0.63
	8b	87	-20	68	2	9.75	3.92	50000	1.63 and 0.73
9	9a	400	-10	68	2	6.5	3.42	250000	1.43 and 0.63
	9b	87	-20	68	2	6.5	3.42	50000	1.43 and 0.63

3. Results and Discussion

In the following sections, the results of the COT at different operating conditions including dry contact and reverse rotation are presented first. Then the surface examination of the specimens is presented. Finally, the effects of the investigated parameters during the RSTs on the initiation of surface damage are compared.

3.1. Coefficient of Traction at Different Testing Conditions

The COT results were obtained according to the sequence and testing parameters in Table 1. For a lubricated test under certain testing conditions, the COT did not vary significantly after a specific number of cycles, as shown in Figure 3 (a). However, for dry contact, the COT reached a very high value as shown in Figure 3 (b). Although dry contact may not be expected in the WTG bearings, it shows the possible COT values during metal on metal contact. It is found that a low slip ratio, -1%, caused a rapid increase in the COT and considerable surface damage. The heat generated could be the main reason for the adhesive surface damage and the increase in COT. However, the accumulation of heat after a number of cycles, and increasing the flash temperature reduce the COT due to the oxide formations.

After the COT measurement tests, the surfaces examination of specimens used for lubricated tests showed a very mild wear track which only reduced the roughness of the surface, as shown in Figure 4 (a), while after the dry test, the surfaces were highly damaged, as shown in Figure 4 (b).

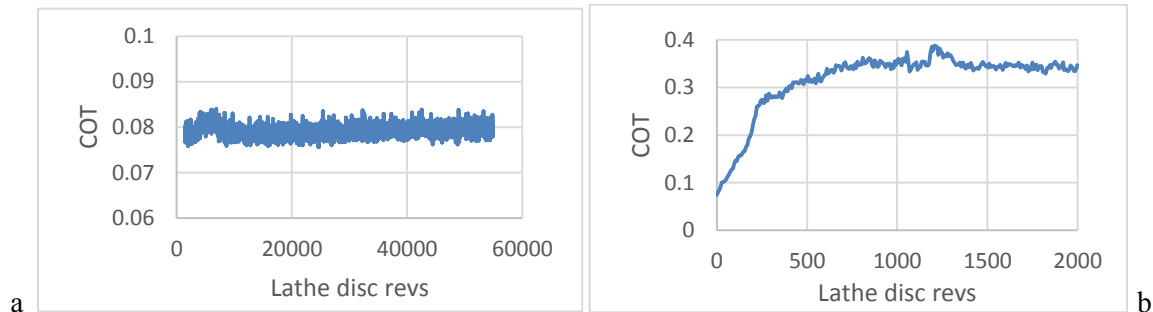

Figure 3: COT variation with number of cycles according to Table 1 (a) lubricated contact (COT2) (b) dry contact (COT3)

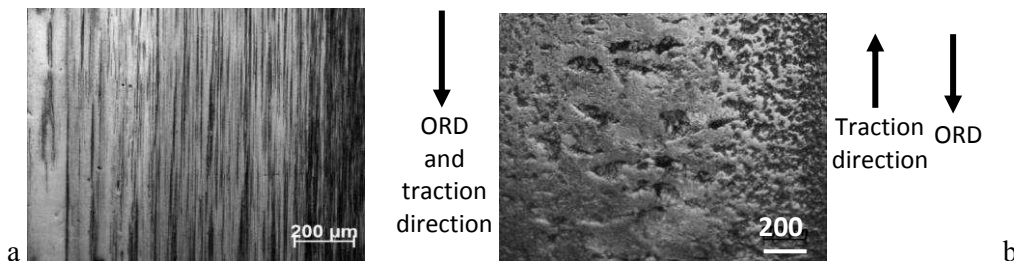

Figure 4: The surface after the COT tests (a) after lubricated tests; (b) after high speed dry test

To investigate the effect of reversed rotation on the COT, RST 1 (b), as specified in Table 1, was conducted. The results are shown in Figure 5. The variation of the COT shows that not only dry contact, such as in Figure 3 (b), can cause a high COT, but a very well lubricated contact surface can do so as well when the reversed rotation occurs for a brief time. In Figure 5, the COT jumped to a higher value after the maximum contact pressure reached 2.78 GPa (3.5 kN) as shown by the dashed line, although the load was being gradually increased. Accordingly, the instantly reversed rotation under this level of contact pressure can cause high values of COT. Reversed test can simulate the torque reversal when a roller moves in the reversed rotational direction. The accelerated damage observed on the surface supports the occurrence of premature failure of wind turbine bearings, which can be caused by changes in the direction of rotation. For the RSTs, the COT was in the range of 0.06 to 0.087 and the value at the low speed step of each test was higher than that during the high-speed step for each test. This indicates that the tests were running in the mixed lubrication regime where higher speed produces a thicker lubricant film thus lower COT.

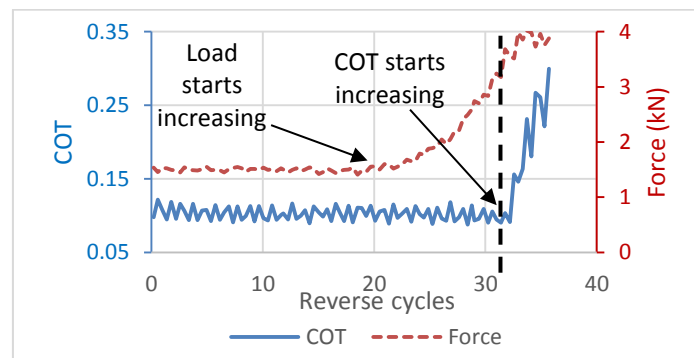

Figure 5: COT during reversed rotation according to testing conditions in Table 2

3.2. Effects of Tested parameters on Surface Damage and Wear

The optical microscope was used to take images, such as those in Figure 6, from four equidistant regions around the circumference and the maximum size of cracks and pits were measured. For all the tests that developed pits, it was found that this was mainly due to axial surface cracks that were close to each other.

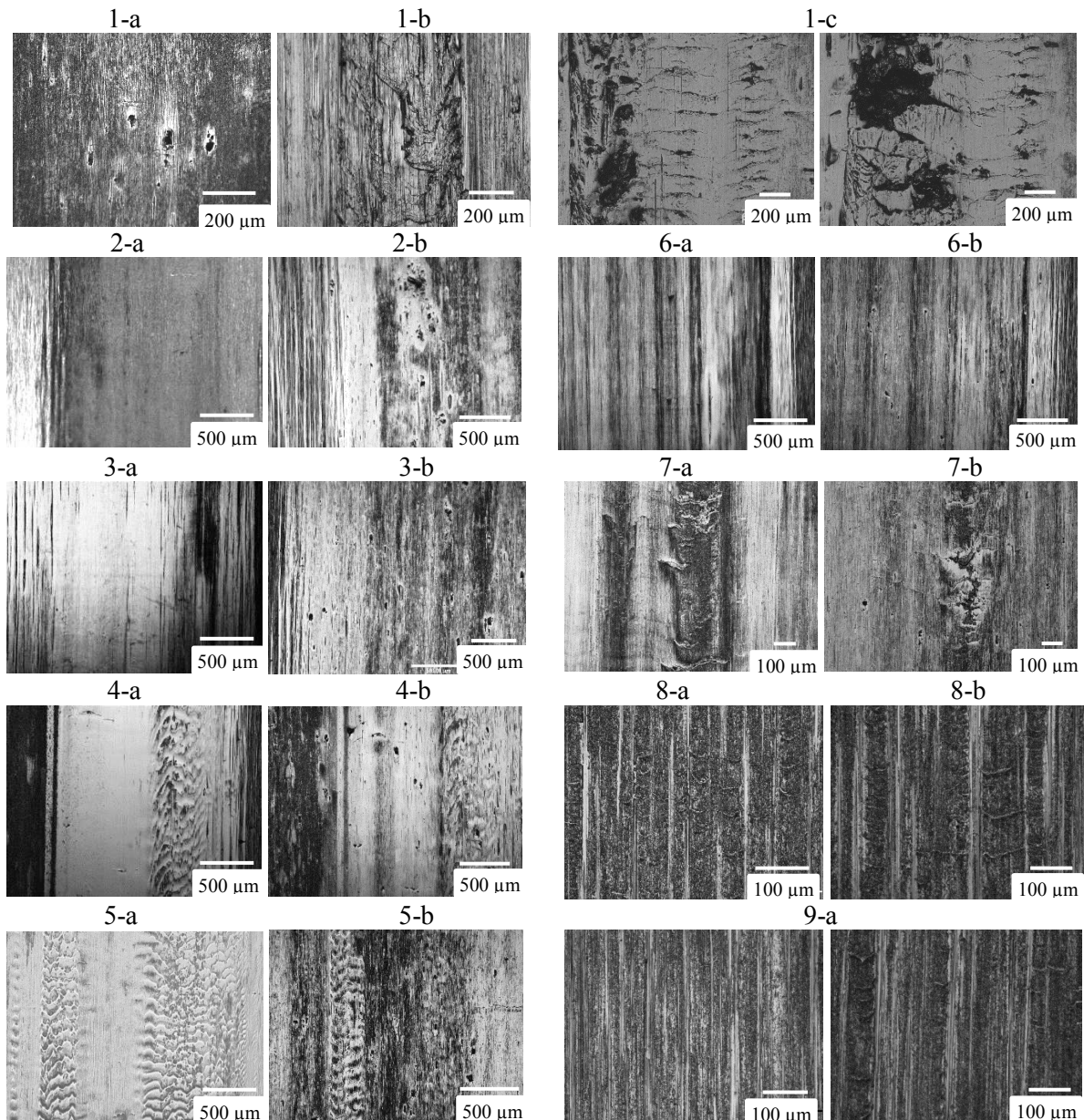

Figure 6: Non-crowned specimen surfaces at the middle of the contact width after each step of RSTs 1 to 9

For all the test steps conducted at 400 rpm, the λ values were almost one, which leads to the asperities on the surfaces being almost separated, whilst at low rotational speeds of 48 and 87 rpm, the h_{\min} is considerably lower than the value of the composite roughness, and thus a mixed lubrication regime and partial contact between the surfaces are expected. No severe damage was observed on the surface, based on the observed optical images and the variation of the roughness. However, considerably more damage occurred during the reverse rotation. The observed variation in the initial

roughness implied that the calculation of the lambda ratio should not be based on the initial surface roughness, which varies and reduces quickly after the running in time. The wear rate was measured by the weight loss from the flat and the crowned specimen after each step of the RSTs. In general, the wear rate is very limited and within the range of milligrams.

Table 3 shows pairs of tests carried out under similar conditions except one investigated parameter that varied in Test B. The observations from Test B were compared to that in test A. The results show some parameters that can increase surface damage, such as increasing the slip ratio and contact pressure (normal load), and other parameters that can mitigate this damage, such as reducing the speed, and changing the sequence of load steps to high speed first. A higher slipping ratio causes more relative sliding between the contacted bodies, and more surface strain that accumulates to fatigue the surface and onset cracking under mode II. Higher speed was found to increase the temperature and the surface damage, which could be due to the higher strain rate at a higher speed. Although damage accumulation theories such as the Miner rule, neglect the effect of load sequence, this research has found that the sequence has an effect on the surface damage during the RSTs. The results show that the propagation of surface damage was accelerated even under less severe conditions when the surface damage initiates first under low speed testing. This highlights the importance of avoiding severe tribological conditions or loading at the beginning of a bearings life.

Table 3: Effects of investigated parameters on surface observations from RSTs 1 to 9 where LS and HS are the low and high speed steps, respectively

Test A	Test B	The different Parameter in Test B	% Change of Roughness	Maximum surface Crack length	Maximum pit size	Wear rate
3	7	Slip ratio was increased in RST 7 at sequence 1	Reduced	Increased	Increased	Increased
7	4	Viscosity was decreased in RST 4	Increased	Increased (LS) Reduced (HS)	Reduced (LS) Reduced (HS)	Increased (LS) Reduced (HS)
7	6	Speed was decreased in Test 6	Increased	Reduced	Reduced	Reduced
9	8	Load was increased in RST 8	Increased	Increase (HS) Increase (LS)	Increase (HS) Reduced (LS)	Reduced (HS) Increase (LS)
7	9	Sequence was changed from 1 to 2 in RST 9 at -20% slip	Reduced	Reduced	Reduced	Reduced
3	2	Sequence was changed from 1 to 2 in RST 2 at -10% slip	Reduced	Reduced	Reduced	Increased

4. Conclusions

The effect of various tribological conditions on the surface initiated damage of bearing steel was investigated. Sets of tests were conducted and the observation of the COT and the topography of the specimens' surface were utilized to characterize the effect of contact pressure, slipping ratio, rotational speed, lubricant viscosity and load sequence. This study concludes that

- The COT did not vary significantly after a specific number of cycles for lubricated tests, and a high slip ratio did not necessarily correlate to high surface traction/COT under full lubrication. However, for dry contact or reversed rotation tests, the COT reached a very high value within a short time or few cycles.

- The severity of the damage observed during reversed rotation revealed more deteriorating effect of this condition compared with the other operating conditions. Accordingly, the severity of spalling correlated to the level of surface traction.
- The initial surface roughness was reduced significantly after the running-in cycles. This results in inaccuracies in the calculation of the lambda ratio based on the initial surface roughness, and invalidates the assumption of boundary lubrication made in many studies.
- It was also found that cracks and spalls on the surface were affected by sequence 1 (low speed step, then high speed step), higher slip ratio, higher contact pressure and higher speed at lambda ratio less than one.

Acknowledgment

The first author would like to thank the Iraqi Ministry of Higher Education and Scientific Research (<http://www.mohesr.gov.iq/en/>) and the University of Baghdad for sponsoring his PhD study in the University of Sheffield, UK.

References

- [1] Faulstich S, Hahn B, Jung H and Rafik K 2009 Suitable failure statistics as a key for improving availability in *Proceedings of the European Wind Energy Conference EWECC* Online resource.
- [2] Evans M H 2012 White structure flaking (WSF) in wind turbine gearbox bearings: effects of ‘butterflies’ and white etching cracks (WECs) *Mater. Sci. Technol.* **28** 1 3–22
- [3] Bruce T, Rounding E, Long H and R. Dwyer-Joyce 2015 Characterisation of white etching crack damage in wind turbine gear- box bearings *Wear* **338–339** 164–177
- [4] Stadler K and Stubenrauch A 2013 Premature bearing failures in industrial gearboxes *Annu. Rev. Mater. Sci.* **9** 1 283–311
- [5] Gould B and Greco A 2015 The Influence of Sliding and Contact Severity on the Generation of White Etching Cracks *Tribol. Lett.* **60** 29 2 1–13,.
- [6] Al-Tameemi H, Long H and Dwyer-Joyce R S 2016 Investigation of wind turbine gearbox bearing subsurface damage considering transient loading and the separation of MnS inclusions *Wind Summit* 145
- [7] Al-Tameemi H A, Long H, and Dwyer-Joyce R S 2018 Initiation of sub-surface micro-cracks and white etching areas from debonding at non-metallic inclusions in wind turbine gearbox bearing *Wear* **406–407** 22–32
- [8] Kruhöffner W and Loos J 2017 WEC Formation in Rolling Bearings under Mixed Friction : Influences and ‘ Friction Energy Accumulation ’ as Indicator *Tribol. Trans.* **60** 3 516–529
- [9] Brückner M, Gegner J, Grabulov A, Nierlich W, and Slycke J 2011 Butterfly formation mechanisms in rolling contact fatigue *Proc VHCF-5* 101–106
- [10] Ruellan A, Ville F, X Kleber, and Liatard B 2017 Understanding white etching cracks in rolling element bearings : State of art and multiple driver transposition on a twin-disc machine *Proc. Inst. Mech. Eng. Part J J. Eng. Tribol.* **231** 2 203–220
- [11] Evans M H, Richardson A D, Wang L, and Wood R J K 2013 Serial sectioning investigation of butterfly and white etching crack (WEC) formation in wind turbine gearbox bearings *Wear* **302** 1–2 1573–1582
- [12] Fletcher D I and Beynon J H 2000 Development of a Machine for Closely Controlled Rolling Contact Fatigue and Wear Testing *Test. Eval. J.* **28** 4 267–275
- [13] Harris T A and Kotzalas M N 2007 *Advanced Concepts of Bearing Technology* 5th ed. CRC Press