



Durham E-Theses

Practical considerations in the reconciliation of the direct and indirect methods of measuring the air-earth current

Darsley, R. R.

How to cite:

Darsley, R. R. (1966) *Practical considerations in the reconciliation of the direct and indirect methods of measuring the air-earth current*, Durham theses, Durham University. Available at Durham E-Theses Online: <http://etheses.dur.ac.uk/10418/>

Use policy

The full-text may be used and/or reproduced, and given to third parties in any format or medium, without prior permission or charge, for personal research or study, educational, or not-for-profit purposes provided that:

- a full bibliographic reference is made to the original source
- a [link](#) is made to the metadata record in Durham E-Theses
- the full-text is not changed in any way

The full-text must not be sold in any format or medium without the formal permission of the copyright holders.

Please consult the [full Durham E-Theses policy](#) for further details.

Academic Support Office, Durham University, University Office, Old Elvet, Durham DH1 3HP
e-mail: e-theses.admin@dur.ac.uk Tel: +44 0191 334 6107
<http://etheses.dur.ac.uk>



PRACTICAL CONSIDERATIONS IN THE RECONCILIATION OF THE DIRECT AND INDIRECT
METHODS OF MEASURING THE AIR-EARTH CURRENT

M.Sc. THESIS

R.R. DARSLEY

1963-66

PRACTICAL CONSIDERATIONS IN THE RECONCILIATION OF THE DIRECT

AND INDIRECT METHODS OF MEASURING THE AIR-EARTH CURRENT

Progress in any field of scientific interest is often advanced by the failure to find agreement between two different approaches to a particular measurement in the field. This is so because it forces attention on the theory behind the measurements and the conditions under which the measurements were made.

Such a problem is identified in the field of Atmospheric Electricity. Differing results have been found for the value of the fine weather air-earth current when measured by the "indirect" and "direct" methods of approach. The indirect method involves the recording of the fine weather conductivity and the potential gradient and equating their product with the conduction current. In the direct method, the total charge arriving at a portion of the earth's surface is measured. The direct method, though more difficult, appears to be the more fundamental measurement and a critical review of previous experiments and the hypotheses attempting to explain their differing results, is made. The limitations of work at ground level, in that it predicts a system from the examination of one of the system's boundaries, is indicated.

The experimental problems associated with the direct and indirect methods are described with particular reference to the site used for the measurement of atmospheric electricity at Durham Observatory. In particular, the effects of pollution and the displacement current are discussed and some details of an unsuccessful attempt to devise a form of the direct method that would enable the true magnitude of any convection current to be found, are given.

Suggestions are made for the measurements required and the conditions under which they should be made if the final resolution of these differences in the recording of the fine weather air-earth current is to be achieved.

R.R. DARSLEY

M.Sc.

1969

INDEX OF CONTENTS

CHAPTER 1. DEFINITION OF THE PROBLEM

- 1.1. Introduction
- 1.2. Fine Weather Electrical Phenomena in the Atmosphere
- 1.3. Methods of Measuring the Air-earth Current
- 1.4. The Problem

CHAPTER 2. THE SITE

- 2.1. Compensation
- 2.2. The Electrode Effect
- 2.3. Pollution
- 2.4. Site Design Features

CHAPTER 3. PREVIOUS WORK

- 3.1. Previous Experiments using Direct Measurement Methods
- 3.2. Previous Experiments using Indirect Measurement Methods
- 3.3. Discussion of Further Experimental Designs

CHAPTER 4. VALUES FOR THE AIR-EARTH CURRENT

- 4.1. Comparison of Published Values for the Air-earth Current
- 4.2. Conclusions

ACKNOWLEDGEMENTS

BIBLIOGRAPHY

CHAPTER 1. DEFINITION OF THE PROBLEM

1.1. Introduction.

A brief perusal of the continually increasing number of scientific journals often leads to the opinion that the progress in science is a succession of minute advances on a very broad front, each gathered fact contributing to the knowledge store. But any system relying on an arbitrary accumulation of information will not advance, save by chance, unless it has direction. Chance discoveries there have been, and probably more than the formal standards of scientific writings allow. Among these were the discoveries of sulphanilamide by Ehrlich and Domagh while working on azo-dyes in 1930, and of penicillin by Fleming as a result of noticing apparently insignificant details of his cultures. It might be argued that these discoveries are reflections on the character of the workers rather than on the success of the 'normal' scientific process of fact-gathering. For normal science is not looking for fundamental novelties, but for the ordered pattern acceptable to its basic commitments and the unexpected discovery is thus not solely factual in its result.

Roentgen (1) interrupted a normal investigation into the properties of cathode rays because he had noted that a barium platinocyanide screen, at some distance from his shielded apparatus, glowed when discharge was in progress. Further investigation showed that the cause of the glow came in straight lines from the cathode ray tube, cast shadows that could not be deflected by a magnet and was an agent with some similarity to light.

The announcement of X-rays was received not only with surprise, but

with some shock, for people had been using cathode ray tubes for some time. Although X-rays were not directly prohibited by theory, for the light spectrum contained visible, infra-red and ultra-violet areas, they did violate deeply entrenched expectations.

The discovery of anomalies thus produces a state of tension within the accepted thought, for a change in the rules may reflect on much scientific work that appears to have been successfully completed.

If there is no major theory to cover an area of science, then there tends to be a rather negative restatement of the fundamentals of the field with little progress, as in the case of electricity, where in the early beginnings of its scientific study, there were three segments of opinion.

Some felt that attraction and frictional generation were the basic electrical phenomena with repulsion, a secondary effect, due to mechanical rebounding. A very small group held that attraction and repulsion were phenomena of equal magnitude and the third school regarded electricity as a 'fluid' running through conductors and their attempts to capture this fluid led to the Leyden jar. It was the concern of Franklin and his immediate successors to explain the behaviour of this new experimental facility which produced a major theory of electrical behaviour.

The alignment of thought around a major theory leads to the selection of experiments with far more precise detail and requiring more specialised equipment. The normal scientific studies of fact collection and theory articulation become highly directed activities and result in scientific papers describing investigations of minute areas with very much reduced vision. This forces a study in depth and detail which may bring up abnormalities that would otherwise be overlooked and in turn, these abnormalities

may lead to the overthrow of the original major theory.

There is always an element of crisis in this method of scientific progress. Indeed the larger the crises, the more major the break with accepted theory. Newton's theory of light and colour was put forward because none of the existing theories would account for the length of the spectrum and the wave theory replaced Newton's because of the growing concern with diffraction and polarisation effects. (2).(3).

Thermodynamics was derived from the collision of two existing nineteenth century physical theories(4) and quantum mechanics from difficulties with black-body radiation, specific heat and the photoelectric theory. (5).

Normal science is not necessarily differentiated from crisis science by a lack of discrepancies, but the research worker must be sensitive to the importance of the discrepancy that confronts him. It may require time before it can be said whether a discrepancy is of importance to the structure of a theory. It was sixty years after Newton's original computation that the discrepancy of the predicted motion of the moon's perigee to that of the observed motion could be shown by Clairant to be only due to the mathematics of application and would not require an alteration of Newton's inverse square law. (5).

It may require experimental techniques more advanced than can be provided at the time, as with Kepler, who in 1628, noted that the tails of comets always curved away from the sun and correctly assigned this curvature to a pressure exerted by the sun's rays; yet this could not be experimentally demonstrated in a laboratory until 1901, when the effects of radiation pressure were noted on delicate torsional balances.

It may also require interpretation as with the discovery of Uranus. Between 1690 and 1781, seventeen different astronomers had seen stars in positions now calculated to be that of Uranus at that time. In 1769, an astronomer had observed it for four days without noticing any motion. Herschel, in 1781, provided the experimental advance required, with a new telescope of his own design, and saw a disc shape which was unusual for stars. He did not identify it until he had given it further scrutiny and, noticing its motion, he then announced that he had seen a new comet. There were then several months of fruitless attempts to fit its orbit to a cometary motion before Lexell suggested that it might be a planet.(7)

The advent of radio-astronomy has meant that astronomy is still an area where anomalies require judgement as to whether they support and confirm the major theory or whether they will become the vexations that lead to the crisis point in the major theory's existence.

Closer to the earth's surface, the study of Atmospheric Electricity, which had its beginnings in the earliest work on electricity, has increasingly felt the benefit of modern electronics. The increased sensitivity in measurement techniques and the development of continuous recording have begun to counteract the difficulty of reproducing experimental conditions, which is one of the major problems of any applied discipline whose ultimate experiments must be under geographical or atmospheric conditions.

These advances in experimental technique have enabled study in greater detail and at greater depth than before and this, as might be expected, has resulted in apparent disagreement in the experimental determination of variables fundamental to the further advance of the science.

The aim of this work is to describe the development of one such problem in the field of Atmospheric Electricity and to examine the postulates on which the matter rests. Specifically the problem is that of the measurement of the electrical conduction current to the earth's surface under conditions of fine weather and its relation to the other major electrical variables of the atmosphere.

1.2. Fine Weather Electrical Phenomena.

The effects of lightning flashes and thunderstorms have been a source of awe and wondering since the beginning of history. The religious significance of lightning as the evidence for, or the retribution of, the gods, has existed up to quite modern times and a more domestic electrical phenomenon in the attractive forces of static electricity has been known almost as long as man's civilised existence. Indeed the study of static electricity was attempted by Thales of Miletus in the 6th century B.C.

It is not surprising therefore that the idea of lightning and thunder as a large-scale version of some of the effects of static electricity and its corollary, that electricity exists in the air, should have existed for many years. WALL(1708) would appear to be the earliest investigator to record this suggestion as a result of his observations. There were several subjective accounts of this comparison but, as has been mentioned, it required the development of the Leyden jar and early electrical machines for the beginning of objective measurements of electric discharges.

The early workers attempted to prove the presence of electricity in thunderclouds and perhaps the most well-known of those engaged in this somewhat hazardous task was FRANKLIN(1750, 1752) who flew a kite with a conducting string ending on an insulating ribbon. Franklin was actually forestalled by D'ALIBARD(1752) who obtained sparks to an earthed wire from an insulated iron rod. LEMONNIER(1752), with apparatus similar to D'Alibard's, first observed that electrical effects could be obtained

even in fine weather which was quite unexpected. His apparatus, an early passive probe(q.v.) consisted of an iron spiked wooden pole, from which an iron wire was led into a building. This wire, without making any other contacts, ended on a stretched silk fibre. He could obtain sparks from the electrified iron wire in fine weather and noted that particles of dust were attracted to it. He suspected a variation in these fine weather effects with the time of day. BECCARIA confirmed this in 1775 and determined that his wire was positively charged in fine weather. DE SAUSSURE(1779) was probably the first to discover an annual variation in the size of fine weather electrical effects. He developed a form of electrometer and used it in a way that foreran all methods of measuring potential gradient dependent on bound charge. DE ROMAS(1753), using a kite, found fine weather effects at a similar time to Lemonnier.

As later workers continued their investigations into atmospheric electrical effects, they established that the active region of the atmosphere can at any one time be divided into areas of charge generation, mainly associated with the development of thunderstorms, and areas of charge dissipation, the fine weather areas where the earth receives a current of positive charge. The current cycle is thus from the thunderstorm top to the electrosphere, from there to a fine weather area, then to the earth where it is returned to the thunderstorm base. The term, electrosphere, allows reference to the conducting area of the ionosphere without reference to the ionosphere's own properties. In the fine weather area, it was established that the three most important variables were the potential gradient, the conductivity and the conduction current and it is the inter-relation of these properties that is of concern.

1.2.1. Potential Gradient,

The definition of the potential difference between two points is that it is the mechanical work per unit charge necessary to move a small positive charge from one point to another. In atmospheric electricity, it is not possible to find out about electrical conditions outside the electrosphere and thus there is no means of calculating the work done in bringing a charge from an infinite distance to earth. Therefore in place of the zero potential of theoretical electrostatics, the potential surface of the earth, a conductor, is taken as zero and all potentials are measured relative to it. This is permissible as all the formulae are concerned with differences of potential. From conductivity measurements at various heights, the total columnar resistance of a column of air of 1m^2 cross-section from the earth to the electrosphere has been found to be about 10^{17} ohms. This means that the electrosphere is of a potential of about $3.6 \times 10^5\text{V}$ with respect to the earth, (GISH, 1951), for the resistance of the whole atmosphere is 200ohms.

The rate of change of potential with distance gives the force acting on a charged body. The direction of the force is such as to move a positively charged body to a position of lower potential.

Electric Intensity $E = -\frac{dV}{dx}$, where $\frac{dV}{dx}$ is the Potential Gradient. The potential gradient and electrical intensity are, in this work, largely vertical. The earth's surface is a conductor so that the potential gradient at its surface and close to it must be vertical. The change in distance dx is therefore a change in height and is measured positively upwards.

Under normal fine weather conditions, the potential V increases with height, so that $\frac{dV}{dx}$ is positive and thus E negative. To avoid sign

confusion, $F = \frac{dV}{dx}$ is used for potential gradient. F is then positive in fine weather. Vertical currents in the atmosphere will be taken as positive if bringing a positive charge downwards. The conduction current will then be positive in a positive potential gradient.

Measurement of the potential gradient in fine weather at different heights above the earth's surface has shown that there is little change in the first few minutes despite the electrode effect.(q.v.) At heights above approximately 100 metres, the potential gradient shows a progressive decrease with height.(CHALMERS - 1957)

1.2.2. Conductivity.

Considerable work on the nature of atmospheric conductivity has shown that ions, particles of molecular size or larger, carrying positive or negative charges, constantly disappear by combination with ions of the opposite sign, or are changed into ions of a greater size by combination with uncharged particles. There must therefore be some compensatory mechanism for the production of ions. Three processes have been found to contribute to this mechanism. Ionisation is caused by 1. cosmic radiation, 2. radiation from the sun, and 3. radiation from the earth and the atmosphere. The last process is only important in the area close to the earth.

The conductivity of the atmosphere is produced by these ions moving in the electric field. OHM's Law is usually obeyed and the current between two points is proportional to the potential difference, the ratio being the conductivity or the reciprocal of the resistance.

It is more convenient to use conductivities as different ions can then

be thought of as conductors in parallel and the total conductivity can be obtained by summing the separate conductivities of the various ions.

If the potential of the electrosphere with respect to the earth is V and the columnar resistance is R , then $\frac{V}{R} = i$, where i is the conduction current density. If r is the resistance of the lowest metre of the column, the potential drop across this is F , the average potential gradient in the lowest metre, then $F = ir = V\frac{r}{R}$. The specific conductivity of air $\lambda = \frac{1}{r}$, therefore $F = \frac{V}{R}$ and the specific conductivity λ_1 for positive ions is $\lambda_1 = \frac{i}{F}$, where i_1 is the current density of positive ions. Similarly, for negative ions $\lambda_2 = \frac{i}{F}$. The specific conductivity can also be related to mobility and charge, so $\lambda_1 = n_1 e w_1$ and $\lambda_2 = n_2 e w_2$, where n_1, n_2 are the numbers of positive and negative ions with mobilities w_1, w_2 and charges $+e, -e$ respectively.

These formulae can only be used for steady conditions or for changes which occur over periods which are long compared with the relaxation time of the atmosphere. The relaxation time is a measure of the rate at which a conductor loses charge or the rate at which the electrical conditions in the conductor adjust themselves after a change.

Large ions, and probably intermediate sized ions, have small mobilities and their numbers are seldom great enough compared with the number of small ions for them to play any significant part in conductivity.

The fine weather conductivity at many places shows a maximum in the early morning with a fall soon after sunrise; this is probably accounted for by the formation of mist or by the increased pollution of the air.

Pollution increases the number of nuclei present and to maintain the equilibrium of ionisation, any increase in the numbers of nuclei present

will lead to an increase of large ions and a decrease in the number of small ions and thus a decrease in conductivity. The yearly variation therefore shows a maximum conductivity in summer and a minimum in winter.

1.2.3. Conduction Current.

The air-earth conduction current i is related to the local potential gradient F and the local conductivity by $i = \lambda F$. This holds especially when F and λ are values measured close to the earth's surface. The potential gradient F at the earth's surface is the most widely measured electrical variable. However, the conduction current is also $i = \frac{V}{R}$, where V is the potential difference between the electrosphere and the earth and R is the columnar resistance. It has become increasingly evident that the value of i is far more fundamental than the value of F , although more difficult to obtain. There are two main reasons for assuming this to be so. Firstly, as both the earth and the electrosphere are good conductors and the currents within them are small, the potential difference between them at any instance is almost exactly the same in all places and local difference in the values of the conduction current must then represent differences in the local columnar resistance. The air-earth conduction current depends on the total columnar resistance and not directly on the local conductivity, thus local changes of conductivity affect the air-earth current only to the extent to which they alter the total columnar resistance. Measurement of potential gradient depends on local variations of the conductivity and is often of doubtful significance. Secondly, if there are no horizontal currents, convection currents or accumulations of charge,

the air-earth current is the same at all levels. This is a result of the quasistatic state.

Although a current is flowing in the atmosphere and so the actual charges do not remain static, in steady conditions, charges which have been moved from a certain region are replaced by others moving into the region with the result that at any one instant, the distribution of charge is the same. This is known as the quasistatic state and it is assumed that the laws of electrostatics can still be applied. If any change in the steady condition occurs, conditions will revert to a new steady quasistatic state in accordance with the relaxation time.

1.3. Methods of Measuring Air-earth Current.

The techniques for measuring the air-earth current can be classified into two categories; the direct method and the indirect method.

The direct method measures the actual charge reaching a portion of the earth's surface in a given time and should be a direct measure of the actual air to earth current. The usual form of the apparatus is a large collecting surface insulated from the ground. To this is attached an instrument, such as an electrometer or a very sensitive galvanometer, which is used to measure the charge collected in a given time.

The indirect method is to measure independently the local conductivity and the local potential gradient and to take their product as the air-earth conduction current. The local conductivity has been measured with variants of the apparatus used by EBERT(1901) for ion counting and GERDIEN(1905) for conductivity. It is basically a hollow cylinder containing a coaxial rod. The rod is connected to some form of measuring apparatus and a potential difference is applied between the rod and the cylinder. Air is drawn through the apparatus and the fraction of the ions in the air collected by the apparatus will depend on the potential gradient, the air-flow and the apparatus dimensions.

The methods of measuring the potential gradient can also be divided into two types. The first type is to measure the potential difference between two points at different heights using a potential equaliser. These equalisers include water-droppers (KELVIN - 1859 and SIMPSON - 1910), fuses (VOLTA - 1800), and radioactive sources (SCRASE - 1934, MUHLEISEN - 1951, et al).

The second method involves measuring the bound charge on a portion of the earth's surface or an earth connected body. The surface density of charge on a flat portion of the surface of the earth $Q = -\epsilon_0 F$ and there will be an exposure factor for an earth connected body. This is the principle behind the Universal Portable Electrometer (WILSON - 1906) and field machines such as the Agrimeter (RUSSELTVEDT - 1925, CHALMERS - 1953a), the Electrostatic Fluxmeter (MATTHIAS - 1926) and the Field Mill (HARNWELL and VAN VOORHIS -1933, et al). The field mill has probably been most widely used for this purpose. A fixed test plate is connected to earth through a resistance and capacitance in parallel. A rotating earthed cover alternately exposes and shields the test plate from the lines of force and the resulting alternating current to earth is amplified, rectified and measured. Many designs of field mill have used plates consisting of equal sectors of a circle with a similar set of earthed sectors rotating above them giving an output of approximately triangular waveform.

The theory of the field mill has been discussed by MAPLESON and WHITLOCK(1955) and its sensitivity by DAHL(1951). The output of this instrument is an alternating current proportional to the magnitude of the potential gradient, but giving no indication of its sign. For many purposes therefore it is necessary to arrange a method of determining this. The field mill has been developed to be a useful, reliable instrument, but has the disadvantage for conduction current work that it is essentially a point source measurement.

Interest in antennae for the measurement of potential gradient was revived by CROZIER(1953) with a passive antenna whose sensing unit had

sufficiently low conductance and capacitance to render the use of equalisers, the water-droppers, fuses and radioactive collectors previously mentioned, unnecessary. The low loading required is achieved by the use of feedback techniques and high quality insulation.

Instruments designed on these lines have been used to measure the fine weather conduction current at several sites and in various circumstances. Unfortunately the results obtained by the indirect and direct methods do not appear to reach a common conclusion and there has been some discussion as to whether these different methods do in fact measure the same things.

It is necessary therefore to study critically the experimental technique and the theory on which they are based, and further in atmospheric electrical work, the meteorological and geographical conditions under which they were applied.

1.4. The Problem.

It is possible for the transfer of charge in a vertical direction to be achieved not only by conduction currents, but by convection currents in which vertical motion of air containing more ions of one sign than the other may occur. Diffusion of ions may also contribute to this charge transfer. The direct method, as it measures the actual air-earth current arriving at a portion of the earth's surface, will measure the summation of these currents. The indirect method, measuring only local conductivity and potential gradient, will give only the conduction current.

The local conductivity that must be used in the indirect method is the sum of the conductivities of both $\lambda_1 + \lambda_2$ because at a height of one metre both signs play a nearly equal part. Close to the earth's surface, in a normal fine weather field, the current can only be carried by positive ions, so while at one metre, it is $i = F(\lambda_1 + \lambda_2)$, close to ground level, it must be $i = F_g \lambda_{1g}$. Measurements have shown that F does not vary near the earth's surface and that F and F_g are very similar which was contrary to the predictions of the simple electrode effect.

Early measurements of the air-earth current by the two methods appeared to indicate that the indirect method gave a value twice as large as the direct method, as would be expected if the conductivities of either sign were of equal magnitude and height and if convection currents such as postulated by WHIPPLE(1932) occurred.

However, the NOLANS(1937) and NOLAN(1940) made simultaneous measurements of the air-earth current by both methods and found the

conductivity measured indirectly exceeded that measured directly by only 10 per cent. With F constant with height, this indicated that $\lambda_1 + \lambda_2$ was equal to λ_{1g} and thus λ_1 must vary with height, a result found by HOGG(1939).

KRAAKEVIK and CLARK(1958) measured the potential gradient and the conductivity from aircraft and found differences in conductivity of 20 per cent in the austausch region; that region of the atmosphere where continued mixing of air occurs. It is possible therefore that the 10 per cent difference found by the Nolsns is not a local deviation, but has a real significance. LAW(1963) implied the existence of a convection current comparable with the conduction current, from his results at Cambridge.

Of these results, those of Hogg are probably the most significant because his site most nearly approached that acceptable to theory, but it is necessary to resolve these differences and to establish the real role, if any, of convection currents. It will be useful first to examine the requirements of an ideal site and then proceed from there to examine the published work in the light of their approach to the theoretical ideal.

CHAPTER 2. THE EXPERIMENTAL SITE

The study of fine weather phenomena is necessarily governed by atmospheric conditions and the experimenter has not only little control over his experimental conditions, but until the development of airborne measurements during the second world war, was in the position of examining the behaviour of his system by effectively studying one 'electrode' and its immediate surroundings. The model adopted for the system is one of classical electrostatics, as can be seen from the definition of the three major variables in the previous chapter, but, in practice, there will be deviations from the simple model and for these, there must be some form of compensation. It will be useful to consider these deviations in terms of an actual experimental site, that of the Observatory site of Durham University which is situated 1km. West of Durham City, 0.75km. North of the Laboratories and 120 metres above sea level.

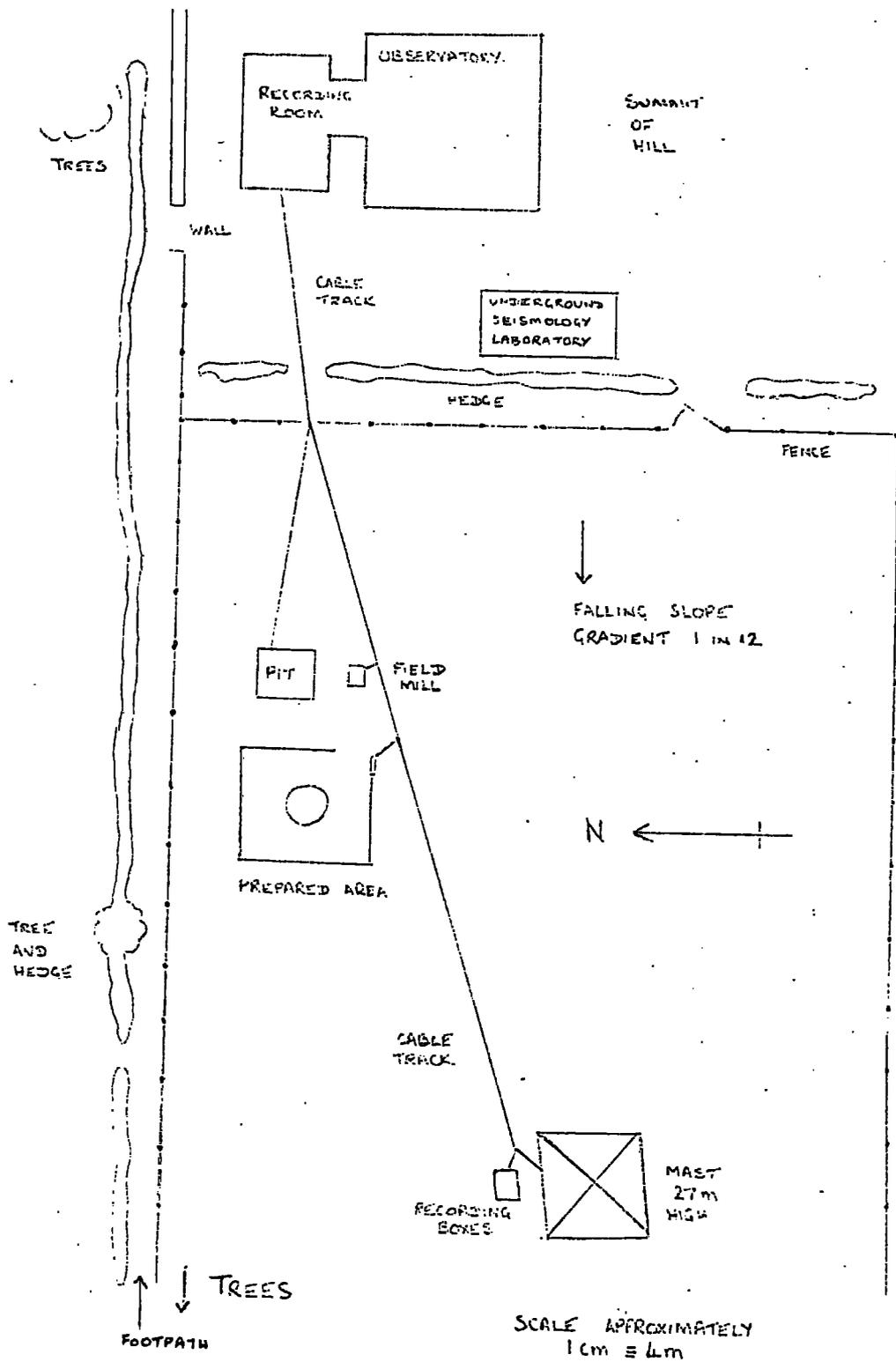

Fig. 1a. The Observatory Site and its Surroundings

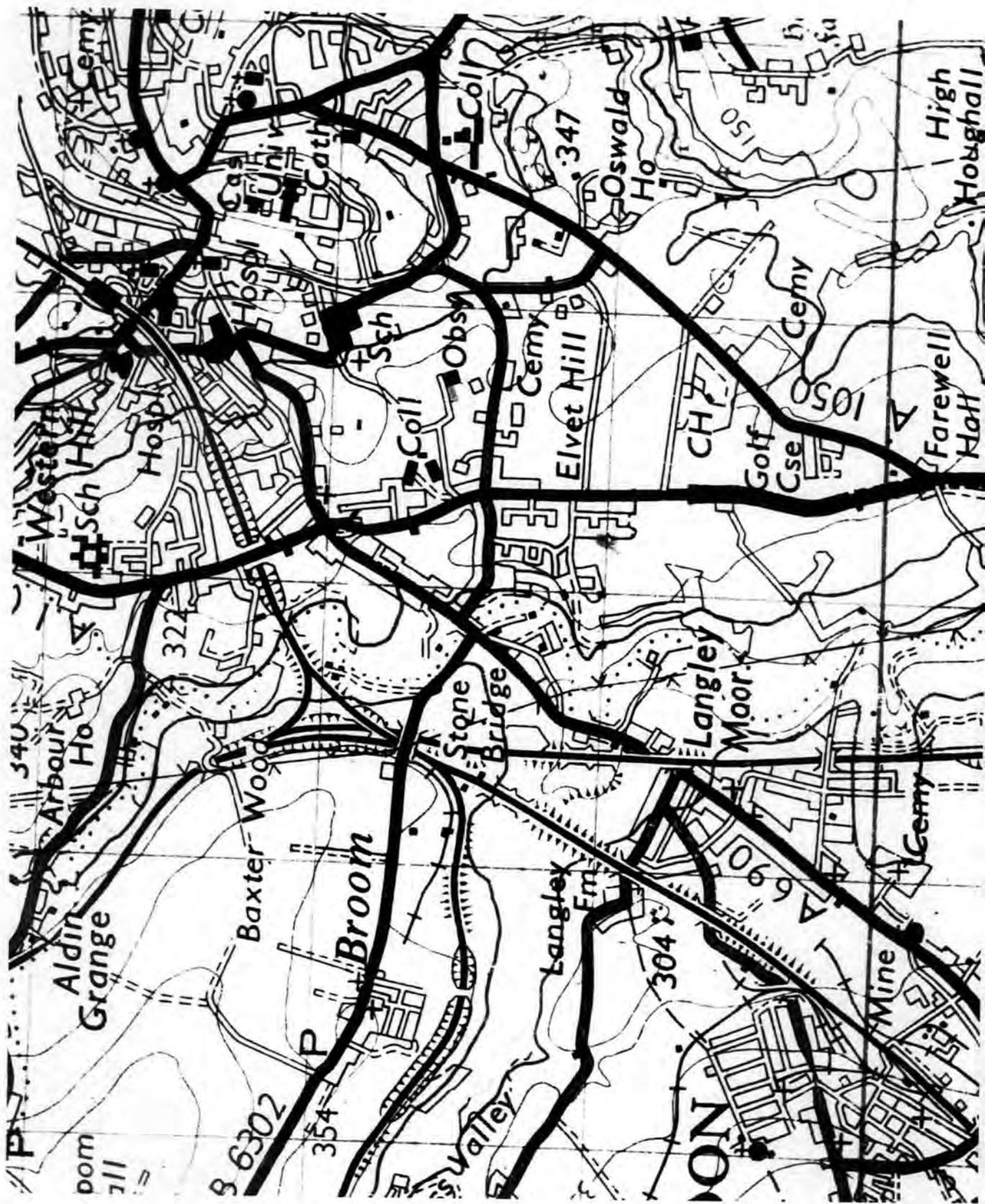

Fig. 1b The Observatory Site



Plate 1b The Observatory Site



Plate 1a The Observatory Site

2.1. Compensation.

In the equivalent circuit of the atmosphere sketched on p.7., the earth is acting as a conductor, transferring by ground currents the charge brought to it in the fine weather areas to those areas of thunderstorm conditions. Lines of force can be pictured arriving on the earth's surface in a direction at right angles to the local plane of that surface. Thus lines of equipotential will lie parallel to the earth's surface. Should the surface not be plane, but have on it such earthed conductors as houses or trees, this will disturb the density of the lines of force and alter the levels of equipotential. Any measurement of the potential gradient within the area of disturbance will not be absolute and a reduction factor must be defined before comparison can be made with absolute values over level ground. If the plane of the ground is not horizontal, then a collector of appreciable area or length must still be parallel to this plane, if it is to cause minimal disturbance to its surroundings.

An example of this can be seen (Plate 1. and Fig. 1.) at the Observatory site where the slope of the available site was 1 in 12. An incidental effect of this is that any frame for a plate type collector must be designed to minimise stressing on any insulating material that may show piezo-electric effects. In Plate 1., it can be seen that the nearness of hedge and tree to the experimental area will constitute disturbances to the lines of equipotential that may not be negligible.

In general, any measuring apparatus standing above the plane of its surroundings will require either the calculation of a reduction factor or

compensation for the disturbance it creates. BERNDORF(1906) considered the matter theoretically and found that a vertical conducting post 1cm. high has less than 1 per cent effect on the potential measured 1m. from the ground 3m. away. This gives the order of separation required between such apparatus if compensation is neglected. ARNOLD et al(1965) have considered the reduction effects of nearby trees both theoretically and practically. In practice, it is simpler to compensate for the reduction factor produced by apparatus, because of the complex shape of the equipment. This is done by measuring the potential gradient near to the conductivity or current measuring device, and applying a potential derived from that measurement to the device, thus maintaining it as close as possible to the potential of its surroundings. When measuring the fine weather current by the direct method there is a further compensation required, for a change of potential gradient during the time of exposure of the collecting surface produces an effect known as the displacement current.

The change in potential gradient produces a change in the bound charge on the collector. For a unit area of the collector, the surface charge $Q = -\epsilon_0 F$. A change of potential gradient with time $\frac{dF}{dt} = \frac{1}{\epsilon_0} \frac{dQ}{dt}$, $\frac{dQ}{dt}$ is effectively a current sometimes greater than the conduction current and it is not directly distinguishable from the true conduction current.

If the true conduction current is of the order of $2 \times 10^{-12} \text{A/m}^2$, an alteration in potential gradient of 300 V/m in an hour will then give a displacement current of $0.74 \times 10^{-12} \text{A/m}^2$.

Unless compensation is made for this displacement current, instantaneous measurement is not likely to give an accurate answer for the conduction current and long exposure times must be used to average this effect.

2.2. The Electrode Effect.

If the earth's surface is considered to be one electrode in the system then the experiments will be carried out in a volume of air bounded at one end by a negative electrode and extending into the central region. Positive ions can enter this volume from the central region and leave it via the negative electrode but no negative ions can enter the system unless they are produced at the negative electrode. In the simple model this is not so and the volume under consideration becomes depleted in negative ions and must acquire a positive space charge. This space charge will increase the potential gradient near the electrode and decrease it near the centre until the same current flows through all cross-sections. The potential gradient and the ionic distribution will, however, no longer be uniform. This is known as the Electrode Effect and in a simple form would show itself in a space charge near the earth and a potential gradient at a height of a few metres, which is appreciably less than that close to the earth's surface.

However, it is found that, in very many observations, there is only a small difference in the potential gradient at the height of one metre and that close to the ground, and so the electrode effect is not found in a simple form. It has been reported to exist for the conditions of the Greenland ice cap. (PLUVINAGE and STAHL - 1953, RUHNKE - 1962) and in the centre of large lakes (MUHLEISEN - 1961), and very still night air. (CROZIER - 1963a, 1965). An account for these results is obviously pertinent to the understanding of the conditions of conductivity and potential gradient and hence to the importance to anomalous results for the fine weather conduction

current by the direct and indirect methods. Attempts have been made to provide explanations, although these have been hampered by lack of a comprehensive theory. Theories with different assumptions with regard to recombination have been advanced by VON SCHWELDER(1908), BEHACKER(1910), SCHOLTZ(1931) and more recently, CHALMERS(1966). These have shown that a decrease of some 30 per cent between the earth's surface and 1m. above it should have been expected.

WHIPPLE(1932) suggested that as the air near the earth's surface is not still, a process of eddy diffusion could carry positive charge upwards and that this would avoid the discrepancy between the simple electrode effect theory and experimental results.

CHALMERS(1946) showed that a quasistatic state with little alteration of potential gradient with height could be achieved with a suitable form of variation of the rate of ionization with height and suggested that this variation could be caused by radioactive materials in the top soil. This would be supported by the tendency for the electrode effect to be found in areas such as ice caps and the effect of radioactivity at the surface would be reduced.

LAW(1963) introduced convection currents as a reason for the absence of the electrode effect.

2.5. Pollution.

Another major consideration in the assessment of an experimental site is the degree of pollution to which it is subjected and the resultant considerations of space charge on the model.

Quite apart from obvious pollution of the atmosphere by industrial and household effluents, appreciable pollution can be caused by road vehicle and railway locomotive exhausts. By the term pollution is meant the alteration of the existing balance of ion production and removal by the influx of ions from an external generator.

The fact that the exhaust of a steam locomotive always gave rise to a positive space charge was noticed by KELVIN(1860) and again by ISRAEL (1950). It was investigated in more detail by MUHLEISEN(1953) who found positive space charges to be also produced by diesel engines and other burning processes. Negative space charges were produced from chemical plant and gasworks. WHITLOCK and CHALMERS(1956) found that these space charges could be identified where the exhausts were some way away and no longer visible. BRASEFIELD(1959) found effects from the exhaust of road traffic. CHALMERS(1952) found negative potential gradients on the lee side of high tension cables under conditions of mist and fog. BENT and HUTCHINSON(1966) found that in places down-wind, where the mist had evaporated, the negative space charge still persisted in the air. MUHLEISEN(1953) observed in fine weather positive space charges from cables whose diameters were too small to be suitable for the voltage carried. Thus local conditions will play a large part in the amount of space charge present at the measuring site and rapid fluctuations of

potential gradient due to this have often been found in fine weather conditions, particularly in or near large towns.

As the indirect method of measuring the air-earth current measures local conductivity and local potential gradient, it is important to assess the degree of pollution at an experimental site before comparing the results with those obtained at a differing site.

The Durham Observatory site has become less tenable as a site, as pollution from road traffic on a major trunk road and its exit road in Durham has increased. These roads pass within $\frac{1}{2}$ km. to windward of the site. A main railway line is only $\frac{3}{4}$ km. from the site also in the direction of the prevailing wind and high tension electricity pylons pass the site on all sides at distances of 1 to 6km. (see Fig.1b.)

2.4. Site Design Features.

There are other more minor points that the nature of the experimental site may impose upon the design of the apparatus. As the resolution of the problem would involve measurement of the air-earth current by indirect and direct methods at different heights close to the earth's surface, a form of consistent base level is required.

It is a great advantage to have an artificially prepared part of the 'earth's' surface, even if it does not contain beneath it an underground recording room such as the one at Kew.(HOGG - 1939). It may be that time and expense are against this and it is true that it would no longer be a 'natural' surface in terms of radioactive content or even thermal radiation, should the local effect of convection be considered. As the indirect method is essentially a method of measurement at a point the size of the prepared area may not be large. With the direct method the exposed plate may be of the order of 1m. across and thus a suitable experimental site may be approximately 10m. square, especially if comparison is to be made between the two methods on the same site. A 'natural' grass surface regularly cut by a mower with blades of a fixed height may be the only practical form. In this case, the environment is preserved, but the accuracy of positioning is reduced .

In any investigation in atmospheric electricity, extreme care must be taken with the insulation. For fine weather measurement, the arrangements required to protect the insulators from the rain and to keep them free from condensation by warming with heating coils are less stringent as the apparatus will not be running under wet conditions. However, the values of the

parameters measured are generally smaller so the measuring instruments have to be more sensitive. If the measurement involves the collection of a charge, there is a leakage which takes place with a time constant $C.R.$, where C is the capacity of the collector and R , the leakage resistance to earth. The collection of the charge is usually expressed as a voltage $V = Q/C$, so C must be reduced for high sensitivity and R must be increased as much as possible. In this not only the leakage at the insulators must be considered, but also the leakage and the capacitance of the cables connecting the measuring apparatus to the recording devices. Besides piezo-electric strain on the insulators and cable, difficulties are experienced with condensation, dust driven up on to low insulators by rain splashes and spiders' webs, so a careful choice of insulating and cleaning procedures must be adopted. There are also hazards specific to the site which have nuisance value. For instance, at Durham Observatory site, the soil is boulder clay with a very high water table and unless underground pits were regularly dried and aired, water tended to seep through the walls into the spaces housing apparatus as the initial water-proofing of the concrete was not adequate. In this case the slope of the site was an advantage as it simplified the construction of drainage sumps.

The other perennial problems with outdoor equipment are earth connections and contact potentials. Different earth connections may be at different potentials because of earth currents or electrolytic effects and induced currents must be avoided. Contact potentials between different metals or the same metals with differing surface conditions caused by oxidation may be of the order of volts which will give effects

comparable with the natural fine weather potential gradients.

It is in the light of these considerations, fundamental and practical, that these experimental results must be interpreted. The next chapter will deal in detail with the experimental techniques that have been used in both the direct and indirect methods of measuring air-earth current.

CHAPTER 3 PREVIOUS WORK

3.1. Previous Experiments using Direct Measurement Methods.

Historically, the first attempt at direct measurement of the air-earth current was made by EBERT(1902). However, as his plate was neither maintained in the plane of the earth nor at earth potential, his results cannot be accurate.

WILSON(1906) had his test plate connected to a gold leaf electrometer. Surrounding the test plate was a guard ring connected to the system through a compensating condenser. The electrometer was brought to the zero position with an earthed cover placed over the test plate. The cover was removed and the compensator adjusted to keep the electrometer in its zero position. After a given time interval, the cover was replaced and the compensator again adjusted to give zero deflection of the electrometer. The difference in compensator positions gave a measure of the charge on the plate when it was exposed. If the compensating condenser was not used, removal of the cover would have brought the plate to a potential other than that of earth.

In his later capillary electrometer, WILSON(1916) automatically adjusted the potential of the plate to that of the earth. Wilson made measurements at 60, 90 and 130cms. from the ground but made no attempt to determine any relationship between the values at these heights. As the test plate has to be covered and uncovered and the readings have to be taken visually, these methods are not readily adapted to continuous recording of the air-earth current. However, the covering of the test plate in this manner means that no compensation for the effect of potential gradient changes is needed as there is no bound charge at the beginning and the end of the observation.

If Wilson's method is used without the compensating condenser, removal of the cover would bring the plate to a potential considerably different from that of earth. SMITH(1956) found that there appeared to be no current at all if this was done and a measuring instrument of small capacity was used. When the cover is removed, the plate acquires a charge $-A\epsilon_0 F$ on its upper side. The corresponding charge $+A\epsilon_0 F$ must reside on the lower surface of the plate as the capacity of the electroscope is small. Assuming the conductivity of the air is the same either side of the plate, the charges will dissipate with the same relaxation time and there will be zero net current.

A recent modification of Wilson's apparatus was used by COBB and PHILLIPS(1962). They used 6 symmetrically disposed circular plates mounted on a rotating table. A circular sector was fixed over the table. On entering the shielded area, the net charge on the plate was due to conduction alone. A brush contact carried away this charge to a filter which alleviated interference from the brush pick-up. This network had a RC product of 240 seconds which determined the time constant of the measuring system. After correction for the current from the lower plate surface due to the capacitance of that surface and conductivity close to it, it was shown that the rotating plate collected about 76 per cent of the air-earth current but the variations from this figure resulted in the absolute value of the air-earth current not being established closer than an error of 10 per cent.

SIMPSON(1910) designed a $17m^2$ collector for a hill site in India. Because of its size and construction the height could not be altered, so it was built in the plane of the earth and attached to it was a water-

dropper which kept the collecting area at the earth's potential. The drops breaking away from the dropping vessel, carry away a charge proportional to the charge on the collecting surface. The drops were collected in an insulated collector attached to an electrometer. The electrometer deflection was registered every 2 minutes and thus the air-earth current could be continuously recorded. The potential gradient was measured on a second electrometer and theoretical corrections for the displacement current made. This form of correction was suitable for Simpson as he was interested in the daily variations in the air-earth current rather than instantaneous relationships.

CHALMERS and LITTLE(1947) used an exposed plate connected to a $\frac{1}{2}\mu\text{F}$ capacitor and through this, to earth. The capacitor was discharged every 10 minutes through a ballistic galvanometer and recorded photographically. The capacitor decreased the leak and also prevented the collector plate from varying much from the potential of the earth. Individual readings are not very valuable because no correction was made for fluctuations of potential gradient. This error was reduced by averaging over long periods. CHALMERS(1956) used a similar method with a valve electrometer. In this work compensation was provided by simultaneous measurements of the potential gradient as in Simpson's method.

SCRASE(1933) attempted to overcome displacement current difficulties and to record continuously, by connecting one pair of quadrants of a quadrant-electrometer through a capacitor to a radio-active equaliser, which recorded the potential gradient, and the other pair of quadrants to the current collector.

So, whereas the normal use of the quadrant electrometer requires one

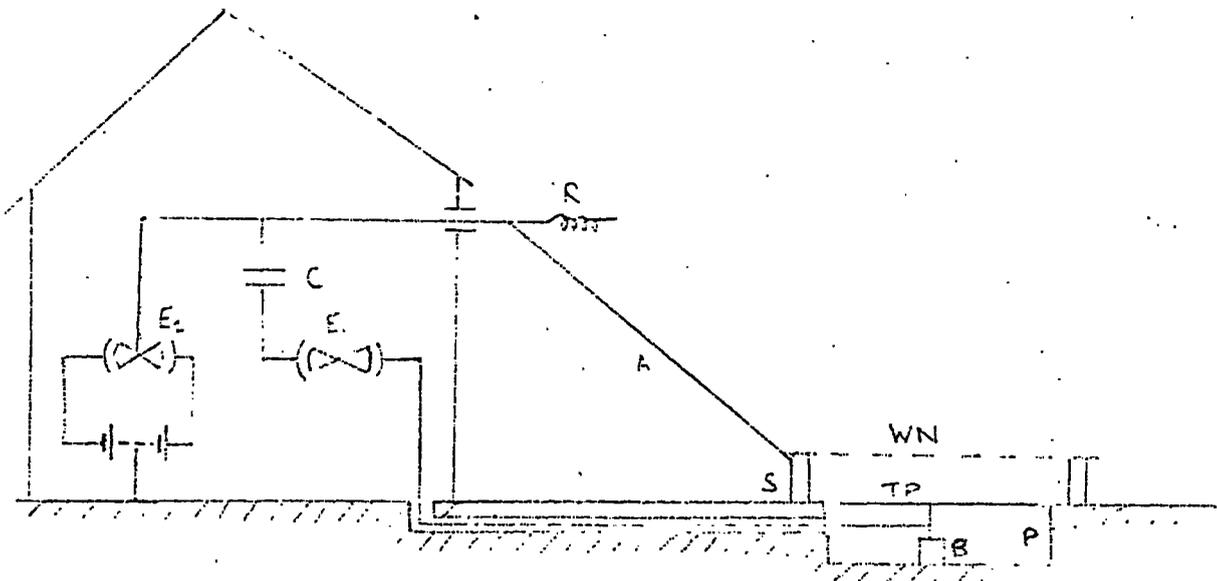

- TP Test Plate
- E₁ Current } Electrometers
- E₂ Potential } Electrometers
- E₂ Gradient }
- R Radioactive Equaliser
- A Lead to Net
- WN Wire Net
- S } Insulators
- B } (Sulphur)
- C Condenser
- D Lead Covered Wire
- P Pit

Fig. 2. Scrase's Apparatus

pair of quadrants connected to the current source and the other pair earthed, here neither pair of quadrants were earthed.(Fig. 2.)

When both pairs of quadrants were earthed and then released, one set received the charge from the collector, that is the sum of the conduction and displacement currents. Simultaneously the radio-active equaliser was affected by any change in potential gradient. These changes affect the second set of quadrants through the condenser. Adjustment of the condenser allowed these changes in potential gradient to affect both sets of plates equally and thus to have no effect upon the electrometer reading.

The material used in the radio-active equaliser was polonium and this was too slow to respond to many field changes. Scrase therefore introduced a wire mesh connected to the equaliser and placed over the collector at a height such that the potential gradient over the plate was always that recorded by the equaliser but any rapid fluctuations of the potential were smoothed out. The quadrants were earthed for 1 minute at 10 minute intervals, giving a trace rising from zero over a period of 9 minutes, the mean slope of each line of which is a measure of the air-earth current for that period.

Little distortion of the lines of force occurred as the capacity of the collecting system was large enough for the potential never to be greatly different from that of earth.

Because of the sluggishness of the collector the potential gradient over the plate was sometimes slightly different from that which would have occurred in the absence of the wire net and under these circumstances the current measured is not quite the natural current to

an area of the earth but is really a measure of the unipolar conductivity of the air between the wire net and the plate.

The apparatus had the advantage that the collector can be placed some distance from the electrometers and it really only failed because of the slow response of the polonium equaliser. If this was replaced by a field measuring device with a more rapid response, greater success should be achieved by this method. Suggestions were made to this effect by GOTO (1951) and CHALMERS(1953b). Chalmers, using an agrimeter, found that the output from this instrument was not steady enough to provide the solution. ADAMSON and CHALMERS(1956) suggested a field mill. ADAMSON(1960) developed Scrase's apparatus using a field mill and a differential amplifier in which the sum of the air-earth and displacement currents was measured at one terminal of the amplifier and the field mill provided automatic and continuous compensation for the displacement current at the other terminal.

By increasing the time constant of a system similar to that of Scrase, MUHLEISEN(1953) avoided Scrase's difficulties. But the increased time constant meant a greater averaging effect on short fluctuations of the variables measured. KASEMIR(1951) produced for expedition work and mountain stations, apparatus designed to measure long term variations and had in consequence a long time constant of an hour. The current was amplified through an electrometer valve and recorded on a six channel recorder. The potential gradient was simultaneously recorded using a radio-active equaliser. The critical point in operation is the maintenance of the high insulation. The long time constant was used to even out the effect of potential gradient change.

$$Ai = A\lambda_1 F$$

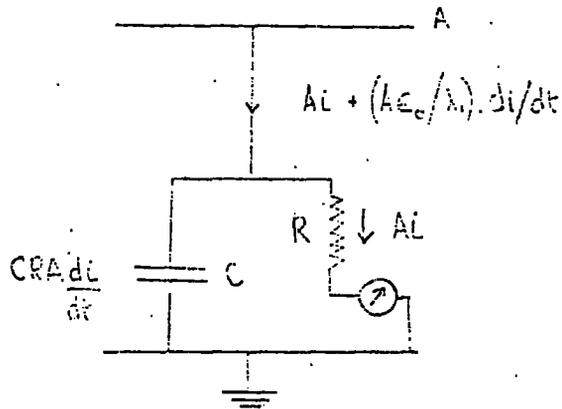

- A = area of plate
 - i = air-earth current density
 - F = potential gradient near the earth
 - λ_1 = positive conductivity at the earth
 - R = resistance
 - C = capacitance
- } in parallel

Fig. 3. Kasemir's Method.

In his second method, KASEMIR(1955) attempted to eliminate the effect of potential gradient changes (Fig. 3.). He considered the air-earth current being collected by a plate exposed to the air. The current flowed through a calibrated resistance to earth and the voltage drop across the resistance was measured. The total current from the collector was $Ai + A\frac{\epsilon_0}{\lambda_1} \frac{di}{dt}$, where A was the surface area of the collector; i, the air-earth current density and $A\frac{\epsilon_0}{\lambda_1}$, the surface density of the bound charge. If the collector was connected to earth through R and C in parallel and V was the potential of the collector with respect to earth, then the current I through R was $\frac{V}{R}$; there was a charge Q on the capacitor C such that $Q = CV$ and, if V altered, there was a current $\frac{dQ}{dt} = C\frac{dV}{dt}$ through C. The total current from the collector was then $I + \frac{dQ}{dt} = I + CR\frac{dI}{dt}$. Since no charge accumulated on the collector apart from the bound charge then $Ai + A\frac{\epsilon_0}{\lambda_1} \frac{di}{dt} = I + CR\frac{dI}{dt}$. If R and C were chosen so that $RC = \frac{\epsilon_0}{\lambda_1}$, then I was equal to Ai and the current through R would be equal to the air-earth current to the collector without the need for correction for the displacement current. This amounts to matching the time constant of the collector circuit to the relaxation time of the lower atmosphere. In practice λ_1 is not constant and so RC would need continual adjustment for complete matching.

ISRAEL(1955) discusses the assumption of the method that any change in potential gradient is accompanied by a change in air-earth current the conductivity remaining constant. A change of conductivity giving a change in potential gradient would appear as an air-earth current.

RUHNKE(1961) also discusses the errors of incorrect matching.

CHALMERS(1962) used a modification of Wilson's method with charge measured by an electronic amplifier. His results showed that the assumption of constant conductivity required by Kasemir's matching circuit was not correct. He measured separately the charges from the plate on uncovering, during collection and on covering and in this form his apparatus was not continuously recording. GOTO(1957) adapted Wilson's method to record continuously by having three plates rotating beneath a hole in an earthed cover. Each plate was earthed when shielded from the field, exposed and then shielded again. The net charge acquired by the electrometer is that from the air-earth current. When the plate leaves the shielded region it acquires a potential different from that of the earth and therefore distorts the lines of force and the current flow. Wilson avoided this by use of a variable compensating condenser, but to compensate automatically Goto used a fixed condenser with a variable potential suitably derived from a water-dropper or an inverted field machine.

If Goto's apparatus was similar in operation to an agrimeter, VON KILINSKI's(1952, 1958) method used the principle of the field mill to avoid direct current amplification. The current from the collecting plate puts a potential on a stationary vane. A similar stationary vane opposite has a fixed potential applied to it, though this vane could be used to compensate for displacement current if the output of a field machine was connected through a condenser to it in place of the fixed potential.

Below the two stationary vanes are rotating sectors alternately

exposing and shielding a second plate from the potentials on the stationary vanes. The alternating signal from the second plate is amplified and rectified. In the later paper he provided a matching circuit in place of the capacitor used to minimise displacement current effects and had the collector plate slowly rotating to break spiders' webs. To avoid the problem of the electrode effect and to investigate more fully the presence of convection currents, DOLEZALEK(1960) and ISRAEL and DOLEZALEK(1960) suggested a direct method of measurement using a surface 2 or 3 metres above the ground and maintained at the natural potential of the atmosphere rather than using a ground reference. They suggested a metal net which would not interfere with the natural motion of the atmosphere. CHALMERS (1962) showed that, although this method would be of use in measuring the convection current, it would not directly measure the conduction current as outside the region of the electrode effect the downward part of the conduction current consisting of positive ions would be nearly equal to the upward part carried by the negatives and the total current to the net would be nearly zero.

KASEMIR and RUHNKE(1958) suggested measurement of the air-earth conduction current by an earthed wire at a height of 1m., causing a concentration of current flow lines which would enhance the conduction current relative to any convection current present. The potential gradient is measured by another wire at 1m. high also equipped with a radio-active equaliser.

If the potential of the wire is V and its capacitance/unit length is C , then the charge/unit length is Q such that $V + \frac{Q}{C} = 0$. Q will not be evenly distributed but there will be no positive charges as they involve

a difference of potential along the wire.

If there is a charge dQ /unit area, then the potential gradient at the surface of the wire $= -dQ/\epsilon_0$. If the conductivity due to ions opposite in sign to the charge Q is λ , the current to the unit area is $di = -\lambda dQ/\epsilon_0$. When integrated for the whole wire, $i = -\lambda Q/\epsilon_0 = \lambda CV/\epsilon_0$ as V is the potential at 1m. V gives the potential gradient F_{av} over the first metre and i measures a multiple of F_{av} which is only the unipolar conduction current at 1m. if the potential gradient remains constant over the first metre. Convection current effects are not included and so the method is more of the indirect type than the direct type. λ can be found from the measurement of F_{av} and λF_{av} .

KASEMIR(1960) adapted this method for balloon radiosonde work as only potential gradient and conductivity measurements had been carried out in the upper air (cf. 3.2.) and it is necessary to measure all three variables, i , λ , and V , to check the degree to which Ohm's Law is obeyed. Below the radiosonde balloon, he suspended on a nylon cord an antenna which was connected via a three-channel matching circuit to an electrometer. The second channel of the matching circuit was connected to a lower antenna held in place relative to the balloon by an inverted parachute. The third channel was used for zero. The upper antenna collected positive charge, the lower negative charge, but the system suffered from the fact that it was measuring λF and not the total vertical current and from the difficulty of matching at different levels in the atmosphere, especially in the region of austausch (cf. 3.2.).

In his paper commenting on the methods of Israel and Dolezalek and of Kasemir and Ruhnke, CHALMERS(1962) suggests a further modification of

Wilson's method which will be considered in section 3.3.

3.2. Previous Experiments using the Indirect Measurement Methods.

The method and the techniques available have been described briefly in section 1.3. There have been three main variants of the conductivity measuring device - those of GERDIEN(1905), SCHERING(1906) and NOLAN and NOLAN(1937). The general theory for a cylindrical condenser instrument of this type (Fig.4.) with a tube radius of a and a central wire radius of b when a potential V is applied and air drawn through at a velocity U is as shown.

At a point r from the axis of the central wire the potential gradient $= \frac{V}{r \ln(a/b)}$. An ion of mobility w at the outer wall will move a radial distance dr in a time dt , where $dt = \frac{dr}{w} \cdot \frac{r \ln(a/b)}{V}$ and integrating over the distance from the outer to inner cylinder $t = \frac{(a^2 - b^2)}{2} \frac{\ln(a/b)}{wV}$. During this time the air will have moved a distance Ut along the cylinder. If this distance is less than L , the length of the inner wire, then the whole of the moving ions will be collected, i.e. $U < \frac{L}{t}$. If U is much larger than $\frac{L}{t}$, then only a fraction of the ions will reach the inner cylinder.

In a similar manner, if the central wire is a distance S from the entry point of the apparatus then only when $U > \frac{S}{t}$ will the ions reach the wire and Ohm's Law hold.

The number of ions under this condition which will then reach the central wire in unit time will be that number in radius R where $U(R^2 - b^2) \ln(a/b) = 2wVL$. If there are n_1 ions per unit volume of mobility w_1 , then the current at the central cylinder $i = \frac{2n_1 e w_1 V L}{\ln(a/b)} = \frac{2\lambda_1 V L}{\ln(a/b)}$ from which λ_1 can be found as can λ_2 , if the potential is reversed. Gerdien's original method was to charge the central electrode to a

potential V_1 with the outer electrode earthed and then find the potential V_2 after a time t , such that $\lambda_1 = \frac{\epsilon_0}{t} \ln. \frac{V_1}{V_2}$.

NOLAN(1940) altered the potential of the outer cylinder in such a way as to keep the central wire at a constant potential, thus making the system a null method and removing the effect of stray capacities on the above system.

SCHERING(1906) used the relaxation time for a charged conductor as a method of finding the conductivity as $\tau_1 = \epsilon_0/\lambda_1$, and $\tau_2 = \epsilon_0/\lambda_2$ under conditions in which Ohm's Law holds. It is difficult to ensure that Ohm's Law does hold because of induced charges which vary as the potential varies. These he avoided by putting the wire in a large earthed cage. If this is done then care must be taken not to enclose the conductor totally and give conditions of saturation rather than Ohm's Law and to avoid the earthed screen from collecting induced charges which may affect ions approaching the conductor. To prevent this, the whole is placed beneath trees or a roof.

NOLAN and NOLAN(1957) obtained λ_1 from $\lambda_1 = n_1 e w_1$ by a combination of the Ebert and Gerdien methods. They used two large identical cylinders, one of which collected all the ions of mobility above a certain value giving $n_1 e$. To the other, smaller potentials were applied in succession and the slope of the resulting current vs potential curves gave $\lambda_1 = n_1 e w_1$. By division, w_1 was obtained which is a more reliable value than that obtained by other methods. The value of $n_1 e$ was then obtained from a standard Ebert ion counter and λ_1 recalculated more accurately.

Modern practice is typified by the apparatus of HIGAZI and CHALMERS

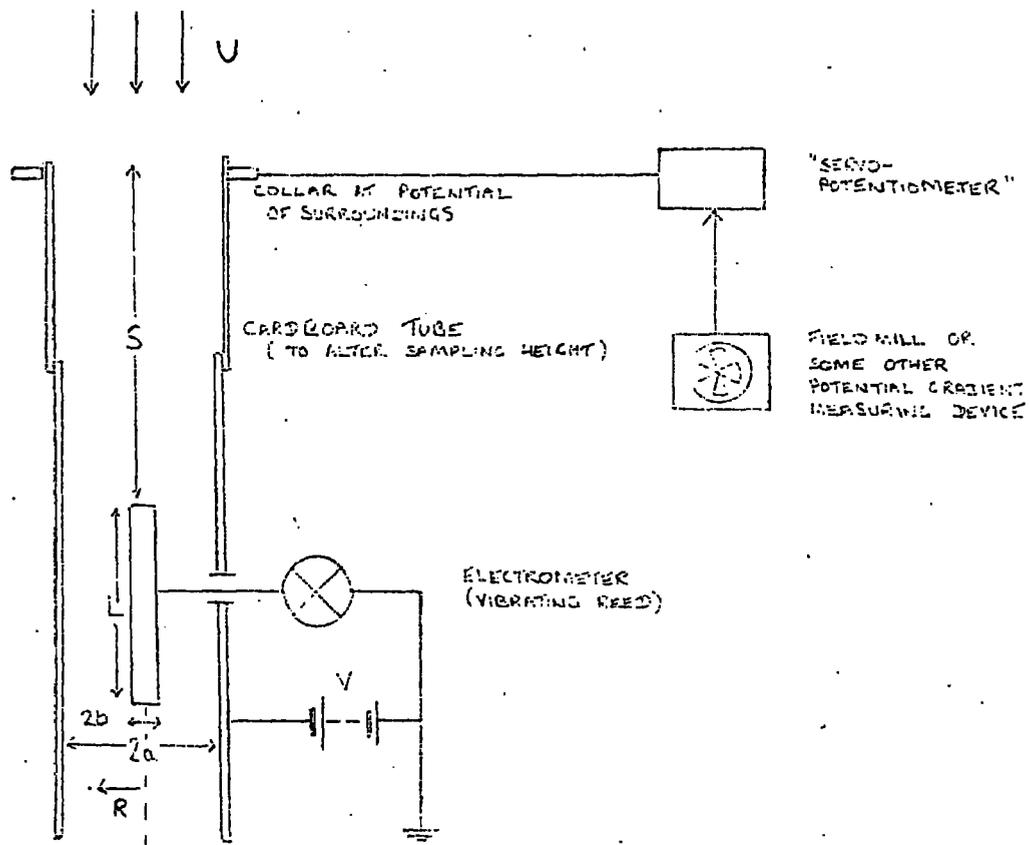

- a = radius of cylinder
- b = radius of central wire
- L = length of central wire
- S = distance of central wire from top
- U = velocity of air
- V = potential applied to cylinder

Fig. 4. Conductivity Measuring System after Hogg(1939) and Higazi & Chalmers(1966)

(1966) which consisted of Gerdien tubes with constant applied potentials, the current being measured by vibrating reed electrometers. The tubes are maintained at the potential of their surroundings by a "servopotentiometer" driven by the amplified and rectified output of a field mill.(Fig.4.). The design of conductivity meters, like the design of field mills, can then be considered to have reached a reasonably satisfactory state in that standardised instruments can be produced and used in a way which will enable the experimenter to distinguish the variations of the system which he is measuring from the effects of the system on his apparatus.

As the effect of space charge, the unbalanced charge present in a volume of air, appears to be important to the consideration of direct and indirect methods of air-earth current it will not be out of place to consider briefly here the main methods of space charge measurement. They can be considered under four headings.

1. Space charge is drawn into an earthed cage and the potential at a point in the cage is measured.
2. The whole space charge in a volume of air is collected and measured.
3. Poisson's Law is used to deduce space charge from changes in potential gradient with height.
4. Collection by electrostatic means; ion counters to which fields of either sign are applied alternately or simultaneously.

A full description of these methods was given by VONNEGUT and MOORE(1958) who developed apparatus of type 1. and suggested the use of apparatus of type 2. with glass wool filters to collect the total space charge. BENT (1964) constructed such an instrument. In order to avoid the effects of induced charges and the disturbance of the existing electrical state it

is desirable to maintain the cover of a filtration apparatus at the potential of its surroundings, although it is obviously undesirable to use an ion or droplet-producing equaliser for this purpose. Perhaps the passive probe of CROZIER(1963b) with an antenna form other than that of the long wire might be of use here.

Measurement of space charge is a sensitive way of measuring a change in potential gradient as for instance it is not possible at the moment to measure a potential gradient change of Vm^{-1} but it is possible to measure the space charge present at this change.

Conductivity measuring apparatus has been adapted for use in balloons (CORINITI et al 1954 and others) and in aircraft (GISH and WAIT 1950, KRAAKEVIK and CLARK 1958 and others) as has potential gradient measuring apparatus. There are difficulties in the use of such apparatus as the aircraft distorts the field and is very liable to become charged itself. It is important, however, to attempt these measurements as they give insight into the system away from the vicinity of the negative electrode and also outside the "austausch" region - a region of continual mixing of the air extending from the earth's surface to a height which is determined by the meteorological conditions particularly temperature.

This region, which may be up to 3km. high is where small-scale convection currents occur mixing the surface air and its constituent ions thoroughly through the region. The height of this region is governed by the level of temperature inversion and SAGALYN and FAUCHER (1954) found a very distinct increase in positive conductivity as well as changes in temperature, humidity and large ion content in passing through the upper limit of this region.

HIGAZI and CHALMERS(1966) found evidence of the effect of turbulence and wind speed on the ratios of the conductivities at and close to ground level, so it is apparent that turbulent mixing must be considered another 'boundary' effect to add to the electrode effect when the conduction current is measured close to the earth's surface.

The importance of convection currents can be assessed if the conduction current is measured by the indirect method at different levels. If there is no convection current, then the conduction current will be the same at all levels.

Measurement of the indirect method involves measuring the potential gradient as well as the conductivity and because of the self charge possessed by the balloon or aircraft, a single field mill cannot be used as the charge on a portion of a conductor will depend on the external potential gradient and on the potential difference between the conductor and its surroundings.

If two field machines are used at places on the conductor symmetrical with respect to a horizontal plane, then the sum of the charges and hence the sum of the outputs of the machines will be proportional to the potential difference between the cases and their surroundings and the difference of outputs will be proportional to the actual potential gradient.

GUNN et al(1946), GUNN(1948) and GISH and WAIT(1950) used two separate field machines above and below the wings. Others, JONES et al(1959), CURRIE and KREIELSHEIMER(1960), KOBAYASHI and KYOZUKA(1962) have used double field machines of various types. By using more field machines still it is possible not only to find the self charge, but also the horizontal components of the potential gradient.

With balloons and gliders, where the speed of movement is less than for aircraft, the self charge has sometimes been neutralised by water-droppers - e.g. LINKE(1904), LECOLAZET(1948).

With a double field mill, the potential gradient can be separated, but the apparatus will still distort lines of force and, where other apparatus is close, this may be important. SMIDDY and CHALMERS(1958) minimised the distortion by designing a servo-mechanism to reduce the sum of the outputs to zero and thus bring the machine to the potential of its surroundings.

WILDMAN(1962) devised a field mill suitable for use when the conduction current is no longer small compared with the induction signal. His machine had a rotor with two concentric rings of holes covering and uncovering two sets of insulated studs giving two separate signals with different dependence on potential gradient and conduction current, allowing these two effects to be distinguished.

3.3. Discussion of Further Experimental Designs.

CHALMERS(1962) showed that the attempts of Israel and Dolezalek and of Kasemir and Ruhnke to avoid the electrode effect and to measure directly the conduction current at another level other than that of ground were not truly measuring conduction current. Chalmers suggested an alternative method based on Wilson's apparatus. WILSON(1908) measured the air-earth current directly with a large collecting plate placed in the plane of the earth and eliminated the displacement current by measuring the average current over a relatively long period of time. Chalmers suggested two horizontal plates separated by a thin layer of insulating material, placed in the plane, but above the level of the earth's surface and held at the potential of the surroundings, which would then receive different components of the conduction current. The upper plate would receive the positive component of the conduction and the lower plate the negative component. By measuring each separately, the total current could be obtained.

The extent to which the system was affected by convection currents would depend on the size of the collecting plates. The method of maintaining the system at the potential of the surroundings should be a more modern version of the apparatus of SCRASE(1933) with a faster response time, so that the system could record simultaneously, and compensation for the displacement current should be based on balancing the change in the bound charge on the collector surface by the use of capacitors. Obviously for this compensation to be effective, the response

time must also be very short.

An unsuccessful attempt was made to put these suggestions of Chalmers in practice and the description of this attempt will be a convenient framework for discussion of further experimental points.

The current collector consisted of two circular plates of aluminium separated by an insulating sheet of perspex approximately 6mm. thick bolted together by nylon nuts and bolts set in perspex insulating collars. The 'sandwich' was mounted on four wooden posts by means of perspex insulators. The posts dropped into brass tubes completely sunk in the ground and held relative to one another by a metal X-piece also below ground. The height of the plate could be altered by adding or removing wood blocks of appropriate size into the brass tubes.

The collector is an unshielded collector and therefore the edge effects are minimised by having a circular shape which has the least circumference for a given area. The size of the collector must be a compromise between obtaining the largest possible signal from the plate and the ease with which the plate can be moved from one height to another. An area of 1 square metre was chosen. This simplifies the current density calculations and means the measuring instrument attached to the plate must be capable of measuring 2×10^{-12} amps. The other factors influencing size are the degree of rigidity required and the number of supports allowed.

To minimise piezo-electric effects in the insulating layer and also to ensure that the plate is truly in the plane of the earth's surface, the plate must be as rigid as possible. To minimise distortion to the lines of force, the number of supports must be the minimum permissible.

Wood was chosen for the supports as, although not an exceptional

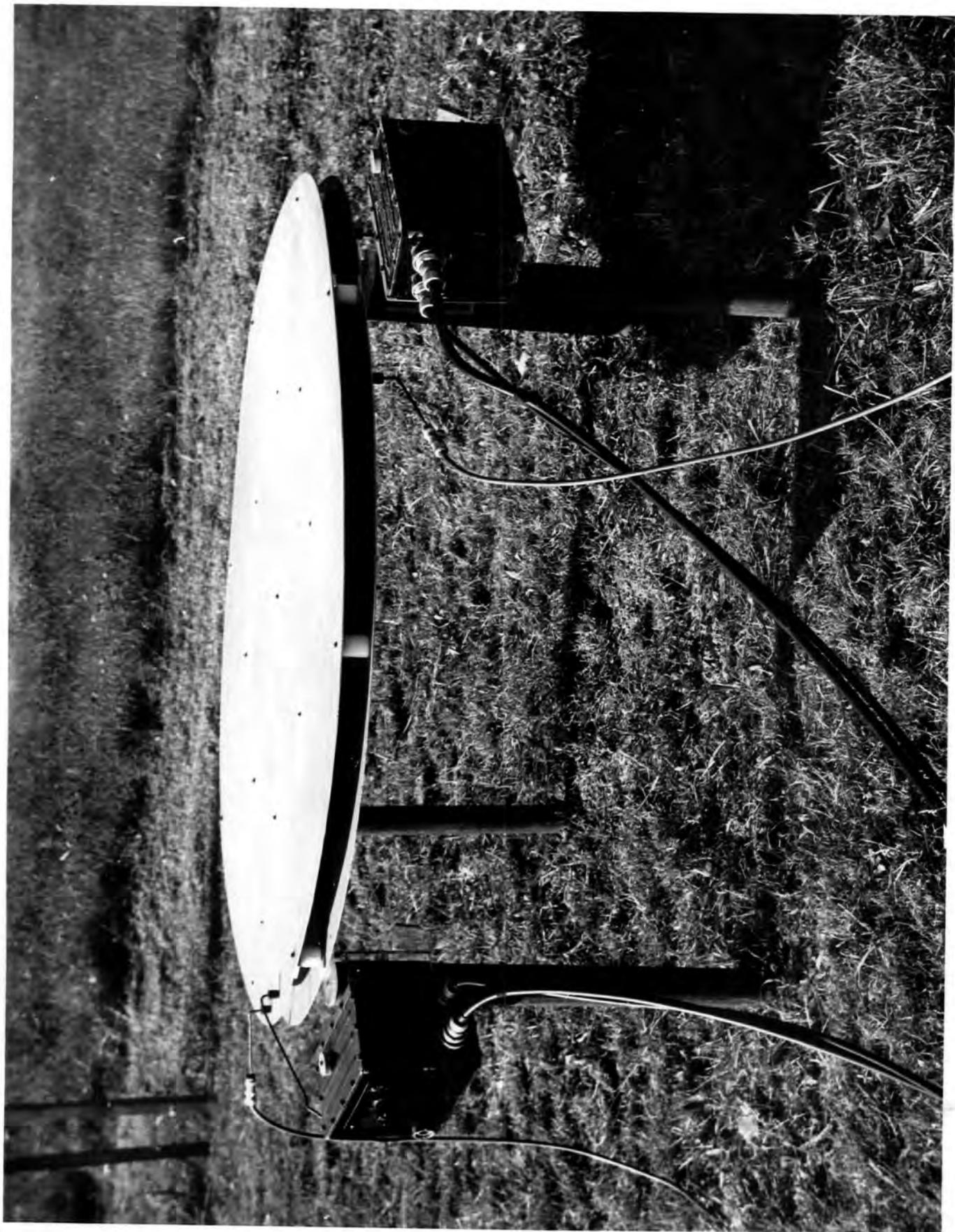

Plate 2a The Current Collector

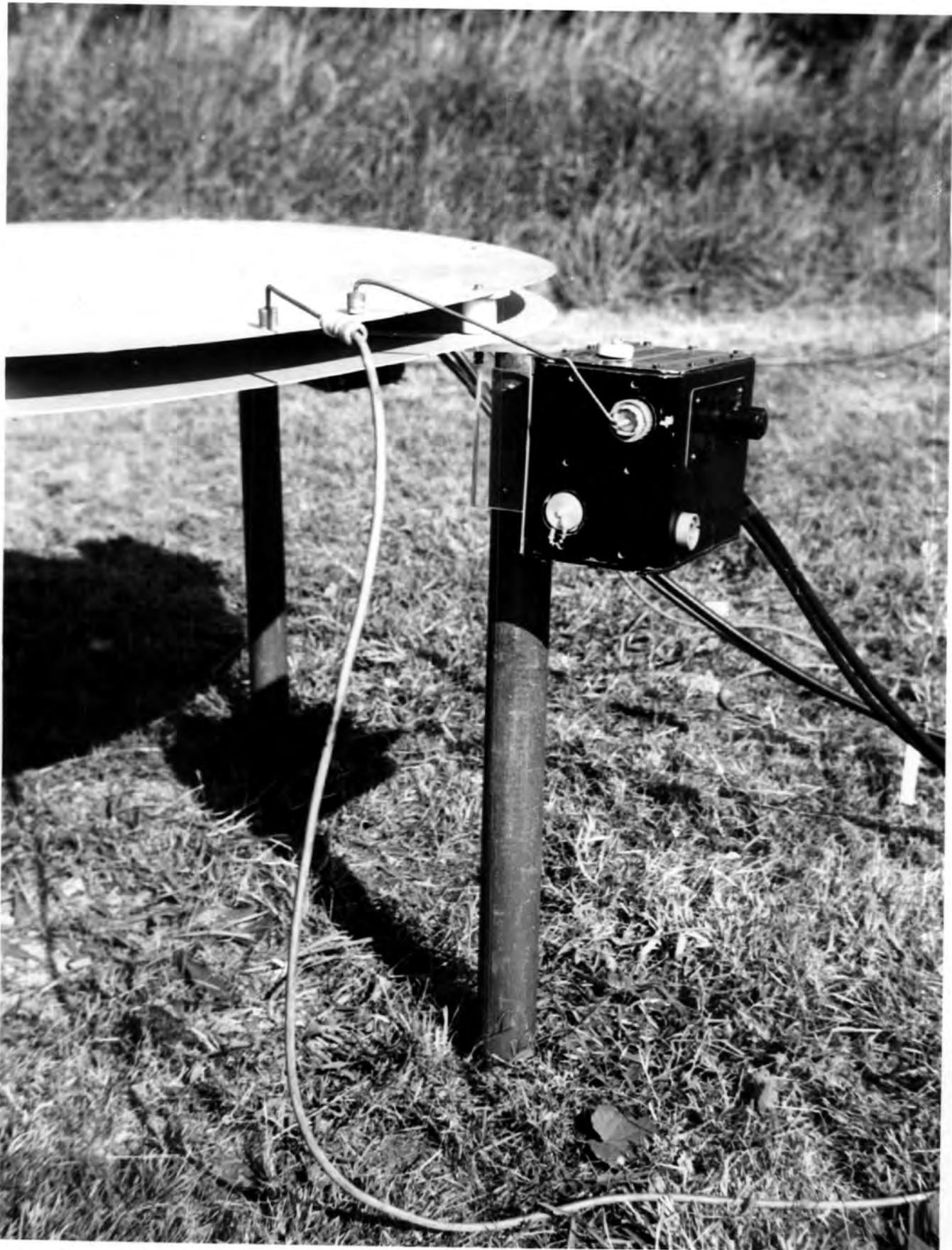

Plate 2b The Current Collector

insulator, the leakage of charge would be small, and yet, because of the slight conductivity, the charge they hold would be small and so the distortion they cause will also be small.

The insulators were not heated, although this can be done by using heater coils wound on the insulator supports, since for fine weather work, the collector is not used in conditions of dampness and the warmth of the heater attracts spiders. When not in use and in rain, the plate was covered by waterproof canvas guyed down. This protected the upper plate, but rain splashes from the ground reached the lower plate even when at 50cm. above the ground.

It was found difficult to prevent piezo-electric effects and leakage between the plates with only 6mm. gap and plate 2. shows the collector rebuilt with 2.5cm. P.T.F.E. pillars between the upper and lower plates with aluminium cross braces on inward facing sides of the sandwich. This is less acceptable theoretically, as the upper and lower plates are now so far separate that they no longer remain at the same height. But the plates must still be kept at the same potential or there will be a conduction current between them.

This form of collector was chosen to be as simple as possible and to allow a natural grass earth surface to be below it.

It would appear necessary, however, that the collector plate should be properly engineered, preferably on the roof of an underground laboratory such that levels and strains can be properly adjusted. It may be an advantage to have more than one sandwich plate after the fashion of GOTO(1957) or COBB and PHILLIPS(1962). Measurement of the charge collected by the plate can be made by an electrometer, by discharge

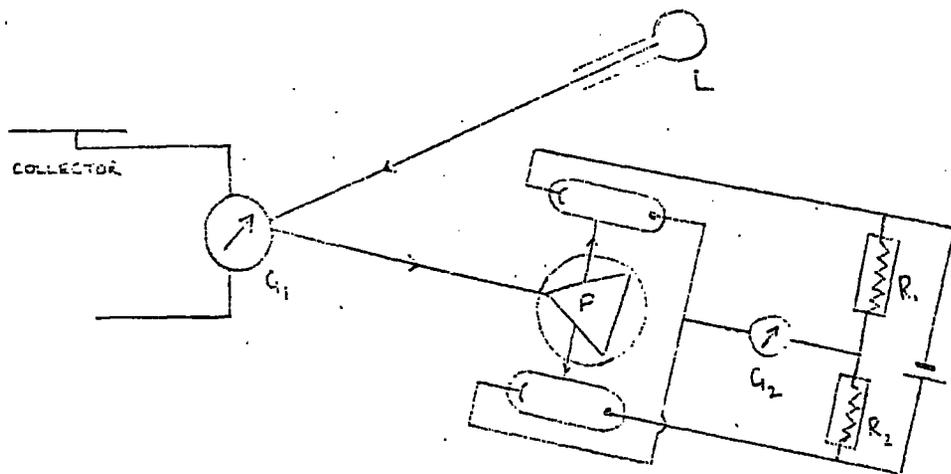

- L Lamp
- P Prism on Rotating Table
- R_1 } Resistance Boxes
- R_2 }
- G_1 Primary Galvanometer
- G_2 Secondary Galvanometer

Fig. 5. The Photocell Galvanometer Amplifier

through a ballistic galvanometer or by direct current amplification.

CHALMERS and LITTLE(1947) obtained results for fine weather conduction current using a highly sensitive ballistic galvanometer. Use of a ballistic galvanometer means that recording must be sequential rather than truly continuous and in an attempt to reduce the time between discharges a photocell amplifier based on the design in reference(11) was constructed(Fig.5). A lamp was mounted so that its beam was reflected by the primary galvanometer to the apex of a right angled prism. The beam is divided by the prism on to two 90CV photocells chosen for their large surface area. The photocells were part of a balance circuit and a secondary galvanometer indicated the out-of-balance throw of the circuit. The prism was mounted on a turn table to increase the degree of adjustment. The necessary sequential operations can be achieved automatically by various methods. A system of polarised relays and a Thorn rotary stepping relay operated by a cam from a synchronous motor was found most reliable (Plate 3.), although a pulse timer such as the cold-cathode valve circuit of BRITEC Ltd.(8) is more sophisticated.

The drawback to all photocell amplification methods of the type used is that the noise level of the primary galvanometer is amplified with the signal and if the signals are close to the limit of sensitivity of the galvanometer then they are no more easily separated than before.

As an alternative to galvanometer measurement a D.C. amplifier using an inverted triode after the fashion of Rowson et al (9) (10) can be built, although in the example constructed for this work great difficulty was experienced in achieving stability. KAY(1950) produced an electronic method of measuring small direct currents. CHALMERS(1956) used a valve

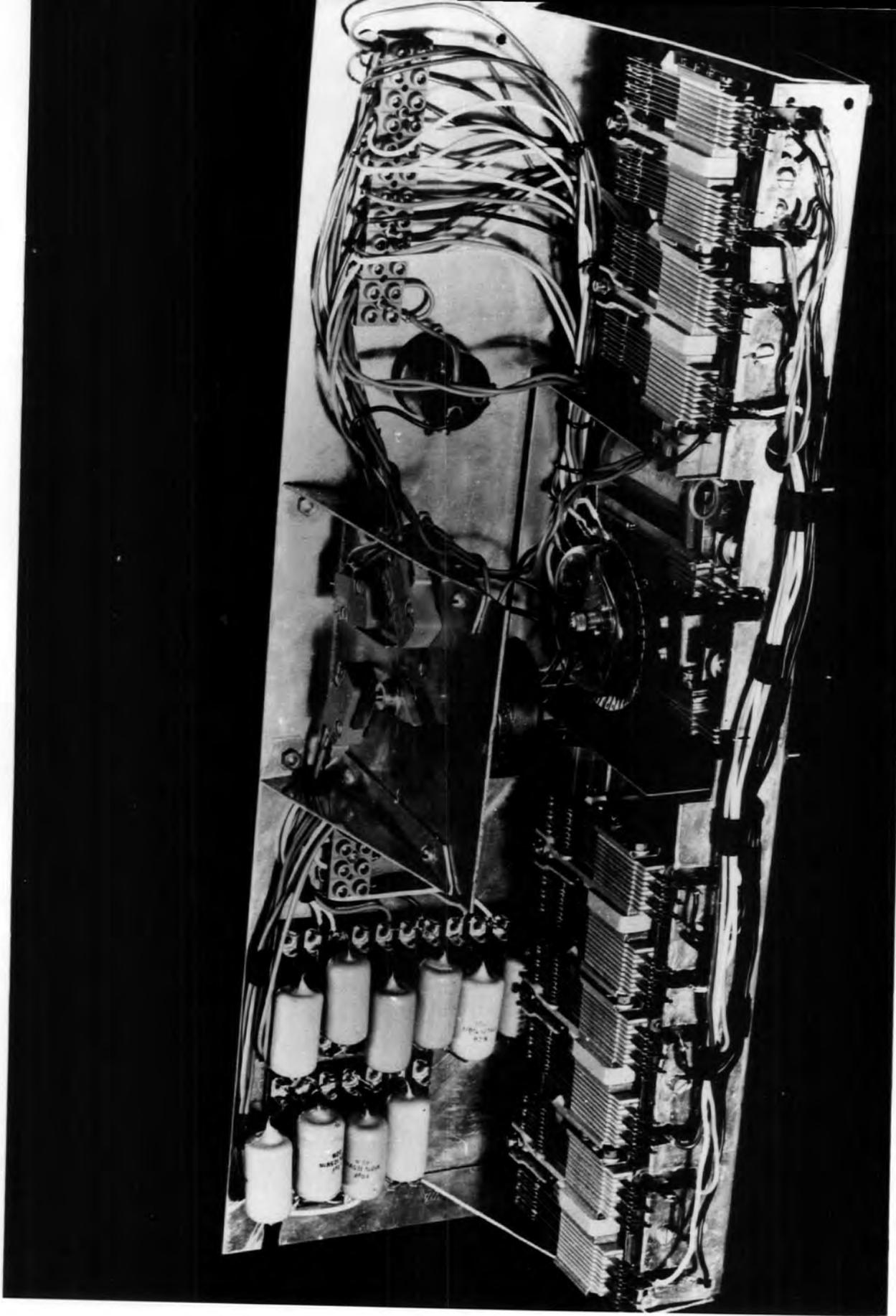

Plate 3 The Timing Mechanism

electrometer and a miniature electrometer valve circuit was used by CROZIER(1963). IMIANITOV(1958) has made a survey of such electronic methods.

Perhaps the most common form of electrometer circuit is the vibrating reed electrometer. This had not been tried originally as the system of compensation for displacement current envisaged required the operation of the electrometer referenced not to earth potential but the potential of the collector plates' surroundings and it was considered that this would affect its stability too drastically. It had, however, the correct sensitivity(3×10^{-14} amps. full scale) and preliminary experiments indicated that it operated successfully at a potential of 100 volts above that of earth and that when this potential was changed rapidly, the disturbance caused was negligible. The head units of two Ekco Vibrating reed electrometers were therefore attached to the collector, one to each plate in such a way as to be insulated from the supports but to minimise distortion(Plate 2.). The measuring units were likewise insulated, so that the system could be maintained at a potential close to that of the collector's surroundings. Their initial performance in the open suggested that the collector plate sandwich, as originally built, generated relatively large piezo-electric charges.

In order to maintain the current-collecting system at the potential of its surroundings, the potential gradient must be measured by a field machine such that the output of the field machine can be applied to the current collector. SMIDDY and CHALMERS(1960) adapted a Honeywell Brown Electronic chart recorder to balance continuously the outputs of a double field mill and thus keep it at the potential of its surroundings.

As originally constructed, the continuous balance unit of the recorder



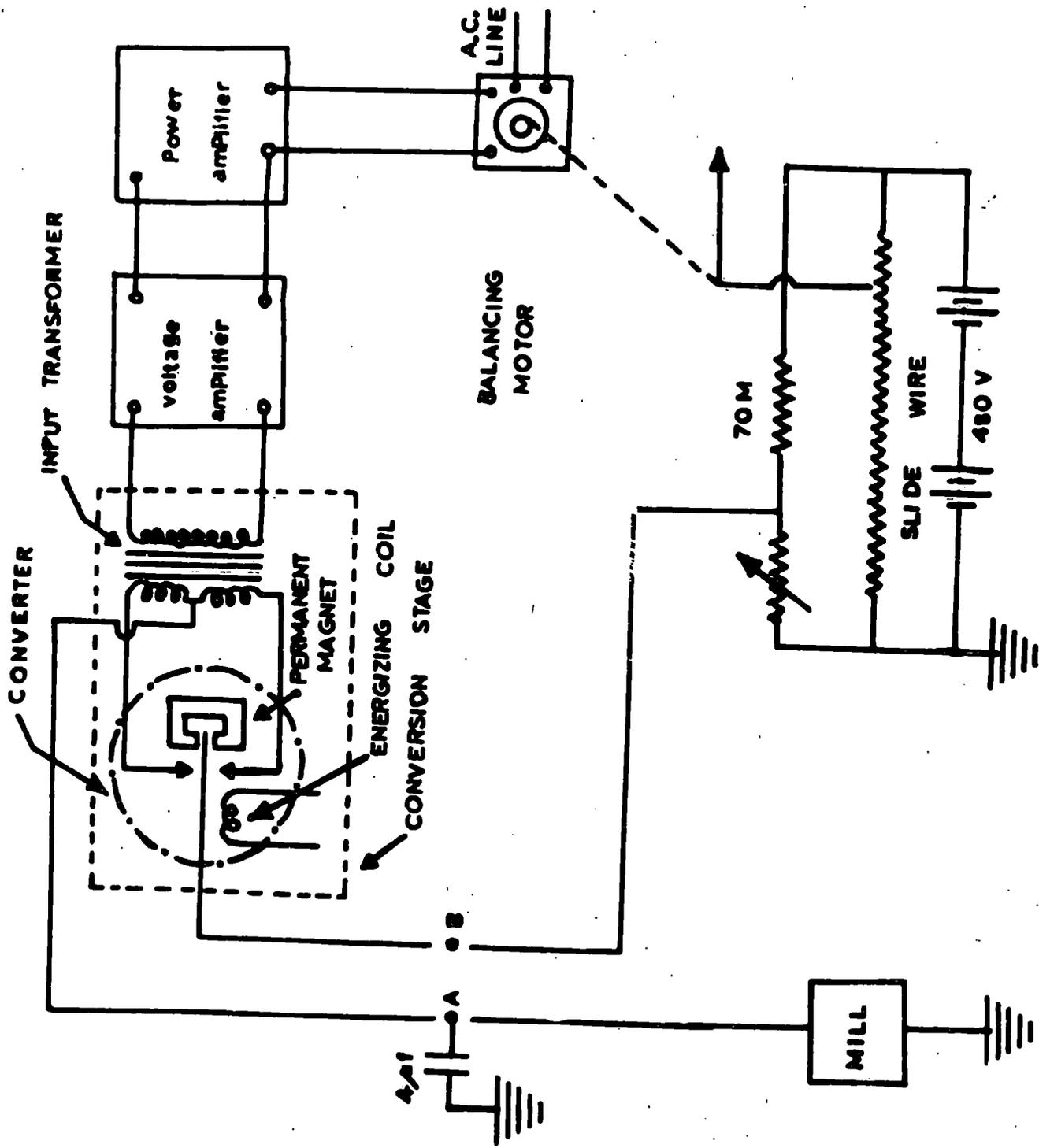

Fig. 6 The Potential Balancing Servo Mechanism

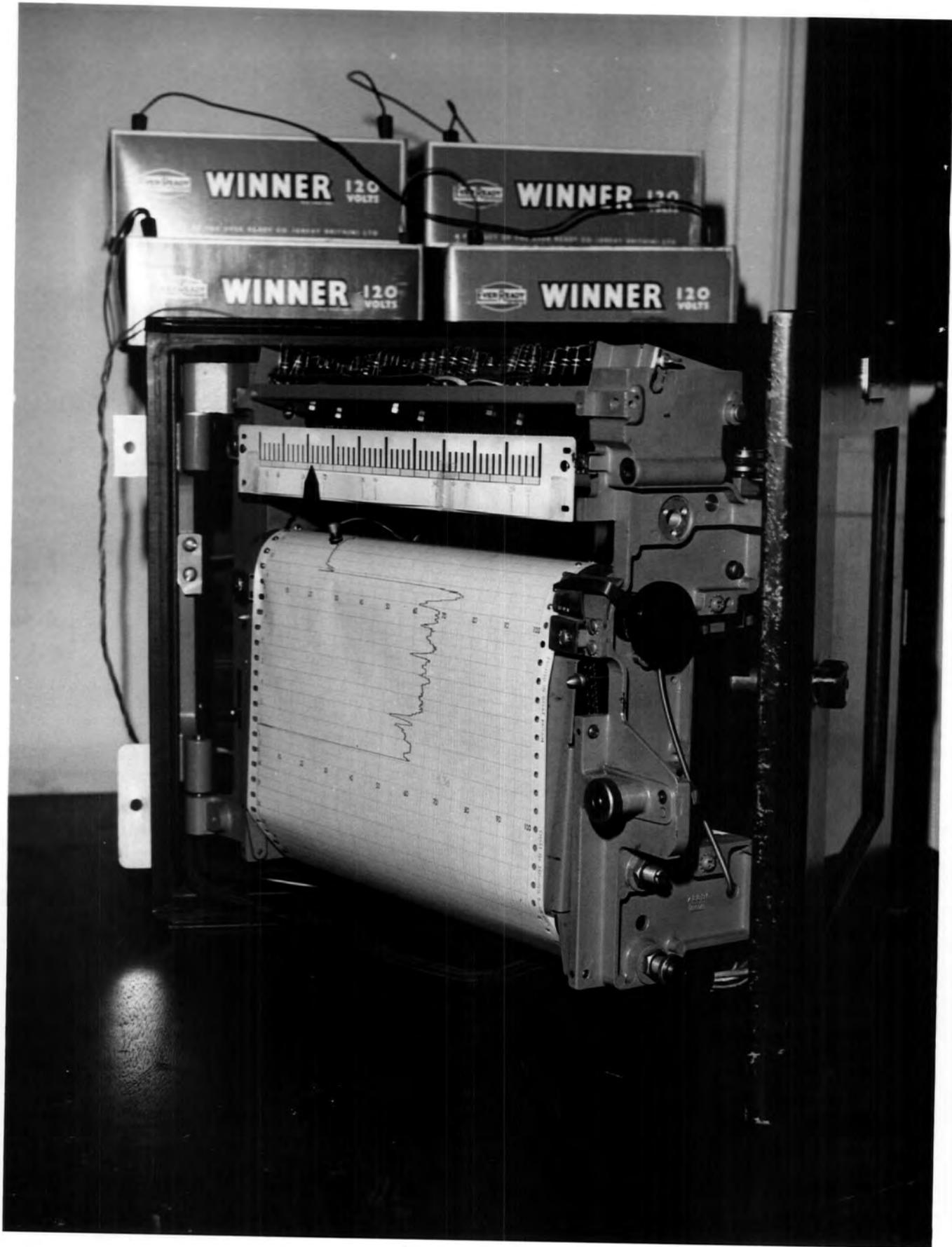

Plate 4 The Potential Balancing Servo Mechanism

compares, by a potentiometric method, an input e.m.f., generated by a thermocouple or similar DC source, with an e.m.f. of known value supplied by the instrument. Any difference between the voltage of the thermocouple and that of the potentiometer slide is converted into AC by a vibrating reed and then in power giving a final output which actuates a servo motor. The servo motor drives the slide to the correct potential (Fig. 6).

For the balancing system to be of use in the provision of voltages equivalent to the potential in the atmosphere, the voltage across the slide wire must be several hundred times that originally supplied. The original slide wire must therefore be replaced by a composite resistance constructed on a tufnol strip. This composite resistance consisted of 101 10BA bolts separated from each other by a $\frac{1}{64}$ " gap, the potentiometer slide moving over the bolt heads. To the reverse side of the bolts, a hundred 10K ohm resistors mounted in banks on printed circuit were soldered. In operation a few contacts at each end have to be shorted out to bring the slide zero and full scale in coincidence with zero and maximum voltage.

HIGAZI and CHALMERS (1966) have described the use of this system to maintain conductivity meters at the potential of their surroundings. The output of a conventional single field mill set up in a pit a few metres from the conductivity meters was amplified and rectified and applied to the recorder. The field mill gives an output independent of the sign of the potential gradient and some method of sign discrimination is usually required. (cf. MAPLESON and WHITLOCK, 1955; ADAMSON, 1960; MALAN and SCHONLAND, 1950; COLLIN, 1962 etc.)

Higazi and Chalmers avoided the need for sign discrimination by

permanently displacing the zero by a small charged plate near the mill. This is permitted if it is assumed that the potential gradient between the ground and the level of the conductivity meters is nearly uniform and thus almost free from space charge. In their case, measurement of space charge (BENT and HUTCHINSON, 1966) justified this assumption. The portion of the field mill output caused by this displacement was backed off by a suitable circuit prior to the output being applied to the Honeywell recorder.

Some work was done on a similar system and the principle could be applied to any field machine with a sufficiently rapid response time. There are disadvantages about using a field mill for the measurement of the potential gradient when the measurement is to be related to the sizeable area of a direct method current collector. The field mill is essentially a point measurement and, if positioned at any level above ground level, requires a reduction factor to compensate for the distortion it causes. The publication of CROZIER's (1963) description of a passive antenna or passive probe offers the advantage of

1. a voltage output equivalent to the average value of the field over the area enclosed by its antenna
2. a fast response time to field changes at the antenna height
3. the feasibility of several antennae, free from mutual interference, vertically above each other and at levels between the ground and 1m.

DOLEZALEK (1963) said that convection currents would charge it like raindrops.

The principle of the passive probe is very old and was used by LEMONNIER (1752) in some of the earliest measurements of fine weather phenomena.

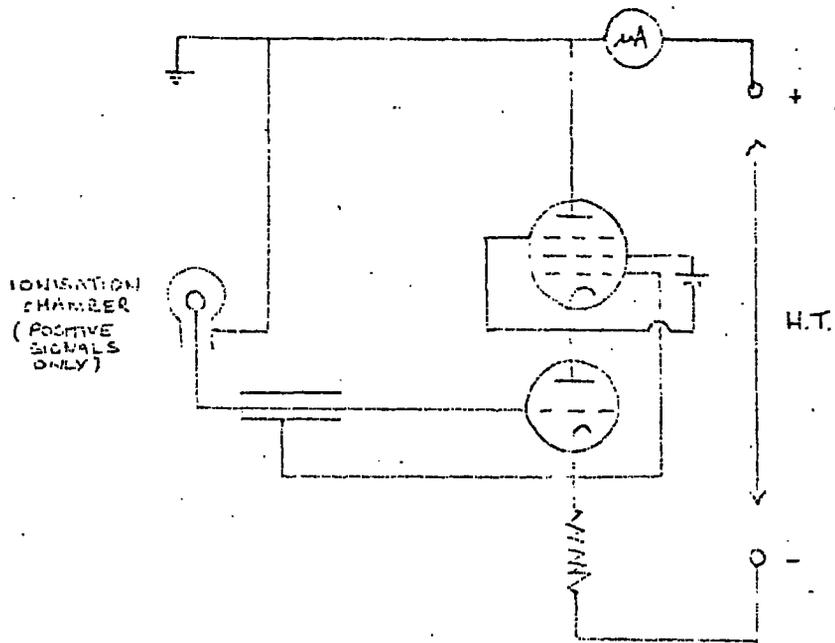

Farmer's Circuit Diagram

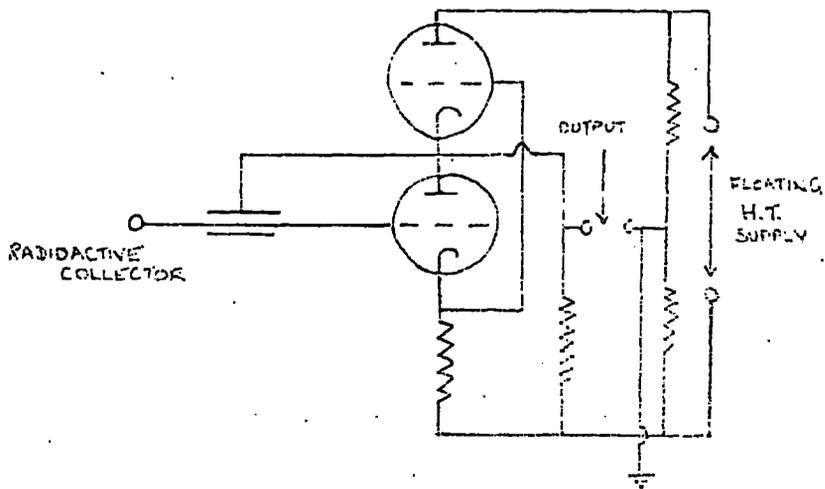

Brewer's Circuit Diagram

A stretched insulated wire or probe acquires the potential of its surroundings because of the conductivity of the air but this is a slow process as to remove a difference in potential, charge of one sign must be carried to the wire or charge of the other sign removed. This process can be speeded up by either ionizing the surrounding air or carrying particles away from the collector. The latter was implemented by VOLTA (1800) using a fuse and by KELVIN(1859) using a water-dropper.

The ionization of the surrounding air can be achieved by using a radio-active source; the most common being polonium, an α -source. As these 'loaded' probes were faster in response and thus more suitable for continuous recording, they became more highly developed than the 'unloaded' or passive probes. It is only recently that the measuring techniques designed for loaded probes have been modified for passive probes.

The radio-active probe is the best of the loaded probes. This measures the potential between the height of the antenna and the earth's surface. If there is a leakage path to earth from the probe, then the antenna will not come to the potential of its surroundings and it would be unlikely that any leak would remain constant.

The first attempt to prevent such leakage was when GISH and SHERMAN (1929) surrounded the insulator of their apparatus with metal connected to a potentiometer and maintained at the potential of the apparatus. Being a null method this gave more sensitive readings but constant adjustment rendered it unsuitable for continuous recording.

BREWER(1953 - Fig.4) used negative feedback to guard a leak-free radio-active collector maintaining the null reading and yet recording

continuously. His circuit was developed from one applied by FARMER(1942 - Fig.7) to an ionization chamber and it is his circuit which has in turn been modified by Crozier for the passive probe.

Farmer replaced the electrometer suspension fibre with the highly insulated grid of an electrometer valve. His original circuit only took a positive signal, although MUMLEISEN(1951) adapted it to take signals of both signs.

Brewer also used a centre zero arrangement to accept negative signals and his circuit produced sufficient power to drive a direct writing recorder. His final circuit had a range of $\pm 500v$ and an amplification factor of 0.99.

The radio-active probe, despite its popularity compared with the passive probe, has its disadvantages. Muhleisen found that the ions produced by the radio-active probe were carried by the wind and could alter the potential by up to 30 per cent.

CROZIER(1963b) therefore applied the basis of Brewer's circuit to the more stringent conditions of the passive probe. The passive probes, whose description follows are based on those of Crozier, adapted for a British electrometer valve.

For the purposes of description the instrument can be divided into two sections, the field installation (Fig.9) and the sensing electronics (Fig.10).

The field installation consists of a suitably insulated antenna, in this case a long stretched wire, one end of which is mounted in the head unit of the sensing electronics. This is connected by a two-conductor cable to an amplifier and power unit housed indoors.

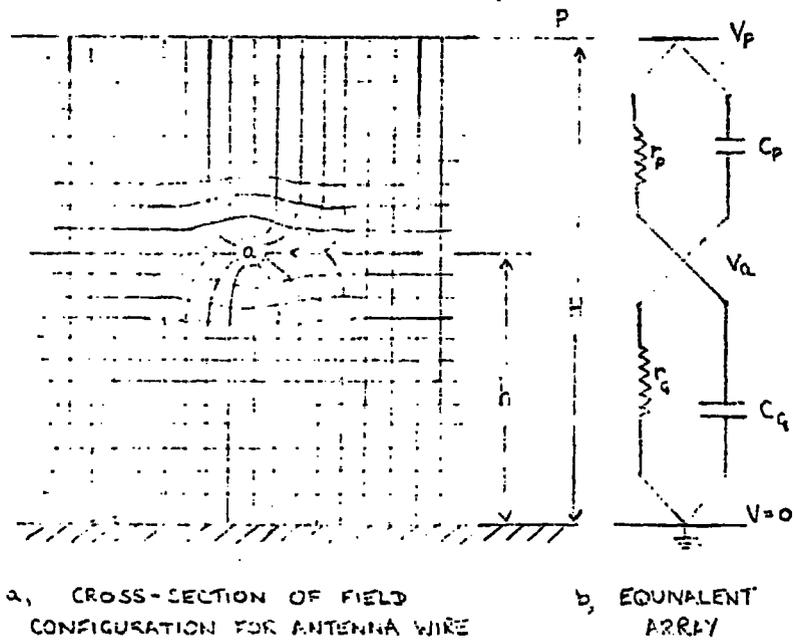

Fig. 8. Passive Probe Equivalent Circuit

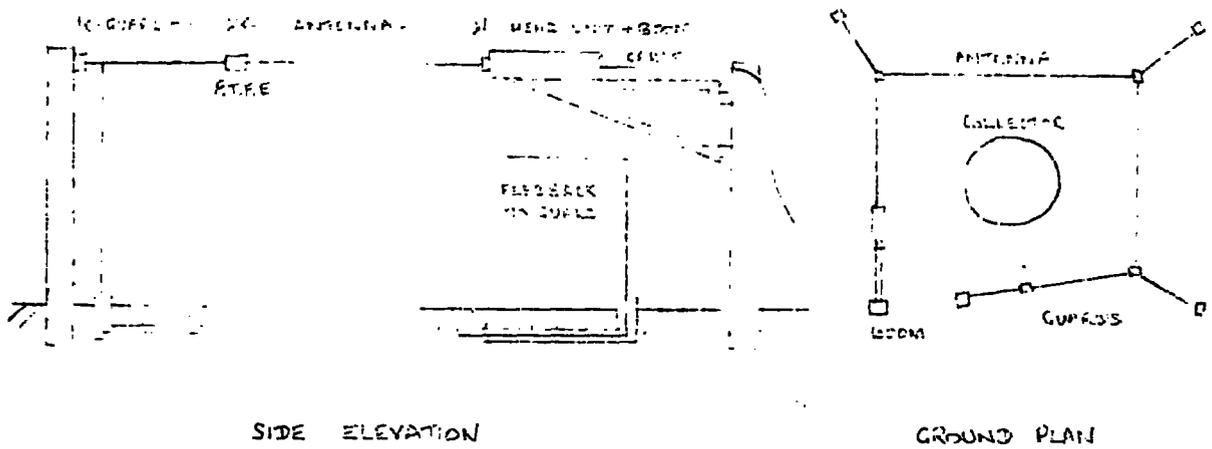

Fig. 9. Passive Probe Field Installation

For theoretical considerations, the antenna may be considered as a well insulated thin wire of cross-section a cms. stretched parallel to the ground at a height h cms. Assuming for the moment, that no instruments are attached, that the atmospheric conductivity is constant and that the potential gradient is steady, then after 10 to 30 minutes (the atmospheric relaxation time) the antenna will have effectively lost any net charge that it may have had. Its potential is then that of the atmosphere at a height h cms. The antenna possesses equal induced charges, negative above and positive below. A current will flow continuously from the antenna through the air to the ground and an equal current flows to the antenna from above. For reference, a plane P at a height H , sufficient to be unaffected by the small distortion of the field near the antenna, will be considered. (Fig.8a.)

It has been assumed that the conductivity λ below P is constant, which implies an absence of space charge. An equivalent resistance and capacitance network that would represent this situation (Fig.8b.) would have the condition,

$$r_G C_G = r_P C_P = \epsilon_0 / \lambda$$

$$C_G = k C_P$$

and $r_P = k r_G$, where ϵ_0 is permittivity of the atmosphere and k a constant determined by the dimensions. The application of an alternating potential $v_P = V_P \exp j\omega t$ to the system at P gives a potential v_a at a equal to $v_P / (k+1)$. Thus the performance of the system is such that the potential of a is a fixed fraction of the potential at P and is in phase with that potential and the fraction is independent of frequency and conductivity. The potential of the free atmosphere at h is

maintained instantaneously at a fraction h/H of that potential at P as the conductivity is assumed constant. Because there is no frequency dependence, then the potential a is also that of the free atmosphere at h .

If the conductivity is not uniform below P, then the condition $r_G C_G = r_p C_p$ does not hold nor is the potential of either the antenna or the free atmosphere instantaneously held at h/H of the value at P. However, the antenna potential can be seen to be maintained at a close approximation to the potential of the free atmosphere. Crozier discusses this non-uniform situation assuming conductivity is a function of height alone. For a cylindrical wire, the distortion of the field is geometrically confined to a space of approximately 10 wire diameters in depth and width. (Fig. 8a.)

For uniform conductivity, the current and field lines converge on the wire from above and below from a width of two wire diameters. Crozier contends that any probable conductivity gradient in the immediate vicinity of the wire will not affect this appreciably. Thus if the ground and the plane P are more than several tens of wire diameters from the antenna, the resistances r_G and r_p are closely approximated by the resistance of air slabs two wire diameters thick extending vertically from the wire to the ground and from the wire to the plane P.

If, now, a step change ΔV_p occurs in the potential at P, then initially there will be a step change ΔV_a in the potential of the antenna and V_h in the potential of the air at antenna height such that

$$\Delta V_a \approx \Delta V_h = \Delta V_p \frac{h}{H} .$$

As the conductivity is non-uniform, r_h/r_H (the ratio of columnar resistances) will differ from h/H and the air potential will relax toward $\Delta V_h = \Delta V_p \frac{r_h}{r_H}$

with a time constant determined by the conductivity distribution. The antenna potential will also relax towards a final value of

$\Delta V_a = \Delta V_p r_G / (r_G + r_p)$, $r_G / (r_G + r_p) \approx r_h / r_H$, so that the final values of ΔV_a and ΔV_h will be practically the same and with almost the same time constant, as, area for area, similar charges must be moved through similar resistances in the antenna current slabs as in the space well to the side.

To develop a numerical example, a 1mm. wire 1m. from the ground would give the plane P, 10 x 1cm. above the wire and the initial step changes ΔV_h and ΔV_a about 99. per cent of the step change ΔV_p . The length of the wire is arbitrary, though if long enough, the magnitude of r_G can be decreased to a point where antenna insulation can be attempted. This increases C_G , making possible the tolerance of a very small capacitance in the sensing unit. (As previously noted, insulation and capacitance problems had previously limited the use of the passive probe.)

Taking the length of the wire as 20m. and assuming the ends are guarded, $\epsilon_o = 8.85 \times 10^{-12}$ farad m^{-1} and a value of $\lambda = 5 \times 10^{-14}$ mho m^{-1} , then on the above model $r_G = 5 \times 10^{14}$ ohms and $C_G = 0.35$ pf. In a potential gradient of 100 volts per metre, a current of 2×10^{-13} amp. flows to this antenna from above, and from this antenna to the ground, through the air. To measure this current to an accuracy of 1 per cent, the current drawn by the sensing unit and across the insulators must be no more than 2×10^{-15} amp. and the input capacitance to the sensing unit around 0.003 pf. The apparatus attempts to meet these rigorous requirements by the use of feedback techniques and high quality insulation. The system used at Durham consisted of antenna of 20 metre 20SWG tinned

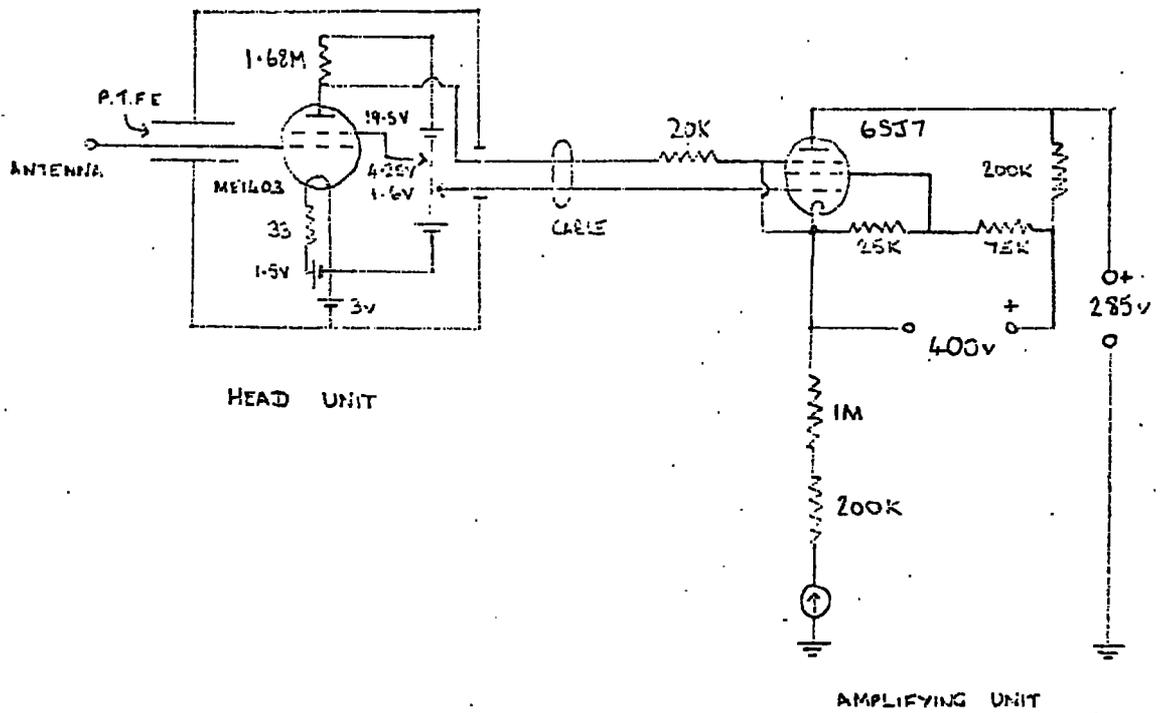

285V POWER PACK

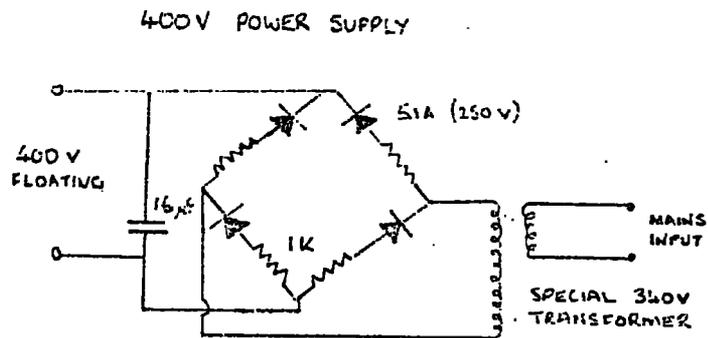
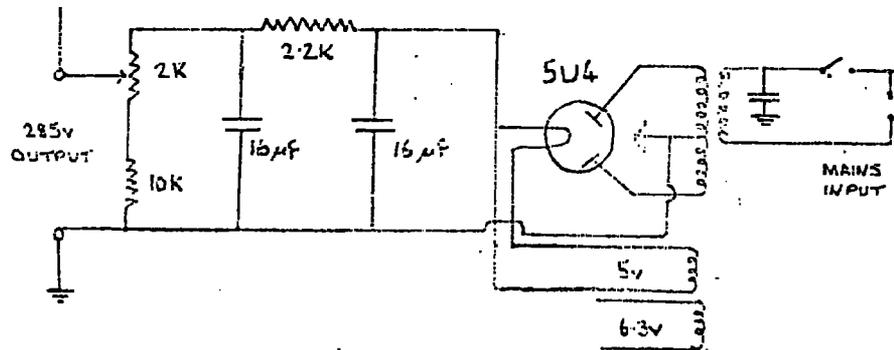

Fig. 10. Passive Probe Circuit Diagrams

copper wire suspended from wooden posts by means of a 2m. guard wire. The sensing unit of the antenna was mounted on an aluminium boom of approximately the same length as the antenna height above ground. The insulation of the antenna and guard wires was P.T.F.E. The head unit boom was supported by insulators of perspex. Since the sensing unit and boom were maintained at a potential close to the antenna potential by the feedback, the end effect was small and the field distortion introduced by the wooden posts was largely neutralised.

The sensing electronics is represented in fig.10. One end of the antenna led through the P.T.F.E. bushing to the control grid of a Mullard ME1403 electrometer valve which was housed with the various biasing batteries in the head unit.

A two-conductor cable took the output signal plus the bias of the electrometer valve and applied it between the control grid and the cathode of the 6SJ7 cathode. The floating 6SJ7 circuit together with the fixed 285v. supply, generated a feedback potential at the 6SJ7 cathode. This feedback potential was applied to the whole electrometer valve circuit, the head unit case and guard wires through the two-conductor cable. The circuit was economical when several probes were in operation as the 285v. supply could be common to all and no separate floating screen voltage supplies were required.

Since the head unit case and boom acted as a guard, it should be near the potential of the antenna, In fig.10. it is attached 3v. below the negative filament terminal resulting in its being maintained at about -0.9v. with respect to the antenna. The insulator leakage would then be in the correct direction to tend to neutralise the negative grid current



Plate 5 The Passive Probe Field Installation

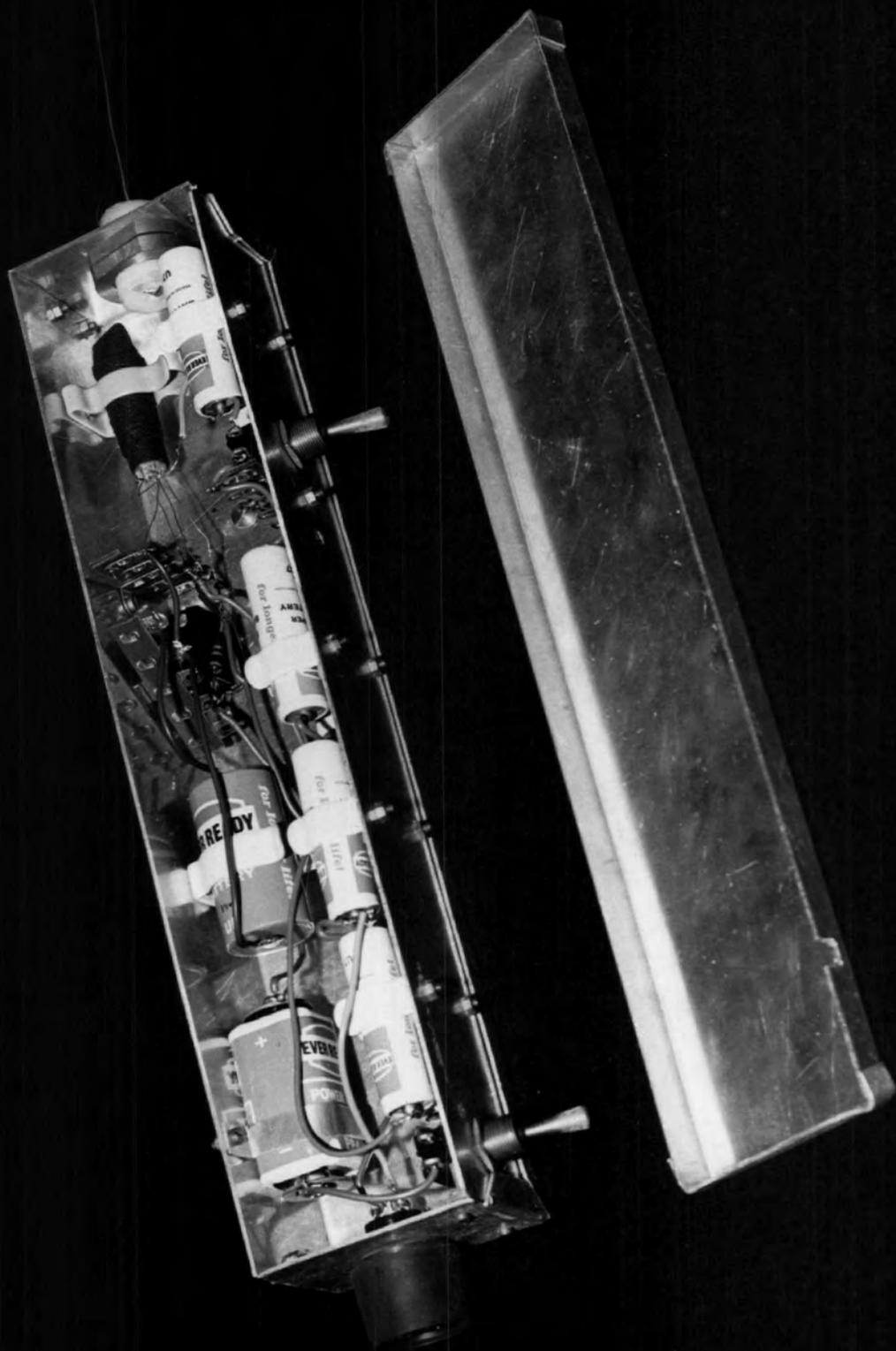

Plate 6 The Passive Probe Head Unit

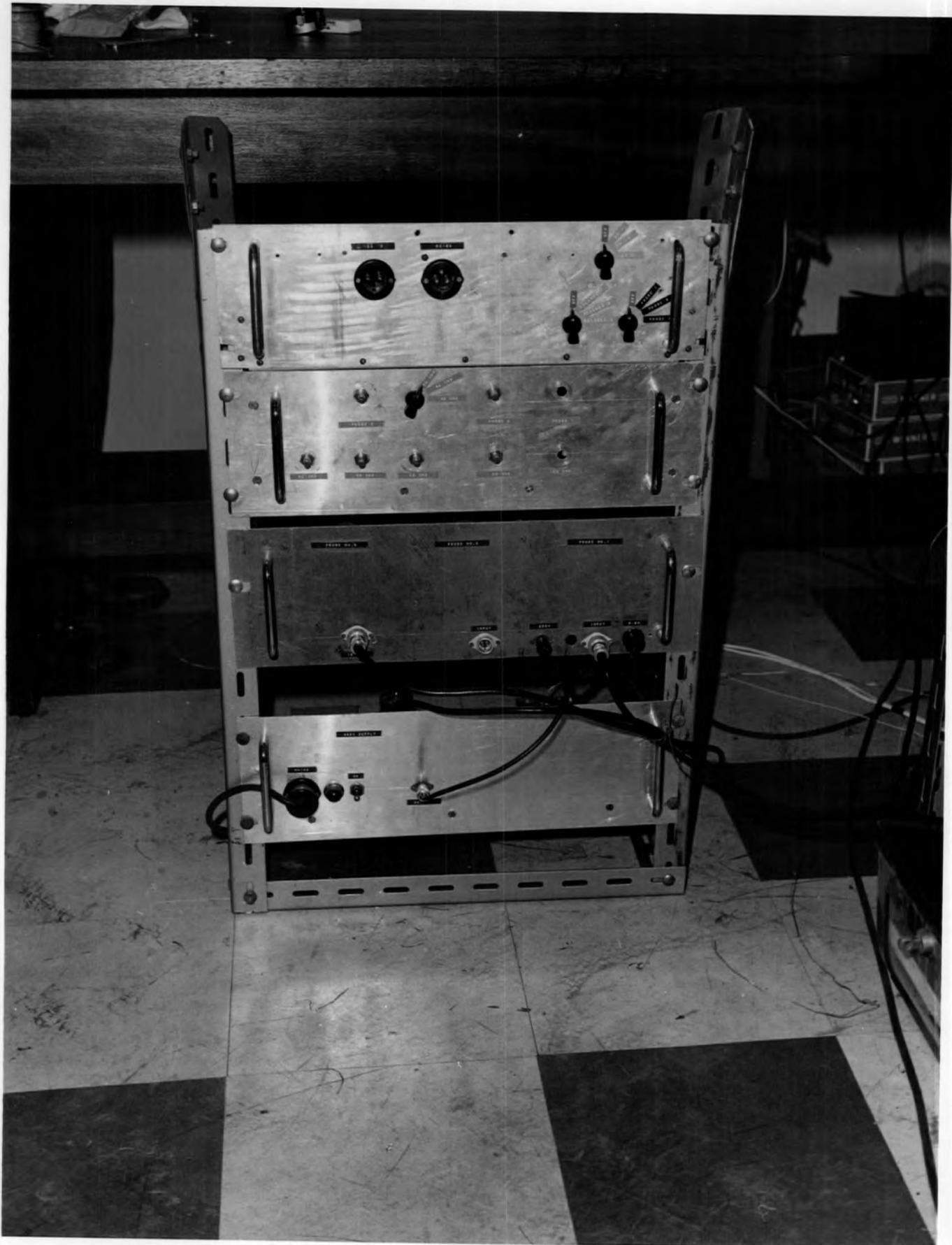

Plate 7a The Passive Probe Ancillary Electronics



Plate 7b The Passive Probe Ancillary Electronics

which at 3.0×10^{-15} amp. is just above the 1 per cent limit acceptable for a 1m. high 20m. antenna. The voltage gain of the arrangement was sufficient to reduce the input capacitance of the ME1403 grid from 0.2 pf. to less than 0.003 pf.

The potential between point B and the ground follows the potential of the antenna at A with a small effect and any suitable voltage measuring unit drawing less than 0.5 mA. can be connected at B. Overall calibration of the circuit could be obtained simply by applying known voltages between the antenna wire and the ground. The expected range for the instrument was from -100v. to 250v. in fine weather. The instrument was not usable during rain, as the moisture lowered the insulation and raindrops hitting the antenna deposited charges or caused charges by splashing. The head unit and booms were protected by tailored polythene covers during wet weather.

The original intention was to effect a modification to the head unit so that only the electrometer valve was housed in it, bias voltages being supplied to it by weatherproof cables. A similar modification was made by SPANGLER(1962) who sealed the electrometer valve in an epoxy assembly with a needle type antenna for the measurement of biological potentials where space was at a premium. The advantage for outdoor use is not so much space as a weight reduction which would allow a lighter, more compact boom and reduce tension on the insulators. Fig.11. shows the layout of the design. The casing was of brass tube, in the lower end of which was fixed a BTG valve base with a P.T.F.E. insert. The electrodes of the ME1403, except the control grid, were soldered to this. The soldered joints must be further than 1.25cms. from the glass sheath of the valve

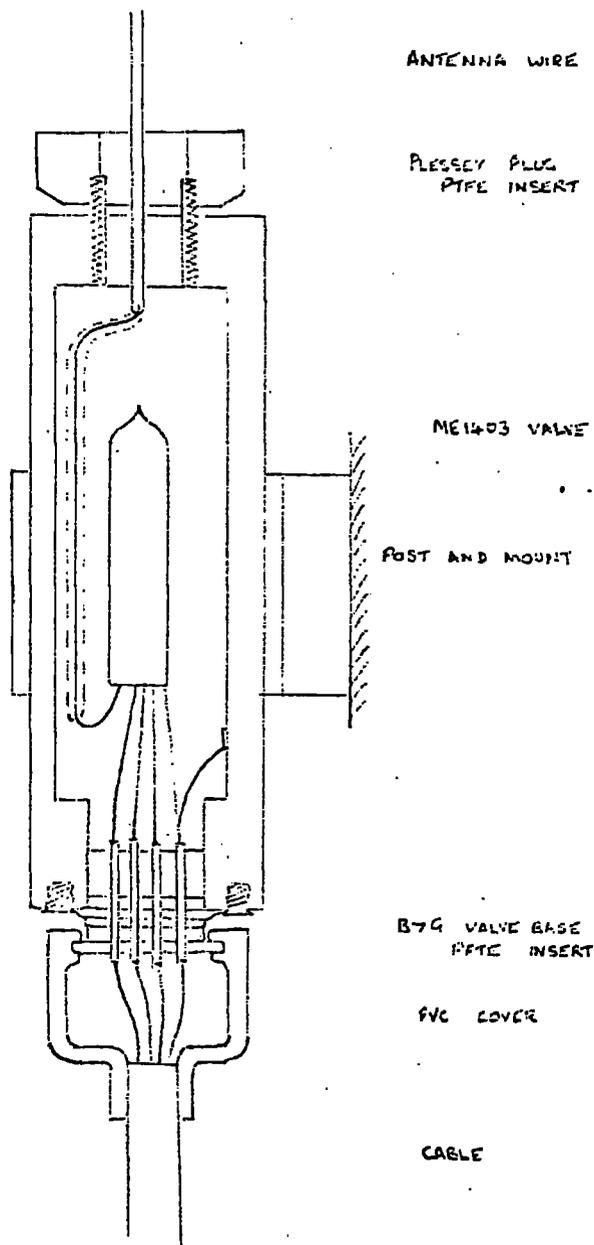

Fig. 11. Experimental Valve Housing after Spangler

to prevent damage to the valve. The control grid electrode was sheathed with PVC and led clear of the valve and wall to a Plessey coaxial plug with a P.T.F.E. insert at the other end of the tube. The mating end of the Plessey plug was attached to the antenna wire. The head unit was fixed to the boom by a curved 'clip' of brass and was connected to the rest of the sensing unit by a six core cable.

Spangler surrounded his valve with an inert atmosphere of nitrogen sealed in with epoxy resin. The ME1403 unit was first tried as described with an air atmosphere and then completely encapsulated with Araldite epoxy resin, but the difficulty with this head unit in outdoor conditions proved to be the collection of dirt and moisture across the insulation of the B7G valve base. Great care must also be taken in handling the valves themselves or insulation breakdown occurs across the glass sheath between electrodes. Once contaminated, they are very difficult to clean successfully. One further disadvantage with the resin sealed valve is that once sealed, it cannot be inspected. The ME1403 grid current, measured over high resistances by a Philips GM6020 electrometer, was found to be higher than the stated characteristics. It was therefore decided to make a larger head unit, more amenable to experimentation and containing its own bias voltages. From this, the final head unit (Plate 6.) was developed. The electrometer valve must be kept in darkness to minimise the photoelectric increase in grid current on exposure to light.

Fig. 12. shows a calibration curve obtained for this probe by applying known voltages between the antenna and the ground. The curve suggests a linear response for an antenna at 1 metre over a range of 300 volts/metre positive to 150 volts/metre negative. It will be noticed that the curve

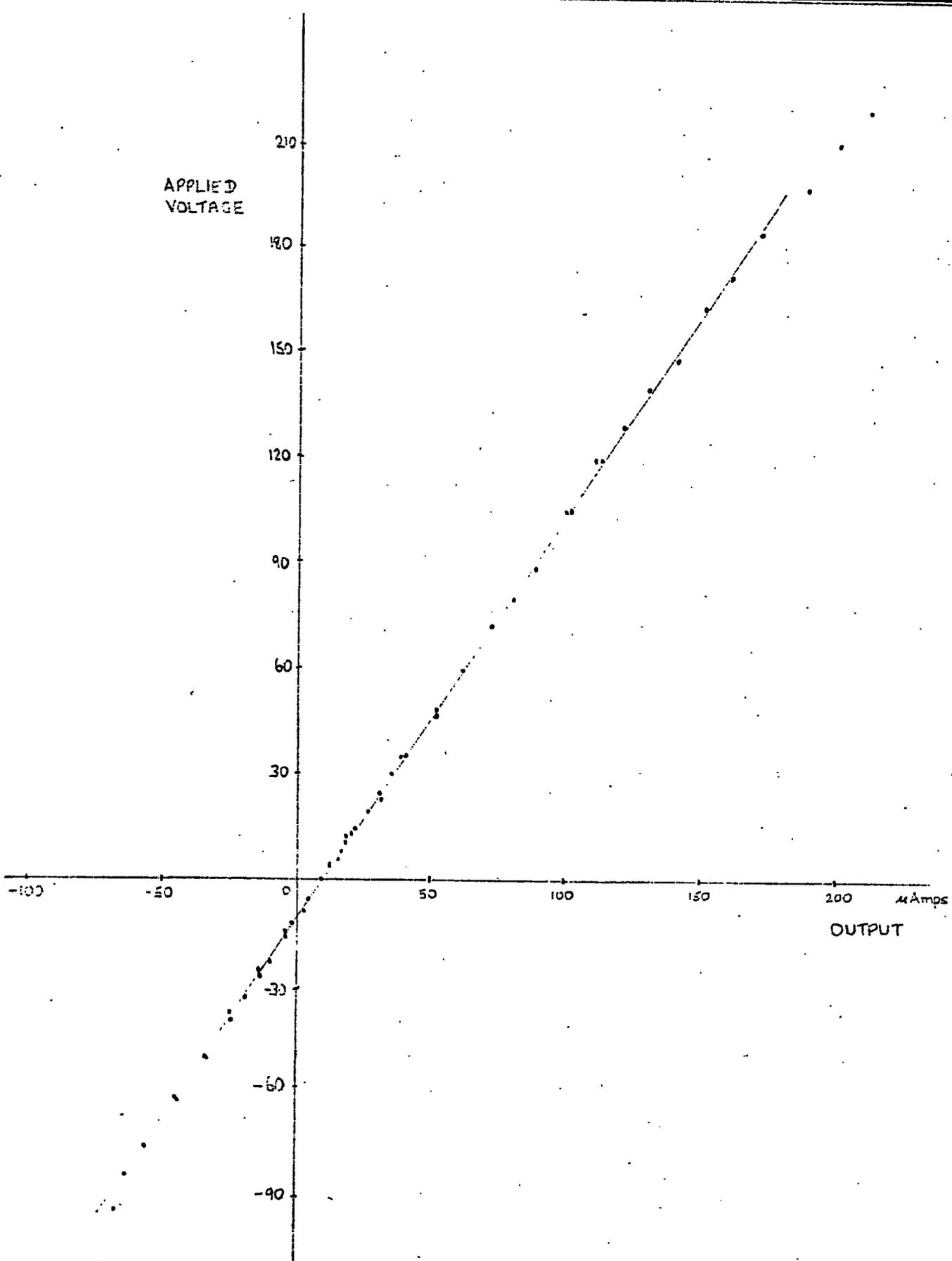

Fig. 12. Calibration Curve of Passive Probe

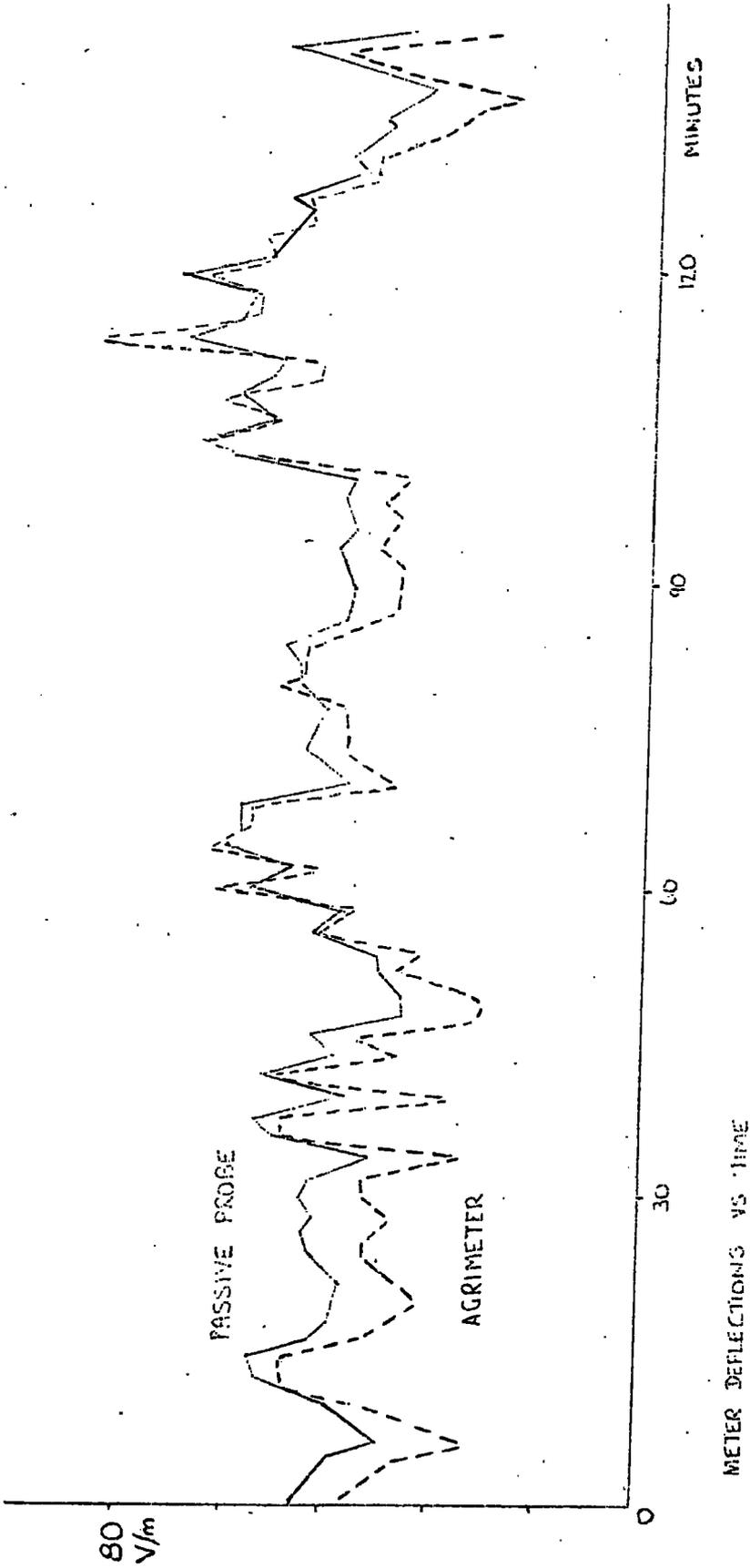
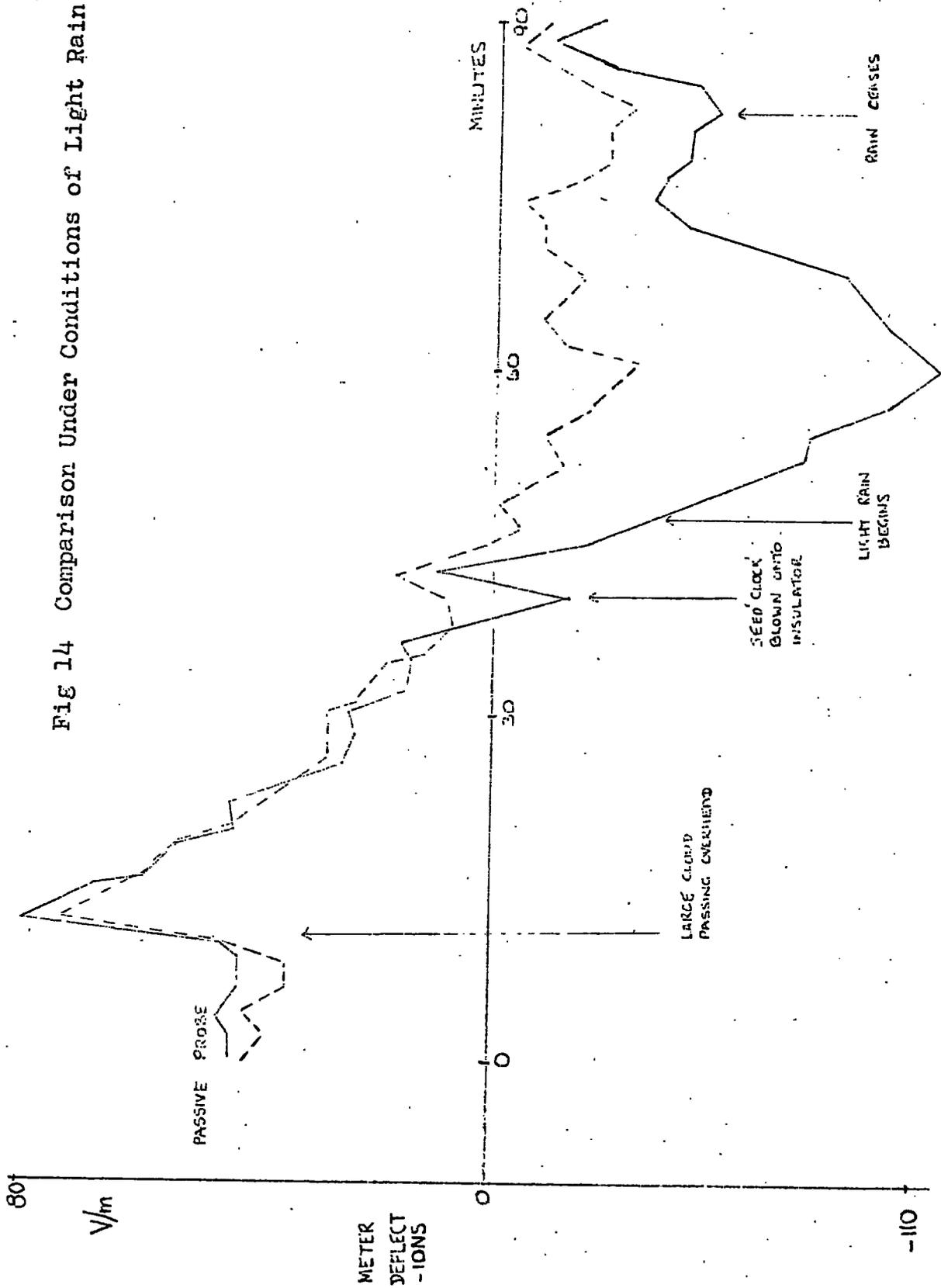

Fig 13 Comparison of Passive Probe and Agrimeter

Fig 14 Comparison Under Conditions of Light Rain



does not go through the origin but gives a zero field output of 84amps. It was thought possible that this was due to contact potentials, though contact potentials in this instrument do not have proportionally the same effect on the measured field as do the internal contact potentials of a field mill.

Typical comparisons are shown in figures 13 and 14. Fig. 13. shows a steady fine weather afternoon with little cloud. It would be expected that the instantaneous variations of the passive probe would be less violent than that of the agrimeter as the latter gives point measurements rather than the probes averaged values.

Fig. 14. indicates charging of the antenna as conditions of very light rain developed. The large positive peak occurred as a big cumulus cloud came overhead. The output from both probe and agrimeter went negative as the rain started, but the probe drifted rapidly more negative and only returned toward a reading comparable with the agrimeter as the rain ceased. It must be emphasised that light rain caused these results. Under moderate and heavy rain, moisture collected on the insulators and the high resistance necessary for operation was broken down. Trouble was also experienced with spiders' webs, wind-blown seeds and air-pollution. It was found advisable to give the insulators a daily routine clean and to check again before use.

Crozier's antenna - a straight two-ended system - apparently gave a fairly satisfactory performance with no guard section and full antenna potential across the insulators.

Keeping the antennae level at their respective heights was another routine adjustment, as the wire stretched under tension and its length

varied with temperature. Occasionally it was severely strained by strong winds or collision with dogs and similar animals. Birds did not perch on the antennae but were content to sit on the support posts and contribute considerably to the insulator cleaning problem. A useful modification would be to have the guard wire insulators made from several metres of nylon attached to a device similar to a fisherman's reel, insulated from but mounted on the support posts. - This would simplify adjustment problems considerably.

Despite the practical difficulties of maintaining the antenna system, it is considered that the reasons for the unsatisfactory performance of the passive probes at the observatory site were primarily connected with the conditions in which the electrometer valve was expected to work. The grid current is required to be very low and this essentially means low leakage. DAGPUNAR(1958) quotes experiments in which a ME1402 valve operating at rated values, had a negative grid current of 1.3×10^{-15} amp. in a light-tight box which rose to 3×10^{-13} amp. when exposed to dust and humid air. It was also noted that a $\frac{1}{4}$ " diameter hole in a box containing the valve in some instances gave a photoelectric current of 10^{-12} amp. Attempts to control the humidity within the sensing unit were made with the installation of desiccator units.

Electrometer valves are also sensitive to vibration and mechanical shock which may result in a change in valve geometry and corresponding changes in the valve characteristics.

However, if the design of the sensing unit can be developed to isolate completely the valve from the uncertainty of its environment, there is no doubt that the instrument is a valuable addition to the range of field

measuring devices. Its development and the accumulation and interpretation of potential gradient measurements by this method are worthy of separate study. Aspects that would be of particular interest would include the determination of exposure factors of other field measuring instruments, the variation of potential gradient with wind speed close to the ground both laterally in tracking the course of charged dust clouds across a test site, or vertically in the measurement of departures from potential linearity such as those during conditions of a strong electrode effect. Correlation with space charge measurements would not be easy because the latter are essentially measured at a single point.

Compensating for the displacement current is perhaps the most difficult part of the direct method of air-earth current measurement, if the resolving time of the apparatus is to be fast enough to give records distinguishing local effects from world-wide effects.

Mention has already been made of the early work, where the measured current was integrated with time and the displacement current effectively neglected, and of the designs of SCRASE(1933), GOTO(1957) and KASEMIR(1955) whose speeds of response were limited by the response of a radio-active collector, of a waterdropper and the relaxation time of the atmosphere.

ADAMSON(1960) developed a system which gave a much faster response time of the order of 20 seconds, although this is still some way from the desired 1 second response. An average change in potential gradient of 1V/m in 1 sec. at a potential gradient of 100V/m will give a displacement current of $8.8 \times 10^{-12} \text{ A/m}^2$, when the conduction current may only be $2 \times 10^{-12} \text{ A/m}^2$. Adamson used a field mill designed with overall negative feedback so that the relation between the field and the output

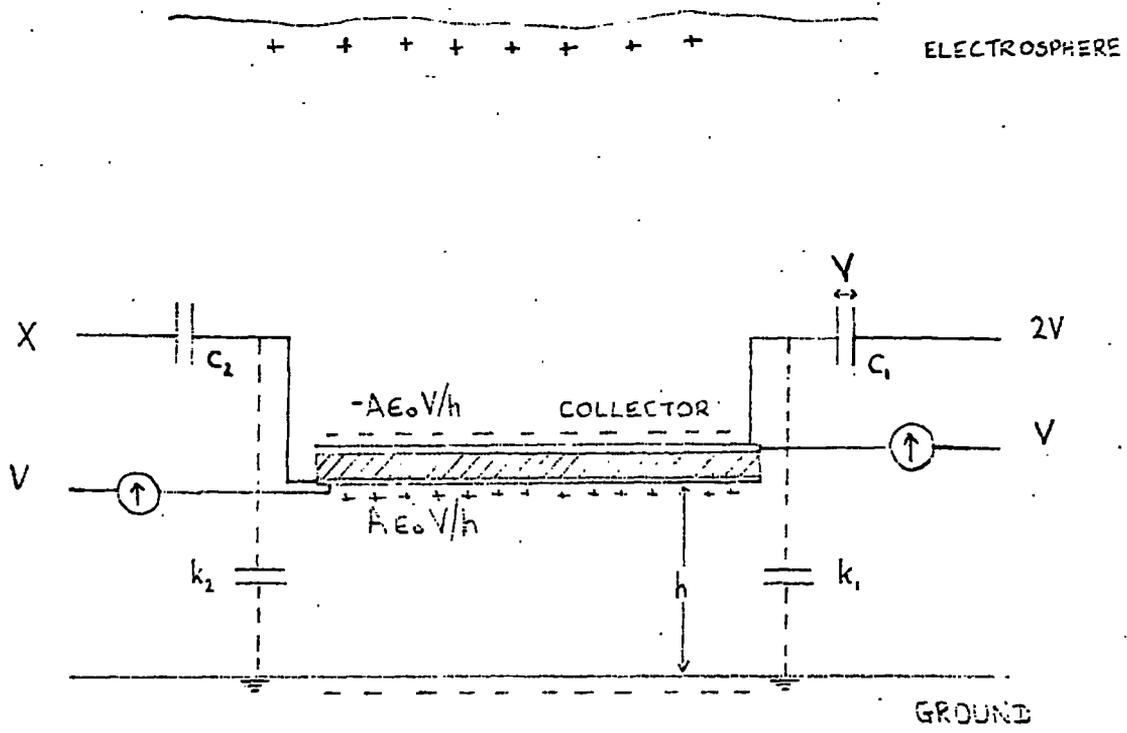

The potential at X must be zero volts if the whole of the bound charge is to be zero. If the net charge is to be zero, X must be $2V - 2dV$ for an incremental change dV in potential and would thus involve a difference meter of some kind.

Fig. 15. Compensation System

was closely linear. The output of the mill was then differentiated and fed into one half of a double electrometer valve. To the other half of the valve, would be fed, for fine weather work, the current from an unshielded current collector. The differentiated signal from the mill is proportional to the displacement current and so both halves of the valve receive the displacement current signal and the final response amplified by the d.c. amplifier is due only to the conduction current.

CHALMERS(1963) suggested the possibility of compensating for the displacement current by using a rapidly responding field machine to measure the potential at the height of the current collector. The output would then be used to apply a voltage to the plate to keep it at the potential of its surroundings and also to apply a voltage equivalent to twice that potential to a condenser that is connected to the collector and that has the same value as the sum of the stray and cable capacitances. The suggestion is that if the response time of the compensating system is sufficiently rapid, then the change in bound charge on the collector plate will always be balanced and the net change in bound charge will be zero. This differs from earlier methods in that the displacement current is eliminated from the collector itself. Applied to the collector system suggested by CHALMERS(1962), the system would appear similar to fig.15. The difficulty may be in the production and application of the doubled voltage and in the speed of the instantaneous matching of the system. HUTCHINSON(1966) described the partial success of a similar system with the current collector at ground level. He was able to show that the compensation could be effective and instantaneous, although he was troubled by zero fluctuations of the field

mill system which limited the sensitivity. In order to reduce the noise level of the system, he suggested the use of a field-difference meter which would respond immediately to the departure of the field from a convenient average value which was itself being adjusted constantly as the potential gradient altered.

The displacement current can be reduced if the current collector is surrounded by a raised shield. If the collector is at ground level this can be earthed. If the collector is raised above the level of the ground, then the shield can either be raised relative to the collector and maintained at the potential of the collector or kept in the plane of the collector at a potential slightly less than that of the collector. The choice would depend on the mechanics of the collector system. The object of the shield is to divert a portion of the displacement current from the collector by altering the disposition of the lines of force. Unfortunately, as the ions will also follow the lines of force, some portion of the conduction current will also be diverted. In fine weather work, the shielded receiver will not suffer from the charging by collision that occurs when raindrops impact upon it but it may interfere with the identification of the effects of local space charge pockets that may move in the atmosphere with a horizontal velocity component. If continuous recording is to be undertaken, it is feasible to translate data direct to a digital form for rapid access to a computing system. This has already been achieved at Durham with records from a mobile instrument van. It would be possible to improve on the original system of integrating the current with time and thus neglecting the displacement current by computing the compensation required at any instant from a

continuous record of potential gradient and adjusting the current records accordingly.

CHAPTER 4. VALUES FOR THE AIR-EARTH CURRENT

4.1. Comparison of Published Values for the Air-Earth Current.

Early measurements of the air-earth current by the direct and indirect methods near the ground seemed to indicate that the indirect result was twice the result given by the direct method which was expected if the conductivities of each sign were constant with height and did not vary and if convection currents were present.

WILSON(1906) had his apparatus set in a site on a hill (Hamildon Hill, near Peebles) reasonably clear of obstructions affecting the field and measured at various heights without attempting to determine any relationship between the heights.

SIMPSON(1910) obtained values, when corrected for displacement current, of the order of $3.4 \times 10^{-12} \text{ A/m}^2$ though his site, a tennis court ringed by stop nets, trees and mountains, was not entirely suitable.

WATSON(1929) used a Wilson apparatus at Kew and compared the results obtained there for the direct method with results obtained at various continental stations by the indirect method.

Kew	$0.79 \times 10^{-12} \text{ amp/m}^2$		
		$\frac{\lambda_1}{\lambda_2}$	$\frac{F\lambda_1}{\lambda_1}$
Gottingen	$2.7 \times 10^{-12} \text{ amp/m}^2$	0.98	$1.3 \times 10^{-12} \text{ amp/m}^2$
Potsdam	$2.37 \times 10^{-12} \text{ amp/m}^2$	1.16	$1.27 \times 10^{-12} \text{ amp/m}^2$
Davos	$1.71 \times 10^{-12} \text{ amp/m}^2$	1.13	$0.91 \times 10^{-12} \text{ amp/m}^2$

The simple electrode effect postulated by VON SCHWEIDLER(1908) and others, was not found by Watson for Kew, as the variation between the potential gradient with height in the first few metres was small and so he concluded that there must be turbulence carrying a positive conduction current

of a magnitude equivalent to $F\lambda_2$ upwards against the field.

WHIPPLE(1932) suggested that a process of eddy diffusion could carry positive charge upwards. The magnitude of eddy diffusion which is greater than that of ordinary diffusion depends on the meteorological conditions, especially the temperature gradient, and will vary with time and place. Eddy diffusion cannot produce any vertical electrical current unless there is a variation of space charge density with height. Space charge depends on dF/dx and thus the electric current of eddy diffusion is proportional to d^2F/dx^2 . The criticism was therefore made that, as the vertical velocity of eddy diffusion was small, a fairly large positive space charge would be needed and this would produce a change of potential gradient with height, greater than that actually found. LETTAU(1941) extended the theory for eddy diffusion varying with height but the criticism remains.

NOLAN and NOLAN(1937) operated both direct and indirect methods simultaneously at Glencree; directly by using Wilson's method and indirectly by counting positive and negative ions and estimating their mobility. They found that the conductivity was the same to within 10 per cent by both methods. Considered with a field that was found to be practically constant over the first metre, this result suggests that $(\lambda_1 + \lambda_2)$ at 1m. is equal to λ_{1g} at the ground and thus λ_1 must vary rapidly with height. NOLAN(1940) repeated these measurements with similar results, finding that the conductivity by the aspiration method exceeded that by the Wilson collector by only 12. per cent. The Glencree site was reasonably free from pollution, although there was a marked increase in the large ion concentration when the wind was from Dublin

(NOLAN and NOLAN, 1931). The site was bordered on two sides by buildings and on the third by a hillside but, by applying an exposure factor, he obtained a value of 2.7×10^{-12} amps/m² by the Wilson method, against Watson's value of 1×10^{-12} amps/m² and the continent average of approximately 2×10^{-12} amps/m². He suggested that the air-earth current at Kew was abnormally low although he postulated the 12 per cent difference as a convection current.

HOGG(1939) making simultaneous measurements from the underground laboratory at Kew, found that the Wilson apparatus at ground level gave a value for the conductivity almost equal to the positive conductivity measured by a Gerdien apparatus at ground level. This also applied to the negative conductivity if the Wilson instrument was exposed to natural reverse fields. He confirmed the virtual absence of variation in potential gradient at this site reported by WATSON(1929) and again by SCRASE(1935). He also found that λ_1 decreased with height, the decrease being most rapid in the first 12.5cms. and being around one half its value at 1m. and higher. λ_2 increased from zero at the surface to about equal to λ_1 at 1m. and consequently the total conductivity remained very nearly constant over the whole range of height considered. He also found that near to the ground there was a small positive space charge of about $1,000e/cm^3$ and that the rate of ionisation was less at 100cms. than it was at ground level. Some of the observations at the various heights were performed in different seasons of the year and some of the apparatus was changed during the observation period. Although corrections were made to make the observations comparable, it is a pity that with the advantages of the underground laboratory, the equipment was not made a little more

flexible.

LUTZ(1959) compared measurements made at Munich in 1936 by the indirect method with measurements made by the direct method in 1909. He found values that gave a ratio of 2:1 which supported the diffusion theory. However, his measured space charges appeared too small to give a sufficient convection current and CHALMERS(1957) suggested that the difference might be due to changing conditions between 1909 and 1936. CHALMERS(1946) took Hogg's result that $\lambda_{1g} = 2\lambda_1$ and showed that with the assumption of a rate of ionisation at ground level five times that at 1m., it was possible to get a variation of conductivity like Hogg's and a potential gradient that was reasonably constant under conditions of a quasistatic state for large and small ions of both signs and small space charge. He suggested that this increase in ionisation near the surface was due to α - and β - radiation from radio-active substances in the top layer of the earth. MESS and O'DONNELL(1951) made measurements which showed a variation in ionisation did in fact occur. PIERCE(1958) showed the actual variation with height was not far different from that suggested by Chalmers in that he found 60 ion pairs/cc./sec. at 1cm. above ground and only 8 ion pairs/cc./sec. at 1m. He pointed out that radio-active fall-out was likely to increase the effect of β - radiation with time. This was further supported by the discovery of primitive electrode effects in areas where the ground radiation would be shielded from the atmosphere, namely the Greenland ice cap(PLUVINAGE and STAHL, 1953, and RUHNKE, 1962) and the surface of a lake.(MUHLEISEN, 1961). O'DONNELL(1952) measuring conductivity, failed to get the changes of conductivity with height that Hogg found, nor did he find the total conductivity at a height of 1m.

equalled the positive conductivity at the earth's surface. CHALMERS(1953a) pointed out that O'Donnell expressly set up his apparatus always under the branches of large trees as protection from the field of the earth and that this is a different experimental condition from measurement in the open. If the protection from the field given by the trees is complete, then F_g , F and i become zero and if the properties of the positive and negative ions were not different, then the ratio $\lambda_{1g}/\lambda_{2g}$ would be expected to be equal to one. λ_{1g}/λ_1 would also tend to unity with increasing turbulence as O'Donnell found.

ISRAEL(1954) collected together results from different stations which gave a mean for direct measurements of $1.9 \times 10^{-12} \text{ A/m}^2$ from 12 sets and a mean for indirect measurements of $2.8 \times 10^{-12} \text{ A/m}^2$ from 26 sets. However, the indirect measurements contain a greater number of results from stations in unpolluted areas such as ice caps and oceans and it has been suggested (CHALMERS, 1957) that the difference is not really significant.

The problem of the two methods of determining air-earth current appeared to have been fairly definitely solved by the agreement found between the NOLANS(1937) and HOGG(1939).

However, LAW(1963) used Ebert ion counters to measure the number of small ions of both signs at four levels close to the ground at a site in Cambridge. He also measured space charge and the potential at 1m. He found that the total conductivity decreased with height under most conditions. He concluded that this was incompatible with a conduction current constant with height and that it implied the existence of a convection current comparable with the conduction current. He has been

able to give an account of his results involving both this convection current and a variation in ionisation with height, thus falling between the theories of Whipple and Chalmers. Law's apparatus differed significantly from that of Hogg and HIGAZI and CHALMERS(1966) obtained results at the Durham Observatory site in general agreement with Law, while using conductivity apparatus very similar to that of Hogg. Higazi and Chalmers found that both λ_1 and λ_2 decreased with height. The average values of the ratios of conductivity at ground level, 20cms. and 1 metre were:-

$\lambda_{1g}/\lambda_{2g}$	1.43	$\lambda_{1g}/\lambda_1(20)$	1.21	$\lambda_{2g}/\lambda_2(20)$	1.30
		λ_{1g}/λ_1	1.28	λ_{2g}/λ_2	1.15

The suggestion derived from this was that there was a significant difference in the conditions between Kew and Durham and Cambridge, particularly in the condensation-nuclei content, as the air at Kew has a high degree of pollution compared with the other sites and consequently this is reflected in the conductivity and potential gradients. The potential gradient at Kew was generally about four times as great as those at Durham and Cambridge. Higazi and Chalmers also found that all ratios tended to unity as the wind speed increased. They suggested that an explanation in terms of turbulent mixing of the air near the ground would tend to a limit in strong winds, when the air in the lowest metre was thoroughly mixed and showed the same characteristics wherever sampled. The mixing would overcome the separating effect of the electric field and would keep the ratio tending to unity, although this would leave the problem of how the current was carried into the ground itself unanswered.

The question of the importance of convection currents had been reopened by KRAAKEVIK and CLARK(1958) with the results they obtained outside the area close to the earth's surface. If there was no significant effect due to convection currents, the conduction current would be the same at all levels in the atmosphere. EVERLING and WIGAND(1921), with earlier airborne measurements, had found the conduction current to decrease with increasing altitude, but KRAAKEVIK(1958) had found the conduction current constant with height over Greenland at a value of $3.7 \times 10^{-12} \text{ A/m}^2$. Over Chesapeake Bay, however, Kraakevik and Clark, measuring conductivity and potential gradient from an aircraft near the boundary of the austausch region found that above the austausch, the conduction current was constant with height at an average of $1.1 \times 10^{-12} \text{ A/m}^2$. Within the austausch in two regions they found values of $1.5 \times 10^{-12} \text{ A/m}^2$ indicating that the conduction current did alter with height. They considered that upward convection of positive space charge within the austausch would cause this and their potential gradient measurements showed space charge of about the right magnitude. Up to this time, those who considered that Hogg's results were most significant had accepted the Nolans' results as confirmatory and taken the 12 per cent difference that Nolan had explained as a convection current to be just a local difference. Kraakevik and Clark's results then gave some greater significance to this convection current. They suggested that the source of positive charge required to support a continuous convection current might be positively charged nuclei from combustion processes.(MUNLEISEN, 1956) Another major source could be the breaking of waves at sea.(BLANCHARD, 1961)

CHALMERS(1964), considering the simple case when the conduction current

within the austausch was the same at all levels, showed that the total vertical current during the time when convection was occurring was less than the value when there was no convection. This latter value would itself be less than the value of conduction within the austausch. However, the fact that the total current into the earth must be equal to the total vertical current and not to the conduction current during convection, again focussed attention on the situation close to the earth's surface.

KASEMIR(1960) made an attempt to measure directly the air-earth current in the upper air, although it has been shown that he was, in fact, measuring λF . He found that above the austausch, the air-earth current density was the same at all heights and was nearly four times as large over Greenland as over the polluted areas of the eastern U.S.A. His results in the austausch were not reliable as matching was not achieved. UCHIKAWA(1961) measuring the conduction current by the indirect method found the value in the austausch to be 1.5 times that above the austausch.

HOGG(1950, 1955) made attempts to relate the local conductivity at the earth's surface more precisely to the air-earth current. At first he divided the columnar conductivity into two parts; the upper part at high levels due to cosmic radiation and unaffected by local changes near the ground, and the lower part dependent on the surface conditions (i.e. radio-active material and concentration of large and small ions) and a function of λ . In the second attempt he used the empirical equation for the variation of conductivity with height given by GISH and WAIT(1950), $\lambda = \lambda_0 + Ah^2$. Neither of these methods, however, can take

into account the abrupt change in conductivity at the upper boundary of the austausch region.

BUIS(1967) has compared over fifty current density measurements derived in four ways:-

1. The potential difference between the electrosphere and the earth and the columnar resistance,
2. Measurements of potential gradient and conductivity above the austausch,
3. The direct method at the surface,
4. The indirect method at a height approximately 1 metre above the surface.

He divides the stations into three areas A. Polar, B. Oceanic and low pollution areas, C. Areas of high pollution, with the following results.

	A	B	C
	10^{-12}A/m^2	10^{-12}A/m^2	10^{-12}A/m^2
1. $i = V/R$	3.4	2.4	1.1
2. $i = F(\lambda_1 + \lambda_2)$	3.3	1.8	1.3
3. Direct i	3.0	-	1.2
4. $i = F\lambda_1$ at 1 metre	3.4	1.9	1.4

He reiterates WATSON's(1929) suggestion of a convection current equal in size to $F\lambda_2$. In his survey he neglects those values for the conduction current measured on mountain sites because of their dependence on their local conditions. Conduction currents of the order of $13 \times 10^{-12} \text{A/m}^2$ for instance, have been found on the summit of Jungfraujoeh against normal values of $2.4 \times 10^{-12} \text{A/m}^2$ which, if the conduction was to be the same at

all levels would be anomalous.

In any detailed comparison of results from different areas, it must also be remembered that the annual variations and sometimes diurnal variations of the air-earth current in different places have shown different results. A list of such variations was given by HOGG(1950). In general, if $i = \lambda F$ and $i = V/R$, as V and R vary less than λ or F , i is more nearly constant than λ or F . R will have a variation inverse to that of λ and of smaller amplitude and so i will follow the changes in λ and give a variation the inverse to F .

SAGALYN and FAUCHER(1956) suggested that the variation of the air-earth current could be described so

$$\frac{1}{i} \frac{di}{dt} = \frac{1}{V} \frac{dV}{dt} - \frac{1}{R} \frac{dR}{dt}$$

variation of i world wide variation local columnar variation

4.2. Conclusions.

It has been shown that for an understanding of the fine weather electrical phenomena in the atmosphere it is necessary to measure the air-earth current directly as well as the conductivity and potential gradient, and that, although the air-earth current is probably a more fundamental variable than the other two, its measurement is more difficult and hence the state of the apparatus so far developed, less satisfactory than the measurement of conductivity and potential gradient.

Provided that the area concerned is a fair sample of the earth's surface, the direct method of measurement at the surface will give a measure of the actual air-earth current. If the results between this and the indirect method do not agree, it can be inferred that the conduction current calculated from the indirect method does not comprise the whole current. It is, however, difficult to say how much of the total air-earth current, measured by the direct method, is conduction current, unless the components of the total air-earth current can be measured at heights above the surface of the earth. DOLEZALEK(1960) took a number of measurements of F , i and λ and discussed the various factors that would give apparent deviation from Ohm's law, for if convection currents exist, then deviations from Ohm's law will appear. He came to the conclusion that a comparison of results from the two methods of determining the air-earth current is not sufficient to give the convection current. If the constructional and operational difficulties can be solved, then a system such as was attempted here may well give a measure of the importance of the convection currents in the lower region of the

atmosphere. It may be also that conclusions based on similar measurements at different heights are less liable to error than those based on a comparison of results from differing measuring methods. The difficulties of defining a system from measurements made from one boundary, the negative electrode, of the system are enhanced by the failure of the theory of the simple electrode effect to satisfy the conditions found in practice. This is not only because of the variation in rate of ionisation at the earth's surface, but also because of the presence of turbulent mixing close to the earth's surface. The assumptions of the quasistatic state and of horizontal stratification lead to a current density the same at all levels. The results from the indirect method suggesting the conduction current is not constant with height leads to the assumption that some other current, the convection current must also not be constant with height.

The development of analogue computing techniques makes it feasible to consider the development of model systems for the theoretical solutions to these problems, if sufficient primary information can be gathered under known conditions. ISRAEL(1957) called for synoptic measurements of F , i and λ to be made to separate local effects from those with a world-wide basis and the separation of local effects is essential, if results are to be compared between different sites. It has been shown that the degree of pollution and the presence or absence of the electrode effect has influenced the conclusions drawn from experimental results in the past. The separation of local effects from more fundamental variations is the more important, since COLLIN, GROOM and HIGAZI(1965) have indicated periods of auto-correlation that indicate the atmosphere has a 'memory'.

Their analysis of HIGAZI and CHALMERS'(1966) results indicated that the length of the memory was due mainly to the replacement and mixing of the air by the wind, although some small effect was made by the exponential relaxation of electrical phenomena in the atmosphere.

WHITLOCK and CHALMERS(1956) found variations in the fine weather potential gradient that suggested the movement of wind borne pockets of space charge. BENT and HUTCHINSON(1966) found repetitive patterns in space charge records that had their counterparts in the wind speed, temperature and humidity records and suggested the movement of wind borne convection cells.

SERBU and TRENT(1958) found changes in conductivity before the onset of fog(and before its dissipation too). DOLEZALEK(1962) found that the conductivity decreased and the potential gradient increased about 1 to 2 hours before fog appeared. The care with which a site must be chosen has already been indicated but these last findings raise the question of the choice of periods for analysis.

It has been usual for fine weather phenomena to choose days that appear undisturbed either from meteorological or potential gradient records, but ISRAEL and LAHMAYER(1948) suggested that conclusions should be based on the analysis of all records except those when precipitation was actually occurring.

The full separation of local influences on the value of the conduction current and the importance of the convection current must therefore call for fully automatic recording. Indeed, it may prove that the automatic provision of a digital output for computer access may be the only satisfactory method of overcoming the problem of the displacement current,

if the direct method of measurement is to be used above ground level.

BENT and HUTCHINSON(1966) have demonstrated such a system for fully automatic recording and automatic data-logging systems for the remote recording of meteorological variables have been commercially available for some time(12).

It is, therefore, suggested that the understanding of the importance of the components of the air-earth current would be materially advanced, if standardised equipment could be set up to run simultaneously and continuously at three sites.

It is suggested that the variables that should be measured are a.) air-earth current by the direct method, b.) conductivity, c.) potential gradient, d.) space charge, and e.) wind speed, and that the equipment should be based on a.) a properly engineered double collecting plate with a computer calculated compensation for displacement current, b.) a conductivity measuring system after HIGAZI and CHALMERS' (1966), c.) a field mill or passive probe system, and d.) space charge apparatus after BENT(1964).

It is suggested that such apparatus should be placed in three carefully chosen sites, one in a polluted area, one in an area free from pollution and one in an area where the electrode effect was found to occur.

Obviously a project of this size would probably require some international cooperation for it is unlikely that all three sites would be found in this country. However, the meteorological sciences have long shown the lead in such forms of scientific cooperation. The project would also be expensive, but in terms of economic and scientific return, it

might be preferable to standardise on equipment at this stage and obtain a long period of results rather than for individual researchers, especially research students, to develop their own variants of apparatus and be often with results covering very small periods of time.

It is also true that in favourable economic climates, government organisations have been prepared to spend such money as would be required in this field. In particular, the author is grateful for the receipt of a U.S. Navy grant. He is also grateful for the privilege of studying under the late Professor J.A. Chalmers and Dr. W.C.A. Hutchinson.

LIST OF PLATES AND FIGURES

<u>Number</u>		<u>Facing Page</u>
Plate 1(^a _b)	The Observatory Site	19
Plate 2(^a _b)	The Current Collector	46
Plate 3	The Timing Mechanism	48
Plate 4	The Potential Balancing Servo Mechanism	49
Plate 5	The Passive Probe Field Installation	57
Plate 6	The Passive Probe Head Unit	57
Plate 7(^a _b)	The Passive Probe Ancillary Electronics	57
Fig.1(^a _b)	The Observatory Site and its Surroundings	19
Fig.2	Scraper Apparatus	31
Fig.3	Kasemir's Method	33
Fig.4	Conductivity Measuring System after HOGG(1939) and HIGAZI and CHALMERS(1956)	40
Fig.5	The Photocell Galvanometer Amplifier	47
Fig.6	The Potential Balancing Servo Mechanism	49
Fig.7	Farmer's and Brewer's Circuit Diagrams	51
Fig.8(^a _b)	Passive Probe Equivalent Circuit	53
Fig.9	Passive Probe Field Installation	53
Fig.10	Passive Probe Circuit Diagrams	56
Fig.11	Experimental Valve Housing after Spangler	58
Fig.12	Calibration Curve of Passive Probe	59
Fig.13	Comparison of Passive Probe and Agrimeter	59
Fig.14	Comparison under Conditions of Light Rain	59
Fig.15	Compensation System	62

SUNDRY OTHER REFERENCES

Chapter 1.

1. T.W. Chalmers Historic Researches London 1949, p.218-9.
2. Isaac Newton's papers and letters in Natural Philosophy.
I.B. Cohnen Camb. Mass. 1958.
3. A History of the Theories of Aether and Electricity.
E.T. Whittaker, London 1951.
4. Life of W. Thomson, Baron Kelvin of Largs.
S.P. Thompson, London 1910.
5. The Quantum Theory 1922 F. Reiche.
6. W. Whewell History of Inductive Sciences 1847.
7. P. Doig A Concise History of Astronomy London 1950.

Chapter 3.

8. Britec Ltd. Elestra Timer Tech. paper No.16.
9. Inverted Triode for Industrial Measurements.
Manual of Industrial Circuits Electronics 1944, p.176.
10. Rowson & Williams. Wireless World Aug. 1960, p.403-4.
11. A Galvanometer Amplifier J. Sci. Inst. 34 p.283

Chapter 4.

12. D-Mac, Hillington Glasgow.

REFERENCES

- ADAMSON J. (1960) Quart. J. R. Met. Soc. 86 pp.252-258
- ADAMSON and CHALMERS (1956) Not yet pub. cf. CHALMERS(1957)
- D'ALIBARD T.F. (1752) Letter to Acad. de Sci.
- ARNOLD, PIERCE and WHITSON (1955) J. Atmos. Terr. Phys. 27 pp.429-430
- BECCARIA G.B. (1775) Del' elettricita terrestre atmosferica a cielo sereno (Turin)
- BEHACKER M. (1910) S.B. Akad. Wiss Wien. 119 pp.675-684
- BENT R. (1954) J. Atmos. Terr. Phys. 26 pp.313-318
- BENT and HUTCHINSON (1966) J. Atmos. Terr. Phys. 28 pp.53-73
- BENNDORF H. (1906) S.B. Akad. Wiss Wien. 115 pp. 425-456
- BRASEFIELD C.J. (1959) J. Geophys. Res. 64 p.141
- BLANCHARD D.C. (1961) Wood's Hole Oceanographic Inst. Ref. 61-69
- BREWER F. (1953) J. Sci. Inst. 30 pp.91-92
- BUIS P.M. (1967) Nature 216 October 28th, 1967
- CHALMERS J.A. (1946) Quart. J. R. Met. Soc. 72 pp.199-205
- CHALMERS J.A. (1952) J. Atmos. Terr. Phys. 2 pp.155-159
- CHALMERS J.A. (1953a) J. Atmos. Terr. Phys. 3 pp.223-224
- CHALMERS J.A. (1953b) J. Atmos. Terr. Phys. 4 pp.124-128
- CHALMERS J.A. (1956) J. Atmos. Terr. Phys. 9 pp.311-321
- CHALMERS J.A. (1957) Atmospheric Electricity Pergamon Press
- CHALMERS J.A. (1962) J. Atmos. Terr. Phys. 24 pp.297-302
- CHALMERS J.A. (1963) Unpublished
- CHALMERS J.A. (1964) Pure and Applied Geophys. 57 pp.189-192
- CHALMERS J.A. (1966) J. Atmos. Terr. Phys. 28 pp.565-579

CHALMERS and LITTLE	(1947)	Terr. Magn. Atmos. Elect. <u>52</u> pp.239-260
COBB and PHILLIPS	(1962)	Tech. Rep. 16. Mauna Loa Observatory
COLLIN H.L.	(1962)	J. Atmos. Terr. Phys. <u>24</u> pp.743-745
COLLIN, GROOM and HIGAZI	(1965)	J. Atmos. Terr. Phys. <u>28</u> pp.695-697
CORONITI, NAZAREK, STERGIS KOTES, SEYMOUR, WERME	(1954)	Geophys. Res. Dir. A.F.C.R.C. Instrum. for Geophys. Res. <u>3</u> pp.7-9
CROZIER W.D.	(1963a)	J. Geophys. Res. <u>68</u> pp.3451-3458
CROZIER W.D.	(1963b)	J. Geophys. Res. <u>68</u> pp.5173-5179
CROZIER W.D.	(1965)	J. Geophys. Res. <u>70</u> pp.2785-2792
CURRIE and KREIELSHEIMER	(1960)	J. Atmos. Terr. Phys. <u>19</u> pp.126-135
DAHL H.	(1951)	Beretn. Michelsens Inst. Vidensk <u>14</u>
DOLEZALEK	(1960)	Geofis. Pur. Appl. <u>46</u> pp.125-144
DOLEZALEK	(1962)	Tech. Rep. Contr. NON R 33.88(00) A.V.C.O. Corps. Res. & Adv. Dev. Dis.
DOLEZALEK	(1963)	J. Geophys. Res. <u>68</u> p.5181
DAGPUNAR S.S.	(1963)	Mullard Tech. Comm. <u>7</u> No.66
EBERT H.	(1901)	Phys. 2.2 pp.662-666
EBERT H.	(1902)	Phys. 2.3 pp. 338-339
EVERLING and WIGAND	(1921)	Ann. Phys. <u>66</u> pp.261-282
FARMER	(1942)	Proc. Phys. Soc. <u>54</u> pp.435-7
FRANKLIN B.	(1750)	Letter to Roy. Soc.
FRANKLIN B.	(1752)	Phil. Trans. <u>47</u> p.289
GERDIEN H.	(1905)	Phys. 2.6 pp.800-801
GISH O.H.	(1951)	Universal Aspects of Atmos. Elect. Compendium of Meteorology pp.101-119
GISH and SHERMAN	(1929)	Terr. Magn. Atmos. Elect. <u>34</u> pp.231-237
GISH and WAIT	(1950)	J. Geophys. Res. <u>55</u> pp. 473-484

- GOTO M. (1951) J. Geomagn. Geoelectr. Kyoto 3 pp.22-23
- GOTO M. (1957) J. Geomagn. Geoelectr. Kyoto 9 pp.133-9
- GUNN L. (1948) J. Appl. Phys. 19 pp.481-484
- GUNN, HALL, KINZER et al (1946) Proc. Inst. Radio Engrs. N.Y. 34 pp.156-177
- HARNWELL and VAN VOORHIS (1933) Rev. Sci. Inst. 4 pp.540-542
- HESS and O'DONNELL (1951) J. Geophys. Res. 56 pp.557-562
- HIGAZI and CHALMERS (1966) J. Atmos. Terr. Phys. 28 pp.327-330
- HOGG A.R. (1939) Mem. Commonw. Solar Obs. Aust. 7
- HOGG A.R. (1950) Arch. Met. Wien.A 3 pp.40-55
- HOGG A.R. (1955) Wentworth Conf. pp.86-90
- HUTCHINSON W.C.A. (1966) J. Atmos. Terr. Phys. 28 pp.823-830
- IMIANITOV I.M. (1958) Trans. Amer. Meteor. Soc.
(Translated from the Russian)
- ISRAEL H. (1950) Arch. Met. Wien. A 3 pp.1-16
- ISRAEL H. (1954) Ann. Geophys. 10 pp.93-116
- ISRAEL H. (1955) J. Atmos. Terr. Phys. 6 pp.322-327
- ISRAEL H. (1957) Contract AF61(514)-680 Final Report
- ISRAEL and DOLEZALEK (1960) Z. Geophys. 26 p.77
- ISRAEL and LAHMAYER (1948) Terr. Magn. Atmos. Elect. 53 pp.373-386
- JONES, MADDEVER and SANDERS (1959) J. Sci. Inst. 36 pp.24-28
- KASEMIR H.W. (1951) J. Atmos. Terr. Phys. 2 pp.32-37
- KASEMIR H.W. (1955) Wentworth Conference pp.91-95
- KASEMIR H.W. (1960) U.S.A.S.R.D.L. Technical Report 2125
- KASEMIR and RUHNKE (1958) Rec. Adv. in Atmos. Elect. p.137 Perg.
Press. U.S.A.S.R.D.L. Tech. Rep. 2022
- KAY A.E. (1950) Ph.D. Thesis Durham University

- KELVIN LORD (1859) Papers on Electrostatics and Magnetism pp.200-203
- KELVIN LORD (1860) Phil. Mag. and B.A. Papers on Electrostatics and Magn. pp.316-320
- VON KILINSKI E. (1952) Z. Met. 6 pp.271-277
- VON KILINSKI E. (1958) Z. Met. 12 pp.352-354
- KOBAYASHI and KYOZUKA (1962) Geophys. Mag. 31 pp.195-236
- KRAAKEVIK J.H. (1958) Rec. Adv. in Atmos. Elect. pp.75-88
- KRAAKEVIK and CLARK (1958) Tran. Amer. Geophys. Un. 39 p.827
- LAW J. (1963) Quart. Jl. R. Met. Soc. 89 p.107
- LECOLAZET R. (1948) Ann. Geophys. 4 pp.81-95
- LEMONNIER L.G. (1752) Memoirs Academi Sci. 2 p.233
- LETTAU H. (1941) Beitr. Geophys. 57 pp.365-383
- LINKE F. (1904) Abh. Geo. Wiss Gottingen 3 p.5
- LUTZ C.W. (1941) Beitr. Geophys. 54 p.337
- MALAN and SCHONLAND (1950) Proc. Phys. Soc. Lond. B.63 p.402
- MAPLESON and WHITLOCK (1955) J. Atmos. Terr. Phys. 7 pp.61-72
- MATTHIAS A. (1926) Elektrizitatzwirkschaff 25 pp.291-308
- MUHLEISEN R. (1951) Z. Naturforsch. 6a. pp.667-671
- MUHLEISEN R. (1953) Z. Geophys. 29 pp.142-160
- MUHLEISEN R. (1951) J. Atmos. Terr. Phys. 20 pp.79-81
- NOLAN P.J. (1940) Proc. R. Irish Acad. A46 pp.65-75
- NOLAN J.J. and P.J. (1937) Proc. R. Irish Acad. A43 pp.79-93
- O'DONNELL G.A. (1952) J. Atmos. Terr. Phys. 2 pp.201-215
- PIERCE E.T. (1958) Rec. Adv. in Atmos. Elect. 1958 pp.5-16. Pergamon Press
- PLUVINAGE and STAHL (1953) Ann. Geophys. 9 pp.34-43
- DE ROMAS J. (1753) Mem. Acad. Bordeaux

- RUHNKE L.H. (1961) U.S.A.S.R.D.L. Technical Report 2232
- RUHNKE L.H. (1962) J. Geophys. Res. 67 2767
- RUSSELTVEDT N. (1925) Beih. Jb. Norweg. Met. Inst. pp.11-15
- SAGALYN and FAUCHER (1954) J. Atmos. Terr. Phys. 5 pp.253-272
- SAGALYN and FAUCHER (1956) Quart. J. R. Met. Soc. 82 pp.428-443
- DE SAUSSURE H.B. (1779) Voyages dans les Alpes(Geneva)
- SCHERING H. (1906) Ann. Phys. Lpz. 20 pp.174-195
- SCHULTZ J. (1931) S. B. Akad. Wiss. Wien 140 pp.49-66
- VON SCHWELDER E. (1908) S. B. Akad. Wiss. Wien 117 pp.653-664
- SCRASE F.J. (1933) Geophys. Mem. Lond. 58
- SCRASE F.J. (1935) Geophys. Mem. Lond. 67
- SERSU and TRENT (1958) Trans. Amer. Geophys. Un. 39 pp.1034-42.
- SIMPSON G.C. (1910) Phil. Mag. 19 pp.715-725
- SHIDDY M. and CHALMERS J.A.(1958) J. Atmos. Terr. Phys. 12 pp.206-210
- SHIDDY M. and CHALMERS J.A.(1950) Quart. Jl. R. Met. Soc. 86 p.79
- SMITH L.G. (1953) Rev. Sci. Inst. 24 p.998
- SMITH L.G. (1956) Air-earth Current by Wilson's method. Unpublished.
- SPANGLER R.A. (1962) Rev..Sci. Inst. 33 p.1406
- SWANN W.F.G. (1914) Terr. Mag. 19 p.18
- UCHIKAWA K. (1961) Geophys. Mag. Japan 30 pp.617-672
- VOLTA A. (1800) Lettres sur la Meteorologie Electrique
- VONNEGOT and MOORE (1958) Rep. on Contract AF19(604) 1920 pp.1-163
- WALL W. (1708) Phil. Tran. 26 p.79
- WATSON R.E. (1929) Geophys. Mem. Lond. 45
- WHIPPLE F.J.W. (1932) Terr. Magn. Atmos. Elect. 37 pp.355-359

WHITLOCK and CHALMERS	(1956)	Quart. J. R. Met. Soc. <u>82</u> pp.325-336
WILDMAN P.J.	(1952)	Ph.D. Thesis Durham University
WILSON C.T.R.	(1906)	Proc. Camb. Phil. Soc. <u>13</u> pp.363-382
WILSON C.T.R.	(1908)	Proc. Roy. Soc. <u>A80</u> p.537
WILSON C.T.R.	(1916)	Proc. Roy. Soc. <u>A92</u> pp.555-574

