

12-1-2016

## Progression Magazine, 2016 Winter

Coastal Carolina University

Follow this and additional works at: <https://digitalcommons.coastal.edu/progression>

 Part of the [Higher Education Commons](#), [Life Sciences Commons](#), [Medicine and Health Sciences Commons](#), [Physical Sciences and Mathematics Commons](#), and the [Social and Behavioral Sciences Commons](#)

---

### Recommended Citation

Coastal Carolina University, "Progression Magazine, 2016 Winter" (2016). *Progression Magazine*. 8.  
<https://digitalcommons.coastal.edu/progression/8>

This Article is brought to you for free and open access by the College of Science at CCU Digital Commons. It has been accepted for inclusion in Progression Magazine by an authorized administrator of CCU Digital Commons. For more information, please contact [commons@coastal.edu](mailto:commons@coastal.edu).

COASTAL CAROLINA UNIVERSITY

# progression

MAGAZINE

WINTER 2016

| KEEPING UP WITH THE EDUCATIONAL MOMENTUM OF THE COLLEGE OF SCIENCE |

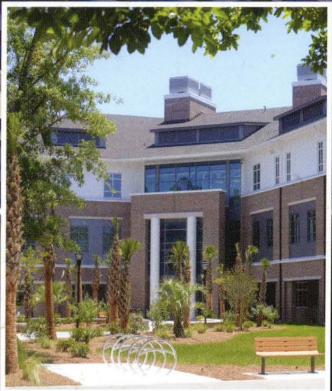

SCIENCE ANNEX II  
**GRAND  
OPENING**

Page 33



**SUBMARINES!**

Page 5

**WATER  
SAFETY**

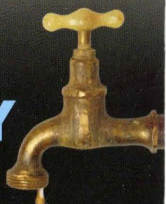

Page 17

# progression



## a message from the dean

Welcome to another issue of *Progression* magazine, which is dedicated to providing information about the College of Science at Coastal Carolina University. The articles are indicative of the sincere interest our faculty have in their scientific area of interest, and we hope you learn more about the activities of our students as they pursue their passions.

It has been another busy year in the College of Science. Certainly, a main highlight has been moving into the new “Science II” building. When we began the planning process for this building, we developed a plan that brought together faculty and students working across disciplines – just as Swain Hall focused on health-related issues and brought together faculty from chemistry to biology to public health, this building emphasizes the marine and environmental sciences and brings together faculty from the departments of biology, chemistry and marine science. Critically, in opening this building we bring marine science back to the main campus after its long residence in the Coastal Science Center on the east campus across U.S. 501. The ability of our faculty and students to work together in cross-disciplinary teams, now facilitated by this new building, is a hallmark of our college. Computer science, the only undergraduate science program still on the east campus, will become a “neighbor” to Science II in Summer 2017 when “Academic Building II,” adjacent to the Wall Building, is completed.

If you have any questions concerning our programs, or want more information on any of the articles within this issue of *Progression*, contact me or the specific authors. My phone number and email are listed below; you can also follow me on Twitter: @CCUScienceDean.

If you wish to make a donation to our college to support the work we do, please feel free to contact the major gift officer for the College of Science, Bryan Steros, at [bsteros@coastal.edu](mailto:bsteros@coastal.edu).

I look forward to you coming to CCU for a visit to see how our campus and programs have grown. We would love to welcome you and show you around!

Regards,

Michael H. Roberts, Ph.D.  
Vice President for Research and Emerging Initiatives  
Dean, College of Science  
[mroberts@coastal.edu](mailto:mroberts@coastal.edu)  
843.349.2282 • 843.349.2926 fax



### ALUMNI INFORMATION

[coastal.edu/info/alumni](http://coastal.edu/info/alumni)

### PHILANTHROPY INFORMATION

[coastal.edu/endowment](http://coastal.edu/endowment)

### PRODUCTION STAFF

#### Rocky Cartisano

*Editor and Research Associate  
College of Science*

#### Jonathan Ady

#### Regis Miner

*Graphic Artists  
Office of University Communication*

### COLLEGE OF SCIENCE AT COASTAL CAROLINA UNIVERSITY

[coastal.edu/academics/colleges/science](http://coastal.edu/academics/colleges/science)

### COASTAL CAROLINA UNIVERSITY

P.O. Box 261954  
Conway, SC 29528-6054

Copyright 2016  
Coastal Carolina University



### ON THE COVER:

*A mural painted by CCU art students is located in the Coastal Science Center Environmental Fluids Lab, which houses a 50-foot recirculating water channel for experimental research.*

# progression contents

WINTER 2016

03 Departments and Chairs

05

## SUBMARINES!



09

## MEET FIBONACCI, DA VINCI AND DONALD DUCK



13

## The Secret to Toned Muscles



17

*Determining*  
**WATER  
SAFETY**



23

## At Sea

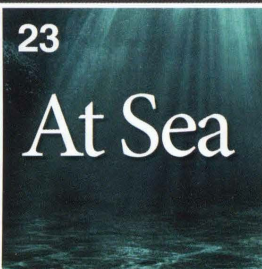

25

## WORKING WITH WORMS



28

## FIRST YEAR SCORE at CCU

29

Travels  
to  
**TURKEY**

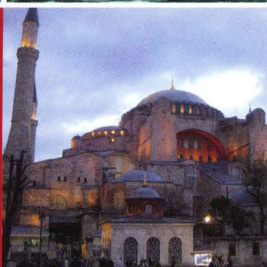

33

## SCIENCE ANNEX II GRAND OPENING

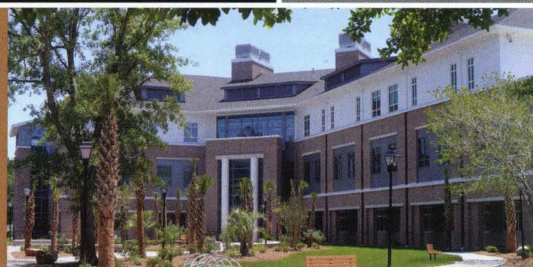

34

## College of Science News and Notes

35

## THE SWAIN SCHOLAR UPDATE

37

## President's Honor List 2016

# progression

[coastal.edu/science](http://coastal.edu/science)



## SEARCHING FOR COS ALUMNI!

Please contact us: Jean Ann Brakefield, *Alumni Director*: [jeanann@coastal.edu](mailto:jeanann@coastal.edu)  
Rocky Cartisano, *Progression Editor*: [rockdot@coastal.edu](mailto:rockdot@coastal.edu)

## WE WANT TO HEAR FROM YOU!

Coastal Carolina University (CCU) does not discriminate on the basis of race, color, religion, sex, sexual orientation, gender identity, gender expression, national origin, age, genetic information, mental or physical disability, or status as a disabled or Vietnam-era veteran in its admissions policies, programs, activities or employment practices. For more information relating to discrimination, please contact the CCU Title IX Coordinator/EEO Investigator, Coastal Carolina University, Kearns Hall 104B, Conway, SC; Title IX email [titleix@coastal.edu](mailto:titleix@coastal.edu); office phone 843-349-2382; Title IX cell phone 843-333-6229; EEO email [eeo@coastal.edu](mailto:eeo@coastal.edu); or the U.S. Dept. of Education Office for Civil Rights at [www2.ed.gov/ocr](http://www2.ed.gov/ocr).

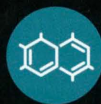

## DEPARTMENT OF MARINE SCIENCE

**Jane Guentzel, Ph.D.**  
Department Chair

The Department of Marine Science is one of the largest undergraduate marine science programs on the East Coast. In addition to undergraduate studies, the department interacts with CCU's coastal marine and wetland studies master's program and the doctoral program in coastal and marine systems science. Lecture, laboratory and field experiences are integrated to provide an outstanding and well-rounded academic program.

With our ideal location near the coast and collection of research-active faculty committed to undergraduate and graduate education, our strength is in providing individual attention and hands-on opportunities for students.

Two major national reports, the Pew Oceans Commission and U.S. Commission on Ocean Policy, have documented the critical importance of marine science to our national health and well-being and called for increased efforts in marine science education, research and funding. This is truly an exciting and dynamic time.

Visit [coastal.edu/academics/colleges/science/departments/marine](http://coastal.edu/academics/colleges/science/departments/marine). Jane Guentzel can be reached at [jguentze@coastal.edu](mailto:jguentze@coastal.edu) or 843.349.2374.

## DEPARTMENT OF PSYCHOLOGY

**Terry F. Pettijohn II, Ph.D.**  
Department Chair

The Department of Psychology enrolls nearly 500 undergraduate majors. We offer a bachelor of science degree and emphasize the scientific nature of psychology and experimental research methods. Our 13 full-time faculty have expertise in a wide variety of areas, including experimental, social, developmental, cognitive, biological, school and clinical psychology. Our faculty are excellent teachers and active researchers in the field, presenting at conferences, contributing articles and books to the research literature, and sharing their findings and expertise with the media.

Through our research methods sequence, students gain extensive knowledge and experience by designing and conducting research. Motivated majors may find additional opportunities to join faculty research labs as research assistants.

Visit [coastal.edu/academics/colleges/science/departments/psych](http://coastal.edu/academics/colleges/science/departments/psych). Terry F. Pettijohn II can be reached at [pettijohn@coastal.edu](mailto:pettijohn@coastal.edu) or 843.349.6447.

## DEPARTMENT OF MATHEMATICS AND STATISTICS

**James Solazzo, Ph.D.**  
Department Chair

The goal of the Department of Mathematics and Statistics at CCU is to improve students' mathematical understanding and competence. However, we also strive to illustrate the importance of mathematics, both as an interesting and challenging subject on its own, and as a tool that can be applied to other disciplines. Our degree program in applied mathematics is designed to develop a high degree of mathematical proficiency as well as extensive reasoning and problem-solving skills.

We are committed to providing quality undergraduate teaching. In addition, we recognize the interdisciplinary nature of the modern mathematical world. Therefore, students may choose to concentrate their studies in analysis, applied mathematics, discrete mathematics, mathematics for secondary education or statistics while still obtaining a solid mathematical background.

Visit [coastal.edu/academics/colleges/science/departments/math](http://coastal.edu/academics/colleges/science/departments/math). James Solazzo can be reached at [jsolazzo@coastal.edu](mailto:jsolazzo@coastal.edu) or 843.349.2717.

## DEPARTMENT OF KINESIOLOGY

**Gregory F. Martel, Ph.D.**  
Department Chair

The Department of Kinesiology at CCU is a dynamic unit of faculty, staff and students who study and promote human movement (kinesiology) as applied to a variety of physical activity, sport and therapeutic settings. The department houses a major in exercise and sport science (EXSS), minors in EXSS and sport coaching, the Physically Active Living Skills (PALS) classes and the Community Fitness Testing Program. Nationally, regionally and locally, there has been an increase in demand for kinesiology-related services and programs; this is reflected in the rapid growth the EXSS major since beginning at Coastal Carolina University in January 2008. The current enrollment of the EXSS major is approximately 700 students, third largest on campus.

Our role is to provide students with the knowledge, skills, abilities and attitudes for effective leadership in the field of kinesiology. We excel not only by teaching well, but by engaging students in hands-on research, community service projects, and field-based learning and leadership opportunities.

Visit [coastal.edu/academics/colleges/science/departments/kinesiology](http://coastal.edu/academics/colleges/science/departments/kinesiology). Contact Greg Martel at [gmartel@coastal.edu](mailto:gmartel@coastal.edu) or 843.349.2957.

## DEPARTMENT OF SOCIOLOGY

**Robert Jenkot, Ph.D.**  
Department Chair

This is an exciting time to explore the Department of Sociology. Sociology has a strong history of being student-centered in teaching and research. We offer our students a wide variety of educational opportunities to explore the social world and to take part in changing that world.

In order to maintain our student-centered approach to education, all of our professors are active researchers. We bring our experience with various topics into the classroom so that our students get to see what sociology is, how it works, and what it can be used for in the world around them. Importantly, our students are invited to work with our professors on research projects that might interest them.

Our students have access to professors who teach courses in: sexuality and gender; race and ethnic relations; social inequality; crime and deviance; religion; popular culture; social justice; health and medicine; sports; HIV/AIDS; juvenile delinquency; and the social relations of the South.

Visit [coastal.edu/academics/colleges/science/departments/sociology](http://coastal.edu/academics/colleges/science/departments/sociology). Robert Jenkot can be reached at [rjenkot@coastal.edu](mailto:rjenkot@coastal.edu) or 843.349.2274.

## DEPARTMENT OF BIOLOGY

**Michael M. Pierce, Ph.D.**  
Department Chair

The Department of Biology is home to more than 530 undergraduate biology majors, 20 graduate students, 15 full-time faculty and three adjunct faculty. Undergraduate students in our department earn a Bachelor of Science degree in biology. We also offer other programs of study that prepare students for entry into various health professions. Our department participates in the Master of Science in coastal marine and wetland studies and offers courses for graduate students in education.

Students in our department have access to professors with expertise ranging from molecules to ecosystems. Faculty in the Department of Biology provide excellent opportunities for learning inside the classroom and out. Our faculty have varied research interests, and undergraduates can participate in that research.

Visit [coastal.edu/academics/colleges/science/departments/biology](http://coastal.edu/academics/colleges/science/departments/biology). Michael M. Pierce can be reached at [mpierce@coastal.edu](mailto:mpierce@coastal.edu) or at 843.349.6483.



## DEPARTMENT OF HEALTH SCIENCES

**Fredanna M'Cormack McGough, Ph.D.**  
Department Chair

The Department of Health Sciences is home to programs that incorporate evidence-based best practices for disease prevention, health assessment, health management, quality care and patient safety. Through community collaborations and diverse faculty research interests, students can participate in research activities that connect theory to practice.

The department offers Bachelor of Science degrees in public health, nursing (completion program) and health administration (completion program). The nursing completion program is committed to advancing the education of registered nurses to meet the local and global growing health care needs. The health administration completion program builds on foundation courses in associate degree and other four-year degree programs.

The public health program focuses on the art and science of promoting healthy communities and healthy behaviors and features four different areas of study:

- Public health with general cognate (designed for students with general health interests or those seeking graduate work in allied health careers)
- Public health with communication option
- Public health with exercise science option
- Public health with health services leadership

Visit [coastal.edu/healthsciences](http://coastal.edu/healthsciences). Fredanna M'Cormack McGough can be reached at [fmcorma@coastal.edu](mailto:fmcorma@coastal.edu) or 843.349.2991.

## DEPARTMENT OF CHEMISTRY AND PHYSICS

**David Evans, Ph.D.**  
Department Chair

Our department is home to several disciplines within the physical sciences, including the fields of astronomy, physics, chemistry and biochemistry. Bachelor of Science degrees are offered in chemistry, biochemistry and applied physics.

We offer a dual-degree engineering program in partnership with Clemson University.

Whether you are here for a course in science as part of the core curriculum or you are interested in becoming a chemistry or applied physics major, please contact us with any questions you may have.

Visit [coastal.edu/chemphys](http://coastal.edu/chemphys). David Evans can be reached at [devans@coastal.edu](mailto:devans@coastal.edu) or 843.349.2209.

## DEPARTMENT OF RECREATION AND SPORT MANAGEMENT

**Colleen McGlone, Ph.D.**  
Department Chair

The recreation and sport management department currently enrolls more than 300 majors and began offering graduate courses in sport management in Fall 2015.

Recreation and sport management professionals create, plan, market, implement and evaluate leisure and recreational activities in both the private and public sectors, as well as in both nonprofit and for-profit industries. In other words, our work is your play.

The program works with CCU Athletics in several capacities and events and is the first in the country to partner with [ticketreturn.com](http://ticketreturn.com) to train students on specialized ticketing technology and sales techniques.

The faculty have a wide range of experience in the field which they bring to the classroom to enhance students' abilities to connect theory and practices. In addition, the faculty maintain very active research agendas and endeavors in which students frequently assist.

Visit [coastal.edu/academics/colleges/science/departments/recreationandsportmanagement](http://coastal.edu/academics/colleges/science/departments/recreationandsportmanagement). Colleen McGlone can be reached at [cmcglone@coastal.edu](mailto:cmcglone@coastal.edu) or 843.349.2989.

## DEPARTMENT OF COMPUTING SCIENCES

**William M. Jones, Ph.D.**  
Department Chair

The Department of Computing Sciences offers three undergraduate degrees, serving roughly 400 actively enrolled majors as of Fall 2016: computer science, information systems and information technology. Both the computer science and information systems programs are accredited by the Accreditation Board for Engineering and Technology Inc., and we are working on obtaining accreditation for the IT program, which launched Fall 2014. We also launched our first master's degree in Fall 2016. This completely online Master of Science in information system technology is a new and innovative program that is relatively unique in that it has a dual concentration in both security and data analytics.

While our faculty continues to focus primarily on quality undergraduate and graduate teaching, we have also seen recent strides in the last two years in externally funded scholarship and equipment totaling more than \$400,000 in grants and contracts.

Visit [coastal.edu/academics/colleges/science/departments/cs](http://coastal.edu/academics/colleges/science/departments/cs). William Jones can be reached at [wjones@coastal.edu](mailto:wjones@coastal.edu) or 843.349.4142.

## SCHOOL OF COASTAL AND MARINE SYSTEMS SCIENCE

**Paul Gayes, Ph.D.**  
Director

The School of Coastal and Marine Systems Science houses CCU's marine and wetland graduate programs and the Burroughs & Chapin Center for Marine and Wetland Studies. The doctoral program in coastal and marine systems science, the master's program in coastal marine and wetland science, and the center all focus their resources and research on the complex and interconnected environments and processes found in the coastal zone. With the expanding coastal population and the increase in economies dependent on the world's coastal resources, there is a growing need to advance the understanding of these interconnected environments and processes to help society best manage coastal resources and economy. This becomes particularly critical as the interfaces between land, sea and atmosphere and associated environments are particularly susceptible to changes in sea level, climate and societal modifications.

The graduate program's focus is on training students to advance understanding of these complex systems, work across disciplines and strive to develop predictive capabilities to aid sound resource management. The region provides an outstanding natural laboratory, offering access to diverse fresh, brackish and marine settings. The school manages CCU's Anne Tilghman Boyce Coastal Reserve at Waties Island, an undeveloped barrier island and adjacent upland, as well as a new 54-foot research vessel and a fleet of small vessels. The school's Waccamaw Watershed Academy maintains a certified Environmental Quality Lab. Other research concentrations in coastal and atmospheric processes, coastal ecology, coastal geologic and geophysical studies also maintain an array of advanced instrumentation and technical resources. Faculty and staff frequently engage in regional and national technical and environmental panels affording students glimpses of real-world application.

Visit [coastal.edu/scmss](http://coastal.edu/scmss). Paul Gayes can be reached at [ptgayes@coastal.edu](mailto:ptgayes@coastal.edu) or 843.349.4015.

FROM THE GREAT DEPRESSION,

# SUBMA

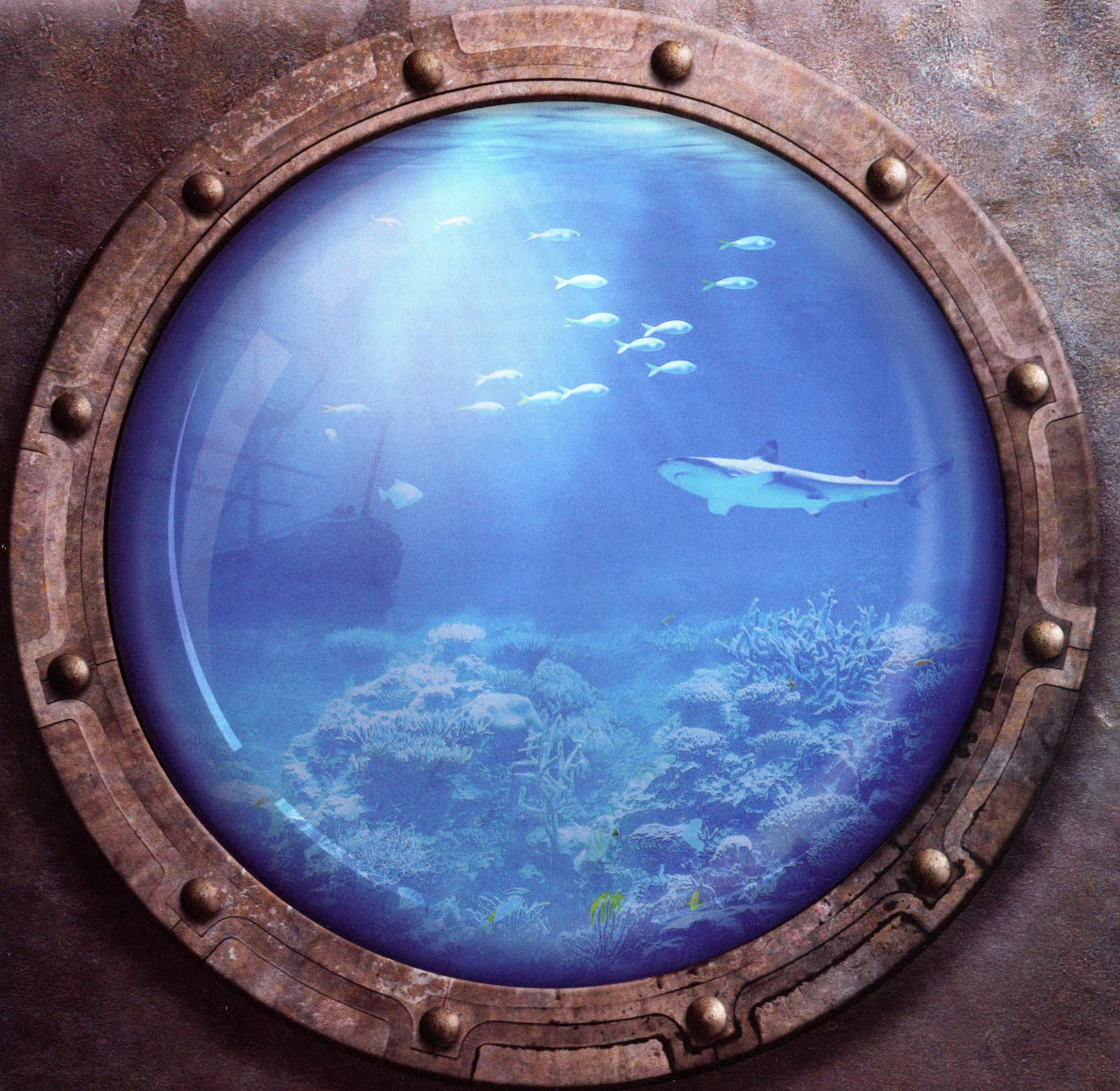

# RINES!

by **Leigha Peterson**, Doctoral Candidate,  
Department of Coastal and Marine Systems Science,  
Coastal Carolina University

**The year is 1930: 9,000 U.S. banks have closed, severe dust storms decimate croplands in the Midwest prairie states, and for the first time ever, deep sea creatures are observed in their natural environment.**



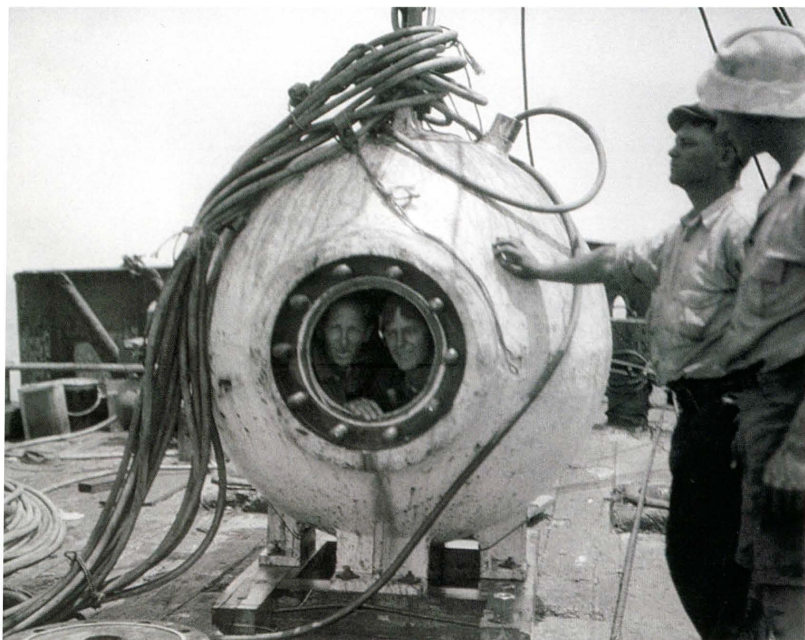

*The Bathysphere, an early submarine which gave rise to the Alvin, was made of cast iron and could hold two people within the sphere. Electricity cables not only tethered the submarine to the ship above (as the sphere had no means of transportation) but also afforded the scientists a telephone line and lights to observe and communicate to the personnel onboard regarding their observations.*

The Bathysphere, engineered by Otis Barton, presented a vehicle design capable of deep sea exploration that far surpassed anything previously developed by thousands of feet. Thirty years later, the Human Occupied Vehicle Alvin (HOV Alvin) launched into the deep ocean, becoming the first deep-sea submersible capable of transporting persons to the ocean depths without needing to be tethered to a ship at the surface.

Although both maintained the same spherical design elements, unlike the Bathysphere, the Alvin is mobile and equipped with two robotic arms for sample collection, which proved to be the elements required to support generations of underwater discovery. This relatively recent history of deep-sea travel has made impressive strides in the world's understanding of the cultural significance of political history and scientific discovery.



*One of two manipulator arms on Alvin. Here, a deep sea tunicate has been collected. Photo credit: Rich Viso.*

Over the years, Alvin and its crew have played a significant role in international welfare and national security, including aiding missions to locate and recover an undetonated H-bomb lost in Spanish waters during the Cold War. Underwater waste disposal sites have also been selected and maintained by Alvin over the years, helping commercial shipping traffic and even assisting in the disposal and containment of nuclear waste.

Alvin has also played an integral role in our understanding of the planet through geoscience and evolutionary biology. For example, the vehicle was the first to provide visual proof of underwater spreading centers, including features now known as the East Pacific Rise and the Mid-Atlantic Ridge. Common seafloor expressions at these locations include volcanic-like features supplying hydrothermal fluids to the overlying ocean. Hydrothermal fluids have been documented to reach temperatures of 750° F (400° C) and contain minerals and nutrients in proportions appropriate to support dense undersea communities. Researchers aboard Alvin presented intriguing evidence for the origins of life as the communities identified by the submarine appeared to thrive thousands of feet below the ocean surface in total darkness near volcano-like features that discharge super-heated water!

*The DSV HOV Alvin being recovered onto the R/V Atlantis. Inside the submarine are two scientists and one pilot. Also pictured is a recovery team, including a swimmer and small boat operator, which ensures the safety of the research vessel, the submarine, the crew and the scientists.*

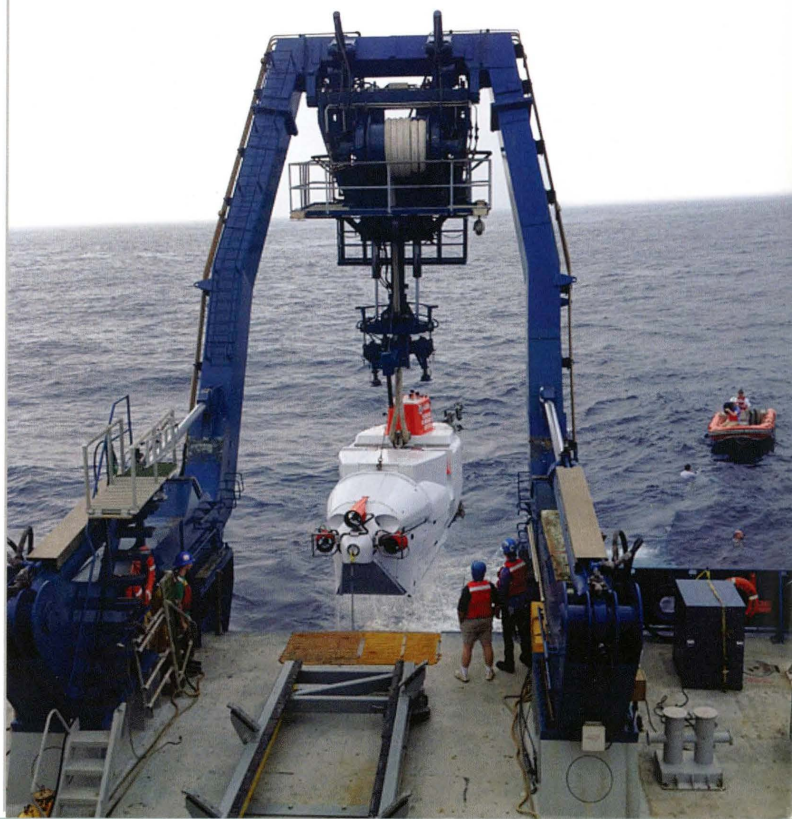

Observations made aboard the submarine have provided a mechanism to support the theory of plate tectonics proposed in the early 1900s and revolutionized our understanding of life on Earth. In addition to discovering countless new species, some of which had been thought to be extinct, in the mid-1980s, Alvin and crew made a dozen dives at the wreck site of the RMS Titanic and provided the world with its first images of the famous vessel since her maiden (and final) voyage across the Atlantic in 1912.

Today, at the ripe old age of 52, Alvin is capable of traveling more than 14,000 feet (~4,500 meters) below the ocean surface and still transports researchers to a world unfathomable to most. As more than two-thirds of our planet is covered by oceans, much remains to be discovered.

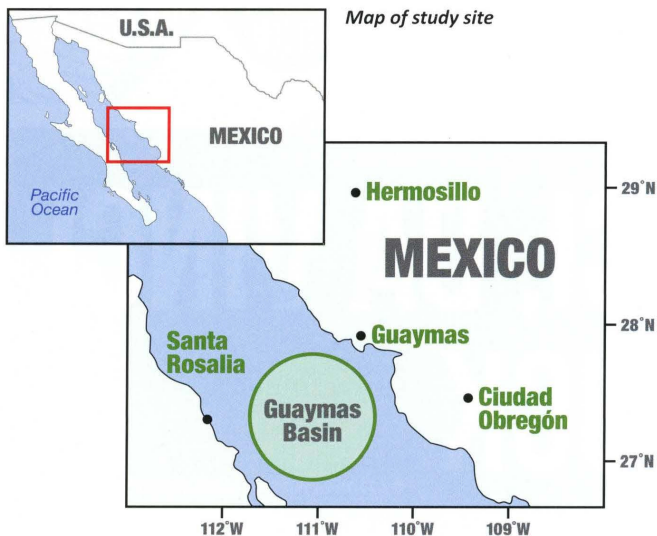

In December 2016, an assistant professor and graduate student from Coastal Carolina University will be traveling across the country to Manzanillo, Mexico, where they will be meeting researchers from the University of North Carolina at Chapel Hill and the University of Georgia to research beneath the waters of the Gulf of California in the Guaymas Basin. Together, we are hoping to understand how potent greenhouse gases like methane and carbon dioxide are transferred from the Earth's interior to the oceans and atmosphere, with specific attention to the role of bacteria and other microorganisms in oceanic carbon cycling along underwater volcanic settings. This holiday season, think discovery! 🇺🇸

For more information concerning CCU's research at the Guaymas Basin, contact Rick Peterson, Ph.D., at [rpeters2@coastal.edu](mailto:rpeters2@coastal.edu).

# Water covers 70% of our planet

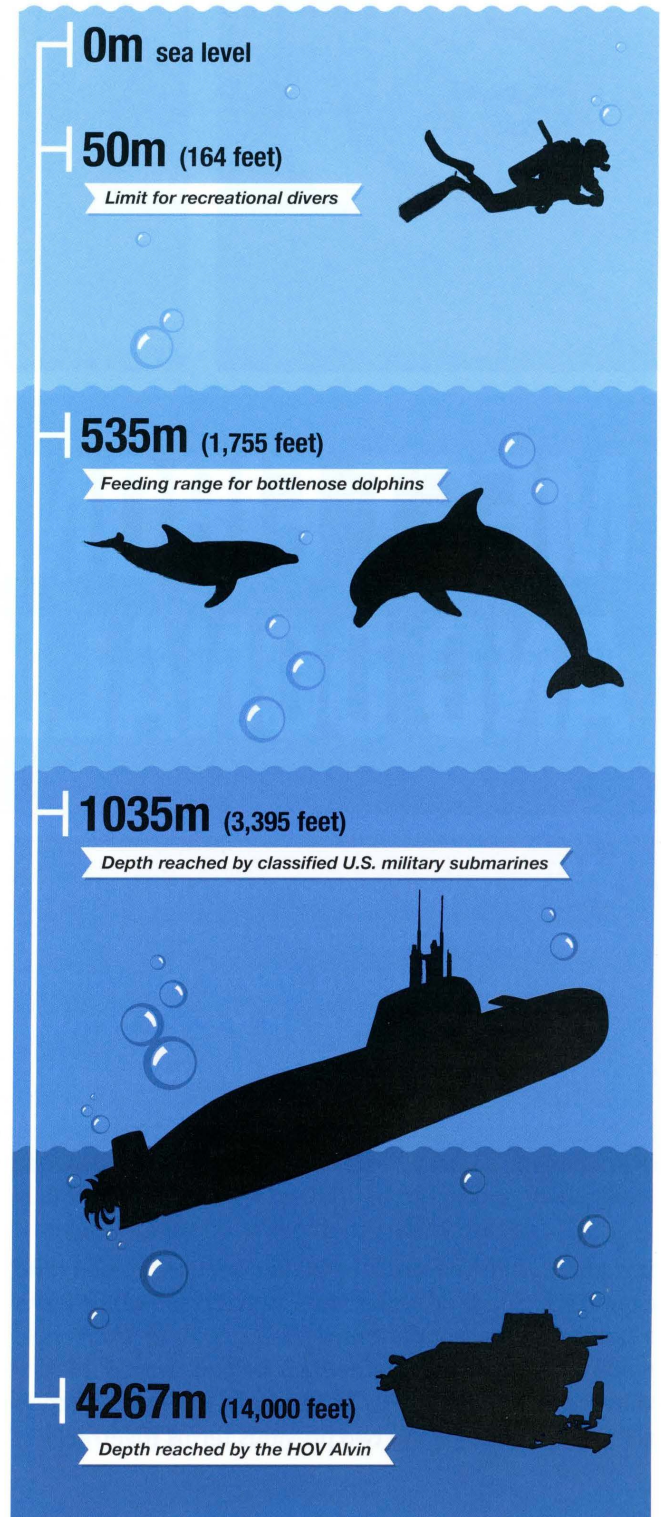

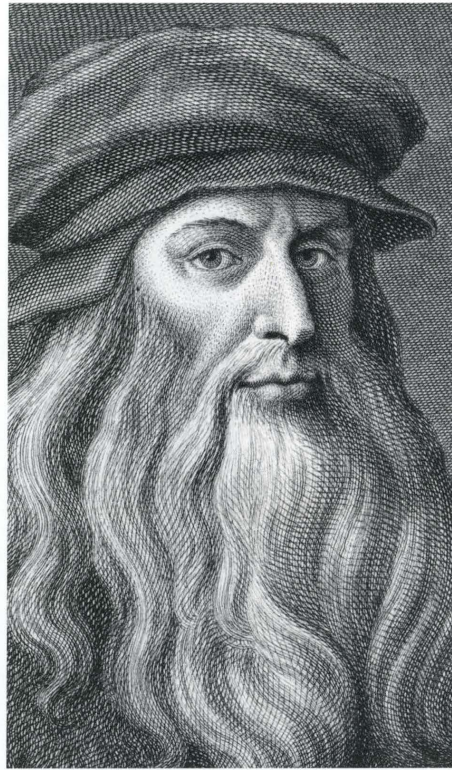

# MEET FIBONACCI, DA VINCI AND DONALD DUCK

by Jamie Hedges, Mathematics Lecturer,  
Coastal Carolina University

**W**hat if you were told that there was a simple mathematical pattern that appears almost universally throughout history and in many aspects of the natural world, from the spirals of a pine cone, to classical art pieces, and even the human body? Would you call it coincidence, or would it be indicative that there is more to existence than what we can empirically measure? This is the debate surrounding the Fibonacci sequence.

Sometimes referred to as the golden section, golden ratio, or even the divine proportion, the Fibonacci sequence starts with a simple but elegant pattern: 1, 1, 2, 3, 5, 8, 13, etc. It gets its name from the Italian mathematician Leonardo Bonacci (better known as Fibonacci) (circa 1170-1250). The terms of the pattern are found by adding the two previous terms together.

$$F_n = F_{n-1} + F_{n-2}.$$

During his travels around the Middle East and Northern Africa with his merchant father, Fibonacci discovered what we call the Hindu-Arabic number system. He saw the value in this number system, most notably its use of the decimal place, and wrote about it in his *Liber Abaci* (1202). This system was widely accepted, and it is what we use today. This text also poses the now-famous question involving a mating pair of rabbits.

**Q:**

**A man put a pair of rabbits in a cage. During the first month, the rabbits produced no offspring, but each month thereafter produced one new pair of rabbits. If each new pair thus produced reproduces in the same manner, how many pairs of rabbits will there be at the end of a year?**

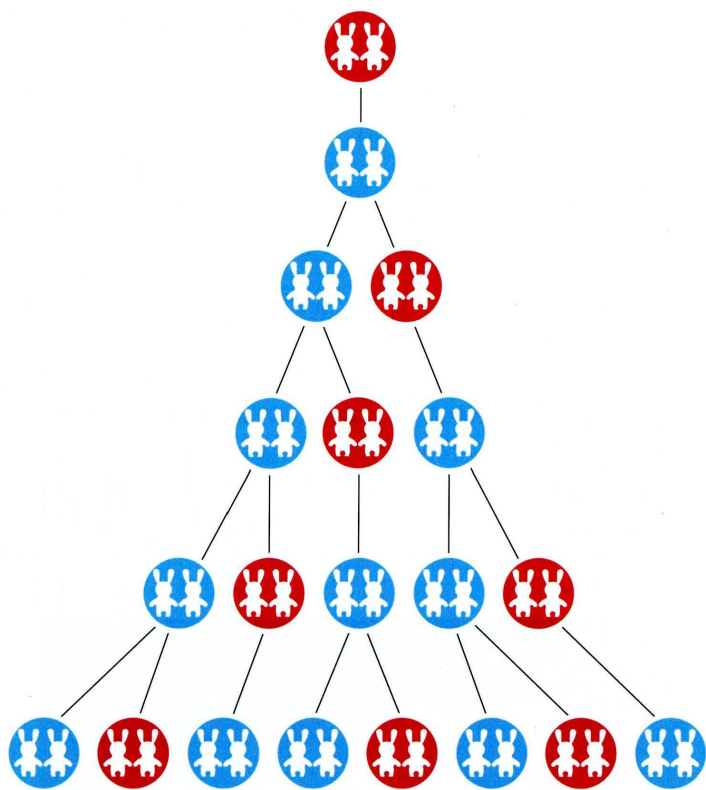

**A:**

The answer to the problem/riddle is found by using the Fibonacci sequence. For a long time, this was thought to be the first mention of the sequence. However, we now know that there are some ancient Indian manuscripts that make mention of the same sequence. However, Fibonacci is given credit for the sequence due to the wide audience of *Liber Abaci*.

The sequence is fairly basic in its creation (adding two numbers together). However, it has many more complicated implications. When looking at the ratio of two consecutive numbers in the Fibonacci sequence, these ratios, over time, converge to the golden ratio,  $\phi$ , 1.618... For example, remember the Fibonacci sequence begins as 1, 1, 2, 3, 5, 8, 13, 21, etc. Looking at the first few ratios of consecutive Fibonacci numbers would give you:

$$\frac{1}{1} = 1$$

$$\frac{2}{1} = 2$$

$$\frac{3}{2} = 1.5$$

$$\frac{5}{3} = 1.\bar{6}$$

$$\frac{8}{5} = 1.6$$

$$\frac{13}{8} = 1.625$$

$$\frac{21}{13} = 1.\overline{615384}$$

If you were to continue to carry out these ratios, the decimal representation for the fractions would approach the golden ratio.

But what is the golden ratio? It is an irrational number, which means that its decimal representation never terminates and does not have a repeating pattern. More plainly speaking, it goes on and on into infinity without any repeating patterns. The idea of infinity comes up again and again when studying the Fibonacci sequence. Even though we can always find the next Fibonacci number, the numbers will never stop.

The golden ratio was already an important number or concept for mathematicians, even before Fibonacci wrote about his sequence. Earlier famous mathematicians, such as Euclid and Pythagoras, were interested in the properties of the golden ratio and also mention it in their works. Artists and scholars throughout history used it as well. The most famous use is in the creation of the golden rectangle, a rectangle with proportion of long side/short side =  $\phi$  (the golden ratio). The golden rectangle shows up most famously in the creation and structure of the Parthenon and also in the work of Leonardo da Vinci. Da Vinci was fascinated with the ratio. He illustrated the book *De divina proportione* by Luca Pacioli. Da Vinci's illustrations show that he used the golden ratio and golden rectangle in his art.

# THE GOLDEN RECTANGLE

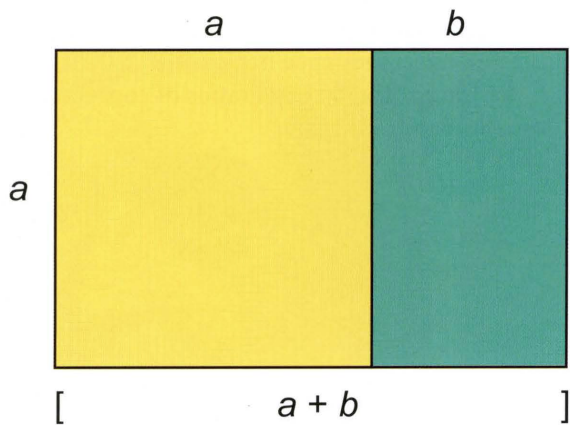

(Figure 1)

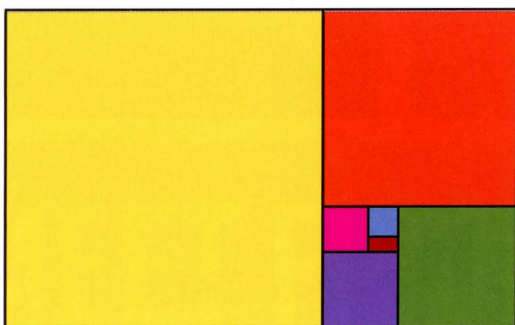

(Figure 2)

The concept of infinity comes into play again with the golden rectangle. There are infinitely many smaller golden rectangles that can be formed from a given golden rectangle, as well as infinitely larger golden rectangles. When looking at a golden rectangle (see Figure 1), create the largest possible square inside. This is done by making a square with sides the same as the length of the shortest side of the golden rectangle. Remove, or imagine removing, that square. What you are left with is a golden rectangle. The same process can then be done for your new, smaller golden rectangle. This process continues into infinity, each time getting a smaller and smaller golden rectangle (see Figure 2).

The converse is also true. Given any golden rectangle, infinitely many larger golden rectangles can be found in a similar fashion. You can use the long side of the golden rectangle to form a new square outside of the rectangle. The entire shape (large square and golden rectangle) will form a new rectangle that also meets the qualifications of being a golden rectangle; the ratio of the new rectangle's long side to the new rectangle's short side is  $\phi$ . Thus, the golden rectangles will also grow and also shrink into infinity.

The golden ratio and Fibonacci sequence appear in many places in our world and its history. Its widespread use and appearances lead some people to call this phenomenon "the divine proportion." These individuals believe that it is no coincidence that the same ratio comes up in so many aspects of our human lives and that there must be something connecting all of this together. Although everyone who has studied the ratio does not accept some of these connections, it is at least worth mentioning.

For example, when comparing many parts of the human body to one another, the ratio of  $\phi$  is found. Imagine creating a rectangle from shoulder blade to shoulder blade

# THE GOLDEN SPIRAL

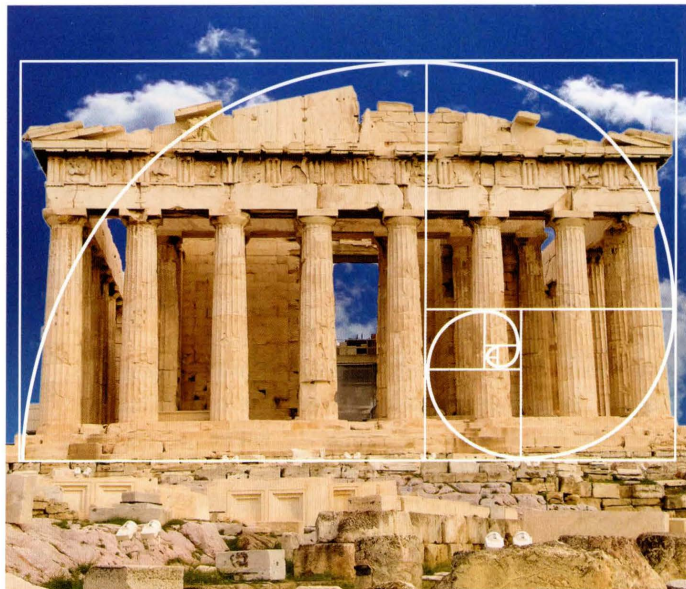
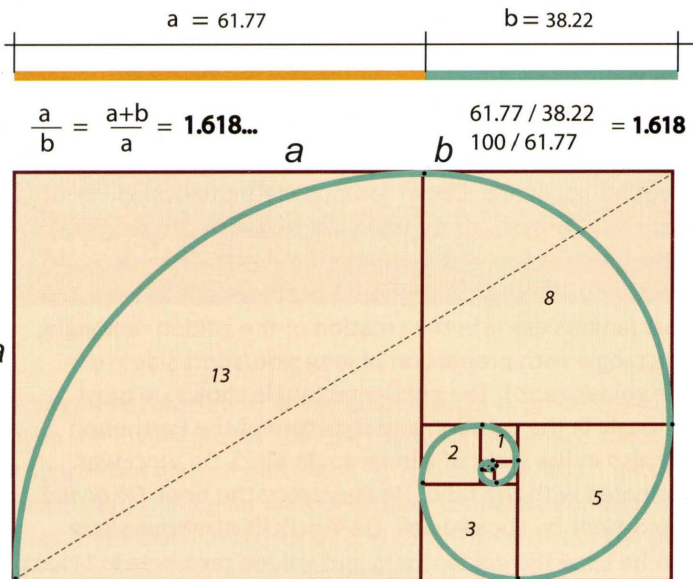

and with height from the bottom of the neck to the bottom of the chest plate. Comparing those lengths (longer shoulder to shoulder to shorter chest plate height) will give a number close to this golden ratio.

An offshoot of the golden rectangle, the golden spiral, is a logarithmic spiral that grows at a factor of  $\phi$  and also appears in the natural world. For every quarter turn, the spiral becomes wider by a factor of  $\phi$ . Scholars who have studied this spiral relate it to some mollusk shells. However, others believe that mollusk shells simply follow any logarithmic spiral and not specifically the golden spiral. Galaxies grow in logarithmic spirals as well and are sometimes associated with the golden spiral. However, most have a different factor of growth than the golden spiral.

Despite contention over some of its appearances, there are some real-life occurrences of the golden ratio that are widely accepted, particularly in music. The famous violin-maker Stradivarius used the golden ratio to ensure that his violins would have optimal tone. This can be seen when comparing different parts of the violin to one another. The company Pearl Drums also says it uses the golden ratio when creating its drums.

Looking at spiraling vegetation, such as pineapples or pine cones, the numbers of spirals clockwise and counterclockwise are almost always adjacent Fibonacci numbers. The same adjacent Fibonacci spiraling idea is found in the seed heads of sunflowers and coneflowers. The reason for such a pattern is for the plant to conserve energy when growing. The consecutive Fibonacci numbers allow for the best possible packing scenario for each spiral. Honeybees also utilize the Fibonacci numbers to help with their mating ratios. When looking at the ratio of females to males in a hive, the answer is usually close to  $\phi$ .

The beauty, simplicity of sums and the subtle nature of the Fibonacci sequence have also inspired artists throughout time and mediums. Georges Seurat's paintings, such as "Bathers," are one example of how artists often incorporate the golden ratio into their paintings. Salvador Dali used a canvas that was a golden rectangle for his "Sacrament of the Last Supper." Many modern architects make use of the golden rectangle and the golden ratio when designing their buildings. Even the rock band Tool wrote the song "Lateralus" after being inspired by this centuries-old concept. The sequence appears in the syllable count of the lyrics, time signature and lyrical content.

Maybe most novel of all, Donald Duck himself made sure that the golden section had a prominent role in his classic short, "Donald Duck in Mathmagic Land," a cartoon in which Donald Duck introduces viewers to the many wonders of mathematics. Currently, the most famous use is probably from the popular movie and novel "The Da Vinci Code." The movie made the Fibonacci sequence popular again because it reintroduced the world to many of the occurrences and relationships that the sequence has to our natural world.

The uses of the Fibonacci sequence and golden ratio seem as infinite as the sequence itself. As we explore different fields of mathematics, this simple sequence keeps appearing. New concepts continue to be linked to it.

All of the aforementioned occurrences lead some people to believe that this irrational number  $\phi$  must be the fingerprint of the divine. Of course, others just think we humans are making too much of coincidence. What do you think? 

*Jamie Hedges can be reached at [jjhedges@coastal.edu](mailto:jjhedges@coastal.edu) or 843.349.6660.*

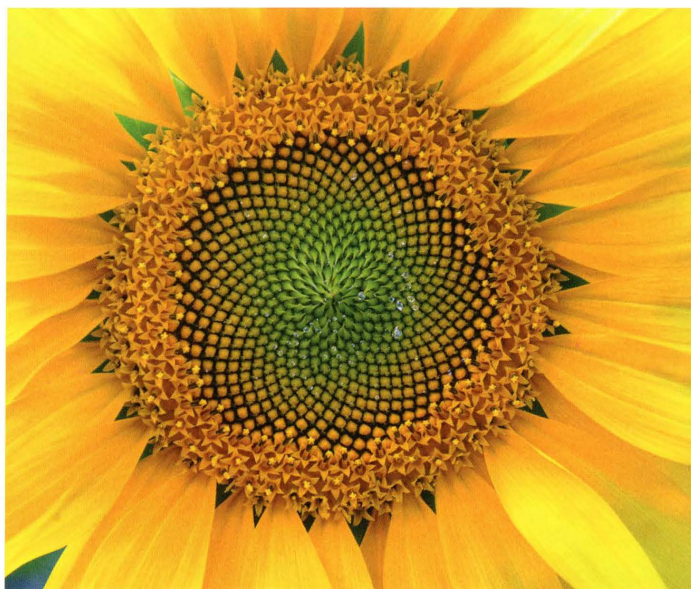

the **Secret**

**T** to

**Toned**



# Muscles:

**It's not just cardio**



*by Jason Cholewa, Ph.D.,  
Assistant Professor of Exercise and Sport Science,  
Department of Kinesiology, Coastal Carolina University*



**R**

esistance training (aka strength training, weightlifting) has become increasingly popular in the past two decades, and for good reason. Strength training, in conjunction with a balanced diet rich in protein, has been shown to increase muscle mass and strength. Additionally, strength training has important health benefits for men and women of all ages, such as an elevated metabolic rate, reduced risk of metabolic diseases such as diabetes and high cholesterol, stronger bones, a reduced risk of osteoporosis, improved coordination, and an increased overall quality of life.

A common misconception held by many in the lay population and mainstream fitness industry is that heavy resistance training results in rapid muscular growth, leading to a “bulky” appearance in females. Fitness magazines and webpages marketed toward female audiences quite frequently display fitness models doing unconventional exercises with small, brightly colored weights. These displays further the stereotypical perception that women should not lift heavy weights by promoting workouts based upon body weight movements, light weights, and an overwhelming emphasis on cardiovascular training. As a result, many females, both young and old, do not train with an adequate volume or intensity to reap the many health benefits associated with strength training. In fact, a recent study conducted at Baylor University reported that nearly two-thirds of college-aged females do not meet the national recommendation to strength train at least two days per week.

A common aesthetic goal of college-aged females is to achieve a “toned” look. In medicine, muscle tone refers to a partially contracted state of the muscles, such as how your lower back muscles are holding your body erect as you are reading this article. On the other hand, the “toned” look so many women strive for is actually the product of a lower body fat percentage and substantial muscular development. Although a calorically appropriate diet and exercise will reduce body fat, only strength training with an adequate load will increase muscle mass enough to bring about the appearance of a “toned” physique.

Several recent studies in men suggest that muscle growth can occur over a variety of loading schemes ranging from heavy weights with low repetitions to moderate weight with higher repetitions; however, this work has not been replicated with female participants.

To better prescribe strength training for female participants, the kinesiology department at Coastal Carolina University conducted a study in the spring semester of 2016 to investigate the effects of two different strength training programs on muscle growth, body composition and strength in college-aged females. A secondary aim of this study was to determine if the belief that lifting heavy weights would “bulk women up” was reality or myth.



Visiting scholar Fabricio Rossi and a team of five undergraduates provided personal training to 23 CCU female volunteers three times a week for nine weeks. All the participants performed two lower-body strength training sessions consisting of squats, deadlifts, glute bridges, lunges, leg extensions, leg curls and abdominal exercises, and one upper-body session consisting of overhead presses, bench presses, rows, pull downs, bicep curls, triceps extensions, and abdominal exercises. The participants were split into two groups equally matched for body fat percentage, weight and strength. One group trained with a heavy load (four sets of five to six repetitions) and the second group trained with a moderate load (two sets of 10 to 12 repetitions).

Following nine weeks of heavy or moderate strength training, both groups gained approximately 3.5 pounds of muscle mass, lost 3 pounds of body fat, and saw a

slight increase in muscle growth of the arm and thigh. Additionally, both groups gained a considerable amount of strength, with the average weight of one repetition maximum back squat increasing from 130 pounds to 180 pounds, and the average weight of one overhead press increasing from 61 pounds to 70 pounds.

*Below: The research team, from left to right: Fabricio Rossi, Samantha Gallo, Ashley Micensky, Jason Cholewa, Amy Hewins and Christian De Angelis.*



With these increases in strength also came improvements in vertical jump height and medicine ball throw distance – indicators that overall physical function had increased. Subjectively, the participants were pleased with their results and reported having more energy, greater confidence and clothes that fit better!

This was the first study (to our knowledge) that demonstrated lifting heavy weights does not result in a bulky appearance in females. To the contrary, the results of this study show that females who want to improve their body composition and achieve a “toned” appearance should indeed lift heavier weights. The muscle growth seen in this study led to an increased metabolic rate, which resulted in reductions in body fat despite the fact that participants did not change their dietary habits. This increase in muscle mass and metabolic rate enhances the ability to maintain a leaner body composition (i.e., keep the fat off), an important consideration

given the prevalence of excess weight regain following dieting in the United States.

To put these findings into practice, our team suggests that anyone new to strength training follow the steps below:

- Begin with two sets of 10 to 12 repetitions. Perform three full-body workouts per week on nonconsecutive days that train all the major muscle groups and focus on increasing the number of repetitions performed. Once 15 repetitions can be accomplished with good technique; increase the weight until you can only perform 10 to 12 repetitions.
- After four weeks, increase the number of sets per exercise to three and reduce the number of repetitions to eight to 10. Again, increase the weight used when you can perform 10 repetitions for all three sets.
- After another four weeks, increase the sets per exercise to four and reduce the repetitions to six to eight. Increase the weight used when eight repetitions can be performed for all four sets.
- Once you have completed all 12 weeks, change the exercises, add in a fourth day per week if it fits your schedule, and use the same progression.
- For the best results, consume an energy appropriate diet with 0.8 to 1 gram of protein per pound of body weight. 

Contact Jason Cholewa at [jcholewa@coastal.edu](mailto:jcholewa@coastal.edu) or 843.349.2041.



*A participant performs an easy one-repetition maximum squat with 185 pounds as Christopher Carney and Fabricio Rossi provide a spot while Jason Cholewa delivers cues for correct technique.*

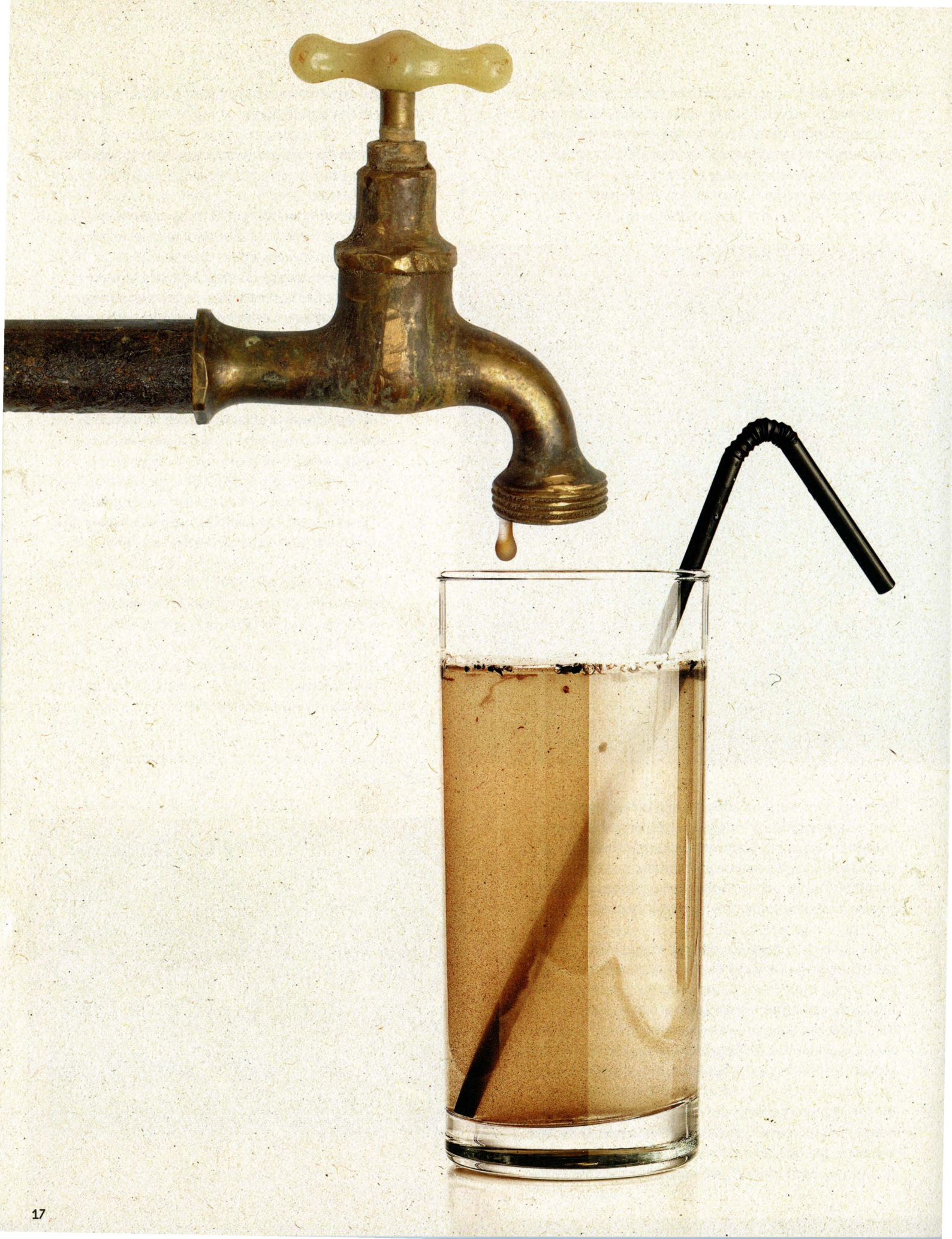

CITIZEN SCIENCE MAKING A DIFFERENCE:

*Determining*

# WATER SAFETY

by Jaime McCauley, Ph.D., Assistant Professor,  
Department of Sociology, Coastal Carolina University

IN APRIL 2014, THE CITY OF FLINT, MICHIGAN, SWITCHED ITS WATER SUPPLY FROM THE DETROIT WATER AND SEWERAGE DEPARTMENT TO WATER DRAWN FROM THE FLINT RIVER. BY AUGUST 2014, THE FIRST OF SEVERAL BOIL WATER ADVISORIES WAS ISSUED TO FLINT RESIDENTS BECAUSE OF HIGH FECAL COLIFORM LEVELS. IN JANUARY 2015, A WARNING WAS ISSUED REGARDING HIGH LEVELS OF A DISINFECTANT BYPRODUCT LINKED TO KIDNEY AND LIVER DAMAGE.

By this time, Flint residents had begun to complain about discolored, foul-smelling water coming from their taps, only to have their complaints repeatedly brushed aside by local and state officials. Worried about her children's health and exasperated by the city's reluctance to take her concerns seriously, stay-at-home mom LeeAnn Walters began researching lead contamination. Her diligence eventually led her to professor Marc Edwards at Virginia Tech, who, years prior, had exposed lead contamination in Washington, D.C.'s water supply. In partnership with Walters, Edwards provided Flint residents with special vials and trained them to collect samples using scientific protocols. They mailed him the samples and he analyzed them, finding extremely high levels of lead contamination. Edwards made the data publicly available and, eventually, it garnered media attention and the city was forced to take action.

Citizen science is a collaboration between lay participants and scientific experts for the purpose of producing scientific data. These collaborations are celebrated for their potential to democratize scientific knowledge production, increase scientific literacy, identify and build public awareness of environmental issues, and empower citizens to hold government agencies accountable for environmental protection.

On the other hand, some observers worry citizen science programs may be vulnerable to co-optation by cash-strapped government agencies willing to hand over responsibility for environmental monitoring to volunteers while retaining control over the citizen-produced data. The real impact of citizen science, of course, can be found somewhere in the middle.



The partnership between Walters' "Water Warriors" in Flint and Marc Edwards' research team at Virginia Tech may be the most high-profile example of citizen science, but it is certainly not the only one. Partnerships between citizens and scientific experts have existed for many years, and citizen science has a long and storied history in the United States.

Volunteer water-quality monitoring got its start in 1969 with the Izaak Walton League's Save Our Streams Program, and there are now more than 500 such programs operating across the United States. Citizen-expert water-quality monitoring partnerships have been in place for decades in Appalachian regions where residents are concerned about the effects of mountain top removal mining. More recently, volunteer monitoring programs have been formed by folks concerned about shale gas development and the effects of hydraulic fracturing (commonly known as "fracking").

In addition to programs started by citizens in response to a potential environmental threat, other volunteer monitoring programs were initiated by state- and county-level environmental management agencies with the goal of utilizing volunteers to establish baseline data. While we may expect to find robust volunteer participation in citizen science partnerships when a pre-identified environmental hazard is present, many volunteer water quality monitoring programs are thriving in places where there is no specific threat to motivate citizen participation.

I have been studying the goals and motivations of participants in volunteer water-quality monitoring programs in the Greater Cincinnati/Northern Kentucky metropolitan region, as well as the outcomes of the programs themselves. There are no acute environmental risks in this region (e.g., no mining or fracking nearby), yet there are five active citizen science-based volunteer water quality-monitoring organizations in this area. Between them, hundreds of volunteers donate anywhere between two to 12 hours of their personal time during the organizations' designated monitoring day to collect samples, run tests in the lab, help with administrative tasks, and perform other duties as needed. Who is involved in these programs, why do they do it and what impact are they having?

## CITIZEN SCIENCE IN ACTION

Unlike the volunteer water-quality monitoring programs highlighted above, the volunteer monitoring efforts in Greater Cincinnati and Northern Kentucky were not born from efforts to make government agencies accountable for some oversight or to expose a specific environmental health threat. Here, many volunteer monitoring organizations work closely with local government agencies that provide monitoring programs with financial support, equipment, and, in some cases, personnel. Still, these citizen science groups have been able to impact local environmental governance in many ways.



## CITIZEN SCIENCE IS A COLLABORATION BETWEEN LAY PARTICIPANTS AND SCIENTIFIC EXPERTS FOR THE PURPOSE OF PRODUCING SCIENTIFIC DATA.

For example, based on citizen data, local governments have made decisions to upgrade wastewater facilities and relocate parks found in contaminated areas, and they have addressed various types of pollution. In addition, these groups have engaged in outreach with farmers and businesses and have been successful in convincing both groups to adopt practices that contribute to increased water quality. Despite these (and other) successes, some participants feel as though the organizations themselves lack control over their data and find it problematic that government agencies determine the outcomes of citizen-produced data.

During my research, I engaged in participant observations at laboratory monitoring sessions, public meetings, volunteer trainings, social events and community forums. In addition, I performed 19 in-depth interviews with participants from each of the five regional water-quality monitoring programs.

Interview participants include lay volunteers, scientific experts, and both volunteer and paid program coordinators. Many of the participants in this study are middle-aged, upper income, highly educated and white. Interview participant ages range from 24-71; 10 women and nine men were interviewed, 18 are white and one is black. For lay volunteers, professional backgrounds range from education and art to engineering and construction.



## MOTIVATIONS FOR PARTICIPATION

Rather than suspecting an acute environmental health threat, participants in these programs are more likely to have a general appreciation for nature and a sense of curiosity about water quality. For example, many of them canoe, kayak or fish in their local waterways. Volunteer monitoring is a way to answer their own questions about water quality and to “leave the world a better place.” For the majority of respondents, participation in volunteer water-quality monitoring is driven by a belief that water is a valued resource. Some volunteers even consider water sacred; describing a “spiritual connection” to the water. Others said simply, “Water is life.”

Participants often developed a deep connection to water as a result of a childhood attachment (growing up near a creek or other body of water), participation in outdoor activities (e.g., canoeing, kayaking, fishing), or through some transformative event. Transformative events typically involved witnessing severe pollution, though, in one case, taking an ecology class in college caused a profound shift in the participant’s worldview and appreciation for nature. Perhaps most importantly, participants see themselves as the kind of person who takes action to correct what they consider wrong or unjust.

While these individual experiences initially motivated folks’ involvement in volunteer monitoring, it is the social experience that takes place during monitoring that keeps them coming back. Participants frequently described the interactions between group members as friendly and easygoing, even “jocular.” One respondent was quite specific about the importance of positive social interaction, saying rather bluntly, “I wouldn’t do it if it were just a bunch of stuck-up people.” This camaraderie includes interactions across the spectrum of citizen science participants – lay volunteers, scientific experts and program coordinators.

Specifically, lay volunteers expressed appreciation for learning from the experts involved in the programs. Many remarked on the enthusiasm, patience, and supportiveness of the scientific experts and group leaders involved in their programs. In the organizations featured in this study, scientific experts and program leaders typically work side-by-side in the lab with lay volunteers. Time and again, a deep mutual respect was observed between the experts and volunteers in these programs, and this was articulated in interviews as well. For all participants, these positive social interactions are a source of great satisfaction. This, in turn, facilitates volunteer retention and program success.

## WHAT DO PARTICIPANTS WANT?

Both lay and expert volunteers recognize that data must be present to determine if action is needed. Each of the participants indicated that collecting data or building databases was the single most important outcome of

volunteer monitoring. However, many participants want the data to move beyond just sitting in a database. This is especially poignant for lay volunteers who wanted something to happen with data, but feel that they themselves did not know what to do with it. Many are confident collecting water samples and performing tests at the lab while under the supervision of experts, but analysis and mobilization of data was seen as the sole responsibility of experts and organizational leadership. While citizen science is celebrated for breaking down barriers between citizens and experts, the line between “lay” and “expert” is never fully erased, nor do participants feel it should be. Lay volunteers are comfortable being a “scout” who alerts experts to a potential problem, rather than “having the final word” in determining whether a problem exists.

The most optimistic proponents of citizen science see lay people and experts participating together as equals, but the lay volunteers in this study more likely see themselves in a supporting role to scientific experts. At the same time, they place a great deal of trust in the experts involved, and they are confident that if the data reveals a problem, the experts and organizational leaders will take action to see that it is addressed. Lay volunteers express pride in their role because they “can help the people who can make a difference.” While this may temper the enthusiasm of some proponents of citizen science, there is still much to celebrate about programs in which lay participants take an active role in producing scientific data and experience a sense of pride in their contribution to program goals.

## OUTCOMES OF VOLUNTEER MONITORING PROGRAMS?

The impact of these citizen science partnerships frequently depend on the structure of the program. The five volunteer monitoring programs featured here have somewhat different origins and organizational structures, and this influences the outcomes of their monitoring efforts. Mobilizing data for action appears to be most difficult for monitoring programs closely managed by government environmental agencies. On one hand, it appears as though these programs should have a direct line to government agencies if they spot a problem in the data; however, the agencies involved use citizen data for establishing baseline trends only. This is true even though the data is produced in a university lab under the supervision of scientific experts. This can create tension for program leaders, especially if volunteer goals conflict with organization goals.

In this study, the program coordinator of such a group expressed some frustration on the part of volunteers who wanted the data to be used beyond simply being turned over to government agencies and being stored in a database. Other than collecting data, this group had no tangible regulatory impact.

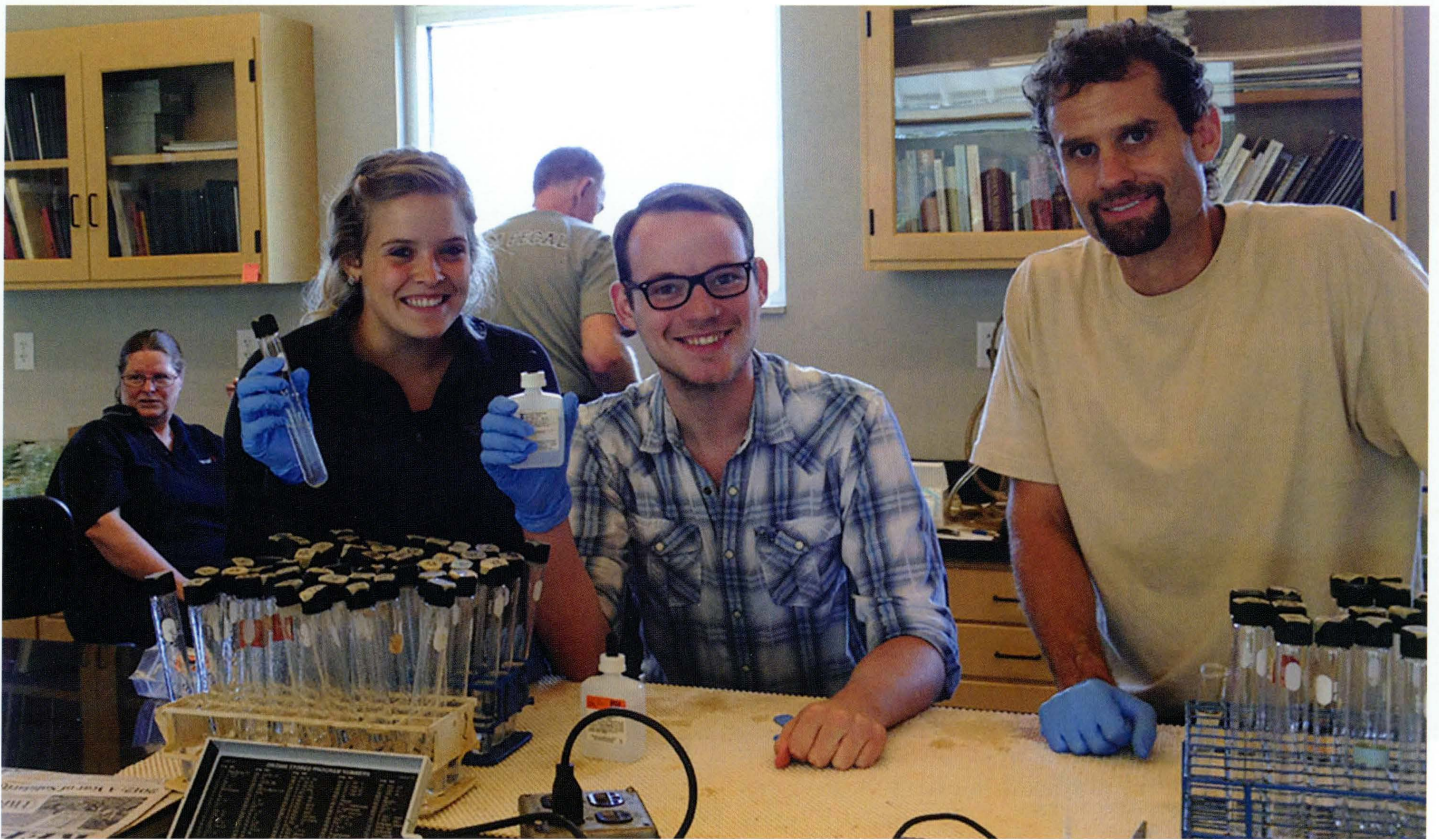

*Sociology students engaging in participant observation in volunteer water quality lab take a break to pose with scientific experts and volunteers.*

Another program in the study was founded by a government agency, but operates without direct oversight (or funding). Respondents from this organization report mixed results. One participant described a “very symbiotic, mutually beneficial relationship between the river basin water-quality monitoring group and [government agencies].” Another participant from this program expressed frustration with state agencies that had included program data in an official report without acknowledging their contribution: “None of the data collected by [our organization] were even mentioned in the documentation ... despite 15 years of data collection.” This erasure of citizen-produced data challenges the assertion that citizen science can be used to hold government agencies accountable for environmental management. However, this program also reported several regulatory or policy impacts. For example, their data had been used to establish stronger environmental regulations for the airport and to convince authorities to upgrade several wastewater treatment plants.

Programs that were initiated by community members and operate without direct government affiliation seem best able to impact environmental governance, frequently doing so through collaborative relationships with local government agencies. One such group is citizen-operated with support and funding coming primarily from a local environmental education foundation. The coordinator of this program describes her organization as educational, not political, and states that her program does not take part in policy matters.

However, because the data produced by the program is publicly available, citizens have mobilized the data to accomplish a great deal, including: reporting point source pollution and toxic waste, calling out a chemical company for falsely labeling its products, and relocating a number of wastewater treatment plants. The program coordinator is quick to point out that each of these was accomplished through collaborative efforts with multiple stakeholders, rather than confrontational tactics like protests and picket lines.

## KEY TAKEAWAYS AND FUTURE DIRECTIONS

A close look at these five programs from one metropolitan area reveals that citizen science and volunteer monitoring programs are not one-dimensional. While there are similarities in the goals and motivations of the people who volunteer – for example, valuing nature and environmental stewardship, and wanting to make a difference – the outcomes of each program are heavily dependent on that group’s structure and relationship to government agencies.

Currently, I am engaged in interviews with a national sample of water-quality monitoring programs in an effort to examine whether regional differences are at play in the factors laid out above. 

*Jaime McCauley can be reached at [jmccauley@coastal.edu](mailto:jmccauley@coastal.edu) or 843.349.6965.*



# At Sea:

## *Marine and wetland studies team continues partnership with Florida Atlantic University*

by Paul Gayes, Director/Palmetto Professor,  
School of Coastal and Marine Systems Science,  
Coastal Carolina University

**B**urroughs & Chapin Center for Marine and Wetland Studies (CMWS) staff Paul Gayes, Len Pietrafesa and Shaowu Bao are continuing their partnership with Florida Atlantic University's Institute for Sensing and Embedded Network Systems Engineering (I-SENSE; [isense.fau.edu](http://isense.fau.edu)) to expand sensing and observational systems to feed CMWS's advanced ocean, atmosphere and wave-modeling system for a wide range of physical, environmental, and biological monitoring and management.

Initially, the CMWS-FAU team installed a meteorological station on the NOMAD buoy ([nomad.catalinasearanch.com](http://nomad.catalinasearanch.com)), which is to support a wide range of instrumentation with the goal of better characterizing the physical, chemical, biologic and environmental character of the site and to evaluate that information to optimize shellfish production and minimize environmental impact.

CMWS is also engaged in deploying a series of Acoustic Doppler Current Profiler systems in experiments intended to characterize the detailed current, wave and turbulent mixing characteristics of the site and how the construction of a large ocean aquaculture facility in the Southern California Bight interacts and potentially modifies circulation, mixing and other phenomenon that could be modeled and used to optimize production.

### NOMAD BUOY

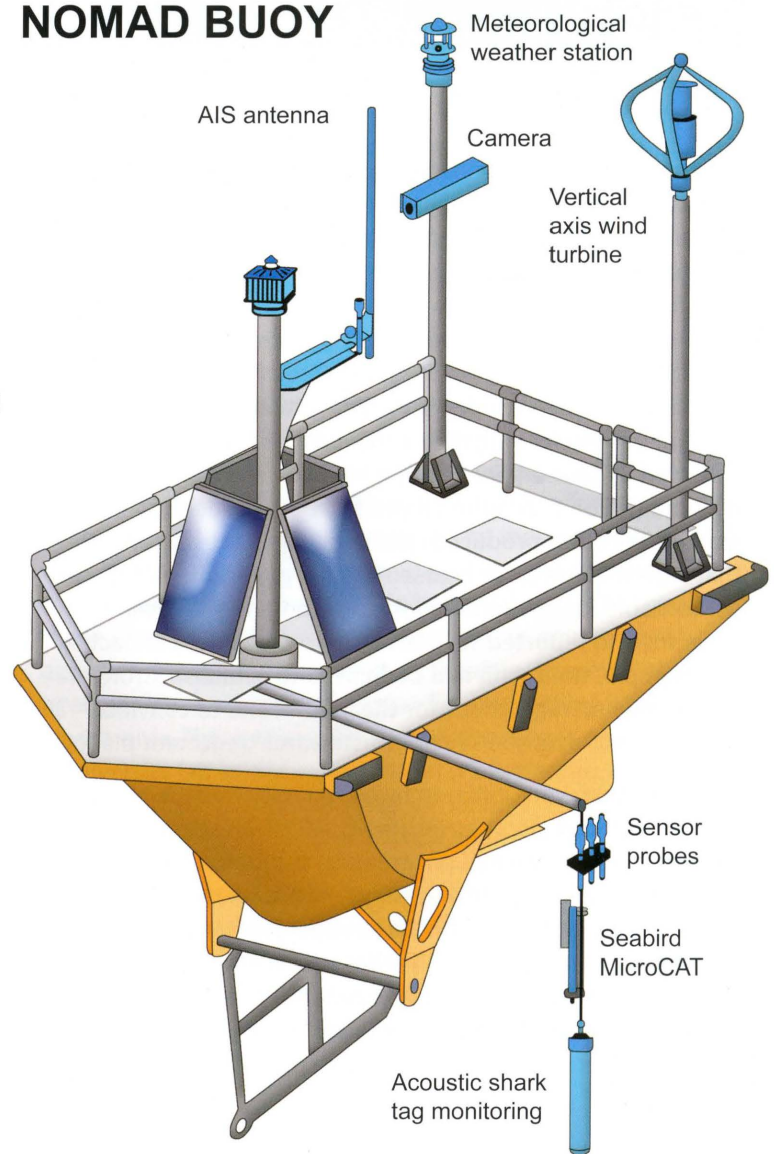

This year, the South Carolina legislature added some funding to the University's budget to help expand the network of meteorological stations in the state with the goal of increasing the resolution of weather phenomenon and through that model resolution and skill.



The effort is part of a broad range of initiatives with Florida Atlantic's I-SENSE program seeking to capitalize on the Coastal Center's environmental and modeling applications and I-SENSE's technological and "big data" capabilities.

This year, the South Carolina legislature added some funding to the University's budget to help expand the network of meteorological stations in the state with the goal of increasing the resolution of weather phenomenon and through that model resolution and skill. This partnership with county emergency managers and other state agencies is a step toward improvement of preparedness and planning and operations in response to natural forces that can threaten our state's infrastructure and economy, as exemplified in Fall 2015 during the historic flooding associated with the Hurricane Joaquin weather complex.

The center and I-SENSE are working toward bridging temporal scales of events, such as individual storms or environmental pressures such as spills, hypoxia or other water quality issues to longer-term threats of sea level rise and change in storm patterns and intensities.

This partnership grew out of collaborative efforts in instrumenting the Savannah River system and then expanded through the national MesoUS network feeding the NOAA National Weather Service's forecast models to now include initiatives such as at the Catalina Sea Ranch and integrated natural disaster and environmental initiatives across the Southeast.

### *Aquaculture research initiative*

A Burroughs & Chapin Center for Marine and Wetland Studies team has begun collaborative research with the Catalina Sea Ranch LLC, a pioneering aquaculture facility being developed six miles off the shore of California.

In addition to developing the first offshore aquaculture facility in the United States, the leaders of the development, Phil Cruver and Reg Olsen, are strongly promoting a vision of the venture benefiting from best science and technology available. Integrated within the "Internet of Things," the Catalina Sea Ranch has engaged a number of universities and companies, bringing a particular technical and research specialty to the overall effort ([catalinasearanch.com](http://catalinasearanch.com)). 

*Paul Gayes can be reached at [ptgayes@coastal.edu](mailto:ptgayes@coastal.edu) or 843.349.4015.*



BIOLOGICAL DEPENDENCE:

# WORKING WITH

# WORMS

by Dan Williams, Ph.D., Assistant Professor,  
Department of Biology, Coastal Carolina University



## WHAT DO YEAST, FRUIT FLIES, NEMATODE WORMS, ZEBRAFISH AND MICE HAVE IN COMMON?

They are all genetic model organisms that have made significant contributions to our understanding of biology. In addition, experiments on these organisms have been part of Nobel Prize-winning research that is well known among biomedical researchers:

- Experiments in yeast were used to identify genes that regulate progression through the cell cycle, and these genes are often mutated in different forms of cancer.
- The fruit fly was instrumental in establishing the chromosomal basis of gene inheritance and the mutagenic effects of radiation.
- Nematode worms were used to discover genes that trigger programmed cell death and the process of RNA interference.
- Genetic screens in zebrafish were used to identify genes and cellular processes that are important for early embryonic development.

- As mice have many similarities to humans, research on them is more applied and has led to important discoveries of how the nervous system works and genetic requirements of pluripotent stem cells.

Without the contributions of many researchers who use these genetic model organisms, our understanding of biology and medicine would be severely reduced.

Work in my laboratory at CCU uses the nematode *Caenorhabditis elegans* because it offers a number of advantages over other model organisms and is well-suited to the types of research questions my lab is interested in.

First of all, these worms are very small and easy to grow in the lab. As adults, they are ~1 mm in length and grow on small plates that have a bit of bacteria the worms eat. Second, worms are very amenable to genetic and molecular

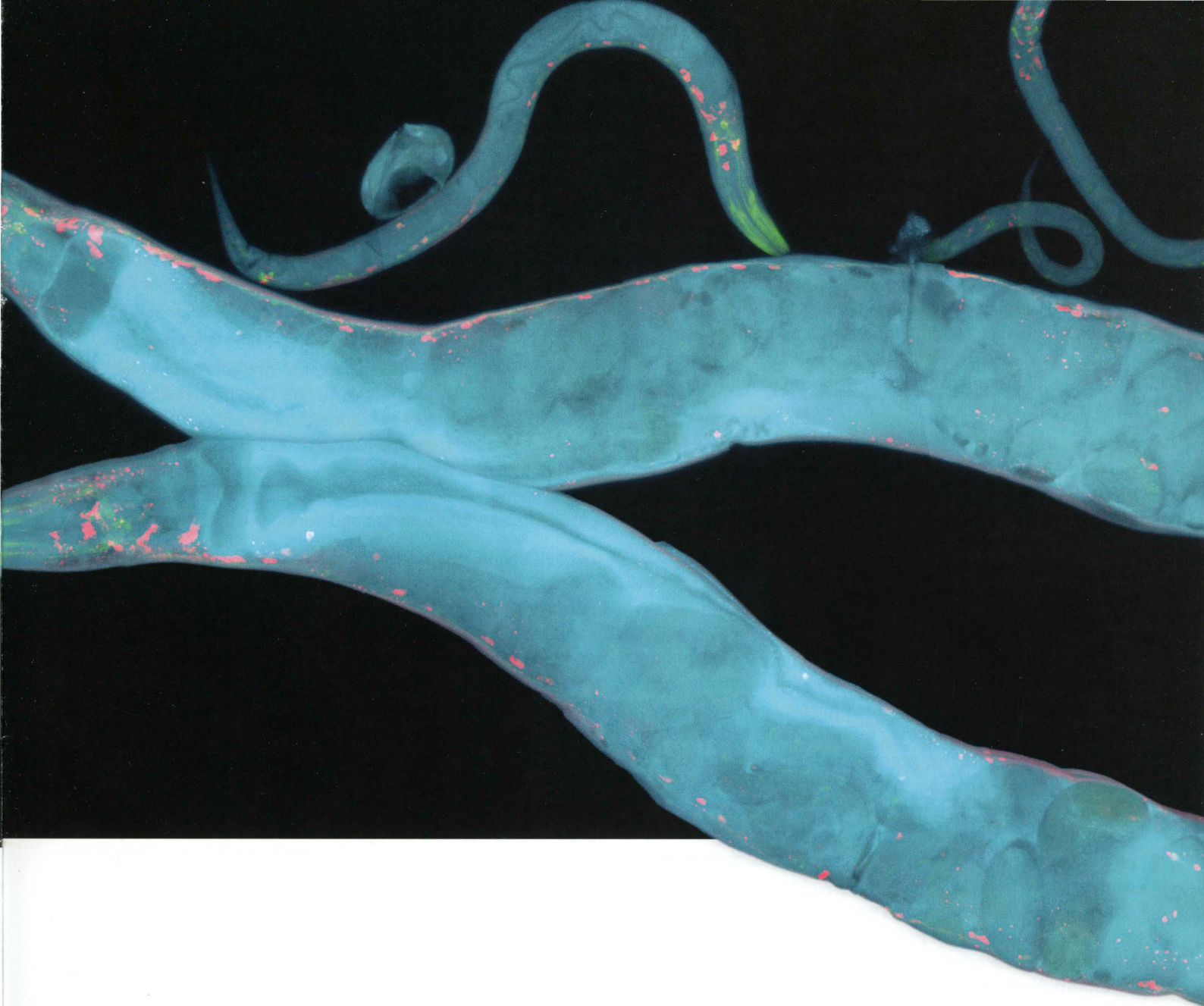

manipulation. It is easy to make mutant worms defective in a given gene, and transgenic animals can be made that contain any specific piece of DNA. This allows worm strains to be generated that express fluorescent proteins to visualize specific tissues, cells or organelles. Third, the cellular anatomy of worms, specifically the nervous system, has been extensively studied and is well characterized. There are exactly 302 neurons in an adult *C. elegans* and the synaptic connections between these neurons have been established at the ultrastructural level. The simplicity of this nervous system makes experiments on worms much easier than on human brains, which have ~86 billion neurons each.

Finally, many human genes, including those that are involved in diseases, have counterparts or homologs in the worm. Because of this, experiments can be done on this simple invertebrate animal that have direct relevance to human

diseases. Many experiments investigating fundamental questions within biology are not possible in humans, but have been and will continue to be done on worms.

Within my research lab, my students and I exploit the benefits of the worm to better understand what happens as neurons degenerate. There are many neurodegenerative diseases – such as Alzheimer’s, Parkinson’s and amyotrophic lateral sclerosis (also known as Lou Gehrig’s disease) – that are characterized by the progressive loss of neuronal function and ultimately neuron death. Collectively, these diseases have significant emotional, economic and social consequences, and, despite the impact of these diseases, the underlying cellular process of neurodegeneration is not well understood.

We cause neurodegeneration in worms using an optogenetic approach by activating a fluorescent protein called

KillerRed. Activation of KillerRed results in the production of superoxide, which is a reactive oxygen species that can cause cellular damage. Reactive oxygen species are natural byproducts of cellular metabolism that lead to oxidative stress and are associated with various neurodegenerative diseases. By using KillerRed in combination with different genetic mutations and various pharmacological manipulations, we are learning more about what happens as a neuron degenerates. This work is particularly exciting because emerging evidence suggests we have uncovered a mechanism of neurodegeneration that is specific to reactive oxygen species.

Another project in my lab is using *C. elegans* as a model for the inherited metabolic disorder galactosemia. Patients with this disease cannot metabolize the simple sugar galactose and have severe symptoms if they are not on a galactose-restricted diet. Even if galactosemic patients avoid galactose, they still have underlying health issues, such as reduced fertility and defects in neurological development, which are not well understood.

The same genes that cause galactosemia are found in worms, and there is a high level of similarity in the human and worm genes. Because of this similarity and the powerful genetic and molecular biology tools available in *C. elegans*, the worm is an attractive genetic model for investigating the cellular causes of galactosemia. My lab has obtained a strain of worms that have the same galactosemia mutations and interestingly, these worms have similar phenotypes as people with galactosemia. Like their human counterparts, these worms fail to develop into adults when grown on media that contains galactose. In addition, when galactosemic worms are grown in the absence of galactose, they have a reduced number of offspring and have locomotor issues that are indicative of neurodevelopmental defects.

In addition to my work on mechanisms of neurodegeneration and galactosemia, there is an expanding group of faculty within the College of Science who focus on a broad range of biomedical research projects. These projects range from the chemical synthesis of new organic compounds for the treatment of malaria or cancer, to phylogenomic investigation of eukaryotic endosymbiosis, to assessing public benefit from various health care services in the area.

These and other biomedical research projects have benefited from a competitive grant awarded to CCU from the South Carolina Idea Networks of Biomedical Excellence (SC-INBRE), which is funded from the National Institutes of Health. This award provides funding to select CCU faculty for research that is performed with CCU undergraduates and local high school students over the summer and during the academic year.

The SC-INBRE program's first funding cycle provided support for 12 undergraduate and high school students to work in labs of faculty mentors. This support included salaries, supplies and travel to state-level meetings for presentation of research projects. Part of being included within the SC-INBRE network allowed me to apply for and receive a Target Faculty grant, awarded to individual faculty members from primarily undergraduate and comprehensive research institutions throughout South Carolina. With this award, I have been able to purchase supplies and equipment to support the research above, expand the number of students in my research lab, and present research results at regional and national meetings.

Collectively, the funding from SC-INBRE has significantly impacted biomedical research at CCU. If you are interested in biomedical research or are just curious about some of the work going on within the College of Science, check out the CCU-INBRE webpage or the accompanying article on Page 28. 

Daniel Williams can be reached at 843.349.6566 or [dwilliams@coastal.edu](mailto:dwilliams@coastal.edu).

## GENETIC MODEL ORGANISMS

MODEL ORGANISM	FORMAL NAME	INTERESTING FACTS	NOBEL PRIZE (AMONG MANY)
YEAST	<i>Saccharomyces cerevisiae</i>	Budding yeast used in making bread and beer	2001 - Key regulators of the cell cycle
FRUIT FLIES	<i>Drosophila melanogaster</i>	Feeds on fermenting fruit in the wild	1933 - The role played by the chromosome in heredity
NEMATODE WORMS	<i>Caenorhabditis elegans</i>	First animal to have a completely sequenced genome	2002 - Organ development and programmed cell death
ZEBRAFISH	<i>Danio reio</i>	Genetically engineered fluorescent zebrafish can be found in pet shops	1995 - Genetic control of early embryonic development
MOUSE	<i>Mus musculus</i>	Most similar to humans among genetic model organisms	2007 - Introduction of specific gene modifications via embryonic stem cells

# FIRST YEAR SCORE AT CCU

## PAUL RICHARDSON, PH.D.

Chemistry, Coastal Carolina University

In 2015, a group of Coastal Carolina University scientists wrote a grant to the South Carolina IDeA Networks of Biomedical Research Excellence (INBRE). More than 17 colleges and universities applied for this grant and CCU was selected to receive one of the five-year, \$750,000 grants to organize a summer research program. The program was named "Summer Coastal Research Experience," SCoRE for short, and focused on biomedical research. The purpose of the program was to provide research mentoring from

faculty that are actively engaged in research and provide professional development for these students as they embark on their emerging careers. Faculty members Stephen Firsing, Megan Cevasco and Bryan Wakefield were selected for the first year of this grant. Sixteen undergraduates and 12 high school students applied for the 12 paid research positions. The following is the personal account of two students, one high schooler and one undergraduate, and what the SCoRE program meant to them.

## JOSHUA SQUIRES

Junior, Coastal Carolina University

This past summer, I was one of 12 students selected to participate in the 10-week South Carolina Idea Networks of Biomedical Excellence program (SC-INBRE). I learned more about laboratory techniques, research, and graduate school and the application process than I thought was possible.

This program gave me the chance to refine the laboratory techniques I learned in curriculum-based labs, as well as allowed me to learn new skills. For example, spending hours micro-pipetting increased my accuracy; I found out the hard way that minuscule errors in micro-pipetting can be catastrophic for the intended reaction.

My sterilization techniques were also sharpened. Working closely with unstable molecules made it imperative to work in a sterile area so contamination was minimal. I learned new DNA/RNA extraction techniques, and I learned about the different types of polymerase chain reactions (PCRs) and how to continuously change the reaction and optimize it to achieve the best results. I learned about creating complementary DNA libraries and primer design and about DNA sequence analysis and editing. All of these techniques are imperative to my future aspirations of continuing biomedical research.

This program made me more competent in lab work, and also taught me what research really entails. For years, students

participate in class labs where the result is already known and failure rates are low. Working on a project where there is not a known result is a different game. This program taught me the importance of dealing with failure and immediately trying again with a new approach. Constant mistakes and failures allowed me learn the importance of patience in the lab, the importance of backtracking to find where the mistake occurred, and the importance of learning from those mistakes.

Often, the results of a PCR were so unsatisfactory that we had to go back and look at what could be changed. We had to ask ourselves where the problem occurred. These constant failures allowed me to learn the importance of being open to deviate from the original plan and understand how crucial it is to look at failures and ask, "How can we fix this?"

The weekly seminars about graduate school, the application process, and paying for graduate school was one of the most helpful things about this program. The seminars on cover letters and personal statements, how to apply to graduate school and hearing the mentors talk about their experiences was extremely enlightening.

Because of the SC-INBRE program at Coastal Carolina University, I have an increased confidence in my laboratory skills and research techniques, but, more importantly, I have a clear sense of direction when it comes to the next step in my life.

## AUGUSTINE BATTEN

High school student

Being a part of the South Carolina Idea Networks of Biomedical Excellence (SC-INBRE) program has honestly been one of the best educational experiences of my life. I have had the opportunity to work with both welcoming college undergraduates and remarkable doctors. During this time, I have learned skills and techniques from professionals that I would have never been taught in an everyday high school science class. I learned how to purify molecules with chromatography, as well as how to analyze and interpret HNMR spectra data. Having the ability to work hands-on with chemical reactions and seeing their results gave me both a sense of purpose and responsibility in the lab.

Before I joined the INBRE team, there were dozens of careers I never thought would be a fit for me but are now viable options. This program has helped me to develop confidence in my decisions and how to push on after encountering multiple obstacles. It has also helped me develop good work ethic and time management skills with regard to my work load. I implore other high school and college students to look into this program if you are interested in any scientific career field.



# Travels to **TURKEY**



## *Learning about stress tolerance in plants (and myself)*

by Douglas Van Hoewyk, Ph.D.,  
Associate Professor, Biology,  
Coastal Carolina University

**A** Fulbright Scholar award supported my recent year in Turkey to investigate rare Turkish plants that can accumulate high levels of nickel. I gave 12 guest lectures at various schools and universities, which allowed me to travel extensively from the European side of Istanbul to within 20 miles of the Syrian border in southeastern Turkey. I spent most of my time in the capital city of Ankara, where I worked at Ankara University with collaborators from three different departments.

Our interdisciplinary project investigated plants appropriately termed nickel hyper-accumulators due to the amount of nickel they can store – up to 3 percent of their weight! This amount of nickel, a heavy metal that induces toxicity in most organisms at high concentrations, would be lethal to all other organisms on the planet.



*Yellow Alyssum plants grow exclusively in nickel-rich soils.*

On a global scale, Turkey has the greatest abundance of nickel hyper-accumulating plants, thus the country represents the ideal place to study nickel hyper-accumulators in their natural habitat. Not only are nickel hyper-accumulating plants often threatened, but many are endemic to – or only found in – Turkey. Luckily, the plant populations that I visited were in idyllic settings. All of my field sites were near the Mediterranean Sea, but some were closer to the beaches and Roman ruins, whereas other sites were situated in the mountains near olive groves and vineyards. Although the plants I studied evolved to survive on and tolerate nickel-rich soils, it remains a molecular mystery how nickel hyper-accumulators pull it off, i.e., how do these plants avoid stress and survive in a toxic environment?

This research question is driven from two needs. Many soils are contaminated with high levels of nickel stemming from industrialization, and there is an urgency to remediate these areas in a cost-effective and environmentally friendly manner. Phytoremediation is a “green technology” that uses plants to meet this challenge. Although nickel-hyper-accumulators grow too slowly to effectively remove nickel from soil, understanding the genes and cellular pathways that contribute to nickel accumulation may one day be used to improve phytoremediation technologies.

Secondly, ensuring food security in the face of a growing population is threatened by environmental changes that can induce stress in plants. How can agriculture increase crop yield on marginalized soils? Discovering how nickel hyper-accumulators tolerate stress may reveal some insight.



The capital city Ankara, Turkey.

## Coping with Stress in an Uncertain Environment

My family arrived in Turkey August 2015 at the start of a civil war between the Turkish government and PKK terrorists. Almost a year later, amid increasing instability, we departed from Istanbul's international terminal where there had been a terrorist attack only 48 hours prior. At times, I realized I was asking scientific questions that seemed insignificant. "Forget about plants tolerating stress in a toxic environment. How can I maintain poise during stress, and at what point does the stress become toxic in my life?"

The scientific journey that brought me to Turkey was trivial compared to the journeys taken by the refugees in Turkey. The refugee crisis is inescapable in Turkey, but not all of the 4 to 5 million refugees are Syrian or poor. Some of my closest friends are refugees and also my classmates; together, we studied the Turkish language for four hours a day. They came from all over the Middle East, yet our similarities were striking. Several were doctors or had advanced degrees; we played soccer and drank the same beer after class; we had similar views. We saw the need for tolerance and identity, but shared concern about mixing politics with religion and nationalism. Turkey represented an opportunity to us all, but the stakes were certainly higher for my friends seeking safety and more freedom.

Despite the instability in Turkey, I paused once when a friend provided solace and reminded me that the media overblows 99 percent of the news coming from Turkey. From a certain lens, he was right: It was still safe in Ankara (safer than most American cities) to walk the streets late at night, go to cafés



and music clubs, and ride the metro; gun violence was also significantly less common.

But it still leaves the 1 percent of news coverage that I couldn't ignore. At least 450 people in Ankara had been recruited by ISIS; increasingly there were alerts from the U.S. embassy that the PKK and ISIS terrorist groups were potentially targeting foreigners in my neighborhood; there had been three bombs in Ankara in less than eight months (one of which shook my apartment), killing more than 150 people. In response to the instability, the U.S. government had ordered dependents of military members stationed in Turkey to return to America.





*The Aya Sophia in Istanbul, Turkey.*

So what prompted my family to stay? I knew several people who directly worked with refugees in Ankara or camps near the Syrian border. I met educators who taught English to Iranian refugees. But I didn't have altruistic motives or work for an international aid agency. There was no "higher calling." I deemed Ankara and most of Turkey safe and wonderful enough to offset the potential worry. I was therefore reluctant to give up the high quality of life I enjoyed: The culture and history provided a stimulating environment, the food was fresh and delicious, and my children were at outstanding schools. Plus, there is something liberating about growing up in a liability-possessed and risk-adverse society and then throwing caution to the wind.

But I also believed my family had something to gain and learn in Turkey. At a time in America when there was debate about barring Muslims from entering the country, my kids played and went to school with Muslims (90 percent of their school population was Turkish). My children and the neighborhood kids had the freedom to play (unsupervised!) and walk to nearby markets, and it was exciting to hear them talk in Turkish to their friends.



*A street vendor selling simits (a bagel, but with more sesame seeds and aerodynamic).*

Despite the instability in Turkey, I paused once when a friend provided solace and reminded me that the media overblows 99 percent of the news coming from Turkey.



"So an Iranian, Russian, Syrian, and an American walk into the same classroom in Turkey... and become friends." (left to right) Az Ade, Nina, Mohanad and Douglas.

(bottom left) Breakfast time at school consisted of fresh bread, olives, walnuts, apricots and feta cheese.



### Life for Students and Faculty in Turkey

There's a misconception that college education is free in Turkey. It's not. Depending on one's major, tuition is somewhere between \$300 to \$600 USD (this would be equivalent to the net pay of three to six weeks of work at minimum wage in Turkey).

The tradeoff is that students have to leave campus if they want to go to play sports, see a doctor or worship at a mosque. Classes in Turkey are only taught by full-time professors who work throughout the year, but receive a 12-month salary in return. The work environment was at times uncomfortably rigid and structured, but came with the upside that there was an hour-and-a-half lunch break that was reinforced by cultural attitudes.

For example, my department had a large kitchen where impromptu potlucks were held at breakfast and lunchtime; the kitchen also served as a place where coworkers congregated for tea breaks. (Turks consume the most amount of tea in the world – 16 pounds per person!) In an attempt to keep faculty content, most universities have resorts that faculty and alumni can use. Ankara University had all-inclusive resorts on the beach in Antalya, as well as a ski lodge at a nearby ski resort. Their tactic worked on me: I was very happy to work at a Turkish university. 

Douglas Van Hoewyk can be reached at 843.349.2431 or [dougvh@coastal.edu](mailto:dougvh@coastal.edu).



## New Science Building Open on Campus



Open for students for Fall 2016, Science Annex II brings many College of Science classes back to the Coastal Carolina University main campus.

Students no longer have to board shuttles or cross and re-cross U.S. 501 to attend classes being held at the Coastal Science Center on the east campus.

Just as the Swain Building has facilitated health-related course issues by bringing biology and chemistry closer to public health, Science Annex II accomplishes more. Bringing marine science back to the main campus enhances that department by being close in proximity to the biology and chemistry departments.

“The ability of our faculty and students to work together in cross-disciplinary teams is a hallmark of our college,” said Michael Roberts, dean of the College of Science.

The completion of Science Annex II finishes the three-building science complex on the main campus.



## College of Science continues to grow

The College of Science continues to grow, as does CCU. The early numbers available for CCU show a total enrollment of 9,754 undergraduate students for Fall 2016, reflecting a five-year growth of 14.5 percent. The College of Science enrollment for Fall 2016 is 4,207 students, showing a five-year growth of 21.3 percent and is 43.2 percent of CCU students.

The occupational demand for graduates with degrees from College of Science disciplines continues. The demand for such degrees is projected to last until 2024-2030 and, according to many sources such as the Bureau of Labor Statistics, U.S. News & World Report, and others, there is a conclusion that a technology element is increasingly growing into all disciplines.

Sodexo Corporate Services, a provider of health care services, has increasingly added COS disciplines with technology into their degree programs for clinical nutrition. Reference is made to students who want a career in clinical nutrition study chemistry, biochemistry, microbiology and physiology, along with courses in business, mathematics, statistics, computer science, psychology, sociology and economics. Dietitians obtain a bachelor's degree and complete an internship before they take the registrant exam. It's stated that by 2024, new education standards will require a master's degree to be a registered dietitian in the U.S.

### 2016 COLLEGE OF SCIENCE STUDENT ENROLLMENT

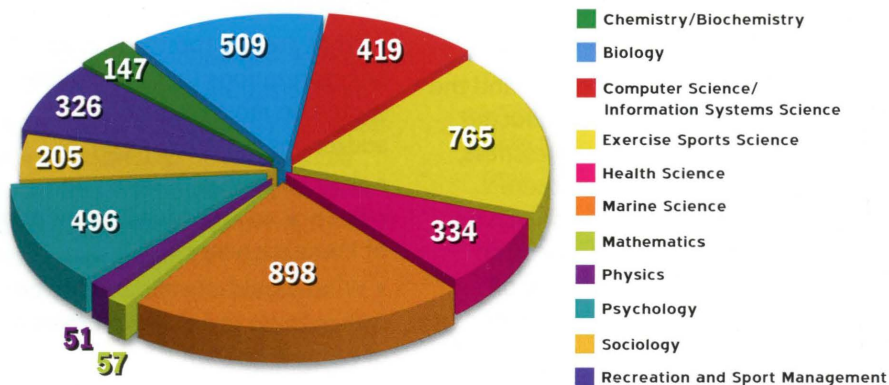

CCU's enrollment growth percentage 2011-2016.



COS enrollment growth percentage 2011-2016.



CCU enrollment percentage of COS students in 2016.

● 2016 CCU ENROLLMENT: 9,754 STUDENTS

● 2016 COS ENROLLMENT: 4,207 STUDENTS

## College of Science institutes changes

Effective Fall 2016, CCU has instituted an organizational change that joins the Department of Marine Science, the School of Coastal and Marine Systems Science, and the Burroughs & Chapin Center for Marine and Wetland Studies under the new School of the Coastal Environment. With the formation of this school, CCU now has the full range of academic degrees located within the same organizational unit: Bachelor of Science in marine science, Master of Science in coastal marine and wetland studies, and Doctor of Philosophy in marine science: coastal marine and systems science. In addition, the Burroughs & Chapin Center for Marine and Wetland Studies will serve as critical resource for research, student support and outreach.

"Marine science has always been an important undergraduate major at CCU," says Jim Luken, associate provost of graduate studies and interim vice dean for the School of the Coastal Environment. "However, now we want to expand our graduate offerings in the marine area and also provide a clear undergraduate to graduate pipeline. There is great potential for CCU to lead in marine education, research and management."

The Department of Marine Science is now housed in the new Science Annex II on the main campus. The Department of Coastal and Marine Systems Science and the Burroughs & Chapin Center for Marine and Wetland Studies will eventually be housed in the Coastal Science Center on the east campus across U.S. 501.

# Community Perceptions of Homelessness in Horry County



by Kerry Dittmeier, Swain Scholar,  
Coastal Carolina University

**Editor's note:** *The Swain Scholar Program was created for students who are resolute about improving the health of the community through research and advocacy. The junior-level Swain Scholars – Kerry Dittmeier, a public health major; Emma Kroger, an exercise and sport science major; and Nancy Phillips, a biology major – have come together to delve into the challenge of changing social stigma toward persons who are homeless within Horry County.*

We began the project by conducting a needs assessment in order to thoroughly understand the problem of homelessness. According to the 2013 Annual Homeless Assessment Report to Congress by the U.S. Department of Housing and Urban Development, in January 2013, more than 600,000 people in the U.S. were homeless. More than 6,500 people were homeless in South Carolina in 2013, and Horry County is ranked first in the state for the highest population of unsheltered homeless individuals, and second for the largest population of homeless.

Due to these high statistics and the lack of prior research conducted on perceptions of homelessness, it was determined that there was need for further research on this topic. This is how we came to develop our overall goal of quantifying public perceptions toward those persons who are homeless and using these research tools to raise awareness, inspire hope and provoke positive change. This was accomplished through a multifaceted, comprehensive community research project that has been divided into two primary components that provided both quantitative and qualitative views.

First, a survey was developed, "Homelessness in Horry County," which was completed by commu-

nity members. The survey was distributed online and in print and contained demographic information and 18 multidirectional items. Data was analyzed through means, percentages and t-tests using a p value of less than 0.5. Most respondents (N = 468) were female (72 percent), white (85 percent), and between the ages of 20-29 (36 percent). We focused on analyzing four different research questions from the results of the survey:

- What are the main factors that people perceive as contributing to homelessness?
- What are the top three groups or organizations that people feel should be most responsible for addressing homelessness?
- How does level of education influence an individual's perception of homelessness?
- What would the community be willing to do to solve the problem of homelessness?

The results from our survey suggest that community members perceive the main cause of homelessness to be alcohol/drug abuse; however, national statistics demonstrate that only 9 percent of individuals are actually homeless due to drugs and alcohol, and the No. 1 cause of homelessness, at 35 percent, is loss of job (Hopsie, 2013). The results from this question alone are consistent with national data



## Meet the Swain Scholars:

Two junior-level students from the College of Science were selected through a competitive process to serve as Swain Scholars for four semesters.

**Sydney Brown** is an exercise and sport science major from Philadelphia, Pa. She is the daughter of Scott and Betty Brown. Sydney has been involved in community service in many areas, including Relay for Life, the American Heart Association, Athletes Helping Athletes and Special Olympics. She is interested in a career in the pharmaceutical field.

**Ashley Lynch** is a biology major and Spanish minor. She is the daughter of Jennifer and Adam Lynch, and has aspirations to become a physician's assistant. She is actively involved on campus as a previous member of the women's soccer team, the secretary of the Student-Athlete Advisory Committee, and is in the CCU Honors Program.



*Swain Scholars: (from left) Sydney Brown and Ashley Lynch.*

More than 6,500 people were homeless in South Carolina in 2013, and Horry County is ranked first in the state for the highest population of unsheltered homeless individuals, and second for the largest population of homeless.

that demonstrate the discrepancies between public opinions on the causes of homelessness and the actual causes of homelessness (Agans, Lie, Verjan, Silverbush and Kalsbeek, 2011).

Regarding the second research question, the top three groups or organizations that community members perceived should be responsible for addressing homelessness were state government (43 percent), city/local government (34 percent), and Department of Health and Environmental Control (23 percent).

We also found a significant relationship between the level of education of respondents and their perceptions of homelessness, particularly regarding two statements: "It's hard to understand how anyone can become homeless" and "There's nothing I can do about homelessness in the area." Based on those two statements, we found that individuals with a bachelor's degree, associate degree or other secondary education were more sympathetic toward the homeless.

The fourth research question led us to observe discrepancies between what the community would be willing to do to solve the problem of homelessness and what they have actually done to help solve the problem of homelessness. Fifty-four percent of respondents would volunteer their time to work directly with the homeless; however, only 23.7 percent of respondents reported that they actually have volunteered their time to work directly with the homeless.

The survey results based on our research questions were presented at the 2016 Undergraduate Research Competition at CCU. This was a wonderful opportunity to bring awareness to the problem of homelessness and serve as advocates for homeless individuals.

The second component of this project – the community outreach-focused, qualitative component – includes detailed interviews with persons who are homeless in Horry County. Through collaborations with the Eastern Carolina Homeless Organization (ECHO) and

North Strand Housing, we had the opportunity to interview about 20 homeless individuals in Horry County. These interviews led to an invaluable collaboration between the Swain Scholars and the Athenaeum Press in hopes of merging the space between science and humanities in order to make the largest impact possible. Through this collaboration, we hope to develop a multimedia publication rich with images, stories, anecdotes and quotes to positively impact and change perceptions of homelessness within Horry County. 

**The Swain Scholar Program is a unique scholarship program that fulfills the wishes of donor Kenneth E. Swain. Scholarship recipients establish student-driven community health outreach and research projects to improve the health of Horry County residents. The scholars are charged with developing and presenting a series of educational outreach programs that highlight guidelines for healthy lifestyles raised by the research findings. The Swain Scholars are comprised of selected undergraduate students from the health sciences, biochemistry, biology, exercise sport science and chemistry programs. Interested Swain Scholar applicants should contact Sharon Thompson, professor of health science, at 843.349.2635 or email [thompson@coastal.edu](mailto:thompson@coastal.edu).**



# President's Honor List 2016

## APPLIED MATHEMATICS

David Joseph Eastman  
Alexandra Leigh Poulos  
Jolie Anne Even  
Dominique Evelyn Forbes

Natasa Savovic  
Tyler James Sullivan  
Bryan Anthony Van Der Riet Sr.  
Dalton O'Brien Watts

## BIOCHEMISTRY

Joseph Francis Cannon  
Dillon Elizabeth King  
Briana Nicole Laws  
Casey Marie McDonald

Joshua Robert Squires  
Melinda Nicole Tapia  
Breana Jade Wilson

## BIOLOGY

Colton John Aksomitius  
Mallory Jeanette Banton  
Kaitlyn Larue Benson  
Christopher Robert Ellis  
Kylie Nichelle Haigh  
Brion Elijah Harrison Elizabeth  
Mae Hauck  
Geary Ian James  
Joshua Jonmichael Jenkins  
Madison Leigh Knight  
Ashley Nicole Lynch  
Christopher Thomas Marlowe

Milani Rae Nicosia  
Nikita Jayesh Patel  
Madison Mae Ridings  
Eric Robles  
Steven Robert Rosen  
Emilie-Katherine Gabrielle Tavernier  
LaChelsie Nicole Thomas  
Hannah Claire Weinberg  
Michelle Christine West  
Lyndsay Elizabeth Ann Young  
Emily Ann Zielonka

## BIOLOGY PRE-ENGINEERING

Alyssa A. Risner

## CHEMISTRY

Nehemiah Kenneth Stafford

Amanda Nicole White

## COMPUTER SCIENCE

David Joseph Eastman  
John Hooper Finamore  
Casey J. Fleck  
Carleton Anthony Fuhs  
Terence Alexander Grove

Megan Louise Hickman  
William Tyler Kirby  
Scott Roger Lavigne Jr.  
Nathan Scott Phillips  
Alexandra Leigh Poulos

## EXERCISE AND SPORT SCIENCE

Sara Elizabeth Alexander  
James Herbert Anderson IV  
Journie Nichole Barbour  
Jamie Lee Barrett  
Amy Marie Baumgardt  
Morgan Hailey Benson  
Megan Patricia Boronski  
Brian Charles Boudreau  
Ashley Morgan Branda  
Samuel Joseph Burkinshaw  
Marissa Elizabeth Cain  
Taylor Marie Cicholski  
Evelyn Mary Clyburn  
MacKenzie Lee Conrad  
Rachael Cormier  
Taylor Marie Creagh  
Robert Marsh Deane  
Lauren Elizabeth Durant  
Brenna Dawn Eigenmann  
Bianca Josphine Esposito  
Brianna Olivia Franklin  
Justine Marie Gillespie  
Austin Dellinger Godwin  
Raven Alexandria Hamilton  
Ethan Michael Hayes  
Benjamin George Henke  
Wendell Albert Hill Jr.  
Leandra Denise Hurlbert  
Janie Loren Javier  
Laura C. Johnson  
Matthew John David Kaplan  
Alexander Michael Karban  
Alexis Kelly  
Caitlin Taylor Kratzer

Emma Grace Kroger  
Dantzler Rae Lambert  
Rachel Elisabeth Liming  
Paige Rena Lovett  
Danielle Nicole Ludlam  
Nicholas Robert Masterson  
Jordan Haley Mauck  
Morgan Sharon Mauck  
Kelly Anne McCarthy  
Debryan Eugene McClurkin Jr.  
Sarah Faith Morley  
Alexandra Cogburn Padgett  
Catherine F. Palomba  
David Robert Parrett  
Chloe Paige Paulsen  
Jenna Shae Pecilunas  
Lindsay Marie Predmore  
Amber Lee Rahman  
Courtney Jo Rapp  
Adam Julian Renshaw  
Laura Beth Reynolds  
Cameron Mitchell Sanders  
Leeon Shamah  
Carson Leigh Shelley  
Latesha Danielle Simpson  
Chelce' Ramona Small  
Nicholas Wallace Tester  
Faith Victoria Tison  
Taylor Nicole White  
Madison Lee Whitney  
Devin Bree Willingham  
Salem Jordan Zeglin  
Sayer Zimmerman

## HEALTH ADMINISTRATION

Michaela Elisabeth Kaltwasser

Amanda Whitney Ware

## INFORMATION SYSTEMS

Sean Patrick Gallagher  
Merwan Luck

Max Mary-Louise Williams

## INFORMATION TECHNOLOGY

Jeffrey Alexander Benjamin  
Brandon Malik Chambers  
Sora Musia Lebowitz

Shaun Edmund Ralko  
Deondre Jakar Williams

# College of Science

## MARINE SCIENCE

Brooke Nicole Anderson  
Cory Bauerlien  
Krishus Elizabeth Bean  
Emily Bernadette Bores  
Nicholas Edward Burroughs  
Joseph Francis Cannon  
Juliane Gabriela Caughron  
Abigail Marie Chaney  
Ariel Lillian Thalia Clark  
Jesse Gareth Clark  
Marinda Rose Cornett  
Kara Leann Criner  
Valerie Aniela Cwiek  
Jacob Michael Dietzel  
Kayla Marie Do Couto  
Rachel M. Eckley  
Carly Christine Fenstermacher  
Randy Louis Fink  
Rebecca George Ford  
Emily Marie Forzono  
Jakob Scott Gessay  
Catharine Cramer Gordon  
Danielle Elizabeth Mary Guy  
Kylie Nichelle Haigh  
Michaela Tiffany Harrington  
Brion Elijah Harrison  
Charlotte Marie Hawkins

Richard Michael Hawley  
Lanie Ray Karstrom  
Shannon Caitlin Kelahan-Pierson  
Dillon Elizabeth King  
David Alexander Klett  
Logan Steven Klinepeter  
Madeleine Anne Lee  
Patrick Brian McCabe  
Christopher Anthony Moorman  
Coral Lynn Mullen  
Jessica Taylor Myers  
Christopher Evan O'Brien  
Emily Elizabeth Otstott  
Rylie Marie Petrangelo  
Hali Marin Phillips  
Samantha Ellen Pope  
Jordan Nicole Roballo  
Bethany Rose Schoppert  
Alexis Nicole Setta  
Brianna Michelle Tramutolo  
Christopher Drake Wankowicz  
Cethlynn Marie Weatherly  
Hannah Claire Weinberg  
Eric Wesley Winkler  
Lyndsay Elizabeth Ann Young  
Emily Ann Zielonka

Victoria Lynn Glass  
Brittany Louise Griffin  
Haley McCall Hilburn  
Marcus Antoine Holmes  
LaVasia Monae Jackson  
Emma Nicole Johnson  
Megan Arlene Kalmbach  
Elena Marie Larose  
Hunter Alexandra Matusevich  
Annakai Bianca McFarlane

Samantha Lynne McKeon  
Zackery Ronald Messetler  
Megan Virginia Morton  
Chloe Paige Paulsen  
Kaitlyn Nicole Powaliev  
Lexi Mikayla Richardson  
Whitney Marie Shifflett  
Alexandra Kayla Simmons  
Arielle Brooke Walters  
Daniel William Woodal

## PUBLIC HEALTH

Celeste Robyn Benson  
Ressa Ann Borkovich  
Kaitlyn Teresa Brown  
Steven Garrison Carruth  
Katherine Rose Dwulet  
Nellie Grey Eckert  
Natalie Marie Fisher  
Alia Nicole Johnson

Justin Frederick Lowes  
Cody Caster Norris  
Mariel Celina Guevara Po  
Juden Nadisha Powell  
Jane Marie Rowe  
ShaQuana Lasai Steed  
Timi Ann Tooley  
Alexandria Nicole Young

## NURSING

Ekaterina S. Cannon

## PHYSICS

Ian Fox Lackey

Kylie P. Thomas

## PHYSICS PRE-ENGINEERING

Kenneth Leon Doyle

## PSYCHOLOGY

Alexis Corine Adams  
Carey Candler Ballard  
Abby Sue Boytos  
Janella Geneva Burgess  
Nicholas Edward Burroughs

Kayla McKenzie Christian  
Valerie L. Davis  
Larissa Nicole DiNatale  
Kimberly Ashlyn Ferner  
Sydney Catherine Gemmill

## RECREATION AND SPORT MANAGEMENT

Matthew Joseph Barlow  
Kiyanna Raven Brown  
Madeline Suzanne Dalie  
Sydney E. Demer  
Joseph Stephen Dessino  
Connor Louis Dugan  
Patrick James Ferro  
Sean Christopher Florenz  
Casey Michael Fries  
Miranda Leigh Gatto  
Brandon Troy George  
Nicole Ann Heideman  
Kyle John Houle  
Chadwyck Evan Howell  
Charles William Kimble

Katie Marie Kreider  
Colin Andrew Marz  
Jeremy A. McDonald  
Jack Ryan Morris  
Nicholas Logan Murphy  
Garrett John O'Neil  
Alexander David Reiss  
Kara Leigh Sanford  
Lena Schaeffner  
Amy Margaret Seymour-Bard  
Anthony Michael Silvia  
Caitlin Elizabeth Smith  
Bryan Andrew Varsalone  
Zachary Beau Vaughan

## SOCIOLOGY

Hannah Lea Arrington  
Michelle Irene Bennett  
Brett Daniel Cooksey  
Noelle Kelsey DeCenzo

Avery John Noel  
Skylar Danielle Norton  
Kerri Ann O'Halloran  
Lindsay Devon Rhodunda





College of Science  
P.O. Box 261954  
Conway, SC 29528-6054

NONPROFIT ORG.  
US POSTAGE  
**PAID**  
GREENVILLE, SC  
PERMIT NO. 1460



[coastal.edu/science](http://coastal.edu/science)