



## **Vibration dynamics of high speed train with Pareto optimized damping of bogie suspension to enhance safety and comfort**

Downloaded from: <https://research.chalmers.se>, 2021-08-31 15:48 UTC

Citation for the original published paper (version of record):

Johnsson, A., Berbyuk, V., Enelund, M. (2010)

Vibration dynamics of high speed train with Pareto optimized damping of bogie suspension to enhance safety and comfort

Proceedings of ISMA2010 International Conference on Noise and Vibration Engineering Including

N.B. When citing this work, cite the original published paper.

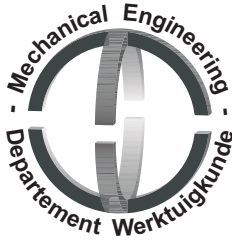

Katholieke Universiteit Leuven  
Department of Mechanical Engineering  
Celestijnenlaan 300B - box 2420  
B-3001 Heverlee (Belgium)

Proceedings of **ISMA2010**  
International Conference on  
**Noise and Vibration Engineering**  
including **USD2010**



**USD2010**

20 to 22 September, 2010

Editors: Sas, P. and Bergen, B.

© Katholieke Universiteit Leuven - Departement Werktuigkunde  
Celestijnenlaan 300B - box 2420, B-3001 Heverlee (Belgium)

Alle rechten voorbehouden. Niets uit deze uitgave mag worden vemenigvuldigd en/of openbaar gemaakt worden door middel van druk, fotokopie, microfilm, elektronisch of op welke andere wijze ook zonder voorafgaandelijke schriftelijke toestemming van de uitgever.

All rights reserved. No part of the publication may be reproduced in any form by print, photoprint, microfilm or any other means without written permission from the publisher.

D/2010/5769/1  
ISBN 9789073802872

# Vibration dynamics of high speed train with Pareto optimized damping of bogie suspension to enhance safety and comfort

**A. Johnsson, V. Berbyuk, M. Enelund**

Chalmers University of technology, Department of Applied Mechanics, Division of Dynamics

Hörsalsvägen 7A, SE-41296, Göteborg, Sweden

e-mail: [albin.johnsson@chalmers.se](mailto:albin.johnsson@chalmers.se)

## Abstract

A methodology to find the optimized, with respect to safety and comfort, lateral damping of both the primary and secondary suspensions of a bogie system for a high speed train (HST) has been developed, implemented and evaluated. The vibration dynamics of three-car HST with safety-comfort Pareto optimized lateral damping of bogie system is analyzed. The sensitivity of vibration dynamics of the HST having Pareto optimized lateral damping and traveling with 250 km/h is studied for different vehicle speeds, wheels and rails wornness, train service loads and frictions between wheels and rails. Numerical results show that Pareto optimized lateral damping of bogie system can significantly improve passenger comfort while maintain safety and reliability of HST performance.

**Keywords:** High speed railway vehicles; Multi-objective optimization; Pareto optimality, Bogie suspension design; Damping; Ride comfort; Vehicle Safety; Lateral dynamics and stability

## 1 Background

The properties of the bogie system suspensions do significantly influence the dynamical behavior of a HST. Both safety and comfort considerations are necessary to take into account. The bogie system has been under investigation for many years with the aim to increase the performance of the railway vehicle in several key areas. Optimization of passive design of components is an important area in order to achieve train systems which are dynamically stable and at the same time fulfill requirements set on the systems, such as for comfort and safety [1, 2].

The introduction of control systems in railway vehicles has been ongoing for several years [3, 4, 5, 6]. However, it is not until recently that the applications are taken into industrial use [7, 8, 9]. These applications mostly focus on improving the comfort performance for the passengers by reducing the vibrations in the car body. Several strategies have been shown to give good results in this matter. Some work has been done on the simultaneously optimization of several performance indices (such as safety and comfort), so called multi-disciplinary optimization. Considerations of the minimal upgrade for the maximal gain in performance have not yet been widely investigated. In this paper we will investigate optimization of the lateral damping coefficients of the primary and the secondary suspensions to clarify the possibilities of a minimal upgrade for a maximal performance of the safety and comfort criteria. The trade-off behavior between safety and comfort for a HST is then studied. Early in [10] investigation of the Pareto optimal lateral damping of a bogie system within the frame of a half car train model has been performed.

With the mapping of optimized parameters to performance of the passive system, investigation of the benefits of a minimally upgraded adaptive system can be made. The introduction of active strategies can be made in several manners and each has to be evaluated against the existing passive solution and thereafter the improvements in importance have to be weighted against increased energy consumption and cost.

The methodology developed in this paper is used to determine the Pareto front as a representation of trade-off between safety and comfort of a three-car HST. The Pareto front is a mapping of the set of optimized lateral damping parameters of primary and secondary suspensions. This set is called the Pareto set. Bi-objective optimization has been performed within a complete three-car HST model by using the multibody dynamics general purpose software Gensys [11]. Further, analyzes of dynamics of HST with the Pareto optimized damping parameters of the bogie system is presented.

## 2 A three-car high speed train model

We consider a complete three-car HST model in order to evaluate the dynamics of a railway vehicle with optimized bogie systems. The complete three-car model is implemented in Gensys. The railway vehicle comprises three cars, each with two bogie systems. The bogie system comprises two wheelsets, one bogie frame and the primary and secondary suspensions. The primary suspension is modeled with a series of nonlinear springs and dampers as well as linkages modeled with rigid bodies. The secondary suspension comprises of a nonlinear air spring, an anti-roll bar as well as some other nonlinear springs and dampers. The tracks are modeled as rigid bodies. Ideal wheel and rail geometries representing Swedish standard are utilized. The train is assumed to be fully loaded. The railway vehicle is considered within the rigid multibody system formulation and has 456 degrees of freedom in total. The equations of motions in state space form is written as

$$\dot{\mathbf{x}} = \mathbf{f}(t, \mathbf{x}, \mathbf{d}, \mathbf{p}, \mathbf{s}, \mathbf{u}, V), \quad \mathbf{x}(0) = \mathbf{x}_0, \quad t \in [t_0, t_f], \quad (1)$$

where  $\mathbf{x}$  is the state vector,  $\mathbf{d}$  is the vector of design parameters,  $\mathbf{p}$  is the vector of system structural parameters which includes the stiffness, mass, inertia parameters and the remaining damping parameters and  $\mathbf{s}$  is the vector of system dynamics parameters including parameters such as coefficient of friction, contact model parameters, and geometrical parameters of track and wheel,  $\mathbf{u}(t, V)$  is the vector of excitations, and  $V$  is the constant forward speed of the train. The model components have been developed by Bombardier Transportation.

A simplified sketch of the bogie system is shown in Figure 1. The design parameters to be optimized are  $C_y^p$  and  $C_y^s$ , the lateral damping parameters of the primary and the secondary suspensions of the bogie system, respectively.

Track irregularities considered are lateral disturbances of the rail. These irregularities will be modeled by a stationary stochastic process and described by a one-sided density function as in [12]

$$\Phi(\Omega) = A \frac{\Omega_c^2}{(\Omega_r^2 + \Omega^2)(\Omega_c^2 + \Omega^2)}, \quad (2)$$

with parameter values

$$\Omega_c = 0.8246 \text{ rad/m}, \text{ and } \Omega_r = 0.0206 \text{ rad/m}, \quad (3)$$

where  $\Omega$  is the distribution factor and  $A = 0.7930 \cdot 10^{-6} \text{ m}$  is the scaling factor that is used to specify the magnitude of the irregularities. A sample of the stochastic excitation profile can now be calculated with the spectral representation method as

$$u(x) = \sqrt{2} \sum_{n=0}^{N-1} a_n \cos(\Omega_n x + \varphi_n), \quad (4)$$

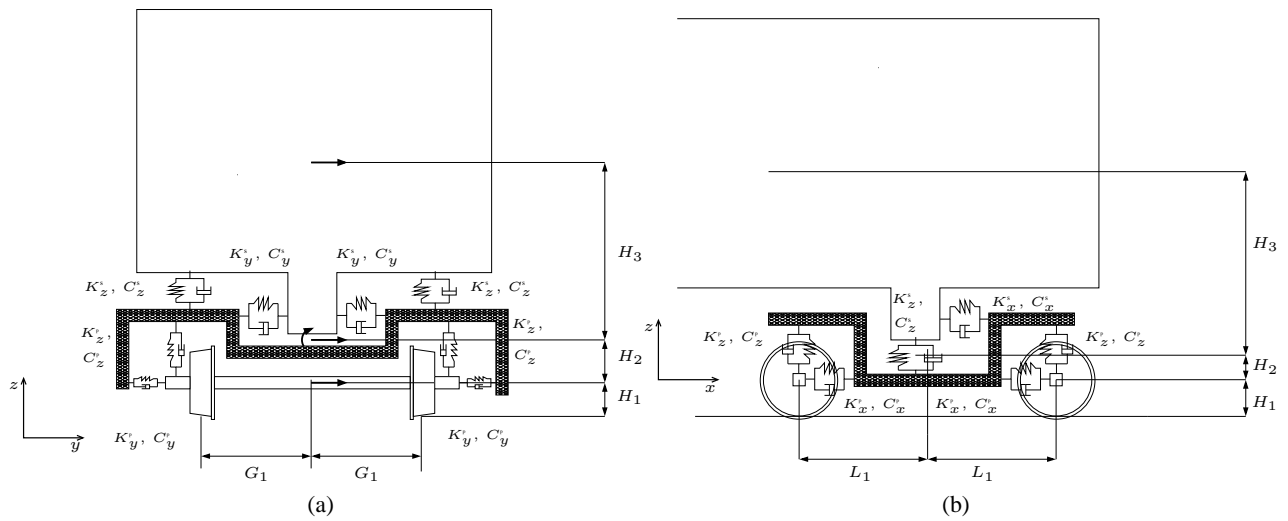

Figure 1: Simplified sketch of the bogie system.

where  $\varphi_n$  are uniformly distributed phase angles in the range  $[0, 2\pi]$ ,  $\Omega_n = n\Delta\Omega$ ,  $\Delta\Omega = \Omega_u/N$ , for  $n = 0, 1, \dots, N - 1$ , and  $\Omega_u$  is the highest frequency while the coefficients  $a_n$  are

$$a_0 = 0, \quad a_1 = \sqrt{\left(\frac{\Phi(\Delta\Omega)}{2\pi} + \frac{\Phi(0)}{3\pi}\right) \Delta\Omega}, \quad a_2 = \sqrt{\left(\frac{\Phi(2\Delta\Omega)}{2\pi} + \frac{\Phi(0)}{12\pi}\right) \Delta\Omega}, \quad \text{and}$$

$$a_n = \sqrt{\frac{\Phi(\Omega_n)}{2\pi} \Delta\Omega}, \quad \text{for } n = 3, 4, \dots, N - 1.$$

This stationary stochastic process has been designed to have the same spectrum as common real track irregularities. One disturbance sample used as input the bogie model is Eq. (4) calculated with  $\Omega_u = 13.57$  rad/s, and  $N = 3540$ . The disturbance of the rail profile in lateral direction is then  $y_{\text{rail}}^{\text{right}} = y_{\text{rail}}^{\text{left}} = u(x)$ , where  $x$  is the distance traveled in meter. Another irregularity used in this paper is the step irregularity  $u(x) = 7H(x - 100 \text{ m})$  mm, where  $H(x)$  is the Heaviside step function. For the given model with the input parameters  $\mathbf{d}, \mathbf{p}, \mathbf{s}, \mathbf{u}, V$  and  $T = [t_0, t_f]$  the state vector, *i.e.* the generalized coordinates and its time derivatives, and any user defined function of the state vector are the solution output. Of particular interest is, for instance, the wheel–rail contact forces.

**Example 2.1** As an example of implementation of computational model of the three-car HST we consider the following case. A railway vehicle runs on a 500 m long tangent track at 250 km/h. The track is smooth except for the step irregularity introduced above. The initial state is  $\mathbf{x}_0 = \mathbf{0}$ . Figures 2-4 show some characteristics of the responding dynamics. From Figures 2(a) and 2(b) it can be seen that the transient responses in the bogie frame and the wheelsets have been damped out at about 200 to 250 meter and stabilized around the new equilibrium position. It is noted that the last bogie system has larger displacements than the first bogie system. However, the car bodies have a much lower damping and we also see coupled effects for the car bodies. For the shift forces in Figures 3(a) and 3(b) no evident coupled effects are shown, but it is seen that the forces on the last bogie are larger than the ones on the first. The peak values occur at the step irregularity and are of the magnitudes 20-70 kN on the different wheelsets. The accelerations in the first and last car bodies are very transient, see Figures 4(a) and 4(b). The peak accelerations are varying between 0.2 and 0.9  $\text{m/s}^2$  over the car bodies. The accelerations are higher in the outer points mainly due to the yaw motion of the car bodies.

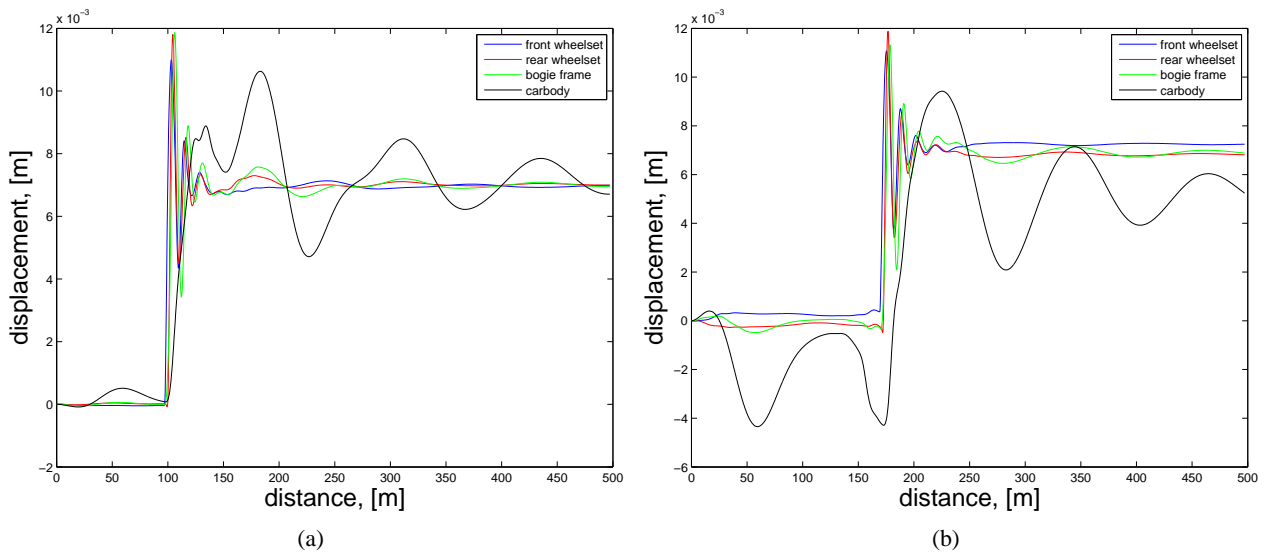

Figure 2: (a) The lateral displacements of the first bogie and the first carbody above the center of the bogie; (b) The lateral displacements of the last bogie and last carbody above the center of the bogie

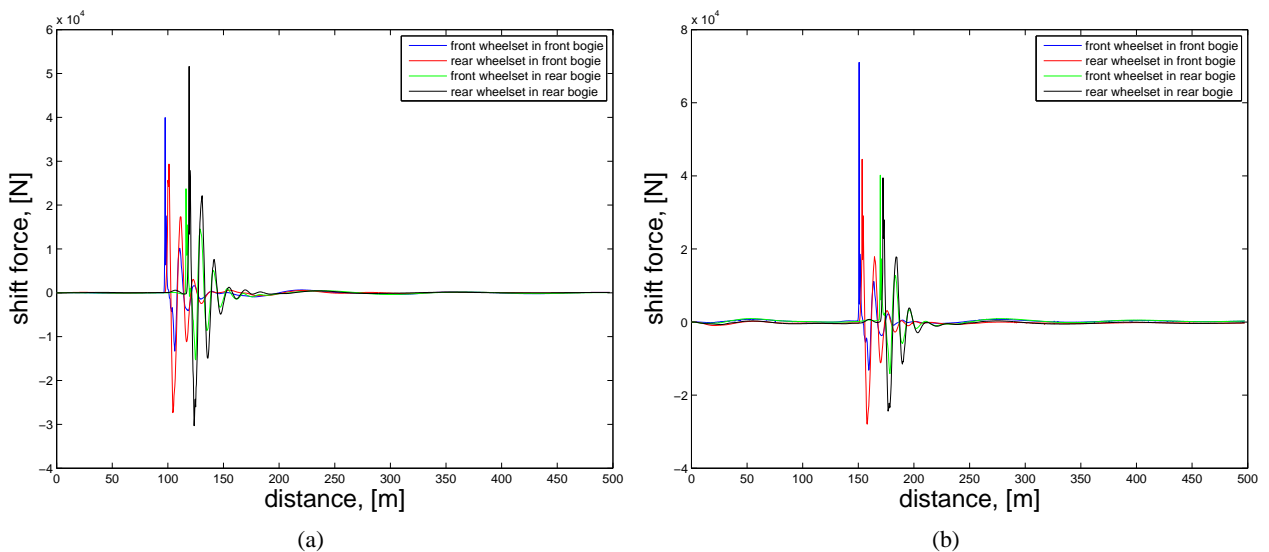

Figure 3: (a) The shift forces of the wheelsets of the first carbody; (b) The shift forces of the wheelsets of the third carbody

### 3 Bi-objective optimization

Here the safety-comfort bi-objective optimization problem is considered by varying the lateral damping parameters of primary and secondary suspensions of bogie system. The chosen optimization strategy is to use a multi-objective evolutionary algorithm (MOEA). The reasons to use such an optimization algorithm are that it is robust, gives good results and additional valuable information not provided by a classical algorithm. The classical algorithm gives one optimized solution, determined by the pre-weighting of the objective functions. In a MOEA no pre-weighting is required but instead a set of Pareto optimized solutions are obtained, denoted the Pareto front.

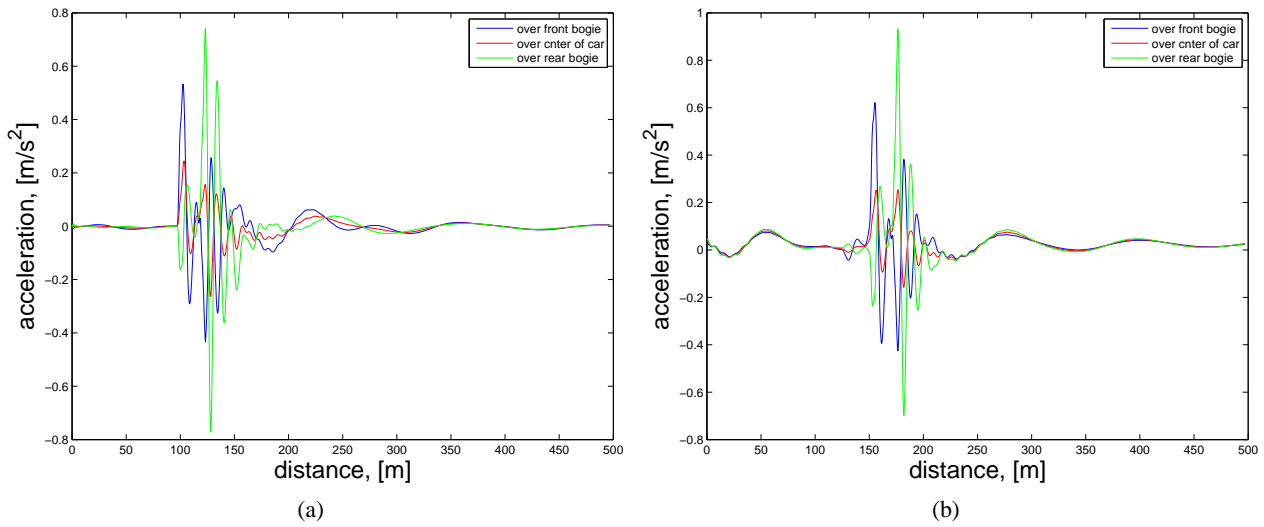

Figure 4: (a) The lateral acceleration of the first carbody measured above the center of each bogie and at the center of the carbody on floor level; (b) The lateral acceleration of the third carbody measured above the center of each bogie and at the center of the carbody on floor level

### 3.1 Objectives for performance evaluation

The main performance qualities that the bogie system can affect are safety, comfort and the ability to avoid wear as well as crack initiating and propagation in rails and wheels. We define objectives for evaluation of safety and comfort. The safety objective is determined by the contact forces on the wheels due to the wheel-rail interaction, which has potential to damage both rails and wheels and to cause derailment. Low lateral forces are associated with stable motions. The safety objective used here is the ratio between the lateral and vertical contact forces of a wheelset and is defined as

$$\mathcal{F}_{\text{safety}} = \max_i \left[ \max_{t \in [t_0, t_f]} \left\{ \max \left( \left| \frac{R_{y,i}^{\text{fw}}(t)}{R_{z,i}^{\text{fw}}(t)} \right|, \left| \frac{R_{y,i}^{\text{rw}}(t)}{R_{z,i}^{\text{rw}}(t)} \right| \right) \right\} \right], \quad i = 1, 2, \dots, 6. \quad (5)$$

Here  $R_{y,i}^{\text{fw}}$  and  $R_{y,i}^{\text{rw}}$  are the shift forces of the front and rear wheelset of bogie system  $i$ ,  $R_{z,i}^{\text{fw}}$  and  $R_{z,i}^{\text{rw}}$  are the normal forces in the contact points of the front and rear wheelset of bogie system  $i$ ,  $t_0$  is the starting time and  $t_f$  is the final time. As the train model contains six bogie system the evaluation results in six objectives where the worst case is considered only. A low value of  $\mathcal{F}_{\text{safety}}$  corresponds to a high level of safety. In fact, this objective is used to indicate risk of derailment. The maximal allowed objective value before the risk of derailment is considered to high is  $\mathcal{F}_{\text{safety}}^{\text{limit}} = 1.15$ . The value is given by the Weinstock Limit [13].

The comfort measure  $\mathcal{F}_{\text{comfort}}$  is introduced as the largest RMS of the lateral acceleration of the car body measured at three points of each car body, namely above the center of each bogie and at the middle of the car body

$$\mathcal{F}_{\text{comfort}} = \max_i \left[ \sqrt{\frac{1}{t_f - t_0} \int_{t_0}^{t_f} (\ddot{y}_i^{\text{cb}}(t))^2 dt} \right], \quad i = 1, 2, \dots, 9. \quad (6)$$

A low value of  $\mathcal{F}_{\text{comfort}}$  corresponds to a high level of comfort.

Continuing Example 2.1, the above introduced objectives calculated with  $t_0 = 100/V = 1.44$  s and  $t_f = 500/V = 7.20$  s have the following values,  $\mathcal{F}_{\text{safety}} = 0.1740$  and  $\mathcal{F}_{\text{comfort}} = 0.1122$  m/s<sup>2</sup>. Figures 5(a) and 5(b) show the variation of the objectives for the different bogies of HST model. We observe that the fifth



bogie system has the highest values for the safety objective while the sixth bogie system has the highest value for the comfort objective. Also, the variations in the objective values between the bogie systems are significant. The difference between the largest and the lowest value for the safety objective is about 20% of the maximum value. We also have the same circumstances for the comfort objective having a difference about 31 % of the maximal value.

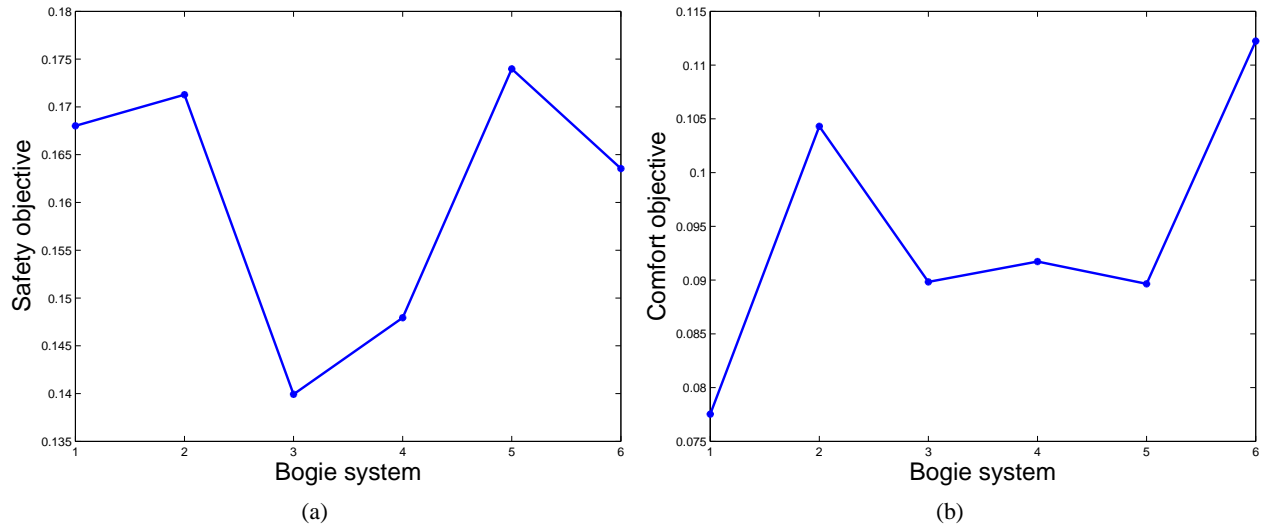

Figure 5: (a) Variation of the safety objective for the six bogie systems; (b) Variation of the comfort objective for the six bogie systems

### 3.2 Problem formulation

Let  $\mathbf{F} : \mathbb{R}^n \mapsto \mathbb{R}^m$  be a vector objective function. The design vector  $\mathbf{d} \in \mathbb{R}^n$  is constrained by  $\mathbf{d} \in \mathcal{X} \subset \mathbb{R}^n$ , where  $\mathcal{X}$  is defined by algebraic and/or differential constraints. A multi-objective optimization method will then solve problem of the type

#### Problem 3.1

$$\begin{cases} \min \mathbf{F}(\mathbf{d}) \\ \mathbf{d} \in \mathcal{X} \end{cases} \quad (7)$$

Since  $\mathbf{F}(\mathbf{d})$  is a vector function with  $m$  components the solution will in general not be a single point  $\mathbf{d}^*$ , but instead the notion of Pareto optimality is introduced.

**Definition 3.1** A point  $\mathbf{d}^* \in \mathbb{R}^n$  is called *Pareto optimal* for the Problem 3.1 if  $\mathbf{d}^* \in \mathcal{X}$  and there does not exist a point  $\mathbf{d} \in \mathcal{X}$ ,  $\mathbf{d} \neq \mathbf{d}^*$ , with  $F_i(\mathbf{d}) \leq F_i(\mathbf{d}^*)$  for all  $i = 1, 2, \dots, m$  with a strict inequality for at least one  $i$ ,  $1 \leq i \leq m$ .

For a given problem, there will exist a subset  $\mathcal{X}^* \subset \mathcal{X}$  of solutions which are Pareto optimal, called the Pareto set. For details of MOEA, see [14].

Here Problem 3.1 is applied to the optimization of bogie systems of the three-car HST by using the objective functions defined in Section 3.1 and the computational model of the railway vehicle implemented in Gensys. We assume that the lateral dampers of primary and secondary suspensions of the bogie systems are linear.

**Problem 3.2** It is required to determine the vectors of damping coefficients,  $\mathbf{d}_{\text{opt}} = [C_y^p, C_y^s]^T$ , which are the solutions of the variational equations

$$\mathcal{F}_i(t, \mathbf{x}, \mathbf{p}, \mathbf{d}_{\text{opt}}, \mathbf{u}) = \min_{\mathbf{d} \in \mathcal{X}} \mathcal{F}_i(t, \mathbf{x}, \mathbf{p}, \mathbf{d}, \mathbf{u}), \quad i = \{\text{safety, comfort}\} \quad (8)$$

subject to the differential constraints, Eq. (1), and the boundaries

$$\begin{aligned} \mathbf{d} &\leq \mathbf{B}_u = [500, 200]^T \text{ kNs/m} \\ \mathbf{d} &\geq \mathbf{B}_l = [0, 0]^T \text{ kNs/m}, \end{aligned}$$

for given  $\mathbf{p} = \mathbf{p}_0$ ,  $\mathbf{u} = \mathbf{u}_0(t)$  and initial state  $\mathbf{x}(t = 0) = \mathbf{x}_0$ .

Algorithm of solution of the Problem 3.2 is implemented in Matlab using the in-built multi-objective optimization routine, `gamultiobj`, with the options given in Table 1. Gensys is called for every evaluation point, and parallelized for execution speedup.

<b>List of optimization options</b>	
Population size	80
Population Initialization Range	$[\mathbf{B}_l, \mathbf{B}_u]$
Tolerance on fitness value (TolFun)	$5 \cdot 10^{-4}$
Stall generation Limit (StallGenLimit)	15
The fraction on non-dominated front (ParetoFraction)	0.5
All other options set to 'default'	--

Table 1: Input for the optimization simulations

### 3.3 Solution of problem 3.2 for $V = 250$ km/h

In this section we will present the solution of the problem 3.2 with the forward speed  $V = 250$  km/h, the track irregularities  $u(Vt)$  as described in Eq. (4) and the initial state  $\mathbf{x}_0 = \mathbf{0}$ . The lateral damping parameters are subjected to optimization and the objectives are calculated from  $t_0 = 100 \text{ m}/V = 1.44$  s to  $t_f = 500 \text{ m}/V = 7.20$  s in order to avoid transient behavior. The optimization results of Problem 3.2 together with all evaluated design points from the optimization procedure are presented in Figures 6(a) and 6(b). These figures give good illustrations of the mapping  $\mathbf{d} \mapsto \mathcal{F}(\mathbf{d})$ . Figure 6(b) shows some tested design candidates and Figure 6(a) shows their respective objective evaluations. The Pareto optimized design points are seen to lie in a subset of the design space. The fact that it is a subset rather than a single point shows the existence of a conflict between the two objectives used. By choosing a design point on the red curve, a Pareto optimal trade-off solution is obtained. In Figures 7(a) and 7(b) the optimization results together with the corresponding damping parameters of a HST in service are shown. The Pareto set is a subset of the considered design space, where  $C_y^p \in [16, 70]$  kN/m and  $C_y^s \in [18, 38]$  kN/m. We identify three design points of special interest in the Pareto set, namely the point corresponding to the largest value of the safety objective, the point corresponding to the largest value of the comfort objective and a point with significant trade-off between the two objectives. The points and their respective objective values are marked with red in Figures 7(a) and 7(b). It can be seen that the damping parameter values of the in service HST are very near the optimized Pareto front with favorable performance of that configuration. In fact the differences are of minor importance. This somewhat validates the optimization procedure. Figure 7(a) shows the optimal safety objective for a prescribed value of the comfort objective and *vice versa* while the corresponding parameter values may be found in Figure 7(b). Comparing the two endpoints on the Pareto front as well as the chosen trade-off point, Table 2 shows the relative gains and losses in the objectives. From that we can conclude that

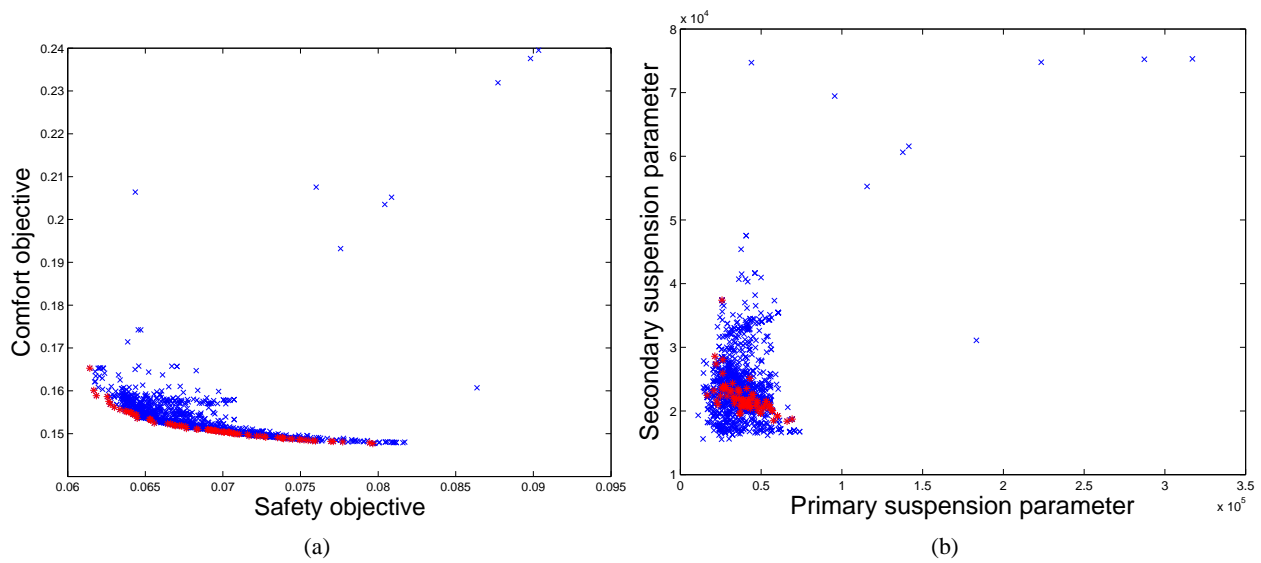

Figure 6: Results from optimization are shown. Blue markers represent points evaluated in the optimization routine. Red markers represent in (a) Pareto front and in (b) Pareto set.

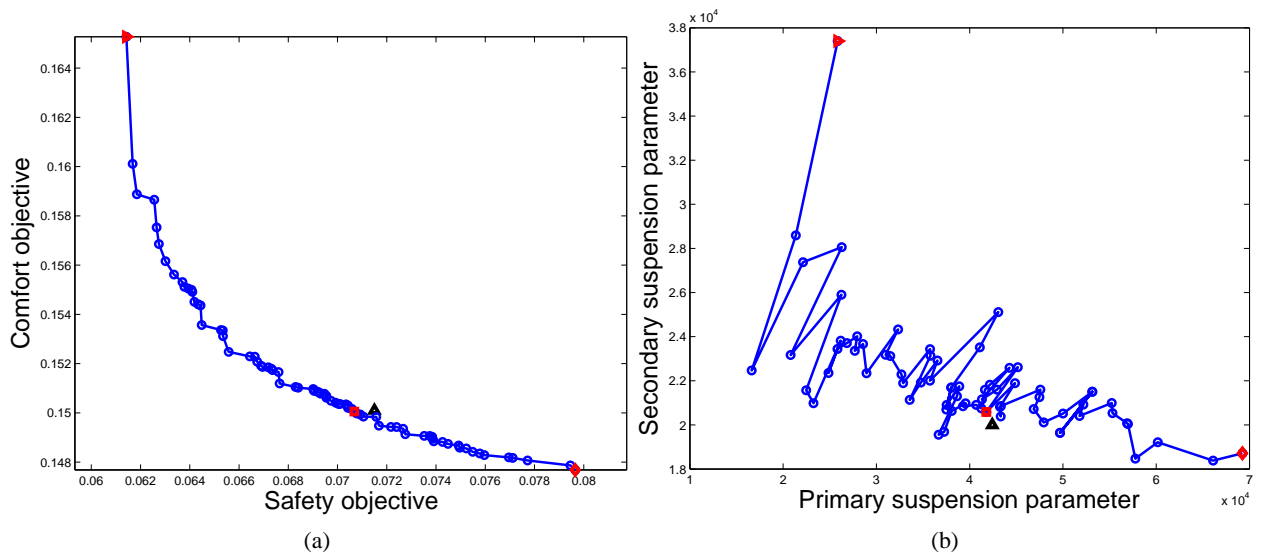

Figure 7: Blue circle markers ( $\circ$ ) represent in (a) Pareto front and in (b) Pareto set for Problem 3.2. Red square markers ( $\square$ ) represent, the chosen trade off solution, read triangle markers ( $\triangleright$ ) represent the solution where  $\mathcal{F}_{\text{safety}}$  is minimized, and red diamond markers ( $\diamond$ ) represent the solution where  $\mathcal{F}_{\text{comfort}}$  is minimized while Black markers ( $\triangle$ ) represent the respective values for the HST in service.

by varying the lateral damping parameters only, a maximum improvement of 23 % in the safety objective, and 10 % in the comfort objective can be achieved, although at the cost in the other objective.

Figures 8(a) and 8(b) show the variation of objectives of Eq. (5) and (6) evaluated for each bogie system for the three selected points of the Pareto set. From analysis it follows that the bogie #1 has the highest safety (solid line, Figure 8(a)) and bogie #5 has the lowest safety (dotted line, Figure 8(a)). Bogie #4 has the best comfort (dotted line, Figure 8(b)) and the worst comfort is seen for bogie #6 (solid line in Figure 8(b)). Thus individual settings of parameters for each bogie system would in theory be more efficient. However, the train

Point (%)	$\Delta\mathcal{F}_{\text{safety}}$	$\Delta\mathcal{F}_{\text{comfort}}$	$\Delta C_y^p$	$\Delta C_y^s$	$\mathcal{F}_{\text{safety}}^{\text{limit}} = 1.15$
Min safety objective, ( $\triangleright$ )	23	0	37	100	5
Trade-off ( $\square$ )	11	9	60	55	6
Min comfort objective, ( $\diamond$ )	0	10	100	55	6

Table 2: Relative improvement (compared to the worst case) of optimization results, relative change in damping parameters (compared to highest value) and percentage of  $\mathcal{F}_{\text{safety}}^{\text{limit}}$ .

in general travels both backward and forward, this would not be possible without adaptive structures.

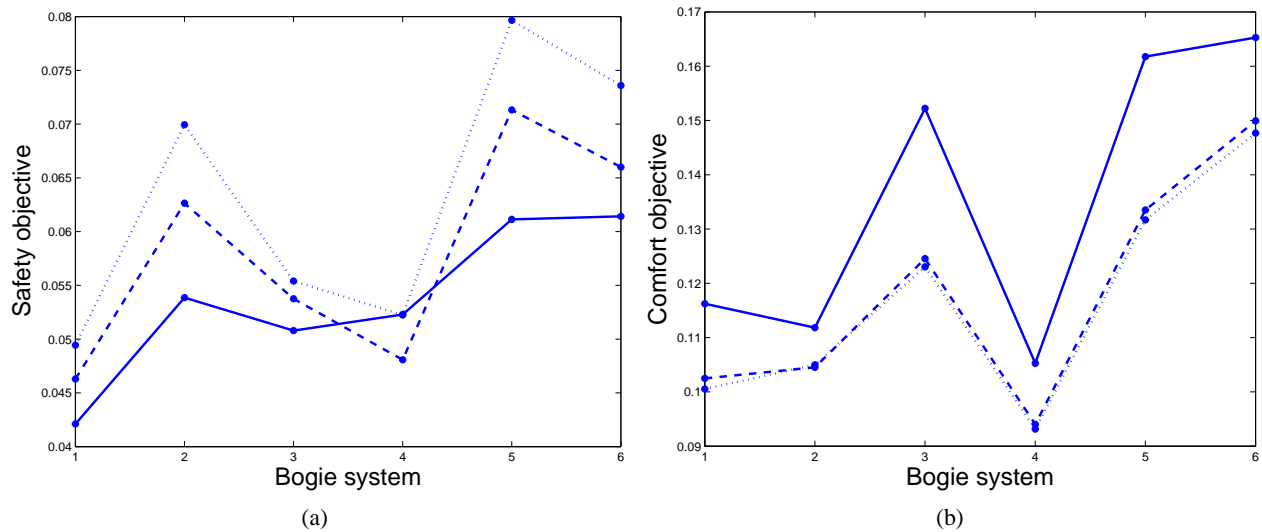

Figure 8: (a) Variation of the safety objective for the six bogie systems and (b) Variation of the comfort objective for the six bogie systems for the three selected design points on the Pareto front. Solid line represents min safety objective, dashed line represents trade-off, and dotted line represents min comfort objective.

## 4 Sensitivity of the safety and comfort of a HST with Pareto optimized lateral damping

The optimization of the lateral damping in the primary and secondary suspensions showed that there exists a trade-off behavior between safety and comfort, and that it is depending on the lateral damping parameters that were subjected to the optimization. Let us consider the HST running in 250 km/h. Assume that the train has Pareto optimized lateral damping parameters of the bogie systems which is the solution of problem 3.2. Now we will study the sensitivity of safety and comfort objectives of the train dynamics with respect to different forward speeds, wheel/rails profiles, service loads of the vehicle and variation in the coefficient of friction presented in Table 3

In Figures 9(a), 9(b), 9(c) and 9(d) the results of the sensitivity analysis are presented. Figure 9(a) shows that both objectives are approximately linearly dependent on the speed. Figure 9(b) shows that the worn profiles have a negative impact on the objectives. It is observed that the wheel profiles mainly effect the safety objective (red line), while the rail profile affect both safety and comfort (green line). The effects of the wornness is cumulative which yields a significant negative effect when using worn profiles for both wheels and rails (black line). It is noted that the effect of wear in this case has approximately the same impact on

Parameter	Values
Forward speed, $V$	[150, <u>250</u> , 275, 300] km/h
Worn profiles	[ <u>ideal/ideal</u> , worn/ideal, ideal/worn, worn/worn]
Load	[tara, service, <u>performance</u> , full]
Friction coefficient $\mu$	[0.4, <u>0.5</u> , 0.6]

Table 3: List of parameters for sensitivity analysis. The parameters used in Problem 3.2 are underlined.

the objective values as an increase in speed from 250 km/h to 300 km/h (black lines in Figure 9(a) and 9(b)). Further, in Figure 9(c) it is observed that the objectives are increasing with reduced loading of the train cars. Figure 9(d) shows that the objectives increase with respect to the coefficient of friction.

Now we are in the position to discuss how the result of the Pareto optimized lateral damping of the primary and secondary suspensions indicate the possibility to introduce adaptive strategy in a minimal upgrade and maximal improvement fashion. One strategy to consider is to control of the lateral damping parameters according to the Pareto set. This can be done in at least the two following ways:

**Case 1:**

$$\mathbf{d}^* \in \mathcal{X}^* \text{ such that } \begin{cases} \mathcal{F}_{\text{safety}}(\mathbf{d}^*) &= \min_{\mathbf{d} \in \mathcal{X}^*} \mathcal{F}_{\text{safety}}(\mathbf{d}) \text{ and} \\ \mathcal{F}_{\text{comfort}}(\mathbf{d}^*) &\leq \mathcal{F}_{\text{comfort}}^{\text{limit}}, \end{cases} \quad (9)$$

**Case 2:**

$$\mathbf{d}^* \in \mathcal{X}^* \text{ such that } \begin{cases} \mathcal{F}_{\text{comfort}}(\mathbf{d}^*) &= \min_{\mathbf{d} \in \mathcal{X}^*} \mathcal{F}_{\text{comfort}}(\mathbf{d}) \text{ and} \\ \mathcal{F}_{\text{safety}}(\mathbf{d}^*) &\leq \gamma \mathcal{F}_{\text{safety}}^{\text{limit}}, \quad 0 < \gamma < 1. \end{cases} \quad (10)$$

The theme is to substitute one of the objective for a constraint with a predetermined limit where this objective will be controlled to be less than or equal to. The other objective we can choose as the minimal configuration of the Pareto front as long as the constraint holds. If the constraint fails, we will move along the Pareto set until the constraint is met. This guarantees the best comfort level for all cases when the safety is not allowed to reach over its limit. The concept requires knowledge of the Pareto set for the particular bogie system, slowly adaptable lateral dampers and sensors which can measure either the acceleration of the car body (case 1), or the acceleration of the wheelsets and have the ability to estimate the wheel/rail contact forces (case 2). Control strategies utilizing the concept of Pareto sets in order to control both safety and comfort in the same manner would be an interesting concept that has the potential to further optimally increase the performance for a small upgrade of the system.

## 5 Conclusions

We have studied the dynamics of a three-car HST. The dynamics of the complete railway vehicle as a mechanical system having 456 degrees of freedom is simulated by a computational model implemented in multibody system software Gensys. Bi-objective optimization problem is stated for the considered vehicle with the aim to enhance safety and comfort simultaneously by optimal variation of lateral damping parameters of primary and secondary suspensions of bogie systems. The numerical algorithm has been developed and implemented in Matlab/Gensys simulation environment to Pareto optimize lateral damping characteristics with respect to safety and comfort. The Pareto front and respective Pareto set of lateral damping parameters have been established for a HST traveling with 250 km/h on a tangent track with realistic track irregularities. The numerical results show that the trade-off for safety and comfort of railway vehicle with respect of lateral damping of bogie system does exist. The numerical results have also demonstrated that by optimizing lateral damping of bogie system the comfort of HST traveling with 250 km/h can be improved by 10%. At the the same time the safety factor of the train performance is only about 5-6% of the critical value.

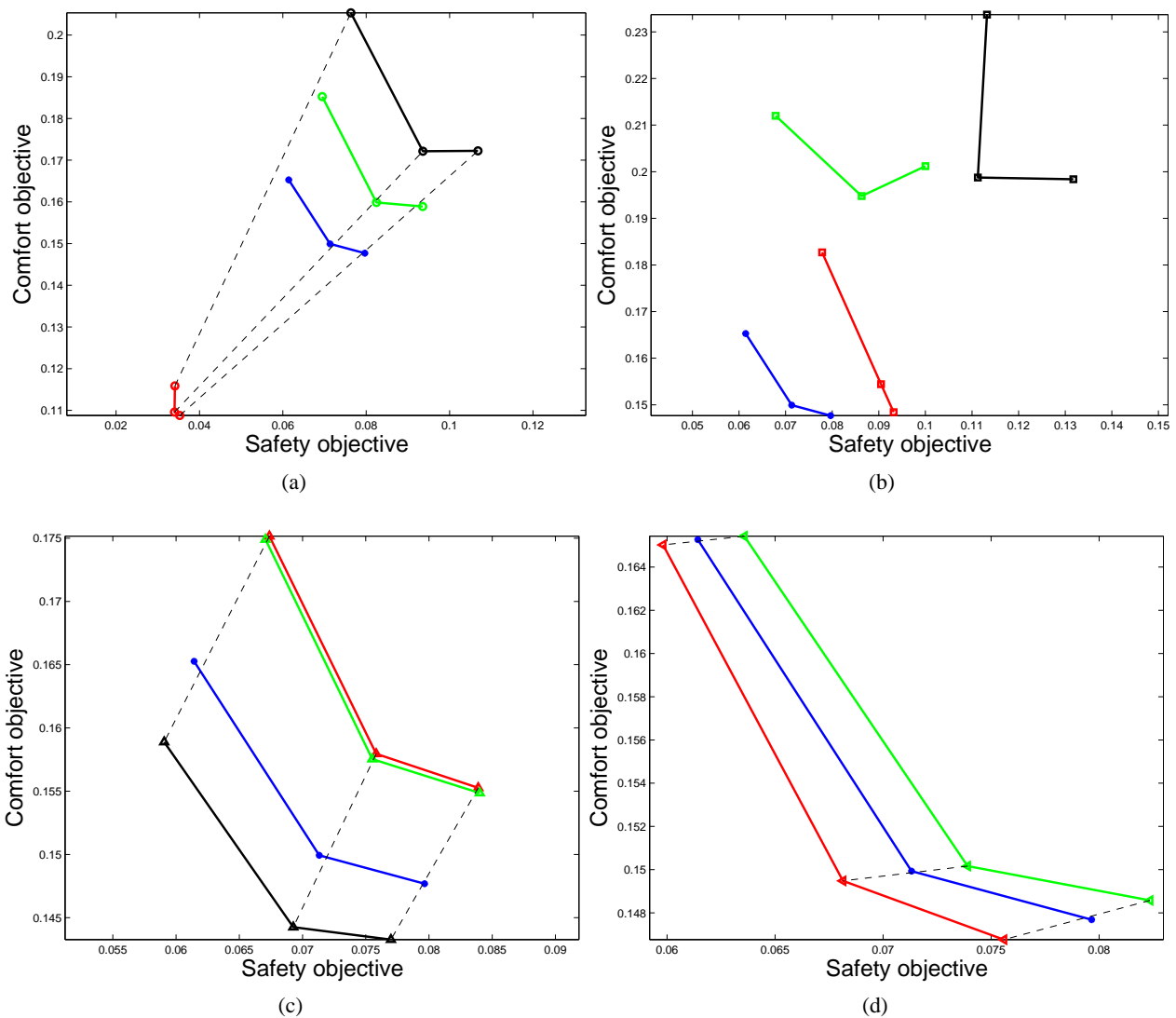

Figure 9: Sensitivity in safety and comfort for the three points in the Pareto set. (a) Variation of speed (red: 150 km/h; blue: 250 km/h; green: 275 km/h; black: 300 km/h), (b) Variation of wornness in wheels/rails, (blue: ideal/ideal; red: worn/ideal; green: ideal/worn; black: worn/worn), (c) Variation of load (red: tara; green: service; blue: performance; black: full), and (d) Variation of friction (red: 0.4; blue: 0.5; green: 0.6).

The results of a sensitivity study of safety and comfort of considered HST having Pareto optimized lateral damping are presented in case of different vehicle speeds, wheels and rails wornness, train service loads and frictions between wheels and rails. We found that the forward speed and the wornness influence the safety and comfort factors significantly.

Further, the results obtained in this paper indicate that the adaptive/semi-adaptive strategies of control of only lateral damping characteristics of bogie system can valuable improve of HST performance to enhance safety and comfort.

## Acknowledgements

The financial support by the Ekman Family Foundation is gratefully acknowledged. The authors also would like to thank Sebastian Stichel, Bombardier Transportation Sweden and Magnus Lundgren, Interfleet Tech-

nology, for fruitful cooperation.

## References

- [1] M. Gobbi, I. Haque, P. Y. Papalamabros and G. Mastinu: Optimization and integration of ground vehicle systems. *Vehicle System Dynamics* 6-7, 437-453, 2005.
- [2] Y. He and J. McPhee: Multidisciplinary Optimization of Multibody Systems with Applications to the Design of Rail Vehicles. *Multibody System Dynamics*, vol. 14, pp. 111-135, 2005.
- [3] R. Goodall: Tilting Trains and Beyond- the Future for Active Railway Suspensions - Part 1 Improving Passenger Comfort. *Computing and Control Engineering Journal* 10, 1999, 153-160.
- [4] R. Goodall: Tilting Trains and Beyond- the Future for Active Railway Suspensions - Part 2 Improving Stability and Guidance. *Computing and Control Engineering Journal* 10, 1999, 221-230.
- [5] J. T. Pearson R. Goodall, T. X. Mei and G. Himmelstein : Active Stability Control Strategies for a High Speed Bogie. *Control Engineering Practice* 12, 2004, 1381-1391.
- [6] A. C. Zolotas, J. T. Pearson and R. Goodall: Modelling Requirements for the Design of Active Stability Control Strategies for a High Speed Bogie. *Multibody Syst. Dyn.* 15, 2006, 51-66.
- [7] D. H. Wang and W. H. Liao: Semi-active suspension systems for railway vehicles using magnetorheological dampers. Part I: system integration and modelling *Vehicle System Dynamics*, Vol. 47, No. 11, November 2009, 1305-1325.
- [8] D. H. Wang and W. H. Liao: Semi-active suspension systems for railway vehicles using magnetorheological dampers. Part II: simulation and analysis *Vehicle System Dynamics*, Vol. 47, No. 12, December 2009, 1439-1471.
- [9] E. Andersson, A. Orvnäs, and R. Persson: On the Optimization of a Track-Friendly Bogie for High Speed. *Proceedings of the 21st International Symposium on Dynamics of Vehicles on Roads and Tracks (IAVSD'09)*, Stockholm 17-21, August 2009.
- [10] A. Johnsson, V. Berbyuk and M. Enelund: Optimized bogie system damping with respect to safety and comfort, *Proceedings of the 21st International Symposium on Dynamics of Vehicles on Roads and Tracks (IAVSD'09)*, Stockholm 17-21, August 2009.
- [11] [www.gensys.se](http://www.gensys.se)
- [12] H. Claus and W. Schielen: Modeling and Simulation of Railway Bogie Structural Vibrations. *Vehicle System Dynamics Supplement*, Vol. 28, pp. 538-552 (1998).
- [13] E. Andersson, M. Berg, and S. Stichel: *Rail Vehicle Dynamics*, Universitetservice AB, Stockholm, Sweden, 2007.
- [14] K. Deb: *Multi-Objective Optimization using Evolutionary Algorithms*. John Wiley & Sons, 2001.