

UNIVERSITY OF VAASA  
FACULTY OF TECHNOLOGY  
INDUSTRIAL MANAGEMENT

Mohammed Assim Mohammed

**NEXT GENERATION BIKE SHARING DESIGN CONCEPT USING  
AXIOMATIC DESIGN THEORY**

Master's thesis in  
Industrial Management

Master of Science in  
Economics and Business Administration

**Vaasa 2017**

**Contents**

Abstract.....	1
1. Introduction .....	2
1.1 Problem/Opportunity .....	2
1.2 Limitations .....	3
1.3 Approach.....	4
2. Literature Review .....	4
2.1 Bike Sharing systems .....	5
2.1.1 Definition .....	5
2.1.2 History of Bike Sharing Systems .....	6
2.1.3 Bike Sharing System Components.....	9
2.1.4 Benefits.....	10
2.1.5 Challenges and opportunities .....	11
2.2 Electric Bicycles .....	12
2.2.1 Definition and terminology .....	12
2.2.2 Electrical bicycle .....	15
3. Method.....	20
3.1 Axiomatic Design Fundamentals .....	20
3.1.1 Domains .....	21
3.1.2 Hierarchies .....	22
3.1.3 Design equations .....	23
3.1.4 Design laws in the form of axioms.....	23
3.2 Data Collection .....	25
3.3 Top level functional requirements for the electrical bicycle design .....	26
3.3.1 Decompositions of the bicycle's FRs.....	26
3.4 Top level Functional Requirements for the Docking Station design.....	35
4. Technical Design .....	41
4.1 Top level Design Parameters for the electrical bicycle design .....	41
4.2 Top level Design Parameters for the Docking Station design .....	52
5. Discussion.....	56
Recommendations.....	57
Conclusion .....	58
References .....	59

## Table of Figures

Figure 1 the evolution of bicycle sharing programs .....	7
Figure 2 Examples of docking stations.....	9
Figure 3 The block diagram of the proposed driving system. ....	15
Figure 4 The integrated hybrid electric bike. ....	17
Figure 5 Proposed E-bike recharging system. ....	19
Figure 6 Design mappings and domains.....	21
Figure 7 Decomposition by zigzagging. ....	22
Figure 8 Axiomatic Design Process. ....	24
Figure 9 Direct drive Hub, axle and stator to the left, moving part to the right. ....	30
Figure 10 Geared Hub Motor 25Watt on the left, 1200 Watt on the right. ....	31
Figure 11 safety laser lines. ....	35
Figure 12 Helsinki City Bike docking station with a sales point. ....	40
Figure 13 The F.Rs and the D.Ps for the Bicycle Concept.....	50
Figure 14 Rough sketch of the bicycle design.....	51
Figure 15 Illustration of charging via coils. ....	54
Figure 16 Helsinki City Bike docking station with a sales point. ....	54
Figure 17 The F.Rs and the D.Ps for the Docking Station Concept.....	55
Figure 18 Rough sketch of the docking station design.....	56

## Table of Tables

Table 1 Bike Sharing Systems Challenges .....	11
Table 2 Crank vs. Hub Motor .....	29
Table 3 Direct Drive Vs, Geared Motor .....	31

---

University Of Vaasa

Author:	Mohammed Assim Mohammed
Topic of the Thesis	Next Generation Bike Sharing Design Concept Using Axiomatic Design Theory
Supervisor	Jussi Kantola
Degree	Master of Science in Economics and Business Administration
Major Subject	Industrial Management
Year of Entering the University	2014
Year of Completing the Thesis	2017

Pages: 66

---

## Abstract

Bike sharing systems have been in use since the 1960's, from the modest beginning to one of the fastest spreading services today. Each generation of bike sharing systems had its challenges, but the advancement in technology was and is a key factor in eliminating any shortcomings or problems facing it as well as opening new opportunities for enhancing the service and the user experience. The main focus of this thesis is to propose a new design concept of bike sharing system using axiomatic design theory, the concept consists of a modified bike sharing model that can help solve some of the challenges faced by the traditional models while meeting the customer's needs and the basic functional requirements of a traditional bike sharing program.

Axiomatic design theory provides a method for the design of products, it makes it possible to design structure and decompose function at the same time. Utilizing currently available technologies such as electrical components and global positioning systems, the new system will include a new design for the bike, the docking station, central control station, and payment systems.

**Keywords:** Bicycle, Bike Sharing Systems, Electric, Docking Stations, Service.

## **1. Introduction**

Urban mobility is a prevalent problem in many cities around the world. Cycling offers a fast and cheap transportation option for short-distance trips, with smaller carbon and physical footprint than driving a car. By consuming considerably less non-renewable natural resources than motorized transport modes, it is one of the most sustainable and efficient transportation modes for trips of distance up to 5 km (Katia et al. 2011, Midgley 2011), it can also play a vital role in increasing public transit ridership (Katia et al. 2011). Moreover, since the spatial efficiency of bicycles is close to that of buses in mixed traffic condition, cycling qualifies as a non-congesting mode (National Research Council 1996). Furthermore, cycling promises health benefits for individual commuters (J. Pucher 2007). These considerations have led to renewed interest in promoting cycling in urban areas, and result in city governments investing public funds in an estimated 135 bike-sharing programs with a total fleet size of more than 235,000 in cities around the world, as of March 2011 (Shaheen, Zhang, et al. 2011)

### **1.1 Problem/Opportunity**

However, bike sharing systems still facing several challenges, aside from weather and safety concerns, financial considerations is on the top of the priority list. Also, Future Development and trends are pointing to several technology implementations in the private bicycles market such as electrical bikes getting cheaper and easier to recharge, which make them a more desirable than choosing both standard bicycles and bike sharing systems.

Some of the development related to bike sharing systems includes implementing electrical bicycles for the fleet, moveable docks or dock-less systems, which diminish some of the main appealing factors of the Bike Sharing systems.

Yet still the main challenge facing the bike sharing system is the cost, how to fulfill the needs of the end users, while providing them with a high quality bicycles, with desired features, while reduce product life cycle cost yet avoiding rework and high research and development cost. This makes it challenging to design products that successfully address

customer needs, especially to the organization running the bike sharing program, since the fee of the ridership must be low enough to be appealing for the end users, otherwise if it was comparable to other public transportation methods, the end users might choose the bus over the bike sharing system.

## **1.2 Limitations**

During the time this research was conducted, there were several obstacles and limitations that led the author to change the approach for this work.

Axiomatic design is a theory that is heavily reliant on the customers' feedback, in order to get access to such feedback, several bicycle companies were contacted, including Pelago, FINNPOWER, SOLIFER, TUNTURI, HELKAMA and Huntteri. As well as the city of Vaasa council. The author was not able to attract any of the companies mentioned above to collaborate on this research, either due to the lack of interest or to the fact that they are currently focusing on other ongoing projects, due to the lack of access to customers feedback, the author switch the source of the customers need from the customers feedback to secondary sources, which includes academic researches and publications as well as online surveys, Kickstarter bicycle companies development forums and public online feedback.

Another limitation is financial, it was not possible to develop a "prototype" in order to test it in the real world situation.

The last limitation is time, the scope of this work is to define a new concepts for bike sharing program for the bicycles as well as the station. There are several publications addressing these issues from a very focused and specific point of view, so to describe each of these publications in details would be outside the scope of this work.

### **1.3 Approach**

Axiomatic design theory provides a method for the design of products, it makes it possible to design structure and decompose function at the same time. Function analysis is critical for the innovation of products/systems. The purpose of the product innovation is to meet the needs of customers as they change with the passing of time, the product must evolve to meet the new needs of the customers.

This is a proposal for developing a concept of bike sharing system using axiomatic design theory, the concept consist of a modified bike sharing model that can help solve some of the challenges faced by the traditional models while meeting the customer's needs and the basic functional requirements of a traditional bake sharing program. Most of the features included in the work will be imported from academic researches and publications related to bike sharing systems, electrical bicycles, and electrical bike sharing systems.

## **2. Literature Review**

The main goal of this work is to provide a brand new design for a service that already exists, there are no academic publications that relate directly to the presented work, so the chosen approach was to review the available publications on the already exciting bike sharing systems, for a better understanding of the current bike sharing system status, and identifying the possible challenges and opportunities.

Electric bikes development is also a topic of interest, it is generally considered to be the future direction of the bike sharing systems and many publications agree on that.

## 2.1 Bike Sharing systems

The literature related to bike sharing systems while being relatively new, has a significant number of publications covering the subject from several point of views. Due to the limited availability of time and scope of the current work, instead of reviewing papers individually, recurrent themes and topics that are heavily related to this work will be reviewed, these topics are listed below:

1. Definition
2. History of Bike Sharing Systems
3. Bike Sharing System Components
4. Benefits
5. Challenges

### 2.1.1 Definition

Different scholars define Bike sharing systems differently, Shaheen, Guzman and Zhang definition is "*Bike-sharing system is a short-term rental scheme allowing bicycles to be collected and returned at any one of several self-serve stations. It enables commuters to flexibly use bicycles without incurring the cost and trouble of owning and maintaining them. (2010).*" Shaheen goes one step further by identifying the concept of Bike sharing "*The principle of bicycle-sharing is simple: individuals use bicycles on an "as-needed" basis without the costs and responsibilities of bicycle ownership, 2010*". In the New York City Department of City Planning definition of the bike sharing system "*Also called "Public-Use Bicycles" (PUBs), "Bicycle Transit", "Bikesharing" or Smart Bikes, bicycle-sharing schemes comprise short-term urban bicycle rental schemes that enable bicycles to be picked up at any self-serve bicycle station and returned to any other bicycle station, which makes bicycle-sharing ideal for point-to-point trips (2009)*". Elliot Fishman in his comprehensive Transport review (Bikeshare: A Review of Recent Literature) simplifies the definition of the bike sharing program as "*Contemporary bikeshare programs (BSPs) refer to the provision of bikes, which can be picked up and dropped off at self-serving docking stations*". Finally, Ma, Liu and Erdogan define



Bicycle Sharing in general as “*a public-accessible short-time bike rental program in which users share a bicycle fleet located at multiple stations.*”

Based on the previous definitions, a common theme is noticeable, which can be used to create a personal definition: Bike Sharing Programs are systems that provide a service to the public, where the users have access to a fleet of bicycles available across the city in stations, the user can temporarily rent a bike from one station for the purpose of transportation, then the bike must be returned to one of the designated stations, giving the user the benefits of a bicycle without the costs and responsibilities of bicycle ownership.

### 2.1.2 History of Bike Sharing Systems

The First bike sharing system was introduced in 1965 in Amsterdam, called “Witte Fietsen (White Bike)” because of the white painted bicycles used at the time, similar programs – Known as first Generation Bike Sharing Programs – existed in other European cities such as La Rochelle (1976) and Cambridge (1993), these programs consisted of bikes available for free in the streets for anyone to use. The total absence of security measures made the bicycles prone to theft and vandalism, there were no consequences for the care for the bicycles and to returning them in bad condition. The first generation programs did not survive for a long time and closed after a short time.

The second generation of systems involved coin deposit systems (similar to trolleys at a supermarket or airport) in order to address the issues faced by the first generation system. Starting 1991, in Farsø and Grenå, Denmark, the program faced a similar problem of the first generation, the anonymity exposed the system to theft (DeMaio, 2009), which led to the development of the third generation systems.

The third generation of bike sharing system differs from the previous generation by having several key components, mainly a dedicated docking station from which the bike can be taken, and returned to. These third generation systems took the form of a “bicycle lending library” (Metrolinx, 2009) with a membership or annual fee. Also, it implemented an automated credit card payment (Shaheen, Cohen, & Martin, 2013). By 1995, the first large scale scheme (called Bycyklen or City Bikes) was introduced in Copenhagen. They

used custom-built “heavy duty” bicycles with non-standard components to reduce theft. The third generation bike sharing system is the foundation of the currently available systems, several improvements were added due to the advancement and the wide spread of technology such as improved bicycle designs, intelligent docking stations and membership smartcard (or magnetic stripe card), advanced bicycle locking mechanism and sophisticated payment systems. Some initiated the use of GPS (Global Positioning System) to track bicycles and prevent theft. Other features improved the overall systems while not changing the bicycles or the docking stations. Operators used networked self-service stations - no need for a sales person to be present - that communicate with a centralized system and Radio Frequency Identification (RFID) chips in the bicycles to monitor the location of bicycles in the system. (New York City Department of City Planning, 2009)

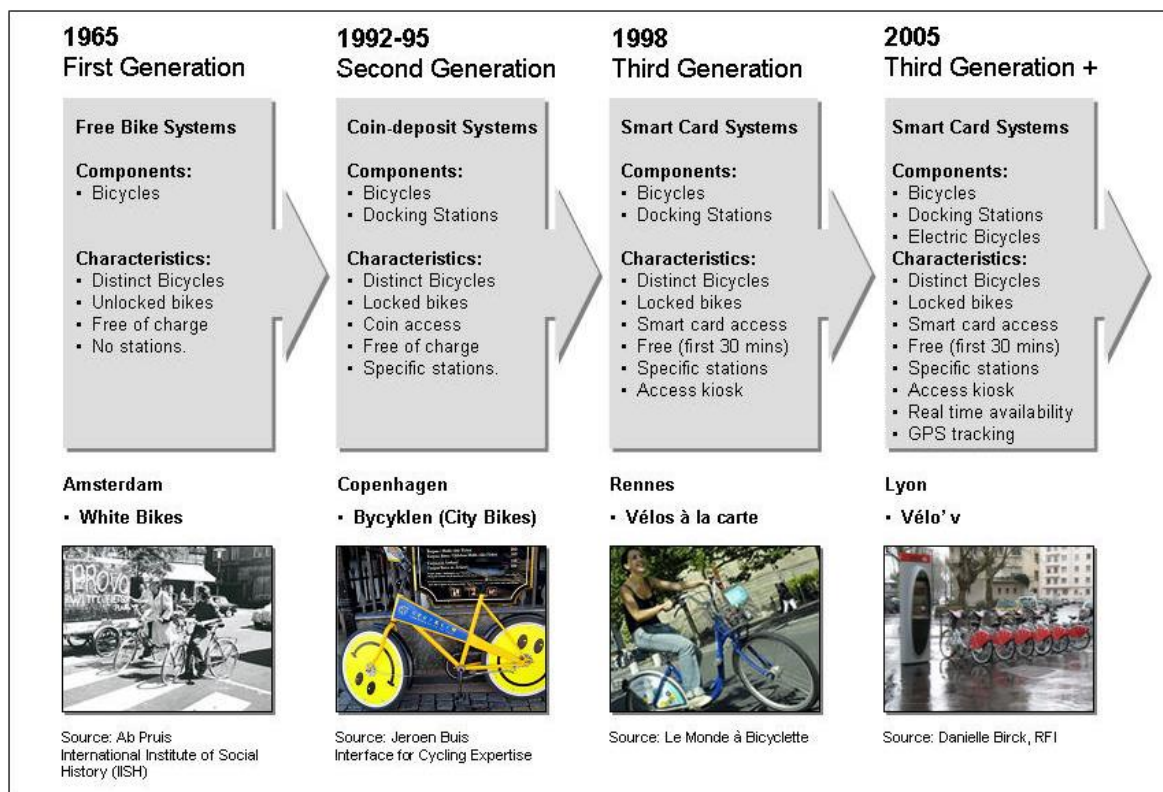

Figure 1 the evolution of bicycle sharing programs

Each generation introduce a fundamental concept that differentiate it from the previous one, a payment system was what made the second generation different from the first one, and the docking stations are what differ the third generation from the second one.

There are two main candidates for the fourth generation of the bike sharing systems, driven by the rapid advancement in two different technologies, Global Positioning Systems (GPS) and Electrically Powered Bicycle (E-Bikes).

Dock-less Systems: due the increasing affordability and ubiquity of GPS chips, implementing them across an entire fleet of bicycles has several advantages for the bike sharing program operators, such as reducing the need for physical docks (Parkes et al., 2013), assisting bikeshare operators by providing a “geo-fence” to detect when a bicycle is being driven outside a specific area (Parkes et al., 2013). The use of real-time tracking will assist the operators with the challenging task of balancing - re-distributing - bicycles across their fleet, as well as informing the end users with real-time information on bicycle availability.

The automated data collection facilitated by the use of GPS tracking systems in the bicycles allows to extrapolate new information which is useful may not only for bikeshare operators to recognize the patterns of how their system is being used, but also may assist governments in planning and evaluating potential bicycle route usage and their effectiveness from a wider transport planning perspective.

Electrical Bike Sharing system is the second candidate, the growth in bike sharing systems was paralleled by the rapid advancement in electric bike design and performance accompanied by increasing affordability and usage. E-bikeshare can help alleviate some of the challenges that hindered those who may not have previously considered bikeshare systems as an option. Such as challenging topography, excessive heat and other factors associated with physical exertion can decrease the attractiveness of travelling by cycling in general (Heinen, vanWee, & Maat, 2010).

### 2.1.3 Bike Sharing System Components

A modern bike sharing system consists of several major components

1. **Bicycles:** The Key component in any bike sharing system, typically have a single standardized design, in order to distinguish them from all other bicycles, they are also heavier and sturdier, so it can handle the constant use through the day. Most common features include an internal hub with three speeds, an adjustable seat, mud guards, portable locks, a positioning unit (GPS) and a Radio Frequency Identification (RFID) tag. To discourage theft, they are made from components that are incompatible with other bicycles, and cannot be disassemble without special tools, (Quay Communications Inc., 2008)
2. **Docking stations:** a designated racks on which the bikes are locked when not in use, according to the Transport Canada Bike Sharing Guide, there are three types of docking stations, Fixed-permanent, Fixed portable, and Flexible. The majority of bicycle sharing systems feature fixed stations.



Figure 2 Examples of docking stations (a) Fixed-permanent (Paris) (b) Fixed-portable (Montreal) (c) Flexible (Copenhagen)

3. **Access and user registration System:** The registration and access process is handled at a designated kiosks located at each docking station. Registered users have access to unlock and use the available bikes from the stations, Requiring pre-registration creates while a barrier to use, but it will increase rider accountability and reduce bicycle theft (Alta Planning + Design, 2009).
4. **Status and information System:** many systems provide real time information on websites about bicycle availability for each docking station in the system, a maps with bicycle marked lanes, and some provide weather updates.

5. Maintenance Program: maintenance and logistic are important factors of customers satisfaction and key components in any successful bike sharing program
6. Bicycle redistribution mechanisms: An optimized network needs to anticipate the asymmetric travel demands in large cities. Suggested solution other than a dedicated team with a vehicle for re-balancing the system, include a premium when returning a bicycles to a lower elevation, conversely a credit for each bicycle returned to a station at a higher elevation. Vélib' introduced such a program in early 2008 (Quay Communications Inc., 2008),

#### 2.1.4 Benefits

There are several benefits gained from bike sharing programs, paired with the advancement in technology helped in the wide spread adoption of such programs globally. Previous researches and publications list the benefits differently from one to another, due to the different perspective in which these benefits are considered, such as: **Urban mobility** "*Apart from being a clean, cheap and equitable mode of transport for short-distance journeys, cycling can potentially reduce traffic congestion, parking space requirements and roadway costs*" (Mcclintock 2002). **Public Transportation ridership** "*By providing efficient first / last mile connectivity, it can also play a vital role in increasing public transit ridership*" (Katia and Kagaya 2011). **Air and Noise Pollution** "*By consuming considerably less non-renewable natural resources than motorized transport modes, it is one of the most sustainable and efficient transportation modes for trips of distance up to 5 km (Katia and Kagaya 2011, Midgley 2011)*". **Health Benefits** "*Overall, however, bikeshare was found to have a positive impact of physical activity, leading to an additional 74 million minutes of physical activity in London, through to 1.4 million minutes of physical activity in Minneapolis/St. Paul, for 2012*" (Fishman et al., 2014b). **Financial Benefits** "*Bike share programs have a variety of economic benefits. Bicycling increases exposure to storefronts compared with driving, which leads to more spending in retail areas. Bicycling facilities can increase home values and consequently add to municipal tax revenues.*" (Kisner, Corinne 2011)

### 2.1.5 Challenges and opportunities

There is a scarcity of research examining barriers to bikeshare systems, mainly due to the difficulty associated with data collection, since the number of participants interested in bikeshare research is lower than number of those who have used bikeshare before (Fishman, 2014). Still, it is possible to identify some challenges and divide them based on the nature of the challenge, whether they are inherently associated to biking in general, or related to the policies of the city or country in which the bike sharing program is deployed.

Table 1 Bike Sharing Systems Challenges

The Source	The Challenge
Biking	Topography, users prefer to bicycles downhill into town but take other modes of transportation to go back uphill, leaving the bicycles behind.
	Climate, Extreme seasonal climates whether it is a hot and humid summer or an icy cold winter are factors in reducing the biking appeal.
	Inexperienced Cyclists, in some cities motorists have suggested that cyclists who use bicycle-sharing schemes tend to be inexperienced riders who do not follow the traffic rules.
	Age and Fitness, Biking might not be suitable for the elderly, obese or disabled people
Bike Sharing Programs	re-distribution, This is not just a problem of cost, but may affect the availability in stations with high demand (Shaheen, Guzman, & Zhang, 2010; Midgley, 2011)
	Theft, vandalism and Misuse
Policy Related	The main hindrance in some regions to implementation of bicycle-sharing programs is helmet laws or helmet culture.
	Safety concerns, cyclists are more prone to accidents in mixed traffic conditions (Pucher and Dijkstra 2000).

## 2.2 Electric Bicycles

Development in the electrification of the bicycles is diverse; each research is conducted from a different point of view, and executed for a specific purpose. In this work, publications related to electric bikes developed for the bike sharing systems, and bike rentals programs will be the main focus, illustrating the current state of research and future development trends regarding such programs. This part will be divided into two parts.

1. Definition and terminology
2. Electrical bicycle literature review

### 2.2.1 Definition and terminology

Electrical bicycle definition can be intuitively acquired from the name itself, there are several forms of definitions can be found in the literature, some may use the similarities and the differences between a regular bicycle and an electric bicycle to formulate a definition, like in Pucher and buehler 2012: 81 in addition to the features that come with a regular bicycle, “*an electric motor supplements pedal power, usually powered by a rechargeable battery*”. **Evelo, Electric Bicycles Company**, answers the “*what are Electric Bicycles?*” question with “*Just picture a regular bicycle, then add several electrical components to it like a motor, a battery, and a controller – all seamlessly integrated into the design. These items make up the fundamentals of all electric bicycles on the market!*” Others choose to define the electric bicycle by the functions it provide, as defined by Chen, et al. (2010) “*The electric bike (E-Bike) systems provide an alternative way of transportation that have the benefits of mobility as a personal vehicle, ease of operation, economical power source from electricity utility, benign to environment protection, and flexibility in scale and cost.*”

Based on the definitions provided in the literature, it is possible to formulate a new definition that can suits the different aspects from which earlier definitions have been based on.

An electric bicycle is any regular bicycle that has a motor to supplements the pedal power provided by the user, electric bicycles most often include also a battery and several

controllers and sensors that facilitate the usage of the motor power in an efficient way, to help increase the range of the travelled distance and ease the operation of the bike.

As stated in the previous title, what differentiate an electric bicycle from a regular bicycle are several components, mainly the motor, the battery, and few sensor. These parts will be the main focus in this part of the work, rather than identifying all the parts required to create an electric bicycles (i.e. the frame, seat, pedals, etc...)

The Motor: the main part of any electrical bicycle, it can be the sole source of power in the bicycles, or it can be one source out of few (usually two, as in hybrid bicycles), the difference between motors is accredited to where they are mounted:

- Front Hub Motor: Located in the front wheel, it provides propulsion to the bicycle by spinning the front wheel, this position of the motor generates the sensation that the bicycle is “*being pulled*” while in operation.
- Rear Hub Motor: as the name implies, the motor is installed in the rear wheel, and it provide propulsion by spinning the back wheel, “Pushing” the bicycle forward, which creates a more “*natural*” feeling during operation, similar to a traditional bicycle.
- Mid-Drive: The motor is not installed in any of the wheels, rather it is located in the middle of the bicycle (either on the chain, or in the pedal hub), its central location creates a “*more natural*” riding sensation than Hub motors, however, it is less efficient in transferring the power to the wheels due to the existence of several mechanical links between the motor and the wheel.

The Battery: the main source of energy to the motor, providing the electrical current need for the operation of the motor, batteries have different capacities and also different mode of operations:

- Pedal Only: The battery does not provide energy to the motor, and the bicycle is ridden like a regular bicycle.
- Pedal Assist: The battery energize the motor only when the pedals are spinning, this is also known as “*Hybrid*” Operation Mode. This mode provides the longest possible journey distance using the energy stored in the battery.



- **Electric Only:** the battery provides electricity to the motor and the motor is the only source of propulsion in the bicycle, the rider controls the speed by controlling the amount of current supplied from the battery. This mode is the most comfortable to the rider, since no physical effort is required to operate the bicycles, beside steering and braking.

The batteries installed in the electrical bicycles are rechargeable, either via the regular operation of the bike (pedal only mode, part of the kinetic energy is used to charge the battery), via regenerative braking (or pedaling downhill), or from an electrical output (plug into another source of electrical power either from the grid, solar panels, or wind turbines).

**The Drivetrain:** It consists of the pedals, chains and various gears that transfer the torque and power required to spin the wheels and move the bicycles, in an efficient manner, Mid-Drive Motor provide its power directly to the drivetrain, making cranking the chain easier than traditional bicycles. Drivetrains also allows the rider to shift gears in order to increase the speed or the torque applied to the wheel (needed for uphill travel). The electric powertrain consisted of an electric controller, controller software, as well as several sensors and switches.

**Sensors and Controllers:** some of the sensors that can be found on an electric bicycles may include

- **Torque Sensor:** measuring the amount of force applied to the pedals by the rider. This helps control and adjust the electrical drivetrain operation, and the main part of identifying under which mode of operation the bicycle is functioning.
- **Speed Sensor:** detects the speed at which the bicycle is traveling.
- **Battery sensor:** measuring how much electrical energy is stored in the battery

Electric bicycles also include an electric controller, which controls all the functions related to the motors, batteries and electrical drivetrain. This controller might be hidden from the rider, or available for the user, through an interactive hub that include a display, and input methods (buttons, via smart phone or touch screen).

### 2.2.2 Electrical bicycle

In the paper Design and Implementation of a Bi-directional Power Converter for Electric Bike with Charging Feature by Lin C. et al. (2010) the proposed bi-directional converter not only transfers the energy stored in battery for driving motor, but also recycles the energy resulted from the back electromotive force (BEMF) to charge battery.

The system block diagram is shown in the proposed system for bidirectional converter, in which a battery, a motor driving inverter and a rectifier are linked. With this system, the battery can provide energy to motor, and the BEMF generated from motor can be transferred to be stored in the battery. Besides, the bidirectional converter is also served as a charger, which converted the rectified voltage from AC source to charge the battery.

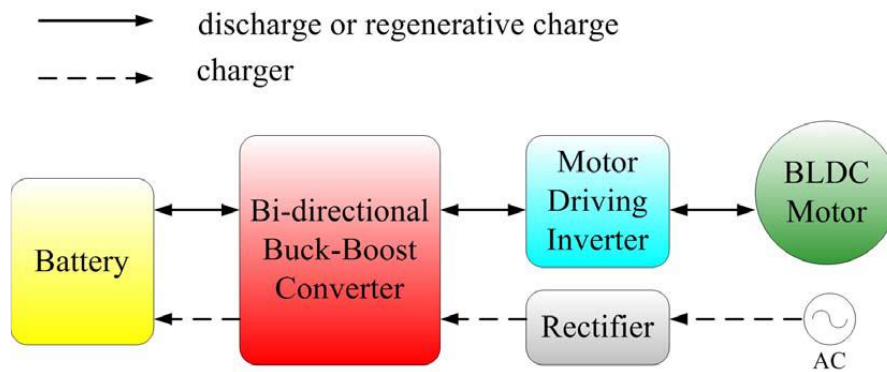

Figure 3 The block diagram of the proposed driving system.

The main objective of the paper was to design and implement a bi-directional converter for electric bike, not only to recycle energy back to the battery for system performance improvement, but also reduce component count and reduce the overall cost. The authors detailed all the components for each block, which is beyond the scope of this work, and hence will not be included.

Hatwar N. et al. (2013) have investigated the use of super capacitors in electric motor bikes in their work “Design Approach for Electric Bikes Using Battery and Super Capacitor for Performance Improvement”. The reason for including this work here is that electrically powered bicycle shares several similar component and structure with electric motor bikes, hence any finding regarding electric motor bike can be imported to the electrically power assisted bicycles. The authors in this paper have tried to address the drawbacks observed in e-bike operations and have presented the results of their

experimentations. Super-capacitor modules are used to provide the high current required during starting and acceleration, and will help increasing lifespan of battery. The authors was able achieve noticeable improvement in the results for different parameters, such as Increased Speed, Increased Range per Charge, Improved Battery Life, and Reduction in Charging Time.

Electrically power assisted bikes, while powered mainly by human energy, still utilize electric power drawn from a battery, and eventually this battery must be recharged from another source of energy. A new design for a completely self-sustaining and grid independent hybrid electric bike was proposed in “A full hybrid electric bike: how to increase human efficiency – 2012” by utilizing the possible energy flux between the cyclist and the electric motor in order to improve the efficiency of the human energy spent to move the bike. The main idea behind this work is presenting the design and realization of a full Hybrid Electric Bike (HEB) as a self-sufficient Electrically Power Assisted Cycle (EPAC).

The author’s design is borrowed from the automotive field; full Hybrid Electric Bike (HEB) is configured as a parallel hybrid vehicle. The main characteristic of the HEB are:

- Charge sustaining mode: bike does not need to be recharged from electric grid differently from EPACs.
- One power source: The cyclist.
- Small added weight: Hybrid Electric Vehicle (HEV) and (HEB) need smaller battery pack, exploiting differently energy fluxes.
  - HEB improves human efficiency: similar to HEV, HEB uses the main power source converter at its best operative point.

## Bicycle Description

The vehicle consists of:

- A) A mechanical frame, which has 2 hydraulic disk brakes, rims, steering handle, and other standard city bike light components.
- B) Electrical components, which contains brushless motor, ECU and motor drive, a custom battery pack and battery management system, pedaling speed sensor and a smartphone to run the needed application.

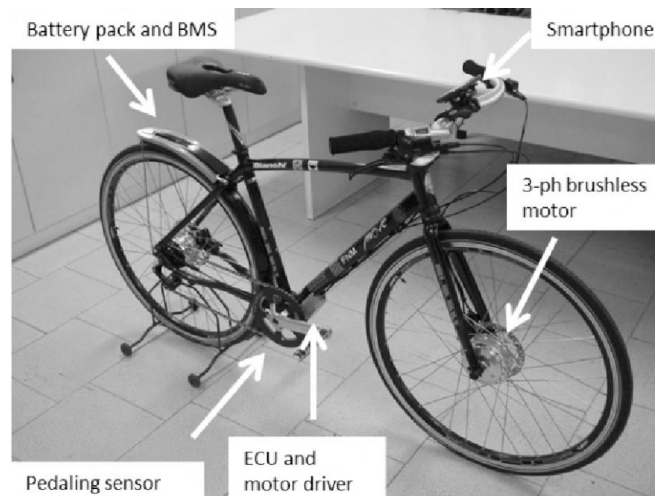

Figure 4 The integrated hybrid electric bike.

The authors presented the design of a self-sustaining hybrid electric bike for improving human efficiency. Energy fluxes from the cyclist and the motor, physiological changes were taken into consideration when deriving an algorithm to prove the possibility of decreasing oxygen consumption. Results showed for a specific protocol, human efficiency can be improved 30% over. Algorithm can be tweaked in order to guarantee a self-sustaining behavior in every condition. Sprints are not considered in the actual version of algorithm and should be included. Moreover the effects of changing covered distance between starts and stops need to be further investigated. This usage case for this proposal was not specified, it is safe to assume the authors intended the design to be used as a personal bicycle.

In 2013, a team from Centro para a Excelência e Inovação na Indústria Automóvel proposed an electrically power assisted bike design specifically for the bike sharing

services. The authors identified some main differences and requirements that separate a regular electric bike general purpose use, and the use for a bike sharing systems. These requirements were divided into 3 different categories:

- 1- Usability: Riding an electric bicycle should be easier than riding a traditional bicycle, this is achieved by including an electric powertrain, which includes a motor, a battery pack with enough energy storage capacity to allow at least two consecutive uses for the average riding times on such systems.
- 2- Design: The use of motor and battery pack will increase the overall weight of the bicycle. Lean Design is needed in order to reduce the weight on other components and the structure itself, in order to keep the bike with the same performance level and energy consumption.
- 3- Cost efficiency: Design should target a low cost, low volume production that could be easily upgraded for medium volumes if needed.

The unique design choices made by the author was done to satisfy several key requirements. Different features were implemented to improve safety requirements, security requirements, ease of use, and ease of maintenance.

The motor was installed inside the pedal crank hub (crank shaft), while its more common to implement the motor in one of the wheels, the author chose the crank shaft position for better protection against theft and vandalism, being covered with a plate will add an extra layer of protection against misuse and everyday wear and tear. Safety laser are also installed in the rear side of the bike, these laser lights project two lines on the ground outlining the need area the bicycle occupies and need to operate safely. The locking mechanism of the bike was a specially design to satisfy the operating conditions of an everyday bike in the bike sharing systems, users have a drop and leave approach to when they return the bike to the station, hence a locking mechanism was developed to not only secure the bike to the station, but to connect the bike so it can be recharged without the need to use charging cable and other measures.

The “Intelligent Box” is an on-board computer provides real time monitoring and control over the bicycle and tracking during its use by combining sensitization, calculation, and communication ability. All the components and the physical frame of the bike are housed

within a plastic body, in order to achieve stylish design at low volume production and low cost, the use of plastic may also be used as publicity support during operation. Development in the electrically power assisted bikes is not strictly related to development on the bike itself. Mainly in the bike sharing programs, where the bike is only one out of many components that constitute the whole system. Docking an electric bike to the station is a complicated process, the connection must not be only physical, but it has to be physical and electrical.

F. Pellitteri et al. in their work E-bike battery charging: methods and circuits have proposed an innovative recharge system for the e-bike batteries. Power transfer from the grid to the load is achieved wirelessly, through a magnetic coupling structure. The suggested wireless solution - Power transmitter, magnetic coupling and power receiver - have been accurately designed for efficient recharge. Simulation results show excellent 98.5% power efficiency referred to the receiver rectifier. Considering a 3cm air gap for the magnetic structure, a 91.6% coupling efficiency is obtained. In the worst-case, the power conversion efficiency including magnetic coupling and receiver section results in a 90.2% value.

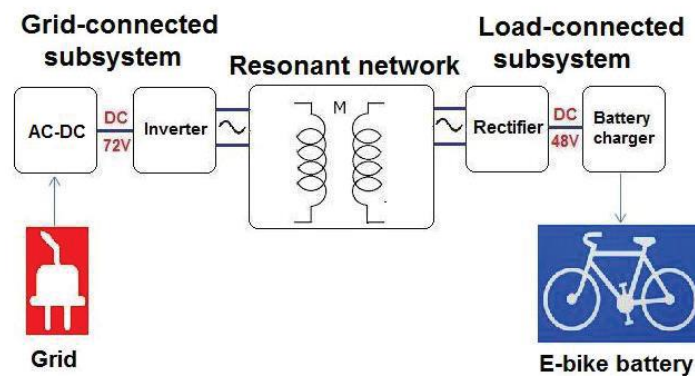

Figure 5 Proposed E-bike recharging system.

Possible use case of this method is in the docking stations of the bike sharing system. Eliminating the electrical hazards of connecting an electric bike to the docking station for charging.

### **3. Method**

Axiomatic Design principles developed by Suh (1990) to form systematic scientific basis for designers, especially in the design processes of product, production systems, and software design.

Axiomatic design (AD) is a formalized methodology that can be used to represent a variety of design problems (National Academy of Sciences 2002). It provides a framework for describing design objects at all levels of detail.

The number of studies using AD principles is gradually increasing as AD's superiorities create important advantages for decision makers in solving multi-criteria decision making problems.

#### **3.1 Axiomatic Design Fundamentals**

The Axiomatic design principles have four Fundamental concepts which are:

- Design as a mapping process.
- Design abstraction in the form of a top-down, hierarchical structure.
- Design equations as a notation for representing functional dependencies.
- Design laws in the form of axioms.

### 3.1.1 Domains

One of the Fundamentals of Axiomatic Design is the use of Domains. Each design activity has its own designated domain. These domains are: Customer domain, Functional domain, Physical domain, and Process domain. Design is conceived as a mapping process across these domains.

- Customer domain: In this domain the customer is looking for a number of customer attributes (CAs) in a product, process, system or material.
- Functional domain: In the functional domain, the CAs are mapped into functional requirements (FRs) and associated constraints (Cs). FRs are defined as a minimum set of independent requirements that completely characterizes the functional needs of the product in the Functional domain. By definition, FRs are independent at the time they are established. Constraints are defined as bounds on the acceptable solutions, in terms of input and output.
- Physical domain: To satisfy the FRs, the designer maps them into conceived design parameters (DPs) in the physical domain. DPs are the physical variables (or other equivalents in the case of software design) in the physical domain, that characterize the design that specifies the specified FRs.
- Process domain: In order to produce the product in terms of its specified DPs, the process domain contains processes that can be characterized by process variables (PVs).

For each pair of adjacent domains, the domain on the left represents “what we want to achieve” while the domain on the right represents the design solution of “how we propose to achieve it”

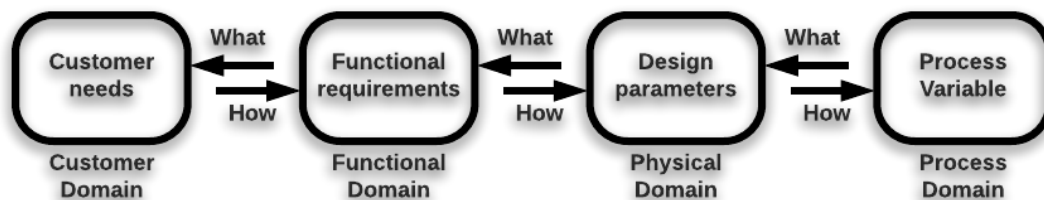

Figure 6 Design mappings and domains.



### 3.1.2 Hierarchies

Also known as Design Decomposition, the designer selects a specific design by decomposing the highest-level FRs into lower-level FRs. The higher levels are more abstract, the lower levels are more detailed. Decomposition proceeds until the design solution can be implemented. The decomposition should be taken down to levels where the DPs are physical parts (i.e., components, geometries), computer programs (i.e., classes, flow charts), and specifications (i.e., tolerances, limits, etc.). . Suh (1990) referred to this decomposition process, which alternates between design domains, as the ‘zigzagging process.

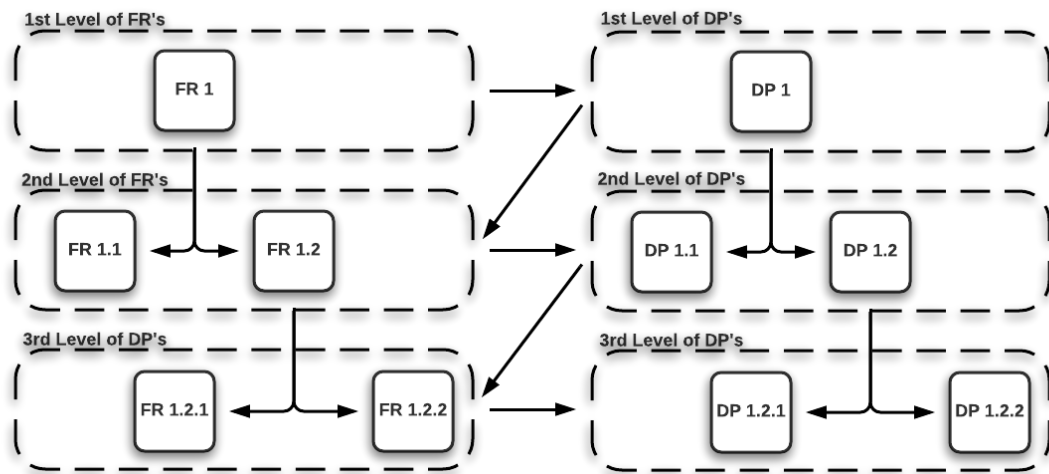

Figure 7 Decomposition by zigzagging.

That means that the DPs at the leaf level should be something that already exist and either needs neither re-design nor further decomposition. The hierarchical structure that emerges from decomposition is known as the system architecture.

### 3.1.3 Design equations

Dependencies or interactions between the functional domain and the physical domain are expressed mathematically in the form of design equations (Suh 1990). At a given abstraction level, the FRs constitute a FR vector and the DPs constitute a DP vector. The relationship between these two vectors can be written as:

$$[FR] = [A][DP] \quad (1)$$

Where  $[A]$  is referred to as a design matrix. Equation 3 is a more detailed version of equation 2.

$$\begin{bmatrix} FR_1 \\ \vdots \\ FR_n \end{bmatrix} = \begin{bmatrix} A_{11} & \dots & A_{1n} \\ \vdots & A_{ij} & \vdots \\ A_{n1} & \dots & A_{nn} \end{bmatrix} \begin{bmatrix} DP_1 \\ \vdots \\ DP_n \end{bmatrix} \quad (2)$$

A Diagonal design matrix (i.e.  $A_{ij} = 0$  for all  $i \neq j$ ) correspond to an Uncoupled design. While a lower triangular design matrix ( $A_{ij} = 0$  for all  $i < j$ ) is a Decoupled Design Matrix, otherwise the design is coupled (Suh 1990).

The design matrices contain a wealth of information about the design and are central to the application of axiomatic design.

### 3.1.4 Design laws in the form of axioms

According to Suh (1990) there are two design axioms, which are known as the independence axiom and the information axiom.

**The Independence Axiom: Maintain the independence of FRs:** In an acceptable design, the DPs and the FRs are related in such a way that a specific DP can be adjusted to satisfy its corresponding FR without affecting other FRs. This is usually achieved through a proper selection of DPs.

**The Information Axiom: Minimize the information content:** Among the designs which satisfy independence axiom, the best design has the minimum information content which

means the maximum probability of success. Information content of a design is calculated according to the following equation:

$$I_i = \log_2 \left( \frac{1}{P_i} \right) \quad (3)$$

Where,  $P_i$  is the probability of satisfying the given  $FR_i$ , which is calculated as illustrated in equation (4).

$$P_i = \frac{\text{Common range}}{\text{System range}} \quad (4)$$

The Common Range (also known as the design range) is a term describing what the design achieves in terms of tolerance, while the system range is what the system is capable of delivering.

Following the axiomatic design approach means that the designer will proceed with a design through repeating a series of activities:

- i. Identify functional requirements in a solution-neutral environment
- ii. Develop design solutions
- iii. Determine design matrices and make sure that the design axioms are satisfied
- iv. Check design consistency with respect to higher-level design decisions
- v. Repeat steps 1-4 at the next level until the leaf-level DPs are developed.

Figure 8 shows a flow chart of the axiomatic design process.

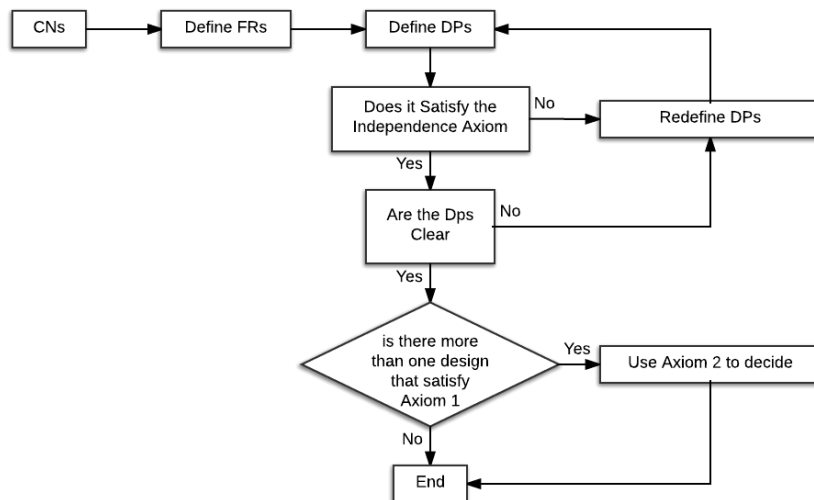

Figure 8 Axiomatic Design Process.

The Axiomatic Design process starts with the customer domain which assesses the needs of customers, the intention of the author is to contact companies and factories that would be interested in designing an electric bike suited for the bike sharing program usage scenario, however it was not possible to find any who would participate in such research, and due to the limited available time, the author and his supervisor have decided to switch the source of data from the preliminary source (customer's reviews and feedback) to the secondary sources (publications and scientific papers), evaluating the general trends and conducting a background research in order to extract the functional requirements and the associated design parameters.

Due to such limitations, most of the functional requirements will not be decomposed to lower levels and will be left at a system level. However, the main goal of this work is to provide a design proposal for an electric assisted bicycle for a bike sharing uses, and as stated earlier in this work, the main difference between a standard regular bicycle and an electrical one (or electrically assisted) is the electrical drivetrain, and this functional requirement will be decomposed as low as possible based on the available resources, academic materials and time.

### **3.2 Data Collection**

Without a base design/product, it is not possible to have customer's feedback which are the corner stone of the axiomatic design process, in other words, a preliminary design is needed in order to use the axiomatic design theory to produce an enhanced design.

For the purposes of this work, general functional requirements associated with biking and electrical bicycles will be the basis for the choosing the design parameters, which will be chosen from several scientific papers and journals in accordance with the axiomatic design theory's axioms.

The system will be divided into two parts, one for the bicycle and the other for the docking station.

### 3.3 Top level functional requirements for the electrical bicycle design

Index	FR
FR1	Provides basic structure
FR2	Moves Smoothly
FR3	Drives forward
FR4	Has sufficient brake force
FR5	Interacts with user
FR6	Facilitates vision in the dark

#### 3.3.1 Decompositions of the bicycle's FRs

FR1: Provide basic structure

Index	FR
FR1.1	Can withstand strenuous use
FR1.2	Suits the majority of riders
FR1.3	Resists Tampering
FR1.4	Can be adjusted

The usage of a bicycle in a bike sharing system varies from one cyclist to another, the usage conditions can be vastly different. Hence, a rigid frame with enough ground clearance is very important, as well as the weight of the frame which can affect the efficiency of the electrical range and may cause fatigue to the cyclist, and thus the rigidity and the weight of the frame must be stated as a system level functional requirements.

FR2: Moves Smoothly

Index	FR
FR2.1	Allows movement
FR2.2	Provides grip and stability

While a low friction tire might provide a better range, an all season tires is a better choice due to the nature of the usage case as well as the variety of weather condition in which the bicycle will be in use, also it is more economical to have tires that needs changing annually rather than seasonally.

### FR3: Drives Forward

Index FR

FR3.1 Drives Mechanically

FR3.2 Drives Electrically

Each of these functional requirements is going to be decomposed as follows:

#### FR3.1: Drive Mechanically

Index FR

FR3.1.1 Transfer the human input to mechanical energy

FR3.1.2 Operates with the electric drive

##### FR3.1.1: Transfer the human input to mechanical energy

Industrial grade pedals, chains and gears with high quality are needed for the use of a bike sharing system where the riders on a single bicycle are always changing, the changes from one trip to another includes, change in physical load (height and weight), amount of force applied to the pedals, the terrains and the style of biking of each cyclist.

##### FR3.1.2: Operates with the electric drive

Electric bicycles needs several gears in order to achieve the most efficient transfer of power and range, while some bicycles may include over thirty combination (three front gears and seven rear wheel gear), for the bike sharing system, the multiple gears can be cumbersome and not convenient, hence most bike sharing system bicycles utilize only three gears on the rear.

Electronic and automatic gear shifting systems have been commercially available since 1990s and gained more popularity starting early 2000s.

The manual gear shifting system utilizes wires and links in order to move the front and back derailleurs to change the chain's position.

An electronic gear changing system exchange the mechanical parts with electric actuators, upon receiving the input from the cyclist, an electric pulse travels from the control unit (changing levers) to a small electric motor in order to change the position of the chain.

Automatic gear changing system is an electronic gear changing system that is not controlled by the cyclist, an on board computer/controller determines the best gears combination possible for the most efficient and comfortable ride.

### FR3.2: Drive electrically

Index      FR

FR3.2.1    Assists the rider

FR3.2.2    Powers the motor sufficiently

FR3.2.3    Controlling the Drivetrain

#### FR3.2.1: Assists the rider

To propel the bicycle into movement, a motor is needed, in order to determine the exact design parameters for the electric motor, a general description of most common types of electric motors is necessary, in order to evaluate which one is more suitable for the bike sharing system use case

##### 1. Mid-Drive motor (crank motor):

Crank drives are located in near the crankset of the bicycle, providing power directly to the crank drive and chains, crank drives are very efficient due to their utilization of the bicycles gears, which help transfer the energy from the motor more smoothly and efficiently. Due to the location of the motor, the center of gravity of the bicycles shifts to the low center of the bicycle, which makes it more stable and balanced.

## 2. Wheel mounted motor (hub motor)

The more common form of electric bicycle motor, available in the market for a longer time than the crank motor, which means several iterations and refinements occurred to its size and efficiency, while not as efficient as the crank motor, the reason for the hub motor popularity is independence from the frame of the bicycle, a hub motor is mounted in the wheel, which makes converting a regular bicycle into an electric one relatively easy. The following table is a comparison between the advantages and disadvantages of a crank motor and a hub motor.

Table 2 Crank vs. Hub Motor

	Crank Motor	Hub Motor
Advantages	<ul style="list-style-type: none"> <li>• Highly efficient.</li> <li>• Utilize gears for smoother operation.</li> <li>• Usually fanned case for better heat dissipation.</li> <li>• Low center of gravity.</li> <li>• High power ratings.</li> </ul>	<ul style="list-style-type: none"> <li>• Simple and self-contained.</li> <li>• Can be retro-fitted to most bicycles</li> <li>• Very durable and low maintenance due to the low amount of moving parts</li> <li>• Low center of gravity</li> <li>• Easily replaceable</li> <li>• Sealed unit impervious to weather conditions.</li> </ul>
Disadvantages	<ul style="list-style-type: none"> <li>• Complicated design</li> <li>• Bicycles must be designed to accommodate a crank motor.</li> <li>• Crank motors usually sealed along with the controller and torque sensors, which makes maintenance difficult.</li> <li>• Large number of moving parts affecting its durability.</li> <li>• The fanned casing is not impervious to the weather elements.</li> <li>• High rated motor will have high torque, which will increase the stress on other parts of the bicycles such as the chains and the sprocket.</li> </ul>	<ul style="list-style-type: none"> <li>• Not as efficient as the crank motor.</li> <li>• High rated motor hub is not feasible.</li> <li>• The sealed design dissipate heat poorly.</li> <li>• While the center of gravity is low, the position of the hub is usually mounted in the back wheel, creating the sensation of imbalanced bicycle.</li> </ul>

Meireles S. et Al. suggested in their published paper (An E.Bike Design for the Fourth Generation Bike-Sharing Services - Barcelona, Spain, November 17-20, 2013) that for a bicycle in a bike sharing system, a mid-drive motor (crank motor) is a better choice than



a wheel mounted motor (hub motor). Arguing that the disadvantages of a crank motor can be considered as advantages in the scenario of a bike sharing system, A mid drive motor is more complex and harder to install or remove from the bicycles, since it is the one of the most valuable parts of the system, Having the motor enclosed inside panels body will protect it against vandalism and robbery.

The main two types of hub motors are direct drive motors and geared motors. Each with their own set of advantages and disadvantages which make them suitable for certain cases

A. Direct Drive Motor: one of the simplest motor available, and due to its simplicity, it is one of the cheapest as well. Consisting of a permanent magnet surrounding copper windings, and the axle of the motor is the axle of the back wheel, direct drive motors are big and heavy compared to other types of motors, they can handle more power than their geared counterparts, and do not generate as much noise as geared motors due to the lack of multiple moving parts. Beside the cost advantage, the other main feature is direct drive motors can be used in a regenerative way, as in once the bicycle is slowing down, the motor with some modification can push electric current back into the battery, minimizing braking waste and recharging the battery, however the efficiency of this procedure is very low, and the recharging process can generate heat in the battery which might reduce the lifecycle of the battery and may even damage it permanently.

Another disadvantage of direct drive motors is their dependency on electrical power for operation, if no power is provided to the moto, direct drive motor have a magnetic drag which makes driving the bicycle in the pedal only mode difficult and fatiguing. <https://www.electricbike.com/motor-tech-learn-the-terms-part-1/>



Figure 9 Direct drive Hub, axle and stator to the left, moving part to the right.

B. Geared Motors: Geared motors are more complex, they have their cases connected to the stator through a planetary gear reduction system. For every rotation of the case, the motor inside actually turns many times faster. This allows the motor to work at higher and more efficient speeds, while still allowing the wheel to spin at a comparatively slower driving speed. One of the reasons that they are very popular is that they incorporate an internal freewheeling clutch, resulting in no resistance when using pedal only mode. <https://www.electricbike.com/motor-tech-learn-the-terms-part-1/>



Figure 10 Geared Hub Motor 25Watt on the left, 1200 Watt on the right.

The following table shows the advantages and disadvantages of a direct drive motor and a geared motor when compared to each other's

Table 3 Direct Drive Vs, Geared Motor

	Direct Drive Motor	Gear Hub Motor
Advantages	<ul style="list-style-type: none"> <li>• Less moving parts (Quieter, More Durable)</li> <li>• Can handle more power (faster)</li> </ul>	<ul style="list-style-type: none"> <li>• Smaller/Lighter</li> <li>• Less Drag (efficient)</li> <li>• More Torque (gear utilization)</li> </ul>
Disadvantages	<ul style="list-style-type: none"> <li>• Magnetic Drag (less efficient)</li> <li>• Larger/Heavier</li> </ul>	<ul style="list-style-type: none"> <li>• More Moving parts (less durable, Noisier)</li> <li>• Lower power limit</li> <li>• Lower top speed</li> </ul>

### FR3.2.2: Powers the motor sufficiently

Lithium Ion batteries are used in various collection of products, from portable technologies such as cell phones, laptops, and power banks. In power tools such as cordless wall drills and wood cutters, to heavy machinery like fully or hybrid vehicles, airplanes and even the mars rover.

For their ubiquity and widespread, lithium ion batteries are commonly used as the energy source for electric bicycles, they offer high energy density relative to their size and weight, relatively adequate charging time and price.

One major consideration of using any type of batteries to power an electric motor is a phenomenon called “motor starting current”, which is also known as “ inrush current, input surge and switch-on surge”. Which is an intrinsic property of electrically powered motor due to the nature of its operation.

The amount of torque needed to start moving a motor from its idle state is significantly larger than the amount of torque needed to increase or decrease its speed once it is moving. This large amount of torque translate to a starting current that is much higher than the current needed to keep the motor rotating at a certain speed.

Drawing a high amount of current from a battery can cause damage to the battery, which if repeated multiple times can shortened the life-cycle of the battery (charge and discharge cycles).

One way to protect the battery is to use Battery Management Systems (BMS), which is a system applied to monitor and protect the battery from an abnormal operation condition. Most lithium ion batteries have BMSs that approach protecting the battery in a different way.

While protecting the battery is important, the high current is actually needed for the motor start operating as quickly as possible, which is why Sousa D. M. et Al. suggest using two different sources of energy in their paper (Electric Bicycle Using Batteries and Supercapacitors), as the title reveals, the authors suggest using a supercapacitor banks to overcome the need of providing a high starting current without damaging the battery.

The authors have designed an algorithm for controlling which source of power source (battery or capacitors bank) is responsible of providing energy to the motor, they have managed to avoid high current peaks and fast discharge from the batteries under heavy load (starting the motor or going uphill). However, the authors have not specified any particular method of recharging those super capacitors banks.

In a paper publish in the proceedings of the 16<sup>th</sup> international IEEE annual conference 2013 titled (Design Approach for Electric Bikes Using Battery and Super Capacitor for Performance Improvement) the authors have used supercapacitors in an electric motor bike to provide high current for the motor and protect the battery. However, they have utilized regenerative brakes and a small solar panel to recharge the super capacitor bank. The authors have managed to increase the speed, range per charge, improved battery life and reduce the charging time of their test electric bike, while some of these benefits can be accredited to implementing the regenerative brakes and the solar cell.

#### FR3.2.3: Controlling the Drivetrain:

The riders should be able to control the mode of operation for the bicycle (throttle, pedal assist, or pedal only), as well as it should also be programmed to obey the local laws and legislations concerning speed limits (speed limit cut-off, so the bicycle cannot go faster than a certain predetermined limit).

The controller also responsible for charging behavior, battery monitoring, speed monitoring, time keeping and rides distances log.

FR4: Have sufficient brake force

Index FR

FR4 The ability to stop the bicycle

Strong breaks are very important for the safety of the cyclists, a sufficient braking force gives the rider the confident in the bicycle and allows him/her to control the speed of the bicycle in every scenario from going downhill to riding on, a wet surface, or to stop at will.

## FR5: Interact with user

Index FR

FR5.1 Ability to access to relative information

FR5.2 Can be understood easily

FR5.3 Can be controlled easily

The user of a bike sharing system needs data about each trip he/she takes, how long has the bicycle been in use?, what is the covered distance?, what is the current speed?, how much battery charge left?, and what driving mode the bicycle is currently operating on? Other info might also be included depends on the features provided by the bike sharing system such as GPS and navigation, internet and mobile connectivity, and any offers, discounts and/or loyalty points. All these data must be presented in a clear, simple and non-distracting way to the rider.

## FR6: Facilitates vision in the dark

Index FR

FR6.1 Illuminates passively

FR6.2 Illuminates actively

FR6.3 Safety indicators

A lighting package is important for the bicycle operation during times of limited visibility (darkness) and they include forward and back facing lights mounted on the frame of the bicycle, and reflectors mounted between the wheel's spokes. A new trend among the private bike market is Safety laser lines, which are lasers projected underneath the bicycles in order to show the horizontal space the bicycle occupies, which improve the safety of the cyclists particularly in congested areas with other cyclists.



Figure 11 safety laser lines.

Other lights that can be included are turn signals and braking lights, while they are not necessary for the operation of the bicycle, their inclusion will help increase the safety of the cyclist especially during night time. Light signals give the rider a way of communication with others on the road (cyclist, drivers or pedestrians).

### 3.4 Top level Functional Requirements for the Docking Station design

Index	FR
1	Provide basic structure
2	Secure the bicycles
3	Recharges the bikes
4	Interact with user
5	Make the station visible in the dark

FR1: Provide basic structure

The most important functional requirement for the bicycle docking station is to provide a designated location/holding space for the bicycles, the amount of bicycles the stations need to accommodate depends on the planning of the bike sharing system, location and expected traffic surrounding the docking station area, most docking stations are fixed and secured to the ground on which they are built, while there are some new research about dock-less bike sharing program, for an electric bike sharing system it is not possible to avoid having a fixed station, due to the need for recharging the bicycles.

## FR2: Secure the bicycles

Securing the bicycle in its position is the second most important functional requirements for a docking station. For an electric bike sharing system, securing the bicycles in their designated position serves another purpose which is securing the charging mechanism for the bicycles, ensuring highest level of efficiency for electrical energy transfer.

The locking mechanism is a system that locks the bicycles to a certain part of the docking station, allowing authorized users to unlock the bicycle. There are several locking positions on the bicycles including the front rod underneath the handle bar (head tube), front wheel (the fork), and the lower section of the bicycle frame (downtube). There are no literature related to the advantages and disadvantages of each position. However, the design of the locking mechanism should stay within the functional requirements and cost restraints of the system.

## FR3: Recharges the bikes.

At the heart of the electric bike sharing system are the electric bicycles, which are powered by rechargeable batteries, these electric components are the differentiator factor between a standard bike sharing system and an electric one, hence designing a recharging system for the batteries included in the bicycles not only necessary, but it has to be done without any interaction from the customers (i.e. the customer should not be responsible for recharging the battery).

Ensuring a fully charged bicycle while maintaining the longevity of its component is (e.g. batteries, connectors and invertors) is another functional requirement for the recharging system.

The top level functional requirement can be decomposed to lower level requirements as follow

- | Index | FR                                   |
|-------|--------------------------------------|
| 3.1   | Provide electrical energy            |
| 3.2   | Managing the bicycles                |
| 3.3   | Transfer the energy to the batteries |

FR3.1: provide electrical energy

The simplest way to achieve meet this requirement is to connect the dock to the main power grid, however, in order to reduce the demand applied by the bike sharing system, there are several researches investigating using renewable power sources such as solar panels and wind turbines.

Wind turbines is indeed a clean source of energy, yet it is not possible to install wind turbines in urban areas due to safety hazards and building regulations, solar panel on the other hand is a feasible solution that can be implemented in the vicinity of the docking station.

Solar cells generates electricity by converting sunlight into electrical energy through semiconductors with photovoltaic properties. The harvested energy can be stored in a battery, which can be used to recharge the batteries of the docked bicycles. One research suggest that renewable energy can be used as the main energy source of a charging station for electric bicycles. However the research was designed for a micro grid as a scaled representation for a macro grid, the study also was conducted in Bucaramanga, a city in Colombia with tropical weather and flat topography, which creates a favorable scenario for harvesting solar panels.

There are several factors to consider when harvesting solar energy for recharging systems, mainly the amount of sunlight exposure, and the size and position of the solar panels used. As an example, in Seattle, from the project “Green My Bungalow - Retrofitting a Classic House for Sustainability” [<http://www.greenmybungalow.com>], it’s evident that environmental conditions can significantly change the harvested energy: 21.4kWh during a sunny day, to 5.4kWh during a dark cloudy day.



### FR3.2: Management system

The docking station for an electric bike sharing system is a complicated system, there are multiple ports for the bicycles to be docked, and each one of these ports represents a different load introduced to the charging circuit. The complexity of the system increases when considering multiple sources of energy such as solar power and the main grid (both ac and dc sources).

Most docking station are equipped with some basic level of management, controlling the locking and releasing the bicycles, plus some measurement and communication systems.

### FR3.3: Transfer the energy to the batteries

There are two main ways for transferring electrical energy between two points, either through physical connection or wirelessly. Physical connection for electrical power transfer between the docking station and the bicycle requires a physical port on both sides. These ports must be protected from the regular wear and tear from the constant usage as well as the weather elements such as rain and dust. These concerns do not affect the private electric bicycles as much as they do to the public electric bicycles. Private electric bicycles are used less frequent than their public counter parts, also they are usually stored indoors protected from the weather.

Wireless Power Transfer of electrical energy (WPT) is gaining popularity since 2007, after a paper published by the Massachusetts institute of technology titled “Wireless Power Transfer via Strongly Coupled Magnetic Resonances” - July 2007, pp. 83-86. A lot of research has done to test the feasibility of implementing WPT into low-powered devices such as handheld devices like smart phones and smart watches, to more high powered systems like electric vehicles, Wireless Charging is commercially available currently for mobile devices and smart wearables.

While the apparent appeal of wireless charging due to the convenience it provide, it is not perfect, WPT relays mainly on electromagnetic waves to transfer the electrical power from the source to the destination, the increase in the amount of the transferred power can result in higher emission of electromagnetic waves which has harmful effect on humans.

Another drawback for WP is the efficiency of the power transfer is less than efficiency provided by the wired charging methods, handheld applications are less burdened by the loss of efficiency than automotive applications, due to the low power levels involved, Whereas prototypes of wireless battery chargers for handheld devices are already available on the market, wireless charging for electric vehicles is still not suited for marketing.

A wireless charging solution for electric bicycle is proposed in the paper (E-bike battery charging: methods and circuits) published June 2013, the system has an improved power conversion efficiency, through a magnetic coupling structure. The level of efficiency was dependent on the size of the air gap between the coil connected to the grid side and the coil connected to the battery side. Simulation results shows maximum efficiency of 98.5% and worst case results of 90.2%. The proposed design of this system however dealt with only one bicycle connected to the charging side, which is not suitable for the public bike sharing system use scenario. However it shows the potentials for using wireless power transfer as a viable method of charging the batteries of electric bicycles.

In another work by Ruikun Mai et Al. a charging method suitable for charging large number of electric bicycles is proposed, by utilizing inductive power transfer and a single inverter to charge multiple electric bicycles simultaneously to increase the economic efficiency and simplify the charging system, reducing its construction cost and maintenance cost. The experimental results validate the performance of proposed method while achieving efficiency level of 92.81% during high power demand, however the efficiency of the system declines to 68.19% with low power demand.

**FR4: Interact with user**

Sales points accompanying the docking station are the ports the customers use to interact with the docking station, from these sales point they can rent, return, subscribe and enquire further information (<http://www.citybikefinland.fi/>)



Figure 12 Helsinki City Bike docking station with a sales point.

**FR5: Make the station visible in the dark**

The docking station must be visible to the users during the dark hours of the day, each individual bicycle bay also must be illuminated for easy extraction and returning during night time.

## 4. Technical Design

In the previous chapter, the functional requirements were analyzed and some of them were decomposed to a lower level, several academic papers and publications were investigated in order to choose the most suitable design parameters that meets the functional requirements.

The design parameters and design equations are created and explained as follows

### 4.1 Top level Design Parameters for the electrical bicycle design

Index	FR	DP
1	Provides basic structure	Frame assembly
2	Moves Smoothly	Wheelset
3	Drives forward	Propulsion system
4	Has sufficient braking force	Quality braking system
5	Interacts with user	Human interaction components
6	Facilitate Vision in the dark	Lighting package

The design equation for the bicycle is given as

$$\begin{Bmatrix} FR1 \\ FR2 \\ FR3 \\ FR4 \\ FR5 \\ FR6 \end{Bmatrix} = \begin{bmatrix} X & 0 & 0 & 0 & 0 & 0 \\ X & X & 0 & 0 & 0 & 0 \\ X & X & X & 0 & 0 & 0 \\ 0 & X & X & X & 0 & 0 \\ X & X & X & 0 & X & 0 \\ X & 0 & X & X & 0 & X \end{bmatrix} \begin{Bmatrix} DP1 \\ DP2 \\ DP3 \\ DP4 \\ DP5 \\ DP6 \end{Bmatrix} \quad (5)$$

## DP1: Frame Assembly

Index	FR	DP
FR1.1	Can withstand strenuous use	DP1.1 Rigid Aluminium alloy body
FR1.2	Suits the majority of riders	DP1.2 Unisex design
FR1.3	Resists Tampering	DP1.3 Custom screws, bolts and nuts for anti-theft purposes
FR1.4	Can be adjusted	DP1.4 Adjustable seats and handle bar

The design equation

$$\begin{Bmatrix} FR1.1 \\ FR1.2 \\ FR1.3 \\ FR1.4 \end{Bmatrix} = \begin{bmatrix} X & 0 & 0 & 0 \\ 0 & X & 0 & 0 \\ 0 & 0 & X & 0 \\ 0 & 0 & 0 & X \end{bmatrix} \begin{Bmatrix} DP1.1 \\ DP1.2 \\ DP1.3 \\ DP1.4 \end{Bmatrix} \quad (6)$$

A rigid aluminum alloy body is the most common way of building the frame for the modern bicycle, the size of the frame and the wheels depends on the average height and weight of the population in a particular region or country. The frame has to be covered with flat panels in order to create space for advertisements, as well as covering the frame and protecting it from misuse incidents and the weather elements, all the screws, nuts and bolts should be of a custom size and design in order to minimize the chance of vandalism and theft. A unisex design differ from the “*traditional*” bicycle design by combining the top tube with the down tube, unisex design will have a thick tube in the middle of the bicycle connecting the bottom cage with the front tube. An adjustable seat and steering handle bar is necessary in order to fit the various heights of the users.

## DP2: Wheelset

Index	FR	DP
FR2.1	Allow movement	DP2.1 Suitable tire diameter
FR2.2	Provides grip and stability	DP2.2 Seasonal tires

And the design equation

$$\begin{Bmatrix} FR2.1 \\ FR2.2 \end{Bmatrix} = \begin{bmatrix} X & 0 \\ 0 & X \end{bmatrix} \begin{Bmatrix} DP2.1 \\ DP2.2 \end{Bmatrix} \quad (7)$$

Seasonal tires of high quality are installed on every bicycle, if the program is active throughout the year than an all season tires might be more suitable. Checking the tires in the beginning of the use season is very important in order to make sure that each tire has the right amount of air. Accurate tire pressure can help optimize the ride comfort and the range provided by the battery.

## DP3: Propulsion System

Index	FR	DP
FR3.1	Drives Mechanically	DP3.1 Mechanical Driving system
FR3.2	Drives Electrically	DP3.2 Electrical driving system

And the design equation

$$\begin{Bmatrix} FR3.1 \\ FR3.2 \end{Bmatrix} = \begin{bmatrix} X & 0 \\ X & X \end{bmatrix} \begin{Bmatrix} DP3.1 \\ DP3.2 \end{Bmatrix} \quad (8)$$

The mechanical assembly and the electrical assembly are both utilized to move the bicycle, each will be discussed separately.

## DP3.1: Mechanical driving system

Index	FR	DP
FR3.1.1	Transfer the human input to mechanical energy	DP3.1.1 Pedals and Gears
FR3.1.2	Compatibility with the electric drive	3.1.2 A compatible crankset (gears, chains and controller)

And the design equation

$$\begin{Bmatrix} FR3.1.1 \\ FR3.1.2 \end{Bmatrix} = \begin{bmatrix} X & 0 \\ X & X \end{bmatrix} \begin{Bmatrix} DP3.1.1 \\ DP3.1.2 \end{Bmatrix} \quad (9)$$

The rider moves the bicycle by spinning the pedals, which are connected to the chainwheels through the crank arm. The chain wheels transfer the kinetic energy to the back wheel via the chain. The chain spins the chainwheels connected to the back wheel. Different sizes of chain wheels are installed in the front and the back in order to maximize the efficiency of the energy transfer. Since the electric motor will be installed in the back wheel, the chain wheels, gears and the gears controller must be compatible with an electric geared hub motor.

For an electric bike sharing system, an automatic gear changing system has several advantages over the other two types, as stated earlier having multiple gears is important in an electric bicycle for achieving high level of efficiency, and an automatic gear shifting system allows having multiple gears while offering a convenient and comfortable ride for the cyclist since they are not responsible for the gear changing and the can focus more on steering and handling the bicycle. Allowing the gear changing controller to talk with the motor controller and battery sensor to work in tandem has several advantages that will increase the appeal of bike sharing system.

## DP3.2: Electrical driving system

Index	FR	DP
FR3.2.1	Assists the rider	DP 3.2.1 Wheel hub motor
FR3.2.2	Powers the motor sufficiently	DP3.2.2 Chemical battery
FR3.2.3	Controlling the Drivetrain	DP3.2.3 Main Bicycle Controller

And the design equation

$$\begin{Bmatrix} FR3.2.1 \\ FR3.2.2 \\ FR3.2.3 \end{Bmatrix} = \begin{bmatrix} X & 0 & 0 \\ X & X & 0 \\ 0 & 0 & X \end{bmatrix} \begin{Bmatrix} DP3.2.1 \\ DP3.2.2 \\ DP3.2.3 \end{Bmatrix} \quad (10)$$

The Electrical driving system has several important design parameters that will be discussed in more details as follows

## DP3.2.1: Wheel Hub Motor

From an axiomatic design point of view, a hub motor is more suitable because it interacts with less parts of the bicycle, making the overall design less complex and simplified, plus the cost restraints for the entire system is another factor to consider, since hub motors are on average cheaper and cost less to maintain.

A geared motor is more suitable to fulfill the functional requirements of an electric bike sharing system, motor efficiency translate to a longer range, as well as the light weight and small size of the motor with the freewheeling feature makes integrating the motor with the bicycle easier and more appealing.

## DP3.2.2: Chemical Battery

A lithium Ion battery is the most common form of batteries used to power electrical vehicles. bicycles in a bike sharing system is prone to several starts-stops per day, due to the nature of the operation, implementing a sophisticated Battery Management System (MBS) in every bicycle is not be possible due to cost constraint, which also affect the lifespan of the batteries inside the bicycles, hence implementing supercapacitors to protect the batteries from the sudden heavy loads is important, the super capacitors will



lengthen the life span of the battery as well as increase the range achieved per in a single charge, since it can provide the extra current that would have been provided by the battery in cases over heavy loads such as going uphill or increased weight on the bicycle.

Those capacitors can be charged in one out of three possible ways, either from the station once the bicycle is docked, from the battery in the bicycle which defeat the purpose of installing them in the first place, and finally by installing a small hub generator in the front wheel can serve as a power source only for the capacitors, this generator will ensure that the capacitors are always full and ready to provide extra current whenever needed, while having a generator in the front wheel will increase the resistant to the back motor, choosing the right size of generator compared to the motor can help alleviate some of the drawbacks, for example if the motor used in the back wheel has a rating of 120 watt and the front wheel generator has a rating of 6 watts, that means that 95% or the motors potential is used to propel the bicycle forward (not including losses and efficiency of the generator and the motor).

The generator is connected to the battery management system, once the capacitors reach a certain level of charging, the generator decouples, in order to increase the efficiency of the motor.

Another benefit of the generator is its output can also be connected to a USB port, once the capacitors are full the power from the generator can be used to charge the riders mobile devices. The implementation for such port is easily implemented and can increase the appeal of the bicycles.

### DP3.2.3: Main Bicycle Controller

The main bicycle controller consists of several controllers and sensors which includes

- Battery management system
- Speed sensor
- Torque sensor
- The automatic gear changer
- Gyroscope

The main controller utilizes all these above mentioned sensors and systems in order to determine the most efficient gears combination (front and back) at the current travelling conditions (speed, ground angle, battery level, etc.) The speed controller is used to switch the mode of driving whether its throttle (fully electric) pedal assist (rider and the battery working in tandem) or pedals only (the riders provide the energy needed to move the bicycle). For example the controller can engage the generator if it senses that the bicycle is accelerating in a downhill, this will provide some control to the rider as well as recharge the capacitors. The controller may also engage the capacitors in order to utilize more current if the bicycle is going uphill and the rider cannot maintain the current speed.

The controller should also include an RFID tag that identifies the bicycle so the docking station can recognize it, and allow the bicycle to have access to the charging port.

#### DP4: Quality braking system

Index	FR	DP
FR4	The ability to stop the bicycle	DP4 Breaking pads on the front and back wheels

A strong braking system is installed in every bicycle, it is necessary to have a high quality braking system, due to the varying nature of the riders. And the several starts/stops the bicycle has to make during every day of use.

Hydraulic disk brake performs better than mechanical disk brakes or rim brakes, however, several other criteria must also be considered alongside the performance such as cost, and longevity.

DP5: Interact with user

Index	FR	DP
FR5.1	Ability to access to relative information	DP5.1 High Contrast, High resolution Display
FR5.2	Easily comprehensible	DP5.2 Graphical user interface
FR5.3	Easily controllable	DP5.3 Physical user interface

And the design equation

$$\begin{Bmatrix} FR5.1 \\ FR5.2 \\ FR5.3 \end{Bmatrix} = \begin{bmatrix} X & 0 & 0 \\ 0 & X & 0 \\ X & 0 & X \end{bmatrix} \begin{Bmatrix} DP5.1 \\ DP5.2 \\ DP5.3 \end{Bmatrix} \quad (11)$$

A Human User Interface Device (HUD) unit that consists of a Display and Physical buttons to control the on board software, the unit itself is weather proof, the graphical interface is easily manageable and not complicated while providing all the needed information, finally while touch screens are already in use in many electrical bicycles, a physical buttons/knobs are more suitable for the bike sharing system program, due to their cost and durability.

Unlike the HUDs attached to personal electric bicycles which can be detached, HUDS on bicycles in a bike sharing system must be weatherproof and can operate in various condition.

There are several displays technologies that can be considered such as liquid crystals displays (LCDs) which has several tiers varying in performance and cost, some LCDs are monochromic and can be found in calculators, clocks and thermometers, this type of LCDs is cheap and power efficient, but it requires back lighting for operation in the dark, also the resolution of such displays is usually very low.

Another option is to use E-Ink papers, these panels are very power efficient, the cost is also very comparable to monochromic LCDs, the main advantages of E-Ink is the legibility under sunlight and the high resolution.

FR6: Make the bicycle visible in the dark

Index	FR	DP
FR6.1	Passive illumination	DP6.1 Reflectors
FR6.2	Active illumination	DP6.2 Mounted lights, front and back
FR6.3	Safety indicators	DP6.3 Turn indicators and Virtual lane lasers

And the design equation

$$\begin{Bmatrix} FR6.1 \\ FR6.2 \\ FR6.3 \end{Bmatrix} = \begin{bmatrix} X & 0 & 0 \\ 0 & X & 0 \\ 0 & 0 & X \end{bmatrix} \begin{Bmatrix} DP6.1 \\ DP6.2 \\ DP6.3 \end{Bmatrix} \quad (12)$$

A lighting package Includes front facing white LEDs, and back facing red LEDs, as well as passive reflectors underneath the lights housing, passive reflectors are also installed on the wheel between the wheel spokes.

The LED housing on the back also include two amber LEDs on each side of the red LEDs, as well as downward facing safety laser lines, traditional lighting signals from the automobile can be imported since they are globally recognizable, blinking yellow light for turning, and red light for slowing down and braking.

The front facing white LEDs are used for illuminating the road ahead of the bicycles during the dark hours of the day. The back facing red LEDs serves has two level of illumination, the standard level is for making the bicycle visible from behind during the dark times, the second level of illumination is used to signal to other occupant of the road that the bicycle is braking. The amber lights on each side are indicators used to show where the rider of the bicycles wants to turn next (left or right).

Laser lights projects lights on the ground underneath the bicycle to show the space needed for the bicycle to operate safely. The rider can control the lights from the human user interface device, which includes a lighting control unit that detects the input from the cyclists and translate them to their corresponding lighting signal.

The Design Matrix for the Entire Bicycle System is shown in the Figure in the next page.

The Functional Requirements and the Design Parameters for the Bicycle Concept		DP1: Frame assembly					DP2: Wheelset		DP3: Propulsion system					DP4: Quality of riding system	DP5: Human interaction components				DP6: Lighting package	
		DP1.1: High Aluminum alloy body	DP1.2: Unique Bicycle Design	DP1.3: Custom screws, bolts and nuts for all High purposes	DP1.4: Adjustable seat and handlebars	DP2.1: Suitable tire diameter	DP2.2: All season tires	DP3.1: Mechanical Driving system			DP3.2: Electrical driving system		DP4.1: High Control High resolution display	DP5.1: Human user interface	DP5.2: Physical user interface	DP6.1: Reflectors	DP6.2: Mounted lights from outside	DP6.3: Two indicators and Virtual indicators		
								DP3.1.1: Fused and Gears	DP3.1.2: compatible controller	DP3.1.3: Motor	DP3.2.1: Motor hub	DP3.2.2: Central Battery							DP3.2.3: Motor Controller	
FR1.1: Provides Best Structure	FR1.1: Controlled remount use	X	0	0	0	0	0	0	0	0	0	0	0	0	0	0	0			
	FR1.2: Suit the majority of Riders	0	X	0	0	0	0	0	0	0	0	0	0	0	0	0	0			
	FR1.3: Needs Tempering	0	0	X	0	0	0	0	0	0	0	0	0	0	0	0	0			
FR2: Shows mobility	FR2.1: Can be adjusted	0	0	0	X	0	0	0	0	0	0	0	0	0	0	0	0			
	FR2.1: Allow movement	X	0	0	0	X	0	0	0	0	0	0	0	0	0	0	0			
	FR2.2: Provide safe stability	0	0	0	0	0	X	0	0	0	0	0	0	0	0	0	0			
FR3: Drive Forward	FR3.1: Drive Mechanically	FR3.1.1: Transfer the human pedal to mechanical energy	X	0	X	0	0	X	0	0	0	0	0	0	0	0	0			
		FR3.1.2: operates with the electric drive	0	0	X	0	0	X	0	0	0	0	0	0	0	0	0			
		FR3.1.3: Assist the rider	0	0	X	0	X	X	0	0	0	0	0	0	0	0	0			
FR3.2: Drive Electrically	FR3.2.1: Power the motor sufficiently	X	0	X	0	0	0	0	X	0	0	0	0	0	0	0	0			
	FR3.2.2: Control the direction	X	0	X	0	0	X	0	0	0	X	0	0	0	0	0	0			
	FR3.2.3: Control the direction	X	0	X	0	0	X	0	0	0	X	0	0	0	0	0	0			
FR4: Has sufficient braking force		0	0	0	0	X	0	0	X	0	X	0	0	0	0	0	0			
FR5: Interacts with User	FR5.1: Ability to access relative information	X	0	0	0	0	0	0	X	X	X	0	0	0	0	0	0			
	FR5.2: Can be understood easily	0	0	0	0	0	0	0	0	0	0	0	0	0	0	0	0			
	FR5.3: Can be controlled easily	0	0	0	X	0	0	0	0	0	0	0	X	0	0	0	0			
FR6: Facilitates vision in the dark	FR6.1: Provide illumination	X	0	0	0	0	0	0	0	0	0	0	0	0	X	0	0			
	FR6.2: Active illumination	X	0	0	0	0	0	0	0	0	0	X	0	0	X	0	0			
	FR6.3: Safety indicators	X	0	0	0	0	0	0	0	0	0	0	0	0	0	X	0			

Figure 1.3 The Functional Requirements and the Design Parameters for the Bicycle Concept

The following figure is an early sketch of the design proposed in this work for the bicycle, with several key component highlighted.

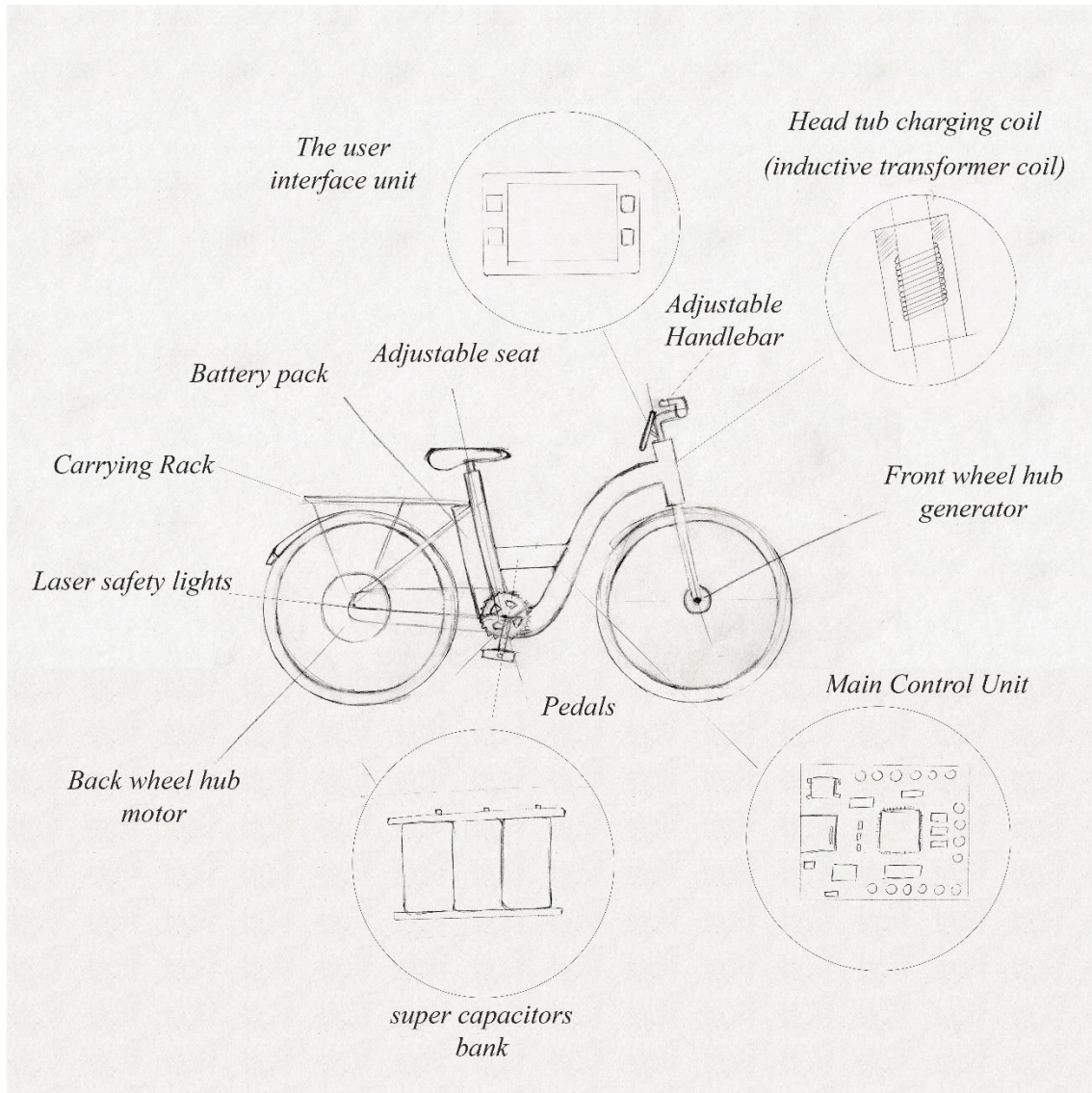

Figure 14 Rough sketch of the bicycle design.

## 4.2 Top level Design Parameters for the Docking Station design

Index	FR	DP
1	Provide basic structure	Frame construction
2	Secure the bicycle	Locking mechanism
3	Recharges the bikes	Charging system
4	Interact with user	Human interaction components (Sales point)
5	Make the station visible in the dark	Lighting package

The design equation for the docking station is given as

$$\begin{Bmatrix} FR1 \\ FR2 \\ FR3 \\ FR4 \\ FR5 \end{Bmatrix} = \begin{bmatrix} X & 0 & 0 & 0 & 0 \\ X & X & 0 & 0 & 0 \\ X & 0 & X & 0 & 0 \\ X & 0 & 0 & X & 0 \\ 0 & 0 & 0 & 0 & X \end{bmatrix} \begin{Bmatrix} DP1 \\ DP2 \\ DP3 \\ DP4 \\ DP5 \end{Bmatrix} \quad (13)$$

DP1: Frame construction

A steel frame or aluminum frame construction, the docking station is weather proof and tamper proof, to minimize the damage done by the elements or by acts of vandalism.

DP2: Locking Mechanism

The front section of the bicycle (the head tube) is more suitable than the other positions (down tube or the fork), since it facilitate easier charging and provide protection for the battery pack and the controller in the bicycle. The system is composed by a coupling mechanism fitted on the bike side and by the respective nest on docking side. On the dock side, there is an RFID receiver that authenticate the bicycles and make sure that only bicycles belonging to the bike sharing system can be locked and charged using the facilities available at this particular docking station.

### DP3: Charging system

The top level design parameters can be decomposed to lower level requirements as follow

Index	FR	DP
FR3.1	Provide electrical energy	DP3.1 Connection to the main power grid/solar panels
FR3.2	Managing the bicycles	DP3.2 Management system
FR3.3	Transfer the energy to the batteries	DP3.3 Inductive charging ports

And the design matrix is given as

$$\begin{Bmatrix} FR3.1 \\ FR3.2 \\ FR3.3 \end{Bmatrix} = \begin{bmatrix} X & 0 & 0 \\ X & X & 0 \\ X & X & X \end{bmatrix} \begin{Bmatrix} DP3.1 \\ DP3.2 \\ DP3.3 \end{Bmatrix} \quad (14)$$

#### DP3.1: Connection to the main power grid/solar panels

The power received from the main power grid will be in the AC form, while the charging the batteries must be done in DC, solar panels also provide DC current. Hence the best way is to utilize several battery packages underneath the docking station, each battery is connected to a docking port, and has the capacity of refilling the bicycle battery several times, this way the power from the grid will be transferred to DC form and stored in the docking batteries, these batteries will also be charged from solar panels connected to the docking station. Hence reducing the load on the main grid.

#### DP3.2: Management system

An advance management system that serves several functions needed for an electric bike sharing system such as controlling locking and releasing the bicycles, determining the most efficient and fastest way to charge the docked bicycles, handling online bicycle booking, and communicating with the bicycles for measurements such as covered distance and trip duration.



### DP3.3: Inductive charging ports

Two inductive coils one in the bicycles middle tube, and the other one will be in the charging station locking pad, power from the batteries will be changed into AC current and fed to the charging coils on the bicycle through the AC bus.

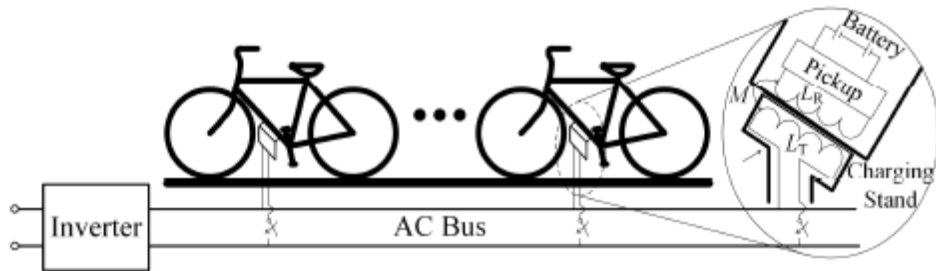

Figure 15 Illustration of charging via coils.

### DP4: Interact with user

Sales points accompanying the docking station are the ports the customers use to interact with the docking station, from these sales point they can rent, return, subscribe and enquire further information (<http://www.citybikefinland.fi/>)



Figure 16 Helsinki City Bike docking station with a sales point.

DP5: Make the station visible in the dark

Lights surrounding the docking station to allow users to identify the station during the dark hours of the day, other lights in the station include lights around each individual bicycle bay for easy extraction and returning during night time.

The design matrix for the docking station is seen in the following figure.

<i>The Functional Requirements and the Design Parameters for the Docking Station Concept</i>		DP1	DP2	DP3			DP4	DP5
				DP31	DP32	DP33		
FR1		X	0	0	0	0	0	0
FR2		X	X	0	0	0	0	0
FR3	FR31	X	X	X	0	0	0	0
	FR32	X	X	X	X	0	0	0
	FR33	X	X	X	X	X	0	0
FR4		X	X	X	0	0	X	0
FR5		X	0	X	0	0	0	X

Figure 17 Functional Requirements and the Design Parameters for the Docking Station Concept.

The following figure is an early sketch of the design proposed for the in this work for the dicking station, with several key component highlighted.

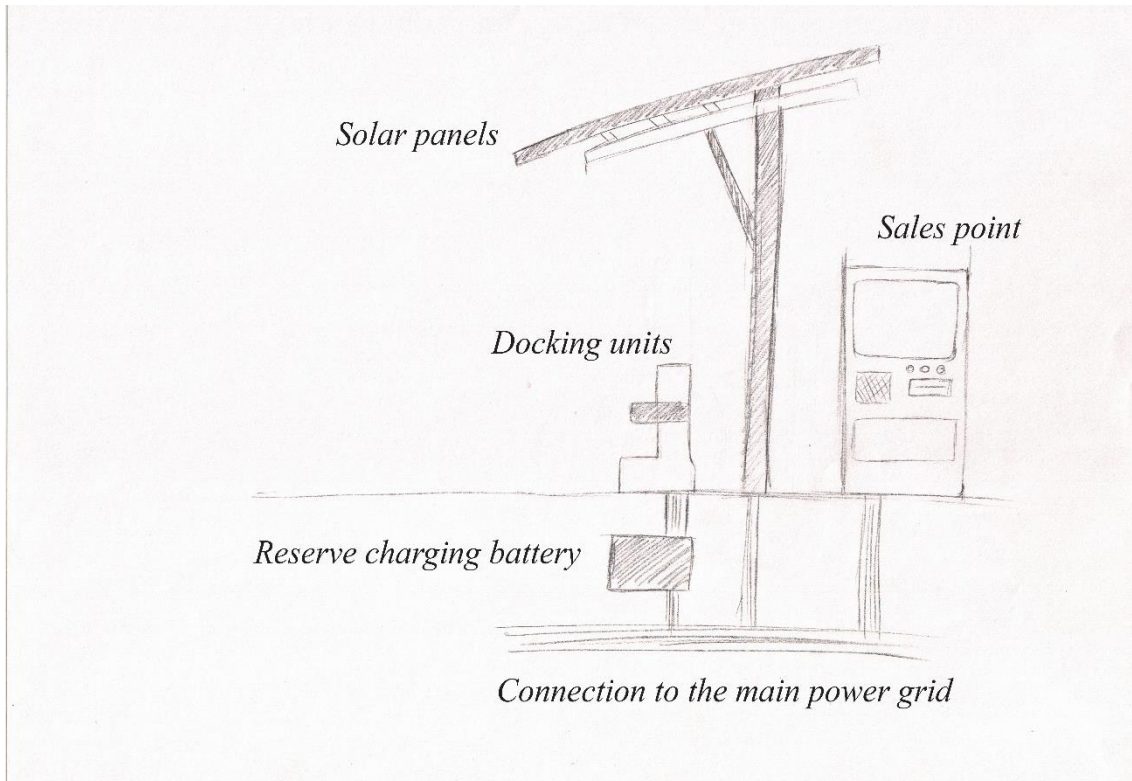

Figure 18 Rough sketch of the docking station design

## 5. Discussion

Due to the limitation stated at the first chapter, it was not possible to neither base the design on a pre-existing bike sharing system nor build a prototype of the proposed one in order to test it. However, all the design elements chosen in this work came from published papers and they were chosen because they fit into the vision and needs for the next generation of bike sharing system as well as they have been tested with positive results either with a prototype or simulation.

As stated in the second chapter, the amount of literature related directly to axiomatic design for electric bike sharing system is very limited, and while some research deals with the more prominent feature of electric bicycle design or docking station design, mainly the electric part of it (the electric motor design, recharging method or battery technology), there is a lack of research on other details such as optimum tire width and material, the most efficient frame size and material, the material of the docking station, the locking

mechanism for the docking station, and the software optimization for recharging the bicycle inside the docking station.

the lack of axiomatic design materials for electric bike sharing system highlight the fact that an axiomatic design theory might not be feasible on bike sharing system from a financial point of view, due to the nature of axiomatic design theory, the design is meant to improve on its previous iteration, which means it is more suitable for products with a relatively short life cycles, compared to bike sharing system bicycles, which are once deployed, will not be changed for a very long time, hence it is not financially feasible to renew the bicycles and the station of a bike sharing system often.

### **Recommendations**

Recommendations for future work is to test the proposed concept, the author recommendation is to test the proposed design on a small scale, a bike sharing program on a university level would be an ideal scenario for several reasons

1. The design parameters can be retro fitted to older slandered bicycles, which means these “modified bicycles” can serve as the bicycles of the bike sharing system reducing the cost significantly.
2. The user base consists of students of the university, which can be considered as a sample of the real user base, due to their varying age, gender, height and weight, which closely resembles a large percentage of the actual bike sharing program user base.
3. Several universities can implement their own different versions of a small scale bike sharing system, in order to expand the number of users as well as test several design parameters for the same functional requirement simultaneously.
4. The different styles and frame shapes represents provide several feedback opportunities from the users on the most effective frame shape and size.
5. The university bike sharing system would be small enough that adapting changes to the design would not cost as much as it would have for a larger scale system, hence it would easily upgradable or changeable with different parameters in order to test them.

6. Once the design parameters have been configured and finalized, the whole design concept can be implemented on a larger scale which would bring the benefits of next generation of bike sharing system to a large number of users.

## **Conclusion**

As stated at the beginning of this work, the main challenge facing Bike Sharing systems is how to design a bicycle that meets the needs of the end user, and offer enough features that makes it a viable alternative to other public transportation methods as well as personal bicycles. While keeping the cost as low as possible.

Axiomatic Design has the potential to address both of these issues. As shown in this work, Axiomatic design can be used to help create the next generation of bike sharing systems. It offers a way of reducing the initial cost of the research and development which leads to a reduction in the total cost of the bicycle, while consulting the customers through feedbacks and questionnaires in order to identify their needs and implement the features wanted the most without going through rework or implementing features that might end up poorly accepted by the end users.

With decoupled design that can yield to a more independent design elements. These features do not have to be implemented all at the same time, but rather one or two at a time in order to reduce the cost as well as familiarize the end users with them gradually.

The concept for the next generation of bike sharing system can have a rich feature set that overcome some of the obstacles current bike sharing system have and help increase its desirability and the number of ridership and trips taken,

## References

- Alta Planning + Design (2009). *Bike Sharing/Public Bikes: An Overview of Programmes, Vendors and Technologies*. Portland.
- Bobba, Phaneendra Babu. K. R. Rajagopal. (2010). *Compact Regenerative Braking Scheme for a PM BLDC Motor Driven Electric Two-Wheeler*.
- Chang-Hua Lin, Hom-Wei Liu, Chien-Ming Wang. (2010). *Design and Implementation of a Bi-directional Power Converter for Electric Bike with Charging Feature*.
- Curran, A. 2008. *TransLink Public Bike System Feasibility Study*. Vancouver: Quay Communications Inc.
- D. M. Sousa, P. J. Costa Branco, J. A. Dente. (2008). *Electric Bicycle Using Batteries and Supercapacitors*.
- DeMaio, Paul. 2009. *Bike-sharing: Its History, Models of Provision, and Future*. Velocity Conference.
- F. Pellitteri, V. Boscaino, A.O. Di Tommaso, F. Gendus and R. Miceli. (2013). *E-bike battery charging: methods and circuits*.
- Fishman, Elliot. (2014). *Bikeshare: Barriers, Facilitators and Impacts on Car Use*. Queensland University of Technology, Brisbane.
- Fishman, Elliot. (2015). *Bikeshare: A Review of Recent Literature*.
- Guarisco, Michael. Gao, Fei. Paire, Damien. (2015). *Autonomy and User Experience Enhancement Control of an Electrically Assisted Bicycle with Dual-wheel Drive*.
- Hamilton, Steven T. Orsi, Christian M. (2013). *Turn and Brake Signal System for a Bicycle*.
- Heinen, E., vanWee, B., & Maat, K. (2010). *Commuting by bicycle: An overview of the literature*. *Transport Reviews*.

Hua, Chih-Chiang. Kao, Shih-Jyun. Fang, Yi-Hsiung. (2013). *Design and Implementation of a Regenerative Braking System for Electric Bicycles with a DSP Controller*. Department of Electrical Engineering National Yunlin University of Science & Technology Douliou, Yunlin, aiwan, ROC.

Iannuzzi, Diego. D'Ostilio, Roberto.(2015). *Inductive Charging Station for Ebike Clever Mobility: A research Project*.

J. Guo, P. Jiang, J.W. Guo, J. Zhang, R.H. Tan. (2012). *Innovation Design Of Existing Product Based On Function Recombination*.

Jalakas, Tanel. Zakis, Janis. (2015). *Experimental Verification of Light Electric Vehicle Charger Multiport Topology*.

Katia, Andrade, and Seiichi Kagaya. (2011). *Cycling in Japan and Great Britain: A Preliminary Discussion. Research Report*. Louvain-la-Neuv. Belgium: European Regional Science Association.

Ke, Weili. Zhang, Ning. (2008). *Charging Models & the Performance of Battery Packs for Electric Bicycles*.

Kisner, Corinne. (2011). *Integrating Bike Share Programs into a Sustainable Transportation System*. Center for Research and Innovation at the National League of Cities.

Kreuzer, Andreas. (2014). *Application of Axiomatic Design to Electric Bicycles*. University of Vaasa.

Kulak Osman, Cebi Selcuk, Kahraman Cengiz. (2010). *Applications of axiomatic design principles: A literature review*.

Kumar, Ashwani, Meng, Kwong, Odoni, Amedeo R. (2012). *A Systems Perspective of Cycling and Bike-sharing Systems in Urban Mobility*.

M. Prist, A. Freddi, S. Longhi, A. Monteriù, P. Antonini. (2016). *Wireless Sensor Network based Management System for Electric Bicycle-Sharing*.

- Ma, Ting, Liu, Chao, Erdogan, Sevgi. (2014). *Bicycle Sharing and Transit: Does Capital Bikeshare Affect Metrorail Ridership in Washington, D.C.*
- Mabrok, Mohamed A., Efatmaneshnik, Mahmoud. , Ryan, Michael. (2015). *Including Non-Functional Requirements in the Axiomatic Design Process.*
- Mai,Ruikun. Chen, Yang. Li, Yong. Zhang, Youyuan. Cao, Guangzhong. He, Zhengyou. (2017). *Inductive Power Transfer for Massive Electric Bicycles Charging Based on Hybrid Topology Switching with A Single Inverter.*
- Matias,Ricardo. Dinis, Joel. Fonseca, Jos´e Alberto. Ferreira, Joaquim Pedreiras, Paulo. (2015). *Energy issues of bike sharing systems: from energy harvesting to contactless battery charging.* Telecommunications Institute - University of Aveiro.
- Mcclintock, Hugh. (2002). *The Mainstreaming of Cycling Policy. In Planning for Cycling: Principles, Practice and Solutions for Urban Planners.* 1-2. FL, USA: Woodhead Publishing and CRC Press.
- METROLINX. (2009). *Bike Share Program Investigation, Best Practices Investigation.* Toronto.
- Midgley, Peter. (2011). *Bicycle-Sharing Schemes: Enhancing Sustainable Mobility in Urban Areas.* Commission on Sustainable Development, Nineteenth Session, New York.
- Midgley, Peter. (2011). *Bicycle-sharing Schemes: Enhancing Sustainable Mobility in Urban Areas. Commission on Sustainable Development.* New York: UN Department of Economic and Social Affairs.
- Muetze, Annette. Ying C. Tan. (1990). *Electric Bicycles: A performance evaluation.* 30 July 2007
- N.P. Suh, Shinya Sekimoto. *Design of thinking design machine.* CIRP Annals-Manufacturing Technology, 39(1):145–148.
- N.P. Suh. (2001). *Axiomatic Design: Advances and Applications.* MIT Pappalardo series in mechanical engineering. Oxford University Press.



NATIONAL ACADEMY OF SCIENCES, (2003). *Approaches to improve engineering design*. Available online at: <http://books.nap.edu/books/NI000469/html/R1.html>.

National Research Council. (1996). *Meeting the Challenges of Megacities in the Developing World*. Washington DC: National Academy Press.

New York City Department of City Planning. (2009). *Bike-Share Opportunities in New York City*. New York.

Nikhil Hatwar, Anurag Bisen, Haren Dodke, Akshay Junghare. (2013). *Design Approach for Electric Bikes Using Battery and Super Capacitor for Performance Improvement*.

O. Maier, M. Krause, S. Krauth, N. Langer, P. Pascher, and J. Wrede. (2016). *Potential Benefit of Regenerative Braking on Electric Bicycles*.

O. Ustun, G. Tanc, O.C. Kivanc and G. Tosun. (2016). *In Pursuit of Proper BLDC Motor Design for Electric Bicycles*.

P. Spagnol, G. Alli, C. Spelta, P. Lisanti, F. Todeschini, S. M. Savaresi and A. Morelli. (2012). *A Full Hybrid Electric Bike: How to Increase Human Efficiency*.

Pucher, J. (2007). *Urban Transport Trends and Policies in China and India*. *Transport Reviews*: 379–410.

Pucher, John, Jennifer Dill, and Susan Handy. (2010). *Infrastructure, programs, and policies to increase bicycling: An International Review*. *Preventive Medicine*: 106-125.

Puviwatnangkurn, Waraporn. Tanboonjit, Bundit. Fuengwarodsakul, Nisai H. (2013). *Overcurrent protection scheme of BMS for Li-Ion battery used in electric bicycles*. Electrical Engineering/Electronics, Computer, telecommunications and Information Technology (ECTI-CON).

Ricardo Meireles, Jose Silva, Alexandre Teixeira, Bernardo Ribeiro. (2013). *An E.Bike Design for the Fourth Generation Bike-Sharing Services*. Barcelona, Spain, November 17-20.

Shaheen, S., Cohen, A. P., & Martin, E. W. (2013). *Public bikesharing in America: early operator understanding and emerging trends*. Transportation Research Record: Journal of the Transportation Research Board: 2387, 83–92.

Shaheen, Susan, Hua Zhang, Elliot Martin, and S Guzman. (2011). *Hangzhou Public Bicycle: Understanding Early Adoption and Behavioral Response to Bikeshare in Hangzhou, China*. Transport Research Board TRR.

Shaheen, Susan, S Guzman, and H Zhang. (2010). *Bikesharing in Europe, the Americas, and Asia: Past, Present, and Future*. Transportation Research Record: Journal of the Transportation.

Solano, Javier. Jácome, Andrés. Boulon, Loïc. (2016). *Modelling and simulation of an electric bicycles charging station based on renewable energy*.

Xiaoyu LIU, Chuang LIU, Ming LU, Diji LIU. (2009). *Regenerative Braking Control Strategies of Switched Reluctance Machine for Electric Bicycle*. Aero-Power Sci-tech Center, Nanjing University of Aeronautics & Astronautics, Nanjing, China.

Zhang, Zhiguo. (2009). *Research on Product Design Based on the Axiomatic Design*.