

Det här verket har digitaliserats vid Göteborgs universitetsbibliotek. Alla tryckta texter är OCR-tolkade till maskinläsbar text. Det betyder att du kan söka och kopiera texten från dokumentet. Vissa äldre dokument med dåligt tryck kan vara svåra att OCR-tolka korrekt vilket medför att den OCR-tolkade texten kan innehålla fel och därför bör man visuellt jämföra med verkets bilder för att avgöra vad som är riktigt.

This work has been digitized at Gothenburg University Library. All printed texts have been OCR-processed and converted to machine readable text. This means that you can search and copy text from the document. Some early printed books are hard to OCR-process correctly and the text may contain errors, so one should always visually compare it with the images to determine what is correct.



7

DOKTORSAVHANDLINGAR
VID
CHALMERS TEKNISKA HÖGSKOLA
Nr 26

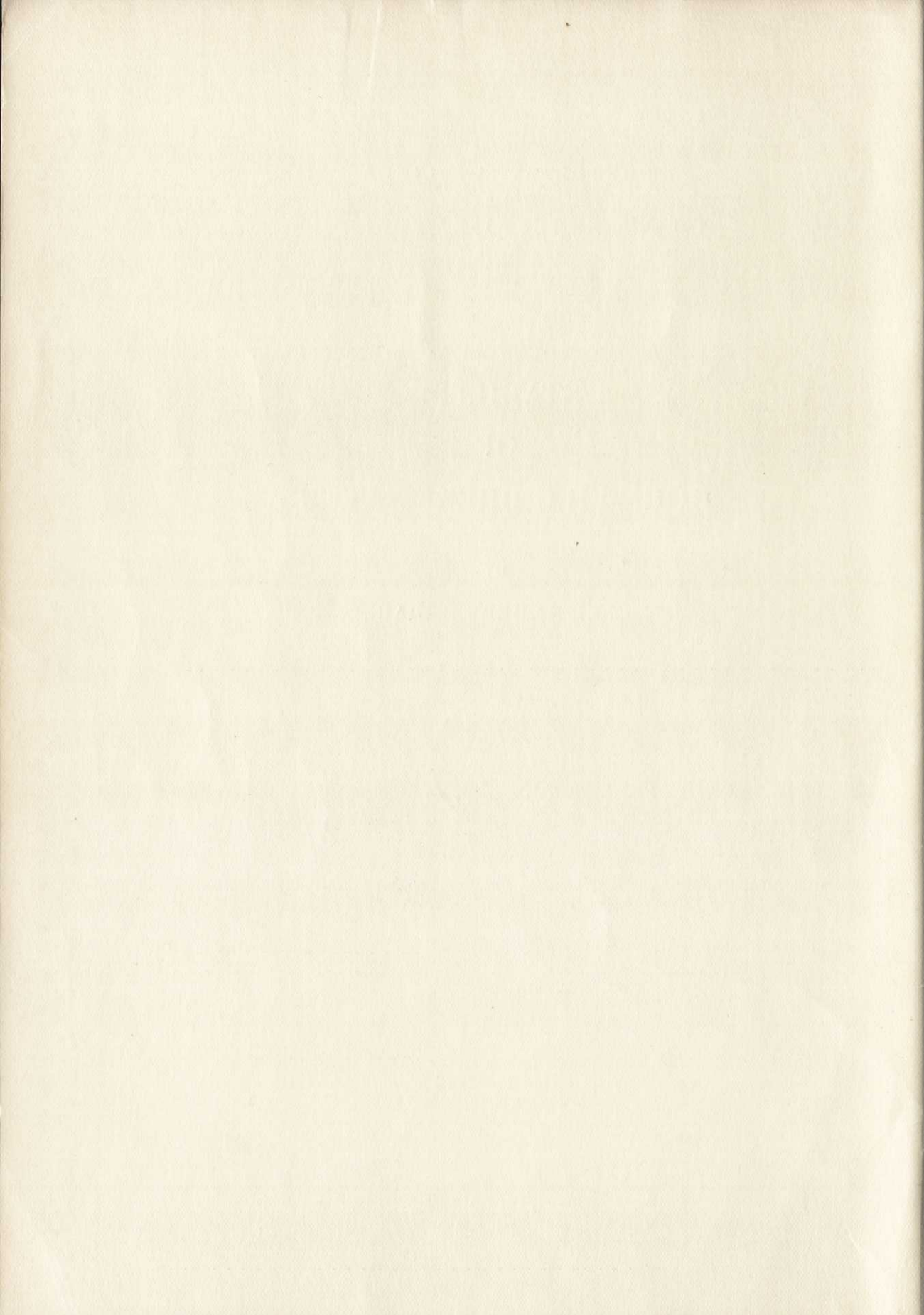
STABILITY
OF
ROCK-FILL BREAKWATERS

BY
PER ANDERS HEDAR



GÖTEBORG 1960





DOKTORSAVHANDLINGAR
VID
CHALMERS TEKNISKA HÖGSKOLA
Nr 26

STABILITY
OF
ROCK-FILL BREAKWATERS

AV
PER ANDERS HEDAR
teknologie licentiat

AKADEMISK AVHANDLING
SOM MED TILLSTÅND AV CHALMERS TEKNISKA HÖGSKOLA
FÖR TEKNOLOGIE DOKTORSGRADES VINNANDE TILL
OFFENTLIG GRANSKNING FRAMLÄGGES Å FÖRELÄSNINGS-
SALEN FÖR FYSIK, GIBRALTARGATAN 5 B, GÖTEBORG,
MÅNDAGEN DEN 12 DECEMBER 1960 KL. 10

GÖTEBORG
ELANDERS BOKTRYCKERI AKTIEBOLAG
1960

DOKTORSÄVHANDLINGAR
VID
CHALMERS TEKNISKA HÖGSKOLA
Nr 26

STABILITY
OF
ROCK-FILL BREAKWATERS

BY
PER ANDERS HEDAR



AKADEMIFÖRLAGET-GUMPERS, *Göteborg*
GYLDENDALSKE BOGHANDEL/NORDISK FORLAG, *København*
AKATEEMINEN KIRJAKAUPPA/AKADEMISKA
BOKHANDELN, *Helsingfors*
WILLIAM HEINEMANN LTD, *London, Melbourne, Toronto*

SCANDINAVIAN UNIVERSITY BOOKS

Gyldendalske Boghandel / Nordisk Forlag, København
Svenska Bokförlaget / P. A. Norstedt & Söner — Albert Bonnier, Stockholm
Akademiörlaget / Gumperts, Göteborg
Akateeminen Kirjakauppa / Akademiska Bokhandeln, Helsingfors
William Heinemann Ltd, London, Melbourne, Toronto

© 1960 *Per Anders Hedar*

GÖTEBORG
ELANDERS BOKTRYCKERI AKTIEBOLAG
1960

In memory of my uncle

David Andersson

Engineer and Contractor

Preface

While working as a designing and constructing engineer on fishing-harbours on the Swedish west coast during the late 1940's, I found that there was a lack of consistent rules by which the block weight in the armour layers of breakwaters and sea-walls could be calculated. The specifications and drawings for breakwaters often prescribed a block weight which was not always possible to obtain from the quarry. Great uncertainty prevailed regarding the construction of stable seaside slopes with the block weights available.

In 1950, at Chalmers University of Technology, Göteborg, I discussed these problems with Professor ERLING REINIUS, who at the time was Head of the Division of Hydraulics and was very interested in these problems and who had also discovered a deficiency in laws for the design of rock-fill slopes attacked by waves. An introductory investigation was commenced at the Division of Hydraulics at Chalmers University of Technology which resulted in a short report 1953. This first investigation clearly showed that a more extensive study of the problem would be necessary, and in 1956 a comprehensive study was commenced at the Division of Hydraulics with the aid of a grant from the State Council of Technical Research. The necessary trips made to study breakwaters and sea-walls in foreign countries were facilitated by contributions from the Chalmers Research Fund and the Ahlsell Fund.

At that time my object was to derive formulae which included the variables to be taken into consideration when determining the stability of a breakwater attacked by waves. I also aimed at finding values for all the inherent coefficients. In the course of the work I found, however, the complex of questions to be answered too great and the problems too complicated to be solved at once and it proved impossible to perform a complete research program studying all variables within reasonable time and at a reasonable cost. And it was also impossible to compute or to determine the influence of each variable separately. Obviously some factors such as the

water velocity along the breakwater slope, caused by the waves, and the variable thickness of the water sheet on the slope had to be studied, but these quantities cannot be investigated with existing instruments. Further I found that the degree of wave reflection from the slope could be of importance for my investigation of the stability but that this question was not yet sufficiently analysed. Therefore I had to restrict my objectives and to leave some problems for future research. One of the assistants, Mr. ANDERS MATSSON, Civ. Eng., at the Division of Hydraulics is now, at my suggestion, making a more detailed investigation of the degree of wave reflection from different types of slopes.

Acknowledgements

I owe a debt of gratitude to the many persons and institutions whose generous assistance and encouragement have made possible the accomplishment of this treatise.

My thanks are due first to Professor ERLING REINIUS, D. Eng., for his stimulating interest as Head of the Division. The Royal Board of Roads and Waterways has frequently given me inspiring tasks in the field of breakwater and sea-wall design, for which I am extremely grateful. My chief at the Board, Mr. JUSTUS OSTERMAN, now Director of the Swedish Geotechnical Institute, Civ. Eng., devoted much of his time to discussions of breakwaters, and also read through the manuscript and made some valuable suggestions. I am particularly indebted to Svenska Entreprenad AB SENTAB, which firm has given me opportunities to study and discuss the problems of rock-fill breakwaters in various places abroad in collaboration with experienced harbour engineers. I am under great obligations to Major RAGNAR SJÖDAHL, Chief Engineer, Civ. Eng., for his support and interest, and to Mr. SVEN KLINGBERG, Chief Engineer, Civ. Eng., for his constructive criticism.

My thanks are also due to my colleagues at the Division of Hydraulics, my assistant engineers, Mr. SÖREN ANDERSSON, Civ. Eng., Mr. MATS KJELLQVIST, Civ. Eng., Mr. ANDERS MATTSSON, Civ. Eng., and Mr. SUNE PETTERSSON, Civ. Eng., who assisted me with calculations and in conducting the tests. In these thanks I will also include Mr. LARS-MAGNUS EKMAN, and Mr. FOLKE BERLANDER who assisted me with the tests, and Mr. ERIC JOHANSSON, who built the wave-flume.

The staff of the Chalmers University Library was always courteous and helpful, and I wish to mention particularly Mr. SVEN WESTBERG, M. A., who checked the references.

Among those who have contributed to the completion of the treatise I wish especially to thank Mr. ALBERT READ who checked the English language, Miss ULLA-BRITT JOHANSSON and Miss BIRGIT

LENBERG, who typed the manuscript, and Mr. WILLY GAUTE-JOHANSEN, who prepared the drawings.

Finally I am greatly indebted for the invaluable help and encouragement rendered by my father, Mr. SAM. HEDAR, Ph. D., former Assistant Keeper of the Public Records, and my wife, Mrs. BIRGIT HEDAR, B. of Pharmacy who never lost faith in my protracted work.

Göteborg, March 1960.

Per Anders Hedar

Contents

	Page
Preface	5
Acknowledgements	7
Contents	9
List of Illustrations	11
Notation	13
1. General Conceptions	16
11. Introduction	16
12. Some Examples of Sloping-faced Structures	17
2. Brief Description of Waves	24
21. Definitions of Wave Characteristics	24
22. Elements of Wave Theory Applied to the Present Investigation	25
23. Breaking Waves	29
3. Present Formulae of Stability for the Design of Breakwaters and Sea-Walls with Sloping Sides	32
31. General	32
32. Symbols Used in the Formulae	32
33. Existing Formulae	33
34. Design Criteria	39
4. Theoretical Derivation of New Formulae for Designing Slope Stability	41
41. Acting Forces	41
411. Gravity Force	41
412. Hydrodynamic Force	41
42. Equations of Stability for the Slope	44
43. Applying the Wave Characteristics to the Formulae of Stability	46
431. Breaking Waves. Uprushing Phase	46
432. Reflected Waves. Uprushing and Downrushing Phase	47
433. Breaking Waves. Downrushing Phase	49
434. Comparison of the Velocities	50
44. Values of Coefficients in the Formulae of Stability	50

	Page
5. Equipment Used for Laboratory Study, Running and Application	54
51. General	54
52. Wave Flume	54
53. Wave Generator	57
54. Wave Filter	62
55. Wave Absorber	64
56. Point Gauges and Wires for Measuring Water Levels	66
57. Model Structures	68
58. Method of Measuring	70
59. Control of the Wave Profile	73
6. Model Tests and Results	76
61. Introduction	76
62. Model Similitude	77
63. Uprushing Waves	77
64. Checking the Value of the Coefficient K_{up}	83
65. Downrushing Waves	85
66. Final Formulae of Stability Giving Required Block Weight in the Armour Layer	94
7. Conclusions	96
8. Some Examples of Application	99
9. Summary	105
91. Summary in English	105
92. Summary in French. Résumé en français	109
Tables	115
References	116

List of Illustrations

Figure

- 12.1. Section of the rock-fill breakwater at Tema in Ghana
- 12.2. Sections of the rock-fill breakwater at Safi in Morocco
- 12.3. The seaside of the rock-fill breakwater at Sinoe in Liberia
- 12.4. The harbour side of the rock-fill breakwater in Monrovia in Liberia
- 12.5. Tetrahedrons, parallelepipeds and tetrapods in the armour layer of the breakwater at La Nouvelle in France
- 12.6. The Marquette breakwater in Michigan in the U. S. A. with smooth slopes
- 12.7. The breakwater at Fishguard in Wales. The inner and the outer part
- 12.8. Typical section of a breakwater with a core of sand fill
- 12.9. Typical section of a breakwater in a small fishing-harbour in Sweden. The core is a stone-filled wooden structure
- 12.10. Section of the outer part of the breakwater at Ymuiden in the Netherlands. The core is impermeable
- 12.11. Section of sea-wall
- 12.12. The sea-wall at den Helder in the Netherlands
- 21.1. Wave characteristics
- 22.1. Profile of a trochoidal wave
- 23.1. The ratio between breaking height and wave height in deep-water and the ratio between depth of breaking and wave height in deep-water
- 23.2. The same curves as in Fig. 23.1, but for use in calculations
- 33.1. Determination of K' (for rubble-mound structures) in terms of $\frac{d}{L}$ and α
- 34.1. The ratio of run-up to wave height, $\frac{R}{H}$, as a function of $\cot \alpha$ with the wave steepness $\frac{H}{L}$ as parameter
- 412.1. Forces acting on armour layer at uprush and downrush
- 42.1. Forces acting on a stone. Uprush
- 42.2. Forces acting on a stone. Downrush
- 431.1. Definition sketch of breaking wave
- 432.1. Reflection and breaking of waves
- 44.1. The box, by means of which the angle of stability (natural slope) was determined
- 52.1. Schematic drawing of the channel
- 52.2. The wave channel
- 53.1. The wave generator arrangement
- 53.2. The wave generator mechanism

Figure

- 53.3. Variation of the amplitudes of the wave-blade
- 53.4. Horizontal amplitude of oscillation for proportional depth
- 53.5. Detail of the movement of the wave-blade with symbols
- 53.6. Calibration curves of the wave generator
- 54.1. The wave filter. Side and end view
- 55.1. Cross section of wave absorber at the end of the flume
- 56.1. Circuit diagram
- 56.2. The flashing apparatus
- 56.3. Two wave height meters. To the right the wires and to the left a twin-channelled recorder
- 57.1. The model structure
- 57.2. The armour layer on hardboard
- 58.1. The positions of the two point gauges for determination of the wave length
- 58.2. The arrangement of the two point gauges for measuring wave heights
- 58.3. The barrier in the wave flume
- 59.1. The wave profile in the flume. Agreement between the actual wave form and the theoretical profile, dashed line
- 63.1. Rupture caused by the uprushing waves
- 63.2. Stones thrown upwards
- 63.3. Determination of the coefficient K_{up}
- 64.1. Elevation of the set-up in the glass-walled flume
- 64.2. Test being made in the glass-walled flume
- 65.1. Determination of the wave height at the limit of stability and instability at downrush, pervious slope
- 65.2. The same as Fig. 65.1, but impervious slope
- 65.3. The variation of the coefficient K_{down}
 - 8.1. Section of the breakwater, slope 1 on 2
 - 8.2. Section of the breakwater, slope 1 on 2, reduced depth at toe
 - 8.3. Section of the breakwater, slope 1 on 4

Notation

Letter symbols are, if necessary, defined where they first appear and listed below.

A	Area
$2 a_{bm}$	Horizontal displacement of bottom particle orbits
a_{bm}	Also: Amplitude of wave-blade
a_{le}	Amplitude of the lower edge of wave-blade
$2 a_s; 2 a'_s$	Horizontal displacement of surface particle orbits
a_s	Also: Amplitude of wave-blade
a_{ue}	Amplitude of the upper edge of wave-blade
$2 a_z; 2 a'_z$	Horizontal displacement of particle orbits
$2 b_s; 2 b'_s$	Vertical displacement of surface particle orbits
$2 b_z; 2 b'_z$	Vertical displacement of particle orbits
b	Subscript b refers to breaking conditions
bm	Subscript bm refers to bottom
C	Wave velocity
C_0	Wave velocity in deep-water
c	Coefficient
d	Water depth, measured from still-water level to the bottom
d'	Water depth, measured from the centre of the surface particle orbits to the bottom
d_b	Depth of breaking
$F; F_{1, 2}$	Reads "function of"
f	Resistance coefficient in the general friction formula
F	Subscript F refers to filter
f	Subscript f refers to water (fluid)
	Also: To friction
g	Gravitational acceleration
	Also: Abbreviation for gram
H	Wave height (incident wave height)
H_b	Wave height on breaking
H_F	Wave height in front of filter
H_l	Wave height at loop
H_n	Wave height at node

H_0	Wave height in deep-water
H_r	Height of reflected wave
H_s	Vertical distance from crest to trough of a wave on a slope
H_z	Hypothetical wave height
$H_{\frac{1}{3}}; H_{\frac{1}{10}}$	Significant wave height; average value of one-tenth highest waves of a given number of waves
HWL	High water level
h_f	Loss of energy head
h_0	The lift of the centre of the particle orbits above SWL
I	Energy gradient
$K; K'; K_{1, 2, 3}$	Coefficients
$K_{up}; K_{down}$	
k	Diameter of a stone
k_{mean}	Mean diameter of stones
L	Wave length
L_b	Wave length at breaking point
L_0	Wave length in deep-water
LWL	Low water level
l	A distance
l	Subscript l refers to loop
l_e	Subscript l_e refers to lower edge
M	See m
$MHWS$	Mean high water springs
$MLWS$	Mean low water springs
MWL	Mean water level
m	1, 2, 3, m , M numbers of stones where M is the sum of stones in the area A
n	Degree of inclination to the horizontal, expressed as the ratio 1:n, indicating one unit rise in n units of horizontal distance
n	Subscript n refers to node
0	Subscript 0 refers to deep-water condition with the exception of the notation h_0
P	Buoyant weight of a stone
P_1	Hydrodynamic force
Q	Weight of an individual stone
Q_{mean}	Mean weight of individual stones
R	Radius of rolling circle Also: Run-up

r	Ratio between wave heights $\left(\text{the ratios } \frac{H}{H_F}; \frac{H_r}{H} \right)$
r	Subscript r refers to reflection
SWL	Still-water level
s_s	Specific gravity of stone
s_f	Unit volume weight of water (fluid)
s	Subscript s refers to water surface terms Also: To stone and slope
T	Wave period
t	Time
ue	Subscript ue refers to upper edge
v	Water velocity
v_b	Velocity of breaking wave
v_{\max}	Maximum velocity
v_{mean}	Mean velocity
x	Horizontal co-ordinate Also: Unknown
y	Vertical co-ordinate
z	Water depth below still-water surface Also: Water depth
z'	Water depth below the mean position of surface particle orbits
$z; z'$	Subscripts $z; z'$ refer to a certain point situated at a distance z below SWL respectively z' below the mean position of surface particle orbits
α	Angle of the slope with the horizontal
β	An angle
θ	An angle
μ	Coefficient of friction between stones
π	3.1416
τ	Shearing stress
φ	An angle
\sin	Sine
\sinh	Hyperbolic sine
\tan	Tangent
\tanh	Hyperbolic tangent
\cos	Cosine
\cosh	Hyperbolic cosine
\cot	Cotangent
\coth	Hyperbolic cotangent

CHAPTER 1

General Conceptions

11. Introduction

Sloping-faced structures of rock-fill are frequently used as shelters against wave action in, for instance, harbour breakwaters, sea-walls, revetments for prevention of erosion and damage to shores, in groins and off-shore breakwaters for diminishing the transport of bed load and in jetties to confine the discharge area of a river or to protect ship channels or inlets.

Although rubble-mound structures have been used as protection against wave action since ancient times, the problem of designing them does not appear to have found an adequate solution and in the past designers have often had to rely on rules with no scientific foundation but based merely on previous practice and observations of existing structures. While rubble-mound structures have a great advantage over solid structures inasmuch as their breakdown by wave action seldom leads to complete destruction and nearly always tends to increase their stability and efficiency after repairs, intimate knowledge of the conditions governing the stability of the rubble-mound structure is essential for an adequate design. The problem is to find a law governing the size of the blocks and the gradient of the slopes in relation to certain wave characteristics.

It was not until 1933 that a formula for the design of rock-fill breakwaters was published by a Spanish professor, D. EDUARDO DE CASTRO. Since then other scientists and engineers have made great efforts to lay down general rules and have published formulae based partly on theory and partly on small-scale tests or observations of existing structures. The most important achievements have been arrived at by another Spanish professor, RAMÓN IRIBARREN CAVANILLES, and ROBERT Y. HUDSON, the Chief of the Wave Action Section of the U. S. Waterways Experiment Station. It seems, however, that a final solution of the problem has not yet been presented

and that the investigations hitherto made in this particular field are not characterized by the degree of exactness commonly required in other spheres of engineering science.

This treatise is intended as a contribution towards the solution of the problem of the stability of rock-fill sloping-faced structures exposed to water waves. The solution presented is based on theoretical studies confirmed by extensive laboratory tests.

12. Some Examples of Sloping-faced Structures

A sloping-faced structure of rock-fill generally consists of a core of quarry-run, surrounded by classified rocks for prevention of erosion and damage.

Such parts of the windward and leeward sides and the crown as are particularly exposed to wave action are armoured by a layer of selected heavy blocks. The size of these blocks depends on the characteristics of the wave action in the sea and in the sheltered area as well as on the degree of overtopping of the waves. The blocks are usually of stone but in certain circumstances it may be more economical to use concrete blocks which may be parallelepipeds, tetrahedrons or tetrapods. The reinforcement layer may either be smooth and nearly impervious or rough and pervious.

The structures mentioned in the introduction are essentially of the same type although their shape may vary according to their use and to the available supply of building materials. The core sometimes consists, for instance, of fine-grained material such as sand, silt or clay and is thus more or less impermeable, such core generally being protected from erosion by a suitable filter. An impermeable core may also consist of a cofferdam used for construction purposes or of a quay wall or similar structures with slopes of rock-fill.

In a sea-wall the seaside part is similar to that of a breakwater and the core generally consists of more or less permeable backfill of shore sediment.

Typical sections of rock-fill breakwaters are shown in Figs. 12.1 and 12.2. Fig. 12.1 shows the rock-fill breakwater at Tema in Ghana with the armour layer made of rip-rap, and Fig. 12.2 the breakwater at Safi in Morocco, where the armour is made of prefabricated parallelepipeds and tetrapods of concrete.

The photograph, Fig. 12.3, was taken at Sinoe in Liberia, during the construction of the breakwater. The seaside slope is a good

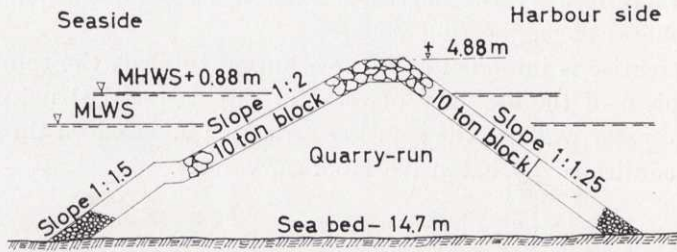


Fig. 12.1. Section of the rock-fill breakwater at Tema in Ghana. (After Report of the Hydraulics Research Board, 1956, p. 37)

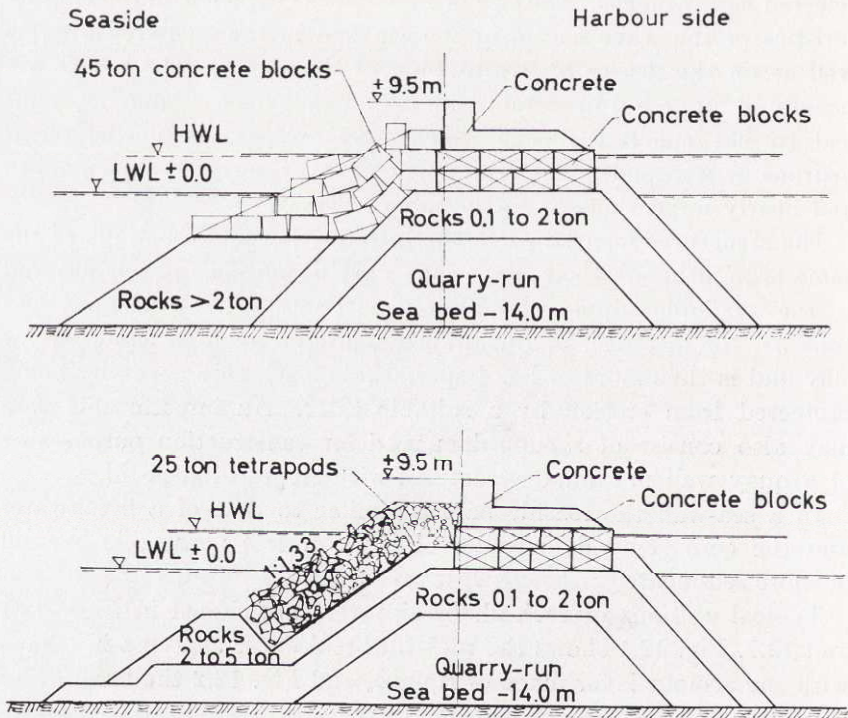


Fig. 12.2. Sections of the rock-fill breakwater at Safi in Morocco. (The tetrapod concrete block. The Dock and Harbour Authority, 1957, p. 50)



Fig. 12.3. The seaside of the rock-fill breakwater at Sinoe in Liberia.
(Sinoe Dec. 1956)

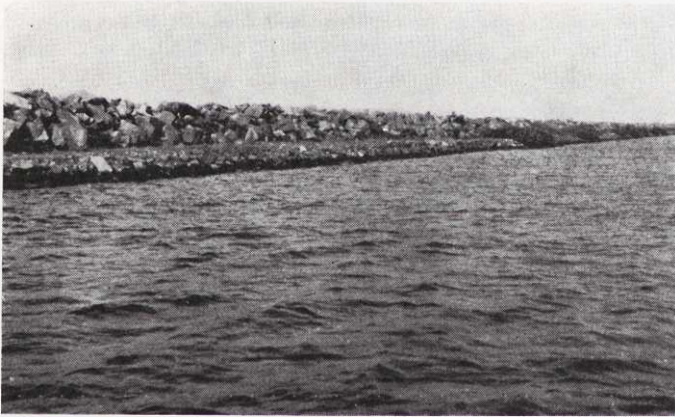


Fig. 12.4. The harbour side of the rock-fill breakwater in Monrovia in Liberia.
(Monrovia Dec. 1956)

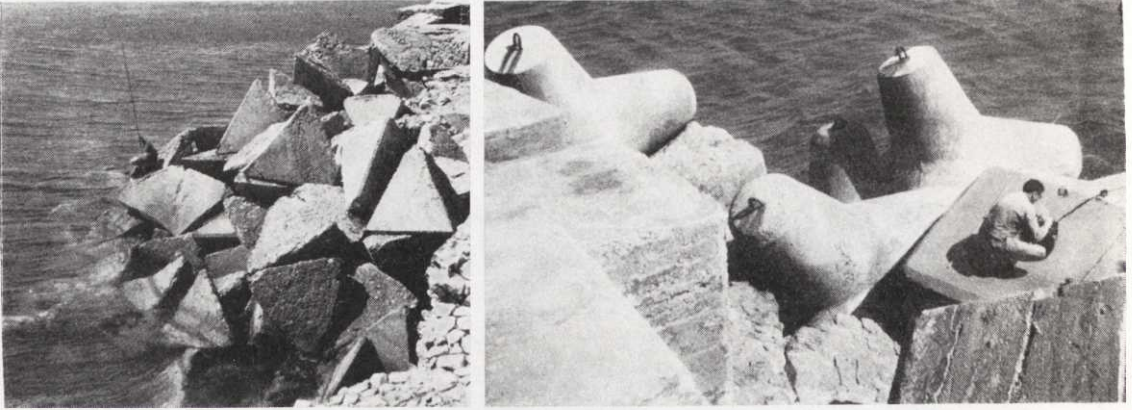


Fig. 12.5. Tetrahedrons, parallelepipeds and tetrapods in the armour layer of the breakwater at La Nouvelle in France. (La Nouvelle Sept. 1955)

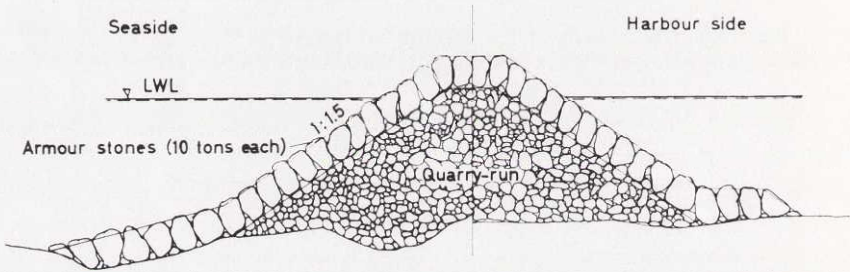


Fig. 12.6. The Marquette breakwater in Michigan in the U. S. A. with smooth slopes. (After Heavy breakwater built in fast time. Engineering News-Record, 1938, p. 790)

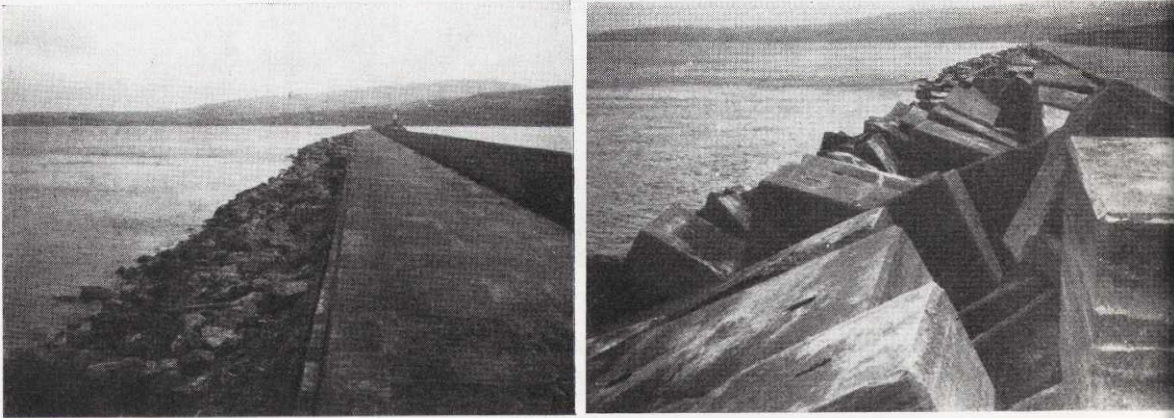


Fig. 12.7. The breakwater at Fishguard in Wales. The inner and the outer part. (Fishguard June 1954)

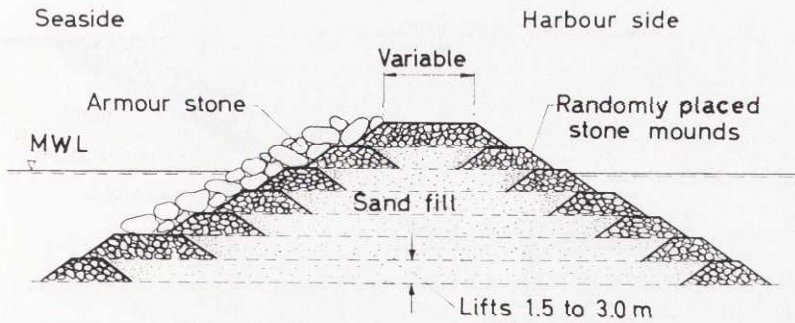


Fig. 12.8. Typical section of a breakwater with a core of sand fill. (After Shore Protection Planning and Design, p. 209)

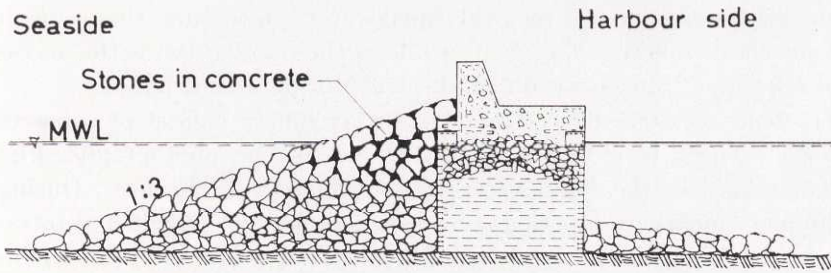


Fig. 12.9. Typical section of a breakwater in a small fishing-harbour in Sweden. The core is a stone-filled wooden structure. (By courtesy of the Royal Board of Roads and Waterways in Sweden)

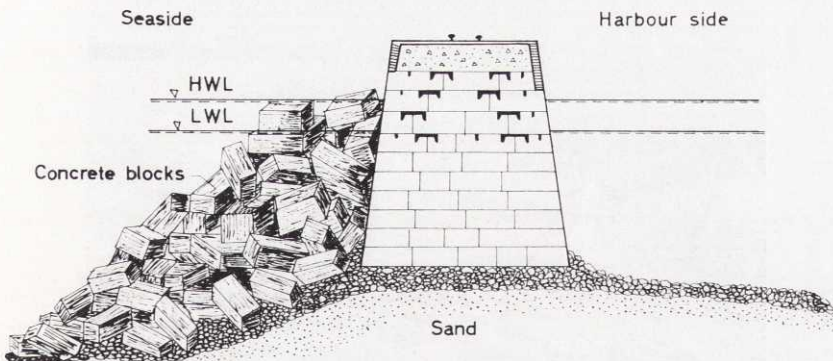


Fig. 12.10. Section of the outer part of the breakwater at Ymuiden in the Netherlands. The core is impermeable. (By courtesy of the Department of the Ministry of Transport and "Waterstaat" in the Netherlands)

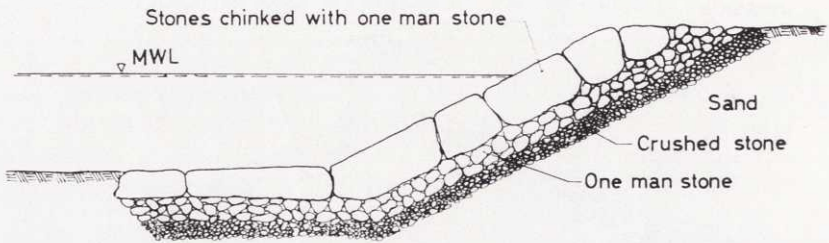


Fig. 12.11. Section of sea-wall. (After Shore Protection Planning and Design, p. 153)

example of a rough slope with voids for water percolation. The concrete blocks on the top of the breakwater are intended for the quay on the harbour side. The photograph, Fig. 12.4, shows the harbour side of the secondary rock-fill breakwater protecting the port of Monrovia in Liberia. The shelf visible in the photograph is the access road for the transportation of rock-fill during construction.

Instead of stone blocks the armour layer may consist of concrete blocks. Three common types are shown in the photographs, Fig. 12.5, taken on the breakwater at La Nouvelle in France. During different construction periods tetrahedrons, parallelepipeds and tetrapods have been used. The rock-fill breakwater at Marquette in Michigan in the U. S. A. is a structure in which cover stones are fitted



Fig. 12.12. The sea-wall at den Helder in the Netherlands. (Photo J. V. Sundberg; Aug. 1954)

together to make a smooth and almost impervious surface, Fig. 12.6. The seaside slope of the breakwater at Fishguard in Wales is made of stone blocks in the inner part and of 40 ton parallelepiped concrete blocks, deposited pell-mell, in the outer part, Fig. 12.7. The crown consists of a heavy concrete structure and the core of quarry-run.

Figs. 12.8 and 12.9 show typical sections of breakwaters, where the cores are made so compact that the penetration of water through the breakwater is retarded in relation to the wave motion. Finally a section of the outer part of the breakwater at Ymuiden in the Netherlands is shown; the core is an impermeable structure of concrete blocks, Fig. 12.10.

Sea-walls are often constructed as shown in Fig. 12.11. A rough porous layer of stones, dumped pell-mell, may be substituted for the smooth surface layer shown in the figure. Fig. 12.12 is a photograph of the sea-wall at den Helder in the Netherlands, where the voids in the armour stone layer are filled with asphaltic concrete. Note the groins projecting from the sea-wall.

CHAPTER 2

Brief Description of Waves

21. Definitions of Wave Characteristics

A wave has four principal characteristics as shown below:

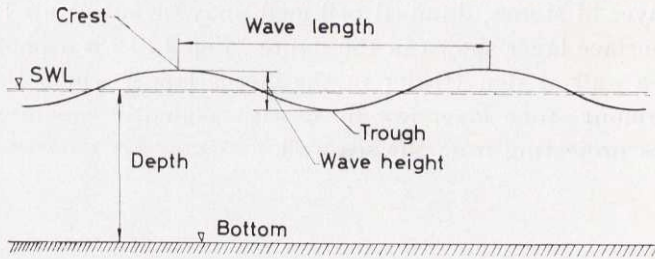


Fig. 21.1. Wave characteristics (the wave profile is distorted)

The *wave length* L is the horizontal distance between two similar points, for instance the crests, of two successive waves, Fig. 21.1.

The *wave height* H is the vertical distance between the highest and lowest points on the wave surface, i. e. between a crest and the preceding trough, Fig. 21.1. In cases where the wave height is not constant, for instance where the wave train is rolling over a moderately inclined bottom, the height is assumed to be the distance between a crest and the preceding trough at a fixed point, i. e. of constant depth of water.

The *wave period* T is the time taken for two successive crests or troughs to pass a fixed point. The period is assumed to be constant, even when a wave train travels into shoaling water.

The *wave velocity* C is the travelling speed of the wave in relation to a fixed point. The velocity can always be expressed by the equation

$$C = \frac{L}{T} \quad (21.1)$$

If, in the following, the subscript $_0$ is added to the wave symbols as in L_0 , it refers to deep-water conditions which occur for $d > L_0$,¹ and if the subscript $_b$ is added, as in L_b , it refers to breaking conditions. Subscript $_s$ refers to surface and $_z$ to a point situated at a distance z below the still-water level.

For the computation of wave characteristics valid to a certain depth of water, see Tables by WIEGEL (1954).

22. Elements of Wave Theory Applied to the Present Investigation

In this treatise the Author has only used such parts of the wave theory as are well known and readily found in the engineering literature on the subject. The following elements of the wave theory are limited to formulae of significance to the present investigation.

AIRY (1845), STOKES (1847), and LAMB (1932) deduced the equation of wave velocity for any depth of water, as distinguished from the basic relation, Eq. (21.1),

$$C = \sqrt{\frac{gL}{2\pi} \tanh \frac{2\pi d}{L}} \quad (22.1)$$

By inserting the value of C according to Eq. (21.1) in Eq. (22.1) we obtain the wave length

$$L = \frac{gT^2}{2\pi} \tanh \frac{2\pi d}{L} \quad (22.2)$$

When the water depth is greater than the wave length, i. e. when deep-water conditions prevail, Eqs. (22.1) and (22.2) are transformed into

$$C_0 = \sqrt{\frac{gL_0}{2\pi}} \quad (22.3)$$

¹ For practical purposes deep-water conditions are considered to prevail for $d > \frac{L_0}{2}$, because the influence of the water depth on the wave characteristics is insignificant and may be ignored, when the water depth decreases from $d = L_0$ to $d = \frac{L_0}{2}$. Shallow water is considered to prevail when $d < \frac{L_0}{2}$.

and

$$L_0 = \frac{gT^2}{2\pi} \quad (22.4)$$

By combining Eqs. (22.2) and (22.4) we obtain the variation of the wave length with the water depth

$$L = L_0 \tanh \frac{2\pi d}{L} \quad (22.5)$$

The wave height also varies with the water depth. Applying RAYLEIGH's considerations of wave energy (1876, 1877) the variation of wave height in shoaling water according to the U. S. NAVY HYDROGRAPHIC OFFICE (1944)¹ can be expressed as follows

$$\frac{H}{H_0} = \sqrt{\frac{2 \cosh^2 \frac{2\pi d}{L}}{\frac{4\pi d}{L} + \sinh \frac{4\pi d}{L}}} \quad (22.6)$$

where the influence of loss of energy due to internal friction, bottom friction, and wave reflection from shore or structures is disregarded.

The particle orbits of an oscillatory wave are affected by the water depth. In deep-water they are circular and in shallow water elliptical, with eccentricities depending on the ratio between the water depth and the wave length. Fig. 22.1 shows the wave profile.

If the wave profile is assumed to be trochoidal according to the theory of GERSTNER (1802), the horizontal displacement $2a_z$ of the water particles for any depth of water below still-water level may be expressed by

$$2a_z = \frac{H \cosh \frac{2\pi}{L} (d' + z')}{\sinh \frac{2\pi d'}{L}} \quad (22.7)$$

¹ Breakers and Surf. Principles in Forecasting. U. S. Navy Hydrographic Office. H. O. No. 234

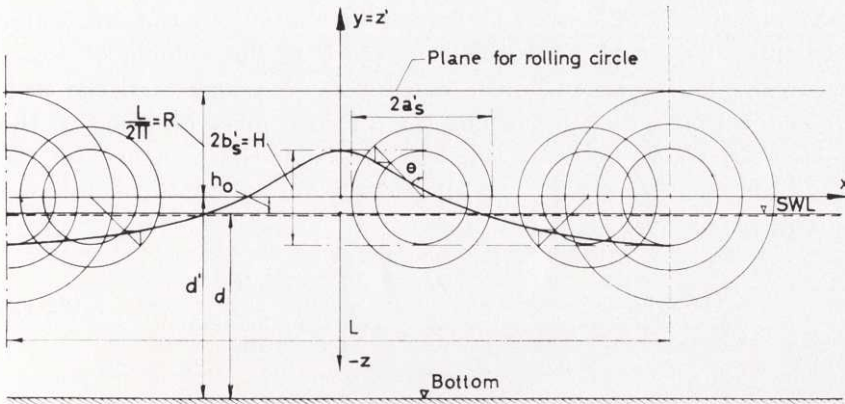


Fig. 22.1. Profile of a trochoidal wave (the wave profile is distorted)

and the corresponding vertical displacement $2b'_z$ by

$$2b'_z = \frac{H \sinh \frac{2\pi}{L} (d' + z')}{\sinh \frac{2\pi d'}{L}} \quad (22.8)$$

where z' is the water depth below the centre of the surface orbits and d' is the water depth measured from the centre of the surface orbits to the bottom.

Thus the surface axes at the level of the centre are

$$2a'_s = \frac{H}{\tanh \frac{2\pi d'}{L}} \quad (22.9)$$

and

$$2b'_s = H \quad (22.10)$$

By integration, the area A of the cross section of a wave, defined as the area between a horizontal line through two successive troughs and the contour line of the wave, will be obtained as follows

$$A = \frac{HL}{2} - \frac{\pi H^2}{4 \tanh \frac{2\pi d'}{L}} \quad (22.11)$$

The positions of crest and trough in relation to the still-water level may be established from the fact that the volume of water between a horizontal plane through the wave troughs and the still-water level on a distance of one wave length must be equal to the volume of water between the level through the troughs and the wave surface. Using Eqs. (22.10) and (22.11) we obtain in relation to still-water level

$$\text{Height of crest} = \frac{H}{2} + \frac{\pi H^2}{4 L \tanh \frac{2 \pi d'}{L}} \quad (22.12)$$

$$\text{Depth of trough} = \frac{H}{2} - \frac{\pi H^2}{4 L \tanh \frac{2 \pi d'}{L}} \quad (22.13)$$

and the lift h_0 of the centre is

$$h_0 = \frac{\pi H^2}{4 L \tanh \frac{2 \pi d'}{L}} \quad (22.14)$$

If the wave height is small compared to the wave length, the trochoidal wave profile approaches a sine curve. Consequently the lift approaches zero and $z' \sim z$ and $d' \sim d$. If the water depth is great, the lift is small in relation to the water depth and one is justified in putting $d' \sim d$. Accordingly the mark ' can be omitted in Eqs. (22.7), (22.8), (22.9), (22.10), (22.11), (22.12), (22.13), and (22.14). This reasoning is confirmed by experiments. WIEGEL and JOHNSON (1951) state: "Experiments (BEACH EROSION BOARD (1941),¹ MORISON (1951), WIEGEL (1950) have shown that the equations for waves of small amplitude continue to be valid, as far as engineering applications are concerned, for waves of appreciable height. It has also been observed that the very long, low ocean swell from distant storms are (*sic*) approximately sinusoidal in deep-water. However, for waves of greater height, theory indicates that certain corrections are necessary."

¹ A study of progressive oscillatory waves in water. Beach Erosion Board. Technical report No. 1

23. Breaking Waves

So far, only oscillatory waves have been discussed. During the movement of the waves towards diminishing depth of water they will pass the breaking point at a certain depth of water, the breaking depth d_b . At this point the waves are transformed into waves of translation. The breaking will occur at the point where the water particles on the same level are just beginning to pass each other in a horizontal direction.

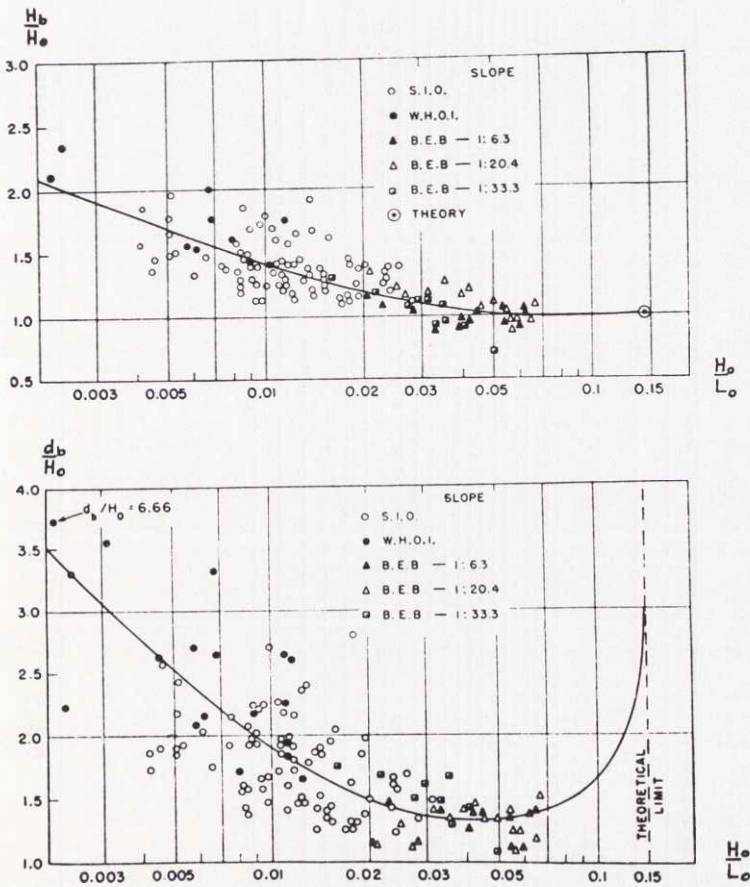


Fig. 23.1. The ratio between breaking height and wave height in deep-water and the ratio between depth of breaking and wave height in deep-water.¹ (STOKER, p. 358)

¹ S. I. O. = Scripps Institution of Oceanography
 W. H. O. I. = Woods Hole Oceanographic Institution
 B. E. B. = Beach Erosion Board

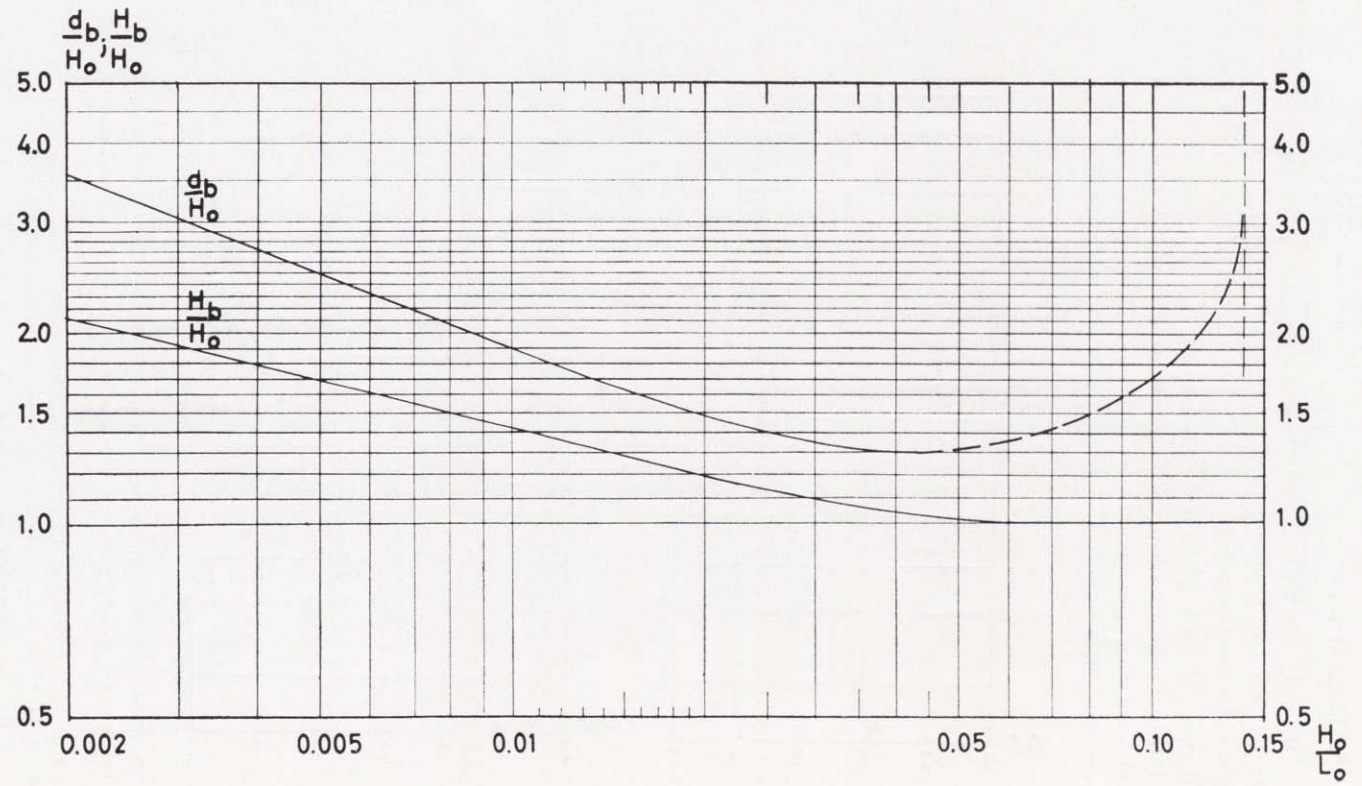


Fig. 23.2. The same curves as in Fig. 23.1, but for use in calculations

The ratio between breaking height and wave height in deep-water and the ratio between depth of breaking and wave height in deep-water as functions of wave steepness in deep-water have been investigated in experiments by several research organisations. The results are reported in the diagram, Fig. 23.1, which is borrowed from STOKER (1957). Refraction effects are ignored.

Theoretically, breakers may also occur in infinitely deep water, when the wave steepness reaches one seventh of the wave length. MICHELL (1893) found theoretically the maximum ratio between wave height and wave length to be 0.142. HAVELOCK (1918) later obtained the maximum value 0.1418. It is unlikely, however, that waves of such steepness exist in nature. The practical maximum value before breaking seems to be about 0.11 (GAILLARD 1904). The theoretical maximum value of the wave steepness is used as a limit for the existence of the curves in the diagrams, Fig. 23.1.

Fig. 23.2 is drawn from Fig. 23.1 for calculations. It is to be observed that, in the calculations below, the ratio $\frac{d_b}{H_0}$ is chosen to the value 1.3 between the minimum of the curve $\frac{d_b}{H_0}$ and the highest value 0.075 of the ratio $\frac{H_0}{L_0}$ in the tests below.

CHAPTER 3

Present Formulae of Stability for the Design of Breakwaters and Sea-Walls with Sloping Sides

31. General

Today there are eleven different types of formulae for calculating the stability of the sloping-faced structure of rock-fill attacked by waves. The formulae give the required weight of individual stones as a function of such variables as slope angle, wave height, specific gravity of stones etc. Below is a summary of the existing formulae, first written in original form and then for comparison transformed in accordance with IRIBARREN's formula of 1938 modified by HUDSON in 1953. The original notation is substituted by that used in this treatise. The IRIBARREN-HUDSON formula is at present (1960) considered the most important one and is used all over the world.

32. Symbols used in the Formulae

For the convenience of the reader some of the symbols in the notation are here repeated. A symbol from the list below is given with the unit applicable to it after transformation and is to be used only for Section 33. The units of the symbols of the original formulae are to be found below in connection with the original form.

d = water depth in metres at the toe of the seaside slope of the structure

z = depth in metres below still-water level

H = wave height in metres at the depth of water d in absence of the structure

L = wave length in metres at the depth of water d in absence of the structure

T = wave period in seconds

v_b = velocity of breaking wave in metres per second

Q = weight in metric tons of individual stones required for stability

k = the required diameter of spherical stones in metres

s_s = specific gravity of stones in metric tons per cubic metre

s_f = unit volume weight of water (fluid) in metric tons per cubic metre

33. Existing Formulae

Original form of formulae and units

Formulae transformed in accordance with IRIBARREN-HUDSON's formula and with units as stated in Section 32

DE CASTRO (1933) and BRIONES

$$Q(\cot\alpha + 1)^2 \sqrt{\cot\alpha - \frac{2}{s_s}} = 704H^3 \frac{s_s}{(s_s - 1)^3} \quad Q = \frac{s_s \cdot 0.704 H^3}{(s_s - 1)^3 \left(\cot\alpha - \frac{2}{s_s}\right)^{\frac{1}{2}} (\cot\alpha + 1)^2} \quad (33.1)$$

where Q is in kilograms

IRIBARREN (1938)

$$Q = \frac{KH_b^3 s_s}{(\cos\alpha - \sin\alpha)^3 (s_s - 1)^3} \quad Q = \frac{s_s KH_b^3}{(s_s - 1)^3 (\cos\alpha - \sin\alpha)^3} \quad (33.2)$$

where Q is in kilograms $K = 15$ for rock-fill $K = 0.015$ for rock-fill $K = 19$ for concrete blocks
dumped pell-mell $K = 0.019$ for concrete blocks
dumped pell-mell

MATHEWS (1948)

$$Q = \frac{6 s_s H^2 T}{(s_s - 64)^3 (\cos\alpha - 0.75 \sin\alpha)^2} \quad Q = \frac{s_s \cdot 0.0150 H^2 T}{(s_s - 1)^3 (\cos\alpha - 0.75 \sin\alpha)^2} \quad (33.3)$$

where H is in feet Q in tons of 2 000 lb. s_s in lb. per cubic foot

EPSTEIN and TYRELL (1949)

$$Q = K \frac{s_s H^3}{(s_s - 1)^3 (\mu - \tan\alpha)^3} \quad \text{Equivalent form} \quad (33.4)$$

where K is a function of α , μ , $\frac{d}{L}$ and s_t

IRIBARREN and NOGALES (1950) supplemented IRIBARREN'S formula above with:

For weights of stones at depths below the water surface, H is replaced by the hypothetical wave height

$$H_z = \frac{\pi H^2}{L_0 \sinh^2 \frac{2\pi z}{L}}$$

whose maximum orbital velocity is the same as that which exists at the depth d . If the depth of water at the toe of the structure is less than $0.06 L_0$

$$\begin{aligned} K &= 23 \text{ for rock-fill} \\ K &= 29 \text{ for concrete blocks} \\ &\quad \text{dumped pell-mell} \end{aligned}$$

$$\begin{aligned} K &= 0.023 \text{ for rock-fill} \\ K &= 0.029 \text{ for concrete blocks} \\ &\quad \text{dumped pell-mell} \end{aligned}$$

RODOLF (1951)

$$Q = \frac{H^2 T s_s}{600 \tan^3 \left(45^\circ - \frac{\alpha}{2} \right) (s_s - 1)^3}$$

$$Q = \frac{s_s \cdot 0.0163 H^2 T}{(s_s - 1)^3 \tan^3 \left(45^\circ - \frac{\alpha}{2} \right)}$$

where H is in feet and
 Q in tons of 2 000 lb.

LARRAS (1952)

$$\sin(45^\circ - \alpha) = \frac{KH s_s^{\frac{1}{3}} \cdot 2\pi \frac{H}{L}}{Q^{\frac{1}{3}} (s_s - 1) \sinh \frac{4\pi z}{L}}$$

$$Q = \frac{s_s KH^3 \left(2\pi \frac{H}{L} \right)^3}{(s_s - 1)^3 (\cos \alpha - \sin \alpha)^3 \sinh^3 \frac{4\pi z}{L}}$$

where $K = 0.175$ for rock-fill
and $1.08 K$ for concrete blocks,
and $z \geq \frac{H}{2}$. Q , derived from
the formula, refers to the level z
below SWL.

$K = 0.0152$ for rock-fill
 $K = 0.0191$ for concrete blocks

IRIBARREN modified by HUDSON (HUDSON and MOORE (1951), HUDSON (1953), HUDSON and JACKSON (1953))

$$Q = \frac{s_s s_j^3 K' \mu^3 H^3}{(s_s - s_j)^3 (\mu \cos \alpha - \sin \alpha)^3} \quad \text{Equivalent form} \quad (33.7)$$

where K' depends on the slope angle α and on the ratio $\frac{d}{L}$ according to BEACH EROSION BOARD (1954, 1957),¹ Fig. 33.1. K' is determined on the basis of undamaged slope.

Average values of K' may be found below (cf. Fig. 33.1):

1:1.25	0.0035
1:1.5	0.0085
1:2	0.0175
1:2.5	0.0285
1:3	0.0365
1:4	0.0325
1:5	0.0300

HEDAR (1953) found that IRIBARREN's formula was only valid for the down-rush of the waves on the slope and proposed a new formula for uprushing waves

$$Q = \frac{s_s K H^3}{(s_s - 1)^3 (\cos \alpha + \sin \alpha)^3} \quad \text{Equivalent form} \quad (33.8)$$

where $\frac{K}{(\cos \alpha + \sin \alpha)^3} = 80 \cdot 10^{-3}$

¹ Shore Protection Planning and Design. Beach Erosion Board. Technical report No. 4. Supplement: Corrections, revisions, and addenda for technical report No. 4

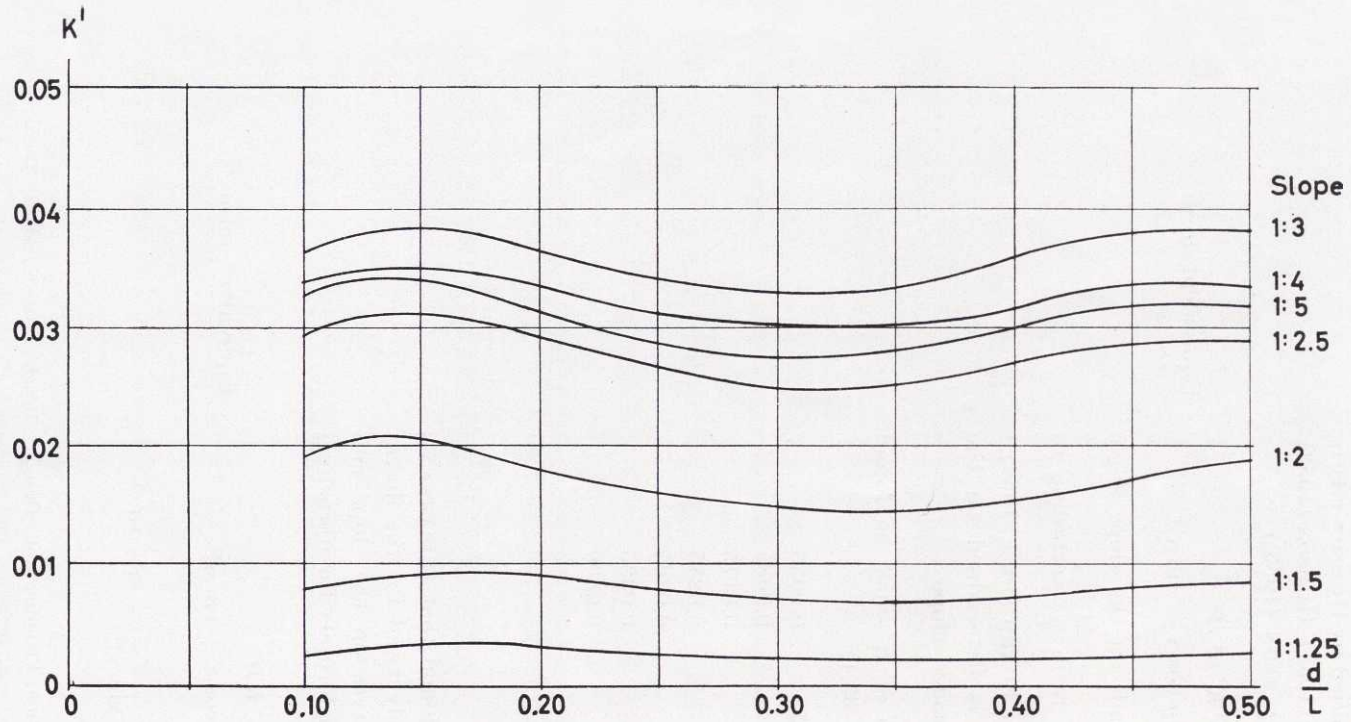


Fig. 33.1. Determination of K' (for rubble-mound structures) in terms of $\frac{d}{L}$ and α .

(Redrawn from Corrections, revisions, and addenda for technical report No. 4, p. D-40)

HENNES and LEONOFF (1953) in a discussion with HUDSON suggested

$$k = \frac{0.00633 v_b^2}{(s_s - 1)(\mu - \tan \alpha)} \quad Q = \frac{s_s K (v_b^2)^3}{(s_s - 1)^3 (\mu - \tan \alpha)^3} \quad (33.9)$$

where k is in feet and
 v_b is in feet per second

BEAUDEVIN (1955) proposed the following empirical formula which has no theoretical basis

$$Q = \frac{s_s}{(s_s - 1)^3} KH^3 \left(\frac{1}{\cot \alpha - 0.8} - 0.15 \right) \quad \text{Equivalent form} \quad (33.10)$$

where $K = 0.25$ for stones
 $K = 0.12$ for cubic blocks

and K includes a factor of safety of 2.5.

Values of K not including any factor of safety and arrived at by the tests:

- $K = 0.10$ for blunt-edged stones
- $K = 0.075$ for coarse, quarry-run stones
- $K = 0.050$ for blunt-edged cubic blocks
- $K = 0.035$ for sharp-edged cubic blocks

As a supplementary condition for oblique waves BEAUDEVIN added

$$Q > \frac{s_s}{(s_s - 1)^3} KH^3 \quad \text{Equivalent form} \quad (33.11)$$

where $K = 0.030$ does not include any factor of safety.

HUDSON (1958, 1959) completed the investigations from 1951 and 1953. In the report from this extensive laboratory work HUDSON has tabulated all the test results, which makes possible their comparison with results from test series conducted in other laboratories.

HUDSON found that the formula

$$Q = \frac{s_s H^3}{3.2 \left(\frac{s_s}{s_j} - 1 \right)^3 \cot \alpha} \quad (33.12)$$

satisfied the requirements of stability with very good accuracy for the no-damage and no-overtopping effect for the downrushing wave phase. However, his theoretical derivation of the formula is not free from objections. And further HUDSON has used a rather high specific gravity of the blocks, (~ 2.80), and as a consequence he does not seem to have observed that the uprushing wave phase may be the most important cause of damage in certain cases. From his report it is not possible to explain certain phenomena of wave attacks against a rock-fill slope.

The formulae give results of considerable variation which have been compared for instance by HICKSON and RODOLF (1951) and BARBE and BEAUDEVIN (1953). The IRIBARREN formulae (IRIBARREN (1938) and IRIBARREN and NOGALES (1950)) have been the object of special interest in many articles, for instance by KAPLAN (1952), who dealt with the stability of underwater slopes of breakwaters, and by VESPER and KAPLAN (1953), who tried to facilitate the application of the formulae from an engineering point of view. IRIBARREN and NOGALES (1953 a, 1954) on their part have discussed the results obtained by EPSTEIN and TYRELL (1949), KAPLAN (1952), LARRAS (1952), HEDAR (1953), and HUDSON and JACKSON (1953). A detailed discussion of all the above references is, however, not necessary for the understanding of the investigations below. In respect of the existing formulae the following may be stated in conclusion:

The formulae are essentially of the same type but differ more or less in details. They can be classified in three categories as follows:

a. IRIBARREN, EPSTEIN and TYRELL, LARRAS, IRIBARREN modified by HUDSON (1953), HENNES and LEONOFF, contend that the required stone weight tends to infinity when the slope angle is approaching the natural slope.

b. DE CASTRO and BRIONES, MATHEWS, RODOLF, BEAUDEVIN, HUDSON (1958) contend that the stone weight tends to finite value when the slope angle is approaching the natural slope.

c. HEDAR (1953) contends that one formula must be used for the uprush and another one for the downrush of the waves, for instance IRIBARREN's formula. This statement has since been confirmed by SUNDBORG (1956, p. 174) in his study of the transport of sand material up and down a slope in the erosion of a river bed.

34. Design Criteria

IRIBARREN (1938) found that the *crest height* of breakwaters and similar structures should be 1.25 times the wave height above still-water level. BEACH EROSION BOARD (1954)¹ recommends that the crest height be set at least 1.5 times the breaking wave height above still-water level if overtopping is to be avoided. Under certain conditions a crest height of only seven-tenths of the breaking wave height may be accepted however. It should also be mentioned that recent model studies indicate that a crest height equal to the breaking wave height may be sufficient. On the basis of his investigations HEDAR (1953) arrived at the conclusion that the crest height must be at least 0.9 to 1.0 times the wave height above still-water level in front of the structure.

HEDAR (1953) and others (e. g. BEAUDEVIN (1955)) found that the armour layer, calculated according to Eqs. (33.7) or (33.8) has to be carried down to a level of about 1.0 to 1.3 times the wave height H below the still-water level.

The *crest width* is arbitrarily determined and usually set equal to about the wave height in front of the structure. Sometimes the crest is only made sufficiently wide for the construction equipment used in placing the stones.

KAPLAN and PAPE Jr. (1951) have recommended the *armour layer* to consist of at least two layers of the calculated stone weight. IRIBARREN and NOGALES (1953 b) prefer three layers.

HUDSON (1958, 1959) made an investigation of wave run-up R , defined as the vertical distance from still-water level to the top of

the uprush. In Fig. 34.1 the ratio $\frac{R}{H}$ is plotted against $\cot \alpha$.

¹ Shore Protection Planning and Design. Beach Erosion Board. Technical report No. 4, pp. 89 and 113

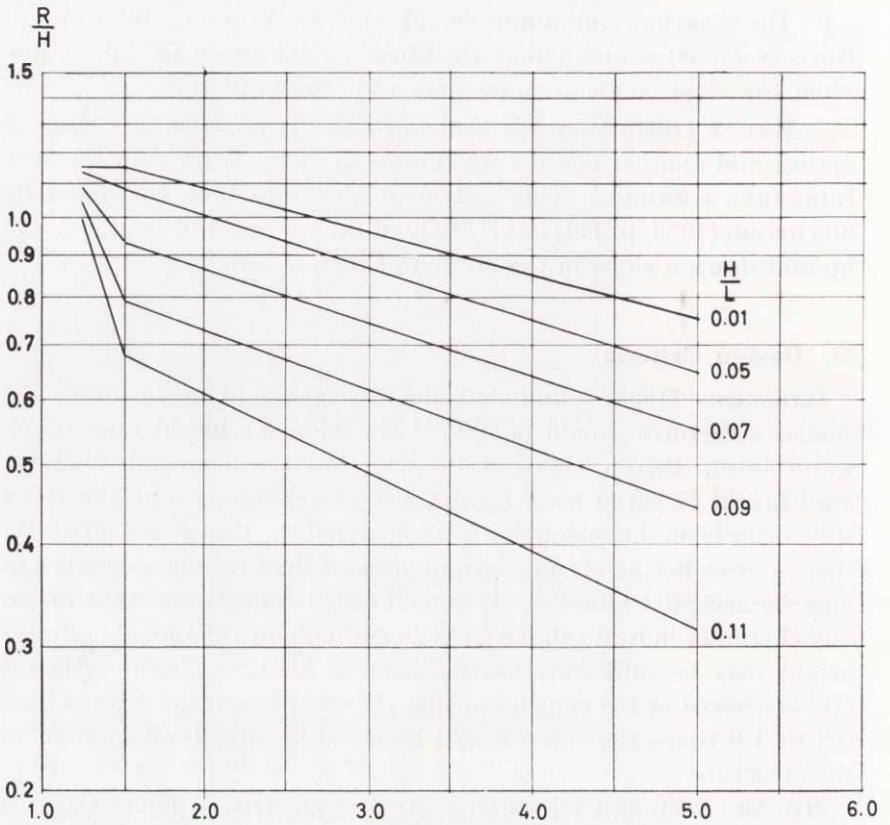


Fig. 34.1. The ratio of run-up to wave height, $\frac{R}{H}$, as a function of $\cot \alpha$ with the wave steepness $\frac{H}{L}$ as parameter. (After HUDSON (1958, 1959))

The Author has also studied this problem in connection with the tests, described below, but his results are not in exact accordance with HUDSON's. No results of these investigations are, however, given in this treatise, the reason being that it has not yet been possible to give a final solution of this problem.

CHAPTER 4

Theoretical Derivation of New Formulae for Designing Slope Stability

41. Acting Forces

411. Gravity Force

The gravity force acting on one individual block is the weight Q in air expressed as follows

$$Q = K_1 s_s k^3 \quad (411.1)$$

where K_1 is a coefficient dependent upon the shape of the blocks and k is a fictive characteristic of the linear dimension of the blocks.

The effective or buoyant weight P similarly expressed is

$$P = K_1 (s_s - s_f) k^3 \quad (411.2)$$

If the blocks are considered as spheres, the coefficient K_1 will have the value of $\frac{\pi}{6}$ and the dimension k will be the diameter.

412. Hydrodynamic Force

Flowing water will exert a hydrodynamic force along a rough bed of grains or stones. The uppermost grains of the bed will be affected by the greater part of this force. There will also be forces of the same type caused by flow around the embedded grains.

If the flow is steady and uniform there is along the surface of the bed a shearing stress τ which may be expressed according to the well-known formula¹

$$\tau = s_f zI \quad (412.1)$$

¹ See for instance KOZENY, J., *Hydraulik*, p. 555

where z is the water depth and I the energy gradient which for steady and uniform flow also is the inclination of the water level. But

$$I = \frac{h_f}{l} \quad (412.2)$$

where h_f represents the loss of energy head over the distance l . h_f may be expressed by the general friction formula

$$h_f = f \frac{l}{4z} \cdot \frac{v^2}{2g} \quad (412.3)$$

where f is the resistance coefficient and v is the mean velocity of water. If PRANDTL's formula¹ for the resistance coefficient for rough flow in pipes at completely developed turbulence is rewritten with the characteristic length of the pipe taken as four times the hydraulic radius instead of the diameter of the pipe, we obtain

$$f = \frac{1}{4 \left(\log_{10} \frac{3.71 \cdot 4z}{k} \right)^2} \quad (412.4)$$

The substitution of the characteristic length in PRANDTL's formula implies a generalization and is treated by CRUMP (1956). Tests at Chalmers University of Technology made by REINIUS 1955–1958 but not yet published showed that this formula is valid also for an open channel.

Combination of Eqs. (412.1), (412.2), (412.3), and (412.4) gives

$$\tau = \frac{s_f}{g} \cdot \frac{v^2}{32 \left(\log_{10} \frac{14.83z}{k} \right)^2} \quad (412.5)$$

In the slope, Fig. 412.1, the shearing force on the area A will thus be

$$\sum_{m=1}^{m=M} P_{1m} \cos \beta_m = A \tau \quad (412.6)$$

from which equation the value of the resultant drag force is obtained. It may be assumed that the hydrodynamic force acting on each individual stone is of the same type as the resultant force but owing

¹ PRANDTL, L., Strömungslehre, p. 156

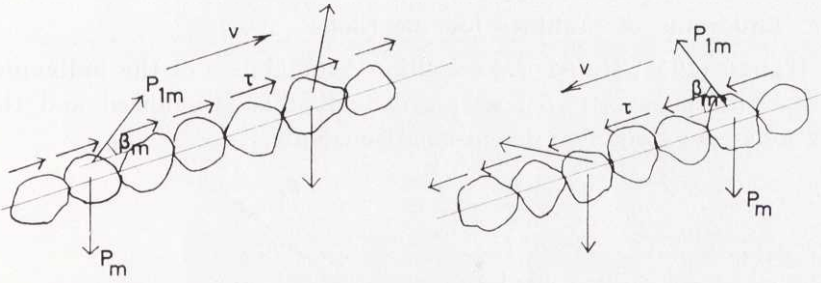


Fig. 412.1. Forces acting on armour layer at uprush and downrush

to turbulence around the stone this force cannot be constant. Its value and direction vary from moment to moment and also from stone to stone. Only a small number of blocks are attacked by a force heavy enough to cause overturning. The upper blocks will be affected by a greater force than the embedded ones. This assumption is also confirmed by the fact that only a few stones move at the same time under the influence of the flow. For a block which is just about to overturn we can therefore in the present case write

$$P_1 \cos \beta = K_2 k^2 \tau \quad (412.7)$$

where the coefficient K_2 depends upon the shape of the block, the degree of packing, the number of blocks per unit area of the first layer and the location of the blocks in the bed. Dependent upon the location of the block and the number of blocks in the topmost layer, a great part of the force expressed by Eq. (412.6) may be concentrated on a few blocks and the value of the coefficient K_2 will therefore be comparatively high.

And thus it follows by combining Eqs. (412.5) and (412.7) that

$$P_1 = \frac{K_2 k^2}{\cos \beta} \cdot \frac{s_f}{g} \cdot \frac{v^2}{32 \left(\log_{10} \frac{14.83 z}{k} \right)^2} \quad (412.8)$$

The waves will, however, in reality cause an unsteady, non-uniform flow over the rock-fill slope. Nevertheless, the formula (412.8) will be applied to the stability problem of the rock-fill slope attacked by waves, the flow being treated as steady and uniform during a short interval of time. Nor has any consideration been paid to the fact that the ratio, the relative roughness $\frac{k}{z}$, is so great that it may be a question of variation of the area of the flow.

42. Equations of Stability for the Slope

HEDAR (1953) stated the condition for stability of the individual stones in the slope. Below, his deduction is generalized and the formulae are given non-dimensional constants.

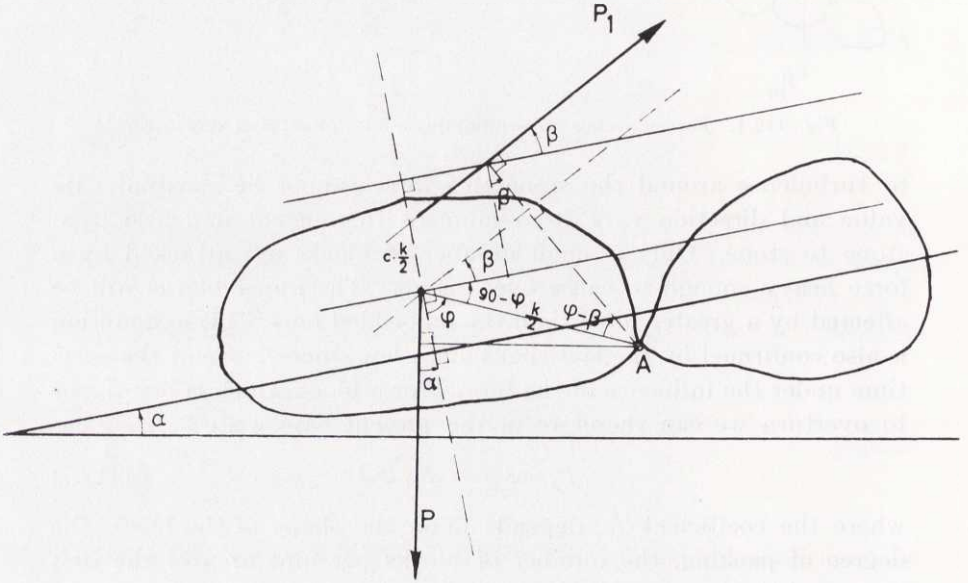


Fig. 42.1. Forces acting on a stone. Uprush

Case I. A wave rushing up the slope.

The distance from centre of gravity to surface of the block is considered to be half of a diameter, symbolized by $\frac{k}{2}$ in Figs. 42.1 and 42.2. The hydrodynamic force P_1 can attack in any direction, but will always be applied inside the contour of the block and at some distance from the centre of gravity, expressed as the distance $c \cdot \frac{k}{2}$, where c is a coefficient. The angle α is the slope from the horizontal and the angle β gives an arbitrary direction of the hydrodynamic force P_1 . The angle φ represents the angle between a perpendicular line through the centre of gravity to the slope, and the line through the centre of gravity and the overturning point A . The angle φ and the diameter k are to be considered as characteristic constants of the rock-fill.

By combining Eqs. (411.2) and (412.8) and the inequality (42.2) the diameter k for the uprushing phase of the waves is readily obtained when the block is just about to overturn

$$k = \frac{s_f}{s_s - s_f} \cdot \frac{K_2}{K_1} \cdot \frac{\frac{v^2}{g}}{32 \left(\log_{10} \frac{14.83 z}{k} \right)^2} \cdot \frac{\left(1 + \tan \varphi \tan \beta + \frac{c}{\cos \varphi} \right)}{(\tan \varphi \cos \alpha + \sin \alpha)} \quad (42.5)$$

Combined with Eq. (411.1)

$$Q = K_1 s_s k^3$$

the required size of stones for slope stability will be obtained.

By combining Eqs. (411.2), (412.8) and the inequality (42.4) k is obtained for the downrushing phase of the waves when overturning is just about to occur

$$k = \frac{s_f}{s_s - s_f} \cdot \frac{K_2}{K_1} \cdot \frac{\frac{v^2}{g}}{32 \left(\log_{10} \frac{14.83 z}{k} \right)^2} \cdot \frac{\left(1 + \tan \varphi \tan \beta + \frac{c}{\cos \varphi} \right)}{(\tan \varphi \cos \alpha - \sin \alpha)} \quad (42.6)$$

And again in combination with Eq. (411.1)

$$Q = K_1 s_s k^3$$

the required size of stones for slope stability will be obtained.

In Eqs. (42.5) and (42.6) the water velocity v and the water depth z ought to be expressed in wave characteristics that are easy to forecast. Further the coefficients are to be determined.

43. Applying the Wave Characteristics to the Formulae of Stability

431. Breaking Waves. Uprushing Phase

When a wave is breaking on a sloping surface, the water particle motion changes from oscillatory to translatory and the whole water mass is moving against the slope with a velocity of

$$v_b = \sqrt{g(d_b + 0.7 H_b)} \quad (431.1)$$

where the height of the breaking wave above still-water level is assumed to be about 70 % of the breaking wave height.

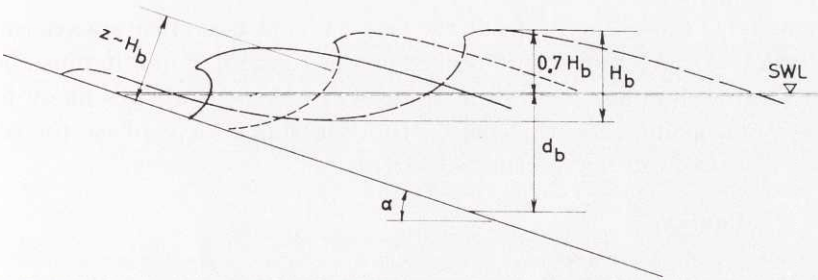


Fig. 431.1. Definition sketch of breaking wave

Immediately after the wave has broken against the slope, the thickness of the uprushing water mass or the water depth z in Eq. (42.5) may be considered to be about equal to or somewhat less than the breaking wave height H_b , Fig. 431.1. The velocity and the thickness naturally decrease continuously when the water mass is rushing up the slope. Eq. (42.5) is thus led to

$$k = \frac{s_f}{s_s - s_f} \cdot \frac{K_2}{K_1} \cdot \frac{(d_b + 0.7 H_b)}{32 \left(\log_{10} \frac{14.83 H_b}{k} \right)^2} \cdot \frac{\left(1 + \tan \varphi \tan \beta + \frac{c}{\cos \varphi} \right)}{(\tan \varphi \cos \alpha + \sin \alpha)} \quad (431.2)$$

It is assumed that the eventual deviation of the thickness z from the breaking wave height H_b is without influence on the diameter k from a practical point of view.

432. Reflected Waves. Uprushing and Downrushing Phase

If the waves do not break on the sloping surface but wave reflection occurs instead, the maximum velocity, v_{\max} , along a stream line, Fig. 432.1, during the motion of the wave may be computed from GAILLARD'S equations for the surface profile of the trochoidal wave (1904), Fig. 22.1,

$$\left. \begin{aligned} y &= b_s \cos \theta \\ x &= R \theta - a_s \sin \theta \end{aligned} \right\} \quad (432.1)$$

As $\frac{t}{T} = \frac{x}{L}$ we obtain for $\theta = 270^\circ$

$$v_{\max} = \left(\frac{dy}{dt} \right)_{\max} = \frac{\pi H_l}{T} \quad (432.2)$$

where H_l is the wave height at the loop. The phases must always run in series. If any movement occurs in the rock-fill slope, it must be downwards, because the downrushing wave phase is always likely to cause movement. For this reason the uprushing wave phase for reflected waves will not be treated further.

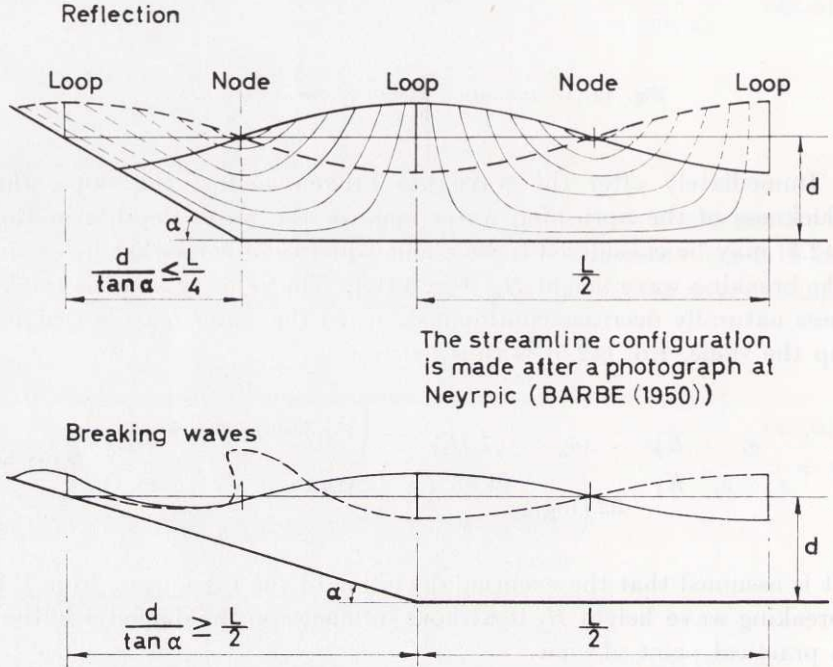


Fig. 432.1. Reflection and breaking of waves

The velocity according to Eq. (432.2) may be transformed in the following way. At reflection we can always write

$$H_l \leq 2H \quad (432.3)$$

and according to Eq. (22.4)

$$T = \sqrt{\frac{2\pi}{g}} L_0$$

and $\frac{H}{L_0} < 0.11$ according to GAILLARD.

Thus

$$v_{\max} < \sqrt{0.2 \pi g H}$$

or

$$v_{\max} = K_3 \sqrt{g H} \quad (432.4)$$

where K_3 is a coefficient dependent on the degree of reflection and the wave characteristics.

The formula of stability, Eq. (42.6) may now be transformed for the case of downrush in the same way as Eq. (42.5) into

$$k = \frac{s_f}{s_s - s_f} \cdot \frac{K_2}{K_1} \cdot \frac{K_3^2 H}{32 \left(\log_{10} \frac{14.83 z}{k} \right)^2} \cdot \frac{\left(1 + \tan \varphi \tan \beta + \frac{c}{\cos \varphi} \right)}{(\tan \varphi \cos \alpha - \sin \alpha)} \quad (432.5)$$

It is impossible theoretically to compute the values of the coefficient K_3 and the thickness z , which depth is perhaps up to a quarter of the wave length for the reflected waves, cf. Fig. 432.1.

433. Breaking Waves. Downrushing Phase

In the case of breaking waves the velocity according to Eq. (432.2) is greater than the velocity of the backwash, which will return along the slope with a velocity equal to that of the free fall. It will form a slide in the water on the slope. In this case the thickness z , no doubt, will be less than the breaking wave height H_b .

The maximum velocity of the backwash may be written

$$v = \text{coefficient} \sqrt{g (d_b + 0.7 H_b)} \quad (433.1)$$

in accordance to Eq. (431.1). The coefficient is always less than unity. However it is also possible to write the velocity in accordance to Eq. (432.4)

$$v = K_3 \sqrt{g H} \quad (433.2)$$

where the coefficient K_3 now involves the position of the water mass and the reduction of velocity dependent upon the friction between the slope and the water mass. The formula of stability will thus be the same as Eq. (432.5).

Writing the velocity in the same way for the downrush of both reflected waves and breaking waves does not mean that the coefficient K_3 is constant. It varies with the degree of reflection and the type of breaking.

434. Comparison of the Velocities

The velocity of the breaking waves, Eq. (431.1), may be written

$$v_b > \sqrt{2gH} \tag{434.1}$$

putting $d_b \sim 1.3 H_b$ or greater and $H_b > H$.

Thus the different velocities along the slope may be summarized as follows.

Breaking waves Downrush	Reflected waves Downrush and uprush	Breaking waves Uprush
coefficient $\sqrt{2gH}$	$K_3 \sqrt{gH}$	$> \sqrt{2gH}$

The model tests will show whether this relation between the velocities is correct.

44. Values of Coefficients in the Formulae of Stability

As has already been mentioned, the value of the coefficient K_1 will be equal to $\frac{\pi}{6}$ (Section 411), if the blocks are considered as spheres.

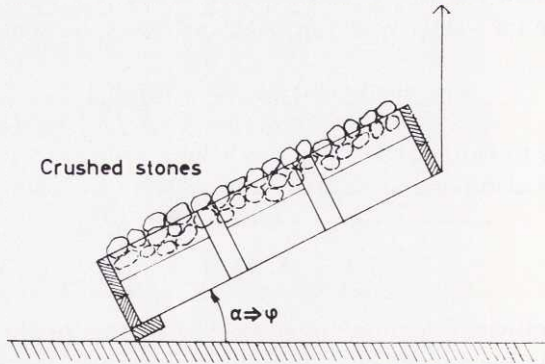


Fig. 44.1. The box, by means of which the angle of stability (natural slope) was determined

For the determination of the angle of stability (natural slope) both in air and in water a tilting wooden box was used, see Fig. 44.1. The inside dimensions were: length 1.15 m, width 0.77 m and depth 0.21 m. During the tests in water a partition wall was inserted and the length was reduced to 0.86 m. The stones were dumped in the box at random for each test and thus different bed-particle geometry was obtained.

By tilting the box as shown in Fig. 44.1 the angle at which the first stones commenced rolling down the slope was ascertained experimentally. This angle occurred when $\alpha = \varphi$ in Fig. 42.2. Twelve tests were made with the box in air and seventeen tests in water. The results are to be found in Tables 44.1 and 44.2.

The separate values of the coefficients K_2 and c , and the angle β in the term $K_2 \left(1 + \tan \varphi \tan \beta + \frac{c}{\cos \varphi} \right)$, in Eqs. (431.2) and (432.5) are difficult to evaluate.

The exact location of the hydrodynamic force P_1 (drag force and lifting force) is unknown and varies for each streamline configuration around the blocks, and the geometry of the bed cannot unambiguously be defined by a function of the characteristic linear dimension k .

Table 44.1. The angle of natural slope

In air		
The first movements in the slope α°	The first stones roll downwards α°	Complete collapse α°
44.7	45.9	49.6
43.8	46.3	48.6
42.5	45.1	53.1
42.5	45.0	48.6
42.7	45.5	48.7
37.8	46.7	50.5
41.5	46.4	46.4
42.7	46.9	51.6
45.3	46.7	50.9
42.6	43.7	49.8
42.3	45.4	47.1
44.6	46.8	50.9

Mean value 42.75 ± 1.23

45.87 ± 0.63

$49.65 \pm 1.21 (95\%)$

$\tan \varphi = 1.03 \pm 0.02$

Table 44.2. The angle of natural slope

In water		
The first movements in the slope α°	The first stones roll downwards α°	Complete collapse α°
—	48.6	53.8
40.1	48.6	53.1
42.1	48.9	52.5
38.9	48.1	53.3
45.2	49.0	51.0
39.0	44.9	51.3
44.9	51.0	52.3
41.8	45.2	50.6
41.7	49.4	53.4
41.4	45.0	50.5
44.1	47.6	54.0
43.0	49.9	53.6
43.9	49.6	55.9
41.6	48.5	50.6
44.1	46.2	52.7
43.1	47.3	51.4
43.8	48.6	50.6

Mean value 42.42 ± 1.12 48.02 ± 0.92 52.39 ± 0.79 (95 %) $\tan \varphi = 1.11 \pm 0.04$

By aid of the model tests the term $K_2 \left(1 + \tan \varphi \tan \beta + \frac{c}{\cos \varphi} \right)$ in Eq. (431.2) will be determined for uprushing breaking waves, and the term

$$\frac{K_2 K_3^2}{\left(\log_{10} \frac{14.83 z}{k} \right)^2} \left(1 + \tan \varphi \tan \beta + \frac{c}{\cos \varphi} \right)$$

for the downrushing reflected and breaking waves.

From Tables 44.1 and 44.2 it is found that the angle of a natural slope is greater in water than in air. The difference 2.15 degrees is significant. The value of $\tan \varphi$ is for the evaluation of the unknown terms, chosen from Table 44.2 as 1.11.

This value 1.11 is in good agreement with the $\tan \varphi$ of the rock being used in the U. S. Waterways Experiment Station tests, for which tests the Station has given an over-all average of about 1.10.

When using the U. S. Waterways Experiment Station test results (HUDSON 1958, 1959), or comparing them with the test results obtained by the Author, the $\tan \varphi$ is considered as 1.11 in water.

Inserting the coefficient $K_1 = \frac{\pi}{6}$ into the formulae of stability, Eqs. (431.2) and (431.5), the following expressions for the necessary stone diameter are obtained

a) Uprush. Breaking wave.

$$k = \frac{s_f}{s_s - s_f} \cdot \frac{K_2}{\frac{16\pi}{3}} \cdot \frac{(d_b + 0.7 H_b)}{\left(\log_{10} \frac{14.83 H_b}{k}\right)^2} \cdot \frac{\left(1 + \tan \varphi \tan \beta + \frac{c}{\cos \varphi}\right)}{(\tan \varphi \cos \alpha + \sin \alpha)} \quad (44.1)$$

where the value of the term $K_2 \left(1 + \tan \varphi \tan \beta + \frac{c}{\cos \varphi}\right)$ in the following is noted as a coefficient K_{up} .

b) Downrush. Reflected and breaking wave.

$$k = \frac{s_f}{s_s - s_f} \cdot \frac{K_2 K_3^2}{\frac{16\pi}{3}} \cdot \frac{H}{\left(\log_{10} \frac{14.83 z}{k}\right)^2} \cdot \frac{\left(1 + \tan \varphi \tan \beta + \frac{c}{\cos \varphi}\right)}{(\tan \varphi \cos \alpha - \sin \alpha)} \quad (44.2)$$

where the value of the term

$$\frac{K_2 K_3^2 \left(1 + \tan \varphi \tan \beta + \frac{c}{\cos \varphi}\right)}{\left(\log_{10} \frac{14.83 z}{k}\right)^2}$$

in the following is noted as K_{down} .

CHAPTER 5

Equipment Used for Laboratory Study, Running and Application

51. General

The equipment used for the model investigation comprised a wave flume, a wave generator, two wave absorbers, a wave filter, some electric point gauges, and model structures. In some of the tests a movable bed was used for the model structures, by which arrangement it was possible to move the models backwards and forwards in the flume and to obtain a certain number of entire half wave lengths between the model structure and the wave-paddle. In other tests the structures were placed on a bed of bricks with a slight slope in front, also made of bricks.

The following characteristics were measured: wave period, wave height, wave length, and the uprush and downrush on the model slope. Movements of stones on the slopes were also studied and the number of moved stones was noted.

52. Wave Flume

In order to study by model tests the course of events when a sloping-faced structure is subjected to wave attacks, a special wave flume was built. The wooden channel was made 26 m long, 0.93 m wide and 0.82 m deep, with the wave generator at one end and the model structure at the other. The channel had to be as long as possible to permit certain measurements to be made before the reflection of the waves from the wave-paddle disturbed the wave motion and so that at least two wave lengths could be perfect between the filter and the structure. The space in the laboratory did not allow the installation of a flume longer than 26 m, and a wave filter was therefore installed to absorb as much as possible of the wave reflection from the paddle and other disturbances. The width and the depth of the flume were

chosen so that the model structures could be made to required sizes. Sheets of glass, through which the water motion in front of the model structures could be studied, were fitted into the front side of the flume. The channel is shown in the schematic drawing, Fig. 52.1, and in the photograph, Fig. 52.2.

In order to minimize the friction between the waves and the walls, the walls of the wave channel were lined with glazed asbestos-cement sheets, a very smooth and hard material. The channel could therefore be regarded as infinitely wide.

In order to ensure that the hydraulic roughness of the channel corresponded to the theoretical relation of the wave period and the wave length, Eq. (22.2), preliminary tests were made with periods and wave steepnesses within the range that could be produced in the flume. A water depth of 0.55 m was chosen. It was found that the observed wave lengths were in good agreement with the theoretical ones and that the measured wave length never deviated more than $\pm 2.0\%$ from the theoretically calculated length. The test showed, however, that the wave length tended to increase with greater wave height.

When the water depth was decreased, the influence of the roughness of the channel increased. At a water depth of 0.30 m the wave length varied at the period 2.20 sec. with the wave height, as may be seen in Table 52.1. The wave length only corresponded to the period at certain values of the wave heights, and the variation of wave length was so great that the accuracy of the tests with the breakwaters is jeopardized, if too little depth of water is used.

Table 52.1. Variation of wave length at small depth of water

T	$L_0 = \frac{g T^2}{2\pi}$	d	$\frac{d}{L_0}$	$\frac{d}{L}$	$\frac{H}{L}$	$L_{\text{calculated}}$	L_{observed}
2.20	7.56	0.30	0.040	0.083	0.042	3.61	3.72
2.20	7.56	0.30	0.040	0.083	0.034	3.61	3.61
2.20	7.56	0.30	0.040	0.083	0.020	3.61	3.47

The conclusion to be drawn from these tests was that the wave length could be theoretically calculated from Eqs. (22.2) and (22.5), if a sufficient water depth was chosen, and under these circumstances it would only be necessary to observe the period and sometimes to check the wave length during the tests.

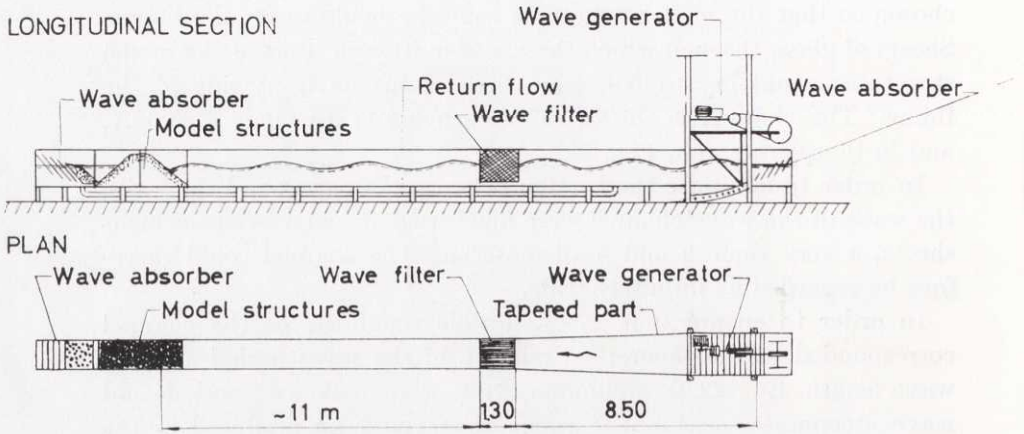


Fig. 52.1. Schematic drawing of the channel

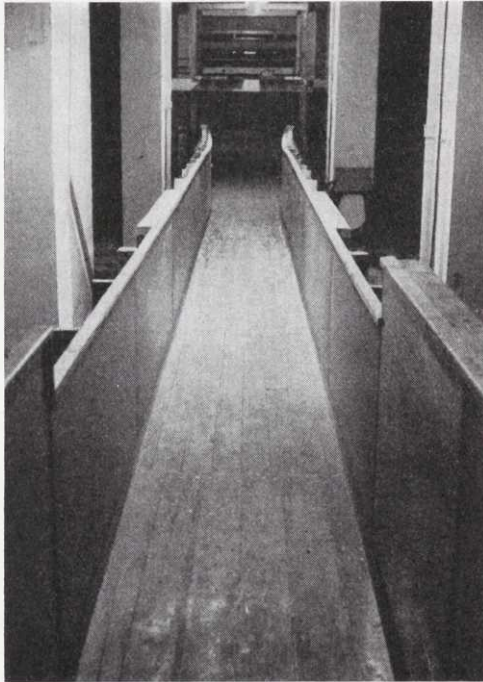


Fig. 52.2. The wave channel

In order to increase the wave height in the flume, the part of the flume in the vicinity of the wave generator blade was made wider than the rest of the flume or 1.43 m, see Fig. 52.1. Over a distance of 6.50 m the flume tapered to the above-mentioned 0.93 m between the wave apparatus and the filter. This made it possible to produce higher waves without making the wave machine much bigger and consequently more expensive.

During the performance of the third series of tests, cf. Chapter 6, Section 61 below, it was found advisable to install a return-flow pipe with the diameter 0.30 m. The pipe debouched beyond the model structures and in front of the wave filter. In this way the water which penetrated through the breakwater under the pressure of the uprush of the waves and which caused a higher water level beyond the breakwater without relation to reality, could return to the front of the wave filter. Prototype conditions were thus simulated with greater fidelity.

53. Wave Generator

If the wave flume is of sufficient length to enable the waves to move over a distance which would allow them to constitute a faithful reproduction of the prototype wave profile and its characteristics, any kind of wave generator might be used. Considering that the length of the wave flume in this case was limited, it was important to ensure also by other means that the waves created by the wave generator assumed as soon as possible a true relationship to the prototype. One of the aids in this matter was to ensure the real particle amplitudes from the beginning of the wave reproduction at the wave-blade.

Among existing types of wave generators the one designed by RANSFORD (1949) and modified by COYER (1953) was found to be suitable, as it fulfilled the above-mentioned condition. Thus an enlarged COYER wave generator, as shown in Figs. 53.1 and 53.2, was fitted to the flume. Fig. 53.3 illustrates the variation of the amplitudes of the wave-blade.

The RANSFORD-COYER arrangement permitted the running of the generator without any connection with the wave flume, thus avoiding the transmission of vibration from the machinery to the structures to be studied. In order to obtain a uniform performance of the wave apparatus, fly-wheels were installed on the shaft between the variator

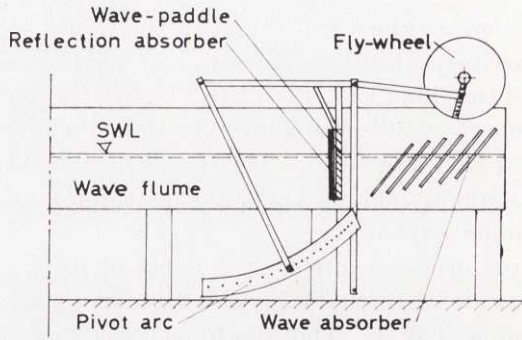


Fig. 53.1. The wave generator arrangement

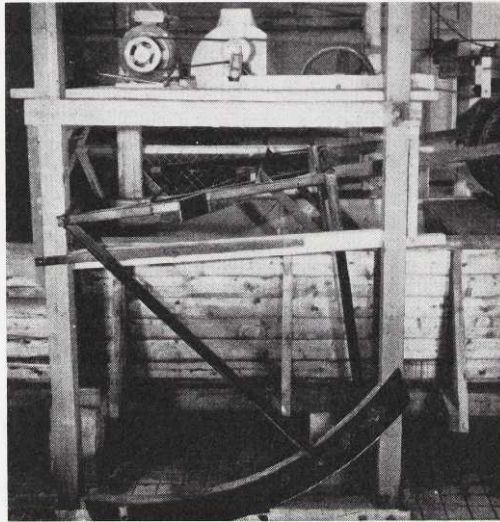


Fig. 53.2. The wave generator mechanism

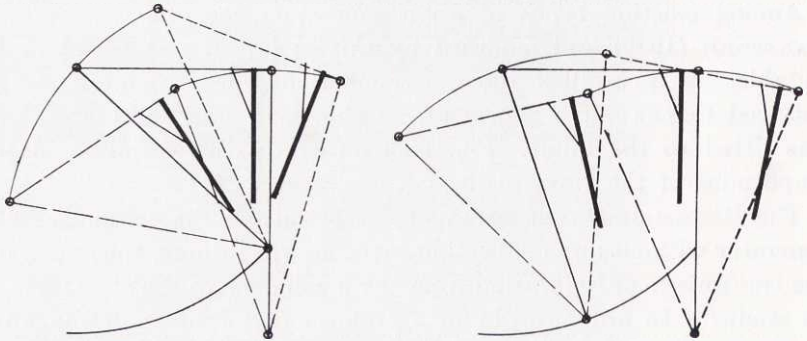


Fig. 53.3. Variation of the amplitudes of the wave-blade. To the left deep-water condition and to the right shallow water condition

and the paddle. At regular distances from the shaft, holes were bored in the fly-wheels for the connecting bolts of the arms connected with the wave-blade. The deviation of the arms on the fly-wheels fixed the amplitudes of the wave-blade and thus the wave height. By placing the bolts supporting the arms at a greater distance from the centre of the fly-wheels the wave height was increased. As is explained below, the ratio between the amplitudes of the wave-blade at the water surface and at the flume bottom remained constant for all holes in the fly-wheels, if the two bolts in the pivot arcs were kept in the same position.

The period (wave length) was infinitely variable by the aid of a speed variator installed between the electric motor and the shaft of the fly-wheels. Any period must effect a correct wave length according to the depth of water in the flume.

The ratio between the amplitude of the wave-blade at the water surface and at the flume bottom could be varied from infinity, i. e. deep-water conditions, to unity by moving the bolts on the pivot arc into different positions, Fig. 53.3. The distance of the movement of the wave-blade at the water surface and the flume bottom must correspond to the amplitude diagram by O'BRIEN and MASON (1942), Fig. 53.4. Since the wave-blade is plane the simplification is made that the curves in Fig. 53.4 are assumed to be straight lines between the still-water level and the bottom.

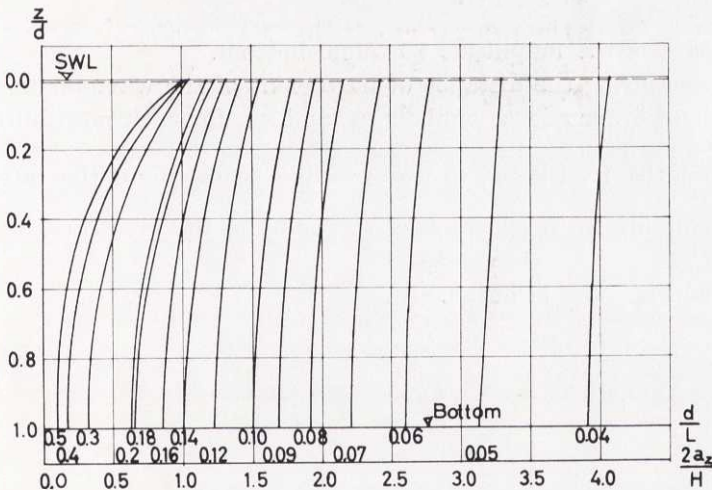


Fig. 53.4. Horizontal amplitude of oscillation for proportional depth. (After O'BRIEN and MASON, p. 11)

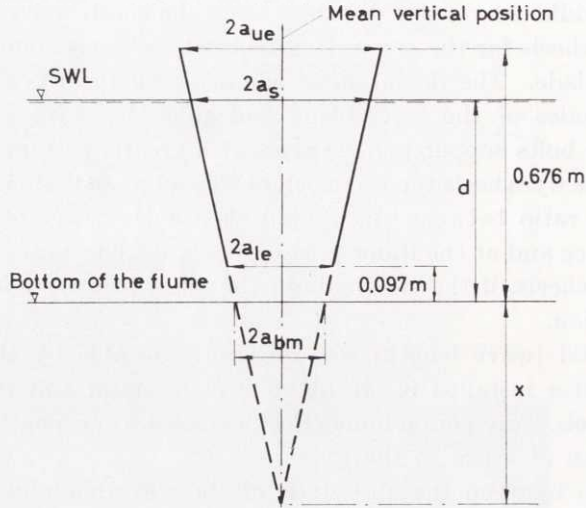


Fig. 53.5. Detail of the movement of the wave-blade with symbols

From Eq. (22.7) the ratio of horizontal amplitudes at water surface and flume bottom is calculated as follows

$$\frac{a_s}{a_{bm}} = \cosh \frac{2\pi d}{L} \quad (53.1)$$

where a_{bm} is the amplitude at flume bottom.

By measuring the distance of movement of the wave-blade at the upper and lower edges, symbols a_{ue} and a_{le} , for each position of the bolts on the fly-wheels, it was possible to calculate the ratio $\frac{a_s}{a_{bm}}$ corresponding to the position of the bolts on the pivot arc.

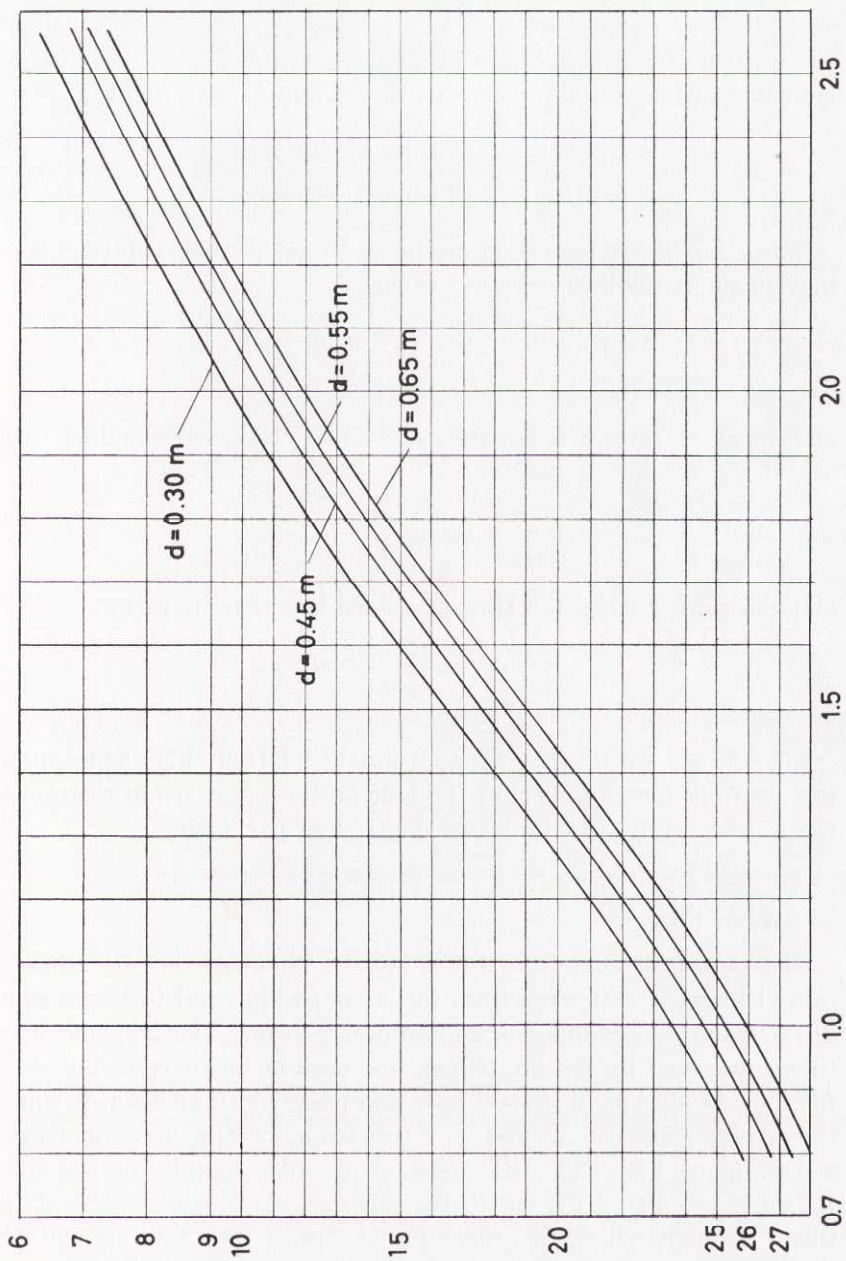
From Fig. 53.5 is obtained

$$\frac{a_s}{a_{bm}} = 1 + \frac{d}{x} \quad (53.2)$$

and

$$\frac{a_{le}}{a_{ue}} = \frac{x + 0.097}{x + 0.676} \quad (53.3)$$

Hole number of
the pivot arc



T s

Fig. 53.6. Calibration curves of the wave generator

from which x may be calculated

$$x = \frac{0.676 a_{le} - 0.097 a_{ue}}{a_{ue} - a_{le}} \quad (53.4)$$

By substituting the value of x in Eq. (53.2) the ratio will be

$$\frac{a_s}{a_{bm}} = 1 + \frac{d (a_{ue} - a_{le})}{0.676 a_{le} - 0.097 a_{ue}} \quad (53.5)$$

Since the wave period is assumed to be constant during wave movement in shallow water we can write

$$\frac{d}{L_0} = \frac{2 \pi d}{gT^2}$$

and for every ratio it is possible to calculate the corresponding value of

$$\cosh \frac{2 \pi d}{L}$$

and according to Eq. (53.1), every wave type has its ratio

$$\frac{a_s}{a_{bm}} = \cosh \frac{2 \pi d}{L}$$

Therefore a calibration curve could be plotted, Fig. 53.6, giving the position (hole number) of the bolt on the pivot arc in relation to the wave period with the water depth d as parameter.

54. Wave Filter

The object of the wave filter was to diminish the disturbances caused by wave reflection from the wave-paddle, and to lessen small disturbances, superimposed on the wave form. The Neyrpic wave filter, described by BIÉSEL (1948), was used as prototype. The wave filter made of expanded steel lath was placed 8.50 m downstream of the average vertical position of the blade of the wave generator according to Fig. 53.3. Fig. 54.1 shows photographs of the filter before it was fitted for use in the channel. The total length of the filter, through which the wave had to pass, was 1.30 m, and the distance between each pair of net-work plates was about 0.02 m.

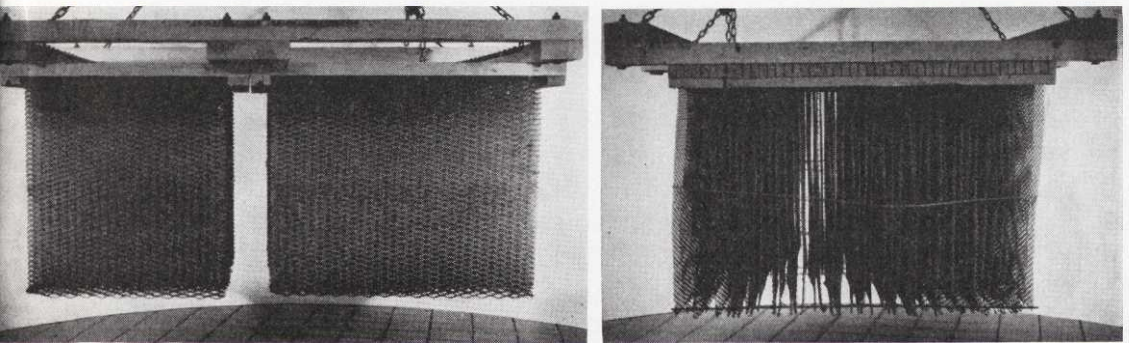


Fig. 54.1. The wave filter. Side and end view

Table 54.1. Influence of the filter on wave heights

T	H_F	H	r
1.16	23.5	14.3	0.61
1.16	19.7	12.2	0.62
1.16	15.7	10.1	0.64
1.16	11.7	8.0	0.68
1.16	7.7	5.8	0.75
1.47	21.5	14.2	0.66
1.47	17.0	11.6	0.68
1.47	13.0	9.0	0.69
1.47	9.1	6.4	0.70
1.47	5.2	3.8	0.73
1.85	23.7	17.7	0.75
1.85	20.8	15.5	0.75
1.85	17.9	13.2	0.74
1.85	14.9	11.0	0.74
1.85	12.0	8.8	0.73
1.85	9.0	6.6	0.73
1.85	6.0	4.3	0.72
2.30	27.0	19.3	0.71
2.30	24.0	16.7	0.70
2.30	19.8	14.2	0.72
2.30	15.8	11.6	0.73
2.30	11.8	9.1	0.77
2.30	7.8	6.6	0.85

A serious disadvantage in using the filter was that, owing to its reducing influence on the wave heights, it was impossible to create waves of the very highest steepness in the flume. In this case a reduction of the wave height of about 20 to 40 % occurred, as shown in Table 54.1. Wave heights, H_F and H , were measured upstream and downstream of the filter with the wave absorbers in each end of the flume functioning most efficiently.

Reflection from the paddle was minimized by covering the blade with a 0.10 m thick layer of sheets of expanded steel lath, Fig. 53.1.

55. Wave Absorber

At the ends of the wave channel wave absorbers were installed, one behind the model structures and the other one of a simplified type behind the wave apparatus. The wave absorber has been described by HEDAR (1956). The purpose of the wave absorbers was to dissipate the wave energy behind the wave-blade in the shortest possible distance without disturbing effects and to stop reflection from the vertical wall at the structure end of the flume. The wave absorber at this end was functioning during the period of trimming the equipment and during the preliminary tests when the waves produced by the wave generator were studied in comparison to their theoretical prototype. Later during the performance of the main tests, this absorber was taken away.

In principle the wave absorber consisted of a number of sloping plates, the top edges of which were above the still-water level, a slight broken slope of macadam below still-water level and an open space with a variable opening between the bottom of the flume and the macadam fill, Fig. 55.1. The macadam fill and the gate were omitted in the simplified absorber behind the wave machine.

The wave absorber acts in the following way. The incoming waves

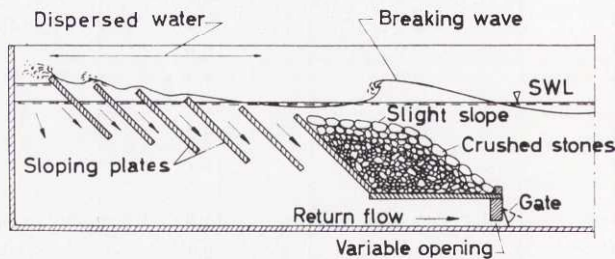


Fig. 55.1. Cross section of wave absorber at the end of the flume

are made to break on the slightly sloping stone bed as a result of which the masses of water in the waves move in the direction of the vertical wall at the end of the flume. All waves are then broken up against the top edges of the sloping plates, the masses of water are dispersed and return between the plates under the macadam fill and finally out through the gate into the flume. The returning water reaches the flume without seriously disturbing the incoming waves. The circular or elliptical particle orbits of the waves are, however, influenced by the escaping water for a distance of about one wave length in front of the wave absorber.

The space between the plates was chosen at about half of the maximum wave height — 0.20 m — which could be produced in the flume, when practically no reflection occurred at the wave-paddle. The distance between the three rear plates was somewhat less. The top edge of the front plate was placed a quarter of the maximum wave height below still-water level, and the top edge of the back plate half the maximum wave height above still-water level. The heights of the top edges of intermediate plates were evenly spaced between the first and the last plates. The height of the space under the stone slope was chosen to restrict the return flow of water in such a way that the height of the water between and behind the plates was constantly above the still-water level.

The gate at the front edge of the opening prevented the water from flowing “backwards” in the wave absorber when the crests of the advancing waves passed over the front of the stone slope. When the wave crest passed, the gate opening was smallest, and when the trough passed, the opening was largest. For the different wave heights, the stone slope was placed at the depth which caused the waves to break completely.

The wave absorber was tested for wave heights varying from 0.04 m to 0.20 m with periods of 1.15 to 2.35 seconds with no other adjustment than the lifting or lowering of the slight macadam slope. When the testing flume was equipped with this wave absorber and the wave filter described in Section 54, the reflected wave height in the flume was small and did not attain more than 2.5 % for the shortest and 7.5 % for the longest waves of the incoming wave height.

When the wave generator was stopped, the waves in the flume rapidly subsided. After the last wave had reached the wave absorber, only a slight swell with a maximum height of 0.03 m remained. A few minutes later the water in the flume was quite still.

56. Point Gauges and Wires for Measuring Water Levels

Wave heights, wave lengths, the positions of uprush and downrush on the slopes, and the elevation of the still-water level were measured by means of electrical point gauges arranged according to the descriptions by DALVERNY (1948) and RANSFORD (1951 a). A common laboratory point gauge was equipped with an insulated point, which was connected to a circuit, Fig. 56.1.

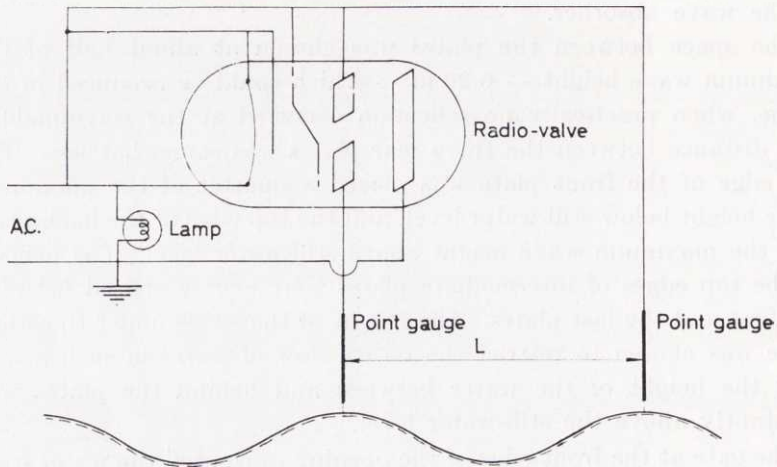


Fig. 56.1. Circuit diagram (the wave profile is distorted)

Besides the points and the radio-valve, the circuit consisted of a neon lamp bulb and a magic eye. The circuit was connected to an A. C. power supply and earthed. As soon as the water touched the point, one of the sectors of the magic eye lit up and the lamp signalled with its coloured light that the electricity was passing through the circuit. The level of the water surface could then be read off on the scale of the point gauge. The apparatus is shown in Fig. 56.2.

During the supplementary tests, cf. Chapter 6, Section 61, the point gauges were exchanged for two parallel, partially submerged, wires by means of which changes of the water level were measured. The variation of the electrical conductivity between the wires was by means of a wave height meter designed on the principle of Wheatstone's bridge, registered by a recorder, where a pen wrote the wave form on a graph-paper. The deflection was linear and proportional to

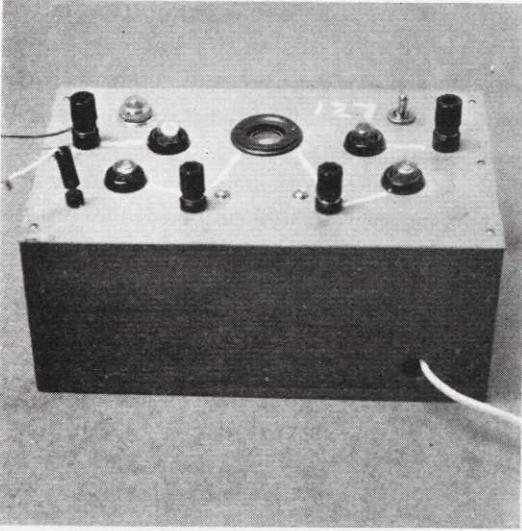


Fig. 56.2. The flashing apparatus

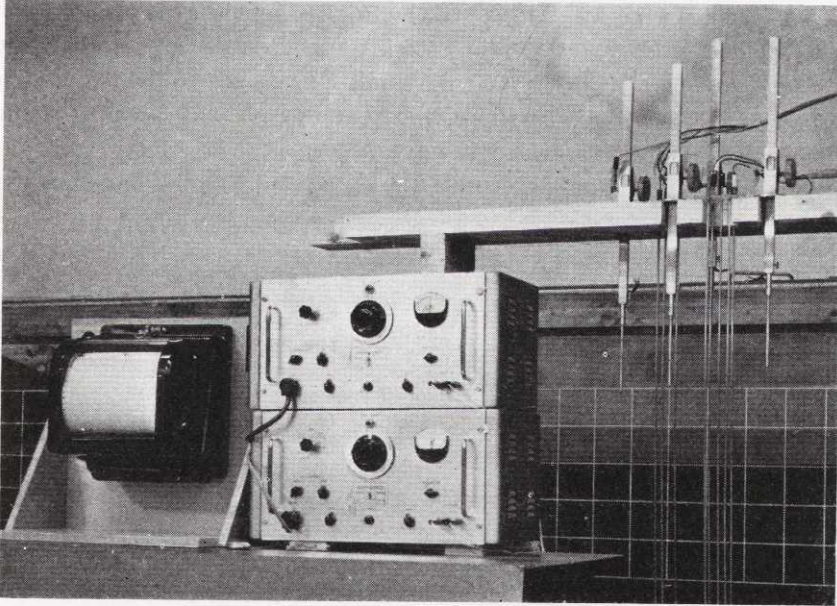


Fig. 56.3. Two wave height meters. To the right the wires and to the left a twin-channel recorder

the wave height. In order to avoid calibration two wires with the points at a known vertical distance from each other were placed along with the registering wires and connected up to the wave height meter. In this way the rising wave surface successively touched the points and caused two sharp marks on the diagram on the graph-paper. The vertical distance was measured and the scale of the wave reproduced on the paper was determined. The wave height meter, Boersma resistance type, is shown in Fig. 56.3.

57. Model Structures

Models of three types of breakwaters and sea-walls were built in such a way that reality was imitated. Thus the different grades of stones were dumped respectively placed without any additional work to increase the stability of armour layers or quarry-run.

The first type was a model of a complete breakwater with a core of quarry-run composed of small crushed stones and sand, and two or three layers of armour stone on the slope surfaces, Fig. 57.1. The object of investigating this type of structure was mainly to study the stability of the slope at uprush and downrush.

The second type was similar to the first, except that a plastic cloth was placed under the armour stone layer to prevent percolation through the core, thus simulating conditions in sea-walls. This type was used for the study of the stability at uprush and downrush, and to obtain some information on wave reflection, Fig. 57.1.

These two types of structures were placed on a wooden platform

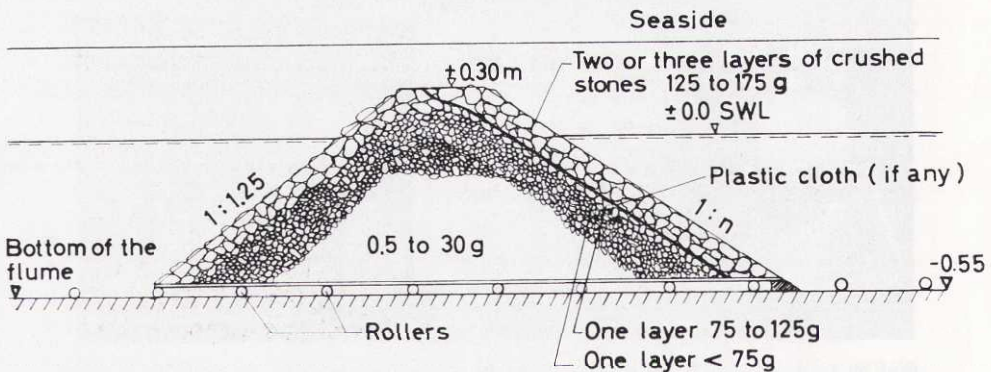


Fig. 57.1. The model structure

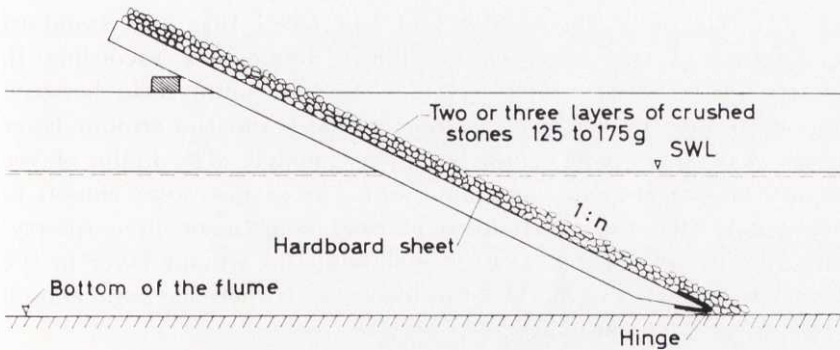


Fig. 57.2. The armour layer on hardboard

on rollers, which made it possible to move the model structures so as to obtain by trials a certain number of entire half wave lengths between the wave-blade and the slope of the structure. Thus any wave period could be used. If half wave lengths were not applied in this way, disturbances of the wave motion would occur due to wave reflection and the uprush and downrush on the slope would not have been completely developed. At times it was necessary to make a small adjustment of the calculated position of the structure in order to obtain maximum uprush and downrush.

The third type was a model structure built on an inner bottom in the flume to obtain moderate slopes in front of the breakwater. The inner bottom was made of bricks and under the first layer of bricks was a plastic sheet to prevent seepage. This type was not movable in the flume and owing to reflection from the structure only periods giving a certain number of half wave lengths could be used.

For some preliminary and some supplementary tests a platform covered with hardboard was used. Three layers of macadam were placed on the hardboard. The sheet was hinged at the bottom of the flume, which made it possible to vary the inclination without any reconstruction of the slope, provided that the waves did not cause any damage, Fig. 57.2. No results from the above preliminary tests are reported in this treatise.

The specific gravity was calculated for a number of stones ground to a very fine fraction according to the pycnometer method. The mean value of the specific gravity was 2.665. The maximum value was 2.673 and minimum 2.661. The stones consisted of gneiss.

In all the tests the armour layer consisted of crushed stones weigh-

ing 125–175 grams. The mean weight was (149 ± 16) grams (standard deviation) and the corresponding linear diameter k according to Eq. (411.1) is (0.0475 ± 0.0017) m. The maximum ratio between the length and the width of a stone was 3:1 and the armour layer consisted of about 850 stones per square meter. The limits of the weights of the stones, 125 grams and 175 grams, were chosen to correspond with the possibilities of easy assortment in a quarry. When the model scale of 1:40 was chosen, the armour layer in the prototype consisted of 8–11.2 ton blocks and when the scale chosen was 1:20, 1–1.4 ton blocks.

58. Method of Measuring

The wave period was determined by counting the number of oscillations of the wave-blade during approximately one minute. For this a stop-watch was used which could be read off with an accuracy of ± 0.2 sec. The maximum period used during the tests was 2.35 sec. The electric motor driving the wave generator was of sufficient power to ensure constant periods. On no occasion, therefore, did the error in the determination of the wave period amount to more than 0.008 sec.

In Section 52 it was stated that the measured wave lengths agreed with the theoretical ones within a margin of $\pm 2\%$. Generally the wave lengths were calculated on the basis of the period the error of which was of no consequence for the calculation of the wave length. The wave lengths were checked by point gauges. The principle for this control, described by DALVERNY (1948) and RANSFORD (1951 b), was to let two point gauges come into contact with two consecutive wave crests and to arrange the distance between the points so that the lamps, or the sectors of the magic eye connected to the respective points, flashed at exactly the same time. The distance between the

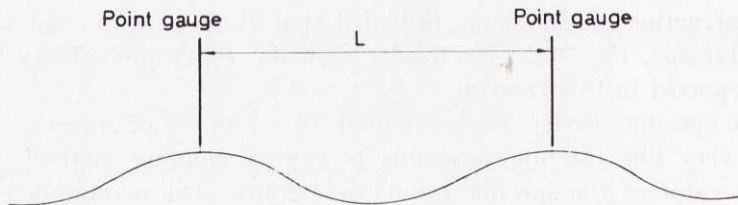


Fig. 58.1. The positions of the two point gauges for determination of the wave length (the wave profile is distorted)

points, equal to one wave length, was then measured by the aid of a millimetre scale along the flume. The procedure is illustrated in Fig. 58.1.

It was obviously easier to locate the crests of the higher waves, and the measuring of their wave lengths therefore also gave an indication of the wave lengths for smaller waves of the same period. No noteworthy variation was observed for the wave types of the same period, as long as the depth of water in the flume was sufficient (cf. Section 52).

The checking of the wave lengths was effected at a point somewhat downstream of the filter where the depth of the flume was constant. As a rule only one wave length was retained between the points.

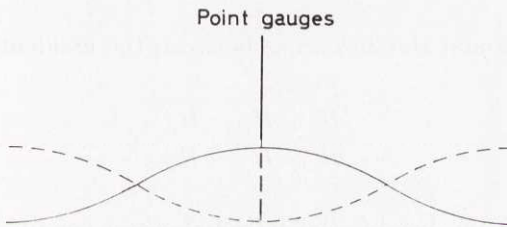


Fig. 58.2. The arrangement of the two point gauges for measuring wave heights (the wave profile is distorted)

To measure wave heights the two point gauges were placed as shown in Fig. 58.2. One point was placed so as to make contact with the wave crest, the other one so as to lose contact with the wave trough. Some variations in the waves were observed; in the crests about 0.01 m and in the troughs about 0.005 m. The point gauges were therefore adjusted so that, during a certain period of time, the same number of contacts and disconnections occurred, by which it was ensured that a median value of water level was obtained in each case.

According to RANSFORD (1951 a) the maximum error of a single reading of such a point gauge is ± 0.0002 m, provided that the water level is at rest. In this case, however, the total error was no doubt much greater, and the error of reading may be disregarded. It can, on the other hand, be stated that the difference between the two water levels was measured with good accuracy, but that the deviation is in every case within ± 0.0075 m.

Since it was impossible to eliminate all reflection from the wave-blade, it was also impossible to determine the original wave height, without influence of the reflection from the structure, by the mere calibration of all positions of the wave machine. Instead, a method commonly used in France was adopted; see, for instance, LAURENT and DEVIMEUX (1951). The loops and the nodes were located by the point gauges or the wires connected to the wave height meters along the flume between the filter and the structure. The heights of the water levels in those positions, H_l and H_n , were measured.

The ratio of the reflected and incident waves is

$$r = \frac{H_r}{H} \quad (58.1)$$

and the sum of and the difference between the incident and reflected waves are

$$\begin{aligned} H + H_r &= H_l \\ H - H_r &= H_n \end{aligned} \quad (58.2)$$

The incident wave height, the reflected wave height, and the ratio between the reflected and incident wave heights may then be calculated as follows

$$H = \frac{H_l + H_n}{2} \quad (58.3)$$

$$H_r = \frac{H_l - H_n}{2} \quad (58.4)$$

$$r = \frac{H_l - H_n}{H_l + H_n} \quad (58.5)$$

When the depth of water is constant in the wave flume it may be assumed that a wave train retains its wave length after reflection. But if the bottom in front of the structure slopes, could it then be assumed that loops and nodes will be located a quarter of a wave length apart, when reflection has occurred? And is Eq. (22.5) valid for the reflected wave moving towards greater depth of water? In order to study these questions tests were made in the flume with a barrier located in the middle, Fig. 58.3.

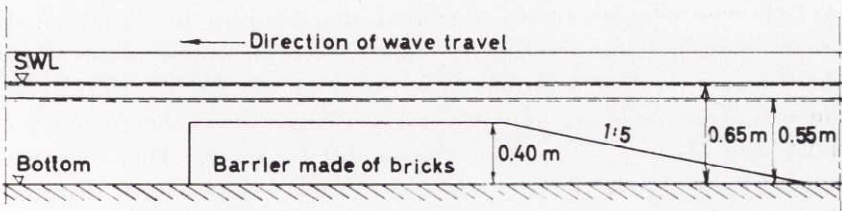


Fig. 58.3. The barrier in the wave flume

During these tests the wave absorber at the end of the flume was in operation. The wave length was measured above the shallow water of the barrier and after passage of the barrier at various periods and at two different depths of water in the flume. From the test results shown in Table 58.1, it may be concluded that the wave length varies according to Eq. (22.5) irrespective of decreasing or increasing depth of water. Standing waves will occur even if the bottom in front of the structure is sloping.

Table 58.1. Wave length in front of, above and behind the barrier

Period T	Depth of water d	Wave length in front of the barrier $L_{\text{calculated}}$	Wave length above the barrier		Wave length behind the barrier L_{measured}
			L_{measured}	$L_{\text{calculated}}$	
1.48	0.65	3.00	2.11	2.14	2.98
1.09	0.65	1.82	1.46	1.47	1.84
0.92	0.65	1.32	1.20	1.16	1.31
1.51	0.55	2.94	1.67	1.75	Disturbed by breakers and reflection
1.09	0.55	1.78	1.33	1.21	1.79
0.925	0.55	1.32	1.07	0.99	1.31

59. Control of the Wave Profile

During the preliminary tests some of the waves were photographed through the glass wall of the flume. The profile was somewhat disturbed by the wave absorber, but agreed fairly well with the reduced trochoidal surface, plotted according to GAILLARD'S Eqs.

(432.1). The comparison is shown in the diagram in Fig. 59.1. It should, however, be pointed out that for various reasons the agreement was not always satisfactory (see the last photograph). Thus the wave generator could not work perfectly when the period was short and the wave height correspondingly great. This fact was observed during the main tests and the wave types were therefore chosen with great care.

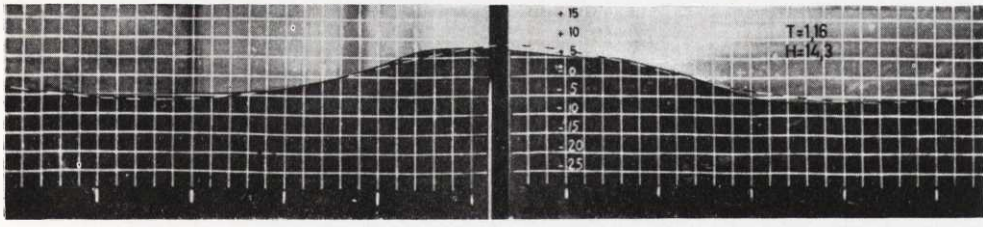
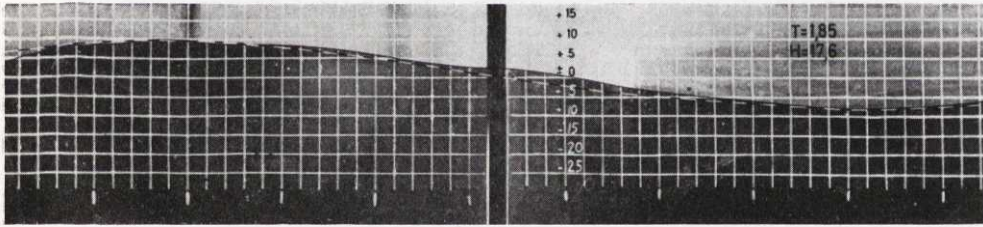
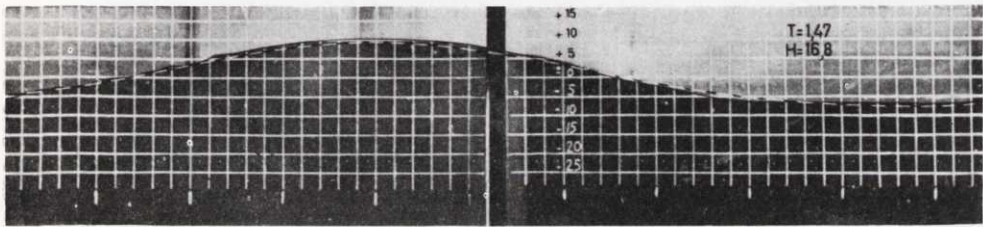
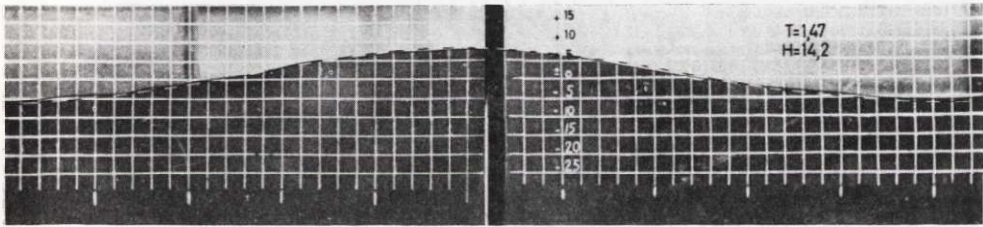
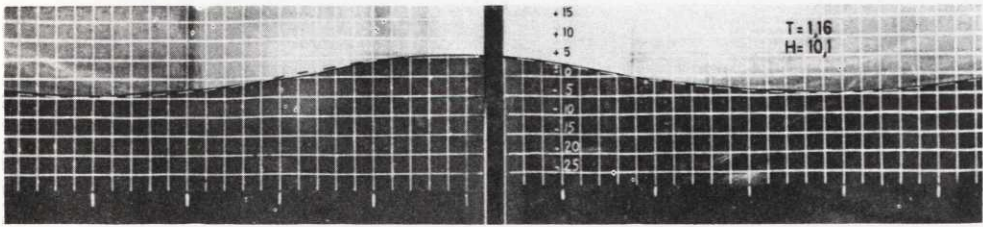


Fig. 59.1. The wave profile in the flume. Agreement between the actual wave form and the theoretical profile, dashed line

CHAPTER 6

Model Tests and Results

61. Introduction

The wave types used in the different series were as a rule the same from group to group. A wave period of between 0.90 and 2.30 seconds was chosen, which periods coincided with the limits for the range of good running of the wave generator. The depth of water in the flume was in some cases 0.55 m and in others 0.45 m and 0.65 m. The gradient of the back or harbour side slope of the model structures was 1: 1.25.

The model tests can be classified in four main groups. The first series of tests was made with a structure similar to a breakwater of conventional type. The depth of water in the flume was 0.55 m. The crest was sufficiently high to prevent overtopping. The gradient of the slope, exposed to wave attacks, was varied between 1: 4 and 1: 1.25. The wave heights were increased until the stones started to move and where possible until rupture of the slope occurred.

The second series of tests was performed with a structure similar to a sea-wall in which all percolation through the core was prevented by a plastic cloth from top to toe under the stone armour layer. The depth of water in the flume was the same as in the first test series. No overtopping of waves was permitted. The slope gradients chosen were 1: 2, 1: 3.5, and 1: 4.5. The wave heights were increased from the lowest that could be produced by the wave generator up to heights at which stone displacements occurred.

In the third series the bottom in front of the structure was given a slight slope in some tests with a gradient of 1: 11.6 and in others 1: 10 on which the highest waves broke. Three depths of water were used, 0.45, 0.55 m, and 0.65 m in the flume and 0.10 m and 0.20 m at the toe of breakwater. The slopes of the model structure were chosen at 1: 4 and 1: 1.5. Both pervious and impervious structures were used.

In the fourth series various types of tests occasioned by the preceding test were performed to supplement and check the test results in the first, second and third series.

Finally some of the test values of HUDSON (1958) are chosen for further verification of the Author's theoretical formulae of stability, when no doubt about the validity of his values exists.

In compiling the test results they were classified according to a new system. The test data referring to uprushing waves causing displacements of the stones were assigned to one group and those referring to downrushing waves causing displacements to another group. Special studies were divided into groups according to their purpose.

Test values from the laboratory study are to be found in Tables 63.1, 2, 3, and 65.1, 2, 3, 4, 5.

62. Model Similitude

All the tests were performed so that the coefficient f in the general friction formula, Eq. (412.3), was independent of the REYNOLD'S number, i. e. the tests are made in the region of distinct rough flow. Thus it is possible to adopt FROUDE'S model law for this type of tests.

However it should be observed that the simulation of permeability conditions may not be correct, owing to the great reduction of the water velocity between the blocks. This implies that the flow below the surface layers is not distinctly rough. In such a case the model is less permeable than the prototype.

63. Uprushing Waves

The theoretical derivations in Chapter 4 of the stability formula give the stone diameter required in order to obtain a stable rock-fill slope under the influence of the uprushing phase of breaking waves, Eq. (44.1). It now remains to verify the formula and to ascertain the value of the coefficient K_{up} experimentally.

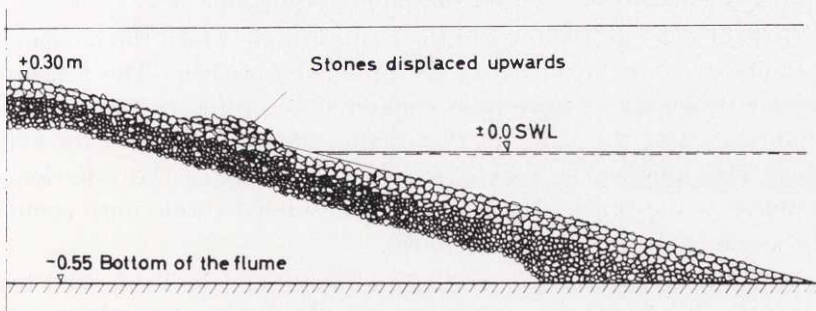


Fig. 63.1. Rupture caused by the uprushing waves

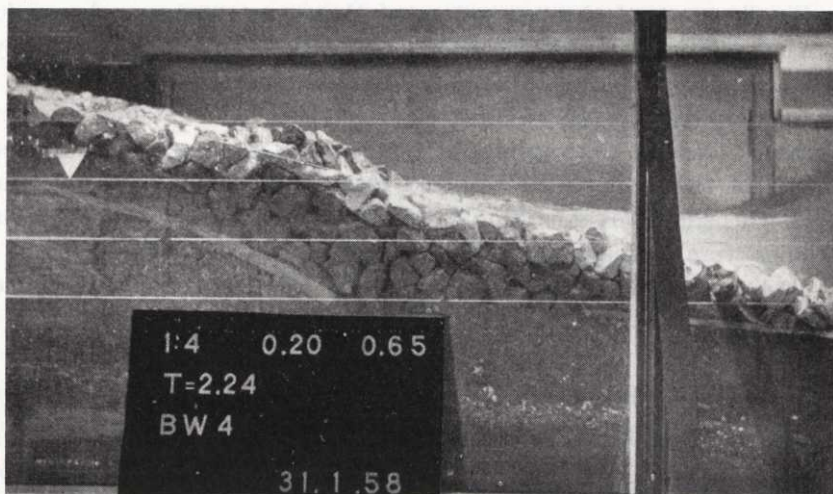


Fig. 63.2. Stones thrown upwards

In order to determine the value of coefficient $K_{up} = K_2 \left(1 + \tan \varphi \tan \beta + \frac{c}{\cos \varphi} \right)$, tests in the investigation series, in which the stones were thrown up along the sloping surface, or in which the movements of the stones were mainly upwards, were selected for further consideration. Fig. 63.1 shows a typical displacement caused by the uprushing wave phase. The slope was sufficiently flat to be stable or almost stable during the downrushing phase. Sometimes some of the stones first moved upwards with the uprush and then downwards with the downrush. Stones thrown upwards during a test can be seen on the photograph, Fig. 63.2.

In Table 63.1 all the tests in the first series, in which the movement was observed to be upwards are grouped together. The measured wave characteristics have been converted according to the theory in Chapter 2 and the value of the coefficient K_{up} computed for every test. The number of moved stones was taken as the criterion of stability of the slope. The slope was considered stable until some of the stones were just about to move.

In Table 63.2 tests from the second series and in Table 63.3 tests from the third series are grouped together, and the value of the coefficient K_{up} has been computed from the diagram, Fig. 63.3.

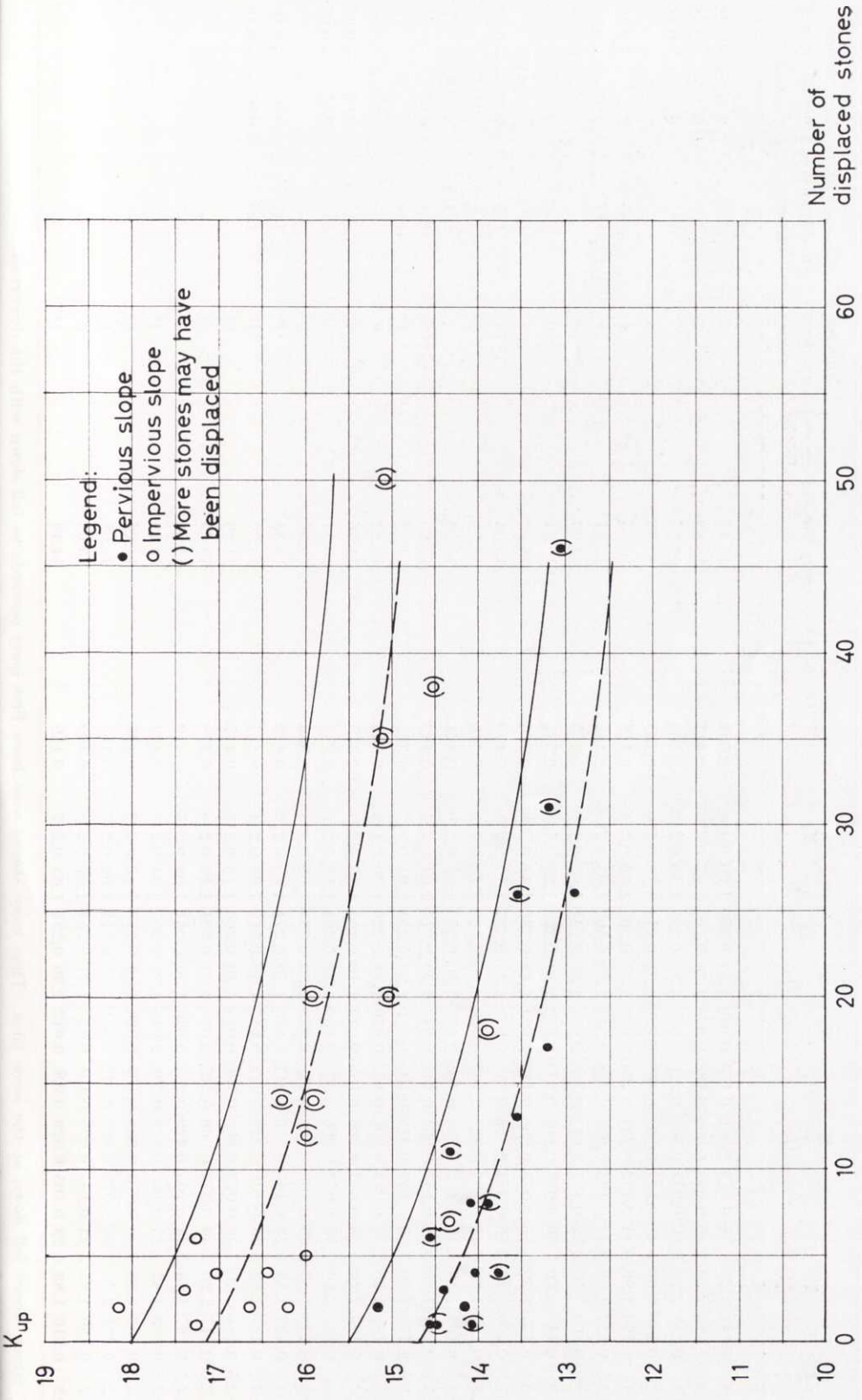


Fig. 63.3. Determination of the coefficient K_{up} (Tables 63.1, 2, and 3)

Table 63.1. Uprush on pervious straight slope. No overtopping. Series 1. Arrangement Fig. 57.1

$$Q_{\text{mean}} = 0.000149 \pm 0.000016 \quad s_s = 2.665$$

$$k_{\text{mean}} = 0.0475 \pm 0.0017 \quad d = 0.55$$

α	H	T	L_0	$\frac{d}{L_0}$	$\frac{H}{H_0}$	H_0	$\frac{H_0}{L_0}$	$\frac{d_b}{H_0}$	d_b	$\frac{H_b}{H_0}$	H_b	$d_b + 0.7 H_b$	$K_2 \left(1 + \tan \varphi \tan \beta + \frac{c}{\cos \varphi} \right)$	Number of displaced stones	$Q_{\text{mean}} \cdot 10^6$ of displaced stones	The stones moved from level
1:4	0.148	2.20	7.56	0.073	0.966	0.153	0.020	1.49	0.230	1.20	0.184	0.357	15.17	2	127	± 0.0 — — 0.10
1:4	0.182	2.20	7.56	0.073	0.966	0.188	0.025	1.40	0.263	1.13	0.212	0.411	14.09	8	150	± 0.0 — — 0.10
1:4	0.213	2.20	7.56	0.073	0.966	0.220	0.029	1.35	0.297	1.10	0.242	0.466	13.22	17	151	± 0.0 — — 0.10
1:4	0.148	1.86	5.41	0.102	0.931	0.159	0.029	1.35	0.214	1.10	0.175	0.337	15.65	0	—	—
1:4	0.190	1.86	5.41	0.102	0.931	0.204	0.038	1.30	0.265	1.06	0.216	0.416	14.05	4	145	± 0 — — 0.10
1:4	0.222	1.86	5.41	0.102	0.931	0.238	0.044	1.30	0.309	1.03	0.248	0.483	12.91	26	147	+ 0.03 — — 0.10
1:4	0.169	1.50	3.52	0.157	0.913	0.185	0.053	1.30	0.241	1.02	0.189	0.373	14.69	0	—	—
1:3.5	0.148	2.20	7.56	0.073	0.966	0.153	0.020	1.49	0.228	1.20	0.184	0.357	15.41	0	—	—
1:3.5	0.177	2.20	7.56	0.073	0.966	0.183	0.024	1.42	0.260	1.14	0.209	0.406	14.42	3	160	+ 0.05
1:3.5	0.209	2.20	7.56	0.073	0.966	0.216	0.029	1.35	0.292	1.10	0.238	0.459	13.56	13	155	+ 0.05 — — 0.05
1:3.5	0.152	1.86	5.41	0.102	0.931	0.163	0.030	1.35	0.220	1.10	0.179	0.345	15.74	0	—	—
1:3.5	0.194	1.86	5.41	0.102	0.931	0.208	0.039	1.30	0.270	1.06	0.220	0.424	14.16	2	134	± 0
1:3.5	0.224	1.86	5.41	0.102	0.931	0.241	0.045	1.30	0.313	1.04	0.251	0.489	13.05	46 ¹	151	+ 0.02 — — 0.05
1:3.5	0.178	1.50	3.52	0.156	0.913	0.195	0.056	1.30	0.254	1.01	0.197	0.392	14.52	1	144	± 0
1:3	0.147	2.20	7.56	0.073	0.966	0.152	0.020	1.49	0.226	1.20	0.182	0.353	15.83	0	—	—
1:3	0.183	2.20	7.56	0.073	0.966	0.189	0.025	1.40	0.265	1.13	0.214	0.415	14.56	6 ¹	147	+ 0.03 — — 0.05
1:3	0.217	2.20	7.56	0.073	0.966	0.225	0.030	1.35	0.304	1.10	0.248	0.478	13.54	26 ¹	145	+ 0.07 — — 0.07
1:3	0.158	1.83	5.23	0.105	0.929	0.170	0.033	1.32	0.224	1.08	0.184	0.353	15.90	0	—	—
1:3	0.196	1.83	5.23	0.105	0.929	0.211	0.040	1.30	0.274	1.05	0.222	0.429	14.33	11 ¹	147	± 0.0 — — 0.10
1:3	0.227	1.83	5.23	0.105	0.929	0.244	0.047	1.30	0.317	1.03	0.251	0.493	13.20	31 ¹	146	+ 0.05 — — 0.10
1:2.5	0.184	2.20	7.56	0.073	0.966	0.190	0.025	1.40	0.266	1.13	0.215	0.417	14.89	0 ²	—	—
1:2.5	0.217	2.20	7.56	0.073	0.966	0.225	0.030	1.35	0.304	1.10	0.248	0.478	13.89	> 8 ²	—	—
1:2.5	0.187	1.83	5.23	0.105	0.929	0.201	0.038	1.30	0.261	1.06	0.213	0.410	15.08	0 ²	—	—
1:2.5	0.219	1.83	5.23	0.105	0.929	0.236	0.045	1.30	0.307	1.04	0.245	0.479	13.78	> 4 ²	—	—
1:2	0.192	2.20	7.56	0.073	0.966	0.199	0.026	1.39	0.277	1.12	0.223	0.433	14.96	0 ²	—	—
1:2	0.224	2.20	7.56	0.073	0.966	0.232	0.031	1.34	0.311	1.09	0.253	0.488	14.08	> 1 ²	—	—
1:2	0.180	1.83	5.23	0.105	0.929	0.194	0.037	1.31	0.254	1.07	0.208	0.400	15.67	0	—	—
1:2	0.210	1.83	5.23	0.105	0.929	0.226	0.043	1.30	0.294	1.05	0.237	0.460	14.49	> 1 ²	—	—

¹ Some stones fell down at the same time. Thus more stones may have first gone upwards to fall down with the downrush.

² Not stable for downrush.

Table 63.2. Uprush on impervious straight slope. No overtopping. Series 2. Arrangement Fig. 57.1

$$Q_{\text{mean}} = 0.000149 \pm 0.000016 \quad s_s = 2.665$$

$$k_{\text{mean}} = 0.0475 \pm 0.0017 \quad d = 0.55$$

α	H	T	L_0	$\frac{d}{L_0}$	$\frac{H}{H_0}$	H_0	$\frac{H_0}{L_0}$	$\frac{d_b}{H_0}$	d_b	$\frac{H_b}{H_0}$	H_b	$d_b + 0.7 H_b$	$K_2 \left(1 + \tan \varphi \tan \beta + \frac{c}{\cos \varphi} \right)$	Number of displaced stones
1:4.5	0.137	2.12	7.02	0.078	0.958	0.143	0.020	1.49	0.213	1.20	0.172	0.333	15.48	0
1:4.5	0.170	2.10	6.89	0.080	0.955	0.178	0.026	1.39	0.247	1.12	0.199	0.386	14.35	7 ¹
1:4.5	0.185	2.12	7.02	0.078	0.958	0.193	0.027	1.37	0.264	1.12	0.216	0.415	13.89	18 ¹
1:4.5	0.143	1.81	5.12	0.107	0.928	0.154	0.030	1.35	0.208	1.10	0.169	0.326	15.68	0
1:4.5	0.159	1.82	5.18	0.106	0.928	0.171	0.033	1.32	0.226	1.08	0.185	0.356	15.02	20 ¹
1:4.5	0.130	1.50	3.52	0.156	0.913	0.142	0.040	1.30	0.185	1.05	0.149	0.289	16.58	0
1:4.5	0.139	1.50	3.52	0.156	0.913	0.152	0.043	1.30	0.198	1.05	0.160	0.310	16.04	12 ¹
1:4.5	0.168	1.51	3.56	0.154	0.913	0.184	0.052	1.30	0.239	1.02	0.188	0.371	14.52	38 ¹
1:3.5	0.080	2.11	6.96	0.079	0.956	0.084	0.012	1.78	0.150	1.36	0.114	0.230	18.60	0
1:3.5	0.112	2.11	6.96	0.079	0.956	0.117	0.017	1.57	0.184	1.23	0.144	0.285	17.04	4
1:3.5	0.139	2.11	6.96	0.079	0.956	0.145	0.021	1.47	0.213	1.18	0.171	0.333	15.93	20 ¹
1:3.5	0.171	2.11	6.96	0.079	0.956	0.179	0.026	1.39	0.249	1.12	0.200	0.389	14.73	75 ¹
1:3.5	0.076	1.81	5.12	0.107	0.928	0.082	0.016	1.60	0.131	1.26	0.103	0.203	19.89	0
1:3.5	0.101	1.81	5.12	0.107	0.928	0.109	0.021	1.47	0.160	1.18	0.129	0.250	18.32	2
1:3.5	0.121	1.81	5.12	0.107	0.928	0.130	0.025	1.40	0.182	1.13	0.147	0.285	17.23	6
1:3.5	0.141	1.81	5.12	0.107	0.928	0.152	0.030	1.35	0.205	1.10	0.167	0.322	16.28	14 ¹
1:3.5	0.165	1.81	5.12	0.107	0.928	0.178	0.035	1.32	0.235	1.07	0.190	0.368	15.19	50 ¹
1:3.5	0.103	1.54	3.71	0.148	0.914	0.113	0.030	1.34	0.151	1.09	0.123	0.237	18.83	0
1:3.5	0.126	1.53	3.66	0.150	0.913	0.138	0.038	1.30	0.179	1.06	0.146	0.281	17.42	3
1:3.5	0.150	1.52	3.61	0.152	0.913	0.164	0.045	1.30	0.213	1.03	0.169	0.331	15.92	14 ¹
1:3.5	0.165	1.53	3.66	0.150	0.913	0.181	0.049	1.30	0.235	1.02	0.185	0.365	15.12	35 ¹
1:3.5	0.113	1.10	1.89	0.291	0.946	0.119	0.063	1.30	0.155	1.00	0.119	0.238	18.41	0
1:3.5	0.144	1.14	2.03	0.271	0.939	0.153	0.075	1.30	0.199	1.00	0.153	0.306	16.38	4

¹ See Table 63.1, footnote ¹

The values of the coefficient were chosen with a small safety margin as can be seen from Fig. 63.3.

It may now be stated that the coefficient K_{up} can be considered as a constant with the value of 15.5 for a permeable breakwater if the waves break on the slope. For a sea-wall the coefficient can be put to 18.0. No variation of the coefficient K_{up} in relation to the depth of water at the toe was observed.

Another conclusion may be drawn from the tests in Table 63.3. When the breaking depth $d_b > d_{toe}$, the breaking takes place in front of the slope. The maximum attack of the waves against the slope occurs when the waves are breaking somewhat in front of the toe, cf. Table 63.3, where some tests showed better stability, although the wave height was increased. Thus the most violent waves which can attack the breakwater slope are those which have their breaking point at a certain distance from the toe. This distance seems to be about $0.5 L_b$, where L_b is the length of the wave at breaking point. This means that if $(d_b - d_{toe}) n < \frac{L_b}{2}$, the present wave determines the block weight, but if $(d_b - d_{toe}) n > \frac{L_b}{2}$, the highest possible wave at

Table 63.3. Uprush on impervious straight slope. No overtopping. Reduced depth at toe. Series 3. Arrangement Fig. 63.3.

$$Q_{\text{mean}} = 0.000149 \pm 0.000016 \quad s_s = 2.665$$

$$k_{\text{mean}} = 0.0475 \pm 0.0017 \quad \text{Inclination of the bottom in front of the breakwater 1:11.6}$$

α	d	d_{toe}	H	T	L_0	$\frac{d}{L_0}$	$\frac{H}{H_0}$	H_0	$\frac{H_0}{L_0}$	$\frac{d_b}{H_0}$	d_b	$\frac{H_b}{H_0}$	H_b	$d_b + 0.7 H_b$
1:4	0.65	0.20	0.087	2.24	7.84	0.083	0.951	0.091	0.012	1.78	0.162	1.36	0.124	0.249
1:4	0.65	0.20	0.117	2.24	7.84	0.083	0.951	0.123	0.016	1.60	0.197	1.26	0.155	0.306
1:4	0.65	0.20	0.146	2.24	7.84	0.083	0.951	0.154	0.020	1.49	0.229	1.20	0.185	0.359
1:4	0.55	0.10	0.099	2.14	7.16	0.077	0.959	0.103	0.014	1.67	0.172	1.30	0.134	0.266
1:4	0.55	0.10	0.130	2.14	7.16	0.077	0.959	0.136	0.019	1.50	0.204	1.21	0.165	0.320
1:4	0.55	0.10	0.155	2.14	7.16	0.077	0.959	0.162	0.023	1.42	0.230	1.16	0.188	0.362
1:4	0.55	0.10	0.176	2.14	7.16	0.077	0.959	0.184	0.026	1.39	0.256	1.12	0.206	0.400
1:4	0.65	0.20	0.105	1.48	3.42	0.190	0.916	0.115	0.034	1.33	0.153	1.08	0.124	0.240
1:4	0.65	0.20	0.133	1.48	3.42	0.190	0.916	0.145	0.042	1.30	0.189	1.05	0.152	0.295
1:4	0.55	0.10	0.104	1.51	3.56	0.154	0.913	0.114	0.032	1.34	0.153	1.09	0.124	0.240
1:4	0.55	0.10	0.127	1.51	3.56	0.154	0.913	0.139	0.039	1.30	0.181	1.06	0.147	0.284
1:4	0.55	0.10	0.158	1.51	3.56	0.154	0.913	0.173	0.049	1.30	0.225	1.02	0.176	0.348

$\frac{L_b}{2}$ is chosen to determine the block weight in the stability formula.

The inclination of the bottom in front of the slope is assumed to be 1:n. The question will be further discussed in Section 65.

The first stones which move are those at the still-water level as can be seen from the last column in Table 63.1.

64. Checking the Value of the Coefficient K_{up}

In order to check the value of the coefficient $K_{up} = K_2 \left(1 + \tan \varphi \tan \beta + \frac{c}{\cos \varphi} \right)$ without regard to shock pressure of breaking waves, tests were made in a glass-walled flume, where the mean water velocity, v_{mean} , could be easily determined. In the flume two or three layers of armour stone were placed on a somewhat permeable bed of brick. A gradient of 1: 41.5 was chosen. The set-up is shown in Fig. 64.1 and photographs of the equipment are shown in Fig. 64.2.

The water level was maintained so that the gradient of the water was kept parallel to the bottom, and the water depth was kept constant

(Table 63.3. *Continued*)

$\left(1 + \tan \varphi \tan \beta + \frac{c}{\cos \varphi} \right)$	$\frac{d_b}{L_0}$	$\frac{d_b}{L_b}$	L_b	$\frac{(d_b - d_{toe}) 11.6}{L_b}$	Number of displaced stones	$Q_{mean} \cdot 10^6$ of displaced stones
17.70					0	—
16.22					2	139
15.12	0.029	0.070	3.27	0.10	76 ¹	146
17.29	0.024	0.063	2.73	0.31	1	157
16.01	0.028	0.069	2.96	0.41	5	162
—	0.032	0.074	3.11	0.48	5 more stable	162
—	0.036	0.079	3.24	0.56	5 more stable	162
18.36					0	—
16.65					2	152
18.36	0.043	0.087	1.76	0.35	0 stable	—
16.99	0.051	0.095	1.91	0.49	0 more stable	—
—	0.063	0.107	2.10	0.69	0 more stable	—

¹ See Table 63.1, footnote ¹

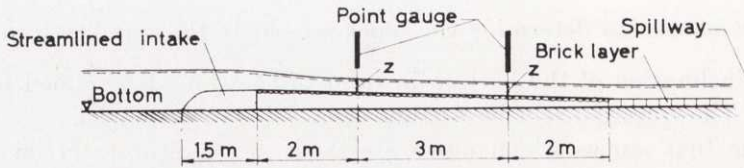


Fig. 64.1. Elevation of the set-up in the glass-walled flume (distorted scale)

along the slope. The discharge in the flume was increased until the individual stones commenced to move. When determining the mean velocity the depth of water was adjusted to suit the void ratio of the armour layer. The test results are presented in Table 64.1, where K_{up} is determined from Eq. (431.2) and a fictive breaking wave height from Eq. (431.1) putting $d_b \sim 1.3 H_b$.

The value of the coefficient K_{up} , when the stones are just about to move, is in good agreement with the values 15.5 and 18.0 determined from the tests above, Section 63.

Table 64.1. Results of the test in flowing water

v_{mean}	z^1	k	K_{up}	Number of displaced stones
1.33	0.123	0.0475	16.7	0
1.38	0.138	0.0475	16.2	4
1.62	0.174	0.0475	14.2	> 8, instability

¹ z is adjusted

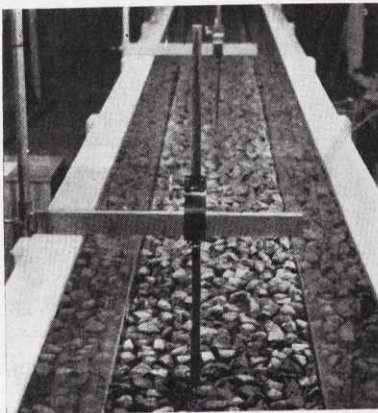


Fig. 64.2. Test being made in the glass-walled flume

65. Downrushing Waves

The theoretical derivations in Chapter 4 gave the stability formula for the downrushing wave phase, Eq. (44.2), from which it remains to determine the value of the coefficient

$$K_{\text{down}} = \frac{K_2 K_3^2 \left(1 + \tan \varphi \tan \beta + \frac{c}{\cos \varphi} \right)}{\left(\log_{10} \frac{14.83 z}{k} \right)^2}$$

by means of the tests in the wave flume for various wave conditions.

In Tables 65.1, 2, 3, 4 and 5 the test values from the different test series are collected on the assumption that the occurring displacements if any were downwards.

In order to determine the boundary between stability and instability, curves were drawn with the wave height as function of the number of displaced stones. The boundary was fixed at the point at which the stones were just about to move. Only the highest wave height is marked at no displaced stones. Fig. 65.1 gives the wave heights for pervious slopes and Fig. 65.2 the wave heights for impervious slopes.

HUDSON (1958, 1959) has made a complete test series for downrush. His tests were performed in a way similar to the Author's, with the important difference that the wave generator was stopped as soon as reflected waves from the breakwater reached it and was started again when the wave motion had died down (HUDSON 1958, p. 16). In this way it was possible to record the incident wave height unaffected by reflected waves. In those tests the water depth was 0.61 m, the characteristic linear dimension $k_{\text{mean}} = 0.0452$ m and 0.0314 m and the specific gravity $s_s = 2.82$ and 2.80. The period was varied from 0.88 to 2.65 sec., the gradient from 1:1.25 to 1:5. At the boundary of stability and instability the variation of the wave height was very small for the different periods. HUDSON does not mention movement of the stones upwards.

In Table 65.6 all the values from the test series conducted by the Author and by HUDSON are classed together in order to determine the value of the coefficient K_{down} .

Table 65.6 is illustrated by the diagram, Fig 65.3, where the coefficient K_{down} is plotted in relation to the angle $(\varphi - \alpha)$. The corresponding gradient is to be found in Tables, p. 115.

Table 65.1. Downrush on pervious straight slope. No overtopping.
Series 1. Arrangement Fig. 57.1

$$Q_{\text{mean}} = 0.000149 \pm 0.000016$$

$$s_s = 2.665$$

$$k_{\text{mean}} = 0.0475 \pm 0.0017$$

$$d = 0.55$$

α	H	T	Number of displaced stones	The stones moved from level
1:1.25	0.103	2.20	0	—
1:1.25	0.150	2.20	not stable	—
1:1.25	0.133	1.83	37	+0.10 — —0.15
1:1.25	0.104	1.50	2	±0.00 — —0.03
1:1.25	0.127	1.50	26	+0.03 — —0.10
1:1.25	0.103	1.10	0	—
1:1.5	0.149	2.20	9	±0.00 — —0.10
1:1.5	0.167	2.20	25	+0.05 — —0.10
1:1.5	0.153	1.83	39	+0.02 — —0.10
1:1.5	0.102	1.50	0	—
1:1.5	0.130	1.50	6	±0.00 — —0.15
1:1.5	0.160	1.50	37	—
1:2	0.147	2.20	7	+0.02 — —0.03
1:2	0.192	2.20	44	+0.05 — —0.10
1:2	0.224	2.20	144	+0.15 — —0.10
1:2	0.161	1.83	24	+0.05 — —0.10
1:2	0.180	1.83	31	+0.05 — —0.13
1:2	0.210	1.83	153	+0.18 — —0.15
1:2	0.114	1.50	0	—
1:2	0.131	1.50	4	±0.00 — —0.03
1:2	0.155	1.50	21	±0.00 — —0.10
1:2.5	0.155	2.20	12	±0.00 — —0.04
1:2.5	0.184	2.20	54	+0.02 — —0.09
1:2.5	0.217	2.20	171	+0.15 — —0.15
1:2.5	0.156	1.83	14	+0.02 — —0.05
1:2.5	0.182	1.83	55	+0.03 — —0.08
1:2.5	0.219	1.83	114	+0.10 — —0.10
1:2.5	0.134	1.50	0	—
1:2.5	0.156	1.50	14	+0.02 — —0.05
1:3	0.147	2.20	0	—
1:3	0.183	2.20	42	+0.03 — —0.05
1:3	0.217	2.20	108	+0.07 — —0.07
1:3	0.158	1.83	0	—
1:3	0.196	1.83	11	±0.00 — —0.10
1:3	0.227	1.83	77	+0.07 — —0.10
1:3	0.161	1.50	0	—

Table 65.2. Downrush on impervious straight slope. No overtopping.
Series 2. Arrangement Fig. 57.1

$$Q_{\text{mean}} = 0.000149 \pm 0.000016 \quad s_s = 2.665$$

$$k_{\text{mean}} = 0.0475 \pm 0.0017 \quad d = 0.55$$

α	H	T	Number of displaced stones	The stones moved from level
1:2	0.090	2.20	0	—
1:2	0.079	1.83	0	—
1:2	0.107	1.83	5	± 0.00 — -0.03
1:2	0.125	1.83	43	$+0.10$ — -0.10
1:2	0.078	1.50	1	—
1:2	0.093	1.50	3	—
1:2	0.106	1.50	5	± 0.00 — -0.03
1:3.5	0.080	2.11	0	
1:3.5	0.112	2.11	4	
1:3.5	0.139	2.11	20	
1:3.5	0.171	2.11	75	
1:3.5	0.101	1.81	0	
1:3.5	0.121	1.81	6	
1:3.5	0.141	1.81	14	
1:3.5	0.165	1.81	50	
1:3.5	0.103	1.54	0	
1:3.5	0.126	1.53	3	
1:3.5	0.150	1.52	14	
1:3.5	0.165	1.53	35	
1:3.5	0.113	1.10	0	
1:3.5	0.144	1.14	4	
1:4.5	0.137	2.12	0	
1:4.5	0.170	2.10	6	
1:4.5	0.185	2.12	17	
1:4.5	0.143	1.81	0	
1:4.5	0.159	1.82	20	
1:4.5	0.130	1.50	0	
1:4.5	0.139	1.50	7	
1:4.5	0.168	1.51	27	

Table 65.3. Downrush on impervious straight slope. No overtopping. Series 4 (supplement to Series 2). Arrangement Fig. 57.2

$$Q_{\text{mean}} = 0.000149 \pm 0.000016 \quad s_g = 2.665$$

$$k_{\text{mean}} = 0.0475 \pm 0.0017 \quad d = 0.55$$

α	H	T	Number of displaced stones
1:2.5	0.081	1.88	0
1:2.5	0.097	1.88	1
1:2.5	0.116	1.88	13
1:2.5	0.124	1.88	41
1:2.5	0.155	1.88	131
1:2.5	0.090	1.63	0
1:2.5	0.108	1.63	3
1:2.5	0.120	1.63	15
1:2.5	0.141	1.63	33
1:2.5	0.090	1.32	0
1:2.5	0.103	1.32	1
1:2.5	0.143	1.32	17
1:2.5	0.166	1.32	39

Table 65.4. Downrush on impervious straight slope. No overtopping. Reduced depth at toe. Series 3

$$Q_{\text{mean}} = 0.000149 \pm 0.000016 \quad \text{Inclination of the bottom in front of the breakwater 1:11.6}$$

$$k_{\text{mean}} = 0.0475 \pm 0.0017$$

$$s_g = 2.665$$

α	d	H	T	L_0	d_{toe}	H_{toe}	d_b	$\frac{d_b}{L_0}$	$\frac{d_b}{L_b}$	L_b	$\frac{(d_b - d_{\text{toe}}) 11.6}{L_b}$	Number of displaced stones
1:1.5	0.65	0.075	2.26	7.98	0.20	0.092	0.150					0
1:1.5	0.65	0.106	2.26	7.98	0.20	0.130	0.186					3
1:1.5	0.65	0.133	2.26	7.98	0.20		0.216	0.027	0.067	3.22	0.06	Not stable
1:1.5	0.55	0.064	2.17	7.36	0.10		0.133	0.018	0.055	2.42	0.16	0
1:1.5	0.55	0.095	2.17	7.36	0.10		0.168	0.023	0.062	2.71	0.29	5
1:1.5	0.55	0.130	2.17	7.36	0.10		0.204	0.028	0.069	2.96	0.41	40
1:1.5	0.55	0.144	2.17	7.36	0.10		0.224	0.030	0.071	3.15	0.46	150
1:1.5	0.55	0.168	2.17	7.36	0.10		0.248	0.034	0.076	3.26	0.53	No more damage
1:1.5	0.65	0.055	1.48	3.42	0.20	0.060	0.092					0
1:1.5	0.65	0.089	1.48	3.42	0.20	0.097	0.132					11
1:1.5	0.65	0.119	1.48	3.42	0.20	0.130	0.170					60
1:1.5	0.55	0.056	1.53	3.66	0.10	0.070	0.096					0
1:1.5	0.55	0.095	1.53	3.66	0.10		0.141	0.039	0.082	1.72	0.28	4
1:1.5	0.55	0.110	1.53	3.66	0.10		0.160	0.044	0.088	1.82	0.38	37
1:1.5	0.65	0.061	0.95	1.41	0.20	0.057	0.081					0
1:1.5	0.65	0.081	0.95	1.41	0.20	0.075	0.107					3
1:1.5	0.55	0.074	0.94	1.38	0.10	0.073	0.099					0

Table 65.5. Downrush on pervious straight slope. No overtopping. Reduced depth at toe.
Series 4 (supplement to Series 3)

$$Q_{\text{mean}} = 0.000149 \pm 0.000016$$

Inclination of the bottom in

$$k_{\text{mean}} = 0.0475 \pm 0.0017$$

front of the breakwater 1:10

$$s_g = 2.665$$

α	d	H	T	L_0	d_{toe}	H_{toe}	d_b	$\frac{d_b}{L_0}$	$\frac{d_b}{L_b}$	L_b	$\frac{(d_b - d_{\text{toe}}) 10}{L_b}$	Number of displaced stones
1:1.5	0.55	0.096	2.02	6.38	0.20	0.113	0.162					0
1:1.5	0.55	0.110	2.02	6.38	0.20	0.129	0.177					2
1:1.5	0.55	0.117	2.02	6.38	0.20	0.138	0.186					17
1:1.5	0.55	0.132	2.02	6.38	0.20	0.156	0.202					96
1:1.5	0.45	0.085	2.17	7.36	0.10		0.153	0.021	0.059	2.59	0.20	0
1:1.5	0.45	0.093	2.17	7.36	0.10		0.160	0.022	0.061	2.62	0.23	6
1:1.5	0.45	0.101	2.17	7.36	0.10		0.171	0.023	0.062	2.76	0.26	10
1:1.5	0.45	0.121	2.17	7.36	0.10		0.191	0.026	0.066	2.89	0.31	28
1:1.5	0.45	0.185	2.17	7.36	0.10		0.262	0.036	0.079	3.32	0.49	165 No more damage for higher wave heights
1:1.5	0.55	0.096	1.75	4.78	0.20	0.111	0.151					0
1:1.5	0.55	0.113	1.75	4.78	0.20	0.129	0.171					10
1:1.5	0.55	0.133	1.75	4.78	0.20	0.152	0.194					93
1:1.5	0.45	0.076	1.85	5.35	0.10		0.131	0.024	0.063	2.08	0.15	0
1:1.5	0.45	0.083	1.85	5.35	0.10		0.139	0.026	0.066	2.11	0.18	12
1:1.5	0.45	0.094	1.85	5.35	0.10		0.148	0.028	0.069	2.15	0.22	ca 15
1:1.5	0.45	0.105	1.85	5.35	0.10		0.163	0.030	0.071	2.30	0.27	> 21
1:1.5	0.45	0.122	1.85	5.35	0.10		0.182	0.034	0.076	2.39	0.34	> 33
1:1.5	0.45	0.126	1.85	5.35	0.10		0.186	0.035	0.077	2.42	0.36	> 66
1:1.5	0.45	0.157	1.85	5.35	0.10		0.221	0.041	0.084	2.63	0.46	> 130 No more damage for higher wave heights
1:1.5	0.55	0.068	1.41	3.10	0.20	0.073	0.104					0
1:1.5	0.55	0.089	1.41	3.10	0.20	0.096	0.130					6
1:1.5	0.55	0.097	1.41	3.10	0.20	0.105	0.141					17
1:1.5	0.55	0.139	1.41	3.10	0.20	0.149	0.198					63
1:1.5	0.45	0.080	1.48	3.42	0.10		0.122	0.036	0.079	1.54	0.14	0
1:1.5	0.45	0.096	1.48	3.42	0.10		0.142	0.042	0.086	1.65	0.25	5
1:1.5	0.45	0.107	1.48	3.42	0.10		0.156	0.046	0.090	1.73	0.32	9
1:1.5	0.45	0.122	1.48	3.42	0.10		0.173	0.051	0.095	1.82	0.40	> 16
1:1.5	0.45	0.133	1.48	3.42	0.10		0.189	0.055	0.099	1.91	0.47	> 69 No more damage for higher wave heights

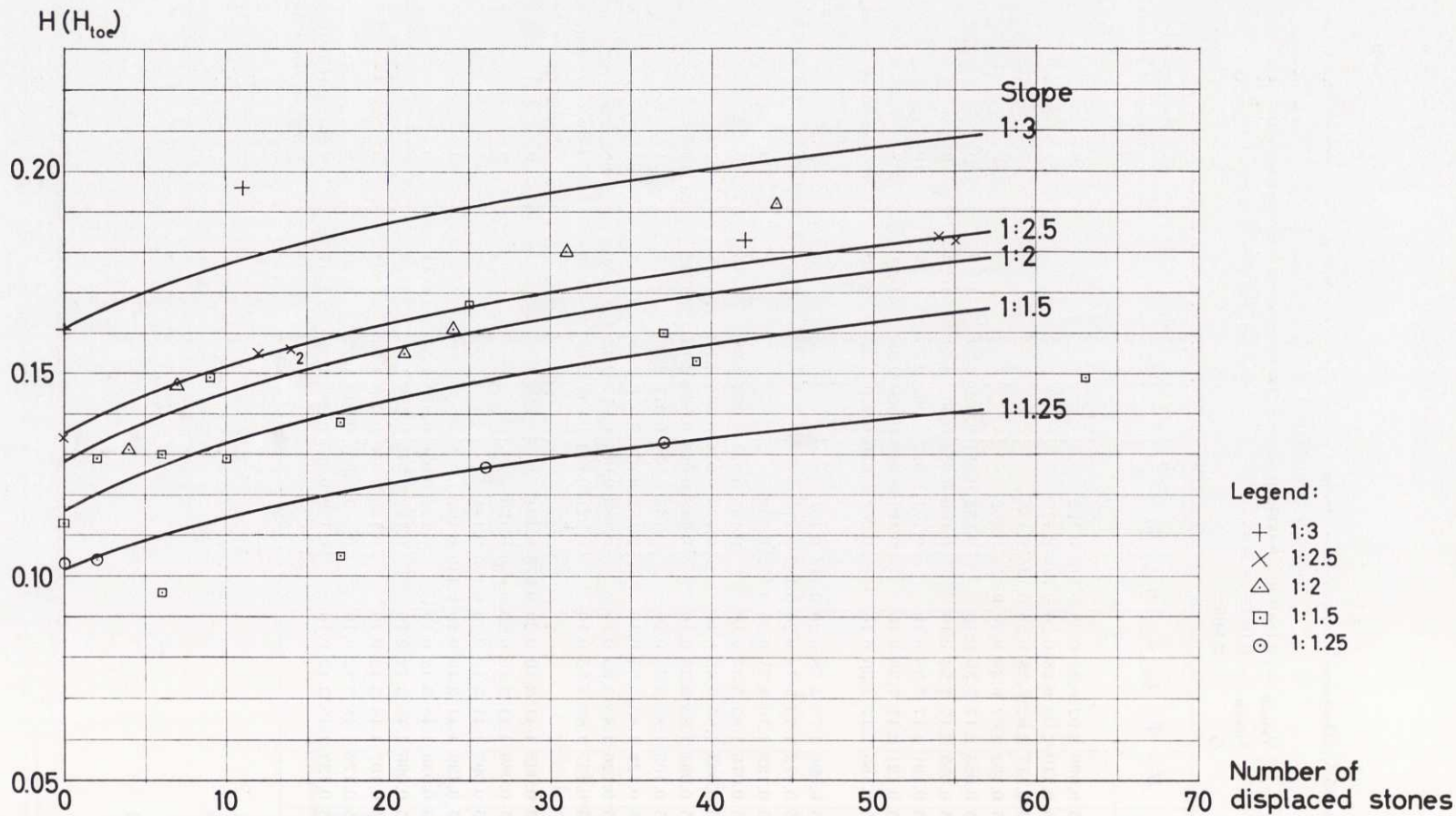


Fig. 65.1. Determination of the wave height at the limit of stability and instability at downrush, pervious slope (Tables 65.1 and 5)

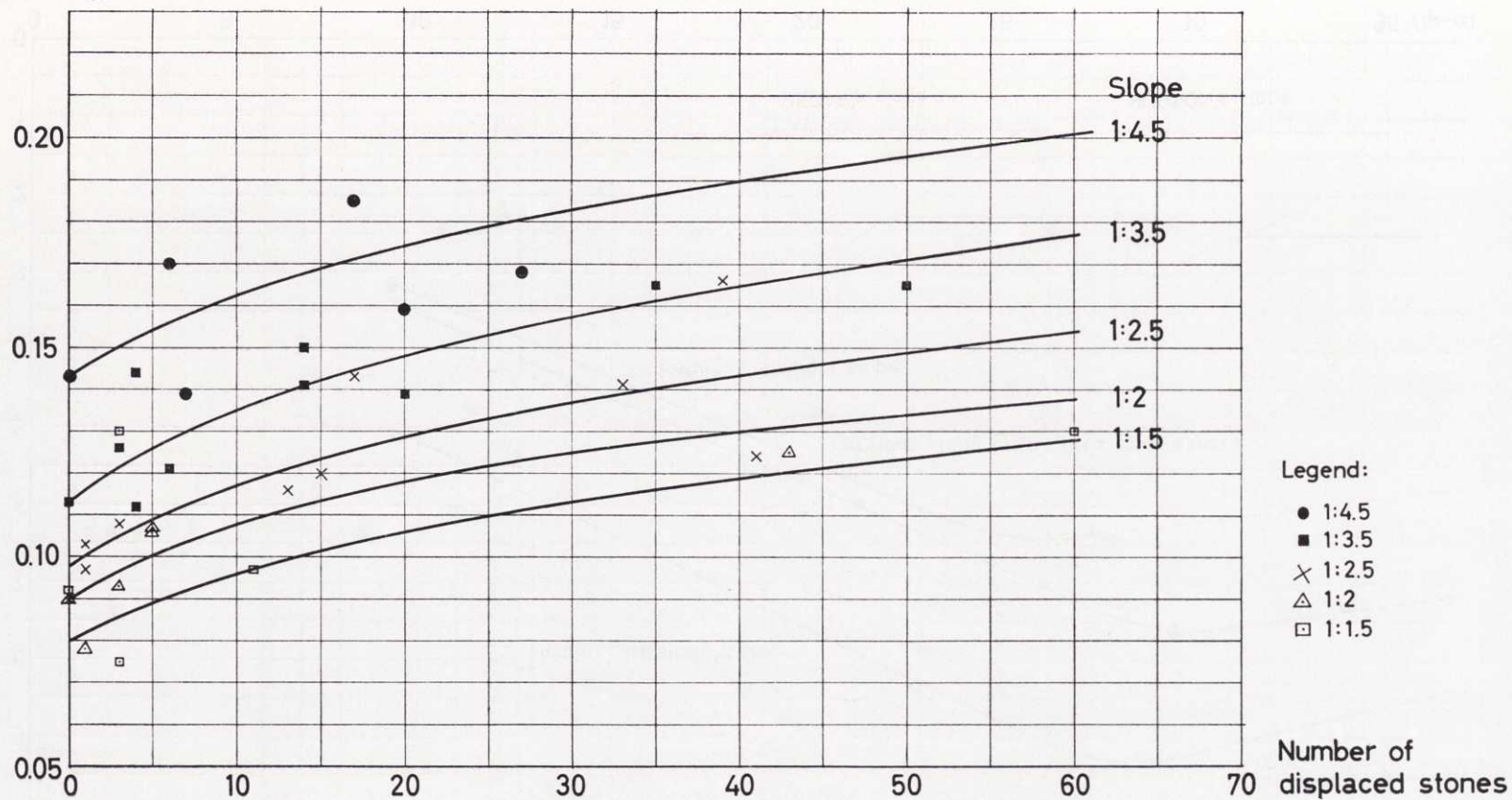
$H(H_{toe})$ 

Fig. 65.2. The same as Fig. 65.1, but impervious slope (Tables 65.2, 3, and 4)

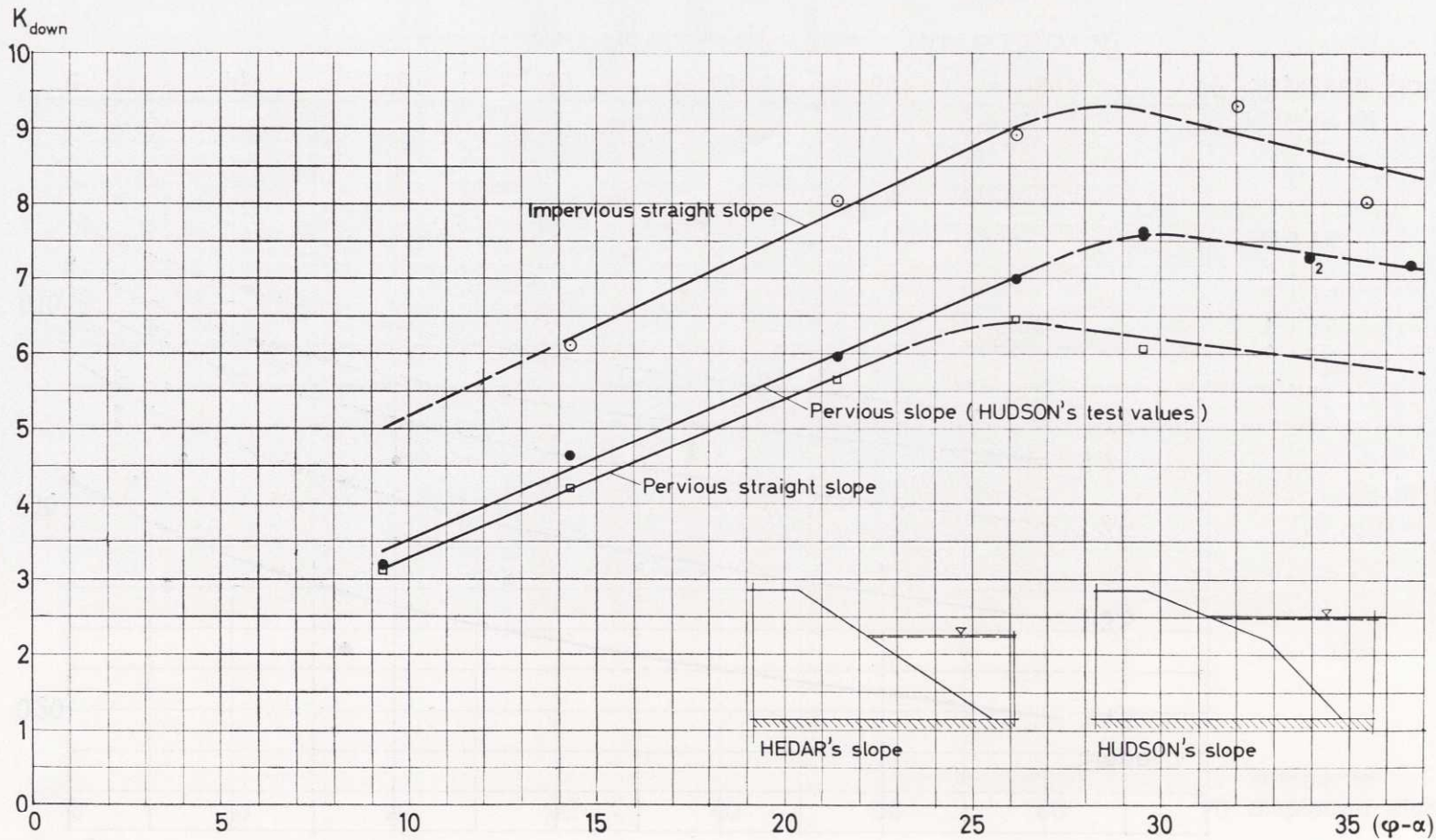


Fig. 65.3. The variation of the coefficient K_{down} (Table 65.6)

Table 65.6. Values of the coefficient K_{down}

Gradient	Pervious slope				Impervious slope	
	The Author		HUDSON		The Author	
	H	K_{down}	H_{mean}	K_{down}	H	K_{down}
1:1.25	0.102	3.14	0.105	3.17 ¹		
1:1.5	0.116	4.22	0.110	4.64 ¹	0.080	6.11
1:2	0.128	5.65	0.126	5.96 ¹	0.090	8.04
1:2.5	0.135	6.47	0.130	7.00 ¹	0.098	8.91
1:3	0.161	6.07	0.134	7.59 ¹		
			0.091	7.64 ²		
1:3.5					0.113	9.30
1:4			0.158	7.29 ¹		
			0.109	7.28 ²		
1:4.5					0.143	8.03
1:5			0.118	7.19 ²		

¹ $k_{\text{mean}} = 0.0452$ m, $s_s = 2.82$. ² $k_{\text{mean}} = 0.0314$, $s_s = 2.80$

The slopes used in the Author's test series were straight from the bottom while HUDSON used broken slopes with a steeper gradient, 1: 1.5 or 1: 2 from the level -0.15 m to the bottom. Only the test series for the slope 1: 1.25 was conducted so that exact correlation with each other exists. It is quite in order that HUDSON's tests have given a curve above the Author's. HUDSON's broken slopes have caused greater reflection and as a consequence the velocity is higher for the same wave height. Thus his slopes required heavier blocks than the Author's.

For the steep slopes, reflection will arise and the value of the water depth z will be great. With increasing reflection, i. e. increasing z , the value of the coefficient K_{down} diminishes. On the other hand, when the slope is flat and the wave breaks, the depth z is small and the coefficient K_{down} thus takes a greater value. With a flatter slope the velocity of the backwash will be more reduced and consequently the coefficient K_{down} decreases.

The value of the coefficient K_{down} increases with increasing degree of imperviousness of the core under the armour layer. The reason is that an impervious slope will cause greater reflection than a pervious one.

At reduced depth of water at the toe the coefficient K_{down} takes the same value as for greater depth of water. But in this case, too, as for uprush (Section 63), it is possible to find a certain depth of

water in front of the breakwater at which the highest possible waves cause the maximum attacks against the breakwater. From Tables 65.4 and 65.5 it is found as before that the depth will be located about $0.5 L_b$ in front of the toe of the slope. And again we find the same rule valid as for uprush: If $(d_b - d_{\text{toe}}) n < \frac{L_b}{2}$ the height of the wave determines the block weight. If $(d_b - d_{\text{toe}}) n > \frac{L_b}{2}$ the highest possible wave at $\frac{L_b}{2}$ is chosen for computation of the necessary block weight. The inclination of the bottom in front of the slope is assumed to be 1:n. Both for uprush and downrush at reduced depth of water, the slope must be calculated for the highest possible waves breaking at a distance of half the wave length from the toe of the slope.

This is expressed by the formula

$$\frac{(d_b - d_{\text{toe}}) n}{L_b} = 0.5 \quad (65.1)$$

For downrush, too, the first stones that moved were situated around the still-water level with the centre main point just below it, see last columns Tables 65.1 and 2. It will therefore be an advantage, if the heaviest blocks in armour layers are placed near the still-water levels.

66. Final Formulae of Stability Giving Required Block Weight in the Armour Layer

It is thus found that the block weight in the two or three surface layers of the slope must amount to

$$Q = \frac{\pi}{6} s_s k^3 \quad (66.1)$$

where for uprushing breaking waves

$$k = \frac{s_f}{s_s - s_f} \cdot \frac{K_{\text{up}} (d_b + 0.7 H_b)}{\frac{16 \pi}{3} \left(\log_{10} \frac{14.83 H_b}{k} \right)^2 (\tan \varphi \cos \alpha + \sin \alpha)} \quad (66.2)$$

The coefficient K_{up} may be put equal to 15.5 for pervious slopes and 18.0 for impervious slopes.

For downrushing wave phase at reflection and at breaking

$$k = \frac{s_f}{s_s - s_f} \cdot \frac{K_{\text{down}}}{16 \pi} \cdot \frac{H}{3 (\tan \varphi \cos \alpha - \sin \alpha)} \quad (66.3)$$

The value of the coefficient K_{down} is illustrated in Fig. 63.3. for both pervious and impervious slopes.

For a certain slope at each combination of the specific gravity and the angle φ the formulae of stability, Eqs. (66.2) and (66.3) together with Eq. (66.1) give the same necessary block weight. For slopes steeper than this boundary value the characteristic linear dimension k has at breaking waves to be calculated from Eq. (66.3) and for flatter slopes from Eq. (66.2).

CHAPTER 7

Conclusions

IRIBARREN (1938) believed that the coefficient in his formula was a constant. The formula aroused great interest among designers of rock-fill structures, especially in the U. S. A. and in France. After World War II the formula was checked by small-scale tests in the U. S. A., and HUDSON (1953) concluded in collaboration with others on the basis of a very extensive investigation that the coefficient could not be a constant but must vary with the slope angle and other variables.

In Chapter 4 the Author presents new general stability formulae, on the basis of which it is possible to explain the course of events occurring when waves attack rock-fill slopes. The conditions for the uprushing wave phase are analyzed. The Author has shown that the coefficient

$K_{\text{up}} = K_2 \left(1 + \tan \varphi \tan \beta + \frac{c}{\cos \varphi} \right)$ is a constant for a certain value of the angle φ , and that the angle β of the hydrodynamic force and the coefficient c , which determines the application point of the hydrodynamic force, are without significance, if the velocity of the uprush is given the value of the velocity of the breaking wave as generally expressed, and the depth of water z is made equal to the breaking wave height H_b , as in the stability formula, Eq. (44.1).

On the other hand, conditions for the downrush are more complicated. In this case it is very difficult to determine the water velocity v and the depth of water z . The Author has in this treatise assumed that the water velocity caused along the slope by the different types of waves may be expressed in the wave height at the spot, where the toe of the breakwater will be built. Also the depth of z varies with the type of wave and with the transformation of the wave, when it hits the slope of the breakwater.

The coefficient in the stability formula Eq. (44.2) is written

$$K_{\text{down}} = \frac{K_2 K_3^2}{\left(\log_{10} \frac{14.83 z}{k} \right)^2} \left(1 + \tan \varphi \tan \beta + \frac{c}{\cos \varphi} \right)$$

and it is proper for the coefficient K_{down} to vary in the way shown by the model tests, Fig. 65.3. For a steep slope the value z must be great. With flatter slopes it decreases and the coefficient K_{down} increases. When the slope is so flat that the waves break, the backwash has a certain thickness, which will not vary a great deal. On the other hand the coefficient K_s , which depends on the velocity, for breaking waves diminishes with flatter slopes, as the backwash has a longer distance to return. Therefore the coefficient K_{down} decreases in this part of the diagram, Fig. 65.3. In the reflection part of the diagram the velocity increases with the increasing reflection, but decreases with increasing period (wave length). The tests show, however, that there is hardly any variation of the stability with the change of the period, which is proved by HUDSON's tests. Possibly, connection may be traced between the degree of reflection and the period so that the velocity v_{max} , Eq. (432.2), is a constant. And further the uprush on the slope at wave reflection according to Fig. 432.1 seems to be a function of the degree of reflection, expressed by

$$H_s = F(H_l \sin \alpha)$$

The tests have shown that the values of the coefficients K_{up} and K_{down} vary with the porosity in the breakwater. A porous breakwater gives a lower value of the coefficient and an armour layer placed on an impervious bed requires a higher value of the coefficients for good stability under the influence of the waves.

The investigation has shown that the depth of water in front of the structure is of no importance, when the waves do not break. At reduced depth it is found that, when the waves are breaking at a distance of more than half the theoretical wave length at breaking from the toe of the breakwater, they will not cause damaging effects, if the slope is designed for the maximum waves just at the distance $\frac{L_b}{2}$ from the toe, Eq. (65.1).

Some variables have not been studied in this treatise. Thus the influence of imperviousness and void ratio of the armour layer have not been investigated. Nor has the difference between types of blocks, rounded stone blocks or special types of concrete blocks. However, in this case it is only a question of routine tests to find the coefficients applicable to the type of slope and type of blocks. Those detail tests will be the object of future research.

Another question is also worthy of notice. In laboratories today it is usually only possible to create waves of constant height, which attack the breakwater all the time. In reality a series of waves consists of a number of waves of different heights. It is usual to refer to significant wave height, which has been defined as the average height of one-third highest waves of a given wave group. The ratio of maximum value to the significant wave height is found to be 1.86 for a great number of waves. It is open to question whether, for the design of a breakwater, the maximum wave height must be chosen, or some other wave height, e. g. $H_{\frac{1}{10}}$, the average height of the highest one-tenth, or the significant wave height $H_{\frac{1}{3}}$ must be chosen. This is a question of the margin of safety demanded. The stability criterion is generally not a sharp limit and sometimes the movement of some stones may be tolerated, especially if repair is easy and cheap. If the maximum wave height at a certain frequency is chosen the breakwater will always be stable provided that no abnormal wave height occurs. If an average wave height of a proportion, explained above, is chosen, some waves higher than the design wave height will occur. These higher waves may cause movements here and there. Until this problem has been solved by further research, engineers must, when choosing the wave height for the computation of the breakwater, bear in mind risks of severe damage and costs incurred in other parts of the establishment due to more or less failure of the breakwater or the sea-wall.

CHAPTER 8

Some Examples of Application

Assume that a breakwater has to be designed for waves with the following conditions.

Wave height 5.0 m and period 13 sec.

The depth of water at the toe of the breakwater is 14 m from MLWS which level is ± 0.0 m.

The tidal range is 1.2 m.

The specific gravity of the rock in the quarry is 2.7 and the unit weight of the water in the sea is 1.03.

Let us try with the gradient 1 on 2 for the armour layer on the seaside. According to Eqs. (66.3) and (66.1) we obtain for down-rush when $K_{\text{down}} = 6.0$ according to Fig. 65.3

$$k = \frac{s_f}{s_s - s_f} \cdot \frac{6.0}{16\pi} \cdot \frac{H}{(1.11 \cos \alpha - \sin \alpha)} = \frac{1.03}{1.67} \cdot \frac{6.0}{16.76} \cdot \frac{5.0}{0.546} = 2.02 \text{ m}$$

and the necessary block weight

$$Q = \frac{\pi}{6} s_s k^3 = \frac{\pi}{6} \cdot 2.7 \cdot 2.02^3 = 11.7 \text{ ton}$$

Known wave characteristics are

wave height $H = 5.0$ m

wave length in deep water $L_0 = \frac{g}{2\pi} T^2 = 264$ m

According to Tables of Functions by WIEGEL (1954) we obtain

$$\frac{d}{L_0} = \frac{14 + 1.2}{264} = 0.0576; \quad \frac{d}{L} = 0.102; \quad \frac{H}{H_0} = 0.999$$

Thus

$$\frac{H_0}{L_0} = \frac{5.0}{0.999 \cdot 264} = 0.019; \quad L = \frac{15.2}{0.102} = 149; \quad \frac{H}{L} = 0.0336$$

and from Fig. 23.2

$$\frac{H_b}{H_0} = 1.20; \quad H_b = 6.0 \text{ m}$$

$$\frac{d_b}{H_0} = 1.50; \quad d_b = 7.5 \text{ m}$$

Thus the waves are breaking on the slope.

For uprush we obtain from Eq. (66.2)

$$k = \frac{s_f}{s_s - s_f} \cdot \frac{15.5}{3} \cdot \frac{(d_b + 0.7 H_b)}{\left(\log_{10} \frac{14.83 H_b}{k}\right)^2} \cdot \frac{1}{(1.11 \cos \alpha + \sin \alpha)} =$$

$$= \frac{1.03}{1.67} \cdot \frac{15.5}{16.76} \cdot \frac{(7.5 + 0.7 \cdot 6.0)}{\left(\log_{10} \frac{14.83 \cdot 6.0}{k}\right)^2} \cdot 1.440$$

$$k = \frac{4.64}{\left(\log_{10} \frac{89}{k}\right)^2}$$

Trial calculations give

k	function
1.50	1.48
1.46	1.46

and the necessary block weight, Eq. (66.1)

$$Q = \frac{\pi}{6} \cdot 2.7 \cdot 1.46^3 = 4.4 \text{ ton} < 11.7 \text{ ton}$$

Thus downrush is decisive in this case.

Fig. 34.1 gives the height of the uprush

$$\frac{H}{L} = 0.034; \quad \frac{R}{H} = 1.05$$

If all overtopping is prevented, the crest height will thus be

$$1.05 \cdot 5.0 + 1.20 = + 6.45 \text{ m}$$

Width: 5.0 m equal to the wave height.

Armour layer starts from $- 5.0$ m.

Fig. 8.1 shows the breakwater.

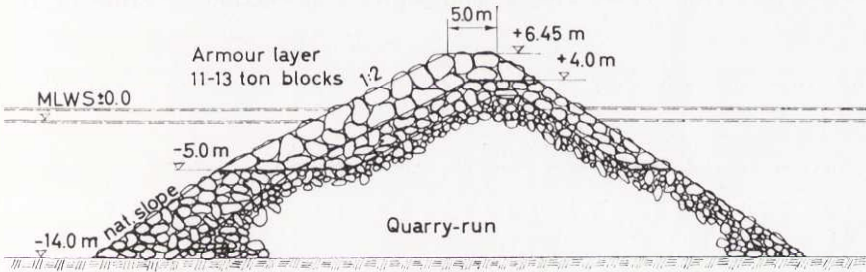


Fig. 8.1. Section of the breakwater, slope 1 on 2

Let us instead assume that the depth of water at the toe is 5.0 m from MLWS and that the inclination of the bottom in front of the breakwater is 1 on 100.

We obtain according to the conclusion about maximum wave attack in Sections 63 and 65, pp. 82 and 94

$$\frac{(d_b - d_{\text{toe}}) n}{L_b} = \frac{(7.5 - 6.2) 100}{L_b} = \frac{130}{108} > 0.5$$

where L_b is obtained in the following way by aid of Tables of Functions by WIEGEL (1954)

$$\frac{d_b}{L_0} = \frac{7.5}{264} = 0.0284; \quad \frac{d_b}{L_b} = 0.0693; \quad L_b = 108 \text{ m}$$

Thus the wave height 5.0 m will never reach the breakwater according to Section 65. The highest attacking wave will, according to the trial calculations below, be found to be 4.85.

Assume $L_b = 90$ m and we obtain the corresponding $d_b = (6.20 + 0.45) = 6.65$ m.

$\frac{d_b}{L_0} = 0.0252$; from the Tables the corresponding ratio $\frac{d_b}{L_b} = 0.0651$ which gives $L_b = 102 \neq 90$.

A new trial. $L_b = 103$ m gives $d_b = (6.20 + 0.515) = 6.715$ m.

$\frac{d_b}{L_0} = 0.0254$; $\frac{d_b}{L_b} = 0.0654$ which gives the assumed value of L_b on the condition that $\frac{(d_b - d_{\text{toe}}) n}{L_b} = 0.5$.

Further trial calculations give the wave height.

$$\frac{d_b}{L_0} = 0.0254; \quad \frac{H}{H_0} = 1.164.$$

Assume $H_0 = 4.00$ m.

$$\frac{H_0}{L_0} = 0.0152.$$

From Fig. 23.2 we obtain $\frac{d_b}{H_0} = 1.62$; and thus $H_0 = 4.15 \neq 4.00$.

A new trial, now with $H_0 = 4.17$ m.

$$\frac{H_0}{L_0} = 0.0158.$$

Fig. 23.2 gives $\frac{d_b}{H_0} = 1.61$; and thus $H_0 = 4.17$ which value agrees with the assumed one, and $H = 1.164 \cdot 4.17 = 4.85$ m.

The maximum wave height to be inserted in the stability formula is therefore 4.85 m for the reduced depth of 5 m at the toe. The block weight will be 10.6 ton and the crest height + 6.10 m.

Fig. 8.2 shows the breakwater.

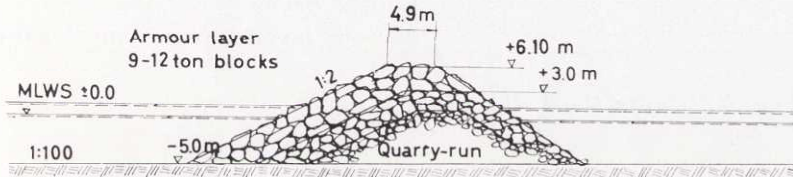


Fig. 8.2. Section of the breakwater, slope 1 on 2, reduced depth at toe

Let us now instead try with the gradient 1 on 4 of the armour layer. In the same way as above we obtain for downrush

$$k = \frac{1.03}{1.67} \cdot \frac{7.4}{16.76} \cdot \frac{5.0}{0.834} = 1.63$$

and

$$Q = \frac{\pi}{6} \cdot 2.7 \cdot 1.63^3 = 6.14 \text{ ton}$$

and for uprush

$$k = \frac{1.03}{1.67} \cdot \frac{15.5}{16.76} \cdot \frac{11.7}{\left(\log_{10} \frac{14.83 \cdot 6.0}{k}\right)^2} \cdot \frac{1}{1.319}$$

$$k = \frac{5.06}{\left(\log_{10} \frac{89}{k}\right)^2}$$

Trial calculations give

k	function
1.70	1.71
1.73	1.73

and again $Q = \frac{\pi}{6} \cdot 2.7 \cdot 1.73^3 = 7.4 \text{ ton} > 6.1 \text{ ton}$

Thus uprush is decisive in this case.

The height of the uprush will be:

$$\frac{H}{L} = 0.034; \quad \frac{R}{H} = 0.80 \quad \text{Crest height:}$$

$$0.80 \cdot 5.0 + 1.20 = + 5.20 \text{ m}$$

Width: 5.0 m

Armour layer starts from $- 5.0$ m.

Fig. 8.3 shows the breakwater.

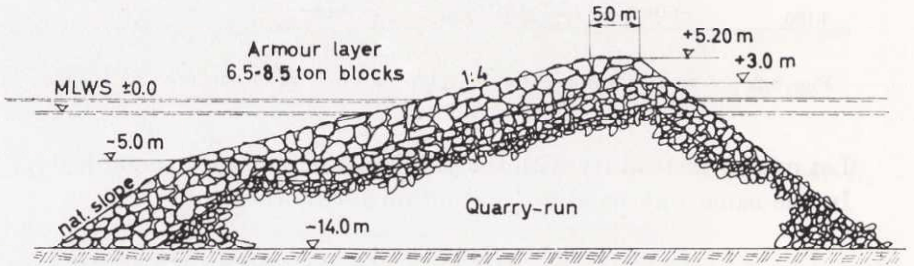


Fig. 8.3. Section of the breakwater, slope 1 on 4

CHAPTER 9

Summary

91. Summary in English

The need of general formulae for the design of rock-fill slopes attacked by waves has been felt for quite some time. Many scientists have grappled with the task and after theoretical studies, often supplemented by small-scale tests, presented formulae for the computation of the required weight of blocks in the armour layer of the break-water.

Most used today is the IRIBARREN-HUDSON formula

$$Q = \frac{s_s s_f^3 K' \mu^3 H^3}{(s_s - s_f)^3 (\mu \cos \alpha - \sin \alpha)^3} \quad (33.7)$$

where American investigations have given the following average values of the coefficient K'

Slope	K'
1:1.25	0.0035
1:1.5	0.0085
1:2	0.0175
1:2.5	0.0285
1:3	0.0365
1:4	0.0325
1:5	0.0300

During the 1950's extensive and systematic research has been performed in several hydraulic laboratories in different parts of the world.

This applies especially to the U. S. Waterways Experiment Station at Vicksburg in the U. S. A., to Société Grenobloise d'Etudes et d'Applications Hydrauliques (SOGREAH) at Grenoble in France and to Chalmers University of Technology at Gothenburg in Sweden. The

results of the American investigations were published by HUDSON (1958, 1959) and the Swedish research, made by the Author, is described in this treatise.

HUDSON (1958, 1959) found that the weight of the blocks in a slope of a breakwater should be computed according to the formula

$$Q = \frac{s_s H^3}{3.2 \left(\frac{s_s}{s_f} - 1 \right)^3 \cot \alpha} \quad (33.12)$$

if good stability was to be obtained.

The Author has, however, arrived at results given here, which theoretically differ from HUDSON's, but it has been possible to use HUDSON's test values to confirm the results arrived at by the Author.

The Author contends that it is necessary to take into consideration both the uprushing wave phase and the downrushing wave phase. At wave breaking on the slope or in front of it the uprushing wave phase may be more dangerous for the slope than the downrushing. Under the circumstances for reflection the wave is going up and down with the same velocity so that the movement downwards must always require heavier blocks than the uprush and is thus always decisive.

Every single stone is assumed to be attacked by a gravity force and by a hydrodynamic force according to Figs. 42.1 and 42.2, valid for uprush and downrush respectively. Stability equations give a fictive average diameter k at the moment when a single block is just about to overturn around a support A .

For uprushing wave phase we obtain

$$k = \frac{s_f}{s_s - s_f} \cdot \frac{K_2}{K_1} \cdot \frac{\frac{v^2}{g}}{32 \left(\log_{10} \frac{14.83 z}{k} \right)^2} \cdot \frac{\left(1 + \tan \varphi \tan \beta + \frac{c}{\cos \varphi} \right)}{(\tan \varphi \cos \alpha + \sin \alpha)} \quad (42.5)$$

and for downrushing wave phase

$$k = \frac{s_f}{s_s - s_f} \cdot \frac{K_2}{K_1} \cdot \frac{\frac{v^2}{g}}{32 \left(\log_{10} \frac{14.83 z}{k} \right)^2} \cdot \frac{\left(1 + \tan \varphi \tan \beta + \frac{c}{\cos \varphi} \right)}{(\tan \varphi \cos \alpha - \sin \alpha)} \quad (42.6)$$

where the hydrodynamic force is inserted in the equations with the value it has when the shearing force between flowing water and a hydraulic rough surface is expressed according to well-known hydraulic laws.

In Eqs. (42.5) and (42.6) the water velocity is expressed in wave characteristics and inherent coefficients are determined by aid of theory or tests.

Since at present the rules for reflection of a given type of wave at a slope of a certain gradient do not give reliable information, it is not possible to express the water velocity in known wave characteristics.

The model tests showed that the coefficient K_{up} is a constant equal to 15.5 with a pervious slope, as in a breakwater, and 18.0 when the armour layer is placed on an impervious bed, as in a sea-wall.

The coefficient K_{down} , on the other hand, cannot have a constant value. It varies according to the diagram, Fig. 65.3. Increasing period means increased reflection and by that increasing velocity and increasing thickness of water. For that reason the tests showed that the coefficient K_{down} does not vary significantly. On the other hand a steeper slope involves increased reflection, and in this case the influence of the increasing depth of water z is greater than that of the increasing velocity v , and the coefficient K_{down} , therefore, takes a decreasing value with a steeper slope. When it is a question of the backwash from a breaking wave on the slope, in which case the thickness z is indubitably less than the height on breaking — perhaps one-third of this height — the reduction of the velocity will be greater for longer return flow and so it follows that the coefficient K_{down} must take a decreasing value at a more gentle gradient of the slope. This fact is confirmed by the appearance of the curve.

Further the tests showed that the coefficient K_{down} varies with the degree of imperviousness of the core or the bed for the armour layer. A less pervious support gives a higher value of the coefficient.

However, it is possible to show that the water velocity on breaking may be expressed for uprush in the breaking wave height H_b , and the depth of water d_b on breaking. At reflection the velocity is a function of the wave height H at the toe of the slope. The thickness z is at uprushing breaking wave phase equal to or somewhat less than the height H_b on breaking, and at reflection less than a quarter of the wave length.

Thus Eqs. (42.5) and (42.6) may be written for uprushing wave phase on breaking, if the coefficient $K_1 = \frac{\pi}{6}$, which is valid for spheres, and if $\tan \varphi = 1.11$, which value is determined by separate tests,

$$k = \frac{s_f}{s_s - s_f} \cdot \frac{K_2}{16\pi} \cdot \frac{(d_b + 0.7 H_b)}{\left(\log_{10} \frac{14.83 H_b}{k}\right)^2} \cdot \frac{\left(1 + \tan \varphi \tan \beta + \frac{c}{\cos \varphi}\right)}{(\tan \varphi \cos \alpha + \sin \alpha)} \quad (44.1)$$

where $K_{up} = K_2 \left(1 + \tan \varphi \tan \beta + \frac{c}{\cos \varphi}\right)$ is to be determined from the tests,

and for downrushing wave phase at reflection and on breaking

$$k = \frac{s_f}{s_s - s_f} \cdot \frac{K_2 K_3^2}{16\pi} \cdot \frac{H}{\left(\log_{10} \frac{14.83 z}{k}\right)^2} \cdot \frac{\left(1 + \tan \varphi \tan \beta + \frac{c}{\cos \varphi}\right)}{(\tan \varphi \cos \alpha - \sin \alpha)} \quad (44.2)$$

where

$$K_{down} = \frac{K_2 K_3^2 \left(1 + \tan \varphi \tan \beta + \frac{c}{\cos \varphi}\right)}{\left(\log_{10} \frac{14.83 z}{k}\right)^2}$$

is to be determined from the tests.

The blocks in the two or three surface layers of a slope from a level equal to the wave height H below SWL must thus have a size according to the following formula in order to get good stability

$$Q = \frac{\pi}{6} s_s k^3 \quad (411.1)$$

where for uprush on breaking

$$k = \frac{s_f}{s_s - s_f} \cdot \frac{K_{\text{up}} (d_b + 0.7 H_b)}{\frac{16 \pi}{3} \left(\log_{10} \frac{14.83 H_b}{k} \right)^2 (1.11 \cos \alpha + \sin \alpha)} \quad (91.1)$$

and for downrushing wave phase at both reflection and breaking

$$k = \frac{s_f}{s_s - s_f} \cdot \frac{K_{\text{down}} H}{\frac{16 \pi}{3} (1.11 \cos \alpha - \sin \alpha)} \quad (91.2)$$

The coefficient K_{up} takes the value 15.5 for a pervious breakwater and 18.0 for an impervious core. The coefficient K_{down} varies according to Fig. 65.3.

In the test a certain variation of the block weight was allowed. This implies that the armour layer may consist of well-graded blocks with the average weight Q and a deviation of up to $\pm 15\%$ for the single blocks.

Eq. (91.1) means decreasing stability the flatter the slope. Eq. (91.2) implies the contrary, that is increasing stability the flatter the slope. At a certain gradient the same block weight for uprushing and downrushing wave phase is obtained for breaking waves. As a general rule, the formula giving the heaviest blocks is to be chosen to ensure stability of the slope.

Considering the wave motion against a slope of rock-fill or concrete blocks in this way, an answer is obtained to the complicated question of what happens when waves are transformed against a slope. A complete explanation of what happens is not possible until future research has solved the problem of velocity and thickness of the water on the slope in relation to every combination of wave characteristics and shape of the slope.

Finally, it is found that the waves breaking at a distance of half the breaking wave length from the toe of the breakwater will cause maximum attacks on the seaside slope, Eq. (65.1).

92. Summary in French. Résumé en français

Depuis longtemps, on a ressenti le besoin d'élaborer des formules générales pour l'étude des talus à revêtement en pierres non taillées exposés à l'attaque de la houle. Bien des savants se sont attaqués

à ce problème et ont, après des études théoriques souvent complétées par des essais, présenté des formules pour calculer la grosseur des blocs formant le revêtement de surface d'un brise-lames. La formule suivante, d'IRIBARREN-HUDSON, est la plus usitée en ce moment:

$$Q = \frac{s_s s_f^3 K' \mu^3 H^3}{(s_s - s_f)^3 (\mu \cos \alpha - \sin \alpha)^3} \quad (33.7)$$

en application de laquelle des recherches effectuées en Amérique ont donné les valeurs suivantes pour le coefficient K' :

Inclinaison	K'
1:1,25	0,0035
1:1,5	0,0085
1:2	0,0175
1:2,5	0,0285
1:3	0,0365
1:4	0,0325
1:5	0,0300

Depuis 1950, des travaux approfondis et systématiques sont poursuivis de différents côtés, notamment à l'U. S. ARMY ENGINEER WATERWAYS EXPERIMENT STATION à Vicksburg aux Etats-Unis, à la Société Grenobloise d'Etudes et d'Applications Hydrauliques (SOGREAH), à Grenoble en France, et à l'Ecole polytechnique de Chalmers à Göteborg, en Suède. Les résultats des travaux américains ont été publiés par HUDSON (1958, 1959) et ceux des recherches effectuées par l'auteur font l'objet de cette thèse.

HUDSON (1958, 1959) préconise l'emploi de la formule suivante pour calculer le profil du talus d'un brise-lames:

$$Q = \frac{s_s H^3}{3,2 \left(\frac{s_s}{s_f} - 1 \right)^3 \cot \alpha} \quad (33.12)$$

afin d'obtenir une bonne stabilité.

L'auteur a cependant abouti à des résultats théoriques qui diffèrent de ceux d'HUDSON, tout en ayant pu utiliser les valeurs des essais d'HUDSON pour confirmer les résultats de ses propres essais.

L'auteur soutient qu'il faut tenir compte tant de la phase de lame montante que de la phase de lame descendante, en les considérant

séparément. Dans le cas d'une lame déferlant sur le talus ou devant celui-ci, la phase montante peut être bien plus dangereuse que la phase descendante. Si, par contre, les circonstances sont telles qu'une réflexion se produit, la lame monte et descend avec la même rapidité, ce qui revient à dire que le mouvement descendant exige des blocs de dimensions plus grandes que le mouvement ascendant, pour que le talus soit stable.

Chaque bloc est supposé être soumis individuellement à l'action de la gravité, ainsi qu'à une force hydrodynamique suivant les figures 42.1 et 42.2 illustrant les phases montante et descendante d'une lame. Des équations de stabilité donnent, pour le cas où un bloc, pris individuellement, est sur le point de se mettre à pivoter autour d'un point d'appui A , un diamètre moyen imaginaire k .

Pour la phase montante:

$$k = \frac{s_f}{s_s - s_f} \cdot \frac{K_2}{K_1} \cdot \frac{\frac{v^2}{g}}{32 \left(\log_{10} \frac{14,83 z}{k} \right)^2} \cdot \frac{\left(1 + \tan \varphi \tan \beta + \frac{c}{\cos \varphi} \right)}{(\tan \varphi \cos \alpha + \sin \alpha)} \quad (42.5)$$

et pour la phase descendante:

$$k = \frac{s_f}{s_s - s_f} \cdot \frac{K_2}{K_1} \cdot \frac{\frac{v^2}{g}}{32 \left(\log_{10} \frac{14,83 z}{k} \right)^2} \cdot \frac{\left(1 + \tan \varphi \tan \beta + \frac{c}{\cos \varphi} \right)}{(\tan \varphi \cos \alpha - \sin \alpha)} \quad (42.6)$$

la force hydrodynamique figure dans l'équation avec la valeur qu'elle prend si le frottement de l'eau sur une surface hydrauliquement rugueuse est déterminé conformément aux lois connues et généralement admises en matière d'hydraulique.

Dans les équations (42.5) et (42.6), la vitesse de l'eau v est exprimée en fonction des caractéristiques de lames et les coefficients qui y entrent ont été déterminés théoriquement ou par des essais.

Tant que les conditions de réflexion ne peuvent pas être directement prévues pour tel type de lame et telle pente de talus, il n'est pas possible d'exprimer, dans chaque cas particulier, la vitesse de l'eau en fonction des caractéristiques de lames connues.

Les essais sur modèle réduit ont démontré que le coefficient K_{up} est une constante égale à 15,5 en cas de talus perméable à l'eau,

comme par exemple celui d'un brise-lames, et 18,0 si le talus repose sur un matériau compacte, comme c'est le cas pour les revêtements de rives.

Par contre, le coefficient K_{down} ne peut pas prendre une valeur constante, mais varie suivant le graphique fig. 65.3. Une période croissante entraîne une réflexion plus forte et, partant, une augmentation de la vitesse et un accroissement de la profondeur z . Il résulte des essais que le coefficient K_{down} reste à peu près sans changement dans ce cas. Par contre, un talus à pente plus forte produit une réflexion plus forte, et dans ce cas la profondeur z croît plus vite que la vitesse v , ce qui signifie que le coefficient K_{down} décroît à mesure que la pente devient plus forte. Dans le cas d'une masse d'eau qui reflue après un déferlement sur le talus; où la profondeur z est incontestablement inférieure à la hauteur de la lame déferlante, peut-être un tiers de cette hauteur, la réduction de la vitesse est d'autant plus grande que la distance à parcourir par la masse d'eau sur le talus est plus longue, et la valeur du coefficient K_{down} devra donc aller en diminuant à mesure que la pente est plus douce. Ce fait est corroboré par la forme de la courbe des deux côtés de son maximum.

Il a été démontré en outre que le coefficient K_{down} varie avec la compacité des couches inférieures du talus, les valeurs obtenues étant plus élevées pour un support étanche.

On peut cependant prouver que la vitesse d'une lame montante qui déferle peut être exprimée par la hauteur H_b de la lame déferlante et la profondeur d_b au moment du déferlement. En cas de réflexion, la vitesse est fonction de la hauteur H de la lame au pied du talus. La profondeur z de l'eau est, pour la phase montante d'une lame déferlante, égale ou un peu inférieure à H_b et, en cas de réflexion, moins d'un quart de longueur d'onde.

Les équations (42.5) et (42.6) peuvent donc s'établir comme suit pour la phase montante d'une lame déferlante, en supposant $K_1 = \frac{\pi}{6}$, ce qui serait le cas si les pierres avaient été sphériques, si $\tan \varphi = 1,11$, valeur qui a été déterminée par des essais séparés:

$$k = \frac{s_f}{s_s - s_f} \cdot \frac{K_2}{16 \pi} \cdot \frac{(d_b + 0,7 H_b)}{\left(\log_{10} \frac{14,83 H_b}{k} \right)^2} \cdot \frac{\left(1 + \tan \varphi \tan \beta + \frac{c}{\cos \varphi} \right)}{(\tan \varphi \cos \alpha + \sin \alpha)} \quad (44.1)$$

où $K_{up} = K_2 \left(1 + \tan \varphi \tan \beta + \frac{c}{\cos \varphi} \right)$ résulte des essais,
et pour la phase descendante en cas de réflexion et de déferlement:

$$k = \frac{s_f}{s_s - s_f} \cdot \frac{K_2 K_3^2}{3} \cdot \frac{H}{\left(\log_{10} \frac{14,83 z}{k} \right)^2} \cdot \frac{\left(1 + \tan \varphi \tan \beta + \frac{c}{\cos \varphi} \right)}{(\tan \varphi \cos \alpha - \sin \alpha)} \quad (44.2)$$

où

$$K_{down} = \frac{K_2 K_3^2 \left(1 + \tan \varphi \tan \beta + \frac{c}{\cos \varphi} \right)}{\left(\log_{10} \frac{14,83 z}{k} \right)^2}$$

résulte des essais.

Afin d'obtenir une bonne résistance aux attaques de la houle, les blocs du revêtement extérieur d'un talus doivent, par conséquent, avoir le même poids au-dessous du niveau d'eau calme jusqu'à une profondeur égale à la hauteur des lames, et ce suivant la formule ci-après:

$$Q = \frac{\pi}{6} s_s k^3 \quad (411.1)$$

où, pour une phase de lame montante et un déferlement:

$$k = \frac{s_f}{s_s - s_f} \cdot \frac{K_{up} (d_b + 0,7 H_b)}{\frac{16 \pi}{3} \left(\log_{10} \frac{14,83 H_b}{k} \right)^2 (1,11 \cos \alpha + \sin \alpha)} \quad (92.1)$$

et pour une phase descendante tant en cas de réflexion que de déferlement:

$$k = \frac{s_f}{s_s - s_f} \cdot \frac{K_{down} H}{\frac{16 \pi}{3} (1,11 \cos \alpha - \sin \alpha)} \quad (92.2)$$

Le coefficient K_{up} a la valeur 15,5 pour un brise-lames perméable à l'eau et la valeur 18,0 pour un brise-lames imperméable. Le coefficient K_{down} varie selon la figure 65.3.

Une certaine variation des poids des blocs a été admise pendant les essais. Il en résulte que le revêtement devra être composé de blocs ayant le poids moyen Q , et qu'un écart du poids individuel des blocs est toléré jusqu'à $\pm 15\%$.

L'équation (92.1) démontre que la stabilité d'un talus diminue à mesure que son inclinaison décroît. L'équation (92.2) indique que la stabilité est d'autant plus grande que la pente est plus douce. A une inclinaison donnée on obtient, en cas de déferlement, un poids de blocs de revêtement égal pour la phase montante et la phase descendante. On peut dire d'une manière générale que la formule donnant le poids maximum doit être utilisée.

En considérant de cette manière l'action de la houle incidente sur un talus en blocs de pierre ou de béton, on parvient à expliquer le mécanisme compliqué de la transformation que subit cette houle au contact du talus. Une analyse complète du processus de transformation ne pourra être faite que lorsqu'on aura déterminé, par des essais qui restent encore à effectuer, la vitesse et la profondeur de l'eau sur le talus, pour chaque combinaison de caractéristiques de lames et de profils de talus.

Il a été démontré enfin que les lames qui attaquent le plus violemment le talus sont celles qui déferlent à la distance $\frac{L_b}{2}$ de son pied, équation (65.1).

Tables

Tables of functions, integrant parts, in the formulae of stability, compiled for the convenience of the reader

Uprush

$$1.11 \cos \alpha + \sin \alpha = F_1(\alpha)$$

Gradient	$F_1(\alpha)$
1:1.25	1.491
1:1.5	1.478
1:2	1.440
1:2.5	1.402
1:3	1.369
1:3.5	1.342
1:4	1.319
1:4.5	1.301
1:5	1.285

Downrush

$$1.11 \cos \alpha - \sin \alpha = F_2(\alpha)$$

Gradient	$F_2(\alpha)$	α	$\varphi - \alpha$ ($\varphi = 48.02^\circ$, $\tan \varphi = 1.11$)
1:1.25	0.242	38.66°	9.36°
1:1.5	0.369	33.69°	14.33°
1:2	0.546	26.57°	21.45°
1:2.5	0.659	21.80°	26.22°
1:3	0.737	18.43°	29.59°
1:3.5	0.793	15.95°	32.07°
1:4	0.834	14.04°	33.98°
1:4.5	0.867	12.53°	35.49°
1:5	0.892	11.31°	36.71°

References

Abbreviations:

- ASCE = American Society of Civil Engineers
Ed. = Edition
IAHR = International Association for Hydraulic Research
IAHSR = International Association for Hydraulic Structures Research
Math. = Mathematical
Medd. = Meddelanden
PIANC = Permanent International Association of Navigation Congresses
Proc. = Proceedings
Ser. = Serie, series
Trans. = Transactions

- AIRY, G. B., On tides and waves. Encyclopaedia Metropolitana. London 1845. Vol. 5, pp. 241–396.
- BARBE, R., Étude expérimentale de la protection et du tracé des ports maritimes. Nouveautés techniques maritimes 14 (1950), p. 10.
- BARBE, R., & BEAUDEVIN, C., Recherches expérimentales sur la stabilité d'une jetée à talus incliné soumise à la houle. La Houille blanche 8 (1953): 346–59.
- BEAUDEVIN, C., Stabilité des digues à talus à carapace en vrac. La Houille blanche 10 (1955): 332–39.
- BEAUDEVIN, C., See also BARBE, R., & BEAUDEVIN, C., Recherches expérimentales . . .
- BIÉSEL, F., Filtre à houle. La Houille blanche 3 (1948): 276–90.
- BREAKERS and Surf. Principles in Forecasting. U. S. Navy Hydrographic Office. H. O. No. 234, 1944.
- COYER, C. B., A multi-purpose wave generator. Minnesota international hydraulics convention. Proc. 1953, pp. 281–91. (IAHR 5th meeting. Minneapolis 1953)
- CRUMP, E. S., Flow of fluids in conduits and open channels. Institution of Civil Engineers. Proc. 5 (1956), part 3, pp. 522–26.
- DALVERNAY, J., Appareil pour mesurer la longueur d'onde de la houle sur modèle. La Houille blanche 3 (1948): 187.
- DE CASTRO, D. E., Diques de escollera. Revista de obras publicas 80 (1933): 183–85.
- DEVIMEUX, W., See LAURENT, J., & DEVIMEUX, W., Étude expérimentale . . .
- EPSTEIN, H., & TYRELL, F. C., Design of rubble-mound breakwaters. 17th international navigation congress, Lisbon 1949, Section 2, Communication 4, pp. 81–98. Brussels 1949. (PIANC)
- GAILLARD, D. D., Wave Action in Relation to Engineering Structures. Fort Belvoir 1904. 2 ed. 1935. Repr. 1945.
- GERSTNER, F. J. VON, Theorie der Wellen. Prag 1802. (Königliche böhmische Gesellschaft der Wissenschaften. Abhandlungen 1)

- HAVELOCK, T. H., Periodic irrotational waves of finite height. Royal Society of London. Proc. Ser. A, 95 (1918): 38—51.
- HEAVY breakwater built in fast time. Engineering News-Record 121 (1938): 789—92.
- HEDAR, P. A., Design of rock-fill breakwaters. Minnesota international hydraulics convention. Proc. 1953, pp. 241—60. (IAHR 5th meeting. Minneapolis 1953). (Abridgement of the following paper)
- HEDAR, P. A., Dimensionering av sprängstensvägbrytare. Typewritten. Göteborg 1953. (Chalmers tekniska högskola, Institutionen för vattenbyggnad)
- HEDAR, P. A., Essais effectués sur un amortisseur de houle de modèle réduit. La Houille blanche 11 (1956): 748—52.
- HENNES, R. G., & LEONOFF, C. E., Discussion of wave forces on breakwaters. ASCE. Paper 2556, pp. 676—85. New York 1953.
- HICKSON, R. E., & RODOLF, F. W., Design and construction of jetties. 1st conference on coastal engineering. Proc. pp. 227—45. Berkeley 1951.
- HUDSON, R. Y., Wave forces on breakwaters. ASCE. Paper 2556, pp. 653—74. New York 1953.
- HUDSON, R. Y., Design of quarry-stone cover layers for rubble-mound breakwaters. U. S. Waterways Experiment Station. Research report No. 2—2. Vicksburg 1958.
- HUDSON, R. Y., Laboratory investigation of rubble-mound breakwaters. ASCE. Paper 2171, pp. 93—121. New York 1959.
- HUDSON, R. Y., & JACKSON, R. A., Stability of rubble-mound breakwaters. Hydraulic model investigation. Corps of Engineers. U. S. Army Waterways Experiment Station. Technical memorandum No. 2—365. Vicksburg 1953.
- HUDSON, R. Y., & MOORE, L. F., The hydraulic model as an aid in breakwater design. 1st conference on coastal engineering. Proc. pp. 205—12. Berkeley 1951.
- IRIBARREN CAVANILLES, R., Una fórmula para el cálculo de los diques de escollera. Pasajes 1938.
- IRIBARREN CAVANILLES, R., & NOGALES Y OLANO, C., Generalización de la fórmula para el cálculo de los diques de escollera y comprobación de sus coeficientes. Madrid 1950.
- IRIBARREN CAVANILLES, R., & NOGALES Y OLANO, C., New confirmation of the formula for the calculation of rock fill dikes. 3rd conference on coastal engineering. Proc. pp. 185—89. Berkeley 1953. [1953 a]
- IRIBARREN CAVANILLES, R., & NOGALES Y OLANO, C., Rapport. 18th international navigation congress, Rome 1953, Section 2, Question 1, pp. 45—66. Brussels 1953. (PIANC). [1953 b]
- IRIBARREN CAVANILLES, R., & NOGALES Y OLANO, C., Other verifications of the formula for the calculation of breakwater embankments. PIANC. Bulletin, No. 39, pp. 119—39. Brussels 1954.
- JACKSON, R. A., See HUDSON, R. Y., & JACKSON, R. A., Stability of rubble-mound breakwaters . . .
- JOHNSON, J. W., See Wiegel, R. L., & JOHNSON, J. W., Elements of wave theory . . .
- KAPLAN, K., Notes on determination of stable underwater slopes. Beach Erosion Board. Bulletin 6 (1952), No. 3, pp. 20—22. Washington D. C. 1952.
- KAPLAN, K., & PAPE, H. E. Jr., Design of breakwaters. 1st conference on coastal engineering. Proc. pp. 213—22. Berkeley 1951.
- KAPLAN, K., See VESPER, W. H., & KAPLAN, K., Charts and tables . . .

- KOZENY, J., *Hydraulik*. Wien 1953.
- LAMB, H., *Hydrodynamics*. 1st American ed. New York 1945. (6th ed. Cambridge 1932)
- LARRAS, J., L'Équilibre sous-marin d'un massif de matériaux soumis à la houle. *Le Génie civil* 129 (1952): 353—54.
- LAURENT, J., & DEVIMEUX, W., Étude expérimentale de la réflexion de la houle sur des obstacles accores. *Revue générale de l'hydraulique* 17 (1951): 235—46.
- LEONOFF, C. E., See HENNES, R. G., & LEONOFF, C. E., Discussion of wave forces . . .
- MASON, M. A., See A SUMMARY of the theory of oscillatory waves . . .
- MATHEWS, W. J., A re-evaluation of rock size formulas for rubble breakwaters. Los Angeles 1948. Los Angeles District Corps of Engineers. (Unpublished)
- MICHELL, J. H., The highest waves in water. *The London, Edinburgh, and Dublin Philosophical Magazine and Journal of Science*. 5th ser. 36 (1893): 430—37.
- MOORE, L. F., See HUDSON, R. Y., & MOORE, L. F., The hydraulic model . . .
- MORISON, J. R., The effect of wave steepness on wave velocity. *American Geophysical Union. Trans.* 32 (1951): 201—06.
- NOGALES Y OLANO, C., See IRIBARREN CAVANILLES, R., & NOGALES Y OLANO, C., Generalización de la fórmula . . .
- NOGALES Y OLANO, C., See IRIBARREN CAVANILLES, R., & NOGALES Y OLANO, C., New confirmation . . .
- NOGALES Y OLANO, C., See IRIBARREN CAVANILLES, R., & NOGALES Y OLANO, C., Rapport . . .
- NOGALES Y OLANO, C., See IRIBARREN CAVANILLES, R., & NOGALES Y OLANO, C., Other verifications . . .
- O'BRIEN, M. P., & MASON, M. A., See a SUMMARY of the theory of oscillatory waves . . .
- PAPE, H. E. Jr., See KAPLAN, K., & PAPE, H. E. Jr., Design of breakwaters . . .
- PRANDTL, L., *Strömungslehre*. Vierte Auflage. Braunschweig 1956.
- RANSFORD, G. D., A wave machine of novel type. IAHSR 3rd meeting. Proc. I—10, pp. 1—9. Grenoble 1949.
- RANSFORD, G. D., A statistical analysis of errors in point gauge measurements. *La Houille blanche* 6 (1951): 518—28. [1951 a]
- RANSFORD, G. D., A method of measuring wave lengths of model waves by synchronization of visual signals. *La Houille blanche* 6 (1951): 764—73. [1951 b]
- RAYLEIGH, J., On waves. *The London, Edinburgh, and Dublin Philosophical Magazine and Journal of Science*. 5th ser. 1 (1876): 257—79.
- RAYLEIGH, J., On progressive waves. *London Math. Society. Proc.* 9 (1877): 21—26.
- REPORT of the Hydraulics Research Board with the report of the director of hydraulics research for the year 1955, pp. 36—39. London 1956. (Department of Scientific and Industrial Research)
- RODOLF, F. W., See HICKSON, R. E., & RODOLF, F. W., Design and construction . . .
- SHORE Protection Planning and Design. Beach Erosion Board. Technical report No. 4. Washington D. C. 1954. (+Supplement: Corrections, revisions, and addenda for technical report No. 4, Washington D. C. 1957)
- STOKER, J. J., *Water Waves*. New York & London 1957.
- STOKES, G. G., On the theory of oscillatory waves. *Cambridge Philosophical Society. Trans.* 8 (1847): 441, Supplement scientific papers 1 (1847): 314.
- A STUDY of progressive oscillatory waves in water. Beach Erosion Board. Technical report No. 1. Washington D. C. 1941.

- A SUMMARY of the theory of oscillatory waves. Beach Erosion Board. Technical report No. 2. Washington D. C. 1942.
- SUNDBORG, Å., The River Klarälven. A Study of Fluvial Processes. Uppsala universitets geografiska institution. Medd. Ser. A, No. 115. Stockholm 1956.
- The TETRAPOD concrete block. A new technique in breakwater construction. Dock and Harbour Authority 38 (1957-58): 50-51.
- TYRELL, F. C., See EPSTEIN, H., & TYRELL, F. C., Design of rubble-mound breakwaters . . .
- VESPER, W. H., & KAPLAN, K., Charts and tables for determining surface stone sizes for rubble mound structures in wave action. Beach Erosion Board. Bulletin 7 (1953), No. 1, pp. 10-25. Washington D. C. 1953.
- WIEGEL, R. L., Experimental study of surface waves in shoaling water. American Geophysical Union. Trans. 31 (1950): 377-85.
- WIEGEL, R. L., Gravity Waves. Tables of Functions. Council on Wave Research. Berkeley 1954.
- WIEGEL, R. L., & JOHNSON, J. W., Elements of wave theory. 1st conference on coastal engineering. Proc. pp. 5-21. Berkeley 1951.



CÖTEBORG
ELANDERS BOKTRYCKERI AKTIEBOLAG
1960