

UNIVERSITY OF ZAGREB
FACULTY OF TRANSPORT AND TRAFFIC SCIENCES

**POSTAL PARCELS DELIVERY PHASE
OPTIMIZATION**

DIPLOMA WORK

ZAGREB, 2015.

University of Zagreb
Faculty of Transport and Traffic Sciences

DIPLOMA WORK

POSTAL PARCELS DELIVERY PHASE OPTIMIZATION

Mentors: prof. dr. sc. Zvonko Kavran

doc. Ing. Radovan Madleňák, PhD.

Student: Igor Baltić

JMBAG: 0135 218 451

Zagreb, September 2015.

SUMMARY

Technological phase end-delivery represents the most expensive activity of postal traffic. By identifying user requirements and separating it as a distinguished holistic system and process it is possible to identify factors which affect efficiency and effectiveness regarding handing over and delivery of postal items. End-delivery has decisive effect on quality because as a service subsystem directly represents postal service to end users.

Postal services are performed by using public or autonomous postal network. Systematic modeling of delivery districts, application of mathematical and heuristic methods with adaptation of intelligent transportation solutions optimize network and everyday operational costs.

KEYWORDS: postal technology, end-delivery, delivery district modelling, optimization of itineraries, mail delivery

TABLE OF CONTENTS:

1. INTRODUCTION	1
1.1. PROBLEM AND OBJECT OF WORK	4
1.2. PURPOSE, OBJECTIVE AND CONTRIBUTION	4
1.3. METHODOLOGY	5
1.4. ANALYSIS OF PREVIOUS STUDIES	5
1.5. STRUCTURE	5
2. ELEMENTARY AND COMPLEMENTARY FACTORS OF DELIVERY	6
2.1. DELIVERY AS A PROCESS	7
2.2. DELIVERY AS A SYSTEM	11
2.3. USER REQUESTS	12
2.4. FACTORS	15
3. APPLICATION OF MATHEMATICAL METHODS	20
3.1. DIJKSTRA'S ALGORITHM	24
3.2. BELLMAN-FORD METHOD	26
3.3. CHINESE POSTMAN PROBLEM	27
3.4. TRAVELLING SALESMAN PROBLEM	29
4. APPLICATION OF HEURISTIC METHODS	31
4.1. CONSTRUCTIVE HEURISTICS	33
4.2. SPECIAL HEURISTICS	34
4.3. METAHEURISTICS	34
4.3.1. SIMULATED ANNEALING	36
4.3.2. GENETIC ALGORITHM	38
4.3.4. ANT COLONY OPTIMIZATION	40
4.3.4. COMPARISON ON TRAVELLING SALESMAN PROBLEM	42
5. INTELLIGENT TRANSPORTATION SYSTEMS (ITS)	43
5.1. INFORMING OF MAIL CARRIERS	44
5.2. INTELLIGENT VEHICLES	46
5.3. APPLICATION TO ENTITY	47
5.4. NEW SOLUTIONS	49
6. DELIVERY DISTRICTS MODELLING	53
6.1. INFLUENTIAL MODELLING ELEMENTS	56
6.2. STATIC COMBINATORIAL DELIVERY DISTRICT MODEL	57
6.3. DYNAMIC COMBINATORIAL DELIVERY DISTRICT MODEL	66
7. CONCLUSION	68
LITERATURE	70
LIST OF FIGURES	72
LIST OF TABLES	73
METAPODACI	74
IZJAVA O AKADEMSKOJ ČESTITOSTI I SUGLASNOST	75

1. INTRODUCTION

At the highest level of scientific research traffic is a phenomenon daily present, noticeable, significant and necessary for everyday life. Traffic and transportation technology is still young and under-researched scientific discipline with unquestionably sustainable and bright future considering the expansion of technological development in the 21st century.

Lower aspect levels of research approach and explain traffic to experts from other fields of science and end-users, and raise awareness of the overall importance. Traffic is generally defined as a system, process and service that transports or transfers people, goods and informations using network of roads for the purpose of performing beneficial economic, social and other activities from point A to point B.¹

The substrate of transport consists of individual objects (people, items, informations). Substrate of transport becomes transported entity with the process of induction, concluding the contract between the customer and the provider of transport services, during which the provider becomes responsible for the protection and safety. A set of transport entities with common features adapt to the selected traffic branch/ mode, the traffic entity and road. Traffic entities are the means of transport who use and occupy part of the road in the space-time framework. Series of traffic entities make organized traffic flow which moves through the road with adequate spacing ranges with the goal of minimal probability of incident occurrence. This generalized model of the transport system function describes each transport system, but not enough to solve universal traffic problems because all transport modes have their own specifics.

Postal traffic is a system, process and service of transferring informations between users. Information is communicated from the sender at point A using the capacity of the postal network as a message for the recipient at point B. Postal service provider receives information as item addressed and in final form - state of item must be the same and unchanged at the moment of acceptance and at the moment of delivery. Because the main function of postal traffic is to communicate the message between two physical and /or legal persons without the knowledge about the content /substrate of transport, although it is physicaly transported like goods, the main goal is the transfer of information.

¹ Bošnjak, I., Badanjak, D.: Osnove prometnog inženjerstva, Sveučilište u Zagrebu, 2005., page 17

Postal traffic has four distinctive features in relation to other transport modes:

- No specific transport infrastructure - but has a special technical means
- It covers the entire geographic territory - the physical contact of mail carrier with almost all users in the world - 3% of the world population does not have access to postal services
- Performance measurement in pieces, not in tons / km
- Unlike transport (transport of people, goods) transmits information, as opposed to information and communication services - information is in material form

The main enabler of postal traffic is the postal network. In general, the network consists of a set of junctions and connected links. The elements of the postal network are human resources, postal facilities in the form of terminal and transit hub (post offices, postal centers and other access points) and technical means. The postal network can be public or autonomous. The public postal network, according to defined geographical areas, is divided into areas of delivery district², post offices, postal centers and areas of national, european and international postal network.

Each system is part of a larger system, defined structure / organization of elements and connections with a predetermined desired behavior of the system. Postal system is, in addition to the transport system, also a part of communication, system of public services (*Service of General Economic Interest* - SGEI), economic and monetary system. The problem of optimizing the system is reflected in the various aspects of consideration. There are three main perspectives: technological, regulatory and economic. Therefore, the predetermined goal of improvement of any part of the postal system, with compulsory holistic approach to optimization, is to find an acceptable solution using existing technologies that will be approved by regulatory authorities and will be manifested through future positive economic results.

Generalized input-output display model of the postal system, adapted from generalized display model for each transport system is shown in Figure 1.

² Delivery district is the area of the post office where mail carrier performs delivery. More delivery district areas make the delivery area of the post office.

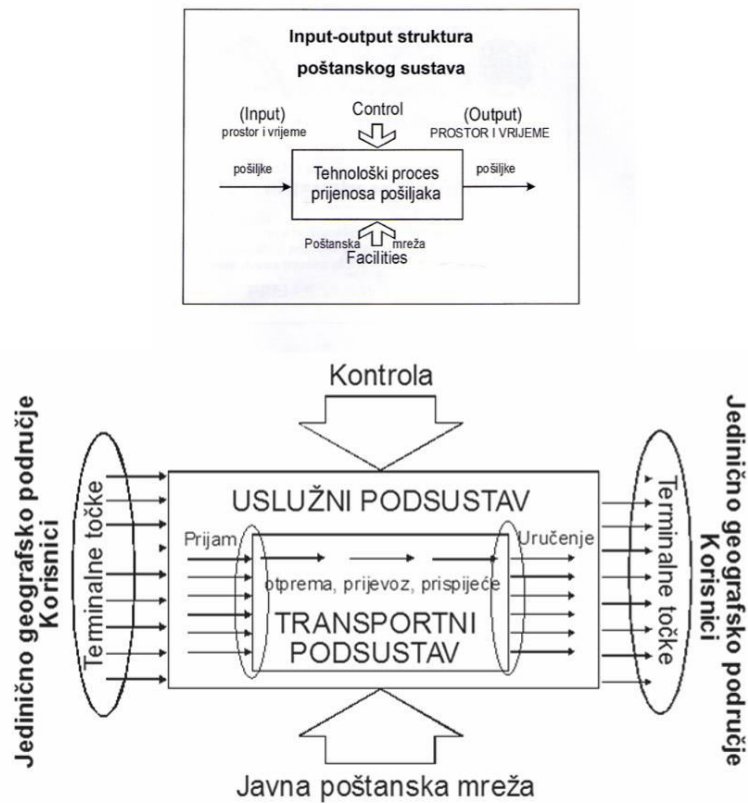

Figure 1. Generalized input-output model of postal system

Source: [16]

Date of acquisition: 30.03.2015.

Technology of postal traffic represents the scientific management and constant optimization of five technological processes:

- ✓ acceptance of parcels at post offices and other access points,
- ✓ concentration of items with forwarding to the relevant postal center,
- ✓ transport of items from forwarding to the destination postal center,
- ✓ arrival of parcels in the destination postal center and diffusion to destined postal offices,
- ✓ mail delivery to recipients

In addition to the scientific approach technology of postal traffic represents the practical approach to resolving postal problems. There are three different types of transfer technology, at the same time three different types of postal services: courier, express and universal postal service. Courier technology implies acceptance of items at the address of the sender and direct transport and delivery to the recipient's address using public transport network.

Express technology implies acceptance of the item at the sender's address and transfer through an autonomous network and delivery to the recipient. Universal technology implies acceptance at access points and transfer through the public postal network and delivery to the recipient. In courier service postal items are not grouped (massified), in express service some items are grouped, and in universal services all items are grouped. Also, considering that the real-time in postal traffic is $D + x$ (D - day of acceptance, x - day of delivery), universal service is the slowest, and courier service is the fastest. Finally, speed of transfer and massification of items are technologically inversely proportional factors. However, it is important to distinguish that postal items are not postal services.

1.1. PROBLEM AND OBJECT OF WORK

The problem of work represents research of technological delivery phase of during the process of postal traffic. Delivery makes the final and most expensive technological phase of technological and within user aspect the basic factor of measuring the quality of postal services.

The subject of the work derives from the situated problem of work that explores basic and secondary factors affecting the realization of delivery and handing over of postal items. Traffic-technological optimization includes an analysis of the structure of modern postal items, analysis of the current technological stage of delivery and proposals for new approaches to problem solving using modern transport tools. The importance of preliminary work for the successful implementation of technological phases in terms of organizational and technological measures as well as coordination with other phases will be also featured.

1.2. PURPOSE, OBJECTIVE AND CONTRIBUTION

The purpose of the work is reflected in the view of the current situation considering the postal service as a complex, dynamic and sustainable traffic system. Information about the space- time delivery features of postal item is known at the time of acceptance, which leads to the conclusion that the quality of postal services certainly can be influenced with this. Aim of work is to increase the efficiency and effectiveness of that technological phases of postal traffic. Business process reengineering is in modern times underutilized tool for solving problems mostly due to

lack of education and self-initiative of employees and historically more common ways to solve business problems.

1.3. METHODOLOGY

The methodology of work comes from the way of data collection in order to get valid informations for the intended subject of the work. Depending on data availability, the use of domestic and foreign literature and other primary and secondary sources of data technological stage of delivery will be analyzed within the various aspects, at the same time external factors that affect the postal system.

1.4. ANALYSIS OF PREVIOUS STUDIES

In scientific and professional papers of other study programs at the Faculty of Transport and Traffic Sciences data about the analysis of delivery and handing over of goods in certain geographic areas are available. It is necessary to research more detailed the relevance of these analysis because postal traffic has it's specifics. In the postal business this topic has not yet been sufficiently explored.

1.5. STRUCTURE

The structure of work is defined by the content that comes from the title of this thesis. It's content will cover a wide range of tools used in the everyday performance of postal services, a detailed analysis of the same and possible substitution of new and technologically better solutions.

Traffic is a multidisciplinary science that in it's research uses, in addition to their own, methods and findings of other scientific disciplines, but research results are interpreted in a special way, different from others. Starting from the general engineering knowledge and insights in related fields traffic engineers systematically identify / explain and solve traffic problems in its domain. Acquired knowledge after scientific validation and system-integration become part of a coherent transport engineering as an independent discipline.³

³ Bošnjak, I., Badanjak, D.: Osnove prometnog inženjerstva, Sveučilište u Zagrebu, 2005., page 3

2. ELEMENTARY AND COMPLEMENTARY FACTORS OF DELIVERY

Delivery (*last mile transport, final mile transport*) represents the final technological phase of postal traffic. Particularity of delivery is reflected in the direct contact of postal operator with the recipient within the service subsystem. Within the time aspect, delivery begins after the arrival technological phase when sacks of items are transferred to destination post office, and ends by delivering the item to the recipient.

Besides making basic criteria of measurement customer satisfaction with postal services, technological stage of delivery is also the most expensive operative part, especially in the universal postal service. Figure 2 shows the cost structure of postal operators by type of cost, and a detailed elaboration of operating costs (by type - the last 20%).

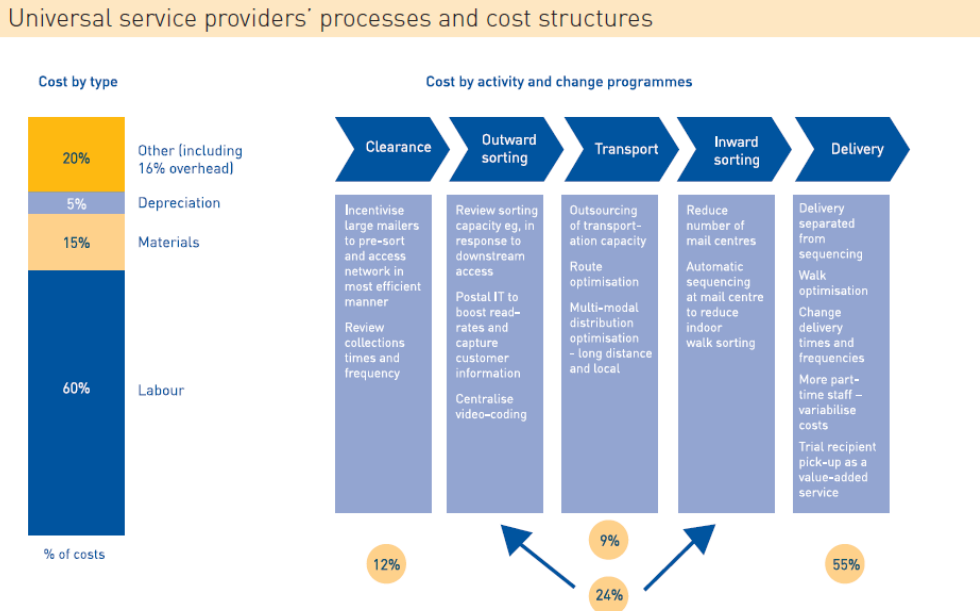

Figure 2.2

Figure 2. Cost structure of postal service provider

Source: [18]

Date of acquisition: 05.04.2015.

Often in foreign literature four technological phases are referred to as activities where the costs of forwarding and arrival are considered together (24%) with economic approach. Within the framework of the European Union postal service is a service that is offered in the single market and basically is not considered primary as transport, more of a service important for the economy in the communication system,

as well as a service of general economic interest.⁴ Mail can not be uniquely classified into one system, which leads to different opinions and increases the complexity, and hence importance of the sustainability of the postal service which always makes up about 1% of business activity talked about the number of employees, revenue or other economic factors. Within engineering approach it is necessary to consider these two stages separately taking into account technical-technological indicators such as, for example, coefficient of manipulative multiplying (CMM).

$$CMM = \frac{X + Y}{Y}$$

X - the total amount of items processed in the primary process

Y - the amount of items that are re-processed (sorted) in secondary process

2.1. DELIVERY AS A PROCESS

There are certain problems in describing and analyzing the delivery as a separate technological process. Postal operators have a lot of freedom when choosing organizational measures of delivery and handing over. For this reason, instead of describing, the process of delivery is often divided according to the size of the post office with delivery area. Small offices have 5 workers, medium from 5 to 50 and large ones have over 50 workers. In small post offices with a couple of distribution districts one or a couple of people are in charge of the execution of complete process, which means that one person can perform the function of sorter, mail carrier and handover worker. Depending on available space, by analogy the size of the post office, arrived sacks from the destination postal centers are opened in one room or more.

Delivery of european and international items is carried out after completion of the conditional acceptance. Provider in the country of acceptance will do all technological process within its jurisdiction, but decision about delivery is exclusively made by provider in the destination country in accordance with applicable customs regulations.

In the phase of delivery basic and ultimate aim is to perform elaboration (sorting) of items according to delivery districts and post boxes, and deliver or handover them to end recipient. Analysis of the generalized model of the

⁴ http://ec.europa.eu/growth/single-market/services/index_en.htm ,
http://ec.europa.eu/transport/index_en.htm

technological process is in Figure 3. There are three basic phases: preparation for delivery, end-delivery and handing over.

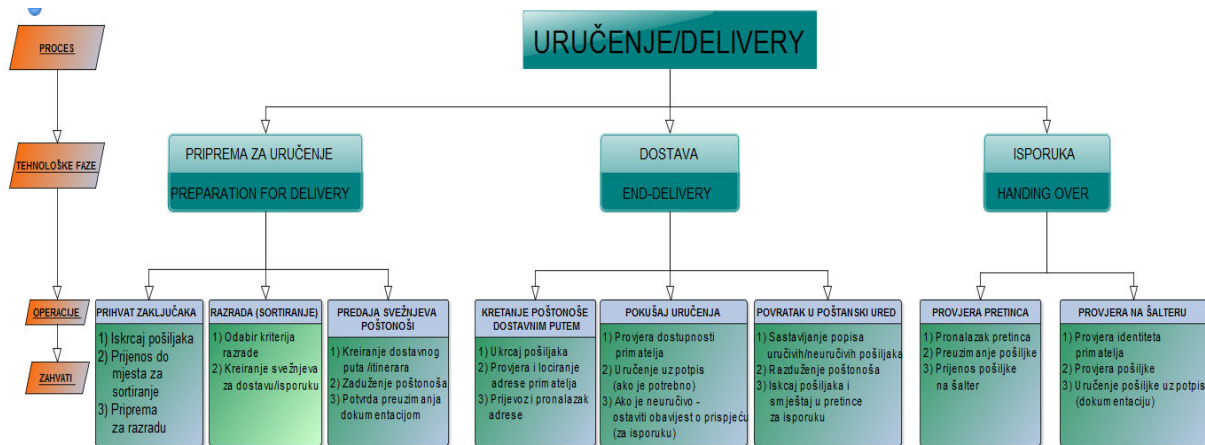

Figure 3. Delivery as a technological process

Source: made by author

Preparation for delivery is a sort of sequel of the work performed in the arrival technological phase. The aim of arrival is to open sacks in destined postal centre, sort items, create optimized sacks and diffuse them to delivery post offices. Within preparation for delivery exist three basic technological operations: acceptance of sacks, sorting out according to given criteria and handing bundles of mail to carrier with defined itinerary⁵. In small post offices usually arrives 1 "S" joint sack containing all items regardless of provided service. In medium post offices are expected minimum 2 sacks, in large ones depends on the amount of items. Sacks may be "V" insured items, "Z" letter-post, "R" registered, "PV" parcel-insured, "P" ordinary parcel and "E" express items.

The way of mail sorting depends on the organization of each post office separately, especially in case of provider that offers universal, express and / or courier service. One possible way is to split items to the priority and non-priority, then within each on end-delivery and handover, and then by service (ordinary, credited (registered and insured), money orders, packages, stationery, damaged and repacked ones, express, courier and special). Special items are those who have specific regulatory requirements for end-delivery such as court documents, customs, military and porto items. Porto items are ones for which postage has not been paid entirely. Postal service provider can expect larger amount of non-priority items at the

⁵ Itinerary is the route which mail carrier travels through delivery district area.

post office because postal traffic, especially in letters, typically accounts for about 90% of non-priority and 10% of priority mail.

Bundles created from part of sorted items are given to carrier for end-delivery and other items are placed in post boxes for handing over. Carrier's itinerary is determined by the document that is usually called Travel Form. One copy of the document is with the carrier, second and third are in the postal center and post office. Travel Form must include the name of the corresponding postal center and office, date of application, the name and number of delivery district, type of transportation mean used for the end-delivery, route, the number of deliveries per week or days when delivery is made, the departure time and return time of from delivery, label of letter-boxes and bulk post-boxes which carrier empties (to perform phase of acceptance), sketch, distance traveled and the total length of the delivery district.

In addition to the Travel Form, in preparation for delivery basic documentation about items are Review of Work and Delivery Book. With Review of Work office manager and carrier document assigned items for daily end-delivery, and Delivery Book function is to keep records of items which are tracked during the transfer - credited, priority, express etc. With signatures carrier, office manager and others as necessary confirm reception, and mail carrier additionally confirms assignation for end-delivery of mentioned items.

End-delivery is executed at the address of the recipient. The address can be a private house / flat, apartment or pre-agreed terminal point / business premises. As a rule, delivery is executed regularly at defined time intervals, although depending on the situation operators can apply urgent delivery for specified recipients, situation or service. Usually those deliveries are agreed by special contract between the operator and the user. Recipients can be physical and legal entities. In the case of legal entities items are delivered to authorized individuals at the address of legal one, and in practice most often those items can be delivered to an personal address of physical entity. Every person may also have his/her warrantee, and items will be given to such person when the recipient is in prison, custody or military. Some categories of items (marked with values up to 500 kn) can be given to the family members and relatives over 15 years. Delivery can be made from hand to hand or inserting items in house mailbox in case of ordinary items. Delivery can be organized as a general, carrier delivers all items, and specific, one delivery is for ordinary items and other one for the rest of the parcels. House mailbox is the recipient's organized box where carrier

inserts delivered letters. Although technological process of delivery potentially ends with a successful delivery or deposition of the notification of arrival, carrier's job is not finished. After return to the post office mail carrier has to put together a list deliverable / undeliverable items, discharge assigned items and prepare undeliverable ones prepare for handing over.

Handing over is final technological phase of delivery. Items can be divided into two types: poste-restante items intended for handover in post office and items failed to be delivered. Items planned for delivery can be picked up in following terms:

- ❖ 24 hours - the items containing live animals
- ❖ 5 working days - for items which have notice of arrival (undeliverable items)
- ❖ 7 working days - express parcels
- ❖ 15 working days - international packages
- ❖ 30 calendar days - poste-restante parcels

Each traffic service, including postal, is non-material and unrepeatable. Any attempt of item delivery is unique, but also an opportunity to confirm the current knowledge of the recipient address or update obsolete informations. It is worth noting that the recipient can always refuse delivery. The postal service provider exclusively earns by transmission, and since he does not know the content of parcel, the same shall in case of refusal return back to the sender. Returning undelivered parcels is free except for packages and insured items. In addition, provider can receive the items that are delivered to the wrong recipient, but can not be returned (for free) items that are delivered to the appropriate recipient if the same one does not want it anymore. If the item can not be delivered nor the recipient, nor the sender, twice a month such parcels are dispatched to the main postal center. If subsequently users can not be found, operator commissionally destroys items or put them to public auction. The money received from the auction is kept for three years and then recorded as extraordinary income.

2.2. DELIVERY AS A SYSTEM

Postal traffic is, as already mentioned, part of multiple systems. But in terms of analysis and understanding with purpose of further optimization and goodness of the system it needs to be "set aside" and considered separately. Same thing is necessary with technological phase of delivery and consider it independently from other phases, with the constant reminder that by researching only one technological components, regardless of the objectivity and accuracy, can not be achieved successfully and effectively solution of the overall problem that postal industry faces today - sustainability and improvement of quality of postal services.

There are two methodological approaches to the development of general templates systems solving problems: inductive and deductive approach. Inductive approach is based on the collection of information by observing, counting, measuring etc. Based on the analysis and synthesis of information and making justified conclusions it leads to general insights that are applicable to every problem similar to investigated one. Deductive approach involves the assumption of axioms that are not proven, but can be considered self-evident. Using general thoughts with integration with axioms individual conclusions are derived for each instance separately. Simply put, the inductive approach explores the whole class of problems while deductive approach is investigating the legality of specific given problem.

One example of deductive methodological approach is a generalized description of the model of input-output system. Figure 4 shows a model for technological phase of delivery.

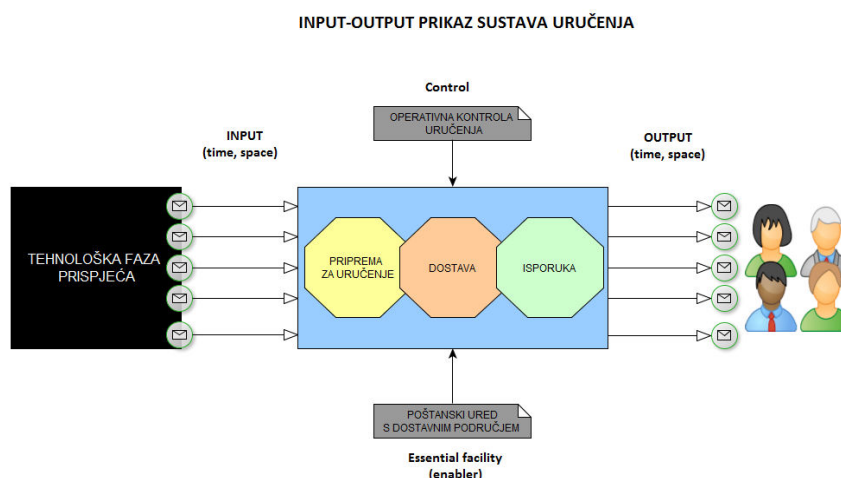

Figure 4. Generalized model of delivery system

Source: made by author with adjustment from source [1]

In the system of delivery the respective technological phases are presented with Venn diagrams. Part of the actions that are performed in preparation for the delivery can be attributed to of end-delivery, such as creating a delivery route / itinerary. Also, items that are not successfully delivered become part of the handing over phase. Undoubtedly, this proves affiliation and interconnection of three technological phases, but on the other hand it represents a bigger problem with unambiguous describing of phase elements with methodological approach.

Traffic engineering is based on two approaches: system and conceptual-functional. With system approach group of occurrences are trying to be understood as comprehensive, and then with associated environment through use methods described as a system. Conceptually-functional approach emphasizes that traffic problems are not primarily related to the technical components of the system but for the relation between the elements of the system.

2.3. USER REQUESTS

Prior to establishment of factors that determine the quality of postal items delivery it is necessary to take into account the opinion of users for which postal services exist. In most European countries, the national regulatory authority (NRA) carries out researches in form of survey of user satisfaction with postal services with a primary focus on universal service. Surveys among others include questions about customer satisfaction of deliveries. In Croatia, the latest research on the satisfaction of universal and courier services was conducted in 2008 for physical. and in 2010 for legal recipients. Both studies did not contain questions about opinion, suggestions and criticisms of users on the matter of delivery performance.

Therefore, for purposes of this section will be used sources from other European and world countries. Postal systems are different and should be taken into account as such, but the goal of universal postal service is to offer a transfer activity "to everyone at same conditions". Certain issues and conclusions of the study with users of postal services from other areas are also relevant to Croatian users.

User study conducted in the US showed that, regardless of the expansion of information and communication services in the last decade, users prefer information about discounts, new products of generally receive newsletters in the following way:⁶

- Direct mail 31%
- Newspapers extras 24%
- Catalogues 18%
- Newspapers ads 11%
- e-mail 10%
- None of the above 6%

The Office of Communications, shortened Ofcom, a national regulatory authority responsible for postal services in the United Kingdom, in 2012. conducted a detailed study on the technological stage of delivery in their area. The results showed no difference in the preferences of male and female users, but significant two distinctive features: type of locality and age of the user, as shown in Table 1. The data in the table by locality and age of users do not cover all the results of the survey, yet show which option was voted the most by users of certain type.

Table 1. Analysis of user requests in United Kingdom

	Type of locality		Age	
	URBAN	RURAL	16-34	55-74
Number of weekly delivered items to customer	3-4 – 16%	5-6 – 20%	1-2 – 35%	5-6 – 17%
	5-6 – 16%	10-15 – 13%	5-6 – 24%	11-15 – 15%
	1-2 – 15%	3-4 – 11%	7-9 – 12%	3-4 – 13%
Max. distance to postbox (in m) which user will travel	320 – 26%	320 – 19%	320 – 25%	320 – 22%
	160 – 16%	160 – 15%	1200 – 15%	160 – 20%
	800 – 15%	1600 – 13%	800 – 13%	500 – 10%
Satisfaction with location of bulk post-boxes	Satisfied – 88%	Satisfied – 93%	Satisfied – 87%	Satisfied – 85%
Opinion about alternative of house delivery with bulk post-boxes: (without undecided)				

⁶ Kljak T.: Automatizacija poštanskog prometa II, separati s predavanja, Fakultet prometnih znanosti, Zagreb, 2014., page.14

a)On the street, next to biggest flat	For – 10% Against – 58%	For – 11% Against – 60%	For – 13% Against – 46%	For –8% Against – 67%
b)On the terminal (train/bus/gas station, store)	For – 5% Against – 81%	For – 3% Against – 90%	For – 8% Against – 75%	For – 3% Against – 90%
Opinion about number of received items in next 3 years	Same – 63% Little less – 15%	Same – 67% Little more – 18%	Same – 50% Little more – 25%	Same – 70% Little less – 17%
D+1 service	Important – 59%	Important – 70%	Important – 63%	Important – 55%
User wishes about quality improvement	Price – 27% Delivery – 16%	Price – 22% Delivery – 13%	Price – 25% Delivery – 15%	Price – 30% Delivery – 14%
Opinion about late delivery (18:00)	Survey included all users without distinctive features. 58% - small, but acceptable inconvenience 29% - bigger inconvenience, but long term adaptation.			

Source: [21], Date of acquisition: 08.04.2015.

Important indicator of the survey is the type of items that recipients of distinctive features receive on a monthly basis. Recipients aged 16-34 are most often receive bills (68%), while about 30% of recipients also receives direct mail, business correspondence by government authorities, insurance companies, banks, etc., and e-commerce parcels. 82% of recipients aged 55-74 also mostly receives bills, 70% of direct mail and 58% of business correspondence, as well as 45% of family items in the form of a postcards or greeting cards. This leads to the well-known opinions that e-commerce is one of the postal services designed for the younger population, accounts, direct mail and important documents will remain about the same, while it is expected that family items will continue to decline. Urban and rural area according to the type of items can relate to the age of the users, relation of percentages is roughly similar, and on this indicator urban may also represent young population.

In international traffic users, when selecting the postal service with a good price-quality of delivery ratio, mostly have problems with the return of item policy in the case of non-delivery, differences in the price of the international postal service between competing postal operators, specific services that offer individual operators and the lack of interoperability. Time-delivery options provider in the country of acceptance displays are often not matched with the options of provider in the destination country and it is represents a comprehensive problem and one of the aims of the service development by the Universal Postal Union.

As an interesting fact, studies have shown that, although it is not an option they want, users have more belief to bulk shared post-boxes at the terminal than their neighbors, and that the recipients are more angry when they get damaged package instead of the same is lost.

2.4. FACTORS

Postal traffic as the system has two main subsystems: service and transportation. The service one consists of the technological phases acceptance and delivery, transportation consists of the others.. While operators are trying to automate as many processes within both, so far the service subsystem remains still largely in form of human work. The reason for this is to keep the human contact with customers (senders and recipients) and the fact that traffic as a phenomenon can not be fully "robotized".

While organizing delivery phase it is necessary to consider the process through three basic aspects - the provider, a mail carrier and recipients point of view. The efficient and effective delivery phase consists of these basic factors:

- System of delivery
- Distinctive features
- Synergy of delivery with other technological phases
- Updated adress database
- Advantage of end-delivery in relation of handing over
- Space-time delivery flexibility
- Statistical traffic analysis
- Operative delivery control
- Postal Directive interpretation (for european postal traffic)

Particularly with the universal service providers, all post offices do not have delivery areas. Certain access points are used in order to respect the regulatory provisions on the density in relation to population for the performance of accepting items. The model of delivery system determines the model of delivery district, according to which delivery routes for carrier are formed. Delivery systems are divided into static and dynamic. Static systems prevail, and within the same ones delivery areas and carrier itineraries are predefined and unchangeable. Examples of static systems are shown in Figure 5. In addition to the above ones exist complete

and the partial decentralized static delivery systems, but those are rarely used. More on such systems can be found in the literature.⁷

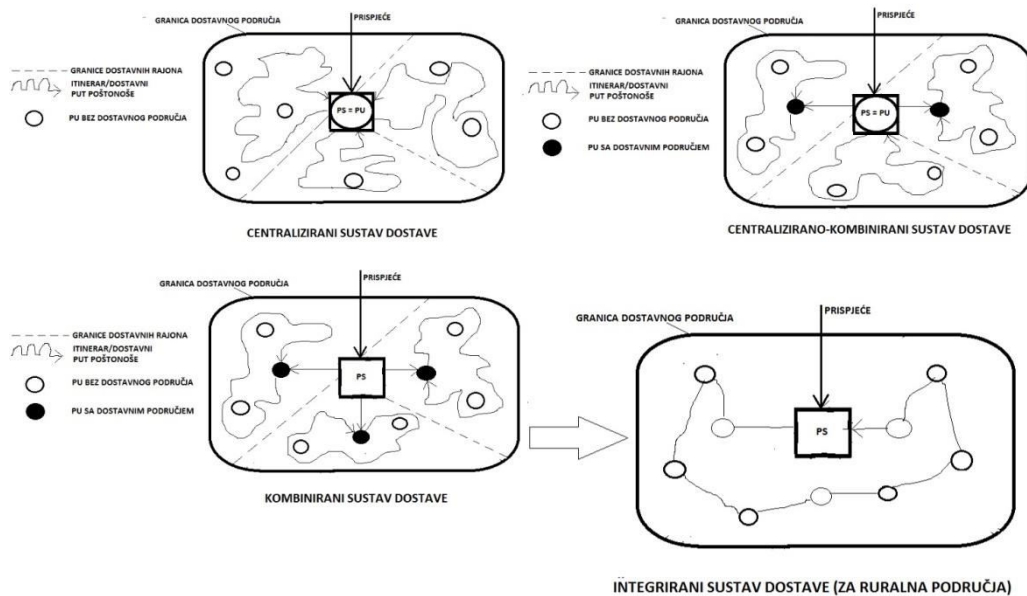

Figure 5. Static system of delivery

Source: made by author

In dynamic systems itinerary of mail carrier is different every day, depending primarily on the location of the recipient. Each type of static systems can be modeled as a dynamic system without changing the basic structure of the delivery area, regarding relevant areas of the destination postal center. Example of centralized dynamic delivery system is situated in the following figure.

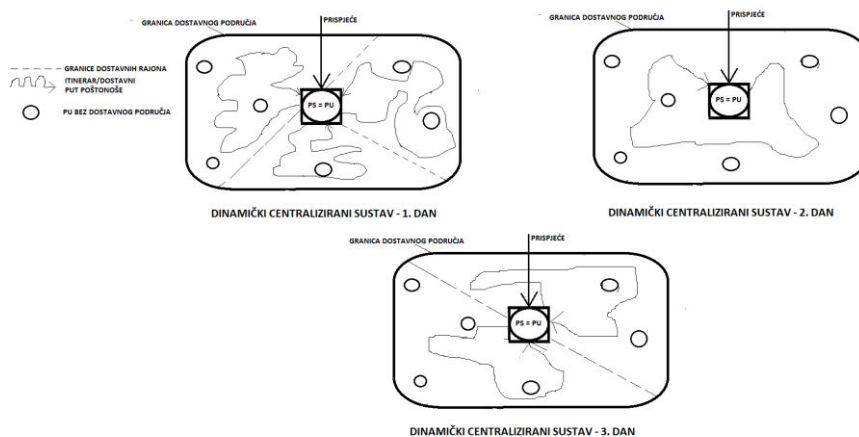

Figure 6. Example of dynamic delivery system

Source: made by author

⁷ Bošnjak, I.: Tehnologija poštanskog prometa II, Fakultet prometnih znanosti, Zagreb, 1999., page 171

Three groups of distinguishing features affect the delivery: type of service, locality type and type of geographical area. Courier service, since it has the shortest period of transfer, is the most difficult for delivery organization. If a provider offers, except courier, express and / or universal postal service, it is desirable to plan integrated delivery due to reductions in total cost with massification of items, with adequate control and compliance of regulatory rules. Localities are divided into urban and rural. Rural areas represent a bigger problem because of the relation of geographical areas and population structure residing in the same. Often in a particular delivery district are a small number of residents who are located few kilometers from each other. Due to the inaccessibility of the terrain and rare population mountainous areas, according to available sources, are higher delivery problem in relation to the islands, as evidenced by Hellenic Post report that 7% of the population in Greece has no five-day delivery, primarily residents of mountain areas.⁸

All postal items do not go through complete technological process, but all must be received and delivered. Acceptance has an important role in identifying recipients and the adequate guidance of item to the destined delivery post office. Adjusted operating within all phases through which item passes before delivery are required for completing in planned time of information transfer. Improving the quality of postal services by optimizing the of delivery phase does not necessarily mean that service as a whole will be performed in a shorter period of time if other technological phases are not coordinated. The synergy of all phases therefore makes an important factor to delivery, but also the entire technological process.

Address database is the basic resource of post. In relation to the population census, which, for example, in Croatia is done every ten years, the universal postal service provider checks five days a week at the entire geographic area availability of all residents. Updated information about the recipients in situations such as sending item to delivery when an entity has a mailbox in the post office, or the re-mailing to the new address because of recipient moving to the new address are necessary to reduce the number of items that must be handled twice and therefore increase total operating costs.

Processing user requests postal traffic engineer can conclude that, regardless of the increasing growth of bulk post-boxes, postal automated machines etc. users

⁸ Project team Universal Service of CEPT, Implementation Guide Universal Service, page 25

still want basic - home delivery. As a contribution to this, in the past, 2/3 of items are delivered with handover, and 1/3 with end-delivery. Today the ratio is reversed in favor of home delivery.

Physical entities today have different work shifts that are no longer in fixed terms. To preserve confidence and adapt to modern needs of users postal service providers must offer space-time flexibility of item delivery. At least two options must be provided considering the place of delivery to recipients, of which one should be home delivery, and other handover over the counter, postal 0/24 slot machines or in premises that are not primarily responsible for the postal service, but by mutual consent items can be given at these locations (gas station, local shops or other premises known and on the way for users). The time of delivery, primarily important to preserve the quality of home delivery, should also be offered in two options, for example in morning around 9 and at afternoon around 16-17 hours. One of the more affordable way to check the appropriate time is to send a text message to the recipient with the provided options for delivery. Most users regularly check notifications on their phones, and although sometimes they are unable to answer a call, to answer a text message takes a few seconds, and such telecommunications services with long-term economic point of service can be a cost-effective with increase in the quality and % of deliverable items.

By keeping statistics about recipients, their preferences through the types and number of items they receive on a weekly, monthly and annual basis, and use of data mining, operator can collect important information and predict demand, traffic and optimize the system for the future. In postal traffic on annual basis there are peak loads in summer and during the holidays when most items passing through postal traffic flows. By analyzing the data, besides in terms of optimization of human resources, it is important to compare capacity of delivery post office, carrier, transportation and other technical means in relation to the number of items that need to be prepared, and then delivered.

Using operative delivery control postal engineer monitors the process from beginning to end and compares the planned course in relation to the real situation on the road. With proper and organized control it is possible to react on time to unforeseen situations and find a suitable alternative.

Postal Directive is interpreted differently by operators of universal services across Europe considering two factors: the frequency of delivery and the reasons for

exceptions for delivery. Most operators perform a five-day delivery, but there are ten countries (Switzerland, Germany, United Kingdom, Turkey, Norway, Malta, Latvia, France, Denmark and Belgium) that offer six-day delivery. But only Latvia from all providers, including those with a five-day delivery, deliver mail more than once a day throughout the whole state territory. For example in Estonia this is available only in urban areas, while in Poland this is the operational decision of local managers in certain areas. Also, in nine states NRA observed differences in the frequency of delivery in urban and rural areas. Each EU member state has users who do not have a five-day delivery and are considered exceptions. The reasons vary from country to country and may be geographical, security ones because of unsuitable roads, demographic - rarely populated areas, economically, and in certain states also historical - traditions and habits of the user. Mostly in areas of such users are installed bulk post-boxes.

Additional factors that could condition the quality of the delivery are education of carrier, type of recipient considering physical ones are globally more distant from each other than legal, which are mostly in the business complexes, within the universal service delivery of non-priority items whose deadlines are not regulated by the Directive and treatment of items that are passed on for transfer by the other operators with access to network (outsourcing) and the culture and habits of the recipient at the designated delivery area.

3. APPLICATION OF MATHEMATICAL METHODS

Mathematical methods in traffic are made of the collection of several scientific disciplines such as operations research, classical mathematics, graph theory and decision theory. For well-structured problems it is possible to define model and with exact method set up a set of "good decision" within which, depending on the required parameters, optimal solution is searched.

Optimization represents determination of changeable variables (decision variables) along pre-defined constraints (conditions) with the aim of achieving optimal/best value of objective function through criteria: maximum utility or minimal cost of resources. Beside only one, the criterion optimization can be minimizing of one value while maximizing some other. The branch of mathematics that deals with such type of realistic system optimization is called linear programming.

$$f(x) = C_1X_1 + C_2X_2 + \dots + C_nX_n \quad f(x) - \text{objective function (min ili max)}$$

$$a_{11}x_1 + a_{12}x_2 + \dots + a_{1n}x_n \leq b_1 \quad x_1, x_2, \dots, x_n - \text{decision variables}$$

$$a_{21}x_1 + a_{22}x_2 + \dots + a_{2n}x_n \geq b_2 \quad b_1, b_2, b_3 - \text{constraints (conditions)}$$

$$a_{31}x_1 + a_{32}x_2 + \dots + a_{3n}x_n = b_3$$

A typical example in traffic represents the transport of identical goods from multiple origins to multiple destinations, in the literature called classical transport problem.⁹ Origins and destinations have predefined supply and demand quantity of goods together with the unit transport price (C_{nn}), as shown in Table 2.

Table 2. Example of classical transportation problem

ORIGINS	DESTINATIONS				SUPPLY
	O1	O2	O3	O4	a_j
I1	$C_{11}=5$	12	1	4	30
I2	7	8	14	6	25
I3	15	4	2	7	35
DEMAND b_j	10	20	20	40	90

Source: [10], date of acquisition: 22.04.2015.

The quantity of goods to be transported on each I_n-O_n line is unfamiliar. Goal of optimization is, due to the transport unit price, transfer all goods to desired

⁹ Pašagić, H.: Matematičke metode u prometu, Fakultet prometnih znanosti, Zagreb, 2003., page 2

destinations and to meet the demand with minimum costs. For this example mathematical model is:

$$f(x) = \min(5x_{11} + 12x_{12} + x_{13} + 4x_{14} + 7x_{21} + 8x_{22} + 14x_{23} + 6x_{24} + 15x_{31} + 4x_{32} + 2x_{33} + 7x_{34})$$

with constraints:

$$x_{11} + x_{12} + x_{13} + x_{14} = 30$$

$$x_{11} + x_{21} + x_{31} = 10$$

$$x_{21} + x_{22} + x_{23} + x_{24} = 25$$

$$x_{12} + x_{22} + x_{32} = 20$$

$$x_{31} + x_{32} + x_{33} + x_{34} = 35$$

$$x_{13} + x_{23} + x_{33} = 20$$

$$x_{14} + x_{24} + x_{34} = 40$$

Postal traffic is not about the transport of identical goods. Each item is unique and therefore this approach does not contribute to improvement of delivery and other technological phases. Number of variables that affect the delivery system is quite large and creation of delivery as classical transportation problem is complex and time unprofitable.

There are three elements that can be optimized within the postal network: flows, capacities and topology. Freedom of optimization the network topology is limited to existing locations of roads, other buildings, regulatory provisions and etc. Capacities of operator are relatively fixed on an annual basis, therefore higher productivity maximization or minimization of costs is not possible. Flows of delivery items can be fixed or adaptive depending on the routing plan, load or priorities and make a promising opportunity for optimization and quality improvement.

Mathematical methods are divided into four groups:

- Analytical – finding the solution in „closed form“
(example: calculating the vehicle cargo area surface)
- Numerical – translation of problem into mathematical language – linear, non-linear, integer, stochastic and dynamic programming, graph theory
- Mathematical-statistical – probability models, descriptive and inferential statistics models, queueing theory
- Approximative – used when analytical methods are not available/possible

Graph theory is a scientific discipline and a branch of mathematics that finds its application significantly in traffic systems. Simplicity of graph structure allows the practical problem of end-delivery within the technological delivery phase to be transformed into a graph and proven theorems and algorithms for mail carrier itinerary are applied. Part or all postal network, and it could be whole European

postal network, post office delivery area of delivery district can be displayed by usage of graph.

The graph is a set of nodes (vertices, junctions) as mutual lines (branches, connections, edges). If line x connects node a and the node b by lying between them, it is said that a and b are adjacent and incident to line x , and that x is incident to node a and node b . The number of lines that are incident to a certain node is called a degree or valence of the node. If the initial-final node of line are the same, that line is called loop. If two nodes are connected to two or more lines, those lines are called multi-lines.

Lines can be directed (one-way and two-way) or undirected. If all lines in the graph are directed, then such a graph is called a directed graph (digraph), otherwise it is a non-directional. In directed graph, in the case of two-way line, two directions are calculated separately as two one-way, reversed lines. Real traffic situation is that the path between two locations (nodes) is not the same depending on the direction of movement.

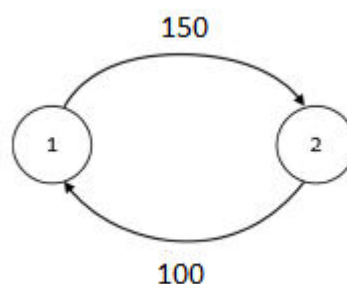

Figure 7. Two-way directed graph

Source: made by author

Graphs are divided into simple ones, multigraphs and pseudographs. A simple graph is a graph that contains no loops nor multiple edges. Multigraf is a graph that "allows" multiple edges, but "does not allow" the loop. Pseudograph a (multi) graph that "allows" multiple loops.¹⁰

¹⁰ Carić, T: Optimizacija prometnih procesa, separati s predavanja, Fakultet prometnih znanosti, 2013., page 6



Figure 8. Graph types

Source: [5]

Date of aquisition: 22.04.2015.

When each line is joined with non-negative value graph becomes weighted. Value of line may indicate distance, time, unit cost, quantity, capacity, depending on the structure of problems. The weighted value is used to create a display of graph with matrix of adjacency. In addition to matrix of adjacency, the graph can be displayed with matrix of incidence and matrix of connections.

Aim of using graph theory is to find the shortest path through the network. One node is defined as the initial, and various algorithms search the optimal solution of passage to certain node or all nodes/all lines and return to the initial one (depending on the algorithm and features of the graph).

Graph movement is defined with four basic terms:

Walk - chronological series of nodes and lines, for example $W = v_0e_1v_1e_2v_2$

Track – if all lines in walk are different, W is a track

Path - if all lines and nodes are different

Cycle – if all lines and nodes are different except initial-final one

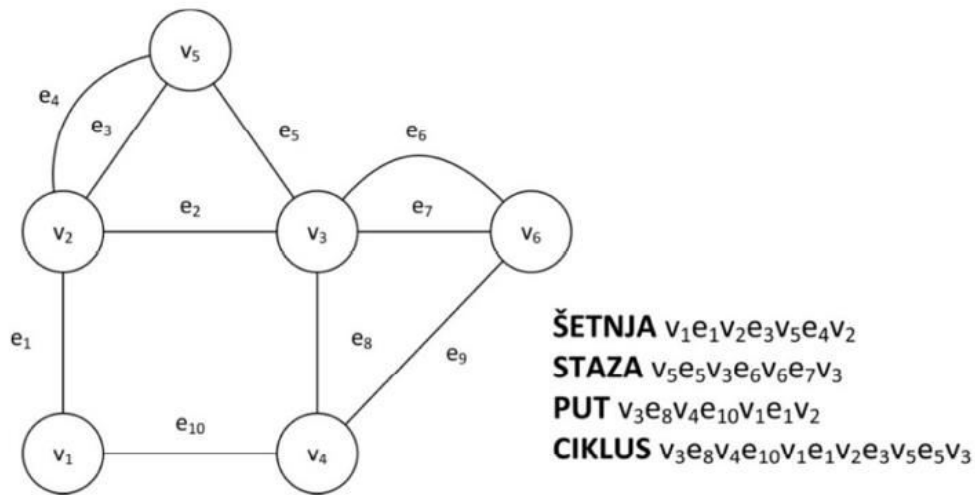

Figure 9. Graph movement

Source: [5]

Date of acquisition: 22.04.2015.

There are two possibilities in presenting postal office delivery area as a postal network graph:

- Lines represent streets, and nodes represent transit points between streets (intersections)
 - for static delivery district areas
- Nodes represent recipient addresses, bulk and ordinary post-boxes (for acceptance), and lines represent connecting streets
 - for dynamic delivery district areas

Lines on district delivery areas can be two-way or one-way oriented. More about modelling and optimization of district areas is in chapter 6.

Specific algorithms mathematically find a solution of the shortest path through a graph connecting nodes. In the following only some of them are mentioned, and more can be found in the literature.¹¹

3.1. DIJKSTRA'S ALGORITHM

Dutch scientist Edsger Wybe Dijkstra in 1956 created an algorithm which finds the shortest path between two nodes defined as initial and final or from one node to all others. With one execution of the algorithm it is possible to find both solutions. The algorithm is executed through four steps:

¹¹ http://en.wikipedia.org/wiki/Shortest_path_problem

1. Define the initial node and assign him with index 0 - zero distance
2. Open one of the neighboring nodes, assign a temporary index depending on the distance, the other nodes are still "unknown"
3. Gradually open all other nodes and check indexes, in case of finding a shorter distance to already predefined node, change index - required minimum permanent index for each node.
4. Print path to the final node/ nodes

Each line between nodes is determined by the weight value that can represent different temporal and spatial factors, depending on the structure of problem. The path between defined initial-final nodes may consist of one or more lines.

Dijkstra's algorithm is applicable for delivery of courier items or urgent delivery. The final node is the address of the recipient or the street, a source node may be the address of the sender or defined transit point for collection of items depending on the organization of the technological process by operator. Example of the algorithm execution is presented in the following figure by minimum distance from node 5 to all other nodes - for example, one day the recipient can be a node 4, and the second day in node 1, etc.

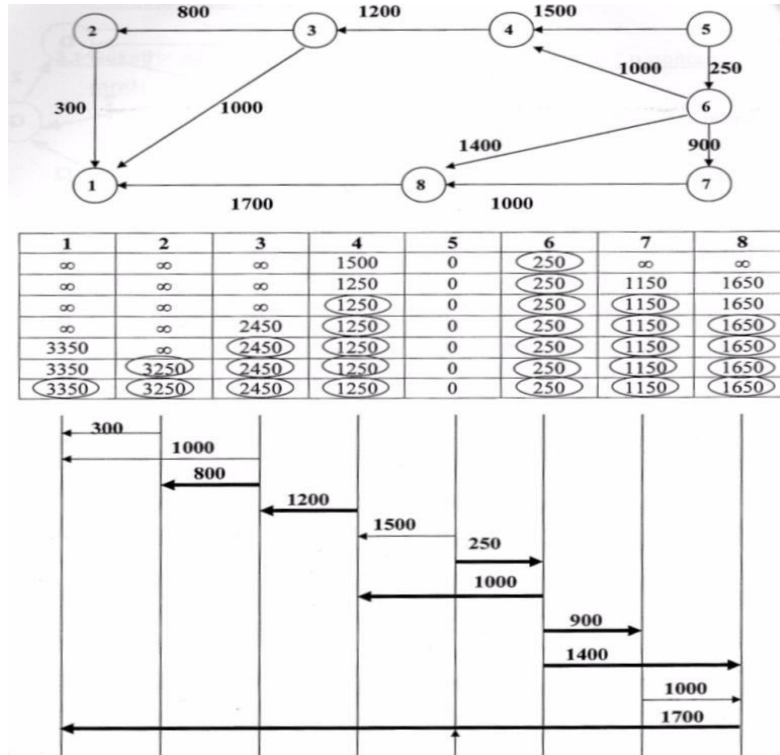

Figure 10. Dijkstra's algorithm

Izvor: [8]

Date of aquisition: 23.04.2015.

3.2. BELLMAN-FORD METHOD

Frequently nodes are numbered so that each node receives a number after his predecessors. For Dijkstra's algorithm that is not necessarily though it is usually done during execution because of simplicity, and the fact that real traffic problems are about directional graphs. To use the Bellman-Ford's method is necessary to number nodes in a way that not a single node does not carry earlier number than node which leads the line to it, which means that method is only applicable to directed graphs. Steps of method are:

1. The initial node is labeled with value
2. Gradually open and label every node
3. (min. distance to initial node, number of previous node)
4. Print the shortest path

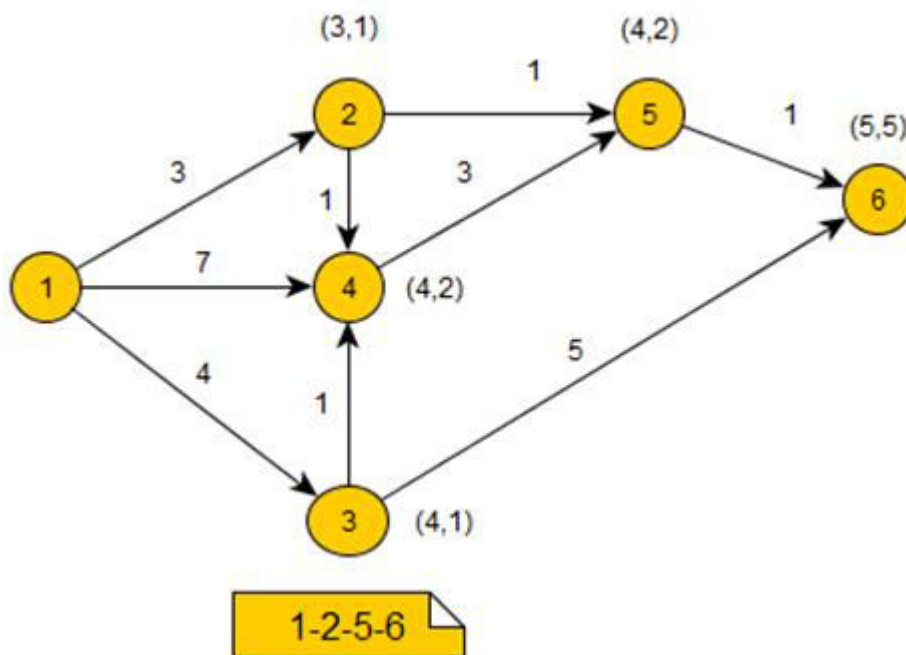

Figure 11. Bellman-Ford method

Source: [10]

Date of acquisition: 23.04.2015.

Compared to Dijkstra's algorithm, Bellman-Ford method gives same result, but on several directed graphs which have fewer nodes retrieves the optimal solution faster.¹²

¹² Hübler, A., Kletter, R., Werner G.: Shortest path algorithms for graphs of restricted In-Degree and Out-Degree, Journal of Information Processing and Cybernetics, 1982., page 143

3.3. CHINESE POSTMAN PROBLEM

Previous algorithms are useful with determining the shortest path for single mail item. In the universal and express postal service mail carrier from a starting location must deliver larger number of items to multiple locations. In case of static/permanent delivery district areas carrier definitely has to go through all streets regardless whether he has to deliver items in those. Problem of carrier's itinerary to visit all streets, return to the post office and make the shortest path is called the Chinese postman problem, according to the Chinese mathematician Kwan Mei-Ko who first studied such mathematical problem in 1962.

Unlike Dijkstra's algorithm and Bellman-Ford method, Chinese postman problem deals with solving unfocused graph. This means that for each line mail carrier must be able to pass it from one node to another in both directions which have the same weighted value.

To solve Chinese postman problem it is necessary to understand following theorems and definitions:

Theorem 1. Connected graph is Eulerian¹³ if it all nodes have even degree - incident with the even number of lines. Connected graph is a graph in which for every two nodes there is a line from one to the other.

Theorem 2. In each graph, the number of nodes with odd degree is an even number.

Definition 1. Eulerian track of Eulerian graph is a track that goes to each line and contains each one exactly once.

Definition 2. Eulerian path is closed Eulerian track

Definition 3. Graph G is Eulerian if allows Eulerian tour.

If each node has an even number of incidents lines (even degree) graph is Eulerian, the shortest path through all lines is the Eulerian path - closed Euler track, and it is possible to visit each line only once and return to the initial node. The shortest path is the sum of weight values of all lines. In case that the graph is not Eulerian, a mail carrier for the passage of all lines has to go through certain ones several times.

¹³ Leonhard Euler, first scientist who displayed geographic locations and connections as a „graph“.

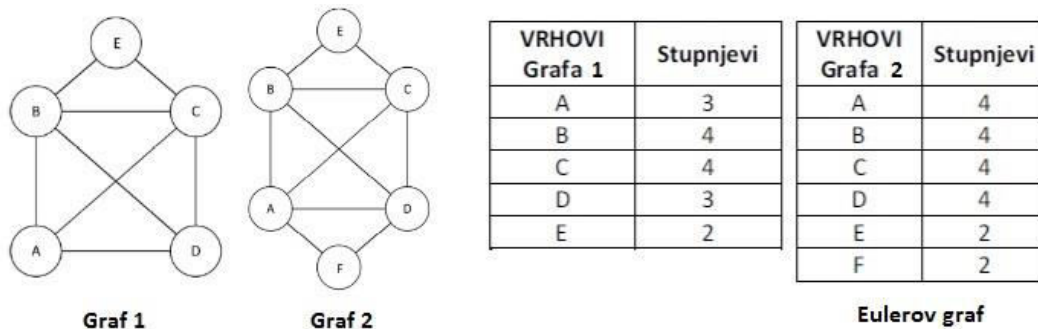

Figure 12. Determination of Eulerian graph

Source: [5]

Date of aquisition: 23.04.2015

For Chinese postman problem lines represent streets, and nodes places where mail carrier moves from one street to another (intersection). In case that a particular node or nodes do not have an even number of incident lines they need to be "converted" into even ones by adding artificial lines. In this way graph becomes Eulerian and it is possible to return to the initial node.

Theorem 2 can be demonstrated in the following manner: each line having two ends, and make two degrees of certain nodes. Number of degrees is twice the number of lines in the graph, and doubled number of even and/or odd lines is always an even number. As the number of degrees must be an even number, number of nodes with odd degree is always 2, 4, 6, etc., as can be seen in Figure 11. The above theorem is important because of the number of possible connections of odd degree nodes by adding artificial lines.

Table 3. Number comparison of odd degree nodes and possible connections

Number of odd degree nodes	Number of possible connections of nodes adding artificial lines
2	1
4	$3 \cdot 1 = 3$
6	$5 \cdot 3 \cdot 1 = 15$
8	$7 \cdot 5 \cdot 3 \cdot 1 = 105$
n	Multiplication of all odd numbers which precede n.

Source: [5], date of aquisition: 23.04.2015.

By connecting the nodes with odd degrees graph becomes Eulerian and can be solved. The number of possible connections reveals the number of combinations and depending on the chosen one it is possible to optimize the postmen itinerary. Criteria which combination to choose is the minimum weight value between two nodes with odd degree. The algorithm which solves the Chinese postman problem consists of following steps:

1. Count the number of all nodes with odd degree
2. Count all the possible connections of pairing nodes with odd degree
3. Find connection of nodes with the lowest weight value of artificial lines (weighted value of artificial lines must be equal to the actual - undirected graph)
4. In the original graph add selected artificial edges - create Eulerian graph
5. Create Eulerian path
6. Print path and the total weighted value - sum of the weight values of all lines

If it is a graph which itself is Eulerian, algorithm moves from step 5. A graph which is Eulerian is ideal for solving Chinese postman problem.

3.4. TRAVELLING SALESMAN PROBLEM

Unlike the Chinese postman problem which raises the question: "How to visit all the lines on the graph and return to the starting node?" traveling salesman problem puts reverse focus: "How to visit all the nodes only once and return to the home?", with condition of shortest path and that every node can be visited by every other node directly (not through the third one). The problem is considered to be NP-hard (*Non-deterministic Polynomial-time hard*) problem because finding exact mathematical solutionse even with computer assistance would take long. Also with this problem come certain definitions according to the author of the problem, the mathematician William Rowan Hamilton:

Definition 1. Hamilton's path on graph is the path which visits all nodes once.

Definition 2. Hamiltonian cycle in the graph is a cycle that visits all nodes once and ends in initial cycle.

Definition 3. Graph is considered Hamiltonian if it contains Hamiltonian cycle.

Direct connection between Eulerian and Hamiltonian graph has not been proven. In general case the number of possible cycles in the graph is: $(n-1)!$. This means that, for example, if there are five nodes, the number of possible cycles is $4 \cdot 3 \cdot 2 \cdot 1 = 24$ cycles. Detailed variations exists like if Hamiltonian graph is displayed

by weight adjacency matrix, and the latter one is has two symmetrical reversed triangles, the number of cycles is $(n-1)!/2$. General case of problem is also displayed on undirected graph, which means that path between two nodes is the same in both ways.

Applicability of the traveling salesman problem in delivery of postal items is based in a different perspective of delivery. If the nodes represent addresses of the recipients, bulk and ordinary post-boxes (for simultaneously performing acceptance), conditioned that each node can reached by every other one through a single line, then it is possible to model the dynamic delivery district areas and look for the optimum - the shortest path.

Inclusively, the application of mathematical methods gives optimum. But, often mathematical methods are withdrawn because of unacceptable time to solve problems, bad structuring of the realistic problems and the impossibility of adequate transformations to mathematical language and the lack or unreliability of the data obtained. Most realistic problems and so as the problem of delivery in postal traffic have complex structure with a large number of different restrictions which leads to the impossibility of formulating a precise mathematical model. Problems in practice contain a certain amount of external impact, probability, subjective decision - human (employee, user) is still the main influential-interest group in the postal traffic, to satisfy more than one required targets. Therefore mostly are used methods explained in the forthcoming chapter that are not optimal, but are close to them and in a reasonable time provide approximately good solution.

4. APPLICATION OF HEURISTIC METHODS

In the mid sixties of twentieth century, following the development of computer science and operational research as separate sub-areas of mathematics, heuristics have developed - alternative methods of solving realistic unstructured problems. Unlike mathematical, heuristic methods do not guarantee an optimal solution because they do not use classic, formal solving procedures, yet with implementing rules based on logic and intuitive thinking, mimicking human thought and experience rapidly come up with a solution.

The term "*heuriskein*" taken from the Greek language means "to find, to discover." Famous shout "Eureka" by greek physicist Archimedes represents the past tense of the same verb.¹⁴ While unwittingly, we use heuristics everyday. When planning a trip abroad, going to the city center, to work and so decision about path selection, means of transport and departure times is brought without calculations, analytical methods and formulation / structuring a mathematical problem. That kind of decisions is made using logical, common-sense assessment. Heuristic methods are based on the same principle.

In order to assessment becoming a method, it is still needed to define a systematic procedure to make individual problem become solvable using computer. As a type of technical method, heuristic detection tries to discover some "good, acceptable solutions" that are close to optimal. It's main advantage compared to the mathematical method is represented with reasonable problem solving time. In transport and logistics realistic, specific, bad-structured problems which require quick solution occur daily, and heuristics have the ability to offer an acceptable solution. The lack of a method is in the fact that there is no guarantee that proposed solution will be optimal and the method itself can not determine how close it is to the optimal solution. Although they were initially underestimated, today an intelligent set of heuristics have the ability to offer satisfactory solutions, which by subsequent analysis can be compared as very close to the optimal ones.

The main criteria that the method should meet are simplicity, user-friendliness, robustness (resistance to the minimum parameter changes so that the entire solution is not drastically different), the interactivity in terms of impact on the user decision

¹⁴ Stanković, R.: Logistika i transportni modeli, separati s predavanja, Fakultet prometnih znanosti, Zagreb, 2014., page 6

process, the possibility of creating more than one "good" solutions and interoperability with geographic information system (GIS). GIS is a computer system used to create, store, analyze, exchange and display geographic nodes and lines associated with important needed informations. The system allows the user to create a questionnaire for exploring geographic spatial locations through requested informations that can be later edited/updated. Combined with heuristic methods duo potentially can create savings during selection of total number of vehicles, reducing the total cost of fuel and transport time.

As in mathematical methods defined systematic procedure is manifested in the form of an algorithm. Each algorithm contains a number of elementary operations to be carried out. Algorithms can be divided into "good" and "bad" in terms of the compute solving complexity. Good algorithms are so-called polynomial, and bad non-polynomial (NP problems, as an example traveling salesman problem mentioned in the previous chapter). If the total number of elementary operations that algorithm needs to execute is, for example, $B = 3n^5 + 2n^3$, where n is the number of nodes, simplified it is said that algorithm requires for the execution n^5 of time units assuming that each operation requires 1 unit of time - seconds, minutes or so. Algorithms requiring n^x time are considered good /polynomial algorithms, the lower x - this algorithm is better in terms of the computer solving complexity.

Bad/non-polynomial algorithms have exponential computer solving complexity. These are algorithms which execute in X^n or $n!$ time. Realistic problems are large dimensional - larger number of nodes and lines, and heuristic methods more efficiently, due to the time limit, function through the good, polynomial algorithms.

Heuristic methods are divided into three groups:

- A. Constructive heuristics
- B. Special heuristics
- C. General heuristics/metaheuristics

4.1. CONSTRUCTIVE HEURISTICS

Constructive heuristics create only one solution to given structured problem with the aim of closeness to optimum. Usually they are simple structured and build a solution from the start by selecting and assembling pieces into a meaningful ensemble. Construction methods are used for problems with polynomial function of time resolving complexity. In most cases it is simply to check whether constructive heuristics perform well, near to optimum. There are two basic principles of constructive methods:

- Greedy approach
- Iterative local search

Greedy algorithms arrive to comprehensive solution in a way that in each stage of the process assign value to one decision variable decisions which maximum (greedy approach) contributes to the overall objective function, so-called "local optimum". Once the variable is assigned with the value, the value never changes. The advantages of the algorithm are highlighted through simplicity of implementation rules for value assignation, speed and application to several problems. The main disadvantages are the need of the algorithm execution to the end in order to reach a final solution and the fact that local optimum does not lead to "global optimum". This means that, although all the variables have the maximum value, the solution is not necessarily optimal.

Iterative local search is a method that searches the adjacent nodes in the graph with the aim of finding the global optimum. Advantages are simplicity, robustness/resilience and efficiency. The basic idea of the method is that the global optimum is potentially located near the local optimum and can be quickly found. The search for solutions close to local optimum at the adjacent nodes in the graph is called intensification.¹⁵ With very repeated examination/iteration method generates a series of solutions and by the input criteria in relation to the local optimum improves total objective function.

The main disadvantage of the method is that algorithm can be completed exactly in local optimum when it can not find a solution that provides better objective function value. With improvement operators that delete certain lines of the objective

¹⁵ Carić, T: Optimizacija prometnih procesa, separati s predavanja, Fakultet prometnih znanosti, 2013., Page 32.

function (path) between nodes and divert them in different way and escape from local optimum the total solution is fixed. Escape from the local optimum is called diversification where algorithm procedurally and intentionally corrupts total solution so the next iteration will not stop the algorithm in local optimum. Modification of solution can have negative effects because with conscious corruption it is possible that the algorithm will not recognize the global optimum close to local one or will again end up in one of the local optimum.

In general, constructive methods are usually used as a starting solution for widespread and more adequate heuristic methods - metaheuristics.

4.2. SPECIAL HEURISTICS

Special heuristics are created for specific optimization problems taking into account the the specifics of each. Each NP-hard problem has at least one special heuristic method that solves it, but the same one can not be applied for any other problem regardless of the structure similarity. With the appearance of heuristics experts were generally most interested at the beginning in these methods.

Special heuristics for every problem have a special objective function, also known as appraisal function or functions heuristics. Functions heuristics are now an integral part of all algorithms based on metaheuristics methods.

4.3. METAHEURISTICS

Generalized heuristic methods that can be applied for more optimization problems, regardless of the potential uniqueness of the individual problem structures, are called general heuristics or metaheuristics. Because of the widespread use popularity of methods increased significantly over the last twenty years and have special attention especially in the process of transportation.

The term metaheuristics was introduced by Fred Glover in 1986 after the appearance of first methods at the beginning of the same decade. The process of method begins with potential solution usually obtained by constructive heuristic methods which is then iteratively improved. Metaheuristics have no guarantee of optimality, and can be run through a pre-defined number of iterations. An important feature of metaheuristics is the use of strategy to find the global optimum, which in some steps accept worse objective function (from special methods) in order that method will focus on the area of other good solutions and achieve escape from local

optimum. Considering that iterative local search is often a part of metaheuristic methods, metaheuristics are trying to find a balance between the two features: the diversification and intensification.¹⁶ Simplified, intensification investigates a particular area of the graph near local optimums and diversification explores larger space of the graph in terms of the search for a global optimum, which may or may not be located in the adjacent area of a local optimum. Often these two mechanisms are contradictory which is the main drawback of metaheuristic methods - the constant need to adjust certain parameters because it depends on the effectiveness of the overall solution.

Most heuristics have found inspiration in natural optimization processes where knowledge of the latter is implemented/simulated as, for example, the transport problem. There are different divisions of methods and some are shown in Table 4.

Table 4. Division of metaheuristics

According to natural process inspiration		According to memory usage	
<u>Inspired</u>	<u>Uninspired</u>	<u>With usage</u>	<u>Without usage</u>
Simulated annealing (SA) Genetic algorithm (GA) Ant colony optimization (ACO)	Greedy randomized adaptive search procedure (GRASP)	Tabu search (TS) - short-term - long-term	Iterative local search (ILS) GRASP SK
According to determination		According to solution integrity	
<u>Stochastic</u>	<u>Deterministic</u>	<u>Based on population</u>	<u>Based on individual solution</u>
SK, GA, GRASP	TR, ILS	GA, ACO	ILS, SK

Source: [6], date of acquisition: 11.05.2015.

During algorithm development two concepts are important: display/encoding of solutions, when it comes to transportation problems commonly used is vector of permutations, and defining the appropriate objective function, often retrieved and/or adapted from special heuristics for individual optimization problem.

¹⁶ Carić, T: Optimizacija prometnih procesa, separati s predavanja, Fakultet prometnih znanosti, 2013., page 30.

4.3.1. SIMULATED ANNEALING

Simulated annealing is one of the first proposed heuristic methods for combinatorial optimization problems. It is based on an Metropolis algorithm developed in fifties of the last century for a description of thermodynamic process of annealing. Annealing is a heat treatment process of element which atoms are heated and move at high temperature. With sudden lowering of temperature atoms become "trapped" and form a structure, so-called energetic local optimum. With lower and balanced cooling/annealing the atoms have enough time to form a proper lattice structure, in other words energetic global optimum.

Description of thermodynamic process can be presented as an optimization problem. By displaying the state of element as a feasible solution with local and global energetic optimums, where energy represents objective function, implementation of algorithm with interpretation of a sudden (quick) lowering as the initial solution obtained by constructive method and the slow cooling as a simulation of annealing problem is "converted" as the optimization one. When it comes to physical elements data about element properties and optimum temperatures are known in advance. The optimization problem considered temperature as the basic "parameter" that controls the annealing, which means that the number which determines the parameter of annealing in terms of the initial and final temperatures, number of iterations that algorithm will execute and the timing when it will end are crucial for finding quality solutions.. Because of the same reasons simulated annealing has a constant need to adjust the temperature to specific optimization problem which is also the biggest disadvantage of this method.

Simplified, simulated annealing algorithm is shown with pseudocode in Figure 13. Initial solution s along with a defined number of k iterations form initial and final temperature T_0 and T_n . After each iteration current solution (path) s' at the current temperature T_i is compared with adjacent solution with s'' and improves the objective function. An important term is "thermodynamic equilibrium" by which worse solutions of adjacent nodes are accepted more often at higher temperatures because of diversification, at lower temperatures rarely, and at the final one are not accepted due to intensification. A function that determines when the adjacent solution will be accepted or not in pseudocode named *VjerojatnostPrihvatanja* represents the probability determined according to Boltzmann distribution:

$$p = e^{-\frac{\Delta E}{T_i}} \quad \Delta E - \text{difference between objective functions of } s' \text{ and } s''$$

The probability p is compared with a randomly generated number valued between 0 and 1. If the randomly generated number is less or equal to p , the solution is accepted and transferred to another iteration. With higher temperature the better the chances are for solution acceptance. At the end of the iteration function for temperature reduction is called and new iteration starts. Since the algorithm does not have the results from past iterations, except those with the best solution and current one, simulated annealing is one of metaheuristics methods without memory usage.

```

1: procedure SA(s, n, k)
2:    $i \leftarrow 1$ 
3:    $T_0 \leftarrow \text{PocetnaTemperatura}(s)$ 
4:    $T_n \leftarrow \text{ZavrснаTemperatura}(s)$ 
5:    $T_i \leftarrow T_0$ 
6:    $s' \leftarrow s$ 
7:   repeat
8:     for  $j = 1 \rightarrow k$  do
9:        $s'' \leftarrow \text{SusjednoRjesenje}(s')$ 
10:      if  $f(s'') < f(s')$  then
11:         $s' \leftarrow s''$ 
12:      else
13:         $p \leftarrow \text{VjerojatnostPrihvatanja}(s', s'', T_i)$ 
14:        if  $\text{Random}(0, 1) \leq p$  then
15:           $s' \leftarrow s''$ 
16:        end if
17:      end if
18:    end for
19:     $i \leftarrow i + 1$ 
20:     $T_i \leftarrow \text{Ohladi}(i, n, T_0, T_n)$ 
21:  until  $\text{UvjetPrekida}(i, n, T_i, T_n)$ 
22:  return  $s'$ 
23: end procedure

```

Figure 13. Pseudocode of simulated annealing algorithm

Source: [6]

Date of aquisition: 12.05.2015.

Four elements affect the modeling of algorithm: determining the initial-final temperatures, program/cooling function, number of iterations and the objective function. Each element with detailed equations improves the algorithm for each problem, including the traveling salesman problem.¹⁷ After each iteration additionally iterative local search can be used, which leads to better solutions, but executing time may be too long depending on the problem.

¹⁷ Galić, A.: Metaheurističke metode problema usmjeravanja vozila s vremenskim prozorima, Master Thesis, Fakultet prometnih znanosti, Zagreb, 2012

4.3.2. GENETIC ALGORITHM

Evolution algorithms represent a special set of heuristic methods. Genetic algorithm is based on Darwin's theory of evolution, which says that more robust individuals adapted to environment and general situation that surrounds them are more likely to survive, with the use of the natural selection process. The first computer programs that simulated the processes of evolution arose in the sixties of the last century, but found its scientific use in technical areas through various algorithms 30 years ago. Unlike the simulated annealing which searches adjoining path of currently selected solutions genetic algorithm searches the set of solutions within randomly created population. Pseudocode of genetic algorithm is shown in the following Figure.

```
1: procedure GA( $n, g, p_x, p_m, elitizam$ )
2:    $P \leftarrow$  GenerirajPocetnuPopulaciju( $n$ )
3:   Evaluiraj( $P$ )
4:    $s_{min} \leftarrow$  Najbolji( $P$ )
5:   for  $i = 1 \rightarrow g$  do
6:      $P^* \leftarrow \emptyset$ 
7:     for  $j = 1 \rightarrow n$  do
8:       if Random() <  $p_x$  then
9:          $r_1 \leftarrow$  SelektirajRoditelja( $P$ )
10:         $r_2 \leftarrow$  SelektirajRoditelja( $P$ )
11:         $P^*[j] \leftarrow$  Krizaj( $r_1, r_2$ )
12:       else
13:          $P^*[j] \leftarrow$  SelektirajRoditelja( $P$ )
14:       end if
15:       if Random() <  $p_m$  then
16:         Mutiraj( $P^*[j]$ )
17:       end if
18:     end for
19:      $P \leftarrow P^*$ 
20:     Evaluiraj( $P$ )
21:      $s \leftarrow$  Najbolji( $P$ )
22:     if  $f(s) < f(s_{min})$  then
23:        $s_{min} \leftarrow s$ 
24:     end if
25:     if  $elitizam = true$  then
26:        $P[\text{IndeksNajgoreg}(P)] \leftarrow s_{min}$ 
27:     end if
28:   end for
29:   return  $s_{min}$ 
30: end procedure
```

Figure 14. Pseudocode of genetic algorithm

Source: [6]

Date of acquisition: 13.05.2015.

For example of travelling salesman problem of the traveling salesman from $(n-1)!$ defined number of solutions - individuals is chosen which form a set - population. Often for forming of the population greedy approach is used. The best

individual is stored in a variable s_{\min} . The algorithm creates an empty set P which will save the descendants of the best individuals created by crossbreeding, mutation or copying. Crossbreeding is an operator which components (nodes) of parents from the same set of population connect into a new individual and store it in an empty set P. Crossbreeding will occur if the randomly generated number is lesser than the parameter p_x who can be valued in the range 0-1. Otherwise unchanged individual will be copied in the collection P. Unchanged individual or individual created by crossbreeding may mutate if randomly generated number is lesser than the probability of mutation p_m . The mutation functions as a criteria that all crossbred individuals are not similar in the same population, algorithm will not go towards the local optimum, ie contributes to the diversity of solutions. Then algorithm with evaluation checks whether new best individual was found. Elitism is a rule that decides whether every time best individual will be transferred to a new cset, because often new individuals produced by crossbreeding contains lower nodes of both parents, and the use of elitism contributes significantly to intensification and reduces diversification. Although elitism speeds up finding a local optimum, correct use can significantly improve the overall efficiency of the algorithm. When it comes to traveling salesman problem solutions are displayed as a vector of integers, and vector elements are node indexes, with the initial-final index at the beginning left-out, and later with coding procedure added. The five elements affects the design of genetic algorithm:

- ❖ Fitness function
- ❖ Selection of individuals
- ❖ Elitism
- ❖ Crossbreeding
- ❖ Mutation

Fitness function is made by total weighted value of lines which connect nodes chronologically written in solution. It is used for quality measurerent of individuals in population beacuse in genetich algorithm, based on that criteria, only the best remain. With fitness function selection of individuals is made using roulette-method or tournament selection. Crossbreeding is usually made by special operators PMX (*Partially Matched Crossover*), OX (*Order-based Crossover*) ili CX (*Cycle Crossover*). For mutation mechanism mutations of transfer and replacement of genes and partial chromosome inversion are used.

4.3.4. ANT COLONY OPTIMIZATION

Ant Colony Optimization method is younger than previous ones, created in 1992. In short time different variants of method for specific combinatorial problems have been developed, and some of them proved as extremely effective. Ant Colony Optimization is part of swarm intelligence methods which are generally based on the behavior of animals.

All versions operate on the principle of stigmergy. Stigmergy is a form of communication between individual specimens of animals, such as ants, bees, termites etc., where individuals do not communicate directly yet leaving traces. By using pheromones - chemical substances (form, basis of matter) trace is left for other individuals who find the latter and then follow it.. Zoological studies have shown that the type of Argentine ant with the use of pheromones is able to find the shortest path between the anthill and food.

basic idea of the adjustment of ant colony behavior to optimization problems is the use of the algorithm through creation of artificial ants. Ants search space graph in all directions, leaving pheromones that with each iteration slowly evaporate. Ants which find a shorter path on the same one will leave more pheromone so that over time the shortest path will contain the largest number of pheromones.

Originally, the ant colony algorithm was applied to the traveling salesman problem and the method is called Ant System . Unlike real ones, ants which are created by algorithm have ability to memorize, which means that they can determine the distances between nodes. Also in the natural process the power of pheromone trail prevents ants from new researches and discovery of new lines, which will not prevent them to find the shortest path, but in algorithm that can lead to a premature end in a local optimum.

Pheromones as a weighted value of lines are shown through the $n \times n$ matrix where n represent number of nodes, and individual element of matrix the amount of pheromone on each $i-j$ line. There are three variants of ant system: Ant-density, Ant-quantity and Ant-cycle. They differ by the way of updating the amount of pheromones on each line. Ant-density between nodes adds a constant amount of pheromones, Ant-quantity inversely proportional one to the line weighted value, and considering Ant-cycle method amount is added only ant creates path as a solution whereby on each line the amount of pheromones is inversely proportional to the total traveled

path. Ant-cycle method has proven to be the best because the matrix is updated as the global optimum of the entire path, while the other two methods matrix update depending on the values of individual lines - as a local optimum. Pseudocode of Ant-cycle method is shown in Figure 15.

```

1: procedure AS( $n, i_{max}, \alpha, \beta, \rho$ )
2:    $mravi \leftarrow$  InicijalizirajAgente( $n$ )
3:    $\eta \leftarrow$  InicijalizirajMatricuUdaljenosti()
4:    $S \leftarrow$  KonstruirajPocetnaRjesenja( $n, \eta$ )
5:    $\tau \leftarrow$  InicijalizirajMatricuFeromona( $S$ )
6:    $s_{min} =$  Najbolji( $S$ )
7:   for  $i = 1 \rightarrow i_{max}$  do
8:     for  $j = 1 \rightarrow n$  do
9:       KonstruirajRjesenje( $mravi[j], \tau, \eta, \alpha, \beta$ )
10:      if  $f(mravi[j]) < f(s_{min})$  then
11:         $s_{min} \leftarrow mravi[j]$ 
12:      end if
13:    end for
14:     $Ispari(\tau, \rho)$ 
15:     $Azuriraj(\tau, mravi)$ 
16:  end for
17:  return  $s_{min}$ 
18: end procedure

```

Figure 15. Pseudocode of Ant-cycle method

Source: [6]

Date of aquisition: 14.05.2015.

Once the n number of ants and matrix weighed values of lines are determined n solutions are obtained with some of constructive methods. Constructive solutions initiate the matrix of pheromones. Number of iterations is determined by the parameter i_{max} . In each iteration ants make a decision partly based on previous iterations, and partly on it's "sight". The best overall solution is stored in the variable s_{min} . After each iteration a function $Ispari$ is called which simulates evaporation with reduction of pheromones by parameter ρ . After completion of iterations algorithm prints the best global solution.

Elements of algorithm design that affect it's effectiveness are procedure of solution construction in each iteration, the initialization function of pheromones conditioned by constructive heuristics, method of updating pheromones in the matrix and extension of the basic algorithm. For the purposes of traveling salesman problem

with larger dimensions most important expansion variants elitist system ant, ant system based on ranking, max-min ant system and ant colony system.¹⁸

4.3.4. COMPARISON ON TRAVELLING SALESMAN PROBLEM

The weight value of lines with traveling salesman problem can be distance, time, cost, quantity, capacity, etc. Also for example distance can be used as weighted value, and cost and time as well as additional criteria and parameters of the algorithm. Various modifications of the problems lead to modifications of algorithms and may give different results, and the problem becomes even more complex when the traveling salesman problem include more vehicles, of which more will be discussed in Chapter 6. Such problems have their own special sets and can be found at the following link.¹⁹ For small dimension problems deviation does not necessarily mean big changes, but for the organization of delivery area with range number delivery districts may totally have a much greater impact on operating costs.

It is important to note that it is not always easy to assess whether the delivery problem should be solved mathematically or heuristically. If the mathematical model does not reliably represent it's original, the global optimum will be far from the actual, adequate solution. Heuristics are more flexible, often finding solutions within a reasonable time, but there are no estimates on the quality of the decision or the time of execution under unfavorable conditions, which may occur later influenced by regulatory, economic, political, environmental or other external factors.

One possible approach is the delivery of items to a small geographical area, with a small number of recipients and minimalism influential-interest factors set as mathematical model and solve with mathematical methods. Typically, such an "ideal" situation is very rare, given that the problem of individual delivery routes can be considered as a Chinese postman problem or the traveling salesman problem (which is NP-problem), heuristic methods through temporal component have an advantage in making everyday, dynamic decision.

¹⁸ Galić, A.: Metaheurističke metode problema usmjeravanja vozila s vremenskim prozorima, Master Thesis, Fakultet prometnih znanosti, Zagreb, 2012., page 73

¹⁹ <http://w.cba.neu.edu/~msolomon/problems.htm>

5. INTELLIGENT TRANSPORTATION SYSTEMS (ITS)

Intelligent Transportation Systems (ITS) represent modern way of traffic system consideration. A significant improvement over the conventional transport system proving attribute "intelligent" which means that these systems are not static with same effect regardless of external influences, instead they collect dynamic data in real time with adaptment to the current situation and make decisions based on "fuzzy" logic. In other words, they manage to find an appropriate solution and function at times when decision is not exact (correct and safe), collected data are partly inaccurate and/or incomplete, and use thinking and conclusions closer to human than machine.

ITS can be defined as a holistic, managerial and information-communication upgrade of the classic system of traffic "fuzzy" logic .²⁰ Holistic upgrade implies that all users of such system and their acceptable user demands were analyzed and by synthesis implemented in the integrated system.

ITS services are defined through 11 functional areas within the International Organization for Standardization (ISO). A complete description of the functional areas and associated services can be found at the following link.²¹ Services of three areas are particularly applicable: informing of carriers, intelligent vehicles and application to transported entity (item). The names of areas are adapted to postal service terminology.

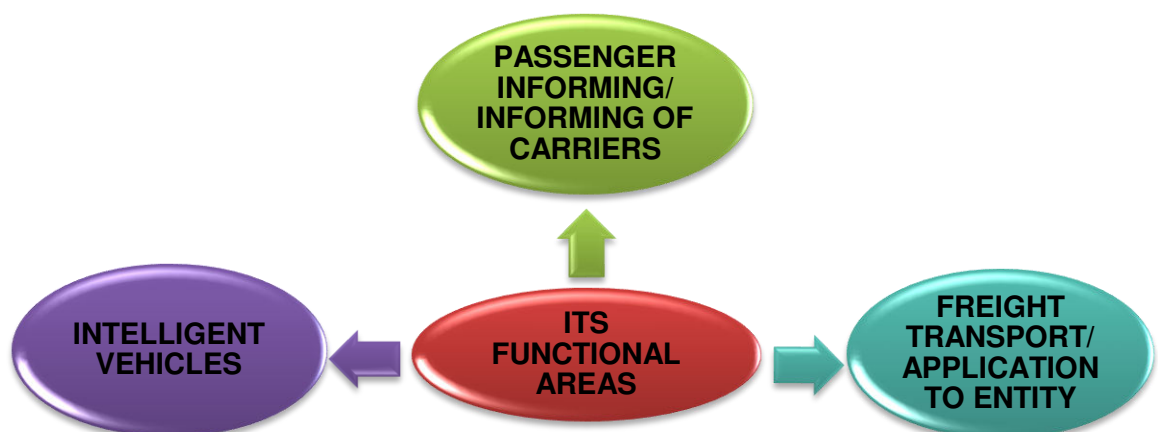

Figure 16. Functional areas of ITS-a adjusted to postal traffic terminology

Source: made by author with adjustment from source [3]

²⁰ Bošnjak, I.: Inteligentni transportni sustavi I, Sveučilište u Zagrebu, Zagreb, 2006., page 2

²¹ www.iso.org.

There are three reasons for ITS application in every traffic system:

- New aspect of solving transportation problems
- Improvement of performances and quality because is valid:

$$PI_{ITS} > PI_{KL}$$

$$QoS_{ITS} > QoS_{KL}$$

PI – index of performance, KL – classical (before ITS) traffic system

QoS – *Quality of Service*

- Modern construction of traffic infrastructure – instead of classical *build only* apply *build+ ITS principle*

Intelligent transportation system which is used for improving the delivery of postal items should be self-optimized and adjustable. In modern times users of postal services increasingly use self-service (pick up/drop off terminals) and they want a choice about the time or place of item delivery. Given that such claims can only be achievable with system that dynamically brings timed decisions it is necessary to use more intelligent transport systems applications in the near future.

5.1. INFORMING OF MAIL CARRIERS

Intelligent informing systems are used to help users of the same, in this case carriers, get information about the external factors affecting the postal system in the preparation and performance in real time. Such impacts are a part of ergonomics in traffic, such as the reaction of drivers to traffic congestion, weather conditions, the state of the roads and so on. Although usually associated with public transport and passengers the same principle is applied to all transport sectors. The services offered by providers of ITS services within the functional areas are located in Figure 17.

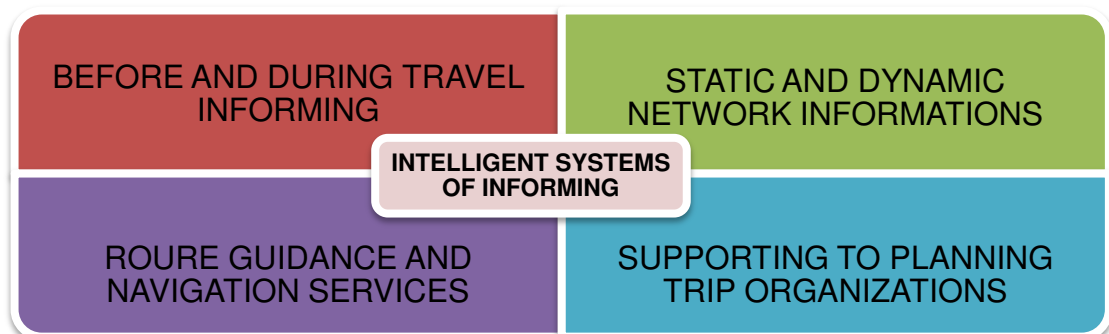

Figure 17. Services of informing carriers functional area

Source: [3]

Date of acquisition: 15.05.2015

These services are valuable when it comes to adjusting carriers itinerary depending on real traffic situation. Services can provide:

- Static informations – known in advance, outdated and familiar
- Dynamic informatons – collected, processed and displayed in real time

S obzirom da je promet nematerijalna i neponovljiva usluga tako i informacije trebaju biti svakodnevno ažurirane dinamičkim prikupljanjem. Nužna je adaptacija stvarnom stanju u prometu. Pružatelji usluga mogu biti javni ili privatni operatori.

The function of before-travel informing is providing information to carriers about selection of vehicles, routes, addresses of end-delivery and time of departure. This system can also be used for the case when it comes to acceptance or express or courier service where items are collected at the address of the sender. Informations should include condition of roads, current meteorological conditions, potential parking places and other useful things depending on the requirements.

Ideally, intelligent information system includes before and during travel informing, although there are frequent examples of separate and often incompatible systems. Travel informing suggest to carrier better variant of the proposed from before-trip informing, in case that the latter one exists. Unplanned external influences on the transport system such as changes in weather conditions, flows at certain roads, traffic accidents, special events (various festivals, matches, strikes, tourist events) can lead to suggesting new routes.

Static and dynamic network information should in principle include two networks: public traffic and postal. Static information relate to the general condition of the buildings that serve as terminal or transit point, post offices from which the mail carrier leaves and returns after the delivery, business areas/services where they will perform deliveries etc. Dynamic information should include the number of free parking spaces in the area of office /business premises and communication with competent personnel for safety approvals when entering the same objects so time will not be wasted.

Services of route guidance and navigation may or may not apply to before and travel informing. They can also be a part of an intelligent vehicle. Such services are exclusively engaged in the shortest route between two locations based on specific algorithms. These intelligent transport systems provide information in a

shorter time than for informing ones, but are limited because they do not take into account external influences. Examples of such services are dynamic in-vehicle route guidance integrated multi-modal travel guide, walking or cycling route guidance and so on. These services are usually focused on specific vehicle of carrier.

For the last type of services is enough to mention that there should be a *back-up* system that will monitor the *potential failure mode* of an information system by which technologists optimize the work of postal workers.

5.2. INTELLIGENT VEHICLES

The means of transport are basic transport entity of a network. They become intelligent with installment of various instruments in existing vehicles, such as devices for driving, stopping, lighting the road, signalization, enabling normal visibility, control and release of exhaust gases and connecting trailers. Although today's means of transport already have a built domr type of such systems it is possible to add additional benefits. Mostly they are road vehicles but it is not limited to one mode of transportation.

Such systems are used to assist the driver become his replacement while driving. They are integrated into existing vehicles through a variety of applications that use the Internet as a resource with possibility of delivering dynamic informations to the system. Such applications are divided into three groups, which are listed in Table 5. Mostly they are M2M (*machine to machine*) applications.

Table 5. Division of intelligent vehicles applications and related services

INTELLIGENT VEHICLES APPLICATIONS		
Driver warnings	Partial control and back-up	Full automatic guidance

Source: [3], date of aquisition: 15.05.2015.

Services that can be offered applications can not be classified clearly in one division. Examples include: improving the visibility, automated processes in vehicles, collision avoidance and stopping, security alerts - keeping safe distance from other vehicles and/or approval when passing through a defined transit points - terminals, border crossings, customs checks, intelligent parking help, control of fuel consumption and so on. The largest number of ITS solutions come precisely in this functional area and the consequent need for interoperability of applications is fully extended.

Intelligent transportation systems which are installed in vehicles can be autonomous, adaptive reasoning is solely based on the data in the vehicle or cooperative, vehicle exchanges information in cooperation with the instruments of roads and/or other vehicles. They are not primary needed within the delivery of postal items, but for performing technological phase of transport should be taken into account within the safety aspect, because at that time the largest amount of items are in one several means of transport between two postal centers.

5.3. APPLICATION TO ENTITY

Transported entity in the postal traffic represents postal item. Individual items are grouped and massified, due to reduction in cost, form a unit adapted to traffic entity and postal network.

Reasons for the applying intelligent transportation solutions excel in improving the efficiency and effectiveness of preparation and delivery, increasing security of carriers when handling mail and the protection of the entity, and environmental sustainability. Various ITS services providers used freight transport to offer its first applications because in general the market is not saturated with various solutions and constant innovation. The structure of the postal system and can be expressed formally as follows:

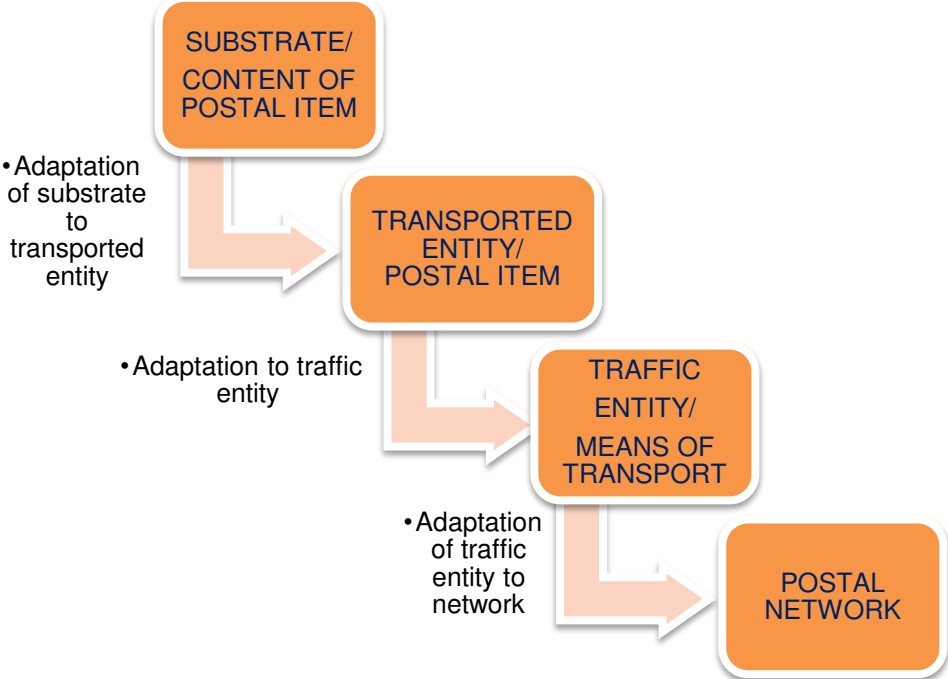

Figure 18. Display of postal system adaptations

Source: made by author

The attribute of intelligence in this area represent digital documentation accompanying items of the way through one or more means of transport, information about manipulation of items during loading and unloading from vehicles, interfaces capable of monitoring the transport, interaction with other ITS systems for planning and control and source of information on the status of item in real time. ITS services are:

- Location of item on postal network
- Current status and control of dangerous/seperated items
- Location of item in vehicle
- Automatic review of documentation
- Operative control of delivery

It is not necessary to use item location on network service because item will be most of time be placed in carrier's vehicle, and entity is followed with during-travel information service. But can serve as a review, sort of back-up, and additional information that build on travel information are time of loading/unloading items from vehicles and significantlprotection against theft and loss of postal items.

Seperated items require special treatment. In the case of dangerous items they need to be additionally marked and divided from the other standard items. The same applies to fragile items, which should be provided with special materials such as additional tapes, nets or special cargo space for their accommodation. ITS possibilites are manifested in process of tracking such items as they inform carrier about initial physical size of the item (weight, dimensions, total amount in the vehicle, the type of item/envelope/package, priority / non-priority) with the unique ID number of each shipment, compared to current state: light, humidity, temperature of the consignment and vehicle and other environmental conditions on the road.

In vehicle item location system shows x , y , and z coordinates of the shipment in the cargo area.. It is useful to enforce this system in preparation for delivery and to link application purpose with que serving in queing theory. Here we examine the order of items in vehicles based on adress location on the itinerary. The most commonly used logic sequencing - putting the sequence of items in the vehicle is LI-FO (*Last In - First Out*), but other rules can be used, such as SPT - *Shortest Processing Time* or PRI - *Priorities*.

As in the case of road transport, documentation and items travel separately in the postal traffic in case of credited items. Automatical documentation review enables

faster verification of documents in digital form with the following processes: validate, orderliness and verification, registration of delivered items in delivery books, enrollment of parcels in required books with accompanying reports, registration of lost items, list of undeliverable items, possibly additional requirements from recipients such as request for damages and the return postage and defining the period of keeping documents.

Control has a core task to ensure quality of services with efficient and rational progress of technological process - in this case delivery. ITS system can divide control into operational and statistical one. Operational control checks time records and accuracy of the sorting items according to districts and boxes, also security and protection. Statistical quality control displays current results through the use of seven basic and additional tools of quality management.

In the future it is anticipated that "intelligent items" will acquire most of other ITS services and will themselves determine the route to the final recipient in a way that will choose the mode of transport, means of transport and way of manipulation. Documentation would follow items to delivery in digital form and electronically signed by recipients via mobile phones or other terminal devices, and then printed as material proof of delivery. Such items should have the ability to make decisions in fuzzy changing conditions, and at all times be aware of their present location and external influences. Technologies that are commonly used today to track postal items are RFID, satellite services and the detect movement sensors. The aim is labeling of each item, but it is economically more profitable to tag consignments with large quantities of the same parcels as unit of the same cargo destinations, and in this way partially affect their way of moving through postal network.

5.4. NEW SOLUTIONS

Innovations of intelligent transportation solutions are mostly related to means of transport. The reason is that vehicle manufacturers within their organizations usually have a department in charge of research and development. This section provides examples of current ITS solutions with the manufacturers, but also from other manufacturers whose main business is not transport, and postal service providers.

Volvo presents their solution "*Roam Delivery Service*" that recipient becomes vehicle, not a person. If the recipient is not at intended delivery address the delivery, and vehicle is, using a special digital keys, with prior notification and approval, carrier using applications installed on tablet or smartphone receives a temporary code to unlock trunk of the vehicle. The trunk is opened for a short period of time and delivery is performed. The recipient is able to constantly monitor the process through application, and temporary code is after the service unusable for the reopening of vehicles, because of safety.

If delivery contains greater amounts of postal items on the pre-defined geographic location, such as a bulk mail - a greater variety of printed matter which should be delivered in the office of shopping center, instead of equipping each item with RFID technology solution such as "*Intelligent plastic pallets*" from Craemer can be used. In this case pallet is equipped with RFID tag/transponder and supervises the entire package. Pallets are made of a special plastic that is impermeable to moisture, can not be bent or narrow and thus improves the process of loading and unloading items. On the front side they do not contain any additives and have a small hole spacing to reduce pallet load which increases protection from damage. Pallets are standard dimensioned, and are up to 20 kilograms lighter than wooden pallets.

In postal traffic one of the new solutions deal with the upgrade of existing postboxes. After inserting the postal items in the postbox recipient is notified by e-mail or SMS about the time of delivery. The system is useful in cases where the recipient is absent a few days from delivery address, but it should be taken into account that there are other services that the recipient may request like remailing or change of address of delivery, which faster and cheaper solutions than building a system that has no real purpose throughout most of the year.

Swiss Post offers an alternative to the recipient as letter-boxes in digital form. All items of correspondence, with previous permission and registration of recipients to use these services, are scanned and the image of the envelope is sent to the recipient via e-mail or Swiss Post application. The recipient then chooses which items should be delivered, and which are unnecessary to deliver (promotional items, incorrectly addressed shipments etc.). In this way, the recipient has the flexibility of deciding which items wants and also takes part in the optimization of delivery by operator who does not waste time and resources on the delivery of items that could

potentially become undeliverable because the recipient will possibly decline to accept them.

Australia Post has decided to use their post-boxes as handing over of parcels that are not delivered, but also to receive new postal items (*Pick-up/Drop-off Parcel Lockers*). Since the service is available 24 hours 7 days a week they improved required five-day delivery universal postal obligation to each recipient. User after registering by email, SMS or application receives access to post-box and pick-up of item, but can also use the same mailbox for the admission of new postal items as the sender to another user.

Lately significantly is talked about drones which will replace carriers. Although technologically advanced solution, tested through several activities especially in the US, regulatory and economic aspects still affect their implementation not only in the postal system. The issue of user privacy remains currently open and the biggest reason why the drones are not yet part of the postal operators. Comparison of quality of delivery with the so far principle is questionable and potentially a research theme in future postal studies.

Contemporary intelligent transportation systems lead to the modernization of postal traffic business, but it is always necessary to consider the economic viability of investing in such a project as far as the long-term profitability and return on investment. The development concept of intelligent transportation systems in the postal traffic includes numerous influential-interest groups (*stakeholders*) as well as experts from more scientific fields. It is therefore necessary in the initial phase of the project to define requirements, specifications and operational concept to create a model "what/how" that connects request to the necessary ITS architecture. In this way a clear picture is shown about the reality of each user request.

Overall, ITS, as well as ICT (*information and communications solutions*) are not main activity of postal services. Their use in the postal traffic has two goals: to indirectly increase user demand using modern technologies, where postal services become more accessible and improving the quality of service, both in delivery and other technological phases/activities. Postal traffic engineer will not build ITS solutions, but will significantly participate in creating user requirements. To build and deploy such systems exist responsible professionals involved in the ITS area as a core business.

ITS solutions in postal traffic should be universal (independent of the mode of transport) and interoperable as "post" integrates all modes of transport and thus accepts the benefits of all modes of transport and also uses all forms of communication within the business (B2C, B2G, G2C and others) depending on the situation. Similarly ITS has no ready-made solutions, but to each situation differently - conceptually based.

Benefits of ITS during delivery are: rationalization of the postal network, improving the quality of postal services, but also to protect the confidentiality of substrate from sender to the recipient. The system must be built so that it works regardless of the further development of technology and ITS is best implemented through re-engineering as well as the correction and improvement of current practice.

6. DELIVERY DISTRICTS MODELLING

Delivery district organization depends on the choice of implemented delivery system, possible types are shown with Figure 5. Every postal center may have their own delivery area, divide the latter to delivery office related areas and a combination thereof. Depending on the system, delivery districts are assigned to postal units. Application of systematic methodology for delivery areas modelling has not been dominate in practice. Most countries use empirical-inductive method, in other words good and bad experiences from the past, learning from mistakes and repetition of good choices. Isolated and rare attempts of scientific approach with aim of raising problem to higher technological level have not yet contributed to practical application and this approach is still in its beginning. Regarding that optimization of postal centers and offices delivery borders also represents reengineering of entire postal network physical structure, primary and lower technological level is modeling of delivery districts.

Delivery areas according to physical structure can be static/daily and dynamic/adaptive. Based on the postal item they are divided into: letter post, parcel, financial, publications, express-courier and combination ones. One or more carriers may deliver on one delivery district. Categorization and used types of district depend on the preferences of each service provider. Shaping of districts and adaptment to external environmental influences such as construction of new facilities, reconstruction of roads, political-economic regulatory decisions, changes in the culture and habits of users is a constant task for postal technologists. Once defined delivery areas can not be permanent. Static district reengineering is necessary according to the literature²² every two to five years.

Method used for district organization greatly affects overall cost of delivery regarding more carriers and transportation means engagement as well as the number of delivery attempts. An important fact is that majority of items does not go through entire "end-to-end" technological process through all five technological phases. Each item requires performing initial-final stage of acceptance and delivery, but only approximately 30% of items enter network of other postal centers and offices. Most items use partial itineraries to travel through network. Distribution of traffic in postal network is shown on the simplified model in Figure 19.

²² Bošnjak, I., Kavran, Z., Matijević, D. : Design of delivery areas of public postal operator by applying AHP model, *Promet- Traffic- Traffico*, Vol. 17, 2005., str. 77-85

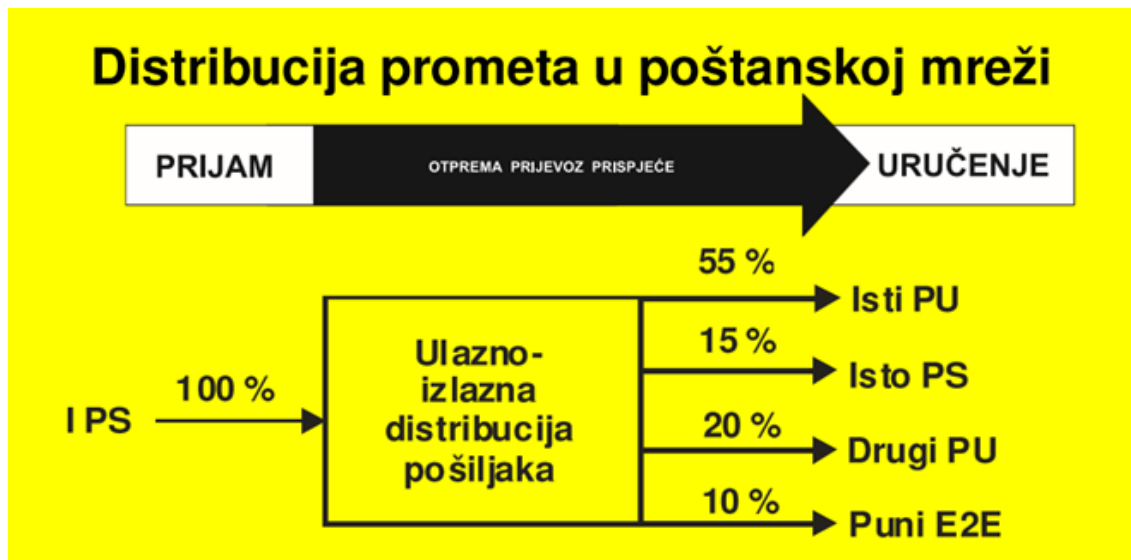

Figure 19. The distribution of traffic in network

Source: [16]

Date of acquisition: 28.05.2015.

Distribution model shows that every post office with delivery area, and in minimum case at least corresponding postal center should be responsible for organizing delivery in their area in order to achieve equalization of efficiency and effectiveness with carriers workload and cost constraints. There are two basic ideas of scientific approach to district modelling:

- ✓ Information on desired delivery address is already known at the time of **acceptance**
- ✓ Logical structure reengineering of existing delivery districts using statistics as the fundamental database – enabler

With usage of acceptance statistics it is possible to prove that quantity of items each year at a specified time (for example number of items in January 2014 and January 2015) does not change significantly in the delivery areas, although it should be distinguished from fact that there are more items around New Year holidays than in May with influence of seasonality. Also, certain days in month have increased delivery, such bills maturity dates. Statistical analysis methods of analysis also foresee future demand using same data.

There are three basic ways to solve end-delivery cost problem: innovation, reengineering and restructuring. Innovation is rare and hardest way. Restructuring is the easiest and most applicable optimization way with closure post offices and /or laying off workers. Information known at acceptance gives enough time for savings with delivery districts reengineering, approach which represents balance between

innovation and restructuring and is also accessible to a larger number of postal traffic stakeholders.

Modeling makes interrelation of four elements: actual situation, problem, model and method. Actual situation of delivery is places as traffic problem. Technologists are trying to develop a model that represents the problem as a copy of the actual situation by using different methods. According to aim models can be descriptive and normative. Descriptive ones are focused on description, analysis and synthesis elements relations with the aim of better understanding how the system works. Normative ones, such as district model, define standard that they want to achieve and are used for the design and optimization of transport and logistics systems.

Model should be considered as a representative of defined problem and can not be better than the input data defined previously. Making of model already brings benefit and if it is possible to make a simple model that will serve the purpose it is unnecessary to perform the complex one. Model should be checked prior to implementation, it can not solve the problems for which it is not designed, and extremely important: can not replace bringer of final decision - technologist. The postal network at global level all the way to district is projected as hub and spoke model, shown in the following picture. In the context of delivery, each delivery system and related district have initial-end point as a hub - delivery post office (PO).

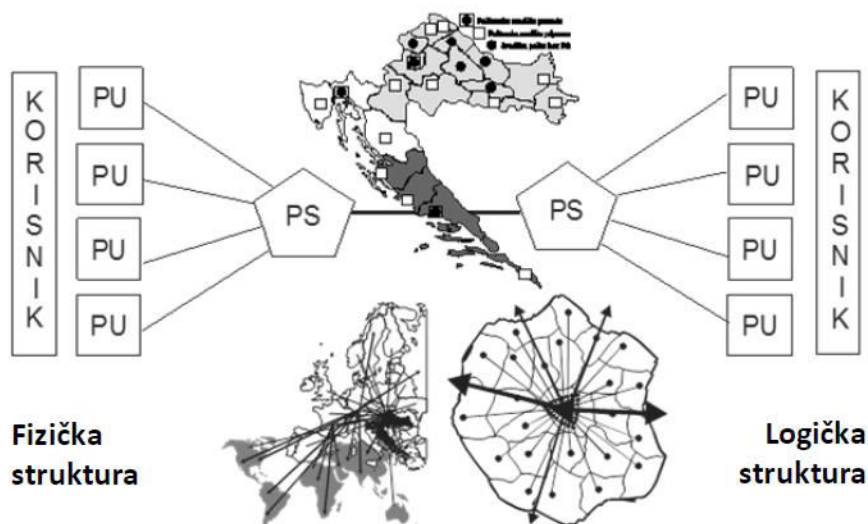

Figure 20. Hub and spoke model with physical and logical structure of network

Source: [16]

Date of acquisition: 04.06.2015.

6.1. INFLUENTIAL MODELLING ELEMENTS

Delivery districts are primarily defined for universal postal service/obligation. If all types of services within the obligation are considered and analogously delivered jointly those are called combinatorial delivery districts. Four basic elements which define the jurisdiction post office with delivery area and set basis for district modelling are shown in Figure 21. interrelation between features of three elements additionally affect carriers transportation means selection, and recommendations based on so far experiences are shown in Table 6.

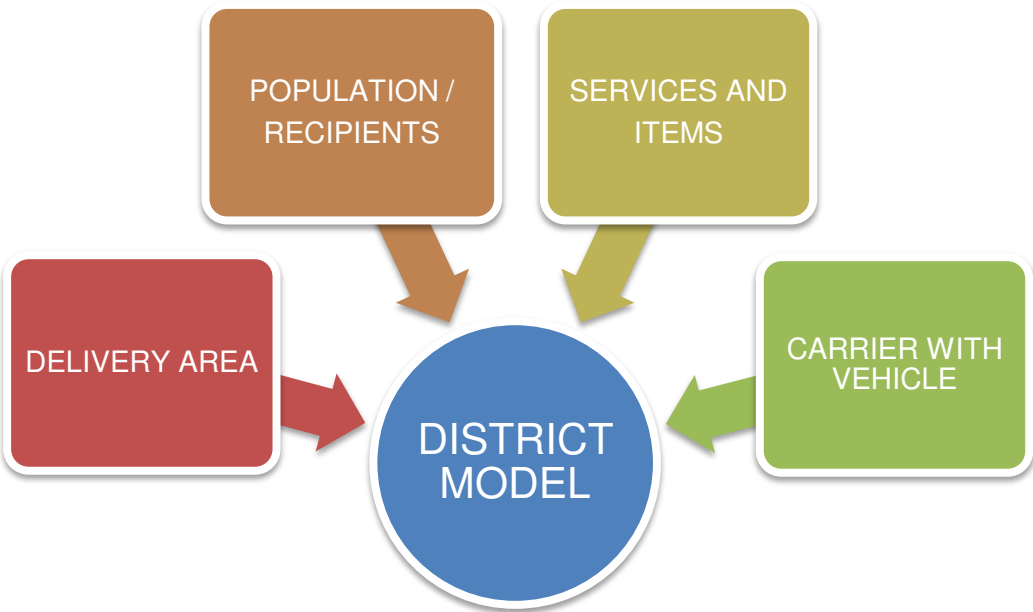

Figure 21. Influential delivery districts modelling elements

Source: made by author

Table 6. Selection of transportation means for carriers delivery district itinerary

DA	Sal	CwV
Itinerary length (km)	Mass and dimension of total amount of delivery items	Choice of transportation means
0-7	15 kg	X (walk)
7-15	Depending on cargo space dimension and capacity.	Freight bicycle
15-40		Moped
40 - ...		Van

Source: made by author with adjustment from source [14]

6.2. STATIC COMBINATORIAL DELIVERY DISTRICT MODEL

Static models observe system states without dynamic analysis, ie change of state in time.²³ Static model covers monthly data in year period and consider of expected, planned equilibrium traffic states on network with included positive (peak) and negative (lack of traffic) deviations. It is possible to adjust same traffic states to daily level. Combinational districts represents joint delivery of mail within the universal postal service, simplified carrier deliver items which are not traced along with ones who have saved records the entire technological process. Choice of itinerary and transportation means for static models is based on relatively fixed demand for postal services and criteria which are not changed through time of traffic monitoring in network.

The static model consists of eight steps. It will be shown in example of a fictive delivery area and the associated data because data based on actual delivery area, corresponding itineraries, quantity of items, number of couriers and the like are not publicly available. Preconditions for model are:

- ✓ Delivery borders are familiar
(mostly administrative-territorial boundaries of cities, municipalities, etc.)
- ✓ Number of carriers is defined for specific delivery area
- ✓ Number of mail carriers determines number of delivery districts
- ✓ Delivery districts are not intertwined due to the difficulty of delivery preparation – sorting items by district
- ✓ Each recipient can be reached by "street", because it can be any type of path, it is essential that it is a walkable geographical area

Step 1. Display delivery area by vector map with traffic layer

Vector map with traffic layer inclusion simplifies street and related intersection location to technologist. In first step it is necessary to detect streets and post office.

²³ Bošnjak, I., Badanjak, D.: Osnove prometnog inženjerstva, Sveučilište u Zagrebu, 2005., page 96

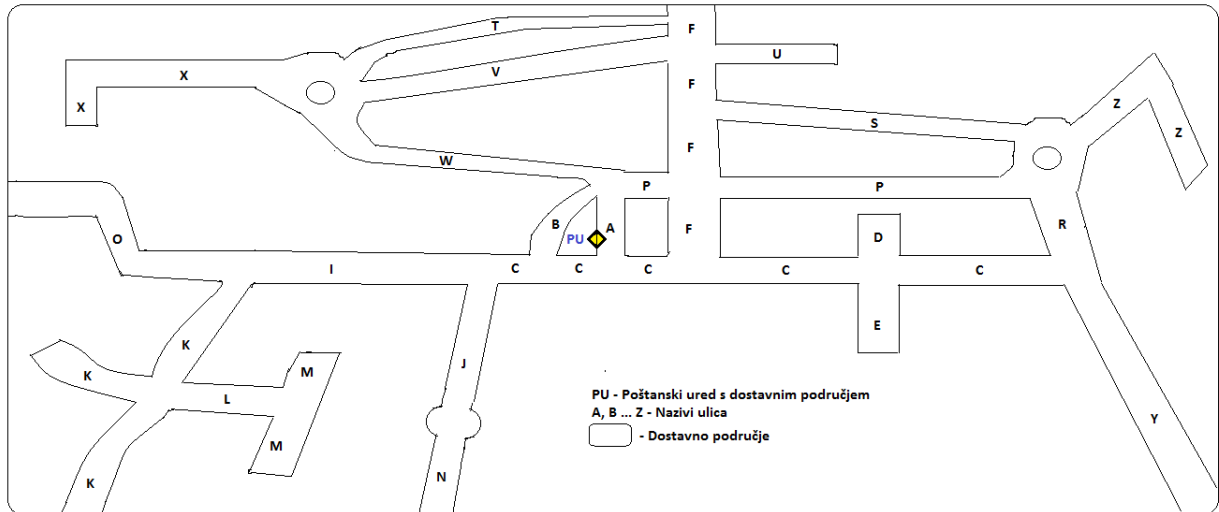

Figure 22. Vector map with traffic layer fictive delivery area

Source: made by author

Step 2. Convert delivery area into a weighted graph

In second step delivery area becomes a weighted graph with converting intersections into nodes and related streets into lines. If a particular street has several sections that connect different nodes, part of street is marked by name and number, such as C3. Each line has to be labeled with number of line and (part of) street - for example 2-A2. Street which has post office is divided into two lines, and the post office becomes the initial-final node 1 of algorithm in the following steps, shown in Figure 23. Although the real traffic situation can be that path between A and B is not always the same depending on the direction of movement (digraph), in this example is assumed that path between each node time is equal in both directions and that it is an undirected graph.

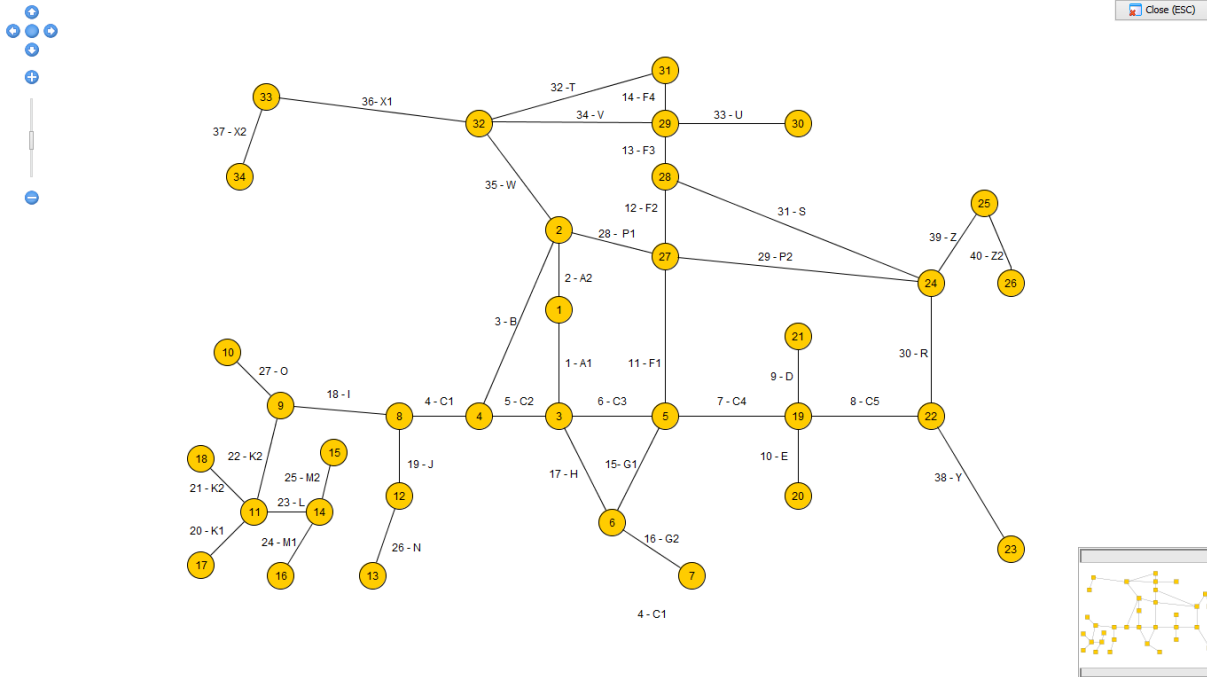

Figure 23. Non-directional weighted graph of fictive delivery area

Source: made by the author

Step 3. Table with input data

Four influential element have been named for modelling. In static delivery model data about population / recipients is not primary because one of preconditions is walkability of line - street, meaning that all potential recipients are located on lines of graph. Density of the population/ households is also not relevant because it covers the entire surface area, which means that it includes areas where there are no streets and no recipients. Required data by elements are:

DA - name, distance of related (parts of) streets and number of lines they mark on the graph

Sal - quantity of items on assigned line - considering that it is a combinational district, total amount of all items is required with calculated monthly traffic equilibrium in network, including positive (peak) and negative (lack of traffic) deviations

CwV - Number of carriers and structure of available vehicle fleet

Delivery area and and services/items data are updated into a table. Data about carriers and fleet will be required in subsequent steps.

Table 7. Delivery area input data on equilibrium monthly basis

Naziv ulice	Pripadajući dijelovi	Broj linije grafa	USLUGA					Ukupno pošiljaka	Dužina ulice (m)
			Obično pismo	Tisak	Preporučene pošiljke	Paketi	Vrijednosne pošiljke		
A	A1 (PART I)	1	6500	4100	150	270	70	11090	750
	A2	2	2250	500	250	140	30	3170	900
B	B	3	2500	850	320	330	110	4110	625
C	C1	4	1500	1000	480	260	90	3330	300
	C2	5	1250	450	440	380	50	2570	50
	C3	6	3500	1150	320	110	30	5110	525
	C4	7	1000	500	20	30	20	1570	765
	C5	8	3000	450	250	120	100	3920	250
D	D	9	5000	800	50	90	30	5970	800
E	E	10	4500	2000	200	130	50	6880	200
F	F1	11	1500	850	20	120	90	2580	100
	F2	12	4500	900	150	310	10	5870	950
	F3	13	1500	1050	280	50	130	3010	200
	F4	14	500	500	450	160	20	1630	400
G	G1	15	750	600	140	70	80	1640	675
	G2	16	500	250	130	20	40	940	375
H	H	17	1500	500	220	370	100	2690	450
I	I	18	1250	250	60	110	70	1740	100
J	J	19	7500	700	50	300	185	8735	1300
K	K1	20	3500	1200	180	290	120	5290	400
	K2	21	1250	500	480	190	100	2520	75
	K3	22	4750	700	70	50	70	5640	1375
L	L	23	2500	1350	180	280	10	4320	250
M	M1	24	1250	150	70	140	70	1680	425
	M2	25	1750	1000	270	200	20	3240	450
N	N	26	1000	1000	360	200	80	2640	400
O	O	27	5000	1250	220	200	10	6680	225
P	P1	28	3750	2750	500	350	60	7410	875
	P2	29	1500	1350	230	280	20	3380	425
R	R	30	1250	1050	250	310	120	2980	475
S	S	31	1200	900	450	70	50	2670	575
T	T	32	1000	600	430	130	70	2230	2000
U	U	33	500	3500	370	180	50	4600	975
V	V	34	1000	750	280	100	80	2210	1375
W	W	35	1500	250	400	350	40	2540	1200
X	X1	36	2000	1150	250	130	90	3620	1000
	X2	37	1500	2000	250	110	10	3870	1525
Y	Y	38	2050	1000	430	270	75	3825	435
Z	Z1	39	1250	150	350	300	50	2100	825
	Z2	40	0	0	0	0	0	0	500
Σ			90000	40000	10000	7500	2500	150000	25000

Source: made by author

Step 4. Potential elimination of lines and indexing

Table above shows that there are no recipients on the line Z2, so it should be eliminated from graph so resources will not be wasted into that area. Lines need to be sorted according to two criteria: length of street and total amount of items. Each criteria indexes lines so that largest value brings the largest index - in this case 39 (the number of lines - Z2 eliminated). In this way two basic problems of carriers worksharing are compensated: some carriers are traveling long distances and deliver small number of items, and some deliver large number of items in smaller areas. Of course, there are lines with small distances and small amounts and vice versa.

Table 8. Lines indexing

Naziv ulice	Pripadajući dijelovi	Broj linije grafa	USLUGA					Ukupno pošiljaka	Dužina ulice (m)	Rangirano po pošiljkama	Rangirano po kilometrima
			Obično pismo	Tisak	Preporučene pošiljke	Paketi	Vrijednosne pošiljke				
A	A1 (PART I)	1	6500	4100	150	270	70	11090	750	39	25
	A2	2	2250	500	250	140	30	3170	900	19	30
B	B	3	2500	850	320	330	110	4110	625	27	23
C	C1	4	1500	1000	480	260	90	3330	300	21	10
	C2	5	1250	450	440	380	50	2570	50	12	1
	C3	6	3500	1150	320	110	30	5110	525	30	21
	C4	7	1000	500	20	30	20	1570	765	2	26
	C5	8	3000	450	250	120	100	3920	250	26	8
D	D	9	5000	800	50	90	30	5970	800	34	27
E	E	10	4500	2000	200	130	50	6880	200	36	6
F	F1	11	1500	850	20	120	90	2580	100	13	4
	F2	12	4500	900	150	310	10	5870	950	33	31
	F3	13	1500	1050	280	50	130	3010	200	18	5
	F4	14	500	500	450	160	20	1630	400	3	12
G	G1	15	750	600	140	70	80	1640	675	4	24
	G2	16	500	250	130	20	40	940	375	1	11
H	H	17	1500	500	220	370	100	2690	450	16	18
I	I	18	1250	250	60	110	70	1740	100	6	3
J	J	19	7500	700	50	300	185	8735	1300	38	35
K	K1	20	3500	1200	180	290	120	5290	400	31	14
	K2	21	1250	500	480	190	100	2520	75	10	2
	K3	22	4750	700	70	50	70	5640	1375	32	37
L	L	23	2500	1350	180	280	10	4320	250	28	9
M	M1	24	1250	150	70	140	70	1680	425	5	15
	M2	25	1750	1000	270	200	20	3240	450	20	19
N	N	26	1000	1000	360	200	80	2640	400	14	13
O	O	27	5000	1250	220	200	10	6680	225	35	7
P	P1	28	3750	2750	500	350	60	7410	875	37	29
	P2	29	1500	1350	230	280	20	3380	425	22	16
R	R	30	1250	1050	250	310	120	2980	475	17	20
S	S	31	1200	900	450	70	50	2670	575	15	22
T	T	32	1000	600	430	130	70	2230	2000	9	39
U	U	33	500	3500	370	180	50	4600	975	29	32
V	V	34	1000	750	280	100	80	2210	1375	8	36
W	W	35	1500	250	400	350	40	2540	1200	11	34
X	X1	36	2000	1150	250	130	90	3620	1000	23	33
	X2	37	1500	2000	250	110	10	3870	1525	25	38
Y	Y	38	2050	1000	430	270	75	3825	435	24	17
Z	Z1	39	1250	150	350	300	50	2100	825	7	28
	Z2	40	0	0	0	0	0	0	500	XX	XX
Σ			90000	40000	10000	7500	2500	150000	25000		

Source: made by author

Step 5. Sum of indexes and new weighted graph

Equalization of criteria is performed by summing received indexes. Resulting value is weighted value - workload of each line in graph. It is necessary to create a new weighted graph with obtained values.

Table 9. Sum of line indexes

Naziv ulice	Pripadajući dijelovi	Broj linije grafa	Rangirano po pošiljkama	Rangirano po kilometrima	Suma indeksa
A	A1 (PART I)	1	39	25	64
	A2	2	19	30	49
B	B	3	27	23	50
C	C1	4	21	10	31
	C2	5	12	1	13
	C3	6	30	21	51
	C4	7	2	26	28
	C5	8	26	8	34
D	D	9	34	27	61
E	E	10	36	6	42
F	F1	11	13	4	17
	F2	12	33	31	64
	F3	13	18	5	23
	F4	14	3	12	15
G	G1	15	4	24	28
	G2	16	1	11	12
H	H	17	16	18	34
I	I	18	6	3	9
J	J	19	38	35	73
K	K1	20	31	14	45
	K2	21	10	2	12
	K3	22	32	37	69
L	L	23	28	9	37
M	M1	24	5	15	20
	M2	25	20	19	39
N	N	26	14	13	27
O	O	27	35	7	42
P	P1	28	37	29	66
	P2	29	22	16	38
R	R	30	17	20	37
S	S	31	15	22	37
T	T	32	9	39	48
U	U	33	29	32	61
V	V	34	8	36	44
W	W	35	11	34	45
X	X1	36	23	33	56
	X2	37	25	38	63
Y	Y	38	24	17	41
Z	Z1	39	7	28	35
	Z2	40	XX	XX	
Σ					1560

Source: made by author

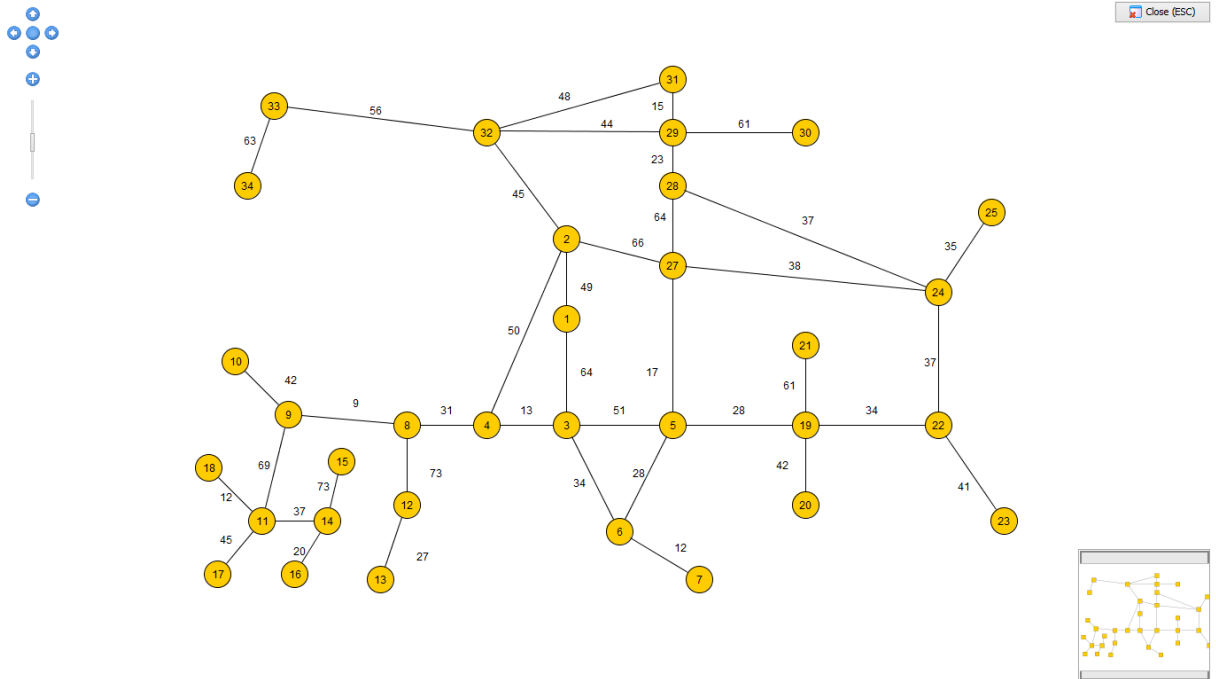

Figure 24. New undirected weighted graph

Source: made by author

Step 6. Defining number of delivery districts and graphical method of graph dividing

Post office employs, for example, three carriers. Weighted graph shown with Figure above has a total weight value of 1560- Σ sum of indexes. Divided into three equals 520 by postmen. This means that graph should be divided into three subgraphs district with equal or nearly equal weighted value of lines with joint node 1, which is the post office. Division in the following figure is made by graphical, intuitive method. A better solution would represent development of algorithm that divides graph into required x subgraph who do not intertwine and have joint initial node. In case that first line is also joint, when more carriers come out to the same side of the first street to further ones, first carrier who "visits "street is allocated with sum index, and others get, instead of sum, just the index of distance because other carriers have to go through distance as a further way to their districts.

Such appearance is seen in the following figure. First and third carrier pass through line A2, but A2 line belongs to first district, and is path to third one. Thus, for third district needs line A2 has assigned index 30 instead of 49 – based on distance shown in Table 9. First district has a full index of 49 because carrier passes line and deliver items. Related to graph theory, if the initial node (PO) does not have equal or twice larger number of incident lines compared to number of carriers/districts, approximate solution of sum indexes is needed and larger than initial one obtained.



Close (ESC)

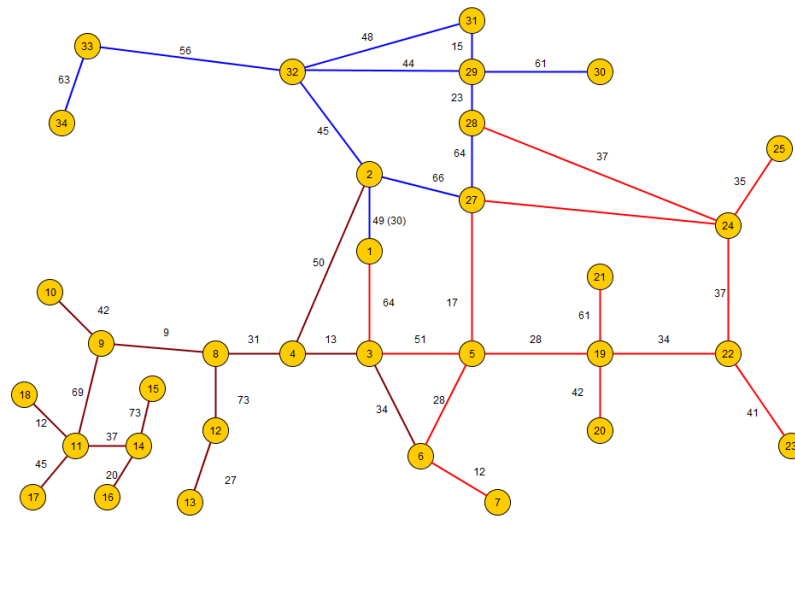

Figure 25. Delivery districts division by graphical method

Source: made by author

Table 10. Delivery districts graphical method solutions

Naziv ulice	Pripadajući dijelovi	Broj linije grafa	Rangirano po pošiljkama	Rangirano po kilometrima	Suma indeksa	Broj dostavljača	Σ/Broj dostavljača	
A	A1 (PART I)	1	39	25	64	3	520	
	A2	2	19	30	49			
B	B	3	27	23	50	Rješenja grafičke metode podjele rajona		
	C1	4	21	10	31	Rajon 1	Rajon 2	Rajon 3
	C2	5	12	1	13	534	525	531
	C3	6	30	21	51	Σ Opterećenja rajona		
	C4	7	2	26	28	1590	Dodane vrijednosti	Σ Rajona - D.V. = Σ
	C5	8	26	8	34		30	1560
D	D	9	34	27	61	Pripadajuće ulice		
E	E	10	36	6	42	A2	A1	A2 (Put prema rajonu)
	F1	11	13	4	17	F2	C3	B
	F2	12	33	31	64	F3	C4	C1
	F3	13	18	5	23	F4	C5	C2
	F4	14	3	12	15	P1	D	H
	G1	15	4	24	28	T	E	I
	G2	16	1	11	12	U	F1	J
H	H	17	16	18	34	V	G1	K1
I	I	18	6	3	9	W	G2	K2
J	J	19	38	35	73	X1	P2	K3
	K1	20	31	14	45	X2	R	L
	K2	21	10	2	12		S	M1
	K3	22	32	37	69		Y	M2
L	L	23	28	9	37		Z1	N
	M1	24	5	15	20			O
	M2	25	20	19	39			
N	N	26	14	13	27			
O	O	27	35	7	42			
	P1	28	37	29	66	Rajon 1	11400	40160
	P2	29	22	16	38	Rajon 2	7175	54655
R	R	30	17	20	37	Rajon 3	7325	55185
S	S	31	15	22	37	(podaci izračunati iz tablice 7.)		
T	T	32	9	39	48			
U	U	33	29	32	61			
V	V	34	8	36	44			
W	W	35	11	34	45			
	X1	36	23	33	56			
	X2	37	25	38	63			
Y	Y	38	24	17	41			
Z	Z1	39	7	28	35			
	Z2	40	XX	XX				
Σ					1560			

Source: made by author

Step 7. Transportation means selection and Chinese postman problem

In next step it is necessary to evaluate on a daily basis amount of items, regarding that certain days of month as well months itself have equilibrium, positive (peak) and negative (lack of traffic) deviations. On this basis, total size of district with the help of Table 6 transportation means are chosen.

Delivery is a part of carriers obligations. It is therefore important to know time of streets visiting and returning to office for further activities (delivery window). Optimal solution is obtained by solving every district as separate graph and using an algorithm for Chinese postman problem. Weighted value of graph represents sum of transit time through the street and time for serving recipients. Transit time is generalized by average passing speed and length of the latter. Time for serving recipients is determined by standards.

Algorithm checks degrees level incidents lines of each node, in case there are an odd degree nodes enumerates such and search for optimal solution based on number of connections (listed in Table 3) and shows itinerary of carrier.

Step 8. Review solution reality and input itinerary in Travel Form

Mathematical methods often vary from actual traffic situation. It is necessary to check solution reality and make changes if is necessary. Solution is submitted to a carrier as part Travel Form and make, from engineering point of view, its most important part.

This model does not take into account mailboxes and pick up/drop off terminals. Carriers during delivery also perform acceptance, so is further needed to consider that vehicle has sufficient capacity for loading such items and distribution to post office.

As noted above, the reengineering of static districts is necessary for every two to five years. At least semi-annually should be checked:

- ✓ Migration of population
- ✓ Construction and elimination of facilities and roads
- ✓ Changes in amount and structure of postal services and items
- ✓ Eventual change in the geographical - topographical terrain features

Companies engaged in the transport, distribution, procurement, freight forwarding, supply chain and logistics services in general often divide geographic delivery areas into so-called polygons. Identical is the purpose of polygons and districts area and static combinational model is also practically applicable in these activities.

6.3. DYNAMIC COMBINATORIAL DELIVERY DISTRICT MODEL

In static model carriers daily have the same itinerary which relatively neglects special days of the month and months regarding lack of traffic and peak loads, which statistical methods compensate.

Dynamic combinational areas would also potentially cover entire delivery area of post office, but itinerary would be different every day. Preconditions of such model are similar to static one:

- Delivery area borders are well known
- Delivery districts are not intertwined
- Each recipient can be reached through "street"- walkable geographical area

Model introduces a new criteria. Carriers delivery is still a part of everyday work, but technologist's is daily required to perform calculations of planning itineraries. For this half an hour is allowed at most so delivery is not delayed. Also, itineraries have to be within the required delivery window.

Model is likewise based on graph theory. Now it includes fourth element of modeling - recipients. In static districts nodes represent intersections, lines streets. Dynamic model represent nodes as recipients, mailboxes and pick up/drop off terminals and lines as node connections. Each recipient/mailbox/terminal is connected with each, and considering that importance this time revolves primarily on visiting each node this is traveling salesman problem. If more carriers participate in a tour, more vehicles are assigned and traveling salesman problem becomes VRP (Vehicle Routing Problem).

A special type of VRP thoroughly investigates and solves problem of such preferences.²⁴ In order to adequately cover dynamic delivery districts and adapt them to postal service needs it is necessary to expand the story. Nodes visiting is still primary, therefore each individual has weighted value. Time of delivery is still first factor of weighted value, delivery standards can be used in a way that value represents time of delivery, time of emptying mailboxes or the sum of two in the case of terminals.

However, time of visiting nodes is different everyday. Dynamic modeling will lead to different results through two weekdays, even if locations of nodes are absolutely the same. Postal network, although unique, lies mostly on the road network, and the

²⁴ Vehicle routing problem with time windows and simultaneous delivery/pickup demands – VRPTWDP

roads are also used by others. Therefore, lines that connect nodes must also have assigned weighted value.

Currently at the Faculty of Transport and Traffic Sciences velocity profiles are researched. Velocity profiles are representations of speed changes on specific road during the day. They are used to determine travel duration on road any day of the week. Concluding, travel time from the starting node - post office to any other node would represent a weighted value of lines on the graph. Based on obtained data modified VRPTWDP which uses heuristics (section 4.3.) can make division of delivery districts and itinerary. Figure 26 present undirected weighted graph of fictive delivery area with five nodes, and every node is connected with each other. Node 1 presents postal office.

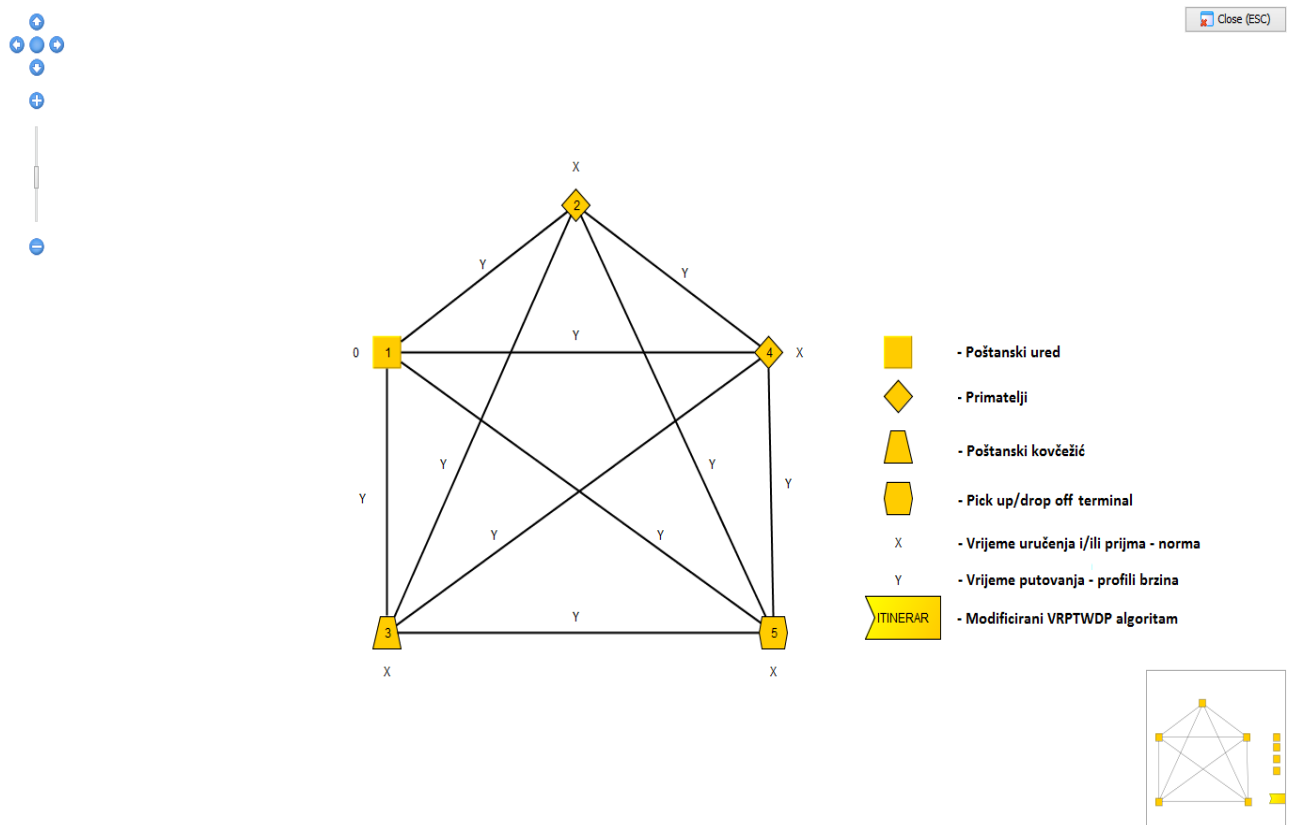

Figure 26. Weighted graph as basis for dynamic combinational districts model

Source: made by author

Delivery district is main indicator of postal network development. From the point of operational cost savings, it should be verified which model type gets better economic results. As an example, Croatia has around 3,000 delivery districts.

7. CONCLUSION

From approximately seven billion people in the world only 3-5% do not have access to the public universal postal service, and about 85% have home delivery. These figures put postal network among largest world network services. Some studies show that number of letters on the national level is in relation to the development and economic situation. It is considered that postal industry holds a share of approximately 1% business activity both at the national and international level, whether employment, income or other economic indicators are mentioned.

Surveys carried out in terms of postal markets research across the European Union show that more than half of respondents believe they will always have to send and receive something through the mail. Most users prefer a five-day delivery and do not agree with the three-day delivery in rural areas regardless of nearly 40% favorable tariff rates, which is proof that they want postal service.

Although within the European Union postal services are classified in the public services sector, it has always been initiator and integrator of every other transport sectors. Usage and development of other modes directly raises quality of services, and indirectly encourages development of modes and customer openness to other transportation sectors. Information and communication solutions, although are not basic postal services, are necessary. In general, e-services are not postal services, since postal service from the beginning to the end has physical form transfer. But are ubiquitous to diversify business and attract new customers.

Postal traffic has three values: address database, world territory coverage and human contact. Address database is a resource that no one else in the world has. In comparison, population census is carried out every ten years, while carriers five days a week visiting whole territory, especially in at least middle-income countries. Carriers have the possibility of direct communication with people and information they provide are unique and extremely significant.

Postal items end-delivery optimization has three objectives: reduce operating costs, increase fleet efficiency and shorten delivery planning. Different algorithms optimize courier, express and universal postal service. In addition to the above methods the system can be improved in other ways. With redesigning mailboxes that are adapted to e-commerce and increasing growth of parcels, special consideration of isolated consignments (oversized and dangerous), simulations

usage, itinerary movement on street research - is it better for carrier to go on one side of the street and than second or "zigzag", specific technological solutions of vehicle cargo area, sorting and manipulation systems shipments overall problem expertise and business performance is improved.

By all means, postal system is a dynamic, complex and currently in middle of transitional adaptment period to new technologies and users generations. End-delivery has crucial effect on quality beacuse as a service subsystem directly represents whole company to customers. In european and international traffic, interoperability of operative technology and operators reciprocity condition e-commerce development as current orientation trend of postal market.

Post offices, especially in rural areas, bear unfair financial burden and are often under authority of local governments. Profitability should not be grounds for office closing. Components of delivery in these areas carry special significance and the slogan "all alike" must be applicable. Five-day delivery in rural, mountainous and island areas is cost demanding, but also an obligation that each Member State of the Universal Postal Union voluntarily accepted with signing Universal Postal Convention. A better solution is the integration of multiple business entities in one place, such as institution where they will be able, at least part time, perform more services.

Mail does not disappear, but is changing. Paper has its own power, and people still want that media. Today postal operators around the world are looking for ways to replace home delivery, but users still want it more than all alternative methods. Real-time item tranfer in postal traffic is D + 1. Today received, delivered tomorrow, with respected space-time delivery.

It is assumed that young people still want want and need postal service. Only more work is needed on adaptation to their customer requirements. Therefore, the future of mail does not look bad as part of communication, transportation, but also other systems. During five-year education one sentence has been repeatedly mentioned that will remain as anonymous quote: "The communication channel knows no substitution". In terms of mail author would add that traffic system, also, knows no substitution.

LITERATURE

- 1) Bošnjak, I., Badanjak, D.: Osnove prometnog inženjerstva, Sveučilište u Zagrebu, 2005.
- 2) Bošnjak, I., Kavran, Z., Matijević, D. : Design of delivery areas of public postal operator by applying AHP model, Promet- Traffic- Traffico, Vol. 17, 2005
- 3) Bošnjak, I.: Inteligentni transportni sustavi I, Sveučilište u Zagrebu, Fakultet prometnih znanosti, Zagreb, 2006.
- 4) Bošnjak, I.: Tehnologija poštanskog prometa II, Fakultet prometnih znanosti, Zagreb, 1999.
- 5) Carić, T: Optimizacija prometnih procesa, separati s predavanja, Fakultet prometnih znanosti, Zagreb, 2013.
- 6) Galić, A.: Metaheurističke metode problema usmjeravanja vozila s vremenskim prozorima, Master Thesis, Fakultet prometnih znanosti,
- 7) Hübler, A., Kletter, R., Werner G.: Shortest path algorithms for graphs of restricted In-Degree and Out-Degree, Journal of Information Processing and Cybernetics, Jena, 1982.
- 8) Kljak, T.: Tehnologija poštanskog prometa II, separati s predavanja, Fakultet prometnih znanosti, Zagreb, 2014.
- 9) Kljak, T.: Automatizacija poštanskog prometa II, separati s predavanja, Fakultet prometnih znanosti, Zagreb, 2014.
- 10) Pašagić, H.: Matematičke metode u prometu, Fakultet prometnih znanosti, Zagreb, 2003.
- 11) Project team Universal Service of CEPT, Implementation Guide Universal Service, Bruxelles, 2009.
- 12) Skorin-Kapov, N.: Heurističke metode optimizacija, separati s predavanja, Fakultet elektrotehnike i računarstva, Zagreb, 2014.
- 13) Stanković, R.: Logistika i transportni modeli, separati s predavanja, Fakultet prometnih znanosti, Zagreb, 2014.
- 14) Tabak, T.: Poštanski sustavi I, separati s predavanja, Fakultet prometnih znanosti, Zagreb, 2014.
- 15) Tabak, T.: Poštanski sustavi II, separati s predavanja, Fakultet prometnih znanosti, Zagreb, 2014.

- 16) Tabak, T.: Tehnologija poštanskog prometa I, separati s predavanja, Fakultet prometnih znanosti, Zagreb, 2014.
- 17) Tabak, T.: Tehnologija poštanskog prometa II, separati s predavanja, Fakultet prometnih znanosti, Zagreb, 2014.
- 18) Walsh, T.: The European Mail Manifesto - growth, partnership and innovation in a changing industry, Postal Users Group, 2006.
Zagreb, 2012.
- 19) http://en.wikipedia.org/wiki/Active_packaging (April 2015.)
- 20) http://en.wikipedia.org/wiki/Shortest_path_problem (April 2015.)
- 21) <http://stakeholders.ofcom.org.uk/binaries/research/post/review-user-needs-2013/england.pdf> (May 2015.)
- 22) <http://w.cba.neu.edu/~msolomon/problems.htm> (May 2015.)
- 23) <https://www.youtube.com/playlist?list=PL8XEaOWotnNqSxXI69u3js7Hk01cT31Fe> (May 2015.)
- 24) www.iso.org (May 2015.)

LIST OF FIGURES

Figure 1. Generalized input-output model of postal system..... 3

Figure 2. Cost structure of postal service provider 6

Figure 3. Delivery as a technological process 8

Figure 4. Generalized model of delivery system..... 11

Figure 5. Static system of delivery 16

Figure 6. Example of dynamic delivery system..... 16

Figure 7. Two-way directed graph 22

Figure 8. Graph types 23

Figure 9. Graph movement..... 24

Figure 10. Dijkstra's algorithm 25

Figure 11. Bellman-Ford method 26

Figure 12. Determination of Eulerian graph 28

Figure 13. Pseudocode of simulated annealing algorithm 37

Figure 14. Pseudocode of genetic algorithm 38

Figure 15. Pseudocode of Ant-cycle method 41

Figure 16. Functional areas of ITS-a adjusted to postal traffic terminology 43

Figure 17. Services of informing carriers functional area..... 44

Figure 18. Display of postal system adaptations 47

Figure 19. The distribution of traffic in network..... 54

Figure 20. Hub and spoke model with physical and logical structure of network 55

Figure 21. Influential delivery districts modelling elements 56

Figure 22. Vector map with traffic layer fictive delivery area 58

Figure 23. Non-directional weighted graph of fictive delivery area 59

Figure 24. New undirected weighted graph 63

LIST OF TABLES

Table 1. Analysis of user requests in United Kingdom 13

Table 2. Example of classical transportation problem 20

Table 3. Number comparison of odd degree nodes and possible connections..... 28

Table 4. Division of metaheuristics 35

Table 5. Division of intelligent vehicles applications and related services 46

Table 6. Selection of transportation means for carriers delivery district itinerary 56

Table 7. Delivery area input data on equilibrium monthly basis..... 60

Table 8. Lines indexing..... 61

Table 9. Sum of line indexes 62

Table 10. Delivery districts graphical method solutions 64



Sveučilište u Zagrebu
Fakultet prometnih znanosti
10000 Zagreb
Vukelićeva 4

METAPODACI

Naslov rada: _____ Prometno-tehnološka optimizacije faze uručenja poštanskih pošiljaka

Autor: _____ Igor Baltić, univ. bacc. ing. traff.

Mentor: _____ prof. dr. sc. Zvonko Kavran

Naslov na drugom jeziku (engleski):

_____ Postal parcels delivery phase optimization

Povjerenstvo za obranu:

- _____ prof. dr. sc. Jasna Blašković Zavada _____, predsjednik
- _____ prof. dr. sc. Zvonko Kavran _____, mentor
- _____ dr. sc. Tomislav Kljak _____, član
- _____ prof. dr. sc. Marinko Jurčević _____, zamjena

Ustanova koja je dodjelila akademski stupanj: Fakultet prometnih znanosti Sveučilišta u Zagrebu

Zavod: _____ Zavod za poštanski promet

Vrsta studija: _____ diplomski

Naziv studijskog programa: _____ Promet

Stupanj: _____ magistar inženjer prometa

Akademski naziv: _____ mag. ing. traff.

Datum obrane diplomskog rada: _____



Sveučilište u Zagrebu
Fakultet prometnih znanosti
10000 Zagreb
Vukelićeva 4

IZJAVA O AKADEMSKOJ ČESTITOSTI I SUGLASNOST

Izjavljujem i svojim potpisom potvrđujem kako je ovaj _____ diplomski rad isključivo rezultat mog vlastitog rada koji se temelji na mojim istraživanjima i oslanja se na objavljenu literaturu što pokazuju korištene bilješke i bibliografija.

Izjavljujem kako nijedan dio rada nije napisan na nedozvoljen način, niti je prepisan iz necitiranog rada, te nijedan dio rada ne krši bilo čija autorska prava.

Izjavljujem također, kako nijedan dio rada nije iskorišten za bilo koji drugi rad u bilo kojoj drugoj visokoškolskoj, znanstvenoj ili obrazovnoj ustanovi.

Svojim potpisom potvrđujem i dajem suglasnost za javnu objavu _____ diplomskog rada pod naslovom Prometno-tehnološka optimizacije faze uručenja poštanskih pošiljaka na internetskim stranicama i repozitoriju Fakulteta prometnih znanosti, Digitalnom akademskom repozitoriju (DAR) pri Nacionalnoj i sveučilišnoj knjižnici u Zagrebu.

Student/ica:

U Zagrebu, _____

(potpis)