



University of Zagreb

Faculty of Organization and Informatics

Goran Banjanin

**METHODOLOGICAL FRAMEWORK OF
IMPROVING THE GOVERNANCE OF
PROJECT PORTFOLIOS BY AGILE AND
LEAN METHODS**

DOCTORAL DISSERTATION

Supervisor:
Prof. Vjeran Strahonja, PhD

Zagreb, 2019



Sveučilište u Zagrebu

Fakultet organizacije i informatike

Goran Banjanin

**METODOLOŠKI OKVIR ZA
OBOGAĆIVANJE UPRAVLJANJA
PROJEKTNIH PORTFELJA AGILNIM I
LEAN METODAMA**

DOKTORSKI RAD

Mentor:
Prof. dr.sc. Vjeran Strahonja

Zagreb, 2019

DOCTORAL THESIS INFORMATION

I. AUTHOR

Name and surname	Goran Banjanin
Date and place of birth	18.03.1955
Faculty name and graduation date for level VII/I	University of Zagreb, Faculty of Economics, 21.12.1979
Faculty name and graduation date for level VII/II	University of Zagreb, Faculty of Organization and Informatics, 01.07.2008
Current employment	Imaging Advice Consultancy

II. DOCTORAL THESIS

Title	Methodological Framework of Improving the Governance of Project Portfolios by Agile and Lean Methods
Number of pages, figures, tables, appendixes, bibliographic information	204 pages, 61 figures, 39 tables, and 1 appendix
Scientific area and field in which the title has been awarded	Social sciences, Information and Communication Sciences
Supervisor	Full Prof. Vjeron Strahonja, PhD
Faculty where the thesis was defended	University of Zagreb, Faculty of Organization and Informatics
Thesis mark and ordinal number	151

III. GRADE AND DEFENCE

Date of doctoral thesis topic acceptance	16.05.2018
Date of doctoral thesis submission	17.07.2018
Date of doctoral thesis positive grade	16.01.2019
Grading committee members	Assist. Prof. Nikolina Žajdela Hrustek, PhD, Committee Chair Full Prof. Katarina Ćurko, PhD Assoc. Prof. Jasminka Dobša, PhD
Date of doctoral thesis defence	28.02.2019
Defence committee members	Assist. Prof. Nikolina Žajdela Hrustek, PhD, Committee Chair Full Prof. Katarina Ćurko, PhD Assoc. Prof. Jasminka Dobša, PhD
Date of promotion	

Information on Supervisor
prof. Vjeran Strahonja, PhD

Prof. Vjeran Strahonja, PhD, is the university lecturer in the area of system and software engineering, IT service management, GIS and ERP at the Faculty of Organization and Informatics, University of Zagreb. The most important positions during his university career were: Full Professor (2009); Dean (2011-2015); vice dean (2007-2011); Associate Professor (2003); Assistant Professor (1997); Senior Assistant (1993); Assistant (1988). He got the Master of EE and Master of Science in EE at the University of Zagreb, Faculty of Electrical Engineering, and the Doctoral degree in Information Science (PhD) at the University of Zagreb, Faculty of Organization and Informatics in 1993.

Prof. Strahonja is author and co-author of three books, more than 80 scientific and professional papers and project studies. He was the mentor of 7 doctoral candidates and more than 170 masters and bachelors. Except of teaching and research, he is an IT specialist with more than 30 years of experience of developing and implementing of complex information systems in different areas (ICMS; Land Registry Information System, Croatian Craft Registry, On-Line Securities Trading System ...). He also has an active experience on research and development projects, including both operational working and management responsibilities.

Acknowledgment

I would like to express gratitude to my mentor, prof. Vjeron Strahonja, PhD, for his guidance and persistent help during this exiting journey of writing my dissertation. Without his support this dissertation would not have been possible. I would also like to express my thankfulness to assoc. prof. Jasminka Dobša, PhD, assist. prof. Nikolina Žajdela Hrustek, PhD, and prof. Katarina Čurko, PhD, for their advices and help in finalizing this work.

I would like to thank the Project Management Institute (PMI) Netherlands Chapter, for their help in disseminating my survey amongst the professional community. Carpe diem, I thank the members of PMI Netherlands Chapter and other contributors for their input to the survey.

Also, I thank my spouse for unconditional support during the challenging time of creating this work.

ABSTRACT

The subject of this research is project portfolio governance, and its improvement based on agile and lean methods and concepts. The existing project portfolio frameworks and governance processes use traditional principles, regulation, planning, and control methods. Whilst this is an area of intensive research, the agile and lean governance is a relative new domain, for which a certain cognizance and practical results related to influence of agile approach and methods on governance processes, risks, and quality are missing. This research confirms that the new proposed conceptual governance framework, emerging as one of the main scientific contributions from this research, improves the management of project portfolio processes' execution and reduces the risks of portfolio components' (projects and programs) implementation.

The expected scientific contribution from this research is foremost methodological in introducing of agile and lean project portfolio governance concepts, methods, and processes, followed by creation of the referent agile process governance framework and its taxonomy, and finally in the evaluation of the possibility for the application of the agile governance framework, with the aim of the portfolio components' implementation risks reduction.

EXTENDED ABSTRACT IN CROATIAN

Obrazloženje teme

Predmet istraživanja su metodike upravljanja projektnim portfeljem i mogućnost njihovog poboljšanja, na temelju obogaćivanja agilnim i lean (vitkim, okretnim) konceptima i metodama. Postojeći modeli i procesi upravljanja projektnim portfeljima koriste tradicionalne principe, procedure, planiranje i metode nadzora. Međutim, iako se radi o području intenzivnih istraživanja, agilno i lean upravljanje je relativno novo područje za koje još uvijek nedostaju odgovarajuće spoznaje i praktični rezultati vezani uz utjecaj agilnog pristupa i metodika na procese upravljanja, rizike i kvalitetu. Istraživanje je potvrdilo da predloženi konceptualni okvir upravljanja, koji proizlazi kao jedan od glavnih znanstvenih doprinosa ovog istraživanja, može poboljšati izvedbu menadžmenta procesa projektnih portfelja te smanjiti rizike izvedbe komponenata portfelja (projekata i programa).

Uvod

Preliminarno istraživanje problemskog područja i teme ove disertacije obuhvatilo je analizu više od 140 znanstvenih radova, članaka i knjiga te postojećih standarda i dobrih praksa, vezanih za temu istraživanja. Istraživanje literature je potvrdilo relevantnost teme, da nema adekvatnih odgovora na postavljena istraživačka pitanja, te da je postizanje istraživačkih ciljeva relevantno, kako sa znanstvenih, tako i praktičkih aspekata. Preliminarno istraživanje je obuhvatilo procese upravljanja projektnim portfeljima u okviru postojećih standarda i metodika, posebno u kontekstu postavljanja ciljeva, usmjeravanja, uspostave kontrolnih mehanizama, nadziranja izvođenja projektnog portfelja, te održavanja usklađenosti s internom i eksternom regulativom. Međutim, nema adekvatnih veza upravljanja s procesima menadžmenta projektnog portfelja i njegove izvedbe te vezanih strateških procesa. Ta neusklađenost u svezi s područjima upravljanja programa i portfelja je isto tako vidljiva i u novim standardima.

Temeljem analize rezultata prethodno navedenih istraživanja, može se zaključiti da su agilni i lean koncepti predmet znanstvenih istraživanja, vezano uz organizacijsko upravljanje općenito, kao u kontekstu upravljanja projektima, posebno IT projektima. Manja je zastupljenost takvih istraživanja u kontekstu upravljanja projektnim portfeljima. Tradicionalne projektno-programske metodike i njihovi modeli upravljanja, bazirani na četverostrukim ograničenjima (djelokrug rada, radni kalendar, troškovi i kvaliteta rada) uzrokuju neusklađenosti i neplanirane izmjene u projektu/programu te rezultiraju povećanjem ukupnih troškova te, na kraju, neuspješnom isporukom planiranih vrijednosti. Sve ukazuje da bi obogaćivanje postojećih metodika agilnim i lean konceptima i metodama moglo poboljšati upravljanje projektnim portfeljima.

Ciljevi istraživanja, istraživačka pitanja i hipoteze

Temeljni cilj ovog istraživanja je oblikovanje okvira upravljanja projektnih portfelja temeljenog na agilnim i lean konceptima i metodama s ciljem unapređenja metodike, a naročito procesa upravljanja, te smanjiti rizike izvedbe komponenti portfelja.

Istraživanje je vođeno primarnim ciljem istraživanja, pet temeljnih istraživačkih pitanja i tri hipoteze.

Istraživačka pitanja:

Istraživačko pitanje 1: Koje su agilne i lean metode i koncepti (izvorne i/ili hibridne) primjenjive za procese upravljanja organizacijskim projektnim portfeljima?

Istraživačko pitanje 2: Koji su njihovi indikatori i kako isti mogu biti prepoznati među povijesnim podacima koji opisuju aktualne projekte i portfelje?

Istraživačko pitanje 3: Kako agilne i lean metode i prakse mogu poboljšati izvedbu procesa projektnog portfelja?

Istraživačko pitanje 4: Kako metoda izvedbene metrike AgileEVM može biti korištena u evaluaciji agilno strukturiranog upravljanja projektnim portfeljem?

Istraživačko pitanje 5: Koje se korektivne mjere mogu razviti s ciljem smanjenja rizika u IT projektnom portfelju?

Hipoteze:

H₁: Metodološki okvir upravljanja projektnih portfelja obogaćen agilnim i lean metodama će potvrditi unapređenje tih procesa upravljanja.

H₂: Identificirani rizici upravljanja portfeljem projekata se mogu utvrditi u više od 75% završenih projekata te se može ustanoviti slijed njihovog nepovoljnog učinka u više od 50% slučajeva.

H₃: Korektivnim mjerama za smanjenje rizika ukupni rizici projektnog portfelja mogu se smanjiti do 40%.

Očekivani znanstveni doprinosi istraživanja, izvedeni iz ciljeva, su slijedeći:

- (a) Definiranje agilnih i lean koncepata u procesima upravljanja projektnim portfeljima, s prijedlogom njihove klasifikacije,
- (b) Oblikovan okvir upravljanja projektnim portfeljima, obogaćen agilnim i lean konceptima,
- (c) Popis i analiza čimbenika redukcije rizika u upravljanju projektnim portfeljima, s posebnim naglaskom na implementacijske rizike,
- (d) Procjena primjenjivosti okvira upravljanja te agilnih procesa upravljanja u poslovnoj praksi,
- (e) Prijedlog korektivnih mjera za redukciju rizika.

Organizacija strukture teza

Disertacija je napisana na engleskom jeziku, sa strukturom i izražajem koji ispunjavaju zahtjeve znanstvenog rada. Rad je strukturiran u osam poglavlja, sadrži 204 stranice, 39 tabela, 61 sliku i 1 dodatak. Sadrži sveukupno 107 bibliografskih referenci na engleskom jeziku.

Prvo poglavlje disertacije sadrži pregled i analizu literature, određuje domenu istraživanja i uočene probleme, definiciju istraživanja te njegove ciljeve i relevantnost. Nadalje, razmatra se struktura i dizajn istraživanja s hipotezama koje će biti testirane.

Drugo poglavlje opisuje metodologiju i metode koje se koriste u istraživanju upravljanja procesa projektnih portfelja, uključujući agilne, lean, lightweight (lagane) discipline procesnog unapređenja. U ovom su poglavlju opisane agilne i lean istraživačke metode. Ovo poglavlje isto tako uključuje elaboraciju postavljenog teoretskog okvira upravljanja i njegove strukture s razradom taksonomije agilnih i lean metodologija u nazivlju, opisu, klasifikaciji i strukturiranju procesa upravljanja projektnih portfelja.

Treće poglavlje elaborira analizu ove studije, njenu strukturu i relevantnost. U ovom se poglavlju elaboriraju svi čimbenici koji su upotrijebljeni u analizi. Analizom literature izdvojeno je dvadeset agilnih čimbenika iz osam najkorištenijih agilnih i lightweight metoda. Svojstva agilnih čimbenika, združenih s nalazima probabilističke analize, razmatraju se u kontekstu postizanja agilne strukture upravljanja procesnim područjima. Kvantitativni skup podataka rizika za probabilističku analizu se prikuplja iz podatkovnog izvora referentnog projektnog portfelja, a rezultati analize adresiraju agilne čimbenike koji utječu na područja procesnog upravljanja. Ovi se rezultati kasnije koriste u unakrsnoj analizi s rezultatima kvalitativne analize.

Četvrto poglavlje elaborira dizajn studija slučaja, mapira procesnu strukturu kvantitativne analize, te analizira stratificirane podatke portfeljnih rizika s ciljem dobivanja najznačajnijih rizika u portfelju da bi se razvio model analize probabilističke distribucije. Cilj modela je kalkilirati individualni i ukupni učinak

rizika portfelja na projektni trošak i radni kalendar komponenata/projekata portfelja. Na temelju analize prepoznati su najkritičniji rizike, vjerojatnost njihove pojave, njihov utjecaj na troškove i radni kalendar, te njihovo rangiranje. Temeljem nalaza analize, predložene su korektivne mjere za rizike, sa svrhom identificiranja, evaluacije i određivanja najpogodnijeg koncepta/agilnog čimbenika koji može biti primijenjen u različitim procesnim fazama modela upravljanja projektnog portfelja.

Peto poglavlje razrađuje kvalitativnu metodu prikupljanja podataka, anketu. Anketni upitnik je dizajniran s ciljem ispitivanja prikladnosti agilnih metodologija i lean konceptata za razvoj organizacijskog okvira upravljanja projektnim portfeljima i procesnim područjima upravljanja. Istraživanje je provedeno tako da je distribuiran elektronički anketni upitnik. Prethodno je obavljen dizajn ankete, testiranje kvalitete dizajna, te određena metoda prikupljanja kvalitativnih podataka. Rezultati ankete će su analizirani i elaborirani, tako da prikažu prikladnost agilnih metodologija i lean konceptata za razvoj organizacijskih okvira upravljanja projektnim portfeljima i procesa upravljanja.

Šesto poglavlje opisuje unakrsnu analizu čiji je cilj objektivizacija nalaza kvantitativne i kvalitativne studije, pokazujući kroz prethodne uzroke djelovanja na promatrani fenomen da objedinjeni agilni i čimbenici rizika utječu na procese upravljanja, te da se može potvrditi njihov utjecaj na unapređenje procesa upravljanja projektnog portfelja. Nalazi unakrsne analize preporučuju konstrukt procesnog modela upravljanja projektnim portfeljem.

Sedmo poglavlje prezentira rezultate istraživanja i diskusiju. Daju se odgovori na istraživačka pitanja te su definirane hipoteze testirane i potvrđene.

Osmo poglavlje (zaključci) prezentira cjelokupne zaključke istraživanja i nalaza, znanstveni doprinos, preporuke za primjenu rezultata istraživanja, te indikaciju daljnjih istraživanja.

Metodologija i plan istraživanja

S obzirom na prirodu istraživačkog problema, istraživačka pitanja i očekivane rezultate istraživanja, kao istraživački pristup i metodika odabrano je znanstveno oblikovanje (eng. design science), koje je prihvaćeno u inženjerskim disciplinama, a i u područjima informacijskih sustava te softverskog inženjerstva, a sačinjava ga pet aktivnosti (razjašnjenje problema, definicija zahtjeva, oblikovanje i razvoj artefakta, demonstracija artefakta, i evaluacija artefakta). Istraživanje je dizajnirano i strukturirano u dva povezana dijela.

Prvi dio istraživanja, dijelom provedenog tijekom prijave disertacije, obuhvaćao je aktivnosti razjašnjenja istraživačkog problema i definicije zahtjeva. Istraživanje se odnosilo na izbor i analizu znanstvenih radova,

članaka i knjiga, te postojećih standarda i relevantnih praksi vezanih uz temu istraživanja. U ovoj je fazi razjašnjen istraživački problem, utvrđena njegova relevantnost, kao i relevantnost istraživanja temeljnih koncepata, metoda i pristupa agilnog razvoja programa (softvera) te lean principa proizvodnje i usluga u menadžmentu projektnih portfelja. Pritom projektni portfelj predstavlja koordinirani skup programa, projekata i operativnih aktivnosti, sa svrhom postizanja nekih strateških ciljeva. Posebno su razmotreni koncepti i metode osam agilnih metodika razvoja softvera za koje se očekivalo da su primjenjivi u upravljanju projektnim portfeljem. To su: Extreme Programming, Adaptive Software Development, Dynamic System Development Method, SCRUM, Crystal, Feature Driven Development, Agile Modeling, i Internet-Speed Development, zatim lean metode koje se fokusiraju na stvaranje vrijednosti unapređenjem procesne izvedbe te otklanjanje procesnih odstupanja i gubitaka (Six Sigma i Lean Six Sigma), te metode usmjerene na kvalitetu procesa (Total Quality Management - TQM, Kontinuirano unapređenje – Kaizen, Business Process Re-engineering/Business Process Management, i Breakthrough Improvement). Razmatrane su razvojne aktivnosti životnog ciklusa tih metodika u odnosu na menadžment aplikativnog životnog ciklusa (Application Lifecycle Management) s naglaskom na procese životnog ciklusa, analizu i usporedbu njihovih značajki, te njihove relacije prema povezanoj disciplini menadžmenta projektnog portfelja i operativnih IT aktivnosti. Na taj će se način odrediti detaljna specifikacija zahtjeva, uključiv specifikiranje agilnih i lean čimbenika relevantnih za oblikovanje i razvoj artefakata. Ove aktivnosti odgovaraju istraživačkom pitanju 1.

Druga faza istraživanja odnosi se na oblikovanje i razvoj artefakta, te procesa njihovog razvoja. Formuliran je okvir upravljanja projektnih portfelja, temeljenog na agilnim i lean konceptima i metodama. Postupak formuliranja okvira obuhvatio je istraživanje procesa i domena upravljanja, određivanje strukture okvira, te kontrole okvira. Metodološki okvir sadržava četiri procesne domene agilnog upravljanja koje utječu na upravljanje projektnog portfelja. Te procesne domene su pristupna domena, domena planiranja, domena nadzora, te domena isporuke. Domene su međusobno povezane kroz sjedinjene čimbenike menadžmenta rizika i promjena. Metodološki okvir uključuje strukturu okvira agilnog upravljanja, njegove elemente i karakteristike, kao i principe upravljanja glede njegovog ponašanja te kontrole. Slijedom razvijenog okvira upravljanja, definira se i razvija taksonomija procesa agilnih i lean metodologija u okviru agilnog upravljanja projektnih portfelja, s ciljem konstruiranja klasifikacijskih principa koji se primjenjuju u konceptualnom modelu upravljanja.

Svrha taksonomije je u validaciji definicije strukture upravljanja projektnim portfeljem, njegovih karakteristika, ugrađenih principa i konstitutivnih elemenata procesnih domena upravljanja, s ciljem da se upravljanje komponentama portfelja učini mogućim i djelotvornim. Rezultat oblikovanja su strukturni i drugi aspekti metodike upravljanja projektnim portfeljem, čiji temelj je neka od poznatih metodika, a obogaćena je agilnim i lean konceptima i metodama. Ove aktivnosti odgovaraju istraživačkom pitanju 2.

Daljnje istraživanje obuhvaća demonstraciju i evaluaciju artefakta kvantitativnom, kvalitativnom i unakrsnom analizom, kojom se odgovara na istraživačka pitanja 3, 4 i 5.

- **Kvantitativna analiza** zbirke podataka i informacija o upravljanju završenim projektima i portfeljima. Ulazne podatke analize čini skup podataka i informacija prepoznatih i izdvojenih u skupu projekata i programa koji su bili izvedeni u posljednjih deset godina, a sačinjava ga portfelj od 28 projekata u okviru 4 programa, izvedenih od 2003 – 2013. godine. Ti su programi bili modeliranje poslovnih procesa, uvođenje organizacijskog ERP sustava, dizajn i uvođenje pravosudnog ERP sustava, te upravljanje poslovnim kontinuitetom. Izdvojeni se skup podataka odnosi na čimbenike rizika za referentne projekte dobivene iz projektnih zapisa, te na čimbenike izvedbe projektnog portfelja koji su agilnog i lean karaktera. Predmet interesa je i analiza vjerojatnosti, bazirana na stratificiranom uzorku varijabilnih čimbenika rizika, koja je provedena s ciljem određivanja ponašanja agilno strukturiranih procesa upravljanja. Analiza je omogućila prepoznavanje i dublji uvid u najbolji koncept procesnog upravljanja okvira projektnog portfelja je s probabilističkim modelom demonstrirala potvrdu postavljenih hipoteza. Ova metoda, radno nazvana AgileEVM, primijenjena je u evaluaciji agilnost upravljanja projektnim portfeljem. Primijenjena je kvantitativna analiza koja uključuje kvantitativnu podatkovnu analizu rizika uporabom binomne, Poissonove i Beta-PERT distribucija s Monte Carlo simulacijom, s ciljem utvrđivanja vjerojatnosti pojave rizika, pojavljivanja rizika u promatranom periodu, devijacije od najizglednije distribucije glede projektnih troškova i radnog kalendara, te određivanja relacija između varijabli primjenom regresijske i analize osjetljivosti. Navedene distribucije su odabrane kao najčešće primjenjivane u domeni projektnog menadžmenta temeljem istraživanja literature. U analizi će se koristiti Palisade @RISK v.5.5 i IBM SPSS Statistics v.22 programska podrška. Kao bitan rezultat, određene su varijable s najvećim utjecajem na procese upravljanja, ulaz za proces optimizacije rizika te korektivne mjere za rizike.

- **Kvalitativna analiza** informacija prikupljenih anketom. Anketni upitnik je distribuiran putem elektroničke pošte sudionicima ankete, odabranim stručnjacima za projektno-programske i procese projektnog portfelja, te ekspertima i istraživačima u ovoj domeni. Kvaliteta dizajniranog upitnika je testirana sa SQP 2.0 (Survey Quality Prediction) sustavom za pitanja upotrijebljena u upitniku. U svrhu osiguranja pouzdanosti dizajna i kvalitete upitnika, zahtjev za odgovorima je izveden u tri faze: pilot upitnik, završna zamolba za odgovorima, te prijavak upitnika. Statistička pouzdanost je utvrđena promatranjem četiri faktora: veličine populacije ili interesne grupe u upitniku te omjera njihovih odgovora, populacijske i segmentacijske analize podatkovnih grupa sa svrhom određivanja statističke pouzdanosti, stupnja odstupanja u odgovorima u populaciji, te razine točnosti rezultata ili dozvoljenog odstupanja u toleranciji potencijalnih kategorija grešaka (obuhvata, uzorkovanja, te grešaka neodaziva). Sadržajna je validacija obavljena metodom pilot ankete poslana selektiranom broju sadržajnih eksperata s ciljem pregleda i komentiranja konceptualne definicije.

Konzistentnost unutar konstrukta te njegova konvergentna valjanost postiže se generalizacijom na višem, holističkom metodološkom nivou, tako da je instrument ankete umjesto aktualnih agilnih i lean metoda strukturiran metodološkim predstavnicima, pojednostavljenjem instrumenta u kojem je ukinuta detaljna dioba agilnih metoda u podatkovnoj kolekciji, te analizom podataka.

- **Unakrsna analiza** nalaza iz podatkovnih kolekcija studije slučaja i ankete. To je kvalitativna metoda s ciljem izradbe objektivnijih i vjerodostojnijih nalaza uslijed potencijalnih ograničenja i manjka generalizacije koje može imati interpretativni karakter kvantitativne analize. Sučeljeni su rezultati studija slučaja (čimbenici rizika koji utječu na komponente projektnog portfelja te korektivne mjere za redukciju rizika) s rezultatima upitnika (metodološki konstrukt okvira upravljanja te raščlambu metodologije upravljanja procesima projektnog portfelja). Rezultati su poslužili kako bi se odredio utjecaj čimbenika rizika te agilnih i lean čimbenika na upravljanje procesima projektnog portfelja.

Istraživački ciljevi, pitanja i hipoteze

Realizacija ciljeva istraživanja, odgovori na istraživačka pitanja, te potvrda hipoteza.

Istraživačka pitanja

Odgovor na istraživačko pitanje 1: Koje su agilne i lean metode i koncepti (izvorne i/ili hibridne) primjenjive za procese upravljanja organizacijskim projektnim portfeljima? Temeljem ocjene relevantne literature određeni su temeljni koncepti, metode i pristupi agilnom (programskom) razvoju kao i lean principima u proizvodnoj i servisnoj sferi, te su njihove analogije u menadžmentu projektnih portfelja identificirane i analizirane. Iscrpno su istraženi koncepti i metode osam agilnih programskih razvojnih metoda, za koje se razmatra primjenjivost u upravljanju projektnih portfelja. To su: Extreme Programming, Adaptive Software Development, Dynamic System Development Method, SCRUM, Crystal, Feature Driven Development, Agile Modeling, i Internet-Speed Development, zatim lean metode koje se fokusiraju na kreiranje vrijednosti unapređenjem procesne izvedbe, eliminacije procesne varijacije i gubitaka (Six Sigma i Lean Six Sigma), te metoda fokusiranih na kvalitetu procesa (Total Quality Management-TQM, Continuous Improvement–Kaizen, Business Process Re-engineering/Business Process Management, i Breakthrough Improvement). Razvojne aktivnosti životnih ciklusa tih metoda su razmatrane vezano za menadžment aplikacijskog životnog ciklusa (Application Lifecycle Management) s naglaskom na procese životnog ciklusa te analizu i usporedbu njihovih atributa i relacija prema povezanoj disciplini menadžmenta projektnih portfelja i operativnih IT aktivnosti. Definirani su detaljni zahtjevi uključujući specifikaciju agilnih i lean čimbenika relevantnih za dizajn artefakata te njihov razvoj.

Odgovor na istraživačko pitanje 2: Koji su njihovi indikatori i kako isti mogu biti prepoznati među povijesnim podacima koji opisuju aktualne projekte i portfelje? je dan u drugoj fazi istraživanja koja se odnosi na dizajn i razvoj artefakata, te na process njihovog razvoja. Formuliran je okvir upravljanja projektnim portfeljem temeljen na agilnim i lean konceptima i metodama. Metodološki okvir sadrži četiri procesna područja agilnog upravljanja koja utječu na upravljanje projektnog portfelja. Ta procesna područja uključuju pročelno područje (Front-end), područje planiranja (Planning), područje nadzora (Monitoring), i područje isporuke (Deliverables). Procesna su područja međusobno povezana i integrirana kroz objedinjene čimbenike menadžmenta promjena i rizika. Metodološki okvir uključuje strukturu agilnog upravljanja, njihove elemente i karakteristike, te principe upravljanja glede ponašanja i kontrole. Slijedom razvijenog okvira se razvija taksonomija agilnih i lean metodologija u agilnom okviru upravljanja projektnog portfelja s ciljem konstrukcije klasifikacijskih principa primijenjenih u konceptualnom modelu upravljanja. Svrha takve taksonomije je validiranje definicije strukture upravljanja projektnog portfelja, njegovih karakteristika, ugrađenih principa te konstitutivnih elemenata upravljanja procesnim područjima, s ciljem da upravljanje komponentama portfelja učini mogućim i učinkovitim. Rezultati dizajna su sadržani u strukturalnim i ostalim aspektima metodologije upravljanja projektnih portfelja, temeljen na poznatim metodama koje su obogaćene agilnim i lean konceptima i metodama.

Odgovor na istraživačko pitanje 3: Kako agilne i lean metode i prakse mogu poboljšati izvedbu procesa projektnog portfelja? Ova je disertacija obavila studiju slučaja i anketu. Studija slučaja je analizirajući podatkovnu kolekciju referentnih programa i projekata upotrijebila probabilističku analizu u određivanju varijabli rizika koje imaju najznačajniji utjecaj na upravljanje procesnim područjima, te omogućila identificiranje, evaluiranje i percipiranje najadekvatnijih koncepata (agilnih čimbenika) u nalazima analize, koji bi se primijenili kod različitih procesnih faza modela upravljanja projektnih portfelja. Anketa je omogućila odgovore na pitanja koja agilna i/ili lightweight metoda najbolje odgovara razvoju okvira i procesa upravljanja projektnih portfelja, te da li agilni čimbenici uzrokuju optimalnu aktualizaciju upravljanja procesnim područjima koje unapređuje izvedbu procesa menadžmenta projektnih portfelja. Nalazi studije slučaja su pokazali da konceptualni model upravljanja temeljen na agilnim i lean konceptima i metodama smanjuje rizike i unapređuje izvedbu procesa projektnog portfelja. (Poglavlje 4.6).

Odgovor na istraživačko pitanje 4: Kako metoda izvedbene metrike AgileEVM može biti korištena u evaluaciji agilno strukturiranog upravljanja projektnim portfeljem? Analiza je u poglavlju 4.5.3 utvrdila i elaborirala da AgileEVM validira agilno obogaćeno upravljanje projektnim portfeljem omogućujući konzistentne podatke troškova, vremenskog perioda i projekcija portfelja donositeljima odluka, omogućavajući im donošenje preciznijih odluka o sveobuhvatnom angažmanu i uporabi organizacijskih resursa. Korištenje AgileEVM prema tome omogućava bolje usklađenje sa strateškim organizacijskim

ciljevima i kreacijom vrijednosti, efikasnije odgovore na promjene i rizike, te pojačanu odgovornost tijekom cijelog životnog ciklusa projektnog portfelja.

Odgovor na istraživačko pitanje 5: Koje se korektivne mjere mogu razviti s ciljem smanjenja rizika u IT projektnom portfelju? Po obavljenoj analizi nekoliko korektivnih mjera je identificirano (elaboriranih u poglavlju 4.5.3). Analiza je pokazala da ako se razviju korektivne mjere za rizike te se one primjene na sve komponente u okviru projektnog portfelja, ukupni se rizici portfelja mogu smanjiti do 40%.

Hipoteze

H₁ hipoteza - Metodološki okvir upravljanja projektnih portfelja obogaćen agilnim i lean metodama će potvrditi unapređenje tih procesa upravljanja.

Glavni razlog testiranja ove hipoteze je bio da se odredi da li su agilne i lean prakse odgovarajuće za razvoj održivih organizacijskih procesa upravljanja projektnim portfeljima i prema tome postaviti temeljni pristup upravljanja IT projektnih portfelja. Testiranje je provedeno kroz analizu studije slučaja, poglavlja 4.3, 4.4, i 4.5 te analizu ankete, poglavlja 5.2 i 5.3. Hipoteza je potvrđena u poglavljima 4.6 i 5.4. Dodatna potvrda hipoteze je obavljena u poglavlju 6. Rezultatima analize u poglavlju 4.6 potvrđeno je da procesi upravljanja temeljeni na agilnim i lean konceptima i metodama smanjuju rizike i unapređuju izvedbu procesa projektnog portfelja. To je učinjeno kroz razvoj agilne i lightweight strategije za procesna područja projektnog portfelja vezano za rizike upravljanja od početnog uvođenja komponenti do pregleda postignutih rezultata te koristi od tranzicije komponente, uključujući razvoj agilnog okvira menadžmenta rizika za procese upravljanja koji omogućuje progresivnu redukciju rizika, kao i postavu čimbenika koji aktiviraju agilni okvir menadžmenta rizika. Rezultati u poglavlju 5.4 pokazuju da je upravljanje pročelnim (front-end) procesnim područjem kompletno agilno konstituirano. Područje procesa planiranja je konstituirano agilno, lightweight i bimodalno (agile i lightweight, uz tradicionalne metodologije), kao procesno područje nadzora (monitoring), koje je konstituirano agilno i bimodalno (kombinirajući agile i lightweight), uz tradicionalne metodologije. Područje procesa isporuke (deliverables) je bimodalno u potpunosti (kombinirajući agile i lightweight). Agilne, lightweight, i bimodalne agilno/lightweight su predominantne metodologije (95%) u strukturiranju okvira upravljanja procesnih područja. Bimodalne (agilne i lightweight) metodologije se mogu sagledati kao glavni pokretač u razvoju agilnih procesa upravljanja projektnih portfelja. Rezultati u poglavlju 6 prezentiraju zaključak o uporabi specifične agilne, lightweight ili hibridne (usklađene) metodologije za modeliranje i razvoj agilnog okvira procesa upravljanja: pročelni (front-end) procesi upravljanja su u potpunosti agilno strukturirani; procesi upravljanja planiranjem su bimodalni (agilni i lightweight) kao i nadzorni (monitoring) procesi upravljanja; područje upravljanja procesima isporuke (deliverables) su u potpunosti agilno strukturirani. Navedeno potvrđuje H₁ (Metodološki okvir upravljanja projektnih portfelja obogaćen agilnim i lean metodama će potvrditi unapređenje tih procesa upravljanja).

H₂ hipoteza - Identificirani rizici upravljanja portfeljem projekata se mogu utvrditi u više od 75% završenih projekata te se može ustanoviti slijed njihovog nepovoljnog učinka u više od 50% slučajeva.

Testiranje ove hipoteze je obavljeno kroz analizu studije slučaja, poglavlja 4.3, 4.4 i 4.5, te potvrđeno u poglavlju 4.5.2. Analiza je ustanovila da je 90% ulaznih podataka (devet od deset rizika) značajno u postizanju postavljenog izlaznog cilja Ha: pojava rizika u portfelju = istina. Taj nalaz potvrđuje H₂ (identificirani rizici upravljanja projektnog portfelja mogu biti sigurno pronađeni u više od 75% završenih projekata). Pojava projektnih rizika u rasponu vjerojatnosti od 53,5% - 62,5% (prosječno 58%) da će se svi rizici pojaviti tijekom životnog ciklusa projekta, potvrđuje H₂ (...te se može ustanoviti slijed njihovog nepovoljnog učinka u više od 50% slučajeva).

H₃ hipoteza - Korektivnim mjerama za smanjenje rizika ukupni rizici projektnog portfelja mogu se smanjiti do 40%.

Testiranje ove hipoteze je obavljeno kroz analizu studije slučaja, poglavlja 4.3, 4.4, i 4.5, te potvrđeno u poglavlju 4.5.2. Ako se mjere za redukciju rizika razviju, vjerojatnost smanjenja rizika je 0.3955 ili 40%. Ovaj nivo vjerojatnosti indicira da ako se poduzme razvoj tih mjera, i ako se te mjere primjene na sve komponente u okviru portfelja, ukupni će rizici portfelja moći biti smanjeni do 40%, što potvrđuje H₃ (korektivnim mjerama za smanjenje rizika ukupni rizici projektnog portfelja mogu se smanjiti do 40%).

Istraživanje u okviru ove disertacije sadrži nekoliko originalnih znanstvenih doprinosa: prvi je vezan za pregled literature te područje i definiciju agilnih i lean koncepata u procesima upravljanja projektnih portfelja s prijedlogom klasifikacije, drugi je u formiranom okviru upravljanja projektnih portfelja obogaćenih agilnim i lean konceptima. Treći doprinos je u oblikovanom registru i analizi čimbenika smanjenja rizika u upravljanju projektnih portfelja, s posebnim naglaskom na implementacijske rizike. Četvrti doprinos je procjena primjenjivosti okvira upravljanja i agilnih procesa upravljanja u poslovnoj praksi. Peti doprinos je razvijen prijedlog za korektivne mjere smanjenja rizika.

Ključne riječi: upravljanje, projektni portfelj, agilne i lean metodologije, okvir upravljanja, taksonomija, redukcija implementacijskih rizika.

Keywords: governance, project portfolio, agile and lean methodologies, governance framework, taxonomy, reduction of implementation risks.

TABLE OF CONTENTS

I	INTRODUCTION	1
II	RESEARCH SUMMARY	2
1	RESEARCH BACKGROUND	4
1.1	LITERATURE REVIEW	5
1.2	DEFINITION OF RESEARCH, OBJECTIVE AND RELEVANCY	7
1.3	RESEARCH STRUCTURE AND DESIGN	11
1.4	HYPOTHESES	16
2	METHODOLOGIES AND RESEARCH METHODS	17
2.1	AGILE METHODOLOGIES	17
2.2	LEAN METHODOLOGIES	21
2.3	IMPROVEMENT METHODS	25
2.3.1	TOTAL QUALITY MANAGEMENT	25
2.3.2	CONTINUOUS IMPROVEMENT - KAIZEN	26
2.3.3	BUSINESS PROCESS RE-ENGINEERING / BUSINESS PROCESS MANAGEMENT	27
2.3.4	BREAKTHROUGH IMPROVEMENT	30
2.4	THEORETICAL FRAMEWORK	31
2.5	CONCEPTUAL MODEL	33
2.6	TAXONOMY OF THE AGILE PROJECT PORTFOLIO GOVERNANCE FRAMEWORK	35
2.6.1	DETERMINING A SUITABLE STRUCTURE FOR THE CONTENT	37
2.6.2	ASSIGNING AND CLASSIFYING THE CONTENT IN THE STRUCTURE	39
2.6.3	INTEGRATING STRUCTURE AND THE CONTENT	51
3	CASE AND SURVEY STUDIES ANALYSIS STRUCTURE	53
3.1	RELEVANCE OF CASE AND SURVEY STUDIES ANALYSIS	53
3.2	CASE AND SURVEY STUDIES ANALYSIS FACTORS	54
3.3	DESIGN OF CASE AND SURVEY STUDIES ANALYSIS	57
3.3.1	APPROACH TO THE QUANTITATIVE DATA COLLECTION ANALYSIS	57
3.3.2	QUANTITATIVE ANALYSIS DEVELOPMENT	65
3.3.3	QUALITATIVE DATA COLLECTION ANALYSIS	71
3.3.4	CROSS-CASE ANALYSIS	71
4	CASE STUDY	72
4.1	CASE STUDY DESIGN CRITERIA	72
4.2	CASE STUDY INTRODUCTION	73
4.3	DESIGN OF THE CASE STUDY	77

4.4	PORTFOLIO RISK DATA STRATIFICATION	80
4.5	PROBABILITY DISTRIBUTION ANALYSIS	87
4.5.1	MODEL DEVELOPMENT	87
4.5.2	MODEL ANALYSIS	89
4.5.3	CORRECTIVE MEASURES DEVELOPMENT	106
4.6	CASE STUDY FINDINGS	129
<u>5</u>	<u>SURVEY STUDY</u>	<u>134</u>
5.1	SURVEY DESIGN	134
5.2	QUALITATIVE DATA COLLECTION	138
5.3	SURVEY RESULTS	139
5.4	SURVEY FINDINGS	158
<u>6</u>	<u>CROSS-CASE ANALYSIS</u>	<u>166</u>
<u>7</u>	<u>RESULTS AND DISCUSSION</u>	<u>172</u>
<u>8</u>	<u>CONCLUSIONS</u>	<u>178</u>
	<u>BIBLIOGRAPHY</u>	<u>180</u>
	<u>GLOSSARY OF TERMS</u>	<u>185</u>
	<u>LIST OF EXIBITS</u>	<u>186</u>
	<u>APPENDICES</u>	<u>188</u>

I INTRODUCTION

Organizational and corporate governance (in further text organizational governance) drives the achievement of organizational/corporate goals and realization of strategies through portfolios, programs and projects. Project portfolio governance framework is a discipline within the organizational governance, and its methods and techniques applied within the context of the organizational governance provide reasonable assurance that the organizational strategy can be achieved (The Standard for Portfolio Management Fourth Ed., 2017). Therefore, the dimension of governance is the essential leveraging point for the execution of organizational programs and projects, and key attribute for the interaction between the organizational strategy and project portfolio delivery. According to the results from surveys on the efficacy of IT projects (Dr. Dobb's IT Project Success survey, 2010), most of projects are still challenged or even failed, more than that, the progress is still not very evident.

We witness intensive structural changes in business world inflict enhanced regulation, standards, methodologies and methods of projects and programs implementation with a need for consistent value delivery for their stakeholders. In accordance with these changes, business organizations require that their projects and programs are governed more effectively and executed cost efficiently, with increased return on investment, shorten implementation times and with results which will allow successful business future.

The overall objective of governance is value creation for the organizational stakeholders through resource and risk optimization and benefits realization. Governance ensures that organizational objectives are achieved by evaluating stakeholder needs, conditions and options; setting direction through prioritization and decision making; and monitoring performance, compliance and progress against agreed-on direction and objectives. In most organizations, governance is the responsibility of the board of directors, under the leadership of the chairperson (COBIT 5, 2012, p. 76). Today's organizational practices recognize various forms of governance structure, levels of complexity and impact: organizational, IT, portfolio, program, and project governance.

While portfolio management is a bridge between organizational strategy, program and project management and operations, portfolio governance is a bridge between organizational strategy and project and program governance, allowing organizations to have an overall view of how the strategic goals are reflected in the portfolio by providing project and program information and metrics to the portfolio governance process.

Portfolio governance is established by the governing body to make decisions about investments and priorities and ensure the portfolio management processes are followed to sustain the organization (COBIT 5, 2012, p. 19). The governing body has the authority to evaluate the portfolio performance and to make resourcing, investment, and priority decisions as needed. Governing body is authorized to make regular reviews of the portfolio and analyze the risks and benefits associated with the portfolio components (programs, projects and other work).

Portfolio governance belongs in one of six key portfolio performance management domains, having impact on the portfolio life cycle (The Standard for Portfolio Management Fourth Ed., 2017, p. 10). This means that the appropriate governance shall be applied on the processes of a portfolio plan development, defining, optimizing, and authorizing a portfolio, and provision of a portfolio oversight. The existing governance frameworks and processes use traditional principles, regulation, planning and monitoring methods.

II RESEARCH SUMMARY

Chapter 1 of this study elaborates on literature review with analysis indicating on research domains and problems, followed by definition of research, its objective and relevance. Further, the research structure and design are considered, with hypotheses that have been tested.

Chapter 2 describes the methodologies and methods that are used to conduct this research on project portfolio governance processes, including agile, lean, lightweight and process improvement disciplines. Further in this chapter the agile and lean research methods were described, with the emphasis on the approaches to the processes covered by the methods' development life cycle and followed by the analysis and comparison of their features. The final part of this chapter includes the elaboration of the established theoretical governance framework and its structure with the elaboration on taxonomy of agile and lean methodologies in naming, describing, classifying, and structuring the project portfolio governance processes.

Chapter 3 elaborates on study analysis, its structure, and relevance. This research conducts a case and survey studies in order to complete the quantitative and qualitative research and analyses of data collections concerning the agile methodology factors and their impact on the project portfolio governance domain processes. This Chapter elaborates on all factors which were used in analysis. The literature review derives twenty agile factors from the eight most used agile and lightweight methods. The agile factor attributes, conjoined with a probabilistic

analysis finding, have been considered to conform the structure of agile governance domain processes. The data collection method retrieves quantitative risk data elements from the referent project portfolio data sources for probabilistic analysis, which findings address the agile method's factors impacting the governance domain processes. The qualitative data collection method utilizes the research survey with the aim to determine which agile, lightweight, or hybrid methodology is best-fit for structuring the project portfolio governance processes. A cross-case analysis explicates findings from a quantitative and qualitative studies.

Chapter 4 elaborates on case study design, maps the quantitative analysis process structure, analyzes stratified portfolio risk data collection in order to attain the most significant portfolio risks to develop the probability distribution analysis model. The model's main purpose is testing if agile and lean enabled governance domain processes are suitable for the development of a sustainable organizational project portfolio governance framework, which improves the performance of project portfolio processes. The aim of the model is to calculate the individual and aggregate impact of the portfolio risk events on the portfolio component/project schedule and costs. Analysis findings identify the most critical risks, the probability of risks' occurrence, their impact on costs and schedule, and their ranking. Based on analysis findings, the risk corrective measures were developed to identify, evaluate, and provide the best-fit concept/agile factor to be applied at the different process stages of the project portfolio governance framework.

Chapter 5 elaborates on survey study, a qualitative data collection method. It was designed with the aim to examine the suitability of agile methodologies and lean practices for the development of organizational project portfolio governance frameworks and governance domain processes. The objective of this observational research was to distribute questionnaire electronically and to receive answers from diverse audience, providing more accurate picture of research phenomenon. Further elaboration includes survey design, testing the design quality, and qualitative data collection method. The survey results were analysed, and findings elaborated, presenting the suitability of agile methodologies and lean practices for the development of organizational project portfolio governance frameworks and governance domain processes.

Chapter 6 presents the cross-case analysis which objective is to leverage findings from a quantitative and qualitative studies showing that the antecedent causes of the observed phenomenon influenced that conjoint corrective risk and agile factors on governance processes

can be acknowledged to improve the project portfolio governance processes. The cross-case analysis findings recommend the construct of the project portfolio governance process framework.

Chapter 7 discloses the research results and discussion. The research questions are answered, and the established and tested hypotheses confirmed.

Chapter 8 presents the conclusions from this research, the anticipated scientific contribution and recommendations with regard its application and further research.

1 RESEARCH BACKGROUND

The growth of a modern management of projects, programs and their portfolios has brought new concerns and questions, especially in the last two decades when the emphasis was put on integration of people and activities with interactivity in orchestrating the contending organizational demands. The collaboration in resolution of organizational project goals and increased pressures on simultaneity in achieving and delivering benefits and values for the stakeholders, results in continuous organizational changes in order to comply with these demands. Is it possible for an organization to “... ever achieve full maturity in its ability to consistently deliver successful programs and projects? Can an enterprise ever achieve perfection or near perfection in the planning and management of all its projects? These are not theoretical questions.” (Dinsmore, Rocha, 2012). Consistent delivery of successful programs and projects and achieved maturity in planning and management of all organizational portfolios of projects and programs, while constantly reducing risks – is this possible? Not without effectual governance.

The term governance comes from the Latin word *gubernare* meaning “to steer”, or provisioning direction, leadership and control. Governance is defined as the framework, functions, and processes of developing, communicating, implementing, monitoring, and assuring the policies, procedures, organizational structures, and practices associated with a given program are managed in order to meet organizational strategic and operational goals (PMI, 2017).

1.1 Literature Review

New developments in the field of corporate/organizational and project portfolio governance are leading not only individuals but also institutions to recognize new approaches and processes in future development towards collaborative, interactive, lightweight and global portfolio governance. The preliminary research of this problem area and the theme of this dissertation comprised of more than 140 scientific articles, books and scrutinized existing standards and best practices regarding the research theme.

The relevancy of this study is indicated by the preliminary literature research which designate that there are no adequate answers on research questions, and that achieving the research objectives is relevant from both scientific and practical aspects.

One of the referent researches of the agile governance methods, conducted by Boehm and Turner (2004), considers that the agile governance is essential for leveraging and harmonizing the users' requirements and achieving a sustainable solution architecture and it is one of the key factors with regard to the exclusion of the critical risks. Dinsmore et al. (2012) have explored the organizational project governance and its key components, as well as integrating the strategic processes with portfolio. Furthermore, they researched how to maintain balanced portfolio and methods on how transform strategies into business reality.

De Luna et al. (2014) in their research have proved that the agile governance is relatively new, multidisciplinary area focused on organizational performance, which needs to be intensively researched. Kumar (2013) explored a connection of governance to agile methods, e.g. connectivity through the Scrum Communities of Practice - CoP, and Scrum of Scrum - SoS agile practices. Cooke (2010) researched the productivity of agile methods and governance and determined their influence on risk control at multiple organizational tiers, reduced costs, and delivery of initial benefits and values for the organization.

Kaplan and Norton (2004) researched on organizations dedicated to improving the quality of financial reporting through operative internal controls and governance structure. They introduced the Balanced Scorecards (BSC) method as an effective means of enhancing organizational governance, which is also applicable on the governance of projects and project portfolios.

Research of Lamm et al. (2010) was focused on an integrated governance (corporate, operational and IT portfolio/project management) as well as the governance, risks and compliance with the regulation requirements and standards (governance, risk and compliance – GRC). Moore (2010) researched the strategic project portfolio management, focused on the

selection and balancing of the portfolio candidates (projects). McMahon (2011) performed his research on the model of process improvement and maturity, and its relationship with agile practices through various business cases. The author considered the existing standard metrics insufficient (in majority of cases) for real process improvement. Olson and Wu (2010) divided governance into strategic, managerial and operational, and technical. They researched the factors involved: sponsorship, strategy selection, IT governance, risk assessment, and measures to be used. Paladino (2007) explored key principles of corporate performance management with regard to strategic planning, mapping and communicating the strategy and cascading the strategy through governing processes.

Krebs (2008) researched the agile project portfolio structure and governance in relation to its influence on project portfolio, idea management, stakeholders' management and agile teams. He proposes an iterative approach in the execution of the project portfolios.

Parmenter (2007) researched performance measures, separating those impacting governance and those impacting management, concluding that organizations should have a governance report (ideally in a dashboard format) and structures indicators. Rad and Levin (2006) research was on models of the project portfolio management, assuming that the difference exists in metrics describing delivery of projects including the metrics of the project's product.

Simons (1995) analyzed the organizational processes resulting in tensions between value creation and control - managing and measuring value. The author introduced the four levers of control framework and developed a framework to manage the tension and improve governance.

Van Grembergen et al. (2012) research was focused on the influence of the organizational governance of the IT practices on business performance, based on case studies. Marks (2012) researched in the area of agile governance, and he is focused on improving governance processes and determining the postulates of enterprise agile governance. Besides scientific researches, the surveys Project success and DDJ State of the IT Union (2009; 2010) are important in the cognition and application of governance processes in the practice of project governance.

Preliminary research comprised the project portfolio governance processes within the existing standards and methodologies (The Standard for Portfolio Management Fourth Ed., 2017; The Standard for Program Management Fourth Ed., 2017; A Guide to the Project Body of Knowledge, Sixth Ed., 2017; Organizational Project Management Maturity Model, Second Ed., 2012; COBIT 5, 2012), especially in the context of setting objectives, steering, establishing controls, monitoring performance of the project portfolio execution, and maintaining compliance with internal and external regulation. However, there is no adequate linkage of

governance with the processes of a project portfolio management and execution including related strategic processes.

Based on the result analysis of the research studies carried out so far, it is possible to conclude that the agile and lean concepts are the subject of scientific research related to general organizational governance, as well as in the context of project governance, and especially in the IT projects. These researches are under-represented in the context of project portfolio governance. Traditional project/program management methodologies and their governance models, based on the basic quadruple constraints (scope, schedule, cost, quality) resulting in unintended modifications (broaden scope, increased costs, extended schedule, disputable quality), increased risks, and finally unsuccessful delivery of intended values. All indicates that the enrichment of the existing methods with agile and lean concepts and methods improves the governance of project portfolios.

1.2 Definition of Research, Objective and Relevancy

The overall objective of governance is value creation for the organizational stakeholders through resource and risk optimization, and benefits realization. Governance ensures that enterprise objectives are achieved by evaluating stakeholder needs, conditions and options; setting direction through prioritization and decision making; and monitoring performance, compliance and progress against agreed-on direction and objectives.

The focus of governance according to The Standard for Portfolio Management (PMI, 2017) is on giving attention to what really matters for the organization - big picture on what the organization is dealing with:

- Setting and monitoring organizational mission, strategies, direction, and priorities,
- Key stakeholders' awareness and their involvement in mission monitoring,
- Key outcomes specifications,
- Risk management – to ensure that risks are managed,
- Policies development and statutory compliance,
- Maintenance of governance processes and planning, and
- Decisions on performance measurements, monitoring and review of the execution.

The common principles of accountability transparency, integrity, and efficiency are major drivers to the governance processes.

Today's organizational practices recognize various forms of governance structure, levels of complexity and impact: organizational, IT, portfolio, program, and project governance. Organizational governance occurs at different decision-making levels of the organization to support specific goals, objectives and strategies defined through the organization's strategic planning process. All governance levels are linked together to ensure that each organizational action is aligned with the defined organizational strategy (The Standard for Portfolio Management Fourth Ed., 2017). The organizational governance drives the achievement of organizational goals and realization of strategies through portfolios, programs and projects. Therefore, the dimension of governance is the essential leveraging point and a key attribute for the interaction between the organizational strategy and project, program and portfolio delivery. The organizational governance establishes controls with intend to maximize value delivery while minimizing risks. By definition (PMI, 2013), organizational (or corporate) governance entails the process by which an organization directs and controls its operational and strategic activities, and by which the organization responds to the legitimate rights, expectations, and desires of its stakeholders, or (ITGI, 2012), enterprise governance entails the system by which organizations are governed and controlled. Organizations use governance to establish strategic directions and performance parameters. The strategic direction provides the purpose, expectations, goals, and actions necessary to guide business pursuit and is aligned with business objectives (A Guide to the Project Body of Knowledge, Sixth Ed., 2017). Organizational governance involves regulatory mechanisms, and the roles and relationships between a

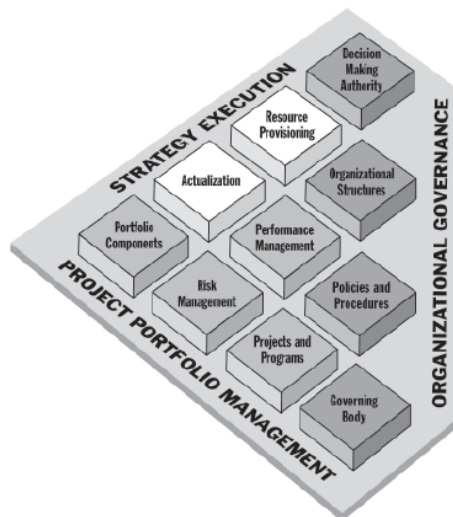

Figure 1.1: Organization Leverage Points (OPM3, 2012, p. 6)

company's management, its board, its shareholders and other stakeholders, and the goals for which the corporation is governed (OECD, 2004). OECD defines corporate/organizational governance as "... the system by which business corporations are directed and controlled" (OECD, 2004). The corporate governance structure sets the right objectives for the organizations and work to attain those objectives by making sure that the resources are used efficiently through performance monitoring. Figure 1.1 shows these leveraging points that support the

execution of organizational strategy, where an organization puts into action its strategic planning decisions and allocates resources to portfolio investments. While portfolio

management is a bridge between organizational strategy, program and project management and operations, the portfolio governance is a bridge between organizational strategy and project and program governance, allowing organizations to have an overall view of how the strategic goals are reflected in the portfolio by providing project and program information and metrics to the portfolio governance process. The governing body, in order to make decisions about investments and priorities and ensure the portfolio management processes are followed to sustain the organization, establishes portfolio governance (OPM3, 2012, p. 19). The governing body has the authority to evaluate the portfolio performance and to make resourcing, investment, and priority decisions as needed. Governing body is authorized to make regular reviews of the portfolio and analyze the risks and benefits associated with the portfolio components (programs, projects and other work). Therefore, the appropriate governance shall be applied on the processes of a portfolio plan development, defining, optimizing, and authorizing a portfolio, and provision of a portfolio oversight.

Program governance covers the systems and methods by which a program and its strategy is defined, authorized, monitored, and supported by its sponsoring organizations and it is defined as establishing processes and procedures for maintaining program management oversight and decision-making support for applicable policies and practices throughout the course of the program (The Standard for Program Management Fourth Ed., 2017, p. 34). It is achieved through the actions of a review and decision-making body, often referred to as the program governance board. The governance board is charged with endorsing or approving recommendations made regarding a program under its authority (The Standard for Program Management Fourth Ed., 2017, p. 61). Program governance establishes organizational capabilities that support the effective and efficient management of programs, including the program management office (PMO), program management information system (PMIS), program management knowledge management, program management audit support, and program management education and training. Upon endorsement of the respective governance board, these capabilities are created either as specific program support organization or as a core organizational asset supporting several programs.

Project governance refers to the framework, functions, and processes that guide project management activities in order to create a unique product, service, or result to meet organizational, strategic, and operational goals (A Guide to the Project management Body of Knowledge Sixth Ed., 2017, p. 44). This is an oversight function that is aligned with the organization's governance model and that encompasses the project life cycle providing the

project manager and team with structure, processes, decision-making models and tools for managing the project, while supporting and controlling the project for successful delivery.

The existing governance models and processes use traditional principles, regulation, planning and monitoring methods. Since there have been no controlled studies which compare differences between existing project portfolio governance processes and governance processes based on agile methods, the aim of this study is to evaluate and validate the following objectives:

Research Objective:

The main objective of this research is design of the project portfolio governance framework based on agile and lean concepts and methods, which application improves the governance methods and especially the governance processes and decreases the risks of the project portfolio component performance.

In order to successfully validate research objectives, this study pursues addressing the following questions:

Research Question 1:

Which agile and lean concepts and practices (native and/or hybrid) are applicable on organizational project portfolio governance processes?

Research Question 2:

What are their indicators and how they can be recognized among the historical data describing the actual projects and portfolios?

Research Question 3:

How can agile and lean methods and practices improve the performance of project portfolio processes?

Research Question 4:

How can the performance measurement method AgileEVM be utilized to measure and validate the agile enabled project portfolio governance?

Research Question 5:

What corrective measures can be developed to reduce risks within the IT project portfolio?

Relevance:

The main contribution of this study is to introduce a new lightweight governance model based on agile and lean concepts that should be used in project portfolio management processes. This study is relevant for practice since governance processes in the domain of project portfolio are relatively new phenomena in the business world, and it is still not known which agile, lean, or hybrid concepts suites the best for their development. Theory can benefit from this study because it should trigger future studies. This study could provide a new insight to already established theories.

1.3 Research Structure and Design

With regard the research problem nature, the research questions and the expected research results, the chosen research approach and method is design science, accepted in engineering disciplines and in the domains of information systems and software engineering. It is comprised from five activities (explicate problem, outline artefact and define requirements, design and develop artefact, artefact demonstration, and artefact evaluation) (Johannesson, Perjons, 2012; Peffers, Tuunanen, Rothenberger, 2007). The research is designed and structured into two correlated parts, as shown in Figure 1.2.

The first part of research, partially conducted during the dissertation registration, covers the activities of the research problem clarification and a problem explication. Research refers on the assortment and analysis of scientific work, articles and books, and the existing standards and relevant practices related to the research theme.

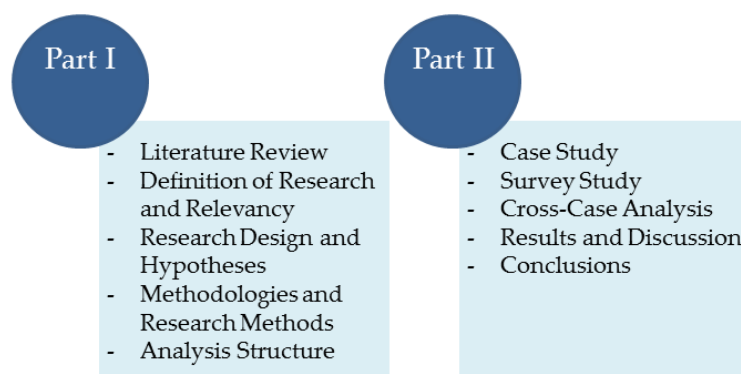

Figure 1.2: Research structure

Further the definition of research and its objectives are introduced, with elaboration on relevancy of this research, the research design and hypotheses are presented, and methodologies and methods used for the research. In this phase the research problem is explicated and depicted as relevant, with defining the requirements. The basic concepts,

methods and approaches towards agile program (software) development, as well as the lean principles in production and services are determined, with their analogies in the management of project portfolios identified and analyzed. Thereby the project portfolio considers a coordinated assembly of programs, projects, and operational activities, undertaken with the aim of achieving certain strategic objectives (The Standard for Portfolio Management Fourth Ed., 2017). The concepts and methods of eight agile software development methods for which it is considered the applicability in project portfolio governance are particularly examined. These are: Extreme Programming, Adaptive Software Development, Dynamic System Development Method, SCRUM, Crystal, Feature Driven Development, Agile Modeling, and Internet-Speed Development, then lean methods focusing on value creation by improving the process execution, elimination of process variation and losses (Six Sigma and Lean Six Sigma), and methods focused on the process quality (Total Quality Management-TQM, Continuous Improvement–Kaizen, Business Process Re-engineering/Business Process Management, and Breakthrough Improvement). The development activities of the life-cycles of these methods are considered in relation to the Application Lifecycle Management (Teng, Mitchell, Wathington, 2011) with emphasis on the methods' life-cycle processes and analysis and comparison of their attributes and relation towards the related discipline of project portfolio management and operational IT activities. Thus, the detailed requirements definition was determined, including the specification of agile and lean factors relevant for artefacts design and development. These activities refer to the research question 1.

The next phase of the research refers to artefacts design and development, and the process of their development. The project portfolio governance framework based on agile and lean concepts and methods was formulated. The construct of the framework is based on the research of governance processes and domains (Hobbs, Miller, 2002), the structure of the frameworks (Klakegg, Williams, Magnussen, Glasspool, 2008), and the control of the frameworks (Simons, 1995). The methodology framework consists of four agile governance process domains which influence the project portfolio governance. These domains are *Front-end*, *Planning*, *Monitoring*, and *Deliverables* process domains. The domains are interrelated and integrated through the conjoint change management and risk management factors. The methodology framework includes the structure of the agile governance, its elements and characteristics, and governance principles concerning the behavior and control. Following the developed framework, the taxonomy of agile and lean methodologies in the agile project portfolio governance framework was developed in order to construct the classification principles applied within the governance conceptual model. The purpose of such taxonomy is to validate the

definition of project portfolio governance structure, characteristics, embedded principles, and constitutive elements of the governance domain processes, with the aim to make the governance of portfolio components possible and effective. The result of design are the structural and other aspects of the project portfolio governance methodology, with the basis of known methods, enriched by agile and lean concepts and methods. These activities refer to the research question 2.

The second phase of the research encompasses the artefact demonstration and evaluation by quantitative, qualitative, and cross-case analysis, responding on the research questions 3, 4, and 5.

The research commences with the introduction of a case study, which aim is to investigate which Agile, lightweight, or a hybrid (tailored) concept is best suited for the development of organizational project portfolio governance frameworks and their constituent governance domain processes. In furtherance of evaluation the analysis findings, an online survey was developed which shall provide a qualitative data array set which gives an insight on how the developed agile governance model benefits businesses. The survey study was aimed for project/program and portfolio professionals, experts and academics in the areas of this research. Also, a cross-case analysis is taking place in order to leverage projectable results between findings from a quantitative and qualitative studies. The last part of the research deals with discussion on findings and provides applied solution to research questions.

The research is designed as depicted in the below Figure 1.3. The data collection strategy and methods' utilization are the principal exertion of this research since this dissertation investigates governance processes setting and how this setting is influenced by agile and lightweight¹ methods.

¹ Lightweight are methodologies which apply short development iterations throughout the project life-cycle. Their development life cycles and integral processes are characterized as adaptive, collaborative, incremental, evolutionary, and artifact oriented (Umphress, Liu, 2008)

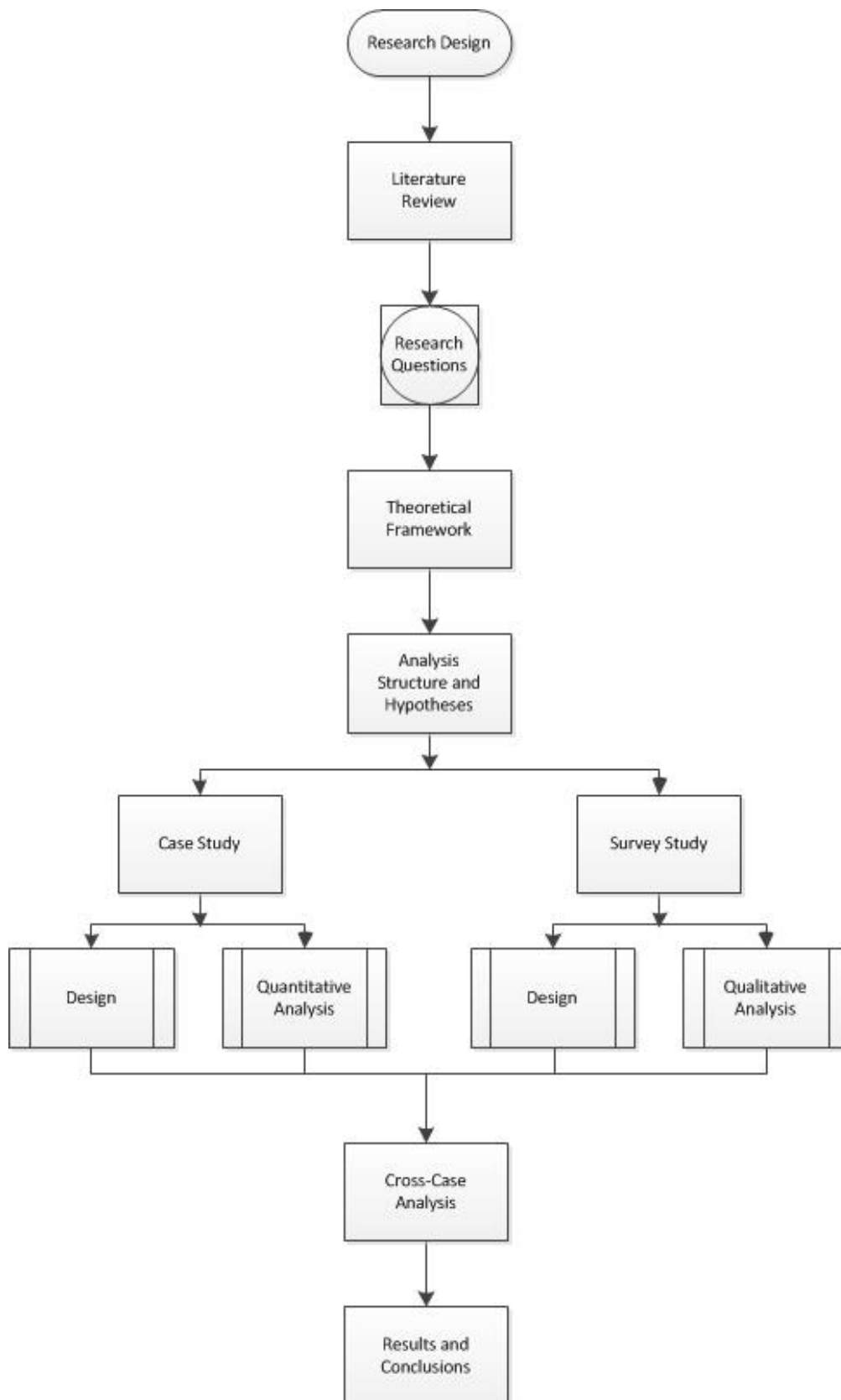

Figure 1.3: Research Design

The research is based on the following analysis structure:

- **Quantitative analysis of data collection and information about the governance of finalized projects and portfolios.** The analysis input is an information and data array recognized and retrieved from the collection of projects and programs executed in the last ten years, consisted from the portfolio of 28 projects within 4 programs, executed from 2003 - 2013. These programs were business process modelling, implementation of the organizational ERP system, design and the implementation of the judicial ERP system, and business continuity management. The data collection refers to the risk factors recognized in the referent projects, and the factors of project portfolio execution with the agile and lean character. The subject of interest was the probabilistic analysis based on stratified sampling of variable risks factors, which was conducted with the aim of determining the behavior of the agile structured governance processes. The analysis findings identify, evaluate, and provide the insight into the best concept of the process governance of the project portfolio framework, and with the probabilistic model demonstrated the confirmation of the set hypotheses. The AgileEVM method (Sulaiman, Barton, Blackburn, 2006) was utilized to validate the agile enabled project portfolio governance. Besides, the quantitative analysis included the quantitative risks data analysis using Binominal, Poisson, and Beta-PERT distributions with probabilistic Monte Carlo simulation, aiming to determine the probability of risks occurrence, risks occurrence in observed period, the deviation from the most probable distribution of project costs and schedule, and in determining the relations between variables by applying the regression and sensitivity analyses. The specified distributions have been chosen as mostly applied in the domain of project management, based on literature research (Goodpasture, 2010; PMBOK, 2017). The Palisade @RISK v.5.5 and IBM SPSS Statistics v.22 software was used in the analysis. As an important result, the variables with the highest impact on governance processes have been determined, constituting the input for the risk optimization process and development of the risk corrective measures
- **Qualitative analysis** of information harvested from the developed survey. The survey's questionnaire was distributed to the respondents, a selected pool of project/program and portfolio processes professionals, experts and researchers in these domains, via e-mail. The quality of designed questionnaire was tested with SQP 2.0 (Survey Quality Prediction) system for the questions used in the questionnaire. In order to ensure the reliability of the design and quality of the survey, the request for answer is staged in three phases: pilot survey, final request for answer, and survey submission. The statistical confidence of the survey was determined by observing the four factors: the size of the population or the group of interest for the survey and the response rate, population and segmentation analysis in

order to determine the statistical confidence, degree of variance in responses from the population, and the level of results accuracy or the tolerance for potential error categories (coverage, sampling, and nonresponse errors). The content validation is conducted by the method of pilot survey sent to the selected content experts with the aim of reviewing and commenting the conceptual definition. The consistency within the construct and its convergent accuracy is achieved by the generalization on a higher, holistic methodological level in the way that the survey instrument is structured by methodological representatives instead of the actual agile and lean methods, by simplification of the instrument where the detailed breakdown of the agile methods in data collection is abolished, and by data analysis.

- **Cross-case analysis** of the findings from the case study and survey data collections. This is a qualitative method with the aim to produce more objective and reliable findings since the interpretive method has potential limitations and lack of generalizability. The results from the case study (risk factors influencing the project portfolio components and corrective risk reduction measures) and survey results (methodological construct of the governance framework with the decomposition of the methodology of the project portfolio processes governance) were confronted. The findings from the cross-case analysis were used to show the influence of the risk and agile and lean factors on the project portfolio governance processes.

1.4 Hypotheses

For the purpose of this research, the following hypotheses were tested:

- H₁:** *Methodological project portfolio governance framework, enriched with agile and lean methods, will affirm the improvement of these governance processes.*
- H₂:** *Identified project portfolio governance risks can be ascertained in more than 75% of finalized projects, and the sequence of their adverse impact can be established in more than 50% of cases.*
- H₃:** *By applying the corrective measures for risks reduction the total project portfolio risks can be reduced up to 40%.*

2 METHODOLOGIES AND RESEARCH METHODS

In this chapter the methodologies, or bodies of knowledge and disciplines that utilize their concomitant research methods or processes and techniques which are used to conduct this research on project portfolio governance processes, are described. These methodologies include agile, lean, lightweight and process improvement disciplines focused on delivering values and high-quality results that attend frequent, incrementally delivered features, functions and products, even in the circumstances of complex and uncertain requirements, and at the same time being adaptive and responsive to evolving customer needs and business circumstances. Agile methodologies, or theories about the research methods that have been used, are primarily about the application of different management frameworks on which to effectuate percipient implementation methods and practices (Goodpasture, 2010).

Further in this chapter the agile and lean research methods are described, with the emphasis on the approaches to the processes covered by the methods' development life cycle and followed by the analysis and comparison of their features. The final part of this chapter includes the elaboration of the established theoretical governance framework and its structure with the elaboration on taxonomy of agile and lean methodologies in naming, describing, classifying, and structuring the project portfolio governance processes.

2.1 Agile methodologies

Agile is an umbrella term for a group of methodologies that follow the values and principles captured in the Manifesto for Agile Software Development² (Agile Manifesto, viewed 14 February 2013, <<http://agilemanifesto.org>>). Agile is encompassing term that includes iterative approaches to software development that embrace the values of the Manifesto and the Principles behind the Agile Manifesto (Agile Manifesto principles, viewed 14 February 2013, <<http://agilemanifesto.org/principles.html>>). The Manifesto including its principles was signed in February 2001, where a significant importance of agile software methodologies was underpinned. The essence of agile methodologies is to overcome perceived and actual weaknesses in conventional software engineering. Agile methodologies were thought of by various software developers in order to accommodate fast changing requirements and at the same time boost organizations' operability, efficiency, and effectiveness. Agility in software

² A philosophical foundation for effective software development, created by representatives from several agile methodologies. In the essence, this foundation promulgates better ways of developing software in achieving values (Manifesto values the items in italics on the left):

- *Individuals and interactions* over processes and tools;
- *Working software* over comprehensive documentation;
- *Customer collaboration* over contract negotiation, and
- *Responding to change* over following a plan.

development emphasizes quality in design. The origin of agile methods was in the product development industry, first in Japan in the 1980s, and more recently in the U.S. software industry. Agile methods are referred as well as *light* or *lean* methods (Pressman, 2010).

Agile approach encompasses constantly evolving processes (e.g. retrospectives at the beginning of each iteration), and daily stakeholder's interaction and feedback (e.g. no delays and lean development). The project-focused approach used in initial development phase was transformed into product-focused approach of rolling deployments during ongoing product lifecycle. Application Lifecycle Management (ALM) is a broad term that usually refers to both processes and tools to "... coordinate people, processes, and tools in an iterative cycle of integrated software development activities, including planning and change management, requirements definition and management, architecture management, software configuration management, build and deployment automation, and quality management" (Pampino, 2011, *Five Imperatives for Application Lifecycle Management*, viewed 15 February 2013, <<https://jazz.net/library/article/637/>>). It can be seen as the governance of a software application from the initial idea until the application is retired. The ALM's value comes from its connections to the separate and related disciplines of project portfolio management (PPM) and IT operations. The best PPM efforts leverage ALM data to inform executive decision-making. The value of these connections corresponds directly to the strength of ALM practices. The five key organizational practices of agile ALM have been outlined (Teng, Mitchell, Wathington, 2011):

- Evolve process definition (configure, use, reflect, process change),
- Embrace heterogeneity (minimum reasonable set of standards, practice good governance, usage of metrics),
- Build the right thing,
- Orchestrate, don't manage, (response to change, alignment of business goals, provision of leadership, distilment of best practices), and
- Practice continuous delivery (organizational value creation, increase of benefits and sustainability).

IBM suggests that an agile ALM platform should support (Pampino, 2011, *Five Imperatives for Application Lifecycle Management*, viewed 15 February 2013, <<https://jazz.net/library/article/637/>>):

- In-context collaboration (response to changing events, and improved predictability),
- Real-time planning (plans up-to-date and fully integrated with project execution),

- Lifecycle traceability (understanding what everyone else on the team is doing),
- Development intelligence (creation of success metrics, tracking progress toward achieving goals), and
- Continuous process improvement (incremental process changes, improvement of the team dynamic, continuous refinement toward greater efficiencies).

Organizations that embrace these key agile ALM organizational practices and provide appropriate tools to support them increase their agility and their ability to compete. They create better products, deliver faster and discover new ways to engage and create value for their stakeholders. They try out new ideas quickly, and they continuously adapt in-line with customer feedback, shifts in the market, and changes in business strategy. The agile methods which are attributed with the selected key ALM practices, including response on process changes, alignment with strategic objectives, usage of best practices and metrics, and incremental improvement were considered in the conceptualization of the agile governance framework, as shown in the below Table 2.1.

Table 2.1: Major agile methods with their key attributes

<i>Agile Method</i>	<i>Description</i>
Extreme Programming (XP)	Ideas and methods associated with XP occurred during the late 1980s. Beck published his seminal work on XP in 1999, followed with technical work by Jeffries et al and additional work on XP planning by Beck and Fowler (Pressman, 2010). XP uses an object-oriented approach as its preferred development method. The framework activities are: planning, design, coding and testing, resulting in software incremental release. The XP is the most widely used agile process (Pressman, 2010).
Adaptive Software Development (ASD)	ASD has been proposed by Highsmith as a technique for building complex software and systems, focusing on human collaboration and team self-organization ASD is defined as “life cycle” that incorporate three phases: speculation, collaboration and learning (Highsmith, 2010). Speculation phase comprises adoptive cycle planning, mission statement, project constraints, basic requirements and time-boxed release plan. During collaboration phase, requirements are gathered and mini-specs created, by applying Joint Application Design (JAD) technique sessions (meeting with a group of stakeholders to gather requirements and/or design part of the system). At the learning phase developed components are tested, formal technical review is done and focus groups given a feedback on results. The output from learning phase is software release increment, with adjustments for subsequent cycles.
Dynamic System Development Method (DSDM)	DSDM method provides a framework for building and maintaining systems with tight time constraints through the use of incremental prototyping in a controlled project environment (Pressman, 2010). DSDM suggests a philosophy that is borrowed from a modified version of Pareto principle, 80% rule: 80% of an application can be delivered in 20% of the time it would take to produce 100% of an application, i.e. a new increment starts after 80% of work is done in previous iteration. The method is maintained by the DSDM Consortium (Agile Business Consortium, viewed 10 March 2013, < https://www.agilebusiness.org >) a worldwide group of member companies who apply the method. The Consortium has defined an agile process model, DSDM life cycle, which defines three iterative cycles, preceded by two additional life cycle activities: Feasibility study, establishing the basic requirements and constraints with analysis whether the application to be built is viable for DSMD process; Business study, providing functional and information requirements that will provide value, with the basic system architecture; Functional model iteration, provides incremental prototypes, intended to evolve into the deliverable; Design and build iteration, reviews produced increments in accordance with

<i>Agile Method</i>	<i>Description</i>
SCRUM	quality standards; and Implementation, where operational prototypes are placed in productive environment. The DSDM method can be combined with XP or ASD concept. SCRUM is a lightweight, highly agile management framework. Developed by Sutherland and his team in 1990s and improved by Schwaber and Beedle, with the aim to be ultra-productive, i.e. the ability to declare a product 'done' whenever required. Working prototypes are delivered in thirty day "sprints." Once a sprint has finished, a new set of features is analyzed and selected for the next iteration. It features the following framework activities: requirements, analysis, design, evolution, and delivery. SCRUM has been successfully used as a standalone development process (Agile Software Development Portal, viewed 12 March 2013, < http://agile.csc.ncsu.edu >).
Crystal	Crystal family of agile methods, created by Cockburn and Highsmith, are designed in order to achieve "human-powered" approach to software development. These methods are centered on the team and individuals involved in the software process instead of a more process-oriented approach. Crystal provides suggestions for team organization and management intended to reduce bureaucracy and paperwork while increasing teamwork, personal satisfaction, and communication. At its core, Crystal methods seek to find the simplest and most compact team structure and process for an organization, thus making the development process more speedy, self-adapting and efficient (Agile Software Development Portal, viewed 12 March 2013, < http://agile.csc.ncsu.edu >).
Feature Driven Development (FDD)	Feature Driven Development, also called Feature Driven Design, is a design-oriented agile process for object-oriented software engineering, originally conceived by Coad, Palmer and Felsing. The project is divided into "features", which are defined as client valued functions that can be implemented in two weeks or less. The FDD defines five collaborating framework activities – processes: Develop an overall model, Build framework list, Plan by feature, Design by feature and Build by feature. This method provides strong emphasis on project management guidelines and techniques (Pressman, 2010).
Agile Modeling (AM)	Agile Modeling (AM), introduced by Scott Ambler, is a practice-based methodology which includes a collection of values, principles, and practices for modeling and documenting software-based systems applied on a software development project in an effective and light-weight manner (Agile Modeling site, viewed 12 March 2013, < http://www.agilemodeling.com >) Principles that make AM unique are: Model with purpose; Use multiple models (it means AM could be tailored into other development methodologies such as XP or RUP, in order to develop a software process which meets customer's requirements); Travel light (keep only those models that will provide long-term value); Content is more important than representation (modeling should convey information to its intended audience); Know the models and the tools you use to create them, and Adopt locally.
Internet-Speed Development (ISD)	Internet-Speed Development is an agile software development method using a mixed methods research design (spiral model/waterfall model) with daily builds aimed at developing a product with high speed (Baskerville, Levine, Pries-Heje, Ramesh, Slaughter, 2002). It was developed in the late nineties in order to adapt the situation where the users' requirements change quickly so the software development was changing rapidly, and companies were having problems delivering products with the correct requirements within the time scheduled. The method allowed structured and intense development with high adaptability and short delivery cycles. One of the main versions is Microsoft's MSF (the Microsoft Solutions Framework). The phases of ISD methods are <i>Envisioning, Planning, Developing, Stabilizing, and Deploying</i> spirals. (Pressman, 2010; Highsmith, 2010; Agile Business Consortium, 2013; Agile Software Development Portal, 2013; Agile Modelling Site, 2013; Baskerville et al., 2002)

The essence of agile methods is to overcome perceived and actual weaknesses in conventional software engineering. The key values that summarize the principles from both the Manifesto and the Declaration are the following (Highsmith, 2010):

- Delivering value over meeting constraints (value over constraints),
- Leading the team over managing tasks (team over tasks),

- Adapting to change over conforming to plans (adapting over conforming).

Agile methodologies are not prescriptive; they define some principles that intentionally require interpretation for a given situation. Thus, the above statements shall be interpreted in the context of a business and project environment with the focus on achieving value (releasable product or service), quality (reliable, adaptable product or service), and adaptive and incremental resolution of constraints (cost, schedule, and scope). Agility can be characterized as the ability to both create and respond to change in order to profit in a turbulent business environment by balancing flexibility and stability. The key agile business objectives are continuous innovation, product or service adaptability, improved delivery (time-to-market), people and process adaptability, and reliable results (Highsmith, 2010).

Today the concepts behind agile methodologies impact organizations, project portfolios, and overall project governance. These concepts and practices can be further broken down and structured into the following layers (Highsmith, 2010):

- *Portfolio governance*, a common framework for evaluating all the portfolio components; a framework that addresses the major concerns—investment and risk,
- *Project management*, involves creating a vision for both the product and the team, developing the project scope and boundary components, and developing an overall feature release plan,
- *Iteration management*, which focuses on planning, execution, and team leadership during short individual iterations, and
- *Technical practices*, such as continuous integration, test-driven development, refactoring, engineering practices, etc.

2.2 Lean methodologies

At its essence, lean is structured common sense that is aimed at understanding what customers want and redesigning the way you the things are done to ensure that deliverables are done in the most cost effective, timely and safe way possible. Lean production methods were pioneered by Toyota in Japan. The Toyota Production System (TPS) was developed in order to provide best quality, lowest cost, and shortest lead time through the elimination of waste. TPS is comprised of two pillars, Just-In-Time production (makes and delivers just what is needed, just when it is needed, and just in the amount needed) and Jidoka (provides machines and operators the ability to detect when an abnormal condition has occurred and immediately stop work, enabling operations to build-in quality at each process). TPS is maintained and improved through iterations of standardized work and Kaizen (continuous improvement of an entire value

stream or an individual process to create more value with less waste), following Deming's improvement cycle method Plan-Do-Check-Act (PDCA) (Hines, 2010). The essence of PDCA cycle is in proposing a change in a process, implementing the change, measuring the results, and taking appropriate action.

The PDCA cycle is the basis for quality improvement and forms a fundamental relationship of quality assurance and control quality in the project management process groups (PMBOK, 2017). In addition, quality improvement initiatives such as Total Quality Management (TQM), Six Sigma, and Lean Six Sigma could improve the quality of the project's management as well as the quality of the project's product. Commonly used process improvement models include Malcolm Baldrige, Organizational Project Maturity Model (OPM3), and Capability Maturity Model Integration (CMMI) (PMBOK, 2017).

The main idea behind lean methods is to maximize customer value while minimizing (with the intention to eliminate) waste, meaning creation of more value with fewer resources by focusing on continuous increase of its key processes. The ultimate goal is to provide perfect value to the customer through a perfect value creation process that has zero waste (Hines, 2010). The five lean principles extend the lean methods to the organizational level (Hines, 2008):

- Specify value from the perspective of the customer,
- Identify all the steps across the whole value stream,
- Make the value stream flowing continuously (without interruption),
- Make only what is pulled by the customer, or introduce pull systems where continuous flow is possible, and
- Strive for (or manage toward) perfection, so that the number of steps and the amount of time and information needed to serve the customer continually falls.

Lean methods are very effective at eliminating process waste and accelerating velocity. A goal of lean is to improve process speed and improve capacity. Organizations that apply lean methods only often fail to sustain their gains because of process variation that can have an adverse impact on speed and required capacity. Lean depends on low process variability but lacks an effective analysis approach.

Six Sigma revolves around the following key concepts (Charantimath, 2011):

- *Critical to quality (CTQ)*: Attributes most crucial for the customer,
- *Defect*: Failing to deliver what the customer wants,

- *Process capability*: What one's process can deliver,
- *Variation*: What the customer sees and feels,
- *Stable operations*: Ensuring consistent, predictable processes to improve what the customer sees and feels,
- *Design for Six Sigma*: Designing to meet customer needs and process capability.

Six Sigma is an aspiration or goal of process performance. A Six Sigma goal is for a process average to operate approximately 6σ away from customer's high and low specification limits (Lean Sigma, 2014). A process whose average is about 6σ away from customer's high and low specification limits has abundant room to "float" before approaching the customer's specification limits. A Six Sigma process only yield 3.4 defects for every million opportunities, in other words, 99,9997% of products are defect-free. Sigma level measures how many "sigma" there are between a process average and the nearest customer specification. For instance, a process operating at 1 sigma has a defect rate of approx. 70%, meaning that the process will generate defect-free products only 30% of the time; a process at the 2 sigma has a defect rate of approx. 31%. Sigma level 6 has a defect rate of 0,00034%.

In order to achieve Six Sigma it is required to improve the process performance by minimizing the process variation so the process has enough room to fluctuate within customer's specification limits, and by shifting the process average so that it is centered between the customer's specification limits (Lean Sigma, 2014). DMAIC or *Define, Measure, Analyze, Improve, Control*, a Six Sigma method consisting of these 5 phases is the systematic method prescribed to achieve Six Sigma, and it can be applied to any process. The Six Sigma approach to problem solving uses a relational transfer function that is a mathematical expression of the relationship between the inputs and outputs of a system: $y = f(x)$, where y refers to the measure or output of a process (primary metrics), and x is the factor or input that affects the y . The objective of Six Sigma project is to identify the critical x 's that have the most influence on the output (y) and adjust them so that the y improves (Lean Sigma, 2014).

Six Sigma methods are known as a highly effective root cause analysis of unknown process variability and as a driver of priority improvements across the organization. However, pure Six Sigma model may lack rapid improvement events such as Kaizens, which can accelerate results and project completion rates. Combined lean efficiencies and rapid improvement, and Six Sigma's process analysis and its ability to eliminate process variation have brought the Lean Six Sigma methods, as shown in Figure 2.1. Characteristics of Lean Six Sigma methods, such

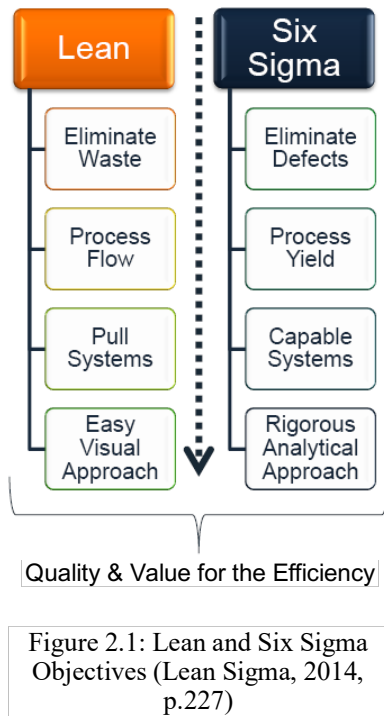

as process mapping, pull systems, and cellular flow, enable projects and organizations for efficient process cost-cutting and eliminating waste in the process stream (Hines, 2008). In the Lean Six Sigma method there are seven common faces of waste (“*muda*” in Japanese): *defects* (making errors in products or services), *overproduction* (cost accumulation in non-optimized processes), *over-processing* (“golden plating” or adding more value than needed), *inventory* (wastes in transactional processes), *motion* (movement of the people who are performing the operations in the process), *transportation* (the movement of process inputs, work-in-process, or outputs), and *waiting* (interruption in process flow) (Hines, 2008).

Defects or defectives are an obvious waste for any working environment, production system, or process. Eliminating defects is an undisputable way to improve product or service quality, customer satisfaction, and cost of service. Overproduction is wasteful because a system expands energy and resources to produce more than required by next function or the customer, which makes the overproduction one of the most detrimental wastes because it leads to others (inventory, transportation, waiting, etc.). Motion is a form of waste occurring as a result of inadequate setup, configuration, or operating procedures. Transportation is considered wasteful because it does nothing to add value or transform the product or service. Waiting is a waste that is typically a symptom of an upstream problem, caused by inefficiency bottleneck, or poorly designed workflows within the value stream.

Lean Six Sigma uses Five-S (5S), a systematic method to organize and improve work environment. 5S method is summarized in five Japanese words all starting with the letter S: *Seiri* (sorting), *Seiton* (straightening), *Seiso* (shining), *Seiketsu* (standardizing), and *Shisuke* (sustaining) (Lean Sigma, 2010). The objectives of 5S method are reducing waste and costs, and establishing a work environment that is self-explaining, self-ordering, self-regulating, and self-improving. In such an environment, there is no more searching, waiting or delaying, there are no obstacles or detours, neither the process nor material excess or waste. As a method, 5S generates immediate improvements and observable results.

2.3 Improvement methods

Besides Agile and Lean methodologies and Six Sigma methods, a range of process improvement methods exist. These include Total Quality Management, Continuous Improvement or Kaizen, Business Process Re-engineering / Business Process Management, Breakthrough Improvement, Concurrent Engineering, Theory of Constraints, Design of Experiments, and Process Excellence.

Process improvement or improving the quality of processes and maintaining the acceptable levels of performance quality, is used to identify, analyze and improve existing processes within an organization in order to meet new goals and objectives. Further enclosed is a brief description of the most important representatives of these methods.

2.3.1 Total Quality Management

Total Quality Management (TQM) is, from the historical point of view, the first quality improvement method introduced in late 1970's and early 1980's. TQM was based on Deming's fourteen points for the transformation of management (The Edwards Deming Institute, 2014), as an integrated effort designed to improve quality performance at every level of the organization: *total* - quality involves everyone and all the activities performed in the organization; *quality* - conformance to the requirements (meeting customer requirements); and *management*- quality can and must be managed.

TQM is a comprehensive management system which (Charantimath, 2011):

- Focuses on meeting the needs of the owners' or customers' by providing quality services at a cost that offers value to the owners/customers,
- Is driven by the quest for continuous improvement in all operations,
- Recognizes that everyone in the organization has internal or external owners or customers,
- Views an organization as an internal system with a common aim rather than as individual departments acting to maximize their own performances,
- Focuses on the way tasks are accomplished rather than simply on what tasks are accomplished,
- Emphasizes on teamwork.

TQM is a process for managing quality, defined as a management approach that tries to achieve and sustain long-term organizational success by encouraging employee feedback and participation, satisfying customer needs and expectations, respecting societal values and beliefs

and obeying governmental statutes and regulations. Product, process, system, people and leadership form the five pillars of TQM approach to continuous improvement in business through a new management model emphasizing the quality of the product or service.

Statistical analysis of processes, reducing rework and wastage costs, and cost reduction of the

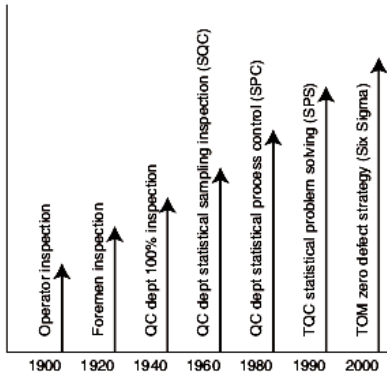

overall business process model was the major TQM focus. TQM led to a revolution in managerial thinking and was embraced on a world-wide basis. Eventually TQM had evolved into Six Sigma, and quality management into ISO 9000 family of quality management systems standards and Lean manufacturing. The phases of TQM development and evolution of TQM are shown in Figure 2.2 and in the Table 2.2 respectively.

Figure 2.2: TQM development phases (Charantimath, 2011, p. 64)

Table 2.2: The evolution of Total Quality Management

Quality Management Stages	Areas of Focus	Scope
Inspection	Detection	Error detection Rectification Sorting, grading, re-blending Decision about salvage and acceptance
Quality control	Maintaining status quo	Quality standards Use of statistical methods Process performance Product testing
Quality assurance	Prevention	Quality system (ISO 9000) Quality costing Quality assurance Prevention Quality planning and policies Problem solving Quality design
Total quality management	Quality as a strategy	Quality strategy Customers, employees and suppliers' involvement Involve all operations Empowerment and teamwork

(Charantimath, 2011, p.61)

2.3.2 Continuous Improvement - Kaizen

The concept of continuous improvement (Kaizen) originated in the post- World War II Japan. The word Kaizen means “continuous improvement”, coined from the Japanese words *kai* (meaning “change” or “to correct”) and *zen* (meaning “good”).

Kaizen is an organization-wide philosophy oriented toward continuous improvement. It applies to continuing improvement applicable to everyone in an organization, with the main idea to maintain and improve work standards with the responsibility delegated to the employee. Kaizen is based on making small incremental changes on a regular basis with the focus on improving productivity, safety and effectiveness while reducing waste.

As the Kaizen is primarily focused on the implementation process, it uses vast array of techniques for implementing Kaizen, such as (Charantimath, 2011):

- Active use of the seven quality control tools—Pareto chart, cause-and-effect diagram, histograms, control charts, scatter diagram, check sheets, graphs, etc.,
- Systematic questioning techniques (e.g. 5W1H - What, When, Where, Whom, Why and How),
- Concept of the Deming Wheel (PDCA) and *poka-yoke* (error proofing, i.e. zero defects) methods,
- Use of the Simply, Combine, Add and Automate, Re-arrange, Eliminate (SCARE) principle,
- Elimination of *muda*, *mura* and *muri* (types of waste) along with 5S (a system for workplace organization and standardization),
- Group dynamics,
- Principles of standardization and visual management,
- Inputs on organizational behavior topics, such as team building, inter-and intra-group behavior.

2.3.3 Business Process Re-engineering / Business Process Management

Business process re-engineering (BPR) is an approach aimed at improving the re-engineered process performance by elevating the efficiency and effectiveness of the processes that exist within and across of an organization. BPR focuses on business processes with the aim of finding the manner on how best to construct these processes to improve the ways of conducting business. It requires a re-design of the strategic and value-added processes and requires a process-oriented approach with a focus on end results and the different tasks involved. The BPR follows the following fundamental questions (Charantimath, 2011): *Why do we do what we do?* and *Why do we do it the way we do?*

The foundation for BPR constitute approaches, methods and techniques introduced since 1950's when organizations began exploring potential impact of computers on the efficiency

and effectiveness of their business processes. In the 1980's, the emergence of quality management steered developments in BPR. During 1990's, the six BPR areas including the total quality approach, industrial engineering, the systems approach, the socio-technical approach, the diffusion of innovations and the use of information systems for competitive advantage were adopted in organizations and by the consulting industry. Since 1996 considering business processes as a starting point for business analysis and redesign has become a widely accepted approach and is a standard part of the change methodology portfolio (Charantimath, 2011).

BPR consists of the three essential phases:

- *Rethink*, where the current objectives and underlying assumptions are examined in order to determine how well they incorporate to the renewed goals,
- *Redesign*, where an analysis of the way the re-engineered processes are structured, who accomplishes what tasks and the results of each procedure,
- *Retool*, where a thorough evaluation of the usage of technologies is done with the identification of opportunities for change that can improve the quality of service and/or products.

BPR prescribes a five-step approach to the BPR model (Charantimath, 2011): develop business vision and process objectives, identify the business processes to be re-designed, understand and measure the existing processes, identify IT levers, design and build a prototype of new process. BPR implementation methodology has five activities—prepare for BPR, map and analyze the as-is process, design the to-be processes, implement the re-engineered processes and improve continuously.

The enablers of BPR in the manufacturing sector are agile manufacturing, lean manufacturing, JIT, collaborative manufacturing, intelligent manufacturing, production planning and control, product design and development. The enablers of BPR in the service sector are making the customer the starting point for change, designing work processes in the light of re-engineered goals and restructuring to support front-line performance (Charantimath, 2011).

BPR and TQM are closely related because these are tools to improve an organizational performance significantly and achieve total quality. BPM and TQM are both focused on customers, being process-oriented and involving cross-functional activities. BPR aims at drastic changes to improve a process, if possible, discarding the existing process and developing an entirely new, improved process, while TQM aims for process improvement.

The future of BPR can be said to revolve around process management, advancements in IT and developments in the re-engineer structure. In recent years the concept of business process management (BPM) gained major attention in the business world. It is considered as a successor to the BPR.

Business process management is the method of designing, executing, and optimizing of business activities that integrate people, systems, and processes with the aim of value creation for the organization. The outcome from BPM are value creation processes and support processes. Value creation processes are core organizational processes, significant for the organizational sustainability and growth. Support processes are backing value creation processes and regular operational activities.

The BPM project implementation framework consists the following phases (Charantimath, 2011):

- *Organization strategies*, where the project team assess and understand the organizational strategy, vision, mission, strategic goals and business drivers,
- *Process architecture*, where the organization establishes a set of rules, principles, guidelines and models for the BPM implementation,
- *Project initiation (launch pad)*, where the BPM project is scoped, established and launched,
- *Understand*, or process “as-is” assessment, where the project team gains understanding of the current business processes,
- *Innovate*, or process design phase including the three key activities—process design, control and improvement,
- *Develop*, where the build of all the components for the implementation of the new process commences,
- *People*, where all the process activities are done to ensure that the stakeholders’ roles and performance measurement match the organization strategy and process goals,
- *Implement*, where the change management activities take place,
- *Realize value*, the phase where the benefit outcomes outlined in the BPM project business case are realized, and
- *Sustainable performance*, with the evaluation of project results, developing of the sustainability strategy, institutionalizing process governance, embedding performance measures, and monitoring sustainability.

BPM uses the process mapping method and process mapping tools in order to establish the overall status of an organization, identifying and defining its processes as well as process strengths and weaknesses. This enables an organization to identify the practices and the necessary changes that should be implemented to improve its overall performance. Most commonly used process mapping tools include flowcharts, swim lane diagrams, value stream maps, SIPOC (Suppliers-Inputs-Process-Outputs-Customer) diagrams, used as well in Six Sigma projects during the project design phase, and spaghetti diagrams (maps), indicating the flow of materials through various areas, business entities or physical spaces.

2.3.4 Breakthrough Improvement

Breakthrough improvement is about the effective management of creativity and innovation, which plays a critical role in developing of competitive advantage for organizations. It refers to discontinuous change, as opposed to the gradual, continuous improvement philosophy of Kaizen. Breakthrough improvements result from innovative and creative thinking; often these are motivated by stretch goals or breakthrough objectives. Breakthrough improvement uncovers and diagnoses the root causes of chronic and costly problems within existing products, services or processes. It devises remedial changes that remove or manage the causes, and implement controls to prevent these from recurring. It seeks to create beneficial change by improving upon the current organizational standards. Breakthrough improvement is carried out by adhering to a universal sequence of events (Charantimath, 2011):

- Identifying a business problem,
- Establishing a project,
- Measuring and analyzing the current process to establish a precise knowledge of baseline performance,
- Generating and testing theories as to the causes of the poor performance,
- Proving the root causes of the poor performance,
- Developing remedial improvements—changes to the process that remove or manage the causes of poor performance,
- Establishing new controls to prevent recurrence and to sustain the new standards,
- Dealing with resistance to change, and
- Replicating the results and starting a new project.

Breakthrough improvement includes the following methods (Charantimath, 2011):

- *The Six Thinking Hats*, a creativity technique to solve problems and arrive at decisions. The method is a framework for thinking and can incorporate lateral thinking. The six hats represent six modes of thinking and are directions to think rather than labels. The

advised hat sequences are white hat, which presents information and data, green hat, providing creative thinking, yellow hat, providing rationale for why it may work, red hat, which feeds back feelings and intuition, black hat, giving rationale for why it may not work, and blue hat, providing guidance to the direction taken by the thinking process,

- *CREATES* (Combine, Rearrange/reverse, Exaggerate (magnify), Adapt Transform, Eliminate (minify), Substitute) is a technique that can be used to trigger new ideas, promote creativity and help overcome challenges,
- *Brainstorming* is a tool for maximizing a group's creativity in problem solving. It is considered to be a group method of listing suggested ideas relating to a solution for a specific problem. Downside of the brainstorming is that it cannot help positively identify causes of problems, rank ideas in a meaningful order, select important ideas or check solutions,
- *Innovation* is generally understood as the introduction of a new thing or method. From an organizational perspective, it defined "... as the successful introduction of a new thing or method. Innovation is the embodiment, combination, or synthesis of knowledge in original, relevant, valued new products, processes, or services" (Luecke, Katz, 2003). Innovations are categorized as incremental (developmental) and radical (breakthrough),
- *Value analysis* or *Value Engineering* is a systematic and function-based approach to improving the value of products, projects or processes. VE involves a team of people following a structured process with the aim of improving value.

2.4 Theoretical Framework

The execution of organizational and project portfolio activities is guided through governance frameworks, which establish rules and regulation, protocols and limits of power that organizations use to manage achieving their strategic goals. Governance is striving to ensure alignment of strategy and execution. The existing governance models did not resolved discrepancies related to the areas of project portfolio governance, as indicated by the analysis of the research studies (see Chapter 1.1).

It is very often misconception that agile process doesn't do enough planning. On the contrary, agile does more planning and risk mitigation than traditional processes. Agile focuses on planning very often instead of doing comprehensive and assumption-based planning once. Agile planning (as known as agile planning onion) has six levels - *Strategy*, *Portfolio*, *Release*, *Iteration*, *Daily*, and *Continuous*, as shown in Figure 2.3 (Agile Helpline, viewed 20 May 2013,

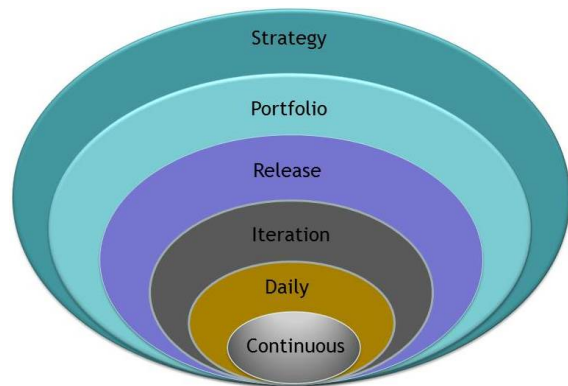

Figure 2.3: Agile planning onion (Agile Governance, 2011)

<<http://www.agilehelpline.com/2011/03/agile-governance.html>>). The levels which belong to the team planning and managing activities are Continuous, Daily, Iteration, and Release. The tactical and strategic planning layers are Portfolio and Strategy, respectively.

Nonetheless, organizations are heterogeneous, and when we deliberate on processes impacting different lines of businesses within the one ecosystem, we can easily anticipate deterioration from the rule “one fit for all”. This means that an organization promulgating its strategic objectives through strategic action mapping cannot actualize portfolio layer immediately from the strategic layer, as shown in Figure 2.4, because diverse business process lines adhere to strategic goals creating assorted organizational themes with its own regulation, process structure and actualization dynamics. In order to consolidate, prioritize and enable this diversity of organizational themes, layers of organizational agile governance and organizational themes are required. The organizational agile onion was introduced and presented by the author of this work at the PMI PgMP LIWg meeting held at the CSC in Utrecht, The Netherlands, on 15 March 2012.

One of the key attributes of agile methods is openness towards changes during the whole life-cycle of a project/program, and proactive risk management. These two factors (change and risk) influence governance processes the most since governance is one of the major contributors in the modeling of the project and/or program processes.

Thus, the strategic layer of the organizational agile governance the author of this work extends into the agile governance framework. The development and implementation of governance

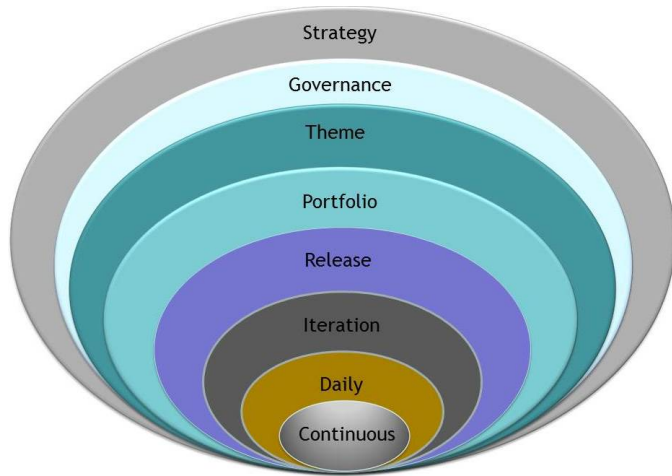

Figure 2.4: Organizational agile onion (PMI PgMP LIWg, 2012)

frameworks is the tool to improve the principles of steering (such as accountability, leadership, integrity, objectivity, honesty and openness) through governance processes and domains (PMI, Governance Frameworks for Public Project Development and Estimation, 2009). An organization that is agile is able rapidly adapting to tomorrow's surprises, and it needs an agile governance to drive agility across the

organization. This governance is not to control. Its main functions are to ensure alignment of agile execution with agile strategy, focuses on integrating value, being driving force for the agile strategy and business success, invests in the predictable delivery, nurtures innovation, and introduces concepts of agile scalability and virtual maintenance of specific governance domains' backlog.

The construct of the agile governance framework is based on the research of governance processes and domains (Hobbs, Miller, 2002), the structure of the frameworks (Klakegg, Williams, Magnussen, Glasspool, 2008), and the control of the frameworks (Simons, 1995).

2.5 Conceptual Model

The agile governance framework construct consists of four agile governance process domains which influence the agile project portfolio governance. These domains are Front-end, Planning, Monitoring, and Deliverables process domains. The domains are interrelated and integrated through the conjoint change management (CM) and risk management (RM) factors, as depicted in Figure 2.5.

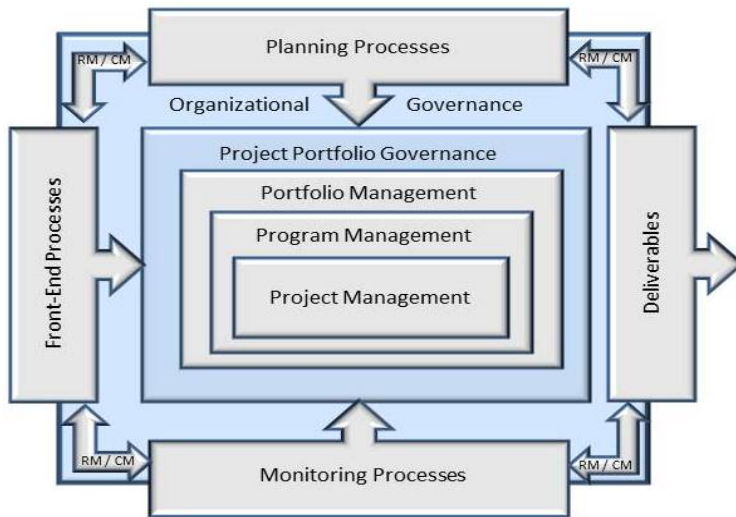

Figure 2.5: Agile governance framework construct (Hobbs, Miller, 2002; Klakegg et. al, 2008; Simons, 1995)

Front-end process is the process of shaping the project and/or program and building its legitimacy through decision-making episodes and time (Hobbs, Miller, 2002). Front-end governance processes include development of feasibility studies and analyses, their justification, influence and negotiation with a broad scale of stakeholders, identification of an endeavor, its adaptation and

alignment with organizational factors, and finally approval.

Planning governance processes include elements impacting time (schedule) and costs, culture (administrative, management, competence), accountability and leadership.

Monitoring governance processes include control framework (Simons, 1995) dealing with the core values of an organization which shall not only be replicated but increased by undertaking a project/program, involved risks, strategic uncertainties, and critical performance variables.

Governance processes in the domain of deliverables that influence project/program outcomes include the proper delivery of products or services, adequate performance of investments, authorization of all undertaken work, and the achievement of objectives in required quality.

2.6 Taxonomy of the Agile Project Portfolio Governance Framework

Taxonomy is defined as “a collection of controlled vocabulary terms organized into a hierarchical structure. Each term in taxonomy is in one or more parent/child (broader/narrower) relationships to other terms in the taxonomy” (ANSI/NISO Z39.19-2005 (R2010), 2010). The ANSI/NISO standard presents guidelines and conventions for the contents, display, construction, testing, maintenance, and management of monolingual controlled vocabularies. It focuses on controlled vocabularies that are used for the representation of content objects in knowledge organization systems including lists, synonym rings, taxonomies, and thesauri.

Why taxonomy? Taxonomy provides a way to describe content. The usual purpose of creating a taxonomy or thesaurus is to manage a collection of information resources. One of the essential means for managing (organizing) such resources is indexing or categorizing each individual resource as a whole, to describe what the resource is about. Taxonomies and thesauri are two examples of controlled vocabularies (Hlava, 2014). According to ANSI/NISO standard, a thesaurus is a controlled vocabulary arranged in a known order and structured so that the various relationships among terms are displayed clearly and identified by standardized relationship indicators.

Taxonomy or thesaurus is used to browse (navigate and search on Internet), to drill down to a more granular and narrower layer, to look at a hierarchical list, and navigate down a tree to end information. Taxonomy and thesaurus often are used interchangeably. A thesaurus is a controlled vocabulary arranged in a known order and structured so that the various relationships among terms are displayed clearly and identified by standardized relationship indicators (ANSI/NISO Z39.19-2005 (R2010), 2010). A hierarchical thesaurus is considered to be taxonomy. Unlike a simple taxonomy, a thesaurus includes equivalence relationships (synonyms), associative relationships (related terms), scope and editorial notes, definitions, and mappings from other thesauri and/or from taxonomies.

Where taxonomies and thesauri are used (Hlava, 2014)?

- In search and the auto-suggestion function in search, to improve search functionality,
- In subject browsing,
- In indexing or categorizing, as subject metadata,
- In author subject tagging and author submission modules,
- In content management systems,
- In linking to society resources based on the article retrieved,

- In filtering data,
- In web crawler applications that automatically search the Internet for content,
- In webpage mashups of widgets and such from various sources,
- In data visualization,
- In social media or on social networking sites,
- In mobile intelligence or data mining applications.

With regards to the research subject tagging and submission of this work, the taxonomy of Agile and Lean methodologies in the agile project portfolio governance (PPG) framework aims to construct the classification principles applied within the governance conceptual model. The purpose of such taxonomy is to validate the definition of PPG structure, characteristics, embedded principles, and constitutive elements of the governance domain processes, in order to make the governance of portfolio components possible and effective. Taxonomy of agile PPG framework includes the hierarchy of its process domains and their processes, adding related terms, synonyms, and other relevant features, providing a PPG thesaurus. Another purpose of this thesaurus is that it can be used as a guide to a field of knowledge in the area of project portfolio governance, a structured network of terms providing a structure, a search path that makes it easy to find the way to that information.

The ANSI/NISO standard lists five purposes that controlled vocabularies (e.g. taxonomies and thesauri) serve (ANSI/NISO Z39.19-2005 (R2010), 2010):

- *Translation*, providing a means for converting the natural language of authors, indexers, and users into a vocabulary that can be used for indexing and retrieval,
- *Consistency*, promoting uniformity in term format and in the assignment of terms,
- *Indication of relationships*, indicating semantic relationships among terms,
- *Label and browse*, providing consistent and clear hierarchies in a navigation system to help users locate desired content objects, and
- *Retrieval*, serving as a searching aid in locating content objects.

According to ANSI/NISO standard, as a taxonomy or thesaurus is also known as an indexing language, an item in taxonomy that is valid descriptor for indexing is a “keyword”, a word occurring in the natural language of a document that is considered significant for indexing and retrieval. Indexing can be described as the systematic application of taxonomy terms to describe what a document is about (ANSI/NISO Z39.19-2005 (R2010), 2010).

Besides indexing, the taxonomy domain uses the term “tagging”, which refers to using a word that isn’t exactly a synonym but is close enough to pass within the domain (e.g. tagging a document with a keyword vs. indexing document using the terms of a controlled vocabulary, such as an authority file, taxonomy, or thesaurus).

Taxonomy build goes through the following stages (ANSI/NISO Z39.19-2005 (R2010), 2010):

- Subject fields’ definition (vocabulary control),
- Collection of terms (grouping the terms according to their conceptual relationships),
- Organizing terms (organize the information into main categories),
- Filling in conceptual gaps in the taxonomy term collection,
- Provision of substance and interrelation to terms (grouping synonyms, poly-hierarchical relationships and quasi- or near-synonyms together),
- Analysis of list of terms using the hierarchy as the point of entry to the term clusters,
- Applying to data and test the concept by using the “all-and-some” test.

The construct of PPG taxonomy first determines a suitable structure for the content (data) it has or will accumulate, assign and classify each part of the content a place in the structure, and then ensure that the structure and the content are integrated in order the taxonomy is kept relevant and its continued maintenance possible (adding and classifying new information). Then the taxonomy is becoming the backbone of executing agile PPG framework, or the instruction manual for the framework to operate. This means that the PPG framework content items must have organized attributes which are provided by taxonomy, resulting in a meta-model as an explicit model of the construct with rules needed to build a specific model within a domain of interest. A valid meta-model is an ontology that can be viewed as a set of building blocks and rules used to build a model of a domain of interest, that is agile and lean PPG (Boyer, Mili, 2011).

2.6.1 Determining a suitable structure for the content

Based on the structure of the project portfolio governance framework and its domain processes, its taxonomy shall be organized into a hierarchical structure, with each term in taxonomy to be in one or more parent-child relationships to other terms in the taxonomy, as shown in Figure 2.6:

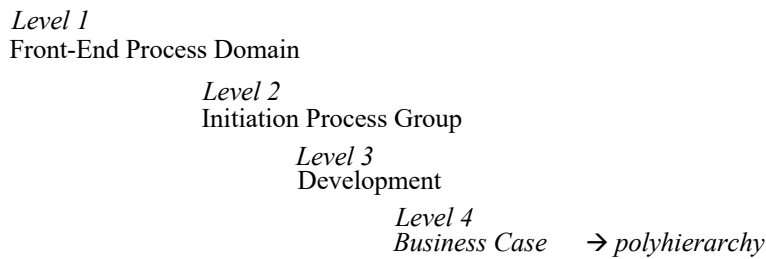

Figure 2.6: Taxonomy relationships

Parent-child relationships to a single parent level are of the same type. Some taxonomy allows polyhierarchy, which means that a term can have multiple parents (as shown in the example above). This means that if a term appears in multiple places in taxonomy, then it is the same term. Specifically, if a term has children in one place in taxonomy, then it has the same children in every other place where it appears.

Hierarchical structure of PPG taxonomy concept is built top down³ (the broadest terms are identified first, and then narrower terms are selected to reach the desired level of specificity), by starting with broad categories and populating them with terms to represent narrower and narrower concepts. The main term structure of the PPG framework taxonomy, its classification system, is shown in Figure 2.7 below:

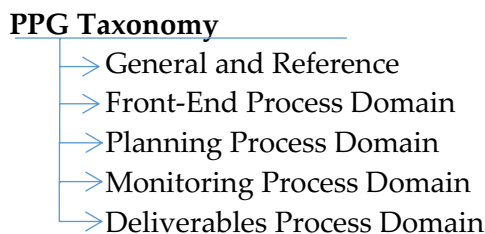

Figure 2.7: Main term structure of the PPG taxonomy

The PPG taxonomy is further structured and categorized on the basis of their baseline features, in order to conceptualize terms which would factor-in the methodological categories for a particular process development. The sampling of the process group defines a rule, or a principle or condition that governs behavior and guiding these processes. It is part of the problem domain guided by requirements, as opposed to the solution domain, guided by a particular technological choice (Boyer, Mili, 2011).

Assigning and classifying the contents within the main structure of the PPG framework is the next stage of taxonomy built.

³ There are two general approaches on building taxonomies – *top-down* (deductive approach) and *bottom-up* (collecting terms approach), as well as their combination [64]

2.6.2 Assigning and classifying the content in the structure

There are five top terms in the PPG structure, consisting information content and representing the PPG framework. The first top term, *General and Reference*, represents the background, setting, and regulatory information content of the PPG taxonomy, as shown below, is based on the ACM Computing Classification System (CCS) structure (ACM CCS, viewed on 14 August 2014, <<http://www.acm.org/about/class/2012?pageIndex=0>>) and detailing on the ACM DL Digital Library page (ACM DL, viewed on 14 August 2014, <<http://dl.acm.org/ccs.cfm?CFID=492460152&CFTOKEN=92425874>>):

General and Reference

Document types

Surveys and overviews

Reference works

General conference proceedings

General literature

Standards and guidelines

Cross-reference methods

Empirical studies

Experimentation

Estimation

Design

Evaluation

Performance

Validation

Verification

Measurement

Metrics

The term breaks down into two classification terms, *Document types* and *Cross-reference methods*. The Document types consist of *Surveys and overviews* referring to the main content area, e.g. recent survey studies and papers on survey overviews; *Reference works*, referring to recent papers on reference work; *General conference proceedings*, referring to recent papers on conference proceedings; *General literature*, referring to recent papers on general subject literature; and *Standards and guidelines*, referring to designated standards and regulation of the subject area (such as PMI standards). The *Cross-reference methods* consist of *Empirical studies*, referring to recent papers on the subject of the main content area; *Experimentation*; *Estimation*; *Design*; *Evaluation*; *Performance*; *Validation*; *Verification*; referring to recent papers on research on the main content area; *Measurement* and *Metrics*, referring to the papers on elaborating the performance of the main content area. The terms in the Cross-reference methods classification are polyhierarchical, which means that a term can have multiple parents.

The second top term, *Front-End Process Domain*, represents the processes of shaping the project and/or program and building its legitimacy through decision-making episodes and time. The Front-End processes are characterized with substantiating the viability of an initiative,

required knowledge of inputs and outcomes (solutions), regulatory and procedural clarity, clear rules of conduct, awareness on the risks associated with the implementation of such initiatives with impact of changes for organization, and therefore required analyses on risks, impact, and cost-benefits.

The term is structured in five classification terms - process groups (PMI, 2017): *Initiation*, referring to requirements elicitation, defining approach and modeling architecture, process methodology planning, impact analysis; *Justification*, referring to identifying valuable initiative, in-context communication with stakeholders, determining clear value-benefit elements and estimates; *Adaptation*, referring to gap and impact analyses, estimating process value stream and process waste, and enabling rapid process formation; *Alignment*, determining oversight and fiduciary responsibilities, aligning the initiative with the strategic vision and objectives, and establishing the control framework with critical performance variables; and *Approval*, referring to collaborative decision making, as shown below:

Front-End Process Domain

- Initiation
 - Development*
 - Feasibility study*
 - Business case*
 - Process stream*
 - Governance principles*
 - Assessment*
 - Risks*
 - Impacts*
 - Changes*
 - Benefits*
- Justification
 - Identification*
 - Product/service candidacy*
 - Communication*
 - Determine stakeholders*
 - Influence*
 - Negotiation*
 - Estimation*
 - Absorption risks*
 - Absorption costing*
 - Cost/benefit*
 - Benefits structuring*
- Adaptation
 - Analysis*
 - Gaps*
 - Impact*
 - Process formation*
 - Process value stream*
 - Process waste*
 - Continuous improvement*
- Alignment
 - Integration*
 - Align with strategic objectives*
 - Integrate value stream*
 - Control framework*

Develop control framework
Oversight
Fiduciary responsibilities
Performance indicators

Approval

Gate review
Value-added collaboration
Decision making

The terms in the Front-End classification are polyhierarchical, which means that terms can have multiple parents. Key agile practices impacting the Front-End processes taxonomy include embracing innovation, adaptability, iterative-incremental and test-driven process development, continuous integration, and direct communication. Agile development keeps the stakeholders structurally involved, and based on its open-scope requirements management, agile effectively alleviate risks of a change-control churn where a high number of changes is based on low quality requirements. Agile integrates the change control mechanism directly into the development process as a continuous activity. The agile stakeholder's management also includes tackling ambiguities related to collecting and managing proposals for initiatives, forming a proposal funnel process. After being submitted into the funnel, the proposals are being assessed and evaluated, resulting in review actions and decision making for most promising funnel items - a list of project proposals - to become portfolio components. For each component, the funnel process establishes attributes such as start date, forecasted end date, name, risk/reward, cost/benefit, return on investment estimates, iteration length, and baseline metrics to be delivered during the project/component lifecycle iteratively. Common tasks for an initial proposal funnel review include the following (Krebs, 2008):

- Is the proposal large enough to become a project?
- Has a similar proposal been rejected in the past, and why?
- Is the proposal a duplicate?
- Is the proposal currently covered by another project?
- Cost / revenue ratio.

Lean Six Sigma is a problem-solving methodology applied primarily if there is a challenging goal linked to a business strategy an organization requires reaching as a priority, or if that goal or issue is valuable to be resolved. Issues that Lean methodologies tackle the best are the process cost cutting and improving the effectiveness or efficiency of operational processes.

The third top term, *Planning Process Domain*, represents the governance processes which include elements impacting project/program planning (scope, time/schedule, and costs), regulative elements, culture (administrative, management, competence), accountability and

leadership. The term is structured in four classification terms (process groups): *Planning, Regulation, Accountability, and Leadership*, as shown below (PMI, 2017):

Planning Process Domain

- Planning
 - Strategic plan*
 - Operational plan*
 - Plan alignment*
 - Gate Review*
 - Decision making*
- Regulation
 - Principles*
 - Policies*
 - Standards*
 - Ethics*
 - Culture*
- Accountability
 - Identification*
 - Critical success factors*
 - Performance indicators*
- Leadership
 - Direction shaping*
 - Capacity creation*
 - Value-added collaboration*
 - Decision making*

Governance planning mechanism, regardless on project type - agile or otherwise, addresses the major executive concerns – investment and risk, or the value of an initiative in terms of ROI and certainty or uncertainty of obtaining that ROI, and the progress in achieving goals that have been set. There are essentially two types of initiatives (projects): production and exploration. Production initiatives are characterized by a known problem and knowledge of inputs, and it is directly related to knowledge of solutions. Due to detail requirements and process knowledge, in these types of initiatives careful planning can reduce much of the project’s risk. Exploration initiatives are characterized by unknowns of the objective or problem – either there is a known problem and unknown solution, unknown problem and unknown solution, or vice-versa. For these initiatives, the knowledge of inputs is limited, and the traditional planning would not reduce risks but contribute to costs. The approach to the problem solving in these types of projects would be applying progressive elaboration of the planning process (or rolling wave planning), which examination is done in the form of simulations, models, prototypes, feature builds, or scientific investigations (McMahon, 2011; PMI, 2017).

Aligning the planning (and consequently funding) model for projects and programs should follow the managerial oversight and fiduciary responsibilities. In order to do so, a systematic way to view information gathered at the specified key intervals shall be created to make the best planning (and investment) decisions based on understanding the risks involved. These intervals are defined by gates, when decisions are made. Gate reviews are about providing

governing body with relevant information to make decisions about funding and acceptable risk (for example, the risk factor prior to the project is at 100% relatively, whereas the investment, project structure and features delivered are at 0%).

What is a good plan? From the traditional planning point of view, a good plan is a clear, reliable, available and structured set of activities – not deliverables – relying on strict sequencing where time over runs are passed to the next phase asserting that the end result is known. The traditional plans are developed for systems instead of features. Why the plan is needed?

As mentioned above, the primary reason of planning is to reduce risks and uncertainties and make informed decisions. Planning process allows conveying a tangible vision and establishing trust. Traditional planning process requires that the functionality and dates (schedules) are mandated, possesses lengthy upfront requirements and signoff process. As a consequence, planning process little regards for reality – a schedule cannot be perfectly predicted due to estimating cone of uncertainty and a way too many intangibles. Therefore, it cannot be accurately stated what will be delivered, resulting in features dropped as deadline approaches.

Agile planning is an iterative, emergent, and continually evolving process and artifacts that, regardless on the planning level (strategic, tactical or operational), establishes a vision and mission (goals), a baseline understanding and connection between the steering (or

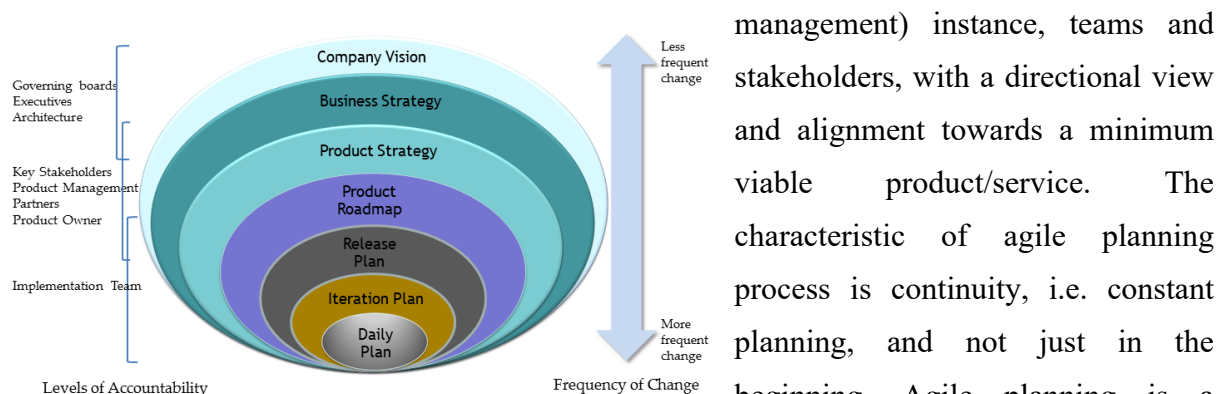

Figure 2.8: Levels of agile planning (Agile Governance, 2011)

management) instance, teams and stakeholders, with a directional view and alignment towards a minimum viable product/service. The characteristic of agile planning process is continuity, i.e. constant planning, and not just in the beginning. Agile planning is a transparent activity, not a document.

It is focused on historical performance, and not on hyper-optimal scenarios. It encourages changes; changing the plan doesn't mean changing timing. Figure 2.8 shows the levels of agile planning (Agile Governance, viewed 20 May 2013, <<http://www.agilehelpline.com/2011/03/agile-governance.html>>).

An effective planning process, attempting to find an optimal solution to the question on what and how should be built, shall reduce risk and uncertainty, establish trust, convey information, and support better decision making. Estimating and planning processes are critical to the success of any development project and/or program. These processes are error prone, with the accuracy determined by the cone of uncertainty (Cohn, 2006), or order of magnitude (PMBOK, 2017). The agile enabled governance planning process conforms to the idea of rolling wave planning, where the estimates are done at a high level when the details are not known, and then progressively elaborated in an adaptive and continuous manner which encourages change. Thus, this iterative and flexible planning refinement process focused on business priorities is capable of defining and expressing value from the organizational perspective.

The *Regulation* classification term refers to the regulatory value system and its scaling factors which address two main regulative categories: complying with regulations imposed upon an organization from external sources (e.g. legal, financial, informational, technical, security, etc.), and choosing to adhere to internal regulations willingly adopted by the organization (e.g. process improvement frameworks).

Organizational culture is a complex, multi-dimensional construct that is not easily manipulated, evolving as it has through interaction between the organization and its environment and interaction between organizational members, creating the infrastructure, the glue that binds together people and processes to generate results (Perkins, Arvinen-Muondo, 2013). Agile and lean requires shifting the organizational culture (administrative, managerial and competence) in order new experiences to be created and reward those who dare to embrace the new and unfamiliar, and the organization must be prepared to examine its old practices with a critical eye and try a new way of doing things. When the new experiences are difficult or uncomfortable, it is common to revert to old habits. Driving true culture change, which agile requires, needs commitment and nurturing from all levels of the organization.

According to the 11th report of The Committee on Standards in Public Life (PMI Governance Frameworks for Public Project Development and Estimation, 2009), the development and implementation of the governance framework is the tool to improve the principles of steering such as accountability, leadership, integrity, objectivity, honesty and openness. The term *Accountability* in the PPG taxonomy means an obligation or willingness to accept responsibility or to account for undertaken actions. The accountability is factored in by critical success factors that that need to be present in an organization (such as strategic leadership,

performance culture, clear authorities and responsibilities, risk management, embedded ethics and values, transparency, shared ownership, and engaged stakeholders), with corresponding indicators that were identified accordingly. A balanced approach is required to ensure each of the critical success factors contributes to an organization's accountability structure.

The term *Leadership* refers to the ability to make strategic decisions and use communication (Bennis, Nanus, 1985), and the human resource skills of interpersonal relationship, motivation, decision making, and emotional maturity, to mobilize project/program team members (Zimmerer, Yasin, 1998) towards achieving the desired objective of successful project outcomes. The characterization of leadership in project/program management is the ability to accomplish the following (Kodjababian, Petty, 2007):

- Motivate a diverse group of team members to follow the leader and build consensus on decisions that affect multiple groups,
- Identify issues that need to be dealt with by the team to keep the project on track,
- Anticipate and resolve people orientated issues that may derail the project,
- Keep executive leaders properly informed by applying in-context communication, and
- Identify and manage project and business risks.

Agile leadership is associated with mode four leaders - generative leadership (Hiefetz, Wilkinson, 2006). These leaders use ambiguity to find opportunity and having the ability to operate in any system of thinking and most importantly see from the perspectives of the other modes, tending to be inveterate learners and innovators. In accordance with Iacocca and Witney (2007), an agile leader is attributed with the possession of vision, critical thinking, curiosity, creativity, conviction, courage, flexibility, tolerance for ambiguity, and emotional resilience. Agile leadership practices continuously evolve, offering tools and techniques to bridge the gaps between hierarchical structures and self-organized teams, such as Management 3.0 (Management 3.0 Leadership Practices, viewed 15 January 2015, <<http://www.agile-lead.com/blog/management-30-leadership-practices>>) involving the principles of energizing people, empowering teams, aligning constraints, developing competences, growing agile structures, and continuous improvement.

The fourth top term, *Monitoring Process Domain*, refers to the control governance processes, or levers of control (internal controls, belief systems, boundary systems, diagnostic control systems, and interactive control systems) to denote managing and measuring of value the core values of an organization which shall not only be replicated but increased by undertaking a

project/program, involved risks, strategic uncertainties, and critical performance variables (Simons, 1995). The term is structured in five classification terms (process groups): *Strategic uncertainties*, *Risk management*, *Change management*, *Control framework*, and *Performance management*, as shown below:

Monitoring Process Domain

- Strategic uncertainties
 - Analysis*
 - External*
 - Impact*
 - Scenario*
 - Internal*
 - Recommendations*
- Risk management
 - Identification*
 - Analysis*
 - Prioritization*
 - Planning*
 - Resolution*
- Change management
 - Formulation*
 - Planning*
 - Implementation*
 - Management*
 - Sustain*
- Control framework
 - Analysis*
 - Performance measures (KPIs)*
 - Monitor and control*
 - Oversight*
- Performance management
 - Planning*
 - Performance measures (KPIs)*
 - Managing resource utilization*
 - Managing value*
 - Performance analysis and reporting*

Developing or adapting organizational strategy starts with external analysis, an analysis of the factors external to a business that can affect strategy. The environmental dimensions of the external analysis include political, economic, social, technological, environmental, and legal segments (Aaker, 2013). Conveniently, the environmental analysis provides estimated structure in the form of areas of inquiry that are often useful: technological trends, consumer trends, and economic (government) forces. Key outputs of external analysis are strategic uncertainties. To be manageable, uncertainties need to be grouped into logical clusters or themes. The importance of each cluster is then assessed in order to set priorities with respect to information gathering and analysis. Impact and scenario analyses are tools that help to evolve the uncertainties into strategy. Impact analysis, addressed first, is designed to accomplish the assessment of the relative importance of strategic uncertainties. The strategic uncertainty is represented occasionally by a future trend or event that has inherent unpredictability. Information gathering, and additional analysis will not be able to

reduce the uncertainty. In that case, scenario analysis can be employed. Scenario analysis, or ways of creating and using future scenarios to help generate and evaluate organizational strategies, essentially accepts the uncertainty as given and uses it to drive a description of two or more future scenarios, from which the strategies are then developed.

The term *Risk management* refers to the process of identifying potential risks in advance, analyzing them, and taking precautionary steps to reduce, eliminate, restrict, mitigate, or accept the uncertainties in organizational decision-making. The agile enabled risk management process applies progressive risk reduction. This risk reduction is possible due to agile visioning, incremental iterative development, and constant stakeholder’s interaction in an early and continuous risk assessment during iterations. Thus, besides provisioning of maximized business value, iterations are focused risk reduction. The agile risk reduction technique is a five-step process including risk analysis and evaluation, building risks in, fixing the process, and monitoring and improvement (Raydugin, 2013; Fenton, Neil, 2013; Kendrik, 2009).

The term *Change management* refers to a comprehensive, cyclic, and structured approach for transitioning individuals, groups, and organizations from a current state to a future state with intended business benefits, helping organizations to integrate and align people, processes,

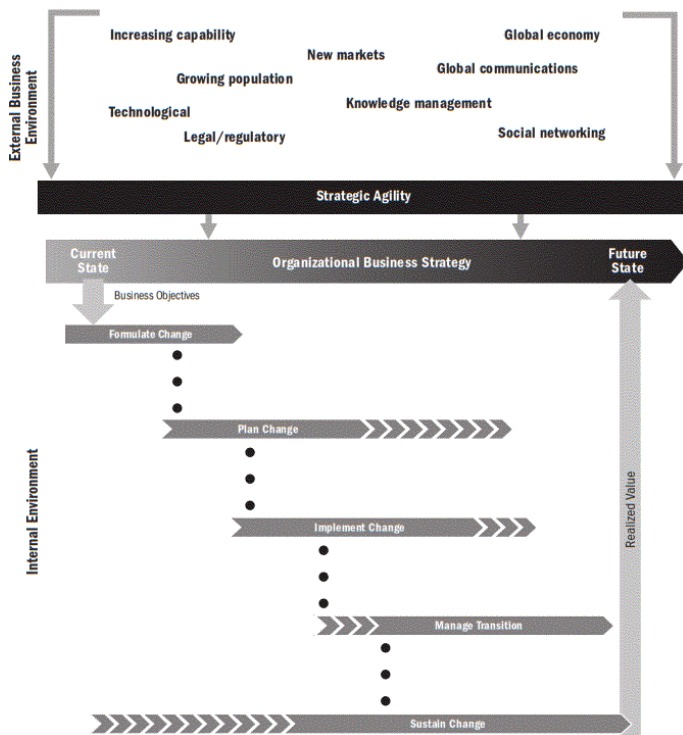

Figure 2.9: Agile change management life cycle (PMI Managing Change in Organization, 2013, p. 48)

structures, culture, and strategy (PMI Managing Change in Organizations, 2013). Organizations are shortening the time horizons for business forecasting and strategic planning due to increased uncertainties of business environments, with complex consequences on business success.

Improving the organizational agility in enabling flexibility and responsiveness to change resulting in better understanding processes encompassing changes inherent in the business environment, as shown in Figure 2.9.

Strategic agility is defined as the capability of business to proactively sense and take advantage of business environment changes while demonstrating resilience resulting from unforeseen changes (PMI Managing Change in Organizations, 2013). In order to strengthen the change responsive capabilities, and improve balance between investment and risks, organizations are advised to mature portfolio management practices and enable benefits realization tracking in order to verify return of values. Already mentioned environmental factors are external drivers of change, impacting organizational ability to prepare for change, and putting pressures on adapting organizational strategies in order to address these changes within the organizational ecosystem.

The term *Control framework* refers to a definition of meaningful measurement criteria for a project/program success by analyzing stakeholders' expectations and requirements across a portfolio of constituent projects/programs in order to accurately control and monitor their performance, identify corrective actions by analyzing their data (variance of costs, schedule, quality and risks) by comparing actual to planned values, and identify potential corrective actions by controlling management of changes. Monitoring, in general, means watching the course, and controlling means acting to either stay the course or to change the wrong course. Monitoring is the tracking of the key elements of program/project performance, usually inputs and outputs, through record-keeping, regular reporting by generating, collecting, and distributing information about the program performance against the planned performance, and assessing overall performance trends.

The four levers of monitoring and control include (Simons, 1995):

- *Core values* controlled by belief systems: if the right vision and values are promulgated, the leading change will move the organization forward, creating the right climate for change. The complete change plan and in particular transition, is based on agile concepts in order to allow for evolutionary and adaptive development,
- *Risks* to be avoided controlled by boundary systems: agile enabled strategic planning mechanism complemented by the conjoined PPG process shall remediate risks of deviating the strategic objectives when executed,
- *Strategic uncertainties* controlled by interactive control system, i.e. monitoring and controlling PPG process domains responsible for reviews of performance indicators and alignment,

- *Critical performance variables* controlled by diagnostic control systems, acting as the corrective factors which are applied in order to diminish deviation towards the strategic objectives, favoring responsiveness as the measure of value in addition to delivering business results regularly, focusing on people and interactions to create congruence and allow for ideation.

Oversight, in contrast, is a type of monitoring, focused on governance and understanding the requirement on strategic alignment. Governing boards execute a key governance function of the portfolio oversight process by monitoring the portfolio performance and recommend changes to the portfolio component mix, portfolio component performance, and compliance to organizational standards in order to instigate changes to the portfolio processes. Agile enabled governance processes utilized through the governance boards create collaborative and mobilized teams of agents and recipients, enabling them to report on progress measured through tangible results. Oversight ensures that activities are implemented as planned by providing strategic direction to principal stakeholders, ensuring policies and procedures are met, instituting financial controls (including independent audits), and following through on key recommendations (PMI, 2017; COBIT 5, 2012).

The term *Performance management* refers to a process by which organizations align their assets, resources, and systems to strategic objectives and priorities, including undertaking activities which ensure that these strategic objectives are consistently being met in an effective and efficient manner, resulting in resource optimization, achieving values and benefits realization, and having provisions for emergent activities. Portfolio performance management is the systematic planning, measurement, and monitoring of the portfolio's organizational value through achievement against the strategic objectives (The Standard for Portfolio Management Fourth Ed., 2017). Agile enabled performance management promotes iterative and cyclic processes based on the impartial assessment of results, measured through perceptible results.

The fifth top term, *Deliverables Process Domain*, refers to the tangible or intangible parts of the project and/or program development process, and its specified function or characteristic in providing quantifiable goods or services upon the project and/or program completion. The term is structured in the two classification terms: *Review* and *Benefit realization*, as shown below (Bradley, 2010; PMI, 2017):

Deliverables Process Domain

Review
Deliverables
Performance
Financial
Quality
 Benefits realization
Alignment
Analysis
Value delivery
Transition

The term *Review* refers to a formal procedure that authorizes a deliverable as a result of the work being done on a specified scheduled activity, work package, iteration, feature, or control account, and helps to ensure that work has been done in the correct sequence, at the right time and by the designated organization. One of the central concepts of agile processes is *definition of done*, the most critical checkpoint of an agile project when the team delivers a product or service at the end of iteration. In agile development, a team defines what exactly shall be delivered by the end of iteration, to be explicitly accepted by the product owner. Therefore, there is no standardized definition of done in agile or a common definition which will ensure that the increment (a feature) produced at the end of iteration is of high quality, with minimal defects, in accordance with the requirements, and 100% completed. There were attempts to standardize the definition of done and make it common, such as “Done thinking grid” (Definition of Done: A Reference, viewed 10 June 2015, <<https://www.scrumalliance.org/community/articles/2008/september/definition-of-done-a-reference>>). Without a consistent meaning of done, the velocity cannot be accurately determined, which impacts the accuracy of the iteration and release planning, and impacts the metrics, which should accurately provide the project health status. The agile governance deliverables process domain shall therefore provide the standardized and common review procedure for the project portfolio components, providing general deliverable authorization system considering required approvals for the component completed under a project or program, to proceed with its product or service transition to operations.

The term *Benefits realization* refers to the management of a set of processes needed to ensure programs, projects and portfolios delivering and embedding into the current day-to-day business all requirements of business strategies, in order to perform a meaningful and sustainable creation of value (Bradley, 2010). Benefits realization management practices ensure the execution of projects and/or programs deliver value to the organization and its business, as well as ensure that portfolios are strategically aligned with the given objectives. On the other side, benefits realization practices reduce project and/or program failure rates and

financial losses related to these failures. Benefits realization practices are strictly related to governance, and in order to enable strategic success of project portfolios, organizations should strengthen governance processes and increase the relevance of success criteria related to the creation of intrinsic and extrinsic values for the business.

2.6.3 Integrating structure and the content

Based on the selected terms list being incorporated into the taxonomy, the terms have been arranged into a logical hierarchical structure and added associative and equivalence relationships that seem potentially useful for a thesaurus, followed by an internal editorial review and testing against the actual content. The testing was used for evaluating candidate terms and determining which of several synonyms to use as the conceptually preferred term.

The PPG taxonomy is developed bearing in mind that the hierarchical relationships are based on specific conceptual links between the terms, and broader/narrower term relationships (parent/child terms, BTs/NTs⁴) define the hierarchical structure of the thesaurus. This means that for one term to be the child term of another, it should be a subset, part, or an instance of the parent term.

The complete structure of the PPG taxonomy is shown in the below Figure 2.10:

PPG Taxonomy

General and Reference

- Document types
 - Surveys and overviews*
 - Reference works*
 - General conference proceedings*
 - General literature*
 - Standards and guidelines*
- Cross-reference methods
 - Empirical studies*
 - Experimentation*
 - Estimation*
 - Design*
 - Evaluation*
 - Performance*
 - Validation*
 - Verification*
 - Measurement*
 - Metrics*

Front-End Process Domain

- Initiation
 - Development*
 - Assessment*
- Justification
 - Identification*

⁴ BT/NT – Broader/Narrower term

- Communication*
- Estimation*
- Benefits structuring*
- Adaptation
 - Analysis*
 - Process formation*
- Alignment
 - Integration*
 - Control framework*
- Approval
 - Gate review*
 - Value-added collaboration*
 - Decision making*
- Planning Process Domain**
- Planning
 - Strategic*
 - Operational*
 - Plan alignment*
 - Gate Review*
 - Decision making*
- Regulation
 - Principles*
 - Policies*
 - Standards*
 - Ethics*
 - Culture*
- Accountability
 - Identification*
 - Critical success factors*
 - Performance indicators*
- Leadership
 - Direction shaping*
 - Capacity creation*
 - Value-added collaboration*
 - Decision making*
- Monitoring Process Domain**
- Strategic uncertainties
 - Analysis*
 - External*
 - Impact*
 - Scenario*
 - Internal*
 - Recommendations*
- Risk management
 - Identification*
 - Analysis*
 - Prioritization*
 - Planning*
 - Resolution*
- Change management
 - Formulation*
 - Planning*
 - Implementation*
 - Management*
 - Sustaining*
- Control framework
 - Analysis*
 - Performance measures (KPIs)*
 - Monitor and control*
 - Oversight*
- Performance management
 - Planning*
 - Performance measures (KPIs)*

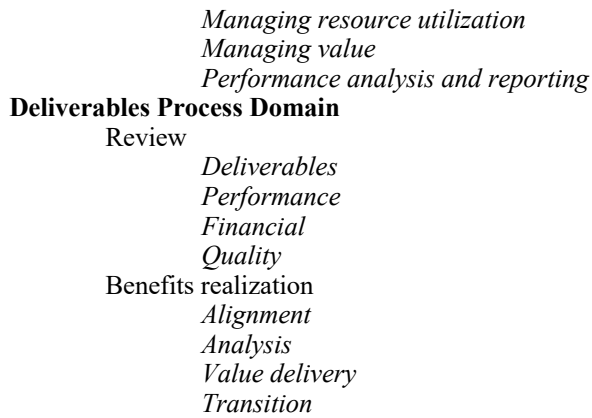

Figure 2.10: Agile PPG taxonomy

The goal of developing the PPG taxonomy was to achieve balance and the appropriate degree of comprehensiveness in coverage of the agile and lean enabled PPG processes. The next stage of the PPG taxonomy development is to let the audience (both scientific and practitioner) review it and provide feedback, so it could be improved and, presumably when the thesaurus is in use, maintained to ensure its currency.

3 CASE AND SURVEY STUDIES ANALYSIS STRUCTURE

This research conducted a case and survey studies in order to complete the quantitative and qualitative research and analyses of data collections concerning the agile methodology factors and their impact on the project portfolio governance domain processes. Also, a cross-case analysis took place in order to leverage projectable results to a larger population and different perspectives between groups and categories of survey respondents and explicate findings from a quantitative and qualitative studies.

3.1 Relevance of Case and Survey Studies Analysis

The underlying analyses created an authentic contribution in problem analysis of the agile methodologies and project portfolio governance processes with regard to establishing:

- The structure of the quantitative data collection with the most significant impact on the governance domain processes,
- The probabilistic analysis in determining the behavior and influence of the internal and external risks variables, specifying how likely the occurrence of these variables is during the period of observation,
- Qualitative analysis of data collection from developed survey, in order to reach a higher reliability of findings,

- Cross-case analysis of the quantitative and qualitative data collections, which findings showed that the antecedent causes of the observed phenomenon can be identified to predict an outcome of the project portfolio governance processes, and
- Analyses findings, where agile factors influenced reducing the risks, balancing the changes, and ensuring more efficient and effective governance of a project portfolio.

3.2 Case and Survey Studies Analysis Factors

This research examined, as determined before, the viability of agile and lightweight methods usage within the governance framework and its processes. The examination considered the effects of different agile factors having impact on related governance domain processes, resulting in the conclusion on using a specific agile, lightweight or hybrid (tailored) methodology for the development of the agile governance framework. Therefore, eight most used and applied agile methods were analyzed with regard their attributes and factors conforming the governance domain processes. The following factors derived from literature review were considered during the analysis:

- | | |
|--|--|
| 1 - Alignment with organizational objectives | 11 - In-context collaboration |
| 2 - Organizational value creation | 12 - Risks adaptation and orchestration |
| 3 - Response to change | 13 - Incremental process change |
| 4 - Alignment of business goals | 14 - Development intelligence |
| 5 - Decision making | 15 - AgileEVM ⁵ (Sulaiman et al., 2006) |
| 6 - Participative alignment | 16 - Continuous delivery |
| 7 - Real-time planning | 17 - Continuous improvement |
| 8 - Regulation, standards, and procedures | 18 - Team dynamic |
| 9 - Lifecycle traceability | 19 - Build the right thing |
| 10 - Project management | 20 - Increase of benefits and sustainability |

The matrix listing the above agile and lightweight factors impacting the governance domain processes, derived from the literature review, is enclosed in the below Table 3.1.

⁵ AgileEVM or Agile Earn Value Management. EVM is a quantitative project measurement technique used to evaluate and predict project performance vs. plan.

Table 3.1: Agile factors impacting the project portfolio governance processes

<i>Factors</i>	<i>Governance processes</i>	
Alignment with organizational objectives	Front-End	Initiation
Organizational value creation		Justification
Response to change		Adaptation
Alignment of business goals		Alignment
Decision making		Approval
Participative alignment	Planning	Strategic planning
Real-time planning: plans fully integrated with project execution		Operational planning supervision
Minimum reasonable set of regulation, standards, and procedures		Regulation (set principles, policies and ethics)
Lifecycle traceability		Accountability identification
Project management in continuous process improvement		Leadership
In-context collaboration	Monitoring	Strategic uncertainties
Risks adaptation and orchestration		Risks
Change distilment and incremental process change		Changes
Development intelligence (success metrics, tracking progress)		Control framework
Usage of metrics (AgileEVM)		Critical performance
Practice continuous delivery	Deliverables	Review of performance
Continuous refinement toward greater efficiencies		Financial review
Improvement of the team dynamic		Quality
Build the right thing		Deliverable review
Increase of benefits and sustainability		Benefits and values and review
Organizational value creation		Alignment with business goals

The case study analyzed data collections from the referent programs and projects and have used a probabilistic analysis in determining the risk variables with the most significant impact on the governance domain processes. The first data collection method was used for collection of quantitative parameters from the referent programs and projects being implemented during last more than ten years at the International Criminal Court, The Hague, The Netherlands, have used the evaluation and closure reports' elements for data collection, where the units of analysis are clearly defined and relevant for testing the research hypotheses. The units of analysis were composed from the following indicators:

Objectives and deliverables	Critical success factors (CSF's)
Development methodology	Key Performance Indicators (KPI's)
Governance	Project performance elements:
Project management elements:	- Performance vs. objectives and deliverables
- Planning and scoping	- Performance vs. CSFs
- Stakeholders management	- Performance vs. outputs
- Change management	- Performance vs. budget
- Risk management	- Performance vs. schedule

The program and project sources for the quantitative data collection are shown in the below Table 3.2:

Table 3.2: Program and project sources for the quantitative data collection

<i>Program</i>	<i>Implementation</i>	<i>Budget⁶</i>	<i>Project</i>	<i>Process Model Category</i>
Business Process Modeling / Reengineering	2003 – 2003 2006 – 2007 2008 – 2008	n/a	I - Administrative processes reengineering II - Judicial processes reengineering III - ICT Services delivery and support processes reengineering	Tailored – Agile Tailored – Agile Tailored – Agile
ERP system	2004 – 2005 2005 – 2006 2005- 2006 2006 – 2007 2006 – 2008 2008 – 2009 2009 – 2011	€ 12 million	I - SAP FI/CO, FM, MM - Finance/Controlling, Funds Management, Material Management II - SAP HRM - Human Resources Management, Payroll III - SAP TM - Travel Management IV - SAP PS - Project System or Management Information Restructure V - SAP BW/BI, EP, XI - Business Warehouse/Business Intelligence, Enterprise Portal, Exchange Infrastructure VI - SAP EH&S - Environment Health and Safety VII - SAP GM - Grants Management	Prescriptive - ASAP ⁷ Prescriptive - ASAP Prescriptive - ASAP Evolutionary - ASAP Evolutionary - ASAP Prescriptive - ASAP Prescriptive - ASAP
Judicial ERP System	2006 – 2007 2007 – 2008	€ 5 million	I - Core Services, Situation and Cases, Translation, Court Services, Detention II - Document Management, Victims/Witnesses, Interpretation, Integration	Agile – DSDM Tailored – CSPI ⁸
Business Continuity Management	2009 – 2010 2010 – 2011 2011 – 2013	€ 1 million	I - Business Impact Analysis, IT Risk Analysis II - IT Continuity Framework III - ICT Disaster Recovery Planning	Tailored – CSPI Tailored – CSPI Tailored – CSPI

(ICC ICT ERP, eCOS, BCM project documentation, 2003-2013)

The selection of the portfolio of referent programs and projects⁹ for the collection of quantitative data were measured, have been made based on the following criteria:

- The process model categories of the components (projects) include methodologies (agile, tailored agile, prescriptive, evolutionary) with attributes which shall contribute to the referent factors’ analysis and modeling of the governance processes,
- The selection of portfolio components, consisting of 28 projects as constituent part of five different program, through their strategic objectives, organizational changes as consequence of their implementation, particular life-cycles and deliverables, interrelate with the governance process domains which has been researched,
- The data was built through the case study design in Chapter 4. A case study design is useful for this research since case studies are considered as an empirical tool used to investigate a singularity of a real-life context with in depth analysis and cause-and-effect relationships, and finally, hypothesis test.

The second data collection method is to utilize the research survey as the contiguous qualitative data collection about the research subject. The survey design criteria with respective elements are part of the Chapter 5. The survey study analysis and its results was confronted to the findings from quantitative analysis in order to perform the cross-case analysis, followed by the final findings with discussion and conclusions.

⁶ Program budget is provided as a projected value due to confidentiality reasons

⁷ ASAP or Accelerated SAP is the SAP implementation methodology, aligned with the industry standard for project management process and guidelines – PMI PMBOK. ASAP supports project, process, application, and value lifecycles

⁸ CSPI (Composite Model of Structural and Process Integration), tailored process model introduced by the author in 2008.

⁹ The author of this research was responsible for the implementation of this referent project portfolio, contributing to the benefits and values delivery from these endeavours

3.3 Design of Case and Survey Studies Analysis

As emphasized in the Chapter 1.3, the quantitative data collection elements were developed at the case study design stage. The data elements were retrieved and built from the referent project portfolio data source. The data collection and their attributes addressed the agile method's factors impacting the governance domain processes. The probabilistic analysis was applied to that data collection, which constitute a system with a large number of possible events, expressing the probability of a given number of events occurring in a fixed interval of time if the events (uncertainties/risks during the portfolio component life-cycle) occur with a known average rate and independently of the time since the last event, providing a certain spread for a period of observation. If these elements (internal and external risk variables) impacting the processes or mix of processes producing the event flow are essentially random, the analysis shall specify how likely is the occurrence of conjoint factors during the period of observation, predicting the degree of spread around a known average rate of risks occurrence. A stratified sampling technique was used for a selection of referent portfolio components, where the entire target population is divided into different strata based on the components life-cycle. The selection was retained based on the risk's occurrence in all observed strata, and significance of risks variables critical to quality characteristics of considered portfolio components. Upon ranking the portfolio risks based on conjoint factors and their prioritization, development of the model and probability distribution analysis commenced.

The analysis identified connections between observations and input model, relationship between input and output variables, and identified risk factors with the most impact on project portfolio. The analysis findings identified, evaluated, and provided the insight into the best concept of the portfolio framework processes' governance, and confirmed the set hypotheses. As an important result, the risk variables with the highest impact on governance processes were determined, constituting the input for the risk optimization process and development of the risk corrective measures.

3.3.1 Approach to the Quantitative Data Collection Analysis

The aim of projects is to return more in financial resources than they absorb, and for the reason of these expected results business executives and project sponsors who charter projects and invest in their success are willing to accept some risk brought by these projects to the investors. Business value is therefore the motivator for projects, and the expected results from projects support directly the objectives and strategies that corroborate the project delivery value models (risk-adjusted returns as either net present value, economic value add, or earned value). Project

and program managers develop corresponding scope statement and resources estimate which is often less than available investment, opening a gap between project capability (quadruple constraints – scope, cost, time, and quality) and value demands from the business. This gap represents the risk value which must be managed by the project/program manager in order to balance project resources, scope, and schedule estimates with expectations, addressing the following project equation:

$$\text{“Value delivered from resources invested = project capability and capacity plus risk taken”}$$

(Goodpasture, 2003).

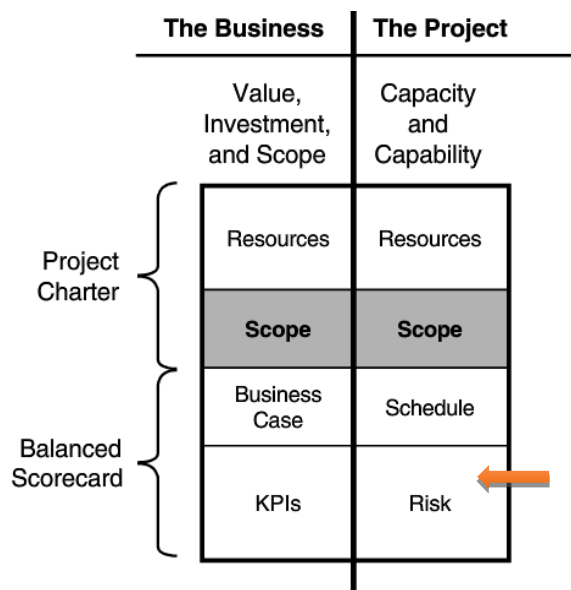

Figure 3.1: Business Model and Project Balance Sheet (Goodpasture, 2003, p. 22)

Figure 3.1 shows integration of the business value model and project balance sheet, where the business model determines the value and investment to which the project must be matched, employing risk as the equalizer (Goodpasture, 2003). The project side of the balance sheet represents capability and risk of successful delivery. In order to address a gap between the project capabilities (scope, schedule, cost, resources, and quality) and values on the business side, a project manager must

manage risks to balance estimates (requirements and expected values) on the business side.

By definition, a project risk is an uncertain event or condition that, if it occurs, has a positive or a negative effect on a project’s objectives (PMI Practice Standard for Risk Management, 2009). The definition includes two dimensions of risk to be considered: *uncertainty*, which may be described as *probability*, and *the effect* on a project’s objectives may be considered as *impact* (or it is possible using other descriptors, such as *likelihood* and *consequence*). A structured description of a risk separates cause, risk, and effect at the following meta-level (ISO 31000:2009 Risk Management – Principles and guidelines, Terms and definitions (2.17, 2.18), 2009):

As a result of [*existing condition*],
 [*uncertain event*] may occur,
 which would lead to [*effect on objectives*]

Existing condition clause represents present condition; uncertain event represents uncertain future, while the third condition represents conditional future. If a project risk is pondered as

undesired event that may cause delays, excessive costs, unsatisfactory project outcomes, environmental or safety hazards, or even complete failure, then indeed the awareness to project risks and the need to manage them as an encompassing process throughout the project life cycle, is the requisite. Therefore, the risk management activities are added to project/program plans as one of the knowledge areas (PMI's PMBOK, Association for Project Management – APM, UK), supported by either standard (ISO 31000¹⁰), practice standards (PMI Practice Standard for Risk Management, 2009), or guides (Project Risk Analysis and Management Guide – PRAM, APM), where the project risk management is viewed as an encompassing, project or program life-cycle process.

Organizations and stakeholders perceive risk as the effect of uncertainty on projects and/or programs and organizational objectives, building their risk attitudes based on a number of factors classified into three themes (PMBOK, 2017): as a degree of uncertainty willing to take on (*risk appetite*), or as a degree of risk they can withstand (*risk tolerance*), or as the measures along the level of uncertainty - the level of impact at which a stakeholder may have a specific interest (*risk threshold*).

Project or program risk management is the systematic process of identifying, analyzing and responding to project risk, and includes conducting the following risk management processes (PMBOK, 2017):

- *Planning risk management* is the process of how to conduct risk management activities for a project. It is important to provide sufficient resources and time for risk management activities and to establish an agreed upon basis for evaluating risks, a baseline or current state of risk-affected areas including scope, schedule, and cost. Risk planning includes analytical techniques such as a stakeholder risk profile analysis to grade and qualify the stakeholder risk appetite and tolerance, strategic risk scoring sheets to provide a high-level assessment of risk exposure of the project/program, and expert judgment to ensure a comprehensive establishment of the risk management plan,
- *Identifying risks* is the process of determining which risks may affect the project and documenting their characteristics, with the aim to expose “all” knowable risks. Common risk identification techniques include brainstorming/workshops, prompt lists, interviews, questionnaires, and other techniques such as document reviews, Delphi groups, diagramming techniques (risk concept map – influence diagram – precision

¹⁰ ISO 31000 is intended to be a family of standards relating to risk management codified by the International Organization for Standardization

tree). The problem with common techniques is that they tend to be threat-focused. The remedy is using specific “two-dimensional” techniques which treat both threats and opportunities, such as SWOT analysis¹¹, Assumption and Constraints analysis¹², or Force Field analysis¹³,

- *Qualitative risk analysis* is the process of prioritizing risks for further analysis or action by assessing and combining their probability of occurrence and impact. The aims of qualitative analysis are to describe and assess risks unambiguously and objectively, evaluate both probability and impacts, prioritize and record key risks, and allow development of effective strategies. Probability-Impact matrix¹⁴ is the technique used for qualitative analysis. Risk data is recorded in a risk register, a structured document consisting a risk cause and description, probability, impacts, timing, preliminary responses, and the owner,
- *Quantitative risk analysis* is the process of numerically analyzing the effect of identified risks on overall project objectives. The aims of quantitative analysis are to quantify combined effects of risks, predict likely outcomes, and identify options (how to respond) in priority areas. In general, it uses two method arrays: 3-point estimate for affected activities, and discrete risk modelling using stochastic branch for opportunities (probabilistic) to assess spread (uncertainty), expected value (mean), chance of achieving targets/milestones, confidence levels, and to identify and assess alternatives;
- *Plan risk responses* is the process of developing options and actions to enhance opportunities and to reduce threats to project objectives, and
- *Control risk* is the process of implementing risk response plans, tracking identified risks, monitoring residual risks, identifying new risks, and evaluating risk process effectiveness throughout the project.

The aim of the quantitative risk analysis process is to analyze numerically the probability of each risk and its consequence on project objectives, as well as the extent of overall project risk. This process uses simulation techniques and decision analysis to determine the probability of

¹¹Strengths, Weaknesses, Opportunities and Threats analysis is a basic model that assesses what an organization can and cannot do as well as its potential opportunities and threats by taking the information from an environmental analysis and separate it into internal (strengths and weaknesses) and external issues (opportunities and threats).

¹²Assumptions are factors believed to be true, but not confirmed, and may reflect an understanding of how desired outcomes are likely to be achieved. Assumption is a response to future uncertainty. Constraints are defined as restrictions or limitations to future action or on possible solutions. Analysis identifies and lists assumptions and constraints (implicit and explicit), assesses instability and sensitivity, and converts into risks (usually threats) if unstable and/or sensitive.

¹³Force field analysis is the change management tool and a decision-making technique which helps making a decision by analyzing the forces for and against a change, and it helps communicating the reasoning behind a decision-making. Analysis identifies and assesses restraining and driving forces, identifies risks, and determines actions (unfreeze/change/freeze).

¹⁴Probability-Impact (P-I) analysis uses agreed project-specific scales (usually 3x3, 4x4, or 5x5 – Low/Med/High, or VLO/LO/MED/Hi/VHI), depending on stakeholder risk thresholds. It defines scales, then rank each risk in both dimensions (probability/impact), determine "size" and relative importance of risks (Red=urgent, Yellow=monitor, Green= OK) for both threats and opportunities. P-I scoring system (P x I) includes linear scores on probability and non-linear (exponential) on impact.

achieving a specific project objective, quantify the risk exposure for the project and determine the size of cost and schedule contingency reserves that may be needed, identify risks requiring the most attention by quantifying their relative contribution to project risk, and identify realistic and achievable cost, schedule, or scope targets. The quantitative assessment stage of the process can be performed by assigning numeric values to the probability and impact of each risk, either by using empirical data or by quantifying qualitative assessments such as ‘high, medium or low’ likelihood of occurrence using a percentage, and a 3-point estimates (best case, most likely, worse case) for potential impact. A typical quantitative project risk analysis is usually referred to as a risk register.

There are several limitations to this deterministic risk register approach because it considers only three discrete scenarios giving equal weight to each 3-point estimate without the assessment of the risks’ interdependence and likelihood of each outcome, as well as the impact on the project plan’s targets. Probabilistic analysis, compared to a deterministic risk register approach, specifies a probability distribution for each risk and then considers the effect of risk in combination.

If a project is observed as a sample space, consisting from sample events (congruent set of successive activities), where each event is a set of sample points (particular activities), then a probability measure can be assigned to the events. This collection of a sample space can be denoted by the symbol Ω , and an object in a sample space, denoted ω , is called a sample point. Each sample point corresponds to a possible outcome of a real-world experiment, and each outcome of the experiment corresponds to exactly one member of the sample space (Kobayashi, Turin, 2011). Therefore, a sample space can be defined as:

$$\Omega = \{\omega_1, \omega_2, \omega_3, \omega_4, \dots, \omega_n\} \quad \text{where } \omega : 0 < \omega \leq n \quad (1)$$

or

$$\Omega = \sum_{i=1}^n \omega(i)$$

The sample point (particular activity outcome) could be anywhere between 1 and a definite sample point number, corresponding with the sample space (project start/end conditions) or event constraints (project stage or the set of project successive activities). An event A is the set of all sample points ω , where certain conditions on ω are satisfied, and therefore a subset of Ω . It is defined by the expression (Kobayashi, Turin, 2011):

$$A = \{\omega : \text{certain conditions on all } \omega \text{ are satisfied}\} \quad (2)$$

A probability measure is an assignment of variables to the events defined on Ω . The probability of an event A is denoted by $p[A]$ (Kobayashi, Turin, 2011):

$$p(A) = n(A)/n(\omega) \quad \text{where } p(A) = \text{probability of event A} \quad (3)$$

$$n(A) = \text{number of times A occurs in the population}$$

$$n(\omega) = \text{number of sample points in the population}$$

Risk, as an uncertain event, represents a random occurrence, because it is possible predicting it in advance from previous situations or experiments, and roughly what will happen, but not exactly what will happen. Although it is not possible predicting *exactly* what will happen, it is possible to find experimentally that certain average properties do exhibit a reasonable statistical regularity (Kobayashi, Turin, 2011). Risk denotes a discrete random variable, or a real-valued function $R(\omega)$ defined on a sample space Ω of points ω , where the range of the function $R(\omega)$ consists of isolated points on the real line, meaning that R can take on only a finite or countable number of values $\{x_1, x_2, x_3, \dots, x_i\}$. The probability distribution $F_R(x)$ of the discrete random variable R is a complete set of probabilities $\{p_R(x_i)\}$ associated with the possible values x_i of R . This function is often called cumulative distribution function:

$$F_R(x) = \sum_{x_i \leq x} p_R(x_i) \quad (4)$$

Random variables are useful in projects when counting discrete events, such as resources (people, physical and tangible objects). The requirement for all values of the discrete random variable is that the sum of their all probabilities of occurrences equals 1. Random variables can be continuous over a range, i.e. their value flows continuously from one to the next. The examples of continuous random variables in project management are the actual cost range of a work breakdown structure work package, schedule duration range, and lifetime ranges of tools, facilities, and components. Cumulative probability functions, or accumulating probability of an event happening, are useful in project management since the maximum cumulative probability is 1 (for instance, a project manager can declare that there is a certainty with probability 0.7 that the schedule will be 15 weeks or shorter, or with probability 1 that the schedule will be shorter than x weeks).

Probability distributions represent the uncertainty in values such as duration of schedule activities and costs of project components (PMBOK, 2017). Numerical measures of processes and systems have an inherent characteristic, which follows the probability distributions determined by the process measure relying on independent accumulated data values. A numerical measure of the system is likely to occur a certain number of times if the system

process is repeated in the long term. The metrics of uncertainty is captured in a probability distribution (Gera, 2011).

According to PMI’s PMBOK Guide (2017) and Goodpasture (2003), the four common continuous probability distributions are used in project management depicting shapes that are compatible with the data typically developed in building a project risk model and during the quantitative risk analysis. These are *normal*, *beta*, *triangular*, and *uniform*. These distributions are determined by two shape parameters; the horizontal axes (X) represent possible values of a random variable (such as time or cost), and the vertical axes (Y) represent probability, a relative likelihood. The other probability distributions, such as *lognormal (or Pareto)*, *discrete*, *Poisson*, and *exponential*, are used as well in estimating statistical parameters relevant to projects.

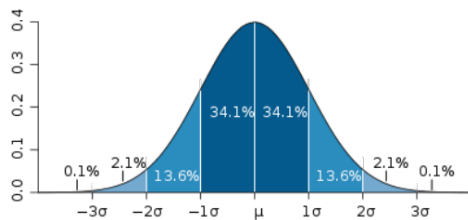

Figure 3.2: Normal distribution (Gera, 2011)

The underlying process for a normal distribution is an accumulation process, meaning whenever an outcome is the sum (or average) of the outcomes of a number of different or the same uncertain quantities, the probability distribution of the outcome is

frequently a normal distribution, as depicted in Figure 3.2 (Gera, 2011). About 68% of values are within one standard deviation σ away from the mean; about 95% of the values lie within two standard deviations; and about 99.7% are within three standard deviations. This is known as the 3-sigma rule. The user defines the minimum and maximum value range, making this distribution the simplest of distributions in terms of the underlying process. This distribution is the least confident available and should be reserved for risks where users don’t know the potential impact.

The beta distribution along with the triangular distribution is used in project management to model distribution of values within the range of the three estimates (PMBOK, 2017). For this reason, the beta and triangular distributions are used extensively in PERT (Project Evaluation and Review Technique), CPM (Critical Path Method, JCSM (Joint Cost Schedule Modeling) and other project management/control systems to describe individual events, such as the time to completion and the cost of a task, costs, durations, resource commitments, and wherever there are unequal optimistic and pessimistic possibilities. Computations are used to estimate the distribution’s mean and standard deviation. The user defines the minimum, most likely, and maximum impact of a risk or uncertainty, similar to the deterministic approach (3-point

estimates). The values around the most likely have a higher relative probability compared to those in the area around the minimum and maximum values.

The uniform or rectangular distribution is a distribution that has constant probability, with all values having an equal chance of occurring. If each value in a range has an equally likelihood of being generated by a process, then a uniform distribution can accurately describe the likelihood of getting individual outcomes.

The Poisson distribution is one of the distributions used in project management for counting the random arrival or occurrence of an event in a given time, area, distance, etc. An example of such counting process includes the number of change requests, or risks that a project encounters per period of observation – interval (quarter, year), and it is generally Poisson distributed. The Poisson distribution has a parameter, λ , for arrival rate. As λ becomes large, the Poisson distribution is approximately normal with $\mu = \lambda$ (Gera, 2011). If the average number of occurrences per interval is large, the normal distribution gives us a good approximation of the Poisson probabilities. The deviation of a Poisson distribution is equal to the square root of m , the normal distribution mean, if the average number of occurrences per interval is large, where the normal distribution provides a good approximation of the Poisson probabilities. The usage of the Poisson distribution in project/program management is in determining the number of times an event occurs during the given period of observation.

The most common form of probabilistic analysis in project management that uses sampling techniques is Monte Carlo simulation. It is used, for example, if an organization compares its projects with similar projects of other organizations in order to avoid systematic errors in data conditioning, ensuring that the bias is well controlled. According to Raydugin (2013), this method relies on the random sampling of data based on an assumed data generating process (DGP), called iterations that can be done many times – the minimum industry standard is 1000 iterations. Each of the iterations is fully deterministic in multiple sampling of uncertainties as inputs for the mathematical models to get information about possible overall project cost and schedule uncertainty. The key value of the Monte Carlo method is the capability to mimic or imitate data statistically for relevant projects, providing advantages over 3-point deterministic analysis in:

- Probabilistic analysis, showing how likely each outcome is,
- Sensitivity analysis, showing the assessed amount of involved project risk by identifying components of a project, or risk exposure factors, that when changed will most impact the outcome of a project. It calculates the impact of variations on different

quantifiable components and identifies potential risk susceptibilities, perceiving which risks have the biggest effect on baseline results,

- Regression analysis, in modeling, estimating and analyzing the relationships between a dependent variable and one or more independent variables, providing analysis estimates of the conditional expectation of the dependent variable given the independent variables (Raydugin (2013)). This analysis is used in prediction and forecasting, such as in Six Sigma allowing predictions to be made based on the presence of a linear relationship between the two variables. Another example of the regression analysis is estimating the relationship among variables that cause fluctuations in project budget outcomes by assuming the budget as dependent variable, and resource skills, availability, and cost as independent variables, looking to see the expectation of achieving the budget based on changes in each independent variable,
- Correlation of risks, showing the interdependence of risks, so when a particular risk occurs, the probability or impact of others goes up or down accordingly, and
- Graphical analysis, for the purpose of communicating findings to stakeholders.

The outputs from Monte Carlo analysis simulate project results while accounting for the variability in the inputs, optimize process settings, identify critical-to-quality factors, and finds a solution to reduce defects.

3.3.2 Quantitative Analysis Development

This Chapter considers outlining the requirements for designing and development of quantitative analysis.

1. Main goals of quantitative analysis

The primary goal of this case study is to investigate which Agile, lightweight method or a hybrid (tailored) form is best suited for the development of organizational project portfolio governance frameworks and their constituent governance domain processes. The analysis identifies, evaluates, and provides insights of findings of the best-fit concept to be applied at the different process stages of the project portfolio governance model, and demonstrates the probabilistic modeling for hypotheses testing and confirming. This includes development of the risk management system from the referent project portfolio data source including deterministic and probabilistic quantitative methods, sensitivity and regression analyses, what-if scenario development, and assessment of the accuracy ranges of costs and schedules distributions. Key points of deterministic risk analysis were reiterated to accentuate the

integration of deterministic and probabilistic methods. The conclusions and recommendations were based on the results produced by both deterministic and probabilistic methods.

2. Steps in analysis preparation

The premise for the probability distribution analysis comes from the specified deterministic quantitative method - risk registers of the referent project portfolio's data sources. Risk management techniques and uncertainty identification used in creation of risk registers during the considered projects/programs life cycles established a fundamental connection between the RBS (Risk Breakdown Structure), a common way to structure risk categories (PMBOK, 2017), and the three dimensions of the risk management reflected into the RBS:

- Vertical integration of the work packages and project levels,
- Incorporating project's external and internal environments, and
- Relations amongst projects' stakeholders (owners, steering committees, vendors, contractors, internal teams).

The purpose of RBS utilization was in introduction of major sources of risks, utilized for portfolio management to include all its constituent components.

Consolidated risks affecting project portfolio, presented in the cause-effect diagram, are shown in Figure 3.3.



Figure 3.3: Project Portfolio Risks (ICC ICT ERP, eCOS, BCM project documentation, 2003-2013)

The structure of risks impacting referent project portfolio is composed from inherent (or organizational, strategic) risks, and acquired risks, coming from the portfolio components – projects. Therefore, as considered by the author, every portfolio risk R_p is an element of the natural join of the inherent risk (R_i) and acquired risk (R_a) relations, and if the probability of R_p occurrence is true then it is also true for the set of all combinations of data structures in R_i and R_a risks that are equal on their common attributes:

$$\forall R_p \in P(R_i \bowtie (R_a)) \quad \text{where: } \begin{array}{l} R_p = \text{portfolio risk} \\ R_a = \text{acquired risk} \\ R_i = \text{inherent risks} \end{array} \quad (5)$$

$$\forall R_g \in |R_p| \wedge R_g \Rightarrow |R_i| \bowtie |R_a| \quad \text{where: } \begin{array}{l} R_g = \text{governance risk} \\ R_p = \text{portfolio risk} \\ R_i = \text{inherent risk} \\ R_a = \text{acquired risk} \end{array} \quad (6)$$

Every governance risk R_g is an element of the set R_p (portfolio risk), and if R_p is true then R_g is also true and joined to overall governance risk. The common attributes of the R_g would then constitute the following data structures in R_p :

$$|R_g| = \left\{ \begin{array}{l} |R_{sp}|, |R_{sp}| \geq 0 \\ |R_{om}|, |R_{om}| \geq 0 \\ |R_{bp}|, |R_{bp}| \geq 0 \\ |R_{ch}|, |R_{ch}| \geq 0 \\ |R_s|, |R_s| \geq 0 \\ |R_{sc}|, |R_{sc}| \geq 0 \\ |R_c|, |R_c| \geq 0 \\ |R_q|, |R_q| \geq 0 \\ |R_{pr}|, |R_{pr}| \geq 0 \\ |R_{rc}|, |R_{rc}| \geq 0 \\ |R_{ch}|, |R_{ch}| \geq 0 \end{array} \right. \quad \text{where: } \begin{array}{l} R_{sp} = \text{strategic planning risk} \\ R_{om} = \text{org. structure and} \\ \quad \text{managerial risk} \\ R_{bp} = \text{org. business process risk} \\ R_{ch} = \text{change risk} \\ R_s = \text{(component) scope risk} \\ R_{sc} = \text{schedule risk} \\ R_c = \text{cost risk} \\ R_q = \text{quality risk} \\ R_{pr} = \text{process risk} \\ R_{rc} = \text{resource risk} \end{array} \quad (7)$$

The analysis phase uses statistics to discover relationship between projects' performance and process inputs in order to determine what are the root causes or drivers of the improvement effort and establishment of the reliable hypotheses' tests. The preparation appropriated the following steps (Kobayashi, Turin, 2013; Goodpasture, 2003; Raydugin, 2013):

- Design of the high-level process map / workflow,
- Project representatives' data stratification. The strata consist traditional (prescriptive), agile, tailored, and lightweight project representatives, being the source of the process to obtain data – common project portfolio risk factors,
- Prioritizing, weighting, and ranking the common project portfolio risk factors with a definition and specification of the process inputs to probabilistic models,

- Development of the analysis model for the case study, with specification of inputs and outputs for quantitative probability method which is based on stratified input parameters,
- Integration of deterministic and probabilistic quantitative methods through the risk analysis workflow,
- Monte Carlo technique based on random sampling of data (iterations),
- Control the variability to perform regression and sensitivity analyses, and
- Parametric and non-parametric hypotheses test.

3. AgileEVM performance measurement

Earn Value Management (EVM) is, along with risk management, one of the leading and most effective performance measurement and decision support techniques. Both EVM and risk management offer powerful insights into factors affecting project performance and should be applied in an integrated way across the organization. EVM examines past performance against clearly-defined quantitative metrics and uses these to predict the future outcome for the project. Risk management looks ahead to identify and assess uncertainties with the potential to affect project performance either positively or negatively and develops responses to address each risk proactively (Kendrick, 2009). Integrated, those two techniques provide a compelling framework for managing change on a project, based on a realistic assessment of both past performance and future uncertainty.

EVM provide organizations with the methodology needed to integrate the management of project scope, schedule, and cost, enabling the closure of the loop in the plan-do-check-act management cycle. The EVM methodology helps identify where problems are occurring, whether the problems are critical or not, and what it will take to get the project (or portfolio component) back on track. EVM implementation can be scaled along the dimensions of granularity and frequency to achieve the degree of rigor required by the uncertainty of the project. Figure 3.4 shows a notional model of the “risk-rigor” relationship (PMI Practice Standard for Earned Value Management, 2005). The EVM requires the recording of resource utilization for the activities performed within each of the activity elements. These captured elements are compared with the performance measurement baseline using the selected earned value measurement techniques. Thus, the earned value data (i.e. planned value from the performance measurement baseline, actual cost data from the component cost tracking system) allows performing the EVM analysis at the control account or other levels of the component breakdown structure.

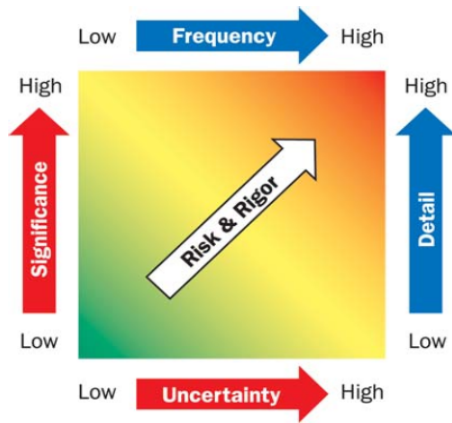

Figure 3.4: EVM as a Function of Project Risk (PMI Practice Standard for Earned Value Management, 2005, p. 4)

The key practice of the EVM include establishing a performance measurement baseline (decomposing activities scope to a manageable level, select EV measurement technique), and measuring and analyzing performance against the baseline. The three basic elements construct the EVM: planned value (PV) or budgeted cost of work scheduled (BCWS), earned value (EV) or budgeted cost of work performed (BCWP), and actual cost (AC) or actual cost of work

performed (ACWP). The fourth data point, budget at completion (BAC) is the final data point on the performance measurement baseline. EVM examines as well the (PMI Practice Standard for Earned Value Management, 2005):

- Variances - schedule (SV), cost (CV), and variance at completion (VAC),
- Indices – schedule performance index (SPI), cost performance index (CPI), and to-complete performance index (TCPI), and
- Forecasts – time estimate at completion (EAC_t), estimate at completion (EAC), and estimate to complete (ETC).

Below Figure 3.5 shows the relationship among the basic EVM performance measures.

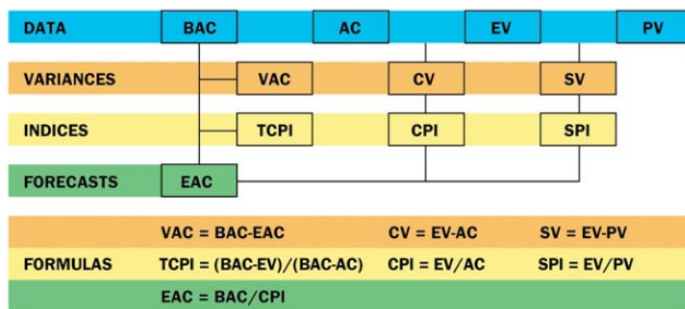

Figure 3.5: EVM Performance Measures (PMI Practice Standard for Earned Value Management, 2005, p. 16)

Table 3.3: AgileEVM definitions

Name	Definition
PRP	Planned Release Points
RPC	Release Points Completed
APC	Actual Percent Complete of Release. This is the ratio of Points completed to Points planned
PPC	Planned percent complete

(Sulaiman et al., 2006)

In comparison with the requirements of traditional EVM, AgileEVM

leverages work items that are integral to the agile (Scrum) process. Progress at the end of each sprint is measured when actual sprint velocity and actual costs are known. Traditional EVM performance measures are compared to AgileEVM performance measures in five key data points, as shown in the below Table 3.4 (Sulaiman et al., 2006):

Table 3.4: Comparison of EVM – AgileEVM performance measures

<i>Performance Measurement Baseline (PMB)</i>	
Traditional EVM	The sum of all work package schedule estimates (duration and effort)
AgileEVM	Total number of story points planned for a release (PRP)
<i>Schedule Baseline - often integrated in PMB</i>	
Traditional EVM	The sum of all work packages for each time period calculated for the total duration
AgileEVM	The total number of planned sprints (PS) multiplied by sprint length
<i>Budget at Complete (BAC)</i>	
Traditional EVM	The planned budget for the release or project
AgileEVM	The planned budget for the release
<i>Planned Percent Complete (PPC)</i>	
Traditional EVM	What % complete did we expect to be at this point in the project? Can be a subjective estimate, or a calculation of the monetary value of the cumulative tasks planned to be complete by this point in time divided by the performance baseline
AgileEVM	The number of the current sprint (n) divided by the total number of planned sprints (PS).
<i>Actual Percent Complete (APC)</i>	
Traditional EVM	The monetary value of work packages actually completed divided by total monetary value of the budget at complete.
AgileEVM	The total number of story points completed (potentially shippable increments) divided by the total number of story points planned.

(Sulaiman et al., 2006)

The correlation of AgileEVM and the EVM metrics is in the following (Sulaiman et al., 2006):

- Schedule forecasting using agile (Scrum) compared to EAC using EVM,
- Mean velocity predictions compared with release date estimates using EAC, where mean velocity is used to:
 - Define the equation of a release date, and
 - Determine iterations left,
- Deriving a release date based on EAC,
- Validating the correspondence of the projected release dates by comparing mean velocity and EVM analysis.

The elements of the AgileEVM measurement have been focused on the agile representatives of EVM variances (CV and SV), indices (CPI, and SPI), and forecast (EAC). Release date estimates using the EAC calculations correlate to mean velocity predictions provided by agile (Scrum), so EVM technique, AgileEVM, can be used on agile projects to calculate EAC with equal precision to the traditional plan-driven projects (Sulaiman et al., 2006).

3.3.3 Qualitative Data Collection Analysis

The qualitative data collection was harvested from the developed electronic survey conducted via Internet. For this survey Google Forms (Google Forms, viewed 5 June 2013, <<https://docs.google.com/forms>>) services were used because of the service's reputation and because the Google Forms is among world's leading online survey tools (Whinot, viewed 5 June 2013, <<http://whinot.com/blog/2012/4-online-survey-tools-which-one-is-best-for-you/>>) Despite the fact that the Google Forms is a relatively new survey service (in comparison to SurveyMonkey, for instance), since its inception the Google Forms offers an accessible way to collect large amounts of data, and an unlimited amount of surveys and space for over 1,000 responses. The service is being upgraded in Google Docs, adding new features for pre-populating forms, collecting data and gathering responses for group questions.

The survey's questionnaire was distributed to the respondents via e-mail with the survey's hyperlink enclosed at the e-mail's body. The survey was sent to a selected pool of project/program and portfolio professionals, experts and academics working and/or researching in these domains in order to reduce the threat of a sample bias, a situation where a sample is collected in such a way that some members of the intended population are less likely to be included than others, producing a biased or non-random sample in which all individuals, or instances, were not equally likely to have been selected (Sampling bias, viewed 9 August 2013, <http://en.wikipedia.org/wiki/Sampling_bias>) and to reach a higher reliability of findings.

The structure and the survey study sections are further elaborated in the Chapter 5.

3.3.4 Cross-Case Analysis

Cross-case analysis is a qualitative method used in social science with the aim of producing more objective and reliable findings since case study research, as an interpretive method, has potential limitations in the analysis of evidence, objective reporting and lack of generalizability. Researcher bias can lead to a lack of precision, with the investigation either dismissing certain patterns or identifying non-existent ones (McGuiggan, Lee, 2008).

The case and the survey studies provided collections of analyzed data, allowing the process of building a specific theory about addressing the research questions for each case. In order to shift the layer of abstraction and to embed the logic of generalization, the cross-case qualitative analysis have been used with the aim of establishing a common or universal relationship between the analysis's factors of the observed phenomenon.

The technique of analytical induction - a strategic group mapping technique (McGuiggan, Lee, 2008) was applied, where the both cases were examined by leveraging the phenomenon through cause-and-effect model to identify the antecedent causes (independent variable) of an observed phenomenon (dependent variable), testing (and reformulating if necessary) the hypotheses until a universal relationship is established.

The findings from the cross-case analysis showed that the antecedent causes of the observed phenomenon (the influence of the considered agile factors on governance processes) can be identified to predict an outcome (the influence and effects of the internal and external risk management variables).

4 CASE STUDY

The primary focus of this research is to actualize the case study strategy as the main data collection method, as it tries to investigate a phenomenon within a real-life context, i.e. particular context within the referent portfolio of implemented projects and programs for collection of quantitative parameters, and how that context is influenced. The aim of the case study is the probabilistic analysis based on stratified sampling of variable risks factors, which is conducted with the aim of determining the behavior of the agile structured governance processes. As emphasized in Chapters 3.2 and 3.3, the quantitative data collection factors development took place at the case study design stage.

The primary advantage of a case study is that it provides much more detailed information than what is available through other methods, such as surveys (Neale et al., 2006). Case study also allows presentation of data collected from multiple methods such as document review, interviews, surveys, and observation. The case study limitations are that it can be lengthy, so a structure has to be embedded; a case study could lack rigor due to bias in findings, so a systematic approach shall be applied in data collection, ensuring data validity at the same time; and already mentioned generalization or overgeneralization issue, which are addressed by the cross-case analysis.

4.1 Case Study Design Criteria

Case study design is useful for this research since in-depth investigation is needed for a phenomenon about which little is known (Paré, 2004). The purpose of empirical data sampling is to identify phenomenon that is relevant to the research question being investigated.

The case is constructed based on the guidelines provided by Paré (2004) and Neale at al. (2006) as shown in Table 4.1.

Table 4.1: Criteria for a Case Study Design

<i>Stage</i>	<i>Description Design</i>
Design of the study	Research question Prior theorizing Unit of analysis Number of cases Selection of cases Case study protocol
Conduct of the study	Plan data collection Develop methods and instruments Collect data Sampling strategies
Analysis of evidence	Dominant mode of analysis Reviews Cross-case analysis
Writing the case study report	Resonance criteria Rhetoric criteria Empowerment Applicability

(Paré, 2004; Neale at al., 2006)

4.2 Case Study Introduction

The case study is designed in order establish collection of quantitative parameters from the portfolio of referent programs and projects (see Table 3.2). The selection of four programs and their components (projects) represents a full process management life cycle of an organizational information ecosystem – from its inception, implementation, production until ensuring sustainability and recovery capabilities, and due to the impact on the organization being consequential and referent for the research.

a) Business Process Modeling / Reengineering Program

The Business Process Modeling / Reengineering (BPM/BPR) program has been undertaken in order to model and/or reengineer the core functional processes of an enterprise, so that the current (or new) processes may be analyzed, consolidated, integrated, and improved. The objective of the BPM¹⁵ program was to create a platform which will allow efficient business processes management of the judicial and administrative processes for the organization. The established platform shall integrate approved BPM processes from various organizational functional entities, based on which the core organization's information systems have been configured and implemented, analyze and optimize them in structured way and ensure that the changes and maintenance of functional organizational processes are done in the most effective

¹⁵ "Business process management is about giving organizations better visibility, agility and accountability over their core business processes", I. Ghalimi, chair of BPML.org

and cost preserving manner. The mapping of the organizational structures and processes was based on the QMS/DCS (Quality Management System/Document Control System), ISO 9000:2000 standards, and TQM modeling techniques. By extending the program's platform, the organization will be able to monitor, improve and optimize its core processes from one central database repository, ensuring its integrity and versatility.

A process-oriented approach applied to business processes implementation went beyond modeling and improving business processes. The information technology was used to support and implement organizational processes with ongoing improvements becoming ever more important. BPM allowed a flexible enough change management to cope with a rapidly changing organizational environment, and it is powerful enough to meet future process design requirements. Business process implementation therefore comprises the seamless realization of business processes in application software without loss of information. The established BPM system encompasses three capabilities: process integration, process automation, and process collaboration, respectively.

The process model category applied during the BMP program life-cycle belongs to agile tailored, despite the fact that the program inception was in the year 2003 when agile methodology was in its cradle, focused solely on software development and not very known to the professional, expert and/or academic communities. The attributes of the applied agile process model, as considered by the author, are shown in Table 4.2:

Table 4.2: BPM Agile-Lightweight Model Attributes

<i>Feature</i>	<i>Method - Agile Lightweight</i>	<i>Description</i>
Requirements definition	User stories	User stories consisted of users' legacy processes, and particular user's view on how functional processes should work, affecting prematurely only user's line of business. User stories mapping was done during the standing meetings
Planning approach	Rolling wave planning	Incremental planning in waves as the project proceeds and later details become clearer Feature ¹⁶ detail planning, feature breakdown structure (FBS) approach with features' lists Feature list completion
	Iteration planning	
	Release planning	
Scope control	Adaptive	Scope was expected to change and expand to meet users' needs
Execution	Iterative and incremental with continuous improvement	A feature was developed and released in three incremental steps during the stand-up meeting with the process owner, business analyst and project manager. The stand-up meeting tool included whiteboard with three

¹⁶ In agile development, a feature is a chunk of functionality that delivers business value. In this case, a feature is drafted business process, released for the review process and further incremental cross-referencing and integration.

<i>Feature</i>	<i>Method - Agile Lightweight</i>	<i>Description</i>
		A-3 format stickers corresponding with the iteration steps: <ul style="list-style-type: none"> - Step 1: methodology and technique/tool introduction (BPM, TQM modeling) - Step 2: first feature draft - Step 3: final feature draft (business process) ready for system entry, review and improvement
Project management approach	Adaptive	Emphasis on flexibility and adaptability to satisfy business need

(ICC ICT ERP project documentation, 2003-2011)

b) ERP System Program

The SAP mySAP Business Suite is the core administrative system of the organization. The SAP system implementation was one of the IT programs with the highest profile in the organization. The program objective was to install and utilize one common ERP system which will integrate and automate organizational administrative functions and contribute to the decision-making process through timely provided business information. SAP system supports and integrates financial and budgetary functions, centralized procurement, human resources and payroll, travel management, facilities management, project system, and business analytics. The implemented components of the SAP system were deployed for the organizational headquarters and field offices (via Citrix clients). The system performs services for 900 active users.

The process model category applied during the SAP program life-cycle belongs predominately to a prescriptive process model (SAP's ASAP method). A twosome of components' implementation acquired evolutionary model, with the characteristics of software prototyping and spiral modeling.

c) Judicial ERP System Program

The organizational application ecosystem supporting the core organizational business, e-Court, is composed from two structurally interrelated systems: In-Court systems for supporting court sessions, and systems for support the management of court's proceedings (Electronic Court System – eCOS), or judicial ERP system. eCOS is the application system suite internally developed based on the users' requirements and in accordance with organizational business entities' specifications, in cooperation with the development and implementation partners. The system is composed from integrated modules. The process model category applied during the development and implementation of the eCOS system was agile DSDM, and tailored agile – CSPI model, respectively (ICC ICT eCOS project documentation, 2005-2012).

d) Business Continuity Management Program

To be effective in recovering an organization's business operations the recovery process requires three integrated elements (ICC BCM/DR project documentation, 2009-2013):

- a. Crisis Management, the purpose of which is to communicate the situation to partners, senior stakeholders, and clients; assess the damage and declare (or not declare) a disaster, protect the reputation including managing the media; effectively communicate the situation to all personnel; provide finance and other resources for emergency logistics required; manage insurance support; and establish Recovery Command & Control (RC&C¹⁷) as the nerve center for recovery efforts,
- b. ICT Recovery, the purpose of which is to recover backup data and re-establish the current status of all files; provide support for remote workers; organize replacement staff if required; normalize help desk support; telecommunication support including telephony, email, Internet and social media; prepare secondary core computing facility for primary operations; provide support to business activities as they prepare for initiating recovery; manage recovery plans through RC&C so that recovery is achieved within RTOs¹⁸,
- c. Business Recovery, the purpose of which is to manage critical business activity workarounds and reconcile new data with electronically recovered files; manage staff accommodation logistics; track lost data and communicate with ICT; keep in regular contact with customers/clients as recovery days continue; and manage recovery progress through RC&C to achieve MAO¹⁹ deadlines.

In 2009 the Business Continuity Management program (ICC BCM/DR project documentation, 2009-2013) was established consisting of the following staged components: Business Impact Analysis; ICT Risk Analysis; ICT Continuity Framework (also known as the Contingency Strategies); ICT Disaster Recovery Planning; and Training, Test, Maintenance and Audit. In 2009/2010, the Business Impact Analysis (BIA) and ICT Risk Analysis (RA) projects were complete in order to assess and analyze the business impact of disruptions and/or weaknesses in the ICT infrastructure and services delivery. The outcome provided appropriate risk analysis findings and remedial actions, which have been addressed. In 2011, the ICT Continuity Framework project was completed. The objective was to provide a cost estimate for BIA

¹⁷ Recovery Command & Control or RC&C is a monitoring and management team ensuring that recovery deadlines are met by all teams.

¹⁸ RTO or Recovery Time Objective is the duration of time and service level within which each IT business process shall be restored after a disaster (or disruption) in order to avoid unacceptable consequences.

¹⁹ MAO or Maximum Allowable Outage is the maximum amount of time (including business workarounds and senior management concerns about reputation protection) that an enterprise's key products or services can be unavailable or undeliverable before its stakeholders perceive unacceptable consequences following an event that disrupts operations.

scenarios based on the MAOs, so that the key stakeholders were fully aware of the impact of any business continuity scenario selected by the business, especially in terms of cost-performances. In 2012, the ICT Disaster Recovery Planning project, a final stage of the BCM program, commenced. Its objectives were implementing policies to ensure executive commitment and standards to ensure operational management understanding, creation of required recovery teams with leadership and members, deputies and reserves in order to enact the ICT disaster recovery testing on an annual basis, and enable the maintenance of disaster recovery plan, quality assurance and audit. The program was planned to be accomplished by the end of 2013. The process model category applied during the development and implementation of the Business Continuity Management program was tailored agile – CSPI model.

4.3 Design of the Case Study

The design of case study's quantitative analysis was structured in steps as elaborated in Chapter 3.3.2. The key approach for the quantitative risk analysis was the following:

- The stratification of project representatives done based on their development life cycle, and risk assessment matrix (RAM) was created per stratified data. Assessment of project portfolio risks was done, as depicted in the cause-and-effect diagram (Figure 3.3). The portfolio RBS repository, or portfolio risk register consisting denotative components' data source risk break down structures, was consolidated at the portfolio level based on constituent portfolio components' RBS data structures,
- Quantitative risk data analysis was using Binomial, Poisson, and Beta-PERT distributions with probabilistic Monte Carlo simulation to determine a probability of risks occurrence, risks arrival per observed period, deviations from the most likely distribution regarding the project costs and schedule, determine relationships between variables by applying regression and sensitivity analyses,
- The output iterations identified critical risks variables and provided elements for developing solution to risk reduction process. The output from regression analysis identified predictions for the process best-fit and modification,
- Variables with the most impact were identified, which constitutes input for risk optimization process,
- Finally, the corrective measures were developed, and AgileEMV metrics was used to provide the information needed to improve processes and to detect when it is time to modify or improve an existing process.

The high-level quantitative analysis process map is shown in Figure 4.1.

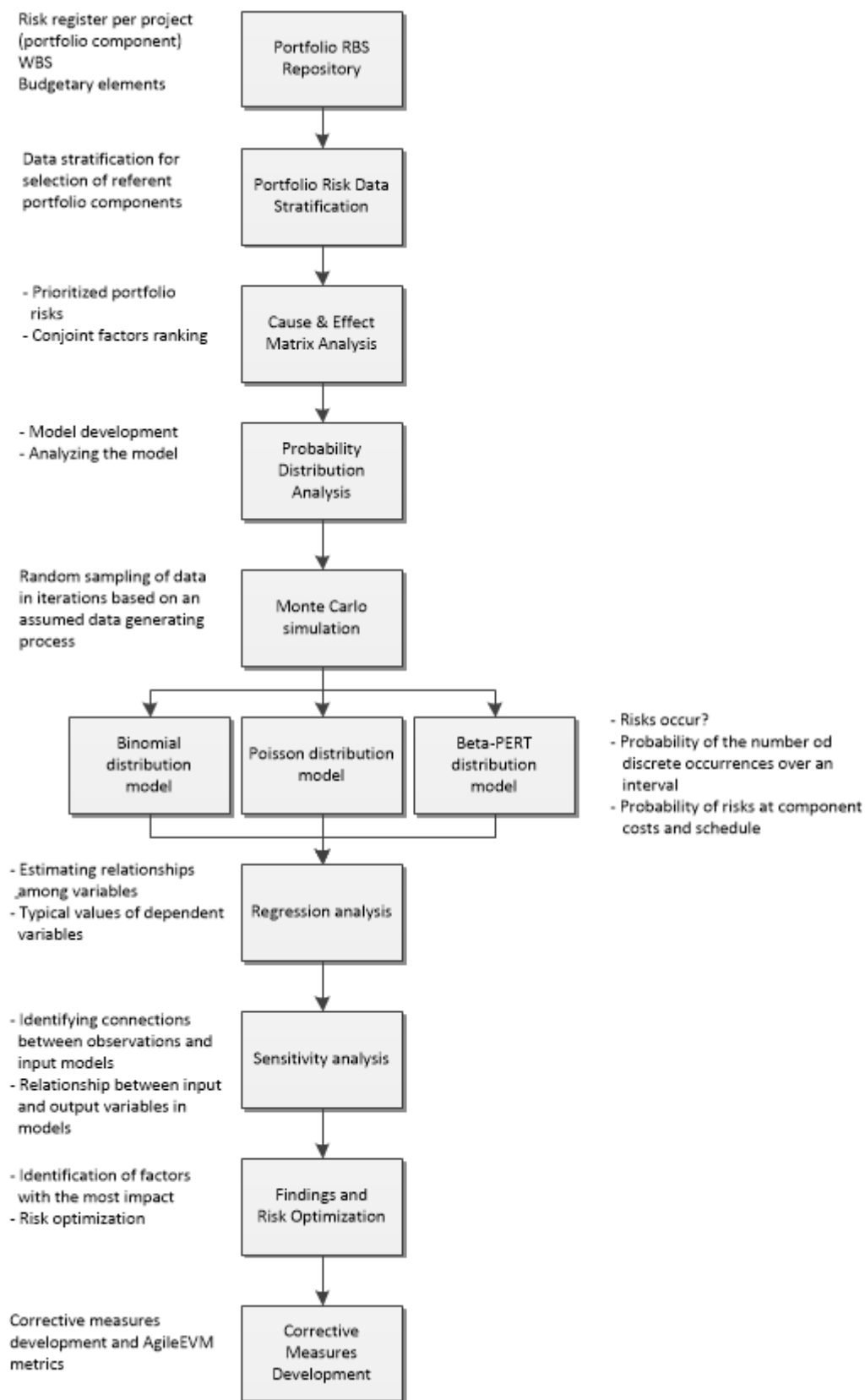

Figure 4.1: High-level analysis process map / workflow

The referent portfolio data sources' risk breakdown structure is shown in Table 4.3, consolidated at the portfolio level based on constituent portfolio components' RBS data structures.

Table 4.3: Referent portfolio data source RBS

<i>RBS Level 1</i>	<i>RBS Level 2</i>	<i>RBS Level 3</i>
Inherent risks	Strategic planning	Requirements unclear
		Strategic objectives not met
	Organizational structure and management	Insufficient management capabilities
		Ineffective decision making
		Unclear managerial responsibilities
	Business process	Ineffective managerial control
		Unconsolidated operating procedures
		Inefficiency of primary and secondary process
	Change management	Suboptimal processes leading to disruption
		Regulative changes
Procedural changes		
Acquired risks	Scope	Financial changes
		Legal changes
		Scope not well defined
	Schedule	Scope doesn't include all the business areas
		Incremental (or modular) delivery not included
		Extended cycles of activities
	Cost	Additional and corrective activities
		Dependencies not clearly identified
		Estimates based on incomplete scope of work
	Quality	Scope of work changes
Modification, improvement, integration activities		
Inadequate process quality		
Process	Insufficiently trained users	
	Inadequately tested systems	
	Missing process	
Resources	Process modification, improvement	
	Process integration and automation	
	Resources not available when needed	
Change	Lack of solution experience	
	Missing communication skills	
	Additional funding due to issues resolution	
		Additional expertise required
		Modifications and scope changes

(ICC ICT ERP, eCOS, BCM project documentation, 2003-2013)

4.4 Portfolio Risk Data Stratification

The starting point of the project representatives' stratification was well-developed project risk registers, as the basis for assessment of a total projects' risk reserves and development the elements for probabilistic analysis. Each of the risks falls under one of the risks categories and being structured in order to denote risks' earliest/latest occurrence, likelihood, impact, probability factor, and its score ($Probability \times Impact/100$), including the risk response strategy.

The project risk registers required for probabilistic analysis of the portfolio risks were well developed, since all these projects were finished, and closed. In addition, project schedules and costs (budgets) were also developed with projects' completion dates, which provide assurance of their confidence level. In order to prioritize the project portfolio risk factors that have the highest impact on processes and to choose the right ones for further measurements, the Lean Six Sigma Cause & Effect Matrix (CEM)²⁰ method was used to link the project portfolio risk factors critical to quality aspects of considered projects to the causes and effects of a problem that have been identified (see Figure 3.3 – Project Portfolio Risks). These risk factors were recognized to be critical to the success of projects/programs, and their business outcome. The CEM denotes a process by presenting inputs, outputs and process indicators to help determine, in a quantitative manner, which inputs and process indicators affect each output. The inputs and outputs of a process are displayed in a table listing the inputs as rows and the outputs as columns. Where they intersect, a numerical assessment is made as to how much effect each input has on each output (Lean Six Sigma Black Belt Training Featuring Examples from SigmaXL, 2014).

The inputs (X's) are risks, derived from RAMs. The outputs (Y's) are conjoint factors impacting the governance process. Each Y is rated (ranked) on a scale of 1 – 10, with 1 being the least important and 10 the most important factor, according to stakeholders' priorities and levels of importance (ICC ICT ERP project documentation, 2003 – 2011). Y's are entered across the top of the CEM. The process inputs (X's or risk variables) are entered in the leftmost column. Within the matrix, the strength of the relationship between the X in the row and the corresponding Y in that column where they intersect, is rated. The scale used to determine the strength of relation is 0, 3, 5, 7, and 10²¹ (Lean Six Sigma Black Belt Training Featuring Examples from SigmaXL, 2014). The totals are calculated by multiplying each X by each Y

²⁰ In Lean SixSigma, the cause and effect matrix (XY Matrix) is a tool to help subjectively quantify the relationship of several X's to several Y's, where X's are derived from the cause and effect diagram as input variables, and Y's should be the primary and secondary metrics or output measures. The CEM matrix functions on the premise of the $Y=f(x)$ equation

²¹ For each X its impact on each Y is rated using a 0,3,5,7,10 scale (0=No impact, 3=Weak impact, 5=Moderate impact, 7=Strong impact, 10=Very strong impact).

and adding those values across each row, determining how much of an influence does a particular X have on a particular Y. X's with the highest values are subject of further analysis. Finally, critical X's were prioritized using the value in the total's column.

Table 4.4 shows the consolidated RAM for the portfolio of project representatives. The analysis of data collection is presented in the below Table 4.5. Prioritized portfolio risks are shown in Table 4.6, where the ten most significant risks influencing process outputs (conjoint factors) are selected.

Table 4.4: Portfolio RAM

<i>Risk Id</i>	<i>Risk Categories</i>	<i>Risk Description</i>	<i>Status explanation</i>	<i>Risk Response Strategy</i>
1	Strategic Planning	Poor communication between Key Stakeholders	Diverging or conflicting objectives and nonalignment of priorities	Mitigate - Prevent
2	Strategic Planning	Non-sharing of required information / communication barriers	Lack of clarity on responsibilities between different organs	Do not accept - Plan to mitigate risk
3	Organizational structure and management	Ineffective decision-making	Unclear managerial responsibilities, ineffective management control, insufficient management capabilities	Do not accept - Plan to mitigate risk
4	Organizational structure and management	Stakeholders expect projects to be an IT driven, focused on the technical aspects and not on process and process owners. Expectation is that the adjustments to the system are more likely than adjustments to the procedures.	Stakeholders not sufficiently aware that the system manages and supports their own processes	Do not accept - Plan to mitigate risk
5	Organizational structure and management	Stakeholders expect the system can do everything and will do so by the end of the phase. During the at validation the client (end users) becomes aware of the difference between the solution and the expected results and does not accept the outcome.	Insufficient stakeholders' awareness. Improve communication circulars, hands-on sessions and awareness workshops	Mitigate - Prevent
6	Organizational structure and management	Organization not ready to use a solution due to many projects and new formalities	Entities are having different priorities. Organizational governance issue.	Adapt - Plan to reduce risk
7	Business process	Processes keep changing due to "new" organization	Unclear procedures	Mitigate - Prevent
8	Business process	Processes are missing; not implemented. Systems cannot go live because not all process function.	Integration manager not appointed yet.	Mitigate - Prevent
9	Business process	Master data consolidation not complete. Systems can go in production, but the support organization needs to spend time on master data where it should spend time on key users' questions.	Master data owner not appointed yet.	Mitigate - Prevent
10	Project Process	Project realization delayed due to "gaps" in blueprint/functional documents	Gaps are currently analysed	Research
11	Project Process	Teams do not meet the required dates and standards. Projects are delayed	Blueprint document delivered in time	Mitigate - Prevent
12	Project Process	Go live disturbed because of badly educated key users, support organization and end users	Extensive knowledge transfer requested by stakeholders	Mitigate - Recover
13	Project Process	Go live disturbed because of badly tested system. Errors occur, system does not work as suggested etc.	Prolonged tests required	Mitigate - Recover
14	Scope	Project delayed or more resources needed due to scope changes.	Scope changes currently under review as a part of blueprint approval	Mitigate - Recover
14	Scope	Workflow system implementation fails	Documents to be approved need to be selected manually	Mitigate - Recover
15	Resources	Process Owners not available when needed	Managerial issue	Do not accept - Plan to mitigate risk
16	Resources	Insufficient staff competence	Additional training required	Do not accept - Plan to mitigate risk
17	Resources	Consultants' lack of public sector experience caused the solution to be less optimal.	Consultants replaced, teams gaining efficiency.	Do not accept - Plan to mitigate risk
18	Resources	Bad documentation and not satisfactory solutions due to performance consultants. Communication skills and public-sector knowledge on a very basic level.	Measures worked. Document now on quality level needed. Consultant replaced.	Mitigate - Prevent
19	Change	Reorganization of the organization reporting structure	Change of the scope of the managerial reporting. The impact of change will affect the whole system's functionality; the risk of the change is high.	Mitigate - Recover
20	Change	System upgrades not planned and executed properly	Change impacts the overall installation (additional costs and schedule change)	Accept: performing the upgrade at a later stage will cause more impact on costs
21	Change	Additional funds for support, improvements and modifications	Change impacts the overall project lifecycle process (additional costs)	Accept: implementing the change will raise customer acceptance and satisfaction

(ICC ICT ERP project documentation, 2003-2011)

Table 4.5: Project portfolio strata Cause and Effect Rating Matrix²²

Weighted by Importance:		7		10		7		5		7		7		7		10		3		3		7		5		
Process input	Output	Management support and commitment to the project		Fit to business strategy		Effective and efficient requirements description and approval		Accurate change management process		Efficient communication between the project team and senior management		End-User acceptance of the optimized process flow		Consistent operating procedures implemented		Improvement in data quality (management reporting and financial accuracy)		Availability of resources during the project		Sufficient in-house knowledge in order to setup contingency for regular system operations		Proper planning		Data integrity		Most Important
		9	63	9	90	7	49	7	35	9	63	5	35	9	63	3	30	7	21	9	27	7	49	3	15	
Communication between Key Stakeholders		9	63	9	90	7	49	7	35	9	63	5	35	9	63	3	30	7	21	9	27	7	49	3	15	510
Sharing of required information / communication barriers		7	49	9	90	7	49	7	35	9	63	7	49	7	49	7	70	9	27	7	21	7	49	1	5	486
Decision-making		10	70	10	100	9	63	9	45	10	70	7	49	9	63	3	30	9	27	3	9	7	49	1	5	550
Stakeholders expectation on the system and not to the procedures adjustments		10	70	9	90	9	63	7	35	3	21	3	21	1	7	1	10	5	15	1	3	9	63	1	5	393
Organizational readiness to use systems		9	63	10	100	10	70	9	45	7	49	9	63	7	49	5	50	7	21	9	27	7	49	3	15	551
Continuous processes change		9	63	7	70	7	49	9	45	7	49	9	63	7	49	7	70	9	27	5	15	7	49	7	35	514
Missing and not functioning processes		9	63	5	50	9	63	7	35	9	63	9	63	9	63	7	70	7	21	5	15	9	63	5	25	524
Incomplete master data		3	21	3	30	3	21	5	25	3	21	1	7	3	21	7	70	7	21	9	27	7	49	9	45	288
Process "gaps" in blueprint/functional document		9	63	7	70	9	63	3	15	9	63	3	21	9	63	3	30	3	9	5	15	5	35	5	25	442
Teams do not meet the required dates and standards		3	21	3	30	3	21	5	25	5	35	7	49	7	49	7	70	3	9	9	27	5	35	1	5	306
Poorly educated key users, support organization and end users		7	49	7	70	3	21	3	15	3	21	7	49	3	21	3	30	7	21	9	27	1	7	5	25	326
Insufficiently tested systems		3	21	3	30	3	21	3	15	5	35	7	49	7	49	7	70	3	9	5	15	7	49	9	45	338
Requirements for additional resources due to scope changes		7	49	3	30	7	49	9	45	5	35	5	35	7	49	5	50	9	27	3	9	9	63	3	15	406
Workflow system not implemented		1	7	1	10	3	21	7	35	7	49	3	21	5	35	7	70	3	9	3	9	3	21	3	15	232
Process Owners not available when needed		9	63	9	90	3	21	5	25	7	49	1	7	7	49	7	70	3	9	7	21	5	35	1	5	374
Insufficient staff competence		3	21	7	70	7	49	5	25	1	7	7	49	7	49	7	70	7	21	9	27	5	35	5	25	378
Lack of public sector experience by consultants		7	49	7	70	9	63	7	35	7	49	3	21	9	63	7	70	7	21	3	9	5	35	7	35	450
Bad documentation		3	21	3	30	3	21	3	15	3	21	7	49	7	49	3	30	3	9	7	21	5	35	3	15	286
Reorganization of the budget and related budget reporting structure		7	49	7	70	3	21	5	25	3	21	1	7	3	21	7	70	3	9	7	21	5	35	5	25	304
Process of upgrading production environments into new versions		3	21	3	30	1	7	5	25	3	21	1	7	1	7	7	70	7	21	3	9	5	35	7	35	218
Additional funds for support, improvements and modifications		7	49	3	30	5	35	7	35	7	49	1	7	3	21	7	70	7	21	3	9	5	35	7	35	326

²² Process inputs (X's): Risks, derived from RAMs
 Process outputs (Y's): Conjoint factors impacting the governance process. Each Y is rated (ranked) on a scale of 1 – 10, with 1 being the least important and 10 the most important factor (Scale 1 – Weighted by importance)
 X/Y relationship rate: The strength of relation scale is 0, 3, 5, 7, and 10 (Scale 2 – Weighted by stakeholders' priorities and level of importance)
 Matrix calculation: Multiplying each X (yellow column – Scale 1) by each Y (top gray column – Scale 2), resulting in dashed gray column
 Most important column: Aggregates the row results

Table 4.6: Sorted priority/Prioritized and Selected Portfolio Risks²³

Importance Level	Process input	Output	7		10		7		5		7		7		7		10		3		3		7		5		Most Important
			Management support and commitment to the project	Fit to business strategy	Effective and efficient requirements description and approval	Accurate change management process	Efficient communication between the project team and senior management	End-User acceptance of the optimized process flow	Consistent operating procedures implemented	Improvement in data quality (management reporting and financial accuracy)	Availability of resources during the project	Sufficient in-house knowledge in order to setup contingency for regular system operations	Proper planning	Data integrity													
1	Organizational readiness to use systems		9	63	10	100	10	70	9	45	7	49	9	63	7	49	5	50	7	21	9	27	7	49	3	15	551
2	Decision-making		10	70	10	100	9	63	9	45	10	70	7	49	9	63	3	30	9	27	3	9	7	49	1	5	550
3	Missing and not functioning processes		9	63	5	50	9	63	7	35	9	63	9	63	9	63	7	70	7	21	5	15	9	63	5	25	524
4	Continuous processes change		9	63	7	70	7	49	9	45	7	49	9	63	7	49	7	70	9	27	5	15	7	49	7	35	514
5	Communication between Key Stakeholders		9	63	9	90	7	49	7	35	9	63	5	35	9	63	3	30	7	21	9	27	7	49	3	15	510
6	Sharing of required information / communication barriers		7	49	9	90	7	49	7	35	9	63	7	49	7	49	7	70	9	27	7	21	7	49	1	5	486
7	Lack of public sector experience by consultants		7	49	7	70	9	63	7	35	7	49	3	21	9	63	7	70	7	21	3	9	5	35	7	35	450
8	Process "gaps" in blueprint/functional documents		9	63	7	70	9	63	3	15	9	63	3	21	9	63	3	30	3	9	5	15	5	35	5	25	442
9	Requirements for additional resources due to scope changes		7	49	3	30	7	49	9	45	5	35	5	35	7	49	5	50	9	27	3	9	9	63	3	15	406
10	Stakeholders expectation on the systems and not to the procedures adjustments		10	70	9	90	9	63	7	35	3	21	3	21	1	7	1	10	5	15	1	3	9	63	1	5	393
11	Insufficient staff competence		3	21	7	70	7	49	5	25	1	7	7	49	7	49	7	70	7	21	9	27	5	35	5	25	378
12	Process Owners not available when needed		9	63	9	90	3	21	5	25	7	49	1	7	7	49	7	70	3	9	7	21	5	35	1	5	374
13	Insufficiently tested systems		3	21	3	30	3	21	3	15	5	35	7	49	7	49	7	70	3	9	5	15	7	49	9	45	338
14	Poorly educated key users, support organization and end users		7	49	7	70	3	21	3	15	3	21	7	49	3	21	3	30	7	21	9	27	1	7	5	25	326
15	Additional funds for support, improvements and modifications		7	49	3	30	5	35	7	35	7	49	1	7	3	21	7	70	7	21	3	9	5	35	7	35	326
16	Teams do not meet the required dates and standards		3	21	3	30	3	21	5	25	5	35	7	49	7	49	7	70	3	9	9	27	5	35	1	5	306
17	Reorganization of the budget and related budget reporting structure		7	49	7	70	3	21	5	25	3	21	1	7	3	21	7	70	3	9	7	21	5	35	5	25	304
18	Incomplete master data		3	21	3	30	3	21	5	25	3	21	1	7	3	21	7	70	7	21	9	27	7	49	9	45	288
19	Bad documentation		3	21	3	30	3	21	3	15	3	21	7	49	7	49	3	30	3	9	7	21	5	35	3	15	286
20	Workflow system not implemented		1	7	1	10	3	21	7	35	7	49	3	21	5	35	7	70	3	9	3	9	3	21	3	15	232
21	Process of upgrading production environments into new versions		3	21	3	30	1	7	5	25	3	21	1	7	1	7	7	70	7	21	3	9	5	35	7	35	218
	Totals		135	945	125	1250	120	840	127	635	122	854	103	721	127	889	117	1170	125	375	121	363	125	875	91	455	8202

²³ The matrix is prioritized in the following manner:

Importance level determined based on the "Most Important" column descending score, sorting out 10 most significant risks (blue area)

Totals: Each column is totaled. Used for ranking process outputs (conjoint factors)

The most important input variables (portfolio risks) that utmost affect the output categories (factors) *organizational structure and management* (3 occurrences), *business processes* (3), *strategic planning* (2), *resources* (1), and *scope* (1), are R_{om} (organizational structure and managerial risk), R_{bp} (org. business process risk), R_{sp} (strategic planning risk), R_{rc} (resource risk), and R_s (component/scope risk), respectively. The below Pareto graph in Figure 4.2 shows the effect of these risks on outputs (conjoint factors).

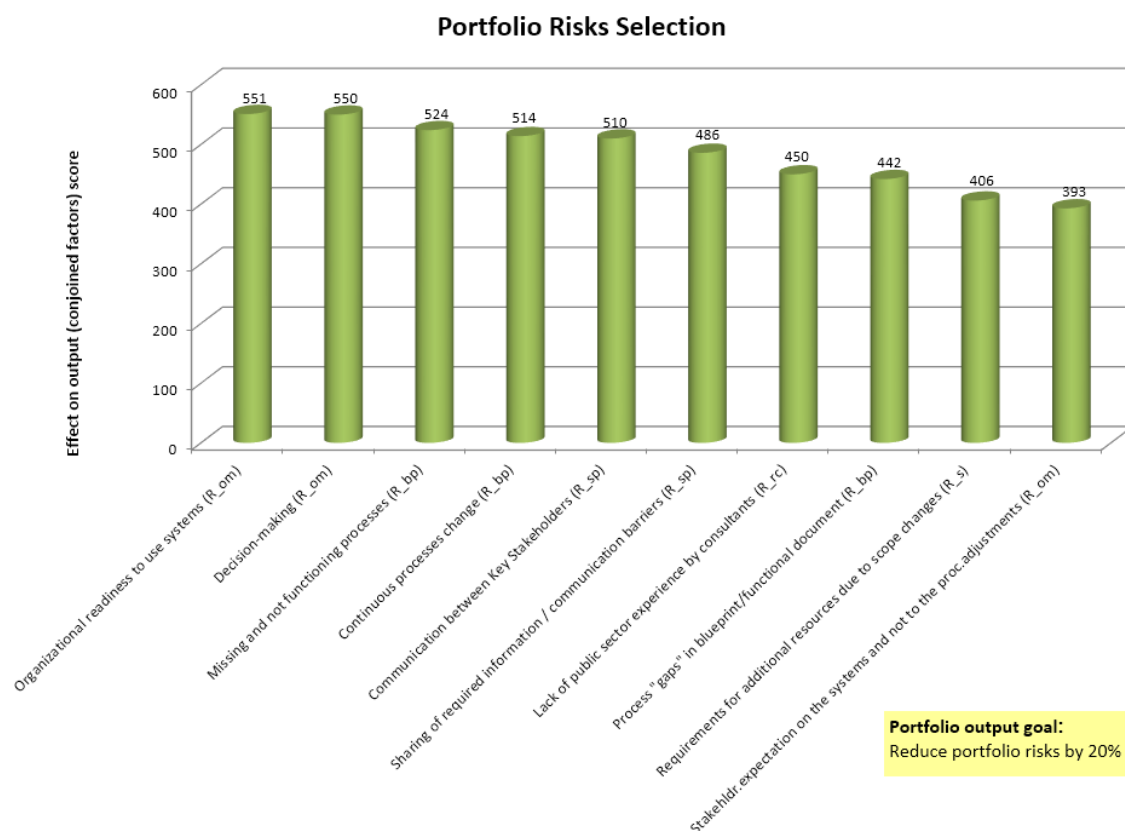

Figure 4.2: Top ten portfolio risks impacting output factors

Risks having the highest impact on outputs (factors) are organizational readiness to use systems, decision making, nonfunctional processes/continuous process change, and key stakeholders' communication. If the portfolio output goal is to reduce portfolio risks by 20%, then these risks shall be managed at the first place. In order to do so, the strategy for validating and/or eliminating the X's (risks) as significant variables to the output $Y=f(X)$ shall be done. The impact of the ten most significant risks on portfolio outcome was analyzed by using @RISK probability distribution analysis and SPSS statistics software²⁴. The SPSS was used in correlation analysis.

²⁴ IBM SPSS Statistics Version 22, IBM Corporation and other(s) 1989, 2013

Table 4.7 shows these ten risks, ranked based on their effect score on conjoint factors and probability of occurrence during the life cycle of projects.

Table 4.7: Ten most significant portfolio risks

<i>Risk Variable</i>	<i>Risk Description</i>
<i>R_sp</i>	Communication between Key Stakeholders
<i>R_sp</i>	Communication barriers
<i>R_s</i>	Additional resources due to scope changes
<i>R_om</i>	Decision making
<i>R_om</i>	Stakeholders' expectations on adjustments
<i>R_bp</i>	Continuous processes change
<i>R_rc</i>	Consultants' lack of public sector experience
<i>R_bp</i>	Missing and not functioning processes
<i>R_bp</i>	Process "gaps" in blueprint/functional document
<i>R_om</i>	Organizational readiness to use systems

Below Table 4.8 shows the ranking of conjoint factors affecting the governance processes (process outputs). Columns' totals represent *Rank* and *Weighted Score* respectively. Management support and commitment to the project is the highest-ranking process output, together with the accurate change management process, consistent operating procedures, project deliverables fitting the business strategy, and availability of resources during the project.

Table 4.8: Process output ranking

<i>Output</i>	<i>Rank</i>	<i>Weighted Score</i>
Management support and commitment to the project	135	945
Accurate change management process	127	635
Consistent operating procedures implemented	127	889
Fit to business strategy	125	1250
Availability of resources during the project	125	375
Proper planning	125	875
Efficient communication between the project team and senior management	122	854
Sufficient in-house knowledge in order to setup contingency for regular system operations	121	363
Effective and efficient requirements description and approval	120	840
Improvement in data quality (management reporting and financial accuracy)	117	1170
End-User acceptance of the optimized process flow	103	721
Data integrity	91	455

Below Figure 4.3 shows graphical representation of sorted process output priority data.

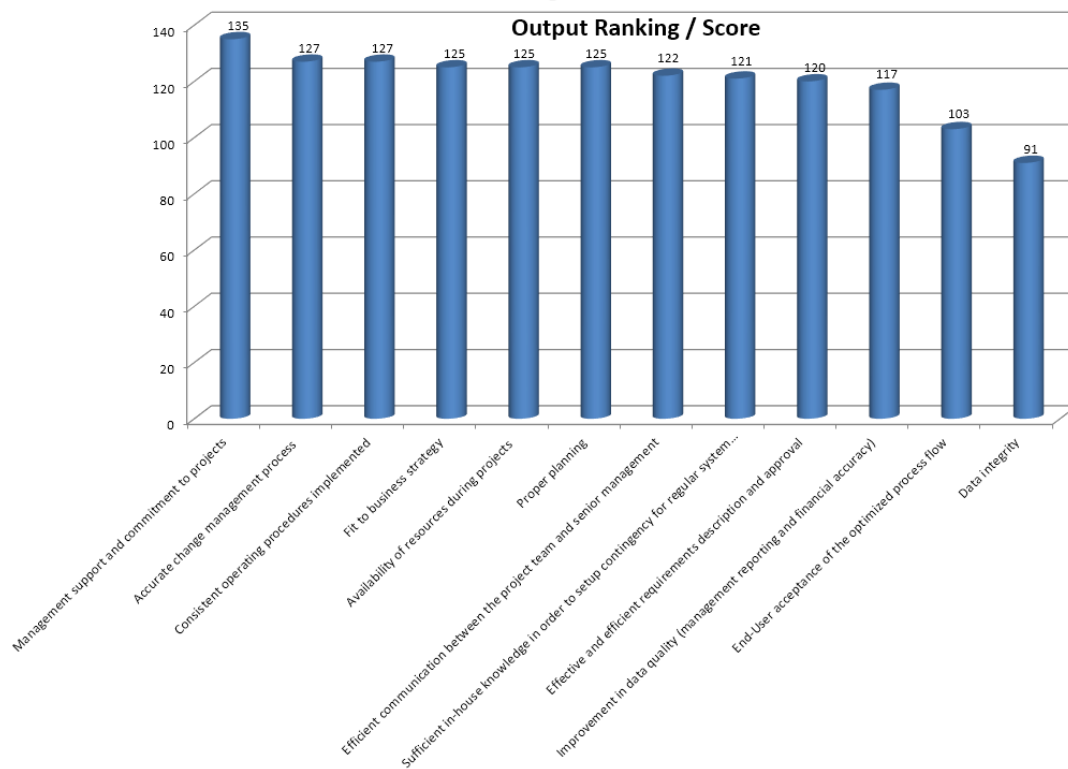

Figure 4.3: Sorted output priority data

The portfolio risks data stratification is used to construct the analysis model.

4.5 Probability Distribution Analysis

The analysis of the case study evidence was performed in Palisade @RISK ver. 5.5 risk analysis and simulation software²⁵, which uses a quantitative method that determine the outcomes of a decision situation as a probability distribution. It encompasses four steps²⁶:

- *Developing a model*, by defining a problem;
- *Identifying uncertainty* in variables and specifying their possible values with probability distributions, and identifying the uncertain results;
- *Analyzing the model with simulation*, in order to determine the range and probabilities of all possible outcomes for the results, and making a basis for
- *Making a decision*, based on the results provided.

4.5.1 Model Development

The main purpose of this research was testing if agile and lean enabled governance domain processes are suitable for the development of a sustainable organizational project portfolio

²⁵ Palisade Corporation, USA, <http://www.palisade.com>

²⁶ *Guide to Using @RISK Risk Analysis and Simulation*, Add-In for Microsoft® Excel, Version 5.5, Palisade Corporation, USA, 2009

governance framework, which improves the performance of project portfolio processes and decrease implementation risks (hypotheses H₁, H₂, and H₃).

The aim of the model was to calculate the individual and aggregate impact of the project portfolio risk events on the project schedule and costs. The input for model build was stratified risk assessment matrix (RAM), project schedule and budgetary data. Since the representative projects were finished and closed, the schedules and budgets show finite planned and actual data.

Generalization of this model was made by:

- Assessing the impact of changing the output variable spread (schedule and cost/budget dependent variables) from each uncertain variable (risk event R_{om} , R_{bp} , R_{sp} , R_{rc} , R_s) into a probability distribution, rather than assuming a static schedule duration and/or budget amount,
- Assessing a probability that each risk could occur (or not) per observed interval. In this model, the "Risk occur?" (yes/no or success/failure) events are modeled with a Binomial distribution,
- Replacing Binomial with a Poisson distribution for counting the random arrival or risks occurrences per period, and assessing the impact if mitigation measures could be developed for certain risks, so the impact is reduced if these risks occur, or probabilities of risks are reduced, or both,
- Assessing a distribution of probabilities of prior expectations on individual risks with regard the project costs and schedule, modeled by Beta-PERT distribution. A prior expresses definitive information about a variable (optimistic/most likely/pessimistic for risk probability factors and sampled actual impact).

The questions answered by the simulations are:

"What is the probability that risks will occur during the project?"

"What is the relative standing of a particular risk within a data set?"

"Which risks contribute significantly towards exceeding the project costs and running behind schedule?"

"What corrective measures can be developed for certain risks within the project portfolio?"

4.5.2 Model Analysis

The project portfolio component representative used in the analysis is Project System or Management Information Restructure project (SAP PS project) (ICC ICT ERP project documentation, 2003 – 2011). The process model of the SAP PS project was evolutionary, driven by the traditional SAP ASAP method, with the aim of improving the existent SAP system in production at the transactional level allowing better support of overall judicial processes, simplification of the budget structure, and fulfilling the budgetary and financial reporting requirements for the organizational governing body.

This project was chosen for the cost and schedule analysis since if the risks were refined during the proof-of-concept, scoping and fit/gap/impact analysis accordingly, then there would be no such a budget overrun and project would not run significantly behind schedule.

The critical success factors (CSFs) anticipated for the project and its relation to the post-production continuous operations are listed in the Table 4.9 below.

Table 4.9: Project's CSF vs. dimensions of post-implementation success

<i>Critical Success Factors of Project Implementation</i>	<i>Critical Dimensions of Success in Post Implementation Stage</i>	<i>Implementation Performance</i>
Fit to business strategy	Evaluation of fit with strategic vision	Extensive fit/gap/impact analysis performed to implement a proper solution
Management support and commitment to the project	Review of management support effectiveness	Tactical management should have been involved as of beginning of project
Apply accurate change management process	Evaluation of change management process	The change management process was applied
Effective and efficient description and approval of requirements and business processes	Evaluation of system integration attainment and reporting flexibility	Difficulties in defining and approving the full requirements and alignment of
Alignment of people, processes, technology	Review of resources, processes, and technological supportability	The internal and external resources have been made available to the project. Difficulties in processes alignment.
Establish efficient communication between the team and management	Evaluation of efficacy of communication	Although the change management process was applied, the communication channels between the key stakeholders didn't work properly
Anticipated benefits from project	Evaluation of level of attainment of expected system benefits	Improvement in data quality for management reporting and financial figure accuracy

(ICC ICT ERP project documentation, 2003-2011)

Initial budget estimation was done based on rough estimate without knowing the full scope of the change, as shown in Table 4.10. The total project expenditure was €411.385,52 vs planned budget of €260.000,00, resulting in 63% overrun.

Table 4.10: Project budget

<i>Project Budget</i>	<i>Planned (€)</i>	<i>Actual (€)</i>
SAP PS (Budget system restructure)	162.500,00	162.500,00
Change Request implementation	97.500,00	100.412,54
Reallocated funds from frozen projects (I)	0	63.538,51
Reallocated funds from frozen projects (II)	0	39.160,04
Final invoice		45.774,43
Total	260.000,00	411.385,52

(ICC ICT ERP project documentation, 2003-2011)

The reported reasons for the budget overrun of 63% were based on the changes of the cost centers structure and not on the introduction of the features of the SAP PS solution, unclear requirements and scope vagueness, embedding additional functionality during the project, readiness of the organization, and data conversion with legacy data consolidation and migration.

The project schedule, presented in Table 4.11, shows the magnitude of variation to the original schedule baseline (24 weeks planned vs. 64 weeks actual). Causes of such a schedule variance were in major changes caused by the clarification of the project scope, decision making process on determining the most appropriate solution between the three proposed, late involvement of the functional organization (process owners, power- and key users), complexity of the data conversion process, duration of the acceptance and integration tests, validation of the solution, and knowledge transfer to the organization.

Table 4.11: Project schedule

<i>Project Stages</i>	<i>Planned Start</i>	<i>Planned Finish</i>	<i>Weeks</i>	<i>Actual Start</i>	<i>Actual Finish</i>	<i>Weeks</i>
Project Preparation	Jan/2006	Jan/2006	2	Mar/2006	Mar/2006	2
Blueprint/Impact analysis	Jan/2006	Feb/2006	6	Mar/2006	Jul/2006	20
Realization	Mar/2006	Apr/2006	8	Aug/2006	Feb/2007	28
Final Preparation	May/2006	May/2006	4	Mar/2007	May/2007	10
Go live and Support	June/2006	June/2006	4	June/2007	June/2007	4
Total			24			64

(ICC ICT ERP project documentation, 2003-2011)

In order to describe the nature of risk variables' uncertainty, the model development had to describe the range of values that variables could take, and the likelihood of occurrence of each value within the range. This was done in @RISK software, where uncertain variables are entered as probability distributions. The first model, aimed to assessing a probability that a particular risk could occur in observed interval, is shown in Table 4.12.

Table 4.12: Risk model using Binomial distribution

<i>Risk Variable</i>	<i>Risk Description</i>	<i>Likelihood</i>	<i>Impact</i>	<i>Probability Factor</i>	<i>Risk Score</i>	<i>Earliest Occurrence</i>	<i>Risk Occur?</i>
<i>R_sp</i>	Communication between Key Stakeholders	High	4	70%	2.8	Charter	RiskBinomial(10,0.7)
<i>R_sp</i>	Communication barriers	High	4	70%	2.8	Charter	RiskBinomial(10,0.7)
<i>R_s</i>	Additional resources due to scope changes	High	4	60%	2.4	Whole Project	RiskBinomial(10,0.6)
<i>R_om</i>	Decision making	High	4	60%	2.4	Blueprint	RiskBinomial(10,0.6)
<i>R_om</i>	Stakeholders' expectations on adjustments	Medium-High	3	60%	2.1	Realization	RiskBinomial(10,0.6)
<i>R_bp</i>	Continuous processes change	Medium-High	3	60%	1.8	Whole Project	RiskBinomial(10,0.6)
<i>R_rc</i>	Consultants' lack of public sector experience	Medium-High	3	60%	1.8	Blueprint	RiskBinomial(10,0.6)
<i>R_bp</i>	Missing and not functioning processes	High	4	20%	0.8	Blueprint	RiskBinomial(10,0.2)
<i>R_bp</i>	Process "gaps" in blueprint/ functional document	Medium-Low	2	40%	0.8	Whole Project	RiskBinomial(10,0.4)
<i>R_om</i>	Organizational readiness to use system	Low	1	80%	0.8	Go Live	RiskBinomial(10,0.8)
<i>Totals</i>							RiskOutput()

In the risk model (Table 4.12), the columns *Likelihood*, *Impact*, *Probability Factor*, *Risk Score*, and *Earliest Occurrence* in the Table 4.12 are brought from the risk register, where the *Risk Score* column is calculated as (*Impact* * *Probability Factor*). The column "Risk Occur?" represents Binomial distribution for each risk variable. For example, *RiskBinomial(10,0.7)* represents the number of risk occurrences from a portfolio of 10 risks, where the risk has a 70% chance of affecting the output.

The binomial distribution is a discrete distribution returning only integer values greater than or equal to zero. This distribution corresponds to the number of events that occur in a trial of a set of independent events of equal probability. The distribution was used to model the occurrence - or not - of an risk event with other values of *p* (probability) associated with the risks in the column, i.e. it transforms register of risks into simulation model of aggregated risks (*RiskOutput()* function).

Scenario analysis allows determining which risk input variables contribute significantly towards reaching a goal. In the first scenario, the Binomial distribution is used in first scenario because this probability distribution describes a random variable that occurs in real life (Goldie, 2012, p. 145), in each trial there are two outcomes, often referred to as success and failure (Goldie, 2012, p. 145), and summarizes the likelihood that the value will take one of two independent values under a given set of parameters. The assumption of the Binomial distribution is that there is only one outcome for each trial, that each trial has the same probability of success, and that each trial is mutually exclusive ("Risk Occur?" or "yes" or

“no” in the scenario). *RiskBinomial*(n, p) specifies a binomial distribution with n number of trials and p probability of success on each trial or samples made.

The simulation was configured in order its setup of distributions return random values by using Monte Carlo sampling in 1000 iterations, enabling convergence testing on all outputs, with convergence tolerance of 3% and confidence level of 95%. For each significant input distribution in a scenario, the three measurements were calculated:

- Actual median of samples in iterations meeting target,
- Percentile median of samples in iterations meeting target. The percentile value of the subset median in the distribution generated for the whole simulation,
- Ratio of median to original standard deviation. The difference between the subset median, and the median for the whole simulation, divided by the standard deviation of the input for the whole simulation, where a negative number indicates that the subset median is smaller than the median for the whole simulation, a positive number indicates that the subset median is greater than the median for the whole simulation. The larger the magnitude of this ratio, the more significant the variable is in reaching the defined target.

The scenario analysis lists all input variables that are significant toward reaching a defined goal for an output variable (risk occur?). Input variables in the scenario were computed for the output, total risk occurrence greater than the 75th percentile, or third quartile data points. The columns “*Risk Occur?*” include data points greater than 75th percentile, less than 25th percentile, and greater than 90th percentiles. For each output, the following steps were followed:

- The median and standard deviation of the samples, for each input distribution for the entire simulation, are calculated;
- A subset is created containing only the iterations in which the output achieves the defined target;
- The median of each input is calculated for the subset of data;
- For each input, the difference between the simulation median and the subset median is calculated and compared to the standard deviation of the input data. If the absolute value of the difference in medians is greater than $\frac{1}{2}$ a standard deviation, then the input is termed significant; otherwise the input is ignored in the scenario analysis;
- Each significant input is listed in the scenario analysis, as shown in the below Table 4.13.

Table 4.13: Scenario analysis using Binomial distribution

Inputs in scenario output >75%	Risk	Risk Occur?	Risk Occur?	Risk Occur?
		Percentile	Percentile	Percentile
		>75%	<25%	>90%
#1	Organizational Readiness	0.899	-	0.899
#2	Communication Barriers	0.871	-	0.871
#3	Communication between Stakeholders	0.853	0.374	0.853
#4	Continuous Process Change	0. 836	0.356	0.836
#5	Consultants Lack of Experience	0.82	0.356	0.82
#6	Additional Resources	0.809	0.369	0.809
#7	Expectations on Adjustments	0.83	0.393	0.83
#8	Gaps in Blueprint/Functional document	0.818	0.374	0.818
#9	Decision Making	0.818	0.374	0.818
-	Missing Processes	-	0.394	-

The composite hypothesis testing (null and alternative) on assumed values of the population parameters performed on output target variable in the scenario analysis was based on a conditional median analysis. In performing the scenario analysis in a two-tail test, the first step was to subset the iterations of the simulation into only those iterations in which the output variable achieves the entered target (H_0 : Portfolio risk occur = False).

In the second step, the values sampled were analyzed for each input variable in those iterations finding the median of a subset of sampled values for each input and comparing that with the median of the input for all iterations. The objective of this process is to find those inputs whose subset, or conditional median, differs significantly from the overall median. If the subset median for the input variable was close to the overall median, the input variable was marked as insignificant because the values sampled for the input in the iterations where the target was achieved do not differ markedly from those sampled for the input for the entire simulation (H_a : Portfolio risk occurs = True). If the subset median for the input variable deviated significantly from the overall median (i.e. at least $\frac{1}{2}$ a standard deviation), the input variable was significant (significance level error = 0).

The scenario analysis shows all inputs (nine out of ten risks) which were significant in meeting the output target H_a : Portfolio risk occurs = True. It also shows that more than 75% of risks fall in a group of observations better than 75th and 90th percentile rank, meaning that more than 75 percent of risks made H_a rank, or within these percentiles more than 75% of the observations could be found. Also, <25th percentile means that 25% or less input risk variables was below (false) on the test, and more than 75% of the input risks scored above (true). Therefore, the composite hypothesis testing confirms H_a : Portfolio risk occurs = True.

The output probability distribution determines the possible range of outcomes and the relative likelihood of occurrence for each possible outcome. Range and likelihood of occurrence is directly related to the level of risk associated with a particular outcome. Figure 4.4 shows the output distribution (*RiskOutput()*).

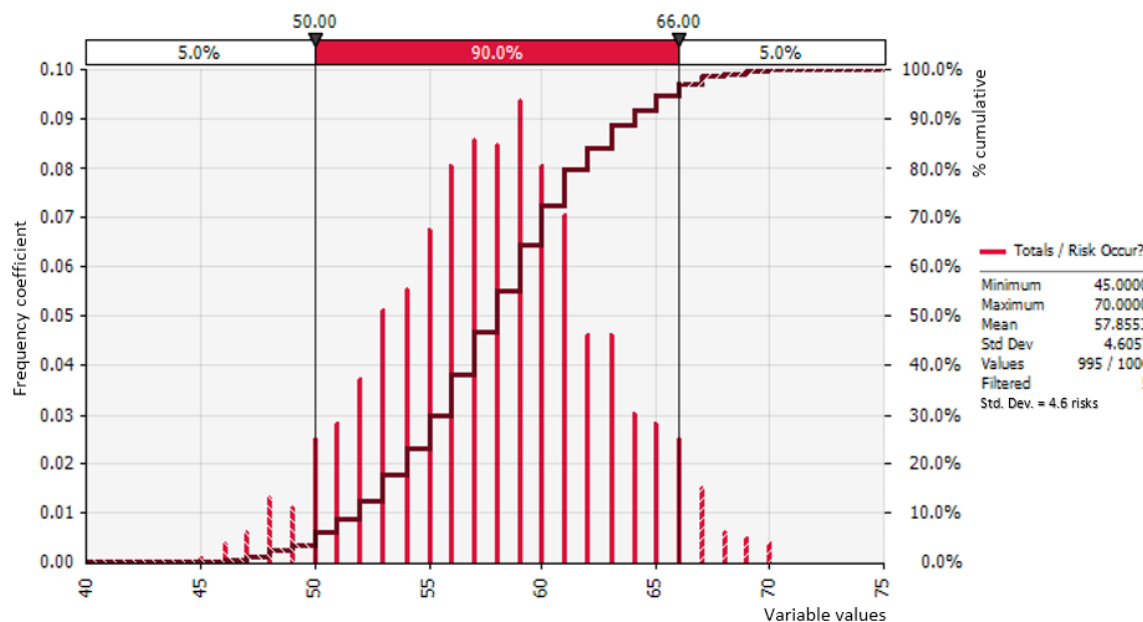

Figure 4.4: Probability histogram and S-curve for the project risks occurrence

The sensitivity analysis, identifying significant inputs, carried out with two different analytical techniques – regression analysis and rank correlation calculation. The results of a sensitivity analysis show the sensitivity of the output variable to the input distributions, identifying the most critical inputs in the model. The results are shown in the Table 4.14, where the variables are ranked for the output.

Table 4.14: Risk sensitivity analysis

Rank	Risk name	Total Risk Occur? Regression coeff. R-Squared=1	Total Risk Occur? Correlation coeff. (Spearman Rank)
#1	Decision Making	0.349	0.302
#2	Expectations on Adjustments	0.341	0.298
#3	Gaps in Blueprint/Functional document	0.337	0.344
#4	Consultants Lack of Experience	0.334	0.300
#5	Additional Resources	0.327	0.318
#6	Continuous Process Change	0.326	0.279
#7	Communication Barriers	0.324	0.350
#8	Communication between Stakeholders	0.302	0.246
#9	Organizational Readiness	0.271	0.275
#10	Missing Processes	0.270	0.297

The results are also displayed as a tornado type chart in Figure 4.5, with longer bars on the top representing the most significant input variables. The values on the X-axis show the amount of change in the output due to a +1 standard deviation change in each input.

The regression analysis was used for estimating and forecasting the relationship between the variables, i.e. predicts the value of dependent variable given known values of the independent variables. It calculates regression values with multiple input values. In the regression analysis, the coefficients calculated for each input variable measure the sensitivity of the output to that particular input distribution. The measurement on how close the data are to the fitted regression line was measured by the coefficient of determination, R-squared of the model, or the percentage of the response variable variation that is explained by a linear model. The R-squared for the measurement in the analysis was $R^2 = 1$ (or 100%), indicating that the model explains all the variability of the response data around its mean (if the R-squares was lower, than the fit would be less stable). The risks' regression coefficient values (0.349 ~ 0.270) show a significant relationship between the input and output.

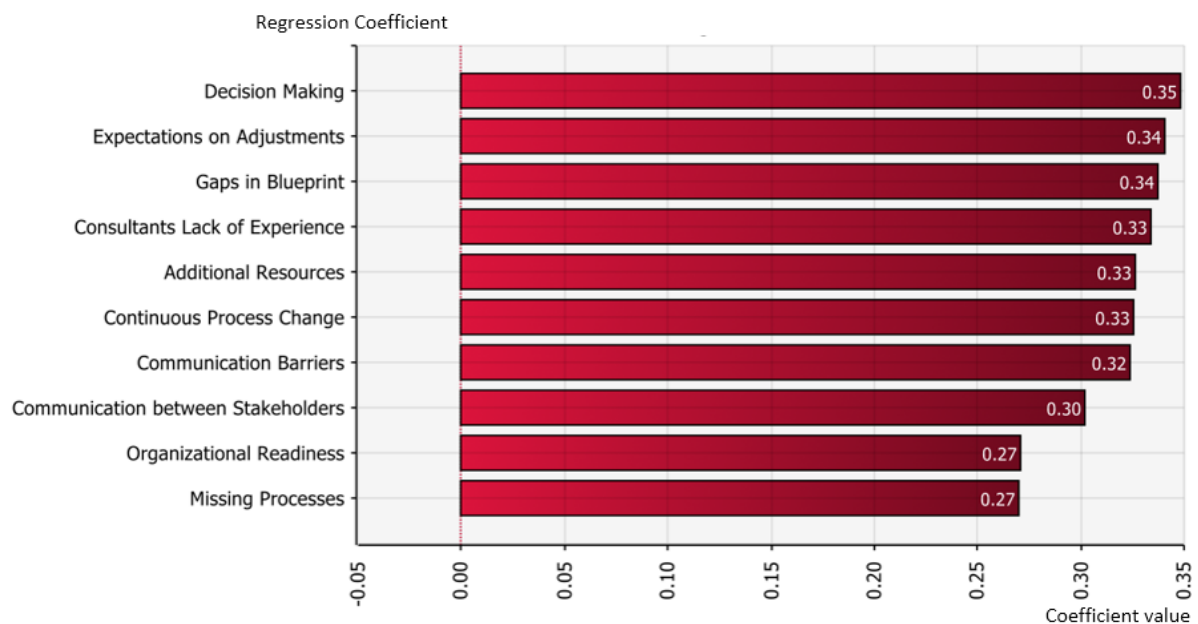

Figure 4.5: Project risks sensitivity analysis

The sensitivity analysis using rank correlations was based on the Spearman rank correlation coefficient calculations. The general form of a H_0 hypothesis for a Spearman correlation was that there is no association between the risk variables in the population. With this analysis, the rank correlation coefficient was calculated between the selected output variable and the samples for each of the input distributions. The statistical significance does not indicate the strength of the Spearman rank-order correlation, but whether H_0 could be rejected or fail to reject. The results show the weak positive correlation between the input and the output. For example, the risk variable ranked #1, decision making, achieved statistically fair Spearman-rank order correlation meaning that we can be sure that there is less than a 30,2% chance that the strength of the relationship between the variable and the output happened by chance if the H_0 were true. Testing the level of statistical significance of the relationship was done by looking up in the

Spearman rank significance table, which ranks significance level at 5% (95% certainty) and 1% (99% certainty). The result has shown that the probability of the determined relationship being a chance event is less than 95% certainty that the hypothesis is correct.

The summary trend in occurrence of project risks is shown in Figure 4.6, with the range of probability from 53,5% - 62%,5 that all the risks will occur during the project life cycle.

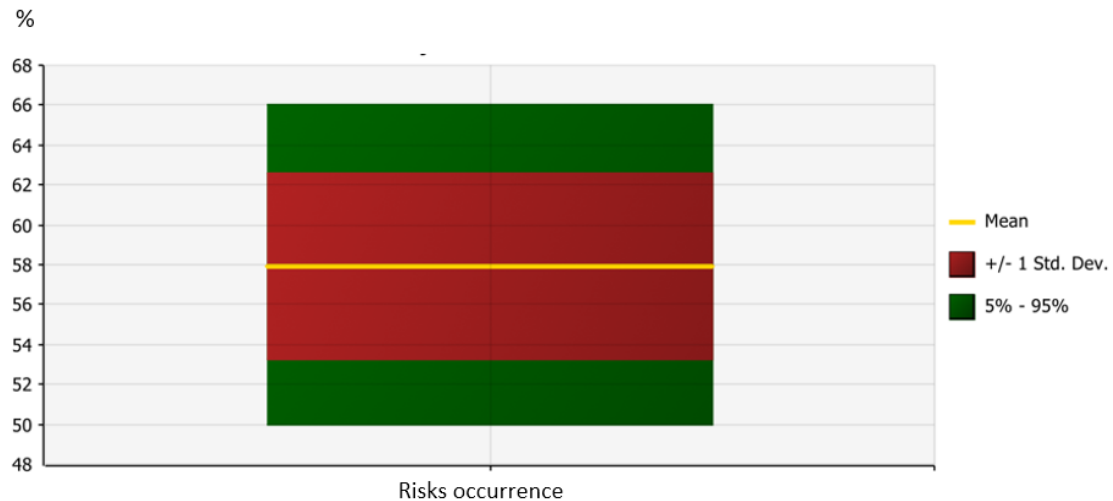

Figure 4.6: Project risks occurrence probability

The second model, aimed to assessing a probability of the number of discrete occurrences over a defined interval, was modeled with a Poisson distribution. Assuming that the processes (risks occurrence) are essentially random, the Poisson distribution determines the probability that a given number of risks could occur per observed fixed interval. In average, there were 4,2 risk occurrences per project stage which conforms the λ (lambda) parameter in Poisson (the project was composed of 5 stages with 21 registered risks in total). The model goal was to find the probability that the project will have at most 3 reported risks per project stage (or at most 15-reported risk per whole project) if mitigation measures were developed for project risks, so the impact is reduced if these risks occur, or probabilities of risks are reduced (Kobayashi, Turin, 2011).

$$f(x) = \frac{\lambda^x \cdot e^{-\lambda}}{x!} \quad \text{where: } f(x) = \text{Poisson distribution formula for calculating probabilities} \quad (8)$$

λ = Mean number of successes in a given time period
 x = Number of successes required
 e = Base of the natural logarithmic function \ln (~2.71828)

Average risk occurrence per project stage: $\lambda = 4.2 / \left(\frac{\text{Registered risks}}{\text{Project stages}} \right)$

The number of risks per project stage: $x \leq 3$

Expected result: $P(x \leq 3)$

$$\begin{aligned}
 P(\text{at most 3 risks}) &= P(0 \text{ risks, 1 risk, 2 risks, 3 risks}) \\
 &= f(0) + f(1) + f(2) + f(3) \\
 &= \frac{4.2^0 * e^{-4.2}}{0!} + \frac{4.2^1 * e^{-4.2}}{1!} + \frac{4.2^2 * e^{-4.2}}{2!} + \frac{4.2^3 * e^{-4.2}}{3!} \\
 &= 0.0150 + 0.0630 + 0.1323 + 0.1852 = 0.3955
 \end{aligned}$$

The probability that the project will have the expectation of at most 3 reported risks per project stage if mitigation measures were developed for project risks, is 0.3955 or 40%. This probability level indicates that if development of such measures is undertaken, and if these measures are applied to all the components within the portfolio, the total portfolio risks can be reduced at least 30% (up to total 15 risks occurrences with risk reduction measures developed vs 21 risks without risk mitigation being done for the case project), which complies with the portfolio output goal set to reduce portfolio risks by 20% (see Figure 4.2).

The third scenario model aimed assessing a distribution of probabilities of prior expectations on individual risks with regard the project costs and schedule, modeled by Beta-PERT distribution. A prior expresses definitive information about a variable (optimistic/most likely/pessimistic for risk probability factors and sampled actual impact). In order to leverage the risk impact on costs (project budget), the actual risk cost impact was calculated as follows:

$$\text{Budget Impact} = (\text{Actual Budget} - \text{Planned Budget}) \tag{9}$$

$$\text{Average Risk Impact per Project Stage} = \frac{\left(\frac{\text{Budget Impact}}{\text{Total Risks}}\right)}{\text{Project Stages}} \tag{10}$$

$$\text{Maximum Risk Impact} = \text{Avg. Risk Impact per Project Stage} * \text{Project Stages Affected} \tag{11}$$

$$\text{Risk Impact} = \text{Max. Risk Impact} * \text{Risk Probability Factor} \tag{12}$$

The Beta-PERT distribution cost scenario is shown in Table 4.15. The objective of this scenario risks model was to find those input risk variables whose subset, or conditional median, differs significantly from the overall median, and marking them as significant in meeting the output target H_a : *Actual Cost Impact* \geq 90th percentile rank.

Table 4.15: Risk cost model using beta-PERT distribution

<i>Risk Factor</i>	<i>Likelihood</i>	<i>Probability Factor</i>	<i>Project Stages Affected (all=5)</i>	<i>Max. Risk Impact if Occurs (000 €)</i>	<i>Risk²⁸ Impact (Sampled) (000 €)</i>	<i>Actual Impact (PERT weighted average) (000 €)</i>
Communication between Key Stakeholders	High	70%	4	120	84	RiskPert(65,84,120)
Communication barriers	High	70%	4	120	84	RiskPert(65,84,120)
Additional resources due to scope changes	High	60%	5	150	90	RiskPert(80,90,150)
Decision making	High	60%	4	120	72	RiskPert(58,72,120)
Stakeholders' expectations on adjustments	Medium-High	60%	3	90	54	RiskPert(43,54,90)
Continuous processes change	Medium-High	60%	5	150	90	RiskPert(72,90,150)
Consultants' lack of public sector experience	Medium-High	60%	2	60	36	RiskPert(29,36,60)
Missing and not functioning processes	High	20%	4	120	24	RiskPert(20,24,120)
Process "gaps" in blueprint / functional document	Medium-Low	40%	5	150	60	RiskPert(48,60,150)
Organizational readiness to use system	Low	80%	1	30	24	RiskPert(20,24,30)
						RiskOutput()

The columns *Likelihood*, *Probability Factor* and *Project Stages Affected* in Table 4.15 are from the project risk register. The columns *Max. Risk Impact if Occurs* and the *Risk Impact* were calculated based on (11) and (12), representing pessimistic (maximum) and most likely cost values, respectively. The last column, *Actual Impact*, is @RISK function *RiskPert(Optimistic, Most likely, Pessimistic)*. The function calculated a weighted average value of the actual cost impact as $(O+4ML+P)/6$.

The scenario analysis shows inputs (six out of ten risks) which were significant in meeting the output target H_a : *Actual Cost Impact* $\geq 90^{th}$ percentile rank. This means that the six risks, as shown in table 4.16, are significantly contributing to actual costs. More than 50% of risks (five risks) could be found in a group of observations better than 75th and 90th percentile rank, meaning that more than 50 percent of risks made H_a rank. Less than 25% input risk variables were at H_0 or below on the test. Therefore, the composite hypothesis testing confirms H_a : *Actual Cost Impact* $\geq 90^{th}$ percentile rank for risks listed in below Table 4.16:

²⁷ The difference between the actual budget impact and the impact if risks occur (€152.000-€110.000=€41.000) clearly indicates on the impact of the remaining 11 risks – see Tables 4.4 and 4.6

²⁸ Budgetary impact per project stage is calculated as (Impact if Occurs * Probability Factor)

Table 4.16: Risk scenario analysis using Beta-PERT distribution

Inputs in Scenario for output >90%	Risk name	Total Actual Cost Impact Percentile >90%	Total Actual Cost Impact Percentile >75%	Total Actual Cost Impact Percentile <25%
#1	Communication between Key Stakeholders	0.814	0.699	-
#2	Process “gaps” in functional document	0.764	0.669	-
#3	Additional resources due to scope changes	0.782	0.703	0.295
#4	Continuous processes change	0.759	0.692	0.258
#5	Stakeholders’ expectations on adjustments	0.698	-	-
#6	Communication barriers	0.693	0.69	0.317

The six key risks variables affecting the project costs outcome, listed in the above table, are shown in the below Figure 4.7.

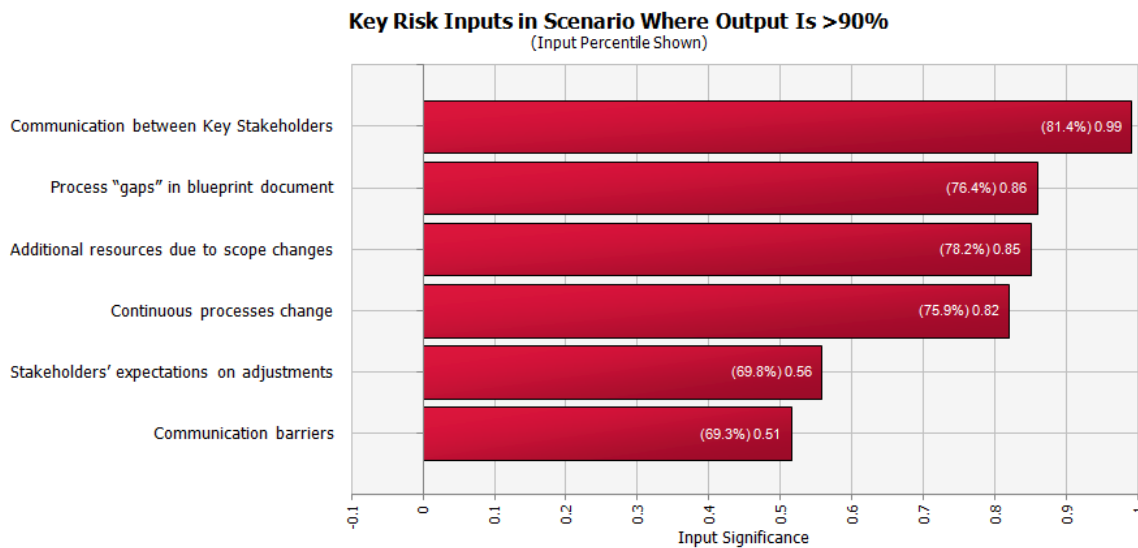

Figure 4.7: Key risk inputs affecting project costs

Range and likelihood of occurrence is directly related to the level of risk associated with a particular outcome. Figure 4.8 shows the output probability density distribution (*RiskOutput()*), describing the relative likelihood of the random risk variables, representing the actual risk impact on project costs.

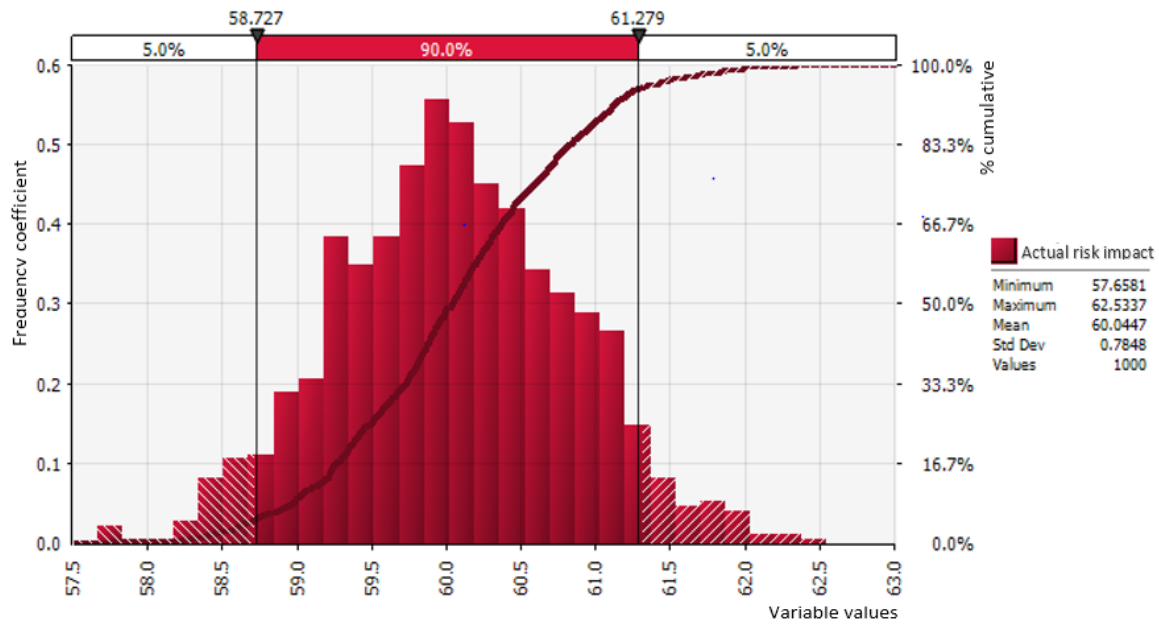

Figure 4.8: Probability density function of actual risks impact on project costs

The significant risk variables affecting the output (project costs) are shown in regression analysis, as represented in Figure 4.9. The values on Y-axis represent the most significant input variables, and the values on X-axis representing the amount of change in the output due to a +1 standard deviation change in each input.

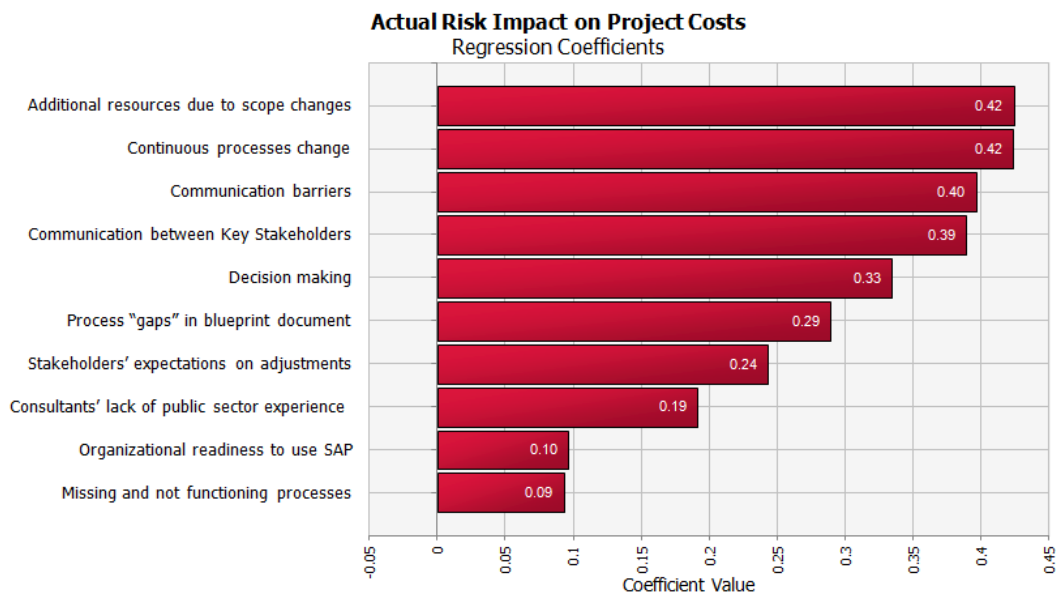

Figure 4.9: Project costs regression analysis

The project schedule distribution was built on risk variables with specified minimum (optimistic), most likely, and maximum (pessimistic) values of the probability factors planned vs. actual weeks. The @Risk $RiskPert(O, ML, P)$ function was used in the analysis, along with the setup of correlation between the planned and actual schedule duration.

The schedule scenario Beta-PERT distribution is shown in Table 4.17, where the risk's schedule impact is revealed by function *RiskOutput()* in columns "Planned Weeks" vs. "Actual Weeks". The input variables, weeks per project stages (planned weeks vs. actual weeks) were computed for outputs (total planned vs. total actual weeks). The objective of this scenario risks model was to find those input variables whose subset, or conditional median, differs significantly from the overall median, and marking them as significant in meeting the output target H_a : *Actual Schedule Impact* $\geq 90^{th}$ percentile rank.

Table 4.17: Schedule risk model using beta-PERT distribution

<i>Project Stages</i>	<i>Beta-PERT @RISK function</i>	<i>Planned Weeks</i>	<i>Beta-PERT @RISK function</i>	<i>Actual Weeks</i>
Project Preparation	RiskPert(1,2,3,RiskStatic(2),RiskCorrmat(Schedule,2))	2	RiskPert(1,2,3,RiskStatic(2),RiskCorrmat(Schedule,1))	2
Blueprint/Impact analysis	RiskPert(4,6,8,RiskStatic(6),RiskCorrmat(Schedule,3))	6	RiskPert(18,20,22,RiskStatic(20),RiskCorrmat(Schedule,7))	20
Realization	RiskPert(6,8,10,RiskStatic(8),RiskCorrmat(Schedule,4))	8	RiskPert(25.2,28,30.8,RiskStatic(28),RiskCorrmat(Schedule,8))	28
Final Preparation	RiskPert(3,4,5,RiskStatic(4),RiskCorrmat(Schedule,5))	4	RiskPert(9,10,11,RiskStatic(10),RiskCorrmat(Schedule,9))	10
Go live and Support	RiskPert(3,4,5,RiskStatic(4),RiskCorrmat(Schedule,6))	4	RiskPert(3,4,5,RiskStatic(4),RiskCorrmat(Schedule,10))	4
<i>Totals</i>			RiskOutput()	RiskOutput()

The column *Beta-PERT @RISK function* contains the @RISK function *RiskPert(O,M,P, RiskStatic(static value), RiskCorrmat(matrix range, instance)*. Embedded *RiskStatic* function defines the static value (most likely value) returned by a distribution function during a standard recalculation and replaces the @RISK function after the functions are swapped out. *RiskCorrmat* function identifies a distribution belonging to a set of correlated distribution functions (planned weeks vs actual weeks). The function was used to specify multivariate correlation, identifying a matrix of rank correlation.

The scenario analysis shows inputs (four out of ten project stages) which were significant in meeting the output target H_a : *Actual Schedule Impact* $\geq 90^{th}$ percentile rank. More than 80% of project stages within observed outcomes could be found in a group of observations better than 75th and 90th percentile rank, meaning that more than 80 percent of risks within observations made H_a rank. Less than 25% input risk variables were at H_0 or below on the test. The composite hypothesis testing was done for planned and actual schedule. The hypothesis testing for planned schedule confirms H_a : *Planned Schedule Impact* $\geq 90^{th}$ percentile rank or value (score) below which 90% of the observations in the group were found, and that the project stages will be affected by risks. The results, ranked by the project stages causing output

scenario, show that the probability of risks' impact is highest at the business blueprint-impact analysis followed by the project realization stage, as listed in below Table 4.18.

Table 4.18: Risk analysis of planned schedule using Beta-PERT distribution

Inputs in scenario for planned schedule >90%	Project Stages (Planned Weeks)	Total Planned Weeks Impact (Percentile)	Total Planned Weeks Impact (Percentile)	Total Planned Weeks Impact (Percentile)
		>90%	>75%	<25%
#1	BBP – Impact Analysis	0.858	0.775	0.238
#2	Realization	0.839	0.792	0.224
#3	Go Live and Support	0.711	0.666	-
#4	Final Preparation	0.694	-	-
#5	Project Preparation	0.667	0.661	0.289

The hypothesis testing for the actual schedule confirms H_a : *Actual Schedule Impact* $\geq 90^{\text{th}}$ percentile rank for project stages where risks have made an impact on, are shown in Table 4.19.

Table 4.19: Risk analysis of actual schedule using Beta-PERT distribution

Inputs in Scenario for actual schedule output >90%	Project Stages (Actual Weeks)	Total Actual Weeks Impact (Percentile)	Total Actual Weeks Impact (Percentile)	Total Actual Weeks Impact (Percentile)
		>90%	>75%	<25%
#1	Realization	0.873	0.835	0.181
#2	BBP – Impact Analysis	0.846	0.744	0.285
#3	Project Preparation	0.696	-	-

The project stages with regard the most critical risk impact were *Realization*, followed by *Business Blueprint-Impact Analysis*, and *Project Preparation*. Based on results from Table 4.7 and 4.14, the critical risks affecting project stages are shown in the following Table 4.20.

Table 4.20: The most critical risks affecting the project stages

Risk name	Realization Stage	BBP – Impact Analysis Stage	Project Preparation Stage
Decision making	x	x	x
Stakeholders' expectations on adjustments	x		
Gaps in blueprint / functional document	x		
Consultants lack of experience	x	x	
Additional resources due to scope changes	x		
Continuous process change	x	x	
Communication barriers	x	x	x
Communication between stakeholders	x	x	x
Organizational readiness			
Missing and not functioning processes	x	x	

The risk sensitivity analysis identified significant inputs by carrying out two analytical techniques – regression analysis and rank correlation calculation. The regression analysis

measured the sensitivity of the output dependent variable (actual weeks) to particular predictors - input distributions (project stages), showing the variation of the dependent variable around the regression function. The goodness of fit of the model includes the coefficient of determination or R-squared, indicating the proportion of variance in the output that is predictable from the independent variable. The input coefficient of 0.757 (or 75.70%) for the Realization stage, ranked #1 for its impact on the output, indicates that the variability of the response data around its mean fits and it is stable, demonstrating on strong relationship between risks and project schedule. The results are shown in the Table 4.21, where the variables are ranked for the output.

Table 4.21: Schedule Sensitivity Analysis

<i>Rank for Total Actual Weeks</i>	<i>Project Stage</i>	<i>Total Actual Weeks Regression coeff. R-Squared=1</i>	<i>Total Actual Weeks Correlation coeff. (Spearman Rank - r_s)</i>
#1	Realization	0.757	0.709
#2	BBP - Impact analysis	0.528	0.475
#3	Final Preparation	0.274	0.217
#4	Project Preparation	0.273	0.238
#5	Go live and Support	0.263	0.242

The correlation and dependence between the schedule independent and dependent variables, quantified by Spearman's rank correlation coefficient, shows the strength of association between the two-paired sets of data, and statistical relationship. The closer the coefficient r_s is to ± 1 the stronger the relationship is.

The reported absolute value of r_s ²⁹(Spearman's correlation, viewed 15 January 2015, <www.statstutor.ac.uk/resources/uploaded/spearmans.pdf>) shows the strong positive correlation between the input and output variables for the Realization stage, moderate positive correlation for the BBP-Impact analysis stage, and weak positive correlation for the stages #3-#5 from the Table 4.21. The testing of the level of statistical significance (H_0 testing of independence between variables) was done by Kendall's Tau-b rank correlation³⁰, which showed that the correlation is significant at the 0.01 level (2-tailed). Therefore, we can conclude that there is very strong evidence to believe H_1 , i.e. that the risks and the actual schedule values are correlated.

²⁹ The absolute guide for value or r_s : .00-.19 – “very weak”; .20-.39 – “weak”; .40-.59 – “moderate”; .60-.79 – “strong”; .80-1.0 – “very strong”

³⁰ Kendall's tau-b rank correlation was calculated in SPSS

Figure 4.10, a scatter diagram of variables “Actual weeks” vs. “Realization stage” shows their relationship as the positive gradient trending with linear association, and strong positive correlation: $r_s=.709$, $p<.001$.

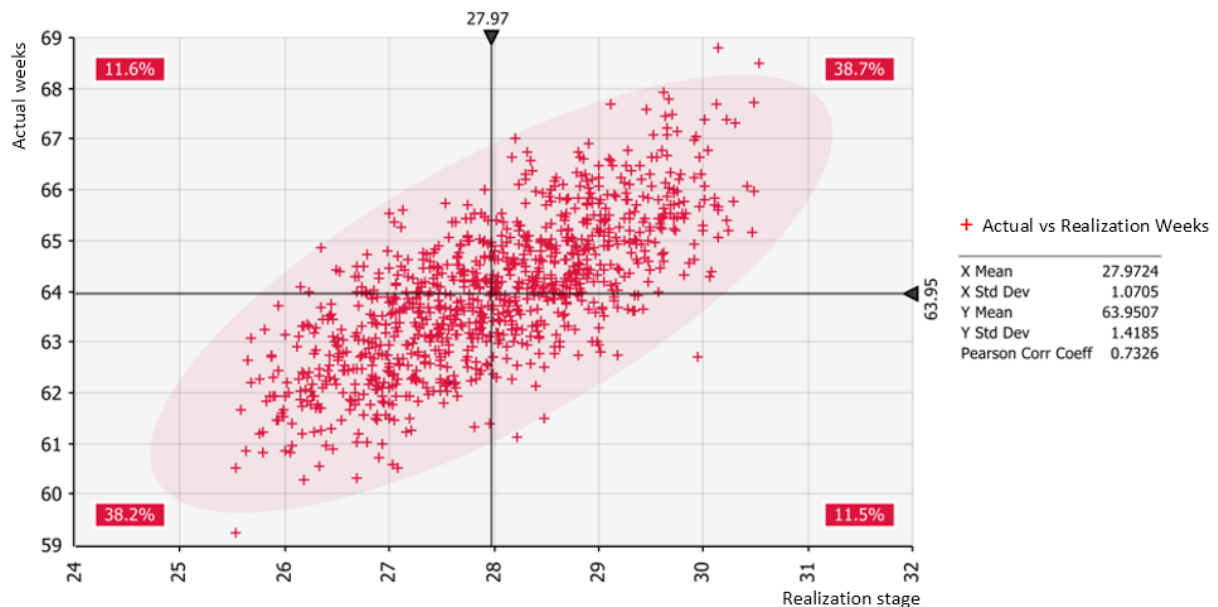

Figure 4.10: Total actual weeks vs. Realization Stage

To conclude, the traditional model analysis presented the sufficient evidence to answer the questions:

“What is the probability that risks will occur during the project?”

The first model, scenario analysis using Binomial distribution, assessed a probability that the total and each particular risk could occur in observed interval. Analysis determined all inputs (nine out of ten risks) which were significant in meeting the output target H_a : *Portfolio risk occurs = True*. There is a range of probability from 53,5% - 62,5% (avg. 58%) that risks will occur during the project.

“What is the relative standing of a particular risk within a data set?”

The relative standing of a particular risk is as follows:

- #1 Decision making
- #2 Stakeholders' expectations on adjustments
- #3 Process “gaps” in blueprint / functional documents
- #4 Consultants lack of experience
- #5 Additional resources due to scope changes
- #6 Continuous process change
- #7 Communication barriers
- #8 Communication between stakeholders
- #9 Organizational readiness
- #10 Missing and not functional processes

“Which risks contribute significantly towards exceeding the project costs and running behind schedule?”

There were six risks contributing significantly towards exceeding the project costs:

- #1 Communication between key stakeholders
- #2 Process “gaps” in blueprint / functional documents
- #3 Additional resources due to scope changes
- #4 Continuous processes change
- #5 Stakeholders’ expectations on adjustments
- #6 Communication barriers

The three most critical risks affecting all project stages are:

- #1 Decision making
- #2 Communication barriers
- #3 Communication between key stakeholders

The most critical risks affecting the project schedule are the following:

- #1 Decision making
- #2 Stakeholders’ expectations on adjustments
- #3 Process “gaps” in blueprint / functional documents
- #4 Consultants lack of experience
- #5 Additional resources due to scope changes
- #6 Continuous process change
- #7 Communication barriers
- #8 Communication between stakeholders
- #9 Missing and not functional processes

“What corrective measures can be developed for certain risks within the project portfolio?”

Development of corrective risk aversion measures, observed in Chapter 4.5.3, shall answer on the above as well as the following viable questions:

Can project portfolio be delivered within the planned budgets upon development of the corrective measures? and,

How much contingency should have been included for the revised budgetary levels to be achieved with a certain degree of confidence?

The analysis results with regard the hypotheses testing done in this Chapter show the following:

- Analysis determined that 90% of inputs (nine out of ten risks) were significant in meeting the output target H_a : *Portfolio risk occurs = True*. This finding confirms the H_2 (*Identified project portfolio governance risks can be ascertained in more than 75% of finalized projects*);
- The occurrence of project risks with the range of probability from 53,5% - 62,5% (avg. 58%) that all the risks will occur during the project life cycle confirms the H_2 (*... and the sequence of their adverse impact can be established in more than 50% of cases*);

- The probability that the risk reduction per project stage will take place if mitigation measures were developed for project risks, is 0.3955 or 40%. This probability level indicates that if development of such measures is undertaken, and if these measures are applied to all the components within the portfolio, the total portfolio risks can be reduced up to 40%, which confirms the H₃ (*By applying the corrective measures for risk reduction the total project portfolio risks can be reduced up to 40%*).

4.5.3 Corrective Measures Development

The Standard for Portfolio Management Fourth Ed. (2017, p. 86) defines the portfolio risk management principles as "... maximizing portfolio value while balancing risks, fostering a culture that embraces change and risk, and navigating complexity to enable successful outcomes". The primary objective of portfolio risk management (ibid, p. 85) "... is to make sure that portfolio components will achieve the best possible success according to the

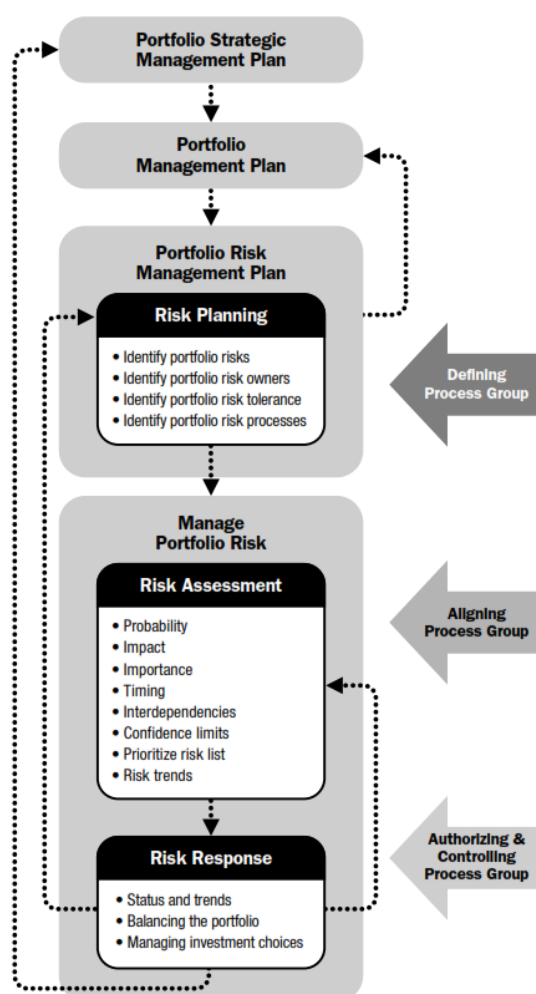

Figure 4.11: Elements of Portfolio Risk Management [The Standard for Portfolio Management Fourth Ed., 2017, p. 90]

organization's strategy and business model. From a risk perspective, this is done through the balancing of risks, both positive (opportunities) and negative (threats)". There are three key elements in portfolio risk management (ibid, p. 90): risk planning, risk assessment, and risk response, as shown in Figure 4.11. There are two major portfolio risk management processes: develop portfolio risk management plan (risk identification, risk owners, risk tolerance, and creation of risk management processes), and manage portfolio risks (executing risk plan including assessing, responding to, and monitoring risks) (ibid, p.118). Portfolio risk management backs the COSO's³¹ enterprise risk management integrated framework (COSO, 2016) in its objectives and essential components,

³¹ Committee of Sponsoring Organizations of the Treadway Commission

where enterprise risk management requires an entity to take a portfolio view of risk. Portfolio risk planning identifies risks important to the organization, risk owners, risk tolerance, and risk processes. For the most part (ibid, p. 87) "... a program or project is concerned with risks and issues that arise inside the specific program or project. Portfolios are concerned with (a) maximizing financial values of the portfolio, (b) tailoring the fit of the portfolio to the organizational strategy and objectives, and (c) determine how to balance the programs and projects within the portfolio given the organization's capacities and capabilities". All the three referenced items liaise with managing either organization's external or internal risks which impact portfolio processes and its functioning to convey successful components' execution in provision of planned values and benefits. While portfolio processes depend on structural risks concerned with an organization's ability to organize its portfolio mission with the organization's hierarchical and clustered structures, which define the methods and approaches in which the organization operates and performs its tasks, and execution risks, concerned with the how an organization manages change in performing the organization's tasks, it is inevitable that the efficient and effective management of risks at the level of portfolio components (projects and programs) will be dependent on the organizational management of structural risks and established value streams at both organizational and portfolio level in planning components and operational work, committing to it, executing, monitoring and controlling, and adopting changes.

In order to strengthen risk averse strategies, determine the variation from strategic forecasting and planning activities and diminish negative impact on business, organizations in the last twenty years are adopting enterprise risk management processes (ERM). Enterprise risk is the aggregate risk from three components (Hampton, 2009, p. 5-12): *business risk*, the possibility of a failure in delivering their products or services; *financial risk*, the possibility of not having sufficient funds for its operations; and *hazard or insurable risk*, or exposures that can cause loss without the possibility of gain (physical risk, moral, behavioral, and legal hazard). The aim of ERM is to improve the quality of organizational management. To determine an organization's exposure to risks and define remediation measures, the ERM assessment developed by Moody's (Hampton, 2009, p. 23-24) includes risk governance, risk management, risk analysis and quantification, and risk infrastructure and intelligence. Portfolio risk management sustains the ERM in the realms of its components (business – component's delivery risk, financial – risk of insufficient funding, and hazard risks), and in the structured risk management process in assessing and analyzing portfolio risks (developing portfolio risk management plan and manage portfolio risks).

In today's rapidly changing business environments traditionally managed projects and programs challenge existing organizational risks mitigating strategies. Usually traditional risk management process includes structured, rules driven change management process for elaborating changes. It is typically formalized procedure covering the change management life cycle and a decision-making organization in the form of change advisory (or change control) board (CAB), comprised from permanent members (e.g. change manager, project manager, security officer, application officer), dynamic members (e.g. change requestor, process owners from the change affected areas, operational stakeholders), and very often external participants (e.g. consultants, vendors' representatives), in order to formulate, assess, analyze, approve (or reject change), plan, implement and manage changes. Although the CAB shall agree with the assessment/analysis, classification, and planning of the change implementation to approve the change, in business practice its role is often limited to the recommendation for approval, and final change approval is subject to a key stakeholder (senior management) decision due to financial or organizational impact of a change. Risk management is integral part of the change management procedure. Author's experience from business practice is that the risks and risks mitigation measures are usually limited to their holistic description related to change classification³² and not sufficiently analyzed, with the main goal to justify additional funds for the "critical" or "urgent" scope changes. To understand why the risks related to change requests were processed in such inaccurate manner, we can identify several reasons: (1) insufficiently processed functional and technical requirements and the system's process definitions (business blueprint) which, upon approval, sealed the scope; (2) managing stakeholders' expectations, leading to organizational (stakeholder's) and project pressures on imposing changes to the scope; (3) changes managed by the lengthy CAB process. In traditionally driven projects these changes are usually late because they involve reactive stakeholder's participation once when it is obvious that the project phase will not deliver the expected outcome. Then, the major focus of the CAB process is to justify the need for the change. Krebs (2008, p. 8-9) considers that the investment in a change control board is expensive, and while doesn't argue the need for a CAB for adopting a modern engineering process, he suggests the change control mechanism integration into agile development process because traditionally managed CAB activities introduce risks of missing outcomes within the time frame set by the CAB decisions; (4) decision making process which is urgent and under pressure of severity of change. The decision makers (key

³² Excerpt from the approved Change Request 2005-011, Reorganization of the Budget and related Budget reporting structure project [87]. Change classified as critical: "... the impact of change will affect the whole system's functionality; therefore, the risk of change is high. Risk mitigation: appoint dedicated resources (consultants and internal staff members) during whole life-cycle of the change". The cost impact of this change request exceeded €162,000.00 (130 consultant/days in duration of 5 months).

stakeholders) are often put in the situation of “damage control” where the problem tends to reach the crisis stage and an alternative is not ceasing the project.

Agile and lightweight practices in change and risk management, embodied in agile estimating and planning, iterative incremental development, test-driven development, and continuous integration, have advantages in reducing uncertainties and risks in projects, compared with traditional approaches. Thus Cohn (2006, p. 18) points on problems with the traditional activity-based planning, leading to the likelihood of delivering late against a schedule derived from an activity-based plan, and opting for the feature-based planning; Krebs (2008, p. 23) observes reduction of risks at the iterative and incremental development of a project, where the highest risks can be reduced or eliminated in early iterations. Silliti et al. (2011, p. 29-112) pointed that decision makers and key stakeholders shall assess at the project inception the significant business and requirements risks which must be addressed before the project kickoff, and they must understand risk/reward trade-off needs before a decision to development is made, because it decreases the project’s likelihood to success. Boehm and Turner (2004, p. 100-142) observe a risk mechanism in comparison of agile and plan-driven risks taking a risk-driven approach and use risk analysis and a unified process framework to tailor risk-based processes into an overall development strategy. This method relies on understanding the environmental and organizational capabilities, and the efficient identification and collaboration amongst the project stakeholders.

Agile and lightweight risk management approach makes risk reduction possible due to their iterative responsiveness to business through focused delivery of specific business function, i.e. each iteration will completely implement a specific and selected business requirement, allowing changes to be substantiated often on project work and deliverable due to justification of business requirement. Therefore, the highest risks can be reduced or eliminated in early iterations (Krebs, 2008, p. 23). Development of an agile and lightweight strategy to address project portfolio governance risks requires channeling risks across the agile factors impacting the entire governance process life-cycle and the correspondent PPG structure (see Figure 2.10), from component’s inception till the review of achieved deliverables and realized benefits of a component transitioned to its owner. As we have seen from the model analysis, the three most critical risks affecting all project (portfolio component) stages are *decision making* (organizational structure and managerial risk), *communication barriers - sharing of required information*, and *communication between key stakeholders* (strategic planning risks). Also, *decision making (stakeholders’ expectations, organizational readiness)*, *business process (missing and not functional processes and process “gaps”)* and *change management risks*

(*continuous process change*) are amongst the most accentuated risks with regard the relative standing of portfolio risks. This denotes that the inherent organizational risks are critical to be managed to achieve progressive project portfolio risk reduction, commencing at the initiation process group of the Front-End governance process domain, and continuing through all the process groups of the governance process domains (see pgs. 41-57).

Development of an agile and lightweight risk management strategy with the applied approach to reducing uncertainties and risks in portfolio components is defined in below Table 4.22 – 4.25, including the project portfolio governance process domains (Front-End, Planning, Monitoring, and Deliverables). The columns 1 – 4 represent risk variables with the most impact on portfolio risks, retrieved from model analysis. The most left row represents the project portfolio governance process domains' structure. Processes significant for triggering uncertainties (risk variables) are filled-in in the tables respectively, resulting with the risk management approach, shown in the column 5.

The agile and lightweight risk management approach is summarized in Figure 4.12, where the risk steps are tailored into project portfolio governance process domain life-cycle, following the corresponding risk management process (risk identification, planning and prioritization, analysis, and resolution). This approach creates the agile risk management framework for project portfolio governance process domains, enabling a progressive risk reduction within the framework.

The approach requires early and continuous feedback from all involved stakeholders, and clarity about investment decisions to whom the benefits will be provided. Each portfolio iteration should focus on continuous risk assessment, with component's features reducing risk and providing maximum business value. It also involves a continuous review and constant readjustment against assumptions and changes in business environment, allowing determining component's criticality and clustering. Realistic, meaningful and adaptive metrics shall be established and reported regularly to the key stakeholders and used as an input to decision making and performance improvement. Also, a formal, repeatable post-implementation review process and benefits register shall be established to track gained benefits.

Table 4.22: Front-End process domain risk management approach

<i>Risk Variable</i>	<i>Organizational structure and managerial (R_{om})</i>	<i>Strategic planning (R_{sp})</i>	<i>Business process (R_{bp})</i>	<i>Change management (R_{bp})</i>	<i>Risk Management Approach</i>
<i>Front-End Process Domain</i>					
Initiation <i>Development</i> <i>Assessment</i>	Define approach Decision making	Governance principles Process methodology planning	Requirements elicitation Modelling architecture	Change assessment Impact assessment	In-context stakeholders' communication Introduce continuous and collaborative (estimating) assessment of inherent risks (likelihood and impact) Rank the risk log
Justification <i>Identification</i> <i>Communication</i> <i>Estimation</i> <i>Benefits structuring</i>	Identify valuable initiative Value-benefit elements Form a proposal funnel process	Communication between stakeholders	Value-benefit estimates	Benefit structuring Cost/benefit assessment	Identify significant risks Estimate risk exposure
Adaptation <i>Analysis</i> <i>Process formation</i>	Continuous improvement		Process formation Estimate process values stream	Gap/impact analysis	Introduce features to deal with risks Prioritize risks - establish risk-reward perspective (Krebs, 2008, p. 117)
Alignment <i>Integration</i> <i>Control framework</i>	Align initiative with strategic vision and objectives Control framework with critical performance variables Decision making	Determine oversight and fiduciary responsibilities	Integrate process value stream	Performance indicators	Plan approach on how to deal with significant risks
Approval <i>Gate review</i> <i>Value-added collaboration</i> <i>Decision making</i>	Monitor-control (gate review) Decision making	Value-added collaboration	Business analysis (such as scenario, SWOT ³³ , or business value analysis)	Performance metrics (cost/benefit analysis, such as NPV, IRR, cost benefit ratio, or options analysis ³⁴)	Factor in risk/impact from business and cost/benefit analyses Recommend the approach for decision making

³³ SWOT=Strengths, Weaknesses, Opportunities, and Threats

³⁴ NPV=Net Present Value; IRR=Internal Rate of Return

Table 4.23: Planning process domain risk management approach

<i>Risk Variable</i>	<i>Organizational structure and managerial (R_om)</i>	<i>Strategic planning (R_sp)</i>	<i>Business process (R_bp)</i>	<i>Change management (R_bp)</i>	<i>Risk Management Approach</i>
<i>Planning Process Domain</i>					
Planning	Value of an initiative in terms of ROI	Managerial oversight	Progressive elaboration of planning process	Ongoing refinement	Continuous risks' assessment and refinement
<i>Strategic plan</i>	Dedicate resources	Directional view and alignment towards a minimum viable product/service	Map the value stream	Adaptation / estimation	Reduce risks and uncertainty
<i>Operational plan</i>	Sets priorities and frequent feedback		Continuous process integration		
<i>Plan alignment</i>	Participatory decision making				
<i>Gate review</i>					
<i>Decision making</i>					
Regulation	Regulatory scaling factors	Regulatory value system	Process improvement framework	Organizational change	Continuous risks' assessment and refinement
<i>Principles</i>	Main regulative categories	Fiduciary responsibilities		Culture change	
<i>Policies</i>	Compliance with external and internal sources				
<i>Standards</i>					
<i>Ethics</i>					
<i>Culture</i>					
Accountability	Critical success factors	Authorities and responsibilities	Identify performance indicators	Accountability structure	Risk management plan
<i>Identification</i>	Performance culture	Ethics and values			
<i>Critical success factors</i>	Engaged stakeholders				
<i>Performance indicators</i>					
Leadership	Define communication channels	Strategic leadership	Identify issues that need to be dealt with	Anticipate and resolve resources' issues	Manage risks
<i>Direction shaping</i>	Motivate and mobilize towards objectives	Strategic decisions		Apply tools and techniques to bridge the gaps between hierarchical structures and self-organizing teams	
<i>Capacity creation</i>	Decision making				
<i>Value-added collaboration</i>					
<i>Decision making</i>					

Table 4.24: Monitoring process domain risk management approach

<i>Risk Variable</i>	<i>Organizational structure and managerial (R_om)</i>	<i>Strategic planning (R_sp)</i>	<i>Business process (R_bp)</i>	<i>Change management (R_bp)</i>	<i>Risk Management Approach</i>
<i>Monitoring Process Domain</i>					
Strategic uncertainties <i>Analysis</i> <i>Recommendations</i>	Group strategic uncertainties into clusters Set priorities	Strategic uncertainties	Scenario analysis of external factors affecting strategy (technological and consumer trends, economic forces)	Impact and scenario analysis Future trends	Assessment of the strategic uncertainties
Risk management <i>Identification</i> <i>Analysis</i> <i>Prioritization</i> <i>Planning</i> <i>Resolution</i>	Take precautionary steps to reduce, eliminate, restrict, mitigate, or accept the uncertainties in decision making	Organizational decision making Constant stakeholder's interaction	Analyze potential uncertainties/risks	Impact analysis	Continuous risk assessment Identify and analyze potential risks in advance Progressive risk reduction
Change management <i>Formulation</i> <i>Planning</i> <i>Implementation</i> <i>Management</i> <i>Sustain</i>	Address the organizational change implementation Manage transition Sustain change Decision making	Environmental factors/ drivers of change Adapt organizational strategy	Impact analysis	Formulate change Plan change	Continuous risk assessment Progressive risk reduction
Control framework <i>Analysis</i> <i>Performance metrics</i> <i>Monitor and control</i> <i>Oversight</i>	Success measurement criteria Monitor and control the key performance elements Portfolio oversight process Institute financial controls	Control strategic uncertainties Review the alignment of critical performance elements Strategic alignment and direction to principal stakeholders	Analyze stakeholders' expectations and requirements	Control and monitor performance Identify corrective actions by comparing actual to planned values Controlling management of change	Analyze data (cost, schedule variances, quality and risks) Identify corrective actions Apply EVM and/or AgileEVM measurements
Performance management <i>Planning</i> <i>Performance metrics</i> <i>Manage</i>	Align assets, resources, and systems to strategic objectives Resource optimization Managing value Values and benefits realization	Monitor and control Oversight	Performance measures (KPIs) Performance analysis and reporting	Management of change Recommend corrective factors Sustain change	Recommend corrective factors Risks resolution

<i>Risk Variable</i>	<i>Organizational structure and managerial (R_om)</i>	<i>Strategic planning (R_sp)</i>	<i>Business process (R_bp)</i>	<i>Change management (R_bp)</i>	<i>Risk Management Approach</i>
<i>Monitoring Process Domain</i>					
<i>resource utilization</i>					
<i>Performance analysis and reporting</i>					

Table 4.25: Deliverables process domain risk management approach

<i>Risk Variable</i>	<i>Organizational structure and managerial (R_om)</i>	<i>Strategic planning (R_sp)</i>	<i>Business process (R_bp)</i>	<i>Change management (R_bp)</i>	<i>Risk Management Approach</i>
<i>Deliverables Process Domain</i>					
<i>Review Deliverables Performance Financial Quality</i>	Approve authorization system Authorize deliverable	Oversight of deliverables with regard performance, financial and quality factors	Develop standardized and common review procedure (authorization system)	Analyze impact of changes	Assess transition risks
<i>Benefits realization Alignment Analysis Value delivery Transition</i>	Identify and assess delivered value Assign responsibility for the realization of benefits Ensure continued realization of benefits	Engage benefits owners Monitor performance of benefits, alignment with strategy, and sustainability duration	Align the benefits with strategic goals Consolidate coordinated benefits	Transition to operation Ensure sustainability Develop “Stop-Start-Continue” process list Benefits realization result chain	Assess operational risks Assess risks of adequacy of benefits realization Benefits risk register

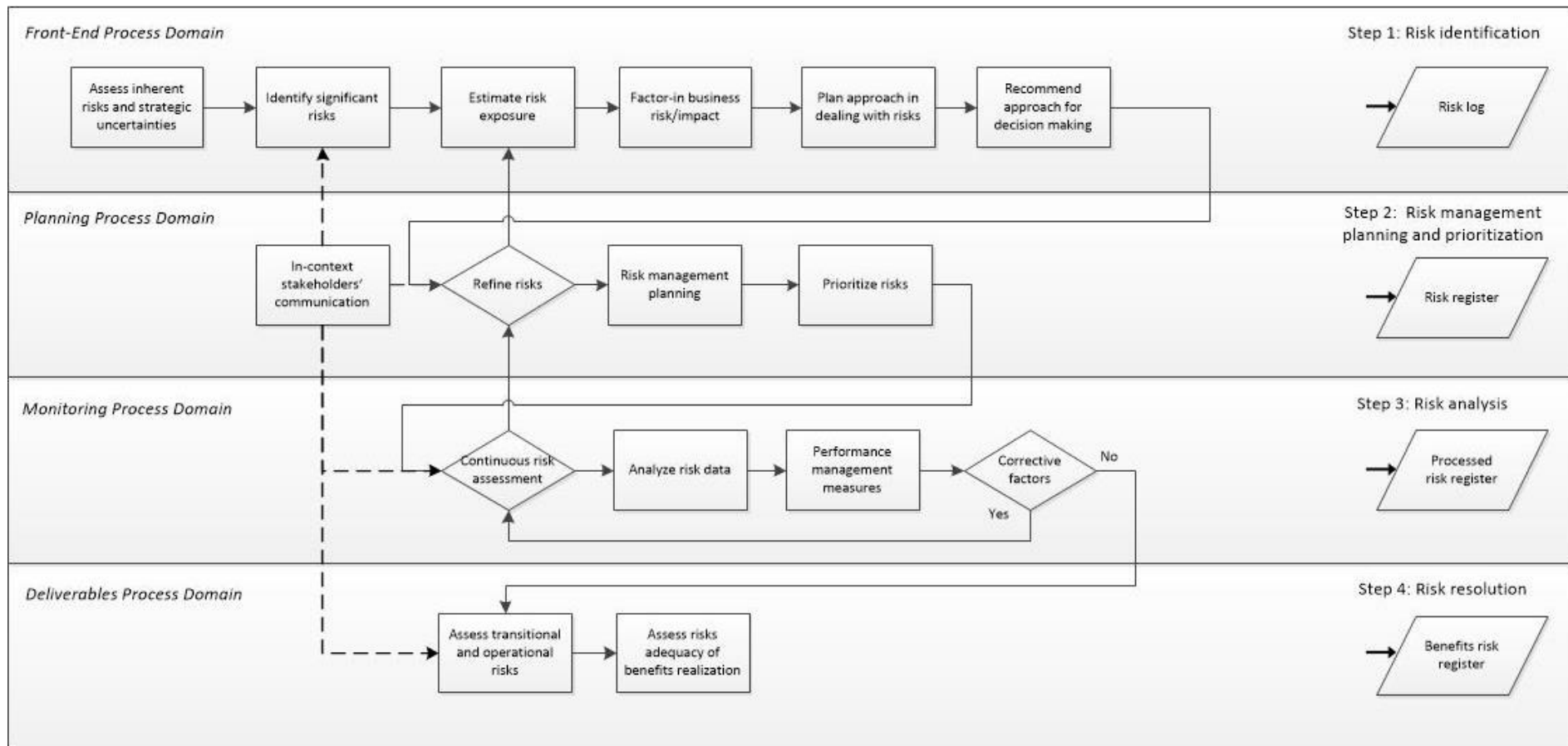

Figure 4.12: Project Portfolio Governance Risk Management Framework

Breaking down barriers and establishing a cross-functional and collaborative approach among stakeholders within the organizational environment is required by an agile and lightweight approach to enable in-context stakeholders' communication and make the established communication channels iteratively fitted in providing the organizational, financial, and procedural value stream decision making. This entails a substantial organizational commitment and change management effort in facilitating imposed process constraints, with organizational enablers required to embrace the portfolio management practice in the evaluation, analysis of existing and potential projects, programs, or operational components, selecting components to be implemented as part of the portfolio, allocating resources to components that have been selected, and collecting and storing data for performance measuring. It is important, thus, that the qualified formal process of components' inception is carried out by evaluating a business case at the project level or a feasibility study at the program level for the portfolio candidate to "... resolve scope, cost, schedule, resource, quality, and risk issues within a shared governance structure" (The Standard for Program Management, 2017, p. 9). The purpose of that document is to present to the project portfolio governing body a comprehensive projection for the component candidate's functional, organizational, staffing, financial, technological, marketing, and scheduling elements, including future organizational benefits and involved risks, to consent a qualified decision-making process. The financial projections are focused on investment risks and are the key elements of the candidates' selection process, including the assumptions on which these projections are based. The assumptions carry the risk factors that arise from the uncertainties regarding potential costs overrun, schedule/milestones slippages, resources, assets and contractual requirements, and component life-cycle financing availability. The financial forecast on potential of a component helps assess its profitability and may be performed by various quantitative methods including net present value (NPV), discounted cash flow (DCF), internal rate of return (IRR), cost benefit ratio, payback period, and options analysis (Krebs, 2008, p. 97-100), the payback period and NPV are common and effective methods of making a case for a project by evaluating its potential and risk, with the NPV method "... considering the time value the time value of money, which is a factor missing in the payback period method, and it carries a strong risk factor that arises from the uncertainty of whether the profit can be realized between the present time and the deadline". The usefulness of the NPV method is especially in the ability of making comparison between the projects and its suitability for agile projects where it allows investments to be assessed on a short time-basis, and it can be applied on a feature level of a project allowing realization of additional benefits (Krebs, 2008, p. 100-101). Findings and recommendations of a business case or feasibility study with regard the initiative's probability of success, anticipated risks and benefits to the

organization shall be evaluated during the component selection process. Because these documents are focused primarily on potentials of a project, they don't assess all the inherent risks and strategic uncertainties nor identify significant risks that are involved in an initiative.

Agile and lightweight project portfolio governance risk management framework includes the steps as depicted in Figure 4.12:

Step 1: Risk identification

The activities depicted in Step 1 shall be performed to identify significant risks, estimate risk exposure, factor-in the impact of risks on business, and plan how to make qualified decisions in dealing with risks. These activities are part of portfolio evaluation criteria associated with organizational aspects of component's evaluation and should be quantifiable so that they can be ranked, prioritized, balanced, and measured in further steps, to fit the organization's risk profiles (The Standard for Portfolio Management, 2017, p. 15). Depending on the organizational perspective of the risk, these activities may be identified by executive management, operations management, portfolio manager, and the program/project management team, and stakeholders (The Standard for Portfolio Management, 2017, p. 91):

- *Assessing inherent risks and strategic uncertainties* is concerned with the issues of strategic planning, organizational structure and management, adequacy of business processes, and organizational changes which may impact the portfolio and its components. The assessment creates the threat pool of positive and negative risks at organizational and portfolio level which makes downstream impact on portfolio components,
- *Estimate risk exposure* is a set of activities where the risks log is created with the estimate of the probability a risk event will occur for each risk in the log, followed by the calculation of the risk exposure – the unmitigated loss if risk occurs multiplied by the probability that the risk will happen,
- *Factor-in business risk/impact* as a root cause correction of negative risks, or capitalization of positive risks at the portfolio level to generate cost effectiveness and provide contingencies across the threat pool, addressing the common risks characteristics in creation of opportunities for components inception at the equity protection level, to establish risk planning process. The tools and techniques available for that purpose are weighted ranking and scoring and graphical methods; the example of these are Risk-reward diagramming, which categorizes projects in terms of risk and

reward, and can condense information about the vision, risk, and potential return of investment (Krebs, 2008, p. 115),

- *Plan approach in dealing with risks* “... outlines the processes by which risk will be managed at the portfolio level” (The Standard for Portfolio Management, 2017, p. 95). The portfolio risk management plan provides guidance regarding governance model, performance management, communication, and stakeholder engagement for developing the risk management plan. It may also define roles and responsibilities for conducting risk management, budgets, risk management activities schedule, risk categories, definition of probability and impact, and stakeholder risk tolerances,
- *Recommend approach for decision making* includes the establishment of comprehensive decisions about selecting one portfolio component over another, or about projects/programs within the portfolio. The approach for decision making comprises the consistent metrics for planned vs actual values, the ROI estimates, technical feasibility, and guidance on risk planning methodology to be used.

Step 2: Risk management planning and prioritization

The approach to the agile risk management embraces progressive risk reduction, where the risk reduction is possible due to agile visioning and incremental iterative development, while each iteration focuses on what features provide maximum business value and what features reduce project risk.

- *In-context stakeholders' communication* includes working on risks together with business and early and continuous feedback from the team is therefore vital for continuous risk assessment and addressing risks in early iterations,
- *Refine risks* is a part of improvement in risk assessment which is brought by continuous feedback and addressing risks early,
- *Risk management planning* details the way risks will be identified and analyzed, and how these risk responses will be developed, managed, and communicated. It provides the methodology, structure and guidance for performing risk identification, roles and responsibilities, risk measures, guidelines on use of tools, and details on the time and budget allocated to risk management process. Agile, however, does not dictate a risk management approach, except DSDM with Atern (Agile Business Consortium, viewed 15 December 2016, <<https://www.agilebusiness.org/content/risk-management> >) agile project delivery framework, where a typical risk management process is composed from the four continuous activities: *Identify risks*, *Assess severity*, *Plan counter-measures*, and *Monitor and manage risks*. The typical agile risk management process

encompasses risk identification, risk analysis, risk prioritization, risk management planning, and risk resolution. The Institute for Agile Risk Management (IARM) comprises the four stages risk management process founded on principles of transparency, balance, and flow: *Understand project objectives, context and risk environment*, *Risk scoping (identify risk drivers and appetite)*, *Risk tailoring (embed risk management in agile process)*, and *Risk management (identify, analyze, manage, and monitor)* (The Institute for Agile Risk Management, viewed 17 December 2016, <<http://institute.agileriskmanagement.org/wp-content/themes/iarm/publications/AgileRiskManagementEmbraceChangeWhitepaper.pdf>>, p. 6),

- *Prioritize risks* agile applies various risk management techniques in decision on how to deal with significant risks, or risks with exposure higher than 50% of the rating scale to decide on what approach to take in dealing with risks (risk retention-mitigation, risk avoidance, risk reduction-elimination, or risk transference). Risk register contains prioritized risks and risk adverse measures.

Step 3: Risk analysis

The execution of a traditional project is focused primarily on control of defined triple constraints (scope, time, and cost) or quadruple constraints (scope, time, cost, and quality). The issue with these constraints is in their variation: scope creep, late delivery, increased costs, or insufficient quality - carrying risks and leading to adding additional resources and objectionable outcomes. Agile and lightweight methods have caused a change in handling the constraint variables (features, time, cost, and quality) by fixing either features or time/cost/quality from variation. This approach enables confronting risks early and iteratively and employs continuous risk assessment in shaping of the risk response strategies.

- *Analyze risk data*. According to the PMI Standard for Portfolio Management Third Ed. (2013, p. 132), management of portfolio risks includes the tools and techniques for risks evaluation - weighted ranking and scoring techniques, and risks analysis - quantitative and qualitative analysis. Qualitative analysis is "... used to measure domains of portfolio risks that are not specifically quantitative. These may include risk probability and impact analysis, risk-portfolio component chart, weighted ranking and scoring techniques, heat maps, and ranking and scoring of portfolio risks." (PMI Standard for Portfolio Management Third Ed., 2013, p. 133). One of the qualitative techniques used in agile and lightweight project portfolio balancing and selection is risk and reward diagramming, which summarize information about portfolio vision, risk, and potential

return of investment (Krebs, 2008, p. 115). The example of such a diagramming technique used at the bi-weekly project portfolio board meetings is shown in the Figure 4.13. The projects are visually represented as bubbles of different sizes, depending on the amount of resources, and colors, representing the unit responsible for the project ownership. The quadrants on the left side of the diagram will significantly reward the organization, with the upper left quadrant having lower risks and higher possibility of success, and lower left quadrant having higher risks. The quadrants on the right side of the diagram show projects with low and high risks of achieving results, although less rewarding for the organization.

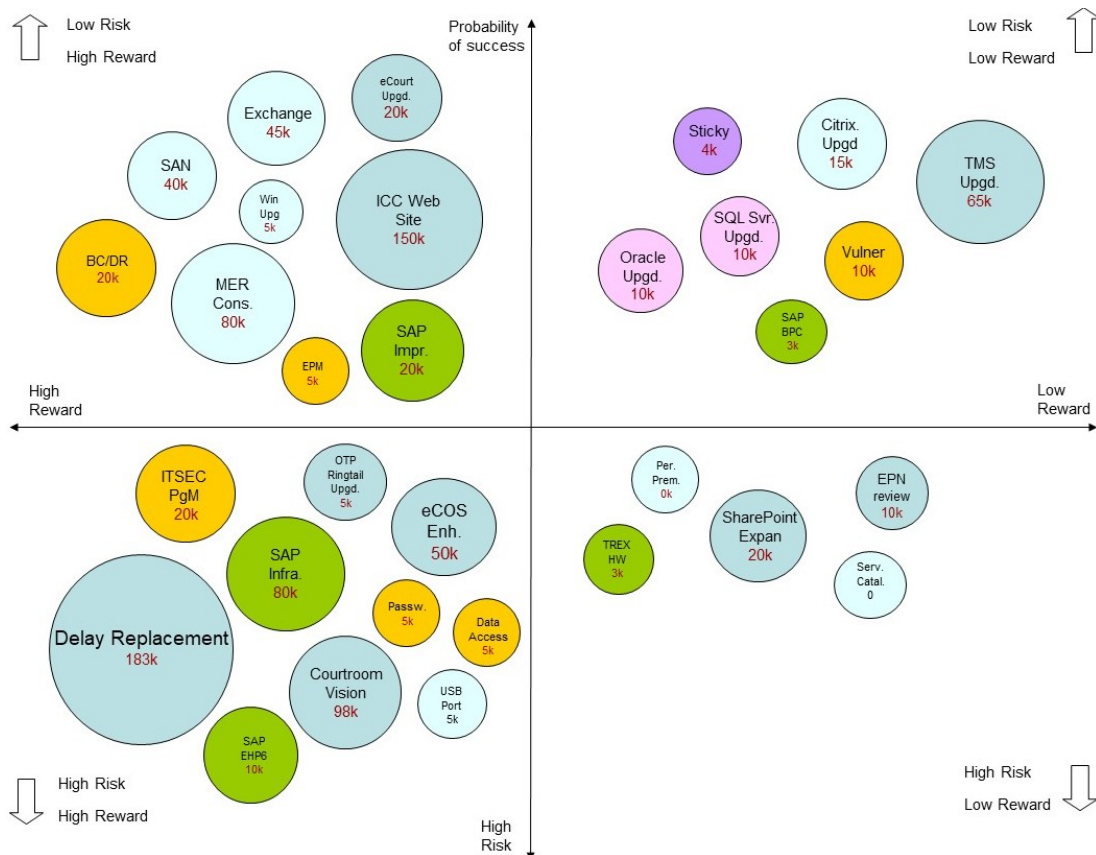

Figure 4.13: ICC ICT Project Portfolio 2013 - Risk-Reward diagram (ICC Strategy 2013-2017 Update, 2012)

The upper-left quadrant, showing the resources spent on low risk, high reward projects, is the area where the well-proportioned portfolio shall show the substantial activities. The advantage of such an approach to the qualitative risk data analysis is that a risk-reward assessment allows managing the progression and improvement of an agile portfolio against the threat pool over a period of iterations, consenting the resources allocation to less risky and more rewarding projects, thus evolving the project portfolio towards further value for the organization.

Quantitative analysis in portfolio risk management is used to determine variability and trends in schedule, budget, performance, and time-to-market (PMI Standard for Portfolio Management Third Ed., 2013, p. 132), such as modeling and simulation using Monte Carlo technique to interpret the uncertainties' impact on portfolio objectives, and sensitivity analysis to determine which risks have the most potential impact on the portfolio. The modeling and simulation and sensitivity analyses were used in this work to determine the risks which significantly impact the project portfolio governance processes. Commonly, quantitative analysis is used in iterative-incremental financial assessment and measurement of the potential of agile projects in materializing project goals during the life-cycle, such as payback period (PBP), net present value (NPV), internal rate of return (IRR), and cost-benefit analysis. In the iterative agile environment, the cost-benefit analysis provides more reliable cost data because the costs are harvested during the retrospectives and then compared with benefits, stipulating more consistent estimates for the next iteration.

- *Performance management measures.* According to the PMI Standard for Portfolio Management (2013, p. 132), "... variance and trend analysis using performance data from the portfolio components may be reviewed on a regular basis to determine deviations from the baseline, which may indicate the potential impact of threats or opportunities. Trends are also useful for evaluating the effectiveness of earlier risk response".

As detailed in Chapter 3.3.2, the EVM, along with risk management, is one of the most effective performance measures and decision support techniques. The EVM analysis in project management processes is fundamentally applicable in planning, executing, and controlling process groups. The emphasis on the EVM fundamental applicability is within the planning and controlling process groups (scope, time, cost, communications, risk, procurement, and integration), and the executing process group (integration and communication), aiming to measure, analyze, forecast and report cost and schedule performance data for evaluation by the key stakeholders (PMI Practice Standard for Earned Value Management, 2005, p. 2).

The EMV analysis was performed on the project portfolio component representative used in Chapter 4.5.2 by establishing a performance measurement baseline (PMB), or planned value (PV) for the project, and measuring and analyzing performance against the baseline, identifying where problems are occurring. The measured data points include earned value (EV), the amount of accomplished work in a given period, actual cost (AC), the level of resources expended to achieve the actual work performed in a

given period, and budget at completion (BAC), the final data point on the PMB. Figure 4.14 shows the cumulative EVM measures for the project.

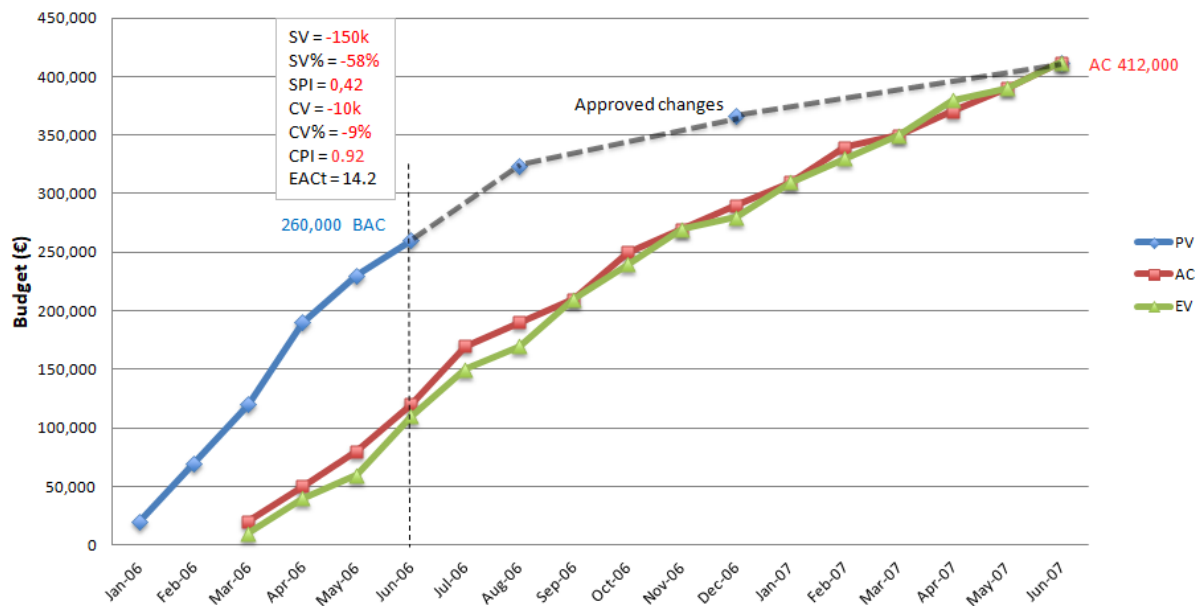

Figure 4.14: Cumulative Planned Value, Earned Value and Actual Cost for the Case Project

The examined measures include schedule (SV) and cost (CV) variances, schedule performance index (SPI) and cost performance index (CPI), and forecasts – time estimate at completion (EAC_t). The measurement period was set on the final data point on the PMB (estimated budget at completion). Schedule analysis shows that the project was behind the work scope and schedule, an unfavorable condition expressed in a negative variance ($SV = -150.000,00$ Euro; $SV\% = -58\%$). The project was 58% behind planned work, meaning that 58% of the planned work has not been accomplished. The schedule performance index (SPI) was 0.42, meaning that the work was accomplished at 42% efficiency, or in average, for each 8-hour project workday only 3 hours and 30 minutes of the planned work have been performed. The schedule variance in time units ($SV_{(t)} = 2$ months; $SPI_{(t)} = 1.67$) show the schedule overrun. The cost analysis shows unfavorable conditions as well ($CV = -10.000,00$ Euro; $CV\% = -9\%$), indicating that the project was nine percent over budget for the work performed. The cost performance index (CPI), determining how efficiently the team used its resources, was 0.92, indicating that the project has had a cost efficiency that provides 0.92 Euro worth of work for every project Euro spent to date. The time estimate at completion ($EAC_t = 14.2$) exposed that if work continued at the rate taken at measurement, the project would take 14.2 months longer than originally planned.

Figure 4.15 shows the project's cumulative cost (CPI) and schedule (SPI) performance index values, showing that cost- and schedule-wise the project was underperforming, or continuously being over budget and behind schedule (index values below 1.0). Data for the last three months of project execution show index values 1.0, meaning that the project was on (changed and approved) additional budget and schedule for completion.

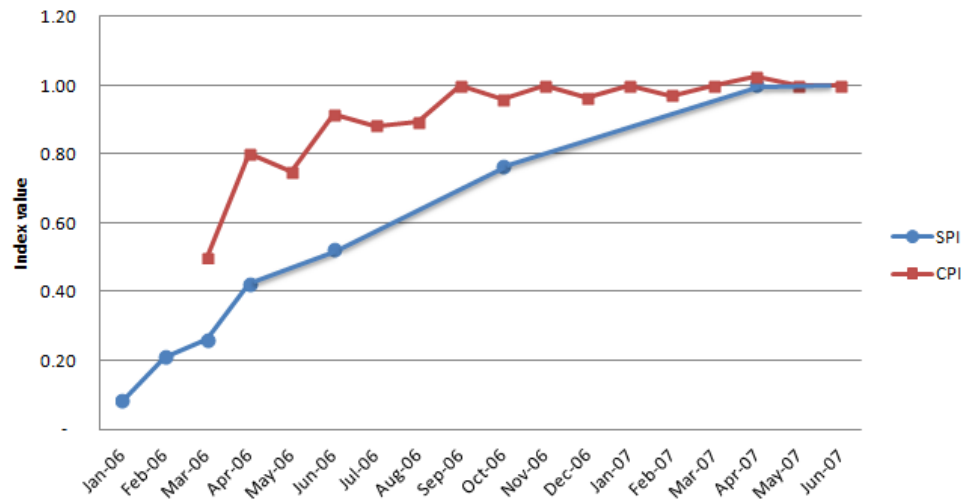

Figure 4.15: Case Project Cost Performance Index and Schedule Performance Index

The model analysis presented the sufficient evidence there were risks contributing significantly towards exceeding the project costs and affecting the project scope and schedule (see pgs. 109-111). Although this was a change management project with the aim of improving the existent system, a full risk assessment, addressing uncertainties in requirements affecting the project scope, resources affecting the costs, and required activities affecting the time, was not done at the phase of project preparation and development of the project plan. Furthermore, the impact analysis phase was done based on the process change assessment during the requirements gathering and scoping, with no full risk assessment which might have produced additional changes and/or an inadequate system structure for overall organization needs. As the model analysis has shown, the three most critical risks affecting all project stages – decision making, communication barriers, and communication between key stakeholders, contributed significantly to the requirements management, and defining the proper project scope, costs, and time, causing delay in project start. In order to address uncertainties and risks at the establishment of the project's performance measurement baseline (planned value), which is derived from costed and resourced project plan, Hillson (2004, p. 3) suggests that a full risk assessment of the project plan addressing time and cost uncertainties, shall be done before the project start. According to Hillson (2004, p. 3), the most suitable method to assess both time

and cost uncertainties is quantitative risk analysis using Monte Carlo simulation. The advantage of this approach is that these risk models take account of variability in planned values and in the effect of discrete risks' probability of occurrence. The modelling shall include both threats and opportunities, with planned risk responses. Incorporating risk management process at the PMB construct allows simulation of worst- and best- case scenarios with regard cost and time and justifies inclusion of contingency funding to account for remediation of project uncertainties and risks during the project life cycle. While the EVM uses indices and calculates the estimate to complete (ETC) in order to estimate the completion of a project, the risk management adds its synergetic value in a prediction of "... a range of possible futures by analyzing the combined effect of known risks and unknown uncertainty on the remainder of the project" (Hillson, 2004, p. 4), resulting in a total budget confidence level (probability of meeting value of planned budget) indicating how much contingency funding should be allocated into the project baseline to cover the expected level of risks. In dealing with the mitigation of the most critical risks affecting the project costs (see pg. 109-110), the project initiation process shall address to the project governing body the two key questions about a project budget proposal: *Can project portfolio be delivered within the planned budgets upon development of the corrective measures*, and *How much contingency should be included for the revised budgetary levels to be achieved with a certain degree of confidence?* The answer on these questions is possible through modelled simulation, where it is assumed that each planned item's actual cost will be within a min-max range (Pert distribution). The generalized description of possible actual costs of each planned item could be made by modelling an unbounded range for the maximum actual value (LogNormal distribution) and including dependencies or correlation relationships between the planned items and the risk variables, to represent risks that certain adverse events may (or may not) occur (Binomial distribution). The same approach is to be applied in addressing the mitigation of the schedule risks (see pg. 109).

Nonetheless, as the most critical risks affecting all the project stages belong to domain of governance risks - organizational structure and managerial risk (decision making), and strategic planning risks (communication barriers and communication between key stakeholders), the necessity of changes in shaping stakeholder's collaboration strategy, shifts in addressing stakeholder's demands, expectations, and their response to changing business conditions, as well as shifts in organizational efficiency, is inevitably required. These shifts and improvements are part of the organizational

change management process, constituting organizational project and program environment which allows agile and lightweight transformation of projects and programs with the aim of refining the efficiencies and effectiveness of project work and achieving values for the organization.

The improvements in the organization of the case study project is possible by transforming its development life cycle into an agile and lightweight. The process model of the project portfolio component analyzed in the case study was traditional SAP ASAP method. As of 2009, SAP AG introduced agile and lightweight add-on to its ASAP 7 methodology based on Scrum and XP methods, making the ASAP a hybrid implementation method (SAP Agile Implementation Methodology, 2009, p. 9). It is incremental, iterative (time-boxed implementation), where each iteration is comprised from planning, requirement analysis, design, coding/configuration, unit testing, and acceptance testing of the working product. Project envisioning, baseline and evaluation construct is done based on agile accelerators.

Transforming the case study project requires that the stakeholders are involved constantly during the project life-cycle, being responsible for what is needed (requirements), what is needed next, and for ongoing refinement and changes. It is therefore required to identify stakeholders and their concerns, conduct stakeholder analysis and brand their empowerment, with forming cross-functional teams. Business interaction points are in participatory decision making (who owns what decision), continuous feedback (what was planned vs. what got done), and the client checkpoints (whether the scope/vision and individual user stories are still accurate). These are the most powerful risk averse measures for the organizational structure and managerial risk (decision making) and strategic planning risks (communication barriers and communication between key stakeholders), especially in resolving stakeholder's misalignment due to conflicting priorities and unshared vision.

The project visioning and chartering aims to establish a baseline view to a project vision and mission, a view towards a minimum viable product, and a baseline understanding and connection between stakeholders and the team. The directional alignment of the project baseline is achieved by running iteration (sprint) #0 chartering, where the connections to an existing organizational level architecture is defined, initial paperwork prototyping is done, story writing workshops and other meetings to establish initial product backlog are performed, teams are formed including establishing roles, assessing skills, etc., running training sessions, and

planning for the first iteration is done. Defining user stories and prioritizing features is the following step in creation of product backlog, followed by progressive elaboration (rolling wave planning) and analysis, which aims to a decision on a release time-box for the project. During the release planning stage, the team develops velocity estimation, a capacity planning tool or metrics that predict how many stories can successfully be completed within a time-boxed iteration. Release planning finalizes with building of a product roadmap, or planned product releases with high-level functionality for a period that usually includes two or three significant feature releases into the future. Release planning is followed by commitment-based iteration planning with the goal to make a work item list for the upcoming iteration event.

Transformation into agile driven development reduces risks which contribute significantly towards exceeding the project costs and schedule (see pg. 109):

- Communication between key stakeholders and communication barriers risks, by stakeholders' empowerment, participatory decision making, continuous feedback, client checkpoints, and resolving stakeholder's misalignment,
- Process "gaps" in blueprint/functional documents risk, by defining features which are built to fulfill stakeholders needs and represent their value, with the ability to test features during incremental deliveries,
- Additional resources due to scope changes risk, by progressive elaboration and analysis to continuously improve and detail project plan as more accurate estimates become available from the successive iterations of the planning process. Velocity estimation is a capacity planning tool which provides a basis for improving the accuracy and reliability of near- and longer-term planning. Estimation can be done based upon historical averages or being calculated by reviewing completed work upon running a few iterations, or by making a forecast (number of hours to work on the project for each person each day). Also, a progressive risk reduction is possible due to continuous risk assessment and working on risks with stakeholders, addressing risks in early iterations,
- Continuous processes change and missing and not functional processes risks, by continuous refinement of requirements vs. current processes aiming to achieve completeness, consistency, correctness, traceability, modifiability, verifiability, and unambiguity of operational processes,
- Stakeholder's expectations on adjustments risk, by their participation in release planning and inspect and adapt workshops, and involvement in the

iteration demos as well as provision of input between iteration demos together with subject matter experts,

- Decision making risk, by empowering participatory decision-making process with clarity on who owns what decision,
- Consultants lack of experience is a risk of external project influencers (subcontractors, suppliers, etc.), considered able to impact/enhance the project and remove impediments. Risk averse measures are brought by proper identification, analysis, and engagement during the stakeholder management process.

Agile project performance management uses AgileEVM method for establishing the performance and schedule management baseline, planned budget for the release, and completion of planned iterations and actual story points. The basic agile measure data points are historical velocity, iteration and release burndowns, indices (CPI, SPI), and forecasts or estimates to complete (mean velocity). AgileEVM establishes results between the completed release backlog data points, and the change in data points during the iteration (from work added or subtracted and iteration cost). Review and control of changes or integrated baseline review is managed during the iteration retrospective, and upon the acceptance of work completed a new project baseline (or budgeted cost of work scheduled) is approved. These continuous refinements of work items integrate risk management with AgileEVM and cost and schedule management, allowing improved cost and schedule performance and risk reduction.

Step 4: Risk resolution

Project portfolio success is measured in terms of the aggregate investment performance, alignment to organizational strategies, and benefit realization (PMI Standard for Portfolio Management, 2013, p. 6). Program management harmonizes its project and program components and manages their interdependencies to realize specific benefits. Project management develops and implements plans to achieve a specific scope that is driven by the objectives of the program or the portfolio (PMI Standard for Portfolio Management, 2013, p. 7). Benefits management is the key building block for a project portfolio and a program performance management, where sustainable benefits realization responsibility relies on program and portfolio managers and a governing body. In order to reduce risks of inadequate benefits realization and ensure alignment with organizational strategy, during the process of benefits transition it is required to:

- *Assess transitional and operational risks* to ensure that benefits are transitioned to operational areas and can be sustained. The benefit risk log shall be created, and risks maintained in order to execute the transition change process as planned,
- *Assess risks adequacy of benefits realization*, ensuring that the realization of benefits impacting operational areas is applied according to acceptance criteria applicable to delivered portfolio components, and to ensure that resulting changes have been successfully integrated.

The answer on the question “*What corrective measures can be developed for certain risks within the project portfolio?*” is achievable through the agile and lightweight project portfolio governance risk management approach, where the risk management measures are integrated into the governance process domains, as elaborated in the previous section, by:

1. Adopting structured risk management processes to the governance of project portfolios in order to strengthen risk averse strategies,
2. Applying and sustaining risk management processes to a project portfolio and its components in assessing, analyzing risks, developing risk management plan, and management of risks,
3. Agile and lightweight practices in change and risk management make project portfolio risk reduction possible for the most critical risks:
 - a. organizational structure and managerial risk (decision making);
 - b. strategic planning risks (communication barriers and communication between key stakeholders),
 - c. organizational business process risks (continuous process change, missing and not functional processes, and process gaps in functional documents),
 - d. resource risk (lack of experience),
 - e. component scope risk (scope changes),
 - f. component cost and schedule risks,
4. Agile and lean practices allow integration of risk management and AgileEVM performance management.

Developed corrective risk aversion measures provide answer on the following questions:

- *Can project portfolio be delivered within the planned budgets upon development of the corrective measures?* Yes, based on the change control process upon finalizing each iteration where shippable work and the release backlog form a new project baseline. The adjustment in baseline correlates with the calculated release date estimates (mean

velocity predictions - EAC), where the fluctuations in planned vs actual costs being reduced in the later iterations.

- *How much contingency should have been included for the revised budgetary levels to be achieved with a certain degree of confidence?* Based on modelled simulation of possible actual costs where the planned item costs are correlated with risk variables.

4.6 Case Study Findings

The main objective of this study was to conduct a probabilistic analysis based on stratified sampling of variable risks factors in determining the behavior of the agile governance processes and proofing the conceptual governance model based on the agile and lean concepts and methods that decreases risks and improves the performance of project portfolio processes.

The case study used statistical analysis to discover relationship between finalized project portfolio components' performance and process inputs in order to determine what were the root causes of the recorded components' performances and why. The analysis elaborated on what the performance improvement measures are and when and how to implement them and established the reliable hypotheses test. The input for the analysis was project portfolio components' historical risk data stratified by the portfolio components' development life-cycle (traditional/prescriptive, agile/lightweight, and tailored), and processed to obtain common project portfolio risk factors. The prioritized, weighted, and ranked common risk factors constituted process inputs to probabilistic models. Quantitative data analysis used Binomial, Poisson and Beta-PERT distributions with probabilistic Monte Carlo simulations to determine a probability of risks occurrence, risks arrival per observed period, deviations from the most likely costs and schedule distributions, and determine relationships between variables by applying regression and sensitivity analyses. The critical risk factors were identified with the elements for developing the risk averse measures and processes improvement.

The case study analysis presented the sufficient evidence to acknowledge the following findings:

1. Each uncertain variable (risk events R_{om} , R_{bp} , R_{sp} , R_{rc} , and R_s) impacting the output variable spread (dependent variables schedule and cost) occurred more than once per observed interval. Analysis determined inputs (nine out of ten risks) which were significant in meeting the output target H_a : *Portfolio risk occurs = True*, exhibiting that more than 75% of risks made H_a rank. The summary risks occurrence trend exposed the probability range from 53,5% - 62,5% that all risks will occur more than once during the project life-cycle.

2. The analysis proved there were three most critical risks affecting all project stages:

- #1 Decision making
- #2 Communication barriers
- #3 Communication between key stakeholders

As these risks belong to a category of organizational structure and managerial risk (decision-making), and strategic planning risks (communication barriers and communication between key stakeholders) and by their nature are inherent risks, these risks institute conjoint portfolio risks where all the constituent portfolio components will be affected consequently.

3. The analysis evidenced that the most critical risks were:

- #1 Decision making
- #2 Stakeholders' expectations on adjustments
- #3 Process "gaps" in blueprint / functional documents
- #4 Consultants lack of experience
- #5 Additional resources due to scope changes
- #6 Continuous process change
- #7 Communication barriers
- #8 Communication between stakeholders
- #9 Organizational readiness
- #10 Missing and not functional processes

The inherent risks (organizational structure and managerial, strategic planning, business process, and change management) build majority of critical risks (60%), while acquired risks (process "gaps" in blueprint/functional documents, consultants lack of experience, additional resources due to scope changes, missing and not functional processes) indicate business process, resources, and scope risks as an effect of continuously present inherent risks influencing and impacting the portfolio component execution.

4. There are six risks contributing significantly towards exceeding costs:

- #1 Communication between key stakeholders
- #2 Process "gaps" in blueprint / functional documents
- #3 Additional resources due to scope changes
- #4 Continuous processes change
- #5 Stakeholders' expectations on adjustments
- #6 Communication barriers

Findings confirm that inherent risks (communication between key stakeholders, continuous processes change, stakeholders' expectations on adjustments, and communication barriers) constitute ~70% of risks contributing significantly towards exceeding component's costs, indicating that the costs of all portfolio components will subsequently be affected.

5. The case analysis exposed that the probability of risks' impact on the planned schedule is highest at the business blueprint-impact analysis followed by the project realization

stage. The risks have made the most impact on the actual schedule at the realization and business blueprint – impact analysis stages. The most critical risks affecting the project stages and schedule are the following:

- #1 Decision making
- #2 Stakeholders' expectations on adjustments
- #3 Process “gaps” in blueprint / functional documents
- #4 Consultants lack of experience
- #5 Additional resources due to scope changes
- #6 Continuous process change
- #7 Communication barriers
- #8 Communication between stakeholders
- #9 Missing and not functional processes

Scheduling resembles a roadmap on what project work to be performed, which resources will perform that work, how that work will be performed, and when the project will deliver services and products defined in project scope. Activities in the schedule model represent work packages identified in the work breakdown structure (WBS) which defines elements of the scope required to complete a schedule activity leading to deliverables. The WBS is associated with the organizational work breakdown structure (OBS) and risk breakdown structure (RBS) through the control accounts, where scope, budget- resources, and schedule are integrated. The issues with the traditional scheduling are primarily in the quality of scope definition, i.e. whether the stakeholder's requirements are clear and complete, involved business processes accounted for and analyzed sufficiently to achieve a clear knowledge on the structure, functioning of a new, changed, or existing processes required for successful project execution, and their mapping to the organizational process structure. The three highest ranked risks impacting the project schedule represent the uncertainties most commonly connected with the scope issues: insufficiently defined and not clear requirements in the situation where the expectations are high, inadequate decision-making, and process gaps, consequently causing the scope change pressures resulting in schedule and costs overrun.

6. The analysis has exposed if the risk corrective measures were developed, the expectation for risk reduction is 40% for the case project, and if these measures are applied to all the components within the portfolio, the total portfolio risks can be reduced up to 40%. The corrective measures include the following:
 - Development of an agile and lightweight strategy for project portfolio process domains to address project portfolio governance risks from component's inception till the review of achieved deliverables and realized benefits of a transitioned component,

- Development of the agile risk management framework for project portfolio governance process domains which enables a progressive risk reduction;
- Establishing factors that enable the agile risk management framework:
 - Early and continuous feedback from all involved stakeholders,
 - Clarity about investment decisions to whom the benefits will be provided,
 - Continuous risk assessment,
 - Continuous review and constant readjustment against assumptions and changes in business environment,
 - Determining a portfolio component's criticality and clustering,
 - Establishing a realistic, meaningful and adaptive metrics reported regularly to the key stakeholders and used as an input to decision making and performance improvement,
 - Integrating performance management, AgileEVM, with risk management in order to maximize the likelihood of achieving portfolio objectives,
 - Instituting a formal, repeatable post-implementation review process and benefits register to track gained benefits.
- Defining the processes that enable project portfolio risk management framework:
 - *Risk identification*, where the activities on assessment of inherent risks and strategic uncertainties with identification of significant risks will take place, followed by the estimation of risk exposure, factoring the impact of risks on business, and planning on how to make qualified decisions in dealing with risks,
 - *Risk management planning and prioritization*, enabling progressive risk reduction by in-context stakeholders' communication, risk refinement, risk management planning, and risk prioritization,
 - *Risk analysis*, which enables confronting risks early and iteratively, and employs continuous risk assessment in shaping of the risk response strategies by:
 - Risk data analysis, where the portfolio risks are evaluated and qualitatively and quantitatively analyzed. The recommended qualitative technique used in agile and lightweight project portfolio balancing and selection is risk and reward

diagramming, which summarize information about portfolio vision, risk, and potential return of investment. Quantitative analysis in portfolio risk management is used to determine variability and trends in schedule, budget, performance, and time-to-market, and in iterative-incremental financial assessment and measurement of the potential of agile projects in materializing project goals,

- Performance management measures, by using performance data from the portfolio components with the aim to measure, analyze, forecast and report component's data for evaluation by the key stakeholders. The EVM analysis was performed on the project representative in the case study, elaborating through the examined measures including schedule and cost variances, performance indices, and forecasts, sufficient evidence there were risks contributing significantly towards exceeding the project costs and affecting the project scope and schedule. The analysis determined that:

(1) in traditionally driven projects, integrating risk management process with the EVM at the performance measurement baseline construct and during the project's life-cycle, allows reduction of uncertainties in costs and schedule,

(2) in agile and lightweight driven projects integration of risk management with AgileEVM and cost and schedule management allow improved cost and schedule performance and progressive risk reduction.

- *Risk resolution*, where the transitional and operational risks are processed in order to ensure that the benefits are transitioned to operations and sustained, ensuring that changes brought by deliverables are integrated and aligned with organizational strategy.

7. Finally, the analysis has confirmed that the conjoint risk and change management factors are interrelating and influencing the agile governance process domains, as depicted at the agile governance framework conceptual model (see Figure 2.5) and elaborated in the project portfolio governance risk management framework.

5 SURVEY STUDY

The survey study represents the second, qualitative data collection method. This survey was designed in order to examine the suitability of agile methodologies and lean practices for the development of organizational project portfolio governance frameworks and governance domain processes. The survey investigated a specific context within the project portfolio governance framework and how that context is influenced by the governance domain processes. These domain processes that enable governance framework are designed based on agile methods used in lightweight process engineering. The aim of this survey was to describe governance domain processes within desired context with the help of survey strategy (Pinsonneault, Kraemer, 1993).

The survey provided answers on specific questions, including what agile and/or lightweight method is the most suitable for the development of project portfolio governance frameworks and processes, and whether agile factors cause the optimal actualization of the governance domain processes that improves the performance of project portfolio management processes and consequently positively affects organizational performance in achieving its values and benefits.

5.1 Survey Design

The survey research was focused on describing the essential reasons behind the agile and lean development of organizational project portfolio governance processes. As the prerequisite for conveying this survey is information standardization, it could be contended that both phenomena (agile, lean, lightweight methodologies and project portfolio governance processes) were standardized to such level that the existing theories are widely accepted by academics and professionals.

The objective of this survey was to distribute questionnaire electronically and to receive answers from diverse audience, providing more accurate picture of research phenomenon and obtaining more significant results because of the possibility of identifying a greater number of variables (Myers, 1997).

For the purpose of this observational research, the most suitable survey design is cross-sectional design or cross-sectional analysis, involving the analysis of data collected from a representative subset at one specific point in time. The strengths and weaknesses of the cross-

sectional studies are shown in below Table 5.1 (PHAST (Public Health Action Support Team), 2011, viewed 25 May 2014,

<<http://www.healthknowledge.org.uk/e-learning/epidemiology/practitioners/introduction-study-design-css>>):

Table 5.1: Strengths and weaknesses of cross-sectional studies

<i>Strengths</i>	<i>Weaknesses</i>
Relatively quick and easy to conduct (no long periods of follow-up)	Difficult to determine whether the outcome followed exposure in time or exposure resulted from the outcome
Data on all variables is only collected once	Not suitable for studying exceptional events with a short duration
Able to measure prevalence for all factors under investigation	As cross-sectional studies measure prevalent rather than incident cases
Multiple outcomes and exposures can be studied	Unable to measure incidence
The variable(s) characteristics are important for assessing the requested concept in a specified population	Associations identified may be difficult to interpret
Good for descriptive analyses and for generating hypotheses	Susceptible to bias due to low response and misclassification due to recall bias

(PHAST, 2011)

Since the results of the survey are collected at one point in time, the results can be generalized. The survey design criteria that must be met are presented in Table 5.2 (Pinsonneault, Kraemer, 1993, p. 82):

Table 5.2: Criteria for a survey study design

<i>Element / Dimension</i>	<i>Description Design</i>
Survey type	Cross-sectional
Mix of research methods	Not necessary
Unit(s) of analysis	Clearly defined and appropriate for the questions/hypotheses
Respondents	Representative of the unit of analysis
Research hypotheses	Questions or hypotheses clearly stated
Design for data analysis	Inclusion of antecedent variables and time order of data
Representativeness of sample frame	Explicit, logical argument; reasonable choice among alternatives
Representativeness of the sample	Systematic, purposive, random selection
Sample size	Sufficient to represent the population of interest & perform statistical tests
Pre-test of questionnaire	With sub sample of sample
Response rate	60-70% of targeted population
Mix of data collection methods	Not necessary

(Pinsonneault, Kraemer, 1993)

Besides the above listed criteria elements, the attention was paid on the measurement error which could have resulted from badly structured questionnaire or request for answers.

The survey's questionnaire, or request for answers, was designed in the three-step procedure (Saris, Gallhofer, 2014):

- Specification of the concept-by-postulation in concepts-by-intuition,
- Transformation of concepts-by-intuition in statements indicating the requested concept, and
- Transformation of statements into questions.

The example of design of the survey question 20 (“In-context collaboration”)³⁵ is depicted in Figure 5.1. This sample presents the operationalization of the concept-by-postulation “an attitude toward In-context collaboration” in terms of concepts-by-intuition, questions, and assertions representing the possible responses.

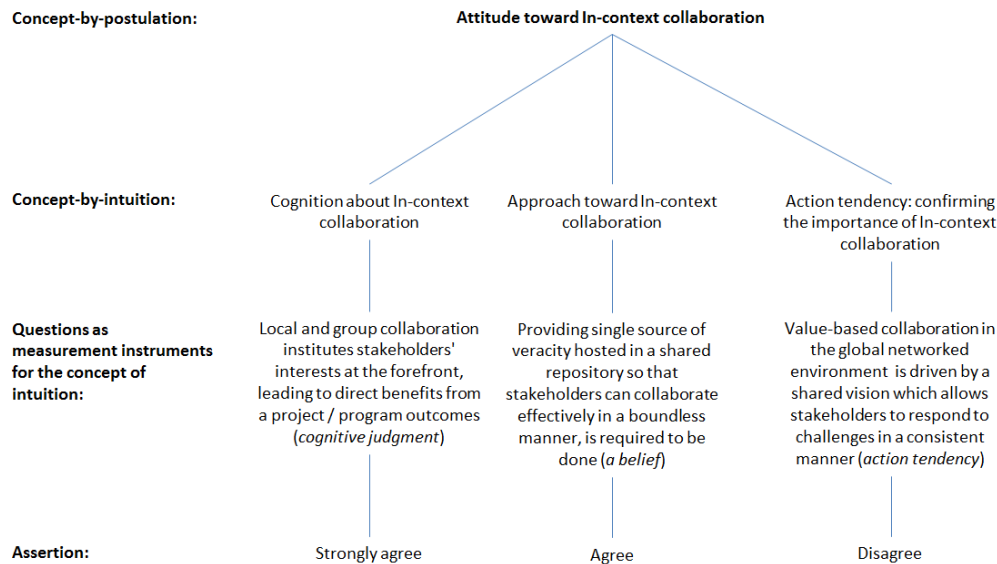

Figure 5.1: Operationalization of an attitude toward In-context collaboration
(Saris, Gallhofer, 2014)

Measuring in-context collaboration shall be possible if we of it as a concept-by-intuition that can be measured with a direct answer on the statement included into the question (R variable):

- *Strongly agree*
- *Agree*
- *Neither agree nor disagree*
- *Strongly disagree*
- *Don't know*

The statement in the example refers to an objective concept (attitude toward in-context collaboration, a behavior), while the answer categories relate to subjective concepts (leveling agreement/disagreement).

In Figure 5.2, this process is presented through a path model (Saris, Gallhofer, 2014). This model suggests that people express their level of agreement/disagreement directly in their response with the exception of some errors. The variable of interest is in-context collaboration (IC), and this is latent or unobserved variable. The responses to the question 20 can be observed directly (“Strongly agree/Agree/...”).

³⁵ See Appendix for details

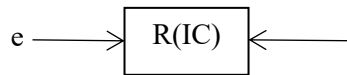

Figure 5.2: A measurement model for a direct measure of in-context collaboration
(Saris, Gallhofer, 2014)

The verbal report of the question, as suggested by this model, was determined by the unobserved variable in-context collaboration and errors (e). As shown in the model, the response to the IC question is denoted as R(IC).

The quality of survey design was tested with the SQP 2.0, the Survey Quality Prediction system³⁶ for questions used in survey research. The SQP program is a continuously growing database of survey questions in most European languages with information about the quality of the questions and the possibility to evaluate the quality of the questions that have not been evaluated so far. To date, there is no other program in the world for that purpose (Saris, Gallhofer, 2014).

For testing the quality of questions, several survey questions were analyzed. Survey prediction overview is presented in below enclosed tables. Table 5.3 shows the statistical dispersion of survey quality coefficients with their prediction, interquartile range (IQR), and standard error. The quality coefficients are the square root of the quality indicators. These are the coefficients that are estimated in the simulation. The uncertainty exists in the estimates presented in the interquartile range and the standard error.

Table 5.3: Survey quality coefficients distribution

<i>Quality Coefficients</i>		<i>Prediction</i>	<i>Interquartile range</i>	<i>Standard error</i>
Reliability Coefficient	(r)	0.858	(0.755, 0.910)	0.180
Validity Coefficient	(v)	0.971	(0.920, 0.990)	0.123
Quality Coefficient	(q)	0.834	(0.703, 0.865)	0.125

(SQP, 2014)

Table 5.4 shows survey quality factors, their variances, and the survey quality prediction.

Table 5.4: Survey quality prediction

<i>Quality Factors</i>	<i>Variance³⁷</i>	<i>Quality prediction</i>
Reliability	r^2	0.737
Validity	v^2	0.943
Quality	q^2	0.695

(SQP, 2014)

Quality prediction indices denoted sufficient confidence in the survey design. Potential improvement of the survey in order to reach the maximum quality was possible, as shown in Table 5.5. The average improvement coefficient was +0,049 or 5%.

³⁶ Survey Quality Predictor, www.sqp.upf.edu

³⁷ Common method variance (cmv) for the simulation was 0.042

Table 5.5: Potential survey improvements

Variable	Potential Max Quality	Change in Variable
avgvrd_total	0.744	+ 0.049
nsyll_total	0.739	+ 0.044
ncategories	0.714	+ 0.019
stimulus	0.704	+ 0.009
scal_neutral	0.700	+ 0.005
labels	0.699	+ 0.004
balance	0.698	+ 0.003
used_WH_word	0.698	+ 0.003
labels_order	0.697	+ 0.002
showc_horiz	0.697	+ 0.002

(SQP, 2014)

The usefulness of this approach to survey quality prediction lies in the fact that the estimates are observable before the data have been collected. The quality estimates using SQP 2.0 were obtained with minimal efforts and allowed researcher to improve data collection.

5.2 Qualitative Data Collection

The qualitative data collection was harvested from the developed self-administered electronic survey conducted via Internet (electronically). For this survey Google Forms services have been used. The request for answer was distributed to the respondents, a selected pool of project/program and portfolio professionals, experts and academics, via e-mail with the survey's hyperlink enclosed at the e-mail's body. This selection was made in order to reduce the threat from sample bias, as the selected pool of respondents had a required knowledge of project portfolio management processes and agile/lean methodologies.

In order to ensure the reliability of the design and quality of the survey, the request for answer was staged in three phases:

- *Pilot survey.* The initial survey was prepared and sent in mid-February 2014 to a selected number of respondents to validate the design. The pilot process provided useful comments (example feedback quoted below):
 - "...although I'm using agile methods in my programs intensively, I'm not used to utilize them in portfolio management, nor do I know all of these subsets to judge them..."
 - "Recommendation: consider re-phrasing to allow a representative panel of answers..."
 - "... my superiors haven't got the word methodology or organizational in their library..."

- “... my current line of work does not cover any form of governance, so the answers would not be out of practical background (only how I should/would do it)...”
- “Within my company various agile techniques are in use as this is the choice of the many countries where the company is active. I have no information which method has contributed to what goal.”

In order to clarify and fully understand the meaning of comments and suggestions, detail explanations have been asked via email and direct phone conversations. Upon discussions, the survey was restructured in order to meet research objectives.

- *Final request for answer.* The survey was restructured and formulated based on the following findings/issues:
 - *Detail knowledge of agile methodologies.* The pilot survey required detail knowledge of eight agile methods, namely XP, ASD, DSDM, Scrum, Crystal, FDD, AM, ISD including their lifecycles.
 - *The requirement to generalize on a higher, holistic methodological level.* Instead of actual methods, structure the questions with methodological representatives.
 - *Simplify questions and abolish detail division of agile methods.*

The changes in the pilot survey included restructuring the group of questions 10 – 17, from which the eight agile methods have been waived and the main methodological representatives have been embedded. Also, in the questions 21 and 24 the further division of agile methods was eliminated, so the questions were generalized at the methodological level. Thus, the results shall be generalizable due to the more homogenous sampling and easier task for respondents to locate a congruent methodology for the requested case.

The final version of the request for answer was created in May 2014.

- *Survey submission.* The LinkedIn service was predominately used for the respondents’ pool construct. The request for answer was sent to 226 respondents before the end of May 2014.

5.3 Survey Results

In this Chapter the survey results are presented based on the collected data from 81 respondents that have the following roles: executives working at a strategic level (15 or 19%), consultants (14 or 17%), project managers (12 or 15%), program managers (9 or 11%), modelers - analysts/designers/architects (6 or 7%), academics (5 or 6%), heads of IT or main IT decision makers - CIO’s (4 or 5%), operations/support (4 or 5%), quality managers (3 or

4%), developers (3 or 4%), IT managers (2 or 2%), business managers (2 or 2%), and business stakeholders (2 or 2%).

Prevalent respondents' area of responsibility was information technology (21 or 26%), followed by program management (14 or 17%), PMO management (13 or 16%), business consultancy (11 or 14%), project management (9 or 11%), administration (5 or 6%), research and development (4 or 5%), general management (3 or 4%), and financial management (1 or 1%). The respondents' work experience showed predominately proficient skills scale: 20+ years (50 or 62%), followed by 10 - 20 years of experience (24 or 32%), and 5 - 10 years (7 or 9%). Business sector involvement exposed that a majority of respondents coming from technology sector (26 or 32%), followed by international (19 or 23%), public (7 or 9%), other sector(s) (5 or 6%), telecommunications (5 or 6%), services (4 or 5%), financial (4 or 5%), utilities (3 or 4%), manufacturing (3 or 4%), retail (3 or 4%), and government (2 or 2%).

42 or 52% of respondents confirmed that their organizations have a project portfolio governance framework, 33 or 41% considered that the project portfolio governance framework generally helps portfolio management to succeed, and 6 or 7% of respondents stated that their organizations don't have project portfolio governance. It is significant to notice that there were zero responses on questions "The project portfolio governance is neither helpful nor harmful", "The project portfolio governance is generally a hindrance to portfolio management processes", and "I don't know what a project portfolio governance is".

Agile methods adopted 41 or 51% of respondents' organizations, 33 or 41% are in the process of adopting agile methods, and only 7 or 9% of respondents do not consider agile methods. The major agile method practiced by respondents is Scrum (56 or 69%), followed by XP (14 or 17%), ISD (13 or 16%), DSDM (12 or 15%), FDD (9 or 11%), Crystal (6 or 7%), ASD (4 or 5%), and AM (4 or 5%)³⁸. 6 respondents or 7% did not practice agile methods at all.

In order to determine the statistical confidence of the survey, the four factors shall be observed (Van Bennekom, 2011):

- *Size of the population*, or the group of interest for the survey, and the response rate,
- *Data set (population and segmentation) analysis*, in order to determine statistical confidence,
- *Degree of variance in responses from the population*. Initially, the variance is conservatively assumed until the data analysis is done,

³⁸ It is important to notice that the question allowed respondents to choose one or more methods of practice in their responses.

- *Tolerance for error*, or the level of results accuracy.

The size of the population for the survey, 226 respondents, was the sample because the request for answer was sent to all 226 respondents. The response rate was 35,8% (81 respondents completed the survey). The chart in Figure 5.3 shows curves depicting levels of accuracy, starting from the first one at the top representing 100% certainty and 100% accuracy. This chart employs the most conservative assumption about degree of variance in responses from the population. The variance found in each survey question and can be calculated for each survey question (as per the example for survey quality prediction). The populations mean most likely

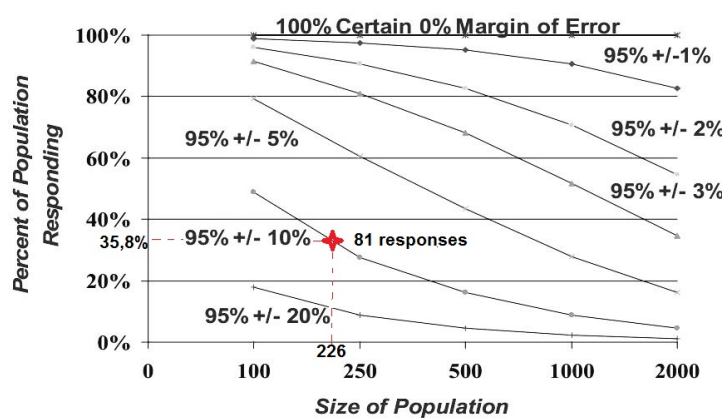

lies in the range with a 95% certainty. Each curve in the graph shows 95% certainty of a certain range of accuracy. The response rate of 35,8% positions the sample mean score of 95% of accuracy with +/- 10% error range. It is to ratify that the survey results findings conform to the quality prediction values.

Figure 5.3: Statistical accuracy of the survey (Van Bennekom, 2011)

Figure 5.4 shows the status of formalization and structuring of project portfolio governance processes, and particularly which governance processes are supported by responders' organizations.

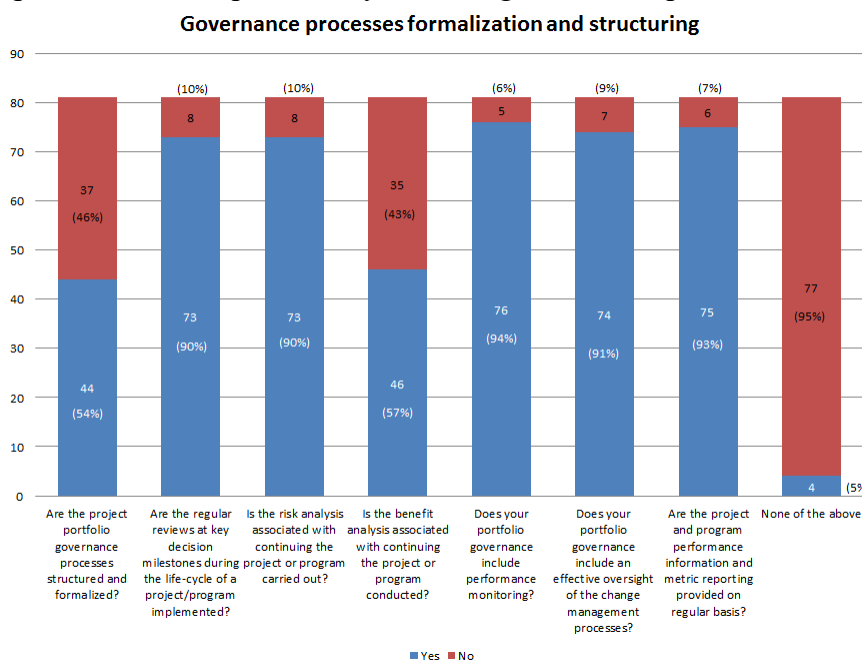

Figure 5.4: Governance processes formalization and structuring

Majority of responses show the inclusion of the performance monitoring processes (94%) and the regular provision of performance metrics (93%), importance of change management processes being carried out (91%), risk analysis (90%), and regular review process (90%).

Conversely, responses to the question whether the governance processes are formalized and structured exposed only 54% of consent. This indicates that organizations are still behind the required level of project portfolio governance formalization and structure.

The importance of governance functions and roles at the respondents' organizations is shown in Figure 5.5. More than half of respondents indicated the governance is important in the processes of resources optimization (63% agree + 17% strongly agree), stakeholders' involvement in mission monitoring (60% + 30%), risk management and optimization (59% + 27%), political advocacy (59% + 12%), policies development and statutory compliance (57% + 28%), setting and monitoring mission, strategies, direction, priorities (54% + 38%), and setup and maintenance of governance processes and planning (52% + 33%).

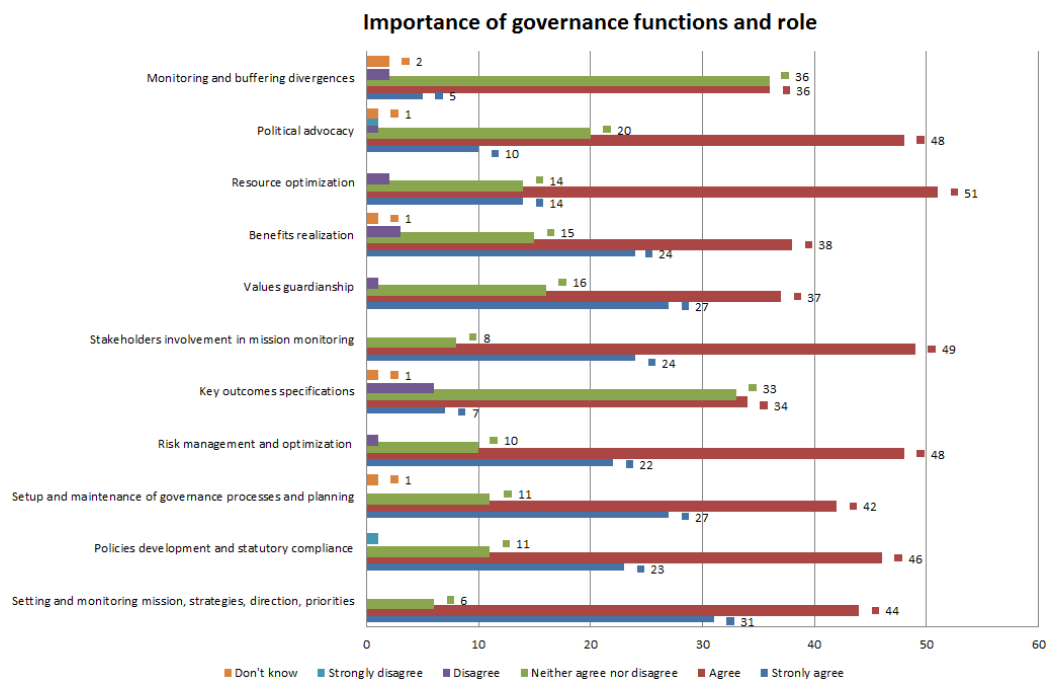

Figure 5.5: Importance of governance functions and role

The examination of agile factors having impact on related governance domain processes is analyzed below.

1. Alignment with organizational objectives

Majority of respondents (78%) confirmed that the alignment with organizational strategic objectives is better if the corresponding project portfolio governance front-end domain process is agile enabled, as shown in Figure 5.6. As this process is also part of the initiation process group, it means as well that the respondents are aware that the success (or failure) of a project or program initiative depends on the alignment of objectives' value chain.

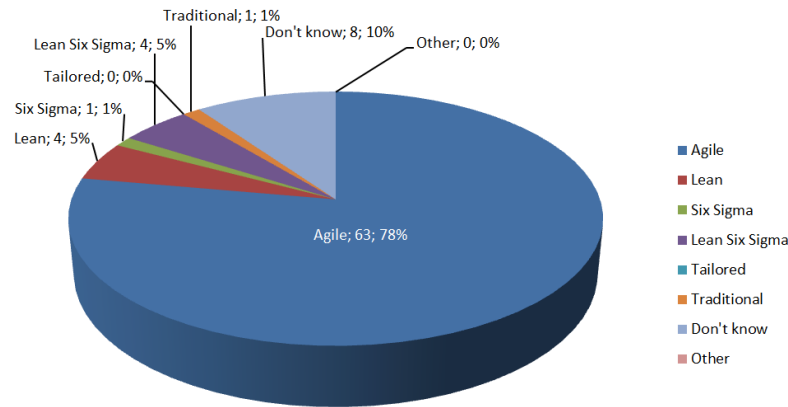

Figure 5.6: Alignment with organizational objectives

2. Organizational value creation

Overwhelmingly, responses (78%) indicate that the organizational value creation is influenced by agile factors, as shown in Figure 5.7. There are four generic determinants of value creation (Pitelis, 2010): a) organizational infrastructure and strategy, b) human and other resources and their services, c) technology and innovativeness, and d) unit cost economies / returns to scale.

Respondents recognized that organizations following agile principles: continuous delivery of valuable products/services, harnessing changes, shortening delivery timescales, improved collaboration and communication channels, sustainable development, continuous innovation through self-organizing teams and motivated individuals, are in position of capturing and creating more values for organizations and people.

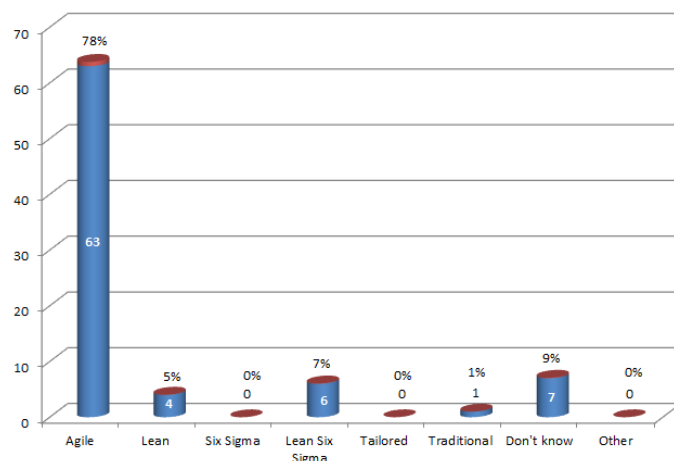

Figure 5.7: Organizational value creation

3. Response to change

Change management is a comprehensive, cyclic, and structured approach for transitioning individuals, groups, and organizations from a current state to a future state with intended business benefits. It helps organizations to integrate and align people, processes, structures, culture, and strategy (PMI Managing Change in

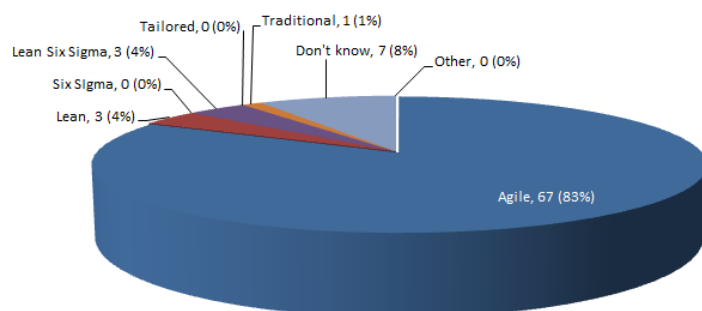

Figure 5.8: Response to change

Organizations, 2013). Survey results significantly indicate, as shown in Figure 5.8, that governance processes based on agile methods leverage organizational capabilities in response to change (83%). Front-end adaptation governance process builds elasticity towards organizational changes impacting portfolio processes, enabling rapid process formation, gap/impact analyses, determines process waste, and estimates values stream. High performing organizations focus on execution and alignment by: a) maturing portfolio management practice to improve the balance between investment and risk, b) improving organizational agility to allow flexibility and quick response, embracing change as an iterative, emergent and continually evolving process, and c) tracking benefits realizations past the end of a project / program through operations to verify return of investment (PMI Pulse of Profession, 2013). The respondents acknowledged that the traditional methods and practices are not sufficient in dealing with the today’s ever-changing business environments.

4. Alignment of business goals

Vast majority of respondents (80%), as presented in Figure 5.9, expressed their view that agile enabled front-end governance processes empower alignment of business goals (objectives)

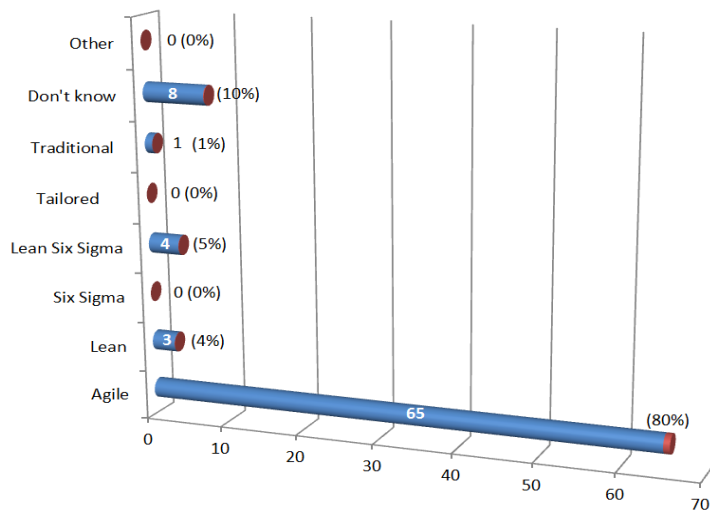

Figure 5.9: Alignment of business goals

with organizational strategy, and that these processes are required to achieve the set performance goals. At the same time, 10% of respondents are not aware of the significance of these processes, or don’t know. Front-end alignment governance process enables alignment of portfolio

processes with the organizational objectives. The strategic initiatives - projects and programs - establish the *why*, the *what*, the *when*, the *how*, and the *who* concerned with sustaining, changing, and improving business processes and infrastructure in support of the corporate strategy (Lyngso, 2014). Alignment of projects and programs with the strategic planning establishes the portfolio(s) required to achieve objectives and performance goals, as well as the oversight and fiduciary responsibilities through establishing the control framework and critical performance variables. Portfolio management balances conflicting demands between programs and projects, allocates resources based on organizational priorities, and manages so as to achieve the benefits identified. Portfolio management provides governing processes in order to

forecast, make decisions that control or influence the direction of a group of portfolio components, and as they work to achieve specific outcomes, monitor their performance.

5. Decision making influence

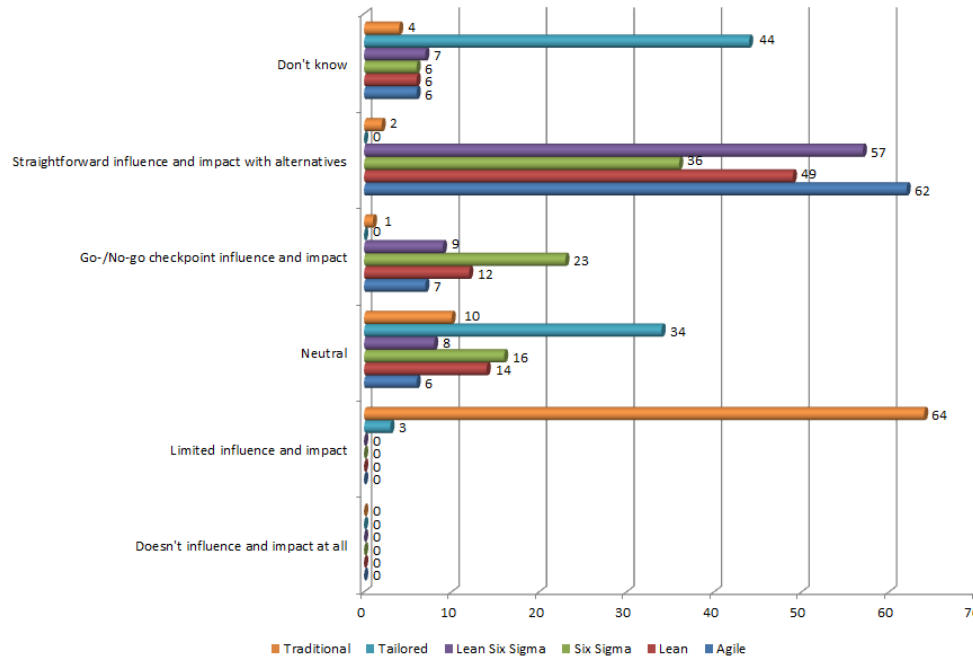

Figure 5.10: Decision making influence

Decision-making and approvals are governance facilitating processes that delineate the responsibility and accountability of stakeholders. Governing body makes decisions that control or influence the direction of a portfolio component or group of components (projects or programs) as they work to achieve specific outcomes.

As shown in Figure 5.10, survey results indicated that the lightweight methodologies (agile 64 or 76% of all responds, Lean Six Sigma 57 or 70%, Lean 49 or 60%, and Six Sigma 36 or 44%) have straightforward influence on governance decision-making process, including the impact of a decision. It is obvious that the traditional decision-making process is having limited decision-making influence and impact (64 or 79% of all responds).

6. Participative alignment

Alignment with strategic plan is the governance planning processes which involves deciding what will be done and how. It includes making strategic decisions about the direction, sets the budget-funding, identifies accountability and leadership, sets policies to

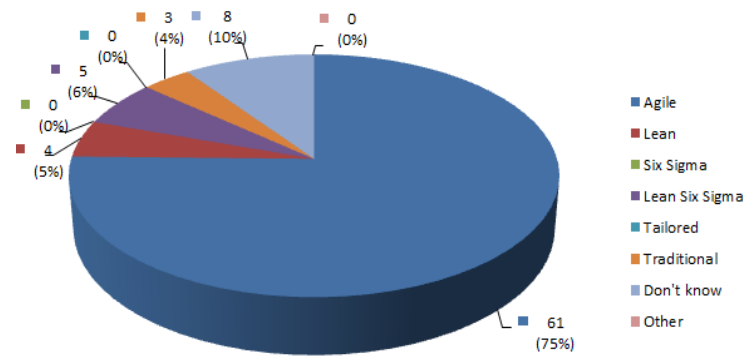

Figure 5.11: Participative alignment

guide how services will be delivered, and supervises. Strategy planning, organization alignment and execution are concurrent and interdependent processes. Internally integrating and aligning an organization is as important and challenging as aligning the whole organization with its customers. The survey results shown in Figure 5.11 designate agile methods as prevalent in alignment with strategic planning and organizational operational processes. It is important to stress that 10% of respondents are not familiar with this process.

7. Real-time planning

Real-time planning enables full planning integration with the project or program execution.

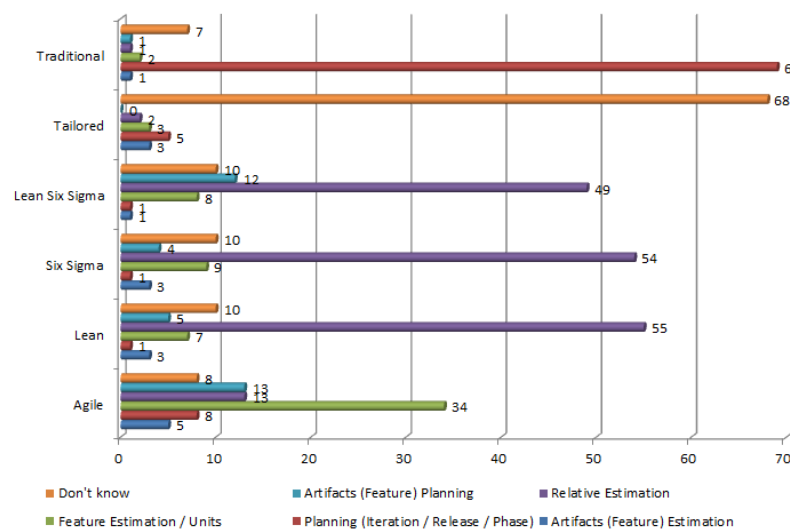

Figure 5.12: Real-time planning

Governance planning process is responsible for supervision of operational plans being implemented and methods of their delivery. The majority of responses, as shown in Figure 5.12, indicate that the traditional planning process is still predominant (69 or 85% respondents), but it is obvious that the lightweight agile planning practices are

emerging: relative estimation, feature estimation/units, and artifacts planning and estimation.

8. Regulation, standards, and procedures

Lean Six Sigma was recognized as a method which builds a minimum reasonable set of organizational regulation, standards and procedures, and balances this regulatory value system the most (47% of respondents).

Other lightweight methods are following (agile 26%, and Lean 13%). Traditional methods collected 1% of responses, indicating that the regulative documentation management is the area of concern. Regulation,

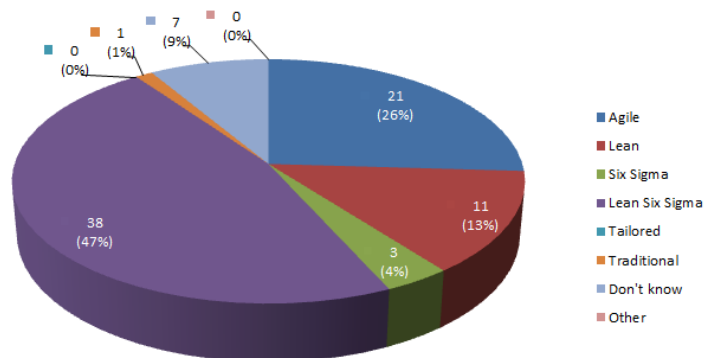

Figure 5.13: Regulation, standards, and procedures

policies, standards, functional processes and procedures, and standard operating procedures and instructions are part of the quality management system for an organization, with the aim of achieving organizational quality objectives. Quality management principles include a strong customer focus, the motivation and implication of top management, the process approach, and continuous improvement. The quality management system’s best practices are standardized and regulated by the family of ISO 9000 standards.

9. Lifecycle traceability

Survey results indicate that the accountability identification (72%) and enabling measurement of results (72%) are predominant factors that should be supported by agile methodology in order to properly identify and align accountability for the plans that are fully integrated with project/program execution, followed by implementation purpose and exact goals (69%) and achievement of reasonable results with minimum waste (69%). Figure 5.14 shows the lifecycle traceability responses.

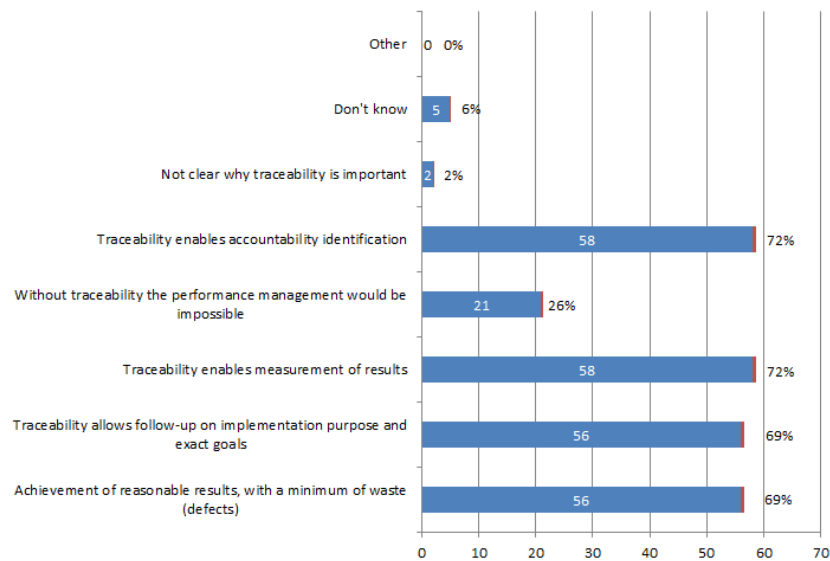

Figure 5.14: Lifecycle traceability

Respondents indicated the importance of lifecycle traceability, which can be seen as the governance of a service/product from the initial idea until the service/product is retired. Traceability, as a function, is responsible for managing of relationships between development artifacts that are used or produced by activities integration, and it is part of collaborative lifecycle management (IBM Rational solution, viewed 25 May 2014, <<https://jazz.net/library/article/637/>>), a platform that integrates requirements management, change and configuration management, quality management, and design management.

10. Project management in continuous process improvement

Survey results indicate the importance of the role of agile project management in continuous process improvement and values delivery: for majority of respondents' delivery of reliable results by engaging customers in frequent interaction and shared ownership (74%) and stakeholder's reporting through tangible progress in achieving manageable piece of functionality (73%) are the most important project management values. The important values to follow are expecting uncertainty and manage for it through iterations, anticipation, and adaptation (68%), verifying estimates with team (68%), facilitating team-managed approach (68%), prioritizing artifacts relevant for the business (64%), and increasing ROI by making continuous flow of value (64%). Figure 5.15 shows the distribution of responses.

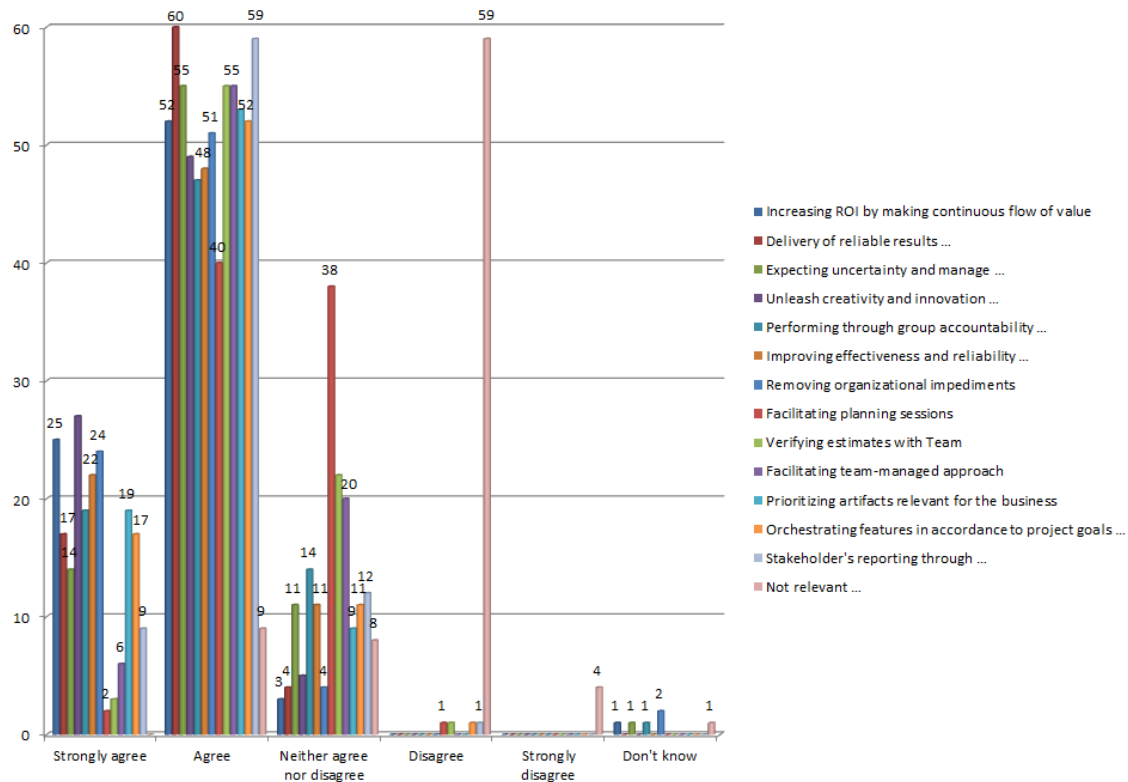

Figure 5.15: Project management in continuous process improvement

The results indicated on high importance of the three from six agile project management core values (Declaration of Interdependence (DOI), viewed 25 May 2014, <<http://pmdoi.org/>>):

- Increasing return on investment by making continuous flow of value,
- Delivery of reliable results by engaging customers in frequent interaction and shared ownership, and
- Expecting uncertainty and manage for it through iterations, anticipation, and adaptation.

11. In-context collaboration

Responses significantly indicate the importance of in-context collaboration, which constitutes the response to changing events and improving process predictability. The results show the following in-context value rank, as shown in Figure 5.16:

- Local and group stakeholders' collaboration which leads to direct benefits from a project or program outcomes earned overwhelming (84% responses),
- Common interest collaboration in achieving outcomes and values (70%),
- Immediate information accessibility to all involved stakeholders (68%),
- Stakeholders' in-context discussions in creating a single source of the veracity for decision making process (68%),
- Value-based collaboration driven by a shared vision allowing stakeholders to respond to challenges in a consistent manner (67%),

- Empowerment of stakeholders’ decision-making collaboration (67%)
- Provision of a shared repository (single source of veracity) in order to ensure an effective and boundless stakeholders’ collaboration (63%).

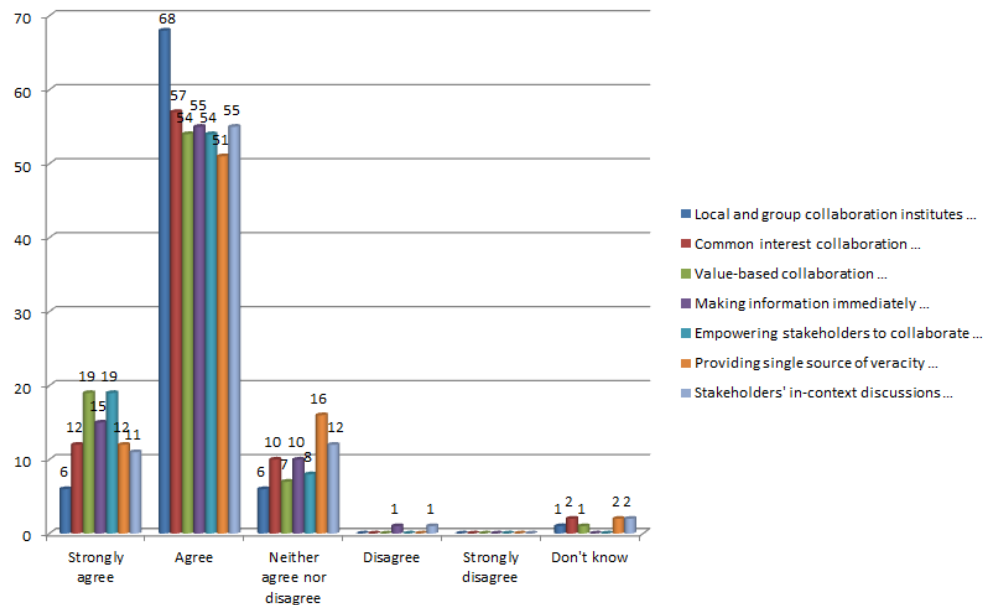

Figure 5.16: In-context collaboration

Answers placed a strong emphasis on the requisite improvement of stakeholder’s collaboration, deliberations on project or program artifacts, and decision-making sourcing and preparation.

12. Risks adaptation and orchestration

Integrating risks into planning, budgeting, reporting and forecasting as well as into the context of overall performance can lead to better decisions through risk-adjusted plans and budgets. Based on the responses, agile methods contribute the most to the governance monitoring processes in its dealing with the risks’ adaptation and orchestration. Results indicated on the significance of the following agile features, as shown in Figure 5.17:

- Risk integrated into feature/release planning (75% of responses),
- Adaptive capacity on vulnerabilities (73%),
- Risk part of performance measurement (72%),
- Capacity for assessment of current, actual, future, and potential vulnerabilities (65%),
- Likelihood on risk adaptation (63%).

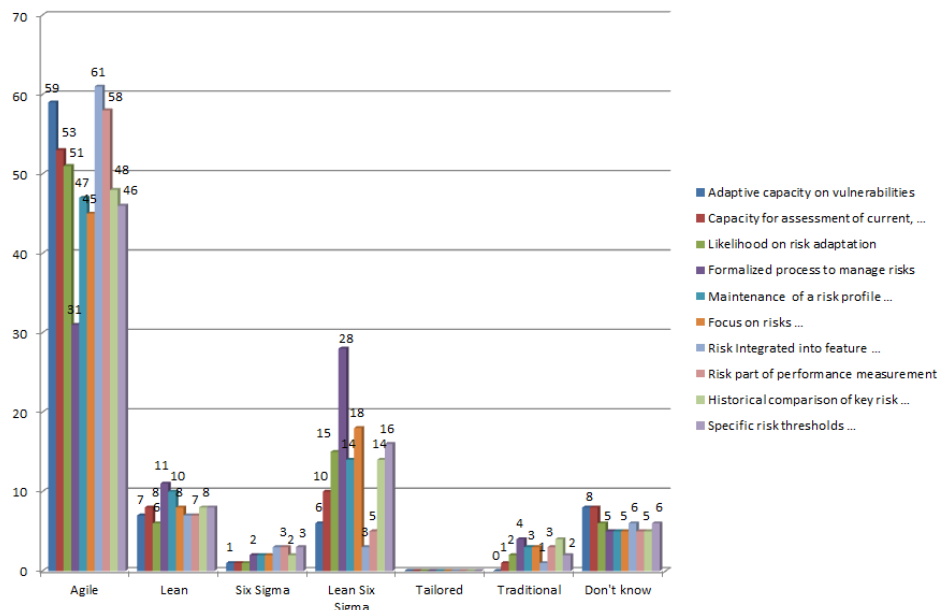

Figure 5.17: Risk adaptation and orchestration

The lightweight Lean Six Sigma method follows agile with regard to the formalization of risk management process (35% respondents). It is significant to notice that respondents consider traditional method insufficiently effective in dealing with risk adaptation and orchestration.

13. Change distilment and incremental process change

Responses indicate that the lightweight methodologies support continuous improvement efforts and incremental process changes: agile methods the most (88% of respondents), Lean (84%), Lean Six Sigma (78%), and Six Sigma (62%), as shown in Figure 5.18.

The survey results confirmed that change distilment, or process of obtaining the baseline volatility contained into the change, and process breakdown in order to set up an incremental improvement in collaborative manner and bridge the transitional stage of the change, is supported the most by agile methods.

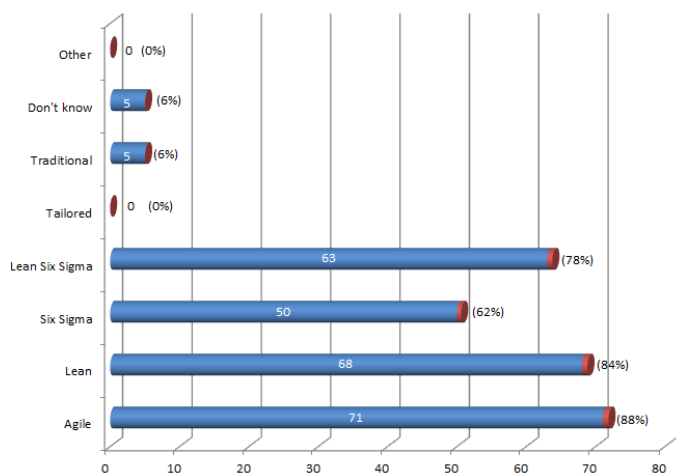

Figure 5.18: Change distilment and incremental process change

14. Development intelligence (success metrics, tracking progress)

Survey results indicated that respondents strived to a certain extent with regard to addressing the performance metrics and project or program progress tracking. Results confirmed that the traditional EVM measures: variances - schedule, cost, variance at completion (68% responses),

indices - schedule performance, cost performance, to-complete performance (63%), status measures - planned / actual % complete (54% agree; 42% strongly agree), and forecasts - time estimate at completion, estimate to complete (53% agree; 37% strongly agree), are predominately considered as performance metrics and development intelligence, as shown in Figure 5.19.

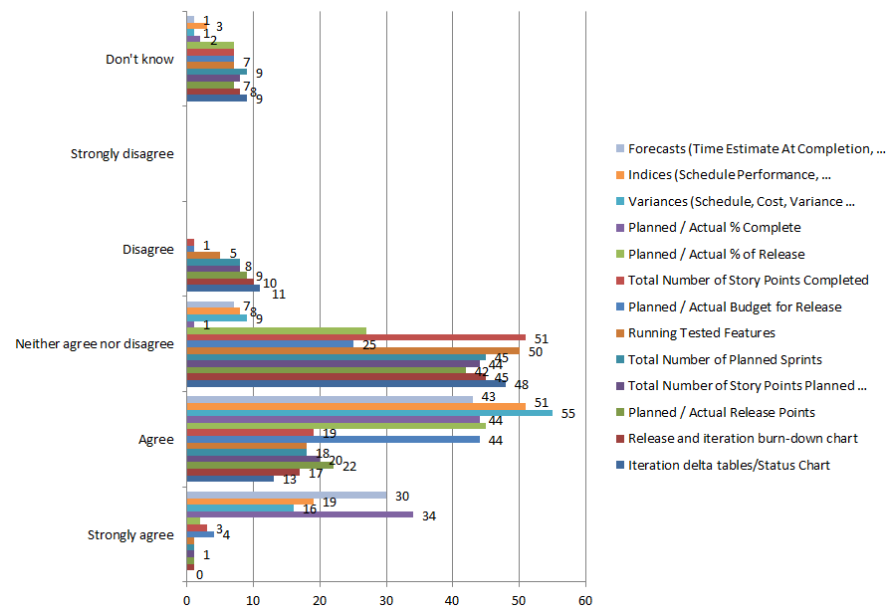

Figure 5.19: Development intelligence (success metrics, tracking progress)

Agile measures: planned / actual % of release (56% responses), planned / actual budget for release (54%), planned / actual release points (27%), and total number of story points planned / completed (25%), indicate on emerging usage of agile performance measurements. Conversely, it is obvious that a high percentage of respondents are neutral (neither agree nor disagree) with regard to the success metrics offered in the question, indicating either their newness to the agile measures, still predominant usage of traditional EVM measures, or not using measurement at all.

15. Usage of metrics

Respondents recognized that predominately lightweight and agile methods use metrics thus providing information to the governing body on their critical performance: 90% agile, 80% Lean, 77% Lean Six Sigma, 60% Six Sigma. Less than half of respondents (47%) indicated

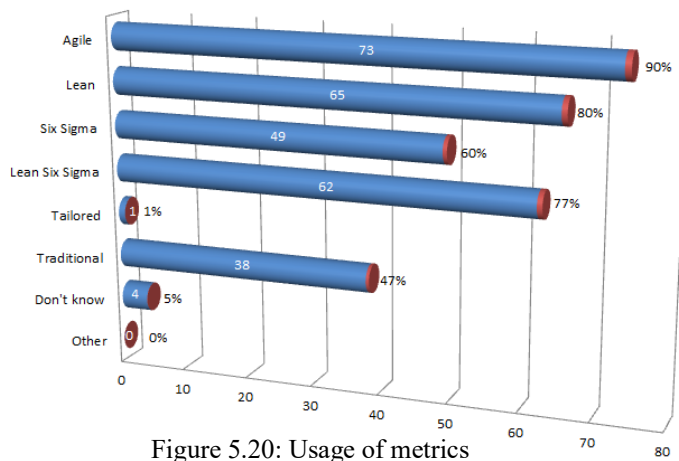

Figure 5.20: Usage of metrics

that the traditional methods provide sufficient information to the governing body on project / program critical performance. Thus, the key strength of the traditional project management is its tracking metrics toolkit (e.g. Gant charts, work breakdown structure, issue and risk logs), and performance reporting capabilities (e.g. overall status

reporting – scope/schedule/cost/quality, or status dashboards with embedded indicators in order to simplify the tracking of projects or programs). Notwithstanding, agile methods utilize other metrics, such as feature breakdown structure, iteration status charts, and burn down charts. It also includes agile EVM performance measures with baselines such as number of planned iterations, number of planned story points in a release, planned budget for the release, total number of story points completed, number of iterations completed, and actual cost of the release.

Possible conclusion from the answers is that project and program management is changing course from predominately traditional into the lightweight project or program management life cycle and its related processes, as response to the organizational pressures in achieving benefits and values.

16. Practice continuous delivery

Survey results indicate that on-time delivery (79% responds) is the most important continuous delivery practice for review of the agile project/program performance, followed by accelerating time-to-market delivery (67%), delivering products in a timely manner to the market (63%), incremental delivery (63%), faster delivery and in shorter cycles (59%), and focus on increasing the pace of delivery and reducing costs (57%).

As organizations begin specifying values and identifying the entire value streams requesting structural changes, development of a culture of continuous delivery commenced influencing project and program management processes. It can be concluded from the survey results that there is an obvious shift in adopting lightweight practices in addressing increased demands on delivery improvement and ensuring that the rapid changes organizations are going through are sustainable.

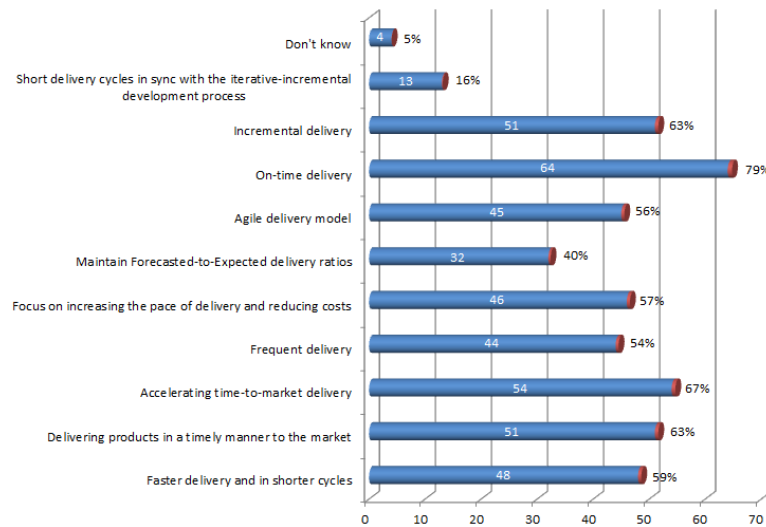

Figure 5.21: Practice continuous delivery

17. Continuous refinement toward greater efficiencies

Answers indicate that continuous and proactive managerial involvement is the major factor in improving efficiencies (75% respondents agree), followed by openness to changes and willingness to take risks (73%), practice flexible and responsive business strategies (70%), implementing standards that would monitor and sustain policies and guidelines in order to decrease risks for fines (70%), and ensuring higher quality decision making (67%). Organizational competitive advantage nowadays comes from continuous, incremental innovation and refinement of traditionally structured processes that undergo a continuous process of incremental change and adaptation. It is indicative that the majority of

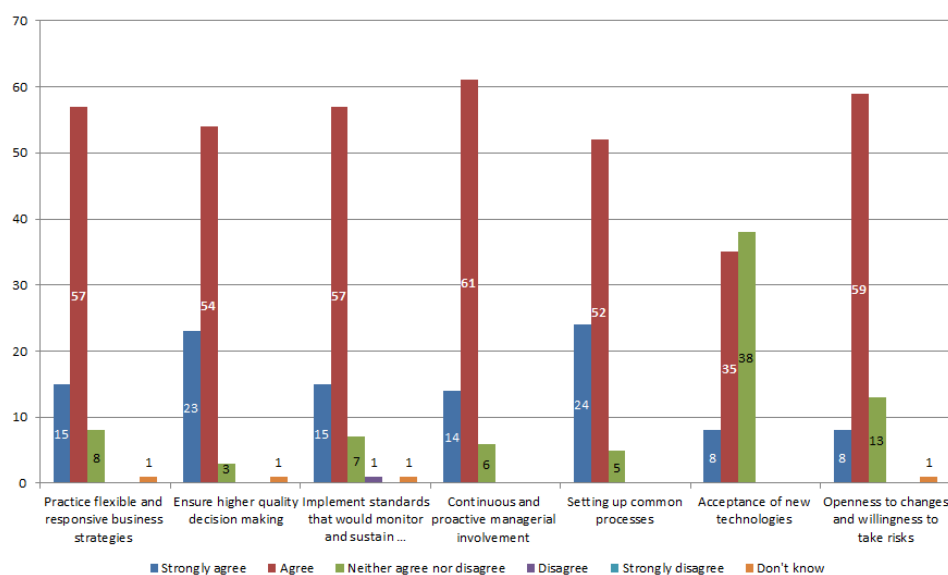

Figure 5.22: Continuous refinement toward greater efficiencies

respondents emphasized that managerial and leadership processes and practices require refinement in order organizations to achieve greater efficiencies, as shown in Figure 5.22.

18. Improvement of the team dynamic

Survey results indicated factors that contribute the most to the improvement of team dynamic, as shown in Figure 5.23: make team decisions (79% respondents), followed by direct collaboration in removing organizational and technical obstacles (77%), establishing clearly defined interface between the project team and the executives (73%), improving performance through group accountability for results and shared responsibility for team effectiveness (70%), and focusing on modern processes development and their management (69%).

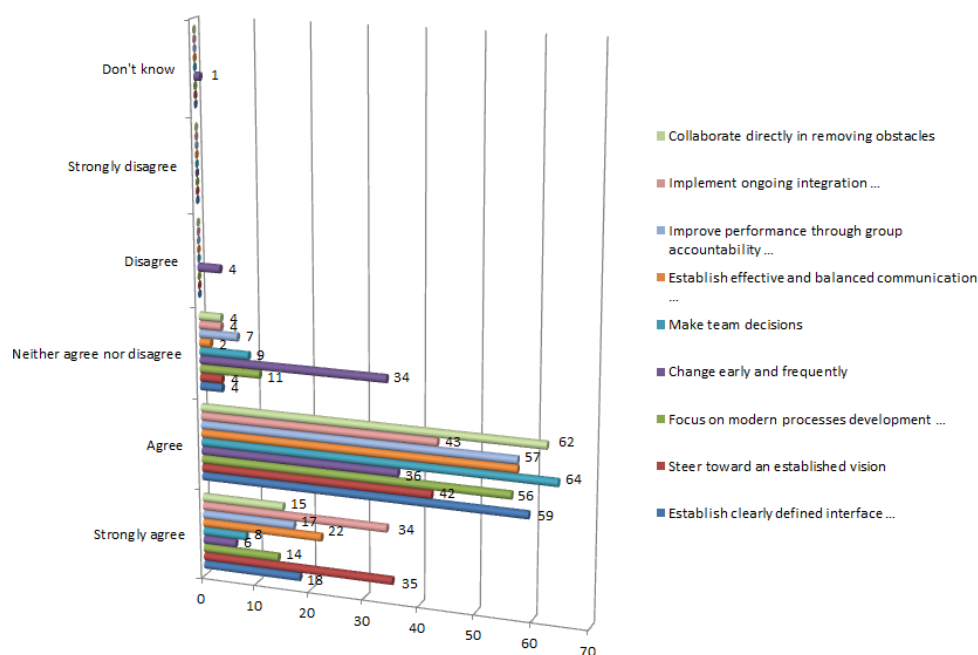

Figure 5.23: Improvement of the team dynamic

Results clearly stipulate that applying lightweight principles of empowering the team and making fact-based decisions through a direct collaboration and established clearly defined relationship with management, leads to the improvement of team dynamic, and consequently to achieving established goals.

19. Build the right thing

Factors that contribute to a product or service delivery to converge on an optimal customer solution are, based on the survey results, predominately characteristics of the lightweight methodologies: build a value stream map (79% responses), create knowledge and optimize (74%), eliminate waste and build quality in (69%), apply real-time decision-making process based on actual events and information (65%), select the best ideas and refine approaches (59%), and highlight the constraints and coordinate team work (54%).

As shown in Figure 5.24, it could be concluded that the agile and lightweight principles should be utilized for development and building the optimal customer solutions.

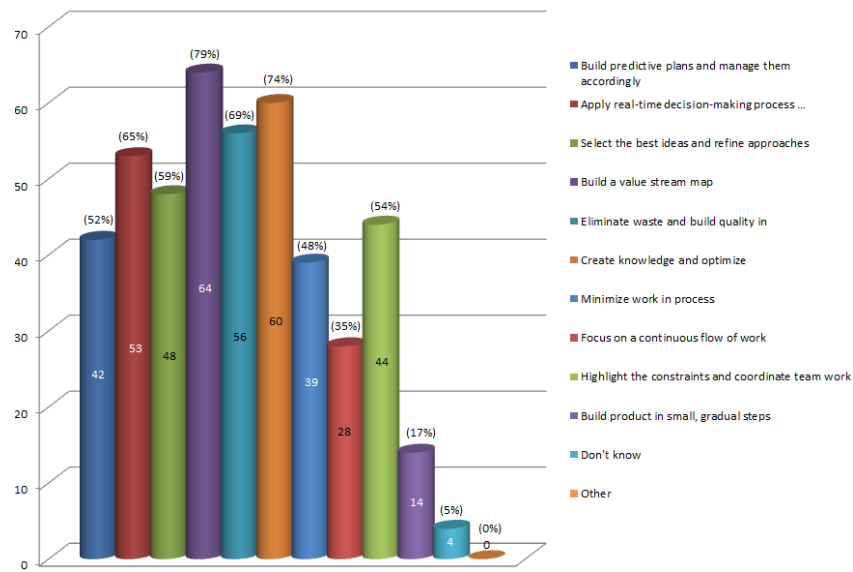

Figure 5.24: Build the right thing

20. Increase of benefits and sustainability

The survey question inquiring from respondents an opinion based on their experience if the agile portfolio governance is a good fit for increasing organizational benefits and therefore sustainability of business values, was descriptive, allowing respondents to enter longer answers. The responds included the following comments: “I believe the agile approach is a power method but not always can satisfy the customer's expectations in creating vision and tracking progress to the expected goals. Agile approach could be best approach in specific environment (context-dependent)”; “Could be best approach”; “I am not familiar enough with agile in order to answer”; “Sure”; “Not sure”; “Good fit”; “n/a”; “Agree”; “I agree”; “Yes”; “I think that agile and lean is a good fit”; “Agile is a good fit”. Opinions are further categorized and consolidated in such manner that the category “Good fit” included opinions such as “Agree / Yes / Good fit / Sure”, category “Could be best approach” included opinions “Could be best approach”, category “Not familiar enough” included opinions “Not familiar enough and Not sure”, and category “Not applicable” included opinions “n/a”, or “not applicable”.

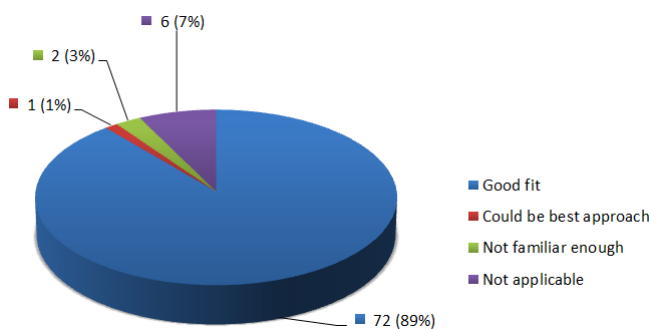

Figure 5.25: Increase of benefits and sustainability

Consolidated opinions are shown in Figure 5.25. Vast majority of respondents (72 or 89%) consider the agile portfolio governance as a good fit for increasing organizational benefits and sustainable

organizational benefits and sustainable

business values. Only minor number of respondents stated that the agile portfolio governance is not applicable (6 respondents or 7%), or not being sufficiently familiar (2 or 3%), and finally 1 respondent expressed the opinion that it could be best approach. It is to conclude that responses indicate the agile portfolio governance and its processes as a good fit for increasing organizational benefits and sustaining business values.

5.4 Survey Findings

Table 5.6: Survey findings

Methods Factors	Methods						Governance Processes		Recommended governance process method
	Agile	Lean	Six Sigma	Lean Six Sigma	Tailored	Traditional			
Alignment with organizational objectives	Initiation processes fully aligned with organizational objectives (78% respondents)	Initiation processes partially aligned with organizational objectives (5% respondents)	Initiation processes marginally aligned with organizational objectives (1% respondents)	Initiation processes partially aligned with organizational objectives (5% respondents)	Initiation processes not supported (0% respondents)	Initiation processes marginally aligned with organizational objectives (1% respondents)	Front-End	Initiation	Agile
Organizational value creation	Justification processes fully support organizational value creation (78% respondents)	Justification processes partially support organizational value creation (5% respondents)	Justification processes marginally support organizational value creation (1% respondents)	Justification processes partially support organizational value creation (7% respondents)	Justification processes not supported (0% respondents)	Justification processes partially support organizational value creation (1% respondents)		Justification	Agile
Response to change	Response to change fully supported (83% respondents)	Response to change partially supported (4% respondents)	Response to change not supported (0% respondents)	Response to change partially supported (4% respondents)	Response to change not supported (0% respondents)	Response to change partially supported (1% respondents)		Adaptation	Agile
Alignment of business goals	Alignment of business goals fully supported (80% respondents)	Alignment of business goals partially supported (4% respondents)	Alignment of business goals not supported (0% respondents)	Alignment of business goals partially supported (5% respondents)	Alignment of business goals not supported (0% respondents)	Alignment of business goals partially supported (1% respondents)		Alignment	Agile
Decision making	Decision making fully supported (76% respondents)	Decision making Fully supported (60% respondents)	Decision making partially supported (44% respondents)	Decision making fully supported (70% respondents)	Decision making not supported (0% respondents)	Decision making partially supported (2% respondents)		Approval	Agile
Participative alignment	Participative alignment fully supported (76% respondents)	Participative alignment partially supported (5% respondents)	Participative alignment not supported (0% respondents)	Participative alignment partially supported (6% respondents)	Participative alignment not supported (0% respondents)	Participative alignment partially supported (4% respondents)	Planning	Strategic plan alignment	Agile
Real-time planning: plans fully integrated with project execution	Real-time planning partially supported (42% respondents)	Real-time planning fully supported (68% respondents)	Real-time planning fully supported (67% respondents)	Real-time planning fully supported (60% respondents)	Real-time planning partially supported (6% respondents)	Real-time planning fully supported (85% respondents)		Operational planning supervision (objectives, scope, resources, schedule, costs, quality)	Traditional Lightweight
Minimum reasonable set of regulation,	Minimum reasonable set of regulation,	Minimum reasonable set of regulation,	Minimum reasonable set of regulation,	Minimum reasonable set of regulation,	Minimum reasonable set of regulation,	Minimum reasonable set of regulation,		Set principles, policies and ethics	Lightweight

<i>Methods</i> <i>Factors</i>	<i>Agile</i>	<i>Lean</i>	<i>Six Sigma</i>	<i>Lean Six Sigma</i>	<i>Tailored</i>	<i>Traditional</i>	<i>Governance Processes</i>		<i>Recommended governance process method</i>
standards, and procedures	standards, and procedures partially supported (26% respondents)	standards, and procedures partially supported (13% respondents)	standards, and procedures partially supported (4% respondents)	standards, and procedures partially supported (44% respondents)	standards, and procedures not supported (0% respondents)	standards, and procedures partially supported (1% respondents)			
Lifecycle traceability	Lifecycle traceability fully supported (based on encountered process factors)	Lifecycle traceability fully supported (based on encountered process factors)	Lifecycle traceability fully supported (based on encountered process factors)	Lifecycle traceability fully supported (based on encountered process factors)	Lifecycle traceability partially supported (based on encountered process factors)	Lifecycle traceability partially supported (based on encountered process factors)		Accountability identification	Agile Lightweight
Project management in continuous process improvement	Project management in continuous process improvement fully supported (based on encountered process factors)	Project management in continuous process improvement fully supported (based on encountered process factors)	Project management in continuous process improvement fully supported (based on encountered process factors)	Project management in continuous process improvement fully supported (based on encountered process factors)	Project management in continuous process improvement partially supported (based on encountered process factors)	Project management in continuous process improvement partially supported (based on encountered process factors)		Leadership	Agile Lightweight
In-context collaboration	Response to changing events and improving process predictability fully supported (based on encountered process factors)	Response to changing events and improving process predictability fully supported (based on encountered process factors)	Response to changing events and improving process predictability fully supported (based on encountered process factors)	Response to changing events and improving process predictability fully supported (based on encountered process factors)	Response to changing events and improving process predictability partially supported (based on encountered process factors)	Response to changing events and improving process predictability partially supported (based on encountered process factors)	Monitoring	Strategic uncertainties	Agile Lightweight
Risks adaptation and orchestration	Risks adaptation and orchestration fully supported (key features supported by avg. 70% respondents)	Risks adaptation and orchestration partially supported (key features supported by avg. 11% respondents)	Risks adaptation and orchestration partially supported (key features supported by avg. 3% respondents)	Risks adaptation and orchestration partially supported (key features supported by avg. 23% respondents)	Risks adaptation and orchestration not supported (key features not supported by respondents)	Risks adaptation and orchestration partially supported (key features supported by average 3% respondents)		Risks	Agile
Change distilment and incremental process change	Change distilment and incremental process change fully supported (88% respondents)	Change distilment and incremental process change fully supported (84% respondents)	Change distilment and incremental process change fully supported (62% respondents)	Change distilment and incremental process change fully supported (78% respondents)	Change distilment and incremental process change not supported	Change distilment and incremental process change partially		Changes	Agile Lightweight

<i>Methods</i> <i>Factors</i>	<i>Agile</i>	<i>Lean</i>	<i>Six Sigma</i>	<i>Lean Six Sigma</i>	<i>Tailored</i>	<i>Traditional</i>	<i>Governance Processes</i>		<i>Recommended governance process method</i>
					(0% respondents)	supported (5% respondents)			
Development intelligence (success metrics, tracking progress)	Responses indicate on predominant traditional EVM metrics (forecasts; indices; variances; status measures) and emerging agile EVM - partially supported	Responses indicate on predominant traditional EVM metrics (forecasts; indices; variances; status measures) - partially supported	Responses indicate on predominant traditional EVM metrics (forecasts; indices; variances; status measures) - partially supported	Responses indicate on predominant traditional EVM metrics (forecasts; indices; variances; status measures) - partially supported	Responses indicate on predominant traditional EVM metrics (forecasts; indices; variances; status measures) - partially supported	Responses indicate on predominant traditional EVM metrics (Forecasts; Indices; Variances) - fully supported		Control framework	Traditional
Usage of metrics (AgileEVM)	Usage of metrics fully provides information on critical performance (90% respondents)	Usage of metrics fully provides information on critical performance (80% respondents)	Usage of metrics fully provides information on critical performance (60% respondents)	Usage of metrics fully provides information on critical performance (77% respondents)	Usage of metrics marginally provides information on critical performance (1% respondents)	Usage of metrics partially provides information on critical performance (47% respondents)		Critical performance	Agile Lightweight
Practice continuous delivery	Agile practices (on-time delivery; accelerating time-to-market; timely delivering; incremental delivery in short cycles) - fully supported	Lightweight practices (specifying values, identifying value streams, structural and process changes) - fully supported	Lightweight practices (specifying values, identifying value streams, structural and process changes) - fully supported	Lightweight practices (specifying values, identifying value streams, structural and process changes) - fully supported	<i>n/a</i>	<i>n/a</i>	Deliverables	Review of performance	Agile Lightweight
Continuous refinement toward greater efficiencies	Supports the major factors in improving efficiencies through continuous, incremental innovation and refinement of traditionally structured processes	Supports the major factors in improving efficiencies through continuous, incremental innovation and refinement of traditionally structured processes	Supports the major factors in improving efficiencies through continuous, incremental innovation and refinement of traditionally structured processes	Supports the major factors in improving efficiencies through continuous, incremental innovation and refinement of traditionally structured processes	Partially supports the major factors in improving efficiencies	Partially supports the major factors in improving efficiencies		Financial review	Agile Lightweight
Improvement of the team dynamic	Supports the improvement of the team dynamic through team decisions, direct	Supports the improvement of the team dynamic through team decisions, direct	Supports the improvement of the team dynamic through team decisions, direct	Supports the improvement of the team dynamic through team decisions, direct	<i>n/a</i>	Insufficient support for the improvement of the team dynamic		Work authorization	Agile Lightweight

<i>Methods</i> <i>Factors</i>	<i>Agile</i>	<i>Lean</i>	<i>Six Sigma</i>	<i>Lean Six Sigma</i>	<i>Tailored</i>	<i>Traditional</i>	<i>Governance Processes</i>		<i>Recommended governance process method</i>
	collaboration and team-executives interface	collaboration and team-executives interface	collaboration and team-executives interface	collaboration and team-executives interface					
Build the right thing	Fully supports build the right thing through value stream mapping, optimization based on knowledge accrual, waste elimination and real-time decision making	Fully supports build the right thing through value stream mapping, optimization based on knowledge accrual, waste elimination and real-time decision making	Fully supports build the right thing through value stream mapping, optimization based on knowledge accrual, waste elimination and real-time decision making	Fully supports build the right thing through value stream mapping, optimization based on knowledge accrual, waste elimination and real-time decision making	<i>n/a</i>	Insufficient support for build the right thing		Deliverable review	Agile Lightweight
Increase of benefits and sustainability	Good fit for the increase of organizational benefits and sustainability	Good fit for the increase of organizational benefits and sustainability	Good fit for the increase of organizational benefits and sustainability	Good fit for the increase of organizational benefits and sustainability	<i>n/a</i>	<i>n/a</i>		Values and benefits review	Agile Lightweight
Organizational value creation ³⁹	Organizational value creation fully supported (85%)	Organizational value creation supported (55%)	Organizational value creation supported (55%)	Organizational value creation fully supported (60%)	Organizational value creation not supported	Organizational value creation partially supported (10%)		Alignment with business goals	Agile Lightweight

³⁹ Organization value creation (OVC) in alignment with business goals is the factor derived from the agile and lightweight analysis factors: % $OVC = (Fs/Ft) * 100$, where *Fs* is a number of fully supported function, and *Ft* is a total number of functions.

In order to clarify findings from Table 5.6, the following agile and lightweight methodologies constitute agile project portfolio governance domain processes and the agile governance framework:

Table 5.7: Agile governance domain process framework methodology break-down

<i>Front-End</i>	<i>Planning</i>	<i>Monitoring</i>	<i>Deliverables</i>
Initiation	Strategic plan alignment	Strategic uncertainties	Review of performance
Justification	Operational planning supervision	Risks	Financial review
Adaptation	Set principles, policies and ethics	Changes	Work authorization
Alignment	Accountability identification	Control framework	Deliverable review
Approval	Leadership	Critical performance	Values and benefits review
			Alignment with business goals

Legend: ■ Agile ■ Bimodal (Agile/Lightweight) (Traditional/Lightweight) ■ Lightweight ■ Traditional

As shown in Table 5.7, the governance front-end domain processes are constituted entirely agile. Planning domain processes are constituted agile, lightweight and tailored, or bimodal (mashing agile and lightweight, along with traditional and lightweight methodologies), as well as monitoring domain processes, which are constituted agile, bimodal (mashing agile and lightweight), and traditional methodologies. Deliverables domain processes are bimodal (mashing agile and lightweight) entirely.

Agile, lightweight, and bimodal agile/lightweight are predominant methodologies (95%) in structuring of the model’s domain processes. There is only one domain process in the model which is traditional – monitoring’s control framework, representing development intelligence (success metrics, tracking progress), or still predominant traditional EVM metrics (forecasts, indices, variances, and status measures). The reason for this could be in the fact that the utilization of the agile representatives of EVM measures (e.g. projected release date, planned release points, release points completed, release date based on mean velocity, or so) are not broadly used yet.

Responses indicated that tailored agile and lightweight (bimodal) methodologies can be seen as the main driver behind the development of the agile project portfolio governance components, as shown in Figure 5.26. Bimodal agile/lightweight methodologies are admitted as applicable in 12 out of 21 factors influencing the development of agile portfolio governance domain processes (57%). Bimodal approach indicates the significance of the process of methodologies tailoring in order to achieve best fit for the methods, practices and tools chosen at the observed portfolio domain process or component life cycle.

Interesting finding is that tailored methods from the survey haven't been considered as suitable. This might supervene from the fact that tailored method(s) have not been contextualized, or structured and put in the context in the survey, so the respondents couldn't evaluate them. Additionally, it could indicate that respondents are custom to the particular methodology (or methodologies) and its processes and practices, and due to certain constraints not inclined considering potential advantages of melded methodologies.

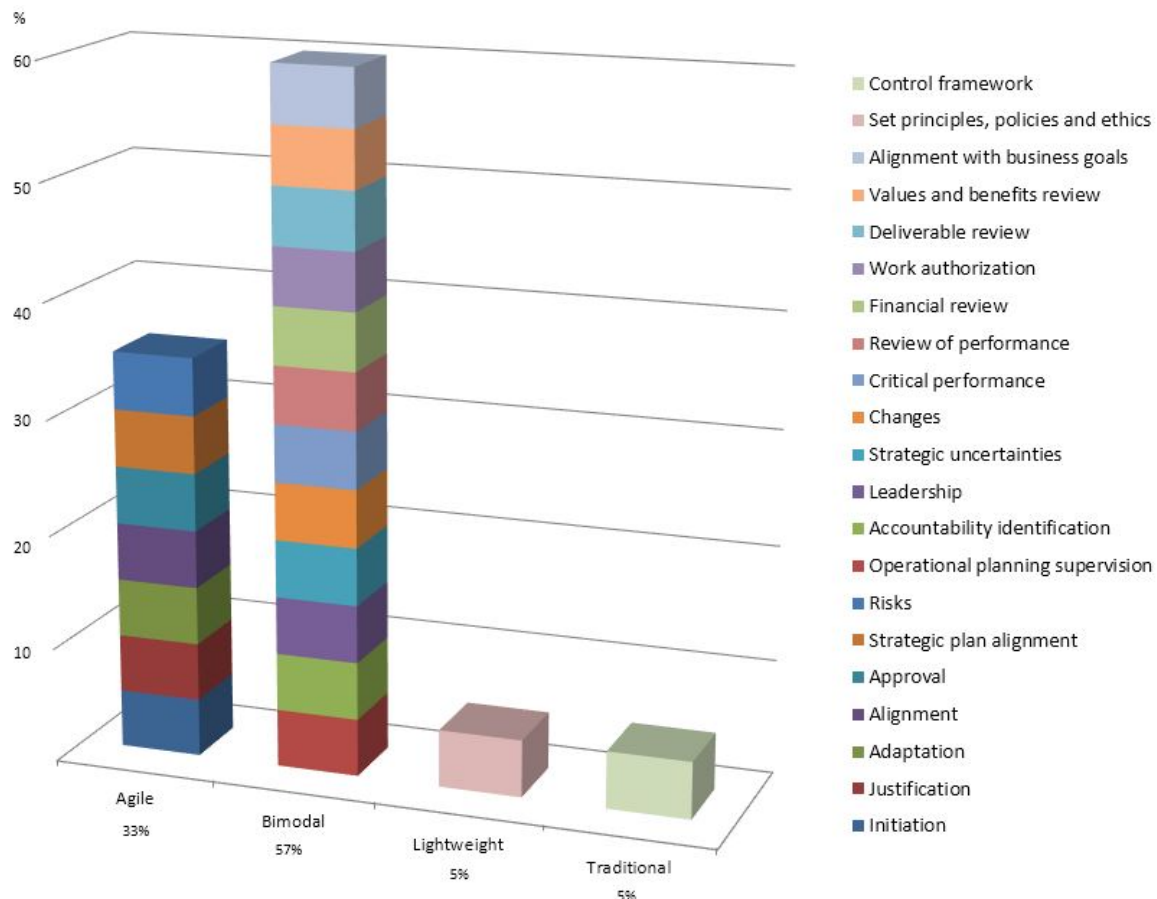

Figure 5.26: Agile project portfolio governance concept

Agile methodologies are admitted as applicable in 7 out of 21 factors influencing the development of agile portfolio governance domain processes (33%). It is indicative that the entire front-end domain governance processes are agile constituted, revealing responders' views on the most adequate resolution for the project/program inception activities (refining the requirements, external and internal constraints, and provision of value and benefits facing the endeavor). The particular agile methods which could therefore candidate for the front-end domain processes construct is based on the comparison of life-cycles, project management, and concrete guidance support, in accordance with Abrahamsson et al. (2003).

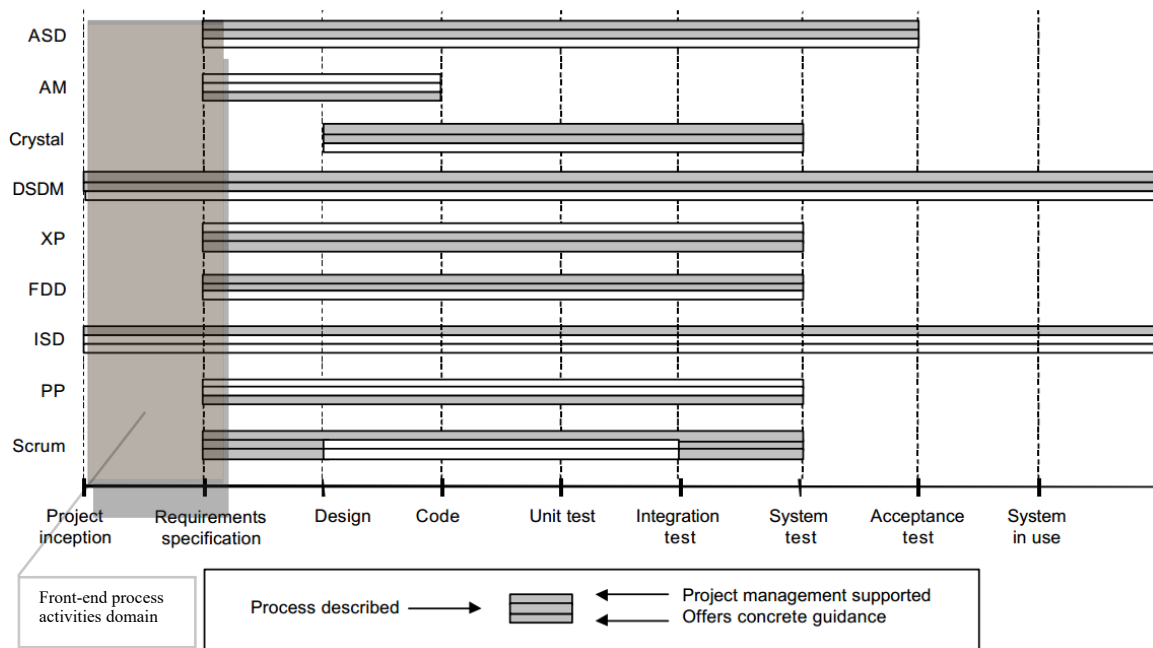

Figure 5.27: Comparing life-cycle, project management and concrete guidance support (Abrahamson, Warsta, Siponen, Ronkainen, 2003)

As shown in Figure 5.27, methods covering the front-end processes domain activities are DSDM and ISD (depicted by grayed area between the project inception and requirements specification).

- DSDM process model suggests a framework of controls which are designated to increase organizational ability to react to business changes, supported by the following iterative life cycle activities: *feasibility study*, establishing the basic requirements and constraints with analysis on the viability of the process, which could efficiently address the initiation and justification front-end processes; *business study*, providing functional and information requirements that will provide value and the basic process architecture, which contributes to the business adaptation and alignment processes; and *functional model* iteration, providing resolution intended to evolve into the incremental deliverable, which is basis for decision and approval making process. This methodology makes a suitable candidate for the development of front-end processes due to its time-boxing paradigm, meaning that user requirements must be set at the early stage, based on MoSCoW⁴⁰ principle (DSDM Consortium, viewed 10 June 2014, <<http://www.dsdm.org/content/10-moscow-prioritisation>>), as well as time, resources, and desired amount of functionality that should be agreed at the inception of each project. DSDM supported decision making must be empowered in order to make team decisions and it must have a direct support from the senior management,

⁴⁰ Acronym for Must Have, Should Have, Could Have, Won't have this time

- ISD is a descriptive, management-oriented framework for addressing the problem of handling fast releases and adapts the situation where the users' requirements change quickly so the product/service development was changing rapidly, and organizations were having problems delivering products with the correct requirements within the time scheduled. In its nature, ISD is bimodal (using a mixed methods research design - spiral /waterfall model). The objective of this method is to ensure executing a project in a structured way, but still sustaining the adaptability to the customer's requirements. The phases of ISD method are *Envisioning*, *Planning*, *Developing*, *Stabilizing*, and *Deploying* spirals. This methodology makes a strong candidate for the development of front-end processes due its structured and process-driven envisioning phase (Microsoft Solutions Framework (MSF) Overview, viewed 10 June 2014, <<http://www.msdn.microsoft.com/en-us/library/jj161047.aspx>>), which includes definition of a project vision, scope, goals and constraints, analysis of requirements, resources, and risk assessment.

6 CROSS-CASE ANALYSIS

As described in the Chapter 3.3.4, the aim of the cross-case qualitative analysis was to ascertain a causal explanation of the observed phenomenon analyzed in the case and survey studies, and by using the analytical induction method to establish general conclusions on the relationship between the analysis's factors.

The main purpose of the research was testing if agile and lean enabled governance domain processes are suitable for the development of a sustainable organizational project portfolio governance framework, which improves the performance of project portfolio processes. This research was conducted through the case study strategy as main data collection method, with the objective to find which agile, lean, or a hybrid concept is best suited for development of project portfolio governance processes. The analysis factors impacting the governance domain processes were derived from literature review and were considered during the analysis (see Table 3.1).

The data collection method used in the case study gathered quantitative parameters (uncertainties/risks occurring during the portfolio component life-cycle) from the selection of portfolio components - delivered referent programs and projects, which constituted systems with a large number of possible events suitable for probabilistic analysis. The analysis established the project portfolio risk management framework quantifying effects of risks on portfolio component's outcomes, resulting in identification of risk factors with the most impact on portfolio and portfolio component's life-cycle, and risk optimization process observing the influence of conjoint corrective risk and agile/lightweight factors on project portfolio governance process domain construct.

The survey study objective was to examine the suitability of agile and/or lightweight methods for development of organizational project portfolio governance frameworks and processes, and whether agile factors cause the optimal actualization of the governance domain processes that improves the performance of project portfolio management processes and consequently positively affects organizational performance in achieving its values and benefits. The survey was done by distributing the questionnaire electronically and receiving responses from diverse audience, including business executives and managers, business stakeholders, project/program managers, academics, IT decision makers, modelers - analysts, designers, architects, and operations/support. Survey findings exposed the construct of the agile project portfolio governance process model, showing that agile, lightweight, and bimodal agile/lightweight are predominant methodologies (95%) in structuring of the governance model's domain

processes. Further methodology break-down showed that the governance front-end domain processes are constituted entirely agile. Planning domain processes are constituted agile, lightweight and tailored, or bimodal (mashing agile and lightweight, along with traditional and lightweight methodologies), as well as monitoring domain processes, which are constituted agile, bimodal (mashing agile and lightweight), and traditional methodologies. Deliverables domain processes are bimodal (mashing agile and lightweight) entirely.

The objective of cross-case analysis was to leverage findings from a quantitative and qualitative studies and to show that the antecedent causes of the observed phenomenon influenced that conjoint corrective risk and agile factors on governance processes can be acknowledged to improve the project portfolio governance processes.

The cross-case analysis process is shown in Figure 6.1.

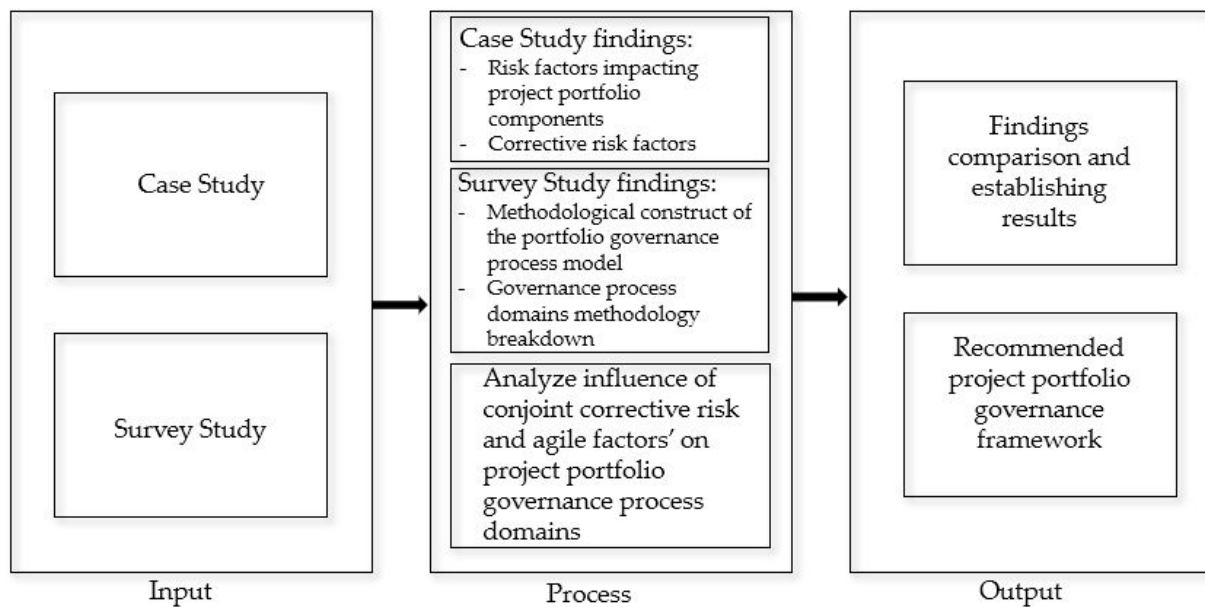

Figure 6.1: Cross-case analysis

The analysis input constitutes the case and survey studies' findings. Both studies explored intrinsic properties of researched phenomenon, i.e. risk being an intrinsic property of any project, program, and/or portfolio, and agile factors representing intrinsic properties of agile, lightweight or hybrid methodologies used for process development of any project, program, and/or portfolio. The cross-case analysis used analytical induction technique to develop the extrinsic or relational properties of the combined studies' findings in order to achieve its causal explanation. In the analysis, the risk and risk corrective factors were conjoined with agile factors, and their combined influence on the portfolio governance process domains have been examined through the stipulations of individual and jointly adequate conditions for the development of project portfolio

governance processes. The analysis results exposed the recommended project portfolio governance model. The cross-case analysis is presented in Table 6.1.

The results of the analysis, concluding on usage of a specific agile, lightweight or hybrid (tailored) methodology for the modelling and development of the agile governance framework, are the following:

- *Front-End governance process domain, Agile methodology.* The entire front-end domain governance process domain is agile established, creating the most adequate solution for the project portfolio aligning process, including:
 - In-context stakeholders' communication,
 - Continuous and value-added collaboration,
 - Collaborative assessment and estimation of inherent risks and external and internal uncertainties and constraints,
 - Substantiated response to changes and requirements refinement,
 - Value stream decision making.

Agile driven Front-end portfolio governance processes make portfolio component's inception, categorization, evaluation and selection activities integrated with risk identification, estimation of risk exposure and development of risk response strategy.

- *Planning governance process domain, Bimodal (Agile and Lightweight methodologies).* The planning governance process domain is structured in a hybrid manner, as a mesh-up of Agile and Lightweight methodologies. This setup creates the most efficient framework for leading, planning, and regulative and process activities by applying the following practices:
 - Participatory decision making,
 - Balanced approach towards achieving an operational regulative value system compliant with the external and internal sources,
 - Progressive elaboration of planning process,
 - Continuous risk assessment and refinement,
 - Alignment towards minimum viable product or service, and
 - Enable stakeholders' engagement and self-organizing teams' participation in value-added collaboration.

The former practices were agile; the following include the lightweight:

- Establishing process modelling architecture and process formation,
- Mapping process value streams,
- Continuous process integration, and
- Process improvement framework.

Table 6.1: Cross-case analysis

		<i>Case Study Findings</i>			<i>Survey Study Findings</i>	
<i>Governance processes</i>		<i>Risk Factors</i>	<i>Corrective Risk Factors</i>	<i>Recommended Portfolio Model</i>	<i>Agile Factors</i>	<i>Portfolio Model based on Survey Findings</i>
Front-End	Initiation Justification Adaptation Alignment Approval	- Communication barriers - Communication between key stakeholders - Organizational readiness - Decision making	- Assessing inherent risks and strategy uncertainties - Estimate risk exposure - Factor-in business risk/impact - Plan approach in dealing with risks - Recommend approach for decision making	Agile	Alignment with organizational objectives Organizational value creation Response to change Alignment of business goals Decision making	Agile
Planning	Strategic planning Operational planning supervision Regulation (set principles, policies and ethics) Accountability identification Leadership	- Communication between key stakeholders - Communication barriers - Continuous process change - Decision making	- In-context stakeholders' communication - Risk refinement - Risk management planning - Risk prioritization	Bimodal (Agile Lightweight)	Participative alignment Real-time planning Minimum reasonable set of regulation Lifecycle traceability Project management in continuous process improvement	Agile Bimodal (Traditional Lightweight) Bimodal (Agile Lightweight) Bimodal (Agile Lightweight)
Monitoring	Strategic uncertainties Risks Changes Control framework Critical performance	- Decision making - Stakeholders' expectations on adjustment - Process gaps in functional documents - Consultants lack of experience - Additional resources due to scope changes - Continuous process change - Communication barriers - Communication between key stakeholders - Organizational readiness - Missing and not functional processes	- Continuous risk assessment - Risk data analysis - Performance management measures - Deploying corrective factors	Bimodal (Agile Lightweight)	In-context collaboration Risks adaptation and orchestration Change distilment and incremental process change Development intelligence Usage of metrics (EVM, AgileEVM)	Bimodal (Agile Lightweight) Agile Bimodal (Agile Lightweight) Traditional Bimodal (Agile Lightweight)

		<i>Case Study Findings</i>			<i>Survey Study Findings</i>	
<i>Governance processes</i>		<i>Risk Factors</i>	<i>Corrective Risk Factors</i>	<i>Recommended Portfolio Model</i>	<i>Agile Factors</i>	<i>Portfolio Model based on Survey Findings</i>
Deliverables	Review of performance Financial review Quality (Work authorization) Deliverable review Benefits and values review Alignment with business goals	<ul style="list-style-type: none"> - Decision making - Organizational readiness - Communication barriers - Communication between key stakeholders 	<ul style="list-style-type: none"> - Assessment of operational risks - Assessment risks of adequacy of benefits realization 	Agile	Practice continuous delivery Continuous refinement toward greater efficiencies Improvement of the team dynamic Build the right thing Increase of benefits and sustainability Organizational value creation	Bimodal (Agile Lightweight)

Agile and lightweight structured planning portfolio governance processes ensure organizational adaptation to changes through regulatory value system, engaged stakeholders with clear authorities and responsibilities, elaborative planning system, collaborative decision making, and progressive risk reduction.

- *Monitoring governance process domain, Bimodal (Agile and Lightweight methodologies)*. Monitoring are critical portfolio governing activities, where agile and lightweight practices improve risk and change management processes, and establishment of the performance management framework. The agile and lightweight practices, elaborated in Chapter 4.5.3, significant to these processes are:
 - Risks adaptation and orchestration,
 - Continuous risk assessment, analysis and progressive risk reduction,
 - Change distilment and incremental process change,
 - Risk management framework integrated with the performance management, and
 - Development of risk corrective measures and risks resolution.
- *Deliverables governance process domain, Agile methodology*. Deliverables governance domain processes oversee delivery of portfolio products and/or services, review their quality, financial and work performances, achieved values and benefits, alignment with business goals, and creation of organizational value. Agile practices substantial to these processes are:
 - Continuous delivery of products and/or services, and
 - Improvement in organizational sustainability, efficacy and value creation.

7 RESULTS AND DISCUSSION

When observing the original research objective and research questions, it is possible to confidently state that the case and survey studies answered on the research questions:

Research Question 1:

Which agile and lean concepts and practices (native and/or hybrid) are applicable on organizational project portfolio governance processes?

As elaborated in this study, the following agile and lean concepts and practices are applicable on organizational project portfolio governance processes:

- In-context stakeholders' communication through continuous and value-added collaboration,
- Participatory decision making,
- Minimum reasonable set of the regulative value system,
- Requirements refinement and substantiated response to changes,
- Process modelling architecture and mapping process value streams,
- Continuous process improvement and integration,
- Change distilment and incremental process change,
- Progressive elaboration of planning process,
- Alignment towards minimum viable product or service,
- Value-added collaboration of engaged stakeholders and self-organizing teams,
- Continuous refinement of inherent risks and external and internal uncertainties and constraints,
- Integration of risk management and performance management in development of risk corrective measures,
- Risks adaptation and orchestration, risk assessment, analysis and progressive risk reduction through developed risk corrective measures,
- Continuous delivery of products and/or services, and
- Improvement in organizational sustainability, efficacy and values' creation.

Research Question 2:

What are their indicators and how they can be recognized among the historical data describing the actual projects and portfolios?

The operationalization of agile and lightweight methodologies' practices in order to construct indicators or measures is "... the process of converting concepts into their empirical

measurements of quantifying variables for the purpose of measuring their occurrence, strength and frequency” (Economic and Social Research Council, 2004, p. 2). As these methodologies are mature and being operationalized in a wide business practices, agile and lightweight indicators are directional instruments which encompass the evaluation of engaged organizational, process, resourcing, and technological elements of projects and/or programs undertaken in accordance with strategic business goals. Their structure originates from strategic organizational objectives and goals channeled into the project, program, and portfolio critical success factors, from where the key performance indicators are established, intended to report performance of an endeavor to the governing body through established performance management metrics and measures. From organizational point of view, agile and lightweight indicators are directional and focused towards decision making potential in achieving strategic goals and organizational improvements through undertaken projects and programs. The example of a strategic indicator at the project portfolio level is *“Percentage of portfolio goals accomplished from most recent strategic plan”*. The lightweight methodologies, such as Lean Six Sigma and Six Sigma, are primarily focused on modelling process formation architecture and establishment and integration of process value streams, thus eliminating process waste. The example of a process indicator is *“Percentage of process cost savings”*, or *“Yield percentage”*. Indicators in agile and lightweight project/program phases are focused on iterations, features and delivery of products/services and include *iteration and release burndown, historical velocity, defect count, iteration cumulative flow, and product backlog depth*. Earn value management measures include variances, indices, and forecasts, e.g. ROI indicator *“Percentage of earned value burn up”* (see Chapters 3.3.2 and 4.5.3 for detailed elaboration).

The structure of the performance management measures and their indicators can be recognized amongst the historical project and program data in their respective Project and Program Charters (ICT ERP, eCOS, BCM project documentation, 2003-2013). The example of that structure is shown in this work (see Table 4.9).

Research Question 3:

How can agile and lean methods and practices improve the performance of project portfolio processes?

This dissertation conducted a case and survey studies in order to undertake the quantitative and qualitative research with the aim to determine the viability of agile and lightweight methods’ usage on the project portfolio governance domain processes. Literature review derived twenty agile factors from the eight most used agile and lightweight methods. These agile factors were considered during analysis with regard their attributes conforming the governance domain processes. The case study, analyzing data collections from the referent programs and projects,

have used a probabilistic analysis in determining the risk variables with the most significant impact on the governance domain processes, and identifying, evaluating, and providing insights of findings of the best-fit concept (agile factor) to be applied at the different process stages of the project portfolio governance model. The survey study provided answers on what agile and/or lightweight method is the most suitable for the development of project portfolio governance frameworks and processes, and whether agile factors cause the optimal actualization of the governance domain processes that improves the performance of project portfolio management processes.

The case study findings proofed that the conceptual governance model based on the agile and lean concepts and methods decrease risks and improve the performance of project portfolio processes (see Chapter 4.6 for detailed elaboration). The improvement of the agile and lightweight enriched project portfolio governance processes is feasible through:

- Reduction of the conjoint inherent project portfolio risks impacting all the constituent portfolio components (decision making, communication barriers, and communication between key stakeholders),
- Reduction of the critical inherent risks influencing and impacting the portfolio component execution (organizational structure and managerial, strategic planning, business process, and change management risks),
- Reduction of risks contributing significantly towards exceeding project portfolio components' costs. Findings confirm that inherent risks (communication between key stakeholders, continuous processes change, stakeholders' expectations on adjustments, and communication barriers) constitute ~70% of risks contributing significantly towards exceeding component's costs, indicating that the costs of all portfolio components will subsequently be affected,
- Reduction of risks contributing significantly towards exceeding project portfolio components' schedules. The three highest ranked risks impacting the project portfolio component schedule represent the uncertainties most commonly connected with the scope issues: insufficiently defined and not clear requirements in the situation where the expectations are high, inadequate decision-making, and process gaps, consequently causing the scope change pressures resulting in schedule and therefore the costs overrun,
- If the project portfolio governance processes are agile and lightweight enabled, the impact of interrelated conjoint risk and change management factors is reduced.

Research Question 4:

How can the performance measurement method AgileEVM be utilized to measure and validate the agile enabled project portfolio governance?

The performance management is using performance data from the portfolio components with the aim to measure, analyze, forecast and report component's data for evaluation by the key stakeholders. The earned value management analysis elaborated sufficient evidence there were risks contributing significantly towards exceeding the component costs and affecting the scope and schedule (see Chapter 4.5.3 for detailed elaboration). The analysis determined that:

- Agile and lean practices allow integration of risk management and AgileEVM performance management,
- Integration of risk management with AgileEVM and cost and schedule management in agile and lightweight driven project portfolios allow improved cost and schedule performance with progressive risk reduction,
- AgileEVM performance measurement method is used for establishing the portfolio components' performance and schedule management baselines and basic agile measures.

AgileEVM validates the agile enabled project portfolio governance by providing consistent quantitative data on portfolio costs, timelines, and projections to decision makers, enabling them to make more accurate decisions on overall organization resources' engagement and usage. Utilization of AgileEVM consequently allows better alignment with organizational strategic objectives and value creation, more efficient response to changes and risks, and improved accountability through the whole project portfolio life-cycle.

Research Question 5:

What corrective measures can be developed to reduce risks within the IT project portfolio?

The analysis has exposed if the risk corrective measures were developed and applied to all the components within the project portfolio, the total portfolio risks can be reduced at least 30%. The corrective measures, elaborated in Chapter 4.5.3, include the following:

- Development of an agile and lightweight risk strategy to address project portfolio governance risks for the project portfolio life-cycle,
- Development of the agile risk management framework processes which enable a progressive risk reduction,
- Establishing factors that enable the agile risk management framework:
 - Early and continuous feedback from all involved stakeholders,
 - Clarity about investment decisions to whom the benefits will be provided,
 - Continuous risk assessment,

- Continuous review and constant readjustment against assumptions and changes in business environment,
 - Determining a portfolio component's criticality and clustering,
 - Establishing a realistic, meaningful and adaptive metrics reported regularly to the key stakeholders and used as an input to decision making and performance improvement,
 - Integrating performance management with risk management in order to maximize the likelihood of achieving portfolio objectives,
 - Instituting a formal, repeatable post-implementation review process and benefits register to track gained benefits.
- In accordance with the case study findings, agile and lightweight practices make project portfolio risk reduction possible for the most critical risks:
- Organizational structure and managerial risk (decision making),
 - Strategic planning risks (communication barriers and communication between key stakeholders),
 - Organizational business process risks (continuous process change, missing and not functional processes, and process gaps in functional documents),
 - Resource risk (lack of experience),
 - Component scope risk (scope changes),
 - Component cost and schedule risks.

It is to consider that the research undertaken in this work has confirmed the established and tested hypotheses:

H₁: *Methodological project portfolio governance framework, enriched with agile and lean methods, will affirm the improvement of these governance processes.*

The main purpose of this hypothesis testing was to determine if agile and lean practices are suitable for the development of a sustainable organizational project portfolio governance processes and therefore constituting a foremost approach in governance of IT project portfolios. The testing was conducted through the case study analysis, Chapters 4.3, 4.4, and 4.5, and survey study analysis, Chapters 5.2 and 5.3. The hypothesis was confirmed in Chapters 4.6 and 5.4. Additional hypothesis confirmation was done in Chapter 6. Analysis results in Chapter 4.6 determined that the governance processes based on agile and lean concepts and methods decrease risks and improve the performance of project portfolio processes. This is done through the development of an agile and lightweight strategy for project portfolio process domains in addressing governance risks from component's inception till the review of achieved deliverables and realized benefits of a transitioned

component, including the development of the agile risk management framework for governance process domains which enable a progressive risk reduction, and establishing factors that enable the agile risk management framework. The results in Chapter 5.4 show that the governance front-end domain processes are constituted entirely agile. Planning domain processes are constituted agile, lightweight and bimodal (mashing agile and lightweight, along with traditional and lightweight methodologies), as well as monitoring domain processes, which are constituted agile, bimodal (mashing agile and lightweight), and traditional methodologies. Deliverables domain processes are bimodal (mashing agile and lightweight) entirely. Agile, lightweight, and bimodal agile/lightweight are predominant methodologies (95%) in structuring of the governance framework's domain processes. Bimodal (agile and lightweight) methodologies can be seen as the main driver behind the development of the agile project portfolio governance processes. The results in Chapter 6 concludes on usage of a specific agile, lightweight or hybrid (tailored) methodology for the modelling and development of the agile governance framework processes - the *Front-End* governance processes are entirely agile structured; the *Planning* governance processes are bimodal (agile and lightweight) as well as the *Monitoring* governance processes; and the *Deliverables* governance processes are entirely agile structured. This confirms the H_1 (*Methodological project portfolio governance framework, enriched with agile and lean methods, will affirm the improvement of these governance processes*).

H₂: *Identified project portfolio governance risks can be ascertained in more than 75% of finalized projects, and the sequence of their adverse impact can be established in more than 50% of cases.*

The testing of this hypothesis was conducted through the case study analysis, Chapters 4.3, 4.4, and 4.5, and confirmed in Chapters 4.5.2. Analysis determined that 90% of inputs (nine out of ten risks) were significant in meeting the output target H_a : *Portfolio risk occurs = True*. This finding confirms the H_2 (*Identified project portfolio governance risks can be ascertained in more than 75% of finalized projects*). The occurrence of project risks with the range of probability from 53,5% - 62,5% (avg. 58%) that all the risks will occur during the project life cycle confirms the H_2 (*... and the sequence of their adverse impact can be established in more than 50% of cases*).

H₃: *By applying the corrective measures for risks reduction the total project portfolio risks can be reduced up to 40%*

- The testing of this hypothesis was conducted through the case study analysis, Chapters 4.3, 4.4, and 4.5, and confirmed in the Chapter 4.5.2. If mitigation measures were developed, the probability of risks reduction is 0.3955 or 40%. This probability level indicates that if development of such measures is undertaken, and if these measures are applied to all the components within the portfolio, the total portfolio risks can be reduced up to 40%, which confirms the H₃ (*By applying the corrective measures for risk reduction the total project portfolio risks can be reduced up to 40%*).

8 CONCLUSIONS

The expected scientific contribution of this research is the following:

- Definition of agile and lean concepts in the processes of project portfolio governance, with the proposal of their classification,
- Formed the project portfolio governance framework, enriched with agile and lean concepts,
- Register and analysis of the risk reduction factors in the governance of project portfolios, with the especial emphasis on the implementation risks,
- Estimation of the applicability of the governance framework and the agile governance processes in business practice,
- The proposal for the corrective risks' reduction measures.

The agile governance of project portfolios provides broader aspect of feasibility and relevance to the business requirements since its existence ensures the achievement of strategic organizational objectives.

The agility of governance comes from the iterative and incremental balancing of its processes with ever changing business objectives, providing more granular insight into portfolio components and related decision making with a realistic possibility of achieving greater return of investment. By balancing project and program reviews with the portfolio management and strategic metrics, it provides more relevancies to the strategic key stakeholders.

Applying the agile governance contributes to the acceleration of projects and programs due to achieved clarity on higher priority features to be utilized and improved communication channels throughout the organization. The intervention cycle is shorter with less surprises and setbacks for the stakeholders, even in case of project/program deceleration or cancellation due to changed

priorities. The iterations allow evaluation of new ideas and more transparency on accepting the improved course of actions.

One of the major constraints in applying the results from this research is in the fact that organizations are still behind the required level of project portfolio governance formalization and structure (the survey study reported that from 52% of respondents' organizations having a project portfolio governance framework, only 54% are formalized and structured), indicating that organizations often struggle with the implementation of their decisions, or lacking participative alignment. Depending on organization's size, structure and culture, there are delays from decision-making to what will be done and how (implementation activities). Also, survey results show that 51% of respondents' organizations adopted agile methods with 41% in the process of adopting agile methods. These findings correspond with the 12th Annual State of Agile Report (2018) where 52% of respondents stated that more than half of teams in their organizations are using agile practices, however, the vast majority of respondents (84%) said their organization was at or below a "still maturing" level. This is the organizational constraint, indicating the need for balancing the organization's regulatory value system with the continuous process improvement and response to changes. Further constraint is that respondents (organizations) are custom to the particular methodology (or methodologies) and its processes and practices, and due to certain restraints not inclined considering potential advantages of melded methodologies (i.e. bimodal), suggested by this work.

To conclude, the author believes that the anticipated benefits of the agile and lean governance are worth considering further research and its application. One of the possible directions of further research could be part of organizational digital transformation and adoption of new forms of processes in the area of governance (e.g. regulative, decision-making, risks orchestration, and development intelligence). In present times, the organizations are more cost-aware and very sensitive on possible losses, so the proper governance is even more important. The application of the agile governance throughout the project and program portfolio life-cycle shall contribute in more successes.

BIBLIOGRAPHY

1. Project Management Institute. (2017). *The Standard for Portfolio Management Fourth Ed.* Newton Square, PA: Project Management Institute.
2. Project Management Institute. (2017). *The Standard for Program Management Fourth Ed.* Newton Square, PA: Project Management Institute.
3. Project Management Institute. (2017). *A Guide to the Project Body of Knowledge (PMBOK® Guide), Sixth Edition.* Newton Square, PA: Project Management Institute.
4. Project Management Institute. (2012). *Organizational Project Management maturity Model (OPM3 Knowledge Foundation), Second Ed.* Newton Square, PA: Project Management Institute.
5. Information Systems Audit and Control Association (ISACA). (2012). *COBIT® 5 – A Business Framework for the Governance and Management of Enterprise IT.* Orangevale, CA: ISACA.
6. ESI International. (2012). *Metrics for Agile Projects: Finding the Right Tools for the Job.* Retrieved from www.esi-emea.com
7. Project Management Institute. (2009). *The Governance Frameworks for Public Project Development and Estimation: The 11th report of The Committee on Standards in Public Life.* Newton Square, PA: Project Management Institute.
8. *Manifesto for Agile Software Development Site.* (2001, February 11-13). Retrieved February 14, 2013, from <http://agilemanifesto.org>
9. *Manifesto for Agile Software Development Site - Agile Manifesto principles.* (2001, February 11-13). Retrieved February 14, 2013, from <http://agilemanifesto.org/principles.html>
10. *Agile Software Development Portal.* (2001, February 11-13). Retrieved February 14, 2013, from <http://agile.csc.ncsu.edu>
11. Boehm, B., Turner, R. (2004). *Balancing Agility and Discipline – A Guide for the Perplexed.* Boston, MA: Addison-Wesley.
12. Beasley, M., Chen, A., Nunez, K., Wright, L. (2006). Working hand in hand: Balanced Scorecards and Enterprise Risk Management. *Strategic Finance* 87(9), 49-55. Retrieved from <https://erm.ncsu.edu/library/research-report/working-balanced-scorecards-erm>
13. Cooke, J. L. (2010). *Agile Productivity Unleashed.* UK: IT Governance Publishing.
14. Dinsmore, P. C., Rocha, L. (2012). *Enterprise Project Governance: A Guide to the Successful Management of Projects Across the Organization.* New York, NY: Amacom.
15. *Agile Business Consortium - DSDM method.* (2001). Retrieved February 14, 2013, from www.dsdm.org
16. *Amysoft DDJ State of the IT Union Survey.* (2009, July). Retrieved March 20, 2013, from <http://www.amysoft.com/surveys/stateOfITUnion200907.html>
17. *Dr. Dobb's IT Project Success survey 2010.* (2010, August 2). Retrieved March 20, 2013, from <http://www.drdoobbs.com/architecture-and-design/2010-it-project-success-rates/226500046?cid=Ambysoft>
18. Dr. Hobbs, B., Dr. Miller, R. (2002). *The Strategic Front End of Large Infrastructure Projects: A Process of Nesting Governance.* Proceedings of PMI Research Conference. Newton Square, PA: Project Management Institute.
19. Haight, F. A. (1967). *Handbook of the Poisson Distribution.* New York, NY: John Wiley & Sons.
20. *Value Based Management.Net.* (2013). Retrieved May 15, 2013 from http://www.valuebasedmanagement.net/methods_change_management_iceberg.html
21. Kaplan, R. S., Norton, D. P. (2004). *Strategy Maps: Converting Intangible Assets into Tangible Outcomes.* Boston, MA: Harvard Business School Press.
22. Klakegg, O. J., Williams, T., Magnussen, O. M., Glasspool, H. (2008). Governance Frameworks for Public Project Development and Estimation. *Project Management*

- Journal, Vol 39, Supplement, S27-S42.* Newton Square, PA: Project Management Institute.
23. Krebs, J. (2008). *Agile Portfolio Management*. Redmond, WA: Microsoft Press
 24. Lamm, J. et al. (2010). *Under Control: Governance Across the Enterprise*. USA: CA Press Apress.
 25. Morris, L. (2008). Innovation Metrics. *InnovationLabs LLC*. Retrieved from <https://www.innovationlabs.com/publications/innovation-metrics/>
 26. Moore, S. (2010). *Strategic Project Portfolio Management – Enabling a Productive Organization*. Hoboken, NJ: John Wiley & Sons, Inc.
 27. McMahon, P. E. (2011). *Integrating CMMI and Agile Development*. Boston, MA: Addison-Wesley.
 28. Neale, P., Thapa, S., Boyce, C. (2006). Preparing a Case Study: A Guide for Designing and Conducting a Case Study for Evaluation Input. *Pathfinder International*. Retrieved from http://www2.pathfinder.org/site/DocServer/m_e_tool_series_case_study.pdf
 29. *OECD Principles of Corporate Governance*. (2004). Retrieved January 26, 2013, from <http://www.oecd.org/corporate/ca/corporategovernanceprinciples/31557724.pdf>
 30. Olson, D. L., Wu, D. (2010) *Enterprise Risk Management Models*. Berlin, Heidelberg: Springer-Verlag.
 31. *Agile Modeling site*. (2001). Retrieved February 14, 2013, from <http://www.agilemodeling.com>
 32. Paladino, B. (2007). *Five Principles of Corporate Performance Management*. Hoboken, NJ: John Wiley & Sons.
 33. Paré, G. (2004). Investigating Information Systems with Positivist Case Study Research, *Communications of the Association for Information Systems, Vol. 13*, Article 18. Retrieved from <http://aisel.aisnet.org/cais/vol13/iss1/18>
 34. Parmenter, D. (2007). *Key Performance Indicators (KPI): Developing, Implementing, and Using Winning KPIs*. Hoboken, NJ: John Wiley & Sons.
 35. Pinsonneault, A., & Kraemer, K. L. (1993). Survey Research Methodology in Management Information Systems: An Assessment. *Journal of Management Information Systems*. Retrieved from http://borders.arizona.edu/classes/mis696a/resources/readings/PinsonneaultKraemer-1993-JMIS-SurveyResearchMethodologyInMIS_AnAssessment.pdf
 36. Rad, P., & Levin, G. (2006). *Project Portfolio Management Tools and Techniques*. New York, NY: IIL Publishing.
 37. Simons, R. (1995). *Levers of Control: How Managers Use Innovative Control Systems to Drive Strategic Renewal*. Boston, MA: Harvard Business School Press.
 38. *University of Massachusetts Amherst – the Poisson distribution*. (2013). Retrieved April 5, 2013, from <http://www.umass.edu/wsp/statistics/lessons/poisson/index.html>
 39. Van Grembergen, W., & De Haes, S. (2012). *Business Strategy and Applications in Enterprise IT Governance*. Hershey, PA: IGI Global.
 40. Schwaber, C. (2006). *The Changing Face Of Application Life-Cycle Management*. Cambridge, MA: Forrester Research, Inc.
 41. Teng, E., Mitchell, C., Wathington, C. (2011). Agile ALM: Redefining ALM with Five Key Practices. *ThoughtWorks Studios*. Retrieved from <http://studios.thoughtworks.com>
 42. *Agile Helpline Site: Agile Governance*. (2013). Retrieved May 20, 2013, from <http://www.agilehelpline.com/2011/03/agile-governance.html>
 43. Marks, E. A. (2012). *A Lean Enterprise Governance Manifesto – Improving Business Performance with Event-Driven Governance*. Portsmouth, NH: Agile Path Corporation.
 44. Highsmith, J. (2010). *Agile Project Management - Creating Innovative Products*. New York, NY: Addison-Wesley.
 45. Hines, P. (2010). The Principles of the Lean Business System. *Lean Enterprise Research Centre, Cardiff University*. Retrieved form

- <https://www.fdf.org.uk/resources/The%20Principles%20of%20The%20Lean%20Business%20System.pdf>
46. Hines, P., Found, P., Griffiths, G., Harrison, R. (2008). *Staying Lean – Thriving, not just surviving*. Boca Raton, FL: CRC Press Taylor & Francis Group.
 47. Umphress, D., Liu, C. (2008). Heavyweight or Lightweight: A Process Selection Guide for Developing Grid Software. *Proceedings of the 46th Annual Southeast Regional Conference*, 99-101. Retrieved from https://www.researchgate.net/publication/220996782_Heavyweight_or_lightweight_a_process_selection_guide_for_developing_grid_software
 48. Goodpasture, J. (2010). *Project Management the Agile Way – Making it Work in the Enterprise* (pp. 5-10). Fort Lauderdale, FL: J. Ross Publishing, Inc.
 49. Saris, W.E., & Gallhofer, I.N. (2014). *Design, Evaluation, and Analysis of Questionnaires for Survey Research, 2nd Edition* (pp. 45-66). Hoboken, NJ: John Wiley & Sons, Inc.
 50. Myers, M. D., & Avison, D. (2002). *Qualitative Research in Information Systems* (pp. 241-242). London, UK: SAGE Publications Ltd.
 51. Van Bennekom, F. (2011). *Organizational Effectiveness Through Feedback Management*. Retrieved from http://www.greatbrook.com/survey_statistical_confidence.htm
 52. *Survey Quality Prediction Site*. (2014). Retrieved May 25, 2014, from <http://spq.upf.edu>
 53. Pitelis, C. (2010). The co-evolution of organizational value capture, value creation and sustainable advantage. *MPPRA Paper No. 23937*, 46-47. Retrieved from <http://mppra.ub.uni-muenchen.de/23937/>
 54. Project Management Institute. (2013). *Managing Change in Organizations: A Practice Guide* (pp. 6-7). Newton Square, PA: Project Management Institute.
 55. Project Management Institute. (2013). *Pulse of Profession 2013*. Newton Square, PA: Project Management Institute.
 56. Lyngso, S. (2014). *Agile Strategy Management: Techniques for Continuous Alignment and Improvement* pp. 32-35. New York, NY: Auerbach Publications.
 57. *Agile Business Consortium Site*. (2001). Retrieved February 7, 2014, from <http://www.dsdm.org/content/10-moscow-prioritisation>
 58. Abrahamsson, P., Warsta, J., Siponen, M.T., Ronkainen, J. (2003). New Directions on Agile Methods: A Comparative Analysis. *Proceedings of the International Conference on Software Engineering*. Retrieved from http://eljabiri1.tripod.com/sitebuildercontent/sitebuilderfiles/2003_icse03_new_directions_on_agile_methods.pdf
 59. *Microsoft Solutions Framework Site*. (2014). Retrieved March 20, 2014, from <http://www.msdn.microsoft.com/en-us/library/jj161047.aspx>
 60. *Lean Sigma Corporation Site*. (2010). Lean Six Sigma Black Belt Training Featuring Examples from SigmaXL. Retrieved May 15, 2015 from <https://www.leansigmacorporation.com/online-training/www/student.php?ctg=lessons>
 61. *The W. Edwards Deming Institute Site*. (2014). The Fourteen Points For The Transformation Of Management. Retrieved April 12, 2014, from <https://www.deming.org/theman/theories/fourteenpoints>
 62. Charantimath, P. M. (2011). *Total Quality Management, 2nd Edition*. Pearson India.
 63. Hlava, M.M.K. (2014). *The Taxobook – Principles and Practices of Taxonomy Construction*. San Rafael, CA: Morgan & Claypool Publishers.
 64. *National Information Standards Organization Site*. (2014). ANSI/NISO Z39.19-2005 (R2010). (2010). *Guidelines for the Construction, Format, and Management of Monolingual Controlled Vocabularies*. Retrieved August 14, 2014, from http://www.niso.org/apps/group_public/project/details.php?project_id=46

65. Boyer, J., & Mili, H. (2011). *Agile Business Rule Development* (pp. 49-71). Berlin Heidelberg: Springer-Verlag.
66. Bennis W., & Nanus B. (1985). *Leaders: The Strategies for Taking Charge*. New York, NY: Harper & Row.
67. Zimmerer, T., & Yasin M. M. (1998). A leadership profile of American Project Managers. *Project Management Journal*, Vol. 29 (pp. 31-38). Newton Square, PA: Project Management Institute.
68. Kodjababian, J., & Petty, J. (2007). Dedicated project leadership: helping organizations meet strategic goals. *Healthcare Financial Management*, 61(11) (pp. 130-135). Bethesda, MD: NCBI Resources.
69. Perkins, S., & Arvinen-Muondo, R. (2013). *Organizational Behaviour*. London, UK: Kogan Page Limited.
70. Cohn, M. (2006). *Agile Estimating and Planning*. New York, NY: Pearson Education, Inc.
71. Iacocca, L., & Witney, C. (2007). *Where have all the leaders gone?* New York, NY: Scribner Book Company.
72. *Agile Leadership Practices Site, Management 3.0* (2013). Retrieved January 15, 2015, from <http://www.agile-lead.com/blog/management-30-leadership-practices>
73. Aaker, D.A. (2013). *Strategic Market Management, 10th Edition*. Hoboken, NJ: John Wiley & Sons.
74. Bradley, G. (2010). *Benefits Realisation Management - Second Edition: A Practical Guide to Achieving Benefits Through Change*. Hampshire, UK: Gower Publishing Ltd.
75. *The 2012 ACM Computing Classification System (CSS)*. ACM DL Digital Library. Retrieved January 18, 2015, from <http://dl.acm.org/ccs.cfm?CFID=492460152&CFTOKEN=92425874>
76. Project Management Institute. (2009). *Practice Standard for Project Risk Management*. Newton Square, PA: Project Management Institute.
77. Kobayashi, H., Mark, B.L., Turin, W. (2011). *Probability, Random Processes, and Statistical Analysis*. New York, NY: Cambridge University Press.
78. Goodpasture, J. (2003). *Quantitative Methods in Project Management*. Boca Raton, FL: J. Ross Publishing.
79. Fenton, N., & Neil, M. (2013). *Risk Assessment and Decision Analysis with Bayesian Networks*. Boca Raton, FL: CRC Press.
80. Gera, B. (2011). *Project and Program Management Analytics*. Newton Square, PA: Project Management Institute.
81. Makhani, Sh., Khan, A.H., Soomro, S. (2010). Project Management Risk Sensitivity Analysis. *Journal of Information & Communication Technology*, Vol.4, No. 1 (pp. 38-48). Institute for Business and Technology, Karachi.
82. Raydugin, Y. (2013). *Project Risk Management: Essential Methods for Project Teams and Decision Makers*. Hoboken, NJ: John Wiley & Sons.
83. Hillson, D. (2004). Combining Earned Value Management and Risk Management to Create Synergy. *PMI 2004 Global Congress Proceedings*. Newton Square, PA: Project Management Institute.
84. Luecke, R., & Katz, R. (2003). *Managing Creativity and Innovation*. Boston, MA: Harvard Business School Press.
85. Kendrick, T. (2009). *Identifying and Managing Project Risk, 2nd Edition*. New York, NY: AMACOM Books.
86. International Criminal Court. (2012). *ICT Strategy 2013-2017 Update, The current support structure of ICT to the organization*. Den Haag, NL: ICC.
87. International Criminal Court. (2013). *ICT ERP project documentation 2003 – 2011*. Den Haag, NL: ICC.
88. International Criminal Court. (2013). *ICT eCOS project documentation 2005 – 2012*. Den Haag, NL: ICC.

89. International Criminal Court. (2013). *ICT Business Continuity Management / Disaster Recovery project documentation 2009 – 2013*. Den Haag, NL: ICC.
90. *Committee of Sponsoring Organizations of the Treadway Commission, The Institute of Internal Auditors Site*. (2016). Applying COSO's Enterprise Risk Management – Integrated Framework. Retrieved November 20, 2016, from <http://www.coso.org/ERM-IntegratedFramework.htm>
91. Hampton, J.J. (2009). *Fundamentals of Enterprise Risk Management: how top companies assess risk, manage exposure, and seize opportunity*. New York, NY: AMACOM Books.
92. Sillitti, A., Hazzan, O., Bache, E., Albaladejo, X. (2011). *Agile Processes in Software Engineering and Extreme Programming*. Berlin Heidelberg: Springer-Verlag.
93. *Agile Business Consortium Site*. (2016). Retrieved December 15, 2016, from <https://www.agilebusiness.org/content/risk-management>
94. *The Institute for Agile Risk Management*. (2016). Agile Risk Management Embrace Change. Retrieved December 17, 2016, from <http://institute.agileriskmanagement.org/wp-content/themes/iarm/publications/AgileRiskManagementEmbraceChangeWhitepaper.pdf>
95. Project Management Institute. (2005). *Practice Standard for Earned Value Management*. Newton Square, PA: Project Management Institute.
96. SAP. (2009). *Agile Implementation Methodology, Introduction & High-Level Overview*. Waldorf, GE: SAP AG.
97. ESRC Economic & Social Research Council. (2004). *Developing Indicators for Concepts UK Data Service Facts sheet*. Retrieved June 18, 2017, from https://www.ukdataservice.ac.uk/media/262823/discover_developingindicatorsforconceptsfactsheet.pdf
98. Sulaiman, T., Barton, B., Blackburn, T. (2006). *AgileEVM – Earned Value Management in Scrum Projects*. Arlington, VA: ESI International.
99. Pinsonneault, A., & Kraemer, K. L. (1993). Survey Research Methodology in Management Information Systems: An Assessment. *Journal of Management Information Systems*, 82.
100. de Luna, A.J.H., Kruchten, P., do E. Pedrosa, M.L.G., de Almeida Neto, H.R., de Moura, H.P. (2014). State of the Art of Agile Governance: A systematic Review. *Int'l Journal of Computer Science & Information Technology (IJCSIT)* Vol 6. No.5.
101. Johannesson, P., Perjons, E. (2012). *A Design Science Primer*. Creative Commons Attribution (pp. 131-137). CreateSpace.
102. Peffers, K., Tuunanen, T., Rothenberger, M. A., Chatterjee, S. (2007). A Design Science Research Methodology for Information Systems Research. *Journal of Management Information Systems*, vol. 24, no. 3 (pp. 45–77).
103. Pressman, R.S. (2010). *Software Engineering A Practitioner's Approach, 7th Ed*. New York, NY: McGraw-Hill.
104. Baskerville, R., Levine, L., Pries-Heje, J., Ramesh, B., Slaughter, S. (2002). Balancing Quality and Agility in Internet Speed Software Development. *ICIS 2002 Proceedings*, Paper 89.
105. McGuiggan, R., Lee, G. (2008). Cross-Case analysis: An Alternative Method. *Proceedings of the Australian and New Zealand Marketing Academy Conference, University of Western Sydney*. Perth, W.A: Promaco Conventions.
106. Goldie, S. (2012). *Statistics – Cambridge International AS and A Level Mathematics*, Hodder Education, pp. 145-153, 2012
107. *Collabnet VersionOne Site*. (2018). 12th Annual State of Agile Report. Retrieved November 15, 2018, from <https://explore.versionone.com/state-of-agile/versionone-12th-annual-state-of-agile-report>

GLOSSARY OF TERMS

<i>Term or Acronym</i>	<i>Explanation</i>
AC	Actual cost or actual cost of work performed
AgileEVM	Performance measurement and feedback Agile tool
ALM	Application Lifecycle Management usually refers to both application processes and tools
BCM	Business Continuity Management (BCM) encompasses Crisis Management, ICT Recovery and Business recovery. BCM is executed through five stages including Business Impact Analysis (BIA), ICT Risk Analysis and mitigation to establish resilience, establishing BC Framework consisting of policies and standards, Contingency strategies to achieve the BIA deadlines, Disaster Recovery Planning (DRP), and Training, Testing and Maintenance.
BPM	Business Process Modeling
CMMI	Capability Maturity Model Integration (CMMI) is a process improvement training and appraisal program and service administered and marketed by Carnegie Mellon University
COBIT	Control Objectives for Information and related Technology published by the International Information Systems Audit and Control Association (ISACA)
EV	Earned Value or budgeted cost of work performed
ERP	Enterprise Resource Planning (system)
GRC	Governance, Risk and Compliance. GRC allows publicly-held companies to integrate and manage IT operations that are subject to regulation.
ISACA	Information Systems Audit and Control Association see www.isaca.org . – a professional association of IT audit and security personnel.
KRI, PI, KPI	Performance indicators. KRI – Key Result Indicator, an outcome measure, observing an activity over months or quarter, describing to the governing body (Board) how the performance was done in a perspective; PI – Performance Indicator, a past-, current-, or future focused measure, describing what to do to the management; KPI – Key Performance Indicator, a current or future focused measure, describing to the project / program / portfolio managers what to do to increase performance dramatically.
MAO	Maximum Acceptable Outage is the maximum amount of time (including business workarounds and senior management concerns about reputation protection) that an enterprise's key products or services can be unavailable or undeliverable before its stakeholders perceive unacceptable consequences following an event that disrupts operations. The final acceptable period is influenced by both tangible and intangible factors explored in the BIA questionnaire discussion.
PMO	Program (or Project) Management Office
PMIS	Program (or Project) Management Information System
PPM	Project Portfolio Management
PV	Planned Value, or budgeted cost of work scheduled
RTO	Recovery Time Objective is the duration of time and service level within which each IT business process shall be restored after a disaster (or disruption) in order to avoid unacceptable consequences. This time shall be such that it allows conditioning and testing (involving normal business users) before commissioning in line with the MAO deadline.
SAN	Storage Area Network is a high-speed special-purpose network that interconnects different kinds of data storage devices with associated data servers on behalf of a larger network of users.

LIST OF EXIBITS

<i>Figure</i>	<i>Description</i>	<i>Page</i>
Figure 1.1	Organization Leverage Points	8
Figure 1.2	Research structure	11
Figure 1.3	Research Design	14
Figure 2.1	Lean and Six Sigma objectives	24
Figure 2.2	TQM development phases	26
Figure 2.3	Agile planning onion	32
Figure 2.4	Organizational agile onion	33
Figure 2.5	Agile governance framework construct	34
Figure 2.6	Taxonomy relationships	38
Figure 2.7	Main term structure of the PPG taxonomy	38
Figure 2.8	Levels of agile planning	43
Figure 2.9	Agile change management life cycle	47
Figure 2.10	Agile PPG taxonomy	51-53
Figure 3.1	Business model and project balance sheet	58
Figure 3.2	Normal distribution	63
Figure 3.3	Project portfolio risks	66
Figure 3.4	EVM as a function of project risk	69
Figure 3.5	EVM performance	69
Figure 4.1	High-level analysis process map / workflow	78
Figure 4.2	Top ten portfolio risks impacting output factors	85
Figure 4.3	Sorted output priority data	87
Figure 4.4	Probability histogram and S-curve for the project risks occurrence	94
Figure 4.5	Project risks sensitivity analysis	95
Figure 4.6	Project risks occurrence probability	96
Figure 4.7	Key risk inputs affecting project costs	99
Figure 4.8	Probability density function of actual risks impact on project costs	100
Figure 4.9	Project costs regression analysis	100
Figure 4.10	Total actual weeks vs. Realization stage	104
Figure 4.11	Elements of portfolio risk management	106
Figure 4.12	Project Portfolio Governance Risk Management Framework	115
Figure 4.13	ICC ICT Project Portfolio 2013 - Risk-Reward diagram	120
Figure 4.14	Cumulative Planned Value, Earned Value and Actual Cost for the case project	122
Figure 4.15	Case project cost performance index and schedule performance index	123
Figure 5.1	Operationalization of an attitude toward In-context collaboration	136
Figure 5.2	A measurement model for a direct measure of in-context collaboration	137
Figure 5.3	Statistical accuracy of the survey	141
Figure 5.4	Governance processes formalization and structuring	141
Figure 5.5	Importance of governance functions and role	142
Figure 5.6	Alignment with organizational objectives	143
Figure 5.7	Organizational value creation	143
Figure 5.8	Response to change	143
Figure 5.9	Alignment of business goals with organizational strategy	144
Figure 5.10	Decision making influence	145
Figure 5.11	Participative alignment	146
Figure 5.12	Real-time planning	146
Figure 5.13	Regulation, standards, and procedures	147
Figure 5.14	Lifecycle traceability	148
Figure 5.15	Project management in continuous process improvement	149
Figure 5.16	In-context collaboration	150
Figure 5.17	Risk adaptation and orchestration	151
Figure 5.18	Change distilment and incremental process change	151
Figure 5.19	Development intelligence (success metrics, tracking progress)	152
Figure 5.20	Usage of metrics	153
Figure 5.21	Practice continuous delivery	154

<i>Figure</i>	<i>Description</i>	<i>Page</i>
Figure 5.22	Continuous refinement toward greater efficiencies	154
Figure 5.23	Improvement of the team dynamic	155
Figure 5.24	Build the right thing	156
Figure 5.25	Increase of benefits and sustainability	156
Figure 5.26	Agile project portfolio governance concept	163
Figure 5.27	Comparing life-cycle, project management and concrete guidance support	164
Figure 6.1	Cross-case analysis	167

<i>Table</i>	<i>Description</i>	<i>Page</i>
Table 2.1	Major Agile methods with their key attributes	19-20
Table 2.2	The evolution of Total Quality Management	26
Table 3.1	Agile factors impacting the project portfolio governance processes ion	55
Table 3.2	Program and project sources for the quantitative data collection	56
Table 3.3	AgileEVM definitions	69
Table 3.4	Comparison of EVM – AgileEVM performance measures	70
Table 4.1	Criteria for a Case Study Design	73
Table 4.2	BPM Agile-Tailored Model Attributes	74-75
Table 4.3	Referent portfolio data source RBS	79
Table 4.4	Portfolio RAM	82
Table 4.5	Project portfolio strata Cause and Effect Rating Matrix	83
Table 4.6	Sorted priority/prioritized and selected portfolio risks	84
Table 4.7	Ten most significant portfolio risks	86
Table 4.8	Process output ranking	86
Table 4.9	Project's CSF vs. dimensions of post-implementation success	89
Table 4.10	Project budget	90
Table 4.11	Project schedule	90
Table 4.12	Risk model using Binomial distribution	91
Table 4.13	Scenario analysis using Binomial distribution	93
Table 4.14	Risk sensitivity analysis	94
Table 4.15	Risk cost model using beta-PERT distribution	98
Table 4.16	Risk scenario analysis using Beta-PERT distribution	99
Table 4.17	Schedule risk model using beta-PERT distribution	101
Table 4.18	Risk analysis of planned schedule using Beta-PERT distribution	102
Table 4.19	Risk analysis of actual schedule using Beta-PERT distribution	102
Table 4.20	The most critical risks affecting the project stages	102
Table 4.21	Schedule sensitivity analysis	103
Table 4.22	Front-End process domain risk management approach	111
Table 4.23	Planning process domain risk management approach	112
Table 4.24	Monitoring process domain risk management approach	113-114
Table 4.25	Deliverables process domain risk management approach	114
Table 5.1	Strengths and weaknesses of cross-sectional studies	135
Table 5.2	Criteria for a survey study design	135
Table 5.3	Survey quality coefficients distribution	137
Table 5.4	Survey quality prediction	137
Table 5.5	Potential survey improvements	138
Table 5.6	Survey findings	158-161
Table 5.7	Agile governance domain process model methodology break-down	162
Table 6.1	Cross-case analysis	169-170

APPENDICES

Agile Governance of Project Portfolios

UNIVERSITY OF ZAGREB
FACULTY OF ORGANIZATION AND INFORMATICS
Postgraduate Doctoral Study in Information Sciences

Dear Participant,

This survey is designed in order to examine the suitability of Agile methodologies and lean practices for the development of organizational project portfolio governance frameworks and governance domain processes. With this survey I would like to answer particular questions, including what Agile method is the most suitable for the development of project portfolio governance frameworks and processes, and whether Agile factors cause the optimal actualization of the governance domain processes that improves the performance of project portfolio management processes and consequently positively affects organizational performance in achieving its values and benefits.

Governance is defined as the process of developing, communicating, implementing, monitoring, and assuring the policies, procedures, organizational structures, and practices associated with a given program (PMI, 2013). Project portfolio governance framework is a discipline within the organizational governance, and its methods and techniques applied within the context of the organizational governance provide reasonable assurance that the organizational strategy can be achieved (PMI, 2013).

This survey is designed with the support of Professor Vjeran Strahonja, Dean of Faculty of Organization and Informatics Varazdin and Head of Department of Information Systems Development.

Please submit your answers by 20.06.2014. Upon completion of the survey analysis, the results will be shared with you.

Thank you for your participation.

Sincerely,

Goran Banjanin
PhD Candidate

*** Required**

1. Please select your role within your organization *

Which best describes your current position?

- Executive working at a strategic level (such as CEO/CFO/COO/MD or equivalent)
- Head of IT or main IT decision maker (CIO)
- Business Manager
- IT Manager
- Business Stakeholder
- Program Manager
- Project Manager
- Operations/Support
- Modeler (Analyst/Designer/Architect)

- Academic
- Quality Manager
- Developer
- Consultant
- Other:

2. What is your main area of responsibility? *

- General Management
- Information Technology
- Financial Management
- Administration
- Project Management
- Program Management
- PMO Management
- Operations
- Business Consultancy
- Research and Development
- Other:

3. How many years of work experience do you have? *

- Less than 5 years
- 5 - 10 years
- 10 - 20 years
- 20+ years

4. Your organization is primarily involved in which sector? *

- Technology
- Manufacturing
- Retail
- Utilities
- Financial
- Services
- Telecommunications
- Public
- International
- Government

Other:

5. How would you rate your organization's project portfolio governance? *

- We have a project portfolio governance framework
- The project portfolio governance framework generally helps portfolio management to succeed
- The project portfolio governance is neither helpful nor harmful
- We don't have project portfolio governance
- The project portfolio governance is generally a hindrance to portfolio management processes
- I don't know what a project portfolio governance is
- Other:

6. Is your organization adopting Agile methods in development and execution of your projects and programs? *

- Yes, we adopted Agile methods
- In process of adopting Agile methods
- No, we do not consider Agile methods

7. Which Agile method have you already practiced *
(Multiple answers allowed)

- Extreme Programming (XP)
- Adaptive Software Development (ASD)
- Dynamic System Development Method (DSDM)
- Scrum
- Crystal
- Feature Driven Development (FDD)
- Agile Modeling (AM)
- Internet Speed Development (ISD)
- No, we did not practice Agile
- Other:

8. Portfolio governance processes shall be structured and formalized, characterized by regular reviews at key decision milestones during the life-cycle of the project or program. Portfolio governance shall include the analyses of risks and benefits associated with continuing the project or program as well as to provide project and program progress information and metric reporting. Portfolio governance is linkage between the organizational strategy and portfolio management, where portfolio governance processes should outline and manage the response to significant strategic change impacting people, processes, assets or technology (The Standard for Portfolio Management Third Ed., PMI, 2013). *
Please indicate which from the below project portfolio governance processes are supported and performed by you or your organization.

	Yes	No
Are the project portfolio governance processes structured and formalized?	<input type="radio"/>	<input type="radio"/>
Are the regular reviews at key decision milestones during the life-cycle of the project or program implemented?	<input type="radio"/>	<input type="radio"/>
Is the risk analysis associated with continuing the project or program carried out?	<input type="radio"/>	<input type="radio"/>
Is the benefit analysis associated with continuing the project or program conducted?	<input type="radio"/>	<input type="radio"/>
Does your portfolio governance include performance monitoring, i.e. project and program progress information and metric reporting?	<input type="radio"/>	<input type="radio"/>
Does your portfolio governance include an effective oversight of the change management processes impacting organizational assets and resources?	<input type="radio"/>	<input type="radio"/>
Are the project and program performance information and metric reporting provided on regular basis?	<input type="radio"/>	<input type="radio"/>
None of the above	<input type="radio"/>	<input type="radio"/>

9. Governance ensures that stakeholder needs, conditions and options are evaluated to determine balanced, agreed-on enterprise objectives to be achieved; setting direction through prioritisation and decision making; and monitoring performance and compliance against agreed-on direction and objectives. (Cobit 5, ISACA, 2012) *

Please indicate the importance of governance functions and roles for your organization:

	Strongly agree	Agree	Neither agree nor disagree	Disagree	Strongly disagree	Don't know
Setting and monitoring mission, strategies, direction, priorities	<input type="radio"/>	<input type="radio"/>	<input type="radio"/>	<input type="radio"/>	<input type="radio"/>	<input type="radio"/>
Policies development and statutory compliance	<input type="radio"/>	<input type="radio"/>	<input type="radio"/>	<input type="radio"/>	<input type="radio"/>	<input type="radio"/>
Setup and maintenance of governance processes and planning	<input type="radio"/>	<input type="radio"/>	<input type="radio"/>	<input type="radio"/>	<input type="radio"/>	<input type="radio"/>
Risk management	<input type="radio"/>	<input type="radio"/>	<input type="radio"/>	<input type="radio"/>	<input type="radio"/>	<input type="radio"/>

	Strongly agree	Agree	Neither agree nor disagree	Disagree	Strongly disagree	Don't know
and optimization	<input type="radio"/>	<input type="radio"/>	<input type="radio"/>	<input type="radio"/>	<input type="radio"/>	<input type="radio"/>
Key outcomes specifications	<input type="radio"/>	<input type="radio"/>	<input type="radio"/>	<input type="radio"/>	<input type="radio"/>	<input type="radio"/>
Stakeholders involvement in mission monitoring	<input type="radio"/>	<input type="radio"/>	<input type="radio"/>	<input type="radio"/>	<input type="radio"/>	<input type="radio"/>
Values guardianship	<input type="radio"/>	<input type="radio"/>	<input type="radio"/>	<input type="radio"/>	<input type="radio"/>	<input type="radio"/>
Benefits realization	<input type="radio"/>	<input type="radio"/>	<input type="radio"/>	<input type="radio"/>	<input type="radio"/>	<input type="radio"/>
Resource optimization	<input type="radio"/>	<input type="radio"/>	<input type="radio"/>	<input type="radio"/>	<input type="radio"/>	<input type="radio"/>
Political advocacy	<input type="radio"/>	<input type="radio"/>	<input type="radio"/>	<input type="radio"/>	<input type="radio"/>	<input type="radio"/>
Monitoring and buffering divergences	<input type="radio"/>	<input type="radio"/>	<input type="radio"/>	<input type="radio"/>	<input type="radio"/>	<input type="radio"/>

10. Alignment with organizational objectives: Please indicate which method(s) (Agile, Lean, tailored or traditional) is aligned the most with the governance initiation front-end processes and thus providing alignment with the organizational objectives? *

Front-end process is the process of shaping the project and/or program and building its legitimacy through decision-making episodes. Front-end initiation governance processes include development of feasibility studies, business cases and analyses, requirements elicitation, process architecture development, rules of conduct, and impact (risk/change) analyses.

- Agile
- Lean
- Six Sigma
- Lean Six Sigma
- Tailored
- Traditional
- Don't know
- Other:

11. Organization value creation: Please indicate which method(s) contribute the most to the governance front-end and deliverables processes in creation of organizational values? *

Front-end justification governance process builds legitimacy for initiated project and/or program, addressing identification of project/program candidates, ways on how to absorb risks and costing, financial constraints, clarifies value-benefit elements and achievement of future values for the organization. Domain of governance deliverables processes include the proper delivery of products or services, adequate performance of investments, authorization of all undertaken work, and the achievement of objectives in required quality.

- Agile
- Lean

- Six Sigma
- Lean Six Sigma
- Tailored
- Traditional
- Don't know
- Other:

12. Response to change: Please indicate which method(s) contribute the most to the front-end governance processes in adopting rapid changes? *

Front-end adaptation governance process builds elasticity towards organizational changes impacting portfolio processes, enabling rapid process formation, gap/impact analyses, determines process waste, and estimates values stream.

- Agile
- Lean
- Six Sigma
- Lean Six Sigma
- Tailored
- Traditional
- Don't know
- Other:

13. Alignment of business goals: Please indicate which method(s) contribute the most to the governance front-end processes in alignment with the business goals? *

Front-end alignment governance process enables alignment of portfolio processes with the organizational objectives. Alignment of projects and programs with the strategic planning establishes the portfolio(s) required to achieve objectives and performance goals, as well as the oversight and fiduciary responsibilities through establishing the control framework and critical performance variables.

- Agile
- Lean
- Six Sigma
- Lean Six Sigma
- Tailored
- Traditional
- Don't know
- Other:

14. Decision making: Please indicate which method(s) influence the most the decision maker (governance decision making process), including the impact of the decision? *

Decision making and approvals are governance facilitating processes that delineate the responsibility and accountability of stakeholders. Governing body makes decisions that control or influence the direction of a portfolio component or group of components (projects / programs) as they work to achieve specific outcomes.

	Doesn't influence and impact at all	Limited influence and impact	Neutral	Go-/No-go checkpoint influence and impact	Straightforward influence and impact with alternatives	Don't know
Agile	<input type="radio"/>	<input type="radio"/>	<input type="radio"/>	<input type="radio"/>	<input type="radio"/>	<input type="radio"/>
Lean	<input type="radio"/>	<input type="radio"/>	<input type="radio"/>	<input type="radio"/>	<input type="radio"/>	<input type="radio"/>
Six Sigma	<input type="radio"/>	<input type="radio"/>	<input type="radio"/>	<input type="radio"/>	<input type="radio"/>	<input type="radio"/>
Lean Six Sigma	<input type="radio"/>	<input type="radio"/>	<input type="radio"/>	<input type="radio"/>	<input type="radio"/>	<input type="radio"/>
Tailored	<input type="radio"/>	<input type="radio"/>	<input type="radio"/>	<input type="radio"/>	<input type="radio"/>	<input type="radio"/>
Traditional	<input type="radio"/>	<input type="radio"/>	<input type="radio"/>	<input type="radio"/>	<input type="radio"/>	<input type="radio"/>

15. Participative alignment: Please indicate which method(s) contribute the most to the alignment with strategic plan? *

Alignment with strategic plan is the governance planning processes which involves deciding what will be done and how. It includes making strategic decisions about the direction, sets the budget-funding, identifies accountability and leadership, sets policies to guide how services will be delivered, and supervises.

- Agile
- Lean
- Six Sigma
- Lean Six Sigma
- Tailored
- Traditional
- Don't know
- Other:

16. Real-time planning: Please indicate which method(s) contribute the most to the real-time planning? *

Real-time planning enables full planning integration with the project/program execution. Governance planning process is responsible for supervision of operational plans being implemented and methods of their delivery.

	Artifacts (Feature) Estimation	Planning (Iteration / Release / Phase)	Feature Estimation / Units	Relative Estimation	Artifacts (Feature) Planning	Don't know
Agile	<input type="radio"/>	<input type="radio"/>	<input type="radio"/>	<input type="radio"/>	<input type="radio"/>	<input type="radio"/>
Lean	<input type="radio"/>	<input type="radio"/>	<input type="radio"/>	<input type="radio"/>	<input type="radio"/>	<input type="radio"/>
Six Sigma	<input type="radio"/>	<input type="radio"/>	<input type="radio"/>	<input type="radio"/>	<input type="radio"/>	<input type="radio"/>
Lean Six Sigma	<input type="radio"/>	<input type="radio"/>	<input type="radio"/>	<input type="radio"/>	<input type="radio"/>	<input type="radio"/>
Tailored	<input type="radio"/>	<input type="radio"/>	<input type="radio"/>	<input type="radio"/>	<input type="radio"/>	<input type="radio"/>
Traditional	<input type="radio"/>	<input type="radio"/>	<input type="radio"/>	<input type="radio"/>	<input type="radio"/>	<input type="radio"/>

17. Minimum reasonable set of regulation, standards, and procedures: Please indicate which method(s) balance this value system the most? *

- Agile
- Lean
- Six Sigma
- Lean Six Sigma
- Tailored
- Traditional
- Don't know
- Other:

18. Lifecycle traceability: In order to properly identify and align accountability for the plans that are fully integrated with project/program execution, please indicate which factors should be supported by Agile methodology? (Multiple answers can be allowed) *

- Achievement of reasonable results, with a minimum of waste (defects)
- Traceability allows follow-up on implementation purpose and exact goals
- Traceability enables measurement of results
- Without traceability the performance management would be impossible
- Traceability enables accountability identification
- Not clear why traceability is important
- Don't know
- Other:

19. Project management in continuous process improvement: Please indicate the importance of the role of agile project management in continuous process improvement and values delivery. *

Please note that the six core values of the Project Management Declaration of Interdependence for Agile project managers are listed as well.

	Strongly agree	Agree	Neither agree nor disagree	Disagree	Strongly disagree	Don't know
Increasing return on investment by making continuous flow of value	<input type="radio"/>	<input type="radio"/>	<input type="radio"/>	<input type="radio"/>	<input type="radio"/>	<input type="radio"/>
Delivery of reliable results by engaging customers in frequent interaction and shared ownership	<input type="radio"/>	<input type="radio"/>	<input type="radio"/>	<input type="radio"/>	<input type="radio"/>	<input type="radio"/>
Expecting uncertainty and manage for it through iterations, anticipation, and adaptation	<input type="radio"/>	<input type="radio"/>	<input type="radio"/>	<input type="radio"/>	<input type="radio"/>	<input type="radio"/>

	Strongly agree	Agree	Neither agree nor disagree	Disagree	Strongly disagree	Don't know
Unleash creativity and innovation by recognizing that individuals are the ultimate source of value and creating an environment where they can make a difference	<input type="radio"/>	<input type="radio"/>	<input type="radio"/>	<input type="radio"/>	<input type="radio"/>	<input type="radio"/>
Performing through group accountability for results and shared responsibility for team effectiveness	<input type="radio"/>	<input type="radio"/>	<input type="radio"/>	<input type="radio"/>	<input type="radio"/>	<input type="radio"/>
Improving effectiveness and reliability through situational specific strategies, processes, and practices	<input type="radio"/>	<input type="radio"/>	<input type="radio"/>	<input type="radio"/>	<input type="radio"/>	<input type="radio"/>
Removing organizational impediments	<input type="radio"/>	<input type="radio"/>	<input type="radio"/>	<input type="radio"/>	<input type="radio"/>	<input type="radio"/>
Facilitating planning sessions	<input type="radio"/>	<input type="radio"/>	<input type="radio"/>	<input type="radio"/>	<input type="radio"/>	<input type="radio"/>
Verifying estimates with Team	<input type="radio"/>	<input type="radio"/>	<input type="radio"/>	<input type="radio"/>	<input type="radio"/>	<input type="radio"/>
Facilitating team-managed and team organized approach	<input type="radio"/>	<input type="radio"/>	<input type="radio"/>	<input type="radio"/>	<input type="radio"/>	<input type="radio"/>
Prioritizing artifacts relevant for the business	<input type="radio"/>	<input type="radio"/>	<input type="radio"/>	<input type="radio"/>	<input type="radio"/>	<input type="radio"/>
Orchestrating features in accordance to project goals and requirements	<input type="radio"/>	<input type="radio"/>	<input type="radio"/>	<input type="radio"/>	<input type="radio"/>	<input type="radio"/>
Stakeholder's reporting through tangible progress (manageable piece of functionality)	<input type="radio"/>	<input type="radio"/>	<input type="radio"/>	<input type="radio"/>	<input type="radio"/>	<input type="radio"/>
Not relevant in continuous process improvement	<input type="radio"/>	<input type="radio"/>	<input type="radio"/>	<input type="radio"/>	<input type="radio"/>	<input type="radio"/>

20. In-context collaboration: Please indicate the importance of in-context collaboration to the portfolio governance monitoring processes, particularly on the approach towards strategic uncertainties and achieving values. *

In-context collaboration is part of the collaborative life cycle management. Includes local and group collaboration, common interest collaboration, and value-based collaboration.

	Strongly agree	Agree	Neither agree nor disagree	Disagree	Strongly disagree	Don't know
Local and group collaboration institutes stakeholders' interests at the forefront, leading to direct benefits from a project / program outcomes	<input type="radio"/>	<input type="radio"/>	<input type="radio"/>	<input type="radio"/>	<input type="radio"/>	<input type="radio"/>
Common interest collaboration is generally accepted as a way to achieve broad outcomes, common solutions and values	<input type="radio"/>	<input type="radio"/>	<input type="radio"/>	<input type="radio"/>	<input type="radio"/>	<input type="radio"/>
Value-based collaboration in the global networked environment is driven by a shared vision which allows stakeholders to respond to challenges in a consistent manner	<input type="radio"/>	<input type="radio"/>	<input type="radio"/>	<input type="radio"/>	<input type="radio"/>	<input type="radio"/>
Making information immediately accessible to all involved stakeholders regarding the context of their work is of utmost importance	<input type="radio"/>	<input type="radio"/>	<input type="radio"/>	<input type="radio"/>	<input type="radio"/>	<input type="radio"/>
Empowering stakeholders to collaborate in the decision making process (reviews and approvals) of artifacts to be delivered so the	<input type="radio"/>	<input type="radio"/>	<input type="radio"/>	<input type="radio"/>	<input type="radio"/>	<input type="radio"/>

	Strongly agree	Agree	Neither agree nor disagree	Disagree	Strongly disagree	Don't know
feedback can be incorporated early and often						
Providing single source of veracity hosted in a shared repository so that stakeholders can collaborate effectively in a boundless manner, is required to be done	<input type="radio"/>	<input type="radio"/>	<input type="radio"/>	<input type="radio"/>	<input type="radio"/>	<input type="radio"/>
Stakeholders' in-context discussions about the project / program artifacts captured online, create a single source of the veracity for decision making process	<input type="radio"/>	<input type="radio"/>	<input type="radio"/>	<input type="radio"/>	<input type="radio"/>	<input type="radio"/>

21. Risks adaptation and orchestration: Please indicate which method(s) contribute the most to the governance monitoring processes in its dealing with the risks' adaptation and orchestration? *

Integrating risks into planning, budgeting, reporting and forecasting as well as into the context of overall performance can lead to better decisions through risk-adjusted plans and budgets.

	Agile	Lean	Six Sigma	Lean Six Sigma	Tailored	Traditional	Don't know
Adaptive capacity on vulnerabilities	<input type="radio"/>	<input type="radio"/>	<input type="radio"/>	<input type="radio"/>	<input type="radio"/>	<input type="radio"/>	<input type="radio"/>
Capacity for assessment of current, actual, future, and potential vulnerabilities	<input type="radio"/>	<input type="radio"/>	<input type="radio"/>	<input type="radio"/>	<input type="radio"/>	<input type="radio"/>	<input type="radio"/>
Likelihood on risk adaptation	<input type="radio"/>	<input type="radio"/>	<input type="radio"/>	<input type="radio"/>	<input type="radio"/>	<input type="radio"/>	<input type="radio"/>
Formalized process to manage risks	<input type="radio"/>	<input type="radio"/>	<input type="radio"/>	<input type="radio"/>	<input type="radio"/>	<input type="radio"/>	<input type="radio"/>
Maintenance of a risk profile and accountability to stakeholders	<input type="radio"/>	<input type="radio"/>	<input type="radio"/>	<input type="radio"/>	<input type="radio"/>	<input type="radio"/>	<input type="radio"/>
Focus on risks with greatest potential	<input type="radio"/>	<input type="radio"/>	<input type="radio"/>	<input type="radio"/>	<input type="radio"/>	<input type="radio"/>	<input type="radio"/>

	Agile	Lean	Six Sigma	Lean Six Sigma	Tailored	Traditional	Don't know
impact and occurrence							
Risk Integrated into feature/release planning	<input type="radio"/>	<input type="radio"/>	<input type="radio"/>	<input type="radio"/>	<input type="radio"/>	<input type="radio"/>	<input type="radio"/>
Risk part of performance measurement	<input type="radio"/>	<input type="radio"/>	<input type="radio"/>	<input type="radio"/>	<input type="radio"/>	<input type="radio"/>	<input type="radio"/>
Historical comparison of key risk and performance indicators	<input type="radio"/>	<input type="radio"/>	<input type="radio"/>	<input type="radio"/>	<input type="radio"/>	<input type="radio"/>	<input type="radio"/>
Specific risk thresholds - formal trigger points for risk mitigation activities	<input type="radio"/>	<input type="radio"/>	<input type="radio"/>	<input type="radio"/>	<input type="radio"/>	<input type="radio"/>	<input type="radio"/>

22. Change distilment and incremental process change: Please indicate which method(s) support the most continuous improvement effort and incremental process change? (multiple answers allowed) *

- Agile
- Lean
- Six Sigma
- Lean Six Sigma
- Tailored
- Traditional
- Don't know
- Other:

23. Development intelligence (success metrics, tracking progress): Please indicate what performance metrics contributes the most to the governance control framework? *

Performance metrics enables progress communication to project stakeholders

	Strongly agree	Agree	Neither agree nor disagree	Disagree	Strongly disagree	Don't know
Iteration delta tables/Status Chart	<input type="radio"/>	<input type="radio"/>	<input type="radio"/>	<input type="radio"/>	<input type="radio"/>	<input type="radio"/>
Release and iteration burn-down chart	<input type="radio"/>	<input type="radio"/>	<input type="radio"/>	<input type="radio"/>	<input type="radio"/>	<input type="radio"/>
Planned / Actual Release Points	<input type="radio"/>	<input type="radio"/>	<input type="radio"/>	<input type="radio"/>	<input type="radio"/>	<input type="radio"/>
Total Number of Story Points Planned / Completed	<input type="radio"/>	<input type="radio"/>	<input type="radio"/>	<input type="radio"/>	<input type="radio"/>	<input type="radio"/>

	Strongly agree	Agree	Neither agree nor disagree	Disagree	Strongly disagree	Don't know
Total Number of Planned Sprints	<input type="radio"/>	<input type="radio"/>	<input type="radio"/>	<input type="radio"/>	<input type="radio"/>	<input type="radio"/>
Running Tested Features	<input type="radio"/>	<input type="radio"/>	<input type="radio"/>	<input type="radio"/>	<input type="radio"/>	<input type="radio"/>
Planned / Actual Budget for Release	<input type="radio"/>	<input type="radio"/>	<input type="radio"/>	<input type="radio"/>	<input type="radio"/>	<input type="radio"/>
Total Number of Story Points Completed	<input type="radio"/>	<input type="radio"/>	<input type="radio"/>	<input type="radio"/>	<input type="radio"/>	<input type="radio"/>
Planned / Actual % of Release	<input type="radio"/>	<input type="radio"/>	<input type="radio"/>	<input type="radio"/>	<input type="radio"/>	<input type="radio"/>
Planned / Actual % Complete	<input type="radio"/>	<input type="radio"/>	<input type="radio"/>	<input type="radio"/>	<input type="radio"/>	<input type="radio"/>
Variances (Schedule, Cost, Variance at Completion)	<input type="radio"/>	<input type="radio"/>	<input type="radio"/>	<input type="radio"/>	<input type="radio"/>	<input type="radio"/>
Indices (Schedule Performance, Cost Performance, To-Complete Performance)	<input type="radio"/>	<input type="radio"/>	<input type="radio"/>	<input type="radio"/>	<input type="radio"/>	<input type="radio"/>
Forecasts (Time Estimate At Completion, Estimate To Complete)	<input type="radio"/>	<input type="radio"/>	<input type="radio"/>	<input type="radio"/>	<input type="radio"/>	<input type="radio"/>

24. Usage of metrics: Please indicate which method(s) use metrics thus providing information to the governing body on their critical performance? (multiple answers allowed) *

- Agile
- Lean
- Six Sigma
- Lean Six Sigma
- Tailored
- Traditional
- Don't know
- Other:

25. Practice continuous delivery: Please indicate what continuous delivery practices are important for review of agile project/program performance? (multiple answers allowed) *

- Faster delivery and in shorter cycles
- Delivering products in a timely manner to the market

- Accelerating time-to-market delivery
- Frequent delivery
- Focus on increasing the pace of delivery and reducing costs
- Maintain Forecasted-to-Expected delivery ratios
- Agile delivery model
- On-time delivery
- Incremental delivery
- Short delivery cycles in sync with the iterative-incremental development process
- Don't know

26. Continuous refinement toward greater efficiencies: Please indicate which factors contribute the most towards achieving greater efficiencies? *

	Strongly agree	Agree	Neither agree nor disagree	Disagree	Strongly disagree	Don't know
Practice flexible and responsive business strategies	<input type="radio"/>	<input type="radio"/>	<input type="radio"/>	<input type="radio"/>	<input type="radio"/>	<input type="radio"/>
Ensure higher quality decision making	<input type="radio"/>	<input type="radio"/>	<input type="radio"/>	<input type="radio"/>	<input type="radio"/>	<input type="radio"/>
Implement standards that would monitor and sustain policies and guidelines in order to decrease risks for fines	<input type="radio"/>	<input type="radio"/>	<input type="radio"/>	<input type="radio"/>	<input type="radio"/>	<input type="radio"/>
Continuous and proactive managerial involvement	<input type="radio"/>	<input type="radio"/>	<input type="radio"/>	<input type="radio"/>	<input type="radio"/>	<input type="radio"/>
Setting up common processes	<input type="radio"/>	<input type="radio"/>	<input type="radio"/>	<input type="radio"/>	<input type="radio"/>	<input type="radio"/>
Acceptance of new technologies	<input type="radio"/>	<input type="radio"/>	<input type="radio"/>	<input type="radio"/>	<input type="radio"/>	<input type="radio"/>
Openness to changes and willingness to take risks	<input type="radio"/>	<input type="radio"/>	<input type="radio"/>	<input type="radio"/>	<input type="radio"/>	<input type="radio"/>

27. Improvement of the team dynamic: Please indicate which factors contribute the most to the improvement of team dynamic? *

Team dynamic is relevant for the efficient actualization of the governance of the work authorization process

	Strongly agree	Agree	Neither agree nor disagree	Disagree	Strongly disagree	Don't know
Establish clearly defined interface between the project team and the executives	<input type="radio"/>	<input type="radio"/>	<input type="radio"/>	<input type="radio"/>	<input type="radio"/>	<input type="radio"/>
Steer toward an established vision	<input type="radio"/>	<input type="radio"/>	<input type="radio"/>	<input type="radio"/>	<input type="radio"/>	<input type="radio"/>
Focus on modern processes development and their management	<input type="radio"/>	<input type="radio"/>	<input type="radio"/>	<input type="radio"/>	<input type="radio"/>	<input type="radio"/>
Change early and frequently	<input type="radio"/>	<input type="radio"/>	<input type="radio"/>	<input type="radio"/>	<input type="radio"/>	<input type="radio"/>
Make team decisions	<input type="radio"/>	<input type="radio"/>	<input type="radio"/>	<input type="radio"/>	<input type="radio"/>	<input type="radio"/>
Establish effective and balanced communication channels	<input type="radio"/>	<input type="radio"/>	<input type="radio"/>	<input type="radio"/>	<input type="radio"/>	<input type="radio"/>
Improve performance through group accountability for results and shared responsibility for team effectiveness	<input type="radio"/>	<input type="radio"/>	<input type="radio"/>	<input type="radio"/>	<input type="radio"/>	<input type="radio"/>
Implement on going integration and make efforts on continuous integration process	<input type="radio"/>	<input type="radio"/>	<input type="radio"/>	<input type="radio"/>	<input type="radio"/>	<input type="radio"/>
Collaborate directly in removing organizational and technical obstacles	<input type="radio"/>	<input type="radio"/>	<input type="radio"/>	<input type="radio"/>	<input type="radio"/>	<input type="radio"/>

28. Build the right thing: Please indicate which factors contribute to product or service delivery to converge on an optimal customer solution? (Multiple answers allowed) *

- Build predictive plans and manage them accordingly
- Apply real-time decision-making process based on actual events and information
- Select the best ideas and refine approaches
- Build a value stream map
- Eliminate waste and build quality in
- Create knowledge and optimize
- Minimize work in process
- Focus on a continuous flow of work
- Highlight the constraints and coordinate team work

Build product in small, gradual steps

Don't know

Other:

29. Increase of benefits and sustainability: Based on your experience, please indicate if the agile portfolio governance is a good fit for increasing organizational benefits and therefore sustainability of business values? *

30. Optional:

Please provide any personal insights about Agile methodologies and lean practices for the development of organizational project portfolio governance frameworks and governance processes.

31. Optional:

If you are interested in sharing the survey findings with you, please provide your full name and e-mail address.

100%

Curriculum Vitae
Goran Banjanin, MSc

Goran Banjanin, MSc, is the program manager with an extensive experience in managing programs, projects and information systems implementation at international level in public and private sectors. Currently he is advising and coaching in the areas of information systems' integration, organizational project, program and portfolio management, governance and change management. The most important positions during his career were Head, ICT Project Management Office at the International Criminal Court in The Hague, The Netherlands (2003-2015), Project Manager at Ashland, Inc., Rotterdam, The Netherlands (1999-2002), Project Manager/Market Coordinator at Ashland Inc., Valvoline International Europe, Zagreb (1997-1999), IT Manager at Gorbis d.o.o, Zagreb (1992-1997), Sales Engineer at MDS Information Engineering d.o.o., Zagreb (1991-1992), and IT Manager at TEŽ, Zagreb (1986-1990).

He earned his bachelor's degree in economics at the University of Zagreb, Faculty of Economics, majoring in Information Systems, and Master of Science in Information Sciences at the University of Zagreb, Faculty of Organization and Informatics in 2008. Goran's areas of proficiency include management of complex organizational information systems development and implementation, covering administrative, financial, commercial, judicial, and production processes (SAP, Oracle, Lawson-Movex), business continuity management, IT security management, business intelligence systems (SAP, StreamServe), and project portfolio systems implementation. Goran holds globally recognized professional certifications in program management (PgMP), project management (PMP, PMI-ACP), and information systems auditing (CISA).

List of published work

1. Banjanin, G., Strahonja, V. (2018) "Factors of Risk Reduction in Agile and Lean Enabled Governance of IT Project Portfolios" Information Systems Development: Methodology and Modelling (ISD2018 Proceedings). In B. Andersson, B. Johansson, S. Carlsson, C. Barry, M. Lang, H. Linger, & C. Schneider (Eds.), Designing Digitalization (ISD2018 Proceedings). Lund, Sweden: Lund University. ISBN: 978-91-7753-876-9. <http://aisel.aisnet.org/isd2014/proceedings2018/ISDMethodologies/4>.
2. Banjanin, G. (2010) "Resolving Troubled Agile Development by applying Mature Project Management - Composite Model of Structural and Process Integration" // 2010 PMI Global Congress Proceedings - Milan Italy. Project Management Institute, 2010. 1-17 <https://www.pmi.org/learning/library/agile-development-mature-project-management-6800>