

SVEUČILIŠTE J. J. STROSSMAYERA U OSIJEKU
FAKULTET ELEKTROTEHNIKE, RAČUNARSTVA I
INFORMACIJSKIH TEHNOLOGIJA OSIJEK

Ivan Tolić

**ZNAČAJ MJERENJA PRIJENOSNIH GUBITAKA I PRIPADAJUĆE
MJERNE NESIGURNOSTI PRI PREKOGRANIČNOJ RAZMJENI
ELEKTRIČNE ENERGIJE**

DOKTORSKI RAD

Osijek, 2018.

Doktorski rad je izrađen na Zavodu za elektrostrojarstvo

Mentor: Prof. dr. sc. Kruno Miličević

Doktorski rad ima: 238 stranica

Doktorski rad br.: 66

Zahvaljujem svojoj obitelji, a posebno supruzi, na velikoj i nesebičnoj podršci tijekom doktorskog studija.

Povjerenstvo za ocjenu doktorske disertacije:

1. Dr.sc. Srete Nikolovski, redoviti profesor u trajnom zvanju, Fakultet elektrotehnike, računarstva i informacijskih tehnologija Osijek, predsjednik
2. Dr.sc. Kruno Miličević, redoviti profesor, Fakultet elektrotehnike, računarstva i informacijskih tehnologija Osijek, mentor
3. Dr.sc. Roman Malarić, redoviti profesor, Fakultet elektrotehnike i računarstva u Zagrebu, član

Povjerenstvo za obranu doktorske disertacije:

1. Dr.sc. Srete Nikolovski, redoviti profesor u trajnom zvanju, Fakultet elektrotehnike, računarstva i informacijskih tehnologija Osijek, predsjednik
2. Dr.sc. Kruno Miličević, redoviti profesor, Fakultet elektrotehnike, računarstva i informacijskih tehnologija Osijek, mentor
3. Dr.sc. Roman Malarić, redoviti profesor, Fakultet elektrotehnike i računarstva u Zagrebu, član
4. Dr.sc. Krešimir Fekete, docent, Fakultet elektrotehnike, računarstva i informacijskih tehnologija Osijek, član
5. Dr.sc. Tomislav Rudec, docent, Fakultet elektrotehnike, računarstva i informacijskih tehnologija Osijek, član

Datum obrane doktorskog rada: 7. prosinca 2018.

SADRŽAJ

1. UVOD.....	7
1.1. Pregled postojećih metoda za izračun mjerne nesigurnosti i njihova zastupljenost u znanstvenim člancima	9
1.2. Hipoteza.....	11
1.3. Struktura doktorske disertacije	12
2. PROCJENA MJERNE NESIGURNOSTI ZASNOVANA NA DOKUMENTU `GUIDE TO THE EXPRESSION OF UNCERTAINTY IN MEASUREMENT`	13
2.1. Povijest dokumenta `Guide to the expression of uncertainty in measurement`	13
2.2. Postupak izračuna mjerne nesigurnosti	14
2.3. Nedostaci metode	17
3. PROCJENA MJERNE NESIGURNOSTI UPORABOM MONTE CARLO METODE.....	18
3.1. Monte Carlo metoda kao alternativa klasičnom GUM pristupu.....	18
3.2. MC metoda u znanstvenoj literaturi	19
3.3. Postupak provedbe Monte Carlo metode.....	20
3.4. Adaptivna Monte Carlo metoda	23
3.5. Validacija rezultata dobivenih u okviru GUM-a	24
4. KONSTANTE PRIJENOSNOG VODA	26
4.1. Nadomjesne sheme prijenosnog voda	27
4.2. Mjerenje otpora prijenosnog voda i izračun pripadajuće mjerne nesigurnosti.....	29
4.2.1. Proračun mjerne nesigurnosti s pomoću klasične GUM metode.....	31
4.2.2. Proračun mjerne nesigurnosti s pomoću AMC metode	32
5. GUBICI PRIJENOSNOG VODA	33
5.1. Mjerenje gubitaka uporabom ugrađene funkcije u brojilu električne energije.....	34
5.1.1. Proračun mjerne nesigurnosti gubitaka s pomoću klasične GUM metode	36
5.1.2. Proračun mjerne nesigurnosti gubitaka s pomoću MC i AMC metode	36
5.1.3. Procjena funkcije gustoće vjerojatnosti gubitaka	37
6. RASPODJELA RAZMIJENJENE ENERGIJE I PRIPADAJUĆIH GUBITAKA IZMEĐU OPERATORA PRIJENOSNIH SUSTAVA	38
6.1. Zakonska regulativa vezana ispravak razmijenjene energije	39
6.2. Ispravak izmjerene energije.....	41
6.2.1. Postupak ispravka izmjerene energije.....	41
6.2.2. Utjecaj promjene strujne, naponske i kutne pogreške na ispravljenju energiju.....	42
6.3. Raspodjela energije između operatora prijenosnih sustava.....	43
6.3.1. Raspodjela neispravljenju energije.....	44
6.3.2. Raspodjela ispravljenju energije	45

6.4. Analiza mjerne nesigurnosti na obračunskom mjernom mjestu.....	46
6.4.1. Sastavnice mjerne nesigurnosti	46
6.4.2. Izračun mjerne nesigurnosti	48
7. REZULTATI PRORAČUNA I SIMULACIJE	50
7.1. Rezultati mjerenja otpora prijenosnog voda	50
7.1.1. Rezultati proračuna mjerne nesigurnosti otpora s pomoću klasične GUM metode.....	55
7.1.2. Rezultati proračuna mjerne nesigurnosti otpora s pomoću MC metode.....	56
7.1.3. Rezultati proračuna mjerne nesigurnosti otpora s pomoću AMC metode	59
7.1.4. Usporedba rezultata izračuna otpora prijenosnog voda	62
7.2. Rezultati mjerenja gubitaka prijenosnog voda	63
7.2.1. Rezultati proračuna gubitaka i pripadajuće mjerne nesigurnosti gubitaka s pomoću klasične GUM metode	63
7.2.2. Rezultati proračuna gubitaka i pripadajuće mjerne nesigurnosti gubitaka s pomoću MC metode	64
7.2.3. Rezultati proračuna gubitaka i pripadajuće mjerne nesigurnosti gubitaka s pomoću AMC metode.....	65
7.2.4. Rezultati proračuna gubitaka kao razlike izmjerenih vrijednosti energije i usporedba s rezultatima drugih metoda.....	67
7.2.5. Procjena funkcije gustoće vjerojatnosti gubitaka	69
7.3. Rezultati praktičnog primjera raspodjele razmijenjene energije između operatora prijenosnih sustava	75
7.3.1. Podaci o obračunskom mjernom mjestu	75
7.3.2. Ispravak razmijenjene energije u jednoj radnoj točki	78
7.3.3. Ispravak razmijenjene energije u cijelom mjesecu	79
7.3.4. Analiza osjetljivosti matematičkog modela za ispravak razmijenjene energije	81
7.3.4.1. Utjecaj naponske pogreške naponskog mjernog transformatora.....	82
7.3.4.2. Utjecaj kutne pogreške naponskog mjernog transformatora.....	83
7.3.4.3. Utjecaj strujne pogreške strujnog mjernog transformatora	83
7.3.4.4. Utjecaj kutne pogreške strujnog mjernog transformatora	84
7.3.4.5. Utjecaj pogreške brojila električne energije.....	85
7.3.4.6. Utjecaj pada napona u naponskim mjernom krugovima.....	86
7.3.4.7. Izračun indeksa osjetljivosti i elastičnosti ispravljene energije	87
8. ZAKLJUČAK	89
9. LITERATURA	92
P. BROJČANI PODACI KORIŠTENI U PRORAČUNIMA.....	101

1. UVOD

U suvremenom elektroenergetskom sustavu (EES), mjeriteljstvo ima sve važniju ulogu jer između ostalog daje uvid u sustav koji se promatra odnosno čiji parametri se nadziru. Osim tehničkih zahtjeva s jedne strane, za rad EES-a u tržišnom okruženju nužno je zadovoljiti i određene ekonomske kriterije. Drugim riječima, sustav mora biti izgrađen, raditi i biti održavan uz minimalne troškove.

Jedna od značajnih, ali često zanemarenih komponenti u takvom okruženju je razmjena električne energije na prijenosnoj razini (110 kV, 220 kV i 400 kV) preko međunarodnih spojnih vodova. Za početak promotrimo ulogu prijenosne mreže u EES. Prijenosna mreža, na koju su priključeni svi veći proizvodni pogoni u smislu priključne snage, ima zadatak prenijeti električnu energiju od mjesta proizvodnje do mjesta predaje. Sa stajališta prijenosne mreže to su mjesta u kojima se električna energija predaje krajnjim kupcima npr. u distribucijski sustav (0,4 kV, 10 kV, 20 kV i 35 kV) i krajnjim kupcima priključenima na visoki napon (npr. elektrificirana željeznička mreža, tvornice i sl.) te mjesta prekogranične razmjene električne energije. Uzimajući u obzir velike količine prenesene energije, lako se dolazi do zaključka da je kvalitetno mjerenje od zajedničkog interesa za sve sudionike razmjene.

Mjerenje je jedan od temeljnih procesa za vrednovanje proizvoda koji nastaju kao rezultat znanstvenih i stručnih procesa, primjerice industrijske proizvodnje i slično. Putem mjernog procesa mjeritelj komunicira s fizičkim sustavom [1]. Rezultat mjerenja mora biti valjan, usporediv i ponovljiv [2], odnosno razumljiv svim zainteresiranim sudionicima predmetnog procesa. Kvalitetno mjerenje podrazumijeva sve uređaje koji čine obračunsko mjerno mjesto (mjerni transformatori, mjerne grane, brojila električne energije, itd.) i, ne manje važno, način iskazivanja mjernog rezultata (izmjerena energija, gubici prijenosa, mjerna nesigurnost, itd.).

Tradicionalni pristup iskazivanju mjernog rezultata temeljio se na tzv. konceptu mjerne pogreške (engl. *measurement error concept*) gdje se iskazivao rezultat mjerenja uz pripadajuću pogrešku. Procjenjivala se najveća pogreška te se mjernom rezultatu pripisivao interval širine dvostruke najveće pogreške simetrično smješten oko mjernog rezultata [3]–[5]. Iskazivanje pogreške podrazumijeva poznavanje prave vrijednosti mjerene veličine što predstavlja ključan problem za ovu teoriju. Zbog nesavršenosti mjernog postupka, prava vrijednost mjerene veličine je nepoznata što dovodi do zaključka da je takav način iskazivanja mjernog rezultata nedostatan. Uvidjevši nedostatke ovog postupka, Međunarodna organizacija za normizaciju (ISO) izdala je usklađeni dokument `Guide to the Expression of Uncertainty in Measurement` (GUM) [6], [7] koji

predlaže novi način za iskazivanje mjernog rezultata, tzv. GUM metodu. Zbog nemogućnosti poznavanja prave vrijednosti mjerene veličine određuje se interval koji s određenom vjerojatnošću sadrži mjerni rezultat i naziva se „mjerna nesigurnost“ koja se u GUM-u definira kao „interval oko mjernog rezultata za koji se može očekivati da obuhvaća velik udio razdiobe vrijednosti koje bi se razumno mogle pripisati veličini podvrgnutoj mjerenju“ [7]. Ovaj dokument postao je referenca u mjeriteljskoj znanosti i struci, ali i mnogim drugim granama kojima je u interesu pravilno iskazivanje mjernog rezultata [8], [9].

Mjerni rezultat u tom kontekstu možemo promatrati kao proizvod koji mora biti svrsishodan odnosno mora imati svoju namjenu, osnovne sastavnice od kojih se sastoji, proces kojim se dobiva mjerni rezultat i uz to podatak koji će govoriti u kojoj mjeri se smatra da je rezultat blizu ili daleko od stvarne vrijednosti mjerene veličine. Mjerna nesigurnost je najjednostavniji i široko prihvaćeni način za iskazivanje stupnja povjerenja u rezultat mjerenja [10]. Mjerna nesigurnost govori o manjku spoznaje mjerene veličine i proizlazi iz nepotpune informacije o mjerenoj veličini i utjecajnim veličinama [11] te se prema [12] može promatrati i kao reciprocitet prema stupnju spoznaje mjerene veličine.

Općenito govoreći, mjerna nesigurnost se može podijeliti na dvije osnovne sastavnice. Prva je slučajna (engl. *random*) sastavnica koja se utvrđuje na temelju rezultata uzastopnog ponavljanja eksperimenta i opisuje se s pomoću funkcije gustoće vjerojatnosti. Druga sastavnica je sustavna mjerna nesigurnost (engl. *systematic*) koja na neki način predstavlja stanje sustava. S obzirom na to da ona predstavlja poznato ponašanje sustava može se i kompenzirati tj. mjerni rezultat se može ispraviti za njezin iznos.

Metoda za iskazivanje mjernog rezultata i pripadajuće mjerne nesigurnosti zasnovana na GUM-u sadrži i niz nedostataka koji su nadoknađeni s pomoću novih metoda. Neke od tih su: Monte Carlo (MC) metoda, adaptivna Monte Carlo (AMC) metoda [13], Joint Random-Fuzzy Variables metoda [4], [14], modifikacija GUM metode zasnovana na Bayesovoj statistici [15]–[17], Polynomial Chaos Theory [18]–[20], itd.

Više detalja o provedbi GUM metode, njezinim nedostacima i načinima na koji su ti nedostaci nadoknađeni nalazi se u sljedećim poglavljima disertacije.

1.1. Pregled postojećih metoda za izračun mjerne nesigurnosti i njihova zastupljenost u znanstvenim člancima

U mjeriteljskoj znanosti postoji niz različitih metoda i pristupa za procjenu mjerne nesigurnosti. Najpoznatiji GUM pristup predložen je u već spomenutoj literaturi [3], ali osim njega postoje i druge metode o kojima će biti riječi u nastavku. Razvoju novih metoda pridonose i određeni nedostaci GUM metode o kojima se detaljnije piše u sljedećim poglavljima disertacije.

U članku [8] detaljno su klasificirane postojeće metode izračuna mjerne nesigurnosti objavljene u 114 znanstvenih članaka izdanih u razdoblju od 2004. do 2010. godine u časopisima *IEEE Transactions on Instrumentation and Measurement*, *Measurement*, *Flow Measurement and Instrumentation* i *Precision Engineering* (Tablica 1.1.).

Tablica 1.1. Raspodjela članaka prema metodi izračuna mjerne nesigurnosti i godini izdavanja u razdoblju od 2004. do 2010. godine

Metoda/Godina	2004	2005	2006	2007	2008	2009	2010	Ukupno
GUM	8	11	10	6	6	13	9	63
Vlastita metoda			3	2	3	4	4	16
Fuzzy varijable	2	1	1	1	1	3	1	10
Više metoda istovremeno	2	1	2	1		2	1	9
Monte Carlo			2	2	1	3		8
Druge metode			1	1		3	3	8
Ukupno	12	13	19	13	11	28	18	114

Najzastupljenija metoda je GUM (55,3 % promatranih članaka). Nakon toga slijede članci koji prikazuju posebne metode koje su autori predložili, a ne mogu se pridružiti nekoj od postojećih metoda (14,03 %). Članci u kojima se koristi metoda temeljena na fuzzy varijablama zastupljeni su s 8,77%. Dio članaka (7,9 %) koristi više metoda istovremeno i to najčešće radi njihove usporedbe, dok osim toga još 7 % članaka koristi Monte Carlo metodu i još neke manje poznate metode (7 %).

Na početku intenzivnog dijela istraživanja prikazanog u disertaciji (kraj 2014. godine) bila je napravljena dodatna analiza objavljenih radova s obzirom na metode za izračun mjerne nesigurnosti u znanstvenim člancima objavljenima u časopisu *IEEE Transactions on instrumentation and measurement* u razdoblju od 2011. do 2014. godine (Tablica 1.2.). Ukupno je analiziran 41 članak koji sadrži izračun mjerne nesigurnosti [3], [10]–[12], [21]–[57].

Tablica 1.2. Raspodjela članaka prema metodi izračuna mjerne nesigurnosti i godini izdavanja u razdoblju od 2011. do 2014. godine

Metoda/Godina	2011	2012	2013	2014	Ukupno
GUM	2	4		2	8
Vlastita metoda		3	1	1	5
Fuzzy varijable		2			2
Više metoda istovremeno		5	2	2	9
Monte Carlo	2	1	2	4	9
Druge metode	2	2	3	1	8
Ukupno	6	17	8	10	41

U ovom razdoblju može se uočiti pad zastupljenosti članaka koji koriste GUM metodu (19,5 %) i značajan porast zastupljenosti članaka koji koriste Monte Carlo metodu (22,0 %) što ujedno čini Monte Carlo metodu trenutno najzastupljenijom metodom za izračun mjerne nesigurnosti. Pored toga pad zastupljenosti bilježe članci u kojima su autori predložili vlastite metode (12,2 %) i članci u kojima se koristi metoda temeljena na fuzzy varijablama (4,9 %). Znatno povećanje bilježe članci u kojima se koristi više metoda istovremeno (22,0 %) i članci koji koriste neke druge manje poznate metode (19,5 %).

Nadalje su isti članci iz razdoblja od 2011. do 2014. godine podijeljeni prema metodi za izračun mjerne nesigurnosti i primjeni u znanstvenim područjima, poljima i granama (Tablica 1.3).

Tablica 1.3. Raspodjela članaka prema metodi izračuna mjerne nesigurnosti i području primjene

ZNANSTVENO PODRUČJE	ZNANSTVENO POLJE	ZNANSTVENA GRANA	GUM	Vlastita metoda	Fuzzy varijable	Više metoda istovremeno	MC	Druge metode	Uk.
Tehničke znanosti	Elektrotehnika	Elektroenergetika	1			1	6	3	11
		Telekomunikacije i informatika	2	2		1	1	2	8
		Automatizacija i robotika	1	1	1			1	4
		Elektronika		1			1	2	4
	Geodezija	Pomorska, satelitska i fizikalna geodezija			1				1
	Građevinarstvo	Hidrotehnika	1						1
	Strojarstvo	Proizvodno strojarstvo	1						1
	Tekstilna tehnologija	Tekstilno-mehaničko inženjerstvo					1		1
Prirodne znanosti	Biologija	Mikrobiologija		1					1
Biomedicina i zdravstvo	Kliničke medicinske znanosti	Interna medicina	1						1
Bez primjene			1			7			8
Ukupno			8	5	2	9	9	8	41

Najšire zastupljena Monte Carlo metoda korištena je isključivo u području tehničkih znanosti i to najviše u elektroenergetici. Kod ostalih metoda ne može se primijetiti posebno velika zastupljenost u niti jednom od područja nego je njihova primjena raspoređena ravnomjerno.

1.2. Hipoteza

U okviru disertacije promatra se prekogranična razmjena električne energije gdje je, zbog velikih količina razmijenjene energije, pravilan način iskazivanja izmjerene energije, gubitaka prijenosa i pripadajuće mjerne nesigurnosti od ključne važnosti. Trenutno ne postoji jedinstvena metoda propisana zakonskom regulativom koja će propisati tehničke detalje vezano uz metodu raspodjele razmijenjene energije i pripadajućih gubitaka. Također, niti jedna od metoda koje se trenutno koriste ne uzima u obzir mjernu nesigurnost odnosno sistematske pogreške uključene u mjerni proces koje je moguće kvantizirati i ispraviti. Nesigurnost u mjernom rezultatu energije i gubitaka koji se raspodjeljuju među operatorima prijenosnih sustava znači posljedično i financijsku nesigurnost operatorima. Stoga je definiranje metode raspodjele energije i gubitaka, uzimajući u obzir i ispravak sistematskih pogrešaka, u zajedničkom interesu svih sudionika razmjene. Pretpostavka je da će se nakon ispravka sistematskih pogrešaka preostala mjerna nesigurnost smanjiti te da će prikazana metoda za raspodjelu energije i gubitaka biti „poštenija“ od trenutno korištenih.

Razmatrat će se način izračuna gubitaka prijenosnog voda s pomoću funkcije za mjerenje gubitaka koje nude proizvođači suvremenih brojila električne energije, tzv. I^2R gubici. Mjerna nesigurnost tako određenih gubitaka odredit će se uporabom klasične metode za izračun mjerne nesigurnosti sukladno dokumentu `Guide to the expression of uncertainty in measurement` i uporabom Monte Carlo metode. Pretpostavka je da Monte Carlo metoda daje bolje rezultate zbog ograničenja klasične metode, prvenstveno zbog nelinearnosti matematičkog modela gubitaka prijenosnog voda te zbog moguće razdiobe mjerenih vrijednosti drukčije od normalne.

Također se razmatra i način izračuna mjerne nesigurnosti otpora prijenosnog prekograničnog voda uporabom klasične metode sukladno dokumentu `Guide to the expression of uncertainty in measurement` u usporedbi s adaptivnom Monte Carlo metodom. Pretpostavka je da potonja metoda daje bolje rezultate zbog ograničenja klasične metode, prvenstveno zbog nelinearnosti matematičkog modela za otpor voda te zbog moguće razdiobe mjerenih vrijednosti drukčije od normalne.

1.3. Struktura doktorske disertacije

1.poglavlje daje uvodni pregled o metodama za izračun mjerne nesigurnosti te pregled zastupljenosti pojedinih metoda u znanstvenoj literaturi. Također je postavljena hipoteza disertacije.

2.poglavlje opisuje klasični način izračuna mjerne nesigurnosti sukladno dokumentu `Guide to the expression of uncertainty in measurement`. Opisuje se povijest tog dokumenta, postupak i uvjeti za provedbu metode te nedostaci.

3.poglavlje opisuje Monte Carlo metodu kao alternativu klasičnoj metodi za izračun mjerne nesigurnosti. Prikazan je pregled zastupljenosti ove metode u znanstvenoj literaturi, postupak i uvjeti za provedbu metode.

4.poglavlje sadrži teorijski uvod vezan uz konstante prijenosnog voda te nadomjesne sheme za njihov izračun. Opisane su metode za mjerenje parametara prijenosnih vodova. Prikazana je metoda za procjenu funkcije gustoće razdiobe gubitaka koji proizlaze kao rezultat simulacije iz adaptivne Monte Carlo metode i njezine modifikacije.

5.poglavlje sadrži teorijski uvod vezano za gubitke u prijenosnom sustavu. Prikazan je način mjerenja gubitaka uporabom ugrađene funkcije u suvremenim brojilima električne energije te izračun mjerne nesigurnosti uporabom klasične i adaptivne Monte Carlo metode.

6.poglavlje prikazuje način ispravka izmjerene energije za iznos sistematskih pogrešaka, analizu lanca mjernih nesigurnosti na obračunskom mjernom mjestu i metode za raspodjelu razmijenjene energije i pripadajućih gubitaka između operatora prijenosnih sustava.

7.poglavlje prikazuje praktične rezultate izračuna i simulacije uz pripadajuću analizu.

8.poglavlje sadrži skraćeni prikaz svih postignuća provedenog istraživanja u sklopu disertacije te zaključna razmatranja vezano za najvažnije rezultate i smjernice za uporabu prikazane metode.

2. PROCJENA MJERNE NESIGURNOSTI ZASNOVANA NA DOKUMENTU `GUIDE TO THE EXPRESSION OF UNCERTAINTY IN MEASUREMENT`

2.1. Povijest dokumenta `Guide to the expression of uncertainty in measurement`

U prošlosti nije postojao općeprihvaćeni način za iskazivanje mjerne nesigurnosti odnosno cjelovitog mjernog rezultata te se stoga ukazala potreba za izradom jedinstvenog međunarodno prihvaćenog dokumenta koji će opisati taj postupak. Takav dokument poslužio bi kao referenca u mjeriteljskoj praksi na svim razinama i u različitim područjima primjene, a mjerni rezultat iskazan u skladu s tim uputama bi bio jedinstven i prepoznatljiv. Međunarodni odbor za utege i mjere (CIPM), zatražio je 1977. godine od Međunarodnog ureda za utege i mjere (BIPM) da pokrene međunarodnu inicijativu za izradu takvog dokumenta. Radna skupina od 11 nacionalnih etalonskih laboratorija izradila je Preporuku INC-1 (1980), Izražavanje eksperimentalnih nesigurnosti. Ta preporuka je odobrena od strane CIPM 1981. godine i ponovno potvrđena 1986. godine. Nakon toga CIPM je dao zadatak Međunarodnoj organizaciji za normizaciju (ISO) da napravi proširenu verziju ove preporuke iz koje će konačno nastati dokument `Guide to the expression of uncertainty in measurement`. U njegovoj izradi sudjelovalo je ovih sedam organizacija:

BIPM: Međunarodni ured za utege i mjere

IEC: Međunarodno elektrotehničko povjerenstvo

IFCC: Međunarodni savez za kliničku kemiju

ISO: Međunarodna organizacija za normizaciju

IUPAC: Međunarodni savez za čistu i primijenjenu kemiju

IUPAP: Međunarodni savez za čistu i primijenjenu fiziku

OIML: Međunarodna organizacija za zakonsko mjeriteljstvo

ILAC: Međunarodna suradnja na akreditaciji laboratorija (od 2005. godine)

Prva verzija dokumenta izdana je 1993. godine (ISO/IEC Guide 98:1993). U međuvremenu je osnovana komisija Joint Committee for Guides in Metrology (JCGM) koja je 2008. godine izdala revidiranu i trenutno važeću verziju GUM dokumenta (JCGM 100:2008). Komisija JCGM sastoji se od dvije radne skupine. Radna skupina 1 „Expression of uncertainty in measurement“ ima zadatak promovirati dokument GUM i izrađivati njegove dodatke. Radna skupina 2 “Working

Group on International vocabulary of basic and general terms in metrology (VIM)” koja ima zadatak promovirati i revidirati dokument International vocabulary of metrology — Basic and general concepts and associated terms (VIM) [58]. Radna skupina 1 izdaje niz dokumenata `Evaluation of measurement data` koji svi zajedno čine jednu cjelinu:

- JCGM 100:2008. Evaluation of measurement data — Guide to the expression of uncertainty in measurement (GUM) [6], [7],
- JCGM 101:2008. Evaluation of measurement data – Supplement 1 to the “Guide to the expression of uncertainty in measurement” – Propagation of distributions using a Monte Carlo method (Dopuna 1) [13], [59],
- JCGM 102. Evaluation of measurement data – Supplement 2 to the “Guide to the expression of uncertainty in measurement” – Models with any number of output quantities [60],
- JCGM 103. Evaluation of measurement data – Supplement 3 to the “Guide to the expression of uncertainty in measurement” – Modelling ,
- JCGM 104. Evaluation of measurement data – An introduction to the “Guide to the expression of uncertainty in measurement” [61],
- JCGM 105. Evaluation of measurement data – Concepts and basic principles,
- JCGM 106. Evaluation of measurement data – The role of measurement uncertainty in conformity assessment [62],
- JCGM 107. Evaluation of measurement data – Applications of the least-squares method

Trenutno je u izradi revidirana verzija GUM dokumenta koja se temelji na Bayesovoj statistici [16], [17], [63]–[66].

2.2. Postupak izračuna mjerne nesigurnosti

Najšire zastupljena, GUM metoda, temelji se na eksperimentalnoj analizi i statističkoj obradi podataka dobivenih mjerenjem. U slučaju kada se mjerena veličina ne mjeri izravno već se dobiva posredno iz drugih mjerenih veličina koristi se posredna funkcija – matematički model mjerenja koja opisuje način na koji ulazne mjerene veličine tvore mjerenu (izlaznu) veličinu. Opći oblik te funkcije glasi

$$Y = f(X_1, X_2, \dots, X_N), \quad (2-1)$$

Složena mjerna nesigurnost u_c računa se prema izrazu [6]

$$u_c(y) = \sqrt{\sum_{i=1}^N \left(\frac{\partial f}{\partial x_i}\right)^2 u^2(x_i) + 2 \sum_{j=1}^{N-1} \sum_{i=j+1}^N \frac{\partial f}{\partial x_i} \frac{\partial f}{\partial x_j} u(x_i, x_j)}. \quad (2-2)$$

U izrazima (2-1) i (2-2) značenje pojedinih veličina je sljedeće: Y – mjerena veličina, y – procjena mjerene veličine čiju mjernu nesigurnost računamo, X_1, X_2, \dots, X_N – ulazne veličine, x_1, x_2, \dots, x_N – procjena ulaznih veličina, N – broj mjerenja, f – funkcija koja opisuje način na koji ulazne veličine tvore izlaznu veličinu, $u(x_i)$ – standardna mjerna nesigurnost ulazne veličine, a $u_c(y)$ složena mjerna nesigurnost izlazne veličine.

Desni član u jednadžbi (2-2) predstavlja kovarijantni član koji se ne smije zanemariti ako postoji značajna korelacija među ulaznim veličinama. Član $u(x_i, x_j)$ predstavlja procijenjenu kovarijancu između veličina x_i i x_j . Stupanj međusobne ovisnosti dviju veličina određuje se s pomoću koeficijenta korelacije [67]

$$r(x_i, x_j) = \frac{u(x_i, x_j)}{u(x_i)u(x_j)}, \quad (2-3)$$

gdje vrijedi $r(x_i, x_j) = r(x_j, x_i)$ te $-1 \leq r(x_i, x_j) \leq 1$. Uvrštavanjem (2-3) u kovarijantni član iz jednadžbe (2-2) dobiva se

$$2 \sum_{j=1}^{N-1} \sum_{i=j+1}^N \frac{\partial f}{\partial x_i} \frac{\partial f}{\partial x_j} u(x_i)u(x_j)r(x_i, x_j). \quad (2-4)$$

Koeficijent korelacije $r(x_i, x_j)$ se iz rezultata mjerenja računa kao

$$r(x_i, x_j) = \frac{\sum_{i=1}^N (x_i - \bar{x}_i)(x_j - \bar{x}_j)}{\sqrt{\sum_{i=1}^N (x_i - \bar{x}_i)^2 (x_j - \bar{x}_j)^2}}. \quad (2-5)$$

Proširena mjerna nesigurnost U izračunava se množenjem standardne mjerne nesigurnosti $u_c(y)$ faktorom proširenja k prema izrazu

$$U = k u_c(y). \quad (2-6)$$

Faktor proširenja k odabire se ovisno o željenoj razini pokrivenosti. Najčešće se odabire faktor proširenja $k=2$ za razinu pokrivenosti 95,4% ili $k=3$ za razinu pokrivenosti 99,7%.

Rezultat mjerenja se tada izražava u obliku $Y = y \pm U$ te se tumači da je y najbolja procjena mjerene veličine Y , a interval $y - U$ do $y + U$ pokriva određeni dio vrijednosti koje se mogu razumno pripisati mjerenoj veličini Y [6].

Dijagram toka prema kojemu se provodi postupak procjene mjerne nesigurnosti prikazuje slika 2.1.

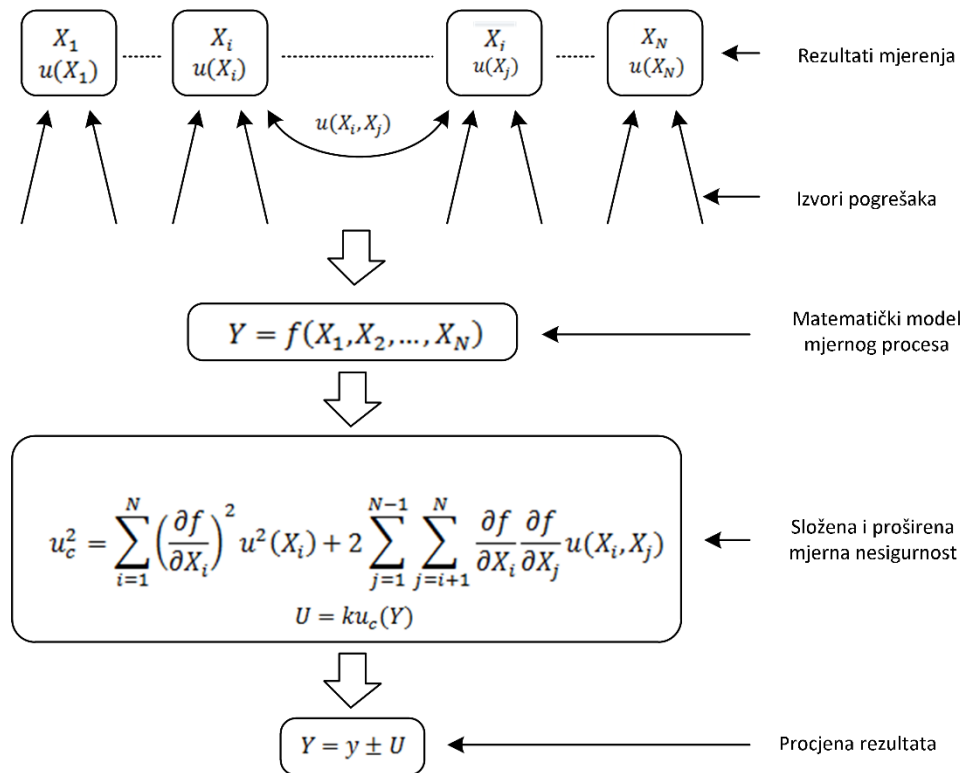

Slika 2.1. Dijagram toka GUM metode

Uvjeti koji moraju biti zadovoljeni za ispravnu primjenu GUM metode su [10]:

- Funkcija f mora biti linearna kako bi se zadovoljili uvjeti za primjenu centralnog graničnog teorema koji omogućava aproksimaciju normalne razdiobe veličine y i u slučaju kada ulazne veličine x_1, x_2, \dots, x_N nemaju normalnu razdiobu. S ciljem prevladavanja ovog problema Dopuna1 [13] na GUM [6] preporuča uporabu Monte Carlo metode [3] o kojoj će više riječi biti u sljedećim poglavljima,
- Izraz za proširenu mjernu nesigurnost vrijedi u slučaju kada jedna ili više ulaznih veličina imaju konačan broj stupnjeva slobode,
- Ulazne veličine moraju biti međusobno neovisne kada je broj stupnjeva slobode konačan,
- Model mjernog procesa mora biti linearan kako bi se mogli zanemariti viši članovi Taylorovog reda prilikom raspisivanja izraza $u_c^2(y)$. U većini slučajeva uvjet linearnosti je i zadovoljen te se viši članovi Taylorovog reda mogu zanemariti. Međutim, postoje i slučajevi kada viši članovi Taylorovog reda nisu zanemarivi u odnosu na drugi član. Za funkciju jedne varijable $R(x)$, Taylorov red razvijen oko točke x_0 glasi

$$R(x) \approx R(x_0) + \left. \frac{dR}{dx} \right|_{x_0} (x - x_0) + \frac{1}{2!} \left. \frac{d^2R}{dx^2} \right|_{x_0} (x - x_0)^2 + \dots \quad (2-7)$$

Uvjet koji mora biti zadovoljen kako bi se mogla izvršiti linearna aproksimacija glasi:

$$\left. \frac{dR}{dx} \right|_{x_0} \gg \left. \frac{1}{2!} \frac{d^2R}{dx^2} \right|_{x_0} (x - x_0) + \left. \frac{1}{3!} \frac{d^3R}{dx^3} \right|_{x_0} (x - x_0)^2 + \dots \quad (2-8)$$

U slučajevima kada taj uvjet nije zadovoljen zbog većih iznosa viših redova derivacije ili zbog većeg iznosa člana $(x-x_0)$ GUM metoda ne zadovoljava.

2.3. Nedostaci metode

U znanstvenoj literaturi pojavljuje se niz članaka koji govore o nedostacima [68]–[70] i mogućnostima unaprjeđenja izračuna mjerne nesigurnosti preporučene u GUM-u [6]. Prema članku [71] GUM metoda u većini slučajeva zadovoljava, međutim, u nekim uvjetima postoje određeni nedostaci. Prvi nedostatak je to što u većini slučajeva funkcija gustoće vjerojatnosti izlazne veličine ostaje nepoznata te je u tom slučaju nemoguće računati proširenu mjernu nesigurnost odnosno proširenu razinu pokrivenosti. Iz tog razloga moraju se uzeti u obzir određena pojednostavljenja. U tom smislu često se uzima pretpostavka da su ulazne varijable međusobno neovisne i da kombinacijom njihovih razdioba nastaje Gaussova razdioba izlazne veličine. Iz toga odmah slijedi i da proširena mjerna nesigurnost uz faktor $k=2$ osigurava 95%-tnu razinu pokrivenosti. Iznimka od ovog pojednostavljenja je kada postoji jedna dominantna ulazna veličina koja je još k tome rezultat ograničenog malog broja mjerenja. U tom slučaju se funkcija gustoće vjerojatnosti izlazne veličine modelira s pomoću pomaknute i prilagođene t -razdiobe. Efektivni stupnjevi slobode neophodni za opisivanje ovakve razdiobe dobivaju se s pomoću Welch-Satterthwaite-ovog (WS) pristupa [6] ili neke od njegovih modifikacija [13]. Drugi nedostatak GUM metode prema članku [71] je problem izračuna koeficijenata osjetljivosti ulaznih veličina, posebice u slučajevima nelinearnih funkcija. Ovaj nedostatak otklanja se uporabom MC metode o kojoj će više riječi biti u sljedećim poglavljima. Uz pomoć MC metode numerički se aproksimira funkcija gustoće vjerojatnosti izlazne veličine što daje znatno više informacija o izlaznoj veličini nego klasični GUM pristup.

3. PROCJENA MJERNE NESIGURNOSTI UPORABOM MONTE CARLO METODE

3.1. Monte Carlo metoda kao alternativa klasičnom GUM pristupu

Monte Carlo (MC) metoda za izračun mjerne nesigurnosti nastala je kao alternativa GUM metodi i primjenjuje se u slučajevima kada je GUM metoda nedostatna, odnosno daje manjkave rezultate. Neki od tih slučajeva su sljedeći:

- a) linearizirani matematički model mjernog procesa nije dovoljno reprezentativan [13], [35], [72]–[74]
- b) funkcija gustoće vjerojatnosti izlazne veličine značajno odstupa od Gaussove razdiobe ili pomaknute i prilagođene t -razdiobe, na primjer uslijed značajne nesimetrije [13],
- c) matematički model je nelinearan te je izračun koeficijenata osjetljivosti vrlo težak [71],
- d) matematički model je suviše složen te je na taj način otežana primjena klasične GUM metode [35],
- e) postoji dominantna ulazna veličina koja je uz to rezultat malog broja ponovljenih mjerenja [71],
- f) matematički model je funkcija više varijabli [75].

Osnovni dokument za primjenu MC metode je `Evaluation of measurement data - Supplement 1 to the “Guide to the expression of uncertainty in measurement” – propagation of distributions using a Monte Carlo method, JCGM, 2008` [13] i koristi se, kao što je već prije spomenuto, isključivo u skladu s osnovnim dokumentom `Guide to the Expression of Uncertainty in Measurement` [6].

Temeljna razlika između GUM i MC metode je u načinu prijenosa informacije (engl. *Law of Propagation*) s ulaznih veličina na izlaznu. GUM metoda iz mjernih nesigurnosti ulaznih veličina tvori mjernu nesigurnost izlazne veličine (engl. *Law of Propagation of Uncertainties – LPU*) te se na taj način prenosi djelomična informacija. MC metoda putem numeričkog proračuna aproksimira funkciju gustoće razdiobe izlazne veličine na temelju funkcija gustoće razdiobe ulaznih veličina [12], [75] (engl. *Law of Propagation of Distributions – LPD*) te time prenosi potpunu informaciju s ulaznih na izlazne veličine [71]. Iz ovog razloga MC metoda čini valjanu alternativu klasičnom GUM pristupu. Praktična prednost MC metode pred GUM metodom prikazana je na dva stvarna

primjera iz mjeriteljske prakse u članku [7]. Detaljnije o usporedbi GUM i MC metode piše se u članku [76]. Osnovni zaključci usporedbe su:

- MC metoda koristi se za širi raspon problema nego GUM metoda te je stoga općenitija,
- može se koristiti za provjeru rezultata GUM metode,
- temelji se na istim načelima kao i GUM,
- proizlazi iz GUM metode,
- koristi se u sprezi s GUM metodom,
- nema potrebe za izračunom stupnjeva slobode.

Općenito rečeno, MC metoda koristi se u slučajevima kada GUM metoda ne zadovoljava ili kad nije jasno zadovoljava li ili ne, a može se koristiti i radi usporedbe u slučajevima kada GUM zadovoljava. U prvom slučaju MC metoda može se koristiti jer daje bolje rezultate, u drugom slučaju može se koristiti za vrednovanje rezultata dobivenih GUM metodom, a u trećem zbog jednostavnosti.

3.2. MC metoda u znanstvenoj literaturi

Razmatrana je zastupljenost članaka koji koriste MC metodu u znanstvenoj literaturi u razdoblju od 2004. do 2014. godine. Za analizu iz razdoblja 2004. do 2010. podaci su preuzeti iz članka *Measurement Uncertainty: Literature Review and Research Trends* [10] u kojemu su autori promatrali 114 članaka iz znanstvenih časopisa *IEEE Transactions on Instrumentation and Measurement*, *Measurement*, *Flow Measurement and Instrumentation* i *Precision Engineering*. Za razdoblje od 2011. do 2014. analiza je proširena za potrebe disertacije na članke objavljene u časopisu *IEEE Transactions on Instrumentation and Measurement* [3], [10]–[12], [21]–[57]. Rezultate istraživanja prikazuje Tablica 3.1.

Tablica 3.1. Zastupljenost MC metode u znanstvenoj literaturi u razdoblju od 2004. do 2014. godine

Godina	2004	2005	2006	2007	2008	2009
Broj članaka	-	-	2	2	1	3
Godina	2010	2011	2012	2013	2014	-
Broj članaka	-	2	1	2	4	-

U razdoblju 2004. do 2014. objavljeno je ukupno 17 znanstvenih članaka koji koriste MC metodu, a od toga najviše u 2014. godini i to njih četiri. Tablica 3.2. prikazuje članke izdane u razdoblju od 2011. do 2014. raspodijeljene prema znanstvenim područjima, poljima i granama.

Tablica 3.2. Primjena MC metode u znanstvenim područjima, poljima i granama

ZNANSTVENO PODRUČJE	ZNANSTVENO POLJE	ZNANSTVENA GRANA	2011	2012	2013	2014	Ukupno
Tehničke znanosti	Elektrotehnika	Elektroenergetika	1	1	2	2	6
		Telekomunikacije i informatika				1	1
		Elektronika	1				1
	Tekstilna tehnologija	Tekstilno-mehaničko inženjerstvo				1	1
Ukupno			2	1	2	4	9

U promatranom razdoblju MC metoda je najviše primijenjena u elektroenergetici (šest članaka), a osim toga objavljen je po jedan članak u telekomunikacijama i informatici, elektronici i tekstilno-mehaničkom inženjerstvu.

3.3. Postupak provedbe Monte Carlo metode

Osnovni koraci procjene mjerne nesigurnosti uporabom MC metode sukladno Dopuni 1 [13] su:

- formulacija: definicija izlazne (mjerene) veličine Y , određivanje ulaznih veličina X_i , razvoj modela $Y = f(X_i)$ po kojemu ulazne veličine tvore izlaznu veličinu, određivanje pojedinih funkcija gustoće vjerojatnosti za sve ulazne veličine,
- proračun: proračun odnosno izrada funkcije gustoće vjerojatnosti izlazne funkcije na osnovu funkcija gustoće vjerojatnosti ulaznih veličina,
- uporaba dobivene funkcije gustoće vjerojatnosti za izračun željenih parametara mjerene veličine (standardne devijacije, intervala pokrivenosti itd.).

Slika 3.1. prikazuje dijagram toka MC metode na primjeru eksplicitno zadane realne funkcije jedne varijable.

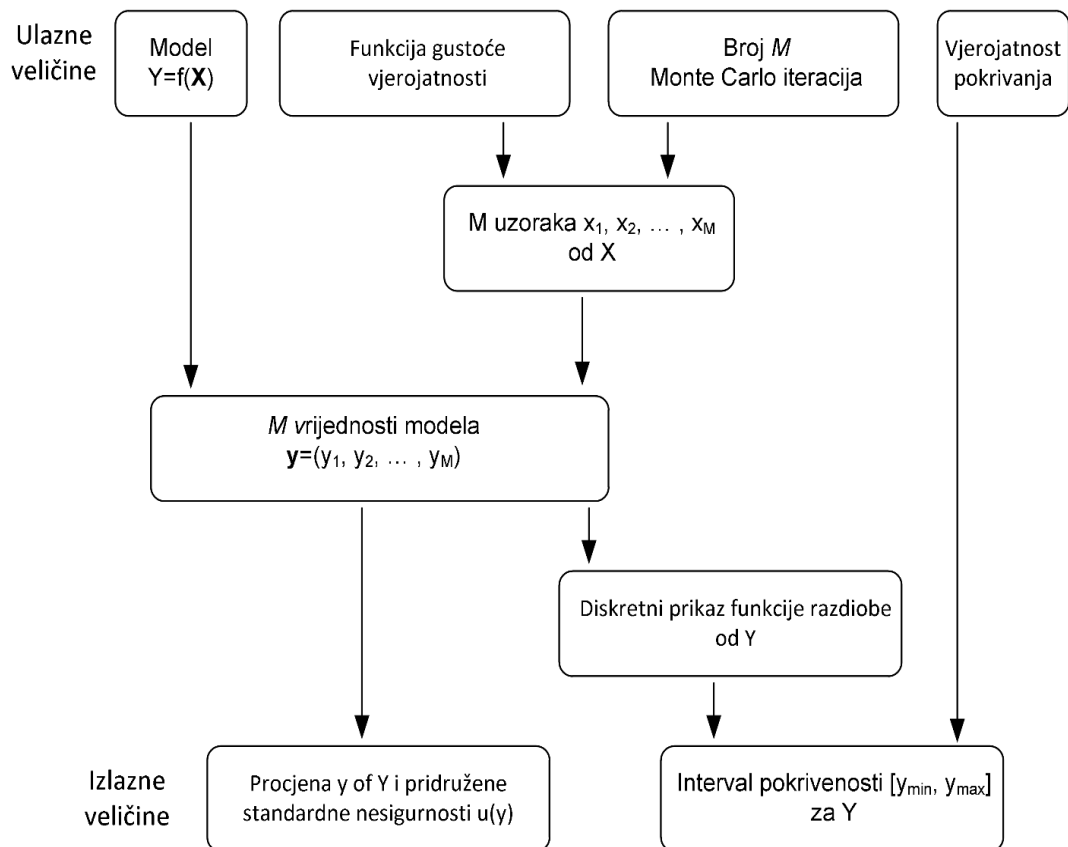

Slika 3.1. Dijagram toka MC metode

Slika 3.2. prikazuje tvorbu funkcije gustoće vjerojatnosti mjerene veličine Y_i iz funkcija gustoće vjerojatnosti ulaznih veličina X_i na primjeru tri ulazne veličine. Ujedno je slikovito prikazana temeljna razlika u fazi propagacije između GUM i MC metode: MC metoda kao rezultat daje funkciju gustoće vjerojatnosti izlazne veličine čime se prenosi potpuna informacija s ulaznih veličina na izlaznu dok se u GUM metodi prenosi ograničena informacija tj. samo najbolja procjena mjerene veličine i pridružena mjerna nesigurnost što čini jednu od osnovnih prednosti MC metode u odnosu na GUM metodu.

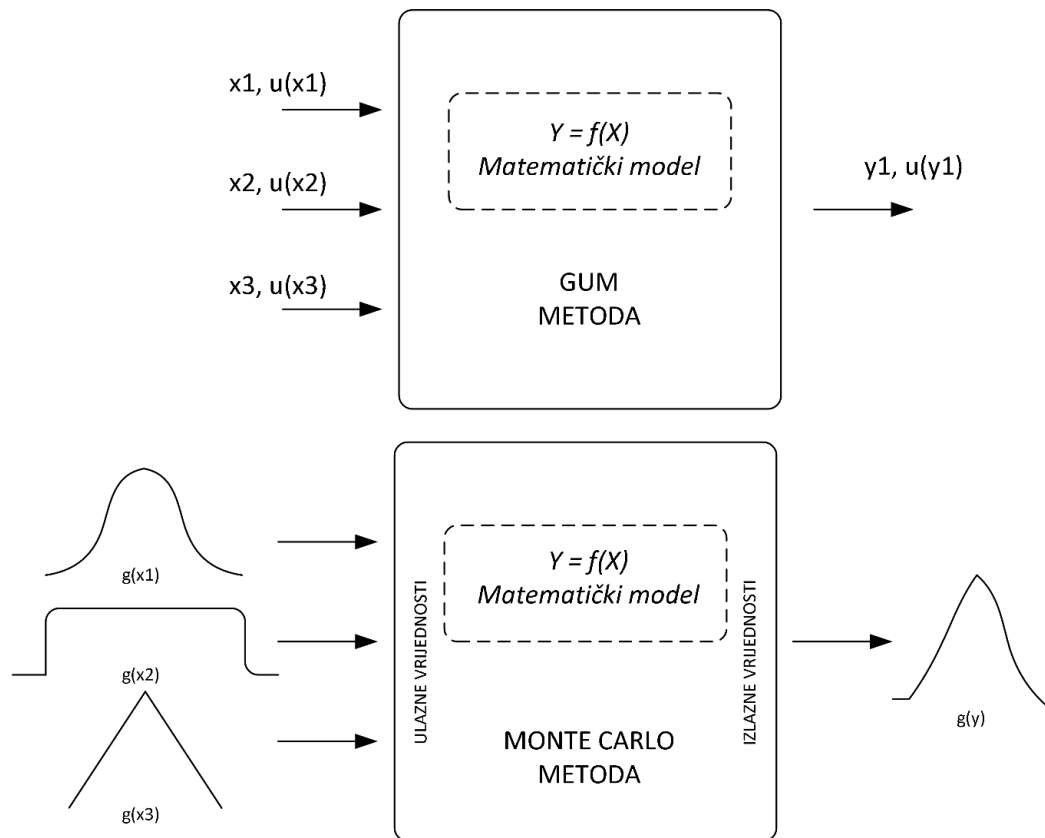

Slika 3.2. Usporedba GUM i MC metode

Uvjeti za primjenu MC metode prema [77] i Dopuni 1 [13] su sljedeći:

- a) f je neprekinuta funkcija s obzirom na elemente X_i iz skupa X u okolini najboljih procjena x_i ,
- b) funkcija razdiobe od Y je kontinuirana i strogo rastuća,
- c) funkcija gustoće vjerojatnosti od Y je
 - neprekinuta na intervalu gdje je pozitivna,
 - unimodalna (ima jedan ekstrem),
 - strogo rastuća (ili nula) lijevo od ekstrema i strogo padajuća (ili nula) desno od ekstrema,
- d) postoje matematičko očekivanje $E(Y)$ i varijanca $V(Y)$,
- e) dovoljno velik broj iteracija M .

Postoje tri načina provedbe MC metode s obzirom na odabir broja iteracija M :

- a) unaprijed određen broj iteracija M
- b) postupno povećanje broja iteracija M (AMC metoda)
- c) approximated adaptive (ili histogram) način rada

U okviru disertacije koristit će se MC metoda s unaprijed određenim brojem iteracija M i adaptivna MC metoda s postupnim povećanjem broja iteracija (AMC metoda) jer su te dvije metode preporučene u Dopuni 1 [13] i prihvaćene u znanstvenoj literaturi.

3.4. Adaptivna Monte Carlo metoda

Kritičan trenutak kod provedbe MC metode je odabir dovoljno velikog broja iteracija M . U literaturi se navodi da najčešće $M = 10^6$ iteracija zadovoljava za 95%-tnu razinu pokrivenosti [78]. Ideja AMC metode je provoditi MC simulacije postupno povećavajući broj iteracija M sve dok se rezultati ne stabiliziraju u statističkom smislu. Sukladno Dopuni 1 [13], rezultat je stabiliziran ako je njegovo dvostruko standardno odstupanje manje od dopuštenog brojčanog odstupanja δ .

Postupak određivanja dopuštenog brojčanog odstupanja je sljedeći:

- a) Odrediti n_{dig} broj značajnih znamenaka u brojčanoj vrijednosti z ,
- b) Broj z zapisati u obliku $c \cdot 10^l$ gdje je c cijeli broj s n_{dig} desetičnih znamenaka, a l cijeli broj,
- c) Nakon toga, brojčano odstupanje δ jednako je

$$\delta = \frac{1}{2} \cdot 10^l. \quad (3-1)$$

Radi lakšeg razumijevanja promotrimo kratki praktični primjer. Procjena mjerene veličine otpora otpornika nazivnog otpora $R_n = 70 \Omega$ je $y = 70,2123 \Omega$ uz standardnu mjernu nesigurnosti $u(y) = 0,0024 \Omega$ gdje se obje znamenke smatraju značajnima te je stoga $n_{dig} = 2$. Standardna nesigurnosti može se izraziti u obliku $u(y) = 24 \cdot 10^{-4} \Omega$ pa iz toga slijedi da je $c = 24$, a $l = -4$. Iz toga slijedi $\delta = \frac{1}{2} \cdot 10^{-4} = 0,00005 \Omega$.

Općenito rečeno, cilj AMC metode je odrediti najbolju procjenu y izlazne veličine Y , standardnu nesigurnost $u(y)$ i krajnje točke y_{low} i y_{high} intervala pokrivenosti uz željenu vjerojatnost pokrivanja p i uz uvjet da sve četiri navedene veličine postignu statističku stabilnost.

Postupak provedbe AMC metode je sljedeći:

- a) Odabrati n_{dig} mali pozitivni cijeli broj,
- b) Odabrati početni broj iteracija M . Preporuka prema Dopuni 1 je da se taj broj odabere kao

$$M = \max(J, 10^4) \quad (3-2)$$

gdje je J najmanji cijeli broj veći ili jednak $100/(1 - p)$,

- c) Odabrati $h=1$ koji označuje prvu primjenu MC metode u nizu,
- d) Provesti MC metodu s M iteracija
- e) Iz dobivenih M vrijednosti modela y_1, \dots, y_M izračunati najbolju procjenu $y^{(h)}$ izlazne veličine Y , standardnu nesigurnost $u(y^{(h)})$ i krajnje točke $y_{low}^{(h)}$ i $y_{high}^{(h)}$ intervala pokrivenosti uz željenu vjerojatnost pokrivanja p za h -ti broj u nizu,
- f) Ako je $h=1$, povećati ga za jedan i ponoviti postupak,
- g) Izračunati standardno odstupanje s_y prosječne vrijednosti procjena $y^{(1)}, \dots, y^{(h)}$ prema izrazu

$$s_y^2 = \frac{1}{h(h-1)} \sum_{r=1}^h (y^{(r)} - y)^2, \quad (3-3)$$

gdje je

$$y = \frac{1}{h} \sum_{r=1}^h y^{(r)}, \quad (3-4)$$

- h) Izračunati standardno odstupanje za $u(y)$ i krajnje točke y_{low} i y_{high} ,
- i) Izračunati dopušteno odstupanje δ ,
- j) Usporediti dvostruka standardna odstupanja $2s_y$, $2s_{u(y)}$, $2s_{y_{low}}$ i $2s_{y_{high}}$ s dopuštenim odstupanjem δ . Ako neki od dvostrukih standardnih odstupanja prelazi dopušteno odstupanje, povećati h za jedan i ponoviti postupak.
- k) Kada su sva odstupanja stabilizirana upotrijebiti svih $h \cdot M$ rezultata za izračun željenih parametara izlazne veličine, obično procjene y , standardne nesigurnosti $u(y)$ i intervala pokrivanja za željenu razinu pokrivanja p .

3.5. Validacija rezultata dobivenih u okviru GUM-a

Unatoč predloženim uvjetima za primjenu klasične metode, kao što je prije navedeno, ipak u praksi je moguće da se pojave situacije u kojima neće biti jasno zadovoljava li klasična metoda ili ne. U takvim situacijama, sukladno preporuci u Dopuni 1 [13], potrebno je usporedno s klasičnom metodom provesti i AMC metodu te usporediti, odnosno validirati, rezultate klasične metode. Ovaj postupak provodi se u dva koraka:

- a) primijeni se klasična GUM metoda uz željeni faktor proširenja tj. odrede se granice intervala pokrivenosti za izlaznu veličinu $y \mp U$,

b) primijeni se AMC metoda uz željenu vjerojatnost pokrivanja p i odrede se krajnje granice intervala pokrivenosti y_{low} i y_{high} .

Cilj validacije, odnosno postupka usporedbe rezultata, je odrediti podudaraju li se krajnje granice intervala pouzdanosti jedne i druge metode.

4. KONSTANTE PRIJENOSNOG VODA

Prijenosni vod u teoriji se modelira s pomoću otpora R , induktiviteta L , kapaciteta C i odvoda G koji se obično zadaju u jediničnim iznosima po jedinici duljine prijenosnog voda. Jedinični iznosi parametara prijenosnog voda uobičajeno se označavaju s indeksom 1 te će takav način označavanja biti prihvaćen i u disertaciji. Stoga je jedinični otpor označen s R_1 , jedinični induktivitet s L_1 , jedinični kapacitet s C_1 i jedinični odvod s G_1 . Električne prilike na vodu ovise izravno o navedenim parametrima iz čega slijedi da dobro modelirani parametri omogućuju dobro modeliranje električnih prilika na vodu i obrnuto. U okviru disertacije razmatraju se djelatni gubici na prijenosnim vodovima te će se stoga pozornost usmjeriti na uzdužni i poprečni djelatni otpor voda jer upravo oni uzrokuju djelatne gubitke voda.

Uzdužni otpor voda R definira se kao opiranje toku električne struje u vodiču. Otpor vodiča ovisi o svojstvima materijala od kojeg je izrađen vodič tj. o njegovoj električnoj otpornosti ρ , duljini vodiča l i presjeku S prema izrazu

$$R = \rho \frac{l}{S}. [\Omega] \quad (4-1)$$

Promjena otpora s temperaturom opisuje se prema jednadžbi [79]

$$R_{\vartheta} = R_0(1 + \alpha(\vartheta - 20^{\circ}\text{C})), \quad (4-2)$$

gdje je: ϑ – temperatura okoline

R_0 – specifični otpor pri 20°C

R_{ϑ} – specifični otpor pri temperaturi ϑ

α – temperaturni koeficijent.

Poprečni otpor prijenosnog voda izražava se kao vodljivost G koja se definira kao odnos gubitaka po jedinici duljine prema kvadratu napona tj. kao odnos djelatne komponente poprečne struje po jedinici duljine prema naponu [80]

$$G_1 = \frac{\Delta I_r}{V} = \frac{\Delta P}{V^2} \cdot \left[\frac{S}{km} \right] \quad (4-3)$$

Sastoji se od dvije sastavnice, a to su: strujno vođenje izolacije G_0 i gubici u izolaciji zbog izmjenične polarizacije G_d

$$G_1 = G_0 + G_d. \quad (4-4)$$

U stvarnosti su parametri raspodijeljeni cijelom duljinom voda i može se promatrati infinitezimalni dio voda duljine dx prema nadomjesnoj shemi prikazanoj na slici 4.1. Integracijom po cijeloj duljini voda dobili bi se stvarni iznosi parametara voda.

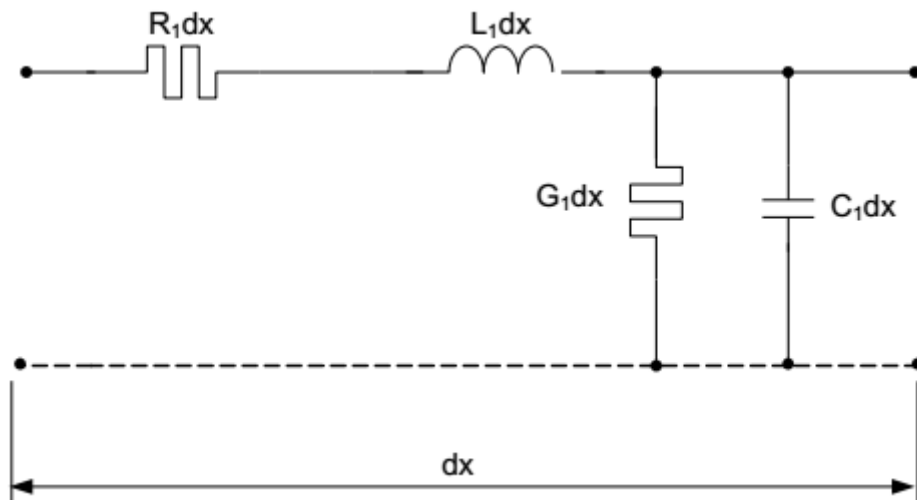

Slika 4.1. Infinitezimalni dio duljine prijenosnog voda

S obzirom na to da u praksi nije moguće odrediti stvarne parametre za svaki infinitezimalni dio prijenosnog voda, za proračun se koriste nadomjesne sheme s koncentriranim parametrima.

4.1. Nadomjesne sheme prijenosnog voda

Za kratke vodove (duljine $l < 200$ km) najčešće se koriste se približne nadomjesne sheme s koncentriranim parametrima. S obzirom na to da se u okviru disertacije promatraju djelatni gubici voda i nadomjesne sheme su prikazane s djelatnim otporima koji uzrokuju djelatne gubitke.

Nadomjesna II shema

Nadomjesna π shema prikazana je na slici 4.2.

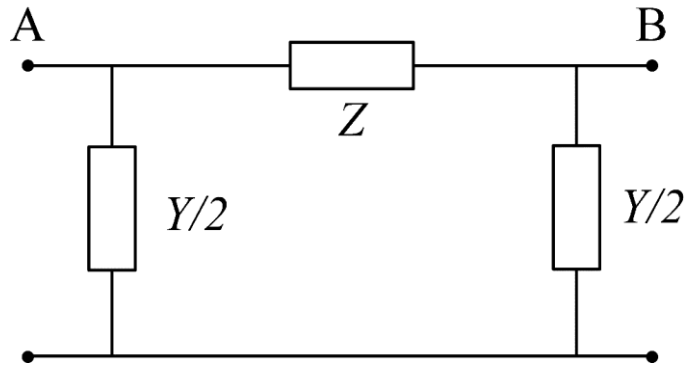

Slika 4.2. Nadomjesna π shema prijenosnog voda

Iznosi elemenata su

$$Z_{\pi} = Z = Z_1 \cdot l, \quad (4-5)$$

$$\frac{Y_{\pi}}{2} = \frac{Y}{2} = \frac{Y_1}{2} \cdot l. \quad (4-6)$$

Nadomjesna T shema

Nadomjesna T shema prikazana je na slici 4.3.

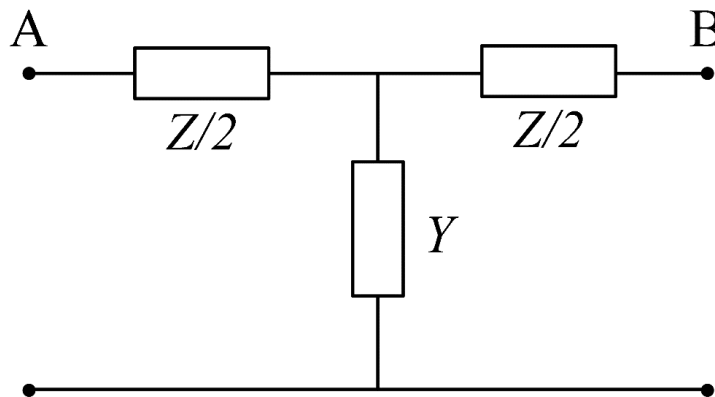

Slika 4.3. Nadomjesna T shema prijenosnog voda

Iznosi elemenata su

$$Y_T = Y = Y_1 \cdot l, \quad (4-7)$$

$$\frac{Z_T}{2} = \frac{Z}{2} = \frac{Z_1}{2} \cdot l. \quad (4-8)$$

Nadomjesna Γ shema

Nadomjesna Γ shema prikazana je na slici 4.4.

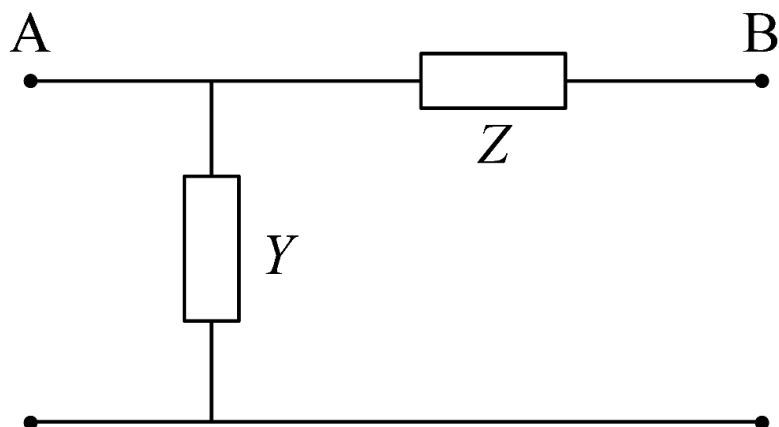

Slika 4.4. Nadomjesna Γ shema prijenosnog voda

Iznosi elemenata su

$$Z_{\Gamma} = Z \cdot l, \quad (4-9)$$

$$Y_{\Gamma} = Y \cdot l. \quad (4-10)$$

Proizvođači suvremenih brojila električne energije [81], [82] za mjerenje gubitaka prijenosa s pomoću ugrađene funkcije u brojlama koriste nadomjesnu Γ shemu te će se stoga u disertaciji ova shema koristiti za izračune gubitaka prijenosa. Druge prikazane nadomjesne sheme također imaju potencijal uporabe za istu namjenu, ali opravdanost toga treba istražiti u budućim istraživanjima.

4.2. Mjerenje otpora prijenosnog voda i izračun pripadajuće mjerne nesigurnosti

Mjerenje otpora prijenosnog voda u praksi se radi s pomoću više različitih pristupa, ali se svi u konačnici svode na tzv. U-I metodu. Načelo ove metode sastoji se u tome da se iz izvora električne energije utiskuje struja kroz vod te se mjeri pad napona te pripadajući fazni kut iz čega se računaju impedancije. Najčešće korištena je jednofazna metoda gdje se mjere impedancije svake faze posebno, a nakon toga se računa srednja impedancija kao aritmetička sredina te se dobiva impedancija mjerodavna za daljnji proračun.

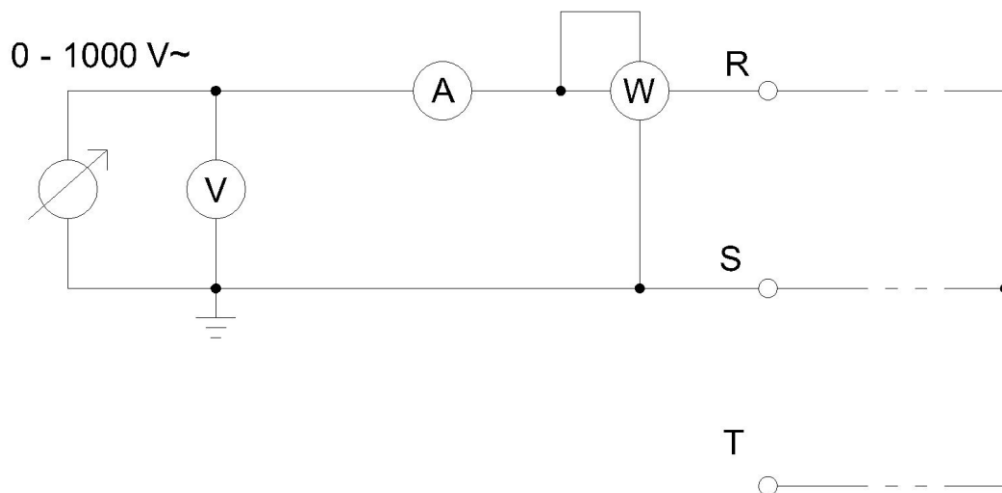

Slika 4.5. Načelna shema jednofaznog mjerenja otpora prijenosnog voda

U zadnje vrijeme pojavljuju se i uređaji za trofazno mjerenje parametara voda koji mjere impedancije svih triju faza istodobno.

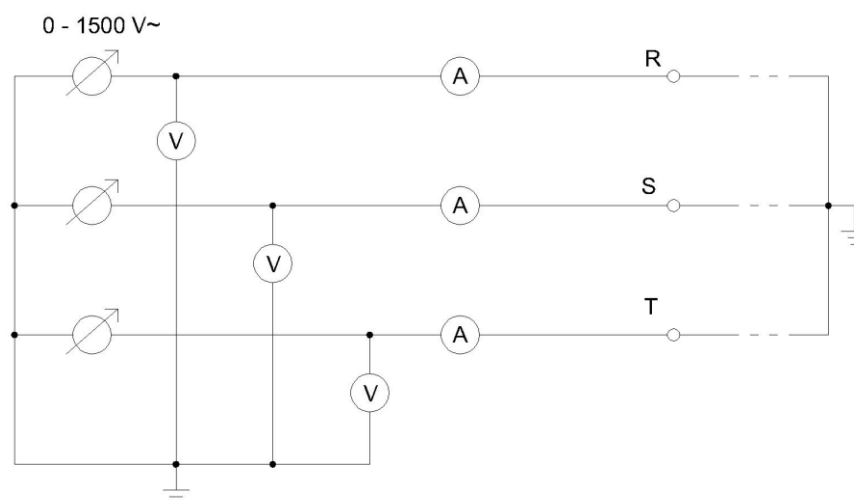

Slika 4.6. Načelna shema trofaznog mjerenja otpora prijenosnog voda

Prednost ove metode je što poznavanje zasebnih impedancija svih faza omogućava dodatan uvid u stanje vodiča. Naime, oštećen vodič jedne faze imat će veći uzdužni otpor nego preostale dvije faze što će se očitovati kroz nesimetriju prilikom mjerenja parametara voda. Matematički model mjerenja otpora voda U-I metodom glasi

$$R = \frac{U}{I} \cos\varphi. \quad (4-11)$$

Doprinosi mjernoj nesigurnosti otpora R proizlaze iz mjernih nesigurnosti napona U , struje I i kuta φ . Nadalje, svaka od navedenih veličina ima svoju slučajnu i sustavnu sastavnicu. Slučajna komponenta je promjenljiva i nemoguće ju je otkloniti stoga će se dovoljnim brojem ponavljanja mjerenja utvrditi njezine karakteristike. Sustavna sastavnica proizlazi iz karakteristika mjerne opreme tj. iz umjernice mjernog uređaja. Sustavnu sastavnicu je potrebno uzeti u obzir prilikom izračuna ukupne mjerne nesigurnosti otpora R .

4.2.1. Proračun mjerne nesigurnosti s pomoću klasične GUM metode

Sukladno definiciji klasične mjerne nesigurnosti [6] za sve ulazne veličine pretpostavlja se Gaussova razdioba ulaznih veličina, a posljedično i izlazne veličine. S obzirom na to da se otpor voda računa iz izmjerene struje i napona, za proračun mjerne nesigurnosti koristit će se složena mjerna nesigurnost prema izrazu (2-2).

Prije izračuna složene mjerne nesigurnosti otpora R potrebno je utvrditi stupanj korelacije između ulaznih veličina napona U , struje I i kuta φ prema jednadžbi (2-5). Korelacija između napona U i struje I računa se kao

$$r(U, I) = \frac{\sum_{i=1}^N (U_i - \bar{U})(I_i - \bar{I})}{\sqrt{\sum_{i=1}^N (U_i - \bar{U})^2 (I_i - \bar{I})^2}}. \quad (4-12)$$

Korelacija između struje I i kuta φ računa se kao

$$r(I, \varphi) = \frac{\sum_{i=1}^N (I_i - \bar{I})(\varphi_i - \bar{\varphi})}{\sqrt{\sum_{i=1}^N (I_i - \bar{I})^2 (\varphi_i - \bar{\varphi})^2}}. \quad (4-13)$$

Korelacija između napona U i kuta φ računa se kao

$$r(U, \varphi) = \frac{\sum_{i=1}^N (U_i - \bar{U})(\varphi_i - \bar{\varphi})}{\sqrt{\sum_{i=1}^N (U_i - \bar{U})^2 (\varphi_i - \bar{\varphi})^2}}. \quad (4-14)$$

Nakon toga izraz (2-2), uzimajući u obzir i (2-4) prelazi u

$$u_c(R) = \sigma_{GUM} = \sqrt{\sum_{i=1}^N \left(\frac{\partial R}{\partial x_i}\right)^2 u^2(x_i) + 2 \sum_{j=1}^{N-1} \sum_{i=j+1}^N \frac{\partial R}{\partial x_i} \frac{\partial R}{\partial x_j} u(x_i) u(x_j) r(x_i, x_j)}, \quad (4-15)$$

iz čega slijedi

$$\begin{aligned}
\sigma_{GUM}^2 = u_a^2(R) &= \left[\frac{\partial R}{\partial U} \cdot u_a(U) \right]^2 + \left[\frac{\partial R}{\partial I} \cdot u_a(I) \right]^2 + \left[\frac{\partial R}{\partial \varphi} \cdot u_a(\varphi) \right]^2 + \\
&+ 2 \sum_{j=1}^{N-1} \sum_{i=j+1}^N \frac{\partial R}{\partial U} \frac{\partial R}{\partial I} u(U) u(I) r(U, I) + \\
&+ 2 \sum_{j=1}^{N-1} \sum_{i=j+1}^N \frac{\partial R}{\partial I} \frac{\partial R}{\partial \varphi} u(I) u(\varphi) r(U, \varphi) + \\
&+ 2 \sum_{j=1}^{N-1} \sum_{i=j+1}^N \frac{\partial R}{\partial U} \frac{\partial R}{\partial \varphi} u(U) u(\varphi) r(U, \varphi).
\end{aligned} \tag{4-16}$$

$$\begin{aligned}
\sigma_{GUM}^2 = u_a^2(R) &= \\
&= \left[\frac{\cos \varphi}{I} \cdot u_a(U) \right]^2 + \left[-\frac{U \cos \varphi}{I^2} \cdot u_a(I) \right]^2 + \left[-\frac{U \sin \varphi}{I} \cdot u_a(\varphi) \right]^2 \\
&\quad - 2 \frac{U \cos^2 \varphi}{I^3} u_a(U) u_a(I) r(U, I) + \\
&\quad + 2 \frac{U^2 \cos(\varphi) \sin(\varphi)}{I^3} u_a(I) u_a(\varphi) r(U, \varphi) - \\
&\quad - 2 \frac{U \cos(\varphi) \sin(\varphi)}{I^2} u_a(U) u_a(\varphi) r(U, \varphi).
\end{aligned} \tag{4-17}$$

Izraz (4-17) predstavlja složenu mjernu nesigurnost otpora prijenosnog voda uzimajući u obzir i korelaciju ulaznih veličina prema GUM metodi odnosno prema uputama u dokumentu [6]. Više detalja o opisanom postupku može se naći u [5]. U nastavku će biti opisan proračun s pomoću AMC metode odnosno prema uputama u Dopuni 1 [13].

4.2.2. Proračun mjerne nesigurnosti s pomoću AMC metode

AMC metoda provodi se u nekoliko koraka sukladno opisu prikazanom u poglavlju 3. U prvom koraku nakon provedenih mjerenja potrebno je utvrditi razdiobe struje, napona i faznog kuta koji će poslužiti kao ulazne veličine. Za tu svrhu koristit će se Matlab Distribution Fitting Tool (MDFT) [83] koji omogućuje aproksimaciju niza teorijskih razdioba na učitane podatke. Za ispitivanje koja od razdioba najbolje aproksimira podatke koristi se *maximum likelihood estimation (MLE)* postupak odnosno izračunavaju se *log-likelihood* vrijednosti [84], [85]. Razdioba s većom vrijednosti bolje aproksimira podatke. U drugom koraku, nakon što su određene razdiobe ulaznih

veličina, izvršava se AMC procedura. Izlazna veličina je otpor prijenosnog voda u obliku M rezultata na temelju kojih se aproksimira razdioba koja će poslužiti kao ulazna veličina za proračun gubitaka prijenosnog voda o čemu će biti riječi u narednim poglavljima.

5. GUBICI PRIJENOSNOG VODA

U aktualnom tržišnom okruženju operatori prijenosnih sustava (OPS) na području Europe udruženi su u veću organizacijsku cjelinu koja se naziva *European Network of Transmission System Operators* (ENTSO-E) [86]. Trenutno ova organizacija uključuje 42 OPS-a iz 35 zemalja i ovlaštena je od institucija Europske Unije (EU) za liberalizaciju tržišta električne energije u sklopu Trećeg energetske paketa (*Third Legislative Package*). Temeljna misija joj je uspostava internog tržišta električne energije te očuvanje integriteta prijenosne mreže koja je sposobna odgovoriti na sve zahtjeve za razvojem uz očuvanje sigurnosti opskrbe električnom energijom.

Sukladno direktivi EU DIRECTIVE 2003/54/EC OF THE EUROPEAN PARLIAMENT AND OF THE COUNCIL [87] liberalizacija tržišta električne energije podrazumijeva da niti jedno poduzeće ne smije imati monopol na razini prodaje električne energije. Drugim riječima, potiče se konkurencija u ovom području. S druge strane, prijenosna i distribucijska mreža prihvaćene su kao javno dobro i pripadaju u tzv. regulirane djelatnosti gdje ovlašteno regulatorno tijelo nadzire primjenu odgovarajućih zakonskih odredbi te određuje tarife za pristup mreži. Pri tome se u obzir moraju uzeti realni troškovi OPS-ova koji moraju osigurati nesmetan i nediskriminirajući pristup mreži svim zainteresiranim sudionicima. Sve cijene u tržišnom okruženju moraju biti javne i transparentne tj. dostupne svim sudionicima na tržištu.

Gubici u prijenosnoj mreži mogu se podijeliti na gubitke prema mjestu nastanka (gubici na elementima mreže) i na gubitke ovisno o opterećenju (ovisni i neovisni o opterećenju) [88]. Druga moguća podjela gubitaka je na tehničke (fizikalne) i netehničke gubitke (gubici koji nastaju kao posljedica neovlaštene ili neizmjerene potrošnje električne energije, pogrešaka mjerenja i obračuna i sl.) [89]. Iznos gubitaka određen je tehničkim stanjem sustava što podrazumijeva broj i parametre vodova i transformatora, konfiguraciju mreže, raspored izvora itd., te režimom rada sustava što podrazumijeva uklopno stanje elemenata mreže, raspodjelu tokova snage, tranzite energije itd. Mjere za smanjenje gubitaka se prema [90] mogu podijeliti na konstruktivne i pogonske. Konstruktivne mjere za smanjenje gubitaka podrazumijevaju investicije u sustav kao npr. izgradnja vodova više naponske razine, izgradnja uređaja za kompenzaciju jalove snage, kontrola spojeva (termovizija itd.). Pogonske mjere za smanjenje gubitaka ne zahtijevaju značajne

investicije nego pogon sustava u što povoljnijim uvjetima što podrazumijeva ispravno održavanje elemenata mreže, pogon mreže s najpovoljnijom konfiguracijom, regulaciju napona i tokova jalove snage itd.

OPS koji djeluje u okviru ENTSO-E zajednice ima određena prava i obveze sukladno odredbama institucija EU. Između ostalog, od velike važnosti je dokument REGULATION (EC) No 714/2009 OF THE EUROPEAN PARLIAMENT AND OF THE COUNCIL of 13 July 2009 on conditions for access to the network for cross-border exchanges in electricity and repealing Regulation (EC) No 1228/2003 [91] koji uređuje naknadu OPS-a za tranzite električne energije i pripadajuće gubitke. Činjenica je da je naknada mala u odnosu na velike količine energije koje se prenesu preko prijenosnih vodova pa stoga pogreške mjerenja mogu izazvati štetu sumjerljivu naknadi koju OPS dobiva. Iz tog razloga je očigledno da je vrhunska kvaliteta mjerenja na obračunskim mjernim mjestima međunarodne razmjene od interesa svim sudionicima. Gubici električne energije u prijenosnom sustavu iznose oko 2.5% prema [92] ili nešto više 3-5% prema [93]–[95]. Loša kvaliteta mjerenja praćena velikim pogreškama može rezultirati značajno izmijenjenim rezultatima mjerenja gubitaka što će učiniti značajne financijske posljedice za sudionike razmjene.

5.1. Mjerenje gubitaka uporabom ugrađene funkcije u brojilu električne energije

Proizvođači suvremenih brojila električne energije [81], [82] prepoznali su problem određivanja gubitaka na prijenosnim vodovima. Primjerice proizvođač Landes&Gyr ugradio je funkciju mjerenja gubitaka u novijim brojilima [81]. Gubici se mjere, tj. računaju, prema nadomjesnoj "Γ" shemi prikazanoj na slici 4.4. i prema jednadžbi

$$E_G = \int_{t=0}^{t=t} \left(\sum_{i=1}^3 I_i^2 R + \sum_{i=1}^3 \frac{U_i^2}{R_{SH}} \right) dt, \quad (5-1)$$

gdje je: E_G – energija gubitaka električne energije

I_i – efektivna vrijednost struje i -te faze izmjerena u mjernoj točki

U_i – efektivna vrijednost napona i -te faze izmjerena u mjernoj točki

R – otpor vodiča prijenosnog voda

R_{SH} – poprečni otpor vodiča prijenosnog voda (tzv. *shunt* otpor)

t – vremenski interval u kojem se mjere gubici

Jednadžba (5-1) sastoji se od dvije sastavnice. Prva sastavnica su uzdužni tzv. I^2R gubici koji ovise o struji I odnosno opterećenju voda i otporu vodiča R . Otpor vodiča je nadalje ovisan o materijalu od kojeg je vodič izrađen i o duljini voda. Obično se mjeri primjenom odgovarajuće mjerne metode kao što je opisano u prethodnom poglavlju. Druga sastavnica su poprečni gubici koji nastaju zbog nesavršenosti izolacije prema zemlji, a ovise o naponu na vodu U i poprečnom otporu R_{SH} , a neovisan je o opterećenju voda. Poprečni otpor R_{SH} nije moguće izmjeriti pa se koriste iskustvene vrijednosti. Npr. za prijenosni 400 kV vod koristi se vrijednost 1000 M Ω /km [92].

Iz konstitucije jednadžbe (5-1) proizlaze i određeni nedostaci. Struja prijenosnog voda I u prvoj sastavnici gubitaka nije jednaka na početku i na kraju voda, prvenstveno zbog odvoda tj. radne komponente poprečnih gubitaka. Otpor vodiča R uzima se kao konstanta i u brojilo električne energije obično se upisuje vrijednost otpora pri 20°C. Međutim, prilikom temperaturnih oscilacija otpor se mijenja što znači da se gubici većinu vremena mjere s netočnom vrijednosti otpora.

Napon prijenosnog voda U nije jednak na oba kraja voda zbog pada napona na impedanciji voda. Poprečni otpor R_{SH} također nije konstantan nego značajno ovisi o atmosferskim prilikama. Praktično iskustvo [92] pokazuje da pretpostavka vrijednosti od 1000 M Ω /km zadovoljava pri suhim atmosferskim prilikama kada gubici prijenosnog voda iznose manje od 1%, međutim, pri velikoj vlažnosti poprečni gubici značajnu rastu pa tako i ukupni gubici voda do red veličine nekoliko postotaka i tada je očito da ta vrijednost ne zadovoljava.

Iz navedenih nedostataka očigledno je da mjerenje gubitaka uporabom ugrađene funkcije u brojlama električne energije ima niz promjenljivih sastavnica koje je u svakodnevnoj praksi nemoguće implementirati u obračun izmjerenih vrijednosti energije gubitaka. Stoga su, na ovaj način izmjerene vrijednosti, podložne značajnim nesigurnostima koje su posljedica matematičkog modela za izračun energije gubitaka. Pretpostavka je da će nedostaci ove metode biti otklonjeni uporabom druge metode u kojoj će se prijenosni gubici računati kao razlika izmjerenih energija na krajevima voda. Navedena pretpostavka provjerit će se na praktičnom primjeru u sljedećim poglavljima.

Mjerna nesigurnost gubitaka proizlazi iz matematičkog modela za proračun gubitaka prema jednadžbi (5-1). Mjerna nesigurnost struje I i napona U rezultat je mjerenja s pomoću strujnih i naponskih mjernih transformatora. Nakon ispravka sustavnih pogrešaka očitanih iz umjernih mjernih transformatora, preostaje nesigurnost umjeravanja koja će se iskazati kao preostala mjerna nesigurnost s pomoću pravokutne razdiobe kao što je preporučeno u [96]. Mjerna nesigurnost otpora R rezultat je proračuna mjerne nesigurnosti iz poglavlja 0.

5.1.1. Proračun mjerne nesigurnosti gubitaka s pomoću klasične GUM metode

Sukladno definiciji klasične mjerne nesigurnosti [6] za sve ulazne veličine pretpostavlja se Gaussova razdioba ulaznih veličina, a posljedično i izlazne veličine. S obzirom na to da se gubici voda računaju iz izmjerene struje, napona i otpora, za proračun mjerne nesigurnosti koristit će se složena mjerna nesigurnost prema izrazu (2-2). Izraz (5-1) za sve tri faze i vremenski period t prelazi u oblik

$$E_G = \left(I^2 R + \frac{U^2}{R_{SH}} \right) t. \quad (5-2)$$

Složena mjerna nesigurnost računa se prema izrazu

$$u_c(E_G) = \sigma_{E_G-GUM} = \sqrt{\sum_{i=1}^N \left(\frac{\partial E_G}{\partial x_i} \right)^2 u^2(x_i) + 2 \sum_{j=1}^{N-1} \sum_{i=j+1}^N \frac{\partial E_G}{\partial x_i} \frac{\partial E_G}{\partial x_j} u(x_i) u(x_j) r(x_i, x_j)}, \quad (5-3)$$

Ulazne veličine za izračun gubitaka prijenosnog voda, struja I , napon U i otpor R rezultat su mjerenja međusobno neovisnih mjernih sustava te se stoga kovarijantni član u jednadžbi (5-3) zanemaruje i jednadžba prelazi u oblik

$$u_c(E_G) = \sigma_{E_G-GUM} = \sqrt{\sum_{i=1}^N \left(\frac{\partial E_G}{\partial x_i} \right)^2 u^2(x_i)}. \quad (5-4)$$

Raspisivanjem se dobiva apsolutna mjerna nesigurnost gubitaka po fazi prijenosnog voda

$$u_c(E_G)^2 = \sigma_{E_G-GUM}^2 = u_a^2(E_G) = \left[\frac{\partial E_G}{\partial U} \cdot u_a(U) \right]^2 + \left[\frac{\partial E_G}{\partial I} \cdot u_a(I) \right]^2 + \left[\frac{\partial E_G}{\partial R} \cdot u_a(R) \right]^2, \quad (5-5)$$

$$= \left\{ \left[\frac{2U}{R_{SH}} \cdot u_a(U) \right]^2 + [2IR \cdot u_a(I)]^2 + [I^2 \cdot u_a(R)]^2 \right\} t. \quad (5-6)$$

5.1.2. Proračun mjerne nesigurnosti gubitaka s pomoću MC i AMC metode

Za razliku od klasične metode za proračun mjerne nesigurnosti, kod MC i AMC metode neće se pretpostavljati Gaussova razdioba ulaznih veličina nego će se odrediti razdioba rezultata mjerenja za sve sastavnice nesigurnosti. Za struju i napon uzet će se pravokutne razdiobe s parametrima iz

umjernica, a za otpor R kao ulazna veličina koristit će se izlazna veličina iz proračuna mjerne nesigurnosti otpora uporabom MC odnosno AMC metode. Više detalja o navedenom postupku može se naći u [97].

5.1.3. Procjena funkcije gustoće vjerojatnosti gubitaka

Rezultat MC i AMC metoda su razdiobe izlaznih veličina koje sadrže značajno bogatiju informaciju o izlaznoj veličini u usporedbi s GUM metodom. Međutim, da bi se iz razdiobe mogle iščitati informacije odnosno željeni parametri, najčešće srednja vrijednost i standardna devijacija, potrebno je poznavati odgovarajuću razdiobu. Dakle, nakon provedene MC ili AMC metode potrebno je provesti tzv. *fitanje* razdiobe, tj. procjenu (aproksimaciju) parametara razdiobe.

Problem aproksimacije razdiobe na određene podatke svodi se na određivanje nepoznatih parametara razdiobe. Postupak će se provesti s pomoću programskih paketa R 3.1.1. i Mathematica 9 uporabom metode nelinearnih najmanjih kvadrata (engl. *non-linear least square (NLS) method*) i Levenberg-Marquardt algoritma [98]–[100]. Programski paket R 3.1.1. sadrži 21 parametarsku razdiobu među kojima traži razdiobu koja najbolje odgovara empirijskoj razdiobi tj. razdiobu koja ima najmanju preostalu sumu kvadrata odstupanja (engl. *residual sum of squares*). Više detalja bit će prikazano niže u poglavljima koja sadrže praktične rezultate. Više detalja o navedenom postupku može se naći u [101].

6. RASPODJELA RAZMIJENJENE ENERGIJE I PRIPADAJUĆIH GUBITAKA IZMEĐU OPERATORA PRIJENOSNIH SUSTAVA

Operatori prijenosnih sustava imaju zajednički interes za propisivanjem metode za ispravak razmijenjene energije i pripadajućih gubitaka zbog velike količine prenesene energije i posljedično značajnog financijskog efekta. Kod međudržavne razmjene električna energije se mjeri obostrano tj. na oba kraja prijenosnog voda (slika 6.1).

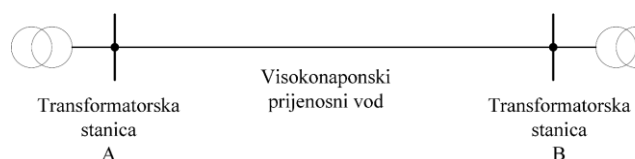

Slika 6.1 Načelna shema smještaja obračunskih mjernih mjesta kod međudržavne razmjene električne energije

Pravilan odabir odgovarajuće metode za raspodjelu prenesene energije i pripadajućih gubitaka važna je tema prilikom bilateralnih pregovora između OPS-ova. Pregovori moraju biti ravnopravni, a detalji moraju biti utvrđeni međunarodnim sporazumom. Odabrana metoda prije svega mora biti pravedna kako niti jedan operator ne bi trpio štetu. Postojeća zakonska regulativa bi na razini ENTSO-E grupe trebala urediti detalje navedene problematike kako se odluka ne bi donosila kao rezultat pojedinačnih dogovora, a niti jedan sudionik ne bi bio izložen npr. političkim pritiscima. Sloboda koju zakonska regulativa prepušta pojedinačnim dogovorima OPS-ova rezultira s nekoliko različitih pristupa koji se pojavljuju u praksi. Jedna od mogućnosti je da se gubici uopće ne obračunavaju jer su obračunske mjerne točke (MT) blizu fizičke granice OPS-ova, a energija mjerodavna za obračun je jednaka izmjerenoj energiji na brojilima električne energije. Ako se gubici ipak uzimaju u obzir, jedna od mogućnosti je uporaba ugrađene funkcije za mjerenje gubitaka u suvremenim brojilima električne energije opisane u prethodnom potpoglavlju. Druga mogućnost je, uz pretpostavku obostranog mjerenja, da se gubici računaju kao razlika izmjerenih energija na suprotnim stranama prijenosnog voda.

Zajedničko za sve metode je da ne uzimaju u obzir mjernu nesigurnost izmjerene energije i gubitaka prijenosa. Posljedice neuvažavanja mjerne nesigurnosti su:

- mjerni rezultat odnosno energija mjerodavna za obračun sadrži veliku količinu nesigurnosti što znači da je i financijski iskaz energije nesiguran,
- prijenosni gubici izračunati iz izmjerene energije s velikom količinom nesigurnosti sadrže također veliku količinu nesigurnosti koja će se obračunati OPS-ovima.

Mjerna nesigurnost se, kao što je spomenuto u uvodnom dijelu disertacije, može podijeliti na slučajne i sustavne sastavnice što u ovom trenutku postaje iznimno važno. Naime, sustavne sastavnice koje su posljedica poznatih izvora mjerne nesigurnosti, npr. mjerna metoda i mjerna oprema, mogu su kvantizirati, a mjerni rezultat se može ispraviti za isti iznos [67], [92]. Na taj način, mjerni rezultat se ispravlja, a mjerna nesigurnost rezultata se smanjuje. Ako uzmemo u obzir velike količine energije koje se razmjenjuju na prijenosnoj razini, svaki ispravak mjernog rezultata znači „pošteniju“ raspodjelu izmjerene energije i pripadajućih gubitaka. Osim toga, mjerna nesigurnost energije koja posljedično znači i financijsku nesigurnost se smanjuje. Nakon što su sustavne sastavnice otklonjene tj. ispravljene i dalje preostaje određena količina nesigurnosti koja je posljedica određivanja ispravaka i slučajnih pogrešaka koje je zbog njihove prirode nemoguće odrediti niti ispraviti. Iz navedenog je očigledno da je u iznimnom interesu svih sudionika razmjene električne energije da se odrede zajednička pravila i urede međusobni odnosi kako nitko ne bi trpio financijsku štetu.

6.1. Zakonska regulativa vezana ispravak razmijenjene energije

Temeljni dokument koji uređuje odnose prilikom prekogranične razmjene električne energije u zemljama Europske Unije je „REGULATION (EC) No 714/2009 OF THE EUROPEAN PARLIAMENT AND OF THE COUNCIL of 13 July 2009 on conditions for access to the network for cross-border exchanges in electricity and repealing Regulation (EC) No 1228/2003“ [91]:

Article 1

Subject-matter and scope

This Regulation aims at:

„(a) setting fair rules for cross-border exchanges in electricity, thus enhancing competition within the internal market in electricity, taking into account the particular characteristics of national and regional markets. This will involve the establishment of a compensation mechanism for cross-border flows of electricity and the setting of harmonised principles on cross-border transmission charges and the allocation of available capacities of interconnections between national transmission systems“.

Sukladno tom dokumentu, svaki OPS ima pravo na pripadajuću naknadu zbog tokova energije koja teče njegovom mrežom:

„(11) In an open, competitive market, transmission system operators should be compensated for costs incurred as a result of hosting cross-border flows of electricity on their networks by the operators of the transmission systems from which cross-border flows originate and the systems where those flows end.“

Article 13

Inter-transmission system operator compensation mechanism

“1. Transmission system operators shall receive compensation for costs incurred as a result of hosting cross-border flows of electricity on their networks.

2. The compensation referred to in paragraph 1 shall be paid by the operators of national transmission systems from which cross-border flows originate and the systems where those flows end.”

Temeljna zakonska regulativa Europske Unije načelno propisuje odnose među operatorima prijenosnih sustava prilikom prekogranične razmjene električne energije, međutim, o tehničkim detaljima kao što su ispravak pogrešaka mjernih transformatora i načinu obračuna prijenosnih gubitaka se ne govori.

Primjer za ovakvu praksu može se naći u više izdanja britanskog *Code of Practice* [102]–[104]. Nadalje pogledajmo detaljnije što je propisano. U poglavlju 4.3.2. u *Code of Practice One* [102] stoji sljedeće:

“To achieve the overall accuracy requirements it may be necessary to compensate Meters for the error of the measurement transformers and the associated leads to the Meters. Values of the compensation shall be recorded and evidence to justify the compensation criteria, including wherever possible test certificates, shall be available for inspection...”

Iz toga je jasno da je ispravak pogrešaka potreban za poboljšanje ukupne točnosti mjerenja. Također stoji:

„...where the Actual Metering Point and the Defined Metering Point do not coincide then a Metering Dispensation shall be applied for and, where necessary, accuracy compensation for power transformer and/or line losses shall be provided to meet the overall accuracy...”

što znači da ako se fizička mjerna točka (engl. *Actual Metering Point*) i definirana mjerna točka međunarodne razmjene (engl. *Defined Metering Point*) ne podudaraju, potrebno je provesti ispravak izmjerenih vrijednosti.

Više tehničkih detalja vezano za ispravak izmjerene energije se ne spominje. Ovo je očigledan nedostatak zakonske regulative na kojem u budućnosti treba raditi. U nastavku disertacije će se opisati tehnički detalji ovog postupka uz obrazloženje financijskih efekata što može poslužiti kao ishodište za buduću implementaciju u zakonsku regulativu.

6.2. Ispravak izmjerene energije

6.2.1. Postupak ispravka izmjerene energije

Postupak ispravka razmijenjene energije podrazumijeva razvoj matematičkog modela mjerenja energije i njezin ispravak za sve sustavne komponente [105]. Mjerena energija je funkcija napona U , struje I i faznog kuta φ_S

$$E = f(U, I, \varphi_S), \quad (6-1)$$

i stoga matematički model mjerenja energije jedne faze glasi

$$E = (U \cdot I \cdot \cos\varphi_S) \cdot t. \quad (6-2)$$

Mjereni napon U , struja I i sekundarni fazni kut φ_S moraju se svaki pojedinačno ispraviti za iznos sustavnih pogrešaka odnosno moraju se odrediti ispravljene vrijednosti napona U^* , struje I^* i faznog kuta φ_S^* . Sukladno izvješću o umjeravanju (engl. *Calibration Certificate*) $p_{U\%}$ i $p_{I\%}$ su postotne fazne pogreške naponskih mjernih transformatora (NMT) i strujnih mjernih transformatora (SMT). δ_U i δ_I su fazne pogreške NMT i SMT. Ispravljene vrijednosti napona U^* , struje I^* i faznog kuta φ_S^* računaju se prema

$$U^* = U(1 - p_U - p_{PN}), \quad (6-3)$$

$$I^* = I(1 - p_I), \quad (6-4)$$

$$\varphi_S^* = \varphi_S - \delta_U - \delta_I. \quad (6-5)$$

gdje je $p_U = p_{U\%}/100$, $p_I = p_{I\%}/100$, a $p_{PN} = p_{PN\%}/100$ je postotni pad napona u naponskim mjernim granama. Jednadžbe (6-3), (6-4) i (6-5) vrijede za svaku fazu sustava.

Matematički model ispravljene ukupne energije za sve tri faze dobije se množenjem svake sastavnice koja se ispravlja odgovarajućim faktorom ispravka

$$E_{mj} = [U_1 \Gamma_1 \cos(\varphi_{s1}) + U_2 \Gamma_2 \cos(\varphi_{s2}) + U_3 \Gamma_3 \cos(\varphi_{s3})] t - p_{BR\%} E_{mj}, \quad (6-6)$$

gdje je E_{mj} energija izmjerena brojiлом, a $p_{BR\%}$ pripadajuća postotna pogreška.

Iz jednadžbi (6-3), (6-4), (6-5) i (6-6) slijedi potpuni izraz za ispravljenu trofaznu energiju

$$\begin{aligned} E_{mj} = & [U_1(1 - p_{U1} - p_{PN1})I_1(1 - p_{I1}) \cos(\varphi_{S1} - \delta_{U1} - \delta_{I1}) + \\ & + U_2(1 - p_{U2} - p_{PN2})I_2(1 - p_{I2}) \cos(\varphi_{S2} - \delta_{U2} - \delta_{I2}) + U_3(1 - \\ & - p_{U3} - p_{PN3})I_3(1 - p_{I3}) \cos(\varphi_{S3} - \delta_{U3} - \delta_{I3})] t - p_{BR\%} E_{mj}. \end{aligned} \quad (6-7)$$

6.2.2. Utjecaj promjene strujne, naponske i kutne pogreške na ispravljenu energiju

Utjecaj promjena strujne, naponske i kutne pogreške na ispravljenu energiju odredit će se s pomoću analize osjetljivosti matematičkog modela(6-7). Osjetljivost ispravljene energije na pojedini parametar odredit će se tako da se jednadžba (6-7) izrazi kao funkcija u ovisnosti o promatranom parametru uzimajući ostale varijable konstantnima

$$E_{p_U} = f(p_U) |_{p_I, \delta_I, \delta_U, \varphi_S, p_{BR}, p_{PN} = const.} \quad (6-8)$$

$$E_{\delta_U} = f(\delta_U) |_{p_U, p_I, \delta_I, \varphi_S, p_{BR}, p_{PN} = const.} \quad (6-9)$$

$$E_{p_I} = f(p_I) |_{p_U, \delta_I, \delta_U, \varphi_S, p_{BR}, p_{PN} = const.} \quad (6-10)$$

$$E_{\delta_I} = f(\delta_I) |_{p_U, p_I, \delta_U, \varphi_S, p_{BR}, p_{PN} = const.} \quad (6-11)$$

$$E_{p_{BR\%}} = f(\delta_{p_{BR}}) |_{p_U, p_I, \delta_U, \delta_I, \varphi_S, p_{PN} = const.,} \quad (6-12)$$

$$E_{p_{PN\%}} = f(p_{PN}) |_{p_U, \delta_I, \delta_U, \varphi_S, p_{BR}, p_I = const.} \quad (6-13)$$

Osim toga, izračunat će se indeks elastičnosti (IE) i indeks osjetljivosti (IO). IE računa se kao postotna promjena ovisne varijable podijeljena s postotnom promjenom neovisne varijable [106](6-7)(6-7)(6-7)(6-7)

$$IE = \frac{\Delta Y\%}{\Delta X\%}. \quad (6-14)$$

IE se koristi za prikazivanje nagiba krivulje i u konkretnom slučaju računat će se sljedeći parametri:

$$IE_{pU} = \frac{E^{\wedge}mj\%}{p_{U\%}}, \quad (6-15)$$

$$IE_{pI} = \frac{E^{\wedge}mj\%}{p_{I\%}}, \quad (6-16)$$

$$IE_{\delta U} = \frac{E^{\wedge}mj\%}{\delta_{U\%}}, \quad (6-17)$$

$$IE_{\delta I} = \frac{E^{\wedge}mj\%}{\delta_{I\%}}, \quad (6-18)$$

$$IE_{pBR} = \frac{E^{\wedge}mj\%}{p_{BR\%}}, \quad (6-19)$$

$$IE_{pPN} = \frac{E^{\wedge}mj\%}{p_{PN\%}}. \quad (6-20)$$

IO daje informaciju o relativnoj osjetljivosti ovisne varijable o neovisnoj varijabli kada ona varira od minimalne do maksimalne vrijednosti [106], [107]

$$IO = \frac{Y_{max} - Y_{min}}{Y_{max}}. \quad (6-21)$$

U konkretnom slučaju IO računat će se prema jednadžbi

$$IO = \frac{E^{\wedge}mj_{max} - E^{\wedge}mj_{min}}{E^{\wedge}mj_{max}}. \quad (6-22)$$

6.3. Raspodjela energije između operatora prijenosnih sustava

Poseban izazov u mjeriteljskoj praksi kod prekogranične razmjene energije predstavlja činjenica da obračunske mjerne točke nisu na fizičkoj granici OPS-ova tj. na obračunskoj točki [105]. Jedino potpuno i teorijski ispravno mjerenje energije bilo bi na fizičkoj granici OPS-ova. Međutim, fizičke granice OPS-ova su međudržavne granice koje se obično nalaze na prirodnim barijerama (npr. rijeke, šume), a mjerne točke su u transformatorskim stanicama na krajevima prijenosnog voda. Iz tog razloga nije moguće utvrditi energiju na stvarnoj granici, odnosno u obračunskoj mjernoj točki, nego se ona mjeri u mjernim točkama na krajevima voda. Na koji način će se energija uz pripadajuće gubitke raspodijeliti nije utvrđeno zakonskom regulativom nego je to prepušteno međudržavnim sporazumima. Prijedlog navedenog problema u sklopu disertacije je uporabom virtualne mjerne točke (VMT) koja će biti smještena u obračunskoj mjernoj točki na stvarnoj granici OPS-ova (slika 6.2). Njezin virtualni mjerni rezultat dobit će se reduciranjem vrijednosti izmjerenih na krajevima voda.

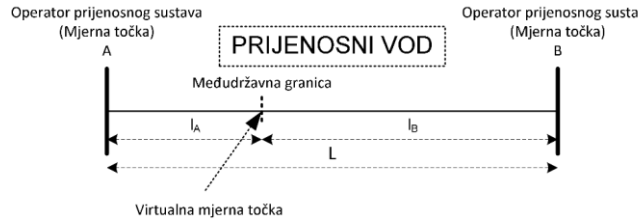

Slika 6.2 Virtualna mjerna točka

Ukupna duljina voda L podijeljena je na dio l_A koji pripada OPS-u A i dio l_B koji pripada OPS-u B tako da vrijedi

$$L = l_A + l_B. \quad (6-23)$$

Iz toga proizlazi da se VMT nalazi na udaljenosti l_A od mjerne točke A i na udaljenosti l_B od mjerne točke B. Stoga se izmjerena energija i pripadajući gubici dijele proporcionalno duljini voda koja pripada pojedinom OPS-u.

6.3.1. Raspodjela neispravljene energije

U prvom koraku se neispravljeni gubici računaju kao razlika izmjerenih (neispravljenih) energija na strani A E_{mjA} i na strani B E_{mjB}

$$E_G = E_{measA} - E_{measB}. \quad (6-24)$$

Uzimajući u obzir mjerne nesigurnosti izmjerene energije na strani A u_{mjA} i na strani B u_{mjB} koji određuju mjernu nesigurnost gubitaka u_G , cjelovit mjerni rezultat gubitaka glasi

$$E_{G_UK} = E_G \pm u_G. \quad (6-25)$$

Izračunati gubici se dijele proporcionalno između OPS-ova i to tako da OPS-u A pripadaju gubici

$$E_{GA} = \frac{l_A}{L} E_G, \quad (6-26)$$

a OPS-u B gubici

$$E_{GB} = \frac{l_B}{L} E_G. \quad (6-27)$$

Virtualna energija E_{VMT} tj. energija izmjerena u VMT mora biti jednaka gledajući s obje strane voda. Ako energija teče iz OPS-a A prema OPS-u B mora vrijediti

$$E_{VMT} = E_{mjA} - E_{GA} = E_{mjB} + E_{GB}, \quad (6-28)$$

$$E_{VMT} = E_{mjA} - \frac{l_A}{L} E_G = E_{mjB} + \frac{l_B}{L} E_G. \quad (6-29)$$

Ako energija teče iz OPS-a B prema OPS-u A mora vrijediti

$$E_{VMT} = E_{mjA} + E_{GA} = E_{mjB} - E_{GB}, \quad (6-30)$$

$$E_{VMT} = E_{mjA} + \frac{l_A}{L} E_G = E_{mjB} - \frac{l_B}{L} E_G. \quad (6-31)$$

6.3.2. Raspodjela ispravljene energije

Postupak ispravka izmjerene energije provodi se na oba kraja voda stoga izmjerena energija E_{mjA} postaje E'_{mjA} , a izmjerena energija E_{mjB} postaje E'_{mjB} . Ispravljeni gubici iznose

$$E'_G = E'_{measA} - E'_{measB}. \quad (6-32)$$

Uzimajući u obzir mjerne nesigurnosti izmjerene ispravljene energije na strani A u'_{mjA} i na strani B u'_{mjB} koji određuju mjernu nesigurnost gubitaka u'_G , cjelovit mjerni rezultat gubitaka glasi

$$E'_{G_UK} = E'_G \pm u'_G. \quad (6-33)$$

Izračunati ispravljeni gubici se dijele proporcionalno između OPS-ova i to tako da OPS-u A pripadaju gubici

$$E'_{GA} = \frac{l_A}{L} E'_G, \quad (6-34)$$

a OPS-u B gubici

$$E'_{GB} = \frac{l_B}{L} E'_G. \quad (6-35)$$

Ispravljena virtualna energija E_{IVMT} tj. energija izmjerena u ispravljenoj VMT (IVMT) mora biti jednaka gledajući s obje strane voda. Ako energija teče iz OPS-a A prema OPS-u B mora vrijediti

$$E'_{VMT} = E'_{mjA} - E'_{GA} = E'_{mjB} + E'_{GB}, \quad (6-36)$$

$$E'_{VMT} = E'_{mjA} - \frac{l_A}{L} E'_G = E'_{mjB} + \frac{l_B}{L} E'_G. \quad (6-37)$$

Ako energija teče iz OPS-a B prema OPS-u A mora vrijediti

$$E'_{VMT} = E'_{mjA} + E'_{GA} = E'_{mjB} - E'_{GB}, \quad (6-38)$$

$$E'_{VMT} = E'_{mjA} + \frac{l_A}{L} E'_G = E'_{mjB} - \frac{l_B}{L} E'_G. \quad (6-39)$$

Konačno, energija u IVMT je mjerodavna za obračun između OPS-ova.

6.4. Analiza mjerne nesigurnosti na obračunskom mjernom mjestu

6.4.1. Sastavnice mjerne nesigurnosti

Ukupna mjerna nesigurnost u mjernoj točki sastoji se od lanca mjernih nesigurnosti počevši od mjernih transformatora (MT), preko mjernih vodiča sve do brojila električne energije. Pogreške NMT i SMT iskazuju se u izvješću o umjeravanju u obliku krivulje u ovisnosti o sekundarnom opterećenju jezgre transformatora (engl. *burden*) i primarnom opterećenju. Tipični primjeri prikazani su na slikama 6.3. i 6.4. U obzir je potrebno uzeti i mjernu nesigurnosti umjeravanja.

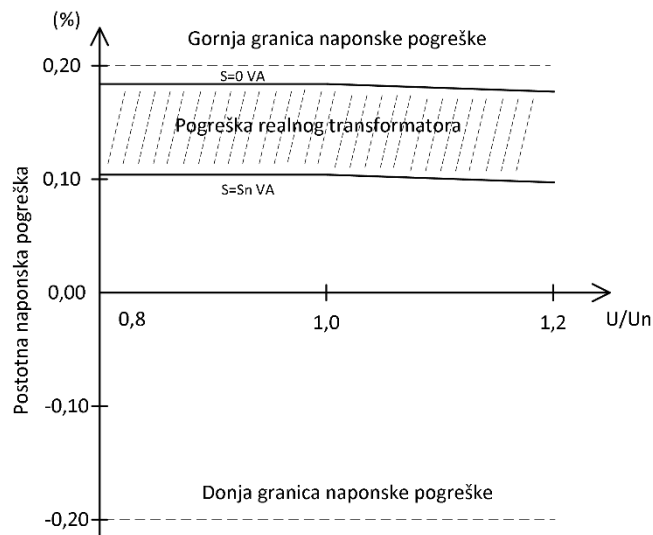

Slika 6.3. Tipični primjer pogrešaka NMT klase točnosti 0,2

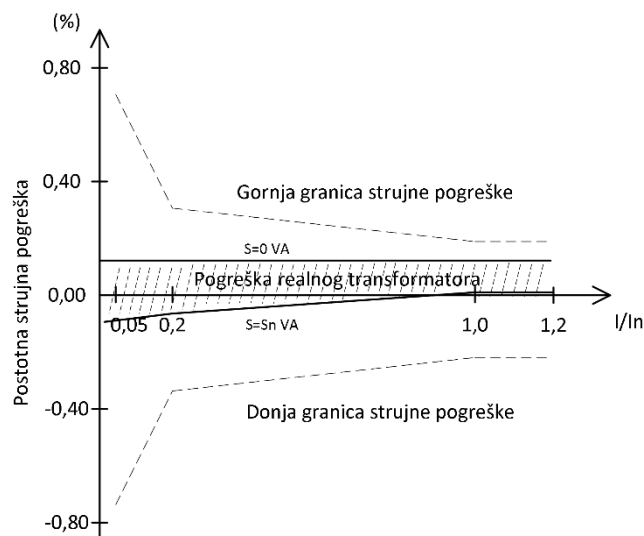

Slika 6.4. Tipični primjer pogrešaka SMT klase točnosti 0,2

Lanac mjernih nesigurnosti (slika 6.5.) sastoji se od:

- $p_{U1\%}, p_{U2\%}, p_{U3\%}$ - postotne pogreške NMT
- $\delta_{U1}, \delta_{U2}, \delta_{U3}$ - absolutne fazne pogreške NMT
- $p_{I1\%}, p_{I2\%}, p_{I3\%}$ - postotne pogreške SMT
- $\delta_{I1}, \delta_{I2}, \delta_{I3}$ - absolutne fazne pogreške SMT
- $u_{NMTcal\%}$ - mjerna nesigurnosti umjeravanja NMT
- $u_{SMTcal\%}$ - mjerna nesigurnosti umjeravanja SMT
- $p_{BR\%}$ - postotna pogreška brojila električne energije
- $u_{BRcal\%}$ - mjerna nesigurnost umjeravanja brojila električne energije
- $p_{PN1\%}, p_{PN2\%}, p_{PN3\%}$ – postotni pad napona u naponskim mjernim krugovima
- $u_{PN\%}$ - mjerna nesigurnost pada napona
- $u_{PMN\%}$ - preostale mjerne nesigurnosti

Bez gubitka općenitosti, preostale mjerne nesigurnosti koje je potrebno procijeniti za konkretno obračunsko mjerno mjesto, a imaju znatno manji utjecaj od navedenih (npr. atmosferski utjecaj na obračunskom mjernom mjestu i sl.) obuhvaćene su kao preostala mjerna nesigurnost $u_{PMN\%}$.

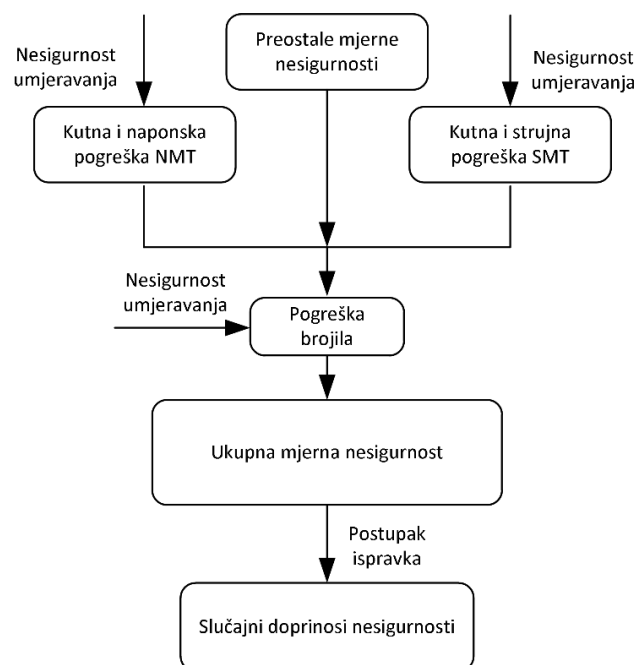

Slika 6.5. Lanac mjernih nesigurnosti

6.4.2. Izračun mjerne nesigurnosti

Matematički model za izračun ukupne mjerne nesigurnosti iskazuje se kao funkcionalna ovisnost o svim sastavnicama mjerne nesigurnosti kao što je opisano u prethodnom potpoglavlju

$$u_{mj} = f[p_{U1\%}, p_{U2\%}, p_{U3\%}, u_{NMTcal\%}, p_{I1\%}, p_{I2\%}, p_{I3\%}, u_{SMTcal\%}, \delta_{U1}, \delta_{I1}, \delta_{U2}, \delta_{I2}, \delta_{U3}, \delta_{I3}, p_{BR\%}, u_{BRcal\%}, p_{PN1\%}, p_{VD2\%}, p_{PN3\%}, u_{PN\%}, u_{PMN\%}]. \quad (6-40)$$

Tablica 6.1. prikazuje prirodu svih sastavnica mjerne nesigurnosti i pogrešaka koje čine lanac nesigurnosti.

Tablica 6.1. Priroda sastavnica lanca mjernih nesigurnosti

Veličina	Vrsta doprinosa	Priroda doprinosa nesigurnosti	Funkcija gustoće vjerojatnosti
$p_{U1\%}, p_{U2\%}, p_{U3\%}$	Pogreška	Sustavna	-
$\delta_{U1}, \delta_{U2}, \delta_{U3}$	Pogreška	Sustavna	-
$p_{I1\%}, p_{I2\%}, p_{I3\%}$	Pogreška	Sustavna	-
$\delta_{I1}, \delta_{I2}, \delta_{I3}$	Pogreška	Sustavna	-
$u_{NMTcal\%}$	Mjerna nesigurnost	Slučajna	Pravokutna
$u_{SMTcal\%}$	Mjerna nesigurnost	Slučajna	Pravokutna
$p_{BR\%}$	Pogreška	Sustavna	-
$u_{BRcal\%}$	Mjerna nesigurnost	Slučajna	Pravokutna
u_{mj}	Mjerna nesigurnost	Slučajna	Gaussova
$p_{PN1\%}, p_{PN2\%}, p_{PN3\%}$	Pogreška	Sustavna	-
$u_{PN\%}$	Mjerna nesigurnost	Slučajna	Pravokutna
$u_{PMN\%}$	Mjerna nesigurnost	Slučajna	Pravokutna

Nakon ispravka svi sustavnih pogrešaka, ukupna ispravljena mjerna nesigurnost je funkcija preostalih slučajnih sastavnica $u_{NMTcal\%}$, $u_{SMTcal\%}$, $u_{BRcal\%}$, $u_{PN\%}$ i $u_{PMS\%}$

$$u_{mj} = f(u_{NMTcal\%}, u_{SMTcal\%}, u_{BRcal\%}, u_{PN\%}, u_{PMS\%}), \quad (6-41)$$

koja se računa prema jednadžbi

$$\begin{aligned}
u_{mj}^2 = & \left(\frac{u_{NMTcal\%1}}{\sqrt{3}}\right)^2 + \left(\frac{u_{NMTcal\%2}}{\sqrt{3}}\right)^2 + \left(\frac{u_{NMTcal\%3}}{\sqrt{3}}\right)^2 + \left(\frac{u_{SMTcal\%1}}{\sqrt{3}}\right)^2 + \\
& + \left(\frac{u_{SMTcal\%2}}{\sqrt{3}}\right)^2 + \left(\frac{u_{SMTcal\%3}}{\sqrt{3}}\right)^2 + \left(\frac{u_{BRcal\%}}{\sqrt{3}}\right)^2 + \left(\frac{u_{PN\%}}{\sqrt{3}}\right)^2 + \left(\frac{u_{PMS\%}}{\sqrt{3}}\right)^2.
\end{aligned} \tag{6-42}$$

Mjerna nesigurnost gubitaka računa se prema [6] kao

$$u_G = \sqrt{u_{mjA}^2 + u_{mjB}^2}. \tag{6-43}$$

Mjerna nesigurnost ispravljenih gubitaka računa se kao

$$u'_G = \sqrt{u_{mjA}^2 + u_{mjB}^2}. \tag{6-44}$$

Provedbom opisanog postupka dobivene su mjerne nesigurnosti razmijenjene energije i gubitaka prijenosa smanjene za iznos sustavnih sastavnica mjerne nesigurnosti. Zajednički s ispravljenom energijom (6-7) navedene mjerne nesigurnosti čine cjelovit mjerni rezultat razmijenjene energije i pripadajućih gubitaka. Ovako dobiveni rezultat može poslužiti kao temelj za pravedan financijski obračun između OPS-ova.

7. REZULTATI PRORAČUNA I SIMULACIJE

Praktični proračuni u okviru disertacije provode se na stvarnim primjerima iz 110 kV i 400 kV prijenosne mreže. Zbog povjerljivosti podataka neće se navoditi nazivi prijenosnih vodova. Prvi dio praktičnih rezultata koji se odnosi na mjerenje otpora prijenosnog voda i izračuna gubitaka uporabom ugrađene funkcije za izračun gubitaka u brojlama električne energije provodit će se na 110 kV prijenosnom vodu. Drugi dio praktičnih rezultata koji se odnosi na ispravak razmijenjene energije i pripadajućih gubitaka računat će se na primjeru 400 kV prijenosnog voda. Ove dvije naponske razine odabrane su jer su najzastupljenije u prijenosnom sustavu Republike Hrvatske dok je 220 kV naponska razina manje zastupljena. U zaključnim razmatranjima nakon provedenog proračuna procijenit će se mogućnost primjene jedne i druge metode za izračun gubitaka na svim naponskim razinama.

7.1. Rezultati mjerenja otpora prijenosnog voda

Mjerenja parametara prijenosnog voda provedena su na 110 kV vodu sljedećih tehničkih karakteristika: duljina 29,025 km, vodič Al/Fe, presjek vodiča 150/25 mm², tip stupa jednostruka jela. Rezultate mjerenja napona U , struje I i kuta φ između struje i napona za sve tri faze prikazuje tablica P.1. u dodatku. Mjerenje je provedeno s 200 ponavljanja. Rezultati umjeravanja mjernog uređaja pokazuju da je garantirana točnost 1% za struju i napon te 1° za kut. Rezultati su prikazani u obliku histograma s aproksimiranom inverznom Gaussovom razdiobom (slike 7.1.-7.3) koja pokazuje najbolje *log-likelihood* vrijednosti (tablica 7.1). Inverzna Gaussova razdioba zadana je jednadžbom

$$f(x; \mu; \lambda) = \left[\frac{\lambda}{2\pi x^3} \right]^{1/2} \exp \left\{ \frac{-\lambda(x - \mu)^2}{2\mu^2 x} \right\}, \quad (7-1)$$

za sve $x > 0$, gdje je $\mu > 0$ srednja vrijednost razdiobe a $\lambda > 0$ parametar oblika. Povećanjem λ prema beskonačnosti inverzna Gaussova razdioba postaje sličnija normalnoj razdiobi.

Tablica 7.1. *Log-likelihood* vrijednosti inverzne Gaussove razdiobe za napon, struju i kut za sve faze

	Log-likelihood
Struja I1	1106,300
Struja I2	1253,110
Struja I3	1263,700
Napon U1	509,273
Napon U2	754,400
Napon U3	730,579
Kut phi 1	518,329
Kut phi 2	660,734
Kut phi 3	670,509

Tablica P.2. prikazuje *log-likelihood* vrijednosti za druge razdiobe koje sadrži Matlab Distribution Fitting Tool: Birnbaum-Saunders razdioba, razdioba ekstremnih vrijednosti, gamma razdioba, poopćena razdioba ekstremnih vrijednosti, log-logistic razdioba, logistic razdioba, lognormalna razdioba, nakagami razdioba, Gaussova razdioba, Ricianova razdioba, t razdioba i Weibullova razdioba.

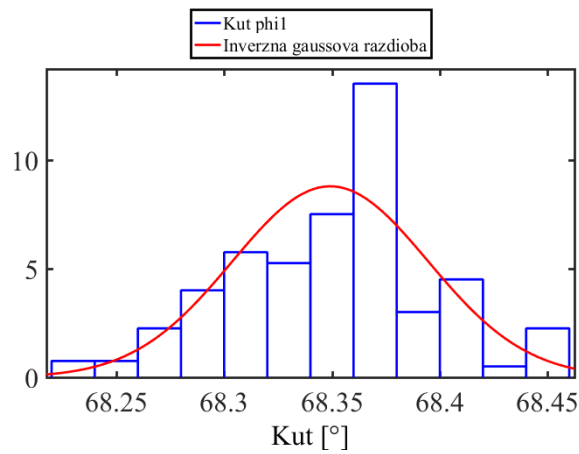
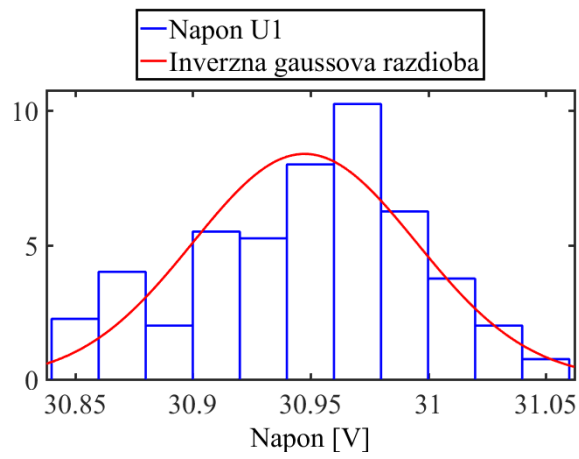
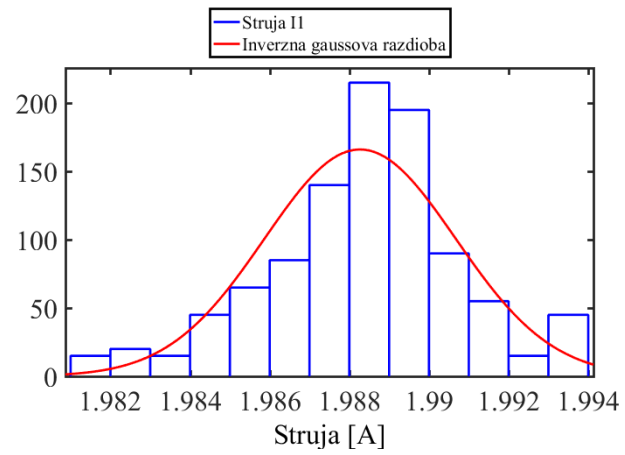

Slika 7.1. Histogram s inverznom Gaussovom razdiobom napona, struje i kuta faze L1

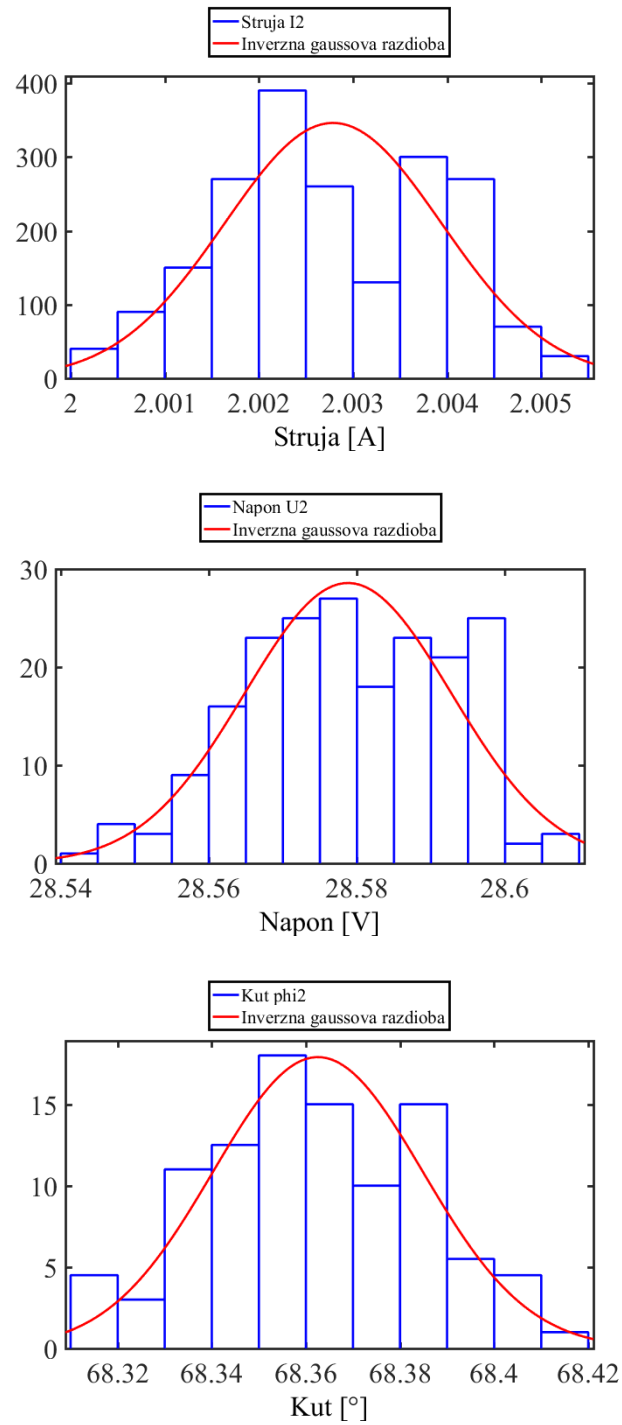

Slika 7.2. Histogram s inverznom Gaussovom razdiobom napona, struje i kuta faze L2

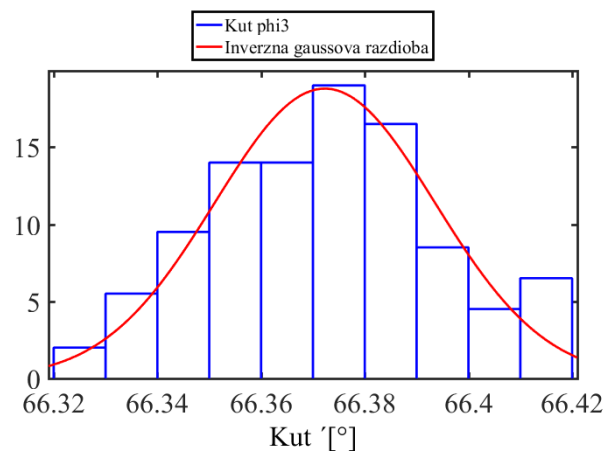
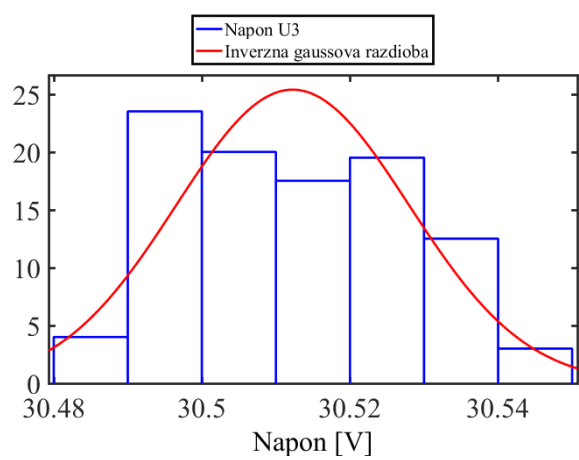
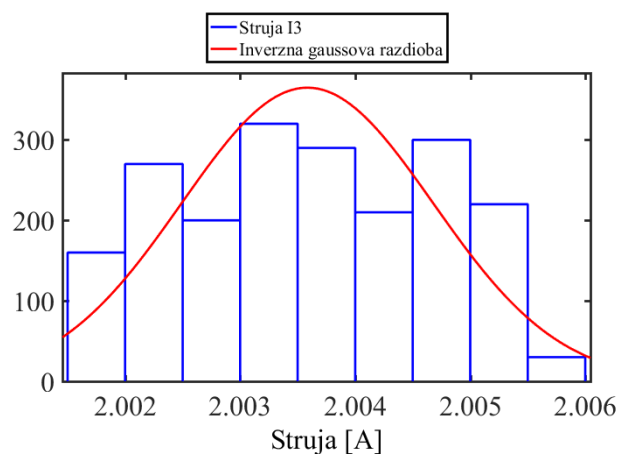

Slika 7.3. Histogram s inverznom Gaussovom razdiobom napona, struje i kuta faze L3

7.1.1. Rezultati proračuna mjerne nesigurnosti otpora s pomoću klasične GUM metode

Za sve mjerene parametre provodi se statistička analiza rezultata mjerenja. Za klasičnu GUM metodu izračunava se aritmetička sredina i standardna devijacija svakog parametra koji proizlaze iz uzastopnog ponavljanja mjerenja (A tip nesigurnosti) te ukupna nesigurnost koji se izračunava uvažavajući garantirane pogreške mjernog uređaja (B tip nesigurnosti) (tablica 7.2).

Tablica 7.2. Rezultati statističke analize rezultata mjerenja struje, napona i faznog kuta

	Srednja vrijednost	Standardna devijacija	Ukupna nesigurnost
Napon U1	30,94763	0,04752	0,1849
Napon U2	28,57880	0,01395	0,1656
Napon U3	30,51226	0,01572	0,1769
Struja I1	1,98827	0,00240	0,0117
Struja I2	2,00279	0,00115	0,0116
Struja I3	2,00359	0,00109	0,0116
Kut phi1	68,34923	0,04542	0,3972
Kut phi2	68,36256	0,02229	0,3953
Kut phi3	66,37231	0,02123	0,3838

Proračun otpora prijenosnog voda i pripadajuće mjerne nesigurnosti provodi se za svaku fazu posebno prema jednadžbama (4-11) - (4-17). Prilikom izračuna u obzir se uzima i matrica korelacija ulaznih veličina koju prikazuje tablica 7.3. Rezultate proračuna prikazuje tablica 7.4.

Tablica 7.3. Matrica korelacija ulaznih veličina

Faza L1			
	Napon U1	Struja I1	Kut phi 1
Napon U1	1	0,83062	0,190565
Struja I1	0,83062	1	0,187115
Kut phi 1	0,190565	0,187115	1

Faza L2			
	Napon U2	Struja I2	Kut phi 3
Napon U2	1	-0,35089	0,104249
Struja I2	-0,35089	1	-0,29584
Kut phi 2	0,104249	-0,29584	1

Faza L3			
	Napon U3	Struja I3	Kut phi 3
Napon U3	1	-0,36212	0,440021
Struja I3	-0,36212	1	0,353057
Kut phi 3	0,440021	0,353057	1

Tablica 7.4. Rezultati proračuna otpora prijenosnog voda i pripadajuće apsolutne mjerne nesigurnosti za svaku fazu uporabom GUM metode

	Srednja vrijednost	Složena nesigurnost
Otpor R1	5,7427	0,1020
Otpor R2	5,2616	0,0930
Otpor R3	6,1036	0,1076

7.1.2. Rezultati proračuna mjerne nesigurnosti otpora s pomoću MC metode

MC metoda provodi se sukladno uputama u potpoglavlju 3.3 s brojem iteracija $M=10^6$ koji se u literaturi navodi kao dovoljan za interval pokrivenosti 95% [78]. Kao ulazne veličine se koriste fitirane inverzne Gaussove razdiobe s parametrima prema tablici 7.5. te se simulira otpor za svaku fazu posebno.

Tablica 7.5. Parametri Inverzne Gaussove razdiobe za sve mjerene parametre

	Srednja vrijednost	Lambda	Standardna devijacija
Napon U1	30,9476	1,31196*10e7	0,04753146
Napon U2	28,5788	1,19879*10e8	0,01395385
Napon U3	30,5123	1,14969*10e8	0,01571887
Struja I1	1,98827	1,3625*10e6	0,00240186
Struja I2	2,00279	6,04508*10e6	0,00115279
Struja I3	2,00359	6,72828*10e6	0,00109335
Kut phi1	68,3492	1,54728*10e8	0,04542708
Kut phi2	68,3626	6,43102*10e8	0,02228885
Kut phi3	66,3723	6,48991*10e8	0,02122567

Izvršen je postupak aproksimacije razdioba na rezultate proračuna otpora prijenosnog voda. Najbolje *log-likelihood* vrijednosti (tablica 7.6) pokazuje ponovno inverzna Gaussova razdioba (slika 7.4) što je i očekivano jer su ulazne vrijednosti također opisane istom razdiobom. Parametre aproksimirane razdiobe prikazuje tablica 7.7. Provedbom MC metode dobivena je standardna devijacija odnosno standardna nesigurnost otpora prijenosnog voda. Rezultati su također prikazani u tablici 7.7. *Log-likelihood* vrijednosti za druge razdiobe prikazuje tablica P.6.u prilogu.

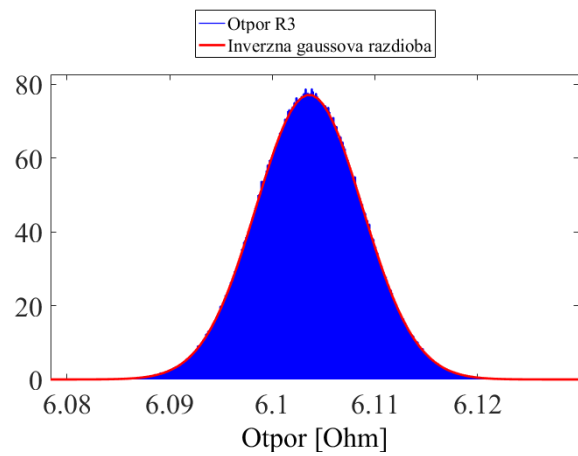
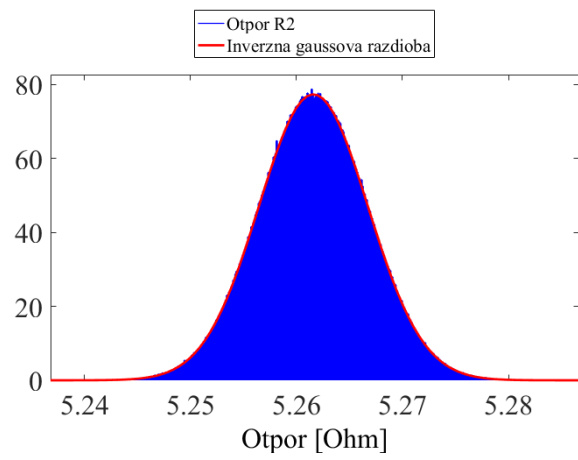
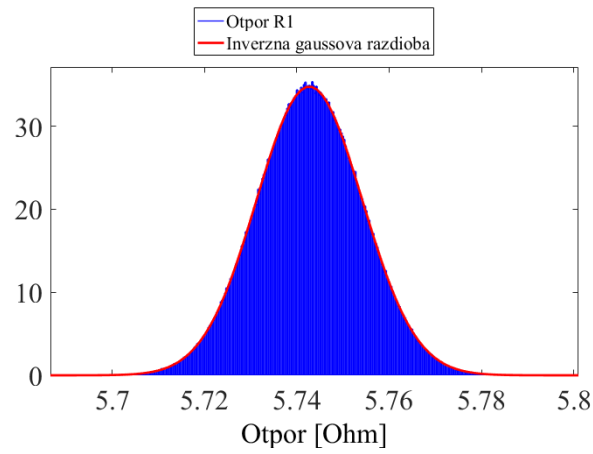

Slika 7.4. Rezultati proračuna otpora prijenosnog voda uporabom MC metode za svaku fazu i aproksimacije inverzne Gaussove razdiobe

Tablica 7.6. Log-likelihood vrijednosti inverzne Gaussove razdiobe

	Log-likelihood
Otpor R1	3968010
Otpor R2	476730
Otpor R3	4765140

Tablica 7.7. Parametri aproksimirane inverzne Gaussove razdiobe i standardna nesigurnost

	Otpor R1	Otpor R2	Otpor R3
Srednja vrijednost	5,7427	5,2616	6,1036
Lambda	1,43951*10e6	5,47608*10e6	8,551145*10e6
Standardna devijacija	0,0115	0,0052	0,0052

7.1.3. Rezultati proračuna mjerne nesigurnosti otpora s pomoću AMC metode

Za AMC metodu se koriste aproksimirane razdiobe s parametrima prema tablici 7.5. Proračun otpora prijenosnog voda i pripadajuće mjerne nesigurnosti provodi se za svaku fazu posebno prema uputama u poglavlju 3. Tablica 7.8. prikazuje broj iteracija AMC metode nakon kojeg je postignuta stabilnost rezultata.

Tablica 7.8. Broj iteracija AMC metode nakon kojeg je postignuta stabilnost rezultata

	Broj iteracija
Otpor R1	120000
Otpor R2	1230000
Otpor R3	1290000

Simulacije za sva tri otpora su proširene kako bi se prikazao uvid u proces stabilizacije rezultata. Naime, AMC metoda se provodi sve dok se rezultati ne stabiliziraju kao što je prethodno opisano u potpoglavlju 3.4. Ako bi se simulacija provela s manjim brojem iteracija stabilnost rezultata ne bi bila postignuta, dok s druge strane, simulacija s većim brojem iteracija je nepotrebna odnosno nepotrebno troši vrijeme i računalne resurse. Simulacija je započeta s $M=10000$ iteracija, sukladno preporuci u Dopuni 1 [13] te je osnovni korak povećanja iteracija također $M=10000$. Za otpor R1 je stabilnost postignuta nakon $M=120000$ iteracija, ali je simulacija proširena do $M=200000$ iteracija (tablica P.3.). Za otpor R2 je stabilnost postignuta nakon $M=1230000$ iteracija, ali je

simulacija proširena do $M=11700000$ iteracija (tablica P4). Za otpor R3 je stabilnost postignuta nakon $M=120000$ iteracija, ali je simulacija proširena do $M=200000$ iteracija (tablica P5).

Izvršen je postupak aproksimacije razdiobe na rezultate proračuna otpora u svim fazama. Najbolje *log-likelihood* vrijednosti (tablica 7.9.) pokazuje ponovno inverzna Gaussova razdioba (slika 7.5) što je i očekivano jer su ulazne vrijednosti također opisane istom razdiobom. Parametre aproksimirane razdiobe prikazuje tablica 7.10. *log-likelihood* vrijednosti za druge razdiobe prikazuje tablica P.6.u prilogu.

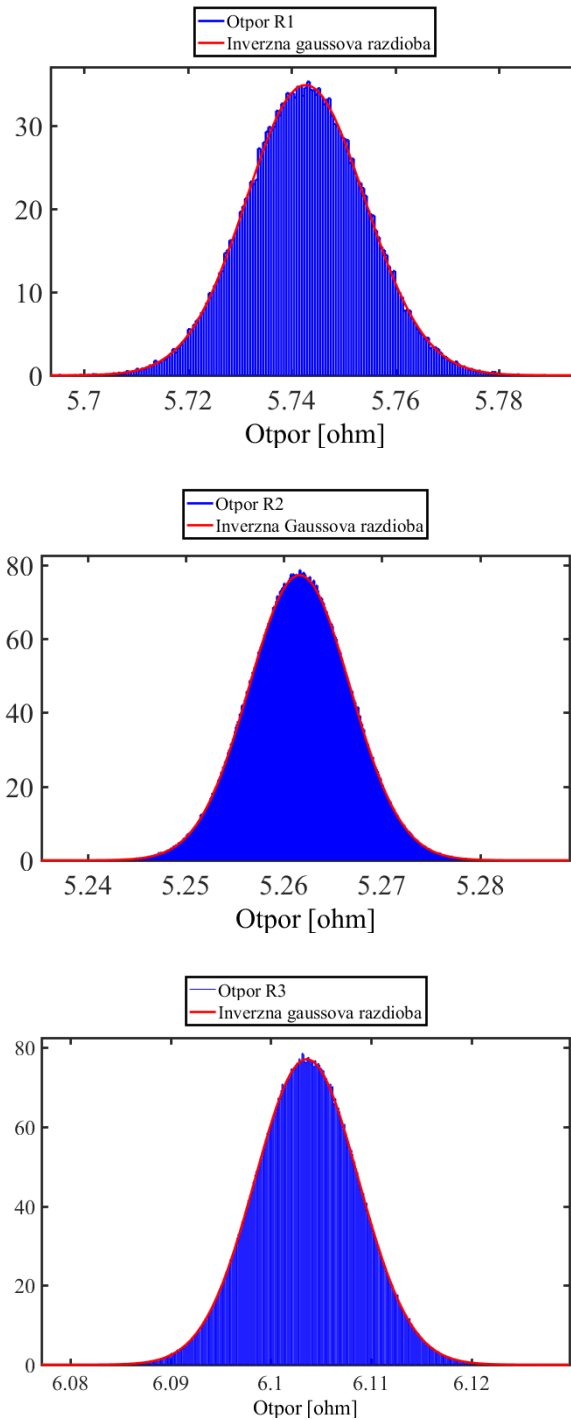

Slika 7.5. Rezultati proračuna otpora prijenosnog voda uporabom AMC metode za svaku fazu i aproksimacije inverzne Gaussove razdiobe

Tablica 7.9. *log-likelihood* vrijednosti inverzne Gaussove razdiobe

	Log-likelihood
Otpor R1	476664
Otpor R2	6243740
Otpor R3	6099220

Tablica 7.10. Parametri aproksimirane inverzne Gaussove razdiobe i standardna nesigurnost

	Otpor R1	Otpor R2	Otpor R3
Srednja vrijednost	5,74272	5,26161	6,10359
Lambda	1,45162*10e6	5,46425*10e6	8,50921*10e6
Standardna devijacija	0,011422215	0,005163129	0,005169313

7.1.4. Usporedba rezultata izračuna otpora prijenosnog voda

Tablica 7.11 usporedno prikazuje rezultate proračuna otpora prijenosnog voda u sve tri faze s pomoću svih primijenjenih metoda. Prikazane su srednje vrijednosti i standardne devijacije u apsolutnom i postotnom iznosu u odnosu na srednju vrijednost (vrijednosti u zagradi).

Tablica 7.11. Usporedba rezultata izračuna otpora prijenosnog voda

	Srednja vrijednost			Standardna devijacija		
	R1	R2	R3	R1	R2	R3
GUM	5,74	5,26	6,10	0,10 (1,78%)	0,09 (1,77%)	0,11 (1,76%)
MC	5,74	5,26	6,10	0,011 (0,19%)	0,005 (0,09%)	0,005 (0,08%)
AMC	5,74	5,26	6,10	0,011 (0,19%)	0,005 (0,09%)	0,005 (0,08%)

Može se uočiti da su srednje vrijednosti međusobno jednake neovisno o primijenjenoj metodi. Međutim, kod standardnih devijacija se mogu uočiti određene razlike. MC i AMC metoda imaju manje standardne devijacije nego GUM metoda. Uzroke navedenih sličnosti i razlika potražiti ćemo u načinu izračuna mjerne nesigurnosti. Sve metode imaju jednake ulazne vrijednosti koje su rezultat metode za mjerenja parametara prijenosnog voda. A tip mjerne nesigurnosti proizlazi upravo iz ponovljenih rezultata mjerenja parametara voda i rezultat je njihove statističke obrade. Stoga se može zaključiti da A tip nesigurnosti ne stvara značajnu razliku u konačnoj složenoj mjernoj nesigurnosti. Razlika se pojavljuje zbog načina uzimanja B tipa mjerne nesigurnosti. GUM metoda ima tzv. klasični način izračuna ukupne nesigurnost prema dokumentu [6] koji se temelji na korijenu iz sume kvadrata A i B tipa mjerne nesigurnosti kao što je prethodno opisano u uvodnim poglavljima te ćemo ga ovdje uzeti kao polaznu vrijednost. MC i AMC metode nemaju jasno iskazan način uzimanja B tipa nesigurnosti odnosno prema Dopuni 1 smatra se da je B tip već sadržan u nesigurnosti koja se odredi uporabom MC i AMC metode .

7.2. Rezultati mjerenja gubitaka prijenosnog voda

Rezultati proračuna otpora prijenosnog voda iz prethodnog potpoglavlja koristit će se za izračun gubitaka prijenosnog voda. U prvom trenutku računat će se gubici prema funkciji za mjerenje gubitaka ugrađenoj u brojila električne energije tj. prema gamma shemi (5-1). Kao i u prethodnom poglavlju, za proračun gubitaka i pripadajuće mjerne nesigurnosti koristit će se klasična GUM metoda, MC metoda i AMC metoda.

Dostupni su podaci o izmjerenim vrijednostima struje i napona na strani A prijenosnog voda za cijeli mjesec (2880 vrijednosti). Podaci su prikazani u tablici P.11. Pored toga dostupni su podaci o izmjerenim vrijednostima energija na stranama A i B prijenosnog voda u istom vremenskom razdoblju (2880 vrijednosti). Podaci su prikazani u tablici P.12.

Brojila električne energije na osnovu upisanog otpora prijenosnog voda kao konstante izračunavaju energiju gubitaka. Pri tome se ne upisuje otpor po fazama nego jedna vrijednost otpora. U promatranom slučaju u okviru disertacije dostupne se vrijednosti otpora po fazama, međutim, zbog sukladnosti proračuna s načelom rada brojila koristit će se srednja vrijednost otpora svih triju faza.

Mjerna nesigurnost mjerenja gubitaka električne energije računat će se za jednu karakterističnu mjernu točku iz promatranog mjeseca za koji se računaju gubici: izmjerena vrijednost napona $U = 116,1$ kV, izmjerena vrijednost struje $I = 34,082$ A. Podaci o strujama i naponima uzimaju se iz brojila električne energije koje ima određenu klasu točnosti za mjerenje energije, a nema za mjerenje struje i napona. Iz tog razloga se za mjernu nesigurnosti struje i napona uzima deklarirana nesigurnost umjeravanja strujnih i naponskih mjernih transformatora u certifikatu o umjeravanju u iznosu od 0,05%.

Rezultati izračuna prijenosnih gubitaka izračunatih prema pojedinoj metodi uspoređivat će se s gubicima izračunatim kao razlika izmjerenih energija na stranama A i B.

7.2.1. Rezultati proračuna gubitaka i pripadajuće mjerne nesigurnosti gubitaka s pomoću klasične GUM metode

Kao ulazna veličina koristi se rezultat proračuna otpora prijenosnog voda s pomoću klasične GUM metode (tablica 7.4.), a računa se prema jednadžbama (5-2) i (5-3). Srednja vrijednost otpora svih triju faza iznosi $R = 5,7026 \Omega$. Ukupni gubici prema gamma shemi za cijeli mjesec

iznose $E_{G_GUM_UK} = 15961$ kWh. Slika 7.6 prikazuje rezultate izračuna gubitaka po 15-minutnim periodima za cijeli mjesec.

Izračunati gubici u promatranoj karakterističnoj mjernoj točki iznose $E_{G_GUM_1} = 4,9685$ kWh. Izračunata standardna devijacija odnosno apsolutna standardna mjerna nesigurnost gubitaka električne energija za promatranu mjernu točku iznosi $u_{G_GUM} = 0,051$ kWh odnosno u postotnom iznosu $u_{G_GUM\%} = 1,022\%$. Cjelovit mjerni rezultat gubitaka glasi

$$E_{G_GUM} = (4,9685 \pm 0,051)kWh .$$

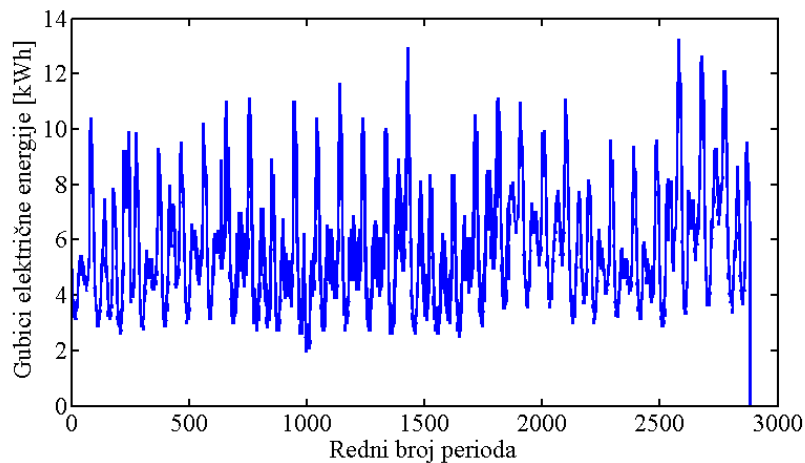

Slika 7.6. Izračunate vrijednosti gubitaka po periodima za cijeli mjesec

7.2.2. Rezultati proračuna gubitaka i pripadajuće mjerne nesigurnosti gubitaka s pomoću MC metode

Kao ulazne vrijednosti za proračun gubitaka s pomoću MC metode koriste se rezultati proračuna otpora prijenosnog voda s pomoću MC metode prikazani u tablici 7.7. Ukupni gubici prema gamma shemi za cijeli mjesec iznose $E_{G_MC_UK} = 15960$ kWh. Slika 7.7 prikazuje rezultate izračuna gubitaka po periodima za cijeli mjesec.

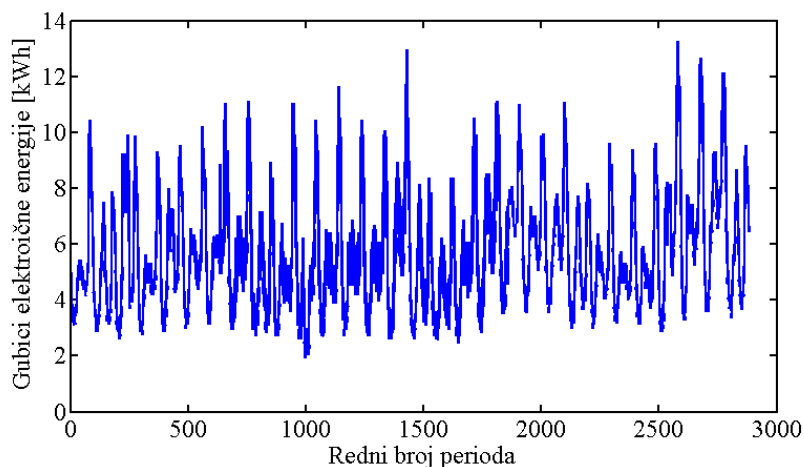

Slika 7.7. Izračunate vrijednosti gubitaka po periodima za cijeli mjesec

Izračunati gubici u promatranoj karakterističnoj mjernoj točki iznose $E_{G_{MC_1}} = 4,9685$ kWh. Izračunata standardna devijacija odnosno apsolutna standardna mjerna nesigurnost gubitaka električne energije za promatranu mjernu točku iznosi $u_{G_{MC}} = 0,0049$ kWh (Slika 7.8).

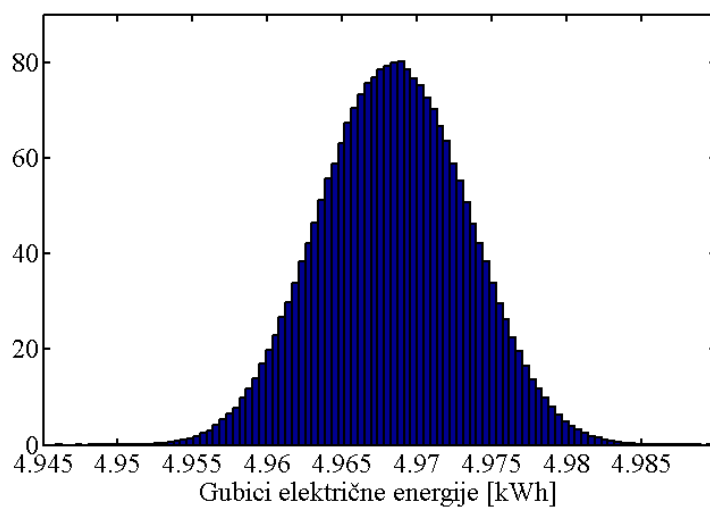

Slika 7.8. Razdioba mjerne nesigurnosti gubitaka u karakterističnoj mjernoj točki

7.2.3. Rezultati proračuna gubitaka i pripadajuće mjerne nesigurnosti gubitaka s pomoću AMC metode

Kao ulazne vrijednosti za proračun gubitaka s pomoću MC metode koriste se rezultati proračuna otpora prijenosnog voda s pomoću MC metode prikazani u tablici 7.10. Ukupni gubici prema

gamma shemi za cijeli mjesec iznose $E_{G_AMC_UK} = 15960$ kWh. Slika 7.9. prikazuje rezultate izračuna gubitaka po periodima za cijeli mjesec.

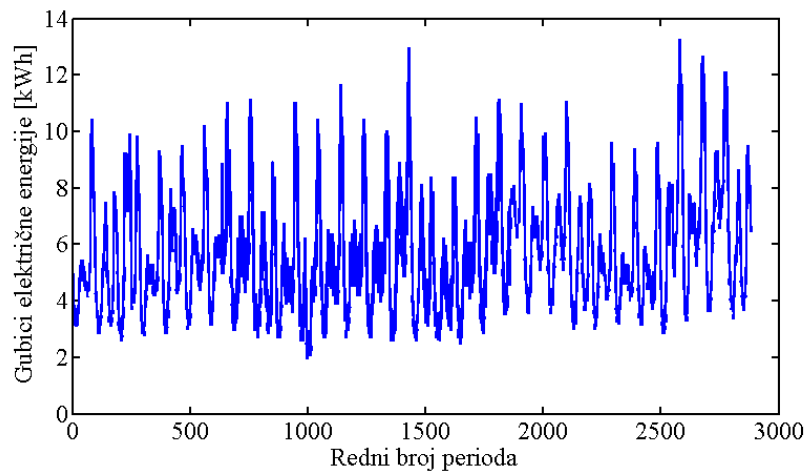

Slika 7.9. Izračunate vrijednosti gubitaka po periodima za cijeli mjesec

Izračunati gubici u promatranoj karakterističnoj mjernoj točki iznose $E_{G_AMC_1} = 4,9684$ kWh. Izračunata standardna devijacija odnosno apsolutna standardna mjerna nesigurnost gubitaka električne energije za promatranu mjernu točku iznosi $u_{G_AMC} = 0,0049$ kWh (Slika 7.10).

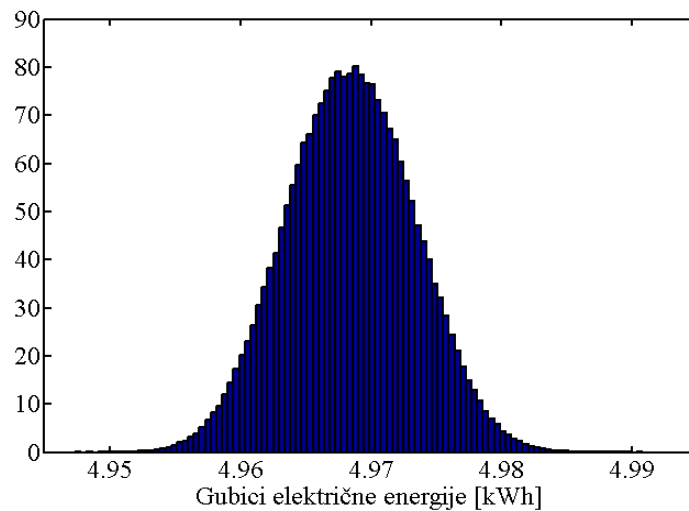

Slika 7.10. Razdioba A tipa mjerne nesigurnosti gubitaka u karakterističnoj mjernoj točki

7.2.4. Rezultati proračuna gubitaka kao razlike izmjerenih vrijednosti energije i usporedba s rezultatima drugih metoda

Često korištena metoda za izračun prijenosnih gubitaka u praksi je razlika izmjerenih energija na krajevima voda s tim da mora biti ispunjen temeljni uvjet da takva mjerenja postoje. Druga mogućnost je izračun energije prijenosnih gubitaka uporabom ugrađene funkcije u brojilo električne energije. U ovom poglavlju usporedit će se energija gubitaka izračunata kao razlika izmjerenih energija s energijom gubitaka izračunatih uporabom ugrađene funkcije u brojilo odnosno izračunatih preko nadomjesne sheme prijenosnog voda.

Ukupna izmjerena energija na strani A iznosi $E_A = 4818990 \text{ kWh}$ (slika 7.11.) i na strani B $E_B = 4836282 \text{ kWh}$ (slika 7.12.). Ukupni gubici izračunati kao razlika izmjerenih energija iznose $E_G = 17292 \text{ kWh}$ (Slika 7.13.) što iznosi 0,36% od energije izmjerene na strani A.

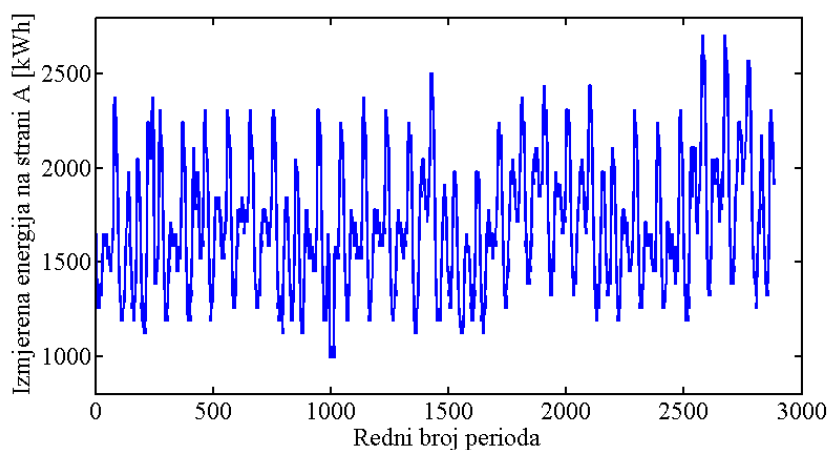

Slika 7.11. Izmjerene vrijednosti energije na strani A za cijeli mjesec

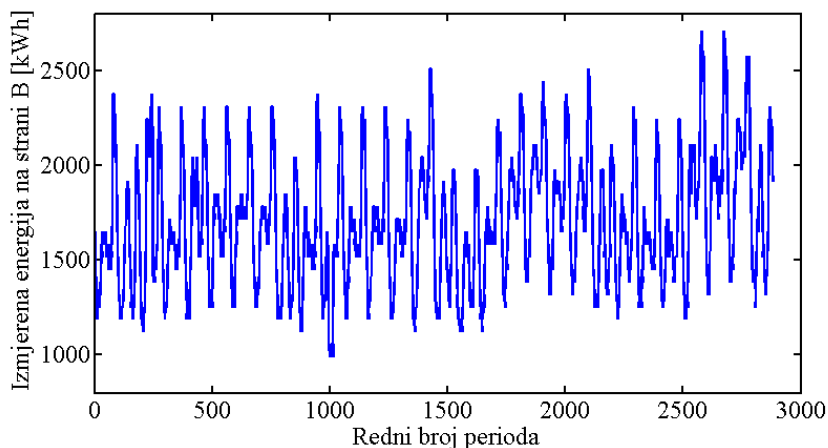

Slika 7.12. Izmjerene vrijednosti energije na strani B za cijeli mjesec

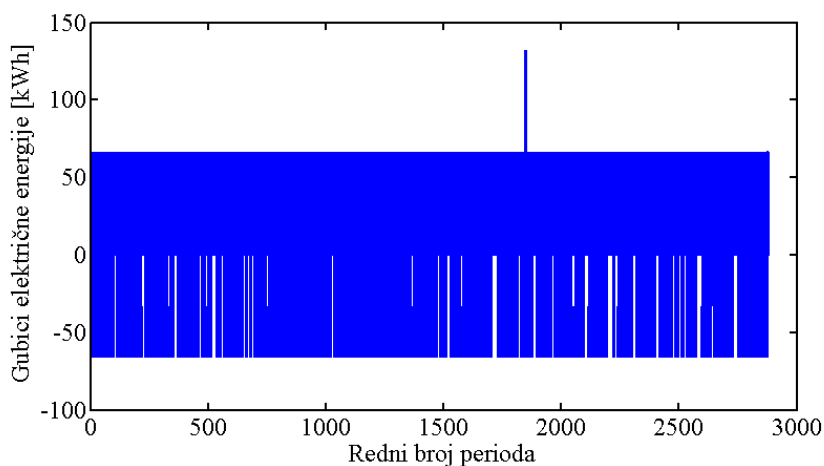

Slika 7.13. Izmjerene vrijednosti gubitaka električne energije izračunati kao razlika izmjerenih energija za cijeli mjesec

Tablica 7.12. usporedno prikazuje ukupne mjesečne gubitke izračunate prema svim navedenim metodama i pripadajući postotni iznos gubitaka u odnosu na razmijenjenu energiju.

Tablica 7.12. Usporedba ukupnih mjesečnih gubitaka

Metoda	Ukupni mjesečni gubici [kWh]	Postotni mjesečni gubici [%]
GUM	15961	0,33
MC	15960	0,33
AMC	15960	0,33
Razlika izmjerenih energija	17292	0,36

Može se uočiti da se ukupni mjesečni gubici izračunati prema GUM, MC i AMC metodama gotovo jednaki (15960 kWh) što daje i jednak postotni udio gubitaka (0,33%) prema razmijenjenoj

energiji. Gubici izračunati kao razlika izmjerenih energija (17292 kWh i 0,36%) su veći za 528 kWh od gubitaka izračunatih uporabom drugih metoda. Ovakav rezultat proizlazi iz niza nedostataka opisanih u poglavlju 5.1 koje sadrži svaka metoda koja koristi nadomjesne sheme voda. Također je potvrđena pretpostavka da izračun gubitaka kao razlike izmjerenih energija nadoknađuje opisane nedostatke i daje prihvatljivije rezultate izračuna prijenosnih gubitaka.

Tablica 7.13. usporedno prikazuje cjelovit mjerni rezultat gubitaka izračunat uporabom GUM, MC i AMC metode.

Tablica 7.13. Usporedba cjelovitih mjernih rezultata u karakterističnom periodu

Metoda	Srednja vrijednost [kWh]	Apsolutna mjerna nesigurnost [kWh]	Postotna mjerna nesigurnost [%]
GUM	4,9685	0,051	1,022%
MC	4,9685	0,045	0,91%
AMC	4,9684	0,046	0,91%

Rezultati MC i AMC metode se podudaraju ali se razlikuju od GUM metode. Ovakva razlika proizlazi prvenstveno iz karakteristika matematičkog modela koji sadrži nelinearne članove te na taj način nisu ispunjeni uvjeti za uporabu GUM metode opisani u poglavlju 2. Iz toga se zaključuje da su MC i AMC prihvatljive alternative za izračun mjerne nesigurnosti gubitaka.

7.2.5. Procjena funkcije gustoće vjerojatnosti gubitaka

Postupak procjene funkcije gustoće vjerojatnosti provest će se na praktičnom primjeru izračuna gubitaka prijenosa sukladno teorijskom uvodu u poglavlju 5.1.3. Proračun će biti proveden na istom prijenosnom 110 kV vodu iz poglavlja 7.1 i 7.2 ali zbog jednostavnosti prikaza na primjeru faze L1. Važno je napomenuti da se isti postupak općenito može provesti na bilo kojem prijenosnom vodu i u bilo kojoj fazi uz uvažavanje odgovarajućih rezultata mjerenja gubitaka.

Rezultati mjerenja struje I i napona U u promatranoj radnoj točki su: $I = 80.5 \text{ A}$, $U = 110.5 \text{ kV}$. Rezultati AMC metode za proračun otpora prijenosnog voda faze L1 iz poglavlja 7.1.3 se koriste kao ulazne veličine za izračun gubitaka prijenosnog voda. Stoga se lanac mjernih nesigurnosti u ovom postupku sastoji od inverzne gausove razdiobe za otpor R prijenosnog voda i dvije

uniformne razdiobe za struju I i napon U koji proizlaze iz umjernice mjernih transformatora gdje stoji da je nesigurnost umjeravanja 0,05%.

AMC metoda je provedena i rezultati su stabilizirani nakon $M=60000$ iteracija. Slika 7.14. prikazuje rezultate simulacije u obliku histograma s aproksimiranom empirijskom razdiobom.

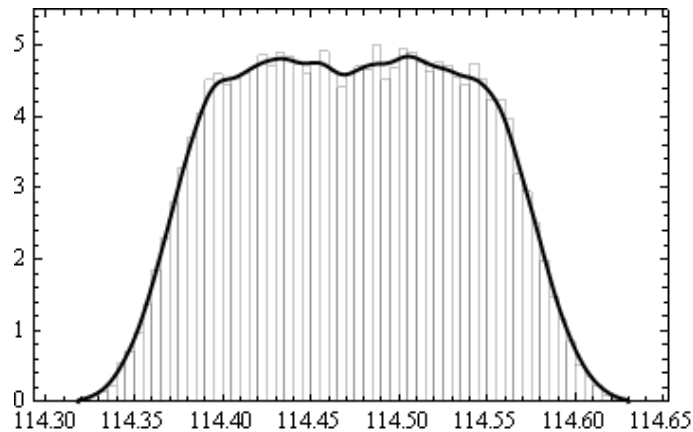

Slika 7.14. Histogram i empirijska razdioba rezultata simulacije gubitaka

Empirijska razdioba prikazana na slici sugerira simetrične parametarske razdiobe koje su mogući kandidati za odgovarajuću razdiobu gubitaka, a to su: četveroparametarska beta razdioba, poopćena trapezna razdioba i suma uniformne i normalne razdiobe. Za početak pogledajmo rezultate deskriptivne statistike u tablici 7.14.

Tablica 7.14. Rezultati deskriptivne statistike

Veličina	Gubici [kWh]
Minimum	114.304
Donji kvartil (25%)	114.421
Medijan (50%)	114.473
Gornji kvartil (75%)	114.526
Maksimum	114.644
Srednja vrijednost	114.473
Standardna devijacija	0.06387

Nadalje promotrimo teorijske karakteristike razdioba koje su mogući kandidati i rezultate aproksimacije njihovih parametara.

Generalizirana trapezna razdioba

Generalizirana trapezna razdioba zadana je funkcijom gustoće razdiobe

$$f_2(x; a, b, c, d) = \begin{cases} u_2 \alpha^2 \left(\frac{x-a}{b-a} \right)^{n_1-1}, & a \leq x < b \\ u_2 \left((\alpha-1) \frac{c-x}{c-b} + 1 \right), & b \leq x < c \\ u_2 \alpha \left(\frac{d-x}{d-c} \right)^{n_3-1}, & c \leq x < d \\ 0, & d < x \end{cases} \quad (7-3)$$

gdje je

$$u_2 = u_2(a, b, c, d, n_1, n_3, \alpha) = \frac{2n_1 n_3}{2\alpha(b-a)n_3 + (\alpha+1)(c-b)n_1 n_3 + 2(d-c)n_1}, \quad (7-4)$$

a parametri razdiobe a , b , c i d su realni brojevi takvi da vrijedi $a < b \leq c < d$ i $n_1, n_3, \alpha > 0$. Osim navedenih postoje još i tri dodatna parametra n_1 , n_3 i α :

- parametar n_1 određuje brzinu porasta funkcije na intervalu $[a, b]$
- parametar n_3 određuje brzinu pada funkcije na intervalu $[c, d]$
- parametar $\alpha = f_2(b)/f_2(c)$ određuje nagib pravca kroz točke $(b, f_2(b))$ i $(c, f_2(c))$.

Tablica 7.15. Procijenjeni parametri poopćene trapezne razdiobe

Parametar	Procjena
a	113.498
b	114.388
c	114.559
d	115.447
n_1	45.379
n_3	43.513

Slika 7.15 prikazuje empirijsku razdiobu i aproksimiranu poopćenu razdiobu prema parametrima iz tablice 7.15.

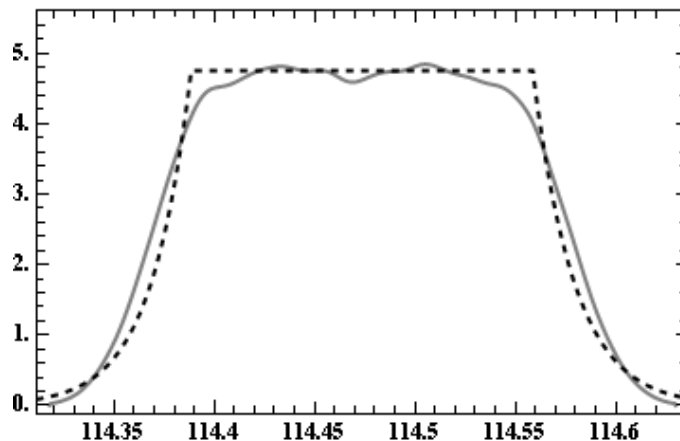

Slika 7.15. Empirijska razdioba i aproksimirana poopcena trapezna razdioba

Može se uočiti da aproksimirana razdioba dobro pokriva empirijsku razdiobu osim u rubnim područjima. Stoga je korisno razmotriti i druge predložene razdiobe.

Četveroparametarska beta razdioba

Četveroparametarska beta razdioba definirana je na intervalu $[c, d]$ gdje su c i d realni brojevi tako da vrijedi $-\infty < c < d < \infty$. Osim toga ova razdioba ima i dva dodatna parametra $\alpha > 0$ and $\beta > 0$ koji određuju oblik razdiobe

$$f_2(x; \alpha, \beta, c, d) = \begin{cases} \frac{1}{B(\alpha, \beta)} \frac{(x - c)^{\alpha-1} (d - x)^{\beta-1}}{(d - c)^{\alpha+\beta-1}}, & x \in [c, d] \\ 0, & \text{nadalje,} \end{cases} \quad (7-5)$$

gdje je $B(\alpha, \beta)$ beta funkcija o čemu se više detalja može naći u [108].

Rezultate aproksimacije metodom najmanjih kvadrata prikazuje tablica 7.16.

Tablica 7.16. Procijenjeni parametri četveroparametarske beta razdiobe

Parametar	Procjena
α	1.447
β	1.482
c	114.352
d	114.598

Slika 7.16. prikazuje empirijsku razdiobu i aproksimiranu četveroparametarsku beta razdiobu prema parametrima iz tablice 7.16.

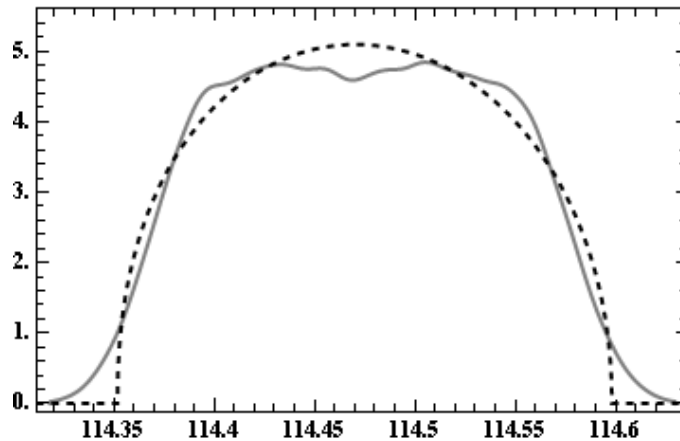

Slika 7.16. Empirijska razdioba i aproksimirana četveroparameterska beta razdioba

Iz slike se vidi da ova razdioba pokazuje odstupanja u rubnim područjima ali isto tako i u području oko srednje vrijednosti.

Suma pravokutne i normalne razdiobe

Suma pravokutne razdiobe na intervalu $[-a, a]$, $a > 0$ i normirane normalne razdiobe sa standardnom devijacijom σ^2 definira se funkcijom gustoće vjerojatnosti

$$f_3(x, a, \sigma) = \frac{1}{2a} \left(\Phi\left(\frac{a-x}{\sigma}\right) - \Phi\left(\frac{-a-x}{\sigma}\right) \right), \quad (7-6)$$

gdje je $\Phi(x)$ Gaussova razdioba definirana kao

$$\Phi(x) = \frac{1}{\sqrt{2\pi}} \int_{-\infty}^x e^{-\frac{t^2}{2}} dt. \quad (7-7)$$

Više detalja o ovoj razdiobi i njezinoj primjeni može se pronaći u [101], [109]. Rezultate aproksimacije *maximum likelihood* metodom prikazuje tablica 7.17.

Tablica 7.17. Procijenjeni parametri sume pravokutne i normalne razdiobe

Parametar	Procjena
α	0.106
σ	0.019

Slika 7.17. prikazuje empirijsku razdiobu i aproksimiranu sumu pravokutne i normalne razdiobe prema parametrima iz tablice 7.17.

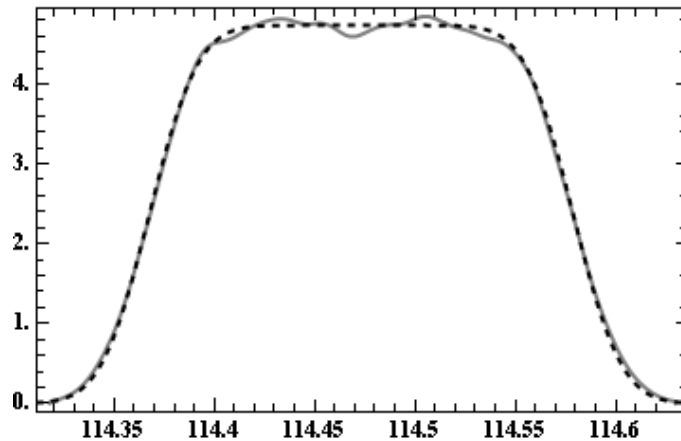

Slika 7.17. Empirijska razdioba i aproksimirana suma pravokutne i normalne razdiobe

Iz slike se vidi da ova razdioba najbolje aproksimira empirijsku razdiobu. Aproksimacija je provedena i za još neke razdiobe kako bi se isključile druge razdiobe kao potencijalni kandidati. Rezultate prikazuje tablica 7.18.

Tablica 7.18. Procjena parametara drugih razdioba

Razdioba	Procjena parametara
Gaussova razdioba	$\mu=114.473$ $\sigma=0.06388$
Log-normalna	$\mu=4.74034$ $\sigma=0.00066$
Rayleigh razdioba	$\sigma=80.9448$

Nadalje će se provesti Kolmogorov-Smirnov (KS) statistički test s ciljem numeričke usporedbe prikazanih razdioba (tablica 7.19).

Tablica 7.19. Vrijednosti KS statistike

Razdioba	KS statistika
Suma pravokutne i normalne razdiobe	0.00234378
Četveroparameterska beta razdioba	0.012209
Poopćena trapezna razdioba	0.012542
Gaussova razdioba	0.0469557
Log-normalna	0.0483328
Rayleigh razdioba	0.631083

Iz tablice se vidi da su vrijednosti KS statistike najmanje za sumu pravokutne i normalne razdiobe najmanje te je stoga ova razdioba potvrđena kao najbolja aproksimacija razdiobe promatranih gubitaka prijenosa.

KS test proveden s razinom značajnosti 0,05 ne odbacuje nul-hipotezu da je razdioba gubitaka dobro aproksimirana sumom uniformne i normalne razdiobe s parametrima iz tablice 7.22 (p vrijednost je 0,896602) dok je za ostale razdiobe odbačena ista nul hipoteza i p vrijednosti su jednake nuli. Na taj način je još jednom potvrđeno da ova razdioba najbolje aproksimira gubitke prijenosa iz promatranog primjera.

Važno je napomenuti da se opisani postupak može ponoviti u bilo kojem drugom praktičnom primjeru ali treba uzeti u obzir da razdiobe koje su ovdje procijenjene kao najbolje neće biti iste općenito u svim drugim primjerima odnosno ovdje provedeni postupak može dati drugačije rezultate ovisno o prirodi promatranih podataka tj. njihove empirijske razdiobe.

7.3. Rezultati praktičnog primjera raspodjele razmijenjene energije između operatora prijenosnih sustava

Postupak raspodjele razmijenjene energije opisan u poglavlju 0 provest će se na praktičnom primjeru koji će biti opisan u ovom poglavlju. Promatra se 400 kV prijenosni vod. Zbog povjerljivosti podataka neće se navoditi ime promatranog voda, a karakteristike obračunskog mjernog mjesta i vrijednosti izmjerene energije su vrlo malo izmijenjeni bez značajnog utjecaja na konačne rezultate i zaključak proračuna.

7.3.1. Podaci o obračunskom mjernom mjestu

Slika 7.25. prikazuje načelnu shemu obračunskog mjernog sustava koji se sastoji od strujnih i naponskih mjernih transformatora, strujnih i naponskih mjernih grana uključujući automatsku zaštitnu preklopku i brojila električne energije.

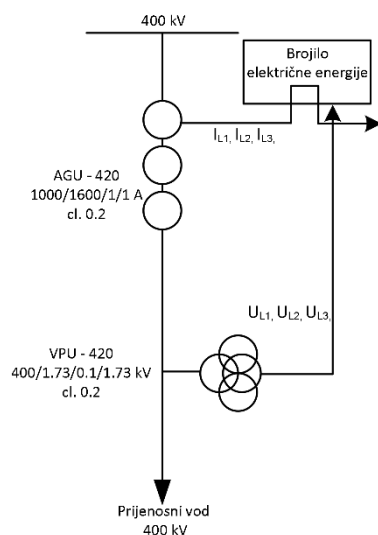

Slika 7.18. Načelna shema obračunskog mjernog sustava

Proračun će se izvršiti u jednoj radnoj točki tj. u jednom 15-minutnom periodu na karakterističnu srijedu mjeseca lipnja 2015. godine. Izmjerene vrijednosti u promatranoj radnoj točki prikazane su u tablici 7.20. Energija teče iz transformatorske stanice A prema transformatorskoj stanici B.

Tablica 7.20. Promatrana radna točka (15.6.2015., 19:45-20:00 h)

Mjerna točka A	Mjerna točka B
$E_{mjA}=82000 \text{ kWh}$	$E_{mjB}=81600 \text{ kWh}$
$\varphi_{S1}=\varphi_{S2}=\varphi_{S3}=18.60^\circ$	$\varphi_{S1}=\varphi_{S2}=\varphi_{S3}=12.71^\circ$
$I_1 = I_2 = I_3 = 489.7 \text{ A}$	$I_1 = I_2 = I_3 = 471.2 \text{ A}$
$U_1 = U_2 = U_3 = 408 \text{ kV}$	$U_1 = U_2 = U_3 = 410 \text{ kV}$

Umjernice strujnih i naponskih mjernih transformatora iskazuju pogreške u cijelom radnom području. Za potrebe disertacije iz umjernice, koja se neće objaviti zbog povjerljivosti podataka, su interpolacijom izračunate pogreške prikazane u tablici 7.21. U naponskim granama priključeno je samo elektroničko brojilo električne energije čiji su naponski ulazi visokoimpedantni te predstavljaju zanemariv teret. Stoga se uzima da je pad napona u naponskim mjernih granama jednak nuli.

Tablica 7.21. Deklarirane mjerne pogreške u promatranoj radnoj točki

Mjerna točka A	Mjerna točka B
$p_{U1\%} = -0,031\%$	$p_{U1\%} = -0,035\%$
$p_{U2\%} = 0,020\%$	$p_{U2\%} = 0,041\%$
$p_{U3\%} = -0,002\%$	$p_{U3\%} = -0,005\%$
$p_{I1\%} = 0,04695\%$	$p_{I1\%} = 0,04683\%$
$p_{I2\%} = 0,00667\%$	$p_{I2\%} = 0,00672\%$
$p_{I3\%} = -0,03719\%$	$p_{I3\%} = -0,03823\%$
$\delta_{UL1}^I = 0,09^I$	$\delta_{UL1}^I = -3,11^I$
$\delta_{UL2}^I = 0,21^I$	$\delta_{UL2}^I = -2,15^I$
$\delta_{UL3}^I = 3,30^I$	$\delta_{UL3}^I = -1,28^I$
$\delta_{IL1} = 3,485^I$	$\delta_{IL1} = -4,231^I$
$\delta_{IL2} = 5,903^I$	$\delta_{IL2} = -3,853^I$
$\delta_{IL3} = 3,742^I$	$\delta_{IL3} = -2,546^I$
$p_{BR\%} = 0,01\%$	$p_{BR\%} = 0,01\%$
$p_{PN1\%}, p_{PN2\%},$ $p_{PN3\%} = 0\%$	$p_{PN1\%}, p_{PN2\%},$ $p_{PN3\%} = 0\%$

Osim pogrešaka strujnih i naponskih mjernih transformatora i brojila električne energije, doprinos ukupnoj nesigurnosti obračunskog mjernog mjesta daju i mjerne nesigurnosti umjeravanja uređaja koji se također iskazuju u umjernici (tablica 7.22.).

Tablica 7.22. Mjerne nesigurnosti umjeravanja uređaja i preostala mjerna nesigurnost

Mjerna točka A	Mjerna točka B
$u_{NMTcal} = 0,05\%$	$u_{NMTcal} = 0,05\%$
$u_{BRcal\%} = 0,03\%$	$u_{BRcal\%} = 0,03\%$
$u_{SMTcal} = 0,05\%$	$u_{SMTcal} = 0,05\%$
$u_{PN\%} = 0\%$	$u_{PN\%} = 0\%$
$u_{PMN\%} = 0,067\%$	$u_{PMN\%} = 0,067\%$

7.3.2. Ispravak razmijenjene energije u jednoj radnoj točki

Proračun je proveden sukladno opisu u poglavlju 0. Rezultati su prikazani u tablici 7.23. a veličine su sljedeće:

- u_{mjA}, u_{mjB} – postotna mjerna nesigurnost energije mjerene na stranama A i B,
- u_{mjA_aps}, u_{mjB_aps} - apsolutna mjerna nesigurnost energije mjerene na stranama A i B, E_A, E'_A ,
- E_B, E'_B – cjelovit mjerni rezultat ispravljene i neispravljene energije mjerene na stranama A i B,
- E_G, E'_G – neispravljene i ispravljene gubici,
- u_G, u'_G – neispravljena i ispravljena postotna mjerna nesigurnost gubitaka,
- u_{Gaps}, u'_{Gaps} - neispravljena i ispravljena apsolutna mjerna nesigurnost gubitaka,
- E_{G_UK}, E'_{G_UK} – cjelovit mjerni rezultat ispravljenih i neispravljenih gubitaka,
- $E_{GA}, E_{GB}, E'_{GA}, E'_{GB}$ – neispravljene i ispravljene gubici pripisani strani A i strani B,
- E_{VMT}, E'_{IVMT} – energija neispravljene i ispravljene VMT.

Tablica 7.23. Rezultati proračuna

Bez ispravka	Uz ispravak
$E_{mjA}=82000$ kWh	$E'_{mjA} = 82052$ kWh
$E_{mjB}=81600$ kWh	$E'_{mjB} = 81593$ kWh
$u_{mjA} = 0,14$ %	$u'_{mjA} = 0,08$ %
$u_{mjA_aps} = 113$ kWh	$u'_{mjA_aps} = 67$ kWh
$E_A = 82000 \pm 113$ kWh	$E'_A = 82052 \pm 67$ kWh
$u_{mjB} = 0,15$ %	$u'_{mjB} = 0,08$ %
$u_{mjB_aps} = 118$ kWh	$u'_{mjB_aps} = 67$ kWh
$E_B = 81600 \pm 118$ kWh	$E'_B = 81593 \pm 67$ kWh
$E_G = 400$ kWh	$E'_G = 459$ kWh
$u_{Gaps} = 164$ kWh	$u'_{Gaps} = 95$ kWh
$E_{G_UK} = 400 \pm 164$ kWh	$E'_{G_UK} = 459 \pm 95$ kWh
$E_{GA} = 219$ kWh	$E'_{GA} = 251$ kWh
$E_{GB} = 181$ kWh	$E'_{GB} = 208$ kWh
$E_{VMT}=81781$ kWh	$E'_{IVMT} = 81800$ kWh

Izmjerena energija na stranama A i B prijenosnog voda je ispravljena, a mjerna nesigurnost je smanjena. Na taj način je postignut prvi cilj: mjerna nesigurnost energije je smanjena s 0,14% na 0,08 % na strani A i s 0,15% na 0,08% na strani B. Drugim riječima, razmijenjena energija je pravednije raspodijeljena među OPS-ovima. Prijenosni gubici povećani su s 400 kWh na 459 kWh dok se pripadajuća apsolutna mjerna nesigurnost smanjila sa 164 kWh na 95 kWh. S time je postignut i drugi cilj: gubici su ispravljene i mjerna nesigurnost im je smanjena. Drugim riječima,

gubici su poštenije raspodijeljeni među OPS-ovima. Važno je uočiti da je energija u ispravljenoj virtualnoj mjernoj točki $E_{IVMT} = 81800$ kWh povećana u usporedbi s energijom u neispravljenoj virtualnoj mjernoj točki $E_{VMT}=81781$ kWh. Stoga, OPS B će morati platiti više isporučene energije.

7.3.3. Ispravak razmijenjene energije u cijelom mjesecu

Dodatni proračun proveden je za cijeli mjesec srpanj 2015. godine. Ulazni podaci za proračun prikazani su u dodatku P.13. u osnovnim obračunskim periodima (15 minuta) za cijeli promatrani mjesec. Ukupna razmijenjena energija izmjerena na strani A iznosi $E_{mjA}=219618,400$ MWh, a na strani B $E_{mjB}=218189,600$ MWh. Energija virtualne mjerne točke iznosi $E_{VMT}=218836,605$ MWh, a vrijednosti po mjernim točkama prikazuje slika 7.19.

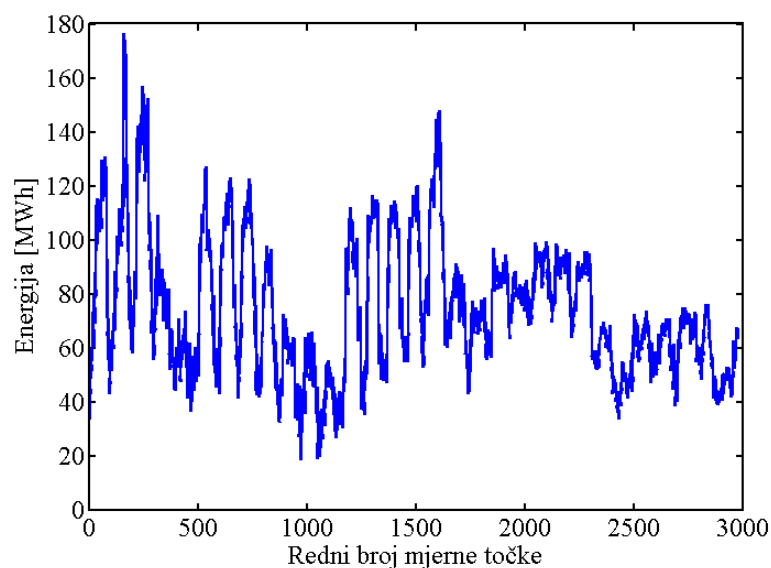

Slika 7.19. Energija virtualne mjerne točke za cijeli mjesec srpanj 2015.

Nakon ispravka, energija virtualne mjerne točke prelazi u energiju ispravljene virtualne mjerne točke $E_{IVMT}=218890,048$ MWh što čini razliku od 53,444 MWh koji bi bili krivo pripisani za obračun električne energije (slika 7.20.).

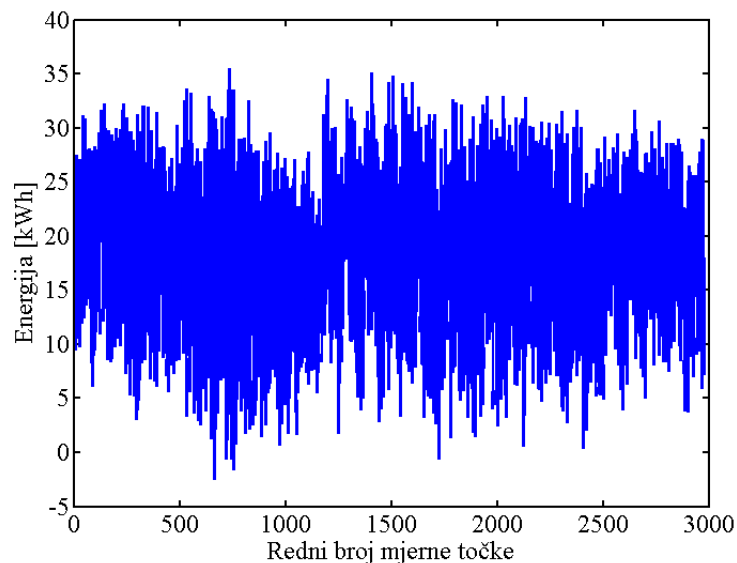

Slika 7.20. Ispravci energije za cijeli mjesec srpanj 2015.

Uzimajući u obzir cijenu električne energije na tržištu preuzete s javno dostupne internetske stranice [110] krivo pripisana električna energija bi na tržištu iznosila 2892,2 € za mjesec srpanj 2015. godine. Ovdje valja napomenuti da je ostvarena cijena razmjene električne energije predmet bilateralnih sporazuma i nije javno dostupna. Iz tog razloga za potrebe disertacije uzeta je javno dostupna cijena po kojoj se energija nudi na tržištu dan unaprijed što ne odstupa značajno od ostvarene cijene i smatra se zadovoljavajućom procjenom za potrebe analize u disertaciji. Iznosi ispravaka u eurima po periodima za cijeli mjesec prikazuje slika 7.21. Cijene električne energije prikazane su u dodatku P.13.

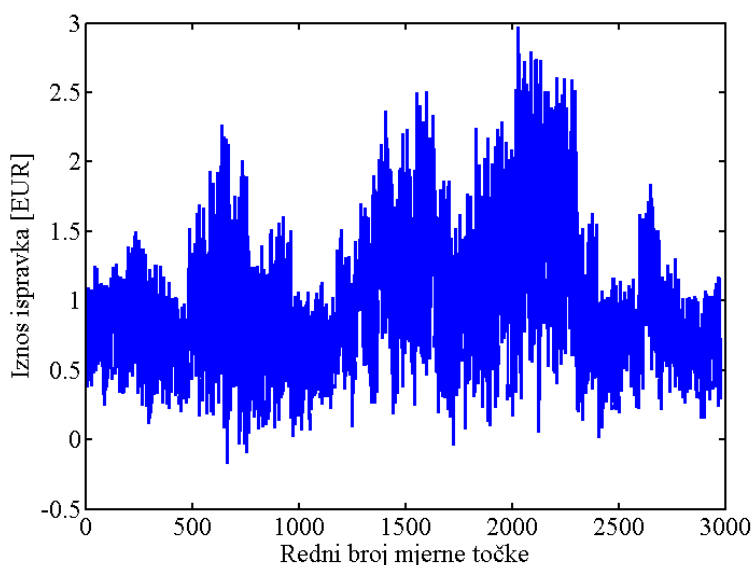

Slika 7.21. Iznos ispravaka u eurima za cijeli mjesec srpanj 2015.

Rezultati proračuna po svim periodima za cijeli mjesec prikazani su u dodatku u tablici P.14.

7.3.4. Analiza osjetljivosti matematičkog modela za ispravak razmijenjene energije

Sukladno opisu u poglavlju 6.2.2, provest će se praktični proračun osjetljivosti matematičkog modela za ispravljenu razmijenjenu energiju (6-7) na promjenu strujne naponske i kutne pogreške. Strujne, naponske i kutne pogreške korištene u proračunu su očitane iz jednog karakterističnog primjera umjernica strujnih i naponskih mjernih transformatora i brojila električne energije uz nazivno opterećenje sekundarnih mjernih grana. Brojčane vrijednosti prikazuju tablice 7.24. i 7.25. Radi jednostavnosti i preglednosti analize pretpostavit će se jednake umjernice u sve tri faze što neće narušiti dobivene rezultate.

Tablica 7.24. Naponske i kutne pogreške naponskog mjernog transformatora

U / U_n	$p_U (\%)$	$\delta_U (^\circ)$
0,8	-0,12	3
1,0	-0,12	2,9
1,2	-0,13	2,7

Tablica 7.25. Strujne i kutne pogreške strujnog mjernog transformatora

I / I_n	$p_I (\%)$	$\delta_I (^\circ)$
0,2	-0,07	3,5
1	-0,03	0,5
2	-0,05	1,5

Linearnom interpolacijom iz tablica 7.24. i 7.25. dobivaju se jednadžbe krivulja pogrešaka:

$$y_{p_U} = \begin{cases} -0.12, & 0.8 \frac{U}{U_N} < x < 1 \frac{U}{U_N} \\ -0.05x - 0.07, & 1 \frac{U}{U_N} < x < 1.2 \frac{U}{U_N} \end{cases}, \quad (7-8)$$

$$y_{\delta_U} = \begin{cases} -0.5x + 3.4, & 0.8 \frac{U}{U_N} < x < 1 \frac{U}{U_N} \\ -x + 3.9, & 1 \frac{U}{U_N} < x < 1.2 \frac{U}{U_N} \end{cases}, \quad (7-9)$$

$$y_{p_I} = \begin{cases} 0.05x - 0.08, & 0.2 \frac{I}{I_N} < x < 1 \frac{I}{I_N} \\ -0.02x - 0.01, & 1 \frac{I}{I_N} < x < 2 \frac{I}{I_N} \end{cases}, \quad (7-10)$$

$$y_{\delta_I} = \begin{cases} -3.75x + 4.25, & 0.2 \frac{I}{I_N} < x < 1 \frac{I}{I_N}, \\ x - 0.5, & 1 \frac{I}{I_N} < x < 2 \frac{I}{I_N}, \end{cases} \quad (7-11)$$

Brojilo električne energije, sukladno umjernici, griješi 0.01%. Analiza osjetljivosti provodi se prema jednadžbama (6-8) do (6-13) uporabom nazivnih vrijednosti pogrešaka $p_U = -0.12\%$, $\delta_U = 2.9'$, $p_I = -0.03\%$, $\delta_I = 0.5'$ i $U = 400 \text{ kV}$ i nazivnih izmjerenih vrijednosti na promatranom obračunskom mjernom mjestu $\varphi_S = 18^\circ$, $I = 430 \text{ A}$ i $E_{mj} = 70917 \text{ kWh}$ za temeljni obračunski period $t=15 \text{ min}$.

7.3.4.1. Utjecaj naponske pogreške naponskog mjernog transformatora

Osjetljivost ispravljene energije E_{mj} na naponsku pogrešku p_U ispitana je sukladno jednadžbi (6-8). Promjena naponske pogreške opisana je jednadžbom (7-8).

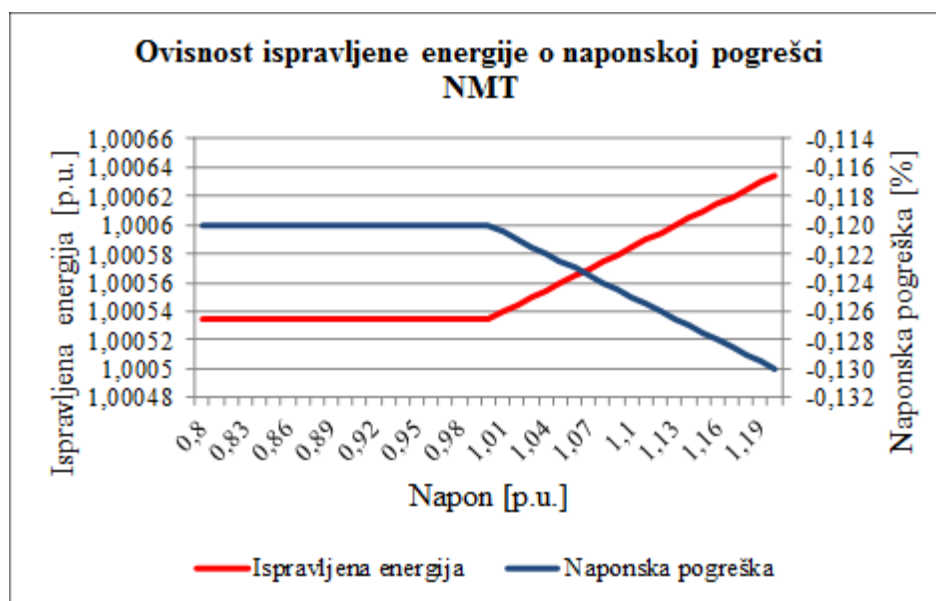

Slika 7.22. Utjecaj naponske pogreške (plava linija) naponskog mjernog transformatora na ispravljenu energiju (crvena linija)

Slika 7.22. prikazuje promjenu ispravljene energije E_{mj} iskazanu u *per unit* (p.u.) jedinicama odnosno normiranu prema izmjerenoj energiji u nazivnim uvjetima kod promjene naponske pogreške u cijelom radnom području primarnog napona na vodu iskazanog također u *per unit* (p.u.) jedinicama odnosno normiranog na nazivni napon. Iz slike se vidi da je naponska pogreška konstantna do nazivnog pogonskog napona te je i ispravljena energija konstantna. Iznad nazivnog napona naponska pogreška (plava linija) linearno pada, a ispravljena energija (crvena linija) linearno raste. Iste način prikazivanja koristi se i na slikama 7.23 – 7.27.

7.3.4.2. Utjecaj kutne pogreške naponskog mjernog transformatora

Osjetljivost ispravljene energije E_{mj} na kutnu pogrešku δ_U ispitana je sukladno jednadžbi (6-9)(6-8). Promjena kutne pogreške naponskog mjernog transformatora opisana je jednadžbom (7-

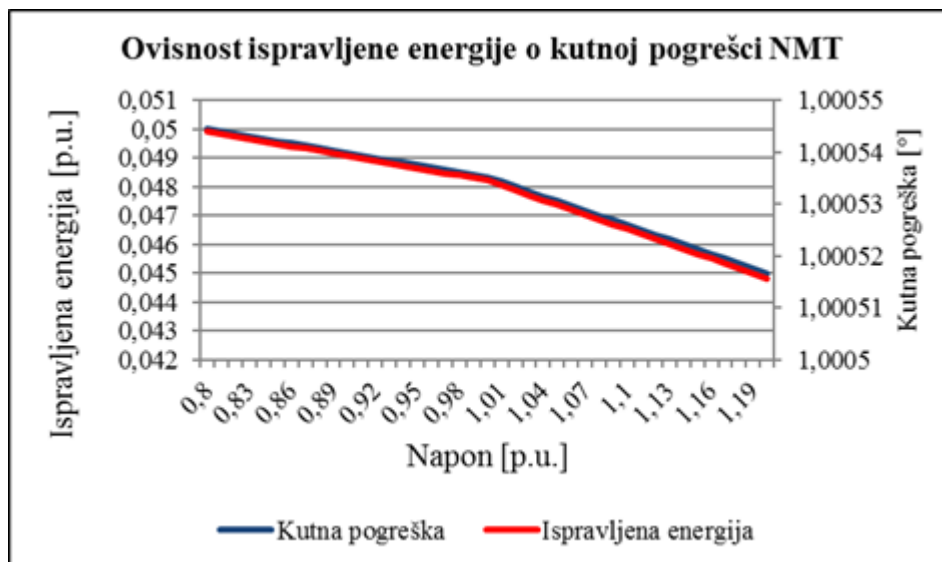

Slika 7.23. Utjecaj kutne pogreške (plava linija) naponskog mjernog transformatora na ispravljenu energiju (crvena linija)

9).

Slika 7.23. prikazuje promjenu ispravljene energije E_{mj} kod promjene kutne pogreške naponskog mjernog transformatora u cijelom radnom području primarnog napona na vodu. Iz slike se vidi da kutna pogreška i ispravljena energija padaju s porastom napona na vodu u cijelom radnom području.

7.3.4.3. Utjecaj strujne pogreške strujnog mjernog transformatora

Osjetljivost ispravljene energije E_{mj} na strujnu pogrešku p_I ispitana je sukladno jednadžbi (6-10)(6-8). Promjena strujne pogreške strujnog mjernog transformatora opisana je jednadžbom (7-

10).

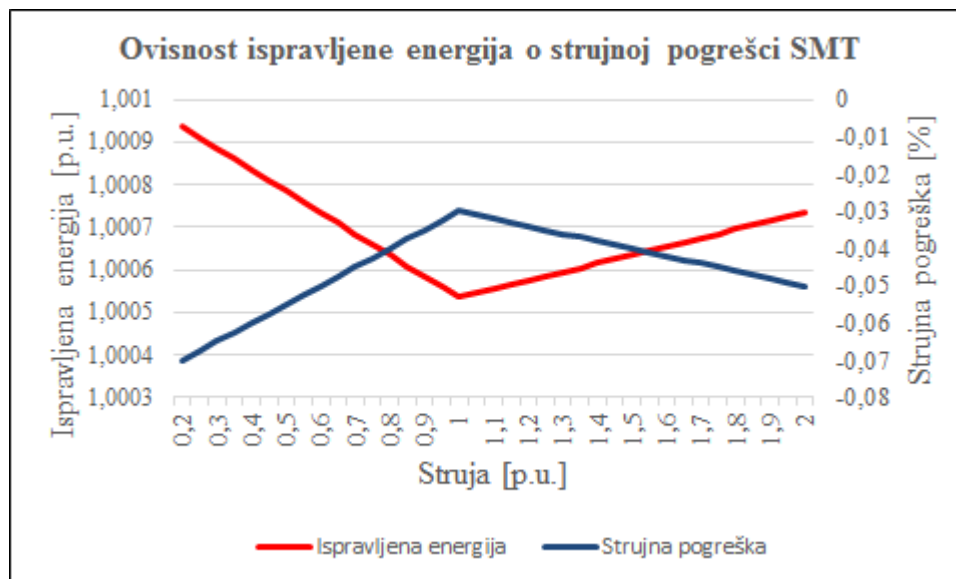

Slika 7.24. Utjecaj strujne pogreške (plava linija) strujnog mjernog transformatora na ispravljenu energiju (crvena linija)

Slika 7.24. prikazuje promjenu ispravljene energije E_{mj} kod promjene strujne pogreške strujnog mjernog transformatora u cijelom radnom području primarne struje na vodu. Iz slike se vidi da strujna pogreška raste do nazivne pogonske struje, a nakon toga pada. Ispravljena energija se ponaša obrnuto tj. pada do nazivne struja, a nakon toga linearno pada.

7.3.4.4. Utjecaj kutne pogreške strujnog mjernog transformatora

Osjetljivost ispravljene energije E_{mj} na strujnu pogrešku δ_I ispitana je sukladno jednadžbi (6-11)(6-8). Promjena strujne pogreške strujnog mjernog transformatora opisana je jednadžbom (7-11).

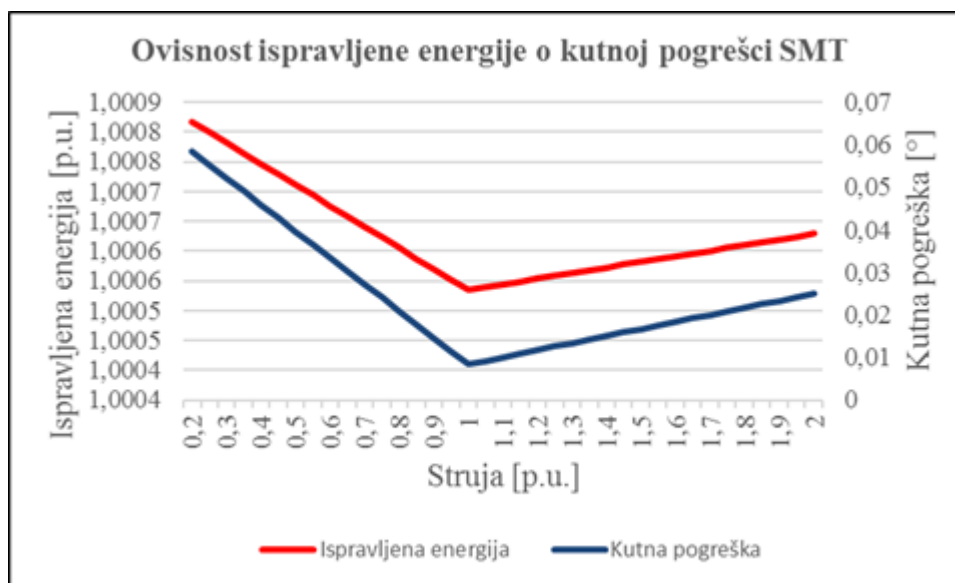

Slika 7.25. Utjecaj kutne pogreške (plava linija) strujnog mjernog transformatora na ispravljenu energiju (crvena linija)

Slika 7.25. prikazuje promjenu ispravljene energije E_{mj}^* kod promjene strujne pogreške strujnog mjernog transformatora u cijelom radnom području primarne struje na vodu. Iz slike se vidi da kutna pogreška struje pada do nazivne struje, a nakon toga raste. Ispravljena energija se ponaša jednako tj. pada linearno do nazivne struje, a nakon toga raste do kraja mjernog područja.

7.3.4.5. Utjecaj pogreške brojila električne energije

Osjetljivost ispravljene energije E_{mj}^* na postotnu pogrešku brojila $p_{BR\%}$ ispitana je sukladno jednadžbi (6-13)(6-8) u realnom rasponu pogrešaka od -0,05% do +0,05%.

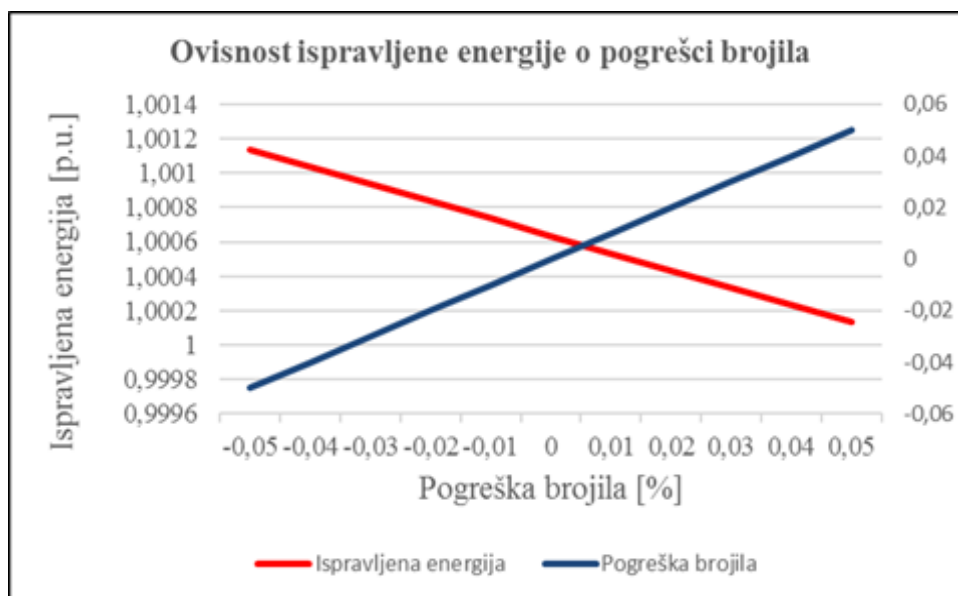

Slika 7.26. Utjecaj postotne pogreške (plava linija) brojila električne energije na ispravljenu energiju (crvena linija)

Slika 7.26. prikazuje obrnuto proporcionalni utjecaj pogreške brojila na ispravljenu energiju. Porastom pogreške u cijelom rasponu ispravljena energija linearno pada.

7.3.4.6. Utjecaj pada napona u naponskim mjernom krugovima

Osjetljivost ispravljene energije E'_{mj} na pad napona u naponskim mjernim krugovima p_{PN} ispitana je sukladno jednadžbi (6-13) (6-8) u rasponu mogućih padova napona od 0-5%.

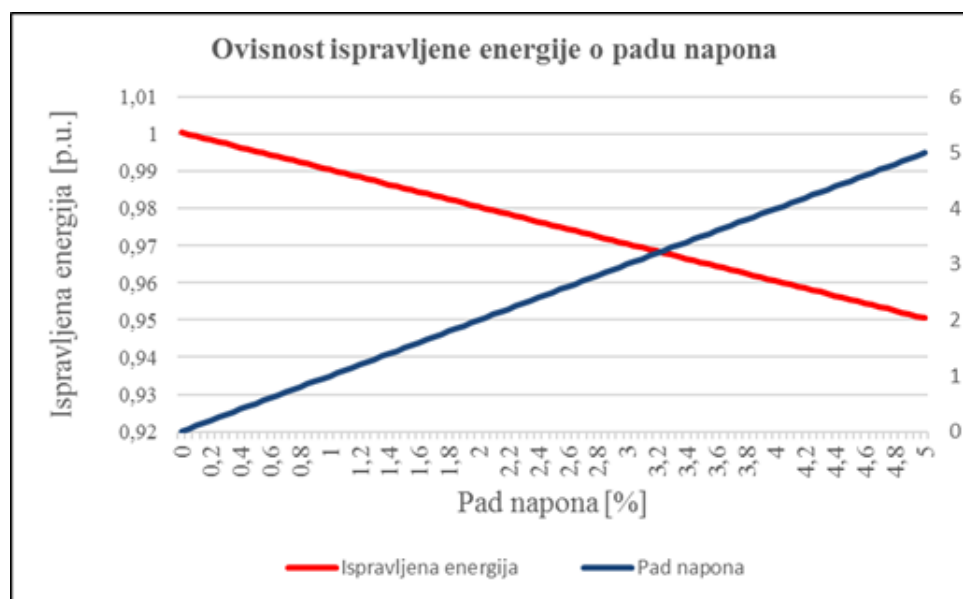

Slika 7.27. Utjecaj pada napona (plava linija) u naponskim mjernim krugovima na ispravljenu energiju (crvena linija)

Slika 7.27. prikazuje obrnuto proporcionalni utjecaj pada napona na ispravljenu energiju. Porastom pada napona u cijelom rasponu ispravljena energija linearno pada.

7.3.4.7. Izračun indeksa osjetljivosti i elastičnosti ispravljene energije

Osjetljivost ispravljene električne energije E_{mj} računata je prema jednadžbama (6-21) i (6-22). Osjetljivost pokazuje relativnu promjenu ovisne varijable pri promjeni neovisne varijable od najmanje do najveće vrijednosti. Rezultate u postocima prikazuje tablica 7.26.

Tablica 7.26. Osjetljivost ispravljene energije

Osjetljivost ispravljene energije na pogreške NMT		
Interval	$0,8U/U_N < x < 1U/U_N$	$1U/U_N < x < 1,2U/U_N$
p_U	0	0,009989
δ_U	-0,00094202	-0,0018843
Osjetljivost ispravljene energije na pogreške SMT		
Interval	$0,2I/I_N < x < 1I/I_N$	$1I/I_N < x < 2I/I_N$
p_I	-0,039976	0,019996
δ_I	-0,028216	0,0094164
Osjetljivost ispravljene energije na pogreške brojila		
Interval	-0,05% - +0,05%	
$p_{BR\%}$	-0,099887	
Osjetljivost ispravljene energije na pad napona		
Interval	0 – 5%	
$p_{PN\%}$	-4,9945	

Predznaci postotne osjetljivosti se podudaraju sa trendovima promjene ispravljene energije prikazane prethodno na grafovima u sklopu analize osjetljivosti. Iz rezultata se vidi da ispravljena električna energija E_{mj} najviše ovisi o padu napona u sekundarnim mjernim granama, i to obrnuto proporcionalno što znači da s većim padom napona ispravljena energija se smanjuje. Navedenu činjenicu treba uzeti u obzir prilikom projektiranja i izgradnje naponskih mjernih grana i težiti da pad napona bude što manji.

Elastičnost ispravljene električne energije E_{mj} računata je prema jednadžbama (6-15) do (6-20). Elastičnost se računa kao omjer postotne promjene ovisne varijable i postotne promjene neovisne

varijable. Drugim riječima, računa se brzina promjene ovisne varijable, tj. nagib krivulje koja opisuje tu promjenu. Rezultate prikazuje tablica 7.27.

Tablica 7.27. Elastičnost ispravljene energije

Elastičnost ispravljene energije na pogreške NMT		
Interval	$0,8U/U_N < x < 1U/U_N$	$1U/U_N < x < 1,2U/U_N$
p_U	0	0,00049945
δ_U	-3,7681e-005	-9,4215e-005
Elastičnost ispravljene energije na pogreške SMT		
Interval	$0,2I/I_N < x < 1I/I_N$	$1I/I_N < x < 2I/I_N$
p_I	-9,994e-005	0,00019996
δ_I	-7,054e-005	9,4164e-005
Elastičnost ispravljene energije na pogreške brojila		
Interval	-0,05% - +0,05%	
$p_{BR\%}$	-0,00049943	
Elastičnost ispravljene energije na pad napona		
Interval	0 – 5%	
$p_{PN\%}$	-0,049945	

Rezultati prikazani u tablici pokazuju da je najbrža promjena ispravljene energije s promjenom pada napona u naponskim mjernim krugovima što se podudara s prethodnim rezultatima kod proračuna indeksa osjetljivosti. Navedenu činjenicu treba uzeti u obzir prilikom projektiranja i izgradnje naponskih mjernih grana i težiti da pad napona bude što manji. To se postiže tako da se u naponske mjerne krugove ugrađuje što manje uređaja, na obračunskim mjernim mjestima obično samo brojila električne energije i automatska zaštitna sklopka. S napretkom tehnologije elektromehanička brojila sve više izlaze iz uporabe, a zamjenjuju ih statička brojila koja imaju visokoimpedantne naponske ulaze i gotovo zanemarivu potrošnju energije što olakšava postizanje vrlo malog, gotovo zanemarivog pada napona.

U primjeru prikazanom u sklopu disertacije uspješno je postignut zanemarivi pad napona upravo zbog takve konfiguracije mjernih krugova što danas postaje redovita praksa kod svih obračunskih mjernih mjesta, a posebno kod međunarodne razmjene.

8. ZAKLJUČAK

U teorijskom dijelu disertacije prezentirane su općenito metode za izračun mjerne nesigurnosti prisutne u znanstvenoj literaturi i mjeriteljskoj praksi. Osnovni i najšire prihvaćeni dokument koji preporuča jedinstven i jednostavan način za izračun mjerne nesigurnosti je `Guide to the expression of uncertainty in measurement`. Dokument opisuje tzv. klasični način izračuna mjerne nesigurnosti koji se primjenjuje u mnogim znanstvenim područjima. Upravo zbog svoje jednostavnosti koja je omogućena zbog niza zanemarenja, ta metoda sadrži određene nedostatke. Najznačajniji su pretpostavka da su ulazne i izlazne veličine opisane normalnom ili t razdiobom te pretpostavka linearnog matematičkog modela mjernog procesa. Kao rezultat toga proizlazi da se kroz matematički model propagira ograničena količina informacija odnosno, točnije rečeno, samo srednja vrijednost i standardna devijacija izlazne veličine. Navedeni nedostaci u velikoj mjeri se nadoknađuju uporabom Monte Carlo metode za izračun mjerne nesigurnosti sukladno dokumentu `Evaluation of measurement data - Supplement 1 to the "Guide to the expression of uncertainty in measurement" – propagation of distributions using a Monte Carlo method, JCGM, 2008`. Ova metoda procjenjuje stvarnu razdiobu ulaznih vrijednosti u mjerni proces na temelju rezultata mjerenja, uzima zadani broj uzoraka i razdiobe te s njima ulazi u mjerni proces. Izlazna veličina sadrži jednak broj uzoraka te se može ponovno procijeniti razdioba izlazne veličine, ovisno o potrebama interpretacije rezultata. Na taj način prenosi se potpuna informacija s ulaznih na izlazne veličine. U istom dokumentu opisana je i adaptivna Monte Carlo metoda koja se temelji na istom načelu kao i Monte Carlo metoda s razlikom što se razdioba ulaznih vrijednosti ne uzorkuje s unaprijed zadanim brojem uzoraka nego se taj broj postupno povećava sve do statističke stabilizacije rezultata.

Praktični rezultati disertacije mogu se podijeliti u dvije cjeline. Prvi dio odnosi se na proračun otpora i gubitaka prijenosnog voda i izračun pripadajuće mjerne nesigurnosti. Za potrebe disertacije dostupni su rezultati mjerenja parametara 110 kV prijenosnog voda te rezultati mjerenja energije gubitaka na oba kraja voda. Mjerna nesigurnost otpora prijenosnog voda računata je s pomoću svih metoda za izračun mjerne nesigurnosti prikazanih u teorijskom dijelu disertacije. Rezultati pokazuju da se srednje vrijednosti otpora ne razlikuju značajno neovisno o odabranoj metodi. Međutim, u standardnim devijacijama odnosno ukupnoj mjernoj nesigurnosti postoje određene razlike. A tip mjerne nesigurnosti je rezultat statističke obrade rezultata mjerenja te ne unosi značajnu razliku u ukupnu nesigurnost dok se razlika u tretmanu B tipa očituje u različitoj ukupnoj nesigurnosti.

Energija prijenosnih gubitaka računata je na istom prijenosnom vodu za jedan cijeli mjesec. Gubici su računati s pomoću funkcije za izračun gubitaka ugrađene u suvremeno brojilo električne energije te kao razlika izmjerenih energija na krajevima prijenosnog voda. Rezultati pokazuju da su potonji gubici nešto veći od gubitaka izračunatih s pomoću brojila električne energije te se mogu smatrati prihvatljivijima prvenstveno zbog utjecaja atmosferskih prilika na gubitke voda. Naime, za potrebe izračuna energije gubitaka, u brojila električne energije upisuje se otpor prijenosnog voda kao konstanta što unosi pogreške zbog utjecaja atmosferskih prilika na otpor voda koji nisu uzeti u obzir.

Drugi dio praktičnih rezultata disertacije odnosi se na raspodjelu razmijenjene energije između operatora prijenosnih sustava uključujući i ispravak izmjerene energije za iznos poznatih sustavnih pogrešaka. Na temelju teorijske podloge u kojoj je prezentirana metodologija proveden je praktični proračun na primjeru 400 kV međunarodnog prijenosnog voda koji je odabran zbog velike količine prenesene energije čime metoda poprima na svojoj značajnosti. Prikazan je postupak ispravka razmijenjene energije i pripadajućih prijenosnih gubitaka za iznos sistematskih pogrešaka. Rezultati pokazuju da su se nakon ispravka mjerne nesigurnosti smanjile, a iznosi razmijenjene energije i gubitaka jednom operatoru smanjili, a drugome povećali. Drugim riječima, razmijenjena energija je raspodijeljena na pravedniji način što potvrđuje pretpostavku iznesenu u hipotezi disertacije. Isti postupak proveden je i za jedan cijeli mjesec te je prikazan financijski iskaz razmijenjene energije na temelju aktualnih cijena prijenosa električne energije koje se nude na tržištu za dan unaprijed. Rezultati pokazuju značajnu financijsku uštedu u slučaju kada se provede postupak ispravka razmijenjene energije i pripadajućih gubitaka.

Provedena je i analiza osjetljivosti matematičkog modela za ispravak razmijenjene energije na promjenu naponske i kutne pogreške naponskog mjernog transformatora, strujne i kutne pogreške strujnog mjernog transformatora, pogreške brojila te pada napona u naponskim mjernim krugovima. Izračunati su i indeksi elastičnosti i osjetljivosti. Rezultati pokazuju da ispravljena energija najviše ovisi i padu napona u naponskim mjernom krugovima. Ovakav rezultat potvrđuje i praktična nastojanja da se u naponske mjerne krugove na obračunskim mjernom mjestima ne priključuju drugi uređaji osim elektroničkog brojila električne energije koje ima visokoimpedantni naponski ulaz te na taj način predstavlja zanemariv teret naponskih mjernih grana i posljedično zanemariv utjecaj na izmjerenu energiju.

Prvi dio praktičnih rezultata prikazan je na 110 kV prijenosnom vodu isključivo zbog toga što su rezultati mjerenja parametara voda dostupni za takav vod. Na isti način proračun se može provesti i na 400 kV vodu kao i na bilo kojoj drugoj naponskoj razini. Drugi dio rezultata proveden je na 400 kV vodu prvenstveno zbog toga što je hrvatski elektroenergetski sustav koncipiran tako da se

većina međunarodne razmjene energije odvija preko 400 kV mreže. Velika količina energije koje se prenosi preko 400 kV vodova čini ovu metodu značajnom za primjenu na takvim vodovima iako se ista metoda može primijeniti na prijenosni vod bilo koje naponske razine.

Rezultati disertacije prikazuju značajnu tehničku i financijsku važnost propisivanja i primjene metode za ispravnu raspodjelu električne energije i pripadajućih gubitaka uključujući i postupak ispravaka izmjerenih vrijednosti za iznos sustavnih pogrešaka.

Mogućnosti nastavka prikazanog istraživanja mogu se podijeliti na dva područja. Prvo područje odnosi se na raspodjelu razmijenjene energije i gubitaka izračunatih s pomoću funkcije za mjerenje gubitaka ugrađene u brojilo električne energije. Ovako izračunati gubici, ako se istovremeno mjere na obje strane prijenosnog voda što je slučaj kod međunarodne razmjene, međusobno se razlikuju. Postavlja se pitanje koje od dva mjerenja je mjerodavno za obračun. U okviru disertacije je prikazano na koji način se takvi gubici računaju uključujući i razdiobu takvih gubitaka ako se računaju s pomoću Monte Carlo metode. U daljnjem istraživanju potrebno je odrediti metodu za raspodjelu takvih gubitaka uzimajući u obzir njihove razdiobe s ciljem da takva metoda bude pravedna odnosno da tako raspodijeljena energija i pripadajući gubici ne budu nikome od sudionika na štetu.

Drugo područje odnosi se na raspodjelu razmijenjene energije i pripadajućih gubitaka ako se mjerenje vrši na obje strane voda, a gubici se računaju kao razlika izmjerenih energija te se vrši ispravak izmjerenih vrijednosti za iznos sustavnih pogrešaka. U okviru disertacije prikazano je na koji način se ovakva metoda provodi. U daljnjem istraživanju je potrebno izraditi algoritam koji će ovu metodu automatizirati tj. omogućiti njezinu implementaciju u praktičnim svakodnevnim mjerenjima.

9. LITERATURA

- [1] M. Basil, C. Papadopoulos, D. Sutherland, and H. Yeung, "Application of probabilistic uncertainty methods (Monte- Carlo simulation) in flow measurement uncertainty estimation," in *Flow Measurement 2001 – International Conference Application*, 2001, pp. 1–21.
- [2] M. Solaguren-Beascoa Fernández, J. M. Alegre Calderón, and P. M. Bravo Díez, "Implementation in MATLAB of the adaptive Monte Carlo method for the evaluation of measurement uncertainties," *Accredit. Qual. Assur.*, vol. 14, no. 2, pp. 95–106, 2009.
- [3] A. Ferrero and S. Salicone, "Uncertainty: Only one mathematical approach to its evaluation and expression?," *IEEE Trans. Instrum. Meas.*, vol. 61, no. 8, pp. 2167–2178, 2012.
- [4] A. Ferrero and S. Salicone, "Fully comprehensive mathematical approach to the expression of uncertainty in measurement," *IEEE Trans. Instrum. Meas.*, vol. 55, no. 3, pp. 706–712, 2006.
- [5] I. Tolić, K. Miličević, and A. Tokić, "Measurement Uncertainty of Transmission Line Resistance Calculation Using GUM and AMC Method," *IET Sci. Meas. Technol.*, vol. 11, no. 3, pp. 339–345, 2017.
- [6] JCGM 100:2008, "Evaluation of Measurement Data—Guide to the Expression of Uncertainty in Measurement," 2008.
- [7] JCGM 100:2008, "Vrednovanje mjernih podataka – Upute za iskazivanje mjerne nesigurnosti," 2008.
- [8] S L R Ellison and A. Williams, *Eurachem/CITAC guide: Quantifying Uncertainty in Analytical Measurement, Third edition*, vol. 3rd. 2012.
- [9] E. Koort, "Uncertainty Estimation of Potentiometrically Measured pH and pKa Values," University of Tartu, Estonia, 2006.
- [10] P. D. S. Hack and C. Ten Caten, "Measurement Uncertainty: Literature Review and Research trends," *IEEE Trans. Instrum. Meas.*, vol. 61, no. 8, pp. 2116–2124, 2012.
- [11] A. Giordani and L. Mari, "Measurement, models, and uncertainty," *IEEE Trans. Instrum. Meas.*, vol. 61, no. 8, pp. 2144–2152, 2012.
- [12] W. Bich, "From Errors to Probability Density Functions. Evolution of the Concept of Measurement Uncertainty," *IEEE Trans. Instrum. Meas.*, vol. 61, no. 8, pp. 2153–2159, 2012.
- [13] JCGM 101:2008, "Evaluation of measurement data — Supplement 1 to the 'Guide to the expression of uncertainty in measurement' — Propagation of distributions using a Monte Carlo method," 2008.

- [14] A. Ferrero, M. Prioli, and S. Salicone, "Joint Random-Fuzzy Variables : A tool for propagating uncertainty through non-linear measurement functions," *IEEE Trans. Instrum. Meas.*, vol. 65, no. 5, pp. 1015–1021, 2015.
- [15] C. Elster, W. Wöger, and M. G. Cox, "Draft GUM Supplement 1 and Bayesian analysis," *Metrologia*, vol. 44, no. 3, pp. L31–L32, 2007.
- [16] R. Kacker, B. Toman, and D. Huang, "Comparison of ISO-GUM, draft GUM Supplement 1 and Bayesian statistics using simple linear calibration," *Metrologia*, vol. 43, no. 4, pp. S167–S177, 2006.
- [17] I. Lira and W. Wöger, "Comparison between the conventional and Bayesian approaches to evaluate measurement data," *Metrologia*, vol. 43, pp. S249–S259, 2006.
- [18] A. Monti, S. Member, F. Ponci, T. Lovett, and S. Member, "A Polynomial Chaos Theory Approach to Uncertainty in Electrical Engineering," in *Proceedings of the 13th International Conference on, Intelligent Systems Application to Power Systems*, 2005, no. 2, pp. 534–539.
- [19] T. E. Lovett, F. Ponci, and A. Monti, "A polynomial chaos approach to measurement uncertainty," *IEEE Trans. Instrum. Meas.*, vol. 55, no. 3, pp. 729–736, 2006.
- [20] K.-K. K. Kim, D. E. Shen, Z. K. Nagy, and R. D. Braatz, "Wiener's Polynomial Chaos for the Analysis and Control of Nonlinear Dynamical Systems with Probabilistic Uncertainties," *IEEE Control Syst. Mag.*, no. October, pp. 58–67, 2013.
- [21] G. Mauris, "A review of relationships between possibility and probability representations of uncertainty in measurement," *IEEE Trans. Instrum. Meas.*, vol. 62, no. 3, pp. 622–632, 2013.
- [22] V. Teppati and A. Ferrero, "A comparison of uncertainty evaluation methods for on-wafer S-parameter measurements," *IEEE Trans. Instrum. Meas.*, vol. 63, no. 4, pp. 935–942, 2014.
- [23] M. Wegener and E. Schnieder, "A measurement standard for vehicle localization and its ISO-compliant measurement uncertainty evaluation," *IEEE Trans. Instrum. Meas.*, vol. 61, no. 11, pp. 3003–3013, 2012.
- [24] L. Angrisani, D. Capriglione, L. Ferrigno, and G. Miele, "A methodological approach for estimating protocol analyzer instrumental measurement uncertainty in packet jitter evaluation," *IEEE Trans. Instrum. Meas.*, vol. 61, no. 5, pp. 1405–1416, 2012.
- [25] E. So, R. Arseneau, and D. Angelo, "An improved current-comparator-based power standard with an uncertainty of $2.5 \frac{w}{VA}$ ($k = 1$)," *IEEE Trans. Instrum. Meas.*, vol. 62, no. 6, pp. 1704–1709, 2013.
- [26] A. Widarta, M. Endo, and T. Kawakami, "Attenuation-Measurement Technique With a Small

- Mismatch Uncertainty Using Phase Characteristics of Multiple Reflected Signals,” vol. 60, no. 7, pp. 2715–2719, 2011.
- [27] G. Di Leo, C. Liguori, and A. Paolillo, “Covariance propagation for the uncertainty estimation in stereo vision,” *IEEE Trans. Instrum. Meas.*, vol. 60, no. 5, pp. 1664–1673, 2011.
- [28] M. Lin and Y. Zhang, “Covariance-matrix-based uncertainty analysis for NVNA measurements,” *IEEE Trans. Instrum. Meas.*, vol. 61, no. 1, pp. 93–102, 2012.
- [29] Z. Shen and Q. Wang, “Data validation and validated uncertainty estimation of multifunctional self-validating sensors,” *IEEE Trans. Instrum. Meas.*, vol. 62, no. 7, pp. 2082–2092, 2013.
- [30] C. Biosensing, C. G. Siontorou, and F. A. Batzias, “Determining the Sources of Measurement Uncertainty in Environmental,” vol. 63, no. 4, pp. 1–11, 2013.
- [31] E. Balestrieri, L. De Vito, S. Rapuano, and D. Slepicka, “Estimating the uncertainty in the frequency domain characterization of digitizing waveform recorders,” *IEEE Trans. Instrum. Meas.*, vol. 61, no. 6, pp. 1613–1624, 2012.
- [32] J. M. Paniagua, M. Rufo, A. Jimenez, A. Antolín, and F. T. Pachón, “Estimation of uncertainties in electric field exposure from medium-frequency AM broadcast transmitters,” *IEEE Trans. Instrum. Meas.*, vol. 61, no. 1, pp. 122–128, 2012.
- [33] V. Teppati and C. R. Bolognesi, “Evaluation and reduction of calibration residual uncertainty in load-pull measurements at millimeter-wave frequencies,” *IEEE Trans. Instrum. Meas.*, vol. 61, no. 3, pp. 817–822, 2012.
- [34] C. Matthews, P. Clarkson, P. M. Harris, W. G. Kürten Ihlenfeld, and P. S. Wright, “Evaluation of flicker measurement uncertainties by a Monte Carlo method,” *IEEE Trans. Instrum. Meas.*, vol. 60, no. 7, pp. 2255–2261, 2011.
- [35] M. Tokarska, “Evaluation of Measurement Uncertainty of Fabric Surface Resistance Implied by the Van der Pauw Equation,” *IEEE Trans. Instrum. Meas.*, vol. 63, no. 6, pp. 1593–1599, 2014.
- [36] R. Morello, C. De Capua, F. Lamonaca, and M. G. Belvedere, “Experimental validation of revised criteria for pulmonary hypertension diagnosis by uncertainty evaluation,” *IEEE Trans. Instrum. Meas.*, vol. 63, no. 3, pp. 592–602, 2014.
- [37] S. S. Agili, S. Member, A. W. Morales, J. Li, M. Resso, I. T. Frequency-domain, and M. Carlo, “Finding the Probability Distribution Functions of S -Parameters and Their Monte Carlo Simulation,” vol. 61, no. 11, pp. 2993–3002, 2012.
- [38] Y. Yan, G. Mauris, E. Trouve, and V. Pinel, “Fuzzy uncertainty representations of coseismic displacement measurements issued from SAR imagery,” *IEEE Trans. Instrum. Meas.*, vol. 61, no.

- 5, pp. 1278–1286, 2012.
- [39] M. Ishii, R. Ketzler, M. Albrecht, S. Kurokawa, and Y. Shimada, “Improvement of formula and uncertainty of the reference magnetic field for AC magnetometer calibration,” *IEEE Trans. Instrum. Meas.*, vol. 62, no. 6, pp. 1443–1449, 2013.
- [40] S. Bergman and A. Bergman, “New reference measurement system for calibration of VLF high voltage,” *IEEE Trans. Instrum. Meas.*, vol. 60, no. 7, pp. 2422–2426, 2011.
- [41] L. C. Stevanatto, V. J. Brusamarello, and S. Tairov, “Parameter identification and analysis of uncertainties in measurements of lead-acid batteries,” *IEEE Trans. Instrum. Meas.*, vol. 63, no. 4, pp. 761–768, 2014.
- [42] S. Chen and C. Chen, “Probabilistic fuzzy system for uncertain localization and map building of mobile robots,” *IEEE Trans. Instrum. Meas.*, vol. 61, no. 6, pp. 1546–1560, 2012.
- [43] A. Ferrero, M. Prioli, and S. Salicone, “Processing dependent systematic contributions to measurement uncertainty,” *IEEE Trans. Instrum. Meas.*, vol. 62, no. 4, pp. 720–731, 2013.
- [44] B. Sanchez, A. L. P. Aroul, E. Bartolome, K. Soundarapandian, and R. Bragós, “Propagation of measurement errors through body composition equations for body impedance analysis,” *IEEE Trans. Instrum. Meas.*, vol. 63, no. 6, pp. 1535–1544, 2014.
- [45] A. Ferrero, M. Prioli, and S. Salicone, “The construction of joint possibility distributions of random contributions to uncertainty,” *IEEE Trans. Instrum. Meas.*, vol. 63, no. 1, pp. 80–88, 2014.
- [46] M. Asprou, E. Kyriakides, and M. Albu, “The effect of variable weights in a WLS state estimator considering instrument transformer uncertainties,” *IEEE Trans. Instrum. Meas.*, vol. 63, no. 6, pp. 1484–1495, 2014.
- [47] G. B. Rossi, “Toward an interdisciplinary probabilistic theory of measurement,” *IEEE Trans. Instrum. Meas.*, vol. 61, no. 8, pp. 2095–2106, 2012.
- [48] D. Georgakopoulos, “Uncertainties in the measurement of AC voltage using a programmable Josephson voltage standard and a phase-sensitive null detector,” *IEEE Trans. Instrum. Meas.*, vol. 60, no. 7, pp. 2178–2183, 2011.
- [49] W. Zhao, X. Yang, J. Xiao, Q. H. Abbasi, H. Qin, and H. Ren, “Uncertainties of multiport VNA S-parameter measurements applying the GSOLT calibration method,” *IEEE Trans. Instrum. Meas.*, vol. 61, no. 12, pp. 3251–3258, 2012.
- [50] F. Attivissimo, A. Di Nisio, M. Savino, and M. Spadavecchia, “Uncertainty analysis in photovoltaic cell parameter estimation,” *IEEE Trans. Instrum. Meas.*, vol. 61, no. 5, pp. 1334–1342, 2012.

- [51] R. Ferrero, M. Marracci, and B. Tellini, "Uncertainty Analysis of Local and Integral Methods for Current Distribution Measurements," *IEEE Trans. Instrum. Meas.*, vol. 62, no. 1, pp. 1–8, 2012.
- [52] H. Zhao, D. Xu, and B. Gao, "Uncertainty assessment of measurement in variation coefficient of drip irrigation emitters flow rate," *IEEE Trans. Instrum. Meas.*, vol. 63, no. 4, pp. 805–812, 2014.
- [53] O. Bottauscio, M. Chiampi, G. Crotti, D. Giordano, W. Wang, and L. Zilberti, "Uncertainty estimate associated with the electric field induced inside human bodies by unknown If sources," *IEEE Trans. Instrum. Meas.*, vol. 62, no. 6, pp. 1436–1442, 2013.
- [54] S. Yanagimachi, K. I. Watabe, T. Ikegami, H. Iida, and Y. Shimada, "Uncertainty evaluation of 100-dBc/Hz flat phase noise standard at 10 MHz," *IEEE Trans. Instrum. Meas.*, vol. 62, no. 6, pp. 1545–1549, 2013.
- [55] G. Sivanagaraju, S. Chakrabarti, and S. C. Srivastava, "Uncertainty in Transmission Line Parameters: Estimation and Impact on Line Current Differential Protection," *IEEE Trans. Instrum. Meas.*, vol. 63, no. 6, pp. 1496–1504, 2014.
- [56] J. Molleda, R. Usamentiaga, F. G. Bulnes, J. C. Granda, and L. Ema, "Uncertainty propagation analysis in 3-D shape measurement using laser range finding," *IEEE Trans. Instrum. Meas.*, vol. 61, no. 5, pp. 1160–1172, 2012.
- [57] J. Randa, J. Dunsmore, D. Gu, K. Wong, D. K. Walker, and R. D. Pollard, "Verification of noise-parameter measurements and uncertainties," *IEEE Trans. Instrum. Meas.*, vol. 60, no. 11, pp. 3685–3693, 2011.
- [58] JCGM, "JCGM 200 : 2008 International vocabulary of metrology — Basic and general concepts and associated terms (VIM) Vocabulaire international de métrologie — Concepts fondamentaux et généraux et termes associés (VIM)," *Int. Organ. Stand. Geneva ISBN*, vol. 3, no. Vim, p. 104, 2008.
- [59] JCGM 101:2008, "Vrednovanje mjernih podataka – Dopuna 1. Uputama za iskazivanje mjerne nesigurnosti – Prijenos razdioba uporabom metode monte karlo," 2008.
- [60] JCGM 102:2011, "Evaluation of measurement data – Supplement 2 to the 'Guide to the expression of uncertainty in measurement' – Extension to any number of output quantities," 2011.
- [61] JCGM 104:2009, "Evaluation of measurement data — An introduction to the 'Guide to the expression of uncertainty in measurement' and related documents," 2009.
- [62] JCGM 106:2012, "Evaluation of measurement data – The role of measurement uncertainty in conformity assessment," 2012.
- [63] C. Elster, "Bayesian uncertainty analysis compared with the application of the GUM and its

- supplements,” *Metrologia*, vol. 51, no. 4, pp. S159–S166, 2014.
- [64] R. Willink and R. White, “Disentangling Classical and Bayesian Approaches to Uncertainty Analysis.” Measurement Standards Laboratory, New Zealand, pp. 1–19, 2011.
- [65] I. Lira, “The GUM revision: the Bayesian view toward the expression of measurement uncertainty,” *Eur. J. Phys.*, vol. 37, no. 2, p. 25803, 2016.
- [66] R. Kacker and a Jones, “On use of Bayesian statistics to make the Guide to the Expression of Uncertainty in Measurement consistent,” *Metrologia*, vol. 40, no. 5, pp. 235–248, 2003.
- [67] Višnja Gašljević, “Nesigurnost mjerenja električne energije na obračunskim mjernim mjestima,” Sveučilište u Zagrebu, 1997.
- [68] B. D. Hall, “Notes on complex measurement uncertainty – part 2,” vol. 2012, no. November. Lower Hutt, New Zealand, 2010.
- [69] F. Pavese, “On the degree of objectivity of uncertainty evaluation in metrology and testing,” *Measurement*, vol. 42, no. 9, pp. 1297–1303, 2009.
- [70] H.-C. Chen, P.-C. Wu, J.-Y. Huang, and L.-A. Chen, “Uncertainty analysis for measurement of measurand,” *Measurement*, vol. 43, no. 9, pp. 1250–1254, 2010.
- [71] M. Vilbaste, G. Slavin, O. Saks, V. Pihl, and I. Leito, “Can coverage factor 2 be interpreted as an equivalent to 95% coverage level in uncertainty estimation? Two case studies,” *Measurement*, vol. 43, no. 3, pp. 392–399, 2010.
- [72] B. D. Hall, “Evaluating methods of calculating measurement uncertainty,” *Metrologia*, vol. 45, no. 2, pp. L5–L8, 2008.
- [73] C. M. Wang and H. K. Iyer, “On non-linear estimation of a measurand,” *Metrologia*, vol. 49, pp. 20–26, 2012.
- [74] P. . Harris, C. E. Matthews, M. G. Cox, and A. B. Forbes, “Summarizing the output of a Monte Carlo,” *Metrologia*, vol. 51, pp. 243–252, 2014.
- [75] P. M. Harris and M. G. Cox, “On a Monte Carlo method for measurement uncertainty evaluation and its implementation,” *Metrologia*, vol. 51, pp. S176–S182, 2014.
- [76] W. Bich, “Uncertainty Evaluation by means of a Monte Carlo approach,” in *BIPM workshop 2 on CCRI*, 2008.
- [77] J.-L. Bertrand-Krajewski, A. S. Ribeiro, and M. do C. Almeida, “Evaluation of uncertainties in measurements,” 2011.

- [78] M. Azpurua, C. Tremola, and E. Paez, "Comparison of the GUM and Monte Carlo methods for the uncertainty estimation in electromagnetic compatibility testing," *Prog. Electromagn. Res.*, vol. 34, no. September, pp. 125–144, 2011.
- [79] V. K. Mehta and R. Mehta, *Principle on Power System*, 4th Revise. 2008.
- [80] Z. Hebel and I. Pavić, "Prijenos električne energije." Sveučilište u Zagrebu, Fakultet elektrotehnike i računarstva, 2008.
- [81] Landes&Gyr AG, "High Precision Metering ZMQ202/ZFQ202 User Manual," Zug, 2005.
- [82] ISKRAEMECO, "Three-phase electronic multi-function meter for industry - Technical Description," 2013.
- [83] Mathworks, "dfittool." [Online]. Available: <http://www.mathworks.com/help/stats/dfittool.html>. [Accessed: 21-Jun-2016].
- [84] B. Silverman, "Density estimation for statistics and data analysis," *Chapman Hall*, vol. 37, no. 1, pp. 1–22, 1986.
- [85] R. J. Beckman and G. L. Tiet jen, "Maximum likelihood estimation for the beta distribution," *J. Stat. Comput. Simul.*, vol. 7, no. 3–4, pp. 253–258, Jul. 1978.
- [86] "European network of transmission system operators for electricity." [Online]. Available: <https://www.entsoe.eu/Pages/default.aspx>. [Accessed: 20-Apr-2016].
- [87] European Parliament, "DIRECTIVE 2003/54/EC OF THE EUROPEAN PARLIAMENT AND OF THE COUNCIL of 26 June 2003 concerning common rules for the internal market in electricity and repealing Directive 96/92/EC THE," 2003.
- [88] R. Goić, M. Lovrić, and Z. Cvetković, "Gubici električne energije u prijenosnoj mreži HEP-a." Split.
- [89] S. Žutobradić, Ž. Rajić, L. Waggmann, and H. Miličić, "Analiza problematike gubitaka električne energije u distribucijskim mrežama članica EU," in *Hrvatski ogranak međunarodne elektrodistribucijske konferencije*, 2010, pp. 1–10.
- [90] R. Goić, M. Lovrić, and Z. Cvetković, "Gubici električne energije u prijenosnoj mreži HEP-a." Split.
- [91] The European Commission, *Regulation (EC) No 714/2009 - on conditions for access to the network for cross-border exchanges in electricity and repealing Regulation (EC) No 1228/2003*, no. 714. 2009.
- [92] Ž. Modrić, Z. Kovač, and K. Fekete, "Determination of Energy Interchanged on the Tie Lines—

- Some Practical Issues,” *J. Energy Power Eng.*, vol. 8, pp. 948–956, 2014.
- [93] K. Il Min, S. H. Ha, S. W. Lee, and Y. H. Moon, “Transmission loss allocation algorithm using path-integral based on transaction strategy,” *IEEE Trans. Power Syst.*, vol. 25, no. 1, pp. 195–205, 2010.
- [94] C. You, K. Min, J. Lee, and Y. Moon, “Allocation of Transmission Loss for Determination of Locational Spot pricing,” vol. 2, no. 2, pp. 194–200, 2007.
- [95] N. B. Dev Choudhury and S. K. Goswami, “Artificial intelligence solution to transmission loss allocation problem,” *Expert Syst. Appl.*, vol. 38, no. 4, pp. 3757–3764, 2011.
- [96] J. D. Ramboz and O. Petersons, “A Calibration Service for Current Transformers.” NIST Special Publication 250-36, 1991.
- [97] I. Tolić, K. Miličević, and S. Mujović, “Cross-Border Transmission Line Losses Calculation Using Adaptive Monte Carlo Method,” *IET Sci. Meas. Technol.*, vol. 11, no. 4, pp. 400–405, 2017.
- [98] A. Bjorck, *Numerical Methods for Least Squares Problems*. SIAM, 1996.
- [99] D. W. Marquardt, “An Algorithm for Least-Squares Estimation of Nonlinear Parameters,” *J. Soc. Ind. Appl. Math.*, vol. 11, no. 2, pp. 431–441, 1963.
- [100] J. J. More, *The Levenberg-Marquardt algorithm: Implementation and theory*. Springer-Verlag, 1978.
- [101] I. Tolić, K. Miličević, N. Šuvak, and I. Biondić, “Non-linear Least Squares and Maximum Likelihood Estimation of Probability Density Function of Cross-Border Transmission Losses,” *IEEE Trans. Power Syst.*, vol. 33, no. 2, pp. 2230–2238, 2018.
- [102] ELEXON, “Code of Practice one - CODE OF PRACTICE FOR THE METERING OF CIRCUITS WITH A RATED CAPACITY EXCEEDING 100MVA FOR SETTLEMENT PURPOSES Issue 2 DATE : 26 February 2015 Code of Practice One CODE OF PRACTICE FOR THE METERING OF CIRCUITS WITH A RATED CAPACITY EX,” no. 2. pp. 1–38, 2015.
- [103] ELEXON, “Code of Practice Two - CODE OF PRACTICE FOR THE METERING OF CIRCUITS WITH A RATED CAPACITY NOT EXCEEDING 100 MVA FOR SETTLEMENT PURPOSES . Issue 4 DATE : 26 February 2015 Code of Practice Two CODE OF PRACTICE FOR THE METERING O,” no. 4. pp. 1–40, 2015.
- [104] ELEXON, “Code of Practice Four CODE OF PRACTICE FOR THE CALIBRATION , TESTING AND COMMISSIONING REQUIREMENTS OF METERING EQUIPMENT Issue 6 Date : 5 November 2015 Code of Practice Four CODE OF PRACTICE FOR THE CALIBRATION , TESTING AND,” no. 6, pp. 1–37, 2015.

- [105] I. Tolić, K. Miličević, and R. Malarić, “Energy correction procedure on cross-border energy exchange using a virtual measuring point,” *Measurement*, vol. 119, no. January, pp. 11–17, 2018.
- [106] David J. Pannell, “Sensitivity analysis: strategies, methods, concepts, examples,” *School of Agricultural and Resource Economics*. [Online]. Available: <http://dpannell.fnas.uwa.edu.au/dpap971f.htm>. [Accessed: 22-Apr-2016].
- [107] D. Hamby, “A comparison of sensitivity analysis techniques,” *Health Phys.*, pp. 1–20, 1995.
- [108] F. W. J. Olver, D. W. Lozier, R. F. Boisvert, and C. W. Clark, *NIST Handbook of mathematical functions*, 1st Editio., vol. 5. Cambridge University Press, 2010.
- [109] M. Benšić and K. Sabo, “Estimating a uniform distribution when data are measured with a normal additive error with unknown variance,” *Statistics (Ber)*, vol. 44, no. 3, pp. 235–246, 2010.
- [110] BSP Energy Exchange, “Tablular presentation of results - BSP SouthPool Energy Exchange.” [Online]. Available: <http://www.bsp-southpool.com/table.html?date=07%2F01%2F2015&dateTo=08%2F01%2F2015&refresh>Show>. [Accessed: 12-Jul-2017].

P. BROJČANI PODACI KORIŠTENI U PRORAČUNIMA

Tablica P.1. Rezultati mjerenja napona U , struje I i kuta φ između struje i napona

Redni broj	Napon U1	Napon U2	Napon U3	Struja I1	Struja I2	Struja I3	Kut phi1	Kut phi2	Kut phi3
1	30,8668	28,5411	30,5174	1,9830	2,0018	2,0020	68,3237	68,3951	66,3661
2	30,8532	28,5479	30,5222	1,9824	2,0019	2,0019	68,2787	68,3827	66,3638
3	30,8549	28,5775	30,5012	1,9851	2,0003	2,0021	68,3679	68,4134	66,3251
4	30,8549	28,5775	30,5012	1,9851	2,0003	2,0021	68,3679	68,4134	66,3251
5	30,9693	28,5555	30,4919	1,9873	2,0006	2,0046	68,2966	68,3470	66,3914
6	30,9693	28,5555	30,4919	1,9873	2,0006	2,0046	68,2966	68,3470	66,3914
7	30,9693	28,5555	30,4919	1,9873	2,0006	2,0046	68,2966	68,3470	66,3914
8	30,9242	28,5700	30,5159	1,9886	2,0017	2,0017	68,2927	68,3722	66,3677
9	30,9242	28,5700	30,5159	1,9886	2,0017	2,0017	68,2927	68,3722	66,3677
10	30,8816	28,5566	30,5253	1,9855	2,0023	2,0019	68,2829	68,3840	66,3660
11	30,8816	28,5566	30,5253	1,9855	2,0023	2,0019	68,2829	68,3840	66,3660
12	30,8816	28,5566	30,5253	1,9855	2,0023	2,0019	68,2829	68,3840	66,3660
13	30,8509	28,5468	30,5216	1,9818	2,0021	2,0025	68,2576	68,3854	66,3753
14	30,8509	28,5468	30,5216	1,9818	2,0021	2,0025	68,2576	68,3854	66,3753
15	30,8509	28,5468	30,5216	1,9818	2,0021	2,0025	68,2576	68,3854	66,3753
16	30,8800	28,5847	30,5129	1,9863	2,0020	2,0017	68,3123	68,3910	66,3526
17	30,8800	28,5847	30,5129	1,9863	2,0020	2,0017	68,3123	68,3910	66,3526
18	30,9302	28,5546	30,5141	1,9852	2,0027	2,0034	68,3074	68,3623	66,3732
19	30,9302	28,5546	30,5141	1,9852	2,0027	2,0034	68,3074	68,3623	66,3732
20	30,9302	28,5546	30,5141	1,9852	2,0027	2,0034	68,3074	68,3623	66,3732
21	30,9548	28,5566	30,5207	1,9872	2,0037	2,0030	68,3076	68,3545	66,3841
22	30,9548	28,5566	30,5207	1,9872	2,0037	2,0030	68,3076	68,3545	66,3841
23	30,9548	28,5566	30,5207	1,9872	2,0037	2,0030	68,3076	68,3545	66,3841
24	30,9510	28,5692	30,4901	1,9864	2,0014	2,0044	68,3249	68,3474	66,3624
25	30,9510	28,5692	30,4901	1,9864	2,0014	2,0044	68,3249	68,3474	66,3624
26	30,9510	28,5692	30,4901	1,9864	2,0014	2,0044	68,3249	68,3474	66,3624
27	30,8613	28,5838	30,4840	1,9829	2,0004	2,0036	68,3631	68,3914	66,3258
28	30,8613	28,5838	30,4840	1,9829	2,0004	2,0036	68,3631	68,3914	66,3258
29	30,9441	28,5880	30,4856	1,9883	2,0009	2,0036	68,3655	68,3755	66,3407
30	30,9441	28,5880	30,4856	1,9883	2,0009	2,0036	68,3655	68,3755	66,3407
31	30,9441	28,5880	30,4856	1,9883	2,0009	2,0036	68,3655	68,3755	66,3407
32	30,8710	28,5915	30,5018	1,9858	2,0011	2,0023	68,2650	68,3742	66,3499
33	30,8710	28,5915	30,5018	1,9858	2,0011	2,0023	68,2650	68,3742	66,3499
34	30,9039	28,5779	30,5207	1,9870	2,0027	2,0017	68,3640	68,3963	66,3500
35	30,9324	28,5919	30,5044	1,9895	2,0020	2,0023	68,3746	68,3871	66,3387
36	30,9324	28,5919	30,5044	1,9895	2,0020	2,0023	68,3746	68,3871	66,3387
37	30,9765	28,5926	30,4933	1,9910	2,0017	2,0030	68,2763	68,3380	66,3851

38	30,9765	28,5926	30,4933	1,9910	2,0017	2,0030	68,2763	68,3380	66,3851
39	30,9765	28,5926	30,4933	1,9910	2,0017	2,0030	68,2763	68,3380	66,3851
40	30,9168	28,5932	30,5091	1,9891	2,0025	2,0022	68,3078	68,3656	66,3712
41	30,9145	28,5711	30,5277	1,9873	2,0038	2,0022	68,3286	68,3758	66,3797
42	30,9496	28,5633	30,5086	1,9864	2,0030	2,0038	68,3933	68,3773	66,3693
43	30,9496	28,5633	30,5086	1,9864	2,0030	2,0038	68,3933	68,3773	66,3693
44	30,9496	28,5633	30,5086	1,9864	2,0030	2,0038	68,3933	68,3773	66,3693
45	30,8495	28,5873	30,5191	1,9853	2,0027	2,0016	68,3382	68,4032	66,3498
46	30,8495	28,5873	30,5191	1,9853	2,0027	2,0016	68,3382	68,4032	66,3498
47	30,8495	28,5873	30,5191	1,9853	2,0027	2,0016	68,3382	68,4032	66,3498
48	30,9048	28,5953	30,4929	1,9874	2,0013	2,0032	68,3896	68,3864	66,3370
49	30,9048	28,5953	30,4929	1,9874	2,0013	2,0032	68,3896	68,3864	66,3370
50	30,9048	28,5953	30,4929	1,9874	2,0013	2,0032	68,3896	68,3864	66,3370
51	30,9520	28,5624	30,5239	1,9877	2,0039	2,0030	68,3783	68,3676	66,3874
52	30,9520	28,5624	30,5239	1,9877	2,0039	2,0030	68,3783	68,3676	66,3874
53	30,9685	28,5875	30,4892	1,9893	2,0017	2,0042	68,3305	68,3419	66,3780
54	30,9685	28,5875	30,4892	1,9893	2,0017	2,0042	68,3305	68,3419	66,3780
55	30,9685	28,5875	30,4892	1,9893	2,0017	2,0042	68,3305	68,3419	66,3780
56	30,8668	28,5710	30,5271	1,9842	2,0034	2,0018	68,2362	68,3643	66,3789
57	30,8668	28,5710	30,5271	1,9842	2,0034	2,0018	68,2362	68,3643	66,3789
58	30,8668	28,5710	30,5271	1,9842	2,0034	2,0018	68,2362	68,3643	66,3789
59	30,9052	28,5988	30,4943	1,9876	2,0015	2,0031	68,3730	68,3785	66,3497
60	30,9052	28,5988	30,4943	1,9876	2,0015	2,0031	68,3730	68,3785	66,3497
61	30,9052	28,5988	30,4943	1,9876	2,0015	2,0031	68,3730	68,3785	66,3497
62	30,9667	28,5836	30,4912	1,9886	2,0019	2,0047	68,3373	68,3312	66,3794
63	30,9667	28,5836	30,4912	1,9886	2,0019	2,0047	68,3373	68,3312	66,3794
64	30,9667	28,5836	30,4912	1,9886	2,0019	2,0047	68,3373	68,3312	66,3794
65	30,9006	28,5955	30,5130	1,9881	2,0022	2,0023	68,3072	68,3656	66,3631
66	30,9006	28,5955	30,5130	1,9881	2,0022	2,0023	68,3072	68,3656	66,3631
67	30,9006	28,5955	30,5130	1,9881	2,0022	2,0023	68,3072	68,3656	66,3631
68	31,0188	28,5982	30,4957	1,9934	2,0022	2,0037	68,3616	68,3383	66,3813
69	31,0188	28,5982	30,4957	1,9934	2,0022	2,0037	68,3616	68,3383	66,3813
70	31,0188	28,5982	30,4957	1,9934	2,0022	2,0037	68,3616	68,3383	66,3813
71	30,9625	28,5986	30,4968	1,9904	2,0022	2,0031	68,3644	68,3594	66,3675
72	30,9625	28,5986	30,4968	1,9904	2,0022	2,0031	68,3644	68,3594	66,3675
73	30,9625	28,5986	30,4968	1,9904	2,0022	2,0031	68,3644	68,3594	66,3675
74	30,9325	28,5998	30,5066	1,9895	2,0023	2,0028	68,3481	68,3599	66,3587
75	30,9325	28,5998	30,5066	1,9895	2,0023	2,0028	68,3481	68,3599	66,3587
76	30,9325	28,5998	30,5066	1,9895	2,0023	2,0028	68,3481	68,3599	66,3587
77	30,9293	28,5754	30,5291	1,9878	2,0041	2,0026	68,3604	68,3829	66,3775
78	30,9293	28,5754	30,5291	1,9878	2,0041	2,0026	68,3604	68,3829	66,3775
79	30,9293	28,5754	30,5291	1,9878	2,0041	2,0026	68,3604	68,3829	66,3775
80	30,9843	28,5655	30,5109	1,9884	2,0038	2,0044	68,3437	68,3382	66,4036

81	30,9843	28,5655	30,5109	1,9884	2,0038	2,0044	68,3437	68,3382	66,4036
82	30,9843	28,5655	30,5109	1,9884	2,0038	2,0044	68,3437	68,3382	66,4036
83	30,9172	28,5967	30,4902	1,9875	2,0012	2,0038	68,3817	68,3707	66,3432
84	31,0015	28,5660	30,5171	1,9892	2,0042	2,0045	68,3092	68,3170	66,4192
85	31,0015	28,5660	30,5171	1,9892	2,0042	2,0045	68,3092	68,3170	66,4192
86	31,0015	28,5660	30,5171	1,9892	2,0042	2,0045	68,3092	68,3170	66,4192
87	31,0055	28,5718	30,5032	1,9896	2,0029	2,0050	68,2946	68,3137	66,4007
88	31,0055	28,5718	30,5032	1,9896	2,0029	2,0050	68,2946	68,3137	66,4007
89	31,0055	28,5718	30,5032	1,9896	2,0029	2,0050	68,2946	68,3137	66,4007
90	30,9418	28,5889	30,5243	1,9898	2,0036	2,0024	68,4413	68,4002	66,3497
91	30,9418	28,5889	30,5243	1,9898	2,0036	2,0024	68,4413	68,4002	66,3497
92	30,9418	28,5889	30,5243	1,9898	2,0036	2,0024	68,4413	68,4002	66,3497
93	30,9846	28,5676	30,5265	1,9892	2,0045	2,0036	68,4061	68,3690	66,3827
94	31,0399	28,5651	30,5185	1,9914	2,0043	2,0045	68,3645	68,3346	66,4142
95	31,0399	28,5651	30,5185	1,9914	2,0043	2,0045	68,3645	68,3346	66,4142
96	30,9976	28,5958	30,4918	1,9912	2,0023	2,0045	68,4406	68,3648	66,3594
97	30,9976	28,5958	30,4918	1,9912	2,0023	2,0045	68,4406	68,3648	66,3594
98	30,9976	28,5958	30,4918	1,9912	2,0023	2,0045	68,4406	68,3648	66,3594
99	30,9603	28,5784	30,4977	1,9873	2,0025	2,0046	68,4010	68,3595	66,3569
100	30,9603	28,5784	30,4977	1,9873	2,0025	2,0046	68,4010	68,3595	66,3569
101	30,9603	28,5784	30,4977	1,9873	2,0025	2,0046	68,4010	68,3595	66,3569
102	30,9691	28,5832	30,4964	1,9884	2,0023	2,0046	68,4169	68,3592	66,3570
103	30,9691	28,5832	30,4964	1,9884	2,0023	2,0046	68,4169	68,3592	66,3570
104	30,9691	28,5832	30,4964	1,9884	2,0023	2,0046	68,4169	68,3592	66,3570
105	31,0007	28,5981	30,5169	1,9932	2,0036	2,0027	68,3310	68,3427	66,3869
106	31,0007	28,5981	30,5169	1,9932	2,0036	2,0027	68,3310	68,3427	66,3869
107	31,0007	28,5981	30,5169	1,9932	2,0036	2,0027	68,3310	68,3427	66,3869
108	30,9895	28,5719	30,5090	1,9888	2,0036	2,0048	68,3722	68,3480	66,3885
109	30,9503	28,6034	30,5027	1,9905	2,0024	2,0034	68,3411	68,3576	66,3649
110	30,9503	28,6034	30,5027	1,9905	2,0024	2,0034	68,3411	68,3576	66,3649
111	30,9495	28,5914	30,5261	1,9904	2,0039	2,0024	68,4392	68,3996	66,3535
112	30,9495	28,5914	30,5261	1,9904	2,0039	2,0024	68,4392	68,3996	66,3535
113	30,9199	28,5718	30,5287	1,9861	2,0042	2,0031	68,4003	68,3836	66,3602
114	30,9199	28,5718	30,5287	1,9861	2,0042	2,0031	68,4003	68,3836	66,3602
115	30,9199	28,5718	30,5287	1,9861	2,0042	2,0031	68,4003	68,3836	66,3602
116	30,9406	28,5868	30,4950	1,9873	2,0020	2,0047	68,4452	68,3780	66,3521
117	30,9406	28,5868	30,4950	1,9873	2,0020	2,0047	68,4452	68,3780	66,3521
118	30,9406	28,5868	30,4950	1,9873	2,0020	2,0047	68,4452	68,3780	66,3521
119	30,8772	28,5883	30,4917	1,9847	2,0010	2,0039	68,3587	68,3852	66,3346
120	30,8772	28,5883	30,4917	1,9847	2,0010	2,0039	68,3587	68,3852	66,3346
121	30,8772	28,5883	30,4917	1,9847	2,0010	2,0039	68,3587	68,3852	66,3346
122	30,9045	28,5945	30,5090	1,9881	2,0017	2,0027	68,3712	68,3849	66,3389
123	30,9045	28,5945	30,5090	1,9881	2,0017	2,0027	68,3712	68,3849	66,3389

124	30,9045	28,5945	30,5090	1,9881	2,0017	2,0027	68,3712	68,3849	66,3389
125	30,9265	28,5932	30,4947	1,9883	2,0012	2,0036	68,4005	68,3827	66,3430
126	30,9265	28,5932	30,4947	1,9883	2,0012	2,0036	68,4005	68,3827	66,3430
127	30,9265	28,5932	30,4947	1,9883	2,0012	2,0036	68,4005	68,3827	66,3430
128	30,9749	28,5716	30,5337	1,9907	2,0042	2,0027	68,3440	68,3544	66,3906
129	30,9749	28,5716	30,5337	1,9907	2,0042	2,0027	68,3440	68,3544	66,3906
130	30,9749	28,5716	30,5337	1,9907	2,0042	2,0027	68,3440	68,3544	66,3906
131	30,8980	28,5877	30,5240	1,9881	2,0027	2,0021	68,2839	68,3675	66,3666
132	30,8980	28,5877	30,5240	1,9881	2,0027	2,0021	68,2839	68,3675	66,3666
133	30,8977	28,5786	30,5314	1,9869	2,0035	2,0022	68,3763	68,4026	66,3529
134	30,8977	28,5786	30,5314	1,9869	2,0035	2,0022	68,3763	68,4026	66,3529
135	30,8977	28,5786	30,5314	1,9869	2,0035	2,0022	68,3763	68,4026	66,3529
136	30,9305	28,5856	30,5264	1,9895	2,0032	2,0025	68,3315	68,3686	66,3771
137	30,9305	28,5856	30,5264	1,9895	2,0032	2,0025	68,3315	68,3686	66,3771
138	30,9305	28,5856	30,5264	1,9895	2,0032	2,0025	68,3315	68,3686	66,3771
139	30,9815	28,5606	30,5324	1,9891	2,0042	2,0038	68,3518	68,3455	66,4133
140	30,9815	28,5606	30,5324	1,9891	2,0042	2,0038	68,3518	68,3455	66,4133
141	30,9752	28,5771	30,5001	1,9886	2,0022	2,0050	68,3745	68,3581	66,3737
142	30,9752	28,5771	30,5001	1,9886	2,0022	2,0050	68,3745	68,3581	66,3737
143	30,9752	28,5771	30,5001	1,9886	2,0022	2,0050	68,3745	68,3581	66,3737
144	30,9764	28,5633	30,5335	1,9892	2,0042	2,0037	68,2613	68,3271	66,4161
145	30,9764	28,5633	30,5335	1,9892	2,0042	2,0037	68,2613	68,3271	66,4161
146	30,9764	28,5633	30,5335	1,9892	2,0042	2,0037	68,2613	68,3271	66,4161
147	30,9617	28,5693	30,5375	1,9894	2,0041	2,0033	68,3177	68,3538	66,3877
148	30,9617	28,5693	30,5375	1,9894	2,0041	2,0033	68,3177	68,3538	66,3877
149	30,9617	28,5693	30,5375	1,9894	2,0041	2,0033	68,3177	68,3538	66,3877
150	30,9744	28,5923	30,4980	1,9902	2,0018	2,0044	68,3642	68,3698	66,3633
151	30,9744	28,5923	30,4980	1,9902	2,0018	2,0044	68,3642	68,3698	66,3633
152	30,9362	28,5939	30,4988	1,9883	2,0015	2,0044	68,3425	68,3598	66,3710
153	30,9362	28,5939	30,4988	1,9883	2,0015	2,0044	68,3425	68,3598	66,3710
154	31,0551	28,5753	30,5055	1,9925	2,0029	2,0057	68,3624	68,3197	66,3947
155	31,0551	28,5753	30,5055	1,9925	2,0029	2,0057	68,3624	68,3197	66,3947
156	31,0551	28,5753	30,5055	1,9925	2,0029	2,0057	68,3624	68,3197	66,3947
157	30,9413	28,5692	30,5114	1,9862	2,0027	2,0049	68,3769	68,3638	66,3718
158	30,9413	28,5692	30,5114	1,9862	2,0027	2,0049	68,3769	68,3638	66,3718
159	31,0238	28,5643	30,5358	1,9914	2,0047	2,0041	68,3593	68,3350	66,4136
160	31,0238	28,5643	30,5358	1,9914	2,0047	2,0041	68,3593	68,3350	66,4136
161	31,0238	28,5643	30,5358	1,9914	2,0047	2,0041	68,3593	68,3350	66,4136
162	30,9895	28,5750	30,5397	1,9912	2,0048	2,0031	68,3618	68,3639	66,4010
163	30,9895	28,5750	30,5397	1,9912	2,0048	2,0031	68,3618	68,3639	66,4010
164	30,9895	28,5750	30,5397	1,9912	2,0048	2,0031	68,3618	68,3639	66,4010
165	30,9640	28,5669	30,5374	1,9888	2,0044	2,0038	68,4153	68,3771	66,3714
166	30,9640	28,5669	30,5374	1,9888	2,0044	2,0038	68,4153	68,3771	66,3714

167	30,9585	28,5640	30,5280	1,9875	2,0040	2,0044	68,3668	68,3488	66,3819
168	30,9585	28,5640	30,5280	1,9875	2,0040	2,0044	68,3668	68,3488	66,3819
169	30,9585	28,5640	30,5280	1,9875	2,0040	2,0044	68,3668	68,3488	66,3819
170	30,9811	28,5826	30,5049	1,9888	2,0023	2,0051	68,3708	68,3565	66,3739
171	30,9811	28,5826	30,5049	1,9888	2,0023	2,0051	68,3708	68,3565	66,3739
172	30,9890	28,5710	30,5117	1,9885	2,0031	2,0050	68,3009	68,3357	66,3941
173	30,9890	28,5710	30,5117	1,9885	2,0031	2,0050	68,3009	68,3357	66,3941
174	31,0002	28,5775	30,5076	1,9897	2,0029	2,0055	68,4067	68,3581	66,3771
175	31,0002	28,5775	30,5076	1,9897	2,0029	2,0055	68,4067	68,3581	66,3771
176	31,0002	28,5775	30,5076	1,9897	2,0029	2,0055	68,4067	68,3581	66,3771
177	30,8608	28,5713	30,5380	1,9837	2,0039	2,0026	68,3579	68,3967	66,3589
178	30,8608	28,5713	30,5380	1,9837	2,0039	2,0026	68,3579	68,3967	66,3589
179	30,8608	28,5713	30,5380	1,9837	2,0039	2,0026	68,3579	68,3967	66,3589
180	30,9859	28,5661	30,5214	1,9883	2,0035	2,0053	68,3873	68,3610	66,3875
181	30,9859	28,5661	30,5214	1,9883	2,0035	2,0053	68,3873	68,3610	66,3875
182	30,9075	28,5774	30,5083	1,9846	2,0022	2,0048	68,3823	68,3820	66,3550
183	30,9075	28,5774	30,5083	1,9846	2,0022	2,0048	68,3823	68,3820	66,3550
184	30,9075	28,5774	30,5083	1,9846	2,0022	2,0048	68,3823	68,3820	66,3550
185	30,9561	28,5736	30,5408	1,9892	2,0044	2,0034	68,2990	68,3530	66,3854
186	30,9561	28,5736	30,5408	1,9892	2,0044	2,0034	68,2990	68,3530	66,3854
187	30,9561	28,5736	30,5408	1,9892	2,0044	2,0034	68,2990	68,3530	66,3854
188	30,9938	28,5729	30,5179	1,9892	2,0037	2,0053	68,3572	68,3448	66,3910
189	30,9938	28,5729	30,5179	1,9892	2,0037	2,0053	68,3572	68,3448	66,3910
190	30,9938	28,5729	30,5179	1,9892	2,0037	2,0053	68,3572	68,3448	66,3910
191	31,0239	28,6082	30,5024	1,9934	2,0029	2,0049	68,3477	68,3373	66,3805
192	31,0239	28,6082	30,5024	1,9934	2,0029	2,0049	68,3477	68,3373	66,3805
193	31,0239	28,6082	30,5024	1,9934	2,0029	2,0049	68,3477	68,3373	66,3805
194	30,9790	28,5836	30,5407	1,9901	2,0055	2,0037	68,3100	68,3299	66,3966
195	30,9790	28,5836	30,5407	1,9901	2,0055	2,0037	68,3100	68,3299	66,3966
196	30,9790	28,5836	30,5407	1,9901	2,0055	2,0037	68,3100	68,3299	66,3966
197	30,9864	28,5802	30,5117	1,9883	2,0035	2,0053	68,3628	68,3442	66,3872
198	30,9864	28,5802	30,5117	1,9883	2,0035	2,0053	68,3628	68,3442	66,3872
199	30,9864	28,5802	30,5117	1,9883	2,0035	2,0053	68,3628	68,3442	66,3872
200	30,9658	28,5930	30,5017	1,9885	2,0023	2,0052	68,3229	68,3474	66,3786

Tablica P.2. *log-likelihood* vrijednosti za napon, struju i kut za sve faze i sve razdiobe

Razdioba	Log-likelihood								
	Struja I1	Struja I2	Struja I3	Napon U1	Napon U2	Napon U3	Kut phi 1	Kut phi 2	Kut phi 3
Birnbaum-Saunders	922,515	1069,330	1079,910	325,485	570,612	546,791	334,541	476,946	486,721
Razdioba ekstremnih vrijednosti	913,557	1058,480	1072,760	321,233	565,433	535,698	324,701	467,256	471,611
Gamma	922,526	1069,330	1079,910	325,499	570,615	546,789	334,545	476,947	486,720
Poopćena razdioba ekstremnih vrijednosti	922,706	1071,380	1083,950	327,359	573,914	550,,36	335,394	478,911	487,948
Inverzna Gaussova	1106,300	1253,110	1263,700	509,273	754,400	730,579	518,329	660,734	670,509
Log-logistic	923,370	1062,790	1071,430	321,758	564,936	538,206	332,568	471,860	483,113
Logistic	923,392	1062,790	1071,430	321,794	564,939	538,201	332,576	471,861	483,112
Lognormalna	922,514	1069,320	1079,910	325,484	570,611	546,790	334,540	476,945	486,720
Nakagami	922,537	1069,320	1079,910	325,513	570,617	546,786	334,548	476,947	486,720
Gaussova	922,546	1069,320	1079,910	325,525	570,619	546,783	334,550	476,946	486,717
Ricianova	922,547	1069,320	1079,910	325,526	570,620	546,784	334,551	476,947	486,719
t razdioba	923,043	1069,320	1079,910	325,526	570,620	546,784	334,551	476,947	486,719
Weibullova	913,647	1058,520	1072,790	321,319	565,456	535,727	324,749	467,277	471,638

Tablica P.3. Stabilizacija rezultata AMC metode kod proračuna otpora R1

M	$R_{sr. vrijednost}$	$R_{st.dev.}$	$R_{donja granica}$	$R_{gornja granica}$	Tolerancija
20000	0,0001	0,0003	0,0003	0,0009	0,0005
30000	0,0001	0,0002	0,0004	0,0015	0,0005
40000	0,0001	0,0002	0,0005	0,0011	0,0005
50000	0,0001	0,0001	0,0005	0,0009	0,0005
60000	0,0000	0,0001	0,0005	0,0008	0,0005
70000	0,0000	0,0001	0,0004	0,0007	0,0005
80000	0,0001	0,0001	0,0004	0,0006	0,0005
90000	0,0001	0,0001	0,0004	0,0005	0,0005
100000	0,0001	0,0001	0,0003	0,0005	0,0005
110000	0,0001	0,0001	0,0004	0,0005	0,0005
120000	0,0001	0,0001	0,0003	0,0004	0,0005
130000	0,0001	6,34E-05	0,0003	0,0004	0,0005
140000	0,0001	5,93E-05	0,0003	0,0004	0,0005
150000	0,0001	5,91E-05	0,0003	0,0004	0,0005
160000	0,0001	5,53E-05	0,0003	0,0004	0,0005
170000	0,0001	0,0001	0,0003	0,0004	0,0005
180000	0,0001	5,07E-05	0,0003	0,0004	0,0005
190000	0,0001	5,23E-05	0,0003	0,0004	0,0005
200000	0,0001	5,44E-05	0,0003	0,0004	0,0005

Tablica P.4. Stabilizacija rezultata AMC metode kod proračuna otpora R2

M	$R_{sr. vrijednost}$	$R_{st.dev.}$	$R_{donja granica}$	$R_{gornja granica}$	Tolerancija
20000	4,79633E-05	9,17642E-05	0,000286331	0,000826533	0,00005
30000	3,99919E-05	7,12081E-05	0,000442457	0,000527407	0,00005
40000	2,84555E-05	5,4775E-05	0,000319404	0,000374921	0,00005
50000	3,28191E-05	4,24664E-05	0,000280485	0,000313833	0,00005
60000	4,0611E-05	3,85779E-05	0,000257189	0,000258704	0,00005
70000	5,41862E-05	3,36749E-05	0,000251119	0,000241455	0,00005
80000	4,72021E-05	3,0015E-05	0,000224016	0,000232405	0,00005
90000	4,39545E-05	2,75368E-05	0,000198566	0,000226066	0,00005
100000	3,93645E-05	2,46557E-05	0,000221541	0,000242626	0,00005
110000	3,58185E-05	2,30139E-05	0,000204456	0,000223862	0,00005
120000	3,71352E-05	2,31809E-05	0,000196472	0,000204496	0,00005
130000	3,42424E-05	2,13469E-05	0,000192863	0,000203065	0,00005
140000	3,53213E-05	2,06173E-05	0,000181801	0,000198514	0,00005
150000	3,38426E-05	1,98057E-05	0,000169761	0,000184827	0,00005
160000	3,27907E-05	1,85533E-05	0,000161838	0,000175422	0,00005
170000	3,08892E-05	1,84647E-05	0,000152474	0,000167795	0,00005
180000	2,91667E-05	1,81159E-05	0,000151161	0,00015901	0,00005
190000	2,78768E-05	1,72928E-05	0,000144478	0,000150448	0,00005
200000	2,70339E-05	1,64259E-05	0,000143333	0,000152279	0,00005
210000	2,58396E-05	1,6023E-05	0,000139046	0,000145395	0,00005
220000	2,56557E-05	1,62295E-05	0,000135236	0,000138629	0,00005
230000	2,56568E-05	1,59825E-05	0,000129224	0,000134516	0,00005
240000	2,69805E-05	1,54544E-05	0,000123911	0,000128976	0,00005
250000	2,588E-05	1,49189E-05	0,000119939	0,000125202	0,00005
260000	2,50251E-05	1,43719E-05	0,000115971	0,000120782	0,00005
270000	2,40873E-05	1,44726E-05	0,000111797	0,000117921	0,00005
280000	2,32237E-05	1,4393E-05	0,000108144	0,000114296	0,00005
290000	2,39156E-05	1,40873E-05	0,000104687	0,000110606	0,00005
300000	2,3106E-05	1,36156E-05	0,000101142	0,000106857	0,00005
310000	2,33891E-05	1,32086E-05	0,000102152	0,000107206	0,00005
320000	2,34037E-05	1,28418E-05	0,000100229	0,000106747	0,00005
330000	2,29329E-05	1,26063E-05	9,80736E-05	0,000105212	0,00005
340000	2,28462E-05	1,2275E-05	9,68808E-05	0,000104835	0,00005
350000	2,21858E-05	1,19235E-05	9,74303E-05	0,000104541	0,00005
360000	2,21431E-05	1,18327E-05	9,48243E-05	0,000104943	0,00005
370000	2,15367E-05	1,15384E-05	9,24913E-05	0,00010329	0,00005
380000	2,10061E-05	1,1455E-05	9,13332E-05	0,000101267	0,00005
390000	2,04708E-05	1,11985E-05	8,90834E-05	9,88878E-05	0,00005
400000	2,04075E-05	1,09197E-05	8,68308E-05	9,65795E-05	0,00005
410000	2,00389E-05	1,06545E-05	8,47588E-05	9,41944E-05	0,00005
420000	1,96669E-05	1,08186E-05	8,30629E-05	9,20972E-05	0,00005
430000	1,92869E-05	1,06026E-05	8,13604E-05	9,04407E-05	0,00005
440000	1,89023E-05	1,04037E-05	7,9497E-05	8,85429E-05	0,00005
450000	1,85086E-05	1,02687E-05	7,77688E-05	8,65553E-05	0,00005
460000	1,81048E-05	1,02868E-05	7,70931E-05	8,46528E-05	0,00005
470000	1,77953E-05	1,00708E-05	7,65365E-05	8,53012E-05	0,00005

480000	1,75438E-05	1,01519E-05	7,51255E-05	8,35477E-05	0,00005
490000	1,75433E-05	9,94267E-06	7,49224E-05	8,18429E-05	0,00005
500000	1,73268E-05	9,81222E-06	7,40559E-05	8,08872E-05	0,00005
510000	1,69881E-05	9,61859E-06	7,26763E-05	7,94164E-05	0,00005
520000	1,7029E-05	9,70714E-06	7,13035E-05	7,78864E-05	0,00005
530000	1,69246E-05	9,59202E-06	7,01801E-05	7,66859E-05	0,00005
540000	1,66144E-05	9,54056E-06	6,89763E-05	7,57238E-05	0,00005
550000	1,63196E-05	9,61749E-06	6,83266E-05	7,45627E-05	0,00005
560000	1,60272E-05	9,47228E-06	6,70957E-05	7,32429E-05	0,00005
570000	1,58031E-05	9,61456E-06	6,82439E-05	7,33231E-05	0,00005
580000	1,58471E-05	9,58523E-06	6,71289E-05	7,21857E-05	0,00005
590000	1,55858E-05	9,42696E-06	6,63774E-05	7,17794E-05	0,00005
600000	1,53786E-05	9,27182E-06	6,54008E-05	7,09922E-05	0,00005
610000	1,5513E-05	9,12205E-06	6,45569E-05	7,00483E-05	0,00005
620000	1,52884E-05	9,12278E-06	6,45737E-05	6,90656E-05	0,00005
630000	1,52768E-05	9,05606E-06	6,47596E-05	6,84531E-05	0,00005
640000	1,51565E-05	8,97123E-06	6,4664E-05	6,74464E-05	0,00005
650000	1,49833E-05	8,84979E-06	6,36805E-05	6,64276E-05	0,00005
660000	1,48419E-05	8,72968E-06	6,32255E-05	6,56231E-05	0,00005
670000	1,48519E-05	8,68694E-06	6,26548E-05	6,55238E-05	0,00005
680000	1,50753E-05	8,58041E-06	6,41076E-05	6,53626E-05	0,00005
690000	1,48555E-05	8,67717E-06	6,33414E-05	6,44929E-05	0,00005
700000	1,4673E-05	8,55861E-06	6,30984E-05	6,38286E-05	0,00005
710000	1,48356E-05	8,60424E-06	6,30956E-05	6,42123E-05	0,00005
720000	1,46281E-05	8,511E-06	6,22183E-05	6,33167E-05	0,00005
730000	1,44367E-05	8,39815E-06	6,14805E-05	6,27698E-05	0,00005
740000	1,4295E-05	8,28393E-06	6,09257E-05	6,2449E-05	0,00005
750000	1,43593E-05	8,3571E-06	6,20452E-05	6,2104E-05	0,00005
760000	1,41801E-05	8,33386E-06	6,13724E-05	6,15855E-05	0,00005
770000	1,40075E-05	8,34615E-06	6,10864E-05	6,14221E-05	0,00005
780000	1,39164E-05	8,27238E-06	6,16215E-05	6,11355E-05	0,00005
790000	1,37391E-05	8,19387E-06	6,22846E-05	6,19216E-05	0,00005
800000	1,38887E-05	8,12095E-06	6,15085E-05	6,11856E-05	0,00005
810000	1,38194E-05	8,2101E-06	6,10335E-05	6,04376E-05	0,00005
820000	1,37801E-05	8,25481E-06	6,13766E-05	5,99479E-05	0,00005
830000	1,36665E-05	8,16828E-06	6,16303E-05	6,05918E-05	0,00005
840000	1,35826E-05	8,17318E-06	6,32425E-05	6,0471E-05	0,00005
850000	1,34542E-05	8,09832E-06	6,28696E-05	6,00774E-05	0,00005
860000	1,33655E-05	8,03129E-06	6,21473E-05	5,95873E-05	0,00005
870000	1,32247E-05	7,94071E-06	6,14371E-05	5,89012E-05	0,00005
880000	1,30839E-05	7,86443E-06	6,08429E-05	5,84038E-05	0,00005
890000	1,29792E-05	7,77835E-06	6,01628E-05	5,79266E-05	0,00005
900000	1,28809E-05	7,72814E-06	5,94984E-05	5,72979E-05	0,00005
910000	1,27728E-05	7,64296E-06	5,88567E-05	5,67454E-05	0,00005
920000	1,26335E-05	7,67663E-06	5,84769E-05	5,65224E-05	0,00005
930000	1,25068E-05	7,62941E-06	5,80154E-05	5,62894E-05	0,00005
940000	1,23762E-05	7,55132E-06	5,74882E-05	5,57072E-05	0,00005
950000	1,22583E-05	7,47175E-06	5,80026E-05	5,56848E-05	0,00005
960000	1,22088E-05	7,54606E-06	5,75684E-05	5,63951E-05	0,00005
970000	1,21481E-05	7,46805E-06	5,71695E-05	5,60981E-05	0,00005
980000	1,20288E-05	7,40253E-06	5,67155E-05	5,59625E-05	0,00005
990000	1,19579E-05	7,58128E-06	5,61776E-05	5,63489E-05	0,00005

100000	1,18378E-05	7,5271E-06	5,57768E-05	5,58354E-05	0,00005
1010000	1,17201E-05	7,50677E-06	5,52426E-05	5,54464E-05	0,00005
1020000	1,16238E-05	7,4377E-06	5,47143E-05	5,50161E-05	0,00005
1030000	1,21228E-05	7,40788E-06	5,43249E-05	5,47867E-05	0,00005
1040000	1,20137E-05	7,37934E-06	5,39043E-05	5,44837E-05	0,00005
1050000	1,21497E-05	7,35459E-06	5,34097E-05	5,39903E-05	0,00005
1060000	1,2043E-05	7,2981E-06	5,2919E-05	5,35701E-05	0,00005
1070000	1,19499E-05	7,22965E-06	5,25513E-05	5,35327E-05	0,00005
1080000	1,18459E-05	7,20925E-06	5,21344E-05	5,30535E-05	0,00005
1090000	1,17799E-05	7,21544E-06	5,18991E-05	5,2565E-05	0,00005
1100000	1,17028E-05	7,15631E-06	5,25498E-05	5,27261E-05	0,00005
1110000	1,16007E-05	7,09222E-06	5,23662E-05	5,24528E-05	0,00005
1120000	1,14967E-05	7,04946E-06	5,20747E-05	5,19895E-05	0,00005
1130000	1,13997E-05	6,98807E-06	5,19979E-05	5,18064E-05	0,00005
1140000	1,13192E-05	7,00421E-06	5,18443E-05	5,14724E-05	0,00005
1150000	1,12573E-05	6,95273E-06	5,20711E-05	5,18243E-05	0,00005
1160000	1,11665E-05	6,97433E-06	5,18935E-05	5,14492E-05	0,00005
1170000	1,11557E-05	6,99116E-06	5,19206E-05	5,1038E-05	0,00005
1180000	1,13008E-05	6,93352E-06	5,15512E-05	5,06368E-05	0,00005
1190000	1,12184E-05	6,88022E-06	5,11745E-05	5,03587E-05	0,00005
1200000	1,11388E-05	6,86266E-06	5,08304E-05	4,9954E-05	0,00005
1210000	1,10796E-05	6,85956E-06	5,04634E-05	4,95718E-05	0,00005
1220000	1,09891E-05	6,82116E-06	5,00974E-05	4,9444E-05	0,00005
1230000	1,09258E-05	6,78882E-06	4,97073E-05	4,91644E-05	0,00005
1240000	1,09219E-05	6,74406E-06	4,9409E-05	4,87777E-05	0,00005
1250000	1,0839E-05	6,7046E-06	4,92294E-05	4,84351E-05	0,00005
1260000	1,09029E-05	6,65979E-06	4,88945E-05	4,84267E-05	0,00005
1270000	1,09818E-05	6,6116E-06	4,86129E-05	4,80757E-05	0,00005
1280000	1,08957E-05	6,56301E-06	4,85217E-05	4,81532E-05	0,00005
1290000	1,08123E-05	6,51658E-06	4,8197E-05	4,7789E-05	0,00005
1300000	1,08873E-05	6,46685E-06	4,78283E-05	4,74207E-05	0,00005
1310000	1,08344E-05	6,41969E-06	4,76233E-05	4,72171E-05	0,00005
1320000	1,0883E-05	6,3833E-06	4,72645E-05	4,69929E-05	0,00005
1330000	1,08242E-05	6,41665E-06	4,6953E-05	4,70725E-05	0,00005
1340000	1,08267E-05	6,3832E-06	4,67857E-05	4,68856E-05	0,00005
1350000	1,09397E-05	6,34003E-06	4,65579E-05	4,67635E-05	0,00005
1360000	1,08723E-05	6,30318E-06	4,65845E-05	4,67071E-05	0,00005
1370000	1,07944E-05	6,29788E-06	4,66767E-05	4,63732E-05	0,00005
1380000	1,07382E-05	6,30169E-06	4,63587E-05	4,65663E-05	0,00005
1390000	1,07972E-05	6,29259E-06	4,61775E-05	4,62552E-05	0,00005
1400000	1,07572E-05	6,25283E-06	4,63627E-05	4,62142E-05	0,00005
1410000	1,06848E-05	6,25476E-06	4,63148E-05	4,67052E-05	0,00005
1420000	1,06327E-05	6,21579E-06	4,63509E-05	4,66439E-05	0,00005
1430000	1,07016E-05	6,17217E-06	4,60577E-05	4,63171E-05	0,00005
1440000	1,06749E-05	6,22071E-06	4,57889E-05	4,71436E-05	0,00005
1450000	1,07647E-05	6,2211E-06	4,57108E-05	4,7505E-05	0,00005
1460000	1,09237E-05	6,20404E-06	4,60294E-05	4,76929E-05	0,00005
1470000	1,08648E-05	6,1713E-06	4,58196E-05	4,76629E-05	0,00005
1480000	1,08679E-05	6,15666E-06	4,55444E-05	4,75249E-05	0,00005
1490000	1,07965E-05	6,12109E-06	4,52986E-05	4,72189E-05	0,00005
1500000	1,07614E-05	6,1722E-06	4,54862E-05	4,72549E-05	0,00005
1510000	1,07282E-05	6,13687E-06	4,53281E-05	4,69419E-05	0,00005

1520000	1,06582E-05	6,10244E-06	4,52887E-05	4,67616E-05	0,00005
1530000	1,06443E-05	6,06611E-06	4,55697E-05	4,68496E-05	0,00005
1540000	1,06544E-05	6,0408E-06	4,55255E-05	4,68345E-05	0,00005
1550000	1,06217E-05	6,00578E-06	4,54738E-05	4,66296E-05	0,00005
1560000	1,06484E-05	5,9749E-06	4,51914E-05	4,63363E-05	0,00005
1570000	1,05812E-05	5,94159E-06	4,49648E-05	4,60488E-05	0,00005
1580000	1,05954E-05	5,90552E-06	4,5008E-05	4,61586E-05	0,00005
1590000	1,05473E-05	5,89075E-06	4,49225E-05	4,59068E-05	0,00005
1600000	1,04949E-05	5,89038E-06	4,46411E-05	4,56197E-05	0,00005
1610000	1,04942E-05	5,85912E-06	4,4367E-05	4,53807E-05	0,00005
1620000	1,04299E-05	5,82919E-06	4,41136E-05	4,51221E-05	0,00005
1630000	1,04148E-05	5,79687E-06	4,38784E-05	4,48445E-05	0,00005
1640000	1,03847E-05	5,82041E-06	4,36346E-05	4,47389E-05	0,00005
1650000	1,03316E-05	5,80524E-06	4,37644E-05	4,45956E-05	0,00005
1660000	1,02694E-05	5,7934E-06	4,37131E-05	4,43269E-05	0,00005
1670000	1,03246E-05	5,76022E-06	4,35476E-05	4,40615E-05	0,00005
1680000	1,02729E-05	5,73737E-06	4,32922E-05	4,38352E-05	0,00005
1690000	1,02122E-05	5,71062E-06	4,30433E-05	4,35789E-05	0,00005
1700000	1,01706E-05	5,69756E-06	4,28483E-05	4,33885E-05	0,00005

Tablica P.5. Stabilizacija rezultata AMC metode kod proračuna otpora R3

M	$R_{sr. vrijednost}$	$R_{st.dev.}$	$R_{donja granica}$	$R_{gornja granica}$	Tolerancija
20000	5,64E-05	7,68E-05	0,000686	0,000547	0,00005
30000	3,33E-05	5,74E-05	0,000463	0,000358	0,00005
40000	2,39E-05	4,06E-05	0,000332	0,000253	0,00005
50000	1,95E-05	3,15E-05	0,000262	0,000236	0,00005
60000	2,31E-05	2,69E-05	0,000215	0,000193	0,00005
70000	2,79E-05	2,28E-05	0,000267	0,000241	0,00005
80000	2,41E-05	2,96E-05	0,000258	0,000211	0,00005
90000	3,28E-05	2,68E-05	0,000227	0,000186	0,00005
100000	3E-05	2,52E-05	0,000222	0,000184	0,00005
110000	2,74E-05	2,59E-05	0,000202	0,000176	0,00005
120000	2,88E-05	2,39E-05	0,00019	0,000168	0,00005
130000	2,76E-05	2,2E-05	0,000176	0,000154	0,00005
140000	2,55E-05	2,21E-05	0,000171	0,000154	0,00005
150000	2,41E-05	2,08E-05	0,000169	0,000146	0,00005
160000	2,44E-05	2,02E-05	0,000158	0,00014	0,00005
170000	2,41E-05	1,95E-05	0,00016	0,000133	0,00005
180000	2,33E-05	1,91E-05	0,000151	0,000129	0,00005
190000	2,21E-05	1,89E-05	0,000147	0,000138	0,00005
200000	2,16E-05	1,79E-05	0,00014	0,000131	0,00005
210000	2,14E-05	1,73E-05	0,000136	0,000126	0,00005
220000	2,04E-05	1,65E-05	0,000145	0,000136	0,00005
230000	2,14E-05	1,6E-05	0,000139	0,00013	0,00005
240000	2,05E-05	1,54E-05	0,000136	0,000129	0,00005

250000	1,97E-05	1,59E-05	0,000131	0,000125	0,00005
260000	2E-05	1,53E-05	0,000128	0,000121	0,00005
270000	1,92E-05	1,47E-05	0,000128	0,000116	0,00005
280000	1,92E-05	1,44E-05	0,000122	0,000115	0,00005
290000	1,85E-05	1,42E-05	0,000118	0,000111	0,00005
300000	1,85E-05	1,37E-05	0,000115	0,000109	0,00005
310000	1,87E-05	1,36E-05	0,000112	0,000105	0,00005
320000	1,84E-05	1,36E-05	0,000109	0,000103	0,00005
330000	1,79E-05	1,33E-05	0,000106	0,0001	0,00005
340000	1,79E-05	1,32E-05	0,000103	9,81E-05	0,00005
350000	1,74E-05	1,33E-05	9,99E-05	9,63E-05	0,00005
360000	1,69E-05	1,3E-05	9,98E-05	9,36E-05	0,00005
370000	1,66E-05	1,3E-05	9,72E-05	9,49E-05	0,00005
380000	1,68E-05	1,32E-05	9,57E-05	9,25E-05	0,00005
390000	1,65E-05	1,29E-05	9,32E-05	9,03E-05	0,00005
400000	1,61E-05	1,29E-05	9,24E-05	8,8E-05	0,00005
410000	1,58E-05	1,27E-05	9,12E-05	8,83E-05	0,00005
420000	1,59E-05	1,27E-05	9,34E-05	8,78E-05	0,00005
430000	1,55E-05	1,25E-05	9,14E-05	8,58E-05	0,00005
440000	1,54E-05	1,27E-05	8,99E-05	8,41E-05	0,00005
450000	1,7E-05	1,25E-05	8,79E-05	8,23E-05	0,00005
460000	1,7E-05	1,22E-05	8,61E-05	8,05E-05	0,00005
470000	1,67E-05	1,2E-05	8,42E-05	7,9E-05	0,00005
480000	1,66E-05	1,17E-05	8,35E-05	7,79E-05	0,00005
490000	1,62E-05	1,16E-05	8,18E-05	7,66E-05	0,00005
500000	1,61E-05	1,14E-05	8,02E-05	7,51E-05	0,00005
510000	1,58E-05	1,12E-05	7,92E-05	7,44E-05	0,00005
520000	1,6E-05	1,11E-05	7,86E-05	7,54E-05	0,00005
530000	1,66E-05	1,1E-05	7,72E-05	7,41E-05	0,00005
540000	1,65E-05	1,1E-05	7,6E-05	7,42E-05	0,00005
550000	1,62E-05	1,09E-05	7,7E-05	7,4E-05	0,00005
560000	1,6E-05	1,08E-05	7,57E-05	7,31E-05	0,00005
570000	1,57E-05	1,12E-05	7,44E-05	7,37E-05	0,00005
580000	1,55E-05	1,11E-05	7,39E-05	7,27E-05	0,00005
590000	1,53E-05	1,09E-05	7,28E-05	7,19E-05	0,00005
600000	1,62E-05	1,11E-05	7,22E-05	7,09E-05	0,00005
610000	1,59E-05	1,09E-05	7,1E-05	6,98E-05	0,00005
620000	1,6E-05	1,07E-05	6,99E-05	6,87E-05	0,00005
630000	1,58E-05	1,06E-05	6,89E-05	6,77E-05	0,00005
640000	1,59E-05	1,04E-05	7,01E-05	6,89E-05	0,00005
650000	1,56E-05	1,03E-05	6,95E-05	6,84E-05	0,00005
660000	1,55E-05	1,02E-05	6,86E-05	6,81E-05	0,00005
670000	1,56E-05	1,01E-05	6,77E-05	6,7E-05	0,00005
680000	1,54E-05	1E-05	6,71E-05	6,73E-05	0,00005
690000	1,52E-05	9,89E-06	6,62E-05	6,67E-05	0,00005

700000	1,5E-05	9,76E-06	6,53E-05	6,63E-05	0,00005
710000	1,49E-05	9,66E-06	6,46E-05	6,55E-05	0,00005
720000	1,48E-05	9,58E-06	6,37E-05	6,47E-05	0,00005
730000	1,46E-05	9,53E-06	6,31E-05	6,42E-05	0,00005
740000	1,46E-05	9,48E-06	6,3E-05	6,41E-05	0,00005
750000	1,44E-05	9,36E-06	6,23E-05	6,35E-05	0,00005
760000	1,44E-05	9,27E-06	6,16E-05	6,26E-05	0,00005
770000	1,43E-05	9,18E-06	6,08E-05	6,18E-05	0,00005
780000	1,42E-05	9,16E-06	6,03E-05	6,11E-05	0,00005
790000	1,41E-05	9,07E-06	5,97E-05	6,05E-05	0,00005
800000	1,48E-05	8,96E-06	6,11E-05	6,15E-05	0,00005
810000	1,49E-05	9,13E-06	6,04E-05	6,08E-05	0,00005
820000	1,47E-05	9,19E-06	5,97E-05	6,08E-05	0,00005
830000	1,45E-05	9,1E-06	5,9E-05	6,01E-05	0,00005
840000	1,44E-05	9E-06	5,91E-05	5,95E-05	0,00005
850000	1,42E-05	8,9E-06	5,89E-05	5,96E-05	0,00005
860000	1,41E-05	8,81E-06	5,82E-05	5,89E-05	0,00005
870000	1,41E-05	8,75E-06	5,83E-05	5,89E-05	0,00005
880000	1,39E-05	8,65E-06	5,8E-05	5,89E-05	0,00005
890000	1,39E-05	8,61E-06	5,81E-05	5,82E-05	0,00005
900000	1,39E-05	8,51E-06	5,76E-05	5,76E-05	0,00005
910000	1,42E-05	8,42E-06	5,96E-05	5,89E-05	0,00005
920000	1,41E-05	8,33E-06	5,95E-05	6E-05	0,00005
930000	1,4E-05	8,25E-06	5,91E-05	5,95E-05	0,00005
940000	1,38E-05	8,19E-06	5,85E-05	5,91E-05	0,00005
950000	1,37E-05	8,1E-06	5,79E-05	5,84E-05	0,00005
960000	1,36E-05	8,02E-06	5,74E-05	5,79E-05	0,00005
970000	1,36E-05	7,96E-06	5,76E-05	5,8E-05	0,00005
980000	1,36E-05	7,94E-06	5,7E-05	5,77E-05	0,00005
990000	1,35E-05	7,86E-06	5,64E-05	5,71E-05	0,00005
1000000	1,36E-05	7,78E-06	5,61E-05	5,73E-05	0,00005
1010000	1,35E-05	7,71E-06	5,56E-05	5,68E-05	0,00005
1020000	1,34E-05	7,64E-06	5,51E-05	5,63E-05	0,00005
1030000	1,34E-05	7,56E-06	5,46E-05	5,59E-05	0,00005
1040000	1,32E-05	7,49E-06	5,47E-05	5,54E-05	0,00005
1050000	1,33E-05	7,48E-06	5,42E-05	5,51E-05	0,00005
1060000	1,32E-05	7,42E-06	5,4E-05	5,46E-05	0,00005
1070000	1,31E-05	7,42E-06	5,35E-05	5,44E-05	0,00005
1080000	1,3E-05	7,35E-06	5,36E-05	5,45E-05	0,00005
1090000	1,29E-05	7,36E-06	5,31E-05	5,41E-05	0,00005
1100000	1,28E-05	7,31E-06	5,34E-05	5,42E-05	0,00005
1110000	1,27E-05	7,33E-06	5,29E-05	5,37E-05	0,00005
1120000	1,26E-05	7,31E-06	5,25E-05	5,32E-05	0,00005
1130000	1,25E-05	7,25E-06	5,2E-05	5,28E-05	0,00005
1140000	1,24E-05	7,2E-06	5,16E-05	5,24E-05	0,00005

1150000	1,23E-05	7,16E-06	5,11E-05	5,19E-05	0,00005
1160000	1,23E-05	7,19E-06	5,07E-05	5,16E-05	0,00005
1170000	1,26E-05	7,17E-06	5,07E-05	5,2E-05	0,00005
1180000	1,26E-05	7,18E-06	5,05E-05	5,16E-05	0,00005
1190000	1,26E-05	7,14E-06	5,02E-05	5,15E-05	0,00005
1200000	1,25E-05	7,13E-06	4,99E-05	5,12E-05	0,00005
1210000	1,24E-05	7,08E-06	5,01E-05	5,17E-05	0,00005
1220000	1,23E-05	7,02E-06	4,97E-05	5,13E-05	0,00005
1230000	1,22E-05	6,97E-06	4,93E-05	5,11E-05	0,00005
1240000	1,23E-05	7E-06	4,89E-05	5,09E-05	0,00005
1250000	1,22E-05	7E-06	4,85E-05	5,07E-05	0,00005
1260000	1,21E-05	6,97E-06	4,83E-05	5,04E-05	0,00005
1270000	1,2E-05	6,92E-06	4,79E-05	5,04E-05	0,00005
1280000	1,19E-05	6,92E-06	4,75E-05	5,02E-05	0,00005
1290000	1,19E-05	6,87E-06	4,71E-05	4,98E-05	0,00005
1300000	1,19E-05	6,82E-06	4,69E-05	4,95E-05	0,00005
1310000	1,18E-05	6,8E-06	4,77E-05	4,93E-05	0,00005
1320000	1,17E-05	6,76E-06	4,75E-05	4,9E-05	0,00005
1330000	1,16E-05	6,72E-06	4,71E-05	4,87E-05	0,00005
1340000	1,15E-05	6,68E-06	4,68E-05	4,84E-05	0,00005
1350000	1,21E-05	6,63E-06	4,66E-05	4,81E-05	0,00005
1360000	1,2E-05	6,6E-06	4,64E-05	4,78E-05	0,00005
1370000	1,2E-05	6,58E-06	4,63E-05	4,78E-05	0,00005
1380000	1,19E-05	6,53E-06	4,6E-05	4,75E-05	0,00005
1390000	1,18E-05	6,5E-06	4,58E-05	4,71E-05	0,00005
1400000	1,17E-05	6,46E-06	4,56E-05	4,7E-05	0,00005
1410000	1,17E-05	6,48E-06	4,54E-05	4,67E-05	0,00005
1420000	1,17E-05	6,44E-06	4,53E-05	4,68E-05	0,00005
1430000	1,16E-05	6,4E-06	4,52E-05	4,66E-05	0,00005
1440000	1,16E-05	6,35E-06	4,53E-05	4,68E-05	0,00005
1450000	1,15E-05	6,32E-06	4,5E-05	4,65E-05	0,00005
1460000	1,14E-05	6,31E-06	4,47E-05	4,63E-05	0,00005
1470000	1,14E-05	6,31E-06	4,57E-05	4,63E-05	0,00005
1480000	1,18E-05	6,29E-06	4,54E-05	4,6E-05	0,00005
1490000	1,17E-05	6,25E-06	4,53E-05	4,57E-05	0,00005
1500000	1,17E-05	6,22E-06	4,5E-05	4,56E-05	0,00005
1510000	1,16E-05	6,19E-06	4,49E-05	4,54E-05	0,00005
1520000	1,16E-05	6,15E-06	4,46E-05	4,51E-05	0,00005
1530000	1,15E-05	6,16E-06	4,43E-05	4,49E-05	0,00005
1540000	1,14E-05	6,2E-06	4,42E-05	4,46E-05	0,00005
1550000	1,14E-05	6,16E-06	4,4E-05	4,44E-05	0,00005
1560000	1,13E-05	6,15E-06	4,38E-05	4,43E-05	0,00005
1570000	1,13E-05	6,11E-06	4,36E-05	4,42E-05	0,00005
1580000	1,12E-05	6,07E-06	4,34E-05	4,41E-05	0,00005
1590000	1,11E-05	6,07E-06	4,33E-05	4,39E-05	0,00005

1600000	1,11E-05	6,07E-06	4,31E-05	4,36E-05	0,00005
1610000	1,1E-05	6,05E-06	4,31E-05	4,33E-05	0,00005
1620000	1,11E-05	6,02E-06	4,3E-05	4,31E-05	0,00005
1630000	1,1E-05	5,98E-06	4,29E-05	4,32E-05	0,00005
1640000	1,1E-05	5,96E-06	4,27E-05	4,3E-05	0,00005
1650000	1,09E-05	5,93E-06	4,25E-05	4,28E-05	0,00005
1660000	1,09E-05	5,9E-06	4,23E-05	4,26E-05	0,00005
1670000	1,09E-05	5,88E-06	4,21E-05	4,26E-05	0,00005
1680000	1,08E-05	5,88E-06	4,19E-05	4,28E-05	0,00005
1690000	1,08E-05	5,84E-06	4,19E-05	4,26E-05	0,00005
1700000	1,08E-05	5,83E-06	4,17E-05	4,24E-05	0,00005

Tablica P.6. *log-likelihood* vrijednosti otpora za sve faze i sve razdiobe (MC metoda)

Razdioba	Log-likelihood		
	Otpor R1	Otpor R2	Otpor R3
Birnbaum-Saunders	3049070	3848360	3846210
Razdioba ekstremnih vrijednosti	2968370	3767680	3765250
Gamma	3049070	3848360	3846210
Poopćena razdioba ekstremnih vrijednosti	3035940	3837280	3833120
Inverzna Gaussova	3968010	476730	4765140
Log-logistic	3039770	3838830	383690
Logistic	3039770	3838830	383690
Lognormalna	3049070	3848360	3846210
Nakagami	3049070	3848360	3846210
Gaussova	3049070	3848360	3846210
Ricianova	3049070	3848360	3846210
t razdioba	3049070	3848360	3846210
Weibullova	2969370	3768170	3765670

Tablica P.7. *log-likelihood* vrijednosti otpora za sve faze i sve razdiobe (AMC metoda)

Razdioba	Log-likelihood		
	Otpor R1	Otpor R2	Otpor R3
Birnbaum-Saunders	366391	5039930	4922980
Razdioba ekstremnih vrijednosti	356655	4933380	4819980
Gamma	366392	5039930	4922980
Poopćena razdioba ekstremnih vrijednosti	365259	5020740	4906370
Inverzna Gaussova	476664	6243740	6099220
Log-logistic	365245	5027520	4910870
Logistic	365245	5027520	4910870
Lognormalna	366391	5039930	4922980
Nakagami	366392	5039930	4922980
Gaussova	366392	5039930	4922980
Ricianova	366392	5039930	4922980
t razdioba	366392	5039930	4922980
Weibullova	356775	4934030	4820510

Tablica P.8. Stabilizacija rezultata modificirane AMC metode kod proračuna otpora R1

M	y_mean_std	y_std_std	y_low_std	y_high_std	tol
20000	0,001782559	0,00045387	0,00241078	0,007661052	0,005
30000	0,001361523	0,00028348	0,00540752	0,008699717	0,005
40000	0,00116601	0,00032086	0,00422609	0,006582421	0,005
50000	0,000909794	0,00029625	0,00679837	0,007161478	0,005
60000	0,000855133	0,00028199	0,00566668	0,005890184	0,005
70000	0,000727978	0,00035073	0,00571262	0,005302512	0,005
80000	0,000630456	0,000306	0,0049627	0,0046206	0,005
90000	0,000767221	0,00037157	0,00445781	0,004084888	0,005
100000	0,000746662	0,00033255	0,00399898	0,003653948	0,005
110000	0,000733639	0,00030567	0,00375582	0,00336914	0,005
120000	0,000769564	0,00028071	0,00350316	0,003116467	0,005
130000	0,000721959	0,00026742	0,00332617	0,002895901	0,005
140000	0,000720177	0,00026432	0,00308376	0,00269467	0,005
150000	0,000694762	0,00026246	0,0029245	0,002510988	0,005
160000	0,000692076	0,00024623	0,00273704	0,002348827	0,005
170000	0,00065952	0,00030961	0,00258695	0,002249177	0,005
180000	0,000660622	0,00029319	0,00252239	0,002267087	0,005
190000	0,000628454	0,00028356	0,00257727	0,002171071	0,005
200000	0,000659202	0,00027595	0,0024455	0,0020603	0,005

Tablica P.9. Stabilizacija rezultata modificirane AMC metode kod proračuna otpora R2

M	y_mean_std	y_std_std	y_low_std	y_high_std	tol
20000	0,000749044	4,8131E-05	0,00871195	0,006283708	0,005
30000	0,001133214	0,00039003	0,00593845	0,003675285	0,005
40000	0,000954621	0,00047	0,0042178	0,0026076	0,005
50000	0,000807136	0,00040944	0,00327148	0,002046845	0,005
60000	0,000832254	0,00042928	0,00292674	0,001714585	0,005
70000	0,000838694	0,00045467	0,00309553	0,002214631	0,005
80000	0,000745648	0,00047062	0,00268194	0,001941156	0,005
90000	0,000659455	0,00046625	0,00236858	0,001713221	0,005
100000	0,000891936	0,00042946	0,00212898	0,001532678	0,005
110000	0,000812847	0,00041385	0,00206366	0,001789086	0,005
120000	0,000760017	0,00039795	0,00232195	0,002009726	0,005
130000	0,000742511	0,00041973	0,00278763	0,002299628	0,005
140000	0,000690396	0,00039458	0,00268918	0,00212933	0,005
150000	0,000662714	0,00036735	0,00250511	0,001982667	0,005
160000	0,000630852	0,00035824	0,00239087	0,00212965	0,005
170000	0,000633469	0,00034348	0,00231122	0,002064529	0,005
180000	0,000630012	0,0003246	0,00218797	0,001960907	0,005
190000	0,000595986	0,0003093	0,00209694	0,001862942	0,005
200000	0,000614257	0,00032285	0,0020200	0,0018490	0,005

Tablica P.10. Stabilizacija rezultata modificirane AMC metode kod proračuna otpora R3

M	y_mean_std	y_std_std	y_low_std	y_high_std	tol
20000	0,003184572	0,00087935	0,00059761	0,000712268	0,005
30000	0,00254688	0,00096198	0,00718409	0,00258705	0,005
40000	0,001810878	0,00101535	0,0051242	0,002291368	0,005
50000	0,001612839	0,00081765	0,00416552	0,001962578	0,005
60000	0,001316895	0,00085915	0,00601168	0,00400899	0,005
70000	0,001147198	0,0007404	0,0056679	0,004764731	0,005
80000	0,001036645	0,00070989	0,005244	0,004129268	0,005
90000	0,000936872	0,000629	0,0046888	0,0036877	0,005
100000	0,000856031	0,00060302	0,00439151	0,00362985	0,005
110000	0,000787676	0,00054633	0,00397242	0,003326135	0,005
120000	0,000804298	0,0005011	0,00371237	0,003105108	0,005
130000	0,000740042	0,00046102	0,00341888	0,002856288	0,005
140000	0,000747958	0,00044144	0,00356347	0,002989372	0,005
150000	0,000696885	0,00041174	0,00344665	0,002851052	0,005
160000	0,000661372	0,00041862	0,00323793	0,002676164	0,005
170000	0,00063089	0,00039325	0,00304843	0,00251405	0,005
180000	0,000635936	0,00037505	0,00296845	0,002490112	0,005
190000	0,000614878	0,00035586	0,00282469	0,002390928	0,005
200000	0,000588643	0,00034348	0,0026798	0,0022700	0,005

Tablica P.11. Izmjerene vrijednosti struje i napona na strani A za cijeli mjesec

Izmjerene vrijednosti struje i napona na strani A za cijeli mjesec								
Redni broj	Napon [kV]	Struja [A]	Redni Broj	Napon [kV]	Struja [A]	Redni Broj	Napon [kV]	Struja [A]
1	116,104	34,082	961	106,073	36,352	1921	116,104	35,712
2	112,204	33,080	962	121,709	30,496	1922	116,104	36,120
3	116,104	30,732	963	121,709	28,912	1923	119,871	33,376
4	116,104	30,732	964	114,171	30,001	1924	116,104	34,459
5	116,104	29,501	965	106,073	32,830	1925	116,104	33,650
6	116,104	29,501	966	121,709	26,976	1926	116,104	31,969
7	116,104	28,279	967	121,709	27,466	1927	116,104	32,424
8	116,104	28,792	968	114,171	27,522	1928	116,104	31,205
9	116,104	27,600	969	121,709	26,329	1929	116,104	31,205
10	116,104	27,064	970	106,073	30,210	1930	116,104	30,535
11	116,104	27,600	971	121,709	24,668	1931	116,104	30,535
12	116,104	27,600	972	114,171	28,067	1932	114,171	29,852
13	116,104	27,064	973	106,073	30,210	1933	119,871	29,051
14	116,104	27,064	974	121,709	25,818	1934	116,104	30,535
15	116,104	27,064	975	121,709	26,329	1935	116,104	28,792
16	116,104	27,064	976	114,171	28,067	1936	116,104	30,535
17	116,104	27,600	977	106,073	30,210	1937	116,104	28,792
18	116,104	27,064	978	121,709	24,668	1938	116,104	30,535
19	116,104	28,279	979	121,709	27,466	1939	116,104	28,792
20	116,104	28,792	980	114,171	28,067	1940	116,104	31,725
21	116,104	27,064	981	106,073	32,291	1941	116,104	31,205
22	116,104	29,501	982	121,709	28,143	1942	116,104	32,424
23	116,104	29,994	983	121,709	29,768	1943	116,104	31,205
24	112,204	29,261	984	106,073	34,156	1944	116,104	32,925
25	116,104	29,994	985	114,171	31,252	1945	116,104	31,725
26	116,104	28,792	986	121,709	31,408	1946	116,104	34,133
27	116,104	29,994	987	121,709	31,682	1947	116,104	33,650
28	119,871	30,728	988	106,073	38,180	1948	112,204	36,577
29	112,204	33,551	989	114,171	35,043	1949	116,104	36,120
30	116,104	32,424	990	121,709	29,316	1950	114,171	36,731
31	116,104	32,424	991	106,073	27,640	1951	116,104	37,363
32	114,171	34,219	992	121,709	24,089	1952	112,204	39,558
33	116,104	33,211	993	106,073	26,379	1953	116,104	39,493
34	112,204	34,819	994	114,171	24,508	1954	116,104	38,229
35	114,171	35,043	995	121,709	21,290	1955	114,171	41,450
36	116,104	33,650	996	106,073	26,379	1956	112,204	39,558
37	112,204	35,657	997	121,709	22,990	1957	116,104	39,164
38	116,104	33,211	998	106,073	26,379	1958	114,171	40,162
39	114,171	35,043	999	121,709	21,907	1959	116,104	38,611
40	112,204	34,366	1000	106,073	26,379	1960	112,204	39,558
41	116,104	33,211	1001	114,171	23,881	1961	114,171	38,876
42	114,171	33,774	1002	121,709	22,990	1962	116,104	38,229
43	116,104	33,211	1003	106,073	25,136	1963	112,204	39,558
44	112,204	35,657	1004	121,709	22,402	1964	116,104	39,493
45	112,204	34,366	1005	114,171	23,353	1965	112,204	40,526
46	116,104	33,211	1006	106,073	26,379	1966	114,171	40,162
47	114,171	33,774	1007	121,709	21,907	1967	112,204	40,526
48	112,204	33,961	1008	106,073	26,379	1968	116,104	39,493
49	116,104	34,459	1009	121,709	21,907	1969	114,171	40,162
50	114,171	32,510	1010	106,073	26,379	1970	116,104	38,229
51	112,204	34,366	1011	114,171	24,508	1971	112,204	40,526
52	116,104	33,211	1012	121,709	22,990	1972	116,104	38,229
53	114,171	32,510	1013	106,073	25,136	1973	116,104	38,229
54	112,204	33,080	1014	121,709	22,990	1974	114,171	40,162
55	116,104	33,211	1015	114,171	28,757	1975	116,104	36,969
56	114,171	32,510	1016	114,171	32,972	1976	112,204	39,558
57	116,104	31,969	1017	114,171	33,774	1977	116,104	36,969
58	112,204	33,080	1018	121,709	31,308	1978	116,104	37,363
59	116,104	31,969	1019	106,073	34,992	1979	114,171	37,594
60	114,171	32,510	1020	121,709	31,308	1980	116,104	36,969
61	116,104	32,424	1021	114,171	32,510	1981	116,104	35,712
62	112,204	31,362	1022	106,073	34,992	1982	116,104	36,120
63	116,104	31,205	1023	121,709	30,496	1983	112,204	36,094

64	114,171	32,510	1024	121,709	30,496	1984	116,104	36,120
65	116,104	31,969	1025	106,073	34,546	1985	116,104	34,459
66	112,204	31,800	1026	114,171	32,096	1986	116,104	36,120
67	116,104	31,969	1027	121,709	31,682	1987	114,171	36,731
68	116,104	31,969	1028	106,073	35,924	1988	116,104	35,712
69	112,204	33,080	1029	121,709	31,308	1989	116,104	36,120
70	116,104	31,969	1030	114,171	32,510	1990	116,104	35,712
71	114,171	32,510	1031	121,709	31,308	1991	112,204	37,375
72	116,104	33,211	1032	106,073	37,718	1992	116,104	37,363
73	112,204	34,366	1033	121,709	32,872	1993	116,104	36,120
74	116,104	33,650	1034	114,171	34,659	1994	116,104	36,120
75	114,171	35,043	1035	106,073	39,089	1995	116,104	36,969
76	116,104	35,712	1036	121,709	34,931	1996	112,204	39,952
77	112,204	37,890	1037	121,709	35,266	1997	116,104	38,229
78	116,104	40,442	1038	106,073	43,962	1998	116,104	39,493
79	114,171	44,378	1039	114,171	43,465	1999	116,104	40,760
80	112,204	48,027	1040	106,073	47,960	2000	114,171	45,036
81	114,171	48,522	1041	121,709	43,037	2001	112,204	48,027
82	112,204	49,373	1042	106,073	49,381	2002	116,104	46,858
83	114,171	47,200	1043	121,709	43,037	2003	114,171	47,407
84	112,204	48,027	1044	106,073	48,196	2004	116,104	46,618
85	114,171	46,092	1045	121,709	40,773	2005	112,204	47,155
86	112,204	46,683	1046	106,073	46,783	2006	116,104	44,033
87	112,204	45,563	1047	114,171	44,778	2007	114,171	47,651
88	116,104	42,742	1048	121,709	40,773	2008	116,104	44,286
89	114,171	43,465	1049	106,073	46,783	2009	112,204	48,238
90	116,104	41,452	1050	121,709	40,773	2010	116,104	45,571
91	112,204	42,893	1051	106,073	45,372	2011	114,171	46,092
92	114,171	41,126	1052	114,171	40,844	2012	116,104	45,571
93	116,104	38,877	1053	121,709	37,361	2013	112,204	45,563
94	112,204	37,890	1054	106,073	40,080	2014	116,104	43,003
95	116,104	35,348	1055	121,709	32,513	2015	114,171	41,126
96	116,104	33,211	1056	106,073	36,352	2016	116,104	39,493
97	114,171	33,375	1057	114,171	32,510	2017	116,104	36,969
98	116,104	31,562	1058	121,709	30,108	2018	116,104	35,712
99	112,204	31,800	1059	106,073	32,291	2019	116,104	34,459
100	116,104	29,501	1060	121,709	28,613	2020	112,204	35,657
101	116,104	29,501	1061	114,171	30,001	2021	116,104	33,211
102	114,171	28,757	1062	114,171	28,757	2022	116,104	32,424
103	116,104	28,279	1063	114,171	28,757	2023	116,104	32,424
104	112,204	29,261	1064	121,709	25,818	2024	118,003	30,703
105	116,104	27,600	1065	106,073	30,210	2025	116,104	29,994
106	114,171	27,522	1066	121,709	25,203	2026	116,104	31,725
107	116,104	27,064	1067	114,171	27,522	2027	116,104	29,994
108	112,204	28,559	1068	106,073	28,918	2028	116,104	30,535
109	116,104	25,859	1069	121,709	26,329	2029	116,104	29,994
110	112,204	28,005	1070	121,709	25,203	2030	114,171	29,279
111	116,104	26,420	1071	106,073	30,210	2031	116,104	30,535
112	116,104	27,064	1072	114,171	28,067	2032	116,104	28,792
113	114,171	26,867	1073	121,709	25,203	2033	116,104	30,535
114	116,104	27,600	1074	106,073	30,210	2034	116,104	29,994
115	116,104	25,859	1075	121,709	25,818	2035	116,104	29,994
116	112,204	28,005	1076	114,171	28,757	2036	116,104	29,994
117	116,104	27,600	1077	106,073	32,830	2037	112,204	32,289
118	114,171	28,067	1078	121,709	28,143	2038	116,104	29,994
119	116,104	27,064	1079	106,073	32,291	2039	116,104	31,725
120	116,104	27,600	1080	121,709	29,768	2040	116,104	30,535
121	112,204	28,559	1081	114,171	31,733	2041	116,104	31,122
122	116,104	28,187	1082	106,073	35,490	2042	116,104	31,725
123	116,104	28,187	1083	121,709	32,872	2043	116,104	31,725
124	114,171	29,852	1084	106,073	37,718	2044	116,104	32,925
125	116,104	30,535	1085	121,709	34,067	2045	114,171	34,219
126	112,204	33,551	1086	106,073	39,089	2046	116,104	35,348
127	116,104	31,205	1087	121,709	35,266	2047	116,104	34,882
128	114,171	34,710	1088	106,073	38,691	2048	116,104	36,570
129	116,104	32,424	1089	114,171	34,659	2049	112,204	36,953
130	112,204	34,819	1090	106,073	38,691	2050	116,104	37,363
131	114,171	35,472	1091	121,709	32,513	2051	114,171	37,594

132	116,104	34,459	1092	106,073	37,305	2052	116,104	37,363
133	112,204	36,094	1093	121,709	34,067	2053	112,204	39,206
134	112,204	36,953	1094	106,073	37,305	2054	114,171	38,876
135	114,171	37,995	1095	121,709	33,720	2055	116,104	38,229
136	112,204	39,558	1096	106,073	37,718	2056	112,204	41,248
137	114,171	38,876	1097	114,171	33,375	2057	112,204	39,558
138	116,104	38,229	1098	106,073	37,305	2058	116,104	39,164
139	112,204	41,248	1099	121,709	33,720	2059	114,171	41,450
140	114,171	38,876	1100	106,073	37,305	2060	112,204	40,866
141	112,204	41,847	1101	121,709	32,197	2061	116,104	39,493
142	114,171	38,876	1102	106,073	38,691	2062	114,171	41,450
143	112,204	39,558	1103	114,171	34,659	2063	112,204	41,847
144	114,171	37,995	1104	114,171	34,659	2064	114,171	42,741
145	112,204	36,953	1105	114,171	33,375	2065	116,104	40,442
146	116,104	33,650	1106	106,073	35,924	2066	112,204	41,847
147	114,171	35,472	1107	106,073	37,718	2067	114,171	41,450
148	112,204	33,551	1108	121,709	31,308	2068	116,104	40,442
149	114,171	32,972	1109	106,073	34,546	2069	112,204	40,866
150	116,104	32,424	1110	121,709	31,682	2070	114,171	41,450
151	112,204	32,289	1111	106,073	34,992	2071	116,104	39,493
152	112,204	32,289	1112	114,171	32,510	2072	112,204	40,866
153	116,104	29,994	1113	114,171	33,375	2073	116,104	38,229
154	114,171	29,279	1114	114,171	32,510	2074	114,171	37,594
155	112,204	31,036	1115	106,073	34,546	2075	116,104	38,611
156	116,104	27,600	1116	121,709	30,496	2076	112,204	36,953
157	114,171	29,279	1117	106,073	34,992	2077	116,104	35,712
158	116,104	27,600	1118	121,709	30,108	2078	116,104	36,120
159	112,204	29,167	1119	114,171	32,510	2079	112,204	36,953
160	116,104	27,600	1120	106,073	34,992	2080	116,104	35,712
161	116,104	27,600	1121	121,709	30,496	2081	114,171	36,731
162	114,171	28,067	1122	106,073	34,546	2082	116,104	34,459
163	116,104	27,032	1123	121,709	31,682	2083	112,204	36,953
164	112,204	28,559	1124	106,073	34,546	2084	116,104	36,120
165	116,104	28,187	1125	121,709	30,108	2085	116,104	35,712
166	114,171	29,279	1126	106,073	34,992	2086	114,171	36,316
167	116,104	27,600	1127	114,171	32,510	2087	116,104	35,712
168	112,204	28,559	1128	121,709	31,682	2088	116,104	36,969
169	116,104	28,792	1129	106,073	34,992	2089	112,204	38,661
170	114,171	29,279	1130	121,709	31,682	2090	116,104	38,611
171	116,104	28,792	1131	106,073	37,305	2091	116,104	38,229
172	112,204	32,289	1132	114,171	36,316	2092	114,171	40,162
173	116,104	31,205	1133	106,073	38,691	2093	116,104	40,442
174	112,204	34,366	1134	121,709	36,145	2094	112,204	43,491
175	114,171	38,229	1135	106,073	45,372	2095	116,104	43,003
176	112,204	41,560	1136	121,709	41,799	2096	114,171	47,200
177	114,171	42,154	1137	106,073	52,226	2097	116,104	47,714
178	112,204	42,893	1138	121,709	44,277	2098	112,204	50,918
179	114,171	42,154	1139	106,073	49,193	2099	114,171	49,845
180	112,204	41,847	1140	114,171	47,200	2100	116,104	49,015
181	114,171	42,154	1141	106,073	48,196	2101	112,204	49,578
182	112,204	40,526	1142	121,709	41,799	2102	116,104	47,913
183	114,171	41,126	1143	121,709	42,005	2103	112,204	48,238
184	112,204	40,229	1144	106,073	49,611	2104	116,104	45,571
185	116,104	40,442	1145	114,171	44,778	2105	116,104	45,325
186	114,171	39,535	1146	106,073	47,960	2106	114,171	47,407
187	112,204	39,206	1147	121,709	40,773	2107	116,104	44,286
188	114,171	38,531	1148	121,709	40,773	2108	116,104	44,286
189	112,204	37,890	1149	106,073	44,266	2109	116,104	41,721
190	116,104	34,082	1150	114,171	39,535	2110	112,204	42,177
191	112,204	34,366	1151	121,709	36,145	2111	116,104	39,164
192	116,104	31,562	1152	106,073	37,305	2112	116,104	36,969
193	114,171	30,001	1153	121,709	32,513	2113	116,104	35,712
194	116,104	29,501	1154	114,171	33,375	2114	116,104	34,459
195	112,204	29,261	1155	114,171	31,252	2115	116,104	33,650
196	116,104	27,064	1156	114,171	31,252	2116	116,104	32,424
197	116,104	28,279	1157	121,709	27,722	2117	116,104	31,969
198	114,171	26,297	1158	114,171	30,001	2118	116,104	31,205
199	116,104	27,064	1159	114,171	29,279	2119	116,104	29,994

200	116,104	27,600	1160	114,171	28,067	2120	116,104	29,994
201	112,204	26,758	1161	121,709	26,329	2121	116,104	29,994
202	116,104	25,859	1162	106,073	30,210	2122	116,104	29,355
203	116,104	26,420	1163	121,709	25,203	2123	119,871	27,887
204	114,171	26,297	1164	114,171	27,522	2124	116,104	28,792
205	116,104	26,420	1165	121,709	26,329	2125	116,104	27,600
206	116,104	24,665	1166	114,171	28,067	2126	112,204	29,167
207	112,204	26,130	1167	114,171	26,867	2127	116,104	29,355
208	116,104	26,420	1168	114,171	27,522	2128	116,104	26,420
209	116,104	25,859	1169	121,709	26,329	2129	116,104	29,355
210	116,104	25,252	1170	114,171	28,067	2130	116,104	27,600
211	114,171	26,867	1171	114,171	27,522	2131	116,104	28,187
212	116,104	25,859	1172	114,171	29,279	2132	116,104	27,600
213	116,104	27,600	1173	121,709	27,466	2133	116,104	28,792
214	112,204	29,793	1174	114,171	30,001	2134	116,104	28,187
215	116,104	28,279	1175	114,171	30,502	2135	116,104	30,535
216	114,171	31,252	1176	114,171	30,001	2136	119,871	27,301
217	116,104	31,969	1177	121,709	29,768	2137	116,104	28,187
218	112,204	33,080	1178	106,073	34,156	2138	116,104	28,822
219	112,204	34,819	1179	114,171	34,219	2139	116,104	28,822
220	116,104	33,211	1180	121,709	31,682	2140	116,104	28,822
221	114,171	43,465	1181	106,073	37,718	2141	116,104	30,535
222	112,204	46,505	1182	121,709	32,513	2142	116,104	31,122
223	114,171	45,704	1183	114,171	36,316	2143	116,104	32,925
224	112,204	46,505	1184	114,171	35,946	2144	112,204	34,633
225	114,171	44,378	1185	114,171	37,237	2145	116,104	34,133
226	110,200	45,977	1186	121,709	35,266	2146	116,104	34,133
227	112,204	45,013	1187	106,073	38,691	2147	116,104	35,348
228	114,171	44,237	1188	121,709	33,416	2148	114,171	37,189
229	112,204	43,808	1189	106,073	37,305	2149	116,104	37,363
230	114,171	42,908	1190	114,171	36,316	2150	112,204	40,389
231	112,204	42,460	1191	106,073	38,691	2151	116,104	39,862
232	114,171	41,729	1192	121,709	34,067	2152	112,204	41,248
233	114,171	41,579	1193	121,709	32,513	2153	116,104	41,118
234	114,171	43,053	1194	106,073	38,691	2154	114,171	41,814
235	116,104	40,887	1195	114,171	35,946	2155	116,104	41,118
236	112,204	43,660	1196	114,171	36,316	2156	112,204	42,547
237	116,104	40,887	1197	114,171	34,659	2157	116,104	40,271
238	114,171	41,579	1198	106,073	40,080	2158	114,171	41,814
239	112,204	42,308	1199	121,709	33,416	2159	116,104	39,862
240	116,104	44,809	1200	121,709	33,720	2160	112,204	39,952
241	114,171	48,135	1201	106,073	39,089	2161	116,104	39,032
242	112,204	47,719	1202	114,171	34,659	2162	116,104	37,363
243	116,104	46,116	1203	106,073	38,691	2163	114,171	37,189
244	114,171	46,802	1204	121,709	32,513	2164	116,104	35,348
245	116,104	46,116	1205	106,073	37,305	2165	116,104	34,133
246	112,204	43,808	1206	121,709	33,720	2166	112,204	35,319
247	114,171	30,821	1207	114,171	33,375	2167	116,104	32,925
248	116,104	30,732	1208	106,073	35,924	2168	116,104	32,925
249	112,204	30,527	1209	121,709	32,513	2169	116,104	32,925
250	116,104	29,501	1210	106,073	37,305	2170	116,104	31,725
251	114,171	30,821	1211	121,709	31,308	2171	116,104	31,725
252	116,104	30,732	1212	114,171	33,375	2172	116,104	30,535
253	116,104	30,308	1213	114,171	33,375	2173	116,104	31,122
254	112,204	31,800	1214	114,171	33,026	2174	116,104	30,535
255	116,104	30,308	1215	121,709	32,513	2175	116,104	29,355
256	112,204	30,527	1216	106,073	35,924	2176	116,104	30,535
257	116,104	30,308	1217	121,709	32,872	2177	116,104	31,122
258	116,104	31,562	1218	106,073	35,924	2178	116,104	29,355
259	116,104	30,308	1219	114,171	34,659	2179	116,104	29,355
260	114,171	30,821	1220	121,709	31,308	2180	116,104	29,965
261	116,104	30,308	1221	106,073	37,718	2181	116,104	30,535
262	116,104	31,562	1222	121,709	32,513	2182	116,104	30,535
263	116,104	30,732	1223	114,171	34,659	2183	116,104	32,291
264	112,204	33,961	1224	106,073	38,691	2184	116,104	30,535
265	116,104	31,969	1225	121,709	34,067	2185	116,104	31,725
266	116,104	31,562	1226	106,073	37,305	2186	116,104	30,535
267	116,104	32,820	1227	121,709	33,720	2187	116,104	33,470

268	116,104	32,820	1228	114,171	35,946	2188	116,104	31,725
269	114,171	36,316	1229	106,073	38,691	2189	112,204	34,069
270	116,104	37,593	1230	121,709	36,145	2190	116,104	33,650
271	112,204	43,997	1231	121,709	38,088	2191	116,104	35,348
272	116,104	43,817	1232	106,073	47,960	2192	114,171	38,876
273	114,171	45,704	1233	114,171	45,879	2193	116,104	40,442
274	112,204	48,027	1234	114,171	47,030	2194	112,204	43,491
275	116,104	43,817	1235	114,171	45,879	2195	114,171	43,731
276	116,104	43,817	1236	121,709	43,037	2196	116,104	42,030
277	114,171	43,239	1237	106,073	49,381	2197	112,204	41,847
278	116,104	42,742	1238	121,709	41,799	2198	116,104	42,030
279	112,204	45,340	1239	106,073	48,196	2199	114,171	42,427
280	116,104	41,452	1240	114,171	44,778	2200	116,104	42,030
281	116,104	41,452	1241	121,709	41,799	2201	112,204	43,171
282	116,104	42,742	1242	106,073	48,196	2202	114,171	42,741
283	116,104	41,223	1243	121,709	41,799	2203	116,104	40,442
284	116,104	40,164	1244	114,171	42,154	2204	112,204	42,177
285	112,204	39,206	1245	106,073	44,266	2205	116,104	39,493
286	116,104	35,030	1246	121,709	37,087	2206	116,104	38,229
287	116,104	34,082	1247	121,709	34,931	2207	114,171	37,594
288	116,104	31,562	1248	106,073	38,691	2208	116,104	34,459
289	116,104	31,562	1249	114,171	34,659	2209	116,104	33,650
290	119,871	28,574	1250	121,709	30,108	2210	116,104	32,424
291	116,104	29,501	1251	121,709	30,496	2211	116,104	31,205
292	112,204	29,261	1252	106,073	33,174	2212	116,104	31,205
293	116,104	27,818	1253	114,171	30,001	2213	116,104	29,994
294	116,104	28,279	1254	121,709	26,976	2214	116,104	28,792
295	119,871	26,213	1255	121,709	27,722	2215	116,104	28,792
296	116,104	27,600	1256	114,171	28,757	2216	114,171	29,852
297	116,104	25,859	1257	106,073	29,623	2217	116,104	27,600
298	116,104	27,064	1258	121,709	26,329	2218	116,104	29,355
299	116,104	26,420	1259	121,709	25,818	2219	116,104	26,420
300	116,104	25,859	1260	106,073	30,210	2220	116,104	28,187
301	116,104	27,064	1261	114,171	26,297	2221	116,104	28,187
302	116,104	27,064	1262	121,709	25,203	2222	116,104	28,187
303	116,104	27,064	1263	121,709	25,203	2223	116,104	27,600
304	118,003	25,443	1264	106,073	28,918	2224	116,104	27,032
305	116,104	27,600	1265	114,171	26,867	2225	116,104	27,600
306	116,104	27,064	1266	121,709	25,203	2226	116,104	28,187
307	116,104	27,064	1267	121,709	25,203	2227	116,104	28,792
308	116,104	27,064	1268	106,073	28,918	2228	116,104	28,187
309	116,104	28,792	1269	114,171	26,867	2229	116,104	28,792
310	116,104	28,279	1270	121,709	25,203	2230	116,104	29,355
311	116,104	29,501	1271	121,709	27,466	2231	116,104	29,355
312	116,104	31,969	1272	106,073	31,515	2232	116,104	30,535
313	116,104	30,732	1273	114,171	29,279	2233	116,104	32,925
314	116,104	33,211	1274	121,709	28,613	2234	116,104	32,424
315	116,104	31,969	1275	106,073	31,515	2235	116,104	34,882
316	116,104	33,211	1276	121,709	30,264	2236	114,171	35,472
317	114,171	36,316	1277	114,171	31,733	2237	116,104	36,120
318	116,104	33,211	1278	106,073	36,832	2238	112,204	38,661
319	112,204	35,657	1279	121,709	30,930	2239	116,104	35,712
320	116,104	35,712	1280	121,709	32,872	2240	114,171	37,594
321	114,171	34,659	1281	106,073	37,718	2241	116,104	36,617
322	116,104	34,082	1282	114,171	36,731	2242	112,204	38,254
323	112,204	35,267	1283	106,073	37,718	2243	116,104	36,617
324	116,104	32,820	1284	121,709	35,266	2244	114,171	37,237
325	114,171	34,323	1285	121,709	34,067	2245	112,204	36,577
326	112,204	35,267	1286	106,073	39,089	2246	116,104	36,969
327	116,104	32,820	1287	114,171	35,043	2247	114,171	35,946
328	114,171	33,375	1288	114,171	36,316	2248	112,204	35,657
329	114,171	33,375	1289	114,171	36,731	2249	116,104	35,348
330	114,171	33,375	1290	121,709	32,872	2250	116,104	34,082
331	112,204	35,267	1291	106,073	39,535	2251	112,204	36,577
332	116,104	32,820	1292	121,709	32,872	2252	114,171	34,659
333	114,171	34,659	1293	106,073	39,089	2253	116,104	34,082
334	112,204	33,961	1294	114,171	36,316	2254	112,204	36,577
335	114,171	33,026	1295	121,709	32,872	2255	116,104	34,082

336	112,204	33,961	1296	106,073	39,089	2256	114,171	33,774
337	114,171	33,375	1297	121,709	34,067	2257	116,104	35,348
338	116,104	32,820	1298	106,073	37,718	2258	112,204	33,961
339	112,204	35,267	1299	114,171	35,043	2259	116,104	34,459
340	114,171	32,510	1300	121,709	31,682	2260	114,171	33,375
341	112,204	34,366	1301	106,073	36,352	2261	116,104	33,211
342	116,104	31,562	1302	121,709	32,872	2262	112,204	33,961
343	114,171	32,510	1303	114,171	33,774	2263	116,104	33,211
344	112,204	32,289	1304	114,171	33,774	2264	116,104	32,424
345	116,104	31,562	1305	114,171	34,219	2265	114,171	32,510
346	114,171	32,510	1306	106,073	36,352	2266	116,104	30,732
347	112,204	31,362	1307	121,709	30,496	2267	116,104	32,424
348	116,104	31,969	1308	121,709	32,100	2268	112,204	32,289
349	112,204	33,080	1309	106,073	34,546	2269	116,104	31,969
350	114,171	31,252	1310	114,171	34,219	2270	116,104	31,205
351	116,104	31,969	1311	121,709	31,308	2271	116,104	31,205
352	112,204	33,080	1312	106,073	36,352	2272	116,104	30,732
353	114,171	32,096	1313	121,709	31,682	2273	116,104	31,205
354	116,104	31,969	1314	114,171	33,774	2274	114,171	31,252
355	112,204	33,080	1315	106,073	37,718	2275	116,104	31,205
356	114,171	33,375	1316	121,709	31,682	2276	116,104	31,205
357	116,104	31,969	1317	121,709	32,872	2277	116,104	32,424
358	112,204	34,366	1318	106,073	37,718	2278	116,104	31,969
359	114,171	32,510	1319	114,171	34,659	2279	116,104	32,424
360	116,104	31,969	1320	121,709	34,067	2280	112,204	33,551
361	112,204	34,366	1321	106,073	37,718	2281	116,104	32,424
362	116,104	33,211	1322	121,709	34,067	2282	116,104	33,211
363	114,171	34,659	1323	114,171	34,659	2283	112,204	36,094
364	116,104	34,082	1324	106,073	39,089	2284	116,104	34,459
365	112,204	38,254	1325	121,709	34,067	2285	116,104	36,969
366	114,171	39,535	1326	121,709	34,931	2286	114,171	37,594
367	116,104	42,742	1327	106,073	42,868	2287	116,104	40,442
368	112,204	46,683	1328	114,171	41,920	2288	116,104	41,721
369	112,204	46,683	1329	121,709	43,237	2289	112,204	46,683
370	114,171	45,879	1330	106,073	47,960	2290	114,171	47,407
371	116,104	43,817	1331	121,709	42,005	2291	116,104	45,325
372	112,204	45,340	1332	106,073	48,196	2292	112,204	45,563
373	114,171	43,465	1333	121,709	40,561	2293	116,104	45,325
374	116,104	40,164	1334	114,171	43,465	2294	114,171	45,036
375	112,204	44,227	1335	106,073	48,474	2295	116,104	44,033
376	116,104	40,442	1336	121,709	40,773	2296	116,104	43,003
377	114,171	41,126	1337	106,073	46,783	2297	112,204	45,563
378	116,104	41,452	1338	121,709	42,005	2298	116,104	44,286
379	112,204	41,560	1339	106,073	47,960	2299	114,171	45,036
380	116,104	39,164	1340	114,171	43,731	2300	116,104	42,742
381	114,171	37,237	1341	121,709	38,314	2301	116,104	40,442
382	116,104	35,348	1342	106,073	43,962	2302	116,104	39,493
383	112,204	35,267	1343	121,709	34,931	2303	116,104	36,617
384	116,104	31,562	1344	114,171	35,946	2304	112,204	36,953
385	114,171	32,510	1345	106,073	37,305	2305	116,104	33,211
386	116,104	30,308	1346	121,709	31,308	2306	116,104	33,650
387	112,204	30,527	1347	121,709	29,316	2307	116,104	31,969
388	116,104	28,279	1348	114,171	30,001	2308	116,104	31,205
389	116,104	29,501	1349	106,073	32,291	2309	116,104	29,501
390	112,204	28,005	1350	121,709	26,976	2310	116,104	29,994
391	116,104	27,064	1351	121,709	26,976	2311	119,871	29,575
392	114,171	28,067	1352	114,171	28,067	2312	114,171	29,279
393	116,104	25,859	1353	106,073	29,623	2313	116,104	27,600
394	116,104	26,420	1354	121,709	24,668	2314	116,104	29,355
395	112,204	27,338	1355	121,709	26,329	2315	116,104	27,600
396	116,104	25,859	1356	114,171	26,297	2316	116,104	27,600
397	114,171	26,867	1357	121,709	26,329	2317	116,104	27,600
398	116,104	27,064	1358	106,073	26,998	2318	116,104	27,600
399	116,104	25,859	1359	121,709	25,203	2319	116,104	28,792
400	112,204	28,005	1360	114,171	26,867	2320	116,104	28,792
401	116,104	27,064	1361	121,709	24,668	2321	119,871	27,301
402	114,171	26,867	1362	106,073	27,640	2322	116,104	27,600
403	116,104	27,064	1363	121,709	25,203	2323	116,104	28,792

404	116,104	27,064	1364	114,171	26,867	2324	116,104	28,792
405	112,204	30,527	1365	106,073	28,304	2325	116,104	29,994
406	116,104	28,279	1366	121,709	26,329	2326	116,104	29,994
407	114,171	30,001	1367	121,709	25,818	2327	116,104	29,994
408	116,104	31,205	1368	114,171	28,664	2328	118,003	30,043
409	112,204	33,080	1369	106,073	30,210	2329	114,171	32,262
410	114,171	32,972	1370	121,709	26,329	2330	116,104	32,424
411	116,104	31,969	1371	121,709	29,129	2331	116,104	32,424
412	112,204	34,819	1372	114,171	30,001	2332	116,104	34,882
413	114,171	33,774	1373	106,073	35,490	2333	112,204	35,657
414	112,204	38,899	1374	121,709	33,275	2334	116,104	35,712
415	112,204	42,655	1375	121,709	31,682	2335	114,171	36,316
416	114,171	43,239	1376	114,171	34,219	2336	116,104	35,348
417	112,204	38,638	1377	106,073	39,089	2337	112,204	36,577
418	116,104	38,633	1378	121,709	35,266	2338	114,171	35,946
419	114,171	40,603	1379	121,709	35,266	2339	116,104	34,082
420	112,204	38,422	1380	106,073	41,844	2340	112,204	35,267
421	114,171	37,972	1381	114,171	39,827	2341	114,171	34,659
422	112,204	39,975	1382	121,709	36,469	2342	116,104	32,820
423	116,104	37,340	1383	106,073	44,266	2343	112,204	34,366
424	114,171	36,658	1384	121,709	37,361	2344	114,171	33,774
425	112,204	38,638	1385	114,171	40,162	2345	116,104	32,820
426	114,171	37,972	1386	106,073	44,266	2346	112,204	34,366
427	116,104	38,432	1387	121,709	39,800	2347	112,204	33,606
428	112,204	39,975	1388	121,709	38,579	2348	114,171	33,375
429	114,171	39,082	1389	106,073	45,667	2349	116,104	32,820
430	112,204	41,315	1390	114,171	42,427	2350	112,204	35,267
431	112,204	41,113	1391	114,171	42,427	2351	114,171	34,323
432	116,104	38,432	1392	114,171	41,126	2352	112,204	33,961
433	114,171	40,603	1393	121,709	38,579	2353	114,171	34,659
434	112,204	41,113	1394	106,073	44,266	2354	116,104	32,820
435	114,171	39,287	1395	121,709	38,579	2355	112,204	34,366
436	116,104	38,432	1396	114,171	40,162	2356	114,171	34,659
437	112,204	38,638	1397	106,073	42,868	2357	112,204	35,267
438	114,171	37,760	1398	121,709	36,145	2358	116,104	33,211
439	112,204	35,267	1399	121,709	36,469	2359	114,171	35,043
440	116,104	31,969	1400	106,073	41,473	2360	112,204	33,080
441	114,171	32,096	1401	114,171	38,531	2361	116,104	31,969
442	116,104	31,969	1402	121,709	36,469	2362	114,171	32,510
443	112,204	33,961	1403	121,709	34,931	2363	116,104	31,969
444	114,171	32,510	1404	106,073	41,473	2364	112,204	33,080
445	116,104	31,562	1405	114,171	38,876	2365	116,104	30,732
446	112,204	34,366	1406	121,709	34,931	2366	112,204	33,080
447	116,104	31,969	1407	106,073	40,465	2367	116,104	30,732
448	114,171	33,375	1408	121,709	33,720	2368	116,104	30,732
449	116,104	31,969	1409	114,171	36,316	2369	114,171	32,510
450	112,204	33,961	1410	121,709	34,067	2370	116,104	30,732
451	116,104	33,211	1411	106,073	40,465	2371	112,204	33,080
452	116,104	32,820	1412	121,709	33,720	2372	116,104	31,205
453	112,204	33,961	1413	114,171	37,594	2373	114,171	32,510
454	116,104	34,459	1414	121,709	35,266	2374	116,104	31,969
455	114,171	33,774	1415	106,073	41,473	2375	112,204	31,800
456	116,104	33,211	1416	121,709	36,145	2376	116,104	32,424
457	112,204	35,657	1417	114,171	40,162	2377	114,171	31,733
458	114,171	35,946	1418	106,073	44,266	2378	116,104	31,969
459	116,104	36,617	1419	121,709	38,579	2379	112,204	34,366
460	112,204	40,229	1420	121,709	38,579	2380	116,104	33,211
461	114,171	40,844	1421	106,073	45,667	2381	114,171	35,043
462	112,204	44,227	1422	114,171	45,036	2382	112,204	38,254
463	114,171	45,879	1423	121,709	44,471	2383	116,104	36,617
464	112,204	46,683	1424	106,073	52,048	2384	114,171	41,126
465	114,171	47,200	1425	121,709	47,999	2385	112,204	43,997
466	116,104	45,325	1426	114,171	49,683	2386	114,171	44,558
467	112,204	46,683	1427	106,073	55,074	2387	112,204	46,900
468	116,104	42,519	1428	121,709	47,999	2388	116,104	44,033
469	114,171	43,465	1429	106,073	52,226	2389	112,204	44,227
470	116,104	42,742	1430	121,709	45,517	2390	114,171	44,778
471	112,204	44,227	1431	114,171	48,522	2391	112,204	44,227

472	116,104	41,452	1432	114,171	47,200	2392	116,104	43,003
473	116,104	41,721	1433	114,171	46,092	2393	114,171	42,154
474	112,204	42,893	1434	121,709	44,277	2394	112,204	44,497
475	116,104	41,721	1435	106,073	49,611	2395	114,171	43,465
476	116,104	38,877	1436	121,709	41,799	2396	112,204	43,171
477	116,104	37,593	1437	114,171	44,778	2397	116,104	39,164
478	114,171	37,237	1438	106,073	44,266	2398	114,171	39,827
479	116,104	35,348	1439	121,709	37,087	2399	112,204	37,890
480	116,104	32,820	1440	114,171	37,594	2400	116,104	34,082
481	116,104	31,969	1441	121,709	32,513	2401	114,171	35,043
482	116,104	31,562	1442	106,073	37,305	2402	116,104	31,969
483	116,104	29,501	1443	121,709	30,496	2403	112,204	32,659
484	116,104	29,501	1444	114,171	31,252	2404	116,104	31,205
485	116,104	29,501	1445	114,171	30,001	2405	114,171	30,001
486	116,104	29,501	1446	114,171	30,001	2406	116,104	29,501
487	116,104	27,064	1447	121,709	26,976	2407	116,104	28,279
488	116,104	28,792	1448	114,171	28,067	2408	112,204	29,793
489	116,104	27,064	1449	114,171	27,522	2409	116,104	27,600
490	116,104	26,420	1450	114,171	26,867	2410	112,204	28,559
491	116,104	27,600	1451	121,709	25,818	2411	114,171	27,522
492	116,104	27,064	1452	114,171	26,867	2412	116,104	27,600
493	116,104	27,064	1453	114,171	27,522	2413	112,204	28,559
494	116,104	27,600	1454	114,171	26,867	2414	116,104	27,064
495	116,104	27,064	1455	121,709	25,203	2415	114,171	28,067
496	116,104	27,064	1456	114,171	26,297	2416	116,104	27,600
497	116,104	27,600	1457	114,171	26,867	2417	112,204	28,559
498	116,104	27,064	1458	114,171	26,867	2418	116,104	27,064
499	116,104	27,064	1459	121,709	24,668	2419	116,104	28,792
500	116,104	28,792	1460	114,171	26,867	2420	114,171	29,279
501	116,104	28,279	1461	114,171	26,297	2421	112,204	31,036
502	112,204	30,527	1462	114,171	26,867	2422	116,104	29,994
503	116,104	31,969	1463	121,709	26,329	2423	114,171	30,502
504	116,104	31,969	1464	114,171	26,867	2424	116,104	29,994
505	116,104	32,820	1465	114,171	28,664	2425	112,204	31,596
506	116,104	34,459	1466	114,171	27,490	2426	114,171	32,972
507	116,104	34,459	1467	121,709	28,003	2427	116,104	33,211
508	114,171	35,946	1468	114,171	29,279	2428	112,204	34,819
509	116,104	36,617	1469	114,171	31,052	2429	112,204	36,953
510	112,204	38,254	1470	114,171	32,262	2430	114,171	35,946
511	116,104	36,617	1471	121,709	30,930	2431	112,204	36,953
512	112,204	39,206	1472	114,171	33,482	2432	114,171	34,659
513	114,171	37,237	1473	114,171	34,219	2433	110,200	37,242
514	116,104	36,310	1474	114,171	35,472	2434	112,204	35,657
515	112,204	37,890	1475	121,709	34,456	2435	114,171	34,323
516	116,104	36,617	1476	106,073	39,535	2436	112,204	35,267
517	114,171	37,237	1477	121,709	34,456	2437	114,171	34,659
518	116,104	36,617	1478	114,171	39,264	2438	112,204	35,267
519	112,204	38,254	1479	106,073	41,844	2439	114,171	33,774
520	114,171	37,237	1480	121,709	36,832	2440	110,200	33,253
521	116,104	36,969	1481	121,709	36,469	2441	112,204	34,366
522	112,204	37,890	1482	106,073	43,632	2442	114,171	32,096
523	116,104	36,617	1483	114,171	39,264	2443	112,204	33,961
524	114,171	38,531	1484	121,709	36,469	2444	112,204	35,267
525	112,204	37,890	1485	106,073	42,262	2445	114,171	33,375
526	114,171	37,237	1486	121,709	35,642	2446	112,204	35,267
527	116,104	35,348	1487	114,171	37,995	2447	114,171	34,323
528	112,204	37,890	1488	106,073	40,896	2448	112,204	33,961
529	114,171	35,946	1489	121,709	34,456	2449	114,171	34,659
530	112,204	37,890	1490	106,073	38,180	2450	112,204	33,606
531	116,104	35,348	1491	121,709	32,100	2451	116,104	32,820
532	112,204	35,657	1492	114,171	34,219	2452	114,171	32,096
533	114,171	33,375	1493	106,073	36,038	2453	112,204	33,961
534	116,104	34,459	1494	121,709	30,264	2454	114,171	33,375
535	112,204	35,657	1495	121,709	29,768	2455	112,204	32,659
536	114,171	32,510	1496	114,171	32,262	2456	114,171	33,774
537	116,104	33,211	1497	106,073	34,725	2457	116,104	30,308
538	112,204	32,659	1498	121,709	29,768	2458	112,204	33,080
539	114,171	33,774	1499	121,709	29,129	2459	112,204	31,800

540	116,104	31,969	1500	106,073	32,830	2460	116,104	30,732
541	112,204	33,080	1501	114,171	31,052	2461	114,171	31,252
542	116,104	32,820	1502	121,709	27,466	2462	112,204	31,800
543	114,171	33,774	1503	106,073	33,422	2463	116,104	29,501
544	112,204	33,080	1504	121,709	28,003	2464	114,171	31,252
545	116,104	33,211	1505	114,171	29,279	2465	112,204	31,800
546	116,104	33,211	1506	114,171	28,664	2466	116,104	30,732
547	114,171	33,375	1507	114,171	29,852	2467	114,171	32,510
548	116,104	33,211	1508	121,709	26,889	2468	116,104	30,308
549	112,204	35,657	1509	106,073	30,852	2469	112,204	34,366
550	116,104	34,459	1510	121,709	28,003	2470	116,104	31,969
551	114,171	36,316	1511	114,171	29,279	2471	114,171	32,510
552	116,104	34,459	1512	106,073	33,422	2472	116,104	30,732
553	112,204	35,657	1513	121,709	28,613	2473	112,204	33,080
554	112,204	35,657	1514	114,171	32,262	2474	114,171	32,510
555	116,104	35,348	1515	121,709	29,768	2475	116,104	33,211
556	114,171	37,594	1516	106,073	35,490	2476	112,204	35,657
557	112,204	37,890	1517	121,709	30,930	2477	116,104	35,348
558	116,104	40,442	1518	114,171	34,219	2478	114,171	37,594
559	114,171	44,558	1519	114,171	35,043	2479	112,204	40,526
560	110,200	48,901	1520	114,171	38,531	2480	112,204	41,560
561	112,204	47,854	1521	106,073	41,148	2481	114,171	44,558
562	114,171	46,092	1522	121,709	38,579	2482	112,204	46,683
563	112,204	46,683	1523	121,709	38,579	2483	114,171	47,407
564	114,171	45,879	1524	106,073	44,266	2484	112,204	45,340
565	112,204	44,227	1525	114,171	41,126	2485	114,171	46,092
566	114,171	43,465	1526	106,073	42,868	2486	112,204	44,227
567	116,104	43,003	1527	121,709	36,145	2487	114,171	44,778
568	112,204	44,227	1528	121,709	36,469	2488	112,204	44,227
569	114,171	45,036	1529	106,073	42,868	2489	114,171	42,154
570	112,204	44,227	1530	114,171	40,162	2490	112,204	44,497
571	112,204	44,227	1531	121,709	36,145	2491	114,171	42,154
572	116,104	41,452	1532	106,073	41,473	2492	112,204	43,171
573	114,171	39,827	1533	121,709	35,266	2493	116,104	38,877
574	116,104	37,890	1534	114,171	35,946	2494	116,104	36,617
575	112,204	37,890	1535	114,171	33,774	2495	114,171	37,237
576	116,104	35,348	1536	114,171	33,774	2496	114,171	34,659
577	114,171	33,375	1537	121,709	29,316	2497	116,104	34,459
578	116,104	33,211	1538	114,171	31,733	2498	116,104	31,562
579	112,204	33,080	1539	114,171	30,001	2499	114,171	31,252
580	116,104	29,501	1540	114,171	29,279	2500	116,104	29,501
581	116,104	30,732	1541	121,709	26,976	2501	116,104	29,501
582	114,171	28,757	1542	106,073	30,210	2502	116,104	28,279
583	116,104	29,501	1543	114,171	28,067	2503	116,104	28,279
584	116,104	28,792	1544	121,709	26,329	2504	116,104	27,064
585	112,204	29,793	1545	106,073	28,918	2505	116,104	27,600
586	116,104	27,600	1546	121,709	25,203	2506	116,104	27,064
587	116,104	27,064	1547	114,171	27,490	2507	116,104	25,859
588	114,171	28,067	1548	114,171	26,867	2508	116,104	27,600
589	116,104	28,792	1549	114,171	26,867	2509	116,104	27,064
590	116,104	27,064	1550	121,709	25,203	2510	116,104	27,600
591	112,204	29,793	1551	106,073	28,918	2511	116,104	25,859
592	116,104	27,600	1552	121,709	24,700	2512	116,104	27,600
593	116,104	27,600	1553	106,073	27,640	2513	116,104	27,600
594	114,171	29,279	1554	114,171	26,867	2514	116,104	27,600
595	116,104	28,279	1555	121,709	25,203	2515	116,104	26,420
596	116,104	29,501	1556	106,073	27,640	2516	116,104	27,064
597	112,204	30,527	1557	121,709	25,787	2517	116,104	28,792
598	116,104	30,732	1558	114,171	26,867	2518	116,104	29,994
599	116,104	31,205	1559	106,073	28,918	2519	116,104	27,600
600	112,204	34,366	1560	121,709	24,700	2520	116,104	28,187
601	116,104	31,969	1561	121,709	24,700	2521	116,104	29,994
602	114,171	35,472	1562	106,073	29,096	2522	116,104	31,205
603	116,104	33,211	1563	114,171	27,490	2523	112,204	33,080
604	112,204	36,953	1564	121,709	26,418	2524	116,104	33,211
605	114,171	37,594	1565	106,073	30,852	2525	114,171	35,043
606	112,204	36,953	1566	121,709	28,003	2526	116,104	38,877
607	114,171	37,594	1567	106,073	34,725	2527	112,204	41,315

608	112,204	38,254	1568	114,171	31,052	2528	116,104	39,732
609	114,171	35,946	1569	121,709	30,930	2529	114,171	39,287
610	112,204	38,254	1570	106,073	36,038	2530	112,204	42,460
611	114,171	37,237	1571	121,709	31,408	2531	114,171	42,908
612	112,204	38,254	1572	106,073	35,490	2532	112,204	43,808
613	114,171	37,237	1573	121,709	32,561	2533	116,104	40,887
614	112,204	37,890	1574	106,073	36,832	2534	112,204	41,113
615	112,204	37,890	1575	114,171	34,710	2535	114,171	40,603
616	114,171	36,316	1576	106,073	38,180	2536	116,104	37,340
617	112,204	36,577	1577	121,709	32,561	2537	116,104	38,633
618	114,171	37,594	1578	106,073	36,832	2538	112,204	41,113
619	112,204	37,890	1579	121,709	32,561	2539	116,104	41,034
620	114,171	35,946	1580	114,171	34,219	2540	114,171	42,908
621	112,204	37,890	1581	114,171	34,219	2541	116,104	42,336
622	114,171	38,229	1582	114,171	34,710	2542	112,204	42,460
623	112,204	38,254	1583	106,073	36,832	2543	116,104	40,887
624	114,171	38,531	1584	121,709	30,930	2544	114,171	41,729
625	112,204	37,890	1585	106,073	37,360	2545	116,104	41,034
626	114,171	36,316	1586	121,709	30,930	2546	112,204	43,660
627	112,204	37,890	1587	106,073	35,490	2547	116,104	42,194
628	114,171	36,316	1588	114,171	33,482	2548	114,171	39,287
629	112,204	37,890	1589	121,709	29,768	2549	112,204	38,422
630	112,204	36,577	1590	106,073	33,422	2550	116,104	37,340
631	114,171	37,594	1591	121,709	29,129	2551	114,171	37,972
632	112,204	35,267	1592	106,073	32,830	2552	116,104	34,758
633	114,171	36,316	1593	114,171	29,852	2553	116,104	36,048
634	90,066	45,567	1594	121,709	28,003	2554	112,204	38,638
635	121,709	34,067	1595	106,073	30,210	2555	116,104	36,048
636	106,073	38,691	1596	121,709	28,003	2556	112,204	37,301
637	114,171	36,316	1597	106,073	29,588	2557	116,104	33,752
638	106,073	38,691	1598	121,709	26,889	2558	116,104	36,048
639	121,709	34,067	1599	106,073	30,210	2559	116,104	36,048
640	121,709	34,931	1600	114,171	29,852	2560	114,171	37,972
641	106,073	39,089	1601	121,709	26,889	2561	116,104	37,340
642	114,171	35,946	1602	106,073	29,588	2562	116,104	36,048
643	121,709	35,266	1603	121,709	26,889	2563	116,104	37,340
644	106,073	38,691	1604	106,073	31,515	2564	116,104	37,340
645	121,709	35,266	1605	114,171	29,852	2565	112,204	38,638
646	106,073	39,089	1606	121,709	26,889	2566	116,104	37,593
647	114,171	37,237	1607	106,073	32,131	2567	116,104	38,633
648	114,171	37,594	1608	121,709	26,329	2568	114,171	39,287
649	114,171	37,594	1609	106,073	33,422	2569	116,104	39,927
650	121,709	36,145	1610	114,171	29,852	2570	116,104	39,927
651	106,073	41,473	1611	114,171	31,733	2571	112,204	43,997
652	121,709	37,674	1612	114,171	31,052	2572	116,104	42,336
653	106,073	42,868	1613	121,709	30,930	2573	114,171	44,558
654	114,171	42,154	1614	106,073	36,832	2574	116,104	46,247
655	106,073	49,381	1615	121,709	32,872	2575	112,204	49,204
656	121,709	43,237	1616	106,073	41,473	2576	116,104	51,266
657	106,073	50,804	1617	114,171	39,827	2577	114,171	53,417
658	121,709	44,471	1618	106,073	44,266	2578	112,204	55,712
659	106,073	47,960	1619	121,709	38,579	2579	114,171	54,801
660	114,171	44,778	1620	106,073	43,228	2580	116,104	52,577
661	121,709	41,022	1621	121,709	37,361	2581	112,204	53,048
662	106,073	45,372	1622	106,073	42,868	2582	112,204	53,048
663	121,709	41,022	1623	114,171	41,126	2583	114,171	50,888
664	106,073	46,783	1624	121,709	37,361	2584	116,104	50,041
665	121,709	39,800	1625	106,073	43,962	2585	112,204	53,048
666	106,073	46,783	1626	121,709	38,579	2586	116,104	51,350
667	114,171	43,731	1627	106,073	44,266	2587	114,171	52,219
668	121,709	39,543	1628	121,709	37,361	2588	116,104	47,424
669	106,073	42,868	1629	106,073	41,473	2589	116,104	46,247
670	121,709	36,145	1630	114,171	35,946	2590	116,104	43,817
671	106,073	38,691	1631	106,073	39,089	2591	112,204	42,460
672	114,171	36,316	1632	121,709	31,682	2592	116,104	39,927
673	121,709	32,872	1633	106,073	34,546	2593	116,104	37,131
674	106,073	34,546	1634	121,709	29,768	2594	116,104	37,340
675	121,709	30,930	1635	114,171	30,001	2595	116,104	35,030

676	114,171	32,510	1636	114,171	30,001	2596	116,104	32,184
677	114,171	30,001	1637	114,171	29,279	2597	116,104	32,477
678	114,171	30,502	1638	121,709	26,329	2598	116,104	32,820
679	121,709	28,613	1639	106,073	29,623	2599	116,104	29,936
680	106,073	32,291	1640	121,709	25,203	2600	116,104	30,308
681	121,709	27,466	1641	114,171	28,067	2601	116,104	28,672
682	114,171	29,279	1642	106,073	28,918	2602	116,104	29,060
683	106,073	30,210	1643	121,709	25,787	2603	116,104	29,060
684	121,709	26,329	1644	121,709	25,203	2604	116,104	27,818
685	106,073	30,953	1645	106,073	28,918	2605	116,104	29,060
686	121,709	26,329	1646	114,171	27,490	2606	114,171	29,552
687	114,171	28,757	1647	121,709	24,089	2607	116,104	29,060
688	106,073	31,515	1648	106,073	28,918	2608	116,104	27,818
689	121,709	26,329	1649	121,709	25,203	2609	116,104	29,060
690	121,709	26,329	1650	114,171	26,867	2610	116,104	29,060
691	106,073	31,515	1651	106,073	29,588	2611	116,104	29,060
692	114,171	28,757	1652	121,709	25,203	2612	116,104	29,936
693	121,709	27,466	1653	121,709	26,329	2613	116,104	30,308
694	106,073	30,953	1654	106,073	31,515	2614	116,104	32,477
695	121,709	27,466	1655	114,171	28,067	2615	116,104	30,732
696	114,171	30,502	1656	106,073	32,131	2616	116,104	31,562
697	106,073	32,131	1657	121,709	29,129	2617	116,104	32,820
698	121,709	28,003	1658	121,709	29,768	2618	116,104	36,617
699	106,073	33,422	1659	106,073	34,156	2619	116,104	36,310
700	121,709	30,264	1660	114,171	33,774	2620	116,104	37,593
701	114,171	32,972	1661	114,171	33,774	2621	112,204	42,655
702	114,171	34,219	1662	114,171	35,043	2622	116,104	39,927
703	114,171	34,219	1663	106,073	37,718	2623	112,204	42,460
704	106,073	38,180	1664	121,709	32,513	2624	116,104	39,927
705	121,709	31,682	1665	106,073	39,089	2625	114,171	40,603
706	106,073	37,718	1666	121,709	33,720	2626	116,104	39,732
707	121,709	34,067	1667	106,073	38,691	2627	112,204	41,113
708	106,073	38,180	1668	114,171	35,946	2628	114,171	41,729
709	114,171	36,316	1669	106,073	40,080	2629	116,104	41,034
710	106,073	40,465	1670	121,709	32,872	2630	112,204	41,113
711	121,709	34,931	1671	106,073	37,718	2631	116,104	38,633
712	106,073	40,465	1672	121,709	34,067	2632	114,171	40,405
713	121,709	35,266	1673	106,073	36,352	2633	116,104	39,927
714	106,073	40,465	1674	121,709	32,513	2634	112,204	41,113
715	121,709	35,266	1675	106,073	37,305	2635	116,104	41,034
716	106,073	39,089	1676	114,171	35,043	2636	114,171	41,729
717	114,171	37,237	1677	106,073	37,305	2637	112,204	41,315
718	106,073	40,465	1678	121,709	32,513	2638	116,104	41,034
719	121,709	35,266	1679	106,073	37,718	2639	114,171	41,729
720	106,073	40,465	1680	121,709	32,513	2640	112,204	41,315
721	121,709	33,720	1681	106,073	37,718	2641	116,104	41,034
722	106,073	40,465	1682	114,171	34,659	2642	114,171	41,729
723	114,171	36,316	1683	114,171	35,043	2643	112,204	39,975
724	114,171	36,731	1684	114,171	34,659	2644	116,104	38,633
725	114,171	35,946	1685	106,073	37,718	2645	112,204	38,638
726	106,073	39,089	1686	121,709	31,682	2646	114,171	36,658
727	121,709	34,067	1687	106,073	37,718	2647	116,104	36,048
728	121,709	32,872	1688	121,709	30,930	2648	112,204	37,301
729	106,073	37,718	1689	106,073	36,352	2649	116,104	35,030
730	114,171	35,472	1690	114,171	33,774	2650	114,171	36,658
731	106,073	37,718	1691	114,171	35,043	2651	116,104	36,310
732	121,709	32,872	1692	114,171	33,774	2652	112,204	37,301
733	106,073	36,832	1693	106,073	36,352	2653	114,171	36,925
734	121,709	31,682	1694	121,709	32,872	2654	116,104	37,340
735	106,073	38,180	1695	106,073	36,352	2655	112,204	37,572
736	114,171	33,774	1696	121,709	31,682	2656	116,104	37,340
737	121,709	33,275	1697	106,073	36,352	2657	114,171	36,925
738	106,073	36,352	1698	114,171	35,043	2658	116,104	37,340
739	121,709	33,275	1699	106,073	36,352	2659	112,204	38,899
740	106,073	37,718	1700	121,709	32,872	2660	114,171	39,287
741	121,709	33,275	1701	106,073	37,718	2661	116,104	38,633
742	106,073	38,180	1702	121,709	32,872	2662	112,204	41,315
743	114,171	36,316	1703	106,073	39,089	2663	114,171	39,535

744	121,709	34,067	1704	121,709	34,067	2664	112,204	38,638
745	106,073	39,089	1705	114,171	37,594	2665	116,104	38,877
746	121,709	35,266	1706	106,073	40,465	2666	112,204	39,975
747	106,073	40,896	1707	121,709	36,469	2667	114,171	40,603
748	114,171	38,876	1708	106,073	41,473	2668	116,104	41,223
749	121,709	36,469	1709	121,709	37,674	2669	112,204	45,340
750	106,073	44,266	1710	106,073	45,372	2670	116,104	45,115
751	121,709	40,773	1711	114,171	44,778	2671	114,171	47,030
752	106,073	49,611	1712	106,073	49,611	2672	112,204	51,691
753	121,709	43,037	1713	121,709	43,037	2673	116,104	53,889
754	106,073	51,027	1714	106,073	49,611	2674	114,171	53,467
755	106,073	51,027	1715	121,709	43,237	2675	112,204	54,405
756	114,171	46,092	1716	106,073	48,196	2676	116,104	51,266
757	106,073	51,027	1717	121,709	40,773	2677	114,171	52,219
758	121,709	43,237	1718	106,073	46,783	2678	112,204	50,427
759	106,073	49,611	1719	114,171	44,778	2679	116,104	47,424
760	121,709	43,237	1720	106,073	47,069	2680	114,171	49,683
761	106,073	48,196	1721	121,709	40,773	2681	116,104	48,733
762	121,709	42,005	1722	106,073	48,196	2682	112,204	53,048
763	114,171	43,465	1723	121,709	40,773	2683	116,104	51,350
764	106,073	45,667	1724	106,073	45,667	2684	112,204	50,427
765	121,709	38,579	1725	114,171	39,535	2685	116,104	46,247
766	106,073	41,473	1726	121,709	36,145	2686	114,171	44,378
767	121,709	34,931	1727	106,073	40,080	2687	116,104	42,519
768	106,073	39,089	1728	121,709	33,720	2688	116,104	39,927
769	114,171	33,774	1729	106,073	37,718	2689	112,204	40,229
770	121,709	30,496	1730	121,709	31,682	2690	116,104	36,310
771	106,073	33,638	1731	114,171	30,821	2691	116,104	35,030
772	121,709	29,768	1732	106,073	34,992	2692	116,104	34,758
773	106,073	31,515	1733	121,709	29,316	2693	116,104	33,752
774	114,171	30,001	1734	121,709	28,143	2694	114,171	34,323
775	121,709	26,329	1735	106,073	32,291	2695	116,104	31,562
776	106,073	31,515	1736	114,171	29,279	2696	118,003	30,703
777	121,709	26,329	1737	121,709	27,466	2697	116,104	30,308
778	114,171	28,067	1738	106,073	31,515	2698	116,104	30,308
779	114,171	28,067	1739	121,709	26,976	2699	116,104	30,308
780	114,171	26,867	1740	114,171	29,279	2700	116,104	29,060
781	121,709	26,329	1741	106,073	30,953	2701	116,104	30,308
782	106,073	28,918	1742	121,709	26,329	2702	116,104	30,308
783	121,709	26,329	1743	106,073	31,515	2703	116,104	29,501
784	114,171	26,867	1744	121,709	25,818	2704	116,104	29,060
785	106,073	28,918	1745	114,171	29,279	2705	116,104	30,308
786	121,709	26,329	1746	114,171	29,279	2706	114,171	31,252
787	121,709	25,203	1747	114,171	28,757	2707	116,104	29,060
788	106,073	30,210	1748	121,709	28,143	2708	116,104	30,732
789	114,171	27,490	1749	106,073	32,830	2709	116,104	30,308
790	121,709	27,466	1750	121,709	28,143	2710	116,104	31,562
791	106,073	30,210	1751	114,171	31,252	2711	116,104	30,732
792	121,709	26,889	1752	106,073	35,490	2712	116,104	30,732
793	114,171	27,490	1753	121,709	29,768	2713	116,104	30,732
794	106,073	29,096	1754	114,171	34,219	2714	116,104	33,211
795	121,709	26,889	1755	114,171	34,219	2715	116,104	33,211
796	121,709	27,494	1756	114,171	33,774	2716	116,104	35,348
797	106,073	32,131	1757	106,073	38,180	2717	116,104	35,348
798	114,171	32,262	1758	121,709	34,456	2718	112,204	39,558
799	121,709	30,264	1759	106,073	40,080	2719	116,104	37,890
800	106,073	37,360	1760	121,709	35,266	2720	116,104	37,593
801	121,709	30,930	1761	106,073	41,844	2721	116,104	37,890
802	114,171	33,482	1762	114,171	38,531	2722	114,171	39,827
803	106,073	38,180	1763	114,171	41,450	2723	116,104	39,164
804	121,709	33,720	1764	114,171	40,162	2724	116,104	38,877
805	121,709	33,275	1765	106,073	44,266	2725	112,204	40,526
806	106,073	40,896	1766	121,709	38,883	2726	116,104	41,721
807	114,171	36,731	1767	106,073	44,615	2727	116,104	40,164
808	121,709	35,642	1768	121,709	38,579	2728	112,204	42,893
809	106,073	40,465	1769	106,073	43,228	2729	116,104	41,452
810	121,709	35,642	1770	114,171	41,450	2730	114,171	43,239
811	114,171	39,264	1771	106,073	44,266	2731	116,104	43,817

812	114,171	37,594	1772	121,709	39,800	2732	112,204	46,505
813	114,171	39,264	1773	106,073	44,266	2733	116,104	45,115
814	121,709	35,642	1774	121,709	38,883	2734	114,171	45,879
815	106,073	40,896	1775	106,073	44,266	2735	116,104	43,817
816	121,709	34,456	1776	121,709	38,579	2736	112,204	46,683
817	114,171	36,731	1777	106,073	44,615	2737	116,104	45,115
818	106,073	37,360	1778	114,171	41,450	2738	114,171	45,879
819	121,709	32,100	1779	106,073	42,868	2739	116,104	45,115
820	121,709	31,408	1780	106,073	41,844	2740	112,204	46,683
821	106,073	35,490	1781	121,709	37,361	2741	116,104	43,817
822	114,171	32,262	1782	106,073	41,844	2742	116,104	44,033
823	121,709	29,768	1783	121,709	35,266	2743	114,171	43,239
824	106,073	33,422	1784	106,073	40,465	2744	116,104	40,442
825	121,709	29,129	1785	121,709	35,266	2745	116,104	40,164
826	114,171	28,664	1786	106,073	40,465	2746	112,204	41,560
827	106,073	32,131	1787	114,171	37,594	2747	116,104	40,164
828	121,709	26,889	1788	121,709	35,266	2748	116,104	40,164
829	121,709	26,329	1789	106,073	39,089	2749	114,171	40,844
830	114,171	28,664	1790	121,709	34,067	2750	116,104	39,164
831	106,073	30,852	1791	106,073	39,089	2751	116,104	40,164
832	121,709	25,787	1792	114,171	37,594	2752	116,104	40,164
833	121,709	25,787	1793	114,171	36,316	2753	112,204	43,171
834	114,171	28,664	1794	114,171	36,316	2754	116,104	40,164
835	106,073	29,588	1795	121,709	34,067	2755	116,104	40,442
836	121,709	26,889	1796	106,073	40,896	2756	116,104	41,452
837	121,709	26,889	1797	121,709	35,266	2757	112,204	43,171
838	114,171	28,067	1798	106,073	40,465	2758	116,104	41,452
839	106,073	30,852	1799	114,171	38,876	2759	116,104	41,452
840	121,709	28,003	1800	106,073	42,262	2760	116,104	41,452
841	121,709	26,889	1801	121,709	37,674	2761	114,171	43,465
842	114,171	29,852	1802	121,709	37,674	2762	116,104	42,742
843	106,073	32,830	1803	106,073	44,266	2763	116,104	42,742
844	121,709	29,129	1804	114,171	41,450	2764	116,104	44,033
845	121,709	28,613	1805	106,073	45,667	2765	116,104	43,817
846	106,073	36,832	1806	121,709	41,022	2766	112,204	46,900
847	114,171	36,316	1807	106,073	49,611	2767	116,104	46,414
848	121,709	37,087	1808	121,709	44,471	2768	114,171	48,522
849	106,073	45,667	1809	106,073	50,804	2769	112,204	51,905
850	121,709	38,314	1810	121,709	45,517	2770	114,171	50,888
851	106,073	45,667	1811	106,073	51,027	2771	112,204	53,256
852	114,171	41,126	1812	114,171	47,407	2772	114,171	52,219
853	121,709	38,579	1813	106,073	49,611	2773	112,204	50,554
854	106,073	44,266	1814	121,709	43,237	2774	114,171	49,683
855	121,709	37,361	1815	121,709	42,005	2775	112,204	50,718
856	114,171	41,126	1816	106,073	49,881	2776	116,104	47,552
857	114,171	40,844	1817	114,171	44,778	2777	112,204	53,256
858	114,171	41,126	1818	106,073	49,881	2778	114,171	51,011
859	106,073	44,266	1819	121,709	43,237	2779	112,204	51,905
860	121,709	37,361	1820	106,073	48,196	2780	114,171	49,683
861	121,709	34,931	1821	121,709	41,022	2781	116,104	47,714
862	106,073	40,080	1822	114,171	42,427	2782	112,204	46,683
863	114,171	35,043	1823	114,171	39,827	2783	116,104	41,452
864	121,709	30,496	1824	114,171	38,876	2784	114,171	42,154
865	121,709	30,496	1825	121,709	35,266	2785	116,104	38,877
866	106,073	32,291	1826	114,171	35,043	2786	112,204	40,229
867	114,171	30,001	1827	114,171	33,774	2787	116,104	37,593
868	121,709	27,466	1828	114,171	35,472	2788	114,171	35,946
869	106,073	30,210	1829	121,709	30,496	2789	116,104	34,082
870	121,709	25,818	1830	114,171	32,972	2790	116,104	32,820
871	114,171	26,867	1831	121,709	30,930	2791	112,204	34,366
872	121,709	25,203	1832	106,073	34,156	2792	116,104	31,562
873	114,171	26,867	1833	121,709	29,768	2793	114,171	31,252
874	114,171	26,867	1834	114,171	30,502	2794	116,104	30,732
875	114,171	26,867	1835	121,709	28,613	2795	112,204	31,362
876	121,709	25,203	1836	121,709	29,129	2796	116,104	29,501
877	114,171	25,680	1837	106,073	32,830	2797	116,104	30,308
878	114,171	26,867	1838	114,171	31,733	2798	114,171	30,001
879	114,171	26,867	1839	121,709	29,768	2799	116,104	29,501

880	121,709	25,203	1840	121,709	28,613	2800	114,171	30,001
881	114,171	25,680	1841	114,171	31,733	2801	114,171	29,552
882	114,171	27,490	1842	106,073	32,830	2802	116,104	29,501
883	114,171	26,867	1843	121,709	29,316	2803	116,104	29,501
884	121,709	26,329	1844	121,709	29,768	2804	112,204	30,070
885	114,171	28,067	1845	114,171	32,972	2805	116,104	29,501
886	114,171	28,757	1846	121,709	29,768	2806	116,104	29,501
887	114,171	30,502	1847	106,073	36,832	2807	114,171	28,067
888	121,709	29,768	1848	121,709	30,930	2808	116,104	28,187
889	114,171	32,972	1849	114,171	34,710	2809	116,104	29,355
890	114,171	32,972	1850	121,709	33,275	2810	112,204	32,289
891	114,171	35,043	1851	106,073	36,832	2811	116,104	31,725
892	121,709	32,872	1852	121,709	34,456	2812	114,171	32,972
893	106,073	37,718	1853	114,171	37,594	2813	116,104	33,650
894	121,709	35,266	1854	106,073	40,896	2814	112,204	35,319
895	114,171	35,946	1855	140,289	32,685	2815	116,104	34,459
896	106,073	39,089	1856	112,204	40,866	2816	114,171	36,316
897	121,709	33,720	1857	116,104	39,493	2817	112,204	35,657
898	106,073	39,744	1858	114,171	41,450	2818	116,104	36,969
899	121,709	32,513	1859	116,104	39,164	2819	114,171	35,472
900	106,073	38,691	1860	112,204	42,177	2820	112,204	36,953
901	114,171	34,659	1861	116,104	41,721	2821	114,171	36,731
902	106,073	35,924	1862	114,171	41,126	2822	112,204	38,254
903	121,709	31,308	1863	116,104	42,030	2823	112,204	39,558
904	106,073	35,924	1864	112,204	41,847	2824	114,171	40,162
905	121,709	31,682	1865	114,171	42,741	2825	116,104	39,493
906	106,073	35,924	1866	116,104	41,721	2826	112,204	41,847
907	121,709	30,108	1867	112,204	43,171	2827	114,171	41,450
908	106,073	35,548	1868	116,104	43,003	2828	112,204	43,171
909	114,171	33,375	1869	112,204	43,171	2829	114,171	45,036
910	106,073	35,924	1870	114,171	42,427	2830	112,204	43,171
911	121,709	31,308	1871	116,104	43,003	2831	114,171	42,427
912	106,073	35,924	1872	112,204	43,171	2832	112,204	40,526
913	121,709	32,513	1873	116,104	43,302	2833	114,171	40,162
914	106,073	34,992	1874	114,171	42,427	2834	112,204	39,558
915	121,709	31,682	1875	116,104	41,721	2835	114,171	37,594
916	106,073	34,546	1876	112,204	43,491	2836	112,204	39,206
917	114,171	33,774	1877	116,104	40,442	2837	116,104	35,712
918	106,073	34,992	1878	116,104	42,030	2838	114,171	36,731
919	121,709	31,682	1879	114,171	41,450	2839	112,204	33,080
920	106,073	34,546	1880	116,104	40,760	2840	112,204	33,551
921	121,709	30,496	1881	116,104	39,493	2841	116,104	33,650
922	106,073	34,546	1882	112,204	39,558	2842	114,171	31,733
923	114,171	32,096	1883	116,104	39,493	2843	116,104	31,205
924	114,171	32,096	1884	116,104	39,493	2844	112,204	31,596
925	114,171	32,510	1885	114,171	39,264	2845	114,171	30,502
926	106,073	33,174	1886	116,104	38,229	2846	116,104	29,994
927	121,709	30,496	1887	116,104	38,611	2847	112,204	31,036
928	106,073	33,174	1888	116,104	39,493	2848	114,171	30,502
929	121,709	30,108	1889	116,104	38,229	2849	116,104	29,994
930	114,171	31,252	1890	116,104	38,229	2850	112,204	30,375
931	106,073	34,992	1891	116,104	38,611	2851	114,171	29,279
932	121,709	28,912	1892	116,104	39,493	2852	116,104	29,994
933	106,073	33,638	1893	116,104	39,493	2853	112,204	30,375
934	121,709	30,496	1894	116,104	39,493	2854	114,171	30,502
935	114,171	32,096	1895	116,104	39,862	2855	116,104	30,535
936	106,073	34,992	1896	112,204	41,248	2856	112,204	31,036
937	121,709	31,682	1897	116,104	40,760	2857	114,171	31,733
938	106,073	35,924	1898	116,104	39,862	2858	116,104	31,205
939	121,709	32,513	1899	116,104	42,030	2859	112,204	33,551
940	114,171	34,659	1900	112,204	43,491	2860	112,204	34,366
941	114,171	35,946	1901	116,104	43,003	2861	114,171	34,219
942	114,171	37,237	1902	116,104	44,577	2862	116,104	35,712
943	106,073	45,372	1903	114,171	47,407	2863	112,204	37,375
944	121,709	42,873	1904	116,104	47,913	2864	114,171	39,827
945	106,073	50,804	1905	112,204	50,718	2865	112,204	42,655
946	121,709	44,117	1906	116,104	47,913	2866	114,171	46,092
947	106,073	50,804	1907	114,171	47,407	2867	112,204	46,683

948	114,171	47,407	1908	112,204	48,238	2868	114,171	47,200
949	106,073	47,960	1909	116,104	46,858	2869	112,204	46,683
950	121,709	43,037	1910	114,171	45,036	2870	116,104	45,325
951	106,073	48,196	1911	116,104	46,858	2871	114,171	43,465
952	121,709	42,005	1912	112,204	45,825	2872	116,104	44,033
953	106,073	46,783	1913	116,104	45,571	2873	112,204	45,340
954	121,709	41,799	1914	116,104	46,858	2874	116,104	45,325
955	106,073	47,069	1915	114,171	44,778	2875	116,104	44,033
956	114,171	42,154	1916	116,104	44,286	2876	114,171	43,239
957	121,709	37,087	1917	116,104	43,003	2877	116,104	42,742
958	106,073	41,473	1918	116,104	41,721	2878	112,204	42,655
959	121,709	33,720	1919	112,204	40,866	2879	116,104	40,164
960	114,171	34,659	1920	116,104	37,890	2880	116,104	38,877

Tablica P.12. Izmjerene vrijednosti energija na stranama A i B za cijeli mjesec

Izmjerene energije na strani A i strani B za cijeli mjesec								
Redni broj	Energija na strani A [kWh]	Energija na strani B [kWh]	Redni broj	Energija na strani A [kWh]	Energija na strani B [kWh]	Redni broj	Energija na strani A	Energija na strani B
1	1650	1650	961	1584	1584	1921	1716	1716
2	1518	1518	962	1518	1518	1922	1716	1716
3	1452	1452	963	1452	1452	1923	1650	1650
4	1452	1452	964	1386	1452	1924	1650	1650
5	1386	1386	965	1386	1320	1925	1584	1584
6	1386	1386	966	1320	1320	1926	1518	1584
7	1320	1320	967	1320	1386	1927	1518	1452
8	1320	1320	968	1254	1254	1928	1452	1518
9	1254	1320	969	1254	1254	1929	1452	1452
10	1254	1254	970	1254	1254	1930	1386	1386
11	1254	1254	971	1188	1188	1931	1386	1386
12	1254	1188	972	1254	1254	1932	1320	1320
13	1254	1320	973	1254	1254	1933	1386	1386
14	1254	1254	974	1254	1254	1934	1386	1386
15	1254	1254	975	1254	1254	1935	1320	1320
16	1254	1254	976	1254	1254	1936	1386	1386
17	1254	1254	977	1254	1254	1937	1320	1386
18	1254	1320	978	1188	1254	1938	1386	1320
19	1320	1254	979	1320	1254	1939	1320	1386
20	1320	1320	980	1254	1320	1940	1452	1386
21	1254	1320	981	1386	1320	1941	1452	1518
22	1386	1320	982	1386	1386	1942	1518	1452
23	1386	1386	983	1452	1452	1943	1452	1518
24	1320	1386	984	1452	1452	1944	1518	1518
25	1386	1386	985	1452	1518	1945	1452	1452
26	1320	1320	986	1518	1518	1946	1584	1584
27	1386	1386	987	1584	1584	1947	1584	1584
28	1452	1452	988	1650	1650	1948	1650	1650
29	1518	1518	989	1650	1650	1949	1716	1716
30	1518	1518	990	1452	1518	1950	1716	1716
31	1518	1584	991	1122	1122	1951	1782	1782
32	1584	1518	992	1122	1056	1952	1848	1914
33	1584	1584	993	1056	1056	1953	1914	1848
34	1584	1650	994	1056	1056	1954	1848	1914
35	1650	1584	995	990	1056	1955	1980	1980
36	1584	1650	996	1056	1056	1956	1848	1848
37	1650	1650	997	1056	1056	1957	1914	1914
38	1584	1584	998	1056	1056	1958	1914	1914
39	1650	1650	999	990	990	1959	1848	1848
40	1584	1584	1000	1056	1056	1960	1848	1848
41	1584	1584	1001	1056	1056	1961	1848	1848
42	1584	1584	1002	1056	1056	1962	1848	1914
43	1584	1650	1003	990	990	1963	1848	1848
44	1650	1584	1004	1056	1056	1964	1914	1914
45	1584	1650	1005	990	1056	1965	1914	1914
46	1584	1584	1006	1056	990	1966	1914	1914
47	1584	1584	1007	990	1056	1967	1914	1914
48	1584	1584	1008	1056	1056	1968	1914	1914
49	1650	1584	1009	990	990	1969	1914	1914
50	1518	1584	1010	1056	990	1970	1848	1914
51	1584	1584	1011	1056	1056	1971	1914	1848
52	1584	1584	1012	1056	1056	1972	1848	1914
53	1518	1518	1013	990	1056	1973	1848	1848
54	1518	1584	1014	1056	990	1974	1914	1848

55	1584	1518	1015	1320	1386	1975	1782	1848
56	1518	1584	1016	1518	1518	1976	1848	1848
57	1518	1518	1017	1584	1584	1977	1782	1782
58	1518	1518	1018	1584	1584	1978	1782	1848
59	1518	1518	1019	1518	1584	1979	1782	1782
60	1518	1518	1020	1584	1518	1980	1782	1782
61	1518	1452	1021	1518	1518	1981	1716	1716
62	1452	1518	1022	1518	1518	1982	1716	1650
63	1452	1452	1023	1518	1518	1983	1650	1716
64	1518	1518	1024	1518	1518	1984	1716	1650
65	1518	1518	1025	1518	1518	1985	1650	1716
66	1452	1518	1026	1518	1584	1986	1716	1716
67	1518	1518	1027	1584	1584	1987	1716	1716
68	1518	1452	1028	1584	1584	1988	1716	1716
69	1518	1518	1029	1584	1584	1989	1716	1716
70	1518	1518	1030	1518	1518	1990	1716	1782
71	1518	1584	1031	1584	1584	1991	1716	1716
72	1584	1518	1032	1650	1650	1992	1782	1716
73	1584	1584	1033	1650	1650	1993	1716	1716
74	1584	1650	1034	1650	1716	1994	1716	1716
75	1650	1650	1035	1716	1716	1995	1782	1782
76	1716	1716	1036	1782	1716	1996	1848	1848
77	1782	1782	1037	1782	1848	1997	1848	1914
78	1980	1980	1038	1980	1980	1998	1914	1914
79	2178	2178	1039	2112	2046	1999	1980	1980
80	2310	2376	1040	2178	2244	2000	2178	2178
81	2376	2376	1041	2244	2244	2001	2310	2310
82	2376	2376	1042	2244	2310	2002	2310	2376
83	2310	2310	1043	2244	2178	2003	2310	2310
84	2310	2310	1044	2178	2244	2004	2310	2244
85	2244	2244	1045	2112	2112	2005	2244	2310
86	2244	2244	1046	2112	2112	2006	2178	2178
87	2178	2244	1047	2178	2112	2007	2310	2310
88	2112	2112	1048	2112	2178	2008	2178	2244
89	2112	2046	1049	2112	2112	2009	2310	2244
90	2046	2112	1050	2112	2112	2010	2244	2310
91	2046	2046	1051	2046	2046	2011	2244	2244
92	1980	1980	1052	1980	2046	2012	2244	2244
93	1914	1914	1053	1914	1848	2013	2178	2178
94	1782	1782	1054	1782	1782	2014	2112	2046
95	1716	1716	1055	1650	1716	2015	1980	2046
96	1584	1650	1056	1584	1584	2016	1914	1914
97	1584	1518	1057	1518	1518	2017	1782	1782
98	1518	1518	1058	1518	1452	2018	1716	1716
99	1452	1518	1059	1386	1452	2019	1650	1716
100	1386	1386	1060	1386	1386	2020	1650	1584
101	1386	1386	1061	1386	1386	2021	1584	1584
102	1320	1320	1062	1320	1320	2022	1518	1584
103	1320	1320	1063	1320	1320	2023	1518	1518
104	1320	1320	1064	1254	1254	2024	1452	1452
105	1254	1254	1065	1254	1254	2025	1386	1386
106	1254	1254	1066	1188	1188	2026	1452	1452
107	1254	1254	1067	1254	1254	2027	1386	1386
108	1254	1254	1068	1188	1254	2028	1386	1386
109	1188	1188	1069	1254	1188	2029	1386	1386
110	1254	1254	1070	1188	1254	2030	1320	1320
111	1188	1254	1071	1254	1254	2031	1386	1386
112	1254	1188	1072	1254	1188	2032	1320	1320
113	1188	1254	1073	1188	1254	2033	1386	1386

114	1254	1188	1074	1254	1254	2034	1386	1386
115	1188	1254	1075	1254	1254	2035	1386	1386
116	1254	1254	1076	1320	1320	2036	1386	1452
117	1254	1254	1077	1386	1320	2037	1452	1386
118	1254	1254	1078	1386	1452	2038	1386	1452
119	1254	1254	1079	1386	1386	2039	1452	1452
120	1254	1254	1080	1452	1452	2040	1386	1386
121	1254	1254	1081	1452	1452	2041	1386	1386
122	1254	1254	1082	1518	1584	2042	1452	1386
123	1254	1254	1083	1650	1584	2043	1452	1518
124	1320	1320	1084	1650	1650	2044	1518	1518
125	1386	1386	1085	1716	1716	2045	1584	1584
126	1518	1518	1086	1716	1782	2046	1650	1650
127	1452	1518	1087	1782	1716	2047	1650	1650
128	1584	1518	1088	1716	1782	2048	1716	1782
129	1518	1584	1089	1650	1650	2049	1716	1716
130	1584	1584	1090	1716	1716	2050	1782	1782
131	1650	1650	1091	1650	1650	2051	1782	1782
132	1650	1650	1092	1650	1650	2052	1782	1782
133	1650	1650	1093	1716	1716	2053	1848	1848
134	1716	1716	1094	1650	1650	2054	1848	1848
135	1782	1848	1095	1716	1716	2055	1848	1848
136	1848	1782	1096	1650	1650	2056	1914	1914
137	1848	1848	1097	1584	1650	2057	1848	1914
138	1848	1848	1098	1650	1650	2058	1914	1914
139	1914	1914	1099	1716	1650	2059	1980	1914
140	1848	1914	1100	1650	1716	2060	1914	1914
141	1980	1914	1101	1650	1650	2061	1914	1980
142	1848	1914	1102	1716	1716	2062	1980	1980
143	1848	1848	1103	1650	1650	2063	1980	1980
144	1782	1782	1104	1650	1650	2064	2046	2046
145	1716	1716	1105	1584	1584	2065	1980	1980
146	1584	1650	1106	1584	1650	2066	1980	1980
147	1650	1584	1107	1650	1584	2067	1980	1980
148	1518	1584	1108	1584	1584	2068	1980	1980
149	1518	1518	1109	1518	1584	2069	1914	1980
150	1518	1518	1110	1584	1518	2070	1980	1914
151	1452	1452	1111	1518	1584	2071	1914	1914
152	1452	1386	1112	1518	1518	2072	1914	1914
153	1386	1452	1113	1584	1518	2073	1848	1914
154	1320	1320	1114	1518	1584	2074	1782	1782
155	1386	1386	1115	1518	1518	2075	1848	1848
156	1254	1254	1116	1518	1518	2076	1716	1716
157	1320	1320	1117	1518	1518	2077	1716	1782
158	1254	1254	1118	1518	1584	2078	1716	1716
159	1254	1254	1119	1518	1518	2079	1716	1650
160	1254	1320	1120	1518	1518	2080	1716	1716
161	1254	1188	1121	1518	1518	2081	1716	1716
162	1254	1254	1122	1518	1518	2082	1650	1716
163	1188	1254	1123	1584	1518	2083	1716	1716
164	1254	1254	1124	1518	1518	2084	1716	1650
165	1254	1254	1125	1518	1584	2085	1716	1782
166	1320	1254	1126	1518	1518	2086	1716	1716
167	1254	1320	1127	1518	1518	2087	1716	1716
168	1254	1320	1128	1584	1518	2088	1782	1782
169	1320	1254	1129	1518	1584	2089	1782	1848
170	1320	1320	1130	1584	1650	2090	1848	1848
171	1320	1386	1131	1650	1584	2091	1848	1848
172	1452	1386	1132	1716	1716	2092	1914	1848

173	1452	1452	1133	1716	1716	2093	1980	1980
174	1584	1650	1134	1848	1848	2094	2046	2046
175	1848	1848	1135	2046	2046	2095	2112	2178
176	1980	1980	1136	2178	2244	2096	2310	2310
177	2046	2046	1137	2376	2310	2097	2376	2376
178	2046	1980	1138	2310	2310	2098	2442	2442
179	2046	2112	1139	2244	2310	2099	2442	2508
180	1980	2046	1140	2310	2310	2100	2442	2442
181	2046	1980	1141	2178	2178	2101	2376	2376
182	1914	1980	1142	2178	2244	2102	2376	2376
183	1980	1914	1143	2178	2178	2103	2310	2310
184	1914	1980	1144	2244	2178	2104	2244	2244
185	1980	1914	1145	2178	2178	2105	2244	2244
186	1914	1980	1146	2178	2244	2106	2310	2310
187	1848	1848	1147	2112	2112	2107	2178	2244
188	1848	1848	1148	2112	2112	2108	2178	2178
189	1782	1782	1149	1980	1980	2109	2046	2046
190	1650	1650	1150	1914	1914	2110	1980	1980
191	1584	1584	1151	1848	1848	2111	1914	1914
192	1518	1518	1152	1650	1716	2112	1782	1782
193	1386	1452	1153	1650	1650	2113	1716	1716
194	1386	1320	1154	1584	1518	2114	1650	1650
195	1320	1320	1155	1452	1518	2115	1584	1584
196	1254	1320	1156	1452	1452	2116	1518	1584
197	1320	1254	1157	1386	1386	2117	1518	1452
198	1188	1254	1158	1386	1386	2118	1452	1452
199	1254	1254	1159	1320	1320	2119	1386	1452
200	1254	1188	1160	1254	1320	2120	1386	1386
201	1188	1254	1161	1254	1188	2121	1386	1386
202	1188	1188	1162	1254	1254	2122	1320	1320
203	1188	1188	1163	1188	1254	2123	1320	1320
204	1188	1188	1164	1254	1188	2124	1320	1320
205	1188	1188	1165	1254	1254	2125	1254	1254
206	1122	1122	1166	1254	1254	2126	1254	1254
207	1122	1188	1167	1188	1254	2127	1320	1320
208	1188	1122	1168	1254	1254	2128	1188	1254
209	1188	1188	1169	1254	1254	2129	1320	1254
210	1122	1188	1170	1254	1254	2130	1254	1254
211	1188	1188	1171	1254	1254	2131	1254	1254
212	1188	1188	1172	1320	1320	2132	1254	1320
213	1254	1254	1173	1320	1320	2133	1320	1254
214	1320	1254	1174	1386	1386	2134	1254	1320
215	1320	1386	1175	1386	1386	2135	1386	1320
216	1452	1452	1176	1386	1386	2136	1254	1320
217	1518	1518	1177	1452	1452	2137	1254	1254
218	1518	1518	1178	1452	1518	2138	1254	1254
219	1584	1584	1179	1584	1518	2139	1254	1254
220	1584	1584	1180	1584	1650	2140	1254	1254
221	2112	2112	1181	1650	1584	2141	1386	1386
222	2244	2244	1182	1650	1716	2142	1386	1452
223	2244	2244	1183	1716	1716	2143	1518	1452
224	2244	2244	1184	1716	1716	2144	1518	1518
225	2178	2244	1185	1782	1782	2145	1584	1650
226	2178	2178	1186	1782	1782	2146	1584	1584
227	2178	2178	1187	1716	1716	2147	1650	1650
228	2178	2178	1188	1716	1716	2148	1716	1716
229	2112	2112	1189	1650	1716	2149	1782	1782
230	2112	2112	1190	1716	1650	2150	1848	1848
231	2046	2046	1191	1716	1716	2151	1914	1914

232	2046	2112	1192	1716	1716	2152	1914	1980
233	2046	2046	1193	1650	1716	2153	1980	1980
234	2112	2046	1194	1716	1716	2154	1980	1914
235	2046	2112	1195	1716	1716	2155	1980	1980
236	2112	2112	1196	1716	1716	2156	1980	1980
237	2046	2046	1197	1650	1716	2157	1914	1980
238	2046	2046	1198	1782	1716	2158	1980	1980
239	2046	2046	1199	1716	1716	2159	1914	1914
240	2244	2310	1200	1716	1782	2160	1848	1914
241	2376	2310	1201	1716	1650	2161	1848	1782
242	2310	2376	1202	1650	1716	2162	1782	1782
243	2310	2310	1203	1716	1650	2163	1716	1716
244	2310	2310	1204	1650	1716	2164	1650	1650
245	2310	2310	1205	1650	1650	2165	1584	1650
246	2112	2112	1206	1716	1716	2166	1584	1518
247	1452	1452	1207	1584	1584	2167	1518	1584
248	1452	1452	1208	1584	1650	2168	1518	1518
249	1386	1452	1209	1650	1584	2169	1518	1518
250	1386	1386	1210	1650	1650	2170	1452	1452
251	1452	1452	1211	1584	1584	2171	1452	1452
252	1452	1452	1212	1584	1584	2172	1386	1386
253	1452	1452	1213	1584	1584	2173	1386	1386
254	1452	1452	1214	1584	1650	2174	1386	1386
255	1452	1386	1215	1650	1584	2175	1320	1386
256	1386	1452	1216	1584	1650	2176	1386	1320
257	1452	1452	1217	1650	1584	2177	1386	1386
258	1518	1452	1218	1584	1650	2178	1320	1320
259	1452	1518	1219	1650	1650	2179	1320	1386
260	1452	1452	1220	1584	1584	2180	1320	1320
261	1452	1518	1221	1650	1650	2181	1386	1386
262	1518	1452	1222	1650	1650	2182	1386	1386
263	1452	1518	1223	1650	1716	2183	1452	1452
264	1584	1518	1224	1716	1650	2184	1386	1386
265	1518	1518	1225	1716	1716	2185	1452	1452
266	1518	1584	1226	1650	1716	2186	1386	1452
267	1584	1584	1227	1716	1716	2187	1518	1452
268	1584	1584	1228	1716	1650	2188	1452	1452
269	1716	1716	1229	1716	1782	2189	1518	1584
270	1848	1848	1230	1848	1848	2190	1584	1518
271	2112	2112	1231	1980	1980	2191	1650	1716
272	2178	2178	1232	2178	2178	2192	1848	1782
273	2244	2310	1233	2244	2244	2193	1980	2046
274	2310	2244	1234	2310	2310	2194	2046	2046
275	2178	2244	1235	2244	2244	2195	2112	2112
276	2178	2178	1236	2244	2310	2196	2046	2046
277	2112	2112	1237	2244	2178	2197	1980	2046
278	2112	2112	1238	2178	2178	2198	2046	2046
279	2178	2178	1239	2178	2244	2199	2046	2046
280	2046	2046	1240	2178	2178	2200	2046	2046
281	2046	2046	1241	2178	2178	2201	2046	2046
282	2112	2112	1242	2178	2178	2202	2046	2046
283	2046	2046	1243	2178	2178	2203	1980	1980
284	1980	1980	1244	2046	2112	2204	1980	1980
285	1848	1848	1245	1980	1980	2205	1914	1914
286	1716	1782	1246	1914	1914	2206	1848	1848
287	1650	1584	1247	1782	1782	2207	1782	1782
288	1518	1584	1248	1716	1716	2208	1650	1650
289	1518	1452	1249	1650	1584	2209	1584	1650
290	1386	1452	1250	1518	1584	2210	1518	1518

291	1386	1386	1251	1518	1518	2211	1452	1452
292	1320	1320	1252	1452	1452	2212	1452	1452
293	1320	1320	1253	1386	1386	2213	1386	1386
294	1320	1320	1254	1320	1320	2214	1320	1320
295	1254	1254	1255	1386	1386	2215	1320	1320
296	1254	1254	1256	1320	1320	2216	1320	1320
297	1188	1254	1257	1254	1320	2217	1254	1254
298	1254	1188	1258	1254	1254	2218	1320	1320
299	1188	1188	1259	1254	1254	2219	1188	1254
300	1188	1254	1260	1254	1188	2220	1254	1254
301	1254	1188	1261	1188	1254	2221	1254	1254
302	1254	1254	1262	1188	1188	2222	1254	1254
303	1254	1254	1263	1188	1188	2223	1254	1188
304	1188	1254	1264	1188	1188	2224	1188	1254
305	1254	1254	1265	1188	1188	2225	1254	1254
306	1254	1254	1266	1188	1188	2226	1254	1254
307	1254	1254	1267	1188	1188	2227	1320	1320
308	1254	1254	1268	1188	1188	2228	1254	1254
309	1320	1320	1269	1188	1188	2229	1320	1320
310	1320	1386	1270	1188	1254	2230	1320	1386
311	1386	1386	1271	1320	1254	2231	1320	1320
312	1518	1452	1272	1320	1320	2232	1386	1386
313	1452	1518	1273	1320	1320	2233	1518	1518
314	1584	1518	1274	1386	1386	2234	1518	1518
315	1518	1584	1275	1320	1386	2235	1650	1650
316	1584	1584	1276	1452	1452	2236	1650	1650
317	1716	1650	1277	1452	1452	2237	1716	1716
318	1584	1650	1278	1584	1584	2238	1782	1782
319	1650	1650	1279	1518	1518	2239	1716	1782
320	1716	1716	1280	1650	1650	2240	1782	1716
321	1650	1650	1281	1650	1650	2241	1782	1848
322	1650	1650	1282	1716	1716	2242	1782	1716
323	1650	1650	1283	1650	1716	2243	1782	1782
324	1584	1650	1284	1782	1716	2244	1782	1782
325	1650	1650	1285	1716	1716	2245	1716	1782
326	1650	1584	1286	1716	1716	2246	1782	1782
327	1584	1650	1287	1650	1716	2247	1716	1716
328	1584	1584	1288	1716	1716	2248	1650	1650
329	1584	1584	1289	1716	1716	2249	1716	1716
330	1584	1584	1290	1650	1650	2250	1650	1650
331	1650	1650	1291	1716	1716	2251	1716	1716
332	1584	1584	1292	1650	1716	2252	1650	1650
333	1650	1650	1293	1716	1650	2253	1650	1716
334	1584	1584	1294	1716	1716	2254	1716	1650
335	1584	1584	1295	1650	1716	2255	1650	1650
336	1584	1584	1296	1716	1716	2256	1584	1650
337	1584	1650	1297	1716	1716	2257	1716	1650
338	1584	1584	1298	1650	1650	2258	1584	1650
339	1650	1584	1299	1650	1650	2259	1650	1584
340	1518	1584	1300	1584	1584	2260	1584	1650
341	1584	1518	1301	1584	1584	2261	1584	1584
342	1518	1584	1302	1650	1650	2262	1584	1650
343	1518	1518	1303	1584	1584	2263	1584	1518
344	1452	1452	1304	1584	1650	2264	1518	1518
345	1518	1518	1305	1584	1584	2265	1518	1518
346	1518	1518	1306	1584	1518	2266	1452	1518
347	1452	1518	1307	1518	1584	2267	1518	1452
348	1518	1452	1308	1584	1584	2268	1452	1518
349	1518	1518	1309	1518	1518	2269	1518	1452

350	1452	1452	1310	1584	1584	2270	1452	1452
351	1518	1518	1311	1584	1584	2271	1452	1518
352	1518	1518	1312	1584	1584	2272	1452	1386
353	1518	1518	1313	1584	1584	2273	1452	1452
354	1518	1584	1314	1584	1650	2274	1452	1518
355	1518	1518	1315	1650	1584	2275	1452	1452
356	1584	1584	1316	1584	1650	2276	1452	1452
357	1518	1518	1317	1650	1584	2277	1518	1518
358	1584	1584	1318	1650	1650	2278	1518	1518
359	1518	1518	1319	1650	1716	2279	1518	1518
360	1518	1518	1320	1716	1650	2280	1518	1518
361	1584	1584	1321	1650	1716	2281	1518	1584
362	1584	1650	1322	1716	1650	2282	1584	1584
363	1650	1650	1323	1650	1716	2283	1650	1650
364	1650	1650	1324	1716	1716	2284	1650	1650
365	1782	1782	1325	1716	1716	2285	1782	1716
366	1914	1914	1326	1782	1782	2286	1782	1848
367	2112	2112	1327	1914	1914	2287	1980	1980
368	2244	2244	1328	2046	2112	2288	2046	2112
369	2244	2310	1329	2244	2178	2289	2244	2178
370	2244	2178	1330	2178	2244	2290	2310	2310
371	2178	2178	1331	2178	2178	2291	2244	2244
372	2178	2178	1332	2178	2178	2292	2178	2244
373	2112	2112	1333	2112	2112	2293	2244	2244
374	1980	2046	1334	2112	2112	2294	2178	2178
375	2112	2112	1335	2178	2178	2295	2178	2178
376	1980	1980	1336	2112	2112	2296	2112	2112
377	1980	2046	1337	2112	2178	2297	2178	2178
378	2046	1980	1338	2178	2178	2298	2178	2244
379	1980	1980	1339	2178	2178	2299	2178	2178
380	1914	1914	1340	2112	2112	2300	2112	2046
381	1782	1782	1341	1980	1980	2301	1980	2046
382	1716	1716	1342	1980	1980	2302	1914	1914
383	1650	1650	1343	1782	1848	2303	1782	1782
384	1518	1584	1344	1716	1716	2304	1716	1716
385	1518	1518	1345	1650	1584	2305	1584	1584
386	1452	1452	1346	1584	1584	2306	1584	1584
387	1386	1386	1347	1452	1518	2307	1518	1518
388	1320	1386	1348	1386	1386	2308	1452	1452
389	1386	1320	1349	1386	1386	2309	1386	1452
390	1254	1320	1350	1320	1320	2310	1386	1386
391	1254	1254	1351	1320	1254	2311	1386	1386
392	1254	1188	1352	1254	1320	2312	1320	1320
393	1188	1254	1353	1254	1254	2313	1254	1254
394	1188	1188	1354	1188	1188	2314	1320	1320
395	1188	1188	1355	1254	1254	2315	1254	1254
396	1188	1188	1356	1188	1254	2316	1254	1254
397	1188	1188	1357	1254	1188	2317	1254	1254
398	1254	1254	1358	1122	1188	2318	1254	1320
399	1188	1254	1359	1188	1188	2319	1320	1254
400	1254	1188	1360	1188	1122	2320	1320	1320
401	1254	1254	1361	1188	1188	2321	1254	1254
402	1188	1254	1362	1122	1188	2322	1254	1320
403	1254	1188	1363	1188	1188	2323	1320	1254
404	1254	1320	1364	1188	1188	2324	1320	1320
405	1386	1320	1365	1188	1188	2325	1386	1386
406	1320	1386	1366	1254	1254	2326	1386	1452
407	1386	1386	1367	1254	1254	2327	1386	1386
408	1452	1452	1368	1254	1254	2328	1386	1386

409	1518	1518	1369	1254	1254	2329	1452	1452
410	1518	1518	1370	1254	1254	2330	1518	1518
411	1518	1518	1371	1386	1386	2331	1518	1518
412	1584	1584	1372	1386	1452	2332	1650	1650
413	1584	1650	1373	1518	1518	2333	1650	1650
414	1848	1848	1374	1650	1584	2334	1716	1782
415	2046	2046	1375	1584	1584	2335	1716	1716
416	2112	2046	1376	1584	1650	2336	1716	1716
417	1848	1914	1377	1716	1716	2337	1716	1716
418	1914	1914	1378	1782	1716	2338	1716	1650
419	1980	1980	1379	1782	1848	2339	1650	1716
420	1848	1848	1380	1848	1848	2340	1650	1650
421	1848	1914	1381	1914	1848	2341	1650	1650
422	1914	1848	1382	1848	1914	2342	1584	1584
423	1848	1848	1383	1980	1980	2343	1584	1584
424	1782	1848	1384	1914	1980	2344	1584	1584
425	1848	1848	1385	1914	1914	2345	1584	1584
426	1848	1782	1386	1980	1980	2346	1584	1584
427	1914	1980	1387	2046	1980	2347	1584	1584
428	1914	1914	1388	1980	2046	2348	1584	1584
429	1914	1914	1389	2046	2046	2349	1584	1650
430	1980	1980	1390	2046	2046	2350	1650	1584
431	1980	1980	1391	2046	2046	2351	1650	1650
432	1914	1914	1392	1980	1980	2352	1584	1650
433	1980	1980	1393	1980	2046	2353	1650	1584
434	1980	2046	1394	1980	1980	2354	1584	1650
435	1914	1914	1395	1980	1914	2355	1584	1584
436	1914	1848	1396	1914	1980	2356	1650	1650
437	1848	1914	1397	1914	1914	2357	1650	1650
438	1848	1848	1398	1848	1848	2358	1584	1650
439	1650	1650	1399	1848	1848	2359	1650	1584
440	1518	1518	1400	1848	1848	2360	1518	1584
441	1518	1518	1401	1848	1848	2361	1518	1518
442	1518	1518	1402	1848	1848	2362	1518	1518
443	1584	1584	1403	1782	1848	2363	1518	1518
444	1518	1518	1404	1848	1848	2364	1518	1518
445	1518	1584	1405	1848	1782	2365	1452	1452
446	1584	1518	1406	1782	1782	2366	1518	1518
447	1518	1584	1407	1782	1782	2367	1452	1452
448	1584	1518	1408	1716	1782	2368	1452	1452
449	1518	1584	1409	1716	1716	2369	1518	1518
450	1584	1518	1410	1716	1716	2370	1452	1452
451	1584	1650	1411	1782	1716	2371	1518	1518
452	1584	1584	1412	1716	1782	2372	1452	1518
453	1584	1584	1413	1782	1782	2373	1518	1452
454	1650	1650	1414	1782	1782	2374	1518	1518
455	1584	1584	1415	1848	1848	2375	1452	1518
456	1584	1584	1416	1848	1848	2376	1518	1452
457	1650	1716	1417	1914	1980	2377	1452	1518
458	1716	1650	1418	1980	1914	2378	1518	1518
459	1782	1782	1419	1980	2046	2379	1584	1584
460	1914	1914	1420	1980	1980	2380	1584	1584
461	1980	2046	1421	2046	2046	2381	1650	1650
462	2112	2112	1422	2178	2178	2382	1782	1782
463	2244	2244	1423	2310	2310	2383	1782	1782
464	2244	2244	1424	2376	2376	2384	1980	1980
465	2310	2310	1425	2508	2508	2385	2112	2112
466	2244	2244	1426	2442	2508	2386	2178	2244
467	2244	2244	1427	2508	2508	2387	2244	2178

468	2112	2178	1428	2508	2442	2388	2178	2244
469	2112	2112	1429	2376	2442	2389	2112	2112
470	2112	2112	1430	2376	2376	2390	2178	2178
471	2112	2112	1431	2376	2376	2391	2112	2112
472	2046	2112	1432	2310	2376	2392	2112	2112
473	2046	1980	1433	2244	2244	2393	2046	2112
474	2046	2112	1434	2310	2310	2394	2112	2112
475	2046	1980	1435	2244	2244	2395	2112	2046
476	1914	1980	1436	2178	2244	2396	2046	2046
477	1848	1848	1437	2178	2112	2397	1914	1980
478	1782	1782	1438	1980	2046	2398	1914	1914
479	1716	1716	1439	1914	1914	2399	1782	1782
480	1584	1584	1440	1782	1782	2400	1650	1650
481	1518	1518	1441	1650	1716	2401	1650	1650
482	1518	1518	1442	1650	1584	2402	1518	1518
483	1386	1386	1443	1518	1518	2403	1518	1518
484	1386	1452	1444	1452	1452	2404	1452	1452
485	1386	1386	1445	1386	1452	2405	1386	1386
486	1386	1320	1446	1386	1320	2406	1386	1386
487	1254	1320	1447	1320	1320	2407	1320	1320
488	1320	1254	1448	1254	1320	2408	1320	1320
489	1254	1254	1449	1254	1254	2409	1254	1320
490	1188	1254	1450	1188	1188	2410	1254	1254
491	1254	1254	1451	1254	1254	2411	1254	1254
492	1254	1254	1452	1188	1254	2412	1254	1254
493	1254	1254	1453	1254	1188	2413	1254	1254
494	1254	1254	1454	1188	1188	2414	1254	1254
495	1254	1254	1455	1188	1188	2415	1254	1254
496	1254	1254	1456	1188	1188	2416	1254	1254
497	1254	1254	1457	1188	1188	2417	1254	1254
498	1254	1254	1458	1188	1254	2418	1254	1320
499	1254	1320	1459	1188	1188	2419	1320	1254
500	1320	1254	1460	1188	1188	2420	1320	1320
501	1320	1386	1461	1188	1188	2421	1386	1386
502	1386	1386	1462	1188	1188	2422	1386	1452
503	1518	1452	1463	1254	1254	2423	1386	1386
504	1518	1584	1464	1188	1254	2424	1386	1386
505	1584	1584	1465	1254	1188	2425	1386	1386
506	1650	1650	1466	1188	1254	2426	1518	1518
507	1650	1650	1467	1320	1254	2427	1584	1584
508	1716	1782	1468	1320	1386	2428	1584	1650
509	1782	1716	1469	1386	1386	2429	1716	1650
510	1782	1782	1470	1452	1452	2430	1716	1716
511	1782	1848	1471	1518	1518	2431	1716	1716
512	1848	1782	1472	1518	1518	2432	1650	1716
513	1782	1782	1473	1584	1584	2433	1716	1650
514	1782	1848	1474	1650	1650	2434	1650	1716
515	1782	1782	1475	1716	1716	2435	1650	1650
516	1782	1782	1476	1716	1716	2436	1650	1650
517	1782	1782	1477	1716	1782	2437	1650	1650
518	1782	1782	1478	1848	1848	2438	1650	1584
519	1782	1782	1479	1848	1848	2439	1584	1650
520	1782	1782	1480	1848	1848	2440	1518	1584
521	1782	1782	1481	1848	1848	2441	1584	1518
522	1782	1782	1482	1914	1914	2442	1518	1584
523	1782	1848	1483	1848	1848	2443	1584	1584
524	1848	1848	1484	1848	1914	2444	1650	1584
525	1782	1782	1485	1848	1782	2445	1584	1650
526	1782	1782	1486	1782	1848	2446	1650	1650

527	1716	1716	1487	1782	1782	2447	1650	1584
528	1782	1782	1488	1782	1782	2448	1584	1650
529	1716	1716	1489	1716	1716	2449	1650	1584
530	1782	1782	1490	1650	1650	2450	1584	1584
531	1716	1716	1491	1584	1584	2451	1584	1584
532	1650	1650	1492	1584	1584	2452	1518	1584
533	1584	1650	1493	1518	1518	2453	1584	1584
534	1650	1650	1494	1452	1452	2454	1584	1584
535	1650	1584	1495	1452	1518	2455	1518	1584
536	1518	1584	1496	1452	1452	2456	1584	1518
537	1584	1518	1497	1452	1452	2457	1452	1518
538	1518	1584	1498	1452	1386	2458	1518	1452
539	1584	1584	1499	1386	1452	2459	1452	1518
540	1518	1518	1500	1386	1386	2460	1452	1386
541	1518	1518	1501	1386	1386	2461	1452	1452
542	1584	1584	1502	1320	1386	2462	1452	1518
543	1584	1584	1503	1386	1320	2463	1386	1386
544	1518	1584	1504	1320	1320	2464	1452	1452
545	1584	1518	1505	1320	1320	2465	1452	1452
546	1584	1584	1506	1254	1320	2466	1452	1452
547	1584	1650	1507	1320	1254	2467	1518	1518
548	1584	1584	1508	1254	1320	2468	1452	1518
549	1650	1650	1509	1254	1254	2469	1584	1518
550	1650	1650	1510	1320	1320	2470	1518	1518
551	1716	1650	1511	1320	1320	2471	1518	1518
552	1650	1716	1512	1386	1386	2472	1452	1518
553	1650	1650	1513	1386	1386	2473	1518	1518
554	1650	1650	1514	1452	1452	2474	1518	1518
555	1716	1716	1515	1452	1452	2475	1584	1584
556	1782	1782	1516	1518	1518	2476	1650	1650
557	1782	1782	1517	1518	1518	2477	1716	1716
558	1980	1980	1518	1584	1584	2478	1782	1782
559	2178	2178	1519	1650	1650	2479	1914	1914
560	2310	2310	1520	1848	1848	2480	1980	2046
561	2310	2310	1521	1848	1914	2481	2178	2178
562	2244	2310	1522	1980	1980	2482	2244	2244
563	2244	2244	1523	1980	1980	2483	2310	2244
564	2244	2244	1524	1980	1980	2484	2178	2244
565	2112	2112	1525	1980	1980	2485	2244	2244
566	2112	2112	1526	1914	1914	2486	2112	2112
567	2112	2178	1527	1848	1914	2487	2178	2178
568	2112	2112	1528	1848	1848	2488	2112	2112
569	2178	2112	1529	1914	1914	2489	2046	2046
570	2112	2178	1530	1914	1848	2490	2112	2112
571	2112	2112	1531	1848	1914	2491	2046	2112
572	2046	2046	1532	1848	1782	2492	2046	1980
573	1914	1914	1533	1782	1782	2493	1914	1914
574	1848	1848	1534	1716	1716	2494	1782	1848
575	1782	1782	1535	1584	1650	2495	1782	1782
576	1716	1716	1536	1584	1584	2496	1650	1650
577	1584	1650	1537	1452	1452	2497	1650	1650
578	1584	1518	1538	1452	1452	2498	1518	1518
579	1518	1518	1539	1386	1386	2499	1452	1452
580	1386	1452	1540	1320	1386	2500	1386	1386
581	1452	1386	1541	1320	1254	2501	1386	1386
582	1320	1386	1542	1254	1320	2502	1320	1320
583	1386	1386	1543	1254	1188	2503	1320	1320
584	1320	1320	1544	1254	1254	2504	1254	1320
585	1320	1254	1545	1188	1254	2505	1254	1254

586	1254	1320	1546	1188	1188	2506	1254	1254
587	1254	1254	1547	1188	1188	2507	1188	1188
588	1254	1254	1548	1188	1188	2508	1254	1254
589	1320	1320	1549	1188	1188	2509	1254	1254
590	1254	1254	1550	1188	1188	2510	1254	1254
591	1320	1320	1551	1188	1188	2511	1188	1254
592	1254	1254	1552	1122	1122	2512	1254	1188
593	1254	1320	1553	1122	1188	2513	1254	1254
594	1320	1254	1554	1188	1122	2514	1254	1254
595	1320	1386	1555	1188	1188	2515	1188	1254
596	1386	1320	1556	1122	1122	2516	1254	1254
597	1386	1386	1557	1188	1188	2517	1320	1320
598	1452	1452	1558	1188	1188	2518	1386	1320
599	1452	1518	1559	1188	1188	2519	1254	1254
600	1584	1584	1560	1122	1188	2520	1254	1320
601	1518	1518	1561	1122	1122	2521	1386	1386
602	1650	1650	1562	1122	1122	2522	1452	1452
603	1584	1584	1563	1188	1122	2523	1518	1518
604	1716	1716	1564	1188	1254	2524	1584	1584
605	1782	1782	1565	1254	1254	2525	1650	1650
606	1716	1782	1566	1320	1320	2526	1914	1914
607	1782	1782	1567	1452	1452	2527	1980	1980
608	1782	1716	1568	1386	1452	2528	1980	1980
609	1716	1782	1569	1518	1452	2529	1914	1914
610	1782	1782	1570	1518	1518	2530	2046	2112
611	1782	1782	1571	1518	1518	2531	2112	2112
612	1782	1782	1572	1518	1584	2532	2112	2046
613	1782	1782	1573	1584	1584	2533	2046	2046
614	1782	1782	1574	1584	1584	2534	1980	2046
615	1782	1782	1575	1584	1584	2535	1980	1980
616	1716	1716	1576	1650	1650	2536	1848	1848
617	1716	1782	1577	1584	1584	2537	1914	1914
618	1782	1716	1578	1584	1584	2538	1980	1980
619	1782	1782	1579	1584	1584	2539	2046	2112
620	1716	1782	1580	1584	1650	2540	2112	2046
621	1782	1782	1581	1584	1584	2541	2112	2112
622	1848	1848	1582	1584	1518	2542	2046	2112
623	1782	1782	1583	1584	1584	2543	2046	2046
624	1848	1782	1584	1518	1584	2544	2046	2046
625	1782	1848	1585	1584	1518	2545	2046	2046
626	1716	1716	1586	1518	1518	2546	2112	2112
627	1782	1782	1587	1518	1584	2547	2112	2112
628	1716	1716	1588	1518	1518	2548	1914	1914
629	1782	1782	1589	1452	1452	2549	1848	1914
630	1716	1782	1590	1386	1386	2550	1848	1848
631	1782	1716	1591	1386	1386	2551	1848	1782
632	1650	1716	1592	1386	1386	2552	1716	1782
633	1716	1716	1593	1320	1320	2553	1782	1782
634	1716	1716	1594	1320	1320	2554	1848	1848
635	1716	1716	1595	1254	1320	2555	1782	1782
636	1716	1716	1596	1320	1254	2556	1782	1782
637	1716	1716	1597	1188	1254	2557	1650	1716
638	1716	1716	1598	1254	1254	2558	1782	1782
639	1716	1716	1599	1254	1254	2559	1782	1782
640	1782	1782	1600	1320	1254	2560	1848	1782
641	1716	1716	1601	1254	1254	2561	1848	1848
642	1716	1782	1602	1188	1254	2562	1782	1848
643	1782	1716	1603	1254	1254	2563	1848	1848
644	1716	1782	1604	1320	1320	2564	1848	1848

645	1782	1716	1605	1320	1320	2565	1848	1848
646	1716	1782	1606	1254	1254	2566	1848	1848
647	1782	1782	1607	1320	1320	2567	1914	1914
648	1782	1782	1608	1254	1320	2568	1914	1914
649	1782	1782	1609	1386	1320	2569	1980	1980
650	1848	1848	1610	1320	1386	2570	1980	2046
651	1848	1848	1611	1452	1386	2571	2112	2046
652	1914	1914	1612	1386	1452	2572	2112	2178
653	1914	1980	1613	1518	1518	2573	2178	2178
654	2046	2046	1614	1584	1518	2574	2310	2310
655	2244	2244	1615	1650	1650	2575	2376	2376
656	2244	2244	1616	1848	1914	2576	2574	2574
657	2310	2310	1617	1914	1914	2577	2640	2706
658	2310	2310	1618	1980	1980	2578	2706	2706
659	2178	2178	1619	1980	1980	2579	2706	2706
660	2178	2178	1620	1914	1914	2580	2640	2640
661	2112	2112	1621	1914	1914	2581	2574	2574
662	2046	2112	1622	1914	1980	2582	2574	2574
663	2112	2112	1623	1980	1914	2583	2508	2574
664	2112	2046	1624	1914	1980	2584	2508	2508
665	2046	2112	1625	1980	1980	2585	2574	2574
666	2112	2112	1626	1980	1980	2586	2574	2574
667	2112	2112	1627	1980	1980	2587	2574	2574
668	2046	2046	1628	1914	1914	2588	2376	2376
669	1914	1914	1629	1848	1848	2589	2310	2310
670	1848	1848	1630	1716	1782	2590	2178	2178
671	1716	1782	1631	1716	1650	2591	2046	2112
672	1716	1716	1632	1584	1584	2592	1980	1980
673	1650	1650	1633	1518	1518	2593	1848	1848
674	1518	1518	1634	1452	1518	2594	1848	1848
675	1518	1518	1635	1386	1386	2595	1716	1716
676	1518	1518	1636	1386	1320	2596	1584	1584
677	1386	1452	1637	1320	1320	2597	1584	1650
678	1386	1386	1638	1254	1320	2598	1584	1518
679	1386	1386	1639	1254	1254	2599	1452	1452
680	1386	1320	1640	1188	1188	2600	1452	1452
681	1320	1386	1641	1254	1254	2601	1386	1452
682	1320	1320	1642	1188	1188	2602	1386	1386
683	1254	1254	1643	1188	1254	2603	1386	1386
684	1254	1254	1644	1188	1188	2604	1320	1320
685	1320	1320	1645	1188	1122	2605	1386	1386
686	1254	1254	1646	1188	1188	2606	1386	1386
687	1320	1320	1647	1122	1188	2607	1386	1386
688	1320	1320	1648	1188	1188	2608	1320	1386
689	1254	1254	1649	1188	1188	2609	1386	1320
690	1254	1254	1650	1188	1188	2610	1386	1386
691	1320	1320	1651	1188	1188	2611	1386	1452
692	1320	1320	1652	1188	1188	2612	1452	1386
693	1320	1320	1653	1254	1254	2613	1452	1518
694	1320	1386	1654	1320	1320	2614	1584	1518
695	1320	1320	1655	1254	1254	2615	1452	1518
696	1386	1320	1656	1320	1386	2616	1518	1518
697	1320	1320	1657	1386	1320	2617	1584	1584
698	1320	1386	1658	1452	1452	2618	1782	1782
699	1386	1386	1659	1452	1518	2619	1782	1782
700	1452	1452	1660	1584	1518	2620	1848	1848
701	1518	1518	1661	1584	1650	2621	2046	2046
702	1584	1584	1662	1650	1650	2622	1980	2046
703	1584	1584	1663	1650	1650	2623	2046	1980

704	1650	1650	1664	1650	1650	2624	1980	2046
705	1584	1650	1665	1716	1716	2625	1980	1914
706	1650	1650	1666	1716	1716	2626	1980	2046
707	1716	1650	1667	1716	1716	2627	1980	1980
708	1650	1716	1668	1716	1716	2628	2046	2046
709	1716	1716	1669	1782	1782	2629	2046	2046
710	1782	1782	1670	1650	1650	2630	1980	1980
711	1782	1782	1671	1650	1716	2631	1914	1980
712	1782	1782	1672	1716	1650	2632	1980	1914
713	1782	1782	1673	1584	1650	2633	1980	1980
714	1782	1782	1674	1650	1584	2634	1980	1980
715	1782	1782	1675	1650	1650	2635	2046	2112
716	1716	1782	1676	1650	1716	2636	2046	2046
717	1782	1716	1677	1650	1650	2637	1980	1980
718	1782	1782	1678	1650	1650	2638	2046	2046
719	1782	1782	1679	1650	1650	2639	2046	2046
720	1782	1782	1680	1650	1650	2640	1980	1980
721	1716	1782	1681	1650	1650	2641	2046	2046
722	1782	1782	1682	1650	1650	2642	2046	2046
723	1716	1716	1683	1650	1650	2643	1914	1980
724	1716	1716	1684	1650	1650	2644	1914	1914
725	1716	1716	1685	1650	1650	2645	1848	1848
726	1716	1782	1686	1584	1650	2646	1782	1782
727	1716	1650	1687	1650	1584	2647	1782	1782
728	1650	1716	1688	1518	1584	2648	1782	1716
729	1650	1650	1689	1584	1584	2649	1716	1782
730	1650	1650	1690	1584	1584	2650	1782	1782
731	1650	1650	1691	1650	1650	2651	1782	1782
732	1650	1584	1692	1584	1584	2652	1782	1782
733	1584	1650	1693	1584	1650	2653	1782	1848
734	1584	1584	1694	1650	1584	2654	1848	1782
735	1650	1650	1695	1584	1584	2655	1782	1848
736	1584	1584	1696	1584	1584	2656	1848	1782
737	1650	1650	1697	1584	1650	2657	1782	1848
738	1584	1584	1698	1650	1584	2658	1848	1848
739	1650	1650	1699	1584	1650	2659	1848	1848
740	1650	1650	1700	1650	1584	2660	1914	1914
741	1650	1650	1701	1650	1650	2661	1914	1914
742	1650	1716	1702	1650	1716	2662	1980	1980
743	1716	1650	1703	1716	1716	2663	1914	1914
744	1716	1716	1704	1716	1716	2664	1848	1914
745	1716	1782	1705	1782	1782	2665	1914	1848
746	1782	1782	1706	1782	1782	2666	1914	1980
747	1782	1782	1707	1848	1848	2667	1980	1914
748	1848	1848	1708	1848	1848	2668	2046	2112
749	1848	1848	1709	1914	1980	2669	2178	2178
750	1980	1980	1710	2046	2046	2670	2244	2244
751	2112	2112	1711	2178	2178	2671	2310	2310
752	2244	2244	1712	2244	2244	2672	2508	2574
753	2244	2310	1713	2244	2244	2673	2706	2640
754	2310	2310	1714	2244	2244	2674	2640	2706
755	2310	2310	1715	2244	2244	2675	2640	2640
756	2244	2310	1716	2178	2178	2676	2574	2574
757	2310	2244	1717	2112	2178	2677	2574	2574
758	2244	2244	1718	2112	2112	2678	2442	2442
759	2244	2244	1719	2178	2178	2679	2376	2442
760	2244	2244	1720	2112	2112	2680	2442	2376
761	2178	2244	1721	2112	2112	2681	2442	2508
762	2178	2178	1722	2178	2178	2682	2574	2574

763	2112	2112	1723	2112	2112	2683	2574	2574
764	2046	2046	1724	2046	2112	2684	2442	2442
765	1980	1980	1725	1914	1914	2685	2310	2310
766	1848	1848	1726	1848	1848	2686	2178	2244
767	1782	1848	1727	1782	1782	2687	2112	2112
768	1716	1650	1728	1716	1716	2688	1980	1980
769	1584	1584	1729	1650	1650	2689	1914	1914
770	1518	1584	1730	1584	1584	2690	1782	1782
771	1452	1452	1731	1452	1518	2691	1716	1716
772	1452	1452	1732	1518	1452	2692	1716	1716
773	1320	1320	1733	1452	1452	2693	1650	1716
774	1386	1386	1734	1386	1452	2694	1650	1584
775	1254	1320	1735	1386	1386	2695	1518	1584
776	1320	1254	1736	1320	1320	2696	1518	1518
777	1254	1254	1737	1320	1320	2697	1452	1452
778	1254	1320	1738	1320	1320	2698	1452	1452
779	1254	1188	1739	1320	1320	2699	1452	1452
780	1188	1254	1740	1320	1320	2700	1386	1386
781	1254	1188	1741	1320	1320	2701	1452	1452
782	1188	1254	1742	1254	1320	2702	1452	1452
783	1254	1188	1743	1320	1254	2703	1386	1386
784	1188	1254	1744	1254	1320	2704	1386	1452
785	1188	1188	1745	1320	1320	2705	1452	1386
786	1254	1254	1746	1320	1320	2706	1452	1452
787	1188	1188	1747	1320	1320	2707	1386	1452
788	1254	1254	1748	1386	1386	2708	1452	1452
789	1188	1254	1749	1386	1386	2709	1452	1452
790	1320	1254	1750	1386	1386	2710	1518	1518
791	1254	1254	1751	1452	1518	2711	1452	1452
792	1254	1254	1752	1518	1452	2712	1452	1452
793	1188	1188	1753	1452	1518	2713	1452	1452
794	1122	1188	1754	1584	1518	2714	1584	1584
795	1254	1188	1755	1584	1584	2715	1584	1584
796	1254	1320	1756	1584	1650	2716	1716	1716
797	1320	1320	1757	1650	1650	2717	1716	1782
798	1452	1452	1758	1716	1716	2718	1848	1782
799	1452	1452	1759	1782	1782	2719	1848	1848
800	1584	1584	1760	1782	1782	2720	1848	1914
801	1518	1518	1761	1848	1848	2721	1848	1848
802	1518	1584	1762	1848	1914	2722	1914	1914
803	1650	1584	1763	1980	1914	2723	1914	1914
804	1650	1650	1764	1914	1980	2724	1914	1914
805	1650	1716	1765	1980	1980	2725	1914	1980
806	1782	1716	1766	1980	1980	2726	2046	1980
807	1716	1782	1767	1980	1980	2727	1980	1980
808	1782	1782	1768	1980	1914	2728	2046	2046
809	1782	1782	1769	1914	1980	2729	2046	2112
810	1782	1782	1770	1980	1980	2730	2112	2112
811	1848	1848	1771	1980	2046	2731	2178	2178
812	1782	1782	1772	2046	1980	2732	2244	2244
813	1848	1848	1773	1980	2046	2733	2244	2244
814	1782	1782	1774	1980	1980	2734	2244	2244
815	1782	1848	1775	1980	1980	2735	2178	2244
816	1716	1716	1776	1980	1980	2736	2244	2244
817	1716	1650	1777	1980	1980	2737	2244	2244
818	1584	1650	1778	1980	1980	2738	2244	2244
819	1584	1584	1779	1914	1914	2739	2244	2244
820	1518	1518	1780	1848	1914	2740	2244	2244
821	1518	1518	1781	1914	1848	2741	2178	2178

822	1452	1452	1782	1848	1848	2742	2178	2178
823	1452	1452	1783	1782	1848	2743	2112	2112
824	1386	1386	1784	1782	1782	2744	1980	1980
825	1386	1386	1785	1782	1782	2745	1980	1980
826	1254	1320	1786	1782	1782	2746	1980	1980
827	1320	1254	1787	1782	1782	2747	1980	2046
828	1254	1254	1788	1782	1782	2748	1980	1980
829	1254	1320	1789	1716	1716	2749	1980	1980
830	1254	1254	1790	1716	1782	2750	1914	1980
831	1254	1254	1791	1716	1716	2751	1980	1980
832	1188	1188	1792	1782	1716	2752	1980	1980
833	1188	1188	1793	1716	1716	2753	2046	1980
834	1254	1254	1794	1716	1716	2754	1980	1980
835	1188	1254	1795	1716	1782	2755	1980	2046
836	1254	1254	1796	1782	1716	2756	2046	2046
837	1254	1254	1797	1782	1848	2757	2046	2046
838	1254	1254	1798	1782	1782	2758	2046	2046
839	1254	1254	1799	1848	1848	2759	2046	2046
840	1320	1254	1800	1848	1914	2760	2046	2112
841	1254	1320	1801	1914	1848	2761	2112	2046
842	1320	1320	1802	1914	1914	2762	2112	2112
843	1386	1320	1803	1980	1980	2763	2112	2178
844	1386	1386	1804	1980	2046	2764	2178	2178
845	1386	1452	1805	2046	2046	2765	2178	2178
846	1584	1584	1806	2112	2112	2766	2244	2244
847	1716	1716	1807	2244	2244	2767	2310	2310
848	1914	1914	1808	2310	2310	2768	2376	2376
849	2046	2046	1809	2310	2376	2769	2508	2508
850	1980	2046	1810	2376	2376	2770	2508	2574
851	2046	1980	1811	2310	2310	2771	2574	2574
852	1980	2046	1812	2310	2310	2772	2574	2574
853	1980	1980	1813	2244	2244	2773	2442	2442
854	1980	1980	1814	2244	2178	2774	2442	2508
855	1914	1914	1815	2178	2244	2775	2442	2376
856	1980	1980	1816	2244	2244	2776	2376	2442
857	1980	1980	1817	2178	2178	2777	2574	2508
858	1980	1980	1818	2244	2310	2778	2508	2574
859	1980	1980	1819	2244	2244	2779	2508	2508
860	1914	1914	1820	2178	2178	2780	2442	2442
861	1782	1848	1821	2112	2112	2781	2376	2376
862	1782	1716	1822	2046	2046	2782	2244	2244
863	1650	1716	1823	1914	1914	2783	2046	2112
864	1518	1518	1824	1848	1848	2784	2046	1980
865	1518	1518	1825	1782	1782	2785	1914	1980
866	1386	1386	1826	1650	1650	2786	1914	1914
867	1386	1386	1827	1584	1650	2787	1848	1848
868	1320	1320	1828	1650	1584	2788	1716	1716
869	1254	1254	1829	1518	1518	2789	1650	1650
870	1254	1254	1830	1518	1584	2790	1584	1650
871	1188	1188	1831	1518	1452	2791	1584	1518
872	1188	1254	1832	1452	1518	2792	1518	1518
873	1188	1188	1833	1452	1452	2793	1452	1452
874	1188	1188	1834	1386	1386	2794	1452	1518
875	1188	1188	1835	1386	1386	2795	1452	1386
876	1188	1122	1836	1386	1386	2796	1386	1452
877	1122	1188	1837	1386	1452	2797	1452	1386
878	1188	1188	1838	1452	1386	2798	1386	1452
879	1188	1188	1839	1452	1452	2799	1386	1386
880	1188	1188	1840	1386	1452	2800	1386	1386

881	1122	1122	1841	1452	1386	2801	1386	1386
882	1188	1188	1842	1386	1452	2802	1386	1386
883	1188	1188	1843	1452	1452	2803	1386	1386
884	1254	1254	1844	1452	1452	2804	1386	1386
885	1254	1254	1845	1518	1452	2805	1386	1452
886	1320	1386	1846	1452	1584	2806	1386	1320
887	1386	1386	1847	1584	1518	2807	1254	1320
888	1452	1452	1848	1518	1518	2808	1254	1254
889	1518	1452	1849	1584	1584	2809	1320	1320
890	1518	1584	1850	1650	1650	2810	1452	1452
891	1650	1584	1851	1584	1650	2811	1452	1452
892	1650	1716	1852	1716	1716	2812	1518	1518
893	1650	1650	1853	1782	1716	2813	1584	1584
894	1782	1782	1854	1782	1848	2814	1584	1584
895	1716	1716	1855	1914	1914	2815	1650	1716
896	1716	1716	1856	1914	1914	2816	1716	1650
897	1716	1782	1857	1914	1914	2817	1650	1716
898	1782	1716	1858	1980	1980	2818	1782	1716
899	1650	1716	1859	1914	1980	2819	1650	1650
900	1716	1650	1860	1980	1980	2820	1716	1716
901	1650	1650	1861	2046	1980	2821	1716	1782
902	1584	1650	1862	1980	2046	2822	1782	1782
903	1584	1584	1863	2046	1980	2823	1848	1848
904	1584	1584	1864	1980	2046	2824	1914	1914
905	1584	1584	1865	2046	2046	2825	1914	1914
906	1584	1584	1866	2046	2046	2826	1980	1980
907	1518	1584	1867	2046	2112	2827	1980	1980
908	1584	1518	1868	2112	2046	2828	2046	2112
909	1584	1650	1869	2046	2046	2829	2178	2112
910	1584	1584	1870	2046	2112	2830	2046	2112
911	1584	1584	1871	2112	2046	2831	2046	2046
912	1584	1584	1872	2046	2112	2832	1914	1914
913	1650	1584	1873	2112	2046	2833	1914	1914
914	1518	1584	1874	2046	2112	2834	1848	1848
915	1584	1584	1875	2046	2046	2835	1782	1848
916	1518	1518	1876	2046	2046	2836	1848	1782
917	1584	1584	1877	1980	1980	2837	1716	1782
918	1518	1518	1878	2046	2046	2838	1716	1650
919	1584	1584	1879	1980	1980	2839	1518	1518
920	1518	1518	1880	1980	1980	2840	1518	1584
921	1518	1518	1881	1914	1914	2841	1584	1518
922	1518	1584	1882	1848	1914	2842	1452	1518
923	1518	1518	1883	1914	1914	2843	1452	1452
924	1518	1518	1884	1914	1914	2844	1386	1386
925	1518	1452	1885	1848	1848	2845	1386	1386
926	1452	1518	1886	1848	1848	2846	1386	1386
927	1518	1518	1887	1848	1848	2847	1386	1386
928	1452	1452	1888	1914	1914	2848	1386	1386
929	1518	1518	1889	1848	1848	2849	1386	1386
930	1452	1452	1890	1848	1848	2850	1320	1320
931	1518	1518	1891	1848	1914	2851	1320	1386
932	1452	1452	1892	1914	1914	2852	1386	1320
933	1452	1518	1893	1914	1914	2853	1320	1386
934	1518	1452	1894	1914	1914	2854	1386	1386
935	1518	1518	1895	1914	1914	2855	1386	1386
936	1518	1584	1896	1914	1980	2856	1386	1386
937	1584	1518	1897	1980	1914	2857	1452	1452
938	1584	1650	1898	1914	1980	2858	1452	1452
939	1650	1584	1899	2046	1980	2859	1518	1518

940	1650	1716	1900	2046	2046	2860	1584	1584
941	1716	1650	1901	2112	2178	2861	1584	1650
942	1782	1848	1902	2178	2178	2862	1716	1650
943	2046	2046	1903	2310	2310	2863	1716	1782
944	2244	2244	1904	2376	2376	2864	1914	1914
945	2310	2310	1905	2442	2442	2865	2046	2046
946	2310	2376	1906	2376	2442	2866	2244	2244
947	2310	2310	1907	2310	2310	2867	2244	2244
948	2310	2244	1908	2310	2310	2868	2310	2310
949	2178	2244	1909	2310	2244	2869	2244	2310
950	2244	2244	1910	2178	2244	2870	2244	2178
951	2178	2178	1911	2310	2310	2871	2112	2178
952	2178	2178	1912	2178	2244	2872	2178	2112
953	2112	2178	1913	2244	2244	2873	2178	2244
954	2178	2178	1914	2310	2244	2874	2244	2178
955	2112	2112	1915	2178	2244	2875	2178	2244
956	2046	1980	1916	2178	2178	2876	2112	2178
957	1914	1980	1917	2112	2112	2877	2112	2112
958	1848	1848	1918	2046	2046	2878	2046	2046
959	1716	1716	1919	1914	1914	2879	1980	1980
960	1650	1650	1920	1848	1848	2880	1914	1914

Tablica P.13. Ulazne veličine za proračun razmijenjene energije za cijeli mjesec srpanj 2015.

Datum	Vrijeme	Mjerna točka A, Radna energija [MWh]	Mjerna točka A, Jalova energija [Mvarh]	Mjerna točka A, Napon [kV]	Mjerna točka B, Radna energija [MWh]	Mjerna točka B, Jalova energija [Mvarh]	Mjerna točka B, Napon [kV]	Cijena [EUR/MWh]
1.7.2015.	0:15	39,200	21,600	418,000	39,200	8,8	416	39,97
	0:30	36,400	22,400	410,000	36,400	9,2	408	39,97
	0:45	35,600	22,000	410,000	35,600	8,8	408	39,97
	1:00	34,000	21,600	418,000	33,600	8,4	416	39,97
	1:15	42,000	22,800	410,000	42,000	9,6	408	39,97
	1:30	44,800	21,200	425,000	44,400	8,4	423	39,97
	1:45	43,200	20,400	418,000	43,200	7,6	416	39,97
	2:00	46,400	20,400	410,000	46,400	8	408	39,97
	2:15	52,800	20,800	425,000	52,800	8,4	423	39,97
	2:30	54,800	20,400	410,000	54,400	8,4	408	39,97
	2:45	53,600	20,400	418,000	53,200	8	416	39,97
	3:00	51,600	20,400	410,000	51,600	8	408	39,97
	3:15	57,600	20,400	418,000	57,200	8,4	416	39,97
	3:30	57,200	20,000	410,000	57,200	8,4	408	39,97
	3:45	58,800	20,000	425,000	58,400	8	423	39,97
	4:00	61,600	20,000	418,000	61,600	8,4	416	39,97
	4:15	60,800	19,600	410,000	60,400	8	408	39,97
	4:30	62,400	20,000	425,000	62,000	8,4	423	39,97
	4:45	65,600	20,000	410,000	65,200	8,8	408	39,97
	5:00	73,600	19,600	418,000	73,200	9,6	416	39,97
	5:15	60,800	20,000	410,000	60,800	8	408	39,97
	5:30	63,600	19,600	425,000	63,200	8	423	39,97
	5:45	62,800	19,600	418,000	62,400	8	416	39,97
	6:00	61,200	19,200	425,000	61,200	7,6	423	39,97
	6:15	79,600	19,200	402,000	79,200	9,2	400	39,97
	6:30	71,600	19,600	425,000	70,800	8,8	423	39,97
	6:45	69,200	20,000	418,000	68,800	9,6	416	39,97
	7:00	81,600	22,400	410,000	81,200	12,8	408	39,97
	7:15	88,000	23,200	425,000	87,600	14,8	423	39,97
	7:30	84,800	23,600	410,000	84,000	14,8	408	39,97
	7:45	79,600	23,600	410,000	79,200	14	408	39,97
	8:00	88,000	23,600	418,000	87,600	15,6	416	39,97
	8:15	111,600	20,400	410,000	110,800	15,6	408	39,97
	8:30	113,600	20,400	410,000	112,400	16	408	39,97
	8:45	110,800	20,800	410,000	109,600	16,4	408	39,97
	9:00	115,600	20,800	410,000	114,800	16,8	408	39,97
	9:15	108,400	21,200	410,000	107,600	16	408	39,97
	9:30	99,200	21,200	418,000	98,400	14,8	416	39,97
	9:45	102,000	21,600	410,000	101,200	15,2	408	39,97
	10:00	104,400	21,600	410,000	103,600	15,6	408	39,97
	10:15	108,800	21,600	410,000	107,600	16,8	408	39,97
	10:30	108,400	22,000	410,000	107,600	16,8	408	39,97
	10:45	110,800	21,600	410,000	109,600	17,2	408	39,97
	11:00	114,000	20,800	410,000	113,200	16,8	408	39,97
	11:15	111,200	21,200	410,000	110,400	16,4	408	39,97
	11:30	110,800	20,800	410,000	109,600	16,4	408	39,97
	11:45	110,400	20,800	410,000	109,600	16	408	39,97
	12:00	111,600	20,800	410,000	110,800	16,8	408	39,97
12:15	103,600	20,800	410,000	102,800	15,2	408	39,97	
12:30	104,400	20,400	410,000	103,200	14,4	408	39,97	
12:45	110,000	20,000	410,000	109,200	15,2	408	39,97	
13:00	112,800	19,600	402,000	112,000	15,6	400	39,97	
13:15	115,600	19,200	410,000	114,400	15,2	408	39,97	
13:30	108,000	19,600	402,000	106,800	15,2	400	39,97	
13:45	112,800	20,400	410,000	112,000	15,6	408	39,97	
14:00	104,800	20,000	410,000	104,000	14,8	408	39,97	
14:15	111,600	20,400	410,000	110,800	16,4	408	39,97	
14:30	120,400	20,400	410,000	119,200	17,2	408	39,97	
14:45	124,800	20,800	410,000	123,200	18,4	408	39,97	
15:00	130,400	20,000	402,000	129,200	19,6	400	39,97	
15:15	127,200	21,200	410,000	126,000	19,6	408	39,97	
15:30	126,000	22,000	410,000	124,800	20	408	39,97	
15:45	128,400	22,000	410,000	126,800	21,2	408	39,97	
16:00	120,400	23,200	410,000	119,200	20	408	39,97	
16:15	114,800	24,000	410,000	114,000	20	408	39,97	
16:30	118,000	24,000	410,000	116,800	20,8	408	39,97	
16:45	124,800	23,200	410,000	123,600	21,2	408	39,97	
17:00	121,600	22,800	410,000	120,800	20,4	408	39,97	
17:15	118,400	23,200	410,000	117,200	19,6	408	39,97	
17:30	121,200	22,800	410,000	120,000	20,4	408	39,97	
17:45	126,400	24,000	410,000	125,200	21,6	408	39,97	
18:00	120,800	24,400	410,000	119,600	21,6	408	39,97	
18:15	124,800	24,400	418,000	123,600	22,4	416	39,97	

	18:30	131,600	24,800	410,000	130,400	23,6	408	39,97
	18:45	131,600	24,400	410,000	130,400	23,6	408	39,97
	19:00	124,400	24,800	410,000	123,200	22,8	408	39,97
	19:15	119,200	24,800	410,000	118,000	21,6	408	39,97
	19:30	121,200	25,600	410,000	120,000	22,8	408	39,97
	19:45	116,400	25,600	418,000	115,200	21,6	416	39,97
	20:00	108,400	24,800	410,000	108,000	20	408	39,97
	20:15	78,000	22,000	410,000	77,600	12,4	408	39,97
	20:30	70,400	22,400	410,000	69,600	12	408	39,97
	20:45	73,200	24,400	425,000	72,800	14,4	423	39,97
	21:00	65,600	24,000	410,000	65,600	12,8	408	39,97
	21:15	64,800	24,000	418,000	64,400	13,2	416	39,97
	21:30	68,000	24,000	410,000	67,600	13,6	408	39,97
	21:45	71,200	26,800	410,000	70,800	16,8	408	39,97
	22:00	63,600	27,200	410,000	63,600	16,4	408	39,97
	22:15	56,000	26,800	418,000	55,600	14,8	416	39,97
	22:30	58,000	26,400	410,000	57,600	15,2	408	39,97
	22:45	60,000	26,400	410,000	59,600	15,6	408	39,97
	23:00	53,600	26,000	425,000	53,600	14	423	39,97
	23:15	45,200	25,600	410,000	44,800	12,8	408	39,97
	23:30	43,200	24,800	410,000	43,200	12,4	408	39,97
	23:45	48,800	24,800	418,000	48,800	12,8	416	39,97
	0:00	46,800	23,200	410,000	46,400	10,4	408	39,97
2.7.2015.	0:15	60,800	23,600	418,000	60,800	12,4	416	39,33
	0:30	55,200	22,800	410,000	54,400	10,8	408	39,33
	0:45	55,200	22,400	425,000	55,600	10,4	423	39,33
	1:00	50,800	21,200	410,000	50,000	9,2	408	39,33
	1:15	62,000	22,000	410,000	62,000	10,4	408	39,33
	1:30	62,000	22,000	418,000	62,000	10,4	416	39,33
	1:45	63,200	21,600	410,000	62,800	10,8	408	39,33
	2:00	55,600	22,000	425,000	55,200	10	423	39,33
	2:15	56,800	22,000	418,000	56,400	10	416	39,33
	2:30	51,600	21,200	410,000	51,600	8,8	408	39,33
	2:45	58,400	21,200	418,000	58,400	9,6	416	39,33
	3:00	58,400	21,200	410,000	58,000	8,8	408	39,33
	3:15	66,400	20,800	425,000	66,000	10	423	39,33
	3:30	64,000	21,200	410,000	64,000	10	408	39,33
	3:45	63,200	20,800	418,000	62,800	9,2	416	39,33
	4:00	60,000	21,200	425,000	59,600	9,6	423	39,33
	4:15	64,400	21,200	410,000	64,000	10	408	39,33
	4:30	65,600	21,200	418,000	65,200	10	416	39,33
	4:45	71,200	20,800	410,000	70,800	10	408	39,33
	5:00	73,200	20,800	425,000	72,800	10,8	423	39,33
	5:15	67,200	22,400	418,000	67,200	10,8	416	39,33
	5:30	74,400	22,400	410,000	74,000	12,4	408	39,33
	5:45	72,800	22,400	418,000	72,400	12	416	39,33
	6:00	67,200	22,800	425,000	66,400	11,2	423	39,33
	6:15	88,400	22,000	410,000	88,000	13,6	408	39,33
	6:30	84,400	22,400	418,000	84,400	13,6	416	39,33
	6:45	81,600	22,800	425,000	80,800	13,2	423	39,33
	7:00	79,200	22,800	410,000	78,400	13,2	408	39,33
	7:15	79,200	23,600	418,000	79,200	14	416	39,33
	7:30	83,600	24,000	410,000	82,800	15,2	408	39,33
	7:45	82,400	24,000	410,000	82,000	14,8	408	39,33
	8:00	81,200	23,600	425,000	80,800	14,4	423	39,33
	8:15	102,000	24,000	402,000	100,800	17,6	400	39,33
	8:30	98,800	19,600	410,000	98,400	13,2	408	39,33
	8:45	98,800	20,800	410,000	98,000	14	408	39,33
	9:00	96,800	20,000	410,000	96,000	13,2	408	39,33
	9:15	97,200	18,800	410,000	96,800	12	408	39,33
	9:30	97,200	19,200	410,000	96,400	12,4	408	39,33
	9:45	94,800	19,200	410,000	94,000	12,4	408	39,33
	10:00	96,400	20,000	410,000	95,600	13,2	408	39,33
	10:15	98,000	20,400	410,000	97,200	14	408	39,33
	10:30	98,400	20,400	410,000	97,600	13,6	408	39,33
10:45	99,200	20,000	410,000	98,400	13,6	408	39,33	
11:00	108,000	20,000	410,000	107,200	15,2	408	39,33	
11:15	112,400	21,600	410,000	111,200	17,2	408	39,33	
11:30	108,400	21,200	410,000	107,600	16,4	408	39,33	
11:45	108,800	21,600	410,000	108,000	16,8	408	39,33	
12:00	109,200	22,000	394,000	108,400	17,2	392	39,33	
12:15	104,000	22,000	410,000	102,800	16,4	408	39,33	
12:30	100,800	22,400	410,000	100,000	16,4	408	39,33	
12:45	99,600	22,800	410,000	99,200	16,8	408	39,33	
13:00	98,000	23,600	410,000	97,200	16,8	408	39,33	
13:15	110,400	23,200	410,000	109,200	18,8	408	39,33	
13:30	103,200	23,200	410,000	102,000	17,2	408	39,33	
13:45	107,600	23,600	410,000	107,200	18,4	408	39,33	
14:00	103,600	23,600	410,000	102,800	18,4	408	39,33	
14:15	110,400	23,600	402,000	109,200	18,8	400	39,33	

	14:30	111,200	30,400	425,000	110,000	26	423	39,33
	14:45	112,800	30,000	410,000	112,000	25,6	408	39,33
	15:00	112,000	30,400	410,000	110,800	26,4	408	39,33
	15:15	130,800	30,800	410,000	130,000	30	408	39,33
	15:30	113,200	31,600	418,000	111,600	27,6	416	39,33
	15:45	122,400	31,600	410,000	121,600	29,6	408	39,33
	16:00	168,400	30,800	410,000	166,000	38,8	408	39,33
	16:15	178,000	30,000	410,000	175,600	40,4	408	39,33
	16:30	173,600	30,800	425,000	171,200	40	423	39,33
	16:45	164,000	32,000	402,000	162,000	38,8	400	39,33
	17:00	164,800	32,400	410,000	162,400	39,2	408	39,33
	17:15	154,400	32,000	410,000	152,400	36,8	408	39,33
	17:30	170,000	30,800	410,000	168,000	38,8	408	39,33
	17:45	168,800	31,200	425,000	166,400	39,6	423	39,33
	18:00	165,200	32,000	410,000	162,800	38,8	408	39,33
	18:15	163,600	31,600	410,000	162,000	38	408	39,33
	18:30	170,000	30,400	418,000	167,600	38,8	416	39,33
	18:45	142,000	30,800	410,000	140,400	32	408	39,33
	19:00	116,000	31,200	410,000	115,200	27,6	408	39,33
	19:15	118,400	30,400	418,000	117,200	27,2	416	39,33
	19:30	117,600	30,800	410,000	116,400	27,2	408	39,33
	19:45	115,600	31,200	425,000	114,800	26,8	423	39,33
	20:00	113,600	30,800	410,000	112,800	26,8	408	39,33
	20:15	107,600	30,800	410,000	106,400	26	408	39,33
	20:30	88,800	31,200	418,000	88,000	22,8	416	39,33
	20:45	98,000	30,800	410,000	97,600	24,4	408	39,33
	21:00	84,800	30,400	425,000	84,000	22	423	39,33
	21:15	86,800	30,400	410,000	86,400	22	408	39,33
	21:30	81,600	30,000	418,000	81,200	20,8	416	39,33
	21:45	86,400	30,400	410,000	86,000	22,4	408	39,33
	22:00	86,400	30,800	410,000	85,600	22,4	408	39,33
	22:15	70,400	31,200	418,000	70,400	21,2	416	39,33
	22:30	80,000	32,000	410,000	79,200	23,2	408	39,33
	22:45	81,600	32,000	425,000	81,200	23,2	423	39,33
	23:00	80,400	30,800	410,000	80,000	22	408	39,33
	23:15	70,000	30,400	410,000	69,600	20	408	39,33
	23:30	67,200	29,600	418,000	66,800	19,2	416	39,33
	23:45	72,400	29,600	410,000	72,000	19,6	408	39,33
	0:00	69,200	29,600	425,000	68,800	19,2	423	39,33
3.7.2015.	0:15	65,600	28,000	402,000	65,200	17,2	400	46,33
	0:30	60,000	28,400	425,000	60,000	16,8	423	46,33
	0:45	64,000	27,600	418,000	63,600	16,4	416	46,33
	1:00	59,600	27,200	410,000	59,200	16	408	46,33
	1:15	70,400	27,600	425,000	70,000	16,8	423	46,33
	1:30	67,200	27,600	418,000	66,800	17,2	416	46,33
	1:45	65,600	28,400	410,000	65,600	17,6	408	46,33
	2:00	58,800	27,600	425,000	58,000	16	423	46,33
	2:15	64,000	26,000	418,000	64,000	14,8	416	46,33
	2:30	62,800	26,000	410,000	62,400	14,4	408	46,33
	2:45	63,600	25,600	425,000	63,600	14,4	423	46,33
	3:00	65,600	26,000	418,000	65,200	15,2	416	46,33
	3:15	76,000	26,000	410,000	75,600	15,6	408	46,33
	3:30	68,800	25,600	418,000	68,400	14,8	416	46,33
	3:45	68,000	26,000	425,000	67,600	15,2	423	46,33
	4:00	68,800	25,600	410,000	68,800	15,2	408	46,33
	4:15	79,600	25,600	418,000	78,800	16	416	46,33
	4:30	80,400	25,600	425,000	80,000	16	423	46,33
	4:45	82,400	25,600	410,000	82,000	16,4	408	46,33
	5:00	88,800	25,600	418,000	88,000	17,2	416	46,33
	5:15	81,200	25,200	410,000	80,800	15,6	408	46,33
	5:30	78,400	25,600	425,000	77,600	16	423	46,33
	5:45	79,200	25,600	418,000	79,200	15,6	416	46,33
	6:00	86,000	24,400	418,000	85,600	15,6	416	46,33
	6:15	82,800	25,200	410,000	82,000	16	408	46,33
	6:30	90,000	26,000	425,000	89,200	17,2	423	46,33
	6:45	94,400	25,200	418,000	94,000	17,6	416	46,33
	7:00	117,600	26,400	425,000	116,400	22,4	423	46,33
	7:15	133,600	26,800	410,000	132,400	26	408	46,33
	7:30	138,400	27,600	410,000	137,200	28	408	46,33
	7:45	132,000	29,200	418,000	130,800	28,4	416	46,33
	8:00	127,600	30,000	410,000	126,000	28,4	408	46,33
	8:15	131,600	30,000	425,000	130,400	29,2	423	46,33
	8:30	136,800	28,000	410,000	135,600	28,4	408	46,33
	8:45	143,200	27,200	402,000	141,200	28,4	400	46,33
	9:00	143,200	26,400	410,000	141,600	28,4	408	46,33
	9:15	132,400	27,600	410,000	131,200	26,8	408	46,33
	9:30	132,000	27,600	425,000	130,800	27,2	423	46,33
	9:45	127,600	28,000	410,000	126,400	26,4	408	46,33
	10:00	125,600	28,000	410,000	124,400	26	408	46,33
10:15	140,800	28,000	410,000	138,800	29,6	408	46,33	

	10:30	134,400	29,600	410,000	133,600	29,6	408	46,33
	10:45	133,200	29,200	418,000	131,600	28,8	416	46,33
	11:00	139,200	27,600	410,000	137,600	29,2	408	46,33
	11:15	142,800	28,400	410,000	141,200	30	408	46,33
	11:30	145,600	29,600	410,000	144,000	32	408	46,33
	11:45	146,000	29,200	410,000	144,800	32,4	408	46,33
	12:00	147,600	31,600	410,000	145,600	34,4	408	46,33
	12:15	138,800	32,400	410,000	137,200	33,6	408	46,33
	12:30	141,600	32,400	410,000	140,000	34	408	46,33
	12:45	151,600	30,800	410,000	150,000	34,8	408	46,33
	13:00	142,400	30,800	402,000	140,400	32,8	400	46,33
	13:15	158,000	30,800	425,000	156,000	36,4	423	46,33
	13:30	152,800	31,600	410,000	151,200	35,6	408	46,33
	13:45	156,800	31,200	410,000	154,800	36,8	408	46,33
	14:00	154,400	32,000	410,000	152,400	36,4	408	46,33
	14:15	144,400	31,600	410,000	143,200	34	408	46,33
	14:30	142,000	31,200	410,000	140,400	32,4	408	46,33
	14:45	136,000	31,200	418,000	134,400	31,6	416	46,33
	15:00	143,600	31,200	410,000	142,000	33,2	408	46,33
	15:15	136,000	31,600	410,000	134,800	32,4	408	46,33
	15:30	138,400	31,600	410,000	136,800	32	408	46,33
	15:45	136,000	31,600	410,000	134,400	32,4	408	46,33
	16:00	135,600	32,000	418,000	134,400	32,4	416	46,33
	16:15	122,400	34,400	410,000	121,200	32	408	46,33
	16:30	128,400	34,800	410,000	127,200	33,6	408	46,33
	16:45	127,200	34,800	425,000	126,000	33,2	423	46,33
	17:00	128,800	34,800	410,000	127,200	33,6	408	46,33
	17:15	129,200	34,400	418,000	128,000	33,2	416	46,33
	17:30	127,600	34,800	410,000	126,400	33,6	408	46,33
	17:45	125,600	34,800	410,000	124,400	32,8	408	46,33
	18:00	130,000	34,400	418,000	128,800	33,6	416	46,33
	18:15	136,000	34,800	410,000	134,800	35,2	408	46,33
	18:30	146,000	34,800	425,000	144,000	36,8	423	46,33
	18:45	148,800	34,000	410,000	147,200	37,6	408	46,33
	19:00	153,200	34,000	410,000	151,600	37,6	408	46,33
	19:15	150,400	34,000	418,000	148,400	37,6	416	46,33
	19:30	115,600	34,000	410,000	114,400	30	408	46,33
	19:45	114,800	33,600	425,000	114,000	29,6	423	46,33
	20:00	113,200	33,600	410,000	112,000	29,6	408	46,33
	20:15	108,400	34,400	418,000	107,600	29,2	416	46,33
	20:30	102,000	34,000	418,000	101,200	27,6	416	46,33
	20:45	103,200	33,600	410,000	102,800	28,4	408	46,33
	21:00	103,200	34,400	425,000	102,000	28,4	423	46,33
	21:15	96,400	33,200	410,000	95,600	26,4	408	46,33
	21:30	101,200	34,000	410,000	100,800	28	408	46,33
	21:45	105,200	35,600	418,000	104,000	30,8	416	46,33
	22:00	107,200	36,000	410,000	106,400	30,8	408	46,33
	22:15	90,800	36,000	425,000	90,400	28,8	423	46,33
	22:30	89,600	36,800	410,000	88,800	29,6	408	46,33
	22:45	96,800	36,800	410,000	96,000	30,4	408	46,33
	23:00	93,600	37,200	418,000	93,200	30	416	46,33
	23:15	74,400	36,400	410,000	73,600	27,2	408	46,33
	23:30	65,600	35,600	418,000	65,600	25,2	416	46,33
	23:45	70,400	34,400	410,000	70,000	24,4	408	46,33
	0:00	69,600	33,200	425,000	69,200	23,2	423	46,33
	0:15	68,400	33,600	410,000	68,400	23,6	408	39,22
	0:30	74,400	34,000	410,000	73,600	24,4	408	39,22
	0:45	60,000	34,400	418,000	60,000	23,6	416	39,22
	1:00	58,800	34,800	410,000	58,400	23,6	408	39,22
	1:15	56,000	34,400	425,000	55,600	23,2	423	39,22
	1:30	62,800	34,000	402,000	62,400	23,2	400	39,22
	1:45	70,800	34,400	425,000	70,400	24,4	423	39,22
	2:00	68,400	34,000	418,000	68,000	23,6	416	39,22
	2:15	65,200	34,800	410,000	64,800	24,4	408	39,22
	2:30	57,200	35,600	425,000	57,200	24	423	39,22
	2:45	60,400	34,400	418,000	60,400	23,2	416	39,22
	3:00	65,200	34,400	410,000	64,400	24	408	39,22
	3:15	74,800	34,000	425,000	74,400	24,4	423	39,22
	3:30	67,600	34,000	418,000	67,200	23,2	416	39,22
	3:45	68,400	33,600	425,000	68,000	23,2	423	39,22
	4:00	66,800	33,200	410,000	66,800	22,4	408	39,22
	4:15	74,800	32,400	418,000	74,400	22,4	416	39,22
	4:30	71,200	32,000	418,000	70,800	22	416	39,22
	4:45	70,000	32,800	425,000	69,600	22	423	39,22
	5:00	78,800	32,400	410,000	78,000	23,2	408	39,22
	5:15	94,000	30,800	418,000	93,600	23,2	416	39,22
	5:30	78,800	30,400	425,000	78,400	20,4	423	39,22
	5:45	76,000	30,800	418,000	75,600	20,8	416	39,22
	6:00	77,600	31,200	425,000	76,800	21,6	423	39,22
	6:15	89,200	29,600	418,000	88,800	21,2	416	39,22
4.7.2015.								

	6:30	82,400	29,600	425,000	81,600	20,4	423	39,22
	6:45	100,000	30,400	418,000	99,200	23,6	416	39,22
	7:00	109,600	30,400	410,000	108,800	25,2	408	39,22
	7:15	96,800	30,400	425,000	96,000	23,2	423	39,22
	7:30	87,200	31,600	418,000	86,800	23,2	416	39,22
	7:45	84,400	32,000	410,000	83,600	23,2	408	39,22
	8:00	93,600	29,200	418,000	92,800	22	416	39,22
	8:15	93,600	29,200	425,000	93,600	21,6	423	39,22
	8:30	95,200	28,800	410,000	94,400	21,6	408	39,22
	8:45	86,800	30,000	418,000	86,000	21,6	416	39,22
	9:00	80,000	30,000	410,000	79,200	20,8	408	39,22
	9:15	87,200	29,600	425,000	86,800	21,2	423	39,22
	9:30	89,200	29,200	410,000	88,400	21,2	408	39,22
	9:45	84,000	29,600	418,000	83,600	20,8	416	39,22
	10:00	86,000	29,600	410,000	85,200	21,2	408	39,22
	10:15	86,400	30,000	425,000	86,000	21,6	423	39,22
	10:30	86,800	30,400	402,000	86,000	22,4	400	39,22
	10:45	84,800	30,400	425,000	84,400	21,6	423	39,22
	11:00	82,800	30,000	410,000	82,400	21,2	408	39,22
	11:15	87,600	29,600	418,000	86,800	21,6	416	39,22
	11:30	84,000	30,400	410,000	83,600	21,6	408	39,22
	11:45	89,600	30,000	410,000	88,800	22,4	408	39,22
	12:00	86,800	30,000	425,000	86,400	21,6	423	39,22
	12:15	78,400	29,200	410,000	77,600	20	408	39,22
	12:30	74,000	30,400	418,000	74,000	20,4	416	39,22
	12:45	70,400	28,800	410,000	70,000	18	408	39,22
	13:00	72,000	28,400	418,000	71,600	18,8	416	39,22
	13:15	78,800	29,600	410,000	78,000	20	408	39,22
	13:30	81,200	29,200	425,000	80,800	20,4	423	39,22
	13:45	85,600	30,000	410,000	85,200	21,2	408	39,22
	14:00	84,000	29,600	418,000	83,200	20,8	416	39,22
	14:15	80,400	29,600	410,000	80,000	20,4	408	39,22
	14:30	71,600	29,200	425,000	71,200	19,2	423	39,22
	14:45	74,800	30,000	418,000	74,400	19,6	416	39,22
	15:00	76,000	29,600	410,000	75,200	20	408	39,22
	15:15	73,200	29,600	425,000	73,200	19,6	423	39,22
	15:30	77,600	29,200	410,000	76,800	19,6	408	39,22
	15:45	77,600	30,000	418,000	77,200	20,4	416	39,22
	16:00	76,000	29,600	410,000	75,600	20	408	39,22
	16:15	75,600	30,000	418,000	75,600	20	416	39,22
	16:30	74,800	29,600	425,000	74,400	20	423	39,22
	16:45	76,400	30,000	410,000	75,600	20	408	39,22
	17:00	75,200	30,400	418,000	74,800	20,4	416	39,22
	17:15	67,200	29,600	425,000	66,800	18,4	423	39,22
	17:30	73,200	29,200	410,000	72,800	19,2	408	39,22
	17:45	74,000	29,200	418,000	73,600	19,2	416	39,22
	18:00	76,400	29,600	425,000	75,600	19,6	423	39,22
	18:15	72,000	29,200	410,000	72,000	19,2	408	39,22
	18:30	77,200	28,800	418,000	76,800	19,2	416	39,22
	18:45	82,400	28,800	418,000	81,600	19,6	416	39,22
	19:00	80,400	29,200	410,000	80,000	19,6	408	39,22
	19:15	75,200	29,200	425,000	74,800	19,2	423	39,22
	19:30	82,000	29,200	410,000	81,600	20,4	408	39,22
	19:45	58,000	27,600	418,000	57,600	15,6	416	39,22
	20:00	57,600	27,600	425,000	57,600	15,6	423	39,22
	20:15	58,400	27,200	418,000	58,400	15,6	416	39,22
	20:30	54,400	27,200	410,000	54,000	15,2	408	39,22
	20:45	57,600	27,200	425,000	57,200	15,6	423	39,22
	21:00	52,400	27,200	418,000	52,000	14,8	416	39,22
	21:15	54,800	26,400	410,000	54,800	14,4	408	39,22
	21:30	67,200	27,200	418,000	66,800	16,8	416	39,22
	21:45	64,000	28,400	410,000	63,600	17,2	408	39,22
	22:00	61,600	30,400	425,000	61,600	19,2	423	39,22
	22:15	56,400	30,000	410,000	56,000	18,8	408	39,22
	22:30	63,600	30,800	418,000	63,200	19,6	416	39,22
	22:45	66,400	31,200	410,000	66,400	20,4	408	39,22
	23:00	66,800	31,600	425,000	66,000	21,2	423	39,22
	23:15	55,600	30,800	410,000	55,600	19,2	408	39,22
	23:30	54,400	31,200	418,000	54,400	19,6	416	39,22
	23:45	57,200	32,000	425,000	56,800	20,4	423	39,22
	0:00	55,600	31,600	418,000	55,200	19,6	416	39,22
5.7.2015.	0:15	54,400	30,400	410,000	54,000	18,8	408	36,14
	0:30	53,200	31,200	418,000	53,600	18,8	416	36,14
	0:45	56,800	31,200	425,000	56,000	19,6	423	36,14
	1:00	52,800	30,400	418,000	52,800	18,4	416	36,14
	1:15	55,600	30,000	410,000	55,200	18	408	36,14
	1:30	44,800	29,600	425,000	44,800	16,8	423	36,14
	1:45	46,400	28,800	418,000	46,000	16	416	36,14
	2:00	45,200	29,200	425,000	45,200	16,4	423	36,14
	2:15	50,800	27,600	418,000	50,400	15,6	416	36,14

2:30	50,400	27,600	410,000	50,400	15,2	408	36,14
2:45	50,400	28,400	425,000	50,400	16	423	36,14
3:00	51,200	28,000	418,000	50,800	16	416	36,14
3:15	50,000	27,600	425,000	50,000	14,8	423	36,14
3:30	44,400	27,200	418,000	44,400	14,4	416	36,14
3:45	45,600	28,400	418,000	44,800	15,6	416	36,14
4:00	46,400	28,000	425,000	46,400	14,8	423	36,14
4:15	54,000	28,000	418,000	53,600	16	416	36,14
4:30	53,200	28,000	425,000	53,200	15,6	423	36,14
4:45	60,400	28,400	418,000	60,400	16,4	416	36,14
5:00	54,800	27,600	425,000	54,400	15,2	423	36,14
5:15	59,200	23,200	418,000	58,800	11,6	416	36,14
5:30	54,000	21,600	425,000	53,600	8,8	423	36,14
5:45	52,800	21,600	418,000	52,800	8,8	416	36,14
6:00	56,400	21,200	425,000	56,000	9,2	423	36,14
6:15	58,000	21,600	410,000	58,000	9,2	408	36,14
6:30	58,800	20,800	418,000	58,400	8,8	416	36,14
6:45	58,800	20,800	425,000	58,400	8,8	423	36,14
7:00	70,800	21,600	418,000	70,800	10,8	416	36,14
7:15	67,600	22,000	418,000	67,200	10,4	416	36,14
7:30	66,400	22,000	425,000	66,000	11,2	423	36,14
7:45	58,000	21,600	410,000	58,000	9,6	408	36,14
8:00	56,400	21,200	418,000	56,000	8,8	416	36,14
8:15	53,200	22,800	425,000	53,200	10,4	423	36,14
8:30	48,000	22,000	418,000	47,600	9,6	416	36,14
8:45	50,000	22,400	410,000	49,600	9,2	408	36,14
9:00	47,600	21,600	425,000	47,600	9,2	423	36,14
9:15	53,600	21,600	418,000	53,600	9,2	416	36,14
9:30	58,000	22,800	410,000	57,600	10,8	408	36,14
9:45	54,800	21,600	425,000	54,800	9,6	423	36,14
10:00	54,400	21,600	418,000	54,000	9,6	416	36,14
10:15	61,200	22,400	410,000	60,800	10,8	408	36,14
10:30	55,600	22,400	418,000	55,600	10,4	416	36,14
10:45	56,800	22,400	410,000	56,400	10	408	36,14
11:00	58,400	21,600	425,000	58,000	10,4	423	36,14
11:15	61,600	23,200	418,000	61,600	11,2	416	36,14
11:30	64,800	23,200	410,000	64,400	12,4	408	36,14
11:45	58,800	22,400	425,000	58,000	10,8	423	36,14
12:00	59,600	22,800	410,000	59,600	10,8	408	36,14
12:15	63,600	22,800	418,000	63,200	12	416	36,14
12:30	63,600	22,800	410,000	63,600	11,2	408	36,14
12:45	62,400	22,800	418,000	62,000	11,6	416	36,14
13:00	62,400	23,200	410,000	62,000	12	408	36,14
13:15	59,600	23,200	425,000	59,600	11,2	423	36,14
13:30	60,400	22,800	410,000	60,000	11,2	408	36,14
13:45	67,200	24,000	418,000	66,800	13,2	416	36,14
14:00	63,200	23,200	410,000	63,200	11,6	408	36,14
14:15	74,000	23,600	425,000	73,200	13,6	423	36,14
14:30	70,400	23,600	418,000	70,400	12,4	416	36,14
14:45	64,000	22,800	410,000	63,200	11,6	408	36,14
15:00	65,600	23,600	425,000	65,600	12,8	423	36,14
15:15	60,000	23,600	410,000	59,600	11,6	408	36,14
15:30	53,600	23,200	418,000	53,200	10,8	416	36,14
15:45	52,800	22,800	418,000	52,800	10,8	416	36,14
16:00	54,000	23,200	410,000	53,600	10,8	408	36,14
16:15	57,600	23,600	425,000	57,200	11,6	423	36,14
16:30	52,400	22,800	418,000	52,400	10,8	416	36,14
16:45	53,600	22,800	410,000	53,600	10,4	408	36,14
17:00	52,000	23,200	425,000	51,600	10,8	423	36,14
17:15	41,600	22,000	418,000	41,600	8,8	416	36,14
17:30	42,400	22,000	410,000	42,400	8,8	408	36,14
17:45	43,200	22,000	425,000	42,800	9,2	423	36,14
18:00	47,600	22,400	418,000	47,600	10	416	36,14
18:15	49,200	22,000	410,000	49,200	9,2	408	36,14
18:30	48,800	22,000	418,000	48,000	9,2	416	36,14
18:45	47,200	21,200	410,000	47,200	8,8	408	36,14
19:00	54,000	22,000	425,000	53,600	9,6	423	36,14
19:15	53,200	22,400	418,000	53,200	10,4	416	36,14
19:30	61,200	22,800	410,000	61,200	11,2	408	36,14
19:45	62,000	22,400	425,000	61,600	10,8	423	36,14
20:00	58,400	22,000	410,000	58,000	10	408	36,14
20:15	38,800	20,400	418,000	38,800	7,2	416	36,14
20:30	42,400	20,800	425,000	42,400	7,6	423	36,14
20:45	43,600	20,800	410,000	43,200	8	408	36,14
21:00	36,400	20,400	418,000	36,400	6,8	416	36,14
21:15	39,600	22,000	410,000	39,600	9,2	408	36,14
21:30	50,000	24,000	410,000	50,000	12,4	408	36,14
21:45	51,200	24,400	418,000	50,800	12,4	416	36,14
22:00	48,400	24,400	410,000	48,400	12	408	36,14
22:15	40,400	22,800	410,000	40,400	10	408	36,14

	22:30	45,200	23,200	410,000	44,800	10,4	408	36,14
	22:45	51,200	23,200	425,000	50,800	11,2	423	36,14
	23:00	50,400	23,600	410,000	50,400	11,6	408	36,14
	23:15	56,800	25,200	410,000	56,800	14	408	36,14
	23:30	54,000	25,600	402,000	53,600	13,6	400	36,14
	23:45	52,800	26,800	425,000	52,400	14,8	423	36,14
	0:00	52,000	26,800	410,000	52,000	14,8	408	36,14
6.7.2015.	0:15	53,200	26,800	418,000	52,800	15,2	416	50,22
	0:30	49,200	25,600	410,000	49,200	13,2	408	50,22
	0:45	44,400	24,800	425,000	44,000	12,4	423	50,22
	1:00	46,400	24,400	410,000	46,800	11,6	408	50,22
	1:15	55,200	24,400	410,000	54,800	12,4	408	50,22
	1:30	52,400	22,800	418,000	52,000	11,2	416	50,22
	1:45	60,400	22,400	410,000	60,400	10,8	408	50,22
	2:00	53,600	22,800	425,000	53,200	10,8	423	50,22
	2:15	54,800	22,400	402,000	54,400	10,4	400	50,22
	2:30	47,600	21,600	425,000	47,600	8,8	423	50,22
	2:45	50,400	21,200	410,000	50,400	8,8	408	50,22
	3:00	49,600	20,800	418,000	49,200	8,4	416	50,22
	3:15	57,200	20,800	410,000	57,200	9,2	408	50,22
	3:30	52,800	21,200	425,000	52,400	8,4	423	50,22
	3:45	54,000	21,200	418,000	53,600	9,2	416	50,22
	4:00	54,000	20,800	410,000	53,600	8,8	408	50,22
	4:15	56,400	21,200	425,000	56,400	9,2	423	50,22
	4:30	54,000	20,400	410,000	54,000	8	408	50,22
	4:45	55,200	20,000	418,000	54,800	8	416	50,22
	5:00	58,800	20,400	410,000	58,400	8,4	408	50,22
	5:15	60,000	20,000	418,000	60,000	8,4	416	50,22
	5:30	56,800	20,000	425,000	56,400	7,6	423	50,22
	5:45	50,000	19,600	410,000	49,600	7,2	408	50,22
	6:00	50,400	18,800	418,000	50,400	6	416	50,22
	6:15	65,600	19,200	425,000	65,200	8	423	50,22
	6:30	65,200	19,600	410,000	64,800	8,4	408	50,22
	6:45	70,000	20,400	418,000	70,000	9,6	416	50,22
	7:00	82,000	20,800	410,000	81,600	12	408	50,22
	7:15	96,000	21,200	410,000	95,200	13,6	408	50,22
	7:30	97,600	22,800	418,000	96,400	15,6	416	50,22
	7:45	100,800	23,600	410,000	100,400	17,6	408	50,22
	8:00	98,000	25,200	410,000	97,200	18,4	408	50,22
	8:15	101,200	24,000	410,000	100,400	18	408	50,22
	8:30	101,200	24,400	425,000	100,400	18	423	50,22
	8:45	92,000	26,000	410,000	91,200	18,4	408	50,22
	9:00	101,200	28,000	410,000	100,400	22,4	408	50,22
	9:15	110,000	28,800	410,000	109,200	23,6	408	50,22
	9:30	107,600	28,400	410,000	106,800	23,6	408	50,22
	9:45	104,000	32,000	418,000	103,200	26,4	416	50,22
	10:00	106,000	32,800	410,000	105,200	27,6	408	50,22
	10:15	108,000	33,200	410,000	106,800	28,4	408	50,22
	10:30	106,400	33,200	410,000	105,600	28	408	50,22
10:45	103,200	32,400	418,000	102,400	26,8	416	50,22	
11:00	108,400	32,000	410,000	107,200	27,6	408	50,22	
11:15	108,400	32,400	410,000	107,600	27,6	408	50,22	
11:30	109,600	32,800	410,000	108,400	28,4	408	50,22	
11:45	112,400	32,400	410,000	111,600	28,8	408	50,22	
12:00	112,800	32,800	410,000	111,600	28,8	408	50,22	
12:15	113,600	31,200	410,000	112,800	28	408	50,22	
12:30	114,000	34,800	410,000	112,800	31,6	408	50,22	
12:45	114,800	37,200	410,000	113,600	33,6	408	50,22	
13:00	114,800	37,600	418,000	114,000	34,8	416	50,22	
13:15	125,600	37,200	410,000	124,400	36,4	408	50,22	
13:30	124,000	38,000	402,000	122,400	36,8	400	50,22	
13:45	126,800	38,000	410,000	125,600	37,6	408	50,22	
14:00	128,000	38,800	410,000	126,400	38,4	408	50,22	
14:15	103,600	38,000	402,000	102,800	32,8	400	50,22	
14:30	98,800	36,000	425,000	98,000	30,8	423	50,22	
14:45	96,400	36,000	410,000	95,600	29,6	408	50,22	
15:00	96,400	36,400	410,000	96,000	30	408	50,22	
15:15	98,400	36,800	410,000	97,200	30,4	408	50,22	
15:30	98,000	36,000	410,000	97,200	30	408	50,22	
15:45	100,400	36,000	410,000	99,600	30,8	408	50,22	
16:00	100,000	36,400	418,000	99,200	30,4	416	50,22	
16:15	100,400	36,400	410,000	99,600	30,8	408	50,22	
16:30	103,600	36,400	410,000	102,400	31,2	408	50,22	
16:45	104,000	36,800	410,000	103,600	31,6	408	50,22	
17:00	99,600	36,000	418,000	98,400	30	416	50,22	
17:15	98,400	35,600	410,000	97,600	29,2	408	50,22	
17:30	96,800	35,200	410,000	96,000	28,8	408	50,22	
17:45	98,400	35,600	410,000	98,000	29,6	408	50,22	
18:00	101,200	35,200	425,000	100,400	29,6	423	50,22	
18:15	94,400	36,000	410,000	93,200	28,8	408	50,22	

	18:30	94,400	35,200	410,000	94,000	28,4	408	50,22
	18:45	94,400	35,200	418,000	94,000	28	416	50,22
	19:00	92,400	34,400	410,000	91,600	27,6	408	50,22
	19:15	96,400	35,200	410,000	95,600	28,4	408	50,22
	19:30	94,800	35,200	418,000	94,000	28,4	416	50,22
	19:45	93,200	34,800	410,000	92,400	27,6	408	50,22
	20:00	91,600	35,200	425,000	91,200	28	423	50,22
	20:15	88,000	35,200	410,000	87,200	27,6	408	50,22
	20:30	83,200	35,600	418,000	83,200	26,8	416	50,22
	20:45	86,000	36,000	410,000	84,800	28	408	50,22
	21:00	80,400	35,600	410,000	80,000	26,8	408	50,22
	21:15	74,400	35,200	425,000	74,000	26	423	50,22
	21:30	79,200	35,600	402,000	78,800	26,8	400	50,22
	21:45	75,600	36,400	425,000	75,200	26,8	423	50,22
	22:00	76,800	36,400	410,000	76,400	27,6	408	50,22
	22:15	65,200	35,200	410,000	64,400	24,8	408	50,22
	22:30	75,200	36,000	418,000	75,200	26,4	416	50,22
	22:45	79,200	35,200	410,000	78,800	26,8	408	50,22
	23:00	79,600	36,000	425,000	79,200	26,8	423	50,22
	23:15	64,400	34,800	410,000	64,000	24	408	50,22
	23:30	54,000	33,600	418,000	53,600	22	416	50,22
	23:45	62,400	34,000	425,000	62,000	23,2	423	50,22
	0:00	57,600	34,400	402,000	57,600	23,2	400	50,22
7.7.2015.	0:15	51,600	34,000	425,000	51,200	22	423	68,72
	0:30	52,400	34,400	418,000	52,400	22,4	416	68,72
	0:45	50,800	34,000	425,000	50,400	21,6	423	68,72
	1:00	50,800	33,600	410,000	50,800	22	408	68,72
	1:15	60,000	33,600	418,000	59,600	22	416	68,72
	1:30	54,800	32,800	425,000	54,400	21,2	423	68,72
	1:45	45,600	32,800	418,000	45,600	20	416	68,72
	2:00	49,200	32,400	410,000	48,800	20,4	408	68,72
	2:15	55,600	33,200	425,000	55,600	21,2	423	68,72
	2:30	48,800	32,000	418,000	48,400	19,6	416	68,72
	2:45	51,600	31,600	425,000	51,600	19,6	423	68,72
	3:00	46,000	31,600	418,000	46,000	18,8	416	68,72
	3:15	49,600	32,000	418,000	49,200	20	416	68,72
	3:30	51,600	32,000	425,000	51,200	20	423	68,72
	3:45	56,800	32,000	410,000	56,400	19,6	408	68,72
	4:00	56,400	32,000	418,000	56,400	20,4	416	68,72
	4:15	52,800	31,200	425,000	52,400	19,2	423	68,72
	4:30	55,600	31,600	418,000	55,600	19,6	416	68,72
	4:45	56,000	30,800	425,000	55,600	19,2	423	68,72
	5:00	56,400	31,600	418,000	56,000	19,2	416	68,72
	5:15	45,600	30,000	425,000	45,600	17,6	423	68,72
	5:30	50,800	30,000	418,000	50,400	17,6	416	68,72
	5:45	43,200	29,200	425,000	43,200	16	423	68,72
	6:00	47,600	30,000	418,000	47,600	17,2	416	68,72
	6:15	67,600	30,000	425,000	67,200	19,2	423	68,72
	6:30	60,800	30,000	402,000	60,400	18,4	400	68,72
	6:45	65,200	29,200	425,000	64,800	18,4	423	68,72
	7:00	62,400	29,200	418,000	62,000	17,6	416	68,72
	7:15	82,400	29,600	425,000	82,000	20,4	423	68,72
	7:30	90,800	30,400	418,000	90,000	22	416	68,72
	7:45	88,800	30,400	410,000	88,400	22,4	408	68,72
	8:00	90,400	30,400	425,000	89,600	22,4	423	68,72
	8:15	95,600	30,800	410,000	94,800	23,6	408	68,72
	8:30	96,800	30,800	418,000	96,400	23,6	416	68,72
	8:45	98,400	31,200	410,000	97,200	24,4	408	68,72
	9:00	99,200	31,200	425,000	98,800	25,2	423	68,72
	9:15	98,400	30,800	410,000	97,600	24	408	68,72
	9:30	99,200	28,800	402,000	98,400	22,8	400	68,72
	9:45	94,000	28,400	425,000	93,200	21,2	423	68,72
	10:00	96,000	28,800	410,000	95,200	21,6	408	68,72
	10:15	102,800	29,200	410,000	102,000	23,6	408	68,72
	10:30	105,600	32,000	410,000	104,800	26,4	408	68,72
	10:45	107,200	32,400	418,000	106,000	27,6	416	68,72
	11:00	106,000	32,000	410,000	105,600	27,2	408	68,72
	11:15	109,200	31,600	410,000	108,000	26,8	408	68,72
	11:30	104,000	30,800	410,000	103,200	25,6	408	68,72
	11:45	105,600	31,200	410,000	104,400	26	408	68,72
	12:00	106,800	31,200	410,000	106,000	26,4	408	68,72
12:15	109,600	33,200	410,000	108,400	28,8	408	68,72	
12:30	106,400	32,800	410,000	105,600	28	408	68,72	
12:45	108,800	32,400	410,000	108,000	28	408	68,72	
13:00	106,800	34,000	410,000	105,600	29,2	408	68,72	
13:15	112,000	33,200	410,000	111,200	29,6	408	68,72	
13:30	111,600	33,600	410,000	110,400	30	408	68,72	
13:45	112,000	34,000	402,000	110,800	30,4	400	68,72	
14:00	118,000	36,000	410,000	116,800	33,6	408	68,72	
14:15	114,800	35,600	410,000	114,000	32,4	408	68,72	

	14:30	112,400	35,200	410,000	111,200	31,6	408	68,72
	14:45	114,400	35,200	410,000	113,200	32	408	68,72
	15:00	114,400	36,800	410,000	113,600	33,2	408	68,72
	15:15	107,600	37,200	425,000	106,400	32,8	423	68,72
	15:30	106,000	37,200	410,000	105,200	32,4	408	68,72
	15:45	113,600	38,000	410,000	112,400	34	408	68,72
	16:00	113,200	37,600	402,000	112,000	34	400	68,72
	16:15	110,400	36,800	425,000	110,000	32,8	423	68,72
	16:30	117,600	37,600	410,000	116,000	34,8	408	68,72
	16:45	119,600	37,600	410,000	118,400	34,8	408	68,72
	17:00	122,400	37,200	418,000	121,200	35,2	416	68,72
	17:15	117,200	36,800	410,000	116,400	34	408	68,72
	17:30	120,800	37,200	410,000	119,200	34,4	408	68,72
	17:45	123,600	37,200	410,000	122,400	35,2	408	68,72
	18:00	118,800	36,400	425,000	117,600	34	423	68,72
	18:15	114,400	36,800	402,000	113,600	32,8	400	68,72
	18:30	119,600	37,200	410,000	118,000	34,4	408	68,72
	18:45	120,800	36,400	425,000	120,000	34,4	423	68,72
	19:00	120,000	36,000	410,000	118,800	33,2	408	68,72
	19:15	118,800	36,400	418,000	117,600	33,6	416	68,72
	19:30	115,600	36,800	410,000	114,800	33,2	408	68,72
	19:45	112,800	36,800	410,000	111,600	32,4	408	68,72
	20:00	113,600	36,000	425,000	112,400	32	423	68,72
	20:15	102,000	36,400	410,000	101,600	30,8	408	68,72
	20:30	98,000	36,400	418,000	97,200	30	416	68,72
	20:45	93,200	36,800	418,000	92,400	29,6	416	68,72
	21:00	96,000	36,400	418,000	95,200	30	416	68,72
	21:15	84,800	35,600	410,000	84,400	26,8	408	68,72
	21:30	81,600	37,600	410,000	81,200	29,2	408	68,72
	21:45	82,800	41,200	425,000	82,000	33,6	423	68,72
	22:00	82,400	43,600	410,000	82,000	36	408	68,72
	22:15	75,200	39,600	410,000	74,400	30,8	408	68,72
	22:30	82,400	39,600	410,000	82,000	31,6	408	68,72
	22:45	84,000	39,600	418,000	83,200	32	416	68,72
	23:00	75,600	39,200	410,000	75,200	30,4	408	68,72
	23:15	71,600	38,400	410,000	71,600	28,8	408	68,72
	23:30	70,400	38,000	410,000	69,600	28,4	408	68,72
	23:45	67,600	38,000	418,000	67,600	28	416	68,72
	0:00	69,600	37,200	410,000	69,200	27,6	408	68,72
8.7.2015.	0:15	63,200	37,600	425,000	62,400	27,2	423	56,61
	0:30	58,000	36,800	410,000	58,000	25,6	408	56,61
	0:45	55,600	36,000	418,000	55,600	24,8	416	56,61
	1:00	57,600	35,600	410,000	57,200	24,4	408	56,61
	1:15	53,600	34,800	425,000	53,200	23,2	423	56,61
	1:30	54,800	34,800	410,000	54,400	23,2	408	56,61
	1:45	60,800	35,200	418,000	60,800	24	416	56,61
	2:00	49,600	34,400	418,000	49,200	22,4	416	56,61
	2:15	49,200	34,800	410,000	49,200	23,2	408	56,61
	2:30	44,000	34,000	425,000	43,600	21,6	423	56,61
	2:45	41,600	33,600	410,000	41,600	21,2	408	56,61
	3:00	44,000	34,800	418,000	43,600	22	416	56,61
	3:15	48,000	34,800	425,000	48,000	23,2	423	56,61
	3:30	51,200	34,400	410,000	50,800	22	408	56,61
	3:45	48,000	33,600	418,000	48,000	21,6	416	56,61
	4:00	47,600	33,600	425,000	47,200	21,6	423	56,61
	4:15	49,600	33,200	418,000	49,200	20,8	416	56,61
	4:30	52,400	32,800	410,000	52,400	20,8	408	56,61
	4:45	52,800	32,400	418,000	52,800	20,4	416	56,61
	5:00	54,800	32,800	425,000	54,000	21,2	423	56,61
	5:15	66,800	32,800	418,000	66,800	22	416	56,61
	5:30	58,000	33,200	425,000	57,600	21,2	423	56,61
	5:45	57,600	33,200	410,000	57,200	21,6	408	56,61
	6:00	56,800	31,600	418,000	56,400	20,4	416	56,61
	6:15	69,200	31,600	425,000	69,200	20,8	423	56,61
	6:30	71,200	30,400	418,000	70,800	20	416	56,61
	6:45	64,400	27,200	410,000	63,600	15,6	408	56,61
	7:00	71,600	26,400	425,000	71,200	16	423	56,61
	7:15	80,800	26,000	418,000	80,400	16,8	416	56,61
	7:30	88,400	28,800	410,000	88,000	20,8	408	56,61
	7:45	86,400	29,600	425,000	85,600	21,2	423	56,61
	8:00	93,600	30,000	402,000	92,800	22	400	56,61
	8:15	104,000	28,400	425,000	103,600	23,2	423	56,61
	8:30	103,200	29,200	410,000	102,000	23,6	408	56,61
	8:45	105,600	30,000	410,000	104,800	24,8	408	56,61
	9:00	106,800	30,800	410,000	106,000	26	408	56,61
	9:15	108,800	30,400	410,000	107,600	25,6	408	56,61
	9:30	103,600	30,800	410,000	102,800	25,6	408	56,61
	9:45	106,000	31,600	410,000	105,200	26,4	408	56,61
	10:00	102,000	31,600	402,000	101,200	26,4	400	56,61
10:15	102,000	33,200	410,000	100,800	28	408	56,61	

	10:30	101,600	33,600	410,000	100,800	28,4	408	56,61
	10:45	104,000	34,800	410,000	103,200	29,6	408	56,61
	11:00	112,800	32,800	410,000	112,000	30	408	56,61
	11:15	110,400	37,200	402,000	109,200	33,2	400	56,61
	11:30	107,200	39,200	410,000	106,000	35,2	408	56,61
	11:45	107,600	38,800	410,000	106,400	35,2	408	56,61
	12:00	106,800	42,400	402,000	106,000	38,8	400	56,61
	12:15	104,800	42,800	410,000	104,000	38,8	408	56,61
	12:30	108,400	42,800	402,000	107,200	39,6	400	56,61
	12:45	109,200	42,800	410,000	108,000	39,6	408	56,61
	13:00	106,800	42,800	410,000	106,000	39,6	408	56,61
	13:15	113,600	43,600	410,000	112,400	41,2	408	56,61
	13:30	114,800	42,400	394,000	113,200	40,4	392	56,61
	13:45	114,400	42,000	410,000	113,600	40	408	56,61
	14:00	112,800	44,000	394,000	111,600	42	392	56,61
	14:15	116,400	44,400	410,000	115,200	42,8	408	56,61
	14:30	114,800	44,000	410,000	113,600	42,4	408	56,61
	14:45	118,800	43,200	402,000	117,600	42	400	56,61
	15:00	119,600	42,000	410,000	118,000	40,8	408	56,61
	15:15	120,000	42,000	394,000	118,800	41,6	392	56,61
	15:30	119,600	42,000	410,000	118,400	40,8	408	56,61
	15:45	120,800	42,800	394,000	119,600	42,4	392	56,61
	16:00	123,200	45,200	410,000	122,000	44,4	408	56,61
	16:15	122,400	45,600	410,000	120,800	45,2	408	56,61
	16:30	121,200	45,600	410,000	119,600	44,8	408	56,61
	16:45	116,400	45,200	402,000	115,600	43,6	400	56,61
	17:00	111,600	45,200	410,000	110,400	42	408	56,61
	17:15	106,400	43,200	410,000	105,200	39,6	408	56,61
	17:30	112,000	43,600	402,000	111,200	40,4	400	56,61
	17:45	109,600	43,600	410,000	108,400	40,4	408	56,61
	18:00	105,600	44,800	410,000	104,800	40,8	408	56,61
	18:15	103,200	45,200	425,000	102,400	40,4	423	56,61
	18:30	101,600	45,200	410,000	100,800	40,4	408	56,61
	18:45	100,400	43,600	410,000	99,600	38,8	408	56,61
	19:00	98,800	44,000	410,000	97,600	38,4	408	56,61
	19:15	98,400	43,600	410,000	98,000	38,4	408	56,61
	19:30	101,200	44,000	418,000	100,000	38,4	416	56,61
	19:45	100,000	43,200	410,000	99,200	38,4	408	56,61
	20:00	94,800	43,200	410,000	94,400	36,8	408	56,61
	20:15	89,600	42,800	410,000	88,400	36	408	56,61
	20:30	78,800	42,800	418,000	78,400	34,4	416	56,61
	20:45	91,200	44,400	410,000	90,800	38	408	56,61
	21:00	86,400	44,400	410,000	85,600	37,2	408	56,61
	21:15	84,000	44,000	425,000	83,200	36,4	423	56,61
	21:30	86,400	44,800	410,000	86,000	37,6	408	56,61
	21:45	82,400	45,600	410,000	82,000	38	408	56,61
	22:00	78,400	45,200	418,000	77,600	36,8	416	56,61
	22:15	65,200	43,600	410,000	64,800	34	408	56,61
	22:30	72,800	43,600	410,000	72,400	34,4	408	56,61
	22:45	76,000	42,800	418,000	75,600	34	416	56,61
	23:00	66,400	41,600	410,000	66,000	31,6	408	56,61
	23:15	49,200	40,000	425,000	48,800	28,8	423	56,61
	23:30	44,400	39,200	418,000	44,400	26,8	416	56,61
	23:45	52,000	37,600	410,000	50,800	26,4	408	56,61
	0:00	42,800	37,200	425,000	42,400	24,8	423	56,61
	0:15	42,800	36,800	418,000	42,400	24,4	416	42,94
	0:30	53,600	36,800	410,000	53,200	24,8	408	42,94
	0:45	58,000	35,200	425,000	57,600	24	423	42,94
	1:00	51,600	33,600	418,000	51,200	21,6	416	42,94
	1:15	52,800	32,800	418,000	52,400	20,8	416	42,94
	1:30	51,200	32,000	410,000	51,200	20	408	42,94
	1:45	50,800	32,400	425,000	50,400	20	423	42,94
	2:00	44,800	31,600	418,000	44,400	19,2	416	42,94
	2:15	45,200	32,000	425,000	45,200	19,6	423	42,94
	2:30	42,000	32,400	418,000	42,000	19,2	416	42,94
	2:45	46,800	31,600	425,000	46,400	19,2	423	42,94
	3:00	42,400	30,800	418,000	42,400	17,6	416	42,94
	3:15	47,600	30,400	425,000	47,200	18	423	42,94
	3:30	48,400	30,400	418,000	48,000	17,6	416	42,94
	3:45	42,800	29,600	425,000	43,200	16,8	423	42,94
	4:00	46,800	30,400	418,000	46,400	17,6	416	42,94
	4:15	49,200	30,000	410,000	49,200	17,6	408	42,94
	4:30	52,400	30,400	418,000	52,000	18	416	42,94
	4:45	52,000	30,000	425,000	51,600	18	423	42,94
	5:00	56,800	30,400	418,000	56,400	18,4	416	42,94
	5:15	55,600	30,000	425,000	55,600	17,6	423	42,94
	5:30	45,600	28,800	418,000	45,600	16	416	42,94
	5:45	47,600	28,800	425,000	47,200	16	423	42,94
	6:00	50,000	29,200	418,000	49,600	16,4	416	42,94
	6:15	62,800	28,800	425,000	62,800	17,6	423	42,94
9.7.2015.								

	6:30	65,600	29,200	418,000	65,200	17,6	416	42,94
	6:45	62,400	28,400	425,000	62,000	17,2	423	42,94
	7:00	63,200	28,000	418,000	62,800	16,4	416	42,94
	7:15	66,000	28,400	425,000	65,600	17,2	423	42,94
	7:30	66,000	29,600	418,000	65,600	18,4	416	42,94
	7:45	75,600	31,600	425,000	75,200	22	423	42,94
	8:00	70,800	32,800	402,000	70,400	22,8	400	42,94
	8:15	84,000	34,000	425,000	83,200	25,2	423	42,94
	8:30	80,800	33,600	410,000	80,400	24,8	408	42,94
	8:45	76,000	34,000	418,000	75,600	24,4	416	42,94
	9:00	79,200	34,400	410,000	78,800	25,6	408	42,94
	9:15	83,600	34,800	425,000	82,800	26,4	423	42,94
	9:30	80,800	34,800	410,000	80,000	26	408	42,94
	9:45	80,400	35,200	418,000	80,000	26,8	416	42,94
	10:00	81,600	36,000	410,000	81,200	27,2	408	42,94
	10:15	87,200	36,400	410,000	86,800	28,8	408	42,94
	10:30	87,600	37,200	418,000	86,400	30	416	42,94
	10:45	89,200	38,000	410,000	88,400	30,4	408	42,94
	11:00	88,400	37,200	425,000	88,000	29,6	423	42,94
	11:15	91,200	39,200	410,000	90,400	32	408	42,94
	11:30	94,400	38,400	410,000	94,000	32,4	408	42,94
	11:45	92,000	38,400	418,000	91,200	31,2	416	42,94
	12:00	94,800	39,200	410,000	94,400	32,8	408	42,94
	12:15	98,400	40,000	410,000	97,200	34	408	42,94
	12:30	94,800	39,200	410,000	94,400	33,6	408	42,94
	12:45	88,800	39,600	425,000	87,600	32	423	42,94
	13:00	91,600	39,600	402,000	90,800	32,4	400	42,94
	13:15	92,400	39,600	410,000	91,600	33,2	408	42,94
	13:30	91,600	39,200	425,000	91,200	32,4	423	42,94
	13:45	92,800	39,600	410,000	92,400	32,8	408	42,94
	14:00	90,000	39,200	410,000	88,800	32	408	42,94
	14:15	86,400	38,800	418,000	86,000	31,6	416	42,94
	14:30	83,600	38,800	410,000	82,800	30,4	408	42,94
	14:45	88,400	38,800	410,000	88,000	31,6	408	42,94
	15:00	90,800	38,800	425,000	90,000	31,6	423	42,94
	15:15	95,200	38,400	402,000	94,400	32	400	42,94
	15:30	91,600	38,800	410,000	91,200	31,6	408	42,94
	15:45	92,400	38,400	425,000	91,600	31,6	423	42,94
	16:00	90,000	38,000	410,000	89,200	30,8	408	42,94
	16:15	88,400	37,200	418,000	87,600	29,2	416	42,94
	16:30	85,600	36,400	410,000	85,200	28,4	408	42,94
	16:45	84,000	36,000	425,000	83,600	27,6	423	42,94
	17:00	96,800	35,600	410,000	96,000	29,2	408	42,94
	17:15	92,400	34,800	418,000	91,600	27,6	416	42,94
	17:30	81,600	35,600	410,000	81,200	26,8	408	42,94
	17:45	80,800	36,000	425,000	80,400	27,2	423	42,94
	18:00	82,800	36,400	402,000	82,000	27,6	400	42,94
	18:15	68,400	34,000	425,000	68,000	24	423	42,94
	18:30	68,800	34,000	418,000	68,400	23,6	416	42,94
	18:45	67,200	34,000	425,000	66,800	23,2	423	42,94
	19:00	68,800	34,000	410,000	68,400	23,2	408	42,94
	19:15	63,200	33,200	418,000	62,800	22,8	416	42,94
	19:30	63,200	33,600	425,000	63,200	22,4	423	42,94
	19:45	62,000	33,600	418,000	61,200	22	416	42,94
	20:00	66,000	34,000	425,000	66,000	23,6	423	42,94
	20:15	61,200	33,600	410,000	60,800	22,4	408	42,94
	20:30	57,200	33,200	418,000	56,800	21,6	416	42,94
	20:45	54,800	33,200	425,000	54,800	21,2	423	42,94
	21:00	58,000	33,600	418,000	57,600	22,4	416	42,94
	21:15	62,000	34,000	410,000	61,600	22,8	408	42,94
	21:30	62,000	33,600	418,000	61,600	22,8	416	42,94
	21:45	62,400	34,800	425,000	62,000	24	423	42,94
	22:00	58,400	34,800	410,000	58,400	23,2	408	42,94
	22:15	45,200	34,400	418,000	44,800	22,4	416	42,94
	22:30	55,600	36,400	425,000	55,600	24,8	423	42,94
	22:45	54,400	36,400	410,000	54,000	24,8	408	42,94
	23:00	49,600	35,600	418,000	49,600	23,6	416	42,94
	23:15	52,400	35,600	425,000	52,000	24	423	42,94
	23:30	44,400	34,000	418,000	44,000	21,6	416	42,94
	23:45	48,400	34,400	410,000	48,400	22,4	408	42,94
	0:00	45,200	33,200	418,000	45,200	20,8	416	42,94
10.7.2015.	0:15	41,600	32,000	425,000	41,200	18,8	423	54,31
	0:30	37,600	31,600	418,000	37,600	18,8	416	54,31
	0:45	35,200	30,800	425,000	34,800	17,2	423	54,31
	1:00	32,800	30,400	418,000	32,800	17,2	416	54,31
	1:15	32,800	30,400	425,000	32,800	17,2	423	54,31
	1:30	36,000	31,600	410,000	35,600	18	408	54,31
	1:45	42,400	31,200	418,000	42,400	18,4	416	54,31
	2:00	40,800	30,800	425,000	40,800	17,6	423	54,31
2:15	33,200	29,200	418,000	32,800	16	416	54,31	

2:30	32,400	29,200	425,000	32,800	15,2	423	54,31
2:45	33,200	28,400	433,000	32,800	15,2	431	54,31
3:00	34,000	28,800	418,000	34,000	15,2	416	54,31
3:15	37,200	29,200	425,000	37,200	15,6	423	54,31
3:30	34,000	28,400	418,000	34,000	14,8	416	54,31
3:45	38,400	28,800	418,000	38,000	15,2	416	54,31
4:00	40,800	29,200	425,000	40,400	16,4	423	54,31
4:15	40,800	28,800	418,000	41,200	15,2	416	54,31
4:30	44,800	28,800	425,000	44,000	16	423	54,31
4:45	48,400	28,800	418,000	48,400	16	416	54,31
5:00	45,200	28,800	425,000	45,200	15,6	423	54,31
5:15	48,800	29,200	433,000	48,400	16,4	431	54,31
5:30	46,800	28,400	418,000	46,800	15,6	416	54,31
5:45	47,200	28,400	425,000	46,800	15,2	423	54,31
6:00	42,400	27,600	418,000	42,400	14,4	416	54,31
6:15	53,200	27,600	425,000	53,200	15,2	423	54,31
6:30	54,000	28,000	418,000	53,600	15,6	416	54,31
6:45	72,800	30,400	425,000	72,000	19,6	423	54,31
7:00	69,200	30,400	418,000	69,200	19,6	416	54,31
7:15	67,600	30,400	425,000	67,200	19,6	423	54,31
7:30	64,000	31,200	418,000	63,600	20	416	54,31
7:45	66,800	32,000	418,000	66,400	21,6	416	54,31
8:00	60,000	32,000	425,000	60,000	20,4	423	54,31
8:15	67,600	33,600	418,000	66,800	22,8	416	54,31
8:30	60,400	33,200	410,000	60,400	22,4	408	54,31
8:45	60,000	34,000	425,000	59,600	22,4	423	54,31
9:00	61,600	34,000	418,000	61,200	23,2	416	54,31
9:15	71,200	35,600	410,000	70,800	25,6	408	54,31
9:30	71,200	34,400	425,000	70,800	24,4	423	54,31
9:45	68,000	33,600	410,000	67,600	23,6	408	54,31
10:00	68,000	34,000	418,000	67,600	23,6	416	54,31
10:15	67,600	35,200	410,000	67,200	24,8	408	54,31
10:30	61,200	34,400	418,000	61,200	23,2	416	54,31
10:45	64,800	35,200	425,000	64,000	24,8	423	54,31
11:00	63,600	35,200	410,000	63,200	24,4	408	54,31
11:15	63,200	34,800	418,000	63,200	24	416	54,31
11:30	64,400	34,400	410,000	64,000	24	408	54,31
11:45	62,400	34,800	425,000	62,000	24	423	54,31
12:00	62,800	34,800	418,000	62,400	24	416	54,31
12:15	56,800	34,400	410,000	56,400	22,8	408	54,31
12:30	54,400	34,400	425,000	54,000	23,2	423	54,31
12:45	57,600	35,200	410,000	57,600	23,6	408	54,31
13:00	56,000	34,800	418,000	56,000	24	416	54,31
13:15	60,800	35,200	410,000	60,400	24	408	54,31
13:30	58,800	34,400	418,000	58,000	23,6	416	54,31
13:45	60,400	35,200	410,000	60,400	24	408	54,31
14:00	57,200	34,000	425,000	56,800	22,8	423	54,31
14:15	57,200	34,400	410,000	56,800	22,8	408	54,31
14:30	59,600	34,400	418,000	59,600	23,6	416	54,31
14:45	58,400	34,400	410,000	58,000	23,2	408	54,31
15:00	58,000	34,400	425,000	57,600	23,2	423	54,31
15:15	58,400	34,800	418,000	58,000	23,6	416	54,31
15:30	55,600	34,800	410,000	55,600	23,2	408	54,31
15:45	62,000	35,200	425,000	61,600	24,4	423	54,31
16:00	62,000	35,600	418,000	61,200	24,4	416	54,31
16:15	62,000	36,000	410,000	62,000	24,8	408	54,31
16:30	60,400	35,200	418,000	60,000	24	416	54,31
16:45	60,800	34,800	425,000	60,800	24	423	54,31
17:00	61,200	35,600	410,000	60,800	24,4	408	54,31
17:15	53,200	34,400	418,000	53,200	22,8	416	54,31
17:30	58,800	35,200	425,000	58,400	23,6	423	54,31
17:45	64,400	34,800	418,000	63,600	23,6	416	54,31
18:00	57,600	33,200	425,000	57,600	22	423	54,31
18:15	58,800	32,400	410,000	58,400	20,8	408	54,31
18:30	62,000	33,200	418,000	62,000	22,4	416	54,31
18:45	59,200	32,800	425,000	58,800	20,8	423	54,31
19:00	63,600	33,200	418,000	63,200	22,4	416	54,31
19:15	52,400	31,600	418,000	52,000	19,6	416	54,31
19:30	48,800	30,400	410,000	48,800	18	408	54,31
19:45	48,800	30,400	425,000	48,400	18	423	54,31
20:00	44,800	30,000	418,000	44,800	17,6	416	54,31
20:15	42,800	30,800	425,000	42,400	17,6	423	54,31
20:30	34,000	29,600	418,000	34,400	16,4	416	54,31
20:45	35,200	30,400	410,000	34,800	16,8	408	54,31
21:00	37,200	30,800	425,000	36,800	18	423	54,31
21:15	42,400	32,000	418,000	42,400	19,6	416	54,31
21:30	38,400	30,800	425,000	38,400	18	423	54,31
21:45	40,400	31,600	410,000	40,400	18,4	408	54,31
22:00	41,200	31,600	418,000	40,800	19,2	416	54,31
22:15	35,200	32,800	410,000	35,600	20	408	54,31

	22:30	39,600	34,400	418,000	39,200	22	416	54,31
	22:45	44,000	34,800	425,000	43,600	22,4	423	54,31
	23:00	40,800	34,400	410,000	40,800	21,6	408	54,31
	23:15	46,800	34,800	418,000	46,400	22,8	416	54,31
	23:30	33,200	33,600	410,000	33,200	20,4	408	54,31
	23:45	36,000	33,600	425,000	36,000	21,2	423	54,31
	0:00	37,200	33,200	418,000	37,200	20	416	54,31
11.7.2015.	0:15	39,200	32,400	425,000	38,800	19,6	423	39,21
	0:30	32,800	31,600	418,000	32,800	18,4	416	39,21
	0:45	28,800	32,400	410,000	28,400	19,2	408	39,21
	1:00	27,200	32,400	425,000	27,200	18,4	423	39,21
	1:15	29,200	32,400	418,000	29,600	19,2	416	39,21
	1:30	34,400	33,600	418,000	34,000	20,4	416	39,21
	1:45	46,000	35,200	425,000	45,600	22,4	423	39,21
	2:00	36,800	32,000	418,000	36,800	19,2	416	39,21
	2:15	32,000	31,200	425,000	32,000	17,6	423	39,21
	2:30	18,400	29,600	418,000	18,400	16	416	39,21
	2:45	23,600	29,200	425,000	23,200	15,2	423	39,21
	3:00	21,600	28,400	418,000	21,600	14	416	39,21
	3:15	24,000	27,200	425,000	24,000	13,6	423	39,21
	3:30	21,600	27,600	418,000	22,000	13,2	416	39,21
	3:45	23,200	27,200	425,000	22,800	13,6	423	39,21
	4:00	26,400	28,400	418,000	26,400	14,4	416	39,21
	4:15	31,600	29,200	425,000	31,600	15,2	423	39,21
	4:30	33,600	28,400	418,000	33,200	14,8	416	39,21
	4:45	34,400	28,800	418,000	34,400	15,2	416	39,21
	5:00	43,200	29,600	425,000	43,200	16,4	423	39,21
	5:15	44,400	30,000	433,000	44,000	17,2	431	39,21
	5:30	44,800	30,800	418,000	44,800	17,6	416	39,21
	5:45	36,400	28,800	425,000	36,000	14,8	423	39,21
	6:00	43,200	28,800	433,000	43,200	15,2	431	39,21
	6:15	45,600	27,200	418,000	45,600	14,4	416	39,21
	6:30	39,200	27,200	425,000	39,200	13,6	423	39,21
	6:45	51,200	28,000	418,000	50,400	15,2	416	39,21
	7:00	48,800	27,200	433,000	49,200	14,4	431	39,21
	7:15	46,400	27,200	425,000	46,400	14,4	423	39,21
	7:30	42,800	28,000	418,000	42,000	14,8	416	39,21
	7:45	35,600	28,000	425,000	35,600	14,4	423	39,21
	8:00	43,200	28,800	418,000	43,200	16	416	39,21
	8:15	64,000	31,600	425,000	64,000	20,4	423	39,21
	8:30	53,600	31,200	410,000	52,800	19,2	408	39,21
	8:45	52,000	31,200	418,000	52,000	18,8	416	39,21
	9:00	49,600	30,800	418,000	49,200	18,4	416	39,21
	9:15	64,000	31,600	425,000	64,000	20,8	423	39,21
	9:30	58,800	31,200	418,000	58,000	19,6	416	39,21
	9:45	52,400	31,200	410,000	52,400	19,2	408	39,21
	10:00	56,000	31,600	425,000	55,600	19,6	423	39,21
	10:15	59,200	31,600	418,000	59,200	20,4	416	39,21
	10:30	60,400	32,000	425,000	60,000	20,4	423	39,21
	10:45	58,400	32,000	410,000	58,000	20,4	408	39,21
	11:00	57,200	32,000	418,000	56,800	20,8	416	39,21
	11:15	58,400	32,400	425,000	58,000	20,8	423	39,21
	11:30	65,600	33,600	410,000	65,600	23,2	408	39,21
	11:45	58,000	33,200	418,000	58,000	21,6	416	39,21
	12:00	60,800	33,200	418,000	60,400	22	416	39,21
12:15	63,200	34,000	410,000	62,400	23,2	408	39,21	
12:30	60,800	33,600	425,000	60,800	22,8	423	39,21	
12:45	56,800	33,600	410,000	56,400	22	408	39,21	
13:00	54,800	33,200	418,000	54,400	21,6	416	39,21	
13:15	52,400	33,200	425,000	52,400	21,2	423	39,21	
13:30	48,000	32,400	410,000	47,600	20	408	39,21	
13:45	50,400	32,800	418,000	50,400	20,8	416	39,21	
14:00	48,000	32,400	425,000	47,600	20	423	39,21	
14:15	58,800	33,200	418,000	58,400	22	416	39,21	
14:30	56,800	33,200	410,000	56,800	21,6	408	39,21	
14:45	56,800	33,200	418,000	56,400	21,6	416	39,21	
15:00	54,800	32,400	425,000	54,400	20,8	423	39,21	
15:15	66,000	33,600	410,000	66,000	22,4	408	39,21	
15:30	64,400	33,200	418,000	63,600	22,4	416	39,21	
15:45	58,800	32,800	425,000	58,800	21,2	423	39,21	
16:00	58,400	32,800	418,000	58,000	21,2	416	39,21	
16:15	55,200	32,800	410,000	55,200	21,2	408	39,21	
16:30	48,000	32,000	425,000	47,600	19,6	423	39,21	
16:45	46,000	31,600	418,000	46,000	19,2	416	39,21	
17:00	49,200	32,000	425,000	48,800	19,6	423	39,21	
17:15	56,000	31,200	418,000	56,000	19,2	416	39,21	
17:30	58,000	31,200	410,000	57,200	20	408	39,21	
17:45	58,400	31,600	425,000	58,400	19,6	423	39,21	
18:00	62,000	28,000	418,000	61,600	16,4	416	39,21	
18:15	45,600	25,200	410,000	45,600	12,8	408	39,21	

	18:30	57,600	26,400	418,000	57,200	14,8	416	39,21
	18:45	54,800	26,000	425,000	54,400	14	423	39,21
	19:00	52,400	25,600	410,000	52,400	13,2	408	39,21
	19:15	53,600	25,600	418,000	53,200	13,6	416	39,21
	19:30	52,400	25,600	410,000	52,400	13,6	408	39,21
	19:45	51,200	25,600	425,000	51,200	13,2	423	39,21
	20:00	42,800	24,000	418,000	42,400	11,2	416	39,21
	20:15	36,800	22,800	410,000	36,800	9,2	408	39,21
	20:30	38,000	22,400	425,000	38,000	9,6	423	39,21
	20:45	36,000	23,200	418,000	35,600	9,6	416	39,21
	21:00	36,000	22,800	410,000	36,000	9,6	408	39,21
	21:15	42,000	26,800	418,000	42,000	13,6	416	39,21
	21:30	45,600	28,000	410,000	45,200	16	408	39,21
	21:45	41,600	29,200	425,000	41,600	16,4	423	39,21
	22:00	36,800	29,600	410,000	36,800	16,8	408	39,21
	22:15	18,800	27,200	418,000	18,800	13,6	416	39,21
	22:30	23,600	28,000	410,000	23,200	14,4	408	39,21
	22:45	26,800	28,000	425,000	26,800	14,8	423	39,21
	23:00	31,600	27,600	410,000	31,600	14,4	408	39,21
	23:15	34,000	28,000	418,000	34,000	14,8	416	39,21
	23:30	30,000	27,600	410,000	29,600	14	408	39,21
	23:45	28,000	26,800	418,000	28,400	13,6	416	39,21
	0:00	28,800	26,000	410,000	28,800	12,4	408	39,21
12.7.2015.	0:15	26,800	25,600	425,000	26,400	12	423	40,66
	0:30	27,600	24,800	418,000	27,600	11,2	416	40,66
	0:45	23,200	24,000	410,000	23,200	10	408	40,66
	1:00	20,000	21,600	425,000	20,000	7,2	423	40,66
	1:15	30,800	21,200	418,000	30,800	7,6	416	40,66
	1:30	23,200	20,800	425,000	23,200	6,8	423	40,66
	1:45	26,000	21,200	418,000	25,600	7,2	416	40,66
	2:00	24,800	21,200	410,000	24,800	7,2	408	40,66
	2:15	36,000	21,600	425,000	36,400	8	423	40,66
	2:30	37,600	20,400	418,000	37,200	6,8	416	40,66
	2:45	34,400	19,200	418,000	34,400	5,6	416	40,66
	3:00	31,600	19,600	425,000	31,600	5,6	423	40,66
	3:15	28,000	18,000	418,000	28,000	4,4	416	40,66
	3:30	28,400	18,800	410,000	28,000	4,4	408	40,66
	3:45	28,000	17,600	425,000	28,000	3,6	423	40,66
	4:00	26,400	17,600	418,000	26,400	3,6	416	40,66
	4:15	32,800	17,600	425,000	32,800	3,6	423	40,66
	4:30	37,200	17,200	418,000	37,200	3,2	416	40,66
	4:45	35,600	17,600	425,000	35,200	3,6	423	40,66
	5:00	38,000	18,400	418,000	38,000	4,8	416	40,66
	5:15	41,200	19,600	433,000	41,200	5,6	431	40,66
	5:30	39,600	22,000	425,000	39,200	8	423	40,66
	5:45	37,200	22,400	433,000	37,600	8,4	431	40,66
	6:00	37,600	22,000	418,000	37,200	8	416	40,66
	6:15	34,800	19,600	433,000	34,800	5,2	431	40,66
	6:30	34,000	18,800	418,000	33,600	4,8	416	40,66
	6:45	31,200	18,400	433,000	31,200	3,6	431	40,66
	7:00	42,400	18,400	425,000	42,400	4,8	423	40,66
	7:15	44,400	18,800	418,000	44,400	5,2	416	40,66
	7:30	44,000	19,200	433,000	43,600	5,6	431	40,66
	7:45	45,600	20,400	425,000	45,600	7,2	423	40,66
	8:00	41,200	19,200	418,000	41,200	5,2	416	40,66
	8:15	54,000	20,400	425,000	53,600	7,6	423	40,66
	8:30	50,400	19,600	433,000	50,400	6,8	431	40,66
	8:45	50,800	22,000	418,000	50,400	8,4	416	40,66
	9:00	50,000	21,200	425,000	49,600	8,4	423	40,66
	9:15	54,400	22,000	418,000	54,400	9,2	416	40,66
	9:30	51,200	22,000	433,000	51,200	8,8	431	40,66
	9:45	49,200	21,200	425,000	48,800	8	423	40,66
	10:00	49,600	21,200	418,000	49,600	8,4	416	40,66
	10:15	55,200	20,800	425,000	55,200	8,4	423	40,66
	10:30	46,400	20,400	418,000	46,000	6,8	416	40,66
10:45	45,600	20,000	425,000	45,200	6,8	423	40,66	
11:00	48,400	20,400	418,000	48,400	7,6	416	40,66	
11:15	48,400	21,200	418,000	48,000	8,4	416	40,66	
11:30	52,800	22,800	425,000	52,800	9,6	423	40,66	
11:45	51,600	22,800	418,000	51,600	10	416	40,66	
12:00	49,200	23,200	425,000	48,800	10,4	423	40,66	
12:15	52,800	23,600	418,000	52,400	10,8	416	40,66	
12:30	51,200	24,000	425,000	51,200	11,2	423	40,66	
12:45	50,800	23,200	418,000	50,400	10,4	416	40,66	
13:00	50,800	23,600	425,000	50,800	10,8	423	40,66	
13:15	46,800	24,000	418,000	46,800	10,8	416	40,66	
13:30	46,000	22,800	425,000	45,600	9,6	423	40,66	
13:45	46,400	21,200	418,000	46,400	8,4	416	40,66	
14:00	45,200	21,600	425,000	44,800	8	423	40,66	
14:15	48,800	21,200	418,000	48,800	8	416	40,66	

	14:30	44,800	20,800	433,000	44,800	8	431	40,66
	14:45	47,200	21,600	418,000	46,800	8	416	40,66
	15:00	49,200	21,200	425,000	49,200	8	423	40,66
	15:15	45,200	20,800	418,000	44,800	7,6	416	40,66
	15:30	41,200	20,800	425,000	41,200	7,2	423	40,66
	15:45	49,200	21,600	418,000	48,800	8,4	416	40,66
	16:00	48,800	21,200	425,000	48,800	8,4	423	40,66
	16:15	48,000	22,400	418,000	48,000	9,2	416	40,66
	16:30	44,000	21,200	425,000	43,600	7,6	423	40,66
	16:45	44,000	21,200	418,000	44,000	8,4	416	40,66
	17:00	45,200	21,600	425,000	45,200	8	423	40,66
	17:15	35,600	20,000	418,000	35,200	6	416	40,66
	17:30	38,000	20,000	433,000	38,000	6,4	431	40,66
	17:45	41,600	20,400	425,000	41,600	6,8	423	40,66
	18:00	43,200	20,000	418,000	42,800	6,8	416	40,66
	18:15	28,800	18,800	425,000	29,200	4,4	423	40,66
	18:30	37,600	19,600	418,000	37,200	5,6	416	40,66
	18:45	39,600	19,200	418,000	39,600	6	416	40,66
	19:00	28,800	18,000	425,000	28,800	3,6	423	40,66
	19:15	26,800	17,200	418,000	26,400	2,8	416	40,66
	19:30	30,000	17,600	425,000	30,400	3,6	423	40,66
	19:45	28,400	18,800	418,000	28,400	4,4	416	40,66
	20:00	30,400	18,800	425,000	30,000	4,8	423	40,66
	20:15	33,600	19,600	418,000	33,600	5,6	416	40,66
	20:30	29,600	18,400	425,000	29,600	4,4	423	40,66
	20:45	33,200	20,000	418,000	33,200	6	416	40,66
	21:00	34,800	19,600	425,000	34,800	5,6	423	40,66
	21:15	35,200	19,600	410,000	34,800	6	408	40,66
	21:30	36,400	20,000	418,000	36,400	6,4	416	40,66
	21:45	38,400	23,600	425,000	38,400	10,8	423	40,66
	22:00	37,200	25,200	418,000	37,200	11,6	416	40,66
	22:15	32,000	24,400	410,000	32,000	11,2	408	40,66
	22:30	40,000	25,200	418,000	39,600	12	416	40,66
	22:45	44,000	25,600	425,000	44,000	12,8	423	40,66
	23:00	37,600	24,800	410,000	37,200	11,6	408	40,66
	23:15	36,000	24,400	418,000	36,000	11,2	416	40,66
	23:30	33,200	24,000	425,000	33,200	10,4	423	40,66
	23:45	35,200	24,800	410,000	34,800	11,6	408	40,66
	0:00	31,600	25,600	418,000	31,600	11,6	416	40,66
13.7.2015.	0:15	39,600	24,800	425,000	39,600	11,6	423	43,87
	0:30	32,800	23,600	418,000	32,800	10	416	43,87
	0:45	38,000	24,000	425,000	38,000	10,8	423	43,87
	1:00	36,400	23,600	418,000	36,400	10	416	43,87
	1:15	36,400	23,600	410,000	36,400	10,4	408	43,87
	1:30	37,200	23,200	418,000	36,800	9,6	416	43,87
	1:45	43,600	22,800	425,000	43,600	9,6	423	43,87
	2:00	41,600	22,400	418,000	41,200	8,8	416	43,87
	2:15	38,800	20,400	425,000	38,800	7,2	423	43,87
	2:30	35,600	20,400	418,000	35,200	6,4	416	43,87
	2:45	34,000	18,800	425,000	34,400	5,2	423	43,87
	3:00	30,400	18,400	418,000	30,400	4	416	43,87
	3:15	36,800	18,400	425,000	36,800	4,8	423	43,87
	3:30	33,600	18,000	418,000	33,600	4	416	43,87
	3:45	38,800	18,800	425,000	38,400	5,2	423	43,87
	4:00	40,800	18,400	418,000	40,800	4,8	416	43,87
	4:15	45,600	18,800	425,000	45,200	5,2	423	43,87
	4:30	47,200	18,400	418,000	47,200	5,2	416	43,87
	4:45	49,600	19,200	418,000	49,200	6,4	416	43,87
	5:00	49,600	18,800	425,000	49,600	5,6	423	43,87
	5:15	52,400	19,200	433,000	52,400	6	431	43,87
	5:30	50,000	19,200	418,000	49,600	6	416	43,87
	5:45	48,000	19,600	425,000	48,000	6,4	423	43,87
	6:00	47,200	18,400	418,000	46,800	5,2	416	43,87
	6:15	66,000	19,200	433,000	65,600	7,2	431	43,87
	6:30	74,000	20,000	425,000	73,600	8,8	423	43,87
	6:45	78,000	20,800	418,000	78,000	10,8	416	43,87
	7:00	82,400	21,200	425,000	81,600	11,2	423	43,87
	7:15	97,200	21,600	410,000	96,400	13,6	408	43,87
	7:30	95,200	22,000	418,000	94,800	14,4	416	43,87
	7:45	90,400	22,000	425,000	89,600	13,6	423	43,87
	8:00	88,800	22,400	418,000	88,400	13,6	416	43,87
	8:15	92,000	23,200	410,000	91,200	14,8	408	43,87
	8:30	85,600	23,600	418,000	84,800	14,4	416	43,87
	8:45	80,000	23,600	425,000	80,000	14,4	423	43,87
	9:00	83,600	25,200	410,000	82,800	16	408	43,87
	9:15	90,000	26,000	418,000	89,600	17,6	416	43,87
	9:30	97,600	26,400	425,000	96,800	19,2	423	43,87
	9:45	95,600	26,400	410,000	94,800	18,8	408	43,87
	10:00	95,200	26,400	418,000	94,400	19,2	416	43,87
	10:15	104,800	26,400	425,000	104,000	20	423	43,87

	10:30	103,600	26,000	410,000	102,800	19,6	408	43,87
	10:45	104,400	25,600	418,000	103,600	20	416	43,87
	11:00	105,200	25,600	410,000	104,400	19,6	408	43,87
	11:15	112,400	24,400	418,000	111,600	19,6	416	43,87
	11:30	109,600	24,400	410,000	108,400	19,2	408	43,87
	11:45	110,400	24,000	410,000	109,600	18,8	408	43,87
	12:00	109,200	24,000	425,000	108,400	18,8	423	43,87
	12:15	110,000	24,000	410,000	109,200	19,2	408	43,87
	12:30	105,600	24,400	418,000	104,800	18,4	416	43,87
	12:45	104,000	24,400	410,000	103,200	18,4	408	43,87
	13:00	105,200	24,800	410,000	104,000	18,4	408	43,87
	13:15	108,000	24,800	425,000	107,200	19,6	423	43,87
	13:30	106,800	24,800	410,000	106,400	19,2	408	43,87
	13:45	106,800	24,800	418,000	105,600	18,8	416	43,87
	14:00	107,200	24,800	410,000	106,400	19,6	408	43,87
	14:15	97,600	24,800	410,000	96,800	18	408	43,87
	14:30	92,000	25,200	418,000	91,600	16,8	416	43,87
	14:45	94,400	24,800	410,000	94,000	17,6	408	43,87
	15:00	96,400	25,600	425,000	95,200	18,4	423	43,87
	15:15	89,200	26,000	418,000	88,800	17,6	416	43,87
	15:30	92,800	25,600	410,000	92,000	17,6	408	43,87
	15:45	96,400	25,600	425,000	95,600	18	423	43,87
	16:00	93,200	25,200	410,000	92,800	18	408	43,87
	16:15	99,600	26,000	418,000	98,800	18,8	416	43,87
	16:30	91,200	24,000	410,000	90,400	16	408	43,87
	16:45	95,200	24,400	418,000	94,800	16,8	416	43,87
	17:00	94,000	24,400	410,000	93,200	16,4	408	43,87
	17:15	96,000	24,400	425,000	95,200	17,2	423	43,87
	17:30	98,800	24,400	418,000	98,000	17,2	416	43,87
	17:45	95,600	24,400	410,000	95,200	16,8	408	43,87
	18:00	99,600	24,400	425,000	98,800	17,6	423	43,87
	18:15	87,200	24,000	410,000	86,800	15,2	408	43,87
	18:30	86,800	23,600	418,000	86,000	14,8	416	43,87
	18:45	96,400	23,600	425,000	95,600	16	423	43,87
	19:00	101,200	24,000	402,000	100,400	17,6	400	43,87
	19:15	95,200	24,400	425,000	94,800	16,4	423	43,87
	19:30	92,400	24,000	410,000	91,600	16	408	43,87
	19:45	74,400	22,800	418,000	74,000	12,8	416	43,87
	20:00	72,400	23,200	425,000	72,000	12,4	423	43,87
	20:15	68,000	22,800	410,000	68,000	12,8	408	43,87
	20:30	66,800	22,800	418,000	66,400	11,6	416	43,87
	20:45	68,400	22,400	425,000	67,600	11,6	423	43,87
	21:00	62,800	24,800	410,000	62,800	11,2	408	43,87
	21:15	70,800	29,200	418,000	70,400	14,4	416	43,87
	21:30	70,400	30,000	410,000	70,000	19,2	408	43,87
	21:45	72,400	30,400	425,000	72,000	20	423	43,87
	22:00	73,600	29,600	402,000	73,600	20,4	400	43,87
	22:15	66,400	30,000	410,000	65,600	19,2	408	43,87
	22:30	72,800	29,600	425,000	72,800	20	423	43,87
	22:45	75,600	29,200	410,000	74,800	19,6	408	43,87
	23:00	69,600	28,800	418,000	69,200	19,2	416	43,87
	23:15	53,600	28,000	425,000	53,200	16,8	423	43,87
	23:30	52,000	27,200	410,000	52,000	16	408	43,87
	23:45	50,800	26,800	418,000	50,800	14,8	416	43,87
	0:00	44,000	26,800	410,000	43,600	14	408	43,87
	0:15	38,400	27,600	425,000	38,400	14,4	423	52,2
	0:30	38,400	26,800	418,000	38,400	14	416	52,2
	0:45	37,200	26,000	418,000	37,200	12,4	416	52,2
	1:00	39,600	25,600	425,000	39,200	12	423	52,2
	1:15	43,600	26,000	418,000	43,200	13,2	416	52,2
	1:30	45,200	24,800	410,000	45,200	12,4	408	52,2
	1:45	51,600	24,800	425,000	51,200	12,4	423	52,2
	2:00	45,600	24,000	418,000	45,600	10,8	416	52,2
	2:15	46,800	23,600	425,000	46,800	10,8	423	52,2
	2:30	42,800	22,800	418,000	42,800	9,6	416	52,2
	2:45	37,200	21,600	425,000	36,800	8	423	52,2
	3:00	42,400	21,600	410,000	42,400	8,4	408	52,2
	3:15	38,800	20,800	418,000	38,400	7,6	416	52,2
	3:30	40,400	21,200	425,000	40,400	7,6	423	52,2
	3:45	39,600	20,400	418,000	39,600	7,2	416	52,2
	4:00	35,600	20,800	418,000	35,200	6,8	416	52,2
	4:15	44,800	21,600	425,000	44,800	8,4	423	52,2
	4:30	50,000	21,600	418,000	50,000	9,2	416	52,2
	4:45	53,600	22,000	425,000	53,200	9,2	423	52,2
	5:00	53,600	22,000	418,000	53,600	9,6	416	52,2
	5:15	48,800	22,400	425,000	48,400	9,6	423	52,2
	5:30	50,000	24,400	418,000	50,000	11,6	416	52,2
	5:45	49,600	24,000	425,000	49,200	11,2	423	52,2
	6:00	48,400	23,600	418,000	48,000	10,4	416	52,2
	6:15	62,800	22,000	425,000	62,800	10,4	423	52,2
14.7.2015.								

	6:30	54,400	20,800	418,000	54,400	8	416	52,2
	6:45	50,800	20,000	425,000	50,400	7,2	423	52,2
	7:00	59,600	19,600	418,000	59,200	7,2	416	52,2
	7:15	69,600	20,000	425,000	69,200	9,2	423	52,2
	7:30	86,400	20,400	402,000	86,000	11,6	400	52,2
	7:45	84,400	21,200	425,000	84,000	11,6	423	52,2
	8:00	77,600	20,400	410,000	77,200	10,4	408	52,2
	8:15	110,000	20,800	418,000	108,800	15,6	416	52,2
	8:30	106,400	20,800	410,000	105,600	14,8	408	52,2
	8:45	106,000	20,800	425,000	105,200	14,8	423	52,2
	9:00	102,400	21,200	410,000	101,600	15,2	408	52,2
	9:15	108,400	21,600	418,000	107,600	15,6	416	52,2
	9:30	104,000	21,600	410,000	103,200	15,6	408	52,2
	9:45	99,600	22,000	425,000	98,800	14,8	423	52,2
	10:00	108,000	22,000	410,000	107,200	16,4	408	52,2
	10:15	103,600	22,400	418,000	102,800	16	416	52,2
	10:30	106,000	22,000	410,000	104,800	16	408	52,2
	10:45	104,000	22,000	410,000	103,200	16	408	52,2
	11:00	109,200	22,000	418,000	108,400	16,4	416	52,2
	11:15	108,000	23,200	410,000	107,200	17,6	408	52,2
	11:30	109,200	22,800	425,000	108,400	18	423	52,2
	11:45	107,200	23,200	410,000	106,400	17,2	408	52,2
	12:00	109,200	23,600	410,000	108,000	18,4	408	52,2
	12:15	107,200	24,000	418,000	106,400	18,8	416	52,2
	12:30	106,400	24,000	410,000	105,600	18	408	52,2
	12:45	108,000	23,600	410,000	106,800	18,4	408	52,2
	13:00	108,000	25,200	418,000	107,200	19,6	416	52,2
	13:15	111,200	25,200	410,000	110,400	20,4	408	52,2
	13:30	108,400	24,800	410,000	107,200	19,6	408	52,2
	13:45	116,800	24,800	425,000	116,000	20,8	423	52,2
	14:00	112,000	25,200	410,000	111,200	20,4	408	52,2
	14:15	110,400	25,200	410,000	109,200	20	408	52,2
	14:30	113,600	25,200	418,000	112,400	21,2	416	52,2
	14:45	114,000	26,000	410,000	113,200	21,2	408	52,2
	15:00	110,800	25,600	425,000	110,000	21,2	423	52,2
	15:15	108,800	26,000	402,000	108,000	20,4	400	52,2
	15:30	108,800	25,600	410,000	107,600	20,4	408	52,2
	15:45	111,200	26,000	425,000	110,400	20,8	423	52,2
	16:00	114,400	26,000	410,000	113,200	22	408	52,2
	16:15	112,400	25,600	418,000	111,600	20,8	416	52,2
	16:30	115,600	25,600	410,000	114,400	21,2	408	52,2
	16:45	113,600	26,000	425,000	112,400	21,2	423	52,2
	17:00	115,200	25,200	410,000	114,800	21,2	408	52,2
	17:15	113,600	25,200	418,000	112,400	20,4	416	52,2
	17:30	114,000	26,000	410,000	113,200	21,2	408	52,2
	17:45	110,400	25,600	418,000	109,200	20,4	416	52,2
	18:00	112,400	25,600	410,000	111,600	20,8	408	52,2
	18:15	110,400	24,000	425,000	109,200	18,8	423	52,2
	18:30	115,200	24,400	410,000	114,400	20	408	52,2
	18:45	114,800	24,000	418,000	113,600	19,2	416	52,2
	19:00	114,000	23,600	410,000	113,200	19,2	408	52,2
	19:15	102,400	23,600	425,000	101,600	16,8	423	52,2
	19:30	93,200	22,400	410,000	92,800	14,8	408	52,2
	19:45	80,400	22,400	418,000	79,600	12,8	416	52,2
	20:00	78,400	22,400	410,000	78,000	12,4	408	52,2
	20:15	60,400	23,200	425,000	60,000	11,6	423	52,2
	20:30	55,200	23,200	418,000	55,200	10,8	416	52,2
	20:45	54,400	22,400	418,000	54,000	10	416	52,2
	21:00	54,000	21,200	410,000	54,000	9,2	408	52,2
	21:15	54,000	20,800	425,000	54,000	8,4	423	52,2
	21:30	65,200	22,000	410,000	64,400	11,2	408	52,2
	21:45	65,600	24,000	418,000	65,600	12,8	416	52,2
	22:00	64,800	29,600	410,000	64,800	19,2	408	52,2
	22:15	58,000	29,600	425,000	57,200	18,4	423	52,2
	22:30	60,400	29,200	410,000	60,400	18	408	52,2
	22:45	63,600	30,000	418,000	63,200	19,2	416	52,2
	23:00	64,800	29,600	410,000	64,400	18,8	408	52,2
	23:15	48,400	28,400	418,000	48,400	16	416	52,2
	23:30	51,200	28,800	410,000	50,800	16,8	408	52,2
	23:45	63,600	29,200	425,000	63,200	18,4	423	52,2
	0:00	53,200	29,600	410,000	53,200	17,2	408	52,2
15.7.2015.	0:15	50,000	28,400	418,000	49,6	16,4	416	67,37
	0:30	49,600	28,000	425,000	49,6	15,6	423	67,37
	0:45	54,800	27,200	410,000	54,4	15,2	408	67,37
	1:00	52,800	27,600	418,000	52,8	15,6	416	67,37
	1:15	53,200	28,000	425,000	52,8	16	423	67,37
	1:30	54,000	28,400	410,000	54	16,4	408	67,37
	1:45	56,000	28,800	418,000	55,6	16,8	416	67,37
	2:00	48,400	28,400	418,000	48	16	416	67,37
2:15	48,000	28,800	410,000	48	16	408	67,37	

2:30	50,400	27,600	425,000	50,4	15,6	423	67,37
2:45	54,400	27,600	418,000	54	15,2	416	67,37
3:00	50,000	27,200	425,000	50	14,8	423	67,37
3:15	52,800	27,200	418,000	52,4	14,8	416	67,37
3:30	54,000	26,800	425,000	54	14,8	423	67,37
3:45	50,400	26,800	410,000	49,6	14,4	408	67,37
4:00	50,800	27,200	418,000	50,8	14,4	416	67,37
4:15	51,200	27,200	425,000	51,2	14,8	423	67,37
4:30	52,800	26,800	418,000	52,4	14,8	416	67,37
4:45	52,800	26,800	425,000	52,8	14,4	423	67,37
5:00	58,000	27,200	418,000	57,6	15,2	416	67,37
5:15	54,400	26,800	418,000	54,4	14,4	416	67,37
5:30	53,600	26,800	425,000	53,6	14,4	423	67,37
5:45	51,600	25,600	418,000	50,8	12,8	416	67,37
6:00	47,200	24,000	425,000	47,2	11,6	423	67,37
6:15	61,200	23,200	410,000	60,8	11,2	408	67,37
6:30	60,800	22,800	418,000	60,8	10,8	416	67,37
6:45	66,400	22,800	425,000	66	11,6	423	67,37
7:00	71,600	23,600	418,000	71,2	12,8	416	67,37
7:15	88,800	23,600	425,000	88,4	15,2	423	67,37
7:30	91,200	24,000	410,000	90,4	16	408	67,37
7:45	84,800	25,600	418,000	84	16,4	416	67,37
8:00	94,800	26,000	410,000	94,4	18,4	408	67,37
8:15	108,400	25,600	425,000	107,6	20,4	423	67,37
8:30	104,400	25,200	402,000	103,2	19,2	400	67,37
8:45	105,600	25,200	425,000	104,8	19,6	423	67,37
9:00	101,600	25,200	410,000	100,8	18,8	408	67,37
9:15	106,800	25,200	410,000	106	19,6	408	67,37
9:30	103,600	25,200	418,000	102,8	19,2	416	67,37
9:45	102,000	24,800	410,000	101,2	18,8	408	67,37
10:00	103,600	25,200	410,000	102,8	19,2	408	67,37
10:15	110,000	30,400	425,000	108,8	25,2	423	67,37
10:30	113,200	30,400	410,000	112,4	26,4	408	67,37
10:45	113,600	30,000	418,000	112,4	25,6	416	67,37
11:00	106,400	30,400	410,000	105,6	24,8	408	67,37
11:15	108,400	29,600	410,000	107,6	24,4	408	67,37
11:30	111,200	29,600	418,000	110	25,2	416	67,37
11:45	107,200	30,000	410,000	106,4	24,4	408	67,37
12:00	110,800	30,000	410,000	110	25,6	408	67,37
12:15	110,800	30,400	425,000	109,6	25,6	423	67,37
12:30	108,800	30,000	410,000	108	24,8	408	67,37
12:45	108,800	30,000	418,000	107,6	25,2	416	67,37
13:00	109,600	30,400	410,000	108,4	25,2	408	67,37
13:15	111,600	30,000	410,000	110,8	25,6	408	67,37
13:30	109,600	30,000	418,000	108,8	25,2	416	67,37
13:45	110,400	30,400	410,000	109,2	25,6	408	67,37
14:00	114,800	30,400	410,000	114	26,4	408	67,37
14:15	112,400	30,400	425,000	111,2	26,4	423	67,37
14:30	113,600	30,400	410,000	112,8	26	408	67,37
14:45	111,200	30,400	418,000	110	25,6	416	67,37
15:00	113,600	30,400	410,000	112,8	26	408	67,37
15:15	104,800	30,400	425,000	104	24,4	423	67,37
15:30	107,200	30,400	410,000	106	25,2	408	67,37
15:45	109,600	30,000	402,000	108,8	25,2	400	67,37
16:00	114,000	30,000	425,000	112,8	25,6	423	67,37
16:15	106,000	30,000	410,000	105,6	24	408	67,37
16:30	110,400	29,600	418,000	109,2	25,2	416	67,37
16:45	107,600	30,800	410,000	106,4	25,2	408	67,37
17:00	110,800	30,400	425,000	110,4	26	423	67,37
17:15	104,800	30,000	410,000	103,6	23,6	408	67,37
17:30	103,600	29,600	418,000	102,8	24	416	67,37
17:45	101,200	30,400	410,000	100,4	23,6	408	67,37
18:00	101,600	29,600	425,000	100,8	23,6	423	67,37
18:15	103,600	30,000	410,000	102,8	23,6	408	67,37
18:30	104,400	29,600	418,000	103,6	23,6	416	67,37
18:45	102,400	29,200	410,000	101,6	23,2	408	67,37
19:00	98,400	29,200	418,000	97,6	22,4	416	67,37
19:15	104,800	29,200	425,000	104	23,2	423	67,37
19:30	104,400	29,200	410,000	104	23,2	408	67,37
19:45	93,200	28,000	418,000	92,4	20,4	416	67,37
20:00	82,000	27,600	410,000	81,6	18,4	408	67,37
20:15	75,600	28,400	425,000	74,8	18,4	423	67,37
20:30	74,000	28,800	418,000	74	18,8	416	67,37
20:45	68,800	28,000	410,000	68,4	17,2	408	67,37
21:00	67,200	28,400	425,000	66,8	18	423	67,37
21:15	72,400	34,800	402,000	72	24,8	400	67,37
21:30	73,200	36,000	410,000	72,8	26,8	408	67,37
21:45	77,200	36,000	425,000	76,4	27,2	423	67,37
22:00	78,800	36,800	410,000	78,4	28	408	67,37
22:15	74,000	36,800	410,000	73,6	27,2	408	67,37

	22:30	75,200	36,800	418,000	74,8	27,6	416	67,37
	22:45	74,000	36,800	410,000	73,6	27,6	408	67,37
	23:00	79,200	37,600	410,000	78,4	28,8	408	67,37
	23:15	70,800	36,800	425,000	70,4	27,2	423	67,37
	23:30	63,600	37,600	410,000	63,6	27,2	408	67,37
	23:45	67,200	37,600	418,000	66,8	27,6	416	67,37
	0:00	61,600	38,400	418,000	61,2	27,2	416	67,37
16.7.2015.	0:15	60,400	38,000	410,000	60,000	27,2	408	64,34
	0:30	59,600	37,200	425,000	59,200	26,4	423	64,34
	0:45	60,400	36,800	410,000	60,400	25,6	408	64,34
	1:00	58,800	36,000	418,000	58,400	24,8	416	64,34
	1:15	57,600	36,800	425,000	57,200	25,6	423	64,34
	1:30	58,400	36,400	410,000	58,000	25,2	408	64,34
	1:45	60,000	36,400	418,000	60,000	25,6	416	64,34
	2:00	54,800	36,000	425,000	54,800	24,4	423	64,34
	2:15	58,400	36,800	410,000	58,000	25,2	408	64,34
	2:30	59,600	36,000	418,000	59,200	25,6	416	64,34
	2:45	60,800	36,400	418,000	60,400	24,8	416	64,34
	3:00	59,600	36,000	410,000	59,200	25,2	408	64,34
	3:15	64,400	37,200	425,000	64,000	26,4	423	64,34
	3:30	59,200	36,800	418,000	58,800	26	416	64,34
	3:45	55,200	36,800	425,000	55,200	25,2	423	64,34
	4:00	61,200	36,800	410,000	60,800	26	408	64,34
	4:15	59,600	36,400	418,000	59,200	25,2	416	64,34
	4:30	57,200	36,000	425,000	57,200	24,4	423	64,34
	4:45	59,200	35,600	410,000	58,400	24,4	408	64,34
	5:00	57,200	35,600	418,000	57,200	24,4	416	64,34
	5:15	63,200	36,000	425,000	62,800	24,4	423	64,34
	5:30	57,600	35,200	418,000	57,200	24	416	64,34
	5:45	54,800	34,800	418,000	54,800	22,8	416	64,34
	6:00	56,800	34,000	425,000	56,400	22,4	423	64,34
	6:15	65,600	33,600	410,000	65,600	23,2	408	64,34
	6:30	64,800	33,200	418,000	64,400	22,4	416	64,34
	6:45	74,400	33,600	425,000	73,600	23,6	423	64,34
	7:00	81,600	32,800	410,000	81,200	24,4	408	64,34
	7:15	99,200	31,600	418,000	98,000	24,8	416	64,34
	7:30	103,200	32,400	410,000	102,400	26,4	408	64,34
	7:45	95,200	32,400	425,000	94,800	25,6	423	64,34
	8:00	100,400	32,400	410,000	99,600	26	408	64,34
	8:15	108,800	32,400	410,000	108,000	27,6	408	64,34
	8:30	103,600	33,200	418,000	102,800	28	416	64,34
	8:45	106,400	34,800	410,000	105,200	29,6	408	64,34
	9:00	106,000	34,800	410,000	105,200	29,6	408	64,34
	9:15	107,200	34,400	418,000	106,000	29,6	416	64,34
	9:30	106,400	34,400	410,000	105,600	29,6	408	64,34
	9:45	105,600	35,200	410,000	104,800	29,6	408	64,34
	10:00	107,200	34,800	425,000	106,000	30	423	64,34
	10:15	107,200	34,400	410,000	106,400	30	408	64,34
	10:30	107,200	35,200	410,000	106,400	30	408	64,34
10:45	105,200	34,400	402,000	104,000	29,6	400	64,34	
11:00	105,600	34,000	425,000	104,800	28,8	423	64,34	
11:15	106,800	34,400	410,000	105,600	30	408	64,34	
11:30	110,400	34,000	410,000	109,600	29,6	408	64,34	
11:45	114,000	33,200	410,000	112,800	29,6	408	64,34	
12:00	116,800	33,600	410,000	116,000	30,8	408	64,34	
12:15	114,400	33,600	410,000	113,200	30	408	64,34	
12:30	110,000	33,200	410,000	108,800	29,2	408	64,34	
12:45	110,400	33,600	410,000	109,200	29,2	408	64,34	
13:00	112,800	33,200	402,000	112,000	29,6	400	64,34	
13:15	112,000	33,600	425,000	110,800	29,2	423	64,34	
13:30	114,000	33,200	410,000	113,200	30	408	64,34	
13:45	114,000	33,200	410,000	113,200	29,6	408	64,34	
14:00	109,600	32,800	410,000	108,400	28,8	408	64,34	
14:15	114,400	32,000	410,000	113,200	28,4	408	64,34	
14:30	112,400	32,000	410,000	111,600	28	408	64,34	
14:45	115,200	32,000	410,000	114,000	28,4	408	64,34	
15:00	111,200	32,800	410,000	110,400	28,8	408	64,34	
15:15	107,600	33,200	418,000	106,000	28	416	64,34	
15:30	115,600	33,200	410,000	114,800	30	408	64,34	
15:45	117,200	33,200	410,000	116,000	30	408	64,34	
16:00	114,800	33,200	410,000	114,000	29,6	408	64,34	
16:15	120,400	34,000	418,000	119,200	30,8	416	64,34	
16:30	120,400	33,200	410,000	118,800	30,8	408	64,34	
16:45	120,800	33,600	410,000	120,000	31,2	408	64,34	
17:00	117,200	33,600	410,000	116,000	30,4	408	64,34	
17:15	110,000	34,000	425,000	108,800	29,2	423	64,34	
17:30	111,200	33,200	402,000	110,400	28,8	400	64,34	
17:45	111,200	33,200	410,000	110,400	29,2	408	64,34	
18:00	106,000	33,200	425,000	105,200	28	423	64,34	
18:15	96,400	32,800	410,000	95,200	25,6	408	64,34	

	18:30	98,000	32,400	410,000	97,600	26	408	64,34
	18:45	100,400	32,000	418,000	99,200	25,6	416	64,34
	19:00	98,800	31,600	410,000	98,400	25,2	408	64,34
	19:15	98,000	31,600	410,000	97,200	24,8	408	64,34
	19:30	98,000	31,600	425,000	97,200	25,2	423	64,34
	19:45	98,400	31,600	410,000	97,600	25,2	408	64,34
	20:00	81,600	31,200	418,000	81,200	22	416	64,34
	20:15	74,400	30,400	410,000	74,000	20,8	408	64,34
	20:30	72,000	30,400	418,000	71,600	20,4	416	64,34
	20:45	72,000	29,600	410,000	71,600	20,4	408	64,34
	21:00	69,600	29,600	410,000	69,600	19,2	408	64,34
	21:15	70,000	29,600	425,000	69,200	19,6	423	64,34
	21:30	73,200	32,400	410,000	72,800	22,8	408	64,34
	21:45	69,200	33,600	410,000	68,800	23,2	408	64,34
	22:00	69,600	33,600	418,000	69,200	24	416	64,34
	22:15	63,600	34,000	410,000	63,600	23,6	408	64,34
	22:30	58,400	33,200	410,000	58,000	22,4	408	64,34
	22:45	71,200	34,000	410,000	70,400	24,4	408	64,34
	23:00	62,000	34,400	418,000	62,000	23,6	416	64,34
	23:15	53,200	33,600	410,000	53,200	22	408	64,34
	23:30	53,200	34,000	410,000	52,800	22,4	408	64,34
	23:45	60,800	33,600	425,000	60,400	22,8	423	64,34
	0:00	54,000	32,800	410,000	53,600	21,2	408	64,34
17.7.2015.	0:15	68,000	32,000	418,000	67,600	22	416	73,26
	0:30	71,200	32,400	410,000	71,200	22,4	408	73,26
	0:45	70,000	32,800	410,000	69,200	22,8	408	73,26
	1:00	70,800	33,200	418,000	70,800	22,8	416	73,26
	1:15	74,000	34,800	425,000	73,600	25,6	423	73,26
	1:30	73,600	34,400	410,000	73,200	24,4	408	73,26
	1:45	76,000	34,000	418,000	75,200	24,4	416	73,26
	2:00	72,800	34,000	425,000	72,800	24	423	73,26
	2:15	78,000	34,400	410,000	77,200	24,8	408	73,26
	2:30	75,600	34,800	418,000	75,200	25,2	416	73,26
	2:45	79,200	35,200	425,000	78,800	25,6	423	73,26
	3:00	79,200	34,400	418,000	78,400	25,2	416	73,26
	3:15	85,600	34,000	410,000	85,200	25,6	408	73,26
	3:30	84,400	33,600	425,000	84,000	25,2	423	73,26
	3:45	84,000	33,600	418,000	83,200	24,8	416	73,26
	4:00	79,600	34,000	418,000	79,200	24,4	416	73,26
	4:15	84,800	34,000	410,000	84,400	25,2	408	73,26
	4:30	86,800	32,800	425,000	86,000	24,4	423	73,26
	4:45	82,800	33,200	418,000	82,400	24,4	416	73,26
	5:00	83,600	33,200	425,000	82,800	24,4	423	73,26
	5:15	87,200	32,800	410,000	86,800	24,4	408	73,26
	5:30	82,000	32,800	418,000	81,600	23,2	416	73,26
	5:45	74,000	32,800	425,000	73,600	23,2	423	73,26
	6:00	72,400	32,400	418,000	72,000	22	416	73,26
	6:15	90,800	30,800	425,000	90,000	22,8	423	73,26
	6:30	103,200	29,600	410,000	102,400	22,8	408	73,26
	6:45	106,400	28,400	418,000	105,600	22,8	416	73,26
	7:00	102,400	28,400	425,000	101,600	22,4	423	73,26
	7:15	104,800	28,800	402,000	104,000	22,8	400	73,26
	7:30	119,600	28,400	425,000	118,400	24,8	423	73,26
	7:45	115,200	28,800	410,000	114,000	24,8	408	73,26
	8:00	117,200	28,400	410,000	116,400	24,8	408	73,26
	8:15	119,200	28,800	418,000	118,400	25,6	416	73,26
	8:30	118,400	28,800	410,000	116,800	25,2	408	73,26
	8:45	118,000	28,400	410,000	117,200	25,2	408	73,26
	9:00	115,600	29,600	410,000	114,400	26	408	73,26
	9:15	123,600	30,400	425,000	122,000	28	423	73,26
	9:30	121,200	30,400	402,000	120,400	27,6	400	73,26
	9:45	119,600	30,400	410,000	118,400	27,6	408	73,26
	10:00	116,800	30,400	410,000	116,000	27,2	408	73,26
	10:15	117,600	31,200	425,000	116,400	27,6	423	73,26
	10:30	118,800	30,800	410,000	117,200	28	408	73,26
	10:45	119,200	31,200	410,000	118,400	28	408	73,26
	11:00	121,600	30,000	410,000	120,400	27,6	408	73,26
	11:15	123,600	29,600	418,000	122,400	27,2	416	73,26
	11:30	124,400	29,600	410,000	123,200	28	408	73,26
	11:45	123,200	29,200	410,000	122,000	26,8	408	73,26
	12:00	118,800	30,400	410,000	117,600	27,6	408	73,26
12:15	112,800	30,400	410,000	111,600	26,4	408	73,26	
12:30	121,600	29,600	410,000	120,400	26,8	408	73,26	
12:45	126,000	29,200	410,000	124,800	28	408	73,26	
13:00	124,800	28,400	410,000	123,600	27,2	408	73,26	
13:15	132,000	27,600	410,000	130,400	27,2	408	73,26	
13:30	130,800	32,800	410,000	129,600	32,8	408	73,26	
13:45	135,600	36,800	410,000	134,000	37,2	408	73,26	
14:00	135,200	36,400	402,000	133,600	37,2	400	73,26	
14:15	145,600	35,200	410,000	144,000	38	408	73,26	

	14:30	142,400	35,200	410,000	140,400	37,2	408	73,26
	14:45	142,400	35,200	410,000	141,200	37,6	408	73,26
	15:00	142,800	35,200	425,000	140,800	37,2	423	73,26
	15:15	134,400	36,400	410,000	133,200	36,4	408	73,26
	15:30	128,800	36,800	410,000	127,200	36	408	73,26
	15:45	129,600	36,000	418,000	128,400	34,8	416	73,26
	16:00	128,800	30,800	410,000	127,200	30	408	73,26
	16:15	127,600	29,600	410,000	126,400	28,4	408	73,26
	16:30	129,200	30,000	410,000	127,600	29,2	408	73,26
	16:45	130,800	30,800	410,000	129,600	30	408	73,26
	17:00	142,400	30,800	410,000	140,800	32,8	408	73,26
	17:15	148,000	30,000	410,000	146,400	33,6	408	73,26
	17:30	147,200	30,400	410,000	145,200	33,2	408	73,26
	17:45	147,200	30,400	410,000	145,600	33,6	408	73,26
	18:00	148,400	30,400	410,000	146,400	33,6	408	73,26
	18:15	142,400	31,600	402,000	140,800	32,8	400	73,26
	18:30	149,200	30,400	410,000	147,200	34,4	408	73,26
	18:45	138,400	30,800	410,000	136,800	31,6	408	73,26
	19:00	136,000	30,800	410,000	134,800	31,2	408	73,26
	19:15	121,200	30,800	410,000	120,000	28	408	73,26
	19:30	111,200	30,400	425,000	110,400	26	423	73,26
	19:45	109,200	30,400	410,000	108,400	26	408	73,26
	20:00	110,800	31,200	410,000	109,600	26	408	73,26
	20:15	107,200	31,600	418,000	106,000	26,8	416	73,26
	20:30	109,200	32,800	410,000	108,400	27,6	408	73,26
	20:45	108,400	32,800	410,000	108,000	28	408	73,26
	21:00	109,600	32,800	418,000	108,400	28	416	73,26
	21:15	106,000	33,200	410,000	105,200	28	408	73,26
	21:30	107,200	33,600	410,000	106,400	28,8	408	73,26
	21:45	105,600	36,000	425,000	104,800	31,2	423	73,26
	22:00	100,400	36,800	410,000	99,600	30,8	408	73,26
	22:15	86,000	34,800	410,000	85,200	26,8	408	73,26
	22:30	87,200	34,400	410,000	86,800	26,8	408	73,26
	22:45	89,200	34,800	418,000	88,800	27,6	416	73,26
	23:00	86,400	34,800	410,000	85,600	26,8	408	73,26
	23:15	84,400	35,200	410,000	83,600	26,8	408	73,26
	23:30	80,000	35,600	418,000	79,600	26,8	416	73,26
	23:45	80,000	35,200	410,000	79,200	26,4	408	73,26
	0:00	78,000	35,600	425,000	78,000	26,4	423	73,26
18.7.2015.	0:15	61,600	35,600	410,000	60,800	24,4	408	59,72
	0:30	66,000	35,200	418,000	66,000	25,2	416	59,72
	0:45	65,600	35,200	410,000	65,200	24,4	408	59,72
	1:00	67,600	35,600	425,000	67,200	24,8	423	59,72
	1:15	70,800	34,800	418,000	70,400	25,2	416	59,72
	1:30	64,400	34,800	410,000	64,000	23,6	408	59,72
	1:45	63,200	34,000	418,000	62,800	23,2	416	59,72
	2:00	65,200	34,000	425,000	65,200	23,2	423	59,72
	2:15	67,200	34,400	418,000	66,800	24	416	59,72
	2:30	60,400	35,200	410,000	60,000	24	408	59,72
	2:45	66,400	34,800	425,000	66,400	24,4	423	59,72
	3:00	60,800	34,800	418,000	60,000	23,2	416	59,72
	3:15	66,000	33,600	425,000	65,600	22,8	423	59,72
	3:30	64,800	33,200	418,000	64,800	22,4	416	59,72
	3:45	66,000	33,600	410,000	65,600	22,4	408	59,72
	4:00	66,000	33,200	425,000	65,600	22,4	423	59,72
	4:15	69,200	33,600	418,000	68,800	23,2	416	59,72
	4:30	66,400	33,200	425,000	66,000	22,4	423	59,72
	4:45	65,200	32,800	402,000	64,800	22	400	59,72
	5:00	64,000	32,400	425,000	64,000	21,6	423	59,72
	5:15	66,400	33,200	418,000	65,600	22	416	59,72
	5:30	73,600	32,800	425,000	73,200	22,8	423	59,72
	5:45	68,000	32,800	418,000	67,600	22,4	416	59,72
	6:00	64,800	33,200	410,000	64,800	22	408	59,72
	6:15	72,800	32,800	425,000	72,400	22,8	423	59,72
	6:30	73,200	32,400	418,000	72,800	22	416	59,72
	6:45	72,000	29,200	425,000	71,200	18,4	423	59,72
	7:00	63,600	27,600	418,000	63,600	16,4	416	59,72
	7:15	77,200	27,600	425,000	76,800	17,6	423	59,72
	7:30	77,600	26,400	410,000	76,800	16,4	408	59,72
	7:45	70,800	26,800	418,000	70,800	16	416	59,72
	8:00	70,800	26,800	418,000	70,400	16	416	59,72
	8:15	78,800	27,200	425,000	78,000	17,6	423	59,72
	8:30	79,200	26,800	410,000	78,800	17,6	408	59,72
	8:45	77,600	26,400	418,000	77,200	16,8	416	59,72
	9:00	78,000	27,600	425,000	77,600	16,8	423	59,72
	9:15	77,600	27,200	410,000	76,800	17,6	408	59,72
	9:30	79,200	27,200	418,000	78,800	18	416	59,72
	9:45	79,600	27,600	410,000	79,200	17,6	408	59,72
	10:00	84,000	29,200	425,000	83,200	18,8	423	59,72
10:15	86,000	29,200	418,000	85,600	20,4	416	59,72	

	10:30	82,000	28,800	410,000	81,600	20	408	59,72
	10:45	82,800	28,800	418,000	82,400	19,6	416	59,72
	11:00	82,000	28,800	410,000	81,200	20	408	59,72
	11:15	81,600	28,800	425,000	81,200	19,6	423	59,72
	11:30	85,200	28,800	410,000	84,800	20	408	59,72
	11:45	80,400	29,200	418,000	79,600	19,6	416	59,72
	12:00	82,000	29,200	410,000	81,200	20	408	59,72
	12:15	87,600	29,200	425,000	87,200	20,8	423	59,72
	12:30	78,800	30,000	410,000	78,400	20	408	59,72
	12:45	85,600	31,600	418,000	85,200	21,2	416	59,72
	13:00	84,400	32,000	410,000	83,600	23,2	408	59,72
	13:15	91,600	32,000	425,000	90,800	24,4	423	59,72
	13:30	86,000	32,000	402,000	85,200	23,6	400	59,72
	13:45	89,200	32,400	425,000	88,800	24,4	423	59,72
	14:00	89,200	33,200	410,000	88,400	24,4	408	59,72
	14:15	90,400	33,200	410,000	89,600	25,2	408	59,72
	14:30	89,200	33,600	418,000	88,800	25,6	416	59,72
	14:45	88,400	33,600	425,000	87,600	25,2	423	59,72
	15:00	88,400	33,200	410,000	88,000	25,6	408	59,72
	15:15	83,600	33,600	418,000	82,800	24,4	416	59,72
	15:30	85,600	33,600	410,000	85,200	25,2	408	59,72
	15:45	84,400	33,600	425,000	84,000	25,2	423	59,72
	16:00	85,200	33,600	402,000	84,400	25,2	400	59,72
	16:15	83,600	33,600	425,000	83,200	24,4	423	59,72
	16:30	76,400	32,800	418,000	75,600	23,2	416	59,72
	16:45	81,200	32,400	410,000	80,800	23,2	408	59,72
	17:00	79,600	32,400	425,000	79,200	23,6	423	59,72
	17:15	70,000	32,800	418,000	69,600	22,4	416	59,72
	17:30	76,800	32,800	410,000	76,400	23,2	408	59,72
	17:45	79,200	32,000	425,000	78,400	22,4	423	59,72
	18:00	79,200	32,400	410,000	79,200	23,2	408	59,72
	18:15	73,600	31,200	418,000	72,800	21,2	416	59,72
	18:30	72,000	31,200	425,000	71,600	21,2	423	59,72
	18:45	73,200	31,200	410,000	73,200	20,8	408	59,72
	19:00	76,400	31,200	418,000	75,600	21,6	416	59,72
	19:15	87,200	31,200	410,000	86,800	22,8	408	59,72
	19:30	84,800	30,800	418,000	84,000	22,4	416	59,72
	19:45	77,200	30,800	425,000	77,200	21,2	423	59,72
	20:00	78,000	31,200	410,000	77,200	21,6	408	59,72
	20:15	76,800	30,800	418,000	76,400	21,2	416	59,72
	20:30	73,200	30,800	425,000	72,400	20,4	423	59,72
	20:45	76,800	30,800	410,000	76,800	21,2	408	59,72
	21:00	76,800	30,000	418,000	76,400	20,8	416	59,72
	21:15	80,000	30,400	410,000	79,200	20,8	408	59,72
	21:30	79,600	29,600	425,000	79,200	20,4	423	59,72
	21:45	84,000	30,400	402,000	83,600	21,6	400	59,72
	22:00	81,200	30,000	425,000	80,800	21,2	423	59,72
	22:15	68,800	28,800	410,000	68,000	18	408	59,72
	22:30	69,600	28,800	418,000	69,200	18,4	416	59,72
	22:45	76,800	29,600	410,000	76,800	20	408	59,72
	23:00	71,200	32,400	425,000	70,800	22	423	59,72
	23:15	66,000	35,200	410,000	65,600	25,2	408	59,72
	23:30	58,400	36,000	418,000	58,000	24,8	416	59,72
	23:45	58,000	36,400	410,000	57,600	25,2	408	59,72
	0:00	58,400	34,800	425,000	58,400	24	423	59,72
19.7.2015.	0:15	62,800	34,000	410,000	62,400	23,2	408	54,29
	0:30	62,400	34,000	418,000	62,000	23,2	416	54,29
	0:45	61,600	33,600	410,000	61,200	22,4	408	54,29
	1:00	59,600	33,200	418,000	59,600	22	416	54,29
	1:15	56,400	32,800	410,000	56,000	21,6	408	54,29
	1:30	55,600	32,800	425,000	55,200	21,2	423	54,29
	1:45	50,000	32,400	418,000	49,600	20,4	416	54,29
	2:00	50,800	32,000	410,000	50,800	20	408	54,29
	2:15	48,800	30,800	425,000	48,800	18,8	423	54,29
	2:30	44,800	30,400	410,000	44,400	17,6	408	54,29
	2:45	43,200	30,000	418,000	43,200	17,6	416	54,29
	3:00	43,600	30,000	425,000	43,200	17,2	423	54,29
	3:15	48,000	30,000	402,000	48,000	17,6	400	54,29
	3:30	48,400	30,800	425,000	48,000	18,4	423	54,29
	3:45	46,000	30,800	418,000	46,000	18,4	416	54,29
	4:00	44,000	31,200	425,000	43,600	18,4	423	54,29
	4:15	45,600	31,600	410,000	45,600	19,2	408	54,29
	4:30	46,000	32,000	418,000	45,600	19,6	416	54,29
	4:45	48,800	31,600	425,000	48,800	19,2	423	54,29
	5:00	49,200	31,200	418,000	49,200	18,8	416	54,29
	5:15	63,600	33,200	410,000	62,800	22	408	54,29
	5:30	51,600	30,400	425,000	51,600	18,4	423	54,29
	5:45	51,600	30,400	418,000	51,200	17,6	416	54,29
	6:00	51,200	30,400	425,000	51,200	18	423	54,29
6:15	65,600	30,400	418,000	65,200	19,6	416	54,29	

	6:30	62,000	30,000	418,000	61,600	18,4	416	54,29
	6:45	66,800	29,200	425,000	66,400	18,4	423	54,29
	7:00	60,800	28,400	418,000	60,400	16,4	416	54,29
	7:15	73,200	27,600	425,000	72,800	17,2	423	54,29
	7:30	72,400	28,400	418,000	72,000	18	416	54,29
	7:45	67,200	28,400	425,000	67,200	17,2	423	54,29
	8:00	68,000	28,400	410,000	67,600	17,6	408	54,29
	8:15	77,600	29,600	418,000	77,200	19,6	416	54,29
	8:30	72,400	30,400	425,000	71,600	20	423	54,29
	8:45	72,400	30,400	418,000	72,400	20	416	54,29
	9:00	71,600	30,400	425,000	70,800	19,6	423	54,29
	9:15	67,600	30,400	418,000	67,200	19,6	416	54,29
	9:30	67,600	30,000	410,000	67,200	19,2	408	54,29
	9:45	66,800	30,000	418,000	66,800	19,2	416	54,29
	10:00	66,000	30,000	425,000	65,200	18,8	423	54,29
	10:15	71,200	30,400	418,000	70,800	20,4	416	54,29
	10:30	70,000	30,400	410,000	70,000	19,6	408	54,29
	10:45	74,000	30,800	425,000	73,600	20,8	423	54,29
	11:00	69,200	30,800	418,000	68,800	20	416	54,29
	11:15	72,800	30,800	410,000	72,000	20,8	408	54,29
	11:30	74,400	31,600	425,000	74,400	21,6	423	54,29
	11:45	72,000	31,200	418,000	71,200	21,2	416	54,29
	12:00	70,800	32,000	410,000	70,400	21,6	408	54,29
	12:15	75,200	32,400	425,000	74,800	22,4	423	54,29
	12:30	72,400	32,000	418,000	72,400	22	416	54,29
	12:45	68,400	32,000	410,000	67,600	21,6	408	54,29
	13:00	70,800	32,800	418,000	70,400	22	416	54,29
	13:15	68,000	32,800	425,000	67,600	22	423	54,29
	13:30	68,800	32,400	410,000	68,400	22,4	408	54,29
	13:45	68,400	32,800	418,000	68,000	22	416	54,29
	14:00	65,200	32,800	425,000	64,800	22	423	54,29
	14:15	67,600	33,600	418,000	67,200	22,8	416	54,29
	14:30	67,200	33,600	410,000	67,200	22,8	408	54,29
	14:45	67,200	32,800	425,000	66,400	22	423	54,29
	15:00	73,200	32,000	418,000	73,200	22	416	54,29
	15:15	73,600	32,400	410,000	72,800	22,4	408	54,29
	15:30	74,000	32,400	425,000	73,600	22,4	423	54,29
	15:45	72,000	32,000	418,000	71,600	22	416	54,29
	16:00	68,400	32,000	410,000	68,000	21,2	408	54,29
	16:15	66,400	32,000	418,000	66,000	21,2	416	54,29
	16:30	68,800	32,000	425,000	68,400	21,2	423	54,29
	16:45	72,000	32,000	410,000	71,600	22	408	54,29
	17:00	72,000	31,600	418,000	71,600	21,6	416	54,29
	17:15	72,800	30,800	425,000	72,400	20,8	423	54,29
	17:30	74,000	30,400	410,000	73,600	20	408	54,29
	17:45	74,000	30,800	418,000	73,600	20,8	416	54,29
	18:00	73,600	30,400	410,000	73,200	20	408	54,29
	18:15	74,400	30,000	425,000	73,600	20,4	423	54,29
	18:30	76,800	30,800	418,000	76,800	21,2	416	54,29
	18:45	78,000	30,400	410,000	77,200	20,8	408	54,29
	19:00	77,600	31,200	418,000	77,200	21,6	416	54,29
	19:15	70,000	30,800	410,000	70,000	20,4	408	54,29
	19:30	73,600	31,600	425,000	72,800	21,6	423	54,29
	19:45	73,200	31,600	418,000	73,200	21,6	416	54,29
	20:00	72,400	31,600	410,000	71,600	21,6	408	54,29
	20:15	75,600	31,600	425,000	75,200	21,6	423	54,29
	20:30	72,400	32,000	418,000	72,400	21,6	416	54,29
	20:45	74,400	32,400	410,000	73,600	22,4	408	54,29
	21:00	76,400	31,600	425,000	76,000	22,4	423	54,29
	21:15	71,200	31,600	402,000	70,800	21,2	400	54,29
	21:30	75,200	34,000	410,000	74,800	24,8	408	54,29
	21:45	79,200	34,800	425,000	78,400	26	423	54,29
	22:00	74,800	36,800	410,000	74,800	27,6	408	54,29
	22:15	66,000	36,000	418,000	65,600	26	416	54,29
	22:30	71,200	36,000	410,000	70,800	26	408	54,29
	22:45	69,200	35,600	410,000	68,800	26	408	54,29
	23:00	65,200	36,000	425,000	64,800	25,2	423	54,29
	23:15	58,800	35,600	410,000	58,400	24,8	408	54,29
	23:30	56,400	35,200	418,000	56,400	24	416	54,29
	23:45	61,600	35,600	410,000	61,200	24,4	408	54,29
	0:00	55,600	34,800	418,000	55,600	23,6	416	54,29
20.7.2015.	0:15	58,800	35,200	410,000	58,400	24	408	69,86
	0:30	60,400	34,400	425,000	59,600	23,6	423	69,86
	0:45	56,000	34,000	410,000	56,000	22,4	408	69,86
	1:00	59,600	33,200	418,000	59,600	22,4	416	69,86
	1:15	60,400	33,200	410,000	60,000	21,6	408	69,86
	1:30	62,000	32,800	425,000	61,600	22	423	69,86
	1:45	66,800	33,200	410,000	66,400	22,8	408	69,86
	2:00	64,400	33,200	418,000	64,000	22	416	69,86
2:15	63,600	33,600	425,000	63,600	22,8	423	69,86	

2:30	58,000	33,600	402,000	57,600	22,4	400	69,86
2:45	57,600	33,600	425,000	57,200	22	423	69,86
3:00	58,000	32,800	418,000	58,000	21,6	416	69,86
3:15	61,200	32,800	410,000	60,800	21,6	408	69,86
3:30	62,400	32,800	425,000	62,000	21,6	423	69,86
3:45	60,000	32,400	418,000	59,600	21,2	416	69,86
4:00	58,000	31,600	410,000	57,600	20	408	69,86
4:15	60,400	32,400	425,000	60,400	21,2	423	69,86
4:30	61,200	32,400	418,000	60,800	21,2	416	69,86
4:45	62,800	32,400	410,000	62,800	20,8	408	69,86
5:00	59,200	32,800	425,000	58,400	21,6	423	69,86
5:15	66,000	32,800	418,000	66,000	22,4	416	69,86
5:30	62,800	29,600	418,000	62,400	18	416	69,86
5:45	62,400	26,400	425,000	62,000	14,4	423	69,86
6:00	56,400	25,600	418,000	56,400	13,6	416	69,86
6:15	75,600	28,400	425,000	75,200	18	423	69,86
6:30	78,000	29,600	418,000	77,600	19,6	416	69,86
6:45	82,400	29,600	425,000	81,600	20	423	69,86
7:00	80,000	29,200	418,000	79,200	19,6	416	69,86
7:15	82,000	28,800	425,000	81,600	19,2	423	69,86
7:30	82,400	28,800	410,000	82,000	19,6	408	69,86
7:45	83,600	29,600	418,000	83,200	20,4	416	69,86
8:00	84,000	29,600	425,000	83,600	21,2	423	69,86
8:15	92,000	28,400	410,000	91,200	20,8	408	69,86
8:30	97,200	28,400	410,000	96,400	22	408	69,86
8:45	90,400	30,000	402,000	90,000	22,4	400	69,86
9:00	92,800	30,400	410,000	92,000	23,2	408	69,86
9:15	86,000	31,600	425,000	85,200	24	423	69,86
9:30	81,200	32,400	410,000	80,800	23,6	408	69,86
9:45	85,200	32,800	410,000	84,400	25,2	408	69,86
10:00	85,200	34,400	410,000	84,800	26,4	408	69,86
10:15	89,200	34,800	394,000	88,400	28,4	392	69,86
10:30	86,000	34,400	410,000	85,600	27,2	408	69,86
10:45	86,800	34,000	410,000	86,400	26,8	408	69,86
11:00	87,200	33,600	394,000	86,000	26,8	392	69,86
11:15	86,800	33,200	410,000	86,400	26	408	69,86
11:30	89,200	32,800	402,000	88,800	26,4	400	69,86
11:45	88,800	32,800	394,000	88,000	26,4	392	69,86
12:00	90,800	32,800	410,000	90,000	26,4	408	69,86
12:15	90,400	32,000	402,000	89,600	26	400	69,86
12:30	87,200	32,400	394,000	86,800	25,6	392	69,86
12:45	88,000	33,200	410,000	86,800	26,4	408	69,86
13:00	84,000	33,200	394,000	83,600	26,4	392	69,86
13:15	84,000	34,000	402,000	83,600	26,8	400	69,86
13:30	82,000	33,600	410,000	81,600	26,4	408	69,86
13:45	86,000	33,600	394,000	84,800	26,8	392	69,86
14:00	86,000	34,000	394,000	85,600	27,2	392	69,86
14:15	84,800	34,800	410,000	84,000	27,6	408	69,86
14:30	83,200	34,400	402,000	82,800	27,6	400	69,86
14:45	84,000	34,800	394,000	83,200	27,6	392	69,86
15:00	85,600	35,200	410,000	85,200	28	408	69,86
15:15	86,400	35,200	402,000	85,600	28,4	400	69,86
15:30	84,800	35,200	410,000	84,400	28,4	408	69,86
15:45	86,000	34,800	394,000	85,600	28	392	69,86
16:00	87,600	35,200	410,000	86,400	28,4	408	69,86
16:15	88,400	36,000	394,000	87,600	29,2	392	69,86
16:30	82,400	36,000	410,000	82,400	28,8	408	69,86
16:45	84,400	35,600	402,000	83,600	28,4	400	69,86
17:00	85,200	35,600	410,000	84,800	28,8	408	69,86
17:15	86,400	35,600	394,000	85,600	28,4	392	69,86
17:30	85,600	36,000	410,000	85,200	28,4	408	69,86
17:45	85,600	35,200	410,000	84,800	28,4	408	69,86
18:00	86,400	35,600	394,000	85,600	28,4	392	69,86
18:15	85,600	34,800	410,000	85,200	28	408	69,86
18:30	88,000	34,800	410,000	87,200	28	408	69,86
18:45	88,000	34,800	402,000	87,600	27,6	400	69,86
19:00	86,800	34,000	410,000	86,000	27,2	408	69,86
19:15	92,000	32,400	394,000	91,200	26	392	69,86
19:30	91,200	31,600	410,000	90,800	24,8	408	69,86
19:45	87,200	31,200	410,000	86,400	24	408	69,86
20:00	87,600	31,200	410,000	87,200	23,2	408	69,86
20:15	85,600	31,200	410,000	85,200	24	408	69,86
20:30	84,400	31,600	410,000	83,600	23,2	408	69,86
20:45	86,800	31,600	410,000	86,000	24	408	69,86
21:00	87,600	30,400	410,000	87,200	23,2	408	69,86
21:15	85,200	30,400	394,000	84,400	22,4	392	69,86
21:30	91,600	29,600	410,000	91,200	23,2	408	69,86
21:45	93,200	30,400	410,000	92,400	23,6	408	69,86
22:00	94,800	30,400	394,000	94,000	24,4	392	69,86
22:15	88,800	30,000	410,000	88,400	22,8	408	69,86

	22:30	91,600	30,400	410,000	90,800	23,6	408	69,86
	22:45	90,400	30,800	410,000	90,000	23,6	408	69,86
	23:00	88,000	30,800	410,000	87,200	23,6	408	69,86
	23:15	92,400	29,600	410,000	92,000	22,8	408	69,86
	23:30	88,400	30,400	410,000	87,600	22,8	408	69,86
	23:45	89,600	31,200	410,000	88,800	23,6	408	69,86
	0:00	86,800	30,800	410,000	86,400	23,2	408	69,86
21.7.2015.	0:15	80,800	32,400	410,027	80,400	23,6	408	69,67
	0:30	78,400	31,600	417,800	78,000	22,8	416	69,67
	0:45	74,000	32,400	410,027	73,600	22,4	408	69,67
	1:00	73,200	32,000	410,027	72,400	22,4	408	69,67
	1:15	67,600	33,200	417,800	67,600	22,8	416	69,67
	1:30	68,000	33,200	425,430	67,600	22,4	423	69,67
	1:45	68,400	33,600	410,027	68,000	23,2	408	69,67
	2:00	67,200	33,600	417,800	66,800	23,2	416	69,67
	2:15	66,400	32,800	410,027	66,000	22,4	408	69,67
	2:30	63,600	33,600	425,430	63,600	22,4	423	69,67
	2:45	65,200	33,600	417,800	64,400	22,8	416	69,67
	3:00	63,600	33,600	425,430	63,600	22,8	423	69,67
	3:15	74,800	33,600	417,800	74,400	23,6	416	69,67
	3:30	71,600	33,200	410,027	71,200	23,2	408	69,67
	3:45	71,200	33,600	425,430	70,800	23,2	423	69,67
	4:00	70,000	33,200	417,800	70,000	22,8	416	69,67
	4:15	69,600	33,200	425,430	68,800	22,4	423	69,67
	4:30	72,400	33,200	417,800	72,000	22,8	416	69,67
	4:45	76,400	32,400	410,027	76,400	22,8	408	69,67
	5:00	73,200	32,400	417,800	72,400	22,4	416	69,67
	5:15	76,800	30,400	425,430	76,400	20	423	69,67
	5:30	80,000	27,600	417,800	79,600	18	416	69,67
	5:45	76,800	28,000	432,924	76,400	17,6	431	69,67
	6:00	73,200	28,400	425,430	72,800	17,2	423	69,67
	6:15	80,800	27,200	425,430	80,400	17,2	423	69,67
	6:30	77,600	28,400	425,430	77,200	18	423	69,67
	6:45	78,000	28,000	417,800	77,200	17,6	416	69,67
	7:00	79,600	26,800	425,430	79,200	16,8	423	69,67
	7:15	86,400	24,800	417,800	86,000	16	416	69,67
	7:30	86,000	25,600	425,430	85,200	16,8	423	69,67
	7:45	82,400	27,200	417,800	82,000	17,6	416	69,67
	8:00	87,200	26,400	410,027	86,800	18	408	69,67
	8:15	88,400	27,200	417,800	87,600	18,8	416	69,67
	8:30	88,000	26,800	410,027	87,600	19,2	408	69,67
	8:45	86,400	27,200	410,027	85,600	18,8	408	69,67
	9:00	88,800	26,400	410,027	88,000	18,4	408	69,67
	9:15	88,400	26,400	410,027	88,000	18,4	408	69,67
	9:30	84,000	28,000	410,027	83,200	20	408	69,67
	9:45	82,800	29,600	410,027	82,400	21,2	408	69,67
	10:00	82,400	29,600	425,430	82,000	21,2	423	69,67
	10:15	80,800	29,600	425,354	80,400	20,8	423	69,67
	10:30	79,600	29,600	409,870	79,200	20,8	408	69,67
	10:45	79,200	29,200	409,870	78,800	20,4	408	69,67
	11:00	81,600	28,000	409,870	80,800	20	408	69,67
	11:15	81,600	28,000	410,027	80,800	19,6	408	69,67
	11:30	81,600	28,400	410,027	81,200	20,4	408	69,67
	11:45	79,600	28,000	394,020	79,200	19,6	392	69,67
	12:00	80,800	29,200	410,027	80,000	21,2	408	69,67
12:15	81,600	29,600	410,027	81,200	21,6	408	69,67	
12:30	80,400	29,600	394,020	80,000	21,6	392	69,67	
12:45	82,000	29,600	410,027	81,600	21,6	408	69,67	
13:00	78,800	30,000	402,103	78,000	21,6	400	69,67	
13:15	79,600	29,600	410,027	79,200	21,6	408	69,67	
13:30	81,600	28,400	394,020	80,800	20,4	392	69,67	
13:45	83,600	28,800	410,027	83,200	21,2	408	69,67	
14:00	80,800	29,600	394,020	80,400	21,6	392	69,67	
14:15	79,600	30,000	410,027	78,800	22	408	69,67	
14:30	79,200	30,800	402,103	78,800	22,4	400	69,67	
14:45	79,200	30,800	410,027	78,800	22,4	408	69,67	
15:00	82,400	30,400	410,027	81,600	22,8	408	69,67	
15:15	76,800	31,200	394,020	76,400	22,4	392	69,67	
15:30	78,000	30,800	410,027	77,200	22,4	408	69,67	
15:45	82,000	31,200	410,027	81,600	23,6	408	69,67	
16:00	81,600	31,600	394,020	81,200	23,2	392	69,67	
16:15	80,800	31,200	410,027	80,000	23,6	408	69,67	
16:30	81,600	31,600	410,027	81,200	23,6	408	69,67	
16:45	83,200	31,600	402,103	82,400	23,6	400	69,67	
17:00	82,400	32,000	410,027	82,000	24	408	69,67	
17:15	76,000	31,600	410,027	75,600	23,2	408	69,67	
17:30	80,000	31,200	394,020	79,200	22,8	392	69,67	
17:45	80,800	31,200	410,027	80,800	23,2	408	69,67	
18:00	80,400	31,600	410,027	79,600	23,2	408	69,67	
18:15	81,200	31,600	410,027	80,800	23,2	408	69,67	

	18:30	78,800	31,600	394,020	78,000	23,6	392	69,67
	18:45	78,800	31,600	410,027	78,400	22,8	408	69,67
	19:00	78,400	31,600	410,027	78,000	23,2	408	69,67
	19:15	74,800	32,000	410,027	74,400	23,2	408	69,67
	19:30	74,000	32,000	410,027	73,600	23,2	408	69,67
	19:45	75,600	32,000	410,027	75,200	22,8	408	69,67
	20:00	76,800	32,000	394,020	76,000	23,2	392	69,67
	20:15	78,000	31,600	410,027	78,000	23,2	408	69,67
	20:30	77,200	30,800	410,027	76,400	22	408	69,67
	20:45	81,200	30,000	410,027	80,800	22	408	69,67
	21:00	80,800	29,200	402,103	80,000	20,8	400	69,67
	21:15	83,200	28,400	402,103	82,800	20,8	400	69,67
	21:30	85,200	28,800	402,103	84,800	21,2	400	69,67
	21:45	84,400	28,800	410,027	84,000	21,6	408	69,67
	22:00	84,000	29,600	410,027	83,200	22	408	69,67
	22:15	76,800	31,200	394,020	76,400	22,4	392	69,67
	22:30	76,400	31,200	410,027	76,000	22	408	69,67
	22:45	81,600	30,800	410,027	81,200	23,2	408	69,67
	23:00	81,600	30,400	410,027	80,800	22,4	408	69,67
	23:15	74,400	30,800	410,027	74,400	21,6	408	69,67
	23:30	71,600	32,800	410,027	70,800	23,2	408	69,67
	23:45	77,200	32,800	410,027	76,800	24	408	69,67
	0:00	68,400	33,600	410,027	68,000	23,6	408	69,67
22.7.2015.	0:15	73,200	34,400	410,000	72,800	25,2	408	90,14
	0:30	77,600	34,000	410,000	77,200	25,2	408	90,14
	0:45	79,200	34,000	418,000	78,800	24,8	416	90,14
	1:00	78,000	34,000	410,000	77,600	24,8	408	90,14
	1:15	75,200	34,000	410,000	74,800	24,8	408	90,14
	1:30	77,200	33,600	418,000	76,400	24	416	90,14
	1:45	76,400	34,000	410,000	76,400	25,2	408	90,14
	2:00	76,400	34,800	425,000	76,000	25,6	423	90,14
	2:15	74,800	35,200	410,000	74,400	25,6	408	90,14
	2:30	71,600	36,400	418,000	70,800	26,4	416	90,14
	2:45	73,600	36,000	410,000	73,200	26,4	408	90,14
	3:00	68,800	36,400	425,000	68,400	26	423	90,14
	3:15	74,000	36,400	418,000	73,600	27,2	416	90,14
	3:30	74,000	36,800	410,000	73,600	27,2	408	90,14
	3:45	71,200	36,800	425,000	70,800	26,4	423	90,14
	4:00	73,200	36,400	418,000	72,800	26,8	416	90,14
	4:15	76,800	36,800	410,000	76,400	27,2	408	90,14
	4:30	78,400	35,600	418,000	78,000	26,8	416	90,14
	4:45	77,600	36,000	410,000	77,200	26,8	408	90,14
	5:00	79,200	36,000	425,000	78,400	26,8	423	90,14
	5:15	86,400	35,200	418,000	85,600	27,2	416	90,14
	5:30	84,800	36,000	410,000	84,400	27,6	408	90,14
	5:45	82,000	36,400	425,000	81,600	27,6	423	90,14
	6:00	78,000	36,400	410,000	77,200	27,2	408	90,14
	6:15	84,000	34,800	418,000	83,600	26,4	416	90,14
	6:30	81,200	32,400	410,000	80,800	23,6	408	90,14
	6:45	81,200	32,000	425,000	80,800	22,8	423	90,14
	7:00	81,200	28,000	418,000	80,400	18,4	416	90,14
	7:15	88,000	25,600	410,000	88,000	17,2	408	90,14
	7:30	88,000	26,000	418,000	87,200	17,6	416	90,14
	7:45	85,600	26,000	425,000	85,200	17,2	423	90,14
	8:00	85,600	25,200	410,000	84,800	16,4	408	90,14
	8:15	98,000	23,200	410,000	97,200	16,4	408	90,14
	8:30	99,600	22,800	410,000	98,800	16	408	90,14
	8:45	97,200	23,200	410,000	96,800	16,8	408	90,14
	9:00	96,800	23,200	410,000	95,600	16,8	408	90,14
	9:15	96,000	23,200	402,000	95,200	16	400	90,14
	9:30	92,400	24,000	410,000	92,000	16,4	408	90,14
	9:45	89,600	24,400	410,000	89,200	17,2	408	90,14
	10:00	90,000	24,400	410,000	89,200	16,8	408	90,14
	10:15	91,200	25,600	410,000	90,400	17,6	408	90,14
	10:30	92,000	25,600	410,000	91,600	18,8	408	90,14
	10:45	90,000	26,400	410,000	89,200	18,8	408	90,14
	11:00	94,800	24,800	410,000	94,000	18,4	408	90,14
	11:15	93,200	24,800	410,000	92,800	18,4	408	90,14
	11:30	94,000	25,600	394,000	92,800	18,4	392	90,14
	11:45	93,600	25,200	410,000	93,200	19,2	408	90,14
	12:00	92,800	27,200	402,000	92,000	20,4	400	90,14
12:15	94,000	26,400	410,000	93,200	20	408	90,14	
12:30	96,000	26,000	394,000	95,200	20,4	392	90,14	
12:45	94,000	26,800	402,000	93,200	20,8	400	90,14	
13:00	92,000	28,000	402,000	91,200	21,6	400	90,14	
13:15	95,600	27,200	402,000	94,800	21,6	400	90,14	
13:30	95,200	28,800	394,000	94,400	23,2	392	90,14	
13:45	95,600	29,200	402,000	95,200	23,6	400	90,14	
14:00	93,200	29,200	394,000	92,800	23,2	392	90,14	
14:15	86,800	29,600	410,000	86,000	22,8	408	90,14	

	14:30	85,200	28,800	394,000	84,400	21,6	392	90,14
	14:45	84,400	29,200	402,000	84,000	22	400	90,14
	15:00	84,400	29,600	410,000	83,600	22	408	90,14
	15:15	82,800	29,200	394,000	82,400	22	392	90,14
	15:30	82,800	29,200	402,000	82,000	21,2	400	90,14
	15:45	84,000	29,200	410,000	83,600	21,6	408	90,14
	16:00	84,400	29,200	394,000	83,600	22	392	90,14
	16:15	84,400	29,200	410,000	83,600	22	408	90,14
	16:30	84,400	29,600	394,000	84,000	22	392	90,14
	16:45	83,600	29,200	402,000	83,200	21,6	400	90,14
	17:00	86,400	29,600	410,000	86,000	22,4	408	90,14
	17:15	89,600	30,800	410,000	88,400	24	408	90,14
	17:30	88,000	31,200	394,000	87,600	24	392	90,14
	17:45	90,400	31,200	410,000	89,600	24,4	408	90,14
	18:00	96,000	30,400	394,000	95,600	24,4	392	90,14
	18:15	94,800	30,000	410,000	93,600	24	408	90,14
	18:30	96,400	30,000	402,000	96,000	24,4	400	90,14
	18:45	96,000	30,000	410,000	95,200	24	408	90,14
	19:00	97,200	29,600	410,000	96,400	24	408	90,14
	19:15	94,800	30,000	394,000	94,000	23,6	392	90,14
	19:30	93,600	30,400	410,000	92,800	24	408	90,14
	19:45	95,600	30,000	394,000	95,200	24,4	392	90,14
	20:00	97,200	30,000	410,000	96,400	24	408	90,14
	20:15	96,000	30,000	402,000	95,200	24	400	90,14
	20:30	97,200	30,000	410,000	96,800	24,4	408	90,14
	20:45	95,200	29,600	410,000	94,400	23,6	408	90,14
	21:00	100,000	28,400	394,000	98,800	23,2	392	90,14
	21:15	99,200	28,400	402,000	98,400	22,8	400	90,14
	21:30	98,800	28,800	402,000	98,400	23,6	400	90,14
	21:45	97,600	30,000	402,000	96,800	24,8	400	90,14
	22:00	98,000	30,000	410,000	97,200	24,4	408	90,14
	22:15	85,600	30,000	394,000	85,200	22,4	392	90,14
	22:30	88,800	30,000	410,000	88,000	22,8	408	90,14
	22:45	91,200	30,000	410,000	90,400	23,2	408	90,14
	23:00	93,200	29,600	402,000	92,800	23,6	400	90,14
	23:15	82,400	31,200	402,000	81,600	22,8	400	90,14
	23:30	78,000	32,000	410,000	78,000	23,6	408	90,14
	23:45	82,000	32,800	410,000	81,200	24,4	408	90,14
	0:00	80,400	33,200	410,000	79,600	24,8	408	90,14
23.7.2015.	0:15	85,600	32,400	410,000	85,200	24,8	408	83,21
	0:30	85,600	32,000	410,000	85,200	24	408	83,21
	0:45	88,000	31,600	410,000	87,600	24	408	83,21
	1:00	82,000	32,000	410,000	81,200	23,6	408	83,21
	1:15	79,200	33,600	410,000	78,800	25,2	408	83,21
	1:30	78,000	34,800	418,000	77,600	25,6	416	83,21
	1:45	77,200	35,200	410,000	76,800	26	408	83,21
	2:00	78,400	34,400	410,000	77,600	25,6	408	83,21
	2:15	81,200	34,000	425,000	80,800	25,6	423	83,21
	2:30	74,000	34,800	410,000	73,600	25,2	408	83,21
	2:45	75,600	34,800	410,000	75,200	25,6	408	83,21
	3:00	76,000	35,200	418,000	75,200	26	416	83,21
	3:15	76,000	35,200	410,000	76,000	26	408	83,21
	3:30	70,000	35,200	425,000	69,600	25,2	423	83,21
	3:45	73,200	34,800	402,000	72,800	25,2	400	83,21
	4:00	73,200	34,800	410,000	72,800	25,2	408	83,21
	4:15	73,200	35,200	425,000	72,800	25,6	423	83,21
	4:30	73,600	35,200	410,000	72,800	25,2	408	83,21
	4:45	74,400	34,800	418,000	74,000	25,6	416	83,21
	5:00	76,000	34,800	410,000	76,000	25,6	408	83,21
	5:15	79,600	36,400	425,000	78,800	27,2	423	83,21
	5:30	80,000	36,400	410,000	79,600	28	408	83,21
	5:45	79,600	36,800	418,000	78,800	27,6	416	83,21
	6:00	76,000	36,000	425,000	75,600	26,8	423	83,21
	6:15	83,200	31,200	402,000	82,800	22,4	400	83,21
	6:30	82,000	28,800	425,000	81,600	19,2	423	83,21
	6:45	76,800	27,600	418,000	76,400	18	416	83,21
	7:00	78,400	26,400	410,000	77,600	16,4	408	83,21
	7:15	88,400	22,800	425,000	88,400	14	423	83,21
	7:30	93,200	21,200	418,000	92,400	13,2	416	83,21
	7:45	92,400	22,000	410,000	91,600	14	408	83,21
	8:00	92,000	21,600	425,000	91,200	13,6	423	83,21
	8:15	96,800	21,600	410,000	96,400	14,4	408	83,21
	8:30	99,200	23,200	410,000	98,400	16,4	408	83,21
	8:45	98,000	23,600	418,000	97,200	16,8	416	83,21
	9:00	97,200	22,800	410,000	96,800	15,6	408	83,21
	9:15	93,600	23,200	410,000	92,800	16	408	83,21
	9:30	92,800	23,600	410,000	92,000	16	408	83,21
	9:45	92,000	23,200	410,000	91,200	15,6	408	83,21
	10:00	93,200	24,000	410,000	92,400	16,8	408	83,21
10:15	86,800	25,200	410,000	86,400	17,2	408	83,21	

	10:30	88,400	25,200	410,000	88,000	17,2	408	83,21
	10:45	92,000	25,200	410,000	91,200	17,6	408	83,21
	11:00	94,000	25,600	410,000	93,200	19,2	408	83,21
	11:15	92,400	25,600	402,000	91,600	18,4	400	83,21
	11:30	90,000	24,800	410,000	89,200	17,6	408	83,21
	11:45	89,200	24,800	402,000	88,800	17,6	400	83,21
	12:00	90,800	26,000	410,000	90,400	18,8	408	83,21
	12:15	88,400	27,200	410,000	87,600	20	408	83,21
	12:30	85,600	28,000	394,000	85,200	20,4	392	83,21
	12:45	89,600	28,400	410,000	88,800	21,2	408	83,21
	13:00	86,800	30,800	410,000	86,400	23,6	408	83,21
	13:15	90,400	29,200	394,000	89,600	22,8	392	83,21
	13:30	87,600	29,600	410,000	86,800	22	408	83,21
	13:45	88,000	29,600	402,000	87,600	22,8	400	83,21
	14:00	89,600	30,000	410,000	88,400	22,8	408	83,21
	14:15	94,000	28,800	394,000	93,600	22,8	392	83,21
	14:30	92,000	28,400	402,000	91,200	22,4	400	83,21
	14:45	90,400	28,800	402,000	89,600	22	400	83,21
	15:00	91,600	29,200	410,000	91,200	22,4	408	83,21
	15:15	91,600	27,600	402,000	90,800	20,8	400	83,21
	15:30	93,200	28,000	410,000	92,400	21,2	408	83,21
	15:45	91,200	27,600	394,000	90,800	20,8	392	83,21
	16:00	92,400	27,200	410,000	91,600	20,8	408	83,21
	16:15	94,800	28,000	410,000	94,000	21,6	408	83,21
	16:30	93,600	27,600	394,000	92,800	21,2	392	83,21
	16:45	92,400	28,400	410,000	91,600	21,6	408	83,21
	17:00	91,600	28,400	410,000	91,200	21,6	408	83,21
	17:15	90,400	28,800	410,000	89,600	21,6	408	83,21
	17:30	92,400	28,800	402,000	92,000	22	400	83,21
	17:45	92,400	29,600	410,000	91,600	22,4	408	83,21
	18:00	91,600	29,600	410,000	90,800	22,8	408	83,21
	18:15	87,600	30,400	410,000	87,200	22,8	408	83,21
	18:30	92,000	29,200	402,000	91,200	22,4	400	83,21
	18:45	92,400	29,600	410,000	91,600	22,4	408	83,21
	19:00	95,600	28,800	402,000	94,800	22,4	400	83,21
	19:15	96,800	28,800	410,000	96,400	22,8	408	83,21
	19:30	96,400	29,200	410,000	95,600	22,8	408	83,21
	19:45	94,400	30,000	410,000	93,600	23,2	408	83,21
	20:00	94,400	30,400	410,000	94,000	24	408	83,21
	20:15	88,800	32,000	410,000	88,000	24,4	408	83,21
	20:30	87,600	32,000	402,000	86,800	24,4	400	83,21
	20:45	89,200	31,200	410,000	88,800	24	408	83,21
	21:00	82,400	31,200	410,000	82,000	23,2	408	83,21
	21:15	82,000	32,400	410,000	81,200	24	408	83,21
	21:30	86,800	32,000	410,000	86,000	24,8	408	83,21
	21:45	88,400	32,400	402,000	88,000	25,2	400	83,21
	22:00	88,400	32,400	410,000	87,600	25,2	408	83,21
	22:15	88,800	32,000	402,000	88,400	24,8	400	83,21
	22:30	92,000	32,000	410,000	91,600	25,2	408	83,21
	22:45	95,600	31,600	410,000	94,800	24,8	408	83,21
	23:00	92,000	32,000	410,000	91,200	25,2	408	83,21
	23:15	83,600	32,000	410,000	83,200	24	408	83,21
	23:30	80,800	31,600	410,000	80,000	22,8	408	83,21
	23:45	83,600	31,200	425,000	83,200	23,2	423	83,21
	0:00	75,200	33,600	410,000	75,200	24	408	83,21
	0:15	72,000	34,400	410,000	71,200	25,2	408	85,35
	0:30	70,000	33,600	402,000	69,600	23,6	400	85,35
	0:45	68,800	34,000	425,000	68,800	23,6	423	85,35
	1:00	68,000	34,000	410,000	67,200	24	408	85,35
	1:15	66,400	34,400	418,000	66,000	24	416	85,35
	1:30	64,400	34,000	410,000	64,400	23,6	408	85,35
	1:45	64,400	34,400	425,000	64,000	23,6	423	85,35
	2:00	64,000	34,800	418,000	63,600	24	416	85,35
	2:15	68,400	34,800	410,000	68,000	24,4	408	85,35
	2:30	66,400	34,400	425,000	66,400	24	423	85,35
	2:45	66,400	34,800	410,000	65,600	24,4	408	85,35
	3:00	66,000	35,200	418,000	65,600	24,8	416	85,35
	3:15	68,400	35,200	410,000	68,400	24,8	408	85,35
	3:30	68,000	34,800	418,000	67,600	24,4	416	85,35
	3:45	68,800	34,800	425,000	68,400	24,8	423	85,35
	4:00	68,000	34,800	410,000	67,600	24,8	408	85,35
	4:15	72,400	34,800	418,000	72,000	24,4	416	85,35
	4:30	75,200	34,400	410,000	74,400	25,2	408	85,35
	4:45	74,800	34,400	425,000	74,400	24,8	423	85,35
	5:00	73,600	34,800	410,000	73,600	25,2	408	85,35
	5:15	76,800	34,800	418,000	76,000	25,2	416	85,35
	5:30	75,600	34,800	425,000	75,200	25,6	423	85,35
	5:45	75,600	35,200	410,000	75,200	25,6	408	85,35
	6:00	75,200	34,800	418,000	74,800	25,2	416	85,35
	6:15	80,800	30,800	418,000	80,000	21,2	416	85,35
24.7.2015.								

	6:30	77,600	28,800	410,000	77,200	19,2	408	85,35
	6:45	74,000	28,000	425,000	73,600	17,6	423	85,35
	7:00	76,400	28,000	418,000	76,000	17,6	416	85,35
	7:15	78,000	27,600	425,000	77,600	18	423	85,35
	7:30	79,200	27,200	410,000	78,800	17,6	408	85,35
	7:45	83,200	26,400	418,000	82,800	17,6	416	85,35
	8:00	82,400	26,000	410,000	81,600	16,8	408	85,35
	8:15	90,800	26,400	425,000	90,400	18,4	423	85,35
	8:30	90,800	27,600	410,000	90,000	20,4	408	85,35
	8:45	90,400	28,000	402,000	89,600	20	400	85,35
	9:00	92,400	28,800	425,000	92,000	21,2	423	85,35
	9:15	90,000	28,400	410,000	89,200	21,2	408	85,35
	9:30	90,000	28,400	410,000	89,200	20,8	408	85,35
	9:45	88,400	28,800	410,000	88,000	21,2	408	85,35
	10:00	86,800	28,800	410,000	86,400	20,8	408	85,35
	10:15	86,800	28,400	410,000	86,400	20,4	408	85,35
	10:30	85,200	28,800	410,000	84,400	20,4	408	85,35
	10:45	85,600	28,800	410,000	84,800	20,8	408	85,35
	11:00	86,000	28,800	402,000	85,600	20,8	400	85,35
	11:15	86,000	28,800	410,000	85,200	21,2	408	85,35
	11:30	86,400	28,800	410,000	86,000	20,8	408	85,35
	11:45	86,400	27,200	410,000	85,600	19,2	408	85,35
	12:00	88,000	27,600	410,000	87,600	20,4	408	85,35
	12:15	88,400	28,000	410,000	88,000	20,4	408	85,35
	12:30	88,400	28,000	410,000	87,600	20,4	408	85,35
	12:45	88,800	28,000	402,000	88,000	20,4	400	85,35
	13:00	86,400	28,000	402,000	85,600	20,4	400	85,35
	13:15	89,200	27,600	410,000	88,800	20,4	408	85,35
	13:30	90,400	27,600	410,000	89,600	20,4	408	85,35
	13:45	90,800	27,600	410,000	90,400	20,8	408	85,35
	14:00	92,000	28,800	410,000	90,800	21,2	408	85,35
	14:15	90,800	28,800	402,000	90,400	22	400	85,35
	14:30	91,600	28,800	410,000	90,800	21,6	408	85,35
	14:45	89,200	28,800	410,000	88,800	21,6	408	85,35
	15:00	89,600	29,200	402,000	88,800	22	400	85,35
	15:15	89,200	29,600	410,000	88,400	22	408	85,35
	15:30	90,000	29,200	410,000	89,600	22	408	85,35
	15:45	91,600	29,200	410,000	90,800	22	408	85,35
	16:00	90,800	28,800	410,000	90,400	21,6	408	85,35
	16:15	87,600	29,200	410,000	86,800	21,6	408	85,35
	16:30	91,600	28,800	410,000	90,800	21,6	408	85,35
	16:45	91,600	28,800	410,000	90,800	21,6	408	85,35
	17:00	92,400	28,800	410,000	91,600	21,6	408	85,35
	17:15	96,000	28,800	410,000	95,600	22,4	408	85,35
	17:30	94,000	28,800	410,000	93,200	21,6	408	85,35
	17:45	89,600	29,200	410,000	89,200	21,6	408	85,35
	18:00	90,400	28,800	410,000	90,000	21,6	408	85,35
	18:15	91,200	28,800	410,000	90,000	21,2	408	85,35
	18:30	90,800	28,400	410,000	90,000	21,2	408	85,35
	18:45	92,800	28,400	410,000	92,400	20,8	408	85,35
	19:00	93,200	28,000	410,000	92,400	21,2	408	85,35
	19:15	96,000	28,000	402,000	95,600	21,2	400	85,35
	19:30	94,800	28,000	410,000	94,000	21,6	408	85,35
	19:45	94,000	28,400	410,000	93,600	21,2	408	85,35
	20:00	94,000	28,400	410,000	93,200	21,2	408	85,35
	20:15	92,800	28,400	410,000	92,000	21,6	408	85,35
	20:30	89,600	29,200	410,000	89,200	21,6	408	85,35
	20:45	87,200	28,800	425,000	86,400	20,4	423	85,35
	21:00	91,600	27,200	394,000	91,200	20,4	392	85,35
	21:15	95,200	26,800	410,000	94,400	20,4	408	85,35
	21:30	94,800	27,200	410,000	94,000	20,4	408	85,35
	21:45	93,600	27,600	410,000	93,200	20,4	408	85,35
	22:00	93,600	28,000	410,000	92,800	21,2	408	85,35
	22:15	84,800	28,400	410,000	84,400	20	408	85,35
	22:30	87,200	28,000	410,000	86,400	20,4	408	85,35
	22:45	91,600	28,000	418,000	91,200	20,4	416	85,35
	23:00	89,600	28,000	410,000	89,200	20,4	408	85,35
	23:15	82,400	29,200	410,000	81,600	20,8	408	85,35
	23:30	82,400	30,400	410,000	82,000	21,6	408	85,35
	23:45	82,000	31,200	418,000	81,200	22,4	416	85,35
	0:00	78,400	30,400	410,000	78,000	21,2	408	85,35
25.7.2015.	0:15	58,800	31,200	425,000	58,800	19,6	423	51,63
	0:30	57,600	31,600	410,000	57,200	20	408	51,63
	0:45	57,200	32,000	418,000	56,800	20,4	416	51,63
	1:00	56,800	31,600	410,000	56,800	20,4	408	51,63
	1:15	58,000	31,600	425,000	57,600	19,6	423	51,63
	1:30	56,400	31,200	418,000	56,400	19,6	416	51,63
	1:45	56,000	32,800	410,000	55,600	21,6	408	51,63
	2:00	56,000	34,000	425,000	55,600	22,4	423	51,63
2:15	58,400	34,000	418,000	58,400	22,8	416	51,63	

2:30	58,000	34,400	410,000	57,600	23,2	408	51,63
2:45	57,200	34,400	418,000	56,800	22,8	416	51,63
3:00	58,000	34,400	425,000	58,000	22,8	423	51,63
3:15	59,200	34,400	410,000	58,800	23,2	408	51,63
3:30	58,800	34,000	418,000	58,400	22,8	416	51,63
3:45	55,600	33,600	425,000	55,600	22	423	51,63
4:00	54,400	33,600	410,000	54,000	22	408	51,63
4:15	54,400	33,600	418,000	54,400	22	416	51,63
4:30	55,600	33,600	425,000	54,800	21,6	423	51,63
4:45	56,000	34,400	418,000	56,000	22,4	416	51,63
5:00	56,000	34,000	425,000	56,000	22	423	51,63
5:15	59,200	34,000	418,000	58,800	22,8	416	51,63
5:30	54,800	34,800	418,000	54,800	22,4	416	51,63
5:45	52,800	34,000	425,000	52,400	22	423	51,63
6:00	54,400	34,400	418,000	54,000	22	416	51,63
6:15	56,000	32,800	433,000	56,000	20,8	431	51,63
6:30	52,400	32,800	425,000	52,000	20	423	51,63
6:45	53,600	32,000	418,000	53,200	19,6	416	51,63
7:00	56,000	32,000	425,000	56,000	20	423	51,63
7:15	57,600	30,800	433,000	57,200	18,4	431	51,63
7:30	53,200	30,000	418,000	52,800	18	416	51,63
7:45	54,400	30,000	425,000	54,400	17,6	423	51,63
8:00	52,800	29,600	418,000	52,400	16,8	416	51,63
8:15	56,400	30,000	425,000	56,400	18	423	51,63
8:30	55,200	30,000	418,000	55,200	18	416	51,63
8:45	56,000	30,000	425,000	55,200	17,6	423	51,63
9:00	52,800	30,000	418,000	52,800	17,6	416	51,63
9:15	61,600	29,600	418,000	61,600	18	416	51,63
9:30	60,000	28,800	425,000	59,200	17,2	423	51,63
9:45	57,200	28,400	410,000	57,200	16,8	408	51,63
10:00	58,400	29,200	418,000	58,400	17,2	416	51,63
10:15	63,600	28,800	425,000	63,200	17,6	423	51,63
10:30	63,600	28,800	418,000	63,200	18	416	51,63
10:45	62,400	29,200	410,000	62,000	17,2	408	51,63
11:00	63,200	28,800	425,000	62,800	18	423	51,63
11:15	65,600	28,800	418,000	65,600	17,6	416	51,63
11:30	65,600	28,400	410,000	64,800	17,6	408	51,63
11:45	68,000	28,800	425,000	68,000	18	423	51,63
12:00	68,000	28,800	418,000	67,200	18	416	51,63
12:15	66,000	28,400	410,000	66,000	17,6	408	51,63
12:30	66,400	28,400	418,000	66,000	17,2	416	51,63
12:45	68,000	28,400	425,000	67,600	17,6	423	51,63
13:00	65,200	28,400	410,000	64,800	17,6	408	51,63
13:15	65,600	28,800	418,000	65,200	18	416	51,63
13:30	65,600	29,200	410,000	65,600	18	408	51,63
13:45	67,200	29,200	425,000	66,800	18,4	423	51,63
14:00	66,400	29,200	418,000	66,000	18,4	416	51,63
14:15	65,200	29,600	410,000	64,800	18,8	408	51,63
14:30	66,000	29,600	425,000	65,600	18,4	423	51,63
14:45	69,600	29,600	418,000	69,600	19,2	416	51,63
15:00	66,800	29,600	410,000	66,000	18,4	408	51,63
15:15	65,600	30,000	418,000	65,200	18,8	416	51,63
15:30	66,400	30,000	425,000	66,400	19,2	423	51,63
15:45	66,000	30,400	410,000	65,600	19,6	408	51,63
16:00	67,200	30,800	418,000	66,800	20	416	51,63
16:15	66,000	30,800	425,000	65,600	20	423	51,63
16:30	66,800	31,600	418,000	66,400	20,4	416	51,63
16:45	66,800	31,600	410,000	66,800	20,8	408	51,63
17:00	66,800	31,600	425,000	66,400	20,8	423	51,63
17:15	60,400	31,600	418,000	60,000	19,6	416	51,63
17:30	64,400	30,800	425,000	64,400	20	423	51,63
17:45	63,200	31,200	418,000	62,400	19,6	416	51,63
18:00	62,800	30,800	425,000	62,800	19,2	423	51,63
18:15	61,600	30,800	418,000	61,200	19,2	416	51,63
18:30	63,600	30,400	418,000	63,200	19,2	416	51,63
18:45	62,400	30,400	425,000	62,400	19,2	423	51,63
19:00	64,800	30,400	410,000	64,400	18,8	408	51,63
19:15	62,000	29,600	418,000	61,600	18,4	416	51,63
19:30	61,600	30,000	425,000	61,200	18,4	423	51,63
19:45	59,600	30,400	418,000	59,600	18,4	416	51,63
20:00	62,000	30,400	425,000	61,600	18,8	423	51,63
20:15	58,800	30,000	418,000	58,400	18,4	416	51,63
20:30	62,800	30,000	425,000	62,400	18,4	423	51,63
20:45	60,000	29,200	418,000	60,000	17,6	416	51,63
21:00	61,200	27,600	410,000	60,800	16,4	408	51,63
21:15	68,400	28,000	425,000	68,000	17,2	423	51,63
21:30	60,400	30,400	402,000	60,000	19,2	400	51,63
21:45	58,400	33,200	425,000	58,400	21,6	423	51,63
22:00	60,000	33,600	410,000	59,600	22,8	408	51,63
22:15	57,200	33,600	418,000	56,800	22	416	51,63

	22:30	57,200	33,600	425,000	56,800	22	423	51,63
	22:45	58,800	33,600	410,000	58,800	22,8	408	51,63
	23:00	58,000	34,400	418,000	57,200	22,8	416	51,63
	23:15	55,200	34,800	410,000	55,200	23,2	408	51,63
	23:30	51,600	35,200	425,000	51,600	23,2	423	51,63
	23:45	54,800	36,000	418,000	54,400	24,4	416	51,63
	0:00	52,000	35,200	425,000	51,600	23,6	423	51,63
26.7.2015.	0:15	45,200	35,200	418,000	45,200	22,4	416	41,36
	0:30	44,000	34,800	418,000	44,000	22,4	416	41,36
	0:45	43,600	34,800	425,000	42,800	22	423	41,36
	1:00	44,000	34,400	418,000	44,000	21,6	416	41,36
	1:15	45,200	34,800	425,000	45,200	22,4	423	41,36
	1:30	46,400	34,400	418,000	46,400	21,6	416	41,36
	1:45	48,000	34,400	410,000	47,600	22	408	41,36
	2:00	47,600	34,400	425,000	47,600	22	423	41,36
	2:15	50,000	34,400	418,000	49,600	22,4	416	41,36
	2:30	45,200	34,800	425,000	44,800	22	423	41,36
	2:45	48,400	34,800	418,000	48,800	22,8	416	41,36
	3:00	48,800	35,200	425,000	48,400	22,8	423	41,36
	3:15	48,800	35,200	418,000	48,400	22,4	416	41,36
	3:30	48,400	34,800	425,000	48,000	22,4	423	41,36
	3:45	46,000	35,200	433,000	46,400	22,4	431	41,36
	4:00	46,400	34,800	418,000	46,000	22,4	416	41,36
	4:15	45,600	34,400	418,000	45,200	21,6	416	41,36
	4:30	40,400	34,400	425,000	40,400	21,2	423	41,36
	4:45	41,200	35,200	418,000	41,200	22	416	41,36
	5:00	42,800	34,800	425,000	42,400	22	423	41,36
	5:15	42,000	32,400	433,000	42,000	19,2	431	41,36
	5:30	41,600	31,600	418,000	41,200	18	416	41,36
	5:45	40,000	32,800	433,000	40,000	19,6	431	41,36
	6:00	38,000	32,800	433,000	37,600	18,8	431	41,36
	6:15	39,600	32,800	425,000	39,600	18,8	423	41,36
	6:30	36,400	28,000	433,000	36,000	14,4	431	41,36
	6:45	38,000	26,400	418,000	38,000	12,8	416	41,36
	7:00	37,600	26,000	425,000	37,600	12,4	423	41,36
	7:15	38,400	27,200	418,000	38,000	13,2	416	41,36
	7:30	36,400	26,800	433,000	36,400	13,2	431	41,36
	7:45	33,600	26,000	425,000	33,600	12	423	41,36
	8:00	36,000	25,600	418,000	35,600	12	416	41,36
	8:15	42,400	26,400	425,000	42,800	12,8	423	41,36
	8:30	44,000	26,000	433,000	43,600	12,8	431	41,36
	8:45	39,600	25,200	418,000	39,200	11,6	416	41,36
	9:00	40,000	24,800	418,000	40,000	11,6	416	41,36
	9:15	43,200	25,200	425,000	42,800	11,6	423	41,36
	9:30	43,200	24,400	418,000	43,200	11,2	416	41,36
	9:45	41,600	24,400	425,000	41,600	11,2	423	41,36
	10:00	38,800	23,600	418,000	38,400	10	416	41,36
	10:15	45,200	24,000	425,000	45,600	10,8	423	41,36
	10:30	46,000	23,600	418,000	45,600	10,4	416	41,36
	10:45	47,200	22,000	425,000	46,800	9,2	423	41,36
	11:00	46,400	22,000	418,000	46,800	8,8	416	41,36
	11:15	44,400	21,600	425,000	44,000	8,4	423	41,36
	11:30	47,200	22,000	418,000	46,800	9,2	416	41,36
	11:45	46,800	22,000	410,000	46,800	9,2	408	41,36
	12:00	51,200	22,400	425,000	50,800	9,6	423	41,36
12:15	54,800	22,800	418,000	54,800	10,4	416	41,36	
12:30	52,800	23,200	418,000	52,400	10,8	416	41,36	
12:45	54,400	23,200	425,000	54,400	10,8	423	41,36	
13:00	53,600	22,800	418,000	53,200	10,4	416	41,36	
13:15	52,400	23,200	425,000	52,000	10,4	423	41,36	
13:30	50,000	22,800	418,000	50,000	10,4	416	41,36	
13:45	49,600	23,200	425,000	49,600	10	423	41,36	
14:00	49,600	23,200	410,000	49,600	10,4	408	41,36	
14:15	50,000	23,200	418,000	49,600	10,4	416	41,36	
14:30	47,600	22,800	425,000	47,200	10,4	423	41,36	
14:45	50,800	23,600	418,000	50,400	10,4	416	41,36	
15:00	48,800	23,600	425,000	49,200	10,8	423	41,36	
15:15	51,200	24,000	418,000	50,800	11,2	416	41,36	
15:30	47,600	23,600	425,000	47,600	10,4	423	41,36	
15:45	48,000	23,600	418,000	47,600	10,8	416	41,36	
16:00	47,200	24,000	433,000	47,200	10,8	431	41,36	
16:15	43,200	24,000	418,000	42,800	10,8	416	41,36	
16:30	44,000	24,400	425,000	44,000	10,8	423	41,36	
16:45	44,800	24,000	418,000	44,400	11,2	416	41,36	
17:00	46,000	24,400	425,000	46,000	11,2	423	41,36	
17:15	46,800	24,400	418,000	46,800	11,2	416	41,36	
17:30	47,600	24,400	425,000	47,200	11,2	423	41,36	
17:45	44,000	23,600	418,000	44,000	10,8	416	41,36	
18:00	41,600	24,000	425,000	41,600	10,4	423	41,36	
18:15	43,600	24,000	418,000	43,600	10,8	416	41,36	

	18:30	45,600	24,000	425,000	45,200	10,8	423	41,36
	18:45	45,200	23,600	418,000	45,200	10,8	416	41,36
	19:00	47,600	24,400	425,000	47,200	11,2	423	41,36
	19:15	48,800	23,600	418,000	48,400	10,8	416	41,36
	19:30	46,000	23,600	425,000	46,000	10,8	423	41,36
	19:45	46,000	24,000	418,000	46,000	11,2	416	41,36
	20:00	45,200	24,000	418,000	45,200	10,8	416	41,36
	20:15	46,400	24,400	410,000	46,000	11,2	408	41,36
	20:30	46,000	24,000	425,000	46,000	10,8	423	41,36
	20:45	49,600	23,200	418,000	49,200	10,8	416	41,36
	21:00	50,000	22,800	425,000	50,000	10,4	423	41,36
	21:15	51,600	24,400	410,000	51,600	12	408	41,36
	21:30	50,800	25,600	418,000	50,400	13,2	416	41,36
	21:45	55,200	27,600	425,000	55,200	16	423	41,36
	22:00	53,200	28,000	410,000	53,200	16	408	41,36
	22:15	46,400	28,400	418,000	46,000	16	416	41,36
	22:30	47,600	28,400	410,000	47,200	16	408	41,36
	22:45	54,400	29,200	418,000	54,400	17,2	416	41,36
	23:00	58,400	29,600	425,000	58,000	18	423	41,36
	23:15	52,400	29,200	410,000	52,400	17,2	408	41,36
	23:30	44,000	28,800	418,000	43,600	16	416	41,36
	23:45	49,200	29,600	425,000	49,200	17,2	423	41,36
	0:00	47,600	29,600	410,000	47,600	17,2	408	41,36
27.7.2015.	0:15	64,800	29,600	418,000	64,000	18,4	416	39,21
	0:30	64,800	29,200	425,000	64,800	18,4	423	39,21
	0:45	63,600	29,600	418,000	63,200	18,4	416	39,21
	1:00	64,400	29,600	425,000	64,000	18,4	423	39,21
	1:15	66,000	29,600	410,000	66,000	18,8	408	39,21
	1:30	65,200	29,600	418,000	64,400	18,4	416	39,21
	1:45	66,400	30,000	418,000	66,400	18,8	416	39,21
	2:00	63,600	28,800	425,000	63,200	17,2	423	39,21
	2:15	72,800	27,200	418,000	72,400	16,8	416	39,21
	2:30	69,200	25,600	425,000	68,800	14,4	423	39,21
	2:45	67,600	25,200	418,000	67,200	13,6	416	39,21
	3:00	60,800	24,800	425,000	60,400	12,8	423	39,21
	3:15	66,800	24,400	418,000	66,800	13,2	416	39,21
	3:30	65,200	24,800	433,000	64,800	12,8	431	39,21
	3:45	64,800	24,800	425,000	64,400	13,2	423	39,21
	4:00	66,000	24,000	418,000	65,600	12,4	416	39,21
	4:15	67,200	23,600	425,000	67,200	12	423	39,21
	4:30	69,600	23,200	418,000	69,200	12	416	39,21
	4:45	68,000	23,200	425,000	67,600	12	423	39,21
	5:00	68,400	23,600	433,000	68,000	12	431	39,21
	5:15	64,800	22,800	418,000	64,800	11,2	416	39,21
	5:30	60,800	22,400	425,000	60,800	10	423	39,21
	5:45	59,200	22,000	418,000	58,400	9,6	416	39,21
	6:00	56,400	22,000	433,000	56,400	9,2	431	39,21
	6:15	62,400	21,200	418,000	62,000	9,2	416	39,21
	6:30	60,400	20,800	425,000	60,000	8,4	423	39,21
	6:45	57,200	19,200	418,000	57,200	6,8	416	39,21
	7:00	54,800	19,200	433,000	54,800	6,4	431	39,21
	7:15	56,400	18,800	425,000	56,000	6,4	423	39,21
	7:30	56,800	19,600	418,000	56,400	7,2	416	39,21
	7:45	55,600	20,400	425,000	55,600	7,6	423	39,21
	8:00	56,800	20,000	418,000	56,800	7,6	416	39,21
	8:15	62,400	20,000	410,000	62,000	8,4	408	39,21
	8:30	61,600	20,400	425,000	61,200	8,4	423	39,21
	8:45	61,200	20,800	418,000	61,200	8,8	416	39,21
	9:00	62,800	20,400	425,000	62,400	8,8	423	39,21
	9:15	60,800	21,200	418,000	60,400	9,2	416	39,21
	9:30	60,400	21,200	425,000	60,000	9,2	423	39,21
	9:45	61,600	21,600	402,000	61,200	10	400	39,21
	10:00	59,200	21,600	425,000	59,200	10	423	39,21
	10:15	63,200	22,400	418,000	62,800	10,4	416	39,21
	10:30	63,200	22,000	425,000	62,800	10,4	423	39,21
	10:45	63,200	22,000	410,000	63,200	10,4	408	39,21
	11:00	63,600	21,600	418,000	63,200	10	416	39,21
	11:15	67,200	21,200	425,000	66,800	10	423	39,21
	11:30	64,800	20,800	410,000	64,400	9,6	408	39,21
	11:45	65,200	20,800	418,000	64,800	9,6	416	39,21
	12:00	67,200	20,400	410,000	66,800	9,6	408	39,21
12:15	66,000	20,400	425,000	66,000	9,2	423	39,21	
12:30	64,800	20,400	402,000	64,400	9,2	400	39,21	
12:45	67,600	21,200	425,000	67,200	10	423	39,21	
13:00	63,200	21,200	410,000	63,200	10	408	39,21	
13:15	69,200	21,200	418,000	68,400	10,4	416	39,21	
13:30	67,200	21,200	410,000	67,200	10,4	408	39,21	
13:45	67,200	21,600	425,000	66,800	10,4	423	39,21	
14:00	67,200	21,600	410,000	66,800	10,8	408	39,21	
14:15	71,600	21,200	418,000	71,200	10,8	416	39,21	

	14:30	69,600	21,200	410,000	69,200	10,4	408	39,21
	14:45	69,200	21,600	425,000	68,800	10,8	423	39,21
	15:00	70,400	21,600	402,000	70,400	10,8	400	39,21
	15:15	70,800	22,000	425,000	70,000	11,6	423	39,21
	15:30	71,600	22,000	410,000	71,600	11,6	408	39,21
	15:45	71,600	22,000	418,000	70,800	11,2	416	39,21
	16:00	74,000	21,600	410,000	73,600	11,6	408	39,21
	16:15	66,800	22,400	425,000	66,400	11,2	423	39,21
	16:30	68,000	22,000	418,000	67,600	10,8	416	39,21
	16:45	65,600	22,000	410,000	65,600	11,2	408	39,21
	17:00	66,400	22,400	425,000	66,000	11,2	423	39,21
	17:15	65,600	22,800	418,000	65,200	11,2	416	39,21
	17:30	68,400	22,400	425,000	68,000	11,6	423	39,21
	17:45	67,200	22,400	410,000	66,800	11,2	408	39,21
	18:00	66,400	22,400	418,000	66,000	11,2	416	39,21
	18:15	59,600	21,600	418,000	59,600	9,6	416	39,21
	18:30	60,800	21,600	425,000	60,400	9,6	423	39,21
	18:45	62,800	21,200	410,000	62,800	9,6	408	39,21
	19:00	61,600	20,800	418,000	60,800	9,2	416	39,21
	19:15	54,800	21,600	425,000	54,800	8,8	423	39,21
	19:30	55,600	20,800	418,000	55,200	9,2	416	39,21
	19:45	55,600	21,600	425,000	55,600	8,8	423	39,21
	20:00	54,800	21,200	418,000	54,400	9,2	416	39,21
	20:15	52,400	21,600	410,000	52,000	8,8	408	39,21
	20:30	47,200	21,200	425,000	47,200	8,4	423	39,21
	20:45	50,000	20,800	418,000	50,000	8,4	416	39,21
	21:00	54,400	19,600	410,000	54,000	7,6	408	39,21
	21:15	58,000	19,600	418,000	57,600	7,6	416	39,21
	21:30	60,800	21,600	410,000	60,800	10	408	39,21
	21:45	62,000	26,000	425,000	61,600	14,8	423	39,21
	22:00	59,600	26,000	410,000	59,200	14,4	408	39,21
	22:15	52,000	25,200	418,000	52,000	13,2	416	39,21
	22:30	50,400	24,800	410,000	50,000	12,8	408	39,21
	22:45	56,800	25,600	425,000	56,400	14	423	39,21
	23:00	54,800	26,000	410,000	54,400	14	408	39,21
	23:15	52,000	26,800	418,000	52,400	14,4	416	39,21
	23:30	50,000	26,800	425,000	49,600	14,4	423	39,21
	23:45	49,600	27,200	402,000	49,200	14,8	400	39,21
	0:00	49,200	27,200	425,000	49,200	14,8	423	39,21
28.7.2015.	0:15	53,200	28,000	418,000	53,200	16	416	58,24
	0:30	49,600	27,600	425,000	49,200	15,2	423	58,24
	0:45	50,800	27,600	410,000	50,400	15,2	408	58,24
	1:00	50,800	28,000	418,000	50,800	15,6	416	58,24
	1:15	57,600	27,600	425,000	57,200	16	423	58,24
	1:30	57,600	27,200	418,000	57,600	15,2	416	58,24
	1:45	59,200	27,600	425,000	58,400	16	423	58,24
	2:00	56,400	27,200	410,000	56,400	14,8	408	58,24
	2:15	54,000	26,400	418,000	54,000	14,4	416	58,24
	2:30	51,600	26,400	425,000	51,200	14	423	58,24
	2:45	50,800	26,000	418,000	50,800	13,6	416	58,24
	3:00	50,400	26,000	418,000	50,000	12,8	416	58,24
	3:15	52,800	25,600	425,000	52,400	13,6	423	58,24
	3:30	52,800	26,000	418,000	52,800	13,2	416	58,24
	3:45	52,000	25,600	425,000	52,000	13,2	423	58,24
	4:00	52,400	25,600	418,000	52,000	13,2	416	58,24
	4:15	55,200	25,600	425,000	54,800	13,2	423	58,24
	4:30	52,400	25,200	418,000	52,400	12,8	416	58,24
	4:45	56,400	25,200	425,000	56,000	13,2	423	58,24
	5:00	57,600	25,200	418,000	57,200	12,8	416	58,24
	5:15	65,200	24,800	425,000	64,800	13,6	423	58,24
	5:30	64,800	25,200	410,000	64,800	13,6	408	58,24
	5:45	64,800	25,200	418,000	64,400	14	416	58,24
	6:00	59,600	24,000	433,000	59,200	11,6	431	58,24
	6:15	58,000	22,400	425,000	57,600	10	423	58,24
	6:30	54,000	22,000	418,000	54,000	9,2	416	58,24
	6:45	57,200	21,600	418,000	56,800	9,2	416	58,24
	7:00	54,800	20,800	425,000	54,400	8	423	58,24
	7:15	54,400	20,000	418,000	54,400	7,6	416	58,24
	7:30	57,200	20,000	425,000	56,800	7,6	423	58,24
	7:45	60,400	20,000	418,000	60,000	8,4	416	58,24
	8:00	60,000	20,800	425,000	59,600	8,4	423	58,24
	8:15	60,800	20,800	410,000	60,400	9,2	408	58,24
	8:30	63,200	21,200	418,000	63,200	9,6	416	58,24
	8:45	63,600	20,800	425,000	63,200	9,6	423	58,24
	9:00	62,800	19,600	410,000	62,400	7,6	408	58,24
	9:15	68,400	18,800	418,000	68,400	8	416	58,24
	9:30	65,600	18,400	410,000	65,200	7,2	408	58,24
	9:45	66,400	19,600	418,000	66,000	8,4	416	58,24
	10:00	66,000	19,600	425,000	65,600	8,4	423	58,24
10:15	69,200	20,000	410,000	68,800	9,2	408	58,24	

	10:30	66,000	19,600	418,000	66,000	8,4	416	58,24
	10:45	64,800	19,200	410,000	64,400	8,4	408	58,24
	11:00	66,400	18,800	410,000	66,000	7,6	408	58,24
	11:15	64,800	19,200	425,000	64,400	8	423	58,24
	11:30	66,000	18,800	410,000	65,600	7,6	408	58,24
	11:45	67,600	18,800	418,000	67,200	8	416	58,24
	12:00	65,200	18,800	410,000	65,200	7,6	408	58,24
	12:15	67,200	19,600	425,000	66,400	8,8	423	58,24
	12:30	64,400	20,000	402,000	64,000	8,4	400	58,24
	12:45	66,000	20,000	410,000	66,000	8,8	408	58,24
	13:00	65,600	19,600	425,000	65,200	9,2	423	58,24
	13:15	64,400	20,400	410,000	64,400	8,8	408	58,24
	13:30	67,600	20,000	418,000	67,200	9,2	416	58,24
	13:45	71,200	20,400	410,000	70,800	10	408	58,24
	14:00	68,400	20,400	410,000	68,000	9,6	408	58,24
	14:15	66,800	21,200	425,000	66,400	10	423	58,24
	14:30	68,400	20,800	410,000	68,000	10,4	408	58,24
	14:45	70,000	20,800	418,000	70,000	10	416	58,24
	15:00	69,600	21,600	410,000	68,800	10,8	408	58,24
	15:15	67,600	22,000	418,000	67,200	10,8	416	58,24
	15:30	70,800	22,000	410,000	70,800	11,6	408	58,24
	15:45	69,600	22,000	425,000	69,200	11,6	423	58,24
	16:00	70,400	22,400	410,000	70,000	11,6	408	58,24
	16:15	67,200	22,400	418,000	66,800	11,6	416	58,24
	16:30	67,600	22,400	410,000	67,200	11,2	408	58,24
	16:45	69,600	22,000	425,000	69,200	11,2	423	58,24
	17:00	69,600	21,600	410,000	69,200	10,8	408	58,24
	17:15	66,800	20,800	418,000	66,400	10	416	58,24
	17:30	71,200	21,200	410,000	70,800	10,4	408	58,24
	17:45	68,800	21,200	418,000	68,800	10,8	416	58,24
	18:00	70,400	21,200	410,000	70,000	10	408	58,24
	18:15	57,200	21,200	425,000	56,800	9,2	423	58,24
	18:30	61,600	20,800	418,000	61,200	9,2	416	58,24
	18:45	60,000	20,800	410,000	60,000	8,8	408	58,24
	19:00	61,200	20,800	425,000	60,800	9,6	423	58,24
	19:15	56,800	21,200	418,000	56,400	8,8	416	58,24
	19:30	56,400	21,200	425,000	56,400	9,2	423	58,24
	19:45	52,000	21,600	410,000	51,600	8,8	408	58,24
	20:00	55,600	21,200	418,000	55,600	9,2	416	58,24
	20:15	55,200	21,200	425,000	55,200	9,2	423	58,24
	20:30	55,600	21,200	402,000	55,200	8,8	400	58,24
	20:45	54,000	20,400	425,000	53,600	8,4	423	58,24
	21:00	58,800	19,600	410,000	58,800	7,6	408	58,24
	21:15	55,200	19,600	418,000	54,800	7,6	416	58,24
	21:30	58,000	20,800	410,000	58,000	8,8	408	58,24
	21:45	55,600	21,200	425,000	55,200	9,2	423	58,24
	22:00	54,400	22,800	410,000	54,400	10,8	408	58,24
	22:15	44,800	22,400	418,000	44,400	10	416	58,24
	22:30	50,800	23,600	410,000	50,800	11,2	408	58,24
	22:45	58,400	24,000	425,000	58,000	12,8	423	58,24
	23:00	61,600	24,800	410,000	61,600	13,2	408	58,24
	23:15	52,800	24,800	418,000	52,400	12,8	416	58,24
	23:30	50,400	25,600	410,000	50,000	13,2	408	58,24
	23:45	50,000	26,400	418,000	50,000	14	416	58,24
	0:00	53,600	26,000	410,000	53,600	14	408	58,24
	0:15	55,600	26,400	425,000	55,200	14,8	423	42,45
	0:30	54,400	26,400	418,000	54,000	14	416	42,45
	0:45	38,400	24,800	425,000	38,800	11,6	423	42,45
	1:00	46,000	25,600	410,000	45,200	12,8	408	42,45
	1:15	47,600	25,200	418,000	47,600	12,4	416	42,45
	1:30	46,800	24,400	425,000	46,800	11,6	423	42,45
	1:45	46,400	24,400	418,000	46,000	11,6	416	42,45
	2:00	46,800	24,400	425,000	46,800	11,6	423	42,45
	2:15	42,000	24,000	418,000	42,000	10,8	416	42,45
	2:30	44,400	24,000	418,000	44,000	10,8	416	42,45
	2:45	43,200	24,000	425,000	43,200	10,8	423	42,45
	3:00	44,800	23,600	418,000	44,800	10,4	416	42,45
	3:15	45,200	24,000	425,000	44,800	10,8	423	42,45
	3:30	40,400	25,200	418,000	40,400	12	416	42,45
	3:45	46,800	24,800	425,000	46,800	11,6	423	42,45
	4:00	47,600	24,400	418,000	47,200	11,6	416	42,45
	4:15	54,000	24,800	425,000	54,000	12,4	423	42,45
	4:30	57,600	25,200	418,000	57,200	12,4	416	42,45
	4:45	62,000	24,800	425,000	61,600	13,2	423	42,45
	5:00	65,200	24,400	418,000	64,800	13,2	416	42,45
	5:15	66,000	24,400	425,000	66,000	12,8	423	42,45
	5:30	64,000	24,800	418,000	63,600	13,2	416	42,45
	5:45	63,600	24,800	425,000	63,600	12,8	423	42,45
	6:00	62,000	24,800	418,000	61,600	13,2	416	42,45
	6:15	62,000	24,800	418,000	61,600	12,8	416	42,45
29.7.2015.								

	6:30	60,000	24,400	425,000	59,600	12,8	423	42,45
	6:45	61,200	24,400	418,000	60,800	12,4	416	42,45
	7:00	66,000	24,000	425,000	66,000	12,8	423	42,45
	7:15	71,200	24,000	410,000	70,400	13,2	408	42,45
	7:30	72,000	24,000	418,000	72,000	14	416	42,45
	7:45	71,200	24,000	425,000	70,800	13,2	423	42,45
	8:00	70,800	22,400	410,000	70,400	11,6	408	42,45
	8:15	71,600	22,000	418,000	71,200	12	416	42,45
	8:30	71,600	21,600	410,000	71,200	11,2	408	42,45
	8:45	74,000	20,800	410,000	73,600	10,4	408	42,45
	9:00	75,200	20,800	418,000	74,800	11,2	416	42,45
	9:15	73,600	21,200	410,000	73,200	10,8	408	42,45
	9:30	74,800	21,600	410,000	74,400	11,6	408	42,45
	9:45	70,400	22,000	425,000	70,000	11,6	423	42,45
	10:00	68,000	22,000	410,000	67,600	11,2	408	42,45
	10:15	69,600	22,800	410,000	69,200	12,4	408	42,45
	10:30	67,200	22,800	418,000	67,200	12	416	42,45
	10:45	69,600	22,800	410,000	69,200	12,4	408	42,45
	11:00	70,800	22,800	410,000	70,000	12,4	408	42,45
	11:15	72,400	22,400	418,000	72,000	12	416	42,45
	11:30	74,400	21,200	410,000	74,000	11,6	408	42,45
	11:45	74,400	21,600	410,000	74,400	11,6	408	42,45
	12:00	73,200	21,600	410,000	72,400	11,6	408	42,45
	12:15	75,200	22,000	410,000	74,800	12,4	408	42,45
	12:30	73,600	22,800	410,000	73,200	12,8	408	42,45
	12:45	74,000	22,800	410,000	73,600	12,8	408	42,45
	13:00	72,000	23,200	425,000	71,600	13,2	423	42,45
	13:15	72,400	22,800	410,000	72,000	12,8	408	42,45
	13:30	70,000	22,800	402,000	69,600	12,8	400	42,45
	13:45	68,800	23,200	410,000	68,400	12,4	408	42,45
	14:00	70,800	22,800	410,000	70,400	12,8	408	42,45
	14:15	71,200	23,200	410,000	70,800	12,8	408	42,45
	14:30	70,000	23,200	425,000	69,600	13,2	423	42,45
	14:45	69,600	24,400	410,000	69,200	14	408	42,45
	15:00	68,800	24,400	410,000	68,400	14	408	42,45
	15:15	73,200	24,400	410,000	72,800	14,4	408	42,45
	15:30	70,800	24,400	418,000	70,400	14	416	42,45
	15:45	73,200	24,400	410,000	72,800	14,4	408	42,45
	16:00	72,400	24,400	410,000	72,000	14,8	408	42,45
	16:15	69,600	25,600	418,000	69,600	14,8	416	42,45
	16:30	72,800	24,800	410,000	72,000	14,8	408	42,45
	16:45	71,200	24,800	410,000	70,800	14,4	408	42,45
	17:00	71,200	24,800	425,000	71,200	14,8	423	42,45
	17:15	70,000	25,200	410,000	69,200	14,4	408	42,45
	17:30	66,000	24,400	410,000	66,000	14	408	42,45
	17:45	68,400	25,200	418,000	68,000	14,4	416	42,45
	18:00	67,200	24,800	410,000	66,800	14	408	42,45
	18:15	61,600	24,800	418,000	61,600	13,6	416	42,45
	18:30	66,000	24,400	410,000	65,600	13,6	408	42,45
	18:45	66,800	24,400	425,000	66,400	13,6	423	42,45
	19:00	71,200	24,400	410,000	70,800	13,6	408	42,45
	19:15	67,600	24,000	410,000	66,800	13,6	408	42,45
	19:30	67,600	24,000	418,000	67,600	13,2	416	42,45
	19:45	66,400	24,000	410,000	66,400	13,2	408	42,45
	20:00	65,600	24,000	425,000	65,200	13,2	423	42,45
	20:15	66,800	24,000	410,000	66,000	13,2	408	42,45
	20:30	64,400	24,000	410,000	64,400	12,8	408	42,45
	20:45	63,200	22,800	418,000	62,800	11,6	416	42,45
	21:00	67,600	22,400	410,000	67,200	12	408	42,45
	21:15	65,600	22,400	410,000	65,600	11,6	408	42,45
	21:30	64,000	23,200	410,000	63,600	12	408	42,45
	21:45	69,200	23,200	418,000	68,800	12,8	416	42,45
	22:00	71,200	23,600	410,000	70,800	13,2	408	42,45
	22:15	69,600	24,000	425,000	69,600	14	423	42,45
	22:30	70,400	25,600	410,000	70,000	15,2	408	42,45
	22:45	72,800	26,800	410,000	72,400	16,8	408	42,45
	23:00	72,800	28,400	410,000	72,400	18,8	408	42,45
	23:15	64,400	28,400	418,000	64,000	17,6	416	42,45
	23:30	73,600	29,200	410,000	72,800	19,6	408	42,45
	23:45	72,400	29,200	410,000	72,400	19,2	408	42,45
	0:00	71,200	29,200	418,000	70,800	18,8	416	42,45
30.7.2015.	0:15	64,000	28,400	410,000	63,600	18	408	35,72
	0:30	63,200	28,000	410,000	62,800	17,2	408	35,72
	0:45	55,200	28,000	425,000	54,800	16	423	35,72
	1:00	57,600	28,400	410,000	57,600	16,8	408	35,72
	1:15	55,200	28,400	418,000	54,800	16,8	416	35,72
	1:30	57,200	29,200	410,000	56,800	17,6	408	35,72
	1:45	61,200	29,200	418,000	61,200	18	416	35,72
	2:00	58,800	29,200	425,000	58,400	17,6	423	35,72
2:15	59,600	29,200	410,000	59,600	17,6	408	35,72	

2:30	60,400	28,800	418,000	60,000	17,6	416	35,72
2:45	59,200	28,800	425,000	59,200	16,8	423	35,72
3:00	57,600	28,400	418,000	57,200	16,8	416	35,72
3:15	59,200	28,400	410,000	58,800	17,2	408	35,72
3:30	59,600	28,000	425,000	59,200	16	423	35,72
3:45	60,400	27,200	418,000	60,000	15,6	416	35,72
4:00	58,000	27,200	425,000	58,000	15,2	423	35,72
4:15	55,200	26,800	410,000	54,800	15,2	408	35,72
4:30	54,000	27,200	418,000	53,600	14,8	416	35,72
4:45	57,200	26,800	418,000	57,200	14,8	416	35,72
5:00	56,400	27,200	425,000	56,400	15,2	423	35,72
5:15	53,200	26,400	418,000	52,800	14,4	416	35,72
5:30	55,600	26,400	410,000	55,600	14	408	35,72
5:45	52,400	26,000	425,000	52,000	14	423	35,72
6:00	50,800	26,000	418,000	50,400	13,6	416	35,72
6:15	53,600	25,200	425,000	53,600	12,8	423	35,72
6:30	48,400	26,000	418,000	48,000	12,8	416	35,72
6:45	49,600	23,200	425,000	49,200	10,8	423	35,72
7:00	51,200	22,000	418,000	51,200	9,2	416	35,72
7:15	57,600	21,200	425,000	57,600	8,8	423	35,72
7:30	55,200	20,000	410,000	54,800	7,6	408	35,72
7:45	57,200	19,600	418,000	56,800	7,2	416	35,72
8:00	57,200	19,200	418,000	57,200	7,2	416	35,72
8:15	61,600	19,600	425,000	61,200	8	423	35,72
8:30	59,200	19,200	410,000	58,800	7,2	408	35,72
8:45	58,400	18,800	418,000	58,400	7,2	416	35,72
9:00	57,600	19,200	425,000	57,200	7,2	423	35,72
9:15	64,400	20,000	410,000	64,400	8,4	408	35,72
9:30	66,800	20,000	418,000	66,400	9,2	416	35,72
9:45	64,800	20,800	410,000	64,400	9,2	408	35,72
10:00	64,000	20,800	425,000	63,600	9,2	423	35,72
10:15	70,800	21,200	418,000	70,400	10,8	416	35,72
10:30	71,200	21,200	410,000	71,200	10,4	408	35,72
10:45	72,800	21,200	425,000	72,000	10,8	423	35,72
11:00	68,400	20,800	402,000	68,400	10	400	35,72
11:15	76,400	20,800	425,000	75,600	10,8	423	35,72
11:30	76,400	21,600	410,000	76,000	11,6	408	35,72
11:45	74,400	22,000	418,000	74,000	11,6	416	35,72
12:00	74,400	22,000	410,000	74,400	12,4	408	35,72
12:15	71,600	22,400	425,000	71,200	11,6	423	35,72
12:30	71,600	22,800	410,000	70,800	12,4	408	35,72
12:45	75,200	22,800	418,000	74,800	12,8	416	35,72
13:00	71,200	23,600	410,000	71,200	12,8	408	35,72
13:15	73,600	23,200	425,000	72,800	13,6	423	35,72
13:30	75,200	23,600	402,000	74,800	13,2	400	35,72
13:45	76,400	23,200	425,000	76,000	13,6	423	35,72
14:00	75,200	24,000	410,000	74,800	13,6	408	35,72
14:15	74,400	24,000	418,000	74,000	14	416	35,72
14:30	74,000	24,000	410,000	73,600	14	408	35,72
14:45	72,000	24,400	425,000	71,600	14	423	35,72
15:00	70,000	24,000	410,000	69,600	13,2	408	35,72
15:15	66,000	24,400	418,000	66,000	13,6	416	35,72
15:30	64,000	24,800	425,000	63,200	13,2	423	35,72
15:45	68,400	24,400	410,000	68,400	14	408	35,72
16:00	66,000	24,800	418,000	65,600	13,6	416	35,72
16:15	60,400	24,000	418,000	60,000	12,4	416	35,72
16:30	62,800	24,400	410,000	62,800	12,8	408	35,72
16:45	62,800	24,000	425,000	62,400	12,4	423	35,72
17:00	61,200	24,000	418,000	60,800	12,4	416	35,72
17:15	58,800	24,000	410,000	58,800	12,4	408	35,72
17:30	56,800	24,000	425,000	56,400	11,6	423	35,72
17:45	58,000	23,600	418,000	57,600	12	416	35,72
18:00	57,200	24,000	425,000	57,200	11,6	423	35,72
18:15	53,200	23,600	418,000	53,200	11,2	416	35,72
18:30	53,600	23,200	425,000	52,800	10,8	423	35,72
18:45	56,400	23,200	410,000	56,800	11,2	408	35,72
19:00	55,200	22,800	418,000	54,800	10,4	416	35,72
19:15	54,800	22,400	425,000	54,400	10,4	423	35,72
19:30	52,400	22,800	418,000	52,400	10	416	35,72
19:45	53,200	22,800	418,000	52,800	10,4	416	35,72
20:00	46,400	22,000	425,000	46,400	9,2	423	35,72
20:15	45,200	21,600	410,000	44,800	8,4	408	35,72
20:30	43,600	20,800	418,000	43,600	8	416	35,72
20:45	41,600	19,600	425,000	41,200	6,4	423	35,72
21:00	43,200	19,600	410,000	43,600	6,4	408	35,72
21:15	48,800	20,000	418,000	48,400	7,6	416	35,72
21:30	48,800	21,600	425,000	48,800	8,8	423	35,72
21:45	48,400	22,800	410,000	48,000	10,4	408	35,72
22:00	49,600	23,600	418,000	49,600	10,8	416	35,72
22:15	42,800	24,400	425,000	42,800	11,6	423	35,72

	22:30	46,000	26,000	402,000	45,600	13,2	400	35,72
	22:45	47,600	26,400	425,000	47,600	14,4	423	35,72
	23:00	48,400	27,600	418,000	48,000	14,4	416	35,72
	23:15	40,800	27,200	410,000	40,800	14,8	408	35,72
	23:30	44,000	28,800	425,000	43,600	15,6	423	35,72
	23:45	44,400	28,000	418,000	44,400	15,6	416	35,72
	0:00	44,000	28,000	410,000	43,600	15,2	408	35,72
	0:15	40,800	27,600	425,000	40,800	14,8	423	40,46
	0:30	39,200	28,400	418,000	39,200	15,2	416	40,46
	0:45	42,000	28,400	425,000	42,000	15,6	423	40,46
	1:00	39,600	27,200	418,000	39,200	14	416	40,46
	1:15	42,400	26,400	410,000	42,400	13,2	408	40,46
	1:30	38,800	26,800	418,000	38,800	13,6	416	40,46
	1:45	40,400	26,800	425,000	40,000	13,6	423	40,46
	2:00	40,800	27,600	418,000	40,800	14,4	416	40,46
	2:15	44,000	28,800	425,000	44,000	15,6	423	40,46
	2:30	42,400	28,000	418,000	42,000	14,8	416	40,46
	2:45	40,000	26,400	425,000	40,000	13,2	423	40,46
	3:00	40,800	26,000	433,000	40,800	12,8	431	40,46
	3:15	42,800	26,400	418,000	42,800	12,8	416	40,46
	3:30	41,600	26,000	425,000	41,200	12,4	423	40,46
	3:45	41,600	25,600	418,000	41,600	12	416	40,46
	4:00	41,200	25,200	433,000	40,800	12	431	40,46
	4:15	40,800	25,600	425,000	40,800	12	423	40,46
	4:30	42,400	25,600	418,000	42,400	12	416	40,46
	4:45	43,600	24,800	425,000	43,200	11,6	423	40,46
	5:00	43,600	25,600	433,000	43,600	12	431	40,46
	5:15	45,200	24,800	418,000	45,200	12	416	40,46
	5:30	45,200	25,200	425,000	44,800	11,6	423	40,46
	5:45	43,200	25,200	418,000	43,200	11,6	416	40,46
	6:00	41,600	24,800	433,000	41,200	11,6	431	40,46
	6:15	44,400	24,000	418,000	44,400	10,4	416	40,46
	6:30	42,400	23,600	425,000	42,000	10	423	40,46
	6:45	40,800	22,800	418,000	40,800	9,2	416	40,46
	7:00	41,200	22,000	425,000	41,200	8,8	423	40,46
	7:15	50,000	22,000	418,000	50,000	8,8	416	40,46
	7:30	43,200	21,600	425,000	43,200	8,8	423	40,46
	7:45	44,000	22,000	418,000	43,600	8,8	416	40,46
	8:00	45,200	22,400	425,000	44,800	9,2	423	40,46
	8:15	46,800	22,000	418,000	46,800	9,2	416	40,46
	8:30	50,400	22,800	425,000	50,400	10	423	40,46
	8:45	50,800	22,400	410,000	50,400	10	408	40,46
	9:00	50,400	22,800	418,000	50,400	10	416	40,46
	9:15	48,000	22,400	418,000	47,600	10	416	40,46
	9:30	46,400	22,400	425,000	46,400	9,6	423	40,46
	9:45	47,200	21,600	410,000	46,800	8,8	408	40,46
	10:00	49,600	22,400	418,000	49,200	9,6	416	40,46
	10:15	50,000	22,800	425,000	49,600	10,8	423	40,46
	10:30	48,000	23,200	410,000	47,600	10,4	408	40,46
	10:45	49,600	22,400	418,000	49,200	9,6	416	40,46
	11:00	48,400	22,000	425,000	48,000	9,6	423	40,46
	11:15	48,800	21,600	410,000	48,800	8,8	408	40,46
	11:30	48,400	21,200	418,000	47,600	8,8	416	40,46
	11:45	49,600	21,600	425,000	49,600	8,8	423	40,46
	12:00	49,600	21,600	410,000	49,600	8,8	408	40,46
	12:15	52,800	22,000	418,000	52,800	9,6	416	40,46
	12:30	53,200	22,000	418,000	52,800	10	416	40,46
	12:45	52,800	22,000	410,000	52,400	9,6	408	40,46
	13:00	50,800	22,000	425,000	50,400	9,6	423	40,46
	13:15	50,800	22,000	418,000	50,800	9,6	416	40,46
	13:30	50,800	22,400	410,000	50,400	9,6	408	40,46
	13:45	52,800	22,400	425,000	52,400	10,4	423	40,46
	14:00	51,200	22,400	418,000	51,200	10	416	40,46
	14:15	50,000	22,800	410,000	50,000	9,6	408	40,46
	14:30	49,600	22,400	425,000	49,200	10	423	40,46
	14:45	50,000	22,800	418,000	50,000	10	416	40,46
	15:00	48,800	22,800	425,000	48,400	10,4	423	40,46

31.7.2015.

15:15	46,800	23,200	418,000	46,400	10	416	40,46
15:30	44,800	22,800	418,000	45,200	10	416	40,46
15:45	46,400	23,200	410,000	46,000	10,4	408	40,46
16:00	46,800	23,600	425,000	46,800	10,4	423	40,46
16:15	42,400	22,800	418,000	42,400	10	416	40,46
16:30	42,000	23,200	425,000	41,600	9,6	423	40,46
16:45	44,400	23,200	418,000	44,400	10	416	40,46
17:00	43,600	23,200	425,000	43,200	10	423	40,46
17:15	43,600	23,200	418,000	43,600	10,4	416	40,46
17:30	47,600	23,600	425,000	47,600	10,4	423	40,46
17:45	44,400	23,200	418,000	44,400	10,4	416	40,46
18:00	43,200	23,200	425,000	42,800	10	423	40,46
18:15	42,800	23,600	418,000	42,800	10	416	40,46
18:30	49,600	24,000	425,000	49,200	11,2	423	40,46
18:45	51,200	23,600	402,000	51,200	11,2	400	40,46
19:00	49,200	23,600	425,000	48,800	10,4	423	40,46
19:15	62,800	24,000	418,000	62,400	12,4	416	40,46
19:30	60,800	24,000	425,000	60,400	12,4	423	40,46
19:45	56,800	24,400	418,000	56,800	12	416	40,46
20:00	56,400	24,000	425,000	56,000	11,6	423	40,46
20:15	53,200	24,000	418,000	53,200	11,6	416	40,46
20:30	53,200	24,000	425,000	52,800	11,6	423	40,46
20:45	52,400	22,800	418,000	52,400	10,4	416	40,46
21:00	54,800	21,600	410,000	54,800	9,6	408	40,46
21:15	55,600	24,000	425,000	55,200	12	423	40,46
21:30	59,200	26,800	410,000	58,800	15,2	408	40,46
21:45	58,800	27,200	418,000	58,400	16	416	40,46
22:00	58,800	28,000	410,000	58,800	16,4	408	40,46
22:15	55,600	27,200	418,000	55,200	15,6	416	40,46
22:30	64,800	27,600	410,000	64,800	16,8	408	40,46
22:45	65,200	28,000	425,000	64,800	16,8	423	40,46
23:00	68,000	28,800	410,000	67,200	18	408	40,46
23:15	67,600	28,400	418,000	67,600	18	416	40,46
23:30	63,600	28,400	425,000	63,200	17,2	423	40,46
23:45	67,200	28,400	410,000	66,800	17,6	408	40,46
0:00	63,600	28,000	418,000	63,200	16,8	416	40,46

Tablica P.14. Rezultati proračuna razmijenjene energije za cijeli mjesec srpanj 2015.

Datum	Vrijeme	Energija virtualne mjerne točke [MWh]	Ispravljena energija virtualne mjerne točke [MWh]	Ispravak energije [kWh]	Iznos ispravka [EUR]
1.7.2015.	0:15	39,200	39,210	9,66	0,39
	0:30	36,400	36,414	13,75	0,55
	0:45	35,600	35,616	16,21	0,65
	1:00	33,781	33,797	16,27	0,65
	1:15	42,000	42,017	16,72	0,67
	1:30	44,581	44,600	19,34	0,77
	1:45	43,200	43,209	9,46	0,38
	2:00	46,400	46,422	22,11	0,88
	2:15	52,800	52,821	20,74	0,83
	2:30	54,581	54,605	23,72	0,95
	2:45	53,381	53,409	27,46	1,10
	3:00	51,600	51,611	10,60	0,42
	3:15	57,381	57,400	18,90	0,76
	3:30	57,200	57,213	12,75	0,51
	3:45	58,581	58,599	17,49	0,70
	4:00	61,600	61,616	15,60	0,62
	4:15	60,581	60,594	12,41	0,50
	4:30	62,181	62,199	17,61	0,70
	4:45	65,381	65,394	12,94	0,52
	5:00	73,381	73,403	21,79	0,87
	5:15	60,800	60,819	19,27	0,77
	5:30	63,381	63,402	21,28	0,85
	5:45	62,581	62,608	27,09	1,08
	6:00	61,200	61,219	19,22	0,77
	6:15	79,381	79,397	15,66	0,63
	6:30	71,162	71,186	23,47	0,94
	6:45	68,981	69,006	25,18	1,01
	7:00	81,381	81,391	9,77	0,39
	7:15	87,781	87,795	13,67	0,55
	7:30	84,362	84,374	11,29	0,45
	7:45	79,381	79,408	26,58	1,06
	8:00	87,781	87,806	25,20	1,01
	8:15	111,162	111,177	14,35	0,57
	8:30	112,943	112,962	18,96	0,76
	8:45	110,143	110,170	27,09	1,08
	9:00	115,162	115,185	23,21	0,93
	9:15	107,962	107,983	20,58	0,82
	9:30	98,762	98,774	11,96	0,48
	9:45	101,562	101,579	16,73	0,67
	10:00	103,962	103,982	19,91	0,80
	10:15	108,143	108,170	27,10	1,08
	10:30	107,962	107,977	15,03	0,60
	10:45	110,143	110,175	31,20	1,25
	11:00	113,562	113,589	26,87	1,07
	11:15	110,762	110,781	18,69	0,75
	11:30	110,143	110,170	27,09	1,08
	11:45	109,962	109,981	18,41	0,74
	12:00	111,162	111,175	12,49	0,50
12:15	103,162	103,177	14,78	0,59	
12:30	103,743	103,761	17,47	0,70	
12:45	109,562	109,589	26,98	1,08	
13:00	112,362	112,377	14,24	0,57	
13:15	114,943	114,974	30,81	1,23	
13:30	107,343	107,365	21,94	0,88	
13:45	112,362	112,380	17,27	0,69	
14:00	104,362	104,388	25,82	1,03	
14:15	111,162	111,176	13,63	0,54	
14:30	119,743	119,766	22,39	0,90	
14:45	123,925	123,945	20,39	0,81	
15:00	129,743	129,771	27,23	1,09	

	15:15	126,543	126,563	19,62	0,78
	15:30	125,343	125,370	26,99	1,08
	15:45	127,525	127,552	27,84	1,11
	16:00	119,743	119,771	27,61	1,10
	16:15	114,362	114,385	22,64	0,90
	16:30	117,343	117,367	23,99	0,96
	16:45	124,143	124,171	27,72	1,11
	17:00	121,162	121,190	28,00	1,12
	17:15	117,743	117,764	20,61	0,82
	17:30	120,543	120,561	17,23	0,69
	17:45	125,743	125,758	14,24	0,57
	18:00	120,143	120,171	28,08	1,12
	18:15	124,143	124,162	18,11	0,72
	18:30	130,943	130,960	16,52	0,66
	18:45	130,943	130,967	23,49	0,94
	19:00	123,743	123,761	17,39	0,70
	19:15	118,543	118,557	13,31	0,53
	19:30	120,543	120,567	23,79	0,95
	19:45	115,743	115,769	25,49	1,02
	20:00	108,181	108,203	22,04	0,88
	20:15	77,781	77,794	12,53	0,50
	20:30	69,962	69,971	8,26	0,33
	20:45	72,981	73,009	27,84	1,11
	21:00	65,600	65,621	21,35	0,85
	21:15	64,581	64,606	24,41	0,98
	21:30	67,781	67,809	27,83	1,11
	21:45	70,981	71,004	22,78	0,91
	22:00	63,600	63,606	6,14	0,25
	22:15	55,781	55,793	11,95	0,48
	22:30	57,781	57,789	8,11	0,32
	22:45	59,781	59,806	25,14	1,00
	23:00	53,600	53,611	11,21	0,45
	23:15	44,981	45,003	21,55	0,86
	23:30	43,200	43,209	9,02	0,36
	23:45	48,800	48,822	21,56	0,86
	0:00	46,581	46,591	9,47	0,38
2.7.2015.	0:15	60,800	60,818	18,36	0,72
	0:30	54,762	54,787	25,18	0,99
	0:45	55,419	55,434	15,24	0,60
	1:00	50,362	50,375	12,24	0,48
	1:15	62,000	62,028	28,32	1,11
	1:30	62,000	62,028	27,76	1,09
	1:45	62,981	62,994	13,02	0,51
	2:00	55,381	55,396	14,72	0,58
	2:15	56,581	56,592	11,19	0,44
	2:30	51,600	51,622	22,13	0,87
	2:45	58,400	58,414	13,80	0,54
	3:00	58,181	58,196	14,58	0,57
	3:15	66,181	66,199	18,31	0,72
	3:30	64,000	64,027	27,17	1,07
	3:45	62,981	63,004	22,40	0,88
	4:00	59,781	59,794	13,06	0,51
	4:15	64,181	64,204	23,12	0,91
	4:30	65,381	65,403	21,86	0,86
	4:45	70,981	70,998	16,98	0,67
	5:00	72,981	72,994	13,23	0,52
	5:15	67,200	67,230	29,58	1,16
	5:30	74,181	74,197	15,63	0,61
	5:45	72,581	72,600	18,77	0,74
	6:00	66,762	66,789	26,98	1,06
	6:15	88,181	88,197	15,59	0,61
	6:30	84,400	84,411	10,98	0,43
6:45	81,162	81,186	23,69	0,93	

7:00	78,762	78,773	11,10	0,44
7:15	79,200	79,220	20,25	0,80
7:30	83,162	83,185	22,60	0,89
7:45	82,181	82,207	26,23	1,03
8:00	80,981	81,003	22,21	0,87
8:15	101,343	101,375	31,60	1,24
8:30	98,581	98,610	28,68	1,13
8:45	98,362	98,382	19,49	0,77
9:00	96,362	96,383	20,75	0,82
9:15	96,981	97,007	25,50	1,00
9:30	96,762	96,782	19,90	0,78
9:45	94,362	94,390	27,30	1,07
10:00	95,962	95,991	28,55	1,12
10:15	97,562	97,574	12,13	0,48
10:30	97,962	97,983	20,67	0,81
10:45	98,762	98,783	21,22	0,83
11:00	107,562	107,585	22,94	0,90
11:15	111,743	111,762	18,71	0,74
11:30	107,962	107,982	20,22	0,80
11:45	108,362	108,389	27,17	1,07
12:00	108,762	108,781	18,29	0,72
12:15	103,343	103,376	32,20	1,27
12:30	100,362	100,387	24,48	0,96
12:45	99,381	99,399	17,89	0,70
13:00	97,562	97,592	30,01	1,18
13:15	109,743	109,757	13,31	0,52
13:30	102,543	102,559	16,09	0,63
13:45	107,381	107,399	17,73	0,70
14:00	103,162	103,190	27,43	1,08
14:15	109,743	109,763	19,33	0,76
14:30	110,543	110,560	16,42	0,65
14:45	112,362	112,385	23,01	0,90
15:00	111,343	111,361	17,95	0,71
15:15	130,362	130,371	8,64	0,34
15:30	112,325	112,342	17,38	0,68
15:45	121,962	121,973	10,82	0,43
16:00	167,087	167,100	13,44	0,53
16:15	176,687	176,702	15,63	0,61
16:30	172,287	172,301	14,49	0,57
16:45	162,906	162,935	29,76	1,17
17:00	163,487	163,510	23,26	0,91
17:15	153,306	153,331	25,02	0,98
17:30	168,906	168,915	9,65	0,38
17:45	167,487	167,502	15,03	0,59
18:00	163,887	163,897	9,90	0,39
18:15	162,725	162,750	25,61	1,01
18:30	168,687	168,714	27,15	1,07
18:45	141,125	141,152	27,41	1,08
19:00	115,562	115,571	8,44	0,33
19:15	117,743	117,767	23,71	0,93
19:30	116,943	116,955	11,72	0,46
19:45	115,162	115,182	19,58	0,77
20:00	113,162	113,178	15,26	0,60
20:15	106,943	106,956	12,28	0,48
20:30	88,362	88,371	8,71	0,34
20:45	97,781	97,811	29,38	1,16
21:00	84,362	84,386	23,66	0,93
21:15	86,581	86,598	17,17	0,68
21:30	81,381	81,394	13,30	0,52
21:45	86,181	86,196	14,55	0,57
22:00	85,962	85,989	27,01	1,06
22:15	70,400	70,415	15,26	0,60
22:30	79,562	79,579	16,45	0,65

	22:45	81,381	81,404	23,22	0,91
	23:00	80,181	80,193	11,96	0,47
	23:15	69,781	69,796	14,43	0,57
	23:30	66,981	66,993	11,56	0,45
	23:45	72,181	72,210	28,77	1,13
	0:00	68,981	68,991	9,74	0,38
3.7.2015.	0:15	65,381	65,406	24,56	1,14
	0:30	60,000	60,023	23,22	1,08
	0:45	63,781	63,807	26,24	1,22
	1:00	59,381	59,404	22,58	1,05
	1:15	70,181	70,202	20,97	0,97
	1:30	66,981	67,008	26,62	1,23
	1:45	65,600	65,617	16,53	0,77
	2:00	58,362	58,392	29,98	1,39
	2:15	64,000	64,024	23,51	1,09
	2:30	62,581	62,601	20,06	0,93
	2:45	63,600	63,620	20,27	0,94
	3:00	65,381	65,406	25,36	1,17
	3:15	75,781	75,795	13,87	0,64
	3:30	68,581	68,604	22,96	1,06
	3:45	67,781	67,805	24,25	1,12
	4:00	68,800	68,822	21,60	1,00
	4:15	79,162	79,191	28,31	1,31
	4:30	80,181	80,194	12,73	0,59
	4:45	82,181	82,192	10,58	0,49
	5:00	88,362	88,380	17,71	0,82
	5:15	80,981	81,010	29,04	1,35
	5:30	77,962	77,982	20,05	0,93
	5:45	79,200	79,226	25,83	1,20
	6:00	85,781	85,810	28,82	1,34
	6:15	82,362	82,387	25,04	1,16
	6:30	89,562	89,582	20,05	0,93
	6:45	94,181	94,210	29,35	1,36
	7:00	116,943	116,953	9,92	0,46
	7:15	132,943	132,973	29,87	1,38
	7:30	137,743	137,760	16,19	0,75
	7:45	131,343	131,358	14,31	0,66
	8:00	126,725	126,751	26,20	1,21
	8:15	130,943	130,971	27,55	1,28
	8:30	136,143	136,156	12,41	0,58
	8:45	142,106	142,121	15,58	0,72
	9:00	142,325	142,356	31,61	1,46
	9:15	131,743	131,760	16,63	0,77
	9:30	131,343	131,368	24,90	1,15
	9:45	126,943	126,957	14,02	0,65
	10:00	124,943	124,955	11,94	0,55
10:15	139,706	139,736	30,63	1,42	
10:30	133,962	133,990	27,98	1,30	
10:45	132,325	132,339	14,10	0,65	
11:00	138,325	138,346	21,61	1,00	
11:15	141,925	141,957	32,27	1,50	
11:30	144,725	144,744	19,62	0,91	
11:45	145,343	145,370	26,26	1,22	
12:00	146,506	146,521	14,98	0,69	
12:15	137,925	137,952	27,72	1,28	
12:30	140,725	140,742	17,57	0,81	
12:45	150,725	150,745	20,06	0,93	
13:00	141,306	141,330	23,86	1,11	
13:15	156,906	156,932	26,71	1,24	
13:30	151,925	151,943	18,01	0,83	
13:45	155,706	155,713	7,28	0,34	
14:00	153,306	153,331	25,38	1,18	
14:15	143,743	143,774	30,92	1,43	

	14:30	141,125	141,142	17,75	0,82
	14:45	135,125	135,150	25,68	1,19
	15:00	142,725	142,733	8,67	0,40
	15:15	135,343	135,363	19,46	0,90
	15:30	137,525	137,534	9,70	0,45
	15:45	135,125	135,144	19,39	0,90
	16:00	134,943	134,962	19,01	0,88
	16:15	121,743	121,767	23,35	1,08
	16:30	127,743	127,752	8,23	0,38
	16:45	126,543	126,565	21,33	0,99
	17:00	127,925	127,950	25,26	1,17
	17:15	128,543	128,568	24,31	1,13
	17:30	126,943	126,953	9,26	0,43
	17:45	124,943	124,959	15,26	0,71
	18:00	129,343	129,373	29,64	1,37
	18:15	135,343	135,349	5,36	0,25
	18:30	144,906	144,930	24,73	1,15
	18:45	147,925	147,933	8,66	0,40
	19:00	152,325	152,347	22,48	1,04
	19:15	149,306	149,335	29,62	1,37
	19:30	114,943	114,960	16,21	0,75
	19:45	114,362	114,388	25,63	1,19
	20:00	112,543	112,571	27,24	1,26
	20:15	107,962	107,982	19,41	0,90
	20:30	101,562	101,590	27,62	1,28
	20:45	102,981	103,007	26,22	1,21
	21:00	102,543	102,572	28,27	1,31
	21:15	95,962	95,983	20,97	0,97
	21:30	100,981	100,990	8,69	0,40
	21:45	104,543	104,561	18,00	0,83
	22:00	106,762	106,774	11,90	0,55
	22:15	90,581	90,610	28,84	1,34
	22:30	89,162	89,188	26,18	1,21
	22:45	96,362	96,384	21,59	1,00
	23:00	93,381	93,394	13,06	0,60
	23:15	73,962	73,967	5,20	0,24
	23:30	65,600	65,616	15,55	0,72
	23:45	70,181	70,206	24,68	1,14
	0:00	69,381	69,397	15,73	0,73
4.7.2015.	0:15	68,400	68,410	10,14	0,40
	0:30	73,962	73,972	9,71	0,38
	0:45	60,000	60,022	22,22	0,87
	1:00	58,581	58,605	23,50	0,92
	1:15	55,781	55,784	3,05	0,12
	1:30	62,581	62,609	27,85	1,09
	1:45	70,581	70,600	18,82	0,74
	2:00	68,181	68,205	24,19	0,95
	2:15	64,981	64,996	14,47	0,57
	2:30	57,200	57,215	14,83	0,58
	2:45	60,400	60,404	3,97	0,16
	3:00	64,762	64,781	18,36	0,72
	3:15	74,581	74,612	31,28	1,23
	3:30	67,381	67,401	20,18	0,79
	3:45	68,181	68,188	6,83	0,27
	4:00	66,800	66,826	26,43	1,04
	4:15	74,581	74,607	25,97	1,02
	4:30	70,981	71,001	19,63	0,77
	4:45	69,781	69,804	22,66	0,89
	5:00	78,362	78,367	4,87	0,19
	5:15	93,781	93,811	29,68	1,16
	5:30	78,581	78,596	14,50	0,57
	5:45	75,781	75,793	12,09	0,47
	6:00	77,162	77,183	21,18	0,83

6:15	88,981	88,988	6,73	0,26
6:30	81,962	81,975	12,66	0,50
6:45	99,562	99,589	26,39	1,04
7:00	109,162	109,188	25,46	1,00
7:15	96,362	96,389	26,28	1,03
7:30	86,981	87,003	22,06	0,87
7:45	83,962	83,971	8,31	0,33
8:00	93,162	93,187	25,13	0,99
8:15	93,600	93,627	27,38	1,07
8:30	94,762	94,787	24,91	0,98
8:45	86,362	86,374	11,88	0,47
9:00	79,562	79,574	11,69	0,46
9:15	86,981	87,013	32,04	1,26
9:30	88,762	88,790	27,88	1,09
9:45	83,781	83,806	25,09	0,98
10:00	85,562	85,580	17,62	0,69
10:15	86,181	86,213	32,04	1,26
10:30	86,362	86,378	16,11	0,63
10:45	84,581	84,605	24,08	0,94
11:00	82,581	82,607	26,35	1,03
11:15	87,162	87,178	15,25	0,60
11:30	83,781	83,801	19,85	0,78
11:45	89,162	89,182	20,00	0,78
12:00	86,581	86,590	8,57	0,34
12:15	77,962	77,984	22,22	0,87
12:30	74,000	74,027	26,70	1,05
12:45	70,181	70,208	26,80	1,05
13:00	71,781	71,804	22,43	0,88
13:15	78,362	78,376	13,42	0,53
13:30	80,981	80,996	14,56	0,57
13:45	85,381	85,403	22,04	0,86
14:00	83,562	83,587	25,03	0,98
14:15	80,181	80,204	22,95	0,90
14:30	71,381	71,398	16,83	0,66
14:45	74,581	74,592	11,15	0,44
15:00	75,562	75,576	13,25	0,52
15:15	73,200	73,219	18,51	0,73
15:30	77,162	77,185	22,33	0,88
15:45	77,381	77,412	30,86	1,21
16:00	75,781	75,794	13,31	0,52
16:15	75,600	75,632	31,92	1,25
16:30	74,581	74,595	14,20	0,56
16:45	75,962	75,988	26,03	1,02
17:00	74,981	75,000	18,58	0,73
17:15	66,981	66,992	10,92	0,43
17:30	72,981	73,010	28,77	1,13
17:45	73,781	73,806	24,86	0,98
18:00	75,962	75,975	12,41	0,49
18:15	72,000	72,010	9,86	0,39
18:30	76,981	76,988	6,84	0,27
18:45	81,962	81,977	15,03	0,59
19:00	80,181	80,191	9,55	0,37
19:15	74,981	75,008	27,34	1,07
19:30	81,781	81,801	19,91	0,78
19:45	57,781	57,811	29,80	1,17
20:00	57,600	57,620	20,35	0,80
20:15	58,400	58,409	9,32	0,37
20:30	54,181	54,192	10,38	0,41
20:45	57,381	57,391	9,74	0,38
21:00	52,181	52,206	25,13	0,99
21:15	54,800	54,820	20,17	0,79
21:30	66,981	67,004	23,23	0,91
21:45	63,781	63,806	25,02	0,98

	22:00	61,600	61,611	11,34	0,44
	22:15	56,181	56,197	16,11	0,63
	22:30	63,381	63,407	25,64	1,01
	22:45	66,400	66,407	6,61	0,26
	23:00	66,362	66,380	17,47	0,69
	23:15	55,600	55,611	11,07	0,43
	23:30	54,400	54,426	26,25	1,03
	23:45	56,981	57,007	25,91	1,02
	0:00	55,381	55,398	17,05	0,67
5.7.2015.	0:15	54,181	54,195	14,13	0,51
	0:30	53,419	53,430	11,05	0,40
	0:45	56,362	56,370	8,12	0,29
	1:00	52,800	52,823	22,87	0,83
	1:15	55,381	55,413	31,41	1,14
	1:30	44,800	44,806	6,17	0,22
	1:45	46,181	46,202	20,46	0,74
	2:00	45,200	45,207	6,60	0,24
	2:15	50,581	50,600	18,53	0,67
	2:30	50,400	50,420	20,03	0,72
	2:45	50,400	50,420	19,77	0,71
	3:00	50,981	50,991	9,37	0,34
	3:15	50,000	50,014	13,57	0,49
	3:30	44,400	44,416	15,66	0,57
	3:45	45,162	45,181	18,85	0,68
	4:00	46,400	46,419	19,48	0,70
	4:15	53,781	53,802	20,82	0,75
	4:30	53,200	53,209	9,43	0,34
	4:45	60,400	60,418	17,69	0,64
	5:00	54,581	54,604	23,30	0,84
	5:15	58,981	59,000	18,71	0,68
	5:30	53,781	53,797	16,14	0,58
	5:45	52,800	52,828	28,17	1,02
	6:00	56,181	56,199	17,88	0,65
	6:15	58,000	58,022	22,24	0,80
	6:30	58,581	58,598	16,51	0,60
	6:45	58,581	58,596	14,61	0,53
	7:00	70,800	70,817	17,39	0,63
	7:15	67,381	67,409	27,62	1,00
	7:30	66,181	66,206	24,59	0,89
	7:45	58,000	58,022	21,88	0,79
	8:00	56,181	56,201	19,57	0,71
	8:15	53,200	53,217	16,61	0,60
	8:30	47,781	47,800	19,30	0,70
	8:45	49,781	49,804	23,24	0,84
	9:00	47,600	47,615	15,36	0,55
	9:15	53,600	53,628	28,28	1,02
	9:30	57,781	57,790	8,80	0,32
	9:45	54,800	54,822	22,13	0,80
	10:00	54,181	54,193	11,96	0,43
10:15	60,981	61,002	20,39	0,74	
10:30	55,600	55,627	27,47	0,99	
10:45	56,581	56,602	21,27	0,77	
11:00	58,181	58,195	13,66	0,49	
11:15	61,600	61,628	28,21	1,02	
11:30	64,581	64,600	19,35	0,70	
11:45	58,362	58,371	9,19	0,33	
12:00	59,600	59,622	22,32	0,81	
12:15	63,381	63,405	23,96	0,87	
12:30	63,600	63,626	25,97	0,94	
12:45	62,181	62,191	9,90	0,36	
13:00	62,181	62,200	18,52	0,67	
13:15	59,600	59,611	10,61	0,38	
13:30	60,181	60,193	11,50	0,42	

	13:45	66,981	66,988	7,07	0,26
	14:00	63,200	63,210	10,27	0,37
	14:15	73,562	73,583	20,42	0,74
	14:30	70,400	70,424	24,12	0,87
	14:45	63,562	63,584	21,43	0,77
	15:00	65,600	65,614	13,93	0,50
	15:15	59,781	59,797	15,94	0,58
	15:30	53,381	53,401	19,87	0,72
	15:45	52,800	52,806	5,67	0,21
	16:00	53,781	53,804	23,34	0,84
	16:15	57,381	57,392	10,99	0,40
	16:30	52,400	52,418	18,27	0,66
	16:45	53,600	53,626	26,37	0,95
	17:00	51,781	51,806	24,84	0,90
	17:15	41,600	41,612	11,81	0,43
	17:30	42,400	42,423	23,40	0,85
	17:45	42,981	42,993	11,90	0,43
	18:00	47,600	47,613	13,37	0,48
	18:15	49,200	49,218	18,21	0,66
	18:30	48,362	48,370	8,14	0,29
	18:45	47,200	47,211	11,22	0,41
	19:00	53,781	53,790	8,58	0,31
	19:15	53,200	53,222	22,29	0,81
	19:30	61,200	61,227	27,16	0,98
	19:45	61,781	61,793	11,41	0,41
	20:00	58,181	58,206	24,65	0,89
	20:15	38,800	38,822	22,41	0,81
	20:30	42,400	42,420	19,84	0,72
	20:45	43,381	43,398	17,25	0,62
	21:00	36,400	36,408	8,34	0,30
	21:15	39,600	39,610	10,22	0,37
	21:30	50,000	50,024	24,12	0,87
	21:45	50,981	50,998	16,42	0,59
	22:00	48,400	48,407	7,33	0,26
	22:15	40,400	40,423	22,68	0,82
	22:30	44,981	44,994	12,76	0,46
	22:45	50,981	50,990	9,27	0,33
	23:00	50,400	50,417	17,45	0,63
	23:15	56,800	56,821	21,21	0,77
	23:30	53,781	53,790	8,96	0,32
	23:45	52,581	52,604	22,55	0,81
	0:00	52,000	52,008	8,48	0,31
6.7.2015.	0:15	52,981	53,004	23,25	1,17
	0:30	49,200	49,214	14,46	0,73
	0:45	44,181	44,190	9,32	0,47
	1:00	46,619	46,644	24,65	1,24
	1:15	54,981	55,004	23,15	1,16
	1:30	52,181	52,199	17,85	0,90
	1:45	60,400	60,430	30,27	1,52
	2:00	53,381	53,406	24,41	1,23
	2:15	54,581	54,605	23,65	1,19
	2:30	47,600	47,616	15,72	0,79
	2:45	50,400	50,421	21,28	1,07
	3:00	49,381	49,394	12,81	0,64
	3:15	57,200	57,213	13,19	0,66
	3:30	52,581	52,598	16,50	0,83
	3:45	53,781	53,804	22,71	1,14
	4:00	53,781	53,790	8,65	0,43
	4:15	56,400	56,418	17,94	0,90
	4:30	54,000	54,014	14,21	0,71
4:45	54,981	55,004	22,86	1,15	
5:00	58,581	58,608	26,72	1,34	
5:15	60,000	60,023	22,54	1,13	

5:30	56,581	56,598	17,12	0,86
5:45	49,781	49,800	18,50	0,93
6:00	50,400	50,412	12,21	0,61
6:15	65,381	65,402	20,49	1,03
6:30	64,981	65,007	25,52	1,28
6:45	70,000	70,025	25,37	1,27
7:00	81,781	81,807	25,37	1,27
7:15	95,562	95,579	16,92	0,85
7:30	96,943	96,970	26,72	1,34
7:45	100,581	100,596	14,76	0,74
8:00	97,562	97,590	28,21	1,42
8:15	100,762	100,788	25,98	1,30
8:30	100,762	100,778	15,63	0,78
8:45	91,562	91,579	16,24	0,82
9:00	100,762	100,771	9,16	0,46
9:15	109,562	109,579	16,53	0,83
9:30	107,162	107,177	14,80	0,74
9:45	103,562	103,585	22,82	1,15
10:00	105,562	105,581	18,59	0,93
10:15	107,343	107,358	14,67	0,74
10:30	105,962	105,989	26,33	1,32
10:45	102,762	102,789	26,74	1,34
11:00	107,743	107,772	28,94	1,45
11:15	107,962	107,995	32,50	1,63
11:30	108,943	108,953	10,05	0,50
11:45	111,962	111,977	15,22	0,76
12:00	112,143	112,168	24,79	1,25
12:15	113,162	113,174	11,89	0,60
12:30	113,343	113,358	14,15	0,71
12:45	114,143	114,147	3,35	0,17
13:00	114,362	114,390	28,15	1,41
13:15	124,943	124,958	15,02	0,75
13:30	123,125	123,158	33,65	1,69
13:45	126,143	126,156	12,85	0,65
14:00	127,125	127,134	9,03	0,45
14:15	103,162	103,191	28,86	1,45
14:30	98,362	98,386	23,87	1,20
14:45	95,962	95,973	10,80	0,54
15:00	96,181	96,195	13,72	0,69
15:15	97,743	97,760	16,46	0,83
15:30	97,562	97,575	12,40	0,62
15:45	99,962	99,990	27,29	1,37
16:00	99,562	99,585	22,93	1,15
16:15	99,962	99,986	23,38	1,17
16:30	102,943	102,949	5,62	0,28
16:45	103,781	103,797	15,46	0,78
17:00	98,943	98,953	9,22	0,46
17:15	97,962	97,977	14,90	0,75
17:30	96,362	96,378	15,96	0,80
17:45	98,181	98,196	14,59	0,73
18:00	100,762	100,773	11,09	0,56
18:15	93,743	93,757	13,16	0,66
18:30	94,181	94,214	33,22	1,67
18:45	94,181	94,212	30,60	1,54
19:00	91,962	91,989	26,85	1,35
19:15	95,962	95,973	10,95	0,55
19:30	94,362	94,373	10,54	0,53
19:45	92,762	92,777	14,37	0,72
20:00	91,381	91,403	21,86	1,10
20:15	87,562	87,584	21,44	1,08
20:30	83,200	83,210	9,87	0,50
20:45	85,343	85,362	18,89	0,95
21:00	80,181	80,196	14,59	0,73

	21:15	74,181	74,200	18,90	0,95
	21:30	78,981	78,997	15,72	0,79
	21:45	75,381	75,398	17,18	0,86
	22:00	76,581	76,585	3,65	0,18
	22:15	64,762	64,771	9,20	0,46
	22:30	75,200	75,210	10,18	0,51
	22:45	78,981	78,989	7,82	0,39
	23:00	79,381	79,408	26,54	1,33
	23:15	64,181	64,192	11,13	0,56
	23:30	53,781	53,795	14,06	0,71
	23:45	62,181	62,190	9,06	0,46
	0:00	57,600	57,627	26,86	1,35
7.7.2015.	0:15	51,381	51,392	11,24	0,77
	0:30	52,400	52,410	10,04	0,69
	0:45	50,581	50,597	16,29	1,12
	1:00	50,800	50,812	11,98	0,82
	1:15	59,781	59,808	27,10	1,86
	1:30	54,581	54,594	13,22	0,91
	1:45	45,600	45,619	19,39	1,33
	2:00	48,981	48,986	4,83	0,33
	2:15	55,600	55,628	28,07	1,93
	2:30	48,581	48,584	3,00	0,21
	2:45	51,600	51,612	12,24	0,84
	3:00	46,000	46,010	9,76	0,67
	3:15	49,381	49,402	21,15	1,45
	3:30	51,381	51,396	14,71	1,01
	3:45	56,581	56,596	14,70	1,01
	4:00	56,400	56,411	10,94	0,75
	4:15	52,581	52,595	13,87	0,95
	4:30	55,600	55,617	17,12	1,18
	4:45	55,781	55,801	19,82	1,36
	5:00	56,181	56,190	8,66	0,59
	5:15	45,600	45,625	24,63	1,69
	5:30	50,581	50,592	10,95	0,75
	5:45	43,200	43,203	2,60	0,18
	6:00	47,600	47,624	23,75	1,63
	6:15	67,381	67,408	26,87	1,85
	6:30	60,581	60,590	9,33	0,64
	6:45	64,981	65,005	23,61	1,62
	7:00	62,181	62,191	10,10	0,69
	7:15	82,181	82,194	12,73	0,87
	7:30	90,362	90,383	20,47	1,41
	7:45	88,581	88,602	20,51	1,41
	8:00	89,962	89,982	20,17	1,39
	8:15	95,162	95,169	6,52	0,45
	8:30	96,581	96,587	5,97	0,41
	8:45	97,743	97,765	21,97	1,51
	9:00	98,981	98,993	11,63	0,80
	9:15	97,962	97,980	17,48	1,20
	9:30	98,762	98,779	16,49	1,13
	9:45	93,562	93,586	23,43	1,61
	10:00	95,562	95,579	16,61	1,14
10:15	102,362	102,369	6,76	0,46	
10:30	105,162	105,170	8,11	0,56	
10:45	106,543	106,565	21,84	1,50	
11:00	105,781	105,802	20,94	1,44	
11:15	108,543	108,571	28,06	1,93	
11:30	103,562	103,578	15,28	1,05	
11:45	104,943	104,951	7,85	0,54	
12:00	106,362	106,377	15,05	1,03	
12:15	108,943	108,947	3,88	0,27	
12:30	105,962	105,987	24,34	1,67	
12:45	108,362	108,375	12,95	0,89	

	13:00	106,143	106,150	6,91	0,47
	13:15	111,562	111,585	22,92	1,57
	13:30	110,943	110,953	9,11	0,63
	13:45	111,343	111,358	15,08	1,04
	14:00	117,343	117,353	9,39	0,65
	14:15	114,362	114,389	26,56	1,83
	14:30	111,743	111,757	13,49	0,93
	14:45	113,743	113,764	20,52	1,41
	15:00	113,962	113,991	28,72	1,97
	15:15	106,943	106,950	6,91	0,48
	15:30	105,562	105,595	32,53	2,24
	15:45	112,943	112,960	16,14	1,11
	16:00	112,543	112,551	7,98	0,55
	16:15	110,181	110,214	32,96	2,27
	16:30	116,725	116,750	25,13	1,73
	16:45	118,943	118,951	7,12	0,49
	17:00	121,743	121,765	21,81	1,50
	17:15	116,762	116,788	26,21	1,80
	17:30	119,925	119,952	27,40	1,88
	17:45	122,943	122,945	1,28	0,09
	18:00	118,143	118,175	31,70	2,18
	18:15	113,962	113,994	31,29	2,15
	18:30	118,725	118,737	12,62	0,87
	18:45	120,362	120,375	13,03	0,90
	19:00	119,343	119,364	20,86	1,43
	19:15	118,143	118,175	31,51	2,17
	19:30	115,162	115,167	4,79	0,33
	19:45	112,143	112,152	8,71	0,60
	20:00	112,943	112,955	11,46	0,79
	20:15	101,781	101,810	28,53	1,96
	20:30	97,562	97,576	13,47	0,93
	20:45	92,762	92,794	31,49	2,16
	21:00	95,562	95,568	5,61	0,39
	21:15	84,581	84,589	8,34	0,57
	21:30	81,381	81,412	30,67	2,11
	21:45	82,362	82,360	-2,43	-0,17
	22:00	82,181	82,191	10,06	0,69
	22:15	74,762	74,768	5,47	0,38
	22:30	82,181	82,184	3,05	0,21
	22:45	83,562	83,593	30,90	2,12
	23:00	75,381	75,401	20,37	1,40
	23:15	71,600	71,615	14,89	1,02
	23:30	69,962	69,964	2,13	0,15
	23:45	67,600	67,625	24,98	1,72
	0:00	69,381	69,403	21,57	1,48
8.7.2015.	0:15	62,762	62,792	29,83	1,69
	0:30	58,000	58,013	13,18	0,75
	0:45	55,600	55,624	24,49	1,39
	1:00	57,381	57,401	19,82	1,12
	1:15	53,381	53,397	16,17	0,92
	1:30	54,581	54,604	23,23	1,31
	1:45	60,800	60,804	3,97	0,22
	2:00	49,381	49,408	26,97	1,53
	2:15	49,200	49,204	3,67	0,21
	2:30	43,781	43,797	15,37	0,87
	2:45	41,600	41,621	20,61	1,17
	3:00	43,781	43,804	22,96	1,30
	3:15	48,000	48,028	28,00	1,59
	3:30	50,981	50,993	11,52	0,65
	3:45	48,000	48,012	11,67	0,66
	4:00	47,381	47,400	18,97	1,07
	4:15	49,381	49,398	17,22	0,98
4:30	52,400	52,427	26,57	1,50	

4:45	52,800	52,828	27,54	1,56
5:00	54,362	54,375	13,15	0,74
5:15	66,800	66,808	8,37	0,47
5:30	57,781	57,791	9,88	0,56
5:45	57,381	57,388	6,76	0,38
6:00	56,581	56,594	12,42	0,70
6:15	69,200	69,231	30,71	1,74
6:30	70,981	71,002	21,10	1,19
6:45	63,962	63,982	19,85	1,12
7:00	71,381	71,411	29,49	1,67
7:15	80,581	80,612	31,04	1,76
7:30	88,181	88,212	30,79	1,74
7:45	85,962	85,986	23,97	1,36
8:00	93,162	93,179	17,01	0,96
8:15	103,781	103,794	13,13	0,74
8:30	102,543	102,562	18,84	1,07
8:45	105,162	105,169	6,89	0,39
9:00	106,362	106,380	17,84	1,01
9:15	108,143	108,166	22,32	1,26
9:30	103,162	103,172	10,18	0,58
9:45	105,562	105,580	17,67	1,00
10:00	101,562	101,582	19,27	1,09
10:15	101,343	101,370	26,47	1,50
10:30	101,162	101,184	21,47	1,22
10:45	103,562	103,580	17,50	0,99
11:00	112,362	112,386	23,76	1,35
11:15	109,743	109,771	28,04	1,59
11:30	106,543	106,555	11,37	0,64
11:45	106,943	106,972	28,20	1,60
12:00	106,362	106,362	-0,58	-0,03
12:15	104,362	104,381	19,11	1,08
12:30	107,743	107,774	30,84	1,75
12:45	108,543	108,558	14,11	0,80
13:00	106,362	106,393	30,90	1,75
13:15	112,943	112,960	17,07	0,97
13:30	113,925	113,930	5,79	0,33
13:45	113,962	113,963	1,14	0,06
14:00	112,143	112,164	20,29	1,15
14:15	115,743	115,751	7,44	0,42
14:30	114,143	114,149	6,04	0,34
14:45	118,143	118,154	10,96	0,62
15:00	118,725	118,758	33,53	1,90
15:15	119,343	119,356	12,68	0,72
15:30	118,943	118,977	33,59	1,90
15:45	120,143	120,164	20,60	1,17
16:00	122,543	122,579	35,54	2,01
16:15	121,525	121,550	25,74	1,46
16:30	120,325	120,347	22,90	1,30
16:45	115,962	115,984	21,42	1,21
17:00	110,943	110,977	33,56	1,90
17:15	105,743	105,757	13,43	0,76
17:30	111,562	111,566	3,51	0,20
17:45	108,943	108,958	14,64	0,83
18:00	105,162	105,173	10,67	0,60
18:15	102,762	102,762	-0,56	-0,03
18:30	101,162	101,176	13,55	0,77
18:45	99,962	99,966	4,11	0,23
19:00	98,143	98,162	18,55	1,05
19:15	98,181	98,195	13,64	0,77
19:30	100,543	100,562	18,32	1,04
19:45	99,562	99,568	5,70	0,32
20:00	94,581	94,597	15,88	0,90
20:15	88,943	88,970	26,42	1,50

	20:30	78,581	78,597	16,08	0,91
	20:45	90,981	90,980	-1,61	-0,09
	21:00	85,962	85,980	17,72	1,00
	21:15	83,562	83,596	33,51	1,90
	21:30	86,181	86,200	18,64	1,06
	21:45	82,181	82,184	3,34	0,19
	22:00	77,962	77,966	3,81	0,22
	22:15	64,981	64,985	4,12	0,23
	22:30	72,581	72,604	22,73	1,29
	22:45	75,781	75,792	11,13	0,63
	23:00	66,181	66,182	0,80	0,05
	23:15	48,981	49,001	19,37	1,10
	23:30	44,400	44,424	23,94	1,36
	23:45	51,343	51,345	1,60	0,09
	0:00	42,581	42,591	9,47	0,54
9.7.2015.	0:15	42,581	42,594	13,00	0,56
	0:30	53,381	53,387	5,62	0,24
	0:45	57,781	57,786	4,94	0,21
	1:00	51,381	51,389	7,65	0,33
	1:15	52,581	52,608	26,94	1,16
	1:30	51,200	51,218	17,66	0,76
	1:45	50,581	50,604	22,66	0,97
	2:00	44,581	44,596	14,42	0,62
	2:15	45,200	45,212	11,63	0,50
	2:30	42,000	42,029	28,96	1,24
	2:45	46,581	46,600	18,50	0,79
	3:00	42,400	42,411	11,34	0,49
	3:15	47,381	47,388	6,64	0,29
	3:30	48,181	48,207	25,38	1,09
	3:45	43,019	43,028	9,35	0,40
	4:00	46,581	46,596	15,31	0,66
	4:15	49,200	49,211	10,51	0,45
	4:30	52,181	52,202	21,36	0,92
	4:45	51,781	51,792	10,52	0,45
	5:00	56,581	56,585	3,89	0,17
	5:15	55,600	55,629	28,98	1,24
	5:30	45,600	45,612	11,82	0,51
	5:45	47,381	47,391	9,61	0,41
	6:00	49,781	49,794	12,77	0,55
	6:15	62,800	62,824	24,15	1,04
	6:30	65,381	65,397	16,00	0,69
	6:45	62,181	62,189	8,04	0,35
	7:00	62,981	62,998	16,54	0,71
	7:15	65,781	65,793	11,99	0,51
	7:30	65,781	65,786	5,00	0,21
	7:45	75,381	75,392	10,80	0,46
	8:00	70,581	70,590	9,26	0,40
	8:15	83,562	83,589	26,76	1,15
	8:30	80,581	80,594	12,39	0,53
	8:45	75,781	75,800	18,79	0,81
	9:00	78,981	78,995	13,54	0,58
	9:15	83,162	83,183	21,22	0,91
	9:30	80,362	80,378	15,29	0,66
	9:45	80,181	80,210	29,06	1,25
	10:00	81,381	81,403	21,69	0,93
	10:15	86,981	86,983	2,07	0,09
	10:30	86,943	86,962	18,95	0,81
	10:45	88,762	88,770	8,08	0,35
	11:00	88,181	88,209	27,78	1,19
	11:15	90,762	90,764	1,77	0,08
	11:30	94,181	94,207	25,50	1,09
	11:45	91,562	91,567	5,23	0,22
	12:00	94,581	94,586	4,75	0,20

	12:15	97,743	97,768	24,60	1,06
	12:30	94,581	94,585	4,02	0,17
	12:45	88,143	88,169	25,41	1,09
	13:00	91,162	91,174	11,88	0,51
	13:15	91,962	91,976	13,37	0,57
	13:30	91,381	91,388	7,09	0,30
	13:45	92,581	92,600	19,25	0,83
	14:00	89,343	89,369	25,36	1,09
	14:15	86,181	86,195	13,74	0,59
	14:30	83,162	83,176	13,57	0,58
	14:45	88,181	88,199	17,82	0,77
	15:00	90,362	90,395	32,51	1,40
	15:15	94,762	94,769	6,61	0,28
	15:30	91,381	91,383	2,18	0,09
	15:45	91,962	91,968	5,86	0,25
	16:00	89,562	89,579	16,51	0,71
	16:15	87,962	87,988	25,94	1,11
	16:30	85,381	85,406	25,34	1,09
	16:45	83,781	83,799	17,59	0,76
	17:00	96,362	96,375	12,73	0,55
	17:15	91,962	91,991	28,51	1,22
	17:30	81,381	81,393	12,16	0,52
	17:45	80,581	80,606	24,56	1,05
	18:00	82,362	82,389	26,57	1,14
	18:15	68,181	68,209	27,61	1,19
	18:30	68,581	68,598	16,92	0,73
	18:45	66,981	67,006	24,49	1,05
	19:00	68,581	68,600	19,22	0,83
	19:15	62,981	62,999	18,26	0,78
	19:30	63,200	63,213	13,21	0,57
	19:45	61,562	61,566	4,09	0,18
	20:00	66,000	66,003	2,58	0,11
	20:15	60,981	60,992	10,84	0,47
	20:30	56,981	57,006	24,41	1,05
	20:45	54,800	54,821	21,02	0,90
	21:00	57,781	57,790	9,36	0,40
	21:15	61,781	61,809	27,73	1,19
	21:30	61,781	61,785	3,43	0,15
	21:45	62,181	62,207	26,30	1,13
	22:00	58,400	58,412	11,75	0,50
	22:15	44,981	44,986	5,16	0,22
	22:30	55,600	55,618	17,80	0,76
	22:45	54,181	54,193	12,14	0,52
	23:00	49,600	49,605	4,80	0,21
	23:15	52,181	52,191	10,08	0,43
	23:30	44,181	44,209	27,89	1,20
	23:45	48,400	48,418	17,54	0,75
	0:00	45,200	45,217	17,07	0,73
10.7.2015.	0:15	41,381	41,388	7,20	0,39
	0:30	37,600	37,627	27,37	1,49
	0:45	34,981	34,994	13,14	0,71
	1:00	32,800	32,820	20,41	1,11
	1:15	32,800	32,819	18,57	1,01
	1:30	35,781	35,788	7,02	0,38
	1:45	42,400	42,423	23,46	1,27
	2:00	40,800	40,828	27,86	1,51
	2:15	32,981	33,003	22,21	1,21
	2:30	32,619	32,639	19,70	1,07
	2:45	32,981	33,003	22,24	1,21
	3:00	34,000	34,008	7,75	0,42
	3:15	37,200	37,223	23,09	1,25
	3:30	34,000	34,011	10,53	0,57
3:45	38,181	38,190	8,39	0,46	

4:00	40,581	40,591	10,27	0,56
4:15	41,019	41,037	18,33	1,00
4:30	44,362	44,386	23,25	1,26
4:45	48,400	48,408	8,34	0,45
5:00	45,200	45,215	14,57	0,79
5:15	48,581	48,595	14,16	0,77
5:30	46,800	46,802	1,52	0,08
5:45	46,981	47,003	22,19	1,21
6:00	42,400	42,406	6,35	0,34
6:15	53,200	53,224	23,53	1,28
6:30	53,781	53,802	21,19	1,15
6:45	72,362	72,373	10,93	0,59
7:00	69,200	69,223	23,01	1,25
7:15	67,381	67,405	23,76	1,29
7:30	63,781	63,798	16,77	0,91
7:45	66,581	66,595	14,37	0,78
8:00	60,000	60,010	9,57	0,52
8:15	67,162	67,189	26,94	1,46
8:30	60,400	60,413	13,39	0,73
8:45	59,781	59,805	23,80	1,29
9:00	61,381	61,394	12,74	0,69
9:15	70,981	70,989	8,20	0,45
9:30	70,981	70,996	14,98	0,81
9:45	67,781	67,794	13,10	0,71
10:00	67,781	67,786	4,86	0,26
10:15	67,381	67,400	18,55	1,01
10:30	61,200	61,229	28,77	1,56
10:45	64,362	64,380	18,17	0,99
11:00	63,381	63,384	2,58	0,14
11:15	63,200	63,226	26,30	1,43
11:30	64,181	64,203	22,04	1,20
11:45	62,181	62,207	26,30	1,43
12:00	62,581	62,597	16,02	0,87
12:15	56,581	56,594	13,26	0,72
12:30	54,181	54,195	13,58	0,74
12:45	57,600	57,622	21,97	1,19
13:00	56,000	56,006	5,57	0,30
13:15	60,581	60,587	5,81	0,32
13:30	58,362	58,387	25,03	1,36
13:45	60,400	60,427	26,98	1,47
14:00	56,981	57,005	24,16	1,31
14:15	56,981	57,005	24,23	1,32
14:30	59,600	59,614	13,94	0,76
14:45	58,181	58,198	17,36	0,94
15:00	57,781	57,787	5,97	0,32
15:15	58,181	58,194	13,31	0,72
15:30	55,600	55,630	29,61	1,61
15:45	61,781	61,792	10,99	0,60
16:00	61,562	61,569	6,41	0,35
16:15	62,000	62,026	25,89	1,41
16:30	60,181	60,204	22,44	1,22
16:45	60,800	60,814	13,95	0,76
17:00	60,981	60,993	12,18	0,66
17:15	53,200	53,210	10,40	0,56
17:30	58,581	58,600	18,53	1,01
17:45	63,962	63,973	10,77	0,58
18:00	57,600	57,608	7,74	0,42
18:15	58,581	58,589	8,35	0,45
18:30	62,000	62,011	10,71	0,58
18:45	58,981	58,998	16,76	0,91
19:00	63,381	63,390	9,07	0,49
19:15	52,181	52,197	15,70	0,85
19:30	48,800	48,817	17,36	0,94

	19:45	48,581	48,600	19,30	1,05
	20:00	44,800	44,818	17,80	0,97
	20:15	42,581	42,604	22,63	1,23
	20:30	34,219	34,245	26,06	1,42
	20:45	34,981	35,000	18,94	1,03
	21:00	36,981	36,998	17,04	0,93
	21:15	42,400	42,426	25,88	1,41
	21:30	38,400	38,422	22,49	1,22
	21:45	40,400	40,422	22,15	1,20
	22:00	40,981	40,994	12,85	0,70
	22:15	35,419	35,426	7,00	0,38
	22:30	39,381	39,388	7,25	0,39
	22:45	43,781	43,804	22,87	1,24
	23:00	40,800	40,823	23,46	1,27
	23:15	46,581	46,604	22,45	1,22
	23:30	33,200	33,226	26,19	1,42
	23:45	36,000	36,020	20,03	1,09
	0:00	37,200	37,228	27,72	1,51
11.7.2015.	0:15	38,981	38,985	4,04	0,16
	0:30	32,800	32,819	19,04	0,75
	0:45	28,581	28,586	4,69	0,18
	1:00	27,200	27,210	10,37	0,41
	1:15	29,419	29,426	6,76	0,26
	1:30	34,181	34,202	21,34	0,84
	1:45	45,781	45,799	18,12	0,71
	2:00	36,800	36,814	13,56	0,53
	2:15	32,000	32,010	9,70	0,38
	2:30	18,400	18,421	20,60	0,81
	2:45	23,381	23,382	0,96	0,04
	3:00	21,600	21,621	20,80	0,82
	3:15	24,000	24,007	6,63	0,26
	3:30	21,819	21,820	0,69	0,03
	3:45	22,981	23,003	22,26	0,87
	4:00	26,400	26,409	9,17	0,36
	4:15	31,600	31,623	23,21	0,91
	4:30	33,381	33,399	17,48	0,69
	4:45	34,400	34,424	24,30	0,95
	5:00	43,200	43,222	22,32	0,88
	5:15	44,181	44,207	26,29	1,03
	5:30	44,800	44,820	19,80	0,78
	5:45	36,181	36,184	2,69	0,11
	6:00	43,200	43,213	12,60	0,49
	6:15	45,600	45,616	15,75	0,62
	6:30	39,200	39,208	8,37	0,33
	6:45	50,762	50,772	10,04	0,39
	7:00	49,019	49,045	25,91	1,02
	7:15	46,400	46,414	14,45	0,57
	7:30	42,362	42,378	15,83	0,62
	7:45	35,600	35,611	10,61	0,42
	8:00	43,200	43,216	16,20	0,64
	8:15	64,000	64,008	8,07	0,32
	8:30	53,162	53,177	14,26	0,56
	8:45	52,000	52,004	4,42	0,17
	9:00	49,381	49,408	27,19	1,07
9:15	64,000	64,008	7,71	0,30	
9:30	58,362	58,369	7,21	0,28	
9:45	52,400	52,408	7,80	0,31	
10:00	55,781	55,806	25,09	0,98	
10:15	59,200	59,218	17,98	0,71	
10:30	60,181	60,200	18,82	0,74	
10:45	58,181	58,203	21,95	0,86	
11:00	56,981	57,002	20,88	0,82	
11:15	58,181	58,203	21,41	0,84	

	11:30	65,600	65,626	25,56	1,00
	11:45	58,000	58,011	10,96	0,43
	12:00	60,581	60,605	23,78	0,93
	12:15	62,762	62,771	8,48	0,33
	12:30	60,800	60,825	24,92	0,98
	12:45	56,581	56,597	15,94	0,62
	13:00	54,581	54,600	18,41	0,72
	13:15	52,400	52,406	6,11	0,24
	13:30	47,781	47,801	20,10	0,79
	13:45	50,400	50,402	1,73	0,07
	14:00	47,781	47,802	21,00	0,82
	14:15	58,581	58,586	5,05	0,20
	14:30	56,800	56,819	19,01	0,75
	14:45	56,581	56,600	18,44	0,72
	15:00	54,581	54,593	11,81	0,46
	15:15	66,000	66,015	15,03	0,59
	15:30	63,962	63,972	9,36	0,37
	15:45	58,800	58,807	7,29	0,29
	16:00	58,181	58,206	24,46	0,96
	16:15	55,200	55,222	22,50	0,88
	16:30	47,781	47,796	14,38	0,56
	16:45	46,000	46,009	9,40	0,37
	17:00	48,981	49,005	24,06	0,94
	17:15	56,000	56,024	24,44	0,96
	17:30	57,562	57,575	12,99	0,51
	17:45	58,400	58,420	20,12	0,79
	18:00	61,781	61,803	22,26	0,87
	18:15	45,600	45,624	23,79	0,93
	18:30	57,381	57,406	24,66	0,97
	18:45	54,581	54,595	14,03	0,55
	19:00	52,400	52,425	25,28	0,99
	19:15	53,381	53,406	24,73	0,97
	19:30	52,400	52,425	24,91	0,98
	19:45	51,200	51,213	13,33	0,52
	20:00	42,581	42,593	12,01	0,47
	20:15	36,800	36,809	9,32	0,37
	20:30	38,000	38,019	18,98	0,74
	20:45	35,781	35,795	13,92	0,55
	21:00	36,000	36,022	22,05	0,86
	21:15	42,000	42,027	27,13	1,06
	21:30	45,381	45,385	3,75	0,15
	21:45	41,600	41,608	8,39	0,33
	22:00	36,800	36,815	15,42	0,60
	22:15	18,800	18,823	22,75	0,89
	22:30	23,381	23,389	8,16	0,32
	22:45	26,800	26,802	1,72	0,07
	23:00	31,600	31,619	19,37	0,76
	23:15	34,000	34,005	4,84	0,19
	23:30	29,781	29,797	15,60	0,61
	23:45	28,219	28,239	20,31	0,80
	0:00	28,800	28,806	5,51	0,22
12.7.2015.	0:15	26,581	26,592	11,25	0,46
	0:30	27,600	27,621	21,43	0,87
	0:45	23,200	23,206	6,49	0,26
	1:00	20,000	20,016	16,02	0,65
	1:15	30,800	30,823	22,78	0,93
	1:30	23,200	23,209	9,18	0,37
	1:45	25,781	25,791	10,03	0,41
	2:00	24,800	24,820	19,72	0,80
	2:15	36,219	36,226	7,46	0,30
	2:30	37,381	37,391	10,36	0,42
	2:45	34,400	34,414	14,13	0,57
	3:00	31,600	31,620	19,94	0,81

3:15	28,000	28,019	19,44	0,79
3:30	28,181	28,194	13,04	0,53
3:45	28,000	28,008	7,90	0,32
4:00	26,400	26,414	13,63	0,55
4:15	32,800	32,821	20,84	0,85
4:30	37,200	37,217	16,69	0,68
4:45	35,381	35,399	17,93	0,73
5:00	38,000	38,025	24,76	1,01
5:15	41,200	41,221	20,98	0,85
5:30	39,381	39,393	11,76	0,48
5:45	37,419	37,427	8,25	0,34
6:00	37,381	37,404	23,11	0,94
6:15	34,800	34,813	13,43	0,55
6:30	33,781	33,807	25,63	1,04
6:45	31,200	31,222	21,67	0,88
7:00	42,400	42,415	14,98	0,61
7:15	44,400	44,426	25,97	1,06
7:30	43,781	43,792	10,49	0,43
7:45	45,600	45,622	21,58	0,88
8:00	41,200	41,213	13,34	0,54
8:15	53,781	53,801	20,30	0,83
8:30	50,400	50,409	9,05	0,37
8:45	50,581	50,606	24,83	1,01
9:00	49,781	49,794	13,35	0,54
9:15	54,400	54,422	21,78	0,89
9:30	51,200	51,209	8,78	0,36
9:45	48,981	49,000	19,02	0,77
10:00	49,600	49,624	23,68	0,96
10:15	55,200	55,223	23,26	0,95
10:30	46,181	46,202	20,45	0,83
10:45	45,381	45,398	16,92	0,69
11:00	48,400	48,411	11,43	0,46
11:15	48,181	48,189	7,45	0,30
11:30	52,800	52,809	9,27	0,38
11:45	51,600	51,627	26,78	1,09
12:00	48,981	49,008	27,21	1,11
12:15	52,581	52,594	12,73	0,52
12:30	51,200	51,223	23,11	0,94
12:45	50,581	50,604	22,38	0,91
13:00	50,800	50,823	22,80	0,93
13:15	46,800	46,828	27,81	1,13
13:30	45,781	45,794	12,49	0,51
13:45	46,400	46,406	6,34	0,26
14:00	44,981	45,005	23,46	0,95
14:15	48,800	48,818	18,09	0,74
14:30	44,800	44,815	14,75	0,60
14:45	46,981	46,999	17,43	0,71
15:00	49,200	49,219	19,09	0,78
15:15	44,981	45,000	19,23	0,78
15:30	41,200	41,216	15,60	0,63
15:45	48,981	49,002	20,86	0,85
16:00	48,800	48,813	13,32	0,54
16:15	48,000	48,017	16,87	0,69
16:30	43,781	43,803	21,87	0,89
16:45	44,000	44,018	17,92	0,73
17:00	45,200	45,224	23,53	0,96
17:15	35,381	35,402	20,55	0,84
17:30	38,000	38,008	7,62	0,31
17:45	41,600	41,623	23,18	0,94
18:00	42,981	43,004	22,76	0,93
18:15	29,019	29,041	21,71	0,88
18:30	37,381	37,405	24,14	0,98
18:45	39,600	39,608	8,08	0,33

	19:00	28,800	28,813	13,07	0,53
	19:15	26,581	26,593	11,64	0,47
	19:30	30,219	30,234	15,54	0,63
	19:45	28,400	28,418	17,95	0,73
	20:00	30,181	30,200	18,51	0,75
	20:15	33,600	33,608	8,41	0,34
	20:30	29,600	29,611	11,41	0,46
	20:45	33,200	33,208	7,68	0,31
	21:00	34,800	34,812	12,38	0,50
	21:15	34,981	34,996	14,91	0,61
	21:30	36,400	36,417	16,63	0,68
	21:45	38,400	38,409	9,02	0,37
	22:00	37,200	37,215	15,22	0,62
	22:15	32,000	32,021	21,13	0,86
	22:30	39,781	39,799	17,93	0,73
	22:45	44,000	44,013	13,16	0,54
	23:00	37,381	37,397	16,00	0,65
	23:15	36,000	36,022	21,99	0,89
	23:30	33,200	33,207	7,28	0,30
	23:45	34,981	34,987	5,50	0,22
	0:00	31,600	31,618	17,65	0,72
	0:15	39,600	39,607	7,39	0,32
	0:30	32,800	32,818	18,06	0,79
	0:45	38,000	38,009	9,11	0,40
	1:00	36,400	36,409	9,20	0,40
	1:15	36,400	36,410	10,39	0,46
	1:30	36,981	37,005	23,40	1,03
	1:45	43,600	43,621	21,10	0,93
	2:00	41,381	41,395	14,12	0,62
	2:15	38,800	38,822	21,61	0,95
	2:30	35,381	35,400	19,15	0,84
	2:45	34,219	34,240	20,73	0,91
	3:00	30,400	30,412	11,94	0,52
	3:15	36,800	36,814	13,62	0,60
	3:30	33,600	33,614	13,50	0,59
	3:45	38,581	38,592	11,03	0,48
	4:00	40,800	40,815	15,19	0,67
	4:15	45,381	45,399	17,48	0,77
	4:30	47,200	47,219	18,63	0,82
	4:45	49,381	49,390	8,44	0,37
	5:00	49,600	49,610	9,91	0,43
	5:15	52,400	52,419	18,98	0,83
13.7.2015.	5:30	49,781	49,800	18,67	0,82
	5:45	48,000	48,017	17,35	0,76
	6:00	46,981	47,000	18,56	0,81
	6:15	65,781	65,805	23,38	1,03
	6:30	73,781	73,803	22,25	0,98
	6:45	78,000	78,026	26,03	1,14
	7:00	81,962	81,986	23,54	1,03
	7:15	96,762	96,793	31,23	1,37
	7:30	94,981	95,003	21,52	0,94
	7:45	89,962	89,983	20,94	0,92
	8:00	88,581	88,597	15,90	0,70
	8:15	91,562	91,573	10,84	0,48
	8:30	85,162	85,188	25,58	1,12
	8:45	80,000	80,024	24,24	1,06
	9:00	83,162	83,176	13,76	0,60
	9:15	89,781	89,807	25,74	1,13
	9:30	97,162	97,190	28,04	1,23
	9:45	95,162	95,188	25,79	1,13
	10:00	94,762	94,781	19,07	0,84
	10:15	104,362	104,395	33,00	1,45
	10:30	103,162	103,178	15,95	0,70

	10:45	103,962	103,980	17,82	0,78
	11:00	104,762	104,783	20,86	0,92
	11:15	111,962	111,997	34,54	1,52
	11:30	108,943	108,959	16,02	0,70
	11:45	109,962	109,980	17,77	0,78
	12:00	108,762	108,780	17,72	0,78
	12:15	109,562	109,588	25,59	1,12
	12:30	105,162	105,186	24,03	1,05
	12:45	103,562	103,584	21,91	0,96
	13:00	104,543	104,559	15,16	0,67
	13:15	107,562	107,588	25,29	1,11
	13:30	106,581	106,600	18,40	0,81
	13:45	106,143	106,164	20,25	0,89
	14:00	106,762	106,791	28,75	1,26
	14:15	97,162	97,173	11,10	0,49
	14:30	91,781	91,805	24,03	1,05
	14:45	94,181	94,208	27,11	1,19
	15:00	95,743	95,760	16,78	0,74
	15:15	88,981	88,989	8,33	0,37
	15:30	92,362	92,385	22,57	0,99
	15:45	95,962	95,979	17,21	0,76
	16:00	92,981	93,006	25,14	1,10
	16:15	99,162	99,189	26,30	1,15
	16:30	90,762	90,792	29,94	1,31
	16:45	94,981	95,000	19,16	0,84
	17:00	93,562	93,573	10,66	0,47
	17:15	95,562	95,573	10,49	0,46
	17:30	98,362	98,382	19,75	0,87
	17:45	95,381	95,402	21,28	0,93
	18:00	99,162	99,176	13,32	0,58
	18:15	86,981	86,997	16,20	0,71
	18:30	86,362	86,388	25,30	1,11
	18:45	95,962	95,976	13,99	0,61
	19:00	100,762	100,792	29,59	1,30
	19:15	94,981	94,996	14,96	0,66
	19:30	91,962	91,974	11,42	0,50
	19:45	74,181	74,206	25,00	1,10
	20:00	72,181	72,194	12,69	0,56
	20:15	68,000	68,027	26,59	1,17
	20:30	66,581	66,611	30,07	1,32
	20:45	67,962	67,987	25,05	1,10
	21:00	62,800	62,829	28,88	1,27
	21:15	70,581	70,605	23,42	1,03
	21:30	70,181	70,192	10,58	0,46
	21:45	72,181	72,195	13,91	0,61
	22:00	73,600	73,618	17,69	0,78
	22:15	65,962	65,982	19,95	0,88
	22:30	72,800	72,821	21,34	0,94
	22:45	75,162	75,186	23,45	1,03
	23:00	69,381	69,397	16,34	0,72
	23:15	53,381	53,393	11,70	0,51
	23:30	52,000	52,015	14,95	0,66
	23:45	50,800	50,817	17,37	0,76
	0:00	43,781	43,807	25,68	1,13
14.7.2015.	0:15	38,400	38,418	18,46	0,96
	0:30	38,400	38,416	16,00	0,84
	0:45	37,200	37,202	1,74	0,09
	1:00	39,381	39,391	9,73	0,51
	1:15	43,381	43,401	20,03	1,05
	1:30	45,200	45,206	6,43	0,34
	1:45	51,381	51,393	11,83	0,62
	2:00	45,600	45,609	9,12	0,48
	2:15	46,800	46,809	8,69	0,45

2:30	42,800	42,823	22,75	1,19
2:45	36,981	37,001	19,65	1,03
3:00	42,400	42,414	13,72	0,72
3:15	38,581	38,594	13,33	0,70
3:30	40,400	40,413	13,34	0,70
3:45	39,600	39,608	8,38	0,44
4:00	35,381	35,397	15,73	0,82
4:15	44,800	44,827	27,34	1,43
4:30	50,000	50,010	9,90	0,52
4:45	53,381	53,399	18,32	0,96
5:00	53,600	53,620	20,16	1,05
5:15	48,581	48,593	11,45	0,60
5:30	50,000	50,021	20,97	1,09
5:45	49,381	49,401	20,08	1,05
6:00	48,181	48,197	16,33	0,85
6:15	62,800	62,822	21,68	1,13
6:30	54,400	54,425	24,78	1,29
6:45	50,581	50,600	19,28	1,01
7:00	59,381	59,399	17,73	0,93
7:15	69,381	69,406	24,86	1,30
7:30	86,181	86,200	19,33	1,01
7:45	84,181	84,206	24,40	1,27
8:00	77,381	77,403	21,76	1,14
8:15	109,343	109,367	23,41	1,22
8:30	105,962	105,982	19,42	1,01
8:45	105,562	105,587	24,94	1,30
9:00	101,962	101,982	19,92	1,04
9:15	107,962	107,982	20,13	1,05
9:30	103,562	103,590	27,71	1,45
9:45	99,162	99,180	17,86	0,93
10:00	107,562	107,585	23,07	1,20
10:15	103,162	103,184	22,04	1,15
10:30	105,343	105,371	27,64	1,44
10:45	103,562	103,595	32,63	1,70
11:00	108,762	108,780	17,98	0,94
11:15	107,562	107,588	26,02	1,36
11:30	108,762	108,785	22,66	1,18
11:45	106,762	106,787	24,39	1,27
12:00	108,543	108,565	21,93	1,14
12:15	106,762	106,785	22,96	1,20
12:30	105,962	105,989	26,27	1,37
12:45	107,343	107,371	27,90	1,46
13:00	107,562	107,590	27,45	1,43
13:15	110,762	110,775	12,76	0,67
13:30	107,743	107,766	22,28	1,16
13:45	116,362	116,380	17,69	0,92
14:00	111,562	111,578	15,60	0,81
14:15	109,743	109,754	10,33	0,54
14:30	112,943	112,968	24,31	1,27
14:45	113,562	113,593	30,82	1,61
15:00	110,362	110,383	20,39	1,06
15:15	108,362	108,390	27,73	1,45
15:30	108,143	108,175	31,93	1,67
15:45	110,762	110,773	10,28	0,54
16:00	113,743	113,765	21,51	1,12
16:15	111,962	111,990	28,19	1,47
16:30	114,943	114,962	18,50	0,97
16:45	112,943	112,968	24,38	1,27
17:00	114,981	115,009	27,41	1,43
17:15	112,943	112,968	25,04	1,31
17:30	113,562	113,593	30,82	1,61
17:45	109,743	109,754	10,45	0,55
18:00	111,962	111,988	26,05	1,36

	18:15	109,743	109,758	14,54	0,76
	18:30	114,762	114,778	16,05	0,84
	18:45	114,143	114,170	26,76	1,40
	19:00	113,562	113,581	18,33	0,96
	19:15	101,962	101,979	16,87	0,88
	19:30	92,981	93,004	22,68	1,18
	19:45	79,962	79,976	13,57	0,71
	20:00	78,181	78,212	30,67	1,60
	20:15	60,181	60,203	21,73	1,13
	20:30	55,200	55,216	16,41	0,86
	20:45	54,181	54,193	11,84	0,62
	21:00	54,000	54,026	26,24	1,37
	21:15	54,000	54,009	9,26	0,48
	21:30	64,762	64,789	27,08	1,41
	21:45	65,600	65,616	16,04	0,84
	22:00	64,800	64,807	7,37	0,38
	22:15	57,562	57,585	22,39	1,17
	22:30	60,400	60,418	18,34	0,96
	22:45	63,381	63,386	5,13	0,27
	23:00	64,581	64,589	7,67	0,40
	23:15	48,400	48,414	13,82	0,72
	23:30	50,981	50,988	7,22	0,38
	23:45	63,381	63,391	9,82	0,51
	0:00	53,200	53,213	13,22	0,69
15.7.2015.	0:15	49,781	49,796	15,32	1,03
	0:30	49,600	49,626	26,16	1,76
	0:45	54,581	54,597	16,22	1,09
	1:00	52,800	52,819	18,54	1,25
	1:15	52,981	52,990	9,00	0,61
	1:30	54,000	54,028	28,24	1,90
	1:45	55,781	55,801	19,71	1,33
	2:00	48,181	48,195	13,76	0,93
	2:15	48,000	48,008	7,76	0,52
	2:30	50,400	50,414	14,15	0,95
	2:45	54,181	54,197	15,69	1,06
	3:00	50,000	50,027	26,71	1,80
	3:15	52,581	52,585	3,94	0,27
	3:30	54,000	54,017	17,37	1,17
	3:45	49,962	49,977	14,85	1,00
	4:00	50,800	50,812	12,29	0,83
	4:15	51,200	51,209	9,46	0,64
	4:30	52,581	52,597	16,04	1,08
	4:45	52,800	52,823	22,98	1,55
	5:00	57,781	57,802	20,63	1,39
	5:15	54,400	54,420	19,62	1,32
	5:30	53,600	53,607	7,25	0,49
	5:45	51,162	51,174	11,64	0,78
	6:00	47,200	47,205	5,05	0,34
	6:15	60,981	60,996	14,92	1,00
	6:30	60,800	60,815	14,52	0,98
	6:45	66,181	66,193	11,44	0,77
	7:00	71,381	71,408	26,47	1,78
	7:15	88,581	88,601	19,61	1,32
	7:30	90,762	90,792	29,94	2,02
	7:45	84,362	84,383	20,73	1,40
	8:00	94,581	94,610	28,82	1,94
	8:15	107,962	107,978	16,17	1,09
	8:30	103,743	103,761	17,24	1,16
	8:45	105,162	105,186	23,30	1,57
	9:00	101,162	101,188	25,68	1,73
9:15	106,362	106,380	17,81	1,20	
9:30	103,162	103,181	18,34	1,24	
9:45	101,562	101,579	16,66	1,12	

	10:00	103,162	103,181	18,76	1,26
	10:15	109,343	109,373	29,95	2,02
	10:30	112,762	112,790	27,33	1,84
	10:45	112,943	112,959	16,01	1,08
	11:00	105,962	105,994	31,55	2,13
	11:15	107,962	107,974	11,70	0,79
	11:30	110,543	110,569	25,14	1,69
	11:45	106,762	106,790	27,25	1,84
	12:00	110,362	110,373	10,84	0,73
	12:15	110,143	110,172	28,96	1,95
	12:30	108,362	108,386	24,03	1,62
	12:45	108,143	108,164	20,95	1,41
	13:00	108,943	108,969	25,40	1,71
	13:15	111,162	111,192	29,77	2,01
	13:30	109,162	109,185	22,48	1,51
	13:45	109,743	109,764	20,16	1,36
	14:00	114,362	114,389	26,97	1,82
	14:15	111,743	111,771	27,49	1,85
	14:30	113,162	113,180	17,55	1,18
	14:45	110,543	110,561	17,58	1,18
	15:00	113,162	113,180	17,55	1,18
	15:15	104,362	104,374	11,37	0,77
	15:30	106,543	106,569	25,55	1,72
	15:45	109,162	109,186	23,46	1,58
	16:00	113,343	113,379	35,14	2,37
	16:15	105,781	105,802	20,45	1,38
	16:30	109,743	109,767	23,35	1,57
	16:45	106,943	106,956	13,01	0,88
	17:00	110,581	110,610	28,72	1,94
	17:15	104,143	104,157	13,87	0,93
	17:30	103,162	103,195	32,27	2,17
	17:45	100,762	100,788	26,23	1,77
	18:00	101,162	101,190	27,39	1,85
	18:15	103,162	103,193	31,11	2,10
	18:30	103,962	103,987	25,04	1,69
	18:45	101,962	101,988	25,74	1,73
	19:00	97,962	97,991	28,44	1,92
	19:15	104,362	104,379	16,90	1,14
	19:30	104,181	104,206	25,32	1,71
	19:45	92,762	92,791	28,68	1,93
	20:00	81,781	81,798	17,08	1,15
	20:15	75,162	75,176	14,08	0,95
	20:30	74,000	74,010	9,85	0,66
	20:45	68,581	68,610	28,96	1,95
	21:00	66,981	66,999	17,79	1,20
	21:15	72,181	72,193	11,39	0,77
	21:30	72,981	72,996	14,70	0,99
	21:45	76,762	76,782	19,68	1,33
	22:00	78,581	78,610	28,68	1,93
	22:15	73,781	73,809	27,69	1,87
	22:30	74,981	74,994	13,19	0,89
	22:45	73,781	73,808	27,32	1,84
	23:00	78,762	78,776	13,61	0,92
	23:15	70,581	70,588	7,00	0,47
	23:30	63,600	63,616	15,63	1,05
	23:45	66,981	67,002	21,36	1,44
	0:00	61,381	61,405	24,14	1,63
16.7.2015.	0:15	60,181	60,186	4,68	0,30
	0:30	59,381	59,390	8,83	0,57
	0:45	60,400	60,403	2,90	0,19
	1:00	58,581	58,589	7,89	0,51
	1:15	57,381	57,387	6,34	0,41
	1:30	58,181	58,205	24,32	1,57

1:45	60,000	60,026	26,08	1,68
2:00	54,800	54,817	16,86	1,08
2:15	58,181	58,201	19,69	1,27
2:30	59,381	59,406	24,93	1,60
2:45	60,581	60,599	17,73	1,14
3:00	59,381	59,406	24,86	1,60
3:15	64,181	64,199	17,53	1,13
3:30	58,981	58,985	4,06	0,26
3:45	55,200	55,212	12,45	0,80
4:00	60,981	60,999	18,00	1,16
4:15	59,381	59,398	16,91	1,09
4:30	57,200	57,215	14,62	0,94
4:45	58,762	58,783	21,05	1,35
5:00	57,200	57,212	12,31	0,79
5:15	62,981	62,986	5,18	0,33
5:30	57,381	57,408	26,91	1,73
5:45	54,800	54,824	23,59	1,52
6:00	56,581	56,597	15,87	1,02
6:15	65,600	65,626	25,56	1,64
6:30	64,581	64,608	26,60	1,71
6:45	73,962	73,982	19,26	1,24
7:00	81,381	81,401	19,83	1,28
7:15	98,543	98,556	12,15	0,78
7:30	102,762	102,792	30,14	1,94
7:45	94,981	94,996	14,58	0,94
8:00	99,962	99,975	13,14	0,85
8:15	108,362	108,376	13,32	0,86
8:30	103,162	103,177	15,01	0,97
8:45	105,743	105,769	25,72	1,66
9:00	105,562	105,574	11,31	0,73
9:15	106,543	106,559	15,86	1,02
9:30	105,962	105,989	26,62	1,71
9:45	105,162	105,193	30,41	1,96
10:00	106,543	106,556	12,20	0,79
10:15	106,762	106,783	20,42	1,31
10:30	106,762	106,773	10,31	0,66
10:45	104,543	104,561	17,95	1,16
11:00	105,162	105,192	29,94	1,93
11:15	106,143	106,149	5,88	0,38
11:30	109,962	109,989	26,67	1,72
11:45	113,343	113,373	29,29	1,88
12:00	116,362	116,396	34,23	2,20
12:15	113,743	113,755	11,54	0,74
12:30	109,343	109,361	17,95	1,16
12:45	109,743	109,770	26,20	1,69
13:00	112,362	112,382	20,10	1,29
13:15	111,343	111,364	20,55	1,32
13:30	113,562	113,591	28,99	1,87
13:45	113,562	113,592	29,36	1,89
14:00	108,943	108,953	9,69	0,62
14:15	113,743	113,769	25,95	1,67
14:30	111,962	111,982	20,21	1,30
14:45	114,543	114,573	29,88	1,92
15:00	110,762	110,788	25,96	1,67
15:15	106,725	106,754	29,85	1,92
15:30	115,162	115,191	29,18	1,88
15:45	116,543	116,566	22,26	1,43
16:00	114,362	114,388	25,50	1,64
16:15	119,743	119,755	11,57	0,74
16:30	119,525	119,550	25,22	1,62
16:45	120,362	120,397	34,80	2,24
17:00	116,543	116,559	15,84	1,02
17:15	109,343	109,355	11,27	0,72

	17:30	110,762	110,790	27,47	1,77
	17:45	110,762	110,790	27,79	1,79
	18:00	105,562	105,581	18,76	1,21
	18:15	95,743	95,764	20,29	1,31
	18:30	97,781	97,800	18,91	1,22
	18:45	99,743	99,759	15,12	0,97
	19:00	98,581	98,611	30,25	1,95
	19:15	97,562	97,576	13,66	0,88
	19:30	97,562	97,573	10,96	0,71
	19:45	97,962	97,980	17,89	1,15
	20:00	81,381	81,409	27,99	1,80
	20:15	74,181	74,205	23,66	1,52
	20:30	71,781	71,797	16,03	1,03
	20:45	71,781	71,811	29,48	1,90
	21:00	69,600	69,626	26,07	1,68
	21:15	69,562	69,586	24,09	1,55
	21:30	72,981	72,993	11,44	0,74
	21:45	68,981	68,998	16,93	1,09
	22:00	69,381	69,390	8,74	0,56
	22:15	63,600	63,623	22,59	1,45
	22:30	58,181	58,202	20,96	1,35
	22:45	70,762	70,784	21,68	1,39
	23:00	62,000	62,020	19,80	1,27
	23:15	53,200	53,207	7,32	0,47
	23:30	52,981	52,990	8,41	0,54
	23:45	60,581	60,606	24,86	1,60
	0:00	53,781	53,792	10,37	0,67
17.7.2015.	0:15	67,781	67,797	16,24	1,19
	0:30	71,200	71,208	8,03	0,59
	0:45	69,562	69,579	16,80	1,23
	1:00	70,800	70,821	21,24	1,56
	1:15	73,781	73,798	16,67	1,22
	1:30	73,381	73,384	3,36	0,25
	1:45	75,562	75,581	18,73	1,37
	2:00	72,800	72,826	26,45	1,94
	2:15	77,562	77,581	19,16	1,40
	2:30	75,381	75,403	21,69	1,59
	2:45	78,981	78,992	11,24	0,82
	3:00	78,762	78,777	14,53	1,06
	3:15	85,381	85,390	8,65	0,63
	3:30	84,181	84,200	18,39	1,35
	3:45	83,562	83,578	15,92	1,17
	4:00	79,381	79,406	24,83	1,82
	4:15	84,581	84,612	30,54	2,24
	4:30	86,362	86,380	18,09	1,33
	4:45	82,581	82,615	34,07	2,50
	5:00	83,162	83,172	9,26	0,68
	5:15	86,981	87,006	25,02	1,83
	5:30	81,781	81,798	16,52	1,21
	5:45	73,781	73,797	16,02	1,17
	6:00	72,181	72,199	18,24	1,34
	6:15	90,362	90,390	28,01	2,05
	6:30	102,762	102,782	19,84	1,45
	6:45	105,962	105,991	28,84	2,11
	7:00	101,962	101,980	18,17	1,33
	7:15	104,362	104,378	15,44	1,13
	7:30	118,943	118,959	15,34	1,12
	7:45	114,543	114,576	32,86	2,41
	8:00	116,762	116,792	29,58	2,17
8:15	118,762	118,779	16,25	1,19	
8:30	117,525	117,543	18,36	1,35	
8:45	117,562	117,588	25,57	1,87	
9:00	114,943	114,952	8,49	0,62	

	9:15	122,725	122,746	21,74	1,59
	9:30	120,762	120,776	13,79	1,01
	9:45	118,943	118,956	12,23	0,90
	10:00	116,362	116,379	16,67	1,22
	10:15	116,943	116,952	8,17	0,60
	10:30	117,925	117,954	29,81	2,18
	10:45	118,762	118,773	10,34	0,76
	11:00	120,943	120,957	13,32	0,98
	11:15	122,943	122,958	15,00	1,10
	11:30	123,743	123,763	19,49	1,43
	11:45	122,543	122,575	31,22	2,29
	12:00	118,143	118,151	7,55	0,55
	12:15	112,143	112,157	13,58	0,99
	12:30	120,943	120,957	14,08	1,03
	12:45	125,343	125,373	29,52	2,16
	13:00	124,143	124,166	22,70	1,66
	13:15	131,125	131,149	24,07	1,76
	13:30	130,143	130,160	16,75	1,23
	13:45	134,725	134,738	13,53	0,99
	14:00	134,325	134,339	14,11	1,03
	14:15	144,725	144,738	13,81	1,01
	14:30	141,306	141,318	12,81	0,94
	14:45	141,743	141,756	12,57	0,92
	15:00	141,706	141,740	34,20	2,51
	15:15	133,743	133,750	6,41	0,47
	15:30	127,925	127,956	31,02	2,27
	15:45	128,943	128,968	24,23	1,77
	16:00	127,925	127,953	28,83	2,11
	16:15	126,943	126,954	10,50	0,77
	16:30	128,325	128,339	13,98	1,02
	16:45	130,143	130,152	8,57	0,63
	17:00	141,525	141,543	18,56	1,36
	17:15	147,125	147,136	11,48	0,84
	17:30	146,106	146,117	11,27	0,83
	17:45	146,325	146,335	10,97	0,80
	18:00	147,306	147,317	11,48	0,84
	18:15	141,525	141,552	27,57	2,02
	18:30	148,106	148,133	27,05	1,98
	18:45	137,525	137,554	29,49	2,16
	19:00	135,343	135,351	7,95	0,58
	19:15	120,543	120,556	12,44	0,91
	19:30	110,762	110,779	16,48	1,21
	19:45	108,762	108,774	11,40	0,83
	20:00	110,143	110,173	29,64	2,17
	20:15	106,543	106,572	28,76	2,11
	20:30	108,762	108,785	22,41	1,64
	20:45	108,181	108,208	27,29	2,00
	21:00	108,943	108,956	13,01	0,95
	21:15	105,562	105,582	20,07	1,47
	21:30	106,762	106,783	21,13	1,55
	21:45	105,162	105,184	22,18	1,62
	22:00	99,962	99,989	26,34	1,93
	22:15	85,562	85,591	28,92	2,12
	22:30	86,981	87,006	25,31	1,85
	22:45	88,981	89,003	21,73	1,59
	23:00	85,962	85,994	31,92	2,34
	23:15	83,962	83,992	29,82	2,18
	23:30	79,781	79,797	16,13	1,18
	23:45	79,562	79,593	30,83	2,26
	0:00	78,000	78,027	26,53	1,94
18.7.2015.	0:15	61,162	61,182	19,44	1,16
	0:30	66,000	66,011	11,16	0,67
	0:45	65,381	65,400	18,68	1,12

1:00	67,381	67,394	12,54	0,75
1:15	70,581	70,594	12,77	0,76
1:30	64,181	64,193	11,49	0,69
1:45	62,981	62,992	11,14	0,67
2:00	65,200	65,230	30,09	1,80
2:15	66,981	67,001	19,58	1,17
2:30	60,181	60,208	26,92	1,61
2:45	66,400	66,408	8,16	0,49
3:00	60,362	60,371	9,18	0,55
3:15	65,781	65,790	9,00	0,54
3:30	64,800	64,827	26,66	1,59
3:45	65,781	65,796	14,96	0,89
4:00	65,781	65,802	21,36	1,28
4:15	68,981	68,998	16,40	0,98
4:30	66,181	66,189	8,11	0,48
4:45	64,981	65,000	19,36	1,16
5:00	64,000	64,005	4,69	0,28
5:15	65,962	65,974	11,67	0,70
5:30	73,381	73,408	26,81	1,60
5:45	67,781	67,784	3,29	0,20
6:00	64,800	64,823	23,46	1,40
6:15	72,581	72,588	7,00	0,42
6:30	72,981	72,996	14,39	0,86
6:45	71,562	71,576	13,92	0,83
7:00	63,600	63,606	5,80	0,35
7:15	76,981	76,995	13,62	0,81
7:30	77,162	77,180	17,44	1,04
7:45	70,800	70,822	22,48	1,34
8:00	70,581	70,604	22,42	1,34
8:15	78,362	78,392	30,22	1,80
8:30	78,981	79,003	21,50	1,28
8:45	77,381	77,401	19,96	1,19
9:00	77,781	77,799	17,77	1,06
9:15	77,162	77,187	25,00	1,49
9:30	78,981	78,994	12,78	0,76
9:45	79,381	79,402	21,26	1,27
10:00	83,562	83,573	10,58	0,63
10:15	85,781	85,792	10,78	0,64
10:30	81,781	81,786	5,30	0,32
10:45	82,581	82,593	11,58	0,69
11:00	81,562	81,567	5,23	0,31
11:15	81,381	81,409	27,57	1,65
11:30	84,981	84,997	15,93	0,95
11:45	79,962	79,973	11,11	0,66
12:00	81,562	81,582	20,21	1,21
12:15	87,381	87,412	31,25	1,87
12:30	78,581	78,608	26,82	1,60
12:45	85,381	85,390	9,36	0,56
13:00	83,962	83,971	8,31	0,50
13:15	91,162	91,167	5,03	0,30
13:30	85,562	85,580	18,16	1,08
13:45	88,981	88,992	10,66	0,64
14:00	88,762	88,785	23,03	1,38
14:15	89,962	89,969	6,72	0,40
14:30	88,981	89,009	27,91	1,67
14:45	87,962	87,986	23,41	1,40
15:00	88,181	88,197	15,39	0,92
15:15	83,162	83,181	18,64	1,11
15:30	85,381	85,410	28,98	1,73
15:45	84,181	84,200	18,39	1,10
16:00	84,762	84,784	21,43	1,28
16:15	83,381	83,400	18,63	1,11
16:30	75,962	75,992	30,22	1,80

	16:45	80,981	80,985	3,67	0,22
	17:00	79,381	79,412	30,61	1,83
	17:15	69,781	69,801	19,68	1,18
	17:30	76,581	76,607	25,64	1,53
	17:45	78,762	78,784	21,60	1,29
	18:00	79,200	79,231	31,26	1,87
	18:15	73,162	73,177	14,46	0,86
	18:30	71,781	71,806	25,37	1,51
	18:45	73,200	73,215	14,60	0,87
	19:00	75,962	75,981	18,52	1,11
	19:15	86,981	87,000	18,99	1,13
	19:30	84,362	84,375	12,95	0,77
	19:45	77,200	77,203	2,69	0,16
	20:00	77,562	77,582	19,39	1,16
	20:15	76,581	76,591	9,98	0,60
	20:30	72,762	72,783	20,38	1,22
	20:45	76,800	76,808	8,48	0,51
	21:00	76,581	76,605	24,31	1,45
	21:15	79,562	79,587	24,31	1,45
	21:30	79,381	79,402	20,42	1,22
	21:45	83,781	83,800	18,82	1,12
	22:00	80,981	80,996	14,75	0,88
	22:15	68,362	68,383	20,63	1,23
	22:30	69,381	69,398	17,07	1,02
	22:45	76,800	76,813	12,91	0,77
	23:00	70,981	70,993	12,17	0,73
	23:15	65,781	65,788	6,53	0,39
	23:30	58,181	58,180	-0,64	-0,04
	23:45	57,781	57,799	18,36	1,10
	0:00	58,400	58,412	12,03	0,72
19.7.2015.	0:15	62,581	62,602	21,19	1,15
	0:30	62,181	62,193	11,53	0,63
	0:45	61,381	61,398	16,86	0,92
	1:00	59,600	59,620	19,57	1,06
	1:15	56,181	56,192	10,53	0,57
	1:30	55,381	55,408	27,01	1,47
	1:45	49,781	49,809	28,05	1,52
	2:00	50,800	50,819	18,74	1,02
	2:15	48,800	48,807	6,92	0,38
	2:30	44,581	44,589	8,33	0,45
	2:45	43,200	43,211	10,57	0,57
	3:00	43,381	43,405	23,38	1,27
	3:15	48,000	48,018	18,35	1,00
	3:30	48,181	48,187	5,84	0,32
	3:45	46,000	46,019	19,37	1,05
	4:00	43,781	43,806	24,71	1,34
	4:15	45,600	45,620	20,34	1,10
	4:30	45,781	45,803	21,51	1,17
	4:45	48,800	48,821	20,58	1,12
	5:00	49,200	49,213	12,69	0,69
	5:15	63,162	63,169	6,90	0,37
	5:30	51,600	51,615	14,60	0,79
	5:45	51,381	51,400	18,85	1,02
	6:00	51,200	51,219	18,86	1,02
	6:15	65,381	65,393	11,86	0,64
	6:30	61,781	61,801	19,83	1,08
	6:45	66,581	66,598	16,84	0,91
	7:00	60,581	60,611	29,86	1,62
	7:15	72,981	72,992	10,51	0,57
	7:30	72,181	72,206	24,74	1,34
7:45	67,200	67,219	18,58	1,01	
8:00	67,781	67,793	12,09	0,66	
8:15	77,381	77,398	17,23	0,94	

8:30	71,962	71,976	13,84	0,75
8:45	72,400	72,411	10,52	0,57
9:00	71,162	71,183	21,15	1,15
9:15	67,381	67,401	20,36	1,11
9:30	67,381	67,408	26,60	1,44
9:45	66,800	66,816	16,30	0,89
10:00	65,562	65,587	24,66	1,34
10:15	70,981	71,002	20,73	1,13
10:30	70,000	70,015	14,86	0,81
10:45	73,781	73,795	14,17	0,77
11:00	68,981	68,999	17,82	0,97
11:15	72,362	72,384	22,15	1,20
11:30	74,400	74,419	18,67	1,01
11:45	71,562	71,585	22,24	1,21
12:00	70,581	70,602	20,67	1,12
12:15	74,981	74,998	17,29	0,94
12:30	72,400	72,427	26,82	1,46
12:45	67,962	67,976	13,54	0,73
13:00	70,581	70,588	7,00	0,38
13:15	67,781	67,783	1,40	0,08
13:30	68,581	68,606	24,93	1,35
13:45	68,181	68,203	22,13	1,20
14:00	64,981	65,000	18,73	1,02
14:15	67,381	67,408	27,01	1,47
14:30	67,200	67,208	8,39	0,46
14:45	66,762	66,781	19,15	1,04
15:00	73,200	73,223	22,98	1,25
15:15	73,162	73,173	10,75	0,58
15:30	73,781	73,814	32,61	1,77
15:45	71,781	71,789	7,45	0,40
16:00	68,181	68,195	13,97	0,76
16:15	66,181	66,204	22,71	1,23
16:30	68,581	68,609	27,98	1,52
16:45	71,781	71,789	7,92	0,43
17:00	71,781	71,797	15,48	0,84
17:15	72,581	72,604	23,21	1,26
17:30	73,781	73,806	25,18	1,37
17:45	73,781	73,796	14,69	0,80
18:00	73,381	73,407	26,10	1,42
18:15	73,962	73,970	7,99	0,43
18:30	76,800	76,810	10,05	0,55
18:45	77,562	77,576	14,14	0,77
19:00	77,381	77,402	20,39	1,11
19:15	70,000	70,032	32,31	1,75
19:30	73,162	73,186	24,12	1,31
19:45	73,200	73,231	30,64	1,66
20:00	71,962	71,978	15,78	0,86
20:15	75,381	75,392	11,17	0,61
20:30	72,400	72,427	27,19	1,48
20:45	73,962	73,990	27,35	1,48
21:00	76,181	76,195	13,78	0,75
21:15	70,981	71,007	25,84	1,40
21:30	74,981	75,009	27,93	1,52
21:45	78,762	78,787	24,88	1,35
22:00	74,800	74,819	18,95	1,03
22:15	65,781	65,803	21,67	1,18
22:30	70,981	71,004	23,30	1,26
22:45	68,981	69,001	20,07	1,09
23:00	64,981	64,998	17,28	0,94
23:15	58,581	58,596	14,77	0,80
23:30	56,400	56,406	5,75	0,31
23:45	61,381	61,401	19,51	1,06
0:00	55,600	55,627	27,28	1,48

20.7.2015.	0:15	58,581	58,598	16,48	1,15
	0:30	59,962	59,968	5,27	0,37
	0:45	56,000	56,005	4,84	0,34
	1:00	59,600	59,619	19,20	1,34
	1:15	60,181	60,195	14,06	0,98
	1:30	61,781	61,789	8,15	0,57
	1:45	66,581	66,607	26,00	1,82
	2:00	64,181	64,191	9,78	0,68
	2:15	63,600	63,632	32,12	2,24
	2:30	57,781	57,795	13,57	0,95
	2:45	57,381	57,389	7,93	0,55
	3:00	58,000	58,011	10,57	0,74
	3:15	60,981	60,994	13,08	0,91
	3:30	62,181	62,208	26,70	1,87
	3:45	59,781	59,787	5,74	0,40
	4:00	57,781	57,791	9,52	0,67
	4:15	60,400	60,416	15,68	1,10
	4:30	60,981	60,998	17,05	1,19
	4:45	62,800	62,812	12,25	0,86
	5:00	58,762	58,778	15,97	1,12
	5:15	66,000	66,024	24,26	1,69
	5:30	62,581	62,609	28,28	1,98
	5:45	62,181	62,209	27,40	1,91
	6:00	56,400	56,420	20,26	1,42
	6:15	75,381	75,396	14,51	1,01
	6:30	77,781	77,794	12,78	0,89
	6:45	81,962	81,975	13,03	0,91
	7:00	79,562	79,570	7,35	0,51
	7:15	81,781	81,793	12,04	0,84
	7:30	82,181	82,195	14,28	1,00
	7:45	83,381	83,402	20,84	1,46
	8:00	83,781	83,806	25,14	1,76
	8:15	91,562	91,570	7,25	0,51
	8:30	96,762	96,780	18,05	1,26
	8:45	90,181	90,193	11,42	0,80
	9:00	92,362	92,387	25,09	1,75
	9:15	85,562	85,577	15,10	1,06
	9:30	80,981	80,984	3,30	0,23
	9:45	84,762	84,766	3,48	0,24
	10:00	84,981	84,992	11,06	0,77
10:15	88,762	88,782	19,25	1,35	
10:30	85,781	85,797	15,88	1,11	
10:45	86,581	86,597	16,14	1,13	
11:00	86,543	86,550	6,77	0,47	
11:15	86,581	86,610	28,99	2,03	
11:30	88,981	88,997	16,34	1,14	
11:45	88,362	88,375	12,93	0,90	
12:00	90,362	90,371	8,39	0,59	
12:15	89,962	89,978	15,52	1,08	
12:30	86,981	86,998	16,47	1,15	
12:45	87,343	87,355	11,36	0,79	
13:00	83,781	83,788	6,47	0,45	
13:15	83,781	83,809	27,40	1,91	
13:30	81,781	81,797	15,60	1,09	
13:45	85,343	85,372	28,59	2,00	
14:00	85,781	85,787	6,12	0,43	
14:15	84,362	84,382	19,83	1,39	
14:30	82,981	82,987	5,95	0,42	
14:45	83,562	83,577	15,08	1,05	
15:00	85,381	85,383	1,87	0,13	
15:15	85,962	85,973	10,55	0,74	
15:30	84,581	84,612	31,06	2,17	
15:45	85,781	85,807	26,29	1,84	

	16:00	86,943	86,961	17,18	1,20
	16:15	87,962	87,970	7,62	0,53
	16:30	82,400	82,417	16,91	1,18
	16:45	83,962	83,969	6,55	0,46
	17:00	84,981	84,990	9,32	0,65
	17:15	85,962	85,975	13,18	0,92
	17:30	85,381	85,404	23,00	1,61
	17:45	85,162	85,164	1,45	0,10
	18:00	85,962	85,975	13,18	0,92
	18:15	85,381	85,406	25,00	1,75
	18:30	87,562	87,571	8,93	0,62
	18:45	87,781	87,790	8,84	0,62
	19:00	86,362	86,378	15,71	1,10
	19:15	91,562	91,580	17,41	1,22
	19:30	90,981	91,005	24,08	1,68
	19:45	86,762	86,780	17,84	1,25
	20:00	87,381	87,402	21,22	1,48
	20:15	85,381	85,406	25,37	1,77
	20:30	83,962	83,985	23,17	1,62
	20:45	86,362	86,381	18,83	1,32
	21:00	87,381	87,410	28,40	1,98
	21:15	84,762	84,788	25,26	1,76
	21:30	91,381	91,400	18,74	1,31
	21:45	92,762	92,774	11,87	0,83
	22:00	94,362	94,374	11,42	0,80
	22:15	88,581	88,596	14,40	1,01
	22:30	91,162	91,170	7,26	0,51
	22:45	90,181	90,201	19,60	1,37
	23:00	87,562	87,581	19,10	1,33
	23:15	92,181	92,191	9,52	0,66
	23:30	87,962	87,972	9,83	0,69
	23:45	89,162	89,180	17,95	1,25
	0:00	86,581	86,610	28,67	2,00
21.7.2015.	0:15	80,581	80,586	4,41	0,31
	0:30	78,181	78,184	3,37	0,23
	0:45	73,781	73,811	30,32	2,11
	1:00	72,762	72,786	23,73	1,65
	1:15	67,600	67,606	6,20	0,43
	1:30	67,781	67,806	25,19	1,75
	1:45	68,181	68,186	5,26	0,37
	2:00	66,981	66,989	7,99	0,56
	2:15	66,181	66,193	11,88	0,83
	2:30	63,600	63,632	32,10	2,24
	2:45	64,762	64,767	4,48	0,31
	3:00	63,600	63,632	31,73	2,21
	3:15	74,581	74,599	18,34	1,28
	3:30	71,381	71,391	9,96	0,69
	3:45	70,981	70,991	9,54	0,66
	4:00	70,000	70,008	7,76	0,54
	4:15	69,162	69,180	18,13	1,26
	4:30	72,181	72,211	29,62	2,06
	4:45	76,400	76,413	12,98	0,90
	5:00	72,762	72,775	13,05	0,91
	5:15	76,581	76,601	20,19	1,41
	5:30	79,781	79,810	28,73	2,00
	5:45	76,581	76,611	29,56	2,06
	6:00	72,981	73,001	19,45	1,35
	6:15	80,581	80,602	21,32	1,49
	6:30	77,381	77,404	22,63	1,58
	6:45	77,562	77,594	31,31	2,18
	7:00	79,381	79,400	19,02	1,33
7:15	86,181	86,208	26,60	1,85	
7:30	85,562	85,579	16,84	1,17	

7:45	82,181	82,191	10,08	0,70
8:00	86,981	87,014	32,92	2,29
8:15	87,962	87,980	17,59	1,23
8:30	87,781	87,807	26,08	1,82
8:45	85,962	85,978	16,22	1,13
9:00	88,362	88,375	12,37	0,86
9:15	88,181	88,205	23,90	1,67
9:30	83,562	83,588	26,08	1,82
9:45	82,581	82,596	15,17	1,06
10:00	82,181	82,192	10,46	0,73
10:15	80,581	80,604	23,14	1,61
10:30	79,381	79,399	17,39	1,21
10:45	78,981	79,007	26,32	1,83
11:00	81,162	81,190	27,99	1,95
11:15	81,162	81,190	27,25	1,90
11:30	81,381	81,394	13,31	0,93
11:45	79,381	79,397	16,28	1,13
12:00	80,362	80,373	11,18	0,78
12:15	81,381	81,408	26,98	1,88
12:30	80,181	80,205	23,82	1,66
12:45	81,781	81,809	28,07	1,96
13:00	78,362	78,393	30,74	2,14
13:15	79,381	79,396	15,35	1,07
13:30	81,162	81,178	15,55	1,08
13:45	83,381	83,400	18,89	1,32
14:00	80,581	80,607	25,71	1,79
14:15	79,162	79,167	4,75	0,33
14:30	78,981	78,990	9,16	0,64
14:45	78,981	78,985	4,09	0,28
15:00	81,962	81,970	7,45	0,52
15:15	76,581	76,604	22,72	1,58
15:30	77,562	77,589	26,81	1,87
15:45	81,781	81,810	28,92	2,02
16:00	81,381	81,393	12,09	0,84
16:15	80,362	80,380	17,59	1,23
16:30	81,381	81,395	13,48	0,94
16:45	82,762	82,776	13,88	0,97
17:00	82,181	82,207	26,04	1,81
17:15	75,781	75,794	12,63	0,88
17:30	79,562	79,582	20,17	1,41
17:45	80,800	80,818	18,09	1,26
18:00	79,962	79,972	10,15	0,71
18:15	80,981	80,994	12,53	0,87
18:30	78,362	78,367	4,44	0,31
18:45	78,581	78,588	7,19	0,50
19:00	78,181	78,187	6,25	0,44
19:15	74,581	74,586	5,17	0,36
19:30	73,781	73,795	13,87	0,97
19:45	75,381	75,411	29,93	2,09
20:00	76,362	76,381	19,18	1,34
20:15	78,000	78,006	5,85	0,41
20:30	76,762	76,765	2,50	0,17
20:45	80,981	80,997	15,70	1,09
21:00	80,362	80,371	8,91	0,62
21:15	82,981	83,009	27,80	1,94
21:30	84,981	84,992	11,19	0,78
21:45	84,181	84,210	28,92	2,02
22:00	83,562	83,581	18,70	1,30
22:15	76,581	76,604	22,72	1,58
22:30	76,181	76,202	20,83	1,45
22:45	81,381	81,390	9,04	0,63
23:00	81,162	81,191	29,19	2,03
23:15	74,400	74,412	12,49	0,87

	23:30	71,162	71,184	22,12	1,54
	23:45	76,981	77,001	20,01	1,39
	0:00	68,181	68,186	4,89	0,34
22.7.2015.	0:15	72,981	72,992	10,90	0,98
	0:30	77,381	77,387	5,95	0,54
	0:45	78,981	79,009	27,95	2,52
	1:00	77,781	77,788	6,84	0,62
	1:15	74,981	75,009	27,93	2,52
	1:30	76,762	76,788	25,80	2,33
	1:45	76,400	76,413	12,57	1,13
	2:00	76,181	76,196	15,30	1,38
	2:15	74,581	74,595	14,30	1,29
	2:30	71,162	71,195	32,96	2,97
	2:45	73,381	73,388	6,84	0,62
	3:00	68,581	68,596	15,12	1,36
	3:15	73,781	73,794	12,44	1,12
	3:30	73,781	73,809	27,69	2,50
	3:45	70,981	71,006	25,36	2,29
	4:00	72,981	73,012	30,80	2,78
	4:15	76,581	76,600	18,93	1,71
	4:30	78,181	78,203	22,23	2,00
	4:45	77,381	77,392	10,73	0,97
	5:00	78,762	78,790	27,27	2,46
	5:15	85,962	85,968	5,32	0,48
	5:30	84,581	84,599	17,91	1,61
	5:45	81,781	81,809	27,78	2,50
	6:00	77,562	77,582	19,58	1,76
	6:15	83,781	83,797	16,01	1,44
	6:30	80,981	80,984	3,30	0,30
	6:45	80,981	81,005	24,24	2,18
	7:00	80,762	80,784	22,05	1,99
	7:15	88,000	88,023	22,76	2,05
	7:30	87,562	87,577	14,86	1,34
	7:45	85,381	85,399	17,56	1,58
	8:00	85,162	85,182	19,88	1,79
	8:15	97,562	97,590	27,92	2,52
	8:30	99,162	99,181	18,56	1,67
	8:45	96,981	97,008	27,23	2,45
	9:00	96,143	96,161	17,87	1,61
	9:15	95,562	95,583	20,76	1,87
	9:30	92,181	92,192	11,12	1,00
	9:45	89,381	89,410	28,89	2,60
	10:00	89,562	89,573	11,13	1,00
10:15	90,762	90,782	20,07	1,81	
10:30	91,781	91,811	30,23	2,73	
10:45	89,562	89,592	29,86	2,69	
11:00	94,362	94,371	8,64	0,78	
11:15	92,981	92,999	17,40	1,57	
11:30	93,343	93,368	24,36	2,20	
11:45	93,381	93,395	13,83	1,25	
12:00	92,362	92,386	24,07	2,17	
12:15	93,562	93,583	20,35	1,83	
12:30	95,562	95,575	12,37	1,12	
12:45	93,562	93,582	19,91	1,79	
13:00	91,562	91,591	28,43	2,56	
13:15	95,162	95,178	15,49	1,40	
13:30	94,762	94,789	27,21	2,45	
13:45	95,381	95,393	11,72	1,06	
14:00	92,981	93,001	20,12	1,81	
14:15	86,362	86,390	27,83	2,51	
14:30	84,762	84,779	16,42	1,48	
14:45	84,181	84,199	17,63	1,59	
15:00	83,962	83,988	25,38	2,29	

	15:15	82,581	82,603	22,10	1,99
	15:30	82,362	82,388	25,80	2,33
	15:45	83,781	83,791	9,76	0,88
	16:00	83,962	83,978	16,23	1,46
	16:15	83,962	83,973	10,85	0,98
	16:30	84,181	84,202	21,15	1,91
	16:45	83,381	83,387	6,36	0,57
	17:00	86,181	86,200	18,58	1,67
	17:15	88,943	88,957	13,12	1,18
	17:30	87,781	87,807	26,33	2,37
	17:45	89,962	89,993	30,99	2,79
	18:00	95,781	95,791	9,57	0,86
	18:15	94,143	94,154	11,08	1,00
	18:30	96,181	96,197	16,09	1,45
	18:45	95,562	95,568	6,22	0,56
	19:00	96,762	96,788	26,01	2,34
	19:15	94,362	94,370	8,17	0,74
	19:30	93,162	93,177	14,99	1,35
	19:45	95,381	95,405	24,33	2,19
	20:00	96,762	96,772	9,53	0,86
	20:15	95,562	95,570	8,21	0,74
	20:30	96,981	96,990	9,23	0,83
	20:45	94,762	94,778	15,98	1,44
	21:00	99,343	99,351	7,57	0,68
	21:15	98,762	98,778	16,03	1,45
	21:30	98,581	98,589	7,64	0,69
	21:45	97,162	97,179	16,94	1,53
	22:00	97,562	97,587	24,84	2,24
	22:15	85,381	85,406	24,79	2,23
	22:30	88,362	88,377	14,33	1,29
	22:45	90,762	90,785	22,39	2,02
	23:00	92,981	93,007	25,67	2,31
	23:15	81,962	81,993	30,30	2,73
	23:30	78,000	78,020	20,09	1,81
	23:45	81,562	81,584	21,34	1,92
	0:00	79,962	79,993	30,41	2,74
23.7.2015.	0:15	85,381	85,404	23,19	1,93
	0:30	85,381	85,395	14,32	1,19
	0:45	87,781	87,791	9,59	0,80
	1:00	81,562	81,585	22,33	1,86
	1:15	78,981	78,996	14,80	1,23
	1:30	77,781	77,812	30,82	2,56
	1:45	76,981	77,001	19,59	1,63
	2:00	77,962	77,974	11,75	0,98
	2:15	80,981	81,000	19,21	1,60
	2:30	73,781	73,794	12,78	1,06
	2:45	75,381	75,405	23,39	1,95
	3:00	75,562	75,563	0,62	0,05
	3:15	76,000	76,006	5,98	0,50
	3:30	69,781	69,800	18,86	1,57
	3:45	72,981	73,004	22,95	1,91
	4:00	72,981	73,003	21,85	1,82
	4:15	72,981	72,996	14,93	1,24
	4:30	73,162	73,166	3,45	0,29
	4:45	74,181	74,190	8,43	0,70
	5:00	76,000	76,016	16,04	1,34
	5:15	79,162	79,171	8,93	0,74
	5:30	79,781	79,791	9,59	0,80
	5:45	79,162	79,183	20,61	1,71
	6:00	75,781	75,814	32,87	2,74
	6:15	82,981	82,992	10,55	0,88
	6:30	81,781	81,793	12,04	1,00
	6:45	76,581	76,595	13,51	1,12

7:00	77,962	77,987	24,49	2,04
7:15	88,400	88,417	16,79	1,40
7:30	92,762	92,789	26,58	2,21
7:45	91,962	91,982	19,60	1,63
8:00	91,562	91,585	22,86	1,90
8:15	96,581	96,603	21,97	1,83
8:30	98,762	98,774	11,82	0,98
8:45	97,562	97,590	27,38	2,28
9:00	96,981	97,006	25,27	2,10
9:15	93,162	93,189	26,81	2,23
9:30	92,362	92,381	18,98	1,58
9:45	91,562	91,572	10,11	0,84
10:00	92,762	92,791	28,89	2,40
10:15	86,581	86,599	17,47	1,45
10:30	88,181	88,206	25,14	2,09
10:45	91,562	91,587	24,57	2,04
11:00	93,562	93,592	30,13	2,51
11:15	91,962	91,979	16,32	1,36
11:30	89,562	89,581	18,26	1,52
11:45	88,981	89,010	29,29	2,44
12:00	90,581	90,597	15,39	1,28
12:15	87,962	87,985	22,28	1,85
12:30	85,381	85,403	21,92	1,82
12:45	89,162	89,176	13,62	1,13
13:00	86,581	86,609	28,31	2,36
13:15	89,962	89,979	16,55	1,38
13:30	87,162	87,172	9,64	0,80
13:45	87,781	87,799	18,30	1,52
14:00	88,943	88,963	19,57	1,63
14:15	93,781	93,811	30,09	2,50
14:30	91,562	91,569	6,39	0,53
14:45	89,962	89,971	8,90	0,74
15:00	91,381	91,393	12,11	1,01
15:15	91,162	91,175	13,18	1,10
15:30	92,762	92,783	20,89	1,74
15:45	90,981	91,008	27,11	2,26
16:00	91,962	91,979	16,63	1,38
16:15	94,362	94,373	10,96	0,91
16:30	93,162	93,189	26,96	2,24
16:45	91,962	91,979	16,92	1,41
17:00	91,381	91,407	26,28	2,19
17:15	89,962	89,974	11,88	0,99
17:30	92,181	92,203	21,68	1,80
17:45	91,962	91,972	9,82	0,82
18:00	91,162	91,181	19,04	1,58
18:15	87,381	87,410	28,76	2,39
18:30	91,562	91,583	21,09	1,75
18:45	91,962	91,972	9,82	0,82
19:00	95,162	95,175	13,13	1,09
19:15	96,581	96,596	15,20	1,26
19:30	95,962	95,974	12,11	1,01
19:45	93,962	93,987	24,25	2,02
20:00	94,181	94,187	5,93	0,49
20:15	88,362	88,388	25,48	2,12
20:30	87,162	87,175	12,58	1,05
20:45	88,981	88,996	14,66	1,22
21:00	82,181	82,209	28,28	2,35
21:15	81,562	81,568	5,80	0,48
21:30	86,362	86,391	28,54	2,37
21:45	88,181	88,209	27,55	2,29
22:00	87,962	87,986	24,03	2,00
22:15	88,581	88,600	19,16	1,59
22:30	91,781	91,798	16,53	1,38

	22:45	95,162	95,176	14,19	1,18
	23:00	91,562	91,579	16,46	1,37
	23:15	83,381	83,410	28,83	2,40
	23:30	80,362	80,371	9,22	0,77
	23:45	83,381	83,393	11,64	0,97
	0:00	75,200	75,209	8,57	0,71
24.7.2015.	0:15	71,562	71,591	29,19	2,49
	0:30	69,781	69,812	30,60	2,61
	0:45	68,800	68,816	15,75	1,34
	1:00	67,562	67,567	4,78	0,41
	1:15	66,181	66,197	15,96	1,36
	1:30	64,400	64,425	25,08	2,14
	1:45	64,181	64,197	16,26	1,39
	2:00	63,781	63,808	27,07	2,31
	2:15	68,181	68,190	9,35	0,80
	2:30	66,400	66,416	16,44	1,40
	2:45	65,962	65,970	7,68	0,66
	3:00	65,781	65,793	11,46	0,98
	3:15	68,400	68,426	25,52	2,18
	3:30	67,781	67,796	14,93	1,27
	3:45	68,581	68,610	28,38	2,42
	4:00	67,781	67,800	19,28	1,65
	4:15	72,181	72,190	9,17	0,78
	4:30	74,762	74,775	12,63	1,08
	4:45	74,581	74,600	18,45	1,57
	5:00	73,600	73,621	20,94	1,79
	5:15	76,362	76,371	8,34	0,71
	5:30	75,381	75,400	19,29	1,65
	5:45	75,381	75,388	6,38	0,54
	6:00	74,981	75,008	26,39	2,25
	6:15	80,362	80,370	7,68	0,66
	6:30	77,381	77,389	8,13	0,69
	6:45	73,781	73,804	22,45	1,92
	7:00	76,181	76,210	29,08	2,48
	7:15	77,781	77,798	16,68	1,42
	7:30	78,981	78,992	10,99	0,94
	7:45	82,981	83,005	24,19	2,06
	8:00	81,962	81,986	23,27	1,99
	8:15	90,581	90,602	20,74	1,77
	8:30	90,362	90,387	24,77	2,11
	8:45	89,962	89,987	24,62	2,10
	9:00	92,181	92,203	21,57	1,84
	9:15	89,562	89,586	23,62	2,02
	9:30	89,562	89,586	23,98	2,05
	9:45	88,181	88,212	30,43	2,60
	10:00	86,581	86,588	7,26	0,62
10:15	86,581	86,603	21,67	1,85	
10:30	84,762	84,778	15,50	1,32	
10:45	85,162	85,179	16,80	1,43	
11:00	85,781	85,802	21,20	1,81	
11:15	85,562	85,588	25,80	2,20	
11:30	86,181	86,209	28,03	2,39	
11:45	85,962	85,976	13,28	1,13	
12:00	87,781	87,804	23,21	1,98	
12:15	88,181	88,194	13,22	1,13	
12:30	87,962	87,975	13,15	1,12	
12:45	88,362	88,382	20,01	1,71	
13:00	85,962	85,974	12,14	1,04	
13:15	88,981	88,996	14,93	1,27	
13:30	89,962	89,977	14,84	1,27	
13:45	90,581	90,606	24,46	2,09	
14:00	91,343	91,359	15,53	1,33	
14:15	90,581	90,597	15,91	1,36	

	14:30	91,162	91,175	12,46	1,06
	14:45	88,981	89,001	19,62	1,67
	15:00	89,162	89,172	9,42	0,80
	15:15	88,762	88,773	11,23	0,96
	15:30	89,781	89,798	16,93	1,44
	15:45	91,162	91,175	12,41	1,06
	16:00	90,581	90,603	22,18	1,89
	16:15	87,162	87,188	25,99	2,22
	16:30	91,162	91,175	12,46	1,06
	16:45	91,162	91,175	12,46	1,06
	17:00	91,962	91,988	25,73	2,20
	17:15	95,781	95,797	15,94	1,36
	17:30	93,562	93,593	30,34	2,59
	17:45	89,381	89,388	7,08	0,60
	18:00	90,181	90,193	11,94	1,02
	18:15	90,543	90,568	25,05	2,14
	18:30	90,362	90,376	13,80	1,18
	18:45	92,581	92,602	20,47	1,75
	19:00	92,762	92,783	20,89	1,78
	19:15	95,781	95,794	13,14	1,12
	19:30	94,362	94,373	10,96	0,94
	19:45	93,781	93,803	21,80	1,86
	20:00	93,562	93,584	21,74	1,86
	20:15	92,362	92,382	19,68	1,68
	20:30	89,381	89,388	7,08	0,60
	20:45	86,762	86,776	13,81	1,18
	21:00	91,381	91,411	29,38	2,51
	21:15	94,762	94,789	26,57	2,27
	21:30	94,362	94,383	20,24	1,73
	21:45	93,381	93,411	29,44	2,51
	22:00	93,162	93,172	9,32	0,80
	22:15	84,581	84,602	20,90	1,78
	22:30	86,762	86,784	21,83	1,86
	22:45	91,381	91,401	19,86	1,70
	23:00	89,381	89,394	12,80	1,09
	23:15	81,962	81,983	20,58	1,76
	23:30	82,181	82,187	6,15	0,52
	23:45	81,562	81,587	24,32	2,08
	0:00	78,181	78,195	14,17	1,21
25.7.2015.	0:15	58,800	58,804	4,24	0,22
	0:30	57,381	57,413	31,52	1,63
	0:45	56,981	57,002	21,25	1,10
	1:00	56,800	56,812	12,00	0,62
	1:15	57,781	57,793	12,04	0,62
	1:30	56,400	56,404	3,88	0,20
	1:45	55,781	55,789	7,82	0,40
	2:00	55,781	55,788	6,45	0,33
	2:15	58,400	58,421	21,28	1,10
	2:30	57,781	57,787	5,63	0,29
	2:45	56,981	57,005	23,96	1,24
	3:00	58,000	58,006	6,40	0,33
	3:15	58,981	58,989	7,47	0,39
	3:30	58,581	58,610	28,58	1,48
	3:45	55,600	55,627	27,16	1,40
	4:00	54,181	54,200	18,91	0,98
	4:15	54,400	54,419	18,54	0,96
	4:30	55,162	55,190	27,39	1,41
	4:45	56,000	56,005	5,23	0,27
	5:00	56,000	56,007	6,88	0,36
	5:15	58,981	58,991	9,38	0,48
	5:30	54,800	54,824	23,95	1,24
	5:45	52,581	52,588	6,37	0,33
	6:00	54,181	54,199	17,71	0,91

6:15	56,000	56,003	2,74	0,14
6:30	52,181	52,208	26,49	1,37
6:45	53,381	53,407	26,15	1,35
7:00	56,000	56,030	29,51	1,52
7:15	57,381	57,409	27,73	1,43
7:30	52,981	52,999	18,06	0,93
7:45	54,400	54,413	12,94	0,67
8:00	52,581	52,590	9,17	0,47
8:15	56,400	56,417	16,82	0,87
8:30	55,200	55,222	21,81	1,13
8:45	55,562	55,573	11,03	0,57
9:00	52,800	52,817	16,61	0,86
9:15	61,600	61,611	10,53	0,54
9:30	59,562	59,585	23,02	1,19
9:45	57,200	57,217	16,73	0,86
10:00	58,400	58,407	6,59	0,34
10:15	63,381	63,392	10,90	0,56
10:30	63,381	63,388	6,53	0,34
10:45	62,181	62,197	15,84	0,82
11:00	62,981	62,998	17,05	0,88
11:15	65,600	65,617	17,06	0,88
11:30	65,162	65,179	16,40	0,85
11:45	68,000	68,009	9,49	0,49
12:00	67,562	67,570	7,83	0,40
12:15	66,000	66,013	12,95	0,67
12:30	66,181	66,190	8,73	0,45
12:45	67,781	67,789	8,28	0,43
13:00	64,981	65,009	27,57	1,42
13:15	65,381	65,398	16,63	0,86
13:30	65,600	65,620	20,08	1,04
13:45	66,981	66,993	11,67	0,60
14:00	66,181	66,211	29,67	1,53
14:15	64,981	65,001	19,69	1,02
14:30	65,781	65,792	11,22	0,58
14:45	69,600	69,630	30,08	1,55
15:00	66,362	66,377	14,25	0,74
15:15	65,381	65,391	9,54	0,49
15:30	66,400	66,419	18,92	0,98
15:45	65,781	65,806	25,12	1,30
16:00	66,981	67,004	22,56	1,16
16:15	65,781	65,805	24,10	1,24
16:30	66,581	66,605	23,92	1,24
16:45	66,800	66,819	18,76	0,97
17:00	66,581	66,599	17,90	0,92
17:15	60,181	60,202	20,65	1,07
17:30	64,400	64,407	7,10	0,37
17:45	62,762	62,773	10,87	0,56
18:00	62,800	62,825	25,26	1,30
18:15	61,381	61,390	8,54	0,44
18:30	63,381	63,413	31,65	1,63
18:45	62,400	62,413	13,13	0,68
19:00	64,581	64,609	28,20	1,46
19:15	61,781	61,805	23,64	1,22
19:30	61,381	61,390	8,60	0,44
19:45	59,600	59,620	20,07	1,04
20:00	61,781	61,802	20,68	1,07
20:15	58,581	58,605	23,98	1,24
20:30	62,581	62,608	26,79	1,38
20:45	60,000	60,009	8,54	0,44
21:00	60,981	60,996	15,21	0,79
21:15	68,181	68,190	8,98	0,46
21:30	60,181	60,205	23,85	1,23
21:45	58,400	58,419	18,51	0,96

	22:00	59,781	59,807	25,48	1,32
	22:15	56,981	57,004	23,11	1,19
	22:30	56,981	57,007	25,73	1,33
	22:45	58,800	58,830	30,09	1,55
	23:00	57,562	57,573	10,79	0,56
	23:15	55,200	55,226	26,32	1,36
	23:30	51,600	51,614	14,06	0,73
	23:45	54,581	54,600	19,07	0,98
	0:00	51,781	51,793	12,29	0,63
26.7.2015.	0:15	45,200	45,216	16,08	0,67
	0:30	44,000	44,023	22,66	0,94
	0:45	43,162	43,173	10,83	0,45
	1:00	44,000	44,021	21,30	0,88
	1:15	45,200	45,214	13,98	0,58
	1:30	46,400	46,400	0,44	0,02
	1:45	47,781	47,801	20,16	0,83
	2:00	47,600	47,601	0,64	0,03
	2:15	49,781	49,803	21,69	0,90
	2:30	44,981	44,995	14,28	0,59
	2:45	48,619	48,635	15,65	0,65
	3:00	48,581	48,600	18,39	0,76
	3:15	48,581	48,595	13,69	0,57
	3:30	48,181	48,199	17,50	0,72
	3:45	46,219	46,238	19,22	0,79
	4:00	46,181	46,184	3,20	0,13
	4:15	45,381	45,405	23,96	0,99
	4:30	40,400	40,416	15,84	0,66
	4:45	41,200	41,217	17,29	0,72
	5:00	42,581	42,596	14,84	0,61
	5:15	42,000	42,026	25,83	1,07
	5:30	41,381	41,400	18,55	0,77
	5:45	40,000	40,002	2,11	0,09
	6:00	37,781	37,793	12,31	0,51
	6:15	39,600	39,623	23,10	0,96
	6:30	36,181	36,187	5,51	0,23
	6:45	38,000	38,010	10,37	0,43
	7:00	37,600	37,607	7,49	0,31
	7:15	38,181	38,200	18,80	0,78
	7:30	36,400	36,408	8,18	0,34
	7:45	33,600	33,624	24,40	1,01
	8:00	35,781	35,802	21,25	0,88
	8:15	42,619	42,636	17,38	0,72
	8:30	43,781	43,794	13,12	0,54
	8:45	39,381	39,389	8,05	0,33
	9:00	40,000	40,014	13,68	0,57
	9:15	42,981	42,992	10,40	0,43
	9:30	43,200	43,207	7,26	0,30
	9:45	41,600	41,617	17,25	0,71
	10:00	38,581	38,598	17,35	0,72
10:15	45,419	45,430	11,52	0,48	
10:30	45,781	45,788	6,51	0,27	
10:45	46,981	46,999	17,56	0,73	
11:00	46,619	46,630	11,01	0,46	
11:15	44,181	44,205	24,17	1,00	
11:30	46,981	46,996	14,65	0,61	
11:45	46,800	46,814	14,38	0,59	
12:00	50,981	51,006	24,82	1,03	
12:15	54,800	54,815	14,63	0,61	
12:30	52,581	52,600	18,93	0,78	
12:45	54,400	54,420	20,27	0,84	
13:00	53,381	53,406	24,76	1,02	
13:15	52,181	52,196	14,84	0,61	
13:30	50,000	50,019	18,83	0,78	

	13:45	49,600	49,608	8,29	0,34
	14:00	49,600	49,609	9,08	0,38
	14:15	49,781	49,795	13,39	0,55
	14:30	47,381	47,397	16,04	0,66
	14:45	50,581	50,604	23,28	0,96
	15:00	49,019	49,041	22,26	0,92
	15:15	50,981	51,001	19,61	0,81
	15:30	47,600	47,612	12,24	0,51
	15:45	47,781	47,794	12,49	0,52
	16:00	47,200	47,207	6,95	0,29
	16:15	42,981	42,986	5,24	0,22
	16:30	44,000	44,019	19,31	0,80
	16:45	44,581	44,594	12,59	0,52
	17:00	46,000	46,022	21,70	0,90
	17:15	46,800	46,824	24,18	1,00
	17:30	47,381	47,409	28,07	1,16
	17:45	44,000	44,021	20,88	0,86
	18:00	41,600	41,615	15,00	0,62
	18:15	43,600	43,625	24,57	1,02
	18:30	45,381	45,389	8,26	0,34
	18:45	45,200	45,210	9,83	0,41
	19:00	47,381	47,409	28,07	1,16
	19:15	48,581	48,601	19,66	0,81
	19:30	46,000	46,007	6,50	0,27
	19:45	46,000	46,011	10,84	0,45
	20:00	45,200	45,207	7,31	0,30
	20:15	46,181	46,206	24,89	1,03
	20:30	46,000	46,005	5,45	0,23
	20:45	49,381	49,390	8,83	0,37
	21:00	50,000	50,019	18,86	0,78
	21:15	51,600	51,619	18,50	0,77
	21:30	50,581	50,608	26,81	1,11
	21:45	55,200	55,212	12,41	0,51
	22:00	53,200	53,205	5,33	0,22
	22:15	46,181	46,192	11,27	0,47
	22:30	47,381	47,401	19,78	0,82
	22:45	54,400	54,421	21,38	0,88
	23:00	58,181	58,195	13,77	0,57
	23:15	52,400	52,424	23,78	0,98
	23:30	43,781	43,795	14,02	0,58
	23:45	49,200	49,223	23,23	0,96
	0:00	47,600	47,608	7,85	0,32
27.7.2015.	0:15	64,362	64,369	6,51	0,26
	0:30	64,800	64,807	6,59	0,26
	0:45	63,381	63,391	9,56	0,37
	1:00	64,181	64,193	11,39	0,45
	1:15	66,000	66,005	4,92	0,19
	1:30	64,762	64,784	21,38	0,84
	1:45	66,400	66,425	24,52	0,96
	2:00	63,381	63,392	11,26	0,44
	2:15	72,581	72,600	18,70	0,73
	2:30	68,981	68,998	17,25	0,68
	2:45	67,381	67,410	29,14	1,14
	3:00	60,581	60,597	16,09	0,63
	3:15	66,800	66,812	11,63	0,46
	3:30	64,981	65,002	20,39	0,80
	3:45	64,581	64,607	25,56	1,00
	4:00	65,781	65,797	15,97	0,63
	4:15	67,200	67,209	8,95	0,35
	4:30	69,381	69,405	23,72	0,93
4:45	67,781	67,806	25,14	0,99	
5:00	68,181	68,207	25,39	1,00	
5:15	64,800	64,815	14,54	0,57	

5:30	60,800	60,825	24,65	0,97
5:45	58,762	58,777	14,50	0,57
6:00	56,400	56,422	21,87	0,86
6:15	62,181	62,194	13,16	0,52
6:30	60,181	60,199	18,11	0,71
6:45	57,200	57,216	16,23	0,64
7:00	54,800	54,821	20,83	0,82
7:15	56,181	56,202	20,40	0,80
7:30	56,581	56,608	27,11	1,06
7:45	55,600	55,625	25,43	1,00
8:00	56,800	56,819	18,78	0,74
8:15	62,181	62,197	15,47	0,61
8:30	61,381	61,404	22,81	0,89
8:45	61,200	61,213	13,33	0,52
9:00	62,581	62,600	18,62	0,73
9:15	60,581	60,600	19,31	0,76
9:30	60,181	60,204	23,02	0,90
9:45	61,381	61,404	22,60	0,89
10:00	59,200	59,224	23,86	0,94
10:15	62,981	63,007	25,68	1,01
10:30	62,981	62,996	15,31	0,60
10:45	63,200	63,215	15,18	0,60
11:00	63,381	63,394	12,70	0,50
11:15	66,981	67,003	21,48	0,84
11:30	64,581	64,597	15,56	0,61
11:45	64,981	64,999	17,68	0,69
12:00	66,981	67,001	19,44	0,76
12:15	66,000	66,018	17,64	0,69
12:30	64,581	64,599	17,37	0,68
12:45	67,381	67,405	24,12	0,95
13:00	63,200	63,228	27,79	1,09
13:15	68,762	68,790	28,22	1,11
13:30	67,200	67,221	20,53	0,80
13:45	66,981	67,007	26,29	1,03
14:00	66,981	67,004	23,31	0,91
14:15	71,381	71,403	22,13	0,87
14:30	69,381	69,406	25,21	0,99
14:45	68,981	69,005	24,28	0,95
15:00	70,400	70,410	9,62	0,38
15:15	70,362	70,378	15,72	0,62
15:30	71,600	71,616	15,69	0,62
15:45	71,162	71,176	13,94	0,55
16:00	73,781	73,795	14,21	0,56
16:15	66,581	66,603	22,30	0,87
16:30	67,781	67,808	27,31	1,07
16:45	65,600	65,624	23,56	0,92
17:00	66,181	66,209	27,68	1,09
17:15	65,381	65,394	13,37	0,52
17:30	68,181	68,206	25,11	0,98
17:45	66,981	67,007	26,32	1,03
18:00	66,181	66,211	29,46	1,16
18:15	59,600	59,619	19,41	0,76
18:30	60,581	60,592	11,24	0,44
18:45	62,800	62,808	8,14	0,32
19:00	61,162	61,174	11,25	0,44
19:15	54,800	54,823	22,86	0,90
19:30	55,381	55,403	21,54	0,84
19:45	55,600	55,622	22,37	0,88
20:00	54,581	54,605	23,95	0,94
20:15	52,181	52,196	15,15	0,59
20:30	47,200	47,218	18,03	0,71
20:45	50,000	50,016	15,94	0,63
21:00	54,181	54,201	20,34	0,80

	21:15	57,781	57,792	11,01	0,43
	21:30	60,800	60,809	8,91	0,35
	21:45	61,781	61,787	5,87	0,23
	22:00	59,381	59,395	14,19	0,56
	22:15	52,000	52,011	11,49	0,45
	22:30	50,181	50,198	16,91	0,66
	22:45	56,581	56,587	6,06	0,24
	23:00	54,581	54,598	17,04	0,67
	23:15	52,219	52,228	9,36	0,37
	23:30	49,781	49,799	17,40	0,68
	23:45	49,381	49,408	26,61	1,04
	0:00	49,200	49,225	25,17	0,99
28.7.2015.	0:15	53,200	53,204	3,91	0,23
	0:30	49,381	49,393	12,09	0,70
	0:45	50,581	50,598	16,62	0,97
	1:00	50,800	50,810	10,09	0,59
	1:15	57,381	57,401	19,92	1,16
	1:30	57,600	57,610	10,47	0,61
	1:45	58,762	58,776	14,20	0,83
	2:00	56,400	56,428	27,81	1,62
	2:15	54,000	54,008	8,11	0,47
	2:30	51,381	51,400	19,20	1,12
	2:45	50,800	50,818	18,43	1,07
	3:00	50,181	50,194	13,25	0,77
	3:15	52,581	52,595	13,50	0,79
	3:30	52,800	52,824	23,65	1,38
	3:45	52,000	52,016	15,80	0,92
	4:00	52,181	52,205	24,26	1,41
	4:15	54,981	54,992	10,87	0,63
	4:30	52,400	52,411	10,86	0,63
	4:45	56,181	56,196	14,90	0,87
	5:00	57,381	57,408	27,30	1,59
	5:15	64,981	65,008	27,27	1,59
	5:30	64,800	64,807	7,14	0,42
	5:45	64,581	64,587	6,31	0,37
	6:00	59,381	59,408	26,73	1,56
	6:15	57,781	57,807	25,41	1,48
	6:30	54,000	54,016	16,21	0,94
	6:45	56,981	56,997	16,29	0,95
	7:00	54,581	54,597	15,90	0,93
	7:15	54,400	54,415	14,62	0,85
	7:30	56,981	56,998	17,02	0,99
	7:45	60,181	60,202	20,59	1,20
	8:00	59,781	59,806	25,18	1,47
	8:15	60,581	60,601	20,16	1,17
	8:30	63,200	63,227	27,11	1,58
	8:45	63,381	63,401	20,11	1,17
	9:00	62,581	62,609	28,02	1,63
	9:15	68,400	68,414	14,13	0,82
	9:30	65,381	65,399	18,08	1,05
	9:45	66,181	66,208	26,81	1,56
	10:00	65,781	65,806	24,58	1,43
10:15	68,981	69,002	20,46	1,19	
10:30	66,000	66,027	27,40	1,60	
10:45	64,581	64,602	21,22	1,24	
11:00	66,181	66,201	20,29	1,18	
11:15	64,581	64,598	16,50	0,96	
11:30	65,781	65,797	16,36	0,95	
11:45	67,381	67,411	29,46	1,72	
12:00	65,200	65,217	16,51	0,96	
12:15	66,762	66,778	15,69	0,91	
12:30	64,181	64,194	12,74	0,74	
12:45	66,000	66,017	16,97	0,99	

	13:00	65,381	65,403	21,70	1,26
	13:15	64,400	64,415	15,27	0,89
	13:30	67,381	67,399	17,88	1,04
	13:45	70,981	71,000	19,23	1,12
	14:00	68,181	68,198	17,32	1,01
	14:15	66,581	66,600	18,93	1,10
	14:30	68,181	68,203	21,96	1,28
	14:45	70,000	70,032	31,65	1,84
	15:00	69,162	69,191	28,26	1,65
	15:15	67,381	67,408	27,26	1,59
	15:30	70,800	70,813	12,75	0,74
	15:45	69,381	69,404	23,11	1,35
	16:00	70,181	70,190	8,69	0,51
	16:15	66,981	67,010	28,79	1,68
	16:30	67,381	67,404	23,18	1,35
	16:45	69,381	69,405	23,47	1,37
	17:00	69,381	69,409	28,32	1,65
	17:15	66,581	66,597	15,49	0,90
	17:30	70,981	70,994	13,34	0,78
	17:45	68,800	68,820	19,92	1,16
	18:00	70,181	70,192	11,15	0,65
	18:15	56,981	57,007	26,11	1,52
	18:30	61,381	61,392	11,31	0,66
	18:45	60,000	60,023	22,93	1,34
	19:00	60,981	60,992	11,08	0,65
	19:15	56,581	56,598	16,47	0,96
	19:30	56,400	56,418	17,94	1,04
	19:45	51,781	51,795	13,52	0,79
	20:00	55,600	55,617	16,84	0,98
	20:15	55,200	55,219	18,88	1,10
	20:30	55,381	55,392	10,77	0,63
	20:45	53,781	53,801	19,57	1,14
	21:00	58,800	58,823	23,19	1,35
	21:15	54,981	55,005	23,67	1,38
	21:30	58,000	58,026	25,87	1,51
	21:45	55,381	55,391	10,20	0,59
	22:00	54,400	54,422	21,61	1,26
	22:15	44,581	44,589	7,80	0,45
	22:30	50,800	50,820	19,77	1,15
	22:45	58,181	58,207	25,84	1,50
	23:00	61,600	61,621	21,39	1,25
	23:15	52,581	52,591	9,78	0,57
	23:30	50,181	50,203	21,60	1,26
	23:45	50,000	50,025	24,64	1,44
	0:00	53,600	53,615	15,36	0,89
29.7.2015.	0:15	55,381	55,401	20,35	0,86
	0:30	54,181	54,198	16,44	0,70
	0:45	38,619	38,626	7,05	0,30
	1:00	45,562	45,576	13,72	0,58
	1:15	47,600	47,619	18,64	0,79
	1:30	46,800	46,824	24,02	1,02
	1:45	46,181	46,202	21,01	0,89
	2:00	46,800	46,824	24,02	1,02
	2:15	42,000	42,028	27,58	1,17
	2:30	44,181	44,193	11,72	0,50
	2:45	43,200	43,205	5,05	0,21
	3:00	44,800	44,816	16,02	0,68
	3:15	44,981	44,993	11,39	0,48
	3:30	40,400	40,409	8,75	0,37
	3:45	46,800	46,820	20,41	0,87
	4:00	47,381	47,404	22,73	0,96
	4:15	54,000	54,012	11,61	0,49
4:30	57,381	57,409	27,67	1,17	

4:45	61,781	61,803	22,31	0,95
5:00	64,981	65,002	20,53	0,87
5:15	66,000	66,020	20,39	0,87
5:30	63,781	63,795	14,30	0,61
5:45	63,600	63,617	16,60	0,70
6:00	61,781	61,798	16,43	0,70
6:15	61,781	61,798	16,79	0,71
6:30	59,781	59,808	26,83	1,14
6:45	60,981	61,006	25,35	1,08
7:00	66,000	66,015	14,93	0,63
7:15	70,762	70,786	23,46	1,00
7:30	72,000	72,025	25,04	1,06
7:45	70,981	71,008	26,41	1,12
8:00	70,581	70,595	13,92	0,59
8:15	71,381	71,394	13,28	0,56
8:30	71,381	71,402	21,30	0,90
8:45	73,781	73,804	22,57	0,96
9:00	74,981	74,997	15,86	0,67
9:15	73,381	73,395	13,42	0,57
9:30	74,581	74,599	18,20	0,77
9:45	70,181	70,194	12,37	0,53
10:00	67,781	67,808	26,54	1,13
10:15	69,381	69,405	23,40	0,99
10:30	67,200	67,230	29,68	1,26
10:45	69,381	69,405	23,40	0,99
11:00	70,362	70,376	13,30	0,56
11:15	72,181	72,199	17,66	0,75
11:30	74,181	74,205	24,12	1,02
11:45	74,400	74,420	20,10	0,85
12:00	72,762	72,790	27,41	1,16
12:15	74,981	75,000	18,43	0,78
12:30	73,381	73,403	21,63	0,92
12:45	73,781	73,809	27,57	1,17
13:00	71,781	71,789	8,07	0,34
13:15	72,181	72,201	19,64	0,83
13:30	69,781	69,805	24,17	1,03
13:45	68,581	68,609	28,02	1,19
14:00	70,581	70,594	13,00	0,55
14:15	70,981	71,009	28,11	1,19
14:30	69,781	69,805	24,04	1,02
14:45	69,381	69,402	20,50	0,87
15:00	68,581	68,607	25,60	1,09
15:15	72,981	73,006	24,77	1,05
15:30	70,581	70,600	19,08	0,81
15:45	72,981	73,006	24,77	1,05
16:00	72,181	72,201	20,18	0,86
16:15	69,600	69,617	16,57	0,70
16:30	72,362	72,384	21,36	0,91
16:45	70,981	71,003	21,52	0,91
17:00	71,200	71,220	20,39	0,87
17:15	69,562	69,584	21,98	0,93
17:30	66,000	66,012	12,49	0,53
17:45	68,181	68,202	21,26	0,90
18:00	66,981	66,994	12,47	0,53
18:15	61,600	61,625	25,43	1,08
18:30	65,781	65,794	12,79	0,54
18:45	66,581	66,590	8,96	0,38
19:00	70,981	71,001	19,44	0,83
19:15	67,162	67,193	30,69	1,30
19:30	67,600	67,626	26,08	1,11
19:45	66,400	66,414	14,16	0,60
20:00	65,381	65,401	20,00	0,85
20:15	66,362	66,373	10,78	0,46

	20:30	64,400	64,425	24,89	1,06
	20:45	62,981	63,007	25,37	1,08
	21:00	67,381	67,404	22,46	0,95
	21:15	65,600	65,614	14,29	0,61
	21:30	63,781	63,801	19,89	0,84
	21:45	68,981	69,004	22,47	0,95
	22:00	70,981	71,007	26,17	1,11
	22:15	69,600	69,627	27,29	1,16
	22:30	70,181	70,193	12,06	0,51
	22:45	72,581	72,605	23,73	1,01
	23:00	72,581	72,605	23,81	1,01
	23:15	64,181	64,201	19,62	0,83
	23:30	73,162	73,190	27,24	1,16
	23:45	72,400	72,408	8,40	0,36
	0:00	70,981	71,002	20,64	0,88
30.7.2015.	0:15	63,781	63,805	24,30	0,87
	0:30	62,981	63,000	19,37	0,69
	0:45	54,981	54,995	13,63	0,49
	1:00	57,600	57,625	24,64	0,88
	1:15	54,981	55,005	24,32	0,87
	1:30	56,981	57,005	23,69	0,85
	1:45	61,200	61,216	16,00	0,57
	2:00	58,581	58,597	16,00	0,57
	2:15	59,600	59,615	15,20	0,54
	2:30	60,181	60,197	15,64	0,56
	2:45	59,200	59,225	24,71	0,88
	3:00	57,381	57,407	26,23	0,94
	3:15	58,981	59,001	20,28	0,72
	3:30	59,381	59,390	8,41	0,30
	3:45	60,181	60,210	28,56	1,02
	4:00	58,000	58,023	22,88	0,82
	4:15	54,981	54,995	13,74	0,49
	4:30	53,781	53,809	27,92	1,00
	4:45	57,200	57,219	19,20	0,69
	5:00	56,400	56,424	23,56	0,84
	5:15	52,981	52,995	13,43	0,48
	5:30	55,600	55,618	18,39	0,66
	5:45	52,181	52,199	17,62	0,63
	6:00	50,581	50,599	18,36	0,66
	6:15	53,600	53,611	10,59	0,38
	6:30	48,181	48,204	22,78	0,81
	6:45	49,381	49,389	7,50	0,27
	7:00	51,200	51,211	11,05	0,39
	7:15	57,600	57,619	18,61	0,66
	7:30	54,981	55,002	20,98	0,75
	7:45	56,981	57,005	24,34	0,87
	8:00	57,200	57,216	15,87	0,57
	8:15	61,381	61,396	14,53	0,52
	8:30	58,981	58,999	18,08	0,65
	8:45	58,400	58,429	28,53	1,02
	9:00	57,381	57,404	22,41	0,80
	9:15	64,400	64,410	9,66	0,34
	9:30	66,581	66,592	10,59	0,38
	9:45	64,581	64,597	15,92	0,57
	10:00	63,781	63,803	22,25	0,79
	10:15	70,581	70,594	12,95	0,46
	10:30	71,200	71,213	13,40	0,48
	10:45	72,362	72,387	24,53	0,88
	11:00	68,400	68,421	21,34	0,76
	11:15	75,962	75,991	28,59	1,02
	11:30	76,181	76,199	17,72	0,63
	11:45	74,181	74,193	12,02	0,43
	12:00	74,400	74,414	14,21	0,51

	12:15	71,381	71,399	18,19	0,65
	12:30	71,162	71,179	16,45	0,59
	12:45	74,981	74,991	10,26	0,37
	13:00	71,200	71,227	26,60	0,95
	13:15	73,162	73,178	15,76	0,56
	13:30	74,981	75,007	25,87	0,92
	13:45	76,181	76,202	20,80	0,74
	14:00	74,981	74,999	18,11	0,65
	14:15	74,181	74,196	14,86	0,53
	14:30	73,781	73,795	14,23	0,51
	14:45	71,781	71,805	23,77	0,85
	15:00	69,781	69,804	22,65	0,81
	15:15	66,000	66,019	19,37	0,69
	15:30	63,562	63,580	17,79	0,64
	15:45	68,400	68,428	28,36	1,01
	16:00	65,781	65,796	15,00	0,54
	16:15	60,181	60,195	14,06	0,50
	16:30	62,800	62,825	25,46	0,91
	16:45	62,581	62,601	20,12	0,72
	17:00	60,981	61,003	21,40	0,76
	17:15	58,800	58,817	16,54	0,59
	17:30	56,581	56,603	21,98	0,78
	17:45	57,781	57,810	28,94	1,03
	18:00	57,200	57,214	13,59	0,49
	18:15	53,200	53,218	18,39	0,66
	18:30	53,162	53,183	20,96	0,75
	18:45	56,619	56,629	9,92	0,35
	19:00	54,981	55,010	28,51	1,02
	19:15	54,581	54,605	24,07	0,86
	19:30	52,400	52,419	19,00	0,68
	19:45	52,981	53,000	19,05	0,68
	20:00	46,400	46,409	8,52	0,30
	20:15	44,981	45,007	26,11	0,93
	20:30	43,600	43,618	17,88	0,64
	20:45	41,381	41,403	22,30	0,80
	21:00	43,419	43,436	17,41	0,62
	21:15	48,581	48,598	16,72	0,60
	21:30	48,800	48,814	14,22	0,51
	21:45	48,181	48,205	24,27	0,87
	22:00	49,600	49,628	27,80	0,99
	22:15	42,800	42,813	12,72	0,45
	22:30	45,781	45,796	14,59	0,52
	22:45	47,600	47,621	20,67	0,74
	23:00	48,181	48,195	13,45	0,48
	23:15	40,800	40,812	12,36	0,44
	23:30	43,781	43,801	20,30	0,73
	23:45	44,400	44,423	22,62	0,81
	0:00	43,781	43,793	11,40	0,41
31.7.2015.	0:15	40,800	40,812	12,34	0,50
	0:30	39,200	39,217	17,21	0,70
	0:45	42,000	42,007	7,29	0,29
	1:00	39,381	39,391	9,92	0,40
	1:15	42,400	42,415	14,96	0,61
	1:30	38,800	38,820	20,02	0,81
	1:45	40,181	40,185	3,81	0,15
	2:00	40,800	40,807	7,06	0,29
	2:15	44,000	44,020	20,36	0,82
	2:30	42,181	42,204	22,52	0,91
	2:45	40,000	40,019	18,54	0,75
	3:00	40,800	40,815	14,56	0,59
	3:15	42,800	42,807	7,25	0,29

3:30	41,381	41,400	19,32	0,78
3:45	41,600	41,620	19,89	0,80
4:00	40,981	40,988	7,25	0,29
4:15	40,800	40,815	15,07	0,61
4:30	42,400	42,418	17,88	0,72
4:45	43,381	43,406	25,13	1,02
5:00	43,600	43,623	23,29	0,94
5:15	45,200	45,204	3,77	0,15
5:30	44,981	45,006	24,58	0,99
5:45	43,200	43,207	6,80	0,28
6:00	41,381	41,397	15,51	0,63
6:15	44,400	44,412	12,14	0,49
6:30	42,181	42,199	17,99	0,73
6:45	40,800	40,814	14,27	0,58
7:00	41,200	41,217	16,96	0,69
7:15	50,000	50,026	26,46	1,07
7:30	43,200	43,214	14,08	0,57
7:45	43,781	43,793	11,60	0,47
8:00	44,981	44,990	8,91	0,36
8:15	46,800	46,813	12,53	0,51
8:30	50,400	50,426	25,94	1,05
8:45	50,581	50,596	14,74	0,60
9:00	50,400	50,423	23,40	0,95
9:15	47,781	47,797	16,07	0,65
9:30	46,400	46,413	13,35	0,54
9:45	46,981	46,998	16,98	0,69
10:00	49,381	49,401	19,51	0,79
10:15	49,781	49,800	18,44	0,75
10:30	47,781	47,798	16,77	0,68
10:45	49,381	49,401	19,51	0,79
11:00	48,181	48,206	24,96	1,01
11:15	48,800	48,813	13,50	0,55
11:30	47,962	47,969	7,02	0,28
11:45	49,600	49,626	25,58	1,04
12:00	49,600	49,621	21,44	0,87
12:15	52,800	52,820	19,56	0,79
12:30	52,981	52,996	14,47	0,59
12:45	52,581	52,603	22,03	0,89
13:00	50,581	50,600	19,02	0,77
13:15	50,800	50,824	23,80	0,96
13:30	50,581	50,596	15,11	0,61
13:45	52,581	52,600	18,42	0,75
14:00	51,200	51,226	25,58	1,03
14:15	50,000	50,018	17,81	0,72
14:30	49,381	49,397	15,55	0,63
14:45	50,000	50,019	19,19	0,78
15:00	48,581	48,607	25,42	1,03
15:15	46,581	46,593	12,08	0,49
15:30	45,019	45,029	9,86	0,40
15:45	46,181	46,191	9,91	0,40
16:00	46,800	46,809	9,05	0,37
16:15	42,400	42,412	12,13	0,49
16:30	41,781	41,799	17,42	0,70
16:45	44,400	44,416	16,45	0,67

17:00	43,381	43,403	21,99	0,89
17:15	43,600	43,622	22,07	0,89
17:30	47,600	47,612	12,24	0,50
17:45	44,400	44,416	16,08	0,65
18:00	42,981	43,008	26,71	1,08
18:15	42,800	42,809	9,39	0,38
18:30	49,381	49,401	20,08	0,81
18:45	51,200	51,228	27,75	1,12
19:00	48,981	49,003	21,39	0,87
19:15	62,581	62,600	18,78	0,76
19:30	60,581	60,608	26,97	1,09
19:45	56,800	56,824	24,07	0,97
20:00	56,181	56,193	11,67	0,47
20:15	53,200	53,210	10,46	0,42
20:30	52,981	52,992	11,17	0,45
20:45	52,400	52,419	18,64	0,75
21:00	54,800	54,821	21,31	0,86
21:15	55,381	55,410	29,02	1,17
21:30	58,981	58,987	5,91	0,24
21:45	58,581	58,601	19,48	0,79
22:00	58,800	58,807	6,57	0,27
22:15	55,381	55,393	12,00	0,49
22:30	64,800	64,809	9,42	0,38
22:45	64,981	65,010	28,87	1,17
23:00	67,562	67,573	10,71	0,43
23:15	67,600	67,615	14,99	0,61
23:30	63,381	63,392	10,50	0,42
23:45	66,981	66,999	17,97	0,73
0:00	63,381	63,388	7,23	0,29

SAŽETAK

U početnoj fazi istraživanja napravljen je pregled znanstvene literature vezano za procjenu mjerne nesigurnosti. Utvrđeno je da je najzastupljenija metoda sukladno međunarodno prihvaćenom dokumentu „Guide to the expression of uncertainty in measurement“, tzv. GUM metoda. Ova metoda sadrži određene nedostatke te je izdana dopuna istog dokumenta koja preporuča uporabu Monte Carlo metode. Nadalje, u disertaciji je prikazan trenutno zastupljeni način za utvrđivanje razmijenjene energije kod prekogranične razmjene električne energije uključujući metode izračuna gubitaka prijenosa. Utvrđeno je da niti jedna metoda ne uključuje mjernu nesigurnost odnosno sistematske pogreške obračunskog mjerenja. Naime, uslijed velikih količina prenesene energije mali postotci sistematskih pogrešaka mogu rezultirati značajnom krivo raspodijeljenom energijom između operatora prijenosnih sustava odnosno potencijalnom financijskom štetom za sudionike razmjene.

U okviru disertacije proveden je postupak izračuna mjerne nesigurnosti otpora prijenosnog voda i gubitaka s pomoću GUM i Monte Carlo metode. Za potrebe potonje metode proveden je postupak procjene razdiobe izlazne veličine. Također je razvijen je način utvrđivanja mjerne nesigurnosti razmijenjene energije i gubitaka prijenosa što uključuje metodu za ispravak razmijenjene energije i gubitaka za iznos sistematskih pogrešaka čime je smanjena ukupna mjerna nesigurnost te metodu za raspodjelu razmijenjene energije i pripadajućih gubitaka. Praktični rezultati pokazuju da je mjerna nesigurnost smanjena nakon ispravka sistematskih pogrešaka čime je potvrđena hipoteza disertacije. Može se zaključiti da ova metoda predstavlja pravedniji način za utvrđivanje razmijenjene energije i gubitaka prijenosa kod prekogranične razmjene energije.

Ključne riječi: procjena mjerne nesigurnosti, Monte Carlo metoda, prekogranična razmjena električne energije, gubici prijenosa

The importance of measurement of transmission losses and associated measurement uncertainty on the cross-border energy exchange

ABSTRACT

In the initial phase of the research process, a review of scientific literature was performed regarding the measurement uncertainty calculation methods. It is found that the most commonly used method is according to the internationally accepted document "Guide to the expression of uncertainty in measurement", i.e. GUM method. However, this method contains certain deficiencies and has been followed by the Supplement 1 which recommends using the Monte Carlo method. Furthermore, the dissertation presents the current method for determining the exchanged energy on the cross-border energy exchange as well as methods for calculation of the transmission losses. It is found that the actual methods do not involve measurement uncertainty nor systematic errors in the calculation procedure. Namely, due to large amounts of exchanged energy small percentages of systemic errors can result in significant erroneously associated energy to the transmission system operators, i.e. potential financial damage for energy exchange participants.

A method for calculating the measurement uncertainty of transmission line resistance and transmission line losses using the GUM and the Monte Carlo method is developed. For the purpose of the latter method, the procedure for estimating the distribution of the output value is performed. A method for determining the measurement uncertainty of the exchange of energy and the transmission losses, including the method for correcting the exchanged energy and transmission losses for the amount of systematic errors is developed, thus reducing the total measurement uncertainty. A method for allocating the exchanged energy and the transmission losses between transmission system operators is developed as well. Practical results show that the measurement uncertainty is reduced after correcting systematic errors, thus confirming the hypothesis of the dissertation. It can be concluded that this method represents a fairer way to determine the exchanged energy and the transmission losses on the cross-border energy exchange.

Keywords: measurement uncertainty estimation, Monte Carlo method, cross-border energy exchange, transmission losses

ŽIVOTOPIS

Ivan Tolić rođen je 9. travnja 1985. godine u Osijeku. Pohađao je osnovnu školu "Mladost" u Osijeku i osnovnu školu "Tenja" u Tenji. 1999. godine upisao je III. Gimnaziju u Osijeku gdje je maturirao 2003. godine s odličnim uspjehom. Za vrijeme osnovne i srednje škole sudjelovao je na više županijskih i državnih natjecanja iz nekoliko predmeta. 2003. godine upisao je Sveučilišni diplomski studij na Elektrotehničkom fakultetu u Osijeku gdje je diplomirao 9. siječnja 2008. godine na temu „Utvrdjivanje naponskih prilika na zaštitnim uzemljivačima visokonaponskih postrojenja“ pod mentorstvom prof. dr. sc. Srete Nikolovskog. Od svibnja 2007. godine primao je stipendiju od strane HEP-Operator prijenosnog sustava d.o.o. - Prijenosno područje Osijek, gdje radi od završetka studija do danas. U akademskoj godini 2009/2010. upisao je poslijediplomski doktorski studij na Elektrotehničkom fakultetu u Osijeku. Za vrijeme trajanja studija kao autor ili koautor objavio je 16 znanstvenih i stručnih radova od čega četiri CC rada u časopisima A kategorije u prvom i drugom kvartilu. Sudjelovao je kao sumentor na završnim i diplomskim radovima na Fakultetu elektrotehnike, računarstva i informacijskih tehnologija u Osijeku. Od 2017. godine sudjeluje na projektu Hrvatske zaklade za znanost pod nazivom „Integracija vjetroelektrana u elektroenergetski sustav sa smanjenom konstantom tromosti“ pod vodstvom prof. dr. sc. Igora Kuzle.