



University of Zagreb

FACULTY OF ORGANIZATION AND INFORMATICS

Boris Tomaš

**MEDIUM ACCESS CONTROL PROTOCOL
FOR VISIBLE LIGHT COMMUNICATION IN
VEHICULAR COMMUNICATION
NETWORKS**

DOCTORAL THESIS

Varaždin, 2017.



Sveučilište u Zagrebu

FAKULTET ORGANIZACIJE I INFORMATIKE

Boris Tomaš

**PROTOKOL KONTROLE PRISTUPA MEDIJU
ZA KOMUNIKACIJU VIDLJIVIM SVJETLOM
U PROMETNIM KOMUNIKACIJSKIM
MREŽAMA**

DOKTORSKI RAD

Varaždin, 2017.



University of Zagreb

FACULTY OF ORGANIZATION AND INFORMATICS

Boris Tomaš

**MEDIUM ACCESS CONTROL PROTOCOL
FOR VISIBLE LIGHT COMMUNICATION IN
VEHICULAR COMMUNICATION
NETWORKS**

DOCTORAL THESIS

Supervisors:

Prof. Neven Vrčec, PhD

Asst. Prof. Mate Boban, PhD

Varaždin, 2017.

Mojoj baki i roditeljima.

ACKNOWLEDGMENTS

This journey started many years ago when I met my mentor, Mate Boban who introduced me with this field of science. Thanks to his efforts I went on an adventurous research visit to the Institute of Telecommunications in Porto, Portugal where I met some remarkable people that remain good friends to this day. After that, Mate arranged another research visit to the Carnegie Mellon University in Pittsburgh, USA where I started working on this topic. Finally was a research visit to National Taiwan University in Taipei, Taiwan where I have continued working on this topic in a laboratory surrounded with state of the art technology and *top-in-the-field* scientists. It was an honour working with all those professionals.

I would like to thank my other mentor and dear professor, Neven Vrček, who was patient enough with all my exhibitions in various fields of science, and for standing up for me when times were hard.

This thesis would never have been possible without my mom and dad, who offered their support and understanding for all these years.

In the end, I would thank to my life partner for all the love and support she has provided me.

Varaždin, September 2017

ABSTRACT

Recent achievements in the automotive industry related to lighting apparatuses include the use of LED or laser technology to illuminate the vehicle environment. This advancement resulted in greater energy efficiency and increased safety with selective illumination segments. A secondary effect was creating a new field for researchers in which they can utilize LED fast modulation using the Pulse Width Modulation (PWM) signal. Using LED to encode and transmit data is a relatively new and innovative concept. On the other field, there have been advancements in vehicular communication using radio frequency at 2.4 or 5GHz. This research focuses mainly on a field in which visible light augments or replaces radio frequency communication between vehicles.

This research also investigates the effect of asymmetry on network performance using Visible Light Communication (VLC) in vehicular networks. Different types of asymmetry were defined and tested in real-world simulation experiments. Research results showed that asymmetry has a negative influence on network performance, though that effect is not significant.

The main focus of the research is to develop a lightweight and new Media Access Control (MAC) protocol for VLC in vehicular networks. To develop a MAC protocol for VLC, special software was developed on top of the existing Network Simulation Environment (NSE).

A new VLC MAC protocol for Vehicle to Vehicle (V2V) was benchmarked using a defined set of metrics. The benchmark was conducted as a set of designed simulation experiments against the referent IEEE 802.11b MAC protocol. Both protocols used a newly defined VLC-equipped vehicle model. Each simulation experiment depicted a specific network and traffic situation. The total number of scenarios was eleven. The last set of simulations was conducted in real-world scenarios on the virtual streets of Suffolk, VA, USA.

Using defined metrics, the test showed that the new VLC MAC protocol for V2V is better than the referent protocol.

PROŠIRENI SAŽETAK

Nedavna dostignuća u automobilskoj industriji koja se tiču opreme za osvjetljivanje uključuju korištenje LED ili laserskih rasvjetnih tijela za osvjetljivanje okoline. Ovime se postižu uštede u potrošnji energije kao i povećana sigurnost u prometu. LED rasvjeta je uniformnija od običnih žarulja tako da osvjetljenje bude ravnomjernije i preciznije. Obzirom da su LED selektivne moguće je odabrati segment ceste koji se želi osvijetliti. Upravo ta fleksibilnost LED otvara novi prostor za istraživače gdje mogu koristiti PWM signal za modulaciju podataka. PWM je poseban signal koji ima varijabilnu širinu pulsa na izlazu. Istraživači i znanstvenici mogu koristiti LED za kodiranje i prijenos podataka između automobila. Prednosti korištenja komunikacije u vidljivom dijelu elektro-magnetskog spektra (eng.VLC) je u činjenici da taj segment nije zaštićen licencama te je otvoren za slobodno korištenje. Osim toga, vidljivo, neintenzivno svjetlo nema biološki negativnih posljedica. Kod korištenja PWM signala za modulaciju, postojeći izlaz svjetla i njegova funkcija (osvjetljivanja ceste) nisu narušeni. Ljudsko oko ne može detektirati oscilacije tako visoke frekvencije (oko 5 kHz)

S druge strane, komponente koje mogu primiti poslani signal su foto diode ili kamere. Kamere su već prisutne na modernom vozilu u obliku prednje kamere ili stražnje kamere za pomoć pri parkiranju. U svakom slučaju, tehnologija je već prisutna na modernom vozilu.

Na drugom području, znanstvenici rade na komunikaciji između vozila koristeći radio valove niže frekvencije 2.4 ili 5 GHz. Komunikacija između automobila je predmet standardizacije i mnoge zemlje već propisuju pravila za obaveznu ugradnju opreme za takav oblik komunikacije. Prednost takvog koncepta je razmjena podatka; od onih za zabavu pa do kritičnih i sigurnosnih podataka npr. informacija o nadolazećem mjestu gdje se dogodila prometna nesreća.

Ovo istraživanje se fokusira na proširenje ili zamjenu radio komunikacije sa komunikacijom koristeći vidljivi dio spektra (npr. LED i kamere). Jedan od glavnih nedostataka takvog koncepta je ne postojanje adekvatnog i specijaliziranog protokola za kontrolu pristupa mediju (eng. MAC). Drugi problem je nepoznati efekt asimetrije u VLC komunikaciji na performanse mrežne komunikacija. Ovo istraživanje je prepoznalo i klasificiralo različite tipove asimetrije. Svaki tip je testiran u sklopu simulacijskog eksperimenta u stvarnim scenarijima. Pokazalo se je da asimetrija negativno utječe na mrežne performanse, međutim taj efekt nije značajan jer uzrokuje manje od 0.5 % neuspješno poslanih poruka.

Glavni fokus istraživanja je razvoj novog i pojednostavljenog MAC protokola za VLC komu-

nikaciju između automobila. Kako bi se razvio novi MAC protokol nad VLC tehnologijom u prometnim mrežama, bilo je nužno napraviti i novu razvojnu okolinu koja se bazira na postojećim mrežnim simulatorima. Novi VLC MAC protokol za komunikaciju između automobila je testiran koristeći definirani set metrika. Testovi su napravljeni u obliku simulacijskih eksperimenata u kojima su uspoređivane performanse novog i referentnog protokola. Referentni protokol, u ovom istraživanju je IEEE 802.11b MAC protokol. U sklopu ovog rada definiran je i model vozila opremljen VLC tehnologijom. U simulacijskim eksperimentima je korišten isti model vozila za oba protokola. Za potrebe istraživanja je definirano jedanaest simulacijskih eksperimenata, svaki od njih opisuje specifične situacije u mrežnim komunikacijama kao i u prometu. Završni simulacijski scenariji uključuju okolinu iz stvarnosti, mreža ulica grada Suffolka, SAD. Osim stvarnih ulica, vozila su se kretala i razmjenjivala podatke koristeći mrežnu komunikaciju na kompletnom ISO/OSI mrežnom stogu sa zamijenjenim MAC podslojem.

Razvojna okolina uključuje preciznu provjeru fizičkih karakteristika na razini putanje zrake svjetlosti. Ova preciznost je bila nužna kako bi simulacije bile što vjerodostojnije stvarnim sustavima. Obzirom da se radi o mnogo kalkulacija, obično računalo nije dostatno za izvođenje simulacijskih eksperimenata; zbog toga su se eksperimenti izvodili na klasteru računala Sveučilišta u Zagrebu.

Koristeći definirane metrike, istraživanje je pokazalo kako je novi VLC MAC protokol za komunikaciju između automobila bolji od referentnog protokola.

KEYWORDS

Traffic communication, Visible light communication, Medium access control, VLC channel asymmetry, Network simulation environment

GLOSSARY

ALOHA Additive Links On-line Hawaii Area.

CCK Complementary Code Keying.

CDMA Code Division Multiple Access.

CSMA Carrier Sensing Multiple Access.

CSMACA Carrier Sensing Multiple Access with Collision Avoidance.

CSMACD Carrier Sensing Multiple Access with Collision Detection.

D2D Device-to-device.

DLL Data Link Layer.

DSRC Dedicated Short Range Communication.

DSSS Direct Sequence Spread spectrum.

EM Electro Magnetic.

FDMA Frequency Division Multiple Access.

FHSS Frequency Hopping Spread Spectrum.

FOV Field Of View.

I2V Infrastructure to Vehicle.

IOT Internet of Things.

IR Infra-Red.

ISO/OSI International Organization for Standardization / Open Systems Interconnection.

ISP Internet Service Provider.

LED Light Emitting Diode.

LLC Logical Link Control.

LOS Line of Sight.

MA Multiple Access.

MAC Media Access Control.

MCS Multiple Concurrent Simulations.

NLOS Non Line Of Sight.

NSE Network Simulation Environment.

OOK On-Off Keying.

PD Photo-Diode.

PDR Packet Deliver Ratio.

PHY ISO/OSO Physical Layer.

PPM Pulse Position Modulation.

PWM Pulse Width Modulation.

RF Radio Frequency.

RSU Road Side Unit, plural = Road Side Units.

Si APD silicon avalanche photodiode.

Si PIN-PD silicon p-type-insulator-n-type photodiode.

STRAW Street Random Waypoint.

SWANS Scalable Wireless Network Simulator.

TDMA Time Division Multiple Access.

UV Ultraviolet.

V2I Vehicle to Infrastructure.

V2V Vehicle to Vehicle.

VCN Vehicular Communication Network.

VLC Visible Light Communication.

VTL Virtual Traffic Light.

CONTENTS

Acknowledgments	
Contents	VI
List of Figures	X
List of Tables	XIII
List of Appendices	XV
1. Introduction	1
1.1. Motivation	1
1.1.1. MAC protocol/layer introduction	2
1.1.2. VLC and RF differences	3
1.2. Problems	4
1.3. Objectives and hypotheses	7
1.3.1. Research questions	8
1.3.2. Hypotheses	8
1.4. Research methodology	9
1.4.1. Research phases	10
1.4.2. Summary	15
1.5. Contribution	15
1.6. Technology and tools used	16
1.7. Thesis structure organization	16
2. State of the art	17
2.1. Introduction	17
2.2. Visible Light Communication (VLC)	18
2.2.1. Transmitting technology	22
2.2.1.1. Conclusion	23
2.2.2. Receiving technology	24
2.2.2.1. Conclusion	27
2.2.3. Visible channel model	28

2.3.	Vehicular communication	29
2.3.1.	Visible light communication in traffic	31
2.4.	Media Access Control Protocol	34
2.4.1.	802.11 standard	37
2.5.	Network Simulation Environment (NSE)	38
2.5.1.	Performance issue	39
2.6.	Conclusion	41
3.	Network simulation environment	42
3.1.	NSE selection	42
3.2.	JiST/SWANS introduction	44
3.2.1.	Architecture	46
3.2.2.	Features	46
3.3.	Issues	48
3.4.	VLC enhanced JiST/SWANS	49
3.4.1.	VLC radio	50
3.4.2.	VLC element	51
3.4.3.	MacVLCMessage	52
3.4.4.	Control signal	53
3.4.5.	Pathloss	55
3.4.6.	Collision and interference detection	57
3.4.7.	LOS detection	59
3.4.8.	Configuration	61
3.5.	VLC-equipped vehicle for NSE	62
3.6.	VLC extended JiST/SWANS validation	66
3.7.	Multiple Concurrent Simulations (MCS)	68
3.7.1.	MCS supported features	68
3.8.	Conclusion	71
4.	Asymmetry in VLC vehicular networks	73
4.1.	Definition	73
4.2.	Asymmetry testing simulation experiment	77
4.3.	Results	80
4.4.	Interpretation and conclusion	81
4.4.1.	Asymmetry design affect	81
4.4.2.	Asymmetry as a cause of packet drops	82
5.	VLC MAC protocol design for V2V and V2I/I2V	84
5.1.	IEEE 802.11 MAC for VLC Vehicular Radio	84

5.1.1.	Unmodified IEEE 802.11b	84
5.1.2.	VLC driven IEEE 802.11b modifications	85
5.2.	VLC V2V MAC protocol	86
5.2.0.1.	Number of vehicles	86
5.2.0.2.	Obsolete IEEE 802.11 features	87
5.2.1.	Frame structure	87
5.2.2.	Addressing	90
5.2.3.	Control channel	91
5.2.4.	Queue messages	91
5.2.4.1.	Deadlock prevention	93
5.2.5.	Encryption	94
5.2.6.	Tx element selection	95
5.2.7.	Interference detection	96
5.2.8.	Diagram	97
5.2.9.	Overview	98
6.	Simulation experiment	100
6.1.	Metrics	100
6.1.1.	Definition of metrics	100
6.1.2.	Randomness in NSE	103
6.1.3.	Implementation in NSE	103
6.1.3.1.	Verification of metrics measurements system	107
6.1.3.2.	Results of metrics measurements system verification	109
6.2.	Experiment setup	110
6.2.1.	Simulation scenarios	110
6.2.1.1.	Static environment	112
6.2.1.2.	Random environment	119
6.2.1.3.	Real-world environment	123
6.3.	Results of simulation experiments	125
6.3.1.	Static environment	126
6.3.2.	Random environment	135
6.3.3.	Real-world environment	139
6.4.	Results discussion	140
7.	Conclusion	143
7.1.	Vehicular communication and VLC	143
7.2.	NSE	144
7.3.	VLC MAC protocol for V2V	145
7.4.	Hypotheses	147

7.5. Research objectives and questions	147
7.5.1. Research questions	150
7.6. Future work	152
7.6.1. Hardware design	152
7.6.2. VLC node addressing	155
7.6.3. Complexity definition and impact on VLC in V2V performance	155
7.6.4. Multipathing in VLC for V2V environments	155
7.6.5. Varying the control signal	156
7.6.6. Other ISO/OSI layers	156
7.6.7. Advanced VLC vehicle model	157
7.6.8. LED PWM frequency and PD sampling rate	158
Bibliography	162

LIST OF FIGURES

Number	Figure caption	Page
Figure 1.	Coverage of an omnidirectional radio frequency (RF) transceiver model (circle <i>a</i>) compared with coverage of a VLC transceiver (sectors <i>b</i> , <i>c</i> , and <i>d</i>).	3
Figure 2.	Example of VLC channel complete asymmetry	6
Figure 3.	Research phases	9
Figure 4.	Complete research process	10
Figure 5.	Objective workflow: 1. Define the simulation environment for V2V and V2I/I2V VLC network systems	11
Figure 6.	Objective workflow: 2. Define the development environment for MAC protocol implementation design and test	12
Figure 7.	Objective workflow: 3. Explore the effects of channel asymmetry in V2V VLC network systems	13
Figure 8.	Objective workflow: 4. Define the theoretical framework for an efficient MAC protocol in V2V and V2I/I2V VLC network systems	14
Figure 9.	Spectral power density of three common ambient light sources. The right figure shows the effect of different optical filters. Source: [48]. . .	19
Figure 22.	Performance analysis of JiST against alternatives [12]	44
Figure 23.	JiST simulator architecture related to network stack [12]	45
Figure 24.	RadioVLC and VLCElement classes	50
Figure 25.	Element definition (Tx or Rx element)	51
Figure 26.	VLCLink pathloss	55
Figure 27.	Element coverage difference	56
Figure 28.	VLC pathloss model [84]	57
Figure 29.	VLC radio receive message workflow	58
Figure 30.	LOS interruption by vehicle	59

Figure 31.	Node (vehicle) element location coordinates	64
Figure 32.	VLC-equipped vehicle model	65
Figure 33.	Validation scenarios for VLC enhanced NSE	66
Figure 34.	802.11 MAC protocol on RF and VLC radio	67
Figure 35.	MCS home screen	69
Figure 36.	MCS scenario designer	70
Figure 37.	MCS node editor	71
Figure 38.	Typical headlight beam light intensity distribution [97]	74
Figure 39.	Design asymmetry	75
Figure 40.	Orientation asymmetry	76
Figure 41.	Positional asymmetry	76
Figure 42.	Experiment node design 1	77
Figure 43.	Experiment node design 2	78
Figure 44.	Experiment node design 3	78
Figure 45.	Loaded scenario with vehicles in Suffolk, USA (GUI)	78
Figure 46.	Friedman’s test for asymmetry design influence	82
Figure 47.	Vehicle model with labeled Tx/Rx elements	90
Figure 48.	VLC MAC protocol for V2V and V2I/I2V workflow	97
Figure 49.	TimeEntry class and usage in NetMesasge class	104
Figure 50.	Metrics verification test scenario 1	108
Figure 51.	Metrics verification test scenario 2	108
Figure 52.	Metrics measurement system verification results	109
Figure 53.	Two nodes	113
Figure 54.	Hidden node	114
Figure 55.	Four nodes	114
Figure 56.	Nine nodes	115
Figure 57.	Twelve nodes - lane join	116
Figure 58.	Crossroads	117
Figure 59.	Roundabout	118
Figure 60.	Random scenario 1	119
Figure 61.	Random scenario 2	120

Figure 62.	Random scenario 3	121
Figure 63.	Average delay results legend	125
Figure 64.	MAC performance (PDR) in two-node scenario	127
Figure 65.	MAC performance (delay) in two-node scenario	127
Figure 66.	Hidden node MAC performance (PDR)	128
Figure 67.	Hidden node MAC performance (delay)	128
Figure 68.	MAC performance (PDR) in four-node scenario	129
Figure 69.	MAC performance (delay) in four-node scenario	130
Figure 70.	MAC performance (PDR) in nine-node scenario	131
Figure 71.	MAC performance (delay) in nine-node scenario	131
Figure 72.	MAC performance (PDR) in twelve-node (join) scenario	132
Figure 73.	MAC performance (delay) in twelve-node (join) scenario	132
Figure 74.	MAC performance (PDR) in crossroad scenario	133
Figure 75.	MAC performance (delay) in crossroad scenario	134
Figure 76.	MAC performance (PDR) in roundabout scenario	135
Figure 77.	MAC performance (delay) in roundabout scenario	135
Figure 78.	MAC performance (PDR) in random scenario 1	136
Figure 79.	MAC performance (delay) in random scenario 1	136
Figure 80.	MAC performance (PDR) in random scenario 2	137
Figure 81.	MAC performance (delay) in random scenario 2	137
Figure 82.	MAC performance (PDR) in random scenario 3	138
Figure 83.	MAC performance (delay) in random scenario 3	138
Figure 84.	MAC performance (PDR) in real-world scenario	139
Figure 85.	MAC performance (delay) in real-world scenario	139
Figure 86.	VLC radio minimum hardware design	153
Figure 87.	VLC radio hardware prototype	154

LIST OF TABLES

Number	Table caption	Page
Table 1.	Comparison of VLC and IR communication technologies (original: [80])	20
Table 2.	Comparison of VLC Tx technologies	23
Table 3.	Comparison of VLC Rx technologies considering implementation on a vehicle	28
Table 4.	NSE selection analysis	43
Table 5.	Time to perform 5 million events, normalized against both the baseline and JiST	45
Table 6.	JiST/SWANS relevant namespaces and descriptions	46
Table 7.	<i>ElementIDRx HashMap</i> example	53
Table 8.	RF and VLC radio comparison on 802.11 MAC	67
Table 9.	Asymmetry detection experiment configuration	79
Table 10.	Asymmetry analysis results	81
Table 11.	Design asymmetry by node design	81
Table 12.	Design asymmetry drop analysis	82
Table 13.	802.11b frame structure (bytes)	88
Table 14.	Frame control field structure (bits)	88
Table 15.	Frame structure for VLC MAC in V2V (bits)	88
Table 16.	Frame control field in frame structure (Table 15) (bits)	89
Table 17.	Example Rx mask	90
Table 18.	Example Tx mask	91
Table 19.	NSE-generated data sample	106
Table 20.	Simulation experiment parameters - Static scenarios	112
Table 21.	Simulation experiment parameters - Random scenarios 1, 2, and 3	122
Table 22.	Simulation experiment parameters - mobility	124
Table 23.	Quick facts about the collected data	125

LIST OF APPENDICES

Number	Appendix name	Page
--------	---------------	------

1.	Appendix one	V
----	------------------------	---

1. Introduction

This chapter defines the initial presumptions that preceded this research. The chapter also describes the motivation behind this research. The chapter investigates the nature of the MAC protocol and the problems it resolves. After that, more specific research problems are defined, including problems related to Vehicle to Vehicle (V2V) and VLC network communication. Problems are then mapped to the specific objectives that are to be reached to approve or disprove the defined hypotheses. This chapter describes in detail the research methodology and research phases. At the end of the chapter, the estimated contribution is presented. To ease the navigation of this thesis, the chapter also describes the thesis's organizational structure.

1.1. Motivation

VLC is a novel communication technology which uses light as a data transfer medium. Light is openly available (unlicensed) in a terahertz-wide frequency band. Most communication used today is positioned in a lower frequency part of the electromagnetic (EM) spectrum. Because of that, VLC has great potential for supplementing or even replacing the existing Radio Frequency (RF) communication technologies in applications as diverse as Device-to-device (D2D) communications, V2V communications, Vehicle to Infrastructure (V2I) and Infrastructure to Vehicle (I2V) communications, and small-cell (e.g., femtocell) systems. The physical characteristics of VLC are similar to Infra-Red (IR) communication: where VLC also uses the spectrum that is under the atmospheric window effect, thus making it highly sensitive to solar radiation noise. The newly released 5.9 GHz band [42] of Electro Magnetic (EM) spectrum is a new field in which many stakeholders are interested. As such, EM is very saturated by different services and applications. The visible part of the EM spectrum is unlicensed and free, making visible light a very interesting alternative to the radio part of the EM spectrum.

In modern vehicles, although they are equipped with state-of-the-art automotive technology, the full potential of present-day computer technology has yet to be introduced. In a vehicular communication setting, VLC is interesting because most of the components needed to enable VLC are already a part of modern vehicles - specifically, an LED, LASER, or any other light-emitting

technology [170] that can be controlled using micro controllers and they can be used as a VLC transmitter (Tx). Similarly, a VLC receiver (Rx) component is usually either a photodiode (PD) [122, 184] or a CMOS camera [178], which can be found in many modern vehicles (e.g., a front camera for lane tracking, a dashboard camera or a rear camera for parking assistance).

1.1.1. MAC protocol/layer introduction

A MAC layer is a part of the ISO/OSI stack as shown on Figure 17. It belongs to the *data link* layer. The advantage of having layers in the stack is that each layer can be easily replaced. For example, the MAC layer might be defined by different protocols without affecting other layers. It is imperative that the interface towards the upper and lower layers remain standard and intact, regardless of the protocols used.

While the MAC layer follows simple rules, it solves a complex problem such as shared medium access, e.g., when using an EM spectrum as a data carrier (physical layer), all participants can communicate but the problem is that the equipment for receiving can interpret only one incoming transmission. If two or more transmissions are concurrent, the receiver is saturated and cannot distinguish incoming signals from each other. This is called *collision* on a receiver. The true purpose of a MAC protocol is to prevent and resolve collisions. And to retrieve data from concurrent signals.

A basic MAC protocol example that illustrates the design issues one faces when designing a MAC protocol is:

Simple MAC protocol example

Four participants would like to communicate. Each participant is assigned a time slot equal to one quarter of a second and is allowed to transmit only in the time slot to which he or she is assigned. All other participants can safely listen because they know that at a single point in time only one node will transmit. This *time slot management* is a simple MAC protocol that is similar to the ALOHA protocol (Figure 18). Furthermore, new problems would be:

- **Slot assignment**, how can nodes agree on the order of slot assignments?
- **Time synchronization**, slots are time based, which requires synchronized internal clocks and eventual corrections to the clock in the case of time offset, so how are clocks synchronized?
- **Channel utilization**, the channel could be fairly unused when participants have nothing

to transmit because the node will remain silent in its own slot, thus making the channel unused while other nodes might utilize the channel more efficiently for their own transmission.

1.1.2. VLC and RF differences

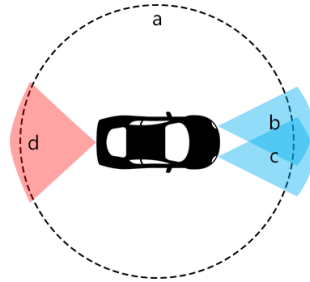

Figure 1: Coverage of an omnidirectional radio frequency (RF) transceiver model (circle a) compared with coverage of a VLC transceiver (sectors b, c, and d).

Since VLC and RF physical characteristics are somewhat different, using VLC as the underlying communication technology instead of RF may render existing network protocols, such as the IEEE 802.11 (Wi-Fi) protocol suite, inoperable. Therefore, the simulation of IEEE 802.11 protocols over VLC needs some modifications because of the different characteristics of the vehicular VLC transceiver. An example on Figure 1. shows the main difference between existing vehicular RF technology (used for, e.g., Wi-Fi) with the coverage area a and VLC. Specifically, VLC has a limited coverage area that can be separated into several sectors, which are not necessarily overlapping (e.g., sectors b , c , and d).

Furthermore, while circle a represents the transmitter (Tx) and receiver (Rx) in RF, in VLC, Tx and Rx often do not have an equal coverage shape, e.g., the VLC Tx area is marked as c and b , whereas Rx is marked as d . VLC communication is somewhat similar to directional antennas in RF. Where RF has a single antenna for both receiving and transmitting, VLC can have multiple separated "channels" for separated and concurrent receiving and transmitting.

Next, VLC is highly sensitive to line-of-sight (LOS) obstruction between Tx and Rx, i.e., no behind-the-corner communications. On the other hand, RF can support communications in non-LOS scenarios. Some of those issues are addressed in the 802.15.7 draft standard [64].

All of these facts indicate that i) *the physical transceiver models designed for RF communi-*

cation cannot be used for VLC in V2V; and ii) the protocols designed for RF communications must be modified to work over VLC in V2V.

The research focus is on designing and implementing an efficient MAC protocol for VLC in vehicular networks (V2V)¹. This protocol should be implemented on a Data Link Layer (DLL) layer of the International Organization for Standardization / Open Systems Interconnection (ISO/OSI) model.

1.2. Problems

Tayal conducted an analysis of challenges regarding VANET implementation and network design [148]. He emphasized issues regarding congestion, lack of infrastructure, privacy issues and others. This section will consider primarily the problems identified by Tayal and other authors regarding MAC for VLC in V2V environments.

For a successful V2V communication using VLC, there two types of problems: *a) physics and hardware related* and *b) protocol related*.

■ Physics and hardware related VLC issues:

- *Line of Sight (LOS)*: VLC is a LOS only communication. It is common knowledge that light does not penetrate opaque objects. On the other hand, RF communication, on certain frequencies, can penetrate physical (visually opaque) obstacles like walls and buildings, according to Chetty et al. [22].
- *Light-specific characteristics*: Light radiation is a part of the EM spectrum. VLC, unlike common radio (RF), uses a higher frequency range (405 THz - 790 THz). Different frequencies in the EM spectrum behave differently [49], thus changing the expected channel characteristics for VLC. The problem is that existing RF protocols and procedures cannot simply be applied to the VLC due to different channel characteristics. For example: the LED light channel model [84] uses the ray path geometrical approach in which the receipt of power depends mainly on the physical dimensions of a receiver and transmitter, and the angles of incidence and irradiance. This is unlike the *pathloss model* for RF communication [100] in which distances and environmental factors (*n*-coefficient) will affect signal attenuation (receive power).
- *Environmental conditions*: VLC is highly sensitive to atmospheric conditions like rain,

¹Related: Vehicular Ad-hoc NETWORK(VANET)

fog, and solar radiation. Those conditions will limit receiver capabilities with respect to receiving and decoding incoming signals and will represent substantial noise. Although this problem is related to physical sensor characteristics, it can be partially addressed with protocol, e.g., filtering or assigning a larger channel capacity to reduce noise for nodes saturated by negative environmental conditions.

- *Reflections and multipath:* Radio waves (and also light waves) bounce off reflective surfaces. A reflected beam (wave) becomes another source that exists in the channel at the same time as the original beam. In this scenario, the receiver will receive multiple beams with a slight spatial and temporal offset. Although the beams carry the same information, the receiver will encounter interference and will not be able to decode the original signal. This can be solved on a MAC layer with shorter data segments which would arrive (and be consumed) before reflected segments arrive. Lee has conducted an analysis of the VLC channel model considering multipathing [94]. However, the effect on multipathing in VLC in V2V environments should be investigated. It is noteworthy that multipathing is a known issue in RF communication and there are techniques used to overcome this problem, such as those demonstrated by Choudhury and Dai [26, 36].

■ Protocol related

- *MAC protocol:* Existing MAC protocols are designed for RF, and not for VLC channel-specific characteristics. Furthermore, MAC protocols for VLC are not considered vehicle-specific configurations: Tx/Rx layout and mobility. Any implementation of a MAC protocol can be used for VLC V2V but the performance of such system implementation could be increased by reducing unnecessary features and leveraging from VLC-specific features like LOS.
- *Channel asymmetry:* VLC in V2V can have multiple receiving and transmitting elements, that is: multiple separated channels, which is considered an advantage over RF. However, there are issues with channel design causing different types of asymmetry:
Node design: The receiving coverage does not need to match the transmitting coverage (overlap).
Node positions: Two nodes can be positioned in a such manner that one node can receive a signal from the other node, while that node cannot receive a signal from the first node (Figure 2).

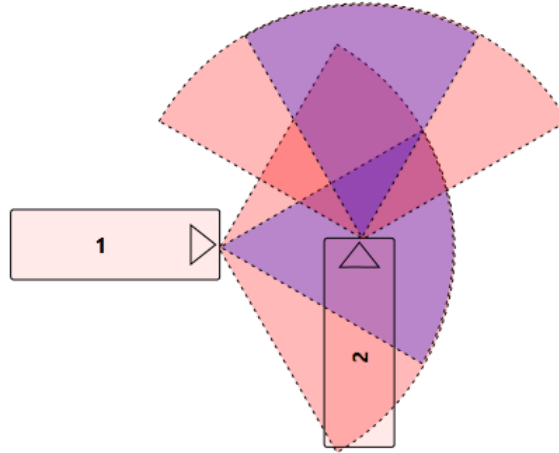

Figure 2: Example of VLC channel complete asymmetry

- Simulation environment:* The research community working with the VLC network design lacks: *i) a proper VLC network simulator* and *ii) a MAC protocol design tool*

Network simulation environments are widely used by researchers and network systems engineers to simulate computer networks and network topology and to predict network performance. Basagni et al. have made a detailed analysis of different network simulators [162]. They conclude that there exists a significant gap between a simulation and experimental results. Also, it has been identified that most of the simulators lack proper or any implementation of: *Carrier sensing, Back-off timing, Radio propagation model* - most of them have a circular coverage estimation, and *no interference detection*

Simulator performance has been recognized as a primary reason for the many gaps identified by authors. Some simulators even lack support for interference detection and have loose PHY model implementation that is a trade-off for increasing simulator performance [54]. None of the widely used simulators: *PhySim, NetSim, OPNET, GloMoSim, cnet, ns2, JiST/SWANS [12], and PARSEC* supports VLC radio communication. For this reason, and because VLC PHY is different from RF, a modular radio model for VLC simulation in a simulation engine must be designed. Many simulators lack obstacle detection (LOS) and VLC support in general. VLC technology is not present in network simulators mainly because VLC is a novel technology and VLC applications did not require real network simulations until now. As for current research, *desired simulation engine* must be selected and modified to support VLC technology

1.3. Objectives and hypotheses

Based on issues previously defined, the overall objective of this research is:

The development of an effective medium access control protocol for vehicular communication using the visible part of the electromagnetic spectrum

To achieve this objective, some specific objectives must be addressed:

O1. Define the simulation environment for V2V and V2I/I2V VLC network systems.

Lack of appropriate simulation environments has been a problem for researchers working on VLC network designs. This objective, if reached, should provide support for VLC in a new or existing network simulation engine.

O2. Define the development environment for MAC protocol implementation design and testing.

This objective should explore and develop the environment for designing and testing MAC protocols. Being an integrated solution, it should provide mechanisms for researchers to focus on *vehicular network design using VLC or MAC protocol, for VLC in V2V systems, design and evaluation.*

O3. Explore the effects of channel asymmetry in V2V VLC network systems.

Asymmetry has been identified as a problem; however, the effect of this problem in V2V must be investigated. If reached, this objective should provide a distinctive conclusion as to whether asymmetry should be considered and solved as a part of the MAC protocol.

O4. Define the theoretical framework for an efficient MAC protocol in V2V and V2I/I2V VLC network systems.

Although there are many MAC protocols being actively used, even in V2V environments and VLC environments, researchers like Yu et al. state that MAC for VLC on V2V networks should be more lightweight [184]. Existing MAC for VLC can be used in V2V but the performance of such a configuration could be insufficient. If reached, this objective will result in a new MAC protocol specification or guidelines for VLC in V2V and V2I/I2V network environments.

1.3.1. Research questions

Continuing on the defined objective, research questions have been defined to aid in the research process:

- **RQ1:** *How can one design and evaluate MAC protocols for VLC V2V and V2I/I2V network environments?*
 - **RQ1.1:** *What are the specific features of the new MAC for VLC in V2V and V2I/I2V network environments?*
 - **RQ1.2:** *What are the specific metrics for evaluating different MAC protocol in network simulations?*
- **RQ2:** *Can channel asymmetry affect network performance?*
 - **RQ2.1:** *What are different types (cases) of asymmetry?*
 - **RQ2.2:** *What are specific scenarios in which asymmetry has a maximum effect on performance?*
 - **RQ2.3:** *How often do those occur in simulated real-life situations?*
- **RQ3:** *How does one simulate VLC in V2V and V2I/I2V network environments?*
 - **RQ3.1:** *Can existing simulators appropriately support VLC for V2V and V2I/I2V network environments?*
 - **RQ3.2:** *What are specific features such a simulator should have and that existing simulators do not have?*
 - **RQ3.2:** *What is a VLC-equipped vehicle model?*

1.3.2. Hypotheses

The research course is driven by two hypotheses:

- H1. In simulated scenarios, incidence of different asymmetry types requires a new MAC protocol design in V2V and V2I/I2V VLC network systems.
- H2. Developed MAC protocol specialized for V2V and V2I/I2V VLC network systems, compared using selected metrics, has better performance than referent IEEE 802.11 MAC protocol in simulated V2V and V2I/I2V scenarios.

1.4. Research methodology

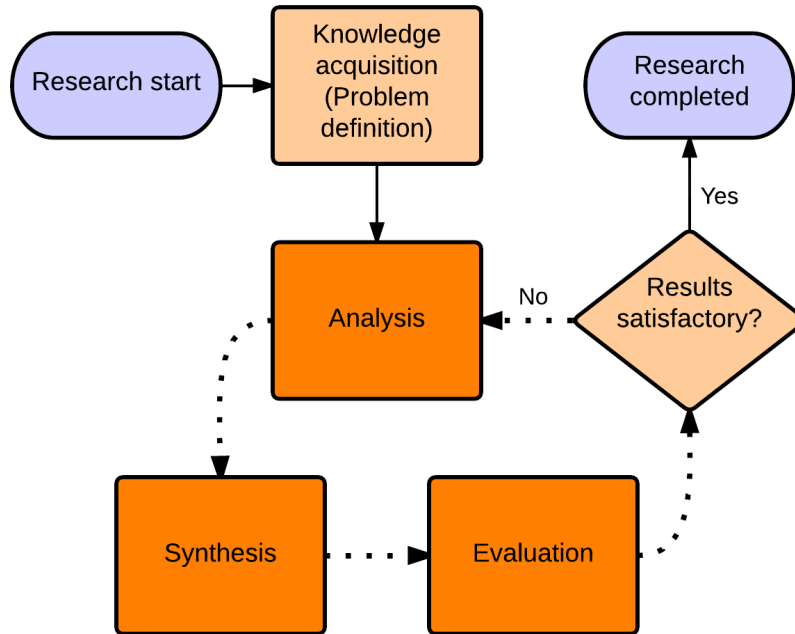

Figure 3: Research phases

The basic research methodology that will be used in this *practical research* is a *simulation experiment*. Other methodologies like a *literature review* and *critical appraisal* will be used in different research phases. Figure 3. shows four main research phases that are used. Phases are inspired by Bloom taxonomy categories [15]:

- **F1:** *Problem definition* is to be done using an intensive literature review, critical appraisal, and existing project analysis in the field of research. As a result, research problems will be identified.
- **F2:** *Analysis* includes an analysis of problems and defined objectives in the previous phase. It also includes a consideration and definition of potential solution characteristics, objectives, and guidelines for the next phase of research; by so doing, it should assist in the finding of solutions to defined problems.
- **F3:** *Synthesis* phase will compile previous phase results as new achievements, in some cases using a *simulation experiment*. Synthesis includes elaboration, development, and solution implementation, as well as implementation of its integral parts.

- **F4: Evaluation** will test results from the previous phase against the desired state (objectives and objectives). If evaluation fails, the whole process should be repeated starting with F2 until the results are considered satisfactory. Evaluation includes consideration, solution comparison, measurements and an analysis of the solution's capacity to solve a defined problem.

1.4.1. Research phases

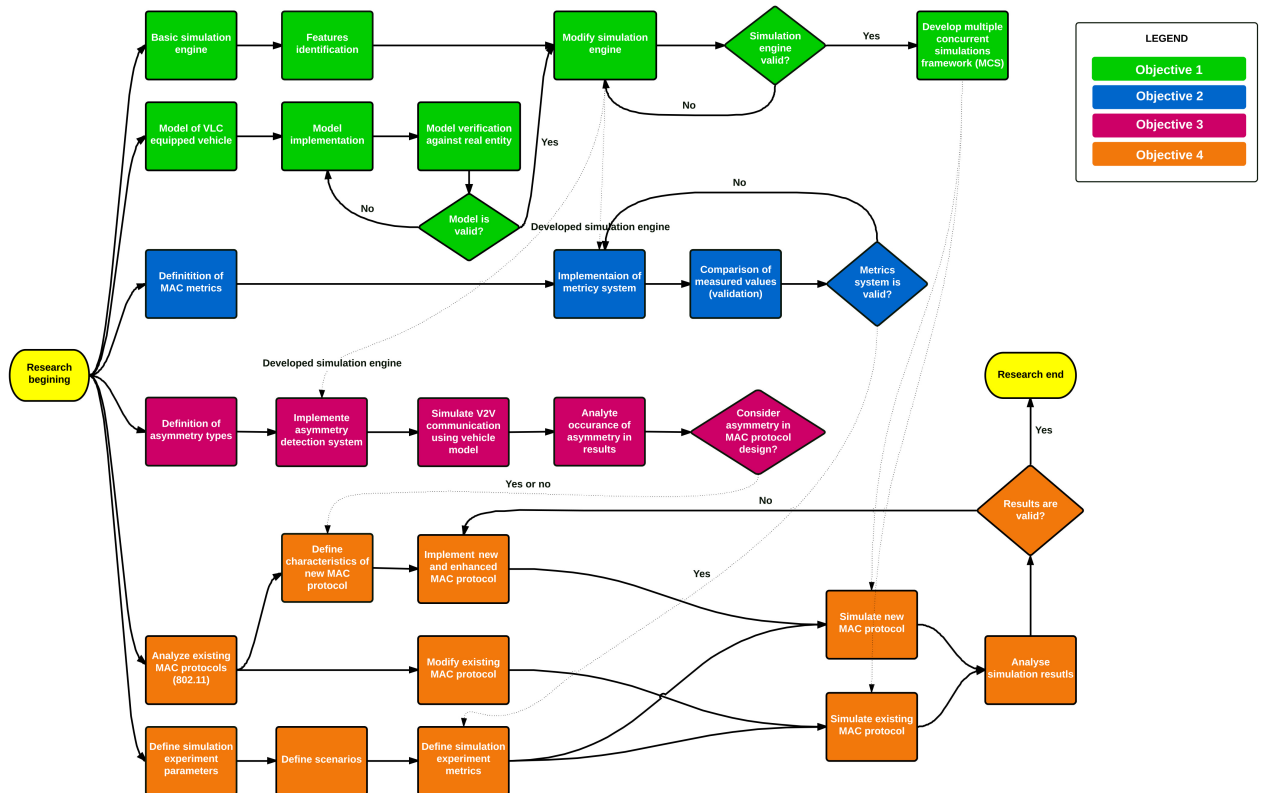

Figure 4: Complete research process

Figure 4 shows the complete research process that combines the research phases previously described with each specific objective. The same figure shows the relationship between research goals. For example, output for one goal is input for another.

Next, each objective is described by each research phase:

F1 research phase can be considered completed for each objective as an SOA analysis (Chapter 2).

The other research phases for each objective are as follows:

■ **Objective O1:** *Define the simulation environment for V2V and V2I/I2V VLC network systems*

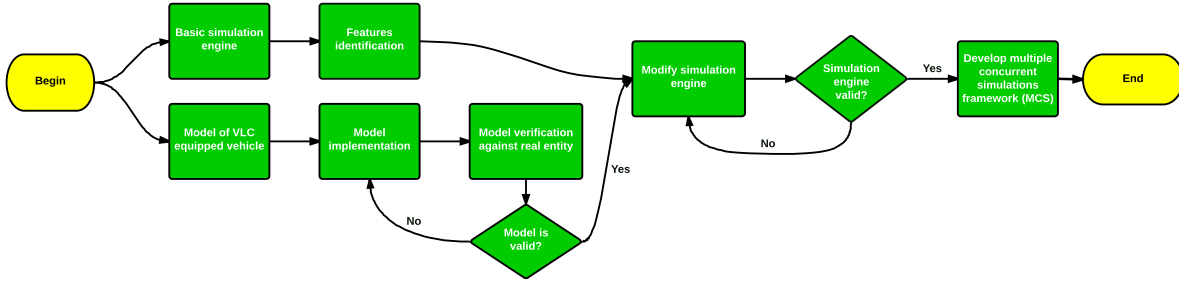

Figure 5: Objective workflow: 1. Define the simulation environment for V2V and V2I/I2V VLC network systems

- **Analysis phase (F2)** During this phase, the desired (basic) simulation engine is selected from a pool of available network simulators. This phase should also identify selected simulation engine missing features that should be implemented to support VLC and MAC protocol evaluation. Furthermore, during this phase, VLC-equipped vehicle model characteristics should be defined.
- **Synthesis phase (F3)**
 1. Modify the selected simulation engine by implementing missing features.
 2. Define the VLC-equipped vehicle model.
 3. Enhance the selected simulation engine with support for the VLC-equipped vehicle model.
- **The evaluation phase (F4)** should verify the VLC vehicle model and modified simulator against real-life scenarios, similar to work done by Yu et al. [183]. If necessary, the research process must return to phase (F2) and make appropriate adjustments to the model and selected simulation engine.

- **Objective O2:** *Define the development environment for the MAC protocol implementation design and test. (designed for V2V and V2I/I2V using VLC).*

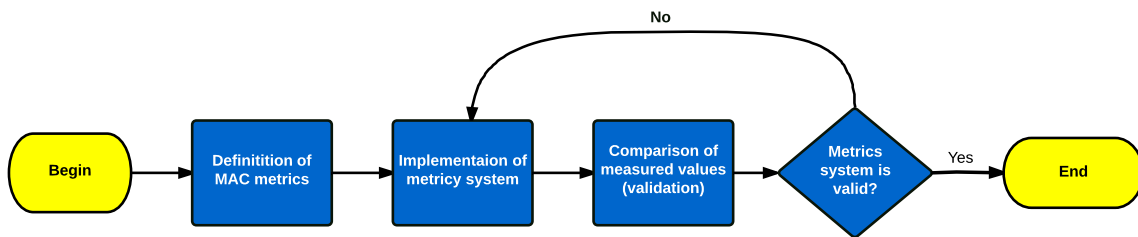

Figure 6: Objective workflow: 2. Define the development environment for MAC protocol implementation design and test

- **Analysis phase (F2)** will analyse the connecting points (interfaces) on ISO/OSI stack implementation in a selected simulation engine. The collection of metrics for evaluating MAC protocol should be defined.
- **Synthesis phase (F3)**
 1. Redefine the MAC protocol interfaces towards the upper and lower ISO/OSI layers in the selected simulation engine.
 2. Implement the MAC protocol performance metrics system.
 3. Implement the measurement mode (data gathering). This mode excludes randomness in simulation. Randomness is a natural occurrence that is present in simulation environments. By removing randomness, gathered data should be constant during each simulation run. This is useful when comparing two different MAC protocols on the same simulation scenarios. This feature should be optional.
 4. Implement data analysis and performance grading.
 5. Implement the MAC protocol evaluation feature in the selected simulation engine.
 6. Implement the MCS framework (tool) for the selected simulation engine that will execute simulations based on the input simulation plan that includes simulation scenarios and configurations. While the simulation is running, MAC protocol performance data is gathered.
- **Evaluation phase (F4)** In this phase, metrics data gathering should be verified by simulating the existing protocol IEEE 802.11 using the newly implemented feature. Results (gathered performance data) should match the results of the analysis of MAC performance

performed by other researchers, like Kumar did in his simulations [89]. After that, necessary adjustments (return to Phase 2) should be made until the results are matched.

- **Objective O3:** *Explore the effects of channel asymmetry in V2V VLC network systems.*

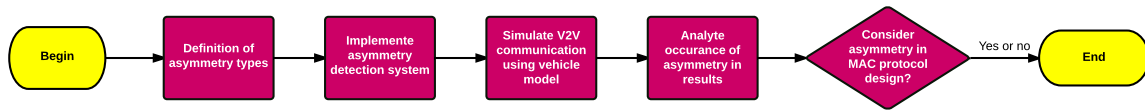

Figure 7: Objective workflow: 3. Explore the effects of channel asymmetry in V2V VLC network systems

- **Analysis phase (F2)** This phase should result in a definition of geometrical conditions that should be met for asymmetry to occur. Not all cases of asymmetry are equally severe, meaning that the types of asymmetry cases should be classified according to severity.
- **Synthesis phase (F3)**
 1. Define the geometrical conditions that identify asymmetry.
 2. Implement an automatic classification of asymmetry events according to their analysed severity.
 3. Implement the asymmetry monitoring feature in the selected simulation engine. This feature should identify data packet loss that is caused only by asymmetry.
 4. Run simulations on a *real-world* simulation scenario.
 5. Gather data about asymmetry classified by severity and number of occurrences.
- **Evaluation phase (F4)** In this phase, gathered data should be interpreted. The result should be a decision regarding whether to consider an asymmetry issue in a *MAC for V2V and V2I/I2V using VLC* protocol design.

- **Objective O4:** Define the theoretical framework for an efficient MAC protocol in V2V and V2I/I2V VLC network systems.

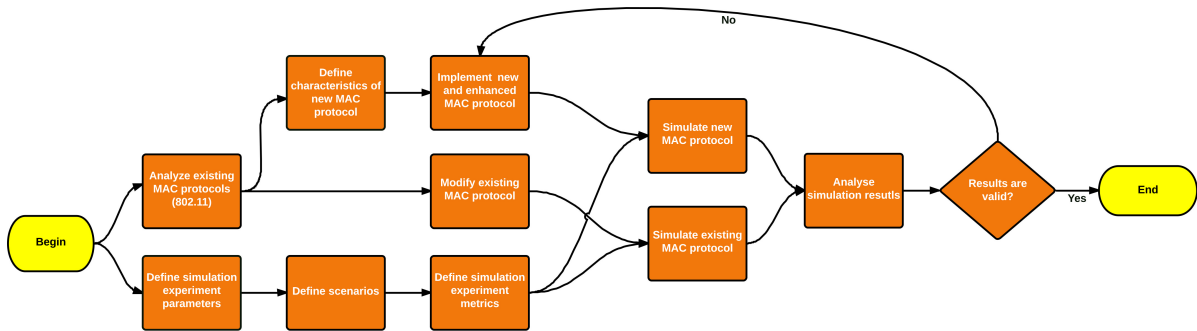

Figure 8: Objective workflow: 4. Define the theoretical framework for an efficient MAC protocol in V2V and V2I/I2V VLC network systems

- **Analysis phase (F2)** In this phase, a set of features is defined such that the new MAC protocol for V2V and V2I/I2V using VLC should and should not have the following guidelines from other researchers, such as Yu et al., and the results of other objectives in this research (e.g. O3).
- **Synthesis phase (F3)**
 1. Implement MAC for V2V and V2I/I2V using VLC
 2. Set up the simulation environment:
 - (a) Define the simulation scenarios (SS).
 - (b) Define the simulation metrics.
 3. Run the simulation using MAC for V2V and V2I/I2V using VLC.
 4. Run the simulation using the IEEE 802.11 MAC protocol as a referent protocol.
 - (a) Make the minimum required adjustment to the IEEE 802.11 MAC so that it can run on a VLC-enhanced selected simulation engine and a VLC-equipped vehicle model.
 5. Gather simulation performance data.
- **Evaluation phase (F4)** gathered performance data will be evaluated and interpreted. If the new MAC protocol for V2V and V2I/I2V using VLC is better than the referent IEEE 802.11 MAC protocol, objective O4 is reached and hypothesis H2 is confirmed. If necessary, the research process should return to the previous phases to modify the design of the new protocol.

1.4.2. Summary

This research will focus on various simulation experiments. Two major experiments will be conducted. The first one will investigate the asymmetry effect on performance in VLC in V2V networks, and the second one will compare and evaluate the newly designed MAC protocol for V2V and V2I/I2V. Simulation will also be used as a development tool, as simulations are to be used to test implementation during the development phase. A literature review is used to gather knowledge that will be used in the synthesis phases of this research (e.g., development). Two major simulations are conducted as an experiment in a documented and controlled scenario. For each simulation, simulation scenarios, parameters, and scripts are to be defined. These will be used by the simulation engine to execute simulations.

1.5. Contribution

The expected contributions of this research are derived from objectives O1-4:

- (a) **MAC protocol** that can be used in vehicular network communications. With this protocol, car manufacturers can extend vehicular communication to new territory (VLC).
- (b) **Asymmetry definition in V2V using VLC** is a definition describing the asymmetry performance impact on vehicular communication using VLC.
- (c) **VLC network simulation environment** is open source software available for other researchers who are researching VLC and vehicular networks.
- (d) **MAC protocol design and evaluation tool** provides a mechanism for designing and evaluating MAC protocols regardless of technology (RF or VLC) and network type.

All the research data and software, and the thesis, are publicly available under Attribution 4.0 International Creative Commons licence. Locations are as follows:

- Research data and this thesis:
github.com/boristomas/phd1
- MCS and simulation scenarios designer tool:
github.com/boristomas/mcs
- Network simulation engine with VLC radio and VLC MAC protocol for V2V:
github.com/boristomas/macvlc

1.6. Technology and tools used

This thesis is written using *TeXstudio* (texstudio.sourceforge.net) in Latex. The document repository is managed using *Mendeley* (www.mendeley.com). The code and content are tracked and controlled using *GitHub* (www.github.com) in public and private repositories.

The simulation engine used is developed in the Java language using *Eclipse* (www.eclipse.org).

The other part of the simulation environment: MCS and simulation scenarios designer is developed in the C# and XAML language using *Visual Studio and Blend* (www.visualstudio.com).

Simulations are executed on *University of Zagreb, Isabella computing cluster* (srce.unizg.hr).

Data gathered is analysed and visualized using *Matlab* (www.mathworks.com)

1.7. Thesis structure organization

The rest of the thesis is organized as follows. Following, *Chapter 2 - State of the art* describes state-of-the-art research that precedes this research and is the first research phase (F1). It describes the history as well as the current state of both vehicular communication systems and visible light communications. Following, *Chapter 3 - Network simulation environment* introduces definitions, problems, and alternatives regarding the simulation environments that are to be used in the experiment phase of this research. Following, *Chapter 4 - Asymmetry in VLC vehicular networks* explores the issue of asymmetry in communication networks with a special emphasis on a VLC in V2V networks. This chapter also describes the simulation experiment and experimental setup that is conducted on a simulation environment defined in the previous chapter. Following, *Chapter 5 - VLC MAC for V2V protocol design* describes the proposal of a new and enhanced MAC protocol that will be used for evaluation in the following *Chapter 6 - Simulation experiment*. Here, a set of evaluation metrics, the simulation experiment setup, and simulation scenarios are defined and, in the end, the experiment is conducted. After that, experiment results are discussed and analysed. At the end of this thesis is a final *Chapter 7 - Conclusion* in which the research impact and results are summarized and future work is defined.

2. State of the art

This chapter explores important concepts when designing a custom MAC protocol. It is a detailed state-of-the-art overview of the fields related to MAC protocols and networking in general, as well as vehicular communications, network simulation environments, and VLC technology. The chapter provides insight into the fields that must be understood when designing, implementing, and testing a MAC protocol for vehicle-to-vehicle communication. This chapter is a result of the first research phase (F1) defined in Section 1.4.1

2.1. Introduction

Modern vehicular communication focuses on a radio technology and ad-hoc distributed and decentralized concept. There are two major research trends in vehicular communication:

- Vehicle to Vehicle (V2V)
- Vehicle to Infrastructure (V2I) and Infrastructure to Vehicle (I2V)

V2V is realized using a radio device installed on each vehicle. Unfortunately, the full potential of Vehicular Communication Network (VCN) is achieved only in a scenario in which every vehicle is equipped with a radio device like Dedicated Short Range Communication (DSRC) device [19]. An example of V2V communication would be a Virtual Traffic Light (VTL) system in which all vehicles on the crossroads must agree on VTL state¹ for a system to be safe [116]. If only one vehicle is unable to communicate, VTL could pose a great risk were that vehicle to enter the crossroad while it was not allowed to do so. Some researchers are focused on accelerating the transition phase by augmenting VTL with I2V technology [139].

Research efforts are focused on defining standards and services for VCN. Many focus groups are gathered around major car manufacturers, which makes a VCN a tool for market and business competition. Regardless of that, whichever standard prevails, the purpose is noble and it will save numerous lives. The most representative example of a VCN/V2V safety application would be a scenario of a traffic accident in which vehicles in the accident instantly sent out (broadcast) a message notifying all nearby vehicles of the event [176]. Thus, nearby vehicles

¹Simple states would be: red, yellow, and green

(drivers) could reduce their speed and, if necessary, stop at the incident location.

Unlike V2V, the concept of V2I/I2V is rather more feasible because it doesn't require full implementation of radio technology but only infrastructure-based implementation. The term "infrastructure" usually includes traffic lights, signs, or posts [101] and special equipment for VCN like Road Side Unit, plural = Road Side Units (RSU) [2] which are essentially wireless (radio) access points that extend and augment existing V2V networks [109]. V2I or I2V can also be a *read only* information provider; a typical example would be: the existing traffic light state is *broadcasted* to nearby vehicles, which will present the traffic light state to the driver, thus improving driving experience and safety.

Currently, RF is being used in VCN; however, there is an alternative: VLC. It is well-known technology that is currently under research focus due to technological achievements like the fact that it is easily controllable Light Emitting Diode (LED) and has a high read speed Photo-Diode (PD). Some researchers organized around IEEE WPAN² are working on using the visible portion of the EM spectrum to transmit and receive information, as unlike the rest of the EM spectrum, visible light is unlicensed and free to use [123]. Also, light (under a reasonable power output level, e.g., up to 100 W) has zero environmental and biological impact.

VLC for V2V communication is a new concept that few research groups are working on. They hope that one day, a vehicle will use its LED headlights to transmit data to other vehicles. To achieve this, standards and procedures must be defined. The IEEE community has already defined standards [130] for VLC but support for V2V specific characteristics is still under ongoing research.

2.2. Visible Light Communication (VLC)

According to Holzmann and Pehrson, one of the first uses of VLC dates back to Greek times when the military used polished, reflective shields to send signals by reflecting sunlight during battles [62]. They used simple codes to transmit information over the battlefield. Modern history reinvented VLC in 1880 when Alexander G. Bell, in his paper *The Photophone* [13], introduced the concept of transmitting data (voice) over a large distance using light as a medium to carry the voice information. The light he used was daylight from the sun. He noticed that some materials vibrated when exposed to vibrating light. In his paper, he reported the results

²Wireless Personal Area Networks (www.ieee802.org)

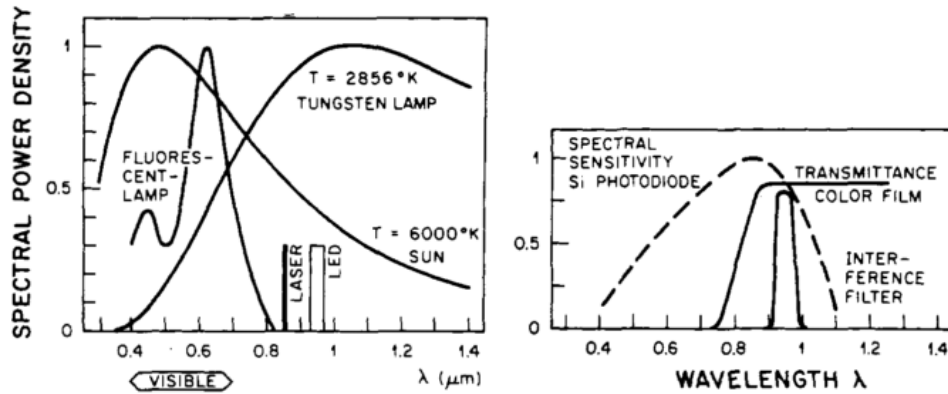

Figure 9: Spectral power density of three common ambient light sources. The right figure shows the effect of different optical filters. Source: [48].

of testing different materials and concluded that selenium is the best material to decode data encoded onto a light carrier. Furthermore, selenium can react to the vibrations of light originating from a candle. Information is encoded as the spatial vibration of a light beam. For example, if the receiving surface is on an xy plane, it is then perpendicular to the incoming light ray (z axis), thereby encoding (modulating) the data differently, e.g., the use of frequency or amplitude was not technologically possible at that time. Vibrations of a light beam shape on a yx plane can be interpreted by the receiving surface, thus making spatial vibration encoding an interesting proof of concept. The photophone was abandoned in favour of electrical wire data transmission (telephone). It is a curious historical remark that the first phone was, in fact, completely wireless.

VLC is very similar to the IR communication that was introduced by Gfeller and Bapst in 1979 [48]. They have developed a data communication system that uses IR electromagnetic spectrum to transmit information, as shown on Figure 9. Gfeller and Bapst define the main source of ambient noise - the sun. In Figure 9 they positioned an IR laser and LED on the EM wavelength scale. Conveniently, they also mapped the visible part of the EM spectrum so that it could be seen that the visible part of spectrum was very saturated by the sun's radiation. It can be concluded that IR communication systems could be more efficient than VLC due to less ambient (environmental) noise.

Table 1: Comparison of VLC and IR communication technologies (original: [80])

	VLC	IR
Data rate	>9 Gbps [23]	16 Mbps
Status	Research phase	Standard(IrDA)
Distance	Several meters	Up to 3 m
Regulation	No	No
Security	LOS	LOS
EM wavelength	380-780 nm	850 nm
Services	Communication and illumination	Communication
Noise source	Sun, ambient lighting	Ambient light
Environmental	Daily usage, Eye safe	Eye safe for low power (invisible)
Application	Indoor and vehicular communication	Remote controllers, Point-to-point connection

Table 1 shows a comparison of VLC and IR communication technologies. It can be noticed that VLC has a far more superior transmission data range; one of the reasons for this is that it has a wider detectable frequency band. One of the advantages of IR is that it is less affected by noise originating from the Sun.

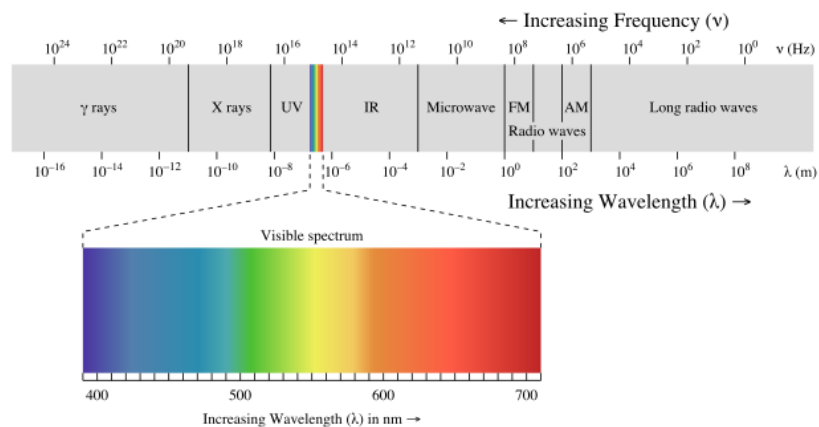

Figure 10: EM spectrum ³

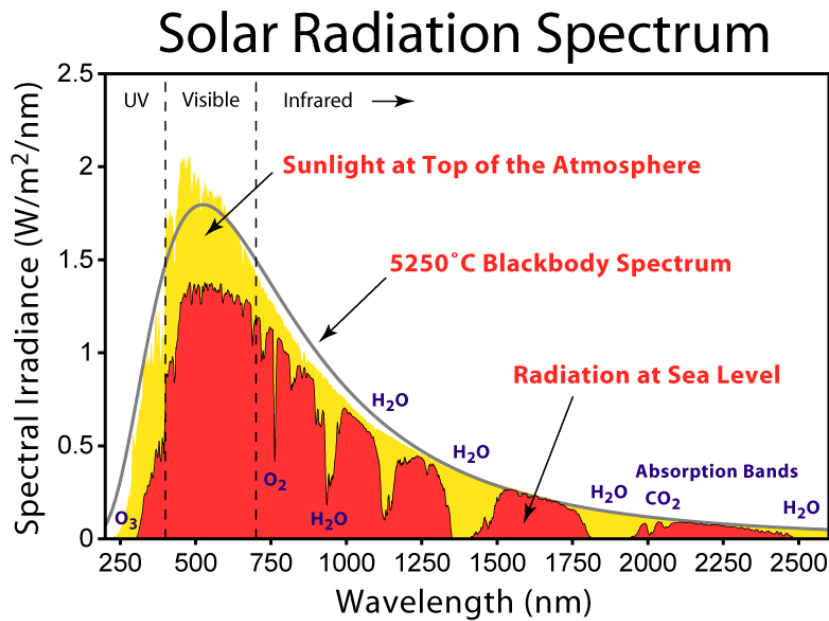

Figure 11: Solar radiation spectrum (Licensed under CC BY-SA 3.0 via Wikimedia Commons)

Figure 10 shows the EM spectrum scale and Figure 11 shows the solar spectrum radiation distribution. It can be seen that the Ultraviolet (UV) part of the EM spectrum is not saturated with the sun's radiation mainly because of the ozone layer (O_3), thus making UV communication more resistant to environmental noise than the visible part of spectrum while having better performance than visible and IR communication systems, especially in outside environments. UV communication systems gained the interest of the military due to their characteristics, data transfer speed, and reliability [125]. Puschell also emphasizes the Non Line Of Sight (NLOS) characteristics of UV communication systems; Xu et.al analysed the performance of NLOS UV communication [177] and proved that performance is satisfactory for data transmission. The characteristics of atmospheric scattering are the main reason why NLOS is possible in UV communication systems. An atmosphere that reflects/scatters the UV part of the EM spectrum is the reason for blocking the large amount of UV EM energy originating from the sun that would otherwise be a significant source of noise for UV communication.

In the latest decade, researchers began re-exploring the ideas presented by Bell. Optical communication gained the scientific spotlight due to the fact, identified by Rajagopal, that traditional RF communication below 6 GHz is rapidly running out of spectrum bandwidth for high-data-rate communication [127]

Using the visible part of the EM spectrum, researchers can use a new band for short-range data

³Licensed under CC BY-SA 3.0 via Wikimedia Commons

transmission. Uysal and Nouri report that the utilization of optical band, which includes IR, visible and ultraviolet frequencies [33], for wireless transmission offers research opportunities, as this area is largely unexplored [161].

Researchers have identified the most common components of VLC systems: LED as the transmitting component (Tx) and PD as the receiving component (Rx) [122, 179]. Other researchers experiment with different technologies and equipment used to achieve communication in the visible part of the EM spectrum.

2.2.1. Transmitting technology

Any device capable of emitting light can be used to transmit data in the VLC system. Emission of light should be controllable in such a manner that it supports modulating schemes, e.g., the device should be able to turn emission on and off for simple On-Off Keying (OOK) modulation.

In his thesis [35], Cui states that VLC is or can be piggybacked on an existing illumination or signalling system. This means that the minimum transmitted optical power should be used to satisfy existing system requirements, e.g., a vehicle headlight should have luminous flux equal to 2000 lm as defined by UN standards [159]. Regardless of usage, a vehicle headlight should always comply with this requirement. The same principle applies to any illumination aperture used in a vehicular system. This minimum intensity, on the receiving side, introduces a new noise source on a receiver component. IEEE802.15.7 [65] also identifies this issue regarding constant illumination flux, especially in multi-colour (frequency) transmitting systems in which fluctuations on output power might render a colour change that is noticeable by the human eye.

Cui also made a detailed analysis of VLC ISO/OSO Physical Layer (PHY) layer characteristics, including different modulation schemes and their comparison. His and related work define the VLC PHY layer sufficiently for it to be used in practice, especially in one-to-one ($1 \rightarrow 1$) or one-to-many single-direction communication ($1 \rightarrow n$).

Other authors propose the use of LASER as a transmitter. According to Grancars et al., the future adoption of laser-produced illumination, if cost effective, could enable significant performance gains in VLC systems due to the high-frequency modulation capabilities of lasers. In the meantime, LEDs with low modulation bandwidths are the most viable in meeting pressing light quality, communication, and cost requirements [46]. Lasers in vehicular headlight systems

are used not to illuminate roads and the environment but to illuminate a phosphorus plate that radiates eye-safe white light [156] .

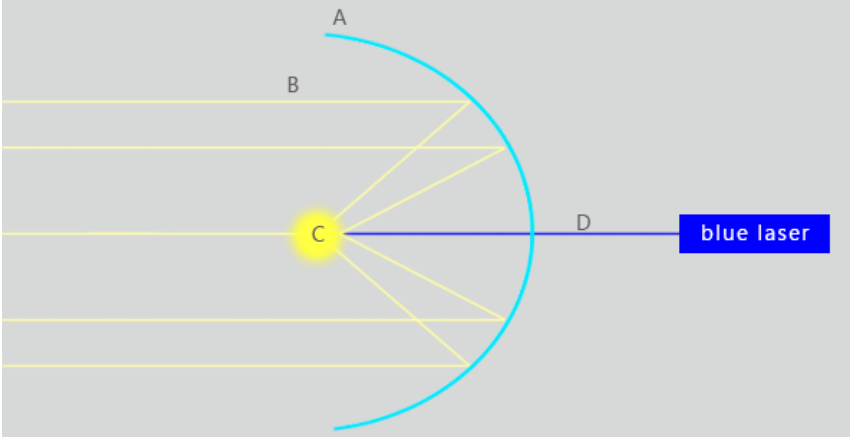

Figure 12: Simple laser lighting aperture

Figure 12 shows the typical laser hardware used in laser-powered vehicular headlights. The source of energy is a blue laser. Laser beam (D) is focused on a phosphorous element (C) which then emits white light (when exposed to blue light (450 nm) as described in [114]). Generated light (B) is concentrated using a parabolic mirror (A) and reflected in the desired direction. It may be a concern that inducing photons from phosphorus atoms has a build-up delay. This is the case in compact fluorescent lamps. However, this is not the case with blue laser-induced phosphorus light due to high-power lasers and direct energy conversion.

2.2.1.1. Conclusion

Table 2: Comparison of VLC Tx technologies

Technology	Pros	Cons
LED	- High data rate (up to 9 Gbps [23]) - Low cost	- Low energy efficiency [117]
Laser	- High data rate - High energy efficiency [117]	- High cost

Table 2 shows a comparison of two VLC transmitting technologies. Some ancient and obsolete devices like incandescent bulbs were not considered in this analysis. The use of lasers, especially in vehicular headlights, is in its beginning. The most promising feature of lasers is

high energy efficiency comparable to LED. Because of its versatility and low cost, and the fact that LED is *de facto* a part of standard equipment, LED is the most feasible solution for the VLC transmitting component.

2.2.2. Receiving technology

The PD with good responsiveness to the visible light are silicon p-type-insulator-n-type photodiode (Si PIN-PD) and silicon avalanche photodiode (Si APD). The silicon material photodiode operates from 400 nm to 1200 nm [80]; this includes the visible light part of the EM spectrum. The authors also state that there are many PD types whose sampling rates are over 200 MHz. According to [174], Pulse Width Modulation (PWM) used in standard LED lighting uses a frequency up to 500 kHz. It can be concluded that PD is far more precise than LED and that it is sufficient for VLC systems with LED. A single PD can decode only one input; it can be considered a single pixel that records every light source in the range. Because of that, a single PD cannot distinguish different light sources.

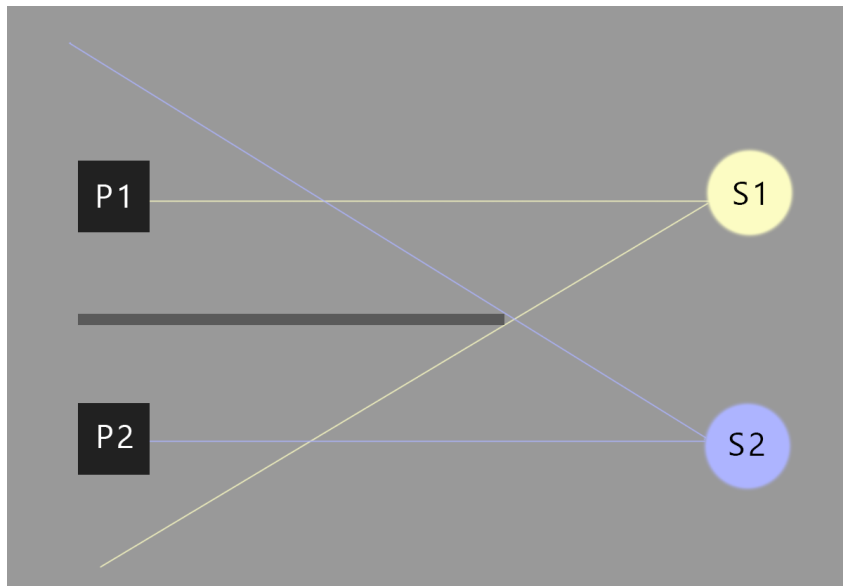

Figure 13: PD multiple source solution

Figure 13 shows a solution that includes a physical barrier between two PD (P1 and P2). With a barrier, each PD can detect only one source (S1 or S2). Splitting space into individual segments is a basic principle that a digital camera uses to capture images.

Although, PD is very cheap, there are alternatives, like a high-speed camera, proposed by Yamazoto and Iwasaki [178, 71]. A high-speed camera could provide multiple concurrent data

streams, whereas PD provides only one input stream.

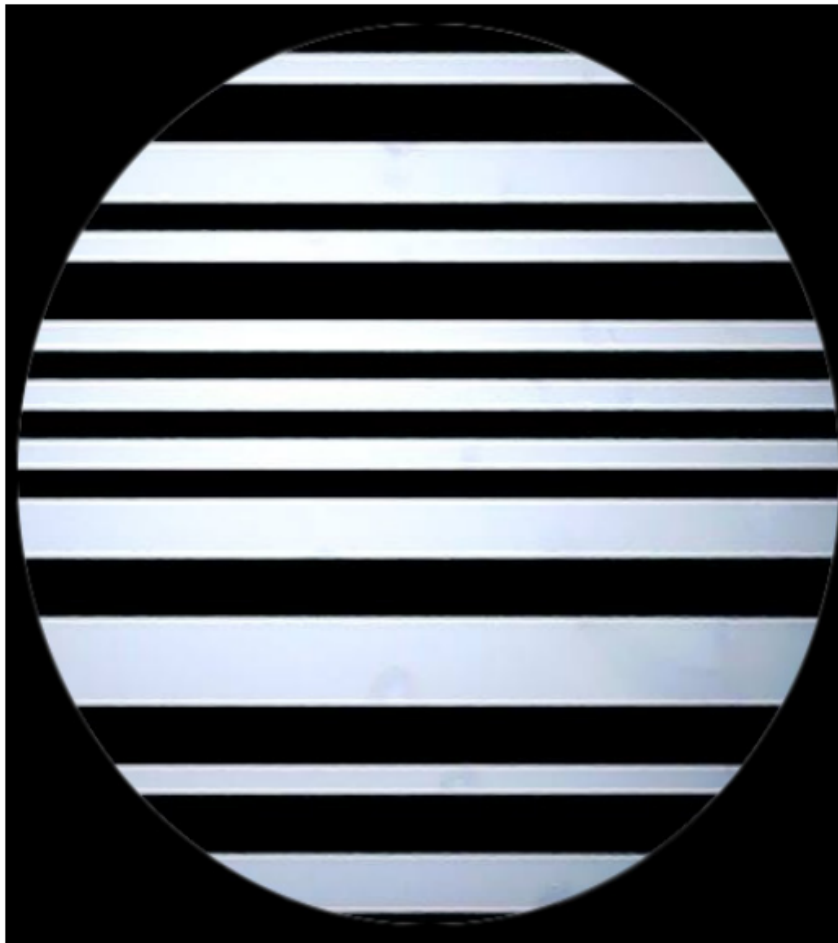

Figure 14: Data from rolling shutter [92]

The latest research efforts utilize the rolling shutter effect of a digital camera used in smartphones [102]. The Rolling shutter effect on a LED is shown on Figure 14. It can be noticed that the rolling shutter captures only one frame segment at a time. Bars on Figure 14 represent information: if the LED has two states, *on* or *off*, the black bar represents the *off* state and the white bar represents the *on* state. Using image processing on a camera video raw feed, LED states can be decoded by recognizing the black or white bars on each video frame.

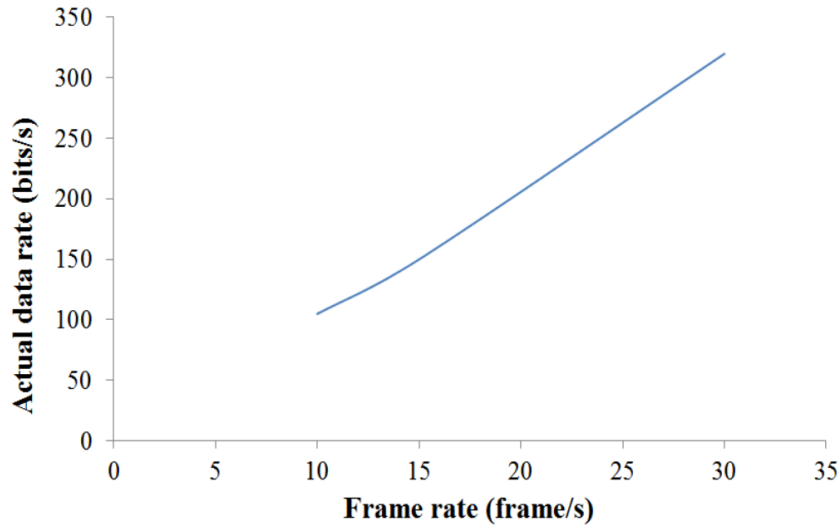

Figure 15: Throughput performance of rolling shutter mode. Source: [92].

Figure 15 shows rolling shutter receiver performance in VLC systems. It can be noticed that maximum performance is around 300 bps at 30 fps, which is far less than the 9 Gbps [23] achieved with high performance PD. However, due to high construction costs, it is not as versatile as a simple PD. To introduce near 360° coverage it would be necessary to equip a vehicle with more than one very expensive camera. The advantage of a rolling shutter and camera would be the use of multiple input streams. This, however, does have its limits because if the distance is large, multiple sources could optically converge to one source, thus rendering communication inoperable. This converging would happen due to the resolution limits of the camera. In low distances, multiple sources might be decoded, but due to the limited resolution, only few large sources could fit the camera frame.

For a rolling shutter camera system to achieve the 9 Gbps that is present in LED VLC systems, it would require 30 000 000 sources. A hypothetical system using a high-end 1080p camera would have a resolution of 1920 * 1080 pixels. This provides a total of 2 073 600 pixels. If the transmitting side of this hypothetical system could be designed to provide at least 2 073 600 sources, this system would be fully efficient and still not as fast as the LED VLC system. For this hypothetical system to be as fast as an LED VLC system, it would require 27 926 400 more sources/pixels. In conclusion, a rolling shutter cannot match the fastest VLC systems.

As discussed in the previous section, LED is the most feasible solution for the VLC Tx component; in addition, LED can be used to receive and decode information on a visible light carrier. LED and PD are both, in essence, semi-conductor components. Miyazaki conducted an inter-

esting experiment that proved that LED can be used as PD [112]. After that, Dietz et al. made a working prototype of an LED-to-LED communication system [38], proving the concept only at short distances (up to 3 centimeters). Due to the fact that LED has low performance in sensing light, the maximum achieved data transmission speed is 250 bps. LED-to-LED communication uses the existing LED which makes it very low cost and, according to authors, in some cases even free. This is the case when the existing LED is controllable by a micro-controller that has updateable firmware, meaning that the LED light sensor capability (Rx) can be achieved even and only on a software level (new firmware).

Researchers at the Disney Research Centre also experimented with LED-to-LED communication and concludes that such a system has [134]:

- Low communication range
- Low throughput
- LED is less sensitive than PD when measuring light levels

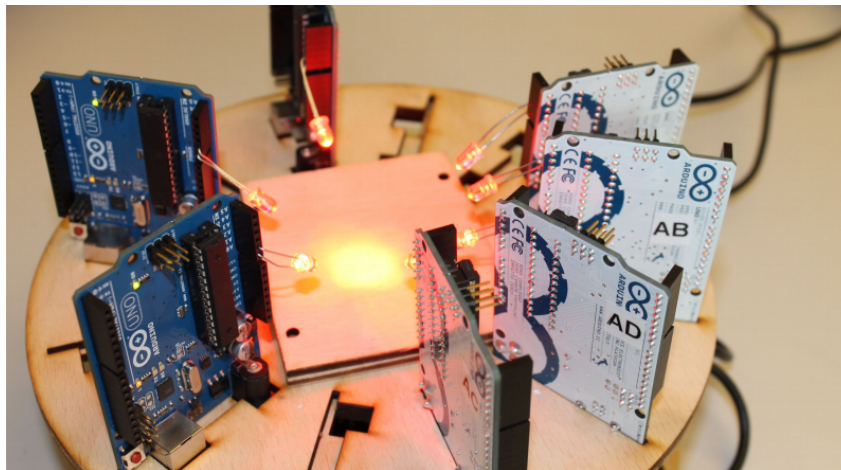

Figure 16: LED-to-LED communication testbed. Source: [134].

Figure 16 shows an LED-to-LED communication testbed with seven prototype nodes. The researchers used Arduino Uno micro-controller prototyping boards with a single LED connected. This LED was being used as a Tx and Rx component intermediately.

2.2.2.1. Conclusion

Some researchers push equipment to the limits of data rate speeds, like Pisek et al., who demonstrate VLC using LED and PD to achieve gigabit speeds. They also identify that IEEE802.15.7 [65] was not developed for *Gigabit* rates. Thus, an alternative baseband method must be designed to support the increased bit rate (>1 Gbps) [122].

Table 3: Comparison of VLC Rx technologies considering implementation on a vehicle

Technology	Pros	Cons
PD	<ul style="list-style-type: none"> - High data rate - Small size - Low cost 	<ul style="list-style-type: none"> - Small resolution (1px) - Not present on vehicle
Camera	<ul style="list-style-type: none"> - Large resolution - Present on vehicle (as smartphone/dashboard camera) 	<ul style="list-style-type: none"> - High cost - Low data rate
LED	<ul style="list-style-type: none"> - Low cost (free) - Present on vehicle 	<ul style="list-style-type: none"> - Low data rate - Low resolution - Short sensing distance

Table 3 shows a comparison of three VLC receiving technologies. It can be concluded that PD is the most feasible technology for receiving due to its low costs and high performance. With defined Rx and Tx technologies, the next phase includes a definition of the *visible channel model* that uses LED/PD technologies to send and receive light-encoded data.

2.2.3. Visible channel model

VLC uses the same medium as a standard radio communication: the EM spectrum, only using a different, higher frequency range (405 THz - 790 THz). Different frequencies in the EM spectrum behave differently [49], thus changing the expected channel characteristics for the VLC.

Light, unlike radio waves, also conforms to the classic mechanics and light particle theory described by Young in his lectures [182]. Because of specific channel characteristics, VLC does not have issues regarding interference with a co-channel, such as is the case in low-frequency radio used in common radio communication [133]. Saadi also states that the light, not being able to penetrate obstacles, is a feature that enhances physical layer security in VLC. This means that the VLC system can detect the intrusion of a malicious entity because any tampering will interfere with and eventually disrupt the light beam. The lack of a light beam can easily be detected by the receiving side, thus identifying a potential security attack on a communication channel.

Chung Ghiu Lee states that IR and visible light constitute light with different wavelength spectra. The modulation formats for the IR system can be adopted in VLC considering the geometrical environment, mobility, and multi-user connectivity [80].

Light is a part of the spectrum in a wide range of frequencies. Each light frequency is recognized by the human eye as a colour. It can be concluded that a multiple frequency channel model is feasible as long as it complies with existing equipment and its purpose, e.g., the minimum output level and colour. This approach, in V2V systems, should be used carefully because it may happen that the red channel (400-484 THz) is the only free channel in the communication channel, resulting in red (or reddish) light output that violates traffic signal standards and security requirements, like United Nations regulations [159].

Current work on defining VLC channel characteristics emphasizes that a VLC channel is very prone to noise, in particular, environmental noise from the sun, which can be reduced with different levels and techniques of filtering on a hardware and a software level. Authors have made substantial effort to define LED and PD physical models as well as a valuable attenuation model for LED light [113]. Komine and Nakagawa have proven a direct link between Field Of View (FOV) and data rate considering the environmental noise originating from signal reflections and refractions, and intersymbol interference [84]. Increasing FOV will increase the data rate by reducing noise.

This concludes the overview of current VLC technology. In the following section, a short introduction to the latest achievements in vehicular communication is analysed.

2.3. Vehicular communication

Vehicular communication enables vehicles to exchange data autonomously either with other vehicles or with an infrastructure using a standardized RF interface. As an enabler of cooperative traffic, vehicular communication offers a huge potential benefit for road safety, traffic flow, and efficiency [140].

In [148] the authors have identified several challenges for vehicular networks, such as having a static network infrastructure that is not sufficient and it should relay to the ad-hoc V2V concept, but this increases channel load and decreases reliability in highly congested urban areas. This disadvantage might be an advantage for the parallel use of VLC, especially for near, line-of-sight scenarios. Data communication in dynamic node architecture, like vehicular networks

where vehicles move and change location, might be an issue. Jafari et al. have made simulations that prove that vehicular speed does not affect the performance of the network (using IEEE802.11p) [72]. This is important because the same results can be applied to VLC because both technologies use the same medium (EM spectrum), and VLC has an even smaller scope (number of network nodes), meaning that the node speed will have an even smaller effect on overall system performance. The scope is smaller because the underlying technology is directional and LOS only, unlike RF which is usually omnidirectional and has some penetrating capabilities [165]

Vehicular communication has these application categories [135]:

1. Active safety (traffic conditions, collision avoidance, crash sensing, pre-crash sensing, incident warning, SOS service)
2. Public service (Emergency vehicle warning...)
3. Improved driving (adaptive cruise control, platooning, traffic sign enhancement, virtual traffic lights)
4. Infotainment (multimedia, diagnostics, Internet access, toll collection, parking payment service...)

Applications identified by Schoch et al. prove that V2V truly improves existing traffic systems (in the domain of Intelligent Transportation Systems). Active safety applications have the highest priority in the communication channel. Because of that, the IEEE802.11p vehicular communication systems standard has a network delay less than acceptable 100ms according to simulations published in 2010 [50]. Some authors have identified several ongoing projects that tackle the standardization of inter-vehicular communication (VCI or V2V) [73, 121]. In their analysis, it can be noticed that the main focus groups are concentrated around vehicle manufacturers in three countries: the USA, EU (Germany) and Japan.

Most of the related projects were completed by the end of 2014, and the next round of funding and research is very intensive, which can be seen in the EU Horizon2020 programme that focuses, among other things, on Internet of Things (IOT), which includes smart vehicles and vehicular communication [146].

Other researchers are focusing on the use of vehicular ad hoc networks as wireless Internet Service Provider (ISP). Jerbi and Senouci have demonstrated and proven the feasibility of such a configuration [74] where each vehicle is, in essence, a wireless (Wi-Fi) access point that pro-

vides service for nearby nodes and users.

In their work, Jiang and Delgrossi offer a short history of the IEEE 802.11p standard for vehicular communication. They identify that "the key purpose of the IEEE 802.11p amendment at the MAC level is to enable very efficient communication group setup without much of the overhead typically needed in the current IEEE 802.11 MAC" [76]. This means that the existing 802.11 MAC protocol is not suited for vehicular communication, in this case for RF, but applicable to the VLC.

2.3.1. Visible light communication in traffic

In previous sections, VLC technology was introduced and the main differences between VLC and RF (in vehicular networks) were presented. Compatibility of VLC and vehicular networks is not questionable, but due to a different medium, adaptations of VLC on a PHY and MAC layer are necessary to maximize the VLC channel utilization. Those adaptations should not affect the upper layers of the ISO/OSI⁴ network stack.

The research focus is mostly on an Infrastructure to Vehicle (I2V) VLC like that demonstrated in [120, 32, 34, 87], where the authors achieved successful data communication from a traffic light to the vehicles. They also pinpointed several key advantages for a VLC in traffic [120]:

- *No radio interference*, meaning that the VLC system can coexist with the existing RF implementations.
- *Saving radio resources*, the RF spectrum is highly saturated and the use of the non-licensed light portion of EM spectrum is an advantage.
- *Utilization of existing infrastructure*, in I2V scenarios, traffic lights have a power source and wired/wireless communication mean and LED is the main information transmitting technology. On the other hand, vehicles can have photodiode, a dashboard camera, or a smartphone camera.
- *Safe for human body*, normal-intensity light is safe for a human's body, whereas RF communication is still a biological concern [69].

Kumar states that VLC adaptation consists of the Media Access Control (MAC) Layer's management and control, services and, monitoring [87]. This clearly identifies MAC with the PHY layer as one of the key elements that must be redefined (compared to RF and 802.11).

In [82], Kim et al. demonstrated a successful implementation of VLC using vehicular headlights

⁴Open Systems Interconnection/International Organization for Standardization

in outdoor environments. This implementation used LED and PD with simple On-Off Keying (OOK) signal modulation. They proved that PD saturation and environmental noise do not harm the VLC in a way which would render it impossible. Also, Yoo et al. demonstrated a simple VLC setting in a vehicle headlight (LED) and demonstrated successful transmission over a distance of 20 m with a 10 kbps data rate [180]. Unlike Kim et al., who used OOK, Yoo et al. used Pulse Position Modulation (PPM) to modulate information on the light carrier wave. An interesting achievement is that transmission was successful during the daytime with the sun incidence angle equal to 30° .

In another research paper, Kim et al. state that V2V communication using VLC LED has not yet been started in real-life scenarios [83]. In his work, only $1 \rightarrow 1$ communication was demonstrated, so there was no need for MAC protocol implementation, which would be the next level demonstrating $n \leftrightarrow n$ communication - multiple node full duplex communication.

Research by Yu et al. also points in this direction by successfully demonstrating VLC implementation using LED and PD on a scooter vehicle [184]. In addition, they demonstrate an interesting use of VLC for positioning where one light source is being captured by at least two PD (stereo vision⁵) so that they can measure the time/phase differences of an incoming signal on a different PD. Those differences can be mathematically calculated as a position of LED source. They also analysed the sources of noise, like environmental lights; they found that reflection from street signs is a strong source of interference but it can be filtered out because the frequency of this noise is 120 Hz (or multiple). This means that VLC can be used during the night and during the day. However, there is a reasonable performance degradation during the day, though the communication link was still stable, according to the authors. In conclusion, Yu et al. state that the next step in their work would be to develop a lightweight MAC protocol for V2V VLC systems.

This concludes vehicular communication and VLC in the latest traffic research. As mentioned, the MAC protocol for VLC in V2V is the next step for researchers. An analysis of MAC protocols follows.

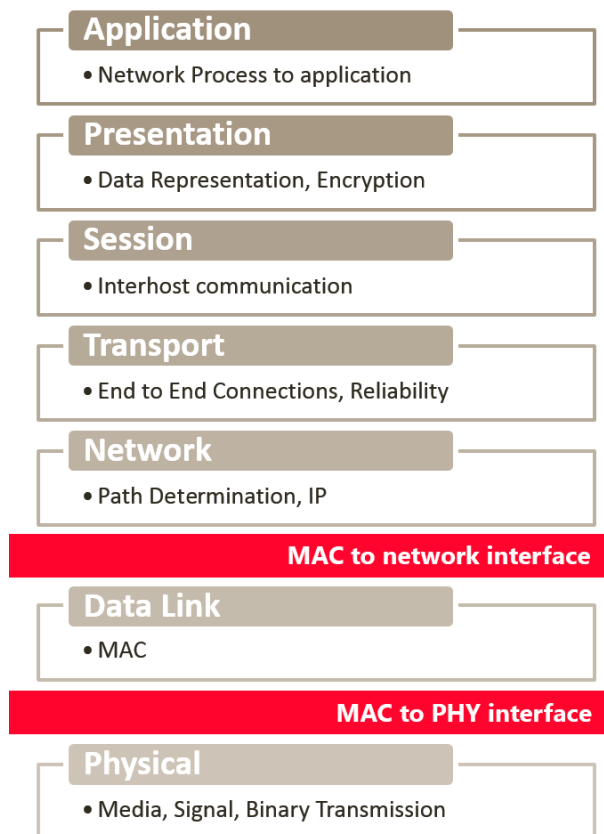

Figure 17: ISO/OSI network stack

2.4. Media Access Control Protocol

In network systems, efficient medium access is the key issue where medium- high utilization is imperative as is the providing of a stable connection. One of the seven layers of the ISO/OSI model of computer networking (shown on Figure 17) is the MAC layer which implements a simple data communication protocol. MAC is a sublayer of the Data Link layer. The MAC protocol, implemented on a MAC layer, provides multiple node access on a shared medium like the EM spectrum or on a wired terminal connection. The MAC layer is the interface between the PHY layer and the Logical Link Control (LLC) layer. It provides several communication features:

- unicast
- multicast
- broadcast

Each of those usually provides a full duplex logical communication channel observed from the upper layers (LLC). The MAC layer, among others, provides error control, collision control mechanisms, and node addressing. The MAC protocol has many features that are selectively used depending on the MAC implementation and version. For example, the simple Token Ring protocol does not have the carrier sensing feature [119]. MAC protocol selection depends highly on a situation and network configuration. In smaller network systems, features like carrier sensing might be an overhead and performance analysis should be conducted to compare alternative MAC protocols.

The history of the MAC protocol is usually related to the start of the Additive Links On-line Hawaii Area (ALOHA) System that was invented by researchers at the University of Hawaii. The purpose of this research was to connect the Hawaiian Islands using a wireless radio connection, and the main concern was using the shared medium for client transmission. The ALOHA System became operational in 1971 with the first packet being broadcasted from the main Oahu campus. The transmission rate achieved by the first implementation of the ALOHA System was 9600 bps [3].

⁵PDs are spaced apart

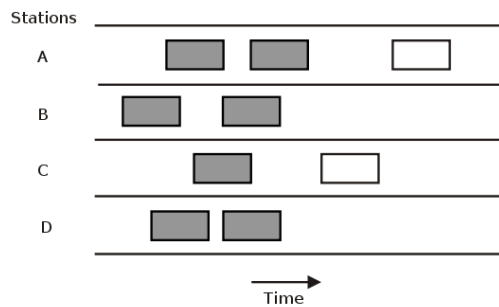

Figure 18: "Pure ALOHA" by helix84.
https://commons.wikimedia.org/wiki/File:Pure_ALOHA1.svg

Figure 18 shows the simple concept of operation of the ALOHA protocol where clients (stations) communicate on a shared medium. Clients send packets regardless of the medium state (busy or clear). In case of collision, a packet is retransmitted after a random backoff time period. The enhanced version of ALOHA is a slotted ALOHA that uses time slots. This means that clients can transmit only at the beginning of each slot [43]

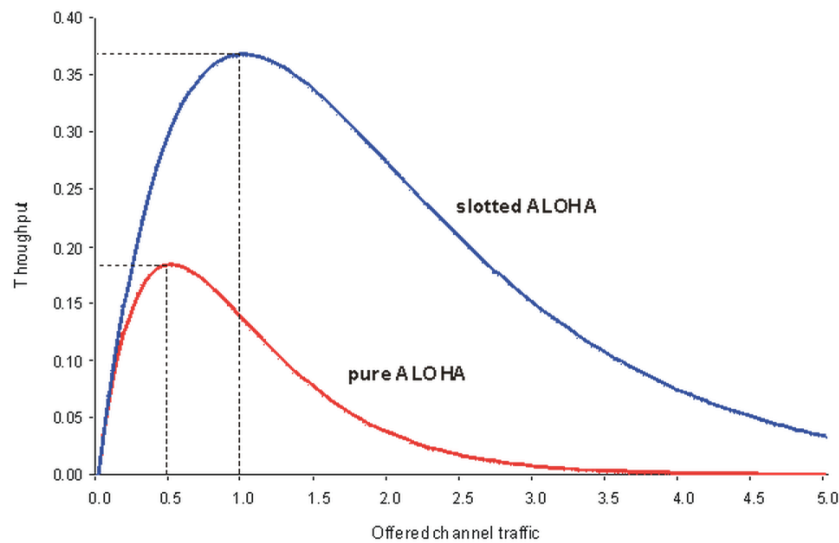

Figure 19: Throughput in ALOHA channels. Source: [68].

Figure 19 shows the throughput analysis of two versions of ALOHA protocols. It can be noticed that slotted ALOHA has significantly better performance than pure ALOHA regardless of the network load.

There are two major types of MAC protocols: static and dynamic.

- **Static access protocols** use static medium fragmentation using several different techniques:

Time Division Multiple Access (TDMA) is a communication technique that divides a single channel or band into time slots. Each slot is then used to transmit one data segment. The most representative example would be the ALOHA protocol.

Frequency Division Multiple Access (FDMA) divides the shared medium bandwidth into individual channels based on frequency band.

Code Division Multiple Access (CDMA) is a spread spectrum multiple access communication technique designed for highly congested systems like cellular mobile networks [167].

- **Dynamic access protocols** allocate medium access time using different protocols:

Random access protocols

Multiple Access (MA) - Nodes do not check the state of the medium and transmit when data is available. Collisions are ignored and if data is not received, it should be retransmitted by upper layer.

Carrier Sensing Multiple Access (CSMA) - Nodes check the medium state and decide to transmit only when the channel is free.

Carrier Sensing Multiple Access with Collision Detection (CSMA/CD) - Like CSMA plus collision detection, if the node detects a collision, the node should refrain from transmitting for a period.

Carrier Sensing Multiple Access with Collision Avoidance (CSMA/CA) - Collisions can be avoided using different techniques like then RTS/CTS sequence in IEEE 802.11.

Scheduling access protocols - Unlike in random access protocols, here nodes agree on transmission time, sometimes introducing a central node that coordinates communication.

Polling - Uses the primary node to channel all communication. There is no direct link with nodes except for a link with the primary node.

Request reservation - Nodes agree on a transmission order using reservation packets. The node should transmit only when the reservation is confirmed by other nodes in the network.

Token ring - Uses a special three-byte packet called the *token*. The token travels around the ring of nodes. The node possessing token is eligible to transmit data on a shared medium. When node transmission is completed, token is passed to the next node in the ring.

2.4.1. 802.11 standard

The first 802.11 standard was published in 1997 by the IEEE P802.11 working group, which is a member of the IEEE LAN MAN Standards Committee [61]. 802.11, in 1997, was a single standard, and now it is considered an initial standard, not a single MAC protocol but, rather, a set of protocols for different applications and PHY implementations. Currently, it has more than 16 major amendments. For example, 802.11p is an approved amendment to the initial standard, covering vehicular communications over the 5.850 - 5.925 GHz EM spectrum band using DSRC [59]. Hassan et al. have proven that 802.11p can be efficiently used in vehicular communication, aside from performance degradation caused by hidden node problems.

According to IEEE Std 802-2014, section 5.2.3, "MAC sublayer", the principal functions of the MAC sublayer are [66]:

- Frame delimiting and recognition
- Addressing of destination stations (both as individual stations and as groups of stations)
- Conveyance of source-station addressing information
- Transparent data transfer of PDUs from the next higher sublayer
- Protection against errors, generally by means of generating and checking frame check sequences
- Control of access to the physical transmission medium

Bianchi conducted a performance analysis of the IEEE 802.11 standard [14]. He also emphasized that before transmitting a packet, a station operating in RTS/CTS mode "reserves" the channel by sending a special Request-To-Send short frame. The destination station acknowledges the receipt of an RTS frame by sending back a Clear-To-Send frame, after which normal packet transmission and ACK response occurs. Because the collision may occur only on the RTS frame, and it is detected by the lack of CTS response, the RTS/CTS mechanism allows for an increase in system performance by reducing the duration of a collision when long messages are transmitted.

Because of numerous analysis and simulations, as well as many research groups, IEEE 802.11 is *de facto* a standard and representative example of an efficient MAC protocol [105]. Testing protocols in real installations (e.g., Hawaiian Island towers in ALOHA) could be expensive and time consuming. Because of that, many network researchers use computer network simulators or similar systems that simplify actual networks. The next section explores various

aspects of network simulation environments.

2.5. Network Simulation Environment (NSE)

NSE is a software that simulates or imitates the behaviour of a communication network. Some simulators provide statistical analysis of network performance. Because of the high complexity of communications networks, a traditional, empirical approach towards network configuration analysis is not a viable option. That is why NSE is primarily used when analysing and designing computer communication networks. Modern NSE should comply with networking standards and can provide a variety of network devices and technologies and end user applications such as web client, peer-to-peer network, etc. NSE are used for researchers to design network protocols and configurations.

Security specialists can use NSE to assess the security risk on network modifications. In addition, NSE can be used to predict security flaws in communication networks and the network stack. Networks can be tested against security attacks without affecting real networks. Network designers can use NSE to simulate the performance of network modifications on existing networks. This has a high economic impact due to the reduced costs of trying and error attempts to improve network performance. According to Rampfl, the main motivation behind network simulation is to accomplish more reliability and lower maintenance costs for the development of a new technology [128].

Most network simulators use discrete event simulation, in which pending events are stored in a queue. Events are processed in a FIFO manner. Processed (executed) events can have implications on the network state, thus invoking new events to be processed.

According to Banks, the simulation of networks is a very complex task. For example, if congestion is high, the estimation of the average occupancy is challenging because of high variance. To estimate the likelihood of a buffer overflow in a network, the time required for an accurate answer can be extremely large [5].

Most network simulators use a graphical representation of network and data transmission, as real-time data representation would be impractical and impose a high load on overall NSE performance.

Weingartner et al. conducted a performance analysis of major NSE present on the market in 2009 [172].

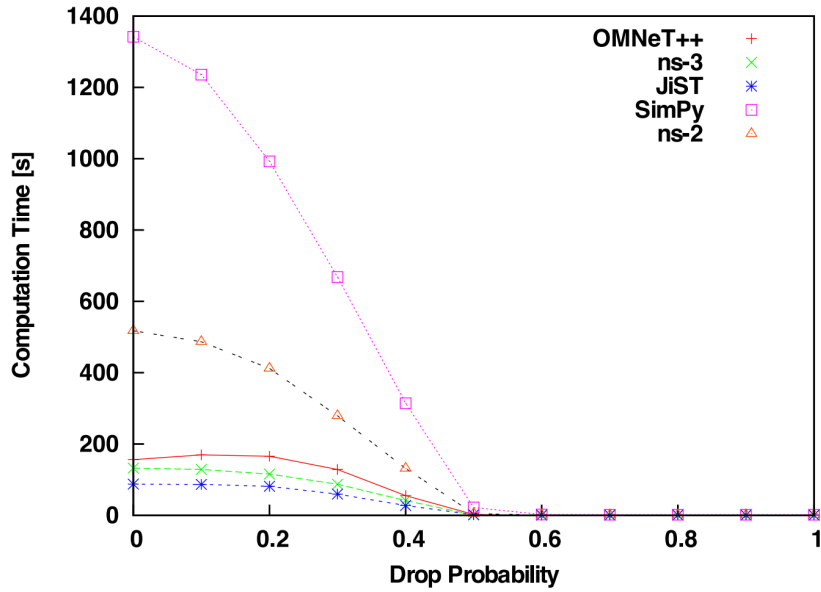

Figure 20: Simulation run-time vs. Drop probability. Source: [172].

NSE they analysed were:

- ns-2
- OMNet++
- ns-3
- SimPy
- JiST/SWANS

They concluded that the fastest simulator was JiST/SWANS, as can be seen on Figure 20. However, JiST/SWANS has the highest memory consumption of analysed simulators; this is due to the Java Virtual Machine engine being used. Due to an abundance of memory and its low costs, this factor can be ignored.

2.5.1. Performance issue

Simulations are usually executed on a CPU (or GPU) and require substantial computing power. A network simulation can have different power demands depending on the level of details simulated. Many authors investigate the performance of network simulators. Performance is the bottleneck of NSE and developers and system designers use various techniques to lower NSE resource demands. Unfortunately, the usual tradeoff involves limiting features or removing some aspects of real network systems from NSE.

Basagni et al. have conducted a detailed analysis of different network simulators [162].

They conclude that a significant gap exists between simulation and experimental results. Also, it has been identified that most of the simulators lack proper or any implementation of: *Carrier sensing, Back-off timing, Radio propagation model.*

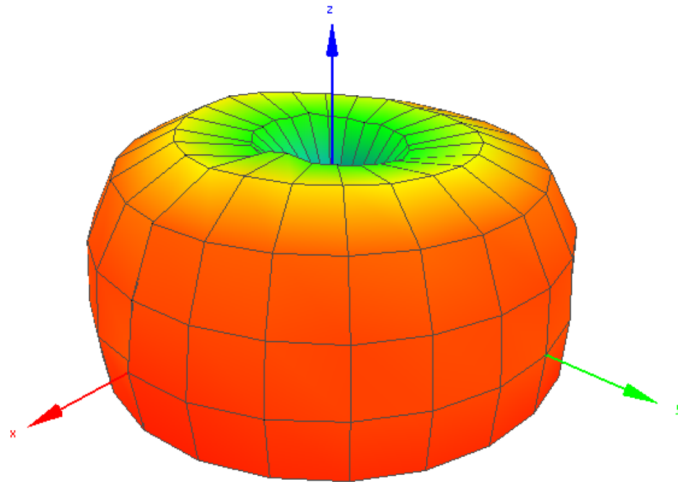

Figure 21: Emission Pattern of a Dipole Antenna. Source: [168].

Furthermore, most of them have a circular (spherical) estimation of radio coverage like one shown on Figure 21, while in real-case scenarios, the radio coverage shape resembles a fuzzy sphere [39] because of the freespace pathloss model. Thus, the probabilistic approach would be more correct when estimating radio coverage [152]. Fuzzy sphere would be the more correct approximation because the signal would never dissipate or disappear, and will forever travel in space, according to the General Theory of Relativity [41]. This circular (spherical) approximation is one example of a tradeoff that improves performance at the cost of system precision.

Simulator performance has been recognized as a main reason for many gaps identified by authors. Some simulators even lack support for interference detection and have loose PHY model implementation, which is a tradeoff to increase performance [54]. None of the widely used simulators *PhySim, NetSim, OPNET, GloMoSim, cnet, ns2, JiST/SWANS [12], and PAR-SEC* support VLC radio communication. For this reason, and because VLC PHY is different from RF, a modular radio model for VLC simulation in the simulation engine must be designed. As defined in previous sections, LOS is one of the main characteristics of VLC. Unfortunately, many simulators lack obstacle detection (LOS) and VLC support in general. The reason why VLC technology is not present in network simulators might be that VLC is a relatively new technology and VLC applications did not require real network simulations.

2.6. Conclusion

Wireless data communication is truly omnipresent and is constantly improving data rate and transmission range. All this is possible because of great scientists like Nikola Tesla and Reginald Fessenden, who experimented on radio wave transmission [45, 149] in the 19th century. Today, the EM spectrum is saturated and there is a struggle to reserve a portion of the spectrum for various applications. This saturation of the spectrum is the reason why the scientific community welcomes new ideas like VLC, which can ease some of the load on the radio part of the EM spectrum.

Researchers did prove that *i) VLC is a promising and feasible technology and that ii) vehicular communication can improve the experience and safety of vehicular systems*. Combining VLC with vehicular systems, i.e., Intelligent Transportation Systems, might have greater market penetration due to a fact that most of the equipment necessary for VLC is already present in today's vehicles. On the other hand, RF V2V requires expensive additional hardware to be installed on each vehicle. Even more, a smartphone or dashboard camera and even LED can be used instead of a PD component for receiving information, which makes VLC very intriguing and challenging.

VLC has a bright future in vehicular communication. To reach that goal, several obstacles must be overcome, such as the lack of an appropriate MAC protocol. A specially designed MAC protocol for VLC in V2V would be necessary for *i) n to n communication* and because *ii) existing MAC protocols might have unnecessary complexity* and data load for simple V2V line-of-sight scenarios.

3. Network simulation environment

There are multiple ways to conduct research in computer networking. If possible, real networks and systems are the most accurate way through which to experiment. However, in some cases, large-scale experiments are not feasible in real environments because of the costs, time, and manpower required. In such cases, simulation models and simulators provide researchers with appropriate tools to conduct large-scale and complex experiments.

This chapter analyses and discusses NSE considering its importance for this research. By reflecting on Section 2.5, which defines the state of the art in the field of NSE, it can be concluded that existing NSEs are not adequate for this research due to issues regarding MAC protocol design and VLC technology support in general.

The chapter introduces a new and enhanced NSE with VLC technology. This enhanced NSE is used in late research phases to design (implement) the MAC protocol and to define the experiment environment for the MAC protocol evaluation. It was used in the previous asymmetry experiment in Chapter 4.

The chapter also defines the VLC-equipped vehicle model that is used in experiments that are part of this research.

*The chapter addresses questions **RQ3** and subquestions defined in Section 1.3.1*

3.1. Network Simulation Environment (NSE) selection

To achieve objectives O1 to O4, a simulation engine must be utilized. As elaborated in Section 2.5, existing NSE are not suitable for this or similar research. There are alternative options that can help provide an appropriate NSE for this research:

1. Develop brand new NSE
2. Modify existing NSE

Option number one would be the most precise and accurate, and developing a new NSE would certainly fix all the missing features to ensure the most accurate network simulator. However, because the domain of this research is mostly MAC protocol, developing a simulator for the complete network stack would require large overhead measured in terms of time and resources.

Table 4: NSE selection analysis

NSE	Performance rank [12]	Full stack implementation	Open source	Technology
GlomoSim	2	Yes	Yes	tcl/tk
ns2	3	Yes	Yes	tcl/tk
JiST/SWANS	1	Yes	Yes	Java
Parsec	4	Yes	Yes	Haskell

As for this research, more feasible is option number two. NSE usually implements a full network stack, and the MAC protocol is just part of one layer (the data link layer) in the stack. If the NSE software architecture is well-designed, replacing one implementation (e.g., a class) should not be an issue. Having a full implementation of network stack is important because testing of the low-level protocols requires real-life scenarios that can be simulated only using full network stacks.

The choice of network simulator follows these guidelines:

- **Performance** - NSE implementation should be reasonably fast when executed on modern-day environments. In Section 2.5 it has been noted that performance is the main concern when designing NSE, especially for application layer service simulations (high-end scenarios like video streaming over the Internet).
- **Full stack implementation** - it is necessary to have full stack implementation to simulate and measure MAC performance in real-world scenarios.
- **Open source** - chosen NSE should be *open source* for it to be augmented (enhanced) with new features.
- **Technology** - the implementation technology used should be Java or .NET (C#), as this is the personal preference of the researcher.

Table 4 compares different NSE (used in [12]) according to desired guidelines for the NSE selection defined previously.

The analysis concluded that: **JiST/SWANS** NSE satisfies most of the desired guidelines and that it should be considered selected NSE in this research.

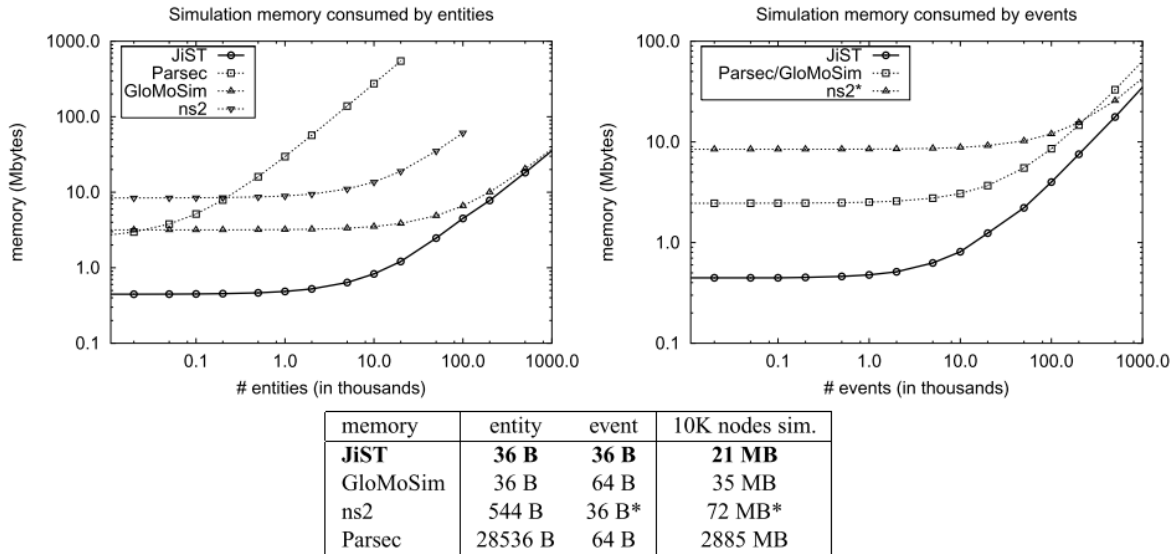

Figure 22: Performance analysis of JiST against alternatives [12]

3.2. JiST/SWANS introduction

JiST is an abbreviation of Java in Simulation Time and SWANS stands for Scalable Wireless Ad-hoc Network Simulator. JiST¹ is a high-performance discrete event simulation engine that runs over a standard Java virtual machine, that is, a Java-based simulation system that executes discrete event simulations both efficiently and transparently by embedding simulation semantics directly into the Java execution model [12]. According to the authors, JiST performance outperforms that of popular network simulators like ns2, Parsec, or GloMoSim. Performance was questionable mainly because of the use of the Java technology against fast and robust C/C++. Figure 22. shows JiST memory performance compared to the alternative simulation engines.

Table 5 shows CPU performance on a complex scenario with 5 million network events. Metric used is total execution time. Simulations are executed on the same hardware equipment.

Java can be considered a JiST advantage because simulations can be executed on every device, including grid computing networks and server clusters, and even more specialized architectures.

Scalable Wireless Network Simulator (SWANS) is implemented using the JiST architecture. It is a standalone set of classes that utilize the JiST infrastructure to achieve reduced memory demands and high performance. On the ISO/OSI application layer, SWANS can even execute any

¹more info at jist.ece.cornell.edu

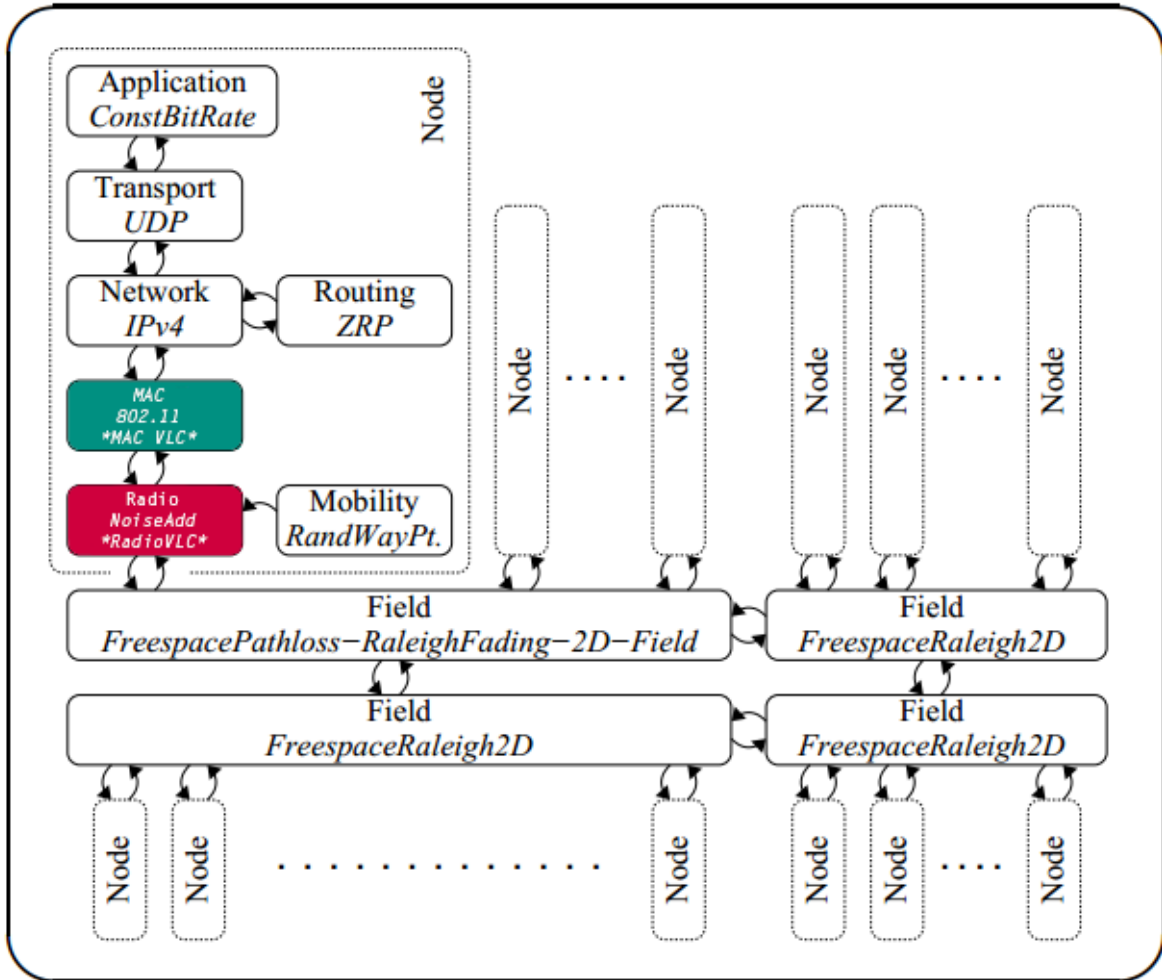

Figure 23: JiST simulator architecture related to network stack [12]

Table 5: Time to perform 5 million events, normalized against both the baseline and JiST

$5 \cdot 10^6$ events	Time (sec)	vs reference	vs JiST
reference	0.738	1.00x	0.76x
JiST	0.970	1.31x	1.00x
Parsec	1.907	2.59x	1.97x
ns2-C	3.260	4.42x	3.36x
GloMoSim	9.539	12.93x	9.84x
ns2-Tcl	76.558	103.81x	78.97x

existing Java network applications using simulated network architecture, thus proving its transparency and real-case-scenario integration in simulations. Unlike its competitors, JiST/SWANS can simulate much larger networks [12]. SWANS can also simulate wired or wireless networks or even wireless sensor networks. SWANS uses a hierarchical binning search/sort mechanism to compute signal propagation in the field; this approach reduces real simulation duration and resources consumption while preserving physical accuracy.

3.2.1. Architecture

JiST/SWANS architecture is a complex system of 550 classes with more than 49000 lines of code. Classes are organized in namespaces, some are shown and described in Table 6

Table 6: JiST/SWANS relevant namespaces and descriptions

Namespace	Description
jist/runtime	JiST simulation framework core
jist/minisim	Regression and benchmark simulations
jist/swans	Wireless ad hoc network simulation components for SWANS
jist/swans/field	Signal propagation, fading, pathloss and mobility, implements EM field
jist/swans/radio	Radio signal transmission and reception, implements radio device e.g. Wi-Fi adapter. PHY layer implementations
jist/swans/mac	Link layer implementations
jist/swans/net	Network layer implementations
jist/swans/route	Routing layer implementations
jist/swans/trans	Transport layer implementations
jist/swans/app	Application layer implementations
jist/swans/app/net	Application sockets
jist/swans/app/io	Application streams
jist/swans/misc	Common data structures and utilities
driver	SWANS simulation configuration drivers

3.2.2. Features

Existing JiST/SWANS has features related to implementation, such as: simulation time management, extensibility, resources management, and entity invocation. Time management is

significant because it introduces three classes of time:

- Actual time: standard Java execution time
- Real time: the real, physical time of execution
- Simulation time: the time inside the simulation; Java instructions have zero duration in the scope of simulation time. Simulation time is advanced using the *sleep* method call.

Network-related features include:

- Full ISO/OSI network stack implementation:

Application - heartbeat, CBR, and any Java network application.

Transport - UDP, TCP.

Network - IPv4.

Routing - AODV, ZRP, DSR, GPSR, Geo-routing.

Link - 802.11b, loop.

- message - each layer in ISO/OSI has an appropriate message class that follows the standard defined by each layer. Embedding of message content (bytes) is enforced and implemented between ISO/OSI layers.
- field - a concept that includes the physical features of the field (EM) and environment where the network system is simulated.
 - placement - grid, street placement, random, input by XML configuration file.
 - mobility - static, street mobility, random waypoint, random walk, random direction, teleport, XML input file.
 - fading - zero, Raleigh, Rician.
 - pathloss - free space, shadowing, two ray.
- field street - complete system for: field, placement, and mobility of nodes in urban environments (streets).
- propagation algorithm - hierarchical binning.

- interference - independent, additive.
- GUI - simple GUI to visualize network systems.

3.3. Issues

Although JiST/SWANS implements a crucial part of NSE features, there are still features that are missing, caused by the performance issue described in Section 2.5.1. Deep analysis of JiST/SWANS code has revealed that it does not even have interference detection.

JiST/SWANS has a circular radiation uniform pattern of an RF omnidirectional coverage area, while more accurate would be the spherical estimation. Furthermore, spherical estimation is less accurate than torus [86] as shown on Figure 21. All those shapes define a geometrical, uniform body that should represent the radiation pattern; however, that is also inaccurate because radiation waves do not have a strict border and radiation never ends [41], meaning that a fuzzy torus would be the most accurate approximation of the radiation pattern in simulators.

Sutaria et al. have designed and implemented an energy model for JiST/SWANS [142] because it is not present in the original implementation. The energy model defines the energy consumption of nodes in the network and allows for the comparison of different protocols used based on energy efficiency.

As mentioned in Section 2.5.1, the reason for omitting those features is performance, and JiST/SWANS is not the only NSE that does such a trade-off. Heavy implementation of collision/interference detection on low layers of an ISO/OSI stack would significantly increase resource demands. Deep code analysis has revealed the reason why those features are not implemented; it is the *Link layer*. In the list of features it can be noticed that 802.11b is the protocol implemented on the *Link layer*. 802.11 is the standard and well-tested protocol, used in everyday communication using Wi-Fi technology. Because 802.11 works very well on collision avoidance, fully implementing only that protocol would mean that collisions would not occur in the first place and that checking for collisions and interference would not be necessary, also because JiST/SWANS is a network simulator and not an environment for MAC protocol design. If researchers would like to design and test a new MAC protocol, the existing JiST/SWANS would not be appropriate because one of the core features of a MAC protocol is medium access control, propagation patterns, and collision detection, which must be performed well in a proper

MAC protocol.

The last feature that is missing in JiST/SWANS is the support for VLC in general. As stated before, JiST/SWANS supports only omnidirectional communication while VLC is mainly directional. Because of that, JiST/SWANS is not capable of simulating networks that use VLC as an underlying technology.

The next section describes missing features implementations and introduces basic network simulator features for the development of a custom MAC protocol.

3.4. VLC enhanced JiST/SWANS

Modifying an existing JiST/SWANS simulator to be able to simulate VLC communication requires substantial intervention on several elements (classes) inside the simulator source code. As shown on Figure 23. most modification are done on green and red elements.

To maintain transparency (interoperability), modifications to the Radio class (the red element on Figure 23.) were necessary. Most of the modifications were required to support the testing and design of the MAC protocol.

JiST/SWANS is, among other things, a vehicle network simulator. According to [184], each VLC-enhanced vehicle can have multiple head and tail lights; each is able to transmit different data. In practice, this means that each node (vehicle) can have several distinct transmit and receive devices that are, in the scope of this work, called Tx or Rx elements. In Java implementation those are referred to as *VLCelement* class objects.

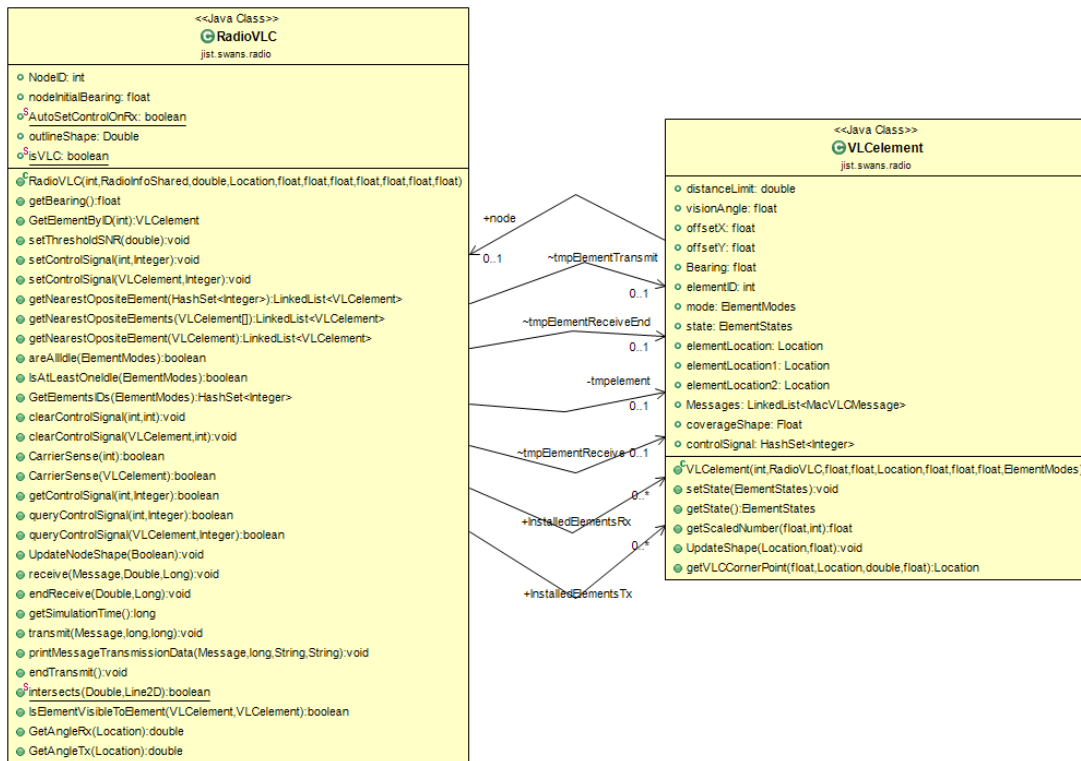

Figure 24: RadioVLC and VLCelement classes

3.4.1. VLC radio

RadioVLC is a new class added to the JiST/SWANS to support VLC physical characteristics. Radio type selection is done in the simulation configuration file, described later. In the scope of the simulator, a radio is a transmitting device, e.g., Wi-Fi, and is referred to as a network node, meaning that every network node is a "radio". Furthermore, a vehicle capable of communicating is also a network node, meaning that "radio" is a vehicle in the scope of VLC communication in vehicular networks.

Inherited methods *transmit* and *receive* are the links to the upper and lower layers of the ISO/OSI stack. *Radio* is the implementation of PHY layer characteristics, meaning that the upper layer is Link (MAC) layer. The lower layer, in the context of the ISO/OSI stack, does not exist. However, in JiST/SWANS there is a *Field* class that represents the EM field that implements data transmission and many other features, like fading and pathloss. Information sent by *Radio*, using the *transmit* method, is relayed to the field and then propagated and delivered to the appropriate nodes - other Radios in the network.

As shown on Figure 1, the existing radio uses omnidirectional coverage estimation while VLC has directional coverage estimation. Because of that, it was necessary to track and update the

radio bearing (orientation) in space and changes over time, which is necessary for mobility in simulations.

3.4.2. VLC element

Figure 24 shows the association between *RadioVLC* and *VLCelement* classes. The *VLCelement* class implements a Tx or Rx element on a single vehicle. The term "element" is used to define both transmitting and receiving elements (described in sections: 2.2.1 and 2.2.2). An element is linked to its radio identified by *R*. The radio class aggregates multiple instances of different elements.

Elements are categorized by type; each element can have only one type (mode) of *M*:

- Receive - for receiving the component.
- Transmit - for transmitting the component.
- Unknown - not used.

VLCelement class tracks the state of the element; the state can be:

- Receiving - element is receiving a signal (message) from the field.
- Transmitting - element is transmitting a signal (message) to the field.
- Idle - element is idle and can be used.

It is a violation and impossible for an element of mode *Receive* to be in the state *Transmitting* as well as for an element of mode *Transmit* to be in the state *Receiving*. This rule is enforced on a PHY layer where an exception is raised if such an event occurs.

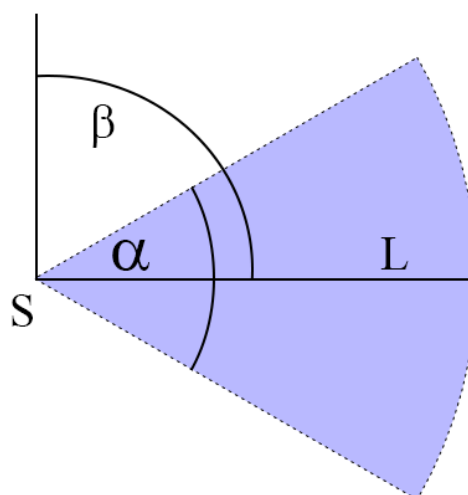

Figure 25: Element definition (Tx or Rx element)

Element coverage is defined by its physical characteristics (Figure 25):

- starting point S
- line of sight distance L
- vision angle α
- bearing angle β

The element coverage shape is defined as a circular segment where starting point S is a circle centre and L is the radius. Bearing β is an angle offset where absolute node bearing is a starting angle and equals 0° .

For implementation reasons, each element contains a linked list named *Messages* that contains messages being sent or received at the current moment (in simulation time).

3.4.3. MacVLCMessage

As mentioned before, layers (classes) communicate by exchanging messages. A message has a different structure depending on the layer where it is used. For example, a message on the Network layer contains IP addresses, while a message on the Link layer contains MAC addresses, all according to the standards and protocols. Actual message memory size (in bytes) is not equivalent to the number of bytes on a simulated message because *Message* is a Java object and the network message is a carefully constructed array of bytes according to the standards. *MacVLCMessage* class inherits the structure and implementation of the 802.11 MAC message to maintain compatibility. However, not all elements must be used. For example, this class supports message types:

- RTS - request to send message.
- CTS - clear to send message.
- ACK - acknowledge message.
- DATA - message containing data.

that are used in the 802.11 MAC protocol and that can be used in any MAC implementation.

A message class designed for VLC was necessary to support the addressing of elements from which a message can be transmitted. To maintain transparency, the same mechanism is used for the receiving element. However, usage and meaning are different: For transmitting, addressing is done using a *HashMap* called *ElementIDTx*, containing the ID of a node and a list of assigned element IDs. Data in this *HashMap* will instruct the simulator to transmit a message from a

Table 7: *ElementIDRx HashMap example*

NodeID	Element1	Element2	...	ElementN
0	1	2		
1	2	4		
3	2	6		

specific node using specific elements.

On the other hand, there is a *HashMap* called *ElementIDRx* that contains the ID of a node that has received the message from the medium (field) and the element ID (one or many) that has actually received the message. It is imperative to note that this mechanism is not a future protocol or any related to any standard, and it does not increase the network message size. Actual element addressing should be done on a protocol level where it will be translated to the mechanism described.

An example of *ElementIDRx HashMap* is shown on Table 7. The first row in the example would mean that the message is received by the node with ID = 0 and it was received on elements with ID 1 and 2. Furthermore, the same message is received by nodes 1 and 3. The assignment of elements to a message is done using the *addElementIDTx(int elementID, int nodeID)* method that uses the node ID and element ID to identify the node and appropriate element. An actual reference for elements and the node is not used in this signature because the caller of this method should be the MAC protocol, while the identification of nodes is done using ID and not the Java object reference. An extra method provided is the one for removing the assignment of node/element; the method signature is *removeElementIDTx(int elementID, int nodeID)*. The described assignment is done for the transmitting element. However, the same principle is done for the receiving element where the PHY layer (VLC enhanced) calls the method *addElementIDRx(int elementID, int nodeID)* that will inform the consumer of the message (MAC) on which the element message was received.

3.4.4. Control signal

The control signal is a well-known mechanism that some MAC protocols use to define and detect the channel state. This new feature allows the control signal broadcast that originates from a single element. The receiving element can sense the existence of a control signal in the medium (field). Although it is not a mandatory feature for any MAC protocol, this new feature simply allows for the use of the control signal. It is up to a MAC protocol to manage and re-

spond to the control signal state. In addition, the MAC protocol should limit its performance if the control signal mechanism is used. The reason for actual performance degradation lays in the fact that the actual control signal is created using an exclusively assigned narrow band of the frequency spectrum. The other technique includes segmenting the spectrum in time slots, where one slot is assigned for transmitting the control signal and the rest for the data. If a frequency-based control signal is used, bandwidth should be reduced, and if a time-based control signal is used, message delay should be increased.

Because the control signal transmits only one piece of information (e.g., one bit), existence or not, it is not necessary to check for interference because the control signal is cumulative information on a receiver. The receiver of the control signal does not value the number of control signals set, just its existence. Because of that, interference detection is not necessary for the control signal because interference has the probability to be destructive when there is a concurrent reception of large information, where large means more than one bit.

Control signal implementation was conveniently easier to implement on a PHY layer where, in actual scenarios, the MAC sub-layer would be responsible for control signal implementation. Nevertheless, this feature does not interfere with the validity of network simulation, considering appropriate performance degradation implementation.

The method signature for setting the control signal is: *setControlSignal(int elementID, int channelID)* and it is a member of the *RadioVLC* class (Figure 24). There is also the overloaded method *setControlSignal(VLCElement element, int channelID)*. The first method uses the element ID (integer) to identify the element and is intended primarily for the MAC protocol, whereas the other method uses a reference to the element Java object and is intended for NSE internal use. However, it is public so it can be used by MAC as well. If the element, defined by any of the overloaded methods, is the *Receiving* type, the nearest *Transmitting* element will be used; this is done because the receiving elements cannot transmit any data, including the control signal.

To retrieve the control signal state, the method *getControlSignal(int elementID, int channelID)* can be used. The method returns a Boolean value - *true* if the control signal is present in the medium. Otherwise, it returns *false*. Both *set* and *get* methods have a second parameter called *channelID* which is a number defining the control signal channel. In a simple scenario, a single control signal *channelID* should be a constant value. This mechanism allows for multiple

"single-bit" control signal channels. It is imperative to note that in real network scenarios, having multiple control channels would proportionally degrade network performance; as noted before, this performance degradation must be implemented on a MAC level. For frequency band, the work by Triana [151] can be used to calculate performance degradation. His model proved that, for example, the capacity of a channel that is 10 MHz wide is approximately 70 Mbps. A simple reduction of width to 5 MHz gives an approximate channel capacity of 35 MHz. His model proved a linear and proportional correlation between channel width and channel capacity. His work was conducted on a basic IEEE 802.11 MAC protocol.

3.4.5. Pathloss

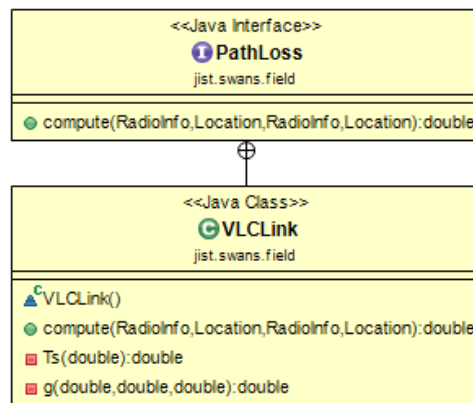

Figure 26: VLCLink pathloss

Figure 26 shows the custom pathloss class (`jist.swans.field.PathLoss.VLCLink`) that implements VLC pathloss for the visible channel model described in Section 2.2.3. Pathloss interface defines one method with the signature `double compute(RadioInfo srcRadio, Location srcLocation, RadioInfo dstRadio, Location dstLocation)`. Parameters used define the source radio (node) and its location as well as the destination and its location. Pathloss is calculated between two nodes. The simplification used here is that pathloss is not calculated between individual elements but between nodes itself. The reason for this simplification is to maintain the transparency of existing NSE. The error caused by this simplification is minimal because the location used is the middle point of the node where the element is spaced not more than 1-3 meters, which is reasonable on a close range. On a large range, this difference is insignificant.

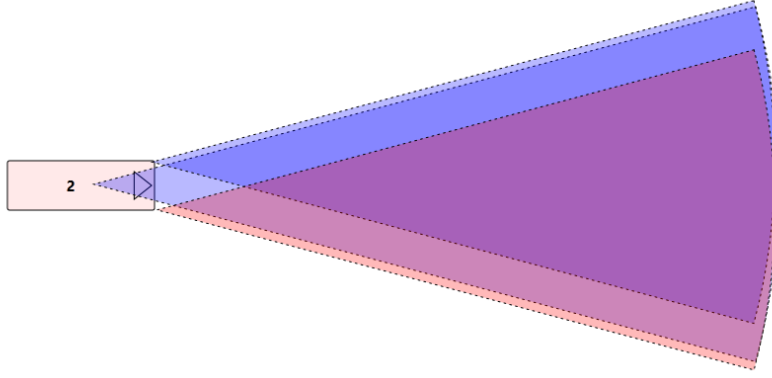

Figure 27: Element coverage difference

Figure 27 shows the coverage difference between elements with different locations on a typical VLC-equipped vehicle. The difference of position can be viewed as a narrow strip near both edges of the circle segment. The cumulative area of those segments is calculated as:

$$\begin{aligned}
 S_1 &= (0, 0) & S_2 &= (2, -0.75) & S_3 &= (2, 0.75) \\
 \alpha_1 &= 30^\circ & \alpha_2 &= 30^\circ & \alpha_3 &= 30^\circ \\
 L_1 &= 202m & L_2 &= 200m & L_3 &= 200m \\
 A_1 &= 3400.33\pi m^2 & A_2 &= 3333.33\pi m^2 & A_3 &= 3333.33\pi m^2 \\
 A_1 - A_2 &= 210,48 \Rightarrow 1.97\% \\
 \text{StripArea} &\approx 40m^2 \Rightarrow 1.17\%
 \end{aligned} \tag{3.1}$$

The area difference between shapes 1 and 2 (or 3) equals 1.97 % and double the actual strip area equals $2 * 1.17\% = 2.34\%$ of the actual element coverage area. It can be safely concluded that this simplification is safe and its performance is more efficient because the computation complexity would increase by the next order of n because each node can have n elements. Thus, the complexity of the *Compute* method remains $O(n^2)$ which is reduced even more by using the hierarchical binning algorithm [129]

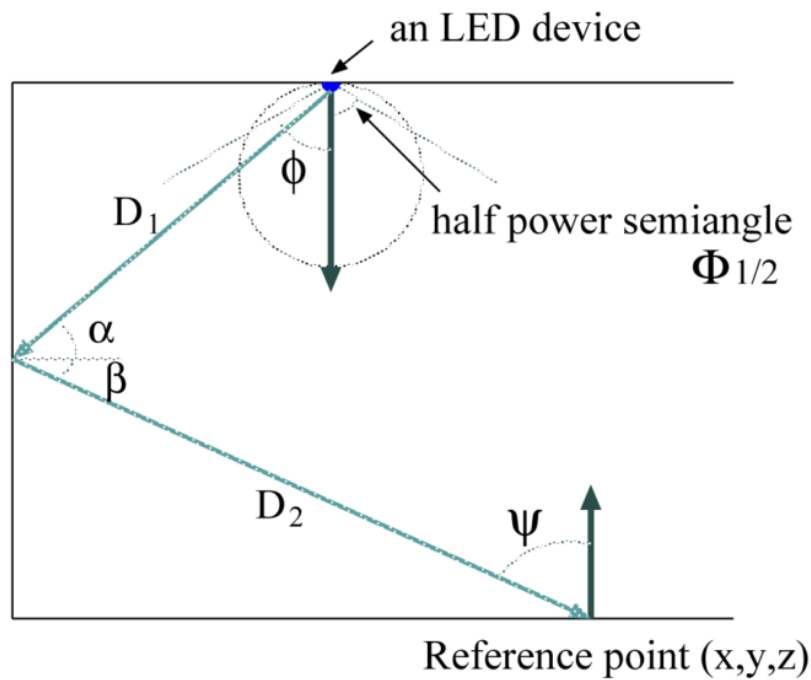

Figure 28: VLC pathloss model [84]

Implementation of VLC pathloss follows work done by Komine and Nakagawa [84]. The authors demonstrated and defined the model (Figure 28) for visible light signal propagation in space that uses relative spatial relation between the receiver and transmitter.

3.4.6. Collision and interference detection

Interference is a physical condition in which a single receiving component (Section 2.2.2) receives two or more concurrent signals. A signal is, in the scope of NSE, one *Message* object. That is why *MacVLCMessage* tracks information on which elements interference occurred in the whole network of nodes. It is up to the MAC protocol to test and respond to the occurrence of interference.

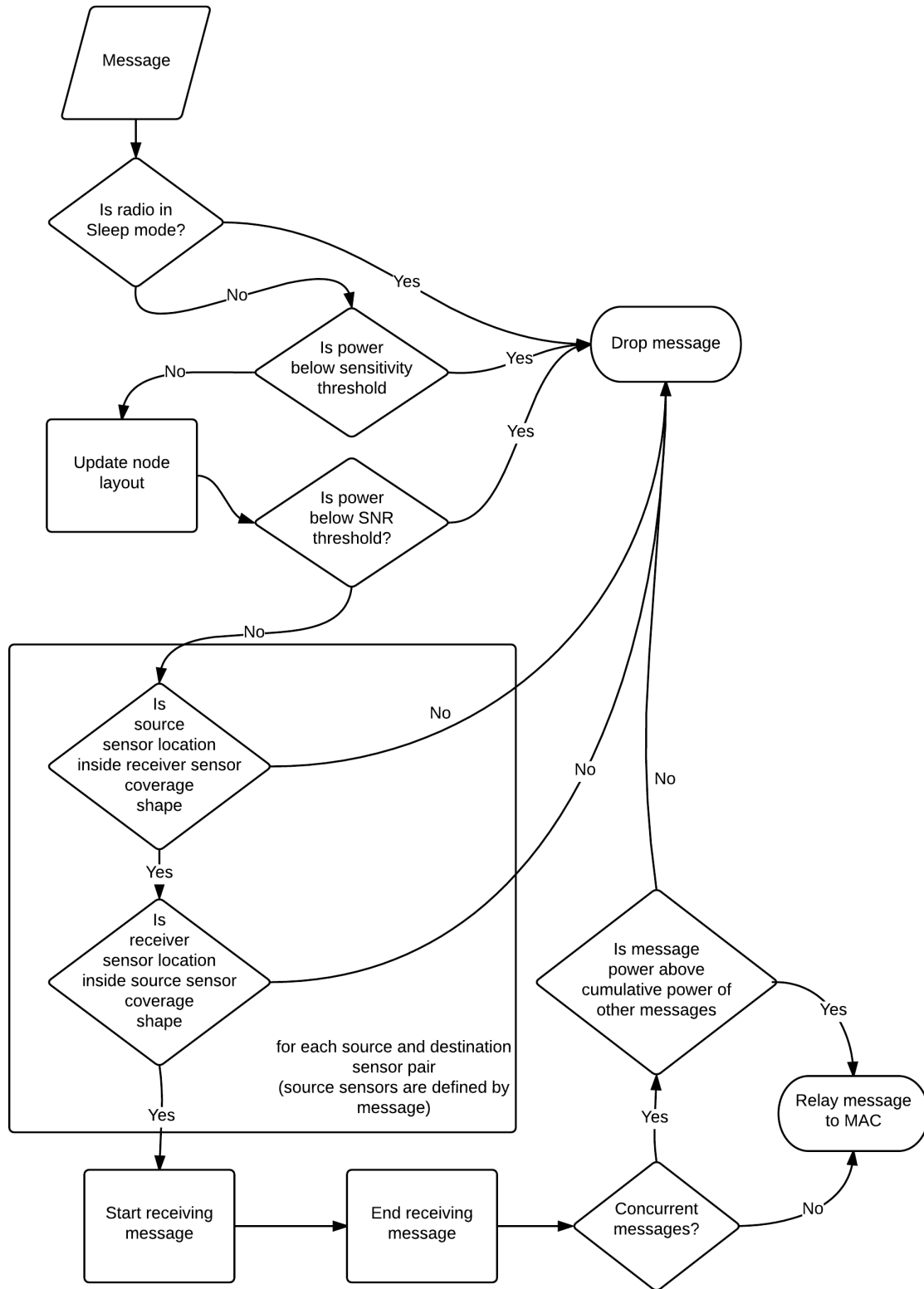

Figure 29: VLC radio receive message workflow

As discussed in Section 2.5.1, an important missing feature is interference detection, espe-

cially when designing and testing the MAC protocol. Figure 29 shows a simplified computational workflow of the VLC radio reception of a single message. Interference and the collision detection mechanism are also shown in the figure.

JiST/SWANS NSE incorporates two methods: *receive* and *endReceive*. Both have zero simulation time, but the latter is executed after message transmission time. The number of concurrent transmissions is counted in *endReceive*. If the cumulative power level is below the current message power level, the message is successfully received and the other messages are dropped. This means that interference does not necessarily mean that the message will be dropped. Only if the message power level is below other power levels will collision occur and the message be dropped. Collision detection considers elements and their coverage areas; because of this modification, it is possible for a single radio to transmit different messages on each installed element. In addition, a single radio can receive multiple concurrent and different data streams. The use of collision and interference detection code increases simulation computation time compared to no collision detection in the original implementation. However, this was necessary for later stages of research such as MAC protocol performance benchmarks and analysis.

3.4.7. LOS detection

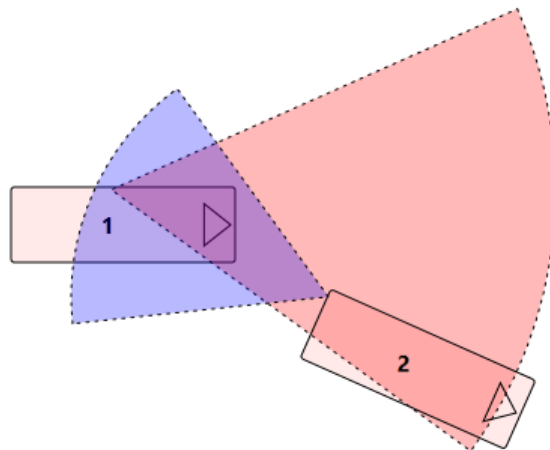

Figure 30: LOS interruption by vehicle

Figure 29 shows the computational workflow that is optimized to reduce the number of CPU cycles used. Because collision and interference detection consumes many CPU cycles for each transmitted message, avoiding that calculation is advisable and is done by enforcing *line of sight communication* only. To detect LOS, each transmitting element should be present in the other

vehicle receiving element coverage area. Prior to checking the intersection, a plain distance calculation is used to verify whether vehicles are in the communication range in the first place. After they are in range and coverages areas overlap, intersection detection is enforced. If there is another vehicle between two nodes, LOS is interrupted and communication is not possible. The LOS interruption detection algorithm, among other vehicles, includes participating vehicles to support unusually placed elements like the example shown on Figure 30 where the LOS of an element on vehicle 1 towards vehicle 2 is physically interrupted by vehicle 1's outer shape. If there is a clear LOS, communication is possible and the algorithm advances to collision and interference detection.

3.4.8. Configuration

JiST/SWANS uses an XML configuration file where the simulation parameters and configuration are defined. The existing configuration mechanism is very scalable and supports numerous varieties of simulation types. The configuration schema is extended with VLC-specific settings, for example, Listing 3.1 shows only the relevant fraction of the complete XML file that is attached as Appendix 1

Listing 3.1: XML configuration file (consolidated)

```
<?xml version="1.0" encoding="UTF-8"?>
<java version="1.4.2_05" class="java.beans.XMLDecoder">
  <object class="driver . JistExperiment ">
    <!-- environment -->
    <void property="pathloss">
      <int>4</int>
    </void>
    <!-- placement options -->
    <void property="placement">
      <int>2</int>
    </void>
    <void property="StaticPlacementOptions">
      <string>
        100,100,0,1.7,5,0,0,
        s1 ,22.47,120,0.98667,0.10782,0, t,
        s2 ,22.2,60,1,0.06861,0, r;
        105.8,102.33,-90,1.7,5,0,0,
        s1 ,22.47,120,0.98667,0.10782,0, t,
        s2 ,22.2,60,1,0.06861,0, r;
      </string>
    </void>
    <void property="ResultsPath">
      <string>../ results /ra39c5f1f-6ab1-42ea-b3c7-c612847874fc.csv</string>
    </void>
    <void property="nodes">
      <int>2</int>
    </void>
    <void property=" transmitters ">
      <int>2</int>
    </void>
    <void property="MACProtocol">
      <string>MAC_802_11</string>
    </void>
    <void property="MeasurementMode">
      <boolean>true</boolean>
    </void>
  </object>
</java>
```

Configuration simulation settings that are VLC related are:

- **pathloss:** an integer value defining the type of pathloss model: 1= *Free Space*, 2 = *Shadowing*, 3 = *Two Ray*, 4= *VLC pathloss*.
- **placement:** an integer value defining the node placement strategy: 1 = *Random*, 2 =

Grid, 3 = Street Random, 4 = Street Circuit.

- **StaticPlacementOptions:** newly added XML segment that defines static (Grid) placement using a specific structure: $R_x, R_y, B, w, l, \Delta w, \Delta l, S(ID), L, \alpha, S_x, S_y, \beta, M[, \dots]; [\dots]$ where values are defined by the VLC vehicle model defined in Section 3.5
Each vehicle can have multiple elements that are defined in the XML configuration. Each element is separated by S keyword followed by an element ID (e.g. $S1$). The configuration file can have a multiple number of vehicles that are separated by ;
- **ResultsPath:** is a location of the local disk where the simulation MAC performance data file is stored. The structure of this file is elaborated on in Section 6.1.3
- **nodes:** is the number of nodes in the simulation.
- **transmitters:** is the number of nodes that are capable of communicating. The number of nodes and transmitters should be less than or equal to the number of nodes defined by **StaticPlacementOptions**.
- **MACProtocol:** is a new value that defines the protocol used. In previous versions only MAC 802.11 was used. Possible values are: MAC_802_11 for the default 802.11 MAC protocol and MAC_VLC_VI for the MAC for VLC prototype.
- **MeasurementMode:** is a Boolean value defining whether to measure MAC performance data.

This was only a fraction of the XML settings options that are available. Some are accessible only when a certain option is used. A more complete example can be found in Appendix 1, which describes the simulation scenario visualized on Figure 2.

Editing of the configuration XML file can be done using the Multiple Concurrent Simulations (MCS) application (described in Section 3.7)

3.5. VLC-equipped vehicle for NSE

The model of the VLC-equipped vehicle includes only a 2D object because existing JiST/SWANS defines network nodes as single points on a 2D map. 3D would be a more accurate approximation; however, it would require more core changes to the existing NSE and more process-

ing power. As concluded before, approximating transmitter and receiver coverage is sufficient enough to be a single circle segment, and the vehicle is approximated as a rectangle. The model of a vehicle used in this research is defined as tuple:

$$(R_x, R_y, B, w, l, \Delta w, \Delta l, S \{ \dots \}) \quad (3.2)$$

where:

- R_x, R_y are coordinates of the centre point of the vehicle (Radio).
- B is vehicle bearing in degrees.
- w is vehicle width in meters.
- l is vehicle length in meters.
- Δw is vehicle uniform (random) width deviation in meters.
- Δl is vehicle uniform (random) length deviation in meters. This and the previous value can be zero if the generated vehicle has static dimensions.
- $S \{ \dots \}$ is a collection of elements attached (installed) on a vehicle.

The definition of a vehicle can be flexible in terms of dimension ($\Delta w, \Delta l$). If simulation scenarios require large number of different nodes, this feature is convenient where a single definition can result in many different vehicles (by dimensions).

Each vehicle can have multiple elements, although it is common for a vehicle to have two front transmitting elements (headlights) and two rear transmitting elements (taillights). The receiving element is a component that is not commonly present in a modern vehicle; to simplify the model, it can be assumed that receiving elements are attached near the transmitting elements: two in the front and two in the back. If the receiving element is a dashboard camera, the vehicle should have only one receiving element in the middle section of the vehicle front part. Each element is defined as tuple of its characteristics:

$$(S(ID), L, \alpha, S_x, S_y, \beta, M) \quad (3.3)$$

where:

- $S(ID)$ is an integer defining element ID; it should be a unique number only on a single vehicle. e.g. An element with ID = 1 can be installed on more than one vehicle.

- L is an element line of sight in meters.
- α is a vision angle of the element in degrees.
- S_x, S_y are offset coordinates of an element with a referent point equal to the centre of the vehicle. It is a relative point on a node (vehicle) defined as the float value between -1 and 1 e.g. if $S = (0, 0)$ then the element is positioned in the middle of the node (vehicle); if $S = (1, 1)$ then the element is positioned at the front left corner of the node. A complete coordinate system for elements on node is shown on Figure 31.
- β is a bearing of the element on a vehicle. It is a relative value where 0° equals vehicle bearing (B).
- M is an element mode. It can be t for transmitting elements and r for receiving elements.

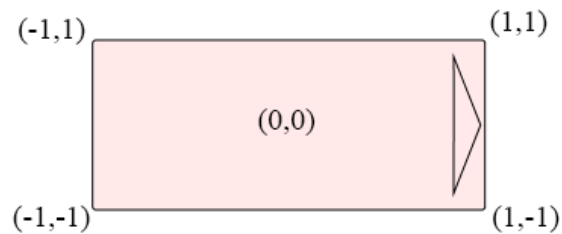

Figure 31: Node (vehicle) element location coordinates

The model used in simulations will have two headlight and two taillight elements (Tx), and one PD in the front of the vehicle, and one in the back. According to Wu and Tsai [175], the receiving element has a vision angle that varies between 60° and 127° . However, because of PD low cost, the node design of the Rx elements can be flexible to match the cover areas of the Tx elements. Vision length, in the context of the receiving element, is not present because it depends on the incoming light beam; e.g., if the Tx element has enough output power to transmit light that can propagate over 2 km, then PD that is 2 km apart will be able to detect that radiation.

According to ECE standard Addendum 111 [160], the vehicle headlight high-beam pattern extends up to 150 m. The shape of the pattern is irregular, two parts shape, the larger shape has a 70° angle.

For rear elements (taillight), ECE standard Addendums 6 and 47 [158, 157] define the element visibility range to be a minimum of 25 m, and the vision angle to be $45^\circ + 80^\circ$ where the centre line is perpendicular to the vehicular surface, making it effectually an 80° angle when observing

the vehicle as a whole.

According to Europe Council Directive 96/53/EC [40], vehicle maximum width is 2.5 m and length is 12 m. Jones created a report regarding vehicle dimensions [77]. He states that the average length of a vehicle is 4.95 m and the average width is 1.52 m. Values vary depending on the vehicle type, though any variation should comply with the EC Directive.

Combined with information from Section 2.2.1 and 2.2.2, the vehicle model used in this research is:

$$(0, 0, 0, 1.7, 5, 0.6, 0.8, \{(S1, 45, 70, 1, -1, 0, t),$$

$$(S2, 45, 70, 1, 1, 0, t),$$

$$(S3, 47, 80, 1, 0, 0, r),$$

$$(S4, 45, 70, -1, 1, 180, t),$$

$$(S5, 45, 70, -1, -1, 180, t),$$

$$(S6, 47, 80, -1, 0, -180, r)\})$$

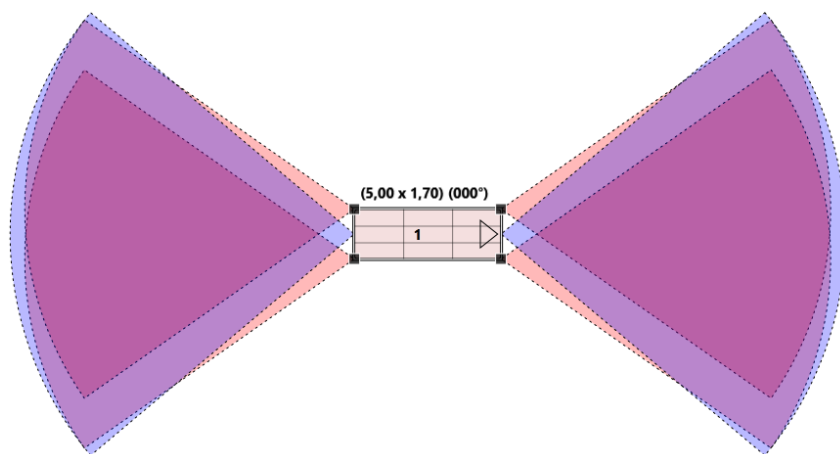

Figure 32: VLC-equipped vehicle model

A visual representation is shown on Figure 32. This model will be used later in the experiment while evaluating MAC protocol performance. The graphical representation contains only Tx Rx elements with length that is shortened four times. The reason for that is to have a clear and readable printed image. In actual simulations, Tx Rx elements have actual length.

3.6. VLC extended JiST/SWANS validation

The alteration of a large software system requires caution so that those alterations do not interfere with the system’s core operations. In the case of JiST/SWANS, it is the network simulation function. Because existing JiST/SWANS software is well tested and verified [78, 173], to validate the new JiST/SWANS version with the VLC modification it would be necessary only to compare network simulation results using the same simulation scenarios before and after modifications. This process is similar to the implementation validation of the MAC protocol for wireless sensor networks in JiST/SWANS done by Tippanagoudar et al. [150].

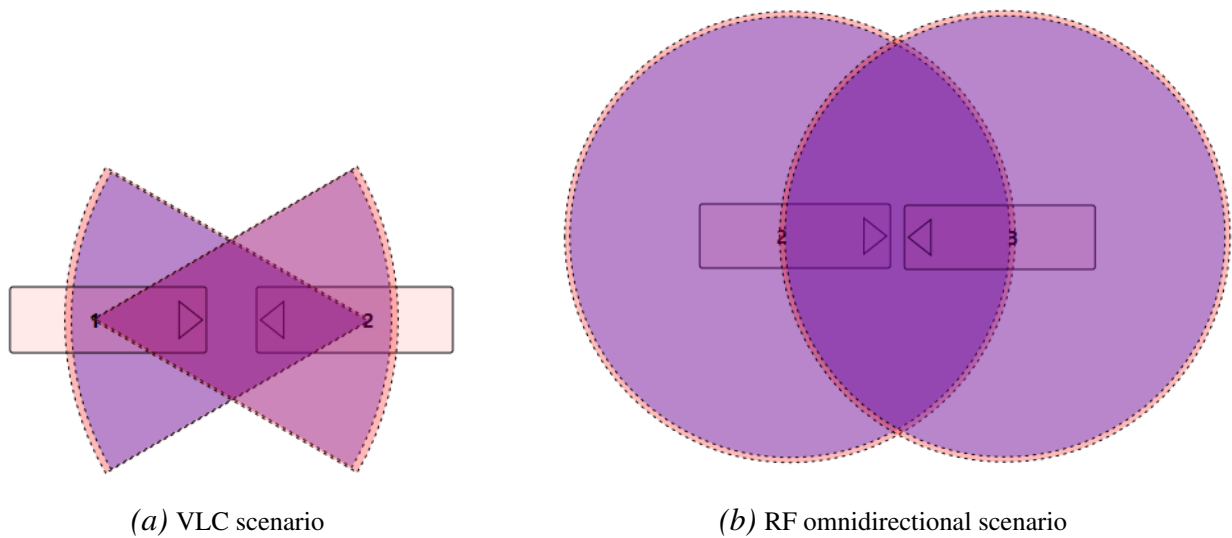

Figure 33: Validation scenarios for VLC enhanced NSE

Figure 33 shows a graphical representation of a simple scenario that is used to verify integrity, where Figure 33b shows an omnidirectional scenario with only two nodes without obstacles and within the communication range; this scenario is used prior to modifications. Although modifications can support exactly the same scenario, to test all the aspects of the newly implemented features, a VLC radio and VLC relevant scenario are used, as shown on Figure 33a. The VLC scenario uses two nodes (vehicles) where there are no obstacles and they are within communication range.

For research purposes and validation, the VLC radio is capable of running simulations that use the existing 802.11 protocol with no modifications as a MAC protocol. Because 802.11 does not support VLC element addressing, the VLC radio responds by transmitting the message on

every transmitting element installed and receiving concurrently from any receiving element installed.

The validation procedure included 58 simulations for each of two scenarios. Although a single simulation run would be enough to verify integrity, it would be necessary to execute multiple numbers of simulations to reduce random oscillations with simple average function. This randomness is natural in actual network systems and is caused by physical EM spectrum fluctuations and EM random noise in general. This phenomenon is simulated in JiST/SWANS.

Table 8: RF and VLC radio comparison on 802.11 MAC

Radio	MAC	Runs	Nodes	Messages	Average PDR (%)
RF Radio	802.11	58	2	628450	88.81412
VLC Radio	802.11	58	2	628450	88.81413

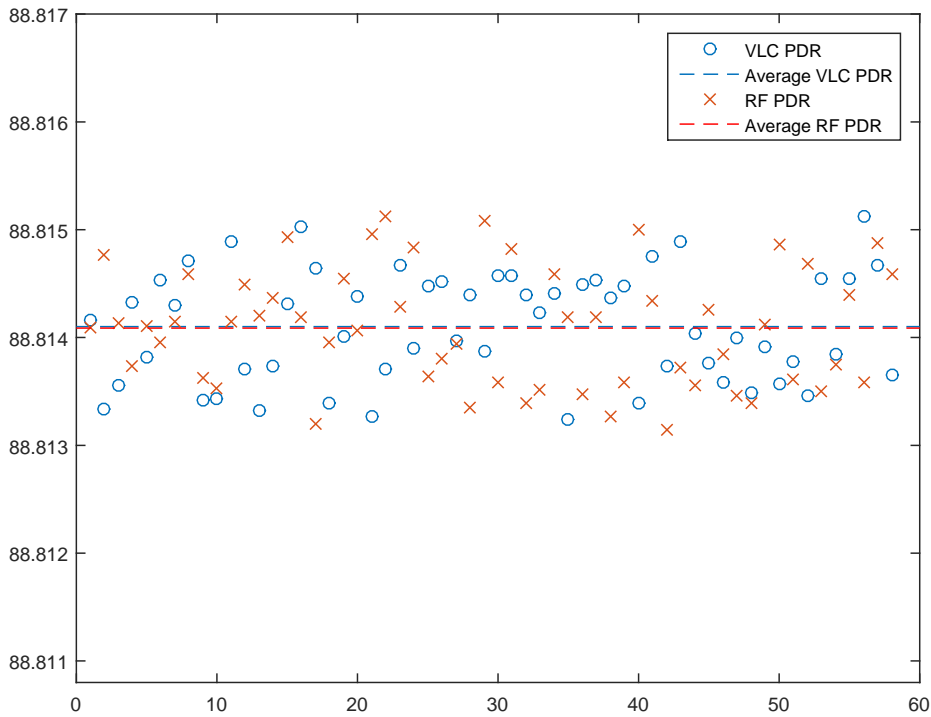

Figure 34: 802.11 MAC protocol on RF and VLC radio

A summary of simulation results is shown on Table 8. Figure 34 shows a detailed graphical representation of results where the Y-axis shows the average PDR for messages in each simulation run that are represented by the X-axis. On the same plot, average lines are shown for each simulation configuration (VLC and RF). PDR are slightly different on each simulation run

regardless of the configuration used; however, the average PDR for every simulation run has a difference of less than 0.00001 %, which strongly confirms the correctness of the implemented alterations.

3.7. Multiple Concurrent Simulations (MCS)

JiST/SWANS uses *generic driver* class to run a simulation using a configuration file that was partially described before in Section 3.4.8. In the original implementation, each configuration file describes only one simulation run. This is an issue in cases in which multiple simulation runs are necessary.

Another issue is configuration file design. The configuration file is an XML file that is not user friendly, meaning that the design of the file is difficult for a human to write. Among other elements, the XML design process includes a simulation scenario nodes layout that is currently defined in a complex manner; the process becomes even more complex when defining the elements layout on each node.

Because of issues identified, it was necessary to develop software that can aid in the configuration design process and simulation execution. The name of this software is the "Multiple Concurrent Simulations" tool. It was developed using .Net UWP technology because it was easier to implement graphical elements manipulation and design. MCS is a wrapper around JiST/SWANS executable (jar) that starts simulation using a designed XML configuration file. In case of multiple runs, MCS starts JiST/SWANS simulation in a separate thread to maximize resource utilization and reduce total execution time.

MCS is software that is the result of research conducted at *Intel - NTU connected context computer*² in Taiwan. The author of MCS is also the author of this thesis.

3.7.1. MCS supported features

To solve issues identified and to enhance the design network simulation experience using JiST/SWANS, MCS supports these features:

- Graphical user interface for static node layout. The user can design the orientation and position of nodes (vehicles) in a network.

²<http://ccc.ntu.edu.tw>

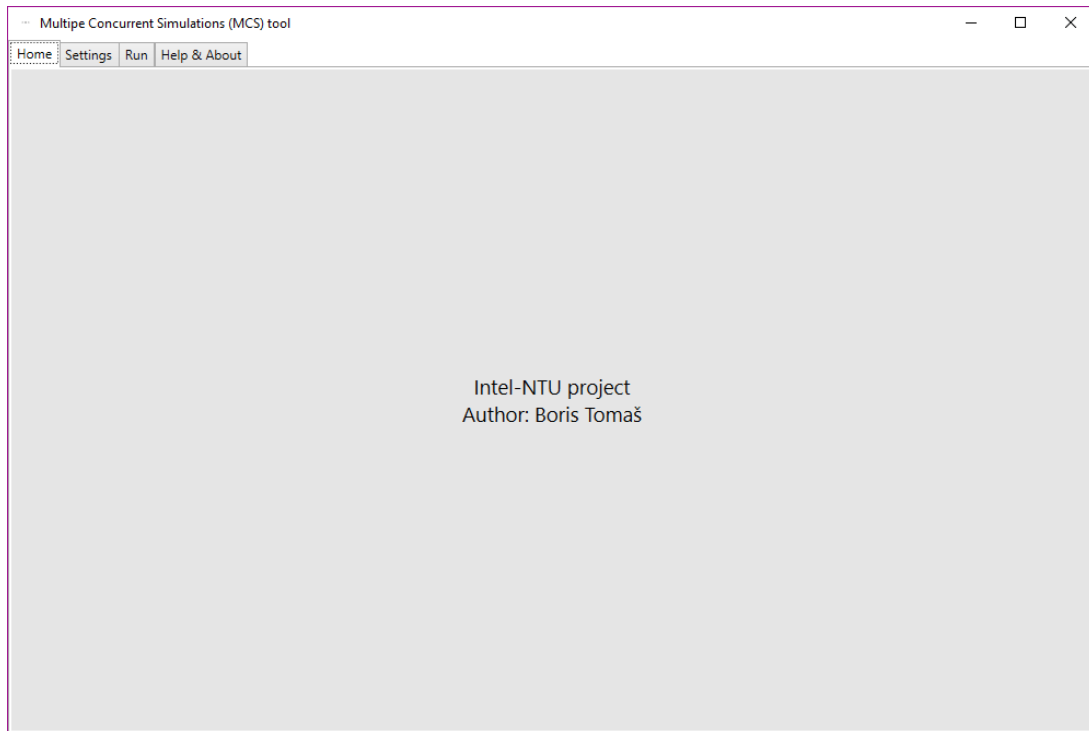

Figure 35: MCS home screen

- Export and import of a configuration file. Each configuration (simulation job) can be exported as a .vlcjob file.
- Drag and drop of a .vlcjob file on the application will trigger the import of a job.
- Multiple simulation jobs loaded in the MCS application.
- Execution of multiple simulations using each loaded job file.
- Mouse-controlled node resizing and rotation (orientation bearing).
- Randomize is a feature that randomly generates variable number of nodes based on the selected node.
- Duplicate selected node.
- Edit properties using property grid (pathloss, fading, results folder...) as shown on Figure 36
- Node design mode:
 - Adding and removing elements on a node.

- Duplicate selected element.
- Mouse-controlled element line of sight, vision angle, and bearing.

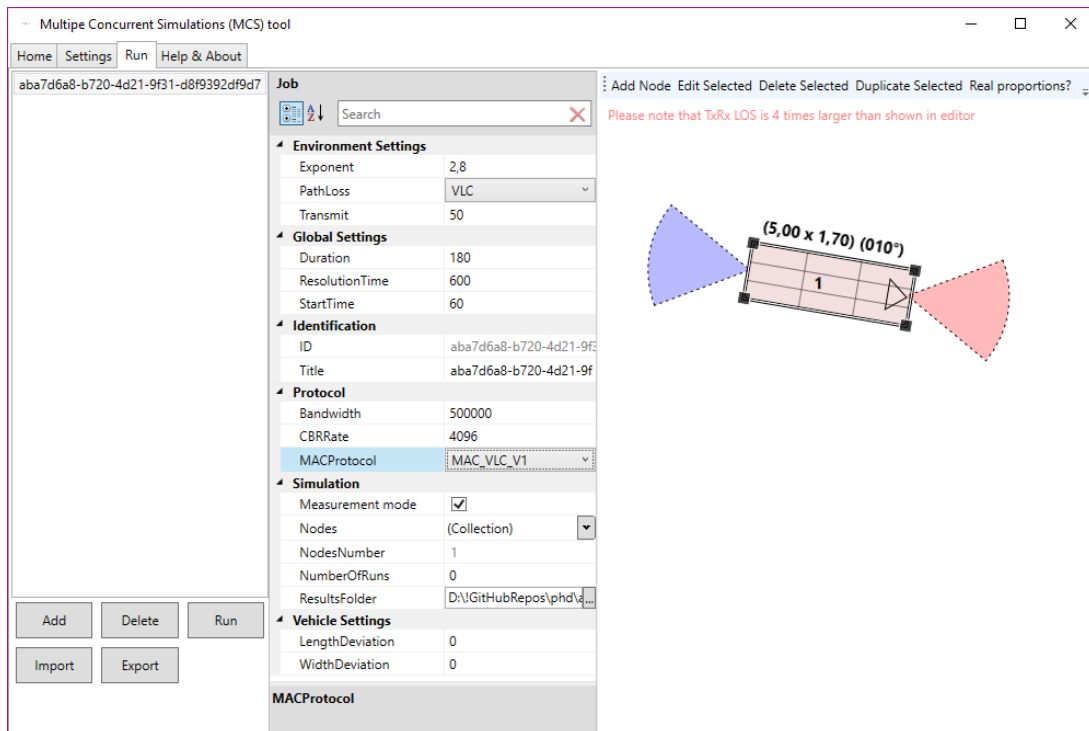

Figure 36: MCS scenario designer

Figure 36 shows the main network simulation scenario designer. Nodes are represented as rectangles with information presented above the node when it is selected. The user can reposition nodes on the screen with a drag-and-drop gesture. On the left side is a list of jobs; currently only one job is loaded. MCS supports multiple jobs that are all executed on JiST/SWANS when the user clicks "Run".

Each node contains elements that can be designed using *node editor*, shown on FigureMC-SnodeEdit. Each node can have multiple numbers of elements that can be positioned using the drag-and-drop gesture. Each element can be individually edited (line of sight, vision angle, and position on a vehicle).

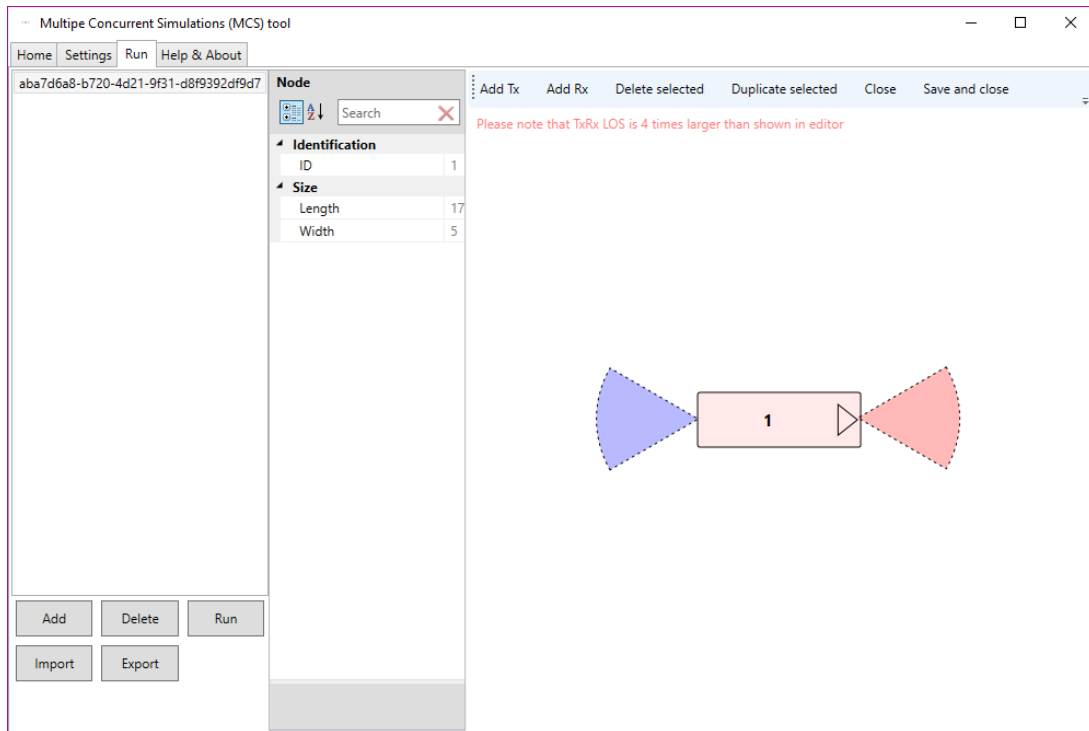

Figure 37: MCS node editor

3.8. Conclusion

MCS is a simple tool that accelerates the process of designing simulation scenarios for JiST/SWANS. This software is open sourced and is under active development. The basic functionality has been implemented and tested on a variety of scenarios and input settings. Testing of MCS was a simple process that included generating multiple configuration files that were loaded in JiST/SWANS. Testing proved that MCS design and JiST/SWANS interpretation of that design were identical in every scenario tested.

MCS software, in the current stage of development, is sufficient for designing simulation scenarios for the MAC protocol evaluation that will be used later on.

This section introduced changes to the core of the JiST/SWANS network simulation environment. All changes were oriented towards enabling the design and evaluation of the MAC protocol using new VLC technology. Caution was used when altering core features of JiST/SWANS so as not to interfere with basic functionalities. Nevertheless, software verification was done and proved that the new version does not produce significantly different results from the original version that was already verified, tested, and accepted by the scientific community.

The combination of MCS and JiST/SWANS now supports the design, implementation, and test-

ing of MAC protocols using any technology including VLC. The simple process for designing a new MAC protocol is as follows:

1. Define the new MAC protocol characteristics.
2. Implement the MAC protocol as a Java class in JiST/SWANS.
3. Define the test simulation scenarios and conditions.
4. Design the test scenarios and conditions using MCS software.
5. Start multiple simulations and gather MAC performance results.
6. Interpret the results.

The process described above is a guideline for the rest of the research.

4. Asymmetry in VLC vehicular networks

The nature of VLC in V2V is such that it involves certain aspects of asymmetry. This concept is a known issue in wireless networking systems, and it is one of the reasons for the famous node deafness issue [147]. It influences network performance and is addressed in various network protocols (MAC).

This chapter investigates asymmetry and its effect on communication using VLC in V2V networks; in Section 1.2 it was recognized as one of the potential issues in VLC communication. Also, this chapter defines different types of asymmetry in communication networks, with an emphasis on VLC. The chapter defines the experiment and controlled environment that test the H1 hypothesis which verifies asymmetry as an issue.

*The chapter addresses questions **RQ2** and subquestions defined in Section 1.3.1*

4.1. Definition

In the context of data communication, asymmetry may refer to several different concepts. Next, each of those concepts will be described and analyzed:

- *Augmenting technologies:* Rahaim et al. describe the use of IR or RF technology to address back channel issues in VLC communication [126]. Back channel refers to an issue with a nature of VLC in which the transmitting device should irradiate light to transmit data. For example, the user is using a smartphone camera to receive data from the LED ceiling lighting. To transmit data, the user should use the phone's flash device and point it towards the receiver on the ceiling. This is a relatively bad user experience and flash light radiation may be biologically intrusive to the other biological entities in the vicinity. Alternatively, what is proposed by Rahaim et al. and Shao et al. is to use a different, more invisible technology to transmit user data like WiFi [137]. The use of different technologies for uplink and downlink is called *asymmetric communication system*.
- *Asymmetry in gain* is a known problem described in [25, 85]. It is caused by using direc-

tional antennas in wireless communication. Directional antennas have a greater gain than omnidirectional antennas, making them more asymmetric. Directional antenna systems have an increased occurrence of hidden node terminal and node deafness.

- *Communication capability*: if two nodes are in the same communication channel and one of them is not able to send information, only receive it, this channel is asymmetrical in capability.
- *Full duplex and half duplex*: in = terms of asymmetry, a half duplex channel can be considered asymmetrical while a full duplex channel is a symmetrical communication channel.

Specifically, VLC in V2V can have multiple receiving and transmitting elements, that is, multiple and separated channels, which is considered an advantage over RF. However, there are issues with channel design, causing three possible types of asymmetry:

- *Node design*: The receiving coverage does not need to match the transmitting coverage (overlap). As mentioned in Section 2.2.1, transmitters can be manufactured using different technologies with different radiation patterns.

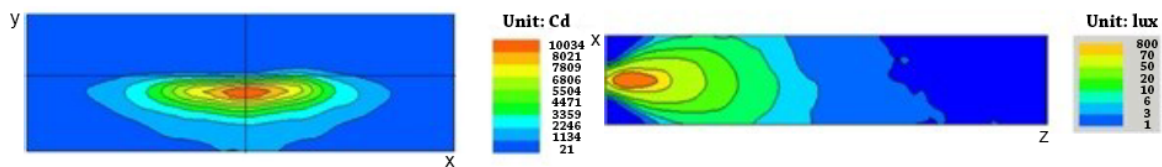

Figure 38: Typical headlight beam light intensity distribution [97]

Circle segment coverage approximation is good enough for this research, but the actual Tx radiation pattern has a rather irregular shape, as shown in example (Figure 38), and provides more asymmetry in all three spatial dimensions.

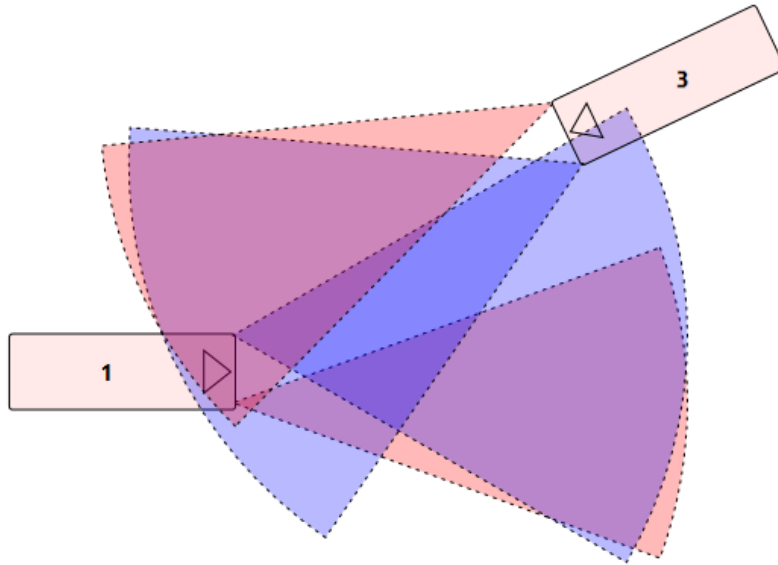

Figure 39: Design asymmetry

Design asymmetry causes one node to "hear" information from the other side while the other side cannot. There are many scenarios in which transmitting devices are not positioned at the same place. In the typical scenario, a vehicle has four Tx and two Rx. Figure 26 shows a detailed view of only one vehicle side (front). The figure also represents the usual misalignment (miscoverage) of Tx and Rx. Figure 39 shows an extreme and forced example of design asymmetry. It can be noticed that there is a deafness zone caused by Tx/Rx misalignment.

- *Node orientations:* Two nodes can be positioned in such a manner that they are in possible communication range distance. However, their orientation prevents communication. This scenario is shown on Figure 40. When and if orientation changes, nodes could be able to communicate again. This type of asymmetry could be minimized by installing extra Tx/Rx components on the vehicle sides.

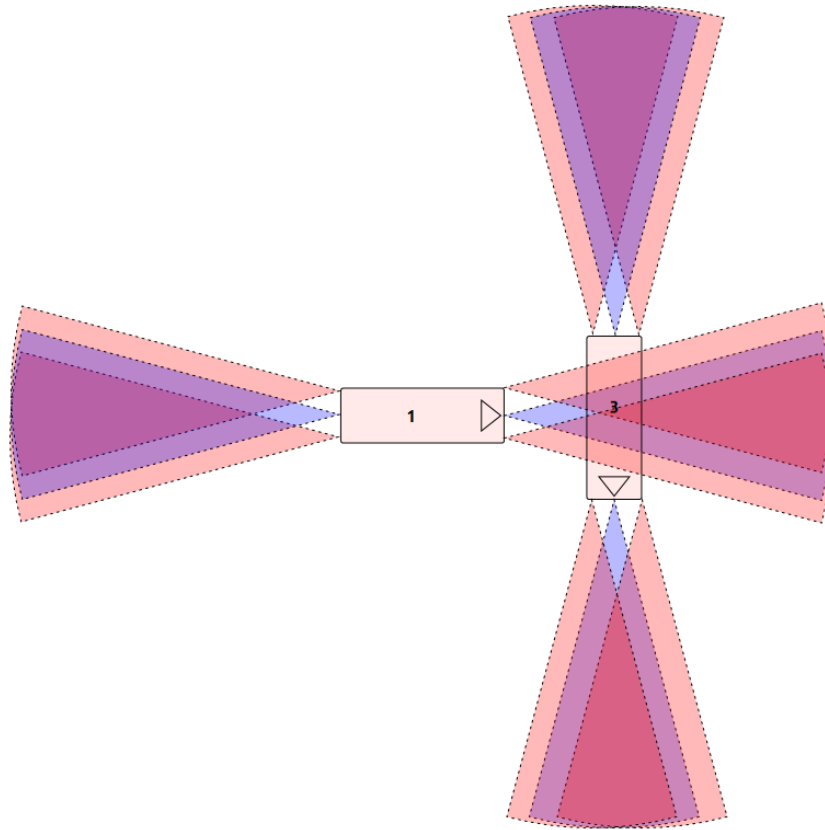

Figure 40: Orientation asymmetry

- *Node position*: Two nodes can be positioned in such a manner that they are completely unable to communicate due to the distance between them. This case is shown on Figure 41. Nodes will be able to communicate when and only if they come within communication range.

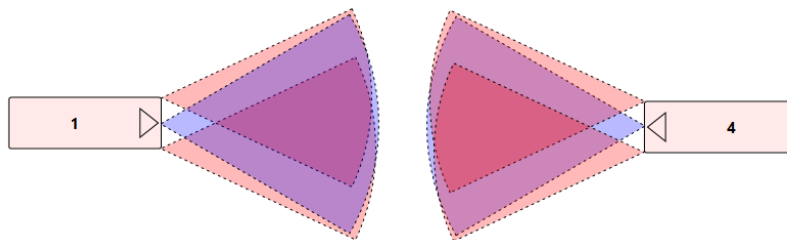

Figure 41: Positional asymmetry

Of all the types of asymmetry, *Node design* is the case that should be most investigated, especially its impact as being the significant cause of packet drops on a MAC layer. Orientation and positional asymmetry are rather specific to network design and organization and could be

an issue on a routing layer of an ISO/OSI stack. In Section 1.3.2 hypothesis H1 questions the incidence of different asymmetry types and their impact on MAC performance. This is important for deciding whether to consider asymmetry as an important problem and if this problem should be minimized or even solved on a MAC layer - if this solution is even possible on a MAC layer.

4.2. Asymmetry testing simulation experiment

To verify the severity of asymmetry, a simple experiment is conducted. The node models used in this experiment are shown on Figure 42, Figure 43, and Figure 44. The first node has been designed to emphasize design asymmetry while the second one has design that represents a real-case scenario as described in Section 3.5. The third node design has minimum asymmetry on the vehicle. It is assumed that the first model will yield more packets being dropped due to asymmetry and the third one will have minimal packets dropped due to asymmetry.

Therm *packet drop* in only this experiment is not strictly network related. It is customized metric that defines that the packet is dropped when the sender and receiver do not meet the physical condition for the packet to be transmitted. Those conditions include: distance, LOS, SNR and Rx/Tx power input/output levels. Asymmetry-caused packet drops are caused only by LOS and distance conditions.

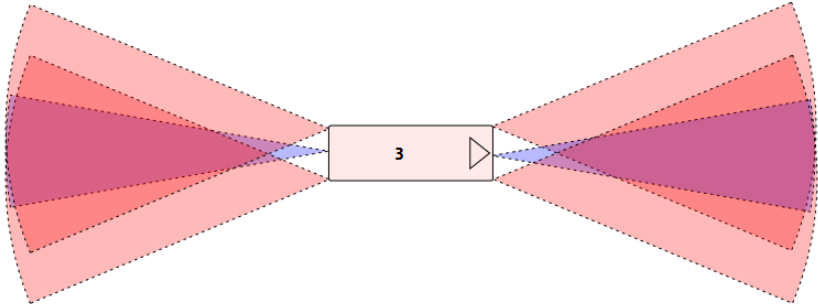

Figure 42: Experiment node design 1

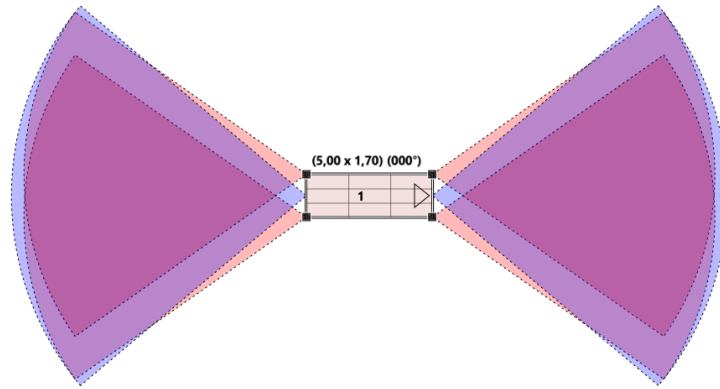

Figure 43: Experiment node design 2

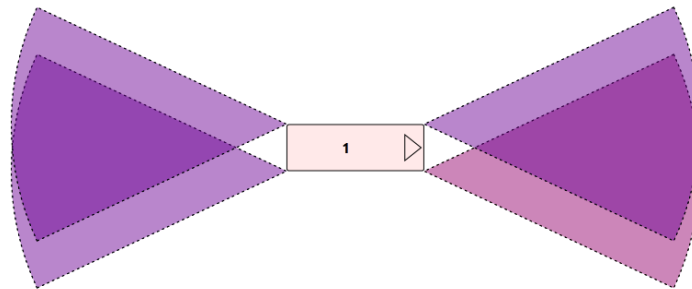

Figure 44: Experiment node design 3

Simulation configuration is shown on Table 9. The city map used is Suffolk in Virginia, USA. This particular map is used in most JiST/SWANS experiments conducted by researchers, and it has become the de-facto standard mobility map for network simulations. It has been integrated into the simulator core code. The mobility model used is Street Random Waypoint (STRAW), and nodes are randomly placed across the map.

For this experiment, 18 simulation runs will be executed with variable configurations. Six will use *node design 1*, another six will use *node design 2*, and the last six will use *node design 3*.

Experiment simulations are to be conducted on a grid computer network at the University Com-



Figure 45: Loaded scenario with vehicles in Suffolk, USA (GUI)

Table 9: Asymmetry detection experiment configuration

Parameter	Value
<i>Field</i>	
Map	Suffolk, VA, USA
Placement	Street random
Mobility model	STRAW
Pathloss	VLC
Number of nodes	43-53
<i>Node</i>	
Node design (number of nodes)	Node 1 (43)
Node design (number of nodes)	Node 2 (49)
Node design (number of nodes)	Node 3 (53)
Radio	VLC radio
MAC protocol	802.11
<i>Network</i>	
CBR packet size	1024 B
CBR	4096
Encryption	No
Bandwidth	11000000 bps
Routing protocol	AODV
Measured characteristic	Custom packet drops
<i>Simulation</i>	
Number of runs	18 (6 per design)
Single run duration (simulation time)	1000 s
Single run duration (estimated actual time)	5883 min

puting Center at the University of Zagreb (srce.unizg.hr/isabella). A grid network is used because it allows for the parallel execution of simulation scenarios that are more complex.

Simulation performance is critical. Implementation of an asymmetry check is very complex and requires many resources, thus making the simulator perform very slowly. Using simple trial and error while executing a single simulation, it is concluded that between 43 and 53 nodes are a reasonable amount of vehicles. One simulation run of 45 nodes lasts about 100 hours on a grid computer network.

MAC protocol used in simulations is modified 802.11b (Section 5.1)

4.3. Results

Cumulative time of execution for all simulations is 572 hours (24 days).

Final results are shown on Table 10. For each node design, six simulation runs were executed. **Messages reached** is the number of packets that reached any destination. A single packet(message) can be dropped or received on multiple nodes in the network. **R** is the number of packets received. **D1** is the number of messages that were dropped due to the positional asymmetry; **D2** is the number of packets that were dropped due to orientational asymmetry; and **D3** is the number of packets that were dropped due to design asymmetry.

R% is a relative value of R related to the number of packets reached. **D1%** is a relative value of D1 related to the number of packets reached. **D2%** is a relative value of D2 related to the number of packets reached. **D3%** is a relative value of D3 related to the number of packets reached.

Rows are color coded so that the first six rows are pink and represent the simulation runs that used *node design 1*. The next six rows are yellow and use *node design 2*. The rest of the rows are blue and use *node design 3*.

Table 10: Asymmetry analysis results

Messages reached	R	D1	D2	D3	R%	D1 %	D2 %	D3%
33774676	638126	29647754	3259537	229259	1,8894%	87,7810%	9,6508%	0,6788%
23667420	506322	20398952	2626310	135836	2,1393%	86,1900%	11,0967%	0,5739%
23956212	431877	21470450	1954735	99150	1,8028%	89,6237%	8,1596%	0,4139%
24801672	572928	21783438	2308928	136378	2,3100%	87,8305%	9,3096%	0,5499%
23744238	475038	21090088	2045866	133246	2,0006%	88,8219%	8,6163%	0,5612%
23772630	473490	20805519	2378060	115561	1,9917%	87,5188%	10,0034%	0,4861%
32088472	568793	28266367	3081907	171405	1,7726%	88,0889%	9,6044%	0,5342%
32230032	624558	28738611	2714801	152062	1,9378%	89,1672%	8,4232%	0,4718%
30823584	581285	27364438	2756741	121120	1,8858%	88,7776%	8,9436%	0,3929%
32011008	566657	28947667	2367590	129094	1,7702%	90,4304%	7,3962%	0,4033%
31985952	644021	28277554	2945831	118546	2,0134%	88,4062%	9,2098%	0,3706%
26593680	578439	22688096	3150630	176515	2,1751%	85,3139%	11,8473%	0,6637%
34496436	396930	30948290	3057045	94171	1,1506%	89,7145%	8,8619%	0,2730%
30222296	299926	27763019	2093325	66026	0,9924%	91,8627%	6,9264%	0,2185%
25230868	245379	22668011	2238343	79135	0,9725%	89,8424%	8,8714%	0,3136%
31660564	374765	28714981	2485228	85590	1,1837%	90,6964%	7,8496%	0,2703%
33032948	425908	29371349	3121216	114475	1,2893%	88,9153%	9,4488%	0,3465%
32075732	364113	29047627	2566256	97736	1,1352%	90,5595%	8,0006%	0,3047%

4.4. Interpretation and conclusion

4.4.1. Asymmetry design affect

To confirm that a varying asymmetric node design affects the number of asymmetry-related packet drops, Friedman's ANOVA test is conducted on the following set of data: Values in Table

Table 11: Design asymmetry by node design

sID	Node design 1	Node design 2	Node design 3
1	229259	171405	94171
2	135836	152062	66026
3	99150	121120	79135
4	136378	129094	85590
5	133246	118546	114475
6	115561	176515	97736

11 correspond to the values **D3** in Table 10. sID is the simulation run ID for each simulation. Row effect is not relevant for Friedman's test.

"Friedman's test is similar to classical balanced two-way ANOVA, but it tests only for column effects after adjusting for possible row effects. It does not test for row effects or interaction effects. Friedman's test is appropriate when columns represent treatments that are under study, and rows represent nuisance effects (blocks) that need to be taken into account but are not of any interest." [107]

Friedman's ANOVA Table					
Source	SS	df	MS	Chi-sq	Prob>Chi-sq
Columns	9	2	4.5	9	0.0111
Error	3	10	0.3		
Total	12	17			

Test for column effects after row effects are removed

Figure 46: Friedman's test for asymmetry design influence

Figure 46 shows the results of the test. The value $Prob>Chi-sq$ is 0.0111 and is a probability value in the interval $[0, 1]$. Test interpretation suggests that if this probability value is small, column treatments do have an effect on population.

In terms of this research, it can be concluded that varying node design does influence packets being dropped due to asymmetry. However, this doesn't prove that asymmetry is a significant cause.

4.4.2. Asymmetry as a cause of packet drops

Table 12: Design asymmetry drop analysis

Node design	μ	σ
1	0,5440%	0,00081
2	0,4728%	0,00102
3	0,2878%	0,00040

Table 10 shows 18 simulation run results. The simple mean function and standard deviation of that data, specifically of **D3** measurements, is shown on Table 12. It can be noticed that *node design 2* has, significantly, a very low number of drops caused by asymmetry: 0.4728%. Furthermore, most "asymmetric" designs (*node design 1*) still have a very low drop rate, so it can be safely concluded that *node design* asymmetry is not a significant cause of packet drops in VLC for V2V systems.

The reason for that might lie in the fact that in a heterogeneous (nonlinear) arrangement of nodes, asymmetry could be a more important cause of packet drops. However, traffic systems are rather linear and the usual vehicle VLC setup simply follows that linearity. In another node design example, in which the vehicle VLC setup is deliberately asymmetric, it is noticed that

asymmetry has more of an effect on packet drops, proving a positive correlation between node design and packet drops caused by asymmetry.

The experiment did prove that asymmetry is an issue and that it is present, though not in a significant amount. Also, it can be concluded that a vehicle's precise design has the most significant influence on lowering packet drops caused by design asymmetry.

As for the VLC MAC protocol, it can be safely assumed that asymmetry is not an issue. Thus, hypothesis **H1** is disapproved, meaning that the MAC protocol for V2V VLC systems does not need to address the asymmetry issue. The experiment did not address scenarios of VLC in non-vehicular systems (not V2V or I2V/I2V), meaning that it is still possible that MAC for VLC should address asymmetry.

5. VLC MAC protocol design for V2V and V2I/I2V

This chapter analyzes the current implementation of referent 802.11 MAC protocols. Changes to the referent protocol are introduced to enable interoperability with the underlying PHY layer that has implemented the VLC-equipped vehicle radio model that was introduced in the previous chapters.

The chapter also defines the new MAC protocol specialized for V2V and V2I/I2V VLC network systems. This protocol will be tested against the referent protocol in various experimental scenarios.

*The chapter addresses questions **RQ1** and subquestions defined in Section 1.3.1*

5.1. IEEE 802.11 MAC for VLC Vehicular Radio

As a referent protocol for the final evaluation of MAC for VLC V2V networks, 802.11 MAC will be used. 802.11 has been the basis of derivative protocols for many other technologies, including VLC (802.15.7) and vehicular network systems (802.11p). It has been implemented in JiST/SWANS NSE as *Mac802_11.java* class. Current implementation corresponds to the 802.11b standard defined by [1]. Although it has been superseded by the next version, it is still valid and widely used in some legacy devices. 802.11b operates at 2.4 GHz at a maximum 11 Mbps throughput. The maximum range is about 50 m. Because it uses unregulated 2.4 GHz frequency in the EM field, it coexists with other technologies like Bluetooth, security devices, wireless monitors and others. This causes the 802.11b Wi-Fi to be prone to interference caused by other technologies and devices. Still, it is used mainly because of its low cost and wide acceptance.

5.1.1. Unmodified IEEE 802.11b

"As is" implementation of the 802.11b MAC protocol in JiST/SWANS operates properly with RF radio implemented by *RadioNoiseAdditive.java*. Implementation uses RTS/CTS protocol short messages to avoid a hidden node problem, and ACK messages to confirm transmission reception on the other side. For collision avoidance, the protocol uses random and incremen-

tal backoff timers (timeout mode). To refrain from transmitting while the channel is busy, the devices using 802.11b use carrier sensing. When the channel (carrier) is busy, the device goes into timeout mode, in which it waits a random time before it is allowed to try sending again.

802.11b also implements the Direct Sequence Spread spectrum (DSSS) and Frequency Hopping Spread Spectrum (FHSS) spread spectrum techniques that can be used only exclusively. DSSS uses a pseudo random noise pattern that is multiplied by the original data and Complementary Code Keying (CCK) is used as a modulation scheme. FHSS uses a predefined sequence of frequency bands to be used. This way, a single device spends only a fraction of the time transmitting in a single frequency band, thus reducing the probability of collisions. A more advanced version of FHSS, called Adaptive FHSS, does not use a fixed sequence of frequency bands but, rather, a dynamic one that uses carrier sensing and avoids frequency bands that are crowded with other devices' transmissions.

Because of the many modifications on the Radio device for VLC, described in Section 3.4.1, 802.11b is rendered nonfunctional in terms of network protocol as well as in terms of Java implementation.

5.1.2. VLC driven IEEE 802.11b modifications

In the experiment phase, it would be necessary to modify the current implementation of the 802.11 MAC protocol so that it can work with the VLC vehicular model. One of the significant differences would be the spatial segmentation of the carrier space. To support that, the VLC radio supports the addressing of different Tx/Rx elements installed on the vehicle. The radio also provides information about the design and capabilities of each element, as described in 3.4.3. Because the referent protocol does not define the addressing of each installed element, it will be modified so that it transmits from all installed Tx elements on a vehicle, as well as receives from all Rx elements concurrently. There is a scenario in which different Rx elements could receive different data streams; in this case, the modified referent protocol will receive two (or more) concurrent data streams without collisions. In real scenarios with RF radio, the referent protocol will be able to receive only one incoming transmission, making this modification an advantage for the referent protocol.

The referent protocol will behave the same as in any Wi-Fi scenario and should operate properly, which has been proven by validating VLC Radio. This validation (Section 3.4.1) proved

that:

- The modified referent protocol (802.11b) behaves like the unmodified (original) version.
- VLC radio implementation is correct in terms of network consistency and performance.
- VLC radio implementation behaves like the referent Wi-Fi radio model in scenarios with appropriate omni-directional setup.

To maintain cross compatibility, the message structure inherits all the necessary features for 802.11 to function properly, as described in 3.4.3. The modified referent protocol has been implemented as *Mac802_11.java* in the project repository. The same protocol has been used to verify the implementation of NSE in Section 3.6 with an emphasis on Radio VLC validity. All the implemented modifications are minimal and preserve the essence and behavior of the referent protocol.

5.2. VLC V2V MAC protocol

Section 2.4 provides a detailed overview of MAC protocols and different features imposed by example protocols. When analyzing protocols and their use, there is evident cause for using a specific protocol. Some are more energy efficient to provide connectivity for low-power devices, like Bluetooth LE. Others may provide high-speed communication using powerful transmissions. Regardless, it is the domain that dictates the design of a protocol. For example, the possible number of nodes may require a different approach when designing the MAC protocol.

5.2.0.1. Number of vehicles

In experiments conducted in 4.2, at the same time a parallel experiment was conducted whose purpose was to estimate the number of vehicles visible in the usual vehicle setup. The word *visible* defines true network connectivity: power thresholds, LOS, "vehicle as obstacle", and spatial segmentation.

The results were: the average number of visible vehicles was **8.3** and the maximum number of visible vehicles was **17** while the mode value was **7**. In accordance, it is noticeable that V2V VLC communication is highly spatially limited and the number of nodes is not large, making a whole system small-scale communication network.

5.2.0.2. *Obsolete IEEE 802.11 features*

802.11b is designed for the different environment, in the domain of VLC V2V. It implements some unnecessary features like RTS/CTS because of separated Rx and Tx channels. Omitting those might simplify MAC for VLC in V2V networks. Carrier sensing is a feature that allows an RF radio to test the medium for ongoing transmissions. If there is an ongoing transmission, the radio should defer any new transmissions. In VLC scenarios, carrier sensing does not represent an important feature because Tx and Rx elements are separated. RadioVLC implementation always receives any transmission in the medium and MAC is aware of such transmissions without intentional probing (carrier sensing). Unlike RF single-antenna radios, VLC has many separated "channels" with separated Tx/Rx elements. It is capable of concurrent transmissions using different elements. Furthermore, RF radio is required to switch from transmitting or receiving mode. This mode switching requires a short amount of time and is considered in referent protocol; it is called "radio turn time". Carrier sensing is used in RF because at the same time the node can only transmit or receive. If the medium is busy, meaning that someone is transmitting, that someone is not able to receive. Furthermore, other nodes are also receiving and cannot receive concurrent transmissions. Because of the different setup and technology, it might be unnecessary to have classical carrier sensing as one present in the referent protocol.

Because of the simplicity of the V2V systems, it may be possible that a simple protocol, inspired by ALOHA, 802.11b, 802.11p, and 802.15.7, might be sufficient enough for VLC communication in V2V and V2I/I2V networks.

As for being part of the *Data link* layer and in direct contact with the PHY layer (Figure 17), MAC for VLC already has some of the features defined on a PHY layer (See: *VLC Radio* in Section 3.4.1)

5.2.1. **Frame structure**

The 802.11b frame structure is shown on Table 13. Total header and CRC length is 34 bytes.

The frame control field has 2 bytes (8 bits) that are organized as shown on Table 14.

The current structure of the 802.11b frame contains elements that might not be necessary in V2V communications using VLC, and yet it requires some specific elements, like addressing

Table 13: 802.11b frame structure (bytes)

2	2	6	6	6	2	6	0 - 2312	4
Frame Control	Duration/ID	Address 1	Address 2	Address 3	Sequence Control	Address 4	Frame Body	CRC

Table 14: Frame control field structure (bits)

2	2	4	1	1	1	1	1	1	1	1
Protocol Version	Type	Subtype	To DS	From DS	More fragments	Retry	Power management	More data	WEP	Order

the TX element on a vehicle.

The proposed frame structure for VLC MAC for V2V is as follows and is shown on Table 15.

All the values are expressed in bits, except for Frame Body, which is measured in bytes.

- **Frame Control** (10 bits) is a control element for frame, described later.
- **Priority** (4 bits), defines the message priority for various purposes. The highest priorities are 14 and 15; those should be reserved for emergency services. Priority is used on a MAC layer during queuing of messages (Section 5.2.4).
- **Address 1** (48 bits) source MAC address
- **Address 2** (48 bits) destination MAC address
- **Tx Mask** (18 bits). This field defines the mask that instructs the PHY VLC radio device as to which Tx element message should be sent. This field has 18 bits, each for one Tx element. This information is transmitted to the receiver because the sender can send using Tx that is not covered by any Rx, meaning that replying to the message would be unsuccessful and should be avoided. This decision is up to the MAC protocol and depends on individual node design.
- **Rx Mask** (18 bits). This field is **not transmitted** but is populated on reception. It is not included in CRC. The Rx mask has 18 bits, each bit for one Rx element. When a message is being received, the receiving Rx bit is set to 1. This way, the MAC protocol is aware of

Table 15: Frame structure for VLC MAC in V2V (bits)

10	4	48	48	18	18	0 - 2313 B	32
Frame Control	Priority	Address 1	Address 2	Tx Mask	Rx Mask	Frame Body	CRC

Table 16: Frame control field in frame structure (Table 15) (bits)

4	4	1	1
Protocol Version	Frame Type	Retransmission	Encryption

which Rx received the message. Tx and Rx masks have only 18 bits, meaning that there can be only 18 Rx and 18 Tx elements on a vehicle. In the future, it might be necessary to expand this field.

- **Frame body** (0-2313 B) is a data payload element of frame structure.
- **CRC** (32 bits) is a frame cyclic redundancy check element that secures data consistency and the correctness of frame transmission.

Frame Control structure is shown on Table 16 and has following structure:

- **Protocol version** (4 bits). For now, the version is set to 0000. This proposal supports up to 16 protocol versions.
- **Frame type** (4 bits). Depending on use, this field defines types of frame. In the referent protocol this field defines the control, management, or data frame type with all subtypes. This field will be used the same way it is used in the referent protocol.
- **Retransmission** (1 bit). This field is used to indicate whether a frame is a retransmission (set to 1) or not (set to 0). Retransmissions are usually used when a message is not received properly, the reason for that being that the link is usually poor quality. This field will be used the same way it is used in the referent protocol.
- **Encryption** (1 bit). This field is used to indicate whether payload data is encrypted (set to 1) or not (set to 0).

The total frame size is 160 bits = 20 bytes. For reference, the frame size of 802.11b is 34 bytes. A reduced header size may have an influence on MAC protocol performance; however, by dropping fields, some features would not be present on the VLC MAC for V2V. Nevertheless, performance will be evaluated in Chapter 6.

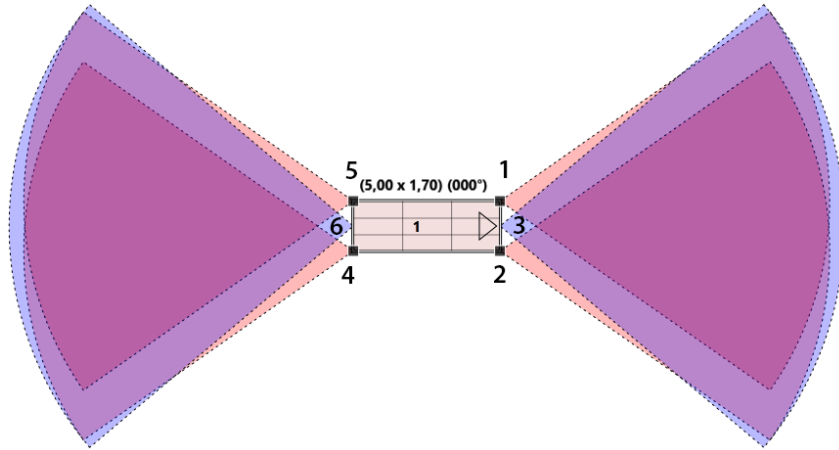

Figure 47: Vehicle model with labeled Tx/Rx elements

Table 17: Example Rx mask

ID	18	17	16	15	14	13	12	11	10	9	8	7	6	5	4	3	2	1
isUsed?	0	0	0	0	0	0	0	0	0	0	0	0	0	0	0	1	0	0

5.2.2. Addressing

To maintain ISO/OSI compatibility, VLC MAC for V2V will adopt MAC addressing. Each node (vehicle) has a unique 48-bit MAC address, thus defining the maximum number of MAC addresses to be $2^{48} = 281474976710656$ addresses. Aside from node addressing, the protocol supports the addressing of an individual Tx element for transmitting. Addressing is done in the form of bit-mask. This mask has a length of 18 bits. It might be possible to use MAC addressing for single Tx/Rx element, meaning that each Tx/Rx element has its own unique address. At first, it may appear as an elegant solution, however, even today vehicles have LCD matrix lights that tend to have increasing resolution. This advancement in technology increases number of Tx elements to several millions and MAC address space simply could not accommodate such scenarios. Addressing is an issue for future researchers; as for now, internal 18 bit addressing is sufficient enough.

The vehicle model used is shown on Figure 32. The current model uses four Tx and two Rx elements, meaning that an 18-bit mask will be sufficient. The same vehicle is shown on Figure 47 with Tx and Rx elements labeled with an ID. An example mask for receiving only on the front Rx is shown on Table 17 Another example is shown on Table 18, where the vehicle transmits data using all available Tx elements.

In this research, the numbering of Tx/Rx elements is unique regardless of the element type.

Table 18: Example Tx mask

ID	18	17	16	15	14	13	12	11	10	9	8	7	6	5	4	3	2	1
isUsed?	0	0	0	0	0	0	0	0	0	0	0	0	0	1	1	0	1	1

However, NSE allows the same element ID to be used, though in different types: Tx or Rx.

5.2.3. Control channel

The control channel is a mechanism that uses the *Control signal* concept defined in Section 3.4.4. Because of the segmental and spatial fragmentation nature of the channel, it would be necessary to provide a mechanism to manage the hidden node issue. Having a single bit control channel might be sufficient.

Some MAC protocols, especially in wireless sensor networks, use a control channel as analyzed by Cormio and Chowdhury [30]. With a control channel, it would not be necessary to implement the RTS/CTS mechanism as in the referent protocol, thus reducing message delay.

Control signal should be used based on a node design. As the VLC MAC for V2V protocol is aware of node design and configuration, it should not pose as an issue. Use of a control channel should follow these rules:

1. If the node (vehicle) is about to transmit from the Tx check control signal on the closest Rx with similar coverage. If the signal is set, refrain from transmission.
2. If the node is receiving data on Rx, set the control signal on the closest Tx. This way, the node informs other participants that it has an ongoing transmission in progress.

The control signal is a small-width frequency band that carries single-bit information. When the signal is present, the node is receiving data. Interference and collisions on the control channel are not relevant because the node inspects only the presence (or lack of presence) of the signal in the control channel.

5.2.4. Queue messages

The VLC MAC for V2V protocol should queue messages when they cannot be transmitted. A message should be queued when:

- The control signal is set.

- There is already an ongoing transmission on an assigned Tx element.

The queue is always sorted by message priority. When a new message is added to the queue, all current queued messages will have their priority increased by one. Using this algorithm, the queue mechanism becomes ipso facto hybrid priority/FIFO queue.

After the message is queued, the node goes to the internal backoff state that is calculated like this:

- If there is an ongoing transmission, get the soonest time of the end of the transmission (X).
- If there is no ongoing transmission, the message was probably queued because the control signal is set. For each such step, calculate time (X) as 1 ms multiplied by the number of steps.
- Delay (sleep) for X time; after that, try sending the first message that is on top of the queue. If this is not possible, repeat the whole procedure again.

When the message is dequeued from top, it is analyzed again. If it cannot be sent in the new iteration, its priority is increased and it is put back into the queue. To avoid possible deadlock, the protocol should select the next message in the queue and try sending it, doing the same until the whole queue is tested.

There is a specific scenaris while sending/queuing messages: For example: if a message has assigned Tx elements 1 and 2, and only 2 is idle and able to transmit, in this case MAC can choose between the following queuing strategies:

1. **Unreliable mode:** send the message on any Tx available, e.g., send using Tx element 2 and ignore sending on 1 if 1 is not idle.
2. **Concurrent mode:** wait while all assigned Tx elements are available by queuing the message.
3. **Reliable mode:** send the message immediately on Tx element 2, and duplicate and enqueue a message with only Tx 1 element assigned.

Queuing strategies are scaffolded in VLC MAC source code for easier experimentation in future research. As for now the current implementation of VLC MAC for V2V implements and will use *Concurrent mode* only.

5.2.4.1. *Deadlock prevention*

Because MAC protocol implementation is perfectly precise, in some **static scenarios** it is possible that nodes enter some sort of deadlock. If the control signal is set, the nodes go into "sleep" mode, refraining from sending and en-queuing the message. At the same time other nodes gain access to the medium and when sleeping node wakes up the channel is still busy and goes to sleep again. And this can last forever and make network inoperable.

Because there is no synchronization or NAV, in VLC MAC the node that is waiting for a message to be sent waits a random time between $1 \mu s$ and $10 \mu s$. When the node sends a message, it waits for propagation and a random delay between $10 \mu s$ and $20 \mu s$. A random delay on a sending node creates a window during which other waiting nodes can start transmission, thus avoiding the infinite queuing of single message. During the development phase, those various delays were tested and the present ones were selected as having the best performance on the final message transmission average delay. Furthermore, selected delays correspond to the referent protocol, which also uses interframe delay. In the case of DSSS it is fixed to $10 \mu s$ and in the case of FHSS it is fixed to $28 \mu s$.

5.2.5. Encryption

The frame control structure (Table 16) defines the bit value that informs the receiving MAC protocol that *Frame Body* is encrypted and that it should be decrypted before relaying to the upper layer. The encryption mechanism is implemented as a static `Encryptor.java` class that contains two public methods *Encrypt* and *Decrypt*. Those methods are used at the MAC entry point when the message is encrypted, and at the MAC exit point when the message is decrypted. Encryption and decryption use the Java implementation of 128 bit AES algorithm. According to [31] and [144], encryption/decryption speed depends on the type of hardware. Average asymmetric encryption is slightly slower ($190 \mu s$) than decryption ($120 \mu s$). Both delays are implemented as *encryption processing delay* using equations 5.1 and 5.2. *Encryption processing delay* is added to the total message transmission delay (in simulation time units).

$$d_e = \frac{S(m)}{S(M)} * 190 \mu s \quad (5.1)$$

$$d_d = \frac{S(m)}{S(M)} * 120 \mu s \quad (5.2)$$

where:

$S(m)$ size of message

$S(M)$ maximum message size

d_e encryption delay

d_d decryption delay

The maximum *encryption processing delay* is $190\mu s$ and is just a fraction of the total message delay that is measured in the next order of values. Nevertheless, it is implemented in the simulator on a MAC layer to preserve the correctness and validity of the actual protocol. The use of encryption in simulations can be controlled by the field *UseEncryption* in the *JobConfigurator* class.

5.2.6. Tx element selection

The VLC radio model and messages frame structure allows for the individual addressing of Tx elements installed on a vehicle. By addressing a specific element, the MAC protocol can have multiple numbers of concurrent transmissions.

At the same time, the VLC radio populates the Rx mask in the message frame structure identifying which element has received the message.

Because the node design is known, the protocol can use that information as a leverage when deciding which Tx element to use when transmitting a message. Also, the receiving node knows which Tx elements were used when the message was sent. Because the model of the VLC equipped vehicle has minimal asymmetry, avoiding sending a message due to asymmetry would be unnecessary. In the case of a different design, the MAC protocol can refrain from sending a message to the node that does not have the appropriate Rx element installed to match the sending Tx element.

The VLC MAC protocol for V2V will keep track of all the messages received in the form of a history log. The message is added to the history log when it is received.

All this information: *Node design, used Rx elements, and history log* is used in the Tx selection mechanism: e.g., node A sends message X to node B.

1. In the history log, find the received message Y that originated from node B not older than 5 ms.
2. Retrieve the Rx element used to receive message Y.
3. Using the known VLC radio model, retrieve the node A Tx elements that correspond to the Rx element retrieved.
4. Assign the retrieved Tx elements on a message X as a Tx mask.

A 5 ms message age limitation is required so as not to use messages that are too old. Value was selected during an empirical analysis of experimental data. An old message could have false in-

formation caused by vehicle movement. A vehicle driving 60 km/h in 5 ms will travel 0.0834 m, which is a relatively small distance that doesn't change network configuration significantly. Of course, this distance changes with speed. At higher speeds, vehicles should maintain a longer distance. Because of that, the network configuration remains mostly unchanged during a short time span.

To summarize, the Tx element selection procedure follows a simple assumption: If the node was heard before on a specific Rx, try sending it in the same direction again using the appropriate Tx elements.

5.2.7. Interference detection

VLC radio provides detailed information about the collision and interference that has occurred on a specific Rx element. In the case of interference, the VLC radio will discard any invalid incoming data, and it will not be propagated to the MAC layer in the first place.

An interference event is raised when the node has concurrent transmissions on the same Rx. Not every collision is destructive; if one signal is stronger than the cumulative powers of other signals, the message can be received using the first signal (additive noise model). The rest of the signals/transmissions experience interference and should be discarded.

The most probable reason for such events is positional asymmetry (described in 4)). In regular, omnidirectional networks, collisions occur in, for example, cases of hidden nodes. However, having a control channel should circumvent that issue in V2V VLC systems.

In case of interference, the VLC MAC protocol for V2V should identify the Tx elements that transmit in the same direction as the Rx element that experienced interference. The priority of the message that is being transmitted should be decreased and the message should be put to the queue as a retransmission. In this scenario message is identified by internal reference (Java). This reference is not part of header information but rather resides as implementation on single node. This mechanism should lower the frequency of transmissions, allowing time for a channel to recover from the interference. The message is being retransmitted and it is up to the network layer (Figure 17) to reassemble the message and to ignore any duplicates caused by retransmissions. For any message, due to interference, retransmission should happen only once, regardless of how many Tx elements are being used.

5.2.8. Diagram

All the concepts previously described are shown on Figure 48 in the form of a workflow diagram. The diagram starts with a MAC event; it can be *receiving* or *sending* a message, *interference*, and *timer resuming*. The VLC MAC protocol for V2V and V2I/I2V uses timers that are JiST concepts used to schedule an event in the future. In this MAC implementation, the timer event that is scheduled is dequeuing a message from the queue after queue time.

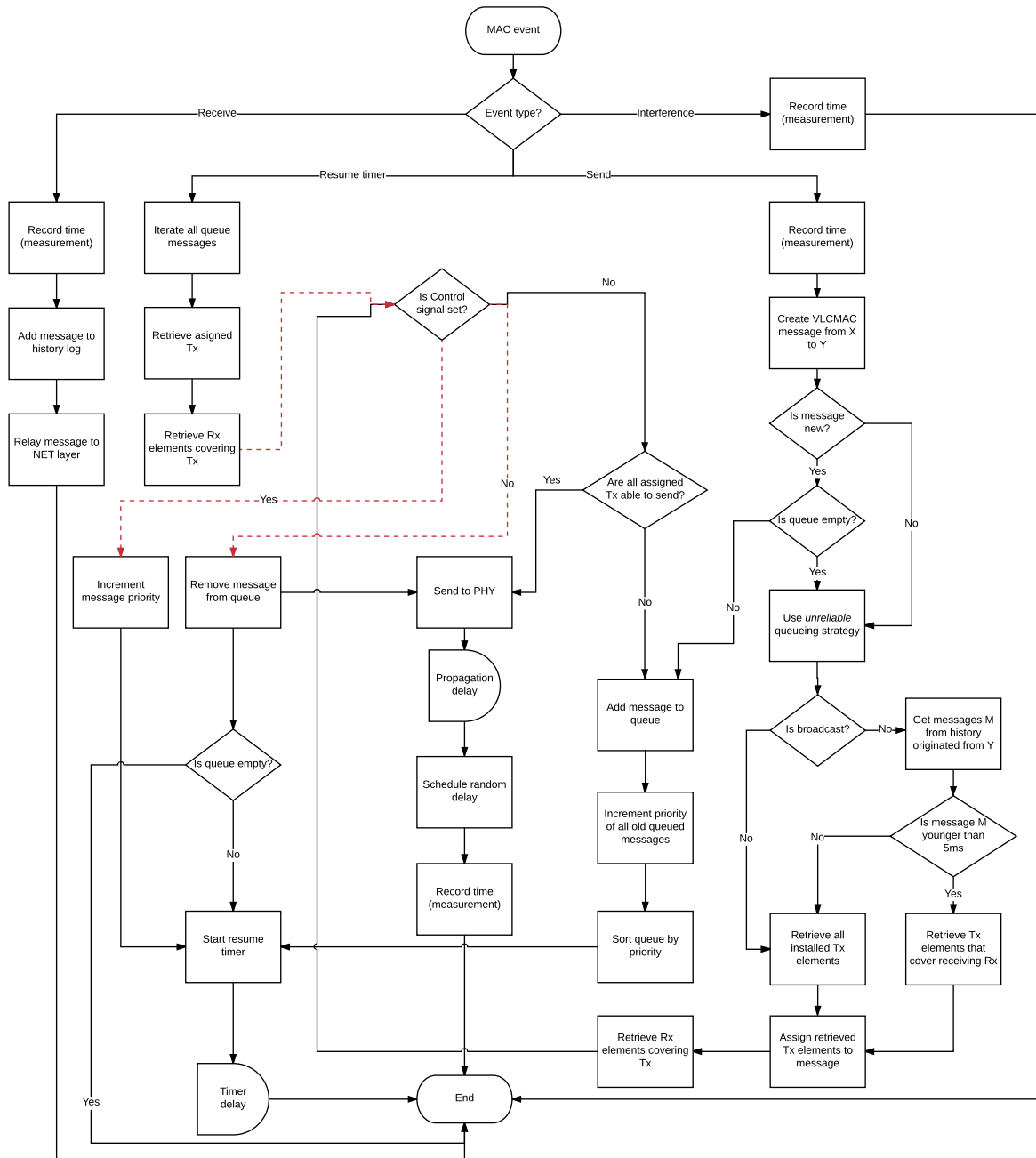

Figure 48: VLC MAC protocol for V2V and V2I/I2V workflow

5.2.9. Overview

The VLC MAC protocol for V2V uses the known concept of *control channel* to verify whether or not it should transmit. If the node is receiving but not transmitting, there is possible case of a hidden node issue. To handle such scenarios, each node should set a control signal on the Tx elements that cover the Rx elements that are receiving data.

To determine which Tx element to use when sending a message, the protocol uses a historical data log. When the destination is set, the protocol should send using the Tx elements that face the same orientation as the Rx elements that received data from the destination in the past. This information has a short lifespan, preventing a situation in which positions significantly change so there is no LOS between source and destination anymore.

Interference detection is tied with PHY, where the VLC radio device notifies the MAC protocol of such an event. Not every interference is destructive, meaning that messages can be received regardless of interference incidence. The VLC radio manages such events and the MAC layer is not even aware that the message is received while being interfered because it is not relevant for the MAC protocol. However, there are cases of destructive interference in which the message is not received. In such cases, an event is raised informing the MAC protocol about which Rx element interference occurred. With such a mechanism, the protocol allows some time and checks the channel state again. Because of mobility, the state of the channel will change, allowing the message to be sent again. Also, the same conditions apply on a control channel where this back off period allows conditions to change. It is possible that the VLC MAC protocol for V2V never receives a message, making it unreliable. The unreliable nature of the protocol is caused by the channel design and linearity, meaning that two vehicles driving parallel on the same road will never share the same medium. It is up to the network layer to define the appropriate route in such cases. The transport layer should manage the reliability of messages in cases in which the VLC MAC protocol for V2V fails due to the dynamic nature of vehicle positions, linearity, and orientations.

The VLC MAC protocol for V2V does not provide for the correct ordering of messages received because it uses a smart queuing system in which messages are ordered by priority. Messages that are queued have a floating priority that changes when a new message is being enqueued and/or retransmission occurs.

Working implementation of the VLC MAC protocol for V2V is implemented as a *MacVLCVI.java* class. During development, it was tested on small-scale simulation scenarios like 2 nodes single hop environments with low CBR and small packet sizes. Small-scale simulation scenarios were used because of development equipment performance.

6. Simulation experiment

This chapter describes the main simulation experiment. The precise parameters and plan are defined to benchmark and validate the previously defined VLC MAC protocol for V2V and V2I/I2V against the referent protocol. The set of metrics is defined and the metrics data collection mechanism is presented and validated. Scenarios are divided into two major groups: static and mobile. When designing experiment scenarios, typical situations in networks and in traffic are reproduced. After data is gathered, it is analyzed, interpreted and presented graphically. Results have an implication on the testing of the H2 hypothesis.

*The chapter addresses questions **RQ1** and the subquestions defined in Section 1.3.1*

6.1. Metrics

To compare two or more implementations of different MAC protocol, there must be appropriate metrics and a mechanism that collects data defined by a metric. As stated before (3), the selected NSE does not have an appropriate implementation for the design, simulation, and evaluation of MAC protocols.

6.1.1. Definition of metrics

MAC protocol behavior has some measurable characteristics that can be interpreted as the MAC protocol *quality*. Throughout the scientific community, various characteristics have been measured. According to Tzeng and Chen, "Performance is measured in terms of drop rate and mean delay" [155]. Ahmed defines metrics: *Packet Deliver Ratio (PDR)* and *Mean Packet Latency* [4]. Guerra et al. define packet success ratio as the fraction of all transmitted packets that successfully reach their destination [51]. Han et al. state that "packet Delivery Ratio (PDR) is used as a metric for evaluating the reliability related to packet transmission and reception" [55]. It can be summarized that:

- PDR
- Average packet latency

are legitimate MAC performance metrics.

PDR is defined as the ratio between the received messages by the destination and the generated packets by the source. In case of broadcast, PDR has an inconclusive meaning, NSE does not know to which destination a package should be delivered. There might be a scenario in which broadcasts would be analyzed in the context of the local node area. However, such calculations are highly CPU intensive and very disadvantageous towards the VLC MAC protocol for V2V because an 802.11 Wi-Fi device has omnidirectional coverage with a truly local context whereas VLC technology has a highly segmented channel space. Because of that, PDR should be calculated only in cases in which the destination is set, providing that the routing layer defines the correct route and addressing.

PDR for measuring the performance of the VLC MAC protocol for V2V is calculated as follows:

$$PDR = \frac{M_r}{M_s} \quad (6.1)$$

where:

M_r is the number of messages successfully received

M_s is the number of sent messages

Average packet latency is calculated as follows:

$$\begin{aligned} \forall m \in M, l_i &= m_r - m_s \\ d &= \bar{l}, l = [l_1, l_2, l_3, \dots, l_i] \end{aligned} \quad (6.2)$$

where:

M is the set of all messages generated

m is an individual message

l is message latency

m_r is the time when the message was received by the MAC layer at the destination node

m_s is the time when the message was passed to the MAC layer

d is average packet latency

When calculating average latency, only successfully received messages are considered. Dropped messages are discarded from latency calculations because they never had a receiving time. PDR

is the appropriate metric to handle dropped messages and their effect on performance. Messages that do not contain information, for example RSC/CTS messages in IEEE802.11 are not considered in time measurements.

In terms of MAC protocol metrics, PDR is a value between 0 and 1. A perfect MAC protocol has a PDR value equal to 1, meaning that no messages have been dropped. In real-case scenarios, this rarely happens. Average packet latency is a metric that tells us how long it takes for a message to be sent from the entry point at the MAC layer on one node to the exit point at the MAC layer on another node. Latency is the appropriate metric because it includes all delays present on a node, including transmission delay in the channel and MAC processing delay, message queuing, etc. Latency has many independent variables that are not controlled by the MAC protocol itself. When applied to a large set of measurements, the effect of those independent variables is minimized by the average function. One of these is the speed of transmission and delay caused by EM wave propagation fluctuations in the channel.

Throughput as a metric is defined as a *fraction* of channel capacity used for data transmissions. It can be expressed as a number(fraction) or as absolute value in same units as channel capacity, e.g. bps. If expressed as a fraction then it tells what percentage of possible capacity is used to transmit valuable information. Theoretically it is not possible to have single hop channel that has throughput equal to 1. Single data stream without headers and error checking could achieve throughput, however it is not useful in network communications. Throughput is calculated as

$$\mu = \frac{M}{C \cdot T} \quad (6.3)$$

where:

- μ is throughput as a fraction between 0 and 1.
- M is message size in bits.
- C is channel capacity in bps.
- T is time in seconds required to send message throughout the network.

Throughput is a derivative metric that is very convenient to express performance of MAC protocol. It can be calculated on single message or total experiment duration. Because being derivative and not fundamental throughput is only calculated in last simulation experiment.

6.1.2. Randomness in NSE

In Section 3.6, randomness was recognized as a natural occurrence caused by EM noise fluctuations; also, in the referent protocol there is a random backoff time. NSE has a single point (class) as a random number generator. To minimize the effect of randomness, this random generator, in measurements mode, generates non-random numbers. This feature is used only in the metrics measurements mode that is activated by setting *MeasurementMode* to *true* in the input XML configuration file. By using measurement mode, NSE provides an experimental environment that is suitable for measurements when using different MAC implementations on the same scenarios. In simulations that use mobility, *MeasurementMode* has no effect and vehicles move truly on random destinations as configured.

NSE and MCS support random vehicle dimensions using base dimensions and a difference that is randomly chosen. In *MeasurementMode*, all vehicles have the same size.

When generating data traffic, NSE randomly assigns sources and destinations. In *MeasurementMode* source and destination nodes are assigned using the assignment function d , which retrieves the node destination ID for given parameters:

$$d(s, N) = N - s - 1 \quad (6.4)$$

where:

s is source id

N is total number of nodes

6.1.3. Implementation in NSE

The MAC performance metrics system is not present in the latest implementation of NSE. To perform the MAC protocol evaluation using metrics, it is necessary to gather data. Necessary data is: message send and message receive times, as well as the existence (or absence) of a message on the destination node. NSE stores times inside of a *NetMessage* object. *NetMessage* is a data container on a Network layer, an upper layer of the Data link layer that contains the MAC protocol. The reason why *NetMessage* is used is to isolate any influence of MAC layer implementation on measurements. Figure 49 shows the class diagram of the *TimeEntry*

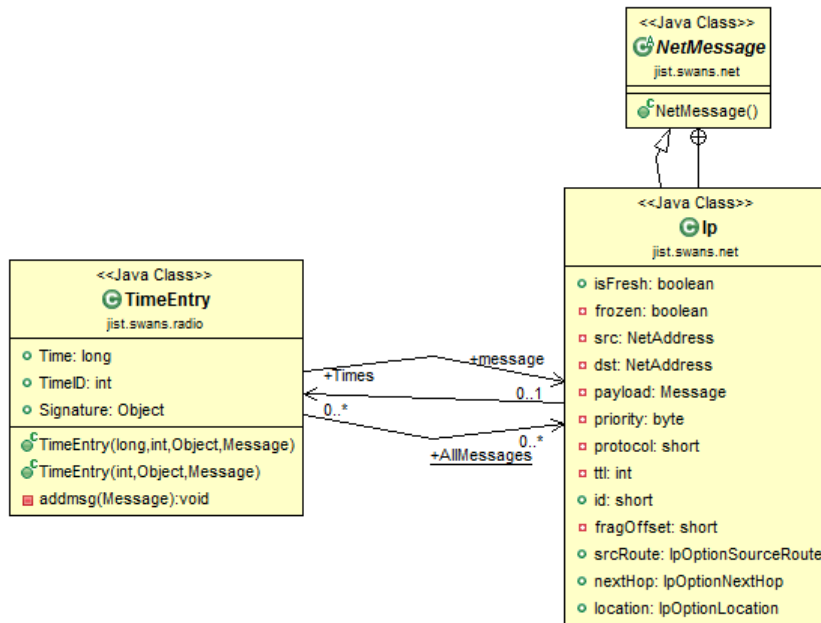

Figure 49: TimeEntry class and usage in NetMessage class

class and how it is used in the *NetMessage.IP* class. TimeEntry contains a static collection of all NetMessages in the current simulation. When NetMessage is created, it is added to the collection. Each instance of *NetMessage.IP* subclass has one TimeEntry collection that contains specific time measurements related to the specific message. Aside from the actual time measurement, sole entry existence contains valuable information that was used when designing the VLC MAC protocol for V2V and V2I/I2V. Throughout the network stack time is measured at specific locations and events. Each measurement is identified by a *TimeID* property that can have these values:

- 0 - when and if the message is created
- 1 - when and if the message is passed to the MAC layer.
- 11 - when and if the message can be sent, after checking whether the element is idle and control signal states.
- 12 - when and if the message is added to the queue.
- 13 - when and if the message is at a MAC layer and has specific destination.
- 14 - when and if the message is at a NET layer and has a specific destination (after net delay).
- 2 - when and if the message is relayed by the MAC layer to the underlying layer (transmit before check).

- 21 - when and if the message is relayed by the MAC layer to the underlying layer (transmit after check).
- 250 - when radio RadioVLC received the message on the other side (without physical checking done).
- 251 - when radio RadioVLC received the message on the other side and it is physically ok but before propagation delay.
- 252 - when and if radio RadioVLC received the message on the other side and after propagation time and interference check, just before relaying to the MAC layer.
- 3 - when and if the MAC layer received the message.
- 31 - when and if the MAC layer received the message and if the message is on the desired destination.
- 4 - when and if the MAC layer relayed the message to the upper layer (NET).
- 41 - when and if the message is not dropped on a NET layer.
- 5 - when and if the MAC layer relayed the received message to the upper layer and the message is on the desired network destination.
- 6 - when and if the message has passed ifForMe(...) check on a NET layer.
- 70 - when and if the message is on the PHY (radioVLC) layer and on the desired destination (evaluated after timeID=251)
- 81 - when and if the message is dropped on a PHY layer due to asymmetry (global position, usually range)
- 82 - when and if the message is dropped on a PHY layer due to asymmetry (positional)
- 84 - when and if the message is dropped on a PHY layer due to asymmetry (design)
- 90 - when and if the message is dropped because of interference
- 92 - when and if the message is dropped because of transmit fail
- 93 - when and if the message is dropped because of receive fail

Times: 90, 92, 93 correspond to the event provided by RadioVLC for the MAC layer that was described earlier.

Times: 81, 82, 84 were used when analyzing the influence of asymmetry. Those time measurements are not taken in this experiment because asymmetry analysis is very CPU intensive and those values are irrelevant for MAC protocol design and performance measurements.

During a message life-cycle it is not necessary and is not the case that all the times are taken at

least once. Furthermore, it is possible that a single message has more than one measurement for the same TimeID. An example is broadcast messages in which a single message can be received by more than one node. Each receiving node would create one TimeEntry when the message is received.

Figure 36 shows that NSE can, for a single simulation, define the Results folder. In that folder, NSE generates data of all the messages and all the TimeEntry objects assigned to each message. Data is exported as a CSV file. Because of multiple times per single TimeID, results cannot be expressed as a simple 2D table. A more appropriate format would be a 3D table that would be difficult to display on a 2D surface. Because of that, a hybrid method is used in which each value has a TimeID descriptor.

Table 19: NSE-generated data sample

ID	Source	Destination	Time 1	Time 2	Time 3	...
0	0.0.0.1	0.0.0.2	0 - 60000000000	1 - 60009950232	11 - 60009950232	
1	0.0.0.1	ANY	0 - 60250050000	1 - 60251028852	11 - 60251028852	

An excerpt of such a file is shown on Table 19. The first column is the message unique ID. The second column is the IP address of a node that is the message source. The third column is also an IP address but of the destination node. This address can be ANY if the message is defined as broadcast. The rest of the columns are individual time entries. The prefix of each value is TimeID followed by a dash and the time value in nanoseconds; the format of this value is: *TimeID - Time*.

To calculate PDR, using the formula 6.1 variables are: M_r is the number of Time entries with TimeID equal to 31 and M_s is the number of Time entries with TimeID equal to 13. Both variables are measured at boundaries of the MAC layer that are in direct contact with the NET layer (send and receive methods).

To calculate *average latency*, using the formula 6.2, the value for m_r is the actual recorded time of *Time Entry* with TimeID equal to 31 and m_s the actual recorded time of *Time Entry* with TimeID equal to 1. After all time entries are summed up, average latency is calculated for all non-broadcast and non-dropped packages.

6.1.3.1. *Verification of metrics measurements system*

To verify the correctness of the metrics measurements system, a secondary simulation experiment is conducted. Because NSE is designed to perfectly simulate true network conditions, it is impossible to control network conditions that will result in a specific drop rate that will reflect on a PDR. Because of that, it was necessary to implement **Pseudo-random message destructor** on a Field level. This feature will destroy random messages based on a setting defined by the environment. Most messages are dropped because of various physical characteristics that occur in the medium. Medium transmission capabilities are implemented in a Field class. Because of that, message destruction should occur in the field and not on PHY or MAC levels.

Pseudo-random message destructor

In class *JobConfigurator.java* there are static configuration values that define the behavior of this feature:

- **DoRandomDrops** is a Boolean value that turns on or off the Pseudo-random message destructor.
- **RandomDropRate** is a float value that defines the probability that a message will be destroyed. The value should be in the interval 0.0 to 1.0 where 0 means no message will be destroyed and 1 means all messages will be destroyed.

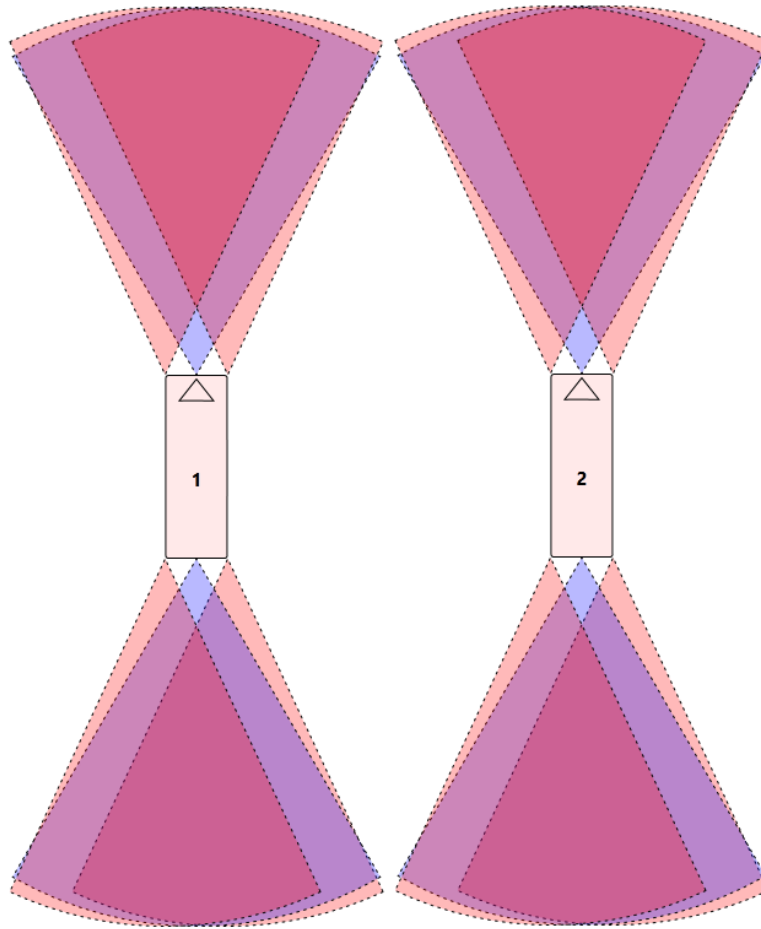

Figure 50: Metrics verification test scenario 1

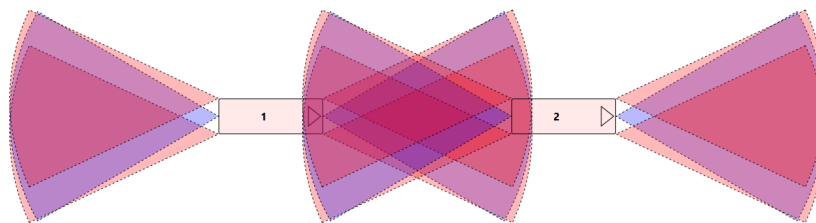

Figure 51: Metrics verification test scenario 2

To verify *Metrics measurements system* the simulation experiment scenario used is shown on Figure 50. The scenario has two nodes that do not have LOS connectivity; thus, all sent messages should be dropped and PDR should be 0. Second, the simulation experiment scenario is shown on Figure 51. It is a simple scenario with only two vehicles equipped with VLC technology (according to the previously defined model). Vehicles are perfectly aligned with clear LOS. The MAC protocol used is the referent 802.11b protocol. This scenario uses **Pseudo-**

random message destructor with varying probabilities: from 0 to 1 with incrementing steps of 0.1. The simulation job configuration file is attached as Appendix 1.

6.1.3.2. Results of metrics measurements system verification

After running simulation scenarios 1 and 2, the results are:

Scenario 1

The simulation scenario is executed for 10 iterations. All measured PDR values were equal to 0, which confirms the correctness of the metrics system in non-LOS scenarios.

Scenario 2 For each incrementing step, one simulation is executed using scenario 2. Results are shown on Figure 52. It can be noticed that the measured PDR corresponds to the expected PDR caused by *Pseudo-random message destructor*. If no message is destroyed, PDR is equal to 1, meaning that all messages are delivered in clear LOS scenarios.

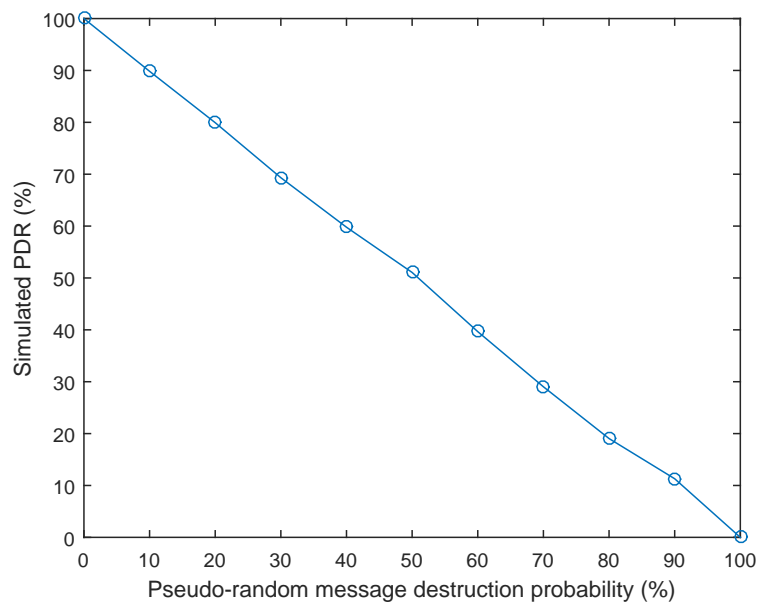

Figure 52: Metrics measurement system verification results

Average delay

When analyzing average delay, it complies with works done by Carvalho et al., Youm et al., and Vardakas et al. in which they analyzed the performance of the referent 802.11 MAC protocol in various conditions and experiments [17, 181, 164]. Among many scenarios, considered were only simple scenarios with single hop arrangements that had a low number of nodes. It is difficult to recreate the exact experimental setup because the purpose of those works was not to define simulation environments but rather to analyze network performance in various conditions.

Simulated and experimental average packet delay ranges between 0.001 and 0.025 seconds. This variation is caused by many parameters used in different simulations and experiments. Aside from layout, experiments had different CBR, bandwidth, and packet size.

Simulating *Scenario 2* with exact parameters, as the authors did in their experiment, resulted in similar average delays ranging between 0.0014 and 0.029 seconds. Again, 10 simulation runs were conducted. Although the results are slightly different, variations in parameters result in the same variations in previous experiments conducted by other authors. Also, slight differences are caused by unknown durations, an unknown number of messages and an unknown spatial layout of network nodes.

6.2. Experiment setup

In this section, the procedure and setup of the simulation experiment is presented. The purpose of these simulation experiments is to measure and evaluate the performances of MAC protocol implementations defined in 5.1 and 5.2. Metrics for such evaluations are defined in the previous section.

Each implementation will use the same experiment parameters and *measurement mode* (described in 6.1.2) while being simulated.

Experiment simulations are to be conducted on a grid computer network at the University Computing Center at the University of Zagreb¹. A computer grid is used because it allows for the parallel execution of large-scale and complex simulation scenarios.

Complexity, in the scope of this experiment, is defined by the number of vehicles, their positions and orientations, the simulation duration, and the level of mobility. The direction of *complexity increase* goes towards an increase in vehicle numbers, simulation duration. Furthermore, more complex scenarios will include vehicular mobility and random vehicle positioning and orientations.

6.2.1. Simulation scenarios

The experiment setup is organized as various *Simulation scenarios* that define a set of environmental and network conditions, vehicle dimensions and positions for each simulation experiment run. Each vehicle has assigned VLC equipment (Tx/Rx) according to the model defined

¹www.srce.unizg.hr/isabella

in Section 3.5 and shown on Figure 32.

The experiment will include three types of simulation scenarios:

- **Static environment:** This type will have several simulation scenarios, each depicting specific network empirical conditions. For example: *Hidden node terminal* is a well-known problem in networking and will certainly represent one static simulation scenario, where others might focus on more realistic conditions (vehicle positions) that may occur in traffic.
- **Random environment:** This type should result in simulation scenarios with random vehicle layout in a free space grid.
- **Real-world environment:** This type will include simulation scenarios that are defined using a spatial map of Suffolk, Virginia, USA.

Although the VLC MAC protocol for V2V and V2I/I2V covers infrastructure, a single infrastructure node can be considered a static mobile node (vehicle). An infrastructure element, like a traffic light, should not have different physical and communication capabilities. Furthermore, static (infrastructure) nodes can have better coverage because they can be designed and produced individually. In communication networks, a more capable device does not create a bottle neck for network performance; even more, it may augment and improve it. In this experiment, a single node and its movement and behavior are bottle necks for network performance.

6.2.1.1. Static environment

The static environment contains six different scenarios. Each of those differs in number of nodes and placement. Simulation experiment parameters are common for all static scenarios and are shown on Table 20. In the table, all parameters are the same for all scenarios except parameter *Number of nodes*, which is a variable depending on the actual scenario node number.

Table 20: Simulation experiment parameters - Static scenarios

Parameter	MAC protocol 1	MAC protocol 2
<i>Field</i>		
Map	Open space	Open space
Placement	Static	Static
Mobility model	Static	Static
Pathloss	VLC	VLC
Number of nodes	2-12	2-12
<i>Node</i>		
Node design	Node1	Node1
Radio	VLC radio	VLC radio
MAC protocol	VLC MAC	802.11
<i>Network</i>		
CBR packet size	1024 B	1024 B
CBR	2048	2048
Encryption	No	No
Bandwidth	10000000 bps	11000000 bps
Routing protocol	AODV	AODV
<i>Simulation</i>		
Number of runs	10	10
Single run duration (simulation time)	1000 s	1000 s
Single run duration (estimated actual time)	49 min	45 min

Two nodes

This scenario is shown on Figure 53. The scenario contains two nodes with clear LOS. It is expected that all simulation runs will result in near 100 % PDR regardless of the protocol used.

Please note that Tx/Rx LOS is 4 times larger than shown in editor

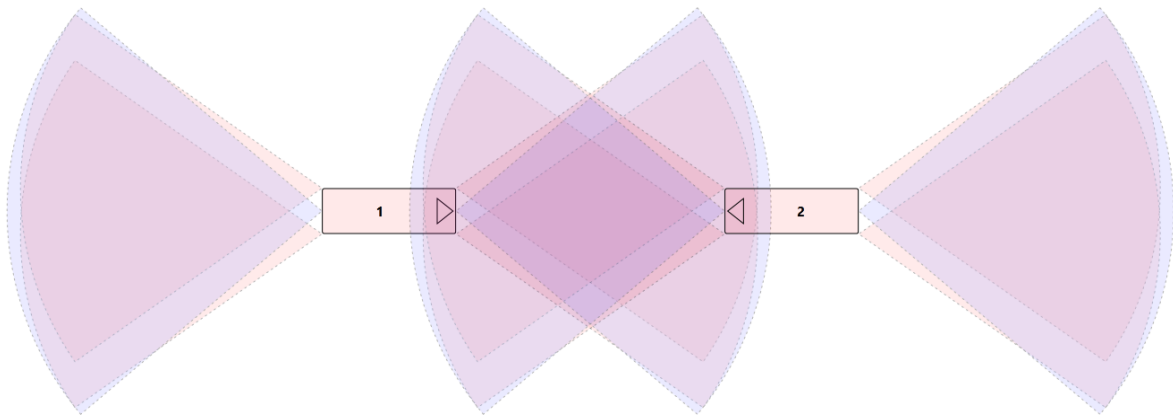

Figure 53: Two nodes

Hidden node

This scenario is shown on Figure 54. The scenario contains three nodes, where node 3 has clear LOS with nodes 1 and 2. However, nodes 1 and 2 do not have clear LOS and are not able to communicate directly. Furthermore, nodes 1 and 2 are not aware of each other and of whether there is an ongoing transmission between 1 and 3 or 1 and 2. This is a known problem in a computer networking called hidden terminal [53]. Nodes 1 and 2 can cause transmission interference and collision on node 3 if they transmit at the same time.

Please note that TxRx LOS is 4 times larger than shown in editor

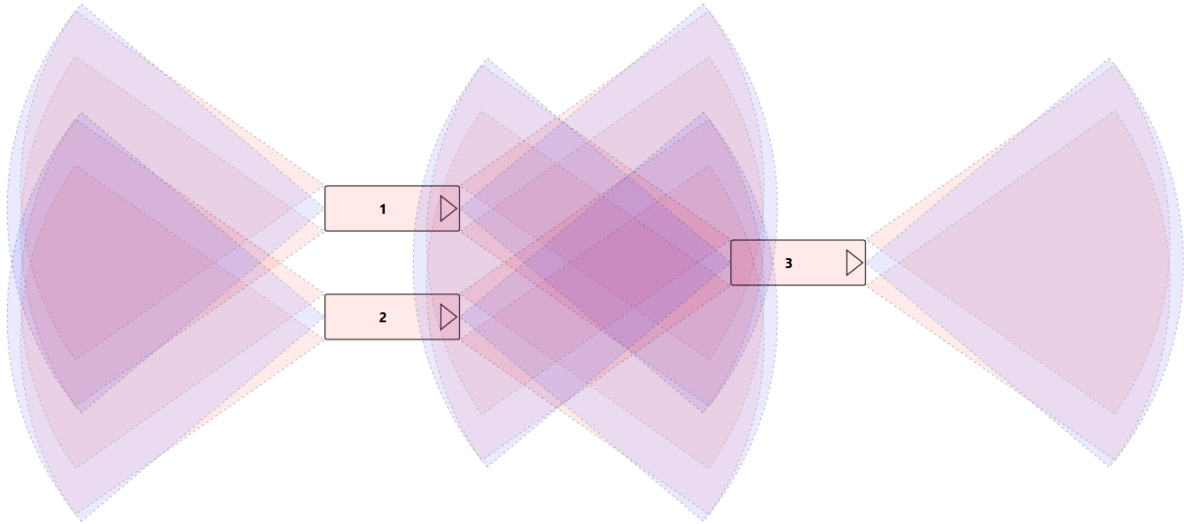

Figure 54: Hidden node

Four nodes

This scenario is shown on Figure 55. It consists of four nodes aligned in a rectangle vertex. Also, this scenario has two hidden terminals (nodes). It represents a typical vehicle position on a double lane road.

Please note that TxRx LOS is 4 times larger than shown in editor

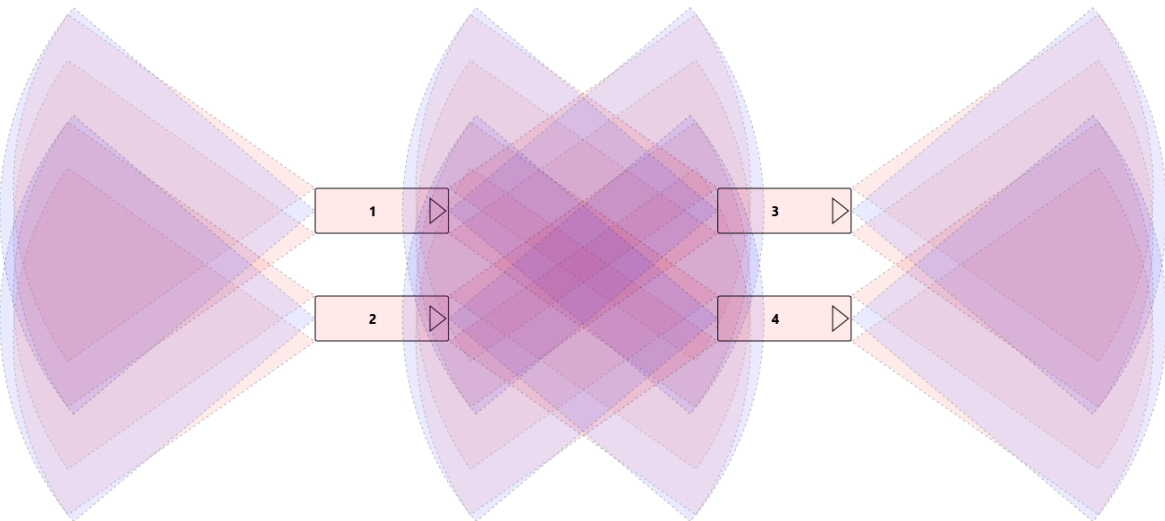

Figure 55: Four nodes

Nine nodes

This scenario is shown on Figure 56. It consists of nine nodes aligned in a grid. Also, this scenario has multiple hidden terminals (nodes). This scenario also depicts situations in which one vehicle obstructs LOS between other two vehicles; for example, LOS between nodes 1 and

7 is obstructed by node 4. This scenario represents typical vehicle positions on a triple lane road.

Please note that TxRx LOS is 4 times larger than shown in editor

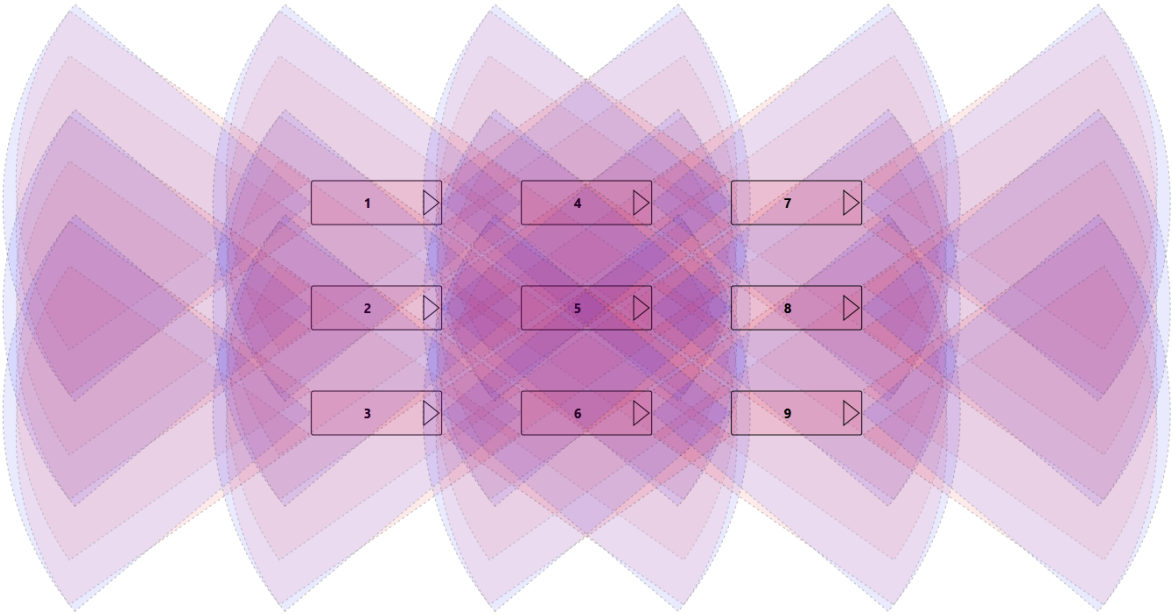

Figure 56: Nine nodes

Twelve nodes

This scenario is shown on Figure 57. It consists of nine nodes aligned in a grid and three nodes that converge to the three-by-four grid. This scenario inherits the previous scenario's complexity and represents typical vehicle positions on a triple lane road with a joining fourth lane.

Please note that TxRx LOS is 4 times larger than shown in editor

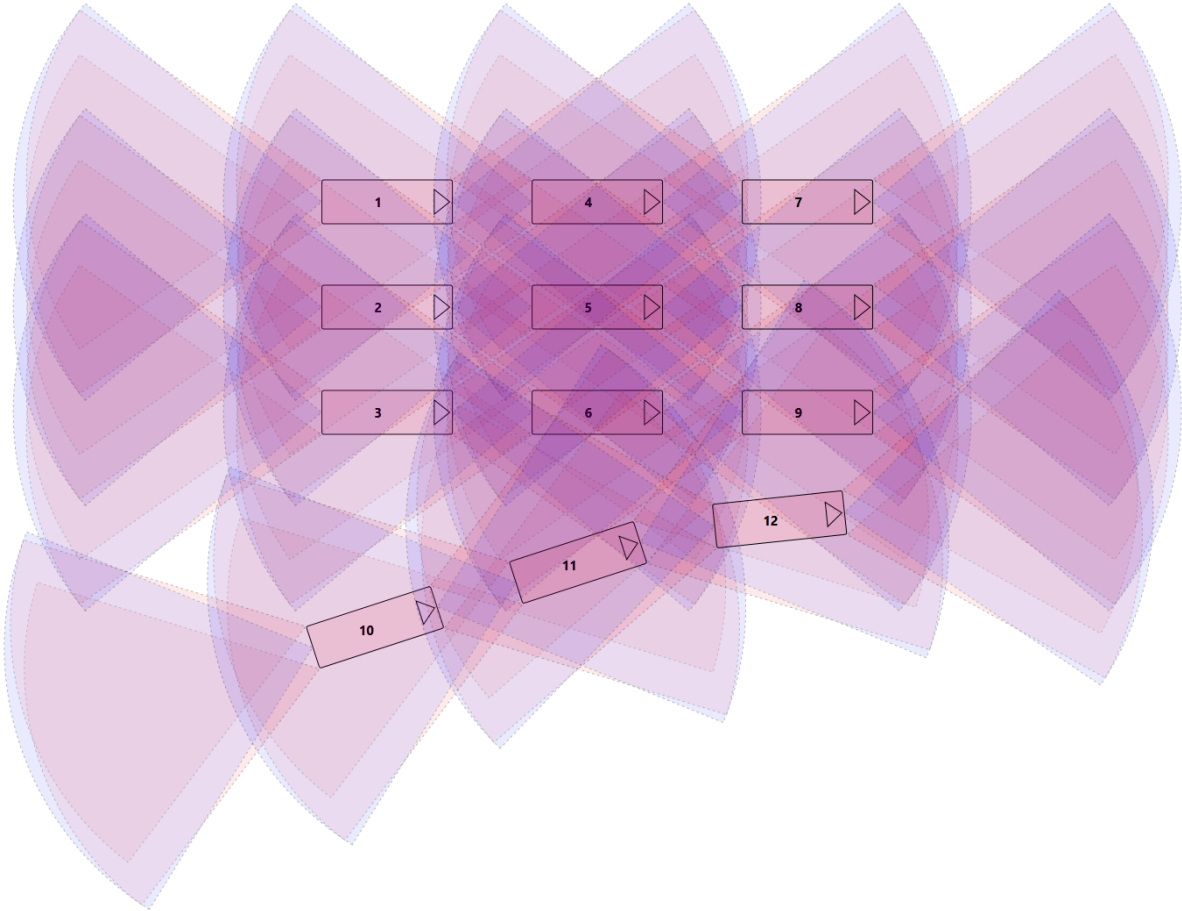

Figure 57: Twelve nodes - lane join

Crossroads

This scenario is shown on Figure 58. It consists of eight nodes. This scenario represents the typical situation at a crossroads (traffic light) where two double lane roads cross with each other.

Please note that TxRx LOS is 4 times larger than shown in editor

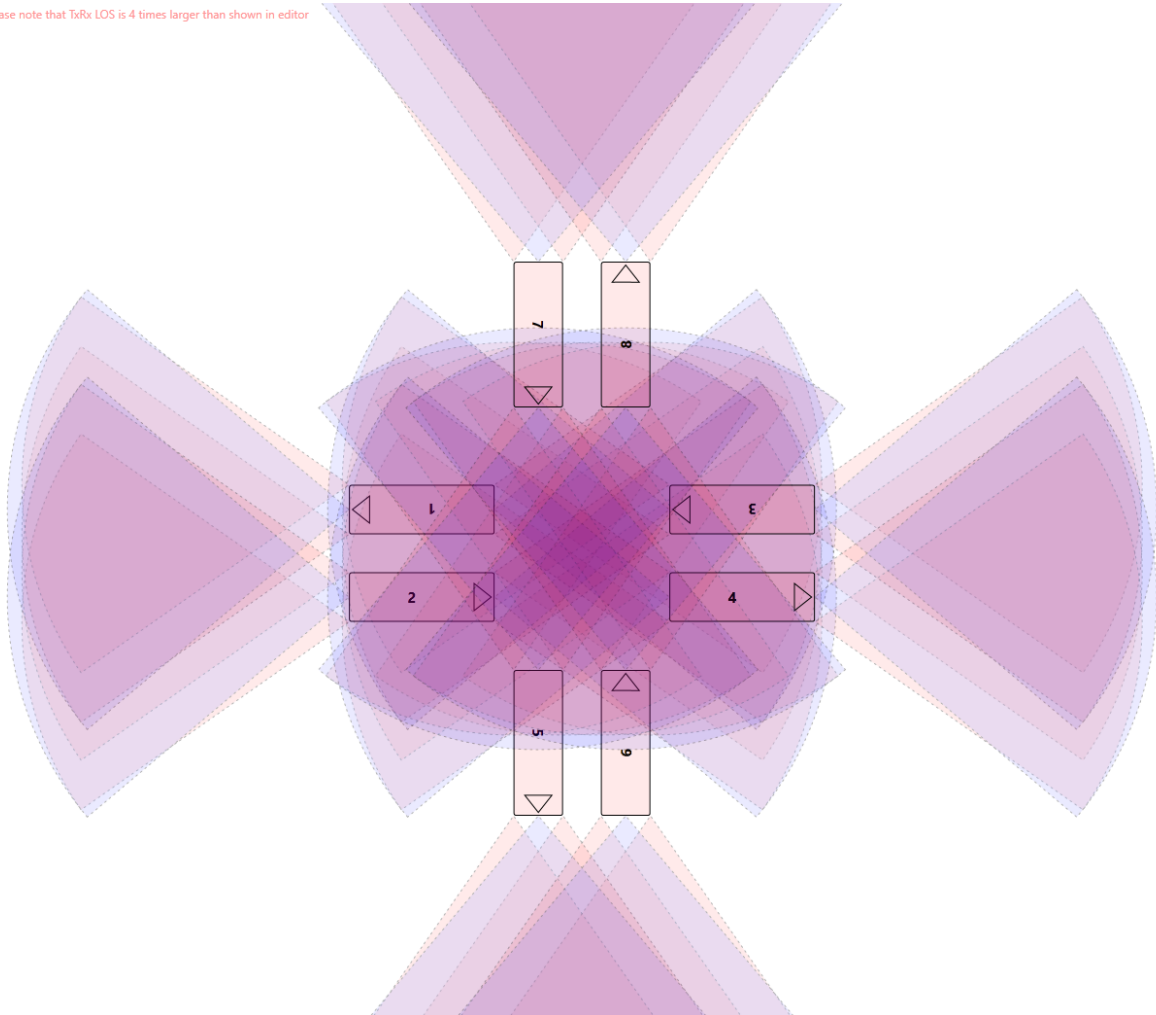

Figure 58: Crossroads

Roundabout

This scenario is shown on Figure 59. It consists of eight nodes aligned on a single circumference. This scenario represents the typical situation at a roundabout with a maximum capacity of vehicles.

Please note that TxRx LOS is 4 times larger than shown in editor

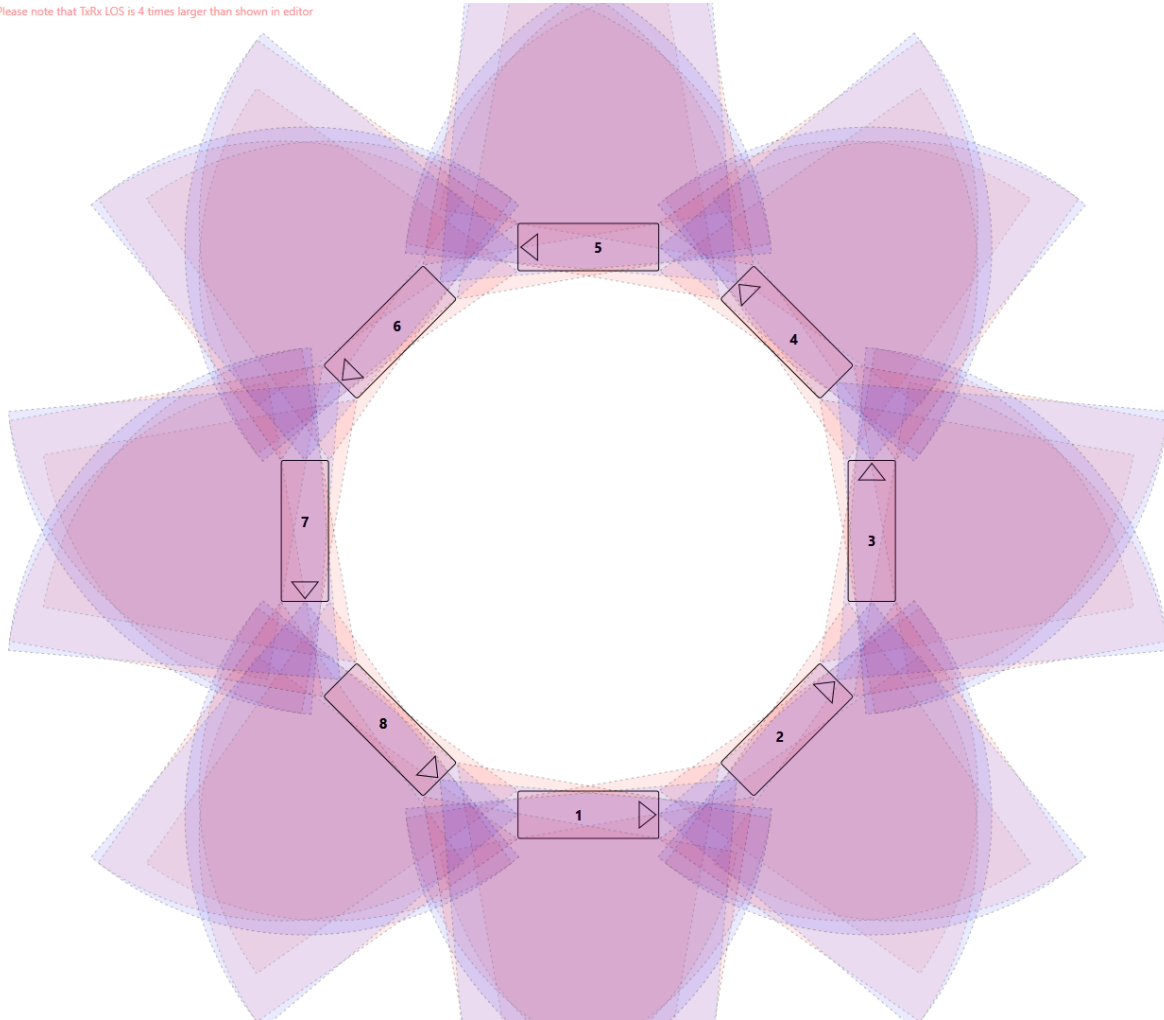

Figure 59: Roundabout

This concludes the definition of static scenarios. There are many other situations that are more complex with respect to the placement and number of vehicles. However, in 2D environments, each complex situation can be simplified to any of the static scenarios presented previously.

6.2.1.2. *Random environment*

The random environment will use three scenarios with 11 vehicles positioned randomly using the MCS *randomize* feature. The number of vehicles is selected based on current MCS running environment limitations. Random generation of nodes is heavy on resources. This number is still larger than 8.3, the average number of visible vehicles, defined by the experiment in Section 5.2.0.1

The random scenarios used are shown on Figure 60, Figure 61, Figure 62.

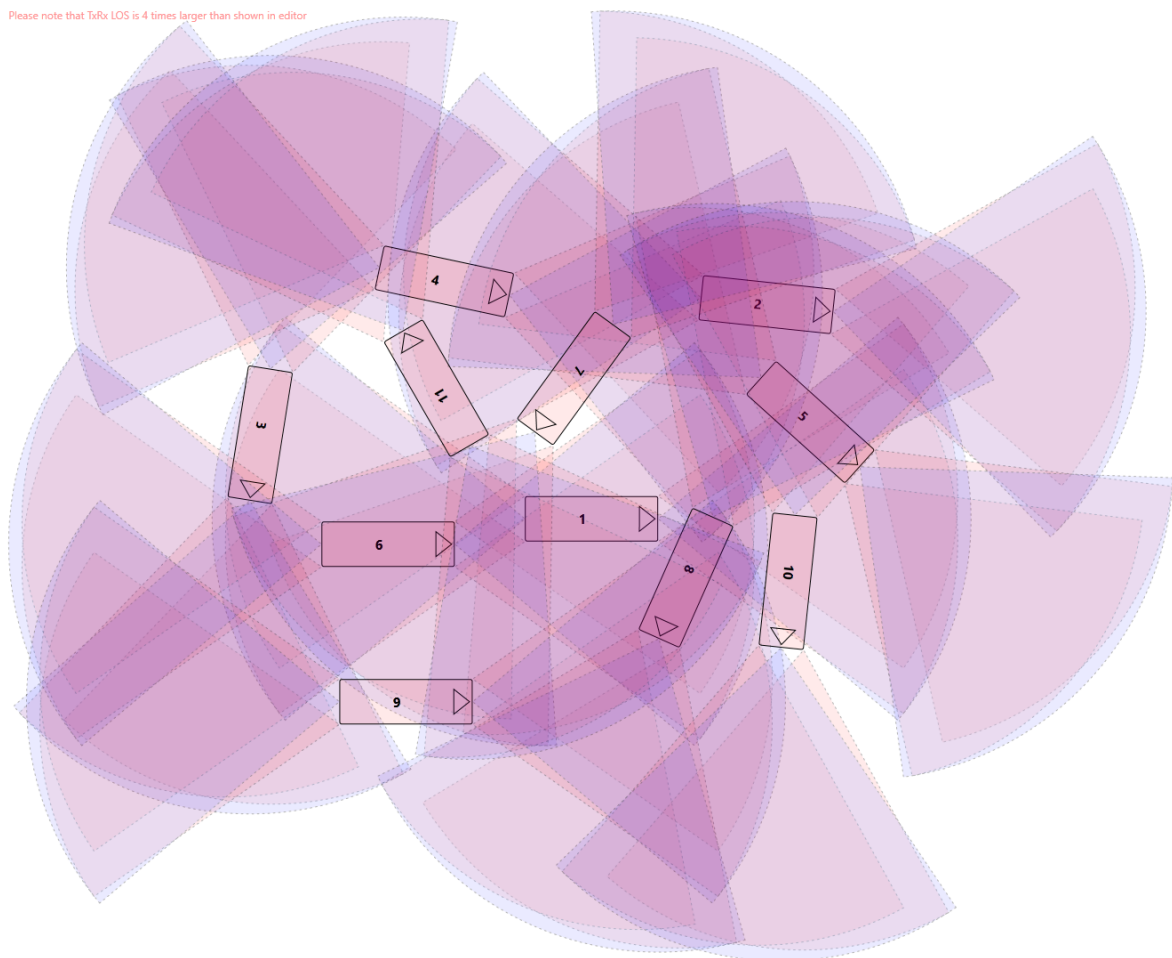

Figure 60: *Random scenario 1*

Please note that TxRx LOS is 4 times larger than shown in editor

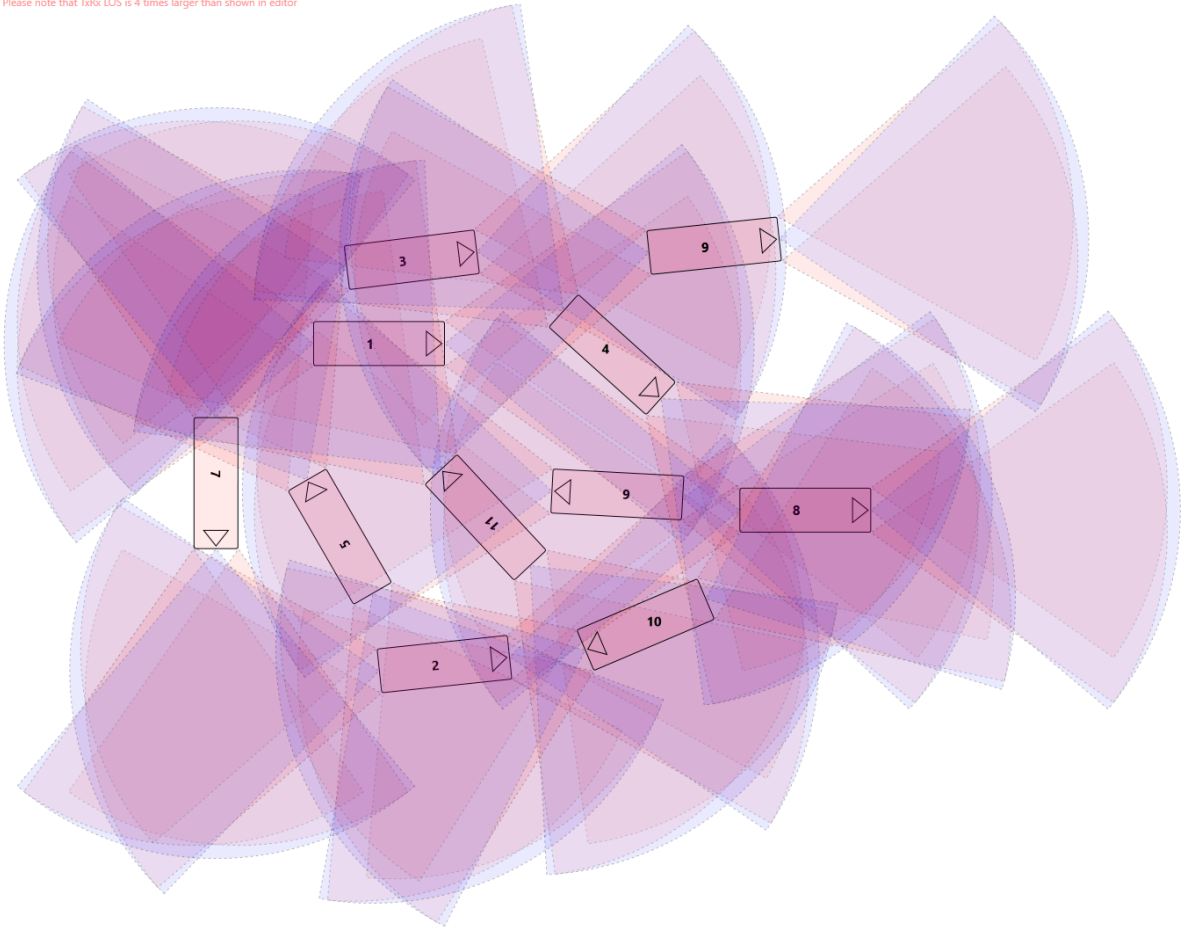

Figure 61: Random scenario 2

Please note that TxRx LOS is 4 times larger than shown in editor

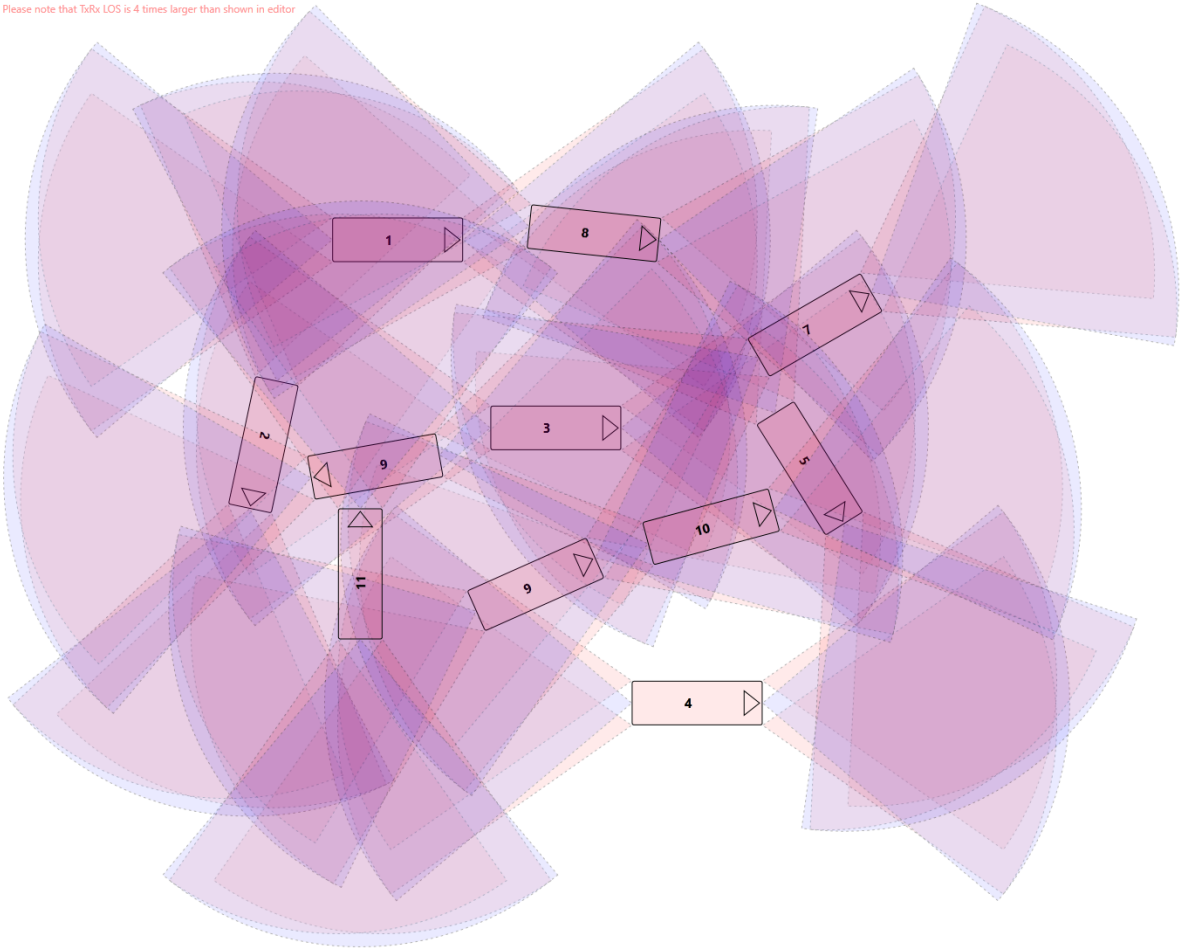

Figure 62: Random scenario 3

Table 21: Simulation experiment parameters - Random scenarios 1, 2, and 3

Parameter	MAC protocol 1	MAC protocol 2
<i>Field</i>		
Map	Open space	Open space
Placement	Random	Random
Mobility model	Static	Static
Pathloss	VLC	VLC
Number of nodes	11	11
<i>Node</i>		
Node design	Node1	Node1
Radio	VLC radio	VLC radio
MAC protocol	VLC MAC	802.11
<i>Network</i>		
CBR packet size	1024 B	1024 B
CBR	2048	2048
Encryption	No	No
Bandwidth	10000000 bps	11000000 bps
Routing protocol	AODV	AODV
<i>Simulation</i>		
Number of runs	10 per scenario	10 per scenario
Single run duration (simulation time)	1000 s	1000 s
Single run duration (estimated actual time)	181 min	132 min

The simulation experiment parameters are shown on Table 21 for experiments including nodes with random spatial positioning.

6.2.1.3. *Real-world environment*

Scenarios in a real-world environment will use an actual street network in Suffolk, Virginia, USA. Unlike static and random scenarios, these scenarios will use moving nodes. Nodes move using different speeds. The location of the node is determined by a random function. Also, the destination of a node is determined by a random function. When the node reaches its designated destination, a new destination is randomly selected. This procedure is called Street Random Waypoint (STRAW) as defined by Choffnes and Bustamante [24]. Nodes move on streets following standard traffic rules like roundabout procedures, right turns, and traffic lights at crossroads. The simulation experiment parameters are shown on Table 22.

Table 22: Simulation experiment parameters - mobility

Parameter	MAC protocol 1	MAC protocol 2
<i>Field</i>		
Map	Suffolk, VA, USA	Suffolk, VA, USA
Placement	Street random	Street random
Mobility model	STRAW	STRAW
Pathloss	VLC	VLC
Number of nodes	50	50
<i>Node</i>		
Node design	Node1	Node1
Radio	VLC radio	VLC radio
MAC protocol	VLC MAC	802.11
<i>Network</i>		
CBR packet size	1024 B	1024 B
CBR	12500	12500
Encryption	No	No
Bandwidth	10000000 bps	11000000 bps
Routing protocol	AODV	AODV
<i>Simulation</i>		
Number of runs	20	20
Single run duration (simulation time)	1000 s	1000 s
Single run duration (estimated actual time)	46080 min	46080 min

This concludes the simulation scenarios selection procedure.

6.3. Results of simulation experiments

After executing all the defined simulation scenarios in the previous section, gathered data was analyzed and presented graphically using licensed Matlab software. In most cases, data is sorted. Because each simulation run in a single scenario is an independent event, sorting does not influence the measured characteristics of each MAC protocol implementation. Results are represented by two graphs. The first one shows PDR performance and the second one shows the average message delay. Both graphs have the average *trend line* for both protocols (dashed lines). Figure 63 shows the legend for average delay graphs. The first line in a legend (graph) shows the actual values of the message average delay for the VLC MAC protocol for V2V, while the second line shows the average *trend line* of the *average delay* for all simulation runs using the new protocol. The third line shows the actual values of message average delay for the referent protocol, while the fourth line shows the average *trend line* of the *average delay* for all simulation runs using the referent protocol.

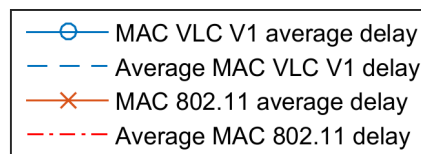

Figure 63: Average delay results legend

Table 23 shows some facts of gathered data.

All the collected data within this research, along with software code, is publicly available in a public GitHub repository (details in Section 1.5).

Table 23: Quick facts about the collected data

Number of simulation runs	240
Results files generated	960
Total data generated	246.64 GB
Total memory used	690.41 GB
Number of created messages (data only)	1571280
Number of vehicle objects created	3580
Total simulation time	66.67 h
Total actual time	40 days

6.3.1. Static environment

Simulation scenarios using static environments yield the following results:

Two nodes

Simulation results using the configuration shown on Table 20 and the node layout shown on Figure 53 are shown graphically on Figure 64 and Figure 65. Both VLC MAC for V2V and the referent protocol have the same PDR - 100 %. This is caused by the simplicity of the simulation scenario. Considering all the simulation runs, the average message delay for VLC MAC for V2V is 24.048 % shorter than the average delay in the referent protocol.

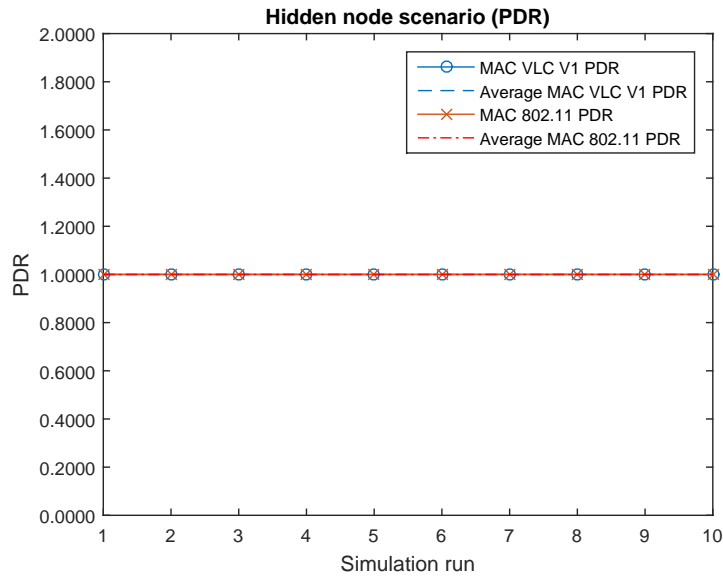

Figure 64: MAC performance (PDR) in two-node scenario

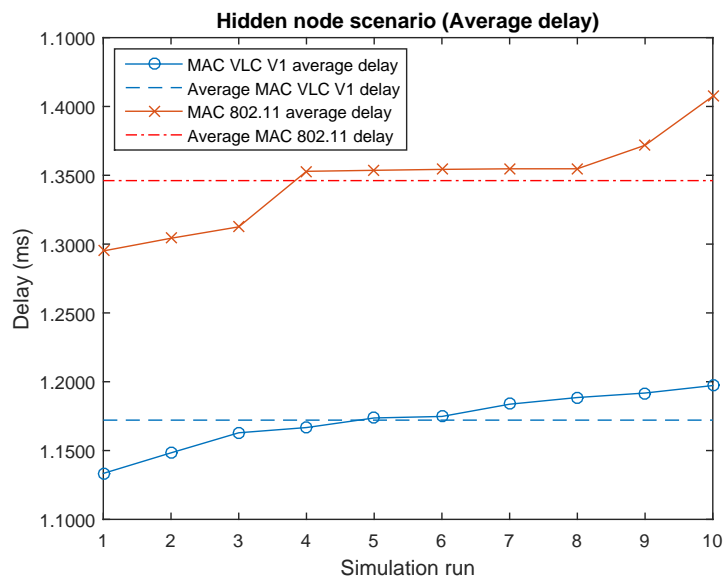

Figure 65: MAC performance (delay) in two-node scenario

Hidden node

Simulation results using the configuration shown on Table 20 and the node layout shown on Figure 54 are shown graphically on Figure 66 and Figure 67. VLC MAC for V2V has shown an insignificantly better PDR rate; on average, it is only 0.2478% better than the referent protocol. Considering all the simulation runs, the average message delay is 14.985% shorter than the average delay in the referent protocol.

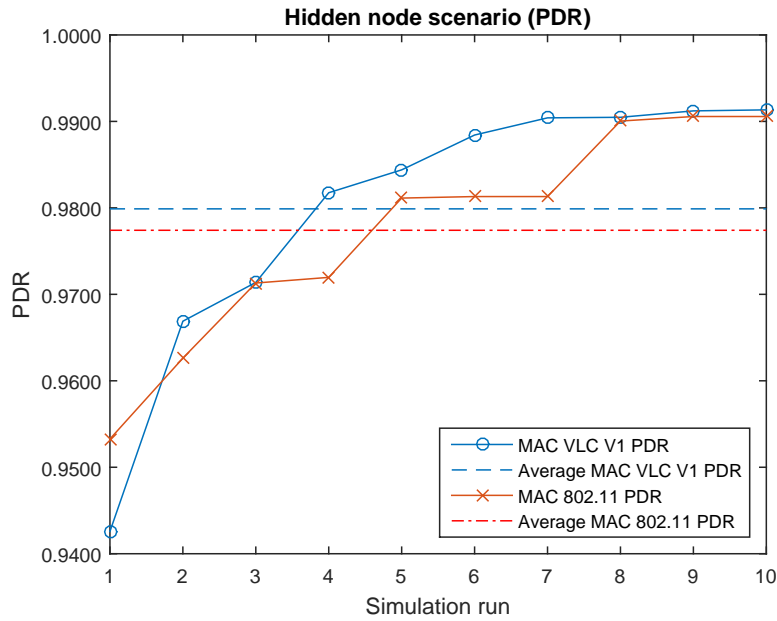

Figure 66: Hidden node MAC performance (PDR)

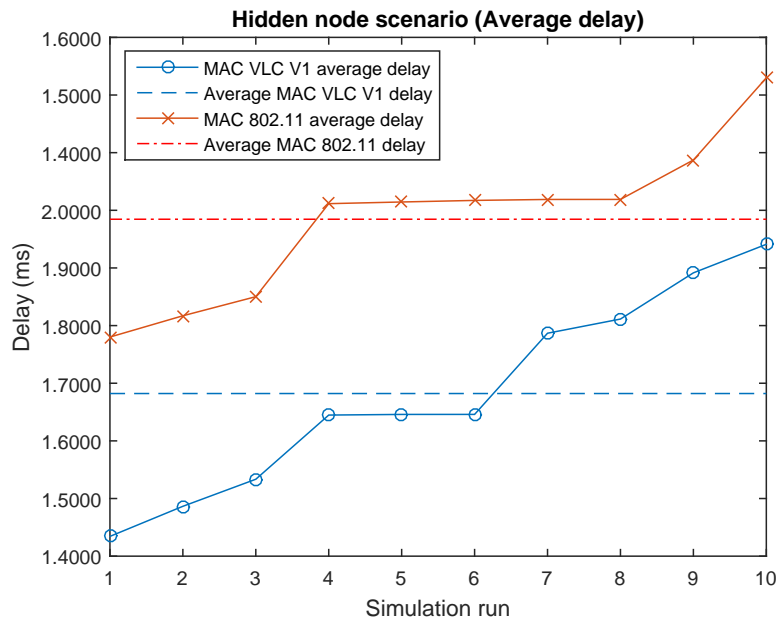

Figure 67: Hidden node MAC performance (delay)

Four nodes

Simulation results using the configuration shown on Table 20 and the node layout shown on Figure 55 are shown graphically on Figure 68 and Figure 69. VLC MAC for V2V has shown an insignificantly better PDR rate; on average, it is only 0.2273 % better than the referent protocol. Considering all the simulation runs, the average message delay is 14.431 % shorter than the

average delay in the referent protocol.

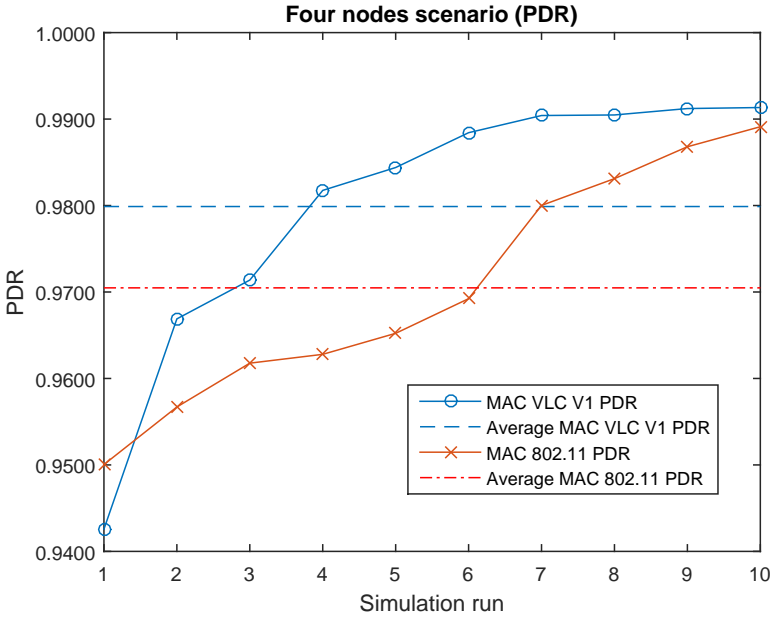

Figure 68: MAC performance (PDR) in four-node scenario

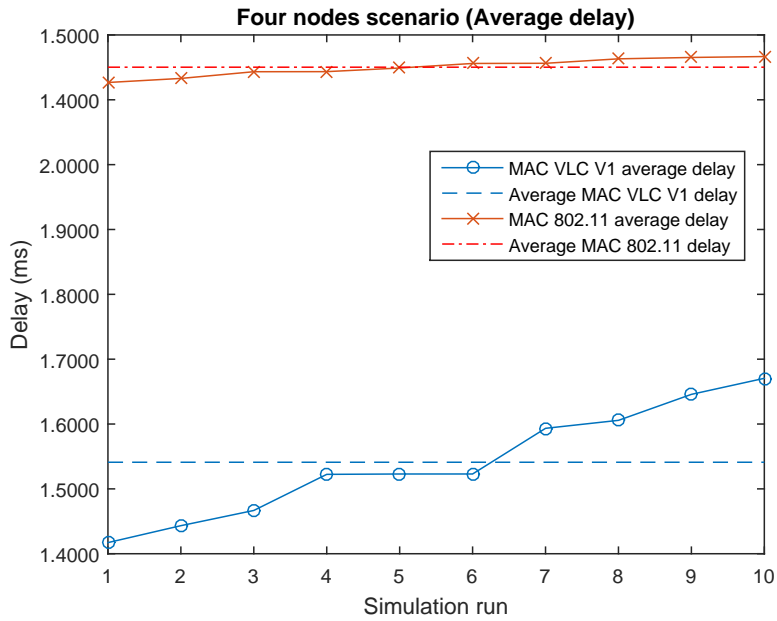

Figure 69: MAC performance (delay) in four-node scenario

Nine nodes

Simulation results using the configuration shown on Table 20 and the node layout shown on Figure 56 are shown graphically on Figure 70 and Figure 71. VLC MAC for V2V has shown a somewhat better PDR rate; on average, it is 8.607 % better than the referent protocol. Considering all the simulation runs, the average message delay is 18.811 % shorter than the average delay in the referent protocol.

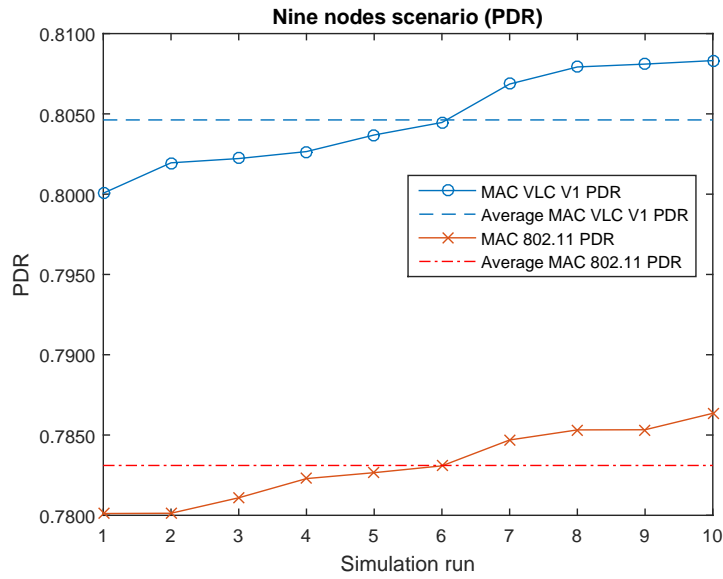

Figure 70: MAC performance (PDR) in nine-node scenario

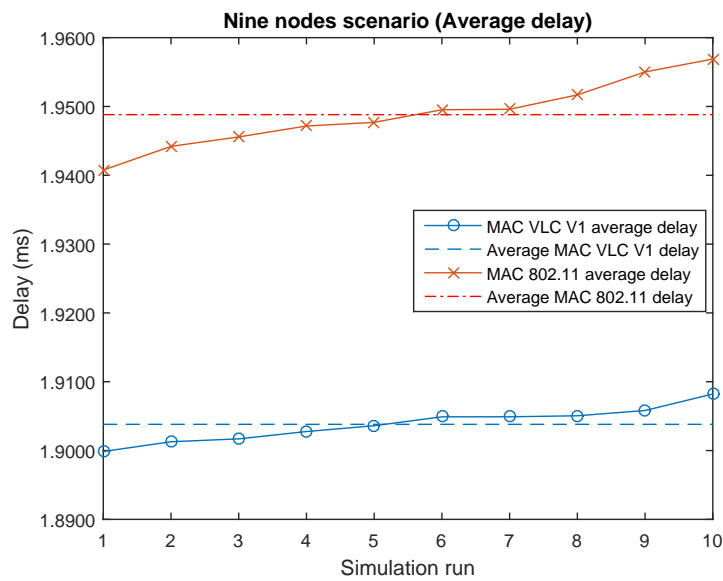

Figure 71: MAC performance (delay) in nine-node scenario

Twelve nodes

Simulation results using the configuration shown on Table 20 and the node layout shown on Figure 57 are shown graphically on Figure 72 and Figure 73. VLC MAC for V2V has shown a better PDR rate; on average, it is 5.626 % better than the referent protocol. Considering all the simulation runs, the average message delay is 18.674 % shorter than the average delay in the referent protocol.

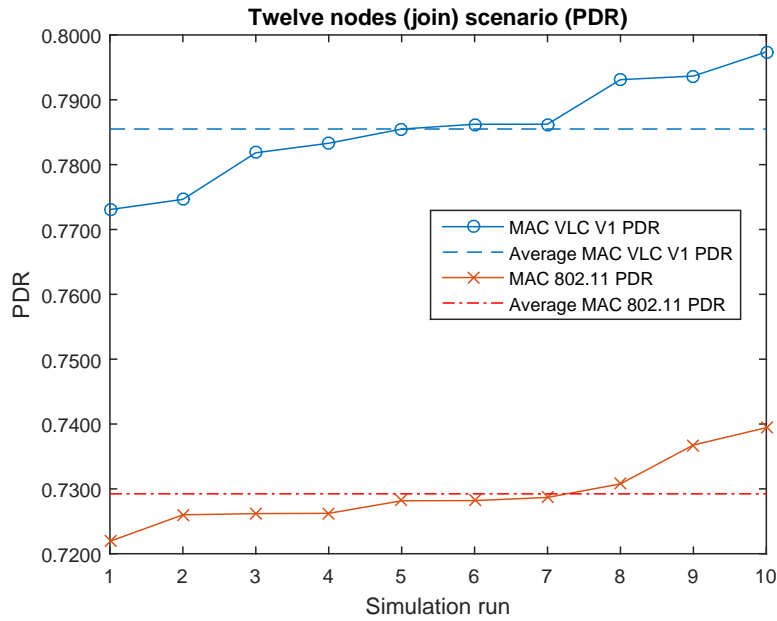

Figure 72: MAC performance (PDR) in twelve-node (join) scenario

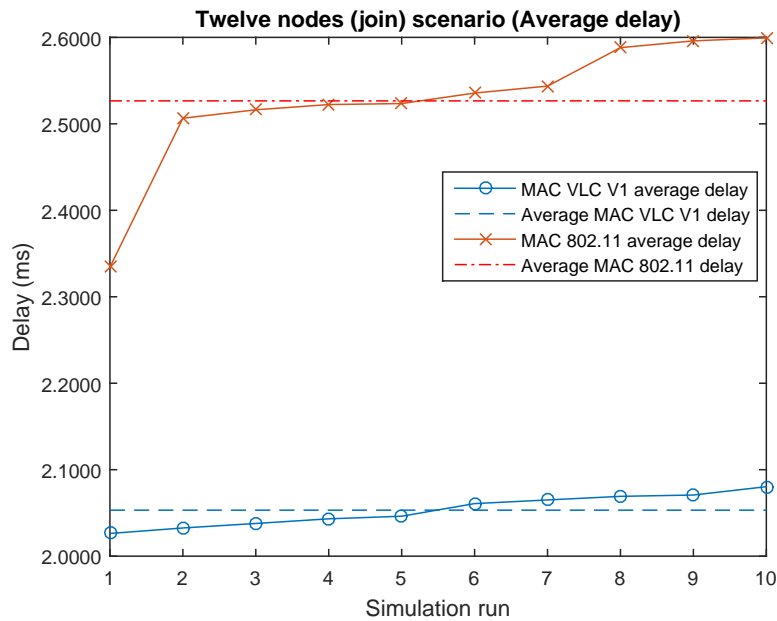

Figure 73: MAC performance (delay) in twelve-node (join) scenario

Crossroads

Simulation results using the configuration shown on Table 20 and the node layout shown on Figure 58 are shown graphically on Figure 74 and Figure 75. VLC MAC for V2V has shown an insignificantly better PDR rate; on average, it is 0.226 % better than the referent protocol. Considering all the simulation runs, the average message delay is 5.402 % shorter than the

average delay in the referent protocol.

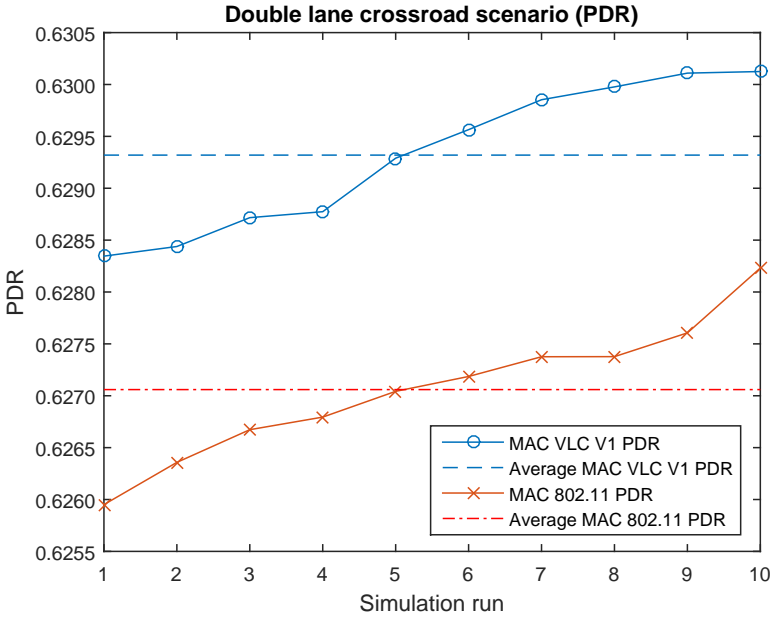

Figure 74: MAC performance (PDR) in crossroad scenario

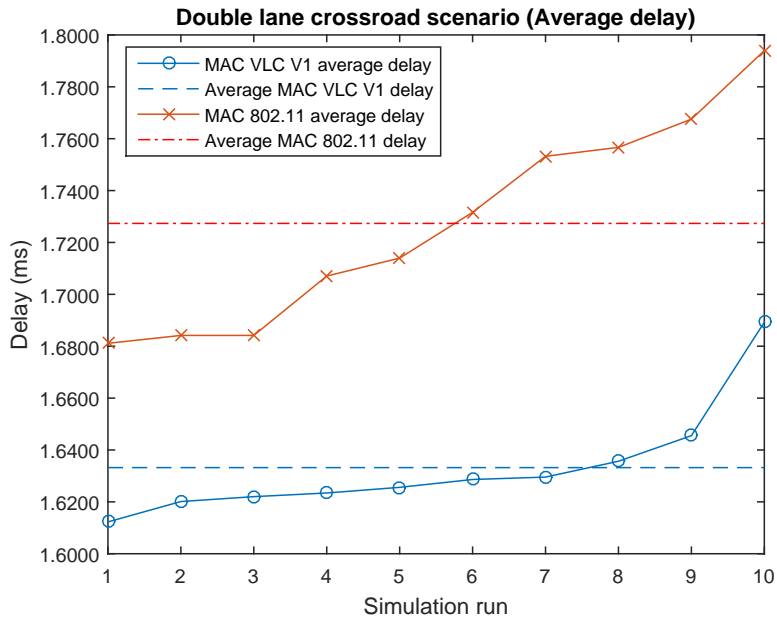

Figure 75: MAC performance (delay) in crossroad scenario

Roundabout

Simulation results using the configuration shown on Table 20 and the node layout shown on Figure 59 are shown graphically on Figure 76 and Figure 77. VLC MAC for V2V has shown an insignificantly better PDR rate; on average, it is 1.9112 % better than the referent protocol. Considering all simulation runs, the average message delay is 12.425 % shorter than the average delay in the referent protocol.

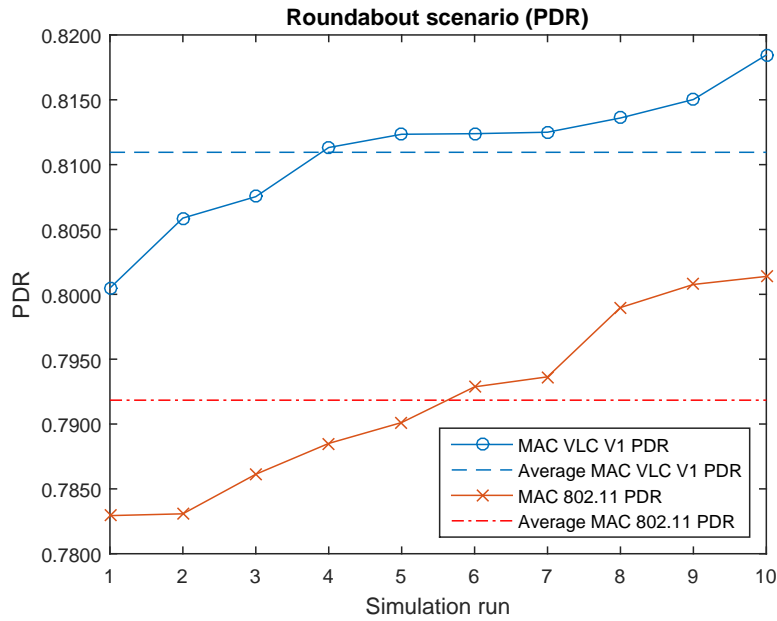

Figure 76: MAC performance (PDR) in roundabout scenario

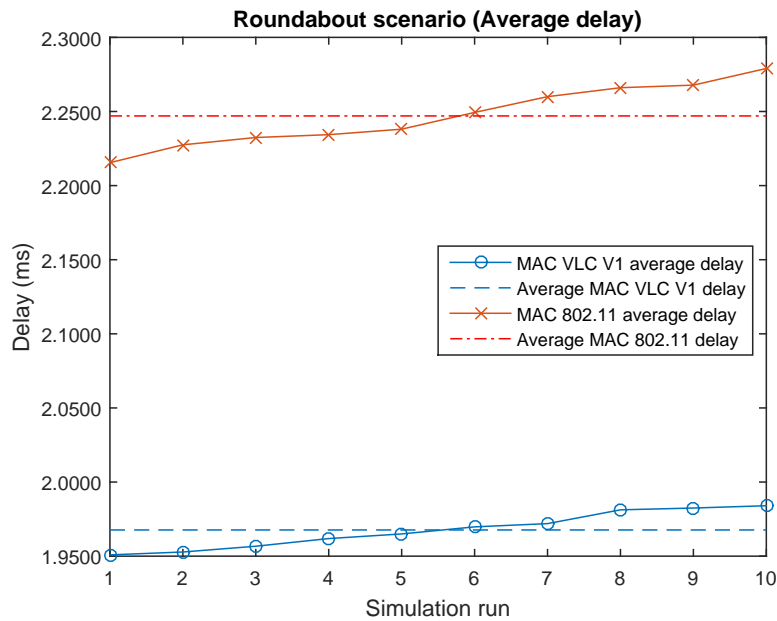

Figure 77: MAC performance (delay) in roundabout scenario

6.3.2. Random environment

Simulation results using the configuration shown on Table 21 and the node layouts shown on Figure 60, Figure 61, Figure 62 are shown graphically on Figure 78 and Figure 79 for the first random scenario, on Figure 80 and Figure 81 for the second random scenario, and on Figure 82 and Figure 83 for the third random scenario.

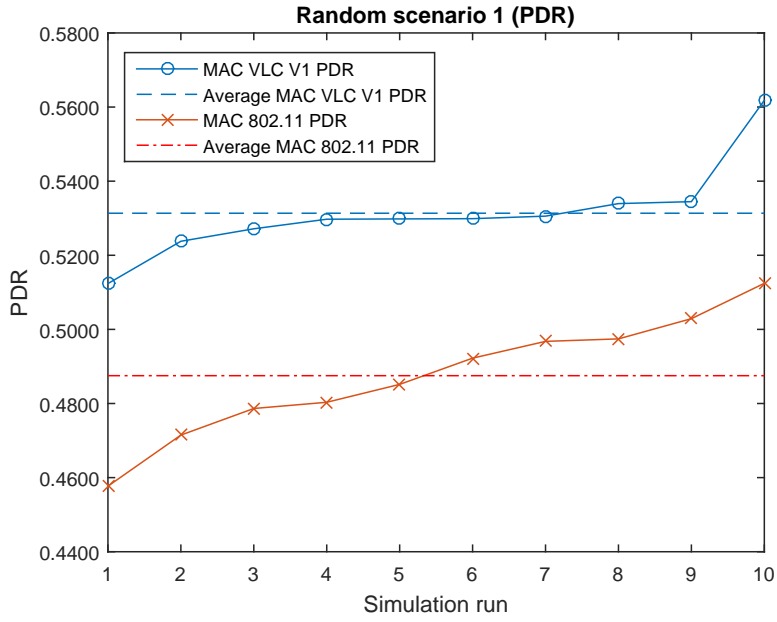

Figure 78: MAC performance (PDR) in random scenario 1

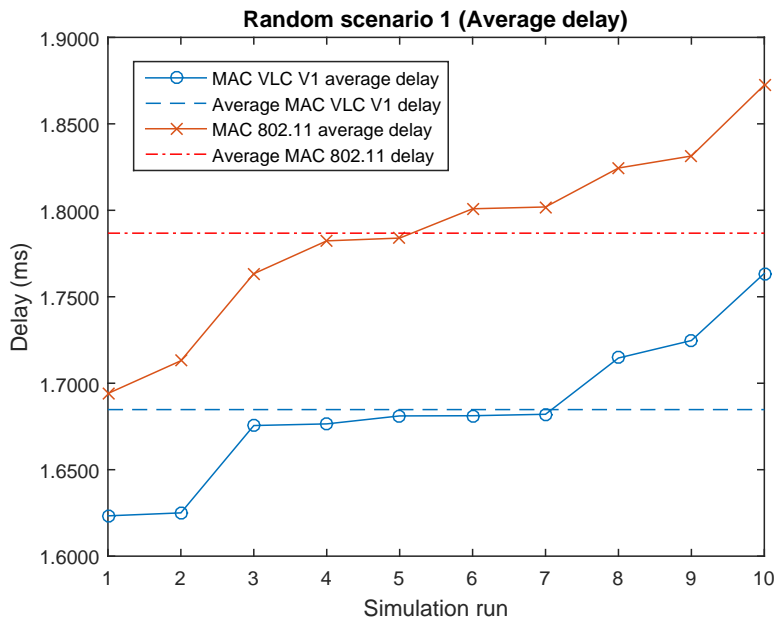

Figure 79: MAC performance (delay) in random scenario 1

In the first random scenario, VLC MAC for V2V has shown a slightly better PDR rate; on average, it is 4.3841 % better than the referent protocol. Considering all the simulation runs, the average message delay is 5.635 % shorter than the average delay in the referent protocol.

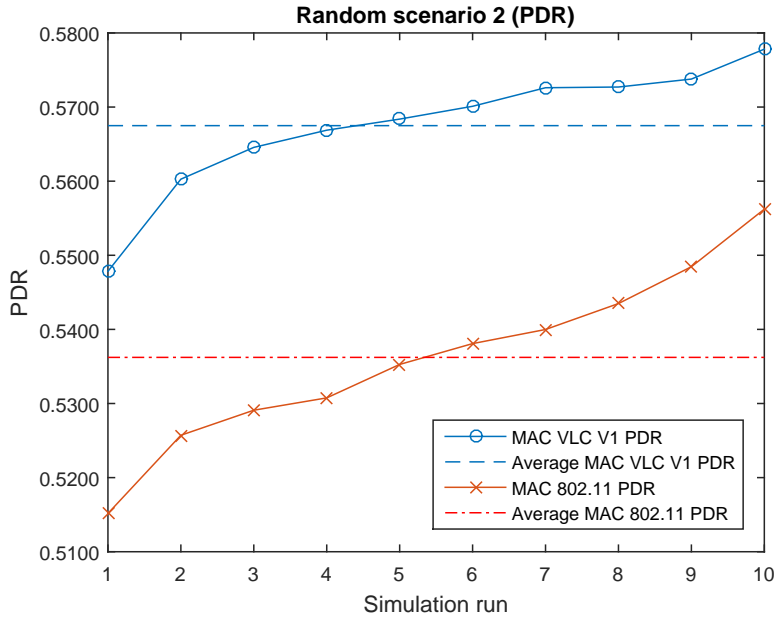

Figure 80: MAC performance (PDR) in random scenario 2

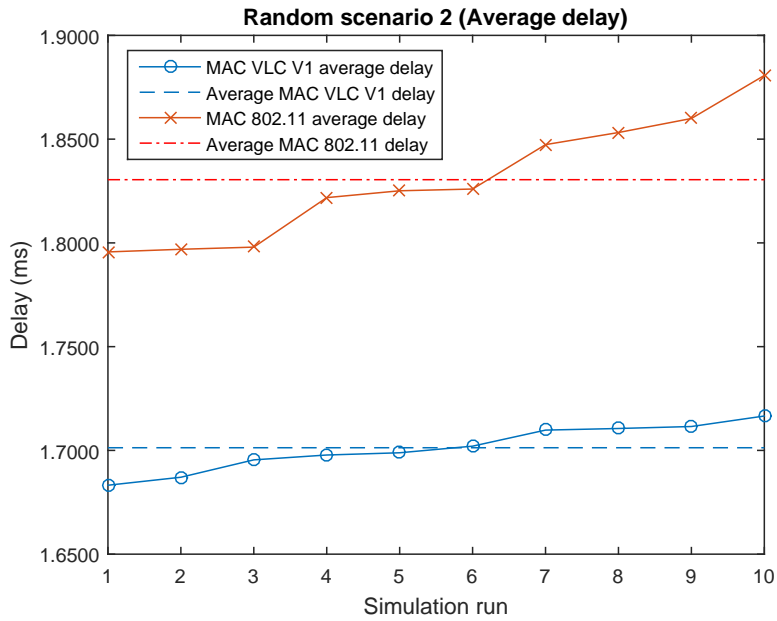

Figure 81: MAC performance (delay) in random scenario 2

In the second random scenario, VLC MAC for V2V has shown a slightly better PDR rate; on average, it is 3.1269 % better than the referent protocol. Considering all the simulation runs, the average message delay is 7.032 % shorter than the average delay in the referent protocol.

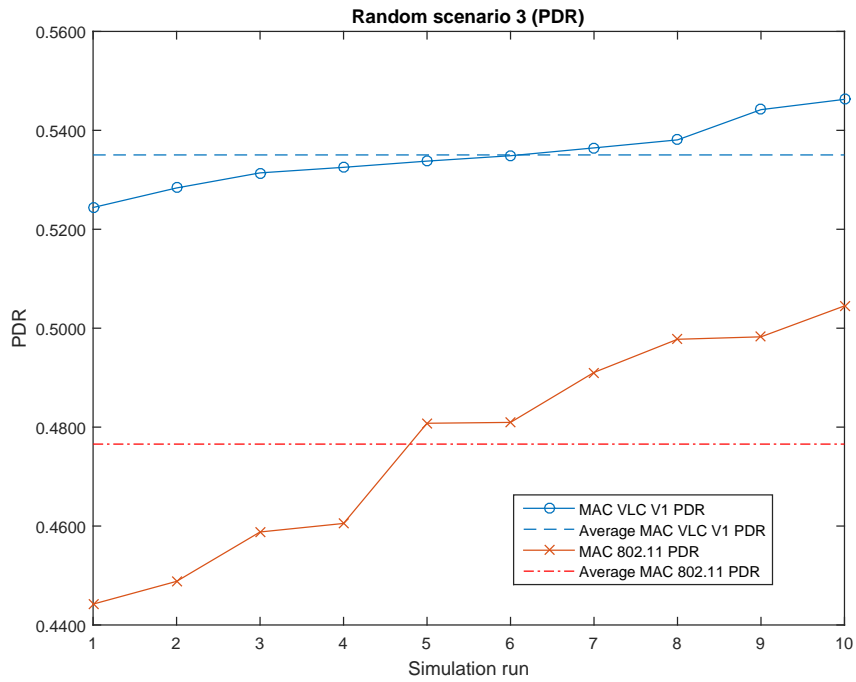

Figure 82: MAC performance (PDR) in random scenario 3

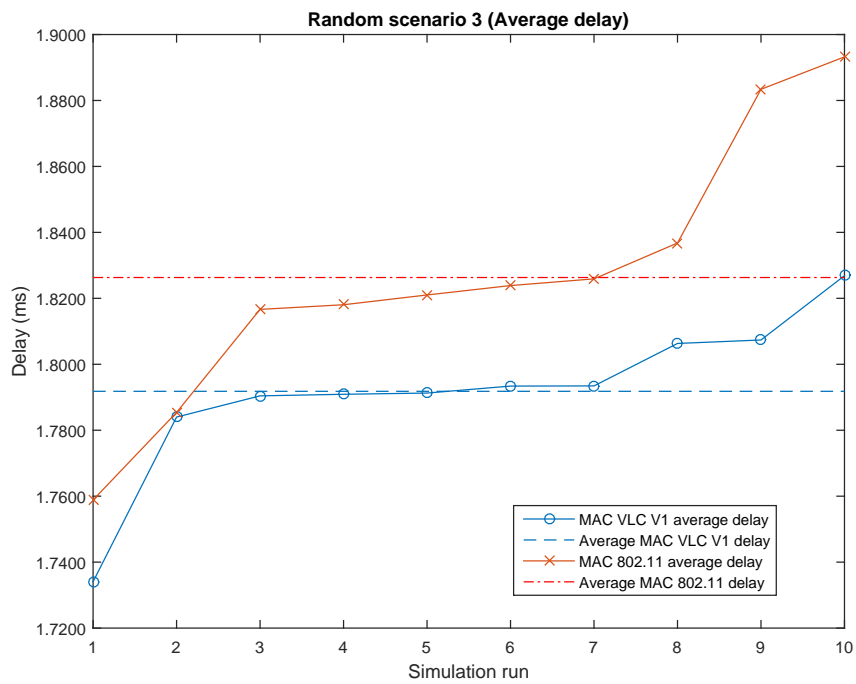

Figure 83: MAC performance (delay) in random scenario 3

In the third random scenario, VLC MAC for V2V has shown a slightly better PDR rate; on average, it is 5.8461 % better than the referent protocol. Considering all the simulation runs, the average message delay is 1.854 % shorter than the average delay in the referent protocol.

6.3.3. Real-world environment

Simulation results using the configuration shown on Table 22 are shown graphically on Figure 84 and Figure 85.

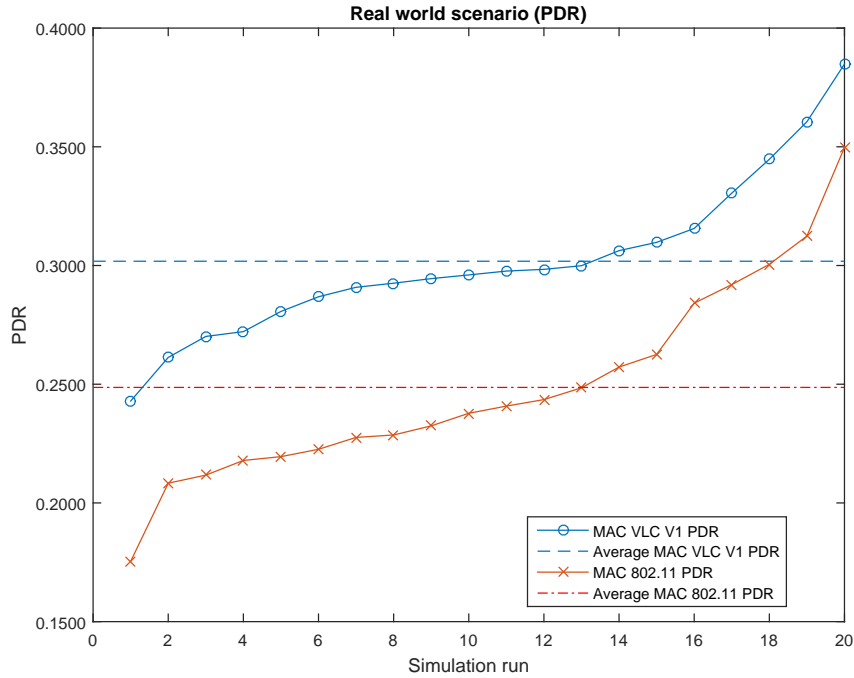

Figure 84: MAC performance (PDR) in real-world scenario

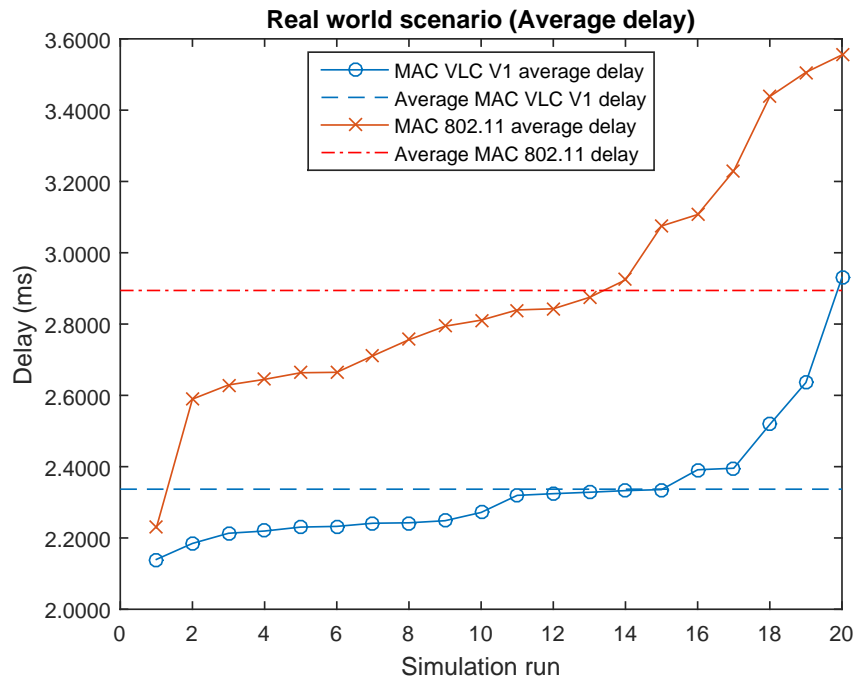

Figure 85: MAC performance (delay) in real-world scenario

As mentioned in Section 6.1.1 throughput for the most relevant scenario is calculated for the whole simulation as follows: $\mu = \frac{M}{C \cdot T}$ where:

- μ is throughput as fraction.
- M is message size (payload only).
- C is declared channel capacity.
- T is transmission time, in this case average message delay (including header and payload) is used for both protocols.

Using experiment setup and results, throughput for VLC MAC for V2V is $\mu = 4.38204 \%$ and for referent protocol throughput is $\mu = 3.21646 \%$. VLC MAC for V2V has 26.5990 % larger throughput than referent protocol. Lower throughput is probably caused by smaller header size and use of control channel.

VLC MAC for V2V has shown a significantly better PDR rate; on average, it is 5.314 % better than the referent protocol. Considering all (20) simulation runs, the average message delay is 18.365 % shorter than the average delay in the referent protocol.

6.4. Results discussion

The results show that in most simulation runs, regardless of the environment and parameters, the VLC MAC protocol for V2V shows varying but better performance than the referent protocol. In simple environments, this difference in performance thrives to none; however, in more complex and real-world environments, that difference increases in favor of the VLC MAC protocol for V2V.

Static environment

Static environments were designed to depict specific positioning and situations in network and in traffic. Results show that in simple scenarios, both protocols show the same and perfect PDR rate = 100 %. However, the network delay is shorter in the VLC MAC protocol for V2V. The reason for this may lay in the fact that for each message sent, the referent protocol uses two more messages: RTS and CTS messages that must propagate through the medium as well. The hidden node terminal is a specific network situation defined by a static scenario (Figure 54).

There, the VLC MAC protocol for V2V has shown slightly better performance: 0.2478 % for PDR and 14.985 % shorter average message delay. Overall, the VLC MAC protocol for V2V shows a slightly better performance in both metrics.

Random environment

Random scenarios have shown variations in both MAC performances. Variations were caused by the actual random layout of nodes. Actual performance is low, especially PDR (around 50 %) for both protocols. Random scenarios are used to test the effect of randomness on the network layout, although such a layout is hardly possible in real-world scenarios in vehicular traffic. Results were gathered using a network of 11 vehicles in which a local group of visible nodes had an average size of 8.3 vehicles. On average, in random environment scenarios, the VLC MAC protocol for V2V has 4.4524 % better PDR and a 4.840 % better message average delay.

Regardless, the VLC MAC protocol for V2V still shows better performance in both metrics.

Real-world environment

Real-world scenarios have results that truly depict the nature of V2V communication networks. According to the previously defined complexity, those scenarios have the highest complexity. MAC performance is very low, especially PDR (around 25 %) for both protocols. On average, in real-world-environment scenarios, the VLC MAC protocol for V2V has 5.314 % better PDR and 18.365 % better message average delay. Regardless of actual performance, in most relevant scenarios, the VLC MAC protocol for V2V shows better performance in both metrics.

Conclusion

Overall, it can be concluded that the VLC MAC protocol for V2V is better than the referent protocol in both relevant metrics: PDR and average delay in all simulation scenarios. On average, it is better by 3.229 % for PDR and 12.878 % for average delay. Although those values cover the sum of all simulations, they do not have significance; it is just presented as a remark.

Furthermore, there were only three random scenarios in the simulation experiment. Pure random nature may suggest that the VLC MAC protocol for V2V shows better performance in possibly *any scenario*, where *any* is defined by a random function.

It can be noticed that with the increasing complexity of simulation scenarios, there is a significant decrease in performance for both protocols. This might be an issue that requires additional analysis.

Also, the results showed that there was no constant level of performance difference. In some scenarios, the VLC MAC protocol for V2V showed a smaller performance difference, while some scenarios showed larger performance gains. The reason for such lies in the fact that there is no correlation between simulation environments and setup. However, it is not excluded that there is an unknown environmental variable linking to the performance. This requires additional analysis.

In real-world scenarios, results are more significant due to the nature of the simulation parameters in those experiments and the level of complexity. All of those facts and simulation experiment results confirm the H2 hypothesis as it was defined in Section 1.3.2. However, this conclusion only applies to the parameters defined in experiment preamble. VLC MAC protocol for V2V is better in terms of speed (delay) and packet delivery rate than referent protocol in a strongly defined environments: VANETs and other vehicular networks; and on a specific equipment that includes VLC radio device that uses LED headlight and PD installed on a vehicle using defined and static layout. VLC MAC protocol for V2V performance in other wireless network systems is unknown and it is not a subject of this particular research.

7. Conclusion

The final chapter in this thesis summarizes the complete research process. The connection between initial assumptions, problems, and goals on the one side and the research results on the other side is highlighted. In the end, recommendations for future work are presented and elaborated on.

7.1. Vehicular communication and VLC

Since the beginning of traffic, people have used various methods to communicate in traffic. If computer technology and networks had been invented before vehicles, we would be communicating wirelessly and not using high/low beams or sound horns. Nevertheless, it is time to change and enhance the current technology. DSRC has been in development for many years and many governments are working on legal frameworks that will enforce its (or alternatives') use in modern, everyday traffic. The automotive industry is passive with respect to the implementation of new technologies. Only recently, with rise of electric and autonomous vehicles, has the industry become more agile. However, this resistance to new trends is somewhat reasonable because vehicles can be hazardous. Technology that has not been properly tested may put human lives at risk. DSRC is one such technology. It has been tested on many testbeds around the world. DSRC allows for true V2V communication without human intervention.

Visible Light Communication (VLC), on the other hand, is a relatively new technology that uses the unlicensed part of the EM spectrum. With recent advancements in LED and laser technology, it was possible to encode information onto a light wave carrier. The IEEE community has defined the VLC standard (802.15p) that defines protocols and layers (PHY and DDL) for VLC communication in computer and other networks. VLC is line-of-sight-only technology. Unlike DSRC, it cannot penetrate non-transparent objects. By using LEDs that are very energy efficient, VLC communication on vehicles is possible with no extra energy requirements. VLC uses high-frequency LED oscillations (e.g., on/off keying) to encode information on the light carrier. Those oscillations are not visible to the human eye and can be safely used in traffic without any risk of endangering lives.

This research combines two technologies into a simple solution that augments existing and future V2V communication systems with a new, energy-efficient, omnipresent, biologically safe and free technology like VLC.

7.2. Network Simulation Environment (NSE)

Appropriate NSE posed a significant challenge. The process of selecting a starting NSE includes an analysis of existing solutions in the community. The selected NSE was JiST/SWANS. It is a robust solution that implements a complete ISO/OSI network stack on a Java virtual machine; even more, it is compatible with computer network systems as a virtual NIC.

Selected NSE, as well as majority alternatives, have non-complete implementations. Those "faulty" implementations do not interfere with basic functionalities like network simulations. However, it was impossible to design, implement and benchmark any MAC protocol, especially a MAC protocol on a VLC enhanced vehicle.

Because of that, the contribution to the selected NSE included:

- Implemented full support for Visible Light Communication (VLC) as a new PHY layer implemented as a Radio VLC device. This implementation included:

Specific light pathloss calculations.

LOS and obstacle detection for light wave propagation.

Control channel feature:

Multiple channels support

Channel probing and testing

Channel selection and setting

Tx/Rx elements selection and complete Java code addressing by ID and by reference.

A new set of Java API (interface) for developing MAC protocols on top of VLC.

- VLC equipped vehicle model implementation. The existing NSE model included only one point for a vehicle, while the enhanced NSE now supports:

Separate width and height.

Dimensions random deviation.

Vehicle local coordinate system for positioning of elements.

Vehicle outline border update in motion.

Vehicle blocks LOS for VLC.

- Integrated measurement mode for MAC protocol benchmarking and metrics evaluations.
- Implemented and tested data gathering mechanism, data are gathered into CSV file and into a standard output stream.
- Collision detection, event propagation. The enhanced NSE now reports to other entities state of network; it provides a set of events that indicates the occurrence of interference, collision or the use of a busy radio device (elements).

According to the defined research methodology and process, each feature is tested and verified. This step was crucial for preparing the testbed for final simulation experiments.

Although not an integral part of the selected NSE, another software (MCS) was developed to aid in the design of the simulation environment and in defining simulation parameters. MCS is a GUI editor through which users can design vehicle nodes, their dimensions, their positions in space, and their Tx/Rx elements. MCS is inter-operable with JiST/SWANS NSE by allowing for automated simulation execution with parameters defined by MCS. Communication between MCS and the selected NSE is established using a standardized configuration XML file and standard application execution framework.

7.3. VLC MAC protocol for V2V

The history of 802.11n starts with an initial meeting that was held in 2002. The protocol was published in 2009. A group of professionals and researchers organized as *IEEE working group* worked on protocol design and development. The total number of *IEEE working group* members in 2009 was 55. Those were only elected members; behind them are numerous assistants, researchers, professionals, etc. It took more than 1300 people and eight years to complete a draft version of a new protocol.

In conclusion, creating a new or enhanced MAC protocol is a tremendous effort requiring much time and many professionals and researchers. In the scope of this research, creating a protocol

from scratch would be an impossible mission. However, thanks to the existing 802.11b implementation in JiST/SWANS, it was possible to continue working on existing protocol, changing it, and augmenting it with new features, with the goal of making it better within given parameters.

With the environment set, the next step towards the goals of this research was the implementation of the VLC MAC protocol for V2V and V2I/I2V networks. Unfortunately, the existing implementation of the referent protocol would not work on VLC enhanced NSE (and VLC radio). Modifications to the referent protocol were implemented, allowing it to work natively (without a wrapping technique) on a VLC radio while preserving the algorithm and workflow of the original protocol.

Prior implementation was done of the VLC MAC protocol for V2V and V2I/I2V networks, and according to the research methodology, an intensive literature review was conducted. While designing, the protocol asymmetry issue was tested and proven to not be a significant issue that might cause performance degradation. The main protocol challenges included:

- Support for a newly developed VLC Radio technology.
- Develop a smaller header footprint for reduced message size.
- New and efficient Tx element addressing for data transmission.
- Implementation of a single control channel.
- A new queuing and message prioritizing algorithm with deadlock prevention.
- Added data encryption support using 128 bit AES.
- Implemented interference detection events from the PHY layer.

The rest of the features were selected from the referent protocol.

A preliminary test concluded that the VLC MAC protocol for V2V does work with VLC radio. However, to have significance, it had to be tested against existing solutions: the referent 802.11b protocol. The test included a set of simulation experiments that were conducted on various scenarios depicting specific network and traffic situations. Also, most intensive simulations included mobility and real-world scenarios on the map of Suffolk, Virginia, USA. In a final simulation experiment, it was proven that the VLC MAC protocol for V2V and V2I/I2V is

better than the referent protocol. Its lightweight design and smart queuing are key features that slightly increased protocol performance.

7.4. Hypotheses

The research postulated two hypotheses (Section 1.3.2):

H1 hypothesis states that in simulated scenarios, the incidence of different asymmetry types requires a new MAC protocol design in V2V and V2I/I2V VLC network systems. To verify this claim, types of asymmetry were defined. After that, using selected NSE, a special asymmetry check module is implemented. This mechanism was used in a simulation experiment that used referent protocol and in a real-world scenario. The results showed that asymmetry is not major cause of message drops. It caused only 0.4728% message drops out of the total number of message drops. It has been proven that node asymmetric design influences message drop rate, but not in a significant manner. This conclusion disproved the H1 hypothesis.

H2 hypothesis states that a new MAC protocol specialized for V2V and V2I/I2V VLC network systems, compared using selected metrics, has better performance than a referent IEEE 802.11 MAC protocol in simulated V2V and V2I/I2V scenarios. The first phase included a detailed analysis of existing MAC protocols for various technologies. By using that knowledge, a new protocol was designed and implemented on top of selected NSE. The protocol itself had to be tested, so the next phase in this research included a definition of metrics and the benchmark environment. Aside from the definition, the actual implementation of the metrics system took place. Using defined metrics and various simulation scenarios and parameters, simulation experiments were conducted.

In most relevant scenarios, gathered data proved that the MAC protocol specialized for V2V and V2I/I2V VLC network systems is better than the referent protocol by 5.314 % in terms of PDR and 18.365 % in terms of message delay. Therefore, **H2** hypothesis was accepted.

7.5. Research objectives and questions

At the beginning of this thesis, (Section 1.3) research objectives and questions were defined to direct the course of this research. In the end, the research objectives were reached and all the research questions were answered.

The overall objective of this research *Development of effective medium access control protocol for vehicular communication using visible part of electro-magnetic spectrum* was reached with the successful implementation of the VLC MAC protocol for V2V and V2I/I2V, and with conducted simulation experiments.

Specific objectives that were addressed:

O1. Define the simulation environment for V2V and V2I/I2V VLC network systems.

The environment was defined and implemented as a selected NSE with VLC enhancements and defined VLC radio. Implementation includes a Java environment (project) containing new classes that are compatible with the existing implementation. The project also contains a fully functional ISO/OSI stack that uses VLC in V2V that can be modified and tested.

O2. Define the development environment for MAC protocol implementation design and test.

This objective was reached with successful implementation of MCS, selected NSE VLC enhancements, and a newly implemented metrics and measurements mode feature. Designing a custom MAC protocol is now a simple process of writing Java code and attaching Java implementation to the existing ISO/OSI stack. To test implementation, it must be able to withhold simulations using various parameters that can now easily be edited using newly a developed graphical user interface - the MCS tool. New tools allow researchers to visualize simulation scenarios: their layout as well as their configuration files. Implementation on Java technology, simulations and tests can be conducted on virtually any hardware, including a PC or, in the case of this research, on computer grid networks.

O3. Explore the effects of channel asymmetry in V2V VLC network systems.

This objective was reached through definitions of various types of asymmetry. Each type was tested in a controlled simulation environment. Tests have proven that asymmetry does influence performance, but that performance degradation is not significant. A possible cause for this lies in the fact that V2V systems have rather linear spatial alignment.

O4. Define the theoretical framework for an efficient MAC protocol in V2V and V2I/I2V VLC network systems.

This objective was reached with the definition, workflow, and implementation of the VLC

MAC protocol for V2V and V2I/I2V, and with the successful simulation experiments and results. This objective has a direct impact on the overall objective of this research.

7.5.1. Research questions

At the beginning of research, several questions arose that helped guide the course of the research. Now that the research has ended, the answers to those questions are as follows:

- **RQ1:** *How does one design and evaluate MAC protocols for VLC V2V and V2I/I2V network environments?*

MAC protocols, not only for VLC but for any RF technology, can now be designed and evaluated using augmented and enhanced NSE. The solution provides benchmarking features with defined metrics.

- **RQ1.1:** *What are specific features of the new MAC for VLC in V2V and V2I/I2V network environments?*

The new MAC should support VLC radio in general and the use of different and separated Tx/Rx elements (similar to the antenna device in RF). Also, the new protocol should be lightweight: short header size and fast (low latency).

- **RQ1.2:** *What are the specific metrics for evaluating different MAC protocols in network simulations?*

Among many metrics, in this research *Packet Deliver Ratio (PDR)* and *average message delay* were used. The same metrics are suggested and used by other researchers. Throughput is another interesting metric; however, it was not used because the variables that influence this metric are closely related to PHY characteristics.

- **RQ2:** *Can channel asymmetry affect network performance?*

Yes, asymmetry can influence network performance, but not in a significant manner. This was tested using simulation experiments.

- **RQ2.1:** *What are different types (cases) of asymmetry?*

There are three types of asymmetry in VLC V2V systems: *i) Node design, ii) Node orientation, and iii) Node position.*

- **RQ2.2:** *What are specific scenarios in which asymmetry has a maximum effect on performance?*

In third, *Node position* situations' asymmetry has a maximum effect on performance, up to a 100 % drop rate.

- **RQ2.3:** *How often do those scenarios occur in simulated real-life situations?*

Of all dropped messages in the simulation experiment, in relevant node design, asymmetry is the cause of only 0.4728 % of message drops.

■ **RQ3:** *How is VLC simulated in V2V and V2I/I2V network environments?*

VLC in V2V and V2I/I2V can be simulated using a combination of selected and VLC-enhanced NSE (JiST/SWANS) and MCS to design simulation scenarios and define parameters.

● **RQ3.1:** *Can existing simulators appropriately support VLC for V2V and V2I/I2V network environments?*

In existing simulators that are available to professionals and researchers, it was impossible to simulate VLC in network environments, especially V2V and V2I/I2V.

● **RQ3.2:** *What are specific features such simulators should have and that existing simulators do not have?*

Existing simulators are well crafted software for simulating small- and large-scale networks. The difference between network-related features is minimal and they differ significantly in performance. Because of performance, many network characteristics were omitted and replaced by thrust in protocols. For example, the IEEE 802.11 family of protocols tackles carrier sensing and interference very well, by design and practice. Because of that, it wasn't necessary to implement interference detection in network simulators. Some of the features include: *VLC radio, Tx/Rx element definition, Control signal, VLC specific pathloss, LOS detection, collision and interference detection.*

● **RQ3.2:** *What is a VLC-equipped vehicle model?*

A VLC-equipped vehicle is an entity with the following attributes:

- * center coordinates of the vehicle.
- * vehicle bearing.
- * vehicle width.
- * vehicle length.
- * vehicle uniform (random) width deviation in meters.
- * vehicle uniform (random) length deviation in meters.
- * collection of Tx/RX elements installed on a vehicle.

All of the questions were answered using knowledge acquired during this research through the literature review, simulation experiments, and software development.

7.6. Future work

In the final section of this thesis, it would be worth mentioning that during this research, many new research topics were opened and explored - topics that deviated from the initial goals and problems. This research has a future that is far from complete. There are still so many problems to solve and things to learn. The list of topics may be a good starting point, serving as a guideline or inspiration for other researchers:

7.6.1. Hardware design

Although it is not the most sophisticated design, the proposal for VLC Radio is shown on Figure 86. It consists of a central processing unit, in this case an ARM-based processor with digital and analog I/O. The digital output uses PWM to control output for LED, apropos Tx element. In this hardware design, the Rx element is represented by the PD component that is connected to the analog input while the voltage surge is controlled with the appropriate resistor.

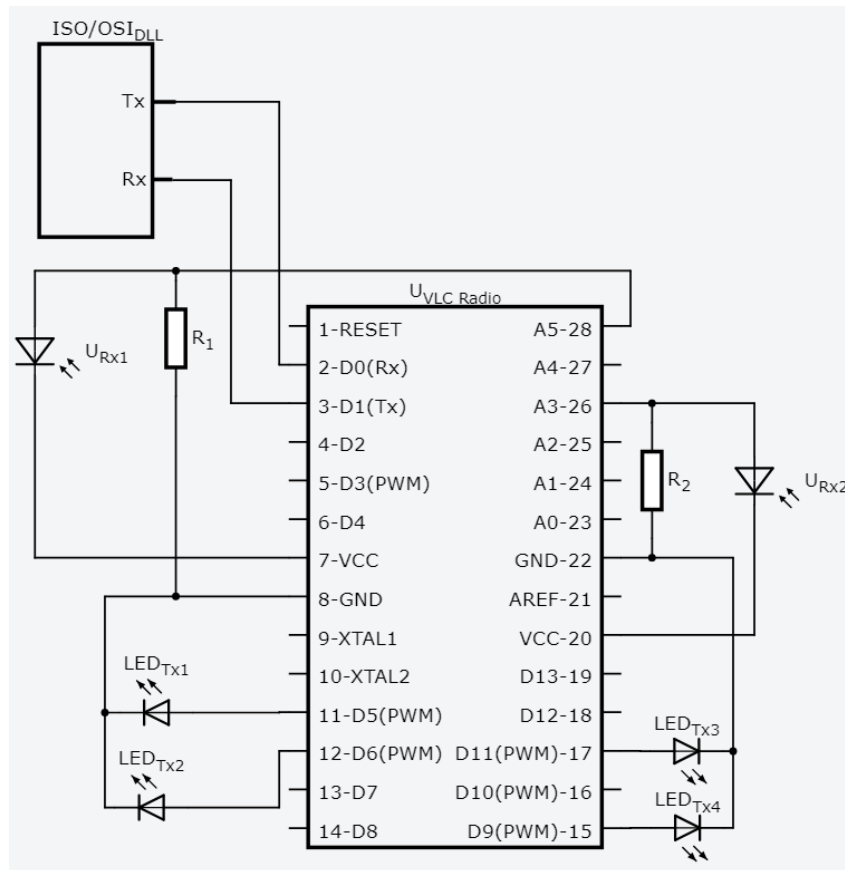

Figure 86: VLC radio minimum hardware design

This VLC Radio is connected to the upper layer via serial communication, a software connection. In a more advanced and sophisticated design, this device should support full network stack and have only interoperability connectors towards other network systems (e.g., Wi-Fi or Ethernet). A future design should also have multiplexing to support a large number of Tx/Rx elements. In this case, there are only four Tx and two Rx, as in the VLC-equipped vehicle model used in this research.

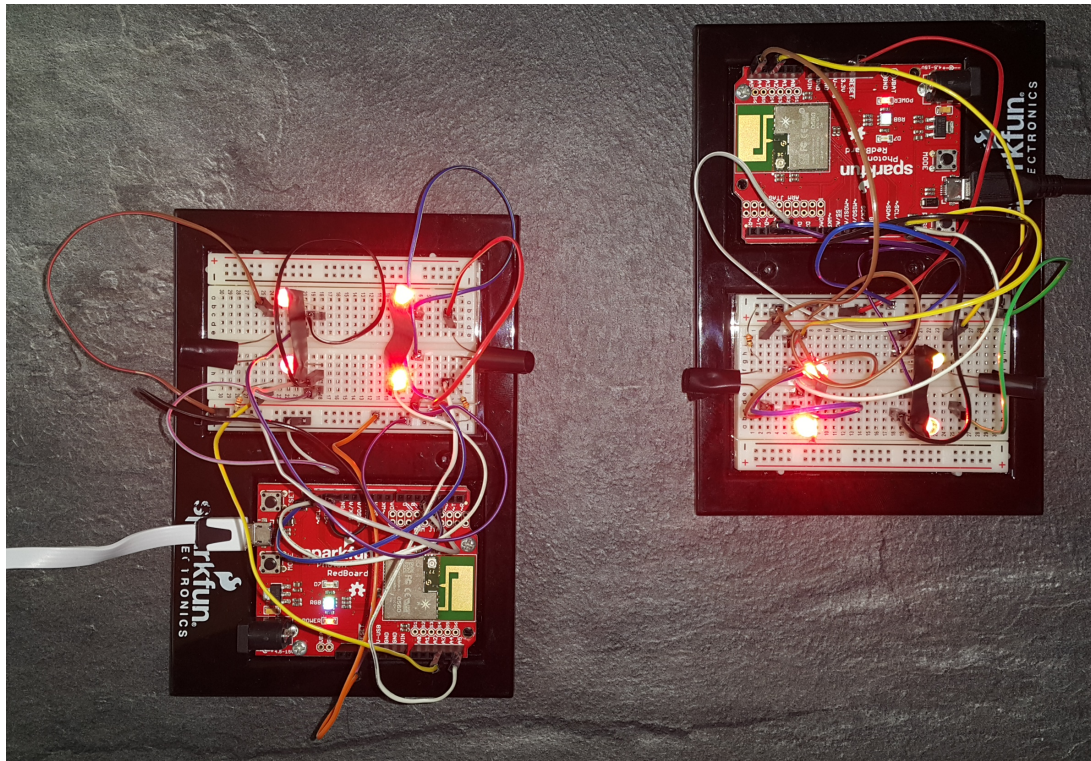

Figure 87: VLC radio hardware prototype

The early prototype is shown on Figure 87. The procession unit used is 120 MHz ARM Cortex M3 with 128 kB of flash memory. The prototype transmits sample data using simple OOK on a 5 kHz PWM signal. Data is relayed to the standard serial output that is displayed on the computer terminal. To have segmented transmission mediums, PD and LED are shielded with black isolation tape. The full VLC MAC protocol for V2V has yet to be implemented. Making a hardware and actual implementation on an actual vehicle is also work for the future.

7.6.2. VLC node addressing

It was possible to avoid Tx/Rx element addressing using an individual radio for each element or pair of elements. Each vehicle would then have multiple MAC addresses. At first, that might appear to be an easier solution; however, it might impose a greater strain on higher levels of ISO/OSI, especially on a Network Layer. The network itself might be impacted because each radio will have its own address and separated headers. They might use the same medium at the same time, especially if coverage even partially overlaps, transmitting redundant header information. Also, an LED aperture might have several hundreds, even thousands, of individual LEDs. If all those are controllable, it means that single vehicle can have a large number of Tx channels and, thus, a large number of MAC addresses. The current version of the VLC MAC protocol for V2V and V2I/I2V predicted a larger number of Tx/Rx elements. Virtually, the number of Rx elements is unlimited. However, the Tx elements (their addresses) are a part of the message header. A larger number of Tx elements will result in a larger header and, thus, reduced performance. Optimum addressing in VLC for V2V should be further researched. Another path would be omitting addressing from the MAC header, and simply relaying on network topological information and deducting the source element of data transmission.

7.6.3. Complexity definition and impact on VLC in V2V performance

In simulation experiments conducted, it was noticed that with the increasing complexity of simulation scenarios, there was a significant decrease in performance for both protocols. In some scenarios, the VLC MAC protocol for V2V shows a smaller performance difference, and in others, larger performance gains. The reason for this lies in the fact that there is no correlation between simulation environments and setup. However, there might be an unknown variable that requires additional analysis. If the complexity model is well-defined, it might be possible to predict performance and ease the network congestion and strain by reducing the node transmit rate.

7.6.4. Multipathing in VLC for V2V environments

This research did not address any effect of multipathing on VLC in V2V. However, multipathing is a well-known issue in wireless networking, where the signal can bounce off the RF reflective surface (e.g. metal) where the reflective surface becomes another source of an

omni-directional signal that arrives at the receiver with time offset due to propagation delay. In V2V there are a lot of reflective surfaces, other vehicles, windows, traffic signs, etc. Light might reflect off those, causing multipathing. Receiving elements are segmented and not omni-directional and it is not clear if it will cause interference and how it can be avoided. The effect of multipathing in VLC in V2V environments should be investigated.

7.6.5. Varying the control signal

The control signal is a mechanism used to signal other participants that a channel is occupied. It is a convenient technique in a segmented channel system. As mentioned in this research, it is a single piece of information that does not require its own MAC protocol. Its existence is suitable enough.

However, control signal strength might be valuable information for other nodes. For example, it can represent the distance between the sending node. Using this distance, another node can calculate its output Tx so that it will not cause interference to the other nodes.

For example, node A is sending data to node B. Node B sets the control signal. This signal is picked up by nodes A and C. Node C can calculate its distance between node B. Using that distance, and receiving strength, node C can define the maximum output power of the new message that is sent towards A (assuming that A is closer to C than C is to B).

Another example may include deliberately controlling signal weakening. Participating nodes can calculate from the speed of signal decline the rest of the time required for the ongoing transmission to be completed.

There may be many other scenarios in which variations in control signal strength may enhance network performance.

7.6.6. Other ISO/OSI layers

Although the VLC MAC protocol for V2V and V2I/I2V works sufficiently enough, there is still room for improvement. Especially on a NET layer, one should consider that a single node should be aware of its surroundings:

- Node's GPS locations.
- Vehicle's speeds.

- VLC equipment installation for each vehicle, layout, and capability of Tx/Rx elements. Although the design should be a standard, the VLC MAC protocol for V2V and V2I/I2V is prone to deviations in design.
- Vehicle navigation route (if available).
- Infrastructure nodes, their locations, and their capabilities.

By being aware of such data, the NET layer should selectively choose nodes for the datagram's next hops. For example, it should avoid sending datagrams to a node that will leave the relevant communication area.

Furthermore, for the application layer there must be a way for information dissemination to the user, e.g., integration with entertainment and other vehicle systems. Also, the application layer should utilize message priority and that concept should propagate throughout the other layers to provide appropriate service, especially emergency service that may require high priority with fast and reliable delivery. This should be implemented on the transport layer.

7.6.7. Advanced VLC vehicle model

This research used a simple 2D model for a VLC-equipped vehicle. In Section 2.2.1 it was mentioned that the actual light beam is highly irregular and that it has a 3rd dimension. A more advanced VLC vehicle model is required. Also, vehicle headlights have high and low beams; manufacturers may have different beam patterns and output power distribution for headlights. A model should include all of that; furthermore, the MAC protocol should consider light intensity (high or low beam) in data transmissions.

Aside from having a 3D model of a headlight, 3rd dimension should be used on a vehicle as well, because vehicles differ even on high; for example, trucks can obstruct LOS for communication. In positioning and mobility, only two dimensions were used. Roads have altitude and slopes, meaning that a vehicle on a slope (facing downward) can perceive more vehicles in the range. MAC/NET could be aware of terrain configuration and use the advantage of terrain for a better communication capacity on the other side to predict possible outages due to terrain configuration.

7.6.8. LED PWM frequency and PD sampling rate

In Section 2.2.2 it was noted that there are many PD types whose sampling rates are over 200 MHz. According to [174] PWM used in standard LED lighting uses a frequency up to 500 kHz. It can be concluded that PD is far more precise than LED and that it is sufficient for VLC systems with LED.

Furthermore, it could be possible to use a precisely timed array of LEDs to transmit a larger amount of data. This timing may be necessary because single LED cannot match the capacity of PD. On the other hand, PD (PHY) should be designed so that it can reassemble data originating from different data/time streams.

Polarized channel

Furthermore, channel width can be extended using polarization. If a headlight has a larger number of LEDs, each can be easily polarized using a filter. On the other hand, the same filter should be applied to PD. This setup requires a matching number of PD. This polarized channeling may improve network performance, but it is questionable whether this may reduce the communication range because only a subset of LEDs is used to transmit data in a single polarized channel.

The advantage of this polarization rests in the fact that it may reduce multipathing caused by reflections. Reflected light is polarized and may not pass the all the PD polarization filter. Polarized light does not diminish the headlight's purpose of providing illumination for the driver because the human eye does not recognize the polarity of a light wave.

LED 2 LED communication

In Section 2.2.1 it was noted that LED uses the same semiconductor technology as PD, and that it can be used as PD. It should be further investigated how this can be applied in V2V communications. As mentioned before, making LED a detector for light is a simple software task that requires no hardware interventions. It has yet to be determined, if such a setup has a feasible application in V2V VLC communication, what the limitations of that setup in terms of communication range and speed would be.

This concludes the final statements in this research thesis.

This work is licensed under the Creative Commons Attribution 4.0 International License. To view a copy of this license, visit <http://creativecommons.org/licenses/by/4.0/> or send a letter to Creative Commons, PO Box 1866, Mountain View, CA 94042, USA.

This work has been (fully) supported by the Croatian Science Foundation under the project IP-2014-09-3877

Bibliography

- [1] ISO/IEC Standard for Information Technology - Telecommunications and Information Exchange Between Systems - Local and Metropolitan Area Networks - Specific Requirements Part 11: Wireless LAN Medium Access Control (MAC) and Physical Layer (PHY) Specificati. *ISO/IEC 8802-11 IEEE Std 802.11 Second edition 2005-08-01 ISO/IEC 8802 11:2005(E) IEEE Std 802.11i-2003 Edition*, 2005.
- [2] Abdalla, G. M. T., Ali, M., Rgheff, A., and Senouci, S. M. Current Trends in Vehicular Ad Hoc Networks. *Ubiquitous Computing and Communication Journal*, UbiRoads-S: 1–9, 2007.
<http://citeseerx.ist.psu.edu/viewdoc/download?doi=10.1.1.120.9706{\&}rep=rep1{\&}type=pdf>.
- [3] Abramson, N. Development of the ALOHANET. *Information Theory, IEEE Transactions on*, 31(2):119–123, 1985. ISSN 0018-9448.
- [4] Ahmed, H. and Khurram, M. Performance Analysis of MAC Layer Protocols in Wireless Sensor Network. *International Journal of Information Engineering and Electronic Business*, 6(5):44–52, 2014. ISSN 20749023.
<http://www.mecs-press.org/ijieeb/ijieeb-v6-n5/v6n5-7.html>.
- [5] Banks, J., Carson, S. J., Nelson, L. B., and Nicol, M. D. *Discrete Event System Simulation*. Prentice Hall, 2004. ISBN 0131446797.
<http://www.pearsonhighered.com/educator/academic/product/0,3110,0131446797,00.html>.
- [6] Barr, R. An efficient, unifying approach to simulation using virtual machines. (May), 2004.
<http://citeseerx.ist.psu.edu/viewdoc/download?doi=10.1.1.91.340{\&}rep=rep1{\&}type=pdf>.

- [7] Barr, R. JiST-Java in Simulation Time Users Guide, 2004.
<http://citeseerx.ist.psu.edu/viewdoc/summary?doi=10.1.1.87.7147>.
- [8] Barr, R. Swans-scalable wireless ad hoc network simulator. *User Guide (March 19, 2004)*, 2004.
<http://studium.baldauf.org/informatik/2004.SS/misc/Bachelor-Arbeit/liquidnetwork/simulator/jist-swans/docs/www.cs.cornell.edu/barr/repository/jist/docs/040319-swans-user.pdf>.
- [9] Barr, R. and Haas, Z. JiST: Java in Simulation Time, 2003.
<http://jist.ece.cornell.edu/docs/040325-yorku.pdf>.
- [10] Barr, R., Haas, Z., and Renesse, R. V. Jist: Embedding simulation time into a virtual machine. ... *on modelling and simulation*, 2004.
<http://cobweb.cs.uga.edu/{~}maria/pads/papers/jist-030612-simtime.pdf>.
- [11] Barr, R., Haas, Z. Z. J., Van Renesse, R., and Renesse, R. V. JiST: an efficient approach to simulation using virtual machines. *Software Practice and Experience*, 35:539–576, 2005. ISBN 1097-024X. ISSN 00380644.
<http://doi.wiley.com/10.1002/spe.647><http://onlinelibrary.wiley.com/doi/10.1002/spe.647/abstract>.
- [12] Barr, R., Haas, Z. J., and Renesse, R. V. Scalable wireless ad hoc network simulation. *Ad hoc Wireless, and Peer-to-Peer Networks*, 2005.
<http://scholar.google.com/scholar?hl=en{&}btnG=Search{&}q=intitle:Scalable+Wireless+Ad+Hoc+Network+Simulation{&}2>.
- [13] Bell, A. G. The Photophone. *Science*, 1(11):130–134, 1880.
- [14] Bianchi, G. Performance analysis of the IEEE 802.11 distributed coordination function. *IEEE Journal on Selected Areas in Communications*, 18(3), 2000. ISBN 0733-8716 VO - 18. ISSN 0733-8716.

- [15] Bloom, B. S., Englehard, M., Furst, E., Hill, W., Krathwohl, D., and Committee of College and University Examiners. *Taxonomy of educational objectives: The classification of educational goals: Handbook I, cognitive domain*, volume 16. 1956. ISBN 9780679302117. ISSN 00131644.
- http://books.google.co.za/books/about/Taxonomy_of_educational_objectives.html?id=hos6AAAAIAAJ&redir_esc=y%5Cnhttp://118.97.161.124/perpus-fkip/Perpustakaan/Pendidikan&Pengajaran/Taxonomy_of_Educational_Objectives_Handbook_1_Cognitive_Domain.pdf.
- [16] Bouchet, O., Porcon, P., Wolf, M., Grobe, L., Walewski, J. W., Nerreter, S., Langer, K.-d., Fernández, L., Vucic, J., Kamalakis, T., Ntogari, G., and Gueutier, E. Visible-light communication system enabling 73 Mb/s data streaming. ... (*GC Wkshps*), 2010 ... , 2010. ISBN 9781424488650.
- http://ieeexplore.ieee.org/xpls/abs_all.jsp?arnumber=5700092.
- [17] Carvalho, M. and Garcia-Luna-Aceves, J. Delay analysis of IEEE 802.11 in single-hop networks. *11th IEEE International Conference on Network Protocols, 2003. Proceedings.*, 2003. ISBN 0-7695-2024-3.
- <http://ieeexplore.ieee.org/lpdocs/epic03/wrapper.htm?arnumber=1249764>.
- [18] Caveney, D. Cooperative Vehicular Safety Applications. *IEEE Control Systems Magazine*, ISBN 9780470740569. ISSN 0272-1708.
- <http://ieeexplore.ieee.org/lpdocs/epic03/wrapper.htm?arnumber=5510714>.
- [19] Chang, C. H., Chou, C. H., Lin, C. J., and Lee, M. D., Chang, Chia Hsiang and Chou, Chih Hsun and Lin, Cheng Jung and Lee, Ming Da, 2009, A WAVE/DSRC-based intersection collision warning system. In *2009 International Conference on Ultra Modern Telecommunications and Workshops*.

- [20] Chen, C. L., Hsu, C. W., and Wu, C. M., Chen, Chun Liang and Hsu, C. W. and Wu, Chi Ming, 2011, A DSRC-based collision warning and autonomous system for inter-vehicle communication. In *Proceedings of 2011 Cross Strait Quad-Regional Radio Science and Wireless Technology Conference, CSQRWC 2011*, volume 1.
- [21] Chen, Q., Tang, J., Tung, D., Wong, C., and Member, S. Directional Cooperative MAC Protocol Design and Performance Analysis for IEEE 802 . 11ad WLANs. 62(6):2667–2677, 2013.
- [22] Chetty, K., Smith, G. E., and Woodbridge, K. Through-the-wall sensing of personnel using passive bistatic wifi radar at standoff distances. *IEEE Transactions on Geoscience and Remote Sensing*, 50(4):1218–1226, 2012. ISBN 0196-2892. ISSN 01962892.
- [23] Chi, Y.-C., Hsieh, D.-H., Tsai, C.-T., Chen, H.-Y., Kuo, H.-C., and Lin, G.-R. 450-nm GaN laser diode enables high-speed visible light communication with 9-Gbps QAM-OFDM. *Optics express*, ISSN 1094-4087 (Electronic).
- [24] Choffnes, D. R. and Bustamante, F. E., Choffnes, David R. and Bustamante, Fabián E., 2005, An integrated mobility and traffic model for vehicular wireless networks. In *Proceedings of the 2nd ACM international workshop on Vehicular ad hoc networks - VANET '05*, organization.
- [25] Choudhury, R. R., Yang, X., Vaidya, N. H., and Ramanathan, R., Choudhury, Romit Roy and Yang, Xue and Vaidya, Nitin H and Ramanathan, Ram, 2002, Using directional antennas for medium access control in ad hoc networks. In *Proceedings of the 8th annual international conference on Mobile computing and networking - MobiCom '02*, number September, organization.
- [26] Choudhury, R. and Vaidya, N. Deafness: A MAC problem in ad hoc networks when using directional antennas. *Network Protocols, 2004. ICNP ...*, 2004.
http://ieeexplore.ieee.org/xpls/abs/_all.jsp?arnumber=1348118.
- [27] Choudhury, R. and Yang, X. Using directional antennas for medium access control in ad hoc networks. ... *and networking*, 2002. ISBN 158113486X.
<http://dl.acm.org/citation.cfm?id=570653>.

- [28] Cimini Jr., L. Analysis and Simulation of a Digital Mobile Channel Using Orthogonal Frequency Division Multiplexing. *Communications, IEEE Transactions on*, 33:665–675, 1985. ISBN 0090-6778. ISSN 0096-2244.
- [29] CISCO. *Cisco Wireless Mesh Access Points, Design and Deployment Guide*.
- [30] Cormio, C. and Chowdhury, K. R. A survey on MAC protocols for cognitive radio networks. *Ad Hoc Networks*, ISBN 1570-8705. ISSN 15708705.
<http://linkinghub.elsevier.com/retrieve/pii/S1570870509000043>.
- [31] Crypto++. Crypto++ 5.6.0 Benchmarks.
<https://www.cryptopp.com/benchmarks.html>.
- [32] Cui, K. *Physical Layer Characteristics and Techniques for Visible Light Communications*. PhD thesis, 2012.
<http://escholarship.org/uc/item/4q24841s.pdf>.
- [33] Cui, K., Chen, G., He, Q., and Xu, Z. Indoor optical wireless communication by ultraviolet and visible light. *Proceedings of SPIE*, 7464(1):74640D–74640D–9, 2009. ISSN 0277786X.
<http://link.aip.org/link/PSISDG/v7464/i1/p74640D/s1{\& }Agg=doi>.
- [34] Cui, K., Chen, G., Xu, Z., and Roberts, R. D. Experimental characterization of traffic light to vehicle VLC link performance. ISBN 978-1-4673-0040-7.
<http://ieeexplore.ieee.org/lpdocs/epic03/wrapper.htm?arnumber=6162566>.
- [35] Cui, K., Chen, G., Xu, Z., and Roberts, R. D. Traffic light to vehicle visible light communication channel characterization. *Applied optics*, ISSN 1539-4522.
<http://www.ncbi.nlm.nih.gov/pubmed/23033030>.
- [36] Dai, H., Ng, K.-w., and Kong, N. T. H. An Overview of MAC Protocols with Directional Antennas in Wireless ad hoc Networks MAC Issues with Directional Antennas. 00(c), 2006. ISBN 0769526292.

- [37] Day, J. and Zimmermann, H. The OSI reference model, 1983. ISBN 0818653523. ISSN 0018-9219.
- [38] Dietz, P., Yerazunis, W., and Leigh, D. Very Low-Cost Sensing and Communication Using Bidirectional LEDs. In *UbiComp 2003: Ubiquitous Computing*. 2003. ISBN 978-3-540-20301-8. ISSN 03029743.
<http://www.springerlink.com/content/40266k12yge3b711>.
- [39] Dolan, B. P. and O'Connor, D. A fuzzy three sphere and fuzzy tori. *Journal of High Energy Physics*, 2003(10):060, 2003. ISSN 1029-8479.
<http://arxiv.org/abs/hep-th/0306231>.
- [40] Ec. COUNCIL DIRECTIVE 96/53/EC. *Official Journal of the European Communities*, L 269(September 2000):1–15, 2000. ISBN 9789279122552. ISSN 0144-557X.
- [41] Einstein, A. The Foundation of the General Theory of Relativity. *Annalen der Physik*, 354:769–822, 1916. ISSN 1521-3889.
<http://www3.interscience.wiley.com/journal/112483878/abstract>.
- [42] FCC. FCC ALLOCATES SPECTRUM IN 5.9 GHz RANGE FOR INTELLIGENT TRANSPORTATION SYSTEMS USES. Technical report, 1999.
https://transition.fcc.gov/Bureaus/Engineering/{_}Technology/News/{_}Releases/1999/nret9006.txt.
- [43] Ferguson, M. J. On the Control, Stability, and Waiting Time in a Slotted ALOHA Random-Access System. *Communications, IEEE Transactions on*, 23(11):1306–1311, 1975. ISSN 0090-6778.
- [44] Ferrari, F., Meier, A., and Thiele, L. Accurate clock models for simulating wireless sensor networks. ... *ICST Conference on Simulation Tools and ...*, 2010.
<http://dl.acm.org/citation.cfm?id=1808171>.
- [45] Fessenden, R. A. METHOD AND APPARATUS FOR COORDINATING RADIO AND PHONOGRAPH REPRODUCTION, 1927.

- [46] Gancarz, J., Elgala, H., and Little, T. Impact of lighting requirements on VLC systems. *IEEE Communications Magazine*, (December):34–41, 2013.
http://ieeexplore.ieee.org/xpls/abs{_}all.jsp?arnumber=6685755.
- [47] Geffroy, B., le Roy, P., and Prat, C. Organic light-emitting diode (OLED) technology: materials, devices and display technologies. *Polymer International*, 55:572–582, 2006. ISBN 0959-8103. ISSN 0959-8103.
<http://doi.wiley.com/10.1002/pi.1974>.
- [48] Gfeller, F. and Bapst, U. Wireless in-house data communication via diffuse infrared radiation. *Proceedings of the IEEE*, 67(11):1474–1486, 1979. ISSN 0018-9219.
<http://ieeexplore.ieee.org/lpdocs/epic03/wrapper.htm?arnumber=1455777>.
- [49] Gibson, M. The electro-magnetic spectrum. *Students Quarterly Journal*, 4:140, 1934. ISBN 0471415421. ISSN 00392871.
- [50] Grafing, S., Mahonen, P., and Riihijärvi, J., Grafing, S and Mahonen, P and Riihijärvi, J, 2010, Performance evaluation of IEEE 1609 WAVE and IEEE 802.11p for vehicular communications. In *Ubiquitous and Future Networks (ICUFN), 2010 Second International Conference on*.
- [51] Guerra, F., Casari, P., and Zorzi, M. A performance comparison of MAC protocols for underwater networks using a realistic channel simulator. *OCEANS 2009, MTS/IEEE Biloxi - Marine Technology for Our Future: Global and Local Challenges*, 2009. ISBN 978-1-4244-4960-6.
- [52] Gupta, A., Min, J., and Rhee, I. WiFox: scaling WiFi performance for large audience environments. *Proceedings of the 8th international conference on Emerging networking experiments and technologies - CoNEXT '12*, 2012. ISBN 9781450317757.
<http://dl.acm.org/citation.cfm?doid=2413176.2413202>.
- [53] Haas, Z. J. and Barr, R. Density-Independent, Scalable Search in Ad Hoc Networks. *International Journal of Wireless Information Networks*, ISSN 1068-9605.
<http://link.springer.com/10.1007/s10776-006-0055-9>.

- [54] Hamida, E. B., Chelius, G., and Gorce, J. M. Impact of the Physical Layer Modeling on the Accuracy and Scalability of Wireless Network Simulation. *Simulation*, ISSN 0037-5497.
<http://sim.sagepub.com/cgi/doi/10.1177/0037549709106633>.
- [55] Han, F., Miyamoto, D., and Wakahara, Y., Han, Fei and Miyamoto, Daisuke and Wakahara, Yasushi, 2015, RTOB: A TDMA-based MAC protocol to achieve high reliability of one-hop broadcast in VANET. In *2015 IEEE International Conference on Pervasive Computing and Communication Workshops, PerCom Workshops 2015*.
- [56] Härrri, J. Vehicular mobility modeling for vanet. *VANET Vehicular Applications and Inter-Networking ...*, 2009. ISBN 9780470740569.
http://books.google.com/books?hl=en&lr=&id=VNbkpbIglEoC&oi=fnd&pg=PA107&dq=Vehicular+Mobility+Modeling+for+VANET&ots=KP2MvgH-jr&sig=HCLndT6w5qVyITe60wbBP4VEg{_}g.
- [57] Hartenstein, H. and Laberteaux, K. *VANET: vehicular applications and inter-networking technologies*, volume 3341. 2010. ISBN 9780470740569.
<http://onlinelibrary.wiley.com/doi/10.1002/9780470740637.fmatter/summary>.
- [58] Haruyama, S. Visible light communications. *Optical Fiber Communication (OFC), collocated National Fiber Optic Engineers Conference, 2010 Conference on (OFC/N-FOEC)*, 2010. ISBN 9781557528841. ISSN 08952477.
- [59] Hassan, M. I., Vu, H. L., and Sakurai, T. Performance Analysis of the IEEE 802.11 MAC Protocol for DSRC Safety Applications. *IEEE Transactions on Vehicular Technology*, ISSN 0018-9545.
<http://ieeexplore.ieee.org/lpdocs/epic03/wrapper.htm?arnumber=5963733>.
- [60] Hassan, M., Vu, H., and Sakurai, T. Performance analysis of the IEEE 802.11 MAC protocol for DSRC safety applications. *IEEE Transactions on Vehicular Technology*, 60 (8):3882–3896, 2011.

http://ieeexplore.ieee.org/xpls/abs{_}all.jsp?arnumber=5963733.

- [61] Hiertz, G., Denteneer, D., Stibor, L., Zang, Y., Costa, X., and Walke, B. The IEEE 802.11 universe. *IEEE Communications Magazine*, ISBN 0163-6804. ISSN 0163-6804. <http://ieeexplore.ieee.org/lpdocs/epic03/wrapper.htm?arnumber=5394032>.
- [62] Holzmam, G. and Pehrson, B. *The early history of data networks*. 1995.
- [63] Hu, M. and Zhang, J. MIMO Ad Hoc Networks with Spatial Diversity : Medium Access Control and Saturation Throughput *. 6(2):3301–3306, 2004. ISBN 0780386825.
- [64] IEEE 802.15 WPAN. IEEE 802.15.7 Draft, 2008. <https://mentor.ieee.org/802.15/file/08/15-08-0667-01-0v1c-5c-draft.pdf>.
- [65] IEEE Community. *Local and metropolitan area networks â” Part 15 . 7 : Short-Range Wireless Optical Communication Using Visible Light IEEE Computer Society*. Number September. 2011. ISBN 9780738166650.
- [66] IEEE Computer Society. *IEEE Standard for Local and Metropolitan Area Networks*, volume 2014. 1995. ISBN 0738129402. http://ieeexplore.ieee.org/xpls/abs{_}all.jsp?arnumber=476643.
- [67] Institute for Energy and Transport. European LED Quality Charter.
- [68] Invocom. Slotted ALOHA. http://www.invocom.et.put.poznan.pl/{~}invocom/C/P1-4/p1-4{_}en/p1-4{_}3{_}4.htm.
- [69] Ishak, N. H., Ariffin, R., Ali, A., Sagiruddin, M. A., and Tawi, F. M. T., Ishak, Nurul Huda and Ariffin, Rusnani and Ali, Azuwa and Sagiruddin, Meor Adzmey and Tawi, Faizal Mohamad Twon, 2011, Biological effects of WiFi electromagnetic radiation. In *Proceedings - 2011 IEEE International Conference on Control System, Computing and Engineering, ICCSCE 2011*.

- [70] Israr, I., Yaqoob, M. M., Javaid, N., Qasim, U., and Khan, Z. A., Israr, I and Yaqoob, M M and Javaid, N and Qasim, U and Khan, Z A, 2012, Simulation Analysis of Medium Access Techniques. In *Broadband, Wireless Computing, Communication and Applications (BWCCA), 2012 Seventh International Conference on*.
- [71] Iwasaki, S., Premachandra, C., Endo, T., Fujii, T., Tanimoto, M., and Kimura, Y., Iwasaki, Shinya and Premachandra, Chinthaka and Endo, Tomohiro and Fujii, Toshiaki and Tanimoto, Masayuki and Kimura, Yoshikatsu, 2008, Visible light road-to-vehicle communication using high-speed camera. In *IEEE Intelligent Vehicles Symposium, Proceedings*.
- [72] Jafari, A., Al-Khayatt, S., and Dogman, A., Jafari, A and Al-Khayatt, S. and Dogman, A, 2012, Performance evaluation of IEEE 802.11p for vehicular communication networks. In *2012 8th International Symposium on Communication Systems, Networks & Digital Signal Processing (CSNDSP)*.
- [73] Jawhar, I., Mohamed, N., and Usmani, H. An Overview of Inter-Vehicular Communication Systems, Protocols and Middleware. *Journal of Networks*, ISBN 9780769541341. ISSN 1796-2056.
<http://ojs.academypublisher.com/index.php/jnw/article/view/9396>.
- [74] Jerbi, M. and Senouci, S. M., SAA 10-4 - Characterizing Multi-Hop Communication in Vehicular Networks. In *2008 IEEE Wireless Communications and Networking Conference*, organization.
- [75] Jiang, B., Yin, J., and Zhao, S. Characterizing the human mobility pattern in a large street network. *Physical Review E - Statistical, Nonlinear, and Soft Matter Physics*, 80 (2):1–11, 2009. ISBN 9781405152730. ISSN 15393755.
- [76] Jiang, D. and Delgrossi, L., IEEE 802.11p: Towards an International Standard for Wireless Access in Vehicular Environments. In *VTC Spring 2008 - IEEE Vehicular Technology Conference*, organization.

[77] Jones, B. No Title, 2007.

[http://usatoday30.usatoday.com/money/autos/
2007-07-15-little-big-cars{_}N.htm](http://usatoday30.usatoday.com/money/autos/2007-07-15-little-big-cars{_}N.htm).

[78] Kargl, F. and Schoch, E. Simulation of MANETs: a qualitative comparison between JiST/SWANS and ns-2. *Performance Evaluation*, 2007. ISBN 9781595937629.

<http://portal.acm.org/citation.cfm?id=1247730>.

[79] Kenney, J. B. *Standards and Regulations*. ISBN 9780470740569.

[80] Khatib, M., editor. *Advanced Trends in Wireless Communications*. ISBN 978-953-307-183-1.

<http://www.intechopen.com/books/advanced-trends-in-wireless-communic>

[81] Kim, D., Yang, S., Kim, H., Son, Y., Won, Y., and Han, S. Implement of visible light communication for CAN signal transmissioin. *Photonics conference*, 2011.

[82] Kim, D.-R., Yang, S.-H., Kim, H.-S., Son, Y.-H., and Han, S.-K. Outdoor Visible Light Communication for inter- vehicle communication using Controller Area Network. ISBN 978-1-4673-2493-9.

[http://ieeexplore.ieee.org/lpdocs/epic03/wrapper.htm?
arnumber=6315865](http://ieeexplore.ieee.org/lpdocs/epic03/wrapper.htm?arnumber=6315865).

[83] Kim, D.-R., Yang, S.-H., Kim, H.-S., Son, Y.-H., Won, Y., and Han, S.-K. Implement of visible light communication for CAN signal transmission. *Photonics conference*, 2011.

[84] Komine, T. and Nakagawa, M. Fundamental analysis for visible-light communication system using LED lights. *IEEE Transactions on Consumer Electronics*, 50(1):100–107, 2004.

[http://ieeexplore.ieee.org/xpls/abs{_}all.jsp?arnumber=
1277847](http://ieeexplore.ieee.org/xpls/abs{_}all.jsp?arnumber=1277847).

[85] Korakis, T., Jakllari, G., and Tassiulas, L. A MAC protocol for full exploitation of directional antennas in ad-hoc wireless networks. *Proceedings of the 4th ACM international symposium on Mobile ad hoc networking & computing - MobiHoc '03*, 2003. ISBN 1581136846.

<http://portal.acm.org/citation.cfm?doid=778415.778428>.

- [86] Kraus, J. and Marhefka, R. Antennas for all applications, 2002. ISBN 9780071232012. ISSN 0072321032 (alk. paper) 0071122400 (International ed.).
<http://adsabs.harvard.edu/abs/2002aaa..book.....K>.
- [87] Kumar, N. Visible Light Communication Based Traffic Information Broadcasting Systems. *International Journal of Future Computer and Communication*, 3(1):26–30, 2014. ISSN 20103751.
<http://www.ijfcc.org/index.php?m=content{\&c=index{\&a=show{\&catid=44{\&id=529>
- [88] Kumar, N., Lourenco, N., Spiez, M., and Aguiar, R. Visible Light Communication Systems Conception and VIDAS, 2008. ISSN 0256-4602.
- [89] Kumar, P. R., Gupta, N., and Kumar, P. R. A performance analysis of the 802.11 wireless lan medium access control. *COMMUNICATIONS IN INFORMATION AND SYSTEMS*, 3:279–304, 2003.
- [90] Latré, B., Mil, P., and Moerman, I. Throughput and delay analysis of unslotted IEEE 802.15. 4. *Journal of networks*, 1(1):20–28, 2006.
<http://www.academypublisher.com/ojs/index.php/jnw/article/viewArticle/01012028>.
- [91] Le, L., Festag, A., and Baldessari, R. Vehicular wireless short-range communication for improving intersection safety. *Communications ...*, ISSN 0163-6804.
<http://ieeexplore.ieee.org/lpdocs/epic03/wrapper.htm?arnumber=5307473><http://ieeexplore.ieee.org/xpls/abs{\&all.jsp?arnumber=5307473>.
- [92] Le, N.-T., Nguyen, T., and Jang, Y. M. Optical Camera Communications: Future Approach of Visible Light Communication. *The Journal of Korean Institute of Communications and Information Sciences*, ISSN 1226-4717.
<http://koreascience.or.kr/journal/view.jsp?kj=GCSHCI{\&py=2015{\&vnc=v40n2{\&sp=380>
- [93] Le, N., Choi, S., and Jang, Y. Cooperative MAC protocol for LED-ID systems. *ICT Convergence (ICTC), 2011 ...*, 2011. ISBN 9781457712685.

http://ieeexplore.ieee.org/xpls/abs/_all.jsp?arnumber=6082569.

- [94] Lee, K. and Park, H. Channel model and modulation schemes for visible light communications. *2011 IEEE 54th International Midwest Symposium on Circuits and Systems (MWSCAS)*, 2011. ISBN 978-1-61284-855-6. ISSN 1548-3746.
- [95] Lee, K., Park, H., Barry, J. R., and Member, S. Indoor Channel Characteristics for Visible Light Communications. *15(2):217–219*, 2011.
- [96] Lee, S.-j. A SNR analysis of the visible light channel environment for visible light communication. ISBN 978-1-4673-4728-0.
<http://ieeexplore.ieee.org/lpdocs/epic03/wrapper.htm?arnumber=6388286>.
- [97] Lee, S. and Kwon, J. Simulation modeling of visible light communication channel for automotive applications. *International IEEE Conference on Intelligent Transportation Systems*, 2012. ISBN 9781467330633.
http://ieeexplore.ieee.org/xpls/abs/_all.jsp?arnumber=6338610.
- [98] Lin, J. C. Are Cell Phones or Radio-Frequency Electromagnetic Fields Possibly Carcinogenic to Humans? [Telecommunications Health and Safety], 2012. ISSN 1045-9243.
- [99] Lochert, C. and Scheuermann, B. *Information Dissemination in VANETs*. ISBN 9780470740569.
- [100] Longley, A., Longley, A.G., 1978, Radio propagation in urban areas. In *28th IEEE Vehicular Technology Conference*, volume 28, organization.
- [101] Lu, M., Wevers, K., and Bekiaris, E., Lu, Meng and Wevers, Kees and Bekiaris, Evangelos, 2005, Traffic safety principles and physical road infrastructure measures. In *19th ICTCT workshop*.
- [102] Luo, P., Ghassemlooy, Z., Minh, H. L., Tang, X., and Tsai, H.-M., Luo, Pengfei and Ghassemlooy, Z and Minh, Hoa Le and Tang, Xuan and Tsai, Hsin-Mu, 2014, Under-

- sampled phase shift ON-OFF keying for camera communication. In *Wireless Communications and Signal Processing (WCSP), 2014 Sixth International Conference on*.
- [103] Ma, X., Yin, X., Butron, G., Penney, C., and Trivedi, K. Packet Delivery Ratio in k-Dimensional Broadcast Ad Hoc Networks. 17(12):2252–2255, 2013.
http://ieeexplore.ieee.org/xpls/abs/_all.jsp?arnumber=6656084.
- [104] Man, L. A. N., Committee, S., and Computer, I. *Part 11 : Wireless LAN Medium Access Control (MAC) and Physical Layer (PHY) Specifications*, volume 2012. 2012. ISBN 9780738172118.
- [105] Manshaei, M., Cantieni, G., Barakat, C., and Turletti, T., Manshaei, M.H. and Cantieni, G.R. and Barakat, C. and Turletti, T., 2005, Performance Analysis of the IEEE 802.11 MAC and Physical Layer Protocol. In *Sixth IEEE International Symposium on a World of Wireless Mobile and Multimedia Networks*, organization.
- [106] Marzetta, T. and Hochwald, B. Fast transfer of channel state information in wireless systems. *IEEE Transactions on Signal Processing*, 54, 2006. ISBN 1053-587X. ISSN 1053-587X.
- [107] Mathworks. Friedman’s test.
<http://www.mathworks.com/help/stats/friedman.html>.
- [108] Mauve, M. and Scheuermann, B. VANET Convenience and Efficiency Applications. ISBN 9780470740569.
- [109] Miller, J., Miller, Jeffrey, 2008, Vehicle-to-vehicle-to-infrastructure (V2V2I) intelligent transportation system architecture. In *IEEE Intelligent Vehicles Symposium, Proceedings*.
- [110] Mishra, A., Shin, M., and Arbaugh, W. An Empirical Analysis of the IEEE 802.11 MAC Layer Handoff Process. *ACM SIGCOMM Computer ...*, 33(2):93–102, 2003. ISSN 01464833.
<http://dl.acm.org/citation.cfm?id=956990>.

- [111] Mittag, J., Schmidt-eisenlohr, F., Killat, M., Torrent-moreno, M., and Hartenstein, H. *MAC Layer and Scalability Aspects of Vehicular Communication Networks*, volume 1. ISBN 9780470740569.
- [112] Miyazaki, E., Itami, S., and Araki, T. Using a light-emitting diode as a high-speed, wavelength selective photodetector. *Review of Scientific Instruments*, 69(11):3751, 1998. ISBN 0034-6748. ISSN 00346748.
<http://dx.doi.org/10.1063/1.1149174><http://scitation.aip.org/content/aip/journal/rsi/69/11/10.1063/1.1149174>.
- [113] Narendran, N. and Gu, Y. Life of LED-based white light sources. *IEEE/OSA Journal of Display Technology*, 1(1):167–170, 2005. ISBN 1551-319X VO - 1. ISSN 1551319X.
- [114] Narukawa, Y., Niki, I., Izuno, K., Yamada, M., Murazaki, Y., and Mukai, T. Phosphor-conversion white light emitting diode using InGaN near-ultraviolet chip. *Japanese Journal of Applied Physics, Part 2: Letters*, 41(4 A), 2002. ISBN 0021-4922. ISSN 00214922.
- [115] Nasipuri, A., Ye, S., You, J., and Hiromoto, R. E., Nasipuri, A and Ye, S and You, J and Hiromoto, R E, 2000, A MAC protocol for mobile ad hoc networks using directional antennas. In *Proceedings of the IEEE Wireless Communications and Networking Conference*, volume 3.
- [116] Neudecker, T., An, N., and Hartenstein, H., Neudecker, Till and An, Natalya and Hartenstein, Hannes, 2013, Verification and evaluation of fail-safe Virtual Traffic Light applications. In *IEEE Vehicular Networking Conference, VNC*.
- [117] Neumann, A., Wierer, J. J., Davis, W., Ohno, Y., Brueck, S. R. J., and Tsao, J. Y. Four-color laser white illuminant demonstrating high color-rendering quality. *Opt. Express*, 19(S4):A982—A990, 2011.
<http://www.opticsexpress.org/abstract.cfm?URI=oe-19-104-A982>.
- [118] Nguyen, H. and Choi, J. A MATLAB-based simulation program for indoor visible light communication system. *Communication ...*, 2010. ISBN 9781861353696.

http://ieeexplore.ieee.org/xpls/abs/_all.jsp?arnumber=5580355.

[119] Okada, H., Nomura, Y., Yamamoto, T., and Nakanishi, Y., Okada, H and Nomura, Y and Yamamoto, T and Nakanishi, Y, 1984, Comparative evaluation of token-ring and CSMA/CD medium-access control protocols in LAN configurations. In *Computer Networking Symposium, 1984. Proceedings*.

[120] Okada, S., Yendo, T., Yamazato, T., Fujii, T., Tanimoto, M., and Kimura, Y. On-vehicle receiver for distant visible light road-to-vehicle communication. ISBN 978-1-4244-3503-6.

<http://ieeexplore.ieee.org/lpdocs/epic03/wrapper.htm?arnumber=5164423>.

[121] Papadimitratos, P., La Fortelle, A., Evensen, K., Brignolo, R., and Cosenza, S. Vehicular communication systems: Enabling technologies, applications, and future outlook on intelligent transportation. *IEEE Communications Magazine*, ISBN 0163-6804 VO - 47. ISSN 0163-6804.

<http://ieeexplore.ieee.org/lpdocs/epic03/wrapper.htm?arnumber=5307471>.

[122] Pisek, E., Rajagopal, S., and Abu-Surra, S. Gigabit rate mobile connectivity through visible light communication. ISBN 978-1-4577-2053-6.

<http://ieeexplore.ieee.org/lpdocs/epic03/wrapper.htm?arnumber=6363739>.

[123] Pohlmann, C., Pohlmann, Christian, 2010, Visible light communication. In *Seminar Kommunikationsstandards in der Medizintechnik*.

[124] Principles, B. Introduction 1.1. ISBN 9780470740569.

[125] Puschell, J. and Bayse, R. High data rate ultraviolet communication systems for the tactical battlefield. *Conference Proceedings on Tactical Communications, Vol.1.*, 1990.

[126] Rahaim, M. B., Vegni, A. M., and Little, T. D. C. A hybrid Radio Frequency and broadcast Visible Light Communication system. *2011 IEEE GLOBECOM Workshops, GC Wkshps 2011*, 2011. ISBN 9781467300407.

- [127] Rajagopal, S. IEEE 802.15. 7 visible light communication: modulation schemes and dimming support. *Communications Magazine*, (March):72–82, 2012.
<http://ieeexplore.ieee.org/xpls/abs/all.jsp?arnumber=6163585>.
- [128] Rampf, S. Network Simulation and its Limitations. *Network Architectures and Services*, (August):83–89, 2013.
- [129] Renesse, R. V., Birman, P. K., Mcadams, P. A., and Barr, R. JiST – Java in Simulation Time An efficient, unifying approach to simulation using virtual machines motivation: simulation cost per MIPS declining. (May), 2004.
- [130] Roberts, R. D., Rajagopal, S., and Lim, S. K., Roberts, Richard D. and Rajagopal, Sridhar and Lim, Sang Kyu, 2011, IEEE 802.15.7 physical layer summary. In *2011 IEEE GLOBECOM Workshops, GC Wkshps 2011*.
- [131] Robinson, C. L. Efficient Application Level Message Coding and Composition. (Md), 2001. ISBN 9780470740569.
- [132] Rohal, P., Dahiya, R., and Dahiya, P. INTERNATIONAL JOURNAL FOR ADVANCE RESEARCH IN ENGINEERING AND TECHNOLOGY Study and Analysis of Throughput, Delay and Packet Delivery Ratio in MANET for Topology Based Routing Protocols (AODV, DSR and DSDV). 1(Ii):54–58, 2013.
- [133] Saadi, M., Wattisuttikulki, L., Zhao, Y., and Sangwongngam, P. Visible Light Communication: Opportunities, Challenges and Channel Models ISSN: .
- [134] Schmid, S., Corbellini, G., Mangold, S., and Gross, T. R., Schmid, Stefan and Corbellini, Giorgio and Mangold, Stefan and Gross, Thomas R., 2012, An LED-to-LED Visible Light Communication system with software-based synchronization. In *2012 IEEE Globecom Workshops, GC Wkshps 2012*.
- [135] Schoch, E., Kargl, F., and Weber, M. Communication patterns in VANETs. *IEEE Communications Magazine*, ISBN 0163-6804. ISSN 0163-6804.
<http://ieeexplore.ieee.org/lpdocs/epic03/wrapper.htm?arnumber=4689254>.

- [136] Schwartz, M., Bennett, W., and Stein, S. Communication Systems and Techniques. *IEEE Communications Magazine*, 34, 1996. ISBN 0780311663. ISSN 0163-6804.
- [137] Shao, S., Khreishah, A., Rahaim, M. B., Elgala, H., Ayyash, M., Little, T. D. C., and Wu, J. An indoor hybrid WiFi-VLC internet access system. *Proceedings - 11th IEEE International Conference on Mobile Ad Hoc and Sensor Systems, MASS 2014, (Vlc): 569–574*, 2015. ISBN 9781479960354. ISSN 1536-1284.
- [138] Siegel, A. M., Siegel, Andrew M., 2004, Short-range communication with ultraviolet LEDs. In *Proceedings of SPIE*, volume 5530.
- [139] Sinha, R., Roop, P., and Ranjitkar, P. Virtual Traffic Lights+ (VTL+): A Robust, Practical, and Functionally-Safe Intelligent Transportation System. *Transportation Research Board 92nd Annual Meeting*, 2013.
<http://trid.trb.org/view.aspx?id=1242582>.
- [140] Stiller, C. What Will Bring Vehicular Communication into Passenger Cars? *IEEE Intelligent Transportation Systems Magazine*, ISSN 1939-1390.
<http://ieeexplore.ieee.org/lpdocs/epic03/wrapper.htm?arnumber=5609608>.
- [141] Sundani, H., Li, H., Devabhaktuni, V., Alam, M., and Bhattacharya, P. Wireless Sensor Network Simulators A Survey and Comparisons. *International Journal Of Computer Networks (IJCN)*, 2:249–265, 2010.
<http://www.cscjournals.org/csc/manuscriptinfo.php?ManuscriptCode=72.73.66.77.44.54.49.99>.
- [142] Sutaria, T., Mahgoub, I., Humos, A., and Badi, A., Implementation of an Energy Model for JiST/SWANS Wireless Network Simulator. In *Sixth International Conference on Networking (ICN'07)*, ICN '07, organization.
- [143] Takata, M., Bandai, M., and Watanabe, T. A MAC protocol with directional antennas for deafness avoidance in ad hoc networks. ... , 2007. *GLOBECOM'07*. ... , 2007.
http://ieeexplore.ieee.org/xpls/abs{_}all.jsp?arnumber=4411031.

- [144] Tamimi, A.-K. A. Performance Analysis of Data Encryption Algorithms. Technical report.
http://www.cse.wustl.edu/~jain/cse567-06/ftp/encryption{_}perf/.
- [145] Tan, I. and Bahai, A. *Physical Layer Considerations for Vehicular Communications*. ISBN 9780470740569.
- [146] Tan, L. and Wang, N., Tan, Lu and Wang, Neng, 2010, Future internet: The Internet of Things. In *2010 3rd International Conference on Advanced Computer Theory and Engineering(ICACTE)*, volume 5.
- [147] Tang, S. Performance modeling of an integrated wireless network using WiMAX as backhaul support for WiFi traffic. *International Journal of Wireless Information Networks*, 19(1):73–83, 2012. ISBN 9781467300810. ISSN 10689605.
- [148] Tayal, S. and Tripathi, M. R., VANET-Challenges in Selection of Vehicular Mobility Model. In *2012 Second International Conference on Advanced Computing & Communication Technologies*, organization.
- [149] Tesla, N. System of signaling., 1903.
<https://www.google.com/patents/US725605>.
- [150] Tippanagoudar, V., Mahgoub, I., and Badi, A., Implementation of the Sensor-MAC Protocol for the JiST/SWANS Simulator. In *2007 IEEE/ACS International Conference on Computer Systems and Applications*, organization.
- [151] Tocancipa Triana, J. Impact of Channel Width on the Performance of Long-distance 802.11 Wireless Links. *Group*, 2009.
- [152] Tomaš, B. WiFi Roaming Access Point Optimum Assignment in Urban Multi-sensor Networks. *Research Papers Faculty of Materials Science and Technology Slovak University of Technology*, 2013.
- [153] Tomaš, B. Visible Light Communication Physical Layer Design for JiST Simulation. *Research papers, Faculty of Materials Science and Technology in Trnava*, 22:41–46, 2014.

http://www.mtf.stuba.sk/docs/doc/casopis{_}Vedecke{_}prace/33SN/1-Tomas.pdf.

- [154] Tranter, W. and Kosbar, K. Simulation of communication systems. *IEEE Communications Magazine*, ISBN 978-0-306-46267-2. ISSN 0163-6804.
<http://ieeexplore.ieee.org/lpdocs/epic03/wrapper.htm?arnumber=295942>.
- [155] Tzeng, H. and Chen, C. Performance comparison of two MAC protocols for wireless ATM networks. *Information Networking, 2001. Proceedings ...*, (Figure 1):805–810, 2001. ISBN 0769509517.
http://ieeexplore.ieee.org/xpls/abs{_}all.jsp?arnumber=905584.
- [156] Ulrich, L. BMW Laser Headlights Slice Through the Dark, 2013.
<http://spectrum.ieee.org/transportation/advanced-cars/bmw-laser-headlights-slice-through-the-dark>.
- [157] United Nations. AGREEMENT CONCERNING THE ADOPTION OF UNIFORM TECHNICAL PRESCRIPTIONS FOR WHEELED VEHICLES, EQUIPMENT AND PARTS WHICH CAN BE FITTED AND/OR BE USED ON WHEELED VEHICLES AND THE CONDITIONS FOR RECIPROCAL RECOGNITION OF APPROVALS GRANTED ON THE BASIS OF THESE . (March 1958):1–116, 2010.
- [158] United Nations. Addendum 6: Regulation No. 7. (November), 2012.
- [159] United Nations. Regulation No. 99, Addendum 98: Uniform provisions concerning the approval of gas-discharge light sources for use in approved gas-discharge lamp units of power-driven vehicles. Technical Report March 1958, 2012.
- [160] United Nations. Addendum 111: Regulation No. 112 Revision 3. (March 1958), 2013.
- [161] Uysal, M. and Nouri, H., Optical wireless communications â” An emerging technology. In *2014 16th International Conference on Transparent Optical Networks (ICTON)*, organization.

- [162] Vallati, C., Omwando, V., and Mohapatra, P. Experimental work versus simulation in the study of mobile ad hoc networks. In Basagni, S., Conti, M., Giordano, S., and Stojmenovic, I., editors, *Mobile Ad Hoc Networking: Cutting Edge Directions*. John Wiley & Sons, Inc., 2 edition, 2013.
- http://books.google.com/books?hl=en&lr=&id=SEbSRhyU4QC&oi=fnd&pg=PT12&dq=Mobile+Ad+Hoc+Networking:+The+Cutting+Edge+Directions&ots=Ye8zTngyx-&sig=0aR4Y3gS4{_}4bzP374h1sB27zWHg.
- [163] Vanhatupa, B. T. and Ph, D. *Wi-Fi Capacity Analysis for*, 2013.
- [164] Vardakas, J. S., Papapanagiotou, I., Logothetis, M. D., and Kotsopoulos, S. A. On the End-to-End Delay Analysis of the IEEE 802 . 11 Distributed Coordination Function. 2010. ISBN 0769529119.
- [165] Venkatesh, S. Radio Wave Propagation. *AIP Conference Proceedings*, 923:164, 2007. ISBN 9783540771241. ISSN 0094243X.
- <http://link.aip.org/link/APCPCS/v923/i1/p164/s1{\&Agg=doi>.
- [166] Vilzmann, R. and Bettstetter, C. A survey on MAC protocols for ad hoc networks with directional antennas. ... *2005: Networks and Applications Towards a ...*, 2006.
- http://link.springer.com/chapter/10.1007/0-387-31170-X{_}14.
- [167] Viterbi, A. J. *CDMA: Principles of Spread Spectrum Communication*. 1995. ISBN 0201633744.
- <http://www.lavoisier.fr/livre/notice.asp?id=03OWRXA22LKOWA>.
- [168] Wallace, R. *Antenna Selection Guide*. Technical report, Texas Instruments, Dallas, 2010.
- <http://www.ti.com/lit/an/swra161b/swra161b.pdf>.
- [169] Wang, Y., Shao, Y., Shang, H., Lu, X., Wang, Y., Yu, J., and Chi, N. 875-Mb/s asynchronous bi-directional 64QAM-OFDM SCM-WDM transmission over RGB-LED-based visible light communication system. *Optical Fiber Communication Conference and Exposition and the National Fiber Optic Engineers Conference (OFC/NFOEC), 2013*, 2013. ISBN 9781557529626.

<http://ieeexplore.ieee.org.ezproxy.unal.edu.co/xpl/articleDetails.jsp?tp={\&}arnumber=6532859{\&}queryText=875-Mb/s+asynchronous+bi-directional+64QAM-OFDM+SCM-WDM+transmission+over+RGB-LED-based+visible+light+communication+system>.

[170] Weidel, E. Vehicle headlight, 2002.

<http://www.google.com/patents/USD556349>.

[171] Weimerskirch, A., Haas, J. J., Hu, Y.-c., and Laberteaux, K. P. *Data Security in Vehicular Communication Networks*. 2015. ISBN 9780470740569.

[172] Weingartner, E. A performance comparison of recent network simulators. ... , 2009. *ICC'09. IEEE ...*, 2009. ISBN 9781424434350.

http://ieeexplore.ieee.org/xpls/abs{_}all.jsp?arnumber=5198657.

[173] Weingärtner, E., Vom Lehn, H., and Wehrle, K., Weingärtner, Elias and Vom Lehn, Hendrik and Wehrle, Klaus, 2009, A performance comparison of recent network simulators. In *IEEE International Conference on Communications*.

[174] Wikipedia. Pulse width modulation.

https://en.wikipedia.org/wiki/Pulse-width{_}modulation.

[175] Wu, L. C. and Tsai, H. M. Modeling vehicle-to-vehicle visible light communication link duration with empirical data. *2013 IEEE Globecom Workshops, GC Wkshps 2013*, 2013. ISBN 9781479928514.

[176] Xu, Q., Mak, T., Ko, J., and Sengupta, R., Xu, Qing and Mak, Tony and Ko, Jeff and Sengupta, Raja, 2004, Vehicle-to-vehicle safety messaging in DSRC. In *Proceedings of the first ACM workshop on Vehicular ad hoc networks - VANET '04*.

[177] Xu, Z., Chen, G., Abou-Galala, F., and Leonardi, M. Experimental performance evaluation of non-line-of-sight ultraviolet communication systems. *Proceedings of SPIE*, 6709:67090Y–67090Y–12, 2007. ISBN 9780819468574. ISSN 0277786X.

<http://link.aip.org/link/PSISDG/v6709/i1/p67090Y/s1{\&}Agg=doi>.

- [178] Yamazato, T., Takai, I., Okada, H., Fujii, T., Yendo, T., Arai, S., Andoh, M., Harada, T., Yasautomi, K., Kagawa, K., and Kawahito, S. Image-sensor-based visible light communication for automotive applications. *IEEE Communications Magazine*, (July): 88–97, 2014.
http://ieeexplore.ieee.org/xpls/abs{_}all.jsp?arnumber=6852088.
- [179] Yeh, C.-H., Liu, Y.-L., and Chow, C.-W. Real-time white-light phosphor-LED visible light communication (VLC) with compact size. *Optics express*, 21:26192–7, 2013. ISSN 1094-4087.
<http://www.ncbi.nlm.nih.gov/pubmed/24216843>.
- [180] Yoo, J. H., Lee, R., Oh, J. K., Seo, H. W., Kim, J. Y., Kim, H. C., and Jung, S. Y., Yoo, Jong Ho and Lee, Rimhwan and Oh, Jun Kyu and Seo, Hyun Wook and Kim, Ju Young and Kim, Hyeon Cheol and Jung, Sung Yoon, 2013, Demonstration of vehicular visible light communication based on LED headlamp. In *International Conference on Ubiquitous and Future Networks, ICUFN*.
- [181] Youm, S. and Kim, E.-j. Latency and Jitter Analysis for IEEE 802 . 11e Wireless LANs. 2013, 2013.
- [182] Young, T. A course of lectures on natural philosophy and the mechanical arts. 1, 1807.
<http://www.biodiversitylibrary.org/item/63005>.
- [183] Yu, S.-h. and Shih, O. Smart automotive lighting for vehicle safety. *Communications ...*, (December):50–59, 2013.
http://ieeexplore.ieee.org/xpls/abs{_}all.jsp?arnumber=6685757.
- [184] Yu, S.-h., Shih, O., and Tsai, H.-M. Smart automotive lighting for vehicle safety. *IEEE Communications Magazine*, (December):50–59, 2013.
http://ieeexplore.ieee.org/xpls/abs{_}all.jsp?arnumber=6685757.

APPENDIX

Listing 7.1: XML configuration file (complete)

```
<?xml version="1.0" encoding="UTF-8"?>
<java version="1.4.2_05" class="java.beans.XMLDecoder">
  <!-- wrap:version=1 -->
  <!-- wrap:offsetleft:wrap=-89,43072222222222wrap:offsetleft:wrap-->
  <!-- wrap:offsettop:wrap=-88,54933333333333wrap:offsettop:wrap-->
  <!-- wrap:scale:wrap=30wrap:scale:wrap-->
  <!-- wrap:id:wrap=d0db530b-e2cb-4bcb-9bb2-d9b6d81431d0wrap:id:wrap-->
  <!-- wrap:title:wrap=d0db530b-e2cb-4bcb-9bb2-d9b6d81431d0wrap:title:wrap-->

  <object class="driver . JistExperiment ">
    <!-- timing --->
    <void property="duration">
      <int>180</int>
    </void>
    <void property="resolutionTime">
      <int>600</int>
    </void>
    <void property="startTime">
      <int>60</int>
    </void>
    <!-- environment --->
    <void property="exponent">
      <double>2.8</double>
    </void>
    <void property="stdDeviation">
      <double>0.0</double>
    </void>
    <void property="bandwidth">
      <int>500000</int>
    </void>
    <void property="loss">
      <int>0</int>
    </void>
    <void property="pathloss">
      <int>4</int>
    </void>
    <void property="transmit">
      <double>50</double>
    </void>
    <!-- mobility options --->
    <void property="mobility">
      <int>1</int>
    </void>
    <void property="max_speed">
      <int>20</int>
    </void>
    <void property="min_speed">
      <int>1</int>
    </void>
    <void property="pause_time">
      <int>5</int>
    </void>
    <void property="granularity">
      <int>5</int>
    </void>
    <void property="segmentFile">
      <string>swanspp/suffolk/segments.dat</string>
    </void>
    <void property="streetFile">
      <string>swanspp/suffolk/names.dat</string>
    </void>
    <void property="shapeFile">
      <string>swanspp/suffolk/chains.dat</string>
    </void>
    <void property="degree">
      <int>4</int>
    </void>
```

```

<void property="probability">
  <double>0.3</double>
</void>
<void property="minLat">
  <float>-1000</float>
</void>
<void property="minLong">
  <float>-1000</float>
</void>
<void property="maxLat">
  <float>1000</float>
</void>
<void property="maxLong">
  <float>1000</float>
</void>
<!-- node options -->

<void property="sendRate">
  <double>1.0</double>
</void>
<!-- placement options -->
<void property="placement">
  <int>2</int>
</void>
<void property="spatial_mode">
  <int>2</int>
</void>
<void property="StaticPlacementOptions">
  <string>
    100,100,0,1.7,5,0,0, s1 ,40,60,1,0,0, r, s2 ,40,50,-1,1,
    -180,t,s3 ,40,60,-1,0,180, r, s4 ,40,50,1,1,0, t, s5 ,40,
    50,1,-1,0, t, s6 ,40,50,-1,-1,180, t;
    120,100,0,1.7,5,0,0, s1 ,40,60,1,0,0, r, s2 ,40,50,-1,1,
    -180,t,s3 ,40,60,-1,0,180, r, s4 ,40,50,1,1,0, t, s5 ,40,
    50,1,-1,0, t, s6 ,40,50,-1,-1,180, t ;</ string>
</void>
<void property="ResultsPath">
  <string>...\ results \rd0db530b-d9b6d81431d0.csv</string>
</void>
<void property="cbrRate">
  <int>4096</int>
</void>
<void property="nodes">
  <int>2</int>
</void>
<void property=" transmitters ">
  <int>2</int>
</void>
<void property="MACProtocol">
  <string>MAC_802_11</string>
</void>
<void property="MeasurementMode">
  <boolean>true</boolean>
</void>
<void property="fieldX">
  <int>600</int>
</void>
<void property="fieldY">
  <int>600</int>
</void>

```

```
<!-- visualization options -->
<void property="useVisualizer">
  <boolean>true</boolean>
</void>
<!-- other options -->
<void property="port">
  <int>3001</int>
</void>
<void property="protocol">
  <int>123</int>
</void>
<void property="help">q
  <boolean>>false</boolean>
</void>
</object>
</java>
```

Appendix 1: Appendix one

Curriculum vitae

Boris Tomaš was born on the 6th of November 1984. He is a junior researcher, teaching assistant and PhD student in the Faculty of Organization and Informatics, University of Zagreb in Croatia, where he works in the Department of Information System Development. His academic assignments at Faculty are laboratory course lectures for: "Internet of Things: Embedded Software Development" and "Software Engineering". His fields of interest are: software development, wireless networking, communications, mobile and embedded development, and bioinformatics. In 2010 he enrolled in doctoral study *Information Science* at the University of Zagreb.

Throughout his career he has worked on several international and national commercial and science projects. In terms of his academic achievements, he has received the Faculty Dean's award and a prestige University Rector's award. In the field of this research he received the *Best paper award* at the International Doctoral Seminar, Dubrovnik, 2013.

LIST OF PUBLICATIONS

- [1] Tomaš, B. Vrčec, N. (2014) Smart City Vehicular Mobile Sensor Network. E: Giaffreda, R., Caganova, D., Li, Y., Riggio, R. Voisard, A. (ur.) Internet of Things. IoT Infrastructures. Cham, Springer International Publishing, p. 70-77.
- [2] Tomaš, B. (2014) Visible Light Communication Physical Layer Design for JiST Simulation. Research papers Faculty of Materials Science and Technology Slovak University of Technology in Trnava, 22, p. 41-56.
- [3] Tomaš, B. (2014) Cortex Simulation System Proposal Using Distributed Computer Network Environments. International Journal of Computer Science Information Security, 12, p. 22-25.
- [4] Tomaš, B. (2013) WiFi Roaming Access Point Optimum Assignment in Urban Multi-sensor Networks. Research papers Faculty of Materials Science and Technology Slovak University of Technology in Trnava, 21, p. 109-115.
- [5] Andročec, D., Tomaš, B. Kišasondi, T. (2017) Interoperability and Lightweight Security for Simple IoT Devices. MIPRO 2017, 40th International convention, Information

Systems Security Section. Zagreb, 22-26.5.2017.

- [6] Tomaš, B., Hsin-Mu Tsai Boban, M. (2014) Simulating vehicular visible light communication: Physical radio and MAC modeling. Vehicular Networking Conference (VNC). Paderborn, IEEE, p. 222-225.
- [7] Vukšić, B., Krajačić, N. Tomaš, B. (2012) Augmented reality in high school education. Central European Conference on Information and Intelligent Systems 23rd International Conference. Varaždin, Faculty of organization and informatics, p. 131-135.
- [8] Krajačić, N., Gregurec, I. Tomaš, B. (2012) Skills Framework for Social Age - SFSA. Central European Conference on Information and Intelligent Systems 23rd International Conference. Varaždin, Faculty of organization and informatics, p. 157-163.
- [9] Tomaš, B. Vukšić, B. (2012) Peer to Peer Distributed Storage and Computing Cloud System. Proceeding of the ITI 2012 34th International Conference on Information Technology interfaces. Cavtat, p. 79-84.
- [10] Gregurec, I., Ćorić, A. Tomaš, B. (2011) Word-of-Mouth Marketing within Social Networking Sites. Proceedings of the 22nd Central European Conference on Information and Intelligent Systems. Varaždin, p. 227-233.