

Displacement Damage and Gas Production Data for ESS Structural Materials

U. Fischer, A. Yu. Konobeyev, M. Majerle^(), P. Vladimirov, B. Weinhorst*

Karlsruhe Institute of Technology

() Nuclear Physics Institute, Rez, CR (permanent address)*

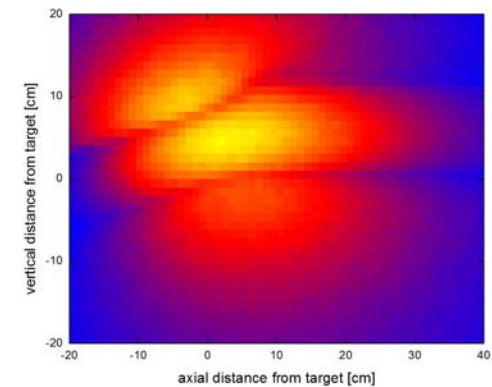
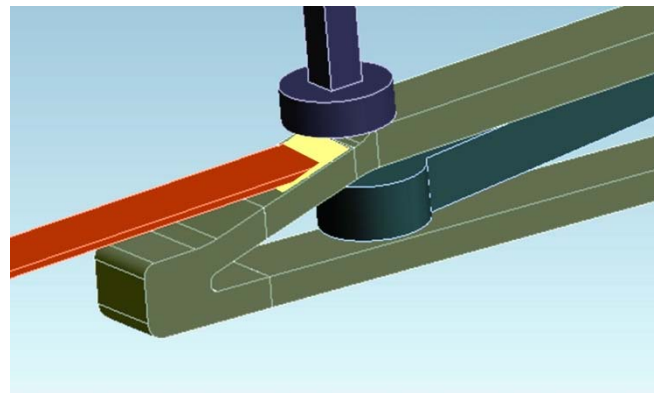
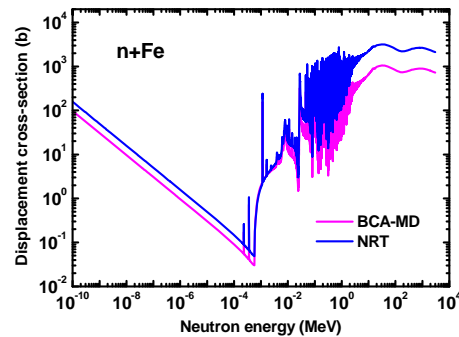

Content

- Background
- Data evaluation methodology (KIT)
- Displacement damage and gas production cross-section data
- Fe, Cr, Ni & others for n & p induced reactions up to 3 GeV
- Application to ESS windowless liquid metal target
- Conclusions

Background

- ESS target and structural materials subjected to intense neutron and proton irradiation
- Materials properties deteriorated due to displacement damages and gas generation
- Very few data available for materials and energy range relevant to ESS
- Evaluation effort at KIT for providing data of n & p induced reactions up to 3 GeV
- Focus on Fe, Cr & Ni

Displacement damage cross-section

$$\sigma_d(E_p) = \sum_i \int_{E_d}^{T_i^{\max}} \frac{d\sigma(E_p, Z_T, A_T, Z_i, A_i)}{dT_i} \eta(T) N_{\text{NRT}}(T_i, Z_T, A_T, Z_i, A_i) dT_i$$

$d\sigma/dT$: recoil energy distribution

E_d : effective threshold displacement energy

Defect production efficiency $\eta(T) = \frac{N_D}{N_{\text{NRT}}}$

$N_D(T)$: number of Frenkel pairs produced by PKA (MD, BCA, experiment)

MD = Molecular Dynamics
BCA = Binary Collision Approximation

NRT model

M.J.Norgett, M.T.Robinson, I.M.Torrens, Nucl. Eng. Des. 33 (1975), 50

Number of defects produced by PKA

$$N_{\text{NRT}}(T) = \frac{0.8}{2E_d} T_{\text{dam}}$$

T: PKA energy

$$T_{\text{dam}}(T) = \frac{T}{1 + k(3.4008 \varepsilon^{1/6} + 0.40244 \varepsilon^{3/4} + \varepsilon)}$$

Available experimental data and MD simulations show pronounced differences with NRT predictions

Typical $\eta(T)$ values: 0.5 (Al), 0.3 (Fe), 0.3 (Cu)

Defect production calculation – KIT approach

Combined BCA-MD approach for the calculation of the number of stable displacements in atom lattices

Transition from BCA to MD at “critical” kinetic energy
(T_{crit})

$T < T_{\text{crit}}$: MD

$T > T_{\text{crit}}$: BCA

T_{crit} typically between 30 – 60 keV

KIT codes IOTA and CASCADE

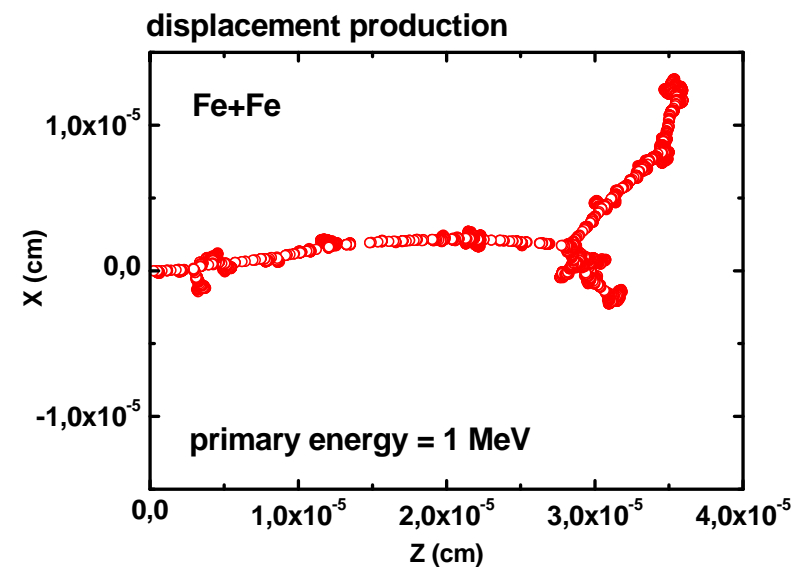

Example: N_D/N_{NRT} for iron

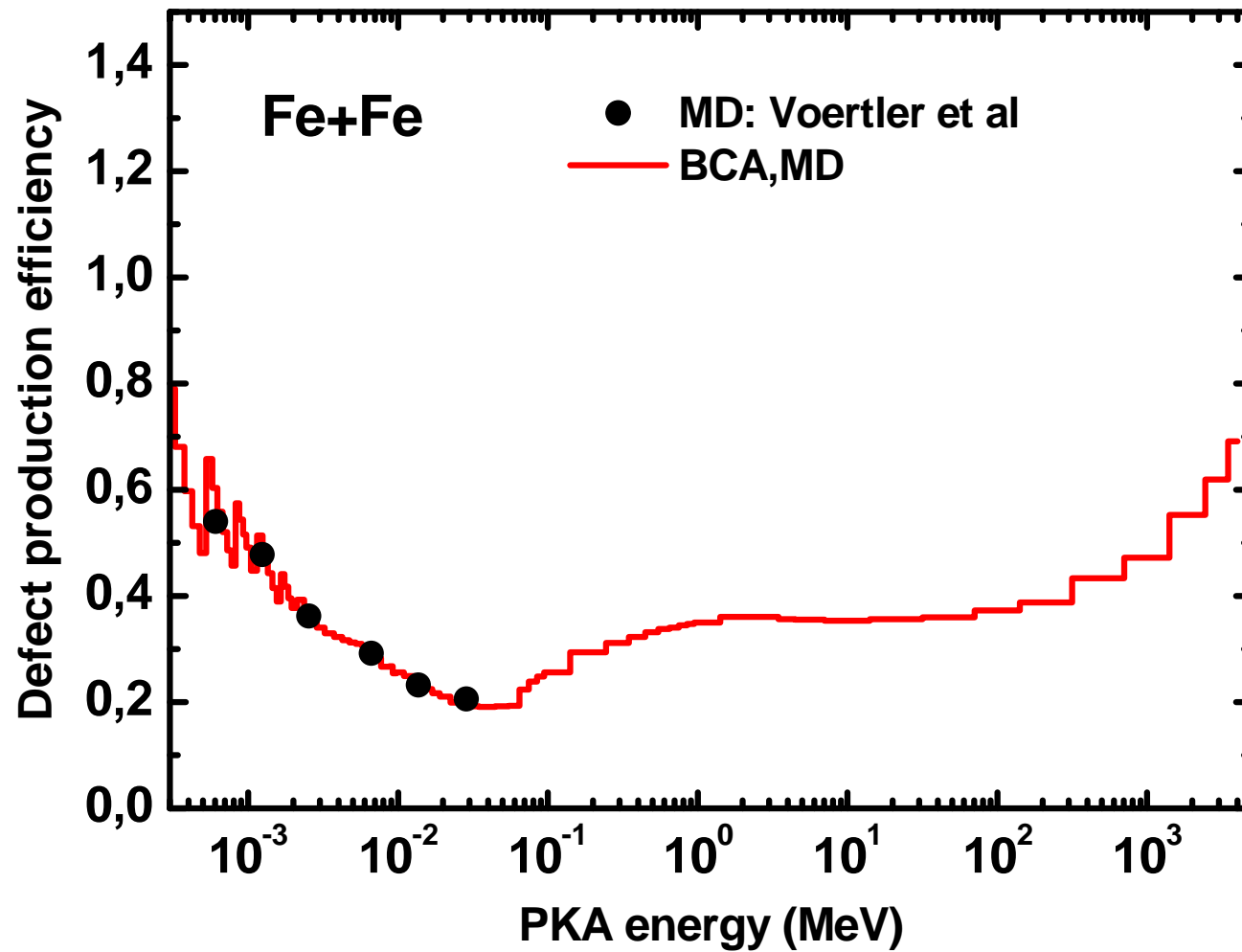

Nucleon elastic scattering

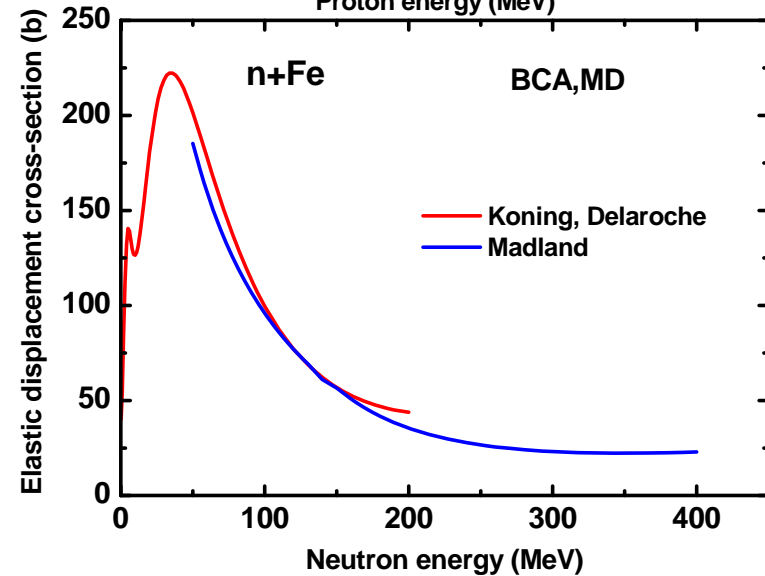
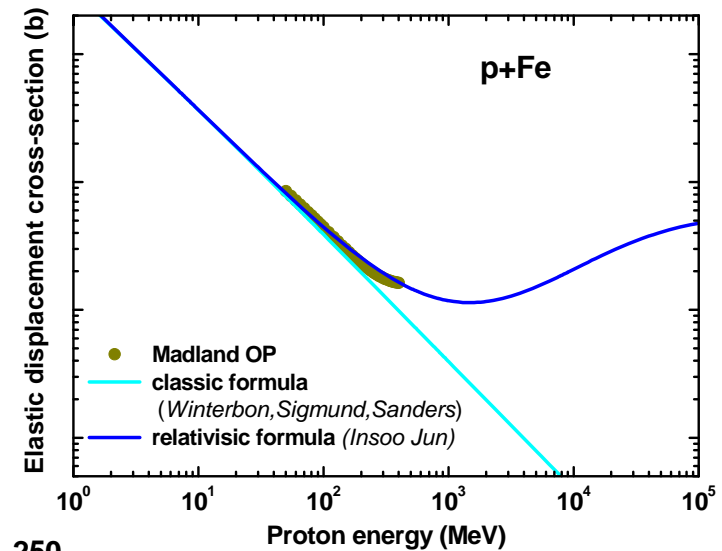
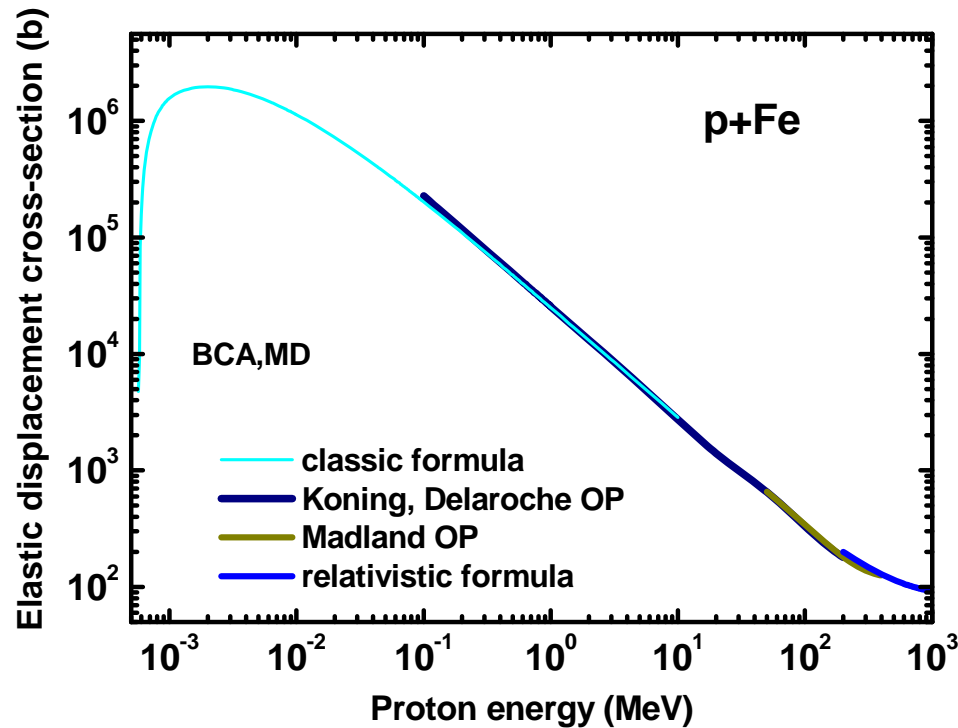

- Optical potentials of Koning, Delaroche and Madland up to 400 MeV
- Relativistic approach above 400 MeV

Non-elastic scattering

Different models & codes

MCNPX: INC+PE+EQ

INC: Bertini, ISABEL, CEM03, INCL4

EQ: Dresner, ABLA

CASCADE (JINR, KIT): INC+EQ

DISCA-C (KIT): INC(+clusters)+EQ

TALYS : PE (exciton model) +EQ (H-F)

HMS ALICE : Hybrid model +EQ

GNASH: PE (exciton model) +EQ (H-F)

Evaluated displacement cross-section :

$$\sigma_{\text{displ}} = \sum_{m=1}^M w_m \sigma_{\text{displ},m}$$

Non-elastic scattering (cont'd)

Example: Displacement cross-sections (b) for non elastic interactions of 0.6 GeV neutrons and protons with ^{56}Fe .
 Calculation of recoil spectra and displacement cross-sections using equally weighted models

Nuclear model	Neutrons	Protons
Bertini/Dresner	807	727
Bertini/ABLA	864	775
ISABEL/Dresner	815	732
ISABEL/ABLA	857	776
CEM03	781	712
INCL4/Dresner	956	849
INCL4/ABLA	1002	894
CASCADE	796	717
DISCA-C	870	786
Average value	861 ± 75	774 ± 62

Evaluated Fe displacement damage cross-sections up to 3 GeV

Neutron induced

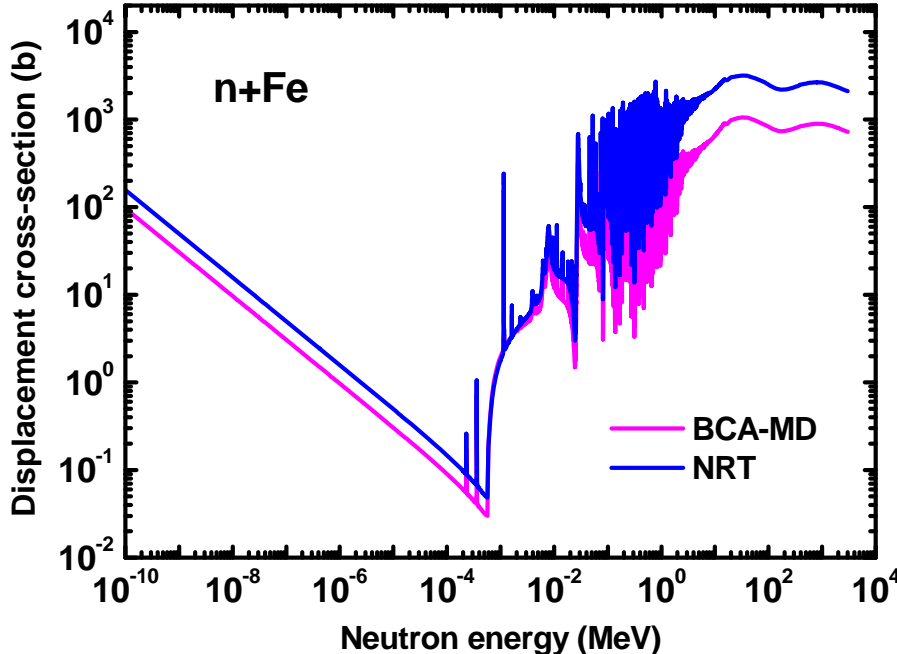

Proton induced

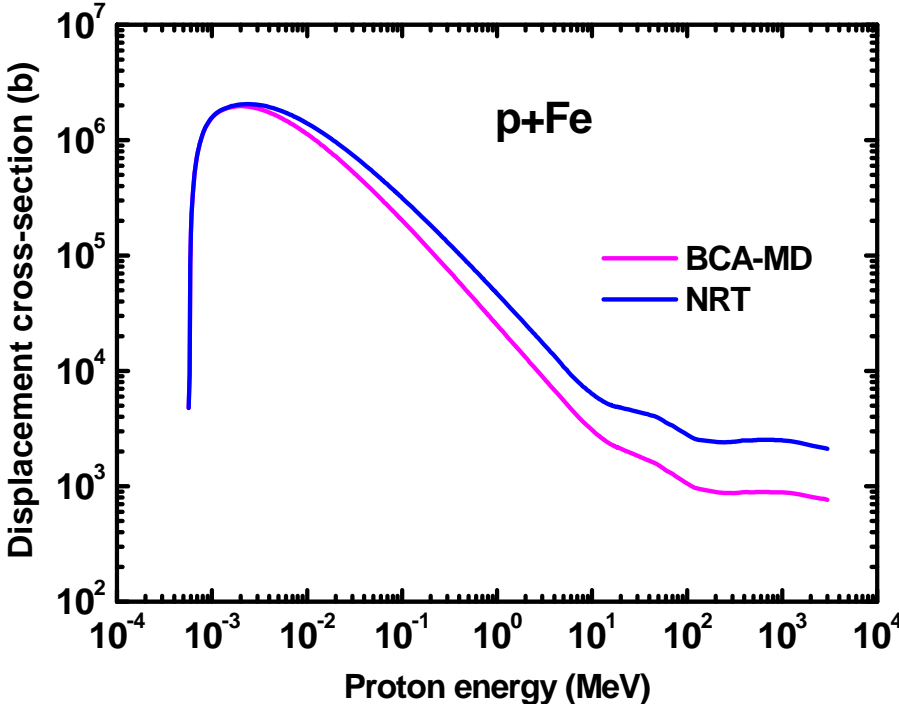

Evaluated Cr displacement damage cross-sections up to 3 GeV

Neutron induced

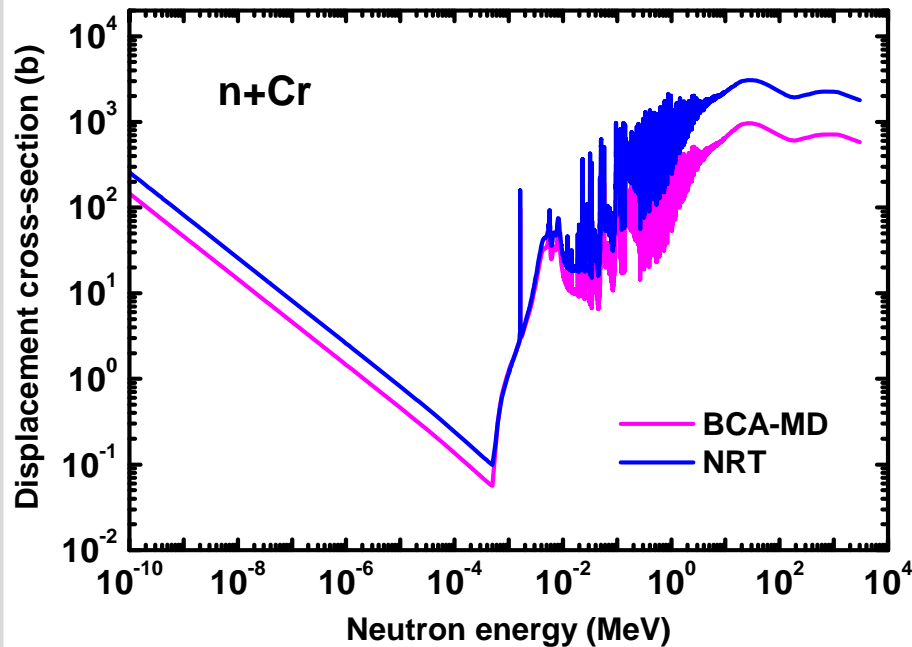

Proton induced

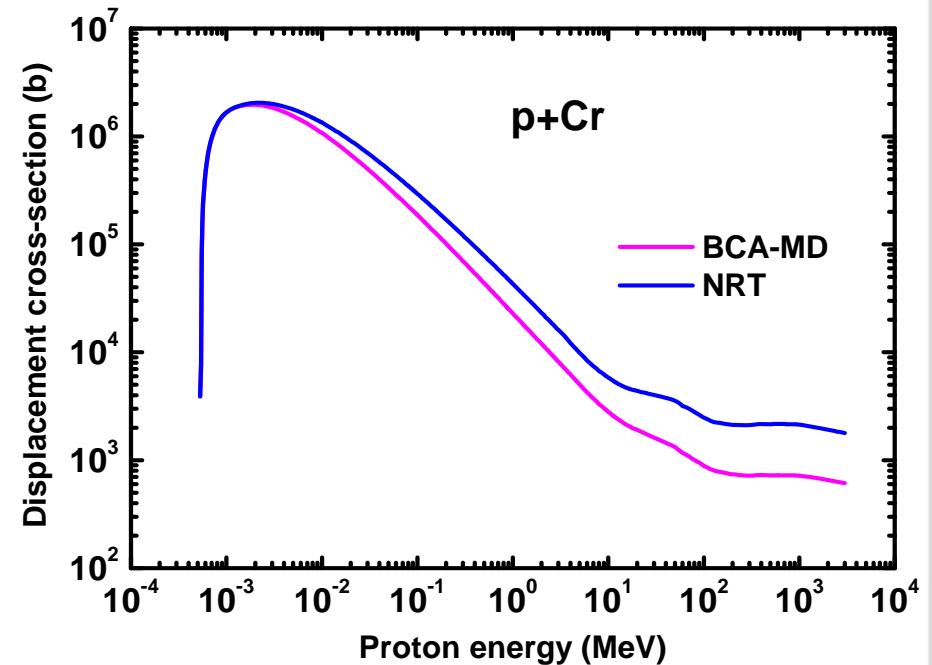

Evaluated Ni displacement damage cross-sections up to 3 GeV

Neutron induced

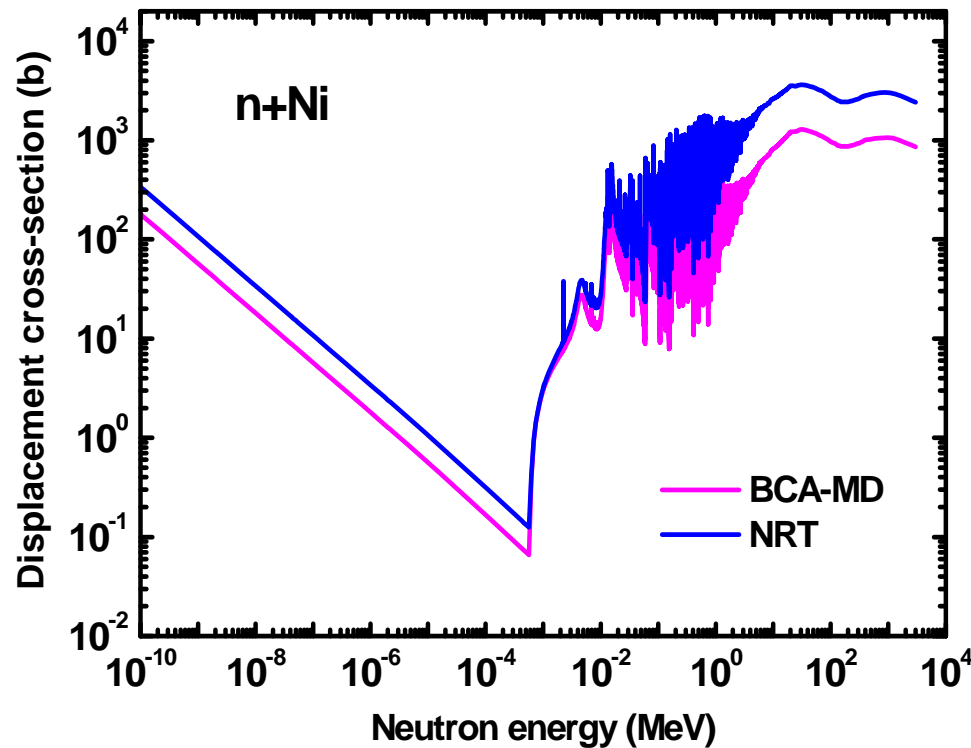

Proton induced

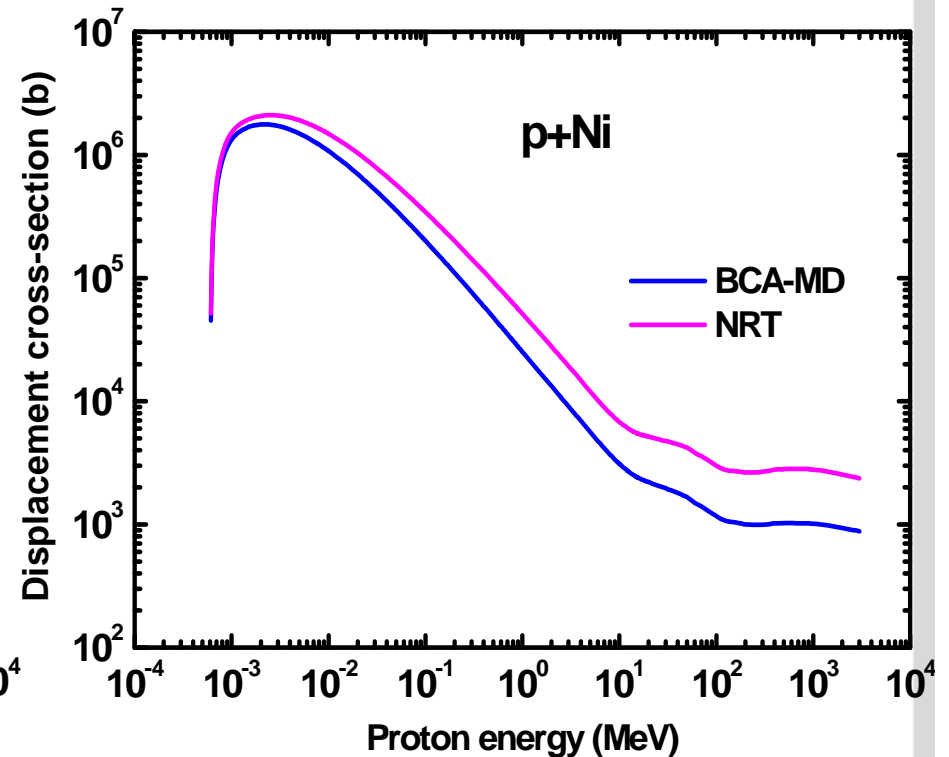

Gas production cross-sections

Proton-, deuteron-, triton, ^3He -, ^4He - production

Experimental data

EXFOR, JINR compilation (1972), and more

(p,x) reactions

Fe, Ni: 24 measurements

Cr: K.Goebel et al, CERN (1964)

Data correction

Cutoff energy: Bertrand F.E., Peelle R.W. (1973)

Spectrum: Herbach C.-M. et al (2006)

Calculations

ALICE/ASH (KIT) : GDH(+non-equilibrium cluster emission) +EQ

TALYS (NRG): PE exciton model +EQ (H-F)

DISCA-C (KIT): INC(+clusters)+EQ

CASCADE (JINR, KIT): INC(+improved coalescence model) +EQ

MCNPX models: for illustration purposes only

Evaluation ...

... comes later

MCNPX model calculations

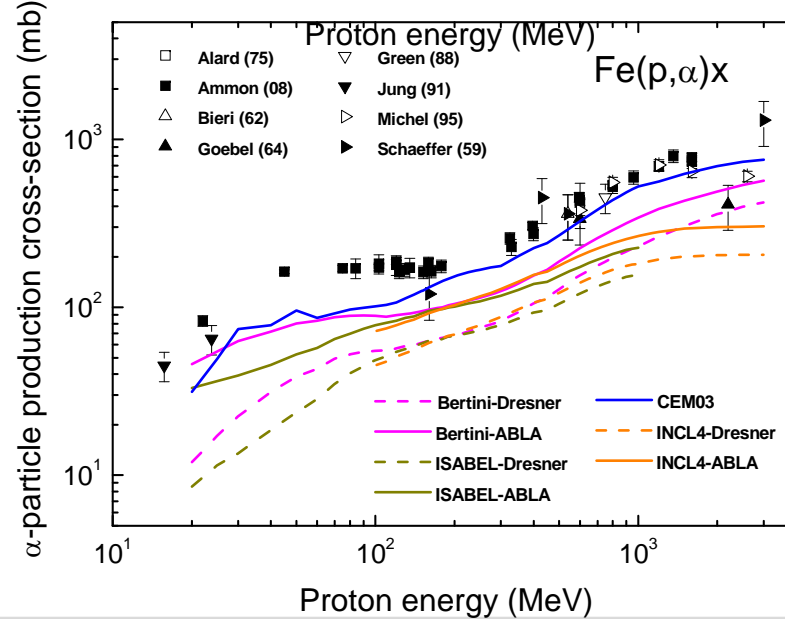
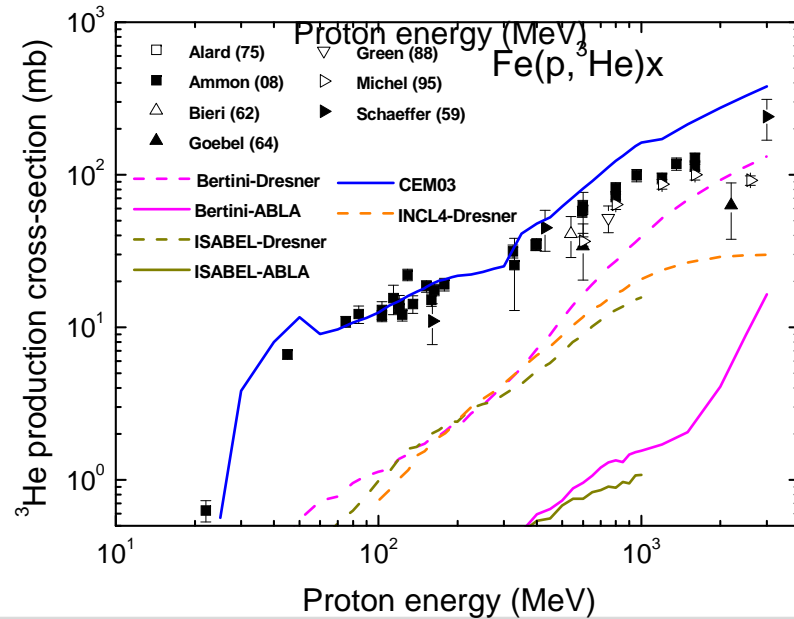
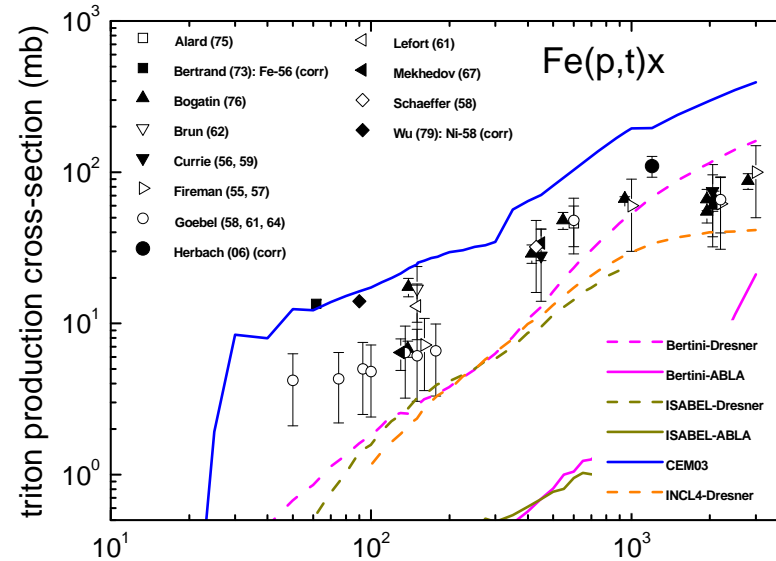
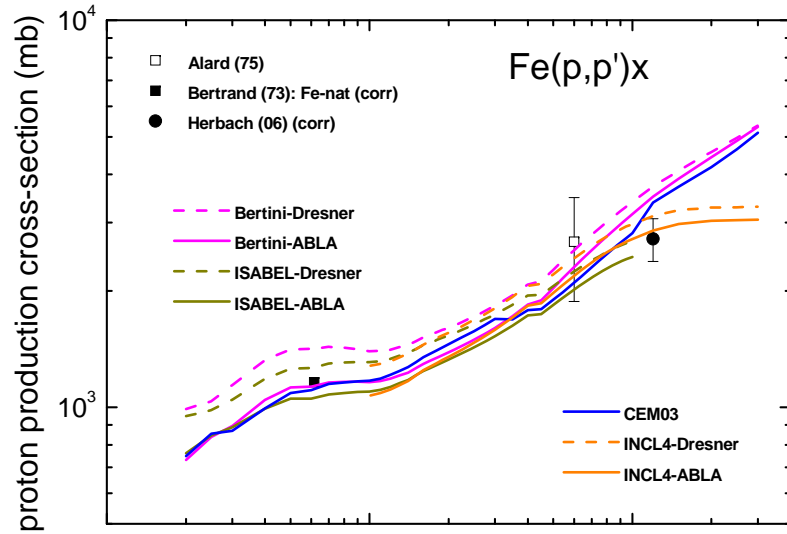

Examples of available evaluations and model calculations

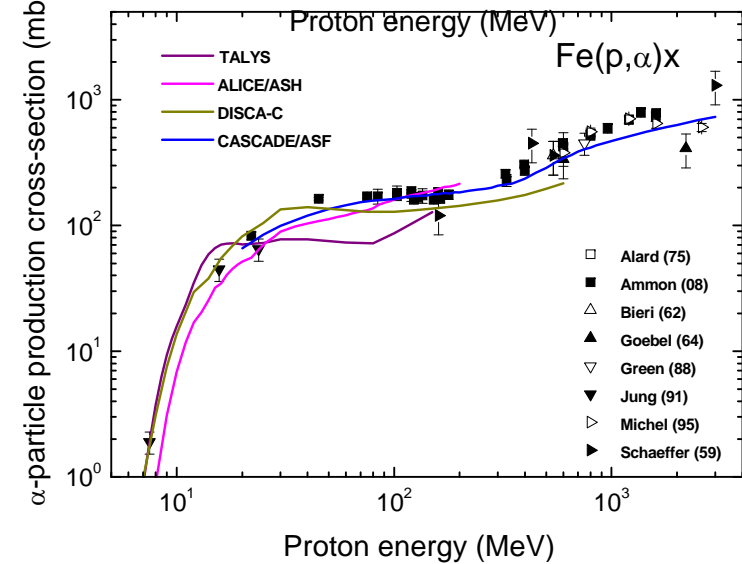
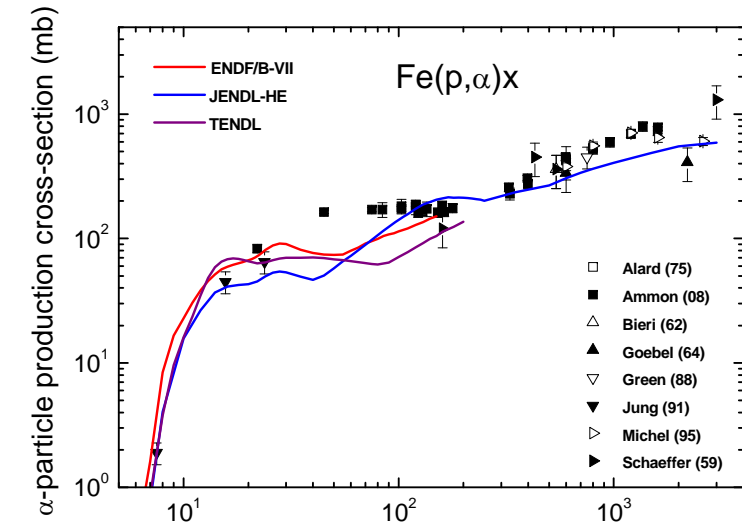
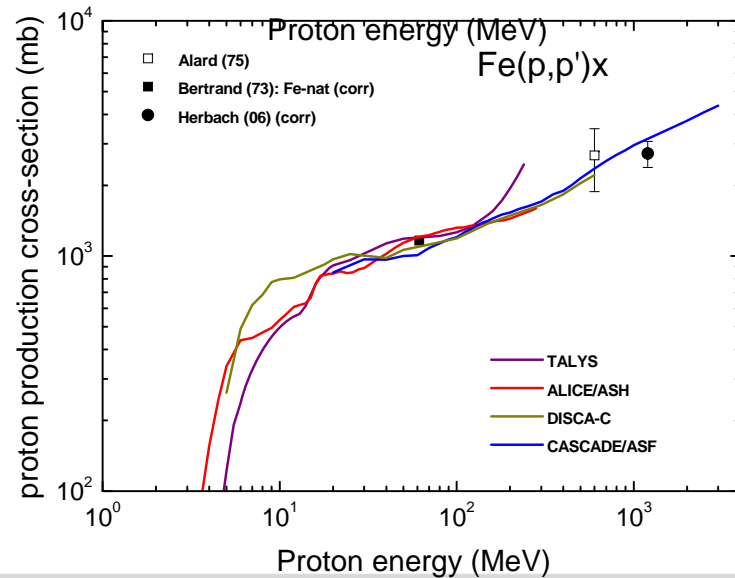
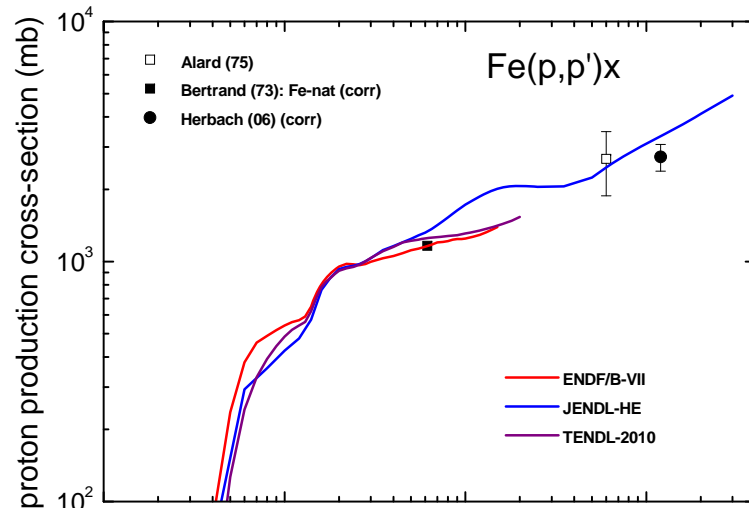

More model calculations ...

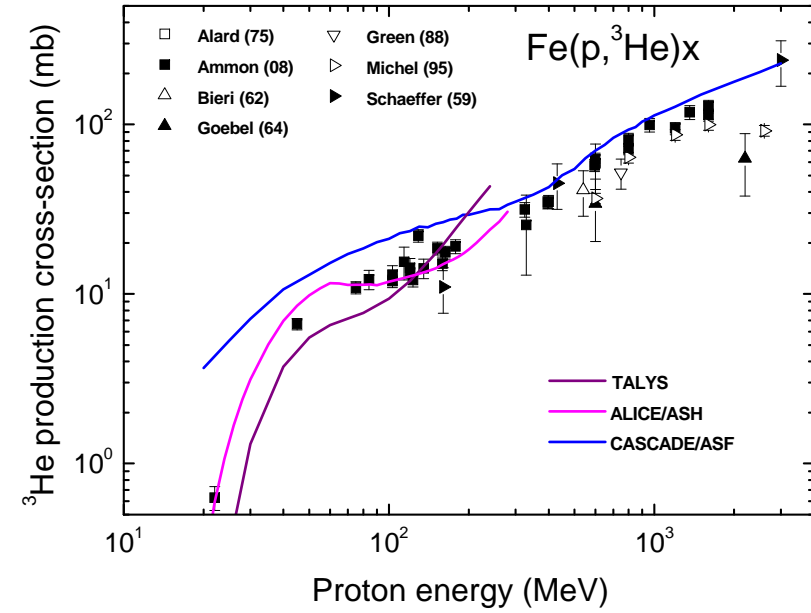
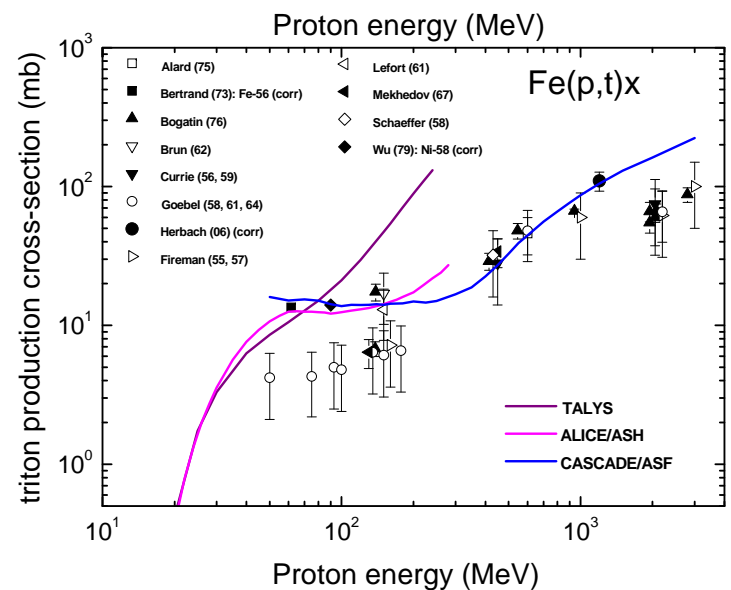
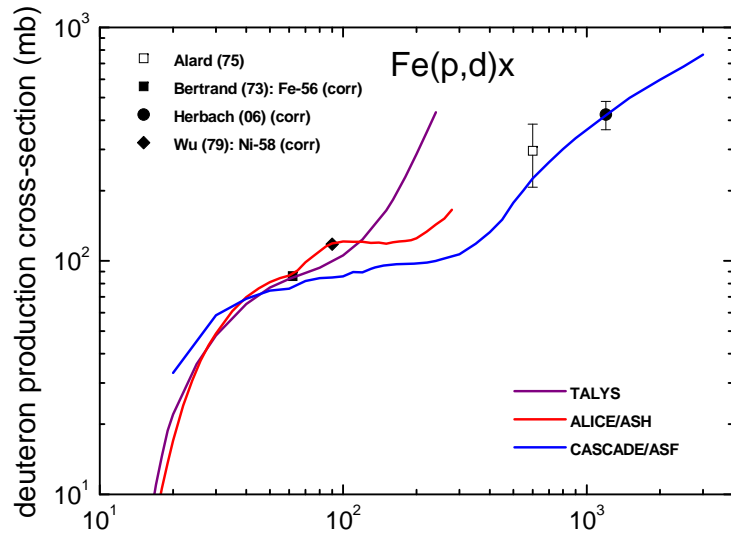

KIT evaluated cross-section data

I. Theoretical data

ALICE/ASH, CASCADE

TALYS: up to several MeV

II: Experimental data

III. Evaluated data = final data

BEKED code system (KIT)

Uncertainties & co-variance information

Generalised Least Square Method (GLSM) +

Unified Monte Carlo (UMC) of D. L. Smith.

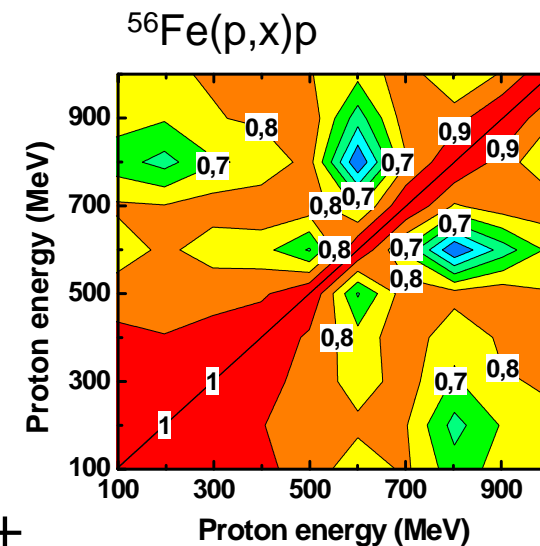

KIT evaluated data - examples

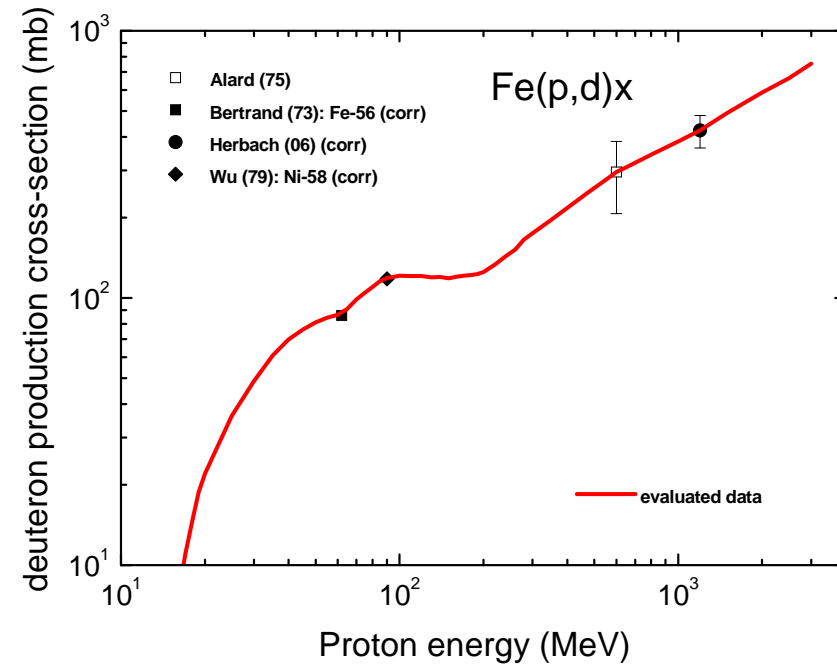
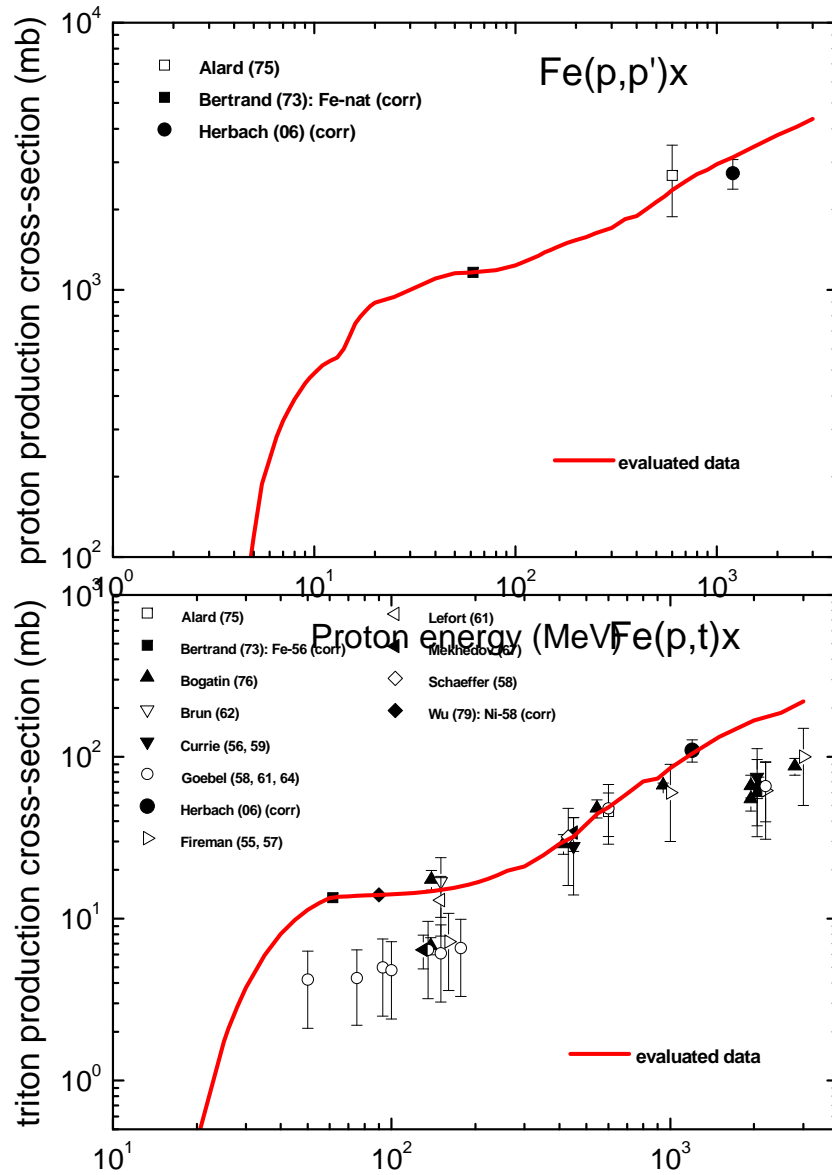

KIT evaluated data – examples (cont'd)

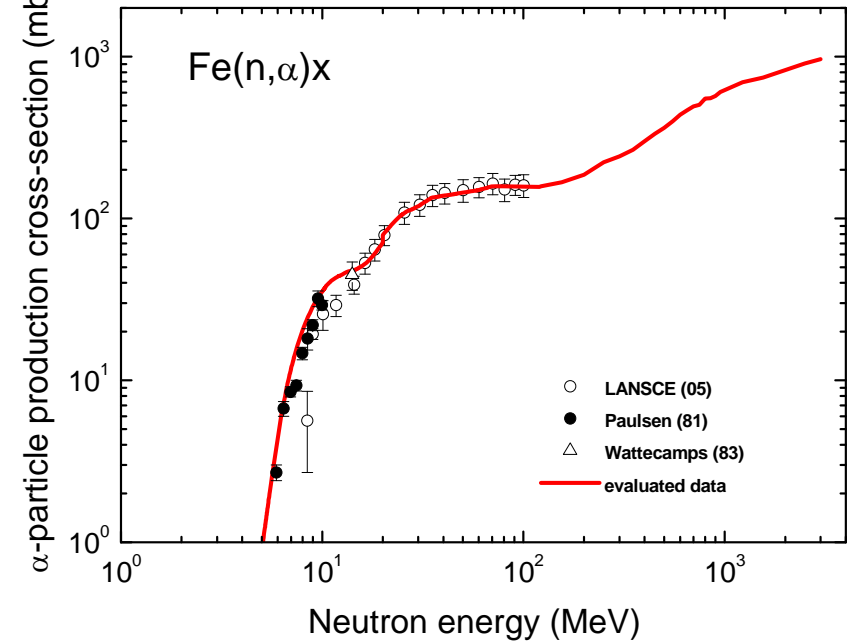
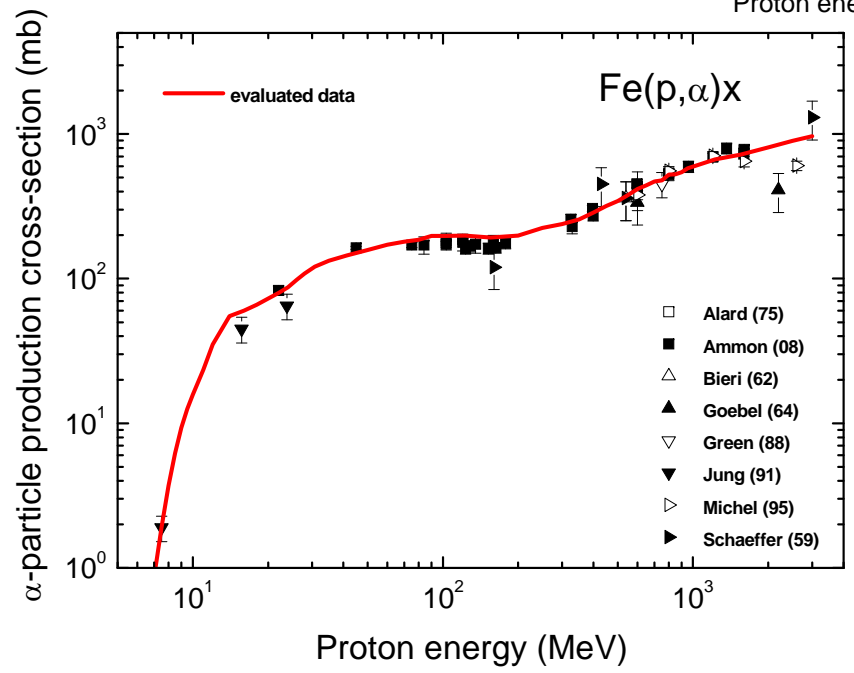
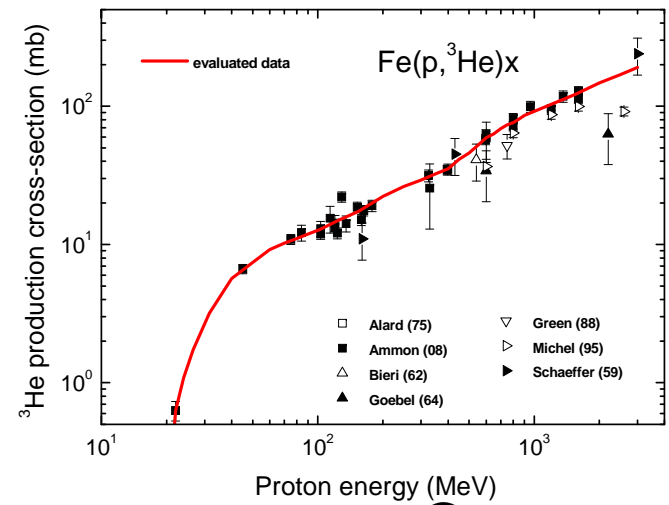

KIT evaluated data files

- Neutron & proton data up to 3 GeV
- Fe, Cr, Ni + Al, Zr, Cu, W
- Data files in standard ENDF-6 format
- Gas production cross-sections for p-, d-, t-, ^3He , ^4He (MT=203-207)
- Displacement cross-sections for BCA-MD (MT=900) and NRT (MT=901)
- Data files can be processed into ACE format for direct use with MCNPX^(*)

^(*) *p data require patch or secondary input*

Windowless Liquid Metal Target Design for ESS

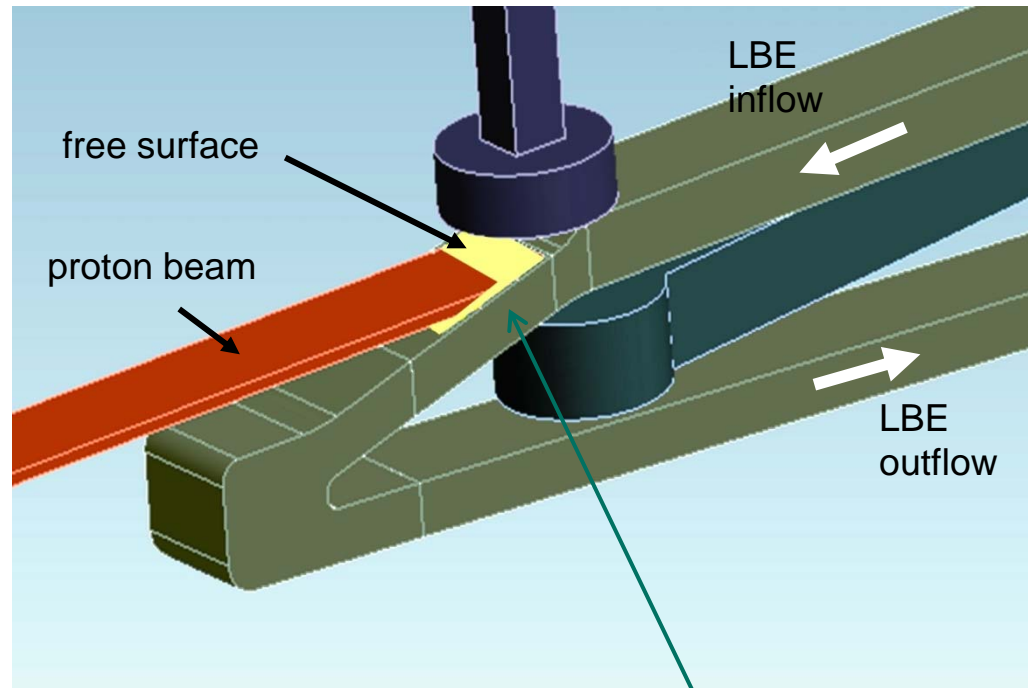

SS-316 structure walls

See A. Class et al, Windowless liquid metal target concept for ESS, this workshop

- Proton beams impinges liquid metal at 15° inclination angle
- No direct interaction of proton beam and solid structures
- Radiation damage to structure walls due to neutron irradiation

Neutronics calculations

- MCNPX, Version 2.7a, using CEM cascade model
- Source: Proton beam $E_p=2500$ MeV with Gaussian profile incident at 15° on PbBi free surface target
- Geometry model: PbBi enclosed in SS-316 steel frame
- Calculations of n-, p-flux, heating, dpa, gas production distributions using mesh tallies
- Use of evaluated dpa & gas production cross-section data for dpa and gas production rates in SS-316
- Typically 10 million source particle histories tracked with fractional standard deviation (FSD) around 1 %.

MCNPX target model

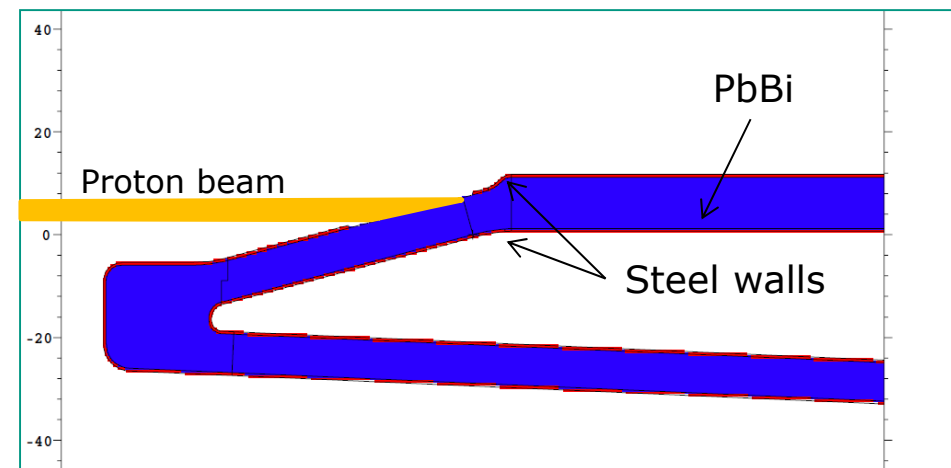

Neutronics results for target side wall (SS-316)

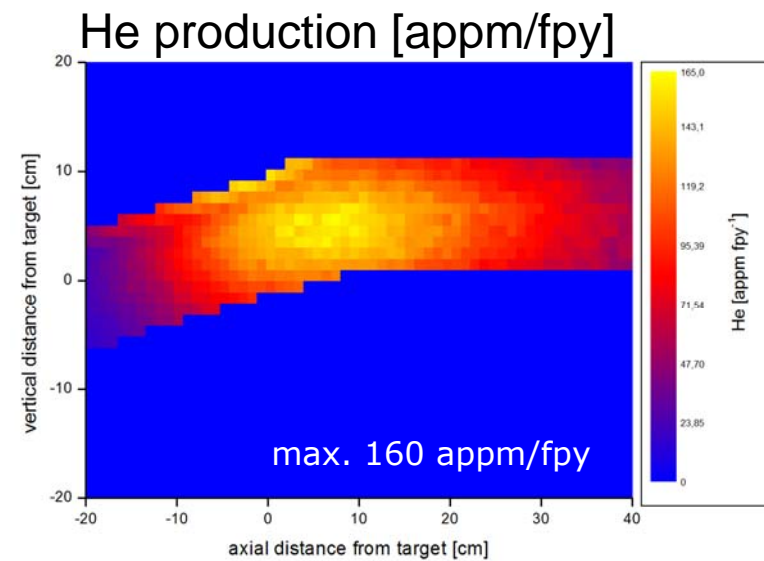
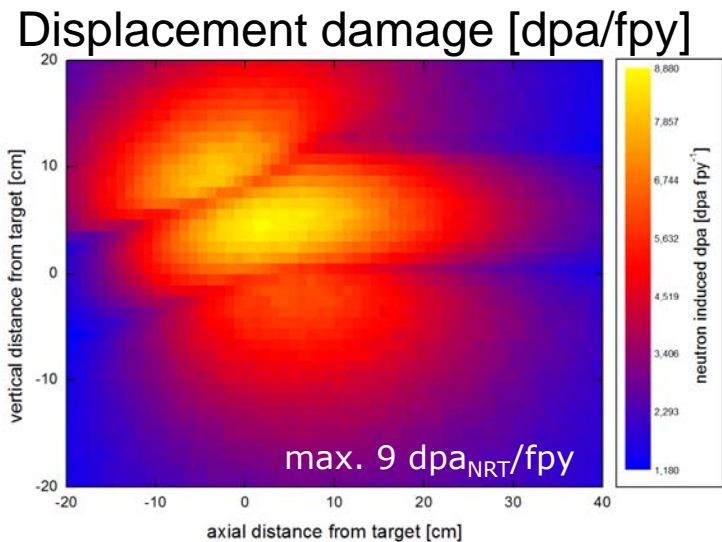
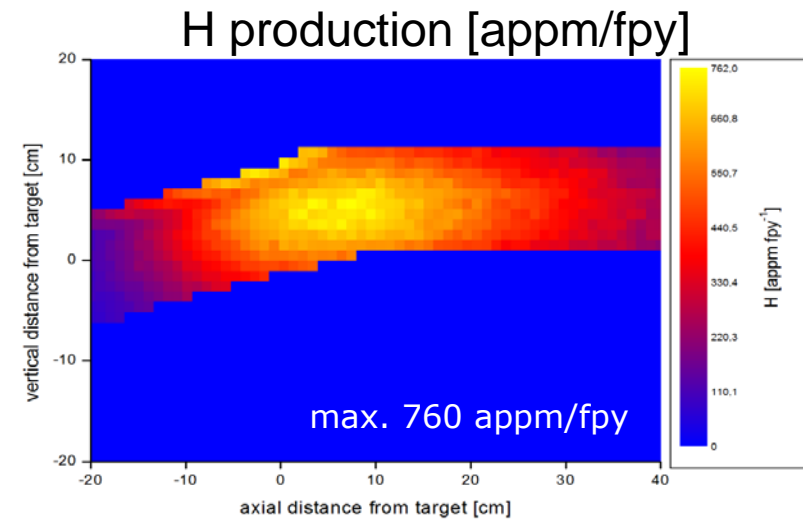
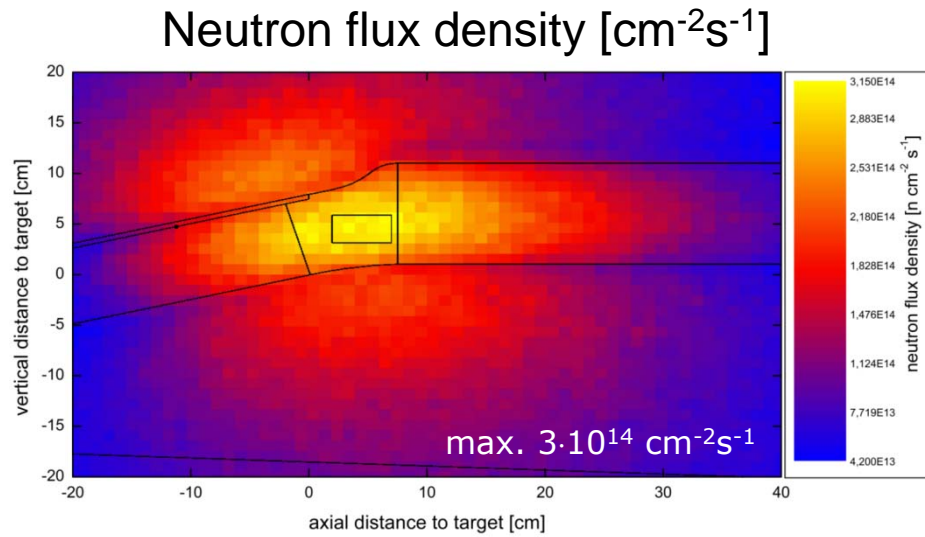

Neutronics results for bottom wall (SS-316)

Neutron flux density [$\text{cm}^{-2}\text{s}^{-1}$]

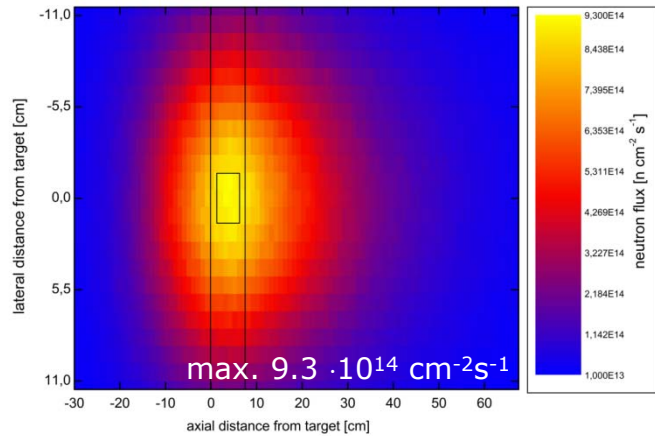

H production [appm/fpy]

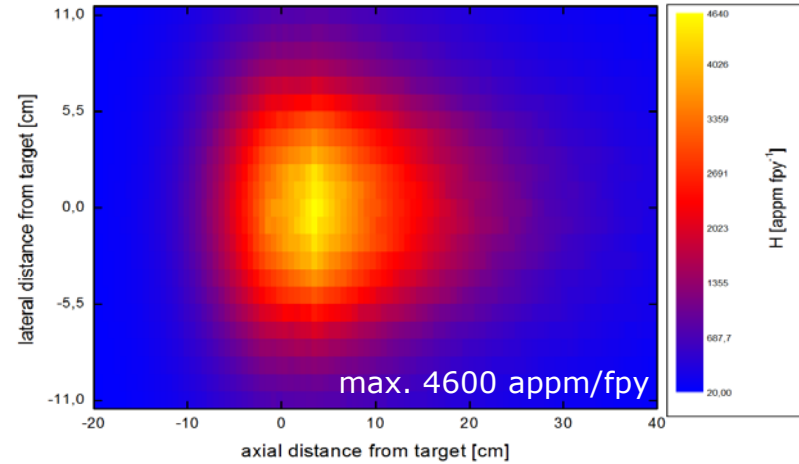

Displacement damage [dpa/fpy]

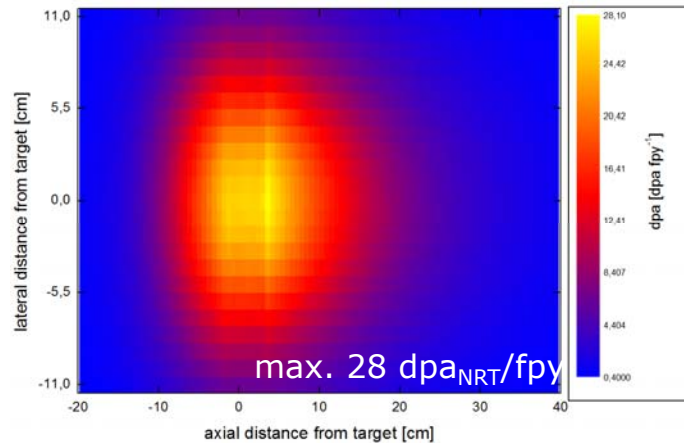

He production [appm/fpy]

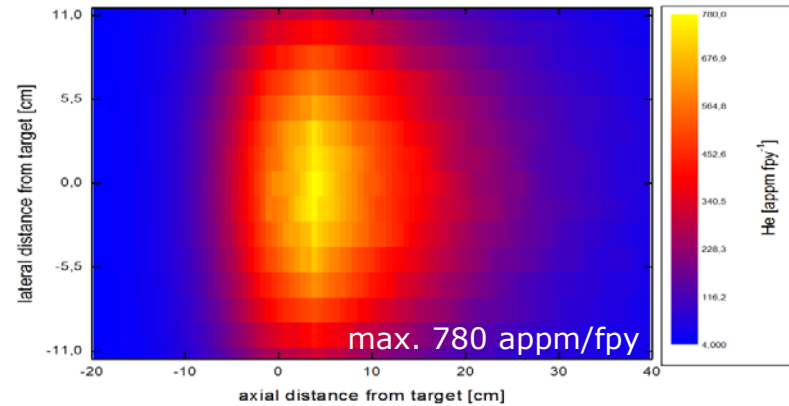

Neutronics results for upper wall (SS-316)

Neutron flux density [$\text{cm}^{-2}\text{s}^{-1}$]

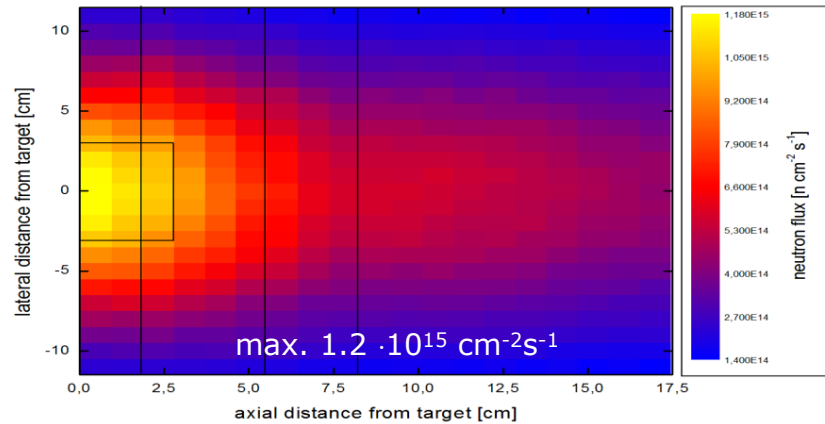

H production [appm/fpy]

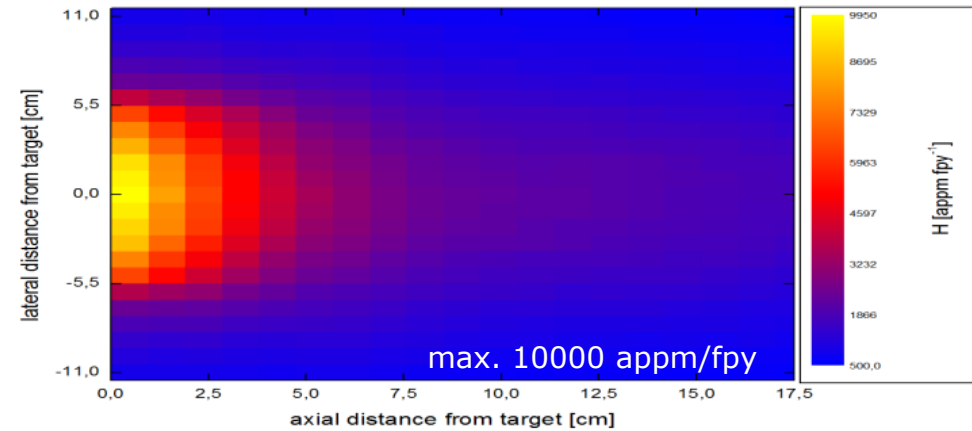

Displacement damage [dpa/fpy]

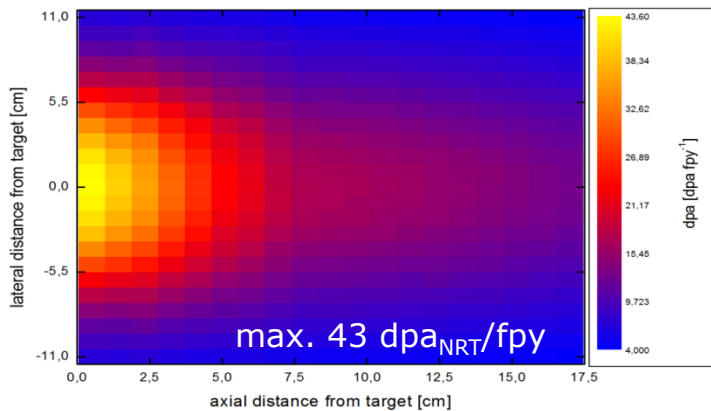

He production [appm/fpy]

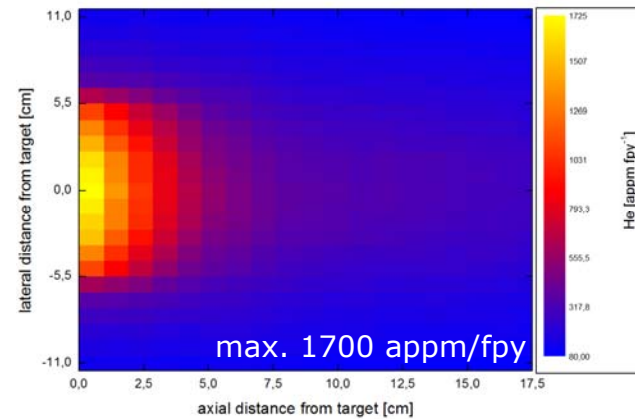

Conclusions

- Evaluations performed for displacement and gas production data using advanced KIT approach
- Data for Fe, Cr, Ni (+Al, Zr, Cu, W), n - and p induced reactions up to 3 GeV
- ENDF data files available upon request
- Application analyses for ESS windowless liquid metal target
- Data can be used with MCNP/MCNPX
... and other codes