

**KERNFORSCHUNGSZENTRUM
KARLSRUHE**

Januar 1975

KFK 2052

Institut für Experimentelle Kernphysik

**Fundamental Aspects for Conductor Arrangements with High
and Very Small Inductances and a Technical Realization**

H. Köfler, W. Maurer, G. Nöther, A. Ulbricht

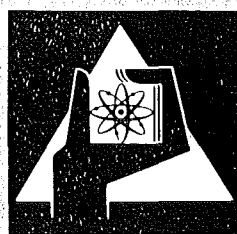

**GESELLSCHAFT
FÜR
KERNFORSCHUNG M.B.H.
KARLSRUHE**

Als Manuskript vervielfältigt

Für diesen Bericht behalten wir uns alle Rechte vor

GESELLSCHAFT FÜR KERNFORSCHUNG M. B. H.
KARLSRUHE

KERNFORSCHUNGSZENTRUM KARLSRUHE

KFK 2052

Institut für Experimentelle Kernphysik

Fundamental aspects for conductor arrangements with high
and very small inductances and a technical realization.⁺)

H. KÖFLER, W. MAURER, G. NÖTHER, A. ULBRICHT

Gesellschaft für Kernforschung m.b.H., Karlsruhe

⁺) Work performed with the financial support of the
"Bundesministerium für Forschung und Technologie", Bonn

Fundamental aspects for conductor arrangements with high and very small inductances and a technical realization.

A b s t r a c t:

Some fundamental aspects for conductor arrangements with high and very small inductances are considered. Based on the formulas for the magnetic energy restrictions for the performance of such arrangements are discussed. A complete unit for storing magnetic energy has been constructed according to the mentioned restrictions. This device is described in detail.

Grundlegende Aspekte von Leiteranordnungen mit hohen und sehr kleinen Induktivitäten und eine technische Realisierung.

Z u s a m m e n f a s s u n g:

Einige grundlegende Aspekte von Leiteranordnungen mit hohen und sehr kleinen Induktivitäten werden erörtert. Anhand der Formeln für die magnetische Energie werden Einschränkungen der Leistungsfähigkeit solcher Anordnungen diskutiert. Ein magnetischer Energiespeicher wurde unter Berücksichtigung der erwähnten Einschränkungen konstruiert und wird im einzelnen beschrieben.

1. Introduction

The practical application of energy storage by means of magnetic fields became importance in magnet technology with the introduction of superconductivity. A complete unit for storing magnetic energy consists of a storage inductor which is superconductively shortened. For the energy extraction the short circuit must be opened at a certain time. The opening device is called a superconductive switch. The storage inductor must have a large inductance for storing energy as much as possible while the switch must have an inductance as small as possible for fast response of the switch and fast extraction of the energy.

In this report, some fundamental aspects for conductor arrangements with high and very small inductances are considered. Based on the formulas for the magnetic energy some restrictions for the performance of such arrangements are discussed. A complete unit for storing magnetic energy has been constructed according to the mentioned restrictions. This device is described in detail.

2. Theoretical Considerations

2.1. Principal Aspects

For a given conductor volume the Brooks-coil has the minimum inductance and therefore the maximum stored energy. All other solenoid configurations have at the same conductor volume and the same total current density a reduced stored energy against Brooks-coils. To store a fixed energy the Brooks-coil has minimum weight. [1] These considerations take only into account the conductor volume used and not the space, where the magnetic field exists. In principle, the field is spread out over the whole space. Storing magnetic energy means high absolute values of magnetic induction. These high values of the field must be confined to a certain volume, to avoid magnetic pollution of the surroundings. This implies the necessity of field screening.

The confinement to a certain volume can be made in practice electrically or by ferromagnetic materials. Electric screening

Eingereicht am: 5.12.1974

means the generation of a field not usable for energy storage. Therefore, such screened configurations have a reduced overall volume energy density against unscreened arrangements. Screening by ferromagnetic materials means guiding the magnetic flux. So, the magnetic field is concentrated to a certain volume without generation of opposite fields.

With one exception - the toroidal coil - all current distributions need screening devices. From this point of view, the toroid seems to be the best for magnetic energy storage, but to optimize magnetic energy storage devices, some other quantities have to be considered, e.g., the total current density, forces, the maximum magnetic field in the winding, the volume, the ac losses, the discharge velocity, and last but not least the costs.

In the following only the stored energy is considered. The expressions for the energy in terms of field induction B and volume V and in terms of current I and inductance L are discussed. Without detailed computation of special geometries the principle problems occurring are elaborated.

2.2 Magnetic Energy Expressed in Field Quantities

The energy density in a magnetic field is given by

$$u_{\text{magn}} = \frac{dE}{dV} = \frac{1}{2\mu_0} \vec{B}^2 \quad (1)$$

In a volume V under consideration the total stored magnetic energy is given by

$$E = \frac{1}{2\mu_0} \int_V \vec{B}^2 dV \quad (2)$$

where $\vec{B} = \sum_{i=1}^n \vec{B}_i$ and \vec{B}_i is the magnetic field generated by the current I_i . By definition the energy E is positive or zero. In the case of $n = 2$, E is given by

$$E = \frac{1}{2\mu_0} \int_V (\vec{B}_1 + \vec{B}_2)^2 dV \quad (3)$$

or

$$E = E_1 + E_2 + \frac{2}{2\mu_0} \int_V \vec{B}_1 \cdot \vec{B}_2 dV \quad (4)$$

Due to $\vec{B}_1 \cdot \vec{B}_2 = |\vec{B}_1| \cdot |\vec{B}_2| \cos \phi$, where ϕ is the angle between \vec{B}_1 and \vec{B}_2 , the integral

$$E_{12} = \frac{1}{\mu_0} \int_V |\vec{B}_1| \cdot |\vec{B}_2| \cos \phi dV \quad (5)$$

is now considered for specific field configurations.

In the case of a field where the angle ϕ is independent on space coordinates, it follows,

$$E_{12} = \frac{1}{\mu_0} \cos \phi \int_V |\vec{B}_1| \cdot |\vec{B}_2| dV = 2 \cdot \cos \phi E'_{12} \quad (6)$$

with the property $E_1 + E_2 \geq 2E'_{12}$. (7)

According Eq. (4) we have

$$E = E_1 + E_2 + 2E'_{12} \cos \phi$$

or

$$\frac{E}{2E'_{12}} = \frac{E_1 + E_2}{2E'_{12}} + \cos \phi \quad (8)$$

Due to Eq. (7) $E/2E'_{12}$ is ≥ 0 for all values of ϕ and has a absolute minimum at $\phi = \pi$. Consequently the stored energy is a minimum if the fields \vec{B}_1 and \vec{B}_2 are in opposite direction. Next consequence, configurations where screening fields opposite to the field considered occur are no effective means for magnetic energy storage.

This statement may be trivial, but it is one of the principal aspects to point out, because it influences strongly the possible conductor arrangements for effective magnetic energy storage. In the simplest case of $|\vec{B}_1| = |\vec{B}_2|$ it follows

$$E_1 = E_2 = E_{12}'$$

and

$$\frac{E}{2E_1} = 1 + \cos \phi$$

In this case the stored energy is zero if $\phi = \pi$.

2.3 Magnetic Energy in Integral Parameters

The field configurations mentioned in the previous section are built up by electric currents flowing in conductors. These currents guided in wires can be replaced by ideal line currents, neglecting the magnetic field inside of the conductor. Describing the energy of such a system from a technical point of view one use the integral parameter of the magnetic field and the currents flowing in the wires. Take in mind that equation (2) is derivated from

$$E = \frac{1}{2} \int_V \vec{A} \cdot \vec{S} \cdot dV \quad (9)$$

with the vector potential \vec{A} and the current density \vec{S} . [2]

For a line current with

$$\vec{S} \cdot d\vec{F} = I$$

$$\vec{A} = \frac{\mu_0}{4\pi} \int_V \frac{\vec{S} \cdot dV}{r} = \frac{\mu_0}{4\pi} I \int_{l_1}^{l_2} \frac{dl_2}{r_{12}} \quad (10)$$

we can write

$$\begin{aligned}
 E &= \frac{1}{2} \int_V \frac{\mu_0}{4\pi} \cdot I \cdot \oint_{l_2} \frac{d\vec{l}_2}{r_{12}} \cdot \frac{I}{dF} \cdot dF \cdot d\vec{l}_1 \\
 E &= \frac{1}{2} \cdot I^2 \cdot \frac{\mu_0}{4\pi} \oint_{l_1} \oint_{l_2} \frac{dl_1 \cdot dl_2}{r_{12}} \\
 &= \frac{1}{2} \cdot I^2 \cdot L \tag{11}
 \end{aligned}$$

The integral containing the geometrical and material constants is the well known inductance L favoured for describing circuits in electrical engineering. Without further explanation we state that similar expressions for more than one circuit are valid [2].

The expression (11) for the energy of the magnetic field of two coils corresponding to Eq. (3) then can be written in the following form

$$E = \frac{L_{11} \cdot I_1^2}{2} + \frac{L_{22} \cdot I_2^2}{2} + L_{12} \cdot I_1 \cdot I_2 \tag{12}$$

with usual meaning for L_{ik} .

If we imagine a perfect magnetic coupling of both the coils and a current flowing in the second coil in such a direction that the magnetic field of coil 2 is counteracting that of coil 1 then it is evident that we can find a system with no stored energy. This system we can meet for a given coil configuration by varying the magnitude of the currents or if the latter are fixed we can vary the coil configuration. This is equal to varying the inductances. Considering this we can form an other equation for the stored energy splitting the inductance of a coil in leakage ($L_{i\sigma}$) and main inductance (L_{ih}).

With

$$\begin{aligned} L_{11} &= L_{1h} + L_{1\sigma} & L_{12} &= \sqrt{L_{1h} \cdot L_{2h}} \\ L_{22} &= L_{2h} + L_{2\sigma} & L_{1h} &= \frac{w_1^2}{w_2^2} \cdot L_{2h} \end{aligned}$$

we can write for two circuits

$$E = \frac{L_{1h}}{2} \cdot \left(I_1 + \frac{w_2}{w_1} I_2 \right)^2 + \frac{L_{1\sigma}}{2} \cdot I_1^2 + \frac{L_{2\sigma}}{2} \cdot I_2^2 \quad (13)$$

A technical realization of the case of no stored energy is impossible. At first, a perfect coupling of circuits cannot be achieved. In addition, there must be wires connecting the coils and the coils with their power supply. This peripheral parts must be accounted when computing the stored energy. A possible form of taking this energy into account is adding a term $L_{add} \cdot (I_1^2 + I_2^2)$ to Eq. (13).

The limits for systems with no and with maximum stored energy here can be seen very clear. To have minimum stored energy we must try to achieve stiff coupling of the circuits carrying the counteracting currents to get small terms for $L_{1\sigma}$ and $L_{2\sigma}$. To attain maximum stored energy an unscreened device would be the best. If screening is necessary one must try to get very weak coupling and large terms for $L_{1\sigma}$ and $L_{2\sigma}$.

The lowest value technically attainable is

$$E_{min} = L_{add} \cdot (I_1^2 + I_2^2)$$

at ideal coupling. The maximum energy value will be reached in the case with no coupling between the coils (this means no electric screening).

3. Practical Realization of Inductive Energy Storage

To get some experience in the development and handling of the fundamental components of inductive storage units two experiments, a 12 kJ and a 100 kJ storage unit were designed and built. The results of the 12 kJ-storage were presented in [3,4]. In the following the design parameters of the 100 kJ-experiment and the properties of the components are presented.

The 100 kJ-Energy Storage Experiment was designed under the following boundary conditions:

- 1) The storage coil and the switch should be built with presently commercial available superconductive and structural materials.
- 2) Some installed experimental facilities should be used.
- 3) The system should have some properties which could be important for future systems, e.g., the switching time and the high voltage in cryogenic environment.

These conditions led to the following design values:

energy:	~100 kJ
current:	1000 - 1500 A
discharge time:	some msec
voltage:	~ 50 kV

The basic components:

- inductive storage coil;
- superconducting switch;
- high voltage - high current lead;

were designed referring to these values. A schematic view of the 100 kJ storage inductor and the superconducting switch is shown in Fig. 1.

3.1 Storage Coil Design

The storage coil is approximately a Brooks coil. It is wound from a soldered cable. To reduce the voltage between the layers the winding was separated in two trapezoidal shaped coils similar to the windings of high voltage transformers. The cable has a braided fiberglass insulation. The layers are separated by 0.4 mm fiberglass mats. The coil was impregnated with epoxy resin. The coil is bath cooled. The liquid helium reaches the inner windings by cooling channels. To reduce the fringing fields in the cryostat two stepped laminated iron shields are mounted perpendicular to the coil axis. (cf. Fig. 1).

Assuming that the main part of the stored energy is concentrated in a cylinder limited by the two iron shields an average magnetic energy density for different cylinder radius were computed [5]. The result is presented in Fig. 2. Taking into account the whole coil volume an average energy density of 2.8 J/cm^3 is reached at a central field of 4.5 T. This energy density is about 30% higher than the energy density of capacitors with the best available dielectric. [6]. All important data and dimensions of the coil are summarized in Table I.

3.2 Switch Design

The basic idea of the construction of a superconductive switch is generating a current distribution with counteracting currents (cf. Fig. 3). This distribution can be realized by laying conductors along meandering lines or winding bifilar disk coils (cf. Fig. 4). The disk configuration is chosen in this experiment. This geometry is applicable for conductors with circular cross section as well as for conductors with rectangular cross section. Undoubtedly a higher filling factor can be yielded with a rectangular conductor cross section. A high filling factor is wanted to get sufficient high resistance of the switch in the so-called "open state".

During fast extraction of the energy a high voltage for current commutation across the switch is required. The length of one bifilar loop is limited by the breakdown voltage of the insulation between the two conductors. Another boundary is the current induced triggering of the switch. To get a full transition to the normal state within a certain time the surge impedance is not allowed to exceed a certain level.

To meet the requirements of high breakdown voltages and high resistance for superconducting switches the stacking up of disk elements is a useful method. In this manner a switch suited for the 100 kJ storage experiment was built. (cf. Fig. 5). It consists of eighty fiberglass reinforced disks. The whole switch is filled with epoxy resin. A ratio of pure conductor volume to structure material of about 1:20 was attained. One piece of cable with a length of 1000 m was manufactured in the switch described. The design values of the switch are summarized in Table II.

A thermal switch enables the charging and the emergency discharge process. Therefore one disk is separated from the stack on the grounded side of the switch and a bifilar heater winding is mounted in parallel to the superconductor. The disk is covered with a cap which gives heat insulation by gaseous helium to reduce electrical power demand for heating in the "open state".

The high voltage requirements have been tested on one dummy disk. After cycling five times in liquid nitrogen an AC breakdown voltage of 30 kV was measured.

3.3 The Trigger Circuit

For a current induced triggering of such large switches the trigger circuit proposed by Laquer [7] was modified. The cable length of the switch is splitted up in four trigger circuits. The number of circuits is limited by technical constraints like the heat inleak of the leads, residual inductance of the switch, the required current rise time, the connecting of the pulse

current feeder to the switch cable and insulation problems. Balancing these requirements we decide to build four triggering circuits. A special problem is the design of the leads (pulse current feeders) from the capacitors and spark gaps to the switch. In order to attain high breakdown voltages the leads must have a sufficient insulation distance. On the other hand, to attain low inductance the leads must be as near as possible. To cancel partly the influence of the necessary insulation distance on the inductance the leads are bundled in such a manner that a counteracting current distribution is reached. To facilitate the installation of the experiment a plug-in connector with a high voltage silicon rubber seal for these leads was developed. After firing of the four spark gaps the whole voltage across the switch lays also on the spark gaps and their trigger electrodes. High voltage capacitors which have a low impedance for the discharge pulse protect the low level trigger electronic (cf. Fig. 6).

3.4 The High Voltage - High Current Lead

One current lead must be designed for high voltage and high current. The lead is gas cooled and optimized for 2 kA. The design value of the maximum voltage is 100 kV. The insulation body is fiberglass reinforced epoxy manufactured by filament winding. The crossing angle of the filaments was chosen in such a way that the linear contraction coefficients of the stainless steel tube and the insulation body were matched. [8]. Powder filled epoxy resins for matching the linear contractions coefficients must be rejected, because for this geometry experiments failed due to the decreasing of Young's modulus at Helium temperature, which generates always cracks [9].

To get some experimental results for construction the lead the beginning of the slide discharge was measured for geometries similar to that used by the original lead at room temperature gaseous helium. The results are presented in Fig. 7.

3.5 The Cryostat

The arrangements of the storage coil and the switch are shown in Fig. 1 . Both are bath cooled. The cryostat is designed to withstand an inner pressure of 5 bar (about 5 kp/cm²). The cryostat is directly connected with the refrigerator by a cold transfer line. Details are similar as described in [10].

3.6 The Experimental Instrumentation

A schematic circuit diagram of the experimental instrumentation is presented in Fig. 8. There are three different circuits:

- The power circuit for charging and discharging the storage system.
- The control and safety circuits for triggering the whole experimental arrangement and protect personal during the measurements.
- The measuring circuit.

In the power circuit the different loads of the energy storage can be switched on and off by disconnecting switches.

During discharge the power supply is disconnected from the storage unit. The charge circuit is designed for long term operation. During discharge a spark gap limits the voltage to maximum 100 kV.

The control circuits allow the handling of the different switches during charging. The preparing of the trigger arrangement for the superconducting switch is also controlled by these circuits. All signals for triggering the scopes and the cameras during discharge are generated in this unit.

To measure the discharging of the inductive storage unit Rogowsky loops for current measurements and voltage dividers for voltage measurements will be used. To get the power and the energy on the scope screen immediately electronical multipliers and integrators are provided. Every lead for feeding in the pulse current in the superconducting switch can be used as a potential lead for switch diagnostic. All leads have Rogowski loops for pulse current measurements.

A field measuring device is provided in the storage inductor just as a temperature measuring device in the switch. To measure temperatures at switch parts with high voltage levels an ungrounded measuring device will be prepared.

3.7 The Protection of the SC-Storage Inductor and the SC-Switch

During charging the conventional methods like inverter mode of the power supply or dump resistors will be used for energy extraction if a quench occurs.

In the storage mode two accidents can occur: the quench of the storage inductor or the quench of the switch.

The first accident requires an immediate opening of the superconducting switch to dump the energy in an external resistor. Two possibilities will be provided: a pulse heating of the thermal switch or a current induced transition of the whole sc-switch. Both are triggered by a quench detector.

The second accident, the quench of the SC-switch, requires a fast natural quench propagation along the switch cable to extract energy with a good efficiency. If that is impossible which will be shown by an experiment the thermal switch or the whole switch must be opened. The resistance of the thermal switch and the external resistor are dimensioned in such a way that 90% of the stored energy can be extracted [11].

Acknowledgement

We are very grateful to Dr. H. Brechna, ETH Zürich, for many fruitful discussions during design and for measuring the field distributions of the current leads. The authors also wish to thank G. F r i e s i n g e r, H. K i e s e l and L. S i e w e r d t for their excellent engineering work.

References:

- [1] S.L. Wipf: Supraleitende Energiespeicher. Herbstschule über Anwendung der Supraleitung in Elektrotechnik und Hochenergiephysik. Titisee, 1972.
- [2] E. Philippow: Grundlagen der Elektrotechnik. Akad. Verlagsgesellschaft, Leipzig 1970.
- [3] K. Grawatsch, H. Köfler, P. Komarek, H. Kornmann, A. Ulbricht: Investigations for the Development of Superconducting Power Switches, ASC, Sept. 30th, 1974.
- [4] H. Kornmann: Aufbau eines supraleitenden Energiespeichers mit einer Energie von 12 kJ und kurzer Entladungszeit; Diplomarbeit, Inst. für Exp. Kernphysik, Universität Karlsruhe, 1974.
- [5] F. Arendt: private communication
- [6] P. Komarek: Kryotechnik für Energiefragen unter besonderer Berücksichtigung supraleitender Magnete, Jül-956-TP, Juni 1973.
- [7] H. Laquer, J.D.G. Lindsay, E.M. Little, J.D. Rogers, D.M. Weldon: Design Options and Trade-Offs in Superconducting Magnet Energy Storage with Irreversible Switching, LA-5314-MS
- [8] G. Hartwig, A. Puck, W. Weiß: Thermische Kontraktion von glasfaserverstärkten Epoxydharzen bis zu tiefsten Temperaturen. Kunststoffe, Bd. 1 (1974), S. 32 - 35

- [9] G. Hartwig: Low Temperature - and Potting Properties of Filled and Unfilled Resins. KFK 1897 (to be published)
- [10] H. Katheder, W. Lehmann, F. Spath: Long-Term Experiences with the Liquefying Stage and a 4.4 K - Cooling-Cycle of 300 W - Refrigerator; 5th ICEC, Kyoto, Japan, May 74
- [11] A. Ulbricht: unpublished note

T a b l e I
Superconducting Storage Coil

MECHANICAL DIMENSIONS:

	<u>Designed</u>
Diameter of the winding:	200 mm
Outer diameter of the winding	380 mm
Length of the two coils:	196 mm
Number of windings:	1040
Layers of one coil:	25
Conductor length:	924 m
Conductor weight:	41 kg

ELECTRICAL DATA:

	<u>Designed</u>
Coil current:	1250 A
Average current density in the winding:	10.7 kA/cm ²
Stored energy:	~ 150 kJ
Inductance:	~ 190 mH
Resistance at 20°C:	4,8 Ω
Voltage between two layers:	1 kV
Electrical field strength between two layers:	700 V/cm
Capacity of the coils:	~ 230 pF

Superconducting cable: Construction: 37 strands (30 NbTi, 7 Cu) cabled and filled with In-Sn solder.

	<u>Designed</u>	<u>Measured</u>
Cross section:	2,28x2,28 mm ²	
Transposition pitch:	50 mm	
Insulation: 0.5 mm braided fiberglass insulation		
Short sample critical current at 5 T:	2000 A	3075 A
Average critical current density at 5 T:	47.7 kA/cm ²	73.3 kA/cm ²

Single strand:Designed:

Matrix:	Cu
Matrix: SC:	1.25:1
Number of filaments:	367
Twist pitch:	4 mm
Filament diameter:	14 μm
Wire diameter:	0,38 mm
Residual resistance ratio:	100

T a b l e II

The Superconducting Switch

MECHANICAL DIMENSIONS:

	<u>Designed:</u>
Length of the switch cable:	1000 m
Length of a bifilar loop:	6,25 m
Number of loops:	80
Disk diameter:	320 mm
Disk thickness:	6 mm
Outer winding diameter:	270 mm
Inner winding diameter:	108 mm
Groove cross section:	2,3x2,8 mm ²
Number of cooling channels in one disk:	12
Dimensions of cooling channels:	5x1 mm ²
Diameter of the switch:	320 mm
Height of the switch:	486 mm
Height of the switch winding:	483 mm
Switch volume:	23,2 dm ³
Conductor volume:	981 cm ³
Conductor volume/Switch volume:	1:23

ELECTRICAL DATA:

	<u>Designed:</u>
Normal resistance:	357 Ω
Inductance:	240 μH
Maximum allowed voltage drop across the switch:	~ 50 kV
Average power density in the cable at 1250 A:	0,6 MW/cm ³

Superconducting cable: Construction: 5 strands cabled

	<u>Designed</u>
Diameter:	1,3 mm
Transposition pitch:	20 mm
Insulation: braided fiber- glass insulation	
Short sample critical current at 0.8 T	2000 A
Average critical current density at 0.8 T:	203 kA/cm ²
Resistance/length unit:	357 mΩm ⁻¹

Single Strand:

Matrix:	Cu(70):Ni(30)
Matrix: SC:	1:1
Number of filaments:	400
Twist pitch:	5 mm
Filament diameter:	17 μm
Wire diameter:	0,5 mm
Insulation:	FORMVAR 25 μm
Specific resistance:	35·10 ⁻⁶ Ωm

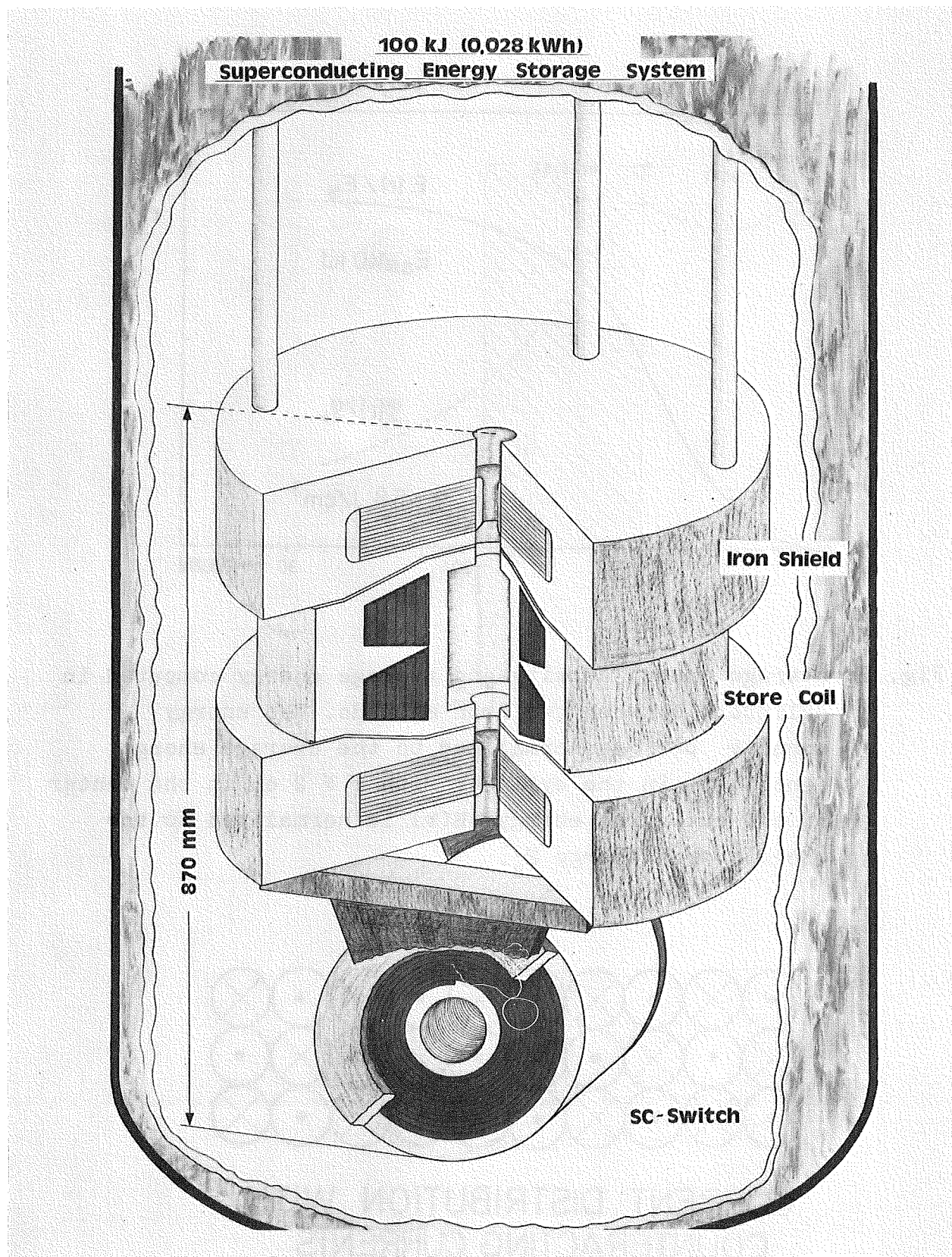

Fig. 1: Schematic view of the 100 kJ storage inductor and of the superconducting switch

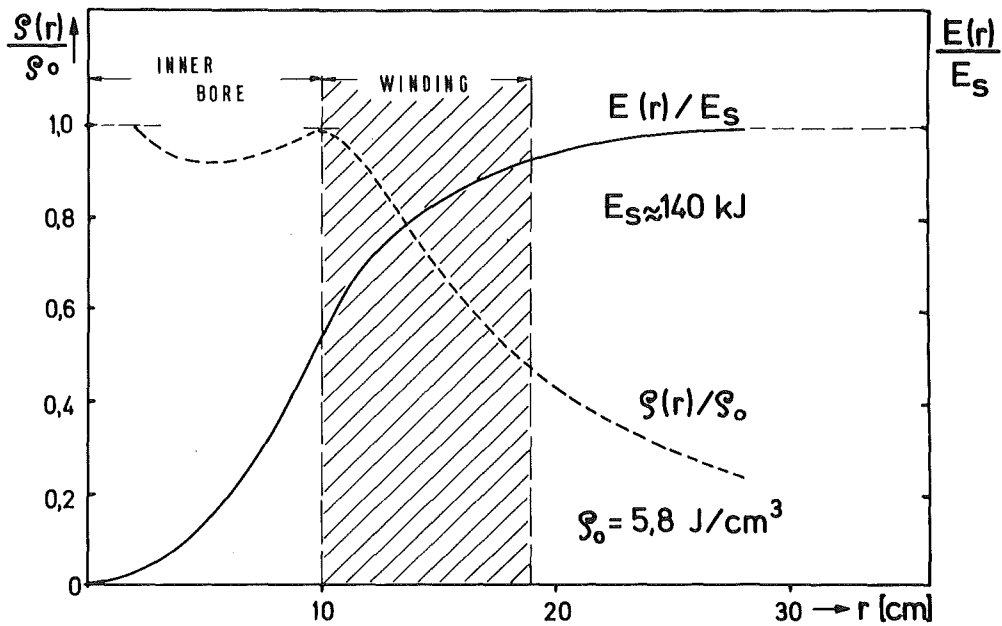
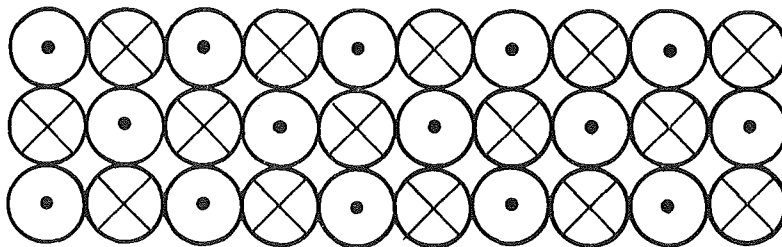

Fig. 2: Average energy density and average energy computed in cylinders between two iron shields. The energy density $\rho(r)$ is normalized to the average energy density ρ_0 in the cylinder with $r = 2$ cm in the center of the coil. The energy $E(r)$ is normalized to the whole stored energy E_s .



CURRENT DISTRIBUTION WITH
COUNTERACTING CURRENTS

Fig. 3

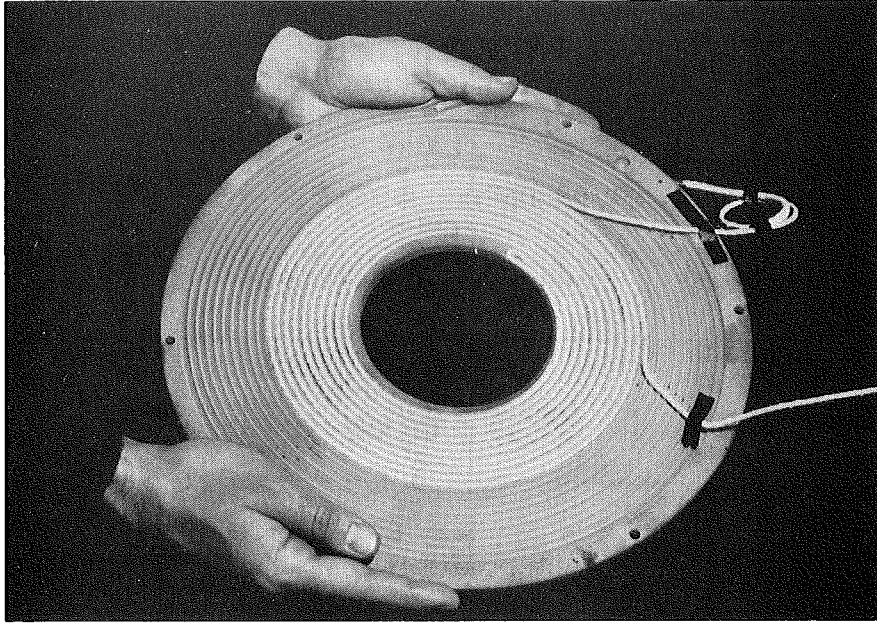

Fig. 4: Single switch disk used for the 12 kJ store

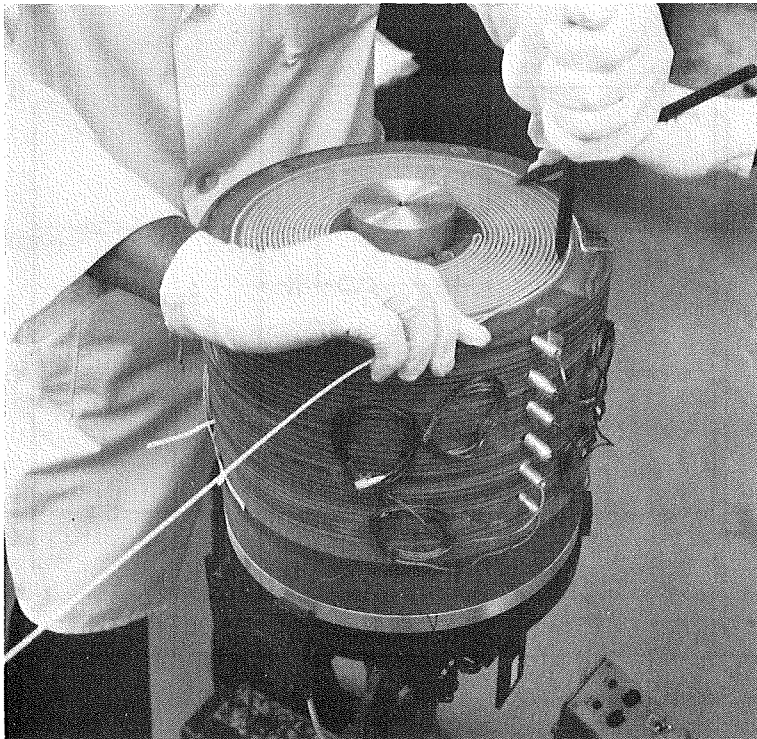

Fig. 5: 100 kJ switch during manufacture

TRIGGER PULSE

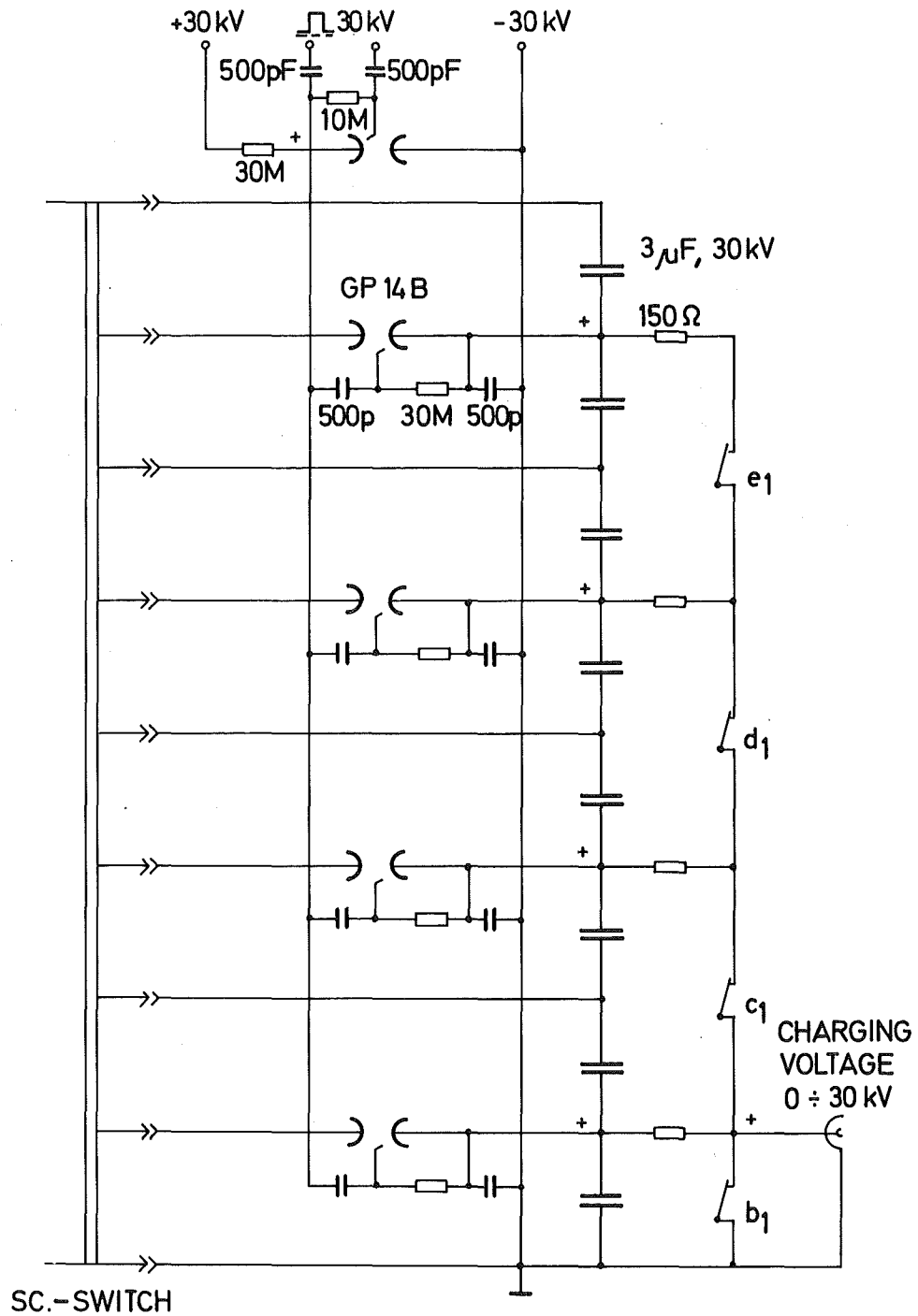

Fig. 6: The circuit for triggering the superconducting switch

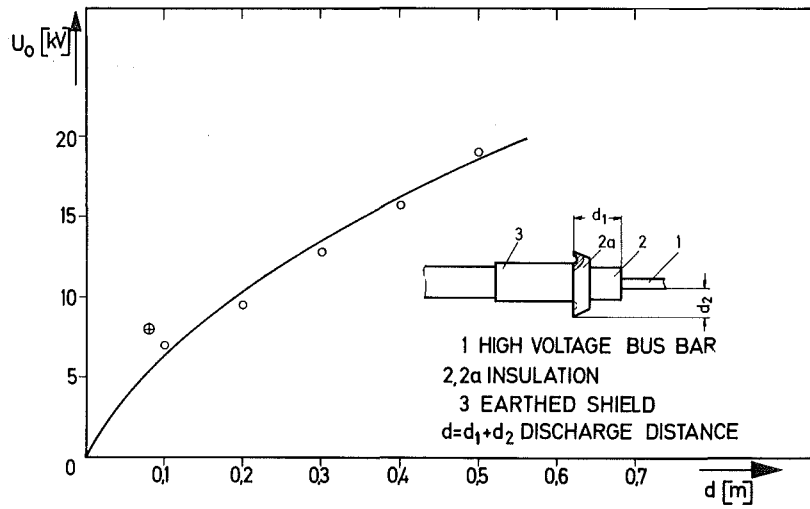

Fig. 7: Breakdown voltage of helium at 295° K (measured on a model of sliding discharge at 50 Hz)

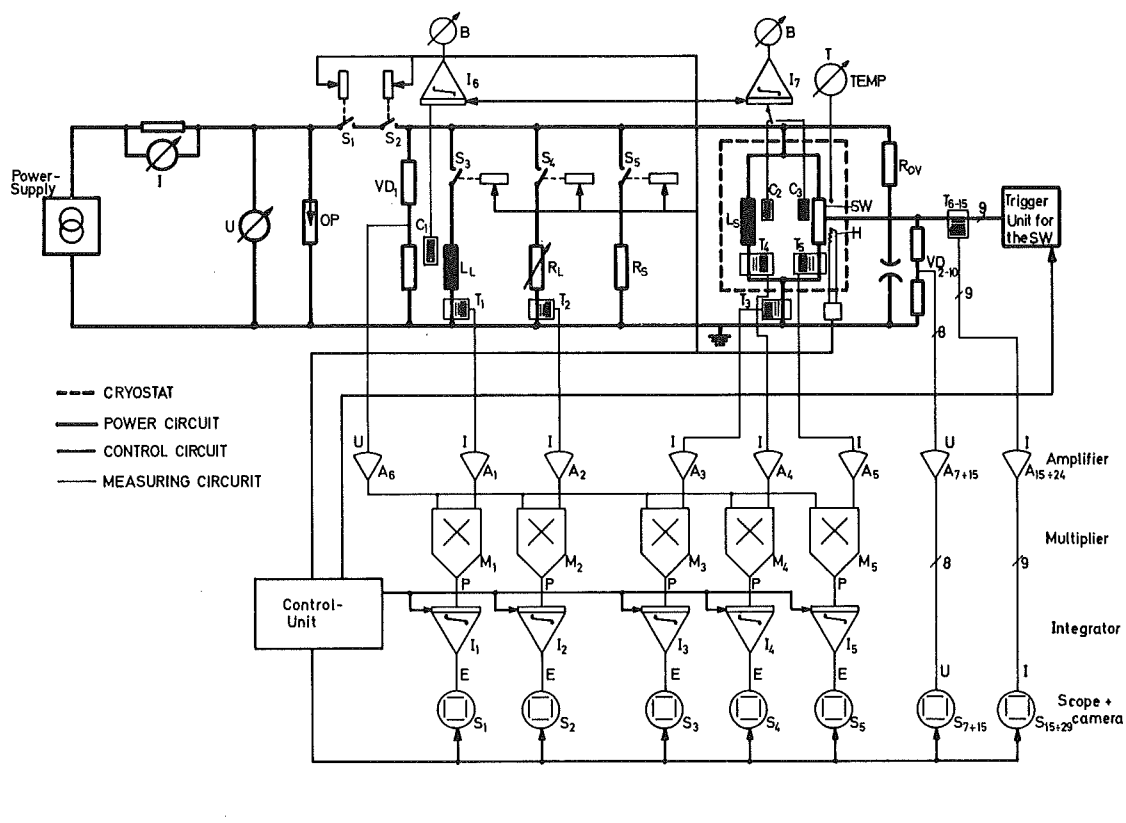

Fig. 8: Schematic circuit diagram of the experimental instrumentation of the 100 kJ store.

The symbols in the power circuit denote

- OP - overvoltage protection
- S_1 - power switch, S_{2-5} -disconnecting switches
- VD_{1-10} - voltage dividers
- C_{1-3} - pick up coils
- L_L - inductive load
- T_{1-15} - Rogowski loops
- R_L - load resistor
- R_S - protection resistor
- L_S - storage load
- SW - superconducting switch
- H - heater
- R_{OV} - overvoltage dump with spark gap