

KfK 3658
März 1984

**FEBA —
Flooding Experiments
with Blocked Arrays
Data Report 1,
Test Series I through IV**

P. Ihle, K. Rust
Institut für Reaktorbauelemente
Projekt Nukleare Sicherheit

Kernforschungszentrum Karlsruhe



KERNFORSCHUNGSZENTRUM KARLSRUHE
Institut für Reaktorbauelemente
Projekt Nukleare Sicherheit

KfK 3658

FEBA - Flooding Experiments with Blocked Arrays
Data Report 1, Test Series I through IV

P. Ihle, K. Rust

Kernforschungszentrum Karlsruhe GmbH, Karlsruhe

Als Manuskript vervielfältigt
Für diesen Bericht behalten wir uns alle Rechte vor

Kernforschungszentrum Karlsruhe GmbH
ISSN 0303-4003

Abstract

This report presents typical data and a limited heat transfer analysis of test series I through IV from an experimental thermal-hydraulic program of Flooding Experiments with Blocked Arrays (FEBA). The experiments consisted of separate effect tests on a full-length 5x5 rod bundle of PWR fuel rod dimensions utilizing electrically heated rods with a cosine power profile approximated by 7 steps of different specific power. Eight test series were performed under idealized reflood conditions using forced feed and system pressure as parameters without the inclusion of the effects of a reactor cooling system. The individual test series were conducted to study the effect of grid spacers and of coplanar blockages of different blockage ratios with and without bypass on the reflood heat transfer. The purpose of the investigations was to obtain an insight into the most important heat transfer mechanisms and to broaden the data base for the development and assessment of improved thermal-hydraulic models.

FEBA - Flutexperimente mit blockierten Anordnungen
Datenbericht 1, Testserien I bis IV

Kurzfassung

In diesem Bericht werden typische Meßergebnisse und eine begrenzte Wärmeübergangsanalyse der Testserien I bis IV vorgestellt, die im Rahmen des FEBA-Programmes gewonnen wurden. Die Experimente zur Untersuchung thermohydraulischer Einzeleffekte in einem 5x5-Stabbündel mit DWR Brennstababmessungen voller Länge wurden mit elektrisch beheizten Stäben durchgeführt, deren axiale Leistung durch sieben Stufen einer Cosinusverteilung angenähert war. Das Programm bestand aus acht Testserien mit Zwangsfluten und Systemdruck als Parameter zur Idealisierung der Flutbedingungen. Effekte des Reaktorkühlsystems waren nicht eingeschlossen. Die einzelnen Testserien dienten der Untersuchung der Einflüsse von Abstandshaltern und koplanaren Blockaden mit und ohne zusätzlicher Umströmung auf den Wärmeübergang während des Flutens. Die Absicht war, ein verbessertes Verständnis der wichtigsten Wärmeübergangsmechanismen zu gewinnen und die Basis experimenteller Daten zu erweitern für Entwicklung und Überprüfung verbesserter thermohydraulischer Rechenmodelle.

<u>Table of Contents</u>	Page
1. Introduction	1
2. FEBA Reflood Program	2
3. Test Loop	5
4. Test Section Design	6
5. Instrumentation	10
6. Test Parameters	12
7. Data Informations	14
8. References	17
9. Test Series I	19
9.1 Test No. 223, v = 3.8 cm/s, p = 2.2 bar	22
9.2 Test No. 216, v = 3.8 cm/s, p = 4.1 bar	38
9.3 Test No. 220, v = 3.8 cm/s, p = 6.2 bar	54
9.4 Test No. 218, v = 5.8 cm/s, p = 2.1 bar	70
9.5 Test No. 214, v = 5.8 cm/s, p = 4.1 bar	86
9.6 Test No. 222, v = 5.8 cm/s, p = 6.2 bar	102
9.7 Listing of Computer Channel Numbers	117
10. Test Series II	123
10.1 Test No. 234, v = 3.8 cm/s, p = 2.0 bar	126
10.2 Test No. 229, v = 3.8 cm/s, p = 4.1 bar	142
10.3 Test No. 231, v = 3.8 cm/s, p = 6.2 bar	158
10.4 Test No. 233, v = 5.8 cm/s, p = 2.0 bar	174
10.5 Test No. 228, v = 5.7 cm/s, p = 4.1 bar	190
10.6 Test No. 230, v = 5.8 cm/s, p = 6.2 bar	206
10.7 Listing of Computer Channel Numbers	221
11. Test Series III	227
11.1 Test No. 241, v = 3.8 cm/s, p = 2.0 bar	230
11.2 Test No. 239, v = 3.8 cm/s, p = 4.1 bar	252
11.3 Test No. 236, v = 3.8 cm/s, p = 6.2 bar	274
11.4 Test No. 240, v = 5.8 cm/s, p = 2.0 bar	296
11.5 Test No. 238, v = 5.7 cm/s, p = 4.1 bar	318
11.6 Test No. 235, v = 5.8 cm/s, p = 6.2 bar	340
11.7 Listing of Computer Channel Numbers	362

	Page
12. Test Series IV	367
12.1 Test No. 267, $v = 2.2$ cm/s, $p = 4.0$ bar	370
12.2 Test No. 262, $v = 3.8$ cm/s, $p = 2.0$ bar	394
12.3 Test No. 263, $v = 3.8$ cm/s, $p = 3.9$ bar	418
12.4 Test No. 268, $v = 3.8$ cm/s, $p = 5.9$ bar	442
12.5 Test No. 261, $v = 5.7$ cm/s, $p = 2.0$ bar	466
12.6 Test No. 264, $v = 5.8$ cm/s, $p = 3.9$ bar	490
12.7 Test No. 269, $v = 5.7$ cm/s, $p = 5.9$ bar	514
12.8 Listing of Computer Channel Numbers	538

1. Introduction

During a loss-of-coolant accident (LOCA) of a pressurized water reactor (PWR) the emergency core cooling systems (ECCS) are usually assumed to provide sufficient capacity to avoid significant fuel damage for current design basis accident cases. However, during such an event situations may arise leading to the heatup of the core by nuclear decay heat for an extended time span. Under design basis accident conditions this may be the case, e.g. during the refill phase after blowdown. The reflood water injection has to terminate this "Second Heatup Phase" before fuel rod damage exceeds specified limits.

In a LOCA of a PWR the fuel in portions of the core may become overheated, whilst at the same time the reactor system pressure may decrease below the internal rod pressure. Under these circumstances the Zircaloy claddings could balloon and reduce considerably the cooling channel cross sections.

To obtain a better understanding of the flow conditions and to provide an expanded data base for an adequate analytical description of the complex heat transfer processes taking place in a bundle of ballooned rods during the reflood phase, separate effect tests under forced reflood conditions were performed. The Flooding Experiments with Blocked Arrays (FEBA) were carried out in eight consecutive test series using a 5x5 rod array as the main arrangement for all of the tests.

Details of the FEBA reflood program as well as a comparison of typical transients measured and evaluated from the different test series are presented in Ref. /1/.

This report is a broader sampling of data selected from tests of the first four 5x5 rod bundle test configurations. A second data report /2/ contains data selected from test series V through VIII.

From the tests presented all data measured as well as selected data evaluated are available on tapes from KfK. The data also are available from the Reactor Safety Research Data Bank of the USNRC at EG&G Idaho, Idaho Falls, ID, U.S.A.

2. FEBA Reflood Program

The specific objectives of the separate effect tests under forced reflood conditions were:

- To measure and to evaluate thermal-hydraulic data for unblocked bundle geometries,
- To measure and to evaluate the effect of grid spacers upon the thermal-hydraulic behavior,
- To measure and to evaluate thermal-hydraulic data for blocked bundle geometries with and without flow bypass.

The FEBA 5x5 rod bundle program consisted of eight test series with different grid spacer and sleeve blockage arrays within the bundle. The bundle geometries and the axial arrangement of grid spacers and flow blockages are shown in Fig. 1. The main purposes of the individual test series are:

- Series I: Base line tests with undisturbed bundle geometry containing all (seven) grid spacers for comparison with the subsequent series,
- Series II: Investigation of the grid spacer effect on the axial temperature profile at the bundle midplane, without grid spacer at the bundle midplane,
- Series III: Investigation of the effects of a 90 % flow blockage with bypass, blockage at the bundle midplane of 3x3 rods placed in the corner of the 5x5 rod bundle, without grid spacer at the bundle midplane,
- Series IV: Investigation of the effect of a 62 % flow blockage with bypass, blockage at the bundle midplane of 3x3 rods placed in the corner of the 5x5 rod bundle, without grid spacer at the bundle midplane,
- Series V: Investigation of the effects of a 90 % flow blockage with bypass, blockage at axial level 2125 mm (100 mm upstream of the bundle midplane) of 3x3 rods placed in the corner of the 5x5 rod bundle, grid spacer at the bundle midplane,
- Series VI: Investigation of the effects of a 90 % and 62 % flow blockage with bypass, 90 % blockage at axial level 2125 mm (100 mm upstream of the bundle midplane) and 62 % blockage at axial level 1925 mm (100 mm downstream of the bundle midplane) of 3x3 rods placed in the corner of the 5x5 rod bundle, grid spacer at the bundle midplane,

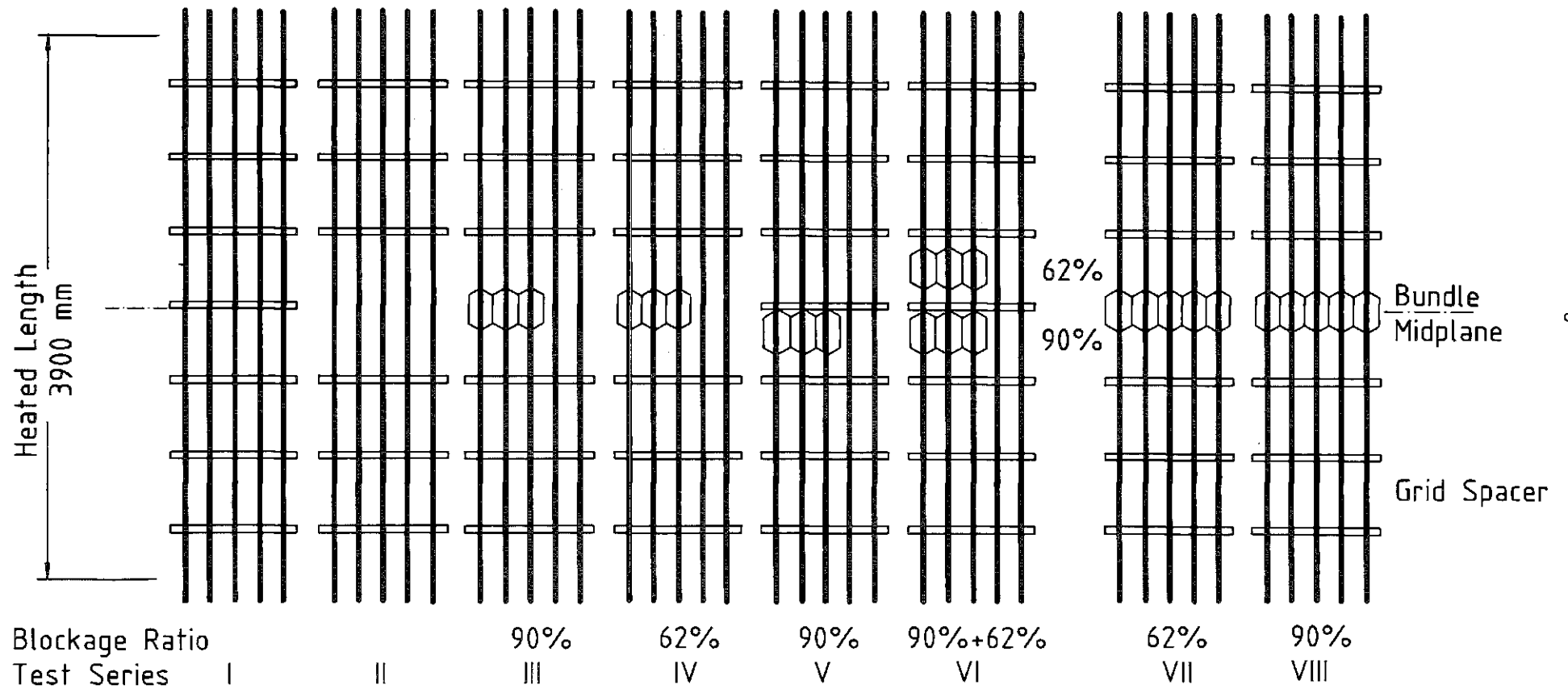
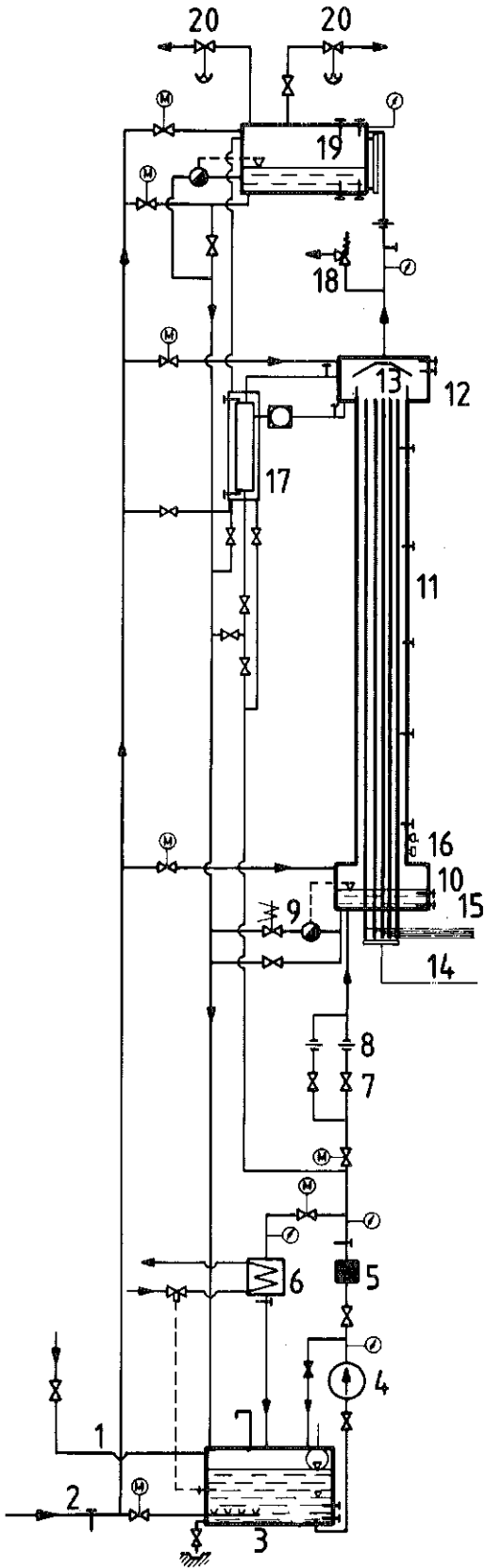

Fig. 1 5x5 rod bundle: Bundle geometries of test series I through VIII axial arrangement of grid spacers and sleeve blockages



LEGEND

- 1 Water Supply
- 2 Steam Supply
- 3 Storage Tank
- 4 Water Pump
- 5 Filter
- 6 Heat Exchanger
- 7 Throttle Valve
- 8 Turbine Meter
- 9 Water Level Regulation Valve
- 10 Lower Plenum
- 11 Test Section
- 12 Upper Plenum
- 13 Water Separator
- 14 Power Supply
- 15 Rod Instrumentation Exits
- 16 Water Level Detector
- 17 Water Collecting Tank
- 18 Outlet Valve
- 19 Buffer
- 20 Pressure Regulator

Fig. 2 FEBA test loop

Series VII: Investigation of the effects of a 62 % blockage without bypass, blockage at the bundle midplane of the 5x5 rod bundle,
Series VIII: Investigation of the effects of a 90 % blockage without bypass, blockage at the bundle midplane of the 5x5 rod bundle.

3. Test Loop

Figure 2 shows schematically the test loop. It is a forced-flow reflood facility with a back pressure control system. Coolant water is stored in a tank (3). During operation, coolant is pumped (4) through a throttle valve (7) and a turbine meter (8) into the lower plenum region (10) of the test section (11). The coolant flow may be directed either upwards through the test assembly, or through the lower plenum (10) and water level regulation valve (9) back into the water supply. When reflood is initiated, coolant water rises in the test assembly and two-phase flow results when water reaches the hot zone of the heater rods. Entrained water droplets are transported upwards by the rising steam and may impinge on the steam water separator (13) placed above the test assembly. The liquid then drains into a collecting tank (17), where the water content is continuously measured. Steam passes around the droplet deflector and is then flowing through a buffer tank (19) to the atmosphere. This tank has an automatic pressure regulator (20) for control of a constant back pressure for the test assembly. A large external steam supply is connected to the buffer to heat up the total system and the buffer contents and to maintain the system pressure. The heater rod instrumentations (15) exit from the lower end of the rod assembly as do the electric power connections (14) for the heater rods. However, the instrumentation of the sleeve blockages is led to the top end of the housing such that it does not influence the two-phase mixture rising from the bottom. The housing is insulated to reduce the heat loss to the outside air environment.

4. Test Section Design

Electrically heated rods of PWR dimensions are used to simulate the nuclear fuel rods. Figure 3, a working drawing of an instrumented heater rod, shows the axial dimensions. Figure 4 shows the cross section of the heater rod which has an outer diameter of 10.75 mm. A spiral wound heating element of NiCr 80 20 (ASTM B 344-60) is embedded in the electrical insulator

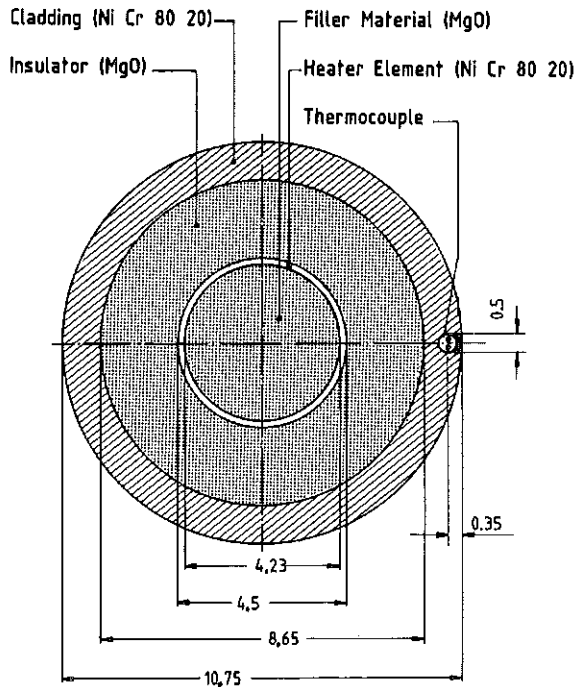

Dimensions are in millimeters

Fig. 4 Cross section of heater rod

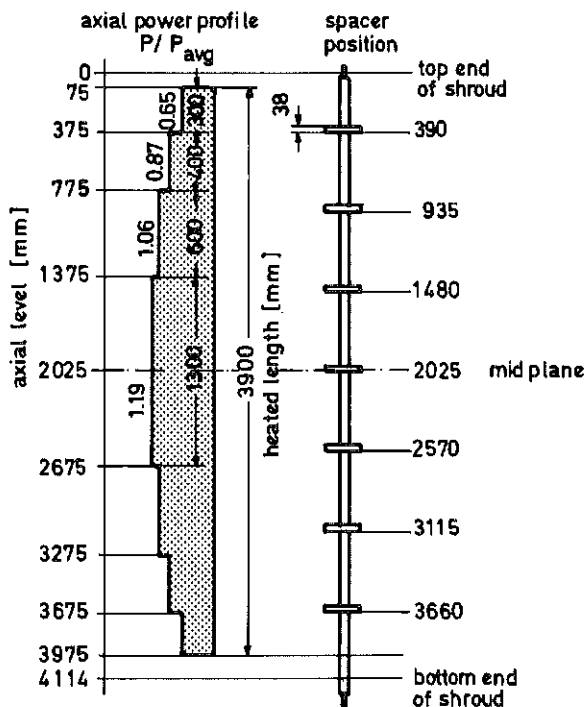

Fig. 5 Axial heater rod layout

(MgO), and then encapsulated in the clad of NiCr 80 20 which has a wall thickness of one millimeter. In contrast to a nuclear fuel rod with a Zircaloy cladding and a gas filled gap, this heater rod is a "solid type" usually used for thermal-hydraulic tests. A gas filled gap between cladding and the electrical insulation is not provided. The cosine power profile of the fuel rods is approximated by seven steps of different specific power. The left-hand side sketch of Fig. 5 shows the axial power distribution of the heater rod with a length of 3900 mm. The average power step level is shown together with the length of each power step. The axial power profile is flat. The peak to average ratio amounts to 1.19. The 5x5 rod bundle is placed in a square section housing with an inside width of 78.5 mm. The housing of stainless steel (AISI 316 Ti) has a wall thickness of 6.5 mm. The heater rod pitch is 14.3 mm. The right-hand side of Fig. 5 shows the axial position of seven original KWU-PWR grid spacers which are located at the bundle midplane (axial level 2025 mm) and every 545 mm above and below that level. The grid spacers are attached to the rods by friction. They are

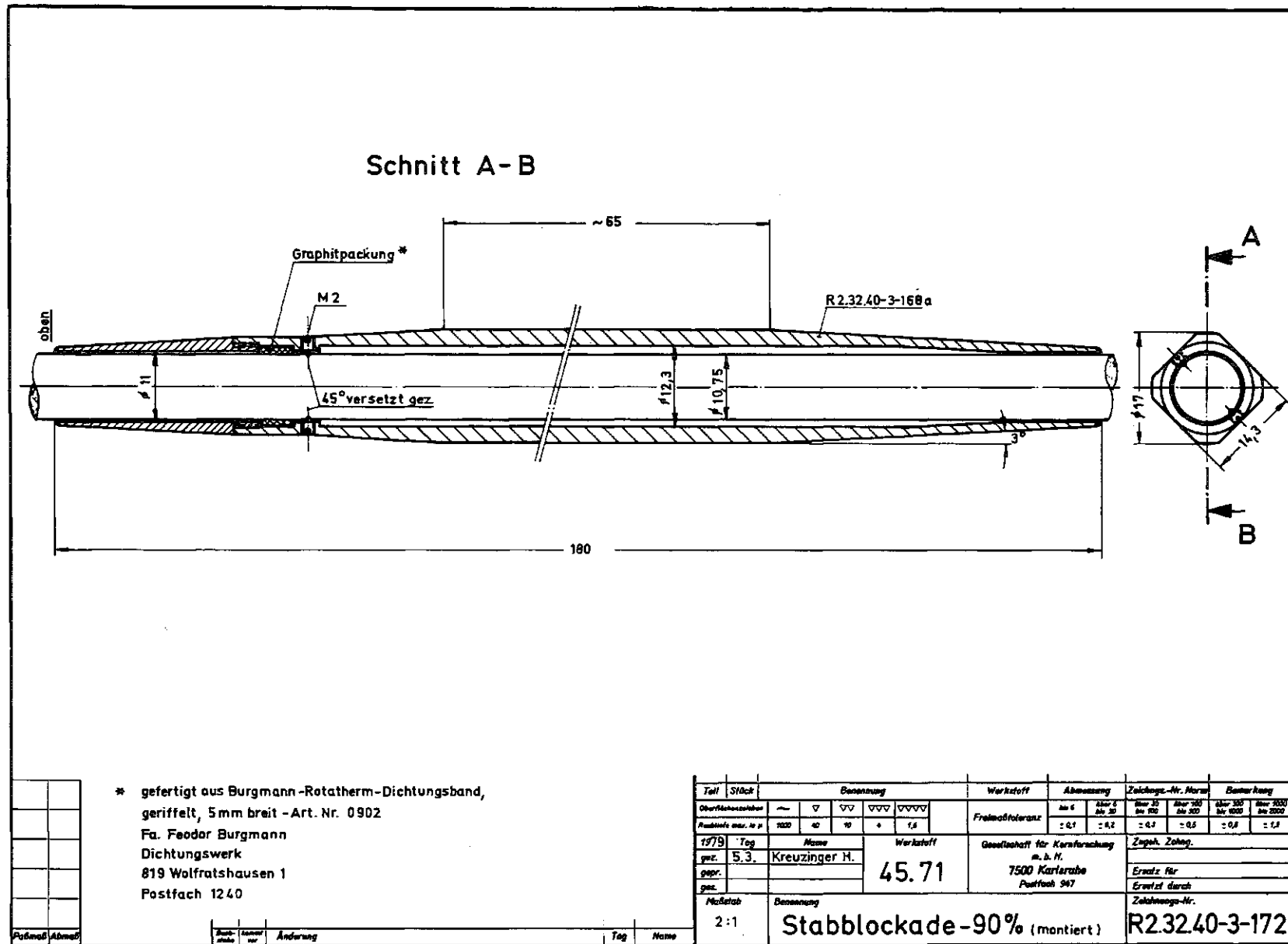

Fig. 6 5x5 rod bundle: Working drawing of the 90% blockage device

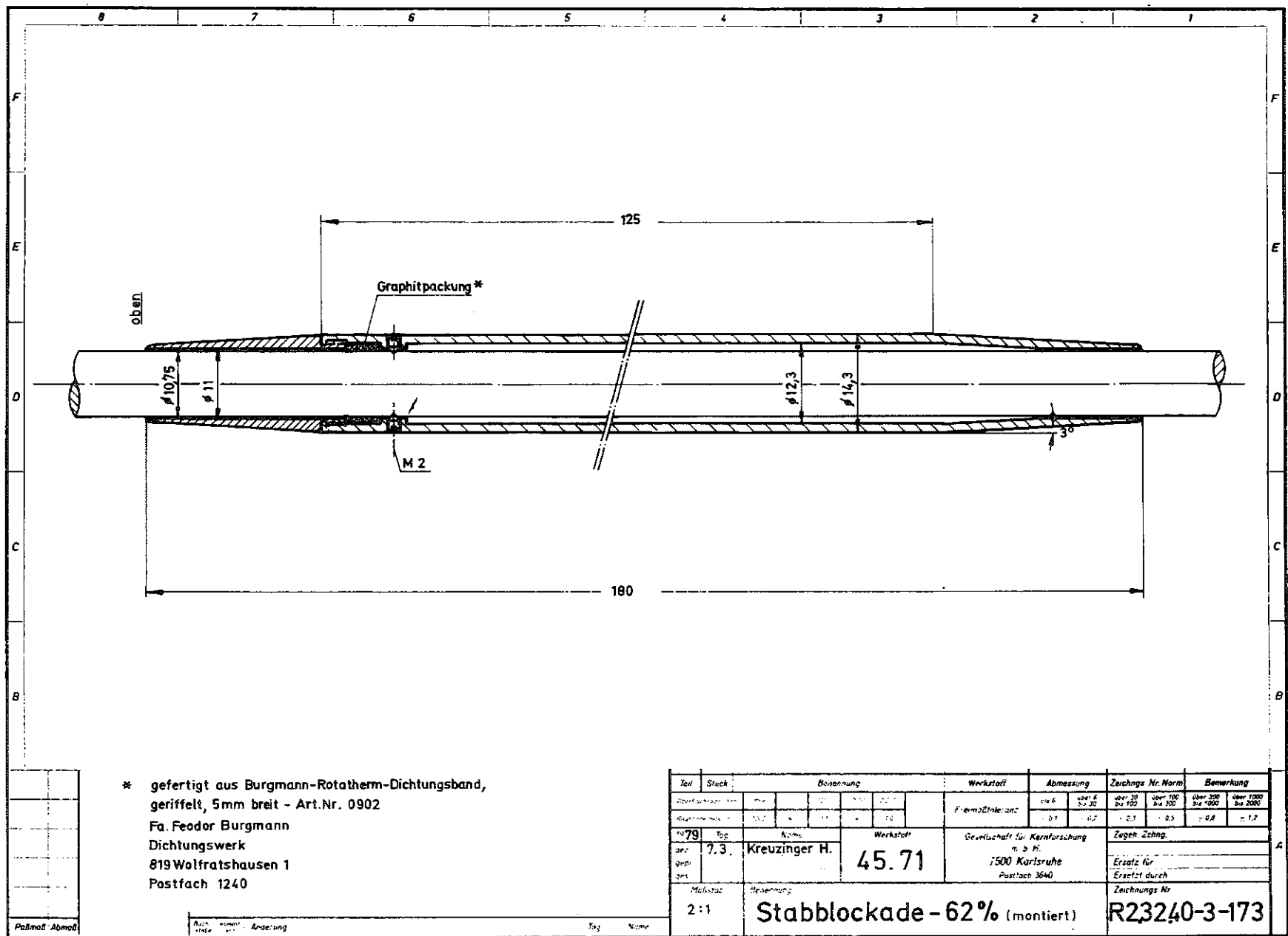

Fig. 7 5x5 rod bundle: Working drawing of the 62% blockage device

sliding in the housing in the case of different axial elongation of housing and rod bundle.

The heater rods are bolted to the top flange of the test section (zero level and therefore reference level for all axial bundle positions), and the lower ends of the rods penetrate through the test assembly pressure barrier. The penetration is accomplished using O-ring sealings and allows axial movement of the heater rods relative to the housing. Weights are hung from the bottom end of the rods to prevent them from bowing due to friction in the sealing during temperature changes.

To investigate effects of ballooned fuel rod claddings on the reflood thermohydraulics, sleeves of 180 mm length are used. Figures 6 and 7 show the shape of sleeves selected to simulate the smooth geometry expected from ballooned rod claddings with blockage of 90 % and 62 %, respectively, of the subchannel flow areas. In addition side plate devices are placed between the sleeves and the housing. They are attached to the sleeves. They are sliding in the housing in the case of different axial elongation of the housing and the rod bundle. The actual length of the remaining subchannels in the 90 % blocked zone is 65 mm. In the 62 % blocked zone, it is 125 mm. The sleeves touch the rod surfaces at the ends of the sleeves only. To simulate the gap resistance between a ballooned cladding and the fuel as well as to reduce the heat capacity of the artificial blockage, the remainder of the sleeve is separated from the rod by a gap of 0.8 mm filled with stagnant steam. The influences of the heat capacity of the sleeves and the heat resistance of the gap on the transient sleeve temperatures were compared by calculation with the behavior of a ballooned fuel rod.

5. Instrumentation

Most part of the test instrumentation consisted of thermocouples (Chromel-Alumel), since cladding (TS), sleeve (TH), fluid (TF), housing (TK) and grid spacer (TA, test series IV and VIII) temperatures were to be measured at various positions. Figure 8 shows a schematic diagram of the axial levels of the TC measuring positions. This diagram enables to relate the measuring positions to the grid spacer positions as well as to the specific power zones. However, not all TC measuring positions were instrumented for the individual test series. More details can be taken from the computer channel

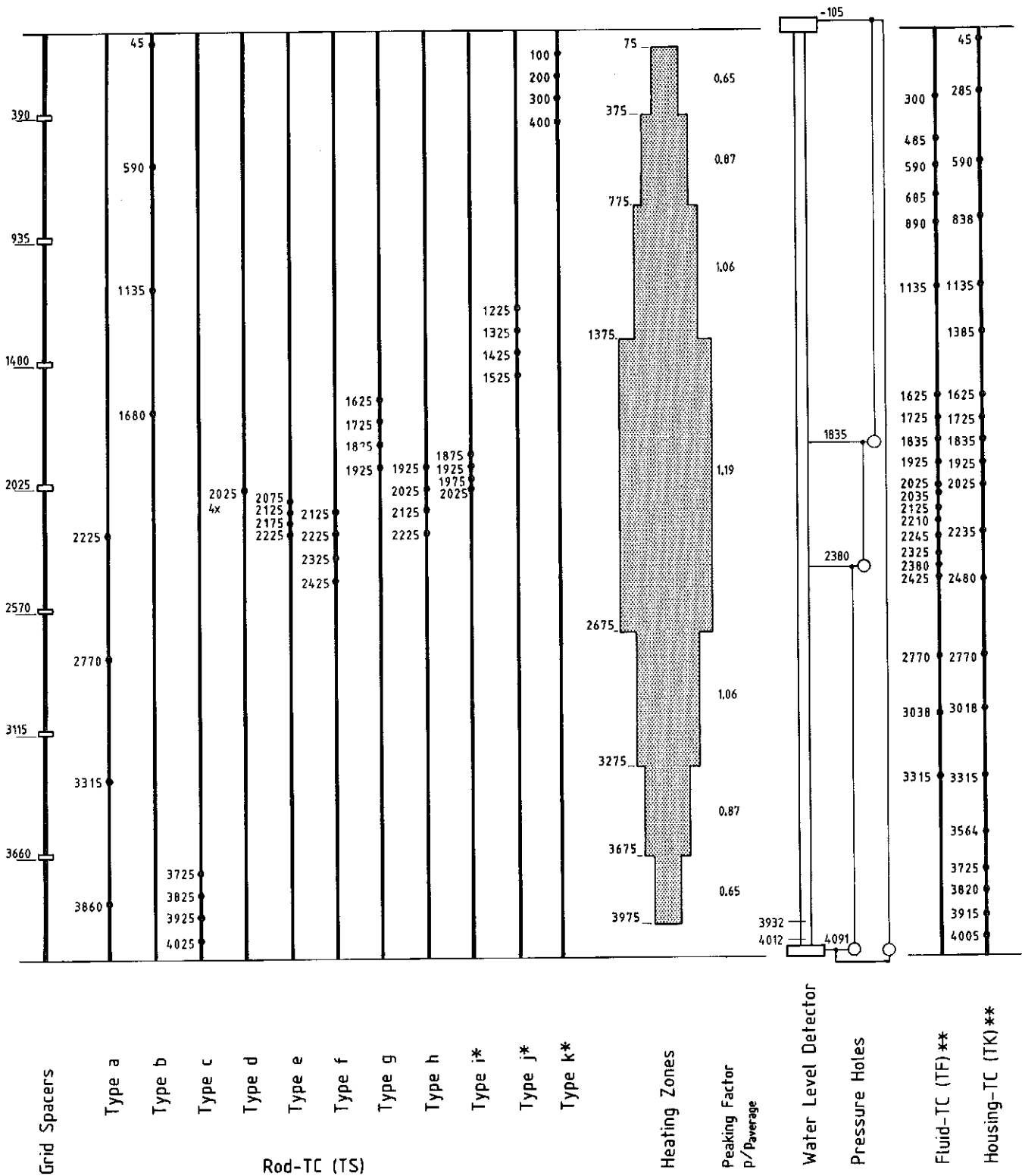

* in Test Series V through VIII only

** not all positions set for the individual tests

Fig. 8 5x5 rod bundle: Axial levels of the measuring positions

listings included in this report for test series I through IV (cf. appendices at the end of the plotted data of each test series).

Cladding and sleeve temperatures were measured with 0.5 mm sheath diameter thermocouples having insulated junctions. These thermocouples were embedded in grooves which were milled into the outer surface of the rod claddings and the sleeves. The grooves were closed by brazing over the total length to avoid any disturbance of the coolant flow.

Generally, the fluid temperature was measured with unshielded thermocouples of 0.25 mm outer sheath diameter. The junctions protruded into the flow channels. Only for test series I through III some few shielded fluid thermocouples were installed. The effect of the shieldings is described in Ref. /1/. Pressures and pressure differences were measured with pressure transducers. In addition to the inlet and outlet pressure, the pressure differences were measured along the entire bundle length, along both the lower and upper portions of the bundle as well as along the bundle midplane. The flooding rate was measured with a turbo flowmeter. The amount of the water carried over was measured continuously by a pressure transducer at the water collecting tank.

All data were digitally recorded with a scan frequency of 10 cycles per second.

The data acquisition system is described in Ref. /1/.

6. Test Parameters

The main test parameters varied are shown in Fig. 9:

- Bundle geometry,
- Flooding rate given as flooding velocity, i.e. the velocity of the rising water level in the cold bundle,
- System pressure.

Flooding rate, system pressure, and feedwater temperature were kept constant during each test run. However, at the beginning of reflood, the feedwater was heated up by the hot environment of the lower plenum. Nevertheless, some few seconds later the feedwater temperature decreased and reached the de-

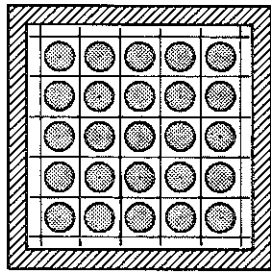

Test Series I
Test Series II

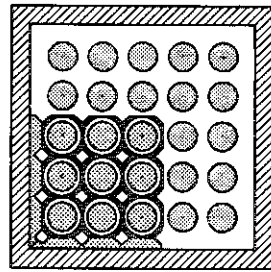

Test Series III
Test Series V
Test Series VI
90% Blockage

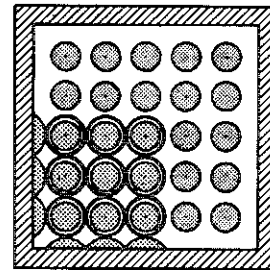

Test Series IV
Test Series VI
62% Blockage

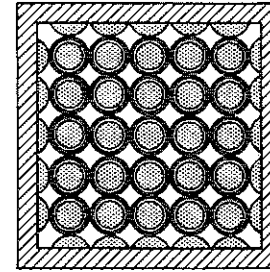

Test Series VII
62% Blockage

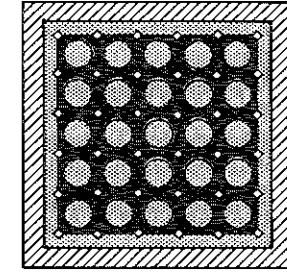

Test Series VIII
90% Blockage

FLOODING PARAMETERS

Test Series		I	II	III	IV	V	VI	VII	VIII
Flooding Velocity (cold bundle) Constant During Each Test	cm/s	3.8, 5.8	3.8, 5.8	3.8, 5.8	3.8, 5.8 (2.2, 10.)	2.2, 3.8 5.8	2.2, 3.8 5.8	3.8, 5.8 (2.2)	3.8, 5.8 (2.2)
System Pressure Constant During Each Test	bar	2, 4, 6	2, 4, 6	2, 4, 6	2, 4, 6 (4)	4	4	2, 4, 6 (4)	2, 4, 6 (2, 4)
Feedwater Temperature Constant During Each Test	°C	40 °C, some few tests with 80 °C							
Max. Cladding Temperature (at start of reflooding)	°C	between 700 and 800 °C, some few tests between 600 and 700°C							
Max. Housing Temperature (at start of reflooding)	°C	between 600 and 700 °C, some few tests between 500 and 600°C							
Bundle Power	kW	at start of reflooding 200 kW, 120% ANS decay heat transient 40 s after shutdown, some few tests with constant bundle power							

Steam Cooling Tests

Test series VII and VIII include steady state and transient tests for which low bundle power and system pressures of 2, 4 and 6 bar were selected.

Fig. 9 5x5 rod bundle: Test matrix of test series I through VIII

sired value. The initial bundle power of about 200 kW was followed by a decay heat transient corresponding to 120 % ANS standard 40 s after shutdown of a reactor.

The tests performed are listed in Tables 1 through 4 by which the plotted data of each test series are introduced.

7. Data Informations

For the data transfer, data management, heat transfer analysis, and data representation a detailed computer code was written /3/ using the physical properties of the specific materials programmed in the PEW code /4/.

For each test series the following tables, figures, plots, and listings are included:

a) Summary and comment table.

This table gives an overlook over the individual test runs, i.e. flooding velocity, system pressure, feedwater temperature, bundle power transient.

b) Information figure for identification of rod bundle measuring positions.

The upper part of the figure shows the cross sectional geometry at the bundle midplane, the rod numbers, the type of rod instrumentation, the thermocouple numbers, the sleeve instrumentation (TH, in case of investigation of blockage effects), the fluid thermocouples (TF), the housing thermocouples (TK), the grid spacer thermocouples (TA, in case of its instrumentation).

In the lower part of the figure the axial positions of the cladding instrumentation are listed.

c) Layout of the bundle geometry.

The main purpose of this layout is to identify the main measuring positions upstream and downstream of the bundle midplane. Again, it is to point out that all axial levels are referenced to the top flange of the rod bundle (zero level).

d) Data plots of test series I.

It should be noted that for each set of data of the individual test

series transients versus reflood time were plotted which were measured at identical rods and elevations, respectively. The same is valid for the transient fluid and housing temperatures which were taken from identical measuring devices to make easier a comparison from test run to test run and from test series to test series, respectively.

The plots show in detail:

- Initial axial temperature profile of the cladding,
- Test parameters: Flooding velocity /cm/s/, system pressure /bar/ measured in the buffer, feedwater temperature /°C/, bundle power /kW/,
- Cladding temperatures /°C/ measured at fixed levels of 345 mm downstream of the leading edge of each grid spacer,
Heat transfer coefficients /W/(cm²K)/ corresponding to the aforementioned cladding temperatures,

The heat transfer coefficients are related to the saturation temperature corresponding to the system pressure. In contrast to all other data plotted in this report, a smoothing subroutine of the computer code was applied to substitute each data point of the cladding temperature transient by the arithmetic mean value of the previous and following 25 points for heat transfer analysis only. In this context it should be reminded that the data were recorded with a scan frequency of 10 cycles per second.

- Cladding temperatures measured upstream of the bundle midplane,
Corresponding heat transfer coefficients,
- Cladding temperatures at the bundle midplane,
Corresponding heat transfer coefficients,
- Cladding temperatures measured downstream of the bundle midplane,
Corresponding heat transfer coefficients,
- Cladding-, fluid-, housing temperatures measured at the same axial position,
- Pressure drop /bar/ along the entire bundle length, the lower portion of the bundle, the bundle midplane, the upper portion of the bundle,
- Coolant outlet: water carried over /kg/ measured in the water collecting tank, steam temperature /°C/ and pressure /bar/ both measured in the upper plenum,
- Axial positions of the quenchfront /mm/ as function of reflood time.

e) Listing of the computer channel numbers and of data identification for the data available on tapes or in the USNRC/RSR Data Bank.

f) Data plots of test series II.

Corresponding to the positions a) through e), the informations for test series II are included.

g) Data plots of test series III.

Corresponding to the positions a) through e), the informations for test series III are included.

However, the cladding temperatures and the corresponding heat transfer coefficients are plotted for both the bypass region and the blocked region.

h) Data plots for test series IV.

Corresponding to the positions a) through e), the informations for test series IV are included.

However, the cladding temperatures and the corresponding heat transfer coefficients are plotted for both the bypass region and the blocked region. In addition two diagrams show the grid spacer temperatures measured at two different axial positions.

i) Additional remarks concerning data informations.

The data acquisition system to recording the data of test series I through VI was limited to a maximum input voltage of 40 mV. This limitation has led to shut down of the thermocouple signals above about 1020 °C when the input was overloaded. In this case "room temperature" was indicated for the time span of the overflow. An example is plotted in Fig. 332 showing data of test run No. 267 of test series IV. This overflow occurred for few measuring positions in this test run only performed with the lowest flooding velocity selected. Such signals are valid for the whole range except the overflow, since it is not caused by thermocouple failures. Thermocouple failures are characterized by meaningless transients and they are easily detectable. However, in the most cases they are mentioned in the data channel listings for each individual test. Since the data are presented as measured please keep in mind these remarks using data from computer storage or tapes.

8. References

- [1] Ihle, P.; Rust, K.:
"FEBA - Flooding Experiments with Blocked Arrays,
Evaluation Report"
KfK 3657, March 1984

- [2] Ihle, P.; Rust, K.:
"FEBA - Flooding Experiments with Blocked Arrays,
Data Report 2, Test Series V Through VIII"
KfK 3659, March 1984

- [3] Rust, K.; et al.:
"DAS - Ein Daten-Auswerte-System"
(to be published as KfK-Report)

- [4] Rust, K.; Malang, S.; Götzmann, W.:
"PEW - Ein FORTRAN IV-Rechenprogramm zur Bereitstellung physikalischer
Eigenschaften von Werkstoffen für LWR-Brennstäbe und deren Simulatoren"
KfK-Ext. 7/76-1, Dez. 1976

TEST SERIES I

Base Line Tests With Undisturbed Bundle Geometry,
7 Grid Spacers

Test No.	Flooding Velocity (cold) cm/s	System Pressure bar	Feedwater Temp. ¹		Bundle Power ²		Remarks
			0-30 s	End	0 s	Transient	
223	3.8	2.2	44	36	200	120% ANS	Figs. 12 Through 26
216	3.8	4.1	48	37	200	120% ANS	Figs. 27 Through 41
220	3.8	6.2	49	37	200	120% ANS	Figs. 42 Through 58
218	5.8	2.1	42	37	200	120% ANS	Figs. 57 Through 71
214	5.8	4.1	45	37	200	120% ANS	Figs. 72 Through 88
222	5.8	6.2	43	36	200	120% ANS	Figs. 87 Through 101
<hr/>							
210	2.8	4.2	48	39	200	120% ANS	Data Not Plotted
221	2.8	6.1	51	37	200	120% ANS	Data Not Plotted
227	3.8	6.1	53	38	200	120% ANS	Data Not Plotted
219	5.8	6.1	50	37	200	120% ANS	Data Not Plotted

1) Measured in the lower plenum

2) Decay heat transient corresponding 120% ANS Standard 40 s after shutdown of the reactor

Table 1 FEBA 5x5 rod bundle: Main test parameters of test series I

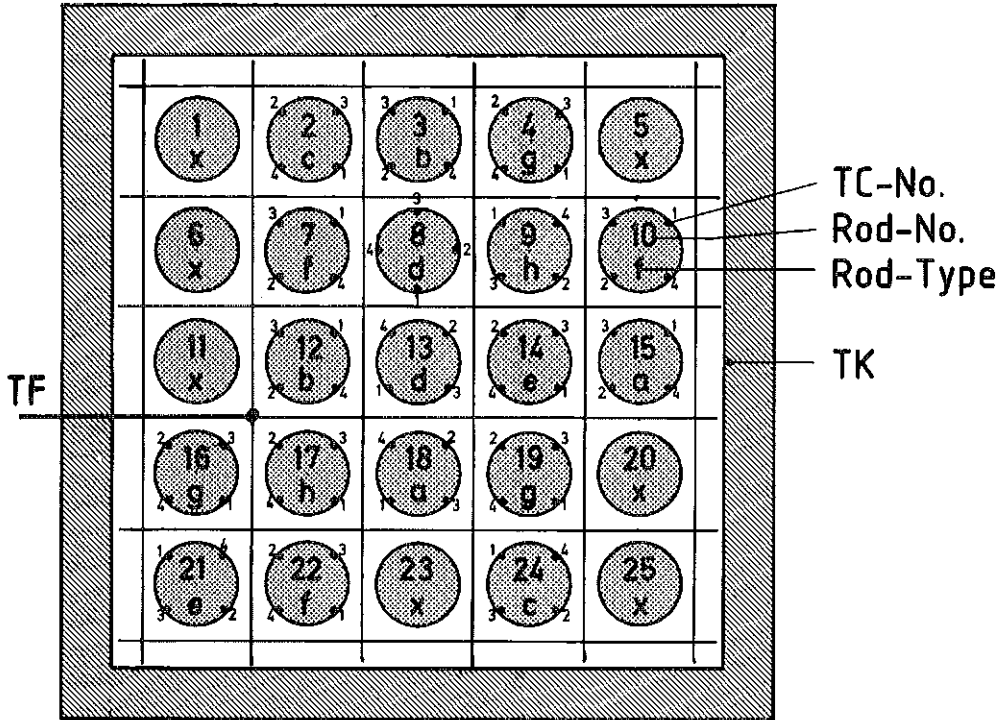

Rod Type	TC No.	Axial Level mm
a	1	2225
	2	2770
	3	3315
	4	3860
b	1	45
	2	590
	3	1135
	4	1680
c	1	3725
	2	3825
	3	3925
	4	4025
d	1	2025
	2	2025
	3	2025
	4	2025

Rod Type	TC No.	Axial Level mm
e	1	2075
	2	2125
	3	2175
	4	2225
f	1	2125
	2	2225
	3	2325
	4	2425
g	1	1625
	2	1725
	3	1825
	4	1925
h	1	1925
	2	2025
	3	2125
	4	2225

Rod Type	TC No.	Axial Level mm
x	without TC's	

Fig. 10 5x5 rod bundle: Radial and axial location of cladding, fluid and housing TC's for test series I

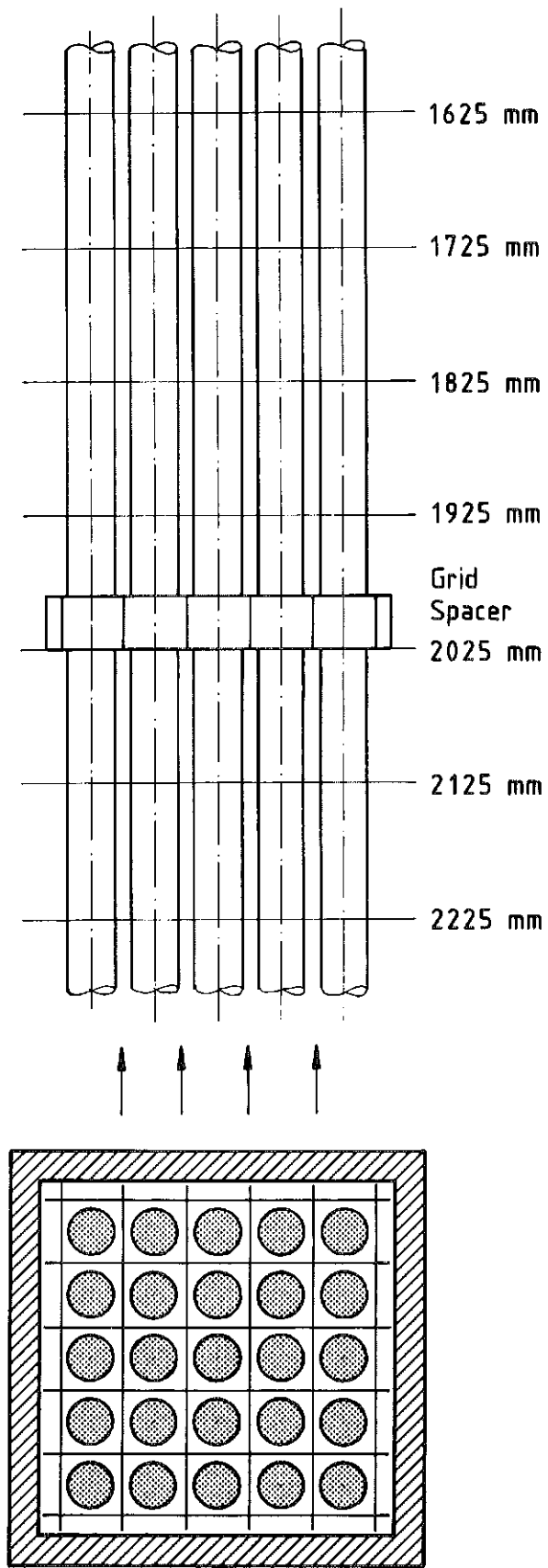
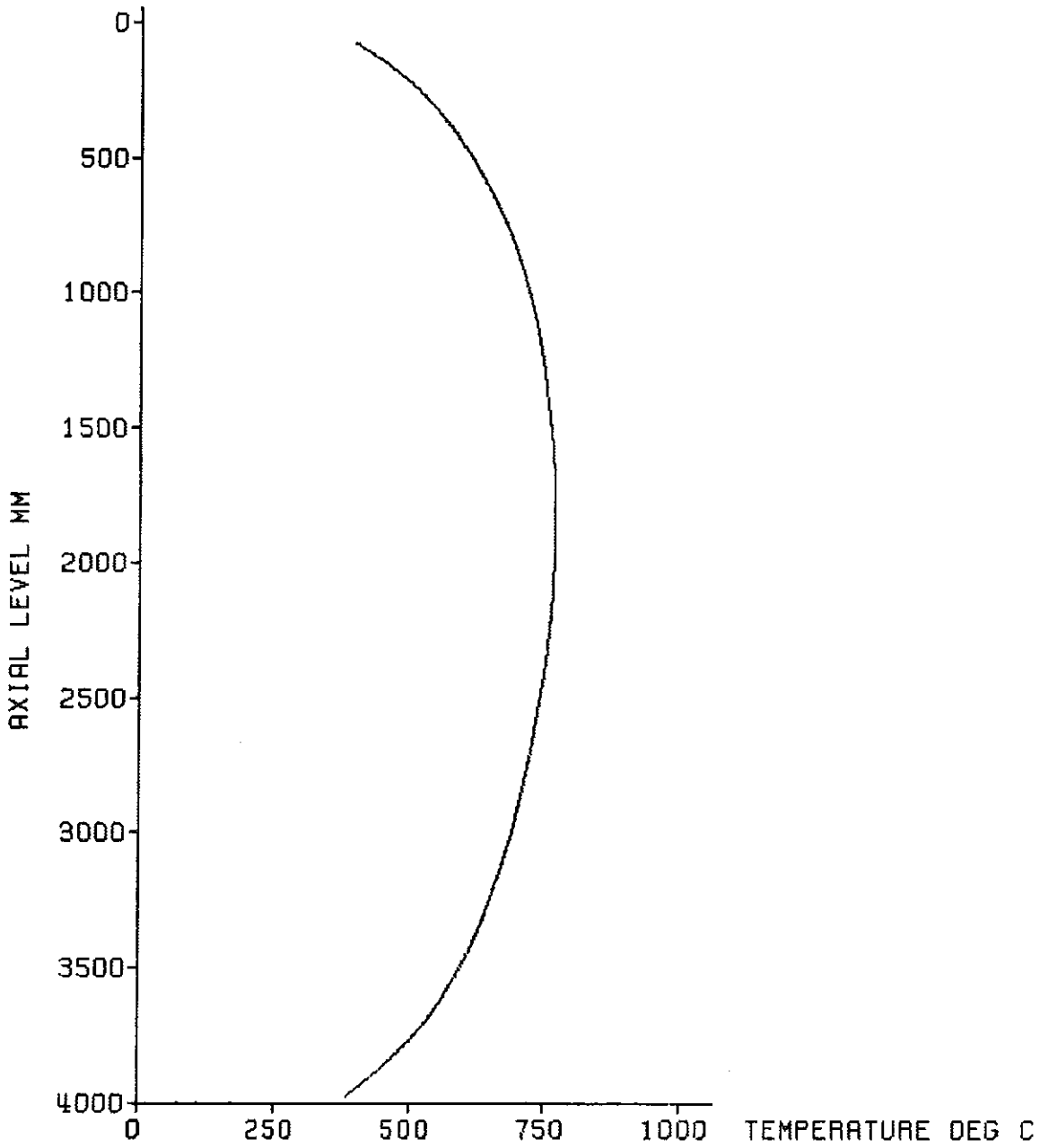

Fig. 11 5x5 rod bundle: Layout of the bundle geometry of test series I

Initial axial temperature profile of the cladding



decay heat	120% ANS standard
flooding rate (cold)	3.82 cm/s
system pressure	2.21 bar
feedwater temperature	40 deg C

KFK TRB

Fig. 12 FEBA: 5x5 ROD BUNDLE
TEST SERIES 1, TEST-No. 223

test parameters:

- ◆ flooding rate
- ▲ system pressure
- feedwater temperature
- bundle power

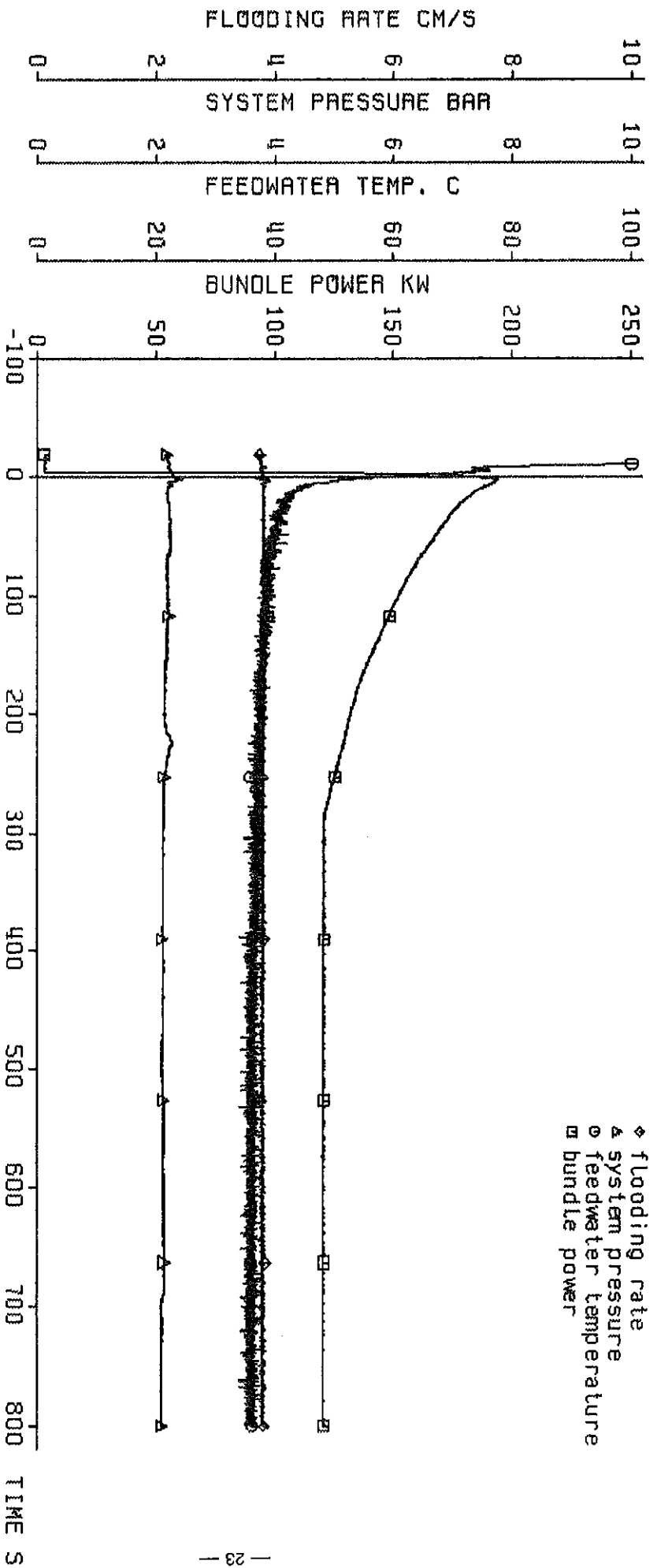

decay heat
 flooding rate (cold)
 system pressure
 feedwater temperature

120% RNS standard
 3.82 cm/s
 2.21 bar
 40 deg C



Fig. 13 FEBRA: 5X5 ROD BUNDLE, TEST SERIES 1, TEST-NO. 223

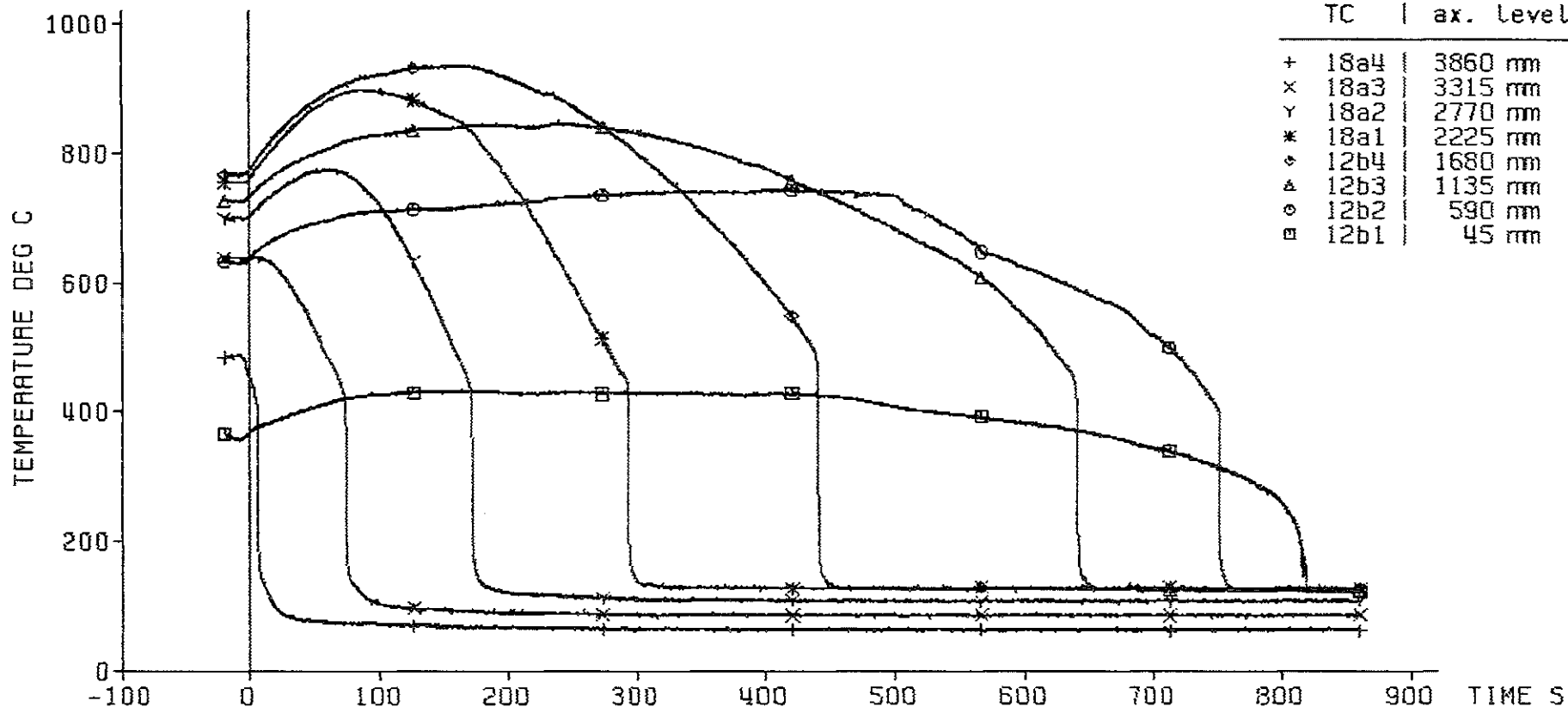

decay heat 120% ANS standard
 flooding rate (cold) 3.82 cm/s
 system pressure 2.21 bar
 feedwater temperature 40 deg C



Fig. 14 FEBA: 5x5 ROD BUNDLE, TEST SERIES 1, TEST-No. 223

heat transfer coeff.

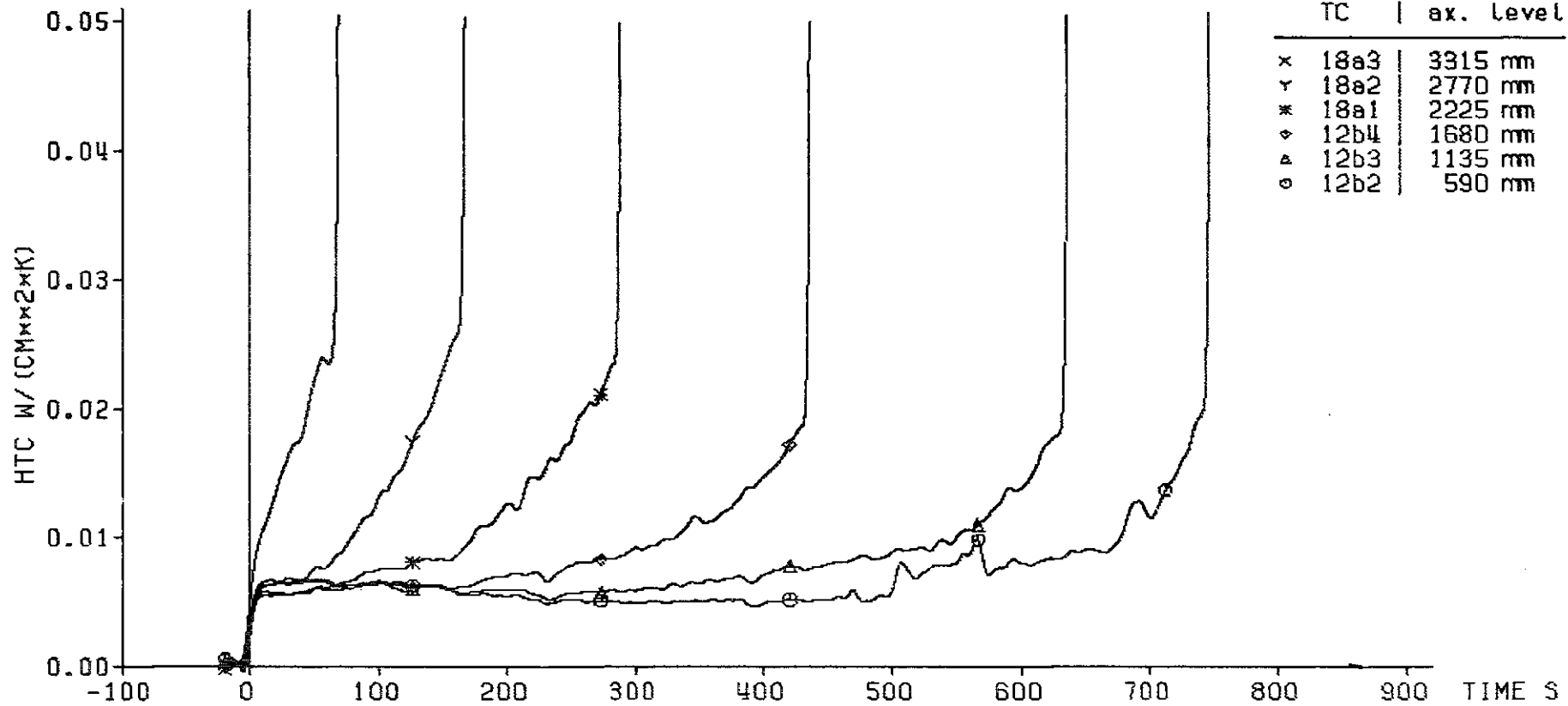

decay heat 120% ANS standard
 flooding rate (cold) 3.82 cm/s
 system pressure 2.21 bar
 feedwater temperature 40 deg C



Fig. 15 FEBA: 5x5 ROD BUNDLE, TEST SERIES 1, TEST-No. 223

cladding temperature

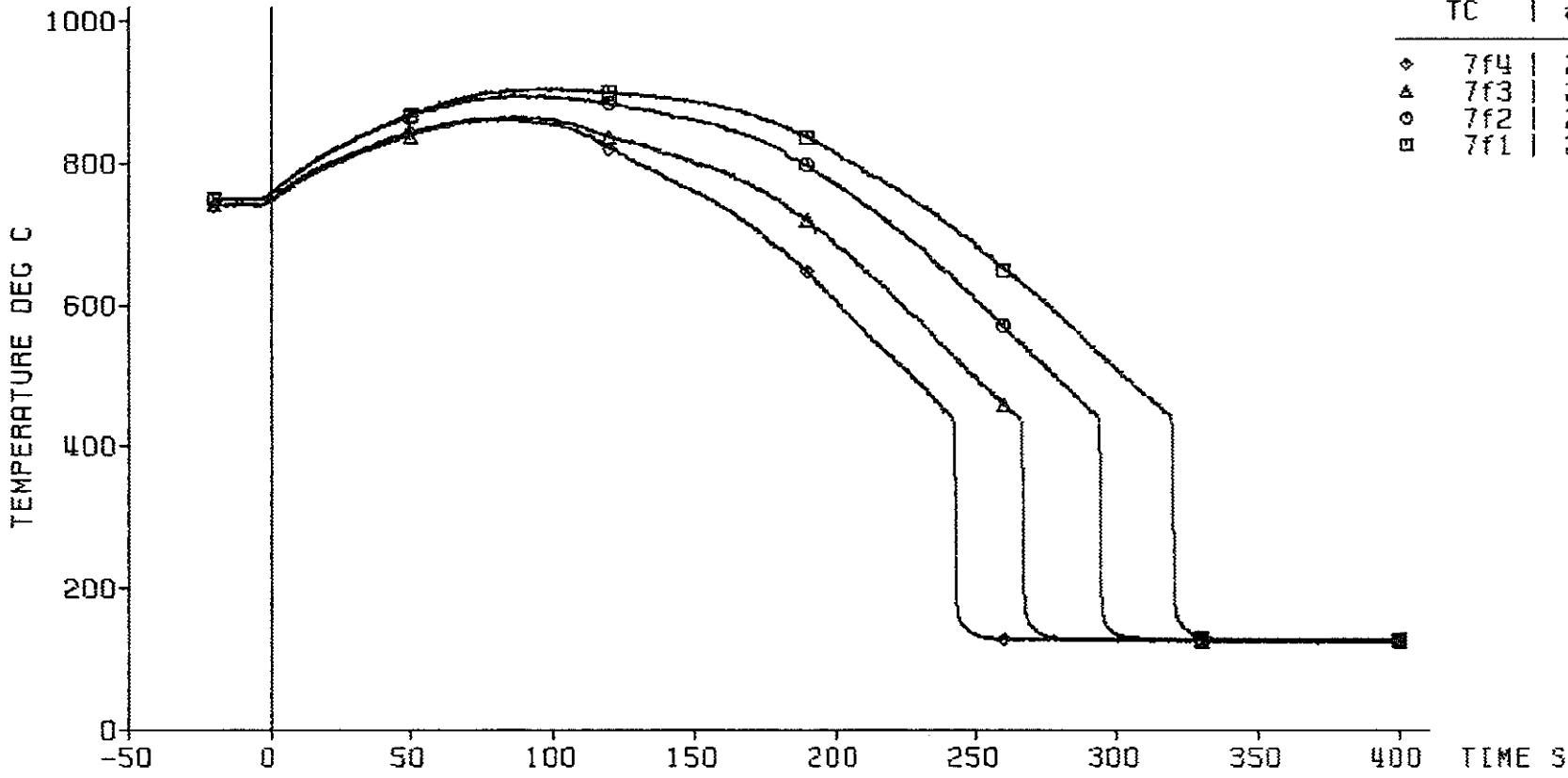

decay heat 120% ANS standard
flooding rate (cold) 3.82 cm/s
system pressure 2.21 bar
feedwater temperature 40 deg C



Fig. 16 FEBA: 5x5 ROD BUNDLE, TEST SERIES 1, TEST-No. 223

heat transfer coeff.

TC	ax. Level
◇	7f4 2425 mm
△	7f3 2325 mm
○	7f2 2225 mm
□	7f1 2125 mm

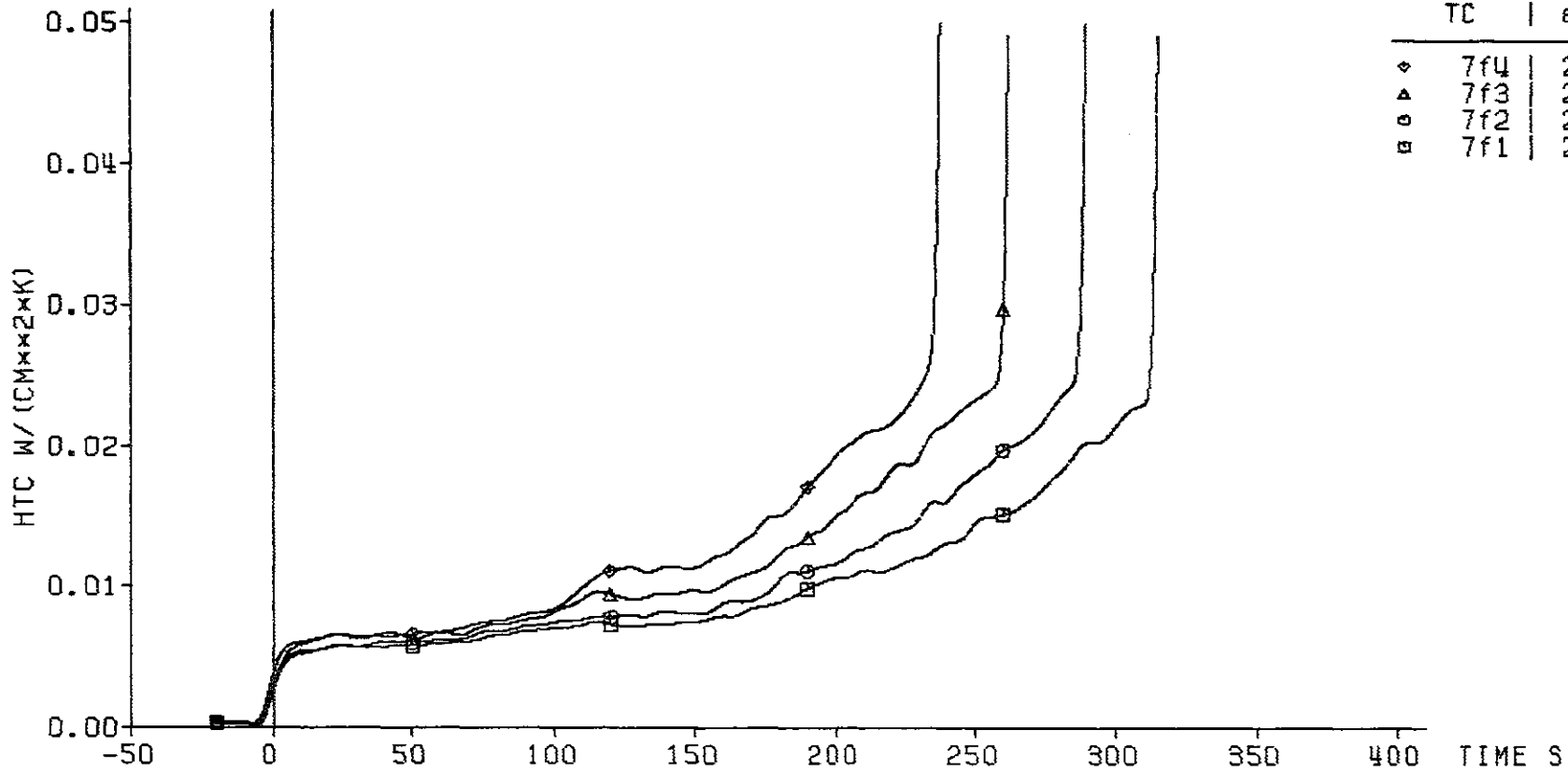

decay heat 120% ANS standard
 flooding rate (cold) 3.82 cm/s
 system pressure 2.21 bar
 feedwater temperature 40 deg C



Fig. 17 FEBA: 5x5 ROD BUNDLE, TEST SERIES 1, TEST-No. 223

cladding temperature

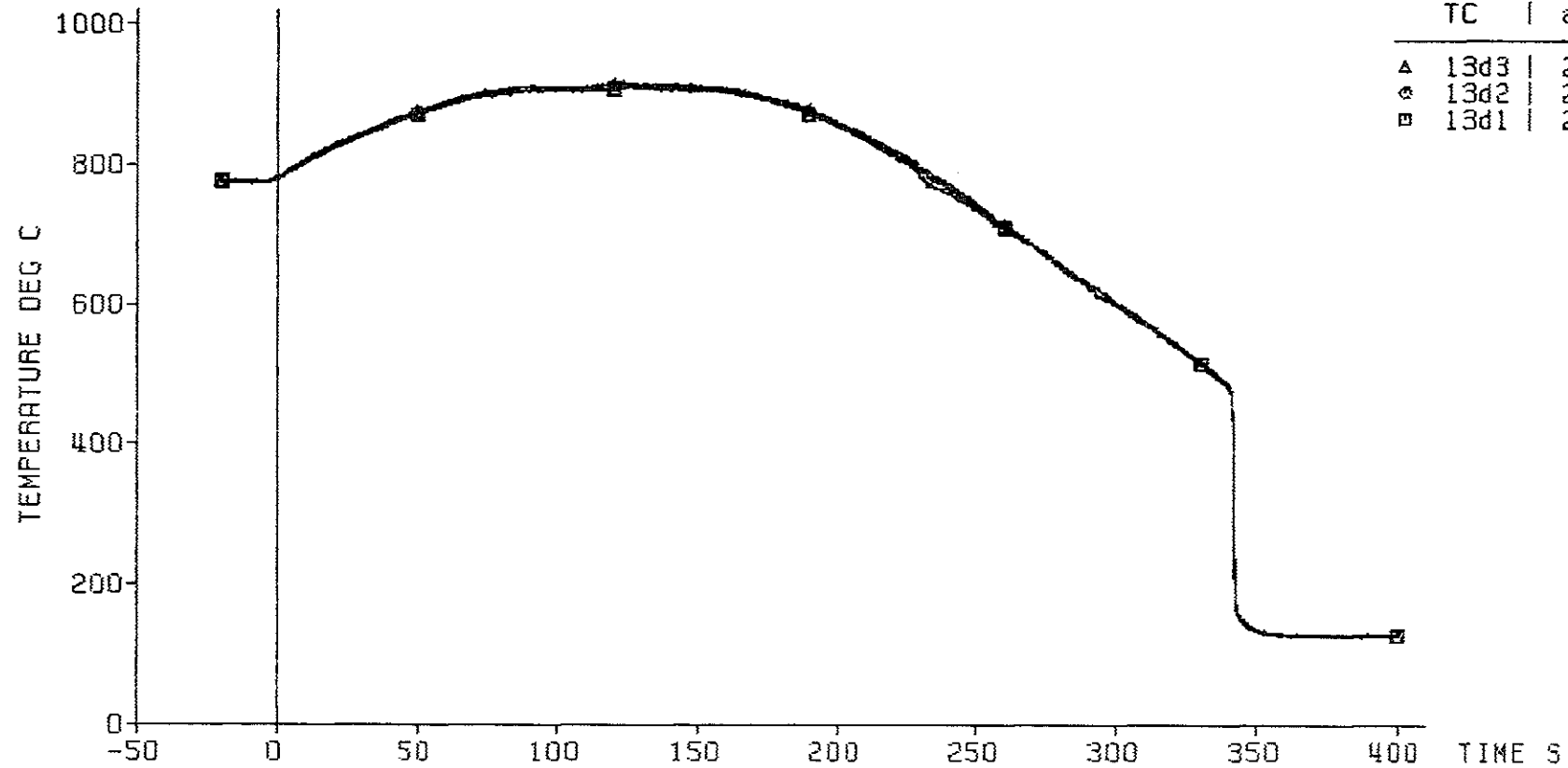

decay heat 120% ANS standard
flooding rate (cold) 3.62 cm/s
system pressure 2.21 bar
feedwater temperature 40 deg C



Fig. 18 FEBA: 5x5 ROD BUNDLE, TEST SERIES 1, TEST-No. 223

heat transfer coeff.

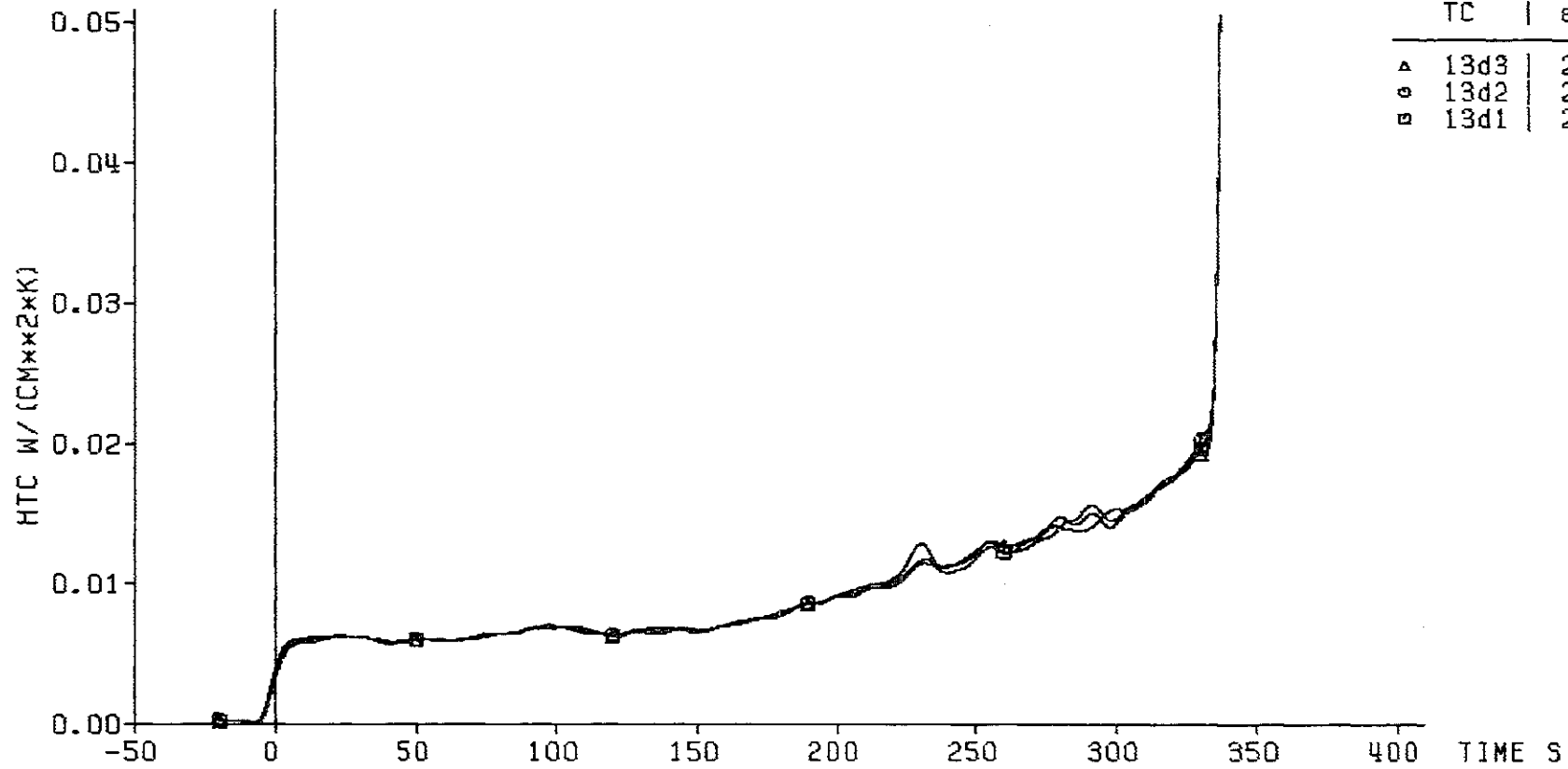

decay heat 120% RNS standard
flooding rate (cold) 3.82 cm/s
system pressure 2.21 bar
feedwater temperature 40 deg C



Fig. 19 FEBA: 5x5 ROD BUNDLE, TEST SERIES 1, TEST-No. 223

cladding temperature

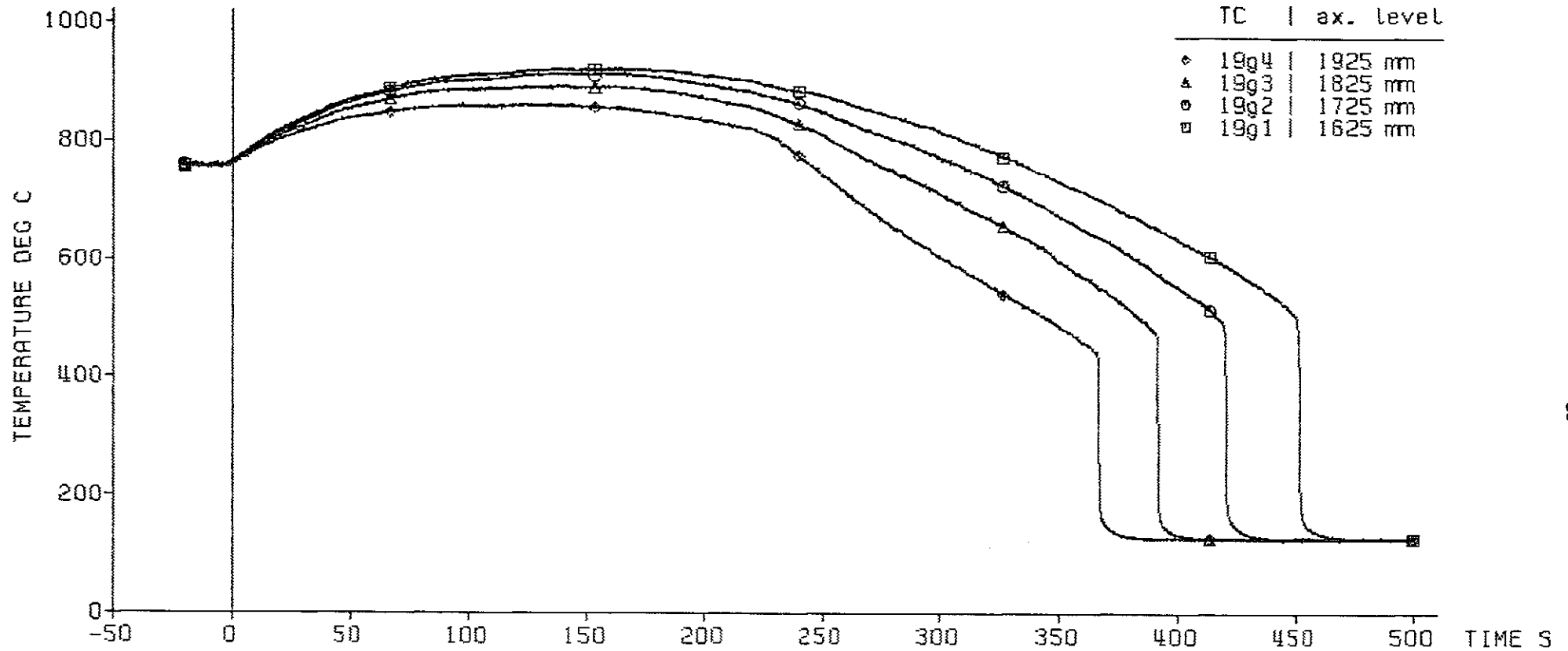

— 30 —

decay heat 120% RMS standard
flooding rate (cold) 3.82 cm/s
system pressure 2.21 bar
feedwater temperature 40 deg C



Fig. 20 FEBA: 5x5 ROD BUNDLE, TEST SERIES 1, TEST-No. 223

heat transfer coeff.

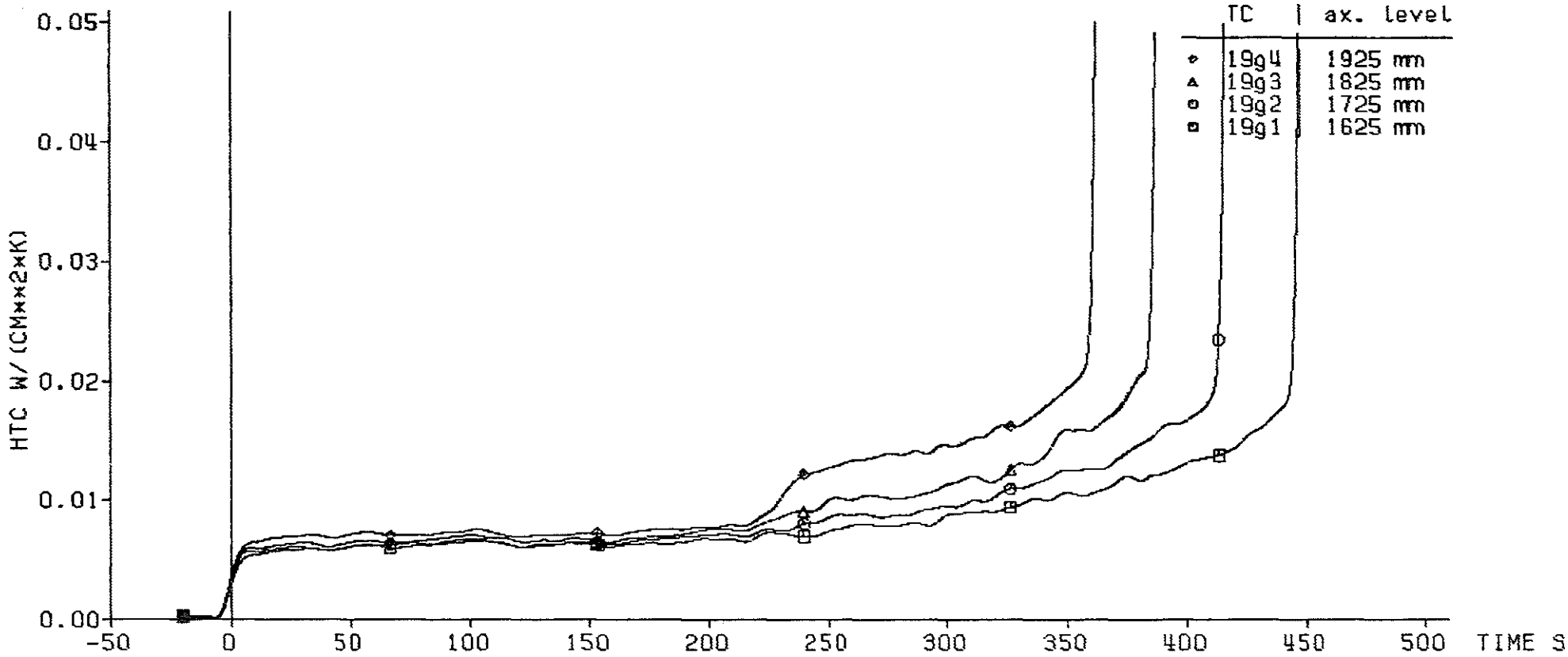

decay heat 120% ANS standard
flooding rate (cold) 3.82 cm/s
system pressure 2.21 bar
feedwater temperature 40 deg C



Fig. 21 FEBA: 5x5 ROD BUNDLE, TEST SERIES 1, TEST-No. 223

axial level: 1725 mm

△ cladding temperature (19g2)
○ fluid temperature
□ housing temperature

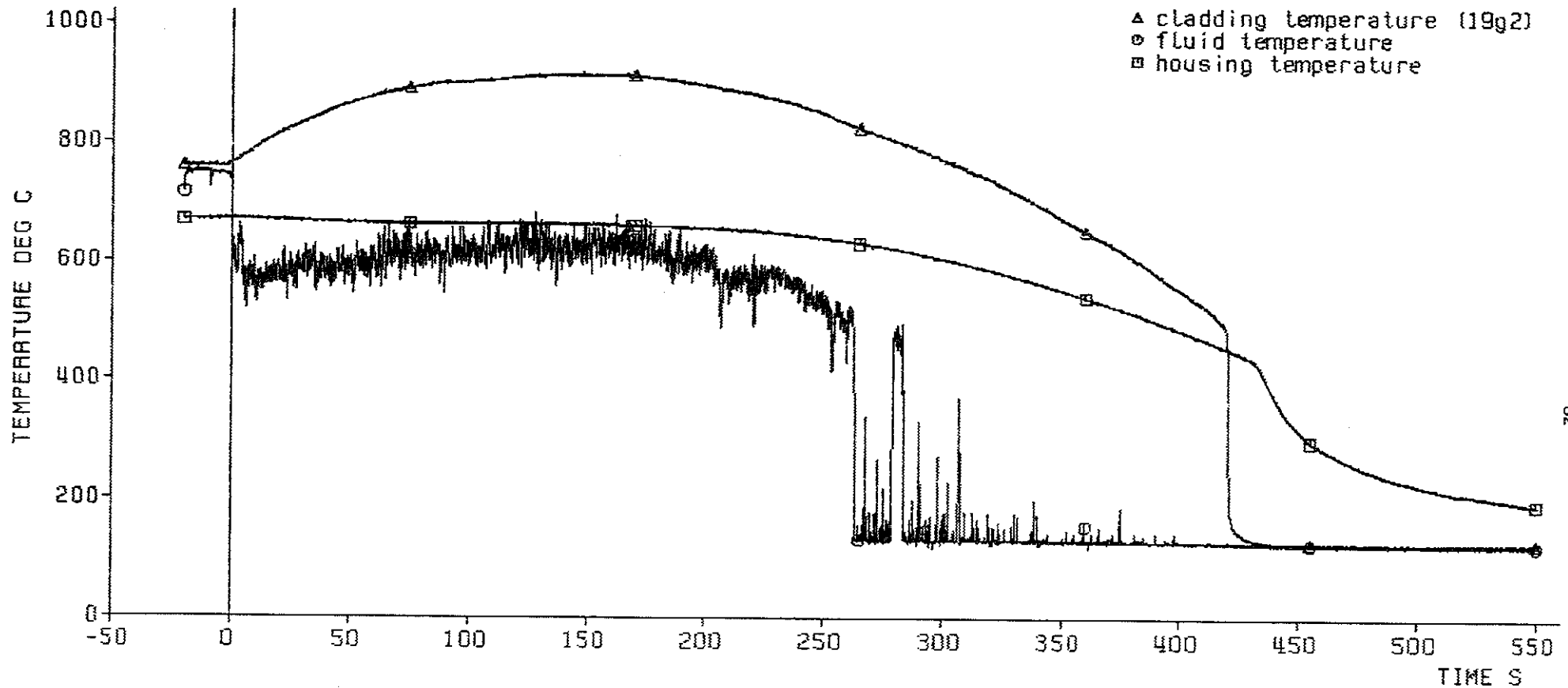

decay heat 120% ANS standard
flooding rate (cold) 3.82 cm/s
system pressure 2.21 bar
feedwater temperature 40 deg C

KIK
IRB

Fig. 22 FEBA: 5x5 ROD BUNDLE, TEST SERIES 1, TEST-No. 223

axial level: 1625 mm

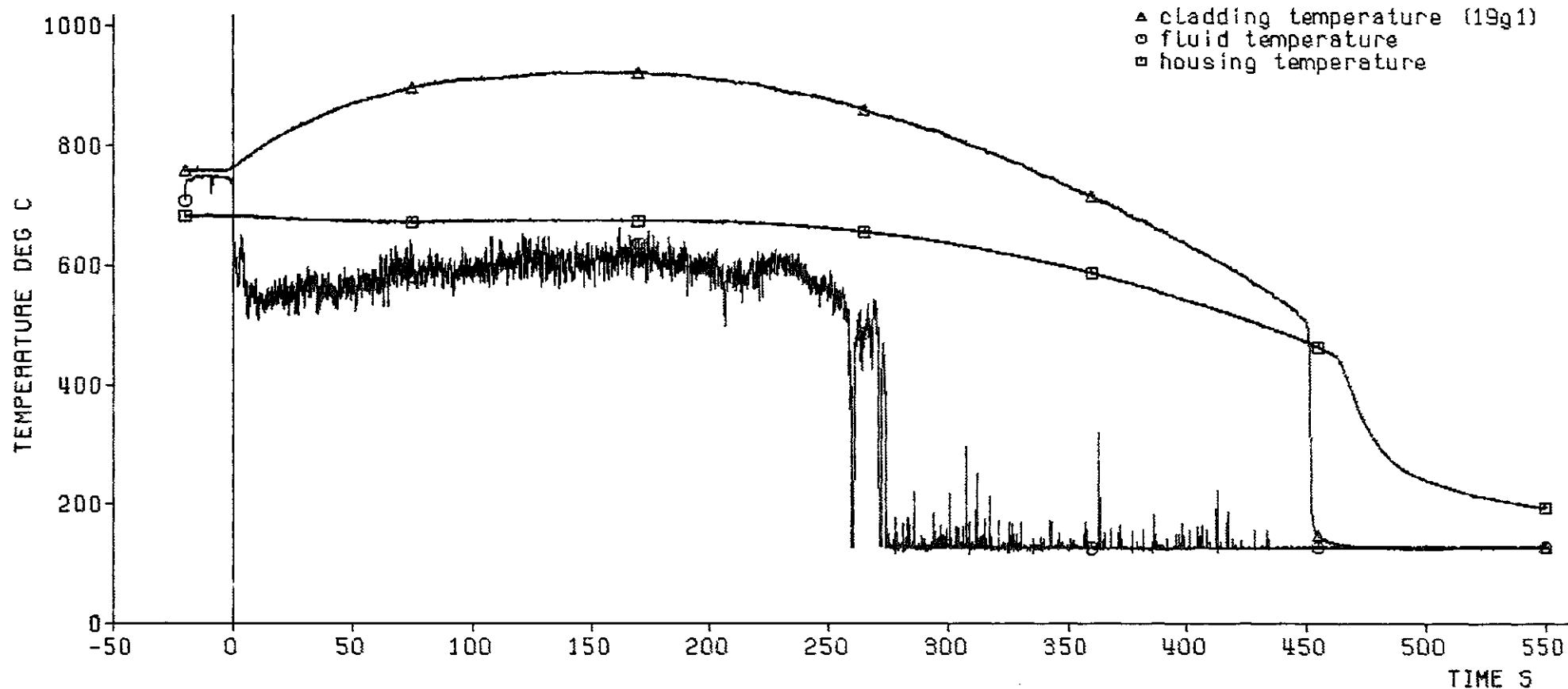

decay heat 120% ANS standard
flooding rate (cold) 3.82 cm/s
system pressure 2.21 bar
feedwater temperature 40 deg C



Fig. 23 FEBA: 5x5 ROD BUNDLE, TEST SERIES 1, TEST-No. 223

pressure loss
along the test section:

◆ total length: 4196 mm
△ lower part: 1711 mm
○ middle part: 545 mm
□ upper part: 1940 mm

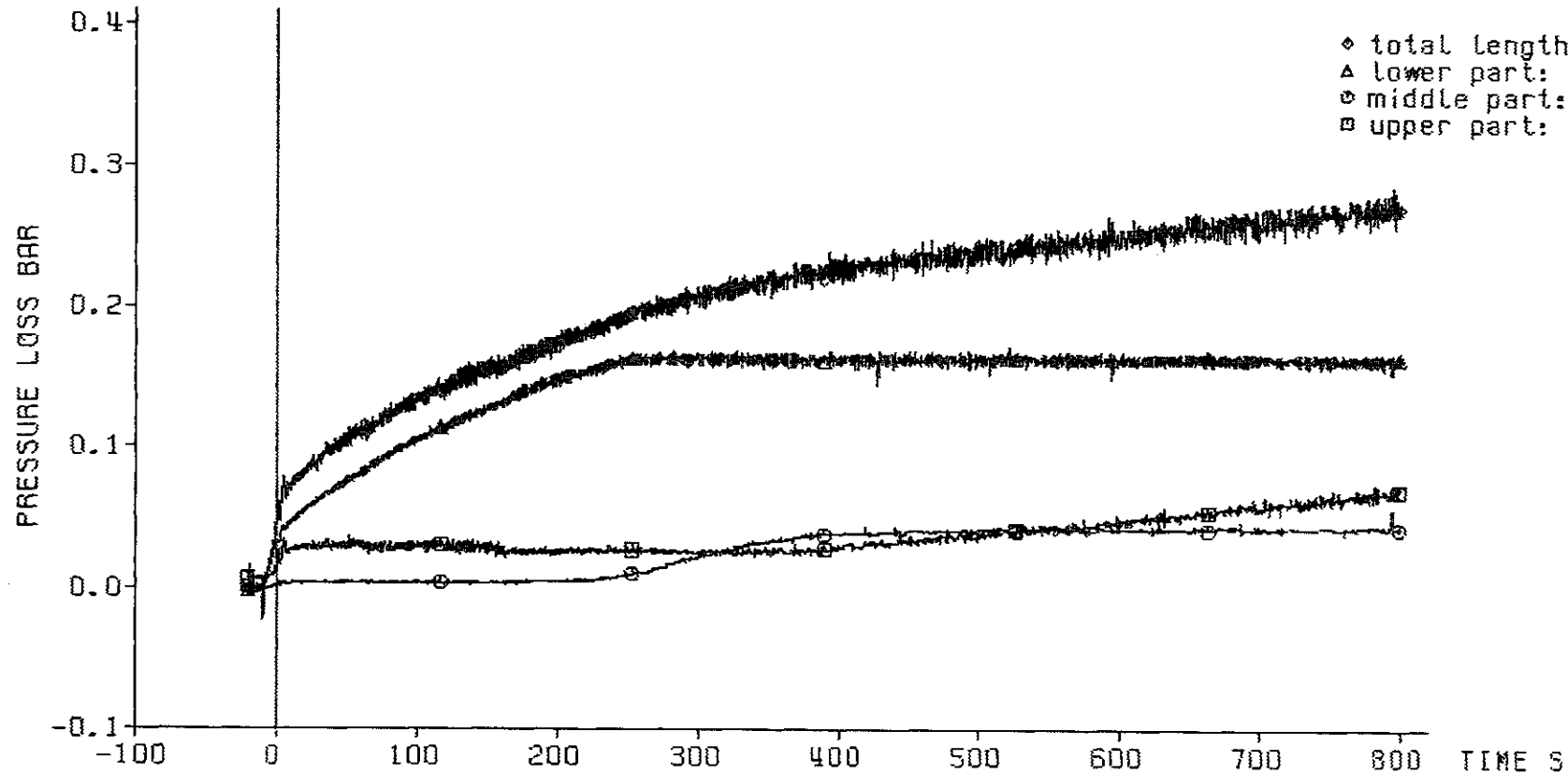

decay heat 120% ANS standard
flooding rate (cold) 3.82 cm/s
system pressure 2.21 bar
feedwater temperature 40 deg C

KTRB

Fig. 24 FEBA: 5x5 ROD BUNDLE, TEST SERIES 1, TEST-No. 223

coolant outlet conditions:

△ water carry over
○ coolant temperature
□ coolant pressure

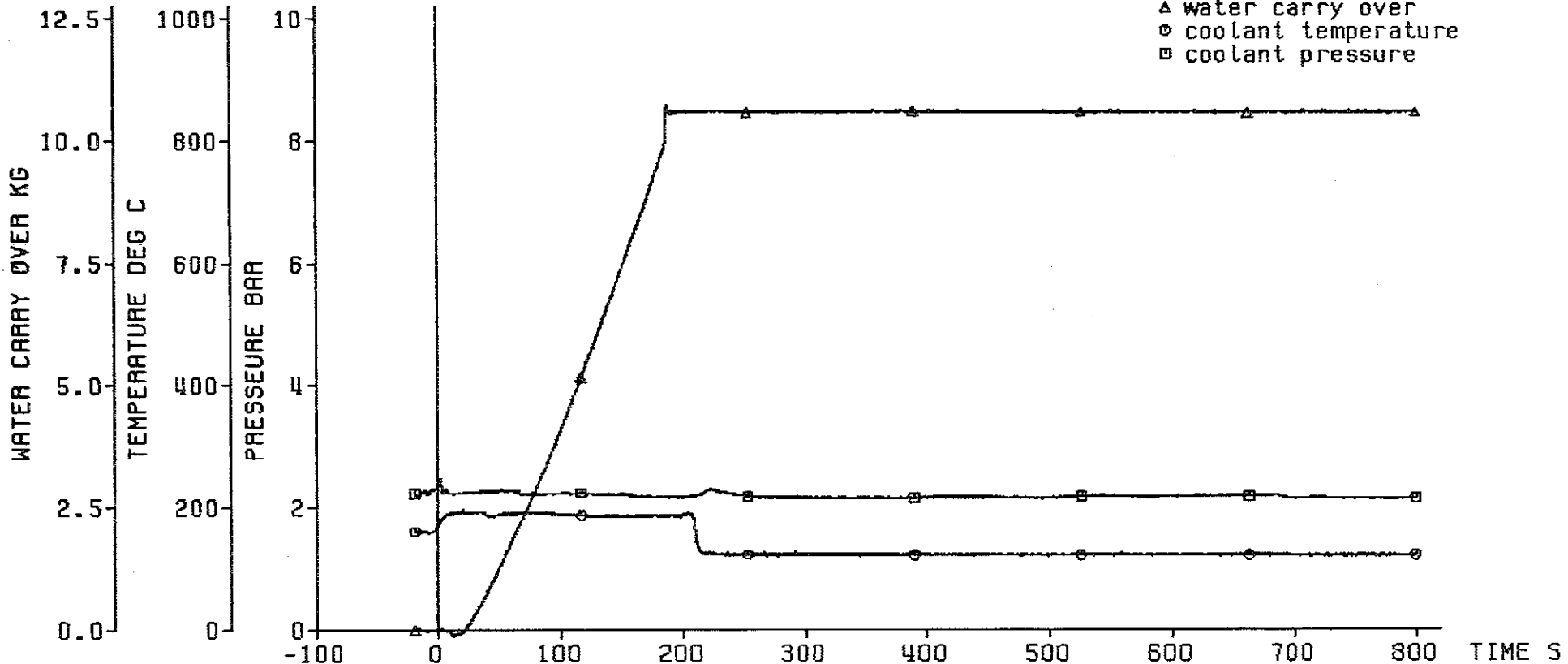

decay heat 120% ANS standard
flooding rate (cold) 3.82 cm/s
system pressure 2.21 bar
feedwater temperature 40 deg C



Fig. 25 FEBA: 5x5 ROD BUNDLE, TEST SERIES 1, TEST-No. 223

axial position of the quench front

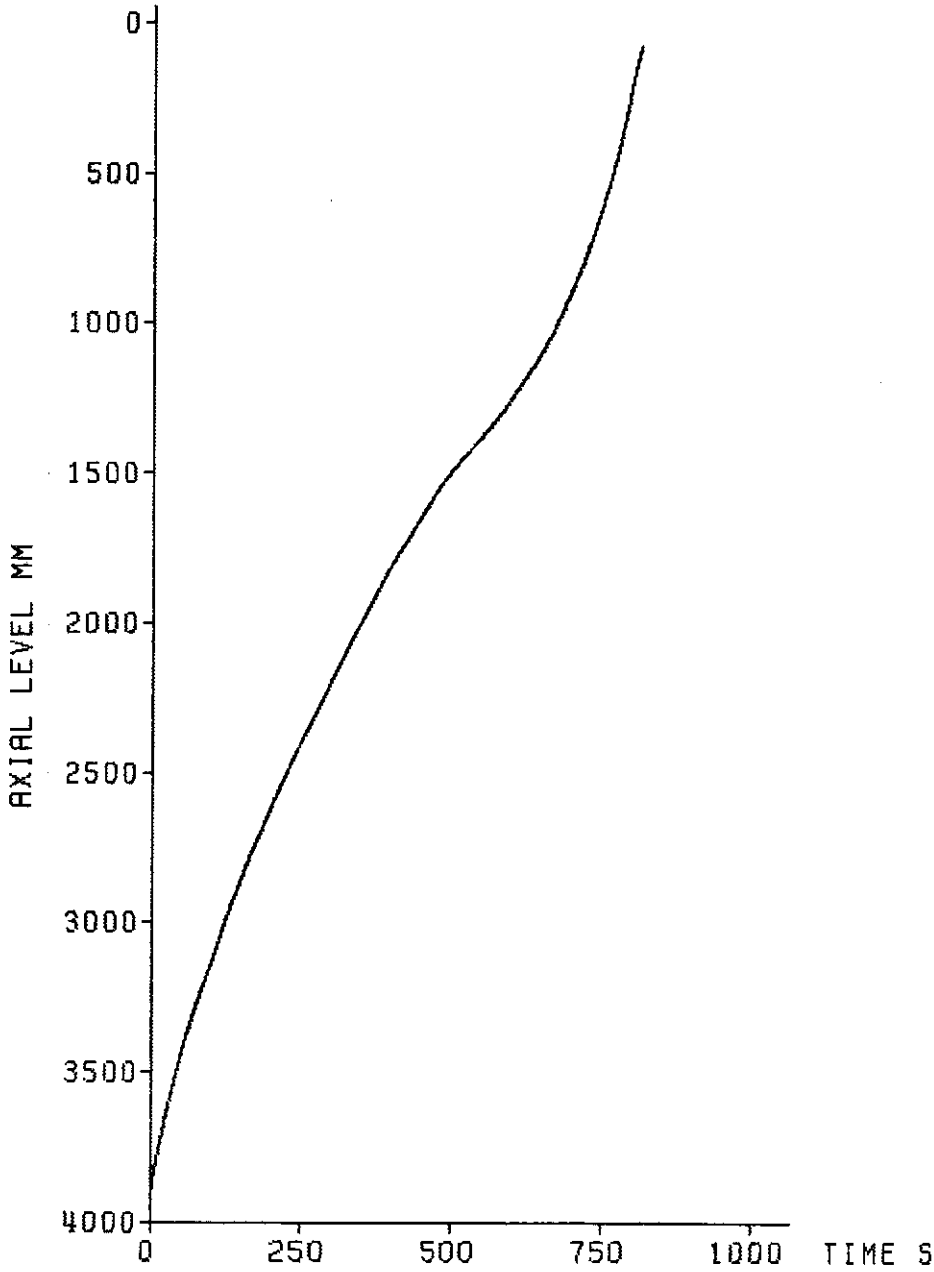

decay heat	120% ANS standard
flooding rate (cold)	3.82 cm/s
system pressure	2.21 bar
feedwater temperature	40 deg C

KIRB

Fig. 26 FEBA: 5x5 ROD BUNDLE
TEST SERIES 1, TEST-No. 223

initial axial temperature profile of the cladding

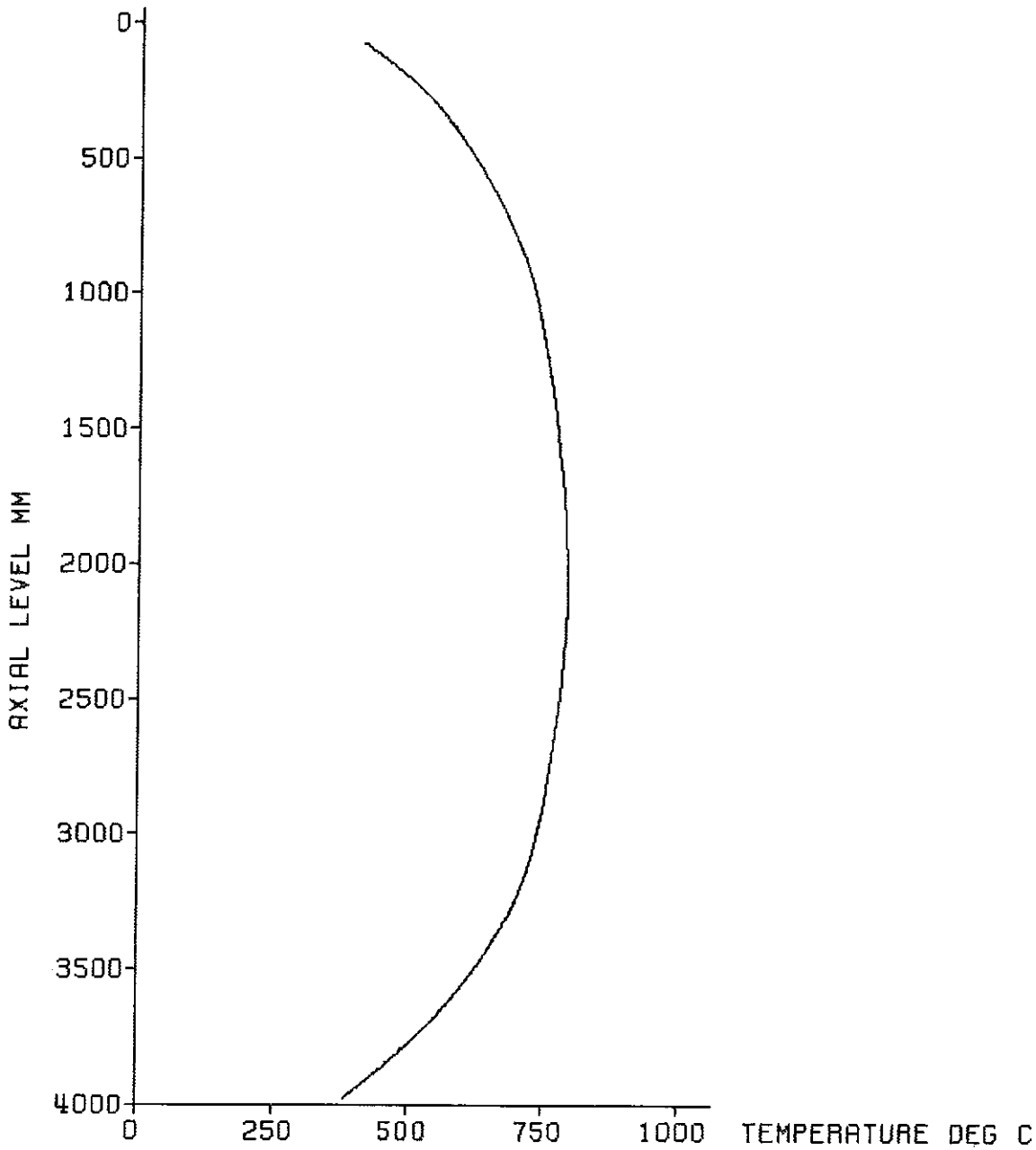

decay heat	120% ANS standard
flooding rate (cold)	3.81 cm/s
system pressure	4.12 bar
feedwater temperature	40 deg C



Fig. 27 FEBA: 5x5 ROD BUNDLE
TEST SERIES 1, TEST-No. 216

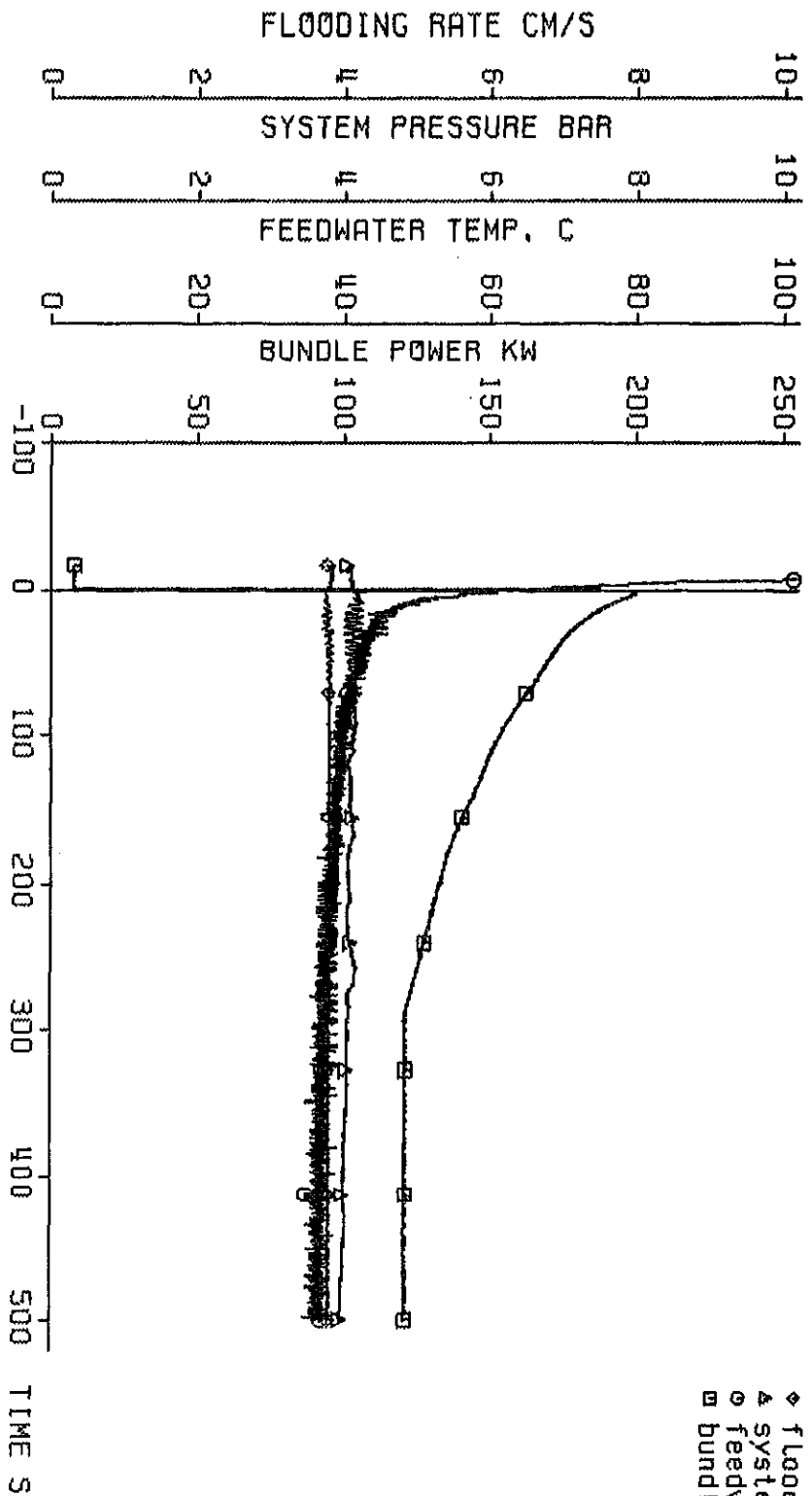

test parameters:
 ◆ flooding rate
 ▲ system pressure
 ○ feedwater temperature
 ▣ bundle power

decay heat
 flooding rate (cold)
 system pressure
 feedwater temperature

120% RMS standard
 3.81 cm/s
 4.12 bar
 40 deg C



Fig. 28 FEBRA: 5X5 ROD BUNDLE, TEST SERIES 1, TEST-NO. 216

cladding temperature

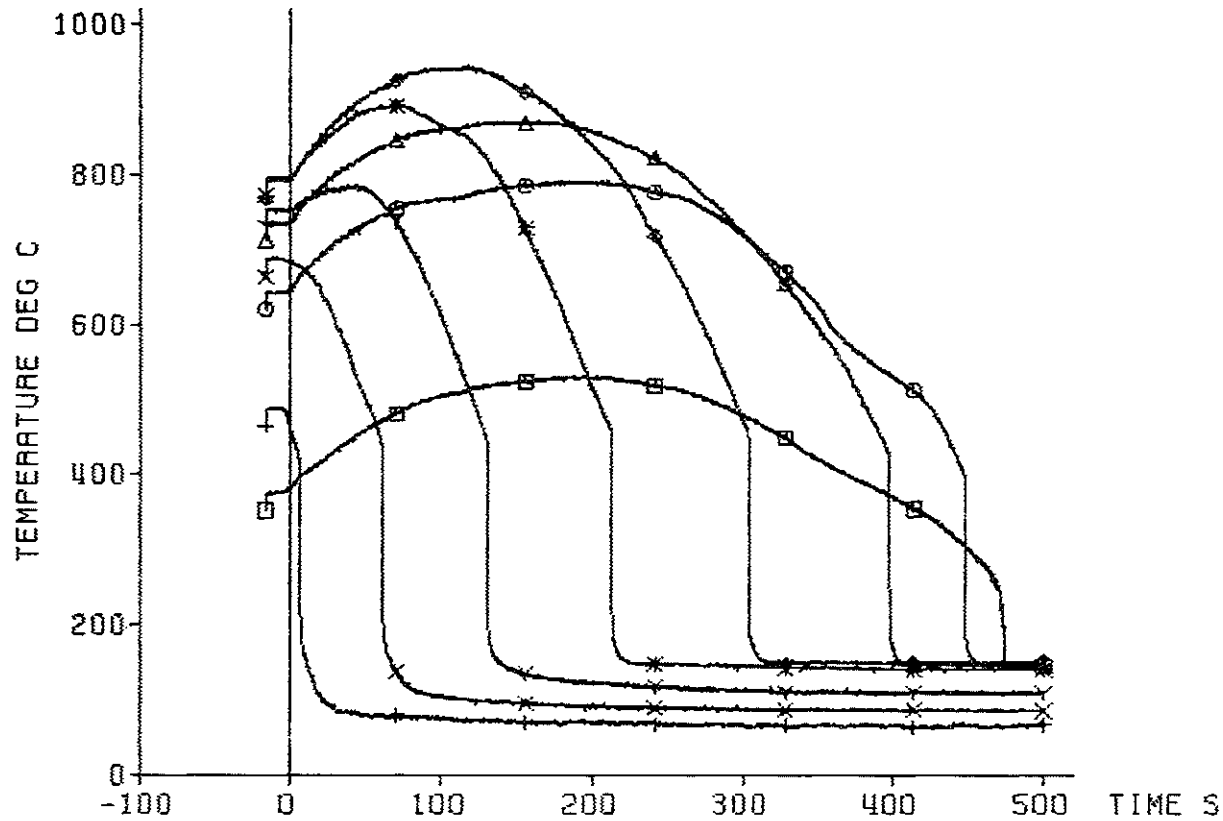

TC	ax. Level
+	18a4 3860 mm
x	18a3 3315 mm
Y	18a2 2770 mm
*	18a1 2225 mm
◇	12b4 1680 mm
△	12b3 1135 mm
○	12b2 590 mm
□	12b1 45 mm

decay heat 120% ANS standard
 flooding rate (cold) 3.81 cm/s
 system pressure 4.12 bar
 feedwater temperature 40 deg C



Fig. 29 FEBA: 5x5 R0D BUNDLE, TEST SERIES 1, TEST-No. 216

heat transfer coeff.

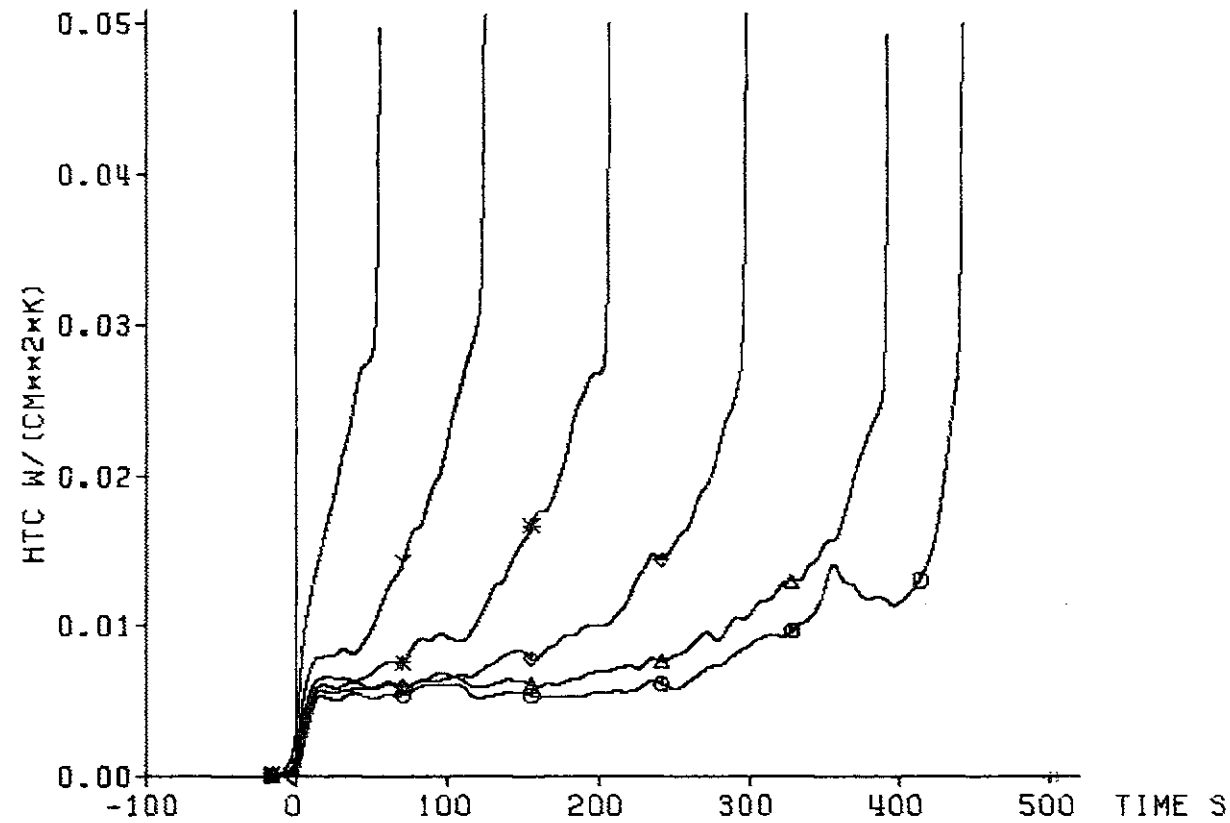

	TC	ax. Level
x	18a3	3315 mm
y	18a2	2770 mm
*	18a1	2225 mm
◇	12b4	1680 mm
△	12b3	1135 mm
○	12b2	590 mm

decay heat 120% ANS standard
 flooding rate (cold) 3.81 cm/s
 system pressure 4.12 bar
 feedwater temperature 40 deg C



Fig. 30 FEBA: 5x5 ROD BUNDLE, TEST SERIES 1, TEST-No. 216

cladding temperature

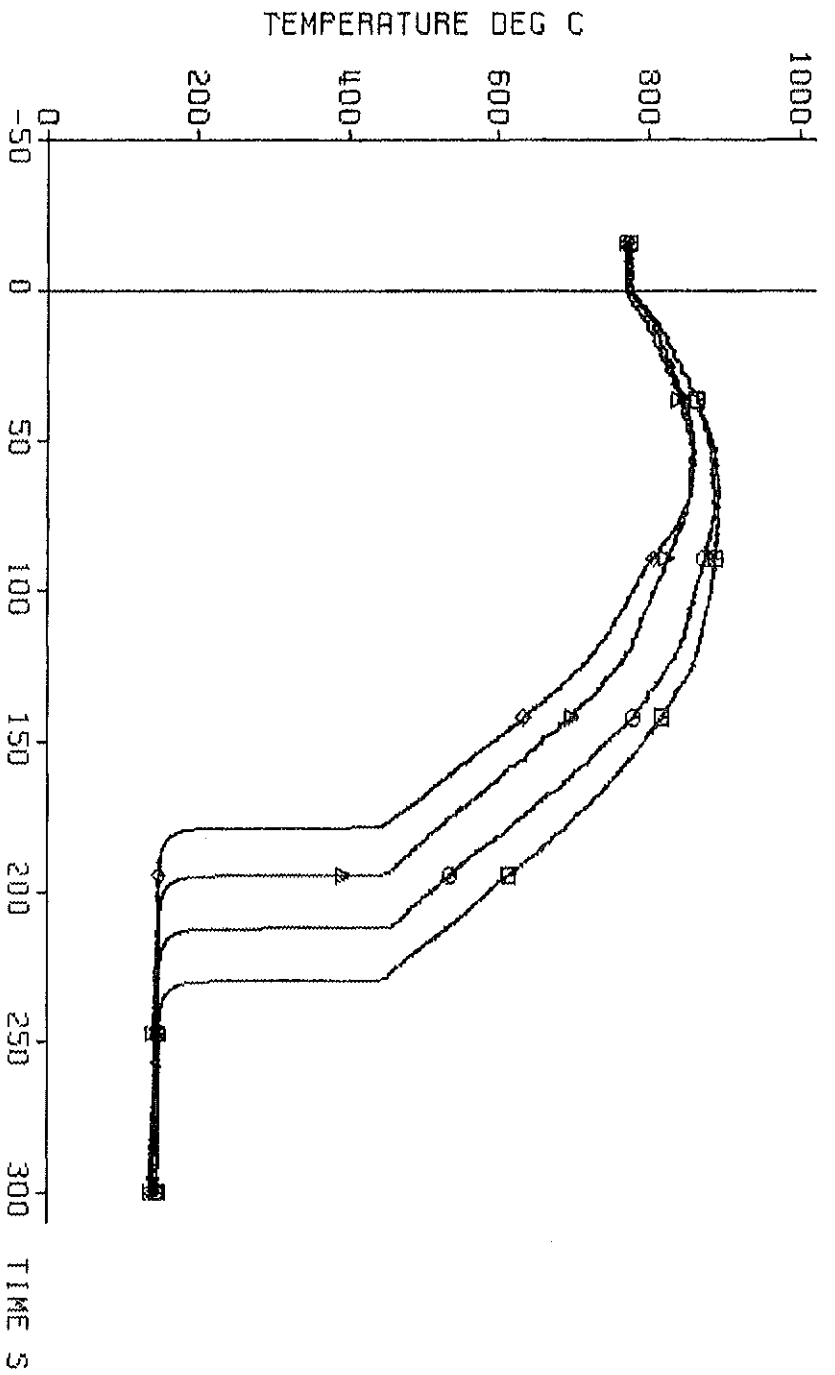

TC	ax. level
◇	7f4 2425 mm
△	7f3 2325 mm
○	7f2 2225 mm
□	7f1 2125 mm

decay heat
 flooding rate (cauld) 120% RMS standard
 system pressure 3.81 cm/s
 feedwater temperature 4.12 bar
 40 deg C



Fig. 31 FEBRA: 5X5 ROD BUNDLE, TEST SERIES 1, TEST-NO. 216

heat transfer coeff.

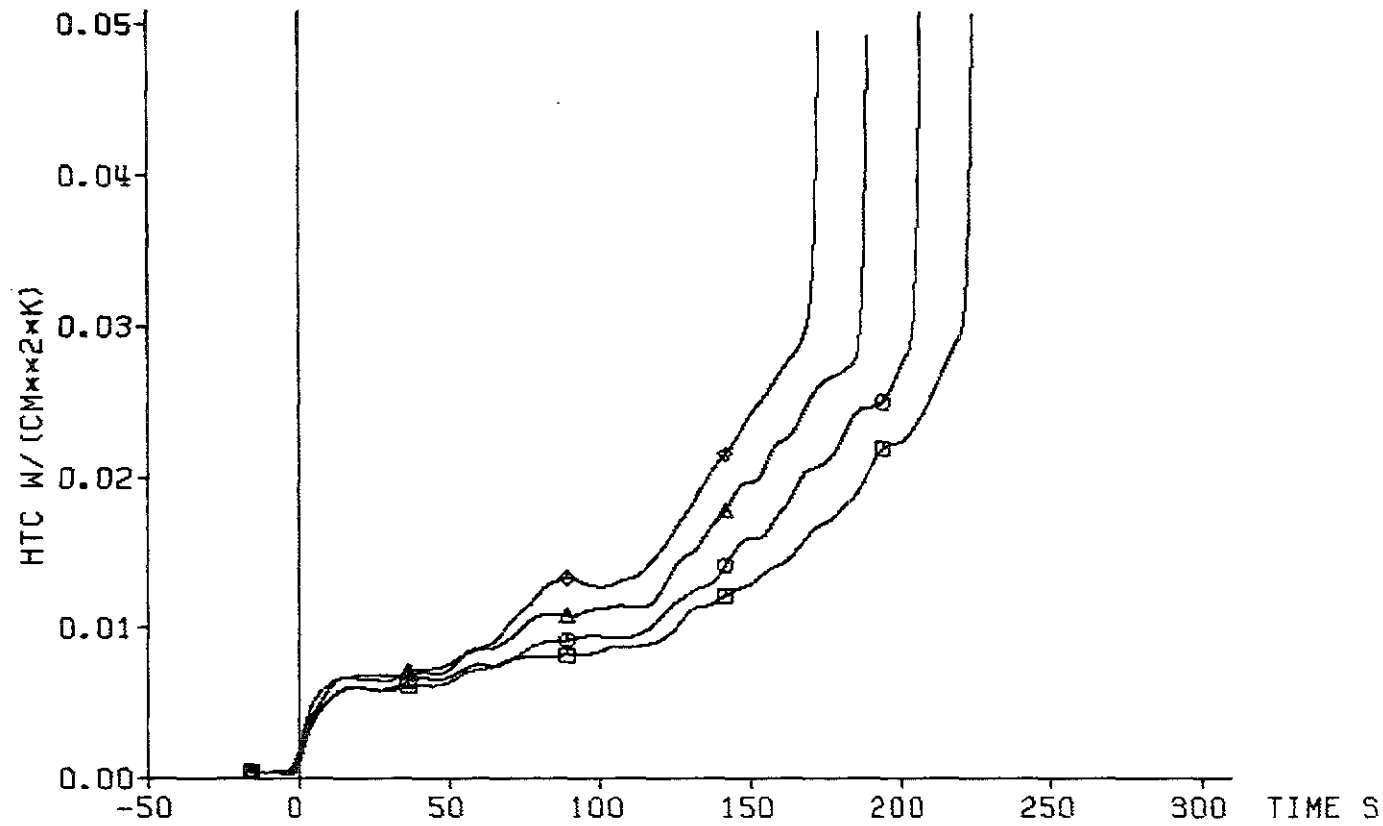

TC	ax. Level
◇	7f4 2425 mm
△	7f3 2325 mm
○	7f2 2225 mm
□	7f1 2125 mm

decay heat 120% ANS standard
 flooding rate (cold) 3.81 cm/s
 system pressure 4.12 bar
 feedwater temperature 40 deg C



Fig. 32 FEBA: 5x5 ROD BUNDLE, TEST SERIES 1, TEST-No. 216

cladding temperature

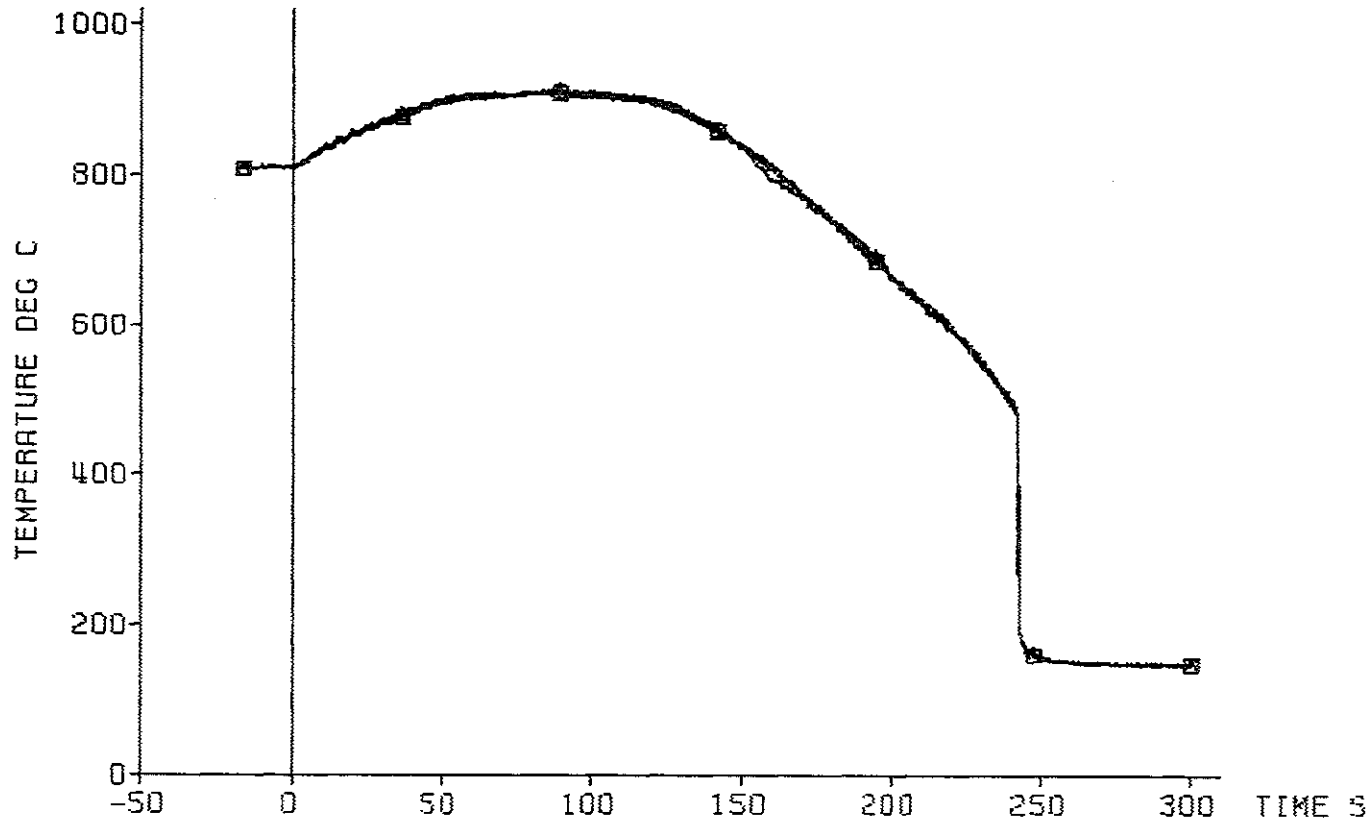

TC	ax. level
△ 13d3	2025 mm
⊙ 13d2	2025 mm
⊠ 13d1	2025 mm

decay heat 120% ANS standard
flooding rate (cold) 3.81 cm/s
system pressure 4.12 bar
feedwater temperature 40 deg C



Fig. 33 FEBA: 5x5 ROD BUNDLE, TEST SERIES 1, TEST-NO. 216

heat transfer coeff.

TC	axial Level
△ 13d3	2025 mm
○ 13d2	2025 mm
□ 13d1	2025 mm

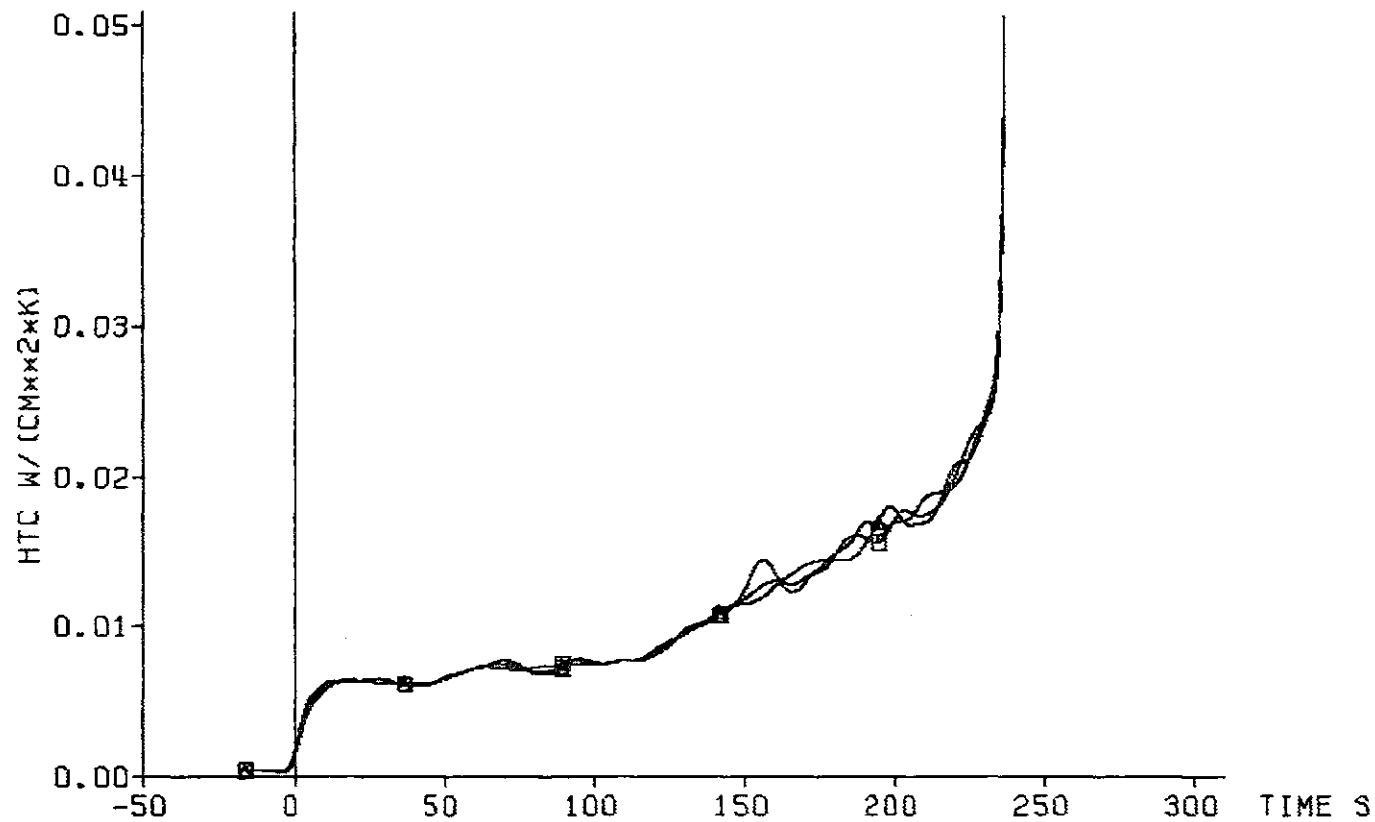

decay heat 120% ANS standard
flooding rate (cold) 3.81 cm/s
system pressure 4.12 bar
feedwater temperature 40 deg C



Fig. 34 FEBA: 5x5 ROD BUNDLE, TEST SERIES 1, TEST-No. 216

cladding temperature

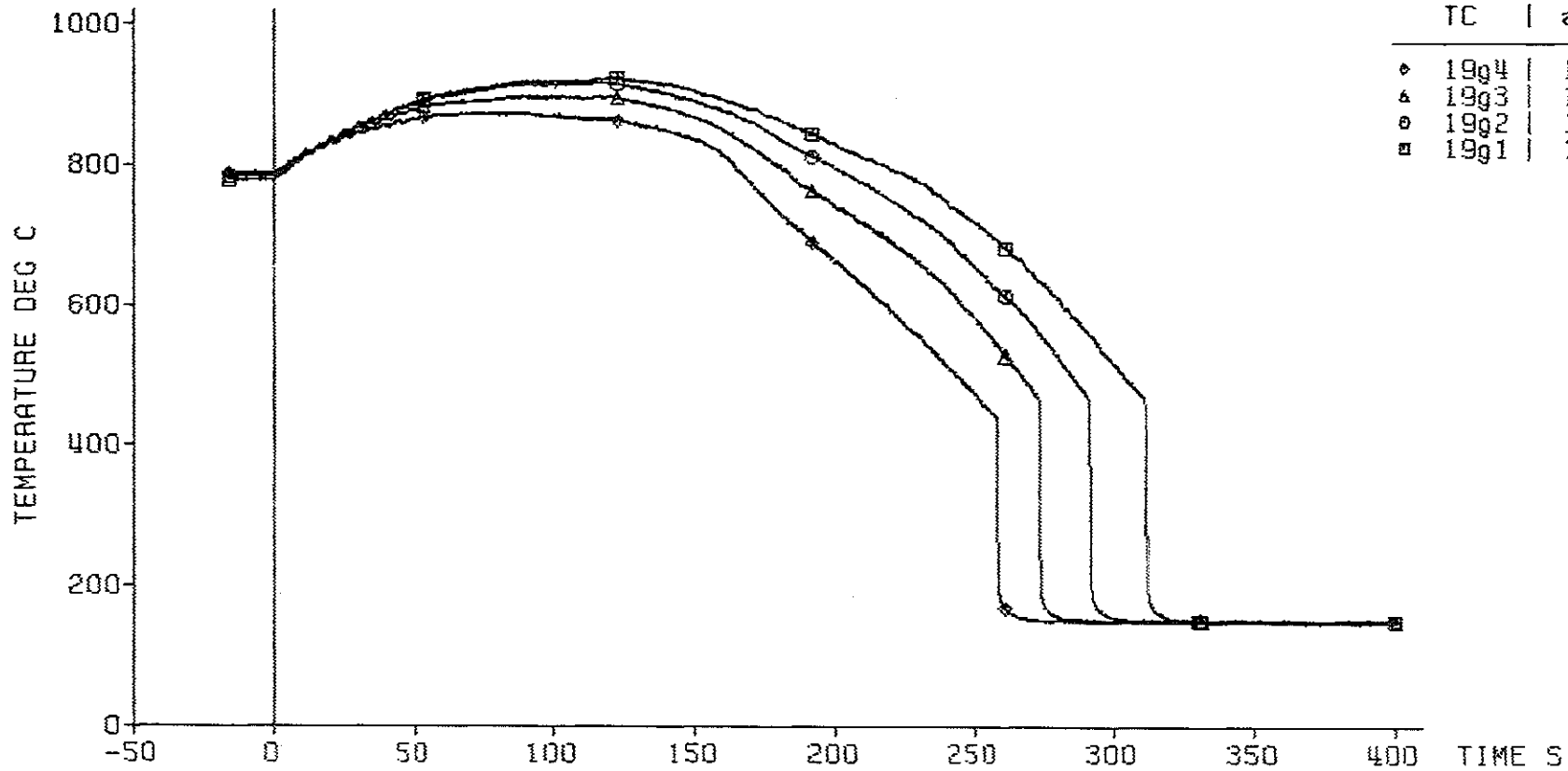

decay heat 120% ANS standard
 flooding rate (cold) 3.81 cm/s
 system pressure 4.12 bar
 feedwater temperature 40 deg C



Fig. 35 FEBA: 5x5 ROD BUNDLE, TEST SERIES 1, TEST-No. 216

heat transfer coeff.

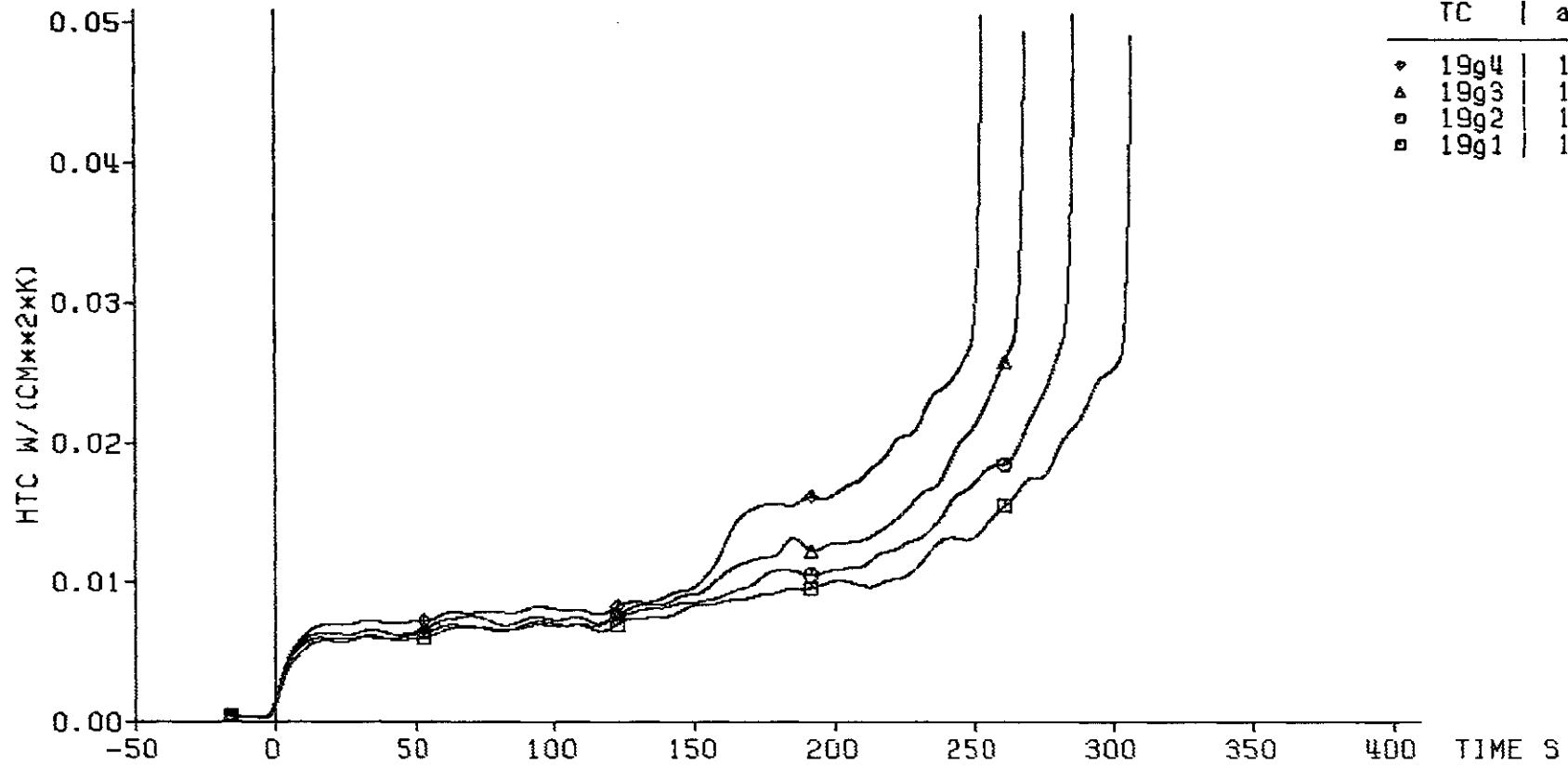

decay heat 120% ANS standard
flooding rate (cold) 3.81 cm/s
system pressure 4.12 bar
feedwater temperature 40 deg C



Fig. 36 FEBA: 5x5 ROD BUNDLE, TEST SERIES 1, TEST-No. 216

axial level: 1725 mm

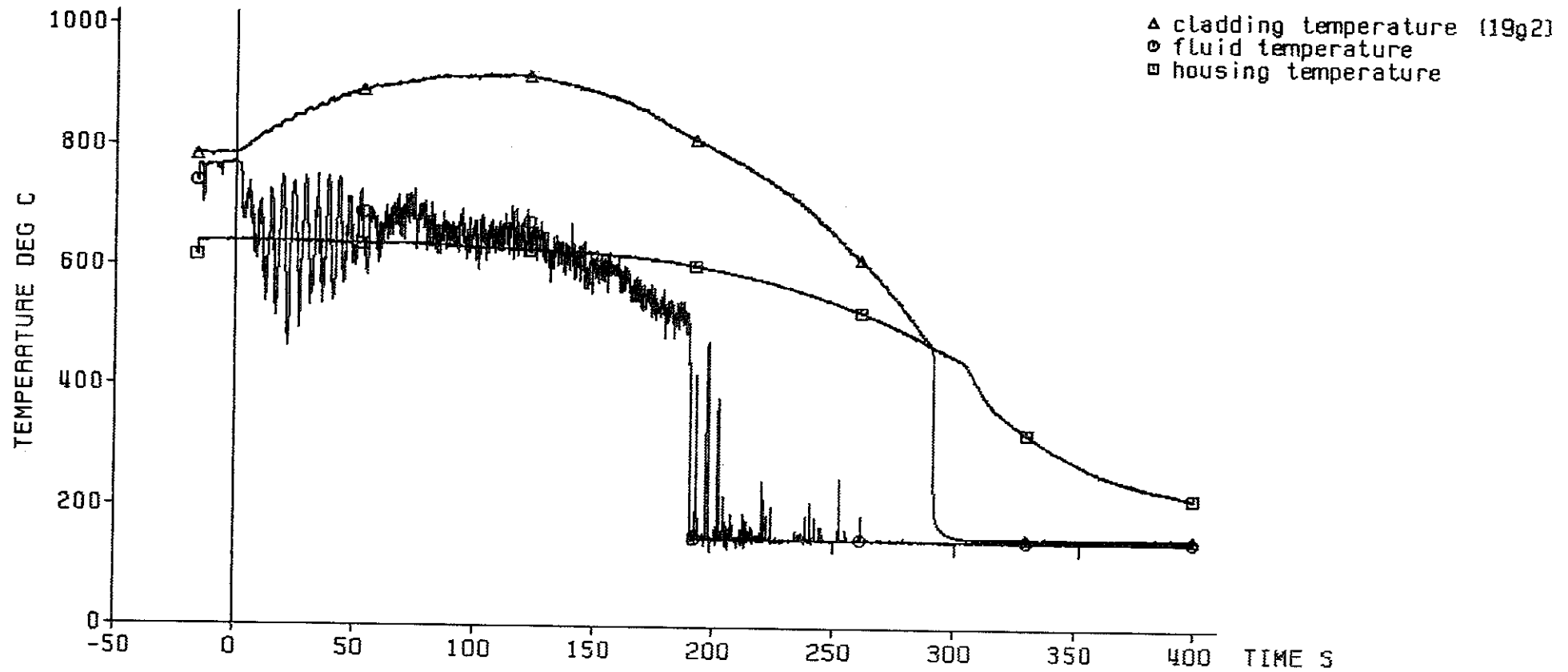

decay heat 120% ANS standard
flooding rate (cold) 3.81 cm/s
system pressure 4.12 bar
feedwater temperature 40 deg C



Fig. 37 FEBA: 5x5 ROD BUNDLE, TEST SERIES 1, TEST-No. 216

axial level: 1625 mm

△ cladding temperature (19g1)
○ fluid temperature
□ housing temperature

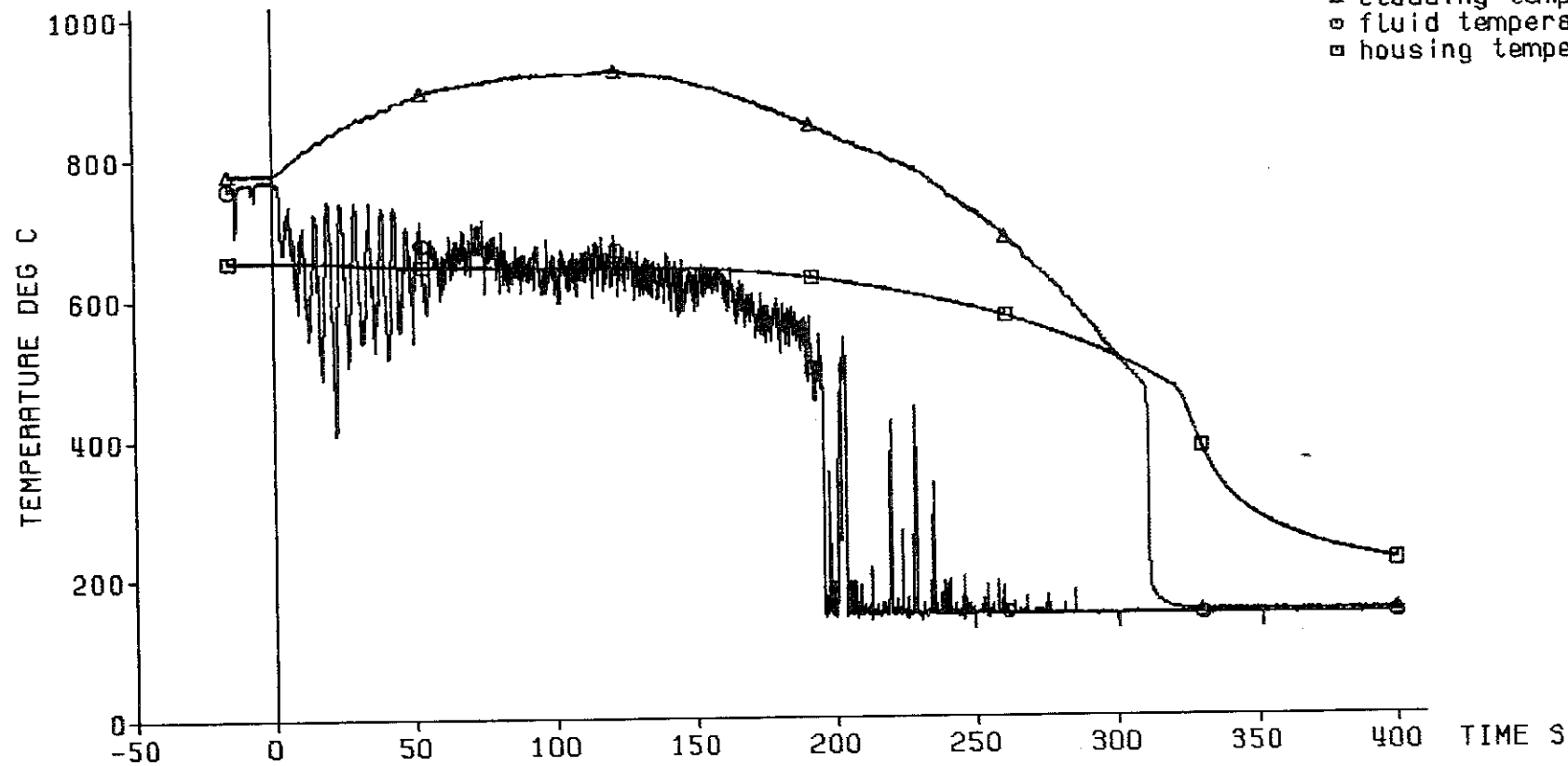

decay heat 120% ANS standard
flooding rate (cold) 3.81 cm/s
system pressure 4.12 bar
feedwater temperature 40 deg C

KFK IRB

Fig. 38 FEBA: 5x5 ROD BUNDLE, TEST SERIES 1, TEST-No. 216

pressure loss
along the test section:

◆ total length: 4196 mm
△ lower part: 1711 mm
○ middle part: 545 mm
□ upper part: 1940 mm

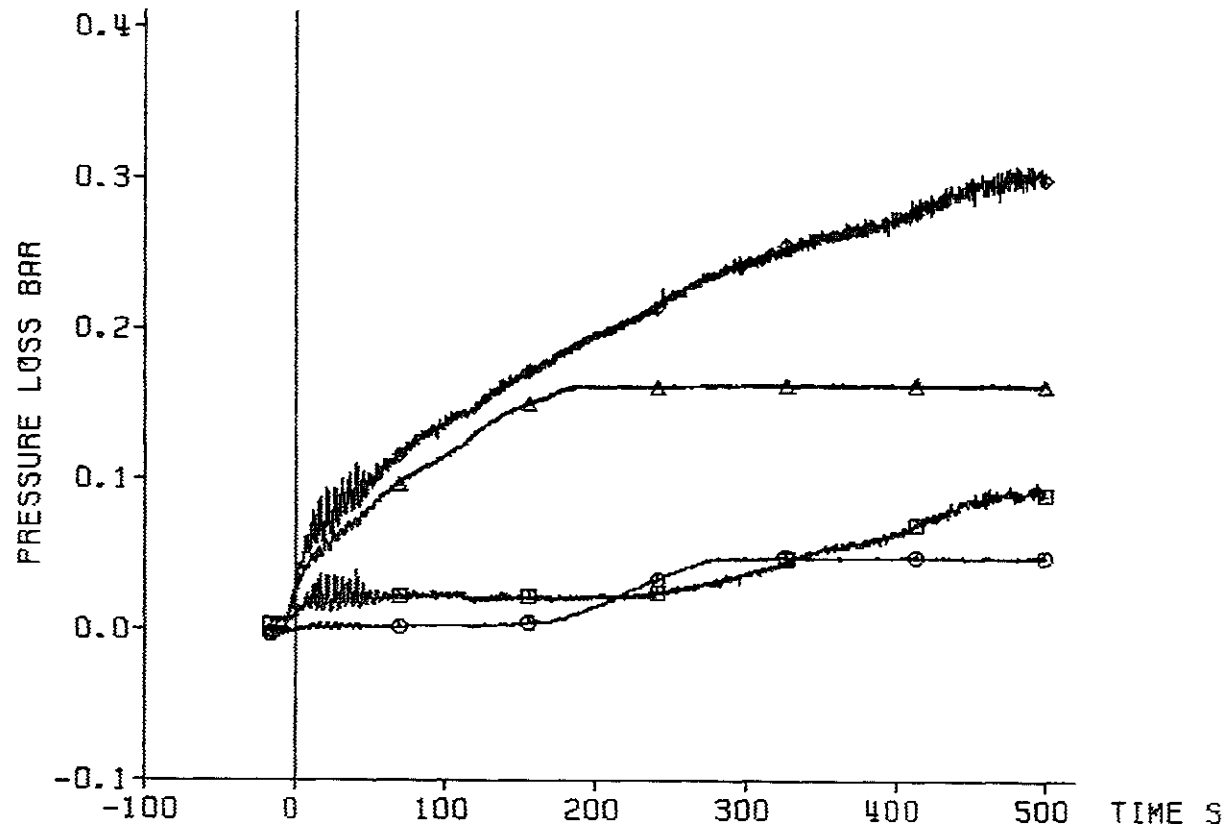

decay heat 120% RMS standard
flooding rate (cold) 3.81 cm/s
system pressure 4.12 bar
feedwater temperature 40 deg C

KJK IRB

Fig. 39 FEBA: 5x5 ROD BUNDLE, TEST SERIES 1, TEST-No. 216

coolant outlet conditions:

△ water carry over
○ coolant temperature
□ coolant pressure

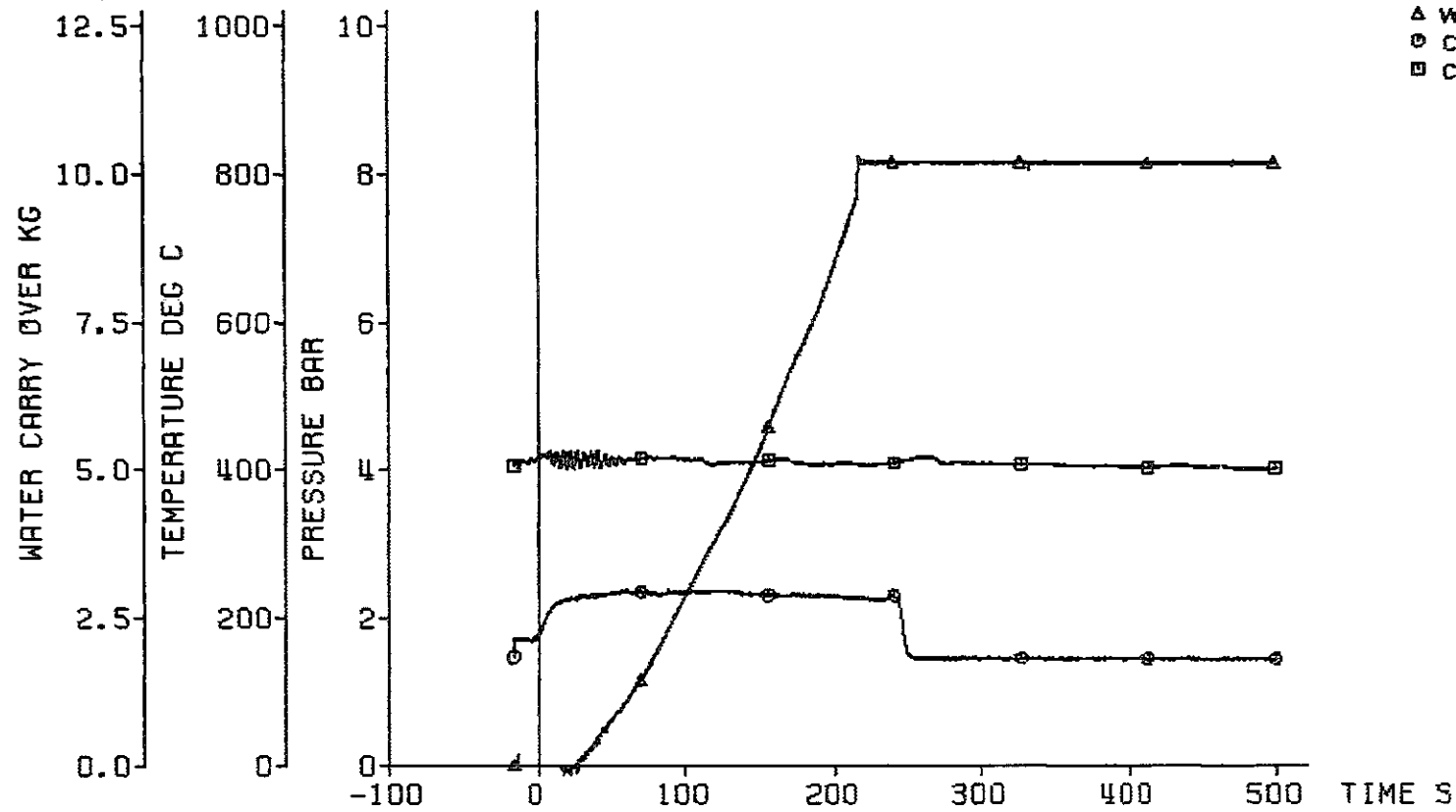

decay heat 120% ANS standard
flooding rate (cold) 3.81 cm/s
system pressure 4.12 bar
feedwater temperature 40 deg C

KJK IRB

Fig. 40 FEBA: 5x5 ROD BUNDLE, TEST SERIES 1, TEST-No. 216

axial position of the quench front

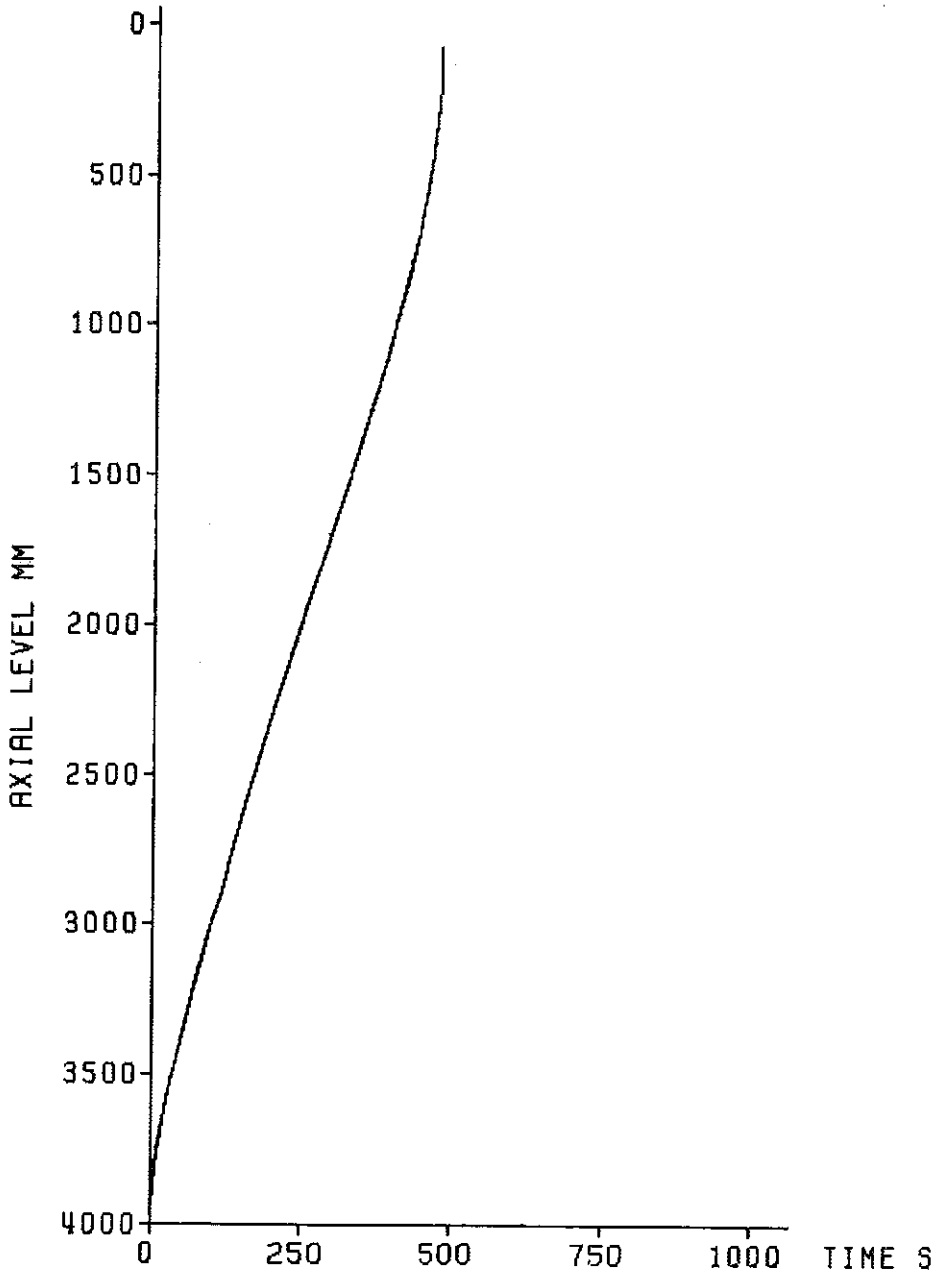

decay heat	120% ANS standard
flooding rate (cold)	3.81 cm/s
system pressure	4.12 bar
feedwater temperature	40 deg C



Fig. 41 FEBA: 5x5 ROD BUNDLE
TEST SERIES 1, TEST-NO. 216

Initial axial temperature profile of the cladding

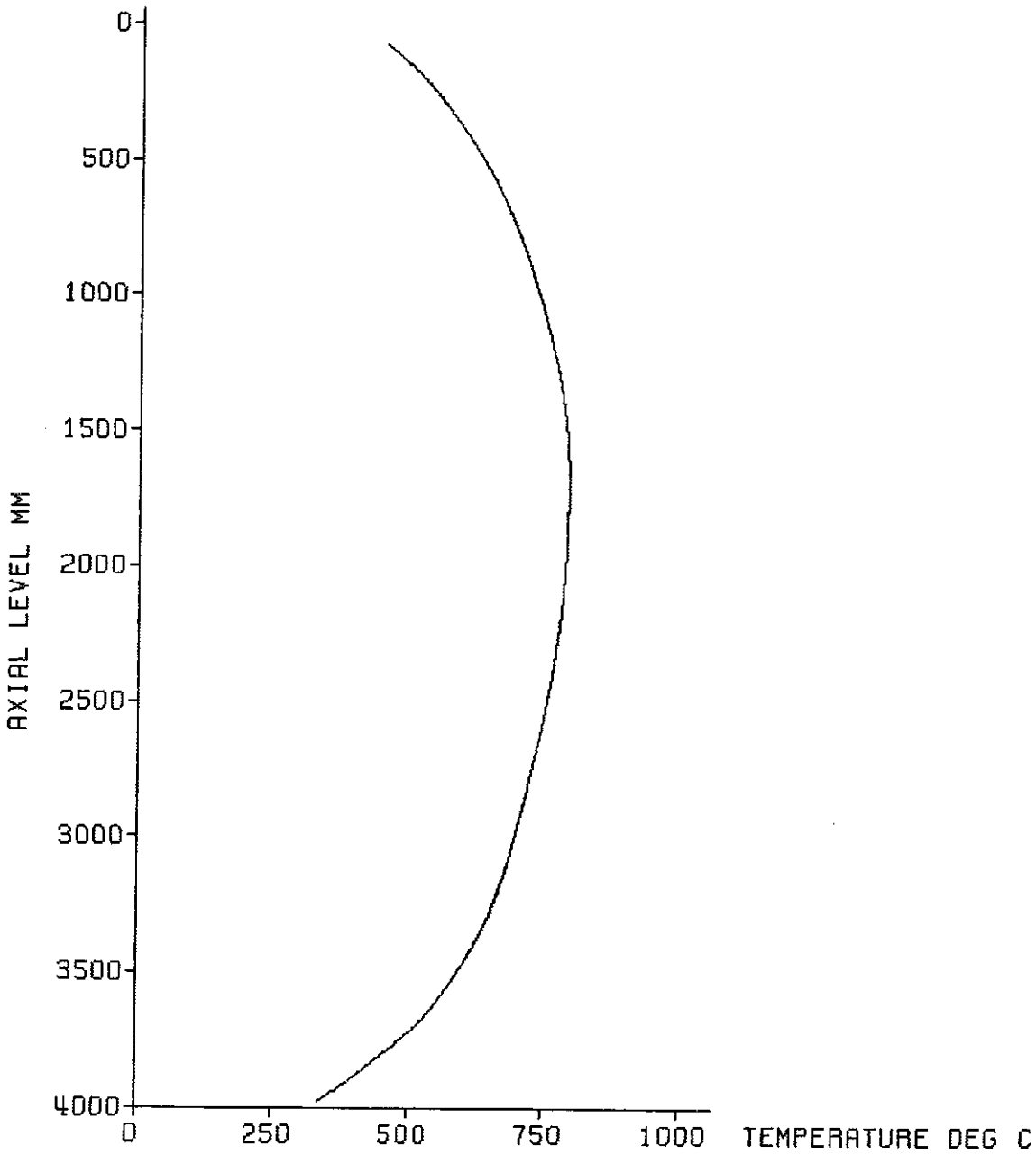

decay heat	120% ANS standard
flooding rate (cold)	3.85 cm/s
system pressure	6.18 bar
feedwater temperature	40 deg C

KIK IRB

Fig. 42 FEBA: 5x5 ROD BUNDLE
TEST SERIES 1, TEST-No. 220

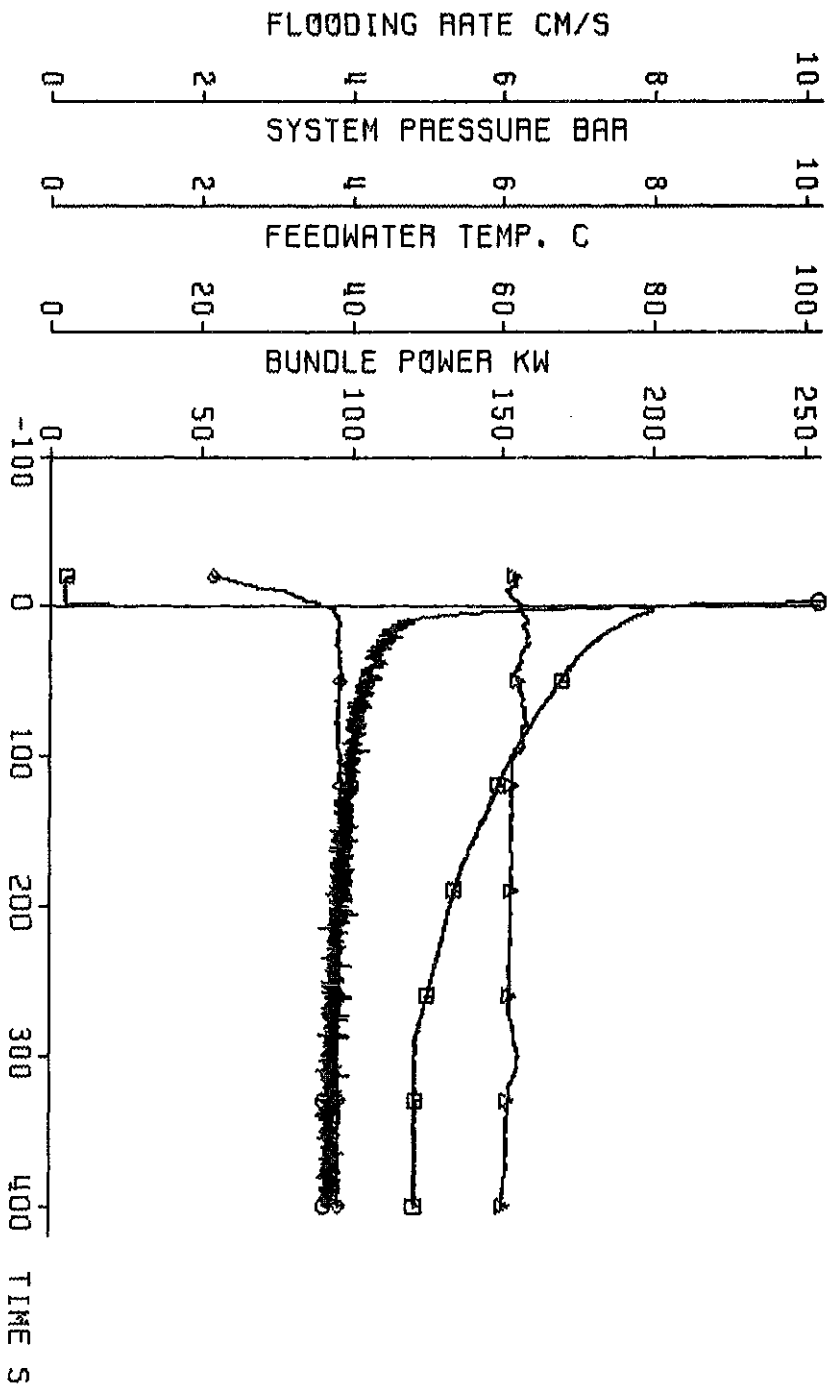

test parameters:
 ◆ flooding rate
 ▲ system pressure
 ○ feedwater temperature
 □ bundle power

decay heat
 flooding rate (cold)
 system pressure
 feedwater temperature

120% RMS standard
 3.85 cm/s
 8.18 bar
 40 deg C



Fig. 43 FEBRA: 5X5 ROD BUNDLE, TEST SERIES 1, TEST-NO. 220

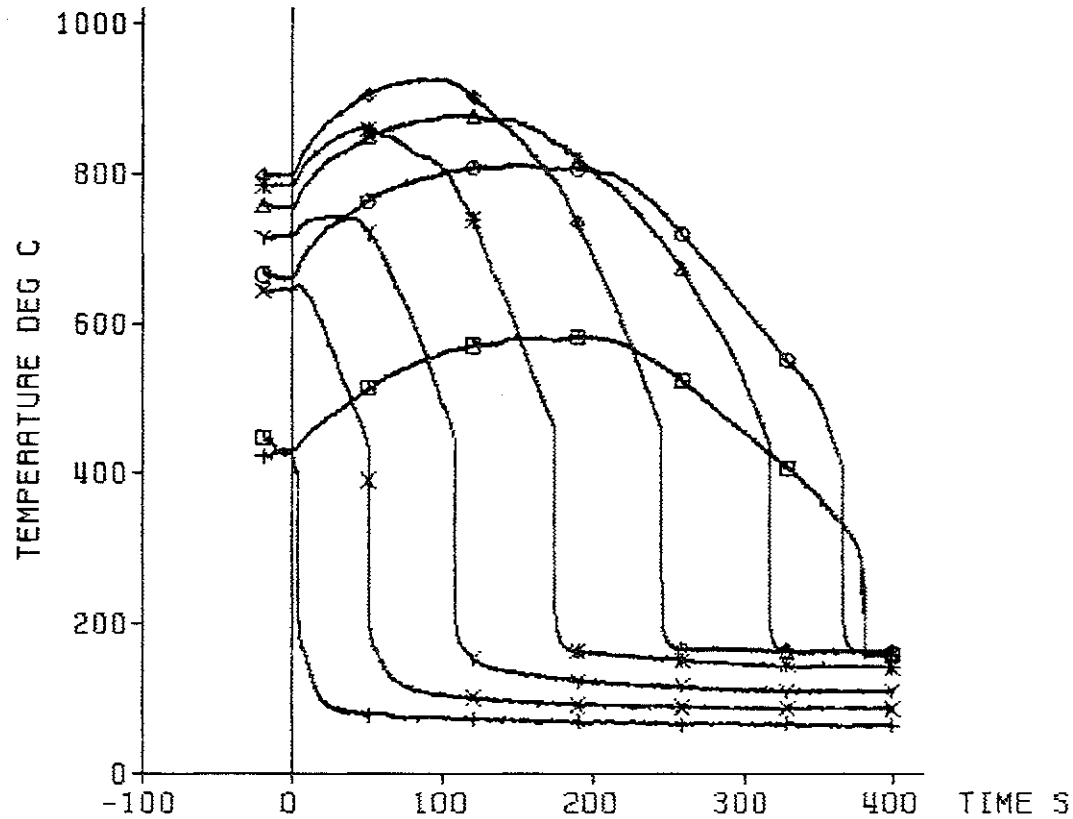

TC	ax. Level
+	18a4 3860 mm
x	18a3 3315 mm
Y	18a2 2770 mm
*	18a1 2225 mm
◇	12b4 1680 mm
△	12b3 1135 mm
○	12b2 590 mm
□	12b1 45 mm

decay heat 120% ANS standard
 flooding rate (cold) 3.85 cm/s
 system pressure 6.18 bar
 feedwater temperature 40 deg C

KFK
IRB

Fig. 44 FEBA: 5x5 ROD BUNDLE, TEST SERIES 1, TEST-No. 220

heat transfer coeff.

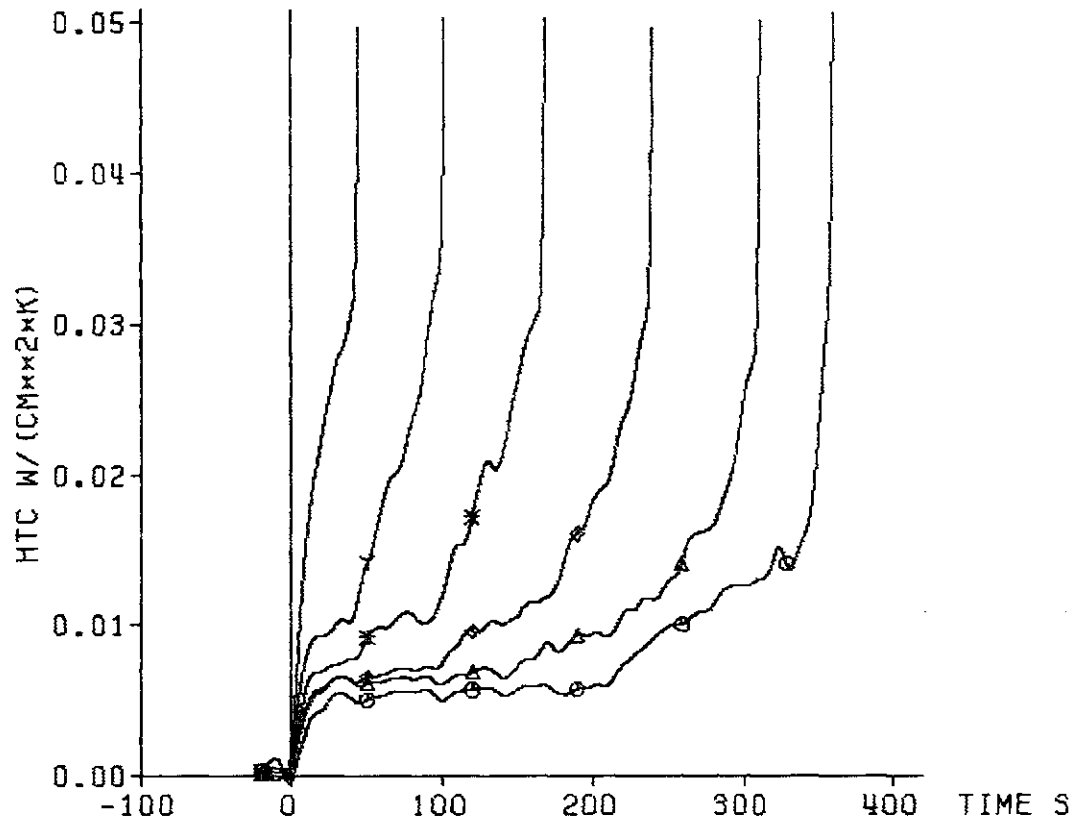

TC	ax. Level
x 18a3	3315 mm
γ 18a2	2770 mm
* 18a1	2225 mm
◇ 12b4	1680 mm
△ 12b3	1135 mm
○ 12b2	590 mm

decay heat 120% ANS standard
 flooding rate (cold) 3.85 cm/s
 system pressure 6.18 bar
 feedwater temperature 40 deg C



Fig. 45 FEBA: 5x5 ROD BUNDLE, TEST SERIES 1, TEST-No. 220

cladding temperature

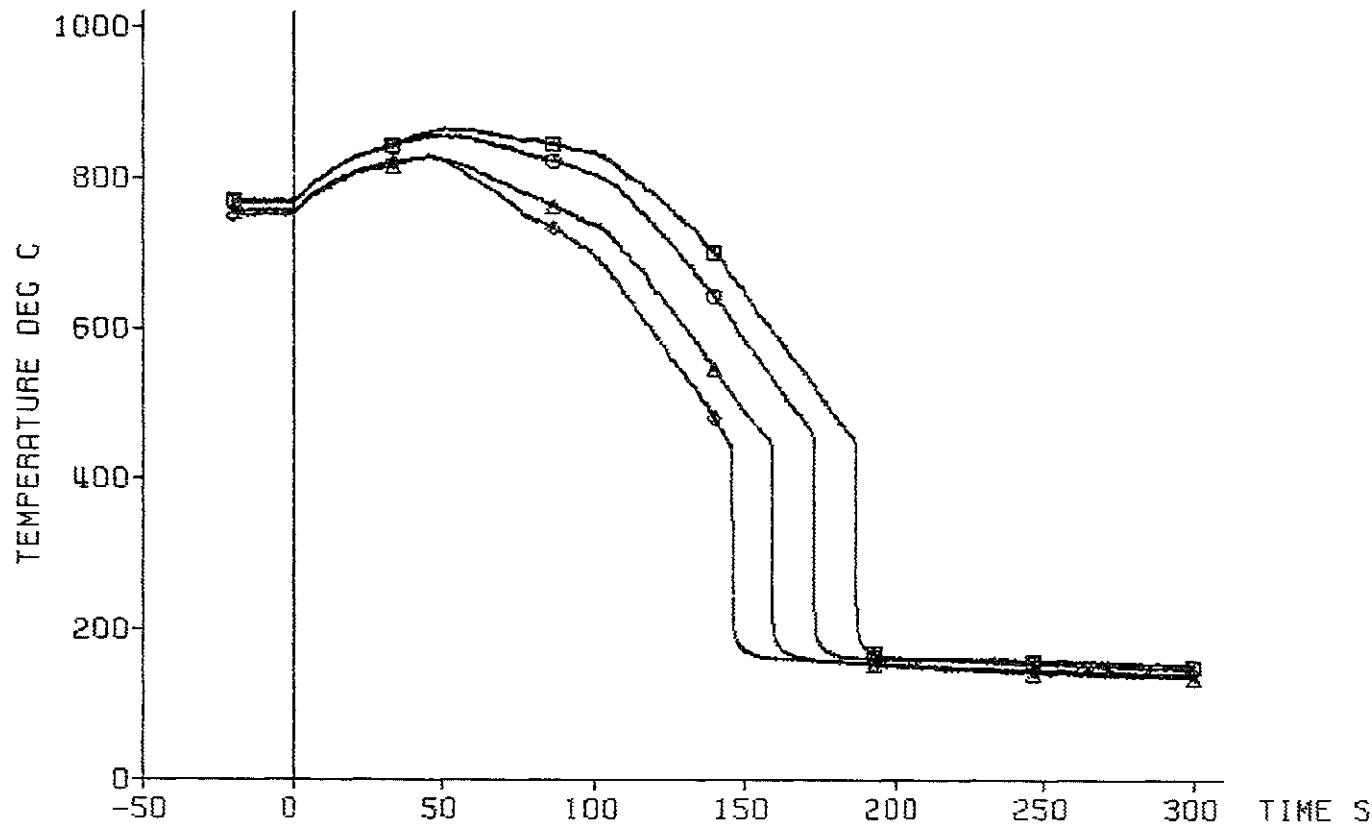

decay heat 120% ANS standard
 flooding rate (cold) 3.85 cm/s
 system pressure 6.18 bar
 feedwater temperature 40 deg C



Fig. 46 FEBA: 5x5 R0D BUNDLE, TEST SERIES 1, TEST-No. 220

heat transfer coeff.

TC	ex. Level
◇	7f4 2425 mm
△	7f3 2325 mm
○	7f2 2225 mm
□	7f1 2125 mm

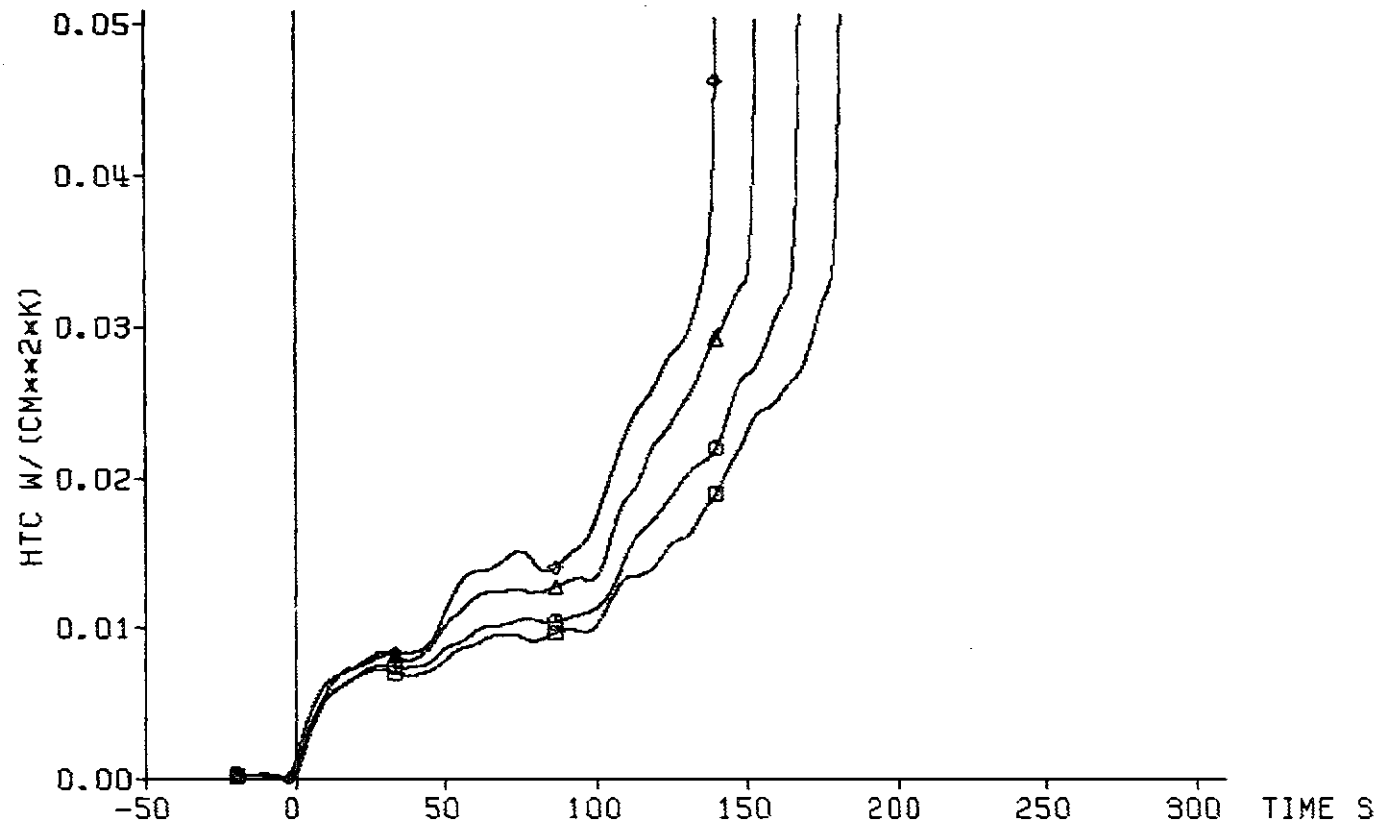

decay heat 120% ANS standard
 flooding rate (cold) 3.85 cm/s
 system pressure 6.18 bar
 feedwater temperature 40 deg C



Fig. 47 FEBA: 5x5 ROD BUNDLE, TEST SERIES 1, TEST-No. 220

cladding temperature

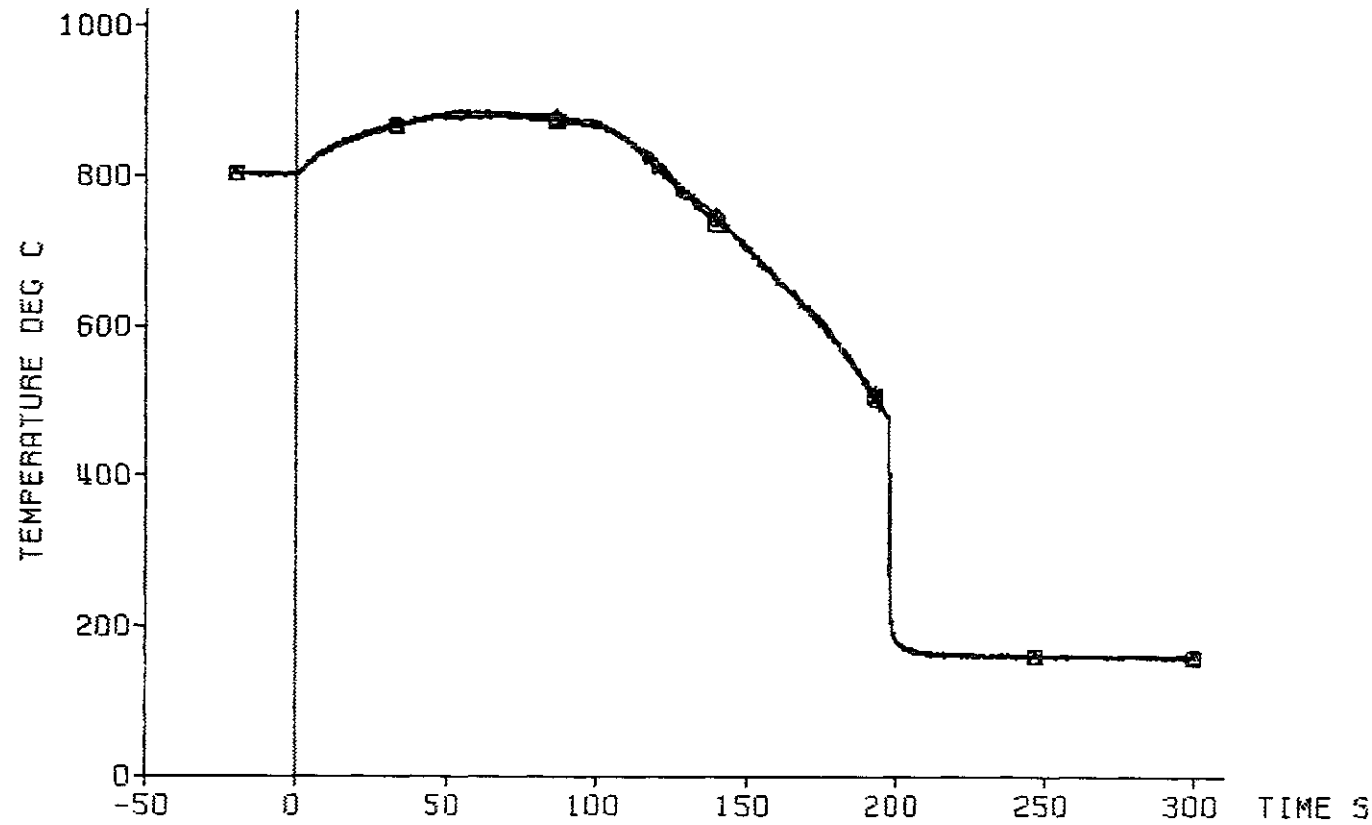

TC	ax. Level
△ 13d3	2025 mm
⊙ 13d2	2025 mm
□ 13d1	2025 mm

decay heat 120% ANS standard
flooding rate (cold) 3.85 cm/s
system pressure 6.18 bar
feedwater temperature 40 deg C

KIK² TRB

Fig. 48 FEBA: 5x5 ROD BUNDLE, TEST SERIES 1, TEST-NO. 220

heat transfer coeff.

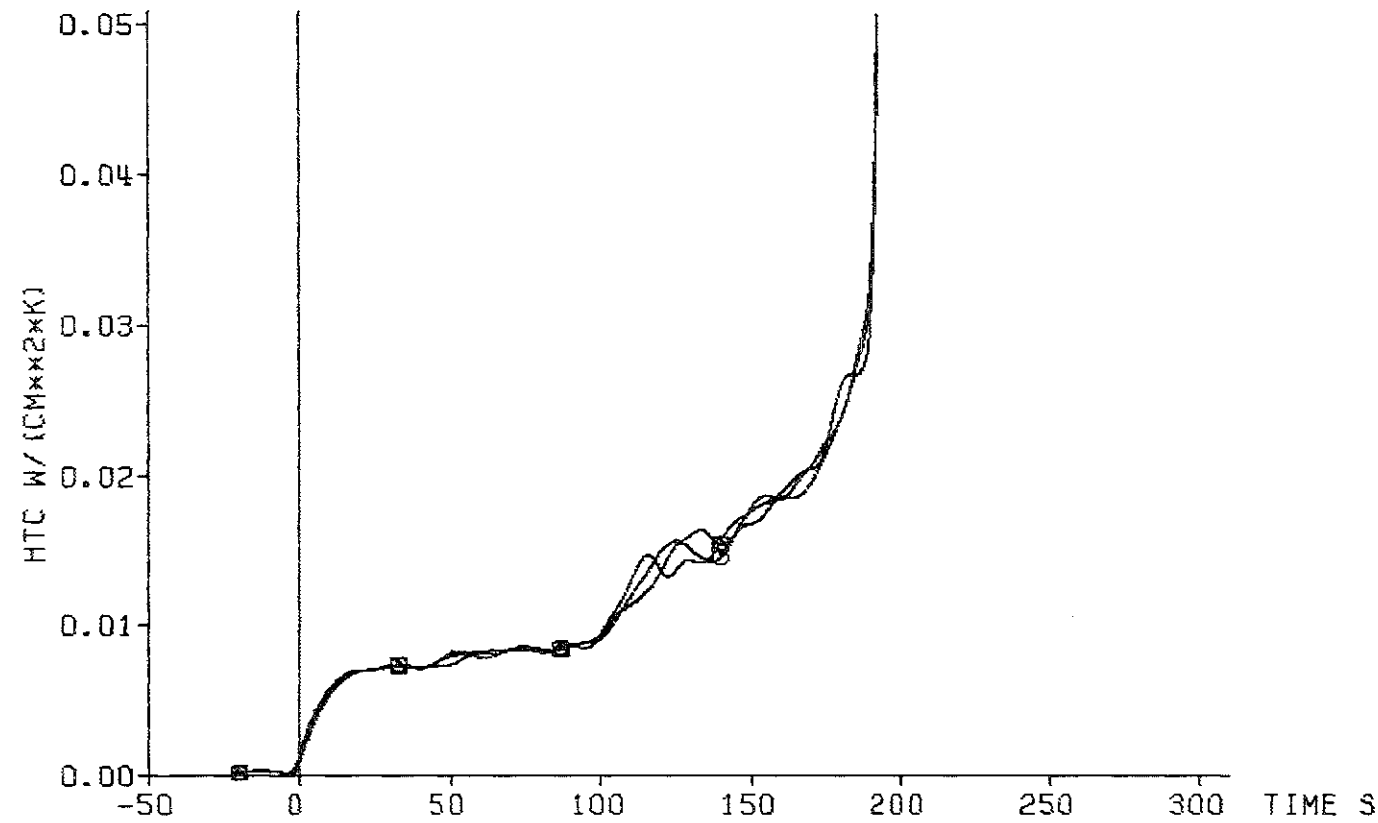

TC	axial Level
▲ 13d3	2025 mm
○ 13d2	2025 mm
□ 13d1	2025 mm

decay heat 120% ANS standard
flooding rate (cold) 3.85 cm/s
system pressure 6.18 bar
feedwater temperature 40 deg C



Fig. 49 FEBA: 5x5 ROD BUNDLE, TEST SERIES 1, TEST-No. 220

cladding temperature

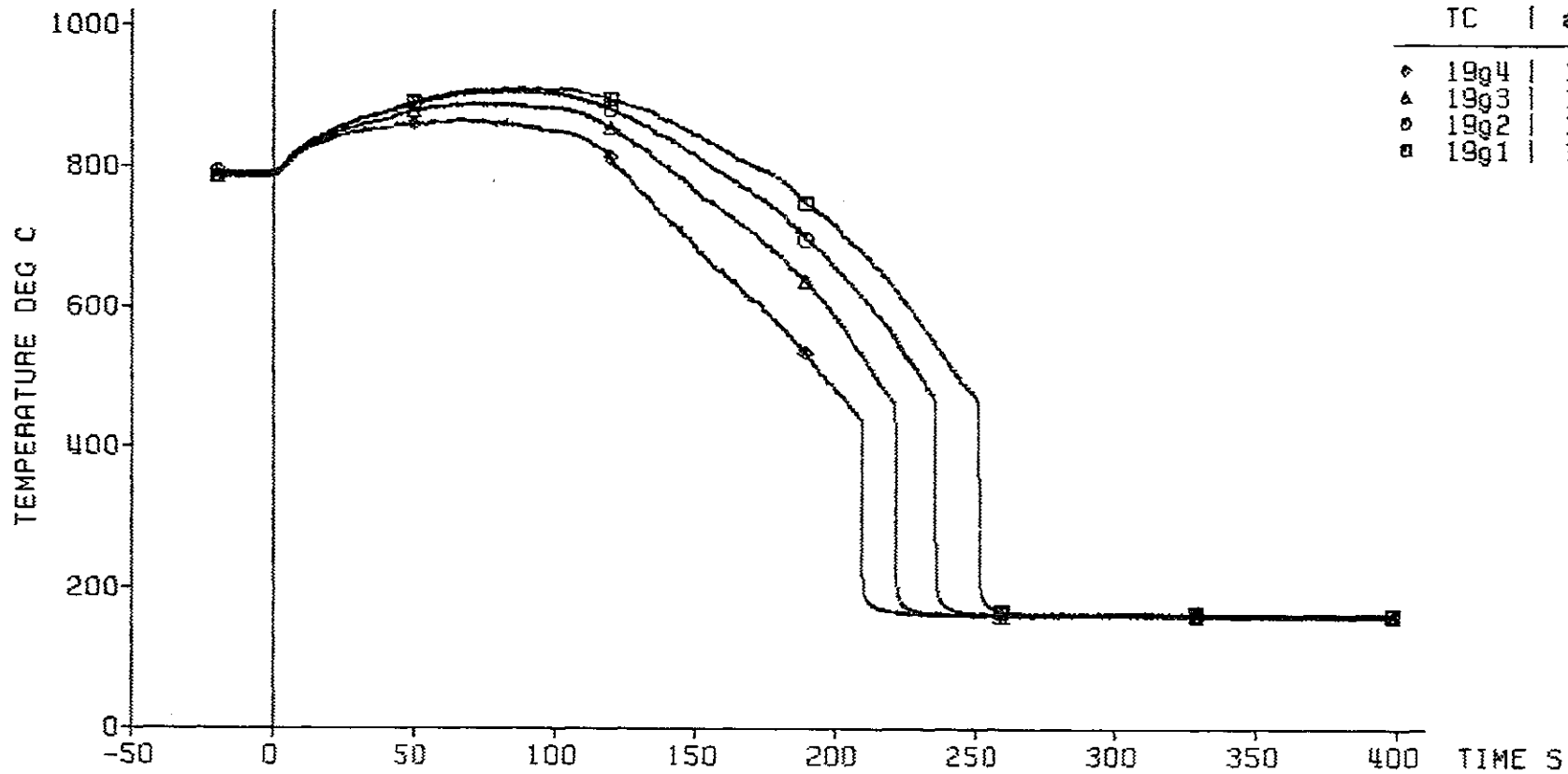

decay heat 120% RNS standard
 flooding rate (cold) 3.85 cm/s
 system pressure 6.18 bar
 feedwater temperature 40 deg C



Fig. 50 FEBA: 5x5 ROD BUNDLE, TEST SERIES 1, TEST-No. 220

heat transfer coeff.

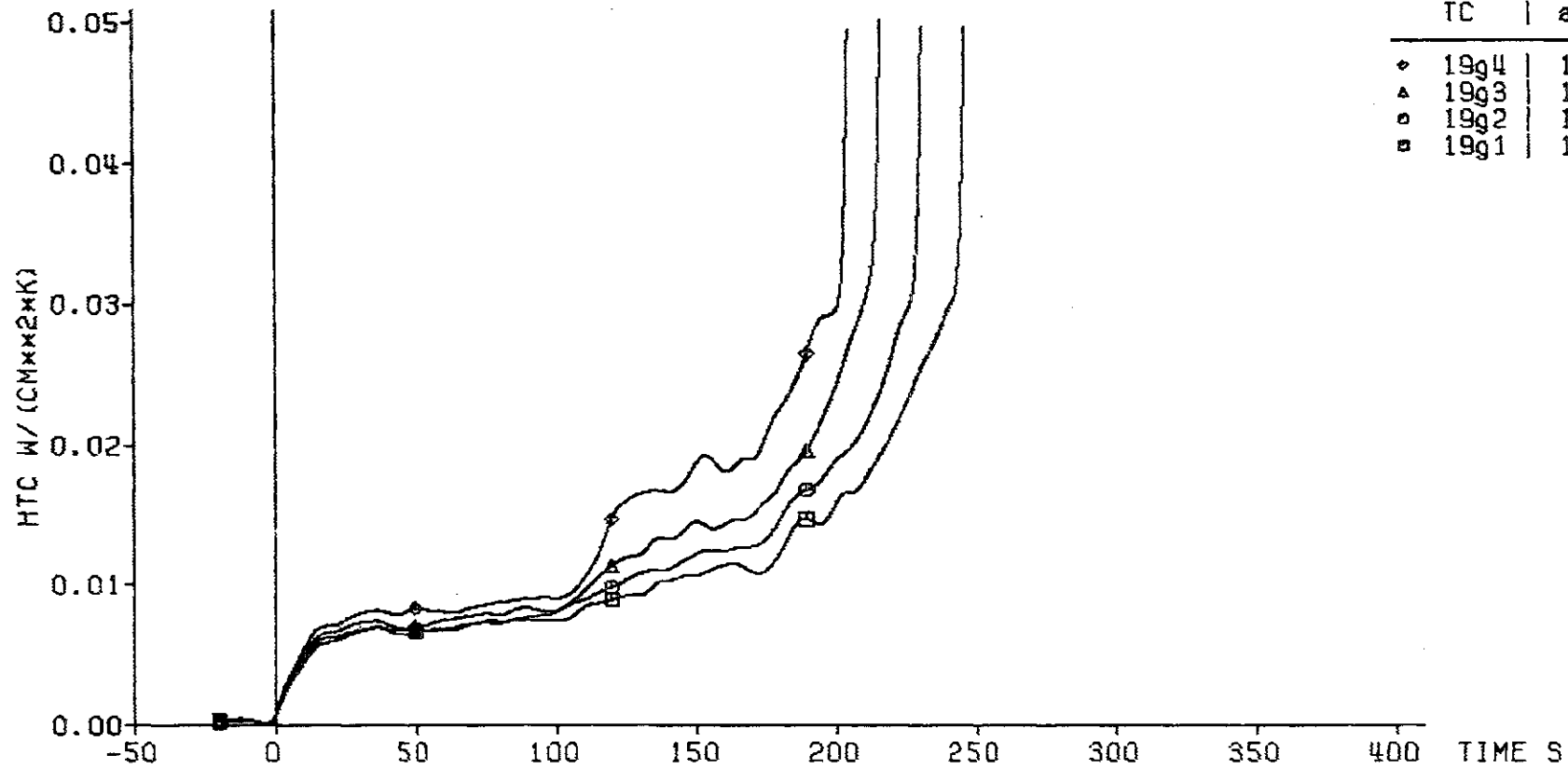

TC	ax. level
◇	19g4 1925 mm
△	19g3 1825 mm
○	19g2 1725 mm
□	19g1 1625 mm

decay heat 120% ANS standard
 flooding rate (cold) 3.85 cm/s
 system pressure 6.18 bar
 feedwater temperature 40 deg C



Fig. 51 FEBA: 5x5 ROD BUNDLE, TEST SERIES 1, TEST-No. 220

axial level: 1725 mm

△ cladding temperature (19g2)
● fluid temperature
□ housing temperature

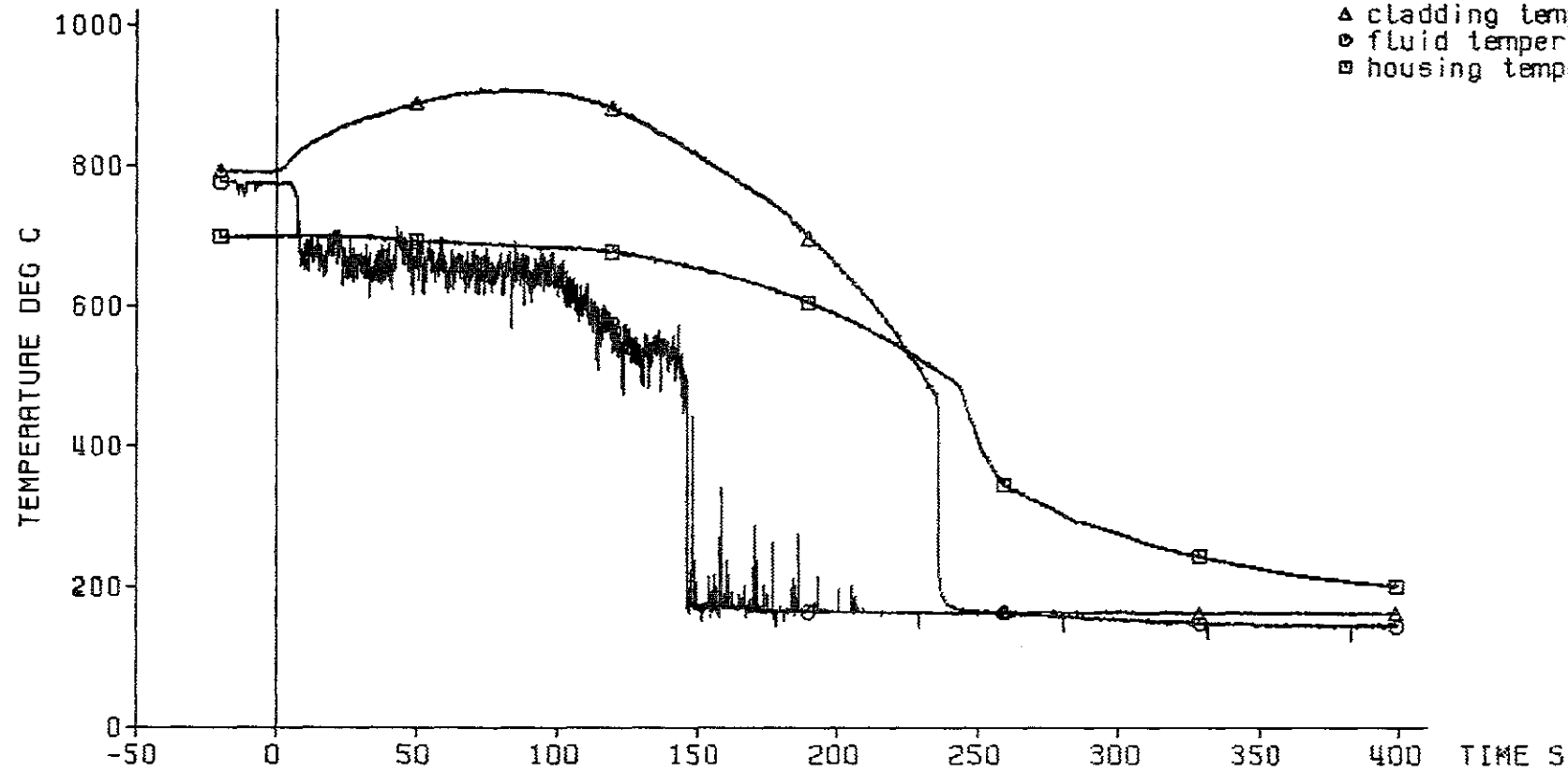

decay heat 120% RNS standard
flooding rate (cold) 3.65 cm/s
system pressure 6.13 bar
feedwater temperature 40 deg C

— 64 —



Fig. 52 FEBA: 5x5 ROD BUNDLE, TEST SERIES 1, TEST-No. 220

axial level: 1625 mm

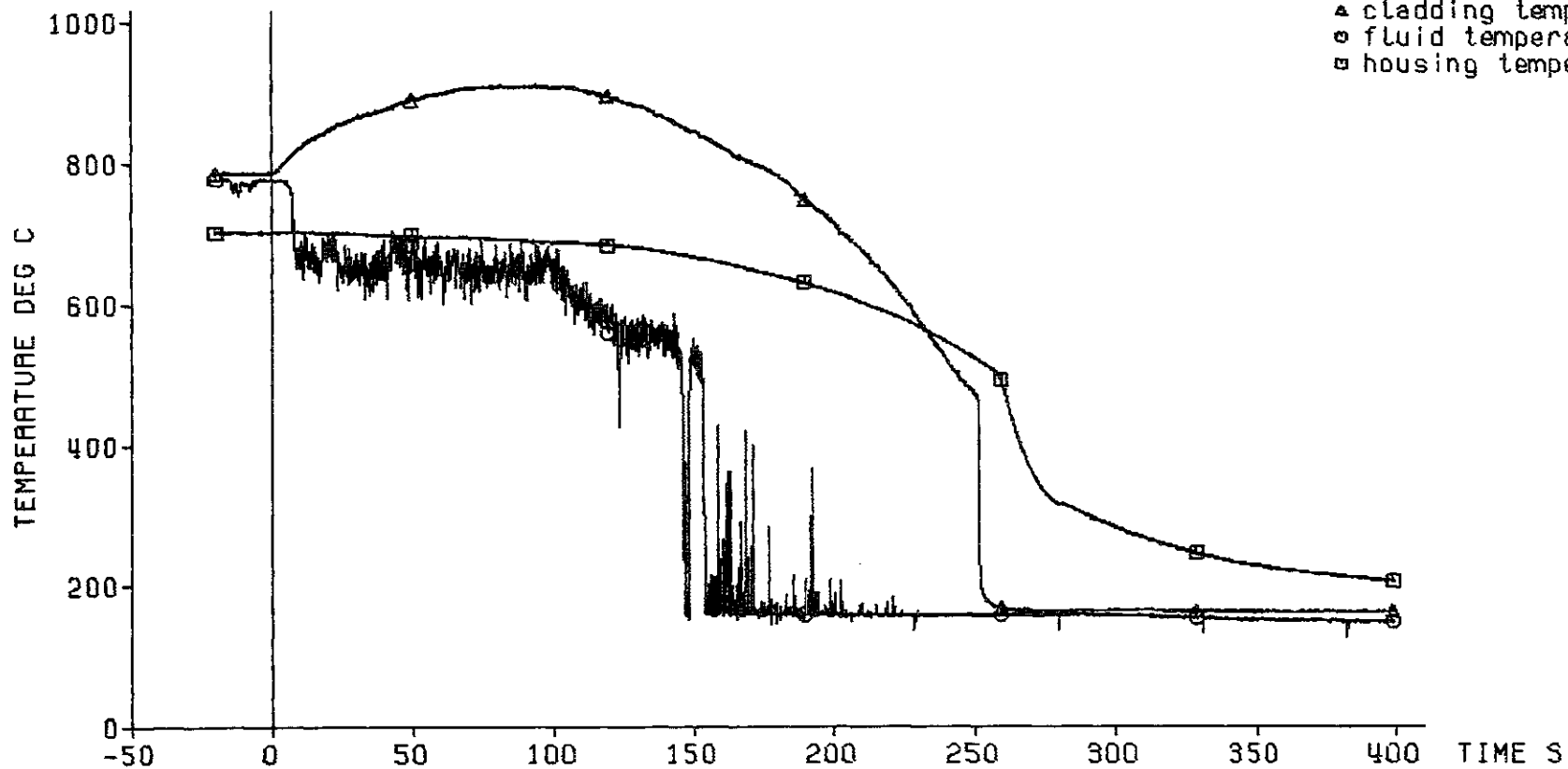

decay heat 120% ANS standard
flooding rate (cold) 3.85 cm/s
system pressure 6.16 bar
feedwater temperature 40 deg C



Fig. 53 FEBA: 5x5 ROD BUNDLE, TEST SERIES 1, TEST-No. 220

pressure loss
along the test section:

◆ total length: 4196 mm
△ lower part: 1711 mm
○ middle part: 545 mm
□ upper part: 1940 mm

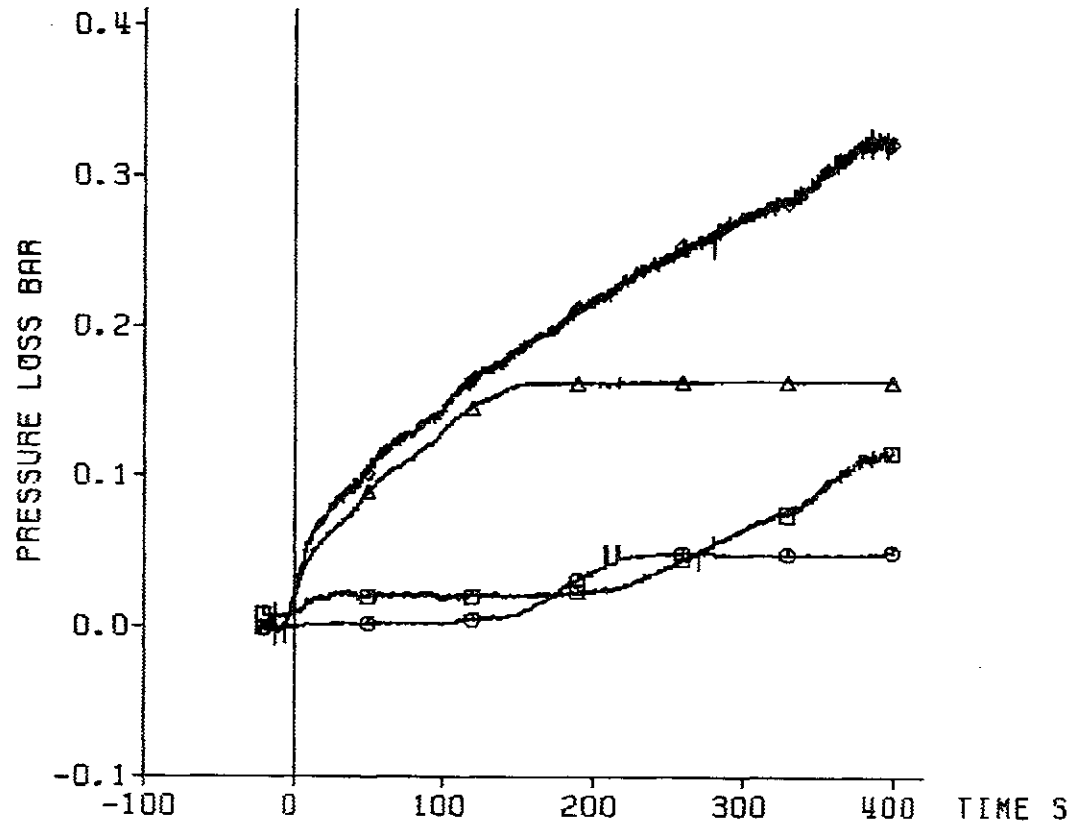

decay heat 120% RNS standard
flooding rate (cold) 3.85 cm/s
system pressure 6.18 bar
feedwater temperature 40 deg C

KIK IRB

Fig. 54 FEBA: 5x5 ROD BUNDLE, TEST SERIES 1, TEST-No. 220

coolant outlet conditions:

- △ water carry over
- coolant temperature
- coolant pressure

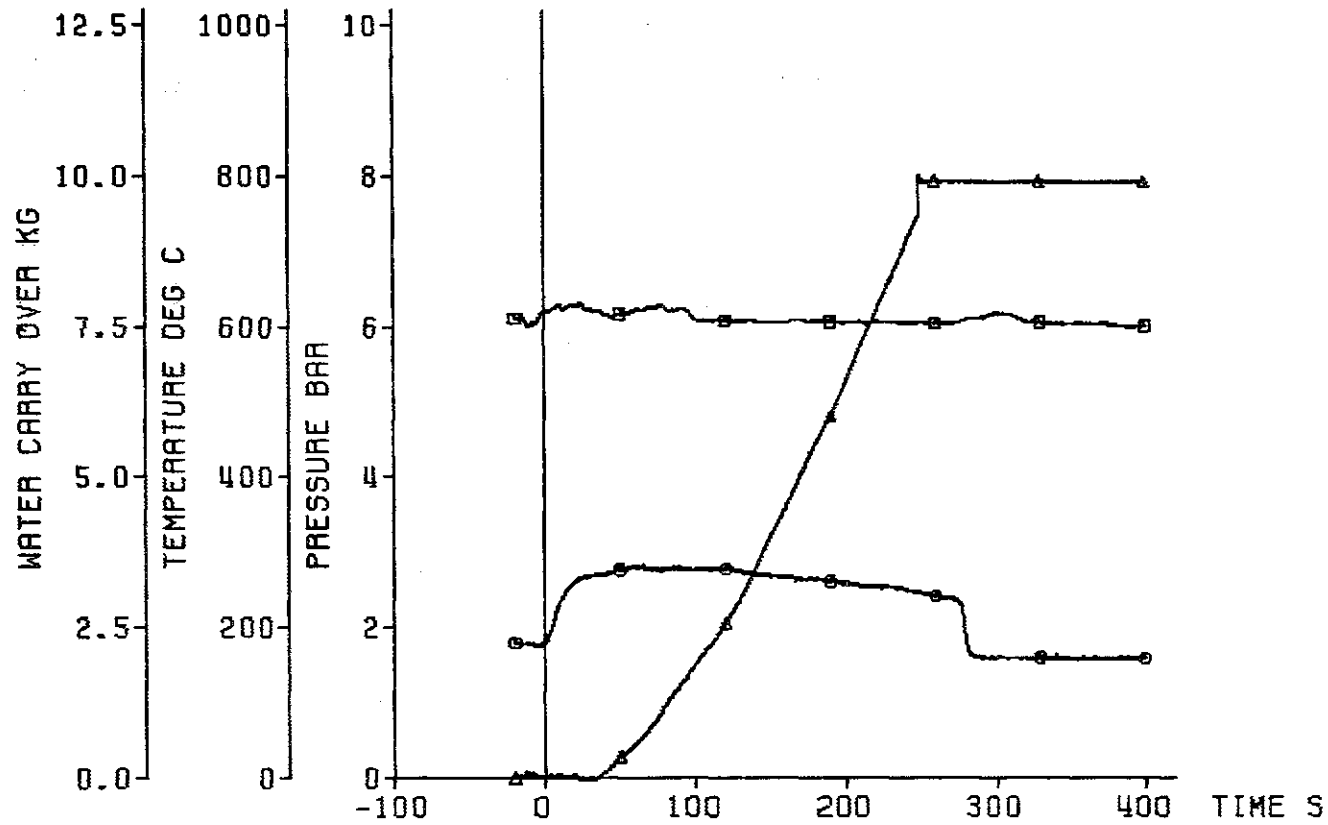

decay heat 120% ANS standard
flooding rate (cold) 3.85 cm/s
system pressure 6.18 bar
feedwater temperature 40 deg C

KIK IRB

Fig. 55 FEBA: 5x5 ROD BUNDLE, TEST SERIES 1, TEST-No. 220

axial position of the quench front

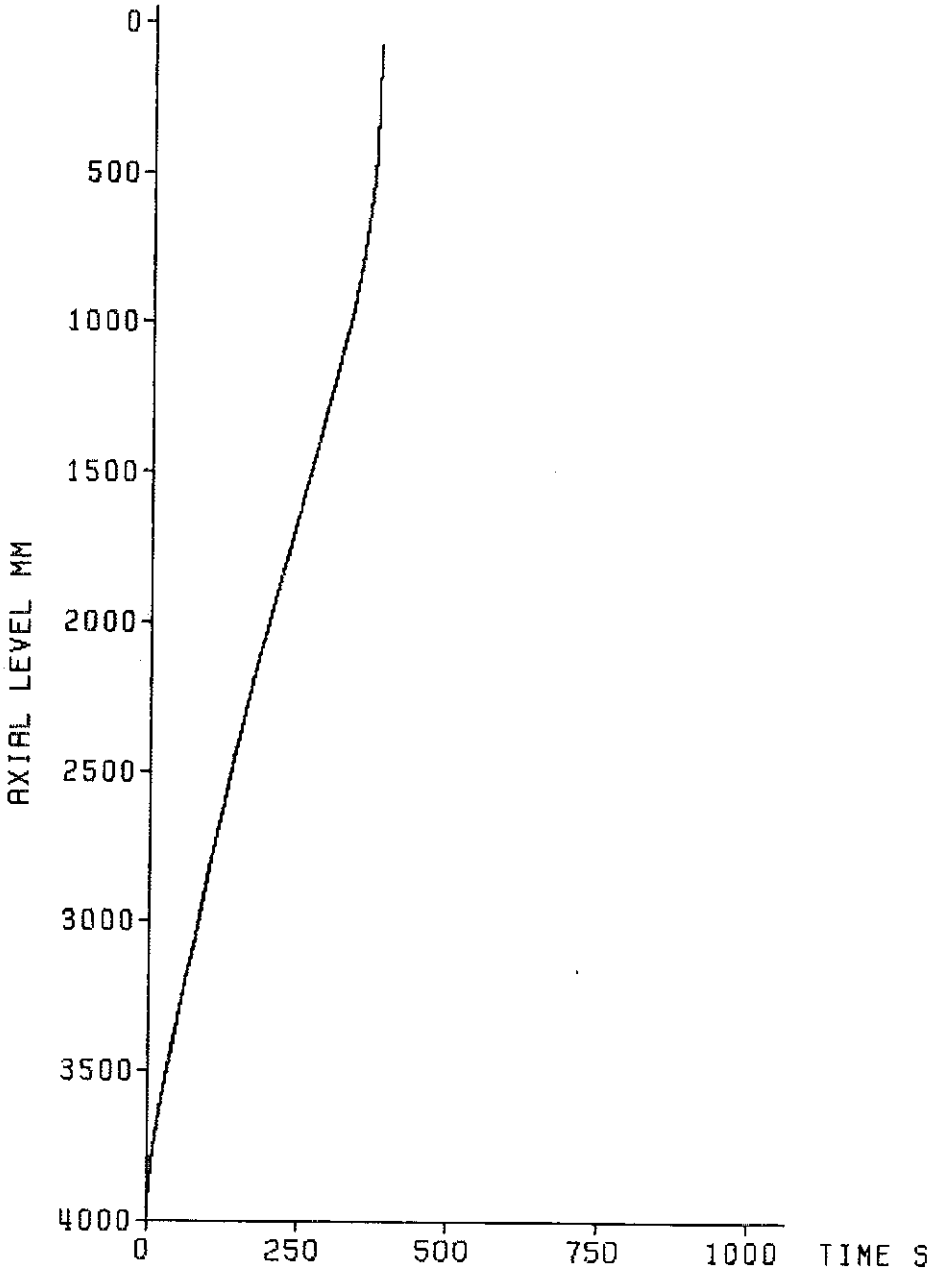

decay heat	120% ANS standard
flooding rate (cold)	3.85 cm/s
system pressure	6.18 bar
feedwater temperature	40 deg C



Fig. 56 FEBA: 5x5 ROD BUNDLE
TEST SERIES 1, TEST-NO. 220

Initial axial temperature profile of the cladding

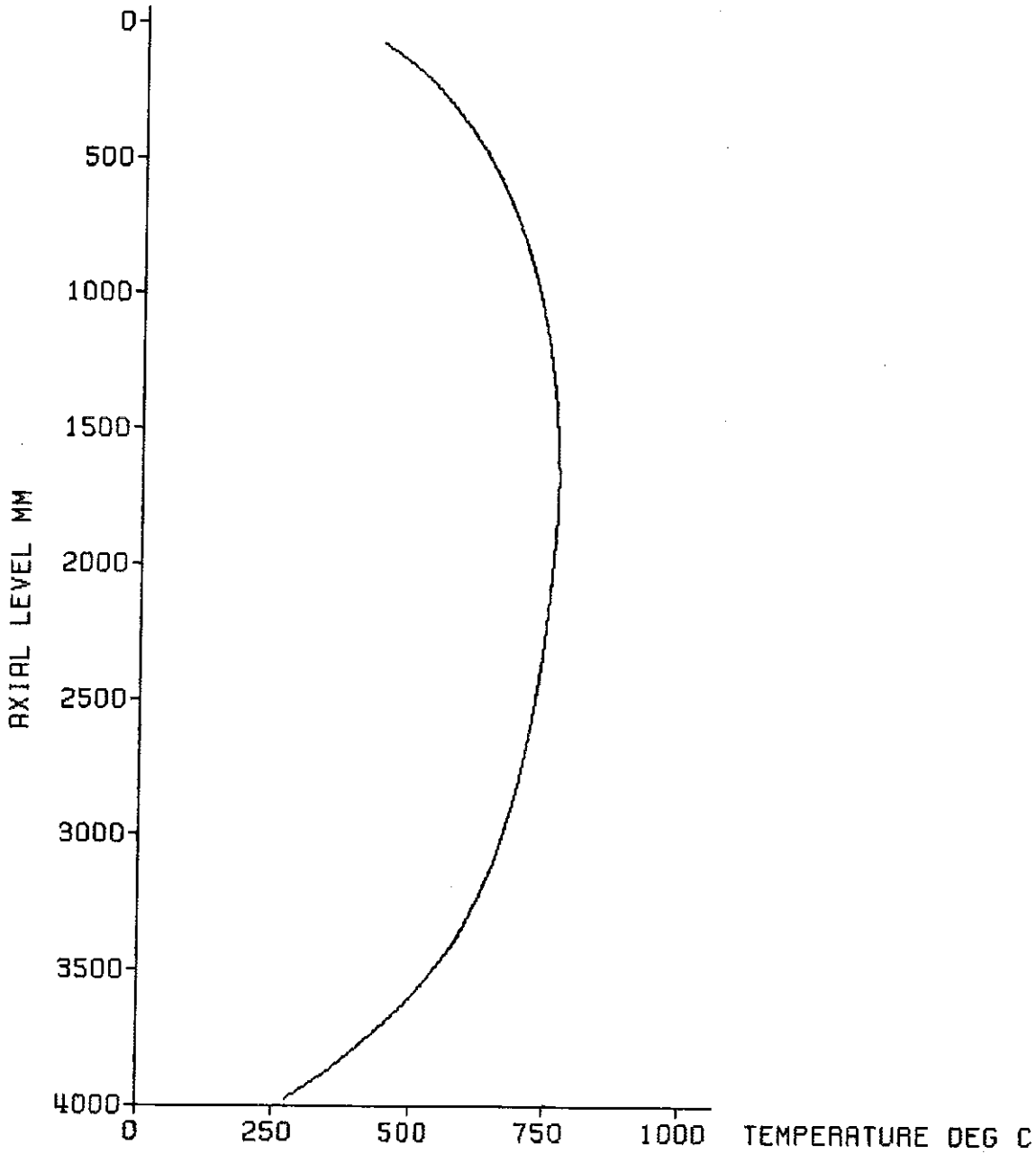

decay heat	120% ANS standard
flooding rate (cold)	5.81 cm/s
system pressure	2.08 bar
feedwater temperature	40 deg C



Fig. 57 FEBA: 5x5 ROD BUNDLE
TEST SERIES 1, TEST-No. 218

test parameters:

- ◊ flooding rate
- △ system pressure
- feedwater temperature
- ◻ bundle power

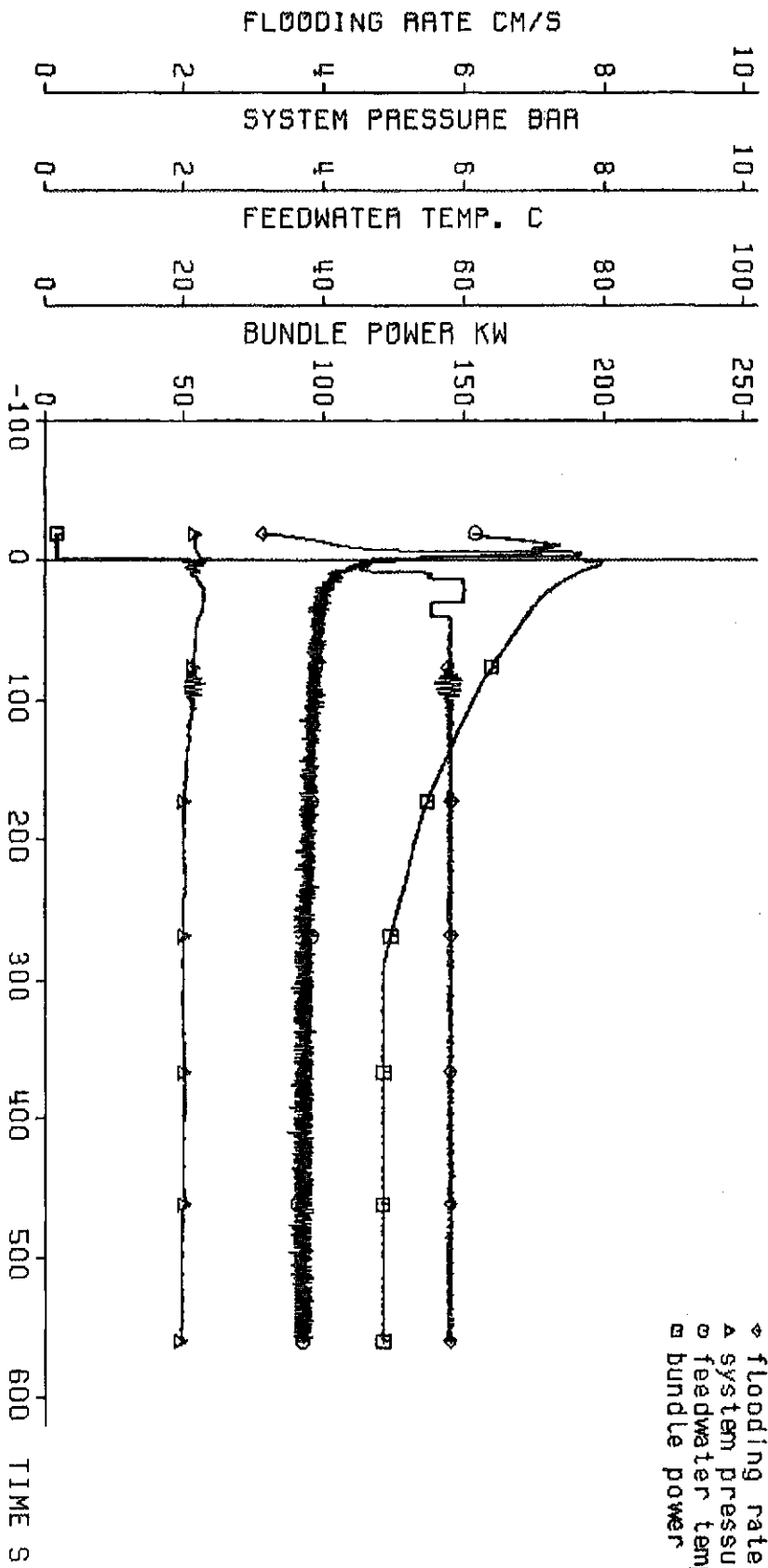

decay heat
 flooding rate (cold)
 system pressure
 feedwater temperature

120% ANS standard
 5.81 cm/s
 2.08 bar
 40 deg C



Fig. 58 FEBRA: 5X5 ROD BUNDLE, TEST SERIES 1, TEST-NO. 218

cladding temperature

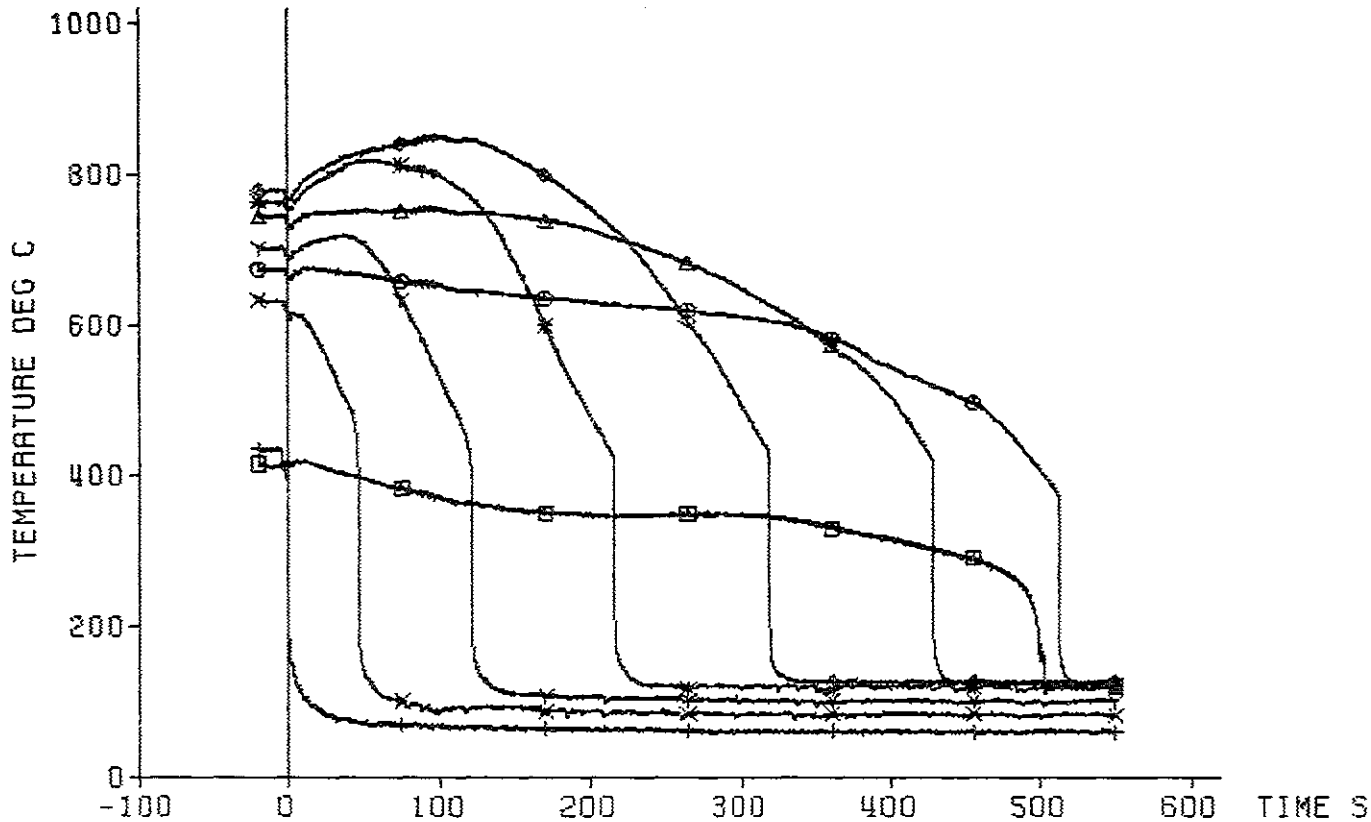

TC	ax. Level
+	18a4 3860 mm
x	18a3 3315 mm
y	18a2 2770 mm
*	18a1 2225 mm
◇	12b4 1680 mm
△	12b3 1135 mm
○	12b2 590 mm
□	12b1 45 mm

decay heat 120% ANS standard
 flooding rate (cold) 5.81 cm/s
 system pressure 2.08 bar
 feedwater temperature 40 deg C



Fig. 59 FEBA: 5x5 ROD BUNDLE, TEST SERIES 1, TEST-No. 218

heat transfer coeff.

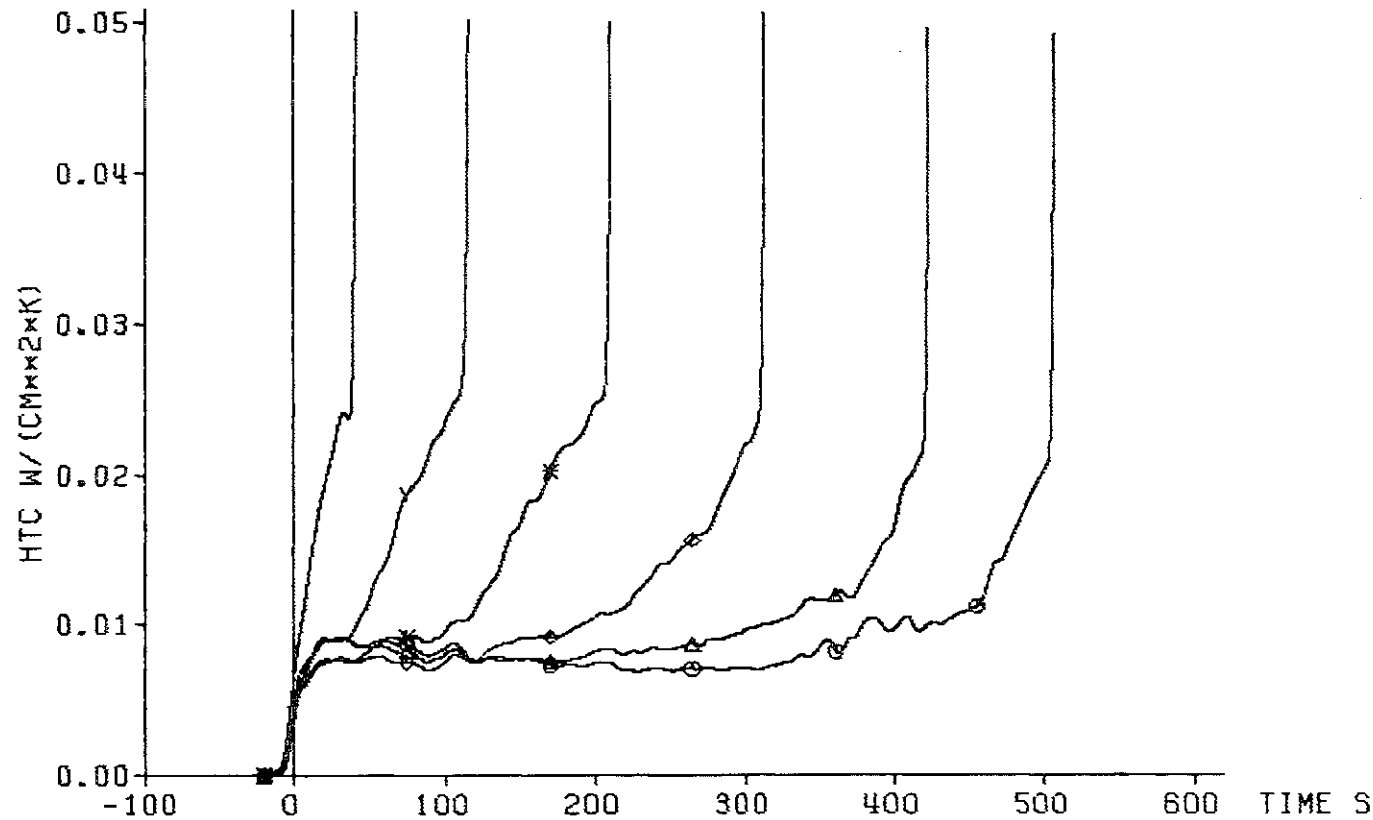

	TC	ax. Level
x	18a3	3315 mm
y	18a2	2770 mm
*	18a1	2225 mm
◇	12b4	1680 mm
△	12b3	1135 mm
○	12b2	590 mm

decay heat 120% ANS standard
 flooding rate (cold) 5.81 cm/s
 system pressure 2.08 bar
 feedwater temperature 40 deg C



Fig. 60 FEBA: 5x5 ROD BUNDLE, TEST SERIES 1, TEST-No. 218

cladding temperature

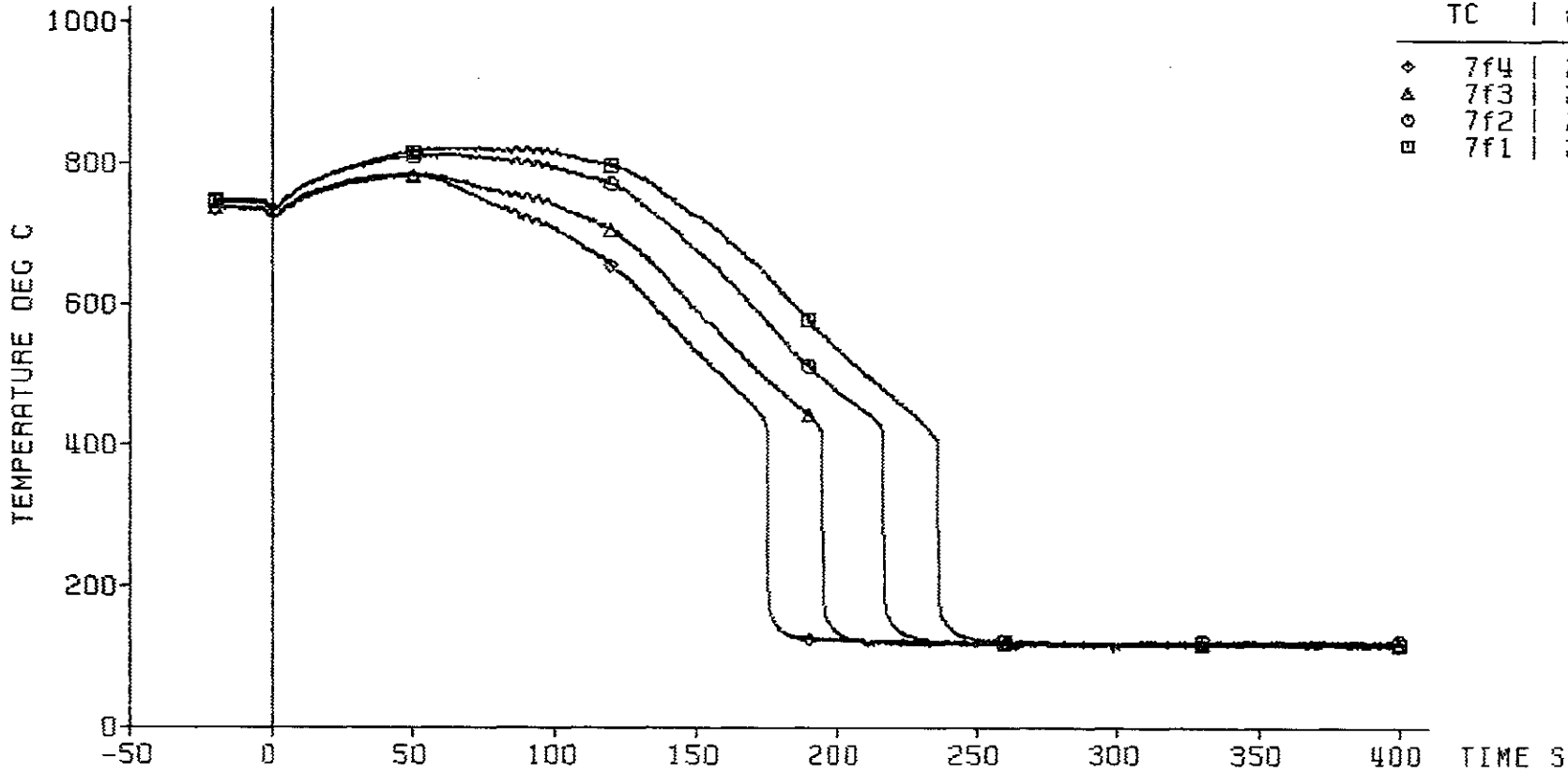

TC	ax. Level
◇	7f4 2425 mm
△	7f3 2325 mm
○	7f2 2225 mm
□	7f1 2125 mm

decay heat 120% RMS standard
 flooding rate (cold) 5.81 cm/s
 system pressure 2.08 bar
 feedwater temperature 40 deg C



Fig. 61 FEBA: 5x5 ROD BUNDLE, TEST SERIES 1, TEST-No. 218

heat transfer coeff.

TC	ax. Level
◇	7f4 2425 mm
△	7f3 2325 mm
○	7f2 2225 mm
□	7f1 2125 mm

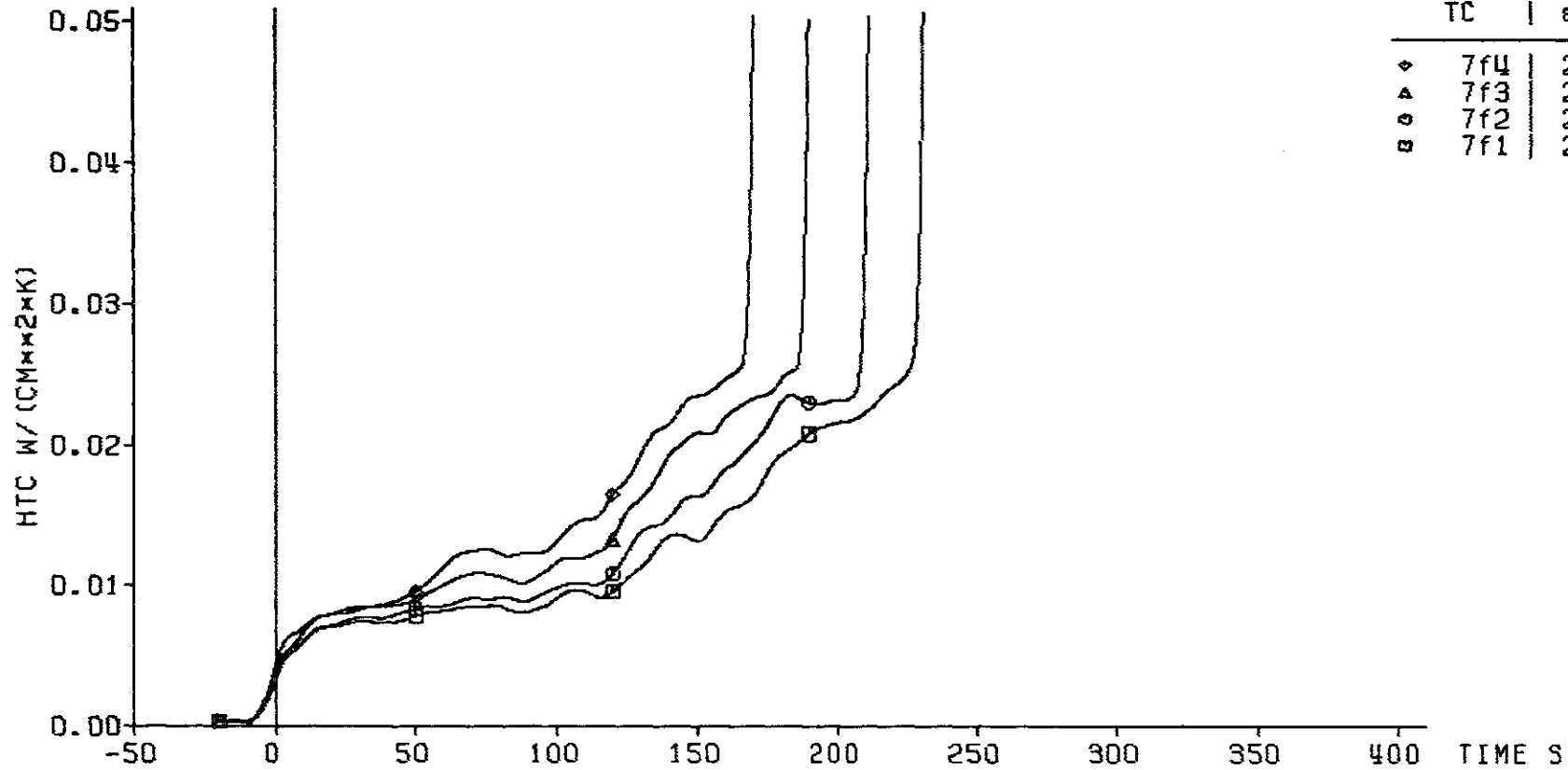

decay heat 120% ANS standard
 flooding rate (cold) 5.81 cm/s
 system pressure 2.08 bar
 feedwater temperature 40 deg C



Fig. 62 FEBA: 5x5 ROD BUNDLE, TEST SERIES 1, TEST-No. 218

cladding temperature

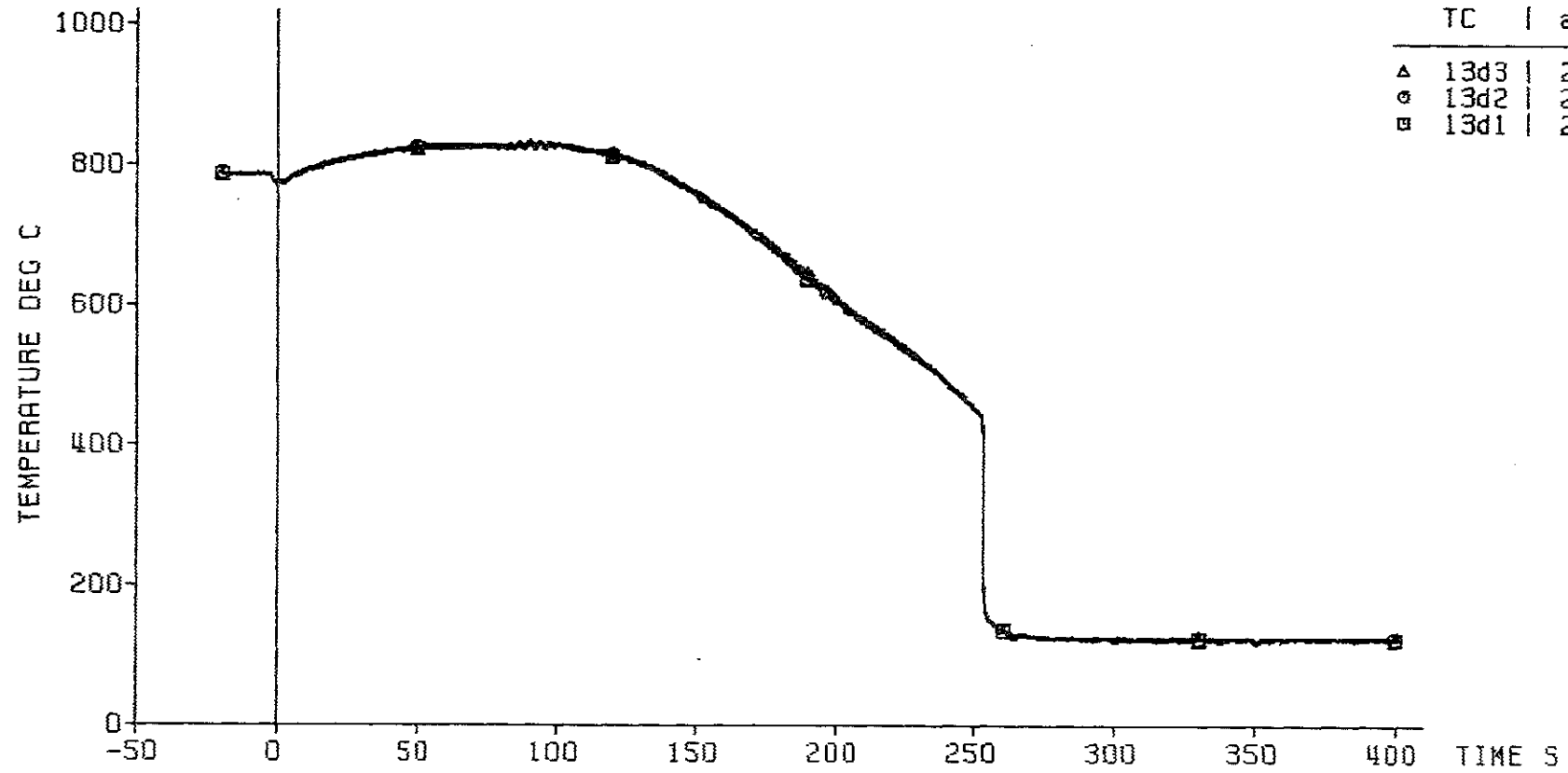

TC	ax. level
△ 13d3	2025 mm
○ 13d2	2025 mm
□ 13d1	2025 mm

decay heat 120% AWS standard
flooding rate (cold) 5.81 cm/s
system pressure 2.08 bar
feedwater temperature 40 deg C



Fig. 63 FEBA: 5x5 ROD BUNDLE, TEST SERIES 1, TEST-NO. 218

heat transfer coeff.

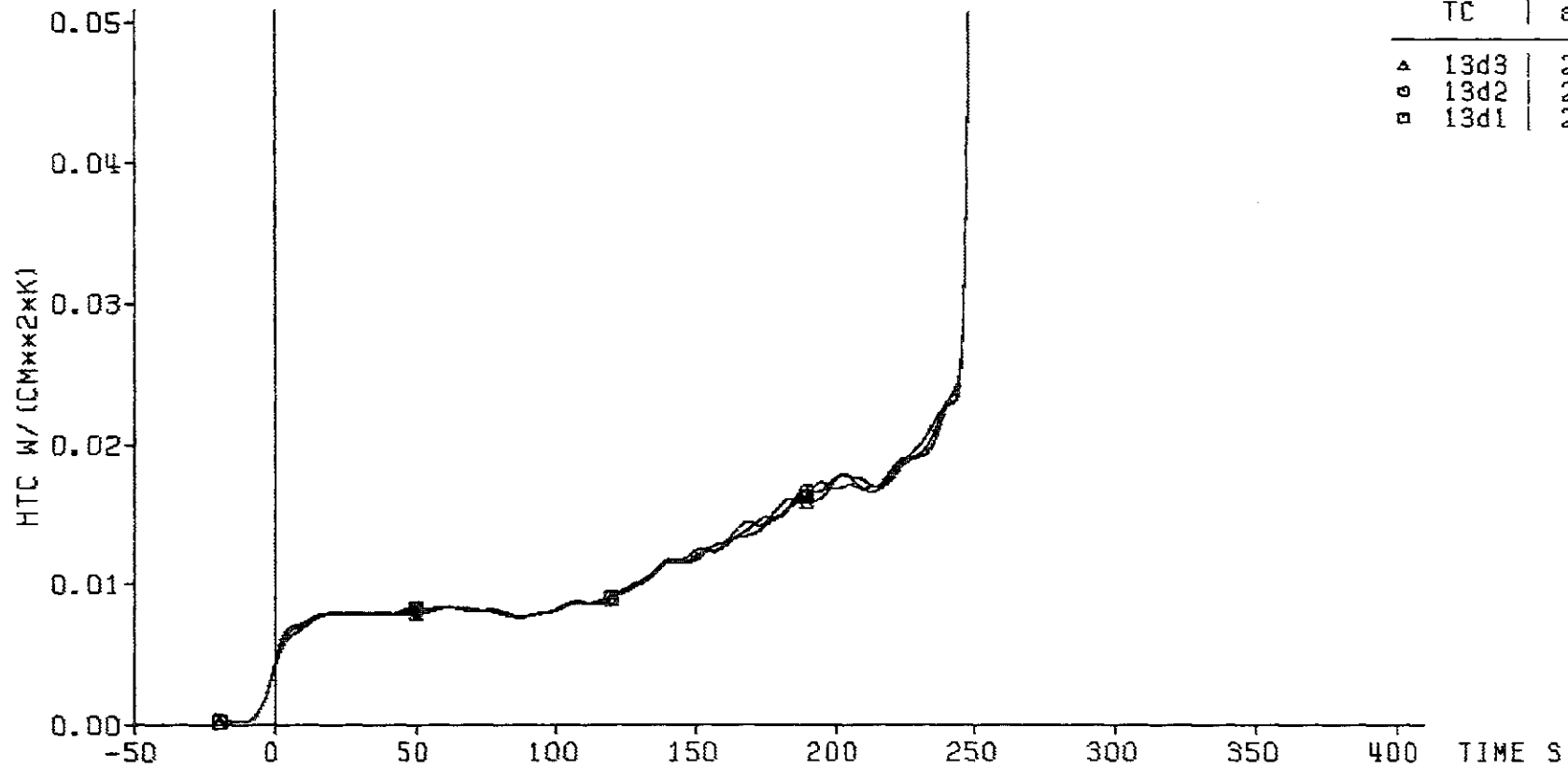

decay heat 120% ANS standard
flooding rate (cold) 5.81 cm/s
system pressure 2.08 bar
feedwater temperature 40 deg C



Fig. 64 FEBA: 5x5 ROD BUNDLE, TEST SERIES 1, TEST-No. 218

cladding temperature

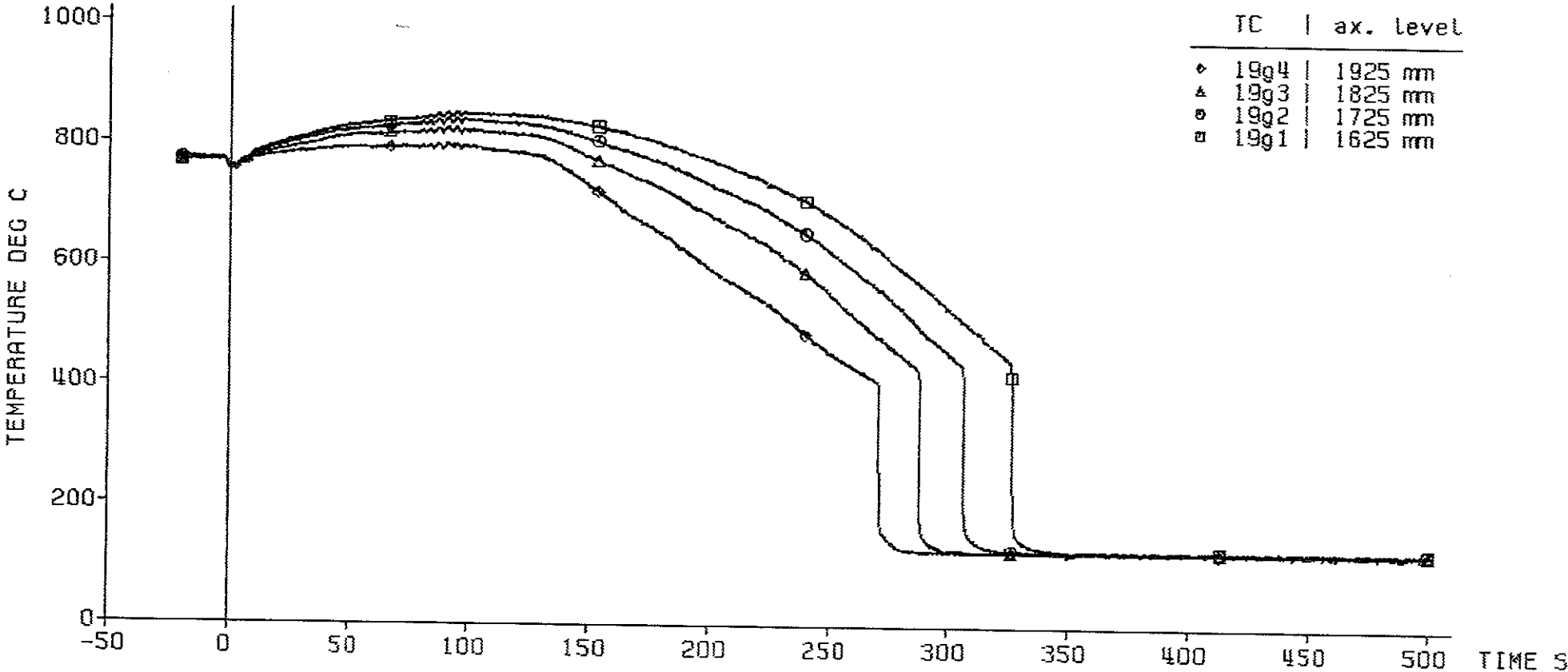

decay heat 120% ANS standard
flooding rate (cold) 5.81 cm/s
system pressure 2.08 bar
feedwater temperature 40 deg C



Fig. 65 FEBA: 5x5 ROD BUNDLE, TEST SERIES 1, TEST-No. 218

heat transfer coeff.

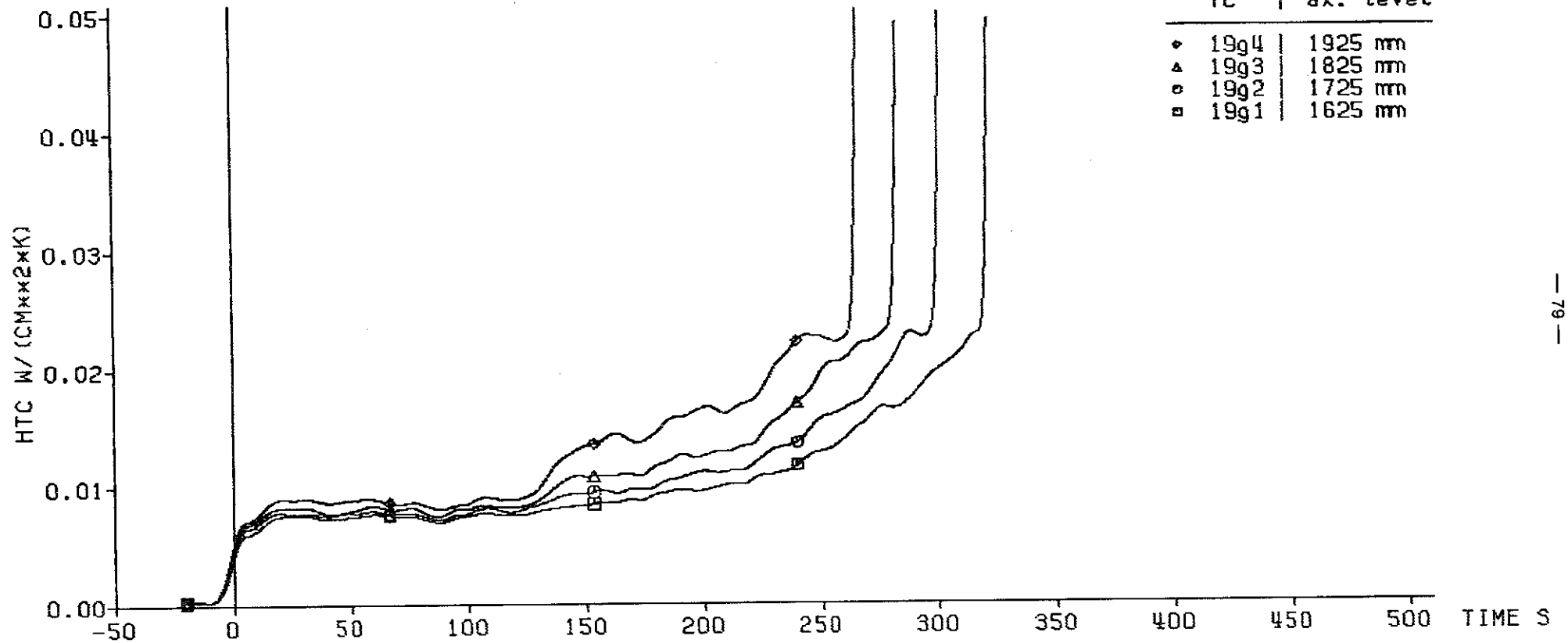

decay heat 120% ANS standard
 flooding rate (cold) 5.81 cm/s
 system pressure 2.08 bar
 feedwater temperature 40 deg C



Fig. 66 FEBA: 5x5 ROD BUNDLE, TEST SERIES 1, TEST-No. 218

axial level: 1725 mm

△ cladding temperature (19g2)
○ fluid temperature
□ housing temperature

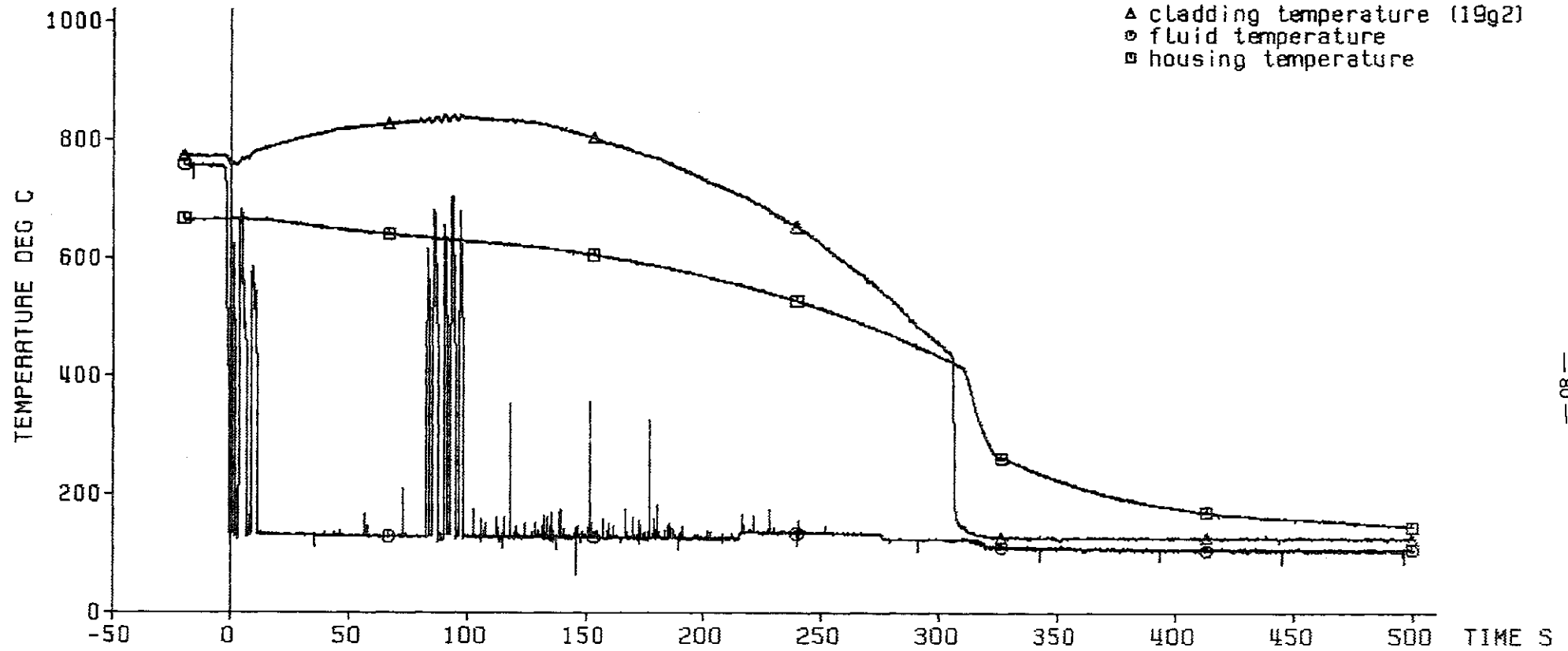

decay heat 120% ANS standard
flooding rate (cold) 5.81 cm/s
system pressure 2.08 bar
feedwater temperature 40 deg C

KfK
IRB

Fig. 67 FEBA: 5x5 ROD BUNDLE, TEST SERIES 1, TEST-No. 218

axial level: 1625 mm

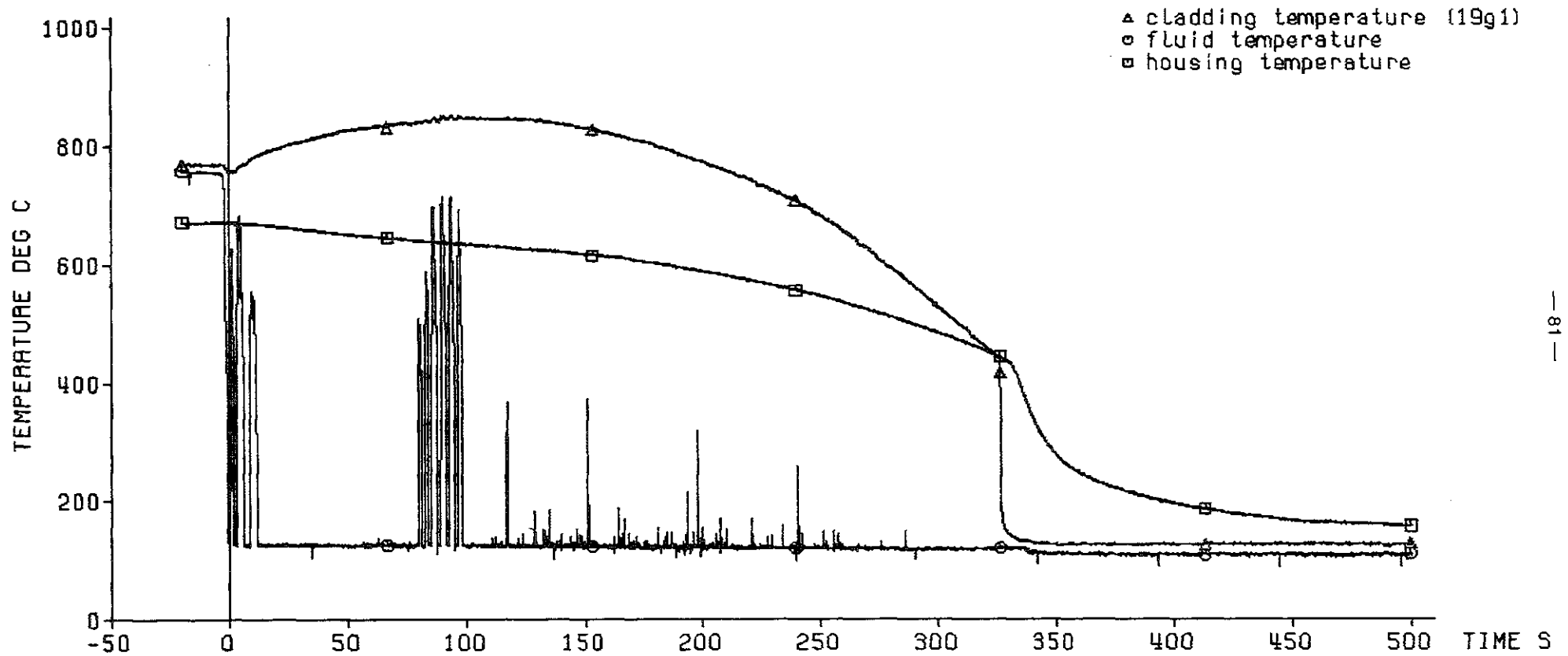

decay heat
flooding rate (cold) 5.81 cm/s
system pressure 2.08 bar
feedwater temperature 40 deg C

120% ANS standard



Fig. 68 FEBA: 5x5 R0D BUNDLE, TEST SERIES 1, TEST-No. 218

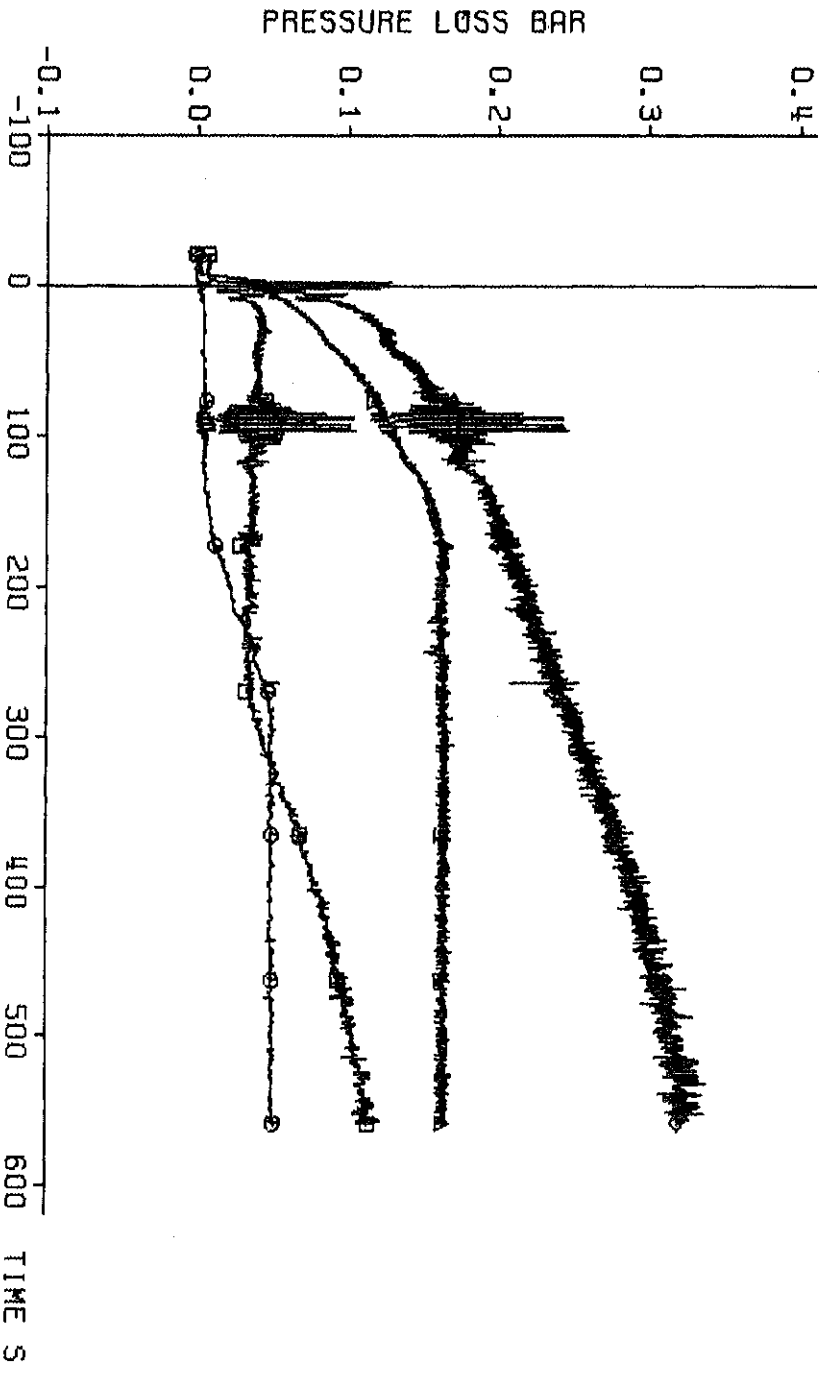

pressure loss
along the test section:

- ◆ total length: 4196 mm
- ▲ lower part: 1711 mm
- middle part: 545 mm
- upper part: 1940 mm

decay heat 120% ANS standard
 flooding rate (cold) 5.81 cm/s
 system pressure 2.08 bar
 feedwater temperature 40 deg C

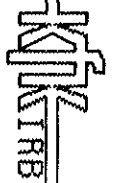
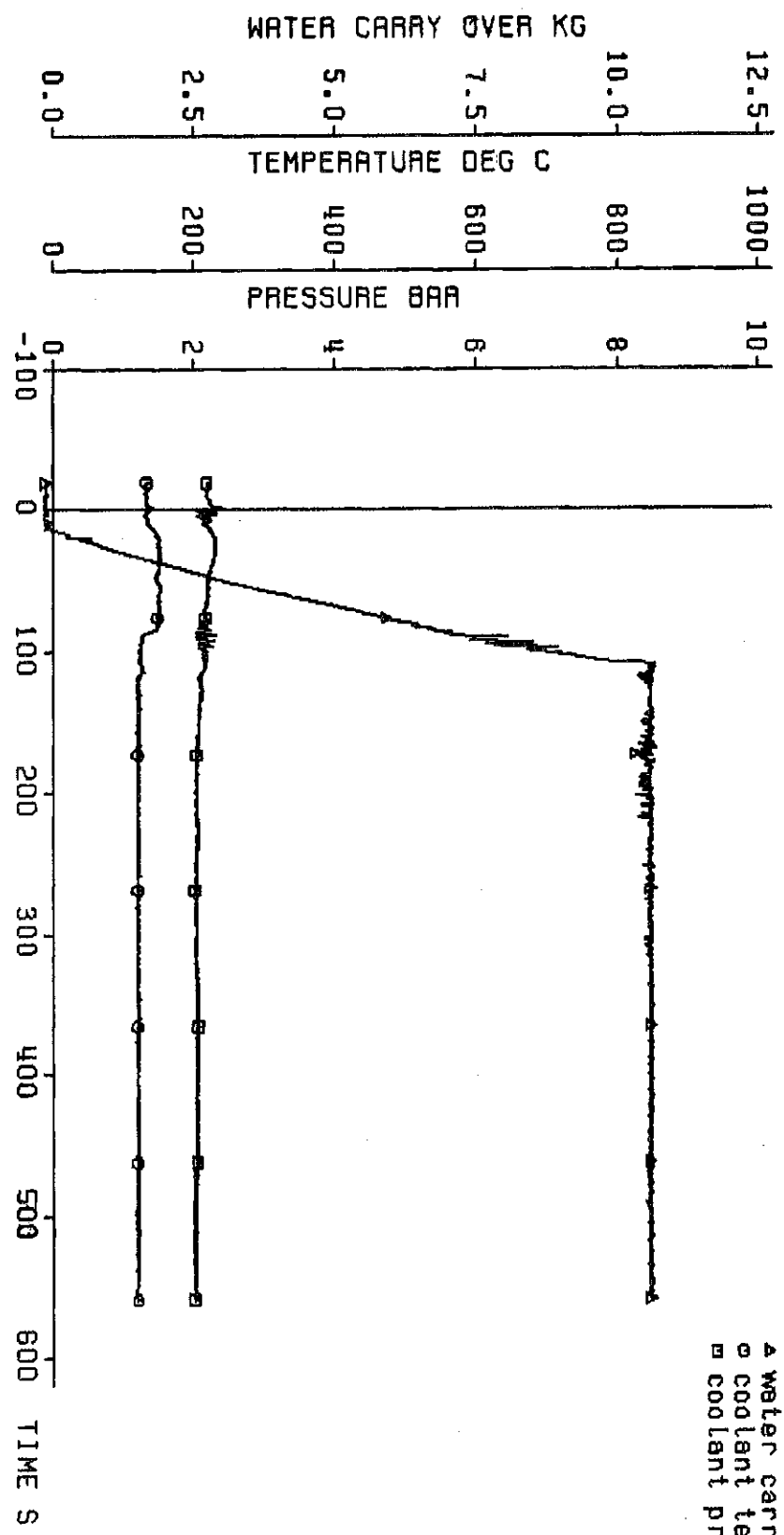

Fig. 69 FEBRA: 5x5 ROD BUNDLE, TEST SERIES 1, TEST-NO. 218

coolant outlet conditions:

- ▲ water carry over
- coolant temperature
- coolant pressure



decay heat
 flooding rate (cold)
 system pressure
 feedwater temperature

120% RNS standard
 5.81 cm/s
 2.08 bar
 40 deg C



Fig. 70 FEBRA: 5X5 ROD BUNDLE, TEST SERIES 1, TEST-NO. 218

axial position of the quench front

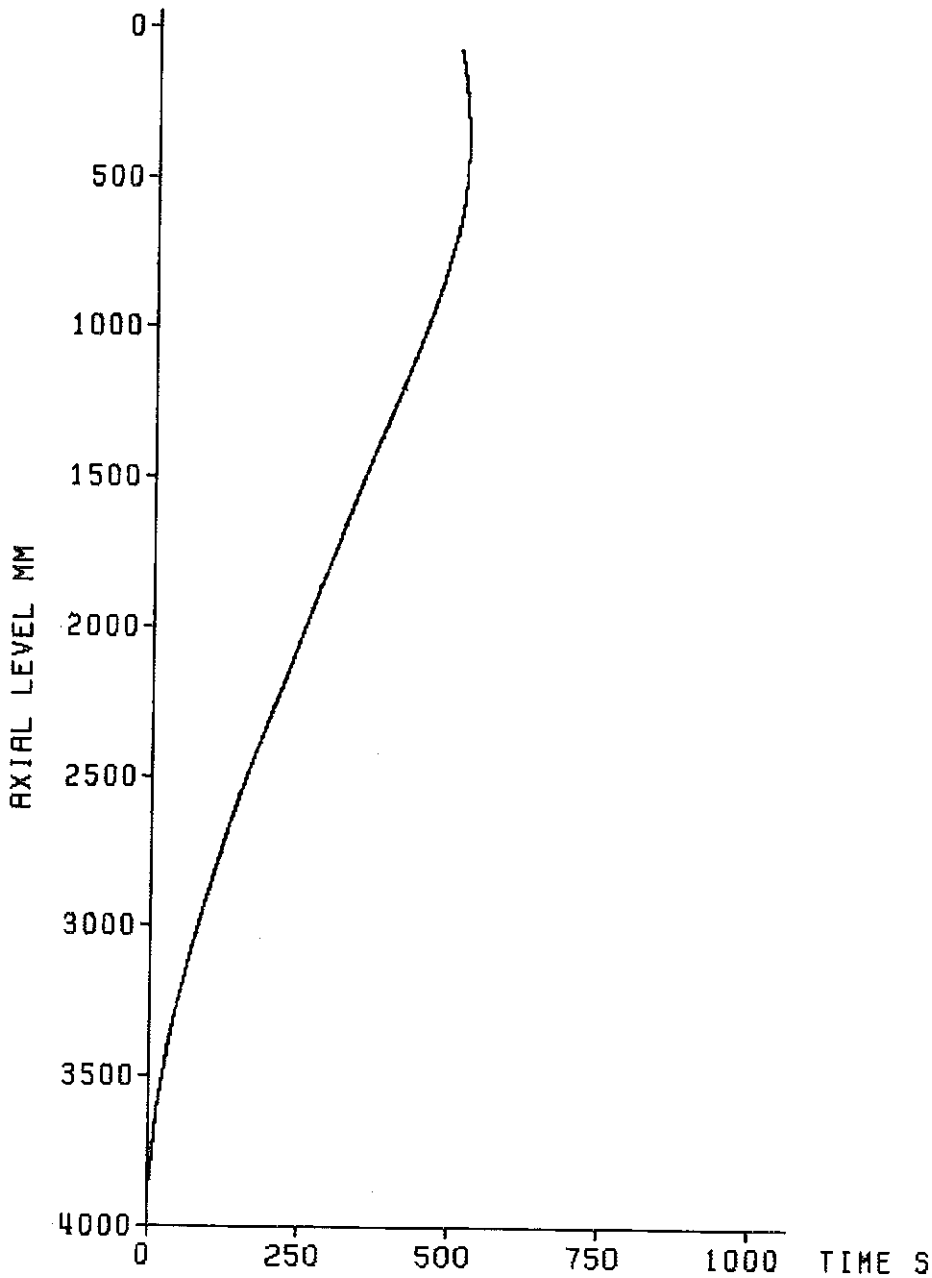

decay heat	120% ANS standard
flooding rate (cold)	5.81 cm/s
system pressure	2.08 bar
feedwater temperature	40 deg C



Fig. 71 FEBA: 5x5 ROD BUNDLE
TEST SERIES 1, TEST-No. 218

initial axial temperature profile of the cladding

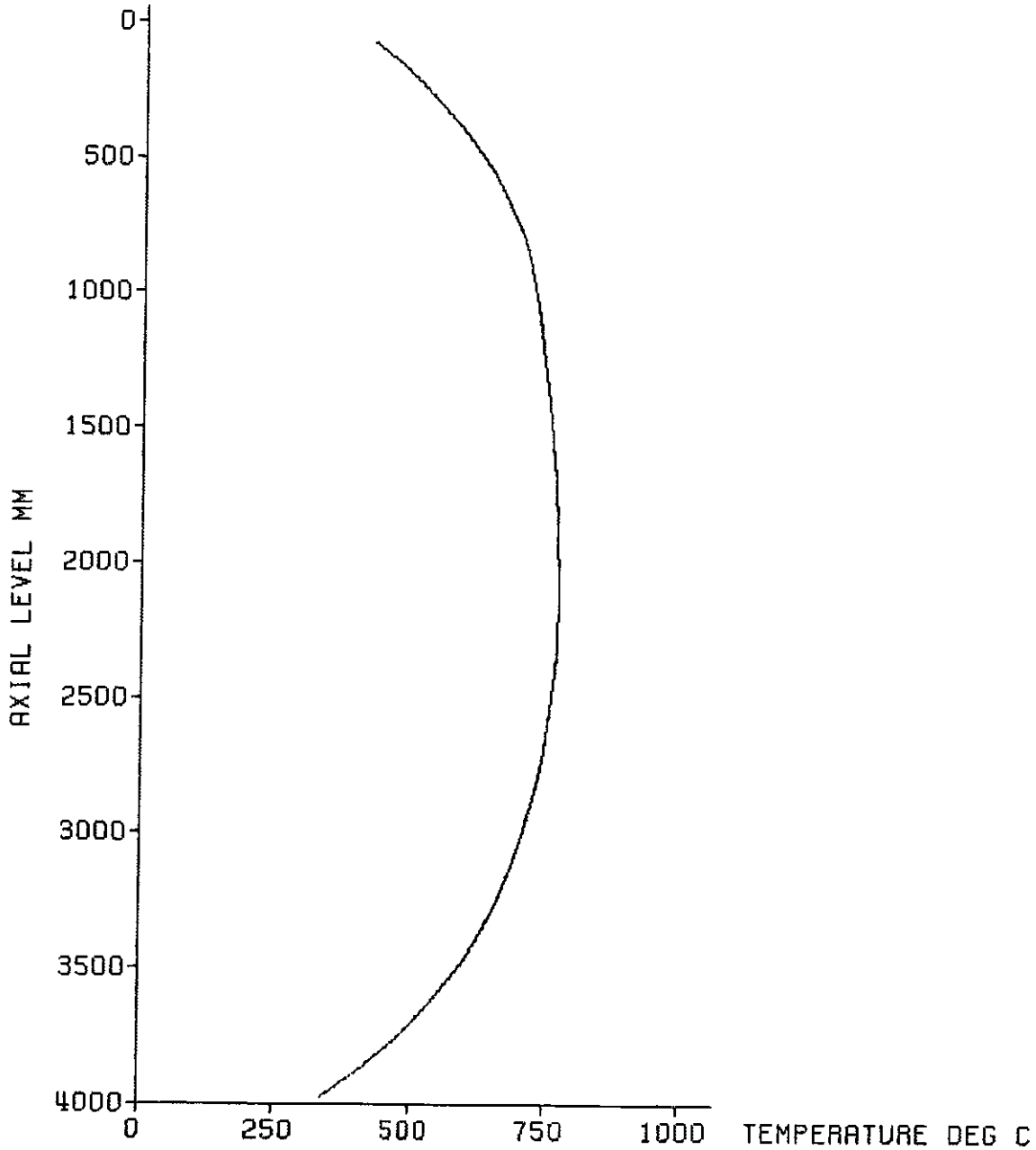

decay heat 120% ANS standard
flooding rate (cold) 5.77 cm/s
system pressure 4.11 bar
feedwater temperature 40 deg C



Fig. 72 FEBA: 5x5 ROD BUNDLE
TEST SERIES 1, TEST-NO. 214

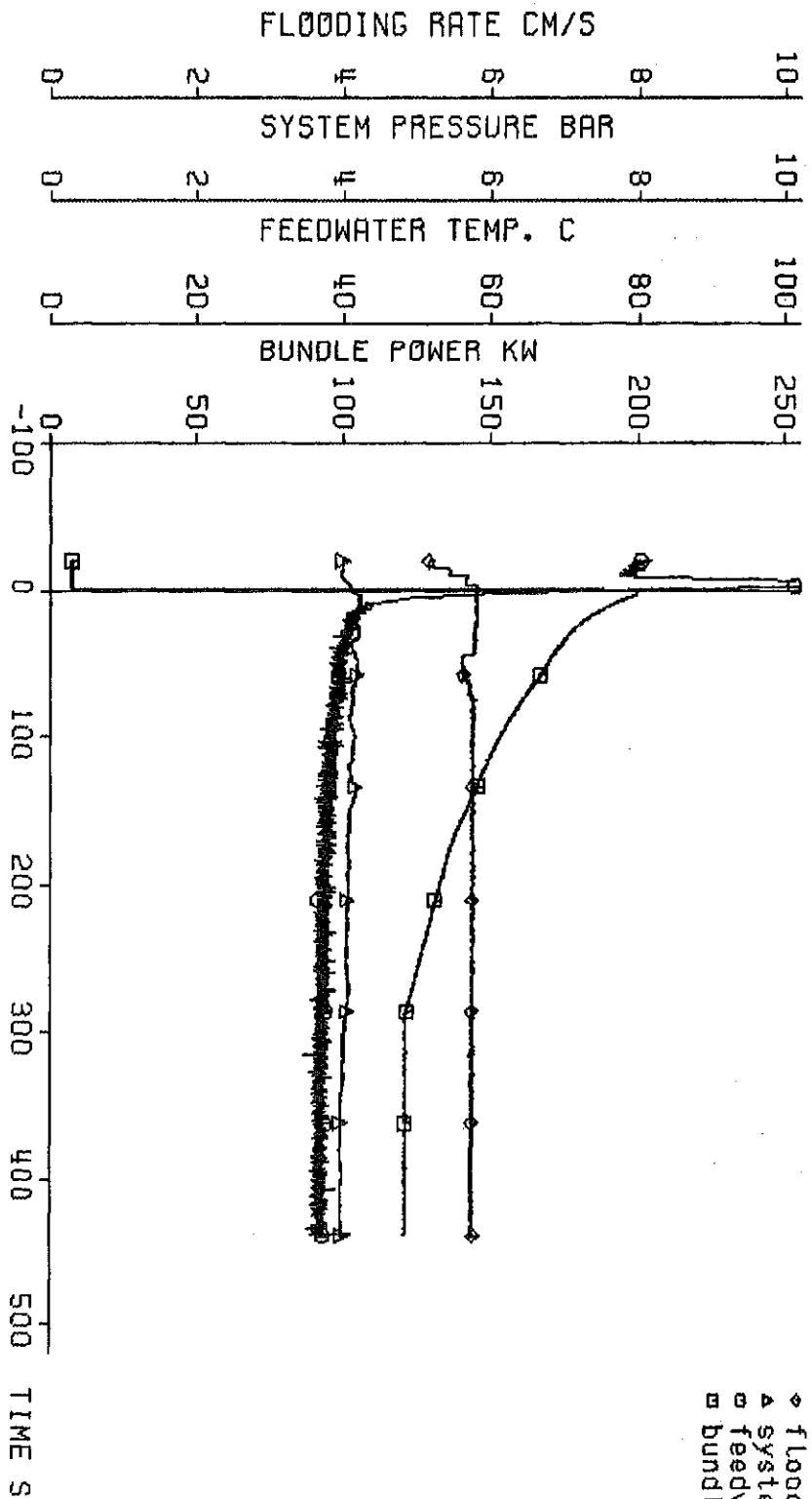

test parameters:
 ◆ flooding rate
 ▲ system pressure
 ◻ feedwater temperature
 ◻ bundle power

decay heat
 flooding rate (cold)
 system pressure
 feedwater temperature

120% ANS standard
 5.77 cm/s
 4.11 bar
 40 deg C



Fig. 73 FEBRA: 5X5 ROD BUNDLE, TEST SERIES 1, TEST-NO. 214

cladding temperature

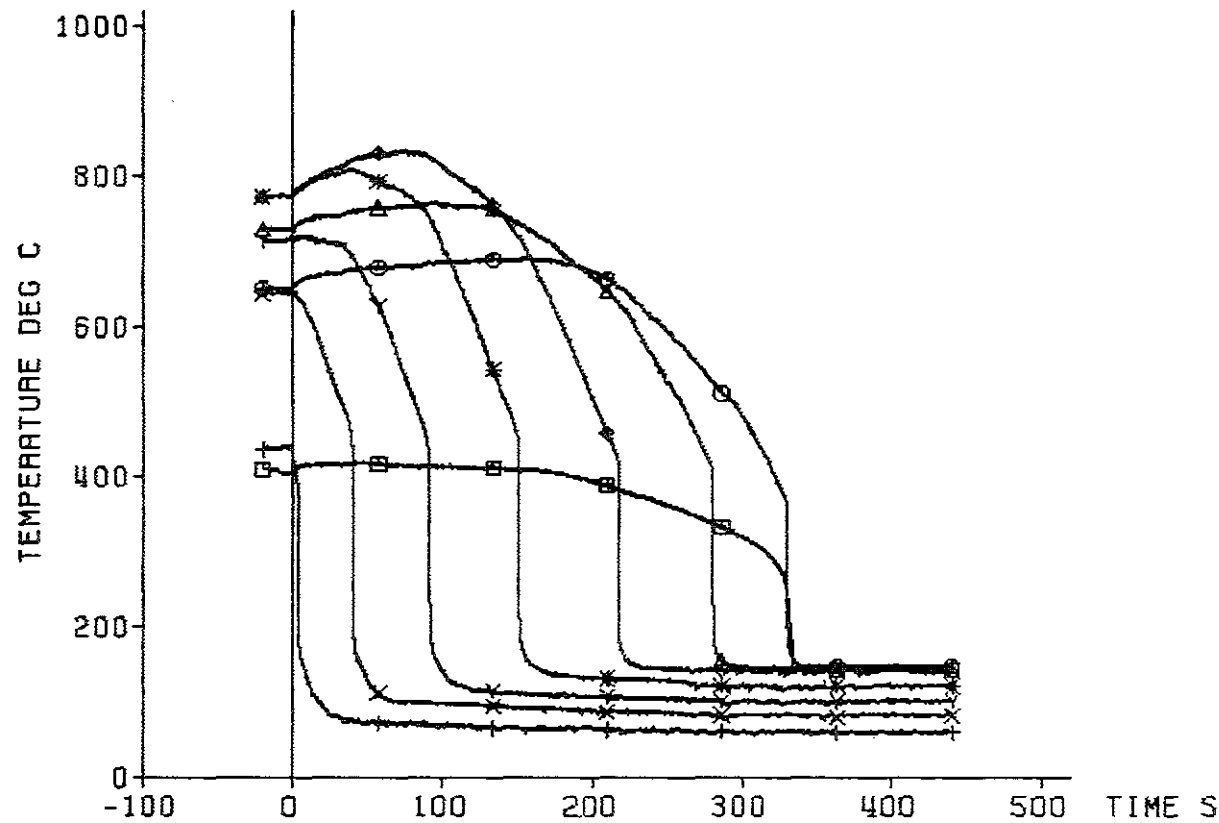

TC	ax. Level
+	18a4 3860 mm
x	18a3 3315 mm
Y	18a2 2770 mm
*	18a1 2225 mm
◇	12b4 1680 mm
△	12b3 1135 mm
○	12b2 590 mm
□	12b1 45 mm

decay heat 120% ANS standard
 flooding rate (cold) 5.77 cm/s
 system pressure 4.11 bar
 feedwater temperature 40 deg C



Fig. 74 FEBA: 5x5 ROD BUNDLE, TEST SERIES 1, TEST-No. 214

heat transfer coeff.

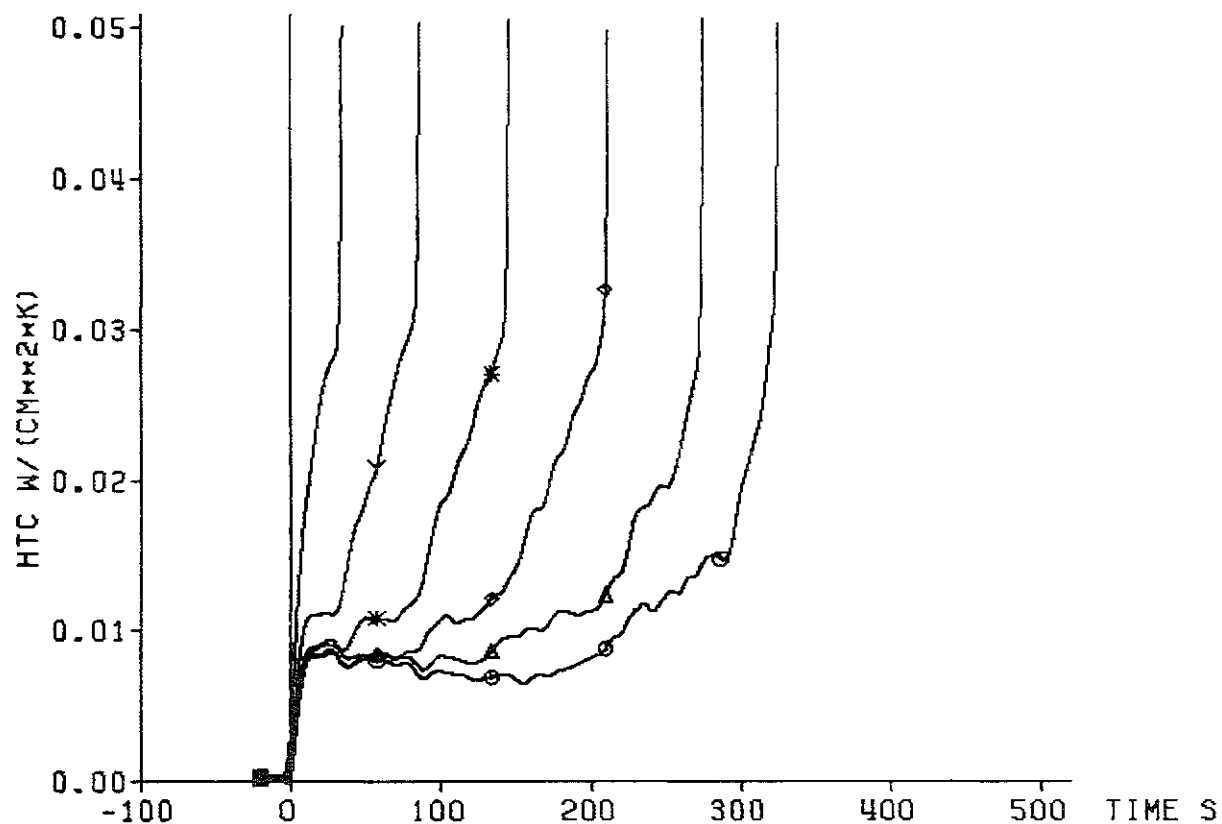

	TC	ax. Level
x	18a3	3315 mm
+	18a2	2770 mm
*	18a1	2225 mm
◇	12b4	1680 mm
△	12b3	1135 mm
○	12b2	590 mm

decay heat 120% RNS standard
 flooding rate (cold) 5.77 cm/s
 system pressure 4.11 bar
 feedwater temperature 40 deg C



Fig. 75 FEBA: 5x5 ROD BUNDLE, TEST SERIES 1, TEST-No. 214

cladding temperature

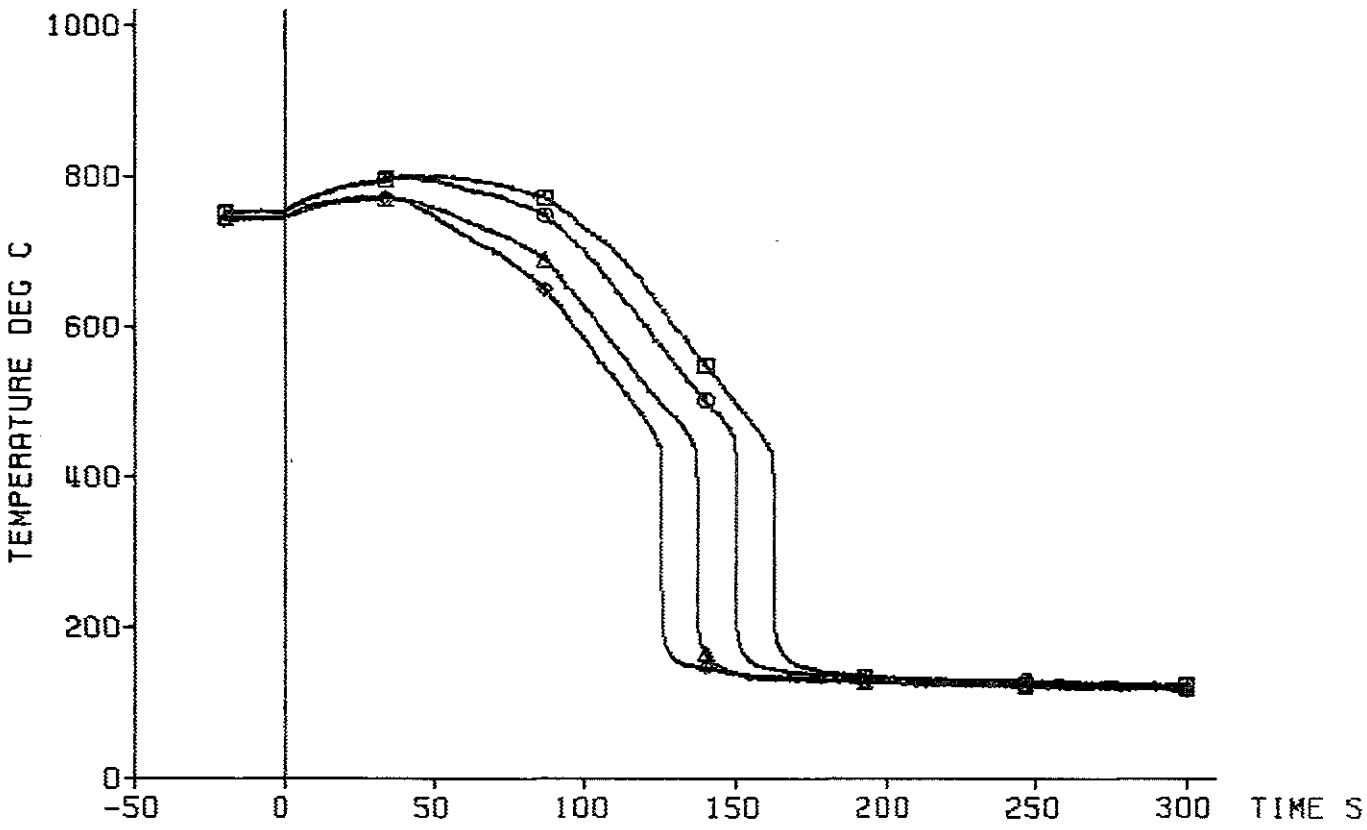

decay heat 120% RNS standard
flooding rate (cold) 5.77 cm/s
system pressure 4.11 bar
feedwater temperature 40 deg C



Fig. 76 FEBA: 5x5 ROD BUNDLE, TEST SERIES 1, TEST-No. 214

heat transfer coeff.

TC	ex. Level
◇	7f4 2425 mm
△	7f3 2325 mm
○	7f2 2225 mm
□	7f1 2125 mm

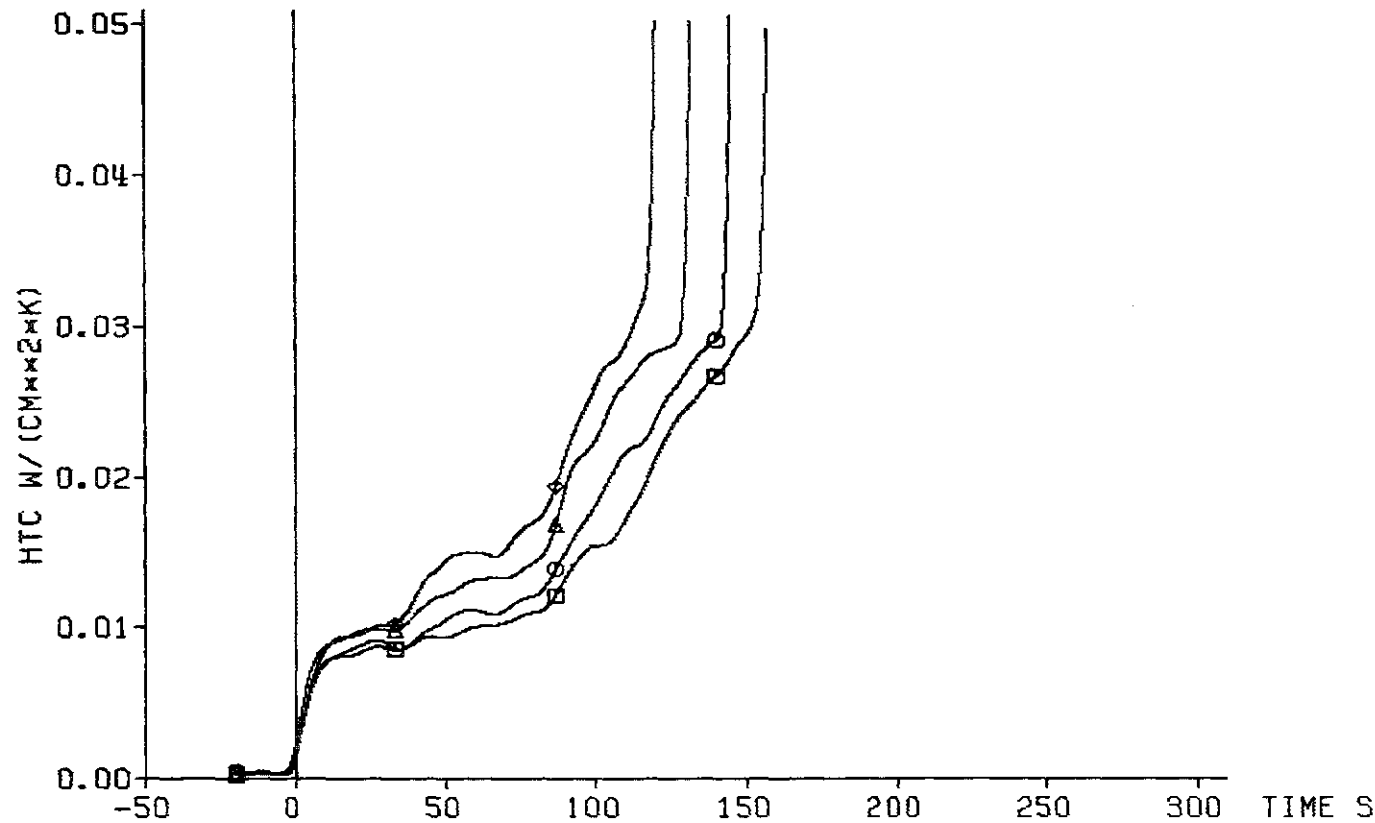

decay heat 120% ANS standard
 flooding rate (cold) 5.77 cm/s
 system pressure 4.11 bar
 feedwater temperature 40 deg C



Fig. 77 FEBA: 5x5 ROD BUNDLE, TEST SERIES 1, TEST-No. 214

cladding temperature

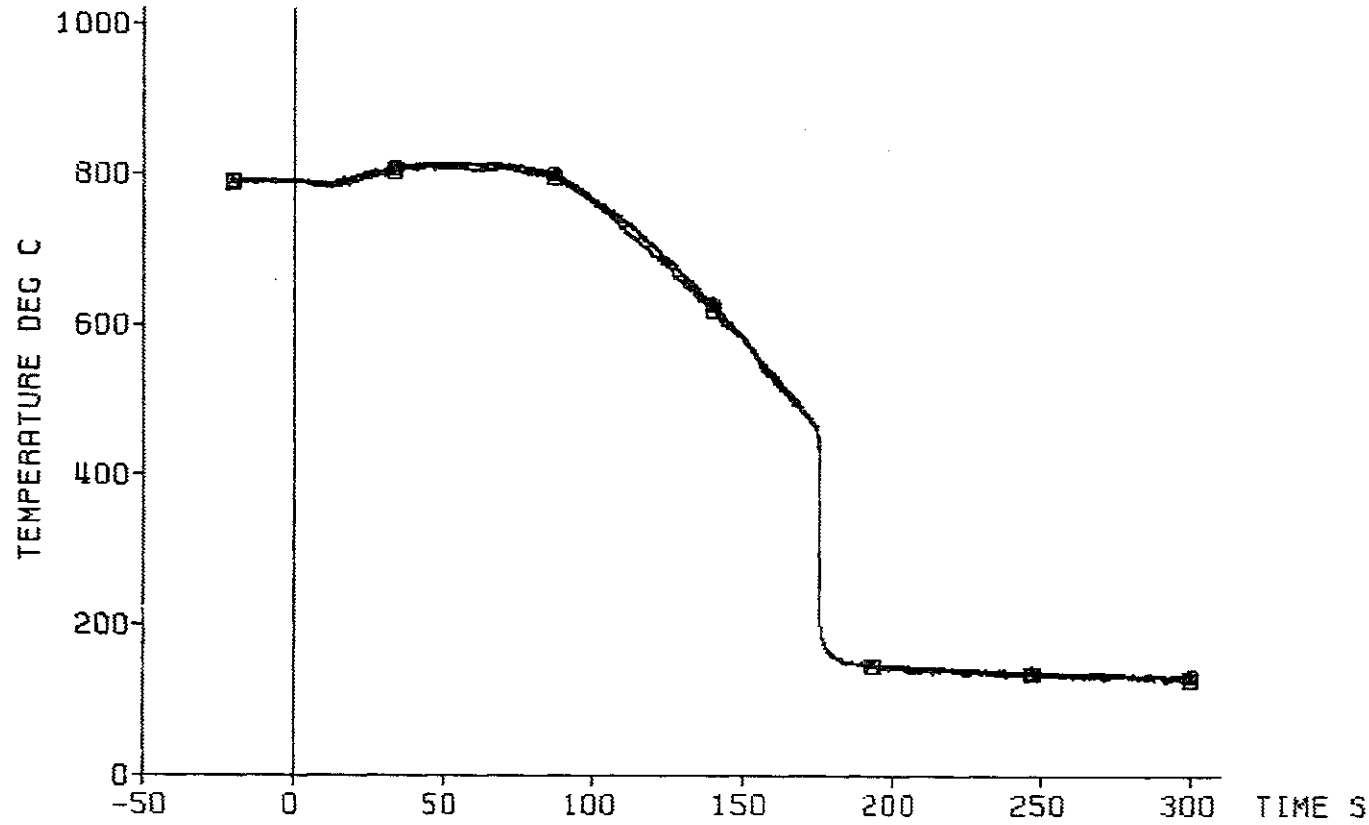

TC	ax. level
△ 13d3	2025 mm
⊙ 13d2	2025 mm
⊠ 13d1	2025 mm

decay heat 120% AWS standard
flooding rate (cold) 5.77 cm/s
system pressure 4.11 bar
feedwater temperature 40 deg C

KIK
IRB

Fig. 78 FEBA: 5x5 ROD BUNDLE, TEST SERIES 1, TEST-NO. 214

heat transfer coeff.

	TC	axial level
▲	13d3	2025 mm
○	13d2	2025 mm
□	13d1	2025 mm

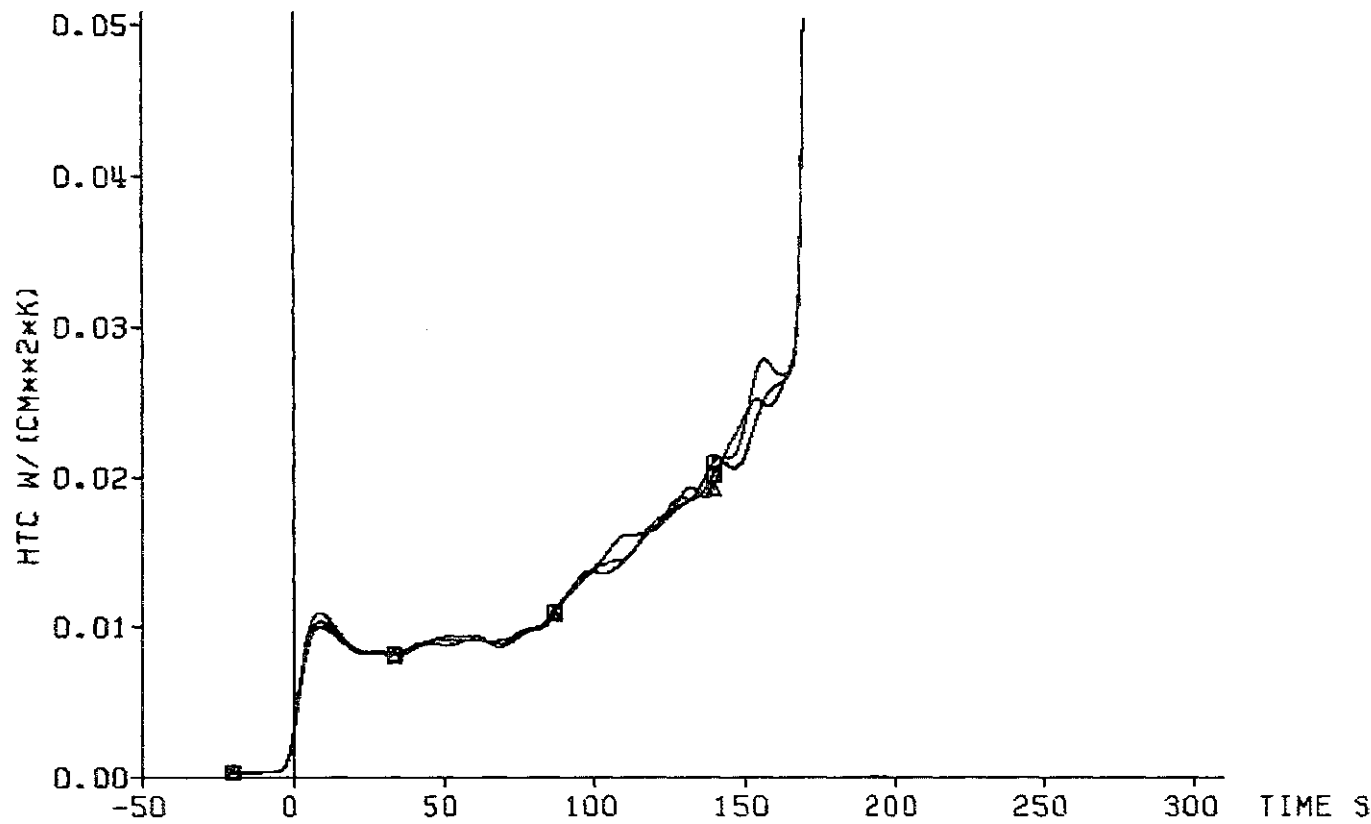

decay heat 120% ANS standard
flooding rate (cold) 5.77 cm/s
system pressure 4.11 bar
feedwater temperature 40 deg C



Fig. 79 FEBA: 5x5 ROD BUNDLE, TEST SERIES 1, TEST-No. 214

cladding temperature

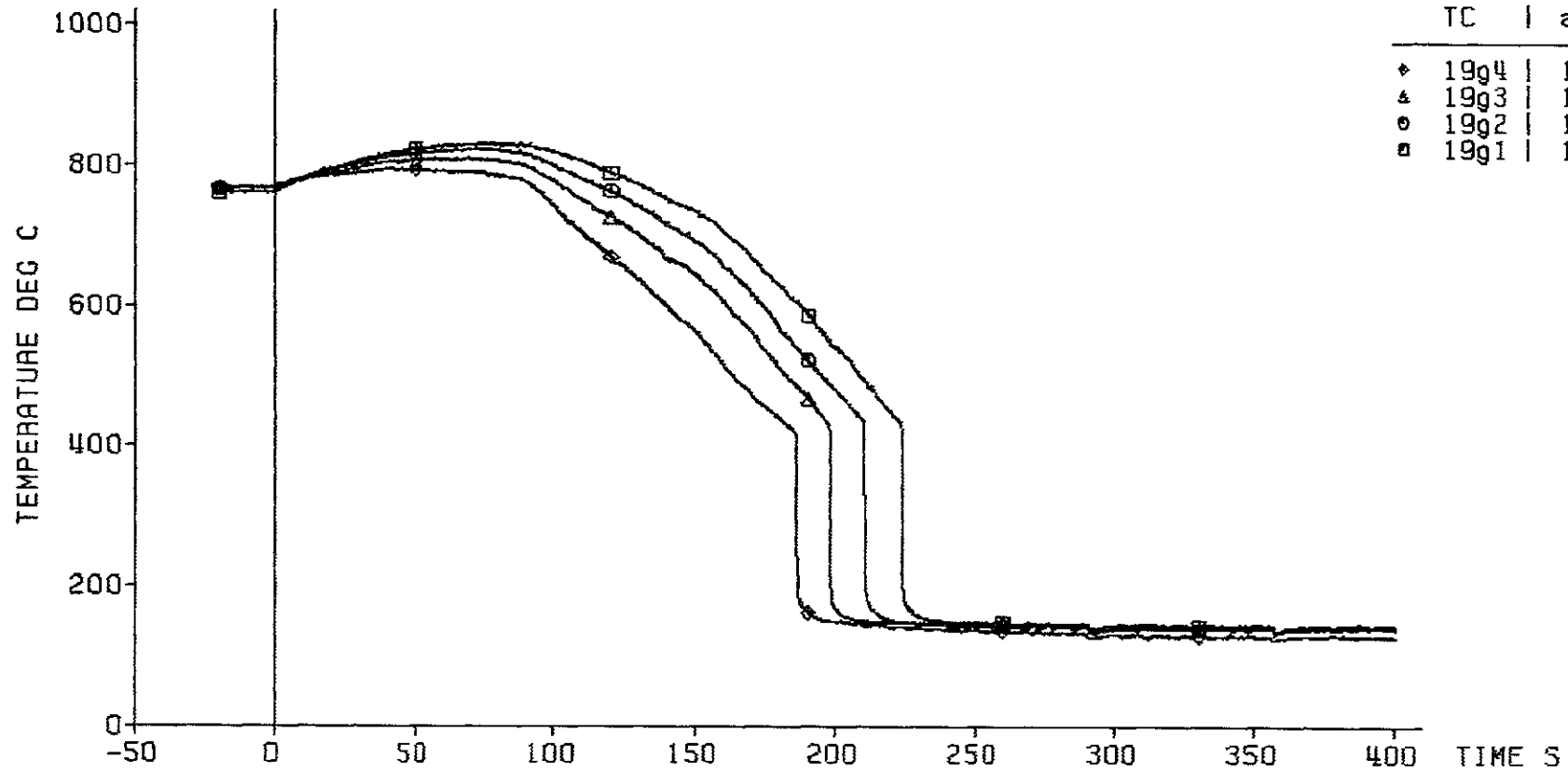

decay heat 120% RNS standard
flooding rate (cold) 5.77 cm/s
system pressure 4.11 bar
feedwater temperature 40 deg C



Fig. 80 FEBA: 5x5 ROD BUNDLE, TEST SERIES 1, TEST-No. 214

heat transfer coeff.

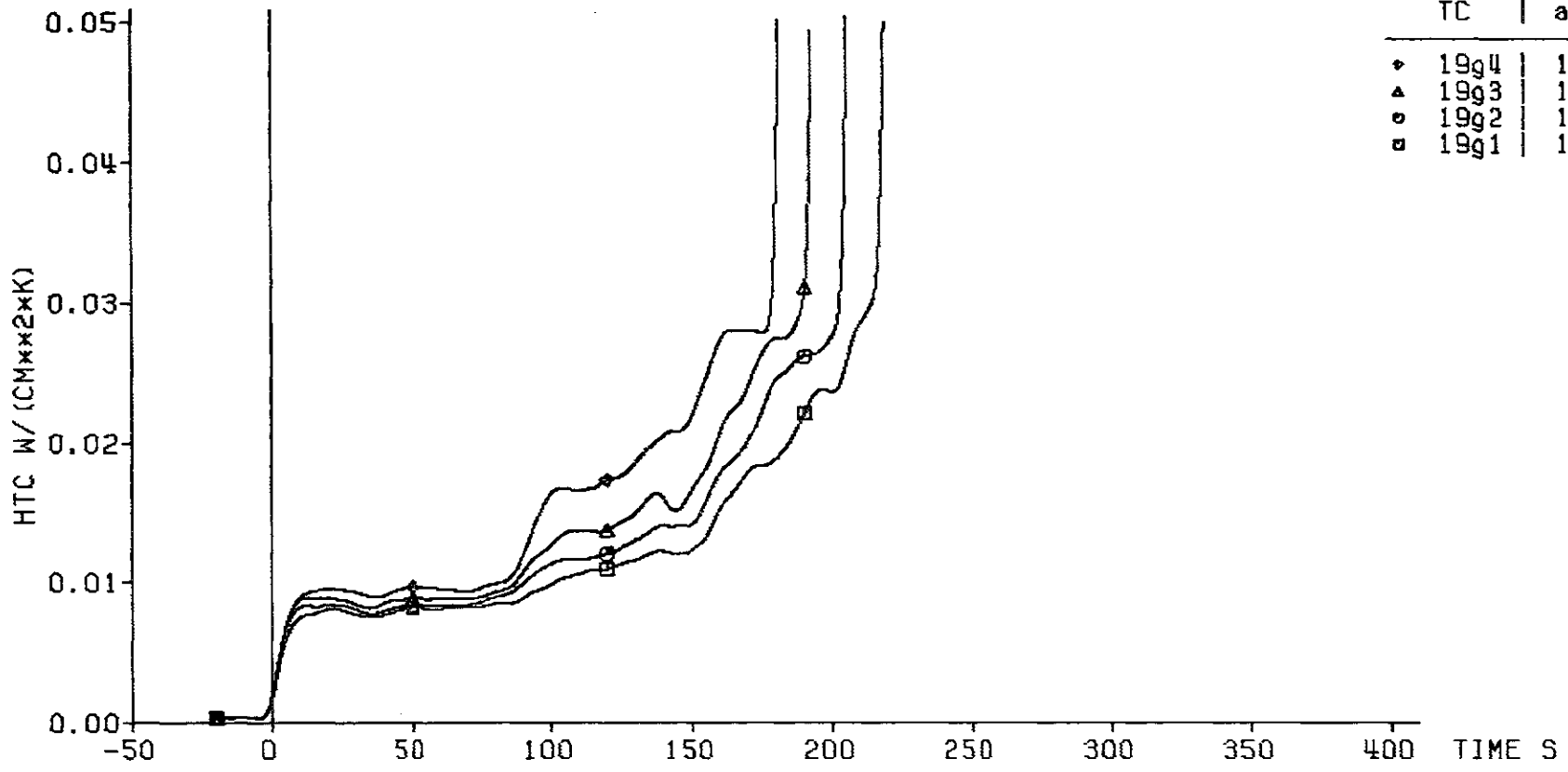

TC	ax. level
◆	19g4 1925 mm
▲	19g3 1825 mm
○	19g2 1725 mm
□	19g1 1625 mm

decay heat 120% ANS standard
 flooding rate (cold) 5.77 cm/s
 system pressure 4.11 bar
 feedwater temperature 40 deg C



Fig. 81 FEBA: 5x5 ROD BUNDLE, TEST SERIES 1, TEST-No. 214

axial level: 1725 mm

▲ cladding temperature (19g2)
● fluid temperature
■ housing temperature

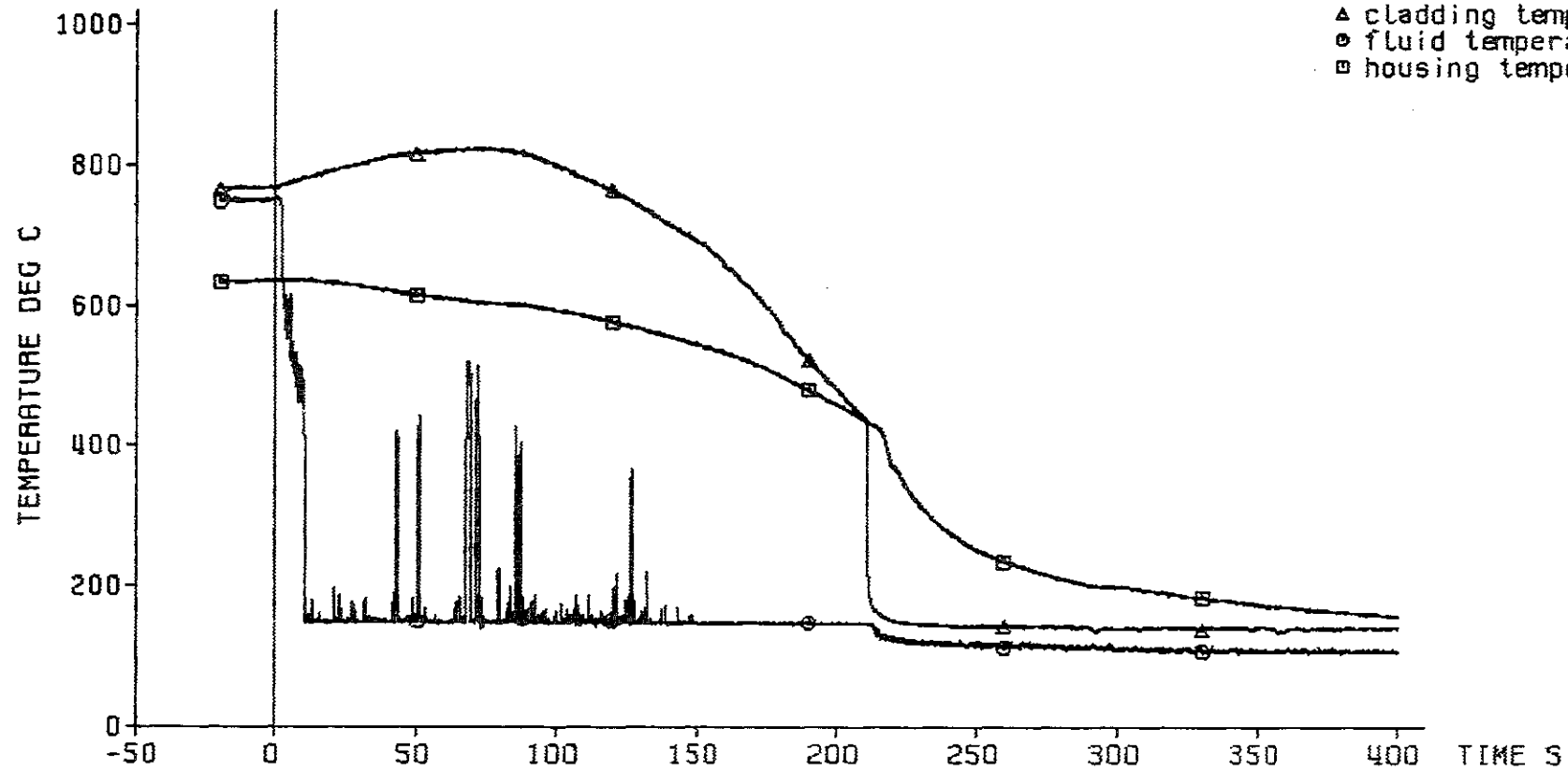

decay heat 120% RMS standard
flooding rate (cold) 5.77 cm/s
system pressure 4.11 bar
feedwater temperature 40 deg C

— 96 —



Fig. 82 FEBA: 5x5 ROD BUNDLE, TEST SERIES 1, TEST-No. 214

axial level: 1625 mm

▲ cladding temperature (19g1)
○ fluid temperature
■ housing temperature

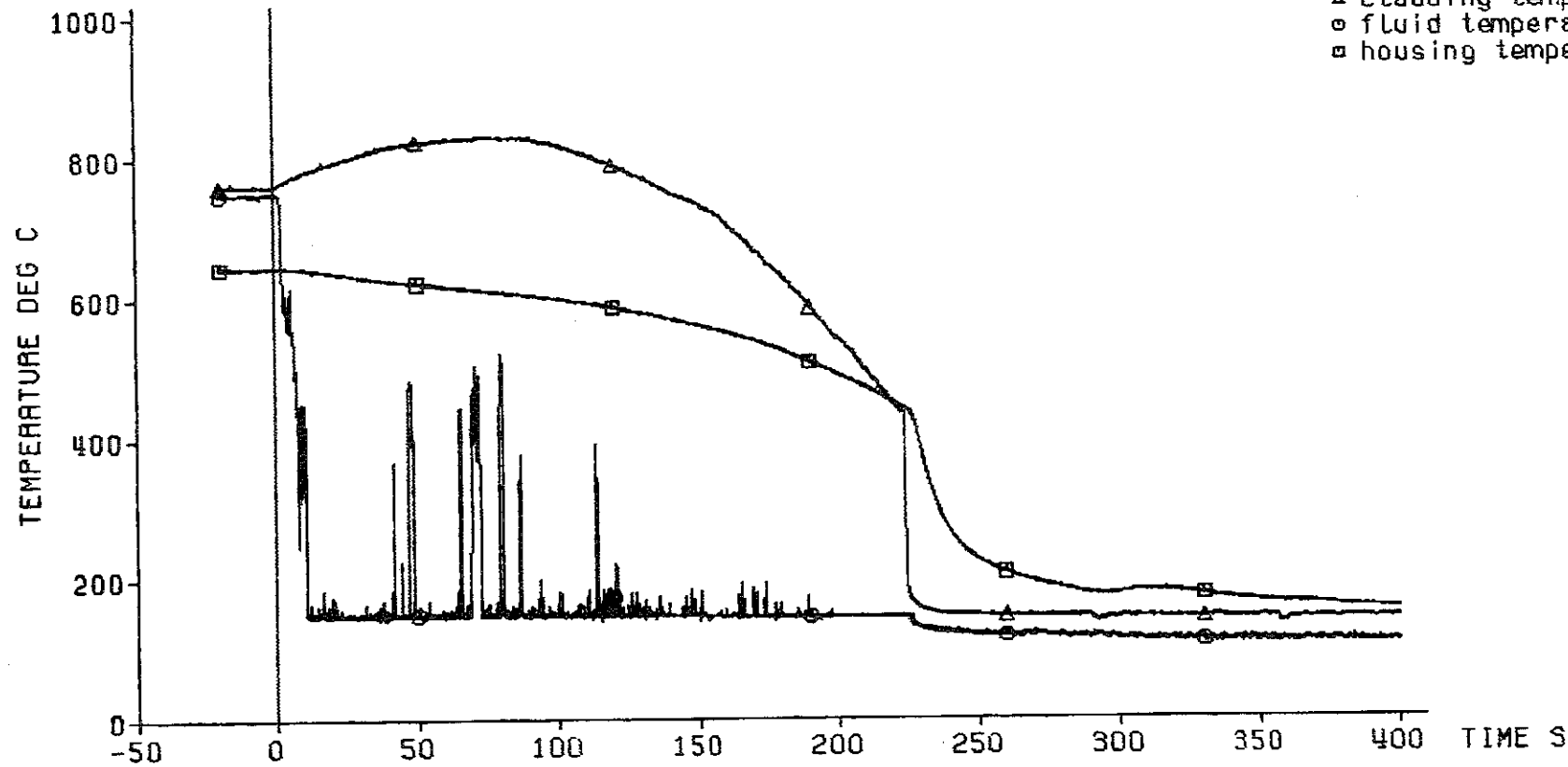

decay heat 120% ANS standard
flooding rate (cold) 5.77 cm/s
system pressure 4.11 bar
feedwater temperature 40 deg C



Fig. 83 FEBA: 5x5 ROD BUNDLE, TEST SERIES 1, TEST-No. 214

pressure loss
along the test section:

◆ total length: 4196 mm
△ lower part: 1711 mm
○ middle part: 545 mm
□ upper part: 1940 mm

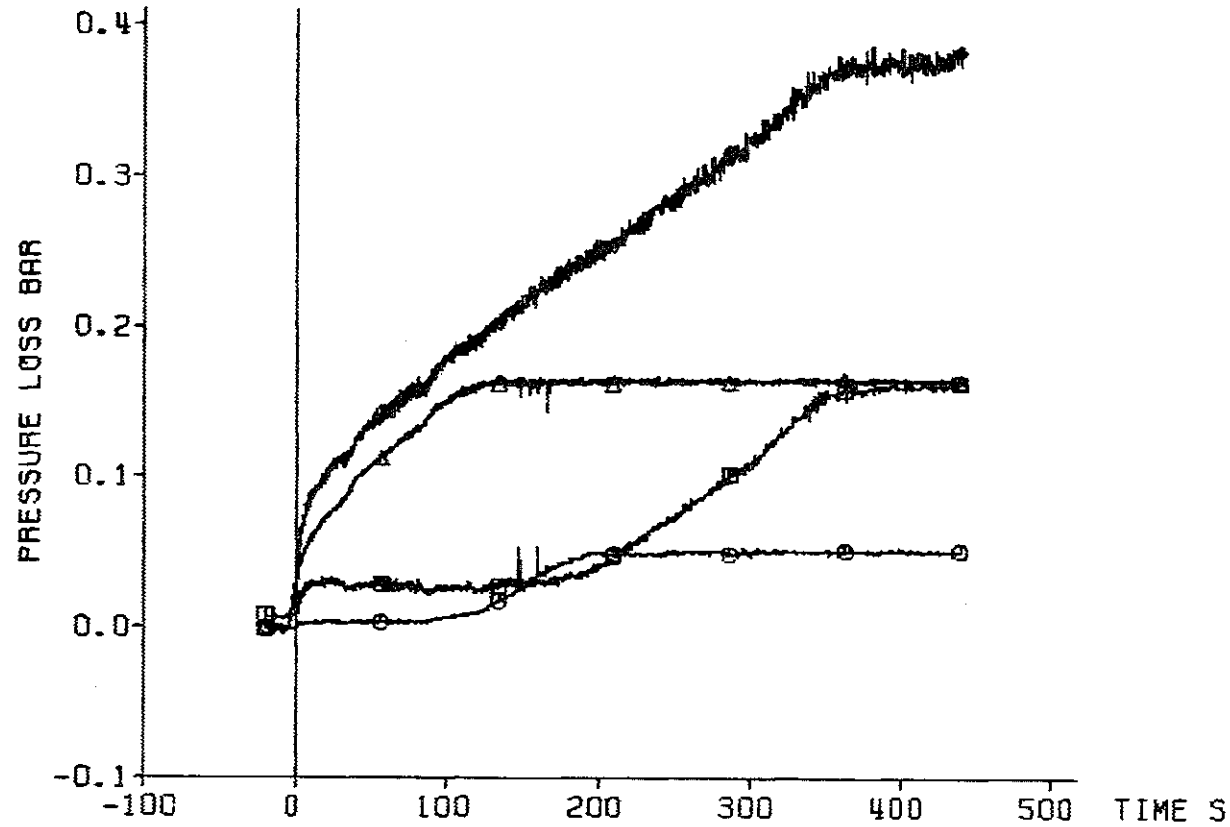

decay heat 120% RMS standard
flooding rate (cold) 5.77 cm/s
system pressure 4.11 bar
feedwater temperature 40 deg C

KIK
IRB

Fig. 84 FEBA: 5x5 ROD BUNDLE, TEST SERIES 1, TEST-No. 214

coolant outlet conditions:

▲ water carry over
○ coolant temperature
■ coolant pressure

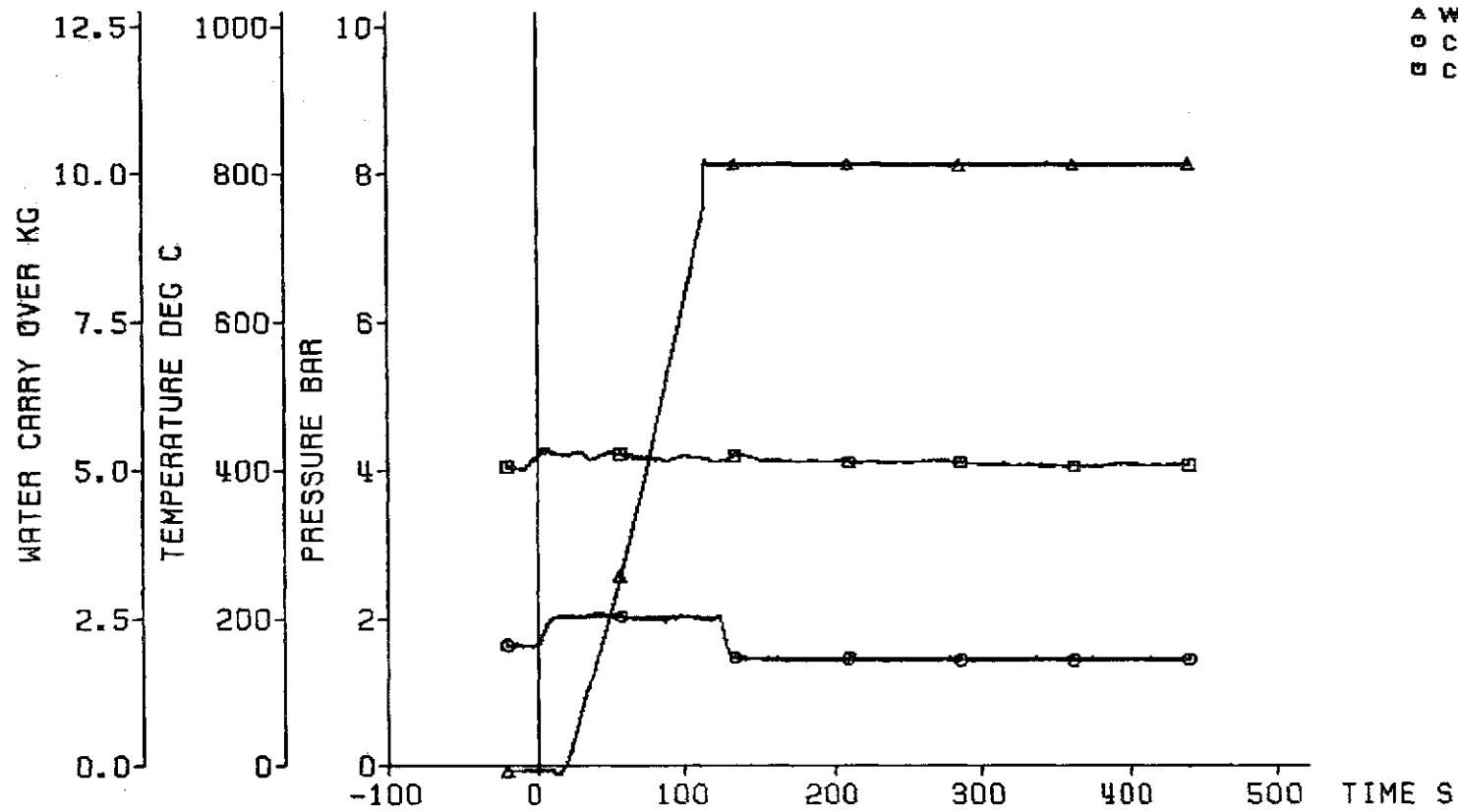

decay heat
flooding rate (cold) 120% ANS standard
system pressure 5.77 cm/s
feedwater temperature 4.11 bar
40 deg C

KIK IRB

Fig. 85 FEBA: 5x5 ROD BUNDLE, TEST SERIES 1, TEST-No. 214

axial position of the quench front

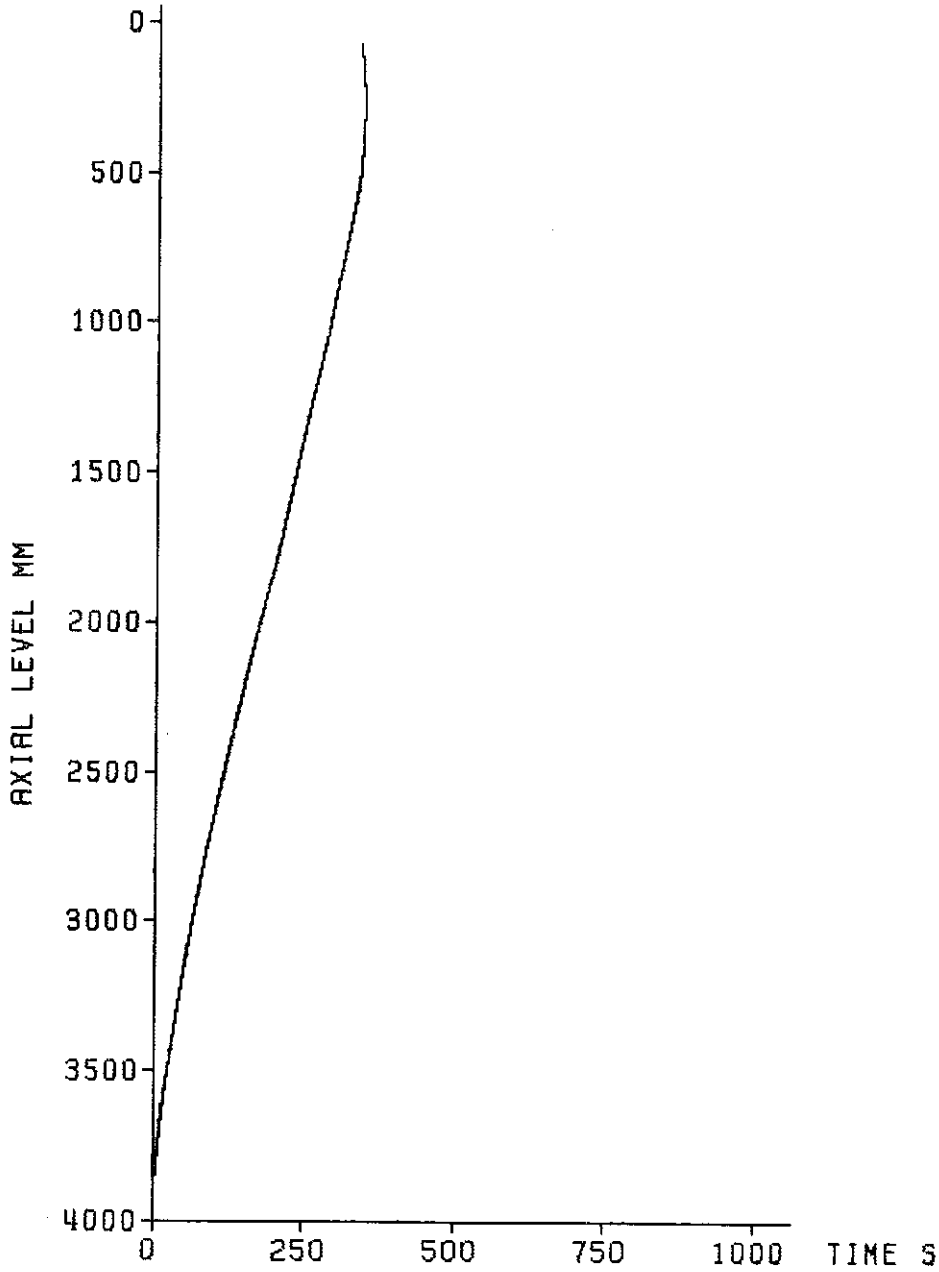

decay heat	120% ANS standard
flooding rate (cold)	5.77 cm/s
system pressure	4.11 bar
feedwater temperature	40 deg C



Fig. 86 FEBA: 5x5 ROD BUNDLE
TEST SERIES 1, TEST-NO. 214

initial axial temperature profile of the cladding

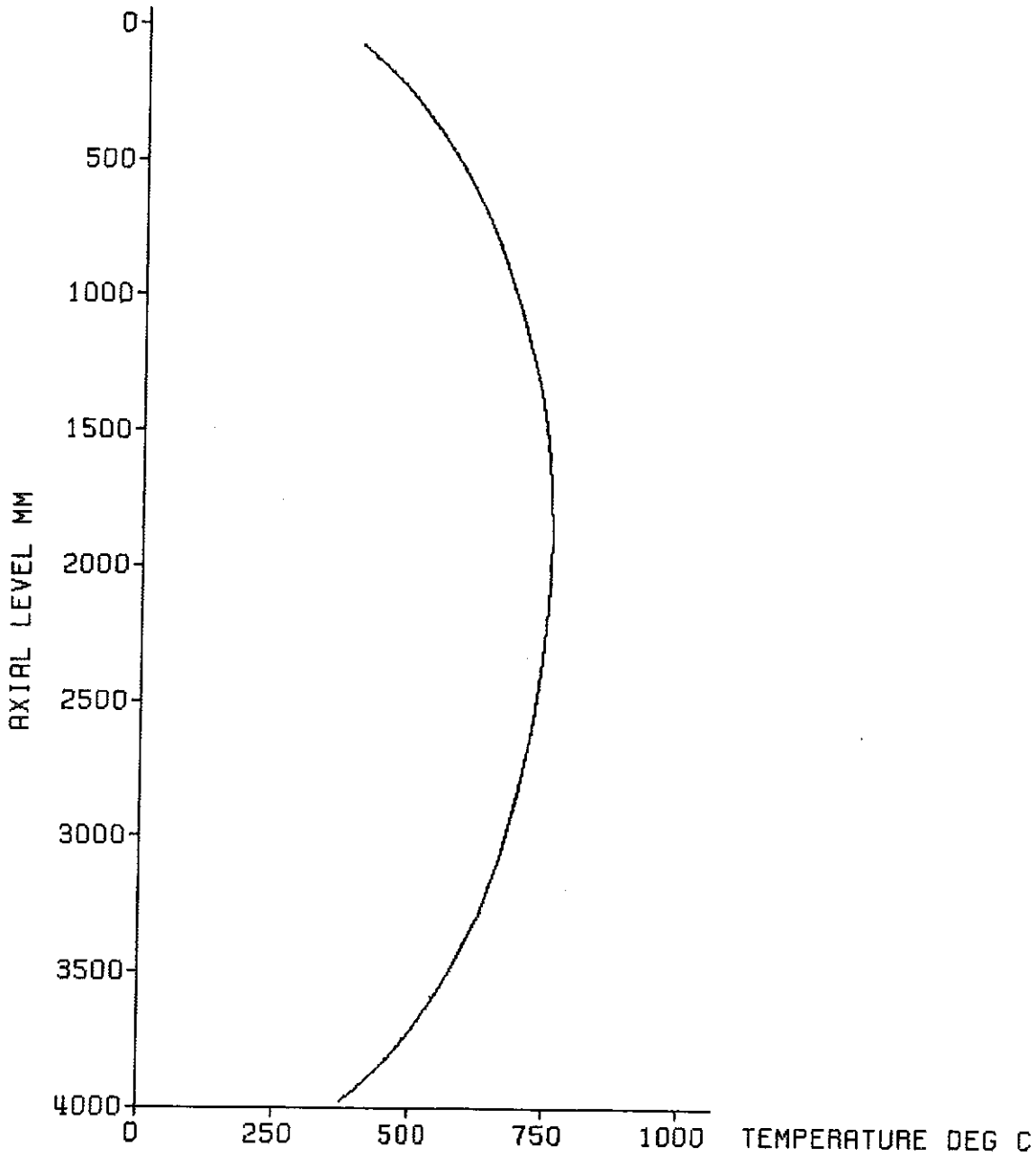

decay heat	120% ANS standard
flooding rate (cold)	5.78 cm/s
system pressure	6.18 bar
feedwater temperature	40 deg C



Fig. 87 FEBA: 5x5 ROD BUNDLE
TEST SERIES 1, TEST-No. 222

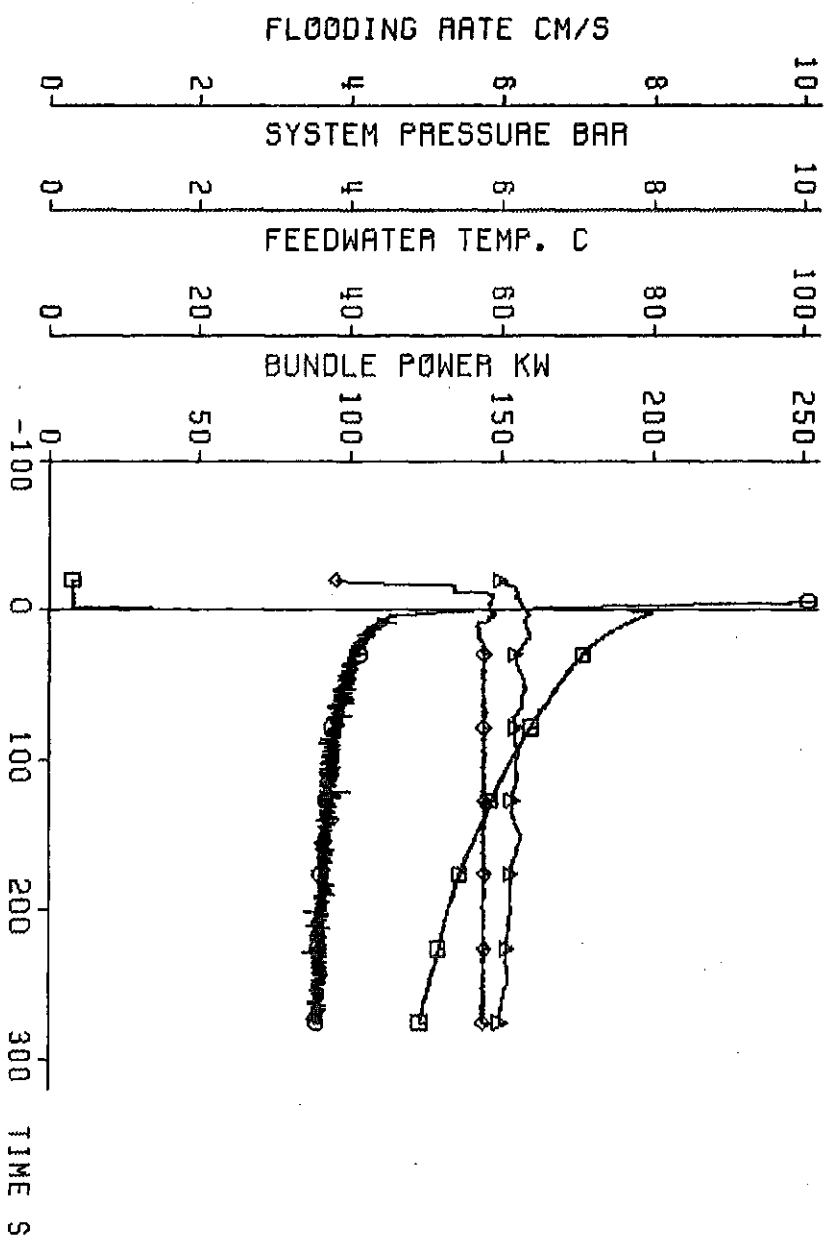

test parameters:

- ◆ flooding rate
- ▲ system pressure
- feedwater temperature
- bundle power

decay heat
 flooding rate (cold) 120% RMS standard
 system pressure 5.78 cm/s
 feedwater temperature 6.18 bar
 40 deg C



Fig. 88 FEBRA: 5X5 ROD BUNDLE, TEST SERIES 1, TEST-NO. 222

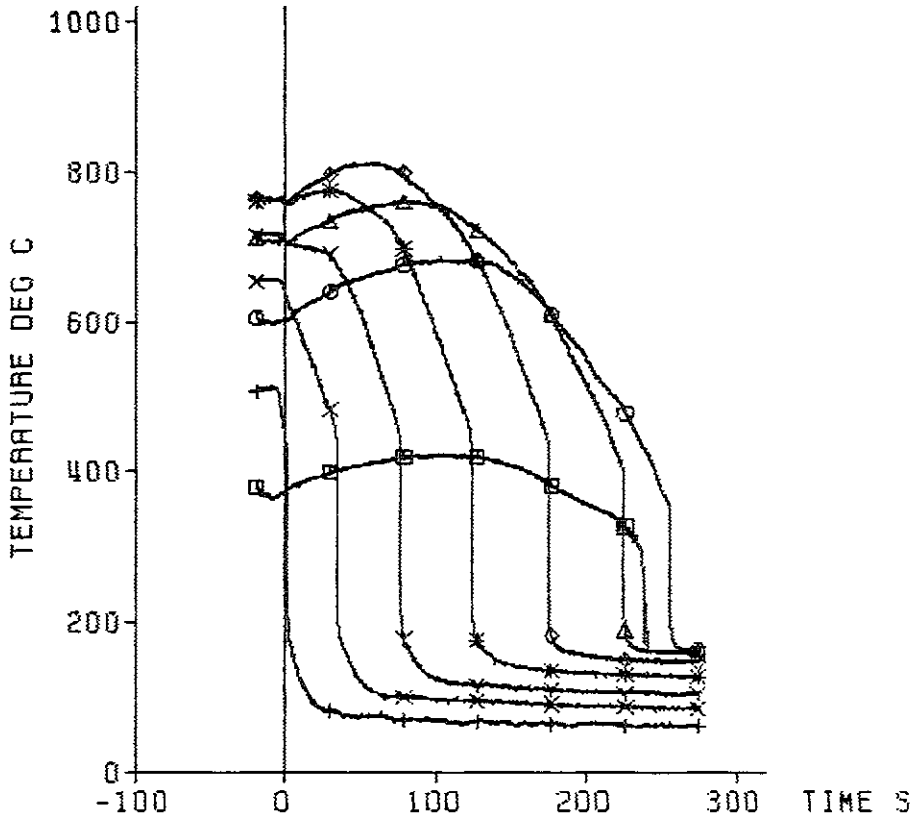

TC	ax. Level
+	18a4 3860 mm
x	18a3 3315 mm
Y	18a2 2770 mm
*	18a1 2225 mm
◇	12b4 1680 mm
△	12b3 1135 mm
○	12b2 590 mm
□	12b1 45 mm

decay heat 120% ANS standard
 flooding rate (cold) 5.78 cm/s
 system pressure 6.16 bar
 feedwater temperature 40 deg C



Fig. 89 FEBA: 5x5 ROD BUNDLE, TEST SERIES 1, TEST-No. 222

heat transfer coeff.

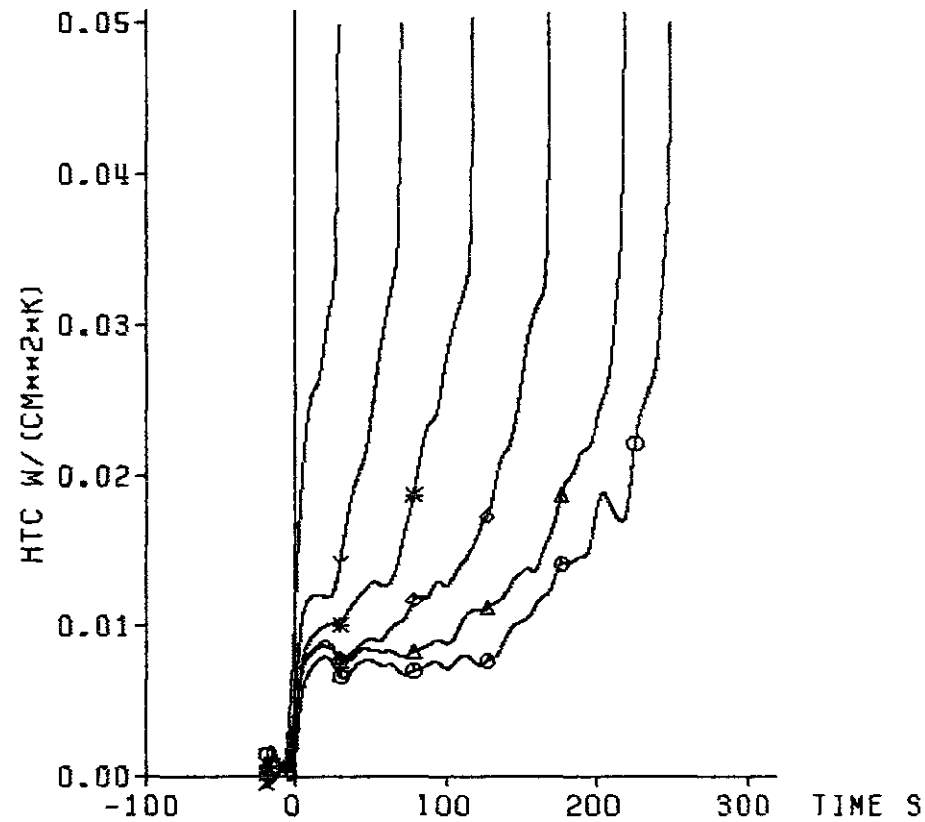

TC	ax. Level
x 18a3	3315 mm
y 18a2	2770 mm
* 18a1	2225 mm
◇ 12b4	1680 mm
△ 12b3	1135 mm
○ 12b2	590 mm

decay heat 120% ANS standard
 flooding rate (cold) 5.78 cm/s
 system pressure 6.18 bar
 feedwater temperature 40 deg C



Fig. 90 FEBA: 5x5 ROD BUNDLE, TEST SERIES 1, TEST-No. 222

cladding temperature

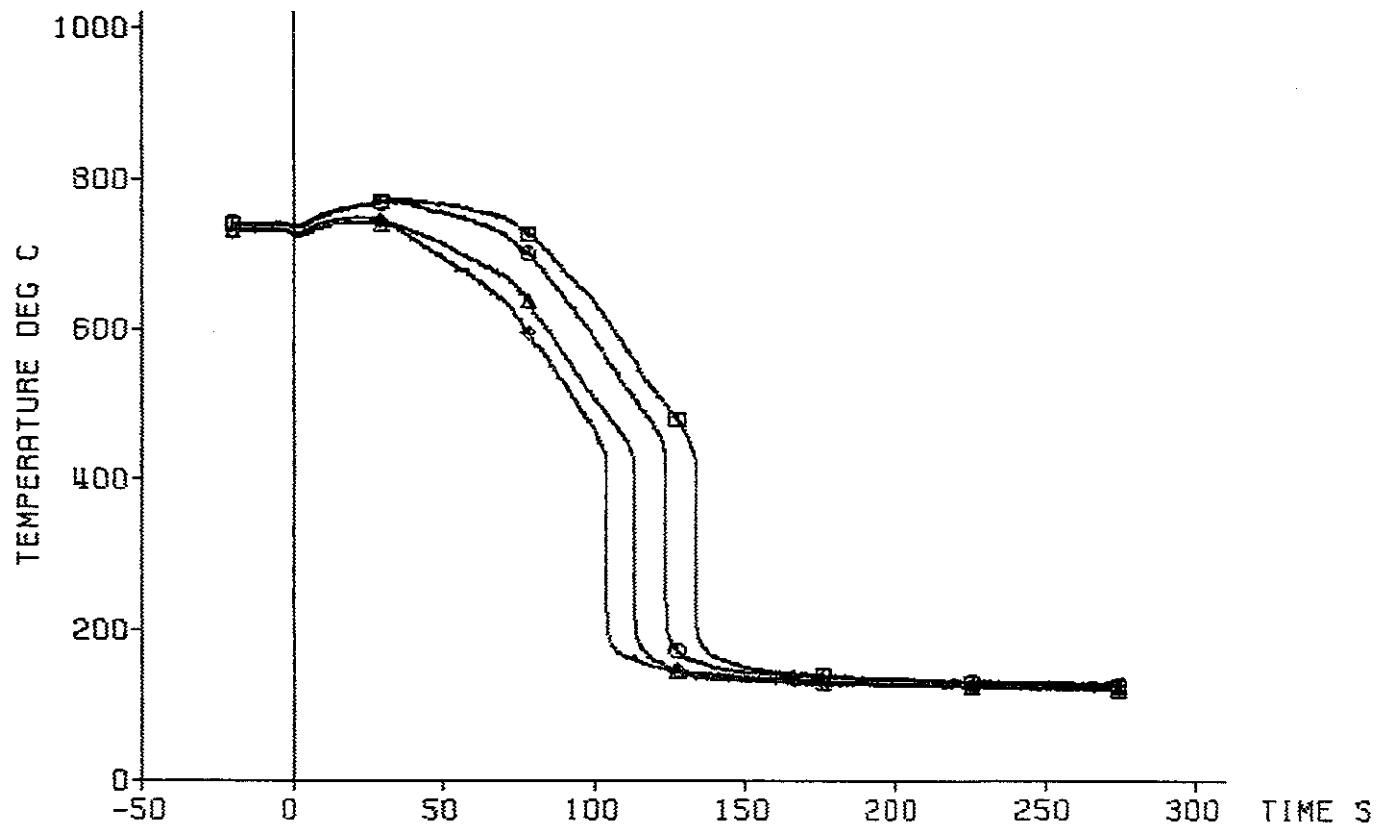

decay heat 120% RNS standard
flooding rate (cold) 5.78 cm/s
system pressure 6.18 bar
feedwater temperature 40 deg C

KfK
IRB

Fig. 91 FEBA: 5x5 ROD BUNDLE, TEST SERIES 1, TEST-No. 222

heat transfer coeff.

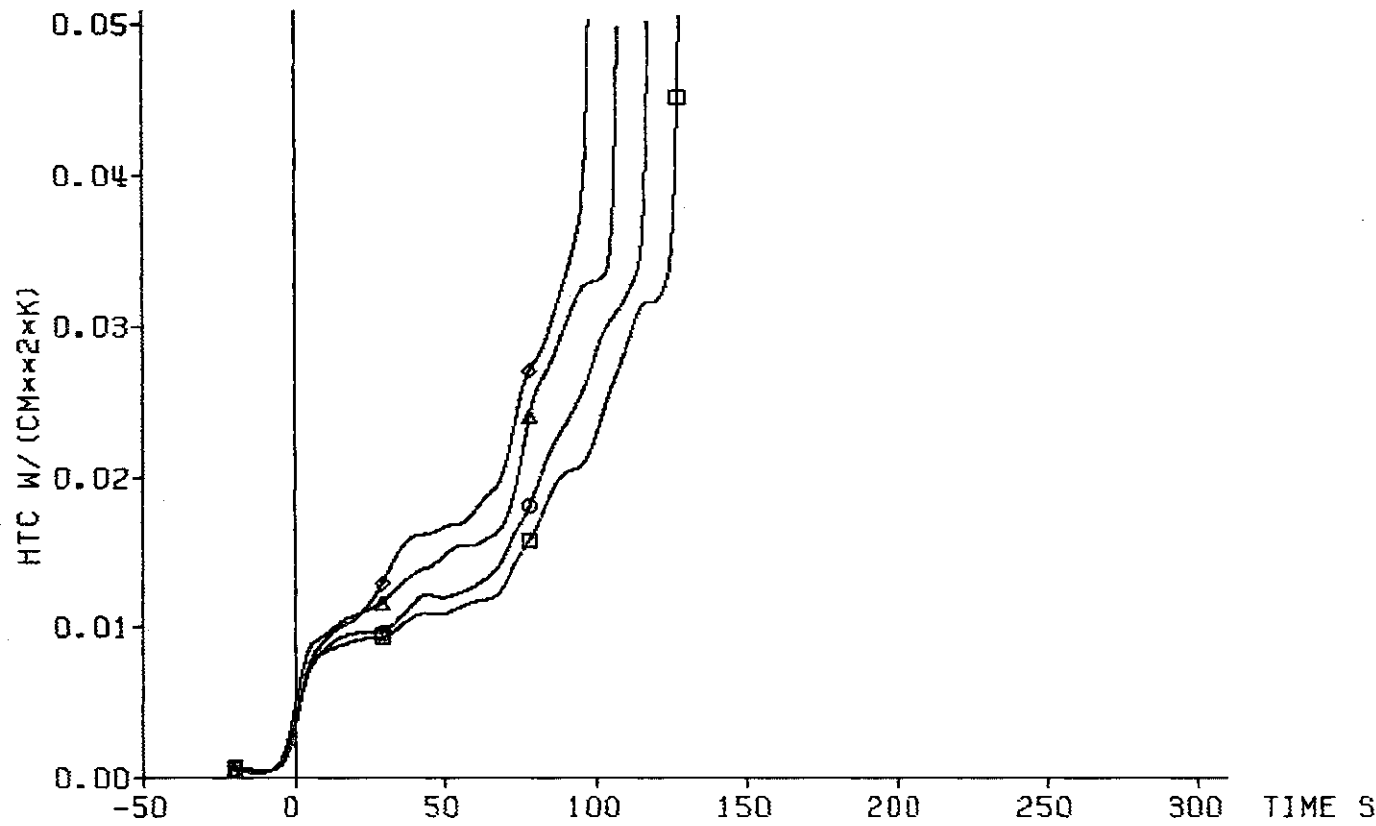

TC	ax. Level
◇	7f4 2425 mm
△	7f3 2325 mm
○	7f2 2225 mm
□	7f1 2125 mm

decay heat
 flooding rate (cold) 5.78 cm/s
 system pressure 6.18 bar
 feedwater temperature 40 deg C
 120% ANS standard



Fig. 92 FEBA: 5x5 ROD BUNDLE, TEST SERIES 1, TEST-No. 222

	TC	ax. level
▲	13d3	2025 mm
●	13d2	2025 mm
■	13d1	2025 mm

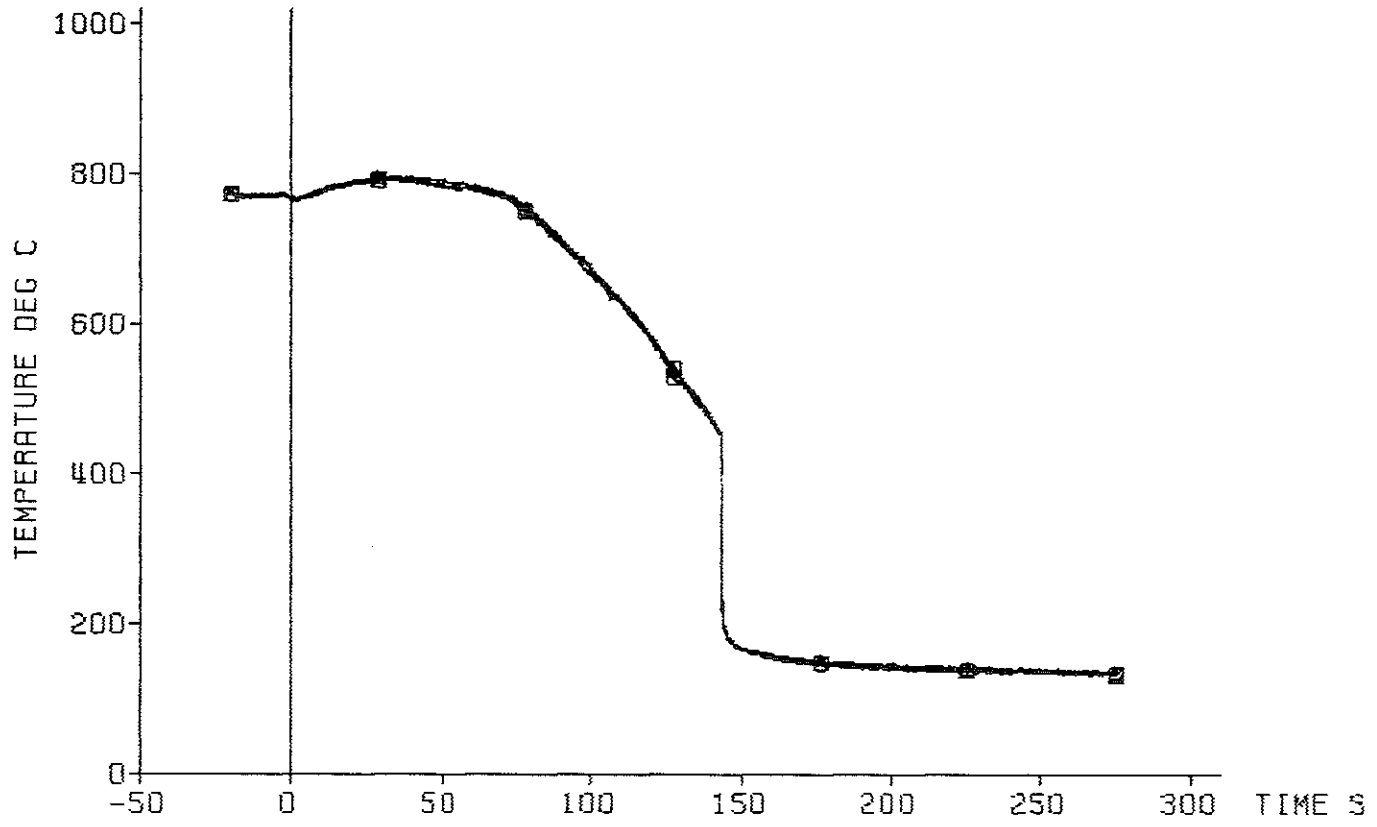

decay heat 120% RMS standard
 flooding rate (cold) 5.78 cm/s
 system pressure 6.18 bar
 feedwater temperature 40 deg C



Fig. 93 FEBA: 5x5 ROD BUNDLE, TEST SERIES 1, TEST-No. 222

heat transfer coeff.

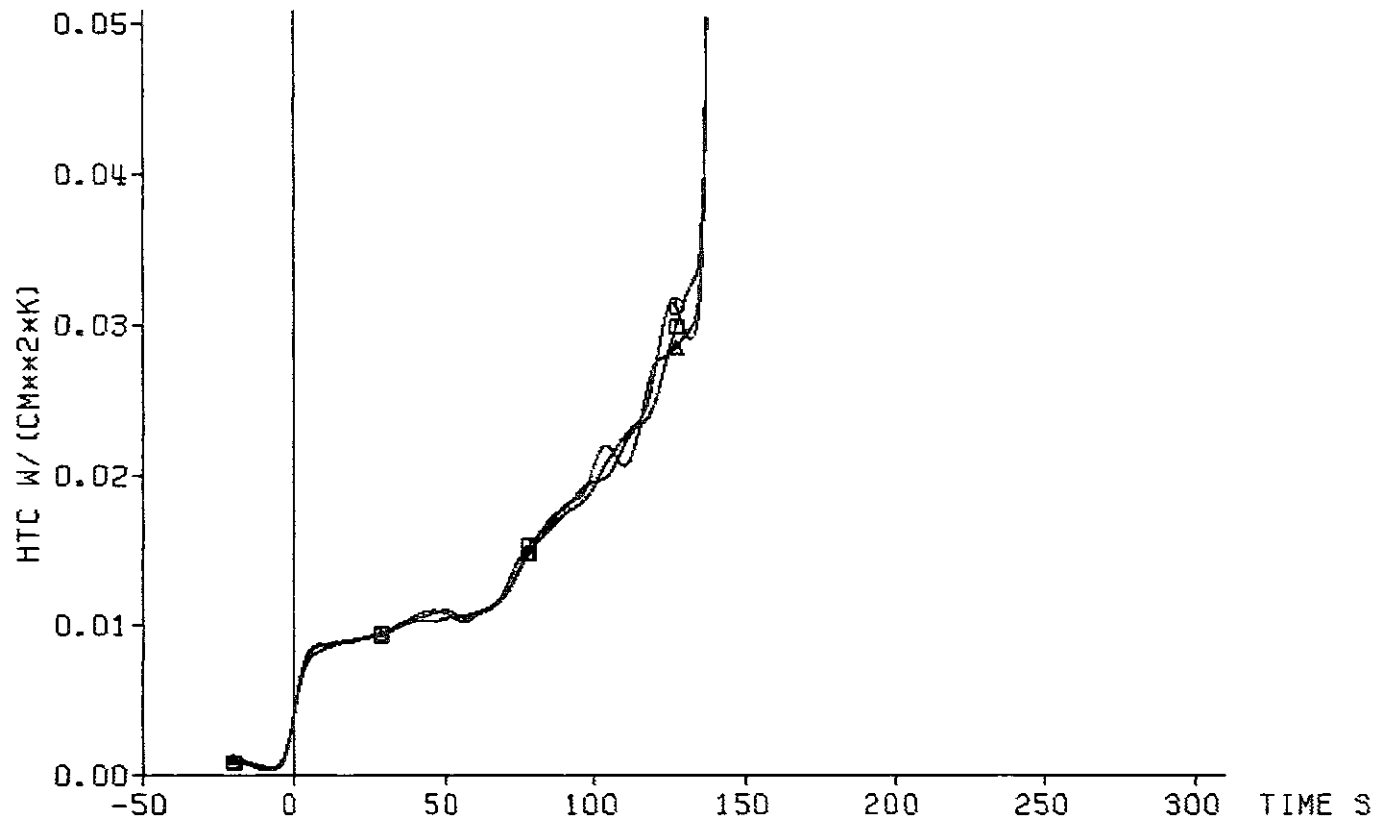

TC	axial Level
△ 13d3	2025 mm
○ 13d2	2025 mm
□ 13d1	2025 mm

decay heat 120% ANS standard
flooding rate (cold) 5.78 cm/s
system pressure 6.18 bar
feedwater temperature 40 deg C



Fig. 94 FEBA: 5x5 ROD BUNDLE, TEST SERIES 1, TEST-No. 222

cladding temperature

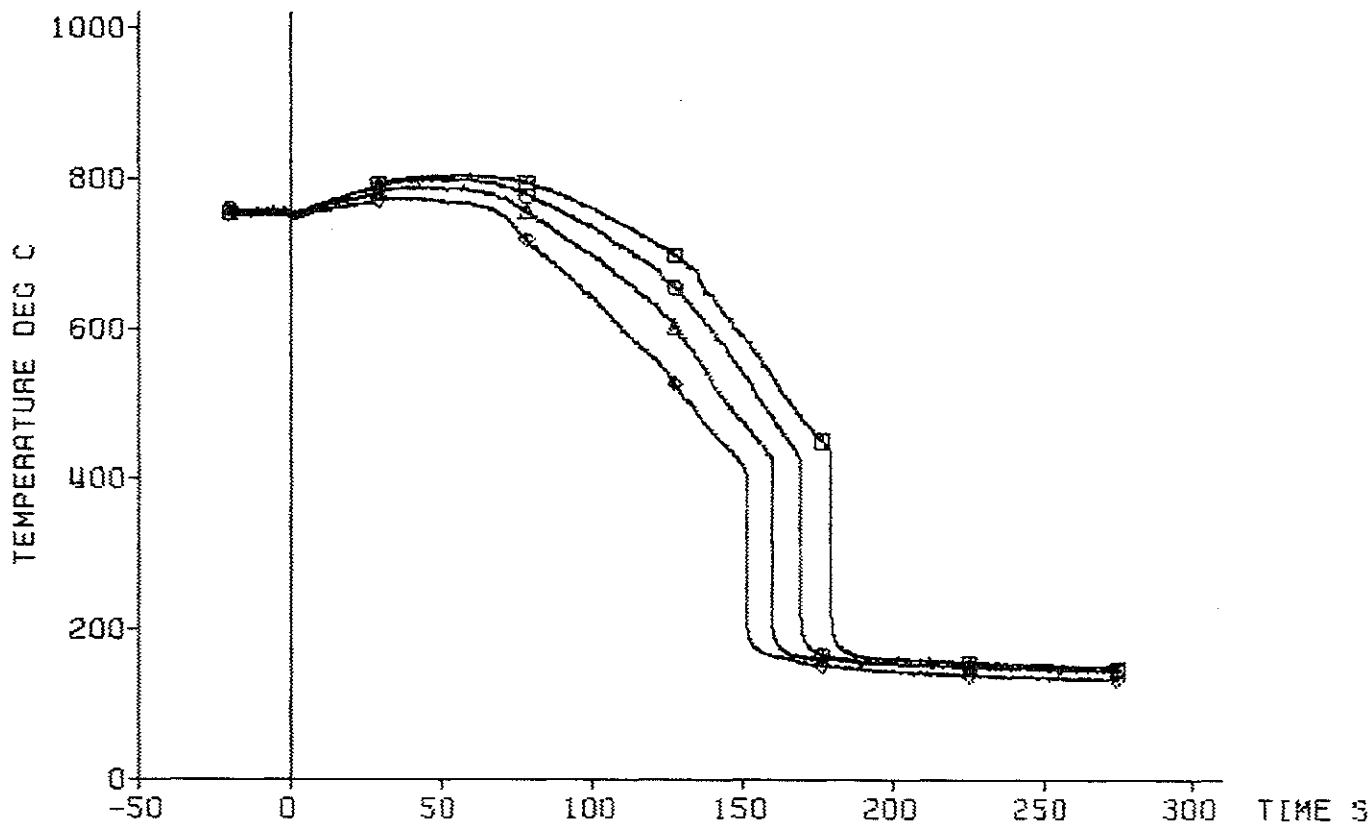

decay heat 120% RNS standard
flooding rate (cold) 5.78 cm/s
system pressure 6.18 bar
feedwater temperature 40 deg C



Fig. 95 FEBA: 5x5 R0D BUNDLE, TEST SERIES 1, TEST-No. 222

heat transfer coeff.

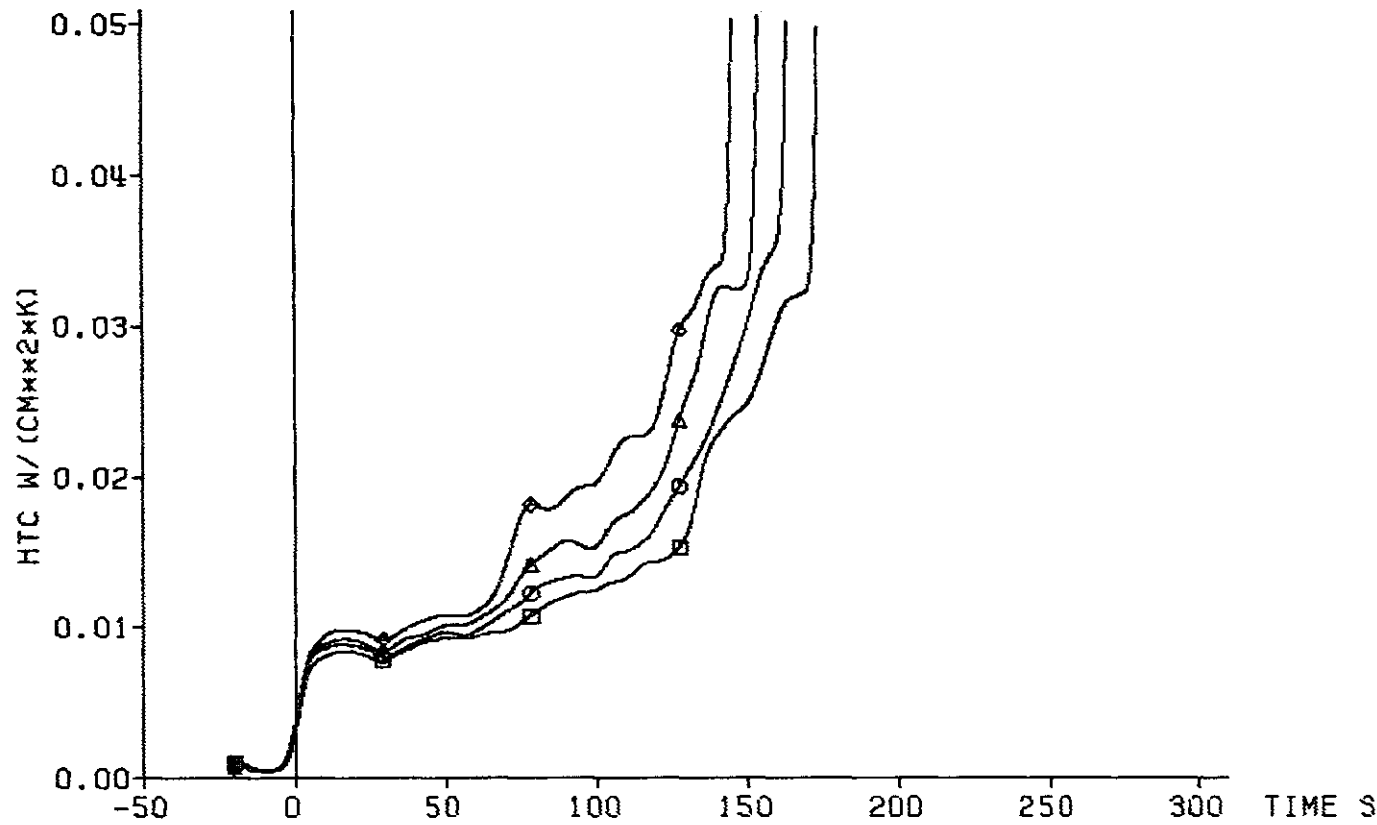

TC	ax. level
◆ 19g4	1925 mm
▲ 19g3	1825 mm
○ 19g2	1725 mm
□ 19g1	1625 mm

decay heat 120% ANS standard
 flooding rate (cold) 5.78 cm/s
 system pressure 6.18 bar
 feedwater temperature 40 deg C



Fig. 96 FEBA: 5x5 ROD BUNDLE, TEST SERIES 1, TEST-No. 222

axial level: 1725 mm

△ cladding temperature (19g2)
○ fluid temperature
□ housing temperature

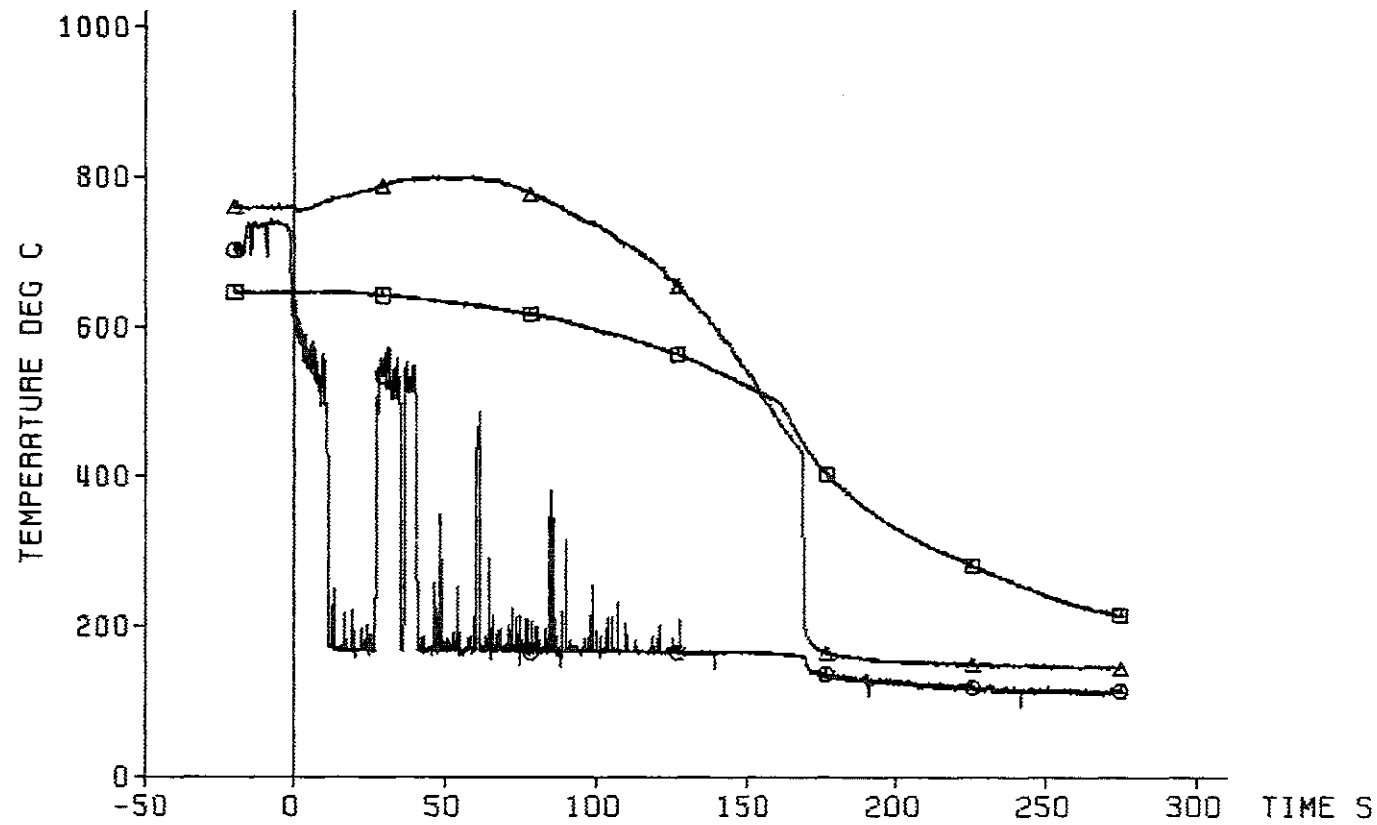

decay heat 120% ANS standard
flooding rate (cold) 5.78 cm/s
system pressure 6.18 bar
feedwater temperature 40 deg C



Fig. 97 FEBA: 5x5 ROD BUNDLE, TEST SERIES 1, TEST-No. 222

axial level: 1625 mm

▲ cladding temperature (19g1)
○ fluid temperature
□ housing temperature

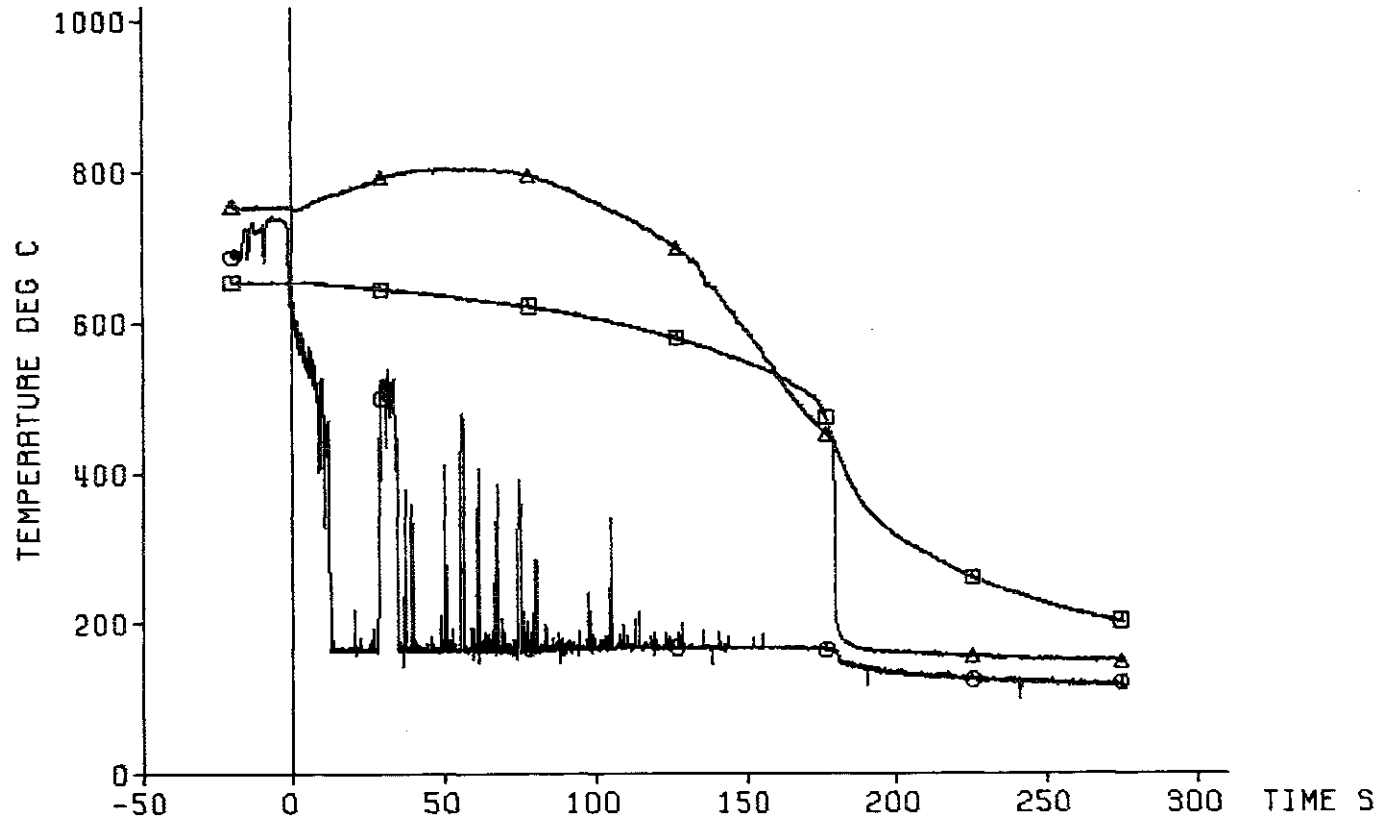

decay heat 120% ANS standard
flooding rate (cold) 5.78 cm/s
system pressure 6.18 bar
feedwater temperature 40 deg C



Fig. 98 FEBA: 5x5 ROD BUNDLE, TEST SERIES 1, TEST-No. 222

pressure loss
along the test section:

◇ total length: 4196 mm
△ lower part: 1711 mm
○ middle part: 545 mm
□ upper part: 1940 mm

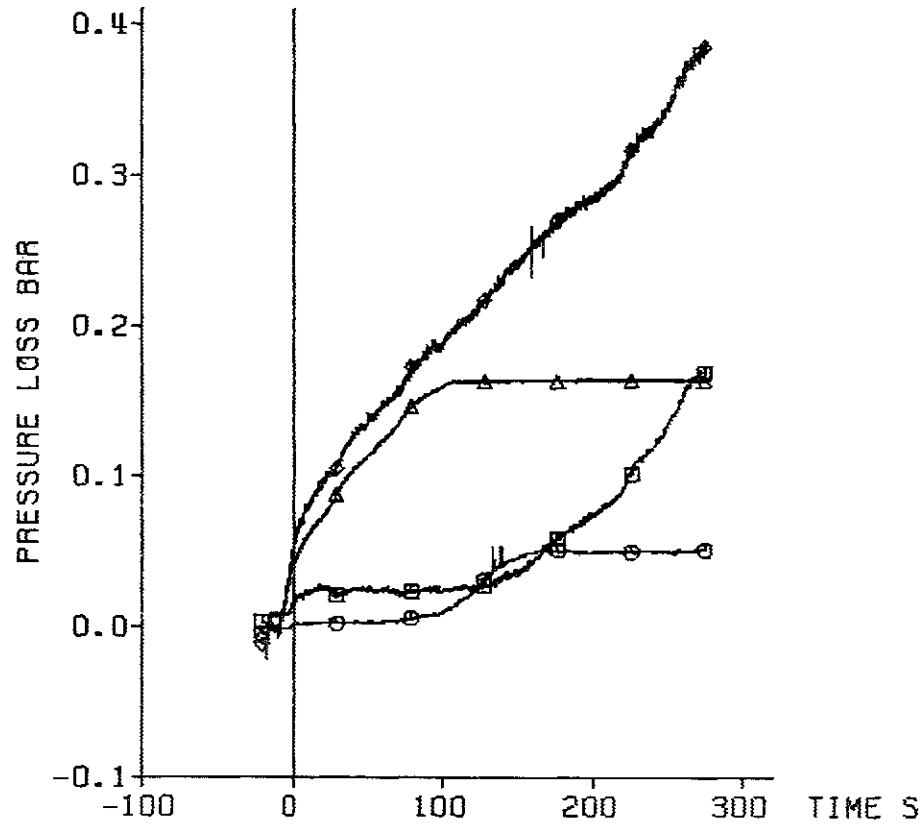

decay heat 120% ANS standard
flooding rate (cold) 5.78 cm/s
system pressure 6.18 bar
feedwater temperature 40 deg C

Fig. 99 FEBA: 5x5 ROD BUNDLE, TEST SERIES 1, TEST-No. 222

coolant outlet conditions:

- ▲ water carry over
- coolant temperature
- coolant pressure

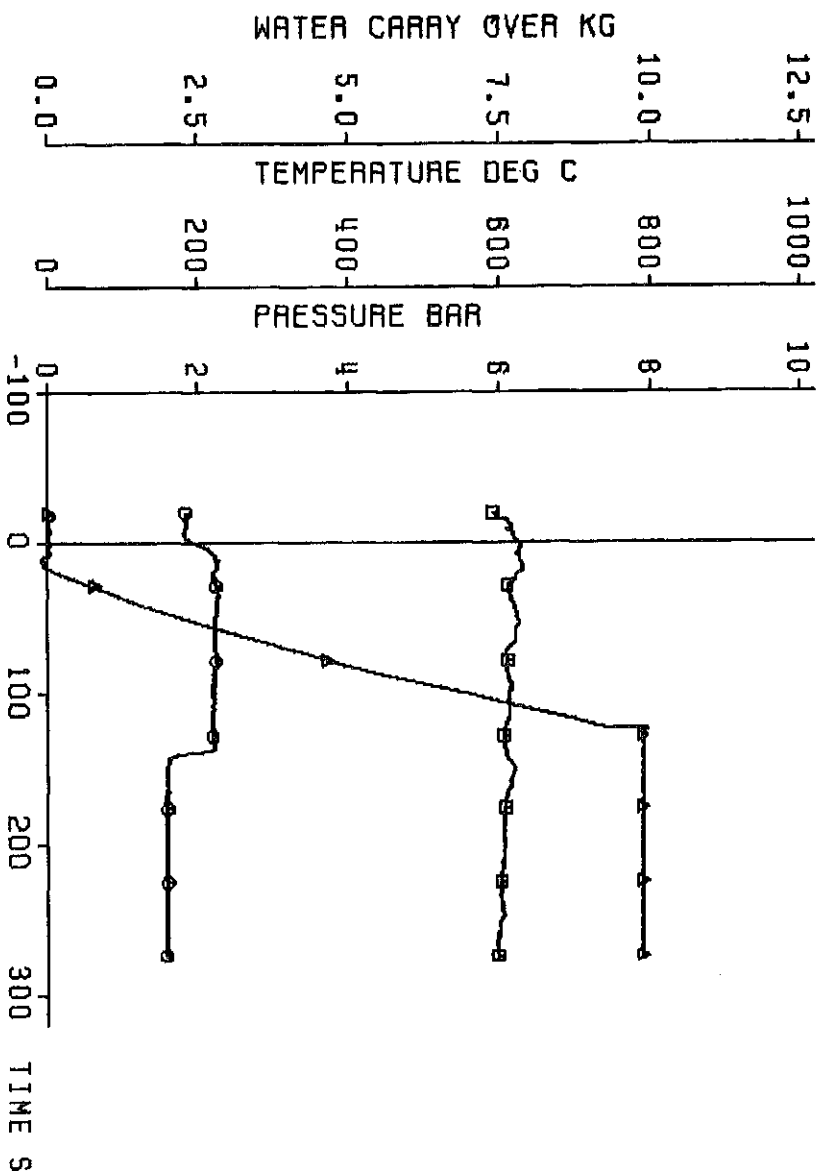

decay heat
flooding rate (cold)
system pressure
feedwater temperature

120% GNS standard
5.78 cm/s
6.18 bar
40 deg C

KfK
IRB

Fig. 100 FEBRA: 5X5 ROD BUNDLE, TEST SERIES 1, TEST-NO. 222

axial position of the quench front

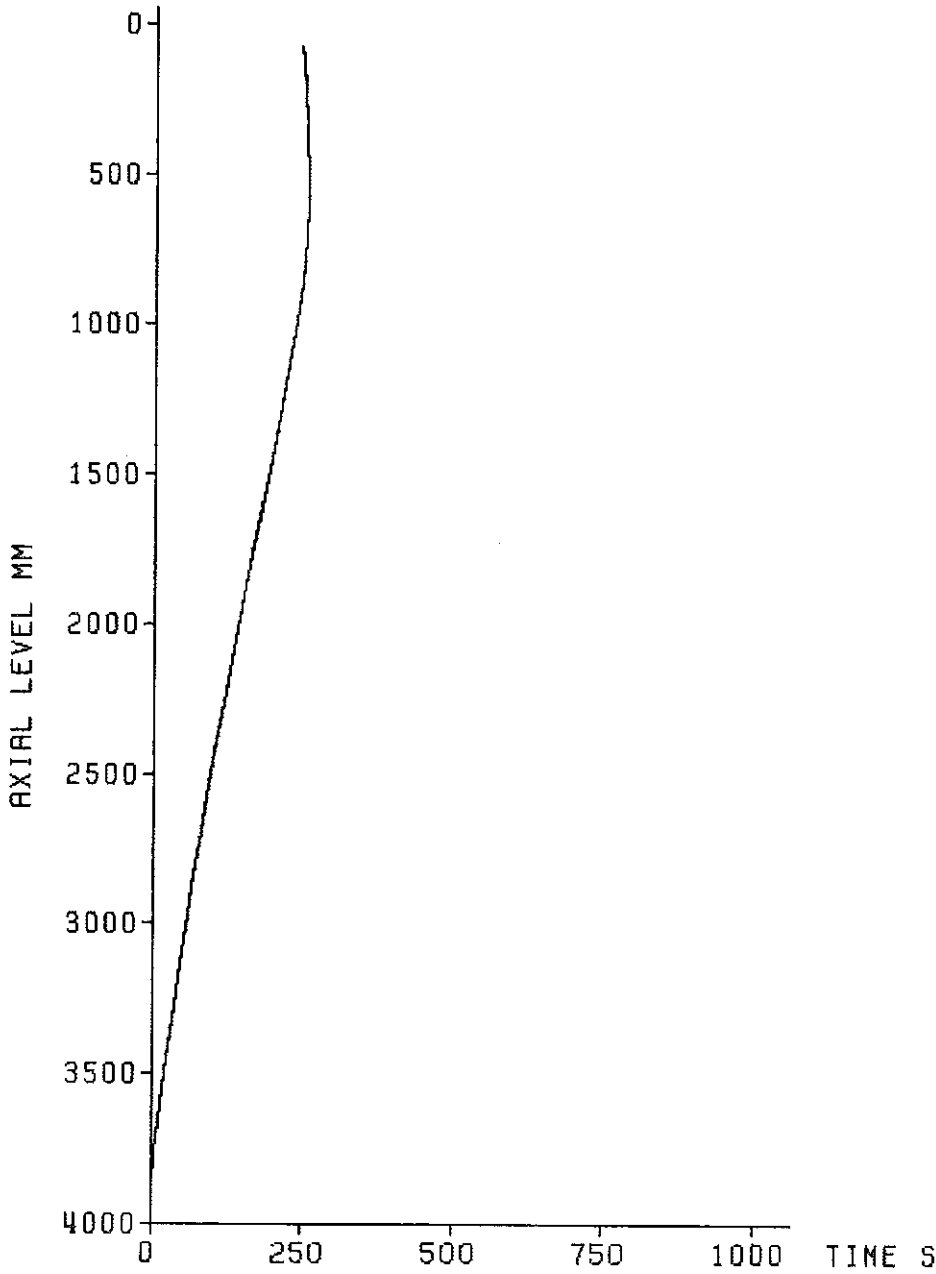

decay heat	120% ANS standard
flooding rate (cold)	5.78 cm/s
system pressure	6.18 bar
feedwater temperature	40 deg C

KJK IRB

Fig. 101 FEBA: 5x5 ROD BUNDLE
TEST SERIES 1, TEST-No. 222

TEST SERIES I

Base Line Tests With Undisturbed Bundle Geometry,
7 Grid Spacers

Channel Listing and Data Identification for Test No. 210 Through 227

Channel No.	Data Identification		Unit	Remarks
	Type	Location		
1	Cladding Temperature	18a4.3860 ¹	°C	
2	Cladding Temperature	18a3.3315	°C	
3	Cladding Temperature	18a2.2770	°C	
4	Cladding Temperature	18a1.2225	°C	
5	Cladding Temperature	12b4.1680	°C	
6	Cladding Temperature	12b3.1135	°C	
7	Cladding Temperature	12b2. 590	°C	
8	Cladding Temperature	12b1. 45	°C	
9	Cladding Temperature	17h4.2225	°C	
10	Cladding Temperature	17h3.2125	°C	
11	Cladding Temperature	17h2.2025	°C	
12	Cladding Temperature	17h1.1925	°C	
13	Fluid Temperature	TF ² 3315	°C	
14	Fluid Temperature	TFS ³ 2380	°C	
15	Fluid Temperature	TF 1725	°C	
16	Fluid Temperature	TFS 485	°C	TC of 0.5 mm Diameter
17	Housing Temperature	TK ⁴ 3315	°C	
18	Housing Temperature	TK 2235	°C	
19	Housing Temperature	TK 1725	°C	
20	Housing Temperature	TK 590	°C	

TEST SERIES I

Channel No.	Data Identification		Unit	Remarks
	Type	Location		
21	Fluid Temperature	Lower Plenum	°C	Heated + Unheated TC's
22	Water Level Detector	4012	°C	
23	Feedwater Temperature		°C	
24	Fluid Temperature	Upper Plenum	°C	
25	Room Temperature		°C	
26	Cladding Temperature	22f4.2425 ¹	°C	
27	Cladding Temperature	22f3.2325	°C	
28	Cladding Temperature	22f2.2225	°C	
29	Cladding Temperature	22f1.2125	°C	
30	Cladding Temperature	21e4.2225	°C	
31	Cladding Temperature	21e3.2175	°C	
32	Cladding Temperature	21e2.2125	°C	
33	Cladding Temperature	21e1.2075	°C	
34	Cladding Temperature	19g4.1925	°C	
35	Cladding Temperature	19g3.1825	°C	
36	Cladding Temperature	19g2.1725	°C	
37	Cladding Temperature	19g1.1625	°C	
38	Cladding Temperature	16g4.1925	°C	TC Failed
39	Cladding Temperature	16g3.1825	°C	
40	Cladding Temperature	16g2.1725	°C	
41	Cladding Temperature	16g1.1625	°C	
42	Cladding Temperature	15a4.3860	°C	
43	Cladding Temperature	15a3.3315	°C	
44	Cladding Temperature	15a2.2770	°C	
45	Cladding Temperature	15a1.2225	°C	
46	Cladding Temperature	14e4.2225	°C	
47	Cladding Temperature	14e3.2175	°C	
48	Cladding Temperature	14e2.2125	°C	
49	Cladding Temperature	14e1.2075	°C	

TEST SERIES I

Channel No.	Data Identification		Unit	Remarks
	Type	Location		
50	Cladding Temperature	13d3.2025 ¹	°C	
51	Cladding Temperature	13d2.2025	°C	
52	Cladding Temperature	13d1.2025	°C	
53	Cladding Temperature	10f4.2425	°C	
54	Cladding Temperature	10f3.2325	°C	
55	Cladding Temperature	10f2.2225	°C	
56	Cladding Temperature	10f1.2125	°C	
57	Cladding Temperature	9h4.2225	°C	
58	Cladding Temperature	9h3.2125	°C	
59	Cladding Temperature	9h2.2025	°C	
60	Cladding Temperature	9h1.1925	°C	
61	Cladding Temperature	8d4.2025	°C	
62	Cladding Temperature	8d3.2025	°C	
63	Cladding Temperature	8d2.2025	°C	
64	Cladding Temperature	8d1.2025	°C	
65	Cladding Temperature	7f4.2425	°C	
66	Cladding Temperature	7f3.2325	°C	
67	Cladding Temperature	7f2.2225	°C	
68	Cladding Temperature	7f1.2125	°C	
69	Cladding Temperature	4g4.1925	°C	
70	Cladding Temperature	4g3.1825	°C	
71	Cladding Temperature	4g2.1725	°C	
72	Cladding Temperature	4g1.1625	°C	
73	Cladding Temperature	3b4.1680	°C	
74	Cladding Temperature	3b3.1135	°C	
75	Cladding Temperature	3b2. 590	°C	
76	Cladding Temperature	3b1. 45	°C	TC Failed

TEST SERIES I

Channel No.	Data Identification		Unit	Remarks
	Type	Location		
77	Cladding Temperature	2c4.4025 ¹	°C	
78	Cladding Temperature	2c3.3925	°C	
79	Cladding Temperature	2c2.3825	°C	
80	Cladding Temperature	2c1.3725	°C	
81	Electrical Power Input	8 Rods	kW	Rods No. 1 Through 8
82	Electrical Power Input	8 Rods	kW	Rods No. 9 Through 16
83	Electrical Power Input	9 Rods	kW	Rods No. 17 Through 25
84	Housing Temperature	TK ⁴ 4005	°C	
85	Housing Temperature	TK 3915	°C	
86	Housing Temperature	TK 3820	°C	
87	Housing Temperature	TK 3725	°C	
88	Housing Temperature	TK 3018	°C	
89	Housing Temperature	TK 2770	°C	
90	Housing Temperature	TK 2025	°C	
91	Housing Temperature	TK 1925	°C	
92	Housing Temperature	TK 1825	°C	
93	Housing Temperature	TK 1625	°C	
94	Housing Temperature	TK 1135	°C	
95	Housing Temperature	TK 835	°C	
96	Housing Temperature	TK 45	°C	
97	Fluid Temperature	TF ² 3038	°C	TC Failed
98	Fluid Temperature	TFS ³ 2425	°C	
99	Fluid Temperature	TF 2770	°C	
100	Fluid Temperature	TFS 2325	°C	
101	Fluid Temperature	TFS 2125	°C	
102	Fluid Temperature	TF 2025	°C	TC Failed
103	Fluid Temperature	TFS 1925	°C	
104	Fluid Temperature	TF 1135	°C	
105	Fluid Temperature	TF 1625	°C	
106	-----		-	Open

TEST SERIES I

Channel No.	Data Identification		Unit	Remarks
	Type	Location		
107	Cladding Temperature	24c4.4025 ¹	°C	
108	Cladding Temperature	24c2.3925	°C	
109	Cladding Temperature	24c1.3825	°C	
110	Time (10 Scans/s)		s	t = 0: Start of Reflooding
111	Pressure in Lower Plenum	4091	bar	
112	Pressure in Upper Plenum	-105	bar	
113	Pressure in Buffer		bar	
114	Bundle Power		kW	Channels: 81 + 82 + 83
115	Flooding Velocity (cold)		cm/s	
116	Water Carry Over Collected		kg	Downstream of Bundle Exit
117	Pressure Diff.	1835 and -105 mm	bar	
118	Measured	2380 and 1835 mm	bar	
119	Between	4091 and 2380 mm	bar	
120	Axial Level	4091 and -105 mm	bar	Values Measured Separately

- 1) TC's of 0.5 mm diameter embedded in rod cladding. Measuring position:
Example: rod No. = 18, type of rod instrumentation = a, TC No. = 4,
axial level = 3860 mm, referenced to the top flange of the bundle.
- 2) TF = TC's of 0.25 mm diameter (bare).
TC's placed in subchannel surrounded by rods No. 12, 17, 16 and 11.
- 3) TFS = TC's of 0.25 mm diameter protected by a radiation shielding.
TC's placed in subchannel surrounded by rods No. 12, 17, 16 and 11.
- 4) TK = TC's of 0.5 mm diameter placed in the wall of the bundle housing of
of 6.5 mm thickness.

TEST SERIES II

Investigation of the Effects of a Grid Spacer,
Without Grid Spacer at the Bundle Midplane

Test No.	Flooding Velocity (cold) cm/s	System Pressure bar	Feedwater Temp. ¹ °C		Bundle Power ² kW		Remarks
			0-30 s	End	0 s	Transient	
234	3.8	2.0	46	37	200	120% ANS	Figs. 104 Through 118
229	3.8	4.1	53	38	200	120% ANS	Figs. 119 Through 133
231	3.8	6.2	54	40	200	120% ANS	Figs. 134 Through 148
233	5.8	2.0	47	37	200	120% ANS	Figs. 149 Through 163
228	5.7	4.1	50	37	200	120% ANS	Figs. 164 Through 178
230	5.8	6.2	48	37	200	120% ANS	Figs. 179 Through 193

1) Measured in the lower plenum

2) Decay heat transient corresponding 120% ANS Standard 40 s after shutdown
of the reactor

Table 2 FEBA 5x5 rod bundle: Main test parameters of test series II

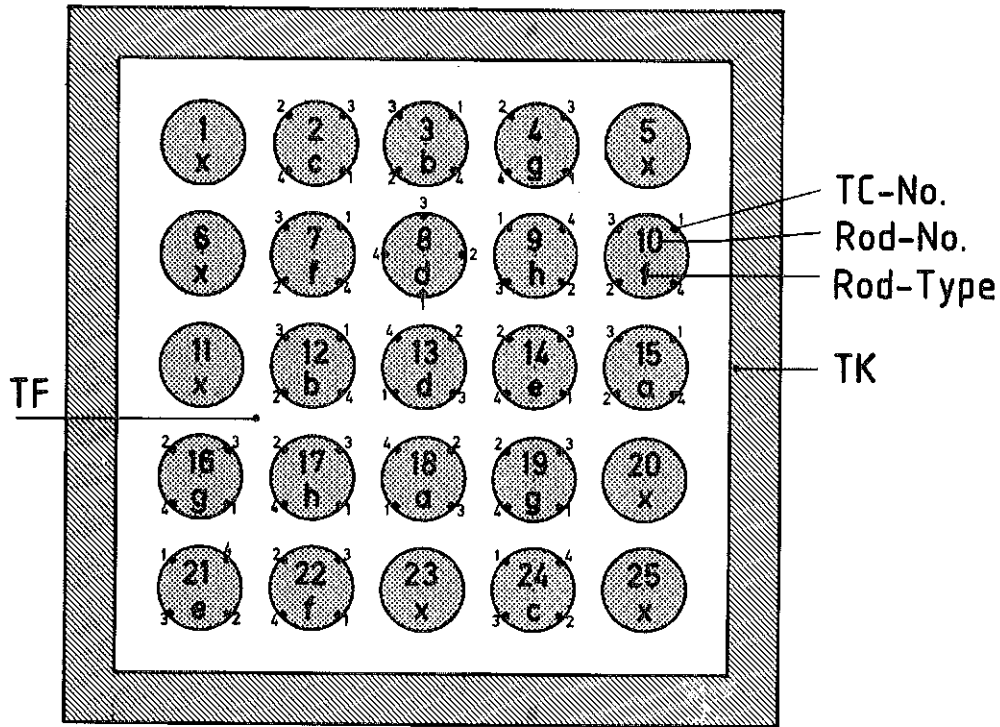

Rod Type	TC No.	Axial Level mm
a	1	2225
	2	2770
	3	3315
	4	3860
b	1	45
	2	590
	3	1135
	4	1680
c	1	3725
	2	3825
	3	3925
	4	4025
d	1	2025
	2	2025
	3	2025
	4	2025

Rod Type	TC No.	Axial Level mm
e	1	2075
	2	2125
	3	2175
	4	2225
f	1	2125
	2	2225
	3	2325
	4	2425
g	1	1625
	2	1725
	3	1825
	4	1925
h	1	1925
	2	2025
	3	2125
	4	2225

Rod Type	TC No.	Axial Level mm
x	without TC's	

Fig. 102 5x5 rod bundle: Radial and axial location of cladding, fluid and housing TC's for test series II

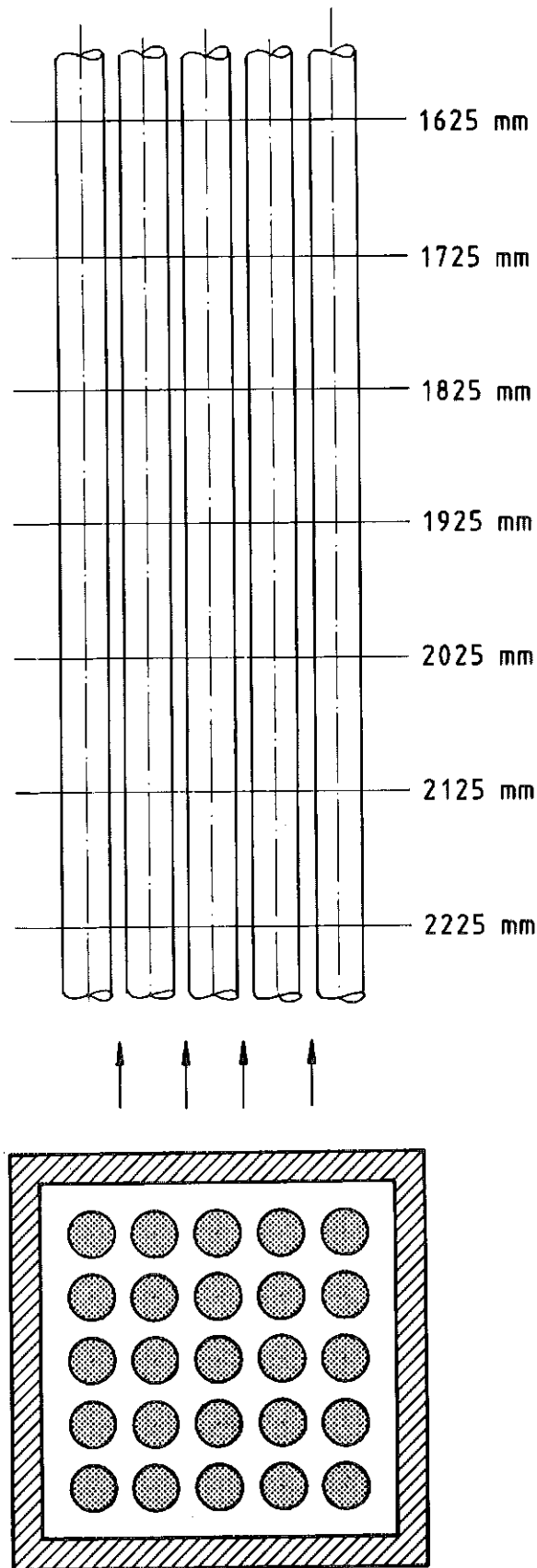
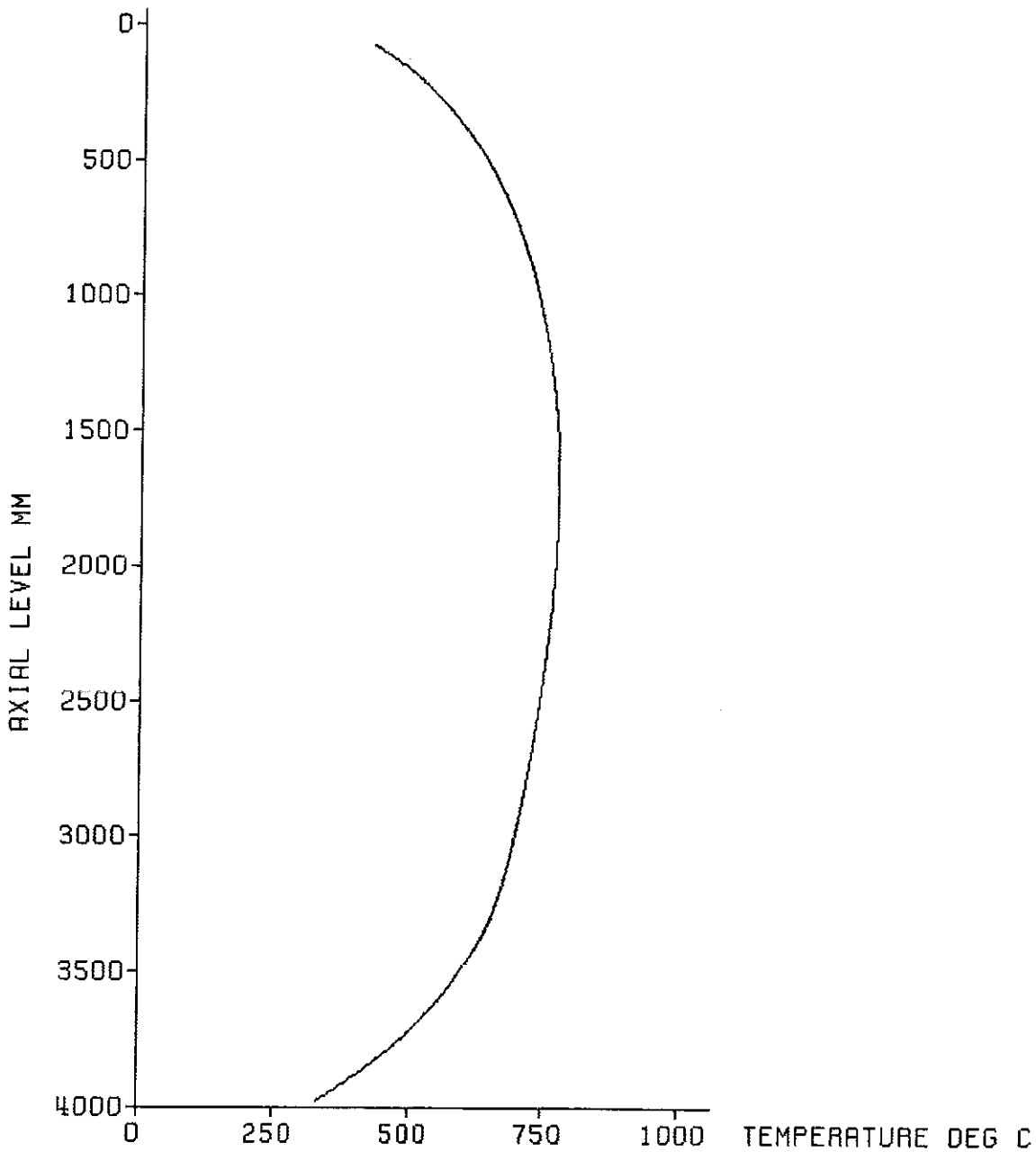

Fig. 103 5x5 rod bundle: Layout of the bundle geometry of test series II

initial axial temperature profile of the cladding



decay heat	120% ANS standard
flooding rate (cold)	3.80 cm/s
system pressure	2.02 bar
feedwater temperature	40 deg C



Fig. 104 FEBA: 5x5 ROD BUNDLE
TEST SERIES 2, TEST-No. 234

test parameters:

- ◆ flooding rate
- ▲ system pressure
- feedwater temperature
- bundle power

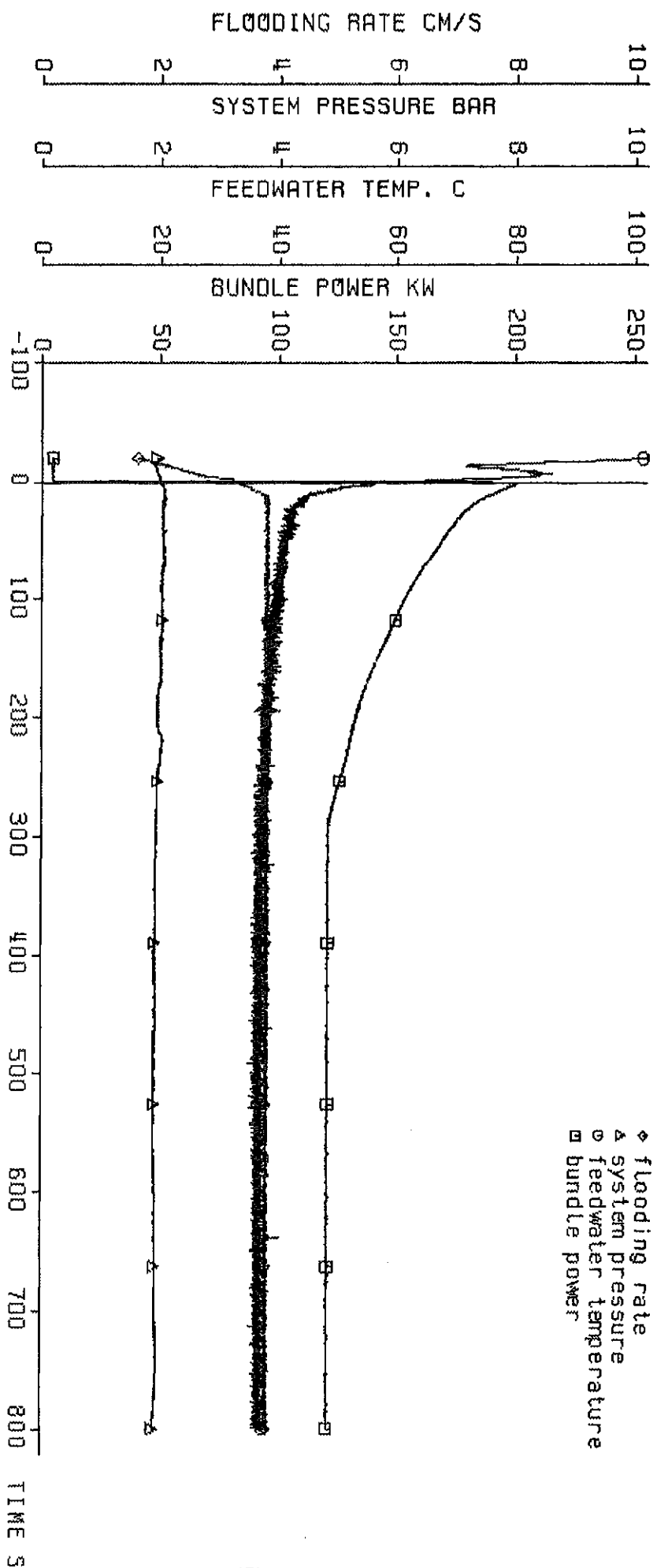

decay heat
flooding rate (cold) 3.80 cm/s
system pressure 2.02 bar
feedwater temperature 40 deg C

120% RMS standard

KFKIRB

Fig. 105 FEBRA: 5X5 ROD BUNDLE, TEST SERIES 2, TEST-NO. 234

cladding temperature

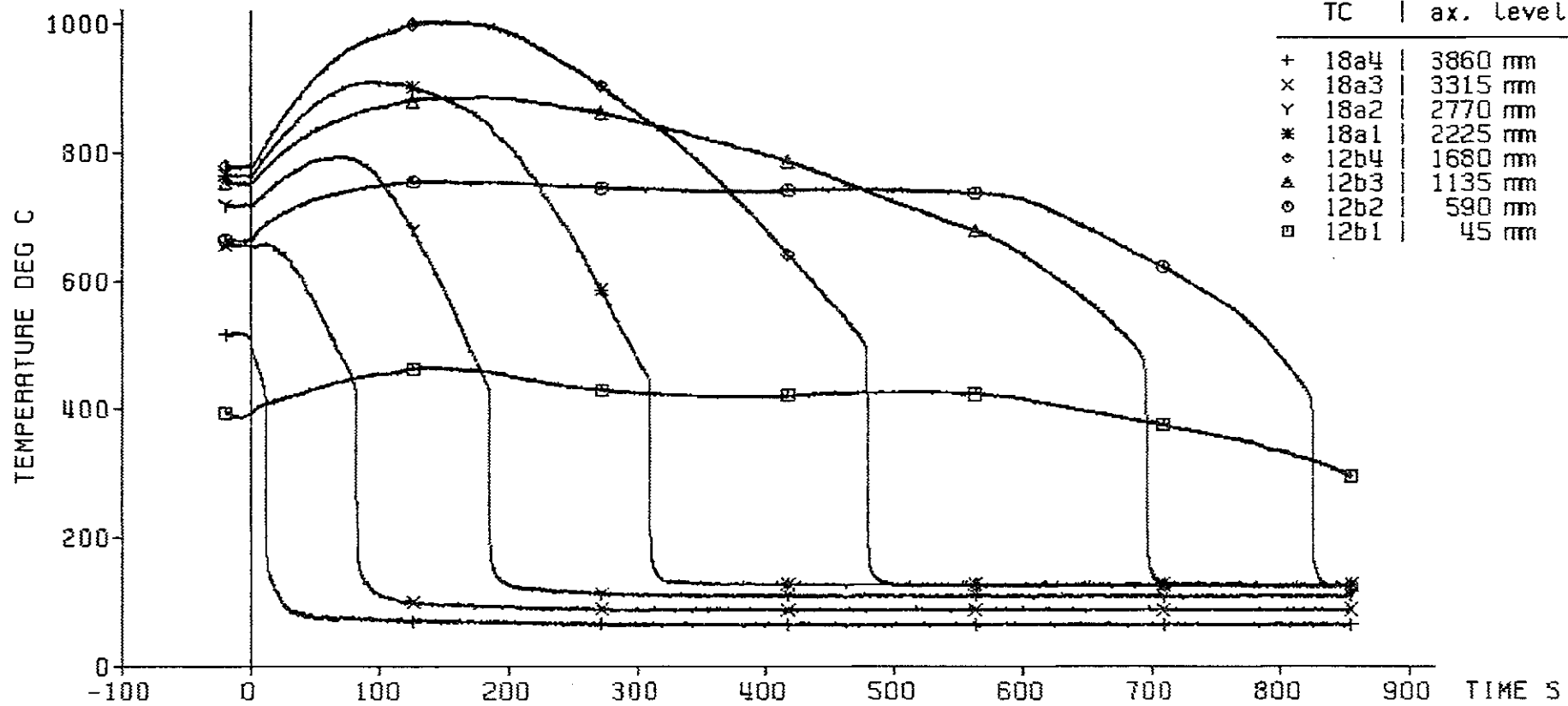

decay heat 120% RNS standard
 flooding rate (cold) 3.80 cm/s
 system pressure 2.02 bar
 feedwater temperature 40 deg C



Fig. 106 FEBA: 5x5 ROD BUNDLE, TEST SERIES 2, TEST-No. 234

heat transfer coeff.

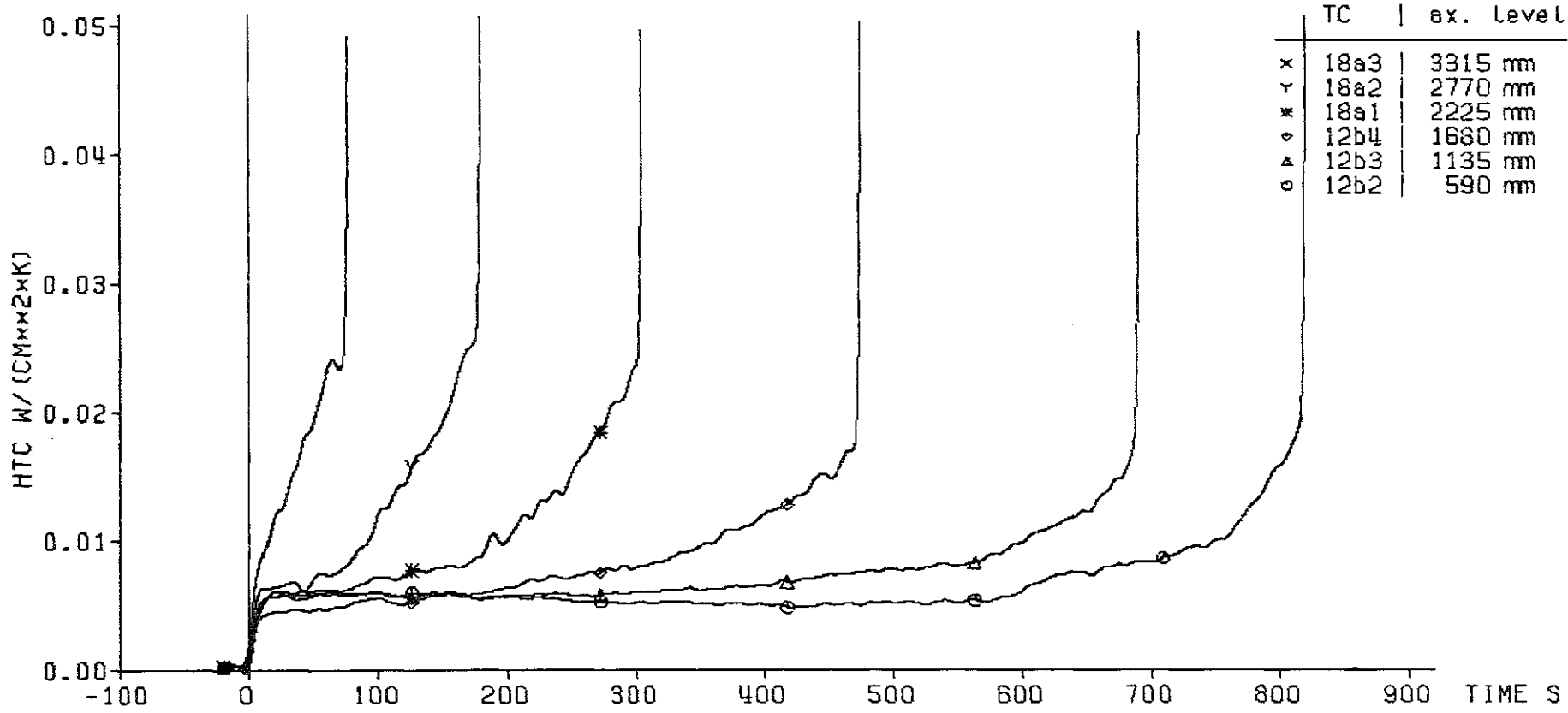

decay heat 120% ANS standard
 flooding rate (cold) 3.80 cm/s
 system pressure 2.02 bar
 feedwater temperature 40 deg C



Fig. 107 FEBA: 5x5 ROD BUNDLE, TEST SERIES 2, TEST-No. 234

cladding temperature

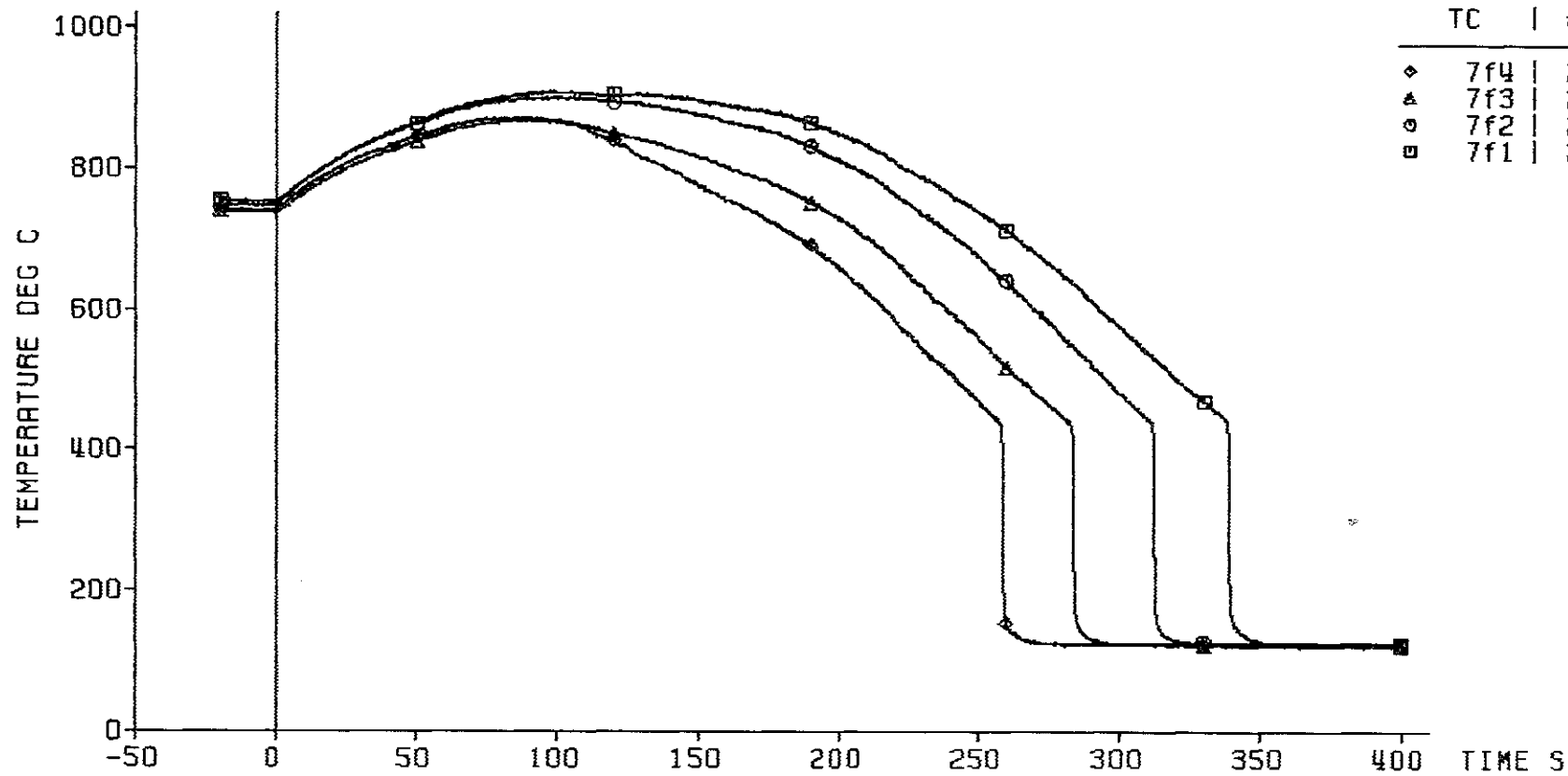

decay heat 120% ANS standard
 flooding rate (cold) 3.80 cm/s
 system pressure 2.02 bar
 feedwater temperature 40 deg C

KIRB

Fig. 108 FEBA: 5x5 ROD BUNDLE, TEST SERIES 2, TEST-No. 234

heat transfer coeff.

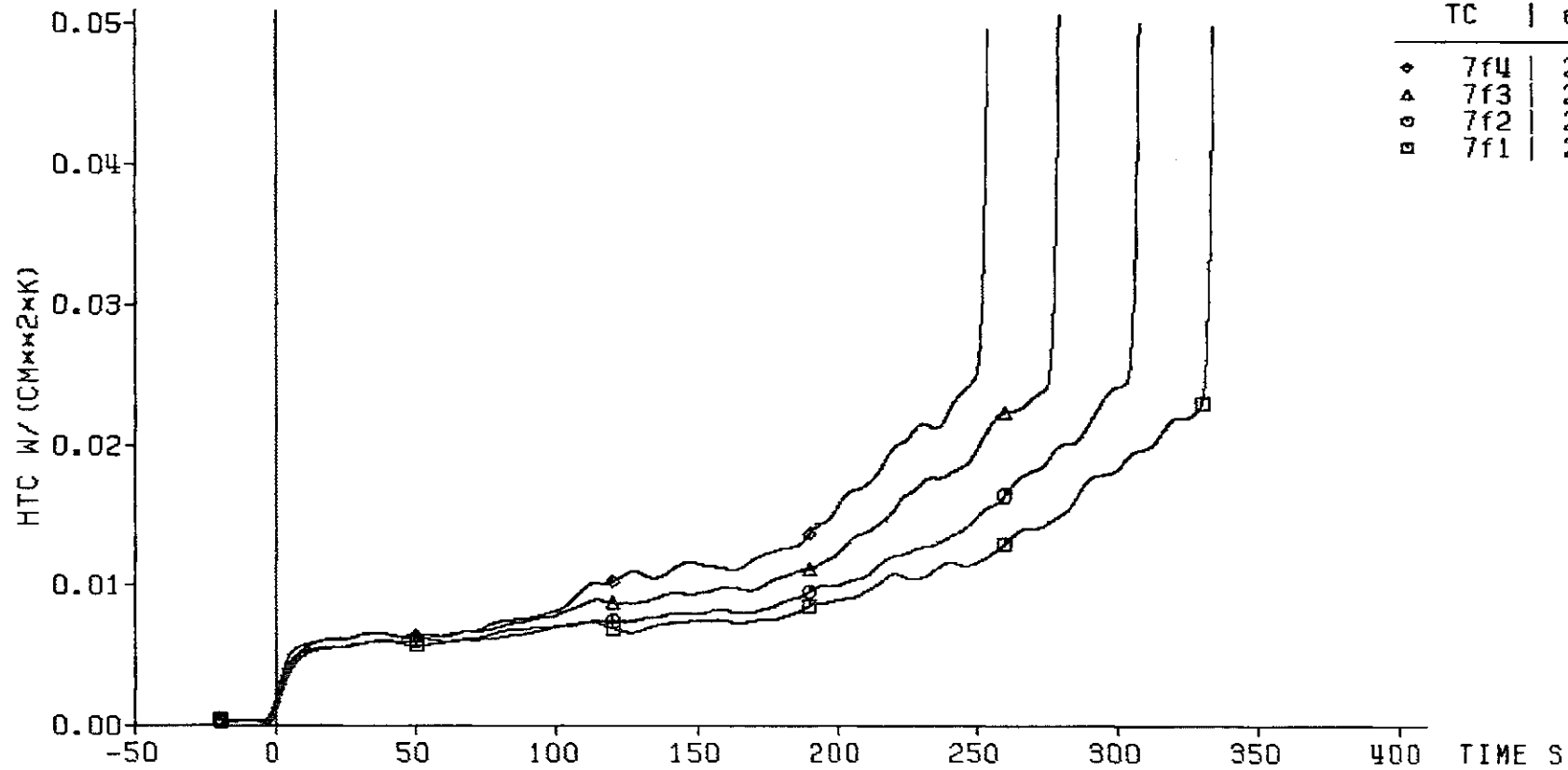

decay heat 120% ANS standard
 flooding rate (cold) 3.80 cm/s
 system pressure 2.02 bar
 feedwater temperature 40 deg C



Fig. 109 FEBA: 5x5 ROD BUNDLE, TEST SERIES 2, TEST-NO. 234

cladding temperature

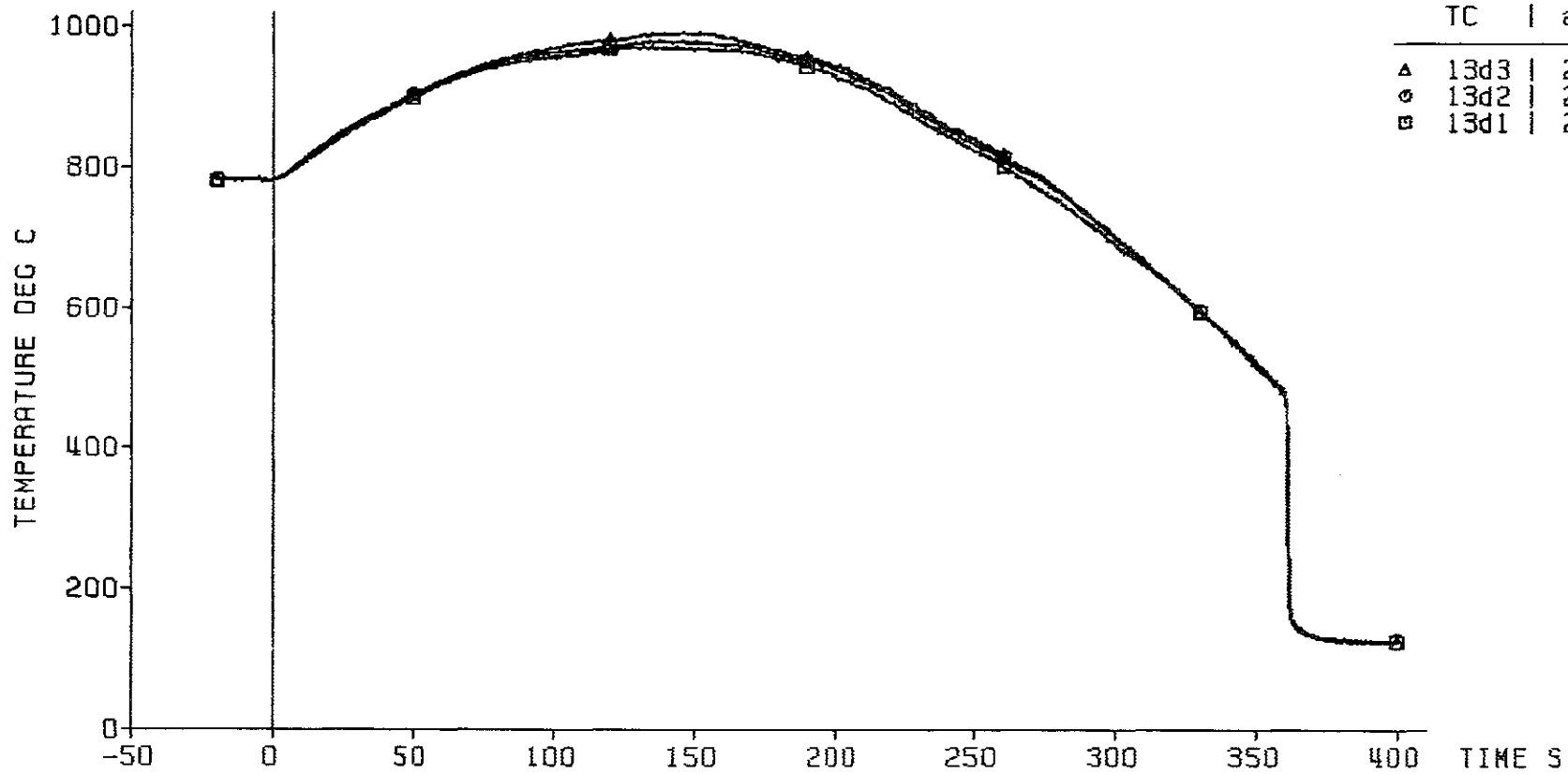

decay heat 120% AMS standard
flooding rate (cold) 3.80 cm/s
system pressure 2.02 bar
feedwater temperature 40 deg C



Fig. 110 FEBA: 5x5 ROD BUNDLE, TEST SERIES 2, TEST-No. 234

heat transfer coeff.

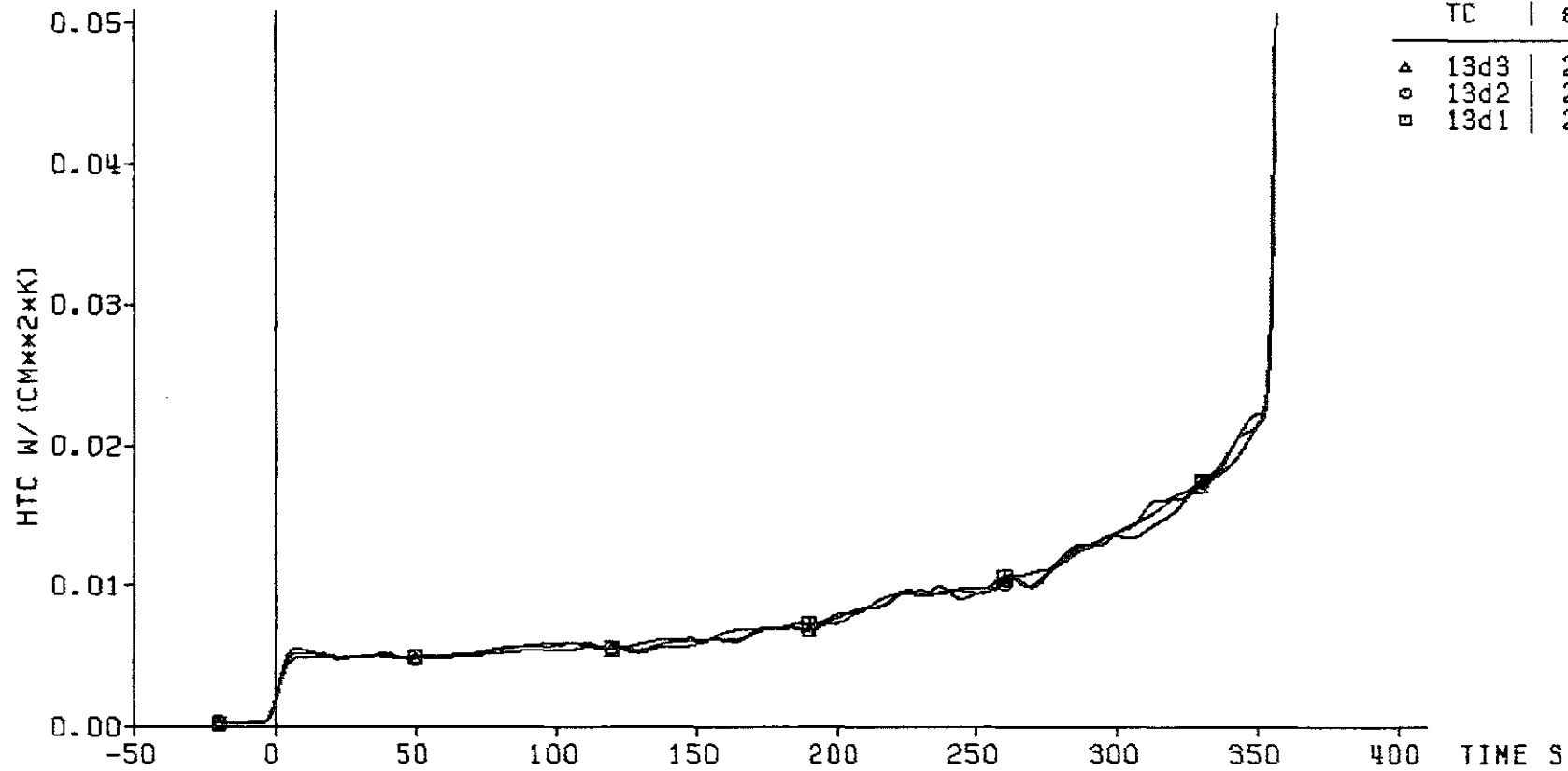

decay heat 120% ANS standard
flooding rate (cold) 3.80 cm/s
system pressure 2.02 bar
feedwater temperature 40 deg C



Fig. 111 FEBA: 5x5 ROD BUNDLE, TEST SERIES 2, TEST-No. 234

cladding temperature

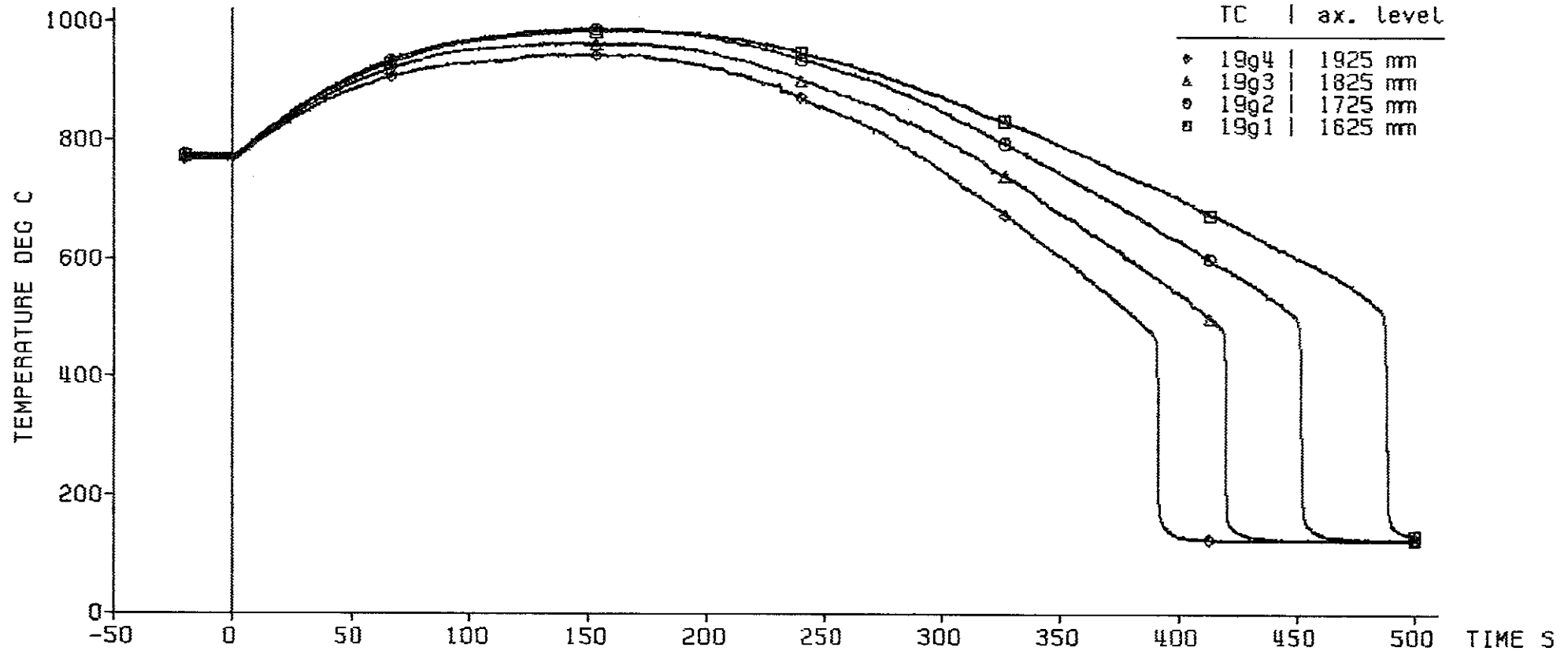

decay heat 120% ANS standard
 flooding rate (cold) 3.60 cm/s
 system pressure 2.02 bar
 feedwater temperature 40 deg C



Fig. 112 FEBA: 5x5 ROD BUNDLE, TEST SERIES 2, TEST-No. 234

heat transfer coeff.

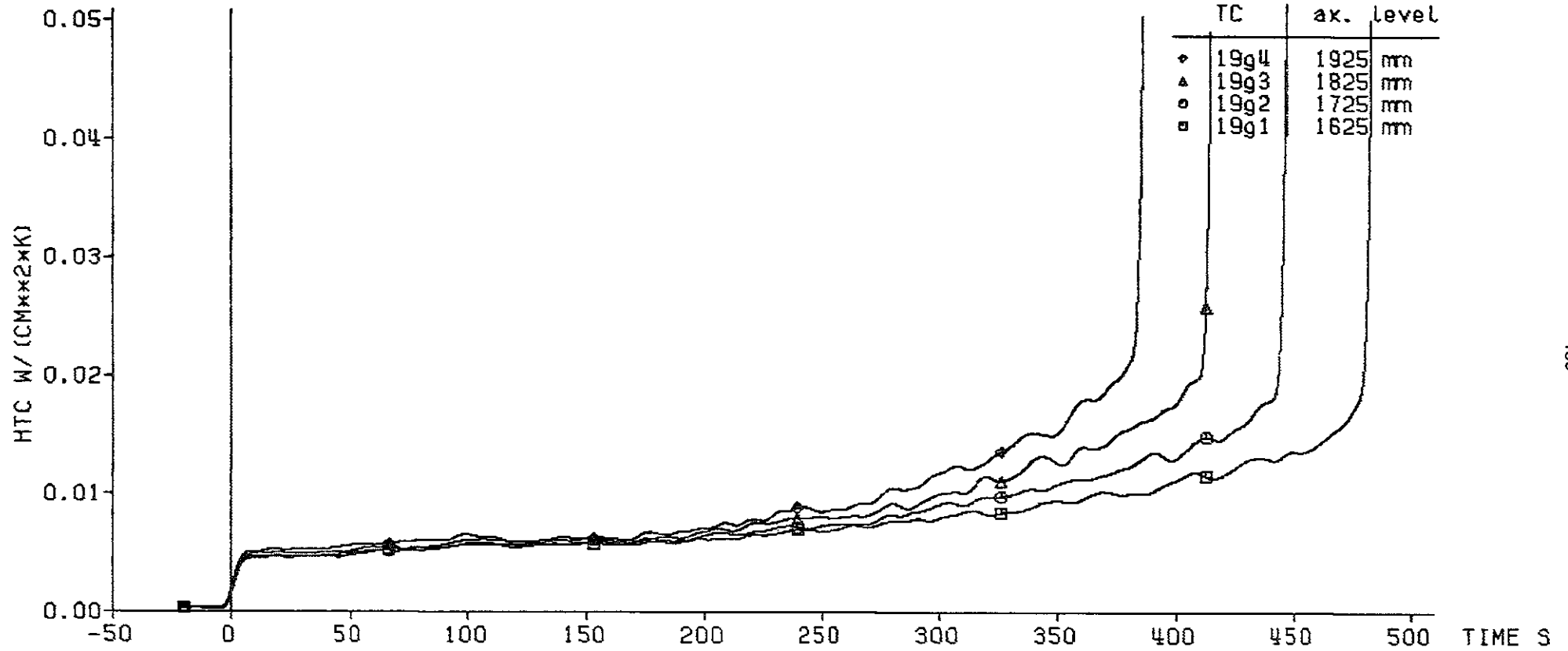

decay heat 120% ANS standard
 flooding rate (cold) 3.80 cm/s
 system pressure 2.02 bar
 feedwater temperature 40 deg C



Fig. 113 FEBA: 5x5 ROD BUNDLE, TEST SERIES 2, TEST-No. 234

axial level: 1725 mm

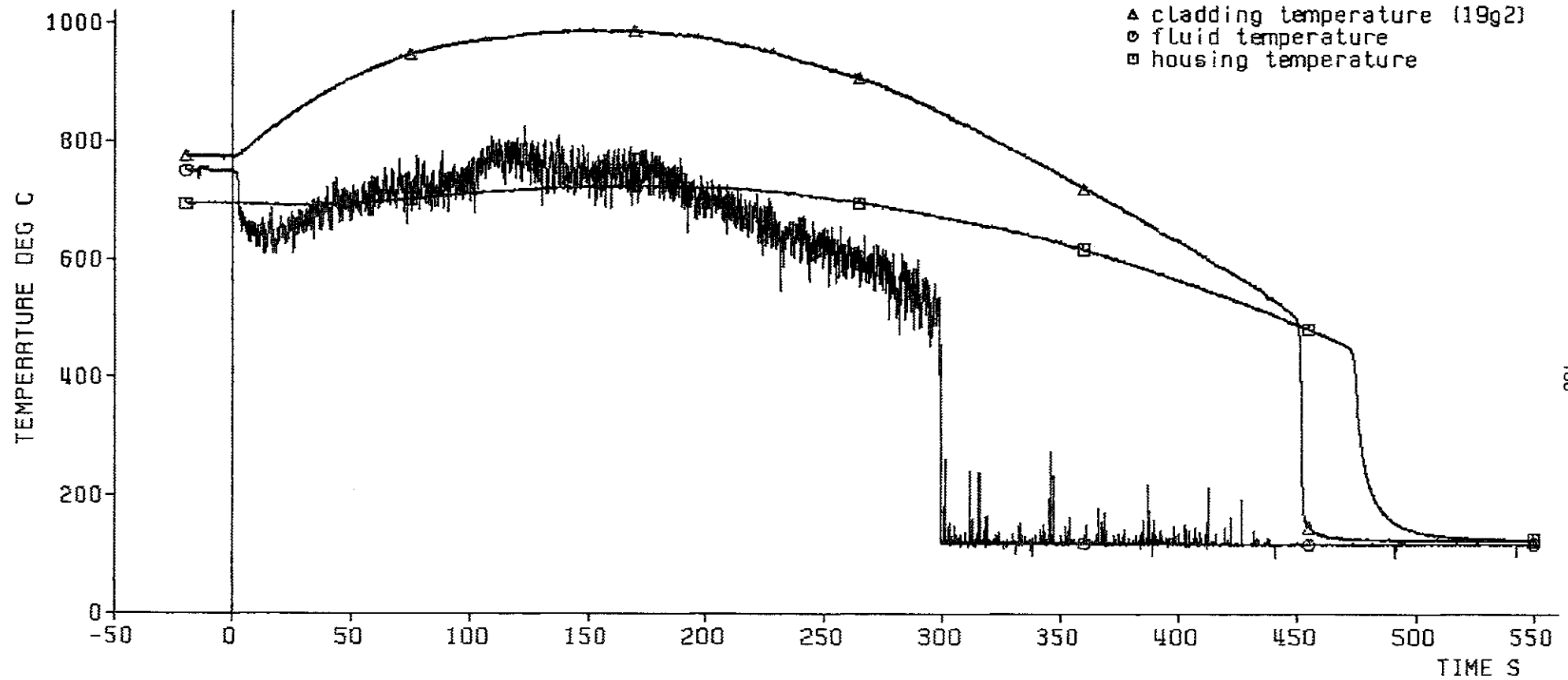

decay heat 120% RNS standard
flooding rate (cold) 3.80 cm/s
system pressure 2.02 bar
feedwater temperature 40 deg C

KIK IRB

Fig. 114 FEBA: 5x5 ROD BUNDLE, TEST SERIES 2, TEST-NO. 234

axial level: 1625 mm

▲ cladding temperature (19g1)
○ fluid temperature
■ housing temperature

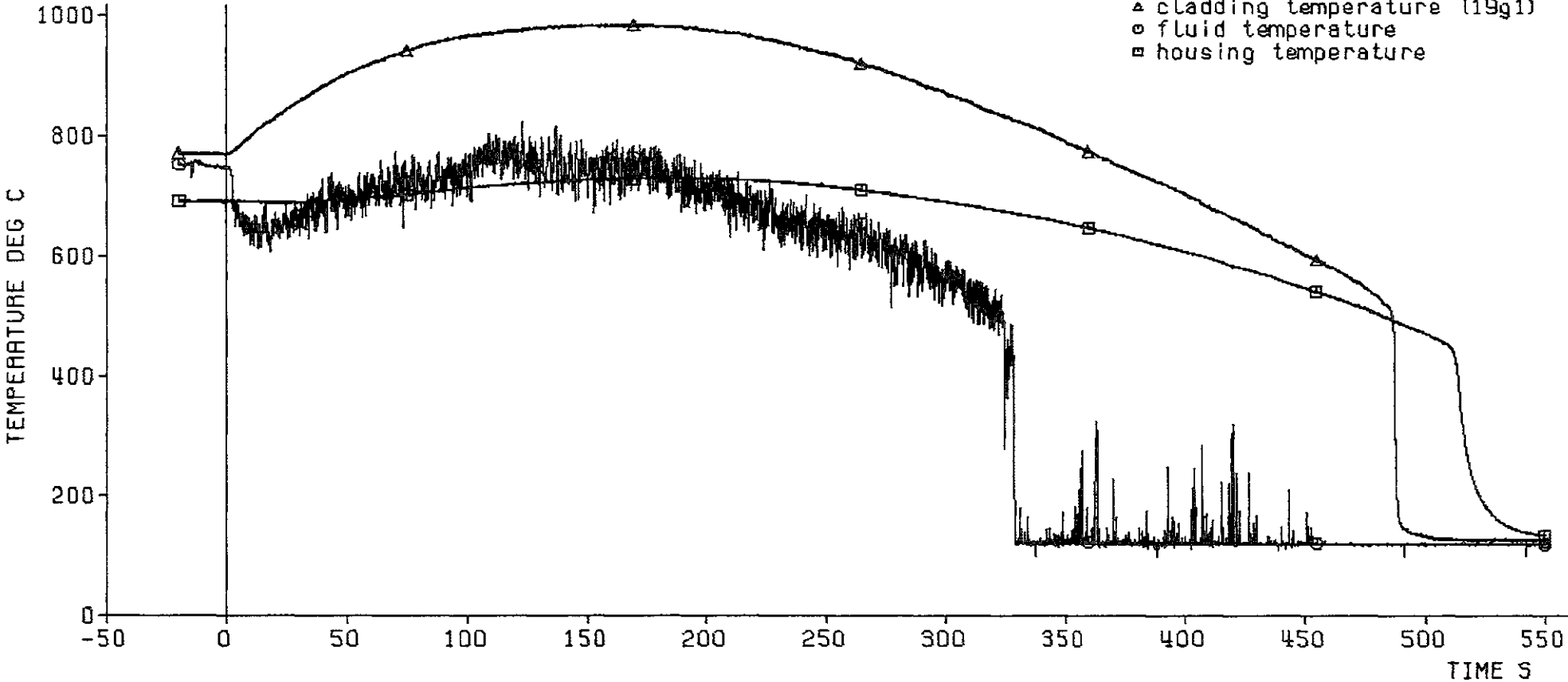

— 137 —

decay heat 120% ANS standard
flooding rate (cold) 3.80 cm/s
system pressure 2.02 bar
feedwater temperature 40 deg C



Fig.115 FEBA: 5x5 ROD BUNDLE, TEST SERIES 2, TEST-No. 234

pressure loss
along the test section:

◇ total length: 4196 mm
△ lower part: 1711 mm
○ middle part: 545 mm
□ upper part: 1940 mm

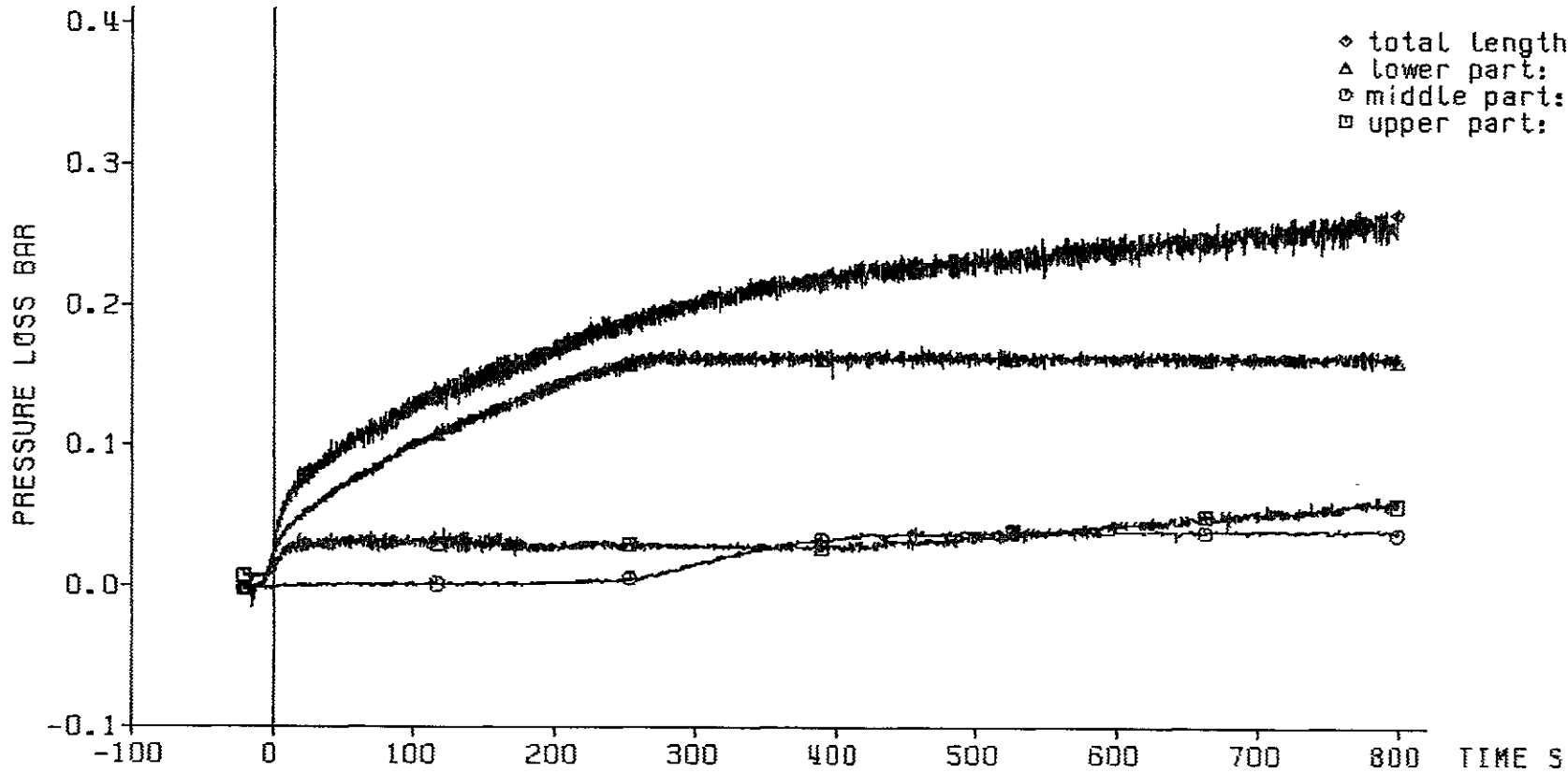

decay heat 120% RMS standard
flooding rate (cold) 3.80 cm/s
system pressure 2.02 bar
feedwater temperature 40 deg C

KIK
IRB

Fig. 116 FEBA: 5x5 ROD BUNDLE, TEST SERIES 2, TEST-No. 234

coolant outlet conditions:

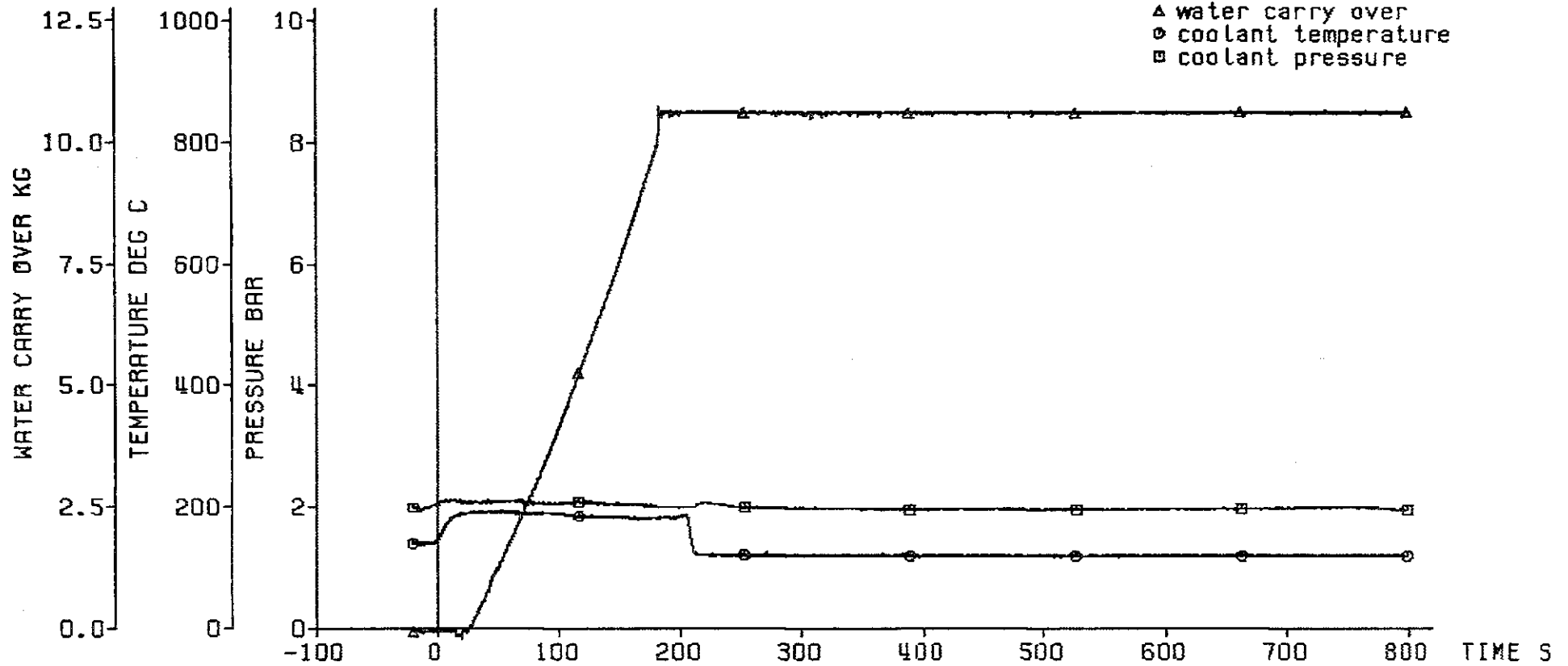

decay heat
flooding rate (cold) 3.80 cm/s
system pressure 2.02 bar
feedwater temperature 40 deg C

120% ANS standard



Fig. 117 FEBA: 5x5 ROD BUNDLE, TEST SERIES 2, TEST-No. 234

axial position of the quench front

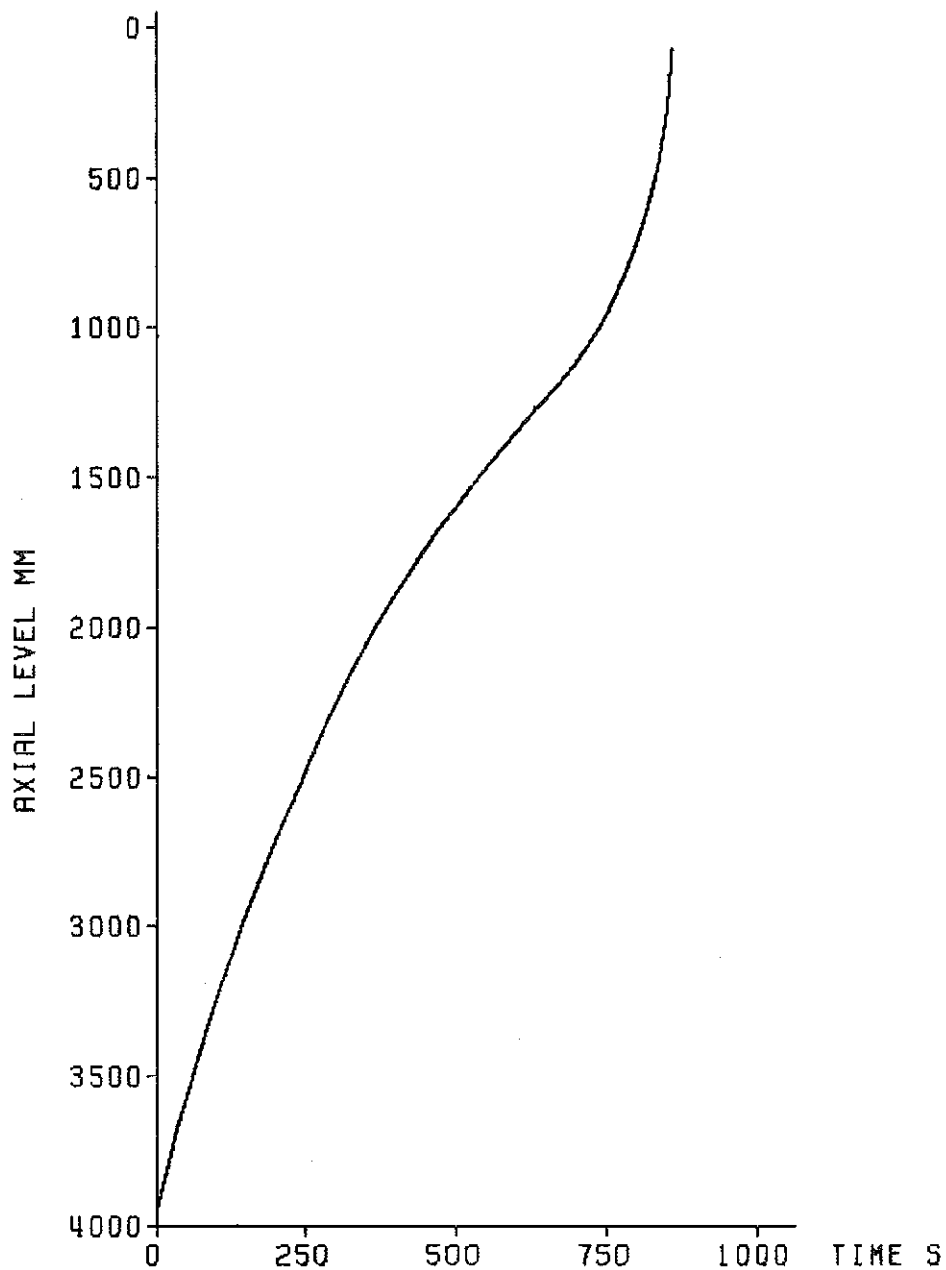

decay heat 120% ANS standard
flooding rate (cold) 3.80 cm/s
system pressure 2.02 bar
feedwater temperature 40 deg C



Fig. 118 FEBA: 5x5 ROD BUNDLE
TEST SERIES 2, TEST-No. 234

Initial axial temperature profile of the cladding

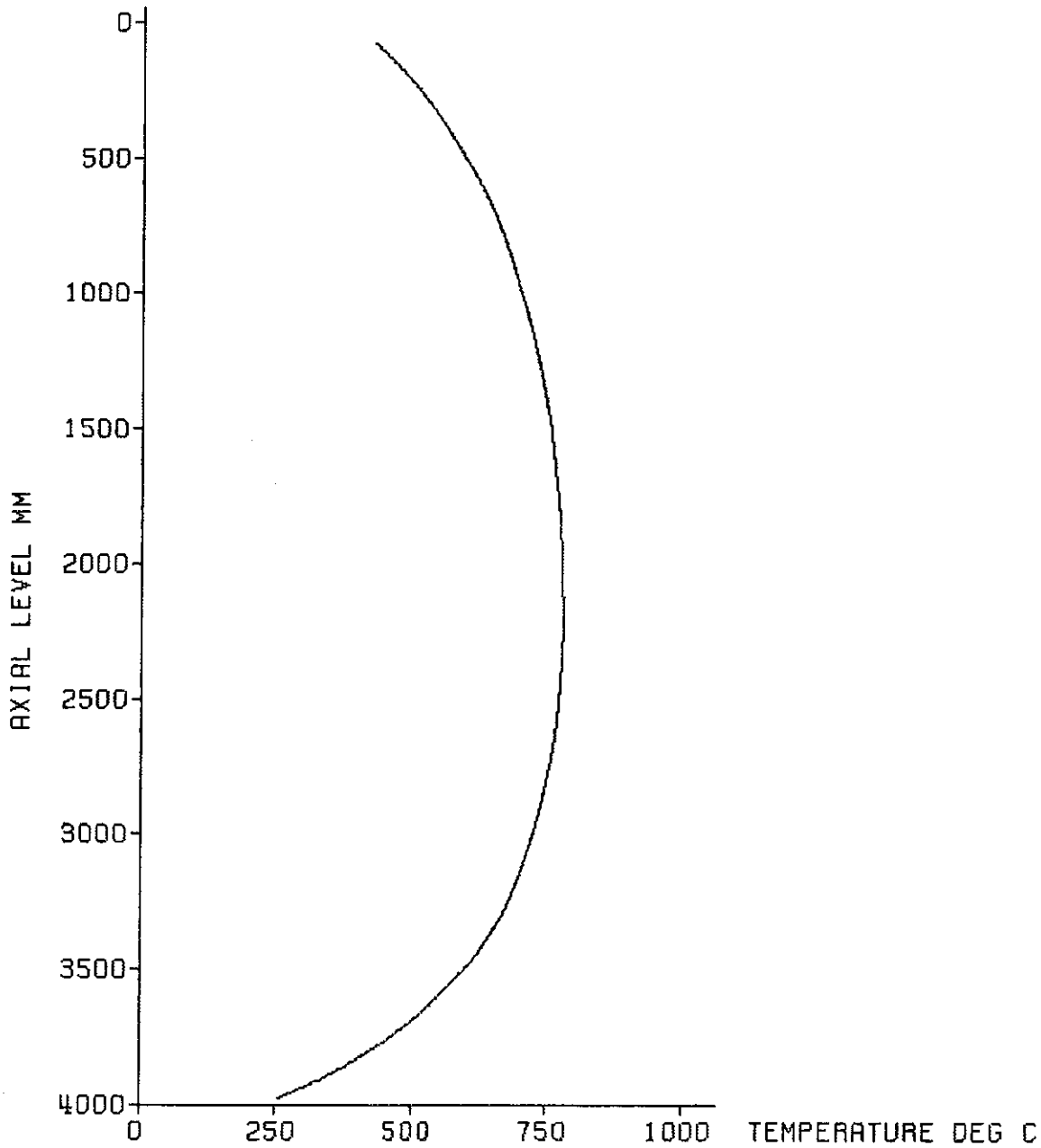

decay heat 120% ANS standard
flooding rate (cold) 3.82 cm/s
system pressure 4.15 bar
feedwater temperature 40 deg C



Fig. 119 FEBA: 5x5 ROD BUNDLE
TEST SERIES 2, TEST-No. 229

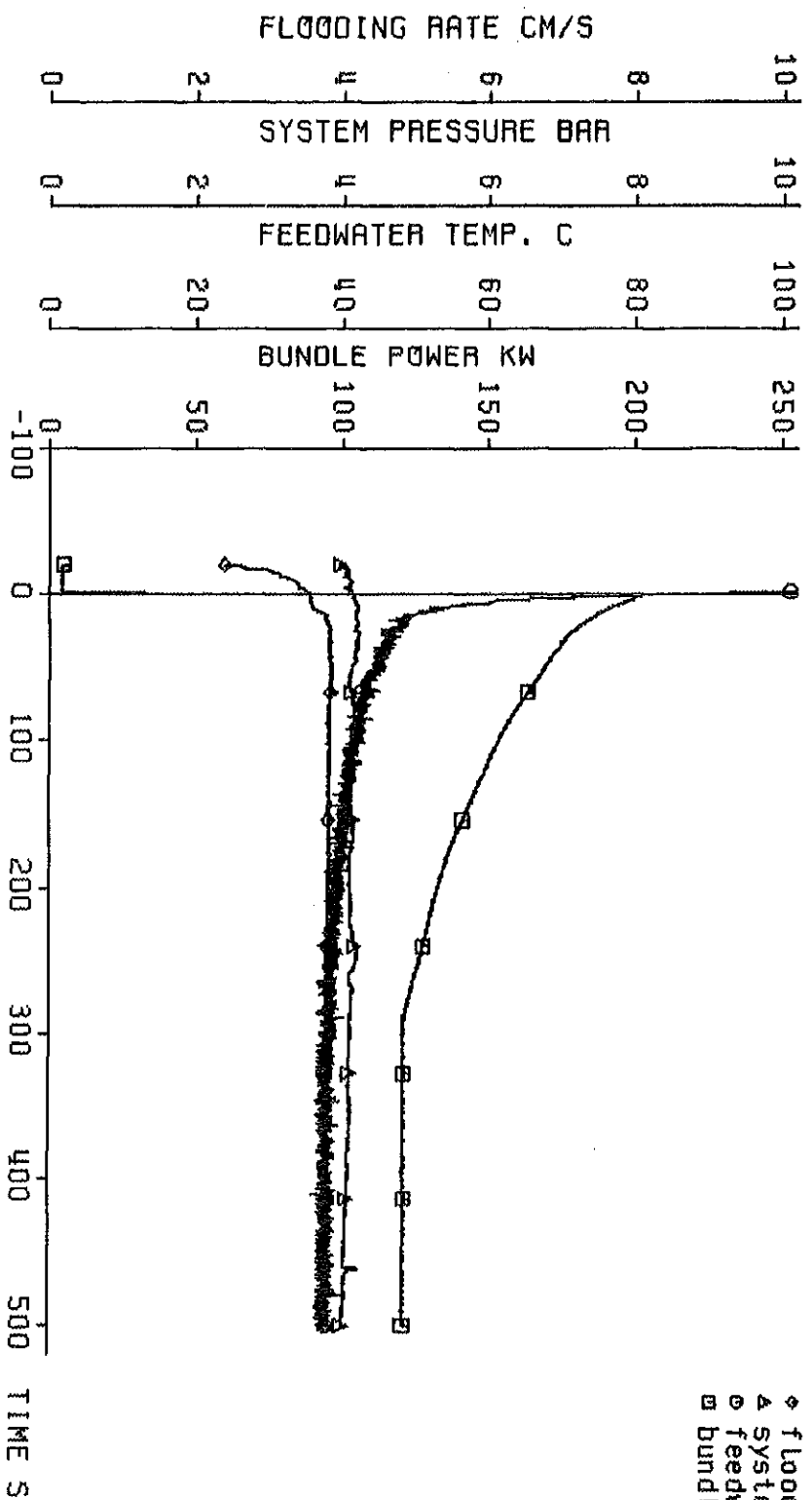

test parameters:

- ◆ flooding rate
- ▲ system pressure
- ◊ feedwater temperature
- ◻ bundle power

decay heat
 flooding rate (cold)
 system pressure
 feedwater temperature

120% ANS standard
 3.82 cm/s
 4.15 bar
 40 deg C



Fig. 120 FEBRA: 5x5 ROD BUNDLE, TEST SERIES 2, TEST-NO. 229

cladding temperature

TC	ax. level
+	18a4 3860 mm
x	18a3 3315 mm
y	18a2 2770 mm
*	18a1 2225 mm
◇	12b4 1680 mm
△	12b3 1135 mm
□	12b2 590 mm
	12b1 45 mm

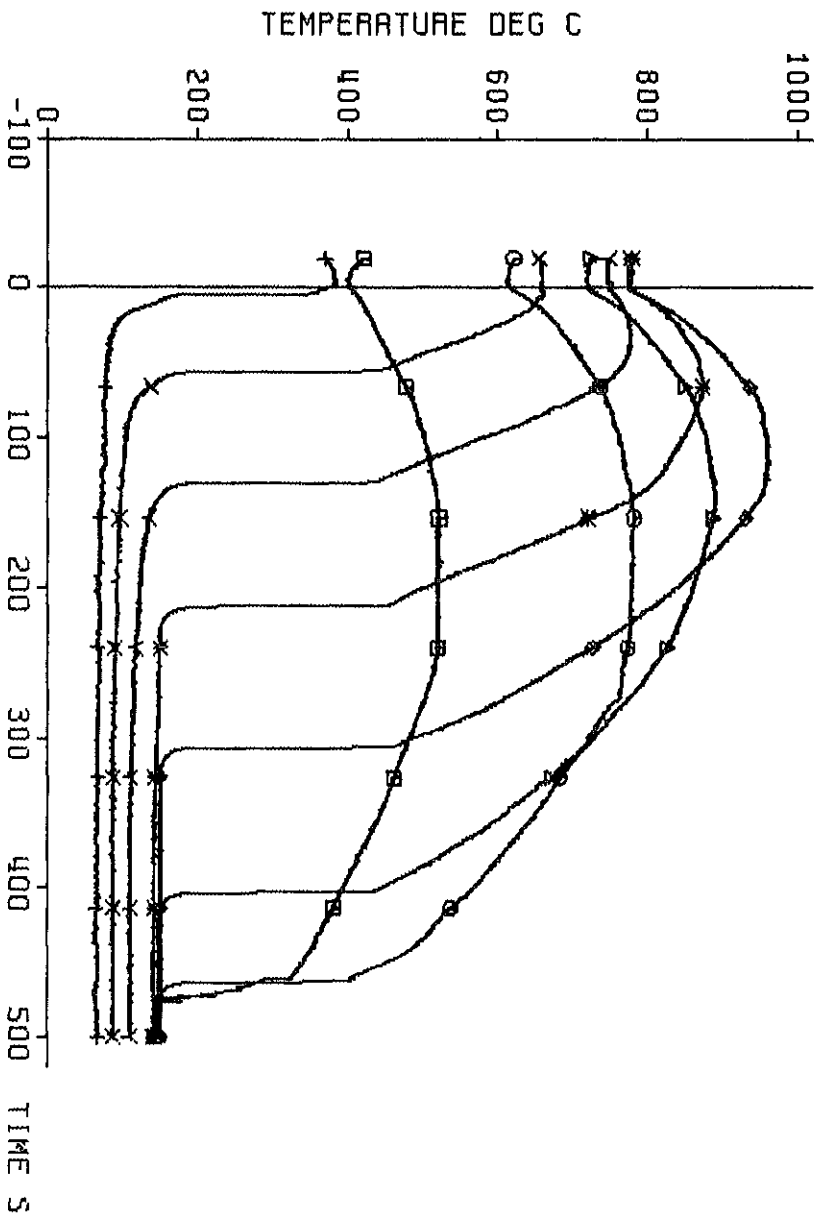

decay heat
 flooding rate (cold)
 system pressure
 feedwater temperature

120% RNS standard
 3.82 cm/s
 4.15 bar
 40 deg C

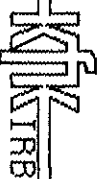
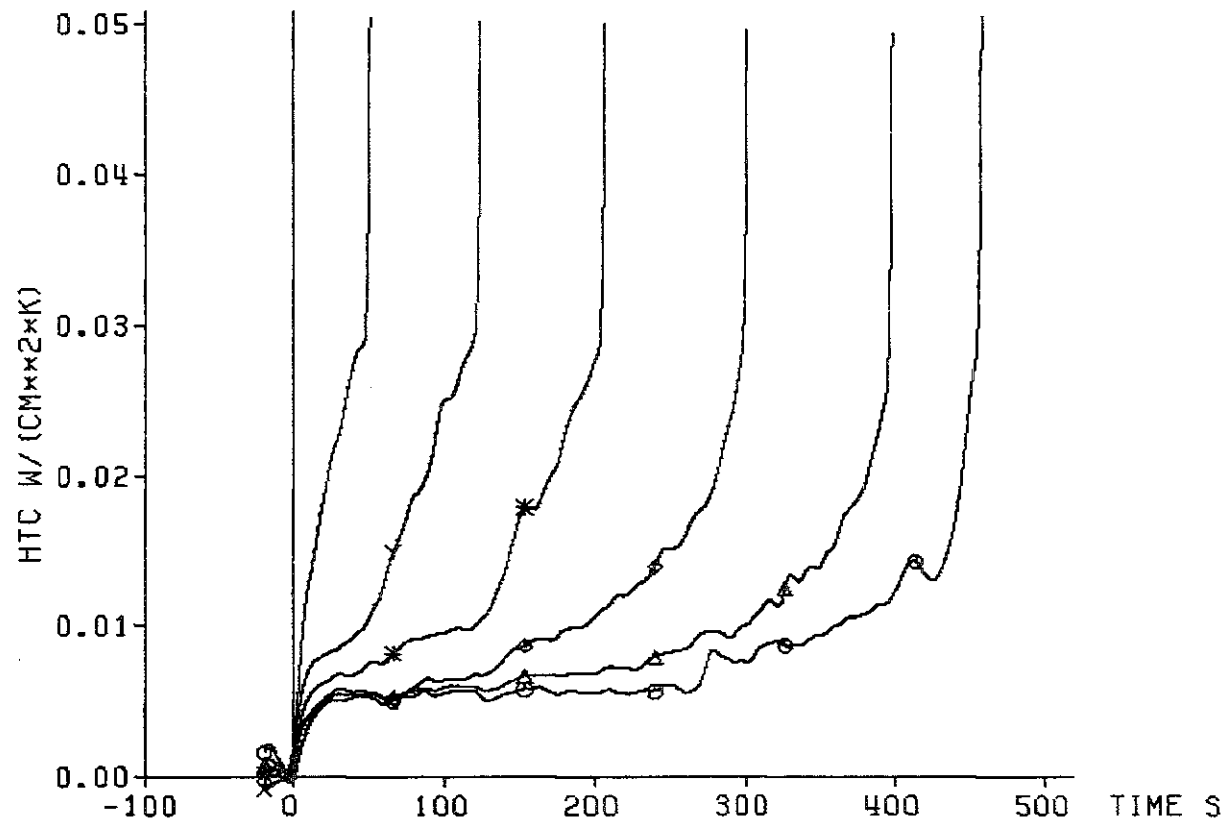

Fig. 121 FEBRA: 5X5 ROD BUNDLE, TEST SERIES 2, TEST-NO. 229

heat transfer coeff.



	TC	ax. Level
x	18a3	3315 mm
y	18a2	2770 mm
*	18a1	2225 mm
◇	12b4	1680 mm
△	12b3	1135 mm
○	12b2	590 mm

decay heat 120% ANS standard
 flooding rate (cold) 3.82 cm/s
 system pressure 4.15 bar
 feedwater temperature 40 deg C



Fig. 122 FEBA: 5x5 ROD BUNDLE, TEST SERIES 2, TEST-No. 229

cladding temperature

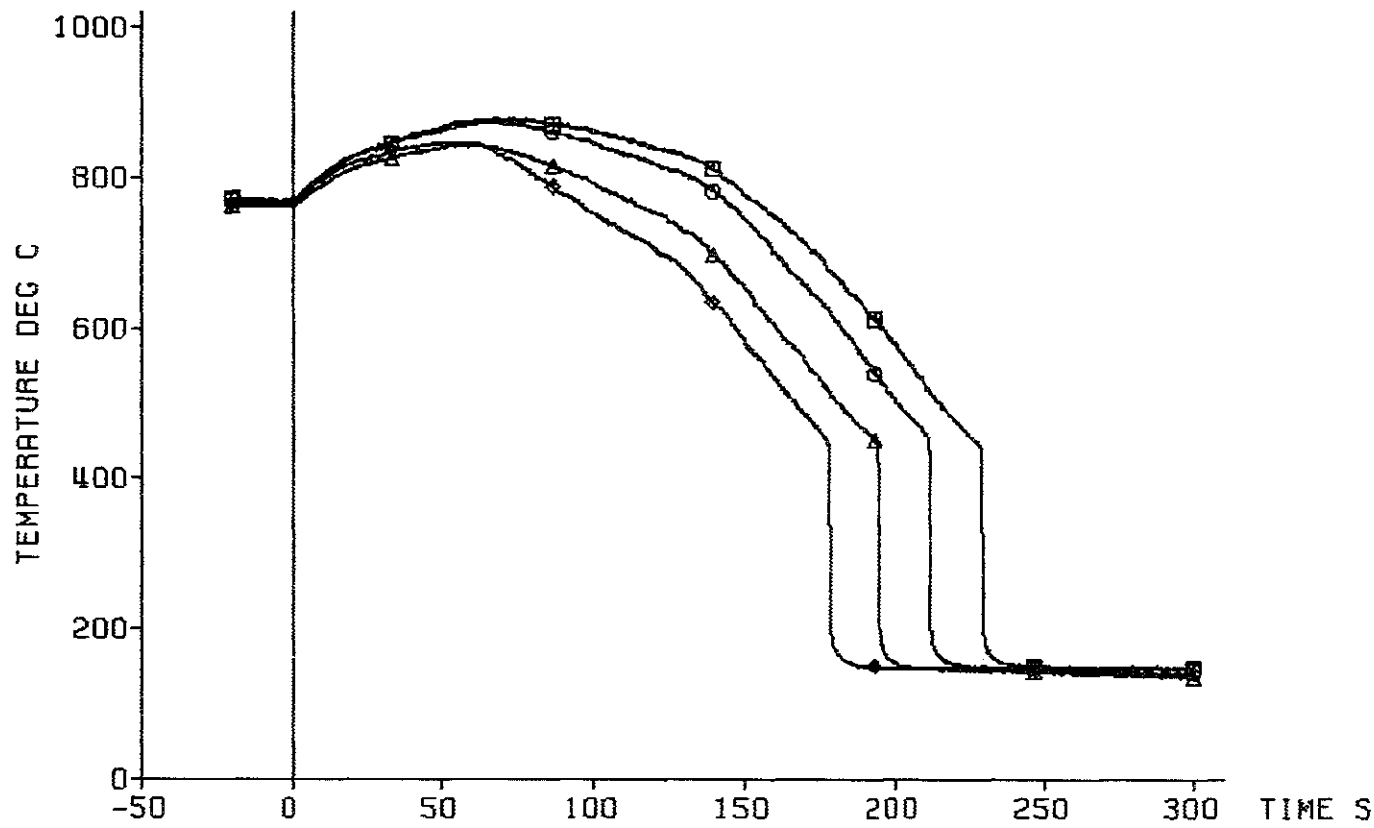

TC	ax. Level
◇	7f4 2425 mm
△	7f3 2325 mm
○	7f2 2225 mm
□	7f1 2125 mm

decay heat 120% ANS standard
 flooding rate (cold) 3.82 cm/s
 system pressure 4.15 bar
 feedwater temperature 40 deg C



Fig. 123 FEBA: 5x5 ROD BUNDLE, TEST SERIES 2, TEST-No. 229

heat transfer coeff.

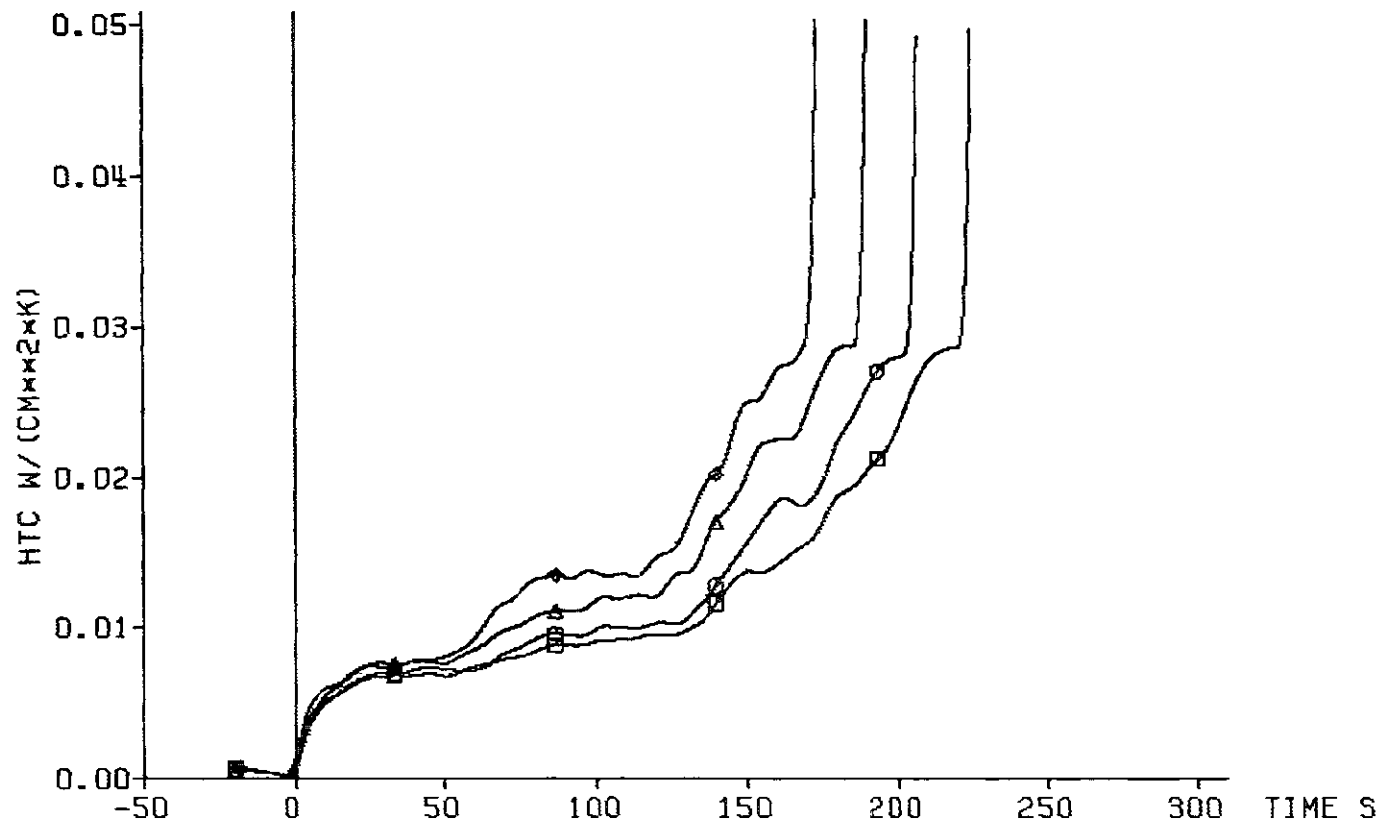

	TC	ax. Level
◇	7f4	2425 mm
△	7f3	2325 mm
○	7f2	2225 mm
□	7f1	2125 mm

decay heat 120% ANS standard
 flooding rate (cold) 3.82 cm/s
 system pressure 4.15 bar
 feedwater temperature 40 deg C



Fig. 124 FEBA: 5x5 ROD BUNDLE, TEST SERIES 2, TEST-No. 229

cladding temperature

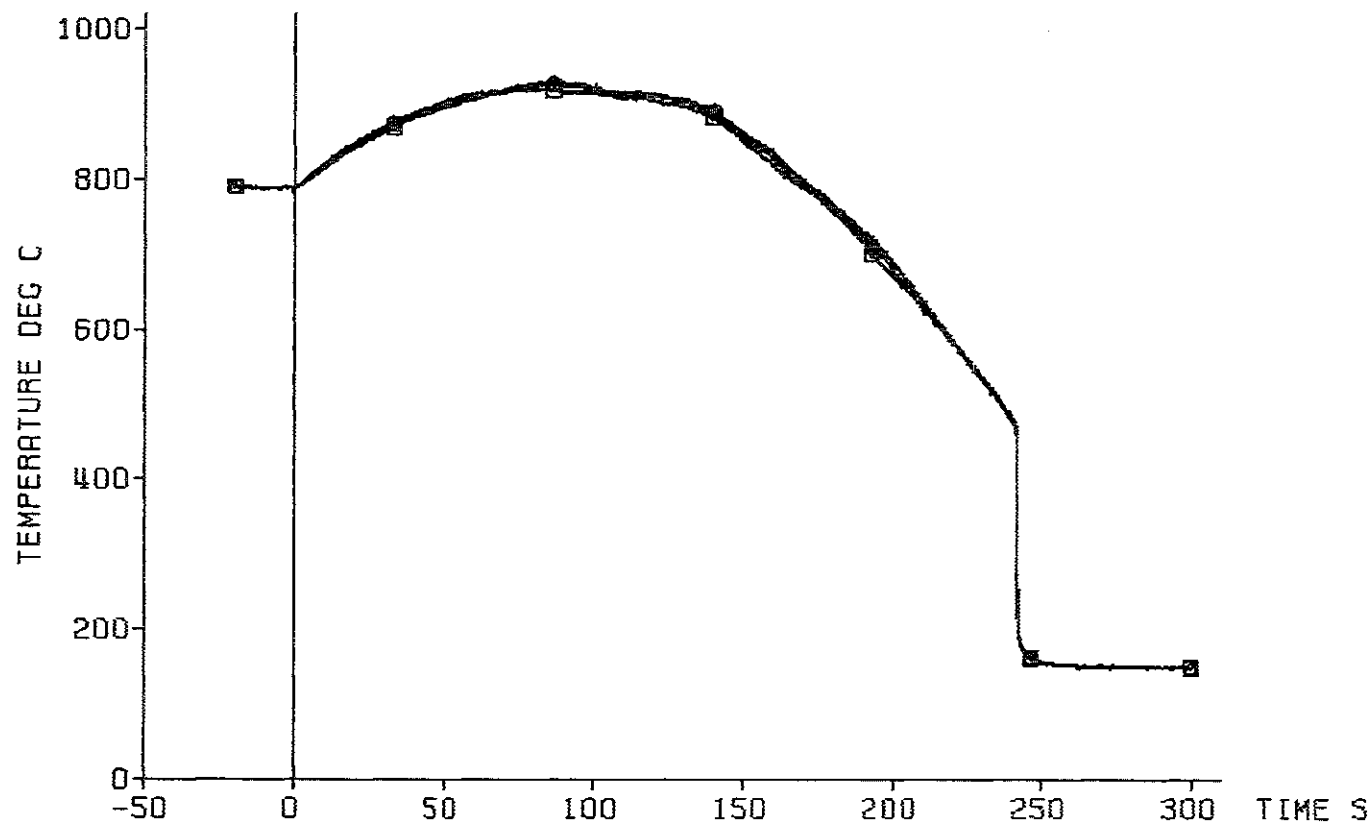

TC	ax. level
△ 13d3	2025 mm
○ 13d2	2025 mm
□ 13d1	2025 mm

decay heat 120% ANS standard
flooding rate (cold) 3.82 cm/s
system pressure 4.15 bar
feedwater temperature 40 deg C



Fig. 125 FEBA: 5x5 ROD BUNDLE, TEST SERIES 2, TEST-NO. 229

heat transfer coeff.

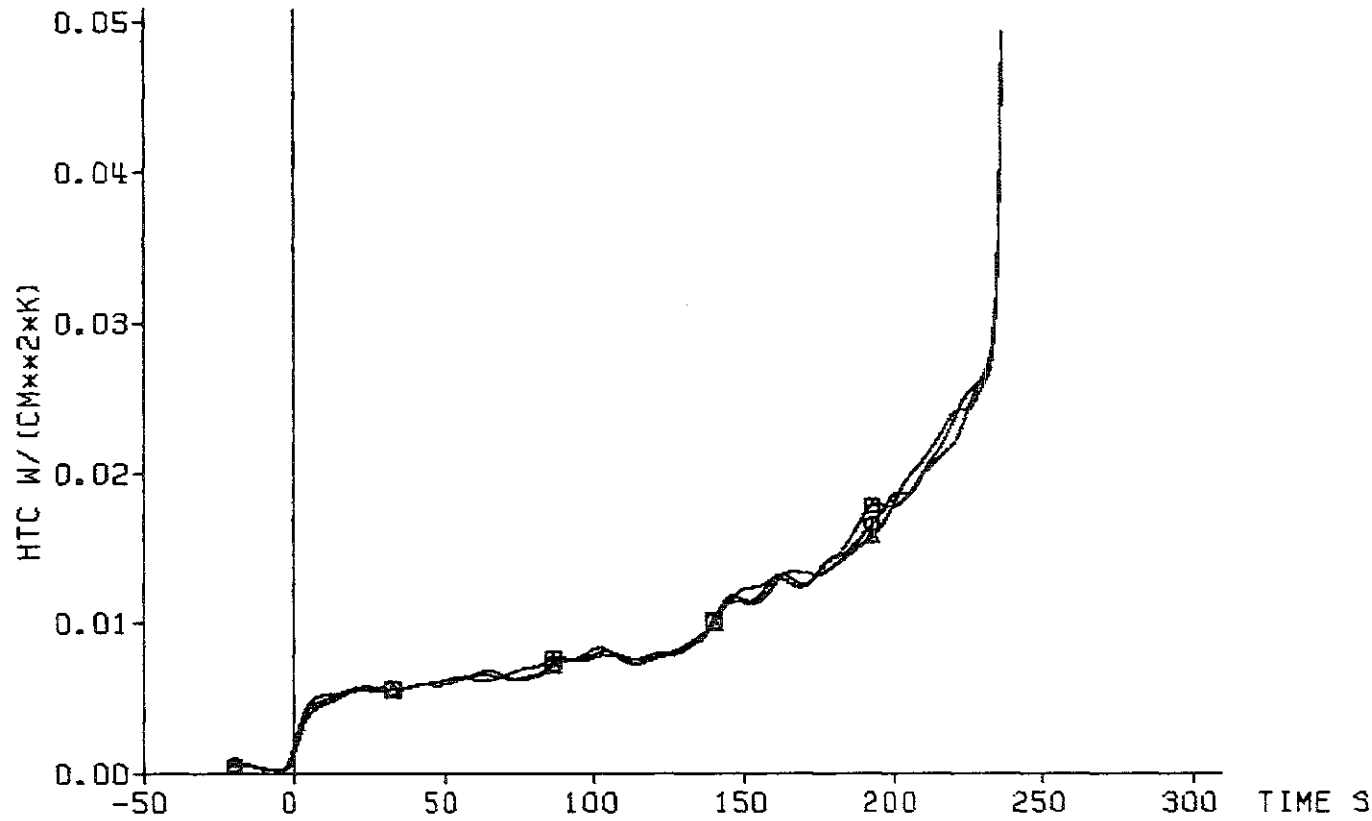

TC	axial level
△ 13d3	2025 mm
○ 13d2	2025 mm
□ 13d1	2025 mm

decay heat 120% ANS standard
flooding rate (cold) 3.82 cm/s
system pressure 4.15 bar
feedwater temperature 40 deg C



Fig. 126 FEBA: 5x5 ROD BUNDLE, TEST SERIES 2, TEST-No. 229

cladding temperature

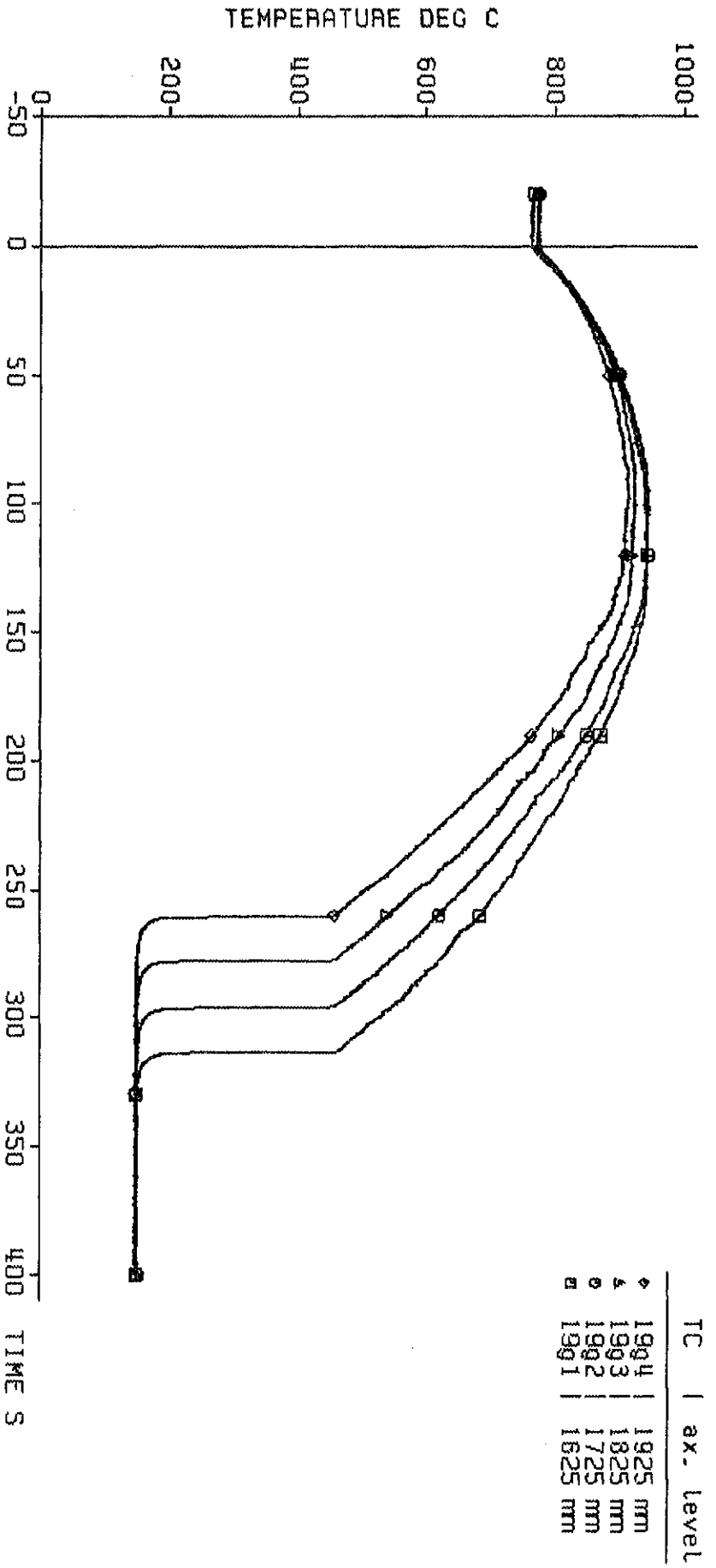

decay heat
 flooding rate (cold)
 system pressure
 feedwater temperature

120% RNS standard
 3.82 cm/s
 4.15 bar
 40 deg C

KIRB

Fig. 127 FEBRA: 5X5 ROD BUNDLE, TEST SERIES 2, TEST-NO. 229

heat transfer coeff.

TC	ax. level
◆ 19g4	1925 mm
▲ 19g3	1825 mm
○ 19g2	1725 mm
□ 19g1	1625 mm

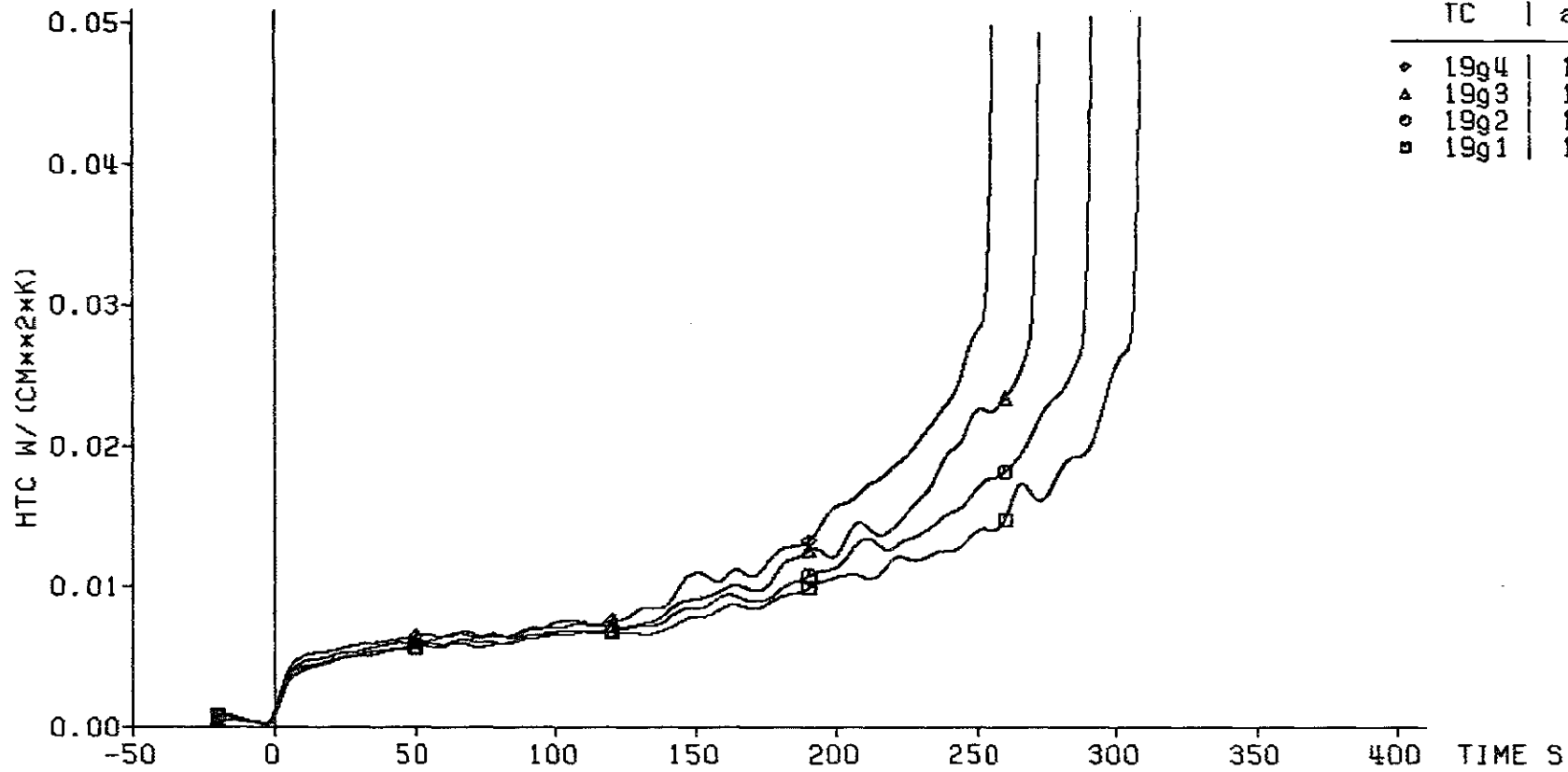

decay heat
 flooding rate (cold) 3.62 cm/s
 system pressure 4.15 bar
 feedwater temperature 40 deg C
 120% ANS standard



Fig. 128 FEBA: 5x5 ROD BUNDLE, TEST SERIES 2, TEST-No. 229

axial level: 1725 mm

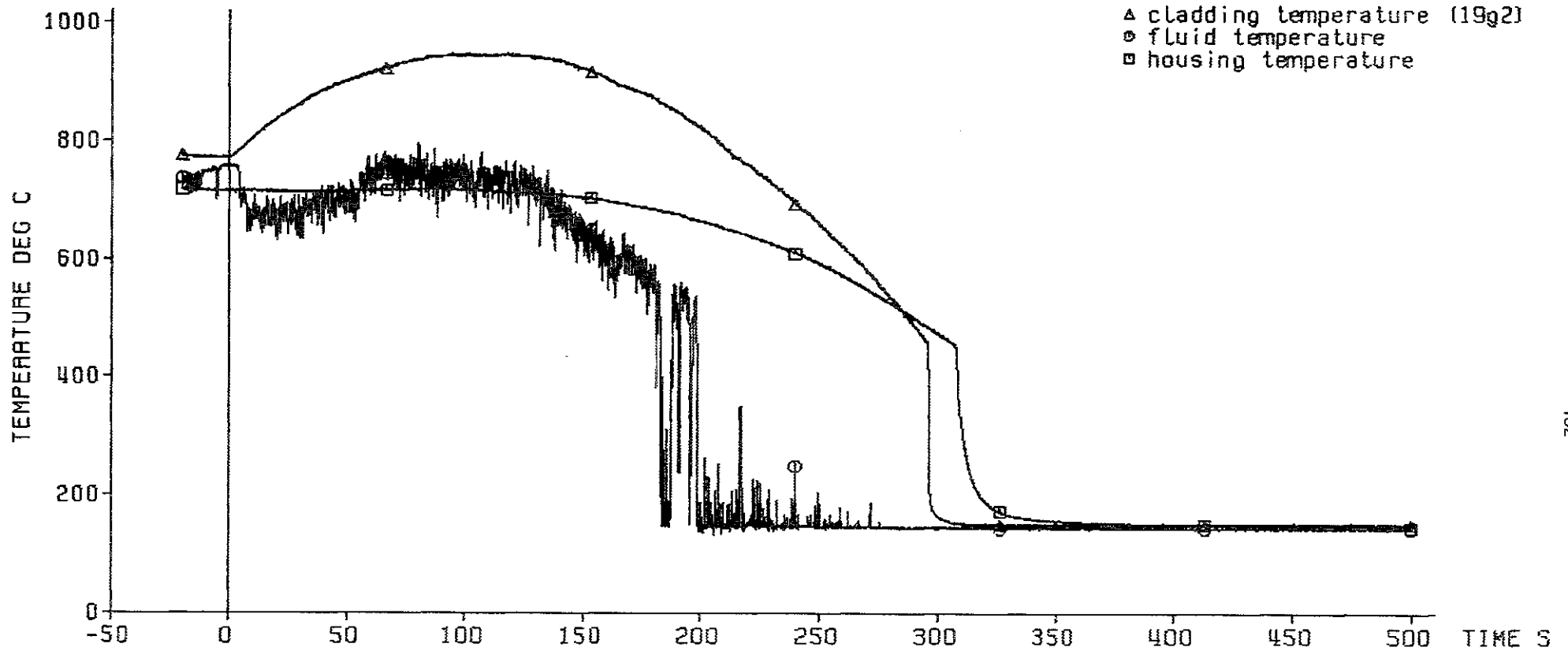

— 152 —

decay heat 120% RNS standard
flooding rate (cold) 3.82 cm/s
system pressure 4.15 bar
feedwater temperature 40 deg C



Fig. 129 FEBA: 5x5 ROD BUNDLE, TEST SERIES 2, TEST-No. 229

axial level: 1625 mm

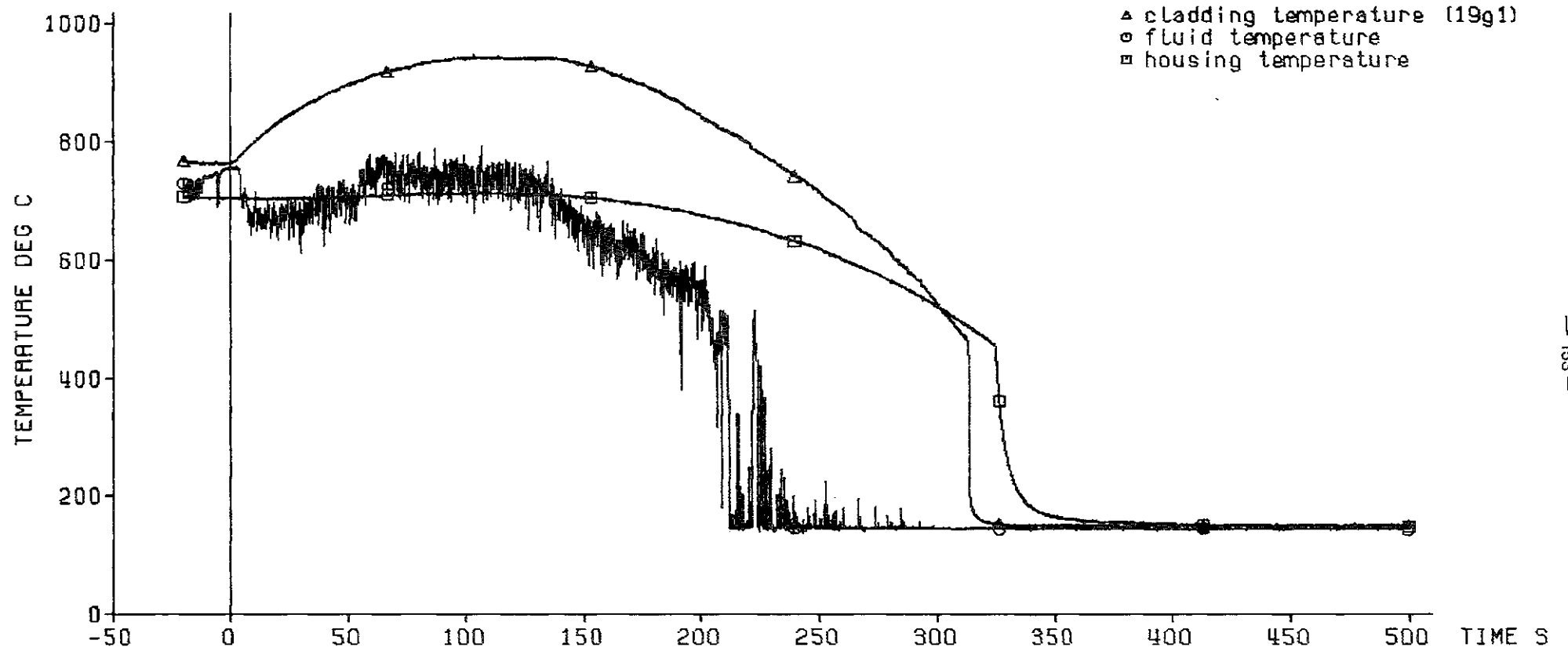

— 153 —

decay heat 120% ANS standard
flooding rate (cold) 3.82 cm/s
system pressure 4.15 bar
feedwater temperature 40 deg C

KfK
IRB

Fig. 130 FEBA: 5x5 ROD BUNDLE, TEST SERIES 2, TEST-No. 229

pressure loss
along the test section:

◆ total length: 4196 mm
△ lower part: 1711 mm
○ middle part: 545 mm
□ upper part: 1940 mm

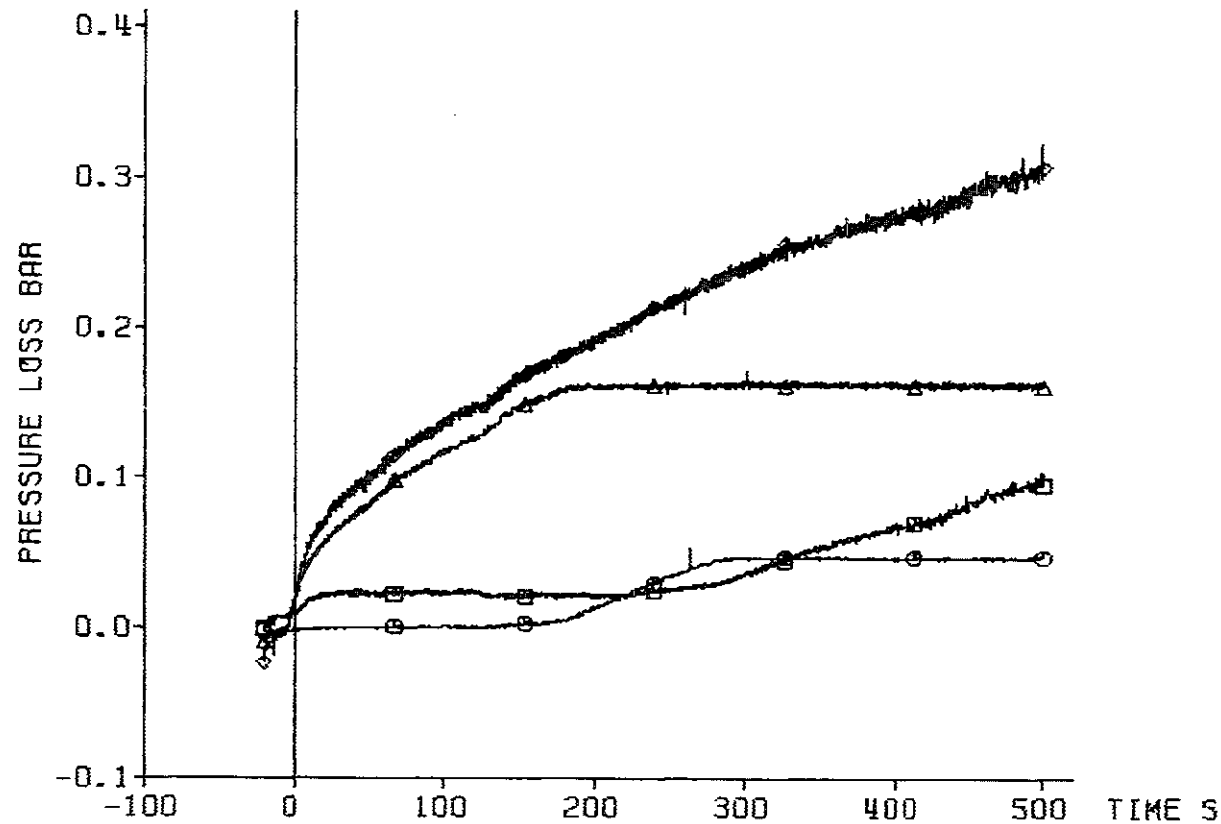

decay heat 120% ANS standard
flooding rate (cold) 3.62 cm/s
system pressure 4.15 bar
feedwater temperature 40 deg C



Fig. 131 FEBA: 5x5 ROD BUNDLE, TEST SERIES 2, TEST-No. 229

coolant outlet conditions:

△ water carry over
○ coolant temperature
□ coolant pressure

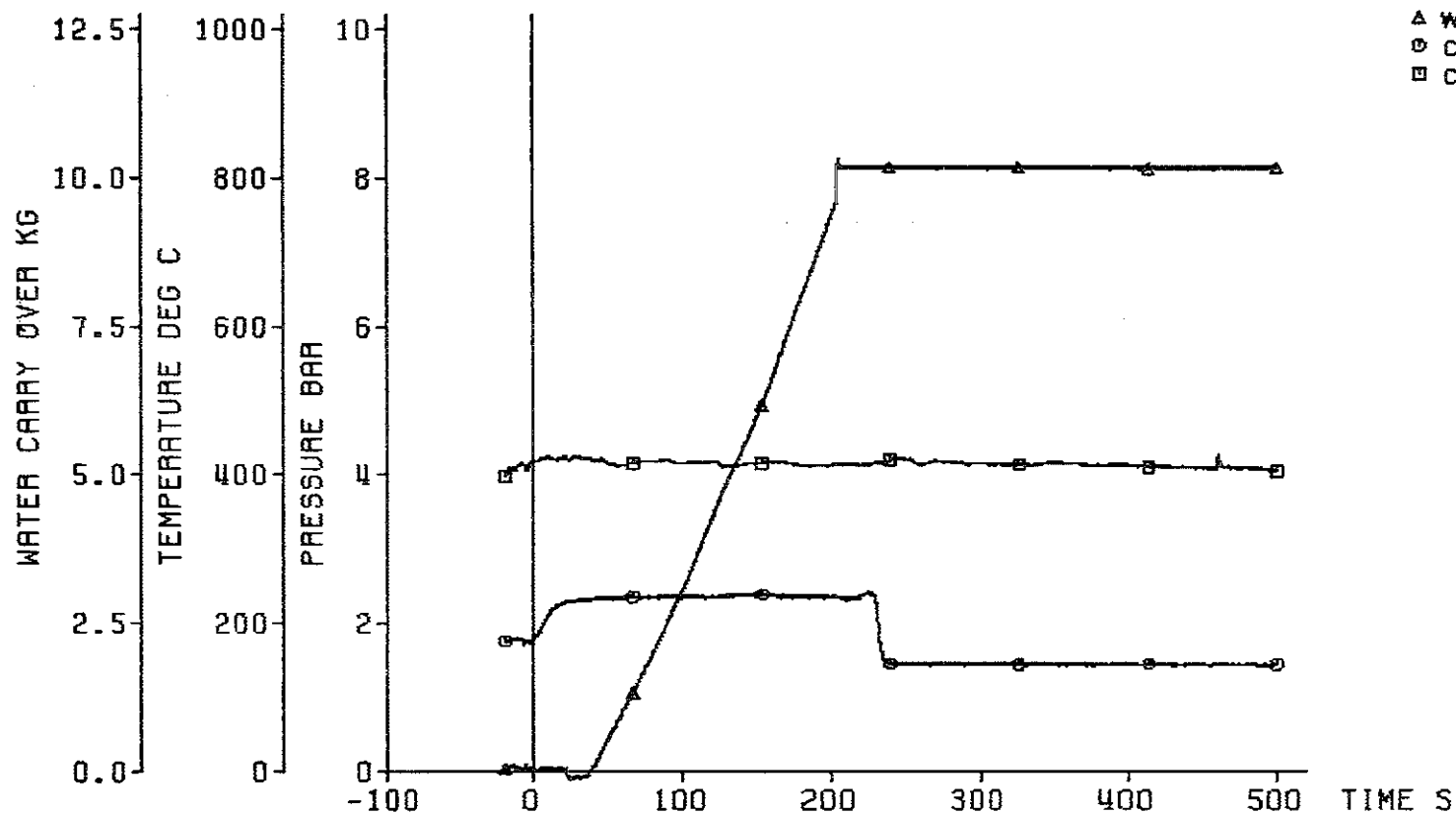

decay heat 120% ANS standard
flooding rate (cold) 3.82 cm/s
system pressure 4.15 bar
feedwater temperature 40 deg C



Fig. 132 FEBA: 5x5 R0D BUNDLE, TEST SERIES 2, TEST-No. 229

axial position of the quench front

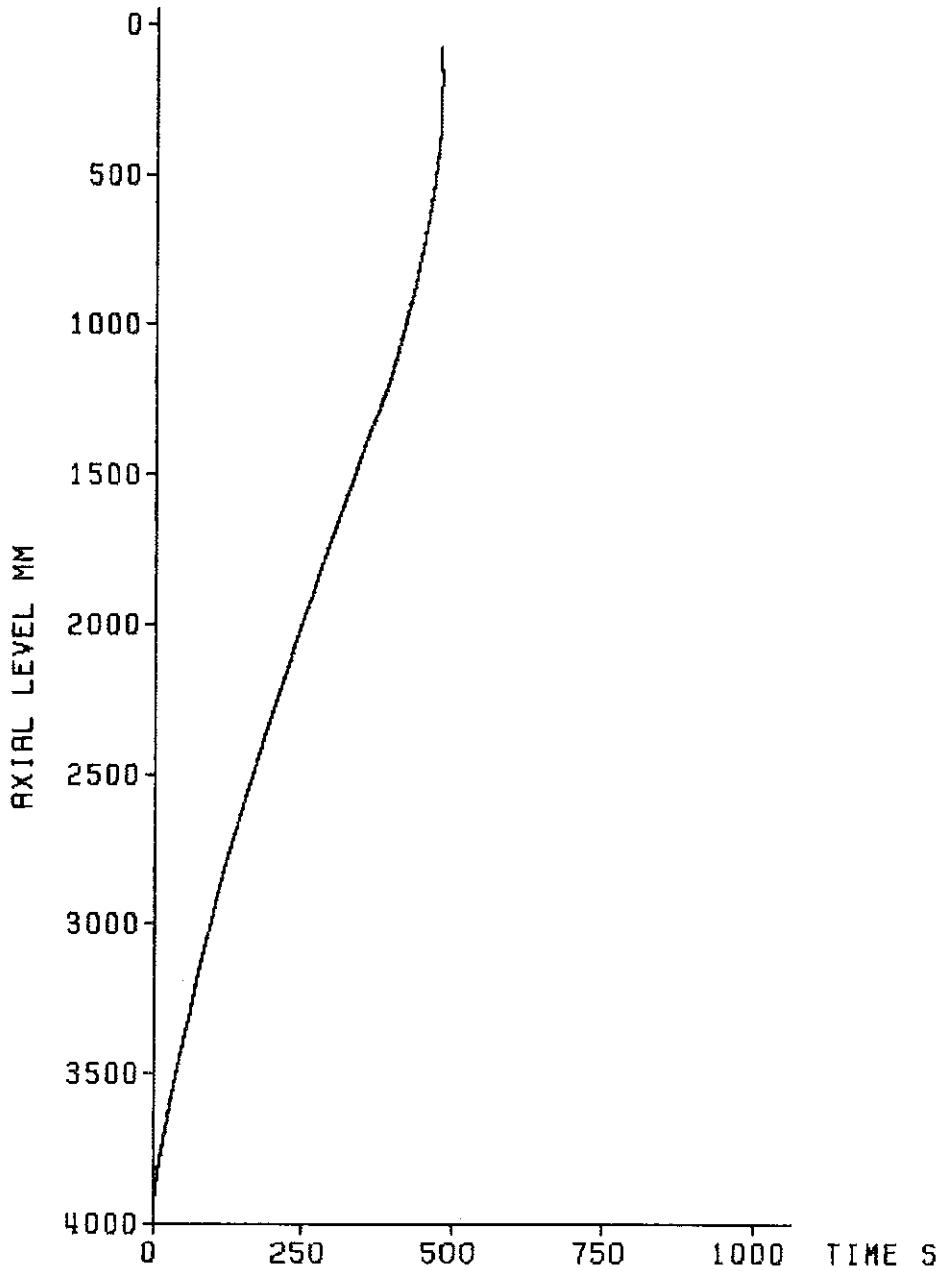

decay heat	120% ANS standard
flooding rate (cold)	3.82 cm/s
system pressure	4.15 bar
feedwater temperature	40 deg C

KIK
IRB

Fig. 133 FEBA: 5x5 ROD BUNDLE
TEST SERIES 2, TEST-No. 229

initial axial temperature profile of the cladding

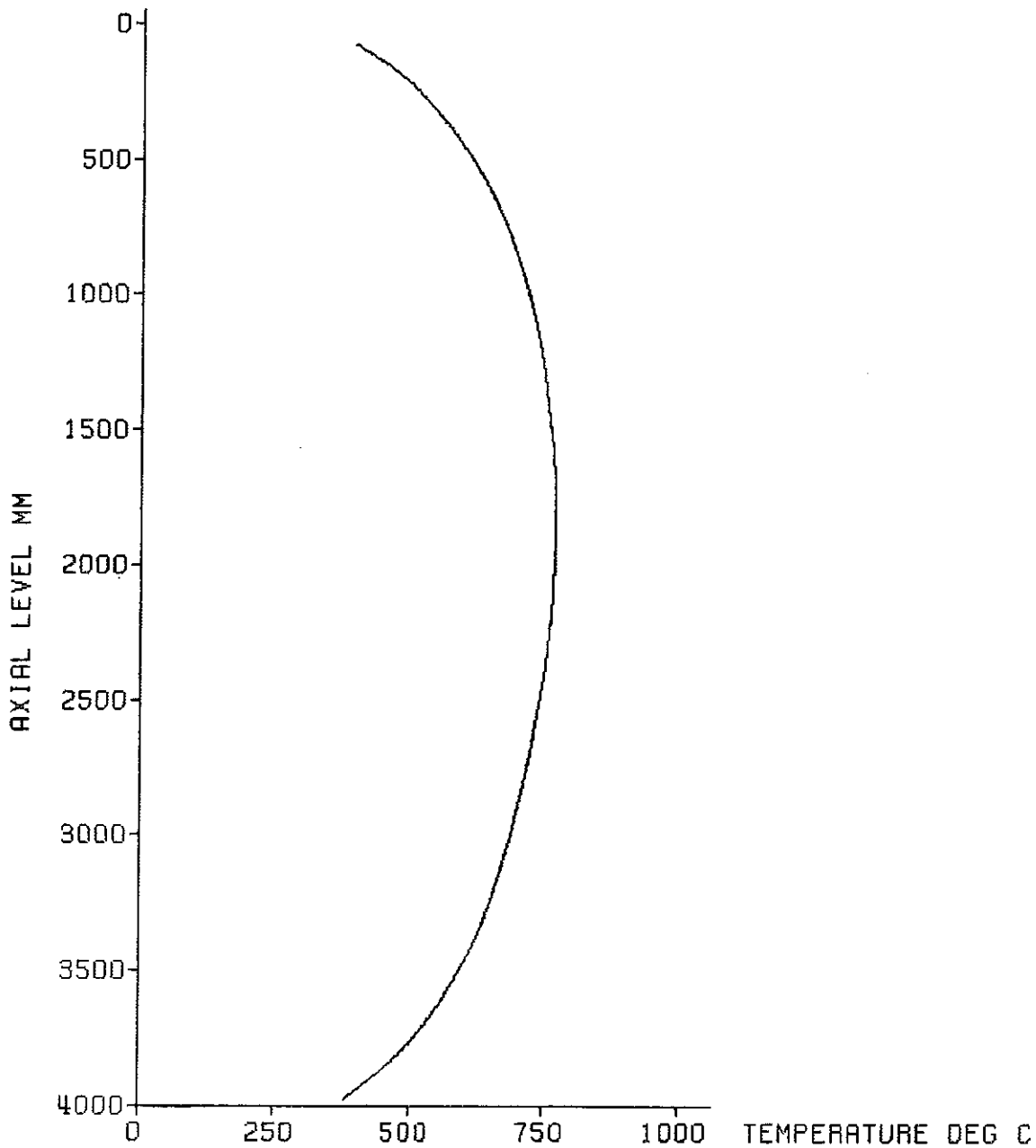

decay heat 120% ANS standard
flooding rate (cold) 3.80 cm/s
system pressure 6.19 bar
feedwater temperature 40 deg C



Fig. 134 FEBA: 5x5 ROD BUNDLE
TEST SERIES 2, TEST-No. 231

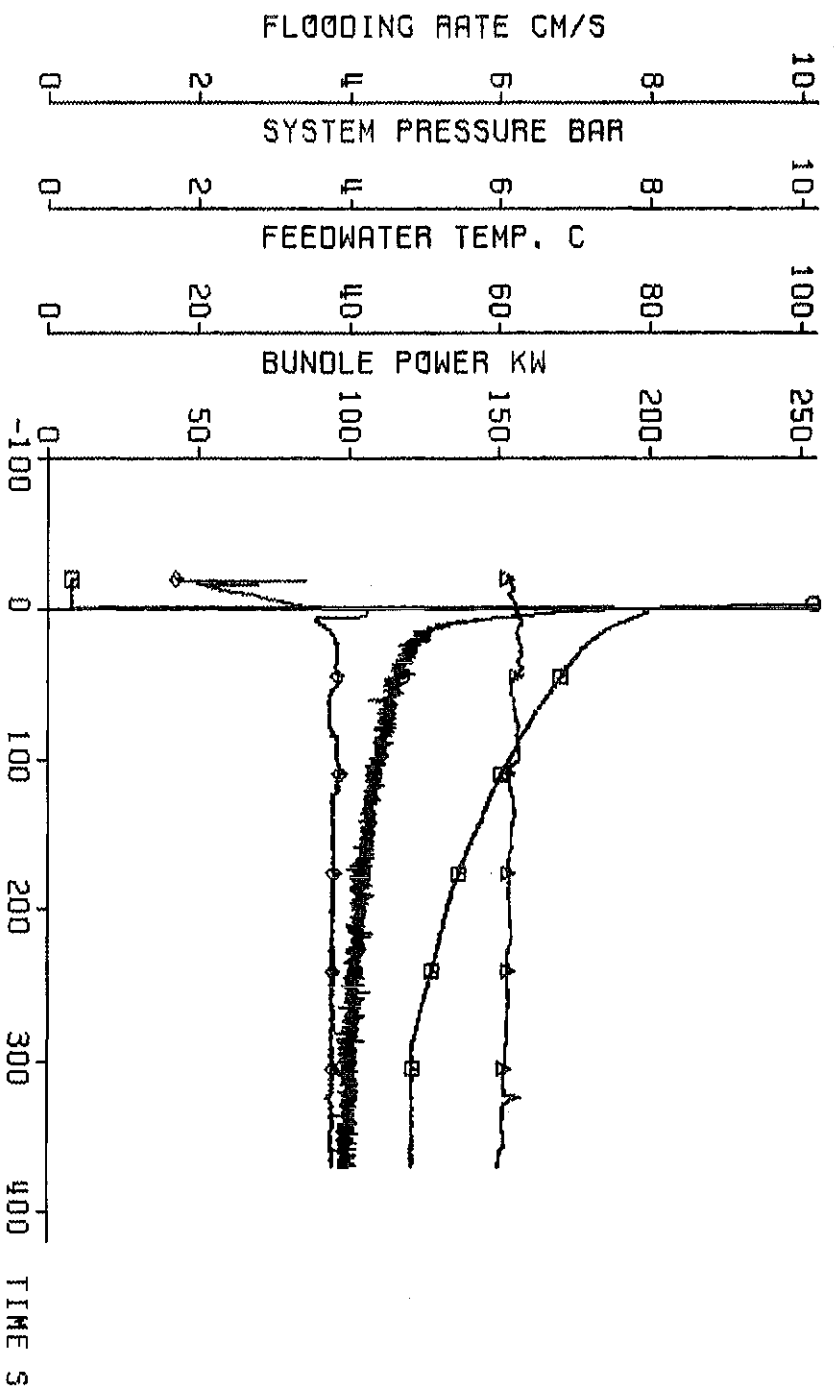

test parameters:

- ♦ flooding rate
- △ system pressure
- feedwater temperature
- bundle power

decay heat
flooding rate (cold)
system pressure
feedwater temperature

120% ANS standard
3.80 cm/s
5.19 bar
40 deg C



Fig. 135 FEBRA: 5X5 ROD BUNDLE, TEST SERIES 2, TEST-NO. 231

cladding temperature

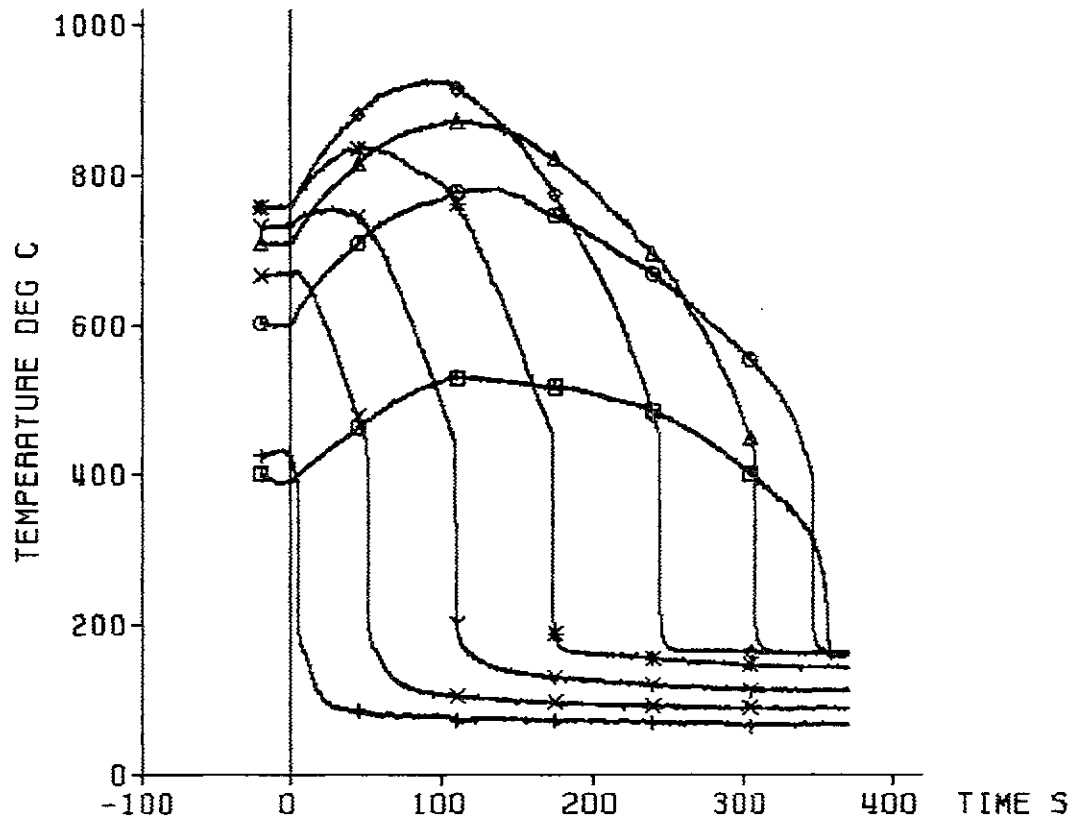

TC	ax. Level
+	18a4 3860 mm
x	18a3 3315 mm
y	18a2 2770 mm
*	18a1 2225 mm
◇	12b4 1680 mm
△	12b3 1135 mm
○	12b2 590 mm
□	12b1 45 mm

decay heat 120% ANS standard
 flooding rate (cold) 3.80 cm/s
 system pressure 6.19 bar
 feedwater temperature 40 deg C



Fig. 136 FEBA: 5x5 ROD BUNDLE, TEST SERIES 2, TEST-No. 231

heat transfer coeff.

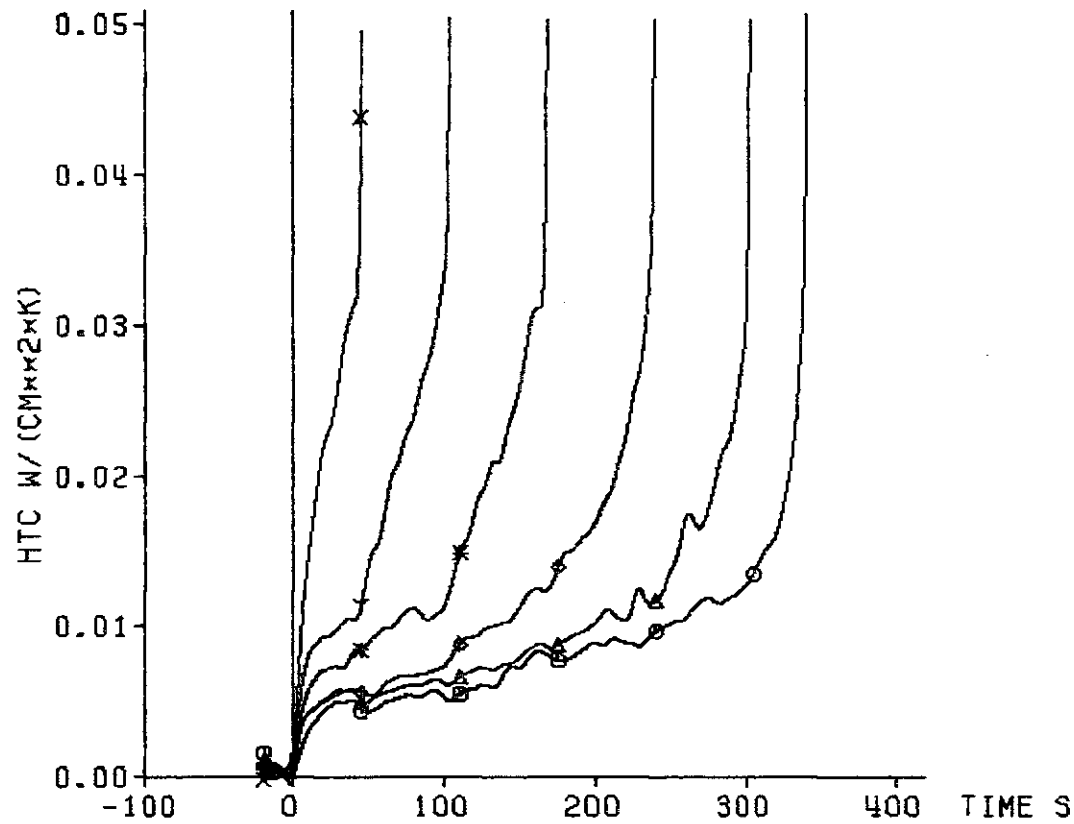

	TC	ax. Level
x	18a3	3315 mm
y	18a2	2770 mm
*	18a1	2225 mm
◇	12b4	1680 mm
△	12b3	1135 mm
○	12b2	590 mm

decay heat 120% ANS standard
 flooding rate (cold) 3.80 cm/s
 system pressure 6.19 bar
 feedwater temperature 40 deg C



Fig. 137 FEBA: 5x5 ROD BUNDLE, TEST SERIES 2, TEST-No. 231

cladding temperature

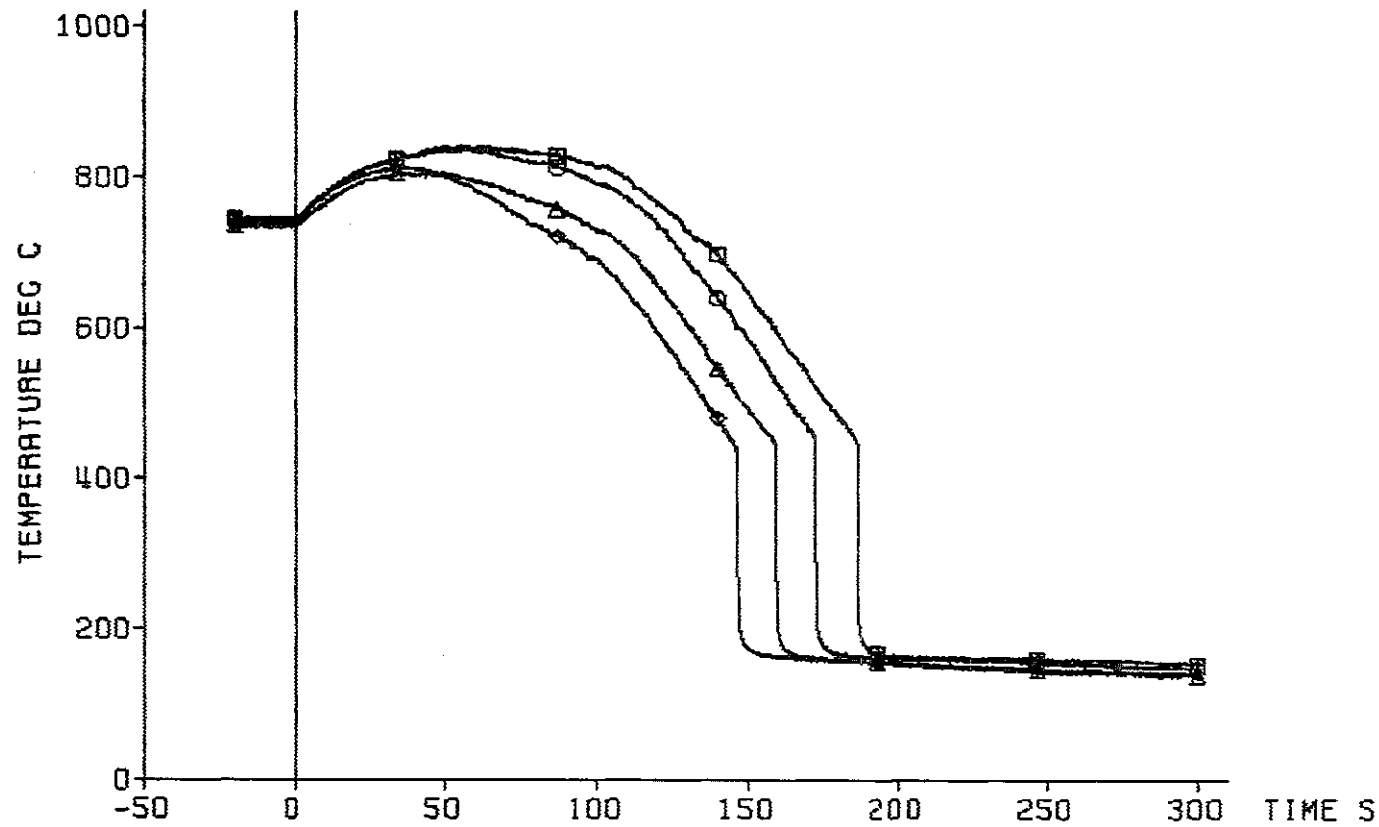

TC	ax. level
◇	7f4 2425 mm
△	7f3 2325 mm
○	7f2 2225 mm
□	7f1 2125 mm

decay heat 120% ANS standard
 flooding rate (cold) 3.80 cm/s
 system pressure 6.19 bar
 feedwater temperature 40 deg C



Fig. 138 FEBA: 5x5 ROD BUNDLE, TEST SERIES 2, TEST-No. 231

heat transfer coeff.

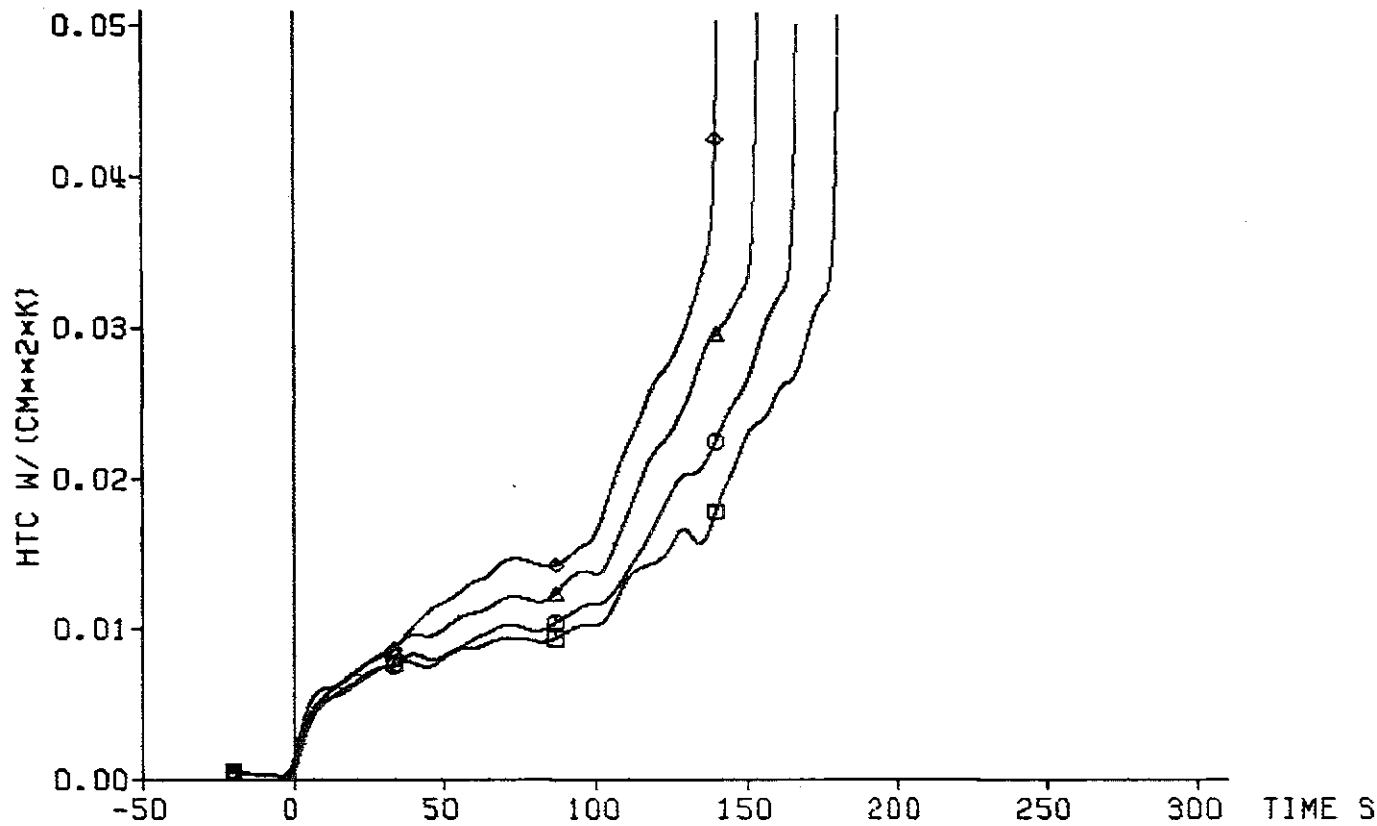

decay heat 120% ANS standard
flooding rate (cold) 3.80 cm/s
system pressure 6.19 bar
feedwater temperature 40 deg C



Fig. 139 FEBA: 5x5 ROD BUNDLE, TEST SERIES 2, TEST-No. 231

cladding temperature

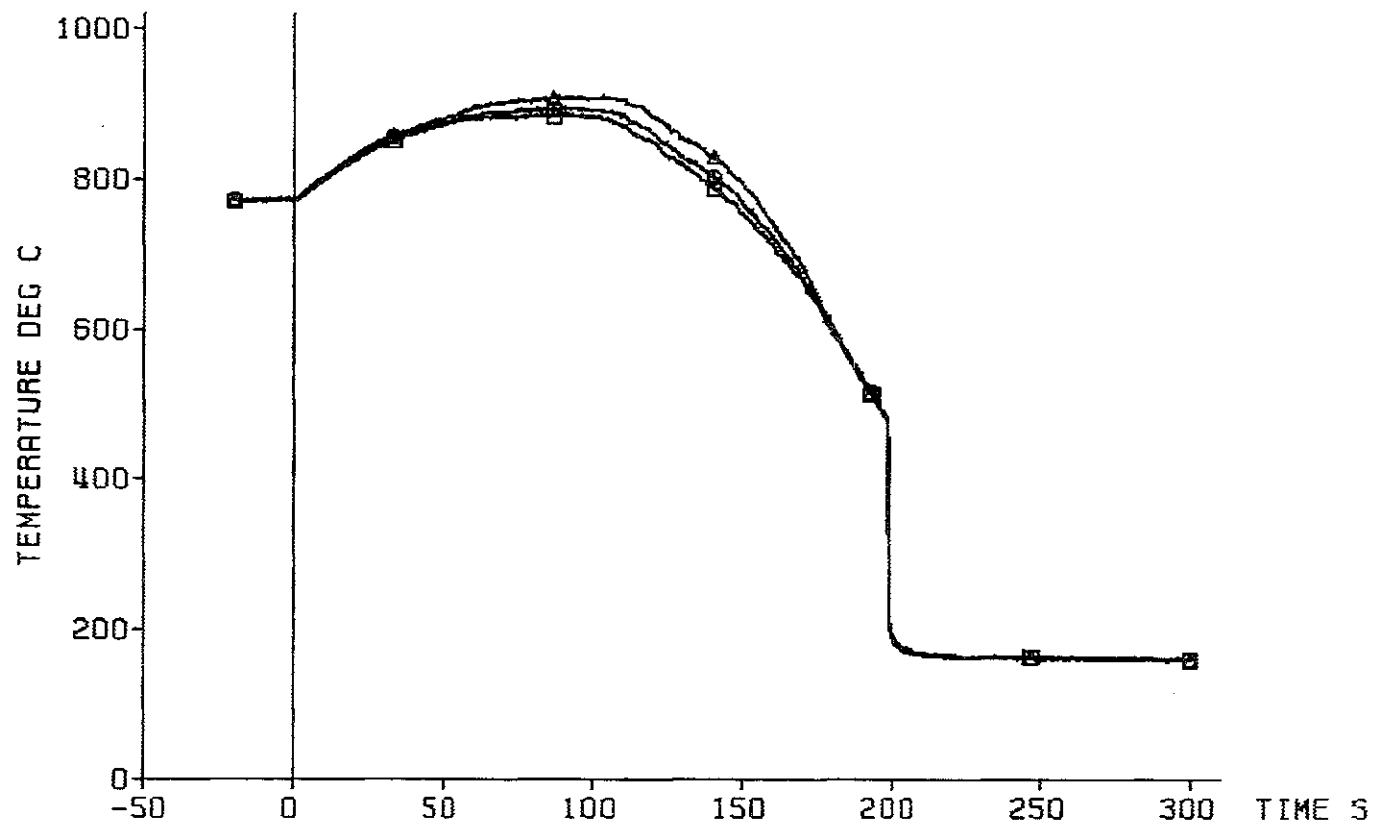

TC	ax. level
▲ 13d3	2025 mm
● 13d2	2025 mm
■ 13d1	2025 mm

decay heat 120% ANS standard
flooding rate (cold) 3.80 cm/s
system pressure 6.19 bar
feedwater temperature 40 deg C



Fig. 140 FEBA: 5x5 ROD BUNDLE, TEST SERIES 2, TEST-No. 231

heat transfer coeff.

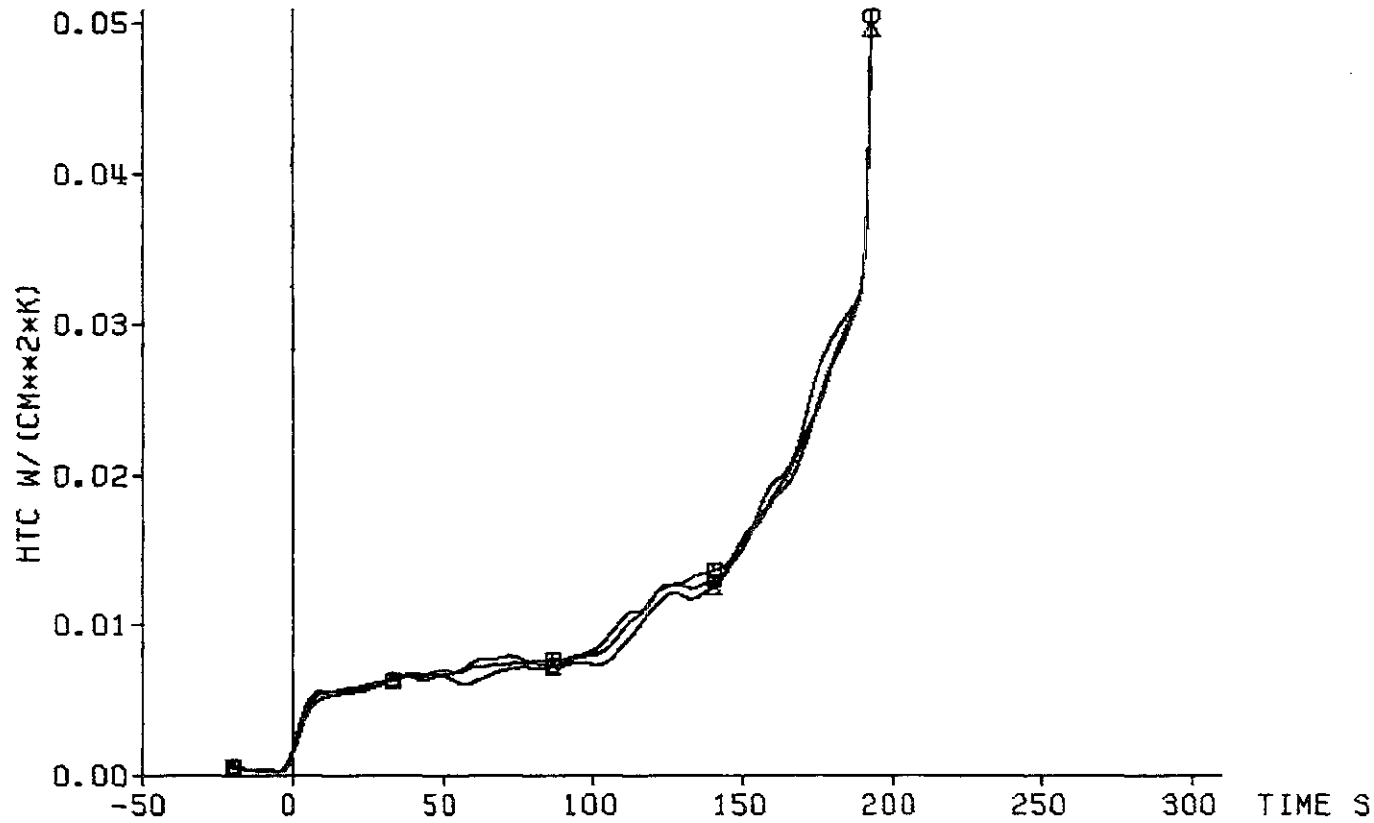

TC	axial Level
△ 13d3	2025 mm
○ 13d2	2025 mm
□ 13d1	2025 mm

decay heat 120% ANS standard
 flooding rate (cold) 3.80 cm/s
 system pressure 6.19 bar
 feedwater temperature 40 deg C



Fig. 141 FEBA: 5x5 ROD BUNDLE, TEST SERIES 2, TEST-No. 231

cladding temperature

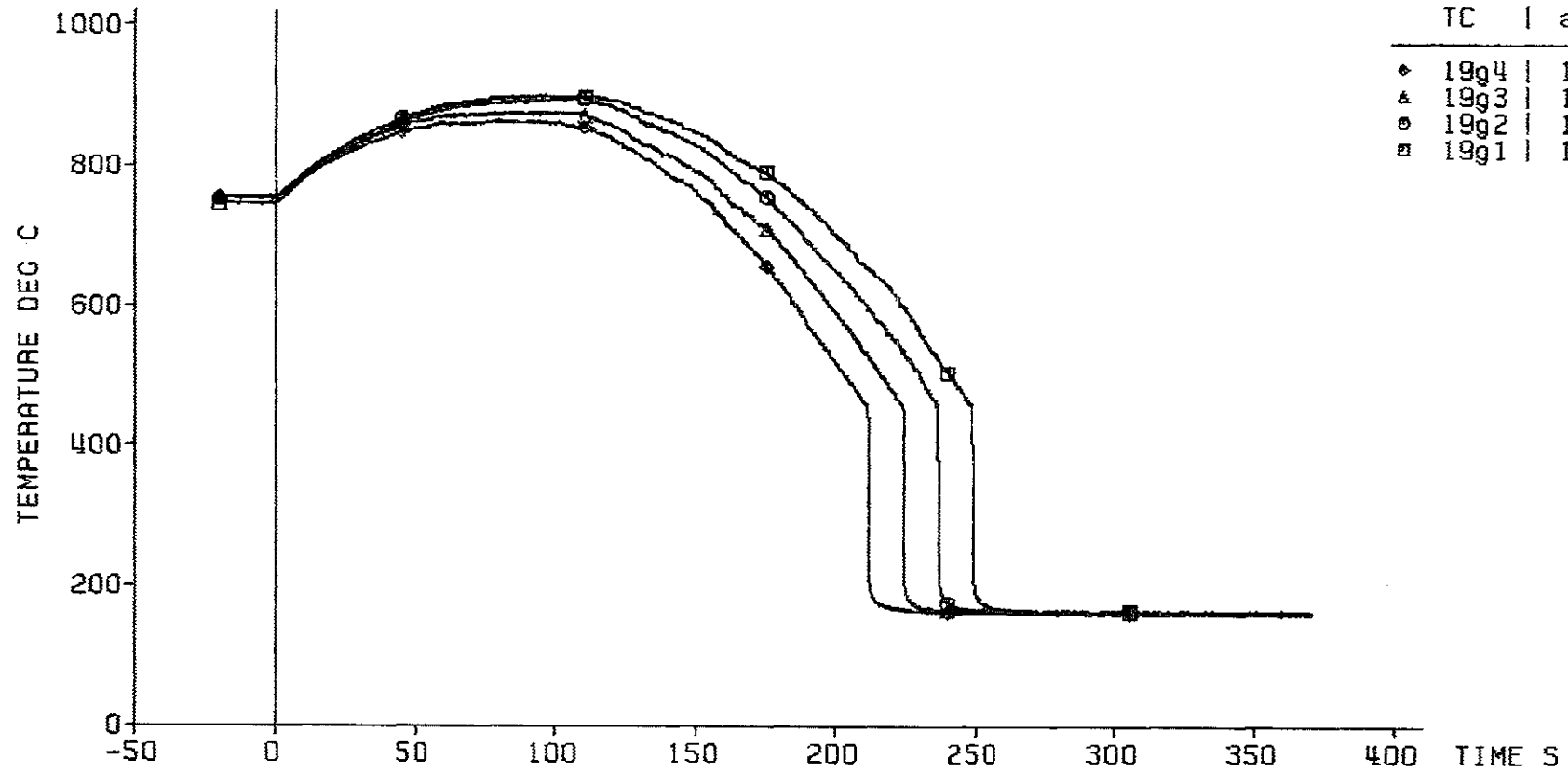

decay heat 120% ANS standard
flooding rate (cold) 3.80 cm/s
system pressure 6.19 bar
feedwater temperature 40 deg C

KIT²
KITRB

Fig. 142 FEBA: 5x5 ROD BUNDLE, TEST SERIES 2, TEST-No. 231

heat transfer coeff.

TC	ax. Level
◊ 19g4	1925 mm
▲ 19g3	1825 mm
◻ 19g2	1725 mm
◻ 19g1	1625 mm

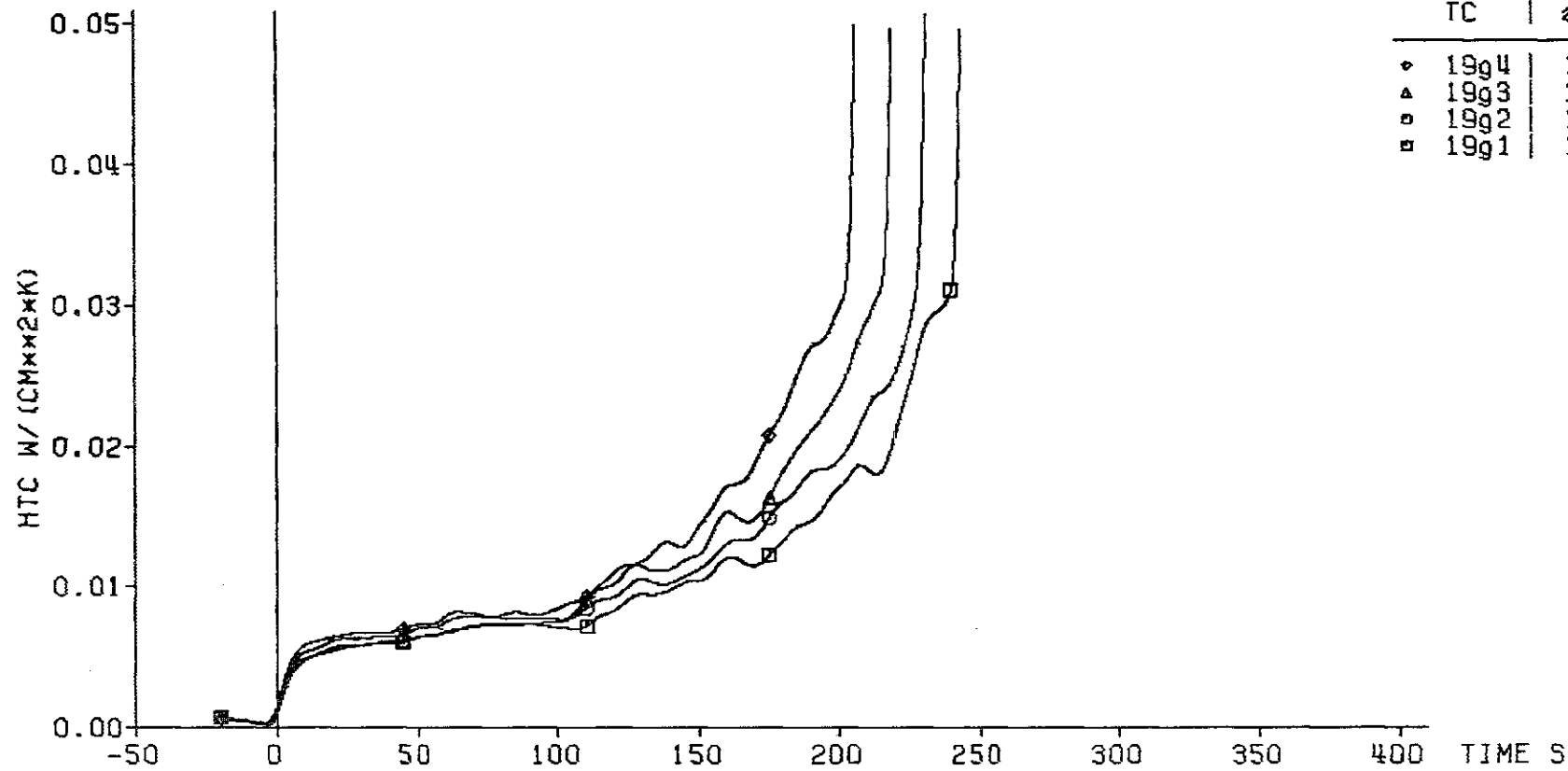

decay heat
 flooding rate (cold)
 system pressure
 feedwater temperature

120% ANS standard
 3.80 cm/s
 6.19 bar
 40 deg C



Fig. 143 FEBA: 5x5 ROD BUNDLE, TEST SERIES 2, TEST-No. 231

axial level: 1725 mm

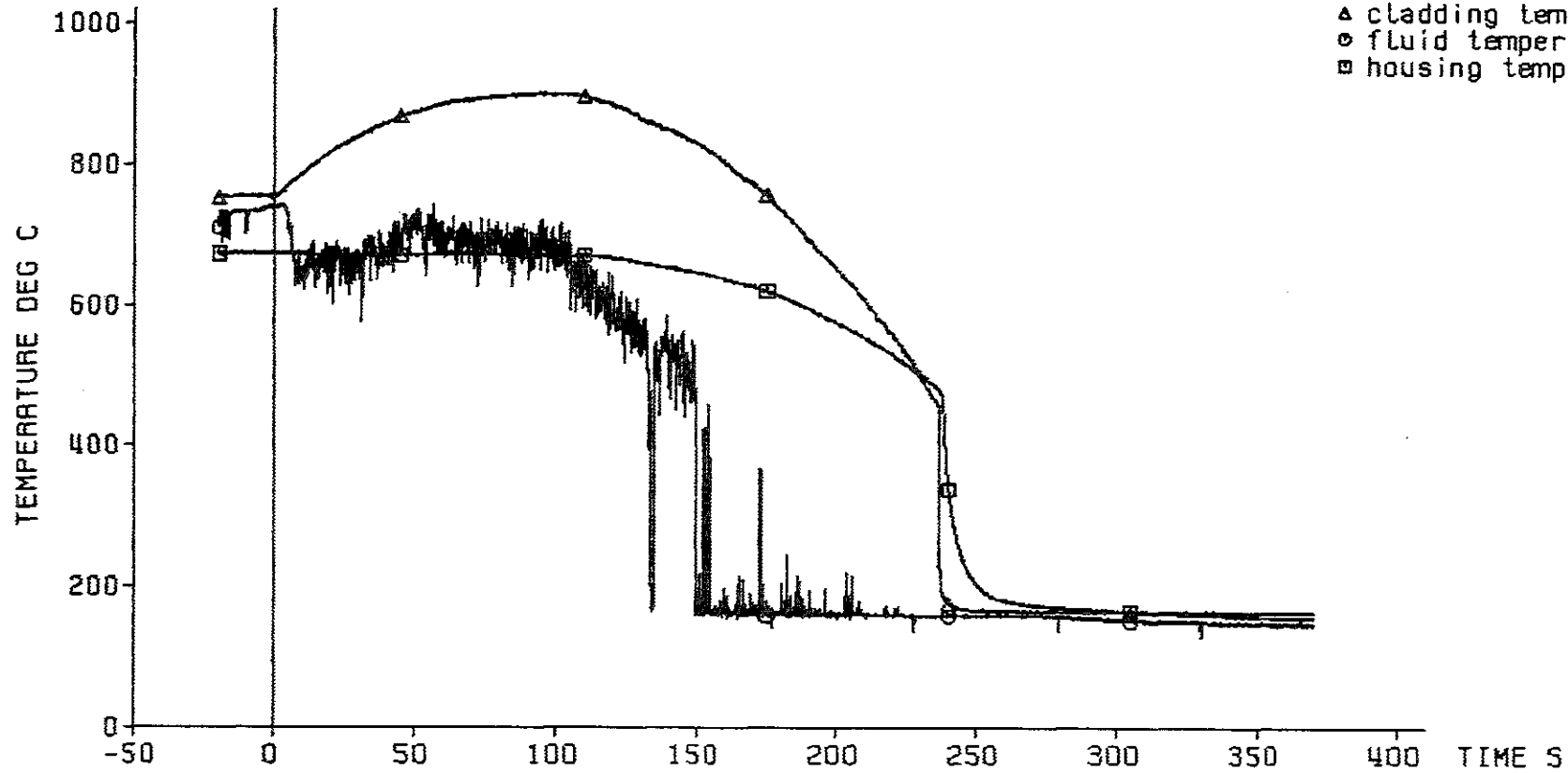

decay heat 120% ANS standard
flooding rate (cold) 3.80 cm/s
system pressure 6.19 bar
feedwater temperature 40 deg C

KfK IRB

Fig. 144 FEBA: 5x5 ROD BUNDLE, TEST SERIES 2, TEST-No. 231

axial level: 1625 mm

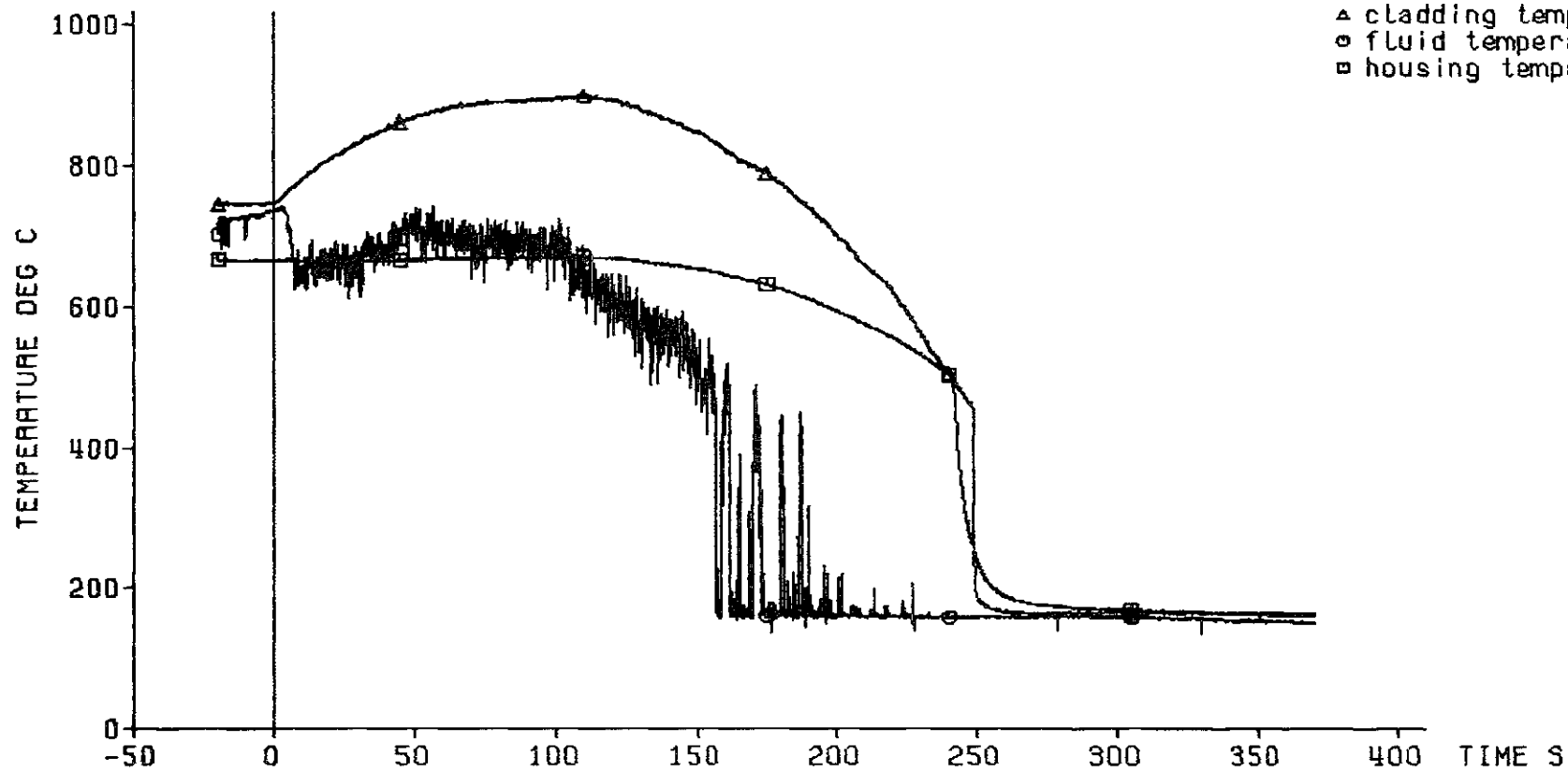

decay heat 120% ANS standard
flooding rate (cold) 3.80 cm/s
system pressure 6.19 bar
feedwater temperature 40 deg C

KIK IRB

Fig. 145 FEBA: 5x5 ROD BUNDLE, TEST SERIES 2, TEST-NO. 231

pressure loss
along the test section:

- ◆ total length: 4196 mm
- ▲ lower part: 1711 mm
- ◊ middle part: 545 mm
- ◻ upper part: 1940 mm

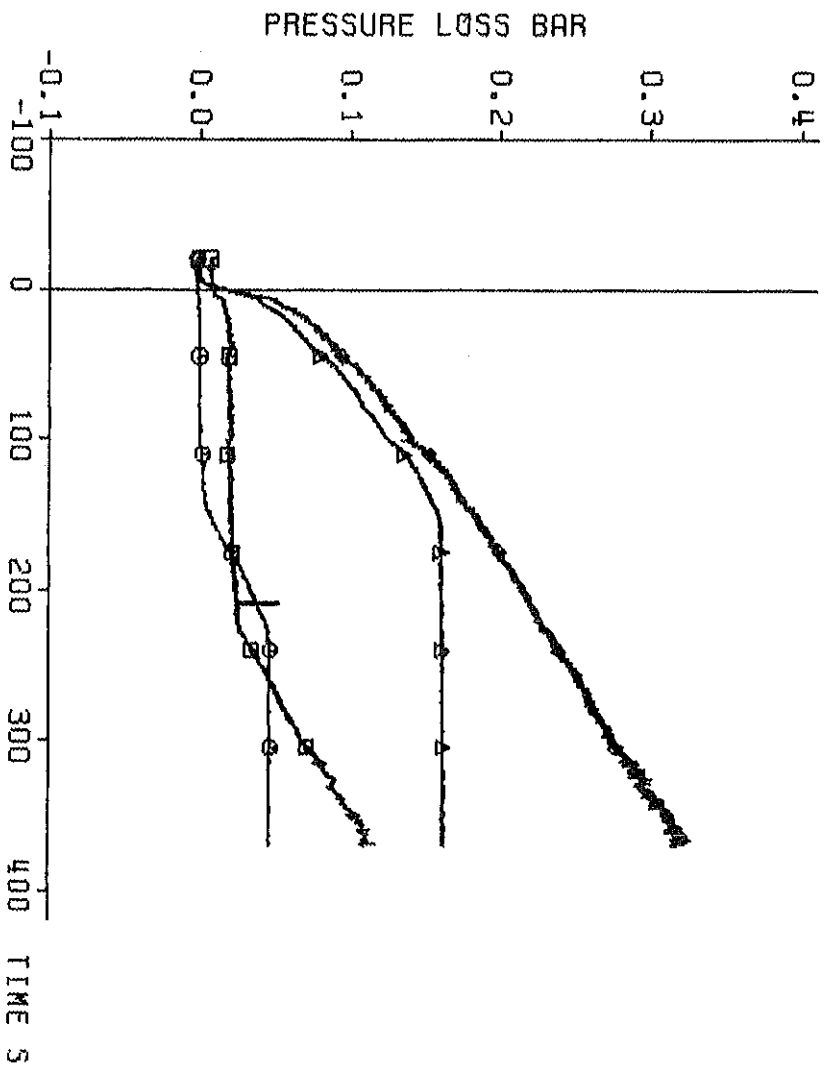

decay heat 120% RMS standard
flooding rate (cold) 3.80 cm/s
system pressure 6.19 bar
feedwater temperature 40 deg C

KfK
KfK IRB

Fig. 146 FEBRA: 5X5 ROD BUNDLE, TEST SERIES 2, TEST-NO. 231

coolant outlet conditions:

▲ water carry over
○ coolant temperature
■ coolant pressure

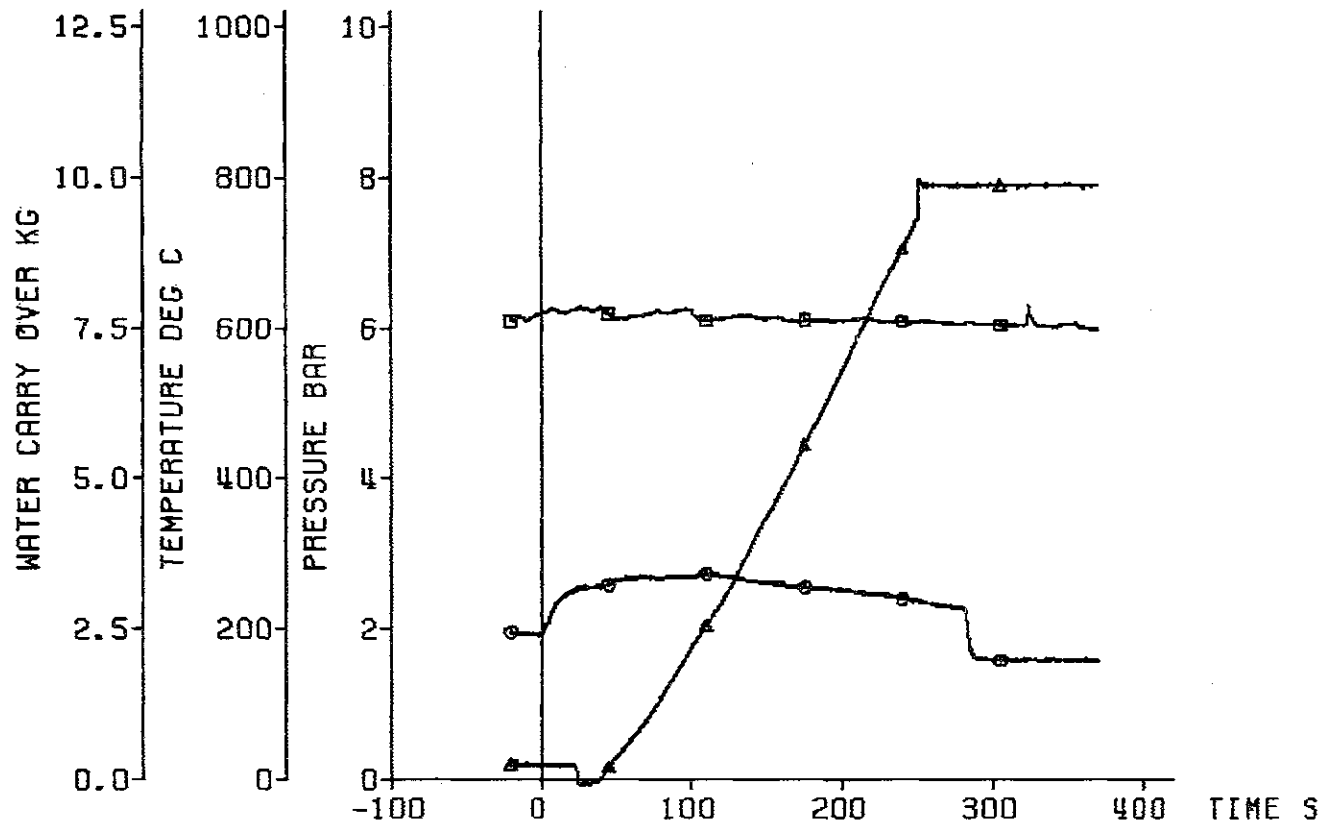

decay heat 120% ANS standard
flooding rate (cold) 3.80 cm/s
system pressure 6.19 bar
feedwater temperature 40 deg C



Fig. 147 FEBA: 5x5 ROD BUNDLE, TEST SERIES 2, TEST-No. 231

axial position of the quench front

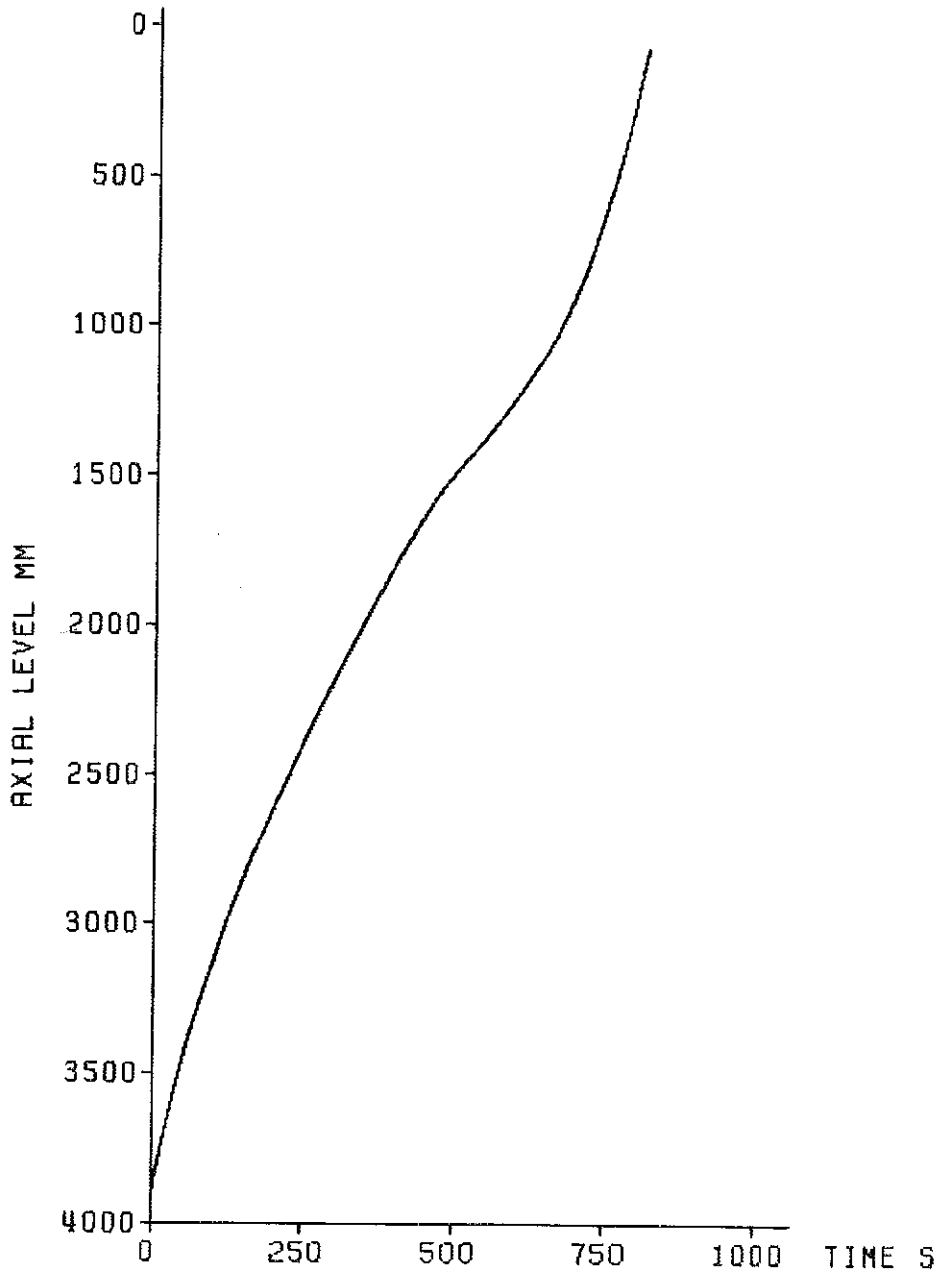

decay heat	120% RNS standard
flooding rate (cold)	3.80 cm/s
system pressure	6.19 bar
feedwater temperature	40 deg C



Fig. 148 FEBA: 5x5 ROD BUNDLE
TEST SERIES 2, TEST-No. 231

initial axial temperature profile of the cladding

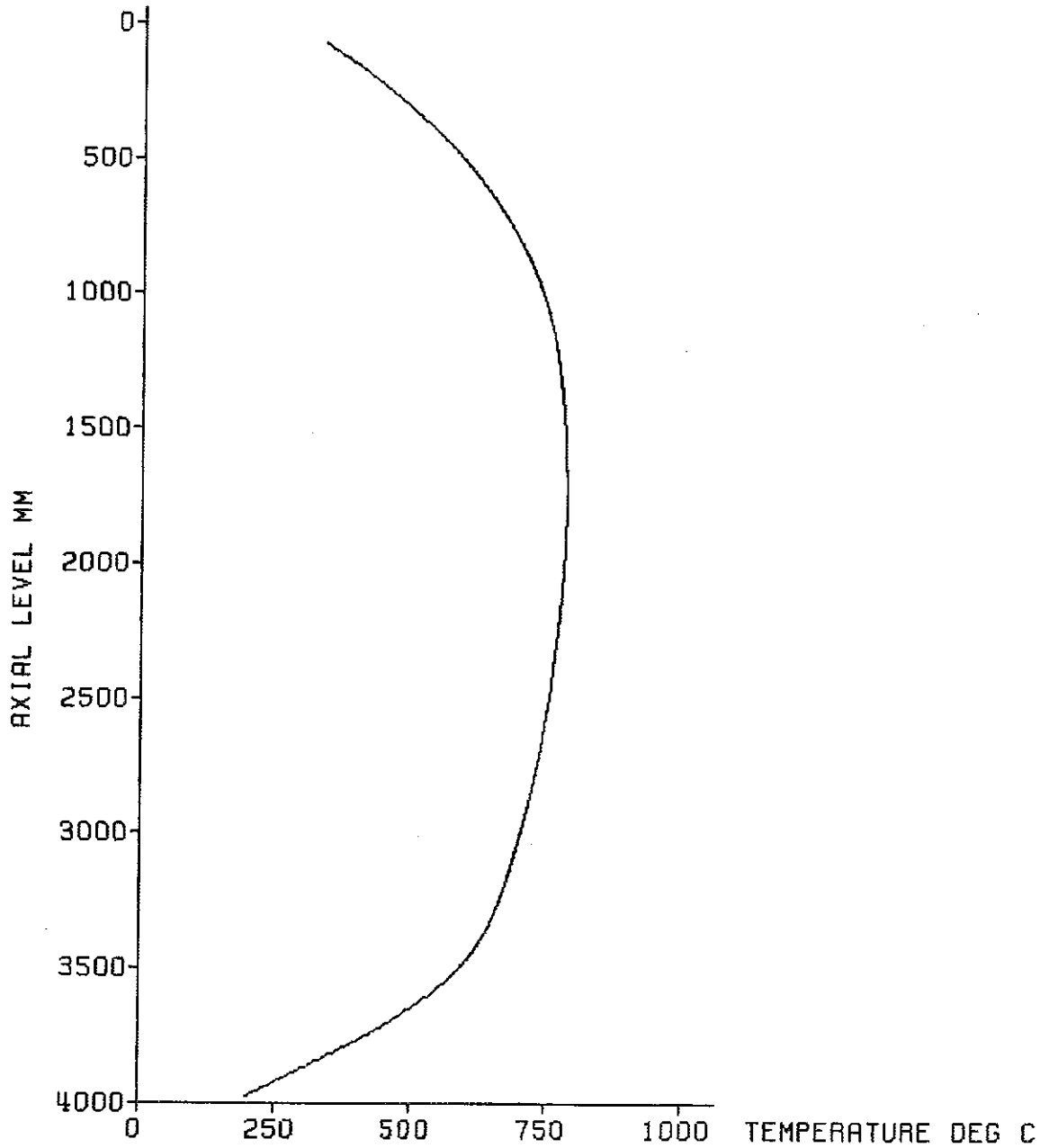

decay heat	120% ANS standard
flooding rate (cold)	5.82 cm/s
system pressure	1.99 bar
feedwater temperature	40 deg C

KfK
IRB

Fig. 149 FEBA: 5x5 ROD BUNDLE
TEST SERIES 2, TEST-No. 233

test parameters:

- ◇ flooding rate
- △ system pressure
- feedwater temperature
- bundle power

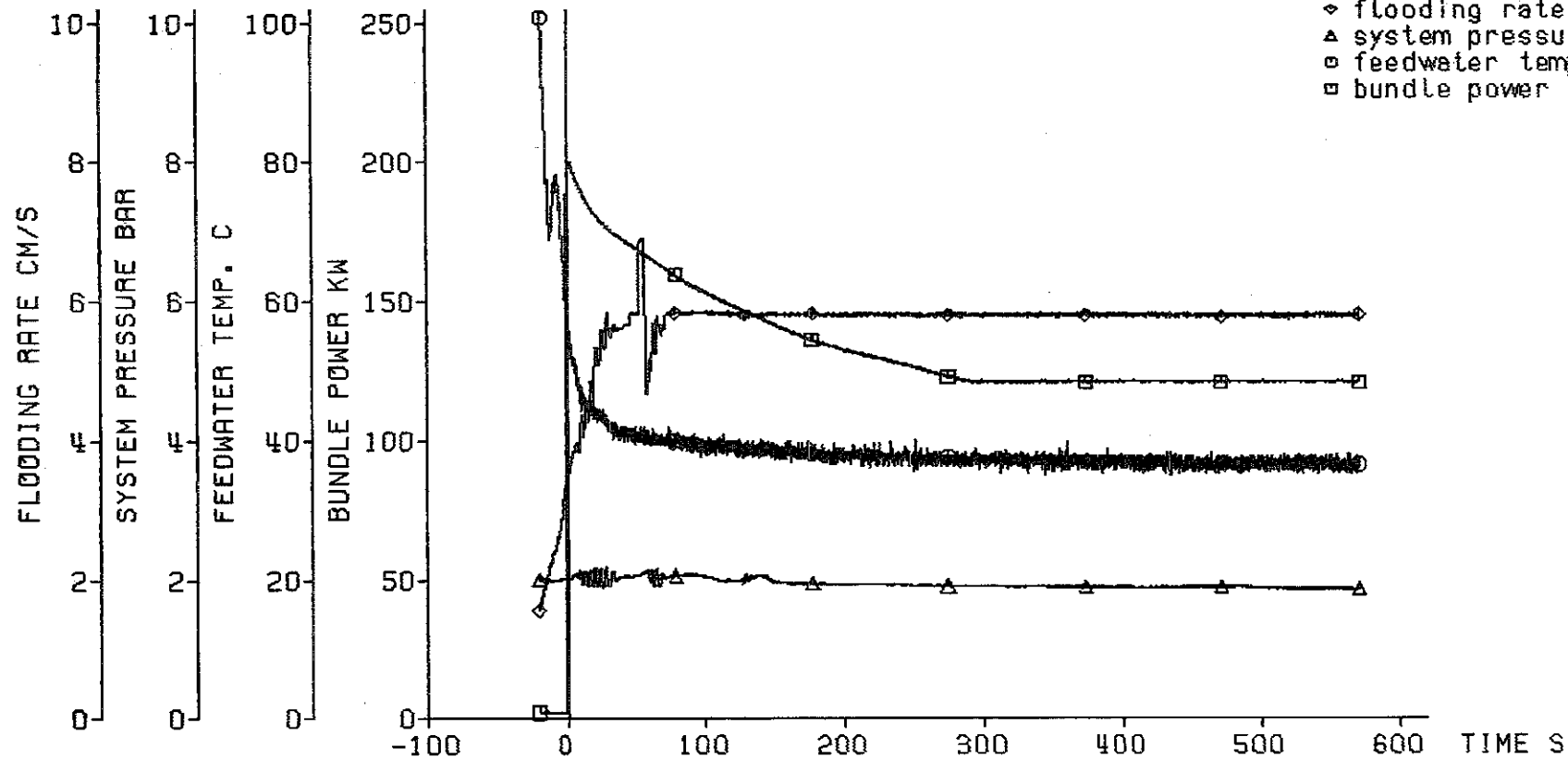

decay heat 120% ANS standard
flooding rate (cold) 5.82 cm/s
system pressure 1.99 bar
feedwater temperature 40 deg C



Fig. 150 FEBA: 5x5 ROD BUNDLE, TEST SERIES 2, TEST-No. 233

cladding temperature

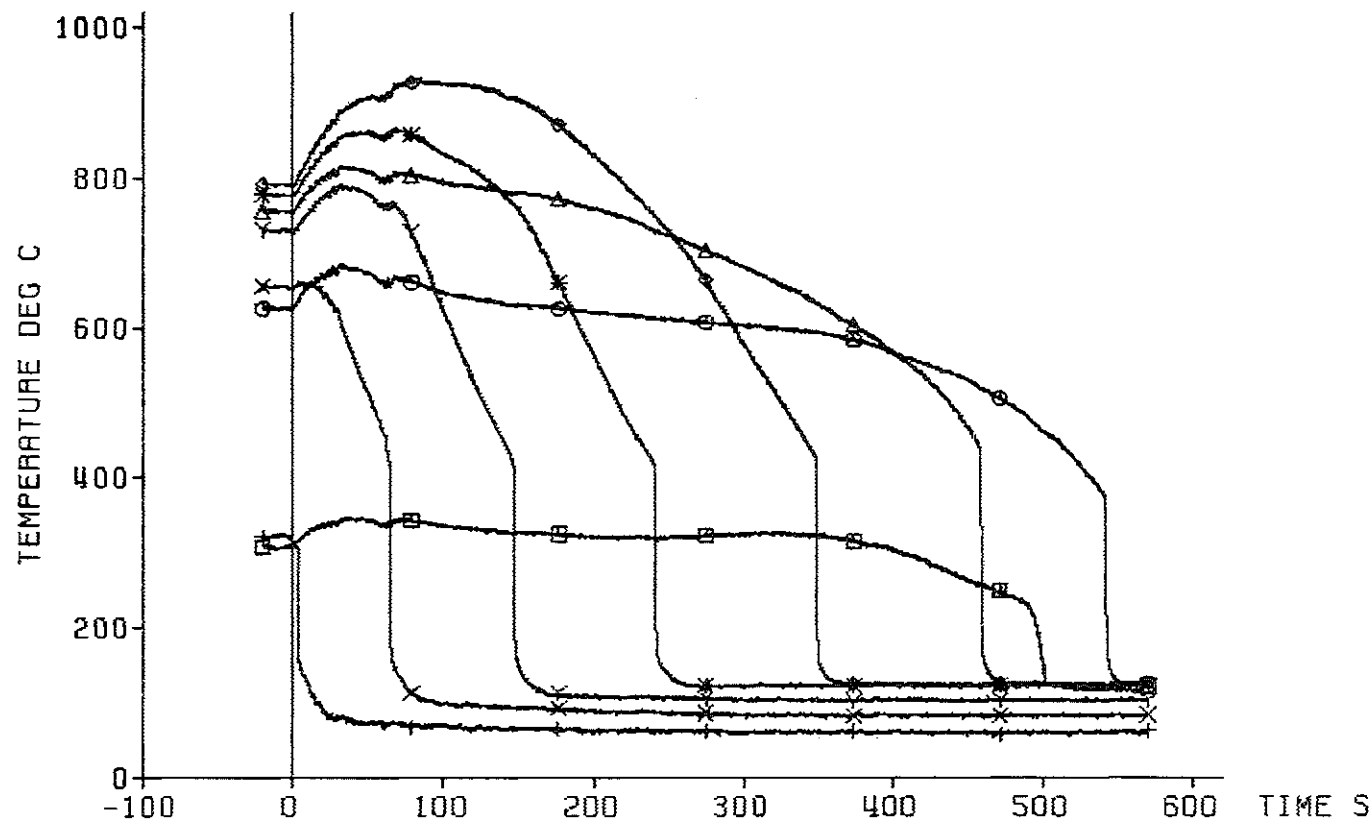

TC	ax. Level
+	18a4 3860 mm
x	18a3 3315 mm
y	18a2 2770 mm
*	18a1 2225 mm
◇	12b4 1680 mm
△	12b3 1135 mm
○	12b2 590 mm
□	12b1 45 mm

decay heat 120% ANS standard
 flooding rate (cold) 5.82 cm/s
 system pressure 1.99 bar
 feedwater temperature 40 deg C



Fig. 151 FEBA: 5x5 ROD BUNDLE, TEST SERIES 2, TEST-No. 233

heat transfer coeff.

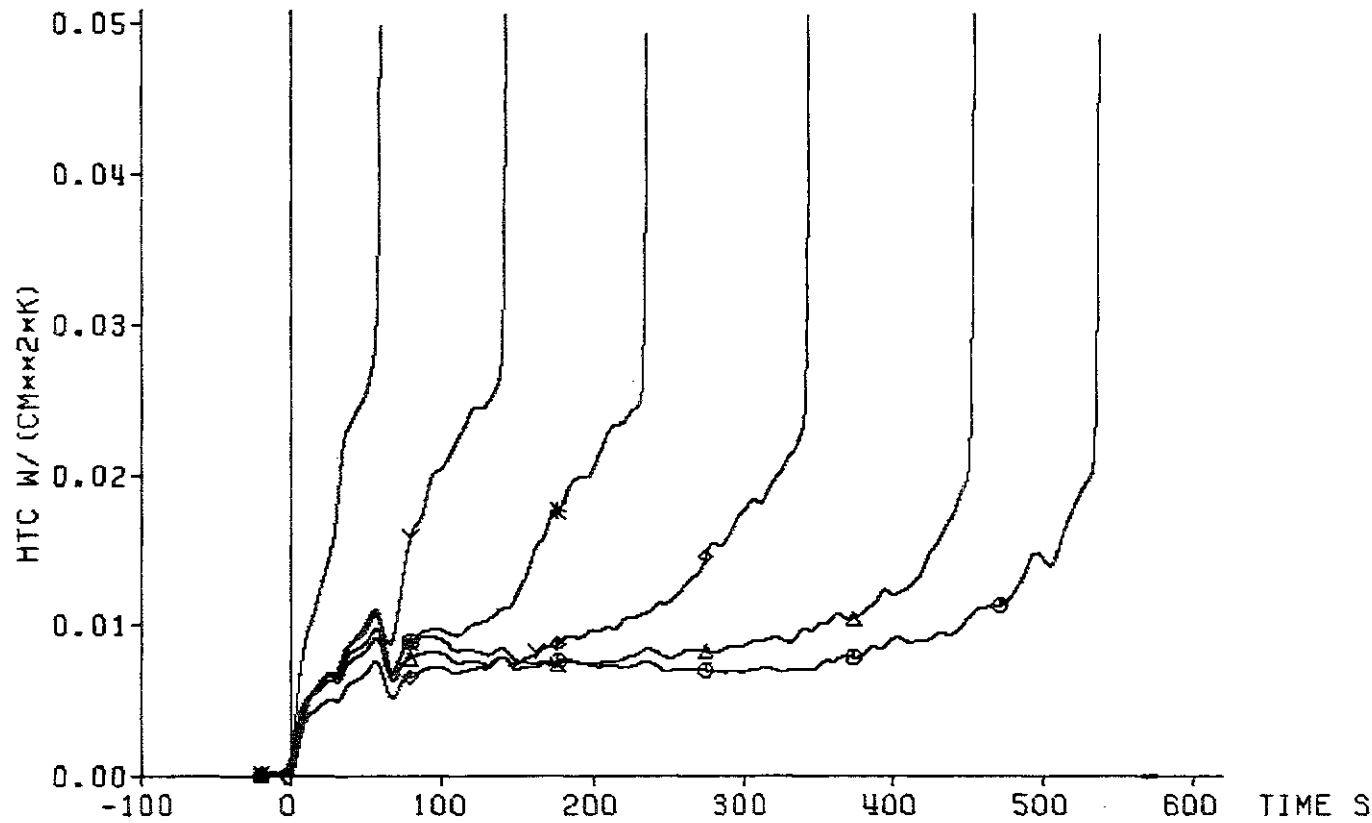

	TC	ax. Level
x	18a3	3315 mm
y	18a2	2770 mm
*	18a1	2225 mm
◇	12b4	1680 mm
△	12b3	1135 mm
○	12b2	590 mm

decay heat 120% ANS standard
flooding rate (cold) 5.82 cm/s
system pressure 1.99 bar
feedwater temperature 40 deg C



Fig. 152 FEBA: 5x5 RØD BUNDLE, TEST SERIES 2, TEST-No. 233

cladding temperature

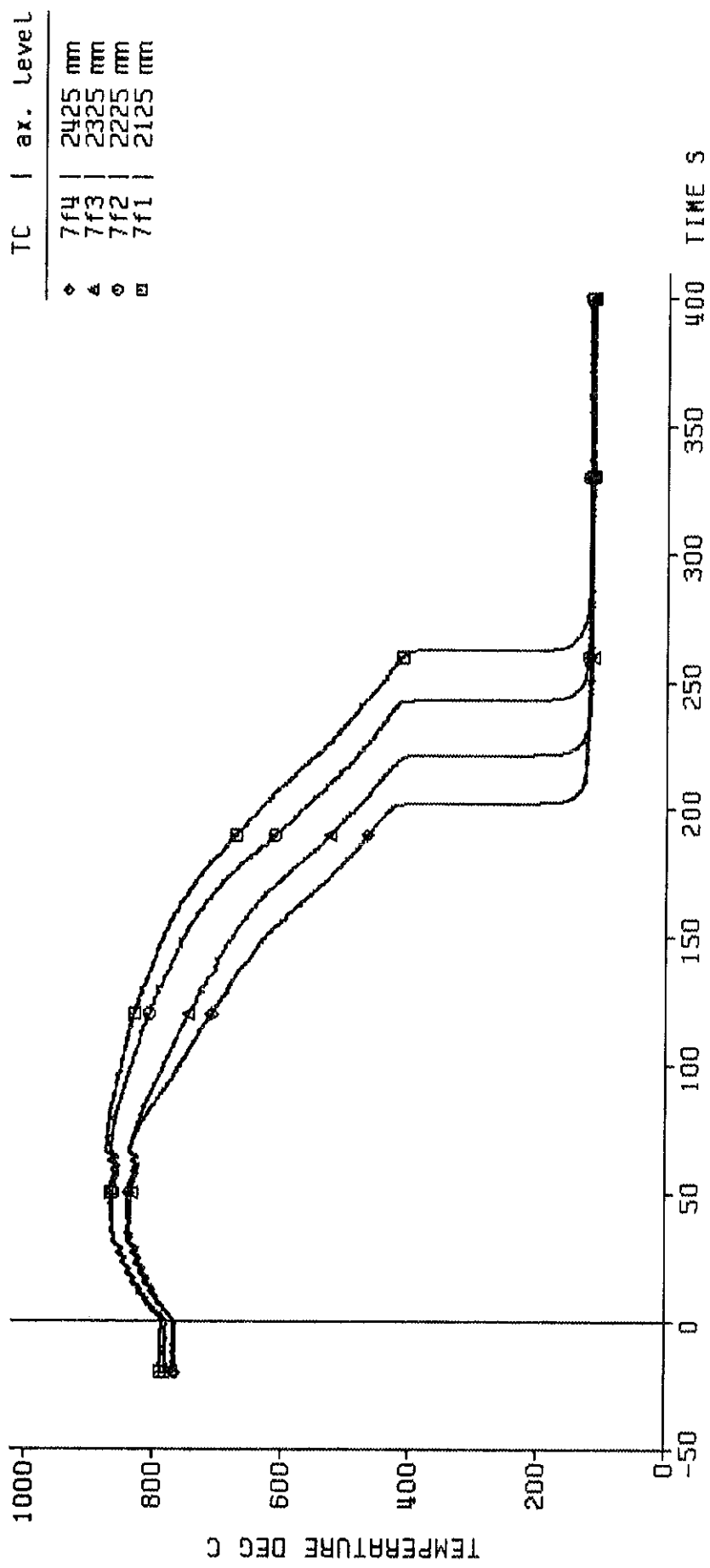

decay heat 120% RMS standard
 flooding rate (cold) 5.82 cm/s
 system pressure 1.99 bar
 feedwater temperature 40 deg C

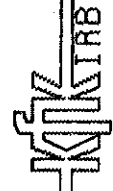
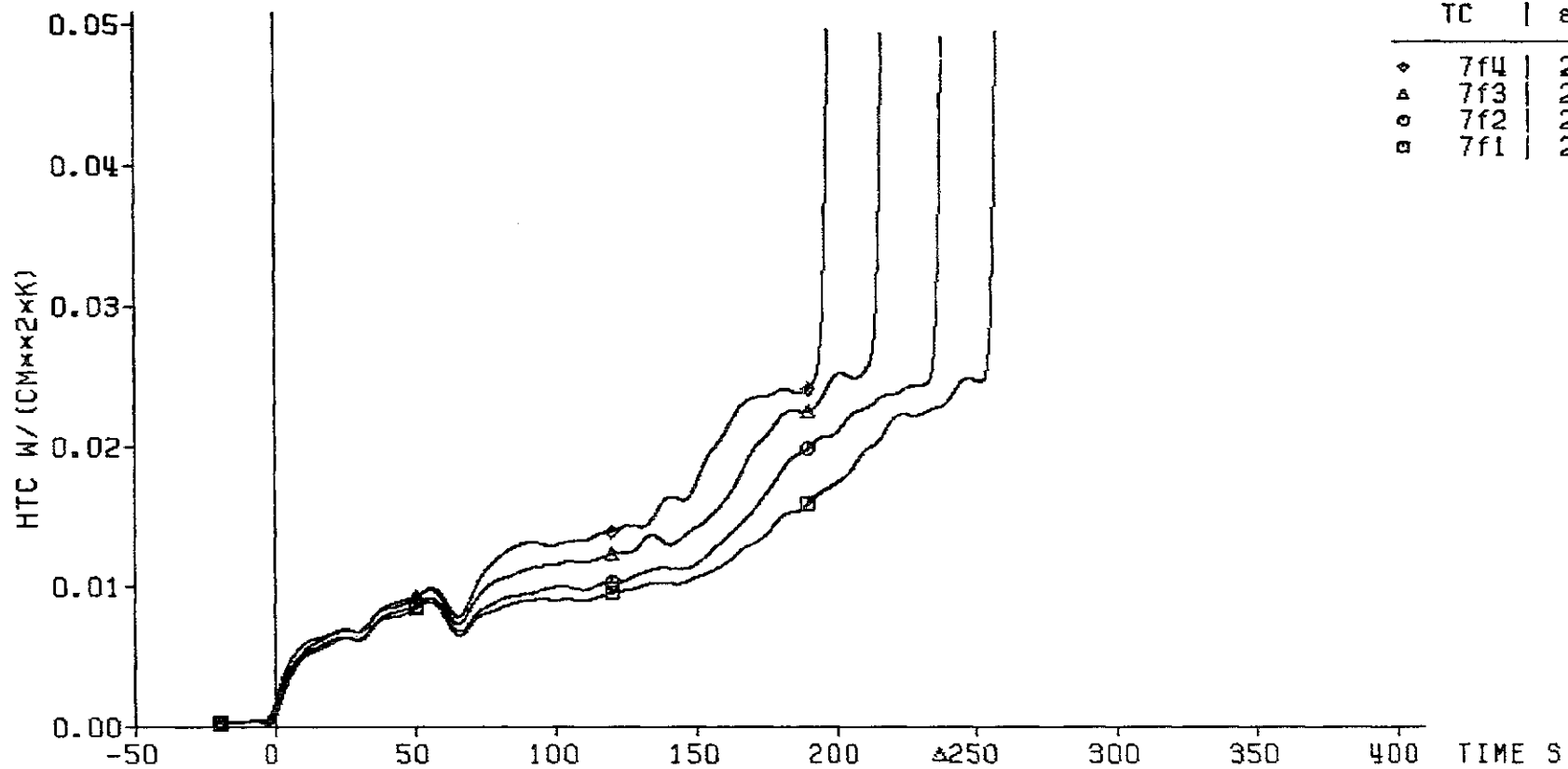

Fig. 153 FEBA: 5x5 ROD BUNDLE, TEST SERIES 2, TEST-NO. 233

heat transfer coeff.



decay heat 120% ANS standard
 flooding rate (cold) 5.82 cm/s
 system pressure 1.99 bar
 feedwater temperature 40 deg C



Fig. 154 FEBA: 5x5 ROD BUNDLE, TEST SERIES 2, TEST-No. 233

cladding temperature

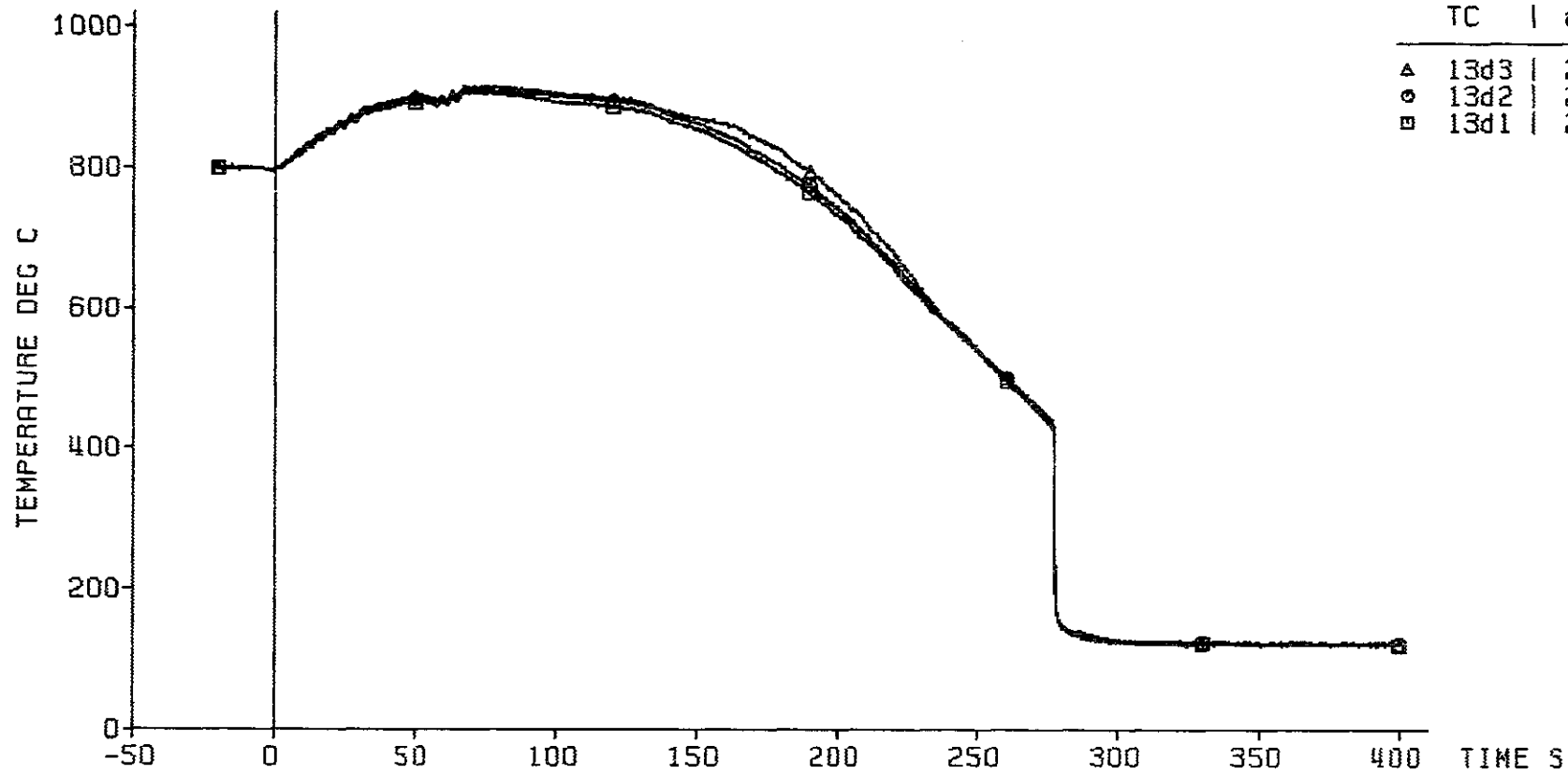

decay heat 120% ANS standard
flooding rate (cold) 5.82 cm/s
system pressure 1.99 bar
feedwater temperature 40 deg C



Fig. 155 FEBA: 5x5 ROD BUNDLE, TEST SERIES 2, TEST-No. 233

heat transfer coeff.

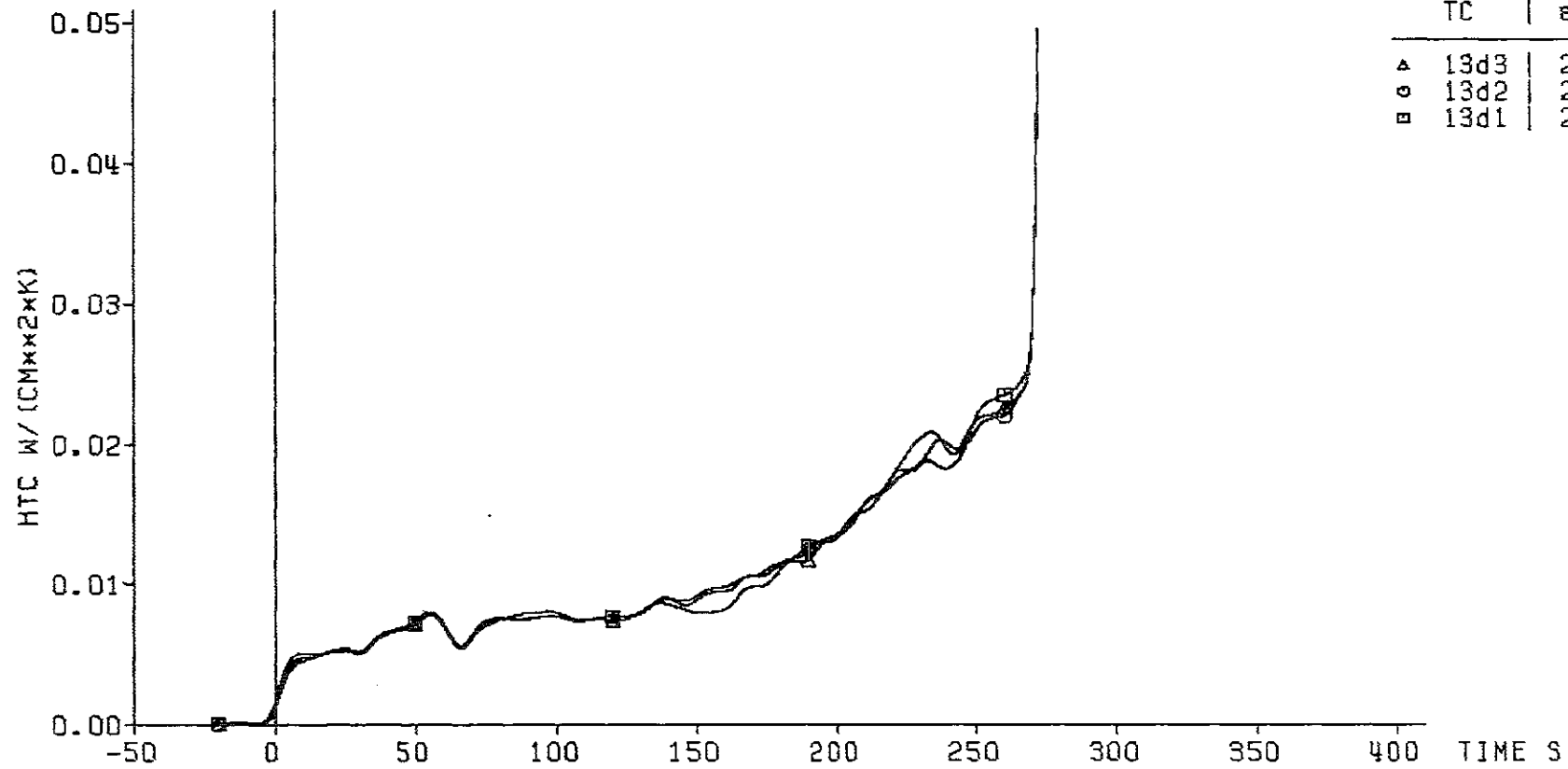

decay heat 120% ANS standard
flooding rate (cold) 5.82 cm/s
system pressure 1.99 bar
feedwater temperature 40 deg C



Fig. 156 FEBA: 5x5 ROD BUNDLE, TEST SERIES 2, TEST-No. 233

cladding temperature

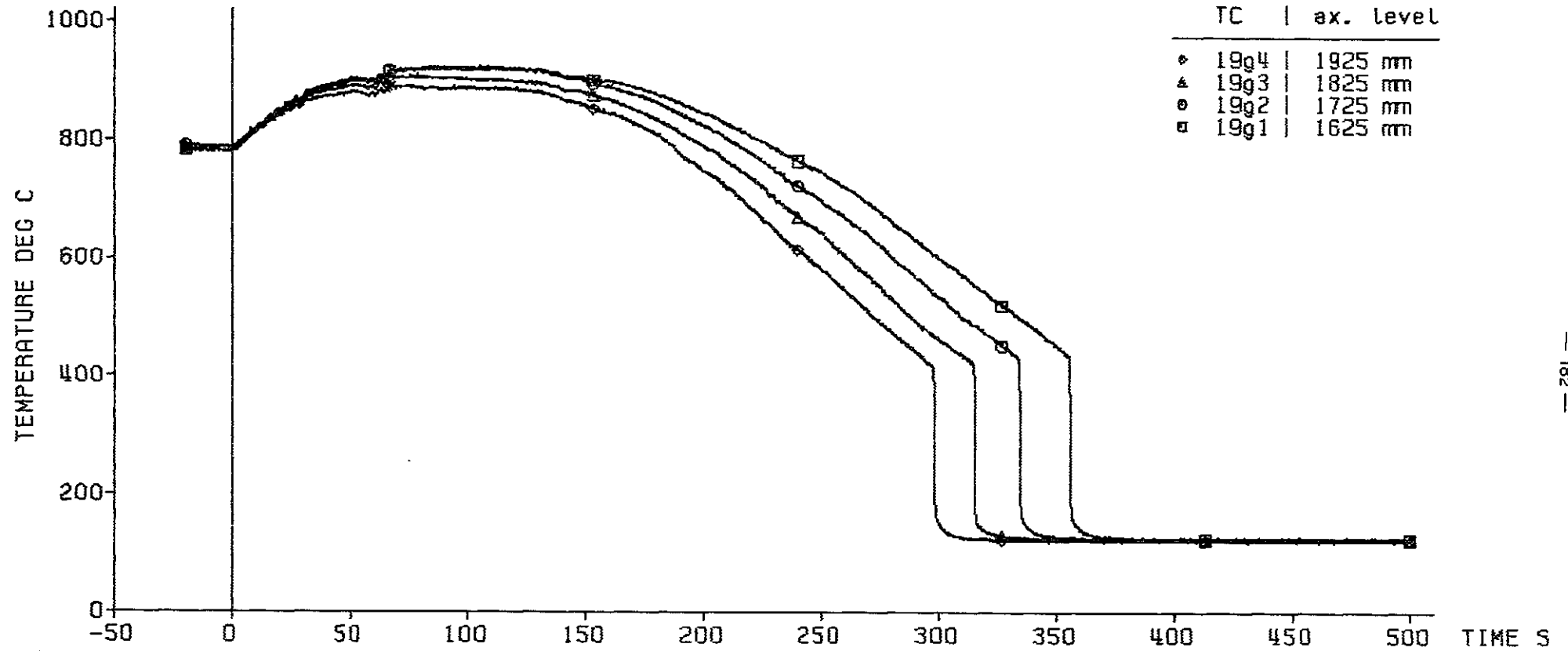

— 182 —

decay heat 120% ANS standard
 flooding rate (cold) 5.82 cm/s
 system pressure 1.99 bar
 feedwater temperature 40 deg C



Fig.157 FEBA: 5x5 ROD BUNDLE, TEST SERIES 2, TEST-No. 233

heat transfer coeff.

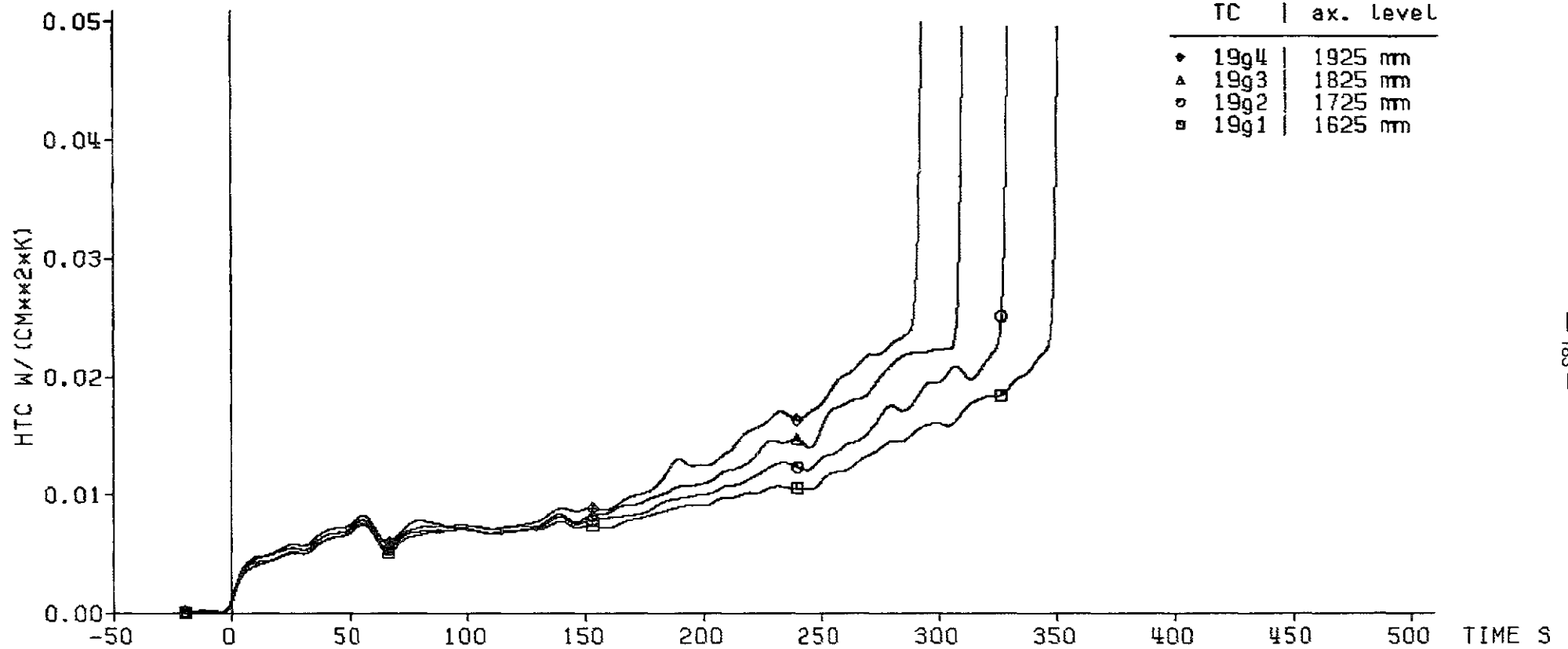

decay heat 120% ANS standard
flooding rate (cold) 5.82 cm/s
system pressure 1.99 bar
feedwater temperature 40 deg C



Fig. 158 FEBA: 5x5 ROD BUNDLE, TEST SERIES 2, TEST-No. 233

axial level: 1725 mm

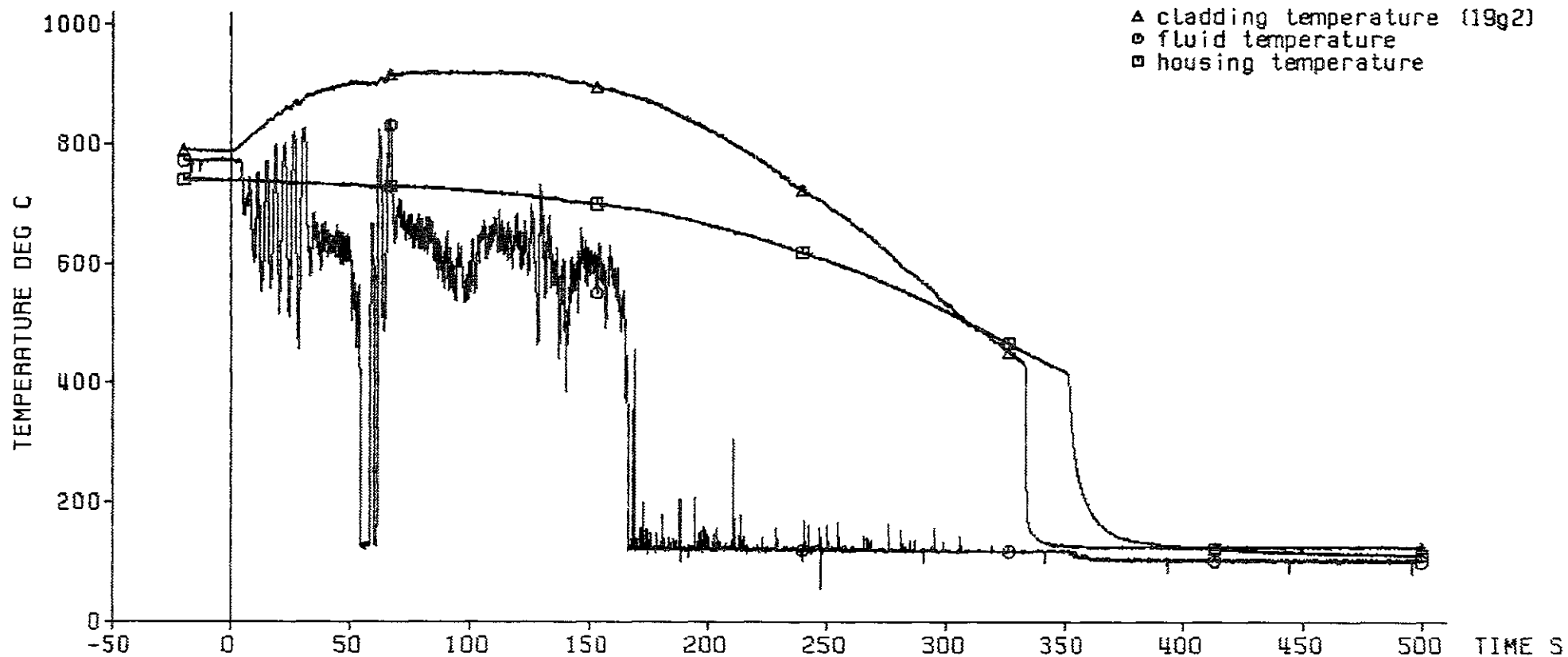

decay heat 120% ANS standard
flooding rate (cold) 5.82 cm/s
system pressure 1.99 bar
feedwater temperature 40 deg C

KJK
TRB

Fig. 159 FEBA: 5x5 ROD BUNDLE, TEST SERIES 2, TEST-No. 233

axial level: 1625 mm

△ cladding temperature (19g1)
○ fluid temperature
□ housing temperature

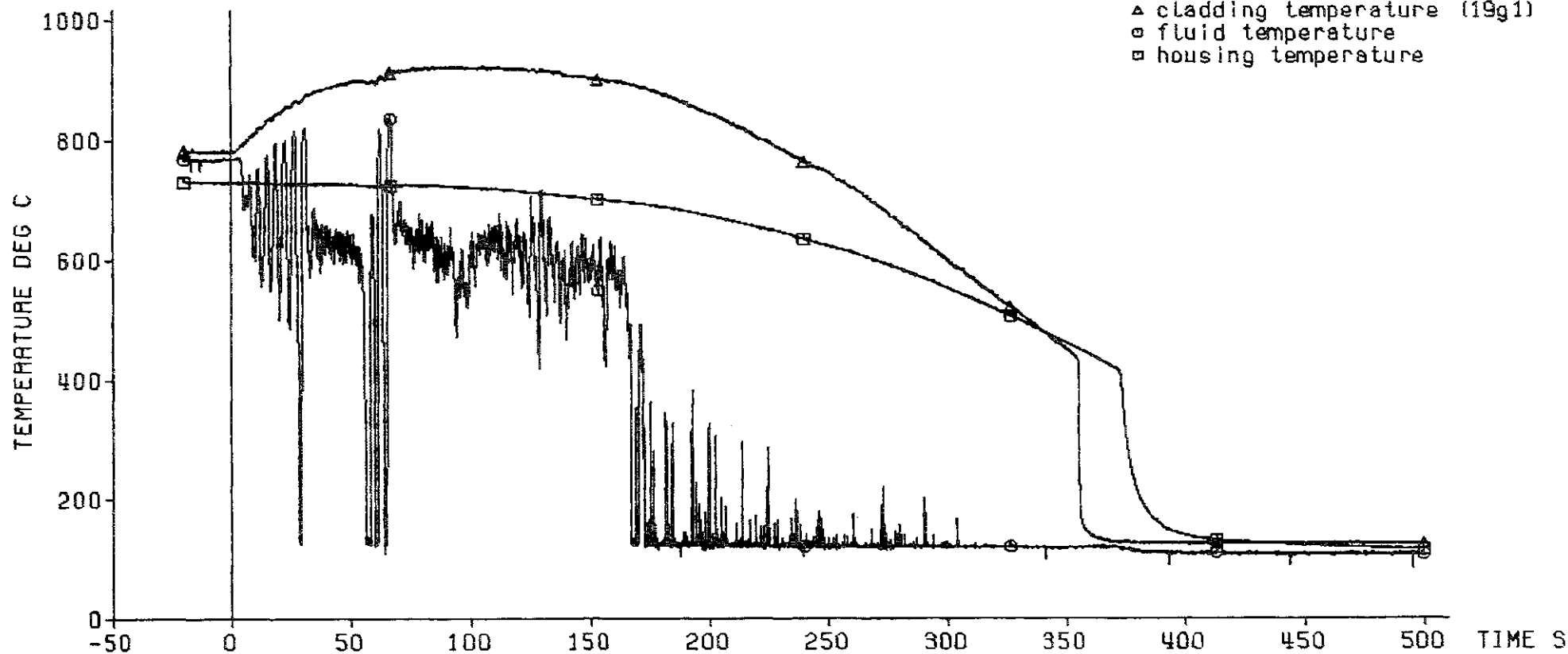

— 185 —

decay heat 120% ANS standard
flooding rate (cold) 5.82 cm/s
system pressure 1.99 bar
feedwater temperature 40 deg C



Fig. 160 FEBA: 5x5 ROD BUNDLE, TEST SERIES 2, TEST-No. 233

pressure loss
along the test section:

◆ total length: 4196 mm
△ lower part: 1711 mm
○ middle part: 545 mm
□ upper part: 1940 mm

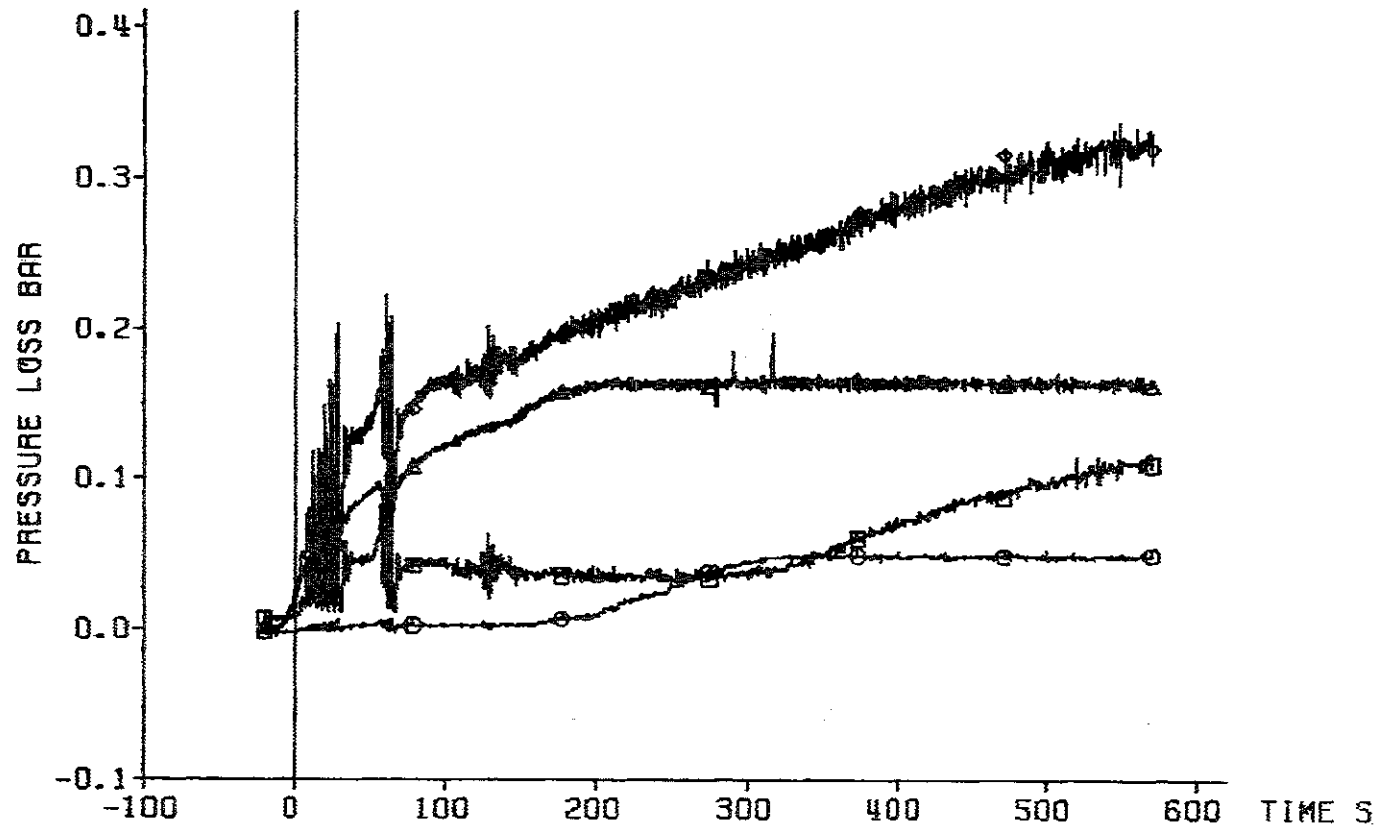

decay heat 120% RMS standard
flooding rate (cold) 5.82 cm/s
system pressure 1.99 bar
feedwater temperature 40 deg C

KfK
IRB

Fig. 161 FEBA: 5x5 ROD BUNDLE, TEST SERIES 2, TEST-NO. 233

coolant outlet conditions:

- ▲ water carry over
- coolant temperature
- coolant pressure

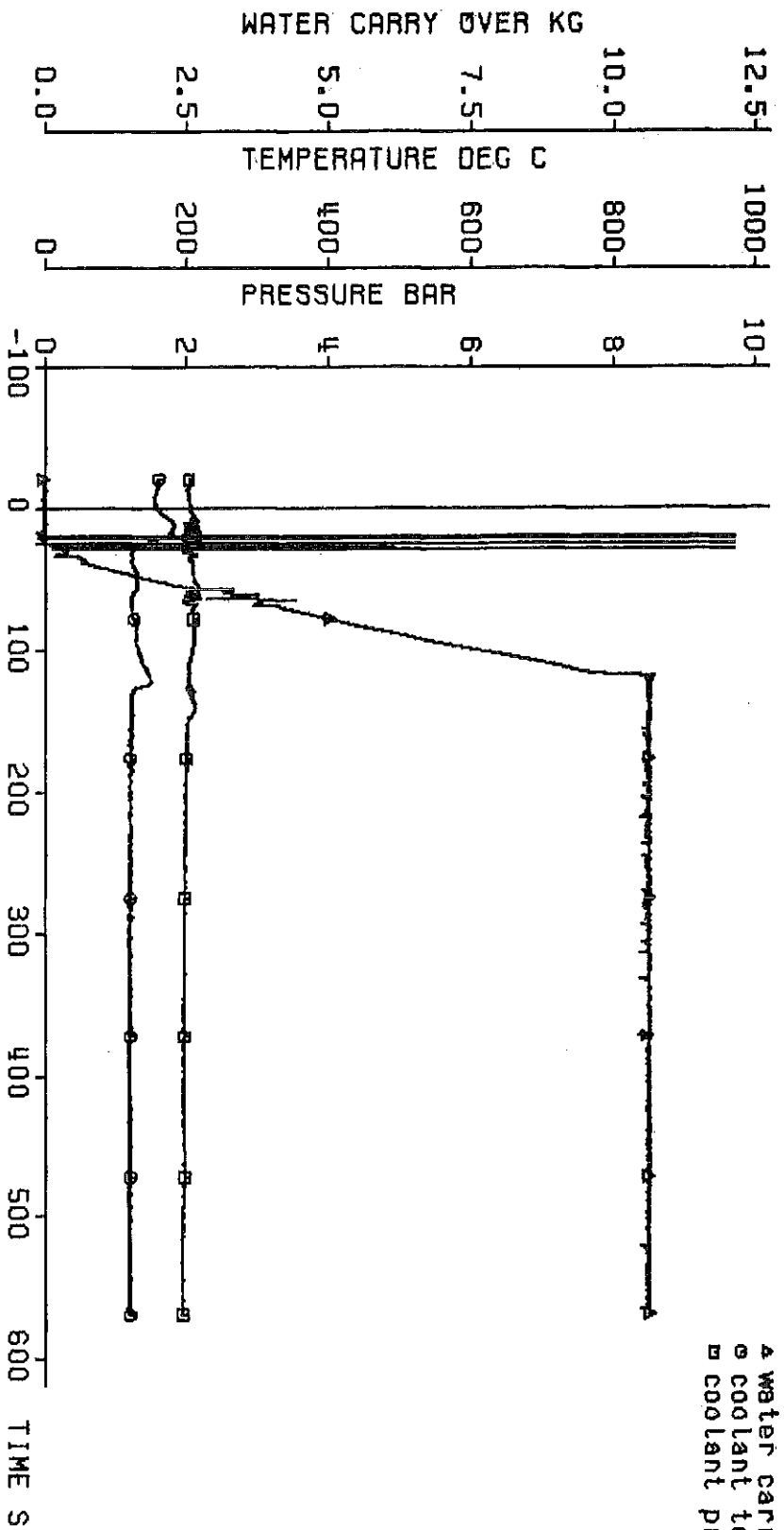

decay heat
flooding rate (cold)
system pressure
feedwater temperature

120% ANS standard
5.82 cm/s
1.99 bar
40 deg C



Fig. 162 FEBRA: 5X5 ROD BUNDLE, TEST SERIES 2, TEST-NO. 233

axial position of the quench front

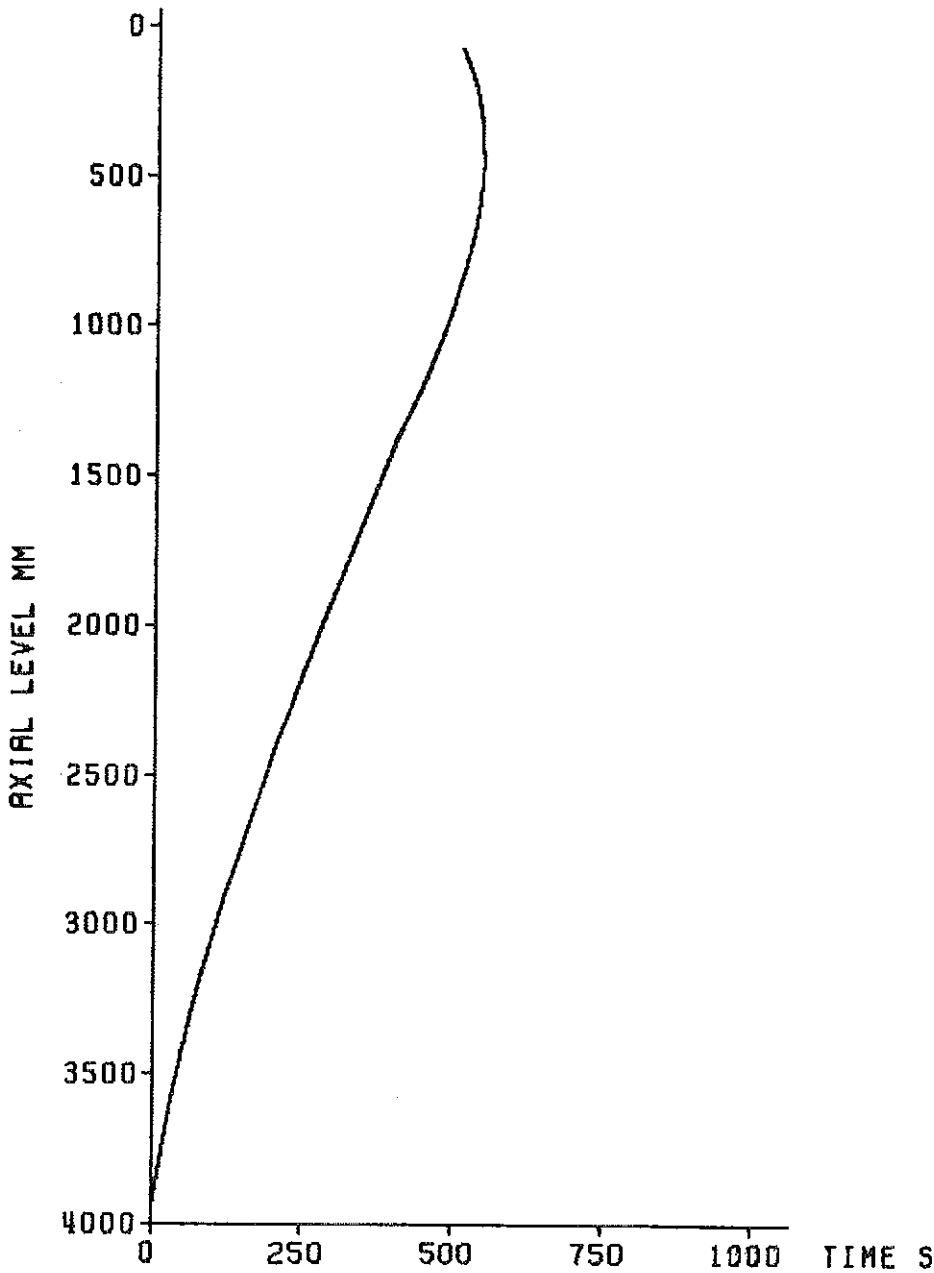

decay heat	120% ANS standard
flooding rate (cold)	5.82 cm/s
system pressure	1.99 bar
feedwater temperature	40 deg C

KIK IRB

Fig. 163 FEBA: 5x5 ROD BUNDLE
TEST SERIES 2, TEST-No. 233

initial axial temperature profile of the cladding

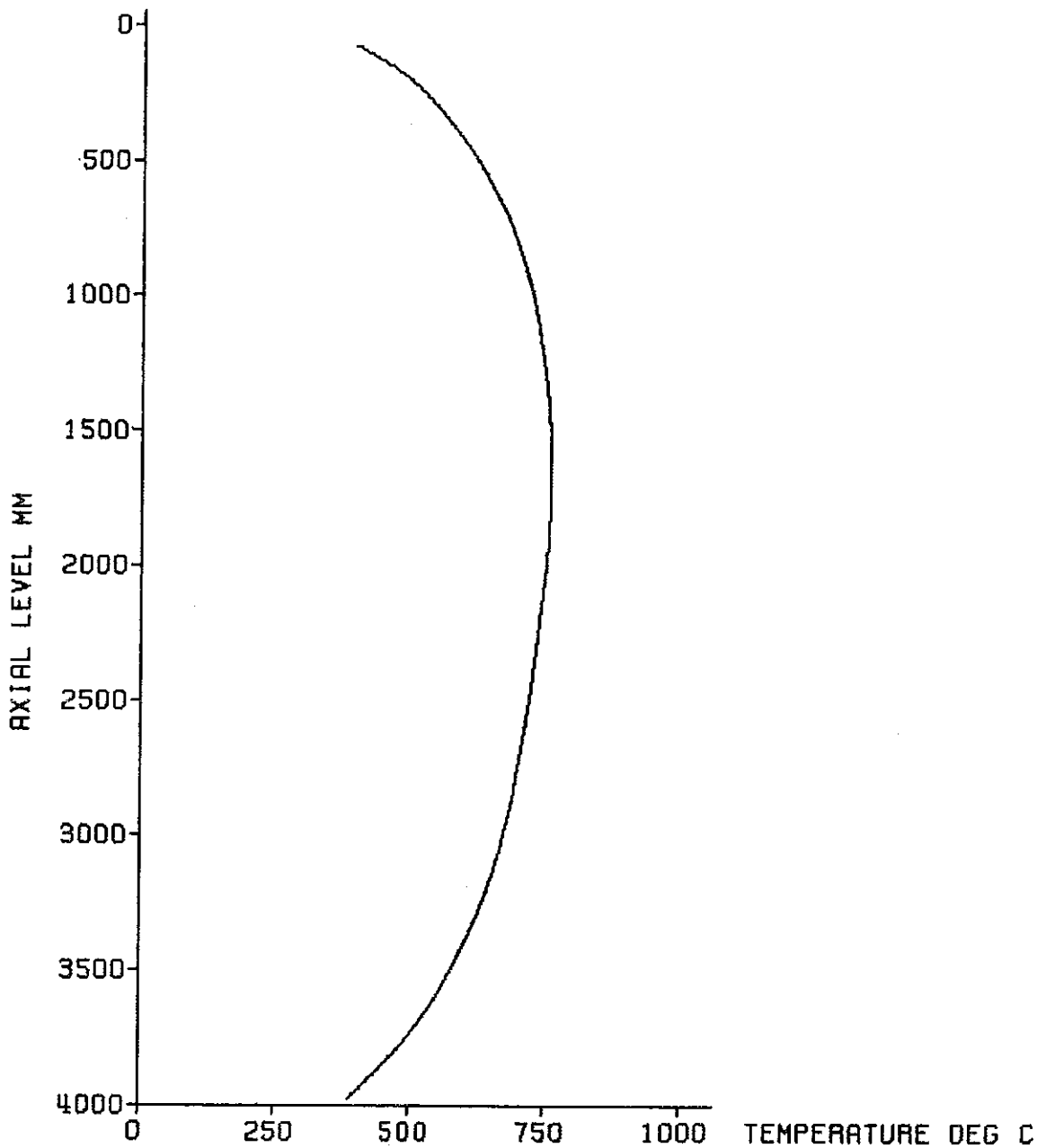

decay heat	120% ANS standard
flooding rate (cold)	5.72 cm/s
system pressure	4.11 bar
feedwater temperature	40 deg C



Fig. 164 FEBA: 5x5 ROD BUNDLE
TEST SERIES 2, TEST-No. 228

test parameters:

- ◊ flooding rate
- △ system pressure
- feedwater temperature
- bundle power

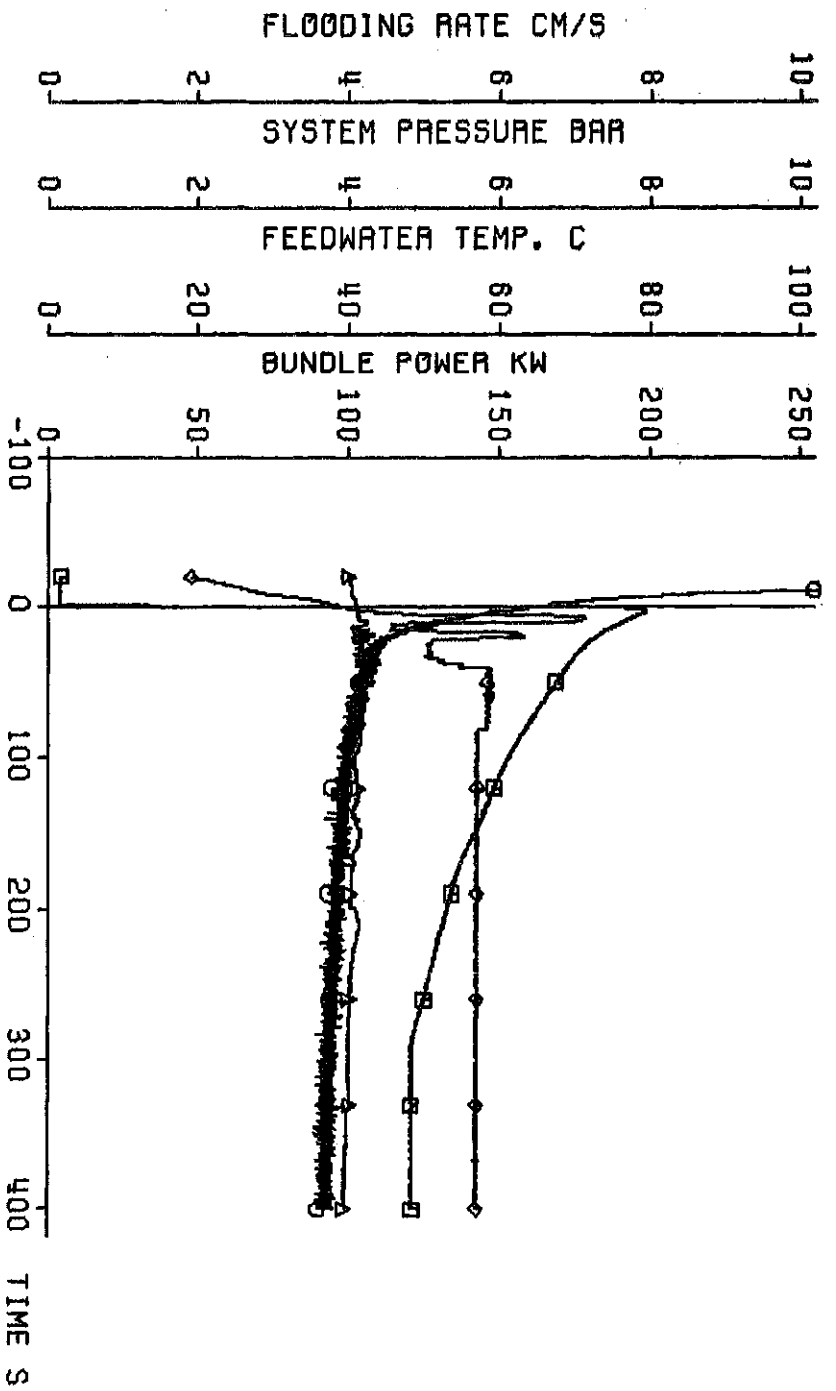

decay heat
flooding rate (cold)
system pressure
feedwater temperature

120% ANS standard
5.72 cm/s
4.11 bar
40 deg C



Fig. 165 FEBRA: 5x5 ROD BUNDLE, TEST SERIES 2, TEST-NO. 228

cladding temperature

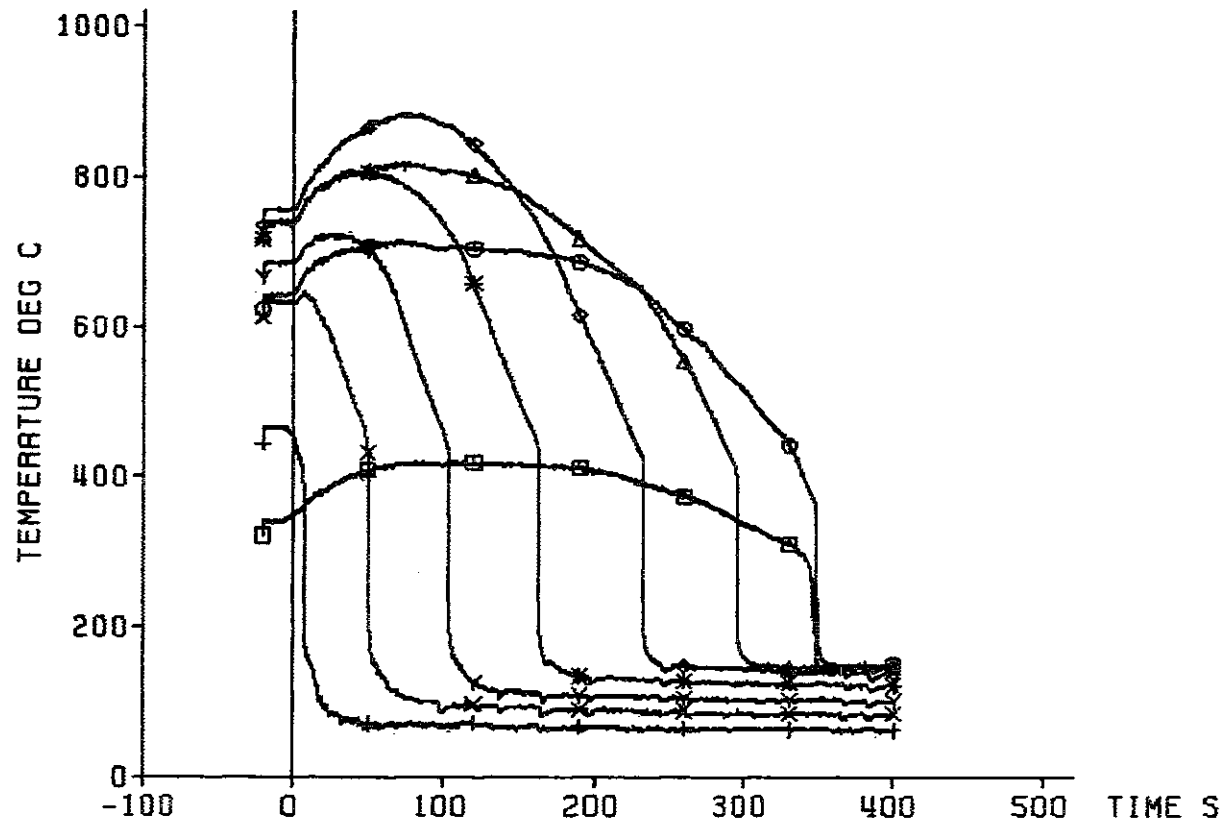

	TC	ax. Level
+	18a4	3860 mm
x	18a3	3315 mm
Y	18a2	2770 mm
*	18a1	2225 mm
◇	12b4	1680 mm
△	12b3	1135 mm
◊	12b2	590 mm
□	12b1	45 mm

decay heat 120% ANS standard
 flooding rate (cold) 5.72 cm/s
 system pressure 4.11 bar
 feedwater temperature 40 deg C



Fig. 166 FEBA: 5x5 ROD BUNDLE, TEST SERIES 2, TEST-No. 228

heat transfer coeff.

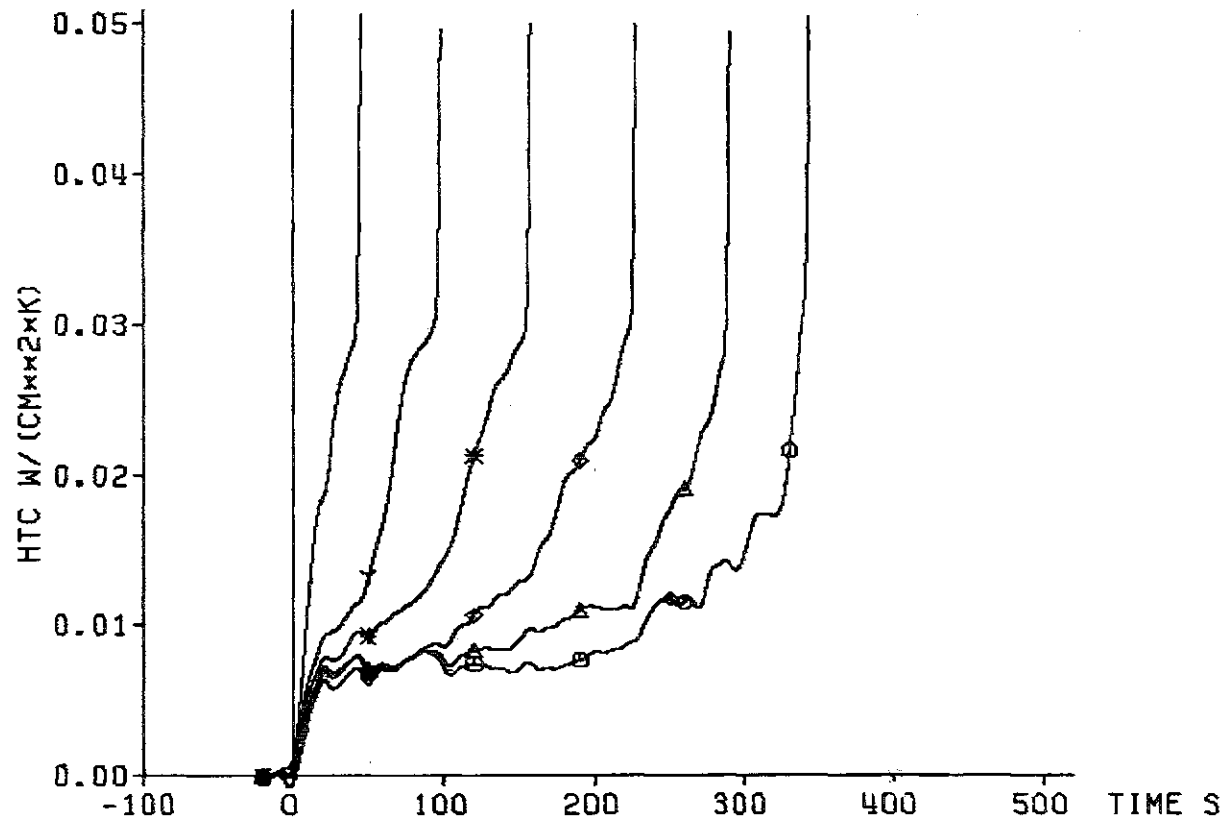

TC	ax. Level
x	18a3 3315 mm
y	18a2 2770 mm
*	18a1 2225 mm
@	12b4 1680 mm
^	12b3 1135 mm
o	12b2 590 mm

decay heat 120% ANS standard
 flooding rate (cold) 5.72 cm/s
 system pressure 4.11 bar
 feedwater temperature 40 deg C



Fig. 167 FEBA: 5x5 ROD BUNDLE, TEST SERIES 2, TEST-No. 228

cladding temperature

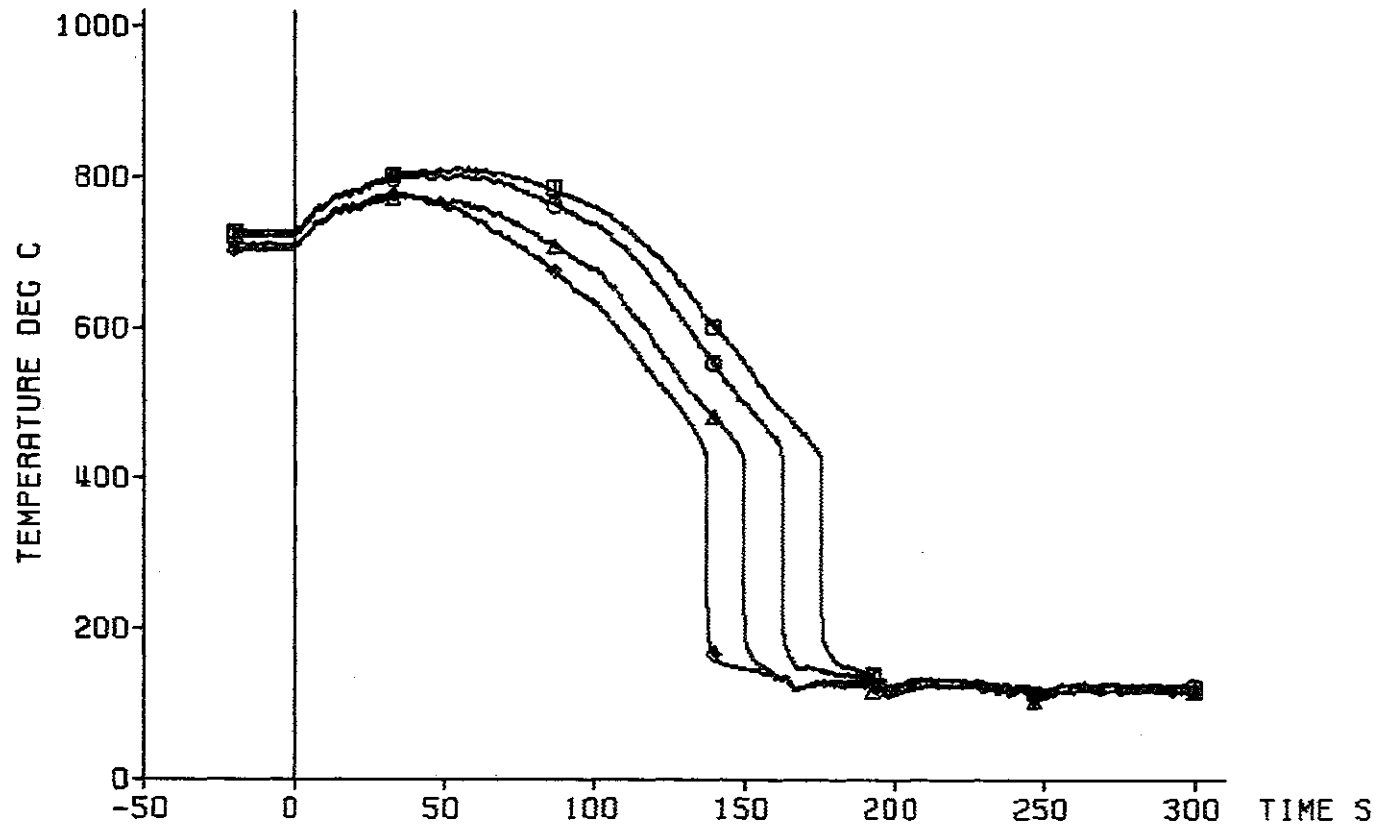

TC	ax. Level
◇	7f4 2425 mm
△	7f3 2325 mm
○	7f2 2225 mm
□	7f1 2125 mm

decay heat 120% RMS standard
flooding rate (cold) 5.72 cm/s
system pressure 4.11 bar
feedwater temperature 40 deg C



Fig. 168 FEBA: 5x5 ROD BUNDLE, TEST SERIES 2, TEST-No. 228

heat transfer coeff.

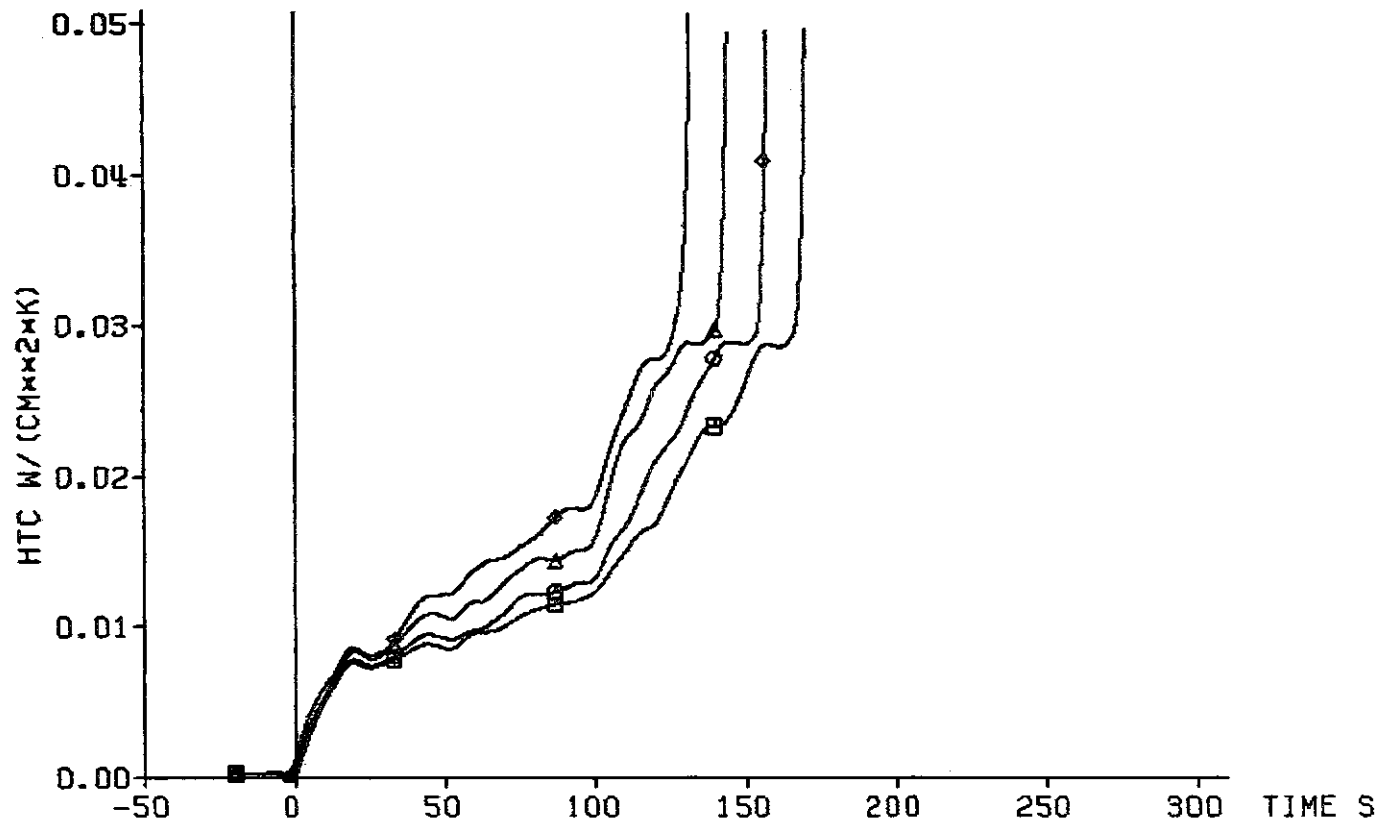

decay heat 120% ANS standard
flooding rate (cold) 5.72 cm/s
system pressure 4.11 bar
feedwater temperature 40 deg C



Fig. 169 FEBA: 5x5 ROD BUNDLE, TEST SERIES 2, TEST-No. 228

cladding temperature

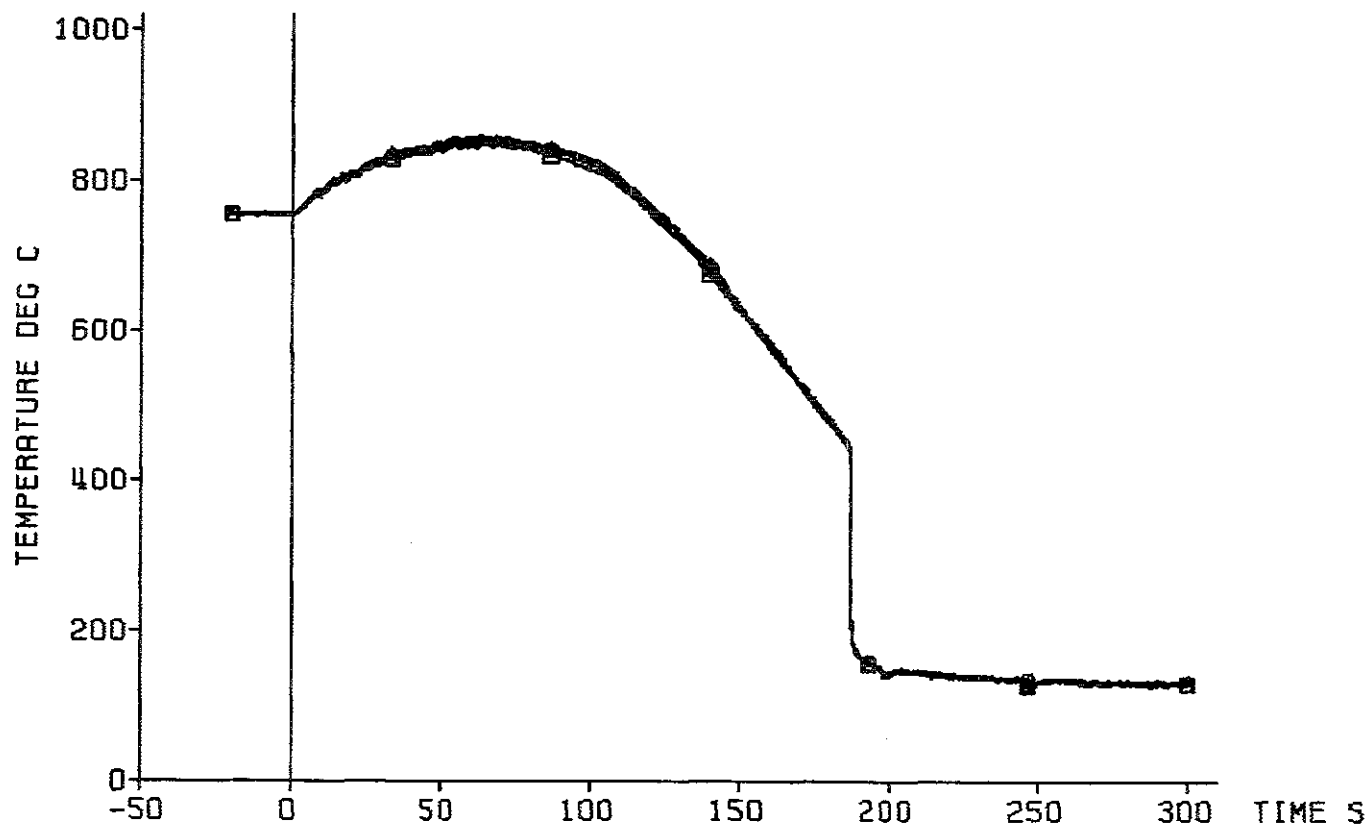

	TC	ax. level
▲	13d3	2025 mm
○	13d2	2025 mm
□	13d1	2025 mm

decay heat 120% ANS standard
flooding rate (cold) 5.72 cm/s
system pressure 4.11 bar
feedwater temperature 40 deg C

— 196 —



Fig. 170 FEBA: 5x5 ROD BUNDLE, TEST SERIES 2, TEST-No. 228

heat transfer coeff.

	TC	axial level
▲	13d3	2025 mm
○	13d2	2025 mm
□	13d1	2025 mm

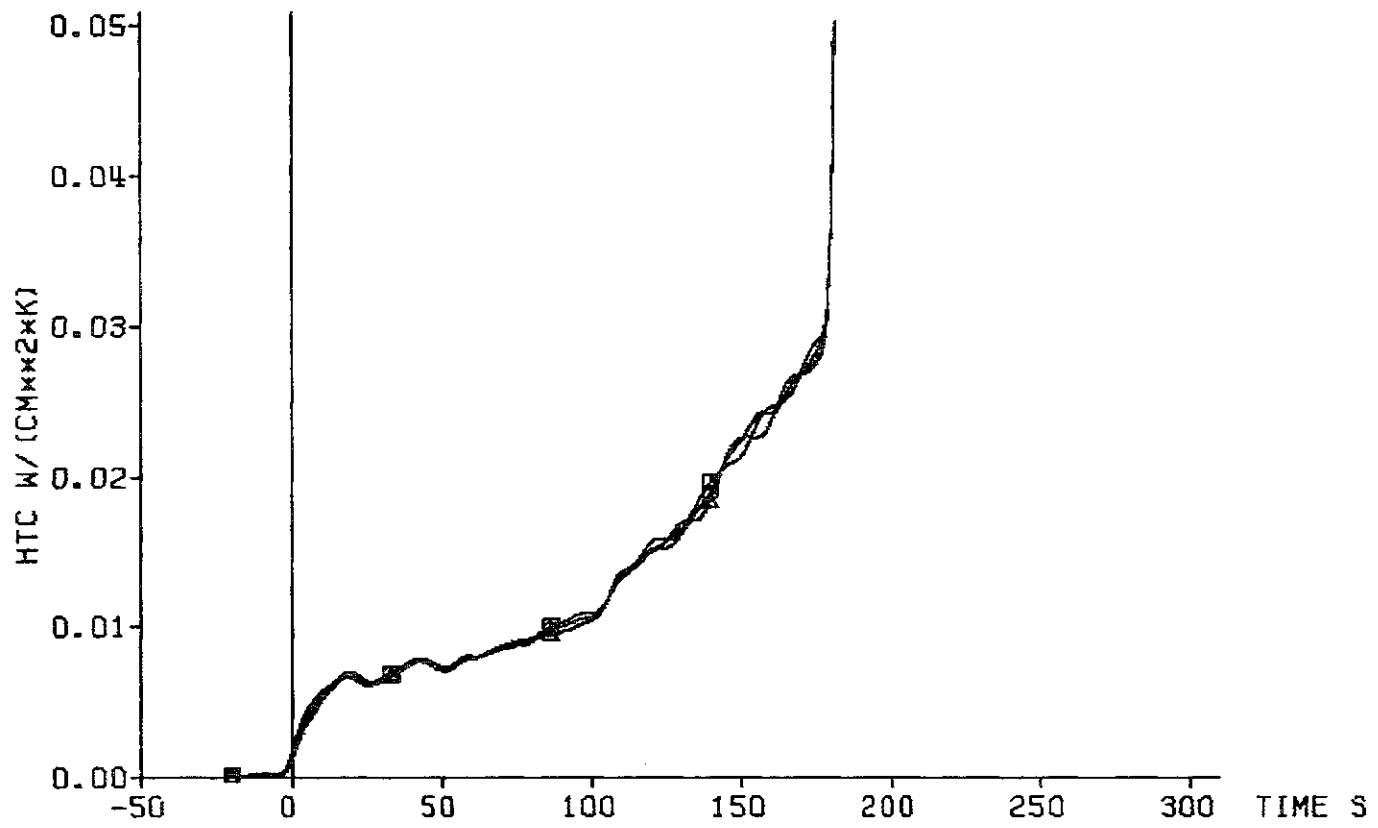

decay heat 120% ANS standard
flooding rate (cold) 5.72 cm/s
system pressure 4.11 bar
feedwater temperature 40 deg C



Fig. 171 FEBA: 5x5 ROD BUNDLE, TEST SERIES 2, TEST-No. 228

cladding temperature

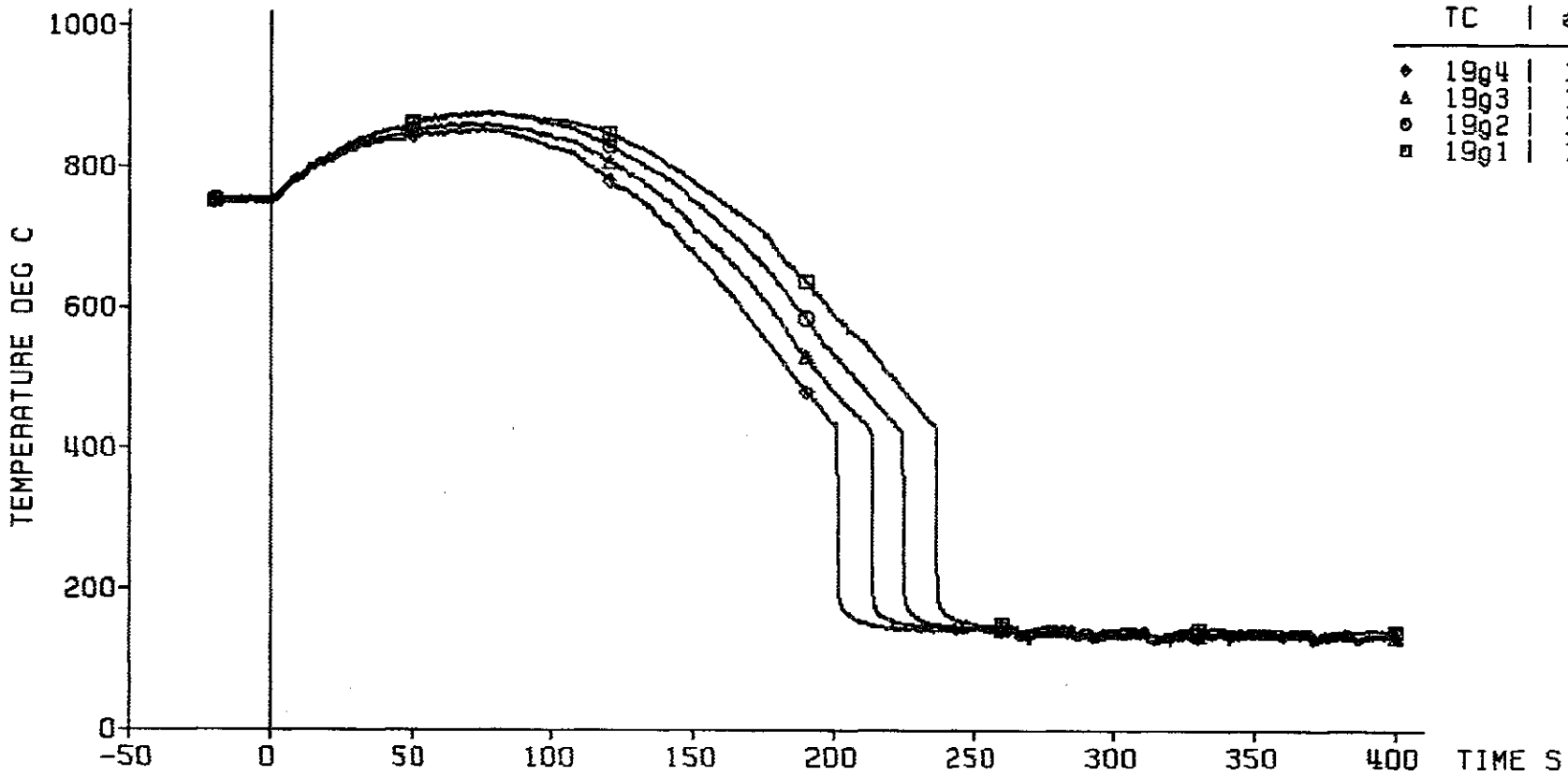

decay heat 120% ANS standard
flooding rate (cold) 5.72 cm/s
system pressure 4.11 bar
feedwater temperature 40 deg C



Fig. 172 FEBA: 5x5 ROD BUNDLE, TEST SERIES 2, TEST-No. 228

heat transfer coeff.

TC	ax. level
◆ 19g4	1925 mm
▲ 19g3	1825 mm
● 19g2	1725 mm
■ 19g1	1625 mm

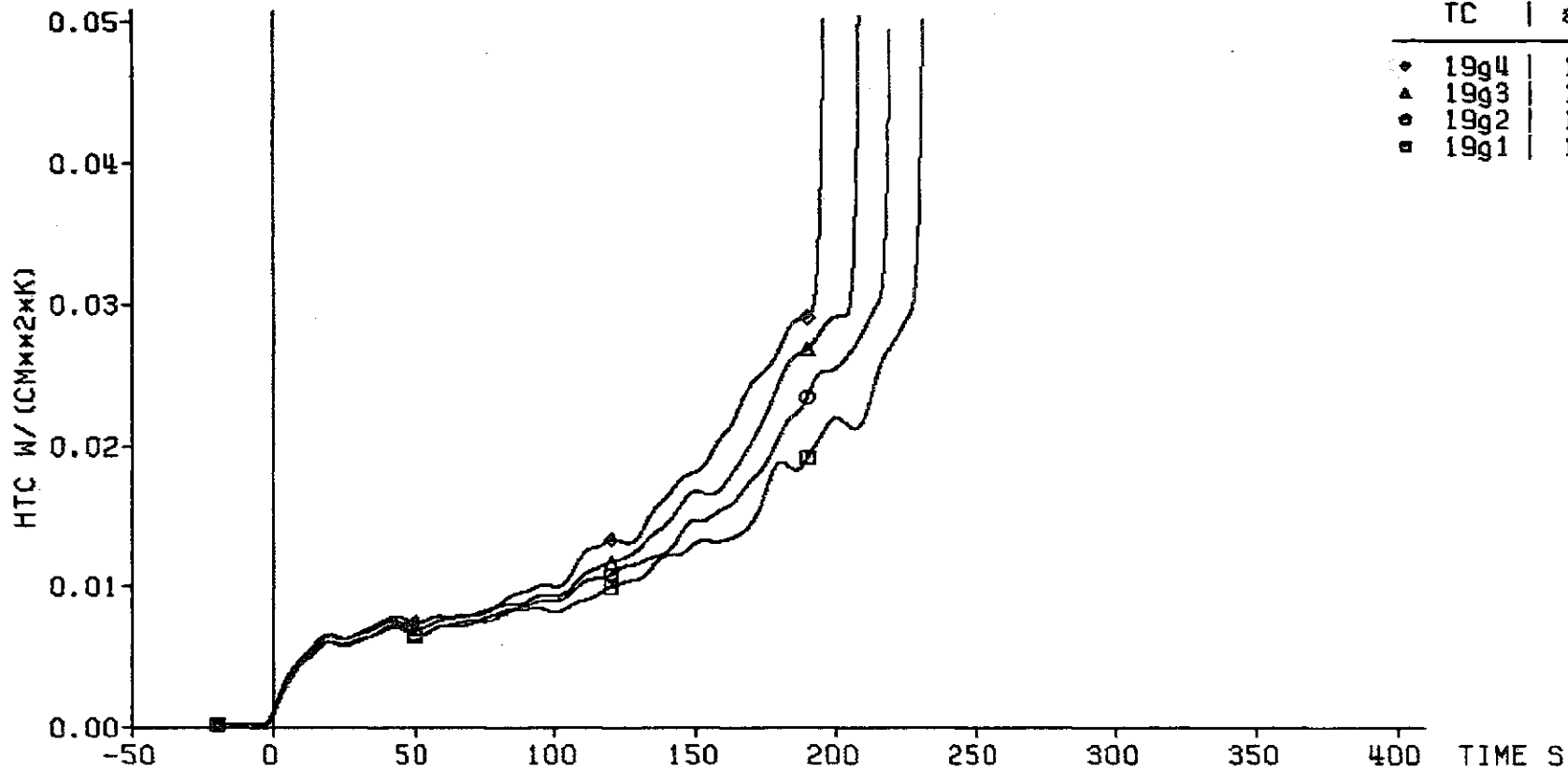

decay heat 120% ANS standard
flooding rate (cold) 5.72 cm/s
system pressure 4.11 bar
feedwater temperature 40 deg C

KfK
IRB

Fig. 173 FEBA: 5x5 ROD BUNDLE, TEST SERIES 2, TEST-No. 228

axial level: 1725 mm

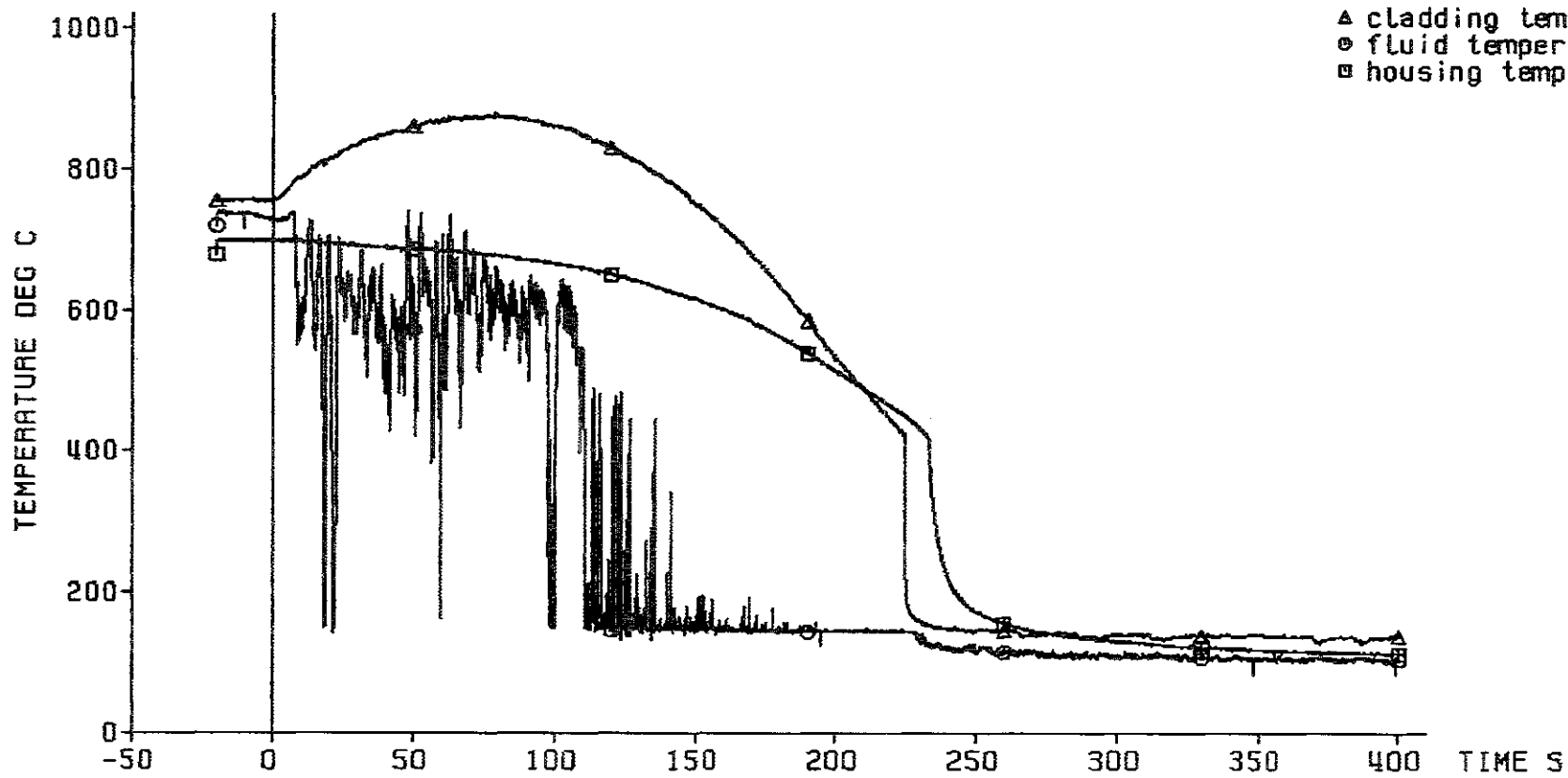

— 200 —

decay heat 120% ANS standard
flooding rate (cold) 5.72 cm/s
system pressure 4.11 bar
feedwater temperature 40 deg C



Fig. 174 FEBA: 5x5 ROD BUNDLE, TEST SERIES 2, TEST-NO. 228

axial level: 1625 mm

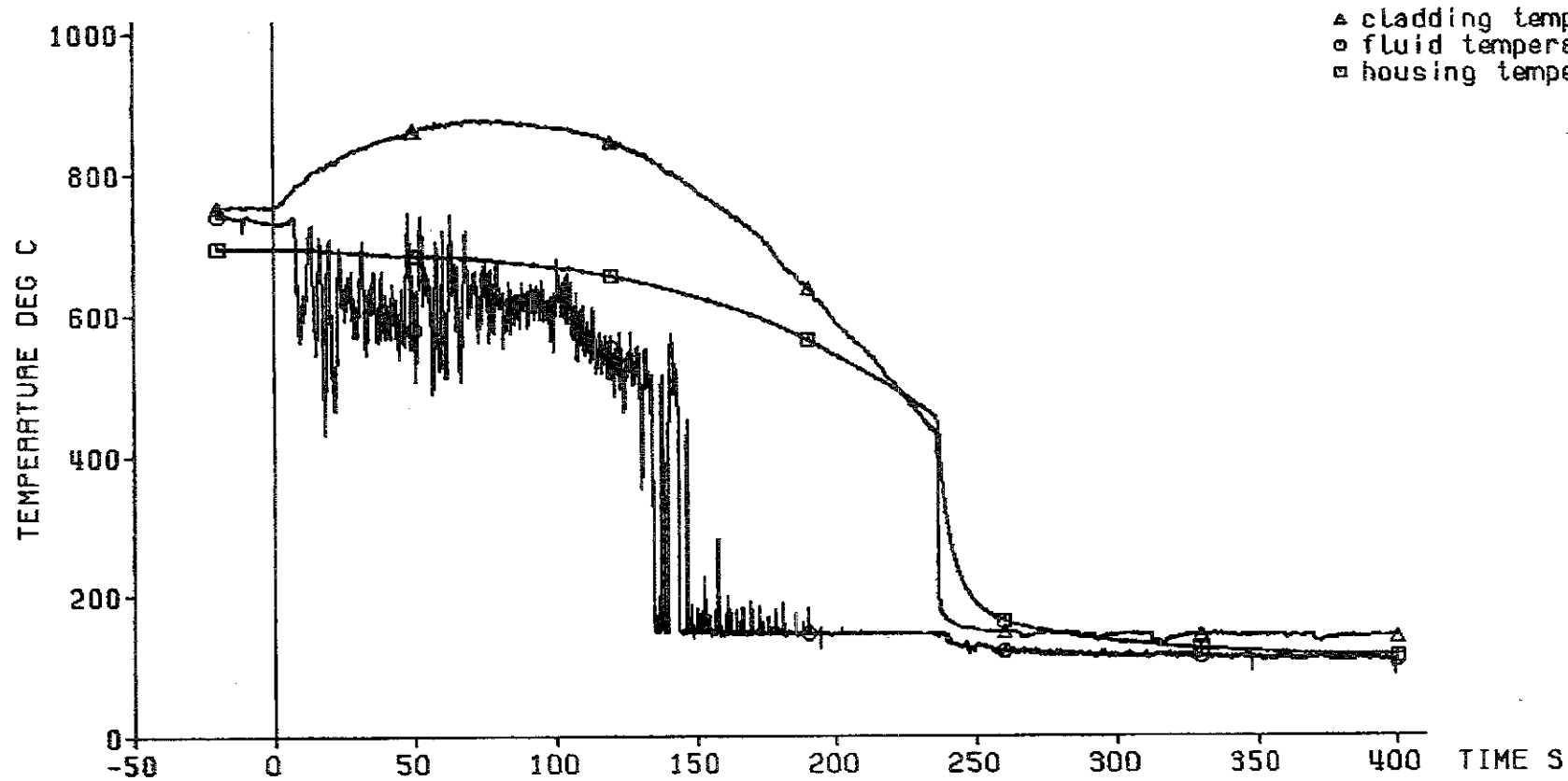

— 201 —

decay heat 120% ANS standard
flooding rate (cold) 5.72 cm/s
system pressure 4.11 bar
feedwater temperature 40 deg C



Fig. 175 FEBA: 5x5 ROD BUNDLE, TEST SERIES 2, TEST-No. 228

pressure loss
along the test section:

- ◆ total length: 4196 mm
- △ lower part: 1711 mm
- middle part: 545 mm
- upper part: 1940 mm

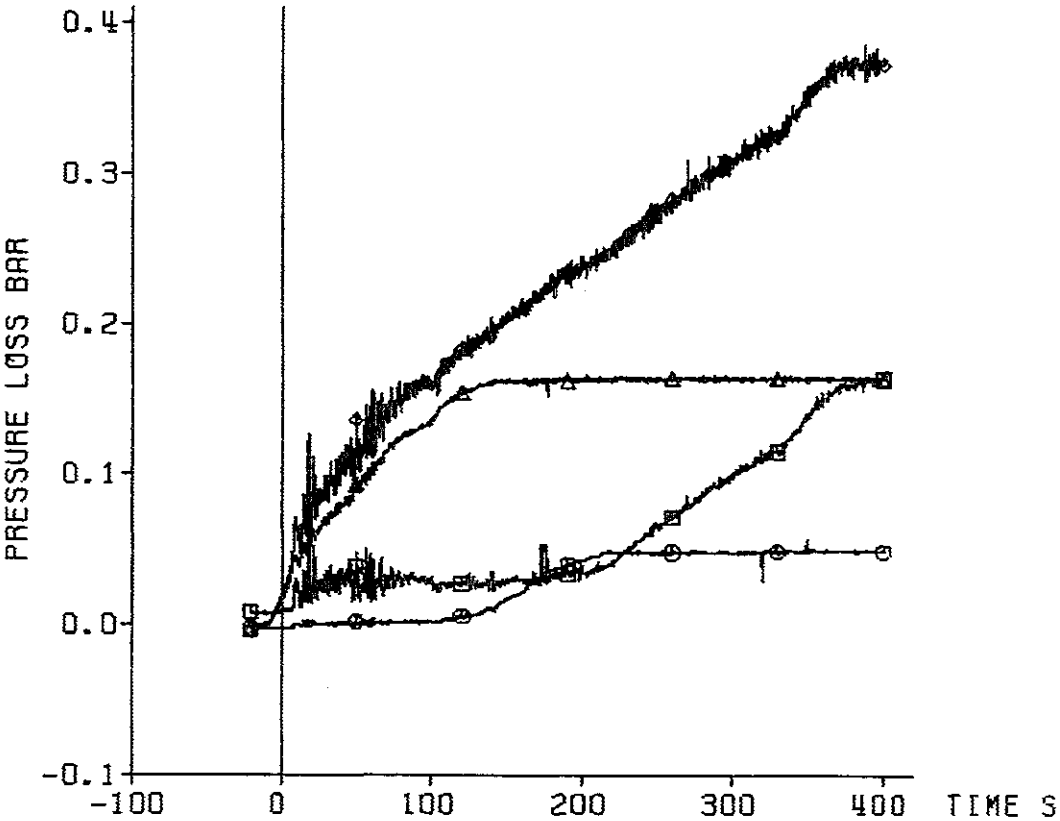

decay heat 120% RMS standard
flooding rate (cold) 5.72 cm/s
system pressure 4.11 bar
feedwater temperature 40 deg C



Fig. 176 FEBA: 5x5 ROD BUNDLE, TEST SERIES 2, TEST-No. 228

coolant outlet conditions:

▲ water carry over
○ coolant temperature
□ coolant pressure

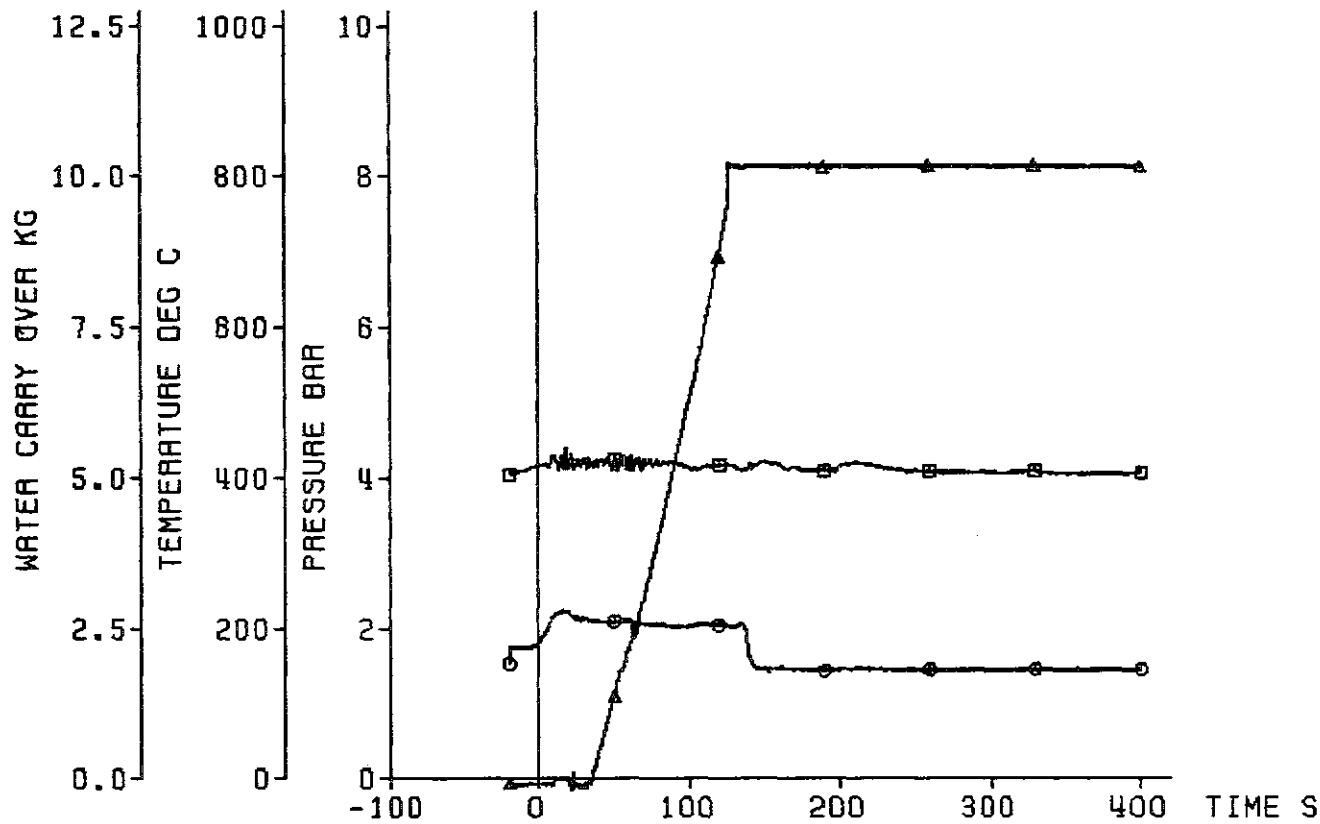

decay heat 120% ANS standard
flooding rate (cold) 5.72 cm/s
system pressure 4.11 bar
feedwater temperature 40 deg C

KfK
IRB

Fig. 177 FEBA: 5x5 ROD BUNDLE, TEST SERIES 2, TEST-No. 228

axial position of the quench front

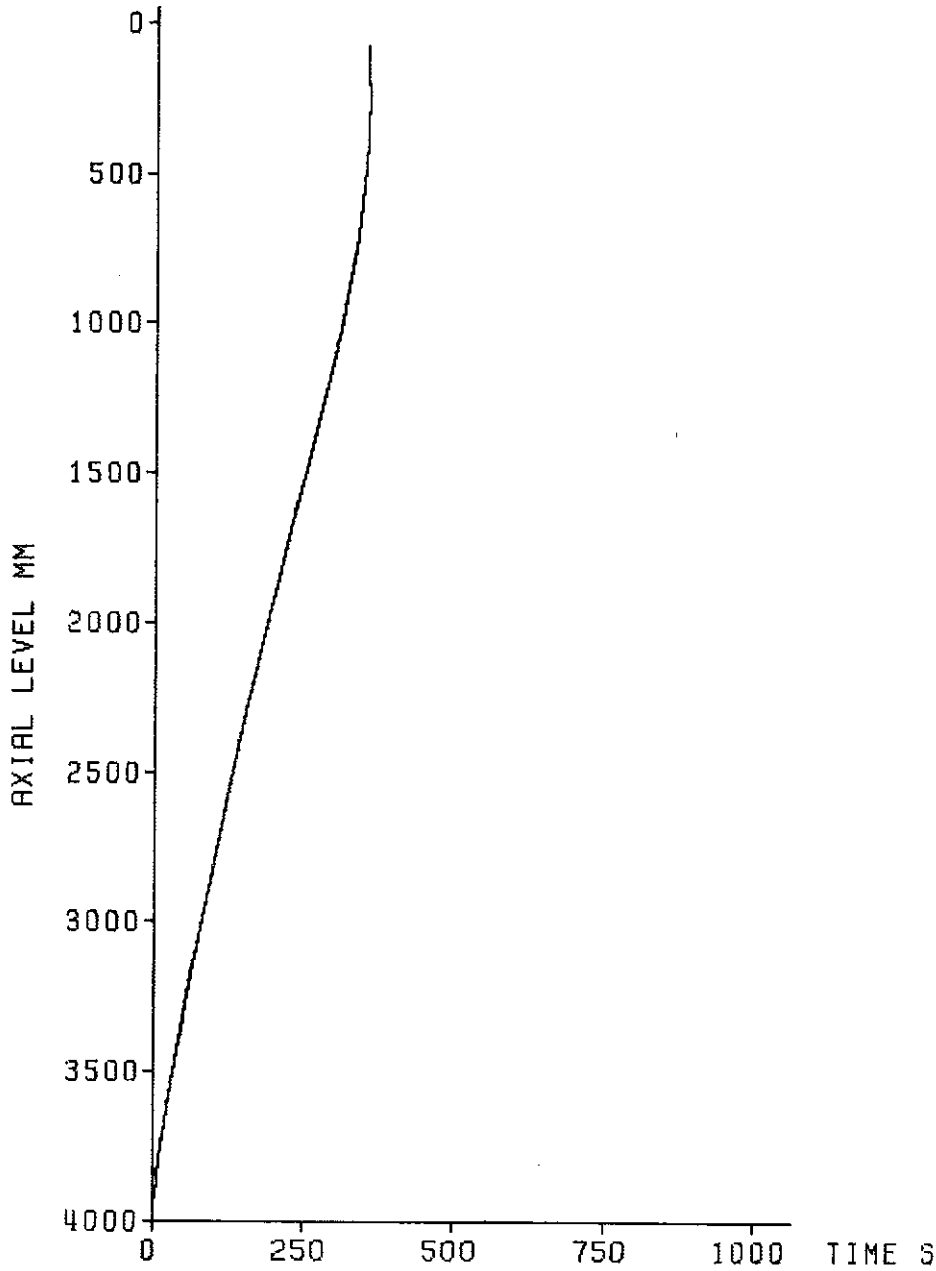

decay heat	120% ANS standard
flooding rate (cold)	5.72 cm/s
system pressure	4.11 bar
feedwater temperature	40 deg C



Fig. 178 FEBA: 5x5 ROD BUNDLE
TEST SERIES 2, TEST-No. 228

initial axial temperature profile of the cladding

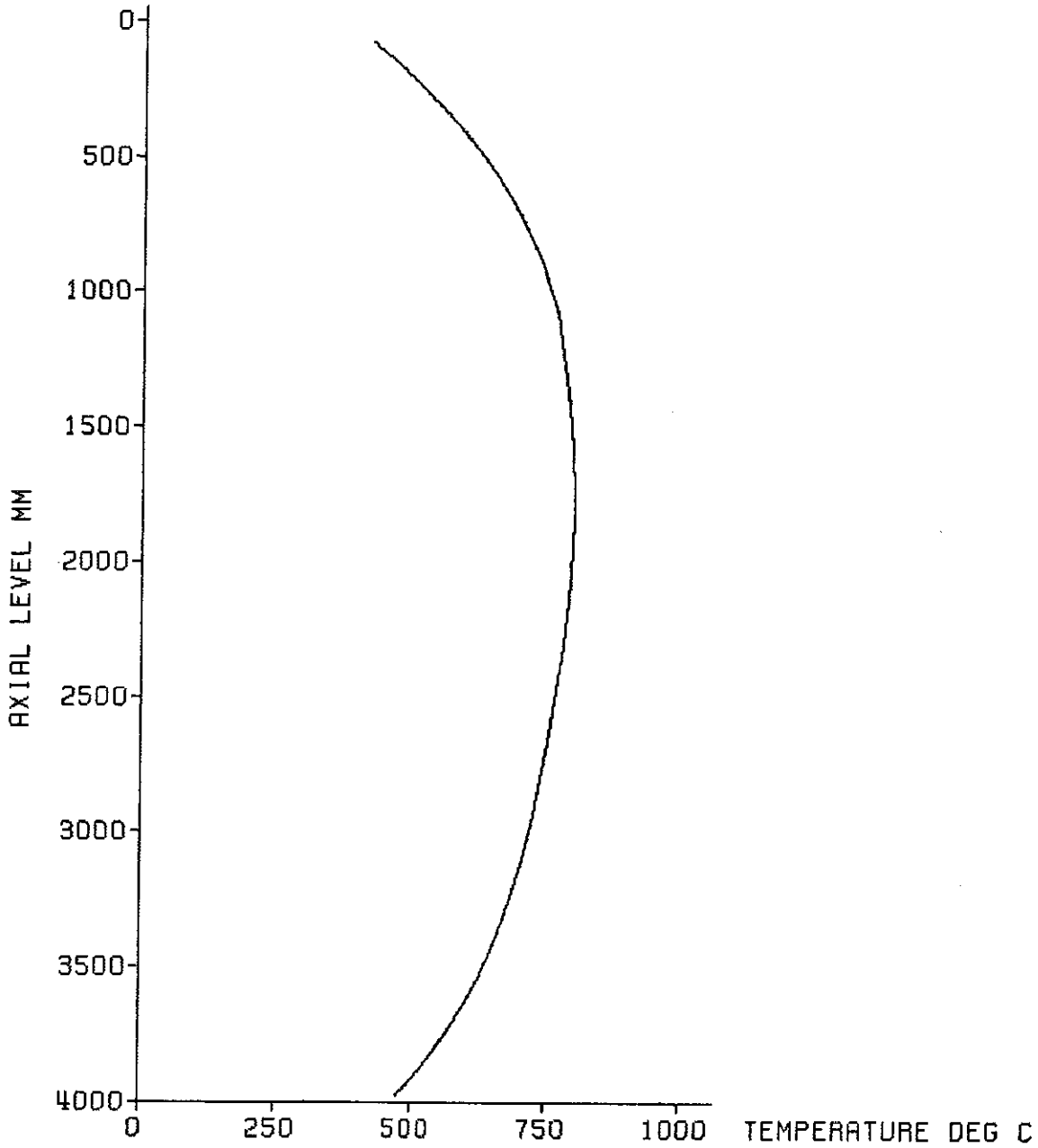

decay heat	120% RNS standard
flooding rate (cold)	5.77 cm/s
system pressure	6.15 bar
feedwater temperature	40 deg C

KFK
TRB

Fig. 179 FEBA: 5x5 ROD BUNDLE
TEST SERIES 2, TEST-NO. 230

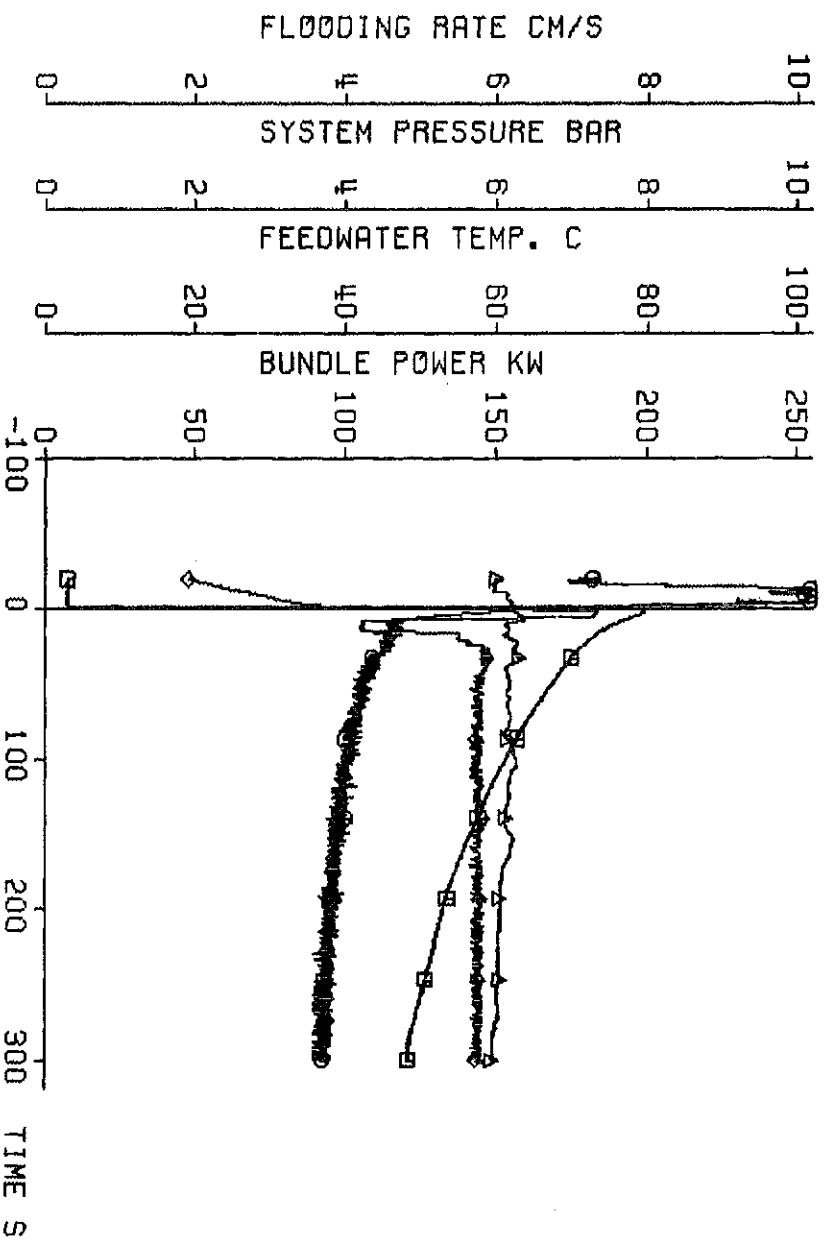

test parameters:

- ◆ flooding rate
- ▲ system pressure
- feedwater temperature
- bundle power

decay heat
 flooding rate (cold) 120% RNS standard
 system pressure 5.77 cm/s
 feedwater temperature 6.15 bar
 40 deg C



Fig. 180 FEBRA: 5X5 ROD BUNDLE, TEST SERIES 2, TEST-NO. 230

cladding temperature

TC	ax. level
+	18a4 3860 mm
x	18a3 3315 mm
y	18a2 2770 mm
*	18a1 2225 mm
◇	12b4 1680 mm
△	12b3 1135 mm
○	12b2 590 mm
□	12b1 45 mm

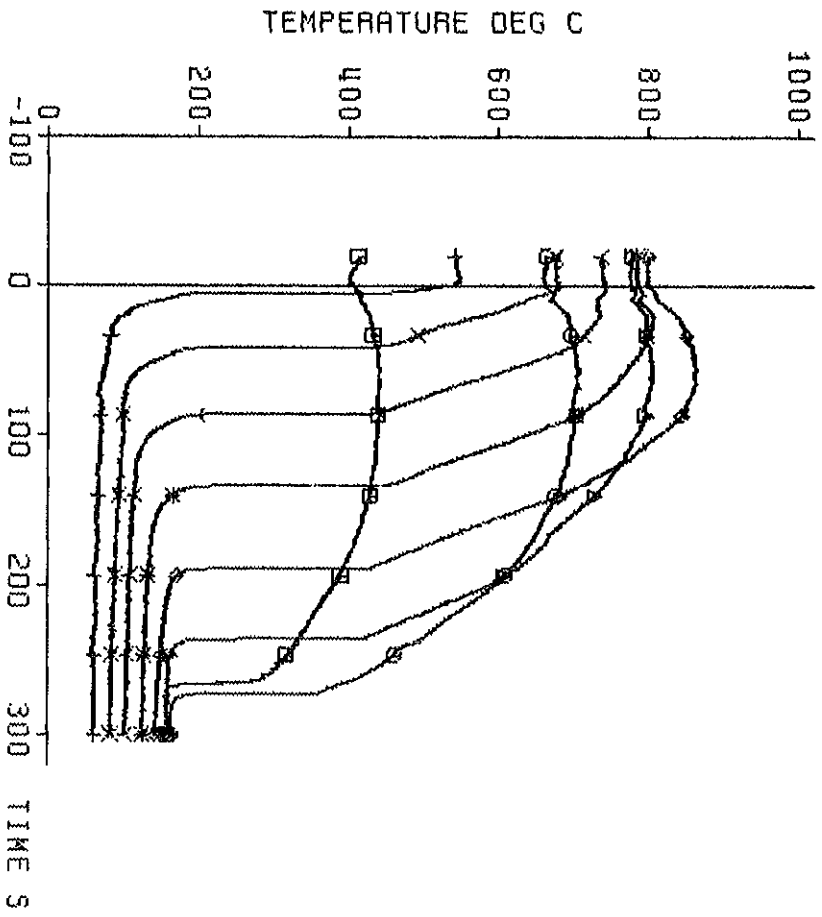

decay heat
 flooding rate (cold)
 system pressure
 feedwater temperature

120% RNS standard
 5.77 cm/s
 6.15 bar
 40 deg C

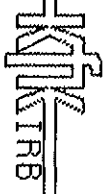
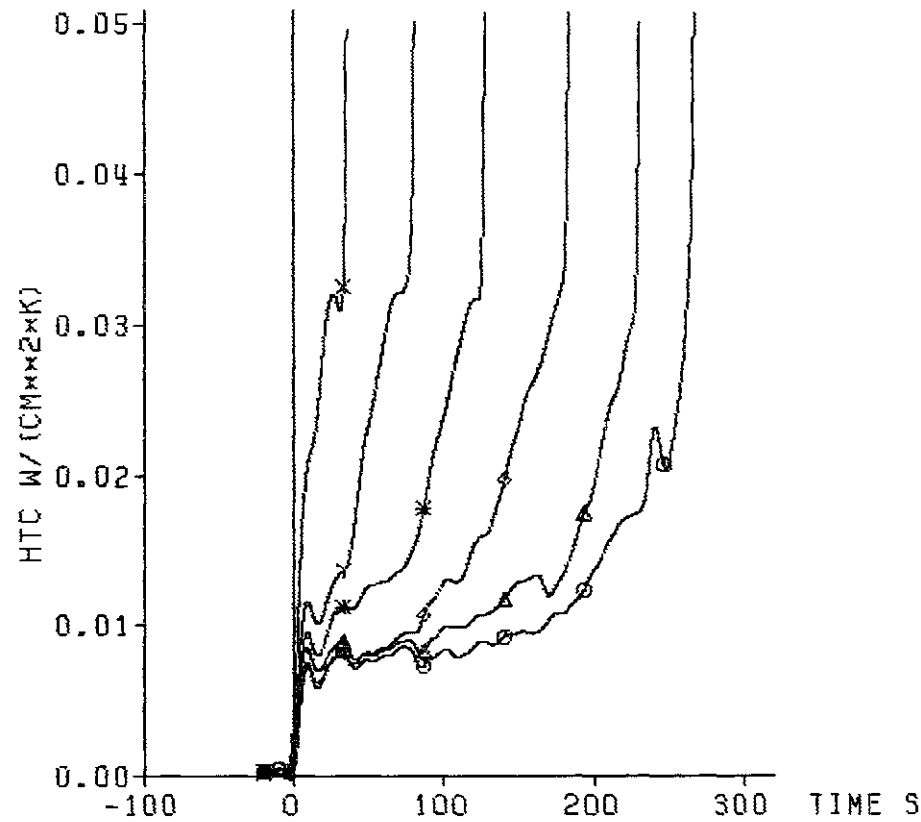

Fig. 181 FEBR: 5x5 ROD BUNDLE, TEST SERIES 2, TEST-NO. 230

heat transfer coeff.



TC	ax. Level
x	18a3 3315 mm
y	18a2 2770 mm
*	18a1 2225 mm
^	12b4 1680 mm
>	12b3 1135 mm
o	12b2 590 mm

decay heat 120% ANS standard
 flooding rate (cold) 5.77 cm/s
 system pressure 6.15 bar
 feedwater temperature 40 deg C



Fig. 182 FEBA: 5x5 ROD BUNDLE, TEST SERIES 2, TEST-No. 230

cladding temperature

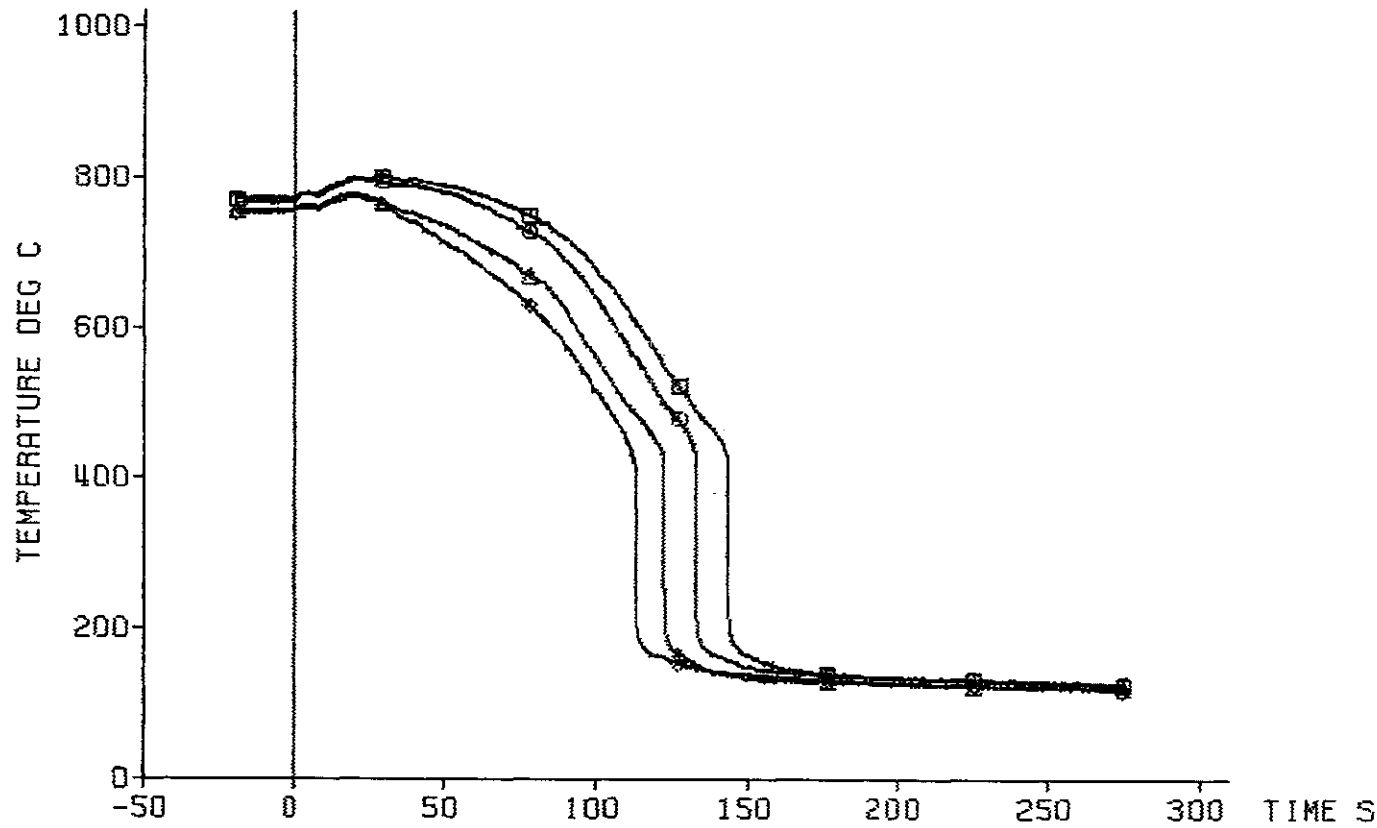

decay heat 120% RMS standard
flooding rate (cold) 5.77 cm/s
system pressure 6.15 bar
feedwater temperature 40 deg C



Fig. 183 FEBA: 5x5 ROD BUNDLE, TEST SERIES 2, TEST-No. 230

heat transfer coeff.

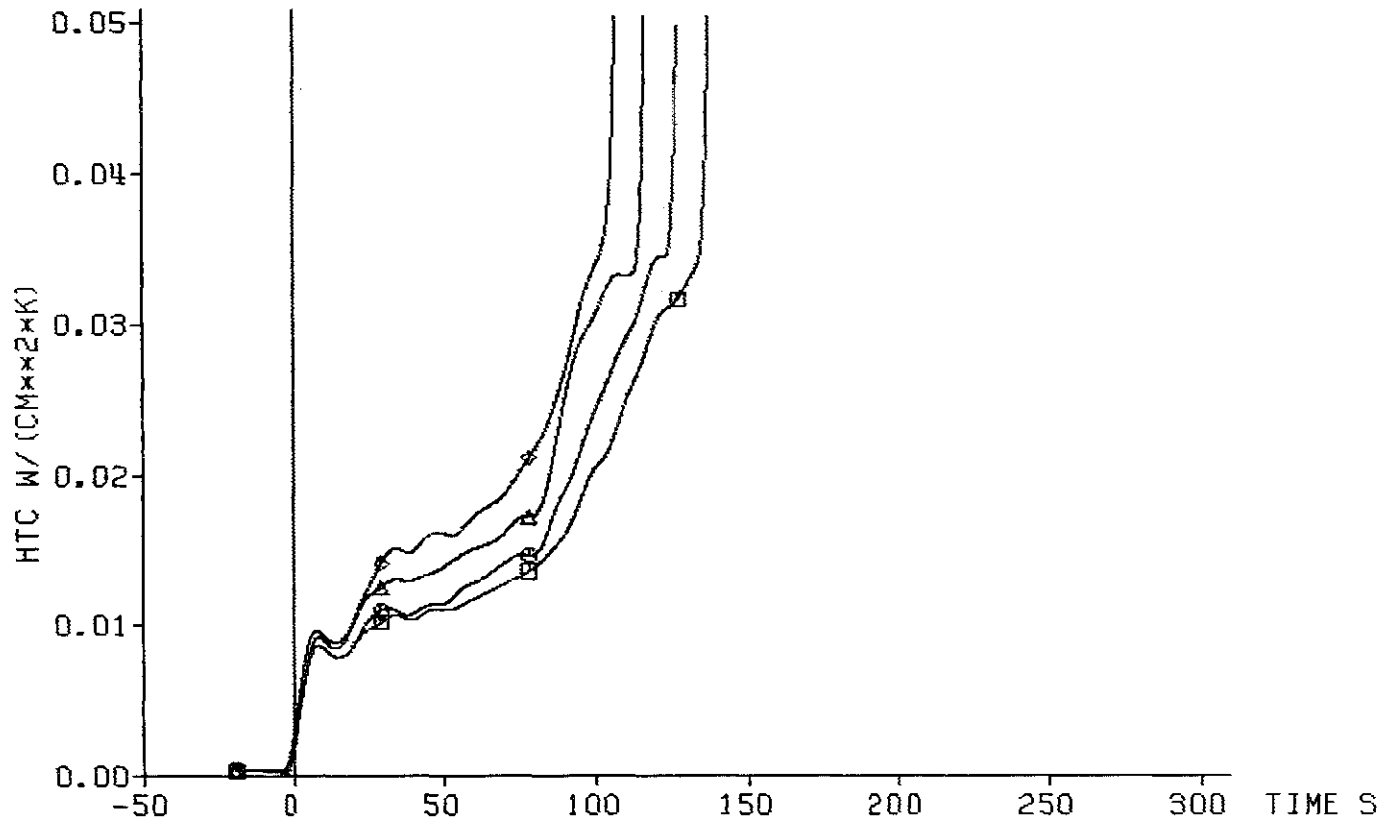

decay heat 120% ANS standard
flooding rate (cold) 5.77 cm/s
system pressure 6.15 bar
feedwater temperature 40 deg C



Fig. 184 FEBA: 5x5 ROD BUNDLE, TEST SERIES 2, TEST-No. 230

cladding temperature.

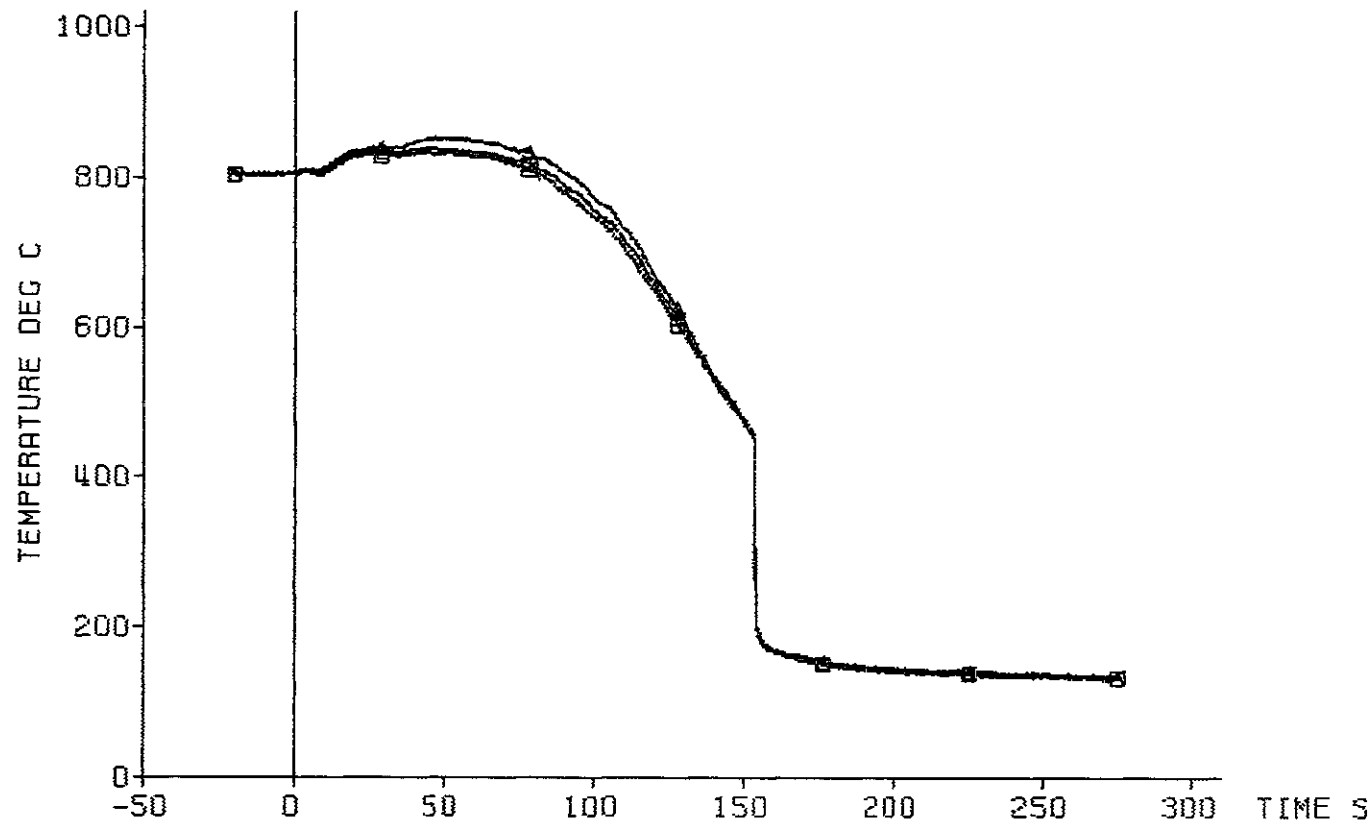

	TC	ax. level
△	13d3	2025 mm
⊙	13d2	2025 mm
□	13d1	2025 mm

decay heat 120% ANS standard
flooding rate (cold) 5.77 cm/s
system pressure 6.15 bar
feedwater temperature 40 deg C



Fig. 185 FEBA: 5x5 ROD BUNDLE, TEST SERIES 2, TEST-No. 230

heat transfer coeff.

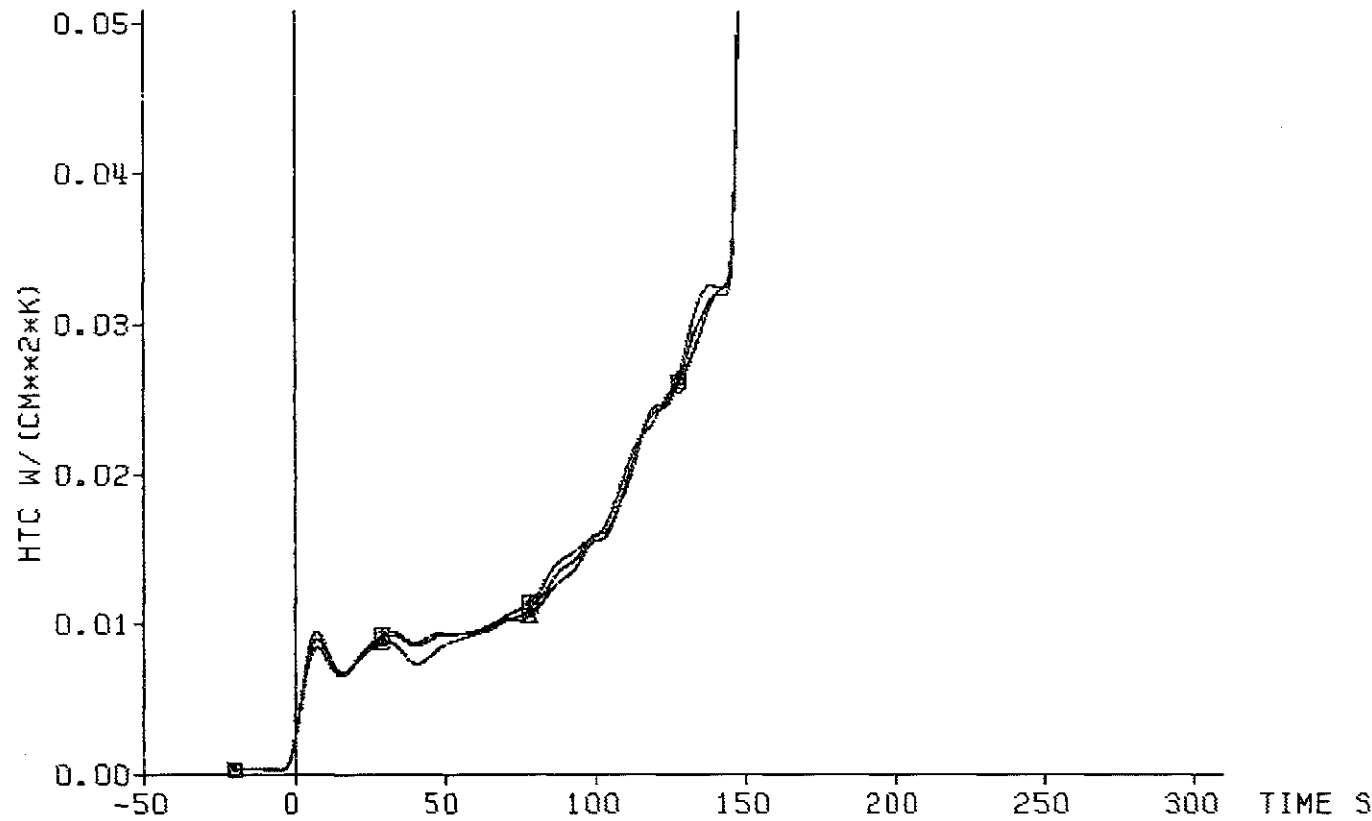

	TC	axial level
△	13d3	2025 mm
○	13d2	2025 mm
□	13d1	2025 mm

decay heat 120% ANS standard
flooding rate (cold) 5.77 cm/s
system pressure 6.15 bar
feedwater temperature 40 deg C



Fig. 186 FEBA: 5x5 ROD BUNDLE, TEST SERIES 2, TEST-NO. 230

cladding temperature

TC	ax. level
◆ 1904	1925 mm
△ 1903	1825 mm
○ 1902	1725 mm
□ 1901	1625 mm

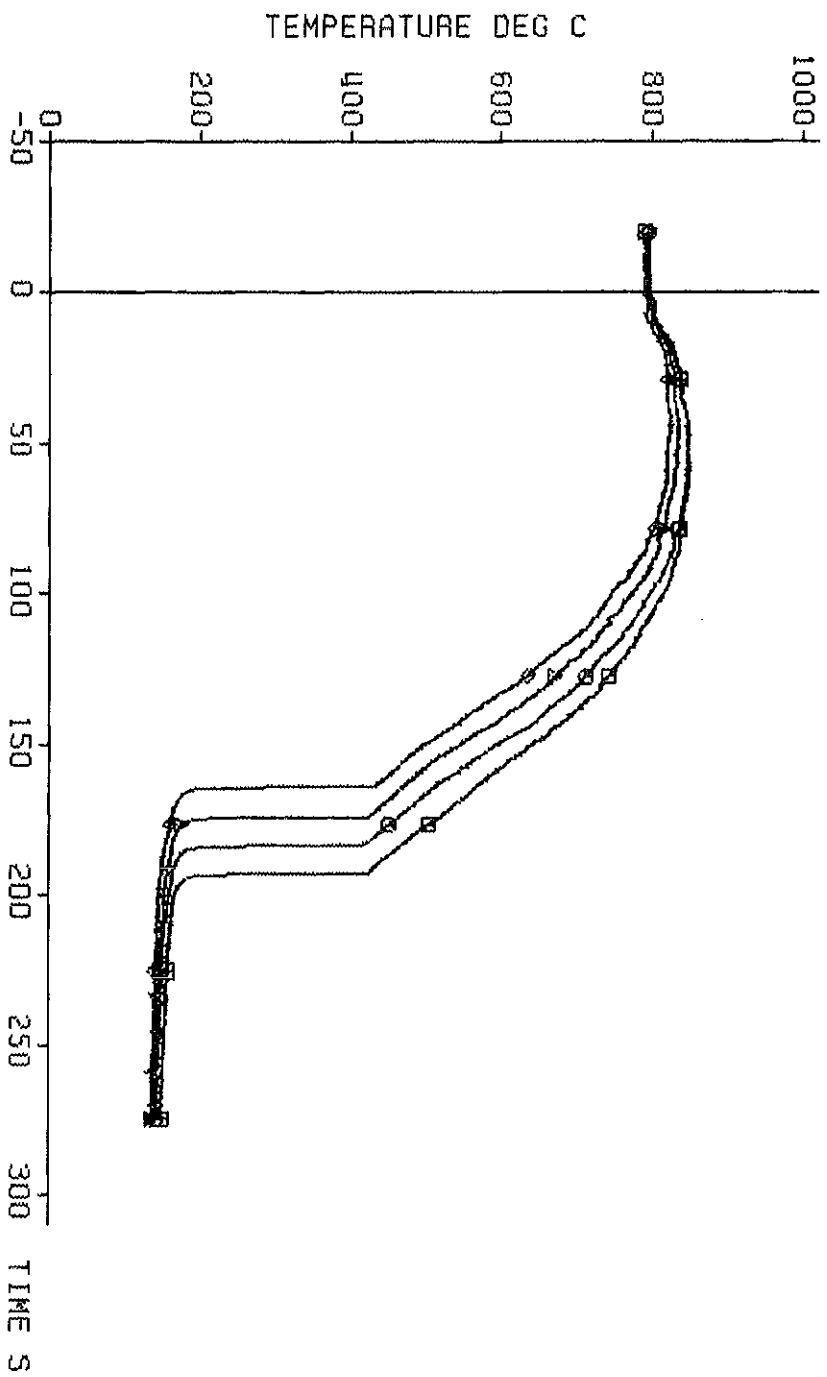

decay heat 120% RMS standard
 flooding rate (cold) 5.77 cm/s
 system pressure 6.15 bar
 feedwater temperature 40 deg C



Fig. 187 FEBRA: 5X5 ROD BUNDLE, TEST SERIES 2, TEST-NO. 230

heat transfer coeff.

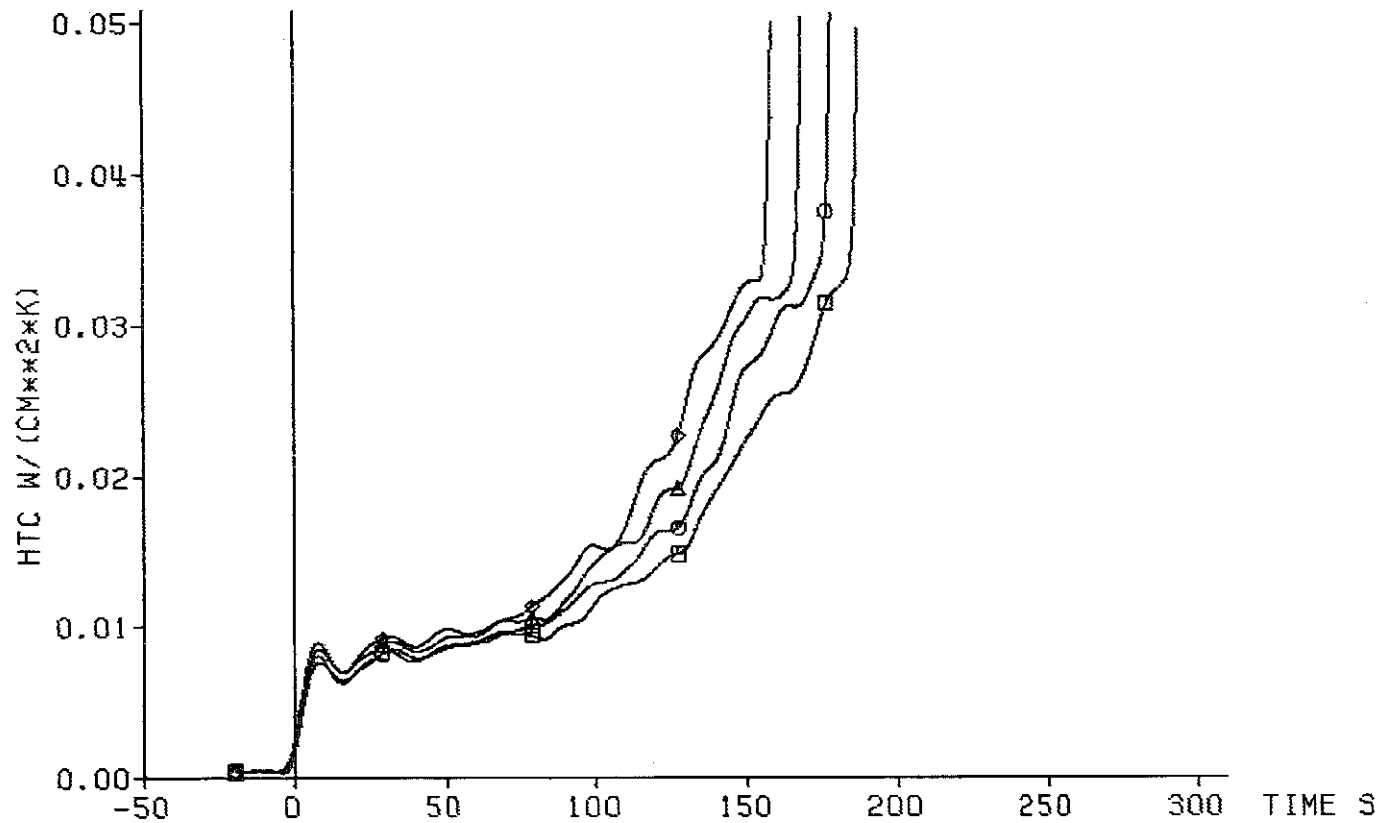

TC	ax. level
◆	19g4
▲	19g3
○	19g2
□	19g1

decay heat
flooding rate (cold) 5.77 cm/s
system pressure 6.15 bar
feedwater temperature 40 deg C

120% ANS standard



Fig. 188 FEBA: 5x5 ROD BUNDLE, TEST SERIES 2, TEST-No. 230

axial level: 1725 mm

▲ cladding temperature (19g2)
○ fluid temperature
■ housing temperature

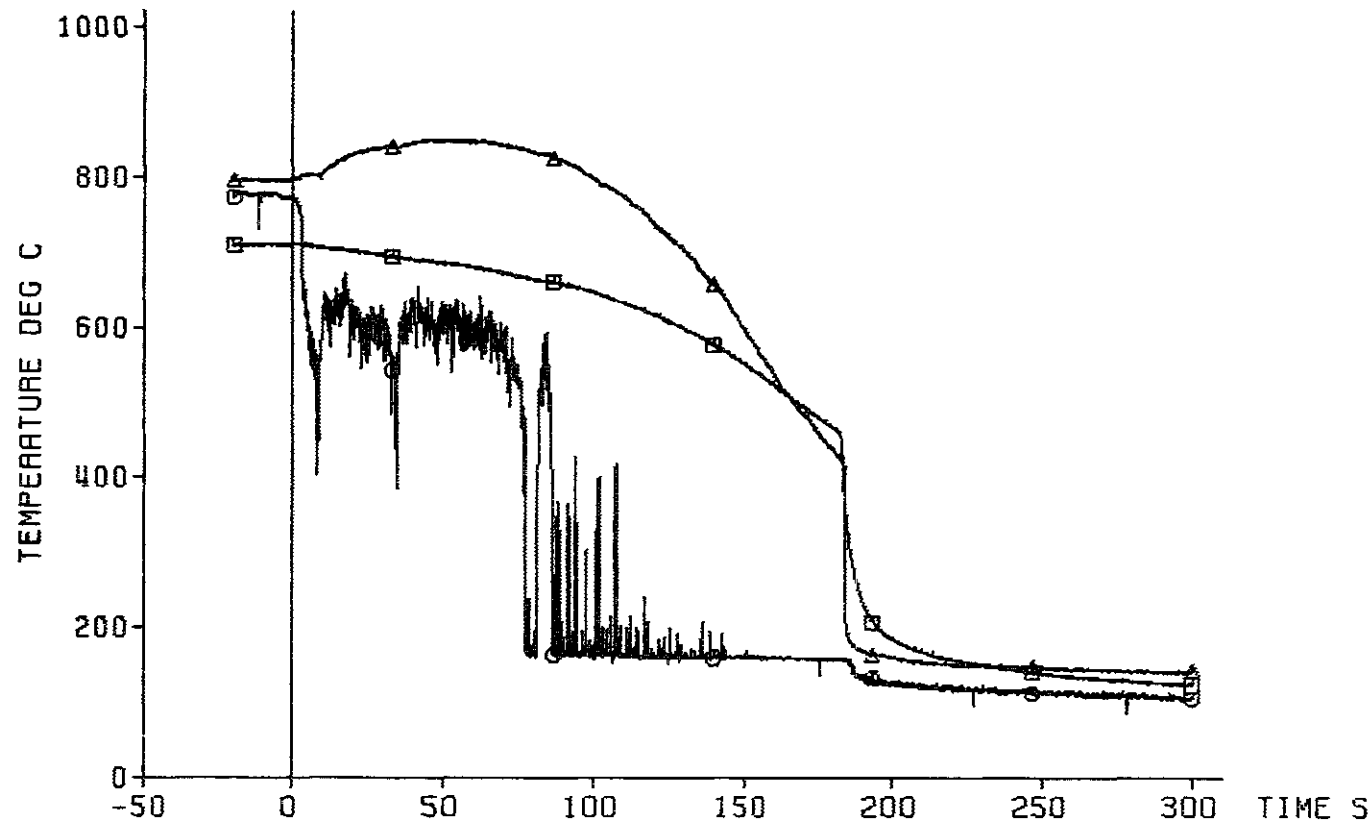

decay heat 120% ANS standard
flooding rate (cold) 5.77 cm/s
system pressure 6.15 bar
feedwater temperature 40 deg C

KIRB

Fig. 189 FEBA: 5x5 ROD BUNDLE, TEST SERIES 2, TEST-No. 230

axial level: 1625 mm

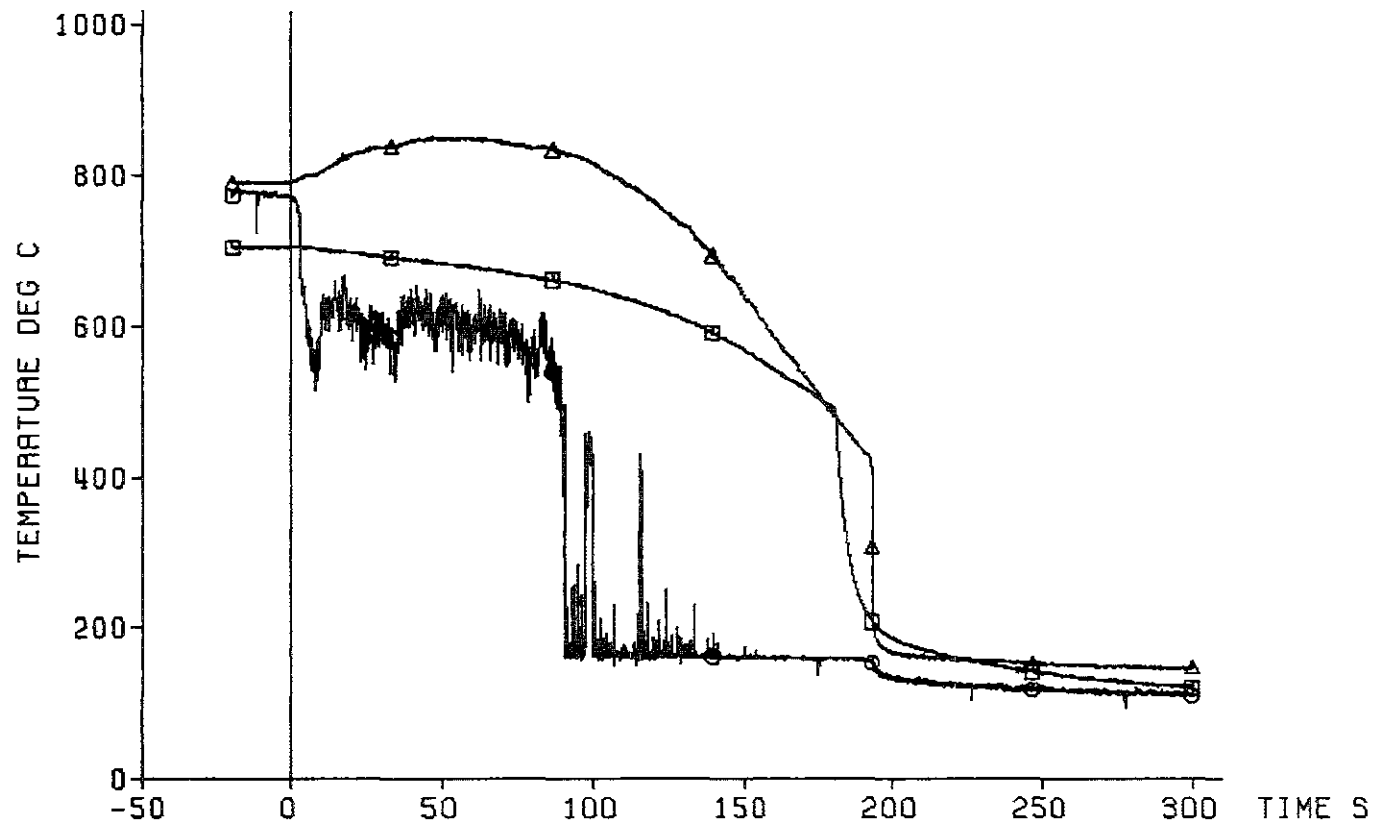

decay heat 120% ANS standard
flooding rate (cold) 5.77 cm/s
system pressure 6.15 bar
feedwater temperature 40 deg C

KfK
IRB

Fig. 190 FEBA: 5x5 ROD BUNDLE, TEST SERIES 2, TEST-No. 230

pressure loss
along the test section:

- ◆ total length: 4196 mm
- ▲ lower part: 1711 mm
- middle part: 545 mm
- ▣ upper part: 1940 mm

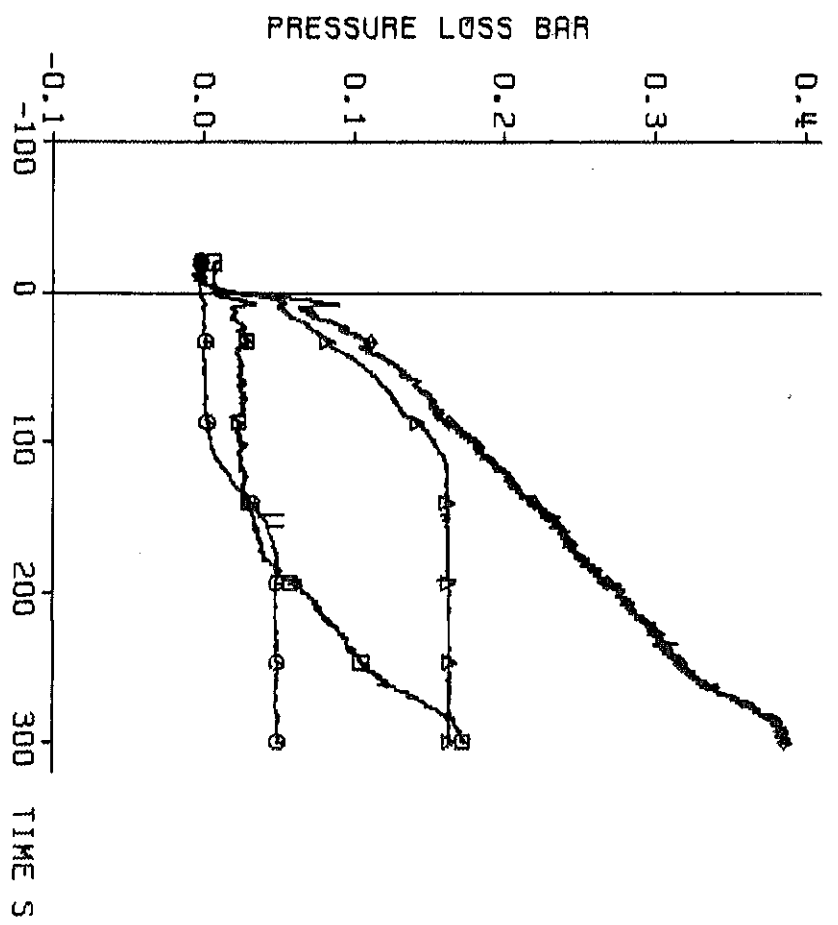

decay heat 120% RMS standard
 flooding rate (cold) 5.77 cm/s
 system pressure 6.15 bar
 feedwater temperature 40 deg C



Fig. 191 FEBRA: 5X5 ROD BUNDLE, TEST SERIES 2, TEST-NO. 230

coolant outlet conditions:

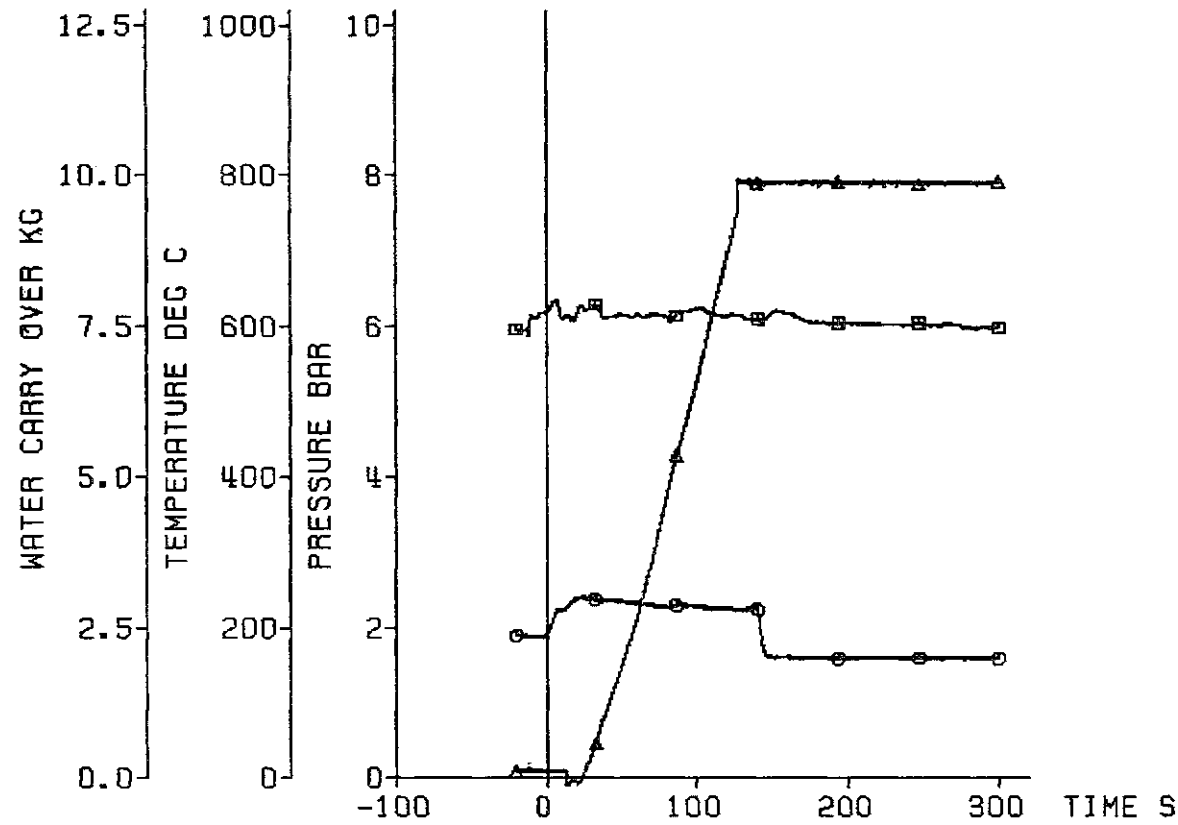

Δ water carry over
 \circ coolant temperature
 \square coolant pressure

decay heat 120% ANS standard
flooding rate (cold) 5.77 cm/s
system pressure 6.15 bar
feedwater temperature 40 deg C

KFK
IRB

Fig. 192 FEBA: 5x5 ROD BUNDLE, TEST SERIES 2, TEST-No. 230

axial position of the quench front

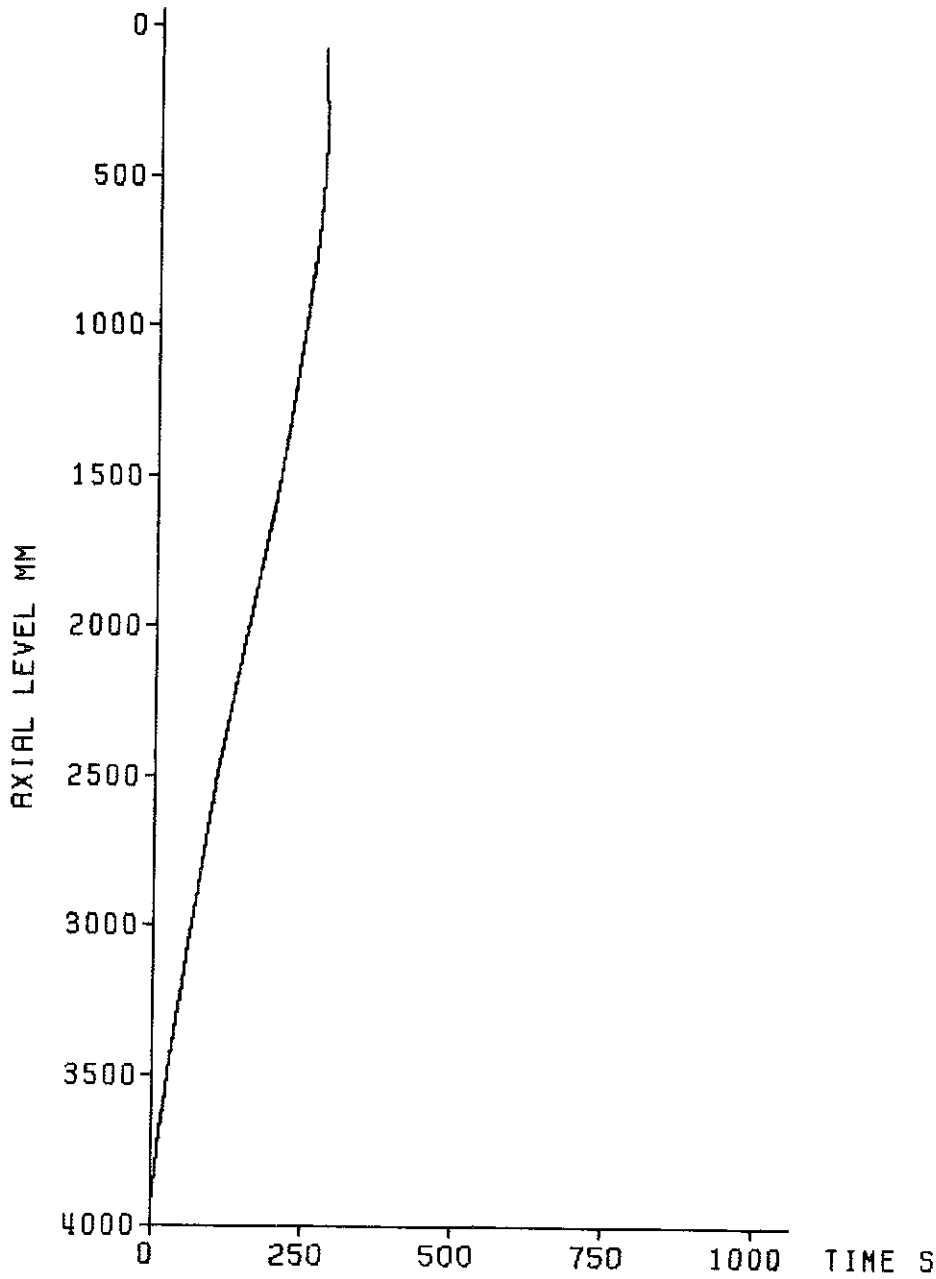

decay heat	120% ANS standard
flooding rate (cold)	5.77 cm/s
system pressure	6.15 bar
feedwater temperature	40 deg C

KfK IRB

Fig. 193 FEBA: 5x5 ROD BUNDLE
TEST SERIES 2, TEST-No. 230

TEST SERIES II

Investigation of the Effects of a Grid Spacer,
Without Grid Spacer at the Bundle Midplane

Channel Listing and Data Identification for Test No. 228 Through 234

Channel No.	Data Identification		Unit	Remarks
	Type	Location		
1	Cladding Temperature	18a4.3860 ¹	°C	
2	Cladding Temperature	18a3.3315	°C	
3	Cladding Temperature	18a2.2770	°C	
4	Cladding Temperature	18a1.2225	°C	
5	Cladding Temperature	12b4.1680	°C	
6	Cladding Temperature	12b3.1135	°C	
7	Cladding Temperature	12b2. 590	°C	
8	Cladding Temperature	12b1. 45	°C	
9	Cladding Temperature	17h4.2225	°C	
10	Cladding Temperature	17h3.2125	°C	
11	Cladding Temperature	17h2.2025	°C	
12	Cladding Temperature	17h1.1925	°C	
13	Fluid Temperature	TFS ³ 3315	°C	TC of 0.5 mm Diameter
14	Fluid Temperature	TFS 2380	°C	TC of 0.5 mm Diameter
15	Fluid Temperature	TF ² 1725	°C	
16	Fluid Temperature	TFS 485	°C	TC of 0.5 mm Diameter
17	Housing Temperature	TK ⁴ 3315	°C	
18	Housing Temperature	TK 2235	°C	
19	Housing Temperature	TK 1725	°C	
20	Housing Temperature	TK 590	°C	

TEST SERIES II

Channel No.	Data Identification		Unit	Remarks
	Type	Location		
21	Fluid Temperature	Lower Plenum	°C	Heated + Unheated TC's
22	Water Level Detector	4012	°C	
23	Feedwater Temperature		°C	
24	Fluid Temperature	Upper Plenum	°C	
25	Room Temperature		°C	
26	Cladding Temperature	22f4.2425 ¹	°C	
27	Cladding Temperature	22f3.2325	°C	
28	Cladding Temperature	22f2.2225	°C	
29	Cladding Temperature	22f1.2125	°C	
30	Cladding Temperature	21e4.2225	°C	
31	Cladding Temperature	21e3.2175	°C	
32	Cladding Temperature	21e2.2125	°C	
33	Cladding Temperature	21e1.2075	°C	
34	Cladding Temperature	19g4.1925	°C	
35	Cladding Temperature	19g3.1825	°C	
36	Cladding Temperature	19g2.1725	°C	
37	Cladding Temperature	19g1.1625	°C	
38	Cladding Temperature	16g4.1925	°C	
39	Cladding Temperature	16g3.1825	°C	
40	Cladding Temperature	16g2.1725	°C	
41	Cladding Temperature	16g1.1625	°C	
42	Cladding Temperature	15a4.3860	°C	
43	Cladding Temperature	15a3.3315	°C	
44	Cladding Temperature	15a2.2770	°C	
45	Cladding Temperature	15a1.2225	°C	
46	Cladding Temperature	14e4.2225	°C	
47	Cladding Temperature	14e3.2175	°C	
48	Cladding Temperature	14e2.2125	°C	
49	Cladding Temperature	14e1.2075	°C	

TEST SERIES II

Channel No.	Data Identification		Unit	Remarks
	Type	Location		
50	Cladding Temperature	13d3.2025 ¹	°C	
51	Cladding Temperature	13d2.2025	°C	
52	Cladding Temperature	13d1.2025	°C	
53	Cladding Temperature	10f4.2425	°C	
54	Cladding Temperature	10f3.2325	°C	
55	Cladding Temperature	10f2.2225	°C	
56	Cladding Temperature	10f1.2125	°C	
57	Cladding Temperature	9h4.2225	°C	
58	Cladding Temperature	9h3.2125	°C	
59	Cladding Temperature	9h2.2025	°C	
60	Cladding Temperature	9h1.1925	°C	
61	Cladding Temperature	8d4.2025	°C	
62	Cladding Temperature	8d3.2025	°C	
63	Cladding Temperature	8d2.2025	°C	
64	Cladding Temperature	8d1.2025	°C	
65	Cladding Temperature	7f4.2425	°C	
66	Cladding Temperature	7f3.2325	°C	
67	Cladding Temperature	7f2.2225	°C	
68	Cladding Temperature	7f1.2125	°C	
69	Cladding Temperature	4g4.1925	°C	
70	Cladding Temperature	4g3.1825	°C	
71	Cladding Temperature	4g2.1725	°C	
72	Cladding Temperature	4g1.1625	°C	
73	Cladding Temperature	3b4.1680	°C	
74	Cladding Temperature	3b3.1135	°C	
75	Cladding Temperature	3b2. 590	°C	
76	Cladding Temperature	3b1. 45	°C	TC Failed

TEST SERIES II

Channel No.	Data Identification		Unit	Remarks
	Type	Location		
77	Cladding Temperature	2c4.4025 ¹	°C	
78	Cladding Temperature	2c3.3925	°C	
79	Cladding Temperature	2c2.3825	°C	
80	Cladding Temperature	2c1.3725	°C	
81	Electrical Power Input	8 Rods	kW	Rods No. 1 Through 8
82	Electrical Power Input	8 Rods	kW	Rods No. 9 Through 16
83	Electrical Power Input	9 Rods	kW	Rods No. 17 Through 25
84	Housing Temperature	TK ⁴ 4005	°C	
85	Housing Temperature	TK 3915	°C	
86	Housing Temperature	TK 3820	°C	
87	Housing Temperature	TK 3725	°C	
88	Housing Temperature	TK 3018	°C	
89	Housing Temperature	TK 2770	°C	
90	Housing Temperature	TK 2025	°C	
91	Housing Temperature	TK 1925	°C	
92	Housing Temperature	TK 1825	°C	
93	Housing Temperature	TK 1625	°C	
94	Housing Temperature	TK 1135	°C	
95	Housing Temperature	TK 835	°C	
96	Housing Temperature	TK 45	°C	
97	Fluid Temperature	TF ² 3038	°C	
98	Fluid Temperature	TFS ³ 2425	°C	
99	Fluid Temperature	TF 2770	°C	
100	Fluid Temperature	TF 2325	°C	
101	Fluid Temperature	TF 2125	°C	
102	Fluid Temperature	TF 2025	°C	
103	Fluid Temperature	TF 1925	°C	
104	Fluid Temperature	TF 1135	°C	
105	Fluid Temperature	TF 1625	°C	
106	-----		-	Open

TEST SERIES II

Channel No.	Data Identification		Unit	Remarks
	Type	Location		
107	Cladding Temperature	24c4.4025 ¹	°C	
108	Cladding Temperature	24c2.3925	°C	
109	Cladding Temperature	24c1.3825	°C	
110	Time (10 Scans/s)		s	t = 0: Start of Reflooding
111	Pressure in Lower Plenum	4091	bar	
112	Pressure in Upper Plenum	-105	bar	
113	Pressure in Buffer		bar	
114	Bundle Power		kW	Channels: 81 + 82 + 83
115	Flooding Velocity (cold)		cm/s	
116	Water Carry Over Collected		kg	Downstream of Bundle Exit
117	Pressure Diff.	1835 and -105 mm	bar	
118	Measured	2380 and 1835 mm	bar	
119	Between	4091 and 2380 mm	bar	
120	Axial Level	4091 and -105 mm	bar	Values Measured Separately

- 1) TC's of 0.5 mm diameter embedded in rod cladding. Measuring position:
Example: rod No. = 18, type of rod instrumentation = a, TC No. = 4,
axial level = 3860 mm, referenced to the top flange of the bundle.
- 2) TF = TC's of 0.25 mm diameter (bare).
TC's placed in subchannel surrounded by rods No. 12, 17, 16 and 11.
- 3) TFS = TC's of 0.25 mm diameter protected by a radiation shielding.
TC's placed in subchannel surrounded by rods No. 12, 17, 16 and 11.
- 4) TK = TC's of 0.5 mm diameter placed in the wall of the bundle housing of
of 6.5 mm thickness.

TEST SERIES III

Investigation of the Effects of a 90% Flow Blockage With Bypass,
 Blockage at the Bundle Midplane of 3x3 Rods Placed in the Corner
 of the 5x5 Rod Bundle,
 Without Grid Spacer at the Bundle Midplane

Test No.	Flooding Velocity (cold) cm/s	System Pressure bar	Feedwater Temp. ¹ °C		Bundle Power ² kW		Remarks
			0-30 s	End	0 s	Transient	
241	3.8	2.0	42	37	200	120% ANS	Figs. 196 Through 217
239	3.8	4.1	49	37	200	120% ANS	Figs. 218 Through 239
236	3.8	6.2	48	37	200	120% ANS	Figs. 240 Through 261
240	5.8	2.0	46	40	200	120% ANS	Figs. 262 Through 283
238	5.7	4.1	49	37	200	120% ANS	Figs. 284 Through 305
235	5.8	6.2	46	37	200	120% ANS	Figs. 306 Through 327
242	3.9	2.0	40	36	200	120% ANS	Data Not Plotted
243	3.9	2.0	76	74	200	120% ANS	Data Not Plotted
237	5.6	4.2	45	37	200	120% ANS	Data Not Plotted

1) Measured in the lower plenum

2) Decay heat transient corresponding 120% ANS Standard 40 s after shutdown
 of the reactor

Table 3 FEBA 5x5 rod bundle: Main test parameters of test series III

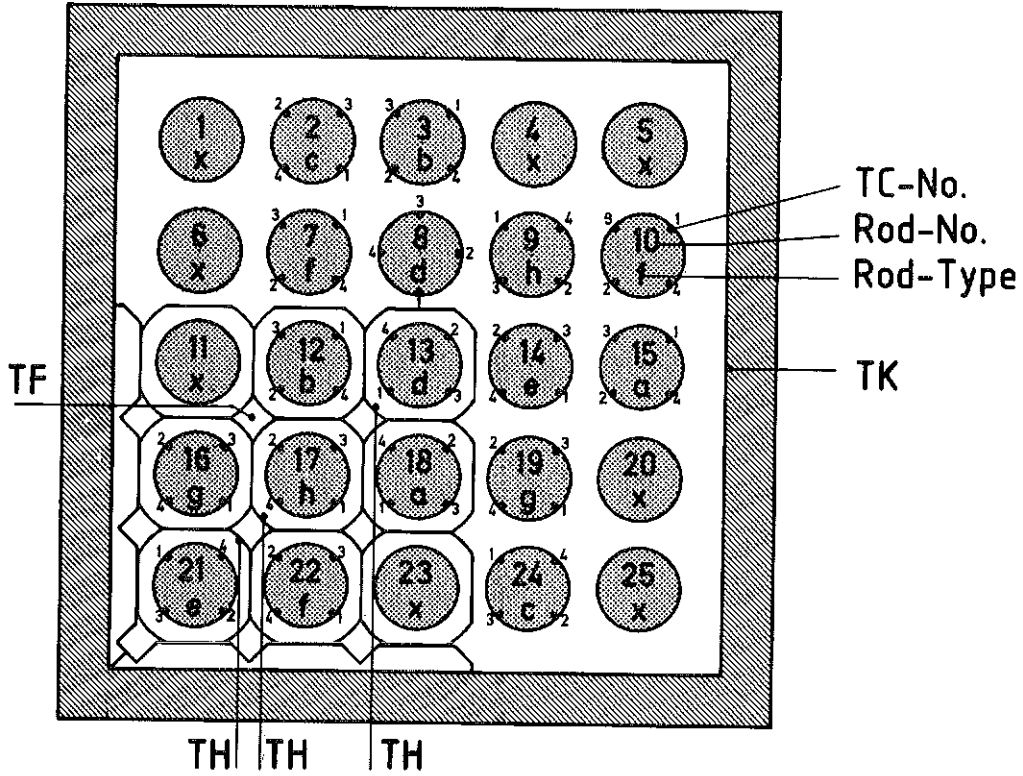

Rod Type	TC No.	Axial Level mm
a	1	2225
	2	2770
	3	3315
	4	3860
b	1	45
	2	590
	3	1135
	4	1680
c	1	3725
	2	3825
	3	3925
	4	4025
d	1	2025
	2	2025
	3	2025
	4	2025

Rod Type	TC No.	Axial Level mm
e	1	2075
	2	2125
	3	2175
	4	2225
f	1	2125
	2	2225
	3	2325
	4	2425
g	1	1625
	2	1725
	3	1825
	4	1925
h	1	1925
	2	2025
	3	2125
	4	2225

Rod Type	TC No.	Axial Level mm
x	without TC's	

Fig. 194 5x5 rod bundle: Radial and axial location of cladding, sleeve, fluid and housing TC's for test series III

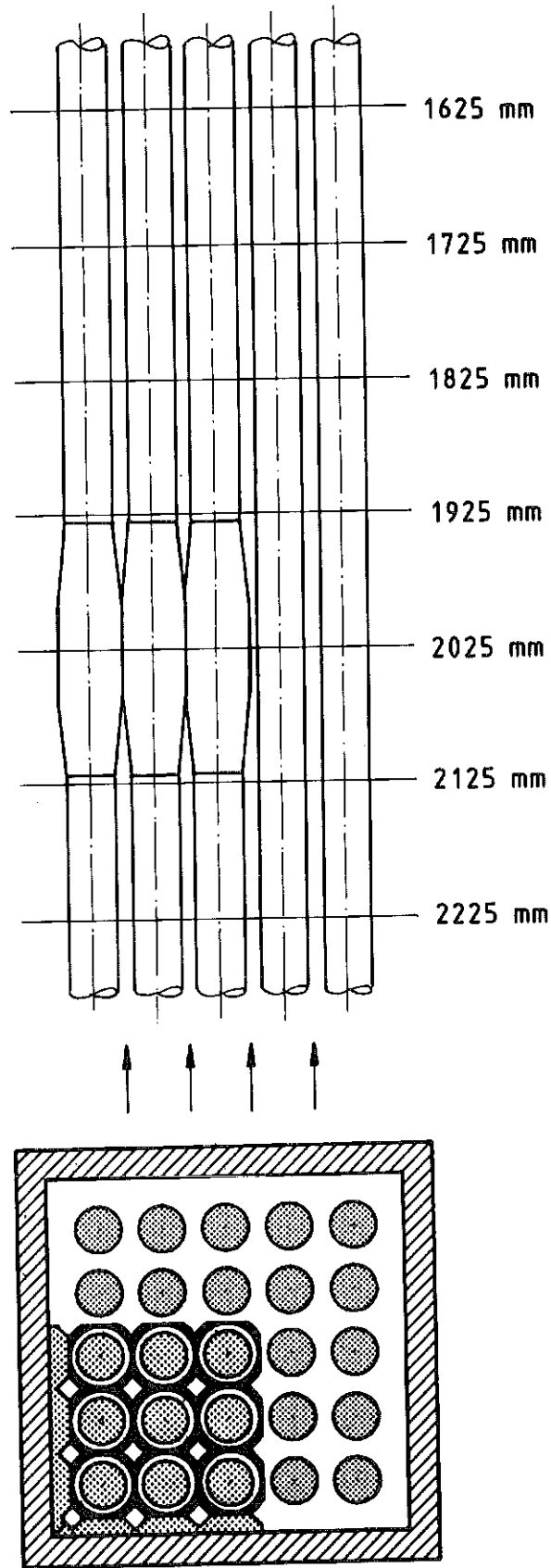
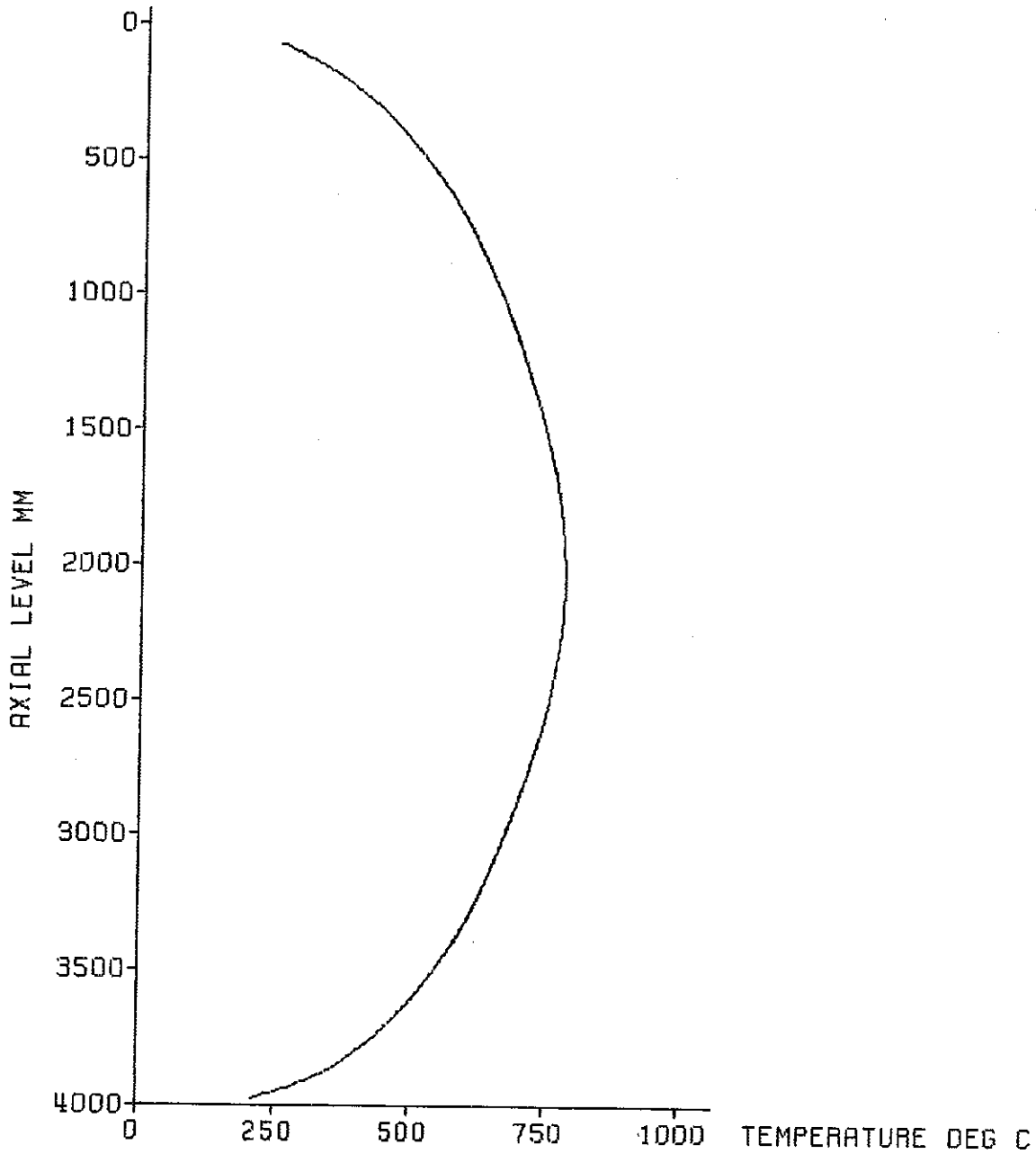

Fig. 195 5x5 rod bundle: Layout of the bundle geometry of test series III.

initial axial temperature profile of the cladding



decay heat 120% ANS standard
flooding rate (cold) 3.60 cm/s
system pressure 2.00 bar
feedwater temperature 40 deg C



Fig. 196 FEBA: 5x5 ROD BUNDLE
TEST SERIES 3, TEST-NO. 241

test parameters:

- ◆ flooding rate
- ▲ system pressure
- feedwater temperature
- bundle power

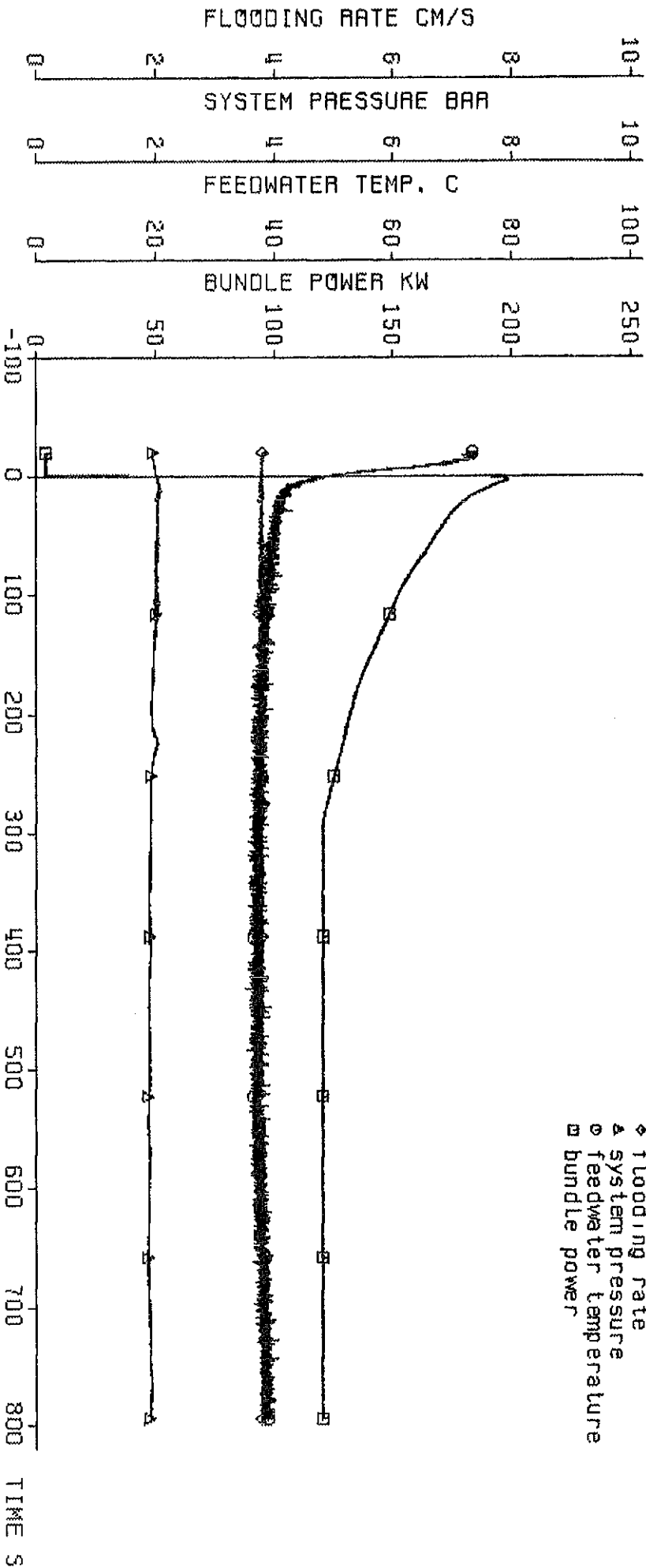

decay heat
flooding rate (cold)
system pressure
feedwater temperature

120% RNS standard
3.83 cm/s
2.00 bar
40 deg C



Fig. 197 FEBRA: 5X5 ROD BUNDLE, TEST SERIES 3, TEST-NO. 241

cladding temperature

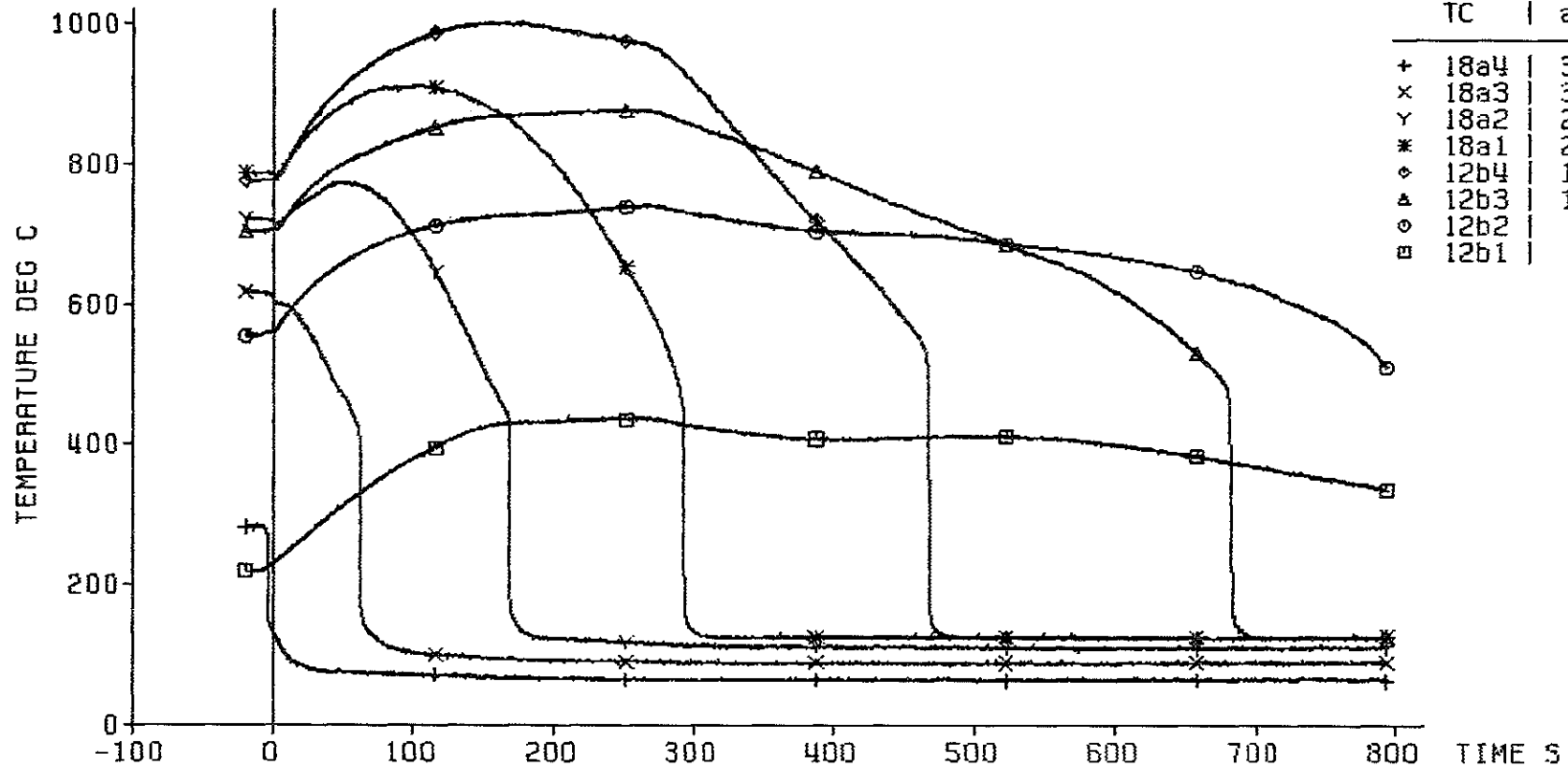

decay heat 120% ANS standard
 flooding rate (cold) 3.80 cm/s
 system pressure 2.00 bar
 feedwater temperature 40 deg C



Fig. 198 FEBA: 5x5 ROD BUNDLE, TEST SERIES 3, TEST-No. 241

heat transfer coeff.

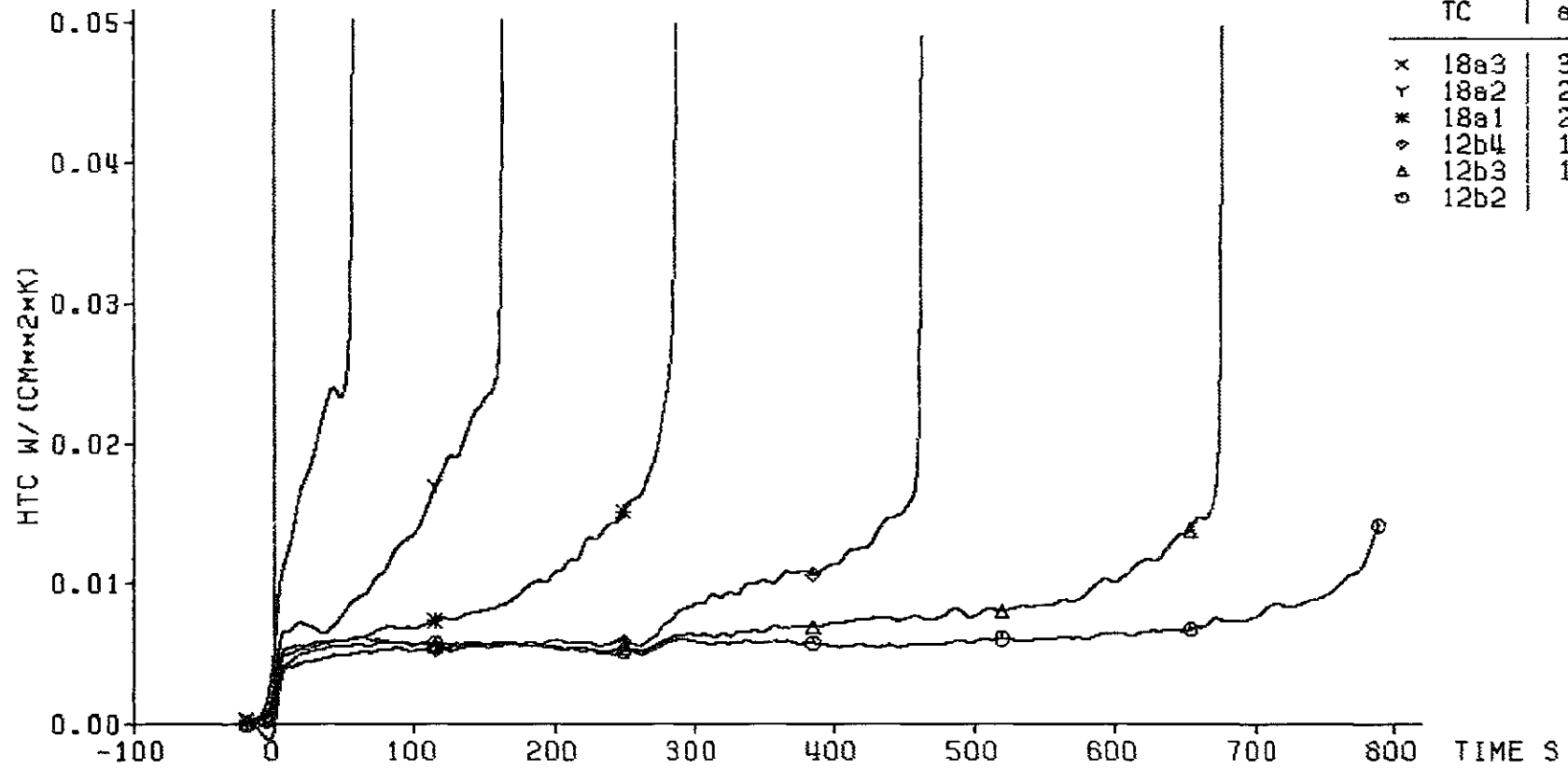

decay heat 120% ANS standard
 flooding rate (cold) 3.80 cm/s
 system pressure 2.00 bar
 feedwater temperature 40 deg C



Fig. 199 FEBA: 5x5 ROD BUNDLE, TEST SERIES 3, TEST-No. 241

cladding temperature

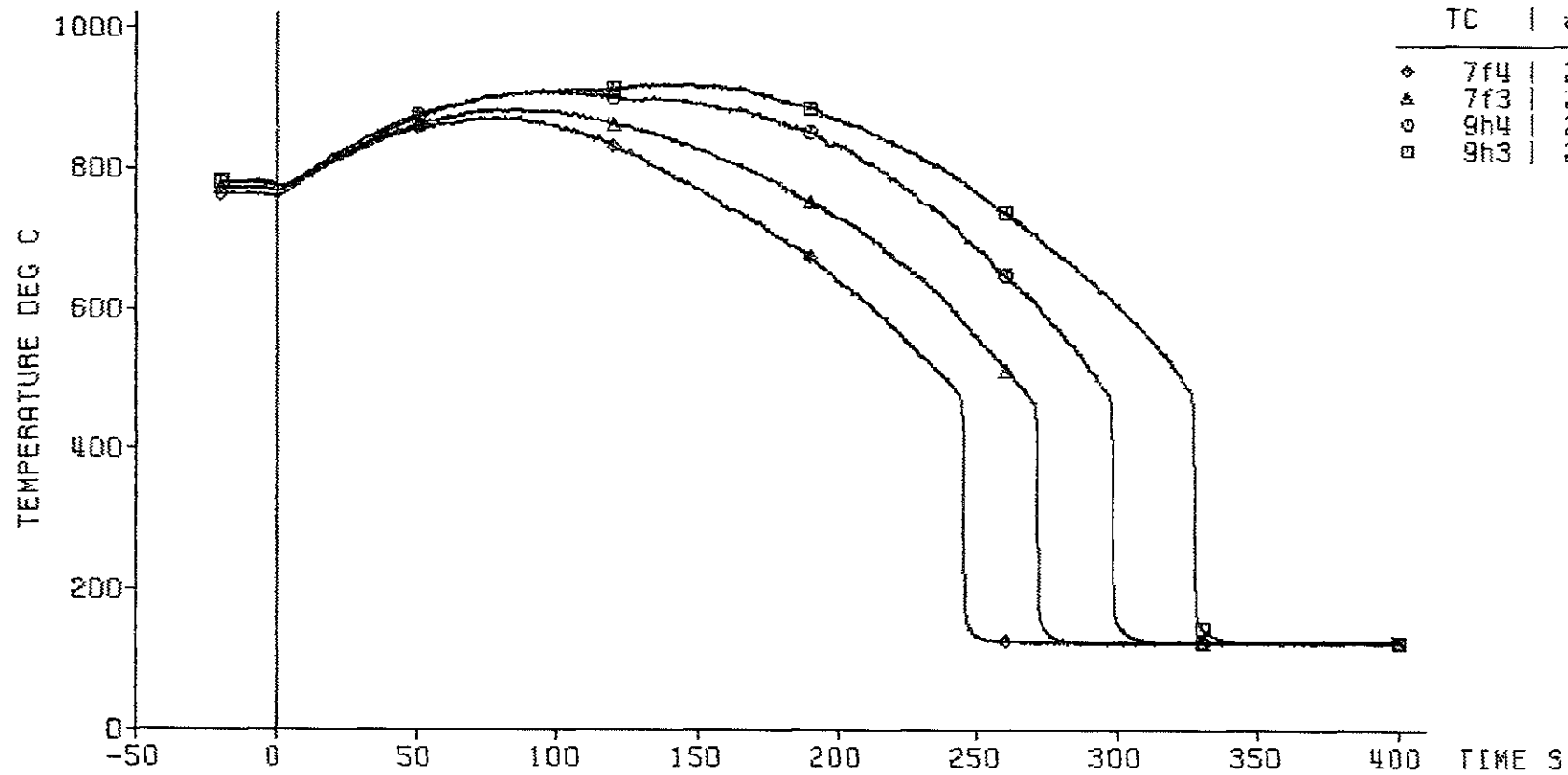

decay heat 120% AWS standard
 flooding rate (cold) 3.80 cm/s
 system pressure 2.00 bar
 feedwater temperature 40 deg C

bypass
 =====



Fig. 200 FEBA: 5x5 ROD BUNDLE, TEST SERIES 3, TEST-No. 241

heat transfer coeff.

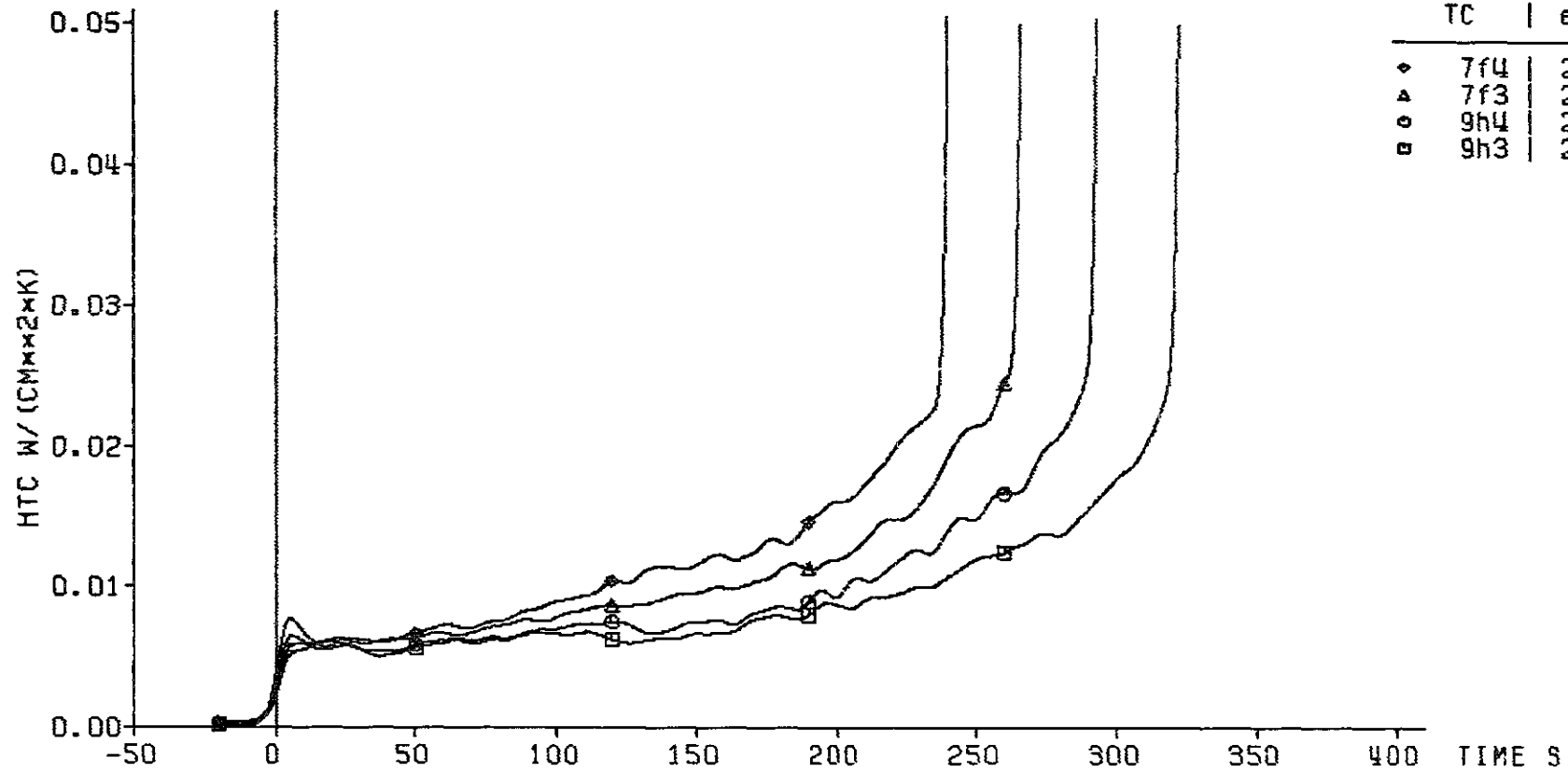

— 236 —

decay heat 120% ANS standard
 flooding rate (cold) 3.80 cm/s
 system pressure 2.00 bar
 feedwater temperature 40 deg C

bypass
 =====



Fig. 201 FEBA: 5x5 ROD BUNDLE, TEST SERIES 3, TEST-No. 241

cladding temperature

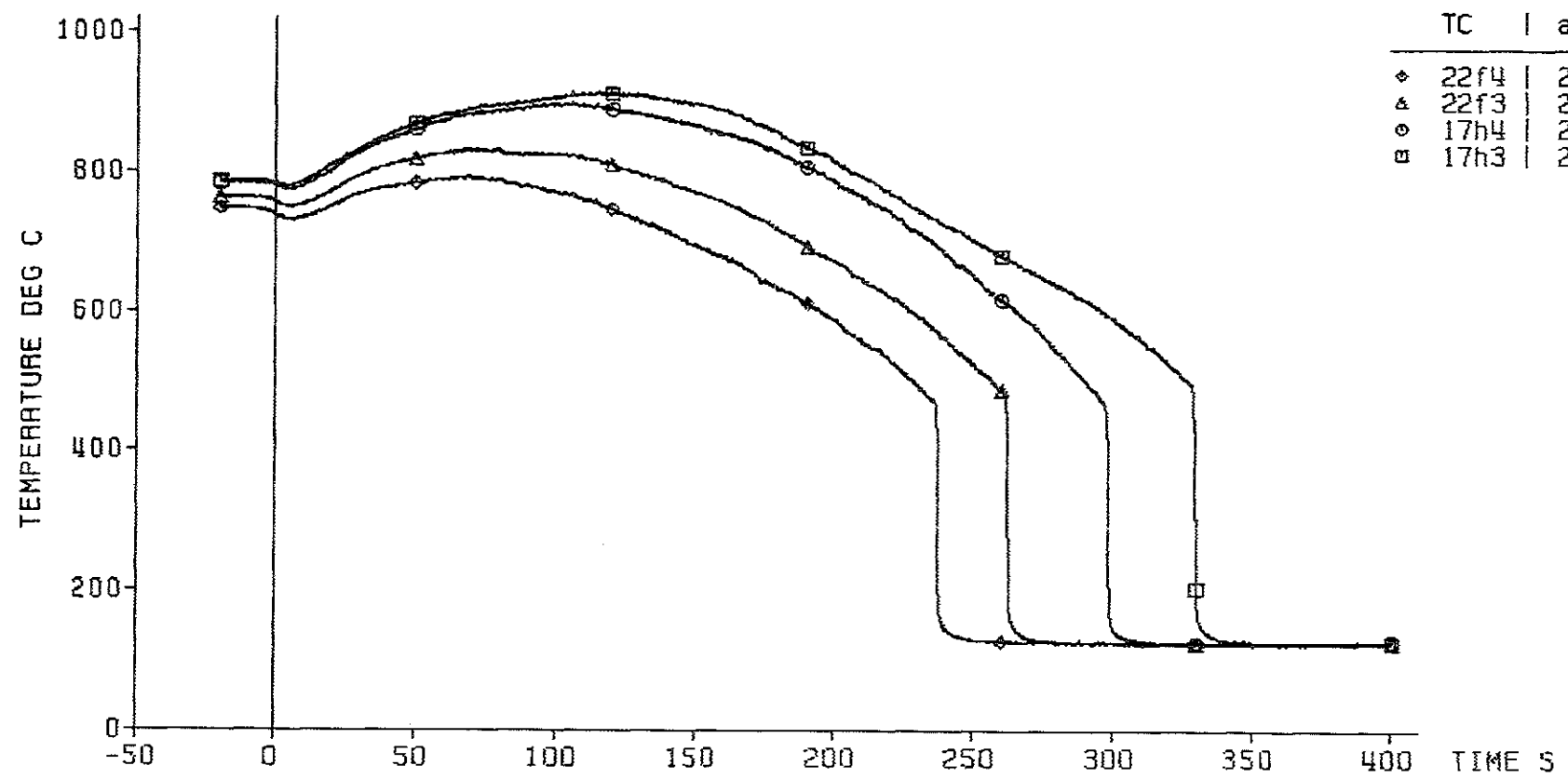

TC	ax. Level
◇ 22f4	2425 mm
△ 22f3	2325 mm
○ 17h4	2225 mm
□ 17h3	2125 mm

decay heat 120% ANS standard
 flooding rate (cold) 3.80 cm/s
 system pressure 2.00 bar
 feedwater temperature 40 deg C

blockage
 =====



Fig. 202 FEBA: 5x5 ROD BUNDLE, TEST SERIES 3, TEST-No. 241

heat transfer coeff.

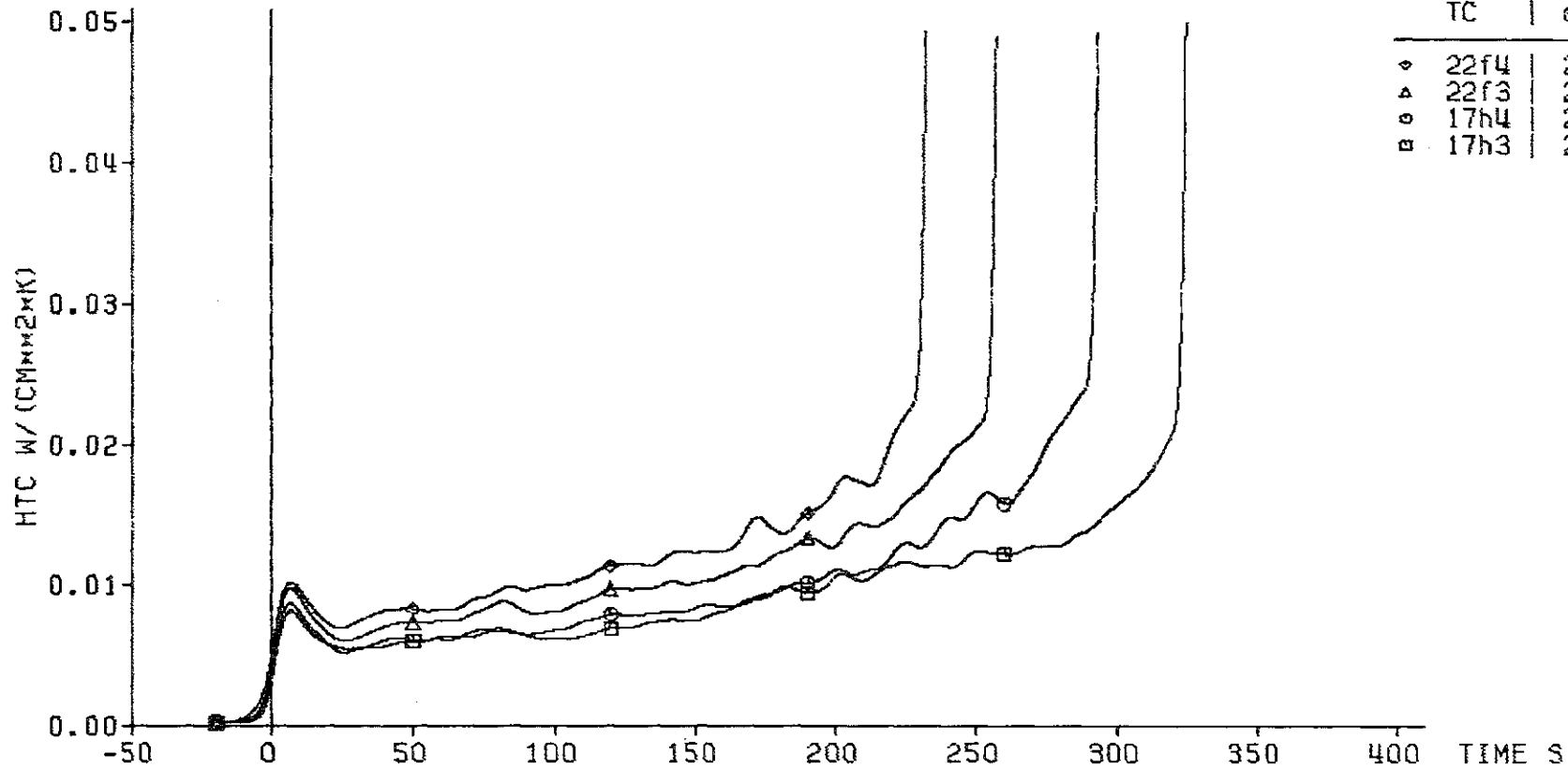

— 237 —

decay heat 120% ANS standard
 flooding rate (cold) 3.80 cm/s
 system pressure 2.00 bar
 feedwater temperature 40 deg C

blockage
 =====



Fig. 203 FEBA: 5x5 ROD BUNDLE, TEST SERIES 3, TEST-No. 241

cladding temperature

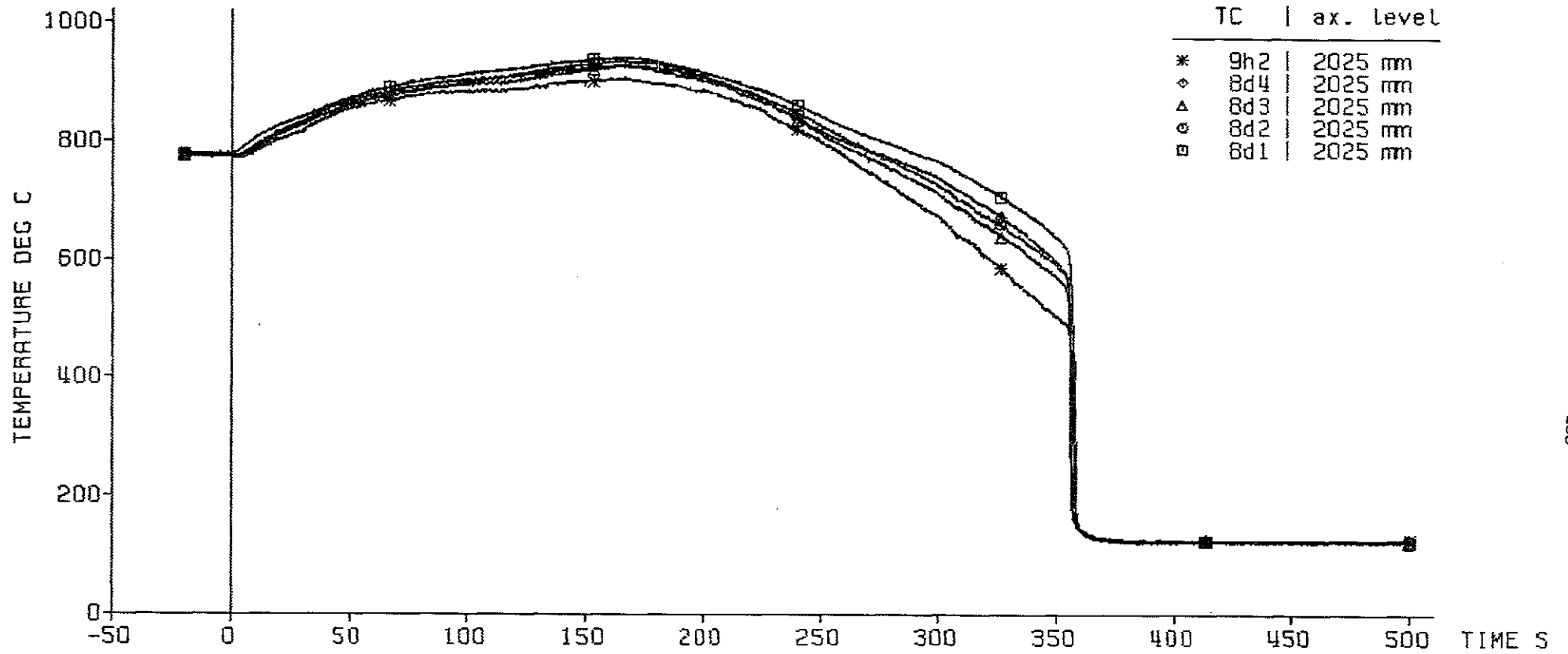

— 238 —

decay heat 120% RMS standard
 flooding rate (cold) 3.80 cm/s
 system pressure 2.00 bar
 feedwater temperature 40 deg C

bypass
 =====



Fig. 204 FEBA: 5x5 ROD BUNDLE, TEST SERIES 3, TEST-No. 241

heat transfer coeff.

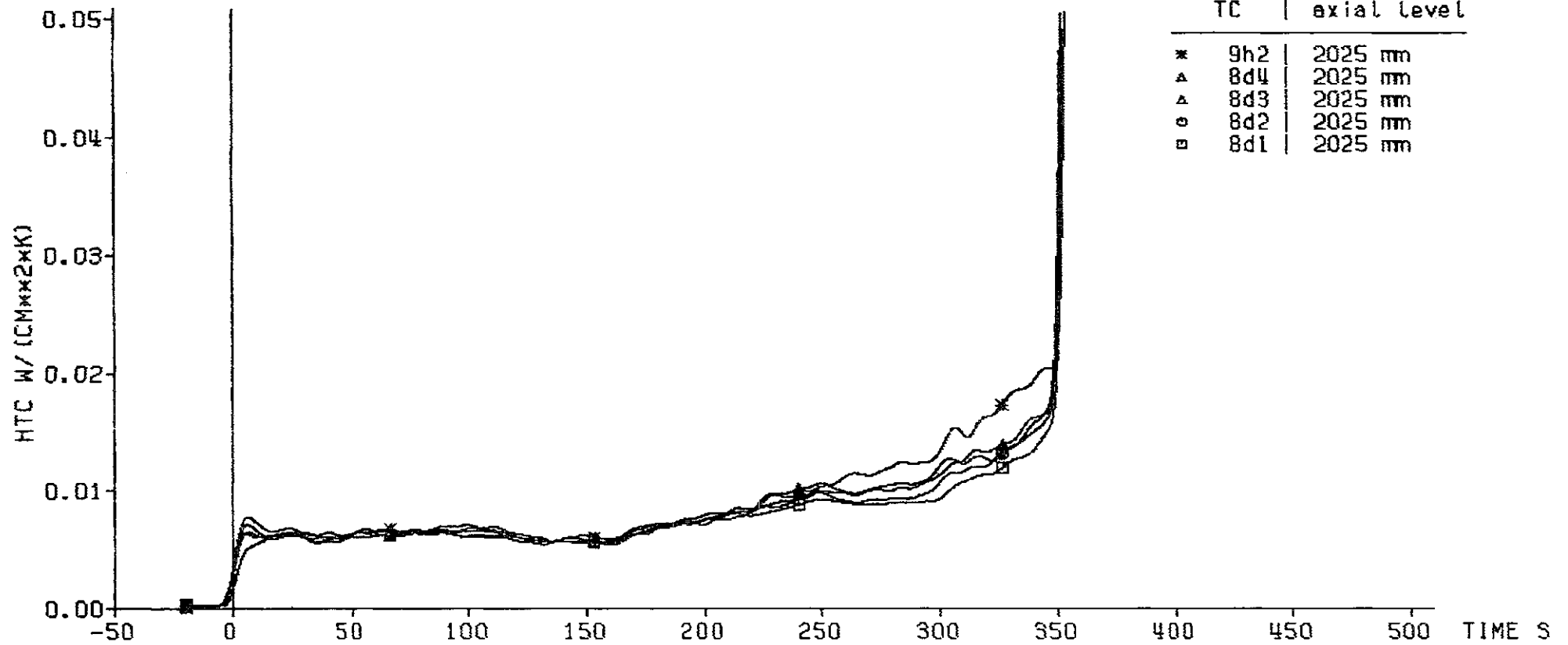

— 239 —

decay heat 120% ANS standard
 flooding rate (cold) 3.80 cm/s
 system pressure 2.00 bar
 feedwater temperature 40 deg C

bypass
 =====



Fig. 205 FEBA: 5x5 ROD BUNDLE, TEST SERIES 3, TEST-No. 241

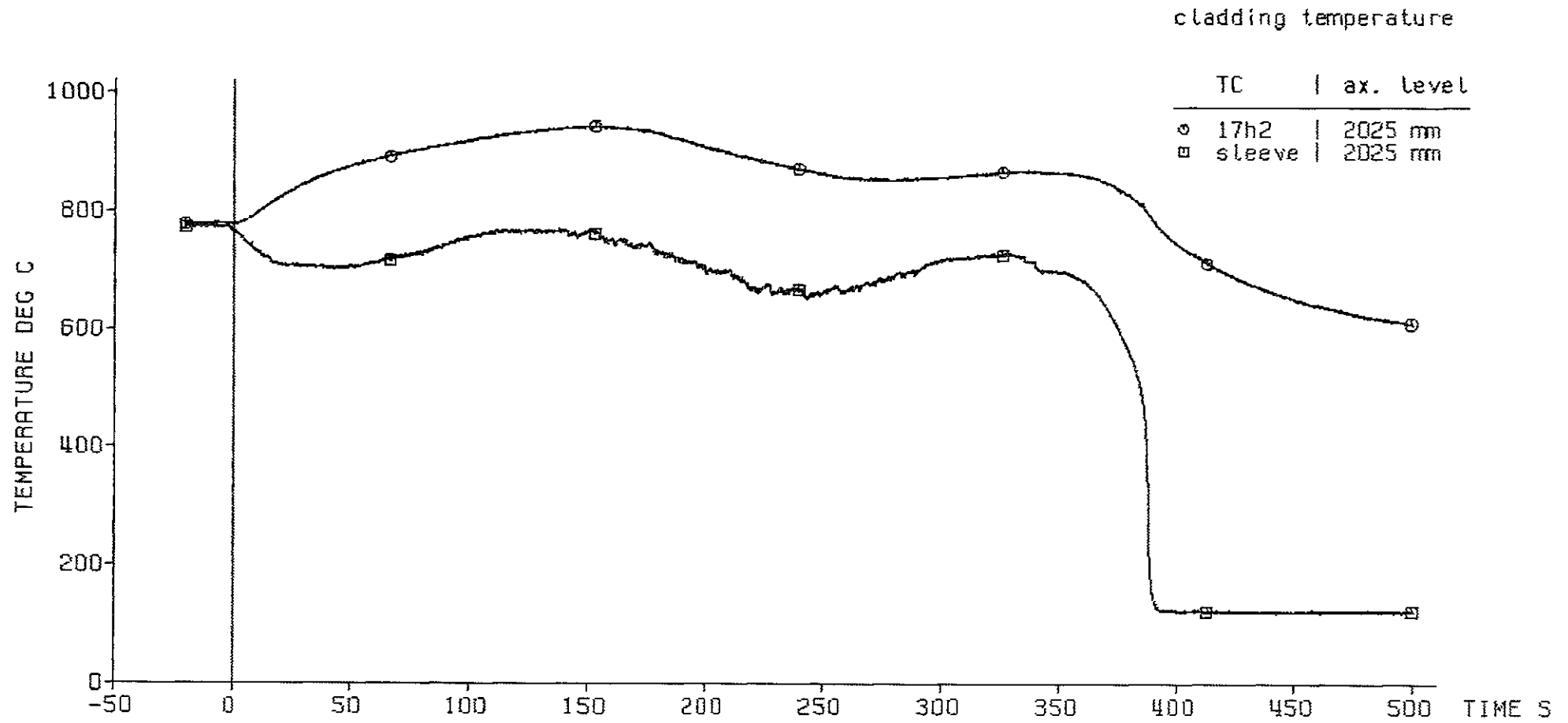

- 240 -

decay heat 120% RMS standard
 flooding rate (cold) 3.60 cm/s
 system pressure 2.00 bar
 feedwater temperature 40 deg C

blockage
 =====



Fig. 206 FEBA: 5x5 ROD BUNDLE, TEST SERIES 3, TEST-No. 241

cladding temperature

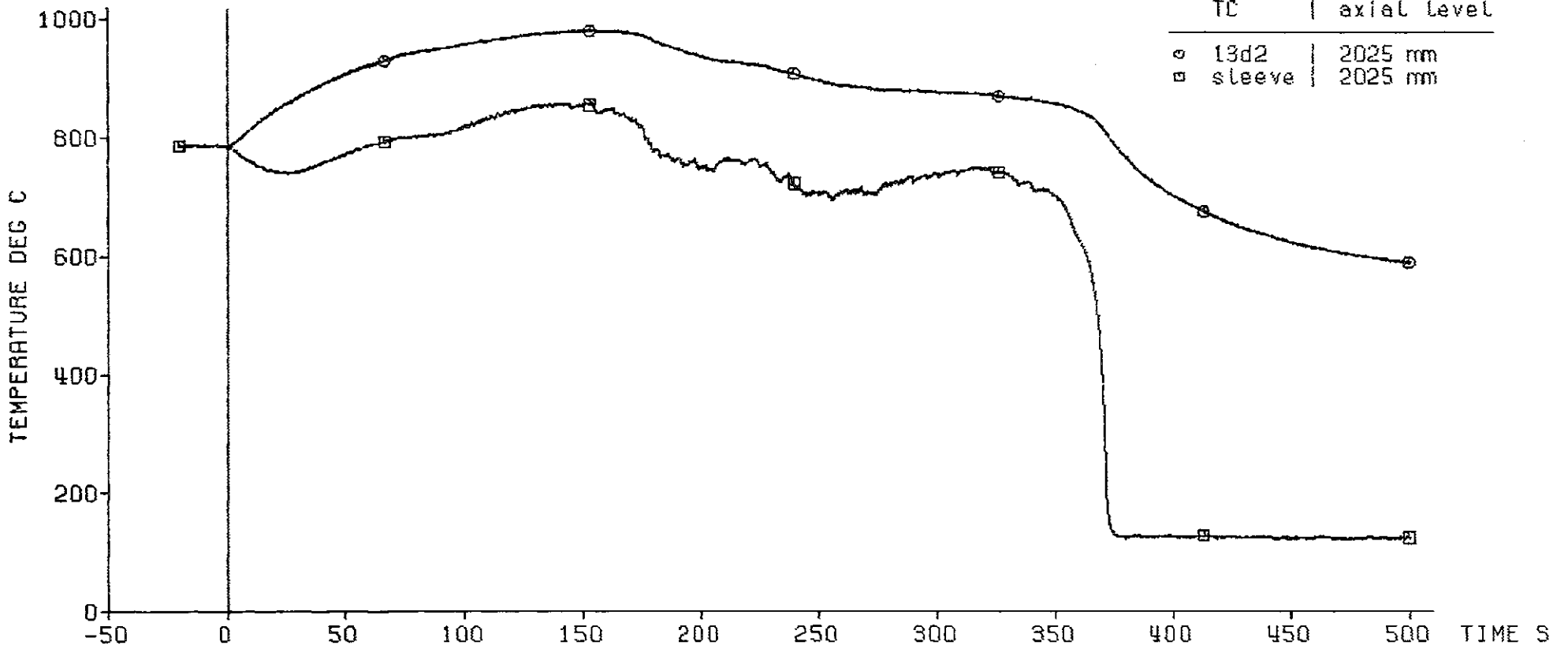

— 241 —

decay heat 120% ANS standard
flooding rate (cold) 3.80 cm/s
system pressure 2.00 bar
feedwater temperature 40 deg C

blockage
=====



Fig. 207 FEBA: 5x5 ROD BUNDLE, TEST SERIES 3, TEST-No. 241

cladding temperature

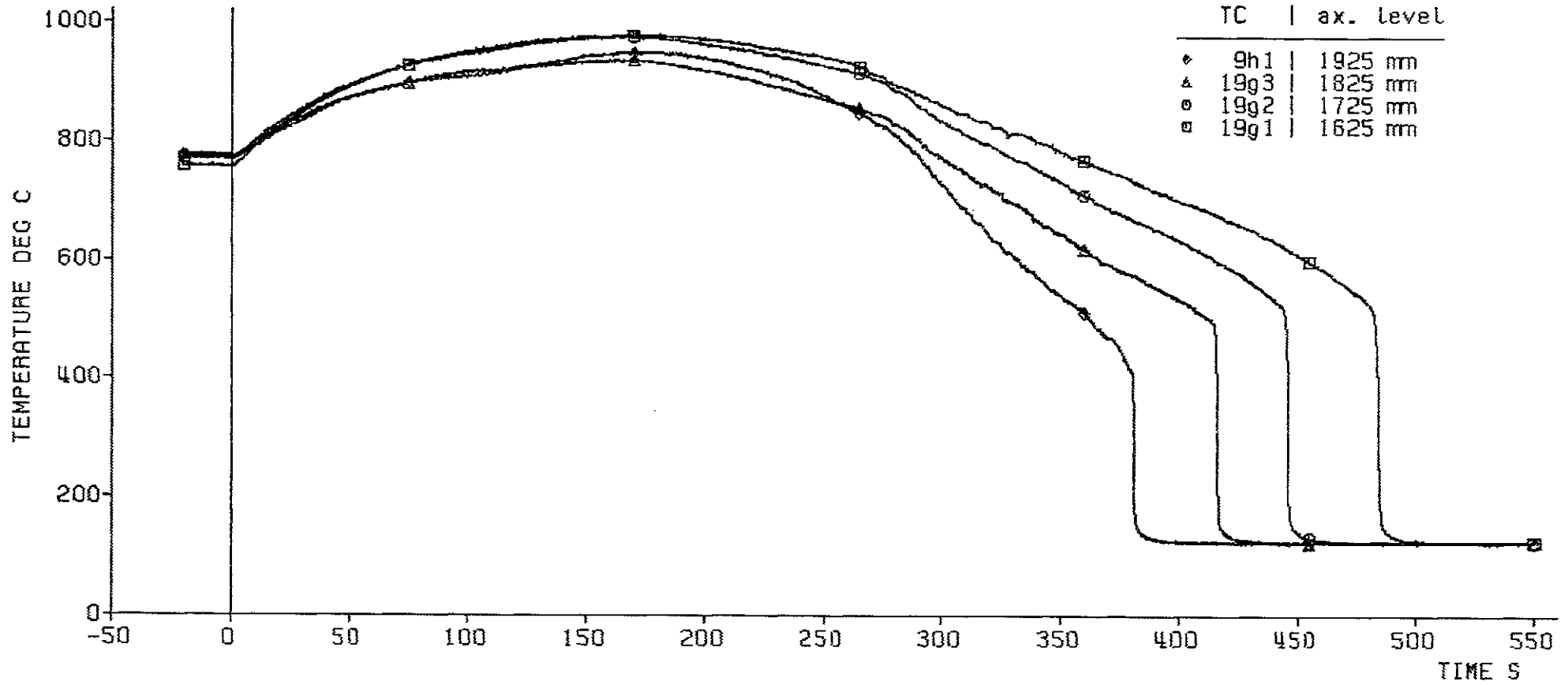

— 242 —

decay heat 120% RMS standard
 flooding rate (cold) 3.80 cm/s
 system pressure 2.00 bar
 feedwater temperature 40 deg C

bypass
 =====



Fig. 208 FEBA: 5x5 ROD BUNDLE, TEST SERIES 3, TEST-No. 241

heat transfer coeff.

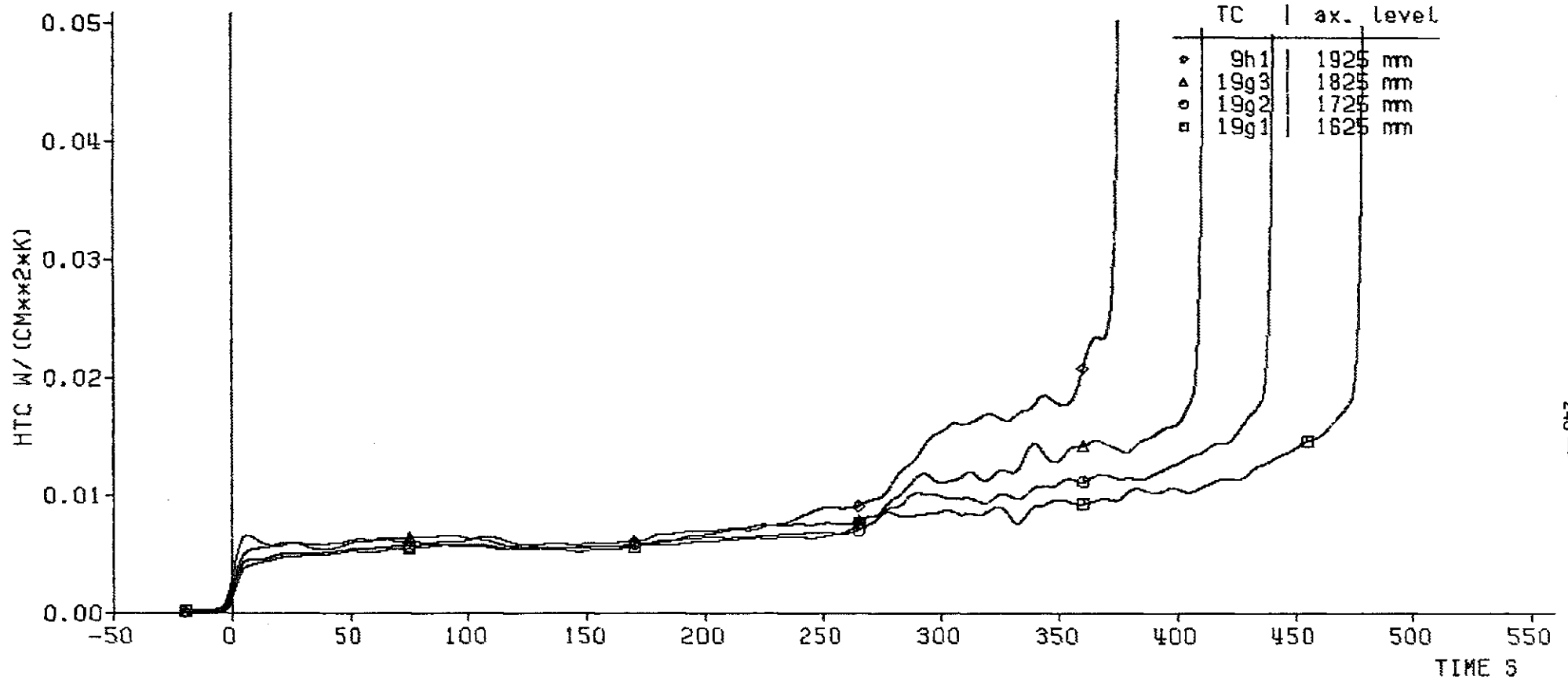

— 243 —

decay heat 120% ANS standard
 flooding rate (cold) 3.80 cm/s
 system pressure 2.00 bar
 feedwater temperature 40 deg C

bypass
 =====



Fig. 209 FEBA: 5x5 ROD BUNDLE, TEST SERIES 3, TEST-No. 241

cladding temperature

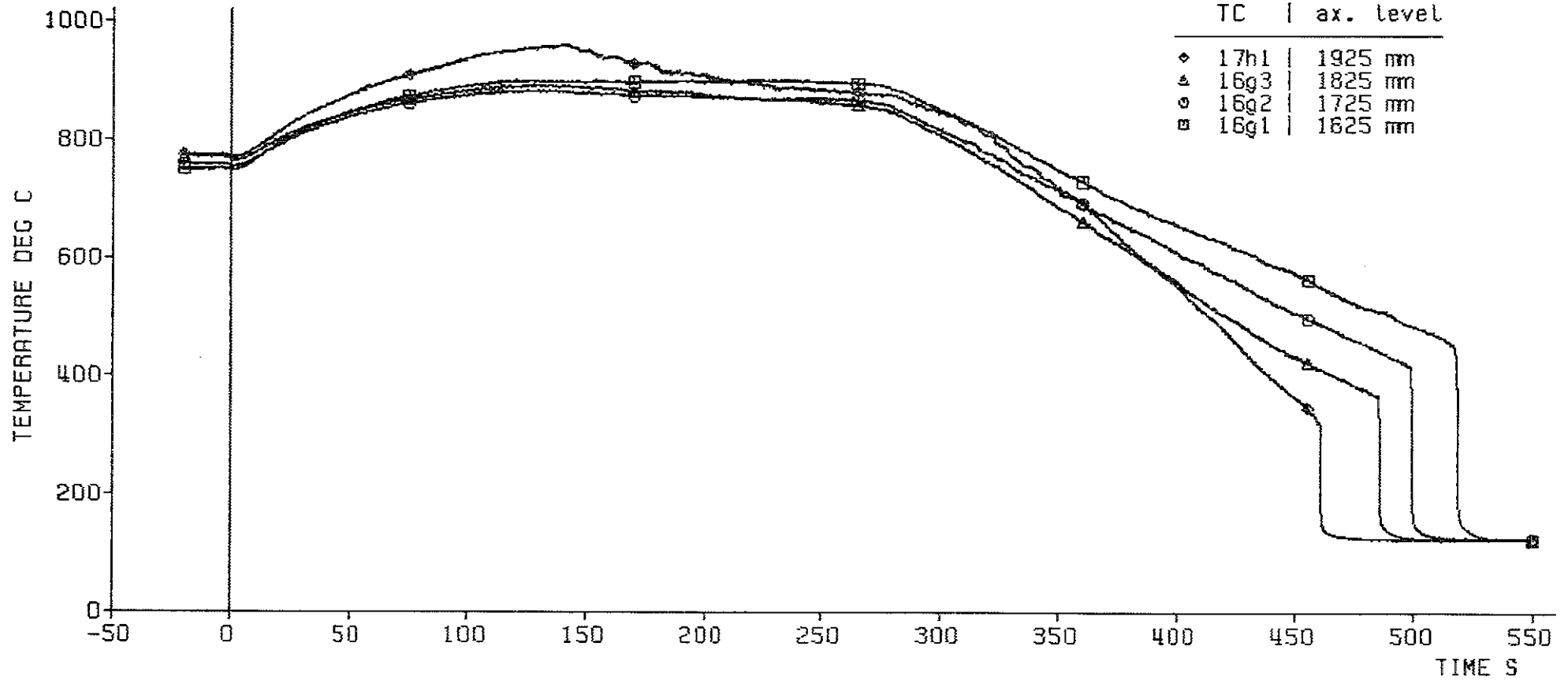

— 244 —

decay heat 120% RMS standard
flooding rate (cold) 3.60 cm/s
system pressure 2.00 bar
feedwater temperature 40 deg C

blockage
=====

KFK
TRB

Fig. 210 FEBA: 5x5 ROD BUNDLE, TEST SERIES 3, TEST-No. 241

heat transfer coeff.

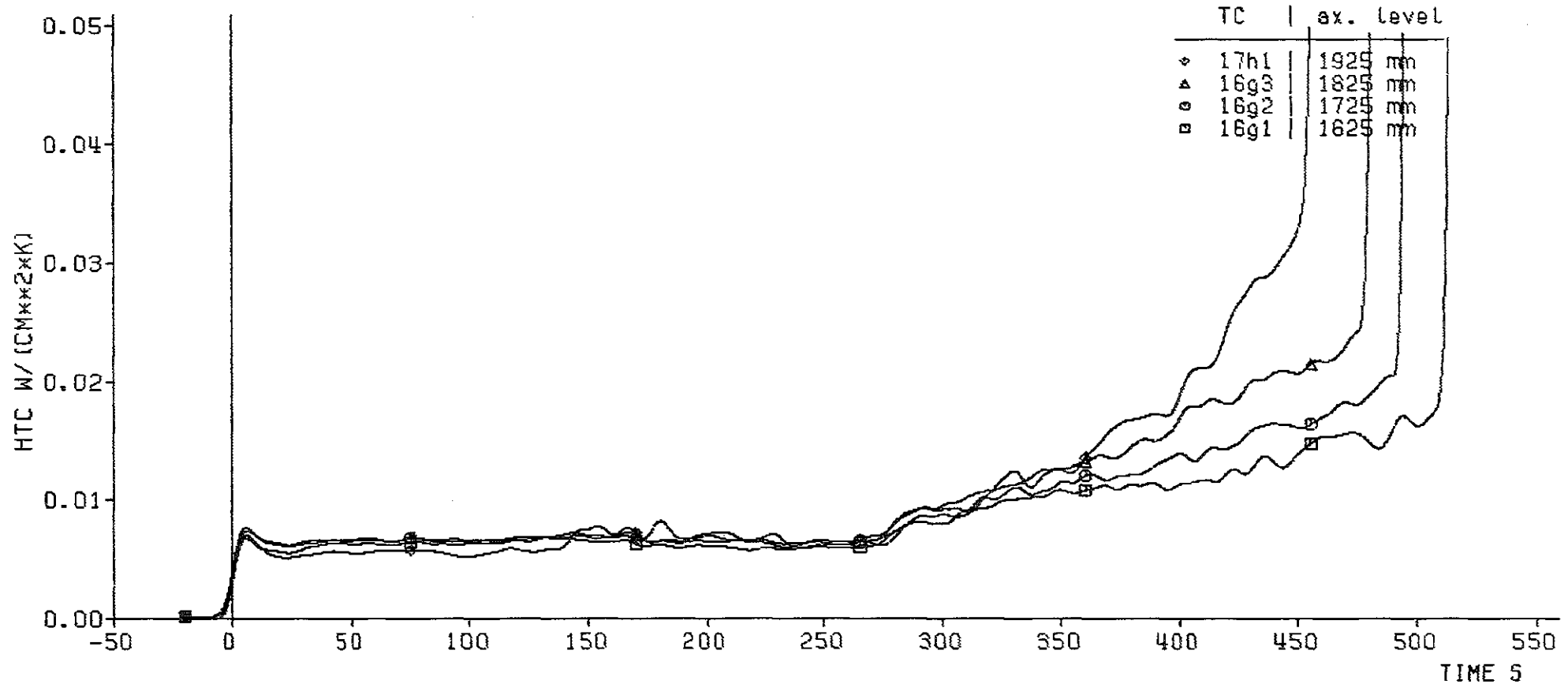

— 245 —

decay heat 120% ANS standard
 flooding rate (cold) 3.80 cm/s
 system pressure 2.00 bar
 feedwater temperature 40 deg C

blockage
 =====



Fig. 211 FEBA: 5x5 ROD BUNDLE, TEST SERIES 3, TEST-No. 241

axial level: 1925 mm

△ cladding temperature (16g4)
○ fluid temperature
□ housing temperature

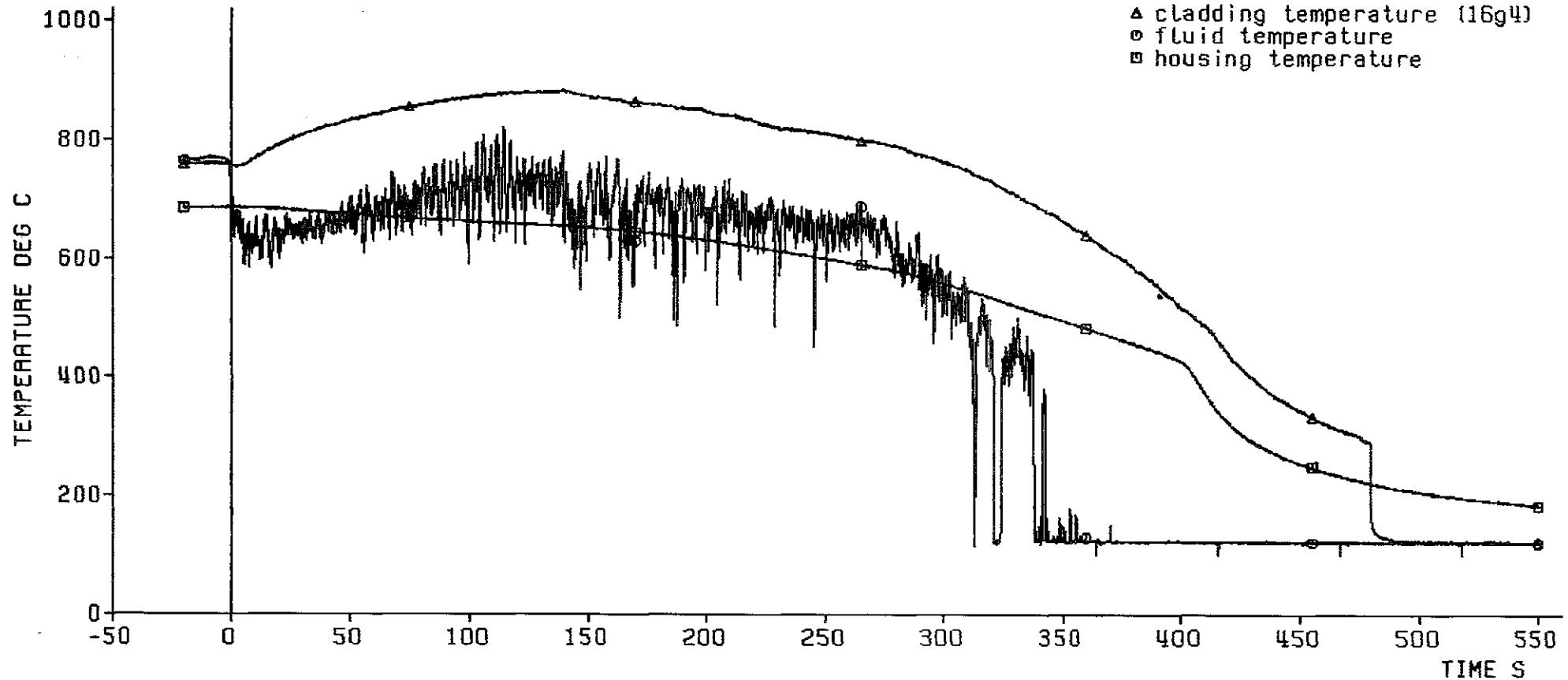

decay heat 120% RNS standard
flooding rate (cold) 3.80 cm/s
system pressure 2.00 bar
feedwater temperature 40 deg C

blockage
=====

— 246 —

KFK
IRB

Fig. 212 FEBA: 5x5 ROD BUNDLE, TEST SERIES 3, TEST-No. 241

axial level: 1725 mm

▲ cladding temperature (16g2)
○ fluid temperature
■ housing temperature

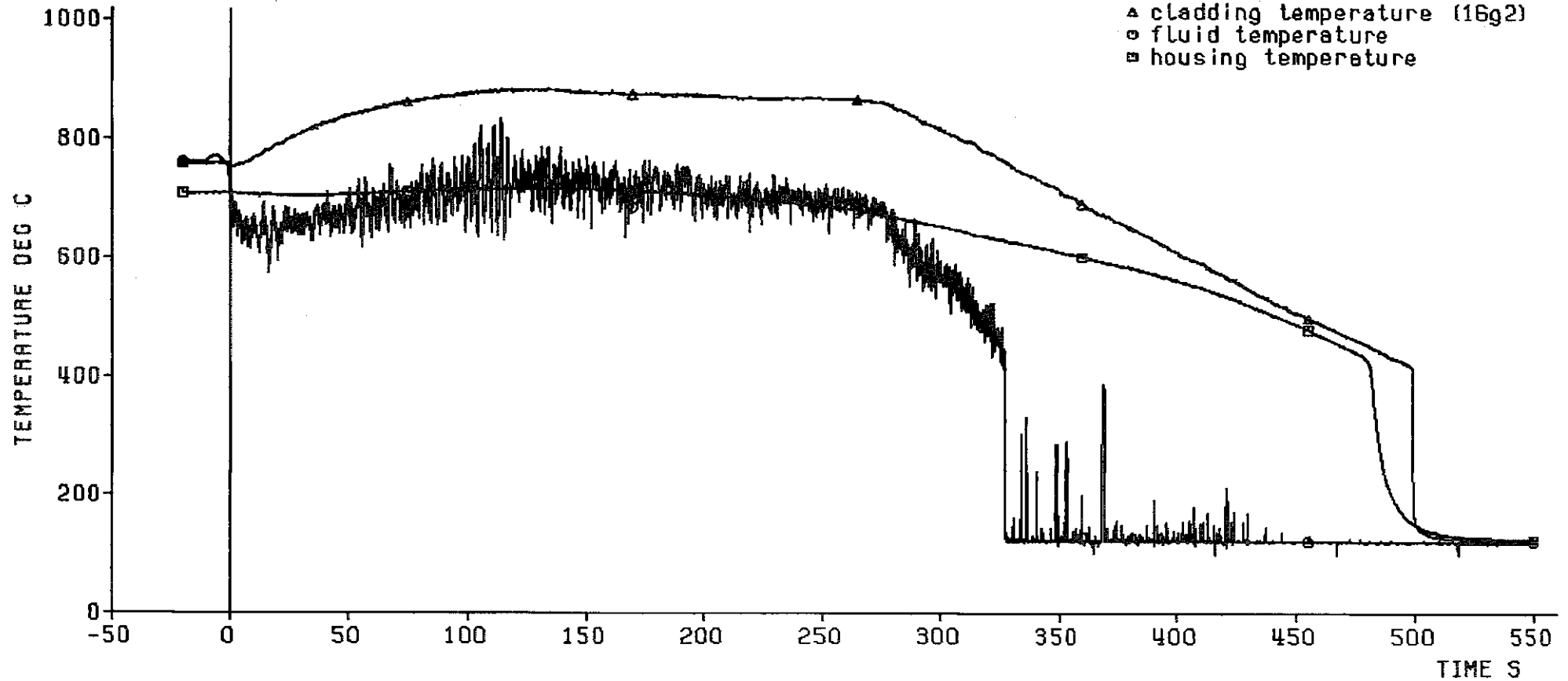

— 247 —

decay heat 120% ANS standard
flooding rate (cold) 3.80 cm/s
system pressure 2.00 bar
feedwater temperature 40 deg C

blockage
=====



Fig. 213 FEBA: 5x5 R0D BUNDLE, TEST SERIES 3, TEST-No. 241

axial level: 1625 mm

△ cladding temperature (16g1)
○ fluid temperature
□ housing temperature

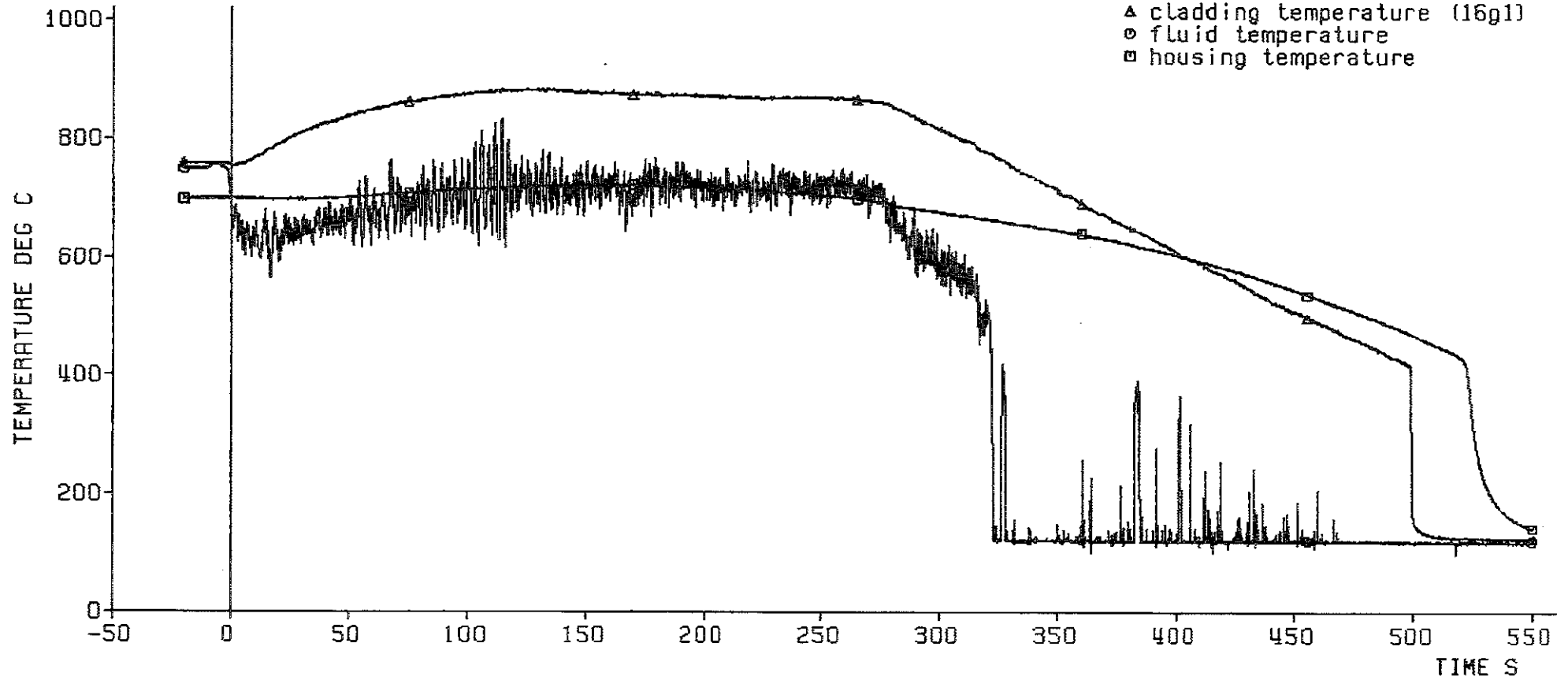

— 248 —

decay heat 120% ANS standard
flooding rate (cold) 3.80 cm/s
system pressure 2.00 bar
feedwater temperature 40 deg C

blockage
=====



Fig. 214 FEBA: 5x5 ROD BUNDLE, TEST SERIES 3, TEST-No. 241

pressure loss
along the test section:

◆ total length: 4196 mm
△ lower part: 1711 mm
○ middle part: 545 mm
□ upper part: 1940 mm

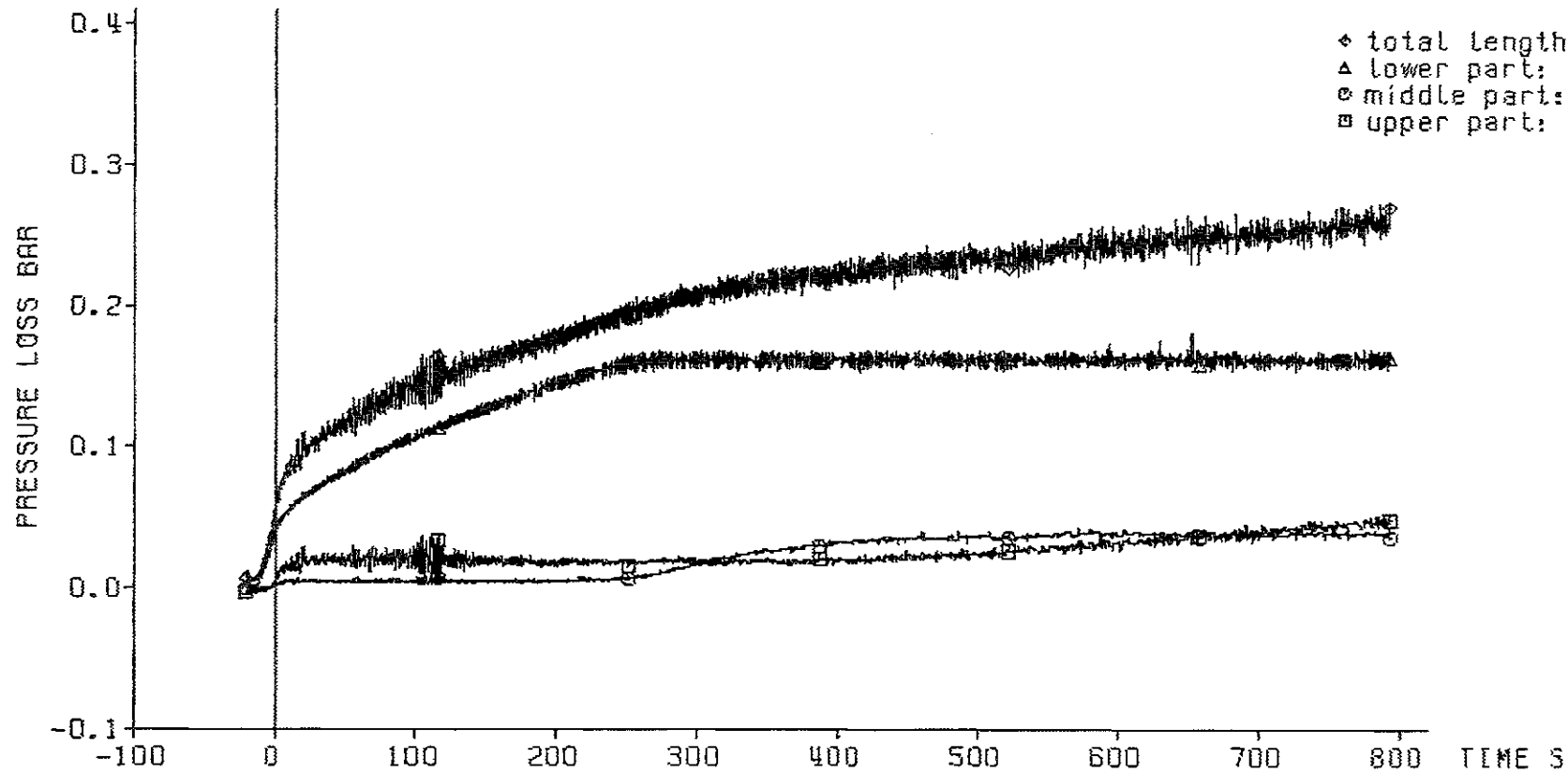

decay heat 120% RNS standard
flooding rate (cold) 3.80 cm/s
system pressure 2.00 bar
feedwater temperature 40 deg C

KfK
IRB

Fig. 215 FEBA: 5x5 ROD BUNDLE, TEST SERIES 3, TEST-No. 241

coolant conditions:

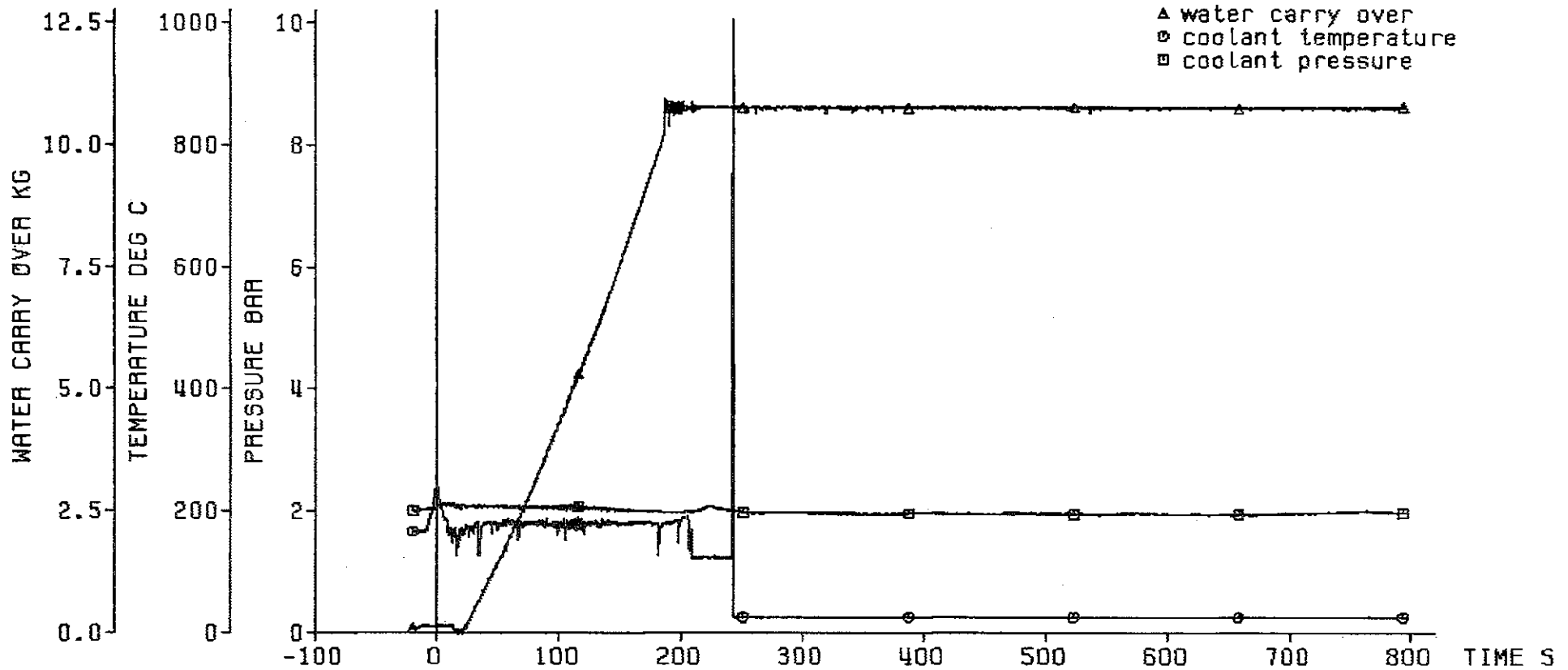

decay heat 120% ANS standard
flooding rate (cold) 3.80 cm/s
system pressure 2.00 bar
feedwater temperature 40 deg C



Fig. 216 FEBA: 5x5 ROD BUNDLE, TEST SERIES 3, TEST-No. 241

axial position of the quench front

- ▣ rewetting of the sleeve at the bundle midplane
- x rewetting of the rod downstream of the blockage

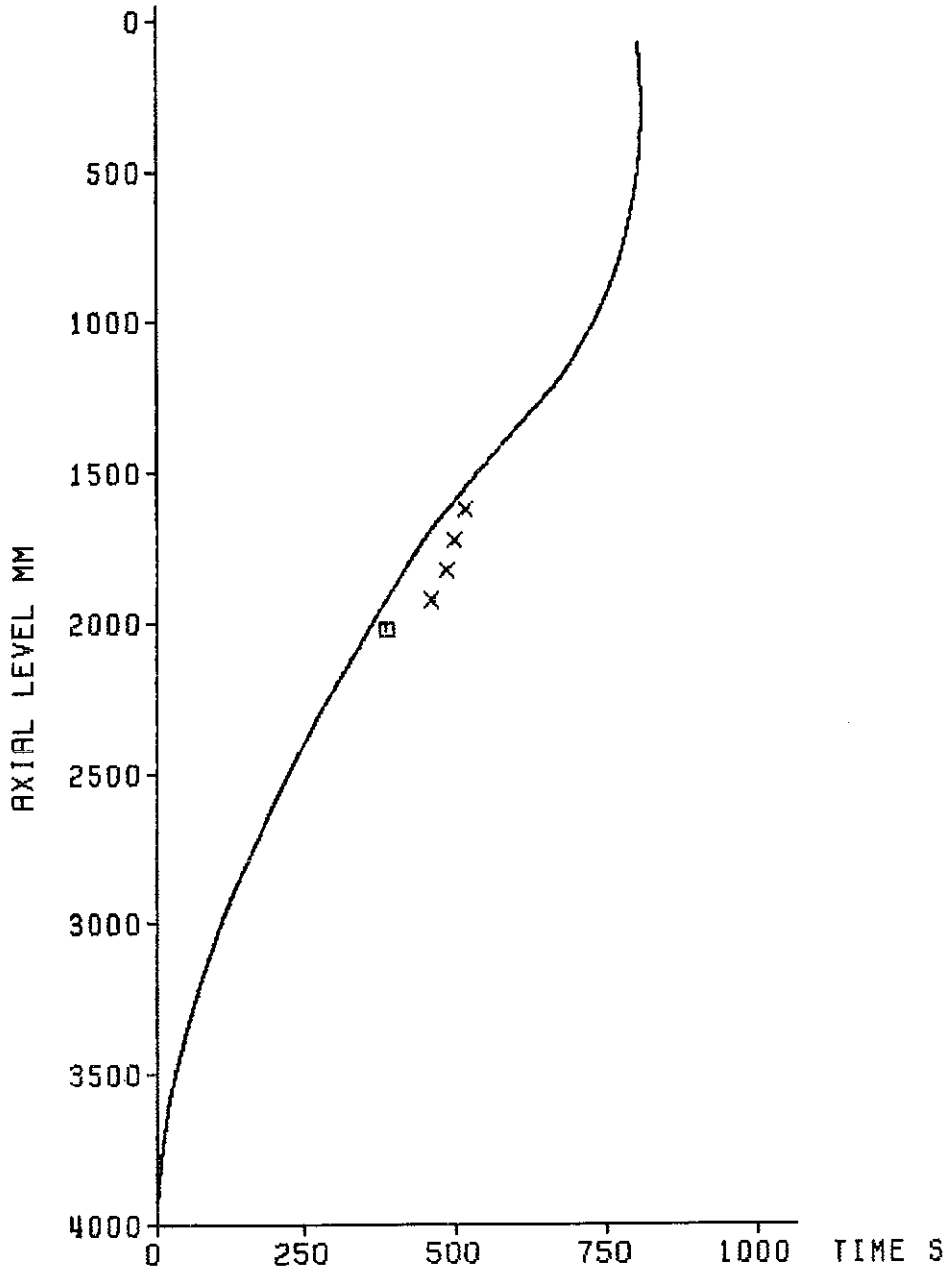

decay heat	120% ANS standard
flooding rate (cold)	3.80 cm/s
system pressure	2.00 bar
feedwater temperature	40 deg C



Fig. 217 FEBA: 5x5 ROD BUNDLE
TEST SERIES 3, TEST-No. 241

Initial axial temperature profile of the cladding

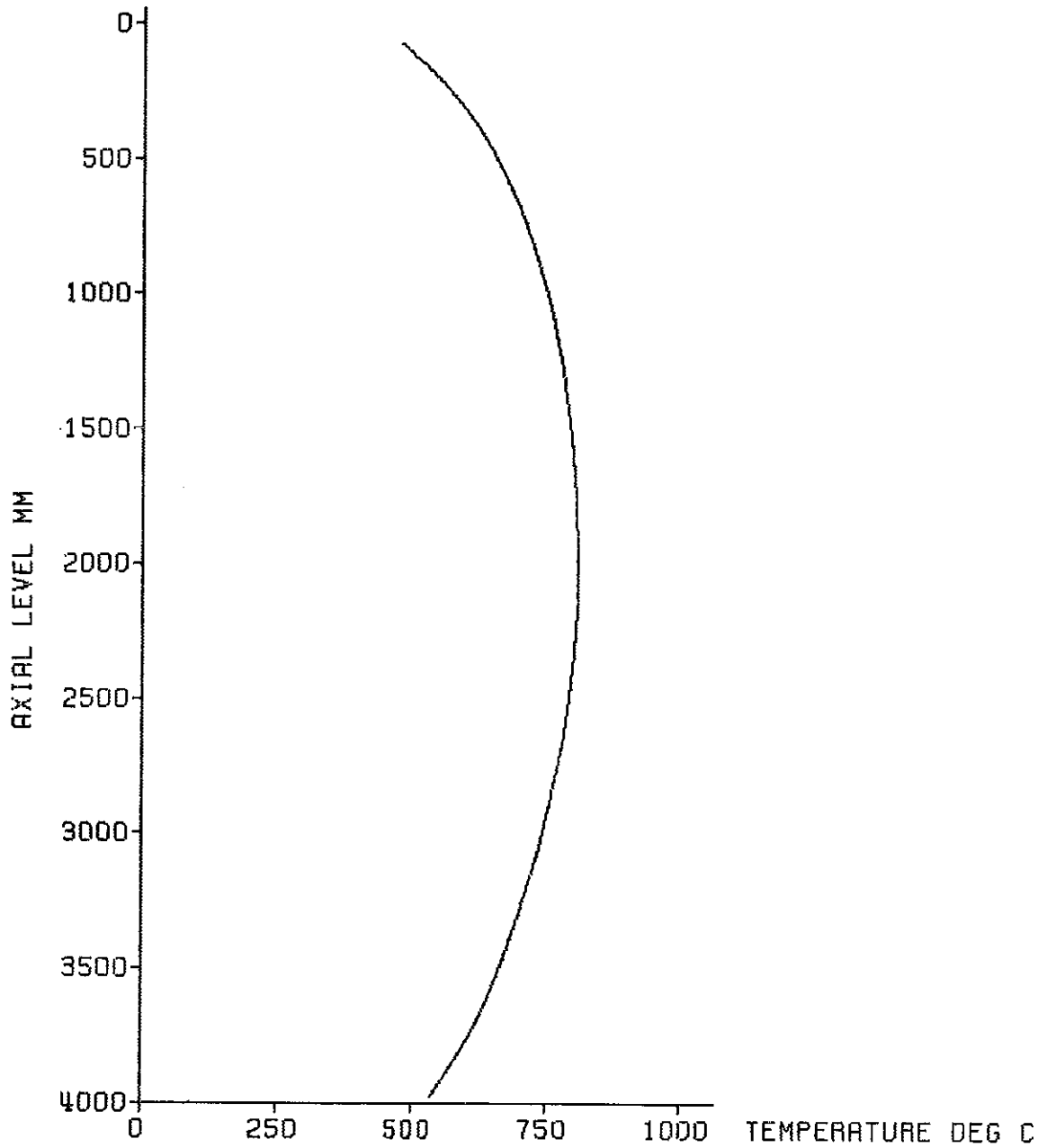

decay heat	120% RNS standard
flooding rate (cold)	3.81 cm/s
system pressure	4.15 bar
feedwater temperature	40 deg C



Fig. 218 FEBA: 5x5 R0D BUNDLE
TEST SERIES 3, TEST-No. 239

test parameters:

- ◆ flooding rate
- ▲ system pressure
- feedwater temperature
- bundle power

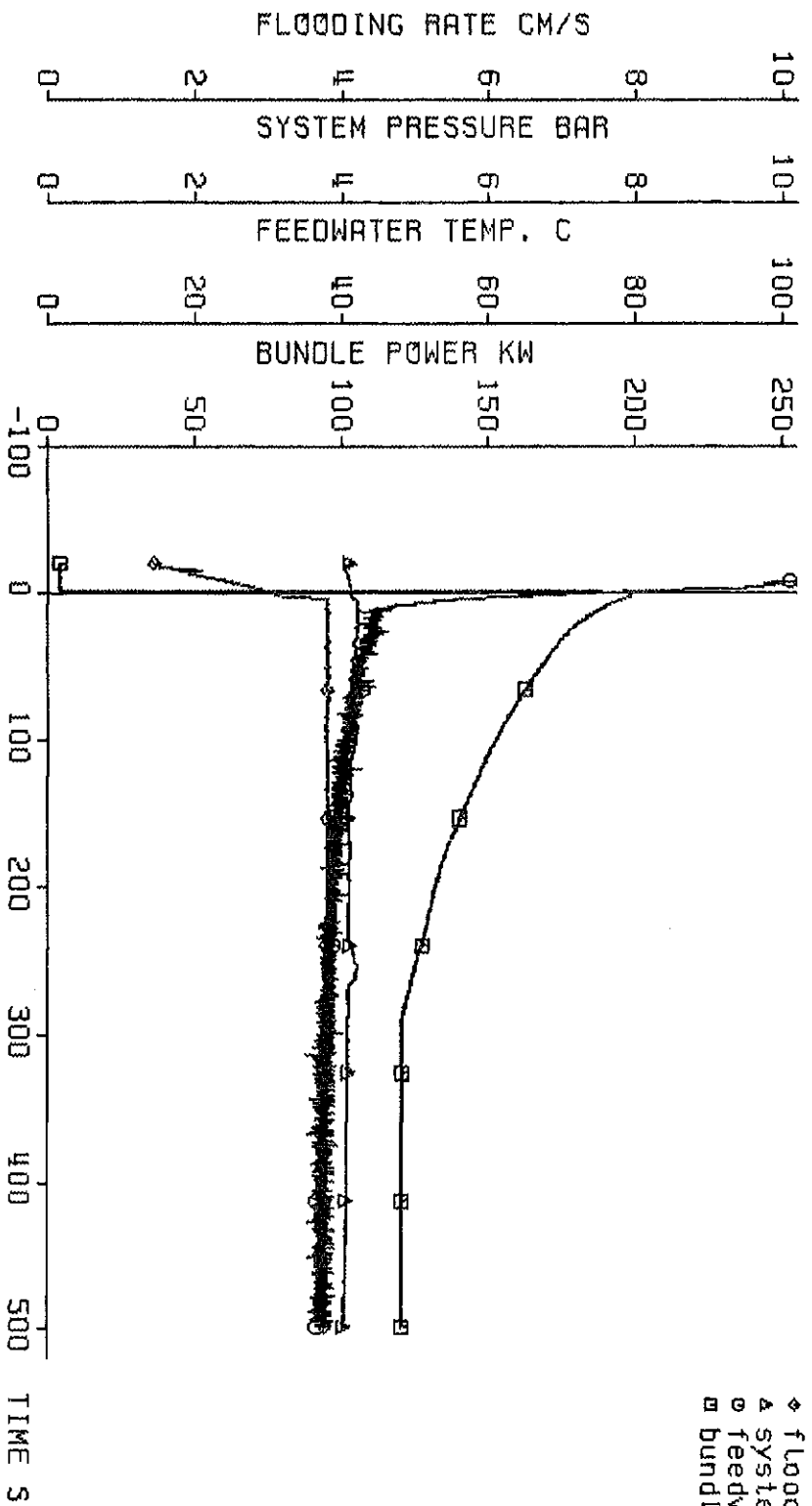

decay heat
flooding rate (cold)
system pressure
feedwater temperature

120% RNS standard
3.81 cm/s
4.15 bar
40 deg C



Fig. 219 FEBRA: 5X5 ROD BUNDLE, TEST SERIES 3, TEST-NO. 239

cladding temperature

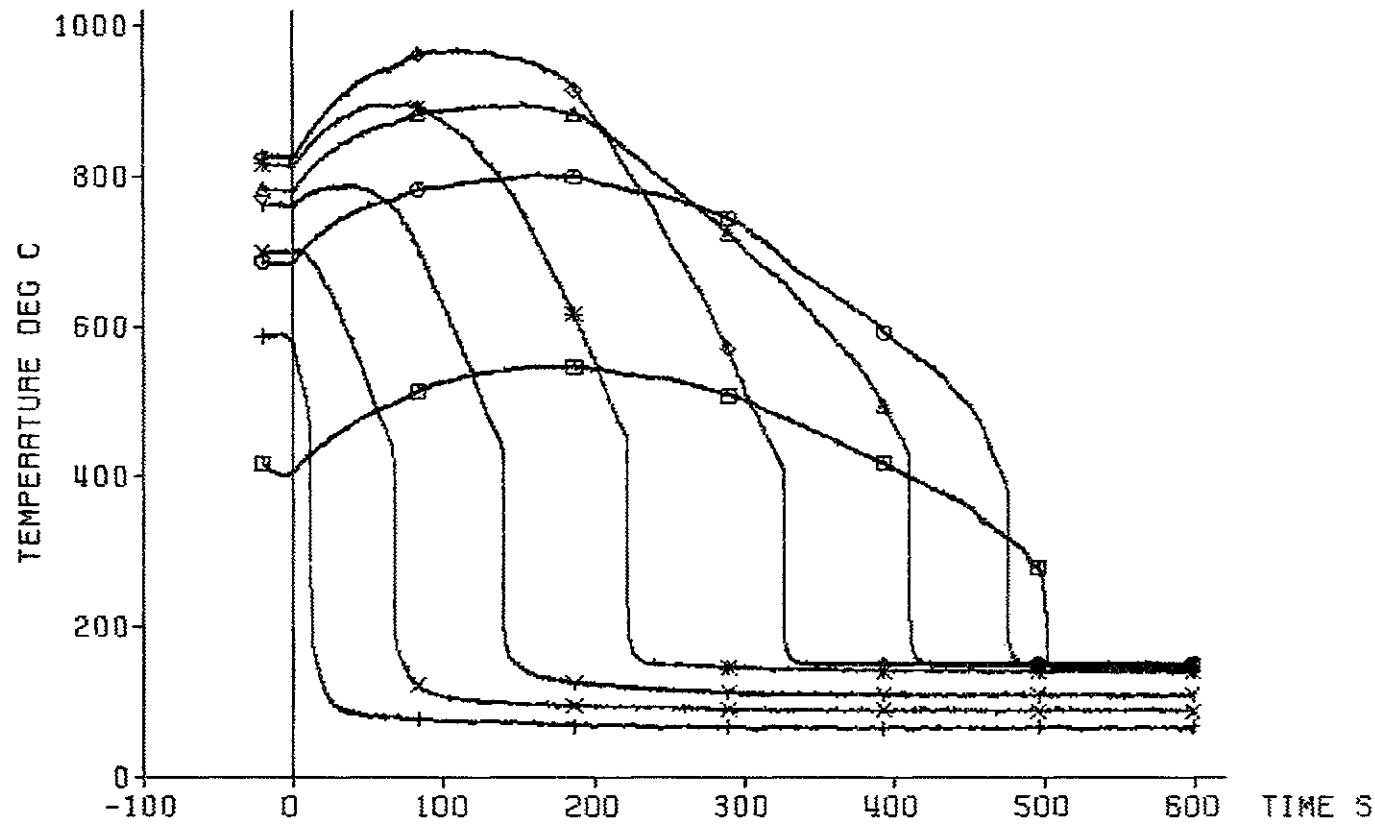

TC	ax. Level
+	18a4 3860 mm
x	18a3 3315 mm
y	18a2 2770 mm
*	18a1 2225 mm
◇	12b4 1680 mm
△	12b3 1135 mm
○	12b2 590 mm
□	12b1 45 mm

decay heat 120% ANS standard
 flooding rate (cold) 3.81 cm/s
 system pressure 4.15 bar
 feedwater temperature 40 deg C



Fig. 220 FEBA: 5x5 ROD BUNDLE, TEST SERIES 3, TEST-No. 239

heat transfer coeff.

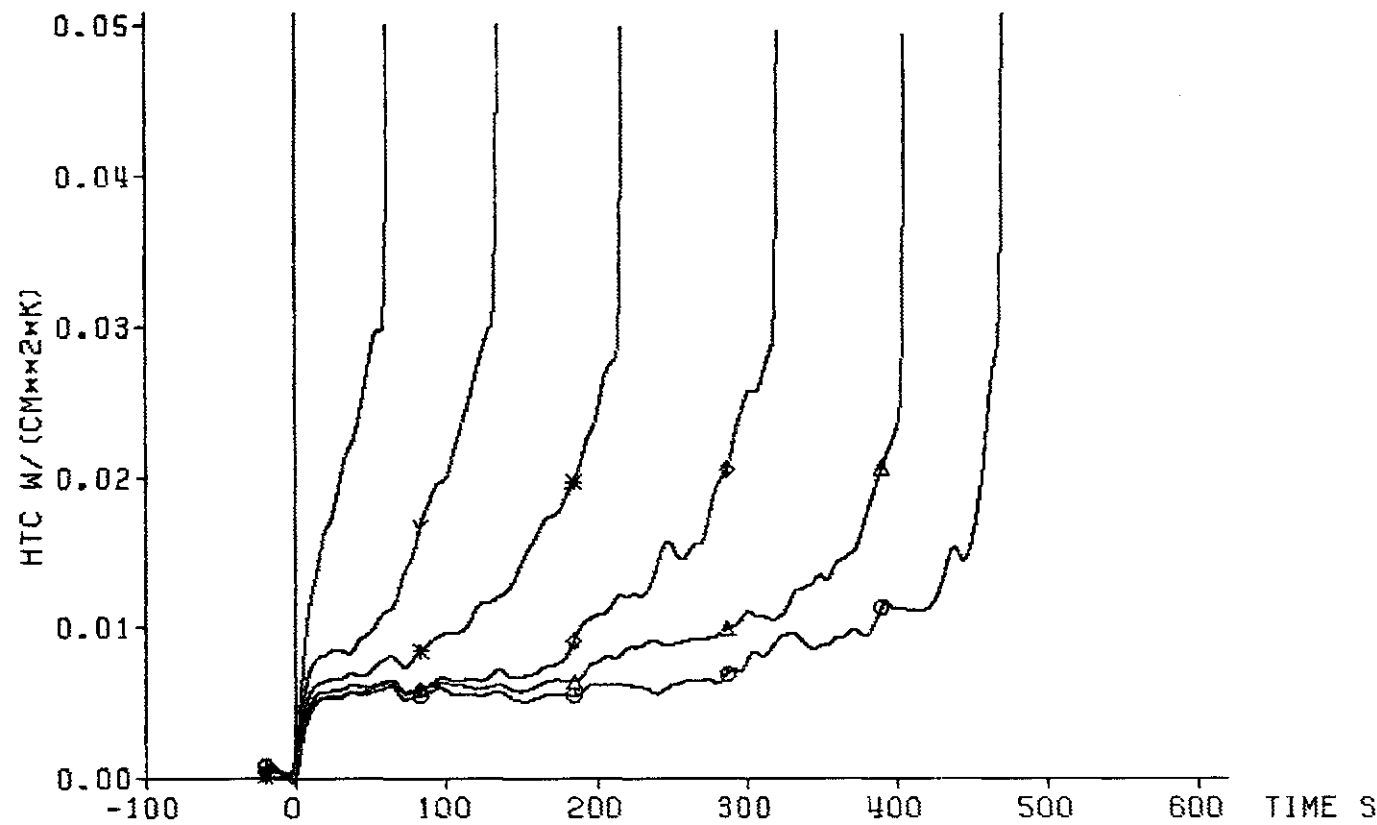

	TC	ax. Level
X	18a3	3315 mm
Y	18a2	2770 mm
*	18a1	2225 mm
@	12b4	1680 mm
^	12b3	1135 mm
o	12b2	590 mm

decay heat 120% ANS standard
 flooding rate (cold) 3.81 cm/s
 system pressure 4.15 bar
 feedwater temperature 40 deg C



Fig. 221 FEBA: 5x5 ROD BUNDLE, TEST SERIES 3, TEST-No. 239

cladding temperature

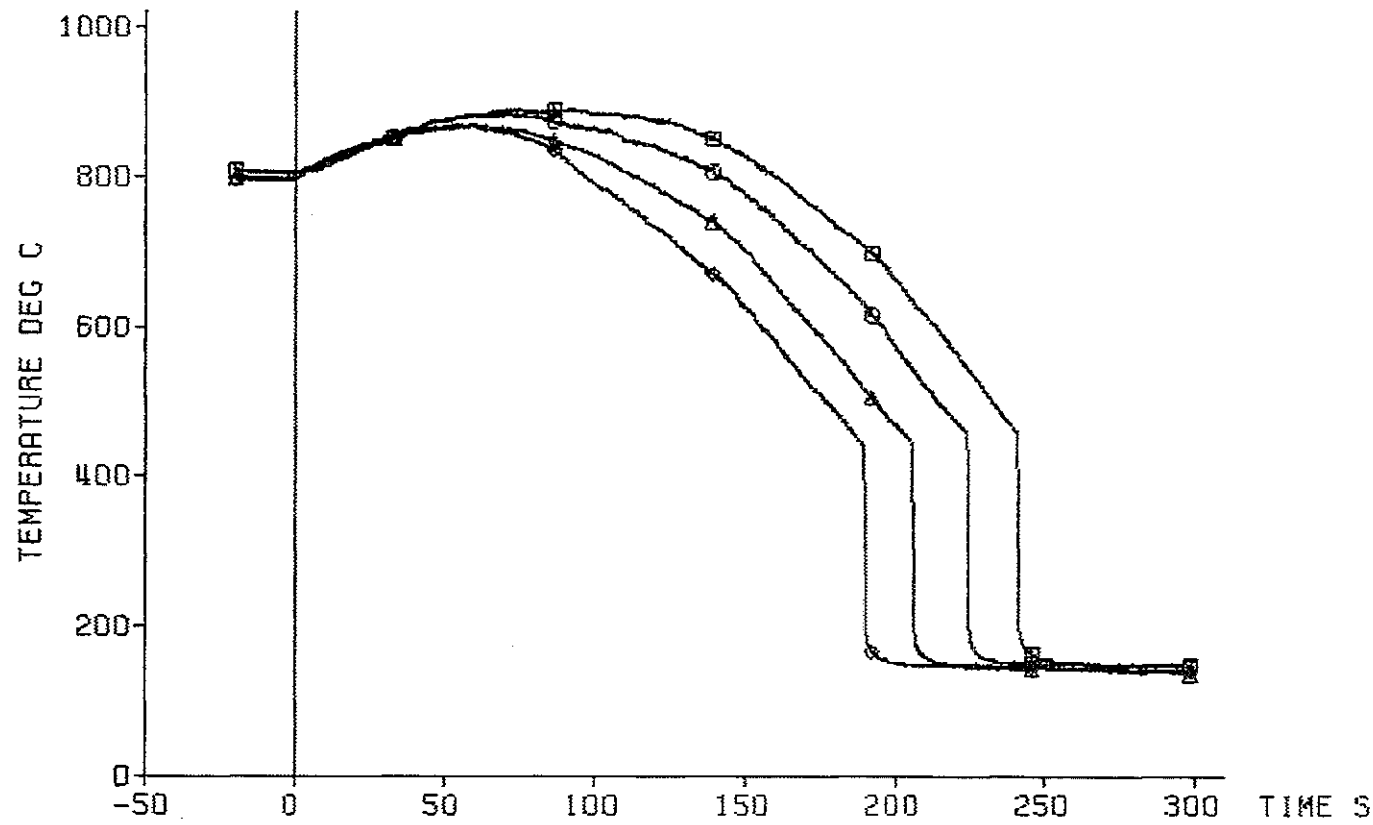

TC	ax. Level
◇	7f4 2425 mm
△	7f3 2325 mm
○	9h4 2225 mm
□	9h3 2125 mm

decay heat 120% ANS standard
 flooding rate (cold) 3.81 cm/s
 system pressure 4.15 bar
 feedwater temperature 40 deg C

bypass
 =====



Fig. 222 FEBA: 5x5 R0D BUNDLE, TEST SERIES 3, TEST-No. 239

heat transfer coeff.

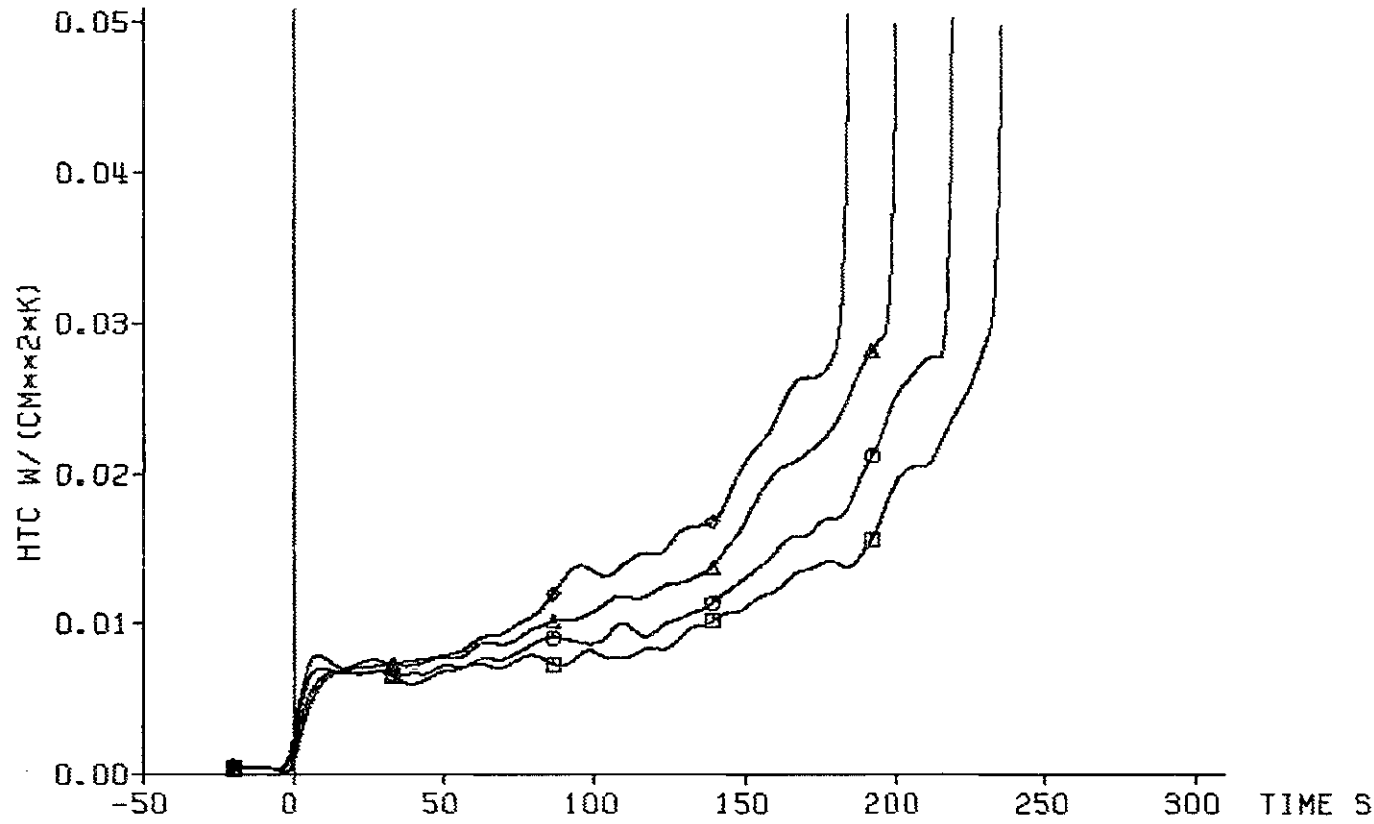

TC	ax. Level
◇ 7f4	2425 mm
△ 7f3	2325 mm
○ 9h4	2225 mm
□ 9h3	2125 mm

decay heat 120% ANS standard
 flooding rate (cold) 3.81 cm/s
 system pressure 4.15 bar
 feedwater temperature 40 deg C

bypass
 =====



Fig. 223 FEBA: 5x5 ROD BUNDLE, TEST SERIES 3, TEST-No. 239

cladding temperature

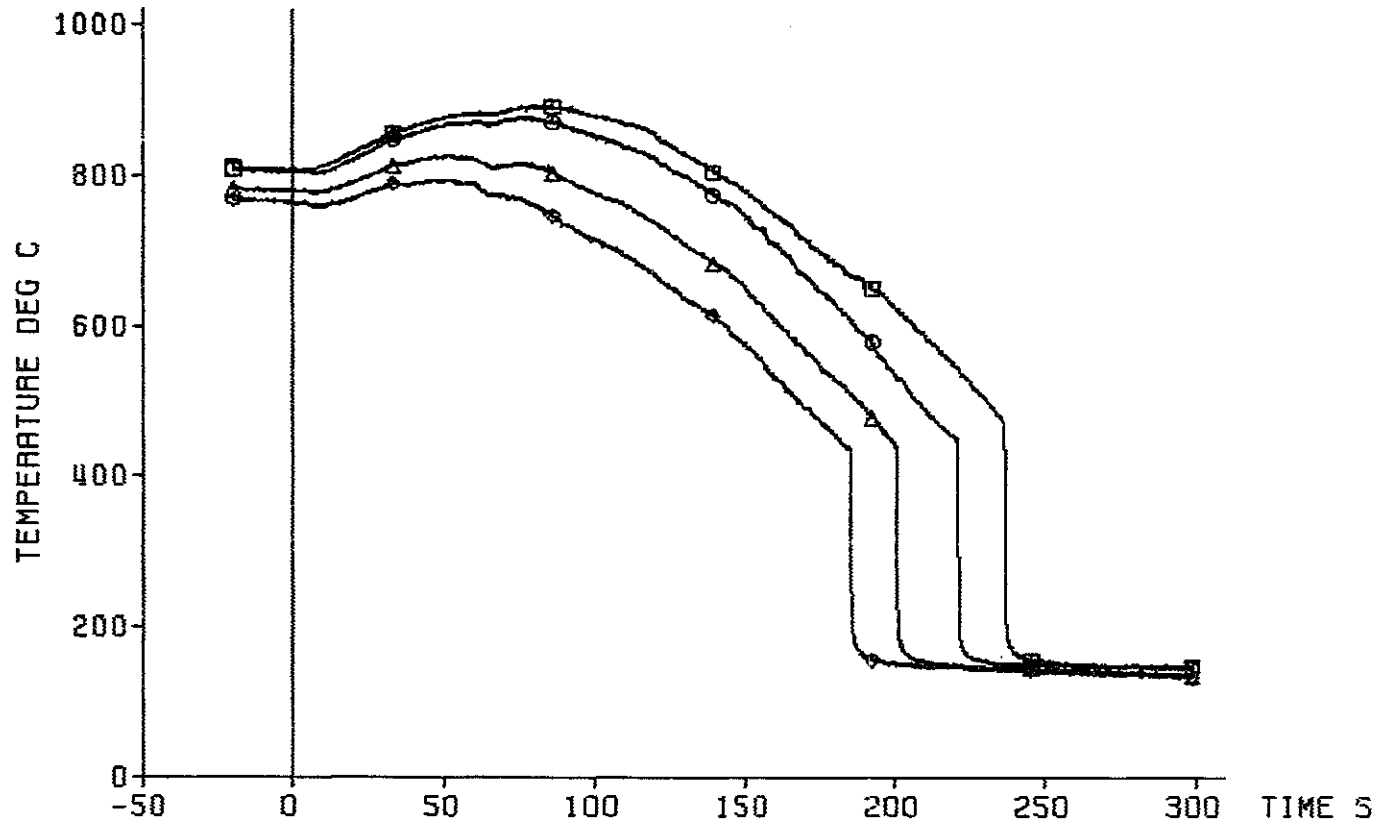

TC	ax. Level
◆ 22f4	2425 mm
▲ 22f3	2325 mm
◊ 17h4	2225 mm
◻ 17h3	2125 mm

decay heat 120% ANS standard
 flooding rate (cold) 3.81 cm/s
 system pressure 4.15 bar
 feedwater temperature 40 deg C

blockage
 =====



Fig. 224 FEBA: 5x5 ROD BUNDLE, TEST SERIES 3, TEST-No. 239

heat transfer coeff.

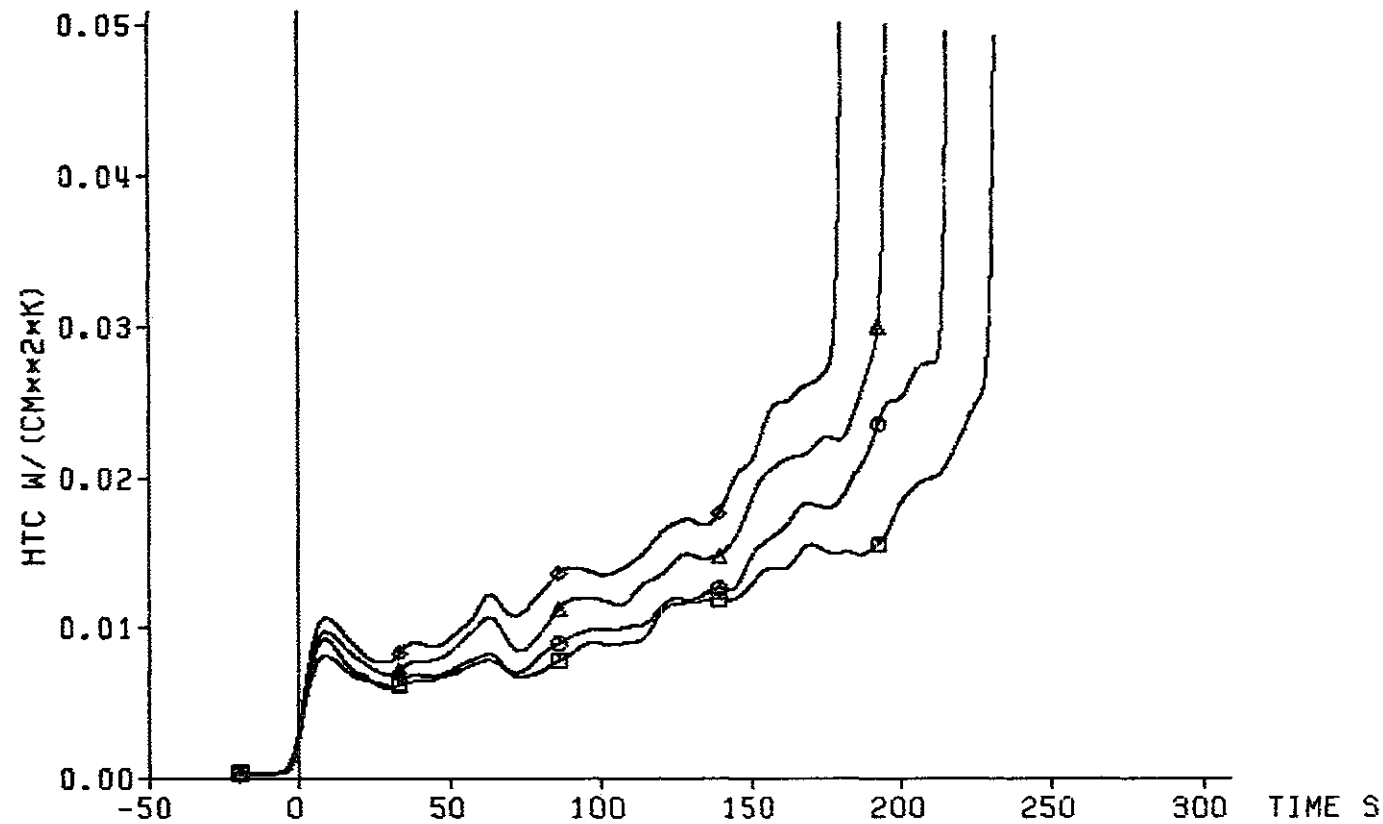

TC	ex. Level
◆ 22f4	2425 mm
▲ 22f3	2325 mm
○ 17h4	2225 mm
□ 17h3	2125 mm

decay heat 120% ANS standard
 flooding rate (cold) 3.81 cm/s
 system pressure 4.15 bar
 feedwater temperature 40 deg C

blockage
 =====



Fig. 225 FEBA: 5x5 ROD BUNDLE, TEST SERIES 3, TEST-No. 239

cladding temperature

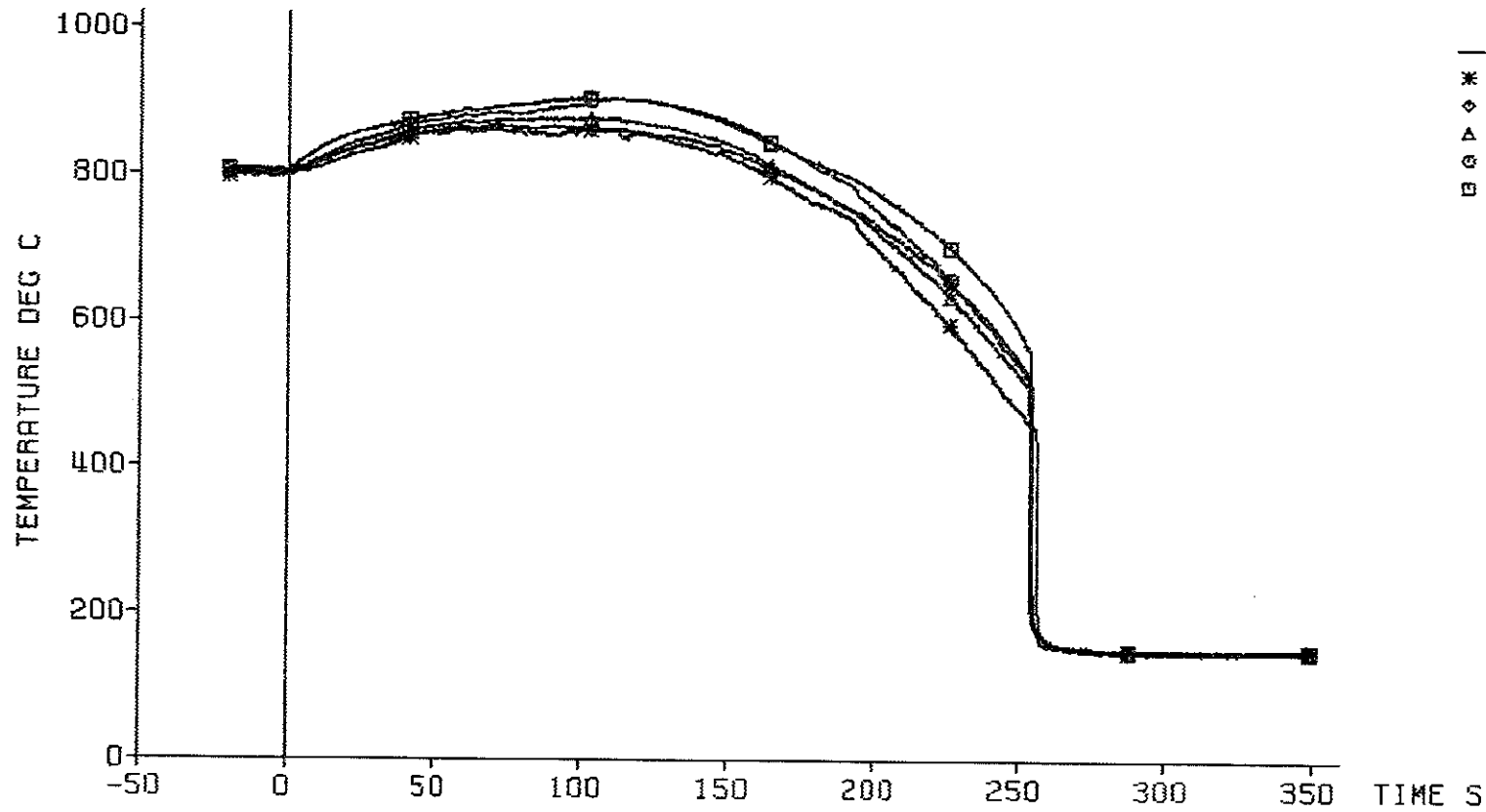

decay heat 120% AMS standard
 flooding rate (cold) 3.81 cm/s
 system pressure 4.15 bar
 feedwater temperature 40 deg C

bypass
 =====



Fig. 226 FEBA: 5x5 ROD BUNDLE, TEST SERIES 3, TEST-NO. 239

cladding temperature

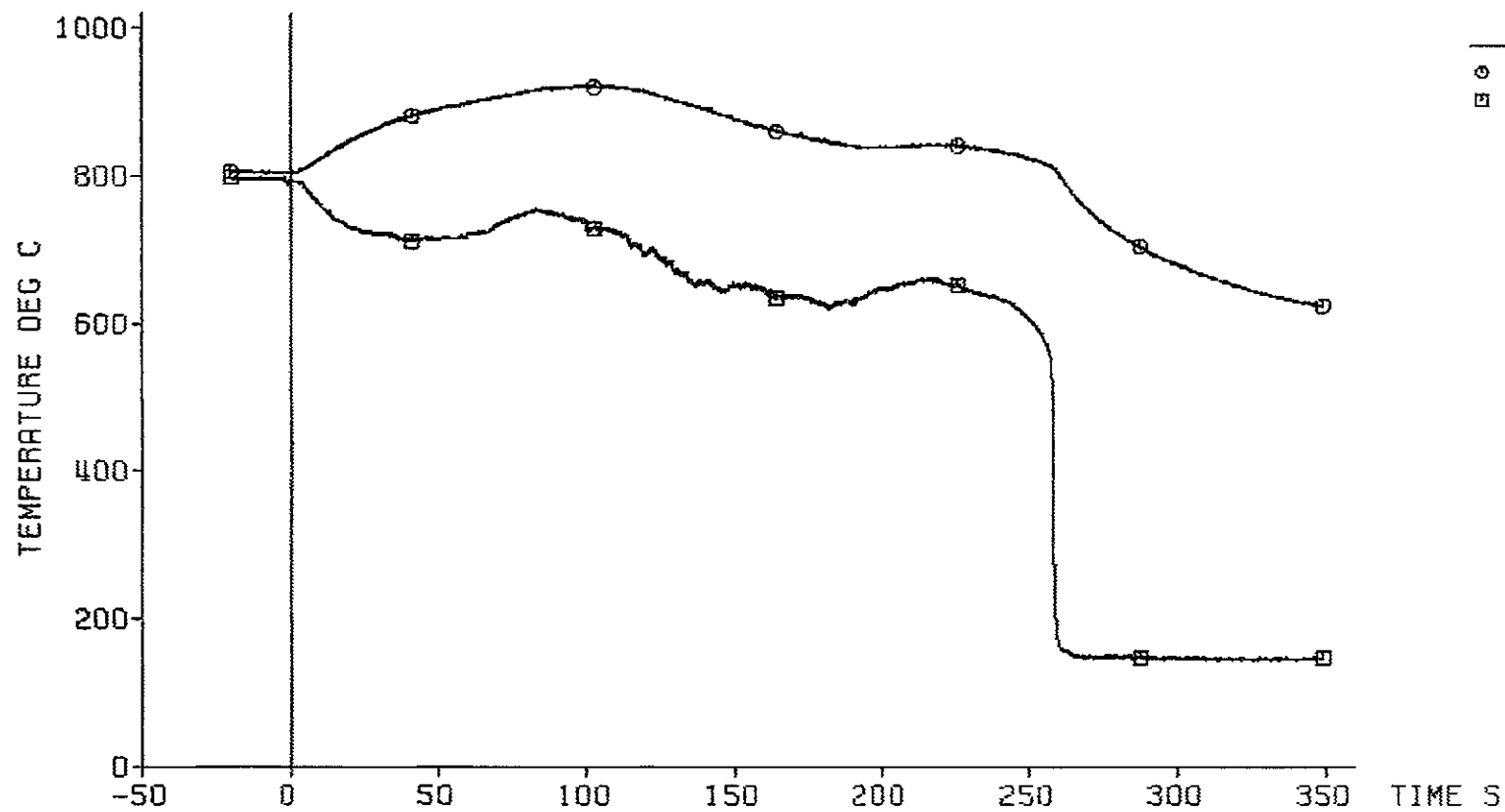

TC	ax. Level
○ 17h2	2025 mm
□ sleeve	2025 mm

decay heat 120% ANS standard
 flooding rate (cold) 3.81 cm/s
 system pressure 4.15 bar
 feedwater temperature 40 deg C

b lockage
 =====



Fig. 228 FEBA: 5x5 ROD BUNDLE, TEST SERIES 3, TEST-No. 239

cladding temperature

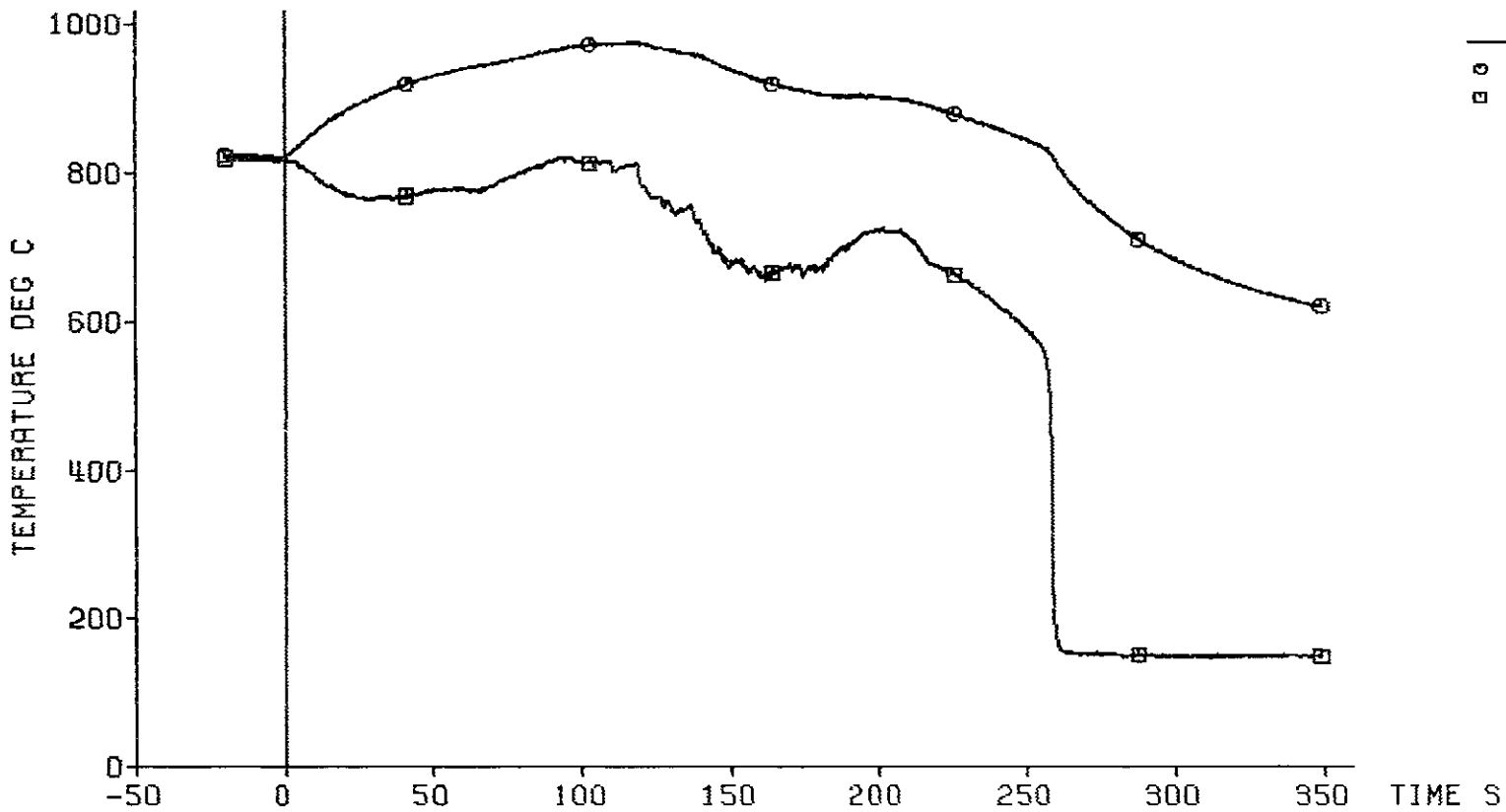

TC	axial level
○ 13d2	2025 mm
□ sleeve	2025 mm

decay heat 120% ANS standard
 flooding rate (cold) 3.81 cm/s
 system pressure 4.15 bar
 feedwater temperature 40 deg C

b lockage
 =====



Fig. 229 FEBA: 5x5 ROD BUNDLE, TEST SERIES 3, TEST-No. 239

cladding temperature

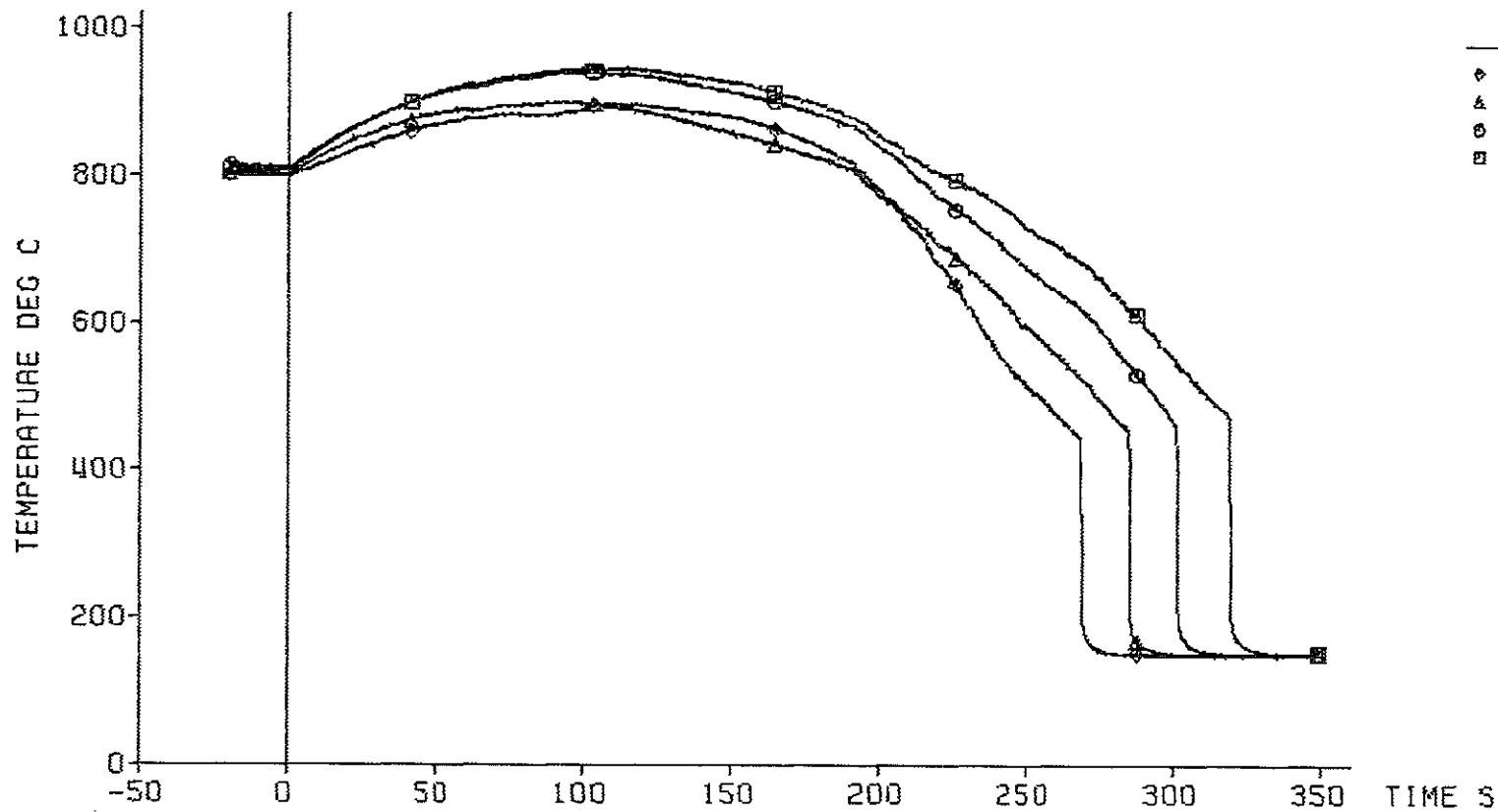

TC	ax. level
◆	9h1 1925 mm
▲	19g3 1825 mm
○	19g2 1725 mm
■	19g1 1625 mm

decay heat 120% ANS standard
 flooding rate (cold) 3.81 cm/s
 system pressure 4.15 bar
 feedwater temperature 40 deg C

bypass
 =====



Fig. 230 FEBA: 5x5 ROD BUNDLE, TEST SERIES 3, TEST-NO. 239

heat transfer coeff.

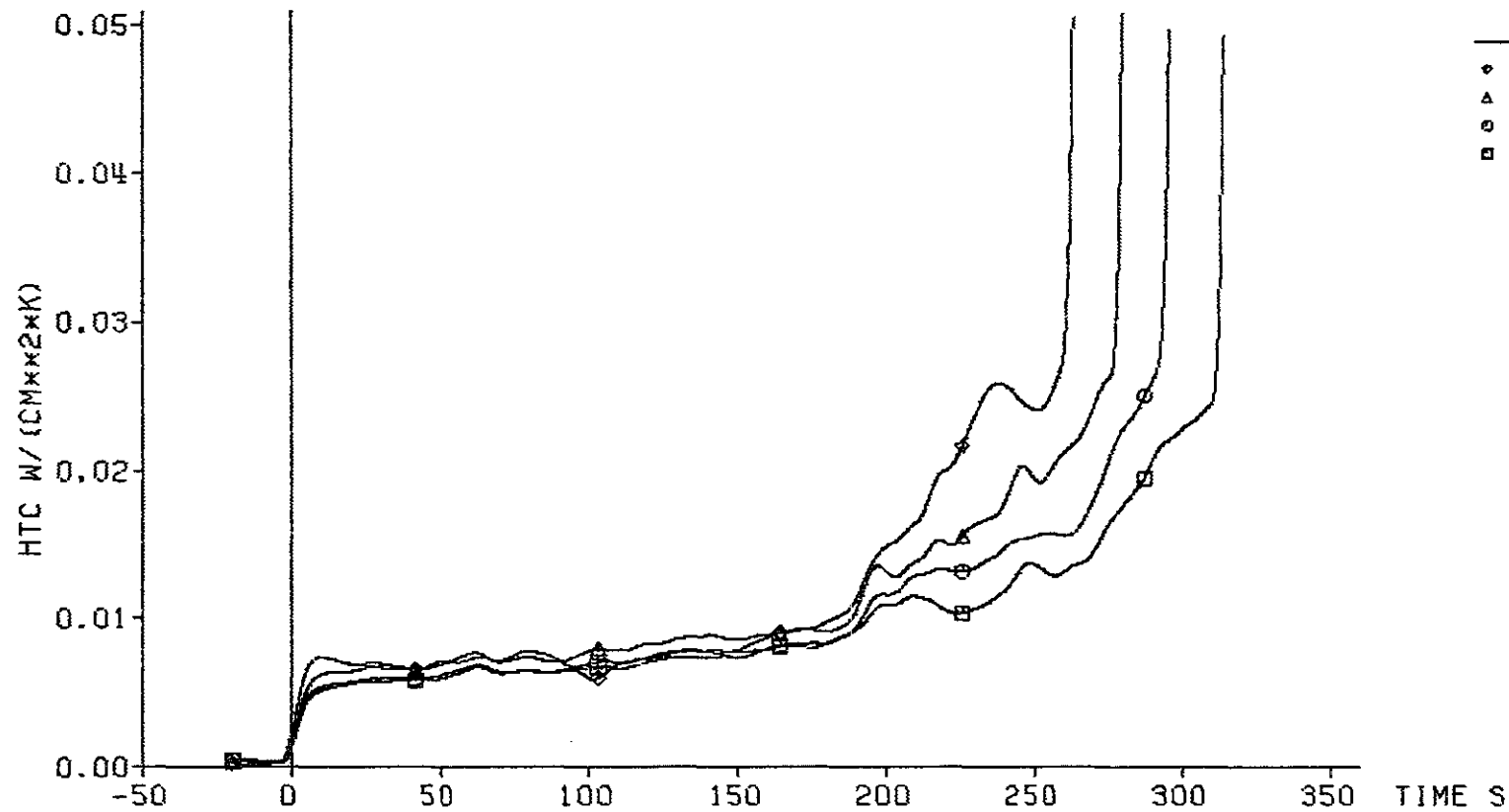

TC	ax. level
◊	9h1 1925 mm
△	19g3 1825 mm
○	19g2 1725 mm
◻	19g1 1625 mm

decay heat 120% ANS standard
 flooding rate (cold) 3.81 cm/s
 system pressure 4.15 bar
 feedwater temperature 40 deg C

bypass
 =====



Fig. 231 FEBA: 5x5 ROD BUNDLE, TEST SERIES 3, TEST-No. 239

cladding temperature

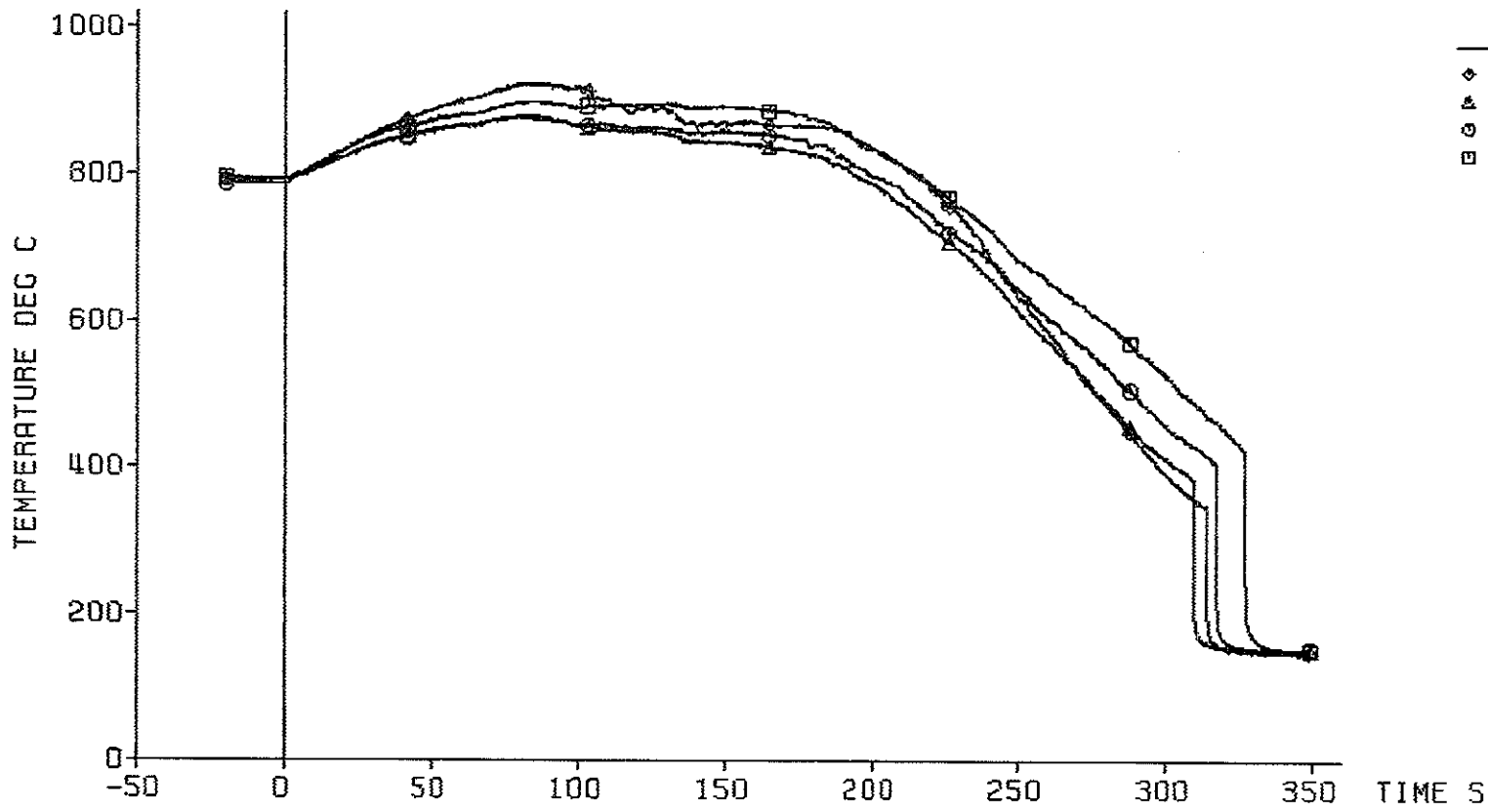

TC	ax. level
◇	17h1 1925 mm
△	16g3 1825 mm
○	16g2 1725 mm
□	16g1 1625 mm

decay heat 120% ANS standard
 flooding rate (cold) 3.81 cm/s
 system pressure 4.15 bar
 feedwater temperature 40 deg C

blockage
 =====



Fig. 232 FEBA: 5x5 ROD BUNDLE, TEST SERIES 3, TEST-No. 239

heat transfer coeff.

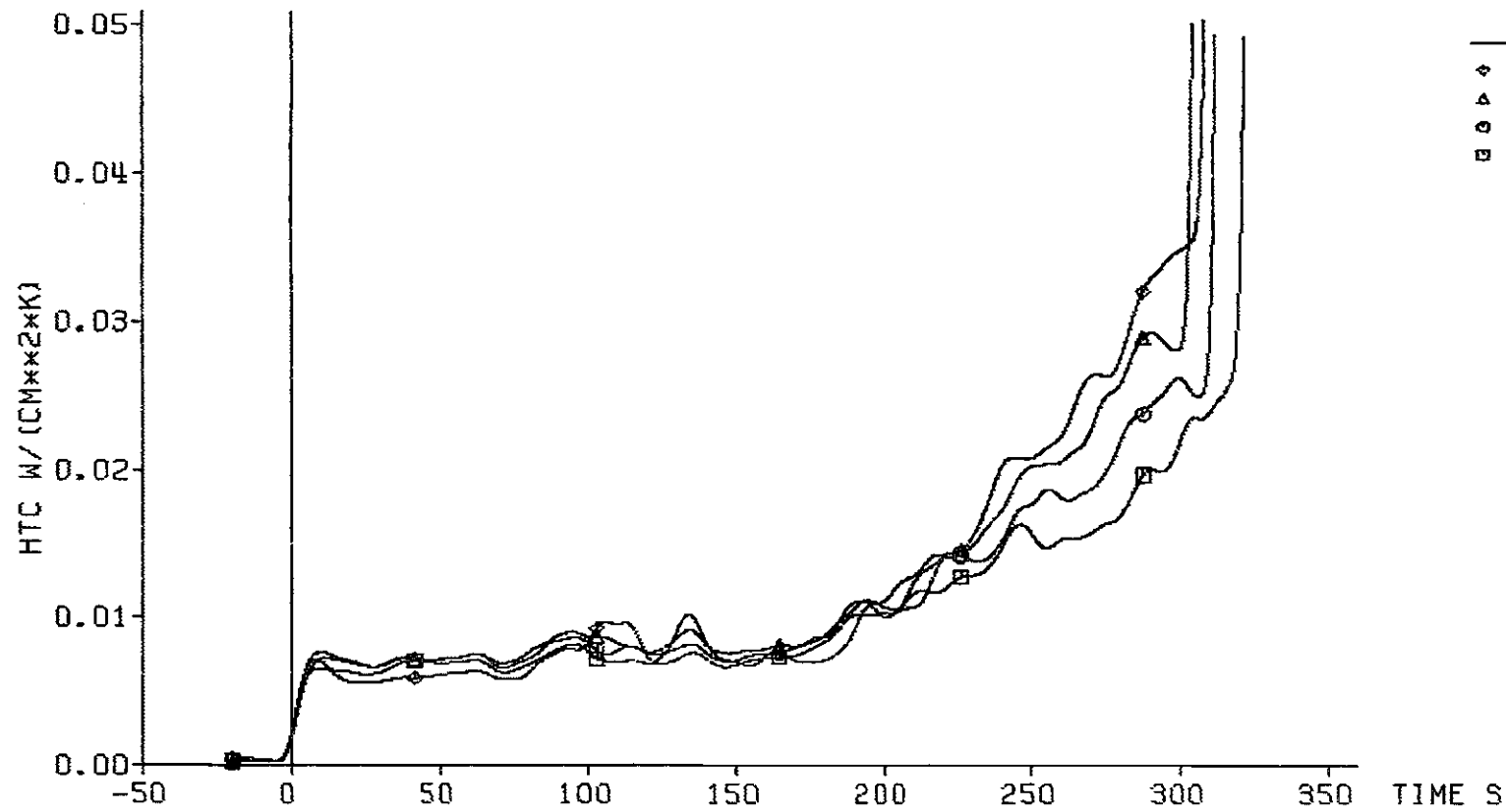

TC	ax. level
◇	17h1 1925 mm
△	16g3 1825 mm
○	16g2 1725 mm
□	16g1 1625 mm

decay heat 120% ANS standard
 flooding rate (cold) 3.81 cm/s
 system pressure 4.15 bar
 feedwater temperature 40 deg C

blockage
 =====



Fig. 233 FEBA: 5x5 ROD BUNDLE, TEST SERIES 3, TEST-No. 239

axial level: 1925 mm

△ cladding temperature (16g4)
○ fluid temperature
□ housing temperature

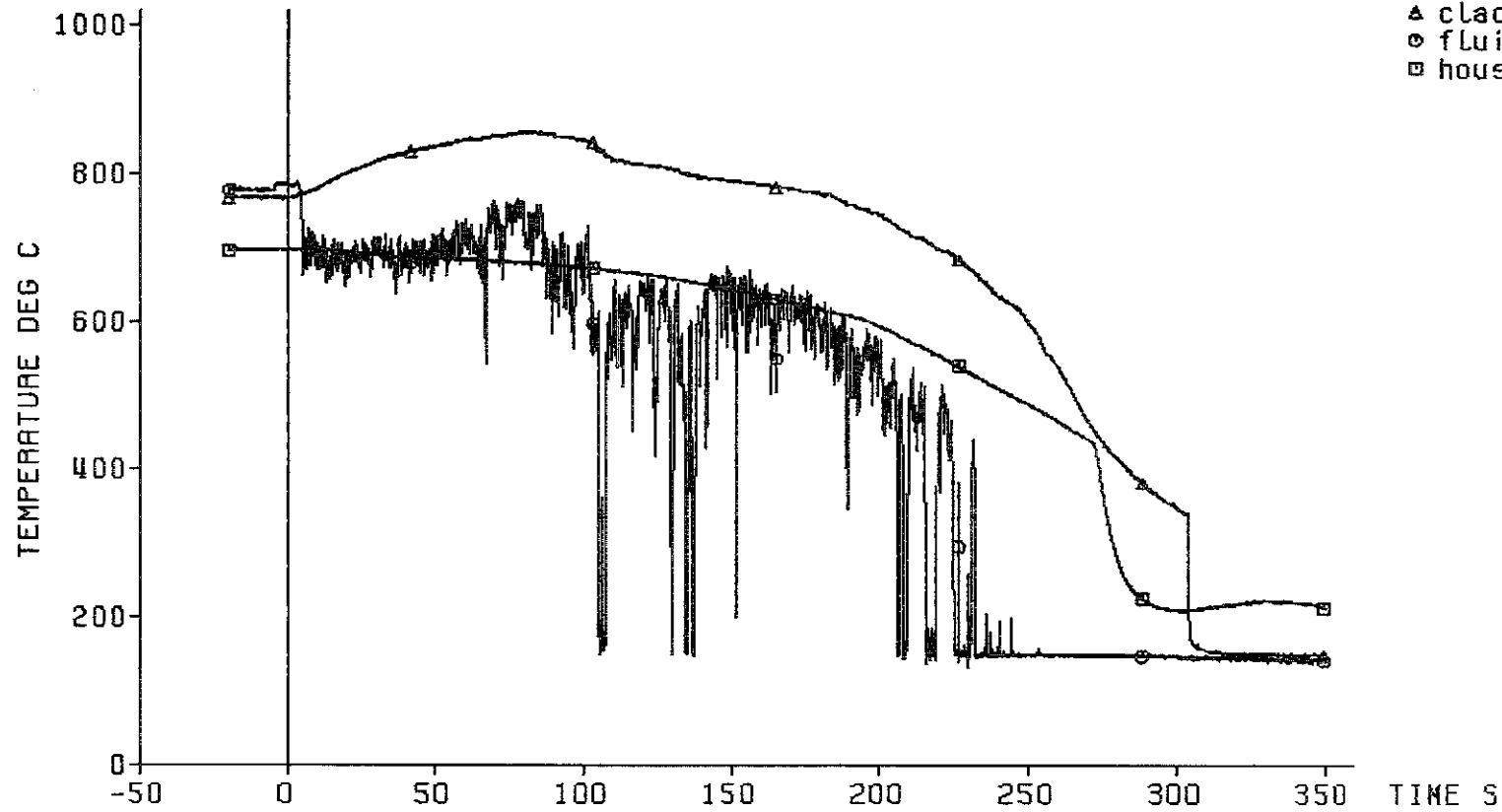

decay heat 120% ANS standard
flooding rate (cold) 3.81 cm/s
system pressure 4.15 bar
feedwater temperature 40 deg C

blockage
=====

KIRB

Fig. 234 FEBA: 5x5 ROD BUNDLE, TEST SERIES 3, TEST-No. 239

axial level: 1725 mm

△ cladding temperature (16g2)
○ fluid temperature
□ housing temperature

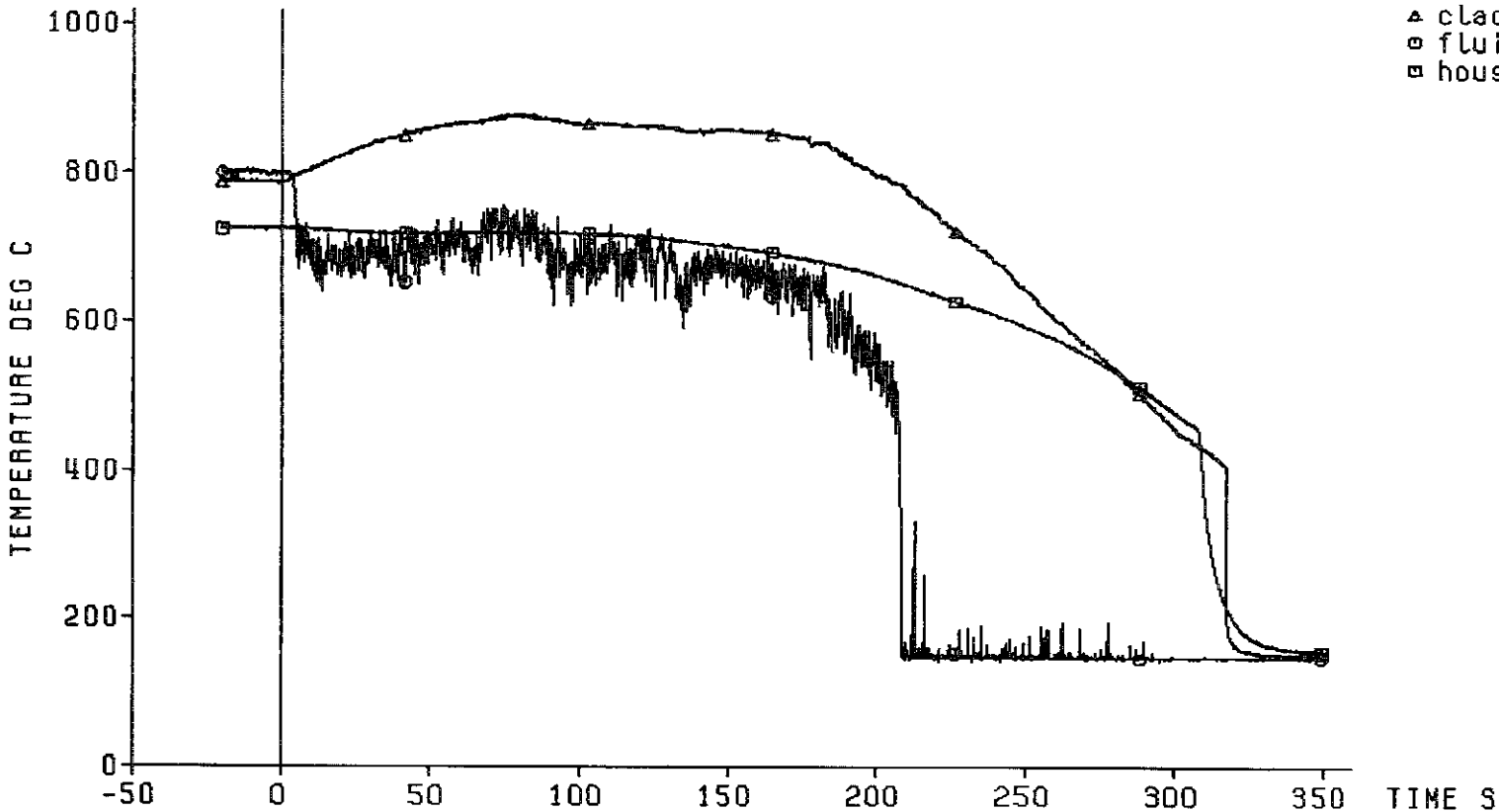

decay heat 120% ANS standard
flooding rate (cold) 3.81 cm/s
system pressure 4.15 bar
feedwater temperature 40 deg C

blockage
=====



Fig. 235 FEBA: 5x5 ROD BUNDLE, TEST SERIES 3, TEST-No. 239

axial level: 1625 mm

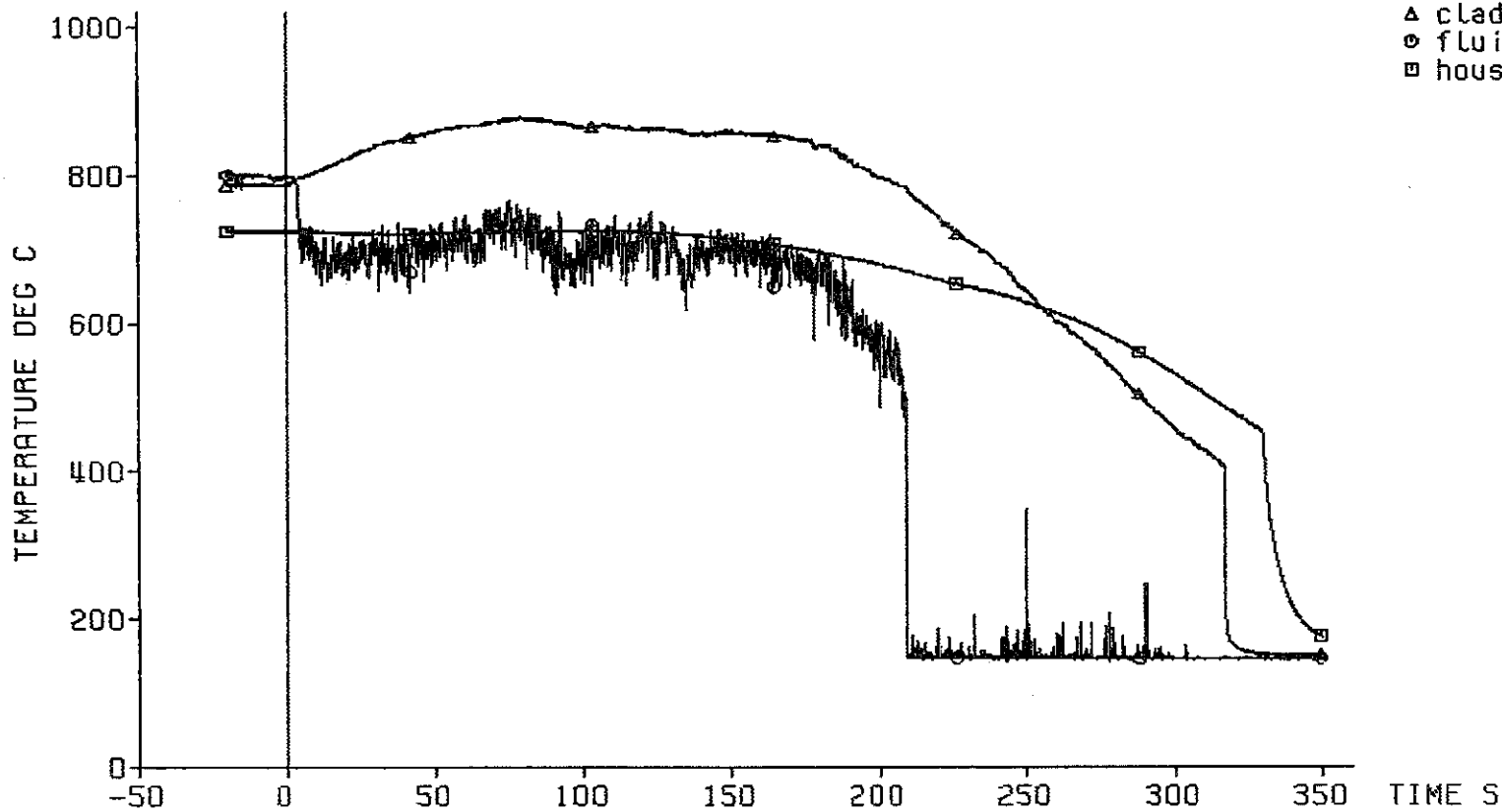

△ cladding temperature (16g1)
○ fluid temperature
□ housing temperature

decay heat 120% ANS standard
flooding rate (cold) 3.81 cm/s
system pressure 4.15 bar
feedwater temperature 40 deg C

blockage
=====



Fig. 236 FEBA: 5x5 ROD BUNDLE, TEST SERIES 3, TEST-No. 239

pressure loss
along the test section:

◆ total length: 4196 mm
△ lower part: 1711 mm
○ middle part: 545 mm
□ upper part: 1940 mm

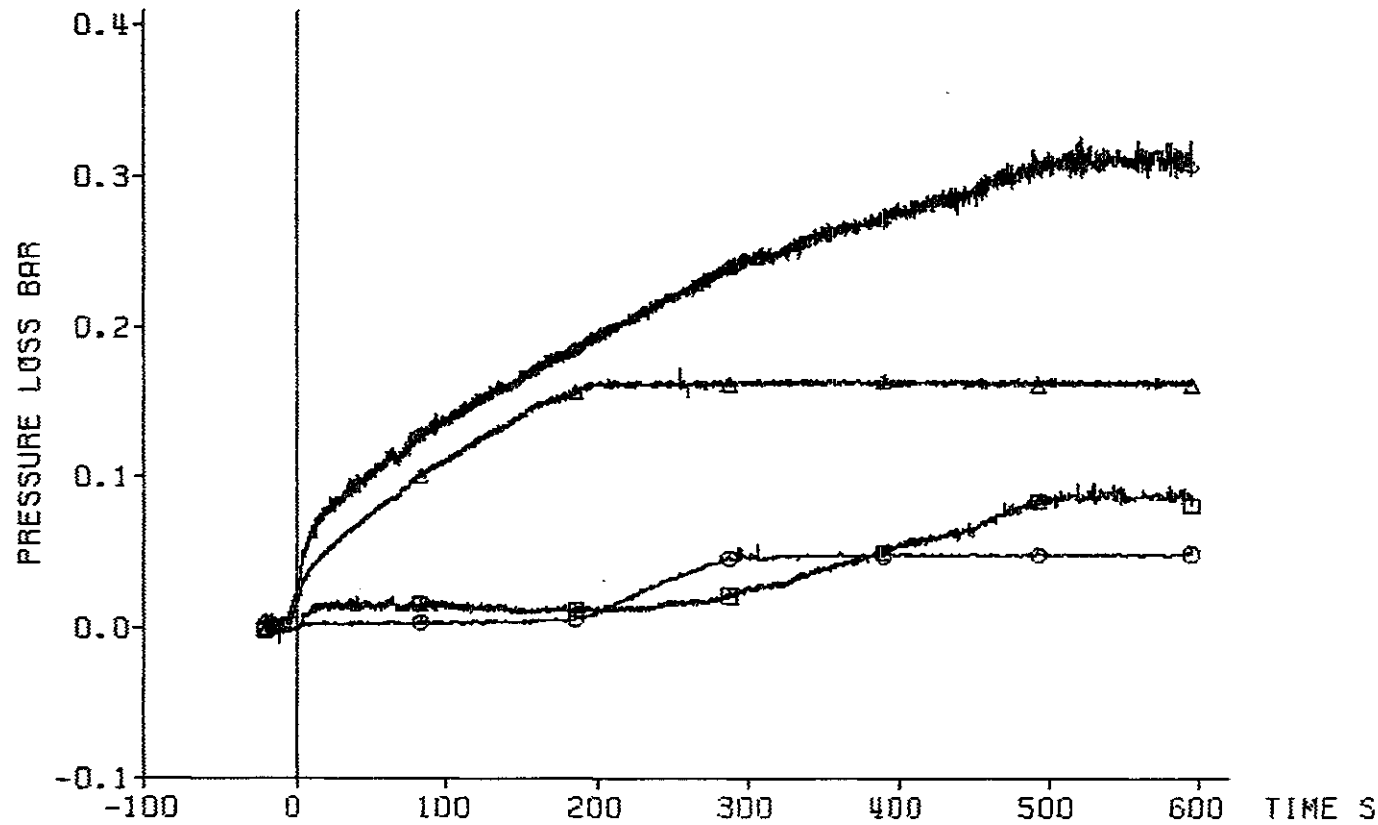

decay heat 120% RMS standard
flooding rate (cold) 3.81 cm/s
system pressure 4.15 bar
feedwater temperature 40 deg C

KfK
IRB

Fig. 237 FEBA: 5x5 ROD BUNDLE, TEST SERIES 3, TEST-No. 239

coolant conditions:

△ water carry over
○ coolant temperature
□ coolant pressure

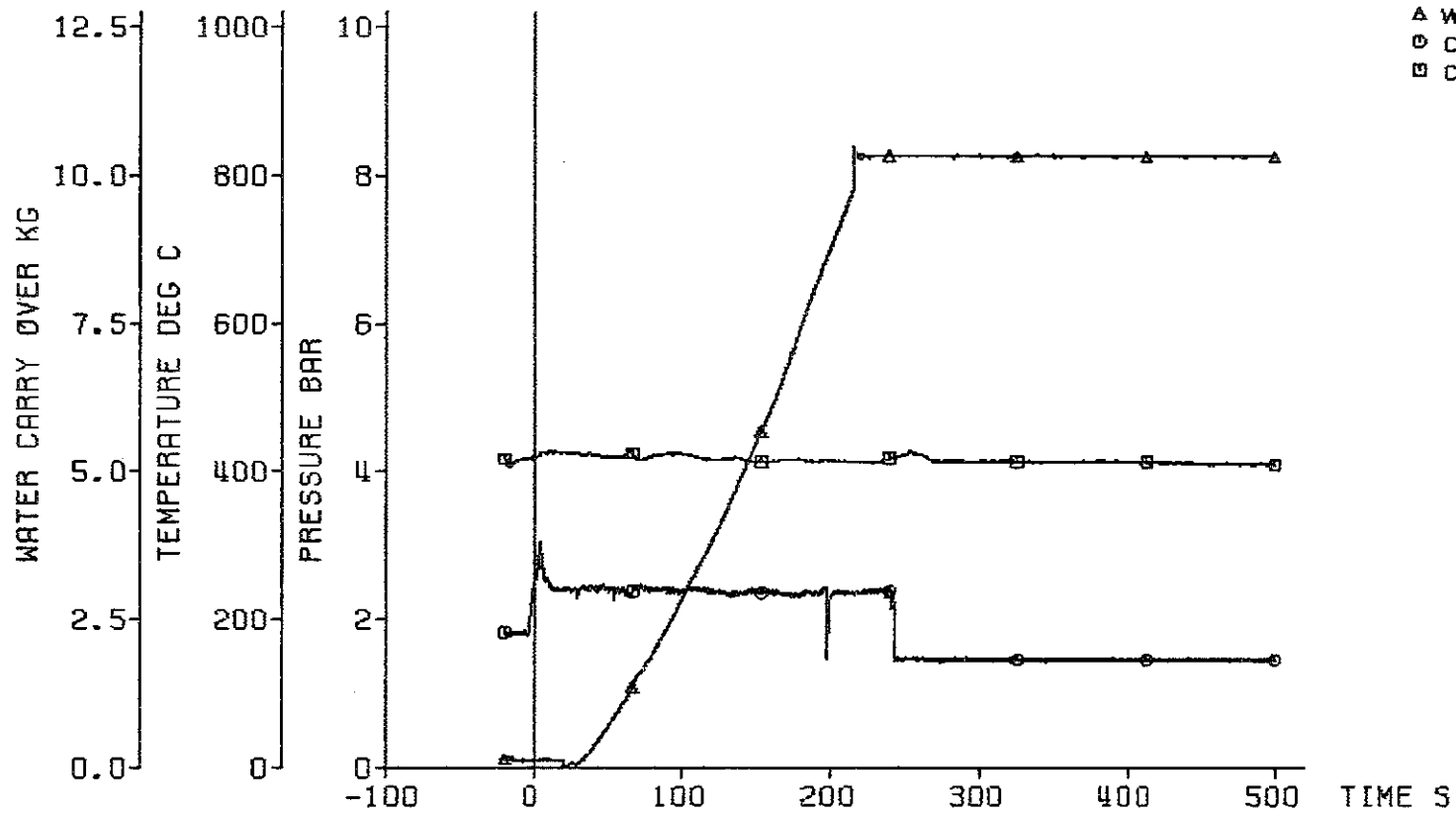

decay heat 120% RMS standard
flooding rate (cold) 3.81 cm/s
system pressure 4.15 bar
feedwater temperature 40 deg C



Fig. 238 FEBA: 5x5 ROD BUNDLE, TEST SERIES 3, TEST-No. 239

axial position of the quench front

- rewetting of the sleeve at the bundle midplane
- x rewetting of the rod downstream of the blockage

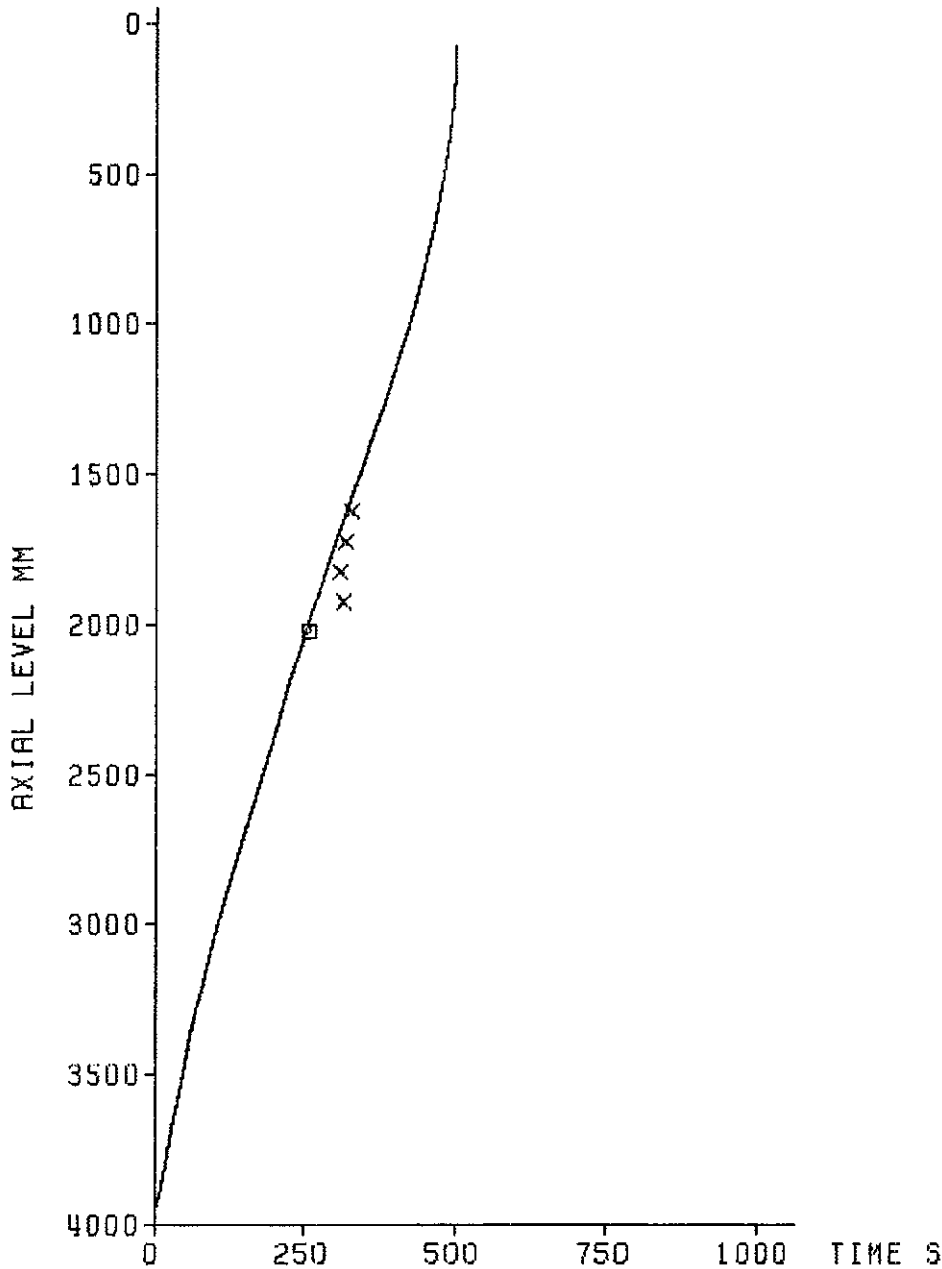

decay heat	120% RNS standard
flooding rate (cold)	3.81 cm/s
system pressure	4.15 bar
feedwater temperature	40 deg C



Fig. 239 FEBA: 5x5 ROD BUNDLE
TEST SERIES 3, TEST-No. 239

Initial axial temperature profile of the cladding

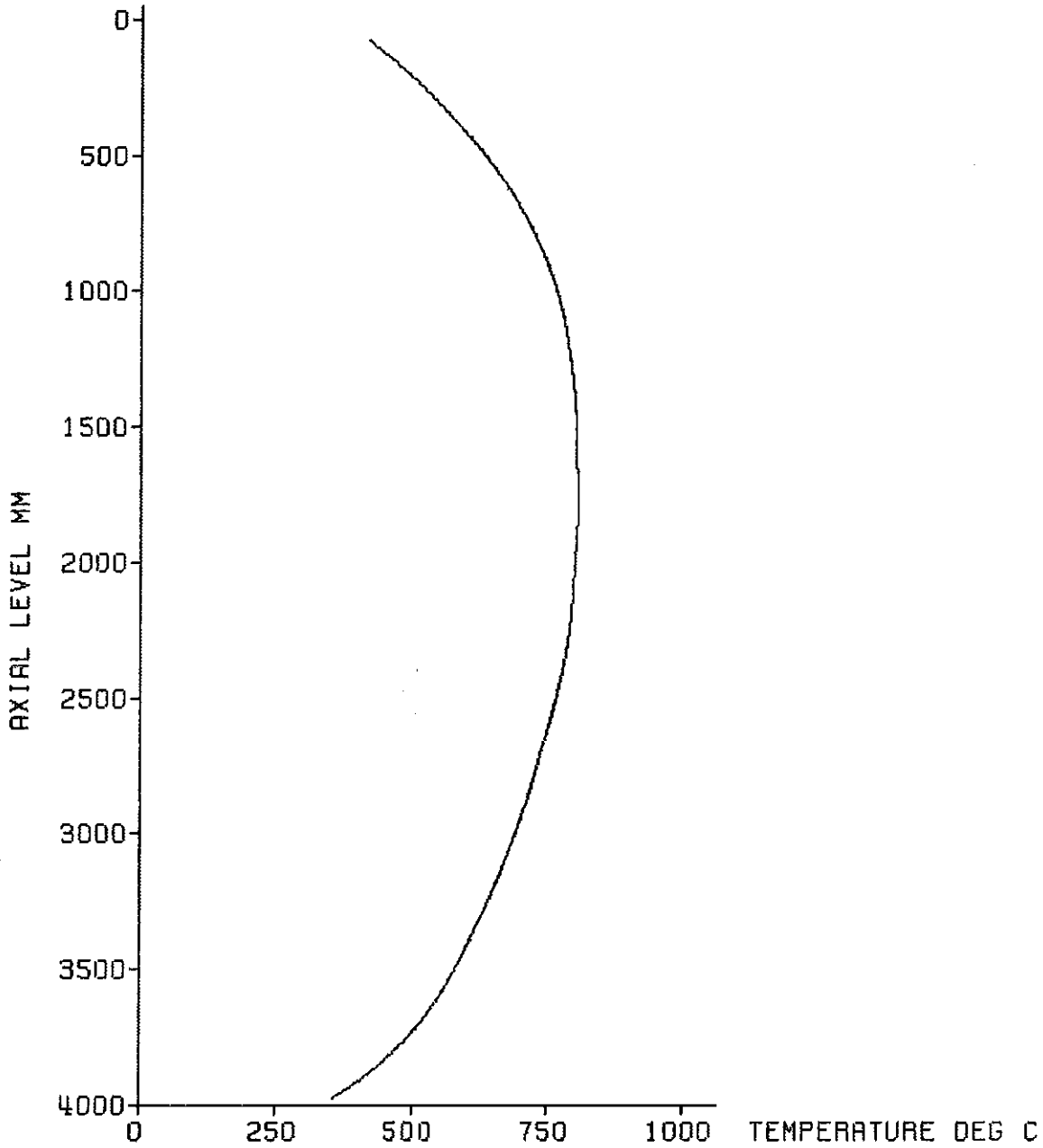

decay heat	120% ANS standard
flooding rate (cold)	3.80 cm/s
system pressure	6.24 bar
feedwater temperature	40 deg C



Fig. 240 FEBA: 5x5 ROD BUNDLE
TEST SERIES 3, TEST-No. 236

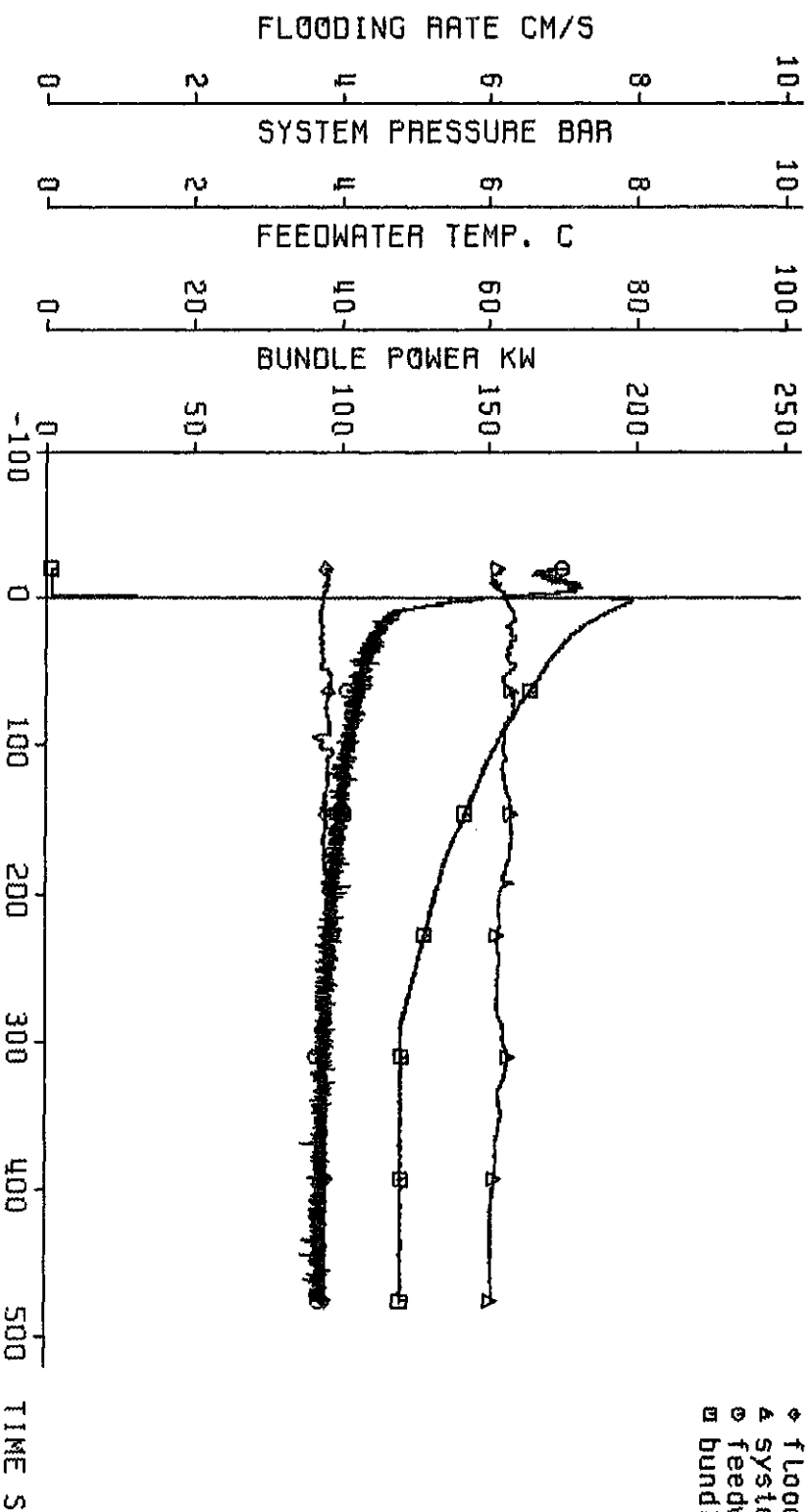

test parameters:

- ♦ flooding rate
- ▲ system pressure
- feedwater temperature
- bundle power

decay heat
 flooding rate (cold)
 system pressure
 feedwater temperature

120% RMS standard
 3.80 cm/s
 8.24 bar
 40 deg C



Fig. 241 FEBRA: 5X5 ROD BUNDLE, TEST SERIES 3, TEST-NO. 236

cladding temperature

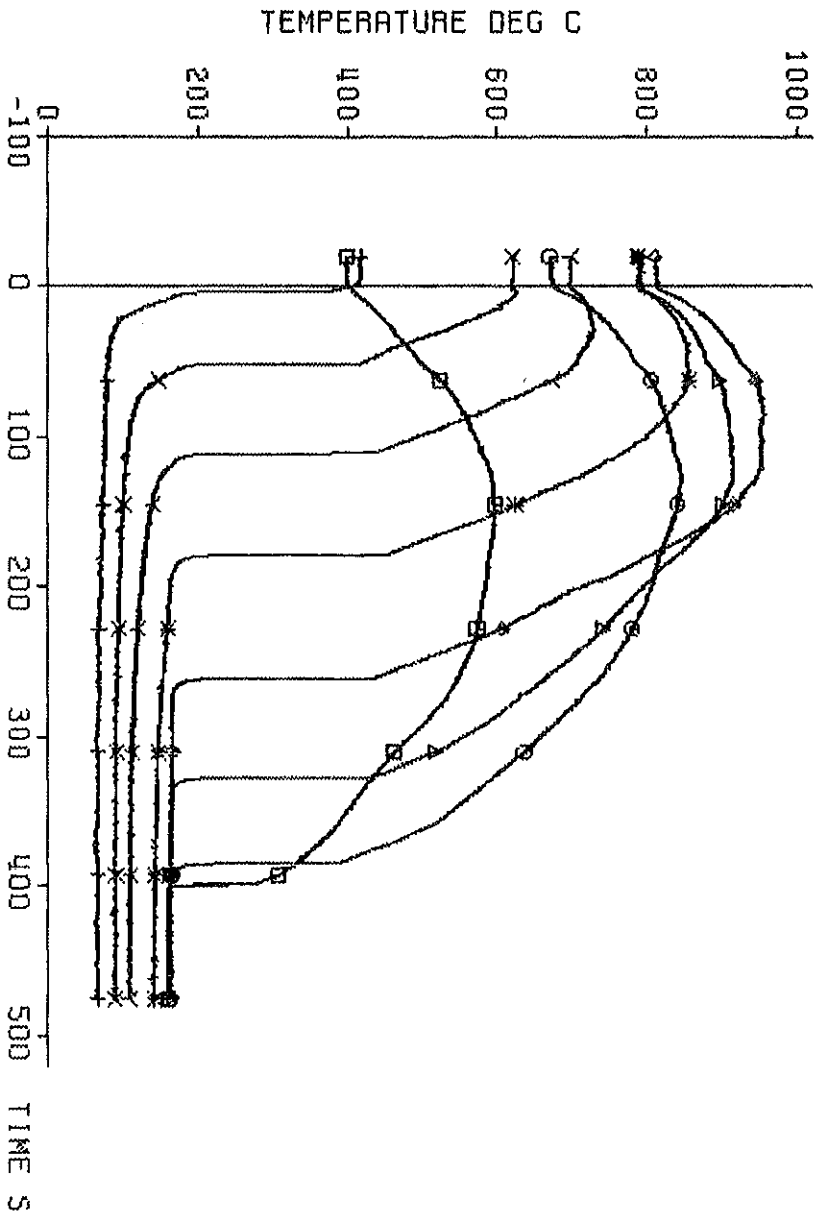

decay heat
 flooding rate (cold)
 system pressure
 feedwater temperature

120% RMS standard
 3.80 cm/s
 5.24 bar
 40 deg C

TC	ax. level
+	18a4 3860 mm
x	18a3 3315 mm
y	18a2 2770 mm
*	18a1 2225 mm
◇	12b4 1680 mm
△	12b3 1135 mm
○	12b2 590 mm
□	12b1 45 mm

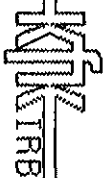
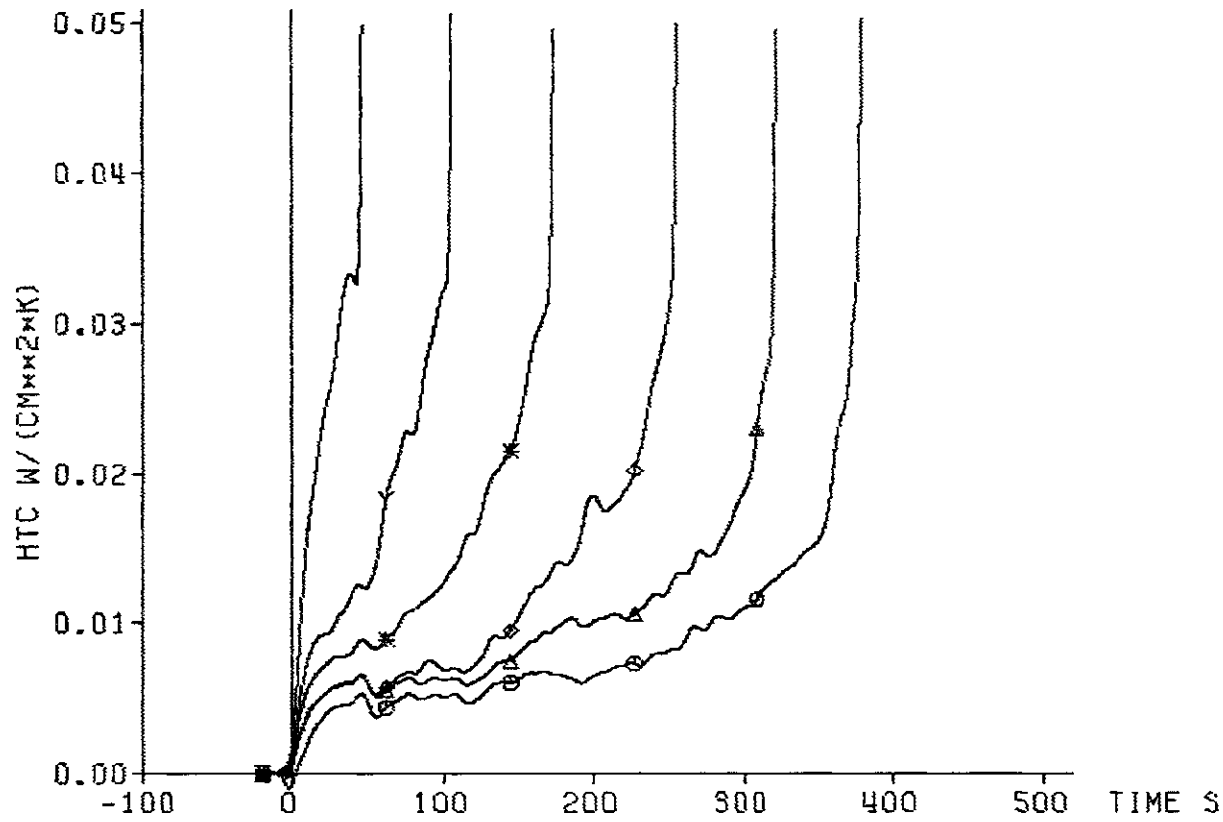

Fig. 242 FEBRA: 5X5 ROD BUNDLE, TEST SERIES 3, TEST-NO. 236

heat transfer coeff.



	TC	ax. Level
x	18a3	3315 mm
y	18a2	2770 mm
*	18a1	2225 mm
◇	12b4	1680 mm
△	12b3	1135 mm
○	12b2	590 mm

decay heat 120% ANS standard
 flooding rate (cold) 3.80 cm/s
 system pressure 6.24 bar
 feedwater temperature 40 deg C



Fig. 243 FEBA: 5x5 ROD BUNDLE, TEST SERIES 3, TEST-No. 236

cladding temperature

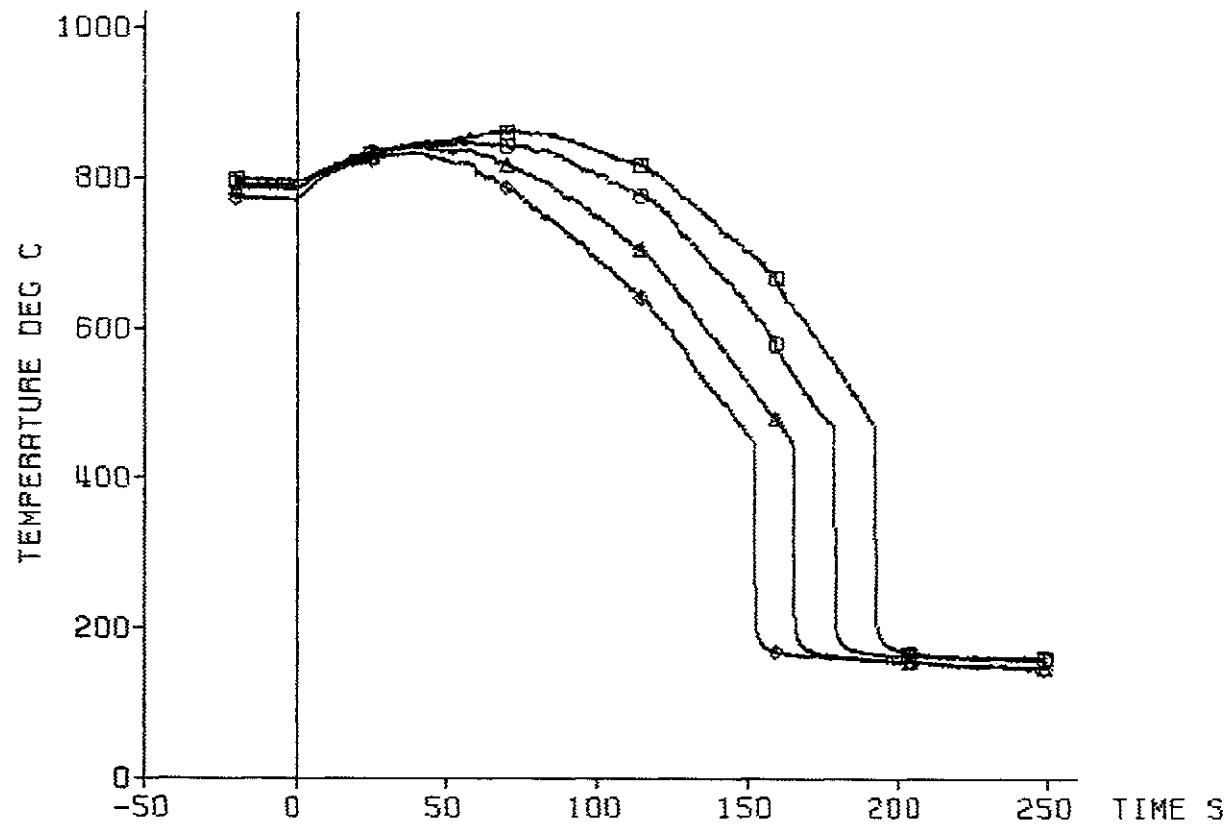

TC	ax. level
◇ 7f4	2425 mm
△ 7f3	2325 mm
○ 9h4	2225 mm
□ 9h3	2125 mm

decay heat 120% ANS standard
 flooding rate (cold) 3.80 cm/s
 system pressure 6.24 bar
 feedwater temperature 40 deg C

bypass
 =====



Fig. 244 FEBA: 5x5 ROD BUNDLE, TEST SERIES 3, TEST-No. 236

heat transfer coeff.

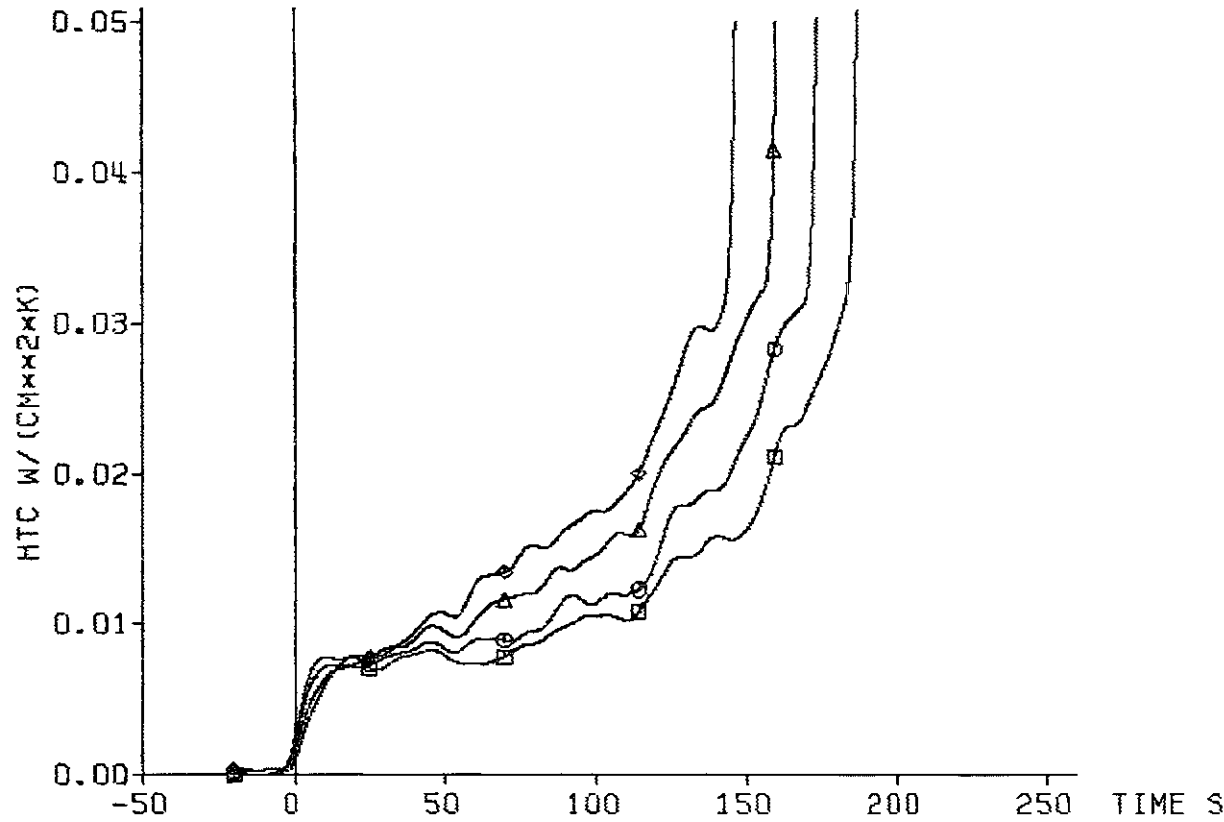

TC	ax. Level
◇	7f4 2425 mm
△	7f3 2325 mm
○	9h4 2225 mm
□	9h3 2125 mm

decay heat
 flooding rate (cold) 120% ANS standard
 system pressure 3.80 cm/s
 feedwater temperature 6.24 bar
 40 deg C

bypass
 =====



Fig. 245 FEBA: 5x5 ROD BUNDLE, TEST SERIES 3, TEST-No. 236

cladding temperature

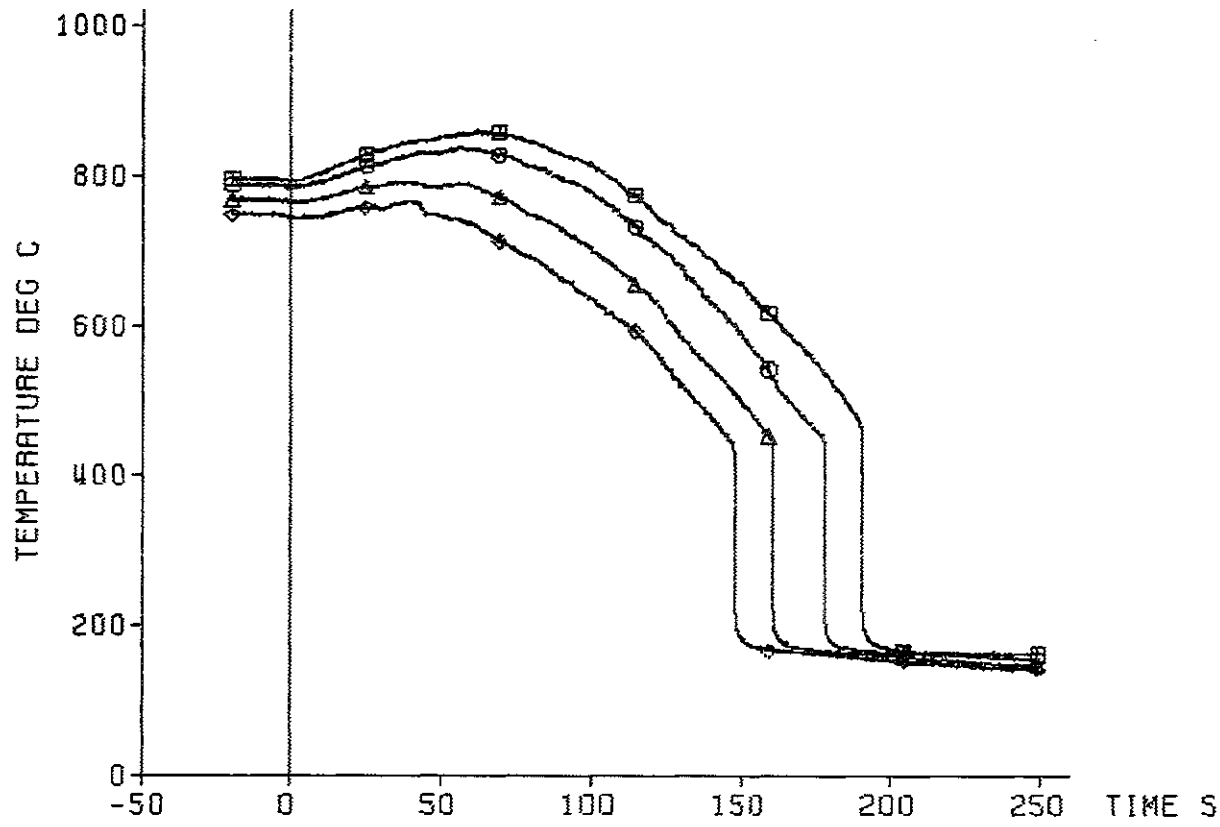

TC	ax. Level
◇	22f4 2425 mm
△	22f3 2325 mm
○	17h4 2225 mm
□	17h3 2125 mm

decay heat 120% ANS standard
 flooding rate (cold) 3.80 cm/s
 system pressure 6.24 bar
 feedwater temperature 40 deg C

blockage
=====



Fig. 246 FEBA: 5x5 ROD BUNDLE, TEST SERIES 3, TEST-No. 236

heat transfer coeff.

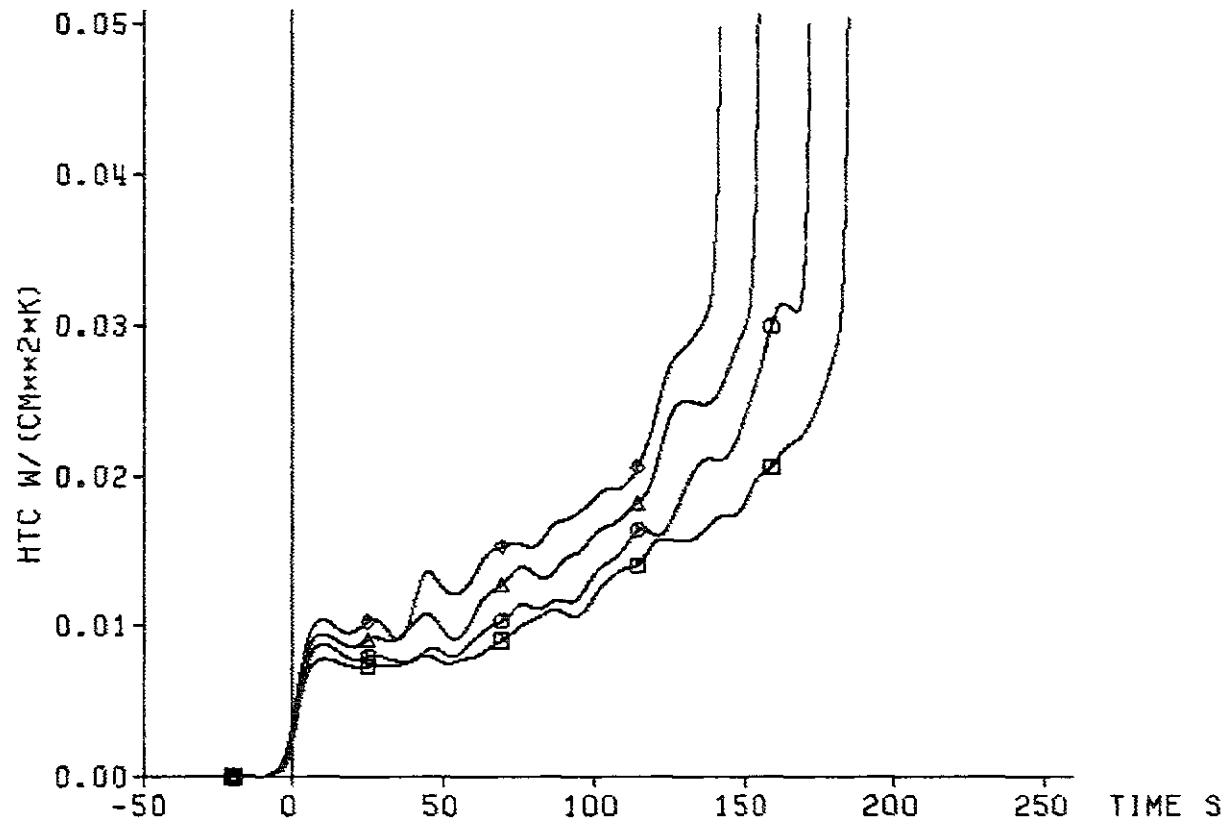

TC	ex. Level
◇ 22f4	2425 mm
△ 22f3	2325 mm
○ 17h4	2225 mm
□ 17h3	2125 mm

decay heat 120% ANS standard
 flooding rate (cold) 3.80 cm/s
 system pressure 6.24 bar
 feedwater temperature 40 deg C

blockage
=====



Fig. 247 FEBA: 5x5 ROD BUNDLE, TEST SERIES 3, TEST-No. 236

cladding temperature

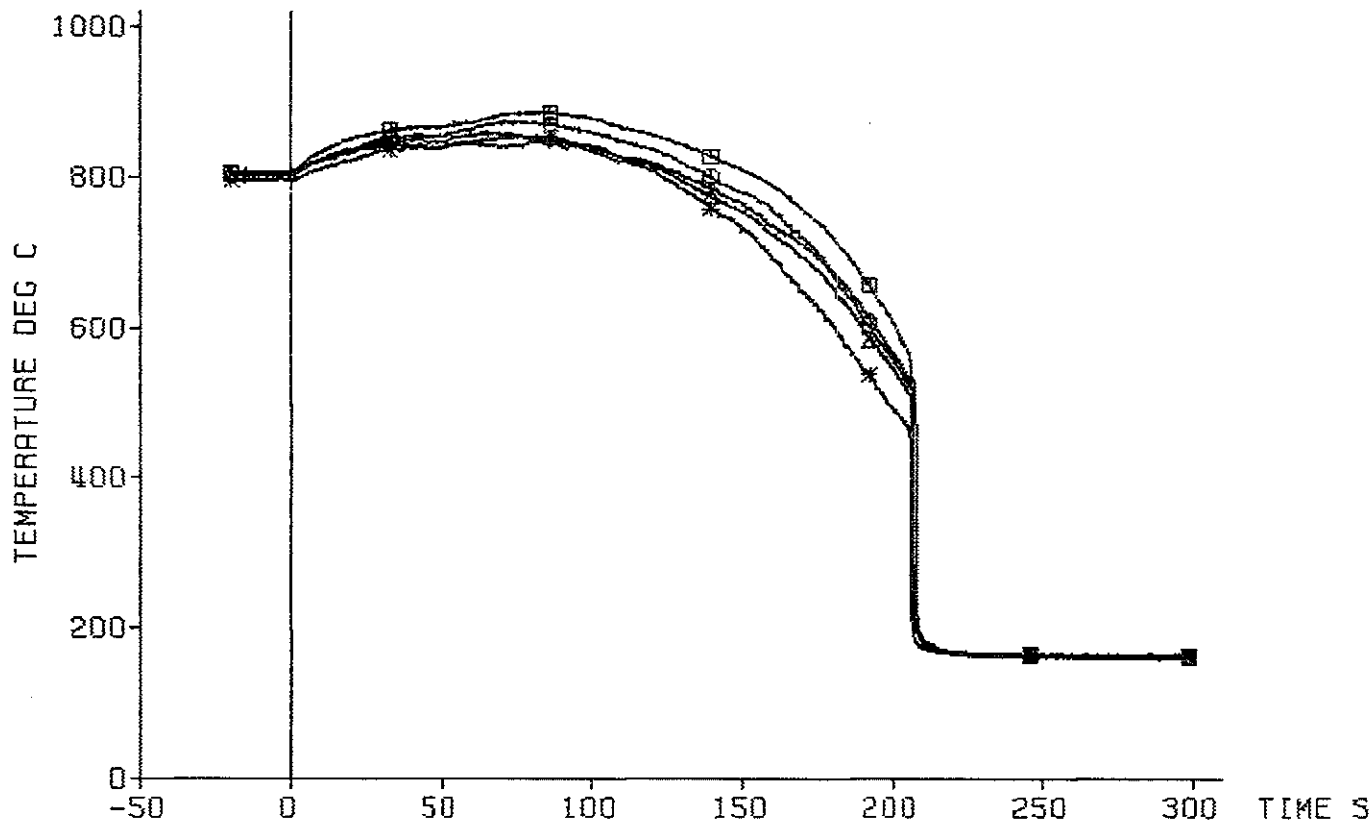

TC	ax. level
*	9h2 2025 mm
◇	8d4 2025 mm
△	8d3 2025 mm
⊙	8d2 2025 mm
□	8d1 2025 mm

decay heat 120% RMS standard
 flooding rate (cold) 3.80 cm/s
 system pressure 6.24 bar
 feedwater temperature 40 deg C

bypass
 =====



Fig. 248 FEBA: 5x5 ROD BUNDLE, TEST SERIES 3, TEST-No. 236

heat transfer coeff.

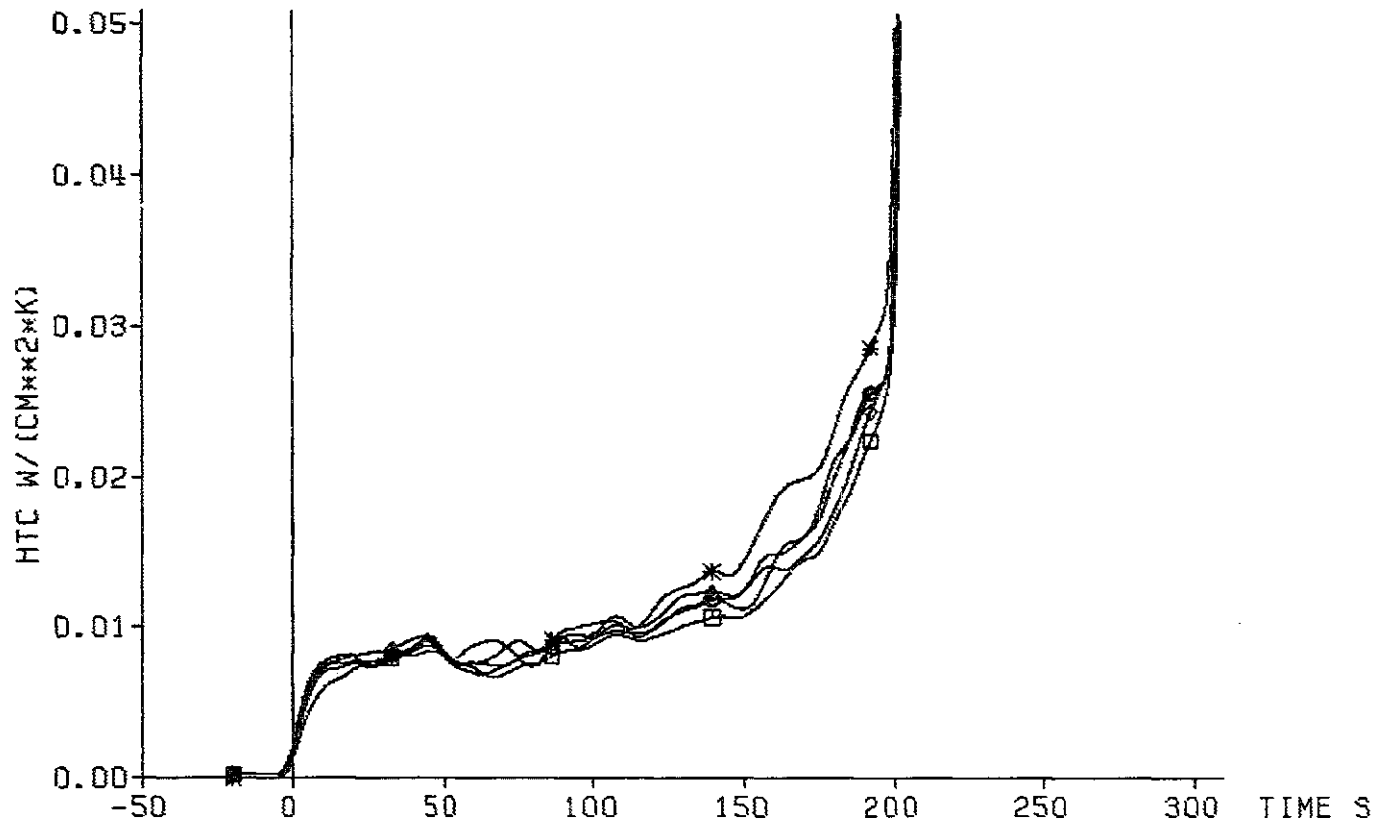

	TC	axial level
*	9h2	2025 mm
Δ	8d4	2025 mm
Δ	8d3	2025 mm
○	8d2	2025 mm
□	8d1	2025 mm

decay heat 120% ANS standard
 flooding rate (cold) 3.80 cm/s
 system pressure 6.24 bar
 feedwater temperature 40 deg C

bypass
=====



Fig. 249 FEBA: 5x5 ROD BUNDLE, TEST SERIES 3, TEST-No. 236

cladding temperature

TC	ax. level
○ 17h2	2025 mm
□ sleeve	2025 mm

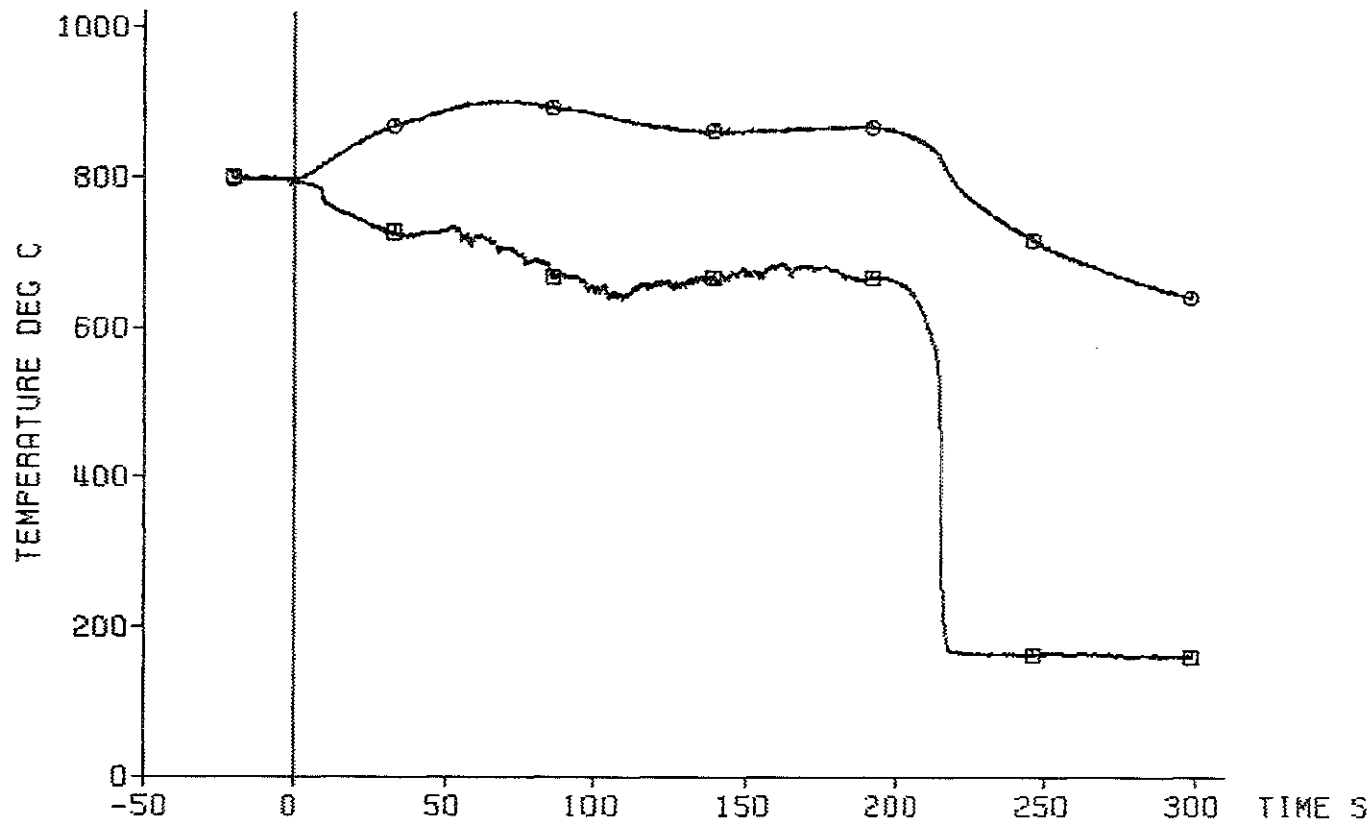

— 284 —

decay heat 120% ANS standard
flooding rate (cold) 3.80 cm/s
system pressure 6.24 bar
feedwater temperature 40 deg C

blockage
=====



Fig. 250 FEBA: 5x5 ROD BUNDLE, TEST SERIES 3, TEST-No. 236

cladding temperature

TC	axial level
○ 13d2	2025 mm
□ sleeve	2025 mm

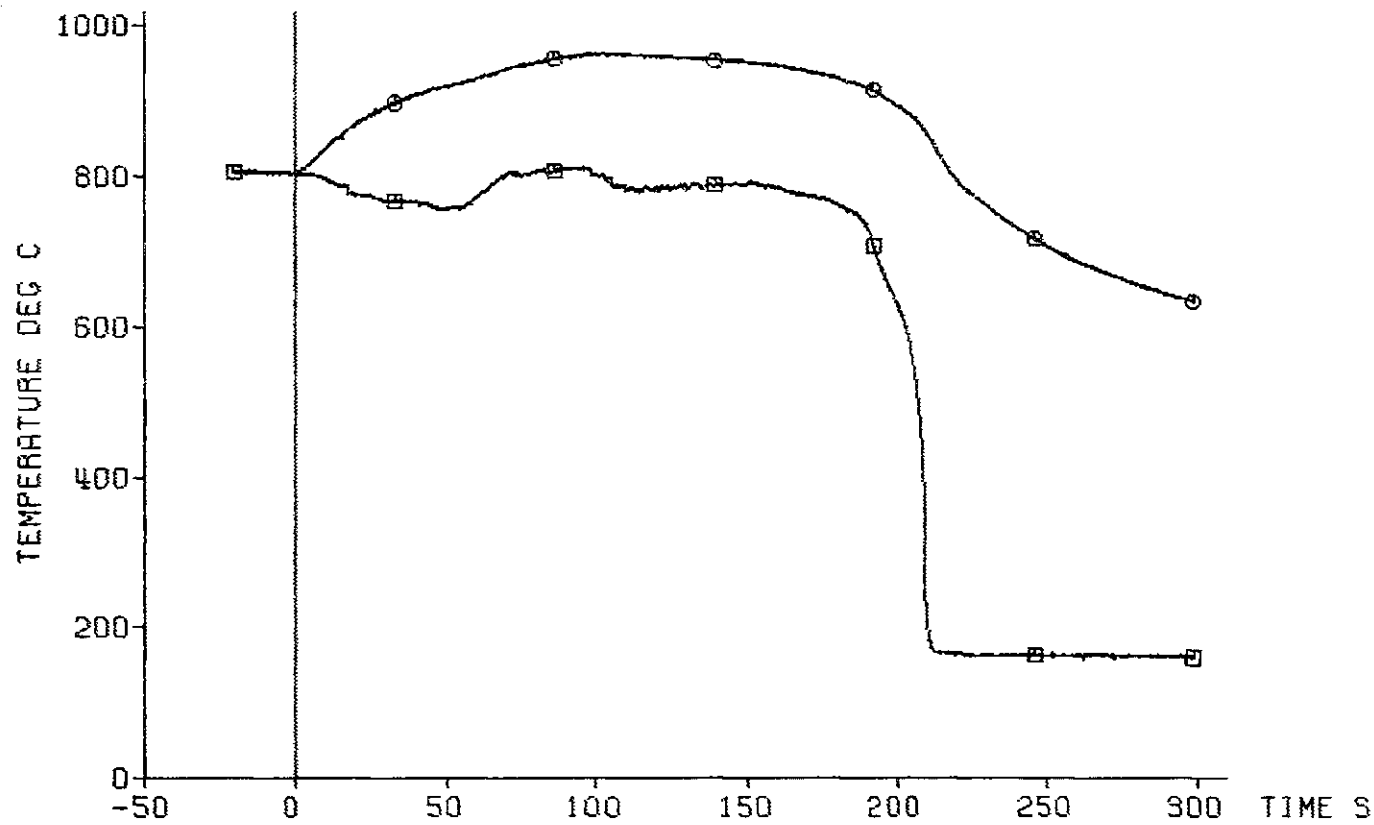

decay heat 120% ANS standard
 flooding rate (cold) 3.80 cm/s
 system pressure 6.24 bar
 feedwater temperature 40 deg C

blockage
 =====



Fig. 251 FEBA: 5x5 ROD BUNDLE, TEST SERIES 3, TEST-No. 236

cladding temperature

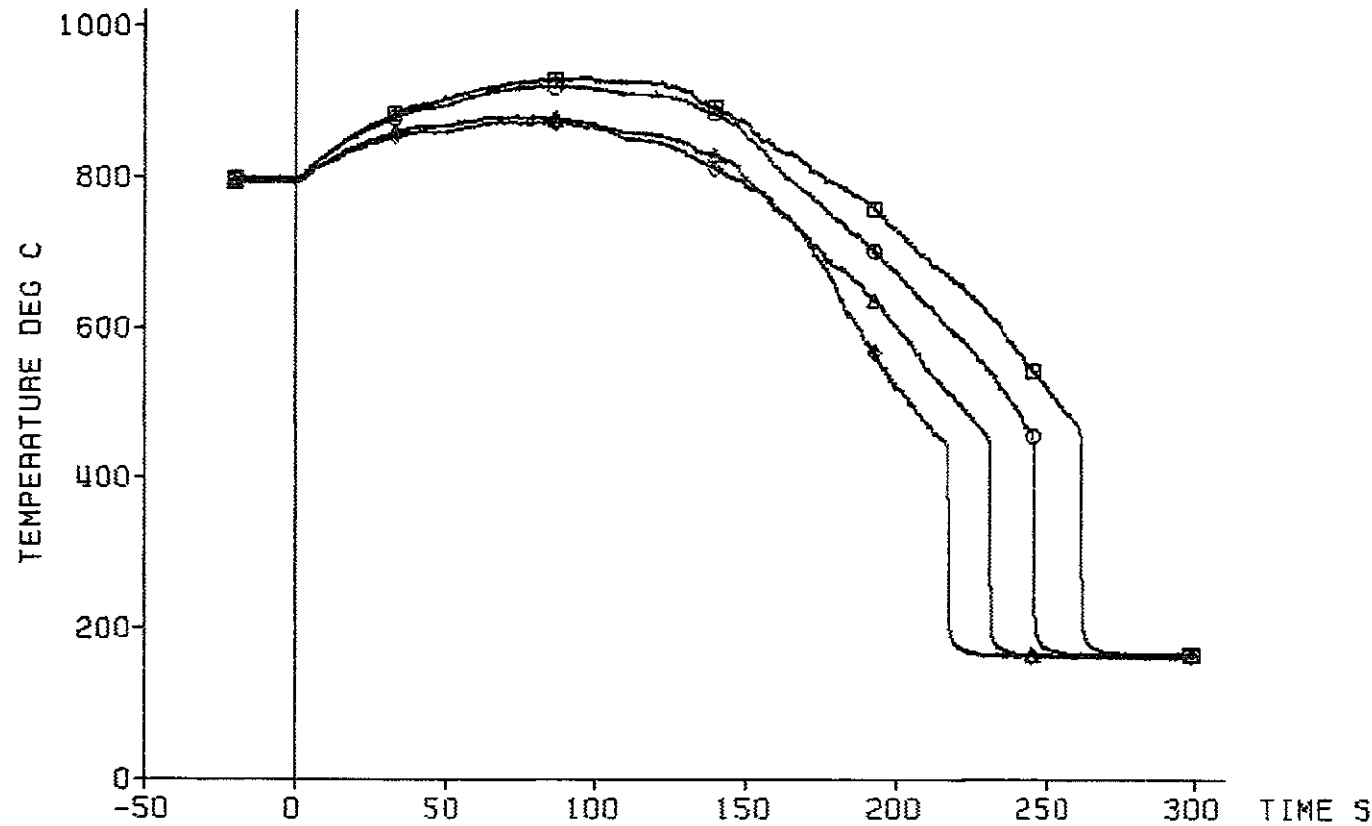

TC	ax. level
◇	9h1 1925 mm
△	19g3 1825 mm
○	19g2 1725 mm
□	19g1 1625 mm

decay heat 120% ANS standard
flooding rate (cold) 3.80 cm/s
system pressure 6.24 bar
feedwater temperature 40 deg C

bypass
=====



Fig. 252 FEBA: 5x5 ROD BUNDLE, TEST SERIES 3, TEST-No. 236

heat transfer coeff.

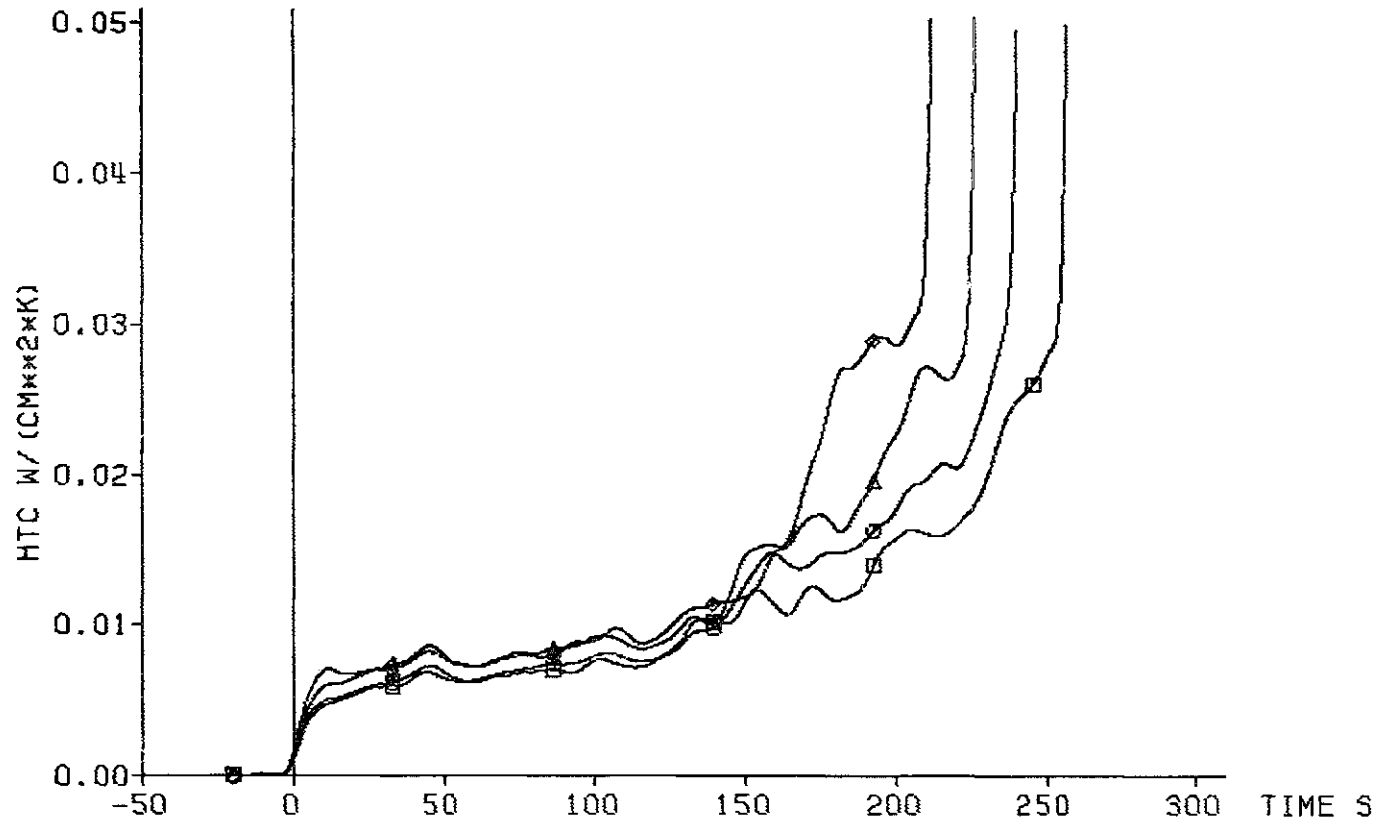

TC	ax. level
◇	9h1 1925 mm
△	19g3 1825 mm
○	19g2 1725 mm
□	19g1 1625 mm

decay heat
 flooding rate (cold) 3.80 cm/s
 system pressure 6.24 bar
 feedwater temperature 40 deg C

120% ANS standard

bypass
 =====



Fig. 253 FEBA: 5x5 ROD BUNDLE, TEST SERIES 3, TEST-NO. 236

cladding temperature

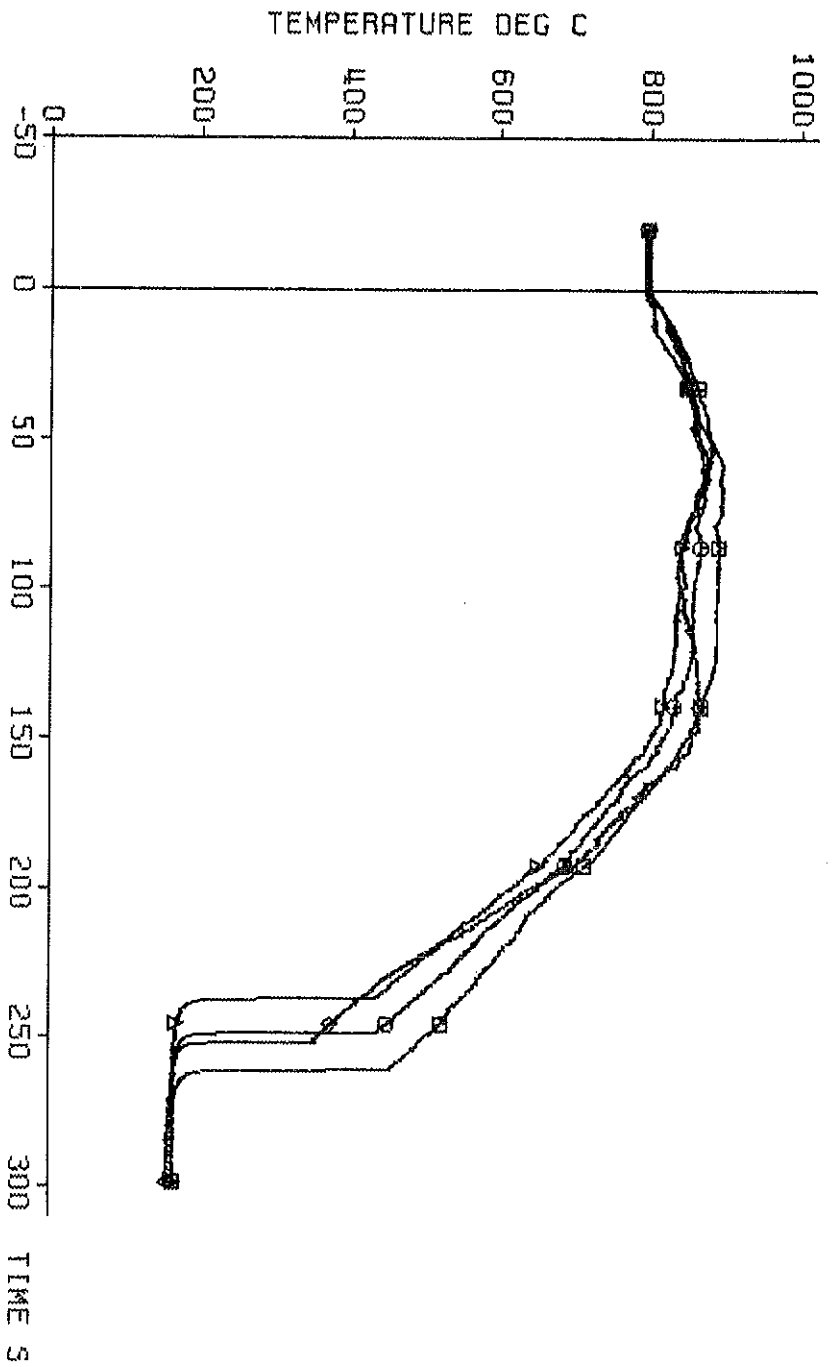

TC	ax. level
◆	17h1 1925 mm
▲	16g3 1825 mm
○	16g2 1725 mm
□	16g1 1625 mm

decay heat
 flooding rate (cold)
 system pressure
 feedwater temperature

120% RMS standard
 3.80 cm/s
 6.24 bar
 40 deg C

cladding
 =====

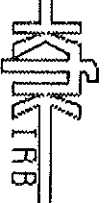
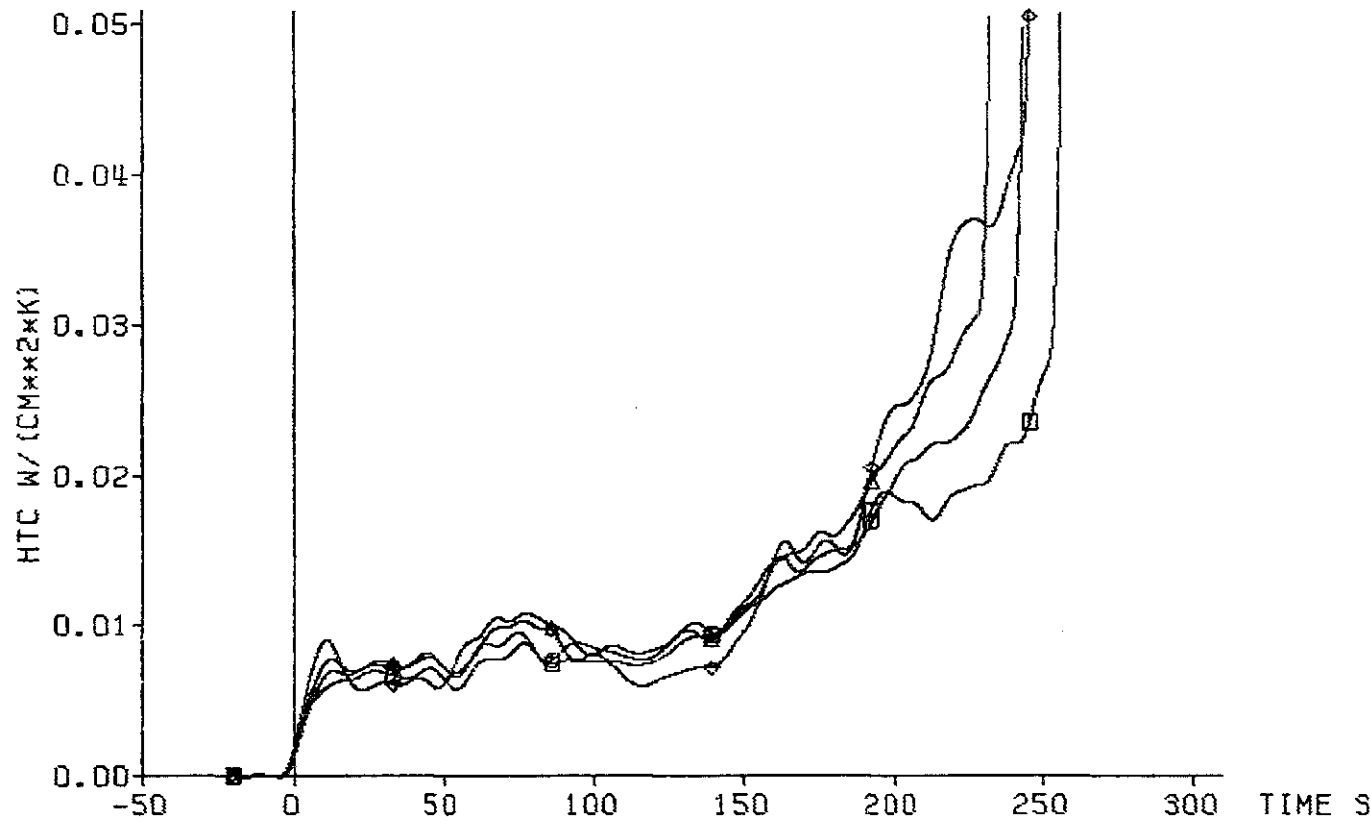

Fig. 254 FEBRA: 5X5 ROD BUNDLE, TEST SERIES 3, TEST-NO. 236

heat transfer coeff.



TC	ax. level
◇	17h1 1925 mm
△	16g3 1825 mm
○	16g2 1725 mm
□	16g1 1625 mm

decay heat 120% ANS standard
 flooding rate (cold) 3.80 cm/s
 system pressure 6.24 bar
 feedwater temperature 40 deg C

blockage
 =====



Fig. 255 FEBA: 5x5 ROD BUNDLE, TEST SERIES 3, TEST-No. 236

axial level: 1925 mm

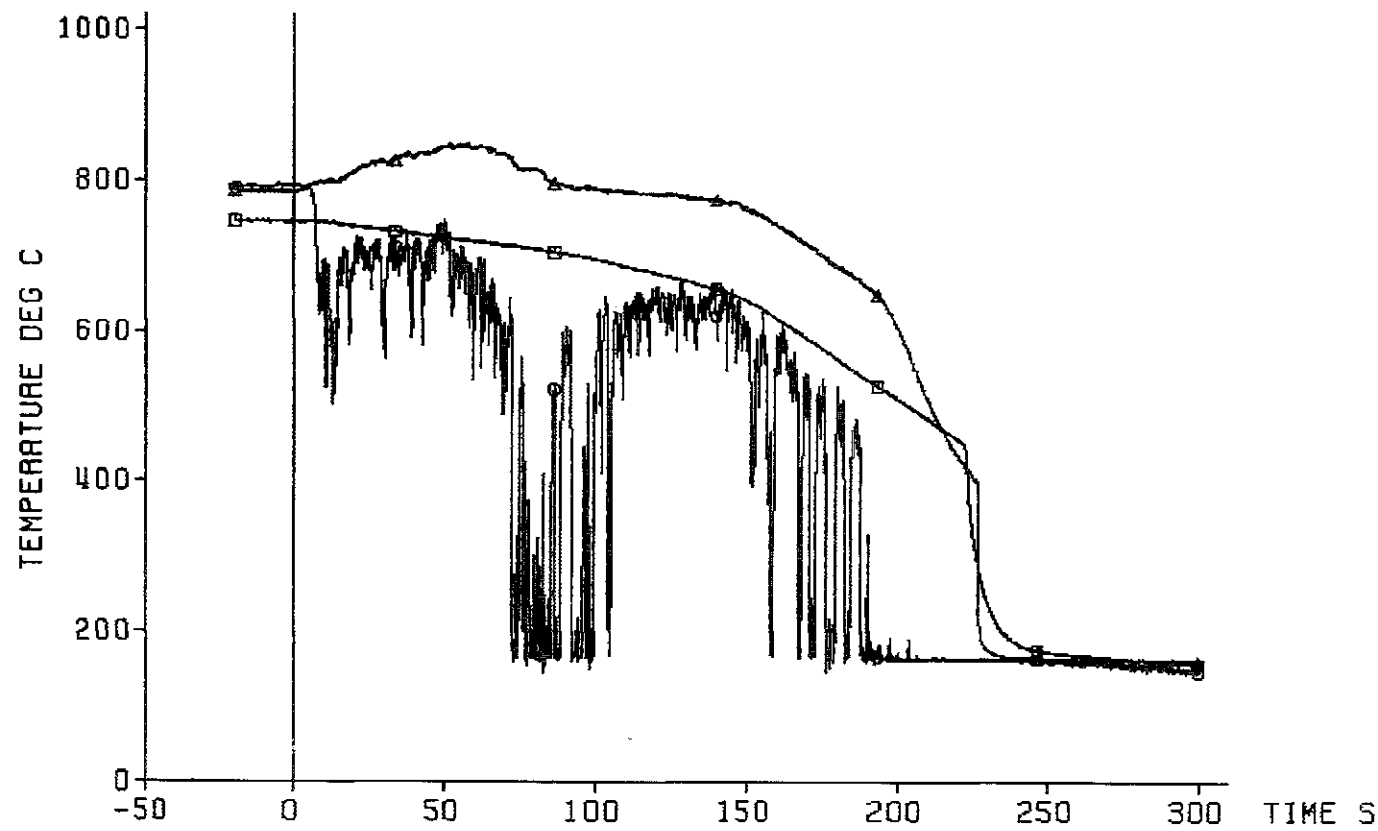

decay heat 120% RNS standard
flooding rate (cold) 3.80 cm/s
system pressure 6.24 bar
feedwater temperature 40 deg C

blockage
=====

KfK
IRB

Fig. 256 FEBA: 5x5 ROD BUNDLE, TEST SERIES 3, TEST-No. 236

axial level: 1725 mm

▲ cladding temperature (16g2)
○ fluid temperature
□ housing temperature

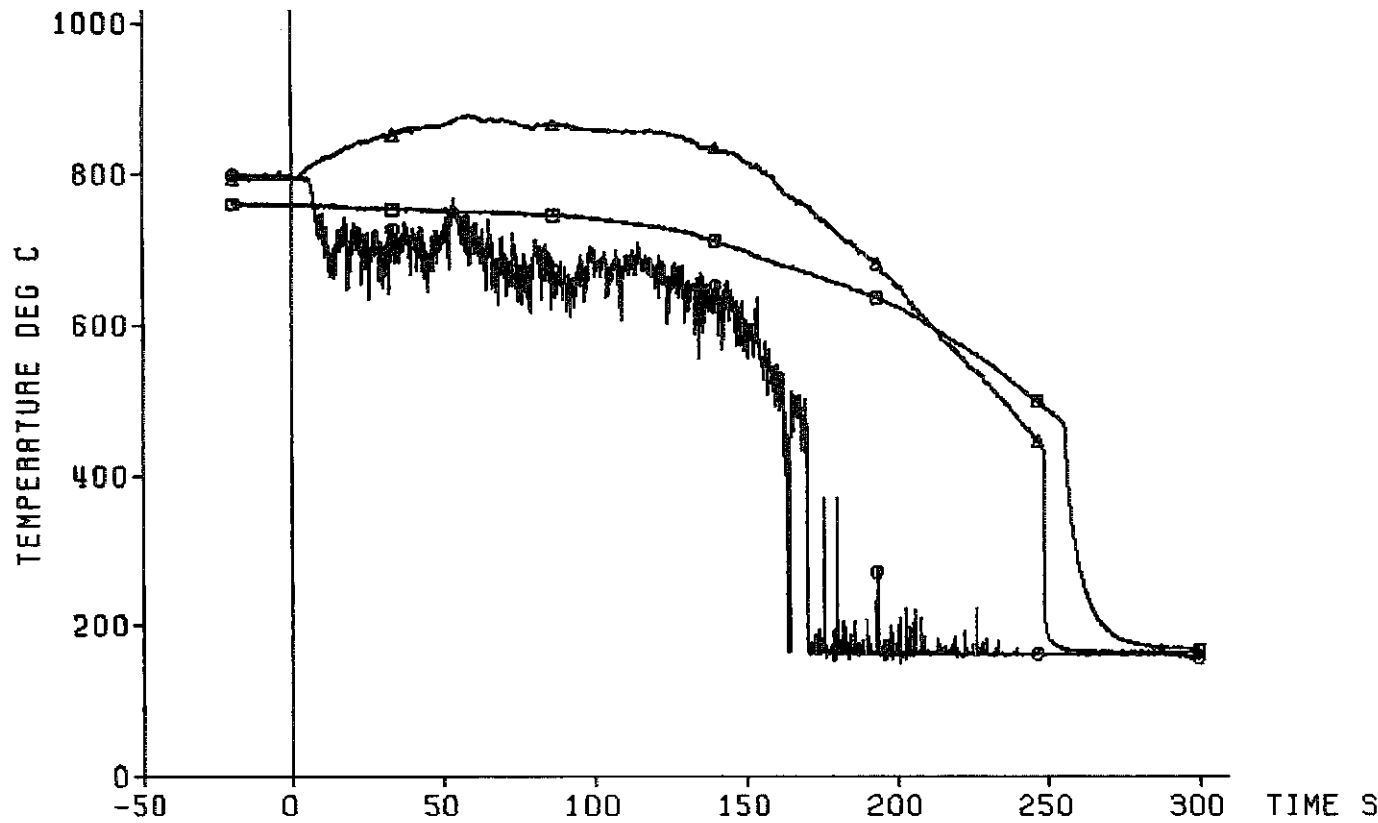

decay heat 120% ANS standard
flooding rate (cold) 3.80 cm/s
system pressure 6.24 bar
feedwater temperature 40 deg C

blockage
=====

KIK
IRB

Fig. 257 FEBA: 5x5 ROD BUNDLE, TEST SERIES 3, TEST-No. 236

axial level: 1625 mm

△ cladding temperature (16g1)
○ fluid temperature
□ housing temperature

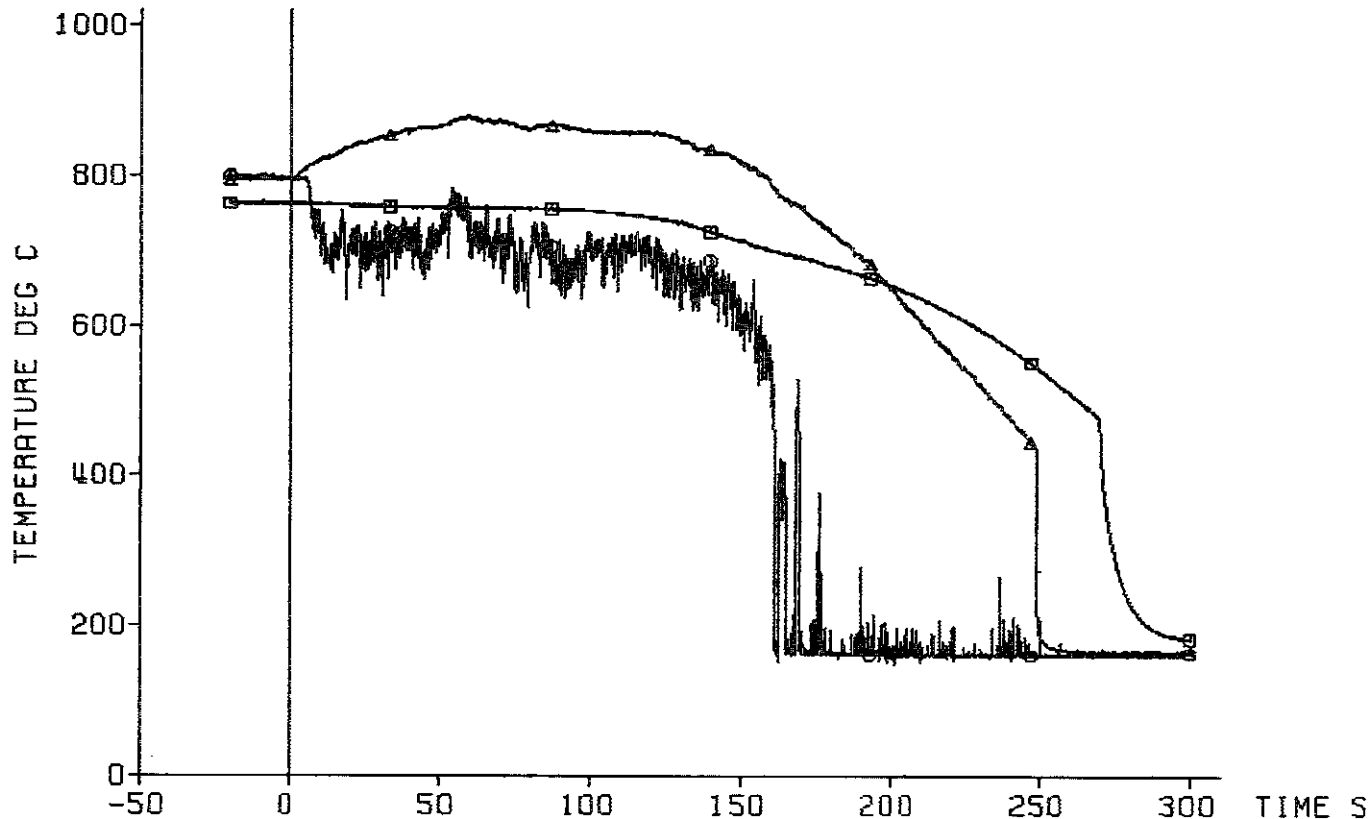

decay heat 120% ANS standard
flooding rate (cold) 3.80 cm/s
system pressure 6.24 bar
feedwater temperature 40 deg C

△ blockage



Fig. 258 FEBA: 5x5 ROD BUNDLE, TEST SERIES 3, TEST-No. 236

pressure loss
along the test section:

◇ total length: 4196 mm
△ lower part: 1711 mm
○ middle part: 545 mm
□ upper part: 1940 mm

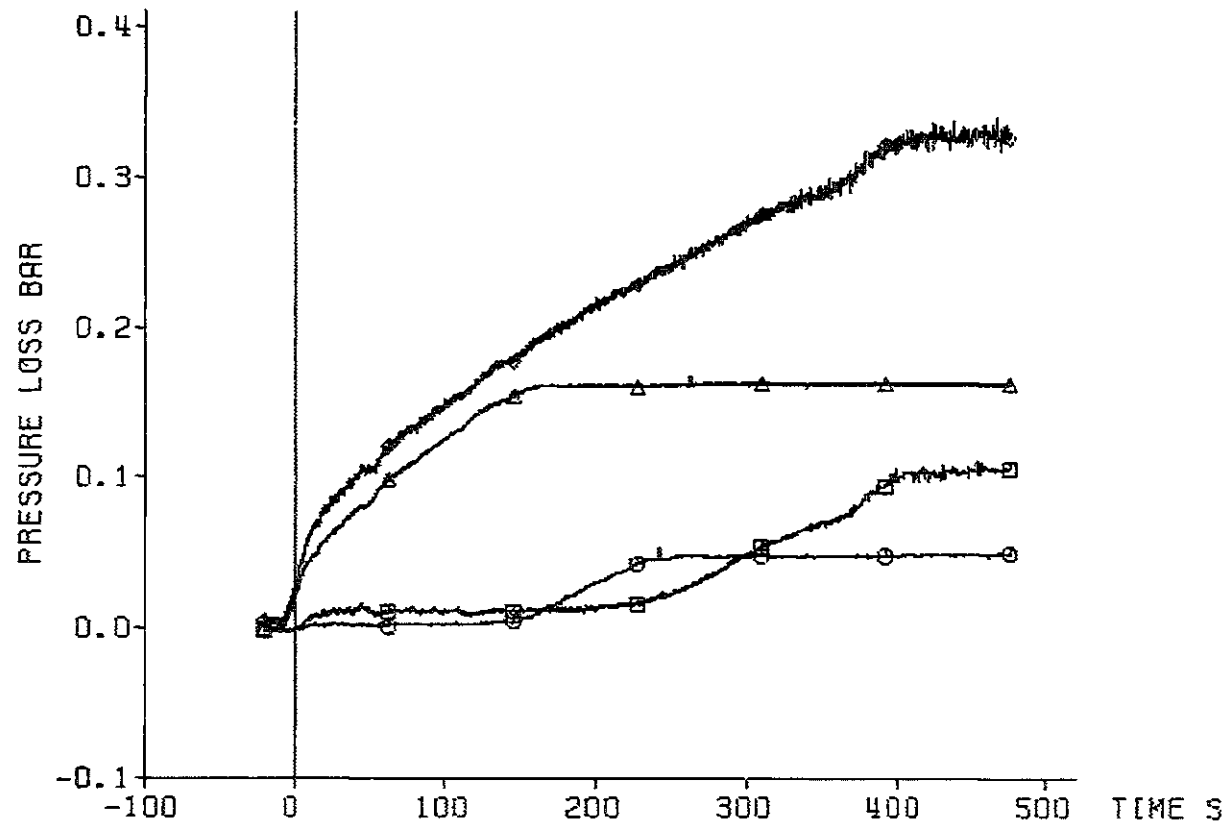

decay heat 120% ANS standard
flooding rate (cold) 3.80 cm/s
system pressure 6.24 bar
feedwater temperature 40 deg C



Fig. 259 FEBA: 5x5 ROD BUNDLE, TEST SERIES 3, TEST-No. 236

coolant outlet conditions:

△ water carry over
○ coolant temperature
□ coolant pressure

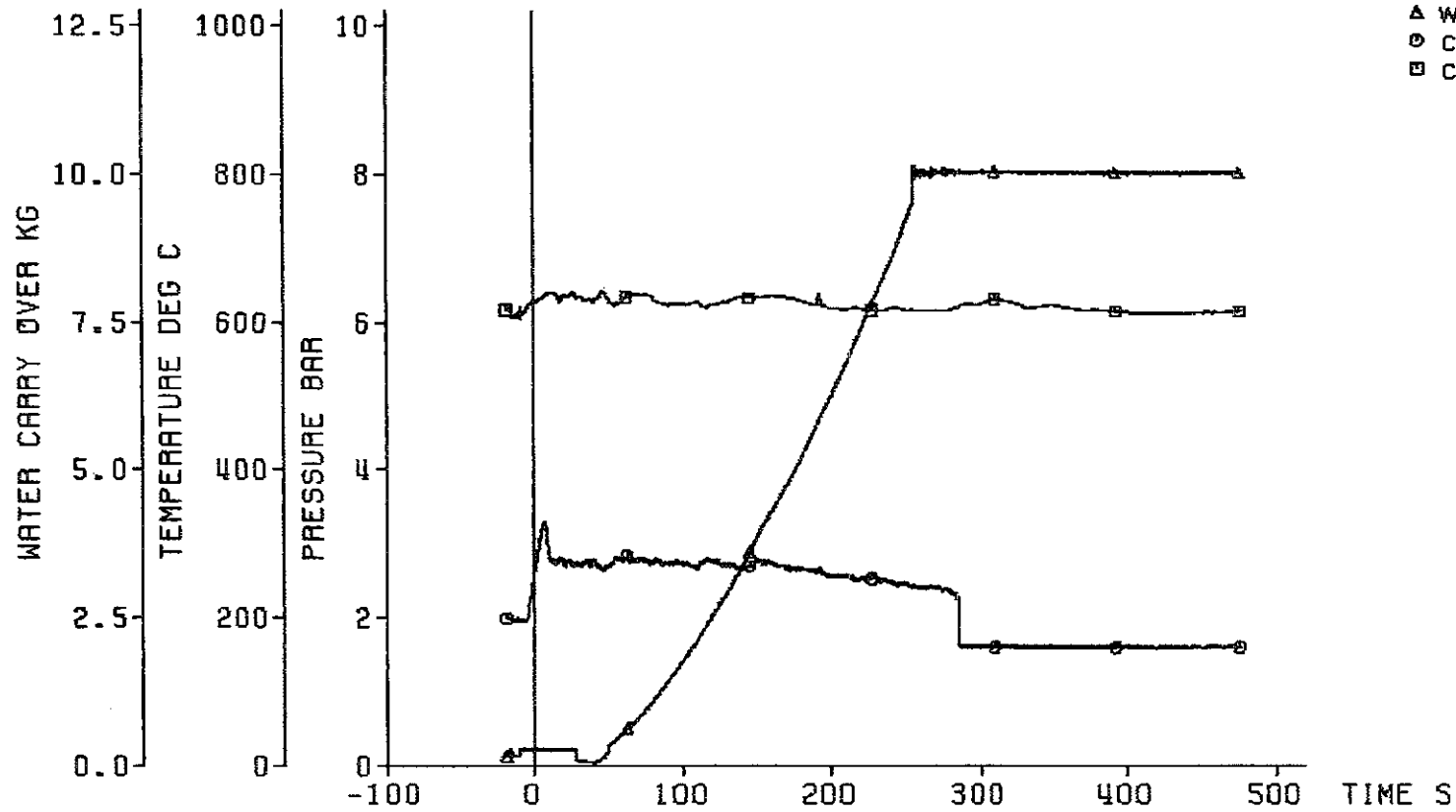

decay heat 120% ANS standard
flooding rate (cold) 3.80 cm/s
system pressure 6.24 bar
feedwater temperature 40 deg C

KIK IRB

Fig. 260 FEBA: 5x5 ROD BUNDLE, TEST SERIES 3, TEST-No. 236

axial position of the quench front

- rewetting of the sleeve at the bundle midplane
- x rewetting of the rod downstream of the blockage

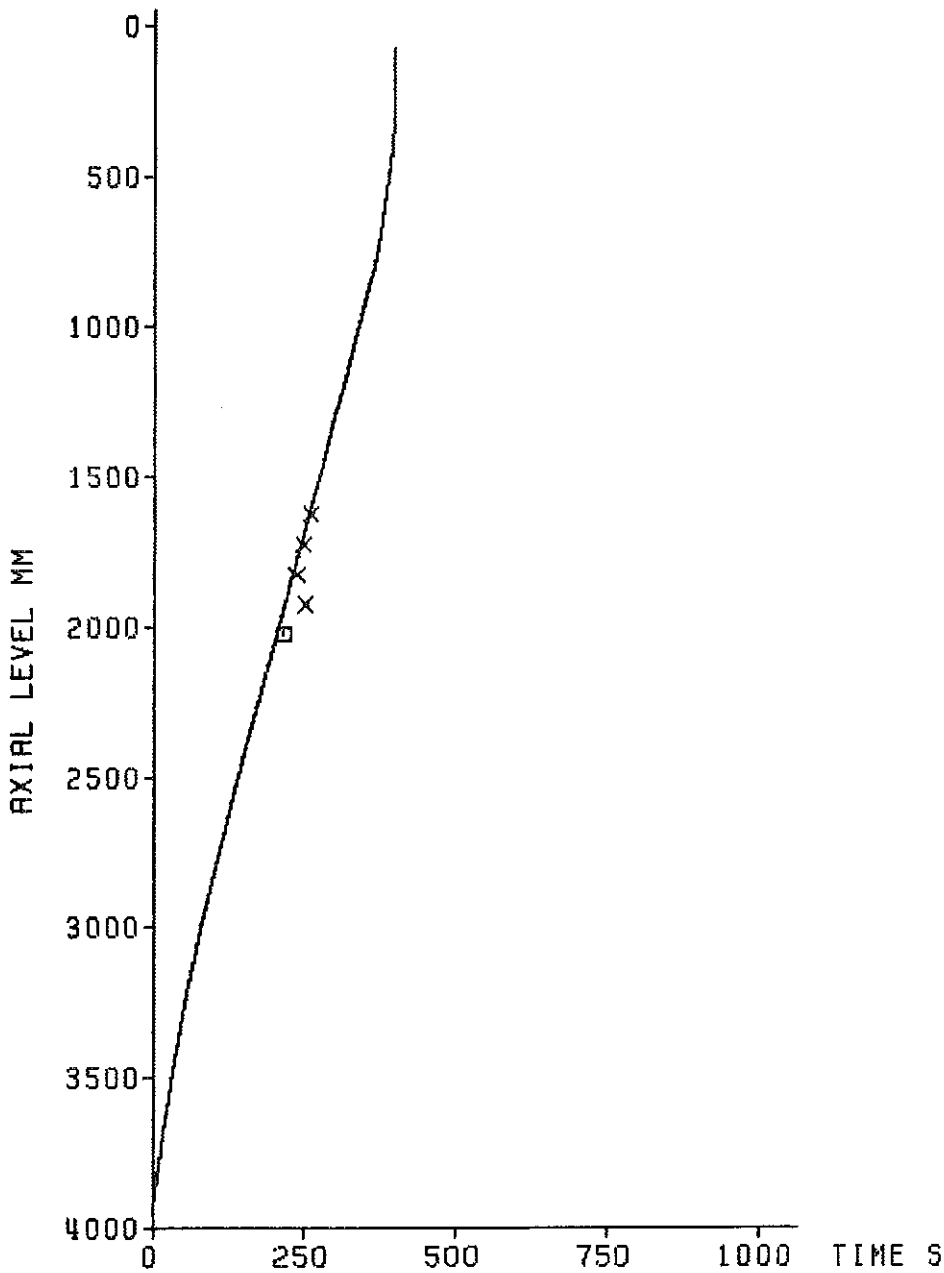

decay heat	120% ANS standard
flooding rate (cold)	3.80 cm/s
system pressure	6.24 bar
feedwater temperature	40 deg C

KJK
IRB

Fig. 261 FEBA: 5x5 ROD BUNDLE
TEST SERIES 3, TEST-No. 236

initial axial temperature profile of the cladding

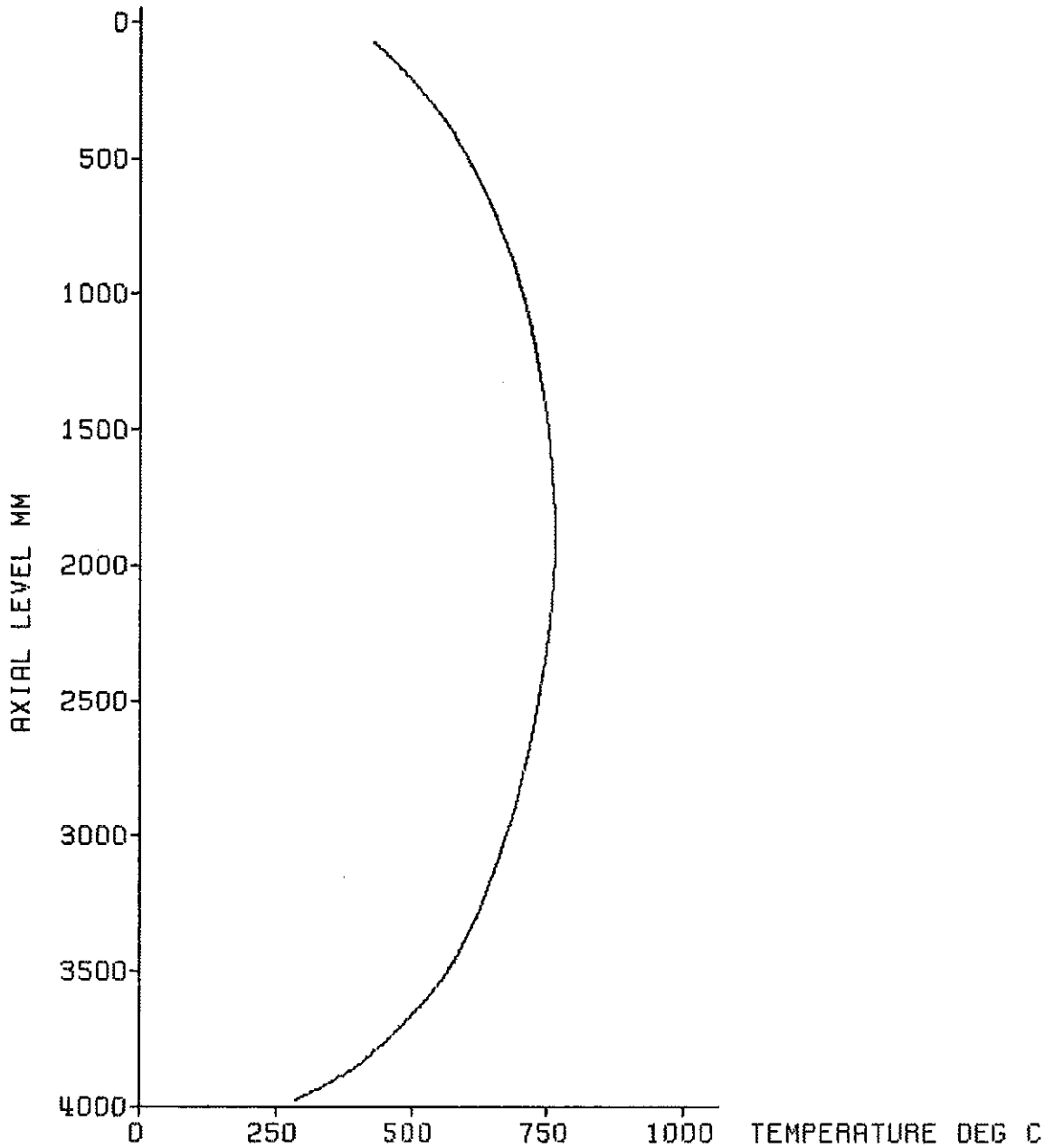

decay heat	120% ANS standard
flooding rate (cold)	5.80 cm/s
system pressure	1.93 bar
feedwater temperature	40 deg C



Fig. 262 FEBA: 5x5 ROD BUNDLE
TEST SERIES 3, TEST-No. 240

test parameters:

- ◊ flooding rate
- △ system pressure
- feedwater temperature
- bundle power

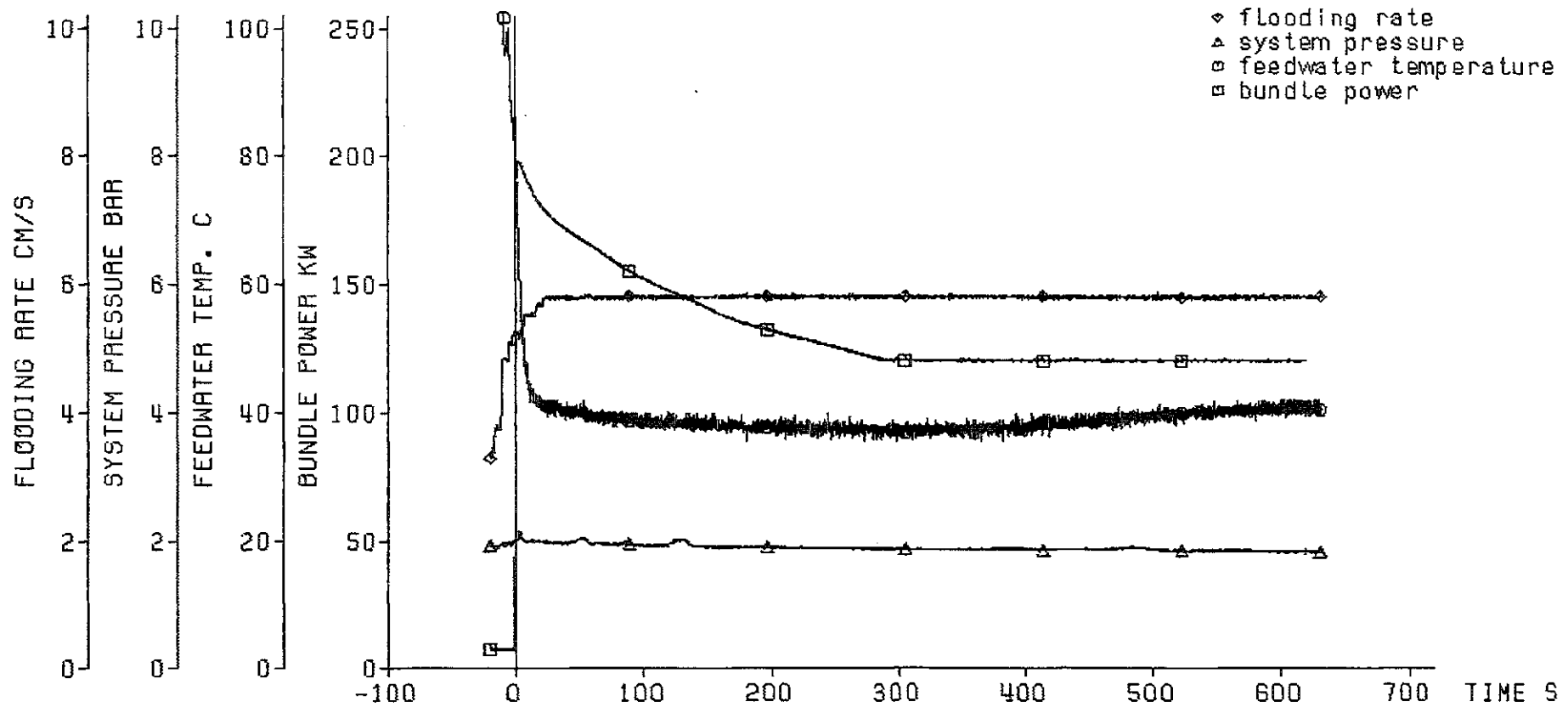

— 297 —

decay heat 120% ANS standard
flooding rate (cold) 5.80 cm/s
system pressure 1.93 bar
feedwater temperature 40 deg C



Fig. 263 FEBA: 5x5 R0D BUNDLE, TEST SERIES 3, TEST-No. 240

cladding temperature

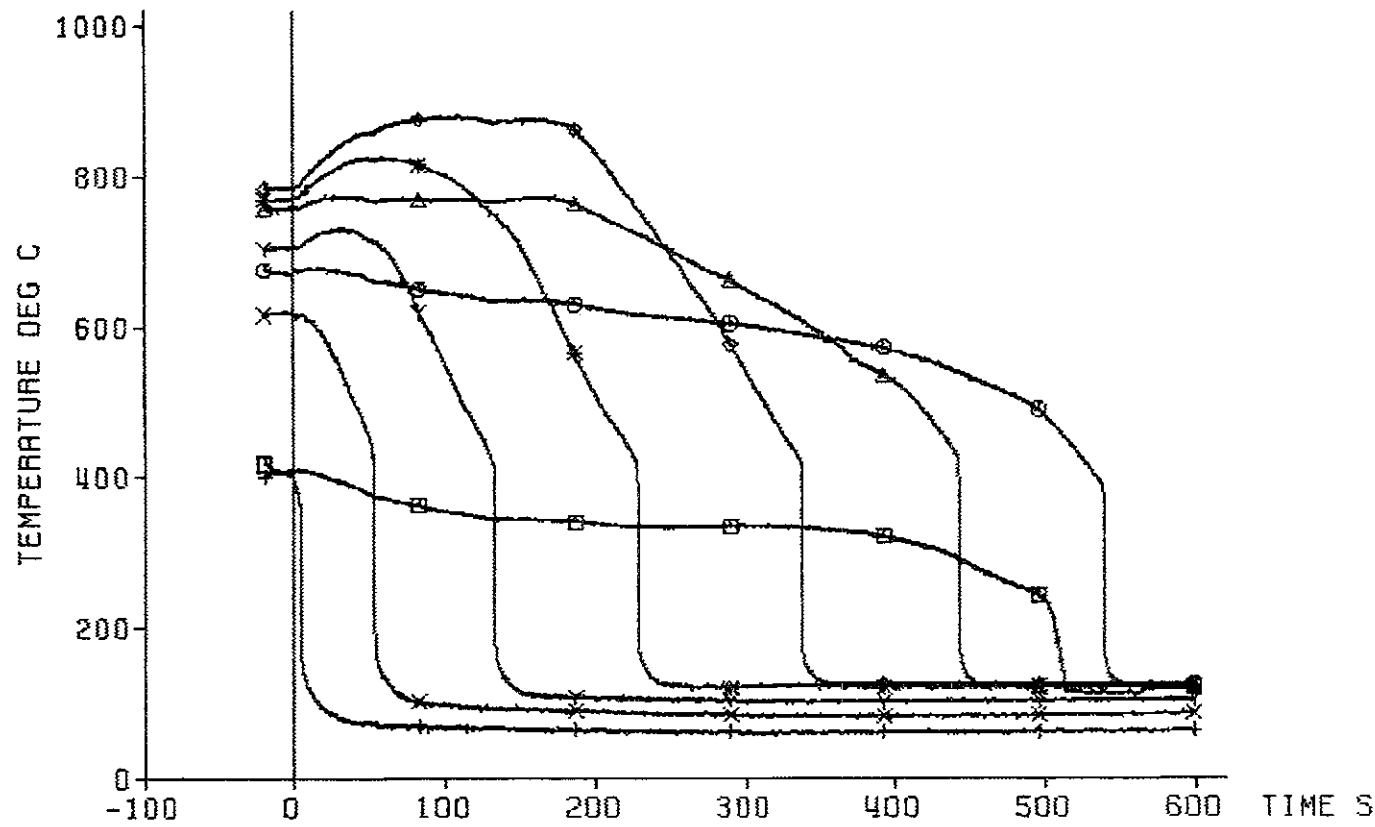

TC	ax. Level
+	18a4 3860 mm
x	18a3 3315 mm
Y	18a2 2770 mm
*	18a1 2225 mm
◇	12b4 1680 mm
△	12b3 1135 mm
○	12b2 590 mm
□	12b1 45 mm

decay heat 120% ANS standard
 flooding rate (cold) 5.80 cm/s
 system pressure 1.93 bar
 feedwater temperature 40 deg C



Fig. 264 FEBA: 5x5 ROD BUNDLE, TEST SERIES 3, TEST-No. 240

heat transfer coeff.

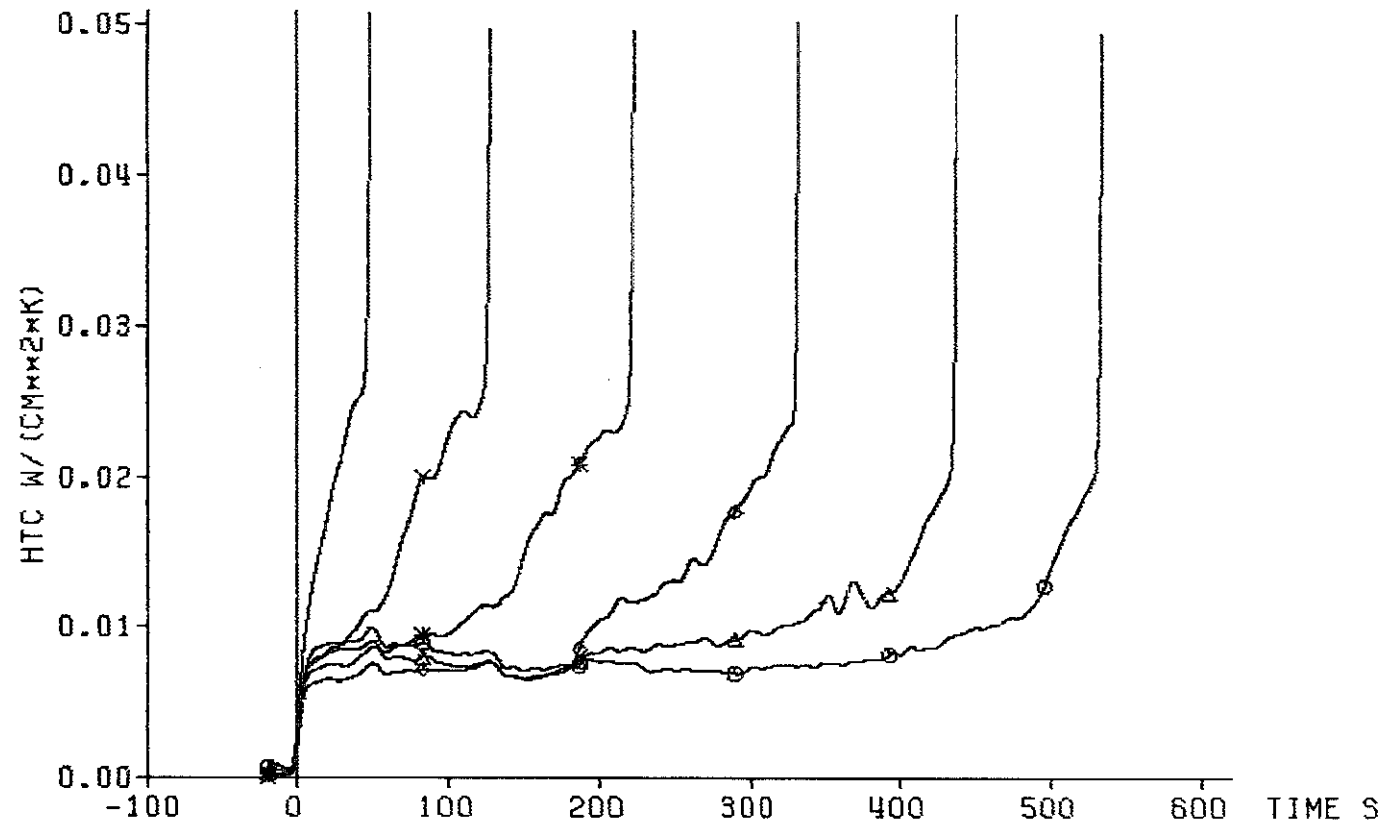

	TC	ax. Level
x	18a3	3315 mm
γ	18a2	2770 mm
*	18a1	2225 mm
◇	12b4	1680 mm
△	12b3	1135 mm
○	12b2	590 mm

decay heat 120% ANS standard
 flooding rate (cold) 5.80 cm/s
 system pressure 1.93 bar
 feedwater temperature 40 deg C



Fig. 265 FEBA: 5x5 ROD BUNDLE, TEST SERIES 3, TEST-No. 240

cladding temperature

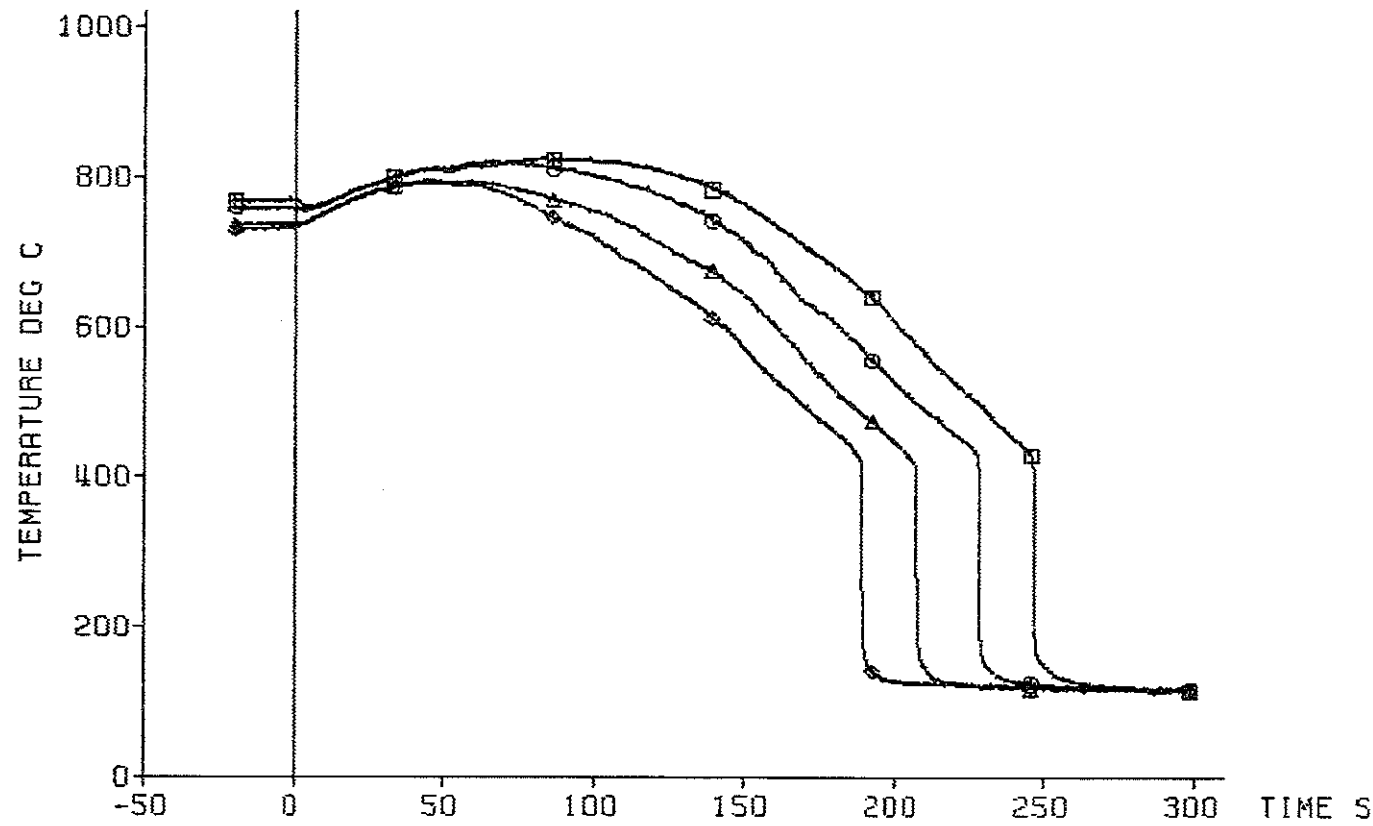

TC	ax. level
◇	7f4 2425 mm
△	7f3 2325 mm
○	9h4 2225 mm
□	9h3 2125 mm

— 300 —

decay heat 120% AWS standard
 flooding rate (cold) 5.80 cm/s
 system pressure 1.93 bar
 feedwater temperature 40 deg C

bypass
 =====



Fig. 266 FEBA: 5x5 ROD BUNDLE, TEST SERIES 3, TEST-No. 240

heat transfer coeff.

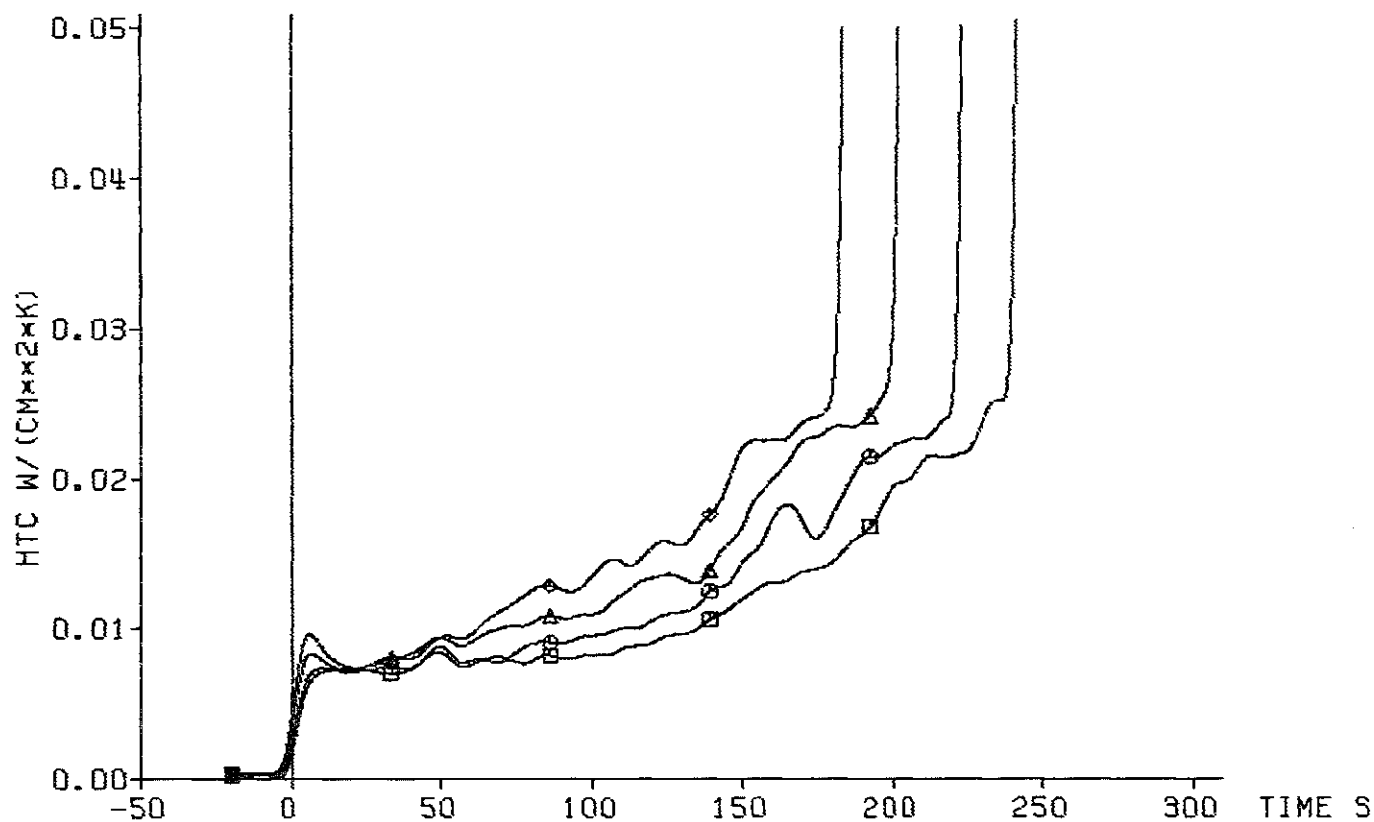

TC	ax. Level
◇	7f4 2425 mm
△	7f3 2325 mm
○	9h4 2225 mm
□	9h3 2125 mm

decay heat
 flooding rate (cold) 5.80 cm/s
 system pressure 1.93 bar
 feedwater temperature 40 deg C

120% ANS standard

bypass
 =====



Fig. 267 FEBA: 5x5 ROD BUNDLE, TEST SERIES 3, TEST-No. 240

cladding temperature

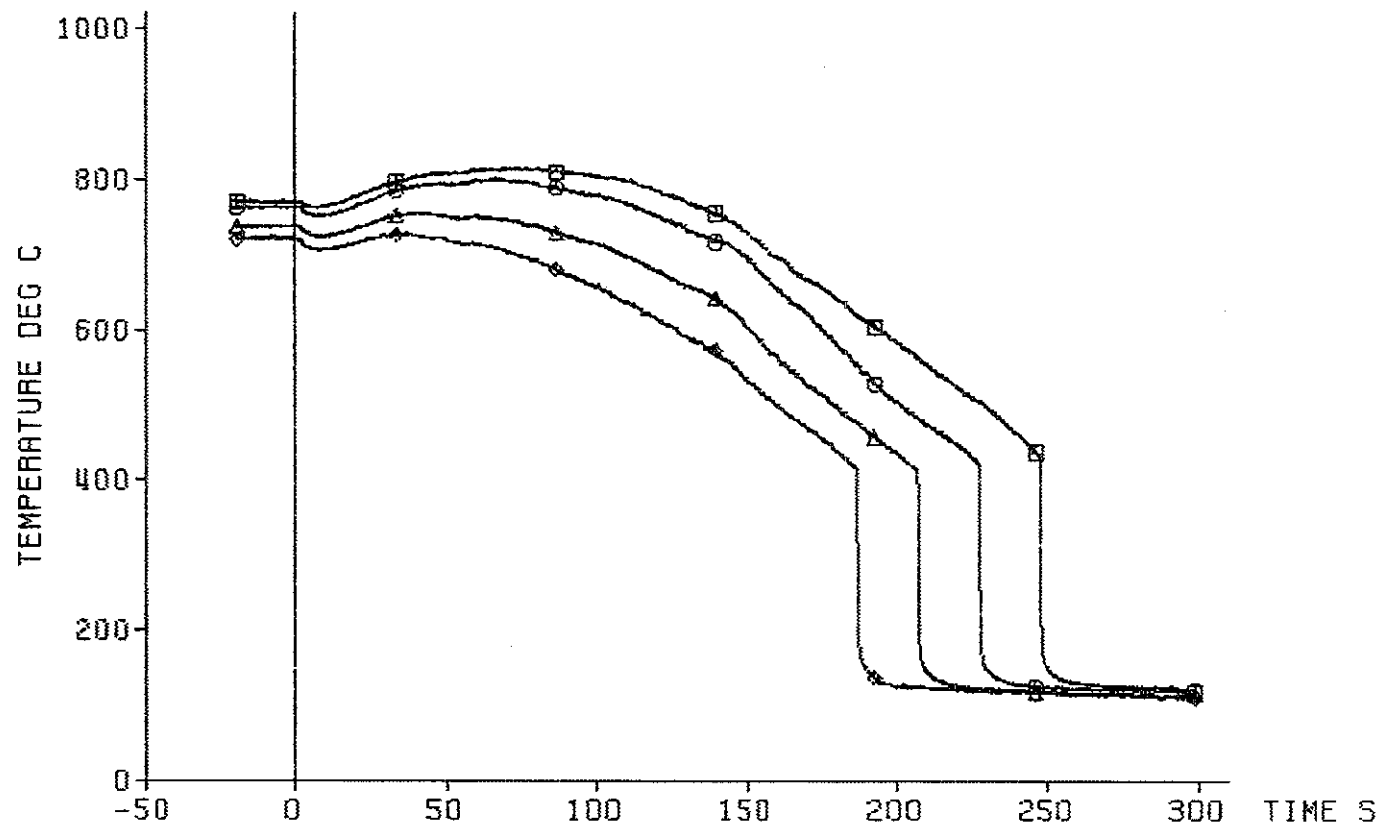

TC	ax. Level
◇ 22f4	2425 mm
△ 22f3	2325 mm
○ 17h4	2225 mm
□ 17h3	2125 mm

decay heat 120% RMS standard
 flooding rate (cold) 5.80 cm/s
 system pressure 1.93 bar
 feedwater temperature 40 deg C

blockage
 =====



Fig. 268 FEBA: 5x5 ROD BUNDLE, TEST SERIES 3, TEST-No. 240

heat transfer coeff.

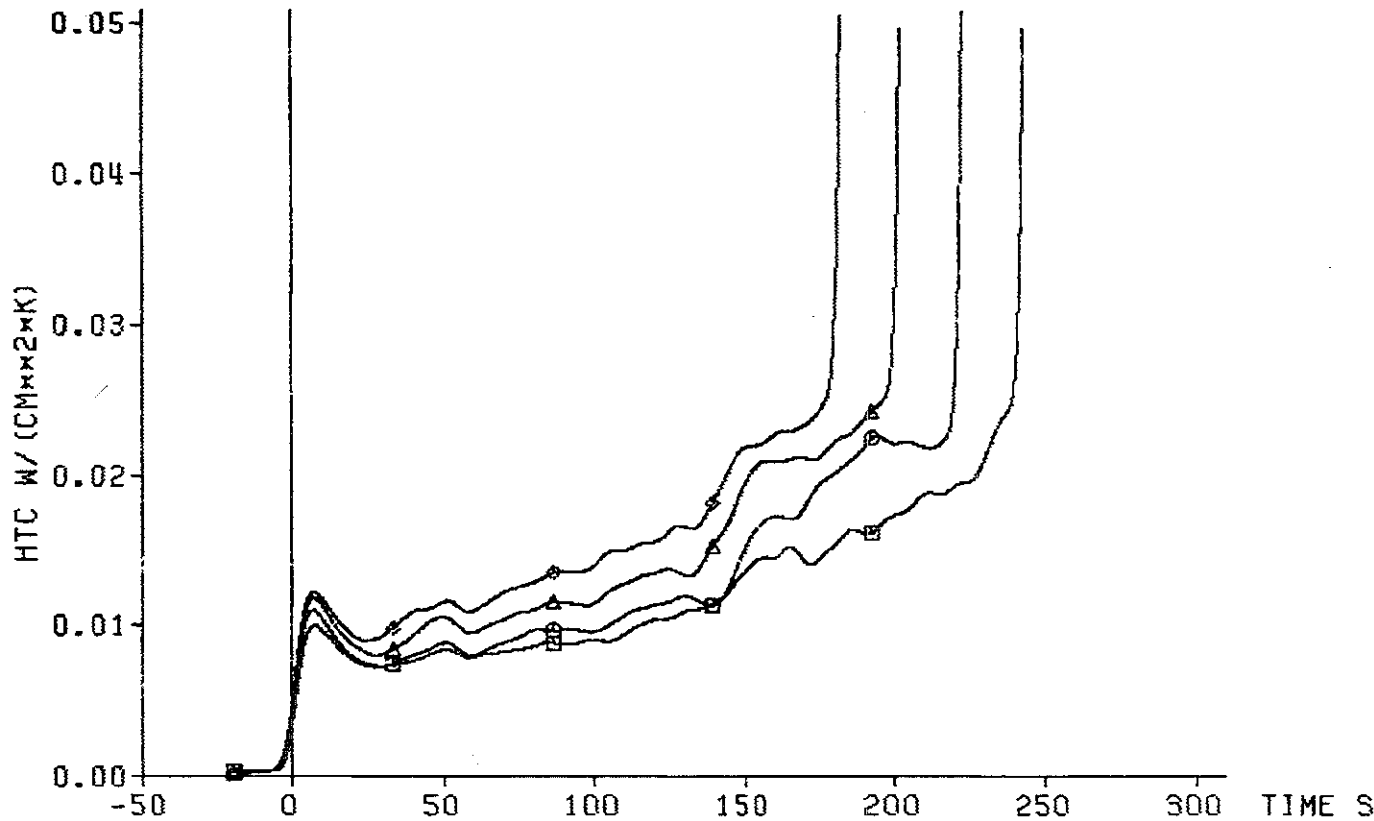

TC	ax. Level
◇ 22f4	2425 mm
△ 22f3	2325 mm
○ 17h4	2225 mm
□ 17h3	2125 mm

decay heat 120% ANS standard
 flooding rate (cold) 5.80 cm/s
 system pressure 1.93 bar
 feedwater temperature 40 deg C

blockage
 =====



Fig. 269 FEBA: 5x5 ROD BUNDLE, TEST SERIES 3, TEST-No. 240

cladding temperature

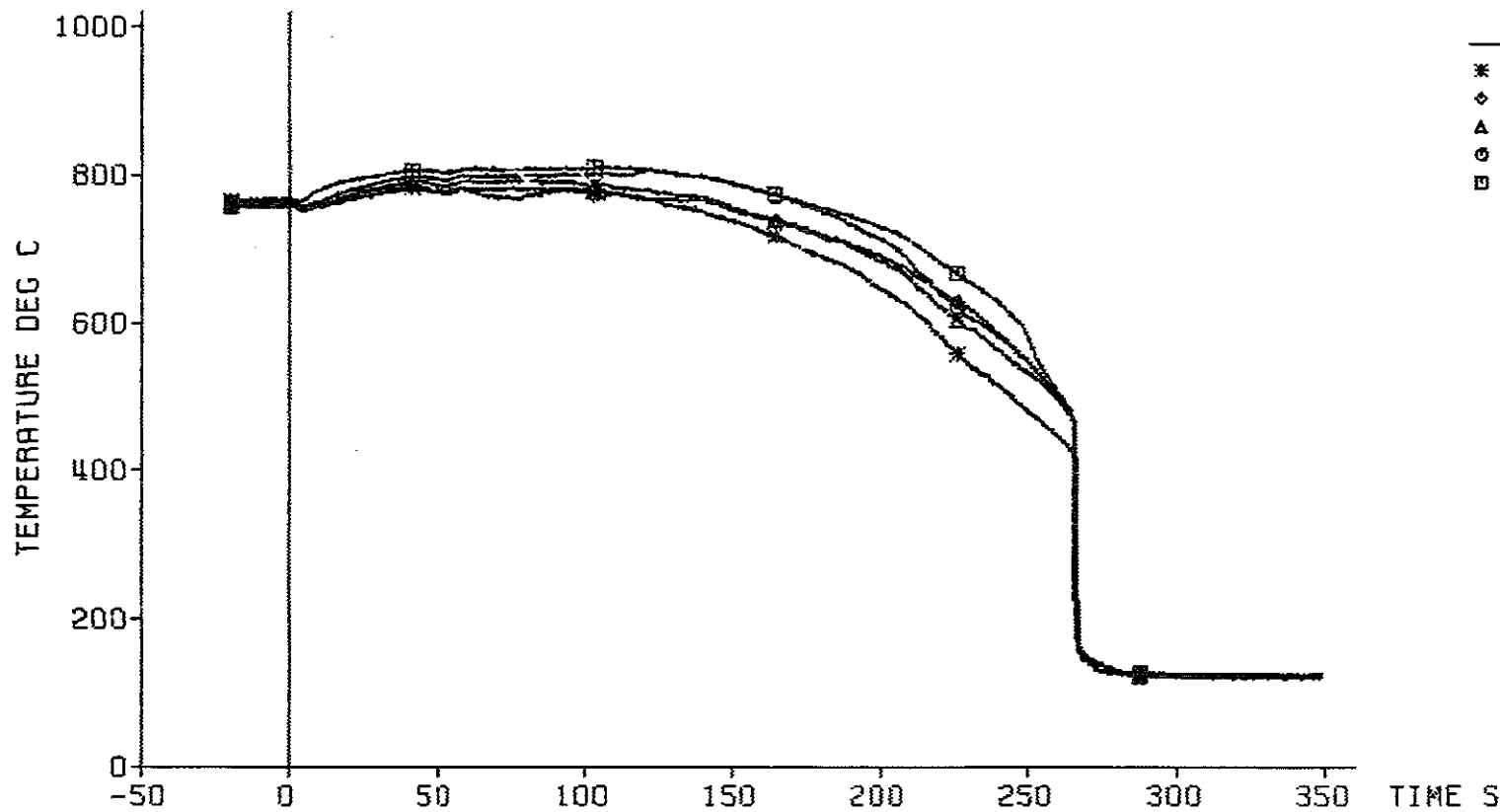

TC	ax. level
* 9h2	2025 mm
◇ 8d4	2025 mm
△ 8d3	2025 mm
⊙ 8d2	2025 mm
⊞ 8d1	2025 mm

decay heat 120% RMS standard
 flooding rate (cold) 5.80 cm/s
 system pressure 1.93 bar
 feedwater temperature 40 deg C

bypass
 =====



Fig. 270 FEBA: 5x5 ROD BUNDLE, TEST SERIES 3, TEST-No. 240

heat transfer coeff.

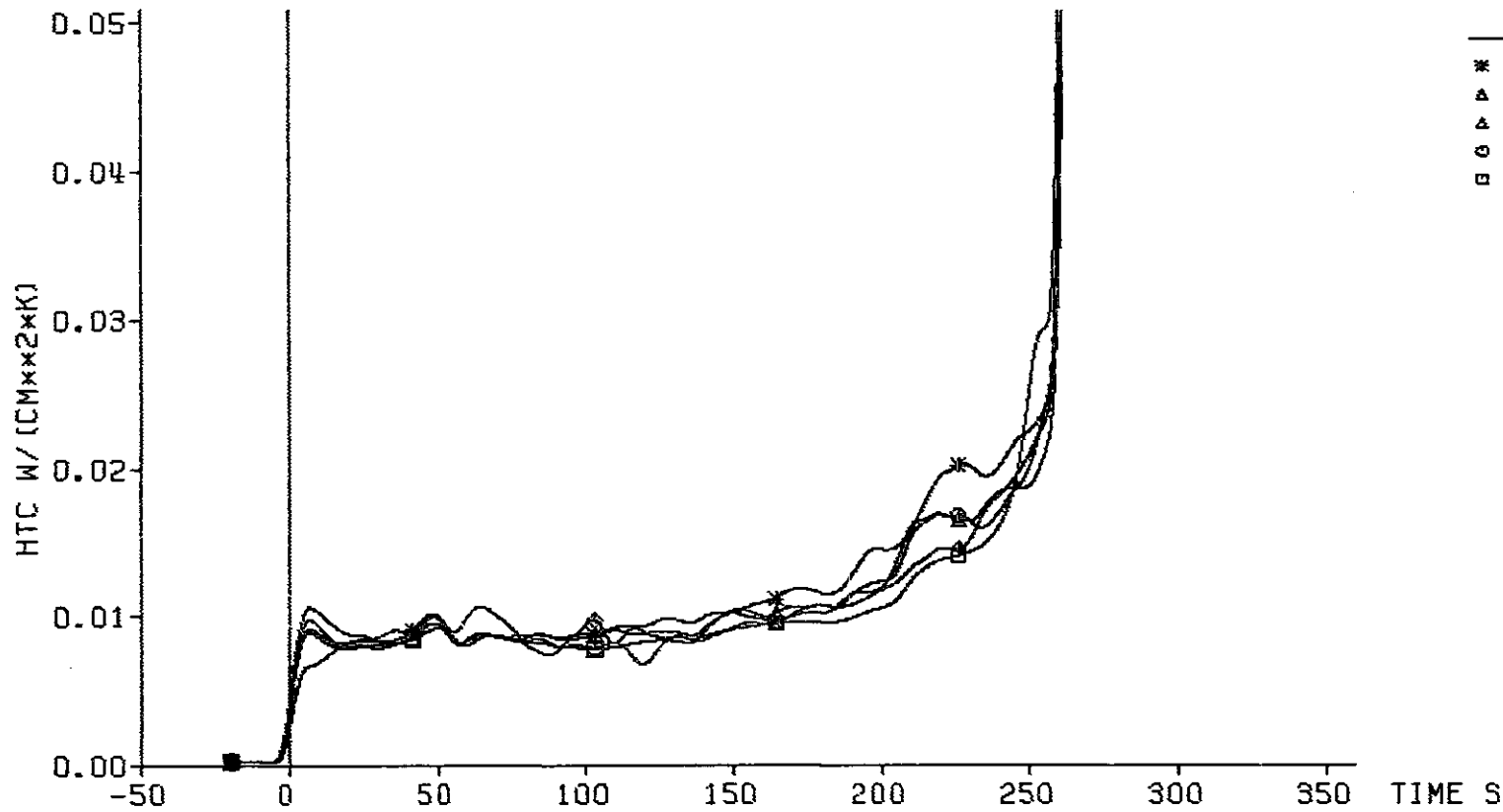

	TC	axial Level
*	9h2	2025 mm
Δ	8d4	2025 mm
∇	8d3	2025 mm
○	8d2	2025 mm
□	8d1	2025 mm

decay heat 120% ANS standard
 flooding rate (cold) 5.80 cm/s
 system pressure 1.93 bar
 feedwater temperature 40 deg C

bypass
 =====



Fig. 271 FEBA: 5x5 ROD BUNDLE, TEST SERIES 3, TEST-No. 240

cladding temperature

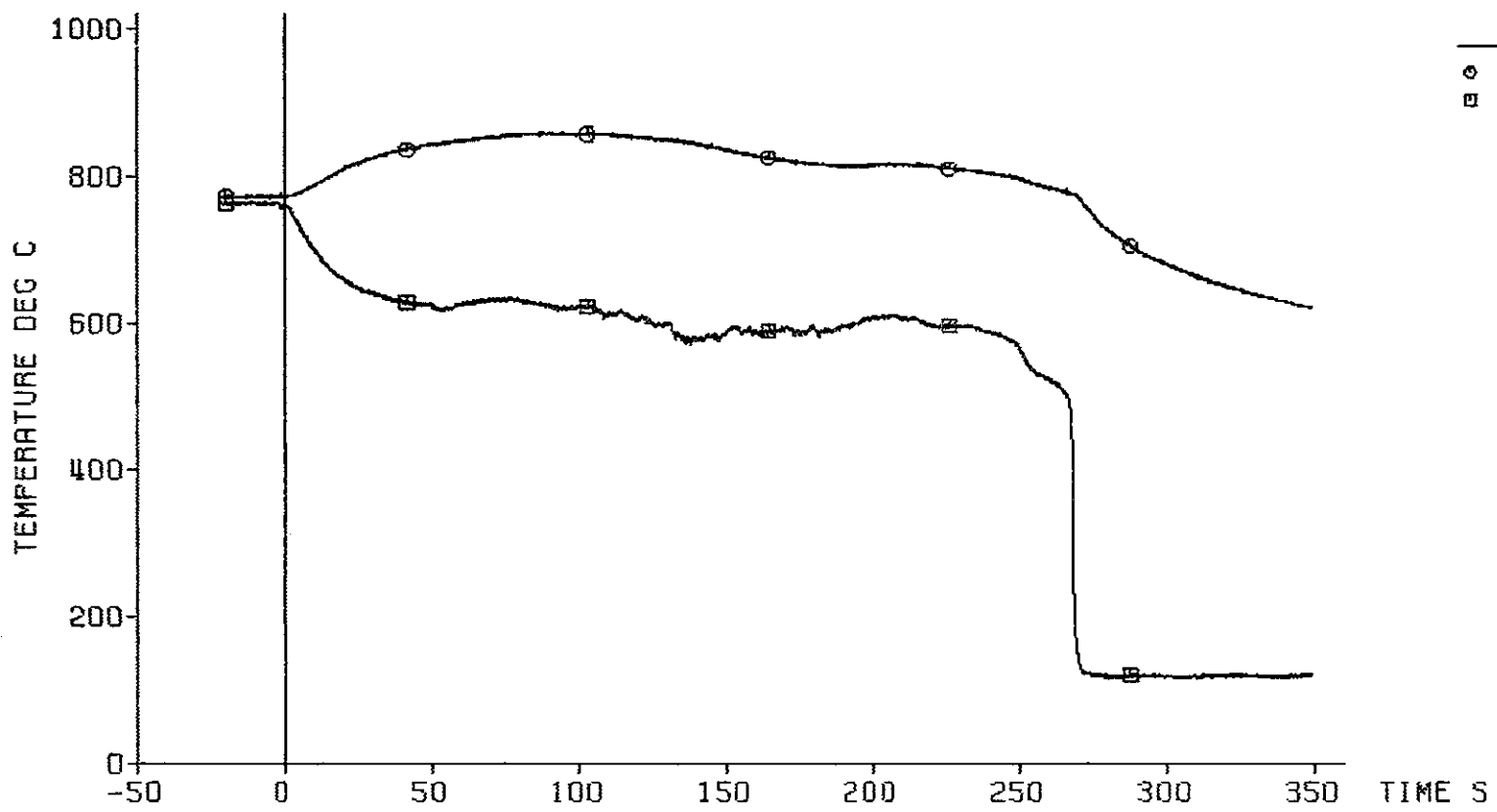

TC	ax. Level
○ 17h2	2025 mm
□ sleeve	2025 mm

decay heat 120% RMS standard
 flooding rate (cold) 5.80 cm/s
 system pressure 1.93 bar
 feedwater temperature 40 deg C

blockage
 =====



Fig. 272 FEBA: 5x5 ROD BUNDLE, TEST SERIES 3, TEST-No. 240

cladding temperature

TC	axial level
○ 13d2	2025 mm
□ sleeve	2025 mm

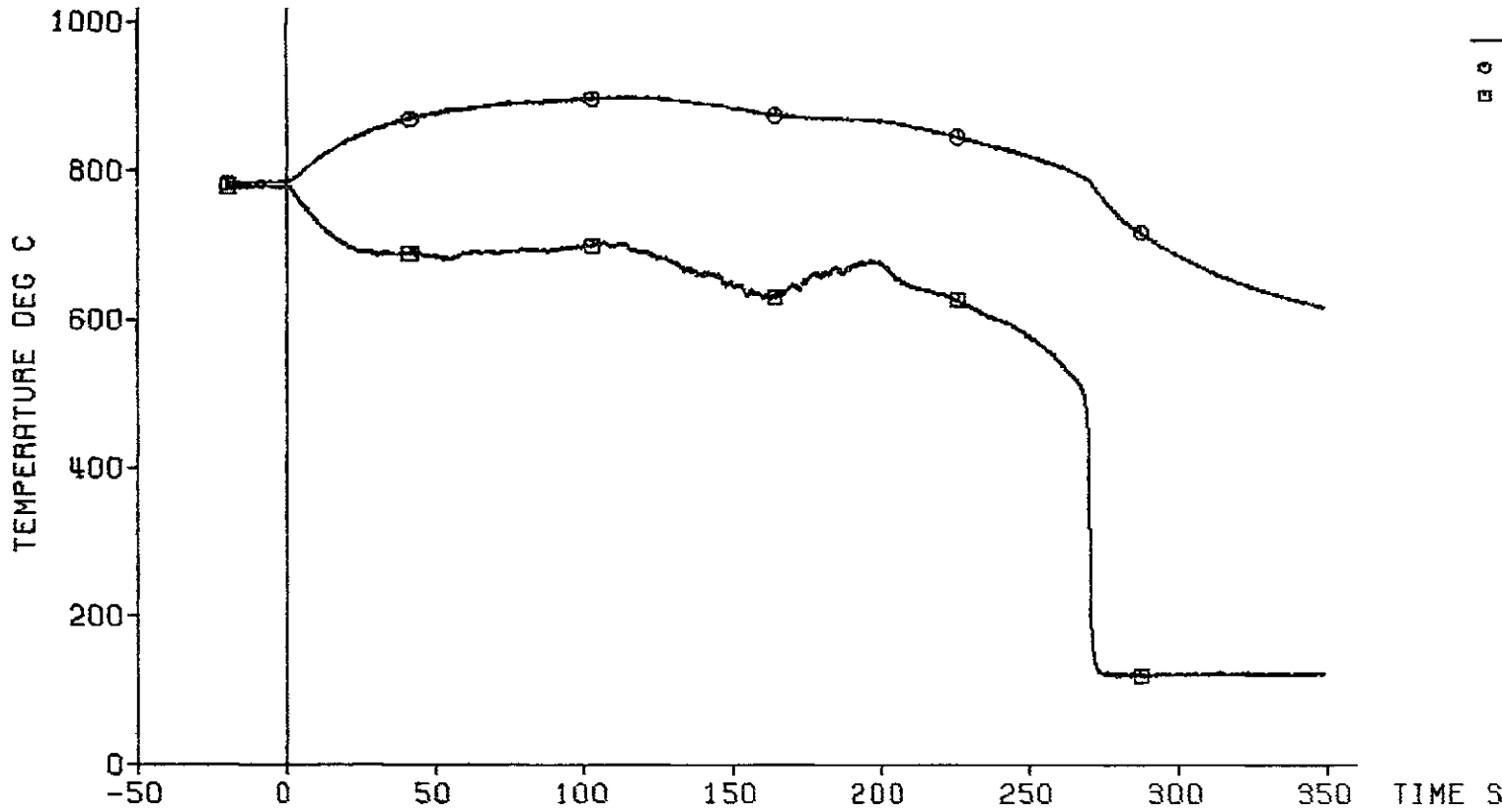

decay heat 120% ANS standard
flooding rate (cold) 5.80 cm/s
system pressure 1.93 bar
feedwater temperature 40 deg C

blockage
=====



Fig. 273 FEBA: 5x5 ROD BUNDLE, TEST SERIES 3, TEST-No. 240

cladding temperature

TC	ax. level
◇	9h1 1925 mm
△	19g3 1825 mm
○	19g2 1725 mm
□	19g1 1625 mm

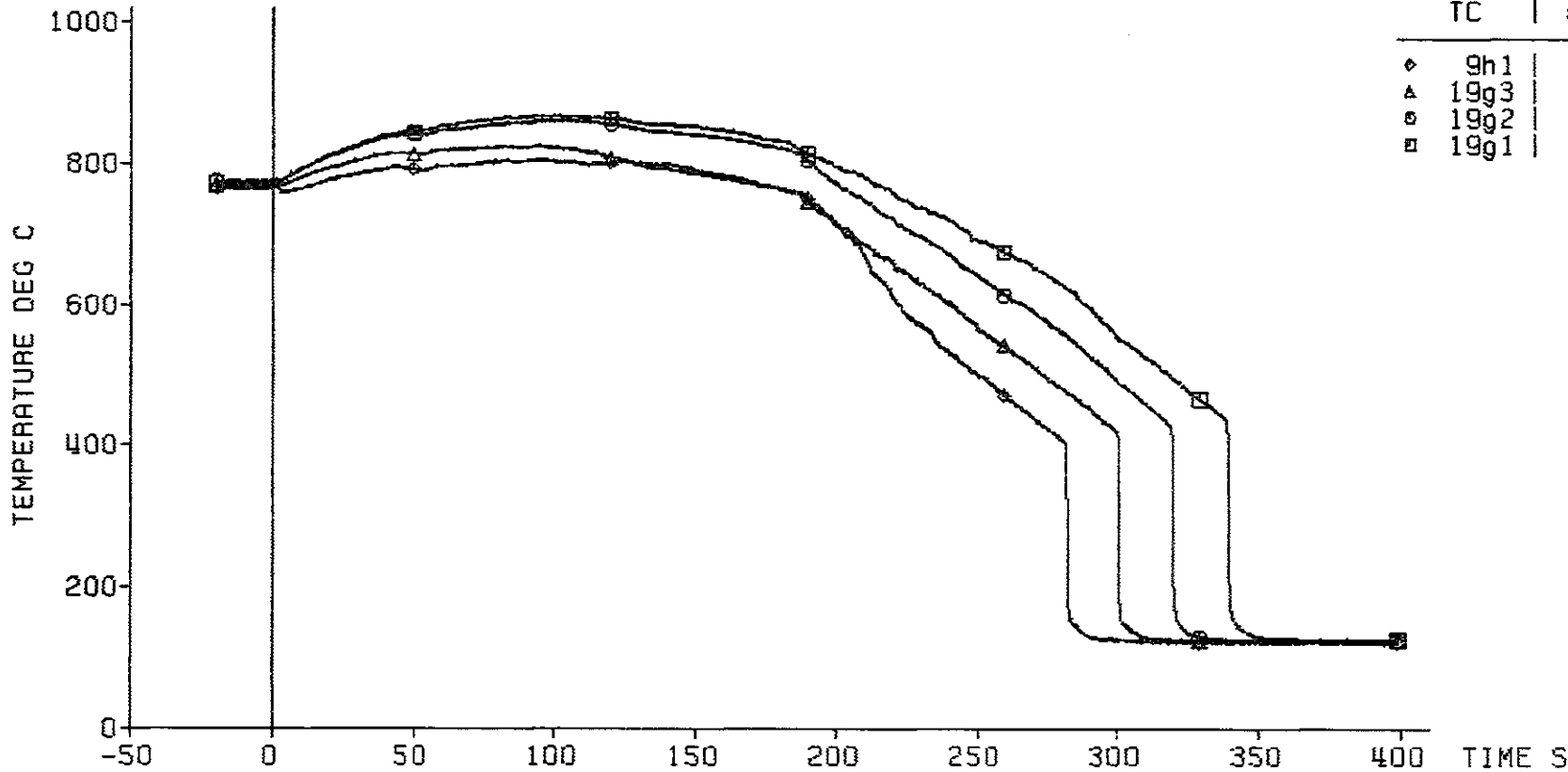

decay heat 120% ANS standard
 flooding rate (cold) 5.80 cm/s
 system pressure 1.93 bar
 feedwater temperature 40 deg C

bypass
 =====



Fig. 274 FEBA: 5x5 ROD BUNDLE, TEST SERIES 3, TEST-No. 240

heat transfer coeff.

TC	ax. level
◆ 9h1	1925 mm
▲ 19g3	1825 mm
○ 19g2	1725 mm
□ 19g1	1625 mm

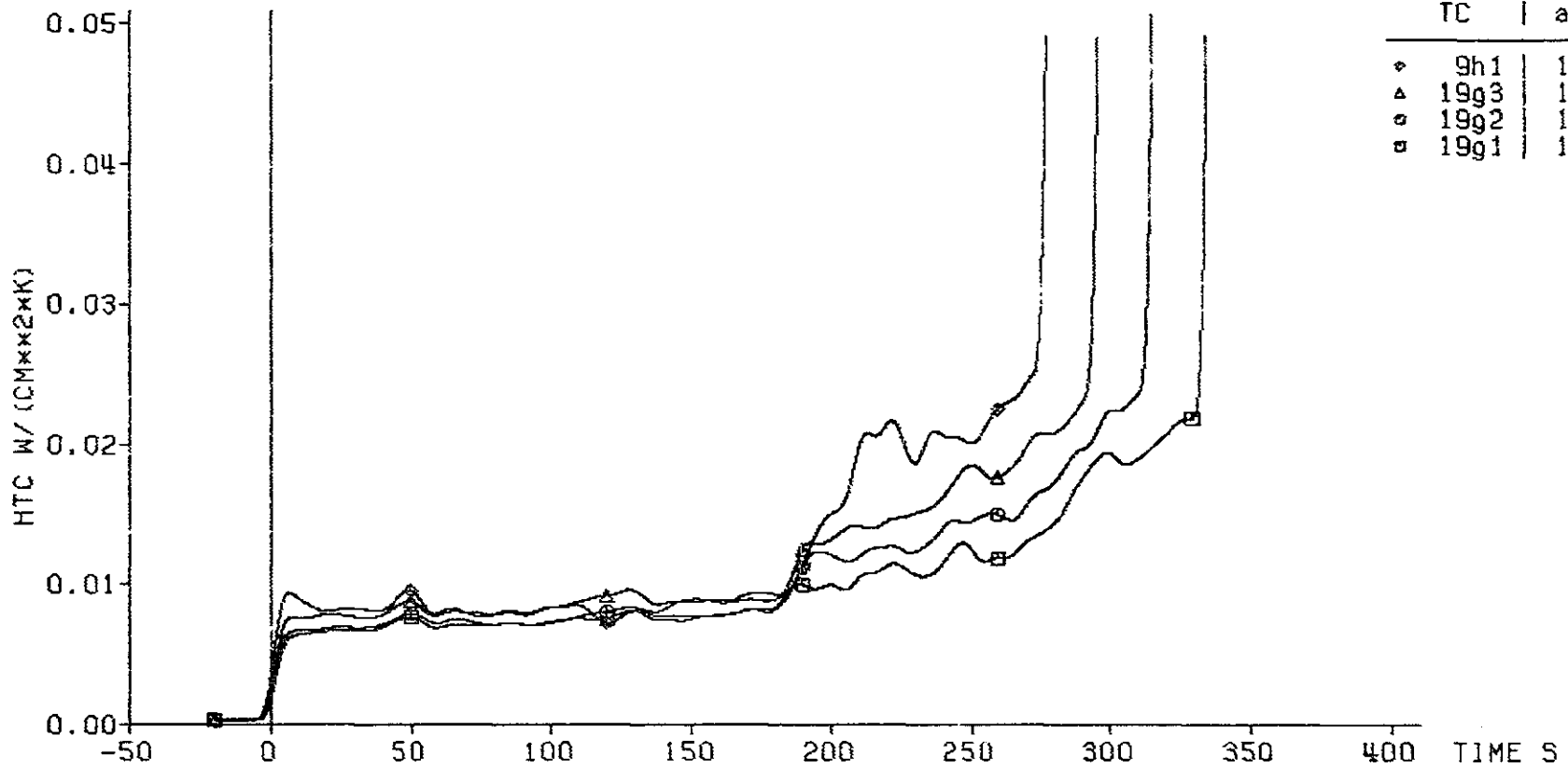

decay heat 120% ANS standard
 flooding rate (cold) 5.80 cm/s
 system pressure 1.93 bar
 feedwater temperature 40 deg C

bypass
 =====



Fig. 275 FEBA: 5x5 ROD BUNDLE, TEST SERIES 3, TEST-No. 240

cladding temperature

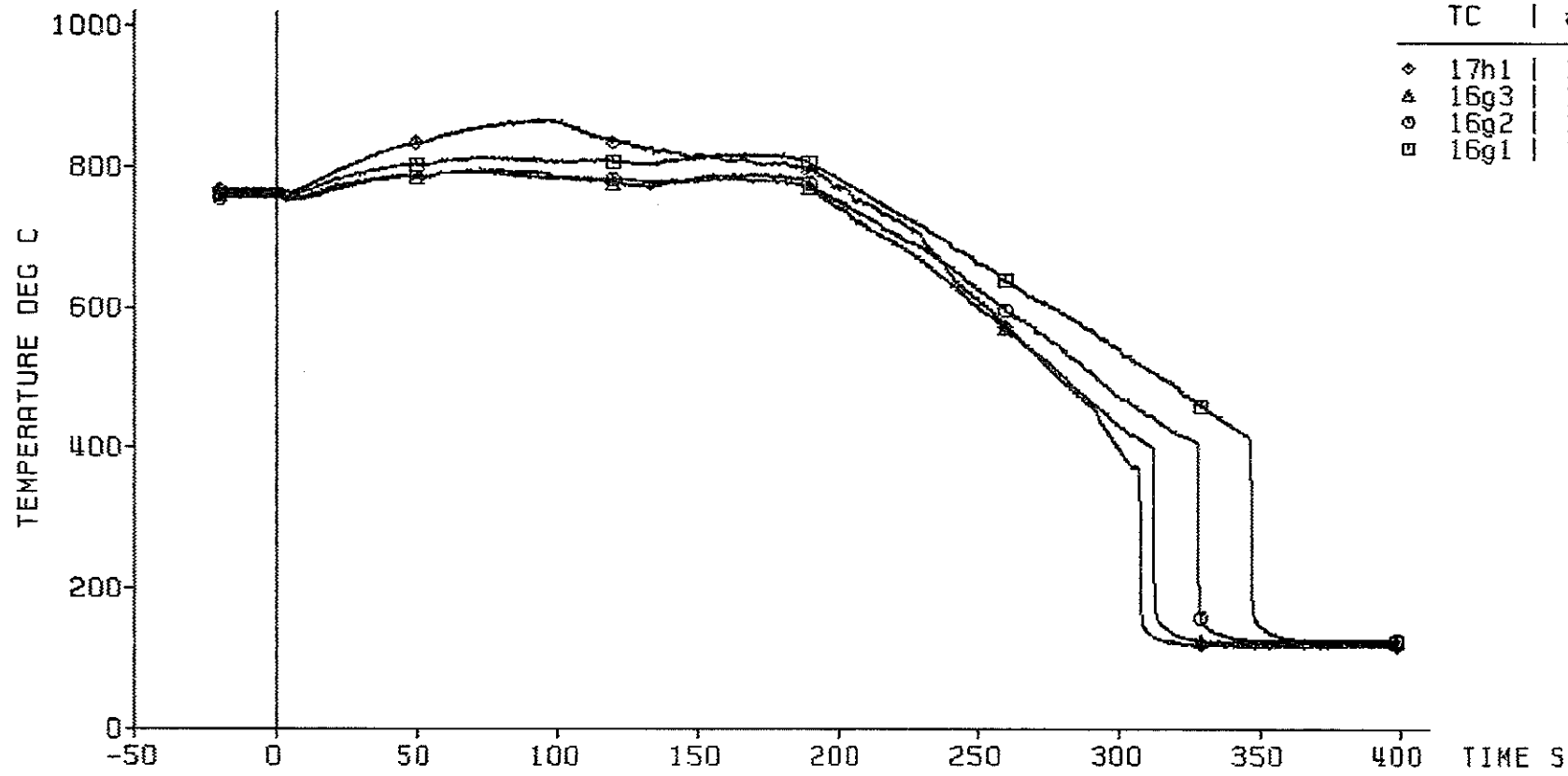

decay heat 120% ANS standard
flooding rate (cold) 5.80 cm/s
system pressure 1.93 bar
feedwater temperature 40 deg C

blockage
=====

KIK IRB

Fig. 276 FEBA: 5x5 ROD BUNDLE, TEST SERIES 3, TEST-NO. 240

heat transfer coeff.

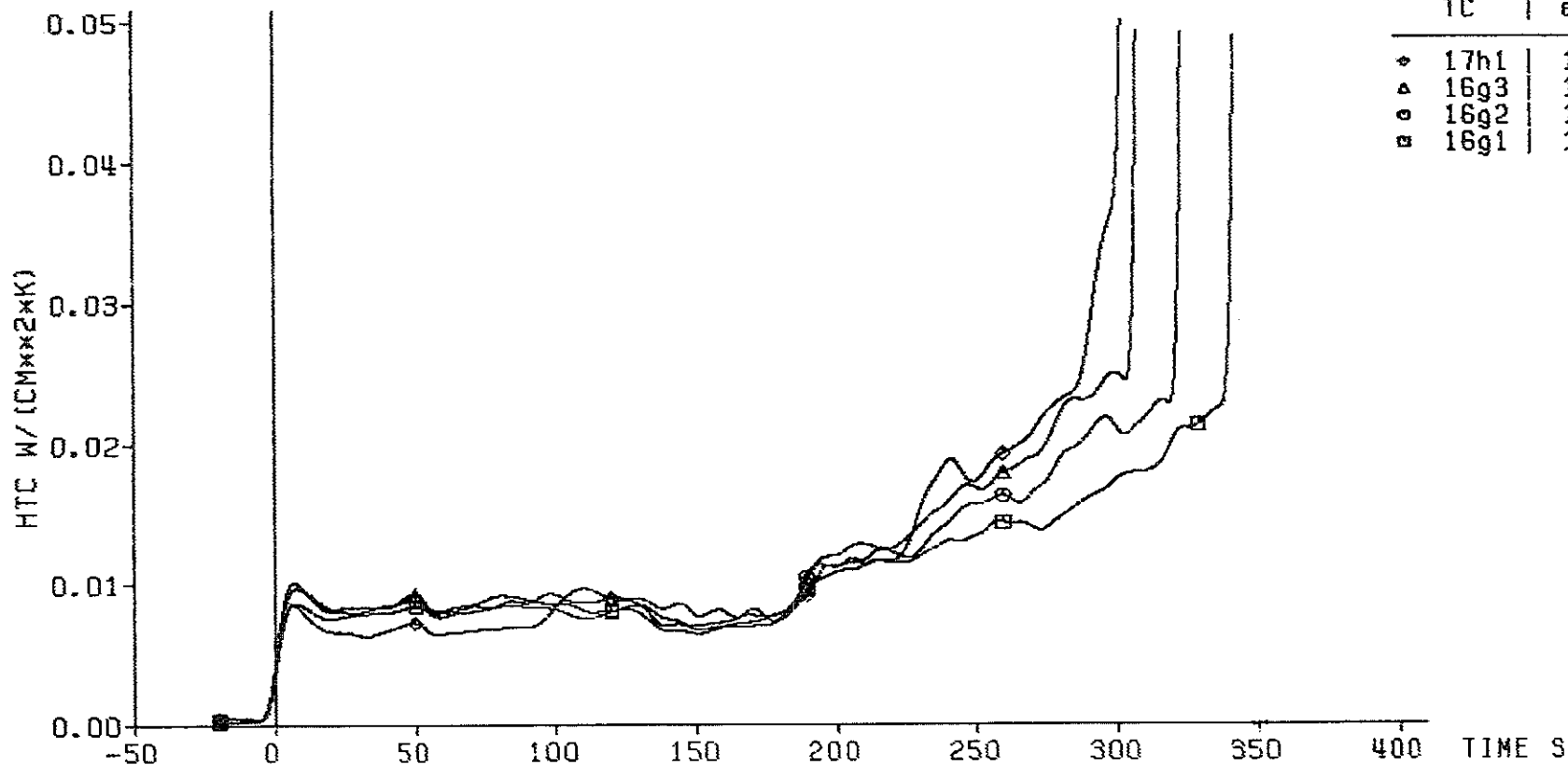

decay heat 120% ANS standard
 flooding rate (cold) 5.80 cm/s
 system pressure 1.93 bar
 feedwater temperature 40 deg C

blockage
 =====



Fig. 277 FEBA: 5x5 ROD BUNDLE, TEST SERIES 3, TEST-No. 240

axial level: 1925 mm

△ cladding temperature (16g4)
○ fluid temperature
□ housing temperature

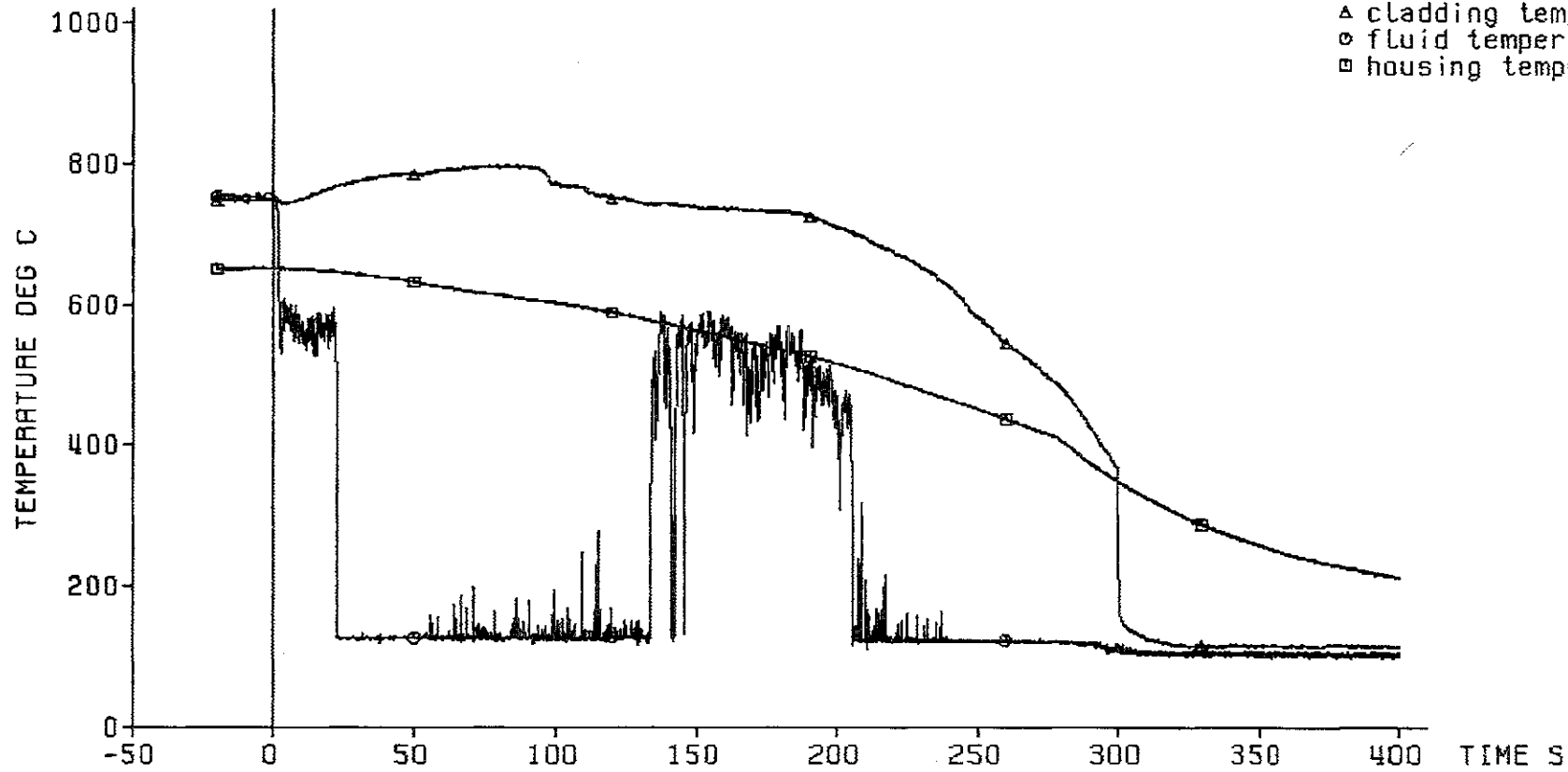

— 312 —

decay heat	120% ANS standard	blockage
flooding rate (cold)	5.80 cm/s	=====
system pressure	1.93 bar	
feedwater temperature	40 deg C	



Fig. 278 FEBA: 5x5 ROD BUNDLE, TEST SERIES 3, TEST-No. 240

axial level: 1725 mm

▲ cladding temperature (16g2)
○ fluid temperature
■ housing temperature

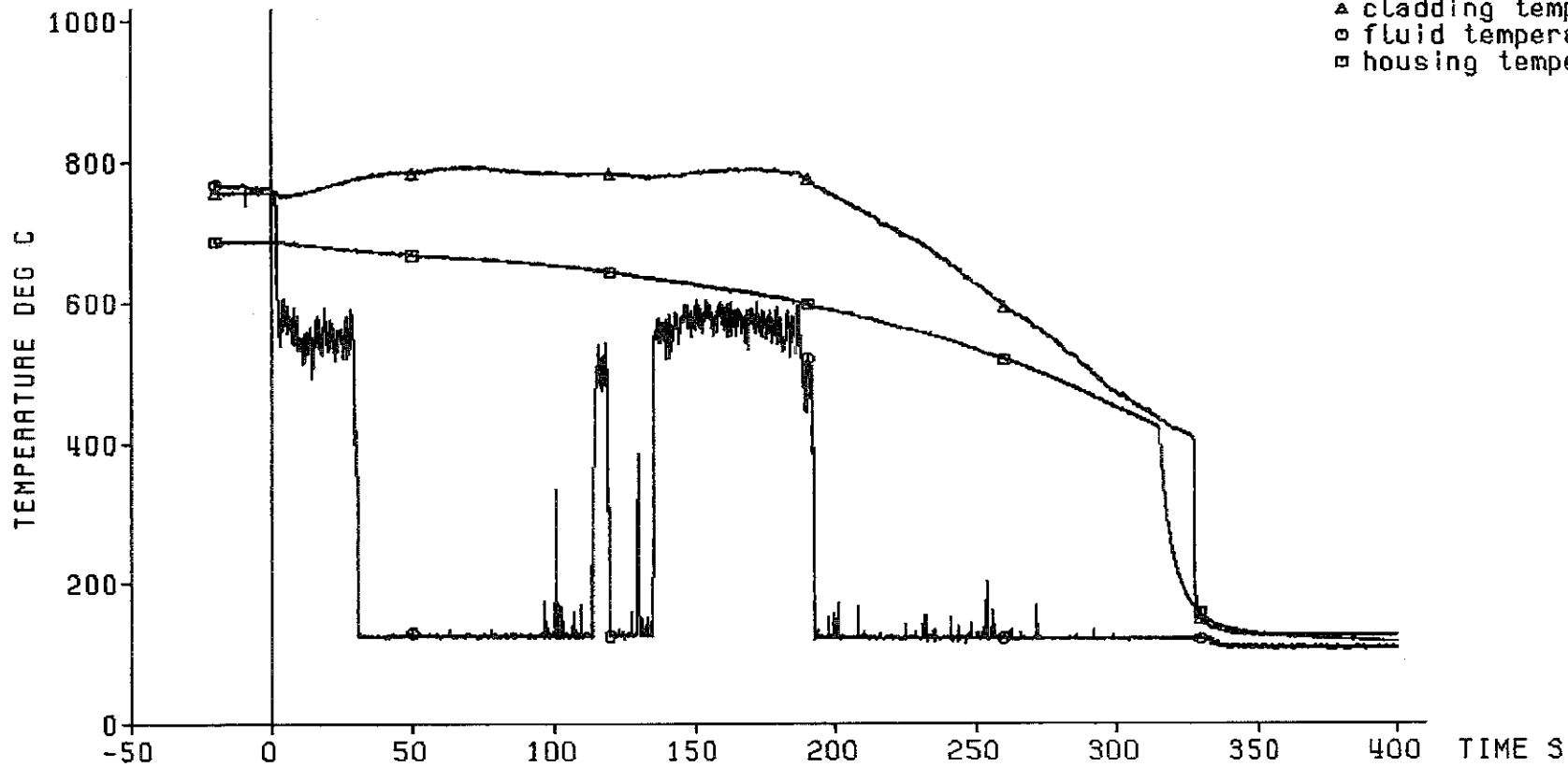

decay heat
flooding rate (cold)
system pressure
feedwater temperature

120% ANS standard
5.80 cm/s
1.93 bar
40 deg C

blockage
=====



Fig. 279 FEBA: 5x5 ROD BUNDLE, TEST SERIES 3, TEST-No. 240

axial level: 1625 mm

△ cladding temperature (16g1)
○ fluid temperature
□ housing temperature

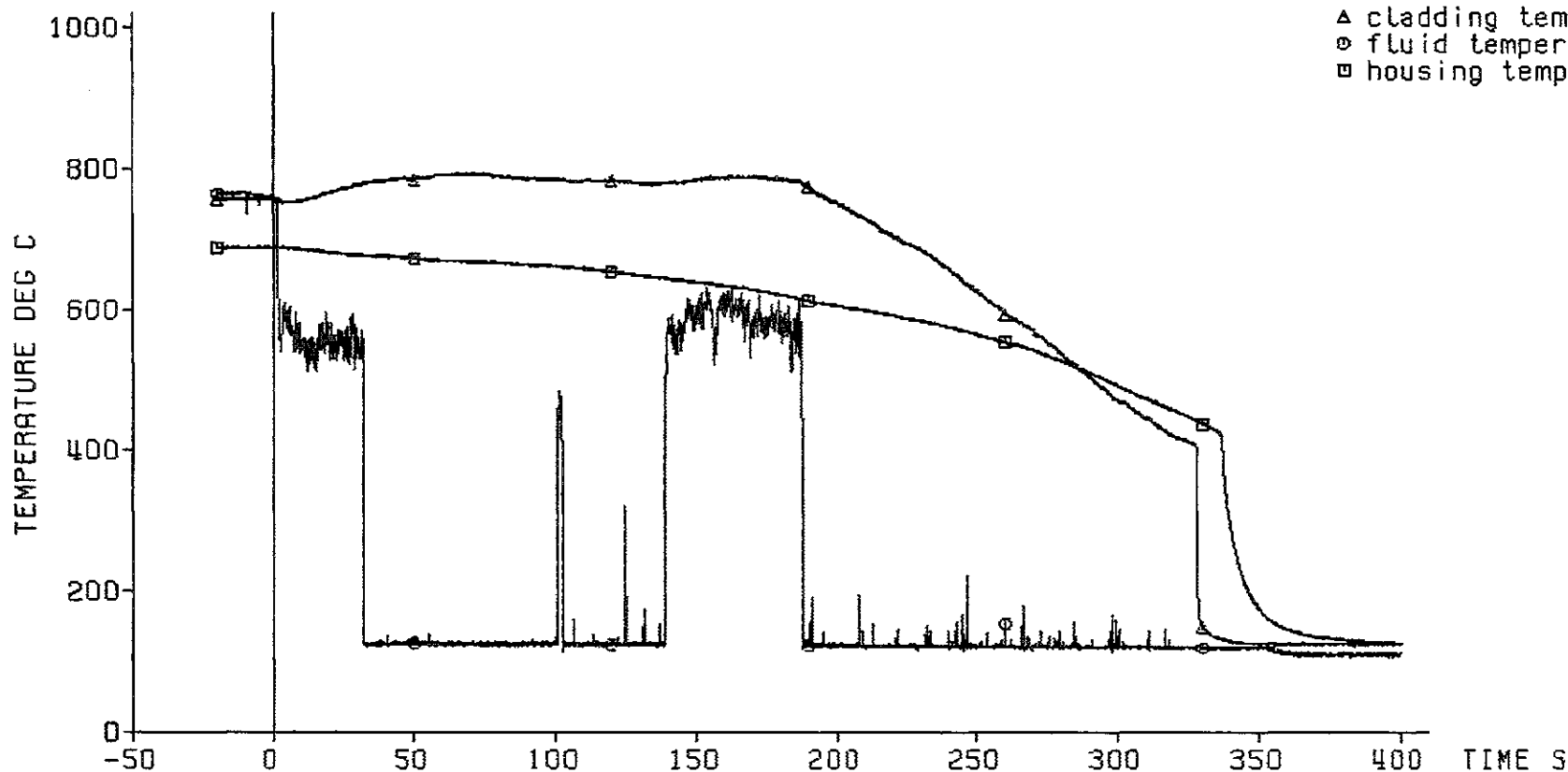

decay heat 120% RMS standard
flooding rate (cold) 5.80 cm/s
system pressure 1.93 bar
feedwater temperature 40 deg C

blockage
=====



Fig. 280 FEBA: 5x5 R0D BUNDLE, TEST SERIES 3, TEST-No. 240

pressure loss
along the test section:

- ◆ total length: 4196 mm
- △ lower part: 1711 mm
- middle part: 545 mm
- upper part: 1940 mm

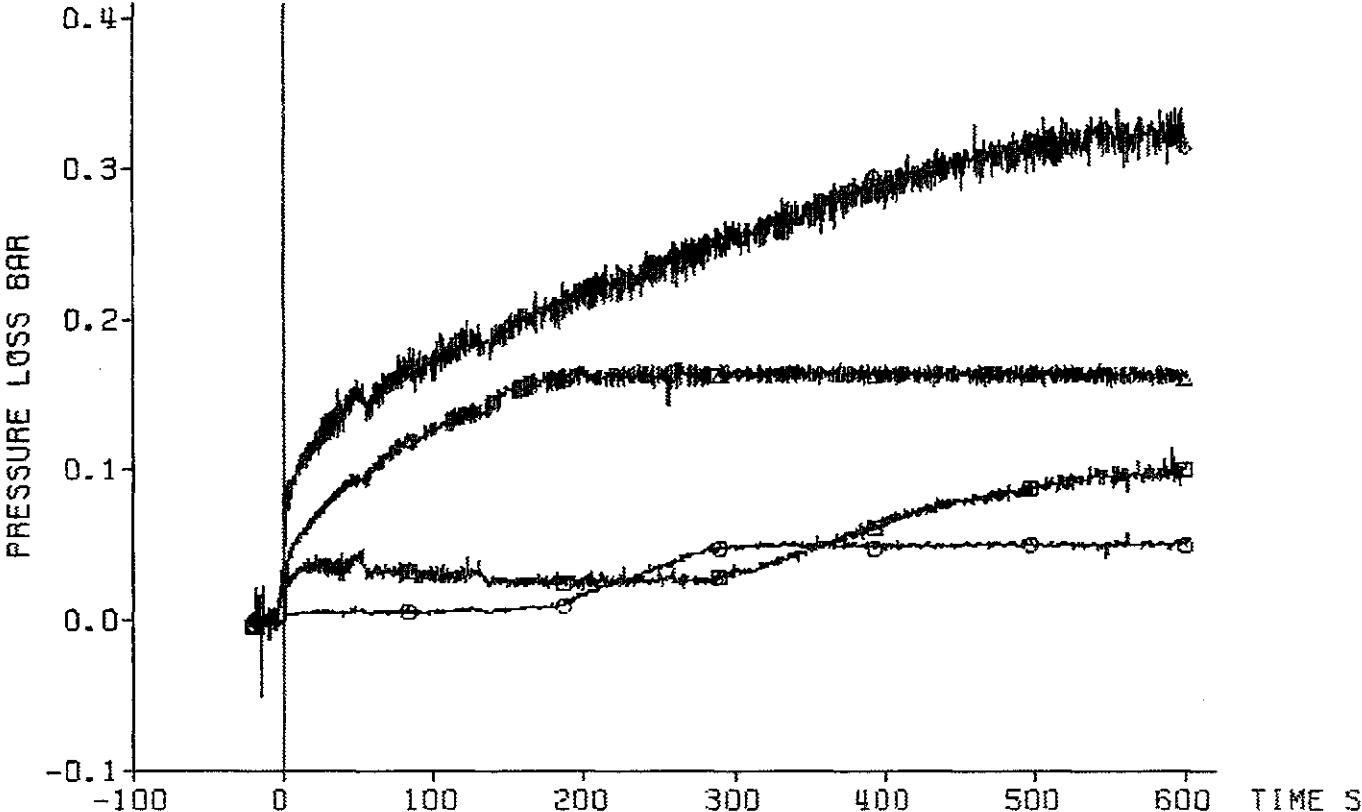

decay heat 120% ANS standard
flooding rate (cold) 5.60 cm/s
system pressure 1.93 bar
feedwater temperature 40 deg C



Fig. 281 FEBA: 5x5 ROD BUNDLE, TEST SERIES 3, TEST-No. 240

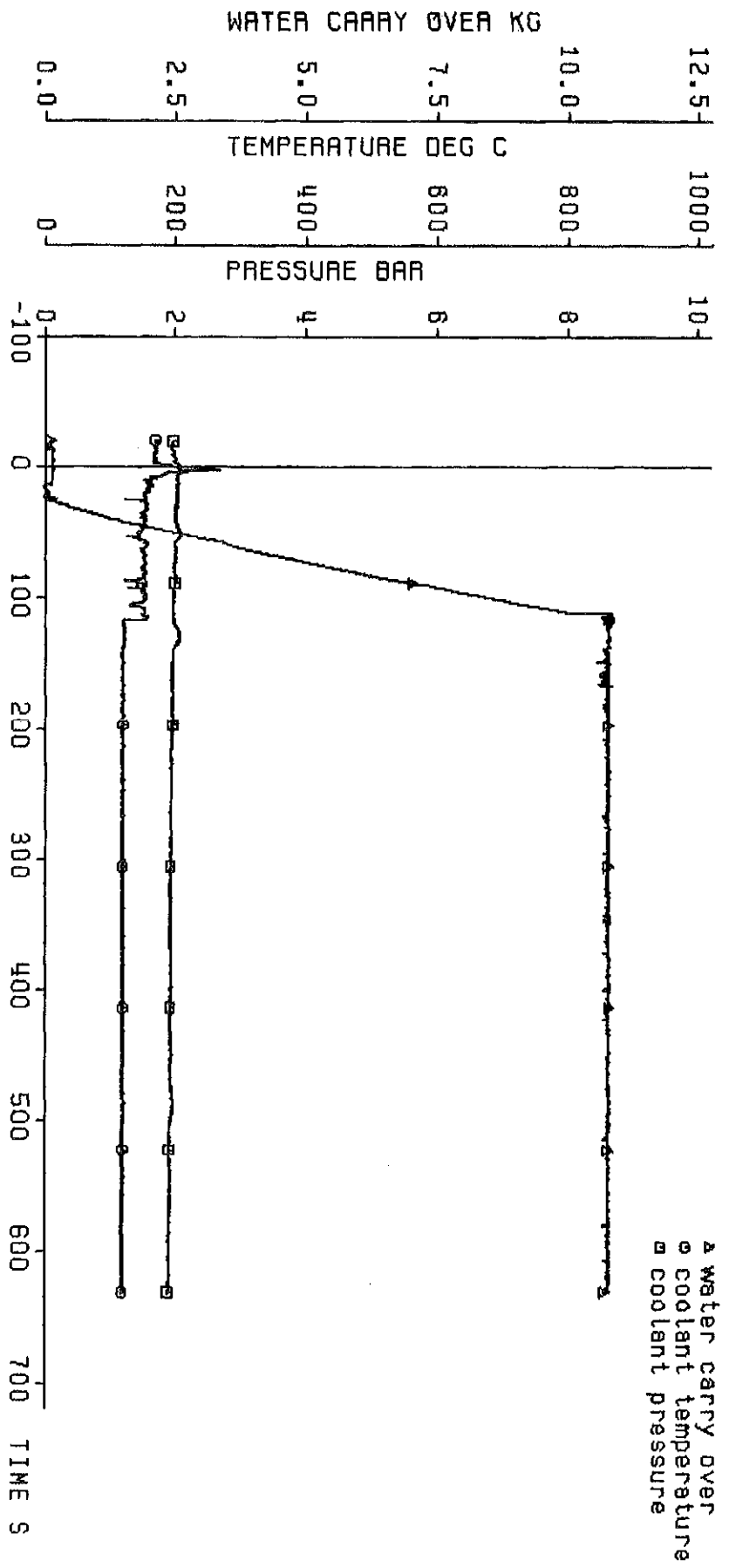

coolant conditions:

- ▲ water carry over
- coolant temperature
- coolant pressure

decay heat
 flooding rate (cold)
 system pressure
 feedwater temperature

120% RNS standard
 5.80 cm/s
 1.93 bar
 40 deg C



Fig. 282 FEBRA: 5x5 ROD BUNDLE, TEST SERIES 3, TEST-NO. 240

axial position of the quench front

- rewetting of the sleeve at the bundle midplane
- x rewetting of the rod downstream of the blockage

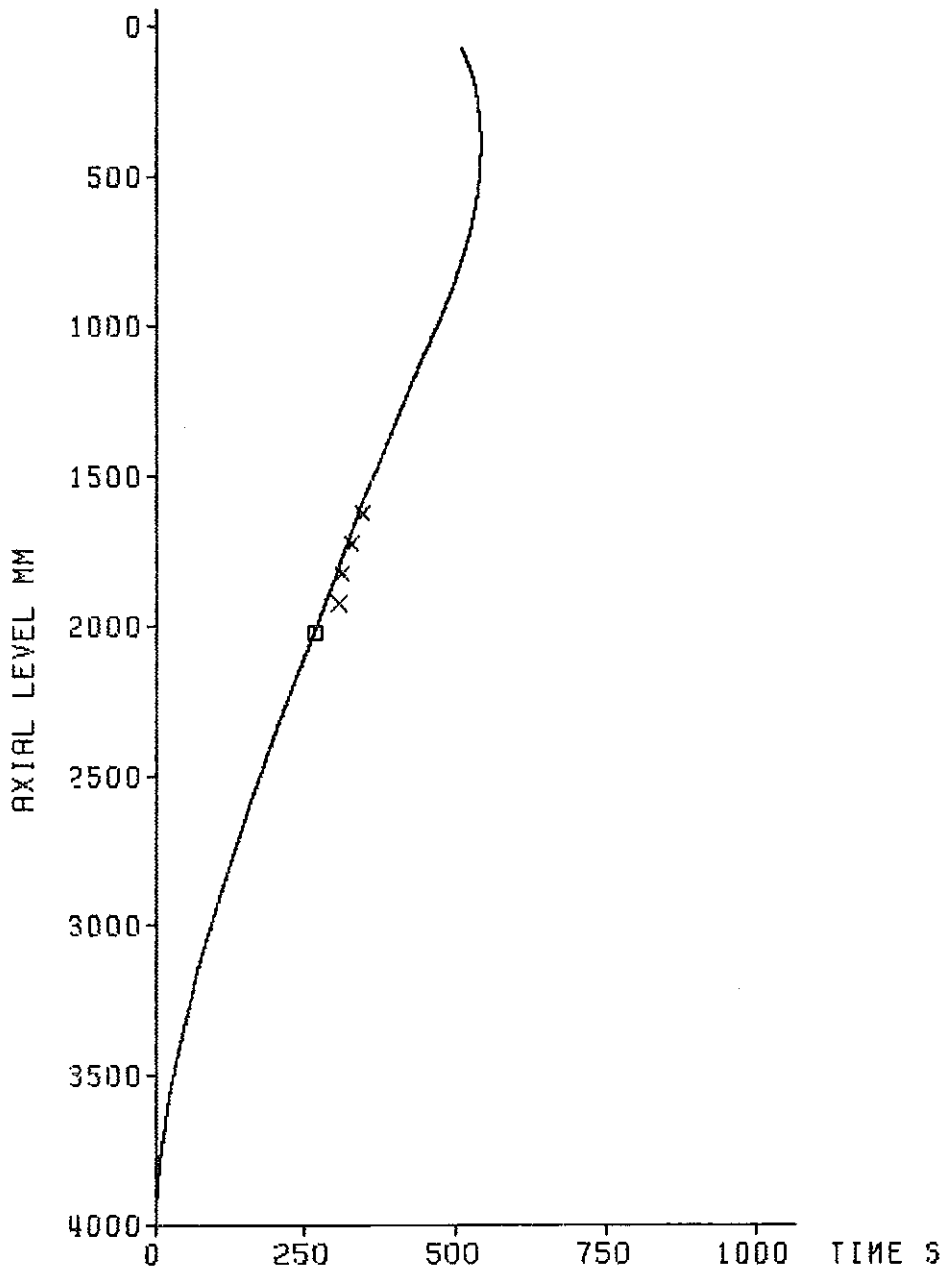

decay heat	120% ANS standard
flooding rate (cold)	5.80 cm/s
system pressure	1.93 bar
feedwater temperature	40 deg C



Fig. 283 FEBA: 5x5 ROD BUNDLE
TEST SERIES 3, TEST-No. 240

initial axial temperature profile of the cladding

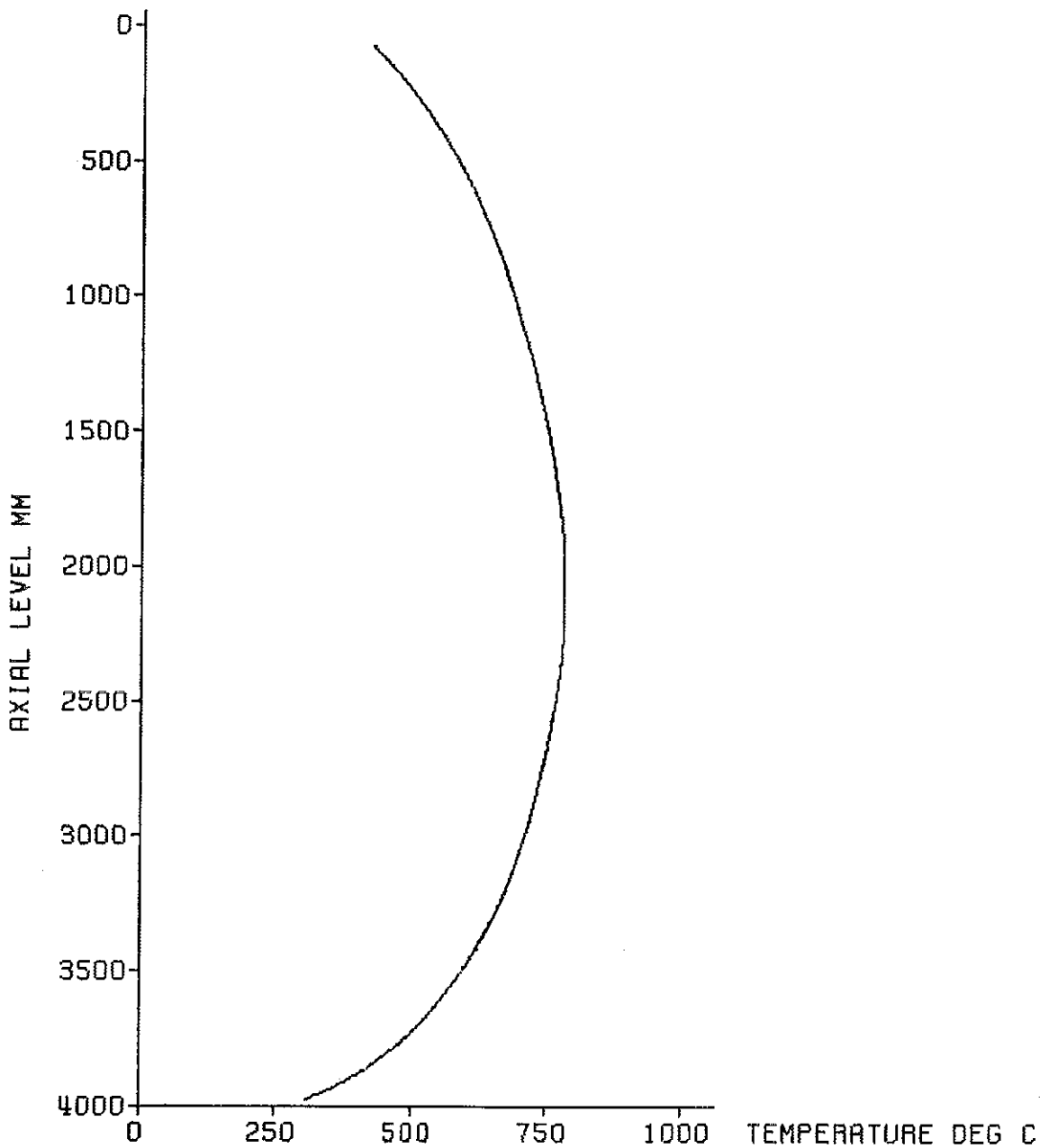

decay heat	120% ANS standard
flooding rate (cold)	5.72 cm/s
system pressure	4.13 bar
feedwater temperature	40 deg C

KfK
IRB

Fig. 284 FEBA: 5x5 ROD BUNDLE
TEST SERIES 3, TEST-No. 238

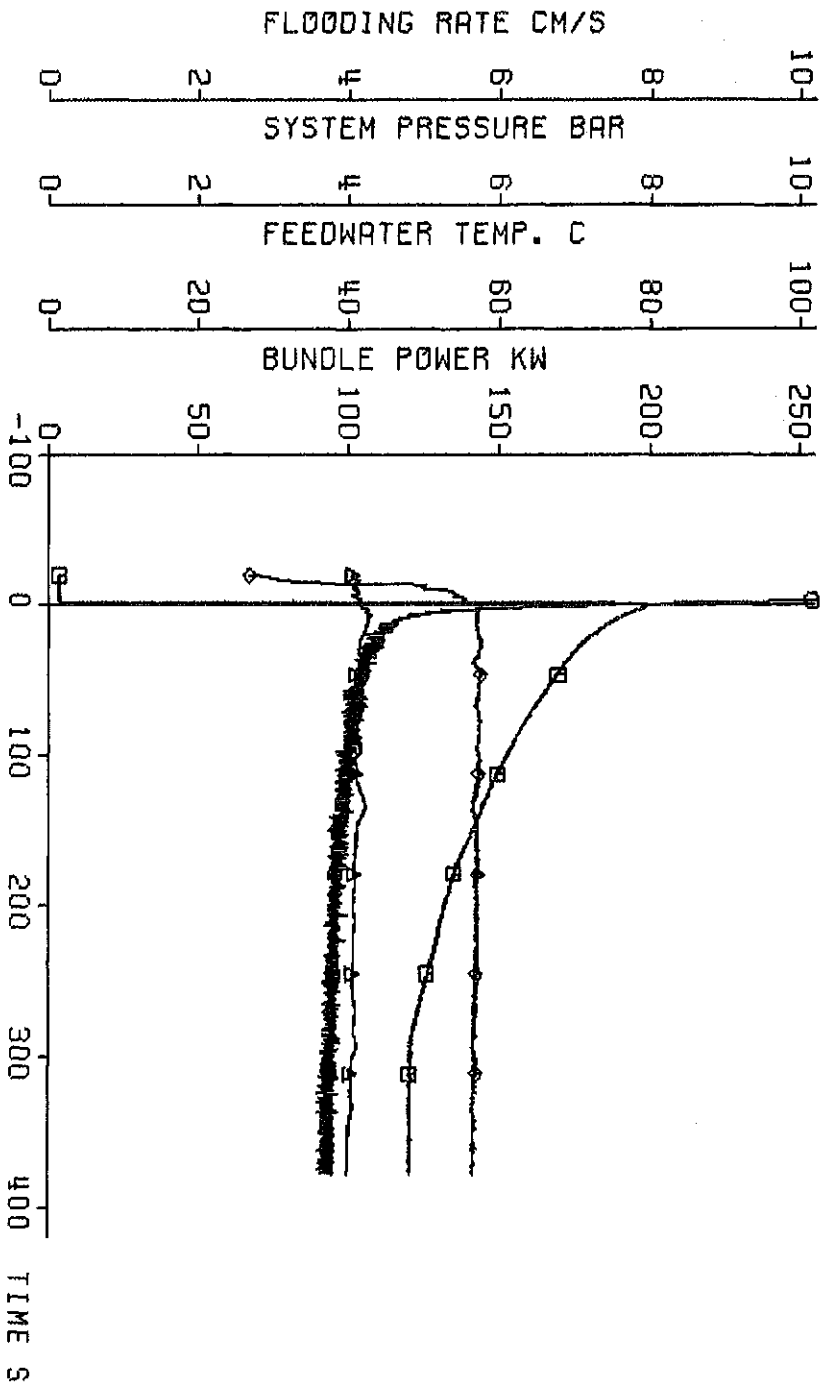

- ◊ flooding rate
- ▲ system pressure
- feedwater temperature
- ◻ bundle power

decay heat 120% RNS standard
 flooding rate (cold) 5.72 cm/s
 system pressure 4.13 bar
 feedwater temperature 40 deg C



Fig. 285 FEBRA: 5X5 ROD BUNDLE, TEST SERIES 3, TEST-NO. 238

cladding temperature

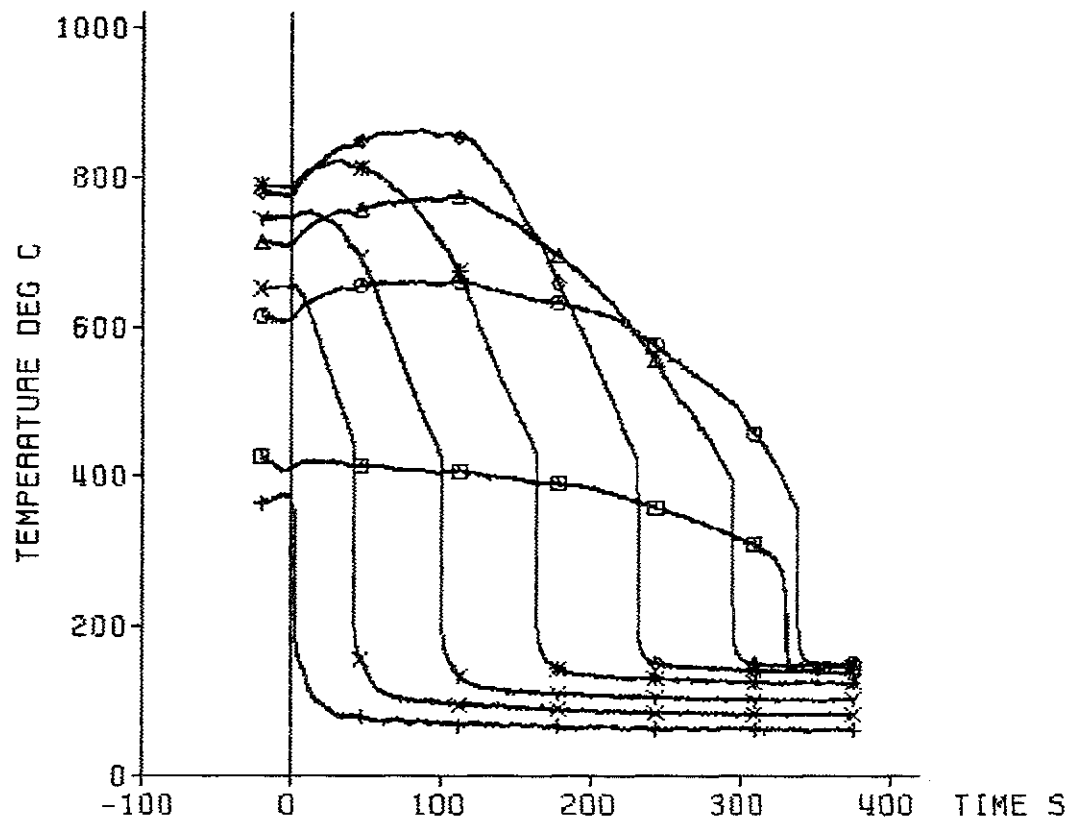

TC	ax. level
+	18a4 3860 mm
x	18a3 3315 mm
y	18a2 2770 mm
*	18a1 2225 mm
◇	12b4 1680 mm
△	12b3 1135 mm
○	12b2 590 mm
□	12b1 45 mm

decay heat 120% ANS standard
 flooding rate (cold) 5.72 cm/s
 system pressure 4.13 bar
 feedwater temperature 40 deg C



Fig. 286 FEBA: 5x5 ROD BUNDLE, TEST SERIES 3, TEST-No. 238

heat transfer coeff.

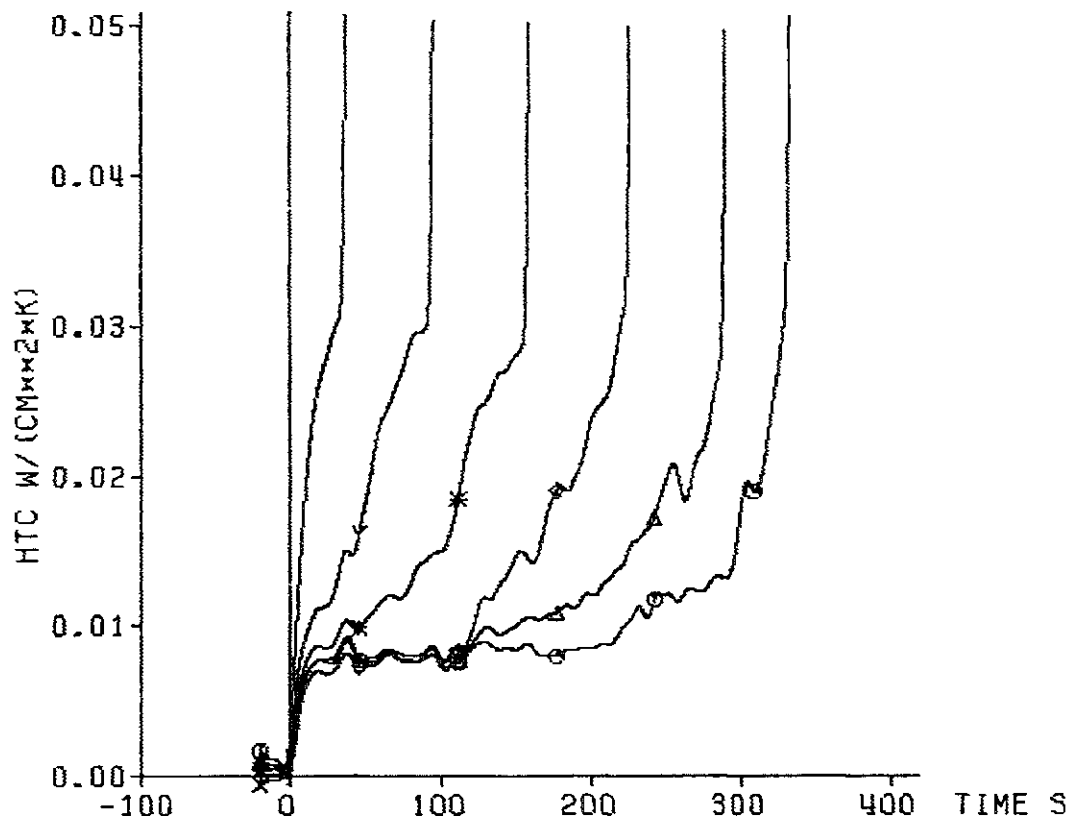

TC	ax. Level
x	18a3 3315 mm
y	18a2 2770 mm
*	18a1 2225 mm
◇	12b4 1680 mm
△	12b3 1135 mm
○	12b2 590 mm

decay heat 120% ANS standard
 flooding rate (cold) 5.72 cm/s
 system pressure 4.13 bar
 feedwater temperature 40 deg C



Fig. 287 FEBA: 5x5 ROD BUNDLE, TEST SERIES 3, TEST-No. 238

cladding temperature

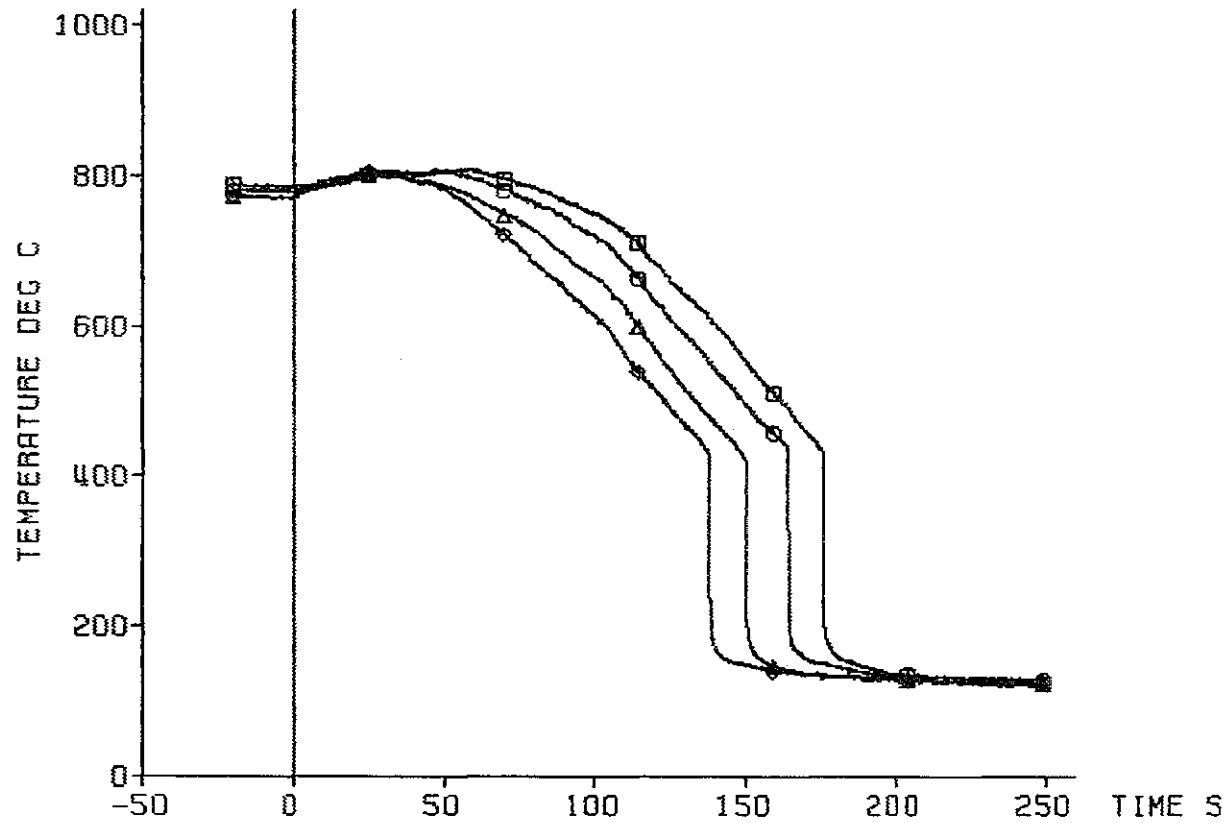

TC	ax. Level
◇	7f4 2425 mm
△	7f3 2325 mm
○	9h4 2225 mm
□	9h3 2125 mm

decay heat 120% RMS standard
 flooding rate (cold) 5.72 cm/s
 system pressure 4.13 bar
 feedwater temperature 40 deg C

bypass
 =====



Fig. 288 FEBA: 5x5 ROD BUNDLE, TEST SERIES 3, TEST-No. 238

heat transfer coeff.

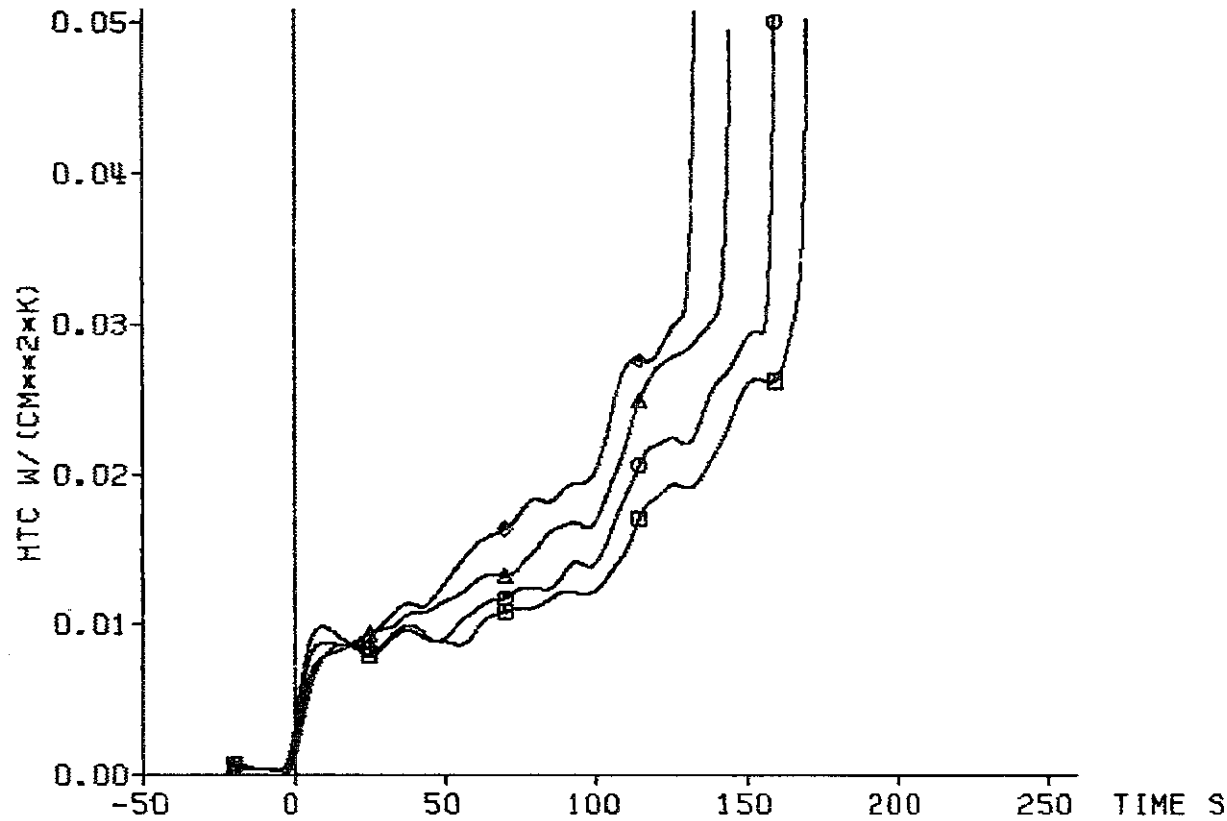

TC	ex. Level
◇ 7f4	2425 mm
△ 7f3	2325 mm
○ 9h4	2225 mm
□ 9h3	2125 mm

decay heat 120% ANS standard
 flooding rate (cold) 5.72 cm/s
 system pressure 4.13 bar
 feedwater temperature 40 deg C

bypass
 =====



Fig. 289 FEBA: 5x5 ROD BUNDLE, TEST SERIES 3, TEST-No. 238

cladding temperature

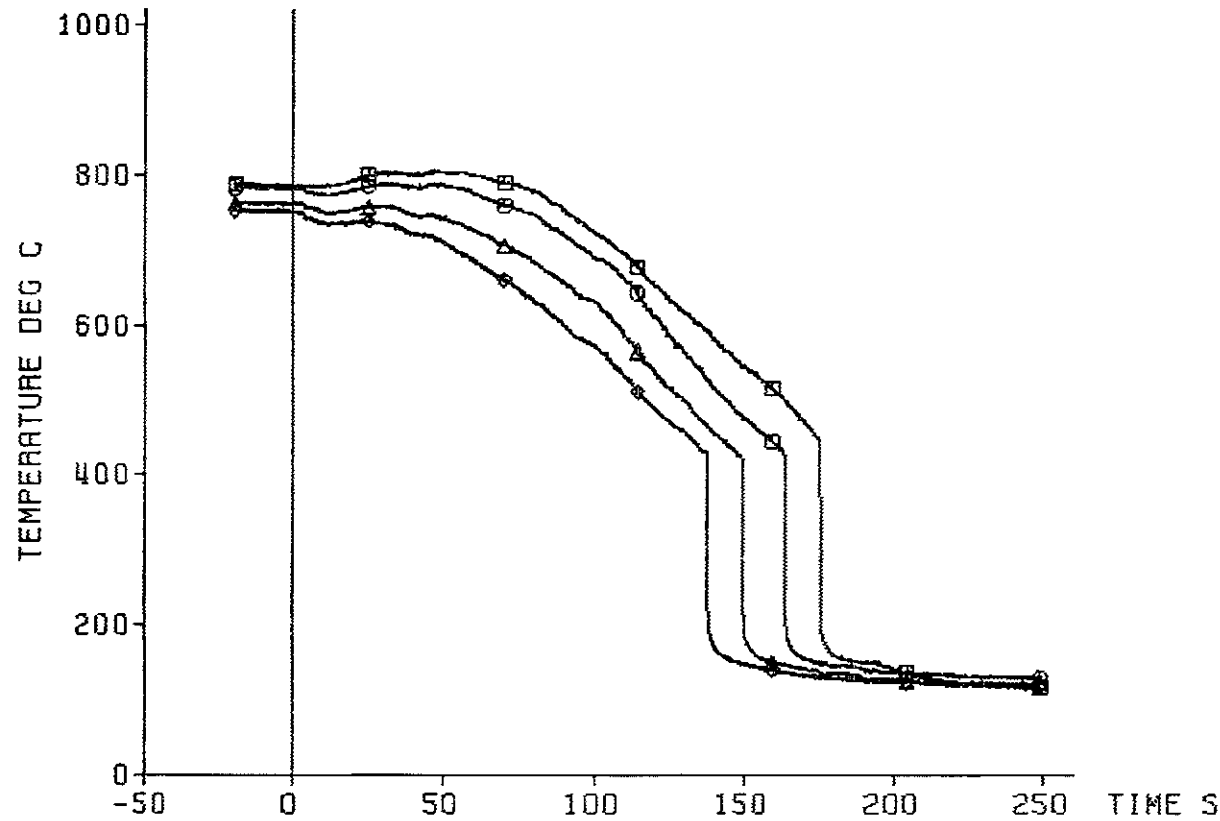

TC	ax. level
◆ 22f4	2425 mm
▲ 22f3	2325 mm
◇ 17h4	2225 mm
■ 17h3	2125 mm

decay heat 120% ANS standard
 flooding rate (cold) 5.72 cm/s
 system pressure 4.13 bar
 feedwater temperature 40 deg C

blockage
 =====



Fig. 290 FEBA: 5x5 ROD BUNDLE, TEST SERIES 3, TEST-No. 238

heat transfer coeff.

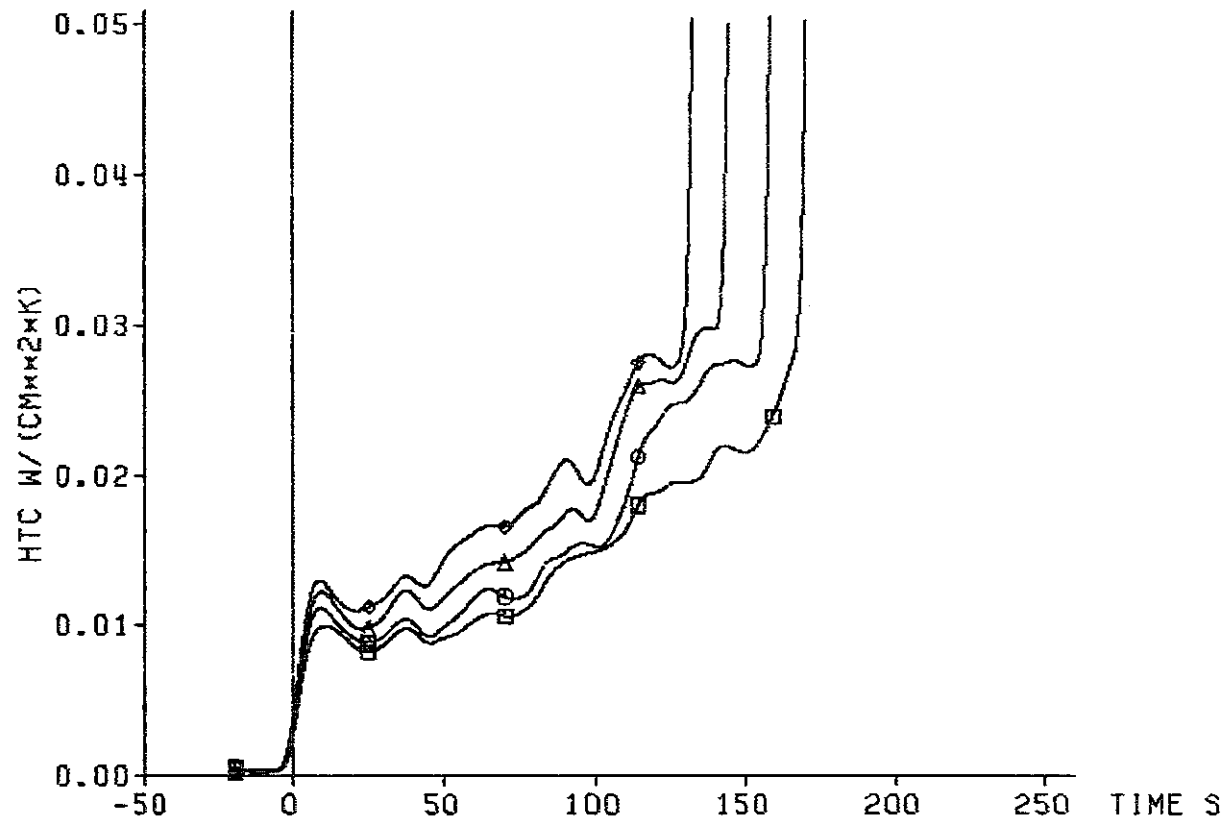

TC	ax. level
◇	22f4 2425 mm
△	22f3 2325 mm
○	17h4 2225 mm
□	17h3 2125 mm

decay heat 120% ANS standard
 flooding rate (cold) 5.72 cm/s
 system pressure 4.13 bar
 feedwater temperature 40 deg C

blockage
 =====



Fig. 291 FEBA: 5x5 ROD BUNDLE, TEST SERIES 3, TEST-No. 238

cladding temperature

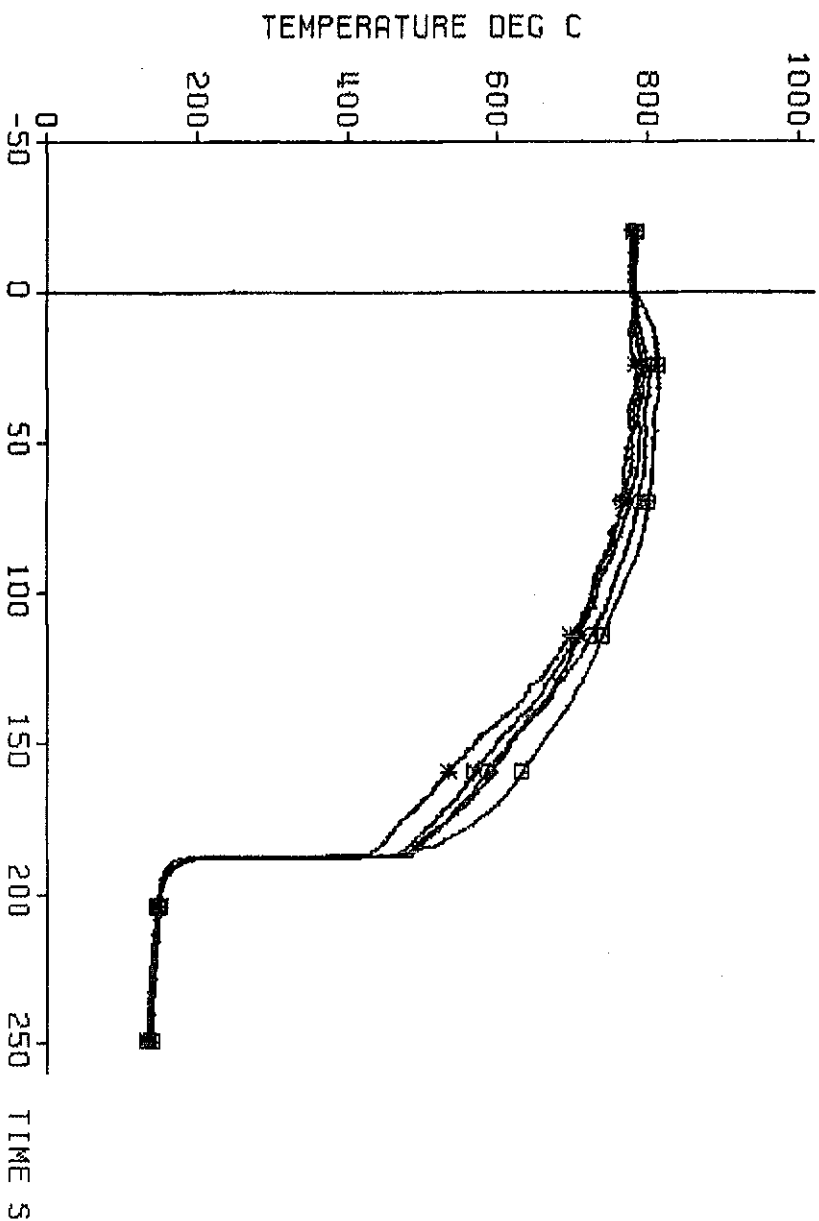
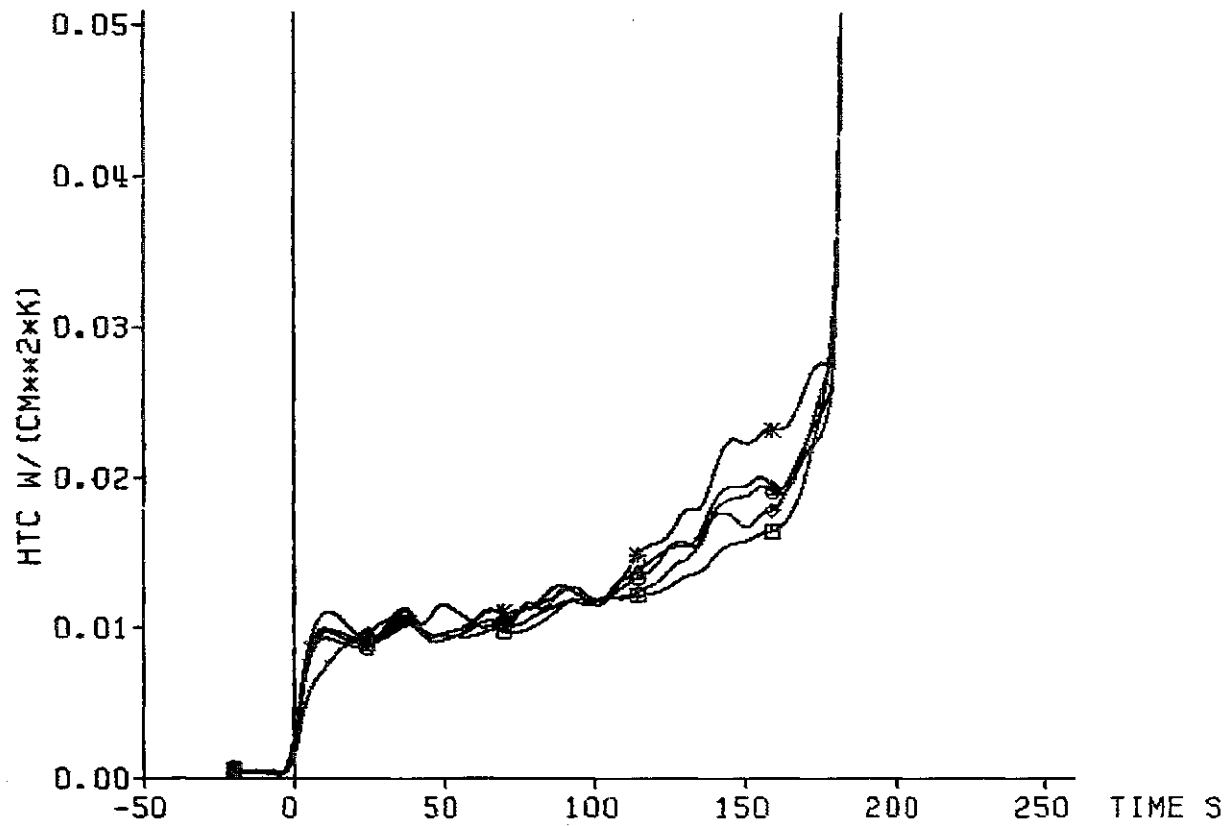

Fig. 292 FEBRA: 5X5 ROD BUNDLE, TEST SERIES 3, TEST-NO. 238

heat transfer coeff.



	TC	axial Level
*	9h2	2025 mm
▲	8d4	2025 mm
▲	8d3	2025 mm
○	8d2	2025 mm
□	8d1	2025 mm

decay heat 120% ANS standard
 flooding rate (cold) 5.72 cm/s
 system pressure 4.13 bar
 feedwater temperature 40 deg C

bypass
=====



Fig. 293 FEBA: 5x5 ROD BUNDLE, TEST SERIES 3, TEST-No. 238

cladding temperature

TC	ax. level
○ 17h2	2025 mm
□ sleeve	2025 mm

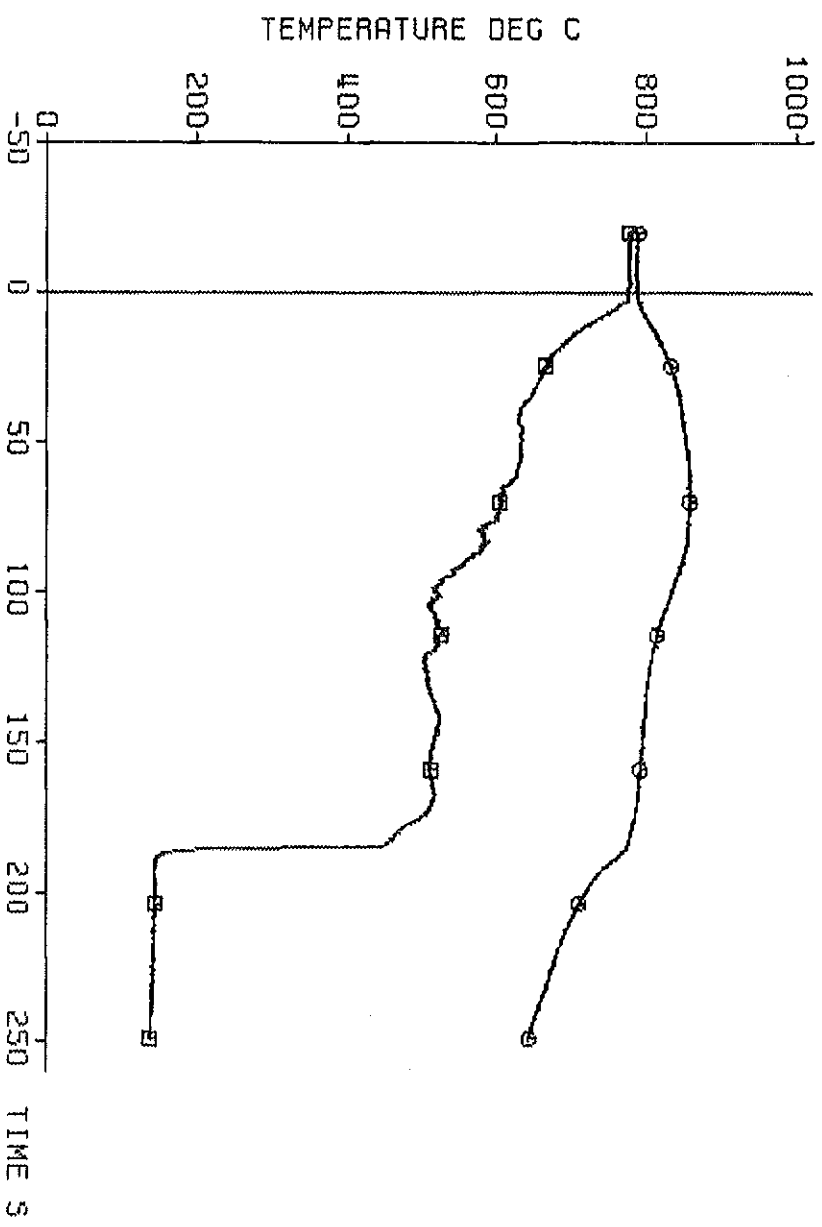

decay heat
flooding rate (bold)
system pressure
feedwater temperature

120% RMS standard
5.72 cm/s
4.13 bar
40 deg C

Blockage
=====



Fig. 294 FEBRA: 5x5 ROD BUNDLE, TEST SERIES 3, TEST-NO. 238

cladding temperature

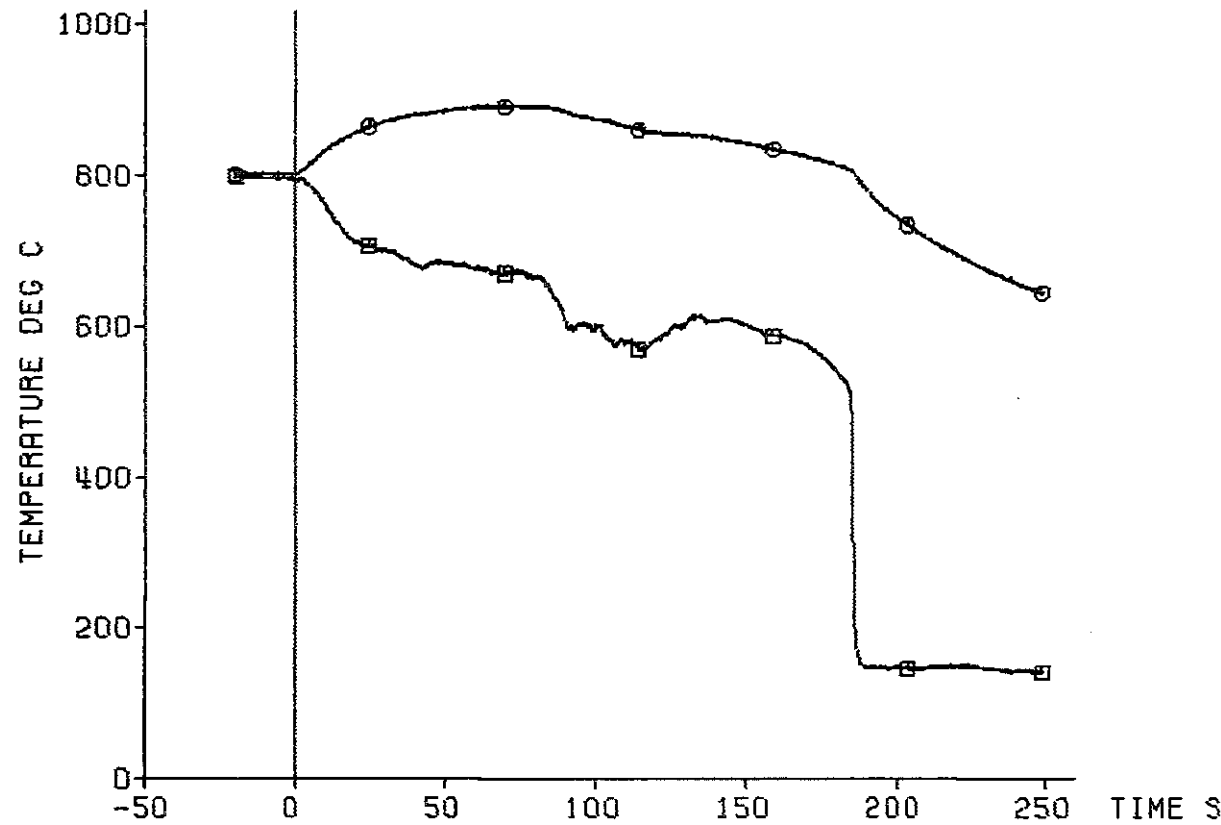

TC	axial Level
○ 13d2	2025 mm
□ sleeve	2025 mm

decay heat 120% ANS standard
flooding rate (cold) 5.72 cm/s
system pressure 4.13 bar
feedwater temperature 40 deg C

blockage
=====



Fig. 295 FEBA: 5x5 ROD BUNDLE, TEST SERIES 3, TEST-NO. 238

cladding temperature

TC	ax. level
◆ 9h1	1925 mm
▲ 19g3	1825 mm
○ 19g2	1725 mm
■ 19g1	1625 mm

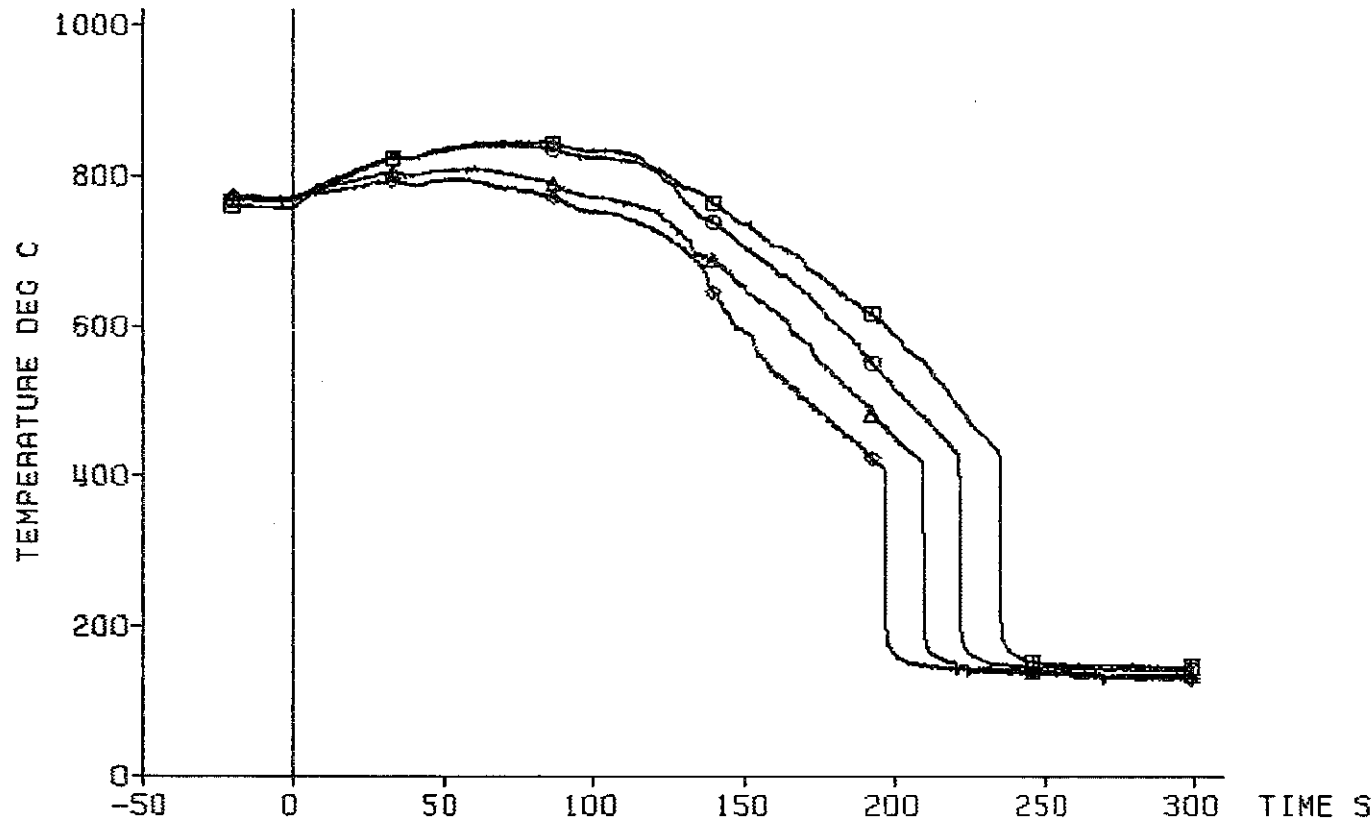

decay heat 120% ANS standard
flooding rate (cold) 5.72 cm/s
system pressure 4.13 bar
feedwater temperature 40 deg C

bypass
=====



Fig. 296 FEBA: 5x5 ROD BUNDLE, TEST SERIES 3, TEST-No. 238

heat transfer coeff.

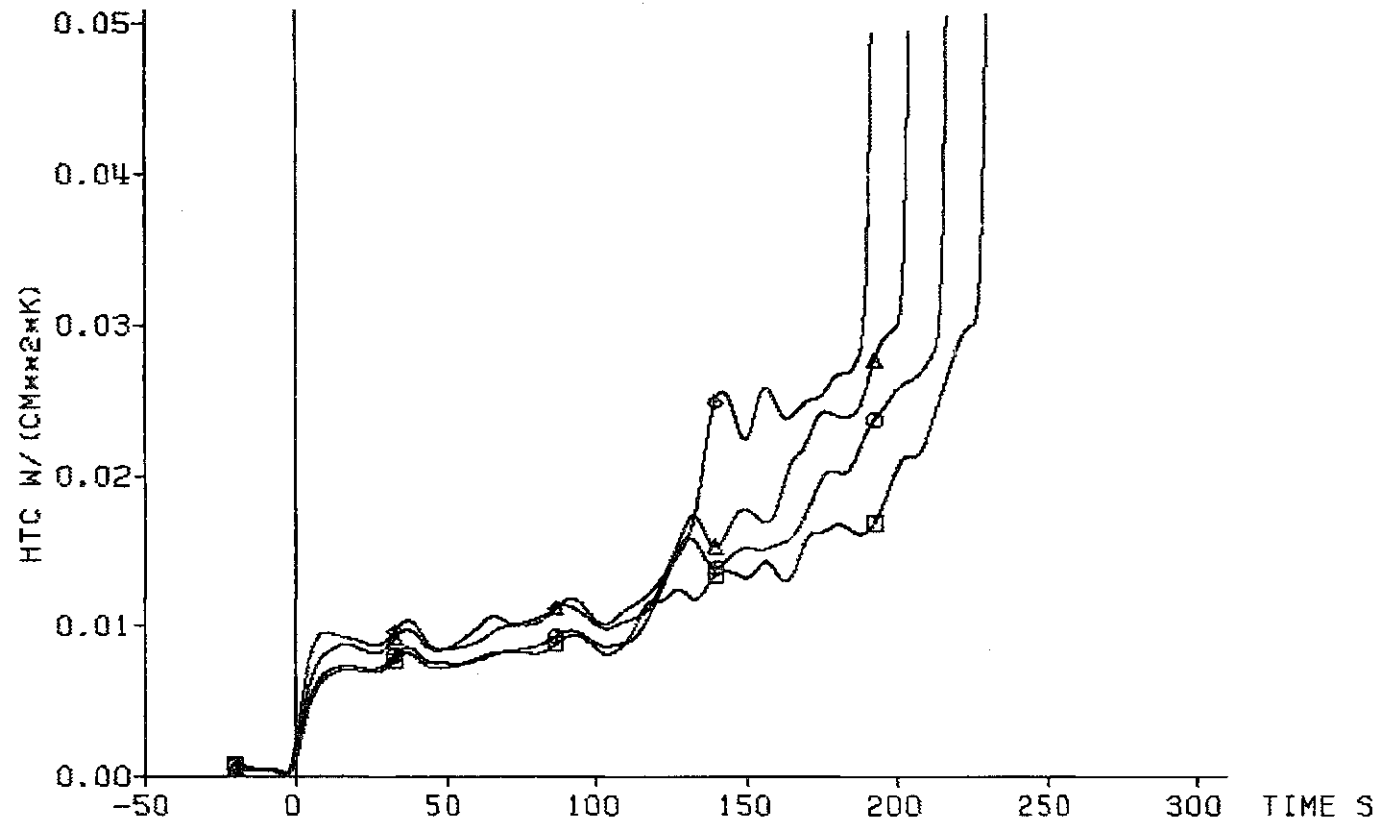

TC	ax. level
♦ 9h1	1925 mm
△ 19g3	1825 mm
○ 19g2	1725 mm
□ 19g1	1625 mm

decay heat 120% ANS standard
 flooding rate (cold) 5.72 cm/s
 system pressure 4.13 bar
 feedwater temperature 40 deg C

bypass
 =====



Fig. 297 FEBA: 5x5 ROD BUNDLE, TEST SERIES 3, TEST-No. 238

cladding temperature

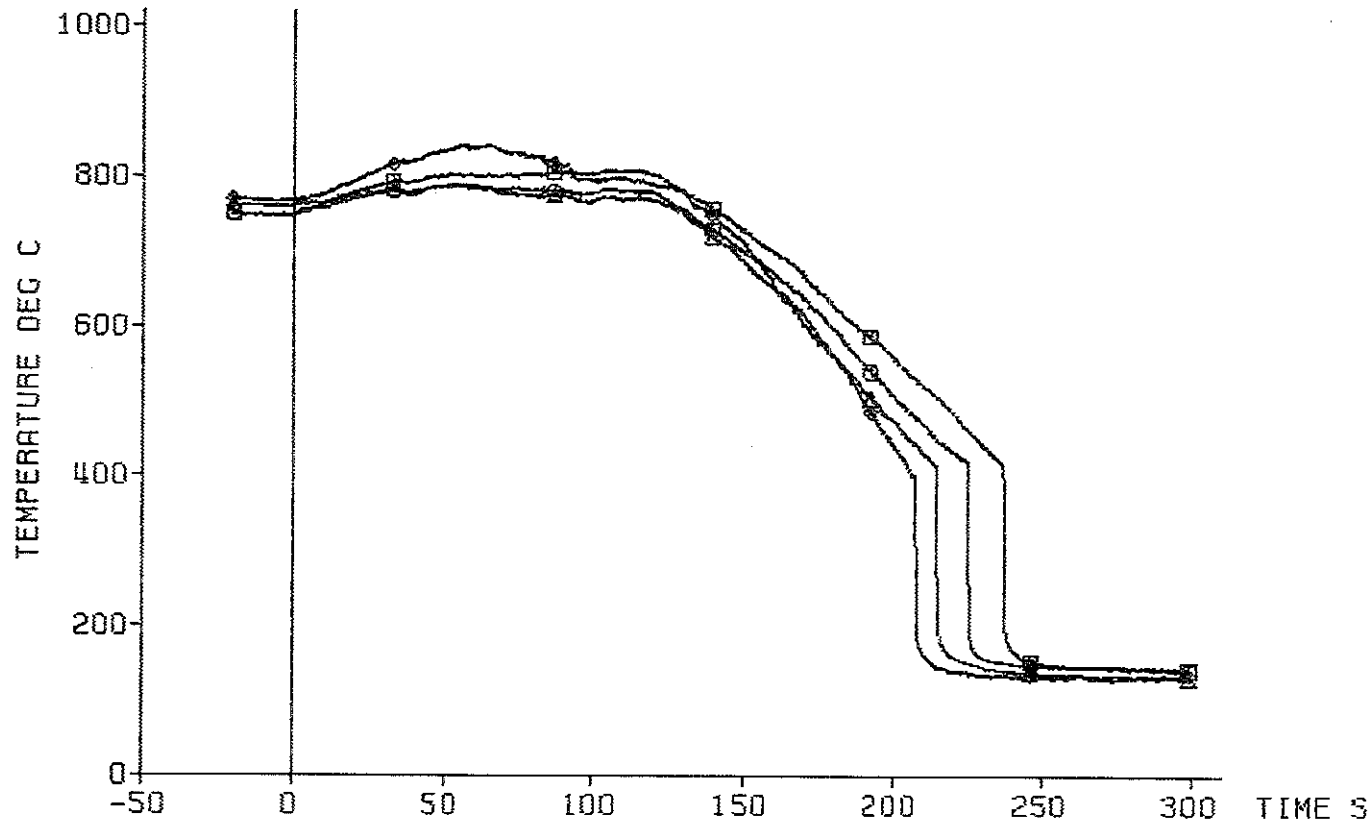

TC	ax. level
◇	17h1 1925 mm
△	16g3 1825 mm
○	16g2 1725 mm
□	16g1 1625 mm

decay heat 120% RMS standard
 flooding rate (cold) 5.72 cm/s
 system pressure 4.13 bar
 feedwater temperature 40 deg C

blockage
=====



Fig. 298 FEBA: 5x5 ROD BUNDLE, TEST SERIES 3, TEST-No. 238

heat transfer coeff.

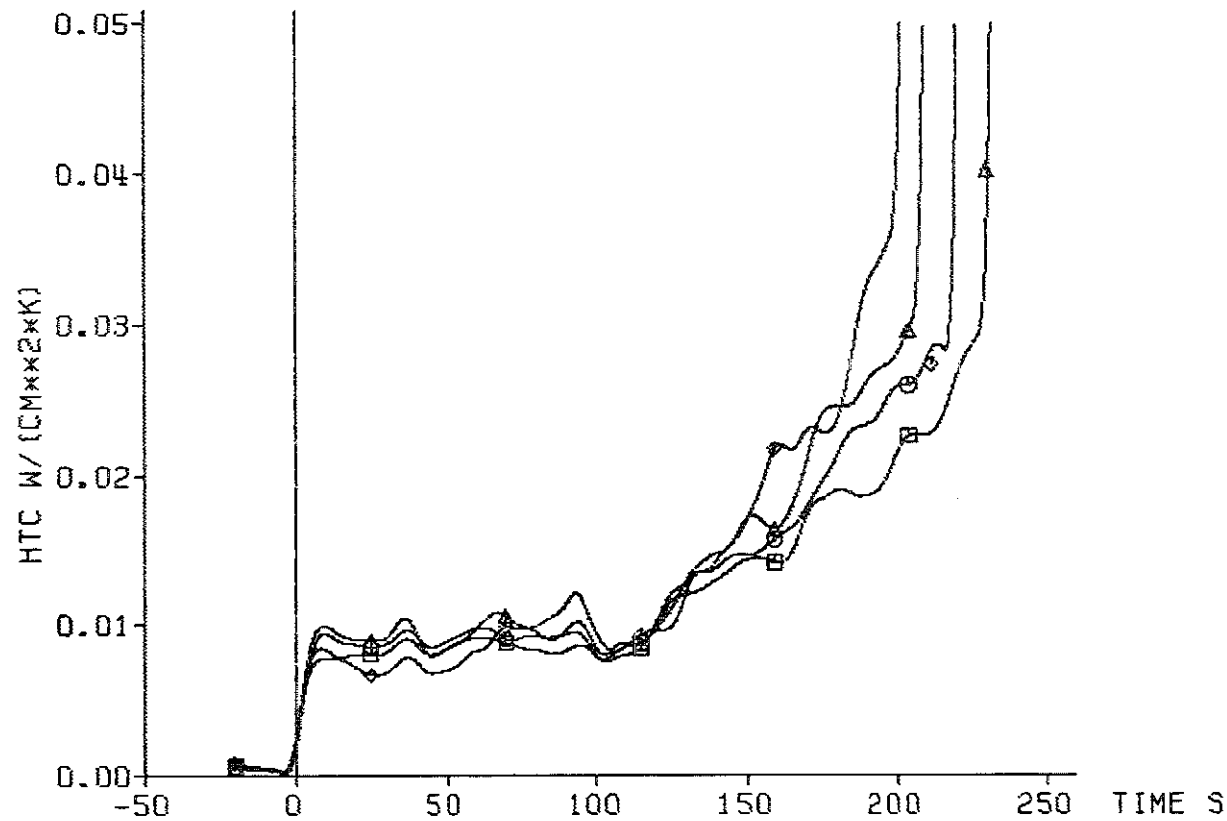

TC	ex. level
◇ 17h1	1925 mm
△ 16g3	1825 mm
○ 16g2	1725 mm
□ 16g1	1625 mm

decay heat 120% ANS standard
 flooding rate (cold) 5.72 cm/s
 system pressure 4.13 bar
 feedwater temperature 40 deg C

blockage
 =====



Fig. 299 FEBA: 5x5 ROD BUNDLE, TEST SERIES 3, TEST-No. 238

axial level: 1925 mm

▲ cladding temperature (16g4)
○ fluid temperature
□ housing temperature

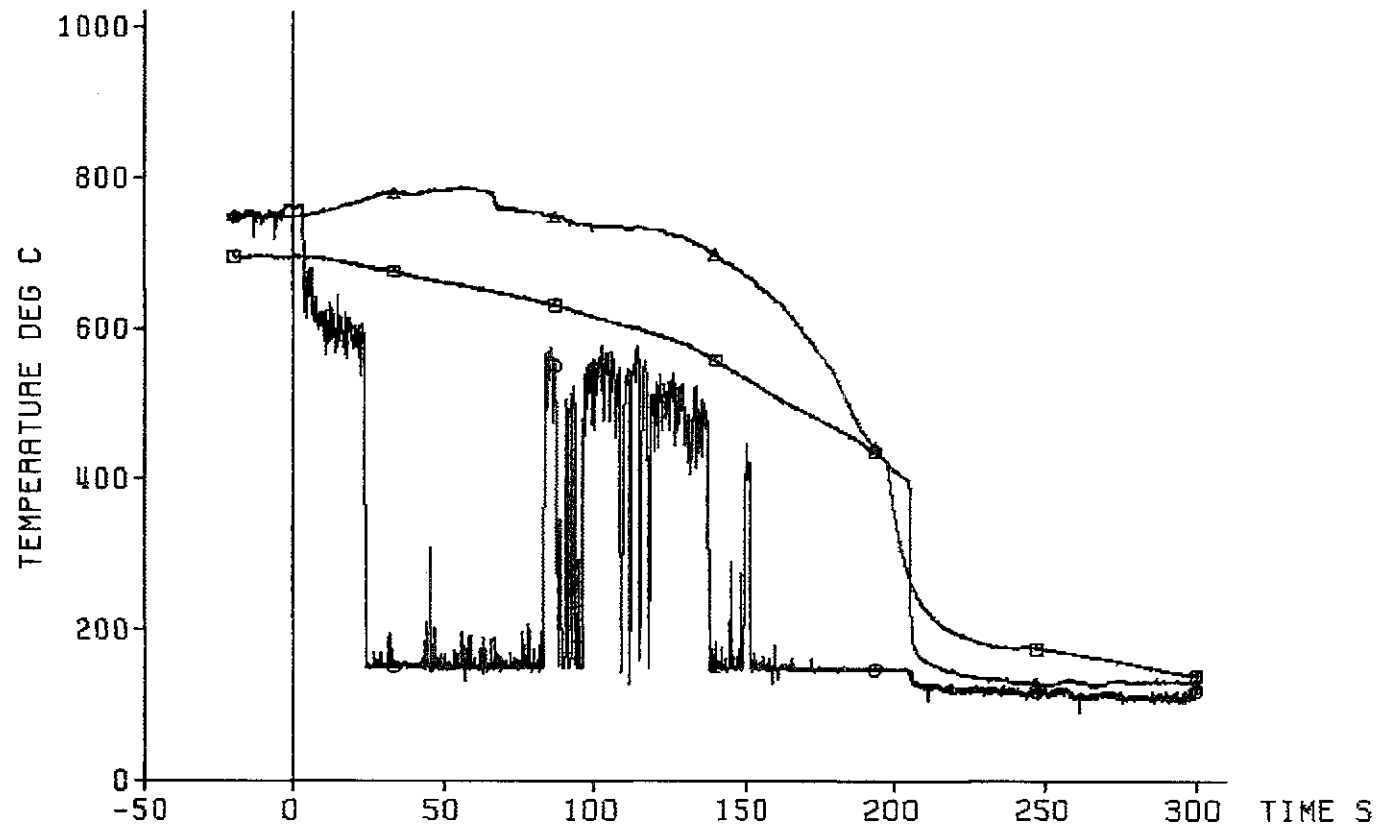

decay heat 120% ANS standard
flooding rate (cold) 5.72 cm/s
system pressure 4.13 bar
feedwater temperature 40 deg C

blockage
=====



Fig. 300 FEBA: 5x5 ROD BUNDLE, TEST SERIES 3, TEST-NO. 238

axial level: 1725 mm

▲ cladding temperature (16g2)
○ fluid temperature
□ housing temperature

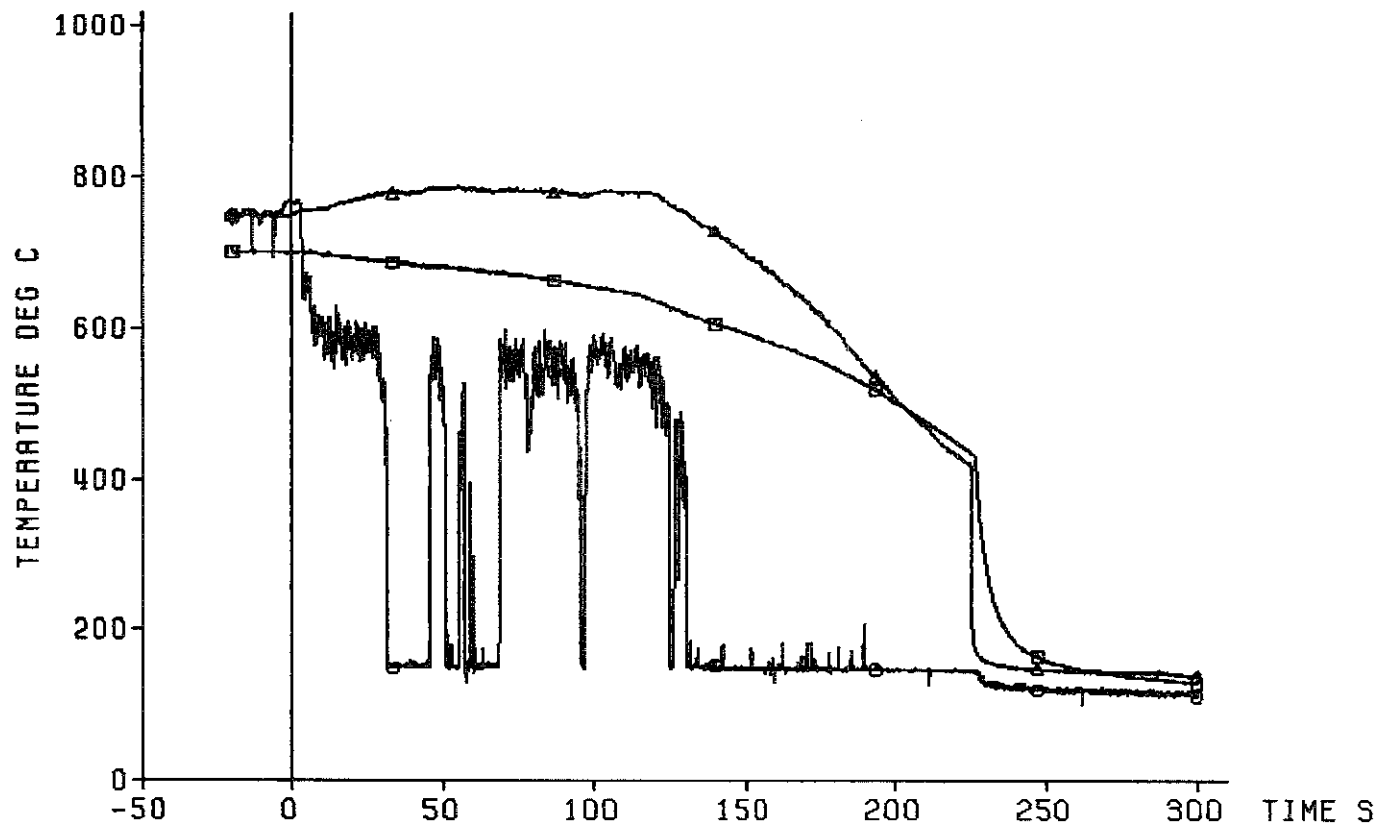

decay heat 120% ANS standard
flooding rate (cold) 5.72 cm/s
system pressure 4.13 bar
feedwater temperature 40 deg C

blockage
=====

KfK
IRB

Fig. 301 FEBA: 5x5 ROD BUNDLE, TEST SERIES 3, TEST-No. 238

axial level: 1625 mm

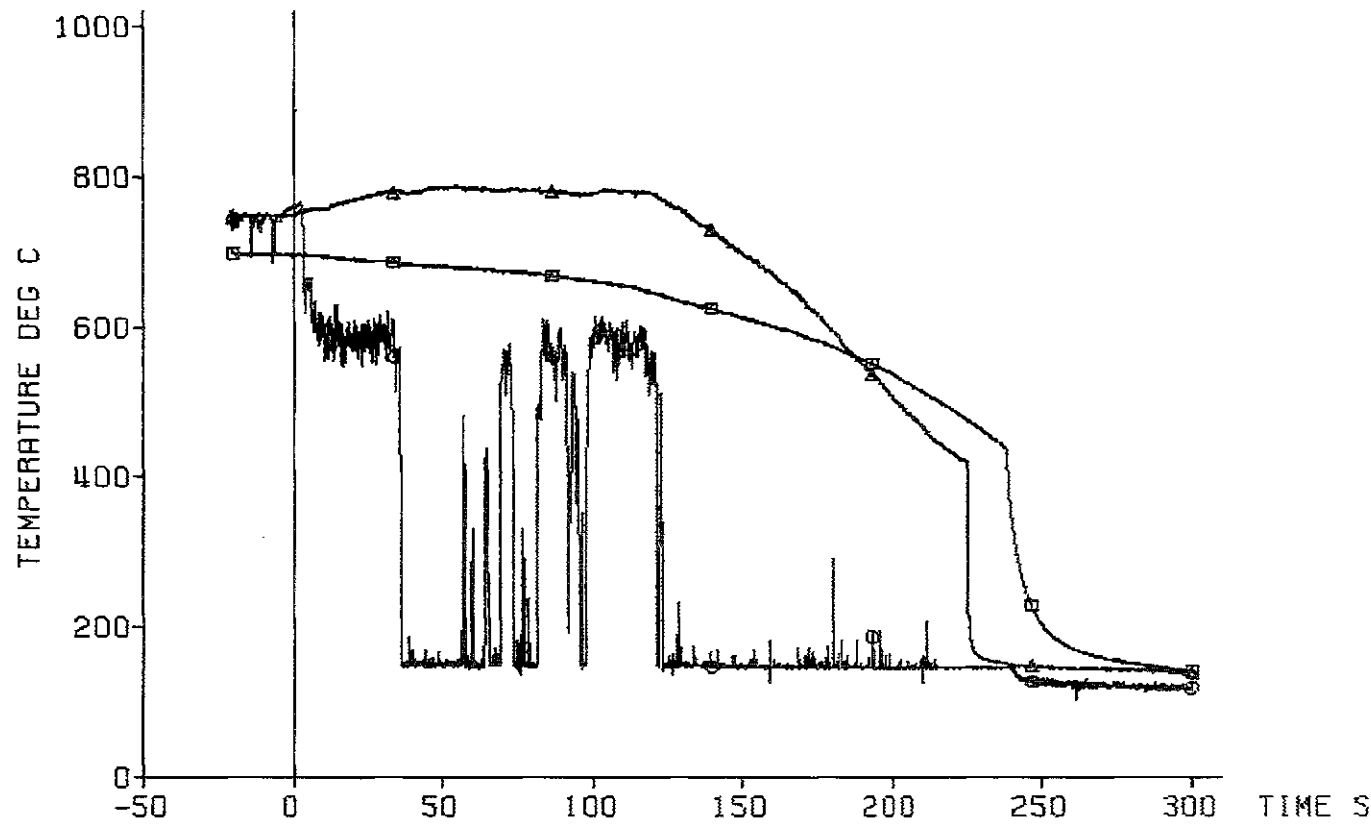

▲ cladding temperature (16g1)
○ fluid temperature
□ housing temperature

decay heat 120% ANS standard
flooding rate (cold) 5.72 cm/s
system pressure 4.13 bar
feedwater temperature 40 deg C

blockage
=====



Fig. 302 FEBA: 5x5 ROD BUNDLE, TEST SERIES 3, TEST-NO. 238

pressure loss
along the test section:

◇ total length: 4196 mm
△ lower part: 1711 mm
○ middle part: 545 mm
□ upper part: 1940 mm

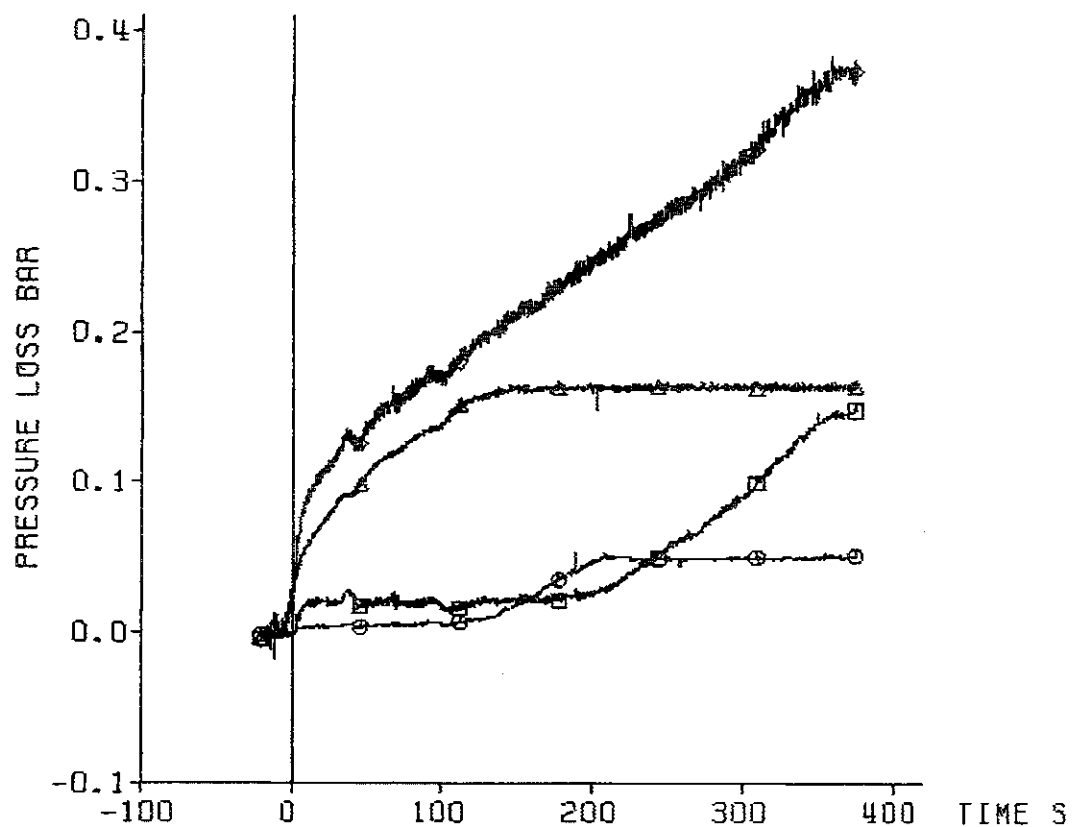

decay heat 120% RMS standard
flooding rate (cold) 5.72 cm/s
system pressure 4.13 bar
feedwater temperature 40 deg C

KIK
IRB

Fig. 303 FEBA: 5x5 ROD BUNDLE, TEST SERIES 3, TEST-No. 238

coolant conditions:

- ▲ water carry over
- coolant temperature
- coolant pressure

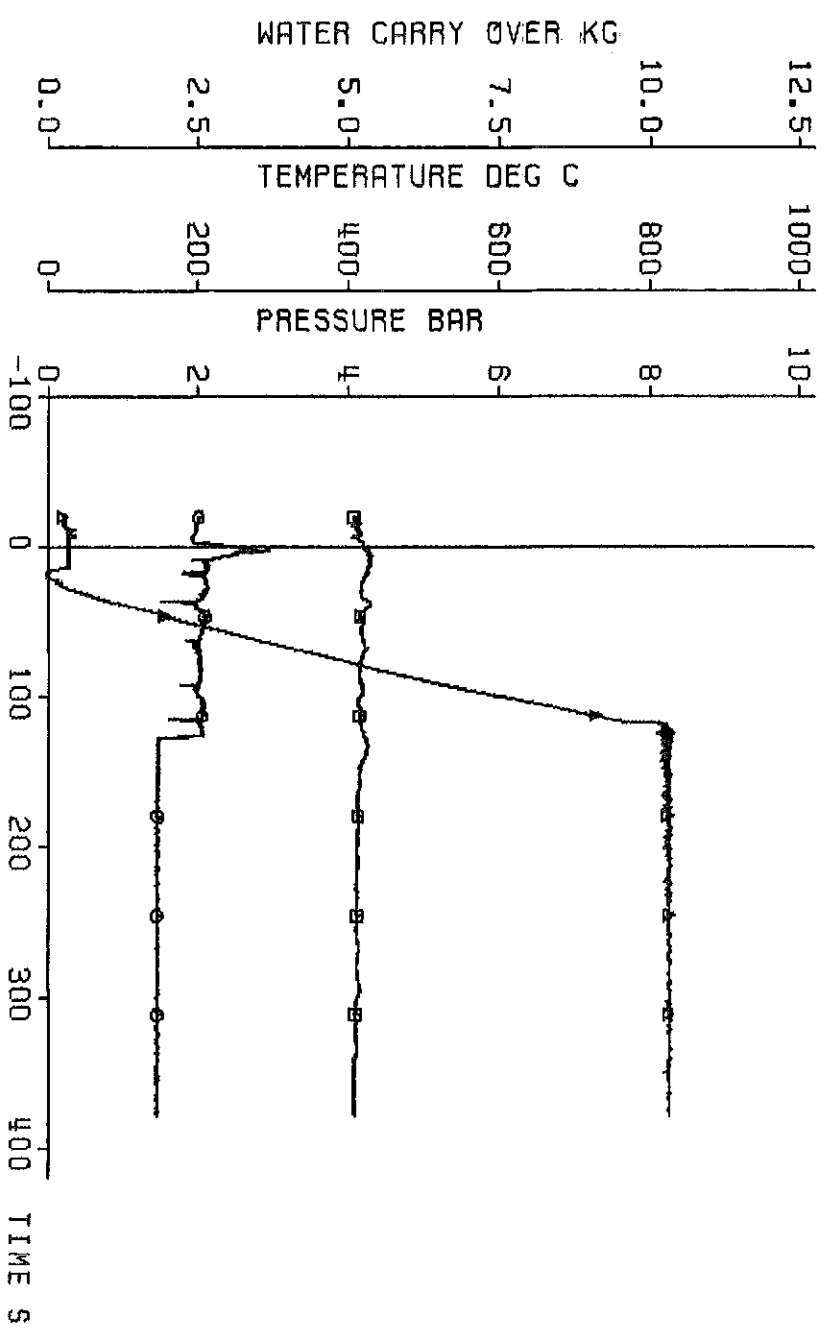

decay heat
flooding rate (cold)
system pressure
feedwater temperature

120% PWS standard
5.72 cm/s
4.13 bar
40 deg C

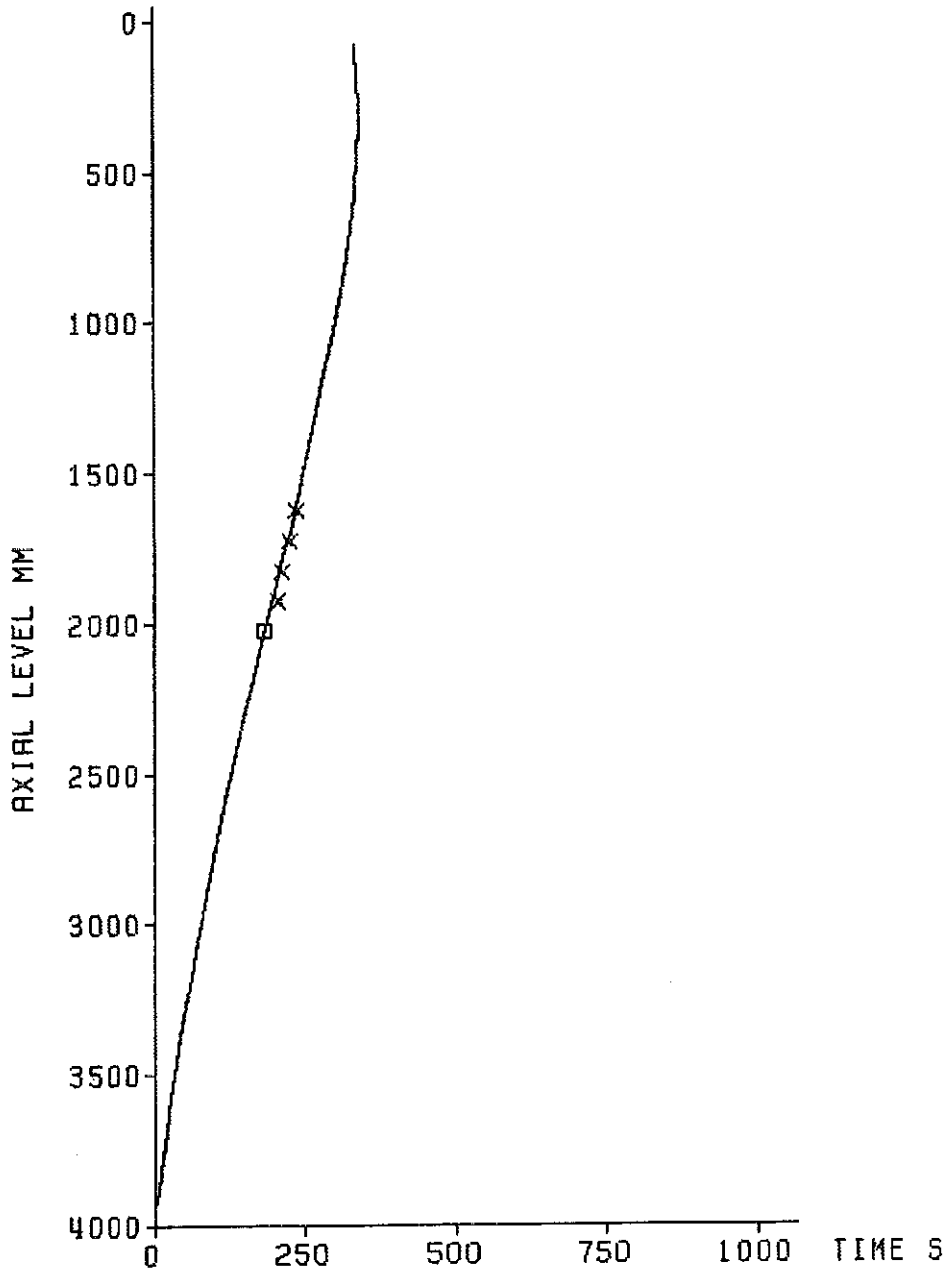

Fig. 304 FEBRA: 5X5 ROD BUNDLE, TEST SERIES 3, TEST-NO. 238

axial position of the quench front

□ rewetting of the sleeve at the bundle midplane

x rewetting of the rod downstream of the blockage



decay heat	120% RNS standard
flooding rate (cold)	5.72 cm/s
system pressure	4.13 bar
feedwater temperature	40 deg C



Fig. 305 FEBA: 5x5 ROD BUNDLE
TEST SERIES 3, TEST-No. 238

initial axial temperature profile of the cladding

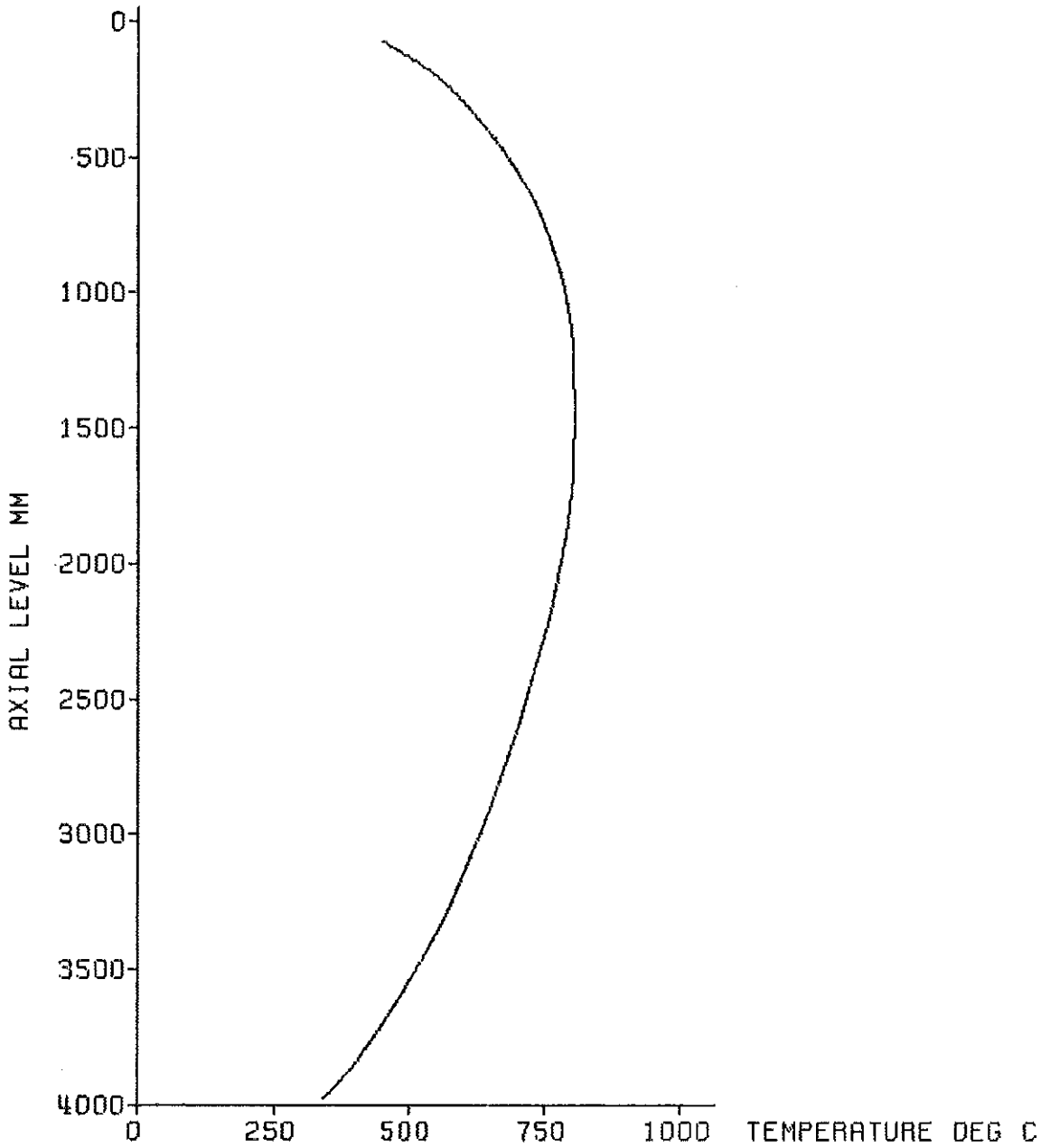

decay heat	120% ANS standard
flooding rate (cold)	5.71 cm/s
system pressure	6.21 bar
feedwater temperature	40 deg C



Fig. 306 FEBA: 5x5 ROD BUNDLE
TEST SERIES 3, TEST-No. 235

test parameters:

- ◊ flooding rate
- △ system pressure
- feedwater temperature
- ▣ bundle power

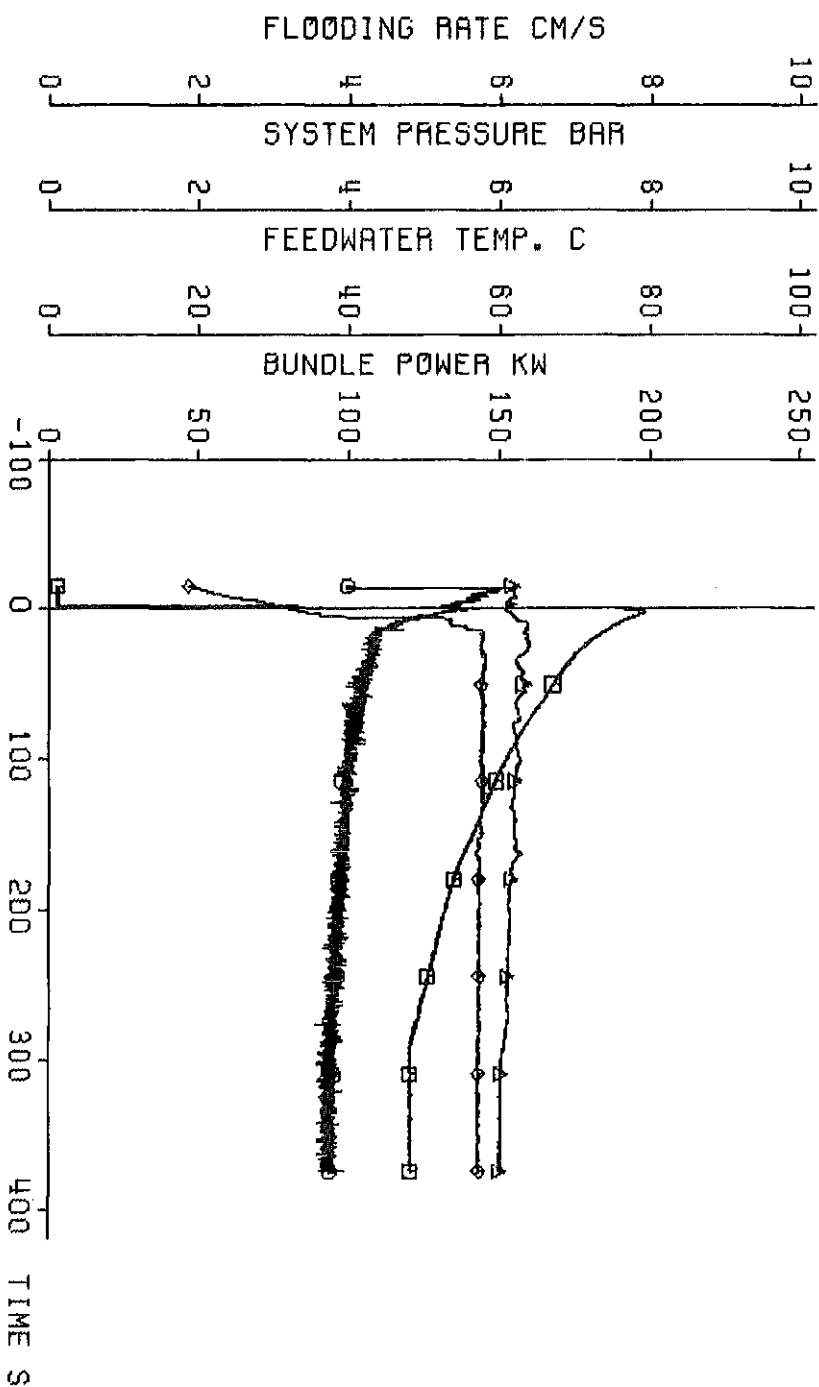

decay heat
flooding rate (cold)
system pressure
feedwater temperature

120% RMS standard
5.71 cm/s
6.21 bar
40 deg C

KIRB

Fig. 307 FEBRA: 5X5 ROD BUNDLE, TEST SERIES 3, TEST-NO. 235

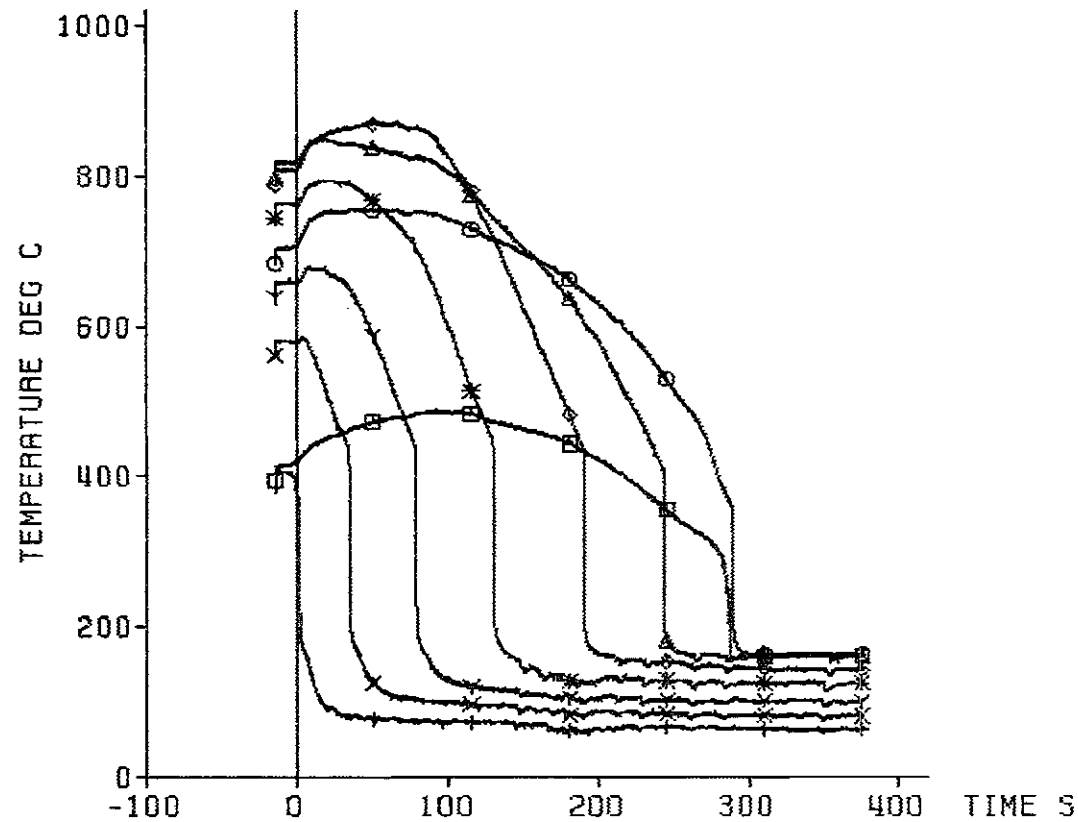

TC	ax. Level
+	18a4 3860 mm
x	18a3 3315 mm
Y	18a2 2770 mm
*	18a1 2225 mm
◇	12b4 1680 mm
△	12b3 1135 mm
○	12b2 590 mm
□	12b1 45 mm

decay heat 120% RMS standard
 flooding rate (cold) 5.71 cm/s
 system pressure 6.21 bar
 feedwater temperature 40 deg C

KIRB

Fig. 308 FEBA: 5x5 ROD BUNDLE, TEST SERIES 3, TEST-No. 235

heat transfer coeff.

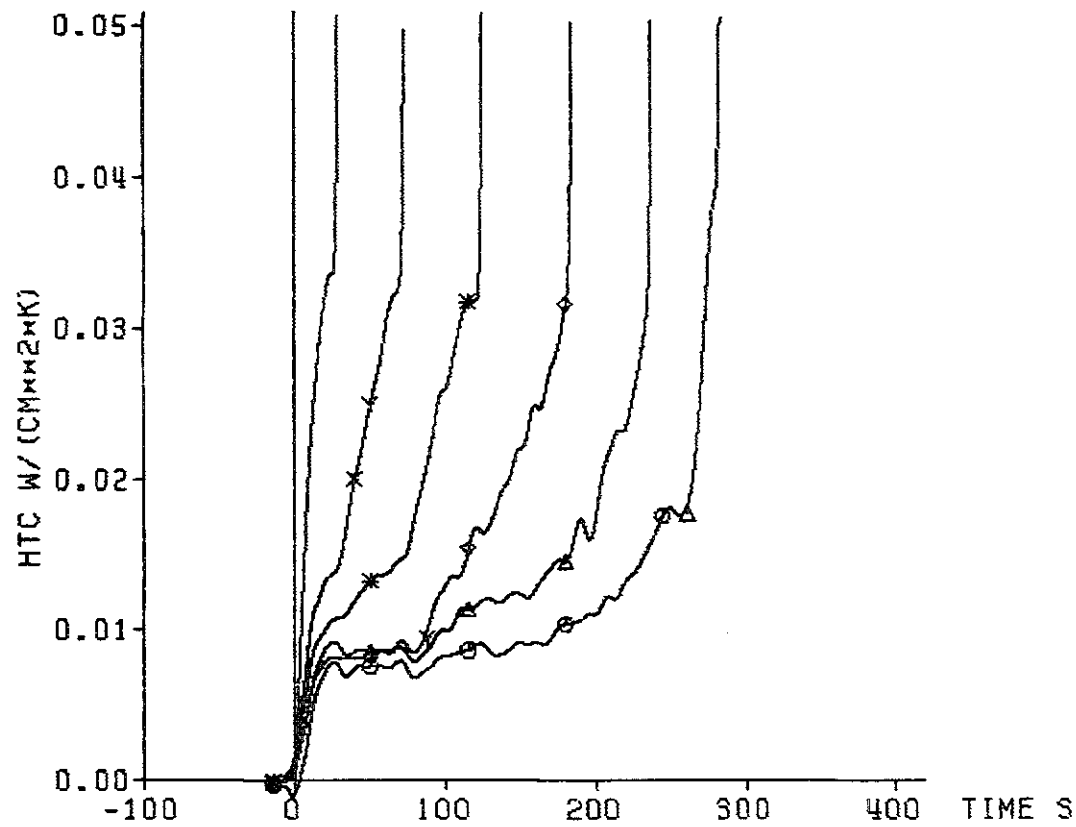

	TC	ax. Level
x	18a3	3315 mm
y	18a2	2770 mm
*	18a1	2225 mm
◇	12b4	1680 mm
△	12b3	1135 mm
○	12b2	590 mm

decay heat 120% ANS standard
 flooding rate (cold) 5.71 cm/s
 system pressure 6.21 bar
 feedwater temperature 40 deg C



Fig. 309 FEBA: 5x5 ROD BUNDLE, TEST SERIES 3, TEST-No. 235

cladding temperature

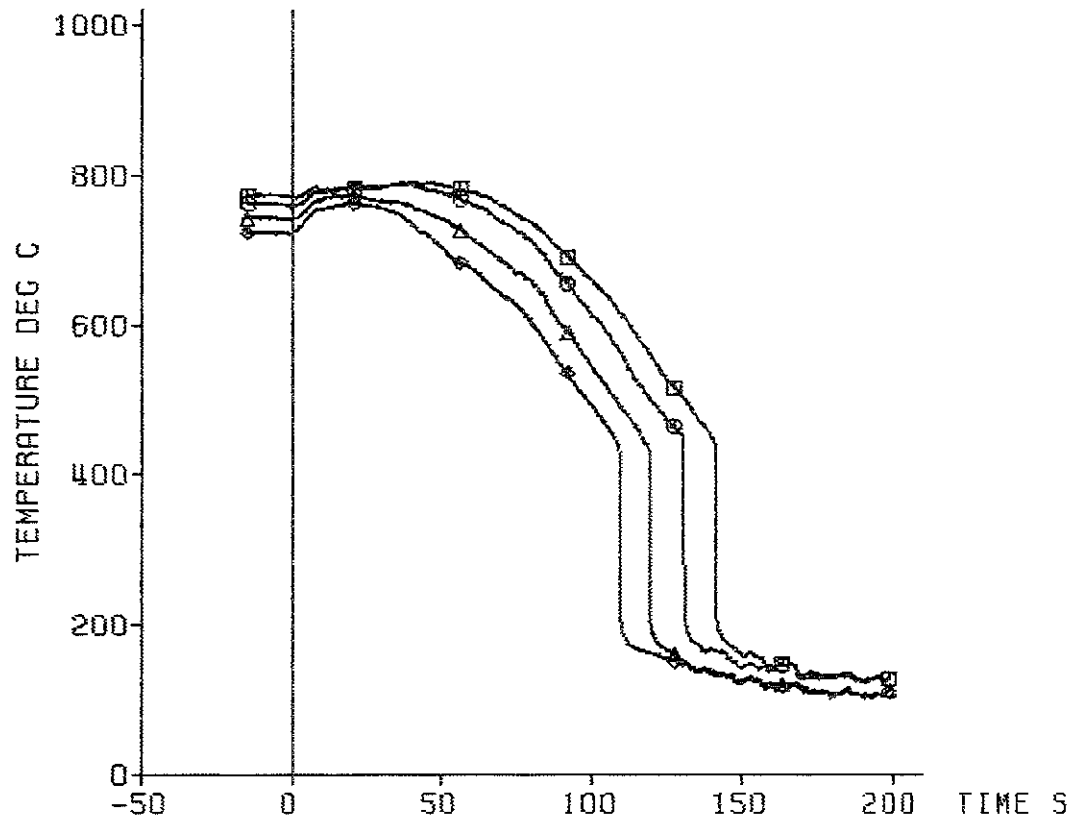

TC	ax. Level
◇	7f4 2425 mm
△	7f3 2325 mm
○	9h4 2225 mm
□	9h3 2125 mm

decay heat 120% RNS standard
flooding rate (cold) 5.71 cm/s
system pressure 6.21 bar
feedwater temperature 40 deg C

bypass
=====



Fig. 310 FEBA: 5x5 ROD BUNDLE, TEST SERIES 3, TEST-No. 235

heat transfer coeff.

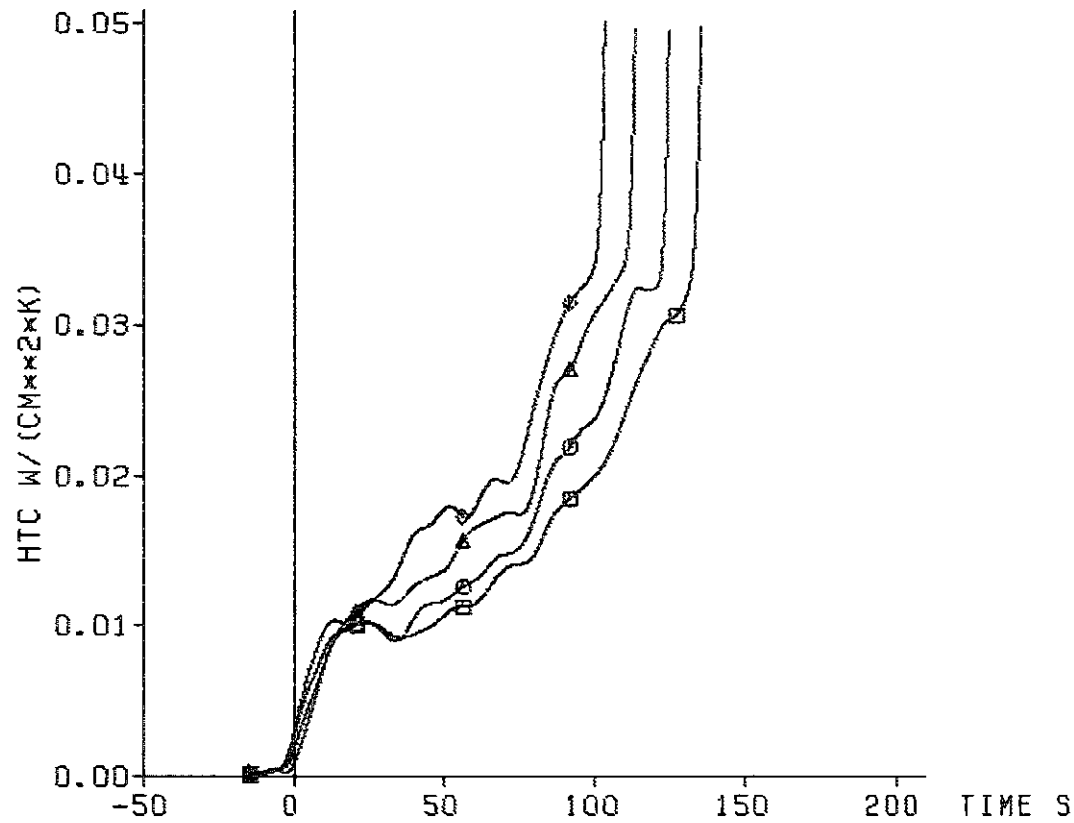

TC	ax. Level
◇	7f4 2425 mm
△	7f3 2325 mm
○	9h4 2225 mm
□	9h3 2125 mm

decay heat 120% ANS standard
 flooding rate (cold) 5.71 cm/s
 system pressure 6.21 bar
 feedwater temperature 40 deg C

bypass
 =====



Fig. 311 FEBA: 5x5 ROD BUNDLE, TEST SERIES 3, TEST-No. 235

cladding temperature

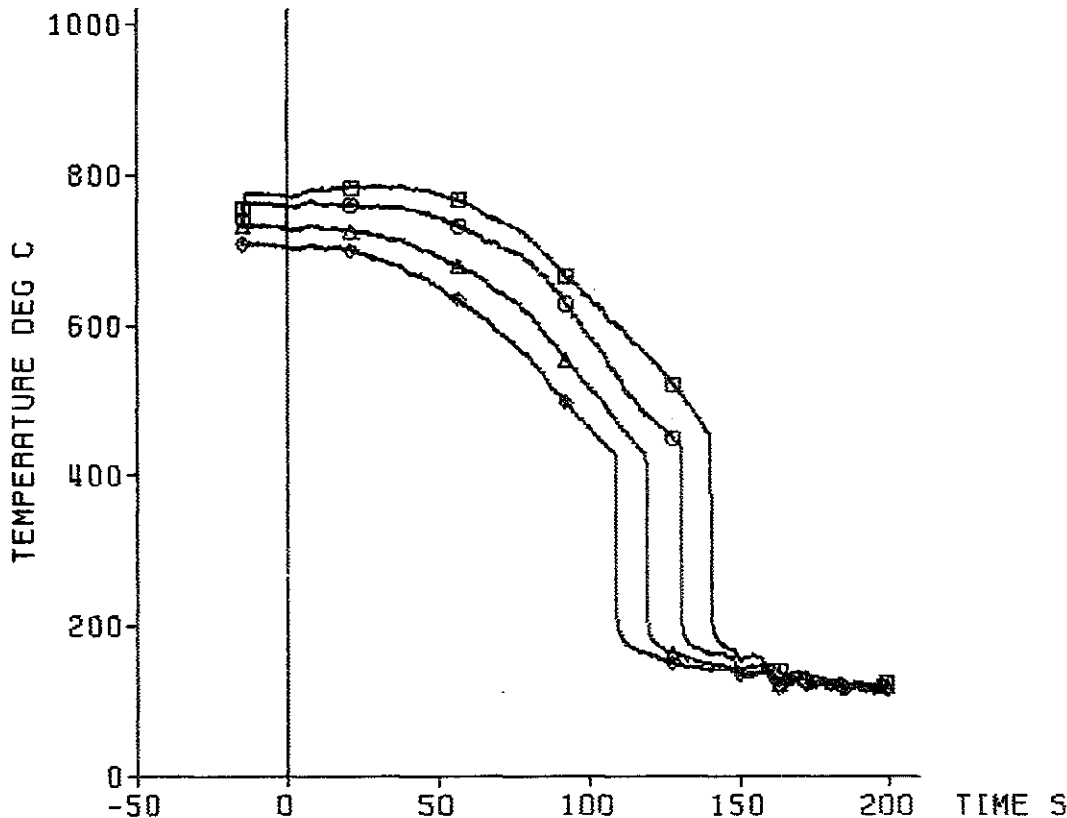

TC	ax. Level
◇ 22f4	2425 mm
△ 22f3	2325 mm
○ 17h4	2225 mm
□ 17h3	2125 mm

decay heat 120% ANS standard
 flooding rate (cold) 5.71 cm/s
 system pressure 6.21 bar
 feedwater temperature 40 deg C

blockage
=====



Fig. 312 FEBA: 5x5 R0D BUNDLE, TEST SERIES 3, TEST-No. 235

heat transfer coeff.

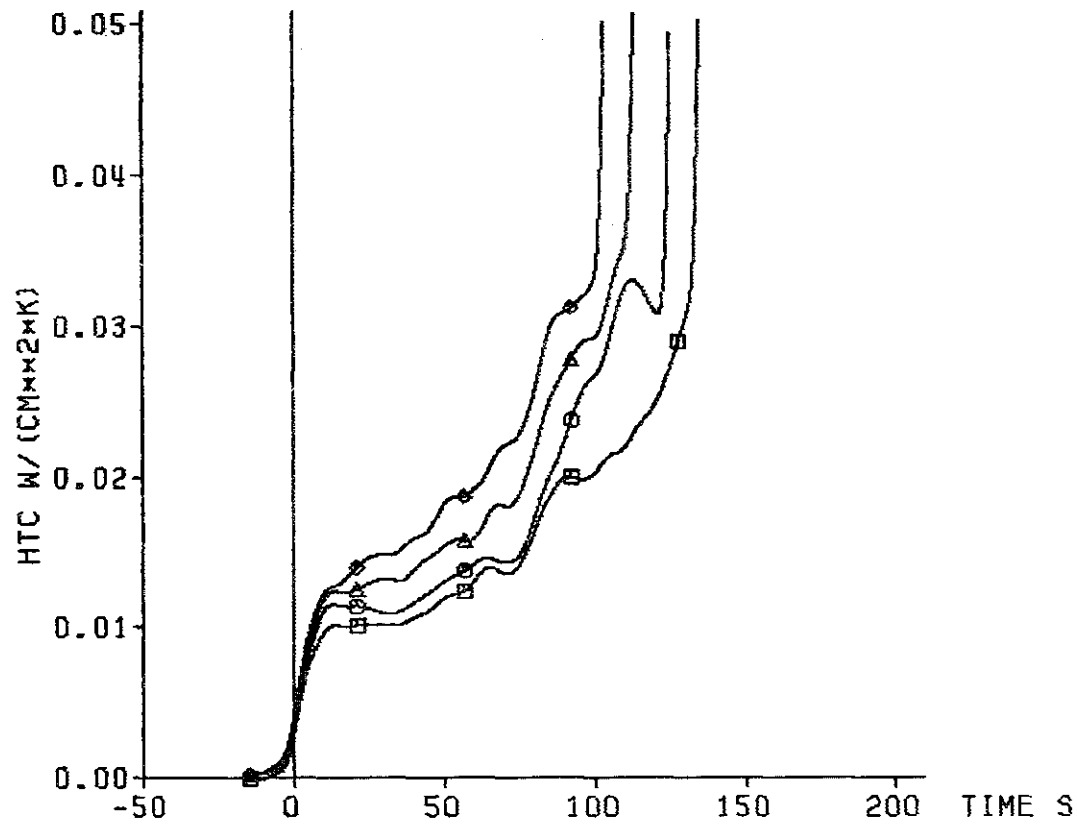

TC	ex. Level
◇ 22f4	2425 mm
△ 22f3	2325 mm
○ 17h4	2225 mm
□ 17h3	2125 mm

decay heat 120% ANS standard
 flooding rate (cold) 5.71 cm/s
 system pressure 6.21 bar
 feedwater temperature 40 deg C

blockage
 =====



Fig. 313 FEBA: 5x5 ROD BUNDLE, TEST SERIES 3, TEST-No. 235

cladding temperature

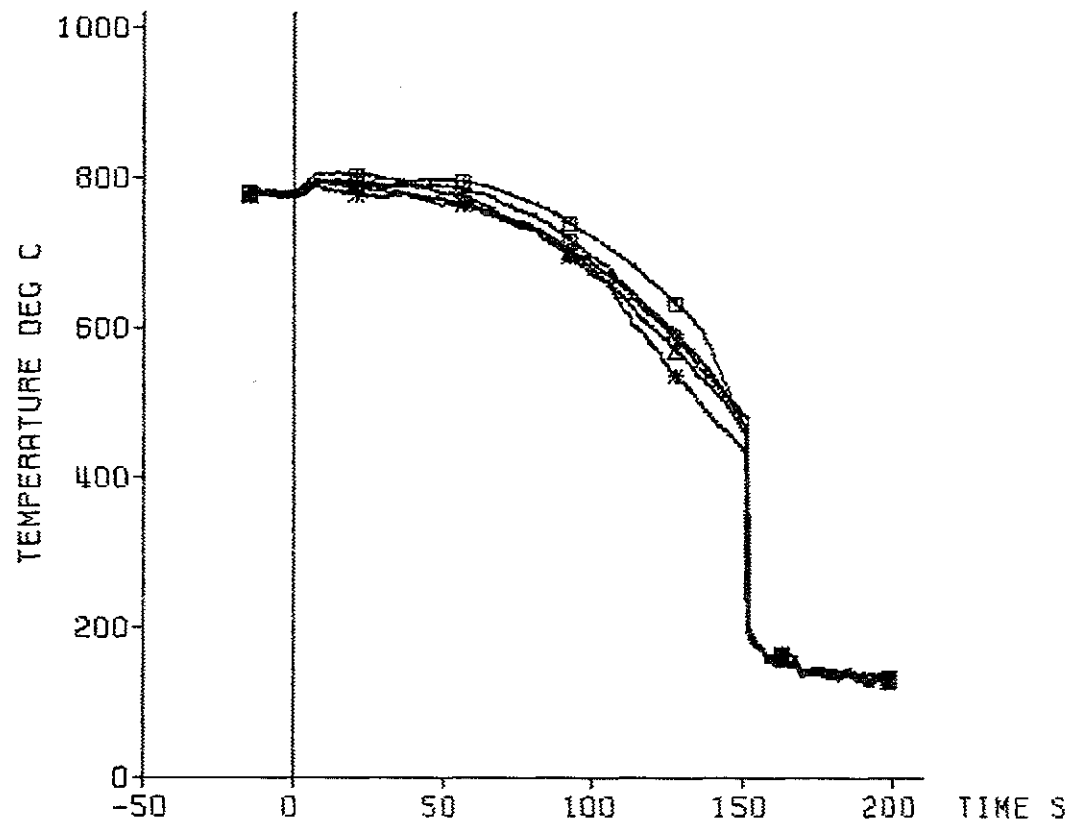

TC	ax. level
* 9h2	2025 mm
◇ 8d4	2025 mm
△ 8d3	2025 mm
⊙ 8d2	2025 mm
⊠ 8d1	2025 mm

decay heat 120% RMS standard
flooding rate (cold) 5.71 cm/s
system pressure 6.21 bar
feedwater temperature 40 deg C

bypass
=====



Fig. 314 FEBA: 5x5 ROD BUNDLE, TEST SERIES 3, TEST-No. 235

heat transfer coeff.

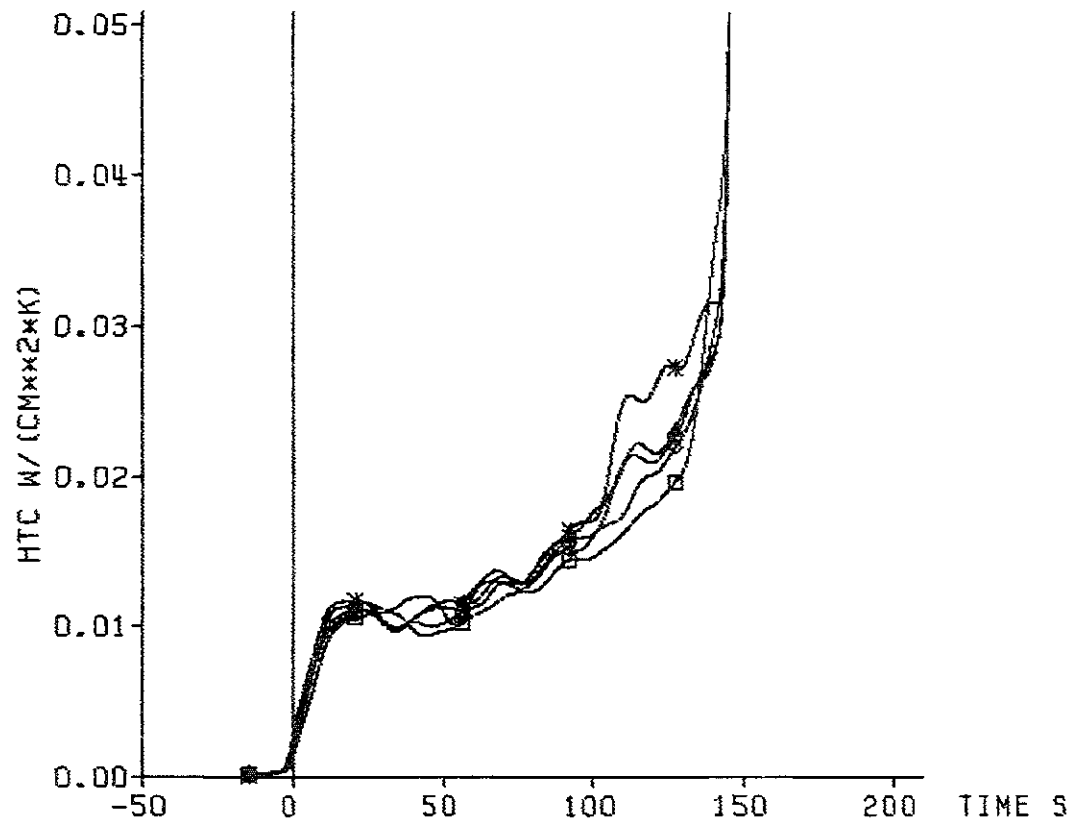

TC	axial level
*	9h2 2025 mm
Δ	8d4 2025 mm
Δ	8d3 2025 mm
○	8d2 2025 mm
◻	8d1 2025 mm

decay heat 120% ANS standard
 flooding rate (cold) 5.71 cm/s
 system pressure 6.21 bar
 feedwater temperature 40 deg C

bypass



Fig. 315 FEBA: 5x5 ROD BUNDLE, TEST SERIES 3, TEST-NO. 235

cladding temperature

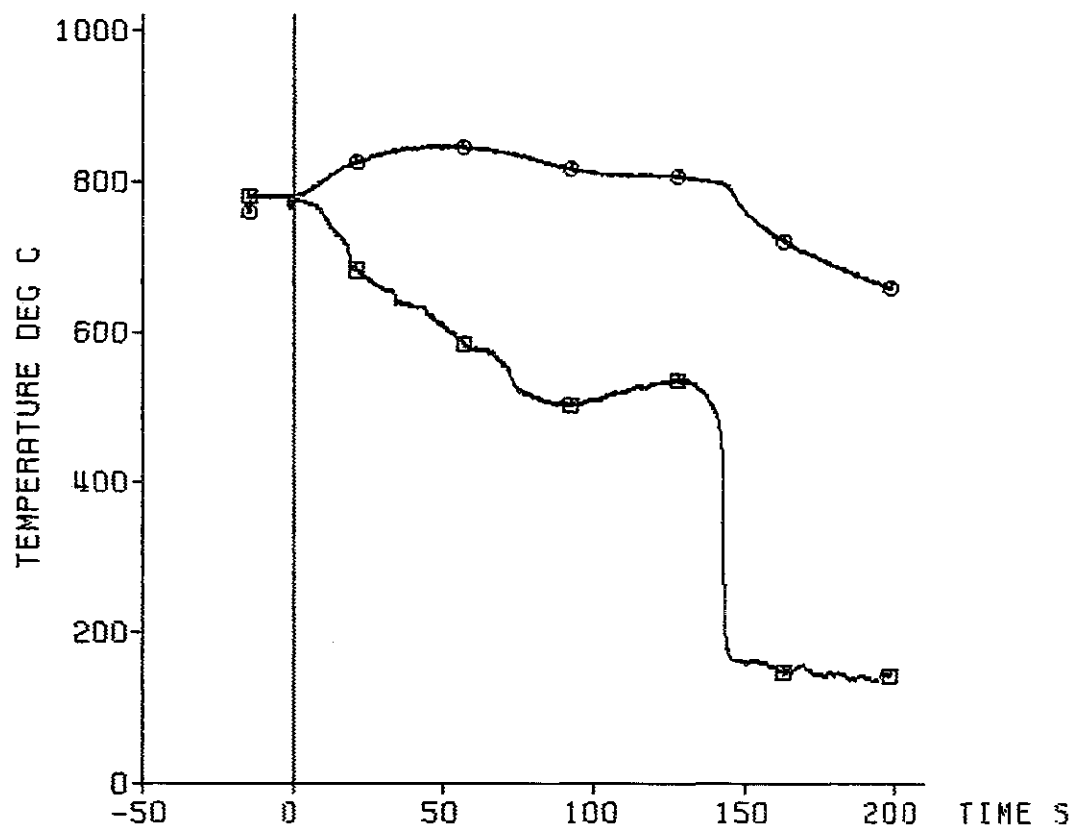

TC	ax. level
○ 17h2	2025 mm
□ sleeve	2025 mm

decay heat 120% AWS standard
flooding rate (cold) 5.71 cm/s
system pressure 6.21 bar
feedwater temperature 40 deg C

blockage
=====



Fig. 316 FEBA: 5x5 ROD BUNDLE, TEST SERIES 3, TEST-No. 235

cladding temperature

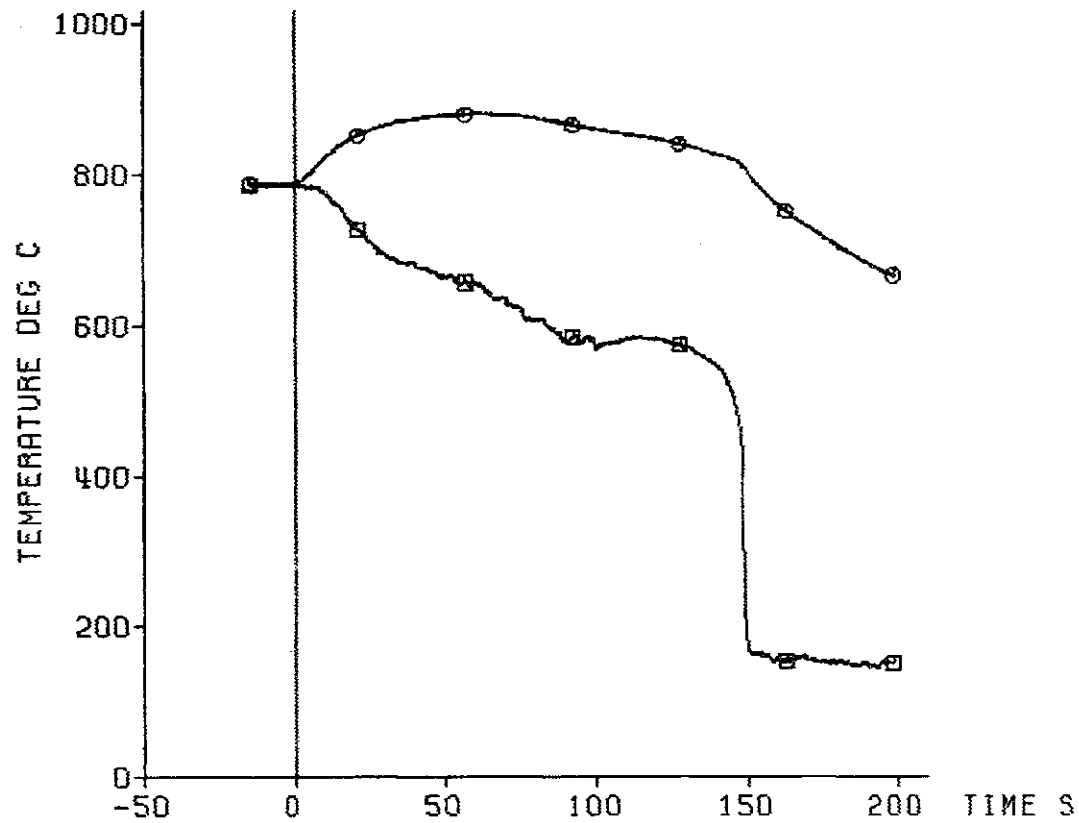

TC	axial level
○ 13d2	2025 mm
□ sleeve	2025 mm

decay heat 120% ANS standard
flooding rate (cold) 5.71 cm/s
system pressure 6.21 bar
feedwater temperature 40 deg C

blockage
=====



Fig. 317 FEBA: 5x5 ROD BUNDLE, TEST SERIES 3, TEST-No. 235

cladding temperature

TC	ax. level
◆ 9h1	1925 mm
▲ 19g3	1825 mm
● 19g2	1725 mm
■ 19g1	1625 mm

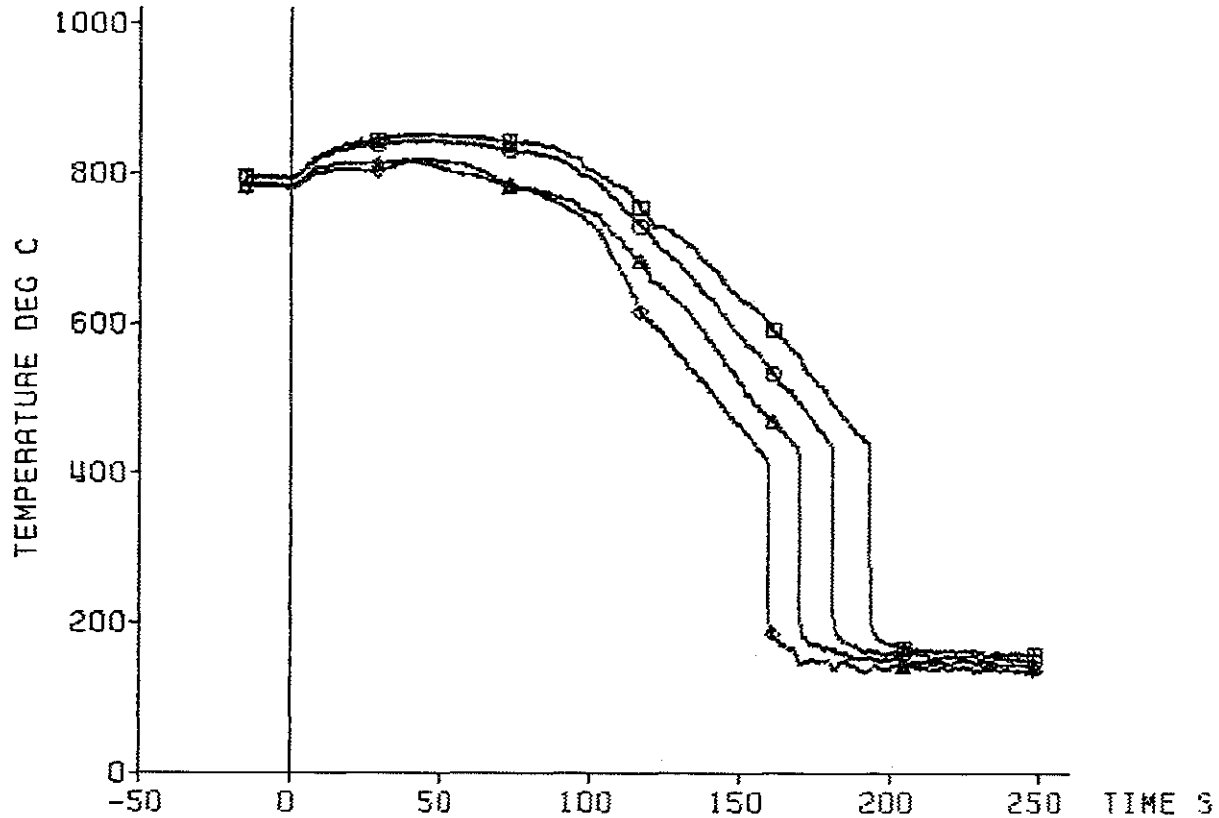

decay heat 120% ANS standard
 flooding rate (cold) 5.71 cm/s
 system pressure 6.21 bar
 feedwater temperature 40 deg C

bypass
 =====



Fig. 318 FEBA: 5x5 ROD BUNDLE, TEST SERIES 3, TEST-No. 235

heat transfer coeff.

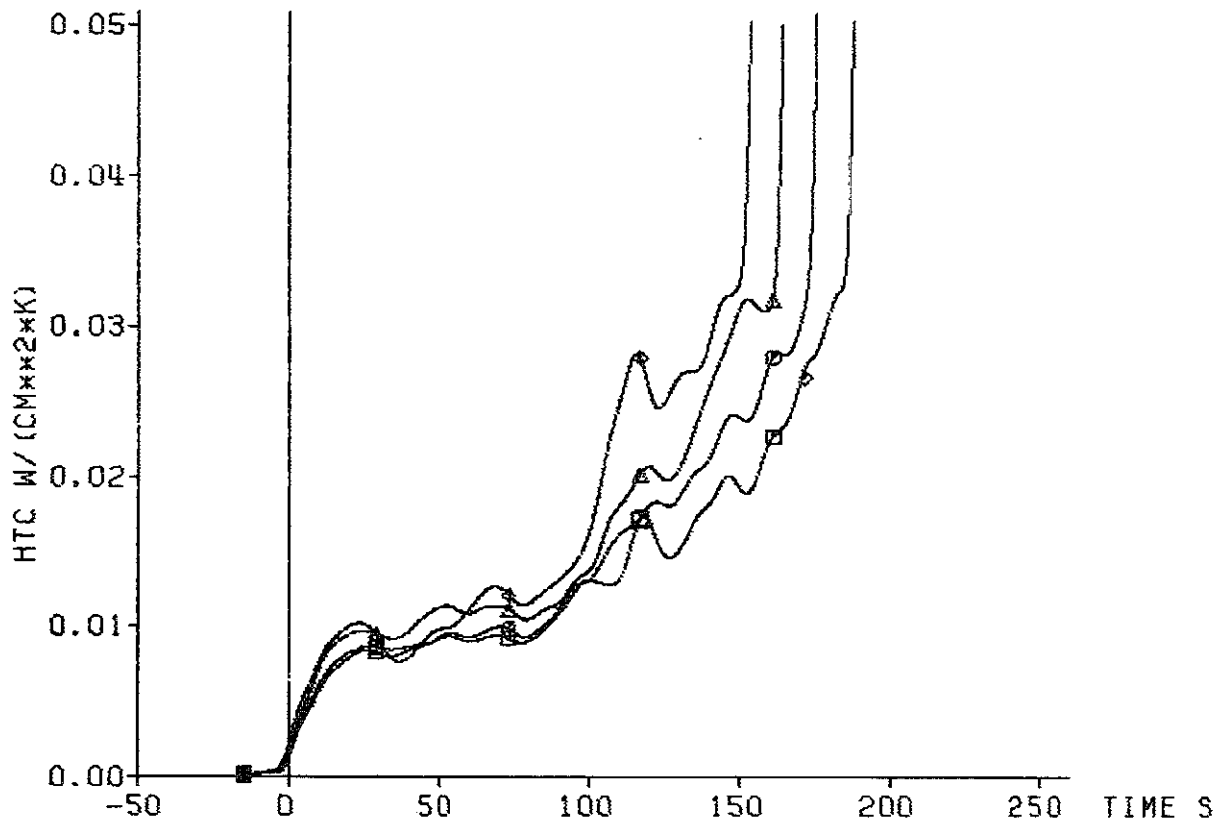

TC	ax. level
♦	9h1 1925 mm
▲	19g3 1825 mm
◊	19g2 1725 mm
◻	19g1 1625 mm

decay heat
 flooding rate (cold) 5.71 cm/s
 system pressure 6.21 bar
 feedwater temperature 40 deg C

120% ANS standard

bypass
 =====



Fig. 319 FEBA: 5x5 ROD BUNDLE, TEST SERIES 3, TEST-No. 235

cladding temperature

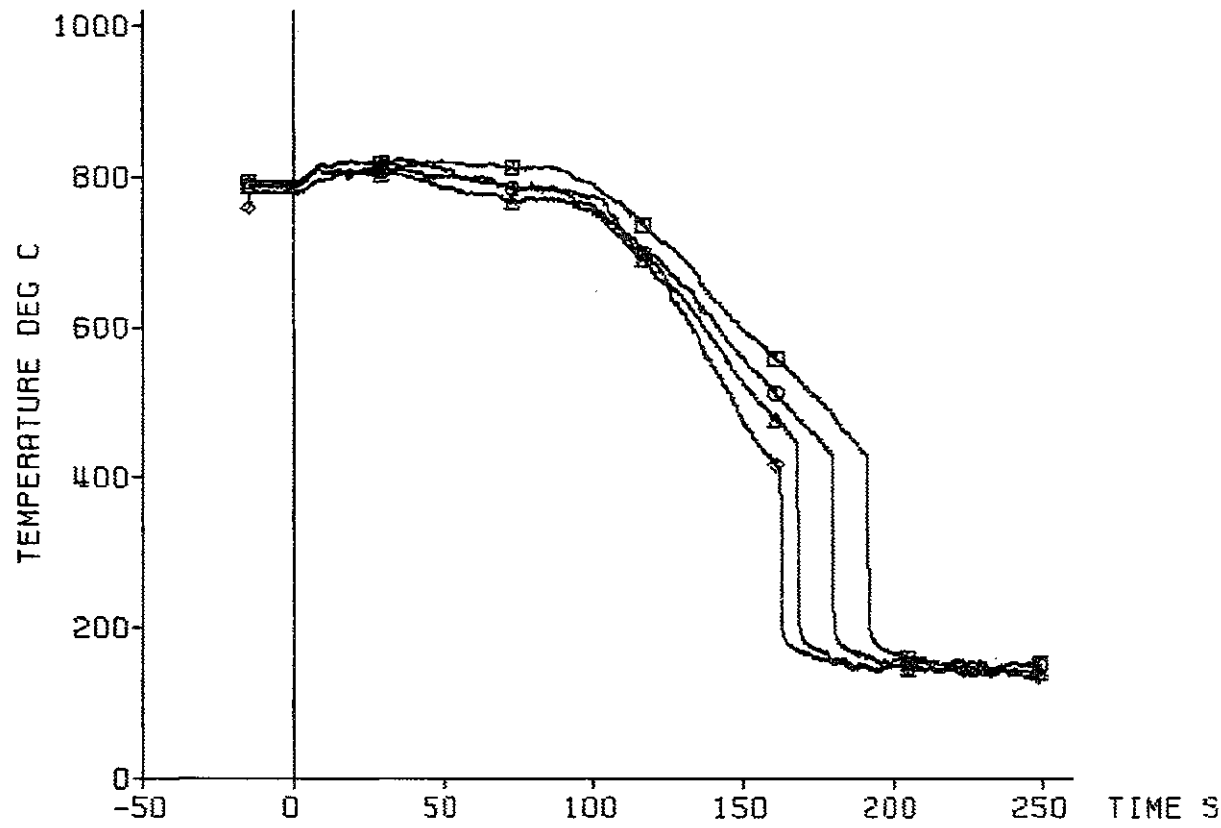

TC	ax. level
◇	17h1 1925 mm
△	16g3 1825 mm
○	16g2 1725 mm
□	16g1 1625 mm

decay heat 120% AWS standard
 flooding rate (cold) 5.71 cm/s
 system pressure 6.21 bar
 feedwater temperature 40 deg C

blockage
 =====



Fig. 320 FEBA: 5x5 ROD BUNDLE, TEST SERIES 3, TEST-No. 235

heat transfer coeff.

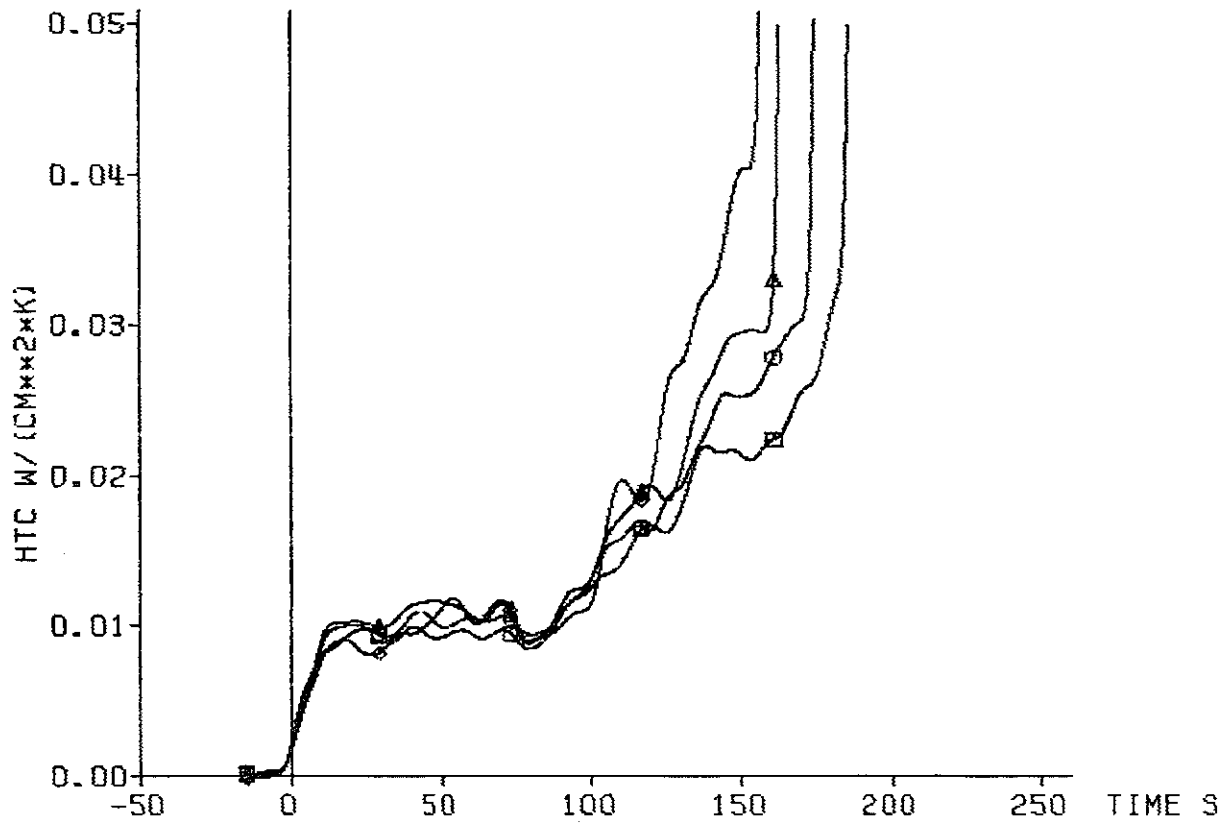

TC	ax. level
◇ 17h1	1925 mm
△ 16g3	1825 mm
○ 16g2	1725 mm
□ 16g1	1625 mm

decay heat 120% ANS standard
 flooding rate (cold) 5.71 cm/s
 system pressure 6.21 bar
 feedwater temperature 40 deg C

blockage
 =====



Fig. 321 FEBA: 5x5 ROD BUNDLE, TEST SERIES 3, TEST-No. 235

axial level: 1925 mm

△ cladding temperature (16g4)
○ fluid temperature
□ housing temperature

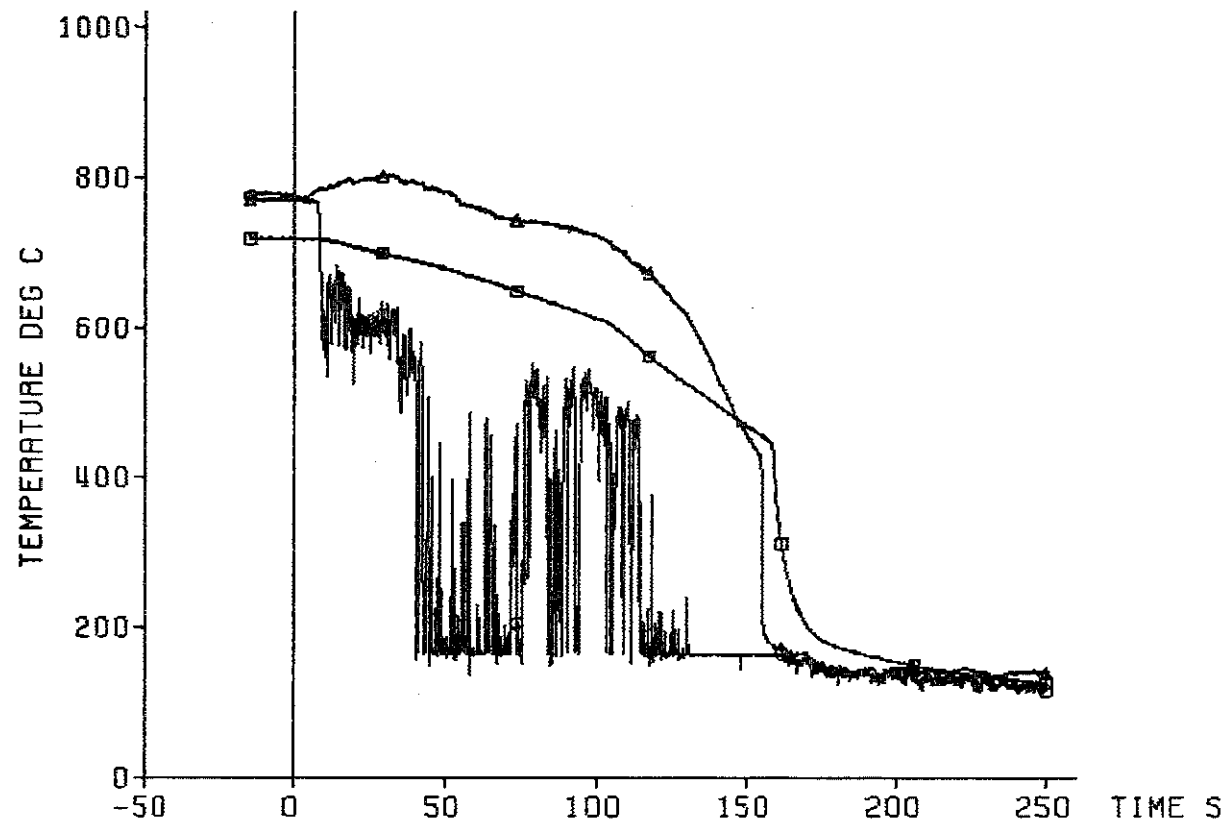

decay heat 120% ANS standard
flooding rate (cold) 5.71 cm/s
system pressure 6.21 bar
feedwater temperature 40 deg C

blockage
=====



Fig. 322 FEBA: 5x5 R0D BUNDLE, TEST SERIES 3, TEST-No. 235

axial level: 1725 mm

▲ cladding temperature (16g2)
○ fluid temperature
□ housing temperature

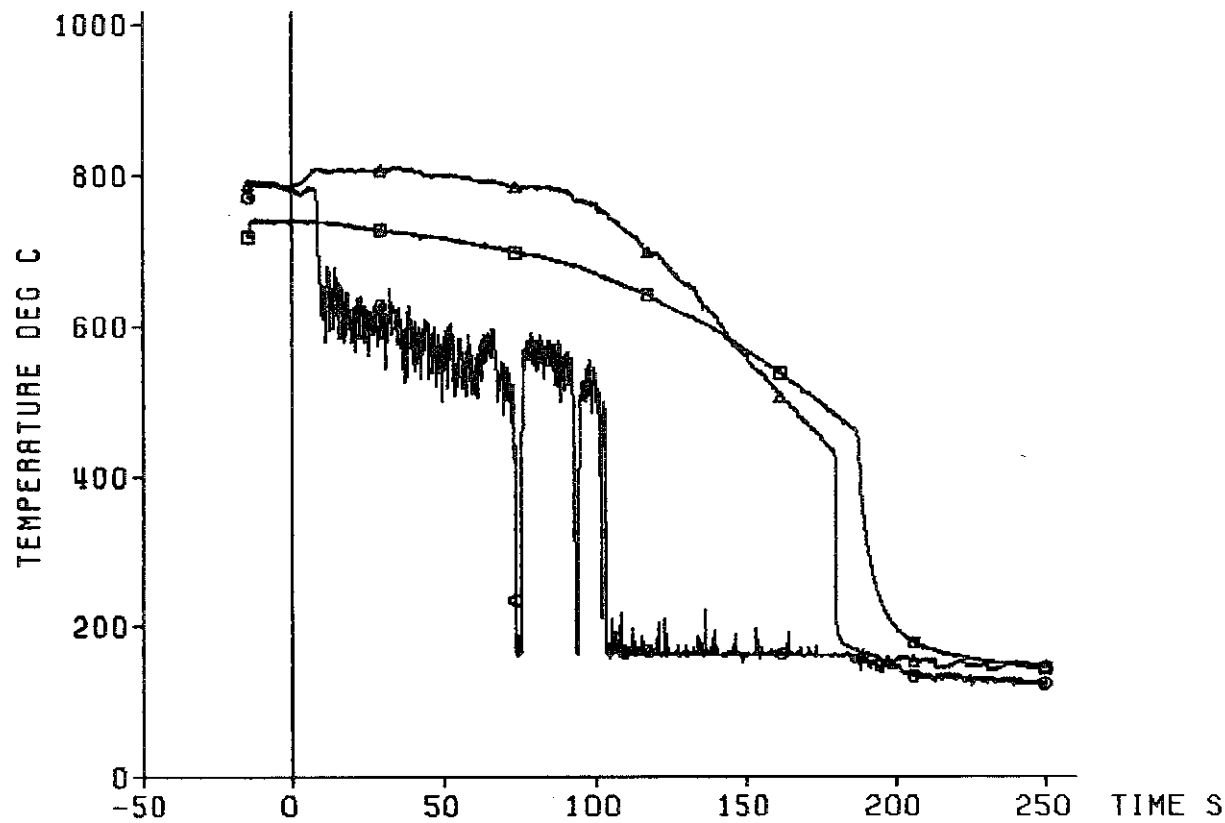

decay heat 120% ANS standard
flooding rate (cold) 5.71 cm/s
system pressure 6.21 bar
feedwater temperature 40 deg C

blockage
=====



Fig. 323 FEBA: 5x5 ROD BUNDLE, TEST SERIES 3, TEST-No. 235

axial level: 1625 mm

△ cladding temperature (16g1)
○ fluid temperature
□ housing temperature

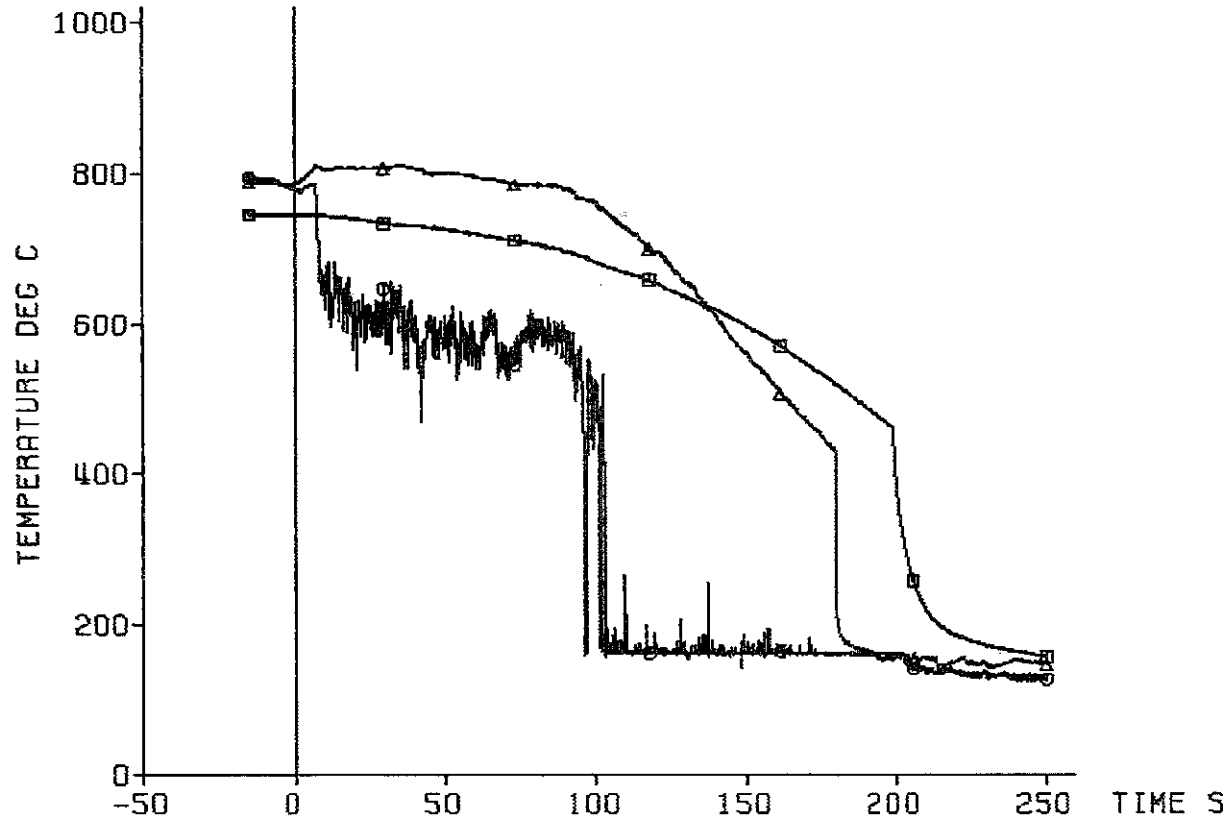

decay heat 120% ANS standard
flooding rate (cold) 5.71 cm/s
system pressure 6.21 bar
feedwater temperature 40 deg C

blockage
=====

KIK IRB

Fig. 324 FEBA: 5x5 ROD BUNDLE, TEST SERIES 3, TEST-No. 235

pressure loss
along the test section:

- ◆ total length: 4196 mm
- △ lower part: 1711 mm
- middle part: 545 mm
- upper part: 1940 mm

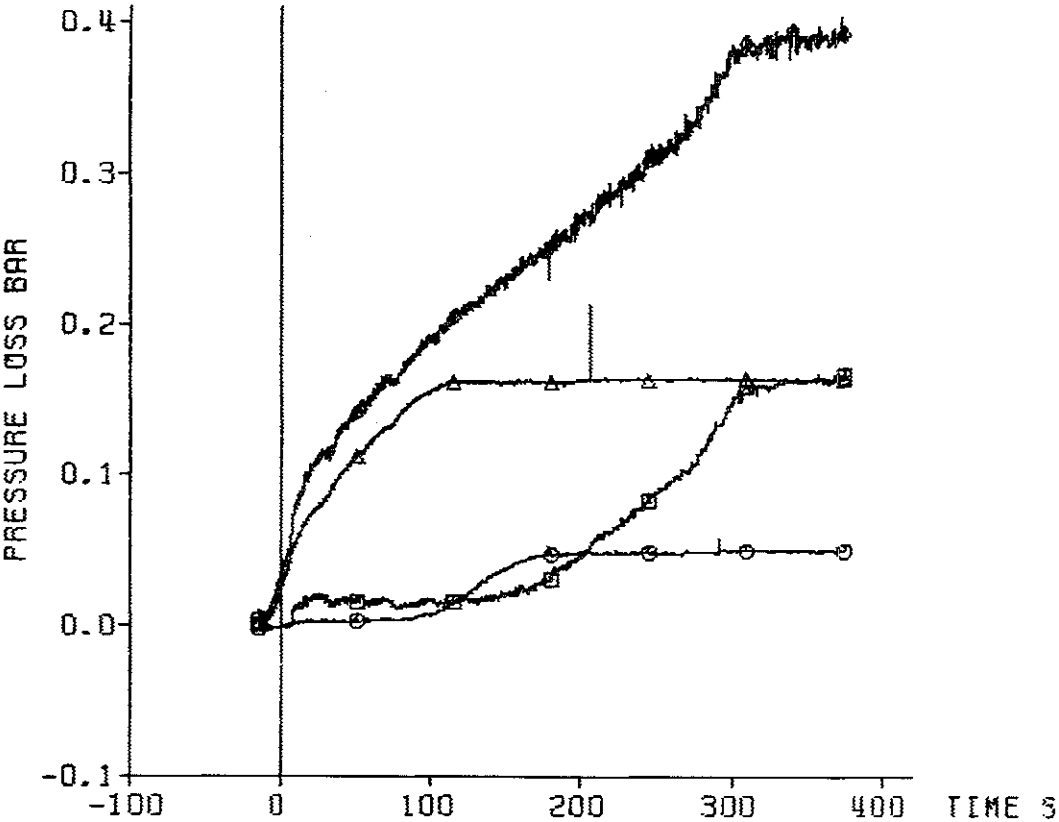

decay heat 120% AWS standard
flooding rate (cold) 5.71 cm/s
system pressure 6.21 bar
feedwater temperature 40 deg C



Fig. 325 FEBA: 5x5 ROD BUNDLE, TEST SERIES 3, TEST-No. 235

coolant outlet conditions:

△ water carry over
○ coolant temperature
□ coolant pressure

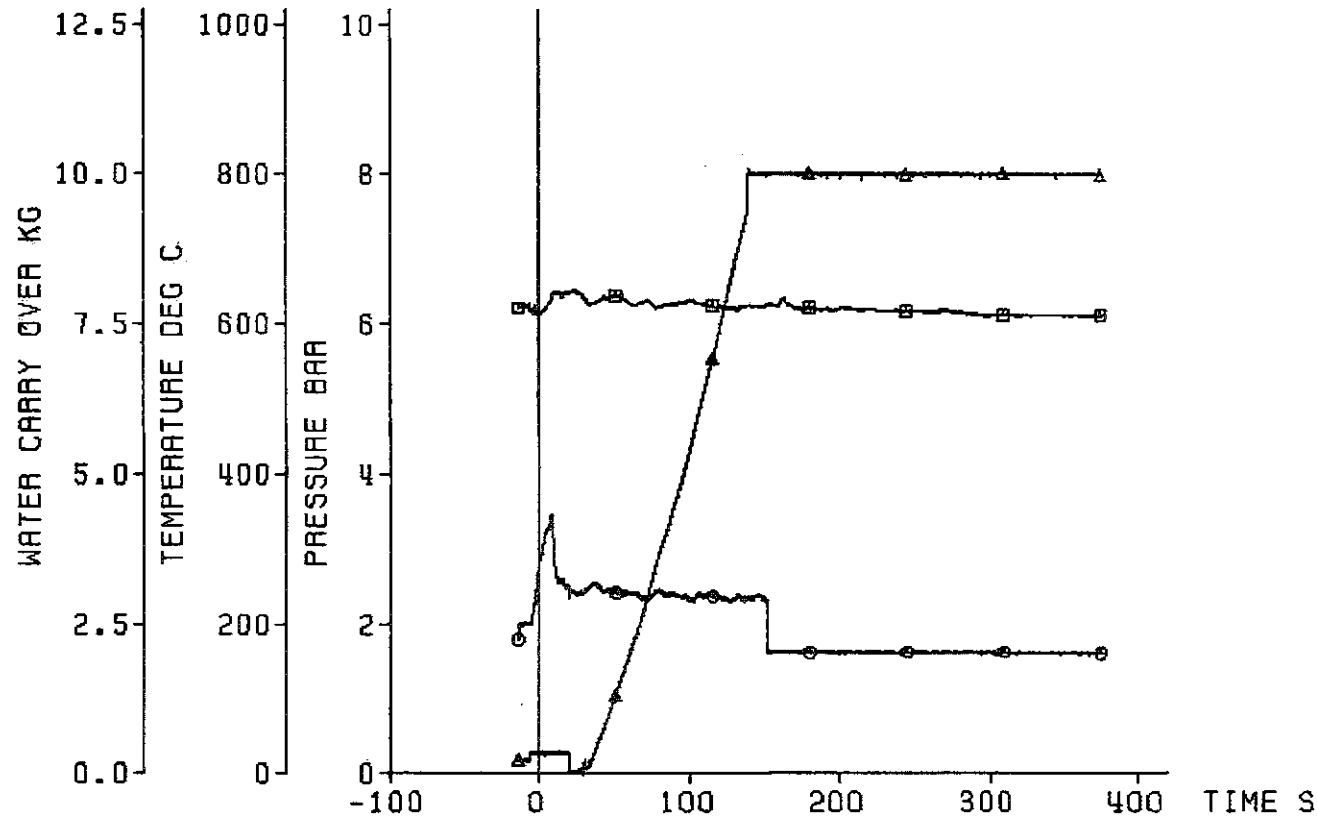

decay heat 120% ANS standard
flooding rate (cold) 5.71 cm/s
system pressure 6.21 bar
feedwater temperature 40 deg C

KIK IRB

Fig. 326 FEBA: 5x5 ROD BUNDLE, TEST SERIES 3, TEST-No. 235

axial position of the quench front

- rewetting of the sleeve at the bundle midplane
- x rewetting of the rod downstream of the blockage

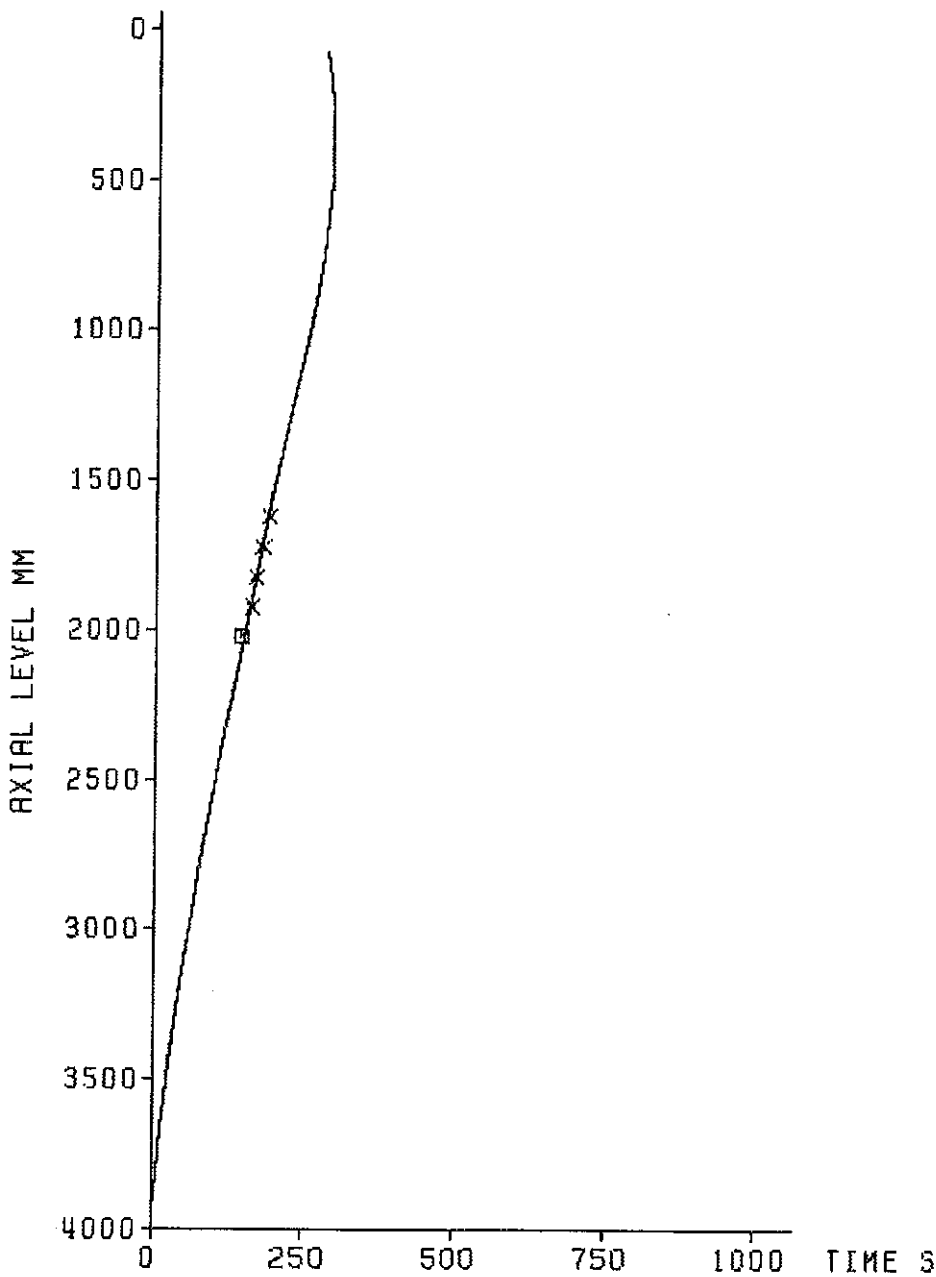

decay heat 120% ANS standard
flooding rate (cold) 5.71 cm/s
system pressure 6.21 bar
feedwater temperature 40 deg C



Fig. 327 FEBA: 5x5 ROD BUNDLE
TEST SERIES 3, TEST-No. 235

TEST SERIES III

Investigation of the Effects of a 90% Flow Blockage With Bypass,
 Blockage at the Bundle Midplane of 3x3 Rods Placed in the Corner
 of the 5x5 Rod Bundle,
 Without Grid Spacer at the Bundle Midplane

Channel Listing and Data Identification for Test No. 235 Through 243

Channel No.	Data Identification		Unit	Remarks
	Type	Location		
1	Cladding Temperature	18a4.3860 ¹	°C	
2	Cladding Temperature	18a3.3315	°C	
3	Cladding Temperature	18a2.2770	°C	
4	Cladding Temperature	18a1.2225	°C	
5	Cladding Temperature	12b4.1680	°C	
6	Cladding Temperature	12b3.1135	°C	
7	Cladding Temperature	12b2. 590	°C	
8	Cladding Temperature	12b1. 45	°C	
9	Cladding Temperature	17h4.2225	°C	
10	Cladding Temperature	17h3.2125	°C	
11	Cladding Temperature	17h2.2025	°C	
12	Cladding Temperature	17h1.1925	°C	
13	Fluid Temperature	TF ² 3315	°C	
14	Fluid Temperature	TFS ³ 2380	°C	
15	Fluid Temperature	TF 1725	°C	
16	Fluid Temperature	TFS 485	°C	
17	Housing Temperature	TK ⁴ 3315	°C	
18	Housing Temperature	TK 2235	°C	
19	Housing Temperature	TK 1725	°C	
20	Housing Temperature	TK 590	°C	

TEST SERIES III

Channel No.	Data Identification		Unit	Remarks
	Type	Location		
21	Fluid Temperature	Lower Plenum	°C	Heated + Unheated TC's
22	Water Level Detector	4012	°C	
23	Feedwater Temperature		°C	
24	Fluid Temperature	Upper Plenum	°C	
25	Room Temperature		°C	
26	Cladding Temperature	22f4.2425 ¹	°C	
27	Cladding Temperature	22f3.2325	°C	
28	Cladding Temperature	22f2.2225	°C	
29	Cladding Temperature	22f1.2125	°C	
30	Cladding Temperature	21e4.2225	°C	
31	Cladding Temperature	21e3.2175	°C	
32	Cladding Temperature	21e2.2125	°C	
33	Cladding Temperature	21e1.2075	°C	
34	Cladding Temperature	19g4.1925	°C	
35	Cladding Temperature	19g3.1825	°C	
36	Cladding Temperature	19g2.1725	°C	
37	Cladding Temperature	19g1.1625	°C	
38	Cladding Temperature	16g4.1925	°C	
39	Cladding Temperature	16g3.1825	°C	
40	Cladding Temperature	16g2.1725	°C	
41	Cladding Temperature	16g1.1625	°C	
42	Cladding Temperature	15a4.3860	°C	
43	Cladding Temperature	15a3.3315	°C	
44	Cladding Temperature	15a2.2770	°C	
45	Cladding Temperature	15a1.2225	°C	
46	Cladding Temperature	14e4.2225	°C	
47	Cladding Temperature	14e3.2175	°C	
48	Cladding Temperature	14e2.2125	°C	
49	Cladding Temperature	14e1.2075	°C	

TEST SERIES III

Channel No.	Data Identification		Unit	Remarks
	Type	Location		
50	Cladding Temperature	13d3.2025 ¹	°C	
51	Cladding Temperature	13d2.2025	°C	
52	Cladding Temperature	13d1.2025	°C	
53	Cladding Temperature	10f4.2425	°C	
54	Cladding Temperature	10f3.2325	°C	
55	Cladding Temperature	10f2.2225	°C	
56	Cladding Temperature	10f1.2125	°C	
57	Cladding Temperature	9h4.2225	°C	
58	Cladding Temperature	9h3.2125	°C	
59	Cladding Temperature	9h2.2025	°C	
60	Cladding Temperature	9h1.1925	°C	
61	Cladding Temperature	8d4.2025	°C	
62	Cladding Temperature	8d3.2025	°C	
63	Cladding Temperature	8d2.2025	°C	
64	Cladding Temperature	8d1.2025	°C	
65	Cladding Temperature	7f4.2425	°C	
66	Cladding Temperature	7f3.2325	°C	
67	Cladding Temperature	7f2.2225	°C	
68	Cladding Temperature	7f1.2125	°C	
69	Sleeve Temperature	TH ⁵ 13.2025	°C	
70	Sleeve Temperature	TH 17.2025	°C	
71	Sleeve Temperature	TH 21.2025	°C	
72	-----		-	Open
73	Cladding Temperature	3b4.1680	°C	
74	Cladding Temperature	3b3.1135	°C	
75	Cladding Temperature	3b2. 590	°C	
76	Cladding Temperature	3b1. 45	°C	

TEST SERIES III

Channel No.	Data Identification		Unit	Remarks
	Type	Location		
77	Cladding Temperature	2c4.4025 ¹	°C	
78	Cladding Temperature	2c3.3925	°C	
79	Cladding Temperature	2c2.3825	°C	
80	Cladding Temperature	2c1.3725	°C	
81	Electrical Power Input	8 Rods	kW	Rods No. 1 Through 8
82	Electrical Power Input	8 Rods	kW	Rods No. 9 Through 16
83	Electrical Power Input	9 Rods	kW	Rods No. 17 Through 25
84	Housing Temperature	TK ⁴ 4005	°C	
85	Housing Temperature	TK 3915	°C	
86	Housing Temperature	TK 3820	°C	
87	Housing Temperature	TK 3725	°C	
88	Housing Temperature	TK 3018	°C	
89	Housing Temperature	TK 2770	°C	
90	Housing Temperature	TK 2025	°C	
91	Housing Temperature	TK 1925	°C	
92	Housing Temperature	TK 1825	°C	
93	Housing Temperature	TK 1625	°C	
94	Housing Temperature	TK 1135	°C	
95	Housing Temperature	TK 835	°C	
96	Housing Temperature	TK 45	°C	
97	Fluid Temperature	TF ² 3038	°C	
98	Fluid Temperature	TFS ³ 2425	°C	
99	Fluid Temperature	TF 2770	°C	
100	Fluid Temperature	TF 2325	°C	
101	-----		-	Open
102	-----		-	Open
103	Fluid Temperature	TF 1925	°C	
104	Fluid Temperature	TF 1135	°C	
105	Fluid Temperature	TF 1625	°C	

TEST SERIES III

Channel No.	Data Identification		Unit	Remarks
	Type	Location		
106	Cladding Temperature	24c4.4025 ¹	°C	
107	Cladding Temperature	24c3.3925	°C	
108	Cladding Temperature	24c2.3825	°C	
109	Cladding Temperature	24c1.3725	°C	
110	Time (10 Scans/s)		s	t = 0: Start of Reflooding
111	Pressure in Lower Plenum	4091	bar	
112	Pressure in Upper Plenum	-105	bar	
113	Pressure in Buffer		bar	
114	Bundle Power		kW	Channels: 81 + 82 + 83
115	Flooding Velocity (cold)		cm/s	
116	Water Carry Over Collected		kg	Downstream of Bundle Exit
117	Pressure Diff.	1835 and -105 mm	bar	Values Measured Separately
118	Measured	2380 and 1835 mm	bar	
119	Between	4091 and 2380 mm	bar	
120	Axial Level	4091 and -105 mm	bar	

- 1) TC's of 0.5 mm diameter embedded in rod cladding. Measuring position:
Example: rod No. = 18, type of rod instrumentation = a, TC No. = 4,
axial level = 3860 mm, referenced to the top flange of the bundle.
- 2) TF = TC's of 0.25 mm diameter (bare).
TC's placed in subchannel surrounded by rods No. 12, 17, 16 and 11.
- 3) TFS = TC's of 0.25 mm diameter protected by a radiation shielding.
TC's placed in subchannel surrounded by rods No. 12, 17, 16 and 11.
- 4) TK = TC's of 0.5 mm diameter placed in the wall of the bundle housing of
of 6.5 mm thickness.
- 5) TH = TC's of 0.5 mm diameter embedded in sleeve. Measuring position:
Example: rod No. 13, axial level = 2025 mm.

TEST SERIES IV

Test No.	Flooding Velocity (cold) cm/s	System Pressure bar	Feedwater Temp. ¹ °C		Bundle Power ² kW		Remarks
			0-30 s	End	0 s	Transient	
267	2.2	4.0	69	45	200	120% ANS	Figs. 330 Through 353
262	3.8	2.0	54	43	200	120% ANS	Figs. 354 Through 377
263	3.8	3.9	61	43	200	120% ANS	Figs. 378 Through 401
268	3.8	5.9	76	44	200	120% ANS	Figs. 402 Through 425
261	5.7	2.0	57	42	200	120% ANS	Figs. 426 Through 449
264	5.8	3.9	63	41	200	120% ANS	Figs. 450 Through 473
269	5.7	5.9	73	44	200	120% ANS	Figs. 474 Through 497
<hr/>							
272	3.0	4.0	57	41	200	120% ANS	Data Not Plotted
273	3.0	4.0	57	41	200	120% ANS	Data Not Plotted
266	3.8	3.9	125	45	200	120% ANS	Data Not Plotted
270	9.5	3.8	57	41	200	120% ANS	Data Not Plotted

1) Measured in the lower plenum

2) Decay heat transient corresponding 120% ANS Standard 40 s after shutdown of the reactor

Table 4 FEBA 5x5 rod bundle: Main test parameters of test series IV

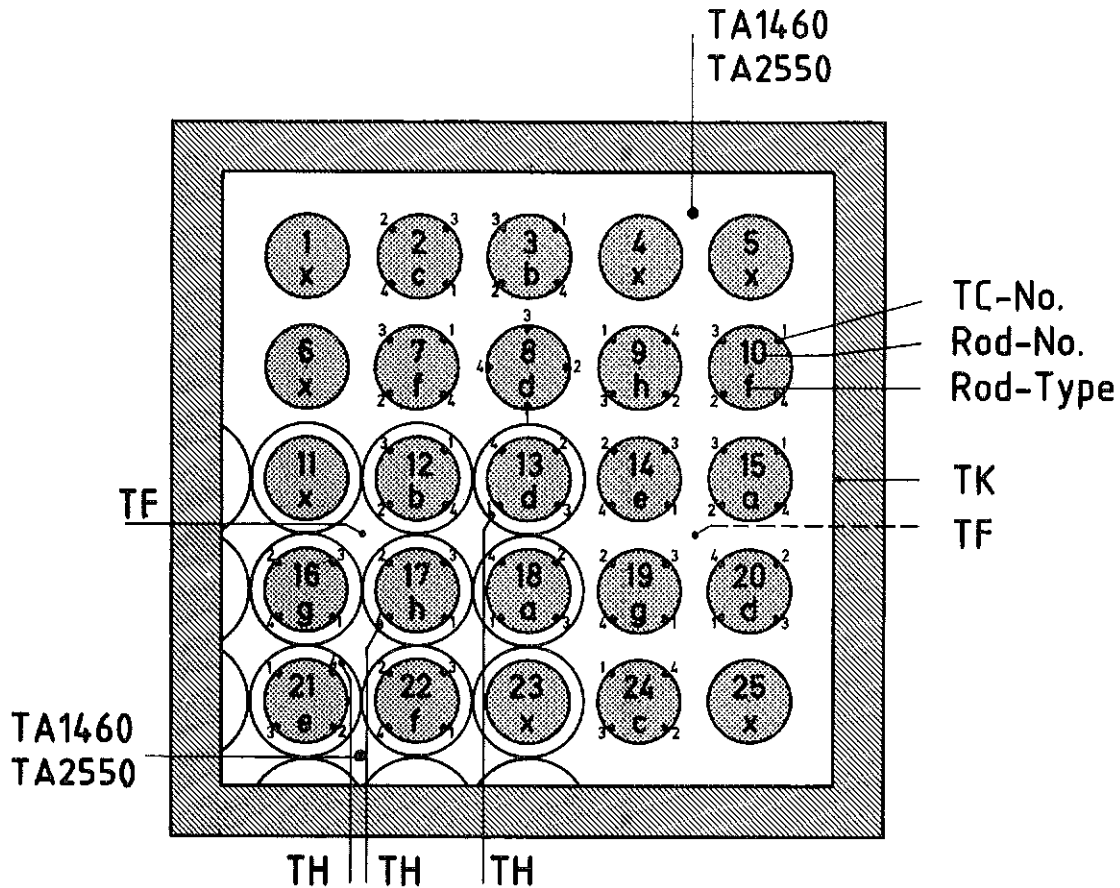

Rod Type	TC No.	Axial Level mm
a	1	2225
	2	2770
	3	3315
	4	3860
b	1	45
	2	590
	3	1135
	4	1680
c	1	3725
	2	3825
	3	3925
	4	4025
d	1	2025
	2	2025
	3	2025
	4	2025

Rod Type	TC No.	Axial Level mm
e	1	2075
	2	2125
	3	2175
	4	2225
f	1	2125
	2	2225
	3	2325
	4	2425
g	1	1625
	2	1725
	3	1825
	4	1925
h	1	1925
	2	2025
	3	2125
	4	2225

Rod Type	TC No.	Axial Level mm
x	without TC's	

Fig. 328 5x5 rod bundle: Radial and axial location of cladding, sleeve, spacer, fluid and housing TC's for test series IV

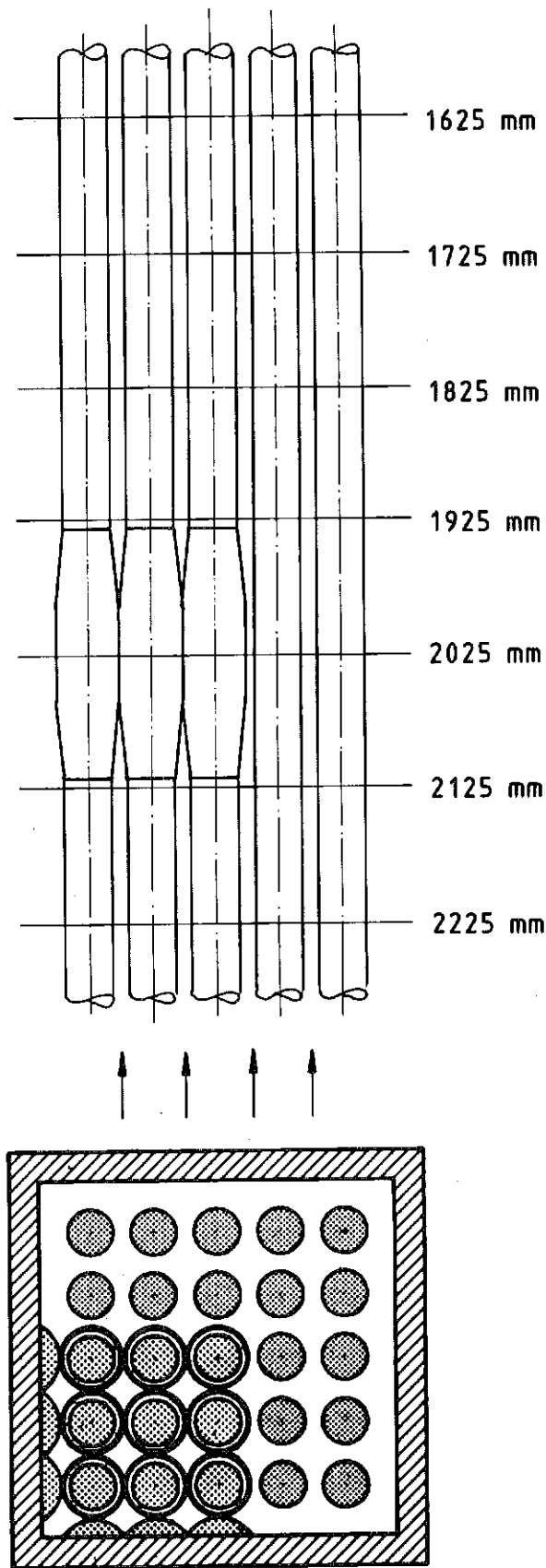
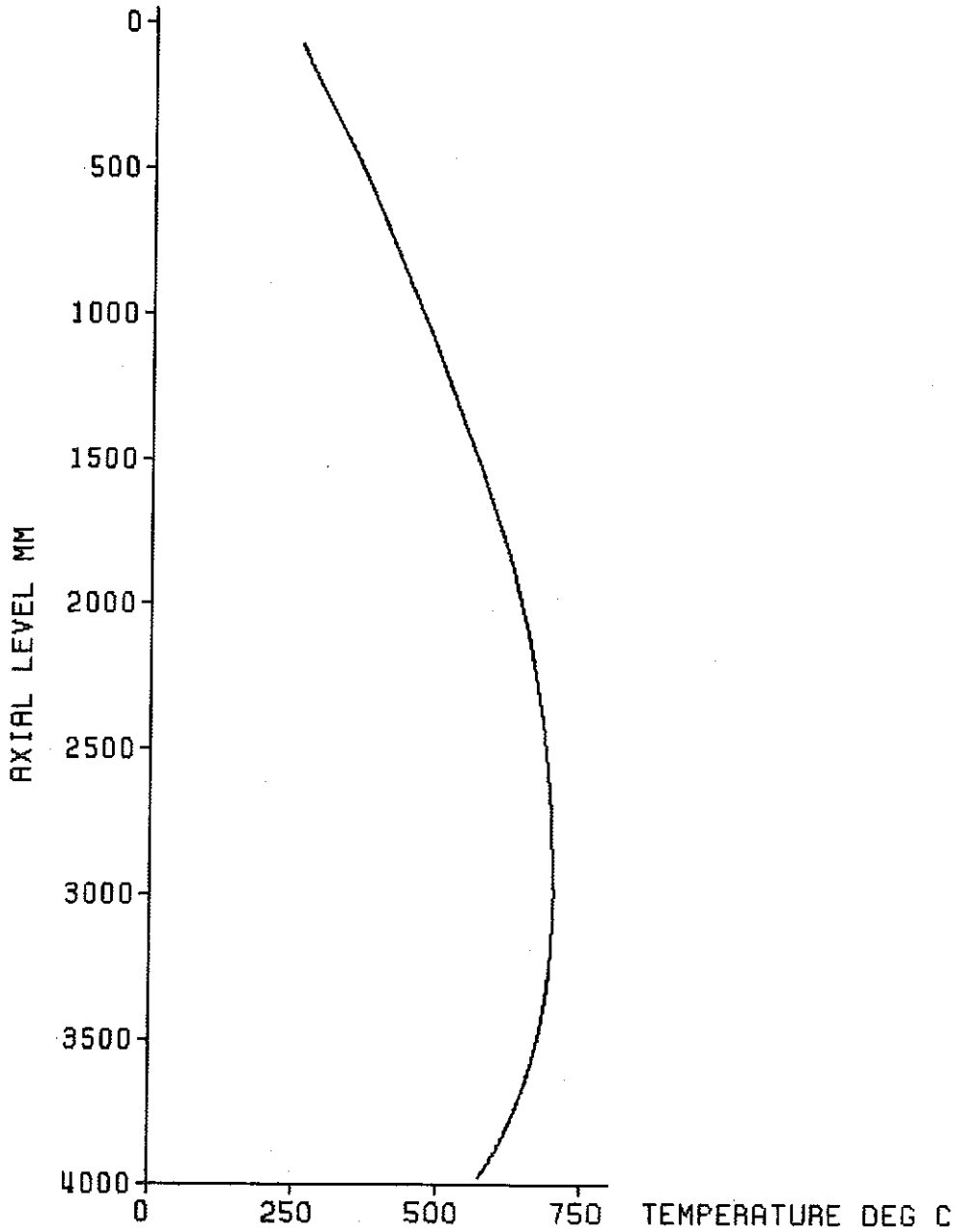

Fig. 329 5x5 rod bundle: Layout of the bundle geometry of test series IV

Initial axial temperature profile of the cladding



decay heat 120% ANS standard
flooding rate (cold) 2.24 cm/s
system pressure 3.96 bar
feedwater temperature 40 deg C



Fig. 330 FEBA: 5x5 ROD BUNDLE
TEST SERIES 4, TEST-No. 267

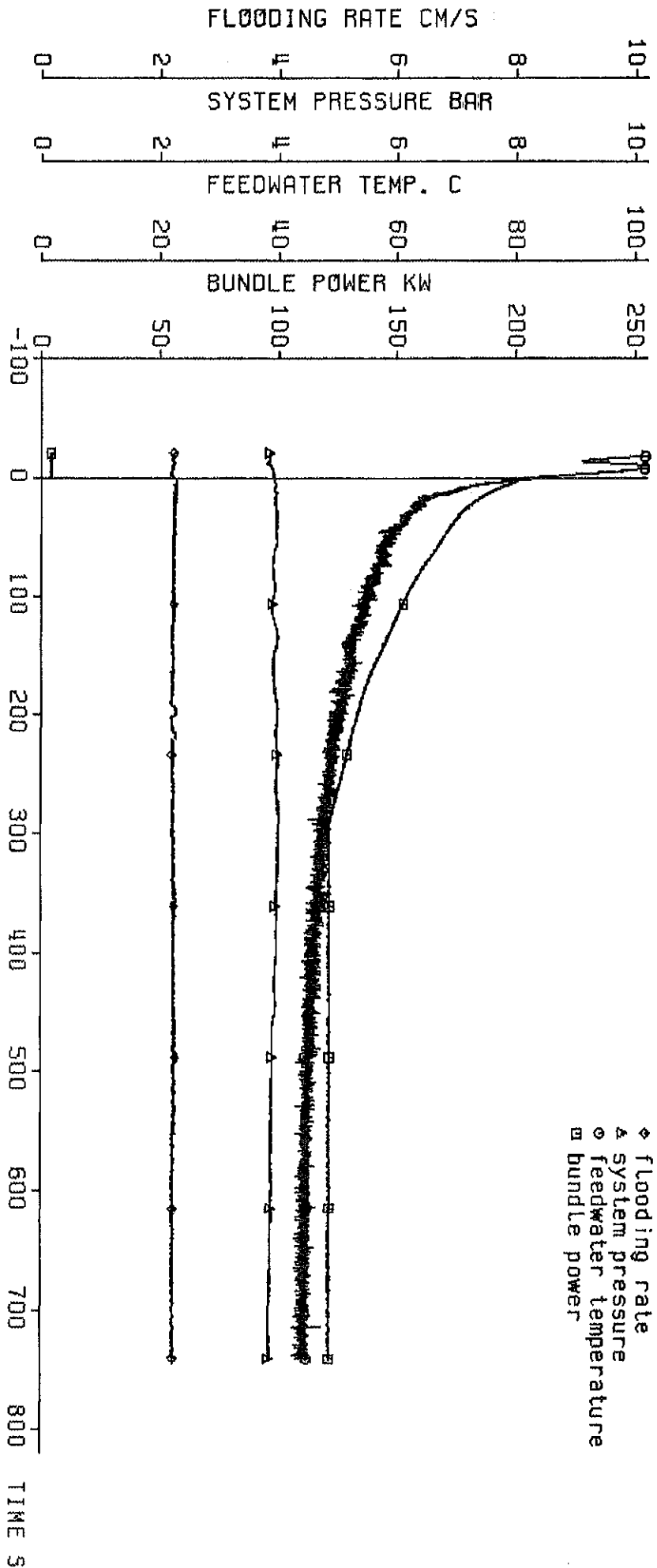

test parameters:

- ◆ flooding rate
- ▲ system pressure
- feedwater temperature
- ▣ bundle power

decay heat
 flooding rate (cold) 120% RMS standard
 system pressure 3.96 bar
 feedwater temperature 40 deg C

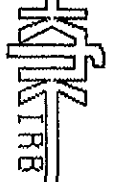
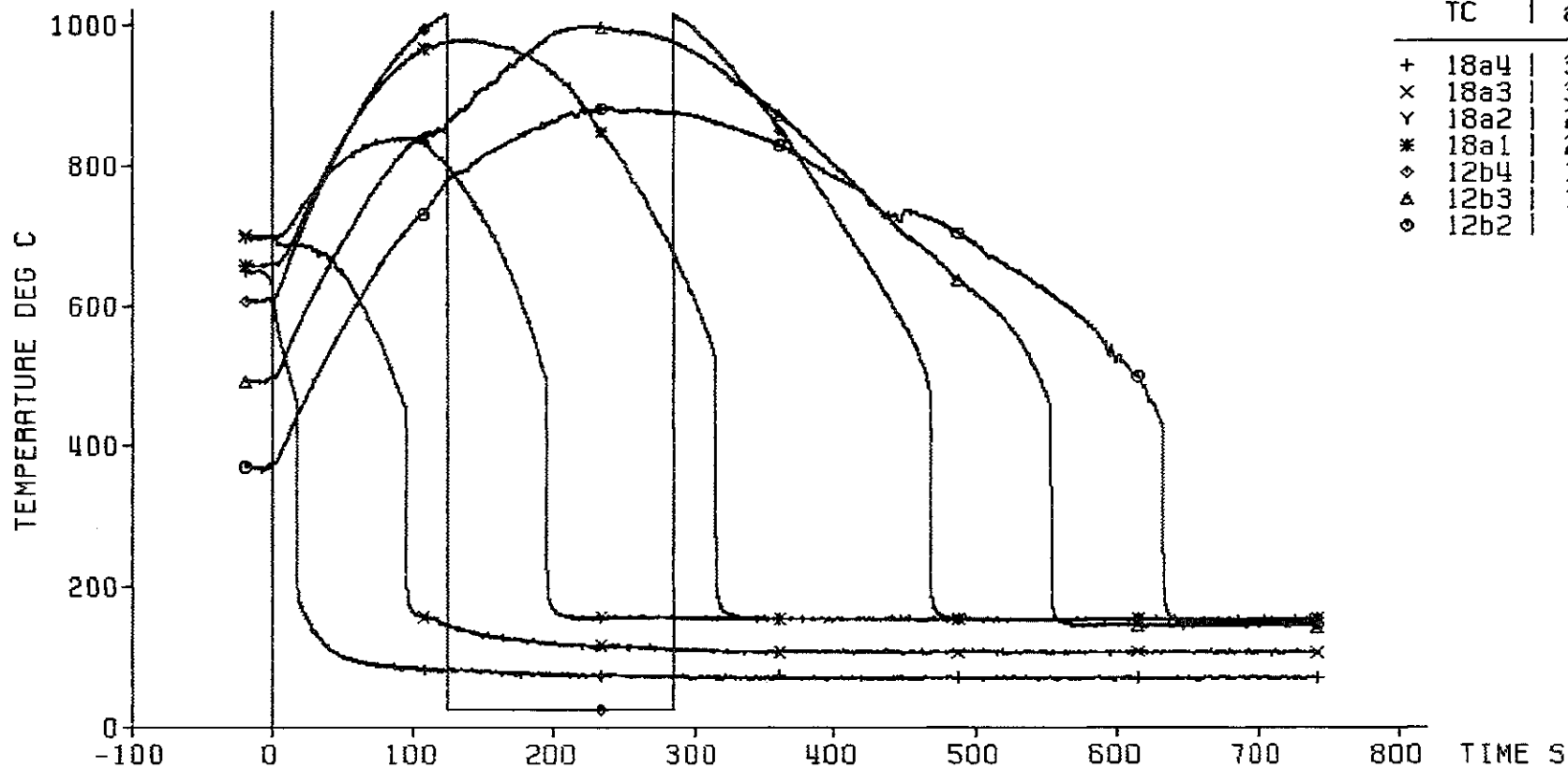

Fig. 331 FEBRA: 5X5 ROD BUNDLE, TEST SERIES 4, TEST-NO. 267

cladding temperature



TC	ax. level
+	18a4 3860 mm
x	18a3 3315 mm
y	18a2 2770 mm
*	18a1 2225 mm
◇	12b4 1680 mm
△	12b3 1135 mm
○	12b2 590 mm

decay heat 120% ANS standard
 flooding rate (cold) 2.24 cm/s
 system pressure 3.96 bar
 feedwater temperature 40 deg C



Fig. 332 FEBA: 5x5 ROD BUNDLE, TEST SERIES 4, TEST-No. 267

heat transfer coeff.

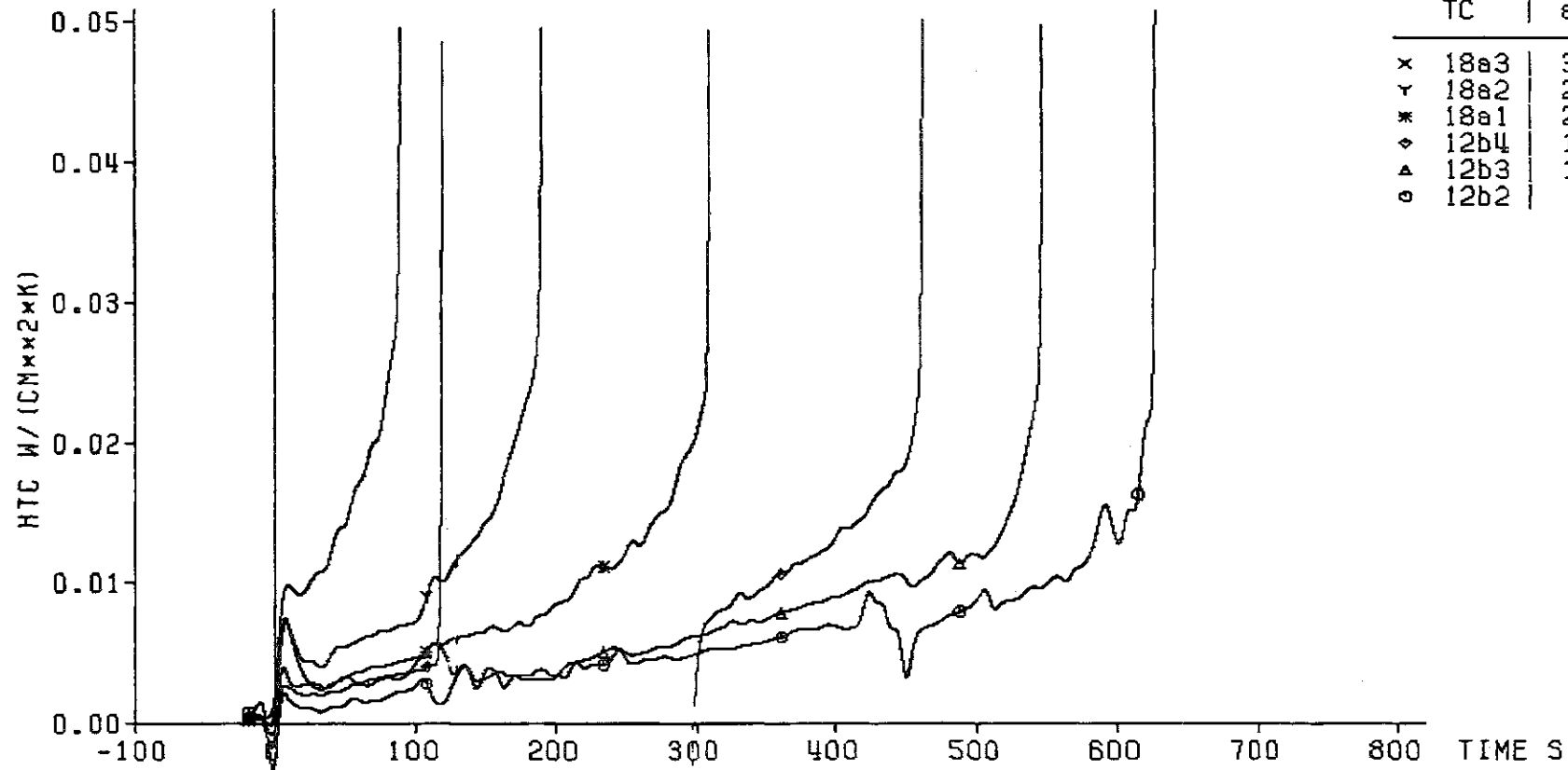

TC	ax. Level
x	18a3 3315 mm
y	18a2 2770 mm
*	18a1 2225 mm
◇	12b4 1680 mm
△	12b3 1135 mm
○	12b2 590 mm

decay heat
 flooding rate (cold) 2.24 cm/s
 system pressure 3.96 bar
 feedwater temperature 40 deg C

120% ANS standard



Fig. 333 FEBA: 5x5 ROD BUNDLE, TEST SERIES 4, TEST-No. 267

cladding temperature

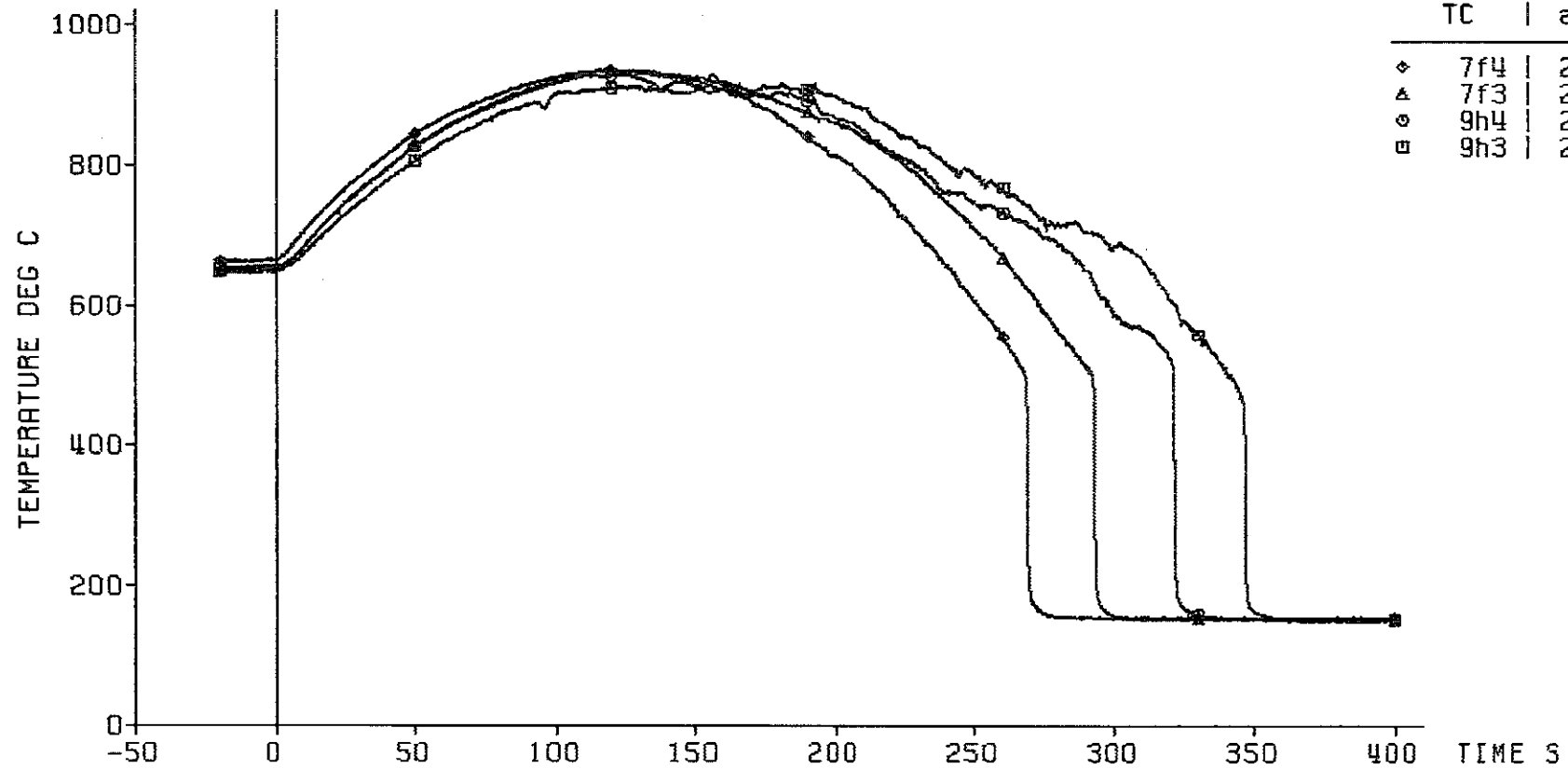

— 374 —

decay heat 120% ANS standard
 flooding rate (cold) 2.24 cm/s
 system pressure 3.96 bar
 feedwater temperature 40 deg C

bypass
 =====



Fig. 334 FEBA: 5x5 ROD BUNDLE, TEST SERIES 4, TEST-No. 267

heat transfer coeff.

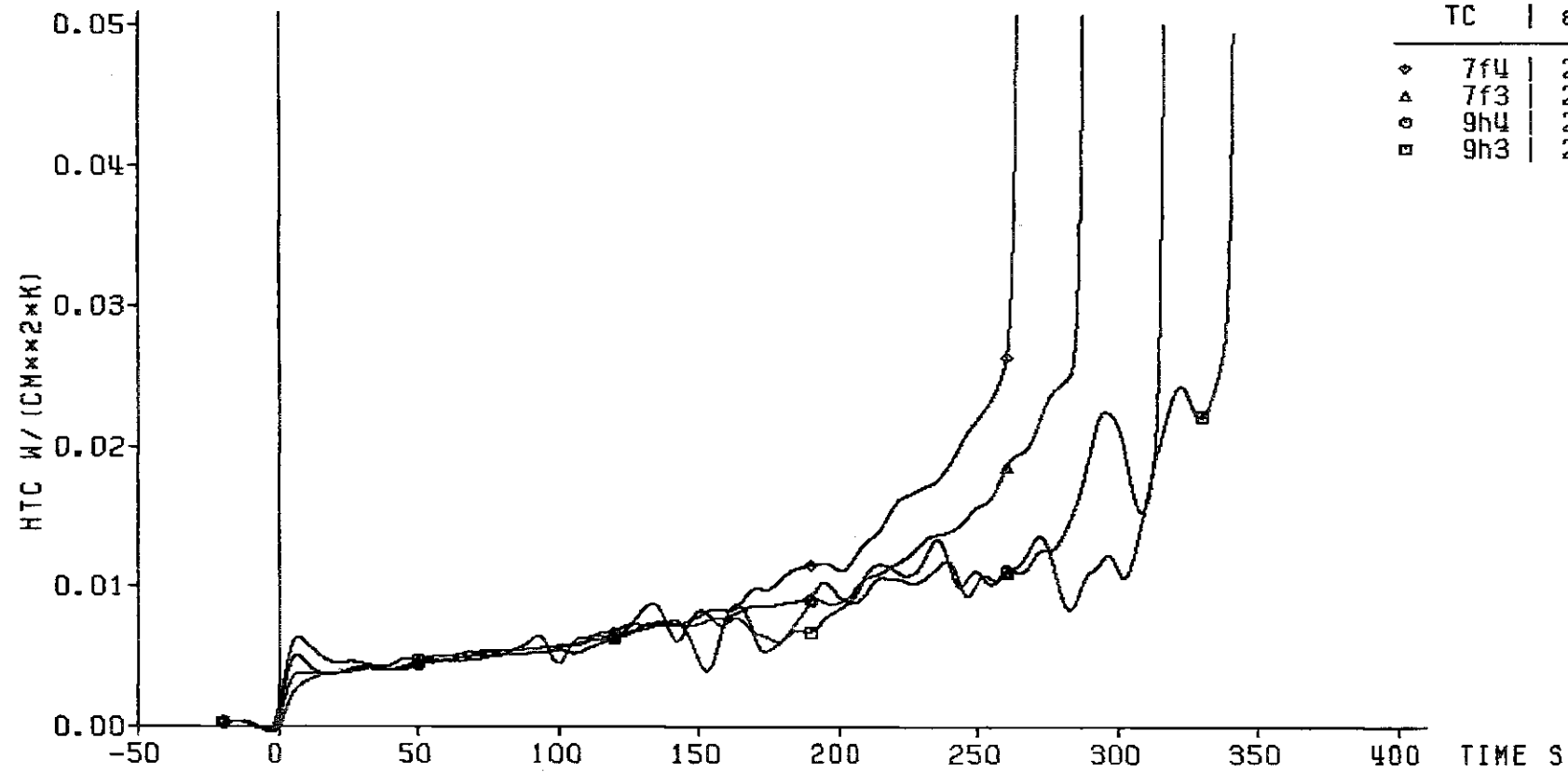

TC	ax. Level
◇ 7f4	2425 mm
△ 7f3	2325 mm
○ 9h4	2225 mm
□ 9h3	2125 mm

decay heat 120% ANS standard
flooding rate (cold) 2.24 cm/s
system pressure 3.96 bar
feedwater temperature 40 deg C

bypass
=====



Fig. 335 FEBA: 5x5 ROD BUNDLE, TEST SERIES 4, TEST-No. 267

cladding temperature

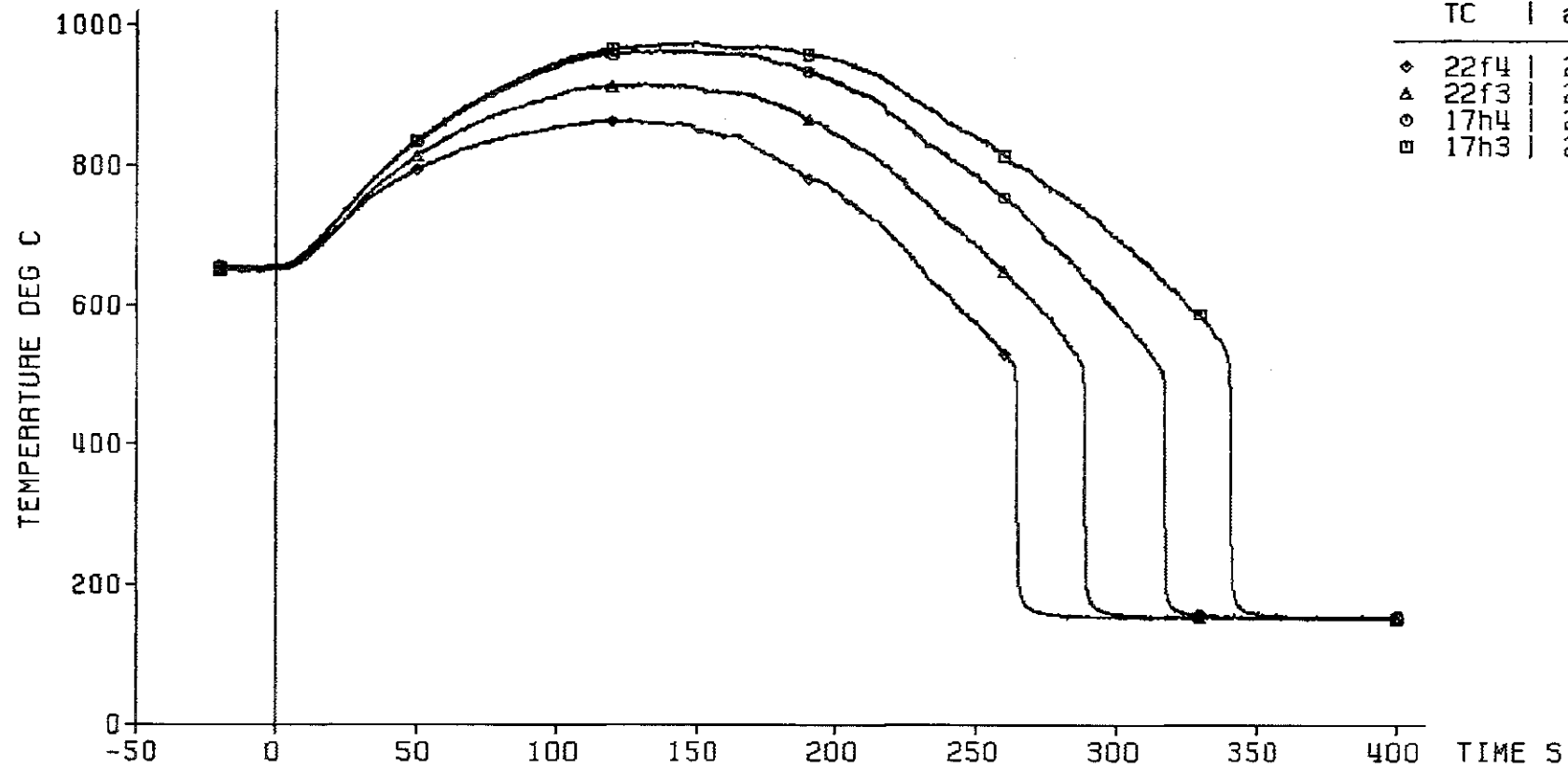

decay heat 120% ANS standard
flooding rate (cold) 2.24 cm/s
system pressure 3.96 bar
feedwater temperature 40 deg C

blockage
=====



Fig. 336 FEBA: 5x5 ROD BUNDLE, TEST SERIES 4, TEST-No. 267

heat transfer coeff.

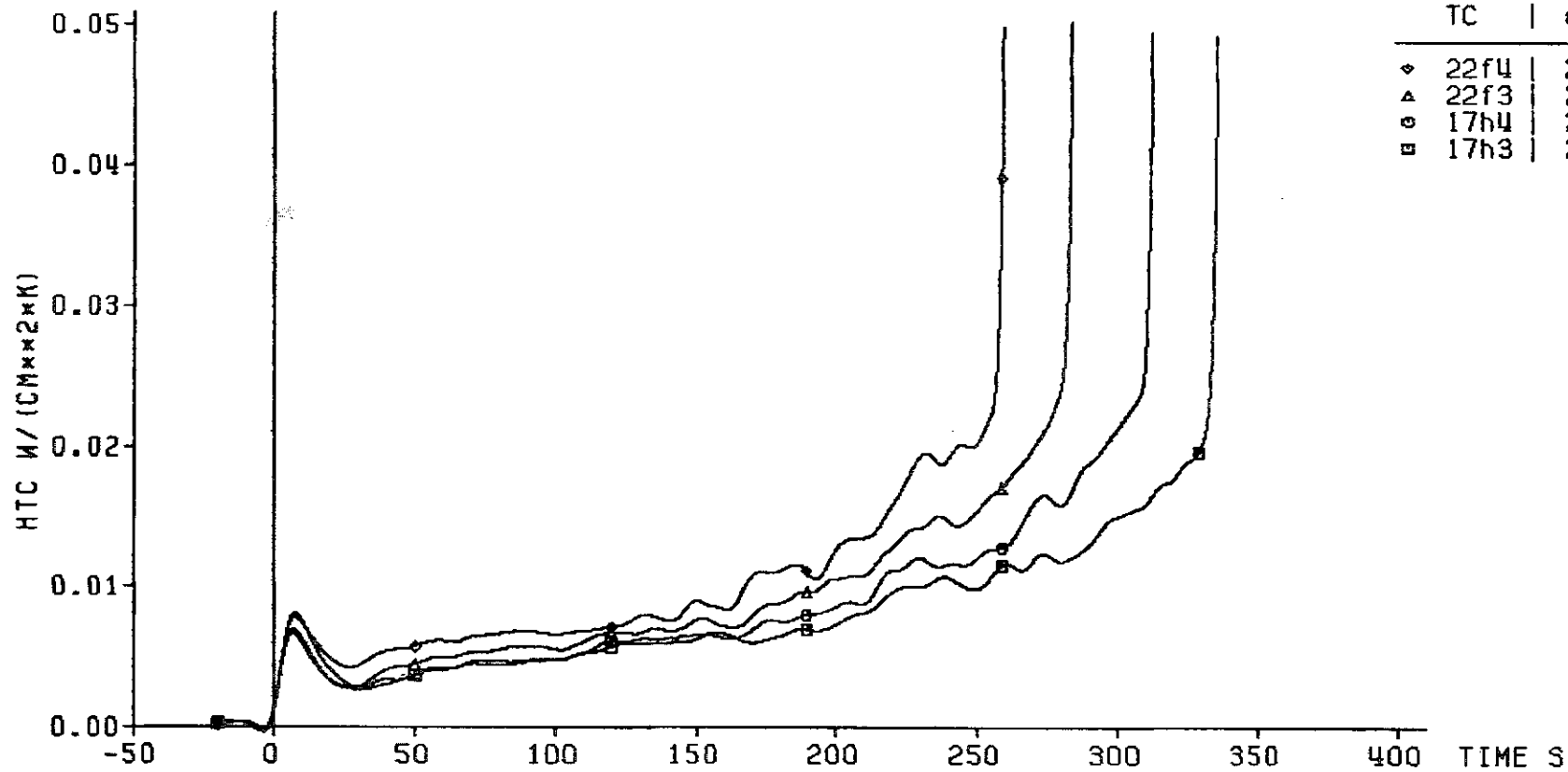

TC	ax. Level
◇	2425 mm
△	2325 mm
○	2225 mm
□	2125 mm

decay heat 120% ANS standard
 flooding rate (cold) 2.24 cm/s
 system pressure 3.96 bar
 feedwater temperature 40 deg C

blockage
 =====



Fig. 337 FEBA: 5x5 ROD BUNDLE, TEST SERIES 4, TEST-No. 267

cladding temperature

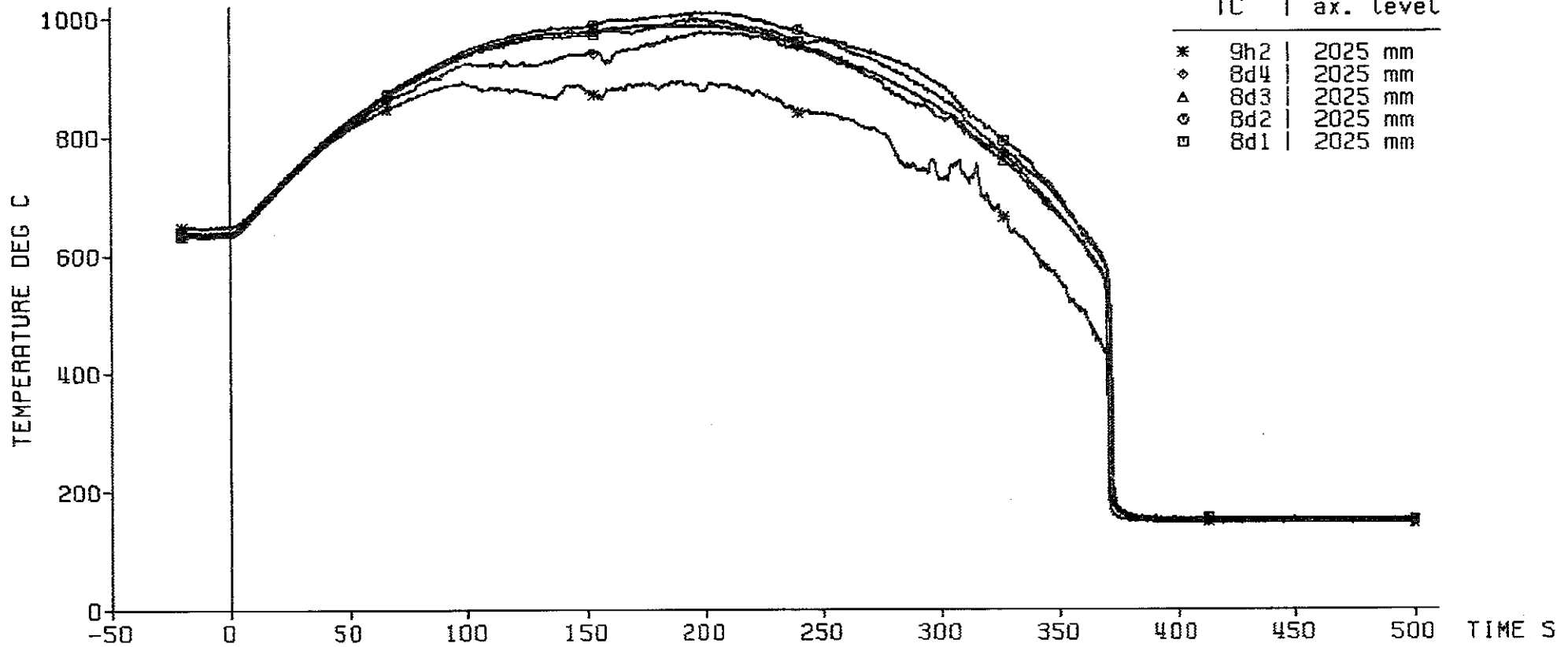

— 378 —

decay heat 120% ANS standard bypass
 flooding rate (cold) 2.24 cm/s =====
 system pressure 3.96 bar
 feedwater temperature 40 deg C



Fig. 338 FEBA: 5x5 ROD BUNDLE, TEST SERIES 4, TEST-No. 267

heat transfer coeff.

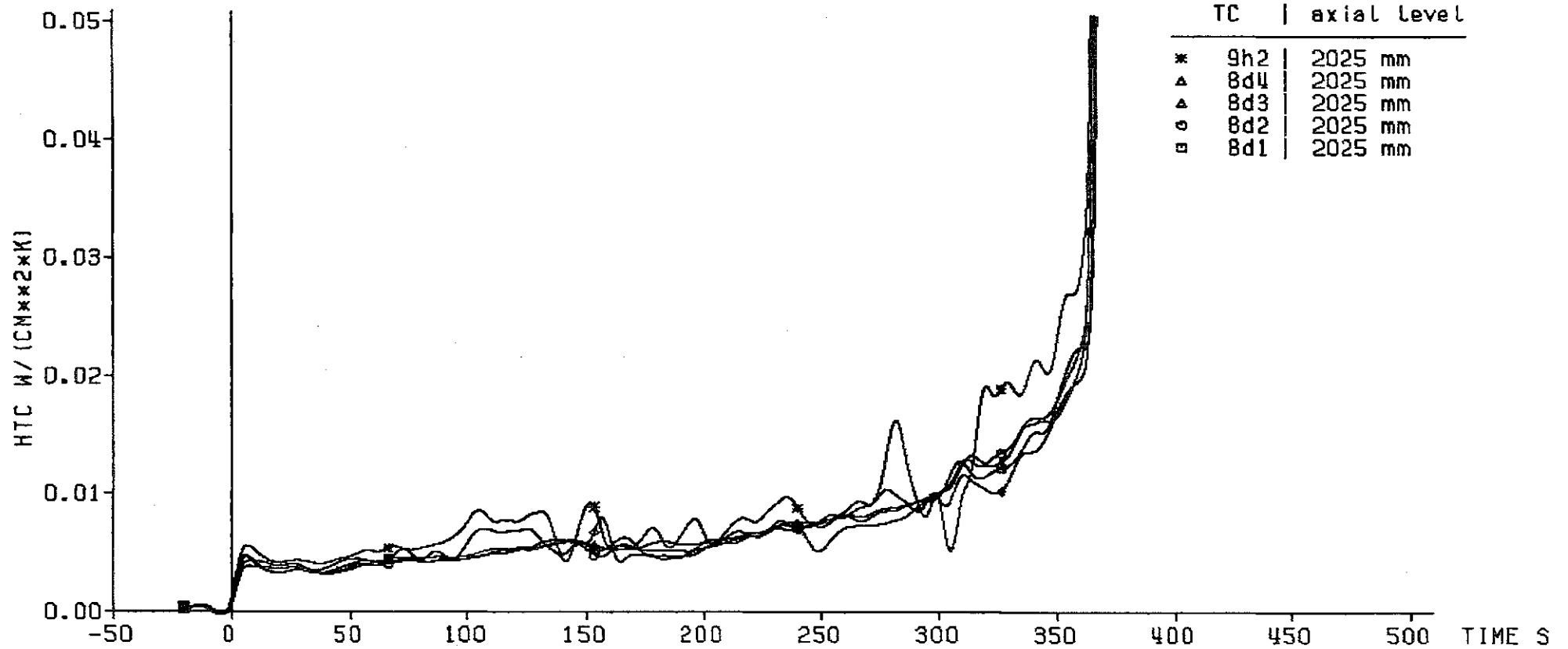

decay heat 120% ANS standard
flooding rate (cold) 2.24 cm/s
system pressure 3.96 bar
feedwater temperature 40 deg C

bypass
=====



Fig. 339 FEBA: 5x5 ROD BUNDLE, TEST SERIES 4, TEST-No. 267

cladding temperature

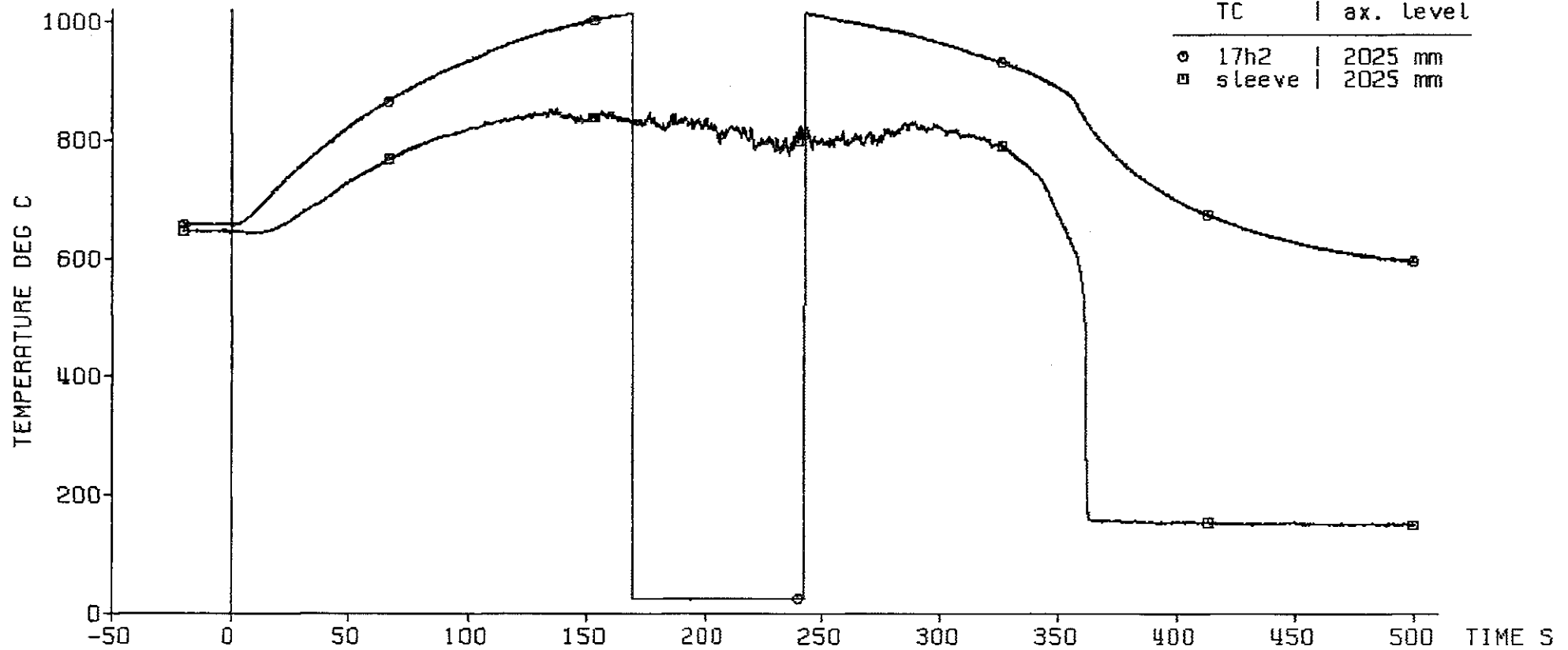

— 380 —

decay heat 120% RMS standard
flooding rate (cold) 2.24 cm/s
system pressure 3.96 bar
feedwater temperature 40 deg C

blockage
=====



Fig. 340 FEBA: 5x5 ROD BUNDLE, TEST SERIES 4, TEST-No. 267

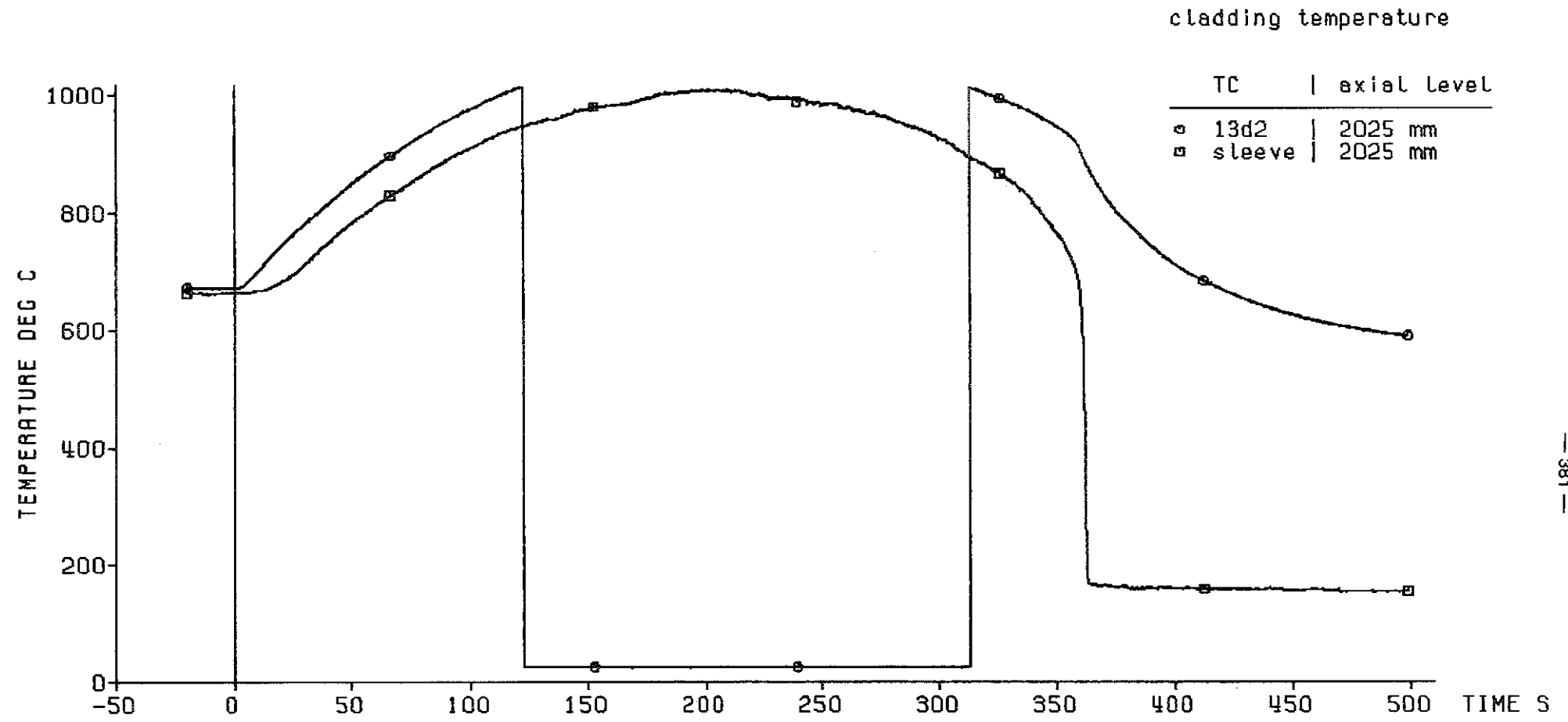

decay heat
 flooding rate (cold)
 system pressure
 feedwater temperature

120% ANS standard
 2.24 cm/s
 3.96 bar
 40 deg C

blockage
 =====



Fig. 341 FEBA: 5x5 ROD BUNDLE, TEST SERIES 4, TEST-No. 267

cladding temperature

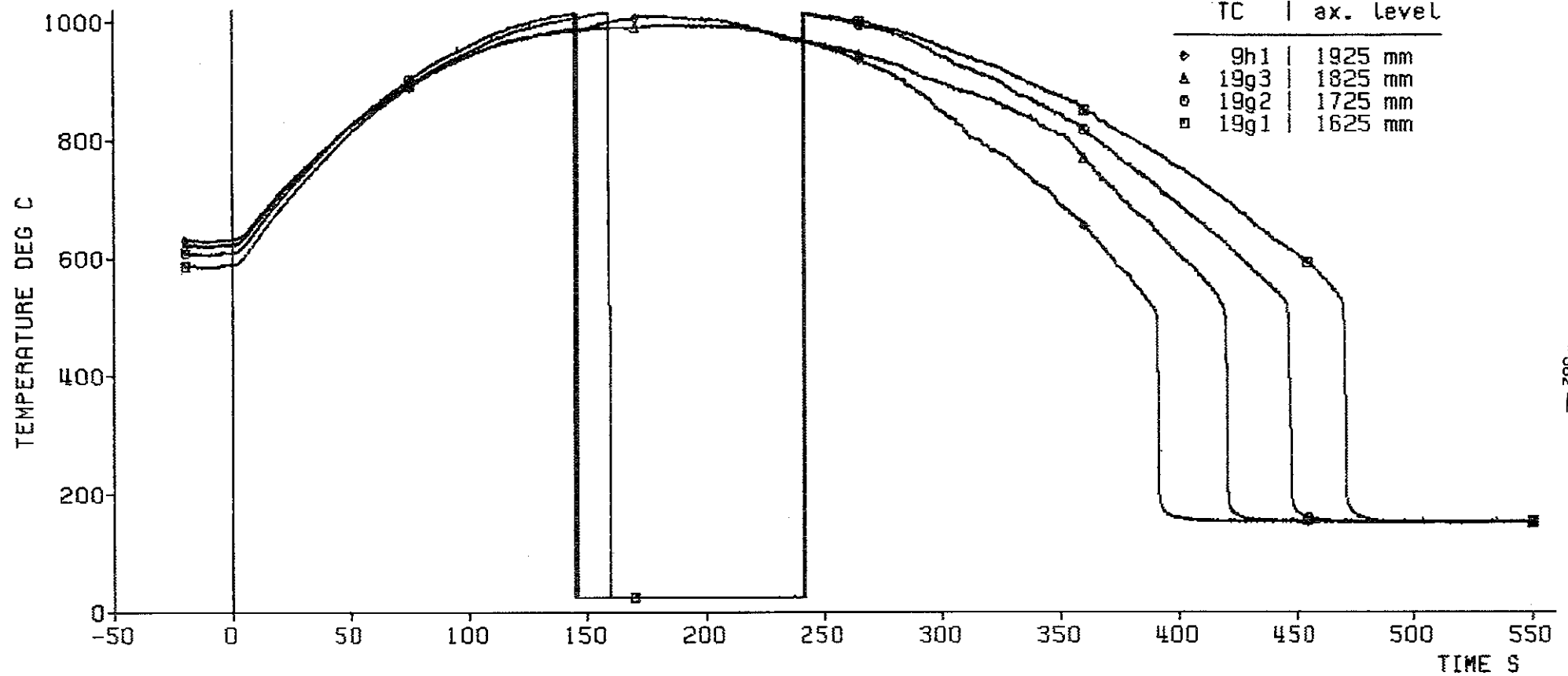

— 382 —

decay heat 120% ANS standard
 flooding rate (cold) 2.24 cm/s
 system pressure 3.96 bar
 feedwater temperature 40 deg C

bypass
 =====



Fig. 342 FEBA: 5x5 ROD BUNDLE, TEST SERIES 4, TEST-No. 267

heat transfer coeff.

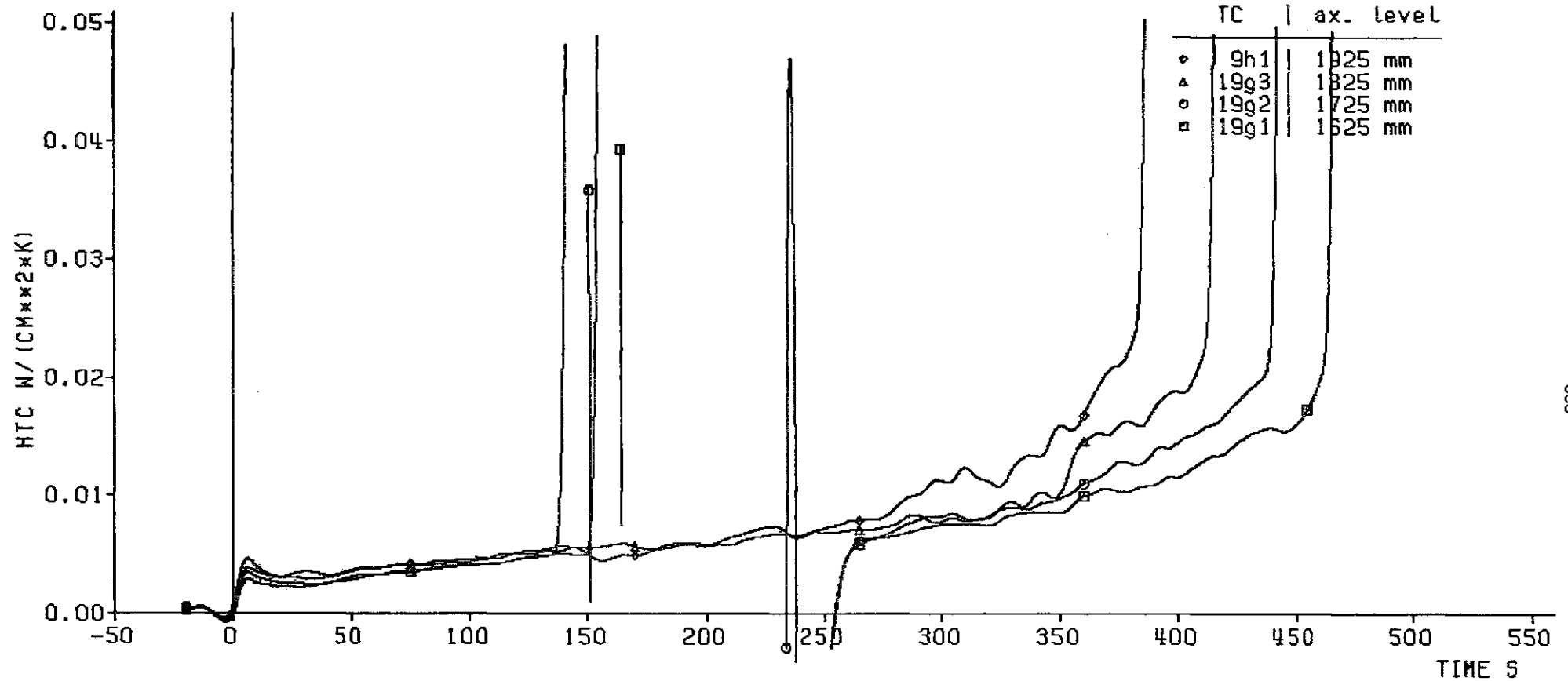

— 383 —

decay heat 120% ANS standard
 flooding rate (cold) 2.24 cm/s
 system pressure 3.96 bar
 feedwater temperature 40 deg C

bypass
 =====



Fig. 343 FEBA: 5x5 ROD BUNDLE, TEST SERIES 4, TEST-No. 267

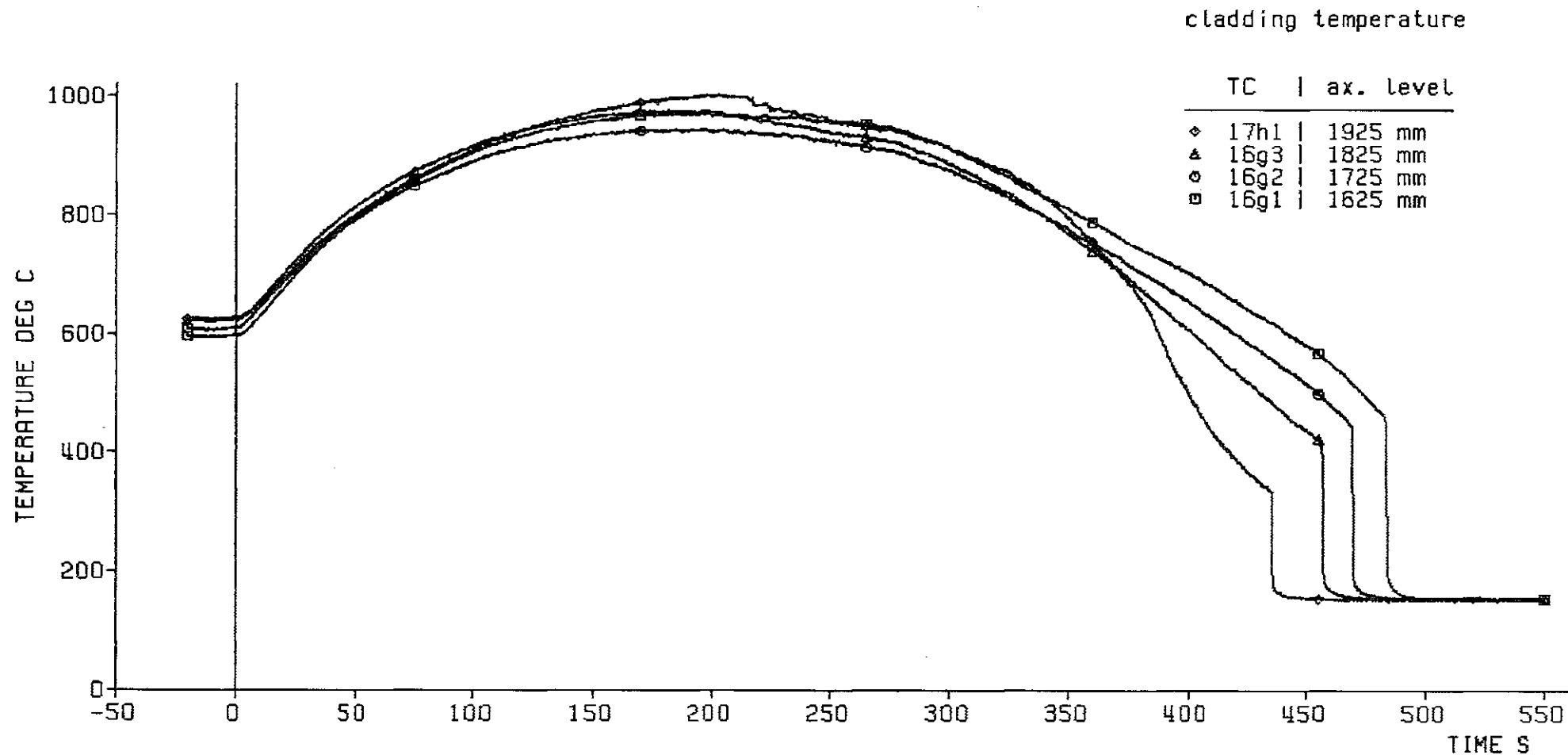

decay heat 120% ANS standard
 flooding rate (cold) 2.24 cm/s
 system pressure 3.96 bar
 feedwater temperature 40 deg C

blockage
 =====



Fig. 344 FEBA: 5x5 ROD BUNDLE, TEST SERIES 4, TEST-No. 267

heat transfer coeff.

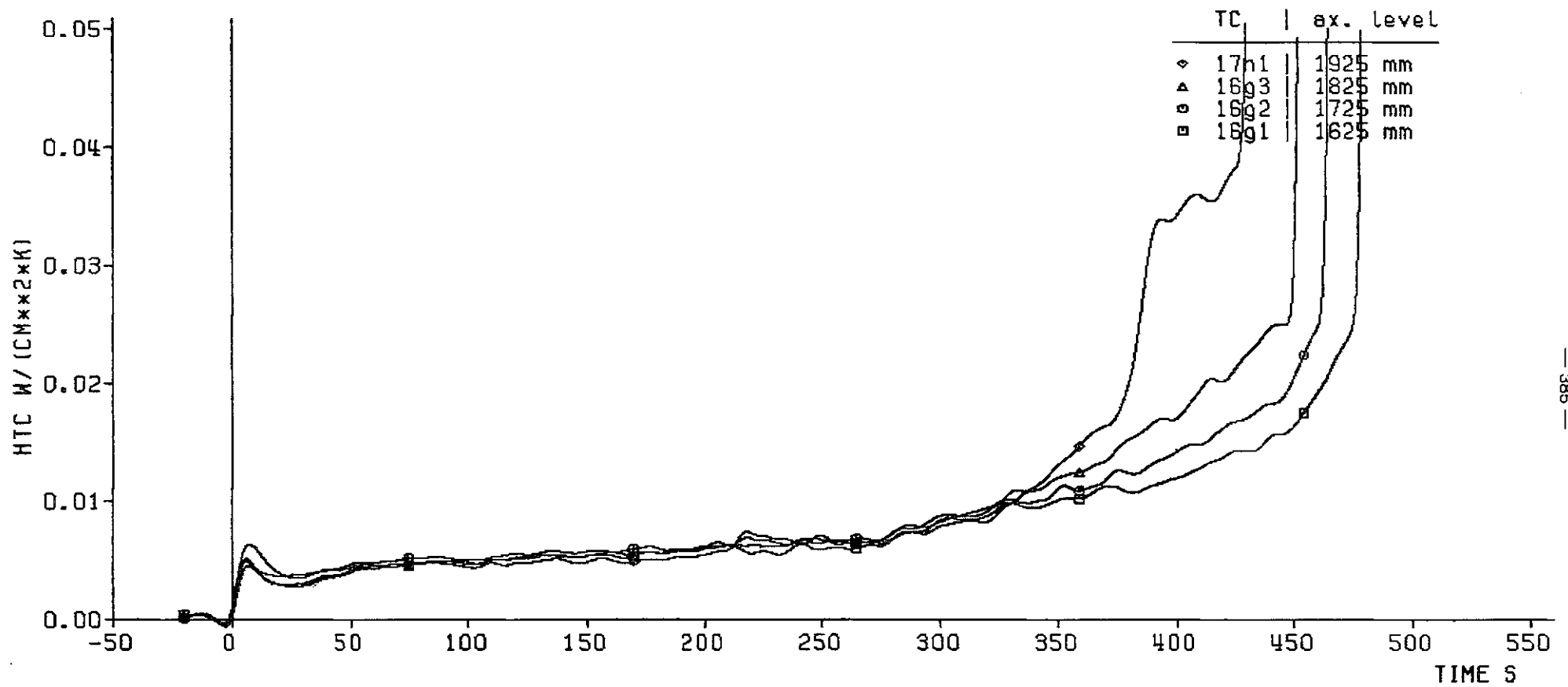

— 386 —

decay heat 120% ANS standard
 flooding rate (cold) 2.24 cm/s
 system pressure 3.96 bar
 feedwater temperature 40 deg C

blockage
 =====



Fig. 345 FEBA: 5x5 ROD BUNDLE, TEST SERIES 4, TEST-No. 267

grid spacer temperature

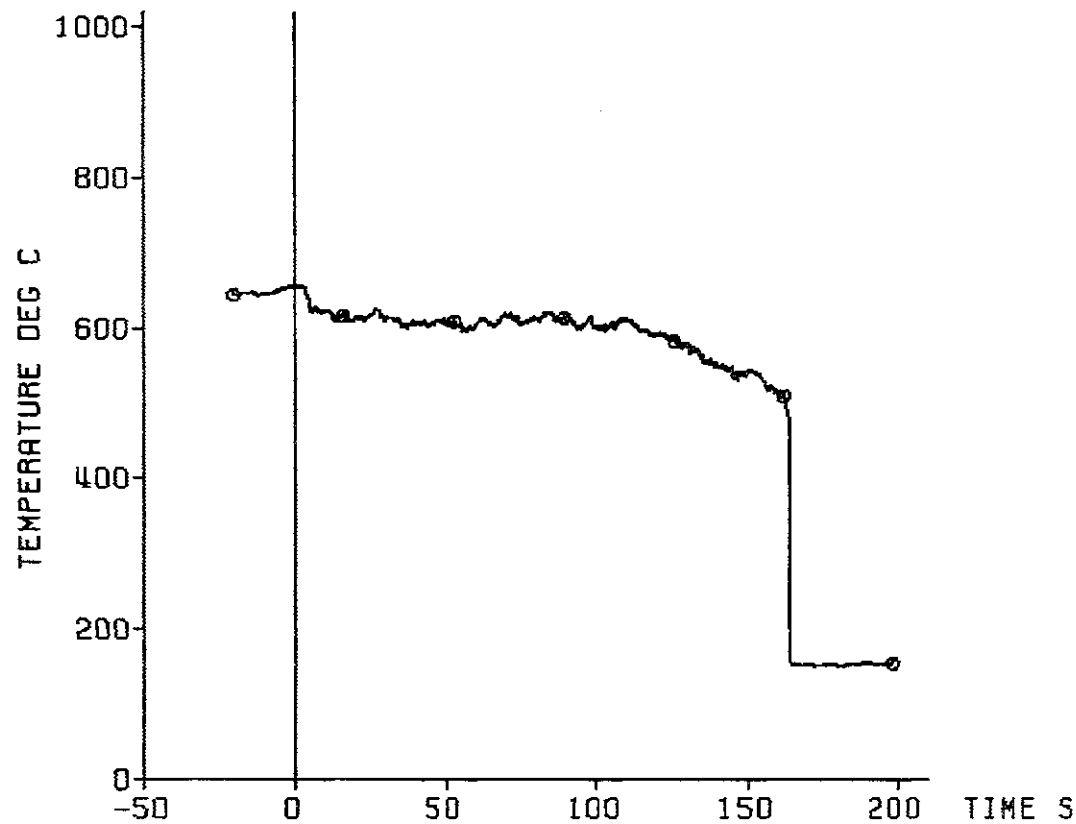

TC	axial level
87	2550 mm

decay heat 120% ANS standard
flooding rate (cold) 2.24 cm/s
system pressure 3.96 bar
feedwater temperature 40 deg C

KFK
IRB

Fig. 346 FEBA: 5x5 ROD BUNDLE, TEST SERIES 4, TEST-No. 267

grid spacer temperature

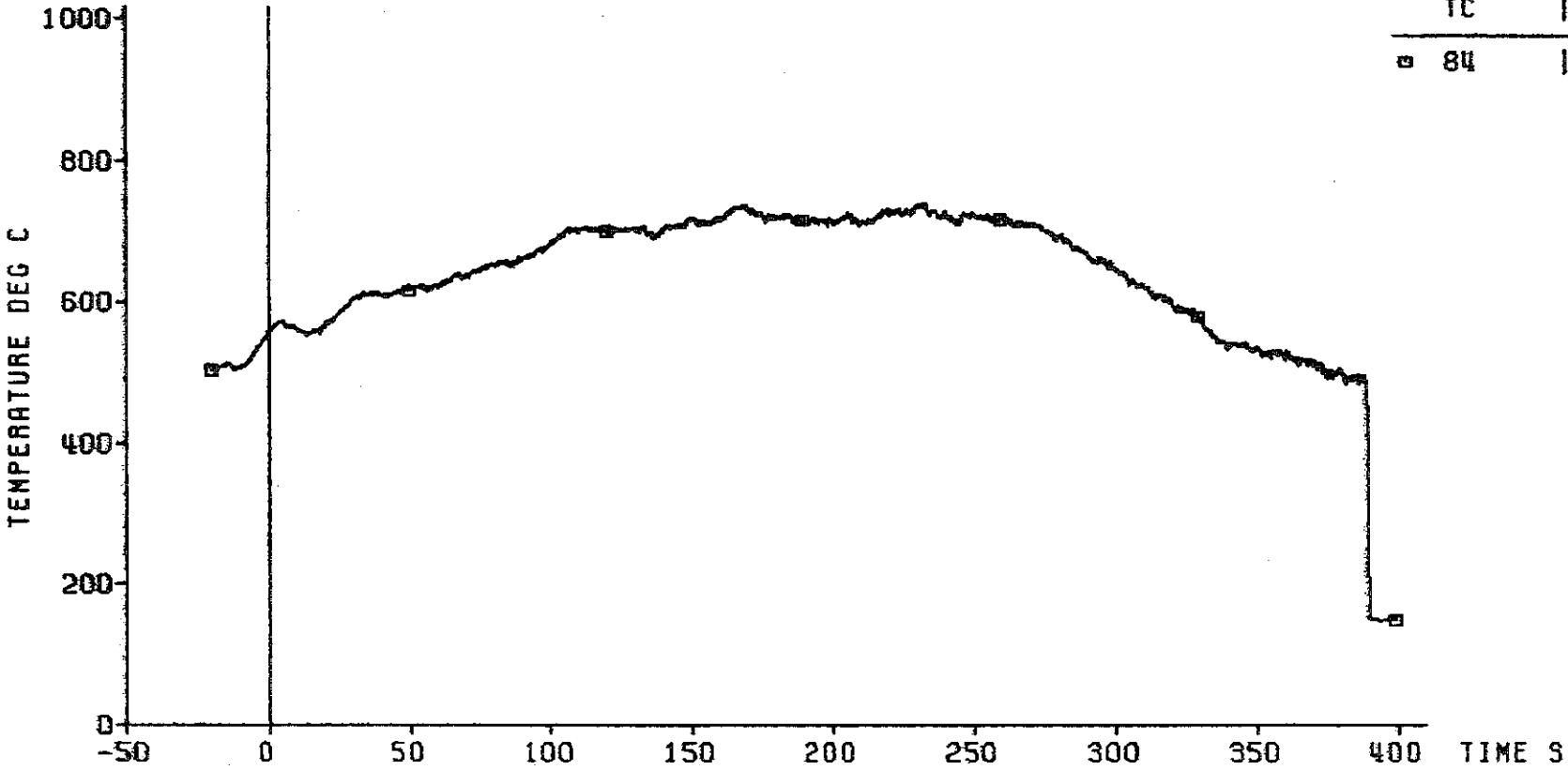

TC	axial level
84	1460 mm

decay heat 120% ANS standard
flooding rate (cold) 2.24 cm/s
system pressure 3.96 bar
feedwater temperature 40 deg C



Fig. 347 FEBA: 5x5 ROD BUNDLE, TEST SERIES 4, TEST-No. 267

axial level: 1825 mm

▲ cladding temperature (19g3)
● fluid temperature

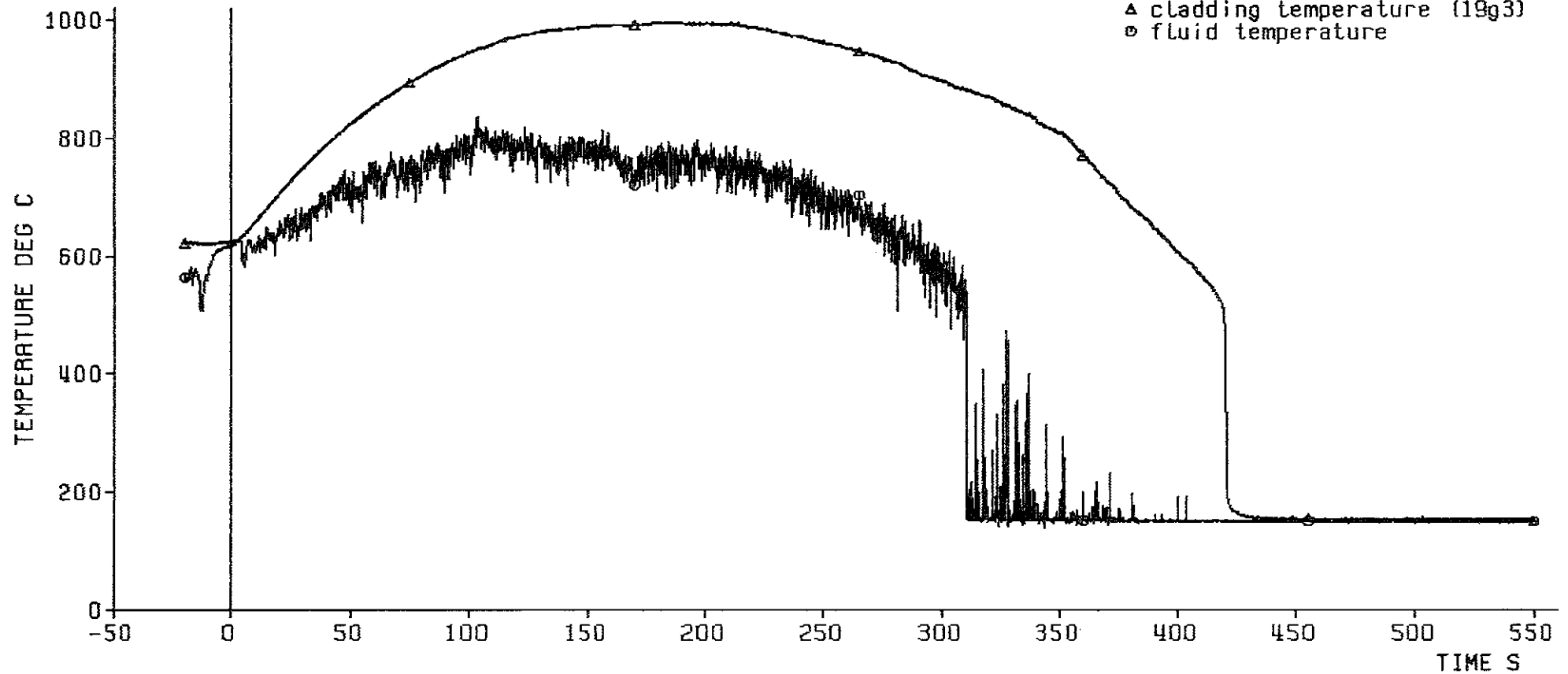

decay heat 120% ANS standard
flooding rate (cold) 2.24 cm/s
system pressure 3.96 bar
feedwater temperature 40 deg C

bypass
=====

KfK
IRB

Fig. 348 FEBA: 5x5 ROD BUNDLE, TEST SERIES 4, TEST-No. 267

axial level: 1825 mm

△ cladding temperature (16g3)
○ fluid temperature

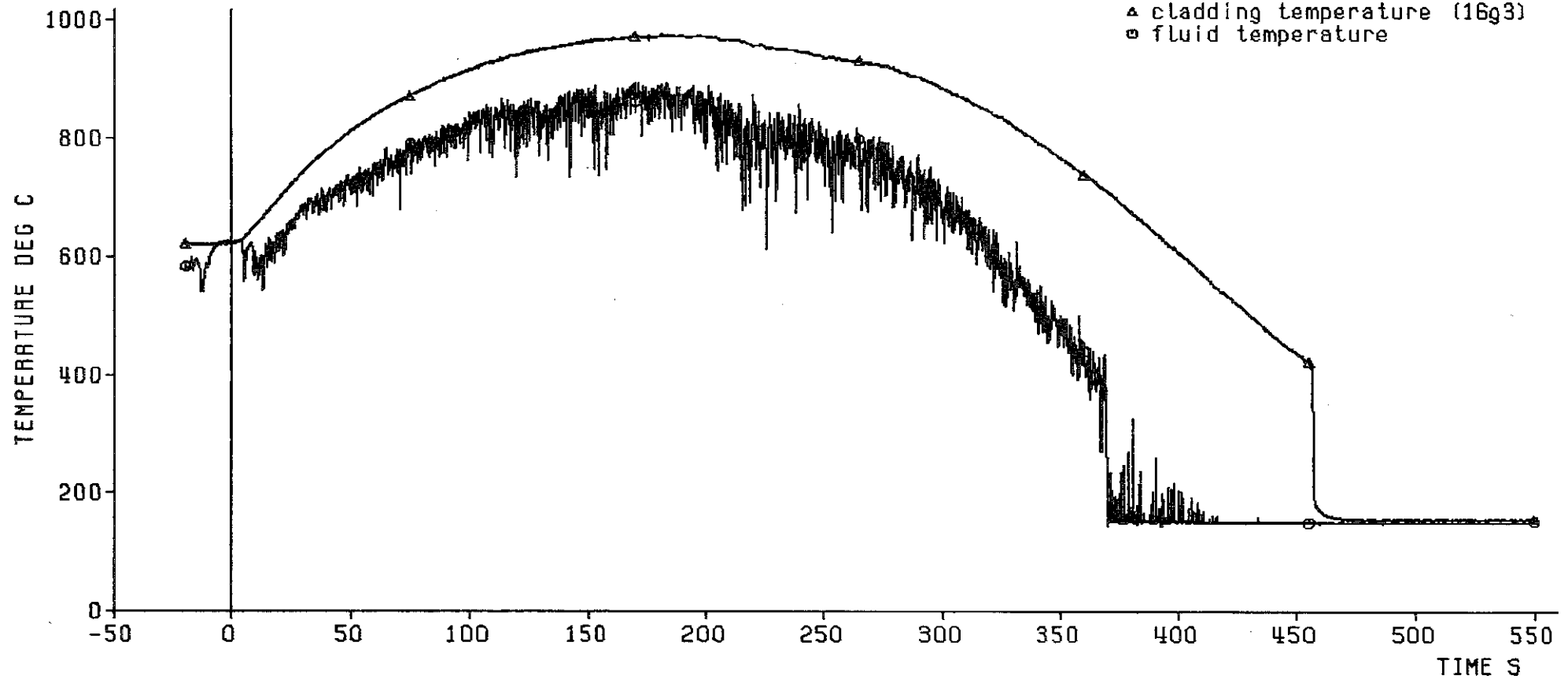

decay heat 120% ANS standard
flooding rate (cold) 2.24 cm/s
system pressure 3.96 bar
feedwater temperature 40 deg C

blockage
=====

KfK
IRB

Fig. 349 FEBA: 5x5 ROD BUNDLE, TEST SERIES 4, TEST-No. 267

axial level: 1725 mm

A cladding temperature (1992)
o fluid temperature
□ housing temperature

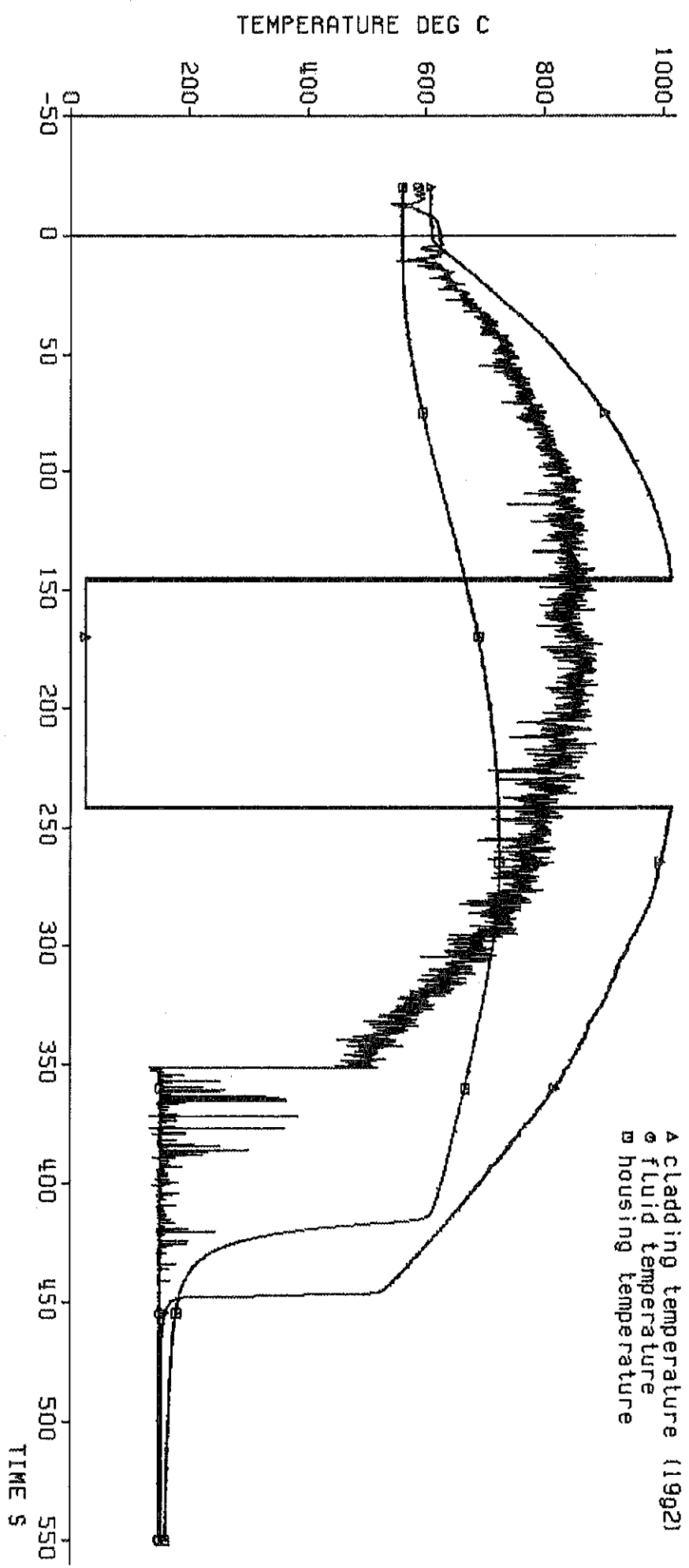

decay heat
flooding rate (cold)
system pressure
feedwater temperature

120% PWS standard
2.24 cm/s
3.96 bar
40 deg C

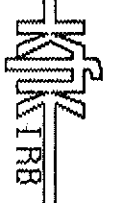
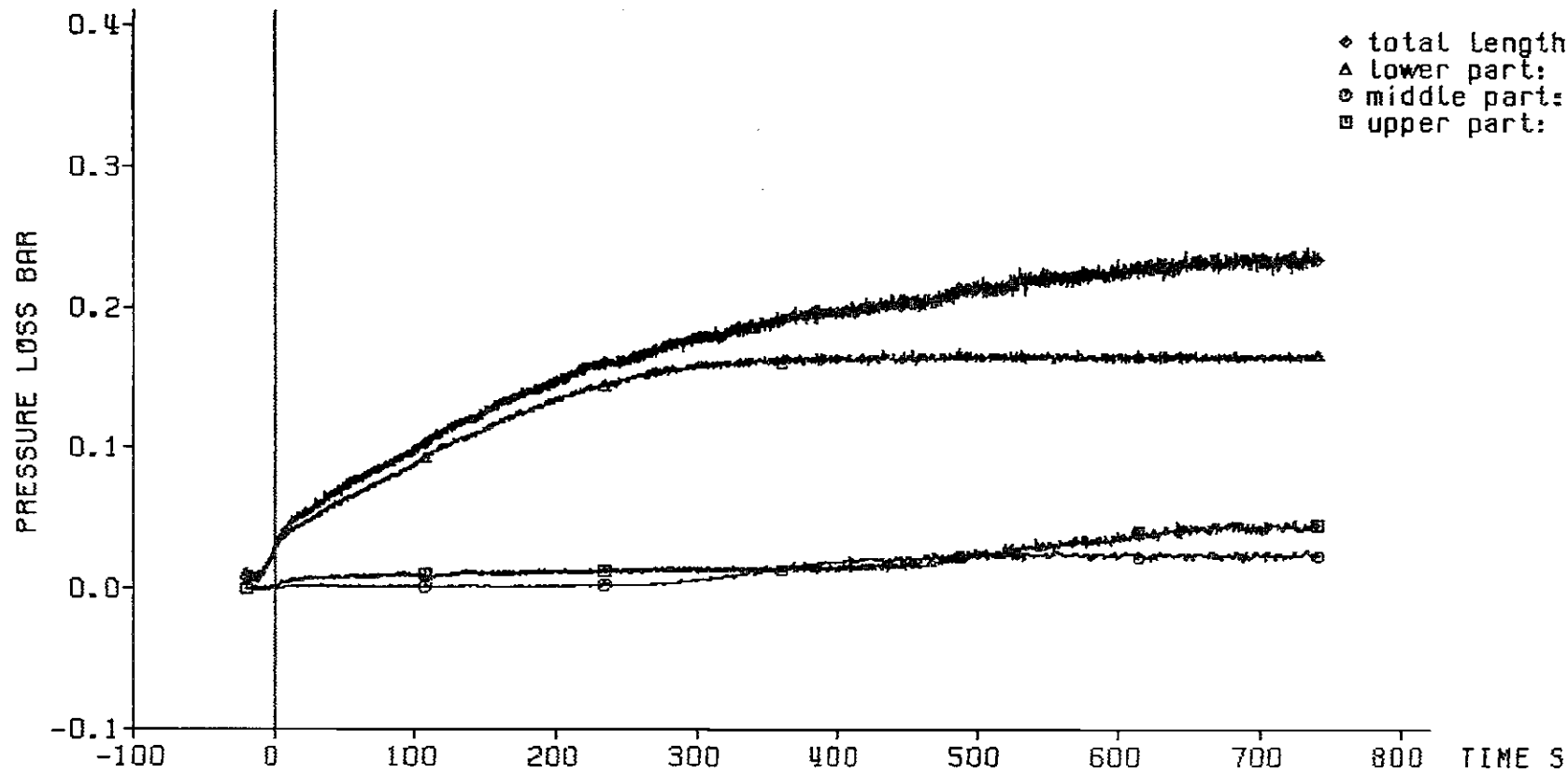

Fig. 350 FEBRA: 5X5 ROD BUNDLE, TEST SERIES 4, TEST-NO. 267

pressure loss
along the test section:

◆ total length: 4196 mm
△ lower part: 1711 mm
○ middle part: 545 mm
□ upper part: 1940 mm



decay heat 120% ANS standard
flooding rate (cold) 2.24 cm/s
system pressure 3.96 bar
feedwater temperature 40 deg C

KIK IRB

Fig. 351 FEBA: 5x5 ROD BUNDLE, TEST SERIES 4, TEST-NO. 267

coolant outlet conditions:

- ▲ water carry over
- coolant temperature
- coolant pressure

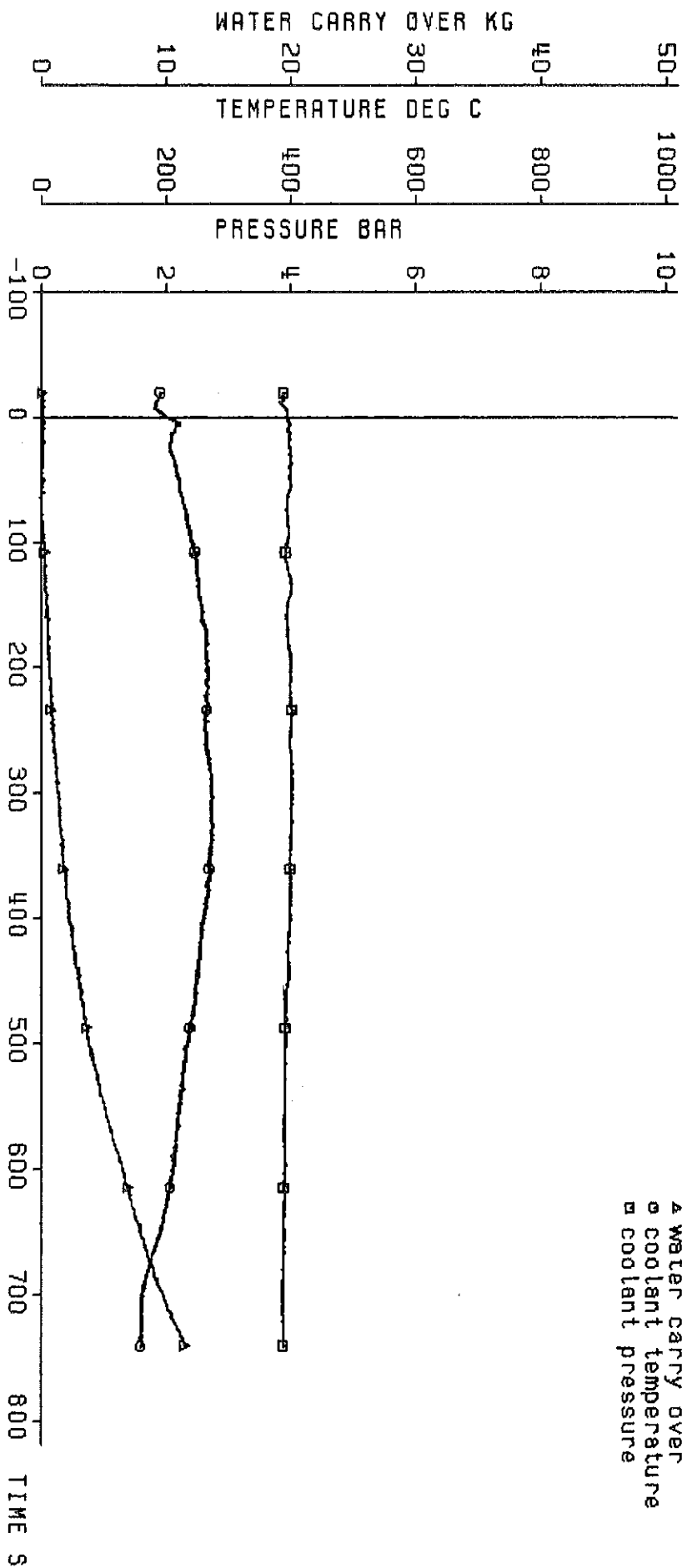

decay heat
 flooding rate (cold)
 system pressure
 feedwater temperature

120% ANS standard
 2.24 cm/s
 3.96 bar
 40 deg C

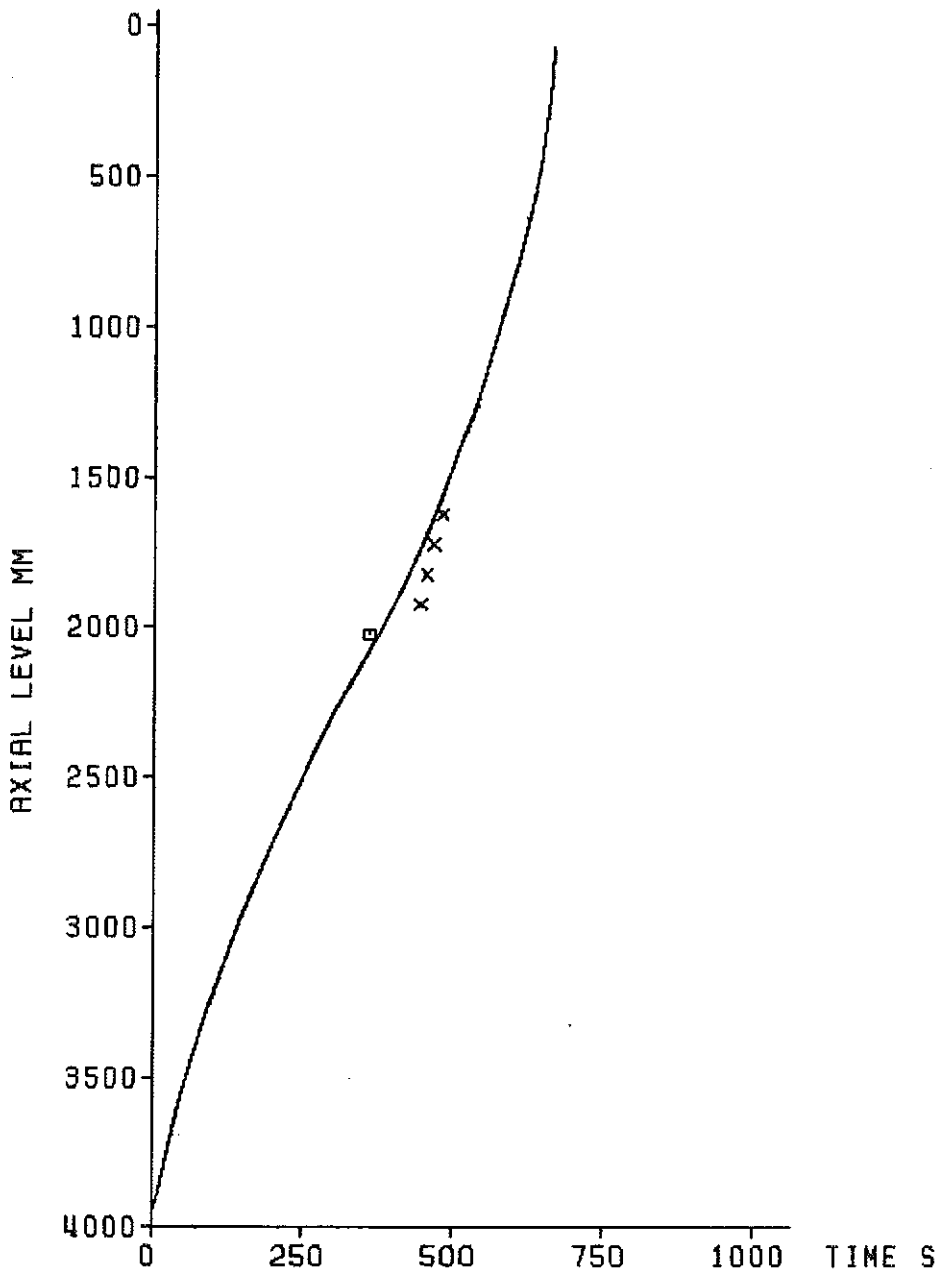

Fig. 352 FEBRA: 5X5 ROD BUNDLE, TEST SERIES 4, TEST-NO. 267

axial position of the quench front

□ rewetting of the sleeve at the bundle midplane

x rewetting of the rod downstream of the blockage



decay heat	120% ANS standard
flooding rate (cold)	2.24 cm/s
system pressure	3.96 bar
feedwater temperature	40 deg C



Fig. 353 FEBA: 5x5 ROD BUNDLE
TEST SERIES 4, TEST-No. 267

Initial axial temperature profile of the cladding

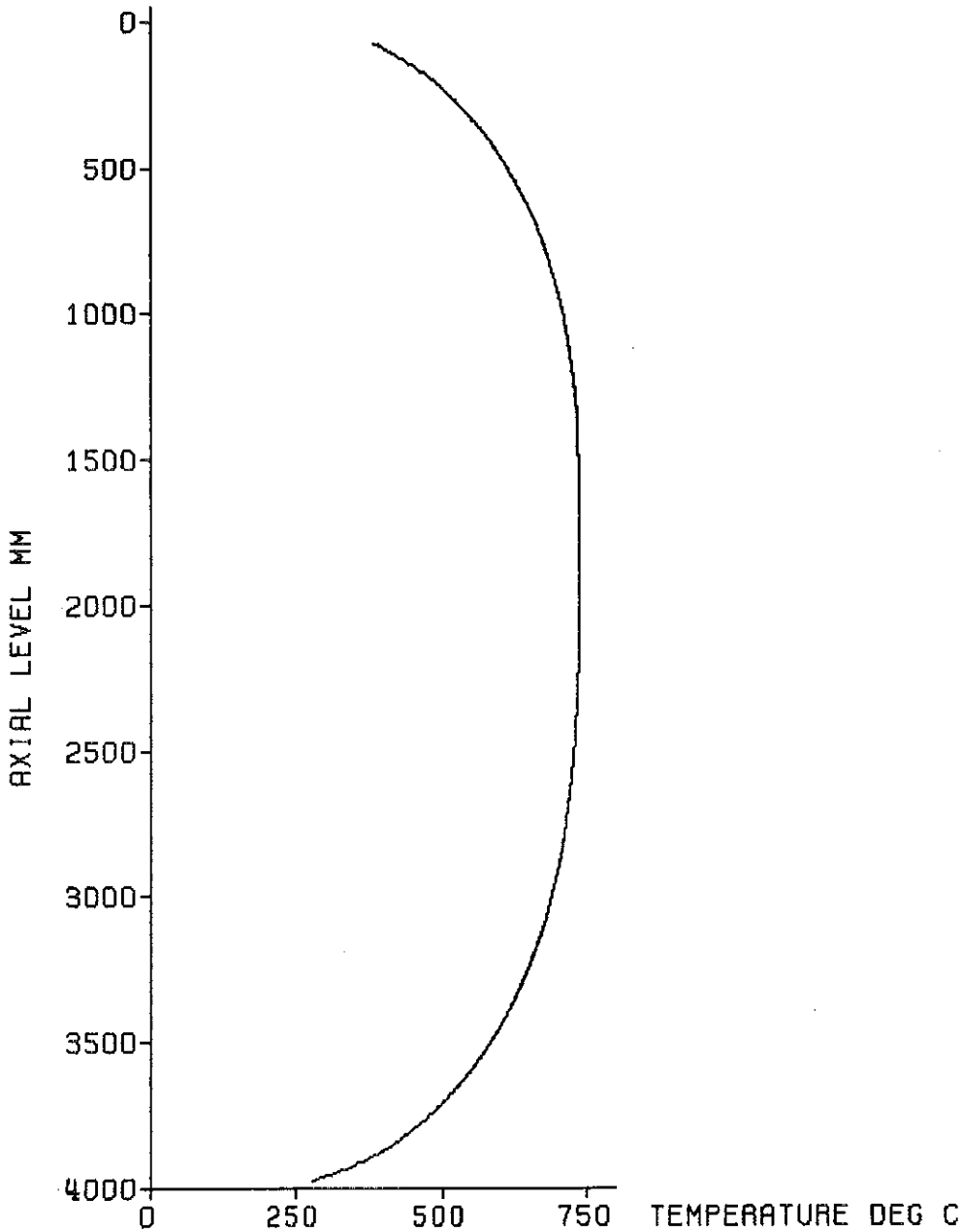

decay heat	120% ANS standard
flooding rate (cold)	3.80 cm/s
system pressure	1.98 bar
feedwater temperature	40 deg C



Fig. 354 FEBA: 5x5 ROD BUNDLE
TEST SERIES 4, TEST-NO. 262

test parameters:

- ◆ flooding rate
- ▲ system pressure
- feedwater temperature
- bundle power

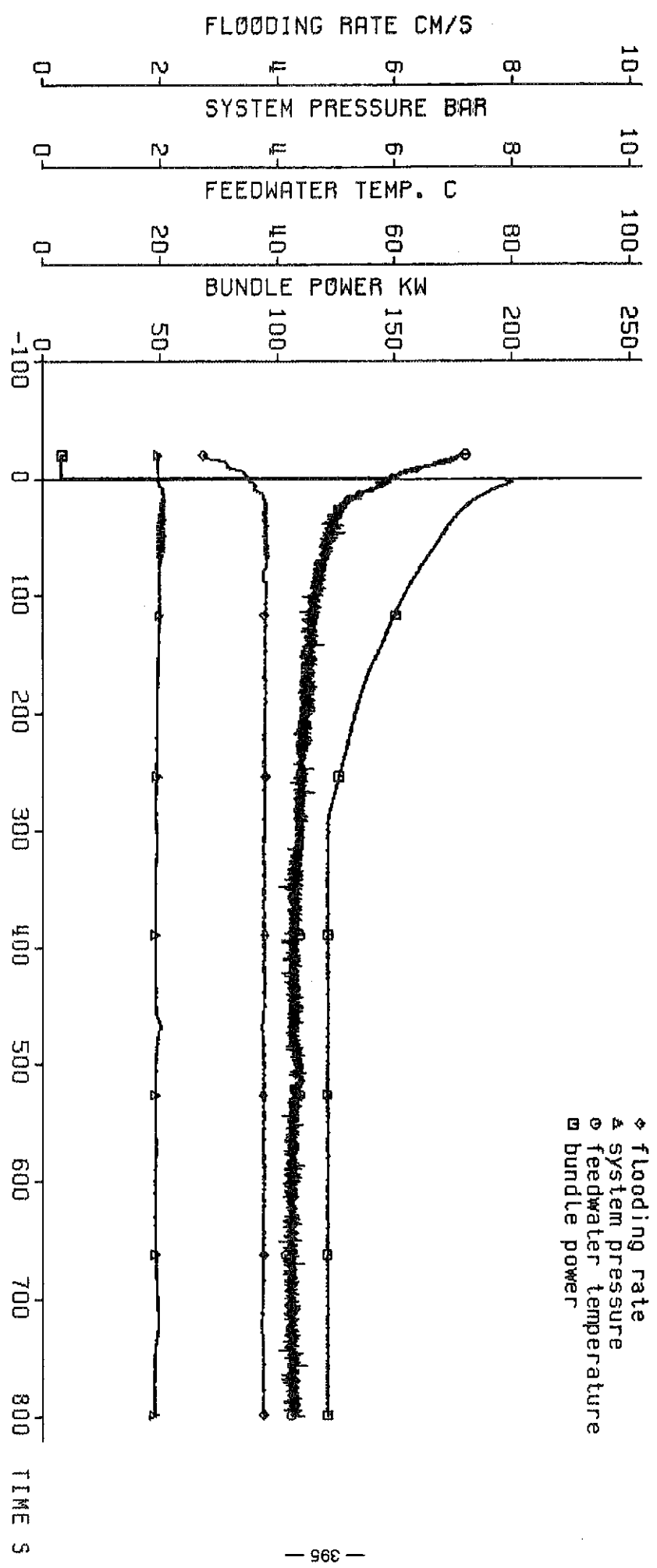

decay heat
 flooding rate (cold) 120% RMS standard
 system pressure 3.80 cm/s
 feedwater temperature 1.98 bar
 40 deg C

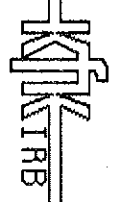
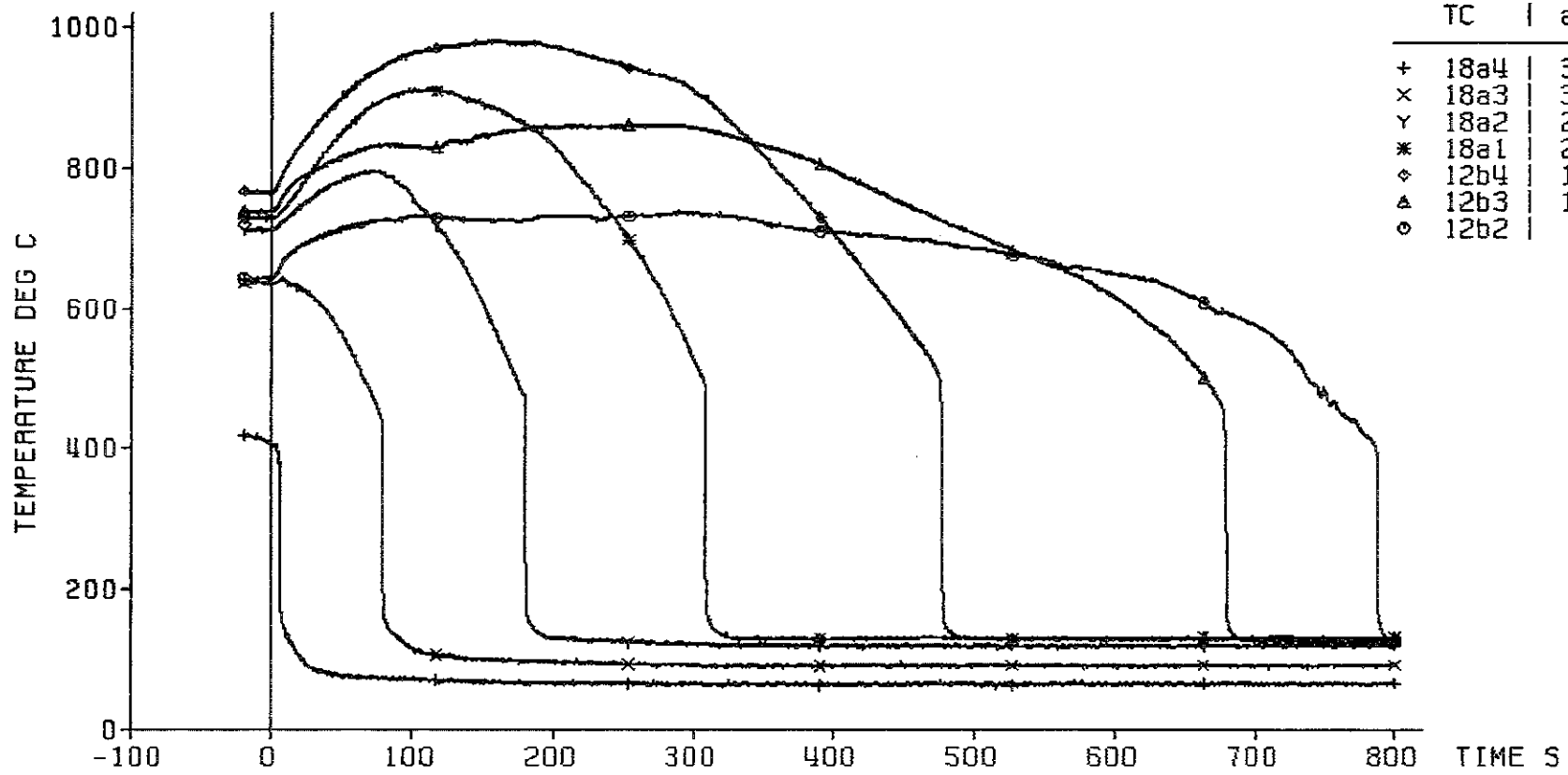

Fig. 355 FEBRA: 5x5 ROD BUNDLE, TEST SERIES 4, TEST-NO. 262

cladding temperature



TC	ax. Level
+	18a4 3860 mm
x	18a3 3315 mm
Y	18a2 2770 mm
*	18a1 2225 mm
◇	12b4 1680 mm
△	12b3 1135 mm
○	12b2 590 mm

decay heat 120% ANS standard
 flooding rate (cold) 3.80 cm/s
 system pressure 1.98 bar
 feedwater temperature 40 deg C



Fig. 356 FEBA: 5x5 ROD BUNDLE, TEST SERIES 4, TEST-No. 262

heat transfer coeff.

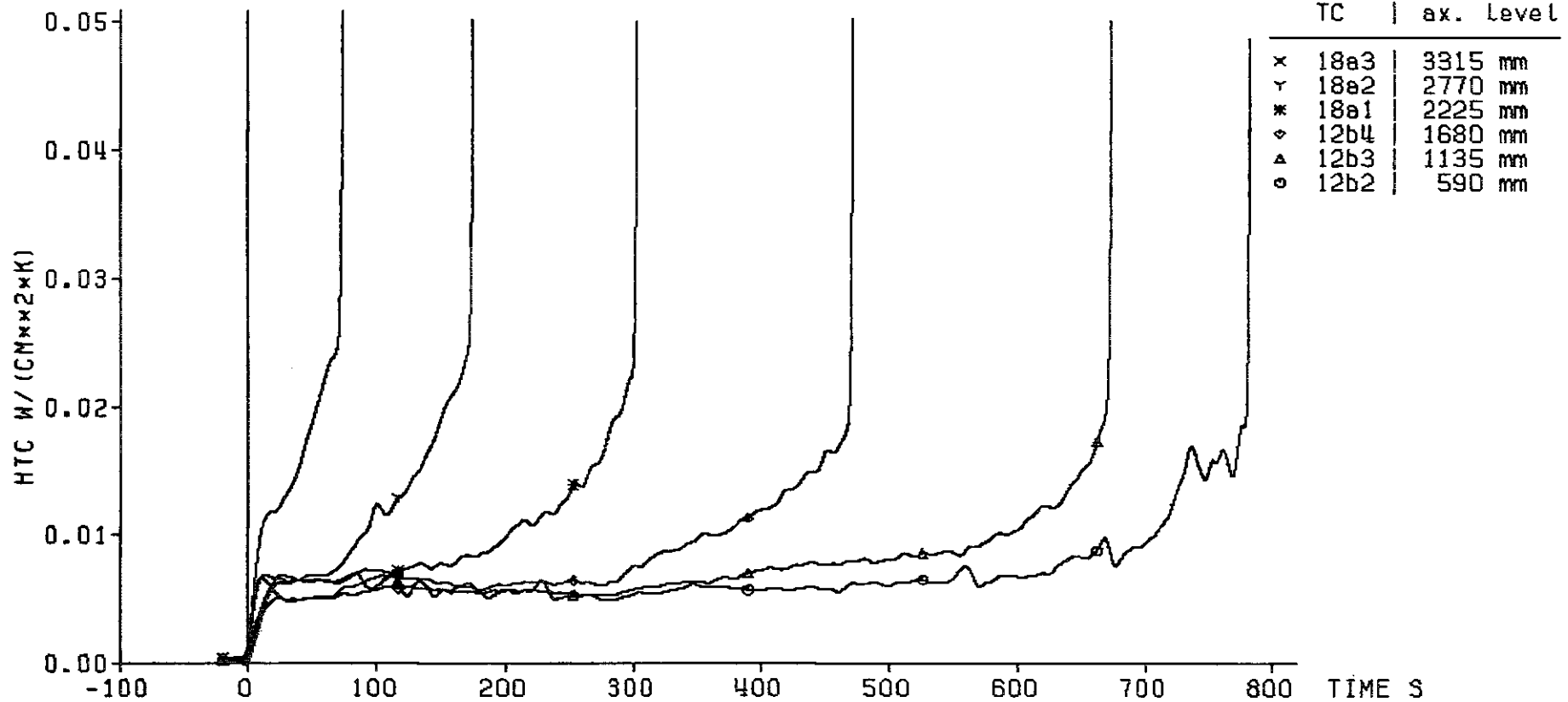

decay heat 120% ANS standard
flooding rate (cold) 3.80 cm/s
system pressure 1.98 bar
feedwater temperature 40 deg C



Fig. 357 FEBA: 5x5 ROD BUNDLE, TEST SERIES 4, TEST-No. 262

cladding temperature

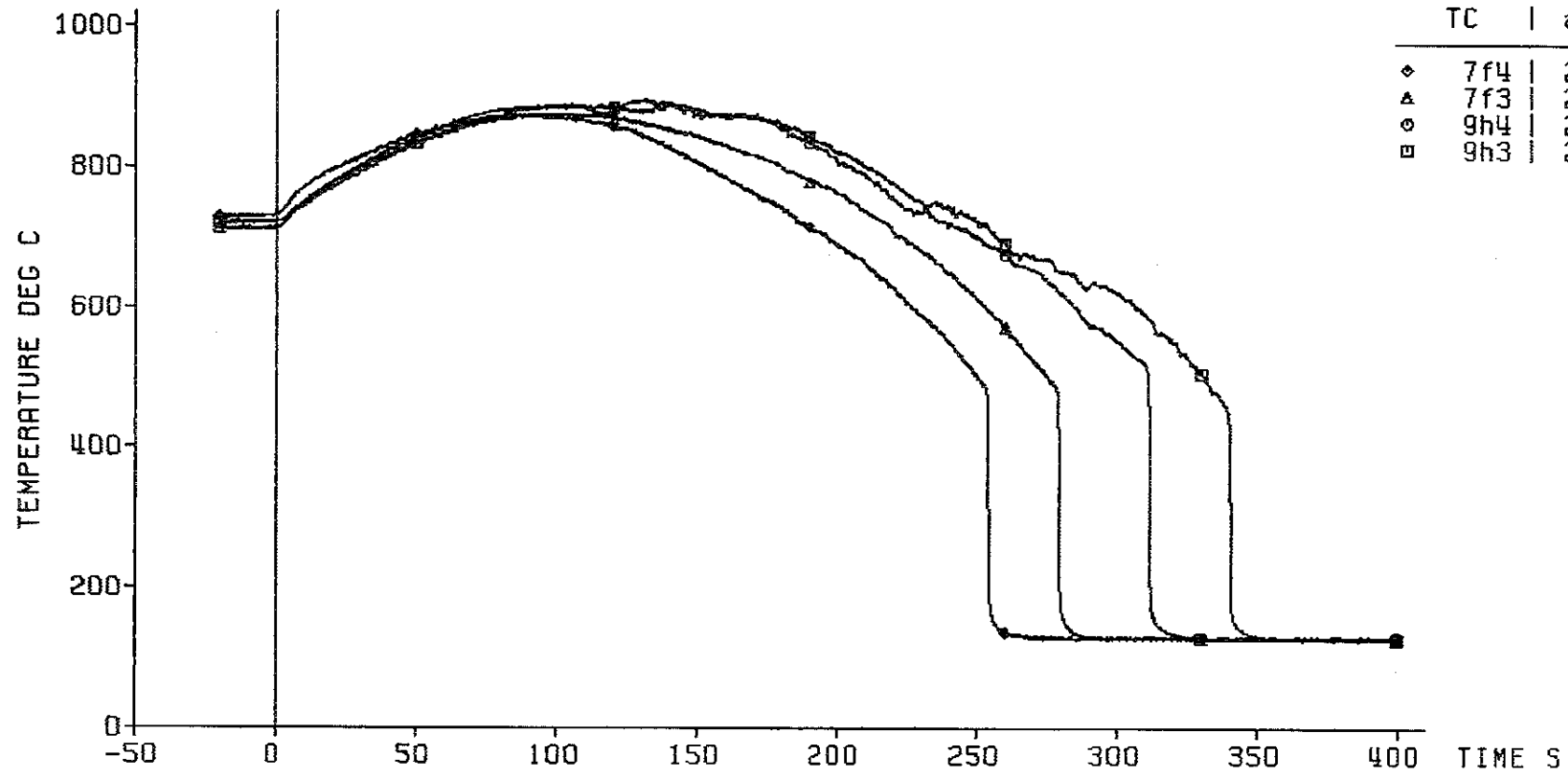

TC	ax. Level
◇	7f4 2425 mm
△	7f3 2325 mm
○	9h4 2225 mm
□	9h3 2125 mm

decay heat 120% ANS standard
flooding rate (cold) 3.80 cm/s
system pressure 1.98 bar
feedwater temperature 40 deg C

bypass
=====



Fig. 358 FEBA: 5x5 ROD BUNDLE, TEST SERIES 4, TEST-No. 262

heat transfer coeff.

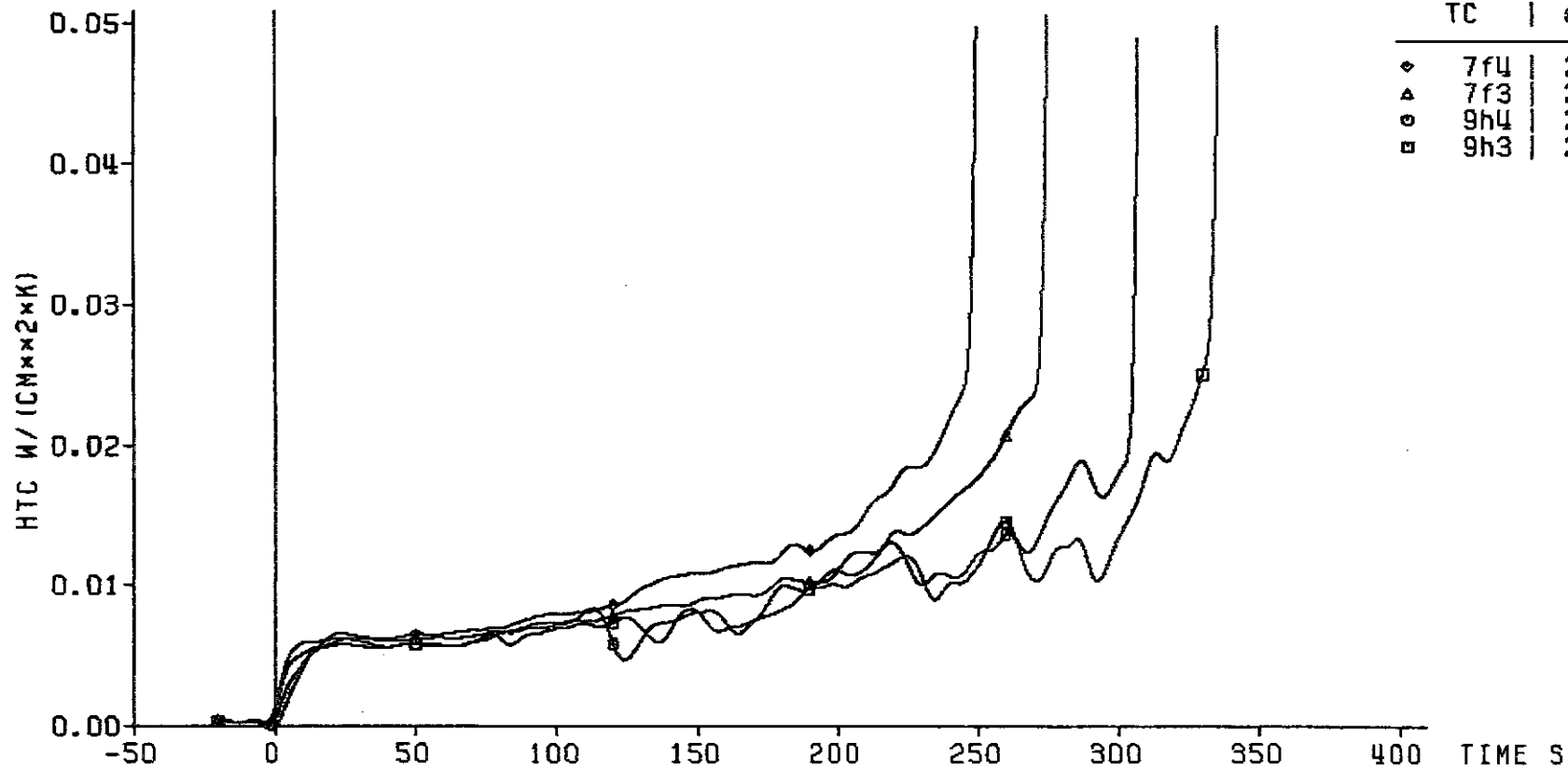

decay heat 120% ANS standard
 flooding rate (cold) 3.80 cm/s
 system pressure 1.98 bar
 feedwater temperature 40 deg C

bypass
 =====



Fig. 359 FEBA: 5x5 ROD BUNDLE, TEST SERIES 4, TEST-No. 262

cladding temperature

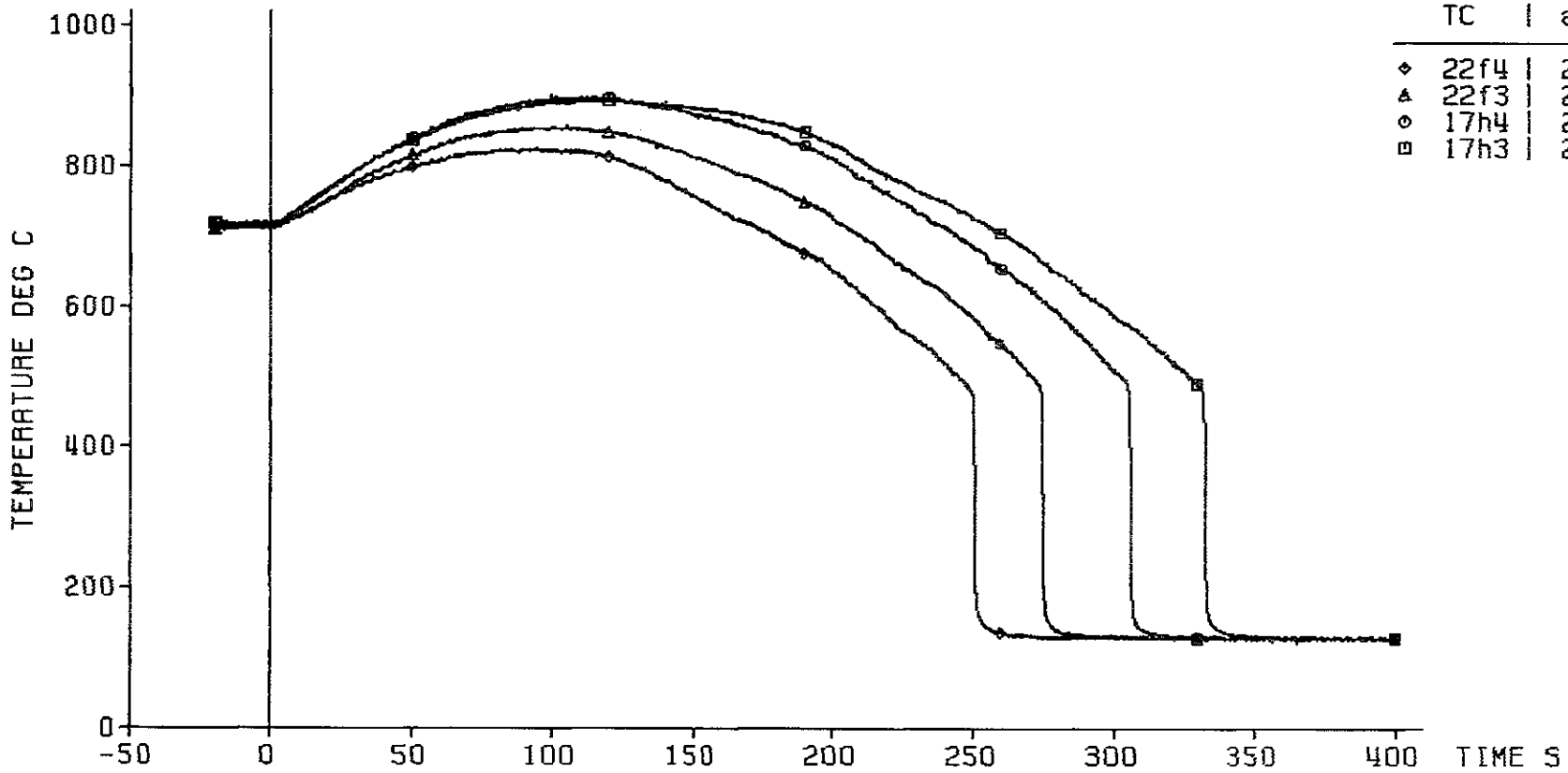

TC	ax. Level
◇	2425 mm
△	2325 mm
○	2225 mm
□	2125 mm

decay heat 120% RNS standard
 flooding rate (cold) 3.80 cm/s
 system pressure 1.98 bar
 feedwater temperature 40 deg C

blockage
 =====



Fig. 360 FEBA: 5x5 ROD BUNDLE, TEST SERIES 4, TEST-No. 262

— 400 —

heat transfer coeff.

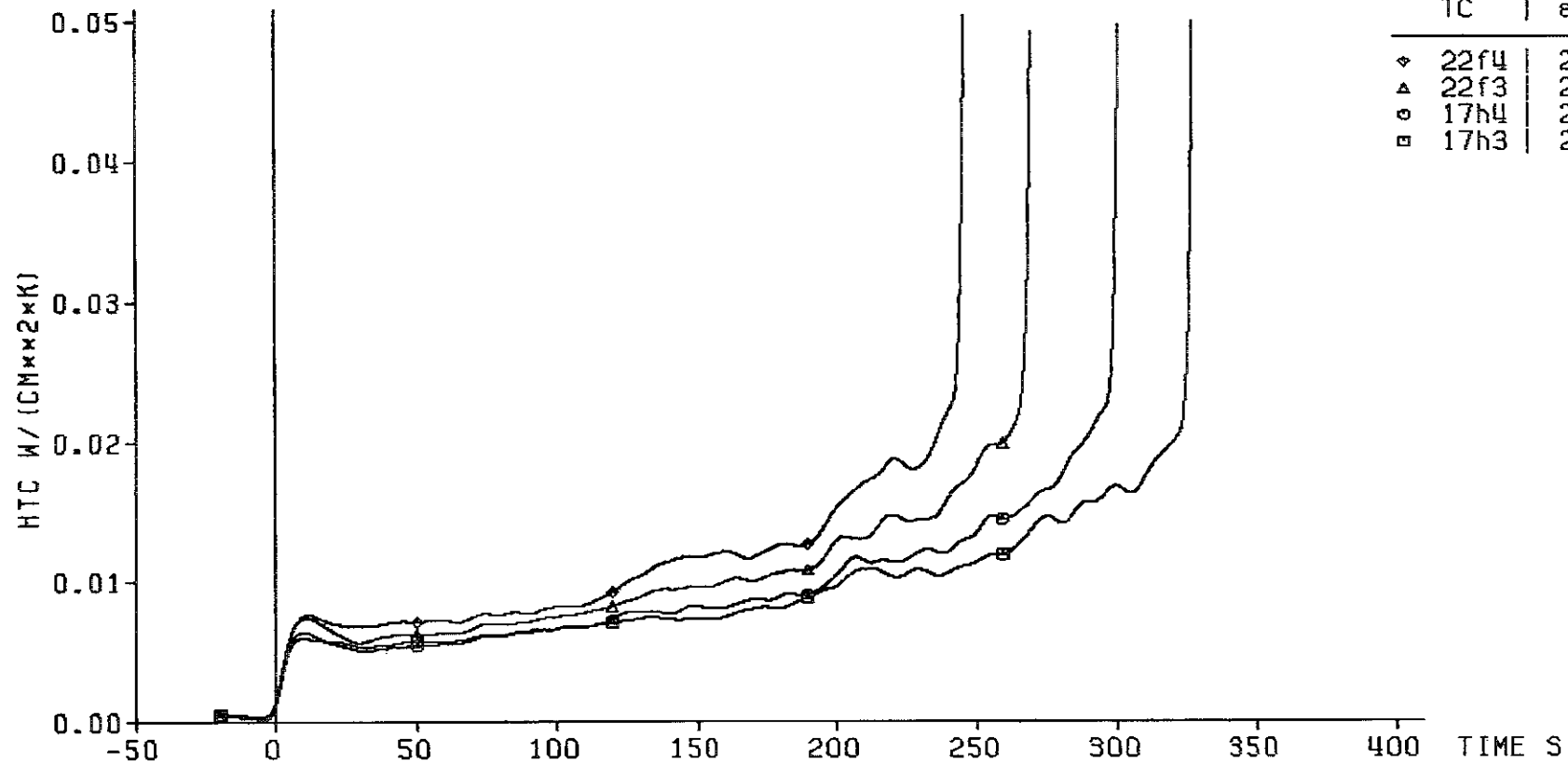

TC	ax. Level
◇ 22f4	2425 mm
△ 22f3	2325 mm
○ 17h4	2225 mm
□ 17h3	2125 mm

decay heat 120% ANS standard
 flooding rate (cold) 3.80 cm/s
 system pressure 1.98 bar
 feedwater temperature 40 deg C

blockage
 =====



Fig. 361 FEBA: 5x5 ROD BUNDLE, TEST SERIES 4, TEST-No. 262

cladding temperature

TC	ax. level
* 9h2	2025 mm
◇ 8d4	2025 mm
△ 8d3	2025 mm
⊙ 8d2	2025 mm
□ 8d1	2025 mm

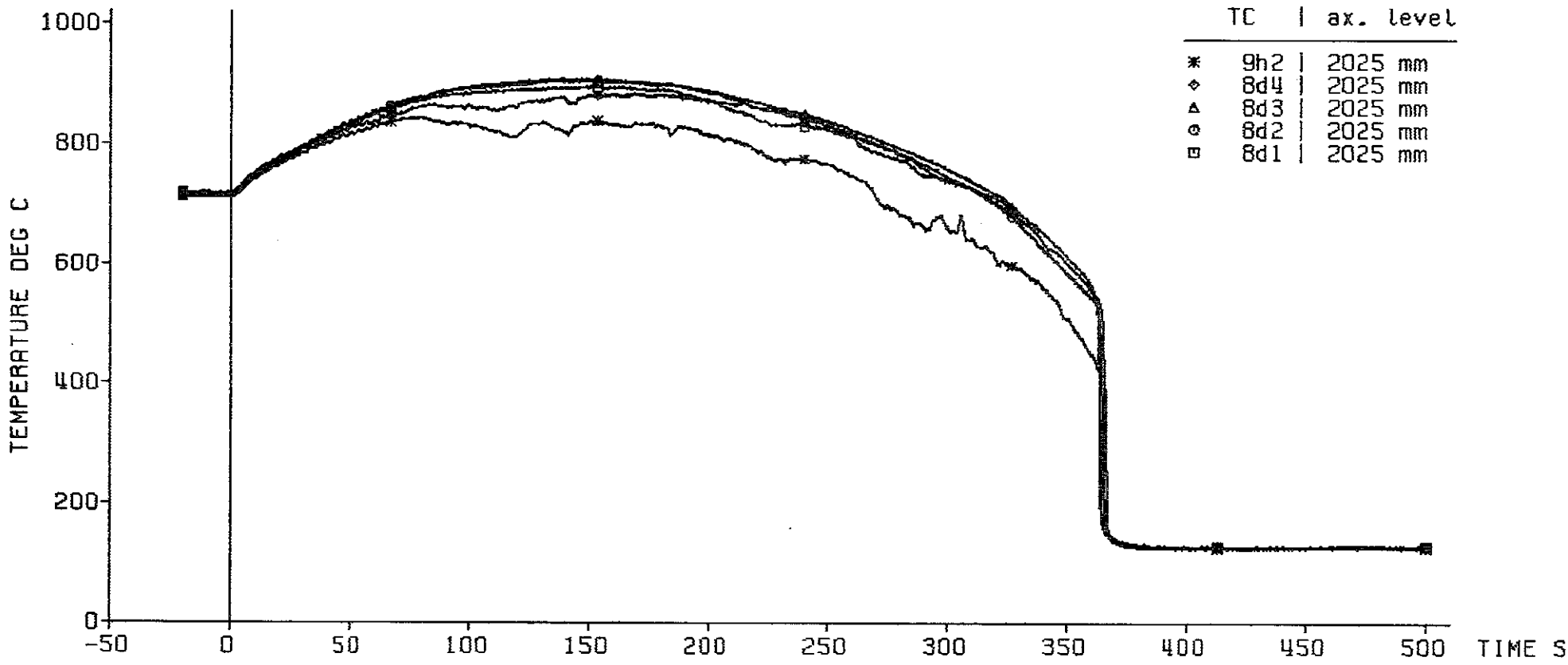

— 402 —

decay heat 120% ANS standard
flooding rate (cold) 3.80 cm/s
system pressure 1.98 bar
feedwater temperature 40 deg C

bypass
=====



Fig. 362 FEBA: 5x5 ROD BUNDLE, TEST SERIES 4, TEST-No. 262

heat transfer coeff.

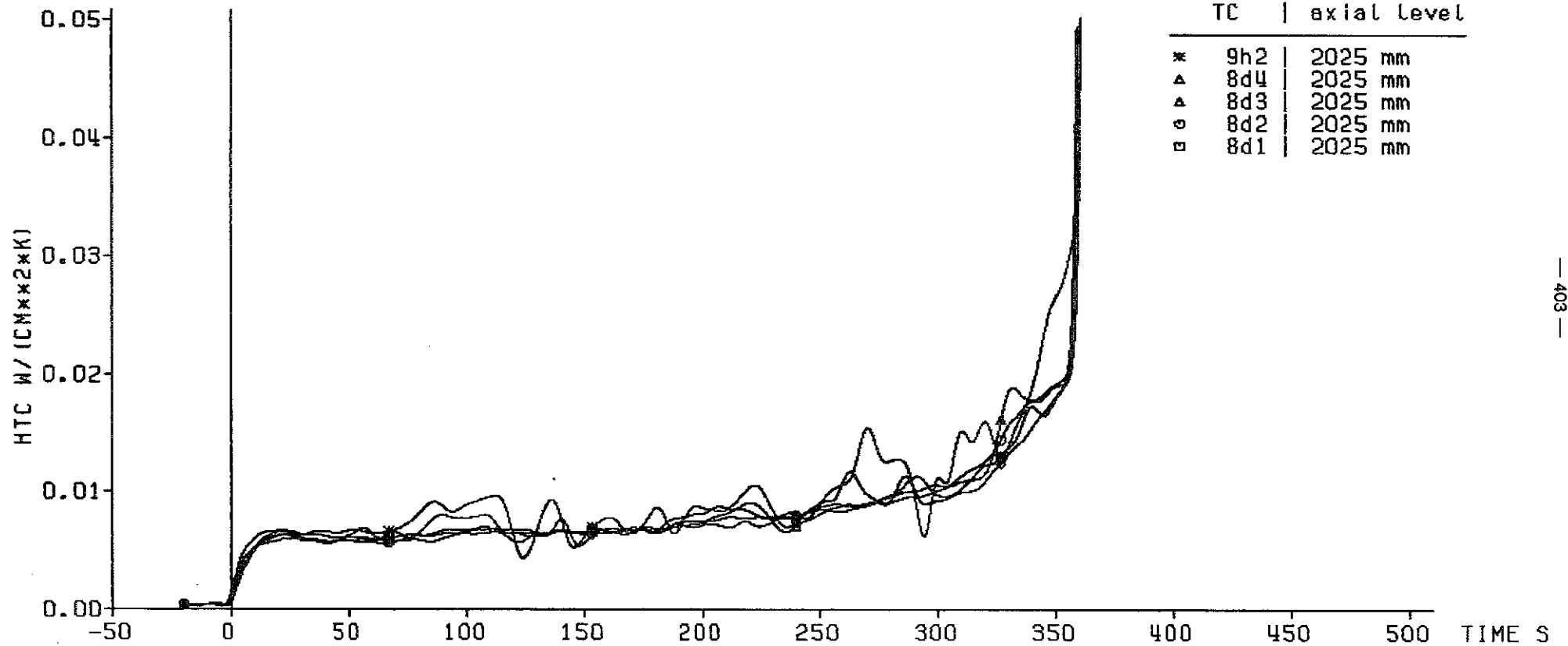

— 403 —

decay heat 120% ANS standard
 flooding rate (cold) 3.80 cm/s
 system pressure 1.98 bar
 feedwater temperature 40 deg C

bypass
 =====



Fig. 363 FEBA: 5x5 ROD BUNDLE, TEST SERIES 4, TEST-No. 262

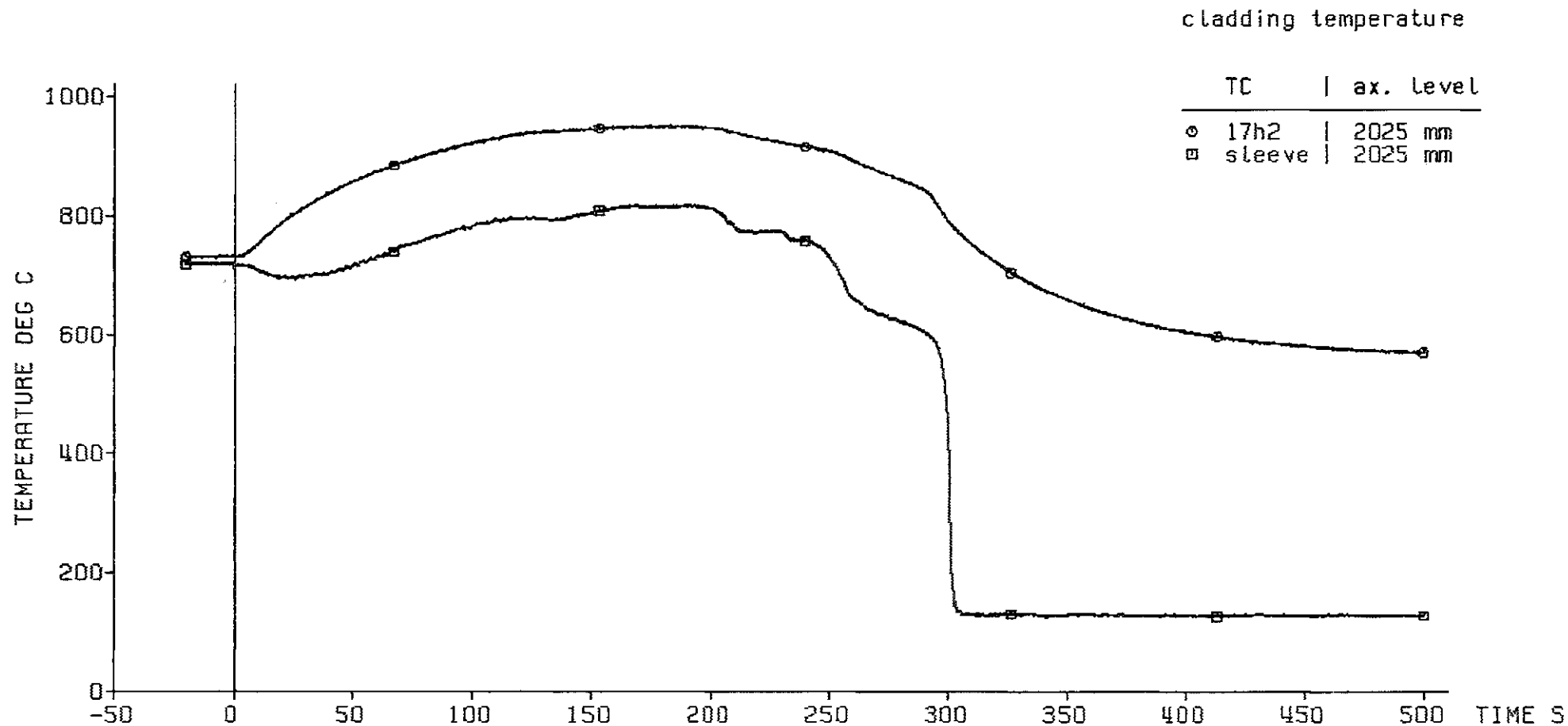

— 404 —

decay heat 120% ANS standard
 flooding rate (cold) 3.80 cm/s
 system pressure 1.98 bar
 feedwater temperature 40 deg C

blockage
=====



Fig. 364 FEBA: 5x5 R0D BUNDLE, TEST SERIES 4, TEST-No. 262

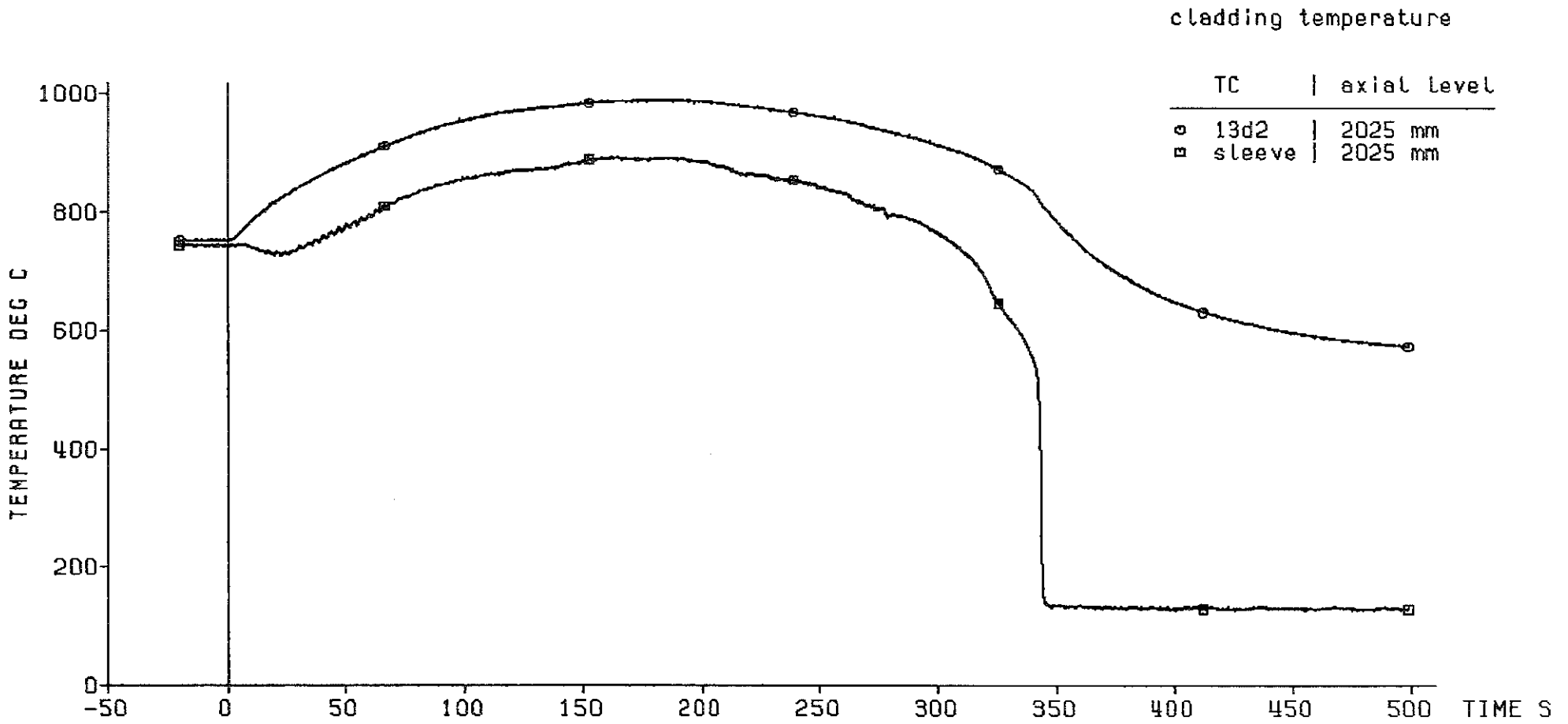

— 405 —

decay heat 120% ANS standard
 flooding rate (cold) 3.80 cm/s
 system pressure 1.98 bar
 feedwater temperature 40 deg C

blockage
 =====



Fig. 365 FEBA: 5x5 ROD BUNDLE, TEST SERIES 4, TEST-No. 262

cladding temperature

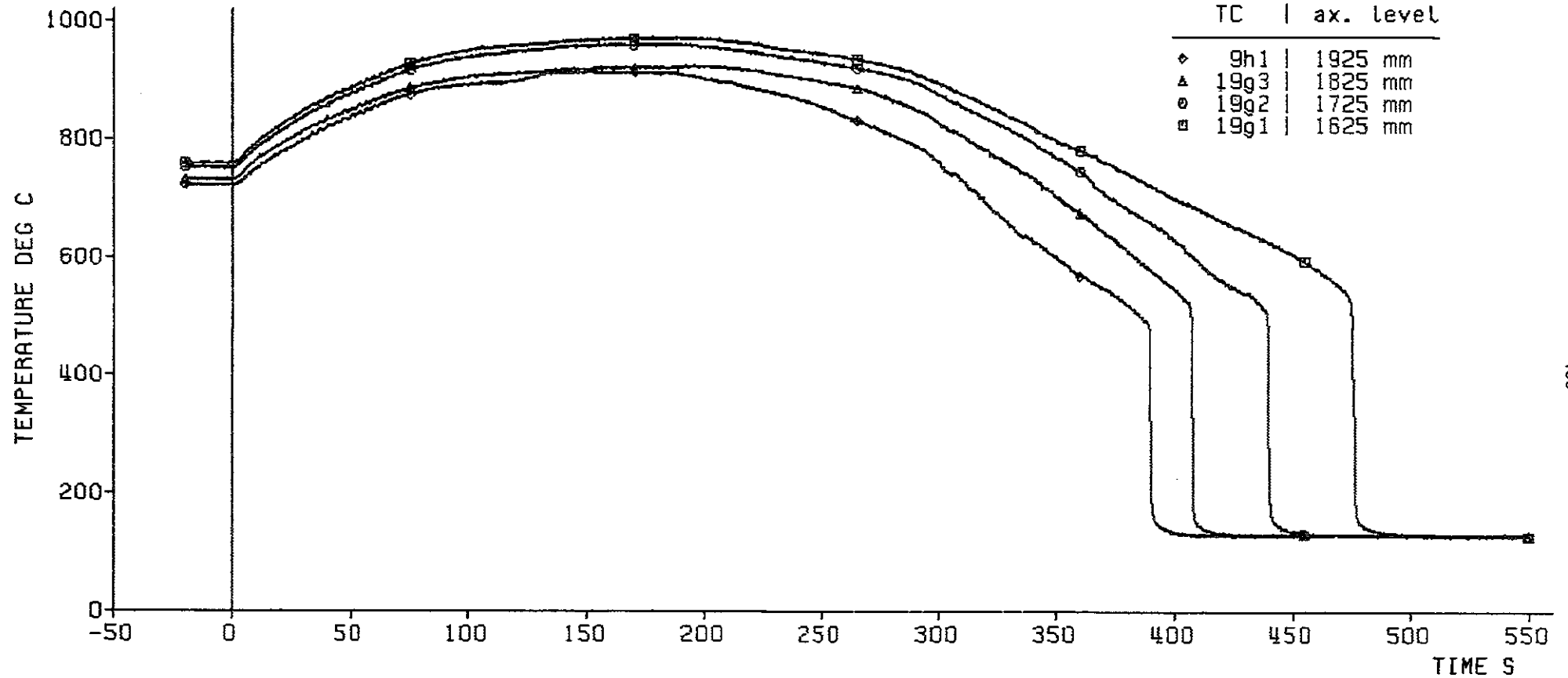

— 406 —

decay heat 120% ANS standard
 flooding rate (cold) 3.80 cm/s
 system pressure 1.98 bar
 feedwater temperature 40 deg C

bypass
 =====



Fig. 366 FEBA: 5x5 ROD BUNDLE, TEST SERIES 4, TEST-No. 262

heat transfer coeff.

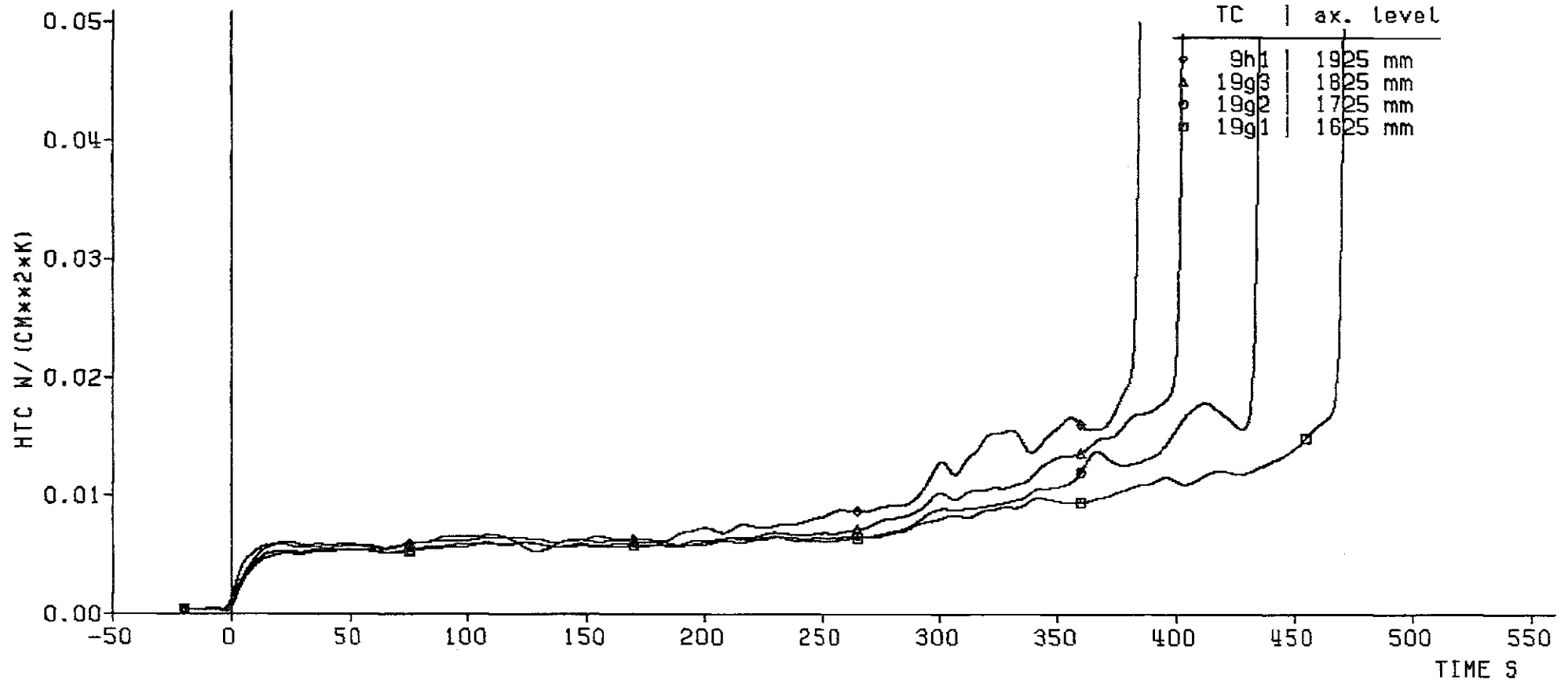

— 407 —

decay heat
 flooding rate (cold) 3.80 cm/s
 system pressure 1.98 bar
 feedwater temperature 40 deg C

120% ANS standard

bypass
 =====



Fig. 367 FEBA: 5x5 ROD BUNDLE, TEST SERIES 4, TEST-No. 262

cladding temperature

TC	ax. level
◇	17h1 1925 mm
△	16g3 1825 mm
○	16g2 1725 mm
□	16g1 1625 mm

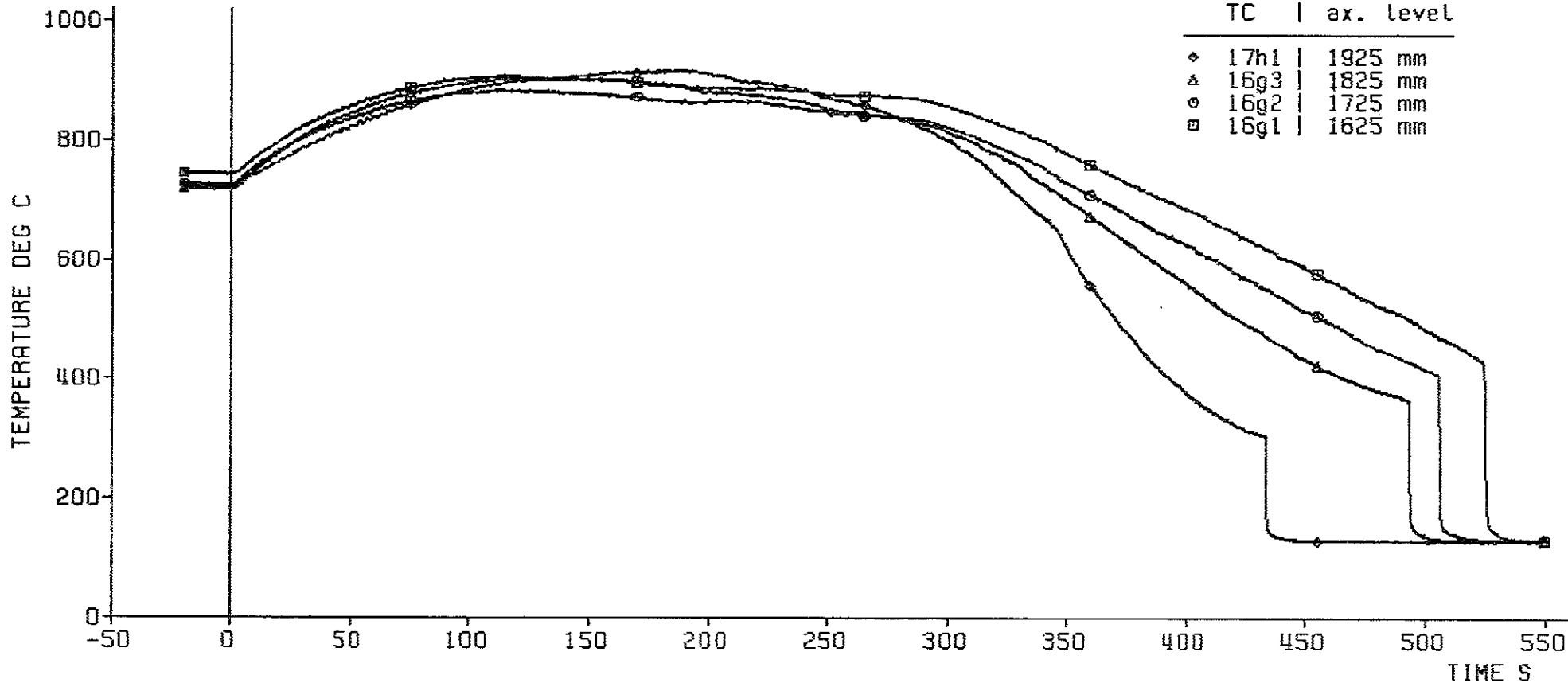

decay heat 120% RMS standard
 flooding rate (cold) 3.80 cm/s
 system pressure 1.98 bar
 feedwater temperature 40 deg C

blockage
=====



Fig. 368 FEBA: 5x5 ROD BUNDLE, TEST SERIES 4, TEST-No. 262

heat transfer coeff.

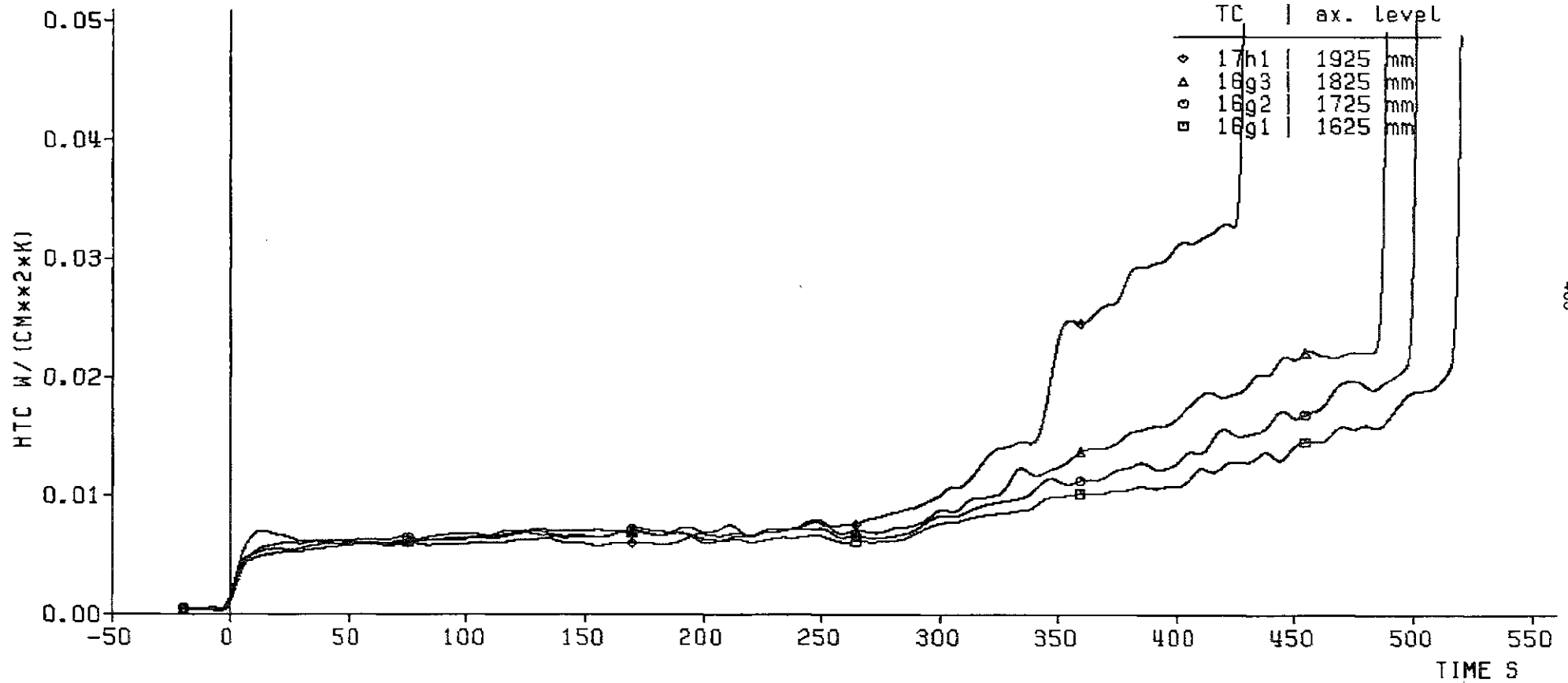

— 409 —

decay heat 120% ANS standard
 flooding rate (cold) 3.80 cm/s
 system pressure 1.98 bar
 feedwater temperature 40 deg C

blockage
 =====



Fig. 369 FEBA: 5x5 ROD BUNDLE, TEST SERIES 4, TEST-No. 262

grid spacer temperature

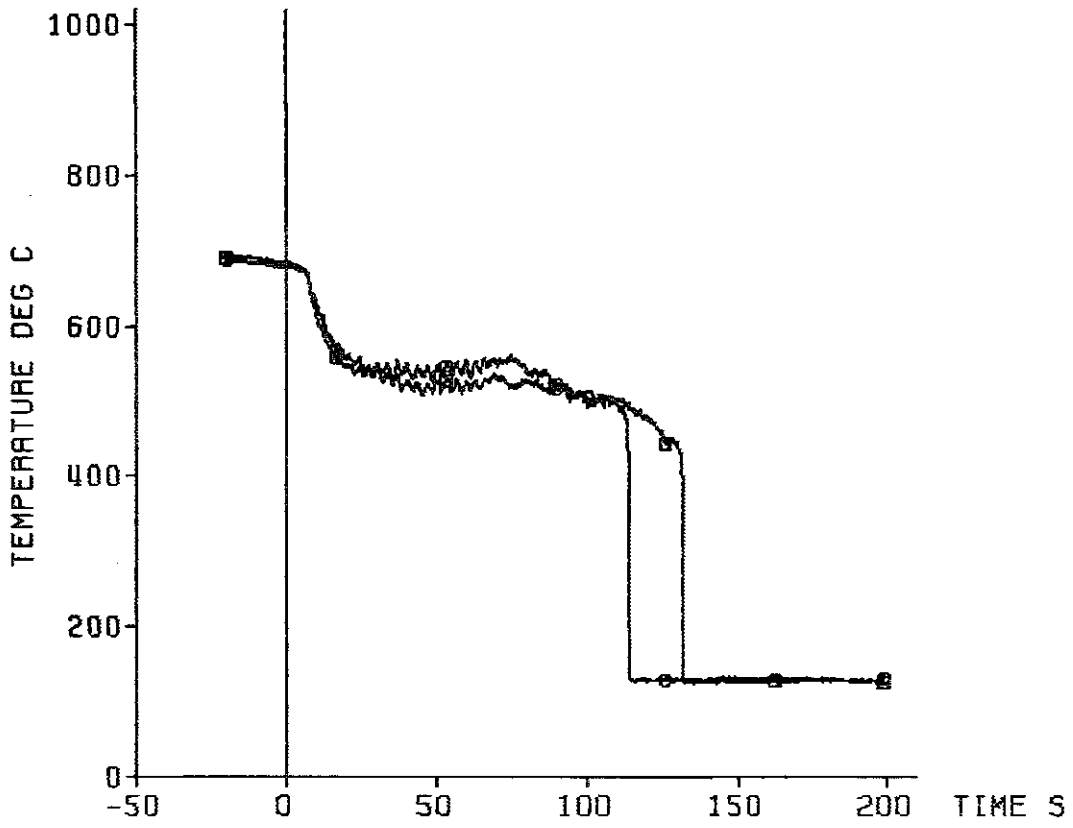

TC	axial level
86	2550 mm
87	2550 mm

decay heat 120% ANS standard
flooding rate (cold) 3.80 cm/s
system pressure 1.98 bar
feedwater temperature 40 deg C

— 410 —



Fig. 370 FEBA: 5x5 ROD BUNDLE, TEST SERIES 4, TEST-No. 262

grid spacer temperature

	TC	axial level
□	84	1460 mm
○	85	1460 mm

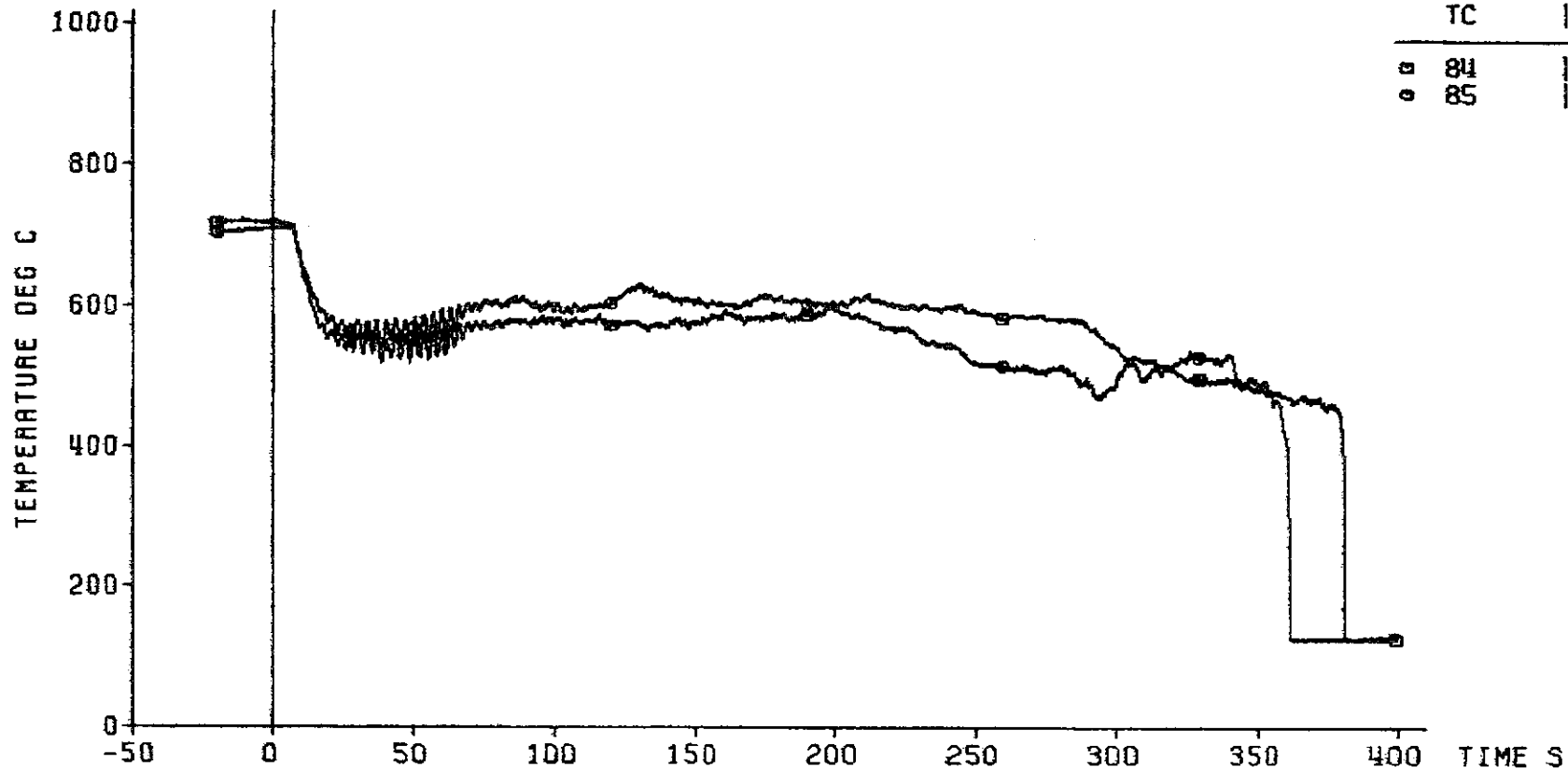

decay heat 120% ANS standard
flooding rate (cold) 3.80 cm/s
system pressure 1.98 bar
feedwater temperature 40 deg C

KJK²
IRB

Fig. 371 FEBA: 5x5 ROD BUNDLE, TEST SERIES 4, TEST-No. 262

axial level: 1825 mm

△ cladding temperature (19g3)
○ fluid temperature

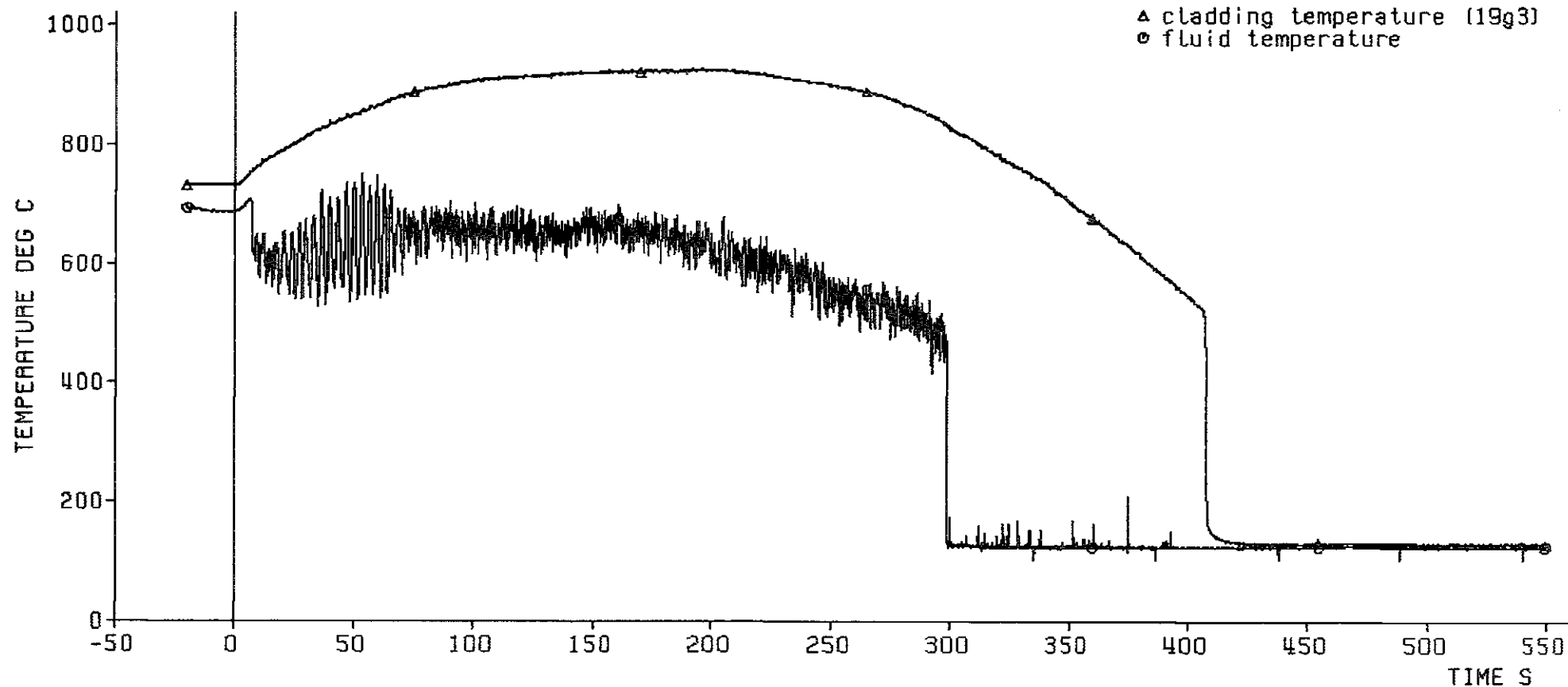

— 412 —

decay heat 120% ANS standard
flooding rate (cold) 3.80 cm/s
system pressure 1.98 bar
feedwater temperature 40 deg C

bypass
=====



Fig. 372 FEBA: 5x5 ROD BUNDLE, TEST SERIES 4, TEST-No. 262

axial level: 1825 mm

▲ cladding temperature (16g3)
○ fluid temperature

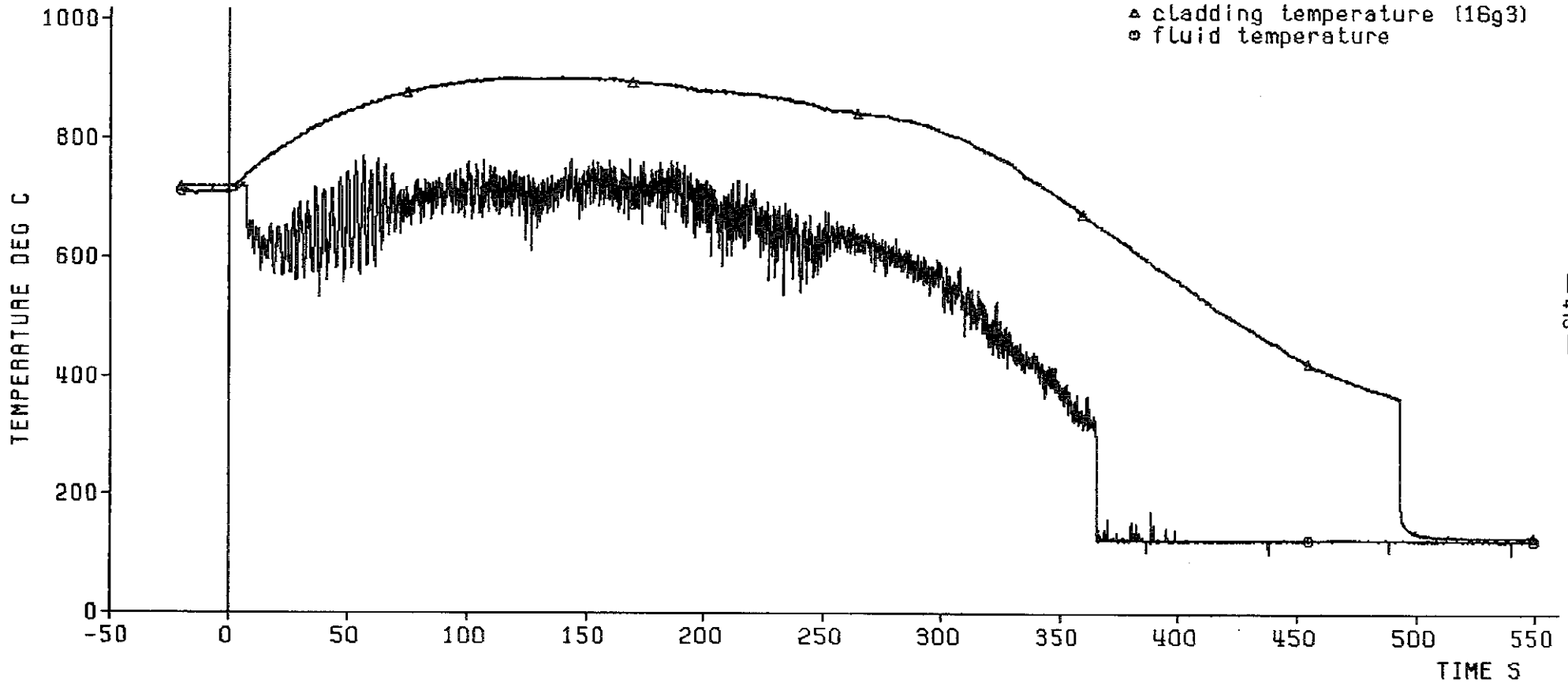

— 413 —

decay heat 120% ANS standard
flooding rate (cold) 3.80 cm/s
system pressure 1.98 bar
feedwater temperature 40 deg C

blockage
=====

KJK
IRB

Fig. 373 FEBA: 5x5 ROD BUNDLE, TEST SERIES 4, TEST-NO. 262

axial level: 1725 mm

▲ cladding temperature (19g2)
● fluid temperature
■ housing temperature

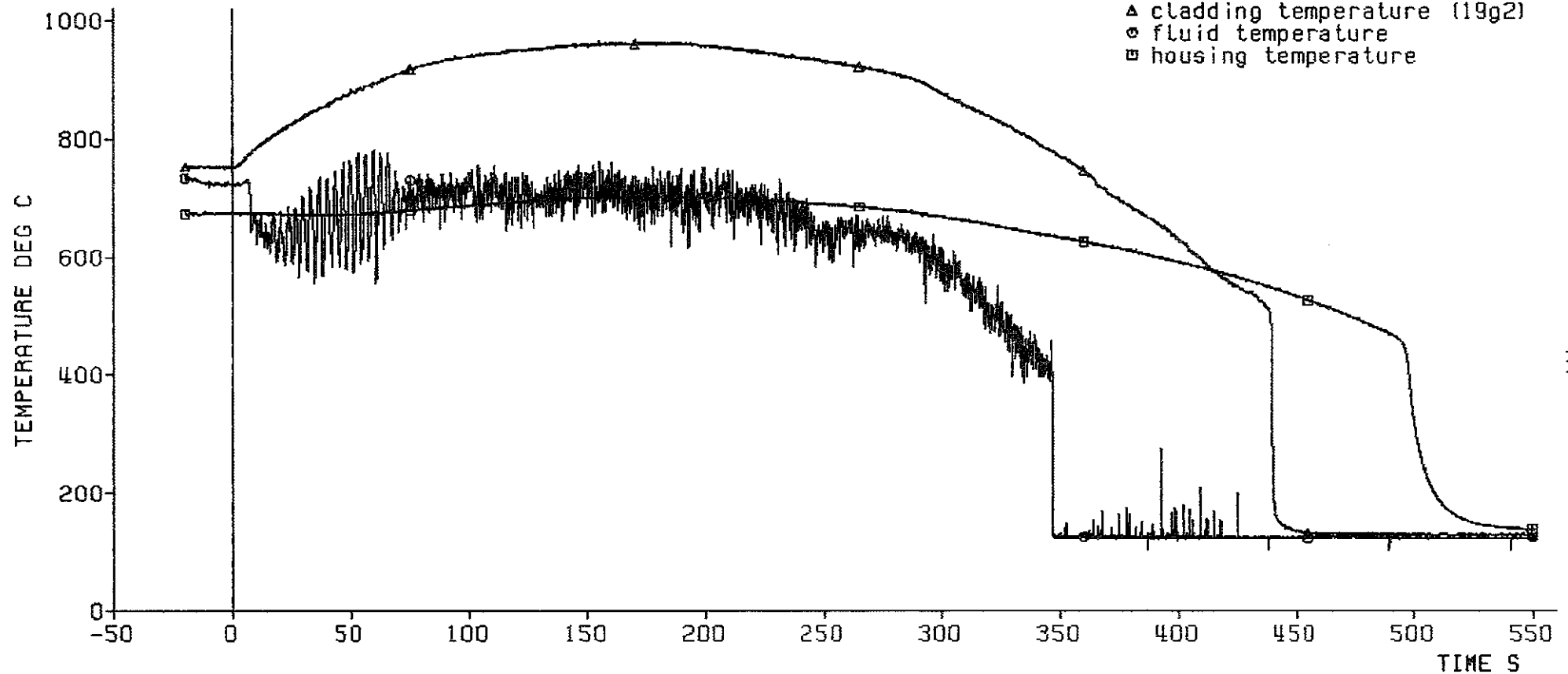

— 414 —

decay heat 120% ANS standard
flooding rate (cold) 3.80 cm/s
system pressure 1.98 bar
feedwater temperature 40 deg C

bypass
=====



Fig. 374 FEBA: 5x5 ROD BUNDLE, TEST SERIES 4, TEST-NO. 262

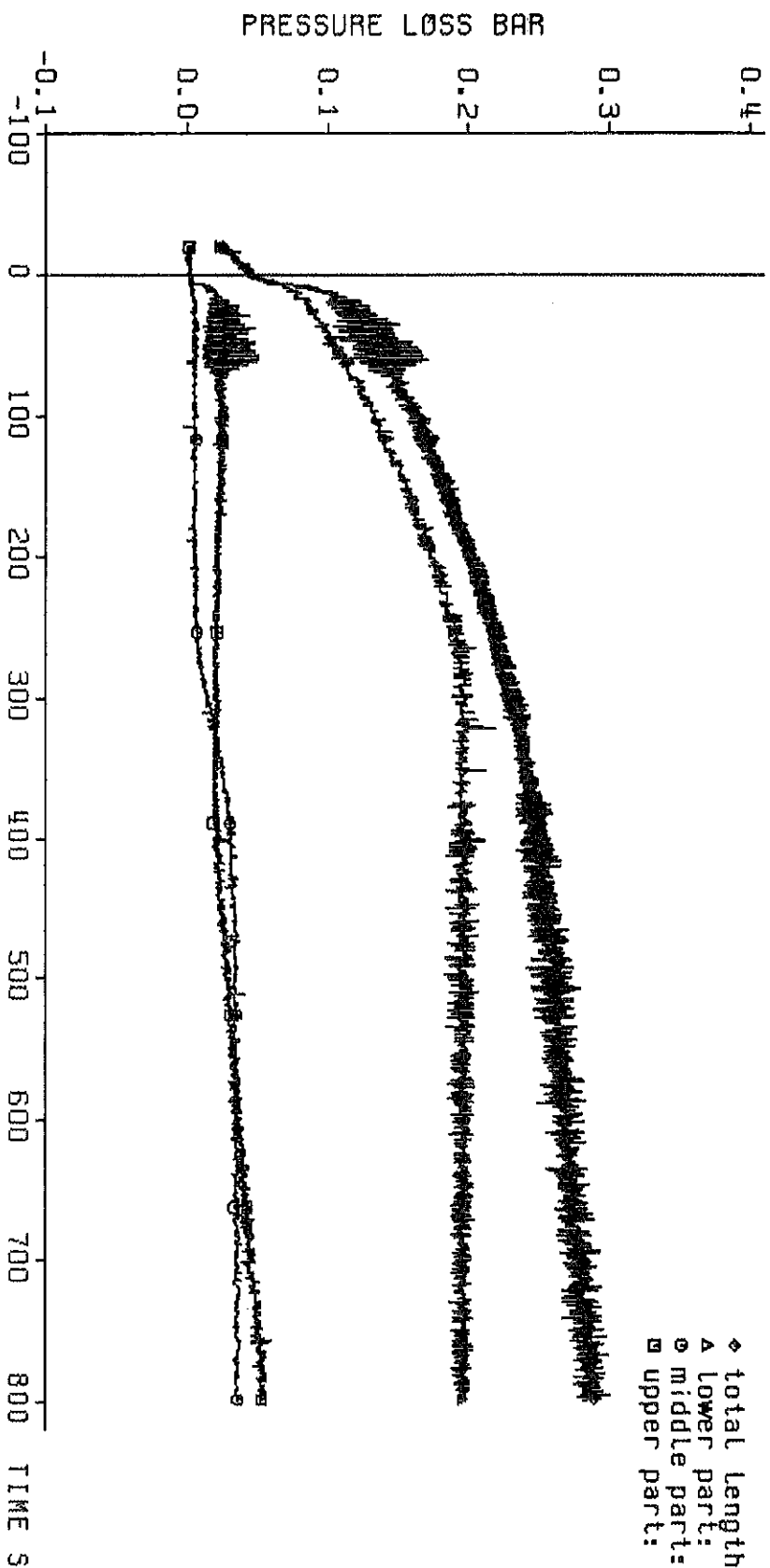

pressure loss
along the test section:

- ♦ total length: 4196 mm
- ▲ lower part: 1711 mm
- middle part: 545 mm
- upper part: 1940 mm

decay heat 120% ANS standard
 flooding rate (cold) 3.80 cm/s
 system pressure 1.98 bar
 feedwater temperature 40 deg C



Fig. 375 FEBRA: 5x5 ROD BUNDLE, TEST SERIES 4, TEST-NO. 262

coolant outlet conditions:

△ water carry over
○ coolant temperature
□ coolant pressure

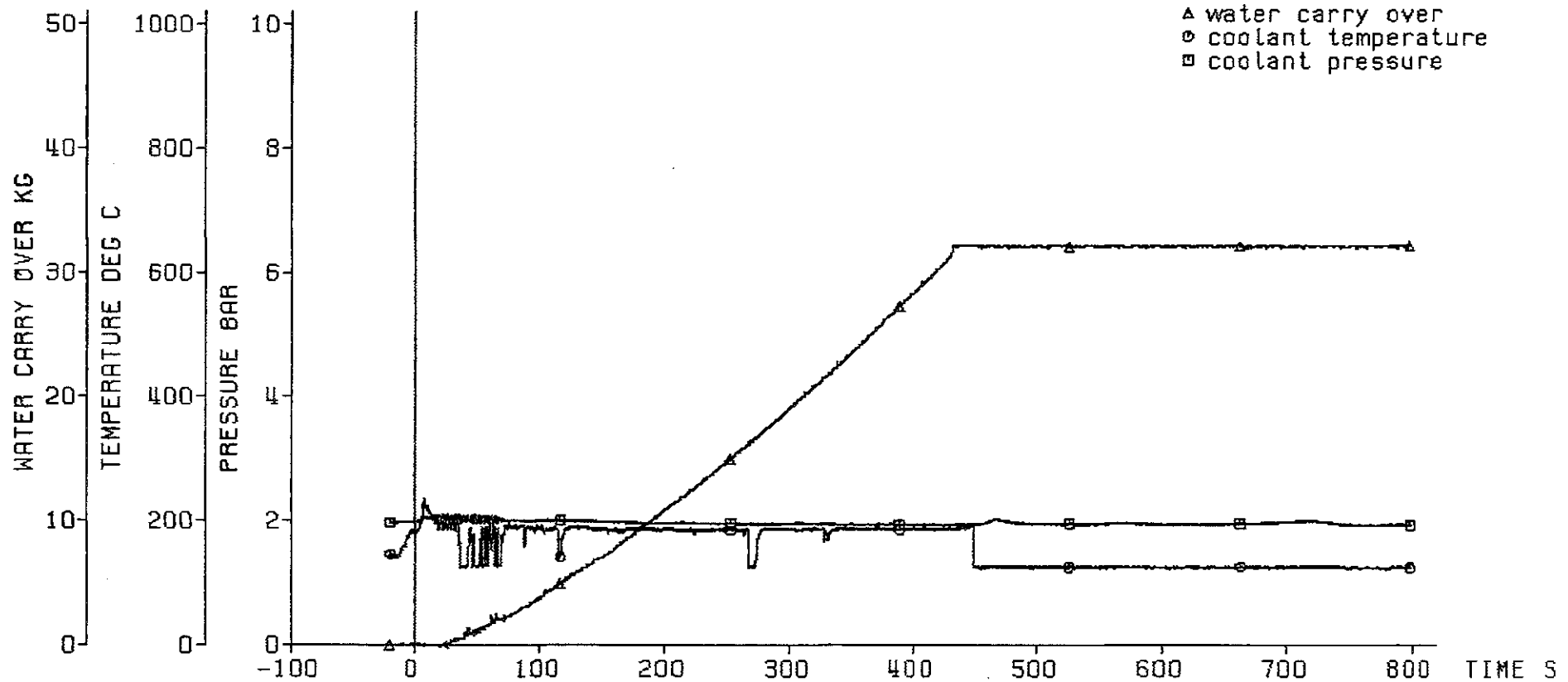

decay heat 120% ANS standard
flooding rate (cold) 3.80 cm/s
system pressure 1.98 bar
feedwater temperature 40 deg C



Fig. 376 FEBA: 5x5 ROD BUNDLE, TEST SERIES 4, TEST-No. 262

axial position of the quench front

- ▣ rewetting of the sleeve at the bundle midplane
- x rewetting of the rod downstream of the blockage

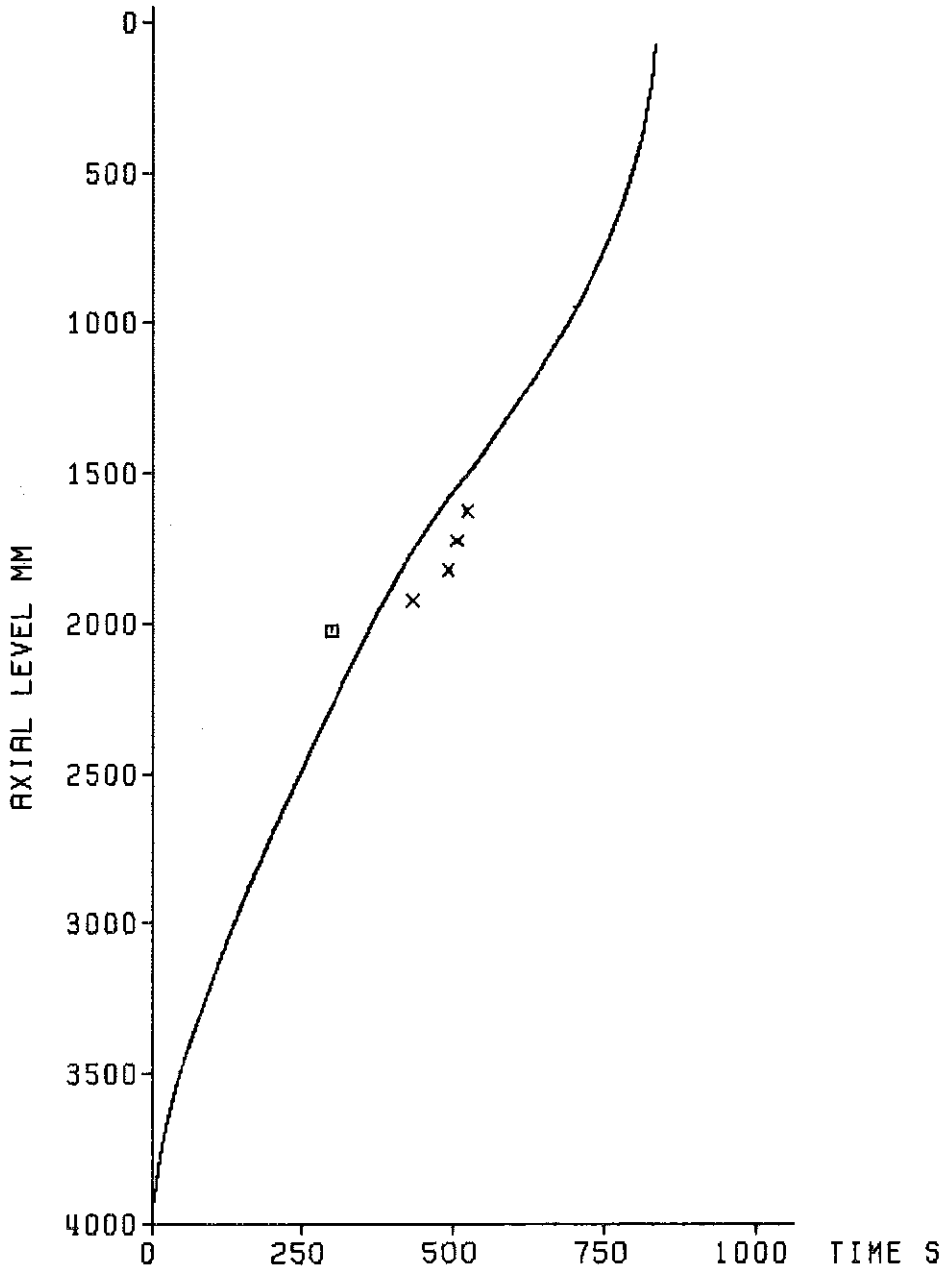

decay heat 120% ANS standard
flooding rate (cold) 3.80 cm/s
system pressure 1.98 bar
feedwater temperature 40 deg C



Fig. 377 FEBA: 5x5 ROD BUNDLE
TEST SERIES 4, TEST-No. 262

initial axial temperature profile of the cladding

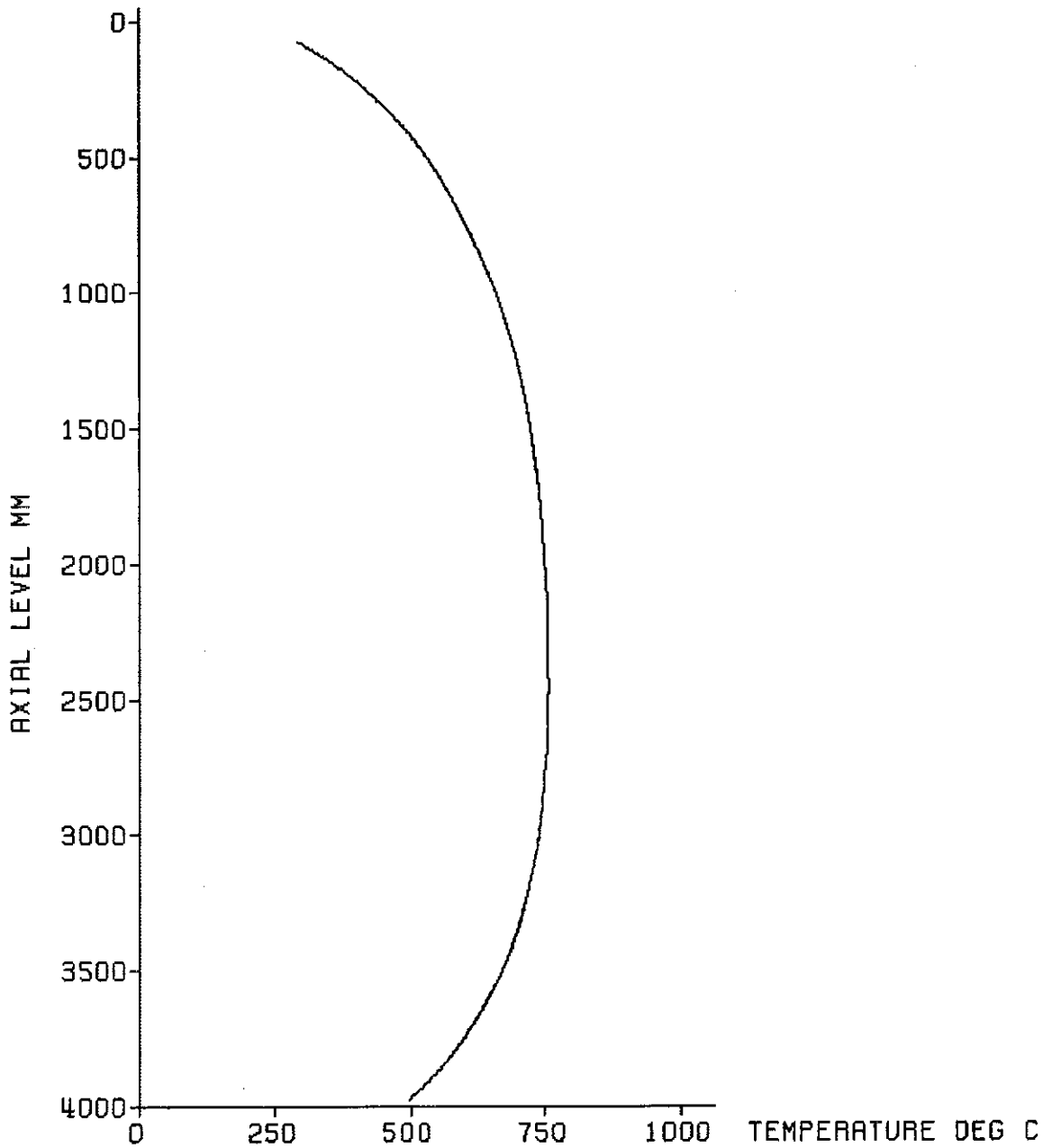

decay heat	120% ANS standard
flooding rate (cold)	3.80 cm/s
system pressure	3.94 bar
feedwater temperature	40 deg C

KIK IRB

Fig. 378 FEBA: 5x5 ROD BUNDLE
TEST SERIES 4, TEST-NO. 263

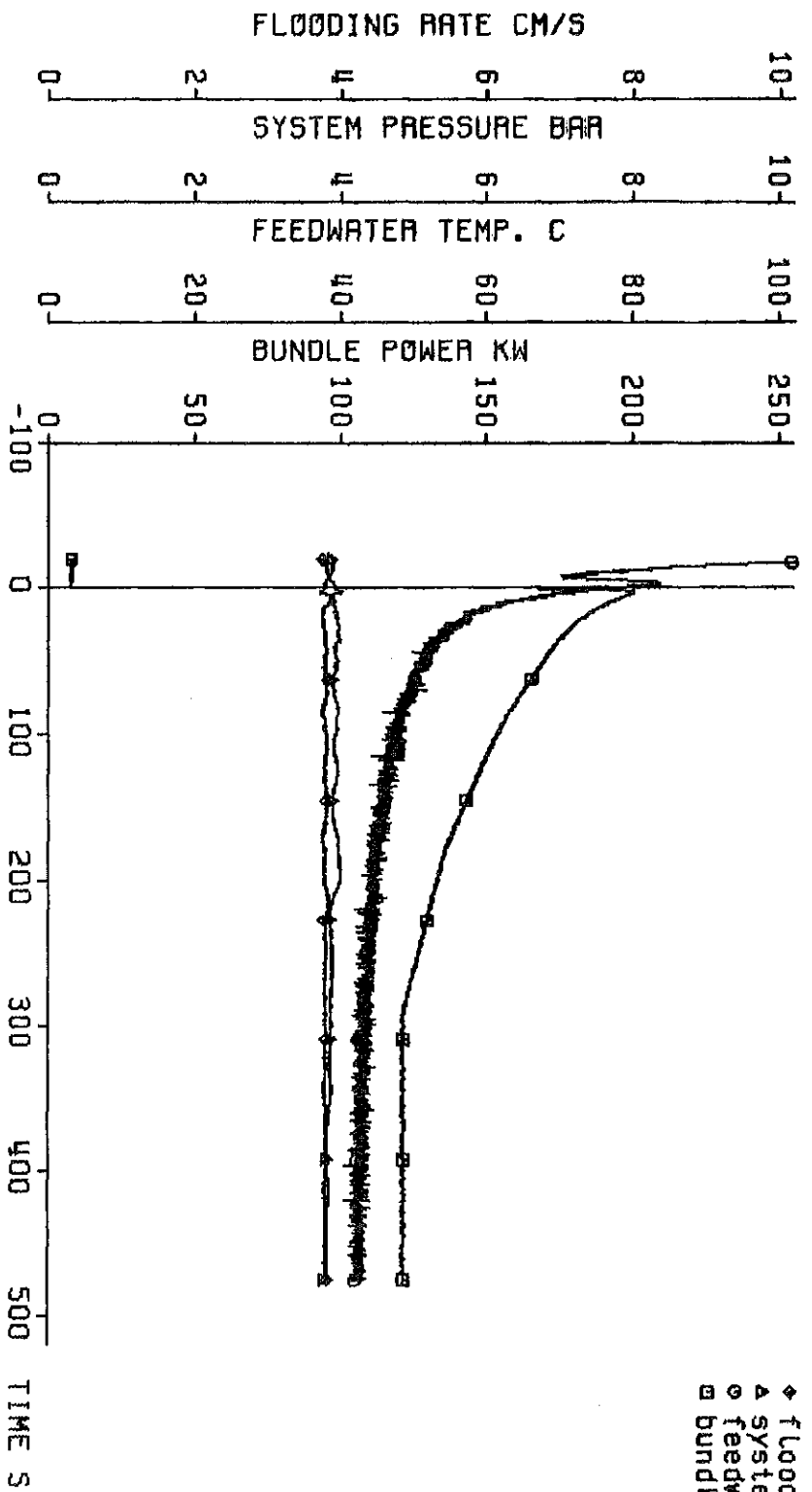

test parameters:

- ◆ flooding rate
- ▲ system pressure
- feedwater temperature
- bundle power

decay heat
 flooding rate (cold)
 system pressure
 feedwater temperature

120% RNS standard
 3.80 cm/s
 3.94 bar
 40 deg C



Fig. 379 FEBRA: 5X5 ROD BUNDLE, TEST SERIES 4, TEST-NO. 263

cladding temperature

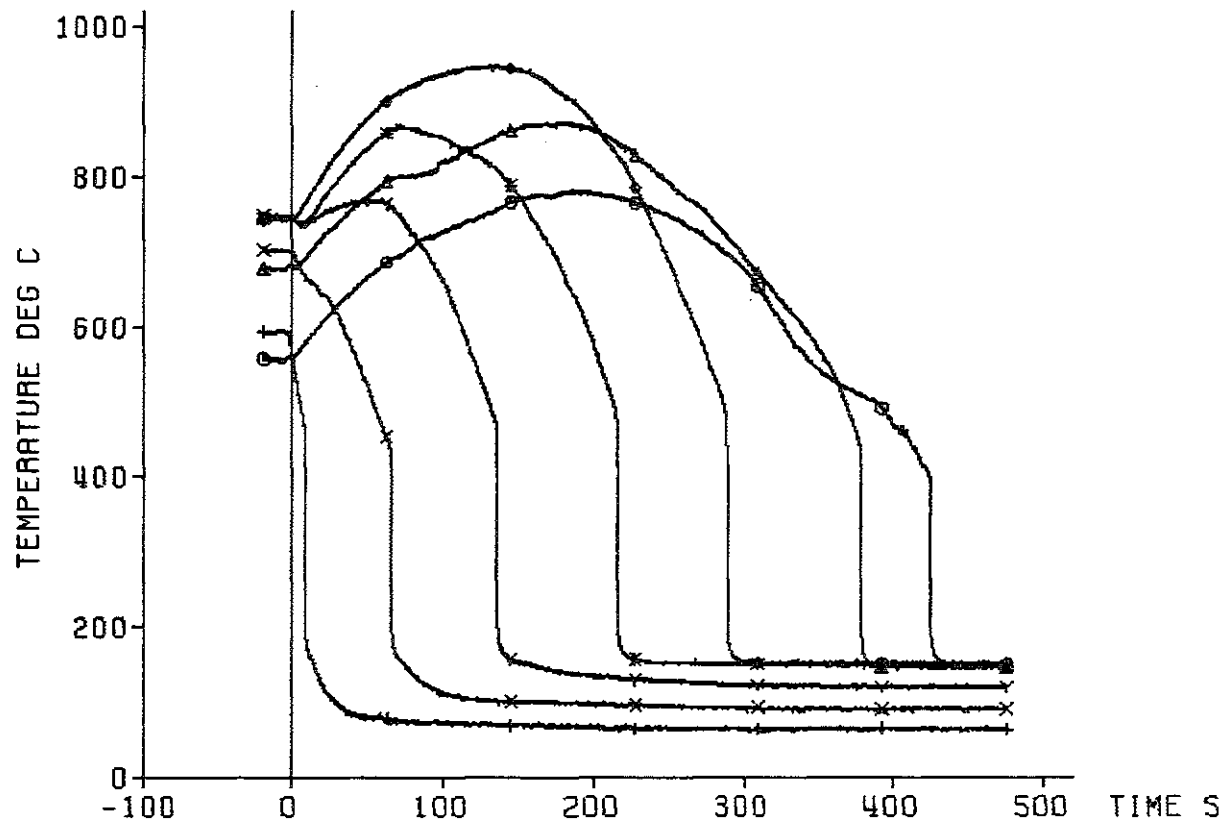

TC	ax. Level
+	18a4 3860 mm
x	18a3 3315 mm
Y	18a2 2770 mm
*	18a1 2225 mm
◇	12b4 1680 mm
△	12b3 1135 mm
○	12b2 590 mm

decay heat 120% ANS standard
 flooding rate (cold) 3.80 cm/s
 system pressure 3.94 bar
 feedwater temperature 40 deg C



Fig. 380 FEBA: 5x5 ROD BUNDLE, TEST SERIES 4, TEST-No. 263

heat transfer coeff.

	TC	ex. Level
x	18a3	3315 mm
γ	18a2	2770 mm
*	18a1	2225 mm
◇	12b4	1680 mm
▲	12b3	1135 mm
○	12b2	590 mm

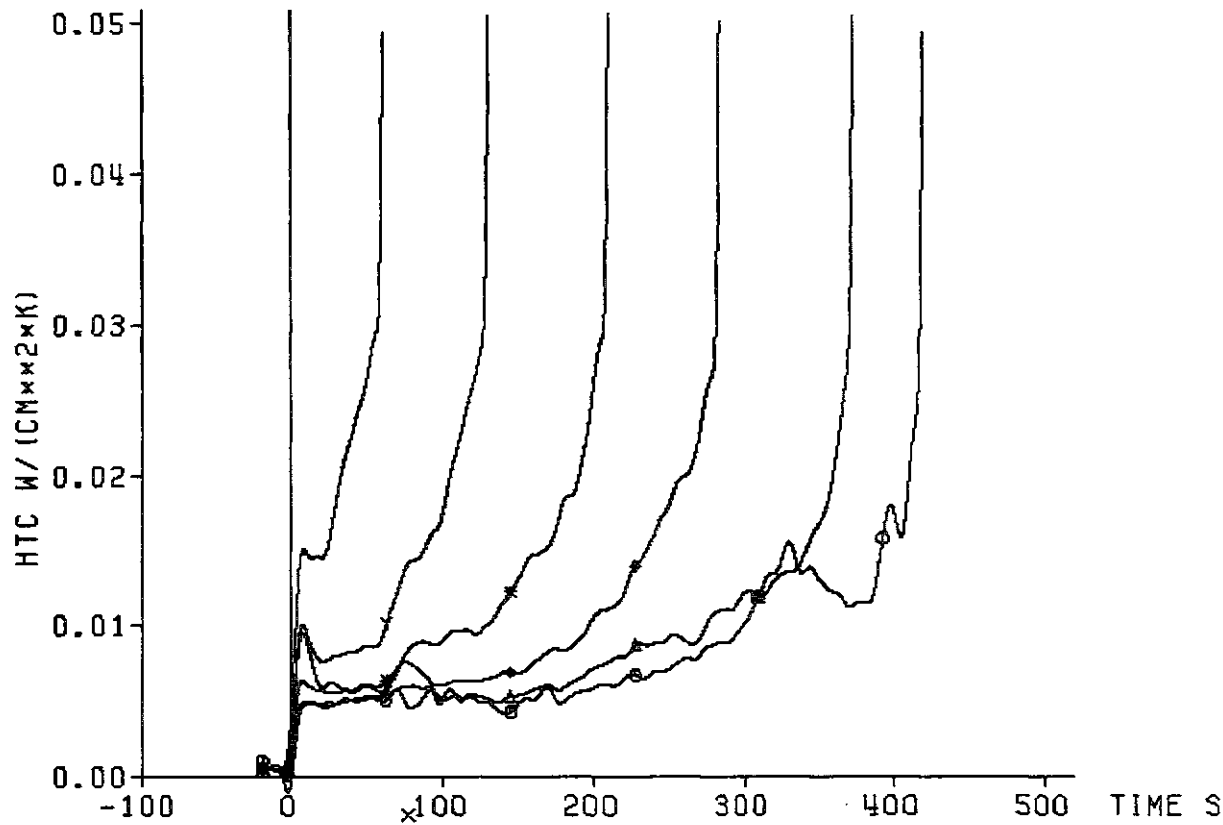

decay heat 120% ANS standard
 flooding rate (cold) 3.80 cm/s
 system pressure 3.94 bar
 feedwater temperature 40 deg C



Fig. 381 FEBA: 5x5 ROD BUNDLE, TEST SERIES 4, TEST-No. 263

cladding temperature

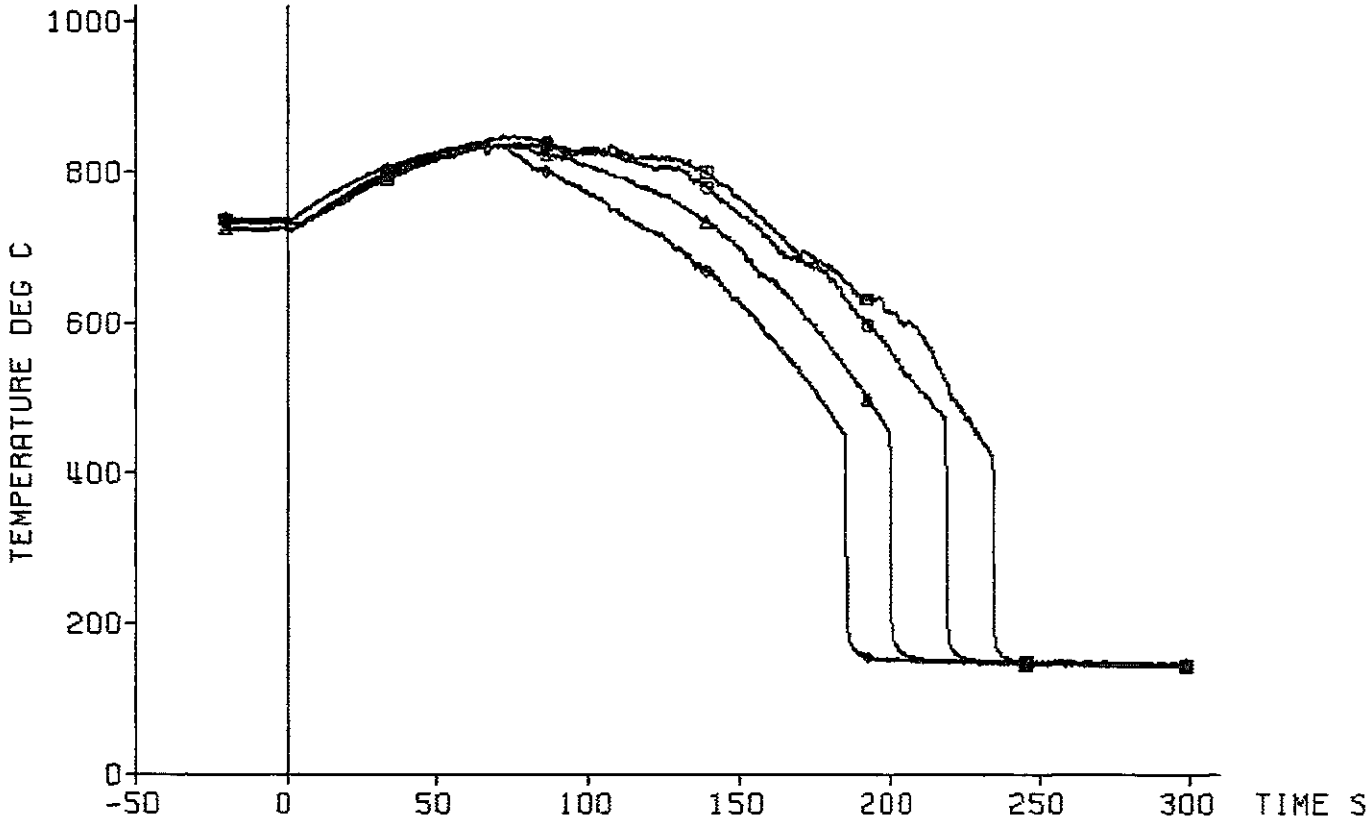

TC	ax. level
◇	7f4 2425 mm
△	7f3 2325 mm
○	9h4 2225 mm
□	9h3 2125 mm

decay heat 120% ANS standard
 flooding rate (cold) 3.80 cm/s
 system pressure 3.84 bar
 feedwater temperature 40 deg C

bypass
=====



Fig. 382 FEBA: 5x5 ROD BUNDLE, TEST SERIES 4, TEST-No. 263

heat transfer coeff.

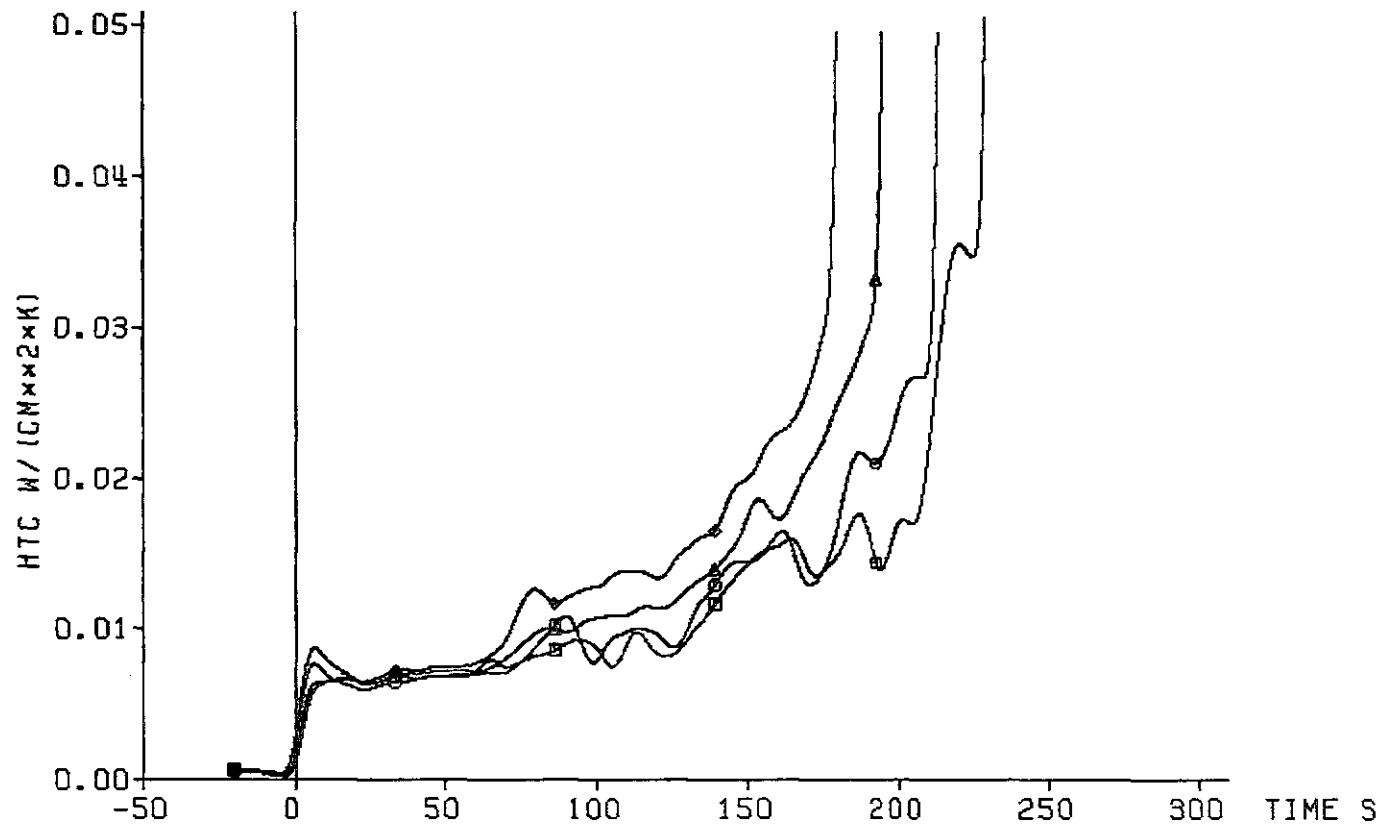

	TC	ax. Level
◇	7f4	2425 mm
△	7f3	2325 mm
○	9h4	2225 mm
□	9h3	2125 mm

decay heat 120% ANS standard
 flooding rate (cold) 3.80 cm/s
 system pressure 3.94 bar
 feedwater temperature 40 deg C

bypass
 =====



Fig. 383 FEBA: 5x5 ROD BUNDLE, TEST SERIES 4, TEST-No. 263

cladding temperature

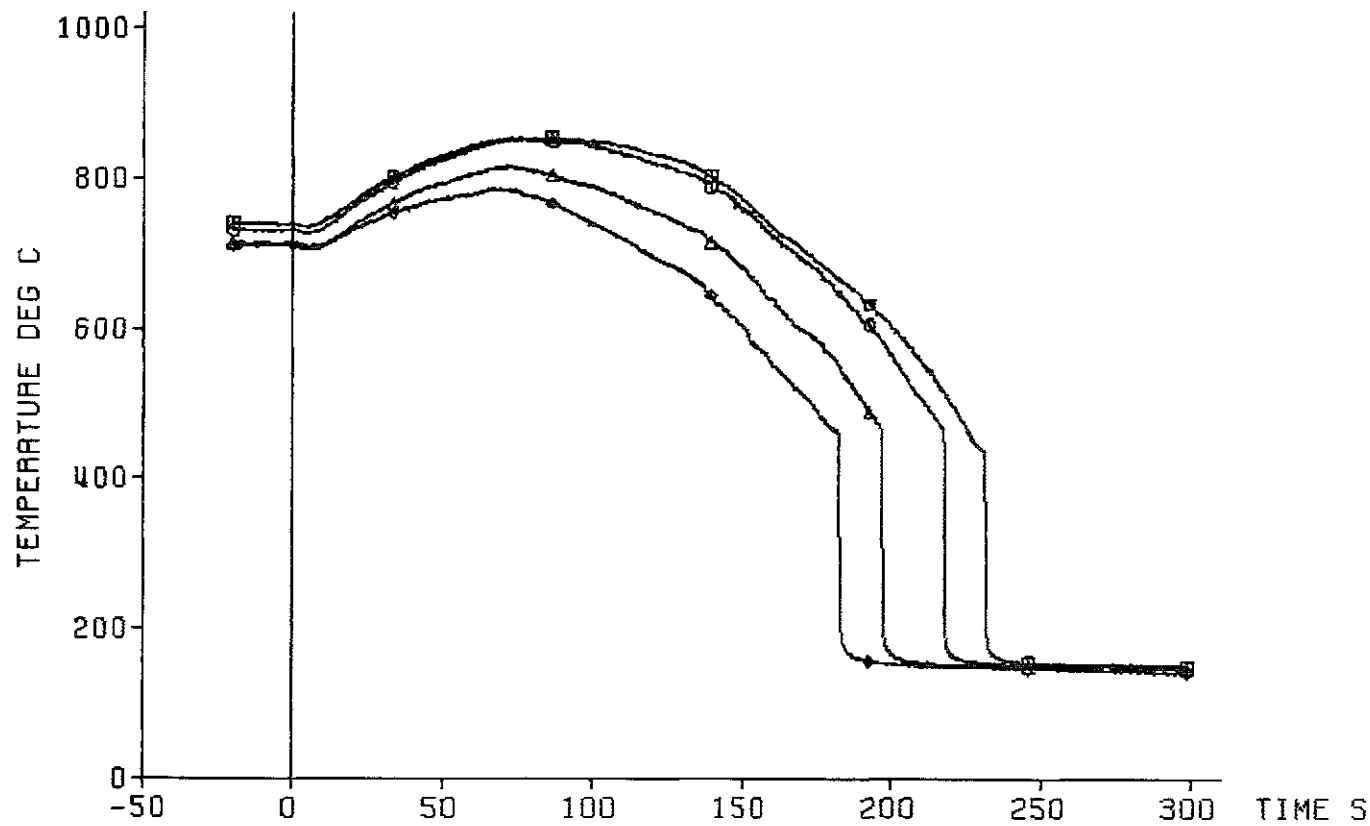

TC	ax. Level
◇	22f4 2425 mm
△	22f3 2325 mm
○	17h4 2225 mm
□	17h3 2125 mm

decay heat 120% ANS standard
 flooding rate (cold) 3.80 cm/s
 system pressure 3.94 bar
 feedwater temperature 40 deg C

blockage
 =====



Fig. 384 FEBA: 5x5 ROD BUNDLE, TEST SERIES 4, TEST-No. 263

heat transfer coeff.

TC	ax. Level
◇ 22f4	2425 mm
△ 22f3	2325 mm
○ 17h4	2225 mm
□ 17h3	2125 mm

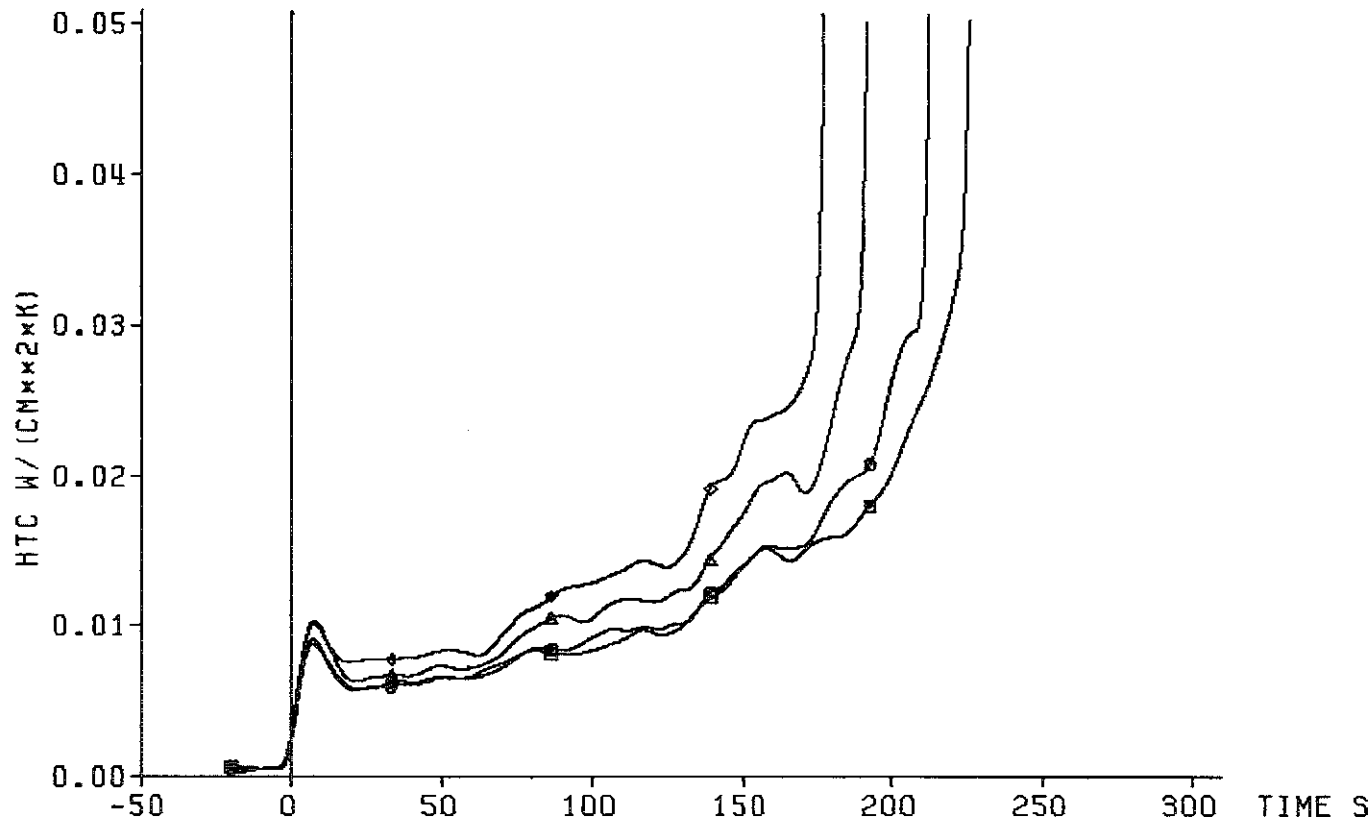

decay heat 120% ANS standard
 flooding rate (cold) 3.80 cm/s
 system pressure 3.94 bar
 feedwater temperature 40 deg C

blockage
 =====



Fig. 385 FEBA: 5x5 ROD BUNDLE, TEST SERIES 4, TEST-No. 263

cladding temperature

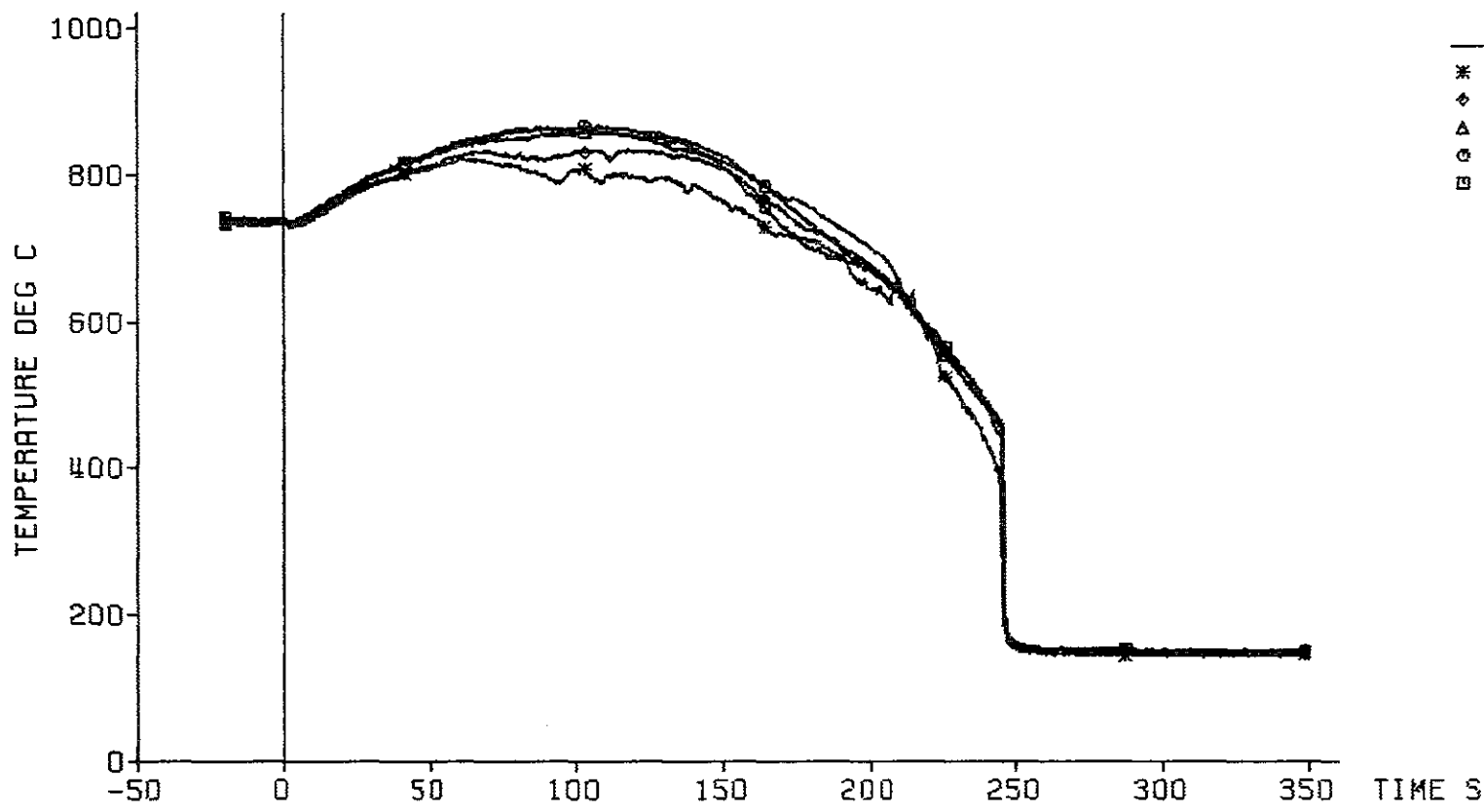

decay heat 120% ANS standard bypass
flooding rate (cold) 3.80 cm/s =====
system pressure 3.94 bar
feedwater temperature 40 deg C



Fig. 386 FEBA: 5x5 ROD BUNDLE, TEST SERIES 4, TEST-No. 263

heat transfer coeff.

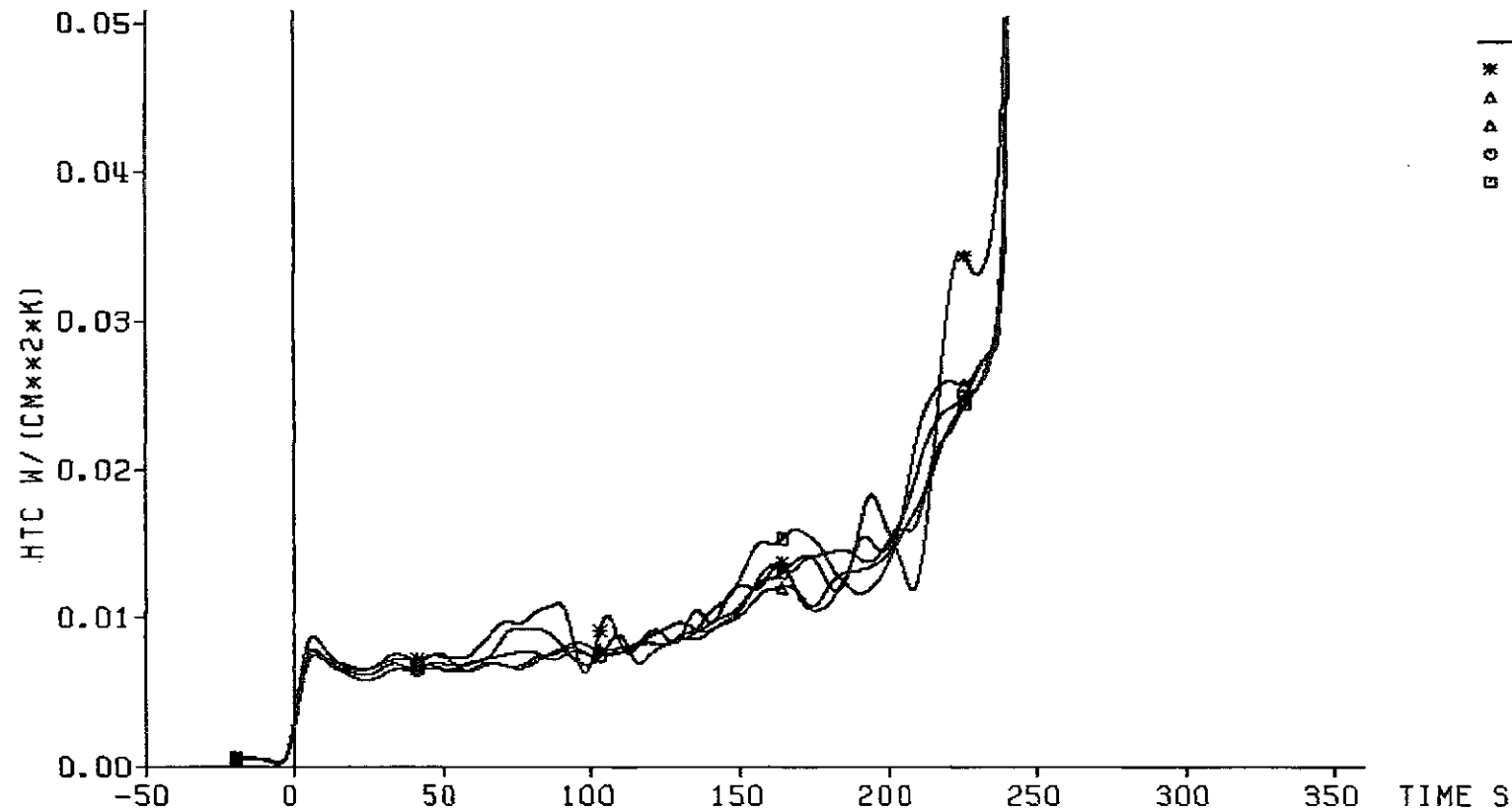

	TC	axial level
*	9h2	2025 mm
Δ	8d4	2025 mm
∇	8d3	2025 mm
○	8d2	2025 mm
□	8d1	2025 mm

decay heat 120% ANS standard
 flooding rate (cold) 3.80 cm/s
 system pressure 3.94 bar
 feedwater temperature 40 deg C

bypass
=====



Fig. 387 FEBA: 5x5 ROD BUNDLE, TEST SERIES 4, TEST-No. 263

cladding temperature

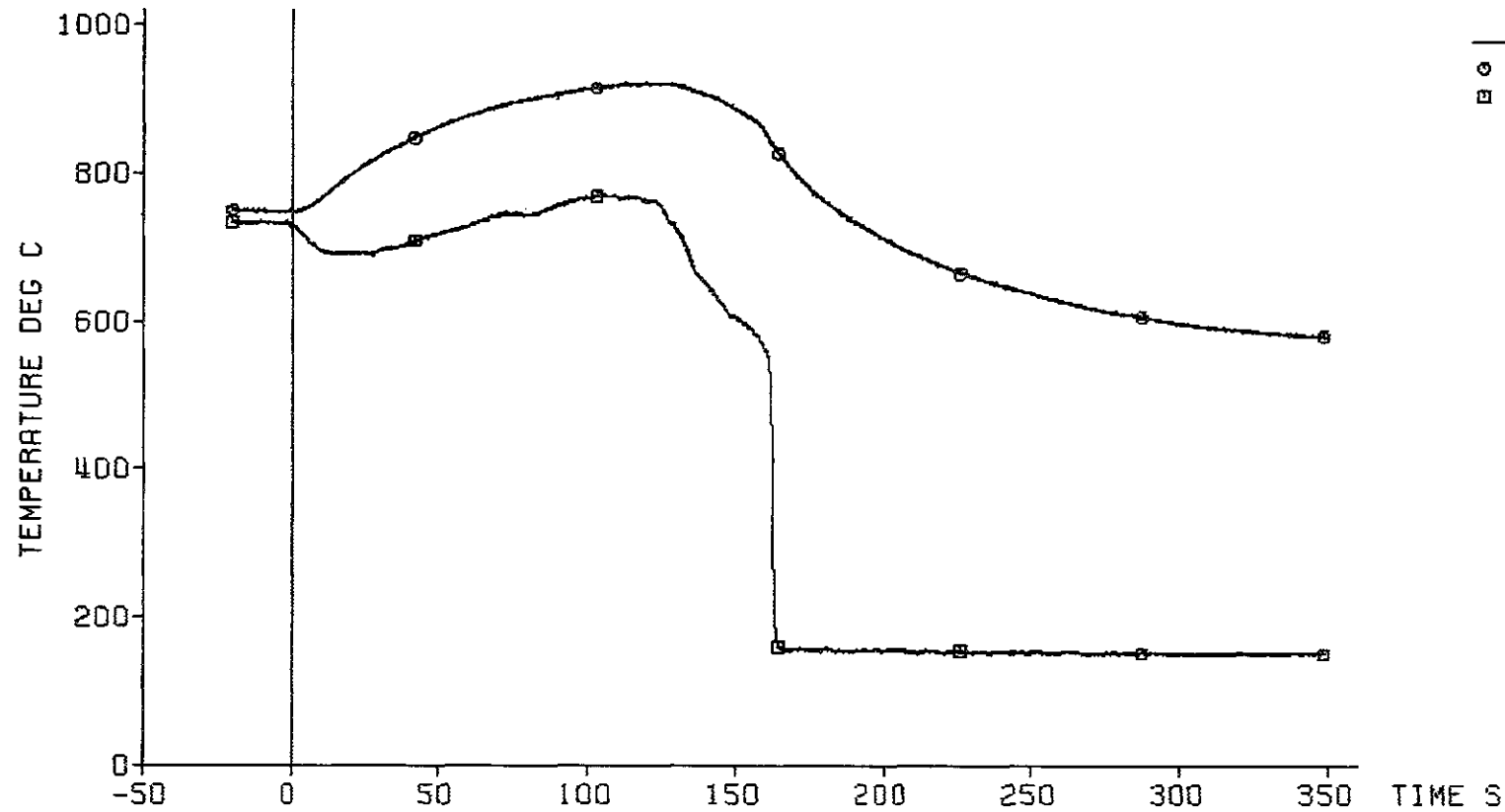

TC	ax. Level
○ 17h2	2025 mm
□ sleeve	2025 mm

decay heat 120% AMS standard
flooding rate (cold) 3.80 cm/s
system pressure 3.94 bar
feedwater temperature 40 deg C

blockage
=====



Fig. 388 FEBA: 5x5 ROD BUNDLE, TEST SERIES 4, TEST-No. 263

cladding temperature

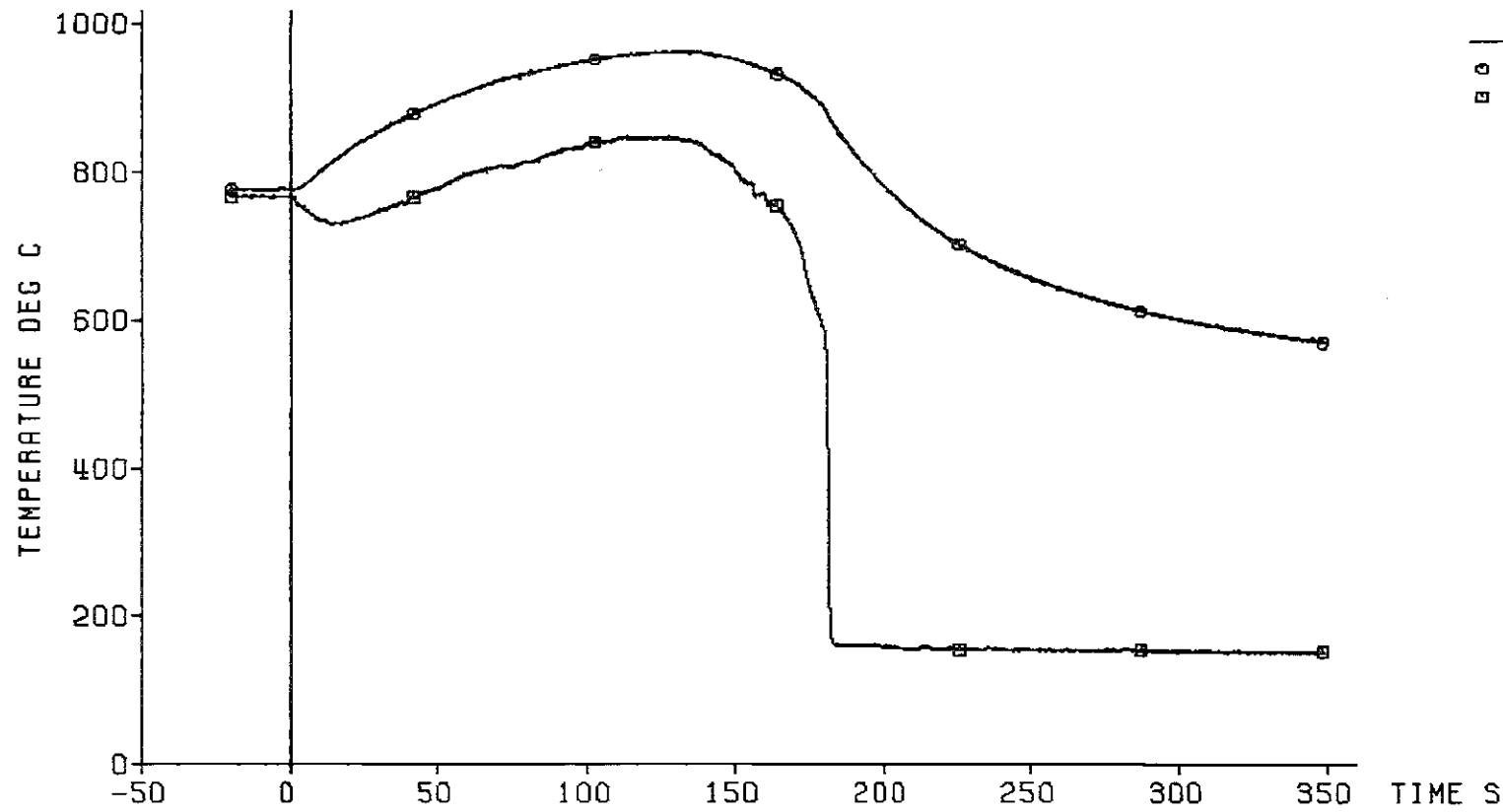

TC	axial Level
○ 13d2	2025 mm
□ sleeve	2025 mm

decay heat 120% ANS standard
 flooding rate (cold) 3.80 cm/s
 system pressure 3.94 bar
 feedwater temperature 40 deg C

blockage
 =====



Fig. 389 FEBA: 5x5 ROD BUNDLE, TEST SERIES 4, TEST-No. 263

cladding temperature

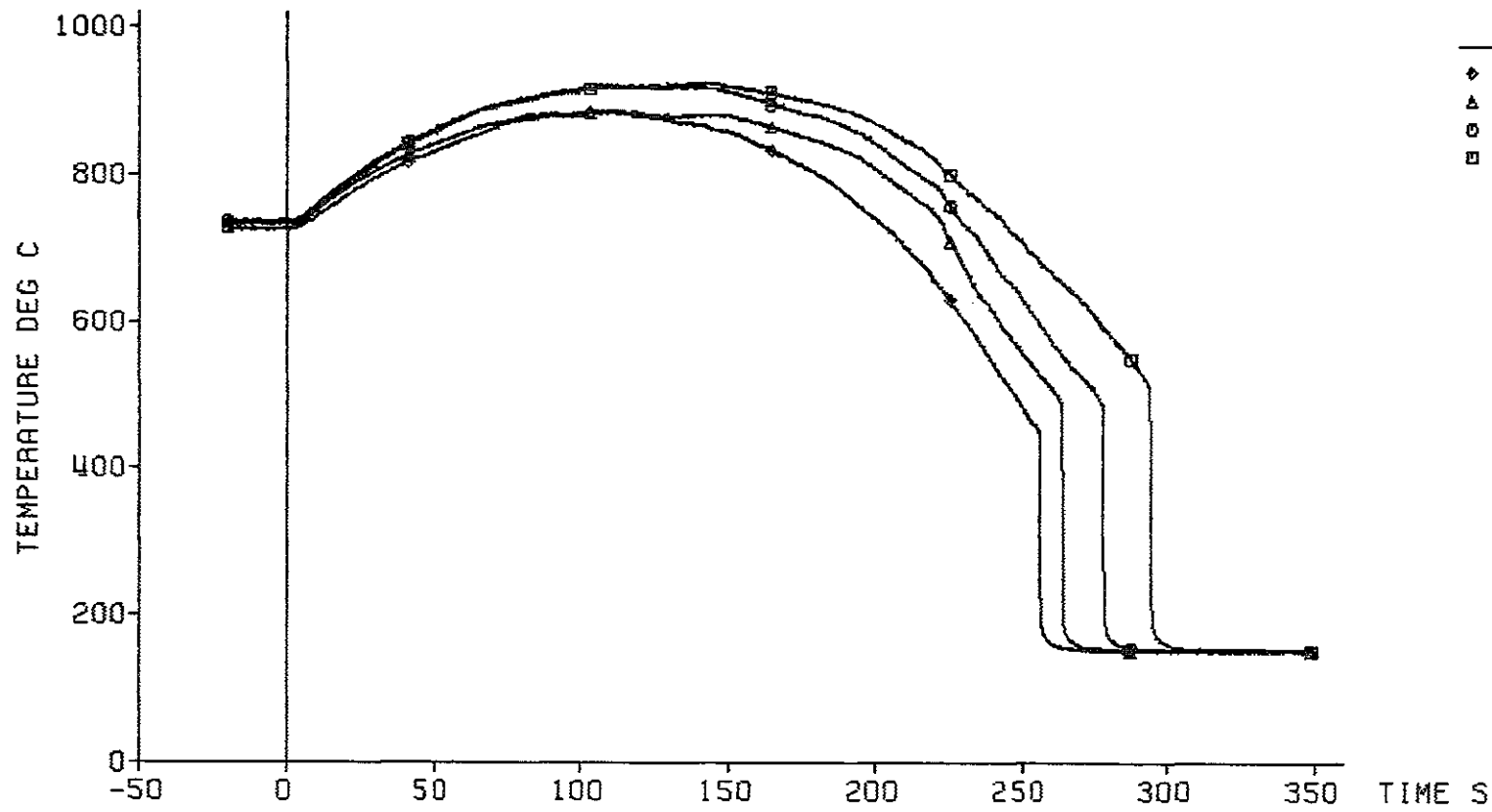

TC	ax. level
◆ 9h1	1925 mm
▲ 19g3	1825 mm
○ 19g2	1725 mm
□ 19g1	1625 mm

decay heat 120% ANS standard
 flooding rate (cold) 3.80 cm/s
 system pressure 3.94 bar
 feedwater temperature 40 deg C

bypass
=====



Fig. 390 FEBA: 5x5 ROD BUNDLE, TEST SERIES 4, TEST-No. 263

heat transfer coeff.

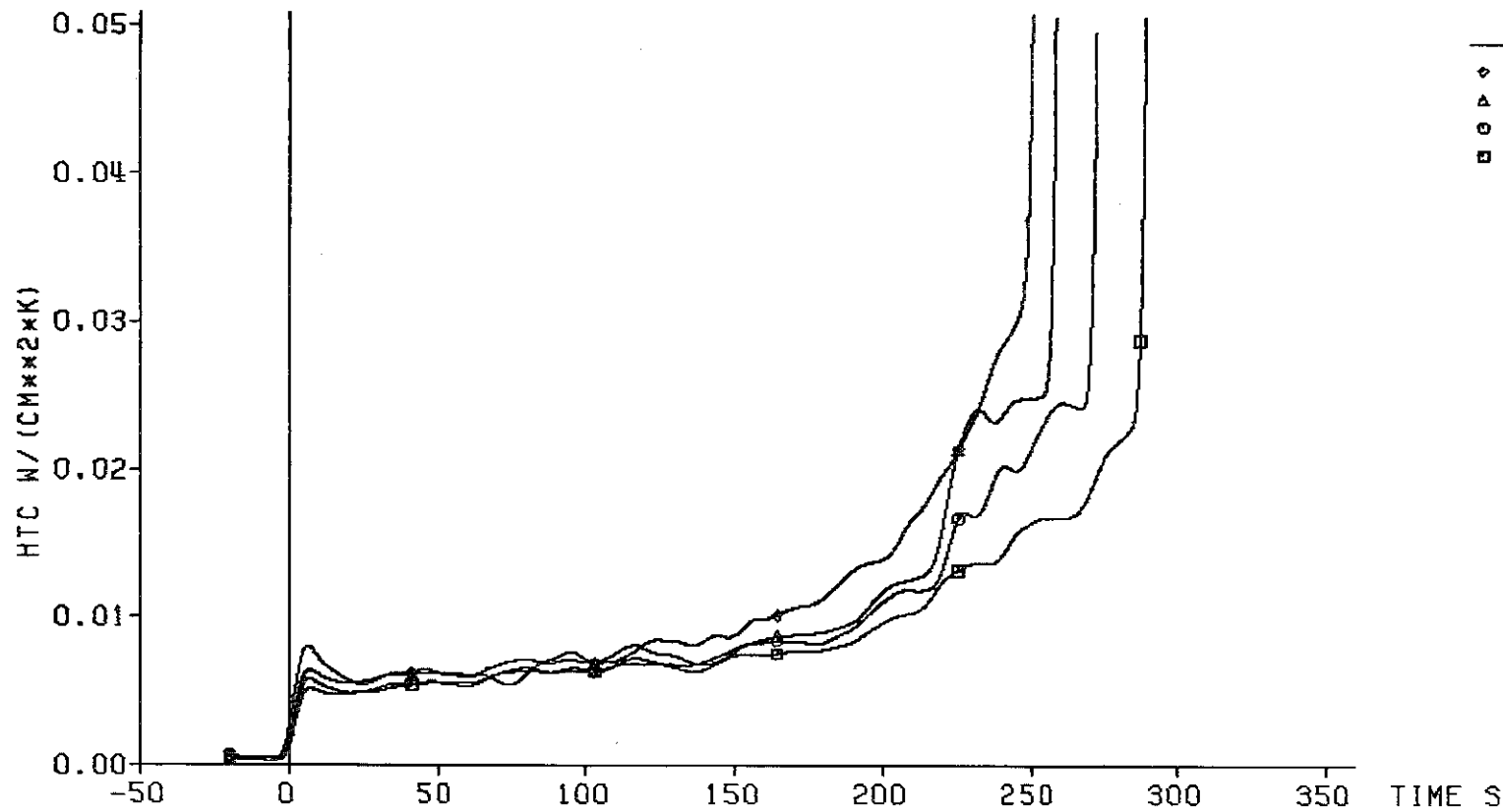

decay heat 120% ANS standard
flooding rate (cold) 3.80 cm/s
system pressure 3.94 bar
feedwater temperature 40 deg C

bypass
=====



Fig. 391 FEBA: 5x5 ROD BUNDLE, TEST SERIES 4, TEST-No. 263

cladding temperature

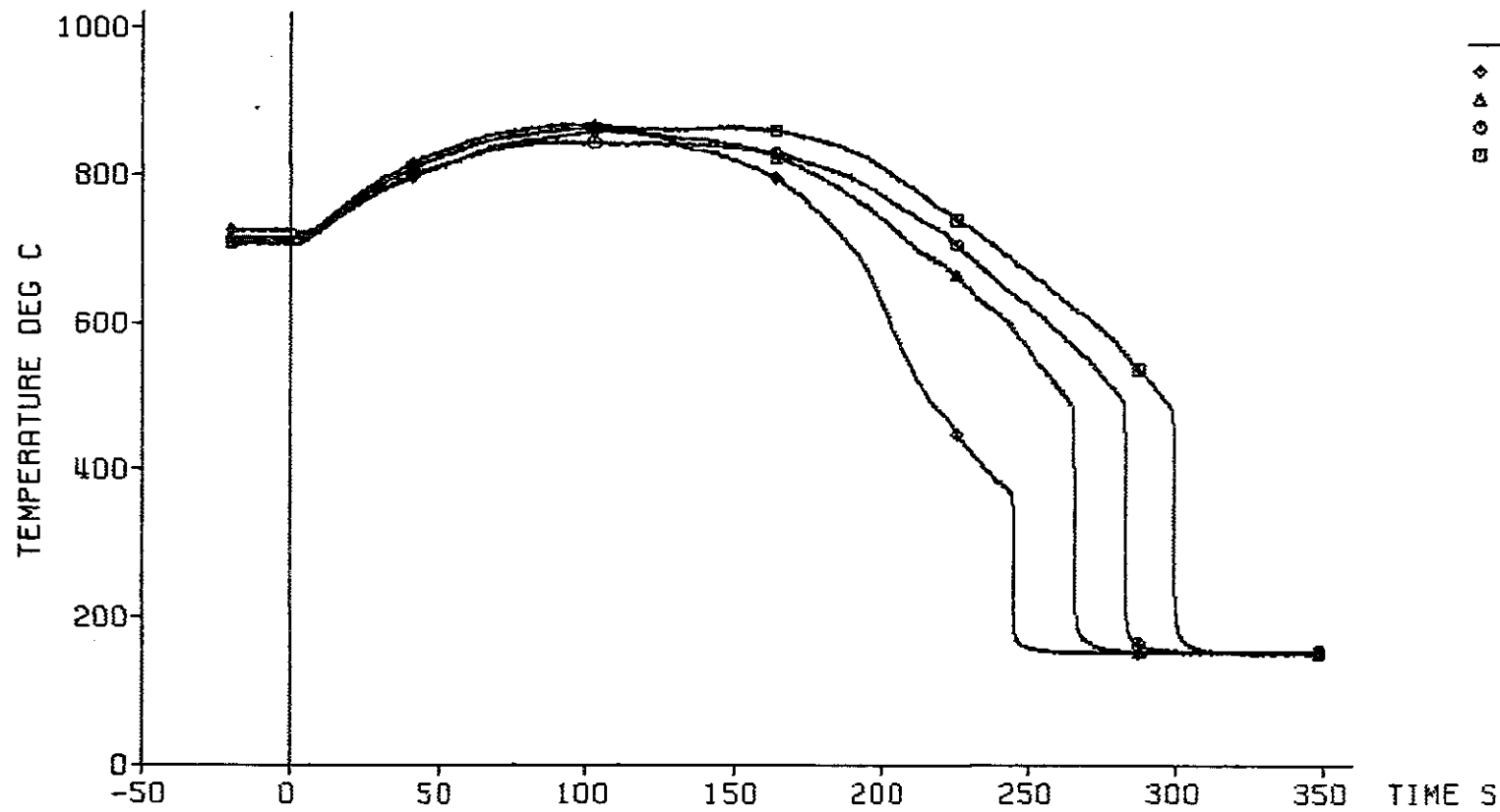

TC	ax. level
◆ 17h1	1925 mm
▲ 16g3	1825 mm
○ 16g2	1725 mm
□ 16g1	1625 mm

decay heat 120% ANS standard
 flooding rate (cold) 3.80 cm/s
 system pressure 3.94 bar
 feedwater temperature 40 deg C

blockage
 =====



Fig. 392 FEBA: 5x5 R0D BUNDLE, TEST SERIES 4, TEST-No. 263

grid spacer temperature

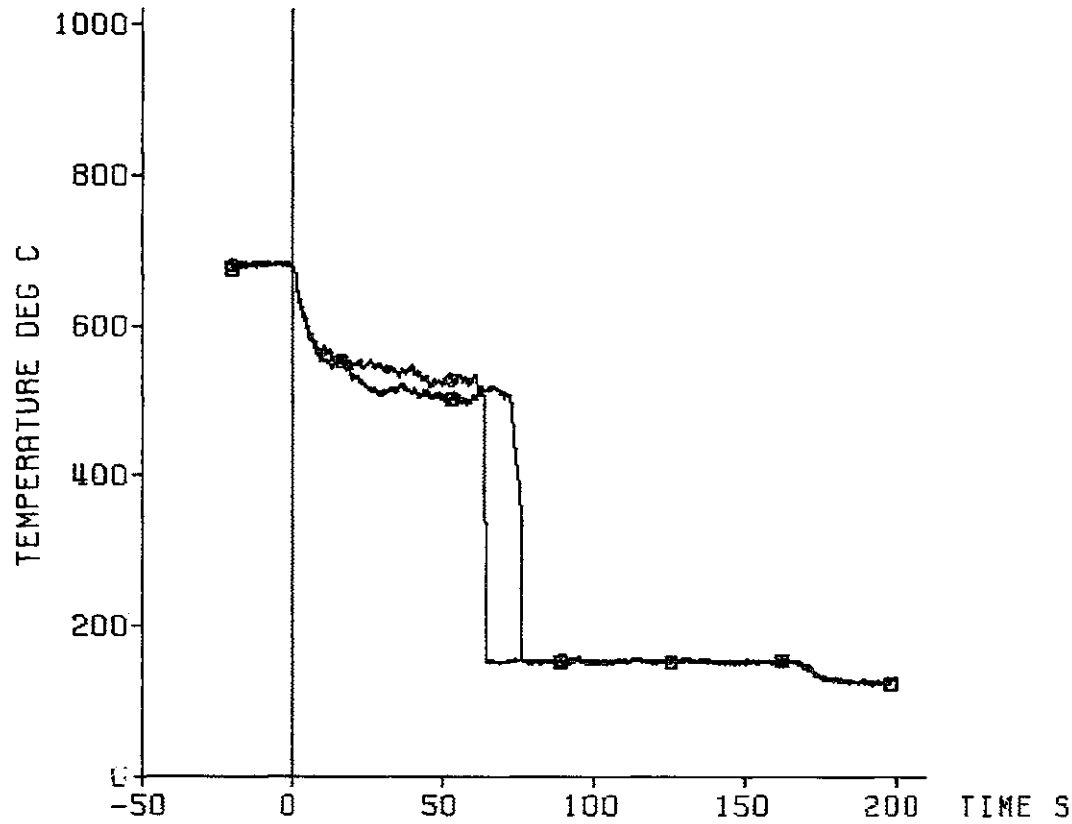

TC	axial level
□ 86	2550 mm
⊙ 87	2550 mm

decay heat 120% RMS standard
flooding rate (cold) 3.80 cm/s
system pressure 3.94 bar
feedwater temperature 40 deg C

KIK IRB

Fig. 394 FEBA: 5x5 ROD BUNDLE, TEST SERIES 4, TEST-No. 263

grid spacer temperature

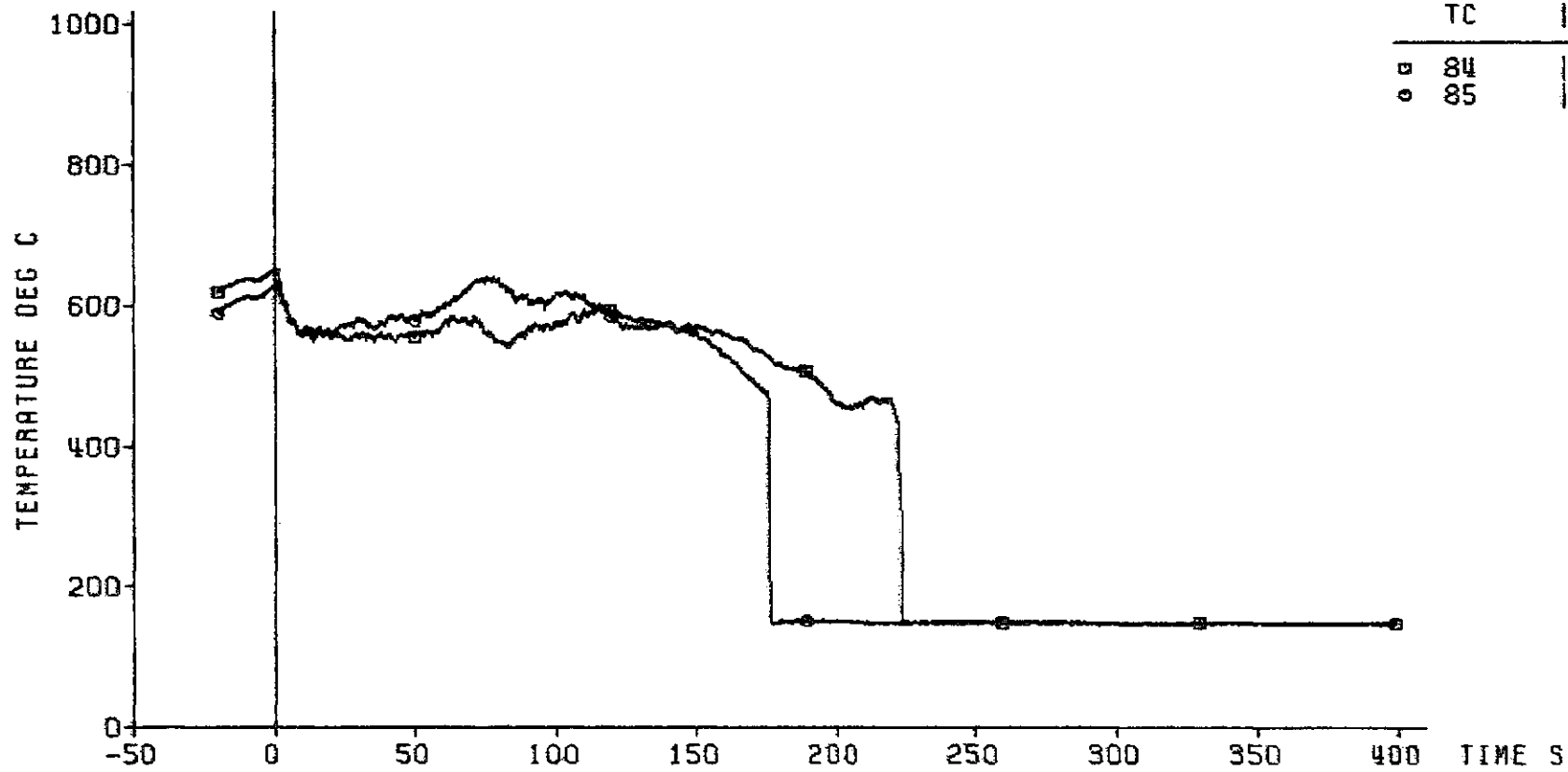

decay heat 120% RNS standard
flooding rate (cold) 3.80 cm/s
system pressure 3.94 bar
feedwater temperature 40 deg C

KIK IRB

Fig. 395 FEBA: 5x5 ROD BUNDLE, TEST SERIES 4, TEST-No. 263

axial level: 1825 mm

△ cladding temperature (19g3)
○ fluid temperature

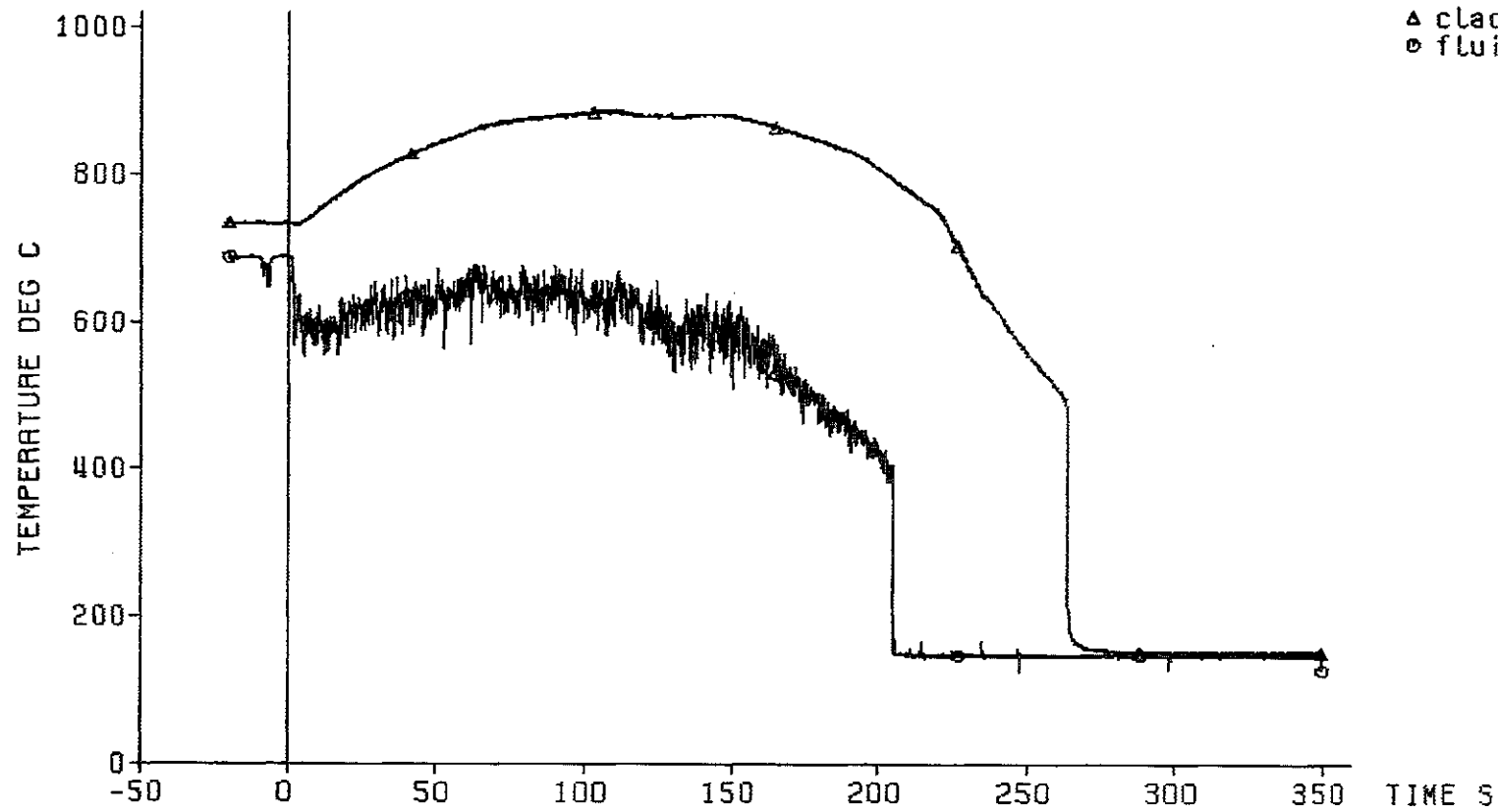

decay heat 120% ANS standard
flooding rate (cold) 3.80 cm/s
system pressure 3.94 bar
feedwater temperature 40 deg C

bypass
=====

KIK IRB

Fig. 396 FEBA: 5x5 ROD BUNDLE, TEST SERIES 4, TEST-NO. 263

axial level: 1825 mm

▲ cladding temperature (16g3)
● fluid temperature

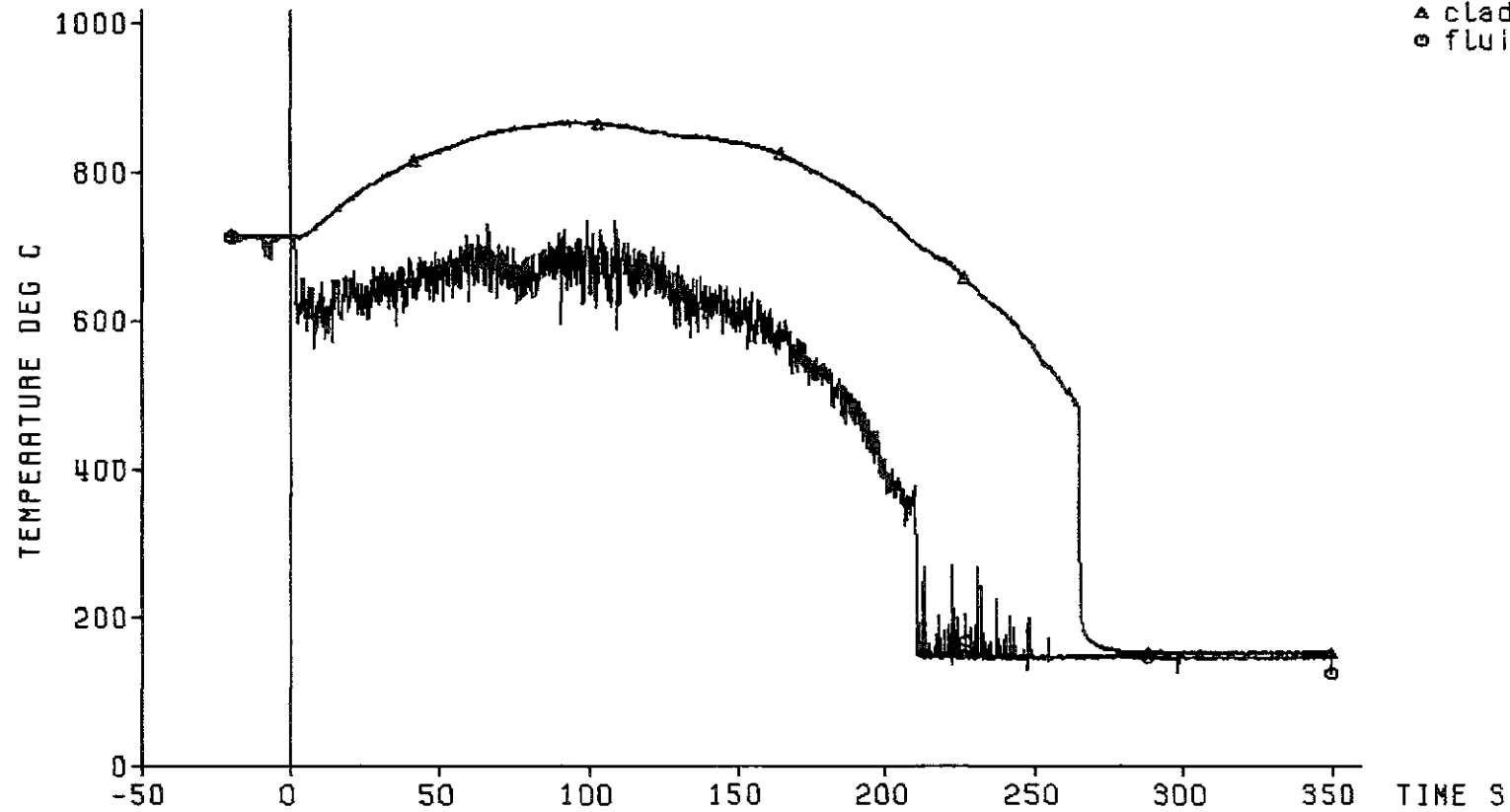

decay heat 120% ANS standard
flooding rate (cold) 3.80 cm/s
system pressure 3.94 bar
feedwater temperature 40 deg C

blockage
=====



Fig. 397 FEBA: 5x5 ROD BUNDLE, TEST SERIES 4, TEST-No. 263

axial level: 1725 mm

△ cladding temperature (19g2)
○ fluid temperature
□ housing temperature

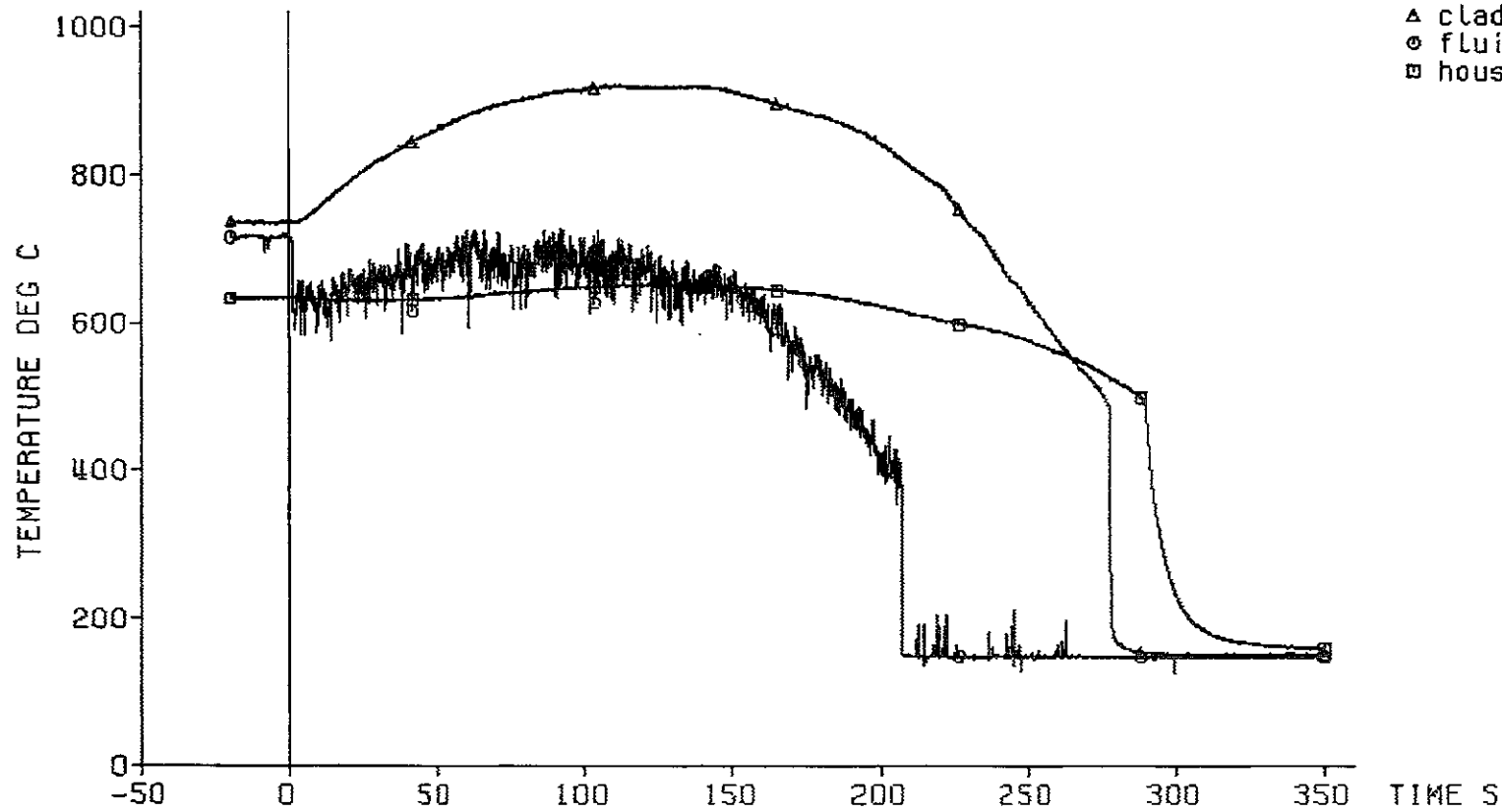

decay heat 120% ANS standard
flooding rate (cold) 3.80 cm/s
system pressure 3.94 bar
feedwater temperature 40 deg C

bypass
=====

KJK
IRB

Fig. 398 FEBA: 5x5 ROD BUNDLE, TEST SERIES 4, TEST-No. 263

pressure loss
along the test section:

- ◆ total length: 4196 mm
- ▲ lower part: 1711 mm
- middle part: 545 mm
- upper part: 1940 mm

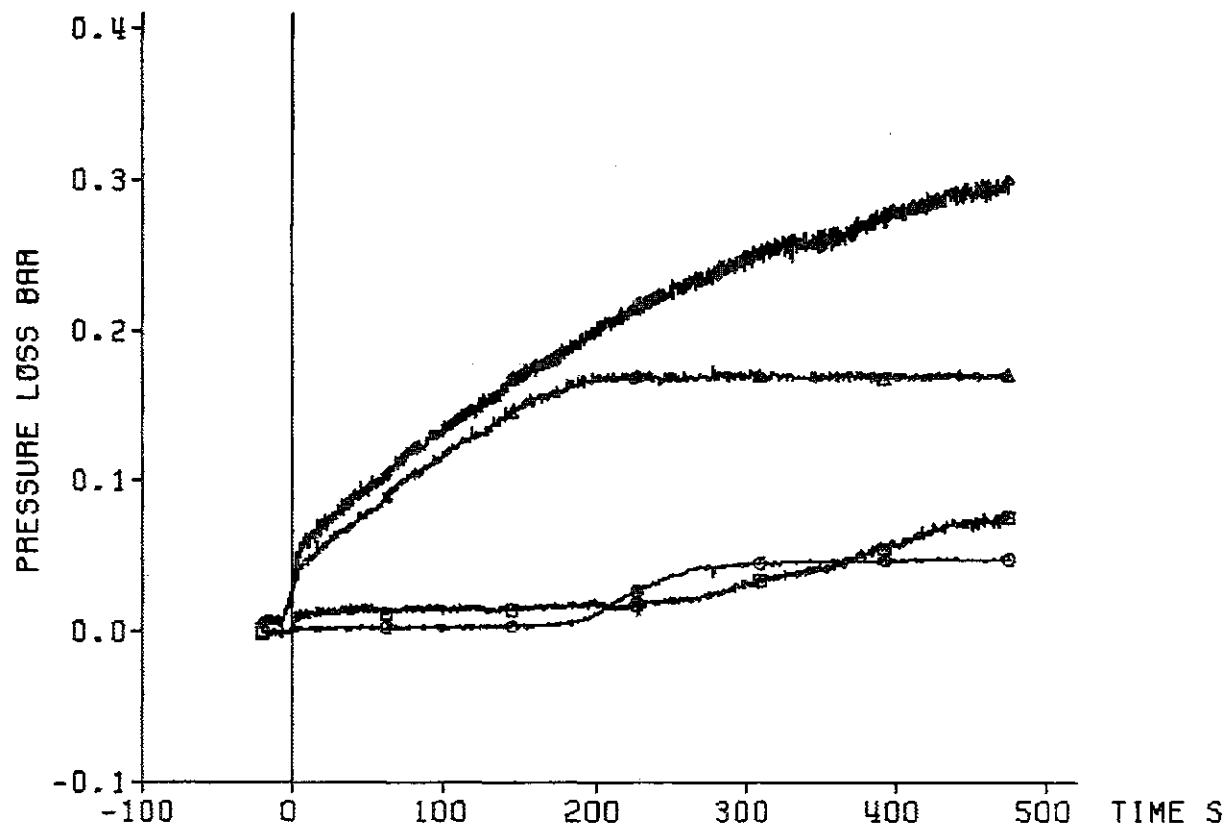

decay heat 120% ANS standard
flooding rate (cold) 3.80 cm/s
system pressure 3.94 bar
feedwater temperature 40 deg C



Fig. 399 FEBA: 5x5 ROD BUNDLE, TEST SERIES 4, TEST-No. 263

coolant conditions:

▲ water carry over
○ coolant temperature
□ coolant pressure

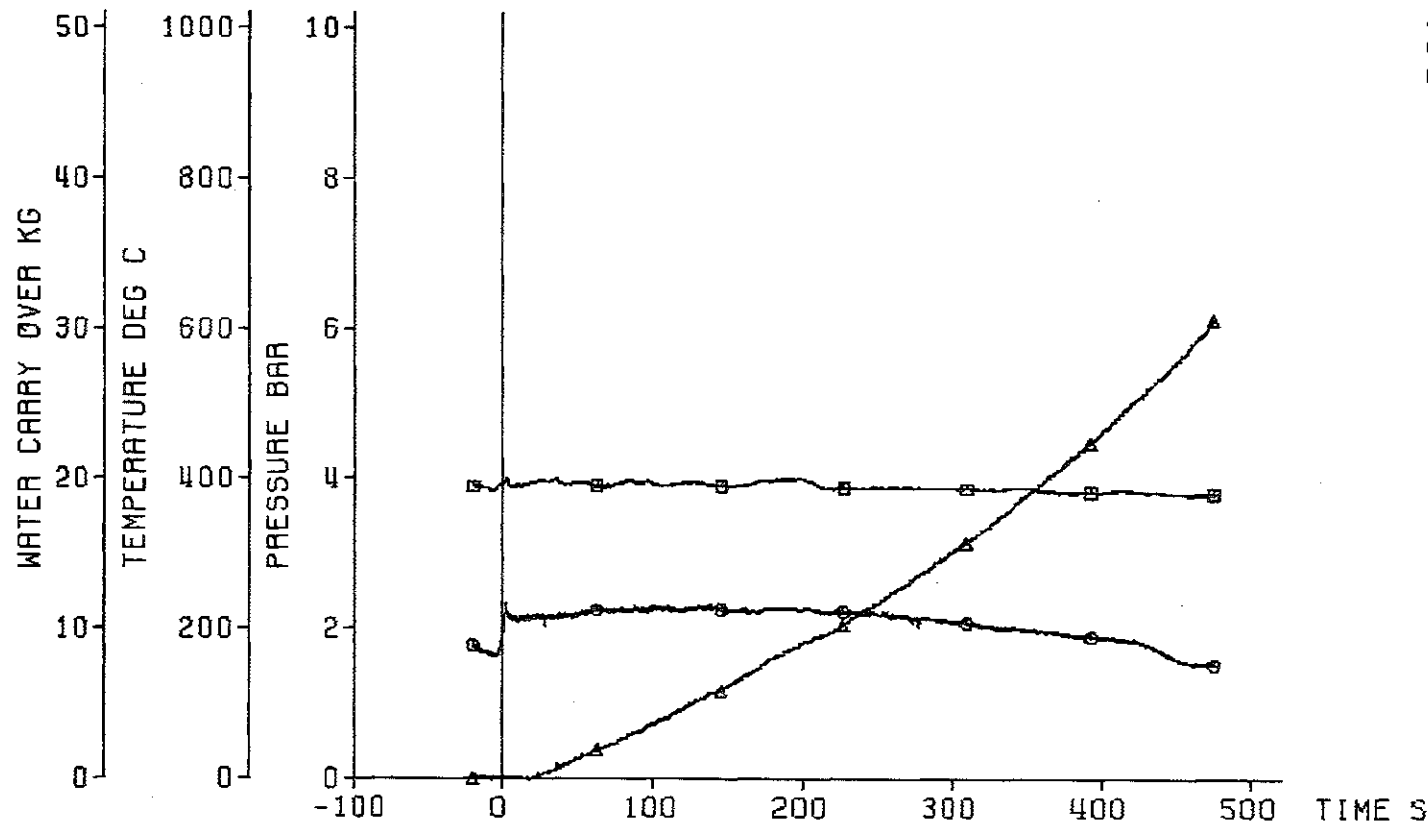

decay heat 120% ANS standard
flooding rate (cold) 3.80 cm/s
system pressure 3.94 bar
feedwater temperature 40 deg C

KIK IRB

Fig. 400 FEBA: 5x5 ROD BUNDLE, TEST SERIES 4, TEST-No. 263

axial position of the quench front

▣ rewetting of the sleeve at the bundle midplane

x rewetting of the rod downstream of the blockage

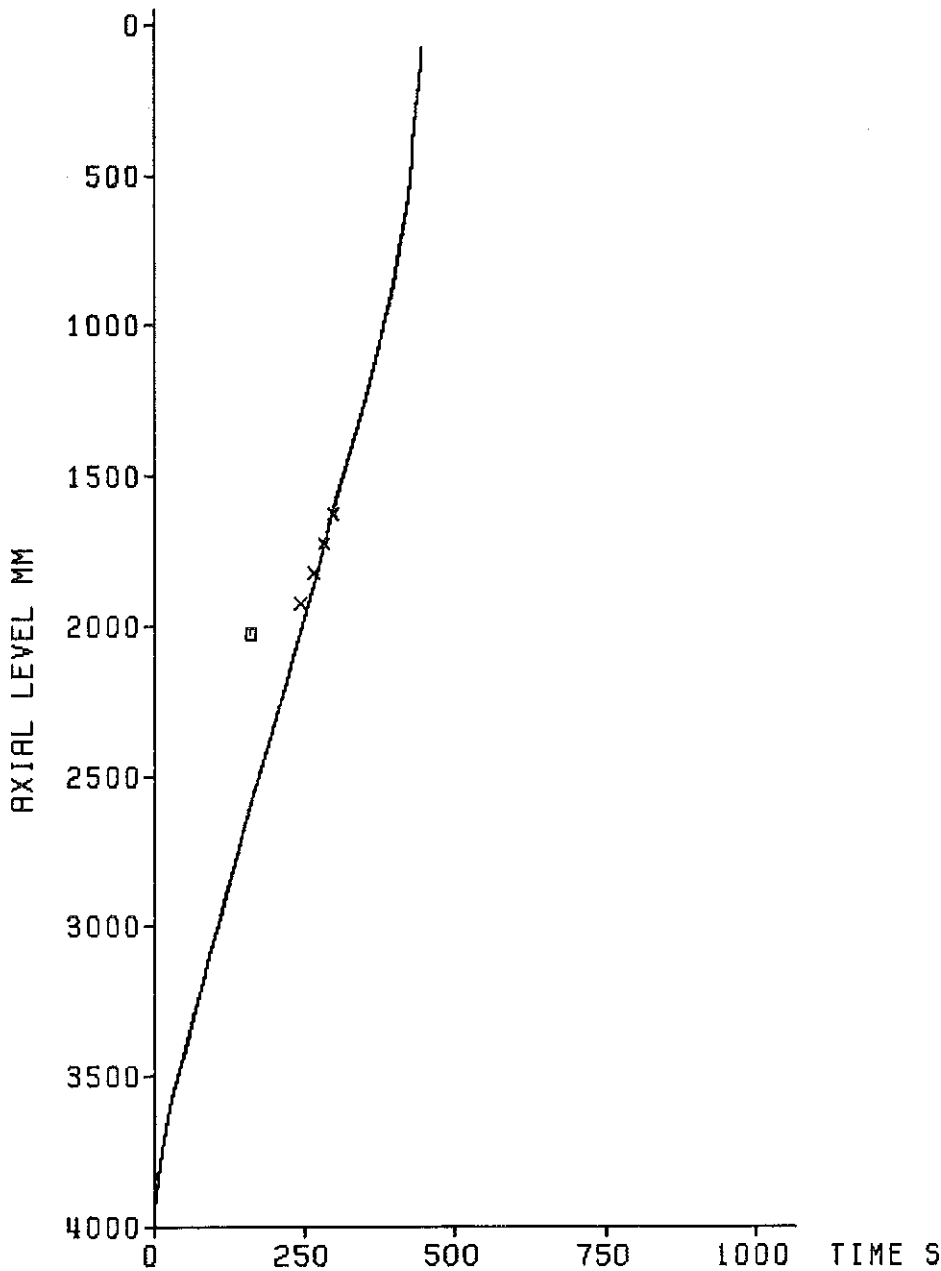

decay heat 120% ANS standard
flooding rate (cold) 3.80 cm/s
system pressure 3.94 bar
feedwater temperature 40 deg C



Fig. 401 FEBA: 5x5 ROD BUNDLE
TEST SERIES 4, TEST-NO. 263

initial axial temperature profile of the cladding

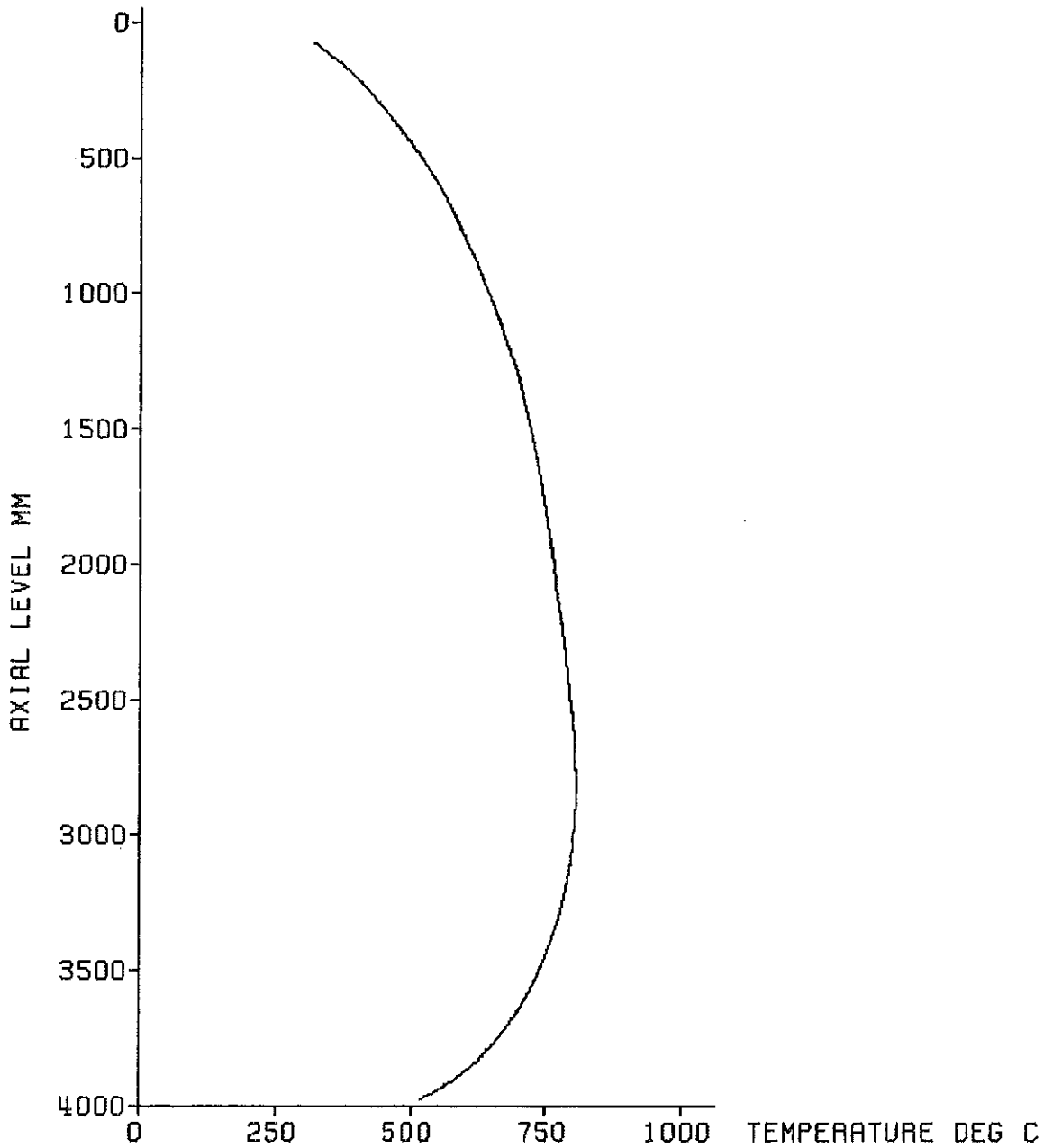

decay heat	120% ANS standard
flooding rate (cold)	3.80 cm/s
system pressure	5.90 bar
feedwater temperature	40 deg C



Fig. 402 FEBA: 5x5 ROD BUNDLE
TEST SERIES 4, TEST-NO. 268

test parameters:

- ◆ flooding rate
- ▲ system pressure
- feedwater temperature
- bundle power

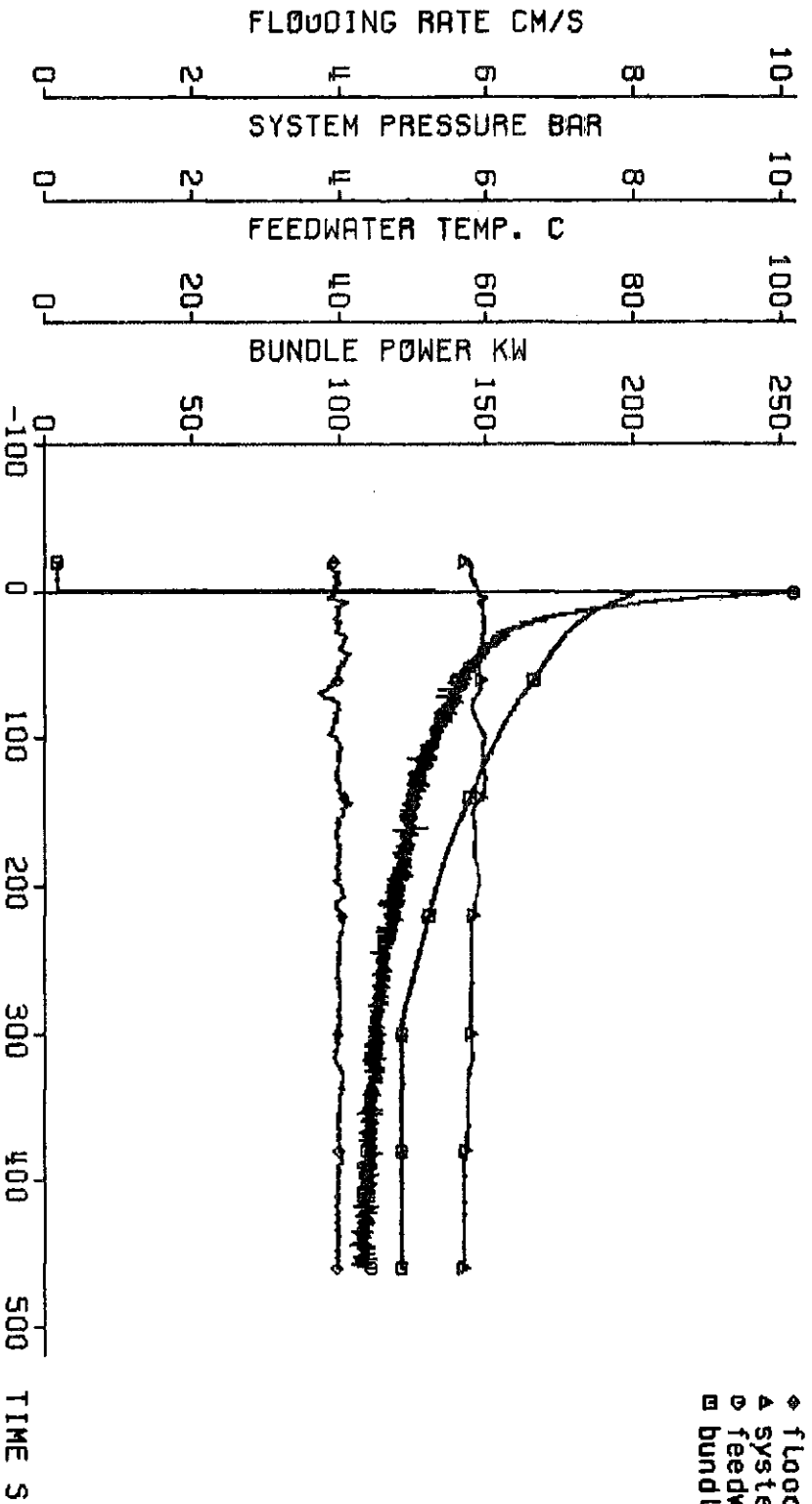

decay heat
flooding rate (cold)
system pressure
feedwater temperature

120% RMS standard
3.80 cm/s
5.90 bar
40 deg C



Fig. 403 FEBRA: 5x5 ROD BUNDLE, TEST SERIES 4, TEST-NO. 268

cladding temperature

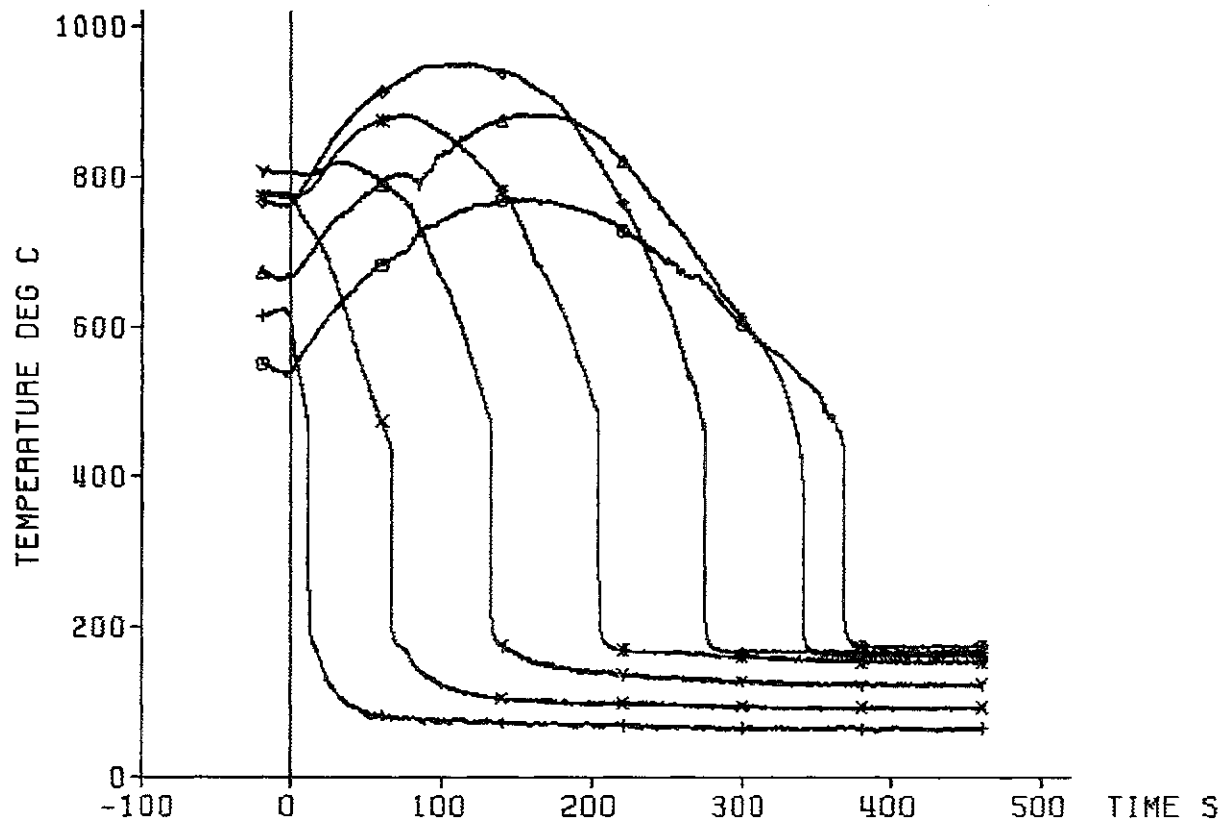

	TC	ax. Level
+	18a4	3860 mm
x	18a3	3315 mm
y	18a2	2770 mm
*	18a1	2225 mm
◇	12b4	1680 mm
△	12b3	1135 mm
○	12b2	590 mm

decay heat 120% ANS standard
 flooding rate (cold) 3.80 cm/s
 system pressure 5.90 bar
 feedwater temperature 40 deg C



Fig. 404 FEBA: 5x5 ROD BUNDLE, TEST SERIES 4, TEST-No. 268

heat transfer coeff.

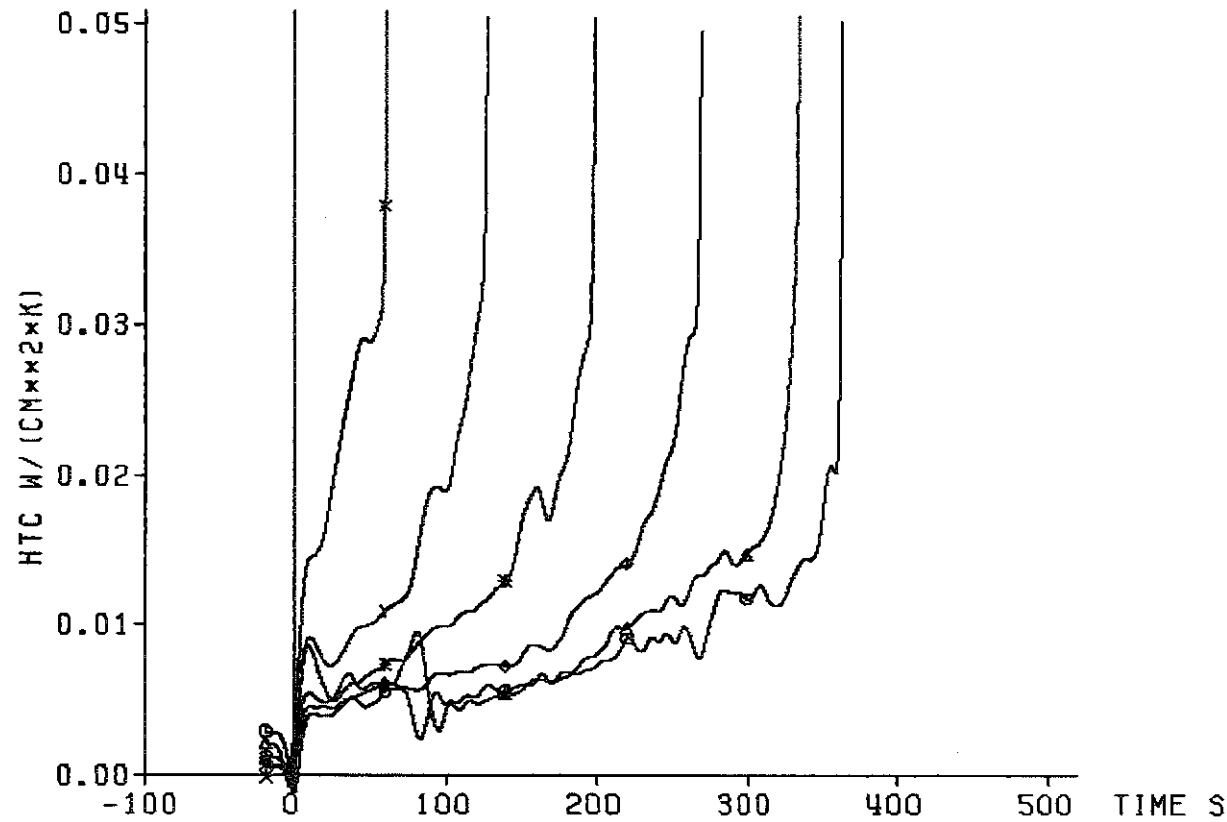

	TC	ax. Level
x	18a3	3315 mm
y	18a2	2770 mm
*	18a1	2225 mm
◇	12b4	1680 mm
△	12b3	1135 mm
○	12b2	590 mm

decay heat 120% ANS standard
flooding rate (cold) 3.80 cm/s
system pressure 5.90 bar
feedwater temperature 40 deg C



Fig. 405 FEBA: 5x5 ROD BUNDLE, TEST SERIES 4, TEST-No. 268

cladding temperature

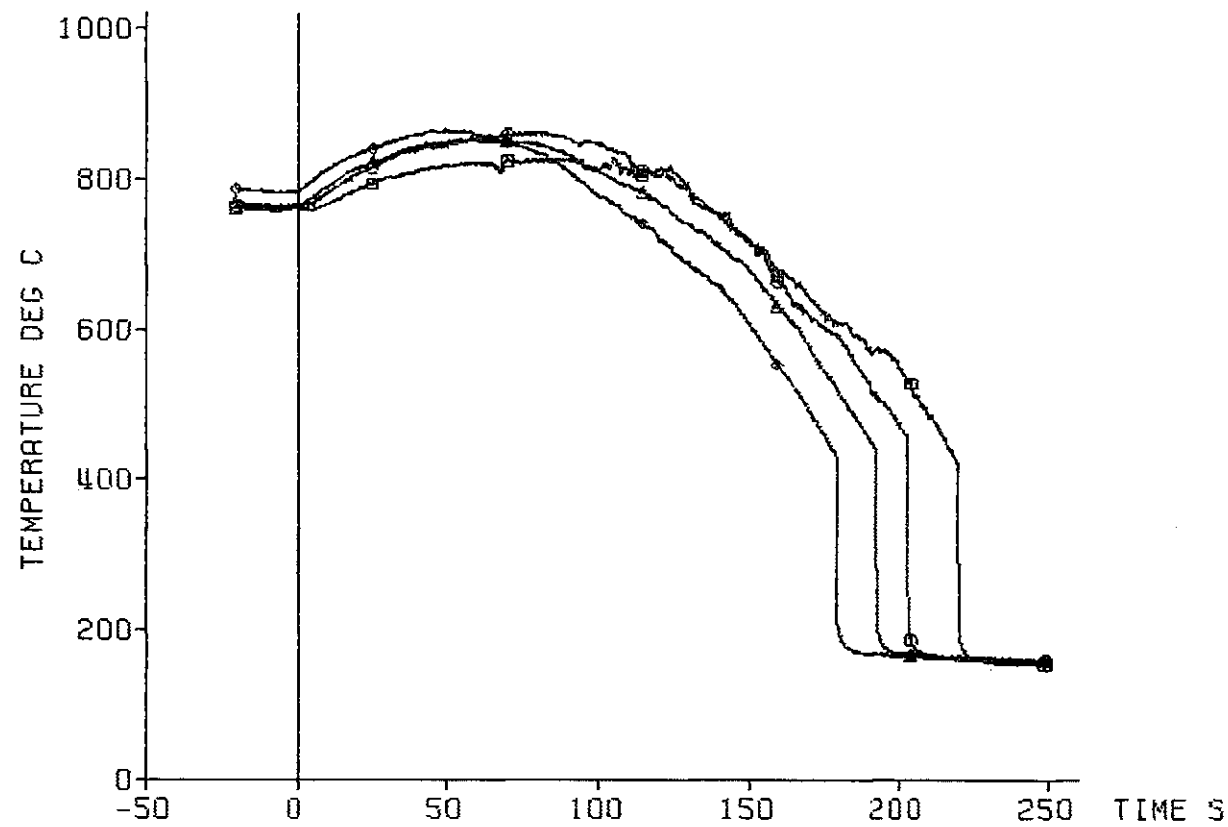

TC	ax. level
◇	7f4 2425 mm
△	7f3 2325 mm
○	9h4 2225 mm
□	9h3 2125 mm

— 448 —

decay heat 120% ANS standard
 flooding rate (cold) 3.80 cm/s
 system pressure 5.90 bar
 feedwater temperature 40 deg C

bypass
 =====



Fig. 406 FEBA: 5x5 ROD BUNDLE, TEST SERIES 4, TEST-No. 268

heat transfer coeff.

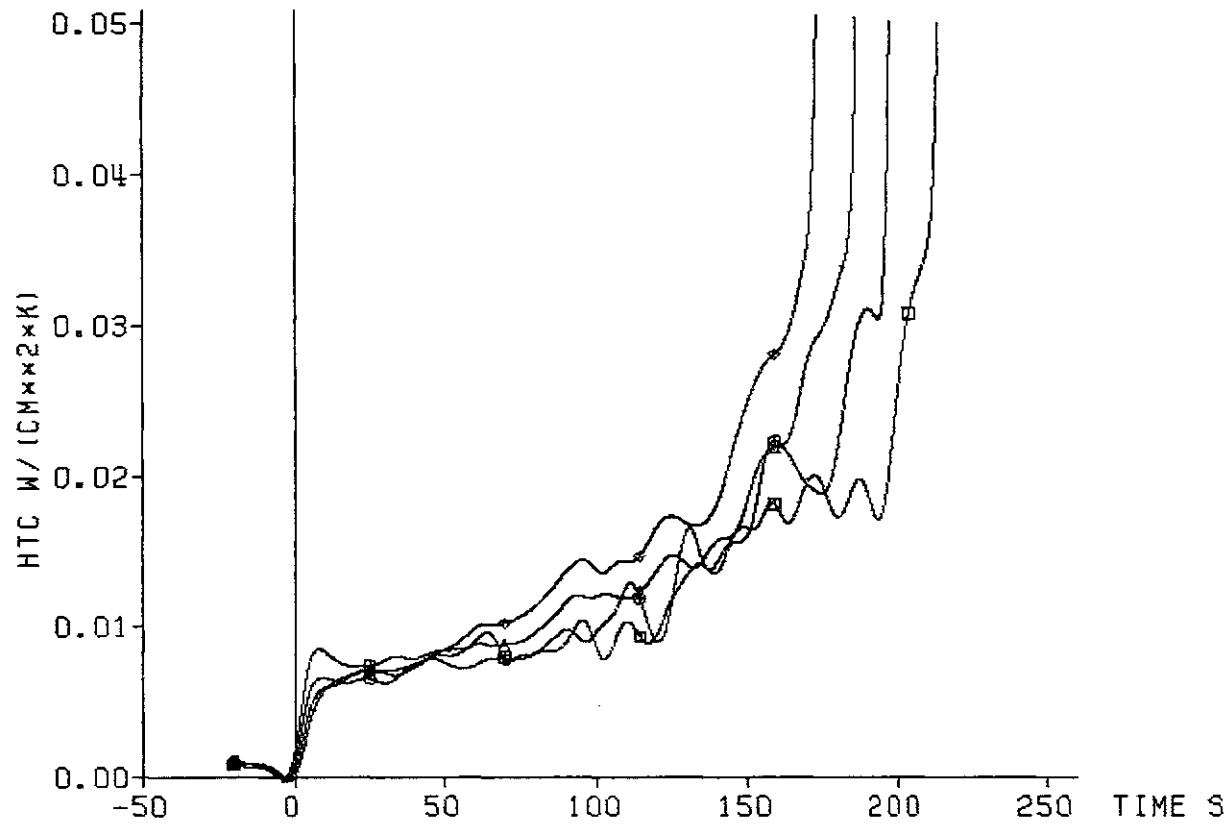

TC	ax. level
◇	7f4 2425 mm
△	7f3 2325 mm
○	9h4 2225 mm
□	9h3 2125 mm

decay heat 120% ANS standard
 flooding rate (cold) 3.80 cm/s
 system pressure 5.90 bar
 feedwater temperature 40 deg C

bypass
=====



Fig. 407 FEBA: 5x5 ROD BUNDLE, TEST SERIES 4, TEST-No. 268

cladding temperature

TC	ax. level
◆ 22f4	2425 mm
△ 22f3	2325 mm
○ 17h4	2225 mm
□ 17h3	2125 mm

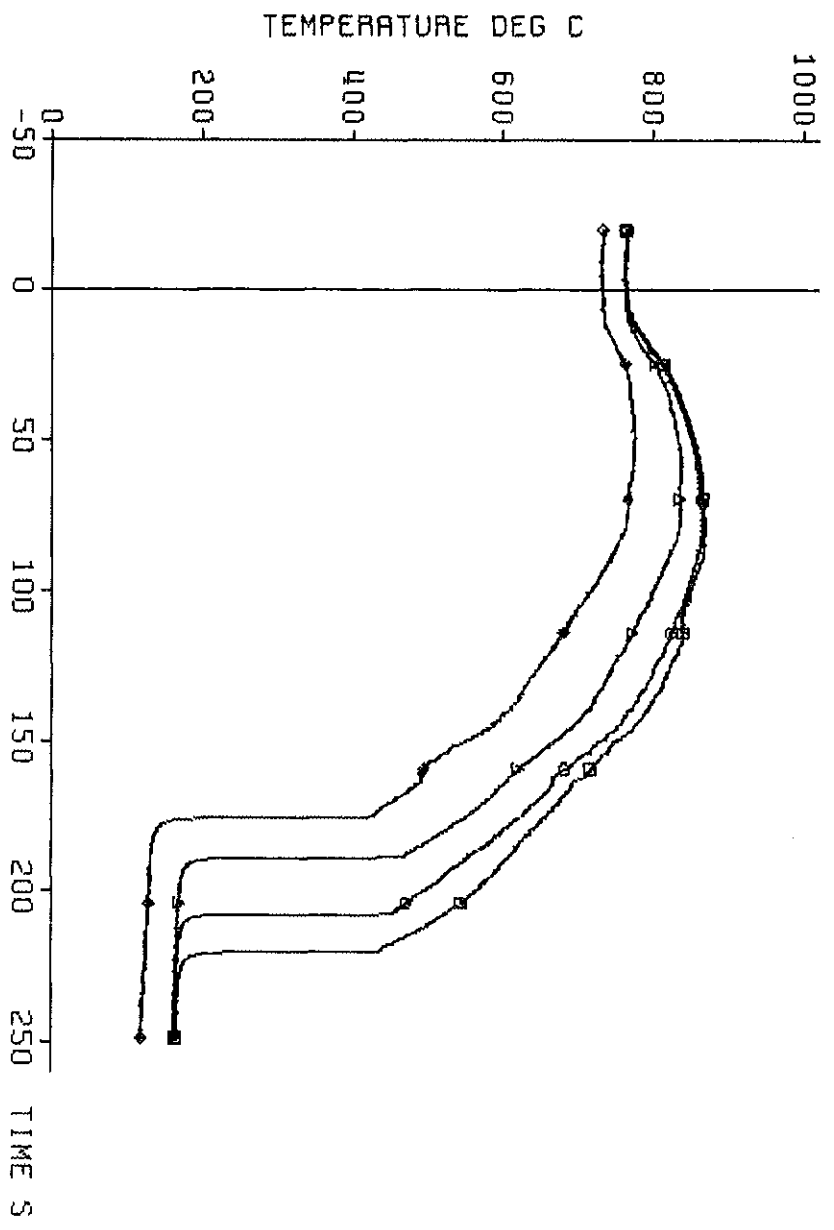

decay heat
 flooding rate (cold)
 system pressure
 feedwater temperature

120% BNS standard
 3.80 cm/s
 5.90 bar
 40 deg C

blockage
 =====

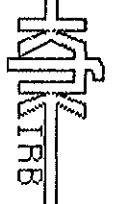
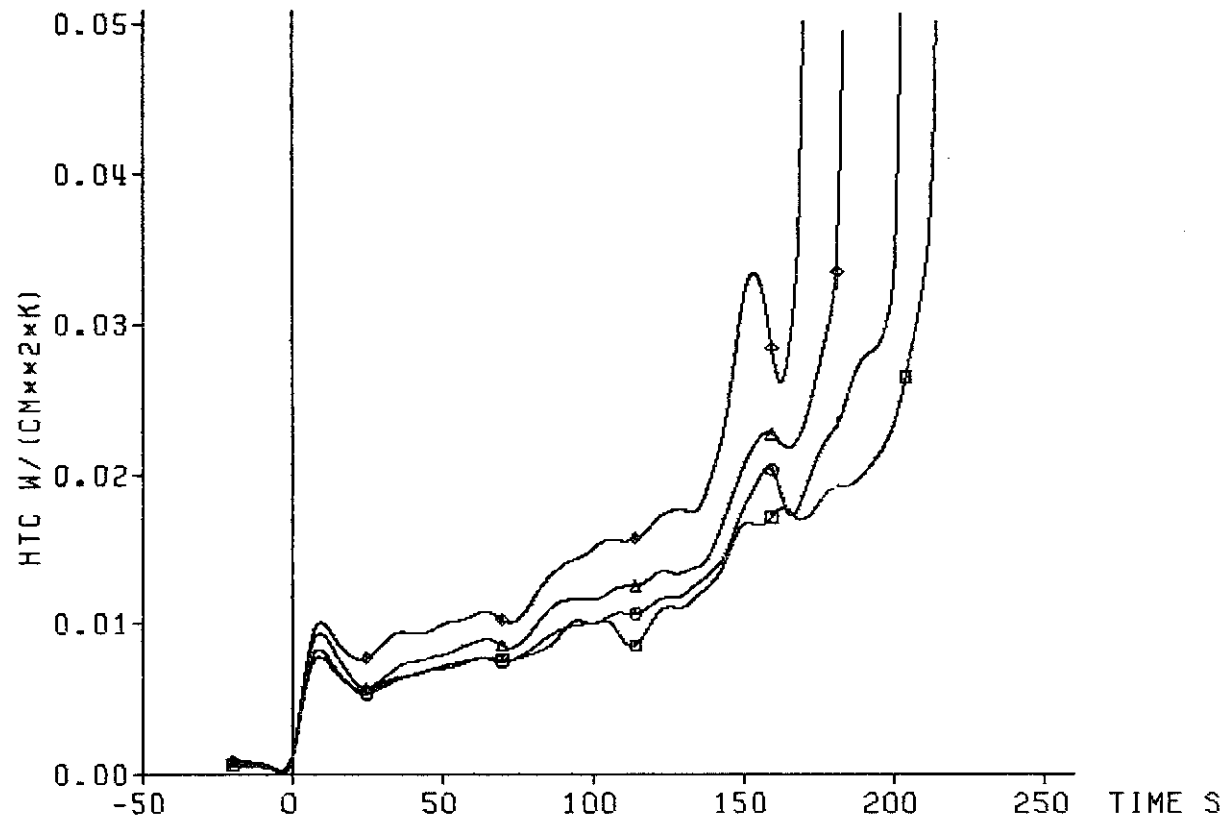

Fig. 408 FEBRA: 5x5 ROD BUNDLE, TEST SERIES 4, TEST-NO. 268

heat transfer coeff.



TC	ax. Level
◇ 22f4	2425 mm
△ 22f3	2325 mm
○ 17h4	2225 mm
□ 17h3	2125 mm

decay heat 120% ANS standard
 flooding rate (cold) 3.80 cm/s
 system pressure 5.90 bar
 feedwater temperature 40 deg C

blockage
 =====



Fig. 409 FEBA: 5x5 ROD BUNDLE, TEST SERIES 4, TEST-No. 268

cladding temperature

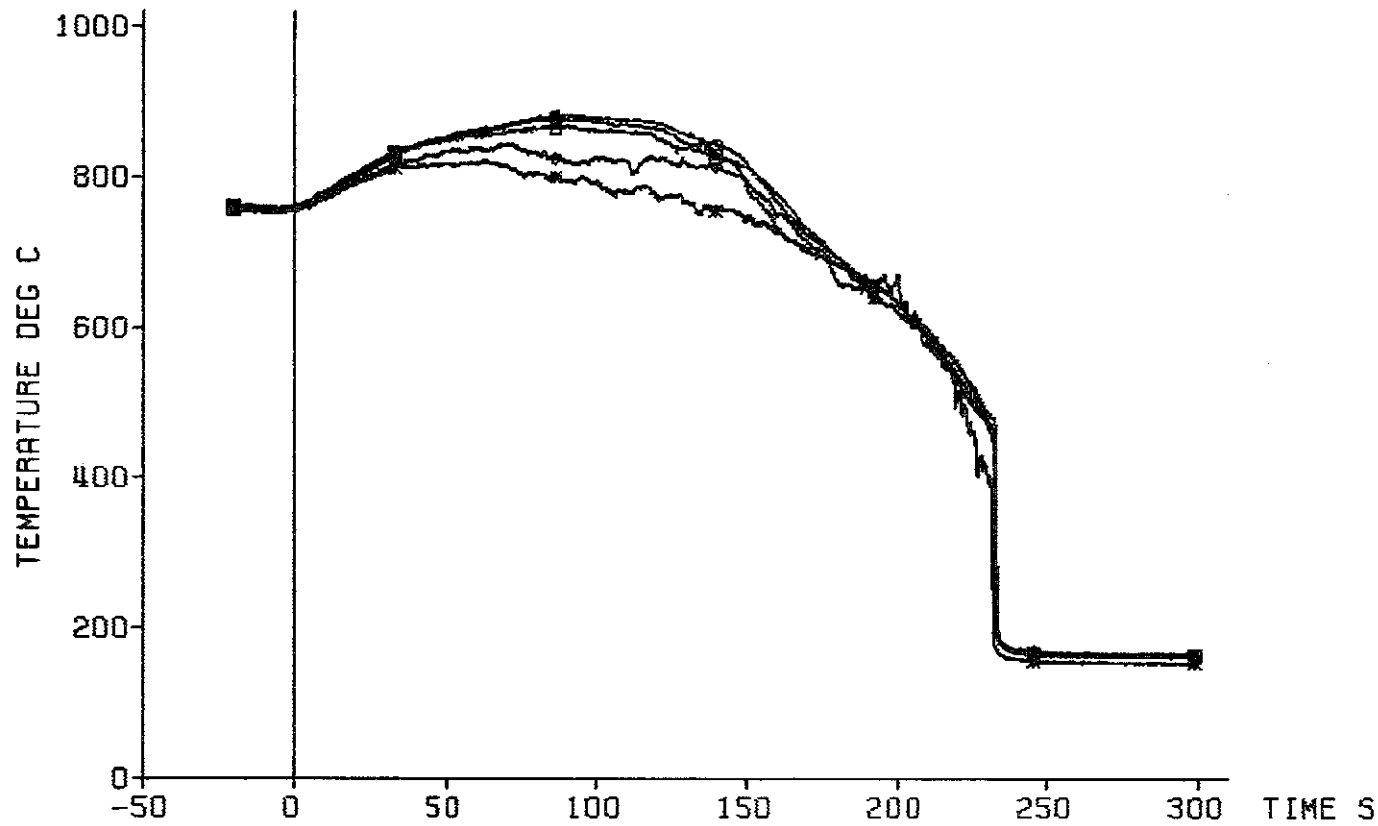

TC	ax. level
* 9h2	2025 mm
◇ 8d4	2025 mm
△ 8d3	2025 mm
⊙ 8d2	2025 mm
□ 8d1	2025 mm

decay heat 120% AWS standard
 flooding rate (cold) 3.80 cm/s
 system pressure 5.90 bar
 feedwater temperature 40 deg C

bypass
 =====



Fig. 410 FEBA: 5x5 ROD BUNDLE, TEST SERIES 4, TEST-No. 268

heat transfer coeff.

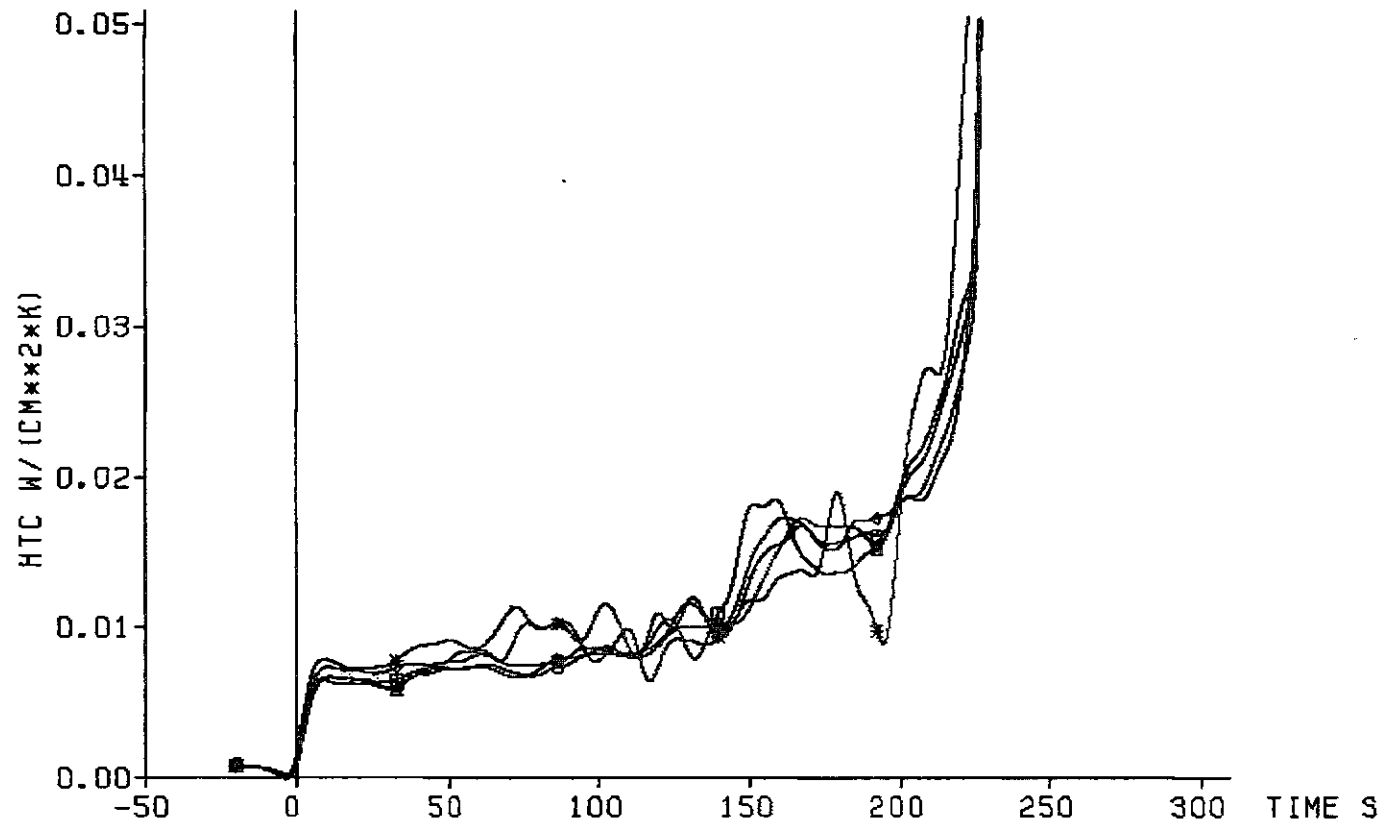

	TC	axial level
*	9h2	2025 mm
△	8d4	2025 mm
△	8d3	2025 mm
○	8d2	2025 mm
□	8d1	2025 mm

decay heat 120% ANS standard
 flooding rate (cold) 3.80 cm/s
 system pressure 5.90 bar
 feedwater temperature 40 deg C

bypass
 =====



Fig. 411 FEBA: 5x5 ROD BUNDLE, TEST SERIES 4, TEST-No. 268

cladding temperature

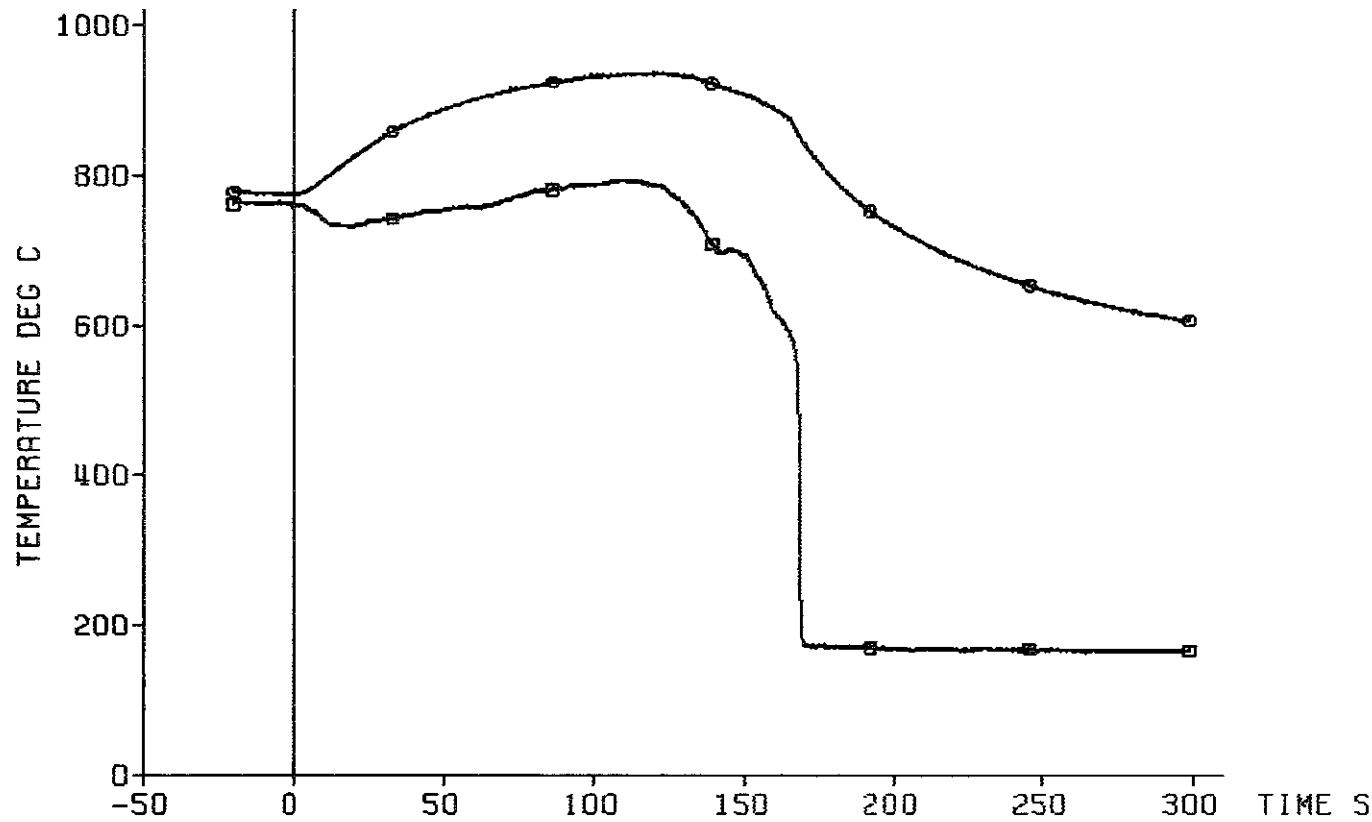

TC	ax. level
○ 17h2	2025 mm
□ sleeve	2025 mm

decay heat 120% ANS standard
flooding rate (cold) 3.80 cm/s
system pressure 5.90 bar
feedwater temperature 40 deg C

blockage
=====



Fig. 412 FEBA: 5x5 ROD BUNDLE, TEST SERIES 4, TEST-No. 268

cladding temperature

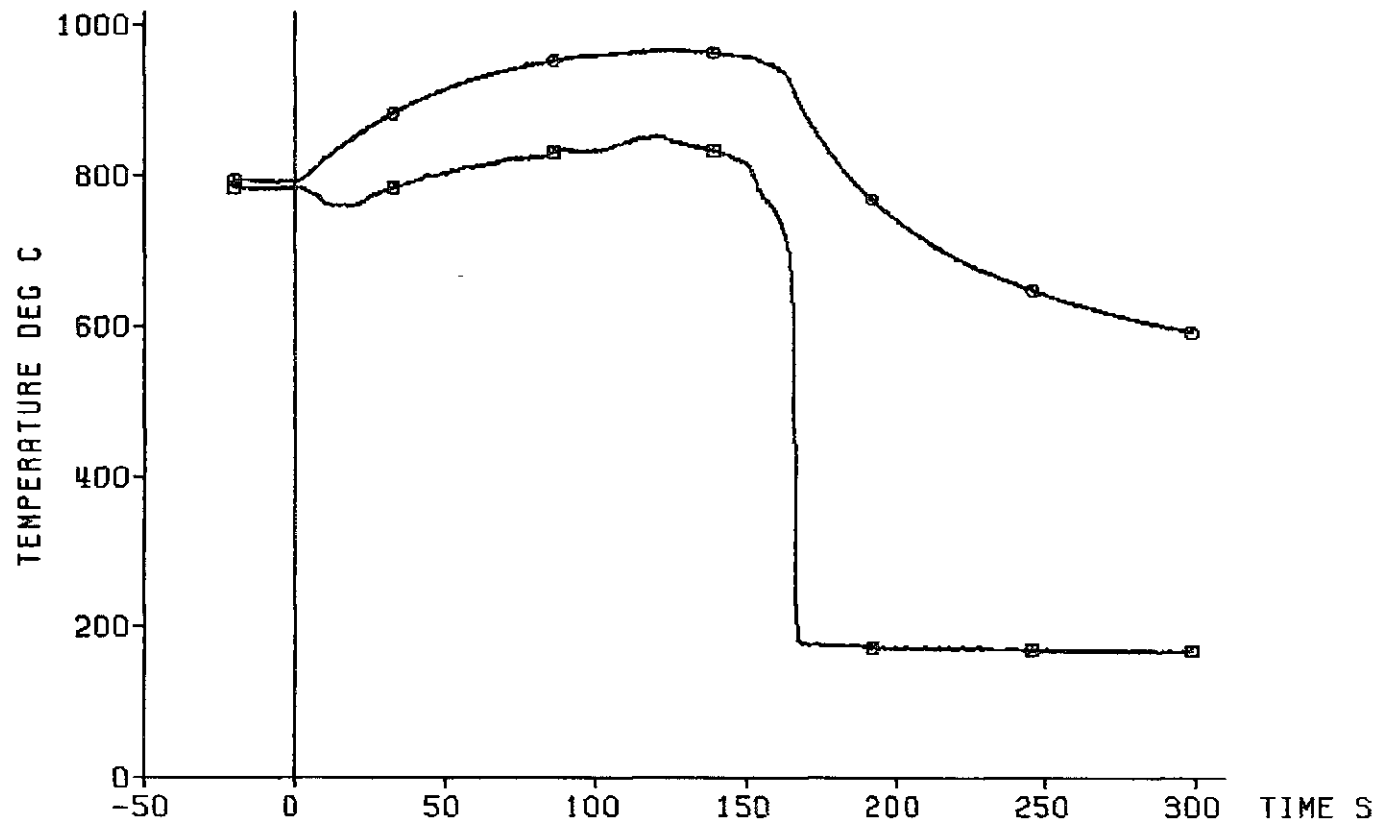

TC	axial level
○ 13d2	2025 mm
□ sleeve	2025 mm

decay heat 120% ANS standard
 flooding rate (cold) 3.80 cm/s
 system pressure 5.90 bar
 feedwater temperature 40 deg C

b blockage
 =====



Fig. 413 FEBA: 5x5 ROD BUNDLE, TEST SERIES 4, TEST-No. 268

cladding temperature

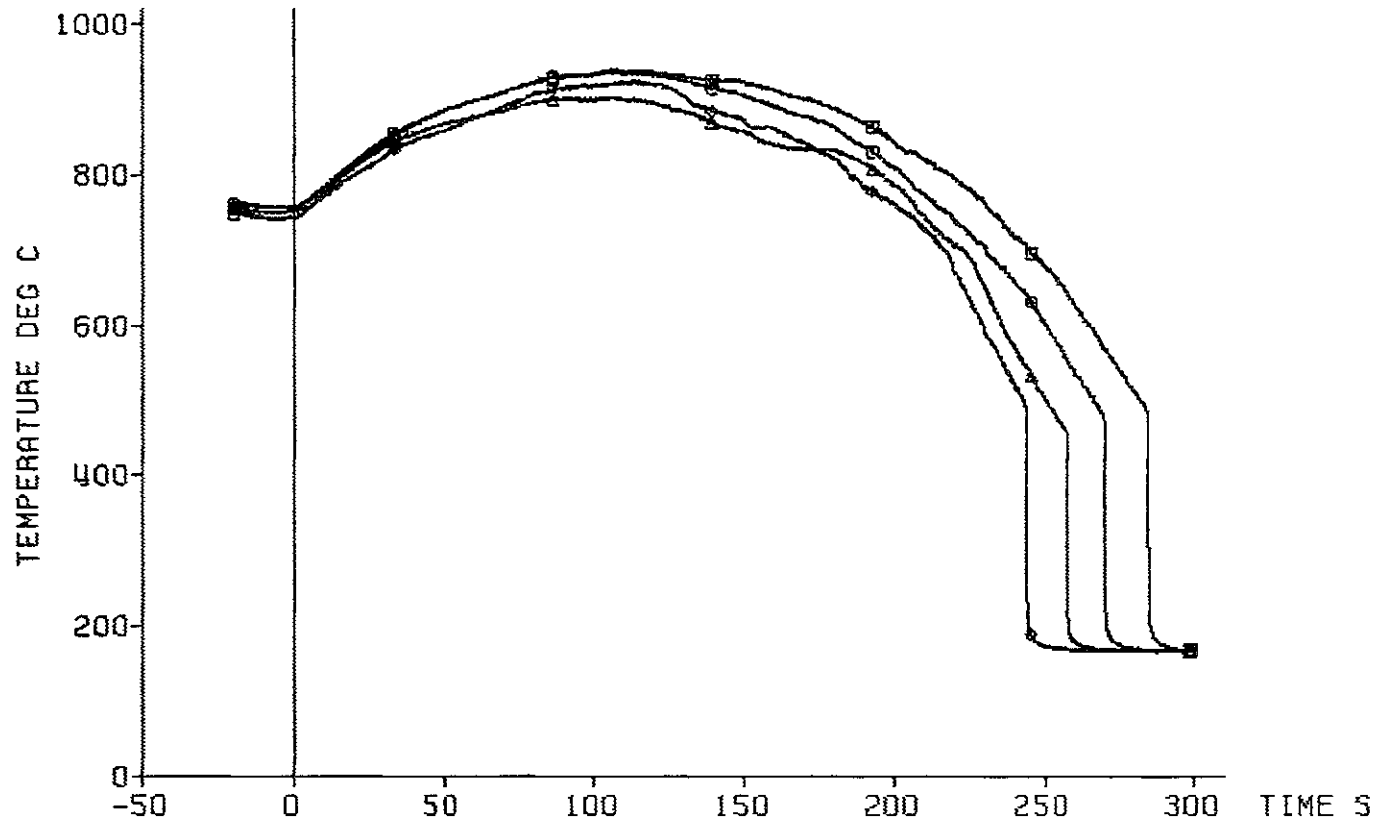

TC	ax. level
◇	9h1 1925 mm
△	19g3 1825 mm
○	19g2 1725 mm
□	19g1 1625 mm

decay heat 120% ANS standard
 flooding rate (cold) 3.80 cm/s
 system pressure 5.90 bar
 feedwater temperature 40 deg C

bypass
 =====



Fig. 414 FEBA: 5x5 ROD BUNDLE, TEST SERIES 4, TEST-No. 268

heat transfer coeff.

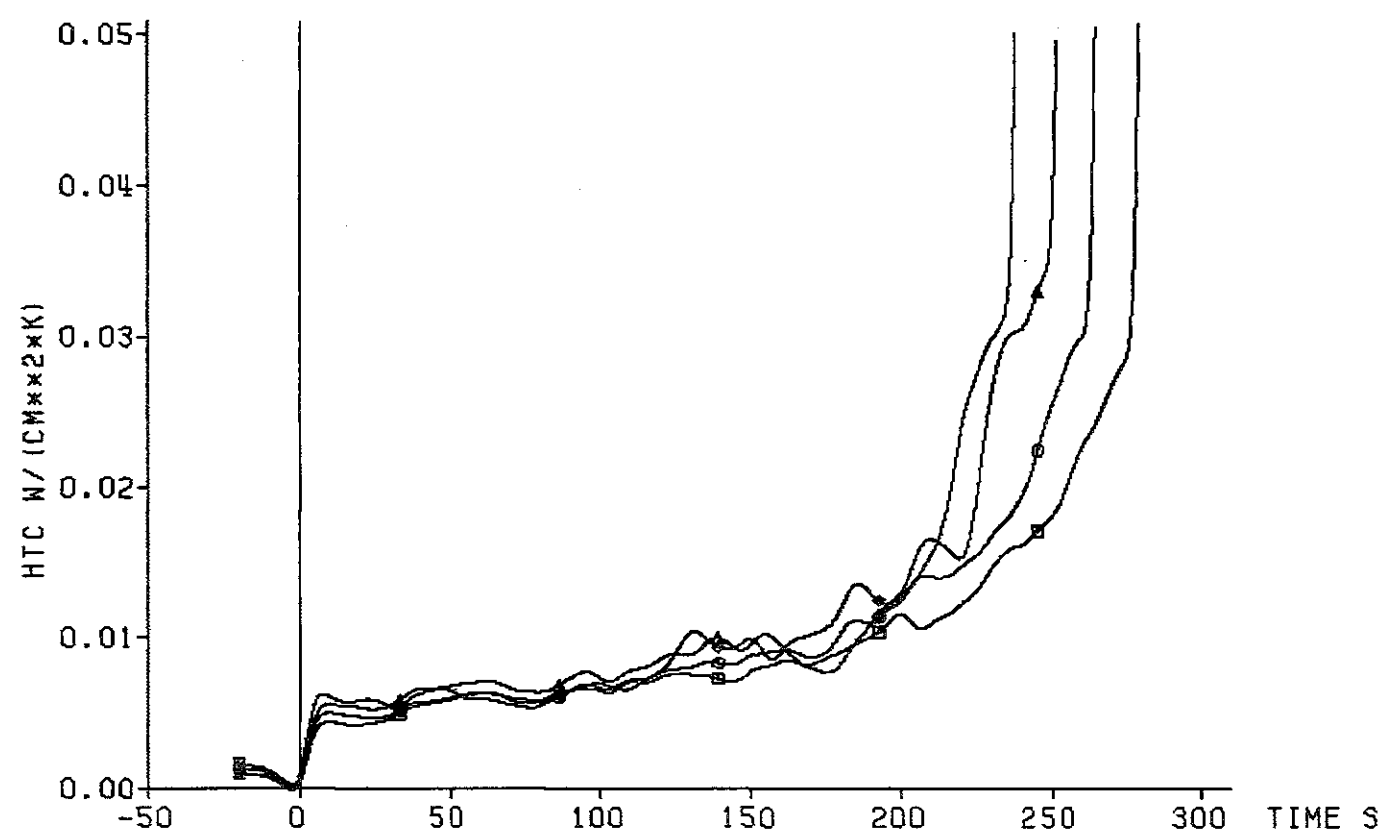

TC	ax. level
♦	9h1 1925 mm
▲	19g3 1825 mm
○	19g2 1725 mm
□	19g1 1625 mm

decay heat 120% ANS standard
 flooding rate (cold) 3.80 cm/s
 system pressure 5.90 bar
 feedwater temperature 40 deg C

bypass
 =====



Fig. 415 FEBA: 5x5 ROD BUNDLE, TEST SERIES 4, TEST-No. 268

cladding temperature

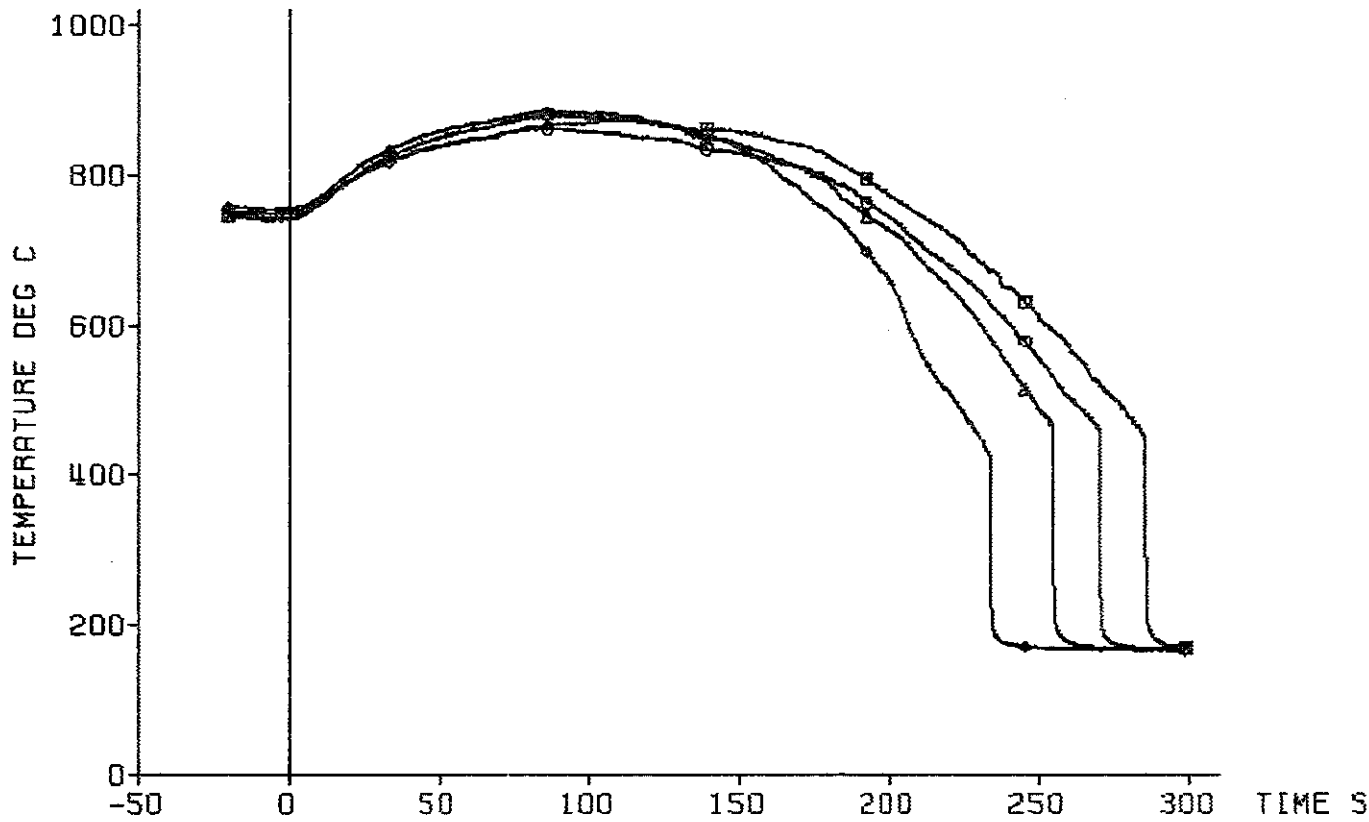

TC	ax. level
◇	17h1 1925 mm
△	16g3 1825 mm
○	16g2 1725 mm
□	16g1 1625 mm

decay heat 120% ANS standard
 flooding rate (cold) 3.80 cm/s
 system pressure 5.90 bar
 feedwater temperature 40 deg C

blockage
 =====



Fig. 416 FEBA: 5x5 ROD BUNDLE, TEST SERIES 4, TEST-No. 268

heat transfer coeff.

TC	ax. Level
◇ 17h1	1925 mm
△ 16g3	1825 mm
○ 16g2	1725 mm
□ 16g1	1625 mm

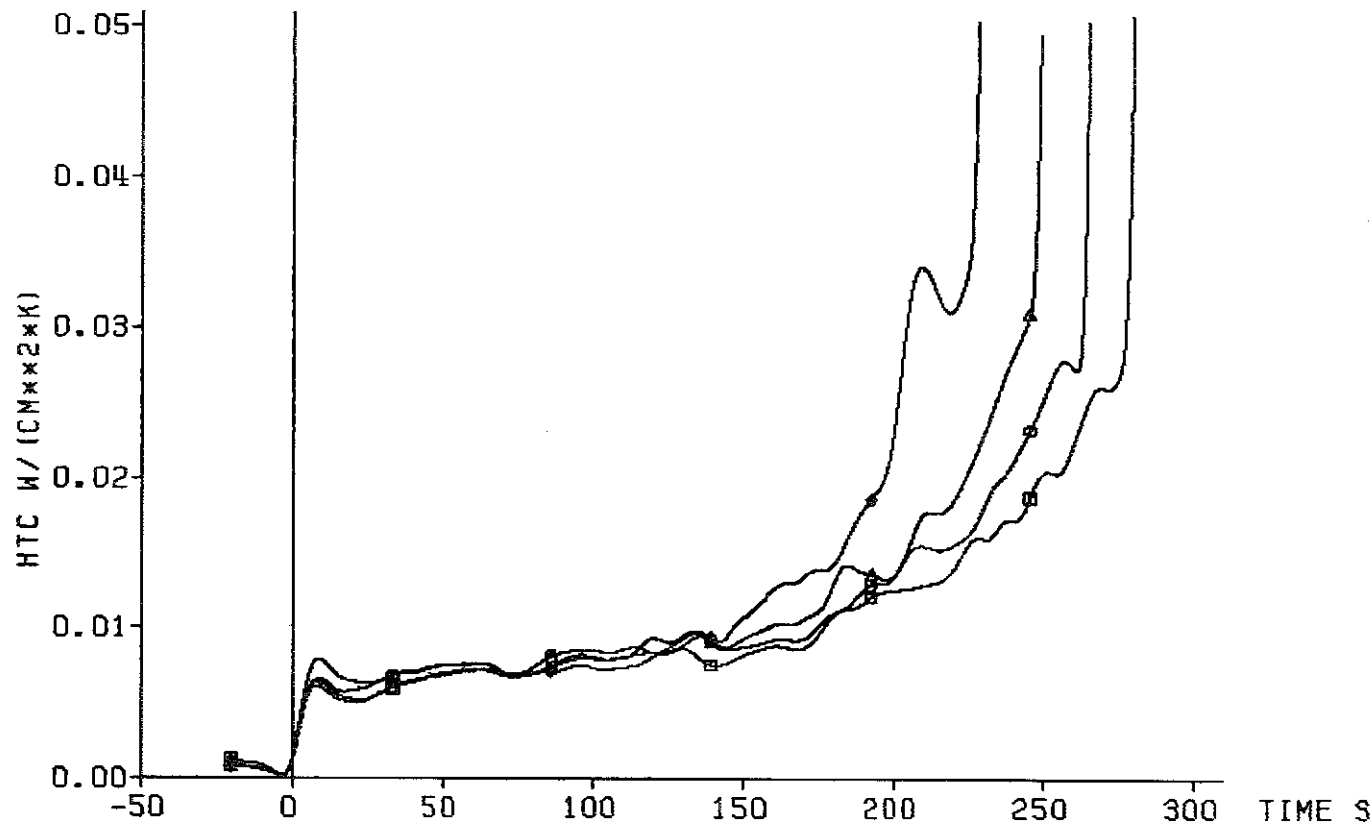

decay heat 120% ANS standard
flooding rate (cold) 3.80 cm/s
system pressure 5.90 bar
feedwater temperature 40 deg C

blockage
=====

KfK
IRB

Fig. 417 FEBA: 5x5 ROD BUNDLE, TEST SERIES 4, TEST-No. 268

grid spacer temperature

TC	axial level
87	2550 mm

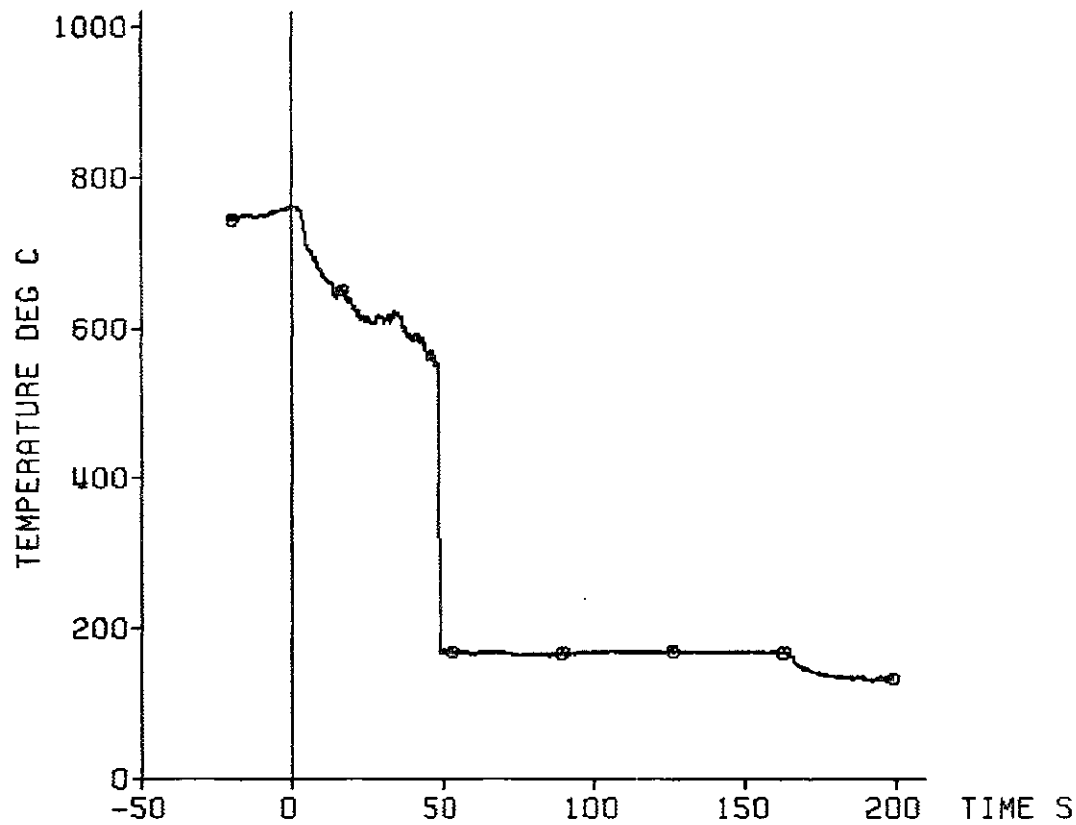

decay heat 120% ANS standard
flooding rate (cold) 3.84 cm/s
system pressure 5.96 bar
feedwater temperature 40 deg C



Fig. 418 FEBA: 5x5 ROD BUNDLE, TEST SERIES 4, TEST-No. 268

grid spacer temperature



— 459 —

decay heat 120% ANS standard
flooding rate (cold) 3.84 cm/s
system pressure 5.96 bar
feedwater temperature 40 deg C



Fig. 419 FEBA: 5x5 ROD BUNDLE, TEST SERIES 4, TEST-No. 268

axial level: 1825 mm

△ cladding temperature (19g3)
◊ fluid temperature

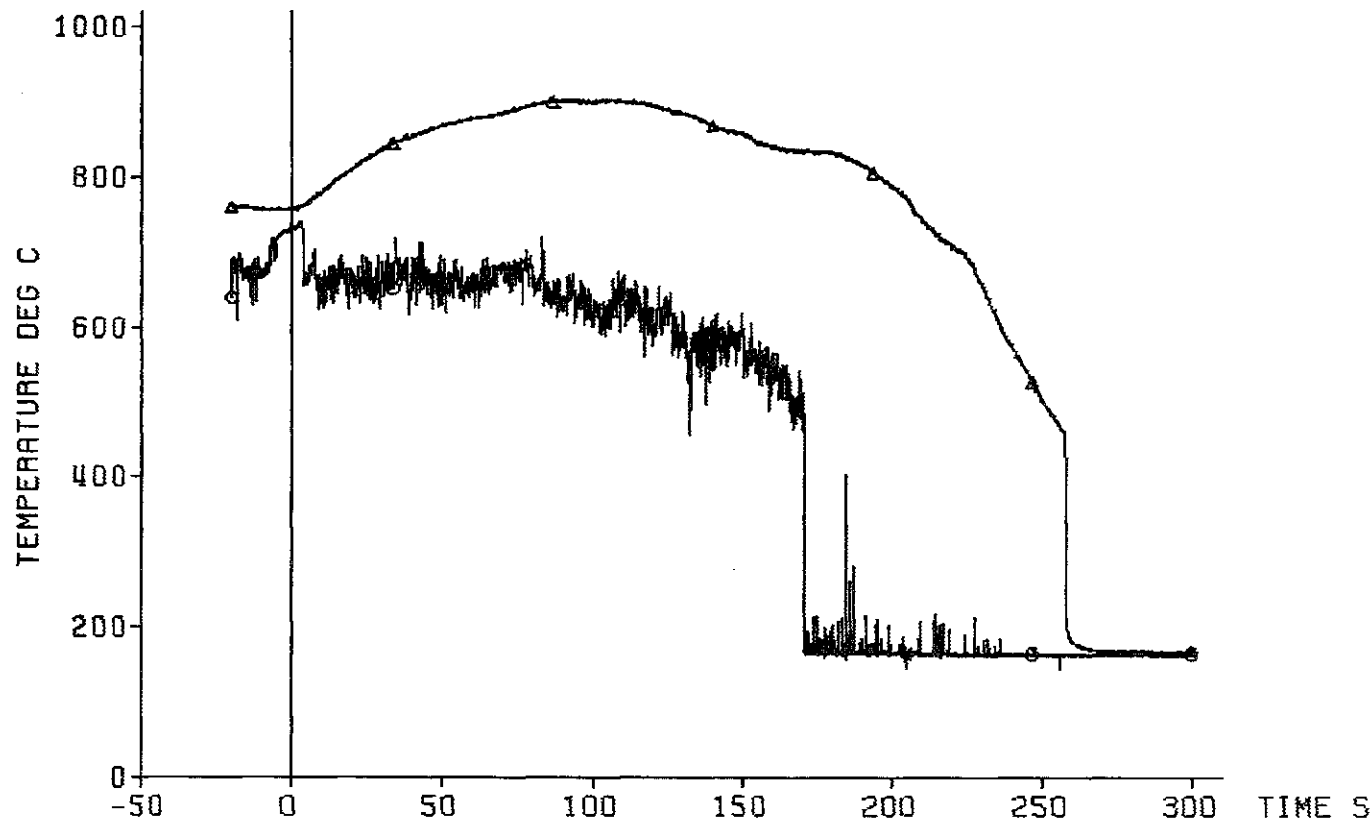

— 460 —

decay heat 120% ANS standard
flooding rate (cold) 3.80 cm/s
system pressure 5.90 bar
feedwater temperature 40 deg C

bypass
=====



Fig. 420 FEBA: 5x5 R0D BUNDLE, TEST SERIES 4, TEST-No. 268

axial level: 1825 mm

△ cladding temperature (16g3)
○ fluid temperature

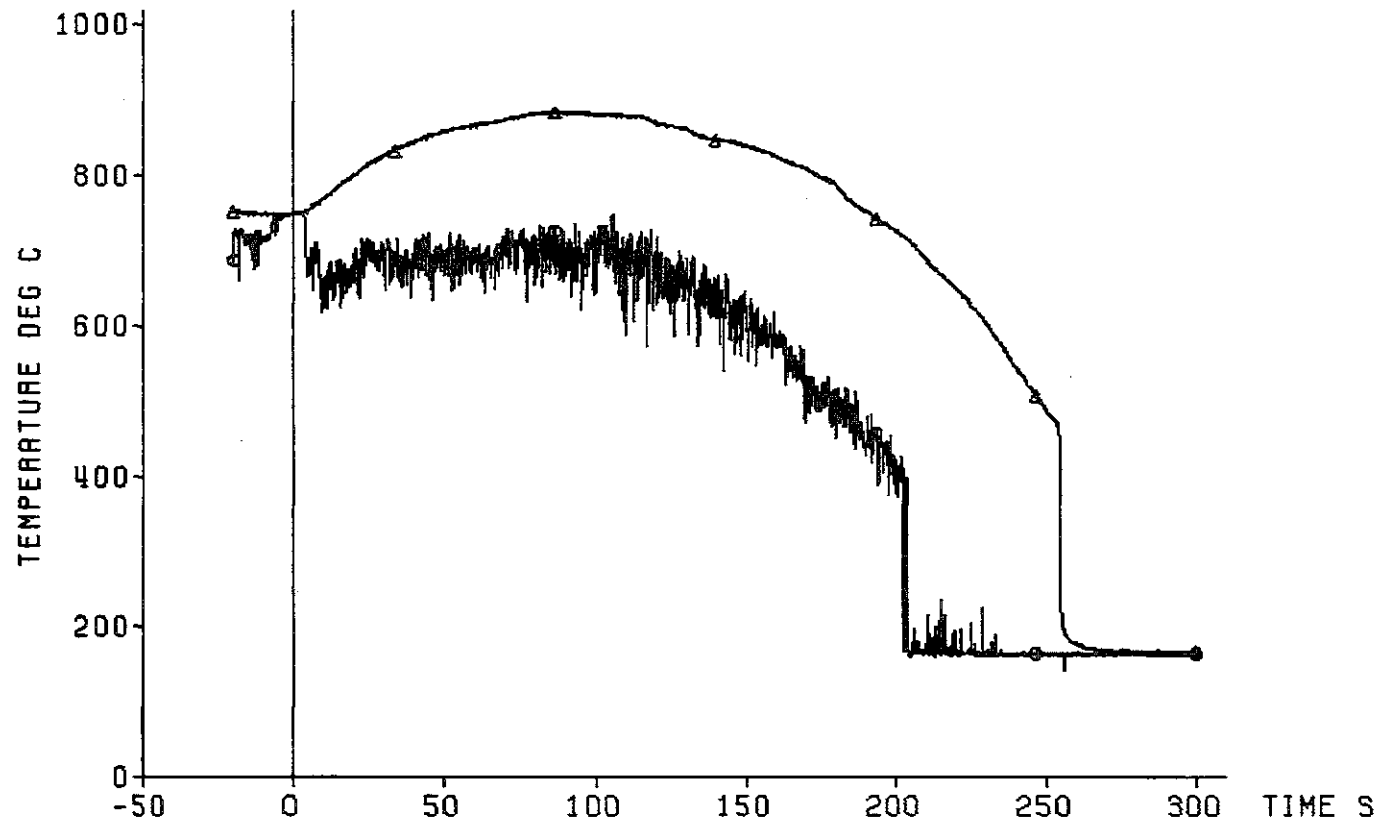

decay heat 120% ANS standard
flooding rate (cold) 3.80 cm/s
system pressure 5.90 bar
feedwater temperature 40 deg C

blockage
=====



Fig. 421 FEBA: 5x5 ROD BUNDLE, TEST SERIES 4, TEST-No. 268

axial level: 1725 mm

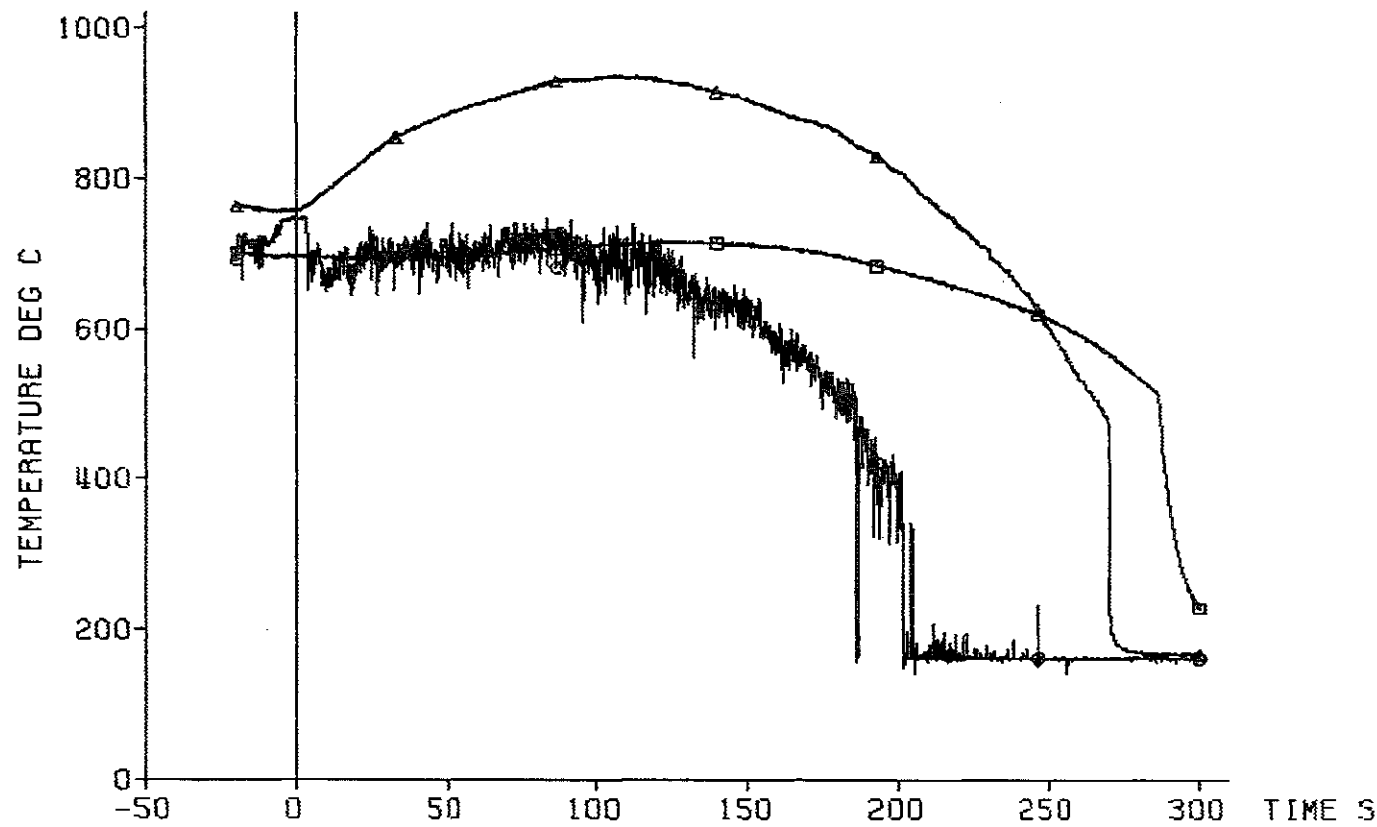

decay heat 120% ANS standard
flooding rate (cold) 3.80 cm/s
system pressure 5.90 bar
feedwater temperature 40 deg C

bypass
=====

KTRB

Fig. 422 FEBA: 5x5 ROD BUNDLE, TEST SERIES 4, TEST-No. 268

pressure loss
along the test section:

◇ total length: 4196 mm
△ lower part: 1711 mm
○ middle part: 545 mm
□ upper part: 1940 mm

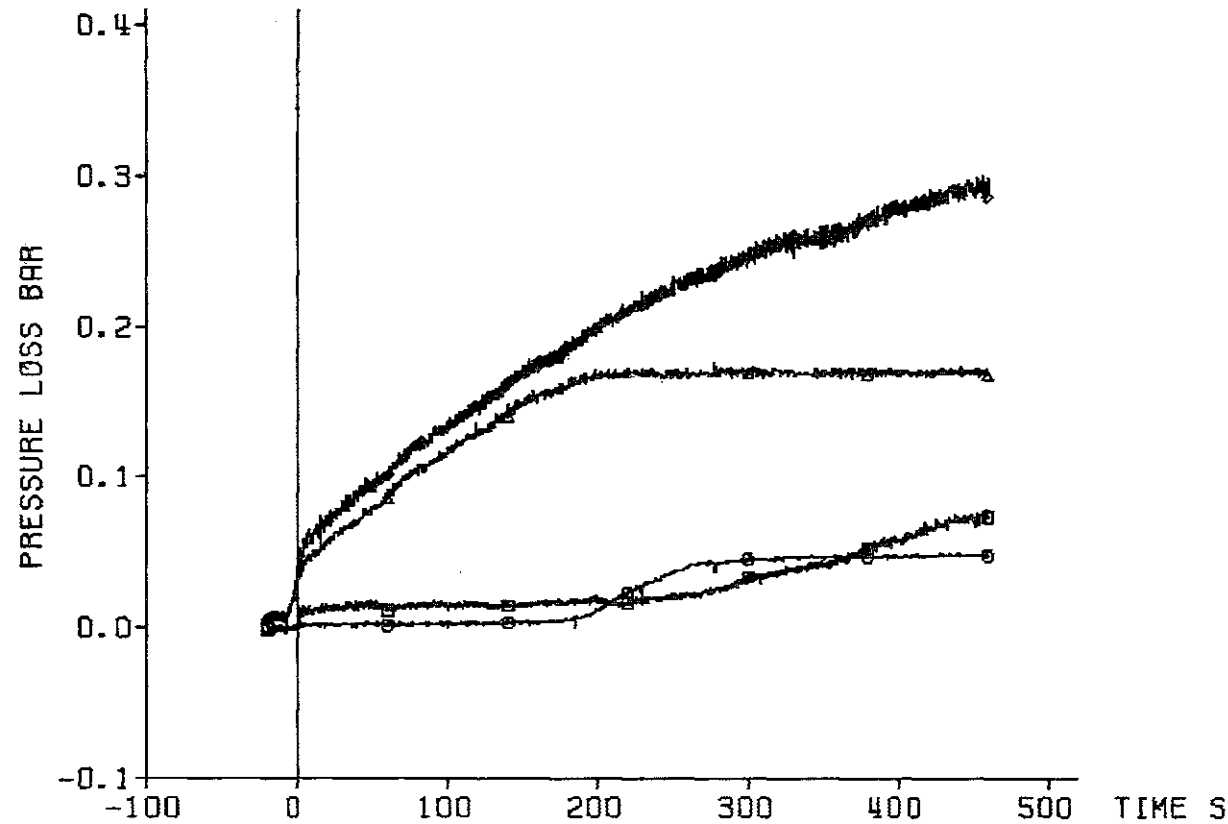

decay heat 120% ANS standard
flooding rate (cold) 3.80 cm/s
system pressure 5.90 bar
feedwater temperature 40 deg C

KIK IRB

Fig. 423 FEBA: 5x5 ROD BUNDLE, TEST SERIES 4, TEST-No. 268

coolant conditions:

- ▲ water carry over
- coolant temperature
- coolant pressure

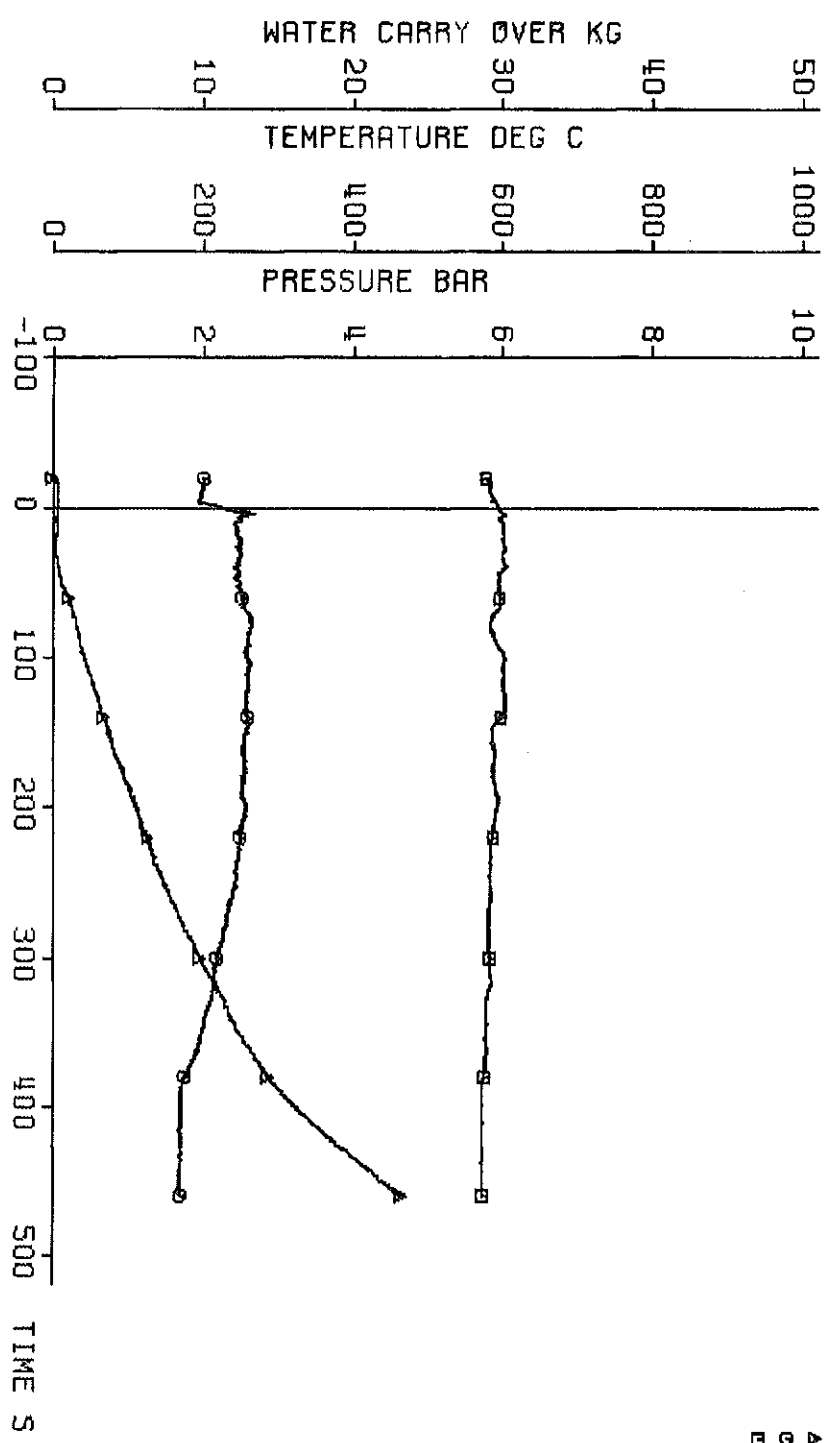

decay heat 120% RMS standard
flooding rate (cold) 3.80 cm/s
system pressure 5.90 bar
feedwater temperature 40 deg C

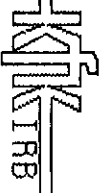
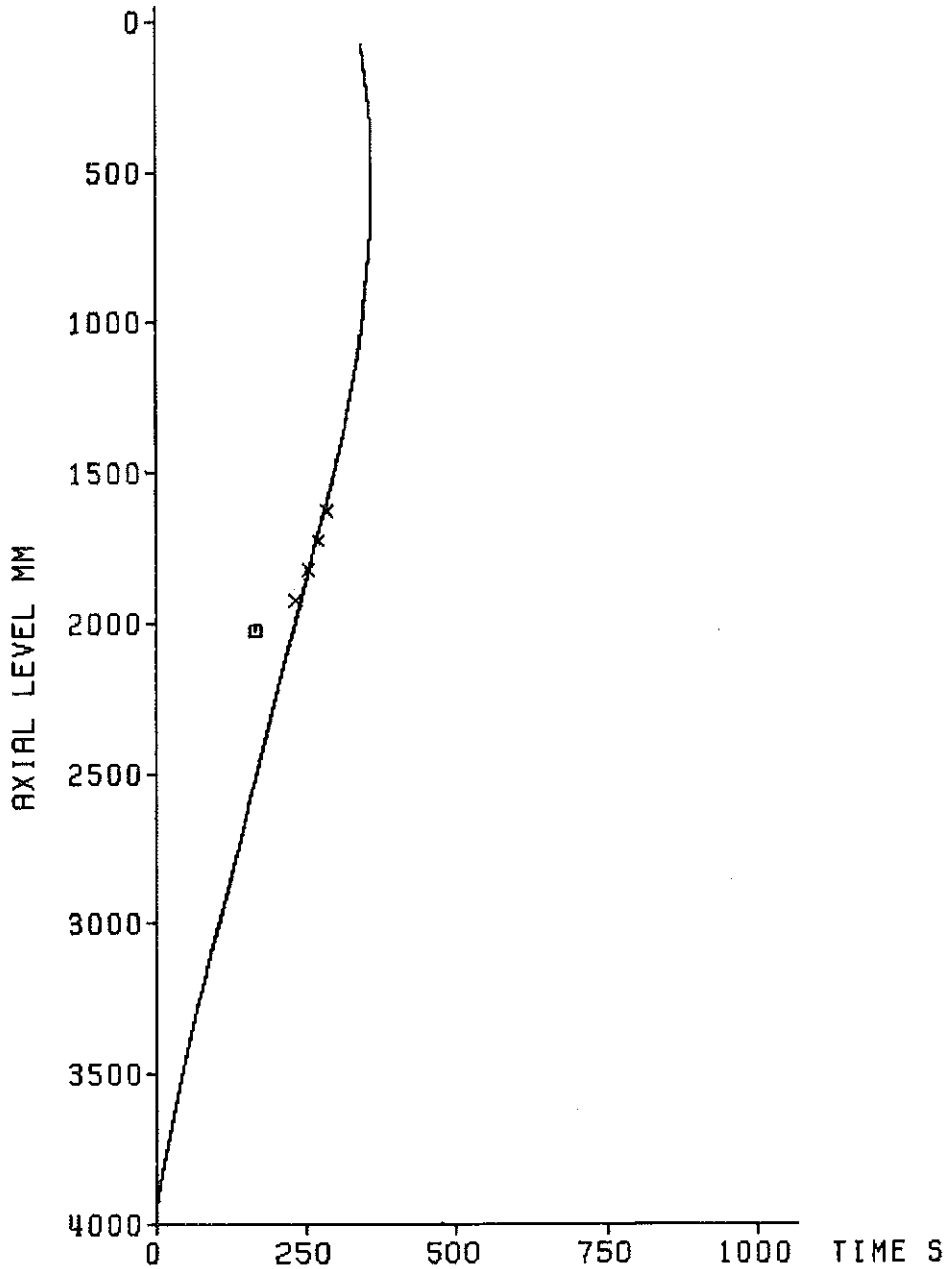

Fig. 424 FEBRA: 5X5 ROD BUNDLE, TEST SERIES 4, TEST-NO. 268

axial position of the quench front

- ▣ rewetting of the sleeve at the bundle midplane
- x rewetting of the rod downstream of the blockage



decay heat	120% ANS standard
flooding rate (cold)	3.80 cm/s
system pressure	5.90 bar
feedwater temperature	40 deg C



Fig. 425 FEBA: 5x5 ROD BUNDLE
TEST SERIES 4, TEST-No. 268

Initial axial temperature profile of the cladding

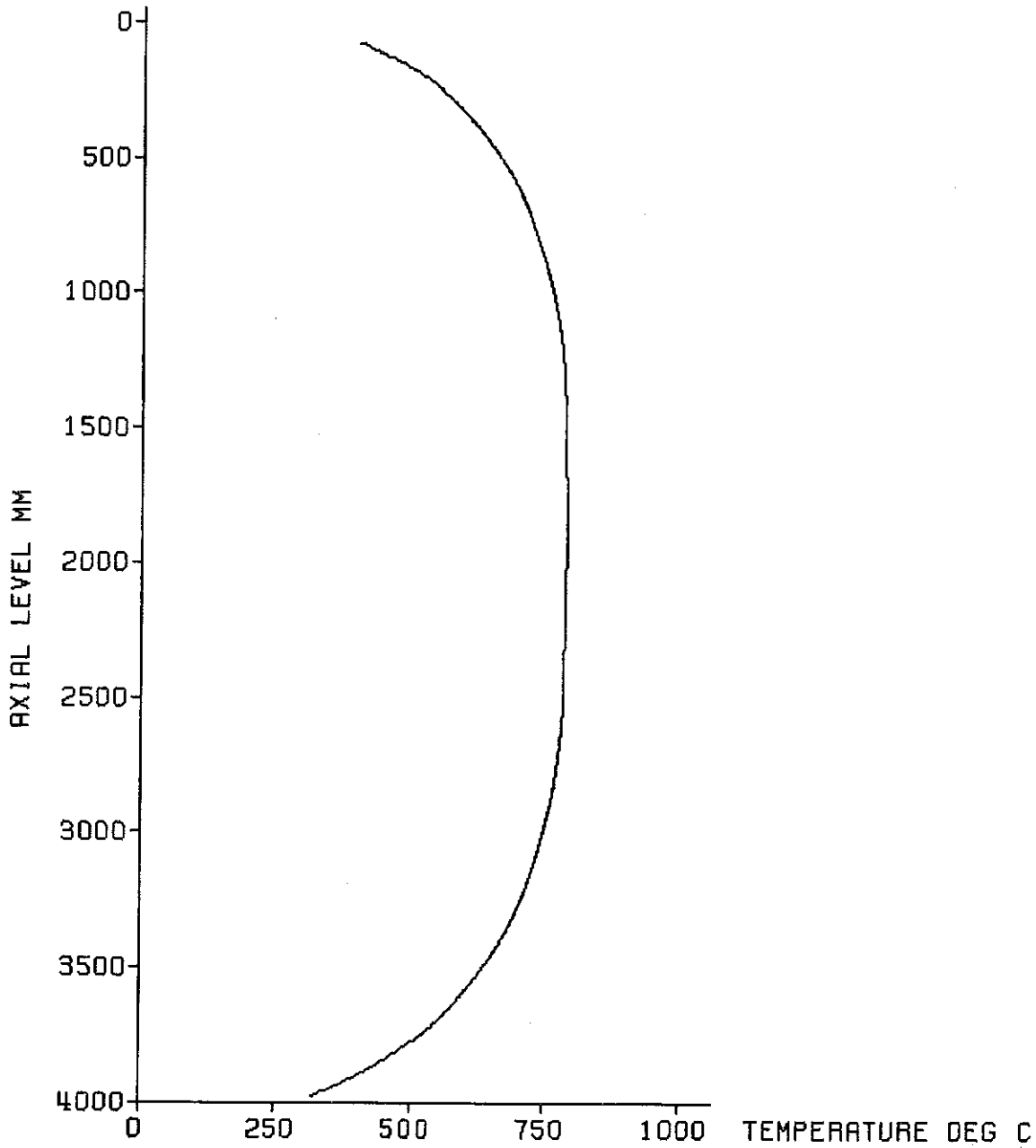

decay heat	120% ANS standard
flooding rate (cold)	5.68 cm/s
system pressure	1.98 bar
feedwater temperature	40 deg C



Fig. 426 FEBA: 5x5 ROD BUNDLE
TEST SERIES 4, TEST-No. 261

test parameters:

- ◆ flooding rate
- ▲ system pressure
- feedwater temperature
- bundle power

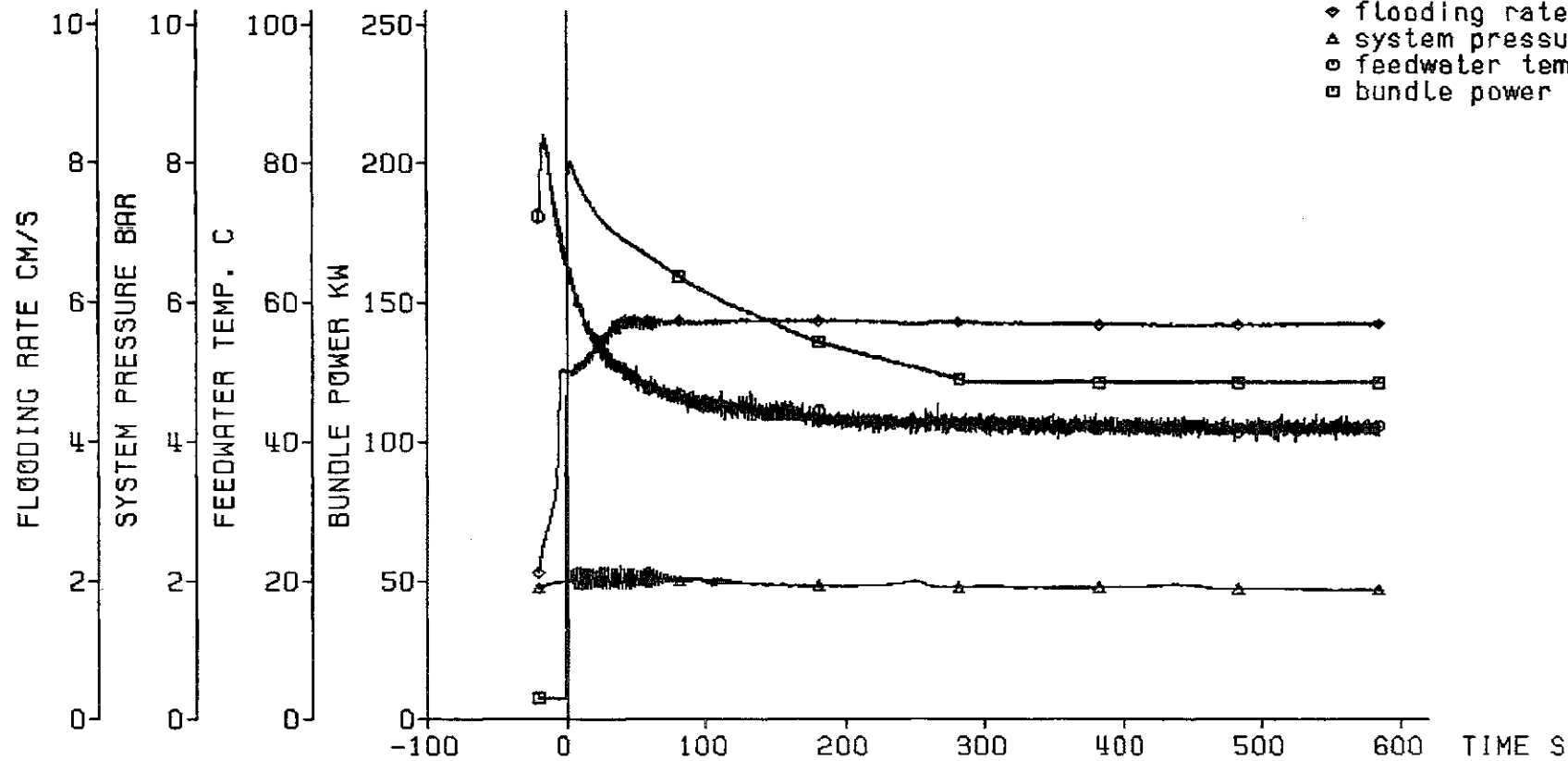

decay heat 120% ANS standard
flooding rate (cold) 5.68 cm/s
system pressure 1.98 bar
feedwater temperature 40 deg C



Fig. 427 FEBA: 5x5 ROD BUNDLE, TEST SERIES 4, TEST-No. 261

cladding temperature

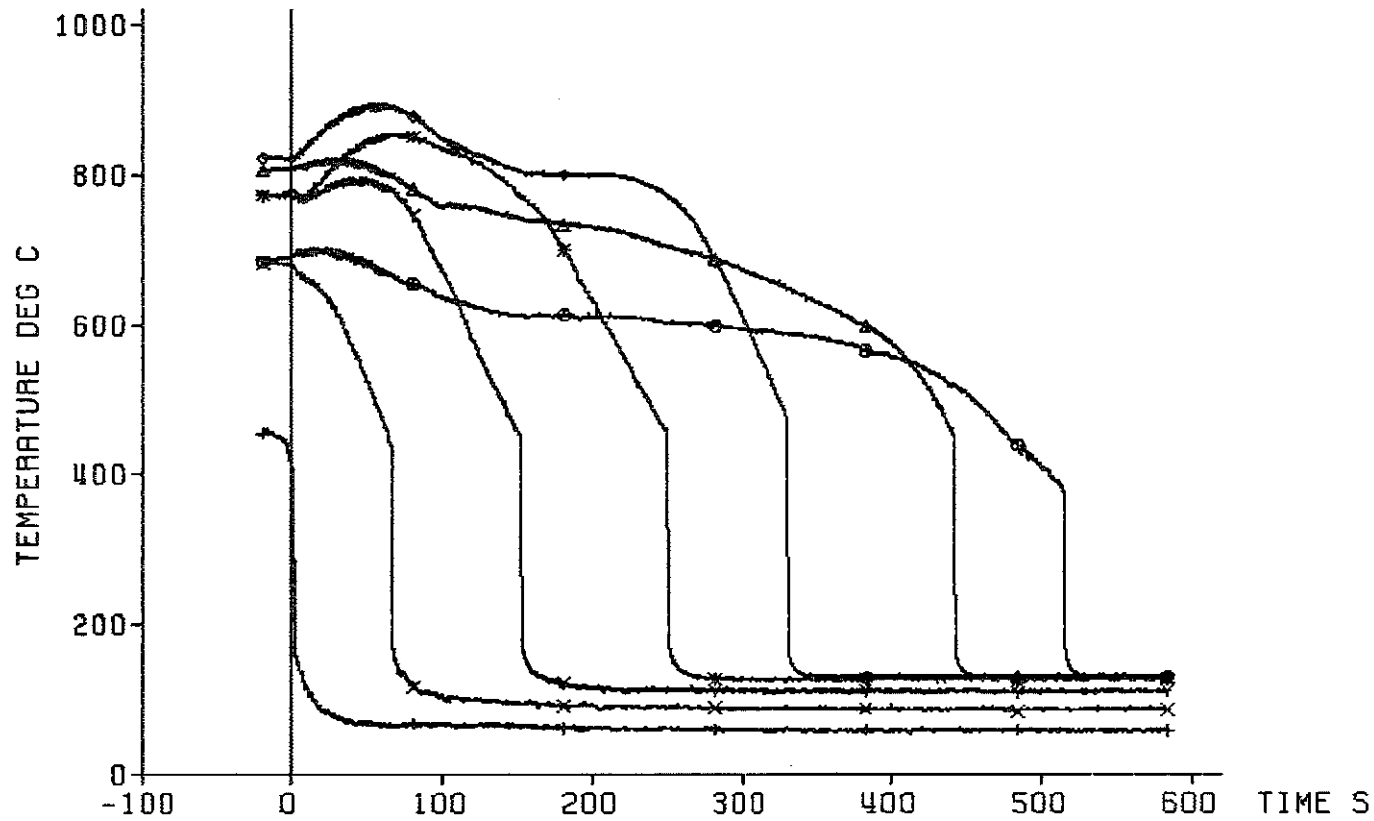

TC	ax. level
+	18a4 3860 mm
x	18a3 3315 mm
y	18a2 2770 mm
*	18a1 2225 mm
◇	12b4 1680 mm
△	12b3 1135 mm
○	12b2 590 mm

decay heat 120% ANS standard
 flooding rate (cold) 5.68 cm/s
 system pressure 1.98 bar
 feedwater temperature 40 deg C



Fig. 428 FEBA: 5x5 ROD BUNDLE, TEST SERIES 4, TEST-No. 261

heat transfer coeff.

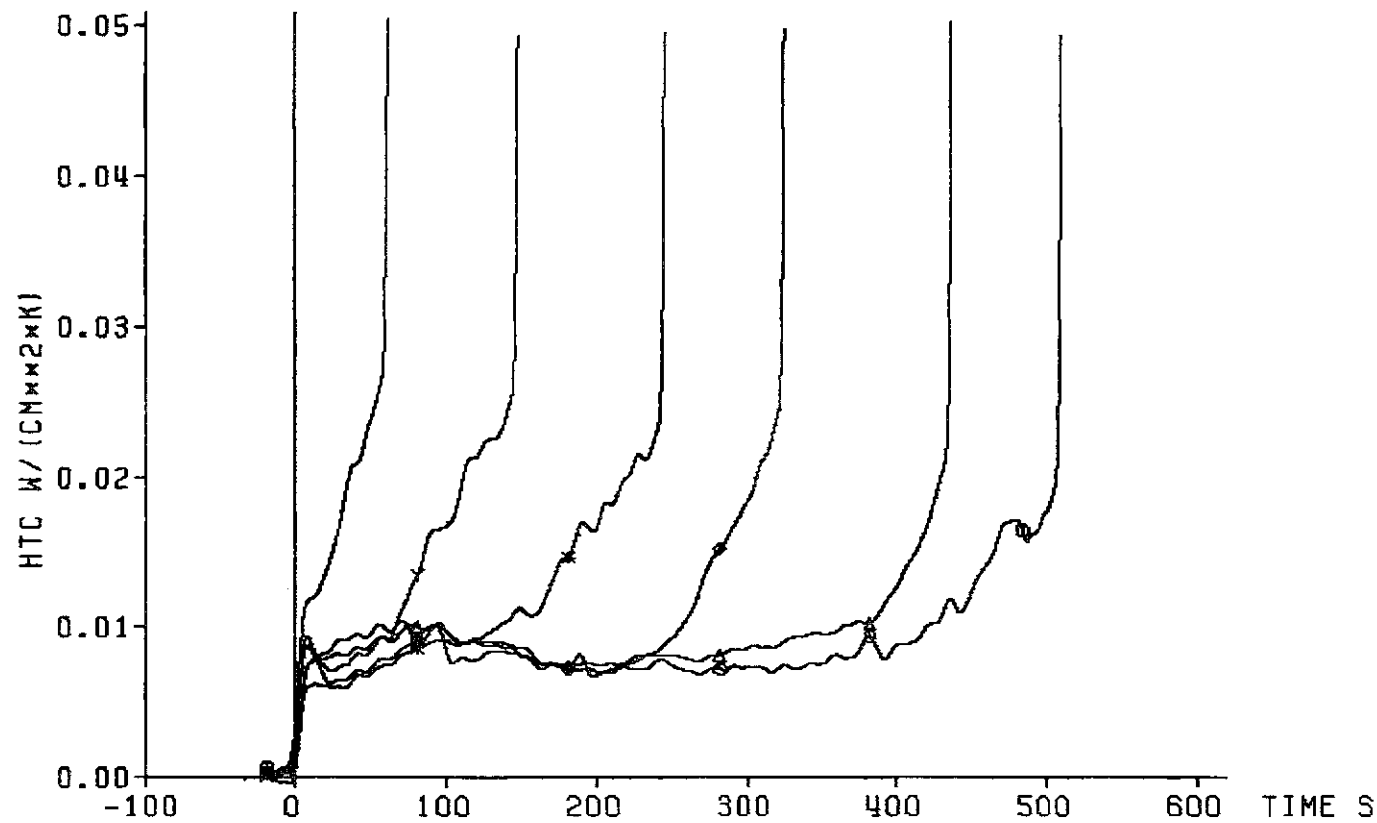

	TC	ax. Level
x	18a3	3315 mm
y	18a2	2770 mm
*	18a1	2225 mm
◇	12b4	1680 mm
△	12b3	1135 mm
○	12b2	590 mm

decay heat 120% ANS standard
 flooding rate (cold) 5.68 cm/s
 system pressure 1.98 bar
 feedwater temperature 40 deg C



Fig. 429 FEBA: 5x5 ROD BUNDLE, TEST SERIES 4, TEST-No. 261

cladding temperature

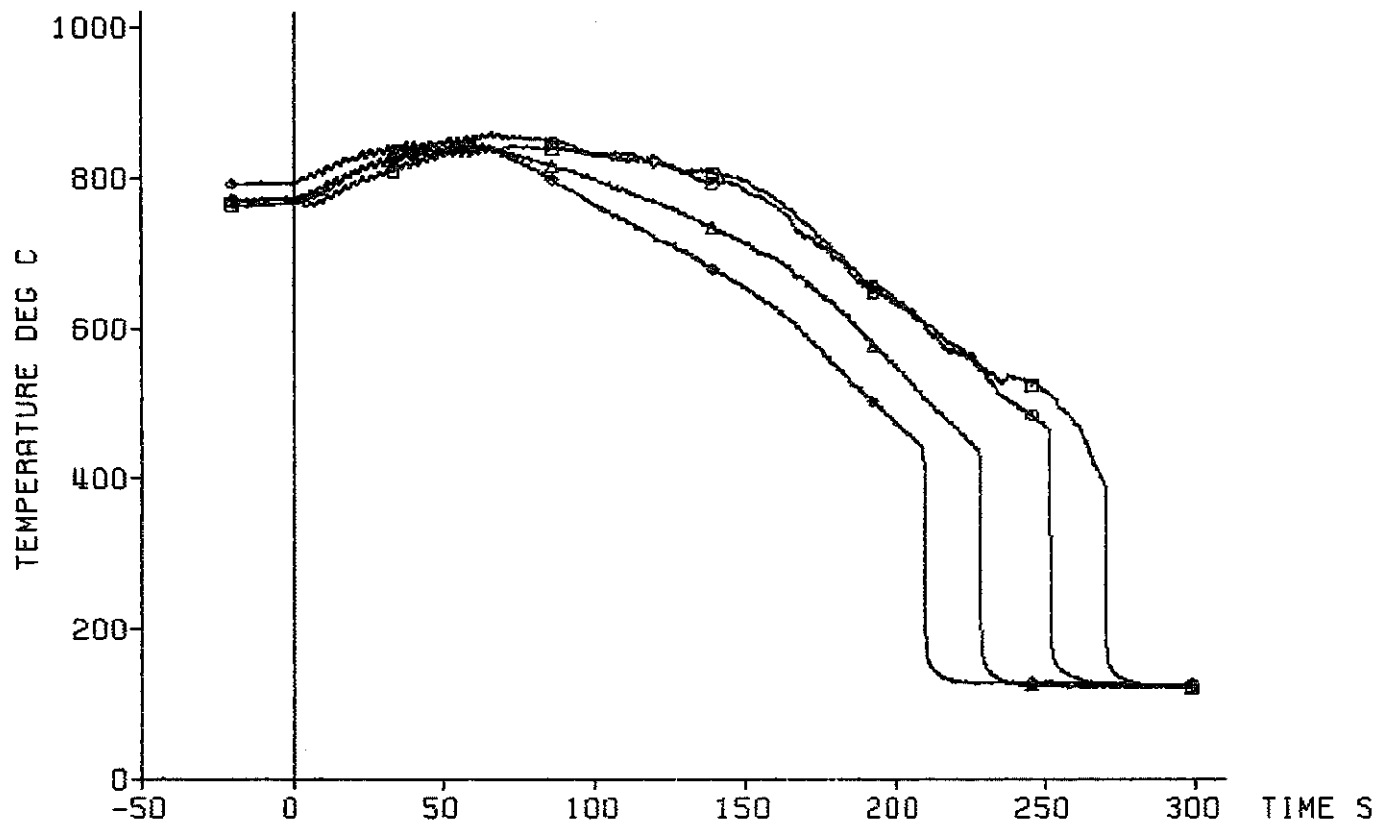

TC	ax. level
◇	7f4 2425 mm
△	7f3 2325 mm
○	9h4 2225 mm
□	9h3 2125 mm

decay heat 120% ANS standard
flooding rate (cold) 5.68 cm/s
system pressure 1.98 bar
feedwater temperature 40 deg C

bypass
=====



Fig. 430 FEBA: 5x5 ROD BUNDLE, TEST SERIES 4, TEST-No. 261

heat transfer coeff.

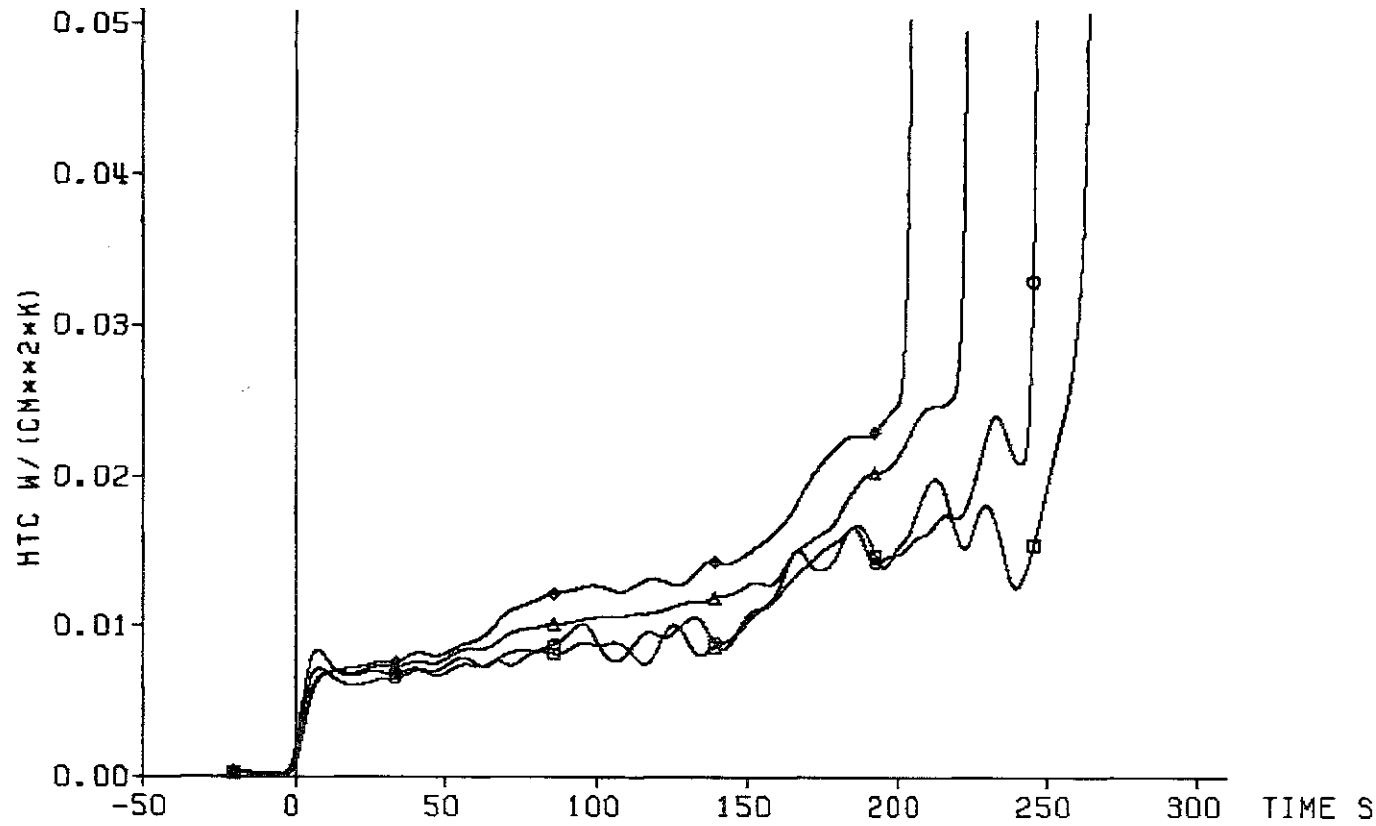

TC	ax. Level
◇	7f4 2425 mm
△	7f3 2325 mm
○	9h4 2225 mm
□	9h3 2125 mm

decay heat 120% ANS standard
 flooding rate (cold) 5.68 cm/s
 system pressure 1.98 bar
 feedwater temperature 40 deg C

bypass
 =====



Fig. 431 FEBA: 5x5 ROD BUNDLE, TEST SERIES 4, TEST-NO. 261

cladding temperature

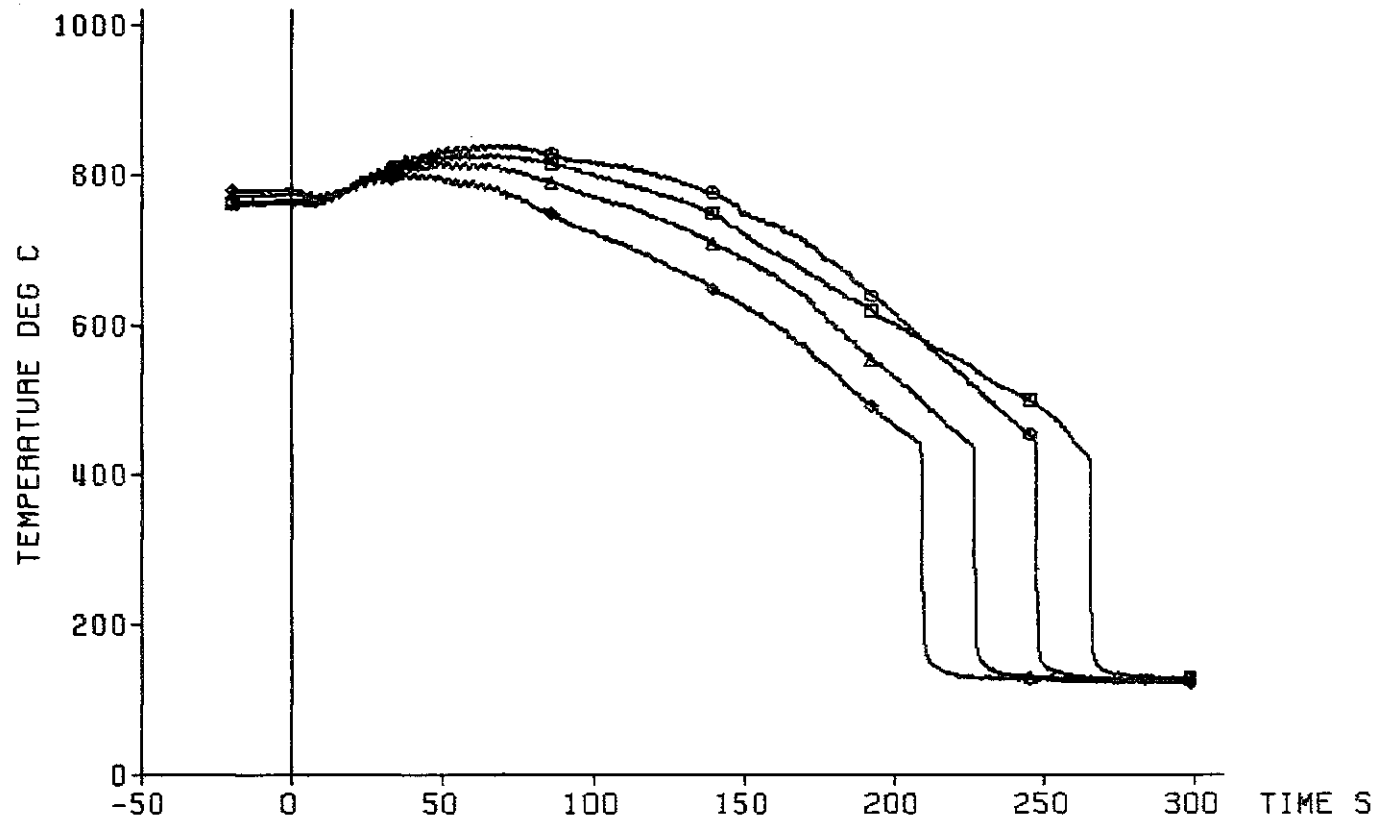

TC	ax. Level
◇ 22f4	2425 mm
△ 22f3	2325 mm
○ 17h4	2225 mm
□ 17h3	2125 mm

decay heat 120% ANS standard
 flooding rate (cold) 5.68 cm/s
 system pressure 1.98 bar
 feedwater temperature 40 deg C

blockage
 =====



Fig. 432 FEBA: 5x5 ROD BUNDLE, TEST SERIES 4, TEST-No. 261

heat transfer coeff.

TC	ax. Level
◇ 22f4	2425 mm
△ 22f3	2325 mm
○ 17h4	2225 mm
□ 17h3	2125 mm

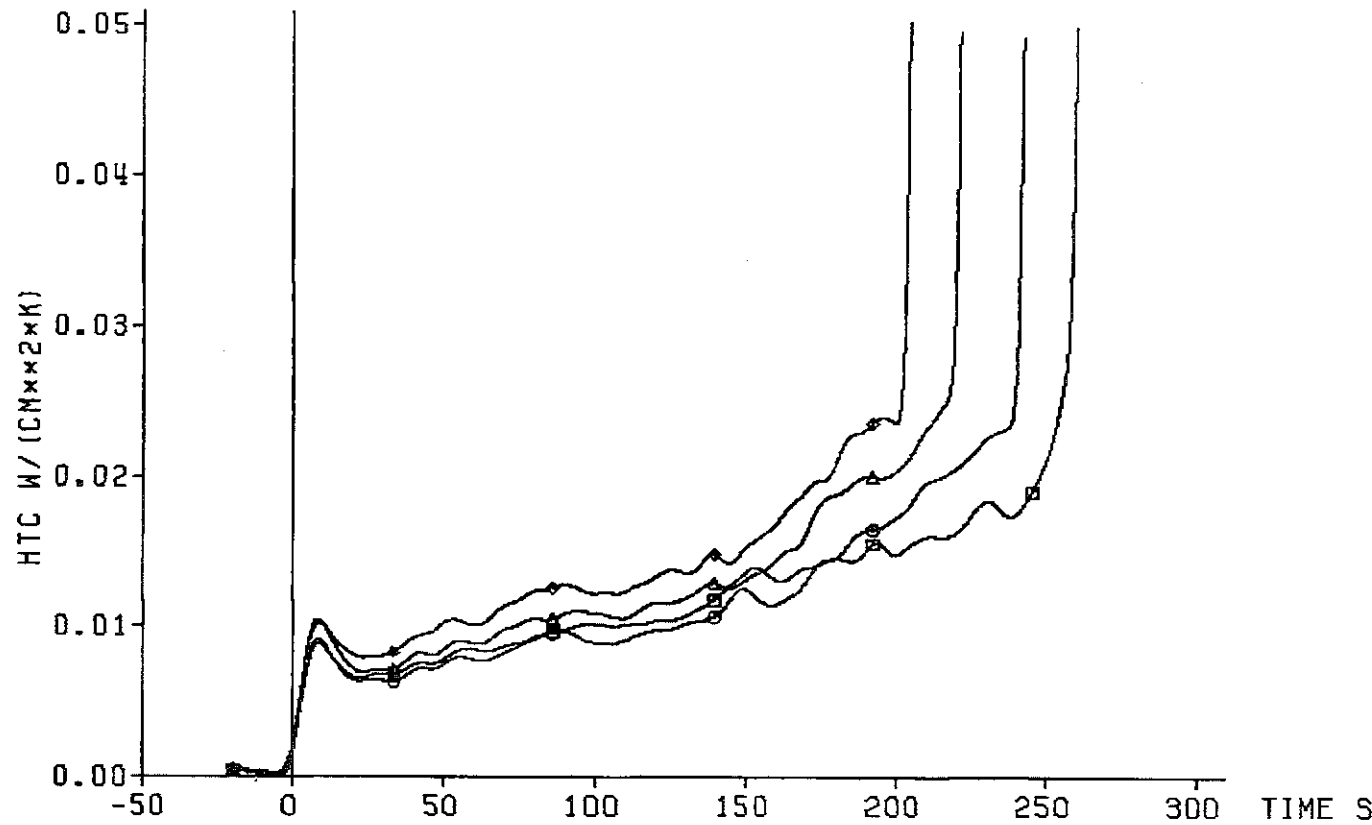

decay heat 120% ANS standard
 flooding rate (cold) 5.68 cm/s
 system pressure 1.98 bar
 feedwater temperature 40 deg C

blockage
 =====



Fig. 433 FEBA: 5x5 ROD BUNDLE, TEST SERIES 4, TEST-No. 261

cladding temperature

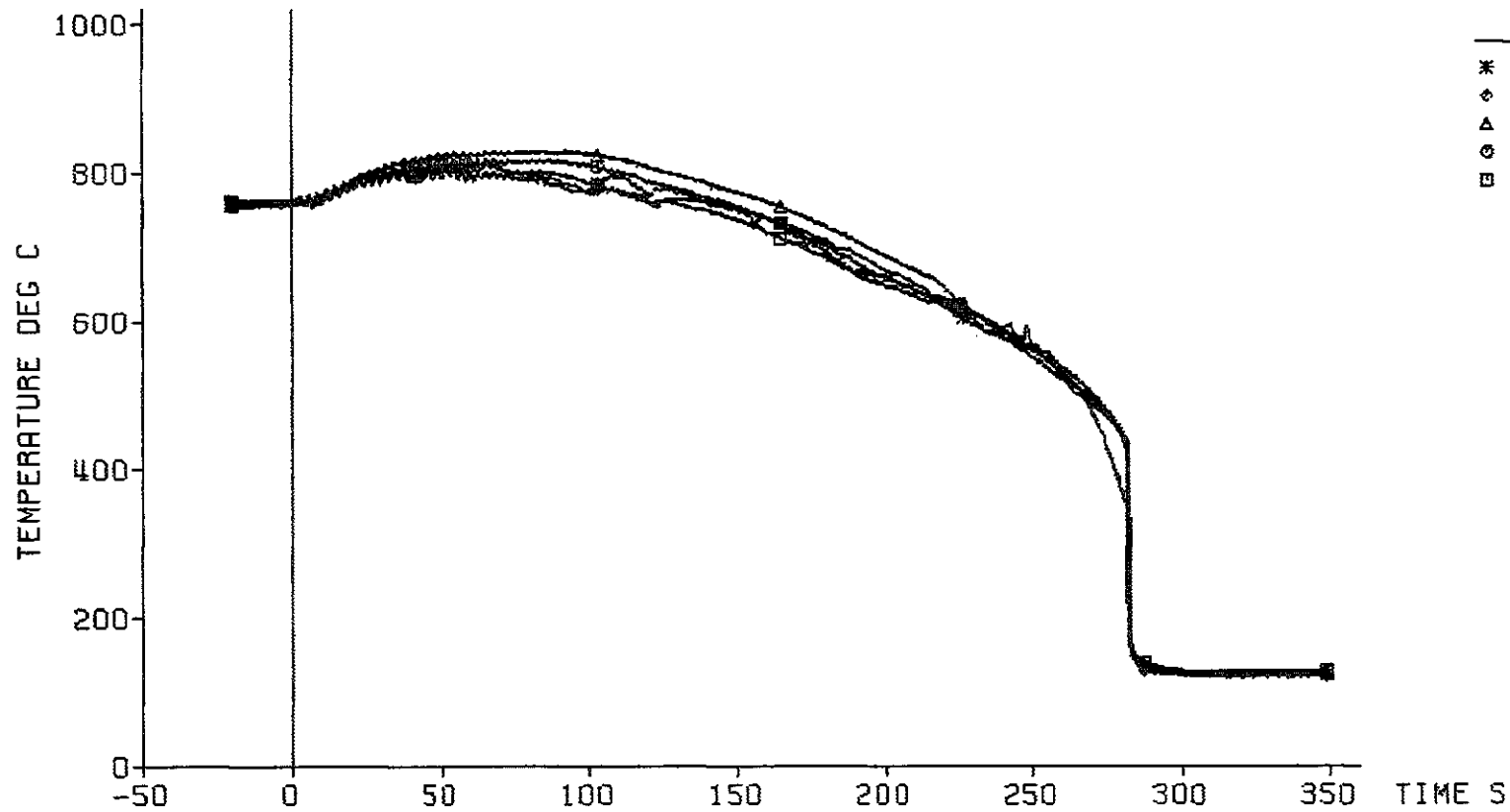

TC	ax. level
* 9h2	2025 mm
◊ 8d4	2025 mm
△ 8d3	2025 mm
○ 8d2	2025 mm
□ 8d1	2025 mm

— 474 —

decay heat 120% ANS standard
 flooding rate (cold) 5.68 cm/s
 system pressure 1.98 bar
 feedwater temperature 40 deg C

bypass
 =====



Fig. 434 FEBA: 5x5 ROD BUNDLE, TEST SERIES 4, TEST-No. 261

heat transfer coeff.

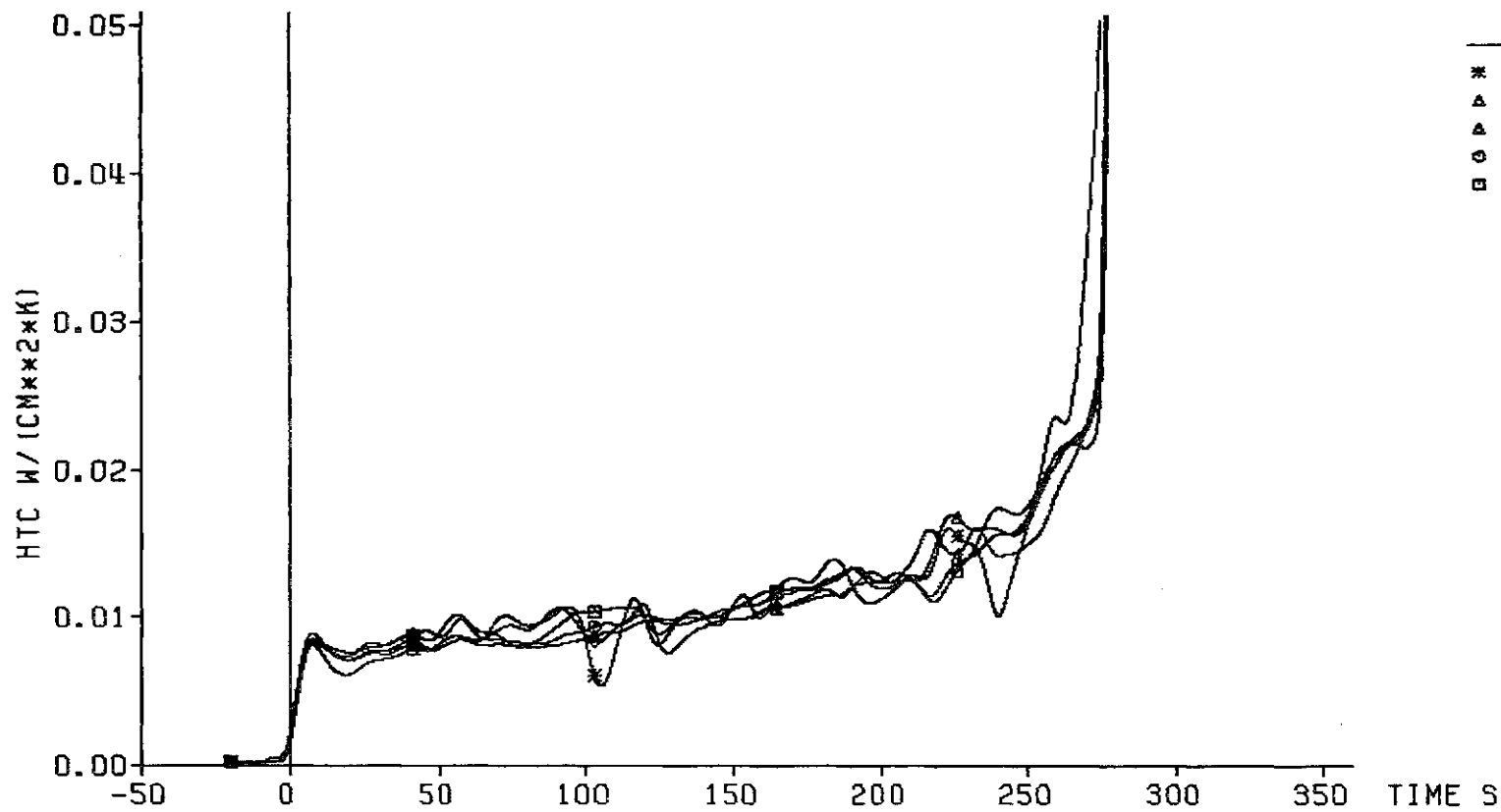

TC	axial level
* 9h2	2025 mm
▲ 8d4	2025 mm
▲ 8d3	2025 mm
○ 8d2	2025 mm
□ 8d1	2025 mm

decay heat 120% ANS standard
 flooding rate (cold) 5.68 cm/s
 system pressure 1.98 bar
 feedwater temperature 40 deg C

bypass
 =====



Fig. 435 FEBA: 5x5 ROD BUNDLE, TEST SERIES 4, TEST-No. 261

cladding temperature

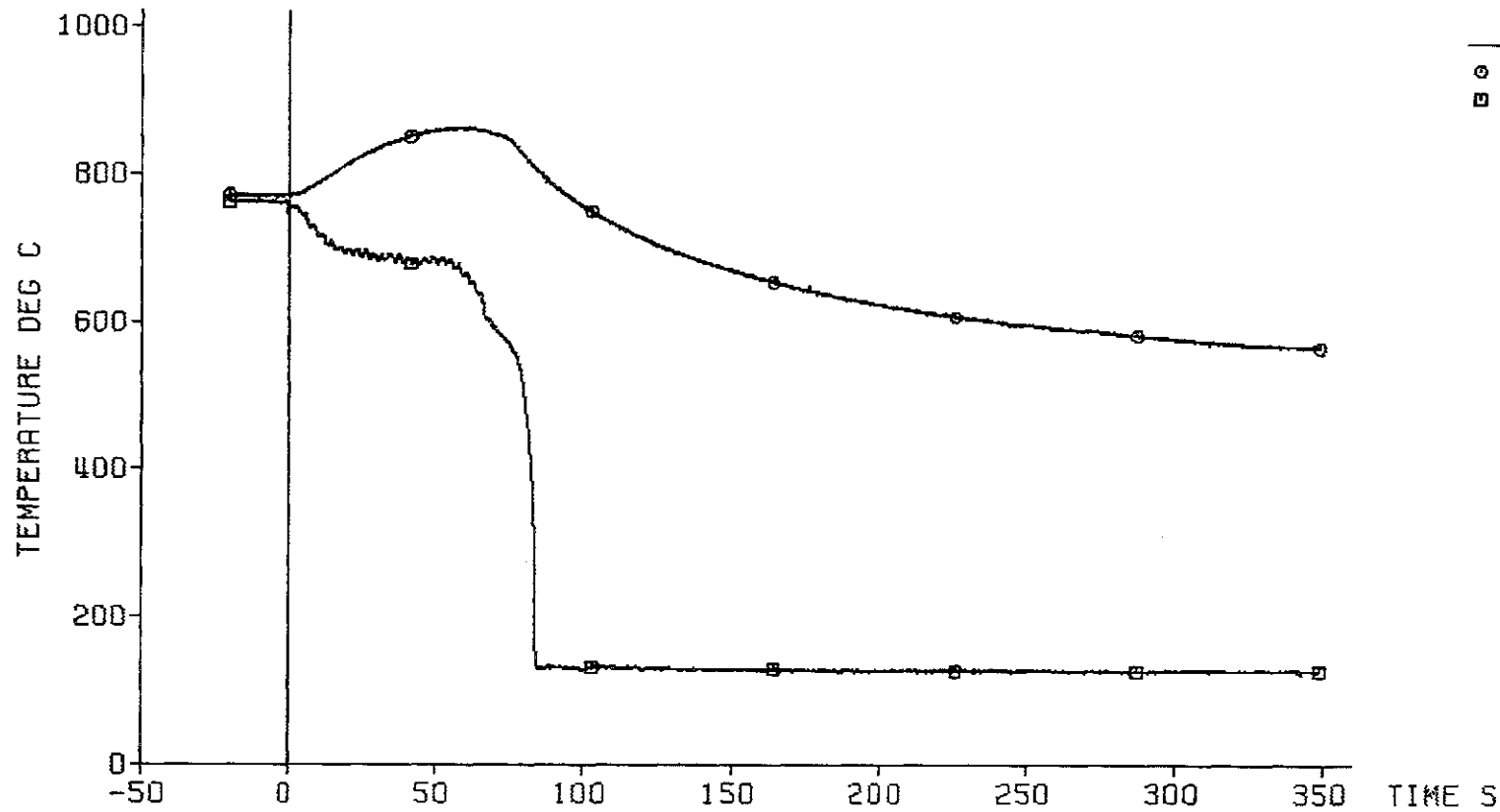

TC	ax. Level
○ 17h2	2025 mm
□ sleeve	2025 mm

decay heat 120% ANS standard
 flooding rate (cold) 5.68 cm/s
 system pressure 1.98 bar
 feedwater temperature 40 deg C

blockage
 =====



Fig. 436 FEBA: 5x5 ROD BUNDLE, TEST SERIES 4, TEST-No. 261

cladding temperature

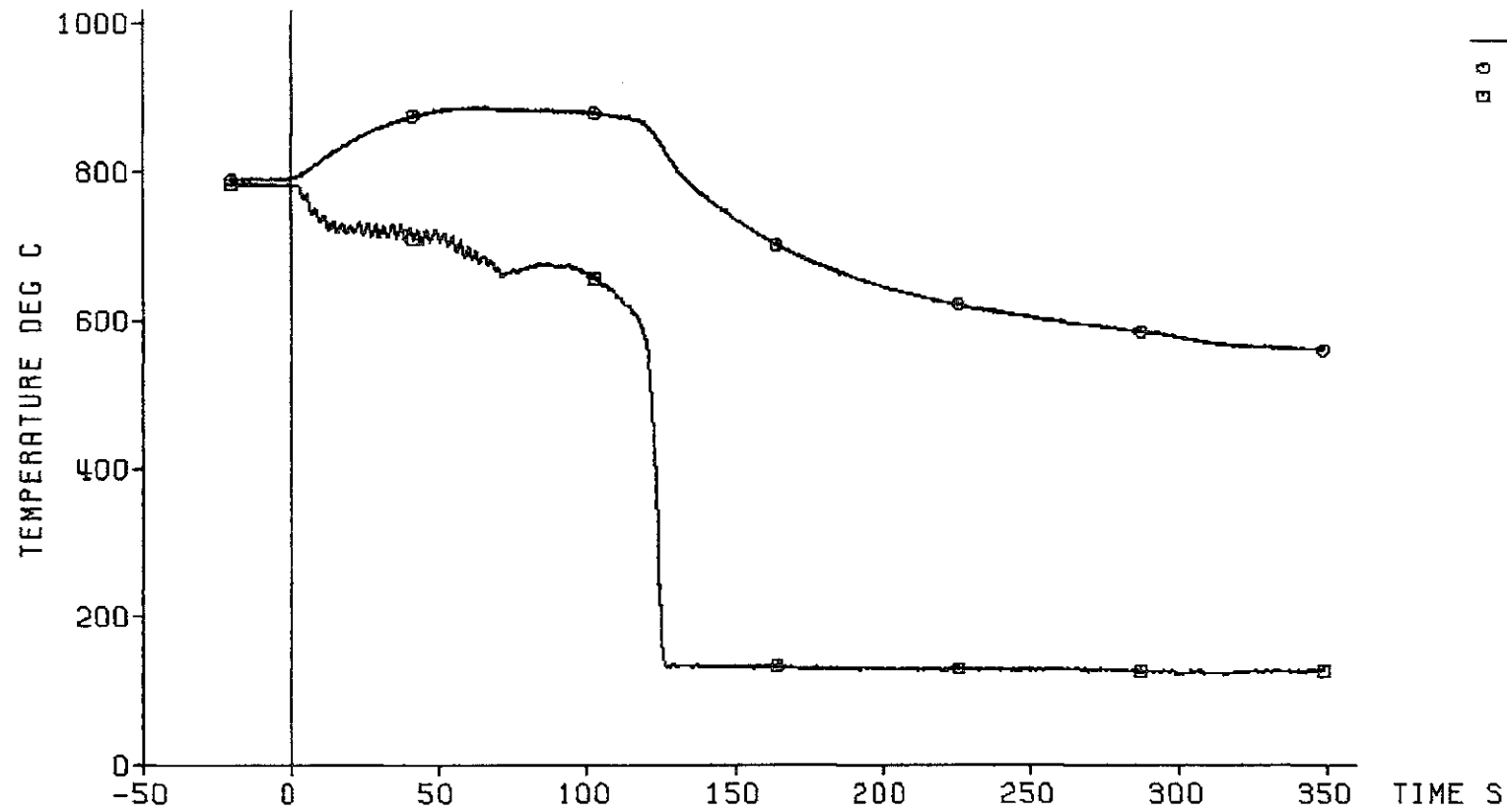

TC	axial level
○ 13d2	2025 mm
□ sleeve	2025 mm

decay heat 120% ANS standard
 flooding rate (cold) 5.68 cm/s
 system pressure 1.98 bar
 feedwater temperature 40 deg C

blockage
=====



Fig. 437 FEBA: 5x5 ROD BUNDLE, TEST SERIES 4, TEST-No. 261

cladding temperature

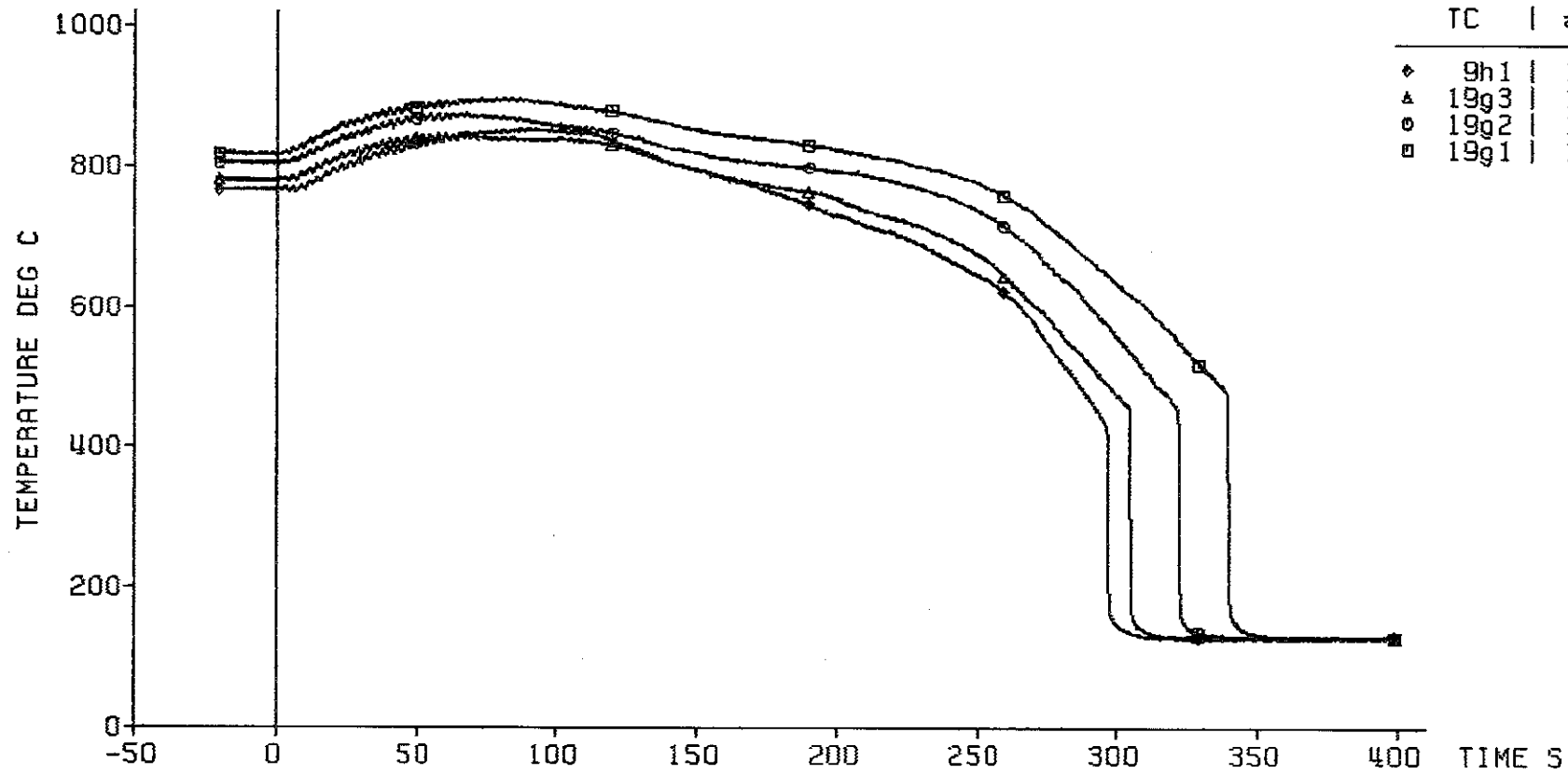

decay heat 120% ANS standard
flooding rate (cold) 5.68 cm/s
system pressure 1.98 bar
feedwater temperature 40 deg C

bypass
=====



Fig. 438 FEBA: 5x5 ROD BUNDLE, TEST SERIES 4, TEST-No. 261

heat transfer coeff.

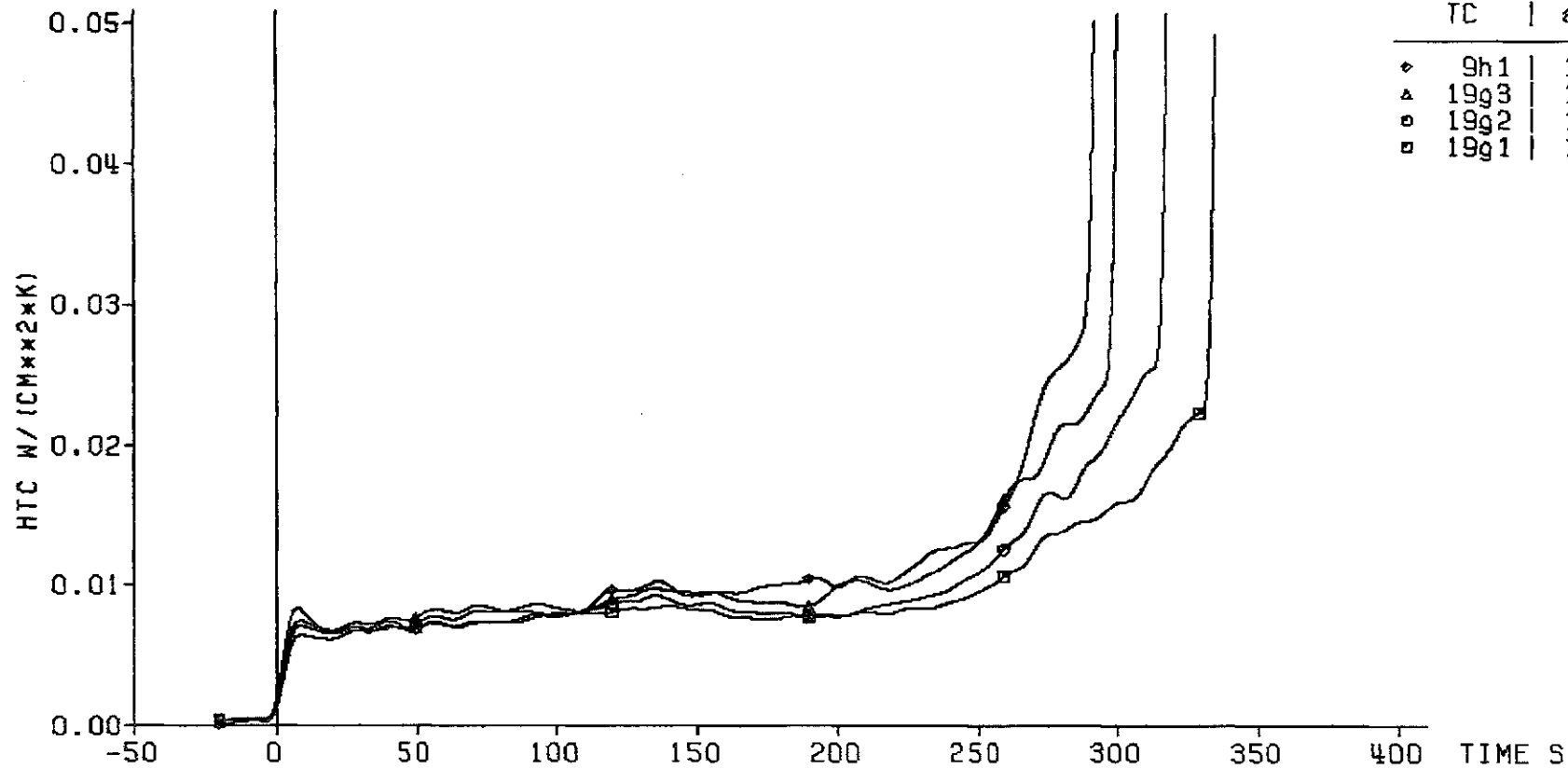

— 479 —

decay heat 120% ANS standard
 flooding rate (cold) 5.68 cm/s
 system pressure 1.98 bar
 feedwater temperature 40 deg C

bypass
 =====



Fig. 439 FEBA: 5x5 ROD BUNDLE, TEST SERIES 4, TEST-NO. 261

cladding temperature

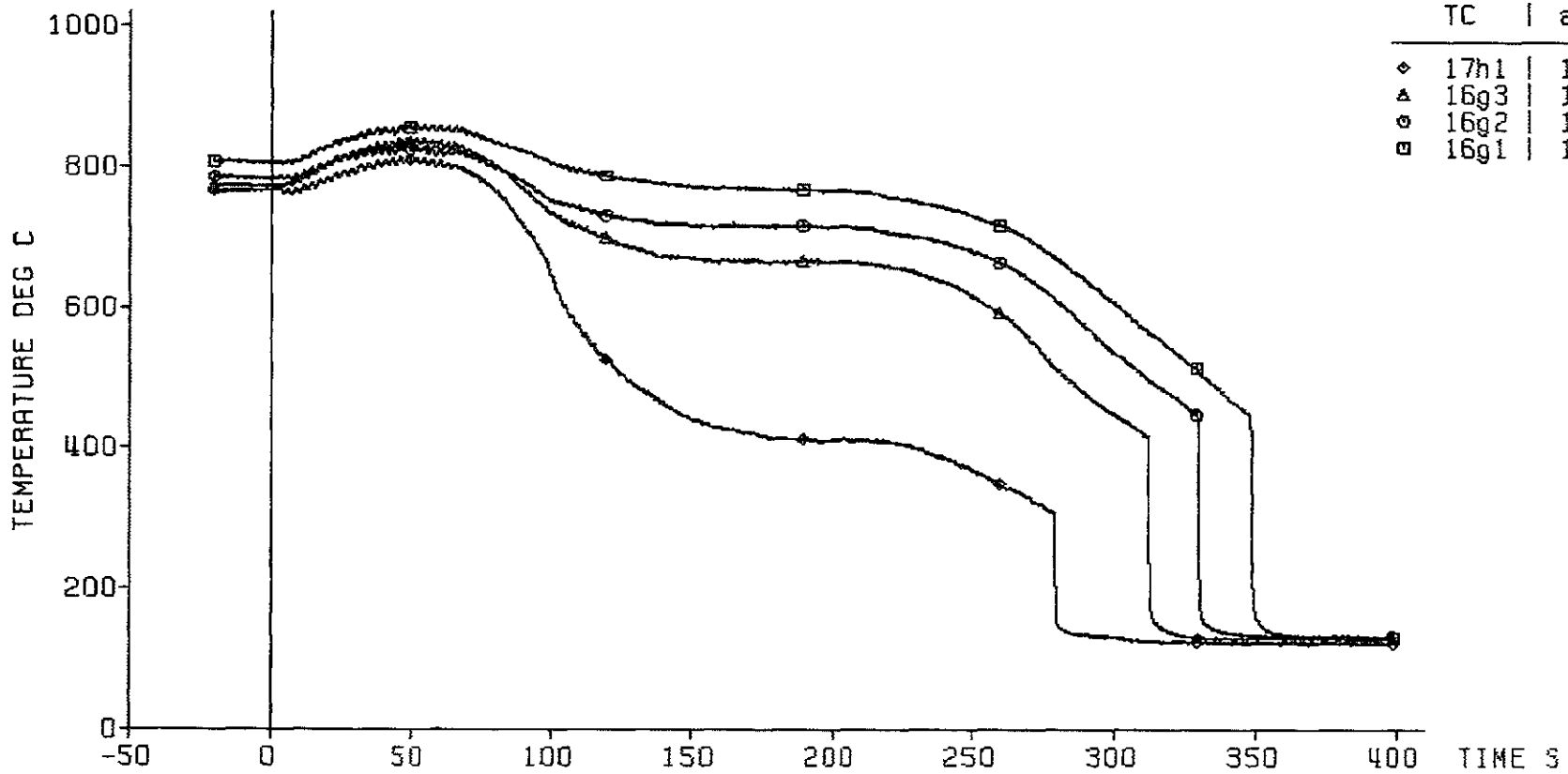

— 480 —

decay heat 120% RMS standard
 flooding rate (cold) 5.68 cm/s
 system pressure 1.98 bar
 feedwater temperature 40 deg C

blockage
 =====



Fig. 440 FEBA: 5x5 ROD BUNDLE, TEST SERIES 4, TEST-No. 261

heat transfer coeff.

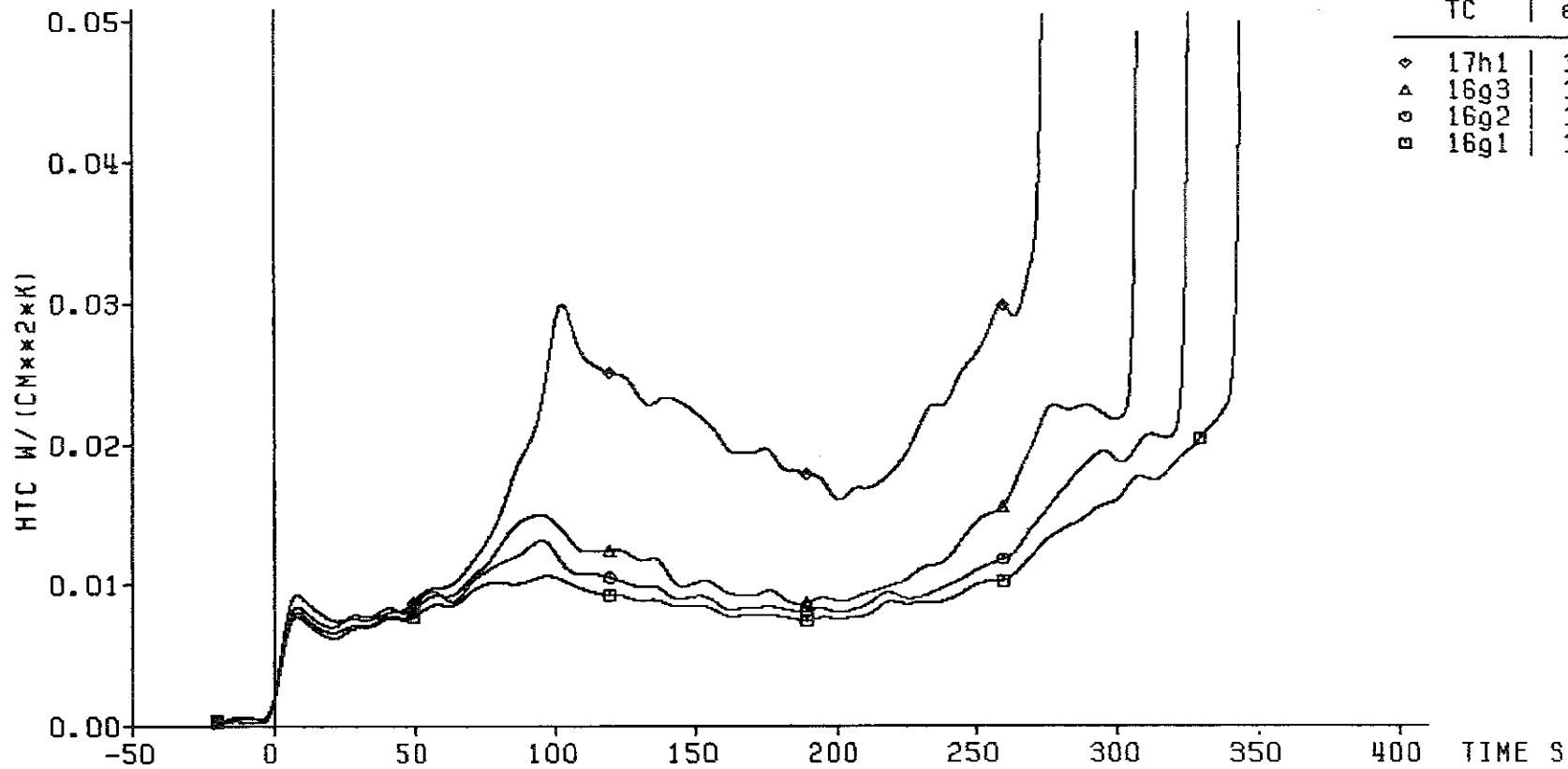

TC	ax. level
◇	17h1 1925 mm
△	16g3 1825 mm
○	16g2 1725 mm
□	16g1 1625 mm

decay heat 120% RNS standard
 flooding rate (cold) 5.68 cm/s
 system pressure 1.98 bar
 feedwater temperature 40 deg C

blockage
 =====

— 481 —



Fig. 441 FEBA: 5x5 ROD BUNDLE, TEST SERIES 4, TEST-No. 261

grid spacer temperature

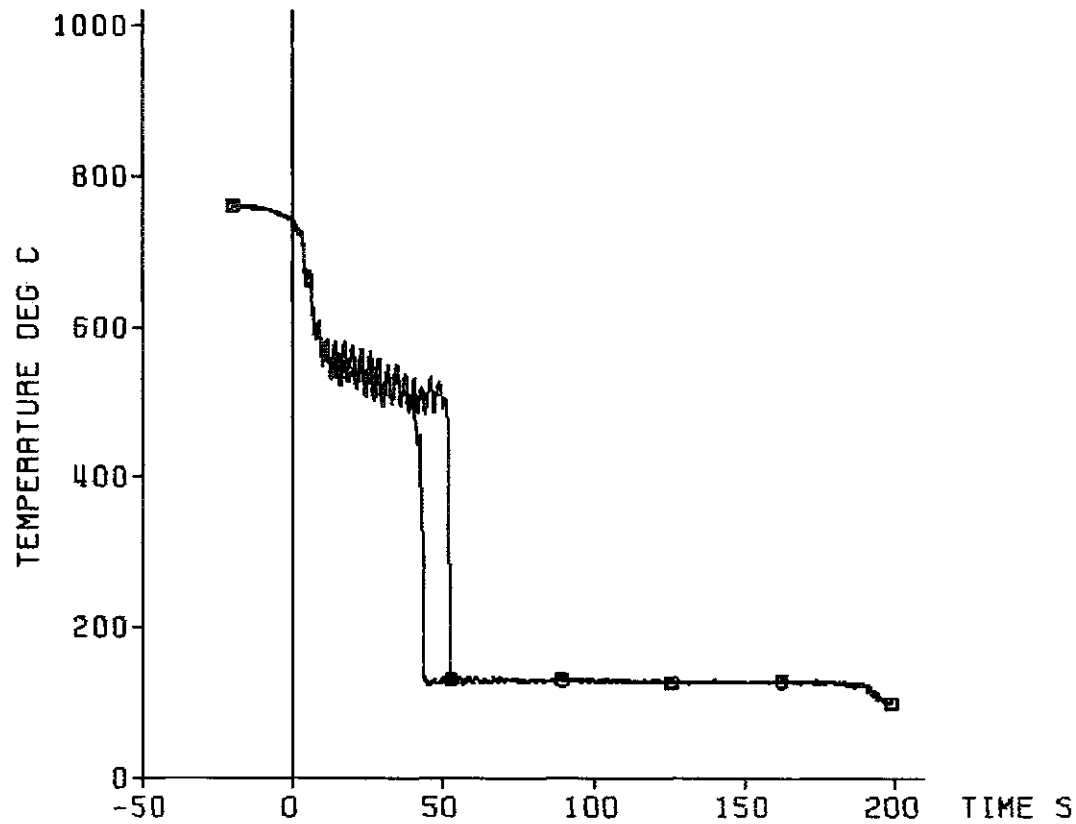

TC	axial level
□ 86	2550 mm
○ 87	2550 mm

decay heat 120% ANS standard
flooding rate (cold) 5.68 cm/s
system pressure 1.98 bar
feedwater temperature 40 deg C

— 482 —



Fig. 442 FEBA: 5x5 R0D BUNDLE, TEST SERIES 4, TEST-No. 261

grid spacer temperature

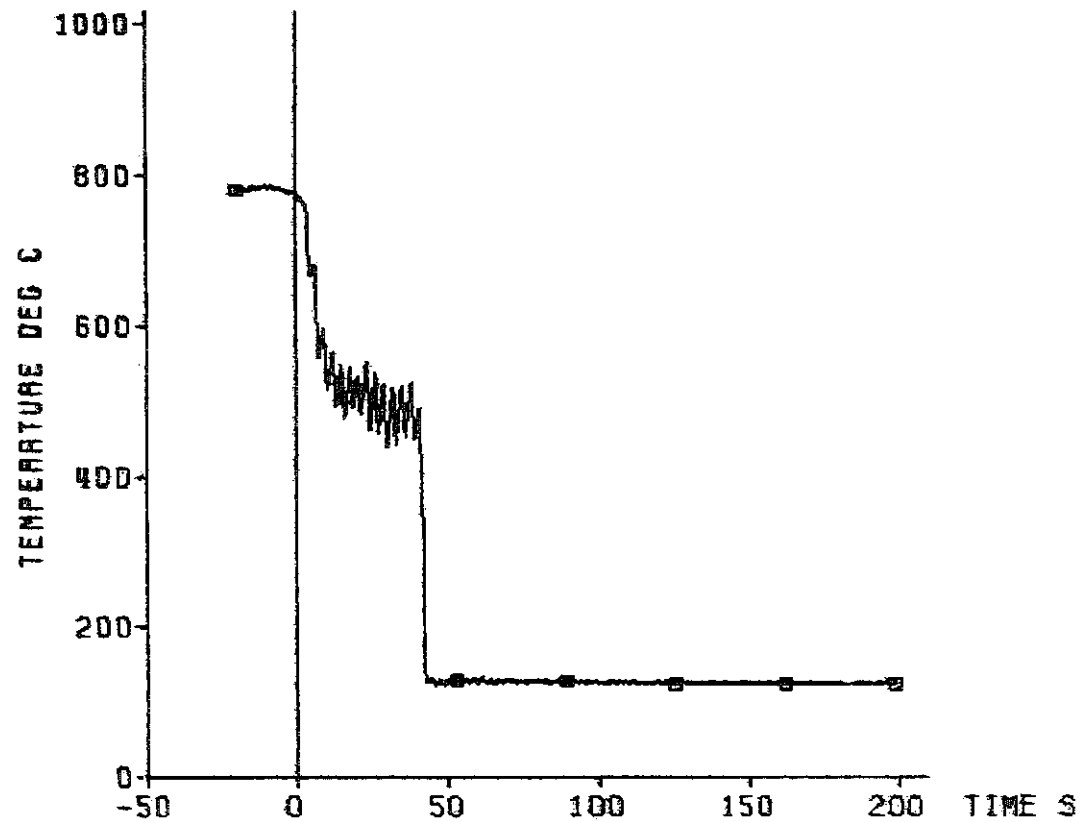

TC	axial level
84	1460 mm

decay heat 120% RNS standard
flooding rate (cold) 5.68 cm/s
system pressure 1.98 bar
feedwater temperature 40 deg C



Fig. 443 FEBA: 5x5 ROD BUNDLE, TEST SERIES 4, TEST-No. 261

axial level: 1825 mm

△ cladding temperature (19g3)
○ fluid temperature

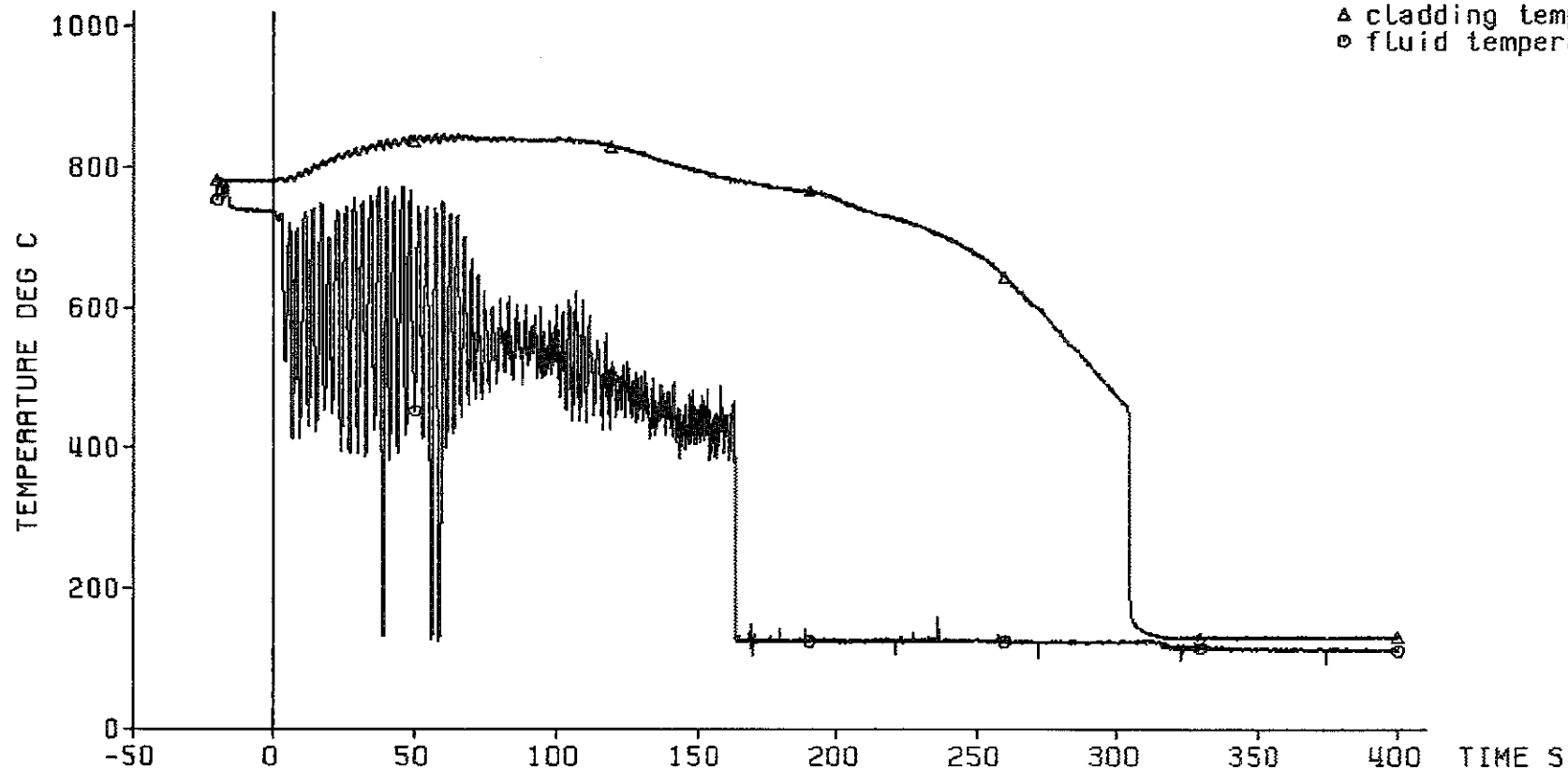

decay heat 120% ANS standard
flooding rate (cold) 5.68 cm/s
system pressure 1.98 bar
feedwater temperature 40 deg C

bypass
=====

KJK
IRB

Fig. 444 FEBA: 5x5 ROD BUNDLE, TEST SERIES 4, TEST-NO. 261

axial level: 1825 mm

▲ cladding temperature (16g3)
○ fluid temperature

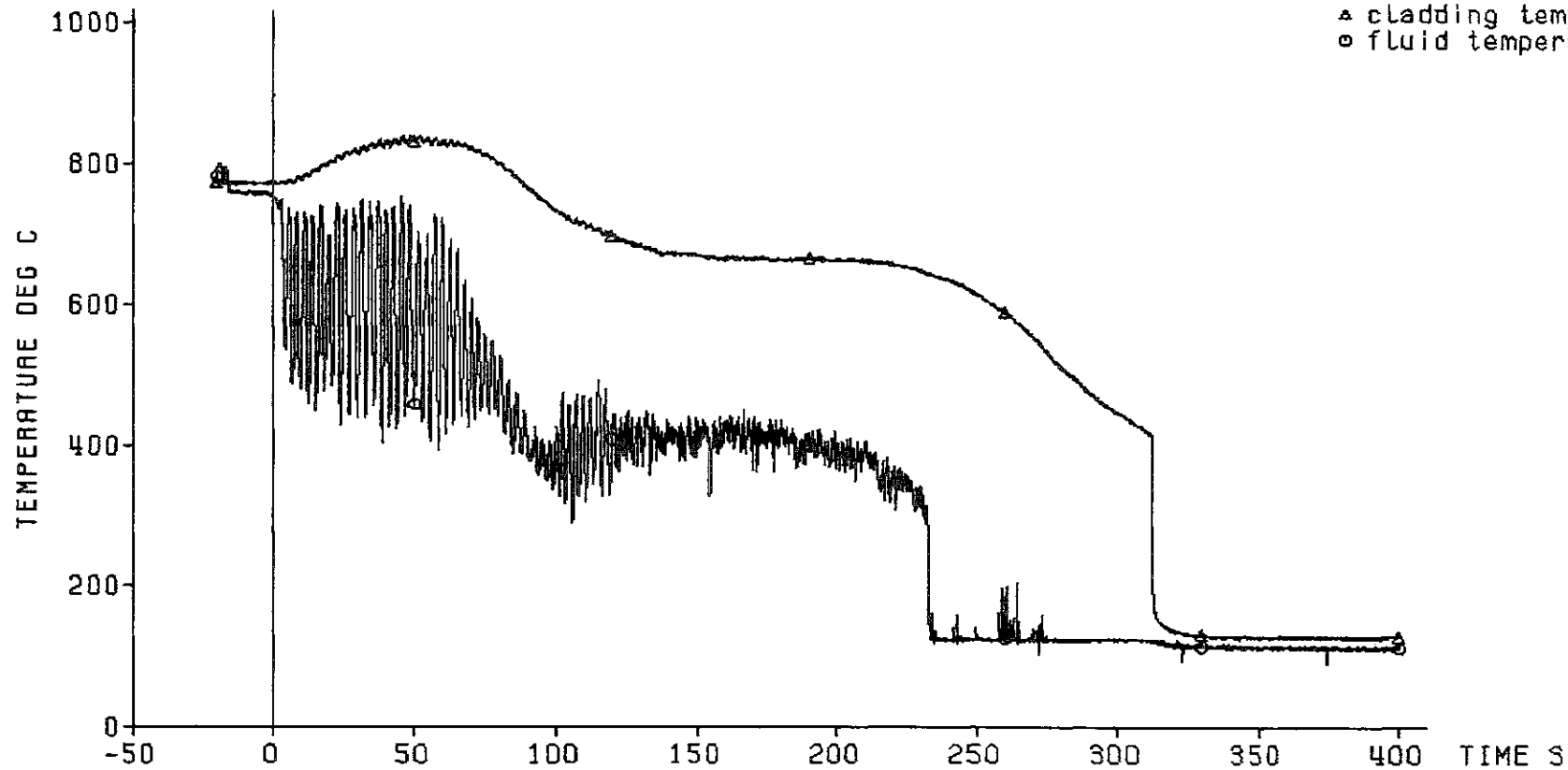

— 485 —

decay heat 120% ANS standard
flooding rate (cold) 5.68 cm/s
system pressure 1.98 bar
feedwater temperature 40 deg C

blockage
=====

KfK
IRB

Fig. 445 FEBA: 5x5 ROD BUNDLE, TEST SERIES 4, TEST-No. 261

axial level: 1725 mm

▲ cladding temperature (19g2)
○ fluid temperature
□ housing temperature

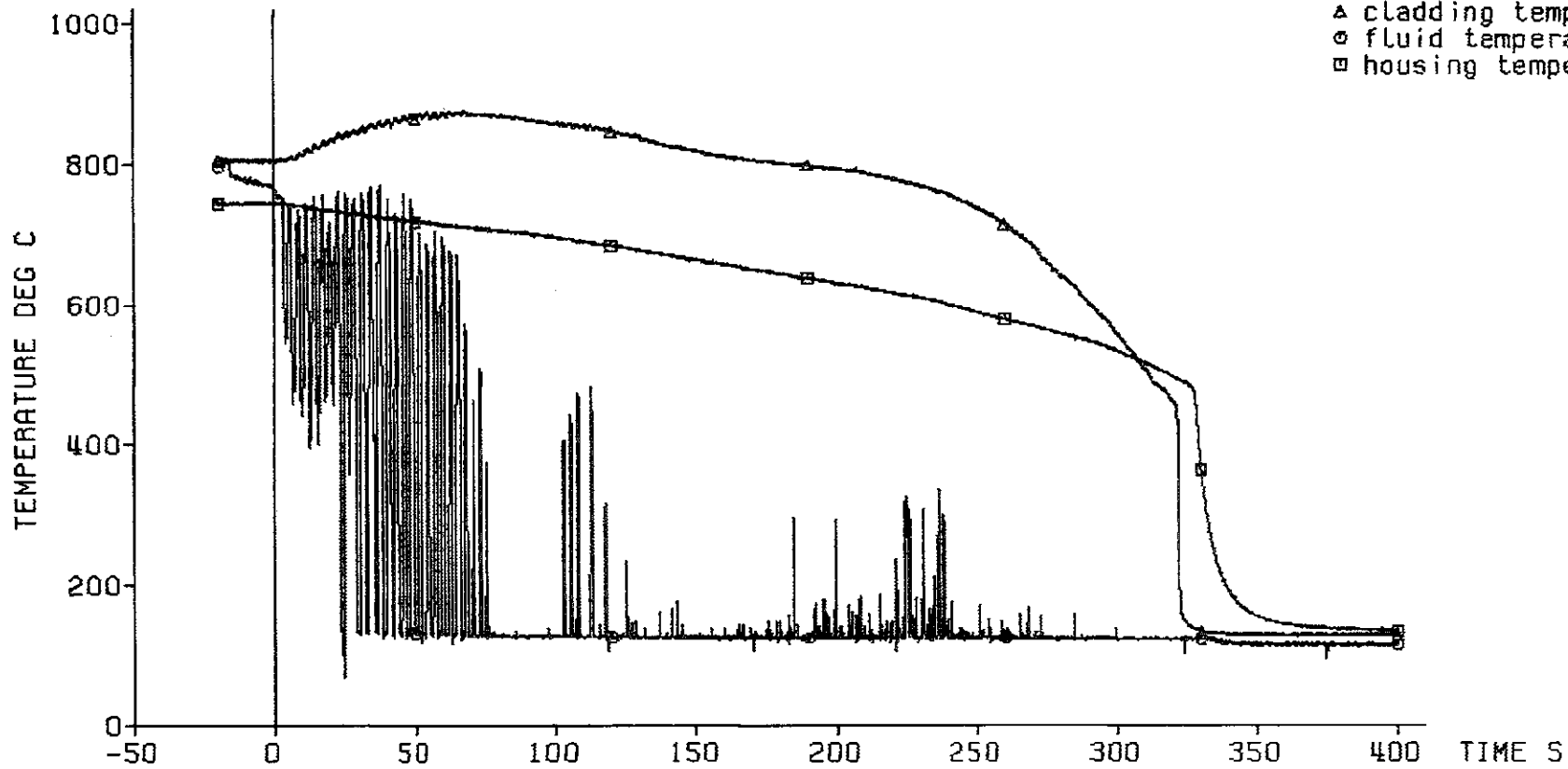

decay heat 120% ANS standard
flooding rate (cold) 5.68 cm/s
system pressure 1.98 bar
feedwater temperature 40 deg C

bypass
=====

KTRB

Fig. 446 FEBA: 5x5 ROD BUNDLE, TEST SERIES 4, TEST-No. 261

pressure loss
along the test section:

- ◆ total length: 4196 mm
- ▲ lower part: 1711 mm
- middle part: 545 mm
- upper part: 1940 mm

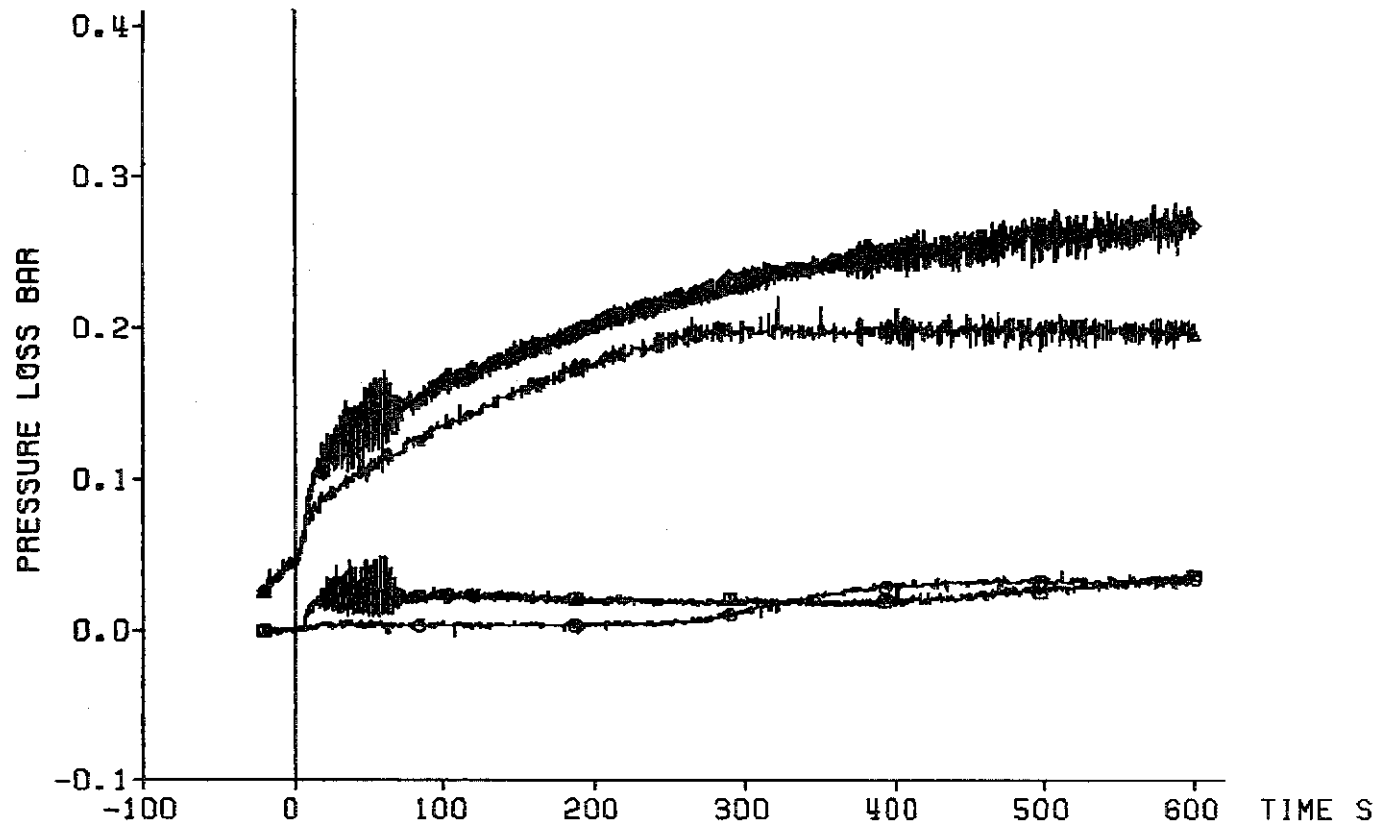

decay heat 120% RNS standard
flooding rate (cold) 5.68 cm/s
system pressure 1.98 bar
feedwater temperature 40 deg C

KIK
IRB

Fig. 447 FEBA: 5x5 ROD BUNDLE, TEST SERIES 4, TEST-No. 261

coolant outlet conditions:

- △ water carry over
- coolant temperature
- coolant pressure

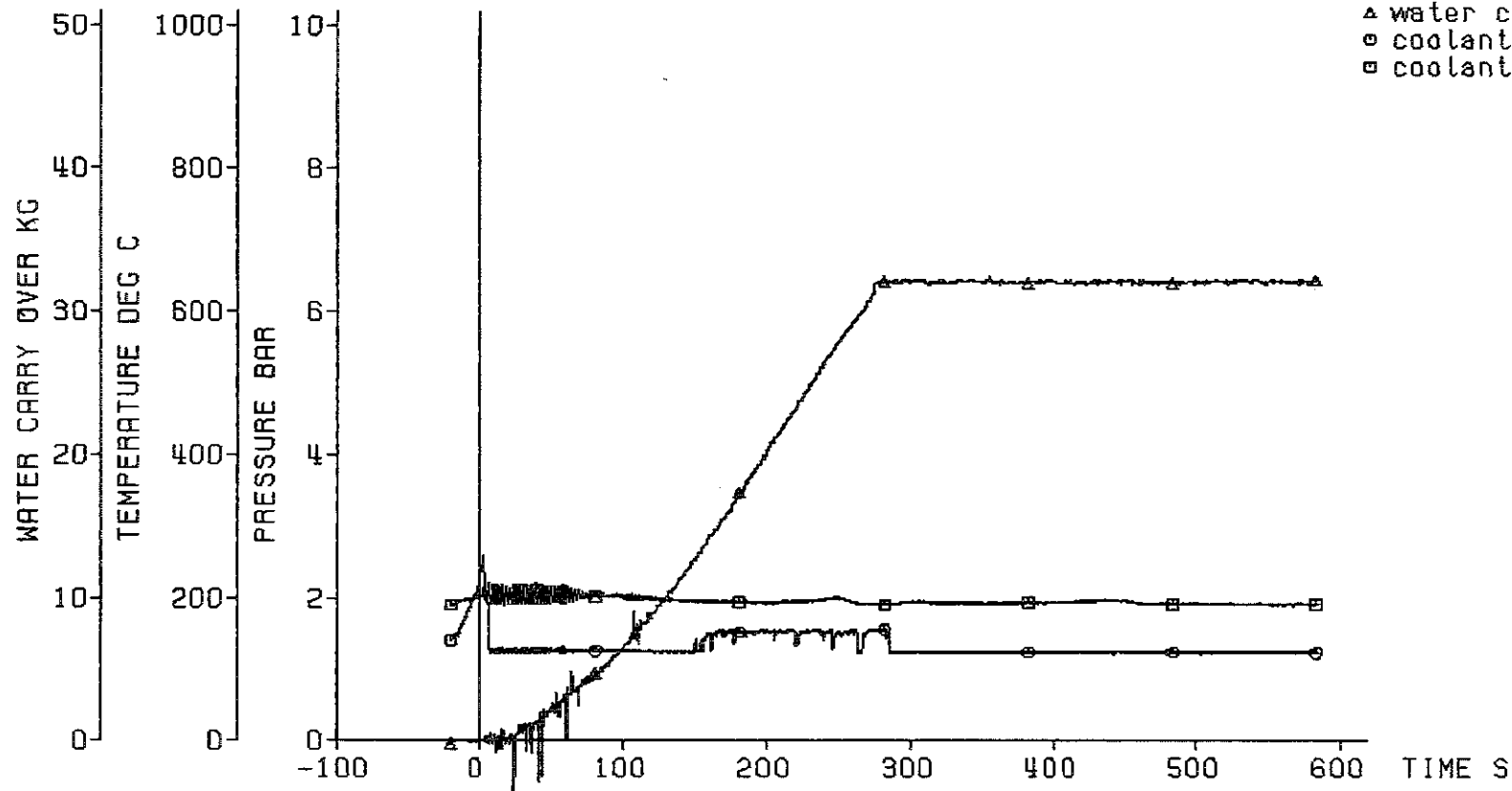

decay heat 120% ANS standard
flooding rate (cold) 5.68 cm/s
system pressure 1.98 bar
feedwater temperature 40 deg C



Fig. 448 FEBA: 5x5 ROD BUNDLE, TEST SERIES 4, TEST-No. 261

axial position of the quench front

- ▣ rewetting of the sleeve at the bundle midplane
- x rewetting of the rod downstream of the blockage

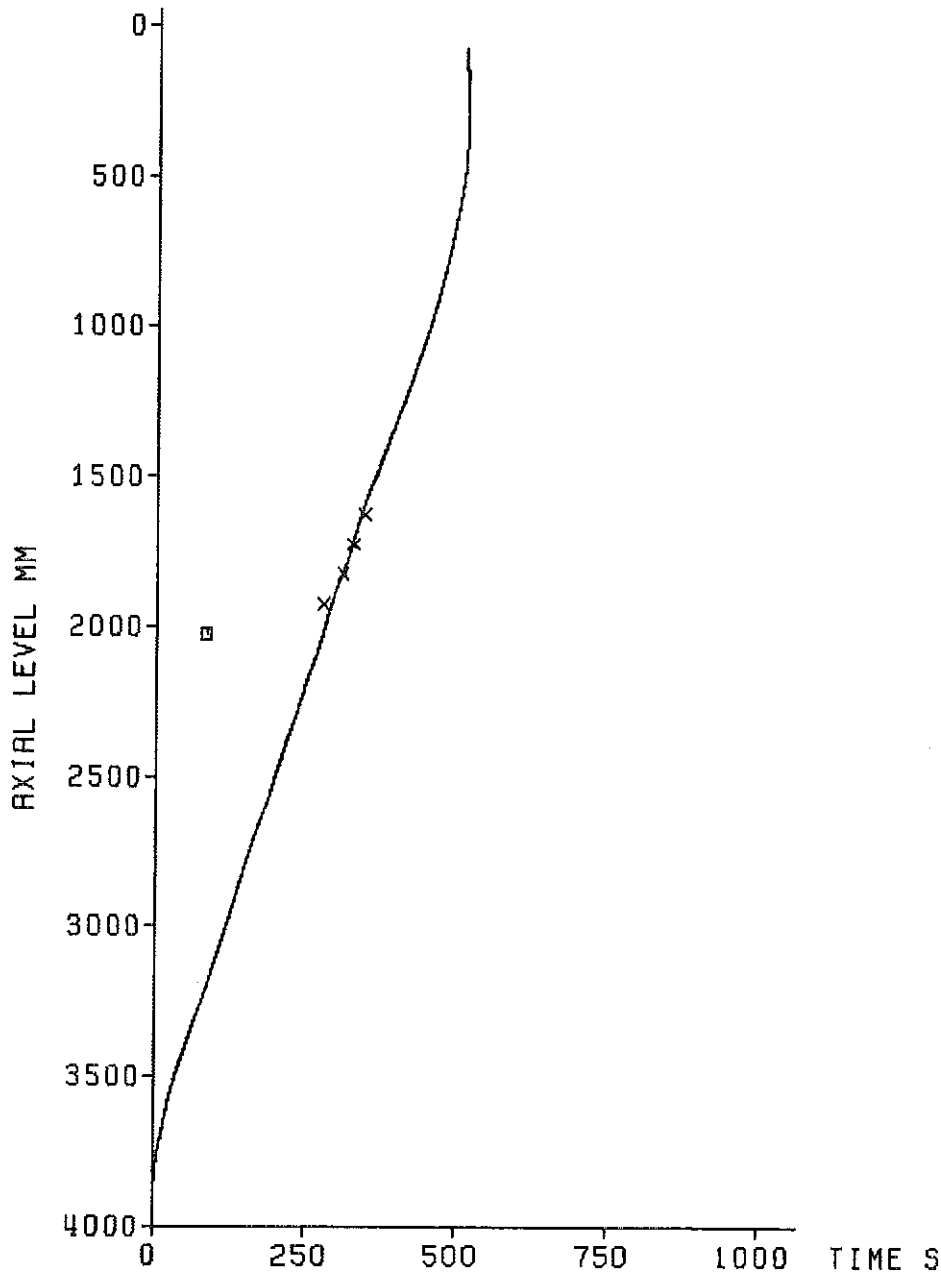

decay heat	120% ANS standard
flooding rate (cold)	5.68 cm/s
system pressure	1.98 bar
feedwater temperature	40 deg C



Fig. 449 FEBA: 5x5 ROD BUNDLE
TEST SERIES 4, TEST-No. 261

Initial axial temperature profile of the cladding

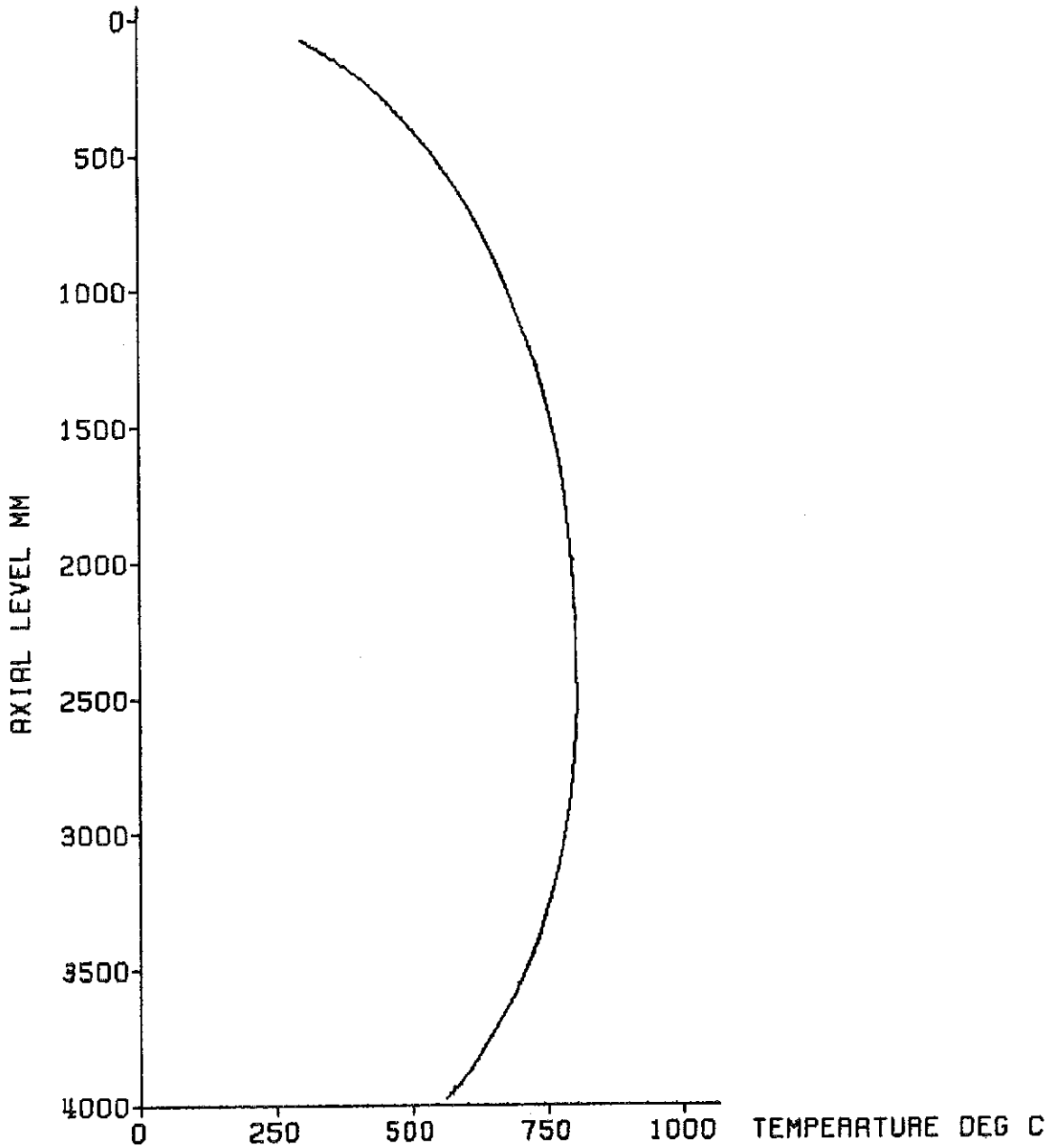

decay heat	120% ANS standard
flooding rate (cold)	5.80 cm/s
system pressure	3.89 bar
feedwater temperature	40 deg C



Fig. 450 FEBA: 5x5 ROD BUNDLE
TEST SERIES 4, TEST-NO. 264

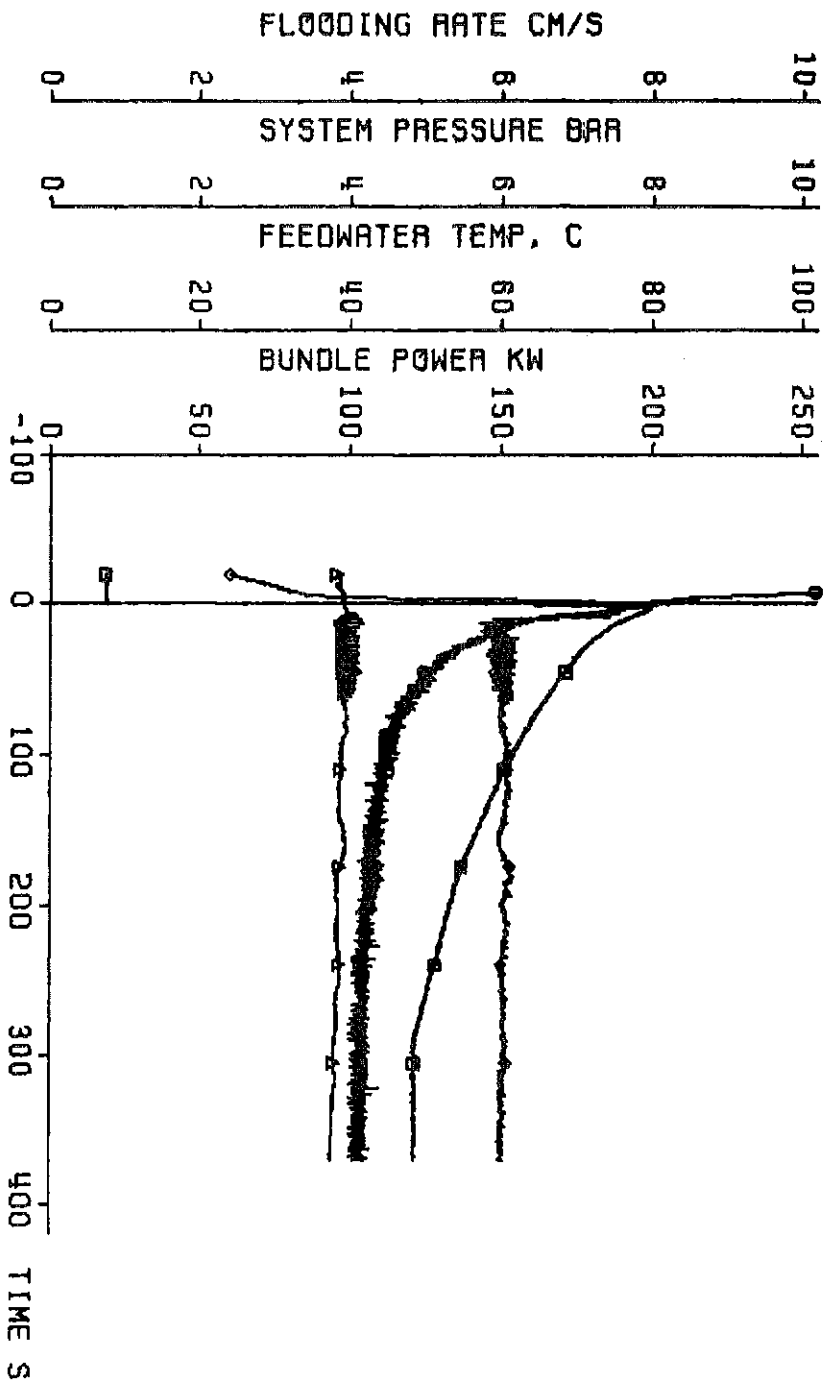

test parameters:

- ◆ flooding rate
- ▲ system pressure
- feedwater temperature
- bundle power

decay heat
 flooding rate (cold)
 system pressure
 feedwater temperature

120% RNS standard
 5.80 cm/s
 3.89 bar
 40 deg C



Fig. 451 FEBRA: 5x5 ROD BUNDLE, TEST SERIES 4, TEST-NO. 264

cladding temperature

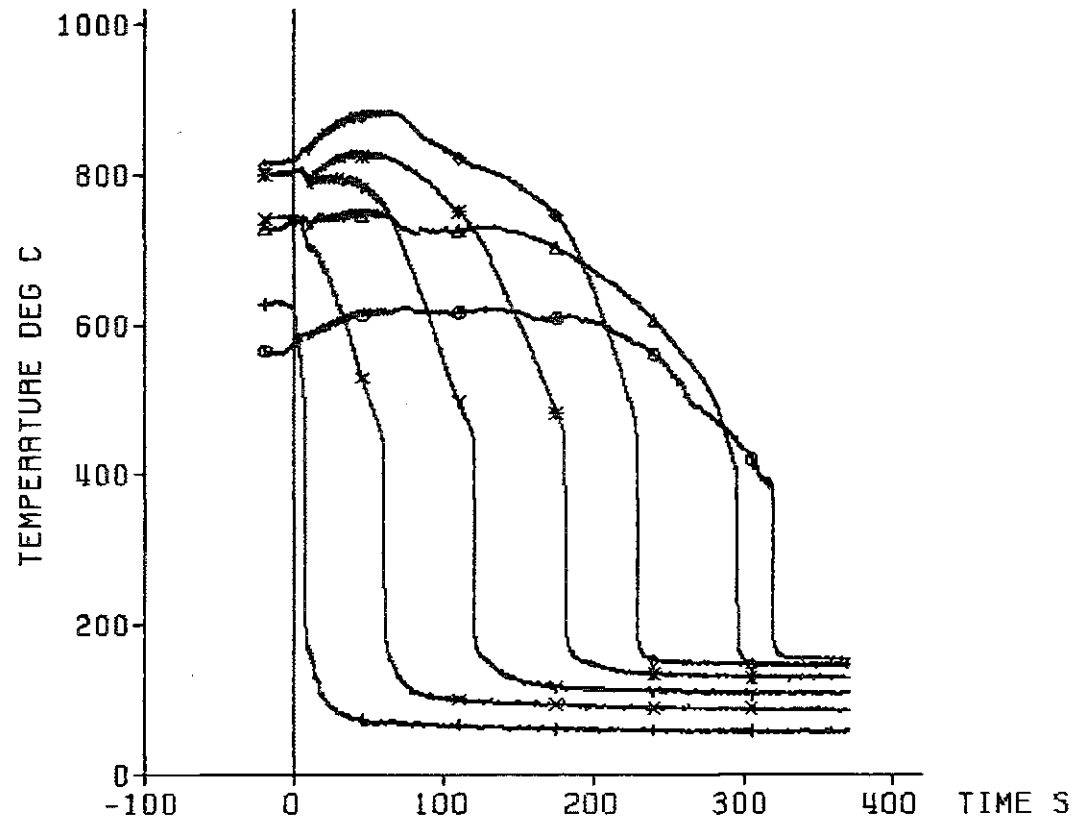

	TC	ax. Level
+	18a4	3860 mm
x	18a3	3315 mm
Y	18a2	2770 mm
*	18a1	2225 mm
◇	12b4	1680 mm
△	12b3	1135 mm
○	12b2	590 mm

decay heat 120% ANS standard
 flooding rate (cold) 5.80 cm/s
 system pressure 3.89 bar
 feedwater temperature 40 deg C



Fig. 452 FEBA: 5x5 ROD BUNDLE, TEST SERIES 4, TEST-No. 264

heat transfer coeff.

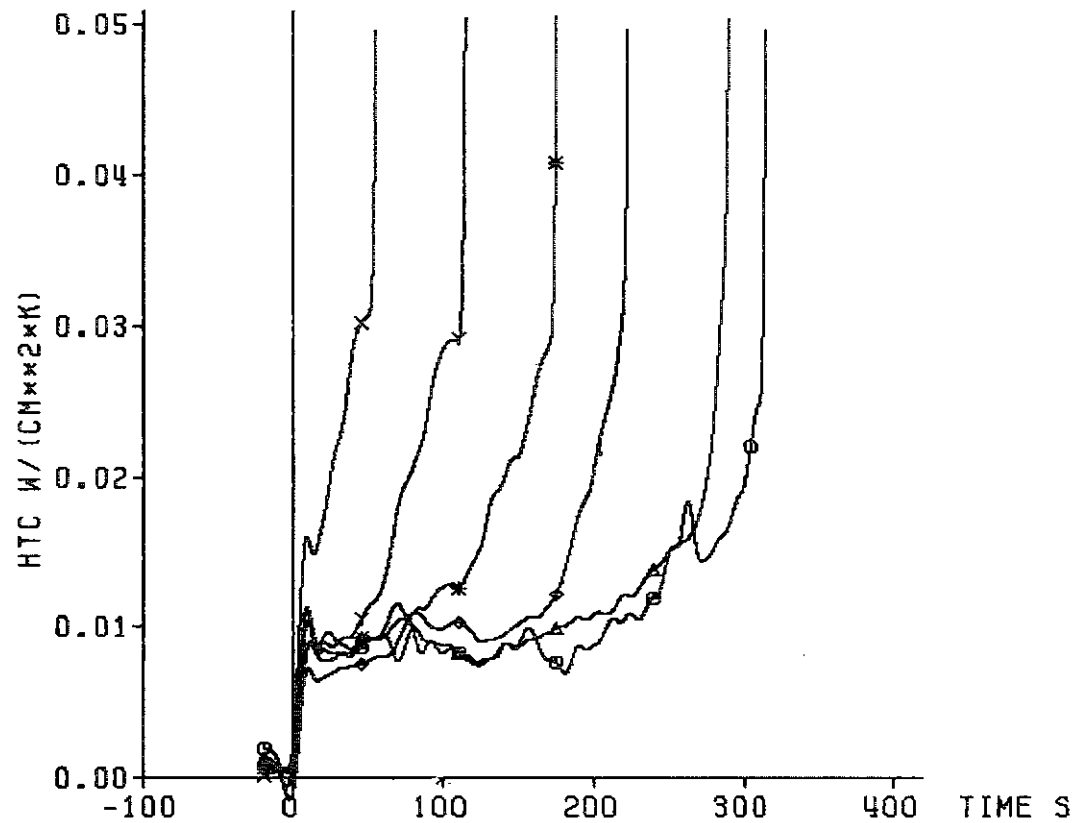

	TC	ax. Level
x	18a3	3315 mm
y	18a2	2770 mm
*	18a1	2225 mm
◇	12b4	1680 mm
△	12b3	1135 mm
○	12b2	590 mm

decay heat 120% ANS standard
 flooding rate (cold) 5.80 cm/s
 system pressure 3.89 bar
 feedwater temperature 40 deg C



Fig. 453 FEBA: 5x5 ROD BUNDLE, TEST SERIES 4, TEST-No. 264

cladding temperature

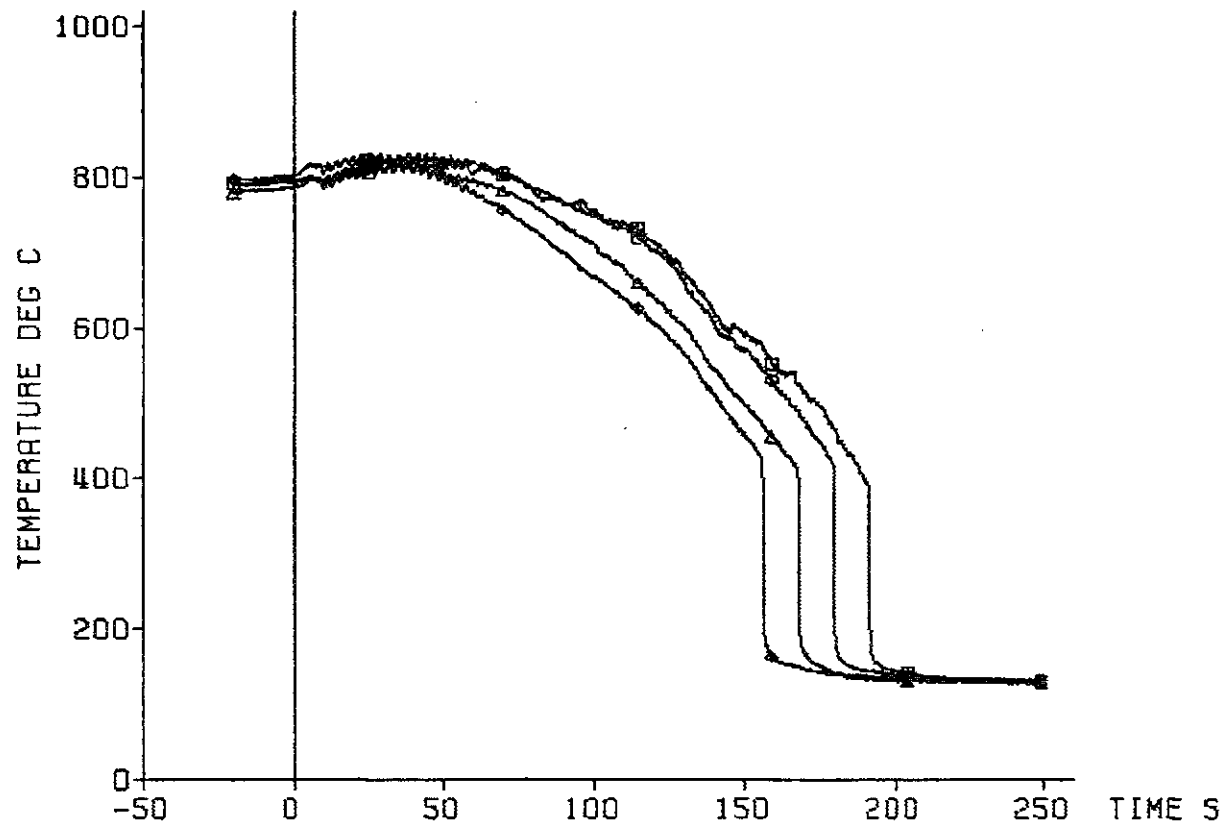

TC	ax. level
◇ 7f4	2425 mm
△ 7f3	2325 mm
○ 9h4	2225 mm
□ 9h3	2125 mm

decay heat 120% ANS standard
 flooding rate (cold) 5.80 cm/s
 system pressure 3.89 bar
 feedwater temperature 40 deg C

bypass
=====



Fig. 454 FEBA: 5x5 ROD BUNDLE, TEST SERIES 4, TEST-No. 264

heat transfer coeff.

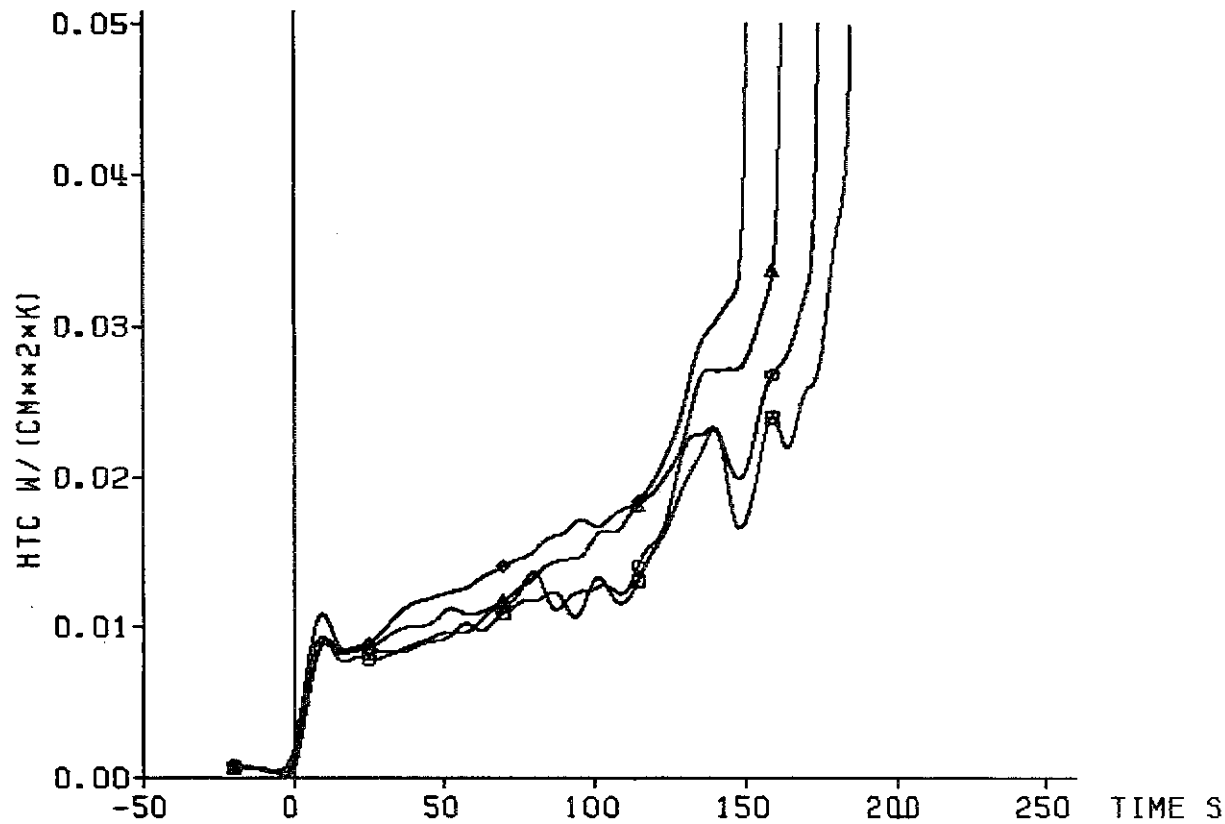

TC	ax. Level
◇ 7f4	2425 mm
△ 7f3	2325 mm
○ 9h4	2225 mm
□ 9h3	2125 mm

— 495 —

decay heat 120% ANS standard
 flooding rate (cold) 5.80 cm/s
 system pressure 3.89 bar
 feedwater temperature 40 deg C

bypass
 =====



Fig. 455 FEBA: 5x5 ROD BUNDLE, TEST SERIES 4, TEST-No. 264

cladding temperature

TC	ax. level
◇	22f4 2425 mm
△	22f3 2325 mm
○	17h4 2225 mm
□	17h3 2125 mm

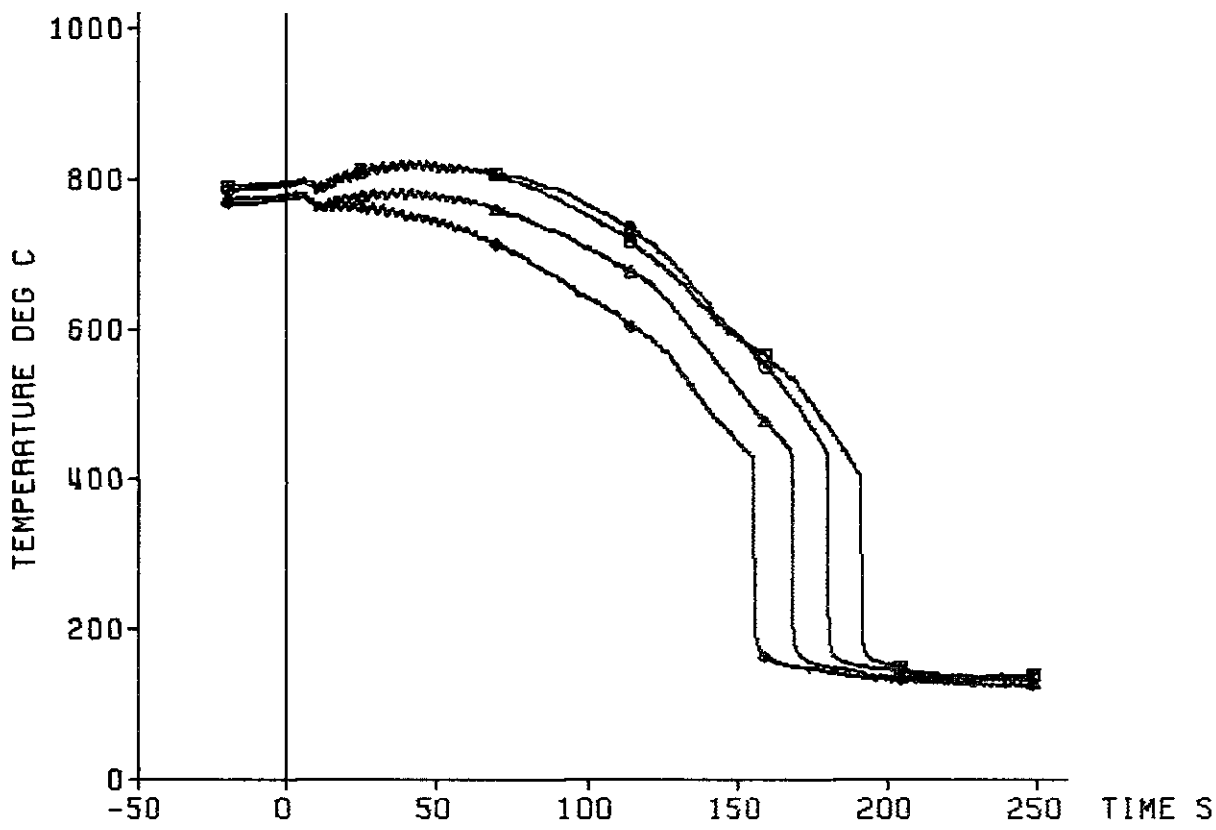

decay heat 120% RNS standard
 flooding rate (cold) 5.80 cm/s
 system pressure 3.89 bar
 feedwater temperature 40 deg C

blockage
=====



Fig. 456 FEBA: 5x5 ROD BUNDLE, TEST SERIES 4, TEST-No. 264

heat transfer coeff.

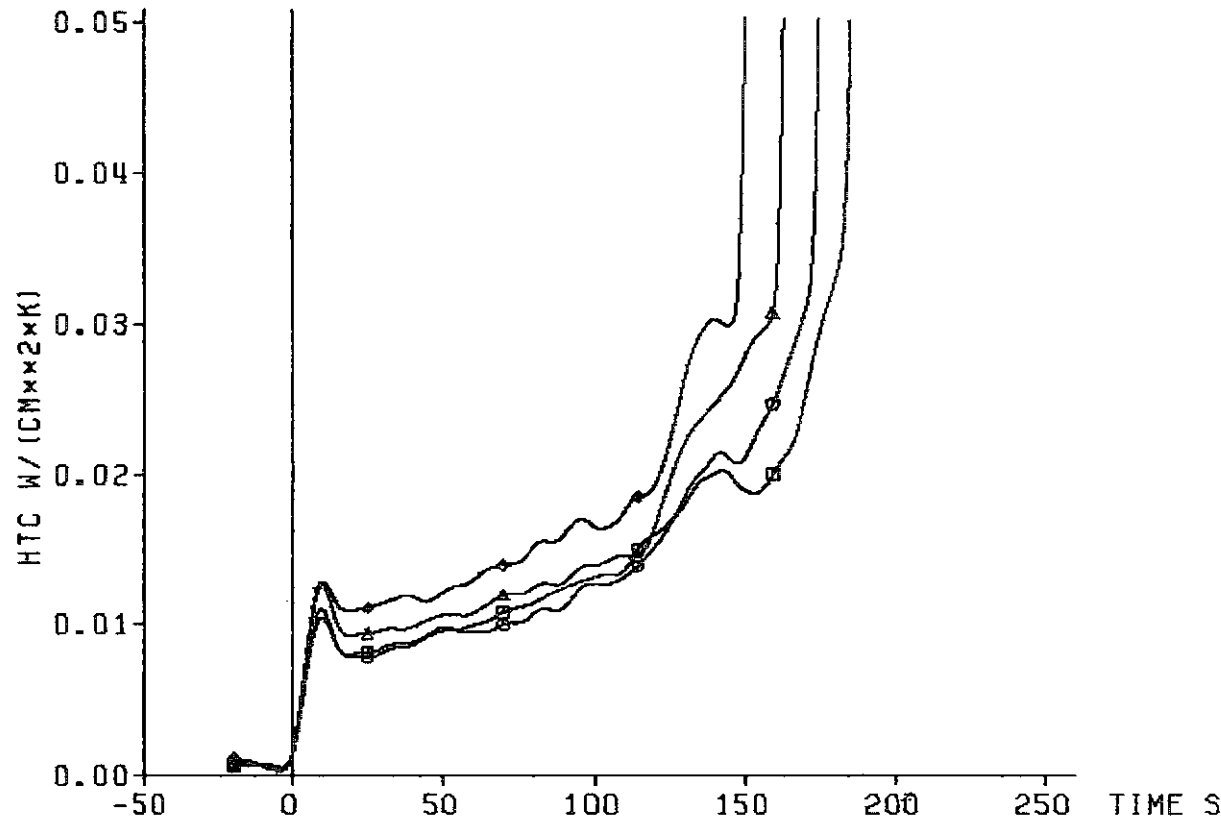

TC	ax. Level
◇ 22f4	2425 mm
△ 22f3	2325 mm
○ 17h4	2225 mm
□ 17h3	2125 mm

decay heat 120% ANS standard
 flooding rate (cold) 5.80 cm/s
 system pressure 3.89 bar
 feedwater temperature 40 deg C

blockage
=====



Fig. 457 FEBA: 5x5 ROD BUNDLE, TEST SERIES 4, TEST-No. 264

cladding temperature

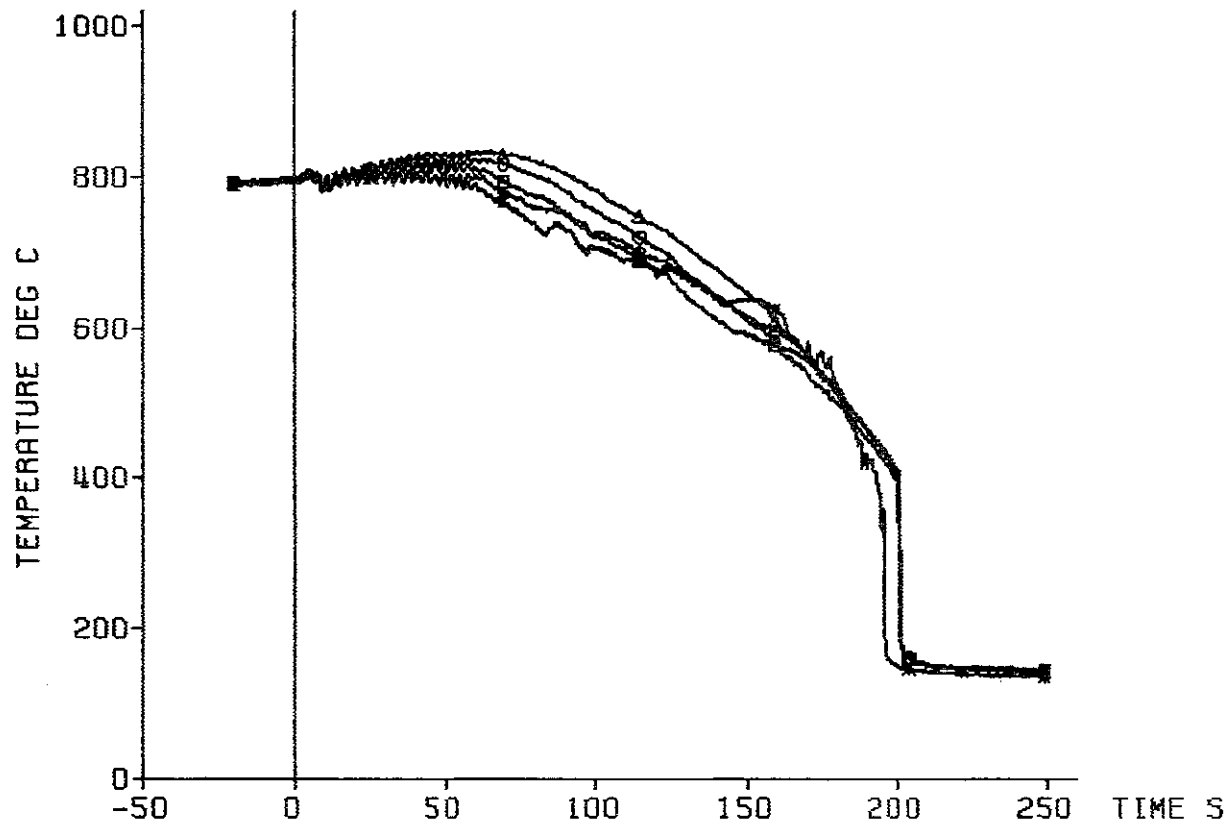

	TC	ax. level
*	9h2	2025 mm
◇	8d4	2025 mm
△	8d3	2025 mm
○	8d2	2025 mm
□	8d1	2025 mm

decay heat 120% ANS standard
flooding rate (cold) 5.80 cm/s
system pressure 3.89 bar
feedwater temperature 40 deg C

bypass
=====

KIK IRB

Fig. 458 FEBA: 5x5 ROD BUNDLE, TEST SERIES 4, TEST-NO. 264

heat transfer coeff.

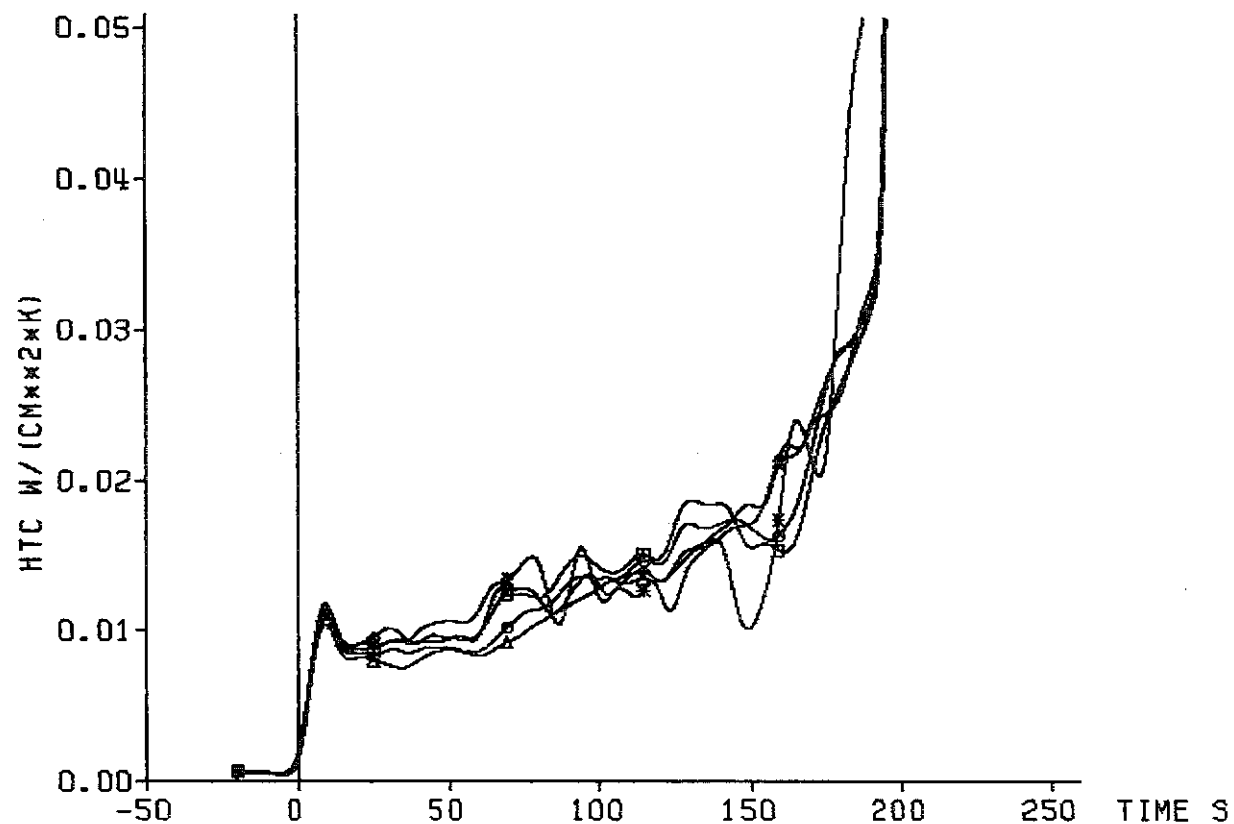

TC	axial Level
* 9h2	2025 mm
△ 8d4	2025 mm
△ 8d3	2025 mm
○ 8d2	2025 mm
□ 8d1	2025 mm

decay heat 120% ANS standard
 flooding rate (cold) 5.80 cm/s
 system pressure 3.89 bar
 feedwater temperature 40 deg C

bypass
 =====



Fig. 459 FEBA: 5x5 ROD BUNDLE, TEST SERIES 4, TEST-No. 264

cladding temperature

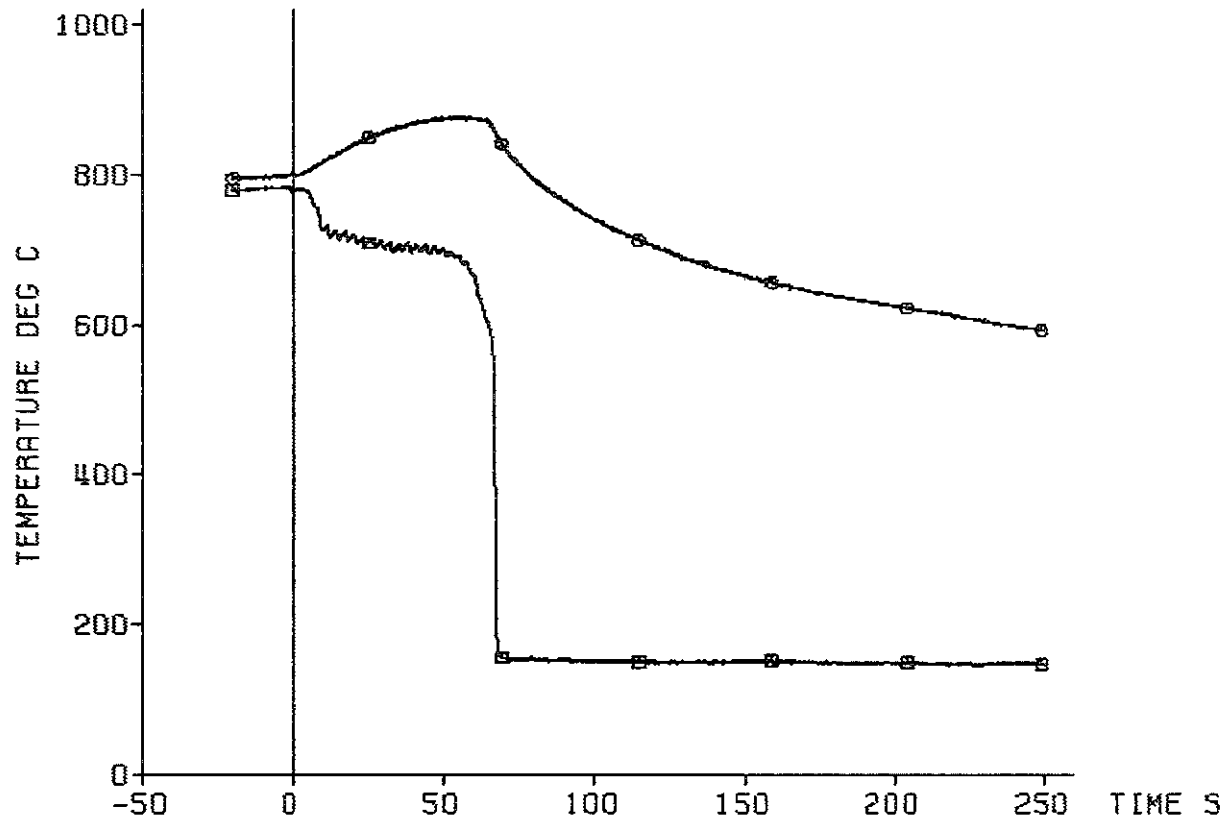

TC	ax. Level
○ 17h2	2025 mm
□ sleeve	2025 mm

decay heat 120% ANS standard
flooding rate (cold) 5.80 cm/s
system pressure 3.89 bar
feedwater temperature 40 deg C

blockage
=====



Fig. 460 FEBA: 5x5 ROD BUNDLE, TEST SERIES 4, TEST-No. 264

cladding temperature

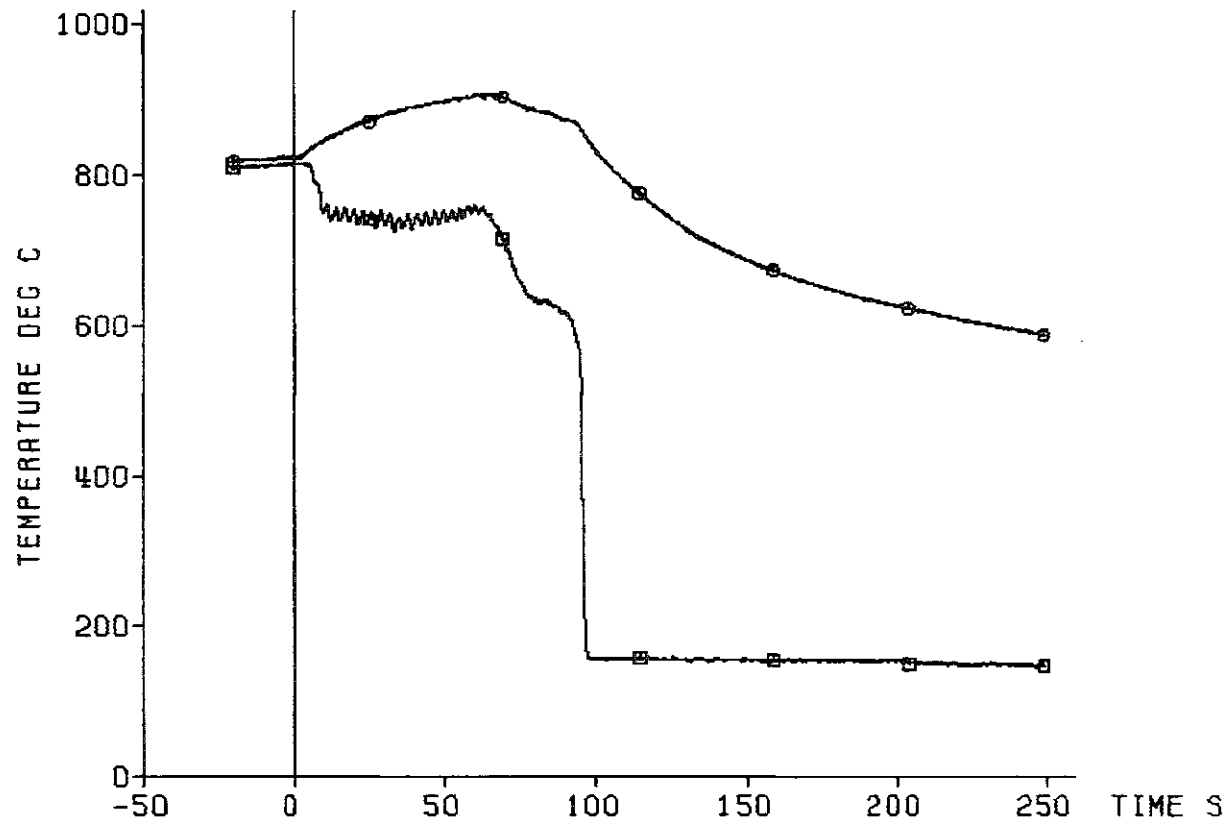

TC	axial level
○ 13d2	2025 mm
□ sleeve	2025 mm

decay heat 120% ANS standard
flooding rate (cold) 5.80 cm/s
system pressure 3.89 bar
feedwater temperature 40 deg C

blockage
=====



Fig. 461 FEBA: 5x5 ROD BUNDLE, TEST SERIES 4, TEST-No. 264

cladding temperature

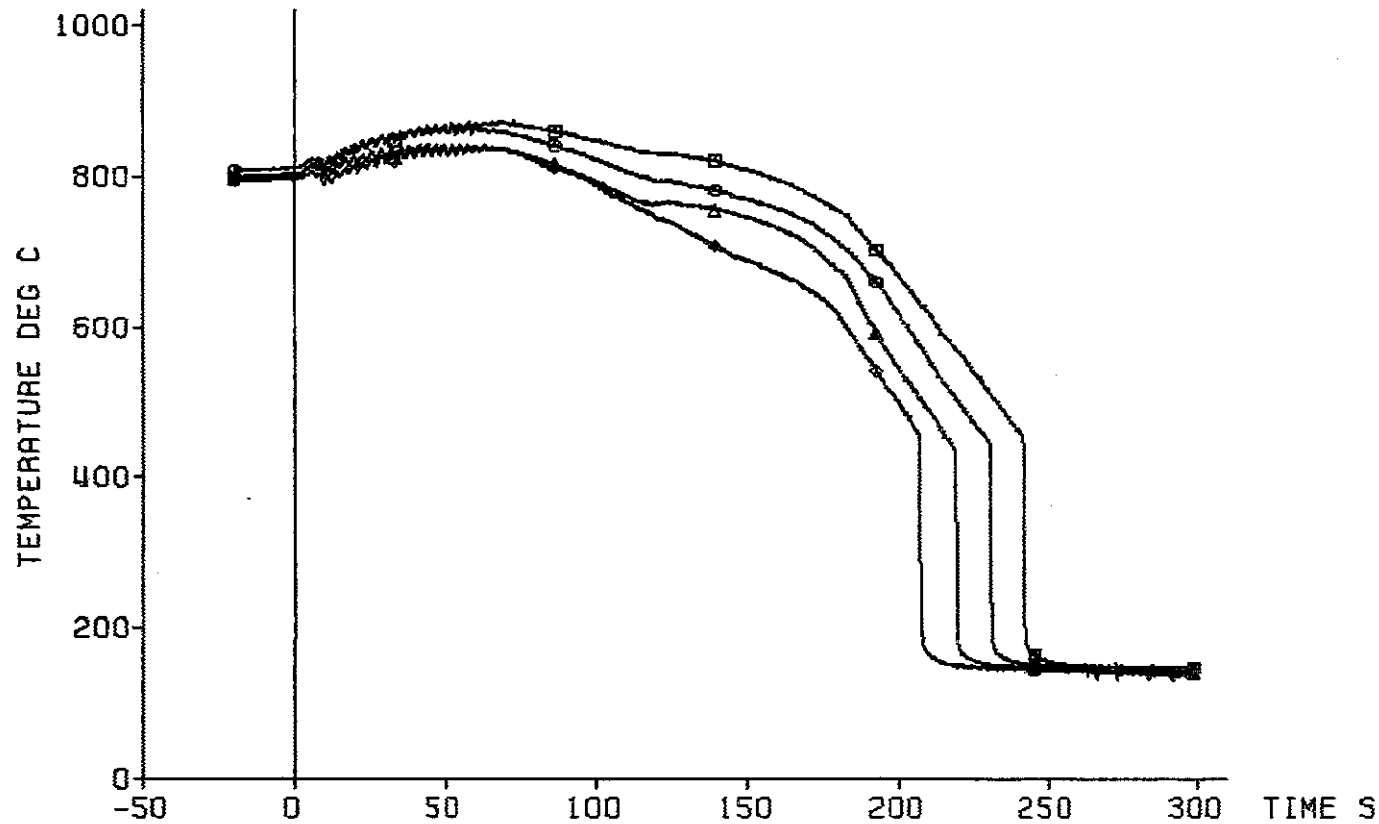

TC	ax. level
◆ 9h1	1925 mm
▲ 19g3	1825 mm
○ 19g2	1725 mm
□ 19g1	1625 mm

decay heat 120% ANS standard
flooding rate (cold) 5.80 cm/s
system pressure 3.89 bar
feedwater temperature 40 deg C

bypass
=====



Fig. 462 FEBA: 5x5 ROD BUNDLE, TEST SERIES 4, TEST-No. 264

heat transfer coeff.

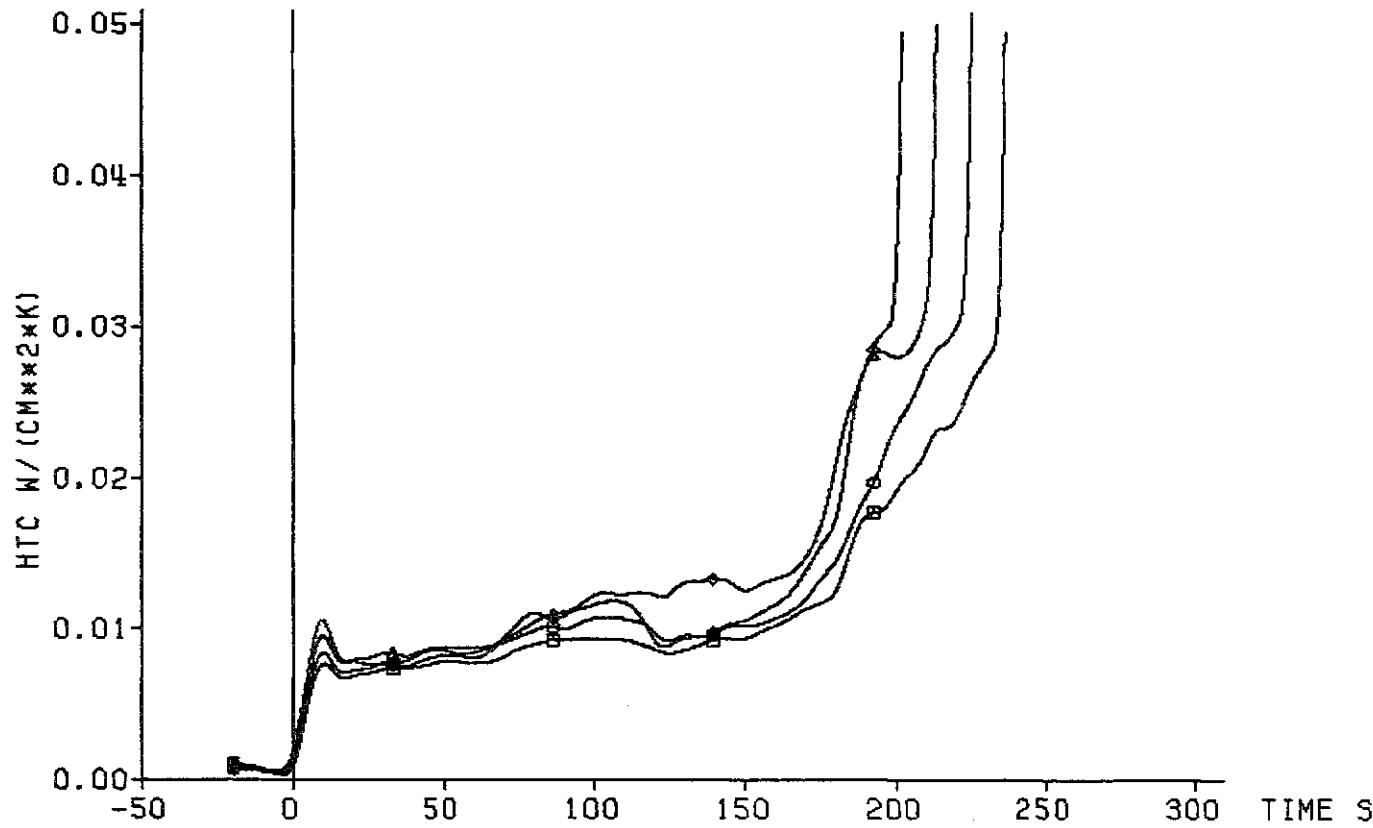

TC	ax. level
♦	9h1 1925 mm
▲	19g3 1825 mm
○	19g2 1725 mm
□	19g1 1625 mm

decay heat 120% ANS standard
 flooding rate (cold) 5.80 cm/s
 system pressure 3.89 bar
 feedwater temperature 40 deg C

bypass
 =====



Fig. 463 FEBA: 5x5 ROD BUNDLE, TEST SERIES 4, TEST-No. 264

cladding temperature

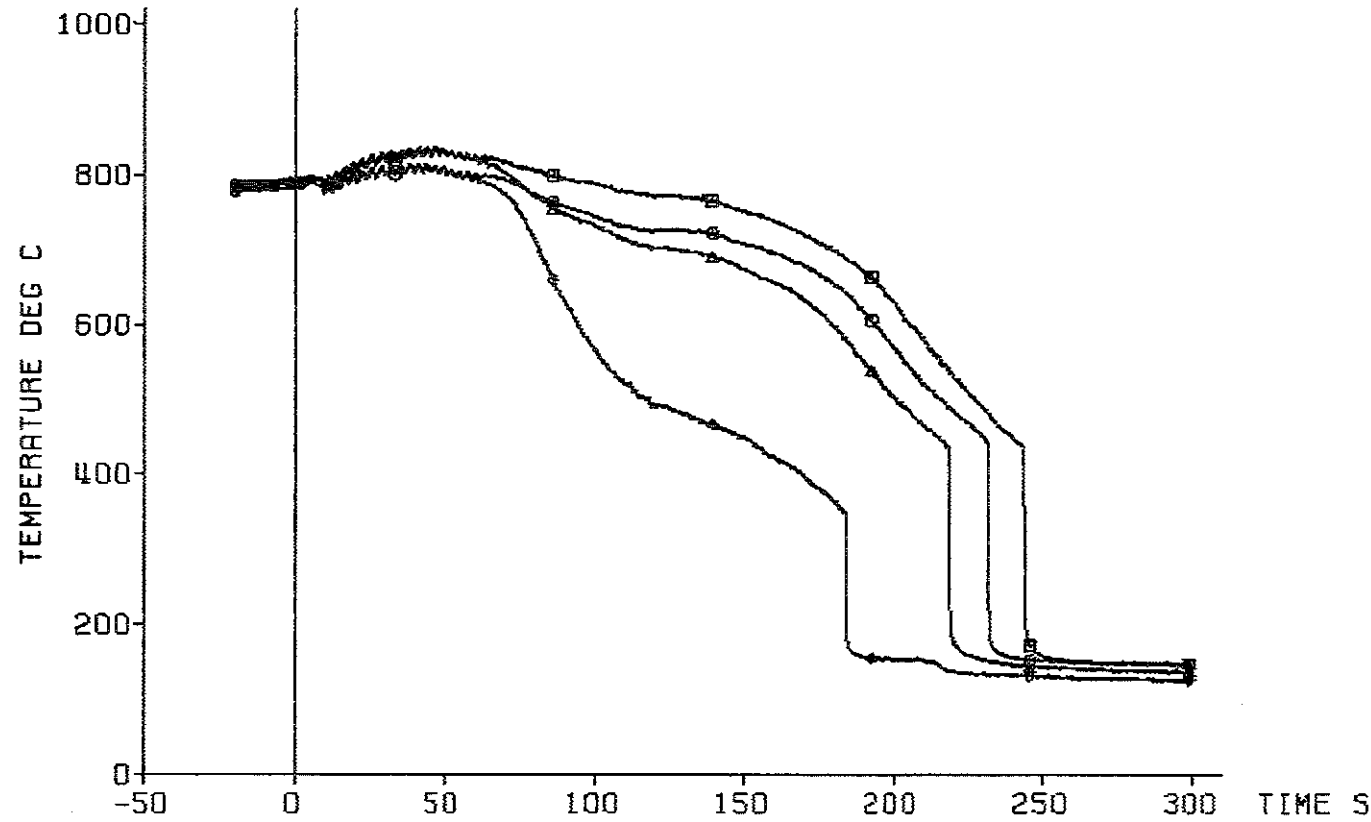

TC	ax. level
◇	17h1 1925 mm
△	16g3 1825 mm
○	16g2 1725 mm
□	16g1 1625 mm

decay heat 120% RMS standard
 flooding rate (cold) 5.80 cm/s
 system pressure 3.89 bar
 feedwater temperature 40 deg C

blockage
 =====



Fig. 464 FEBA: 5x5 ROD BUNDLE, TEST SERIES 4, TEST-No. 264

heat transfer coeff.

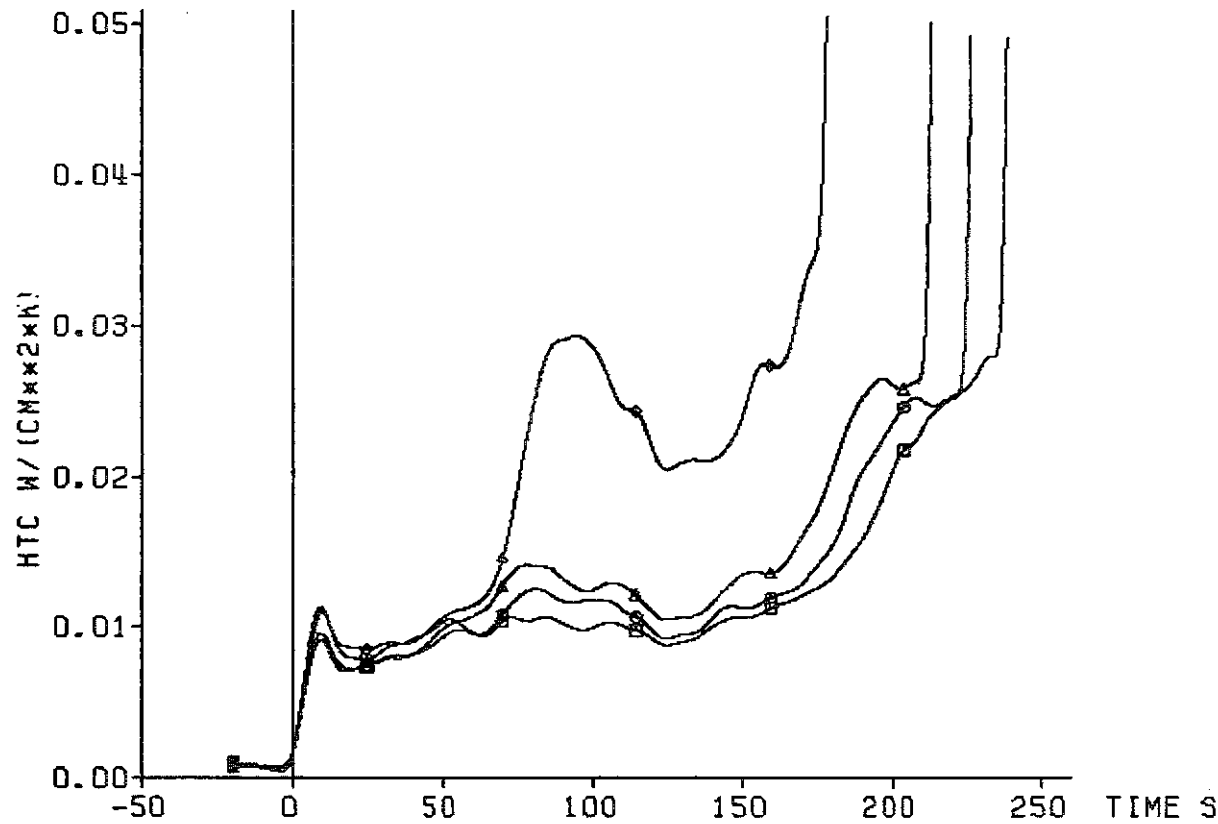

TC	ax. level
◆ 17h1	1925 mm
▲ 16g3	1825 mm
○ 16g2	1725 mm
□ 16g1	1625 mm

decay heat 120% ANS standard
 flooding rate (cold) 5.80 cm/s
 system pressure 3.89 bar
 feedwater temperature 40 deg C

blockage
 =====



Fig. 465 FEBA: 5x5 ROD BUNDLE, TEST SERIES 4, TEST-No. 264

grid spacer temperature

TC	axial level
86	2550 mm
87	2550 mm

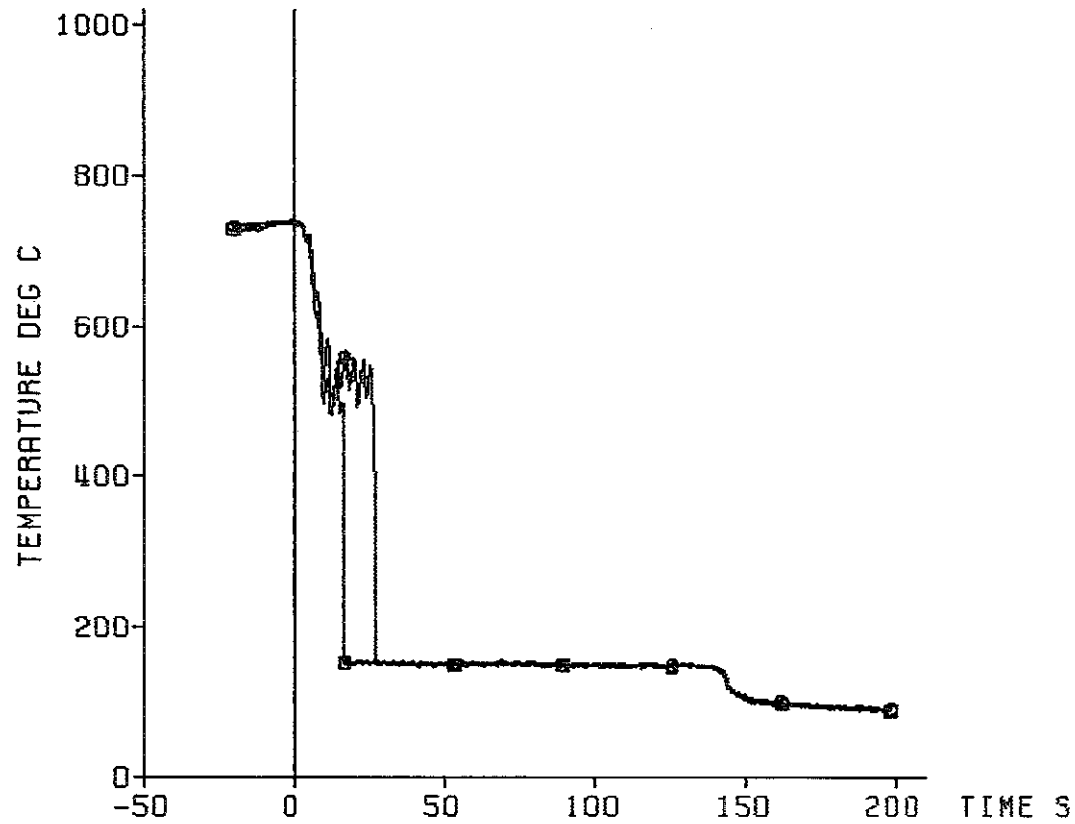

decay heat 120% ANS standard
flooding rate (cold) 5.80 cm/s
system pressure 3.89 bar
feedwater temperature 40 deg C



Fig. 466 FEBA: 5x5 ROD BUNDLE, TEST SERIES 4, TEST-No. 264

grid spacer temperature

TC	axial level
84	1460 mm

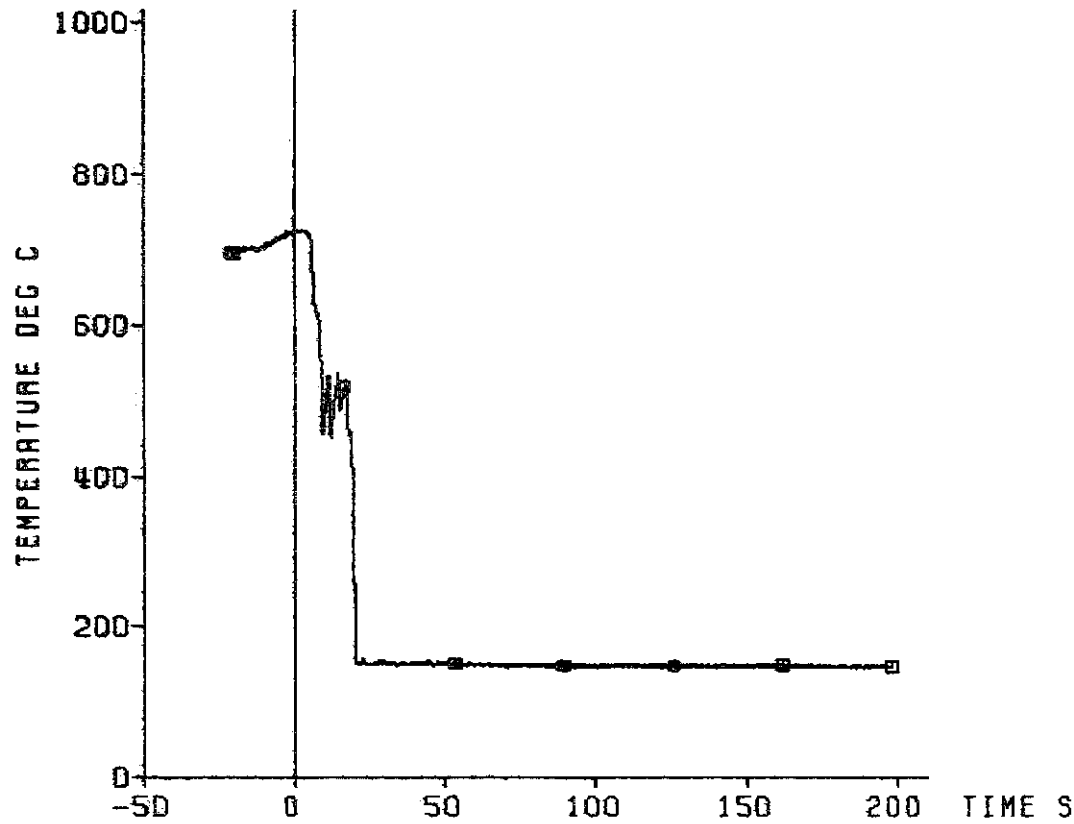

decay heat 120% ANS standard
flooding rate (cold) 5.80 cm/s
system pressure 3.89 bar
feedwater temperature 40 deg C



Fig. 467 FEBA: 5x5 ROD BUNDLE, TEST SERIES 4, TEST-No. 264

axial level: 1825 mm

△ cladding temperature (19g3)
○ fluid temperature

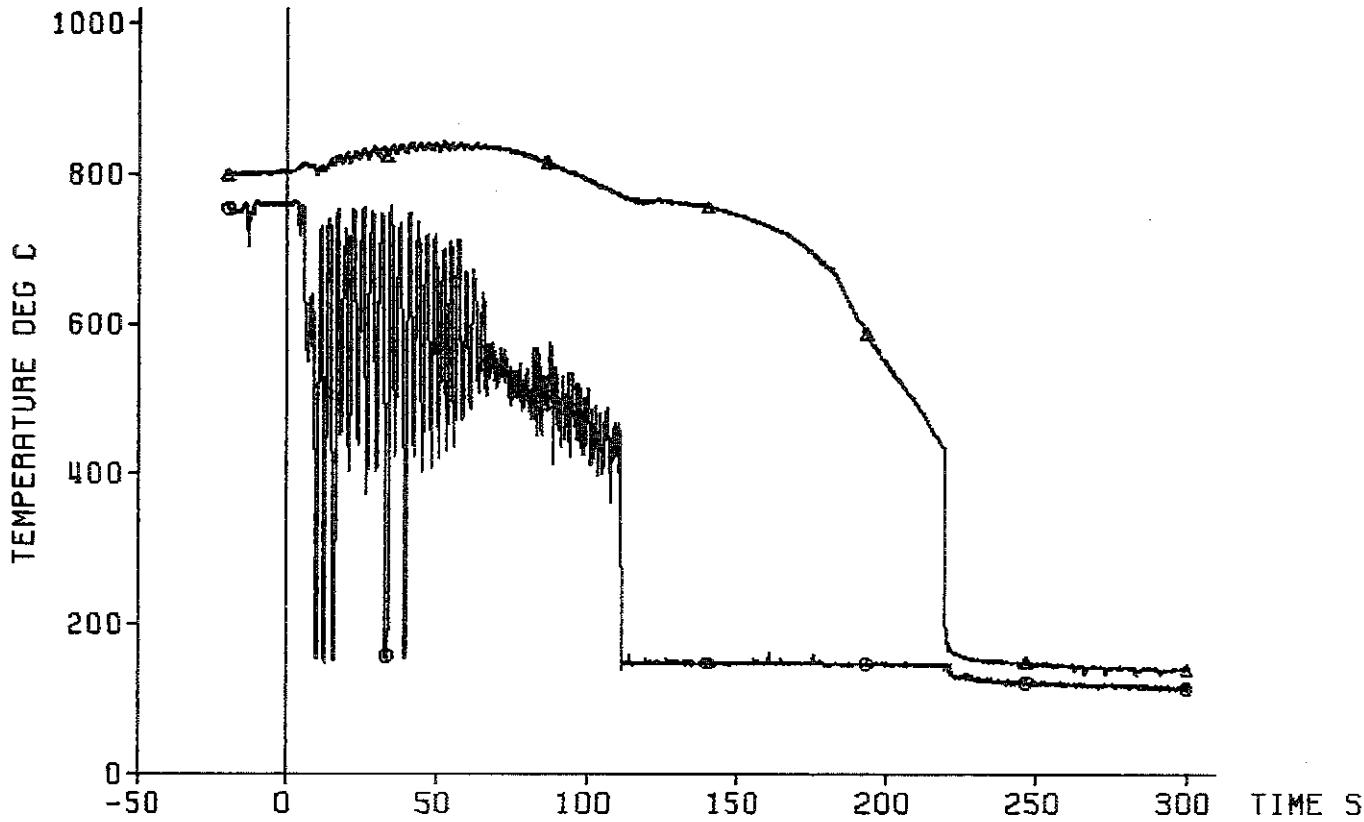

— 508 —

decay heat 120% ANS standard
flooding rate (cold) 5.80 cm/s
system pressure 3.89 bar
feedwater temperature 40 deg C

bypass
=====



Fig. 468 FEBA: 5x5 ROD BUNDLE, TEST SERIES 4, TEST-No. 264

axial level: 1825 mm

△ cladding temperature (16g3)
○ fluid temperature

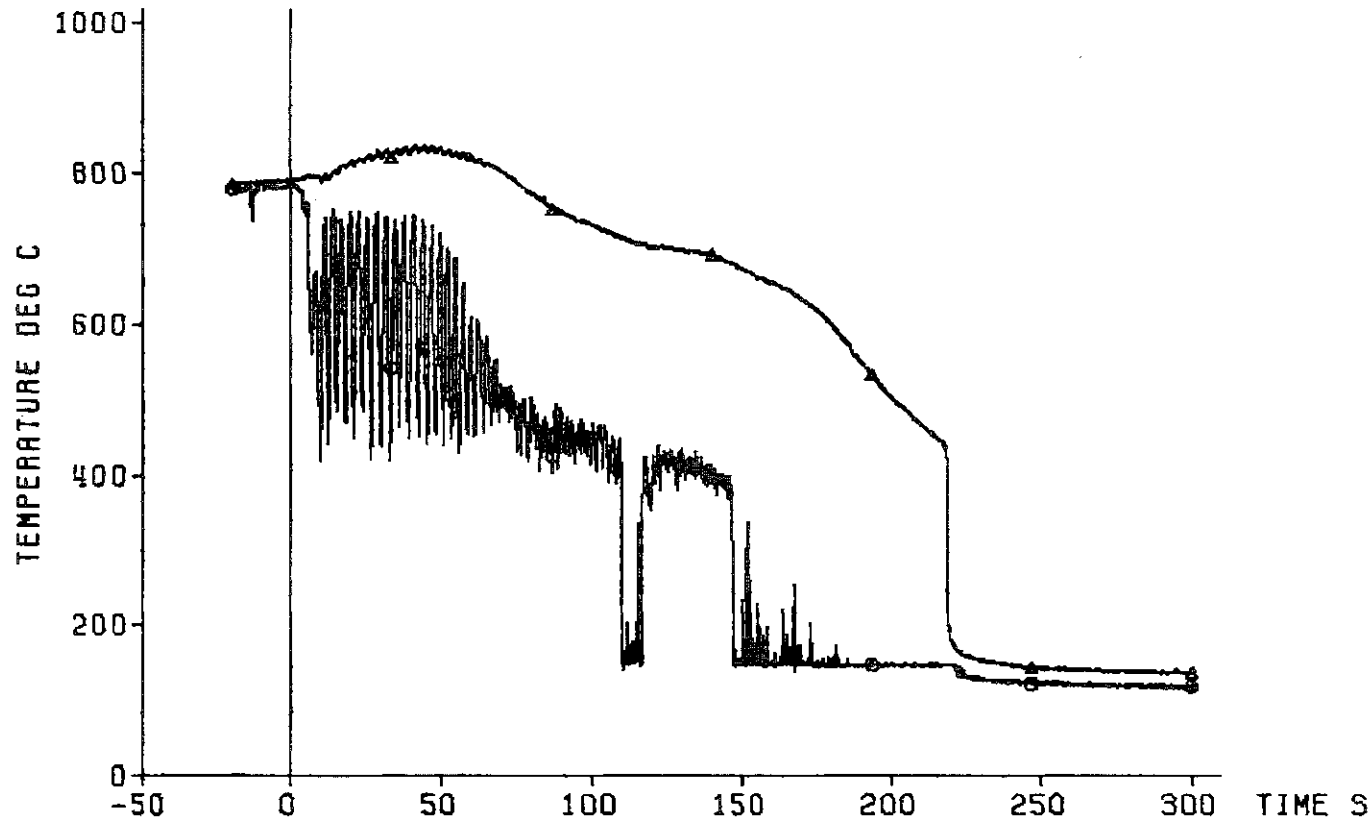

decay heat 120% ANS standard
flooding rate (cold) 5.80 cm/s
system pressure 3.89 bar
feedwater temperature 40 deg C

blockage
=====

KfK
IRB

Fig. 469 FEBA: 5x5 ROD BUNDLE, TEST SERIES 4, TEST-No. 264

axial level: 1725 mm

▲ cladding temperature (19g2)
○ fluid temperature
■ housing temperature

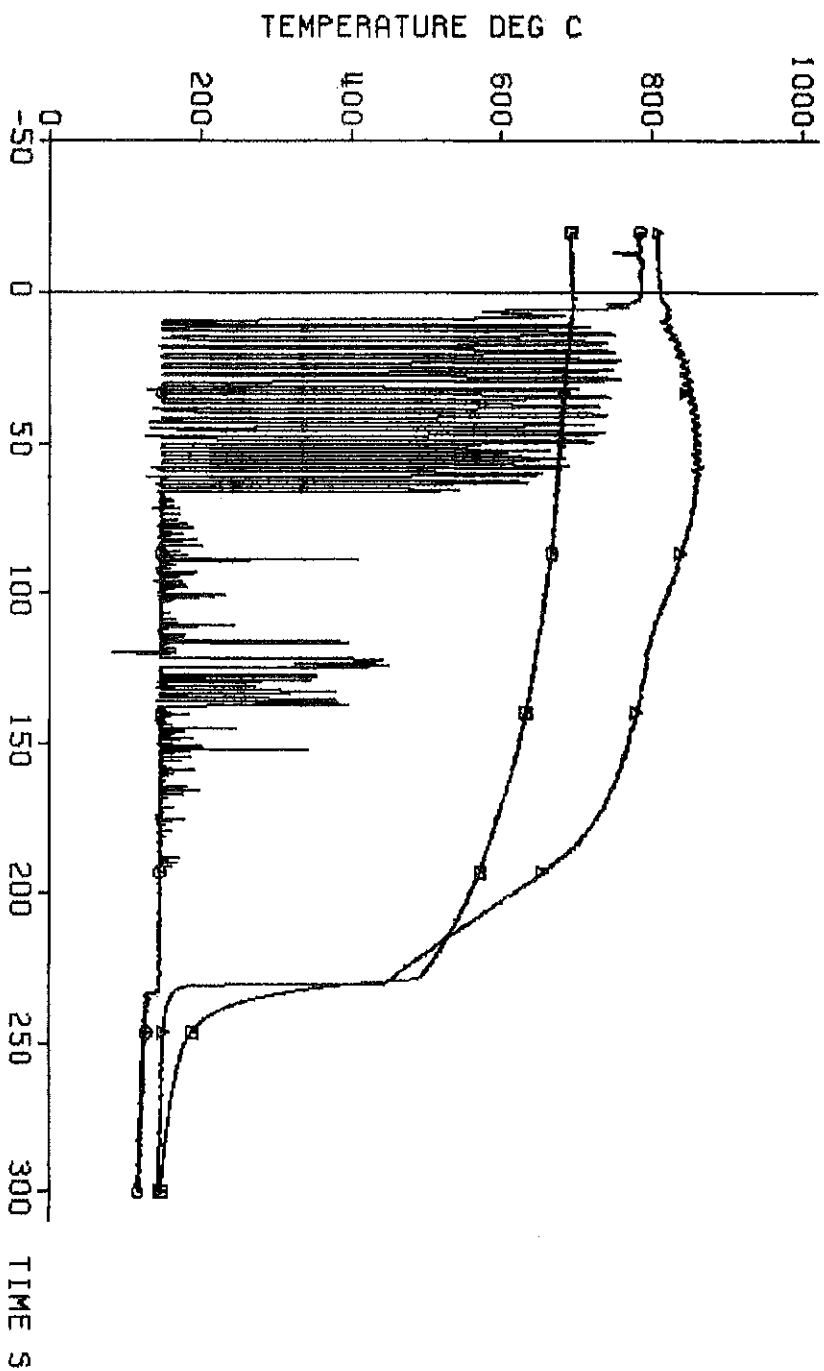

decay heat
flooding rate (cold)
system pressure
feedwater temperature

120% RNS standard
5.80 cm/s
3.89 bar
40 deg C

by pass
=====

KTRB

Fig. 470 FEBRA: 5X5 ROD BUNDLE, TEST SERIES 4, TEST-NO. 264

pressure loss
along the test section:

◊ total length: 4196 mm
△ lower part: 1711 mm
○ middle part: 545 mm
◻ upper part: 1940 mm

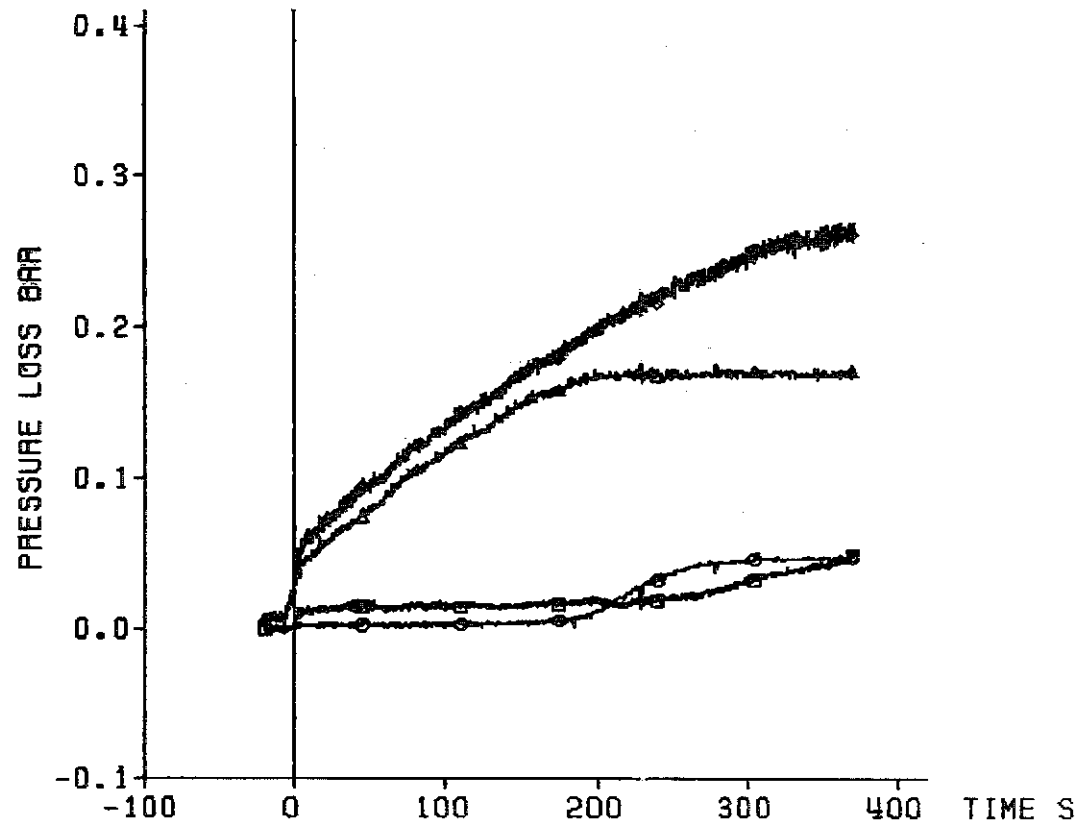

decay heat 120% ANS standard
flooding rate (cold) 5.80 cm/s
system pressure 3.89 bar
feedwater temperature 40 deg C

KfK
IRB

Fig. 471 FEBA: 5x5 ROD BUNDLE, TEST SERIES 4, TEST-No. 264

coolant conditions:

▲ water carry over
○ coolant temperature
□ coolant pressure

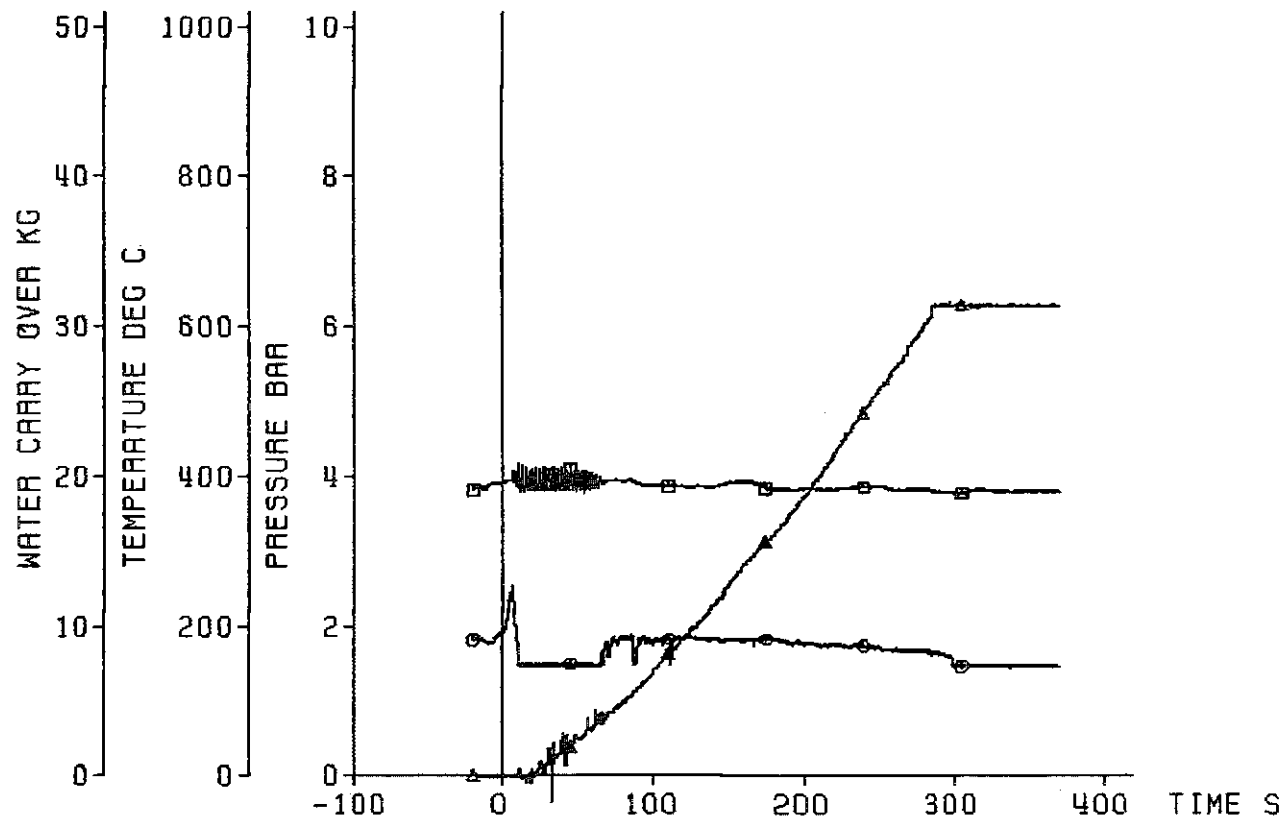

decay heat 120% ANS standard
flooding rate (cold) 5.80 cm/s
system pressure 3.89 bar
feedwater temperature 40 deg C



Fig. 472 FEBA: 5x5 ROD BUNDLE, TEST SERIES 4, TEST-No. 264

axial position of the quench front

- ▣ rewetting of the sleeve at the bundle midplane
- x rewetting of the rod downstream of the blockage

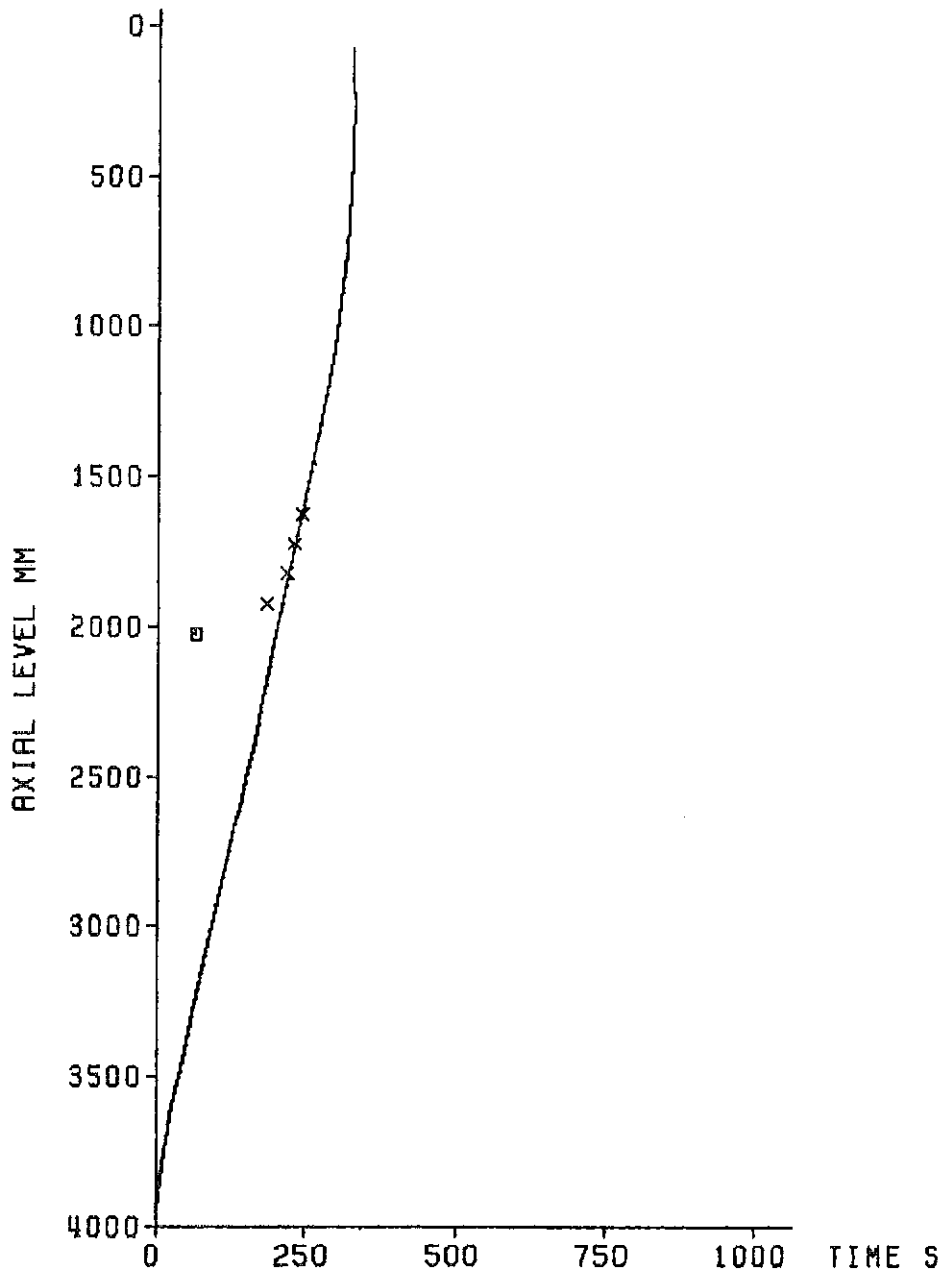

decay heat	120% ANS standard
flooding rate (cold)	5.80 cm/s
system pressure	3.89 bar
feedwater temperature	40 deg C



Fig. 473 FEBA: 5x5 ROD BUNDLE
TEST SERIES 4, TEST-NO. 264

Initial axial temperature profile of the cladding

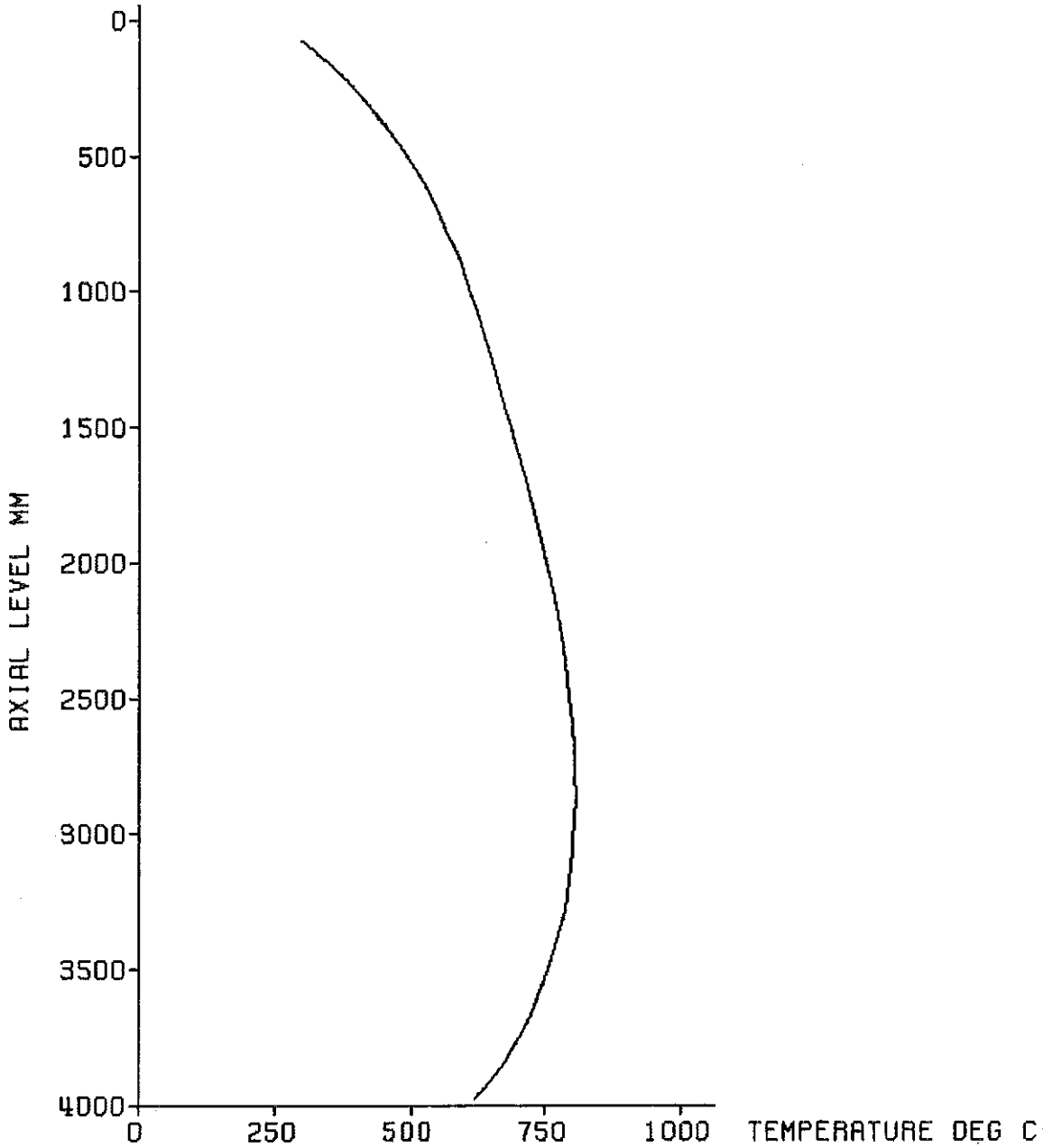

decay heat	120% ANS standard
flooding rate (cold)	5.68 cm/s
system pressure	5.89 bar
feedwater temperature	40 deg C



Fig. 474 FEBA: 5x5 ROD BUNDLE
TEST SERIES 4, TEST-NO. 269

test parameters:

- ◆ flooding rate
- ▲ system pressure
- feedwater temperature
- bundle power

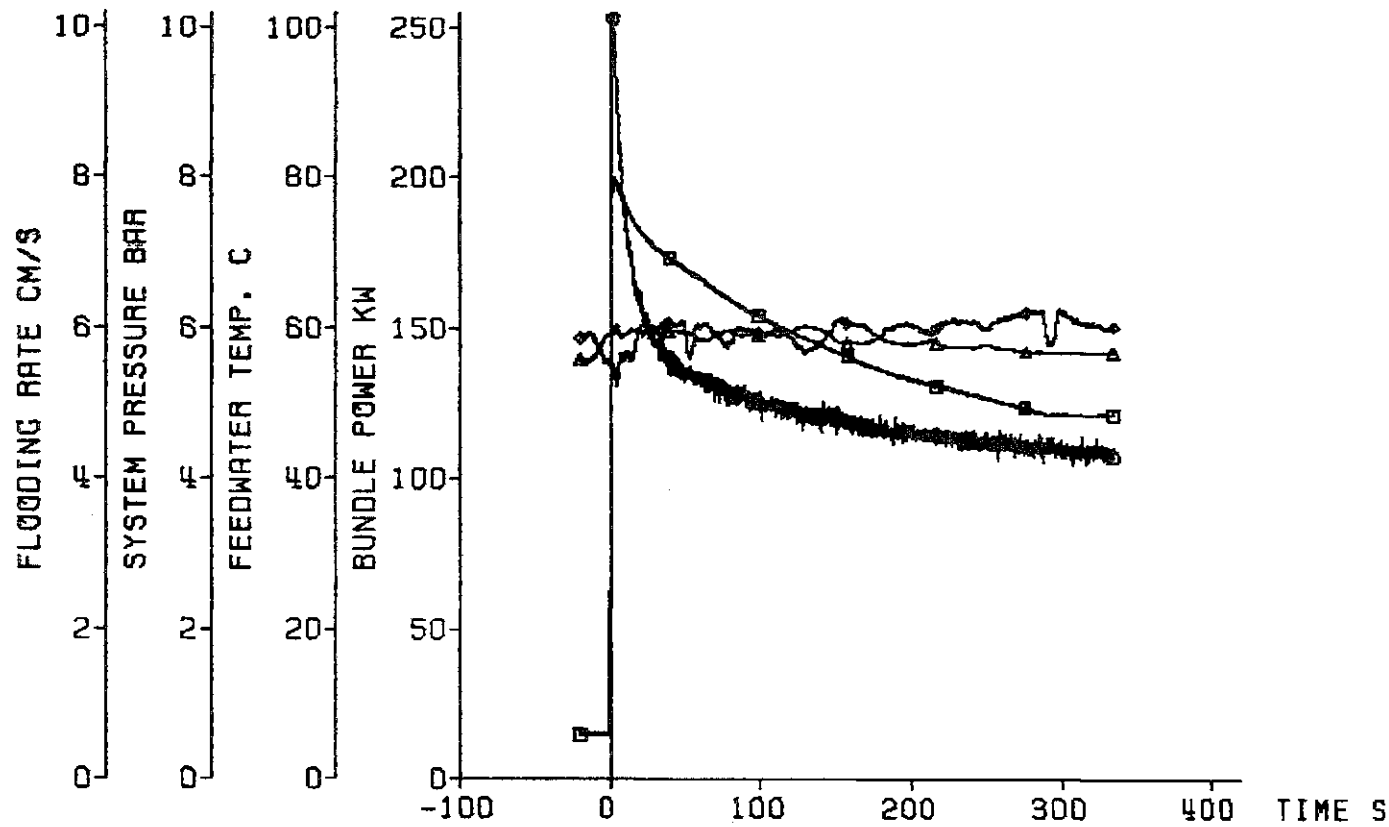

decay heat 120% ANS standard
flooding rate (cold) 5.66 cm/s
system pressure 5.89 bar
feedwater temperature 40 deg C



Fig. 475 FEBA: 5x5 ROD BUNDLE, TEST SERIES 4, TEST-No. 269

cladding temperature

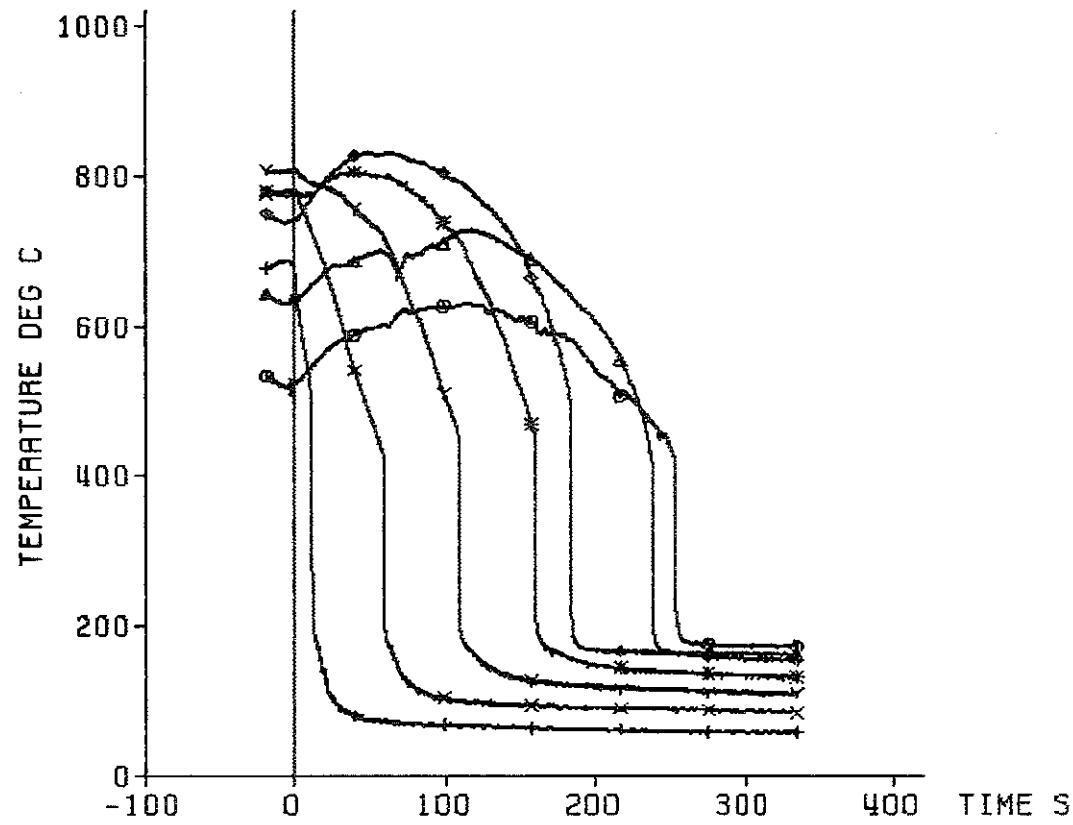

	TC	ax. Level
+	18a4	3860 mm
x	18a3	3315 mm
Y	18a2	2770 mm
*	18a1	2225 mm
◇	12b4	1680 mm
△	12b3	1135 mm
○	12b2	590 mm

decay heat 120% ANS standard
 flooding rate (cold) 5.66 cm/s
 system pressure 5.89 bar
 feedwater temperature 40 deg C



Fig. 476 FEBA: 5x5 ROD BUNDLE, TEST SERIES 4, TEST-No. 269

heat transfer coeff.

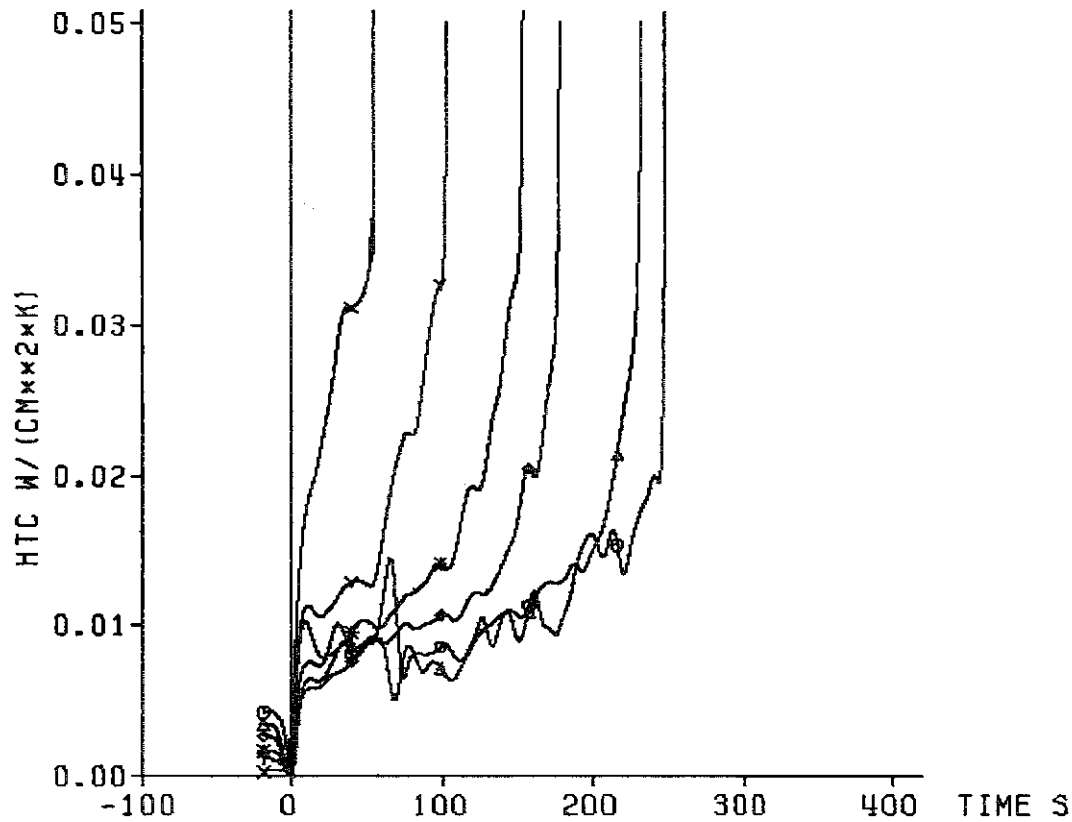

	TC	ax. Level
x	18a3	3315 mm
y	18a2	2770 mm
*	18a1	2225 mm
◇	12b4	1680 mm
△	12b3	1135 mm
○	12b2	590 mm

decay heat 120% ANS standard
 flooding rate (cold) 5.66 cm/s
 system pressure 5.89 bar
 feedwater temperature 40 deg C



Fig. 477 FEBA: 5x5 ROD BUNDLE, TEST SERIES 4, TEST-No. 269

cladding temperature

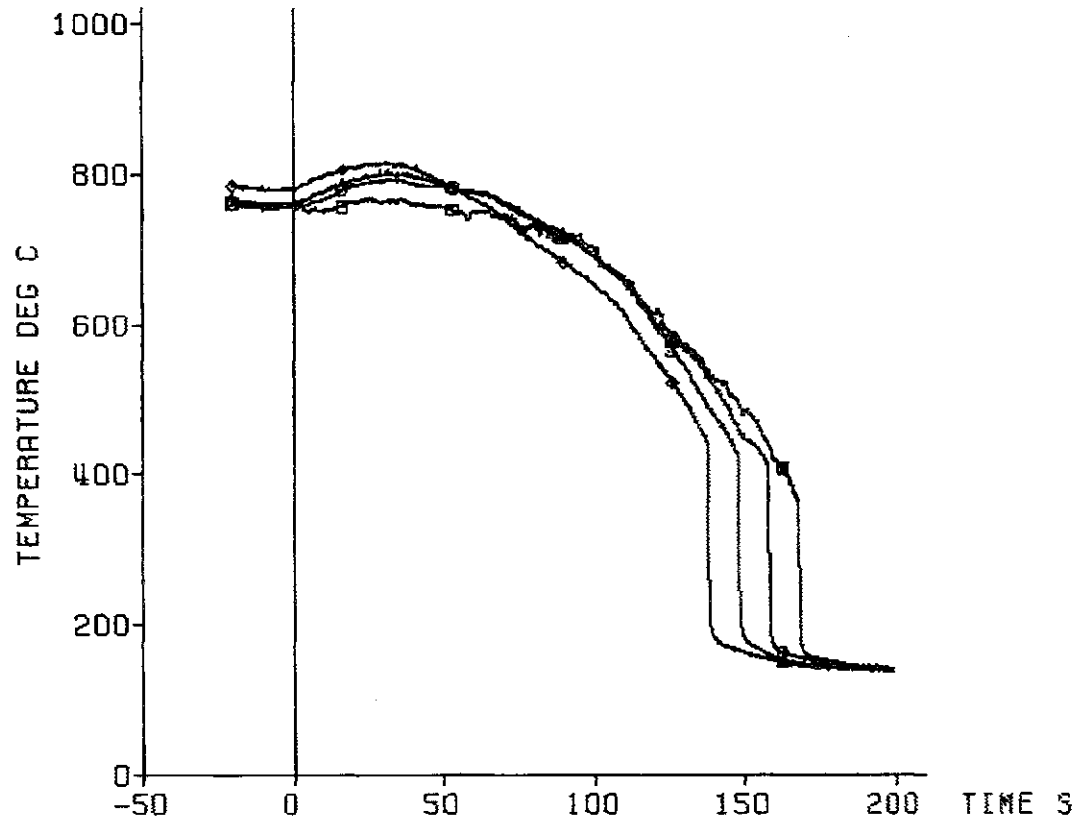

	TC	ax. level
◇	7f4	2425 mm
△	7f3	2325 mm
○	9h4	2225 mm
□	9h3	2125 mm

decay heat 120% ANS standard
flooding rate (cold) 5.66 cm/s
system pressure 5.89 bar
feedwater temperature 40 deg C

bypass
=====



Fig. 478 FEBA: 5x5 ROD BUNDLE, TEST SERIES 4, TEST-No. 269

heat transfer coeff.

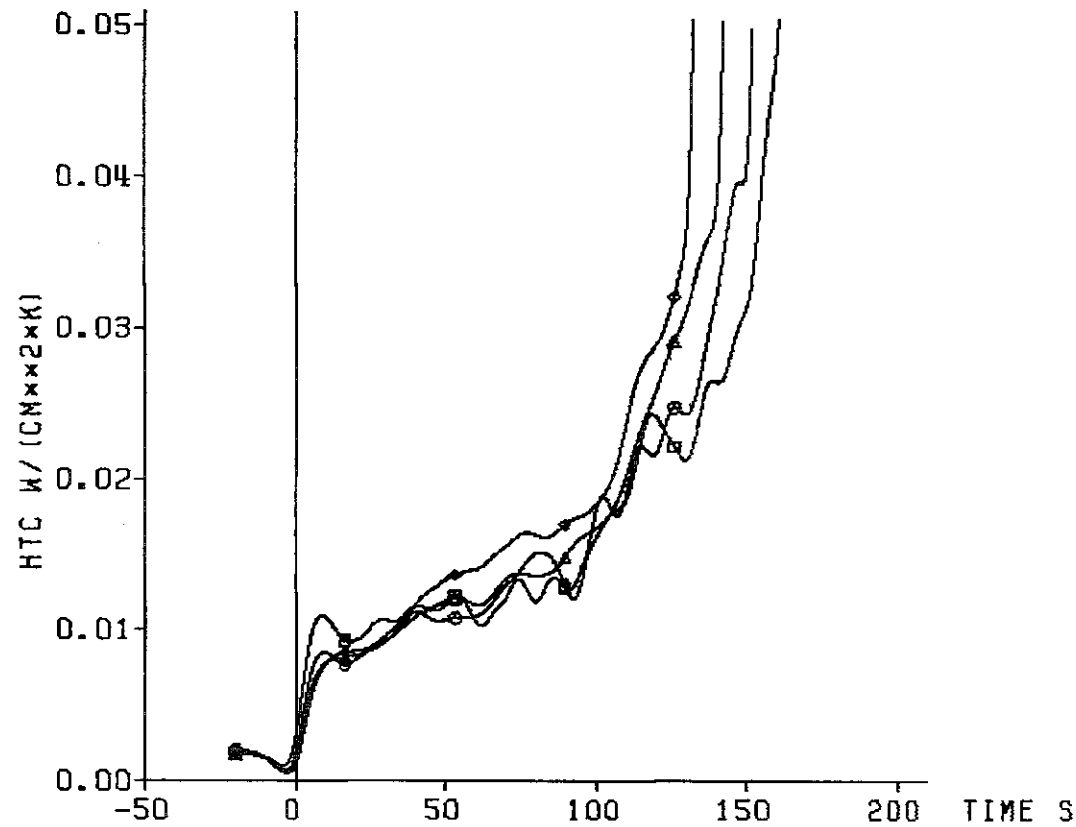

	TC	ax. Level
◇	7f4	2425 mm
▲	7f3	2325 mm
○	9h4	2225 mm
□	9h3	2125 mm

decay heat 120% ANS standard
 flooding rate (cold) 5.66 cm/s
 system pressure 5.89 bar
 feedwater temperature 40 deg C

bypass
 =====



Fig. 479 FEBA: 5x5 ROD BUNDLE, TEST SERIES 4, TEST-NO. 269

cladding temperature

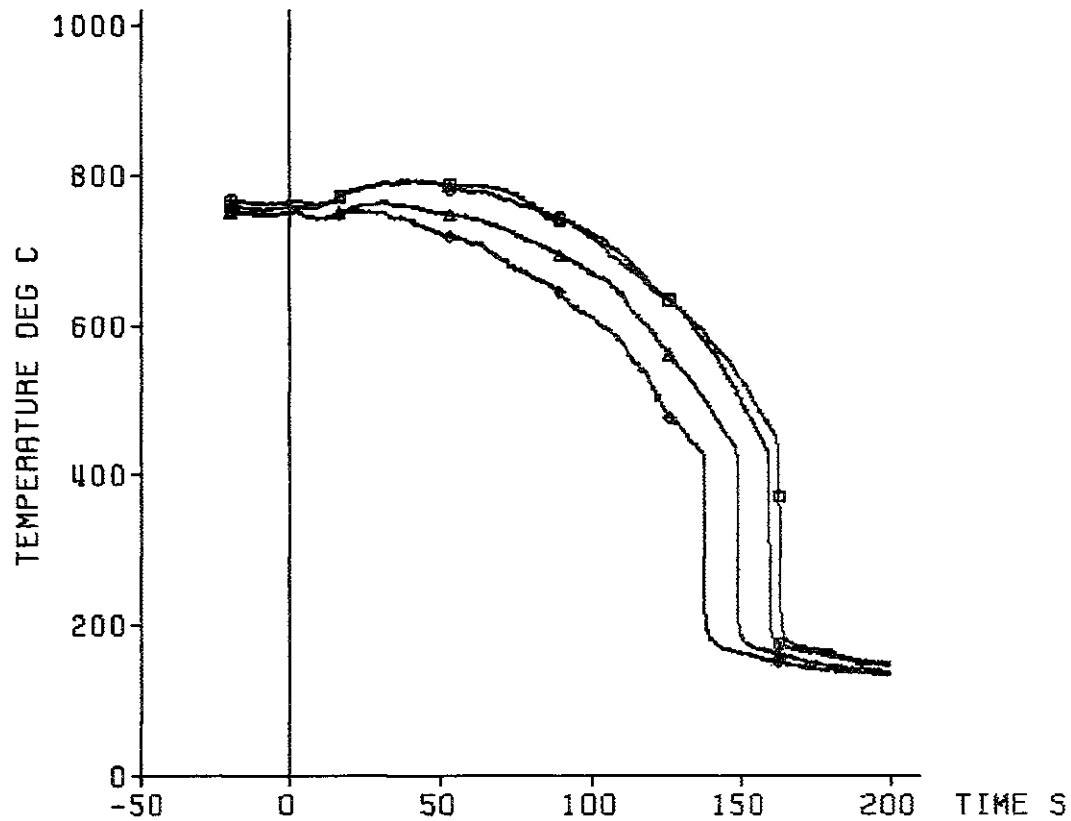

	TC	ax. level
◇	22f4	2425 mm
△	22f3	2325 mm
○	17h4	2225 mm
□	17h3	2125 mm

decay heat 120% ANS standard
flooding rate (cold) 5.66 cm/s
system pressure 5.89 bar
feedwater temperature 40 deg C

blockage

=====

KJK IRB

Fig. 480 FEBA: 5x5 ROD BUNDLE, TEST SERIES 4, TEST-No. 269

heat transfer coeff.

TC	ax. Level
◇ 22f4	2425 mm
△ 22f3	2325 mm
○ 17h4	2225 mm
□ 17h3	2125 mm

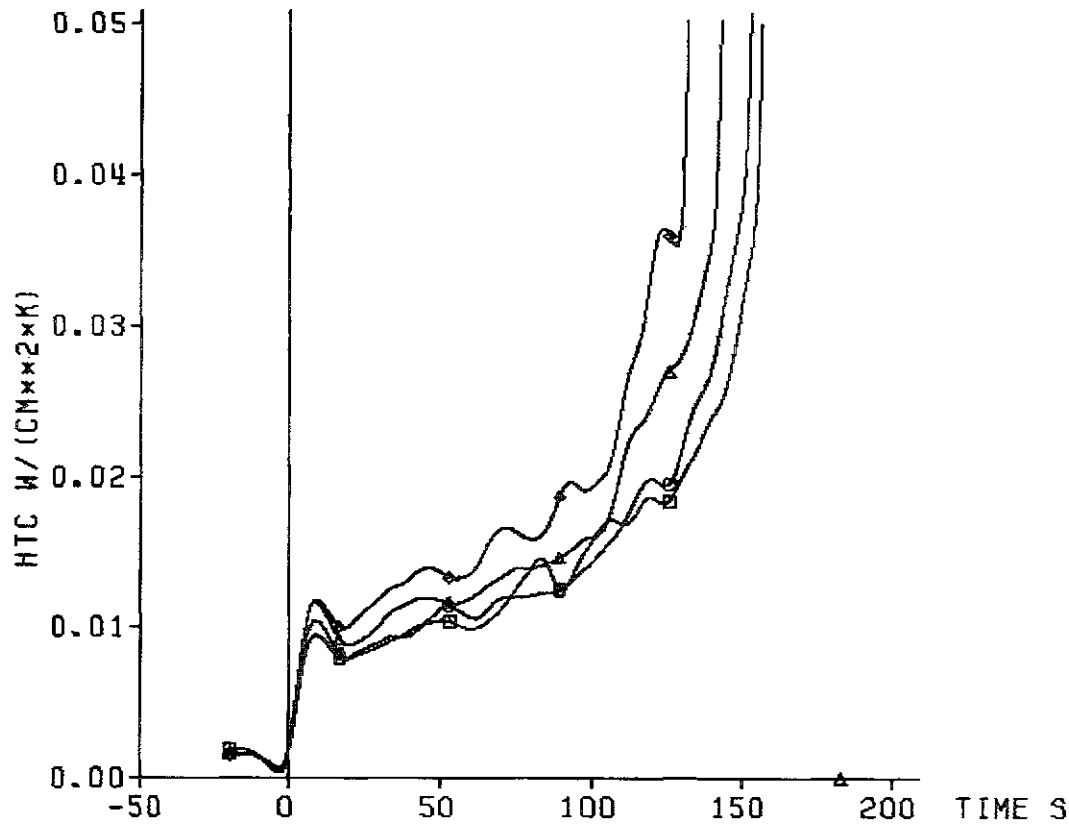

decay heat 120% ANS standard
flooding rate (cold) 5.66 cm/s
system pressure 5.89 bar
feedwater temperature 40 deg C

blockage
=====

KfK
IRB

Fig. 481 FEBA: 5x5 ROD BUNDLE, TEST SERIES 4, TEST-No. 269

cladding temperature

	TC	ax. level
*	9h2	2025 mm
◇	8d4	2025 mm
△	8d3	2025 mm
⊙	8d2	2025 mm
⊞	8d1	2025 mm

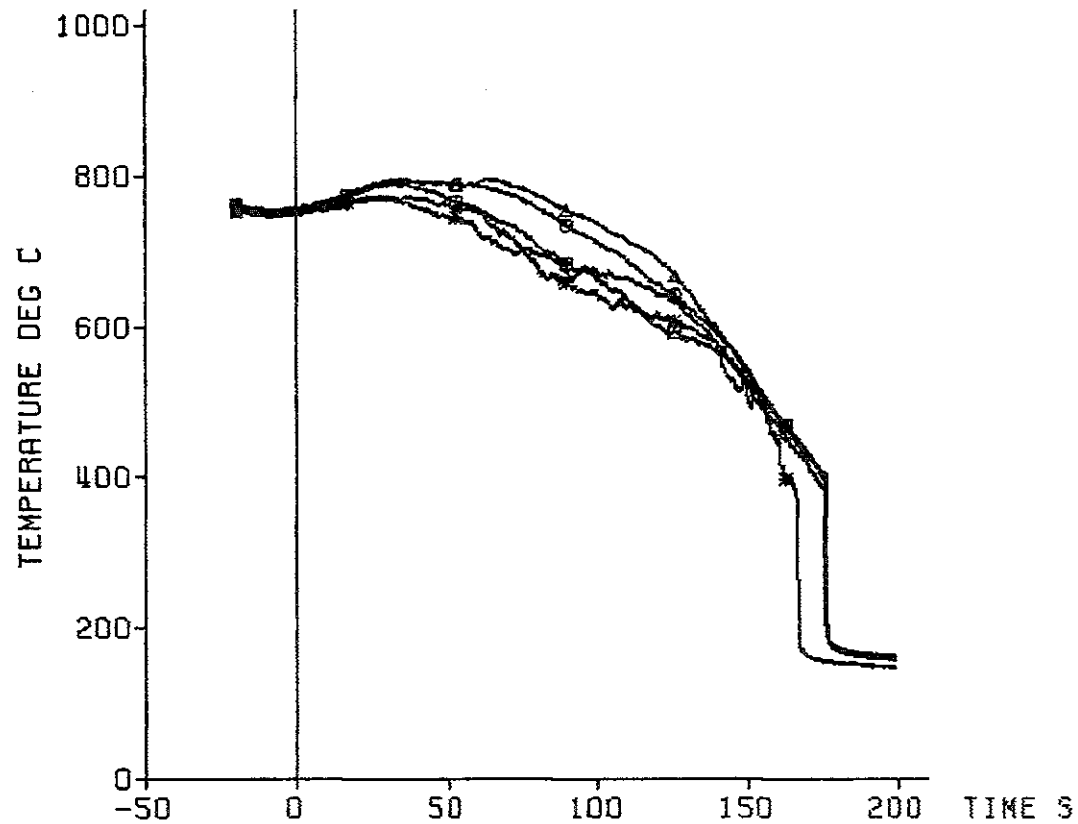

decay heat 120% RMS standard
 flooding rate (cold) 5.66 cm/s
 system pressure 5.89 bar
 feedwater temperature 40 deg C

bypass
 =====



Fig. 482 FEBA: 5x5 ROD BUNDLE, TEST SERIES 4, TEST-No. 269

heat transfer coeff.

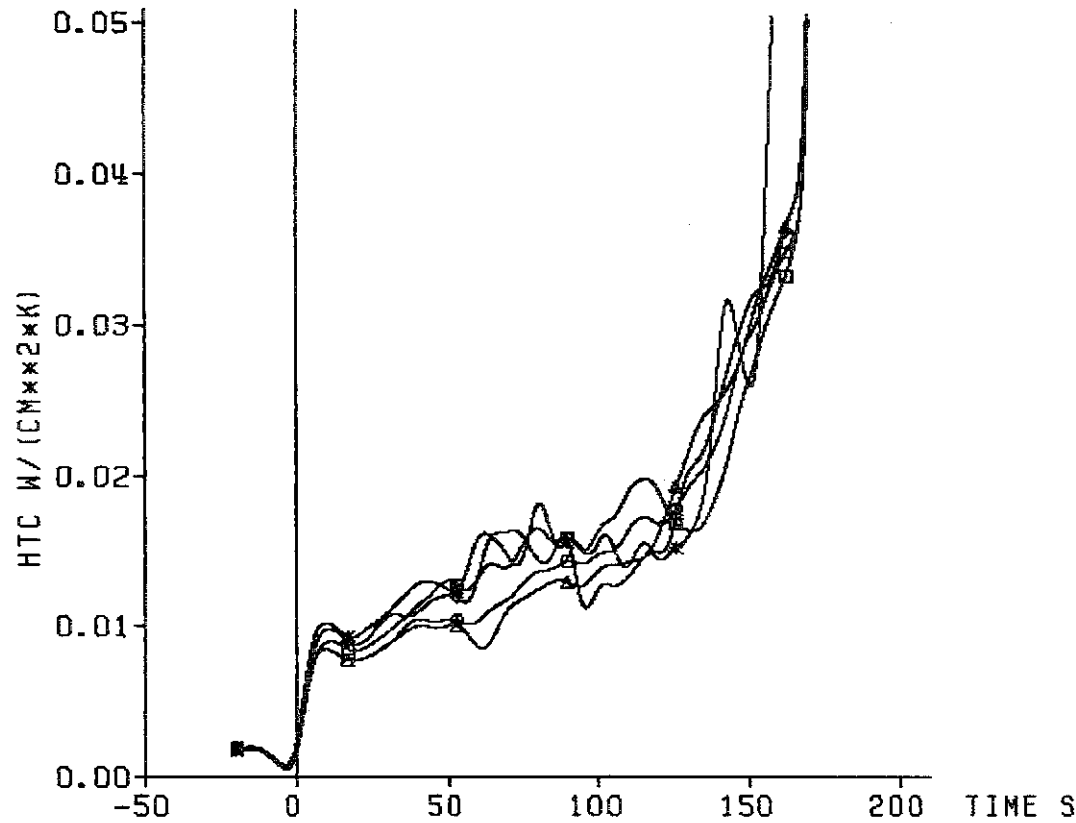

	TC	axial level
*	9h2	2025 mm
Δ	8d4	2025 mm
△	8d3	2025 mm
○	8d2	2025 mm
□	8d1	2025 mm

decay heat 120% ANS standard
flooding rate (cold) 5.66 cm/s
system pressure 5.89 bar
feedwater temperature 40 deg C

bypass
=====



Fig. 483 FEBA: 5x5 ROD BUNDLE, TEST SERIES 4, TEST-No. 269

cladding temperature

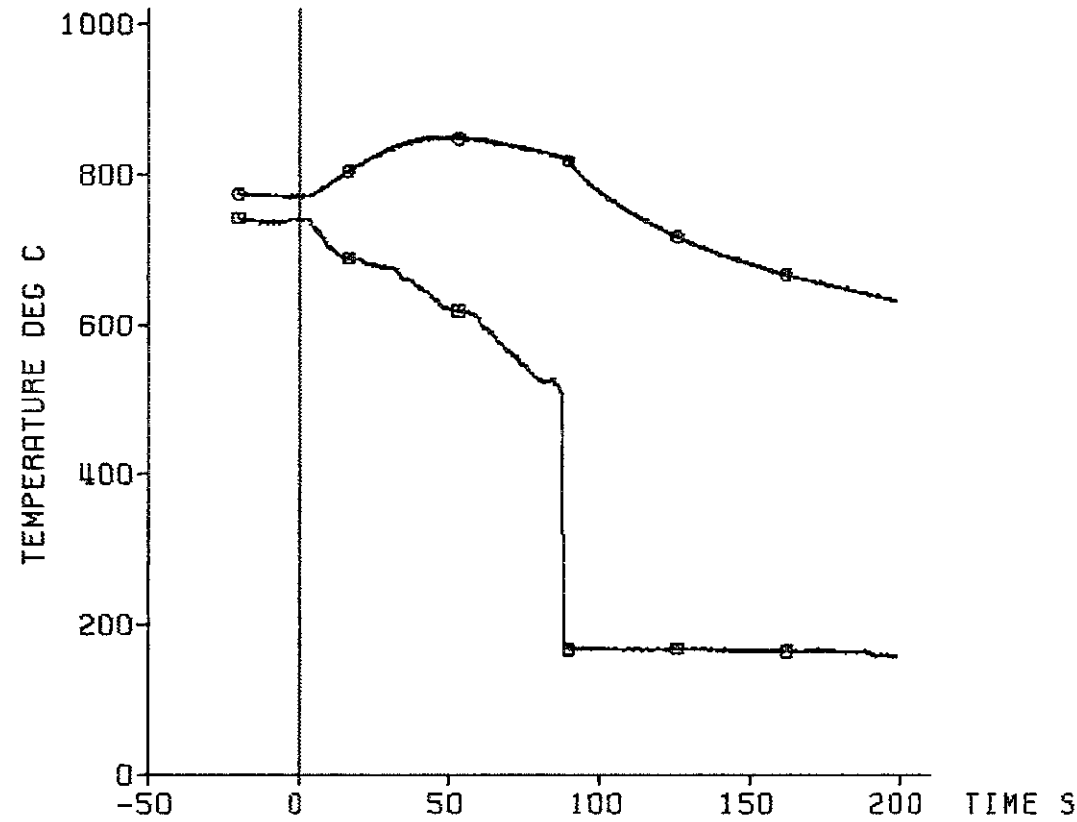

TC	ax. level
○ 17h2	2025 mm
□ sleeve	2025 mm

decay heat 120% ANS standard
flooding rate (cold) 5.66 cm/s
system pressure 5.89 bar
feedwater temperature 40 deg C

blockage
=====



Fig. 484 FEBA: 5x5 ROD BUNDLE, TEST SERIES 4, TEST-NO. 269

cladding temperature

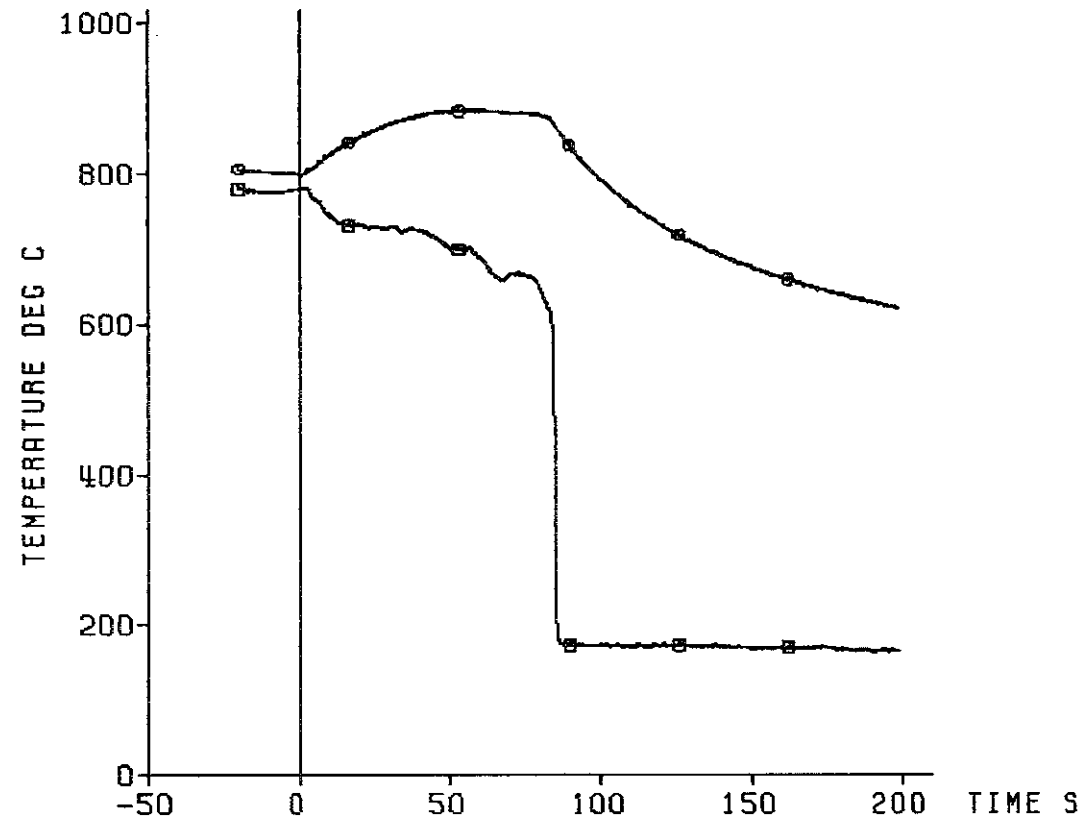

TC	axial level
○ 13d2	2025 mm
□ sleeve	2025 mm

decay heat 120% ANS standard
flooding rate (cold) 5.66 cm/s
system pressure 5.89 bar
feedwater temperature 40 deg C

blockage
=====



Fig. 485 FEBA: 5x5 ROD BUNDLE, TEST SERIES 4, TEST-NO. 269

cladding temperature

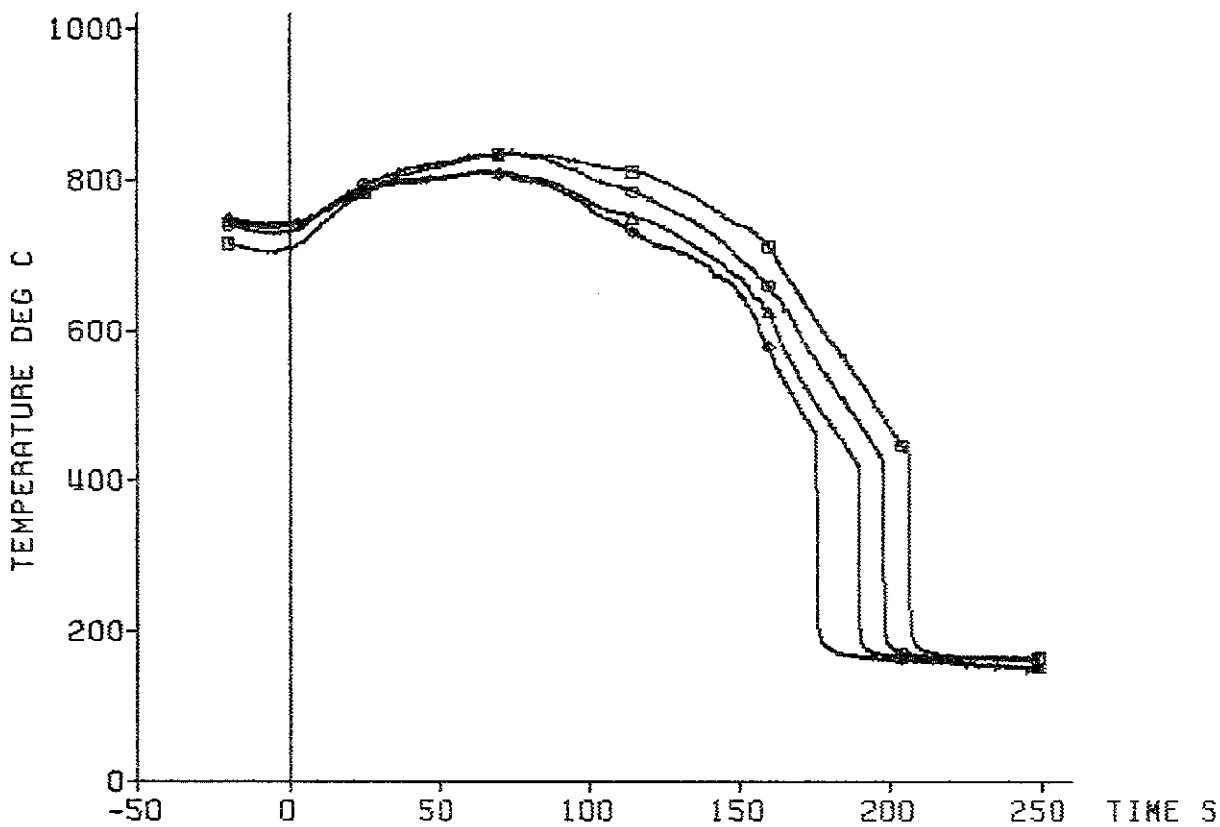

TC	ax. level
◇	9h1 1925 mm
▲	19g3 1825 mm
○	19g2 1725 mm
□	19g1 1625 mm

decay heat 120% ANS standard
 flooding rate (cold) 5.66 cm/s
 system pressure 5.89 bar
 feedwater temperature 40 deg C

bypass
 =====



Fig. 486 FEBA: 5x5 ROD BUNDLE, TEST SERIES 4, TEST-No. 269

heat transfer coeff.

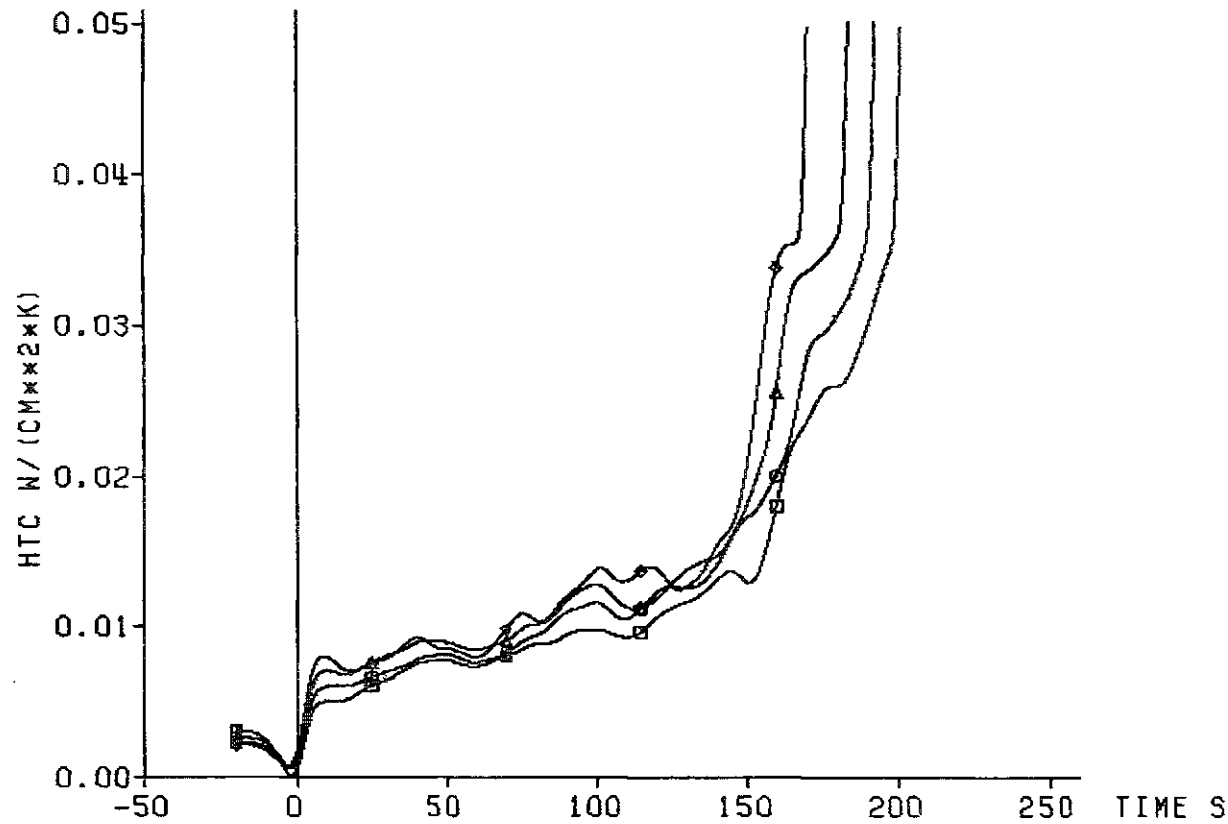

TC	ax. level
◇	9h1 1925 mm
▲	19g3 1825 mm
○	19g2 1725 mm
□	19g1 1625 mm

decay heat
 flooding rate (cold) 5.66 cm/s
 system pressure 5.89 bar
 feedwater temperature 40 deg C

120% ANS standard

bypass



Fig. 487 FEBA: 5x5 ROD BUNDLE, TEST SERIES 4, TEST-No. 269

cladding temperature

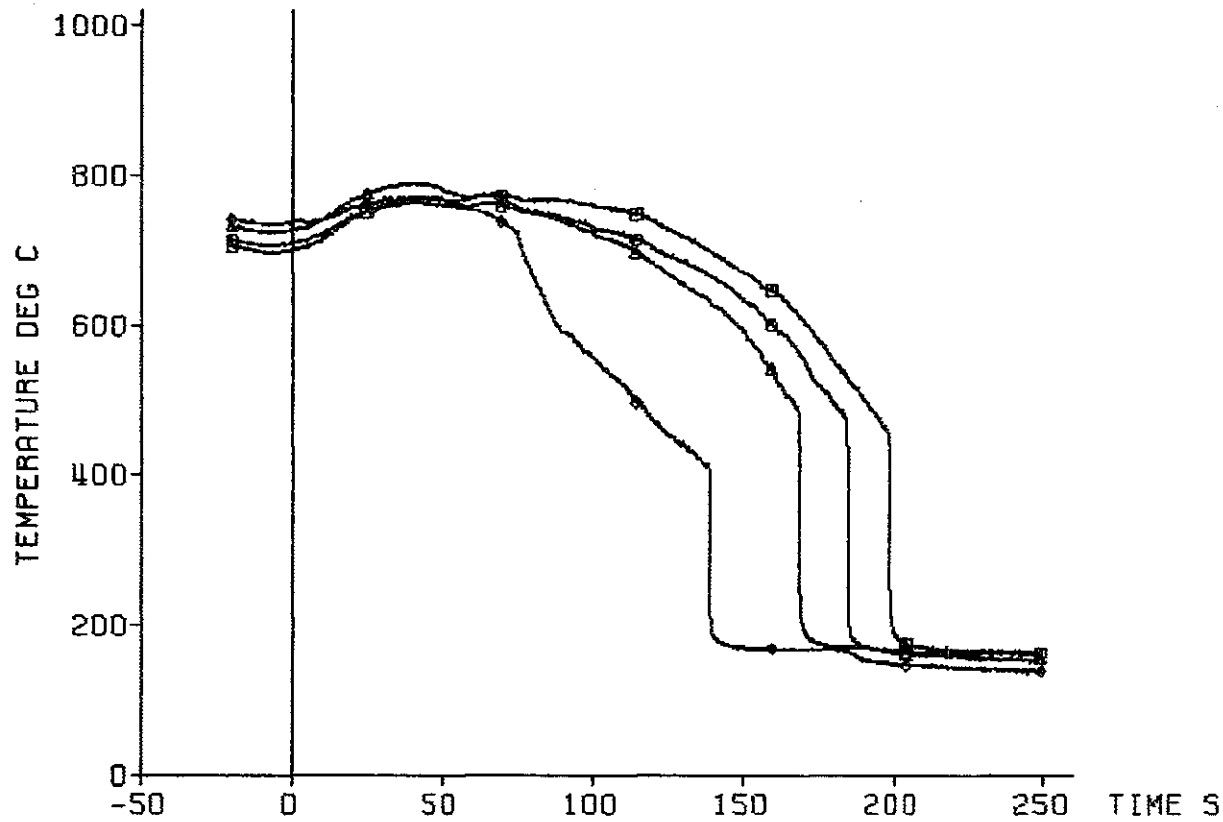

TC	ax. level
◇	17h1 1925 mm
▲	16g3 1825 mm
○	16g2 1725 mm
□	16g1 1625 mm

decay heat 120% ANS standard
 flooding rate (cold) 5.66 cm/s
 system pressure 5.89 bar
 feedwater temperature 40 deg C

blockage
 =====



Fig. 488 FEBA: 5x5 ROD BUNDLE, TEST SERIES 4, TEST-No. 269

heat transfer coeff.

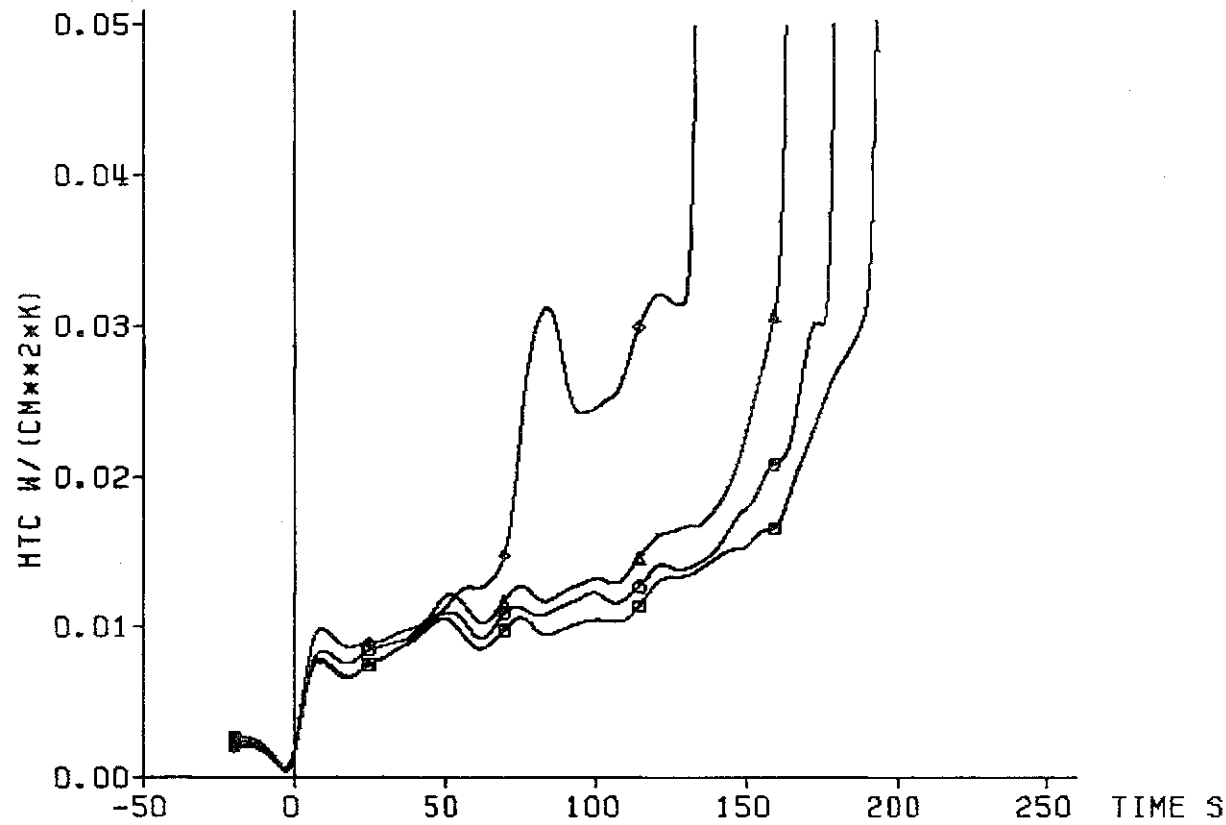

TC	ax. level
◇ 17h1	1925 mm
△ 16g3	1825 mm
○ 16g2	1725 mm
□ 16g1	1625 mm

decay heat 120% ANS standard
 flooding rate (cold) 5.66 cm/s
 system pressure 5.89 bar
 feedwater temperature 40 deg C

blockage
 =====



Fig. 489 FEBA: 5x5 ROD BUNDLE, TEST SERIES 4, TEST-No. 269

grid spacer temperature

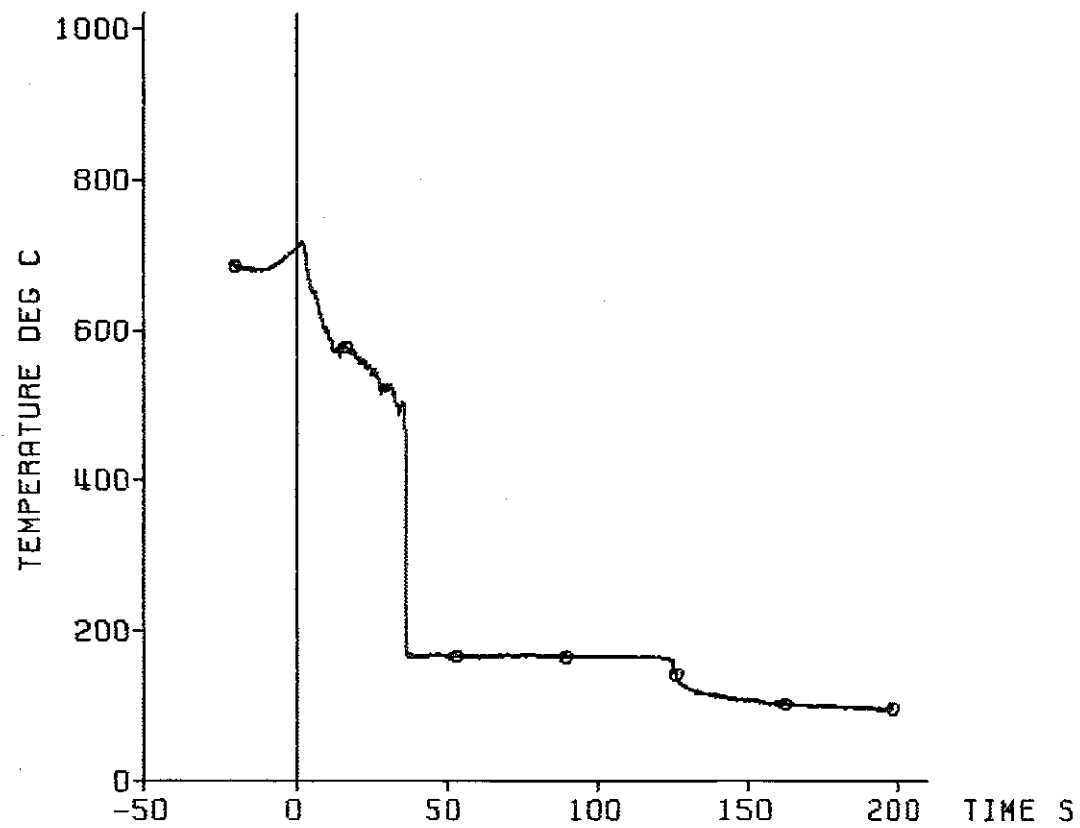

TC	axial level
87	2550 mm

decay heat 120% ANS standard
flooding rate (cold) 5.66 cm/s
system pressure 5.89 bar
feedwater temperature 40 deg C

— 530 —



Fig. 490 FEBA: 5x5 R0D BUNDLE, TEST SERIES 4, TEST-No. 269

grid spacer temperature

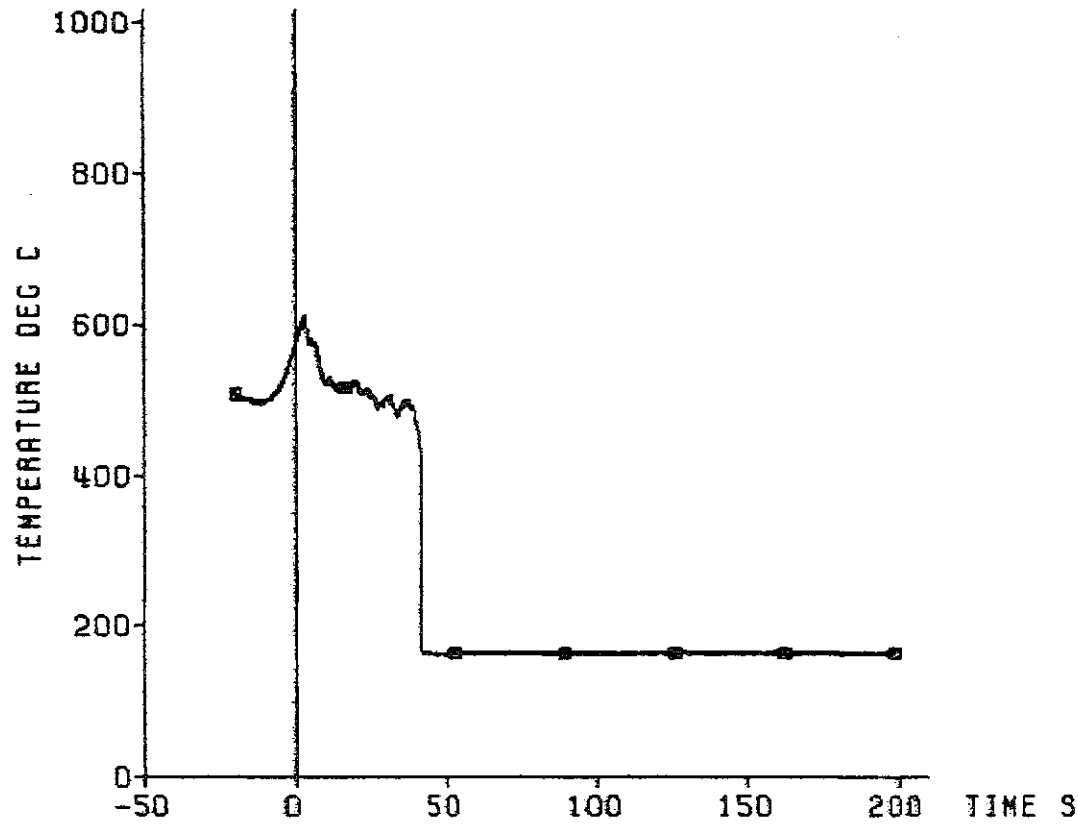

TC	axial Level
84	1460 mm

decay heat 120% ANS standard
flooding rate (cold) 5.66 cm/s
system pressure 5.89 bar
feedwater temperature 40 deg C

KfK
IRB

Fig. 491 FEBA: 5x5 ROD BUNDLE, TEST SERIES 4, TEST-No. 269

axial level: 1825 mm

△ cladding temperature (19g3)
○ fluid temperature

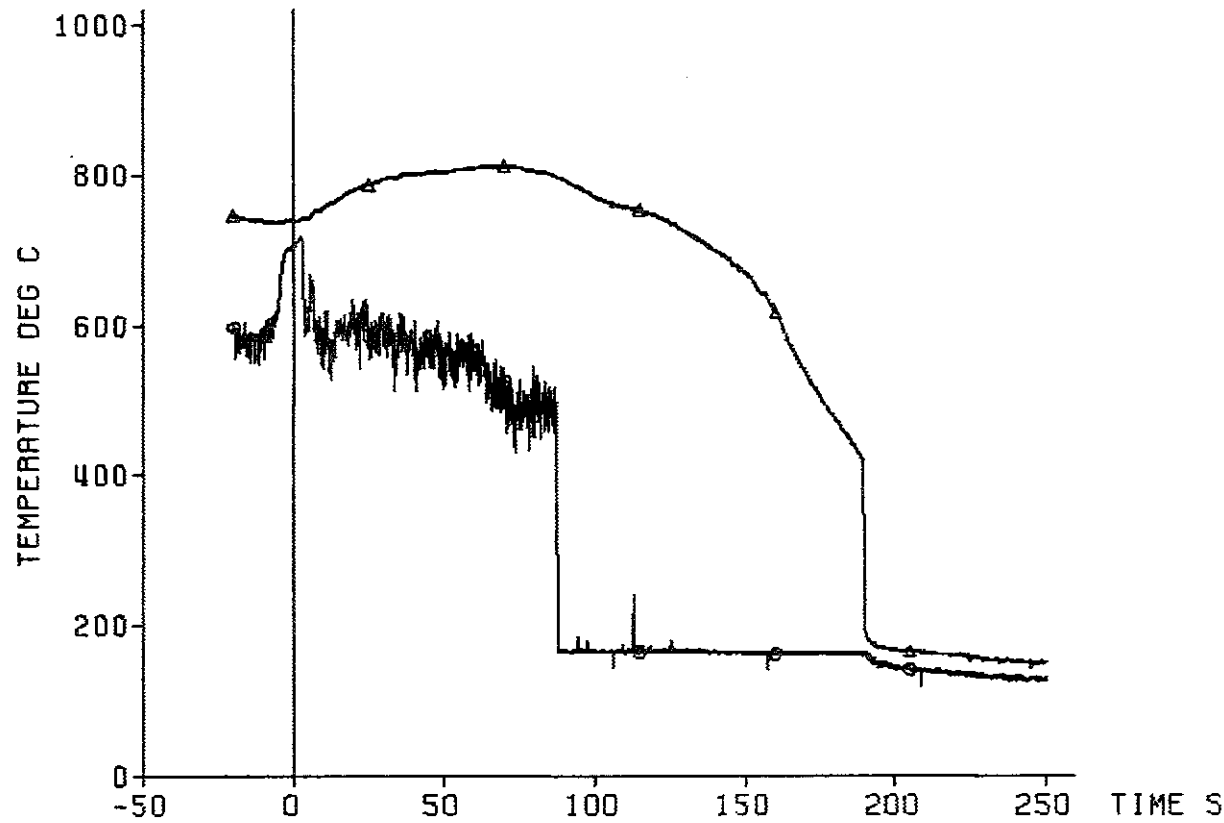

decay heat 120% ANS standard
flooding rate (cold) 5.66 cm/s
system pressure 5.89 bar
feedwater temperature 40 deg C

bypass
=====



Fig. 492 FEBA: 5x5 ROD BUNDLE, TEST SERIES 4, TEST-No. 269

axial level: 1825 mm

▲ cladding temperature (16g3)
○ fluid temperature

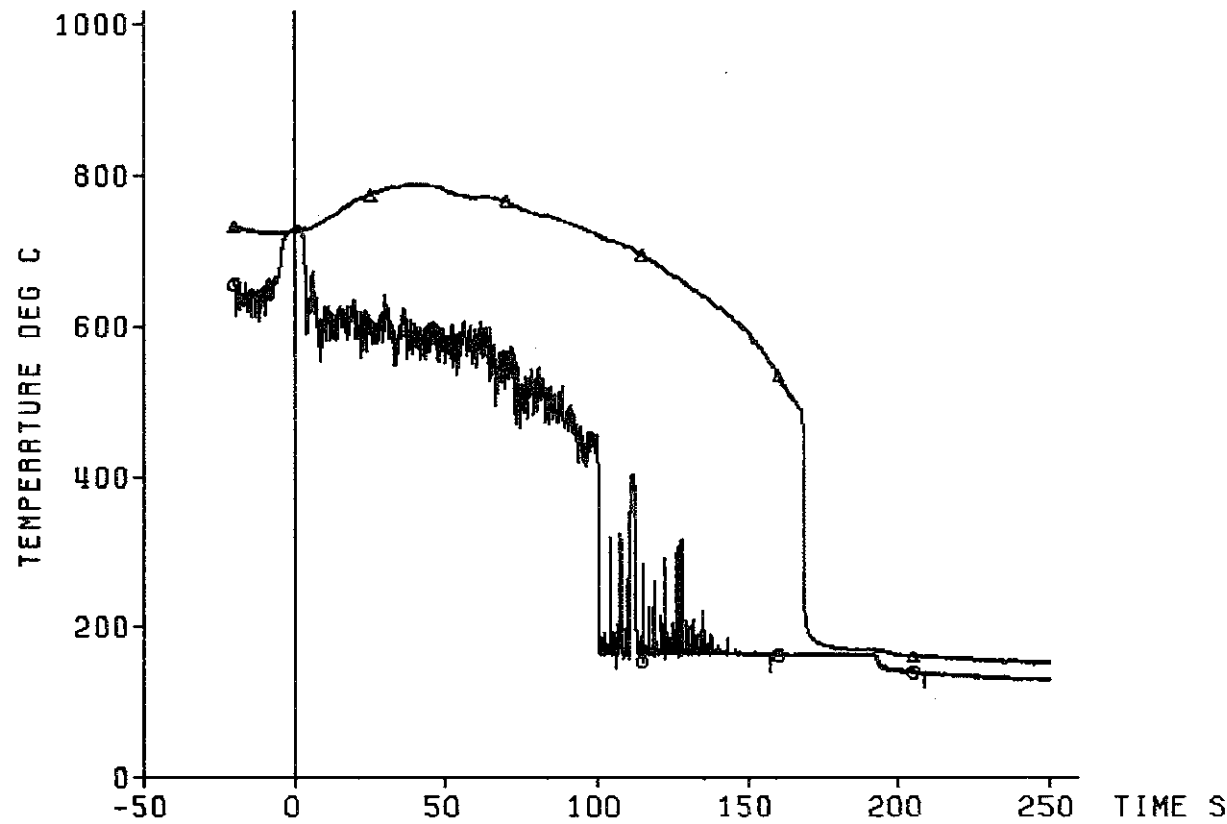

decay heat 120% ANS standard
flooding rate (cold) 5.66 cm/s
system pressure 5.89 bar
feedwater temperature 40 deg C

blockage
=====



Fig. 493 FEBA: 5x5 ROD BUNDLE, TEST SERIES 4, TEST-No. 269

axial level: 1725 mm

△ cladding temperature (19g2)
○ fluid temperature
□ housing temperature

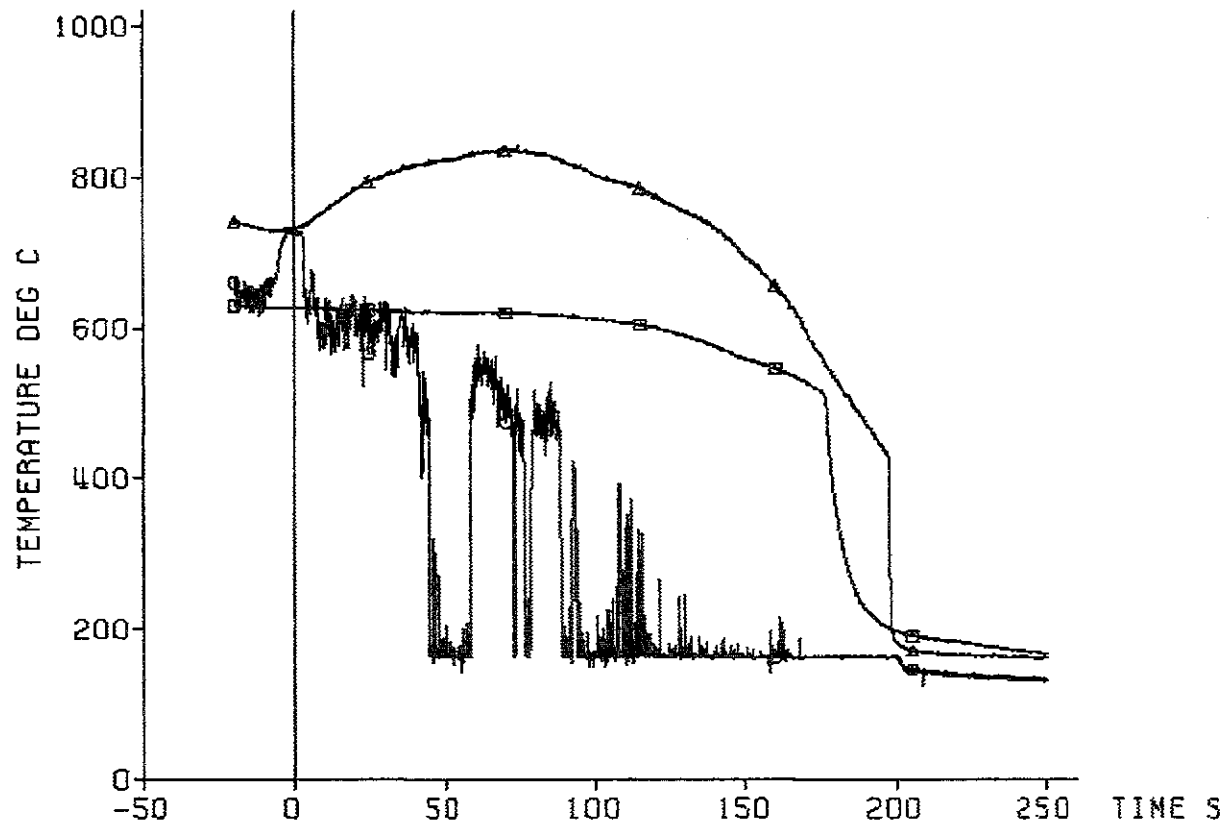

decay heat 120% ANS standard
flooding rate (cold) 5.66 cm/s
system pressure 5.89 bar
feedwater temperature 40 deg C

bypass
=====



Fig. 494 FEBA: 5x5 ROD BUNDLE, TEST SERIES 4, TEST-No. 269

pressure loss
along the test section:

◇ total length: 4196 mm
△ lower part: 1711 mm
○ middle part: 545 mm
□ upper part: 1940 mm

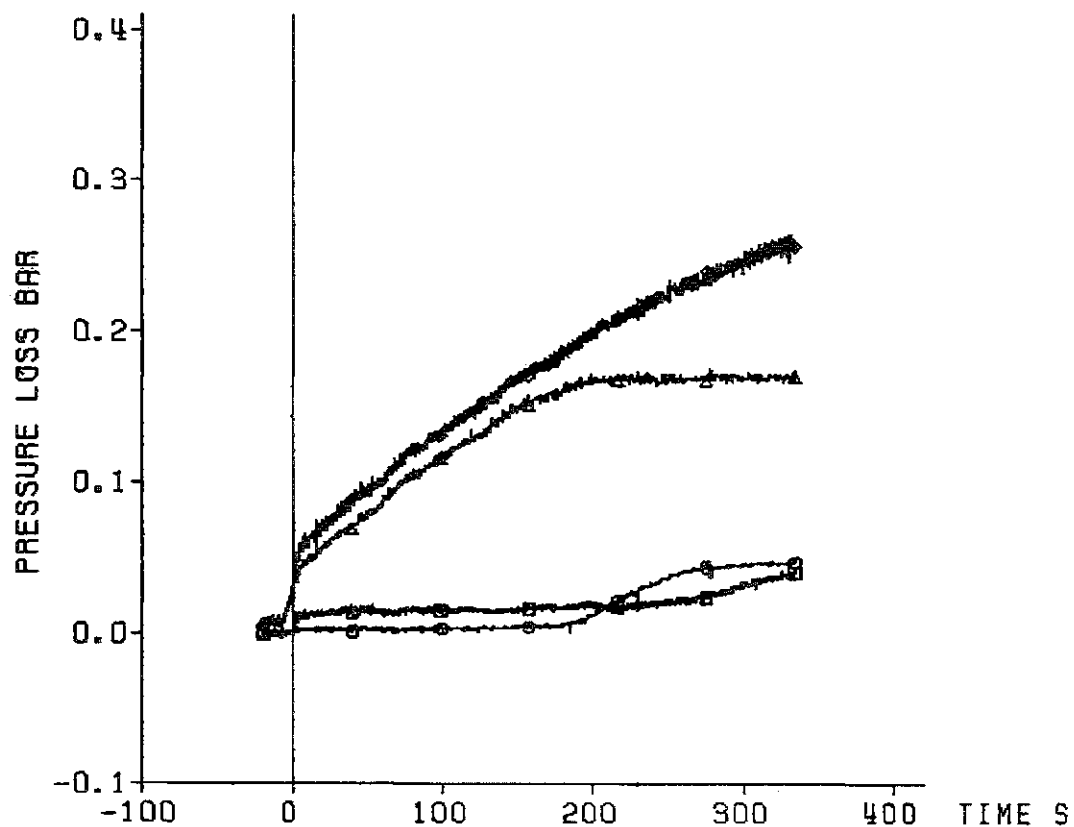

decay heat 120% ANS standard
flooding rate (cold) 5.66 cm/s
system pressure 5.89 bar
feedwater temperature 40 deg C

KfK
IRB

Fig. 495 FEBA: 5x5 ROD BUNDLE, TEST SERIES 4, TEST-NO. 269

coolant conditions:

▲ water carry over
○ coolant temperature
◻ coolant pressure

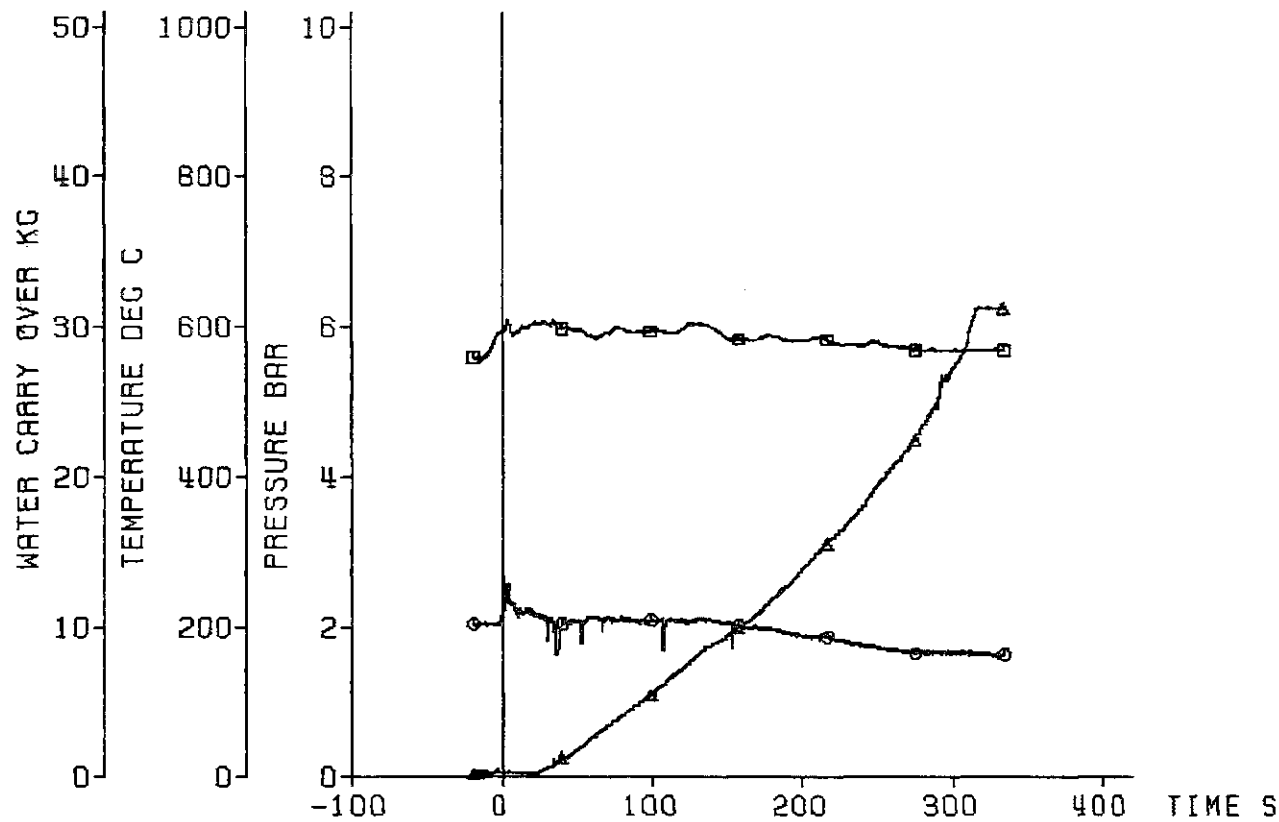

decay heat 120% ANS standard
flooding rate (cold) 5.66 cm/s
system pressure 5.89 bar
feedwater temperature 40 deg C



Fig. 496 FEBA: 5x5 ROD BUNDLE, TEST SERIES 4, TEST-No. 269

axial position of the quench front

- ▣ rewetting of the sleeve at the bundle midplane
- x rewetting of the rod downstream of the blockage

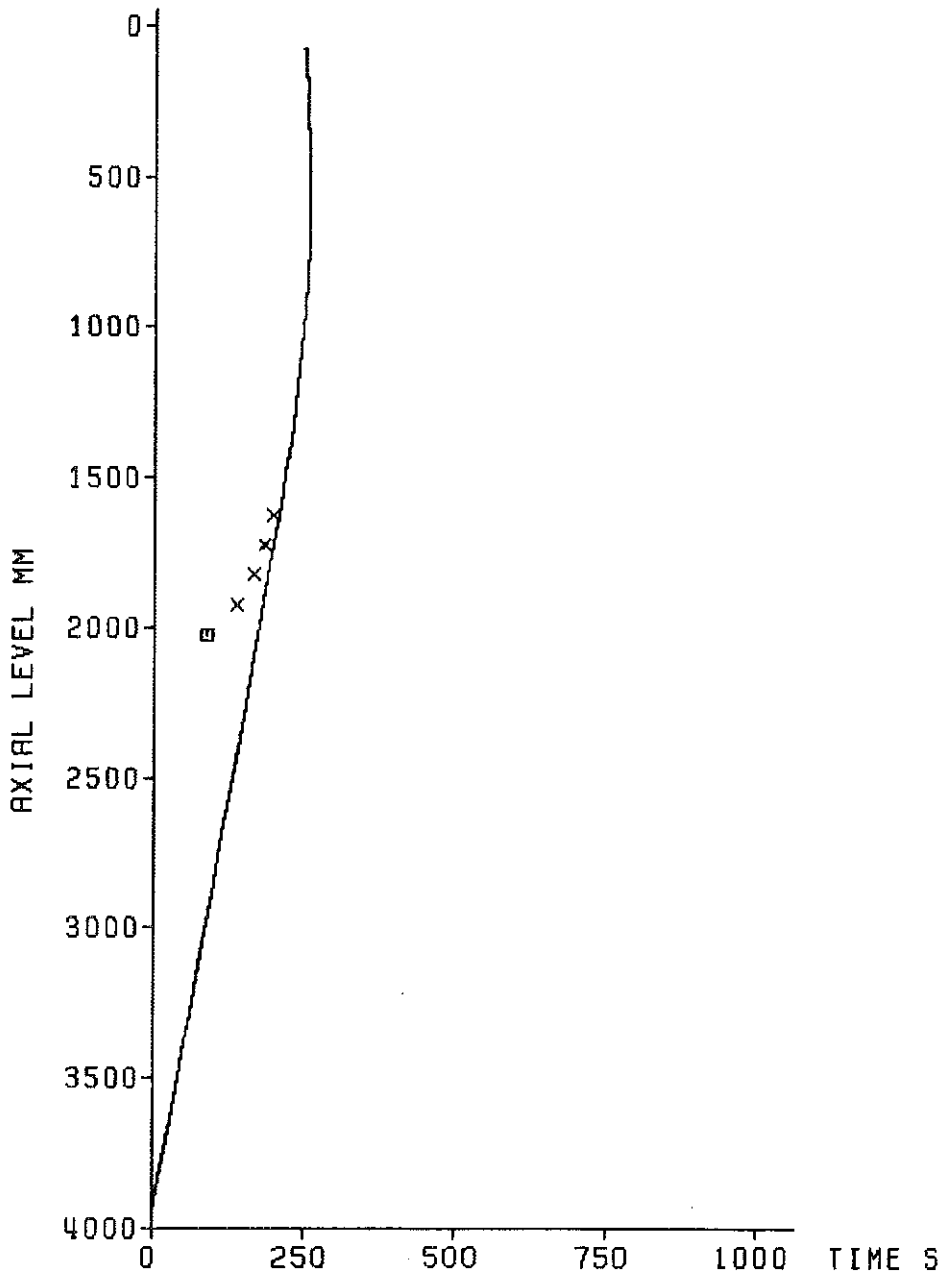

decay heat	120% ANS standard
flooding rate (cold)	5.66 cm/s
system pressure	5.89 bar
feedwater temperature	40 deg C



Fig. 497 FEBA: 5x5 ROD BUNDLE
TEST SERIES 4, TEST-No. 269

TEST SERIES IV

Investigation of the Effects of a 62% Flow Blockage With Bypass,
 Blockage at the Bundle Midplane of 3x3 Rods Placed in the Corner
 of the 5x5 Rod Bundle,
 Without Grid Spacer at the Bundle Midplane

Channel Listing and Data Identification for Test No. 261 Through 273

Channel No.	Data Identification		Unit	Remarks
	Type	Location		
1	Cladding Temperature	18a4.3860 ¹	°C	
2	Cladding Temperature	18a3.3315	°C	
3	Cladding Temperature	18a2.2770	°C	
4	Cladding Temperature	18a1.2225	°C	
5	Cladding Temperature	12b4.1680	°C	
6	Cladding Temperature	12b3.1135	°C	
7	Cladding Temperature	12b2. 590	°C	
8	Cladding Temperature	12b1. 45	°C	
9	Cladding Temperature	17h4.2225	°C	
10	Cladding Temperature	17h3.2125	°C	
11	Cladding Temperature	17h2.2025	°C	
12	Cladding Temperature	17h1.1925	°C	
13	Fluid Temperature	TF ² 3315	°C	
14	Fluid Temperature	TF ² 2380	°C	
15	Fluid Temperature	TF ² 1725	°C	
16	Fluid Temperature	TF ² 485	°C	
17	Housing Temperature	TK ⁴ 3315	°C	
18	Housing Temperature	TK 2235	°C	
19	Housing Temperature	TK 1725	°C	
20	Housing Temperature	TK 590	°C	

TEST SERIES IV

Channel No.	Data Identification		Unit	Remarks
	Type	Location		
21	Fluid Temperature	Lower Plenum	°C	Heated + Unheated TC's
22	Water Level Detector	4012	°C	
23	Feedwater Temperature		°C	
24	Fluid Temperature	Upper Plenum	°C	
25	Room Temperature		°C	
26	Cladding Temperature	22f4.2425 ¹	°C	
27	Cladding Temperature	22f3.2325	°C	
28	Cladding Temperature	22f2.2225	°C	
29	Cladding Temperature	22f1.2125	°C	
30	Cladding Temperature	21e4.2225	°C	
31	Cladding Temperature	21e3.2175	°C	
32	Cladding Temperature	21e2.2125	°C	
33	Cladding Temperature	21e1.2075	°C	
34	Cladding Temperature	19g4.1925	°C	
35	Cladding Temperature	19g3.1825	°C	
36	Cladding Temperature	19g2.1725	°C	
37	Cladding Temperature	19g1.1625	°C	
38	Cladding Temperature	16g4.1925	°C	
39	Cladding Temperature	16g3.1825	°C	
40	Cladding Temperature	16g1.1625	°C	
41	Cladding Temperature	16g2.1725	°C	
42	Cladding Temperature	15a4.3860	°C	
43	Cladding Temperature	15a3.3315	°C	
44	Cladding Temperature	15a2.2770	°C	
45	Cladding Temperature	15a1.2225	°C	
46	Cladding Temperature	14e4.2225	°C	
47	Cladding Temperature	14e3.2175	°C	
48	Cladding Temperature	14e2.2125	°C	
49	Cladding Temperature	14e1.2075	°C	

TEST SERIES IV

Channel No.	Data Identification		Unit	Remarks
	Type	Location		
50	Cladding Temperature	13d3.2025 ¹	°C	
51	Cladding Temperature	13d2.2025	°C	
52	Cladding Temperature	13d1.2025	°C	
53	Cladding Temperature	10f4.2425	°C	
54	Cladding Temperature	10f3.2325	°C	
55	Cladding Temperature	10f2.2225	°C	
56	Cladding Temperature	10f1.2125	°C	
57	Cladding Temperature	9h4.2225	°C	
58	Cladding Temperature	9h3.2125	°C	
59	Cladding Temperature	9h2.2025	°C	
60	Cladding Temperature	9h1.1925	°C	
61	Cladding Temperature	8d4.2025	°C	
62	Cladding Temperature	8d3.2025	°C	
63	Cladding Temperature	8d2.2025	°C	
64	Cladding Temperature	8d1.2025	°C	
65	Cladding Temperature	7f4.2425	°C	
66	Cladding Temperature	7f3.2325	°C	
67	Cladding Temperature	7f2.2225	°C	
68	Cladding Temperature	7f1.2125	°C	
69	Sleeve Temperature	TH ⁵ 13.2025	°C	
70	Sleeve Temperature	TH 17.2025	°C	
71	Sleeve Temperature	TH 21.2025	°C	TC Failed
72	-----		-	Open
73	Cladding Temperature	3b4.1680	°C	
74	Cladding Temperature	3b3.1135	°C	
75	Cladding Temperature	3b2. 590	°C	
76	Cladding Temperature	3b1. 45	°C	

TEST SERIES IV

Channel No.	Data Identification		Unit	Remarks
	Type	Location		
77	Grid Temperature	TA ⁶ 1460	°C	TC Failed After Test 267 TC Failed After Test 268
78	Grid Temperature	TA ⁷ 1460	°C	
79	Grid Temperature	TA ⁶ 2550	°C	
80	Grid Temperature	TA ⁷ 2550	°C	
81	Electrical Power Input	8 Rods	kW	Rods No. 1 Through 8
82	Electrical Power Input	8 Rods	kW	Rods No. 9 Through 16
83	Electrical Power Input	9 Rods	kW	Rods No. 17 Through 25
84	Housing Temperature	TK ⁴ 3915	°C	
85	Housing Temperature	TK 3564	°C	
86	Cladding Temperature	2c4.4025 ¹	°C	
87	Cladding Temperature	2c3.3925	°C	
88	Cladding Temperature	2c2.3825	°C	
89	Cladding Temperature	2c1.3725	°C	
90	Cladding Temperature	24c4.4025	°C	
91	Cladding Temperature	24c3.3925	°C	
92	Cladding Temperature	24c2.3825	°C	
93	Cladding Temperature	24c1.3725	°C	
94	Cladding Temperature	20d4.2025	°C	
95	Cladding Temperature	20d3.2025	°C	
96	Cladding Temperature	20d2.2025	°C	
97	Cladding Temperature	20d1.2025	°C	
98	Fluid Temperature	TF ² 3038	°C	
99	Fluid Temperature	TF ² 2770	°C	
100	Fluid Temperature	TF ³ 2245	°C	
101	Fluid Temperature	TF ² 2210	°C	
102	Fluid Temperature	TF ³ 2045	°C	
103	Fluid Temperature	TF ² 1825	°C	
104	Fluid Temperature	TF ³ 1825	°C	

TEST SERIES IV

Channel No.	Data Identification		Unit	Remarks
	Type	Location		
105	Fluid Temperature	TF ² 2770	°C	TC of 0.5 mm Diameter
106	Fluid Temperature	TF ² 2770	°C	TC of 1.0 mm Diameter
107	Fluid Temperature	TF ² 3038	°C	TC of 0.5 mm Diameter
108	Fluid Temperature	TF ² 3315	°C	TC of 0.5 mm Diameter
109	Fluid Temperature	TF ² 3315	°C	TC of 1.0 mm Diameter
110	Time (10 Scans/s)		s	t = 0: Start of Reflooding
111	Pressure in Lower Plenum	4091	bar	
112	Pressure in Upper Plenum	-105	bar	
113	Pressure in Buffer		bar	
114	Bundle Power		kW	Channels: 81 + 82 + 83
115	Flooding Velocity (cold)		cm/s	
116	Water Carry Over Collected		kg	Downstream of Bundle Exit
117	Pressure Diff.	1835 and -105 mm	bar	
118	Measured	2380 and 1835 mm	bar	
119	Between	4091 and 2380 mm	bar	
120	Axial Level	4091 and -105 mm	bar	Values Measured Separately

- 1) TC's of 0.5 mm diameter embedded in rod cladding. Measuring position:
Example: rod No. = 18, type of rod instrumentation = a, TC No. = 4,
axial level = 3860 mm, referenced to the top flange of the bundle.
- 2) TF = TC's of 0.25 mm diameter (bare).
TC's placed in subchannel surrounded by rods No. 12, 17, 16 and 11.
- 3) TF = TC's of 0.25 mm diameter (bare).
TC's placed in subchannel surrounded by rods No. 15, 20, 19 and 14.
- 4) TK = TC's of 0.5 mm diameter placed in the wall of the bundle housing of
of 6.5 mm thickness.

TEST SERIES IV

- 5) TH = TC's of 0.5 mm diameter embedded in sleeve. Measuring position:
Example: rod No. 13, axial level = 2025 mm.
- 6) TA = TC's of 0.5 mm diameter placed at the grid spacer in subchannel surrounded by housing and rods No. 21 and 22.
- 7) TA = TC's of 0.5 mm diameter placed at the grid spacer in subchannel surrounded by housing and rods No. 4 and 5.