

**KfK 3659
März 1984**

**FEBA —
Flooding Experiments
with Blocked Arrays
Data Report 2,
Test Series V through VIII**

**P. Ihle, K. Rust
Institut für Reaktorbauelemente
Projekt Nukleare Sicherheit**

Kernforschungszentrum Karlsruhe

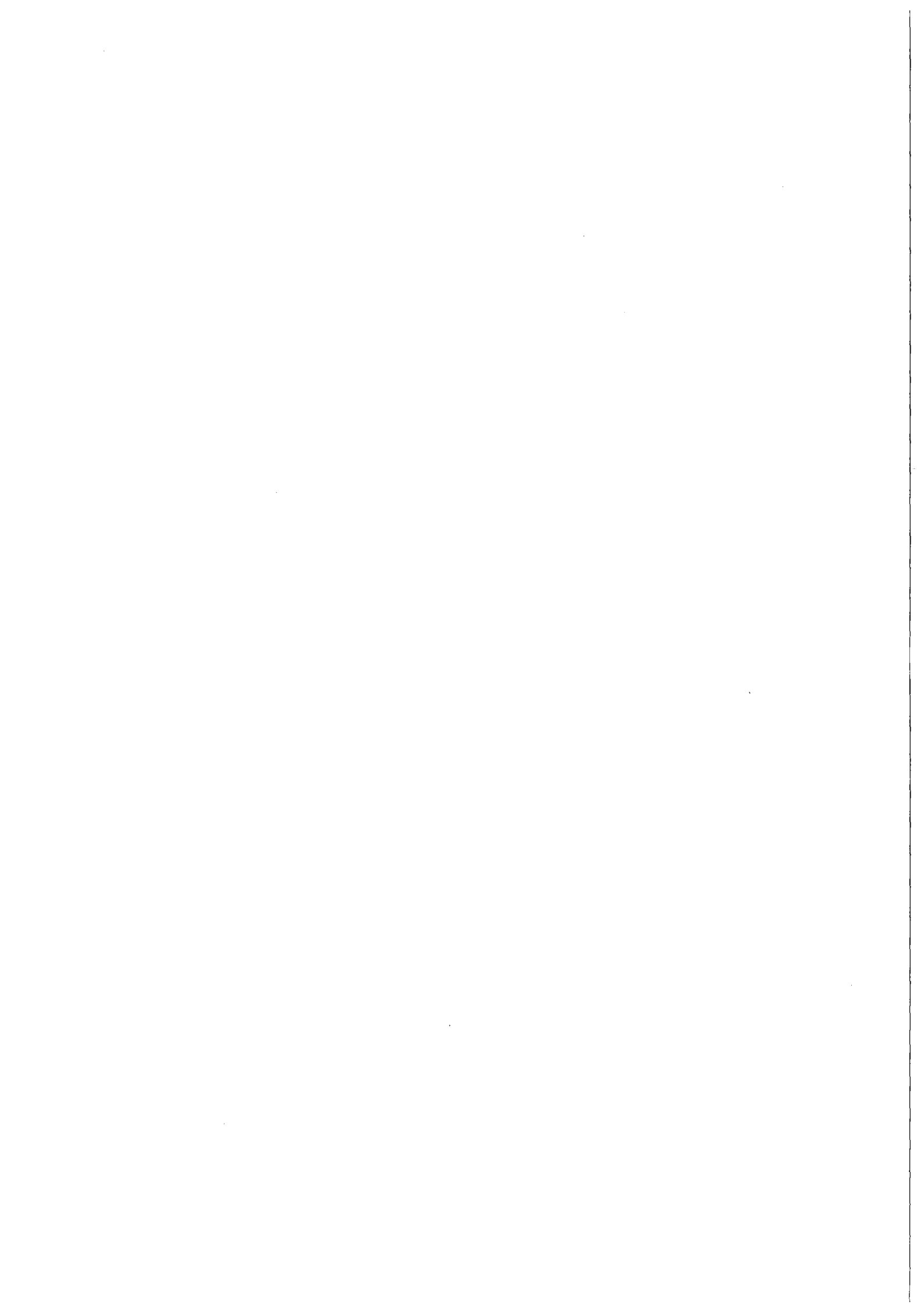

KERNFORSCHUNGSZENTRUM KARLSRUHE
Institut für Reaktorbauelemente
Projekt Nukleare Sicherheit

KfK 3659

FEBA - Flooding Experiments with Blocked Arrays
Data Report 2, Test Series V through VIII

P. Ihle, K. Rust

Kernforschungszentrum Karlsruhe GmbH, Karlsruhe

Als Manuskript vervielfältigt
Für diesen Bericht behalten wir uns alle Rechte vor

Kernforschungszentrum Karlsruhe GmbH
ISSN 0303-4003

Abstract

This report presents typical data and a limited heat transfer analysis of test series V through VIII from an experimental thermal-hydraulic program of Flooding Experiments with Blocked Arrays (FEBA). The experiments consisted of separate effect tests on a full-length 5x5 rod bundle of PWR fuel rod dimensions utilizing electrically heated rods with a cosine power profile approximated by 7 steps of different specific power. Eight test series were performed under idealized reflood conditions using forced feed and system pressure as parameters without the inclusion of the effects of a reactor cooling system. The individual test series were conducted to study the effect of grid spacers and of coplanar blockages of different blockage ratios with and without bypass on the reflood heat transfer. The purpose of the investigations was to obtain an insight into the most important heat transfer mechanisms and to broaden the data base for the development and assessment of improved thermal-hydraulic models.

FEBA - Flutexperimente mit blockierten Anordnungen
Datenbericht 2, Testserien V bis VIII

Kurzfassung

In diesem Bericht werden typische Meßergebnisse und eine begrenzte Wärmeübergangsanalyse der Testserien V bis VIII vorgestellt, die im Rahmen des FEBA-Programmes gewonnen wurden. Die Experimente zur Untersuchung thermohydraulischer Einzeleffekte in einem 5x5-Stabbündel mit DWR Brennstababmessungen voller Länge wurden mit elektrisch beheizten Stäben durchgeführt, deren axiale Leistung durch sieben Stufen einer Cosinusverteilung angenähert war. Das Programm bestand aus acht Testserien mit Zwangsfluten und Systemdruck als Parameter zur Idealisierung der Flutbedingungen. Effekte des Reaktorkühlsystems waren nicht eingeschlossen. Die einzelnen Testserien dienten der Untersuchung der Einflüsse von Abstandshaltern und koplanaren Blockaden mit und ohne zusätzlicher Umströmung auf den Wärmeübergang während des Flutens. Die Absicht war, ein verbessertes Verständnis der wichtigsten Wärmeübergangsmechanismen zu gewinnen und die Basis experimenteller Daten zu erweitern für Entwicklung und Überprüfung verbesserter thermohydraulischer Rechenmodelle.

<u>Table of Contents</u>	<u>Page</u>
1. Introduction	1
2. FEBA Reflood Program	2
3. Test Loop	5
4. Test Section Design	6
5. Instrumentation	10
6. Test Parameters	12
7. Data Informations	14
8. References	19
9. Test Series V	21
9.1 Test No. 284, v = 2.2 cm/s, p = 3.9 bar	24
9.2 Test No. 282, v = 3.8 cm/s, p = 3.9 bar	48
9.3 Test No. 281, v = 5.7 cm/s, p = 3.9 bar	72
9.4 Listing of Computer Channel Numbers	96
10. Test Series VI	103
10.1 Test No. 276, v = 3.8 cm/s, p = 3.9 bar	106
10.2 Listing of Computer Channel Numbers	135
11. Test Series VII	141
11.1 Test No. 327, v = 2.2 cm/s, p = 4.1 bar	144
11.2 Test No. 322, v = 3.8 cm/s, p = 2.1 bar	168
11.3 Test No. 324, v = 3.8 cm/s, p = 4.1 bar	192
11.4 Test No. 329, v = 3.8 cm/s, p = 5.9 bar	216
11.5 Test No. 321, v = 5.8 cm/s, p = 2.1 bar	240
11.6 Test No. 325, v = 5.8 cm/s, p = 4.1 bar	264
11.7 Test No. 330, v = 5.8 cm/s, p = 5.9 bar	288
11.8 Listing of Computer Channel Numbers	311
12. Test Series VIII	317
12.1 Test No. 342, v = 2.2 cm/s, p = 2.2 bar	320
12.2 Test No. 338, v = 2.2 cm/s, p = 4.1 bar	346
12.3 Test No. 341, v = 3.8 cm/s, p = 2.2 bar	372
12.4 Test No. 337, v = 3.8 cm/s, p = 4.0 bar	398
12.5 Test No. 334, v = 3.8 cm/s, p = 5.8 bar	424

	Page
12.6 Test No. 340, $v = 5.8$ cm/s, $p = 2.2$ bar	450
12.7 Test No. 336, $v = 5.8$ cm/s, $p = 4.1$ bar	476
12.8 Test No. 333, $v = 5.8$ cm/s, $p = 5.8$ bar	502
12.9 Listing of Computer Channel Numbers	528

1. Introduction

During a loss-of-coolant accident (LOCA) of a pressurized water reactor (PWR) the emergency core cooling systems (ECCS) are usually assumed to provide sufficient capacity to avoid significant fuel damage for current design basis accident cases. However, during such an event situations may arise leading to the heatup of the core by nuclear decay heat for an extended time span. Under design basis accident conditions this may be the case, e.g. during the refill phase after blowdown. The reflood water injection has to terminate this "Second Heatup Phase" before fuel rod damage exceeds specified limits.

In a LOCA of a PWR the fuel in portions of the core may become overheated, whilst at the same time the reactor system pressure may decrease below the internal rod pressure. Under these circumstances the Zircaloy claddings could balloon and reduce considerably the cooling channel cross sections.

To obtain a better understanding of the flow conditions and to provide an expanded data base for an adequate analytical description of the complex heat transfer processes taking place in a bundle of ballooned rods during the reflood phase, separate effect tests under forced reflood conditions were performed. The Flooding Experiments with Blocked Arrays (FEBA) were carried out in eight consecutive test series using a 5x5 rod array as the main arrangement for all of the tests.

Details of the FEBA reflood program as well as a comparison of typical transients measured and evaluated from the different test series are presented in Ref. /1/.

This report is a broader sampling of data selected from tests of the second four 5x5 rod bundle test configurations. A first data report /2/ contains data selected from test series I through IV.

From the tests presented all data measured as well as selected data evaluated are available on tapes from KfK. The data also are available from the Reactor Safety Research Data Bank of the USNRC at EG&G Idaho, Idaho Falls, ID, U.S.A.

2. FEBA Reflood Program

The specific objectives of the separate effect tests under forced reflood conditions were:

- To measure and to evaluate thermal-hydraulic data for unblocked bundle geometries,
- To measure and to evaluate the effect of grid spacers upon the thermal-hydraulic behavior,
- To measure and to evaluate thermal-hydraulic data for blocked bundle geometries with and without flow bypass.

The FEBA 5x5 rod bundle program consisted of eight test series with different grid spacer and sleeve blockage arrays within the bundle. The bundle geometries and the axial arrangement of grid spacers and flow blockages are shown in Fig. 1. The main purposes of the individual test series are:

- Series I: Base line tests with undisturbed bundle geometry containing all (seven) grid spacers for comparison with the subsequent series,
- Series II: Investigation of the grid spacer effect on the axial temperature profile at the bundle midplane, without grid spacer at the bundle midplane,
- Series III: Investigation of the effects of a 90 % flow blockage with bypass, blockage at the bundle midplane of 3x3 rods placed in the corner of the 5x5 rod bundle, without grid spacer at the bundle midplane,
- Series IV: Investigation of the effect of a 62 % flow blockage with bypass, blockage at the bundle midplane of 3x3 rods placed in the corner of the 5x5 rod bundle, without grid spacer at the bundle midplane,
- Series V: Investigation of the effects of a 90 % flow blockage with bypass, blockage at axial level 2125 mm (100 mm upstream of the bundle midplane) of 3x3 rods placed in the corner of the 5x5 rod bundle, grid spacer at the bundle midplane,
- Series VI: Investigation of the effects of a 90 % and 62 % flow blockage with bypass, 90 % blockage at axial level 2125 mm (100 mm upstream of the bundle midplane) and 62 % blockage at axial level 1925 mm (100 mm downstream of the bundle midplane) of 3x3 rods placed in the corner of the 5x5 rod bundle, grid spacer at the bundle midplane,

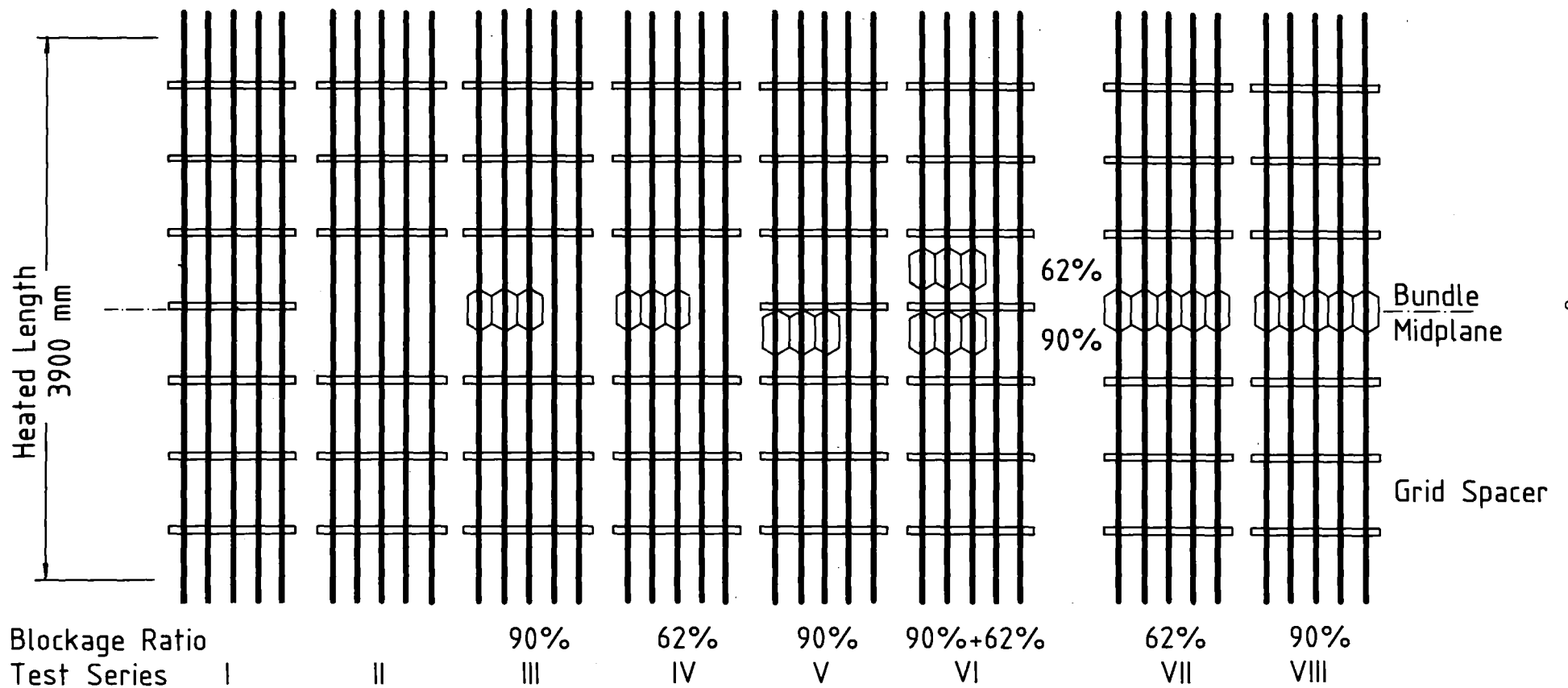
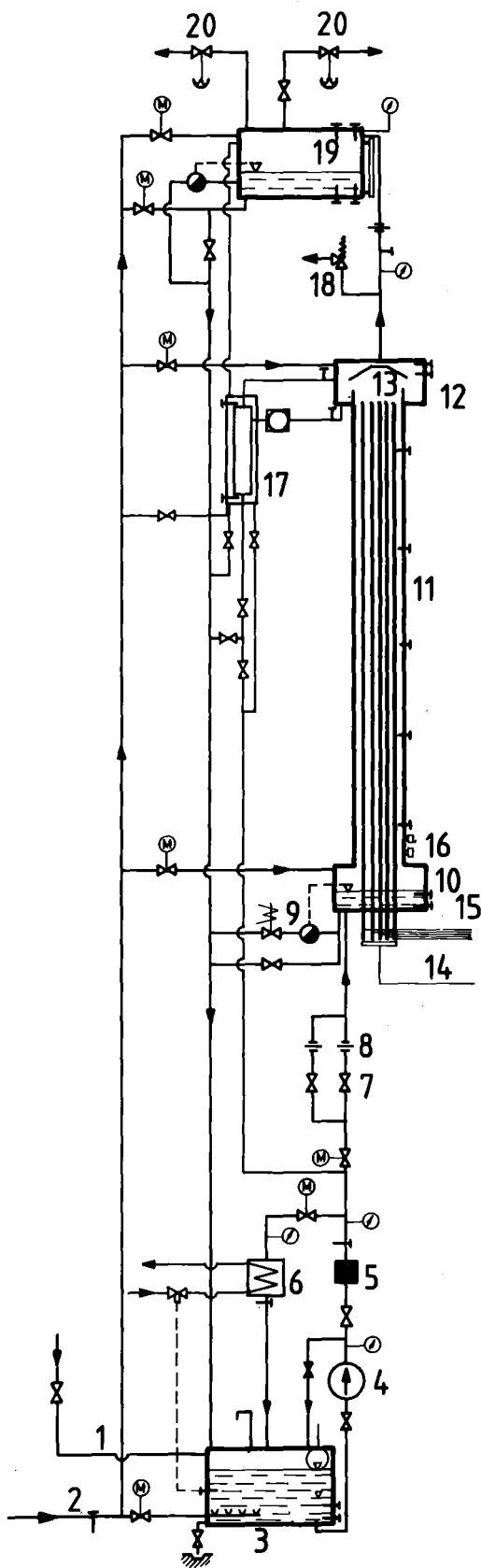

Fig. 1 5x5 rod bundle: Bundle geometries of test series I through VIII axial arrangement of grid spacers and sleeve blockages



LEGEND

- 1 Water Supply
- 2 Steam Supply
- 3 Storage Tank
- 4 Water Pump
- 5 Filter
- 6 Heat Exchanger
- 7 Throttle Valve
- 8 Turbine Meter
- 9 Water Level Regulation Valve
- 10 Lower Plenum
- 11 Test Section
- 12 Upper Plenum
- 13 Water Separator
- 14 Power Supply
- 15 Rod Instrumentation Exits
- 16 Water Level Detector
- 17 Water Collecting Tank
- 18 Outlet Valve
- 19 Buffer
- 20 Pressure Regulator

Fig. 2 FEBA test loop

Series VII: Investigation of the effects of a 62 % blockage without bypass, blockage at the bundle midplane of the 5x5 rod bundle,

Series VIII: Investigation of the effects of a 90 % blockage without bypass, blockage at the bundle midplane of the 5x5 rod bundle.

3. Test Loop

Figure 2 shows schematically the test loop. It is a forced-flow reflood facility with a back pressure control system. Coolant water is stored in a tank (3). During operation, coolant is pumped (4) through a throttle valve (7) and a turbine meter (8) into the lower plenum region (10) of the test section (11). The coolant flow may be directed either upwards through the test assembly, or through the lower plenum (10) and water level regulation valve (9) back into the water supply. When reflood is initiated, coolant water rises in the test assembly and two-phase flow results when water reaches the hot zone of the heater rods. Entrained water droplets are transported upwards by the rising steam and may impinge on the steam water separator (13) placed above the test assembly. The liquid then drains into a collecting tank (17), where the water content is continuously measured. Steam passes around the droplet deflector and is then flowing through a buffer tank (19) to the atmosphere. This tank has an automatic pressure regulator (20) for control of a constant back pressure for the test assembly. A large external steam supply is connected to the buffer to heat up the total system and the buffer contents and to maintain the system pressure. The heater rod instrumentations (15) exit from the lower end of the rod assembly as do the electric power connections (14) for the heater rods. However, the instrumentation of the sleeve blockages is led to the top end of the housing such that it does not influence the two-phase mixture rising from the bottom. The housing is insulated to reduce the heat loss to the outside air environment.

4. Test Section Design

Electrically heated rods of PWR dimensions are used to simulate the nuclear fuel rods. Figure 3, a working drawing of an instrumented heater rod, shows the axial dimensions. Figure 4 shows the cross section of the heater rod which has an outer diameter of 10.75 mm. A spiral wound heating element of NiCr 80 20 (ASTM B 344-60) is embedded in the electrical insulator

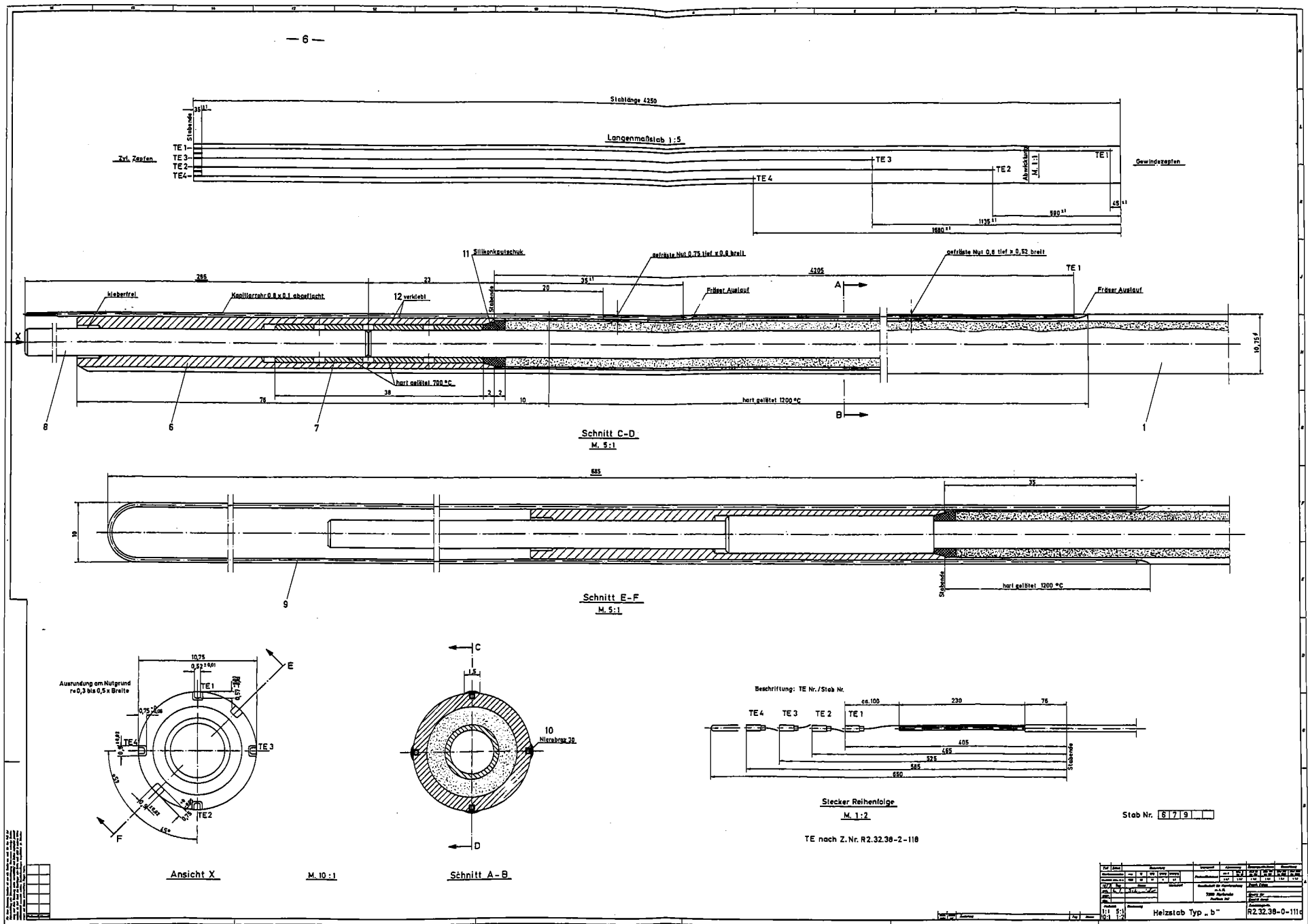
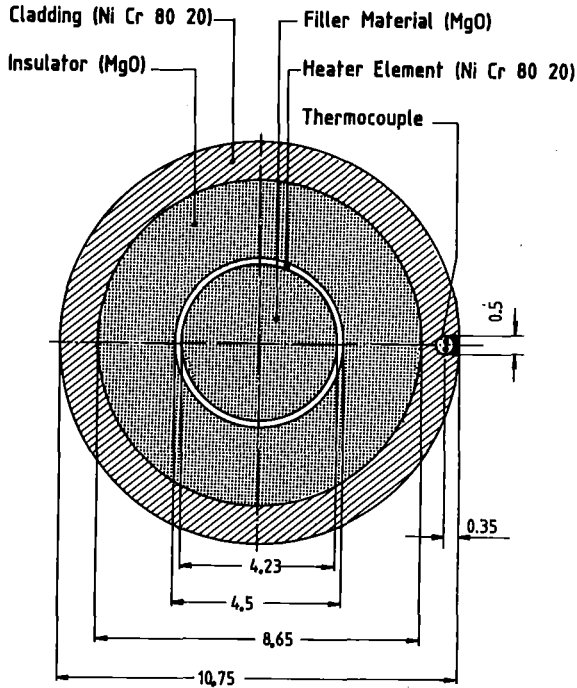

Fig. 3 Working drawing of an instrumented FEBA heater rod (type b of the cladding instrumentation)



Dimensions are in millimeters

Fig. 4 Cross section of heater rod

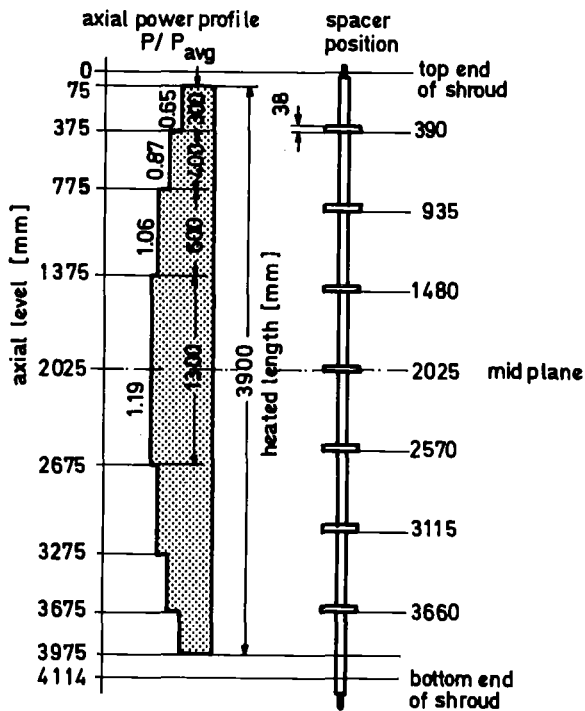

Fig. 5 Axial heater rod layout

(MgO), and then encapsulated in the clad of NiCr 80 20 which has a wall thickness of one millimeter. In contrast to a nuclear fuel rod with a Zircaloy cladding and a gas filled gap, this heater rod is a "solid type" usually used for thermal-hydraulic tests. A gas filled gap between cladding and the electrical insulation is not provided. The cosine power profile of the fuel rods is approximated by seven steps of different specific power. The left-hand side sketch of Fig. 5 shows the axial power distribution of the heater rod with a length of 3900 mm. The average power step level is shown together with the length of each power step. The axial power profile is flat. The peak to average ratio amounts to 1.19. The 5x5 rod bundle is placed in a square section housing with an inside width of 78.5 mm. The housing of stainless steel (AISI 316 Ti) has a wall thickness of 6.5 mm. The heater rod pitch is 14.3 mm. The right-hand side of Fig. 5 shows the axial position of seven original KWU-PWR grid spacers which are located at the bundle midplane (axial level 2025 mm) and every 545 mm above and below that level. The grid spacers are attached to the rods by friction. They are

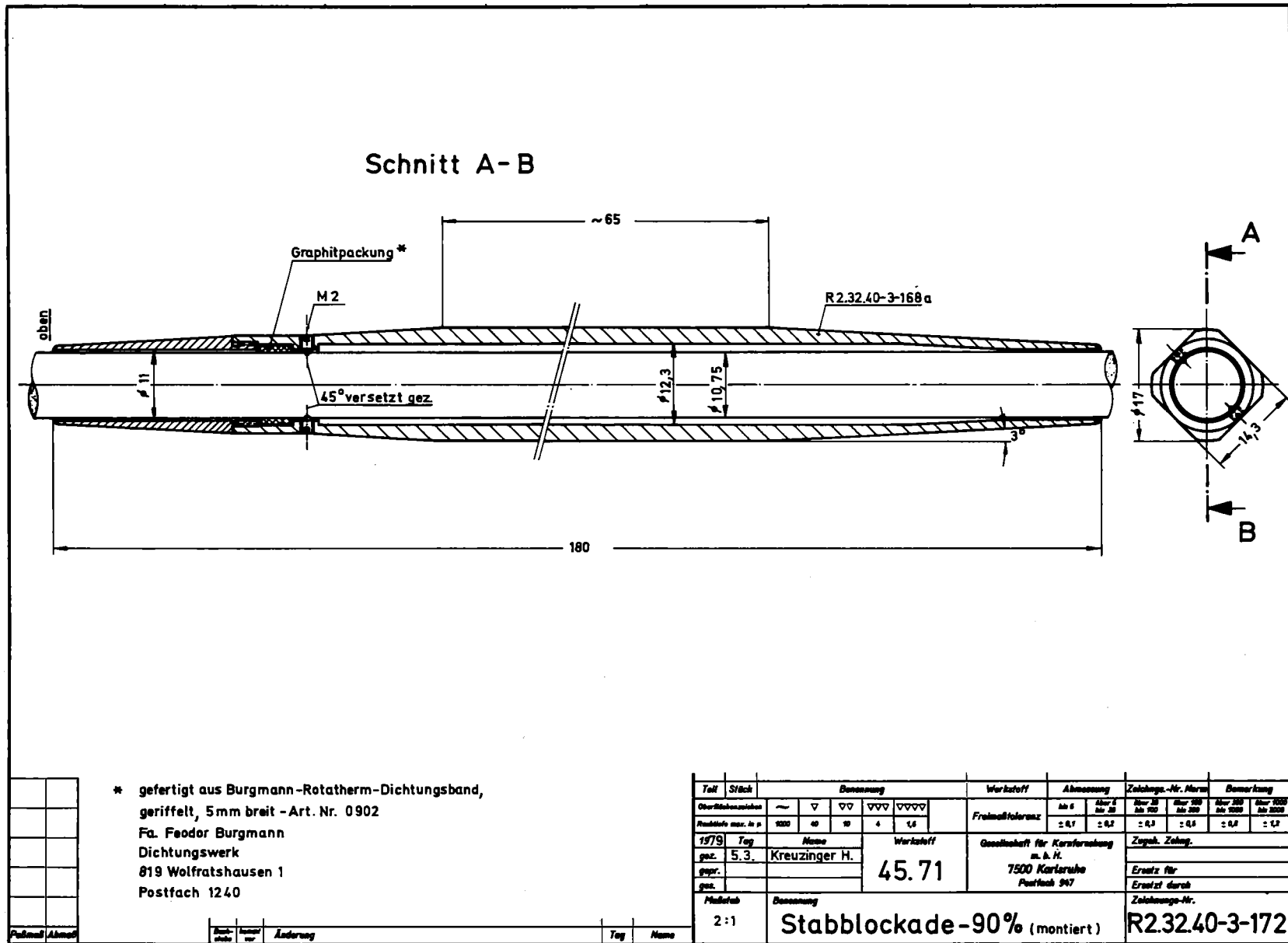

Fig. 6 5x5 rod bundle: Working drawing of the 90% blockage device

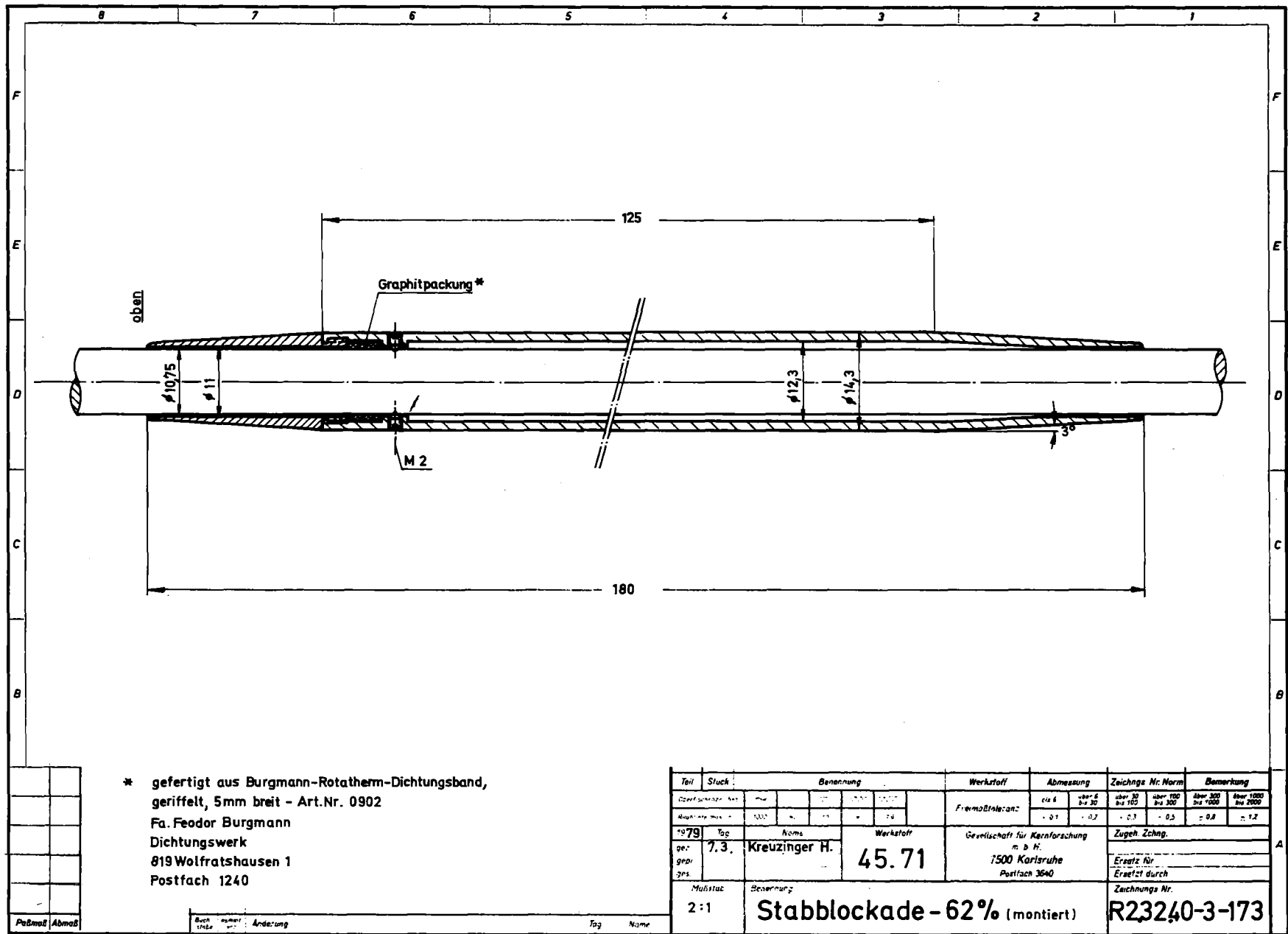

Fig. 7 5x5 rod bundle: Working drawing of the 62% blockage device

sliding in the housing in the case of different axial elongation of housing and rod bundle.

The heater rods are bolted to the top flange of the test section (zero level and therefore reference level for all axial bundle positions), and the lower ends of the rods penetrate through the test assembly pressure barrier. The penetration is accomplished using O-ring sealings and allows axial movement of the heater rods relative to the housing. Weights are hung from the bottom end of the rods to prevent them from bowing due to friction in the sealing during temperature changes.

To investigate effects of ballooned fuel rod claddings on the reflood thermohydraulics, sleeves of 180 mm length are used. Figures 6 and 7 show the shape of sleeves selected to simulate the smooth geometry expected from ballooned rod claddings with blockage of 90 % and 62 %, respectively, of the subchannel flow areas. In addition side plate devices are placed between the sleeves and the housing. They are attached to the sleeves. They are sliding in the housing in the case of different axial elongation of the housing and the rod bundle. The actual length of the remaining subchannels in the 90 % blocked zone is 65 mm. In the 62 % blocked zone, it is 125 mm. The sleeves touch the rod surfaces at the ends of the sleeves only. To simulate the gap resistance between a ballooned cladding and the fuel as well as to reduce the heat capacity of the artificial blockage, the remainder of the sleeve is separated from the rod by a gap of 0.8 mm filled with stagnant steam. The influences of the heat capacity of the sleeves and the heat resistance of the gap on the transient sleeve temperatures were compared by calculation with the behavior of a ballooned fuel rod.

5. Instrumentation

Most part of the test instrumentation consisted of thermocouples (Chromel-Alumel), since cladding (TS), sleeve (TH), fluid (TF), housing (TK) and grid spacer (TA, test series IV and VIII) temperatures were to be measured at various positions. Figure 8 shows a schematic diagram of the axial levels of the TC measuring positions. This diagram enables to relate the measuring positions to the grid spacer positions as well as to the specific power zones. However, not all TC measuring positions were instrumented for the individual test series. More details can be taken from the computer channel

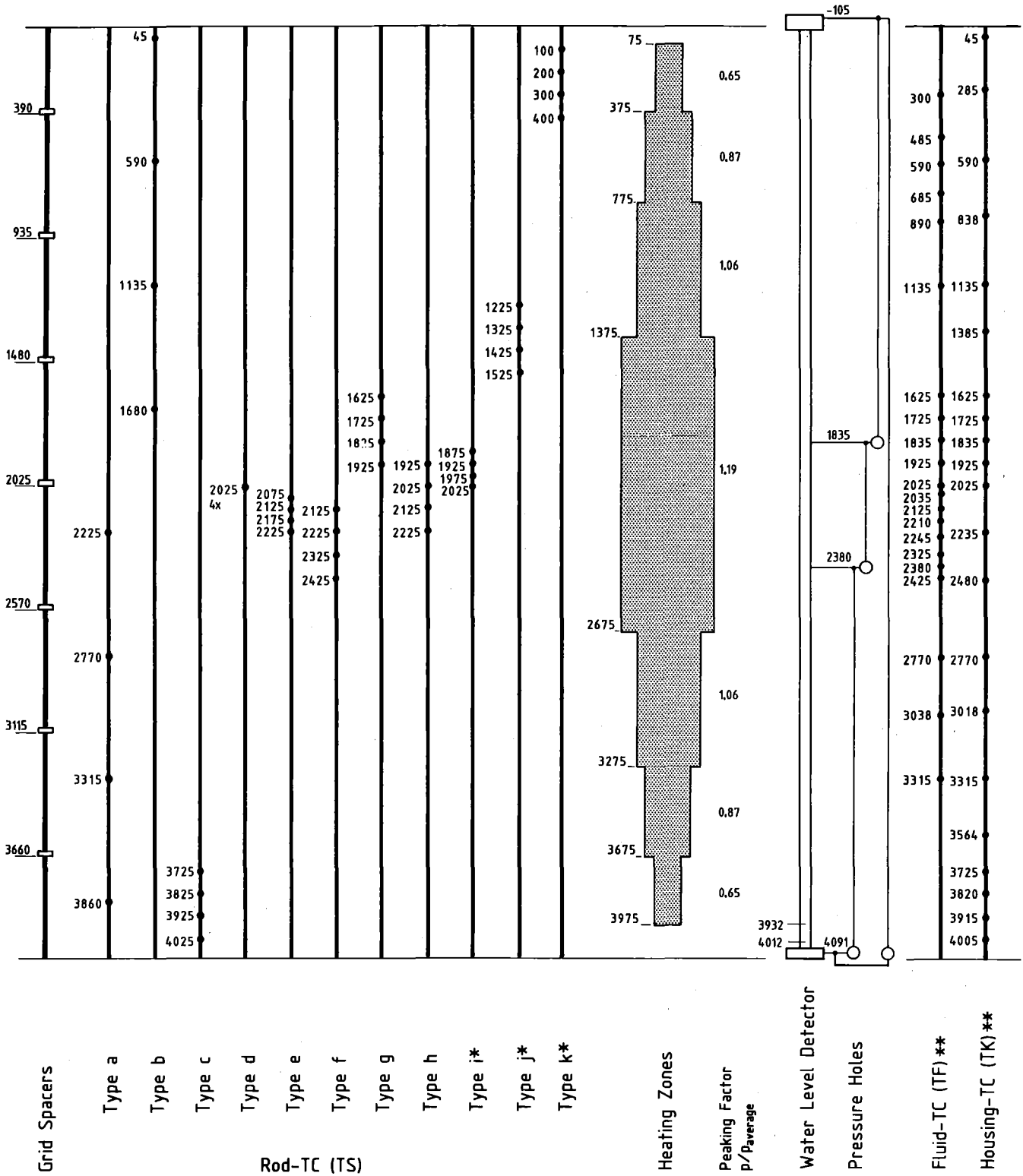

* in Test Series V through VIII only

** not all positions set for the individual tests

Fig. 8 5x5 rod bundle: Axial levels of the measuring positions

listings included in this report for test series V through VIII (cf. appendices at the end of the plotted data of each test series).

Cladding and sleeve temperatures were measured with 0.5 mm sheath diameter thermocouples having insulated junctions. These thermocouples were embedded in grooves which were milled into the outer surface of the rod claddings and the sleeves. The grooves were closed by brazing over the total length to avoid any disturbance of the coolant flow.

The fluid temperature was measured with unshielded thermocouples of 0.25 mm outer sheath diameter. The junctions protruded into the flow channels. Pressures and pressure differences were measured with pressure transducers. In addition to the inlet and outlet pressure, the pressure differences were measured along the entire bundle length, along both the lower and upper portions of the bundle as well as along the bundle midplane section. The flooding rate was measured with a turbo flowmeter. The amount of the water carried over was measured continuously by a pressure transducer at the water collecting tank.

All data were digitally recorded with a scan frequency of 10 cycles per second.

The data acquisition system is described in Ref. /1/.

6. Test Parameters

The main test parameters varied are shown in Fig. 9:

- Bundle geometry,
- Flooding rate given as flooding velocity, i.e. the velocity of the rising water level in the cold bundle,
- System pressure.

Flooding rate, system pressure, and feedwater temperature were kept constant during each test run. However, at the beginning of reflow, the feedwater was heated up by the hot environment of the lower plenum. Nevertheless, some few seconds later the feedwater temperature decreased and reached the desired value. The initial bundle power of about 200 kW was followed by a

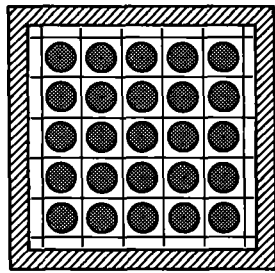

Test Series I
Test Series II

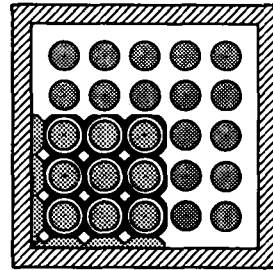

Test Series III
Test Series V
Test Series VI
90% Blockage

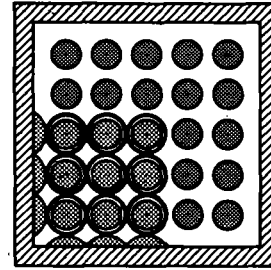

Test Series IV
Test Series VI
62% Blockage

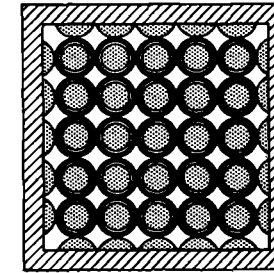

Test Series VII
62% Blockage

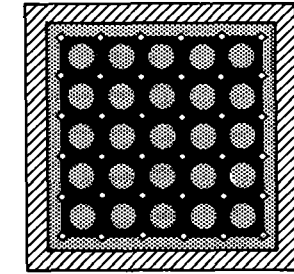

Test Series VIII
90% Blockage

FLOODING PARAMETERS

Test Series		I	II	III	IV	V	VI	VII	VIII
Flooding Velocity (cold bundle) Constant During Each Test	cm/s	3.8, 5.8	3.8, 5.8	3.8, 5.8	3.8, 5.8 (2.2, 10.)	2.2, 3.8 5.8	2.2, 3.8 5.8	3.8, 5.8 (2.2)	3.8, 5.8 (2.2)
System Pressure Constant During Each Test	bar	2, 4, 6	2, 4, 6	2, 4, 6	2, 4, 6 (4)	4	4	2, 4, 6 (4)	2, 4, 6 (2, 4)
Feedwater Temperature Constant During Each Test	°C	40 °C, some few tests with 80 °C							
Max. Cladding Temperature (at start of reflooding)	°C	between 700 and 800 °C, some few tests between 600 and 700°C							
Max. Housing Temperature (at start of reflooding)	°C	between 600 and 700 °C, some few tests between 500 and 600°C							
Bundle Power	kW	at start of reflooding 200 kW, 120% ANS decay heat transient 40 s after shutdown, some few tests with constant bundle power							

Steam Cooling Tests

Test series VII and VIII include steady state and transient tests for which low bundle power and system pressures of 2, 4 and 6 bar were selected.

Fig. 9 5x5 rod bundle: Test matrix of test series I through VIII

decay heat transient corresponding to 120 % ANS standard 40 s after shutdown of a reactor.

The tests performed are listed in Tables 1 through 4 by which the plotted data of each test series are introduced.

7. Data Informations

For the data transfer, data management, heat transfer analysis, and data representation a detailed computer code was written /3/ using the physical properties of the specific materials programmed in the PEW code /4/.

For each test series the following tables, figures, plots, and listings are included:

a) Summary and comment table.

This table gives an overlook over the individual test runs, i.e. flooding velocity, system pressure, feedwater temperature, bundle power transient.

b) Information figure for identification of rod bundle measuring positions.

The upper part of the figure shows the cross sectional geometry at the bundle midplane, the rod numbers, the type of rod instrumentation, the thermocouple numbers, the sleeve instrumentation (TH, in case of investigation of blockage effects), the fluid thermocouples (TF), the housing thermocouples (TK), the grid spacer thermocouples (TA, in case of its instrumentation).

In the lower part of the figure the axial positions of the cladding instrumentation are listed.

c) Layout of the bundle geometry.

The main purpose of this layout is to identify the main measuring positions upstream and downstream of the bundle midplane. Again, it is to point out that all axial levels are referenced to the top flange of the rod bundle (zero level).

d) Data plots of test series V.

The readily available bundle of 5x5 fuel rod simulators was used for the investigation of the combined effect of a 90 % blockage with bypass and a

grid spacer at the bundle midplane. However, some few heater rods were replaced by new rods. This change was necessary after failure of some cladding thermocouples during performance of test series I through IV. In addition the axial and radial bundle instrumentation of the 5x5 rod array was slightly modified also with respect to the location of the different flow obstacles. Nevertheless, it was tried to the greatest possible extent to plot transients versus reflood time which were measured at identical rods and elevations, respectively. This form of representation should make easier a comparison from test run to test run and from test series to test series.

The plots show in detail:

- Initial temperature profile of the cladding,
- Test parameters: Flooding velocity /cm/s/, system pressure /bar/ measured in the buffer, feedwater temperature /°C/, bundle power /kW/,
- Cladding temperatures /°C/ measured in the bypass area at fixed axial levels of 345 mm downstream of the leading edge of each grid spacer, Heat transfer coefficients /W/(cm²K)/ corresponding to the aforementioned cladding temperatures.

The heat transfer coefficients are related to the saturation temperature corresponding to the system pressure. In contrast to all other data plotted of this test series, a smoothing subroutine of the computer code was applied to substitute each data point of the cladding temperature transient by the arithmetic mean value of the previous and following 25 points for heat transfer analysis only. In this context it should be reminded that the data were recorded with a scan frequency of 10 cycles per second.

- Cladding temperatures measured upstream of the partial blockage in both the bypass and blockage area,
Corresponding heat transfer coefficients,
- Cladding temperature measured at the midplane of the partial blockage in the bypass area,
Corresponding heat transfer coefficients,
- Sleeve and cladding temperatures measured at the midplane of the partial blockage,
- Cladding temperatures measured at the bundle midplane and downstream of it in both the bypass and blockage area,
Corresponding heat transfer coefficients,

- Cladding-, fluid-, housing temperatures measured at the same axial position,
Data measured in both the bypass and blockage area,
- Pressure drop /bar/ along the entire bundle length, the lower portion of the bundle, the bundle midplane, the upper portion of the bundle,
- Coolant outlet: water carried over /kg/ measured in the water collecting tank, steam temperature /°C/ and pressure /bar/ both measured in the upper plenum,
- Axial positions of the quenchfront /mm/ as function of reflood time.

e) Listing of the computer channel numbers and of data identification for the data of series V available on tapes.

f) Data plots of test series VI.

Summary and comment table, information figure for identification of rod bundle measuring positions, layout of the bundle geometry are corresponding to positions a) through c). For this test series served the same rod bundle as for test series V. However, a second blockage with bypass was installed at the same 3x3 rod cluster downstream of the bundle midplane. The ratio of this blockage amounted to 62 %.

The plots show in detail:

- Initial axial temperature profile of the cladding,
- Test parameters: Flooding velocity /cm/s/, system pressure /bar/ measured in the buffer, feedwater temperature /°C/, bundle power /kW/,
- Cladding temperatures /°C/ measured in the bypass area at fixed levels of 345 mm downstream of the leading edge of each grid spacer,
Heat transfer coefficients /W/(cm²K)/ corresponding to the afore mentioned cladding temperatures,

Again the heat transfer coefficients are related to the saturation temperature corresponding to the system pressure. In contrast to all other data plotted for this test run of series VI, a smooth subroutine of the computer code was applied to substitute each data point of the cladding temperature transient by the arithmetic mean value of the previous and following 25 points for heat transfer analysis only.

- Cladding temperatures measured upstream of the 90 % partial blockage in both the bypass and blockage area,
Corresponding heat transfer coefficients,
- Cladding temperature measured at the midplane of the 90 % partial

blockage in the bypass area,

Corresponding heat transfer coefficient,

- Sleeve and cladding temperatures measured at the midplane of the 90 % partial blockage,
- Cladding temperatures measured downstream of the 90 % partial blockage, but upstream of the 62 % partial blockage in both the bypass and blockage area,
Corresponding heat transfer coefficients,
- Cladding temperatures measured downstream of the 62 % partial blockage in both the bypass and blockage area,
Corresponding heat transfer coefficients,
- Cladding- and fluid temperatures measured at the same axial position for both the bypass and the blocked area,
- Pressure drop /bar/ along the entire bundle length, the lower portion of the bundle, the bundle midplane, the upper portion of the bundle,
- Coolant outlet: water carried over /kg/ measured in the water collecting tank, steam temperature /°C/ and pressure /bar/ both measured in the upper plenum,
- Axial positions of the quenchfront /mm/ as function of reflood time.

g) Listing of the computer channel numbers and of data identification for the data of series VI available on tape.

h) Data plots of test series VII

For the performance of test series VII and VIII a new rod bundle was installed. The rod instrumentation was to the greatest possible extent the same as used for test series I through VI. However, the test instrumentation became more extensive, since cladding-, sleeve-, fluid-, housing- and grid spacer temperatures (the latter were recorded in test series VIII only) were measured at additional axial and/or radial positions. For the investigation of test series VII and VIII the second data acquisition system was used which is described in Ref. /1/.

For the calculation of the heat transfer coefficients the cladding temperatures were smoothed by substituting each data point of the cladding temperature transient by the arithmetic mean value of the previous and following 25 points. The same smoothing routine of the computer program was applied to substitute each point of the pressure drop and water carry over transients by the mean value of the previous and following 10

points. In contrast to all other data plotted, this procedure offers in these cases the advantage of an easier identification of the data presented in the individual graphs.

The plots show in detail:

- Initial axial temperature profile of the cladding,
- Test parameters: Flooding velocity /cm/s/, system pressure /bar/ measured in the buffer, feedwater temperature /°C/, bundle power /kW/,
- Cladding temperatures /°C/ measured at fixed levels of 345 mm downstream of the leading edge of each grid spacer,
Heat transfer coefficients /W/(cm²K)/ corresponding to the aforementioned cladding temperatures,
The heat transfer coefficients are related to the saturation temperature corresponding to the system pressure.
- Cladding temperatures measured upstream of the bundle midplane,
Corresponding heat transfer coefficients,
- Sleeve and cladding temperatures at the bundle midplane,
- Cladding temperatures downstream of the bundle midplane,
Corresponding heat transfer coefficients,
- Cladding-, fluid-, housing temperatures measured at the same axial positions,
- Pressure drop /bar/ along the entire bundle length, the lower portion of the bundle, the bundle midplane, the upper portion of the bundle,
- Coolant outlet: water carried over /kg/ measured in the water collecting tank, steam temperature /°C/ and pressure /bar/ both measured in the upper plenum,
- Axial positions of the quenchfront /mm/ as function of reflood time.

i) Listing of the computer channel numbers and of data identification for the data of series VII available on tapes or in the USNRC/RSR Data Bank.

j) Data plots of test series VIII.

Corresponding to the positions h) through i), the informations of test series VIII are included.

k) Additional remarks concerning the data informations. The initial axial profile of the cladding temperatures shows a dip at the midplane of the bundle for series VII and VIII. Two effects caused the heat loss in radial direction during the heat up phase prior to the individual tests:

First, the sleeves attached at all of the 25 rods including the side plate devices attached at the outer rows of the sleeves led to heat conduction to the housing. Second, the thermal insulation of the housing had openings near the midplane for windows in an alternative bundle housing. The openings were closed for the test series VII and VIII. However, the insulating effectiveness was diminished locally.

In Fig. 289, e.g., sleeve temperature signals are plotted which show beginning of thermocouple failures or outer influences on the electrical ducts. Such signals only may be used qualitatively. The same is true for some few fluid temperature signals as plotted e.g. in Fig. 298. Most part of the signal of the fluid temperature at axial level 1925 seems to be correct compared with corresponding transients. The underflow for a certain time span calls for elimination of this signal for quantitative analysis.

8. References

- /1/ Ihle, P.; Rust, K.:
"FEBA - Flooding Experiments with Blocked Arrays, Evaluation Report"
KfK 3657, Feb. 1984

- /2/ Ihle, P.; Rust, K.:
"FEBA - Flooding Experiments with Blocked Arrays, Data Report 1, Test Series I through IV"
KfK 3658, Feb. 1984

- /3/ Rust, K. et al.:
"DAS - Ein Daten-Auswerte-System"
(to be published as KfK-Report)

- /4/ Rust, K.; Malang, S.; Götzmann, W.:
"PEW - Ein FORTRAN IV-Rechenprogramm zur Bereitstellung physikalischer Eigenschaften von Werkstoffen für LWR-Brennstäbe und deren Simulatoren"
KfK-Ext. 7/76-1, Dez. 1976

TEST SERIES V

Investigation of the Effects of a 90% Flow Blockage With Bypass,
 Blockage at Axial Level 2125 mm of 3x3 Rods Placed in the Corner
 of the 5x5 Rod Bundle,
 Grid Spacer at the Bundle Midplane

Test No.	Flooding Velocity (cold) cm/s	System Pressure bar	Feedwater Temp. ¹		Bundle Power ²		Remarks
			0-30 s	End	0 s	Transient	
284	2.2	3.9	69	45	200	120% ANS	Figs. 12 Through 35
282	3.8	3.9	77	45	200	120% ANS	Figs. 36 Through 59
281	5.7	3.9	75	48	200	120% ANS	Figs. 60 Through 83
286	2.2	3.9	96	79	200	120% ANS	Data Not Plotted
285	3.8	3.9	101	80	200	120% ANS	Data Not Plotted

- 1) Measured in the lower plenum
- 2) Decay heat transient corresponding 120% ANS Standard 40 s after shutdown of the reactor

Table 1 FEBA 5x5 rod bundle: Main test parameters of test series V

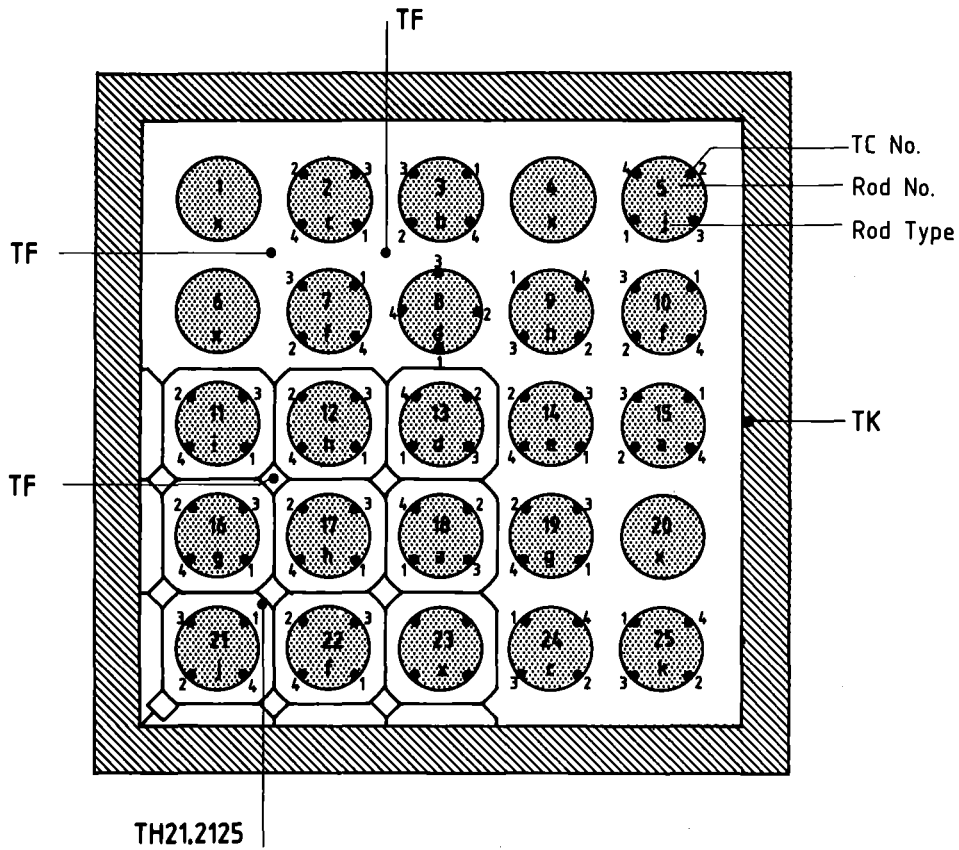

Rod Type	TC No.	Axial Level mm
a	1	2225
	2	2770
	3	3315
	4	3860
b	1	45
	2	590
	3	1135
	4	1680
c	1	3725
	2	3825
	3	3925
	4	4025
d	1	2025
	2	2025
	3	2025
	4	2025

Rod Type	TC No.	Axial Level mm
e	1	2075
	2	2125
	3	2175
	4	2225
f	1	2125
	2	2225
	3	2325
	4	2425
g	1	1625
	2	1725
	3	1825
	4	1925
h	1	1925
	2	2025
	3	2125
	4	2225

Rod Type	TC No.	Axial Level mm
i	1	1875
	2	1925
	3	1975
	4	2025
j	1	1225
	2	1325
	3	1425
	4	1525
k	1	100
	2	200
	3	300
	4	400
x	without TC's	

Fig. 10 5x5 rod bundle: Radial and axial location of cladding, sleeve, fluid and housing TC's for test series V

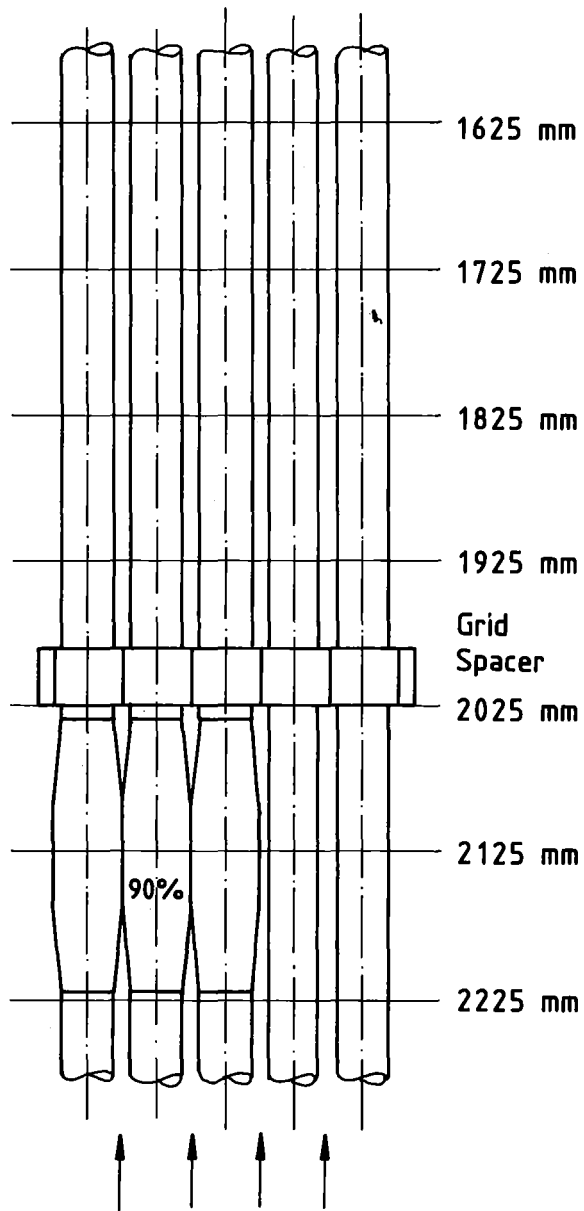
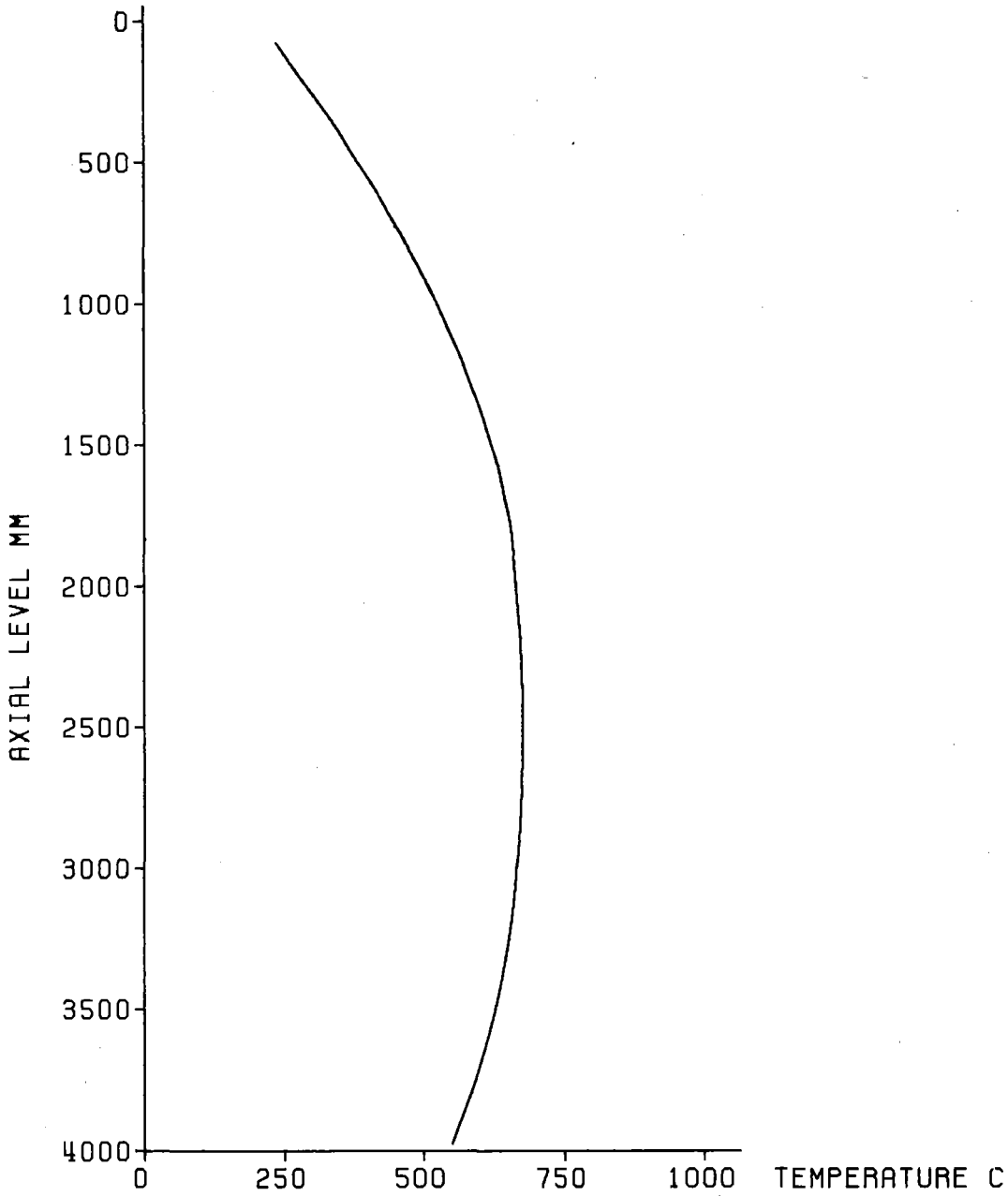

Fig. 11 5x5 rod bundle: Layout of the bundle geometry of test series V

Initial Axial Temperature Profile of Claddings



Decay Heat	120% ANS Standard
Flooding Rate (cold)	2.21 cm/s
System Pressure	3.92 bar
Feedwater Temperature	40 C

KIK TRB

Fig. 12 FEBA: 5x5 ROD BUNDLE
TEST SERIES 5, TEST-No. 284

Test Parameters:

- ◇ Flooding Rate
- △ System Pressure
- Feedwater Temperature
- Bundle Power

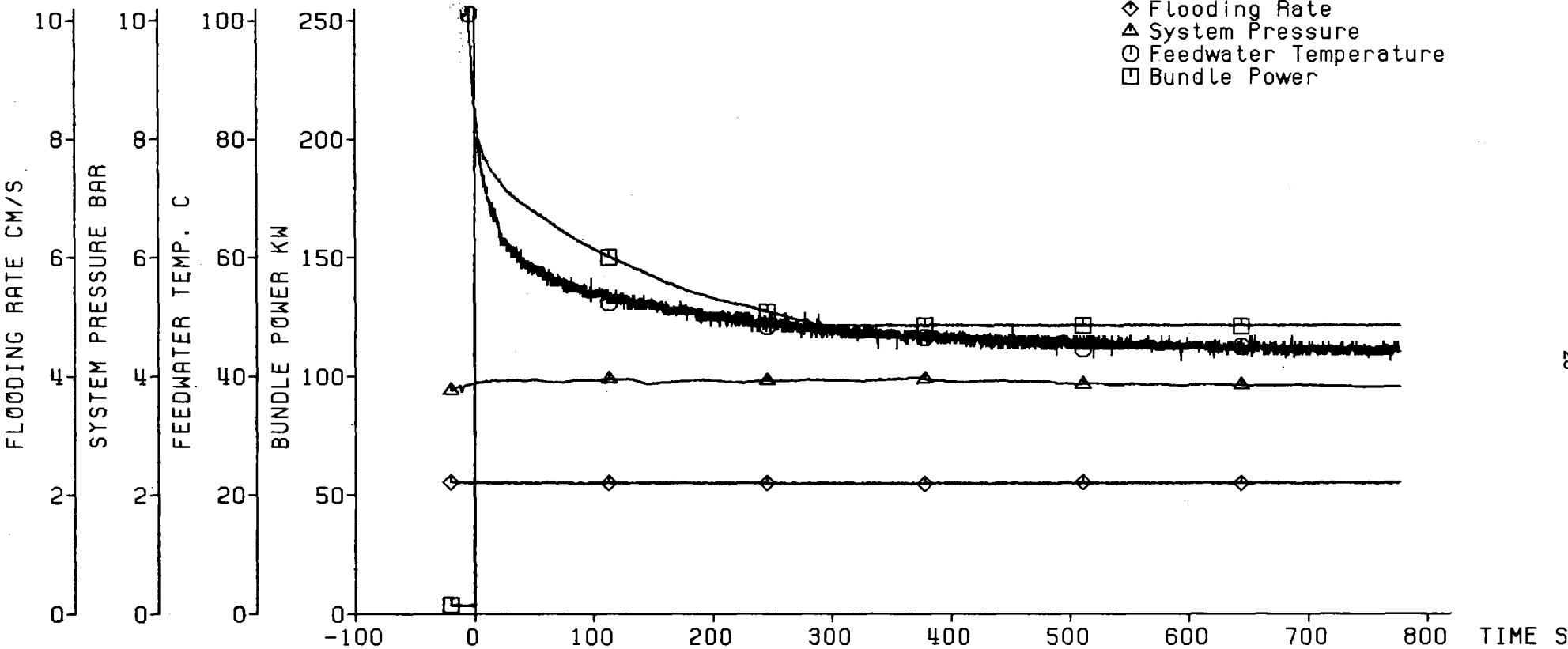

— 25 —

Decay Heat 120% ANS Standard
Flooding Rate (cold) 2.21 cm/s
System Pressure 3.92 bar
Feedwater Temperature 40 C



Fig. 13 FEBA: 5x5 ROD BUNDLE, TEST SERIES 5, TEST-No. 284

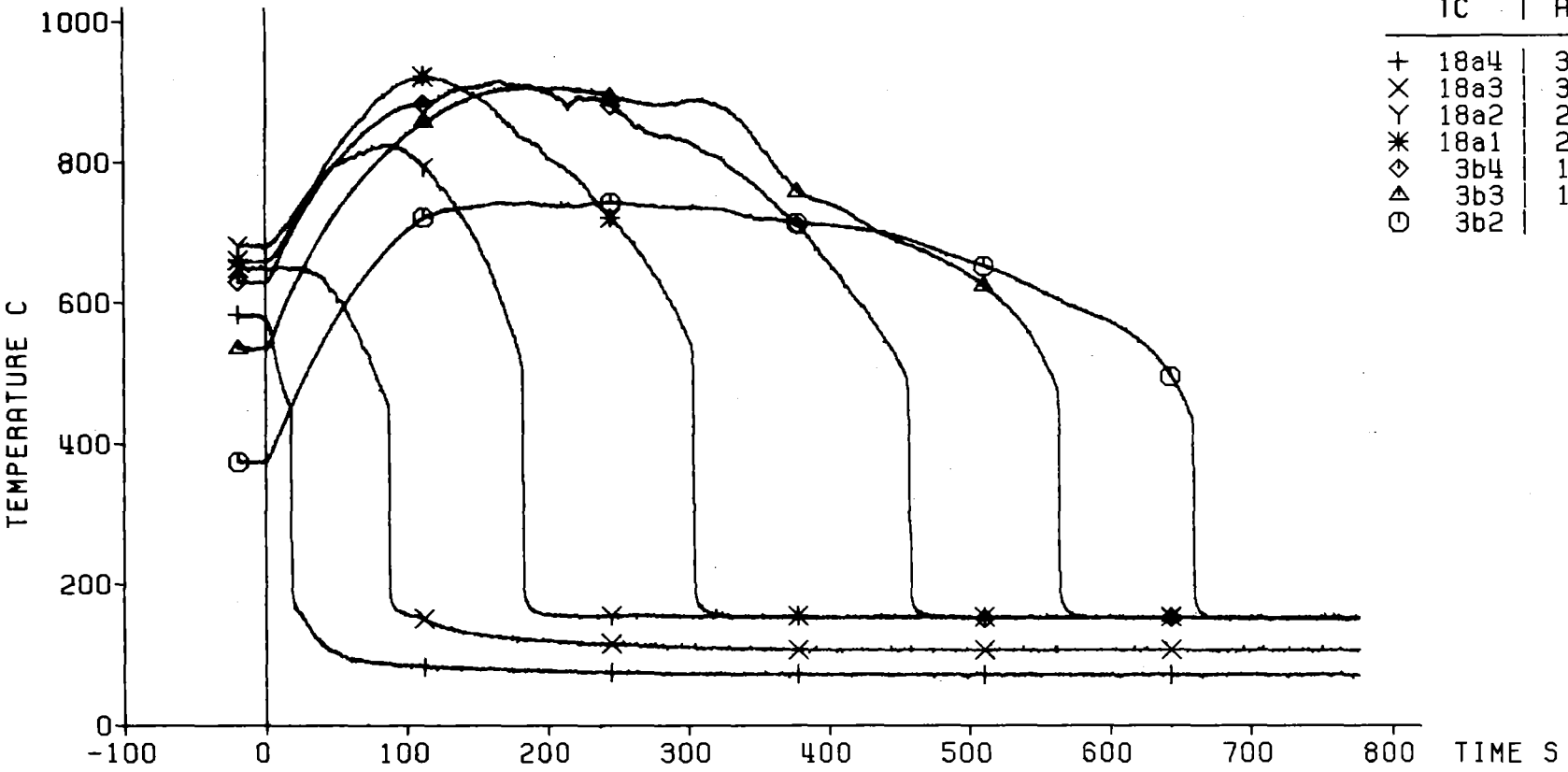

Decay Heat 120% ANS Standard
Flooding Rate (cold) 2.21 cm/s
System Pressure 3.92 bar
Feedwater Temperature 40 C



Fig. 14 FEBA: 5x5 ROD BUNDLE, TEST SERIES 5, TEST-No. 284

Heat Transfer Coeff.

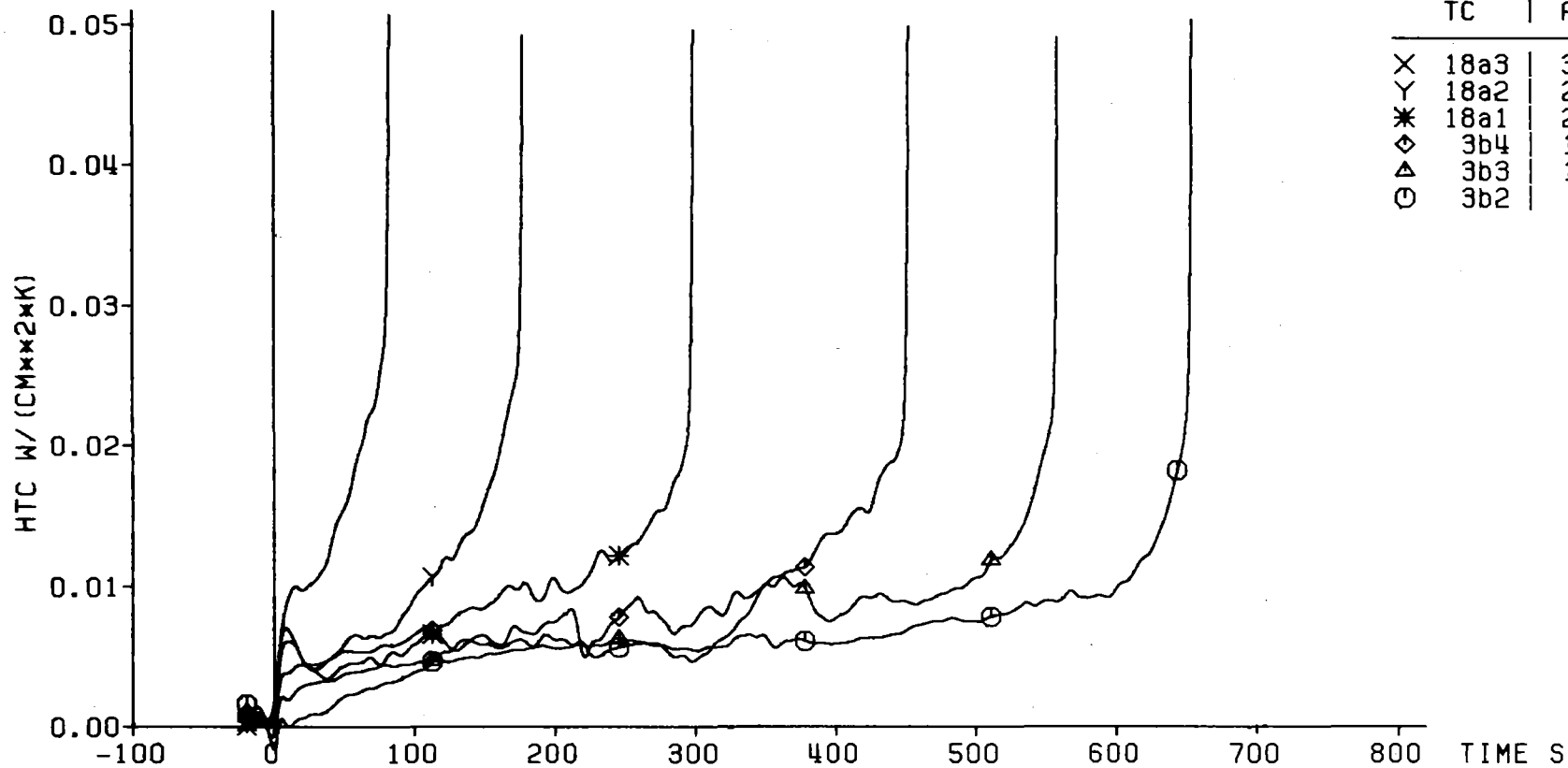

Decay Heat 120% ANS Standard
 Flooding Rate (cold) 2.21 cm/s
 System Pressure 3.92 bar
 Feedwater Temperature 40 C



Fig. 15 FEBA: 5x5 ROD BUNDLE, TEST SERIES 5, TEST-No. 284

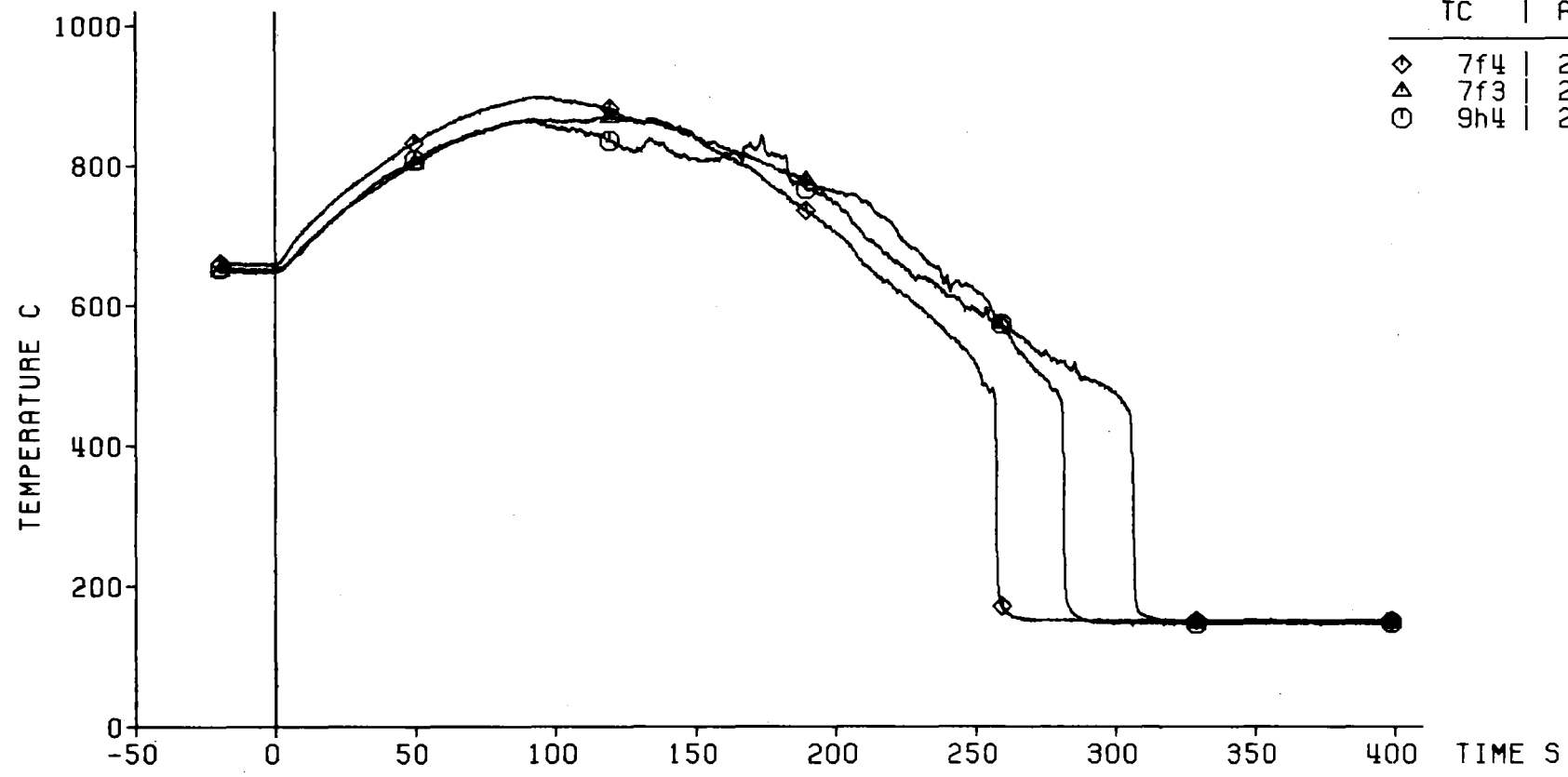

Decay Heat	120% ANS Standard	Bypass Area
Flooding Rate (cold)	2.21 cm/s	=====
System Pressure	3.92 bar	
Feedwater Temperature	40 C	



Fig. 16 FEBA: 5x5 ROD BUNDLE, TEST SERIES 5, TEST-No. 284

Heat Transfer Coeff.

	TC	Ax. Level
◇	7f4	2425 mm
△	7f3	2325 mm
○	9h4	2225 mm

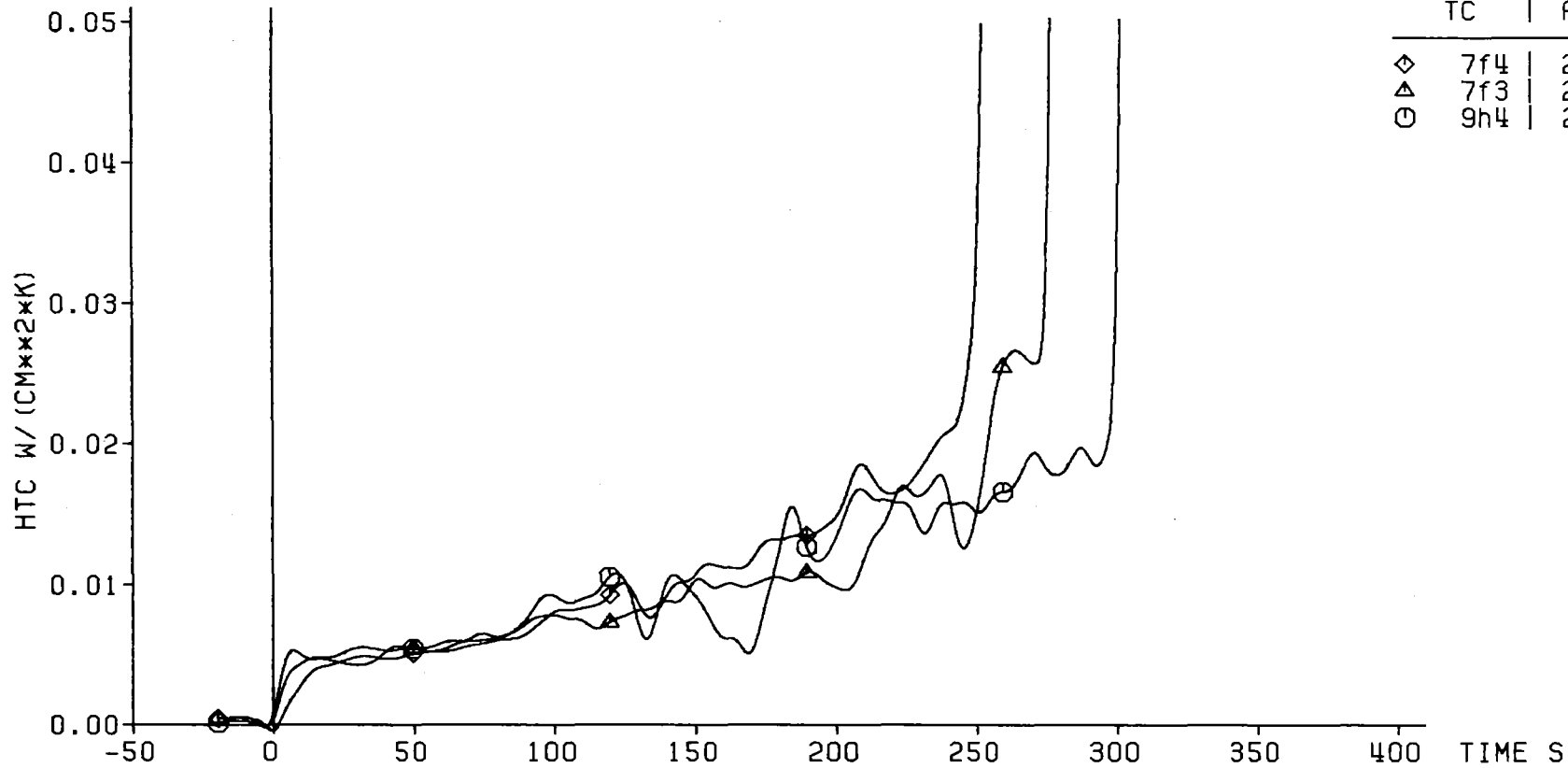

Decay Heat 120% ANS Standard
 Flooding Rate (cold) 2.21 cm/s
 System Pressure 3.92 bar
 Feedwater Temperature 40 C

Bypass Area
 =====



Fig. 17 FEBA: 5x5 ROD BUNDLE, TEST SERIES 5, TEST-No. 284

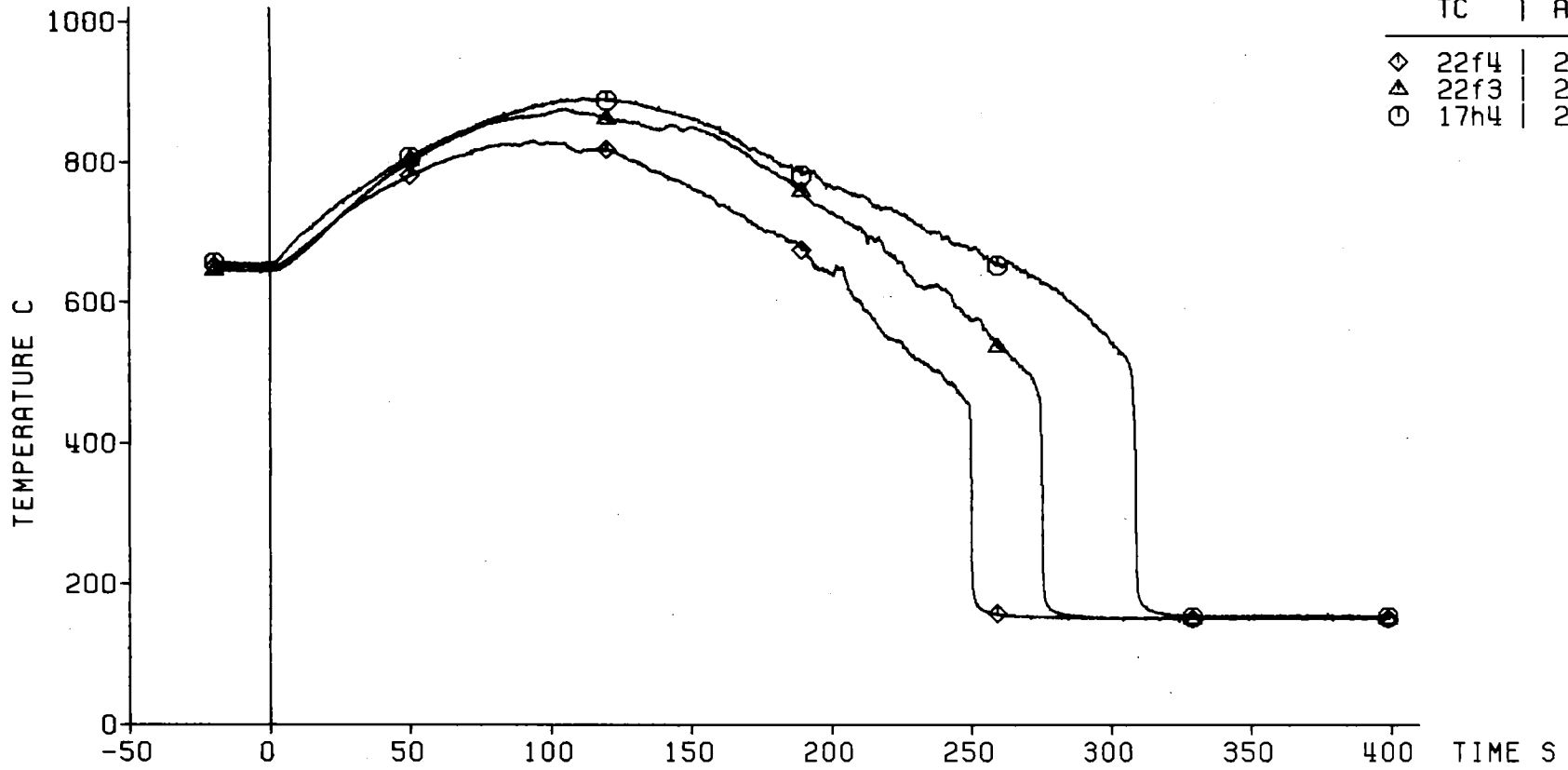

Decay Heat 120% ANS Standard
Flooding Rate (cold) 2.21 cm/s
System Pressure 3.92 bar
Feedwater Temperature 40 C

Blockage Area
=====



Fig. 18 FEBA: 5x5 ROD BUNDLE, TEST SERIES 5, TEST-No. 284

Heat Transfer Coeff.

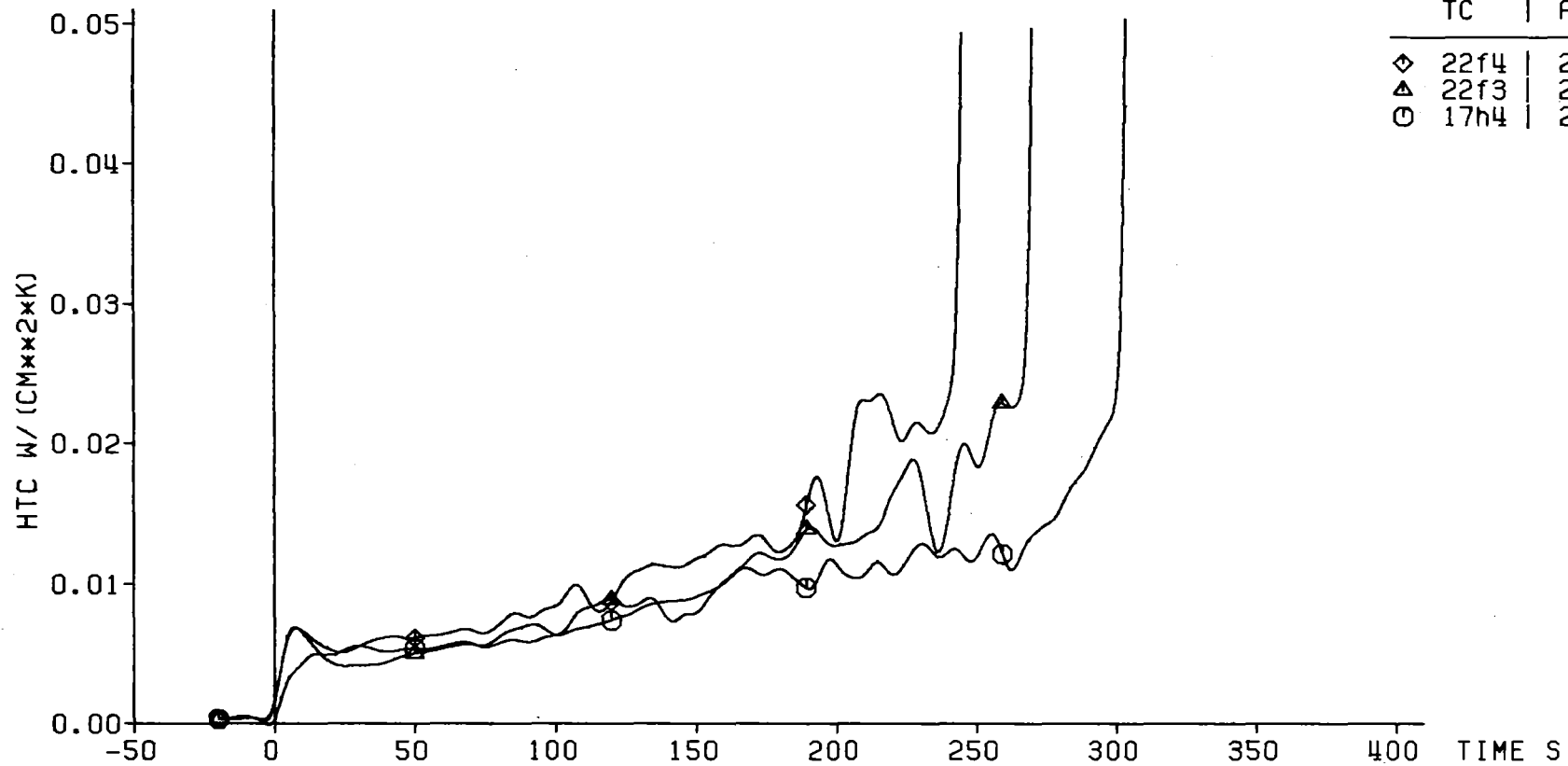

Decay Heat 120% ANS Standard
 Flooding Rate (cold) 2.21 cm/s
 System Pressure 3.92 bar
 Feedwater Temperature 40 C

Blockage Area
 =====



Fig. 19 FEBA: 5x5 ROD BUNDLE, TEST SERIES 5, TEST-No. 284

Cladding Temperature

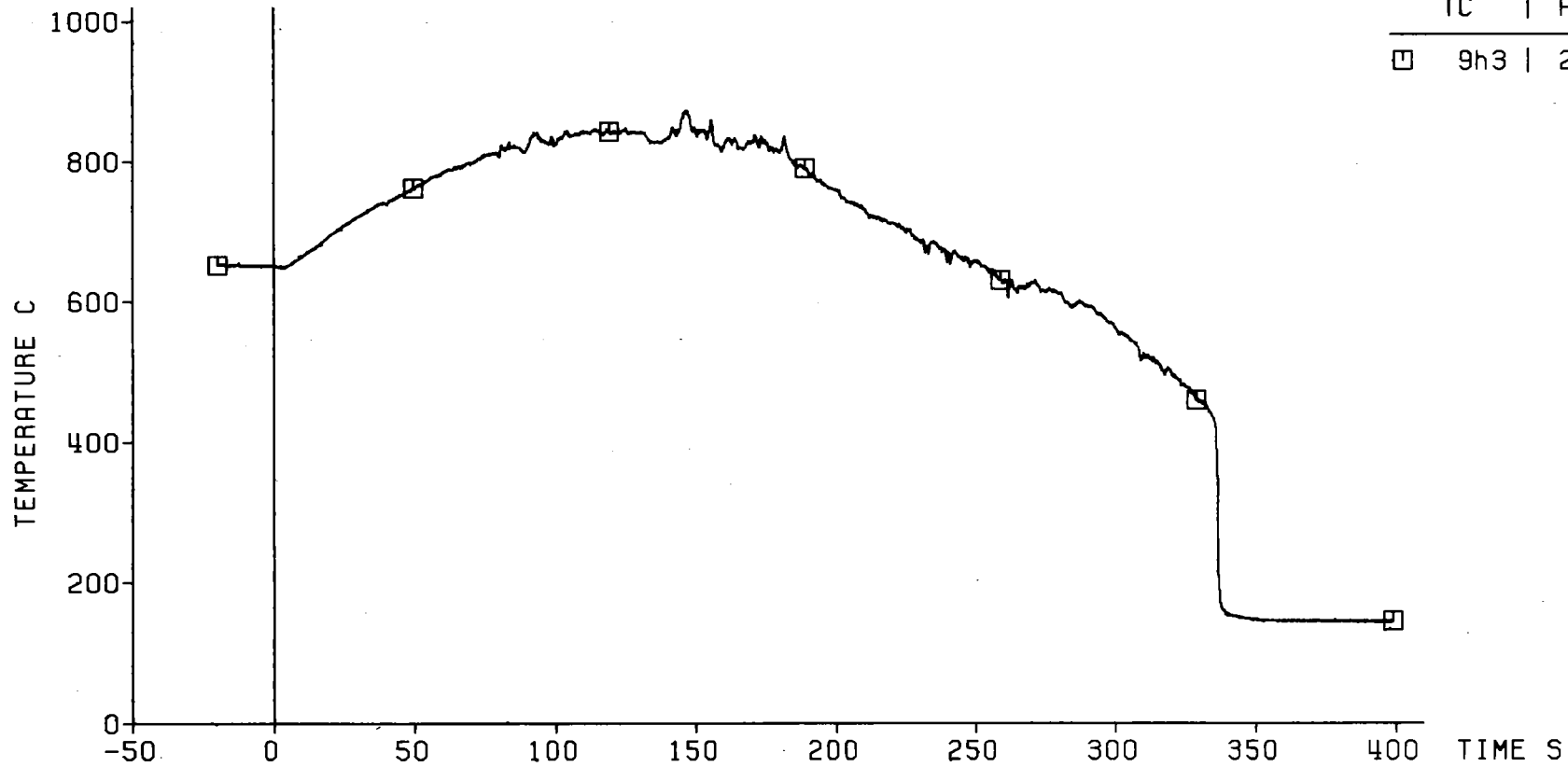

TC	Ax. Level
□	9h3 2125 mm

Decay Heat 120% ANS Standard
Flooding Rate (cold) 2.21 cm/s
System Pressure 3.92 bar
Feedwater Temperature 40 C

Bypass Area
=====



Fig. 20 FEBA: 5x5 ROD BUNDLE, TEST SERIES 5, TEST-No. 284

Heat Transfer Coeff.

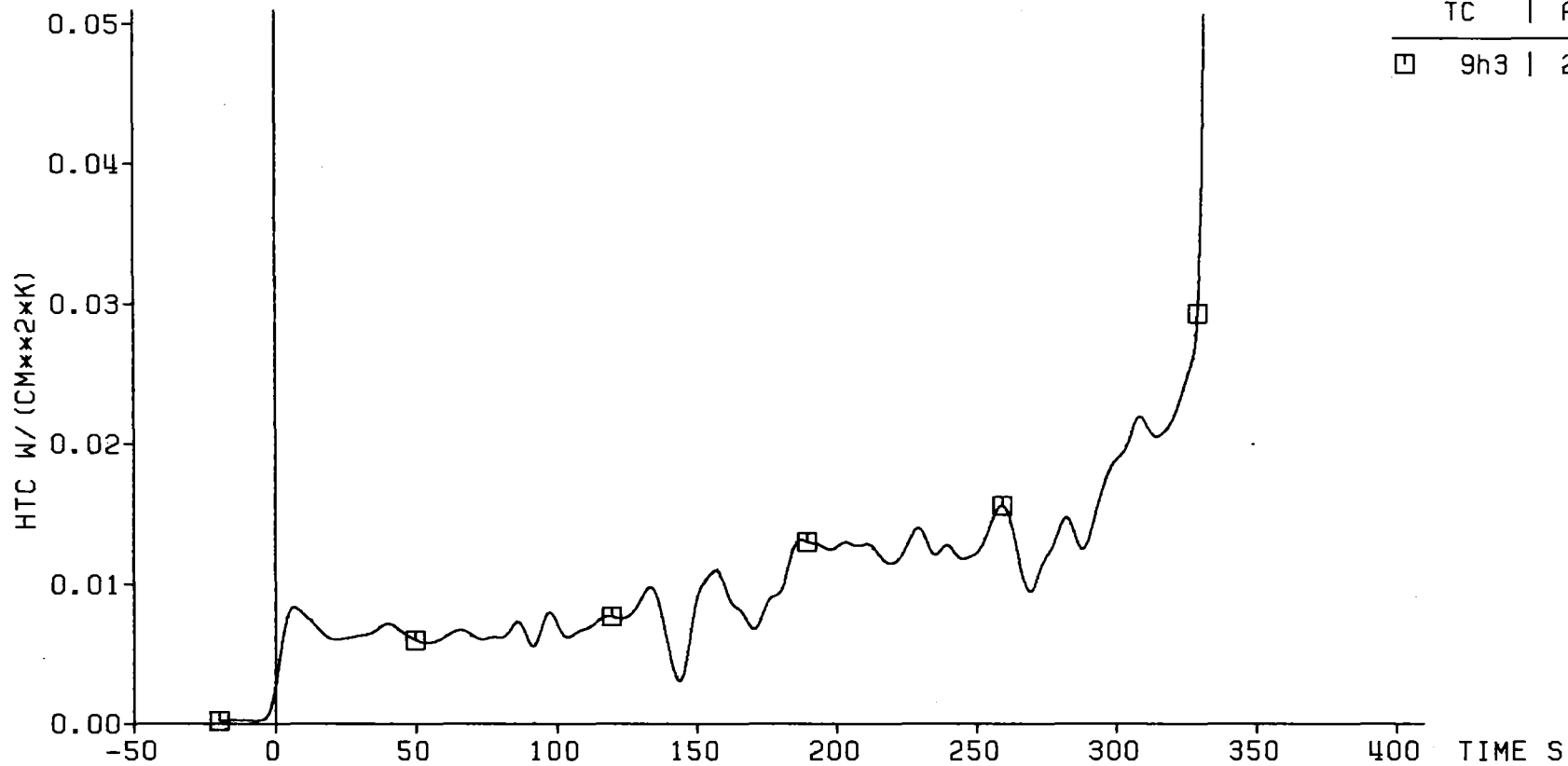

TC	Ax. Level
□	9h3 2125 mm

Decay Heat 120% ANS Standard
Flooding Rate (cold) 2.21 cm/s
System Pressure 3.92 bar
Feedwater Temperature 40 C

Bypass Area
=====



Fig. 21 FEBA: 5x5 ROD BUNDLE, TEST SERIES 5, TEST-NO. 284

Cladding Temperature

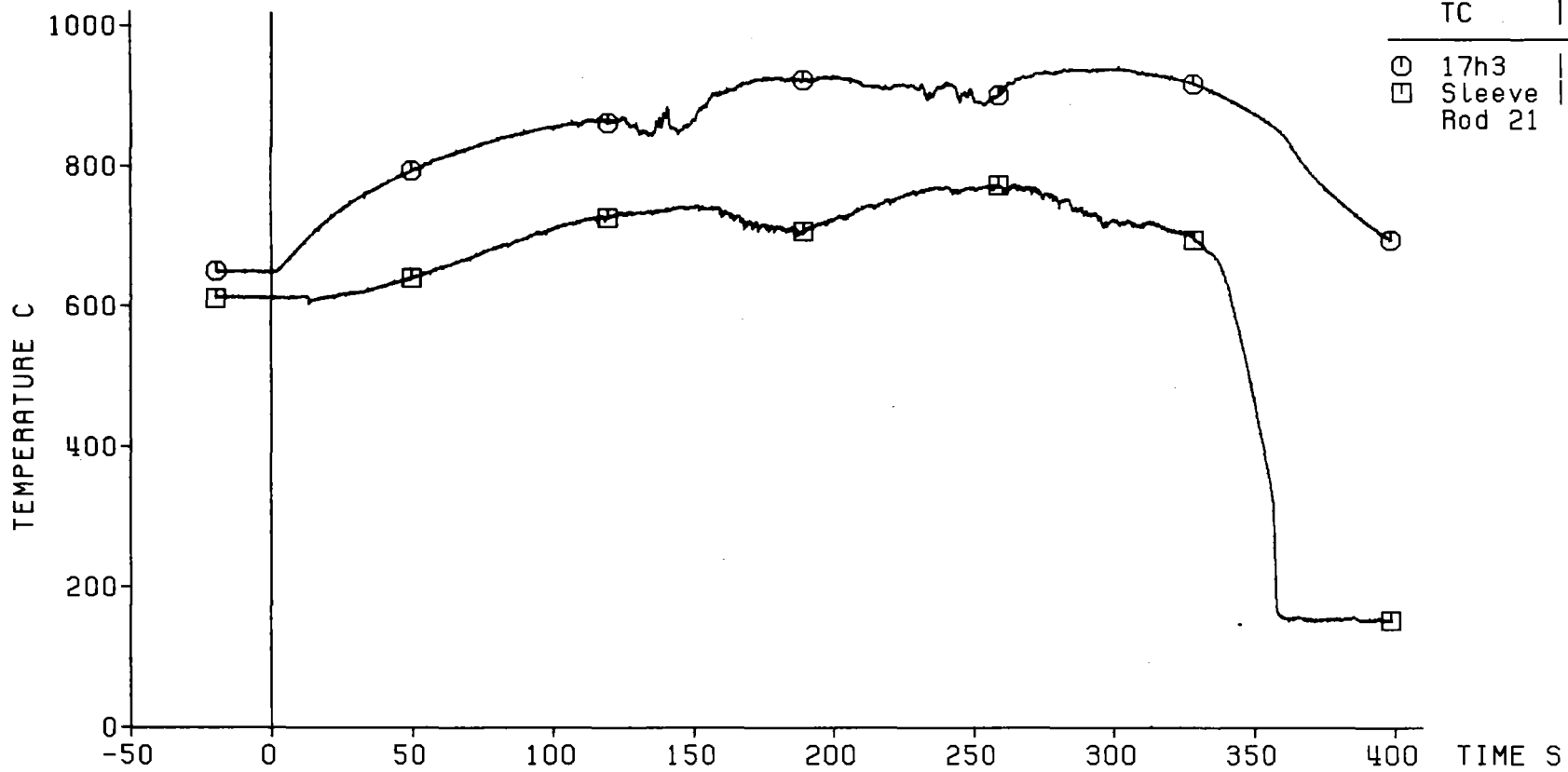

Decay Heat 120% ANS Standard
 Flooding Rate (cold) 2.21 cm/s
 System Pressure 3.92 bar
 Feedwater Temperature 40 C

Blockage Area
 =====



Fig. 22 FEBA: 5x5 ROD BUNDLE, TEST SERIES 5, TEST-NO. 284

Cladding Temperature

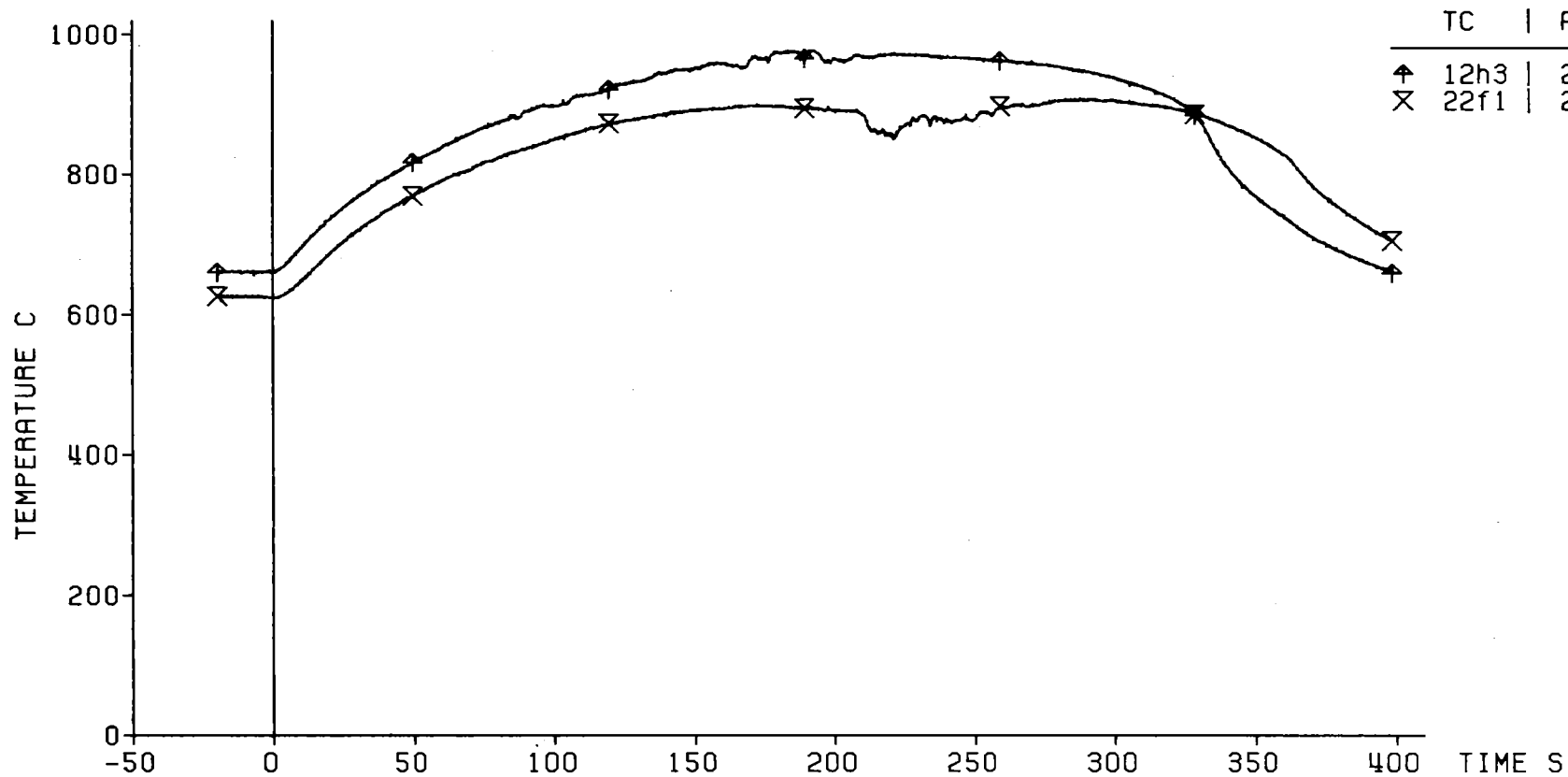

Decay Heat
 Flooding Rate (cold) 2.21 cm/s
 System Pressure 3.92 bar
 Feedwater Temperature 40 C

120% ANS Standard

Blockage Area
 =====



Fig. 23 FEBA: 5x5 ROD BUNDLE, TEST SERIES 5, TEST-No. 284

Cladding Temperature

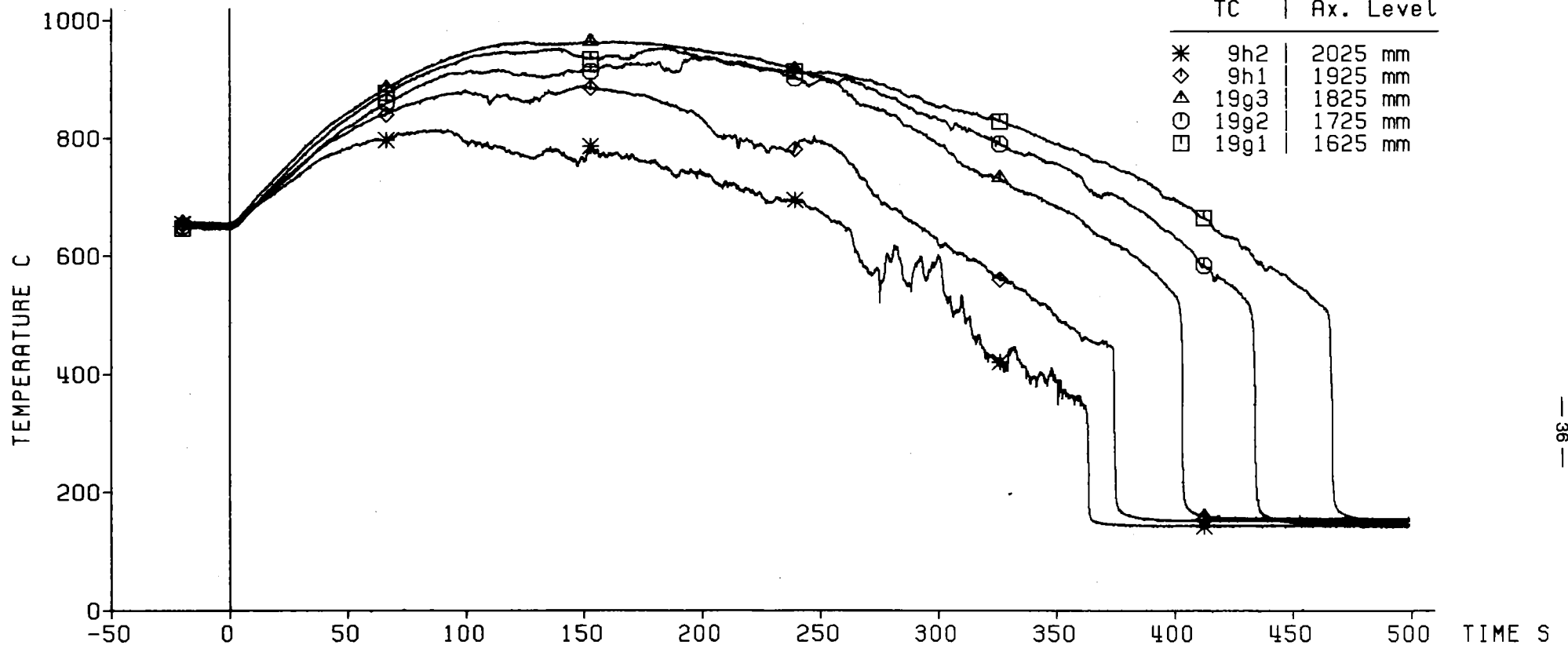

Decay Heat 120% ANS Standard
 Flooding Rate (cold) 2.21 cm/s
 System Pressure 3.92 bar
 Feedwater Temperature 40 C

Bypass Area
 =====



Fig. 24 FEBA: 5x5 ROD BUNDLE, TEST SERIES 5, TEST-No. 284

Heat Transfer Coeff.

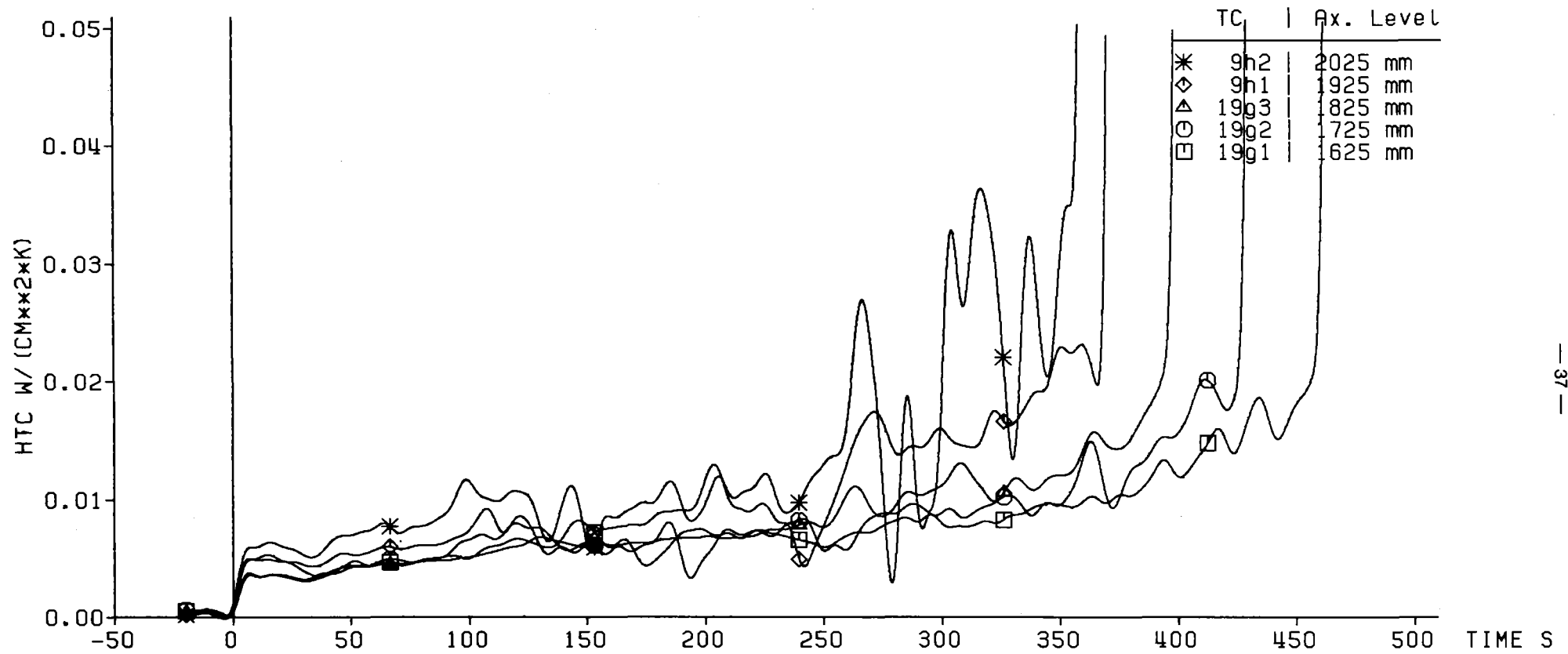

Decay Heat 120% ANS Standard
 Flooding Rate (cold) 2.21 cm/s
 System Pressure 3.92 bar
 Feedwater Temperature 40 C

Bypass Area
 =====



Fig. 25 FEBA: 5x5 ROD BUNDLE, TEST SERIES 5, TEST-No. 284

Cladding Temperature

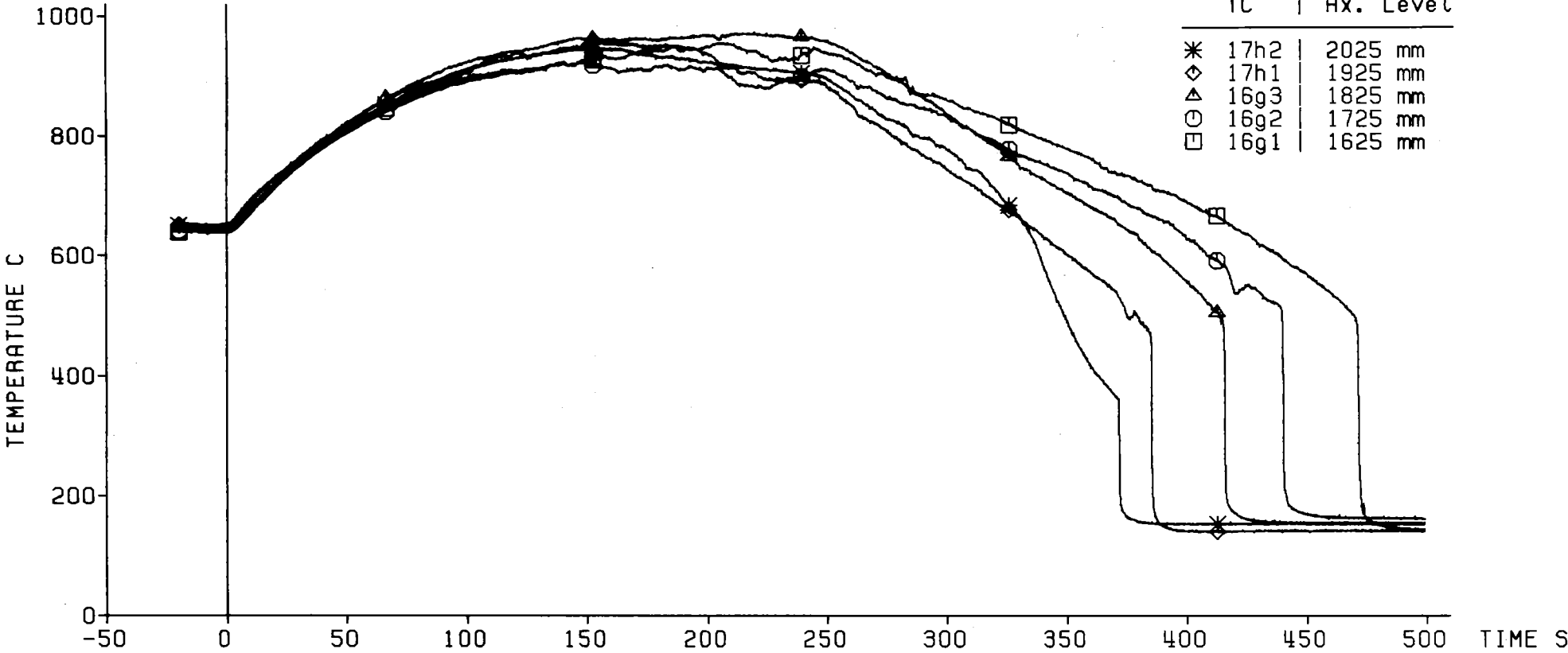

Decay Heat 120% ANS Standard
 Flooding Rate (cold) 2.21 cm/s
 System Pressure 3.92 bar
 Feedwater Temperature 40 C

Blockage Area
 =====



Fig. 26 FEBA: 5x5 ROD BUNDLE, TEST SERIES 5, TEST-No. 284

Heat Transfer Coeff.

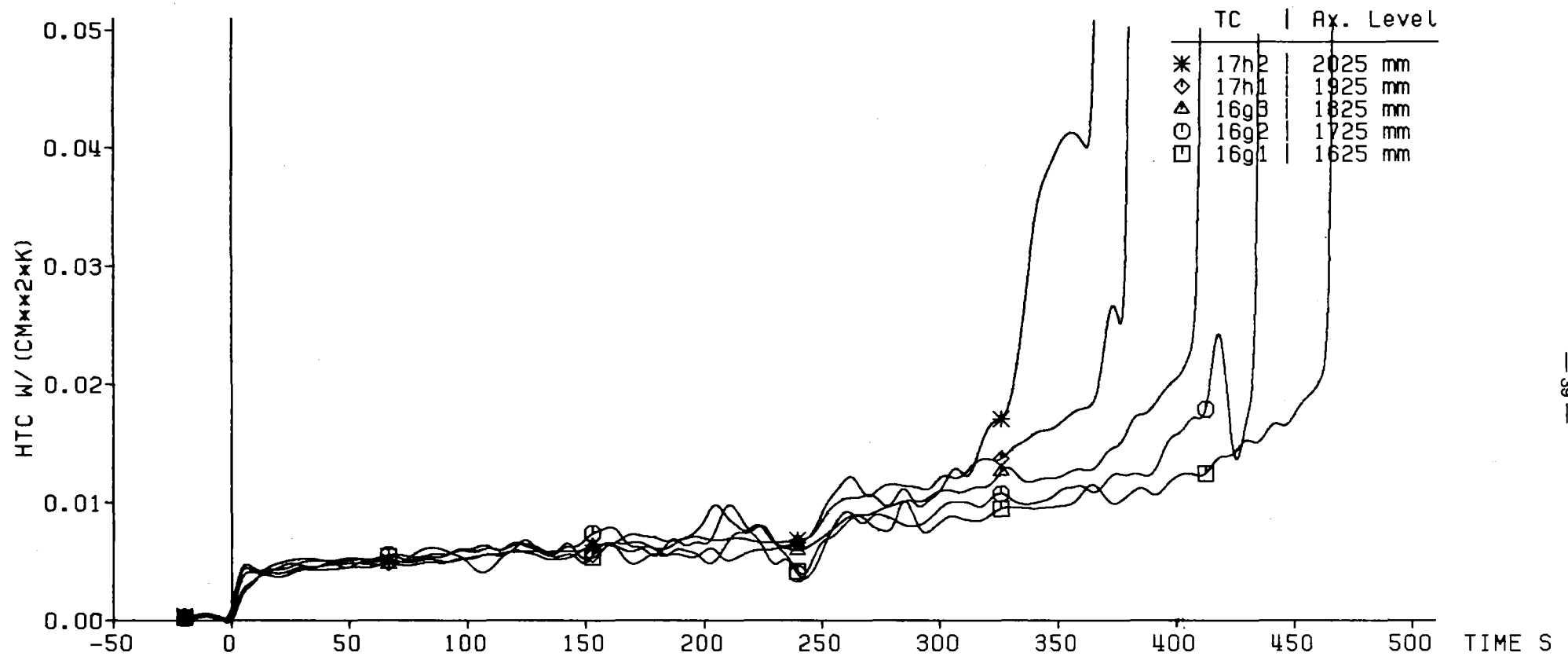

— 39 —

Decay Heat 120% ANS Standard
 Flooding Rate (cold) 2.21 cm/s
 System Pressure 3.92 bar
 Feedwater Temperature 40 C

Blockage Area
 =====



Fig. 27 FEBA: 5x5 ROD BUNDLE, TEST SERIES 5, TEST-No. 284

Axial Level: 1825 mm

△ Cladding Temperature (19g3)
○ Fluid Temperature

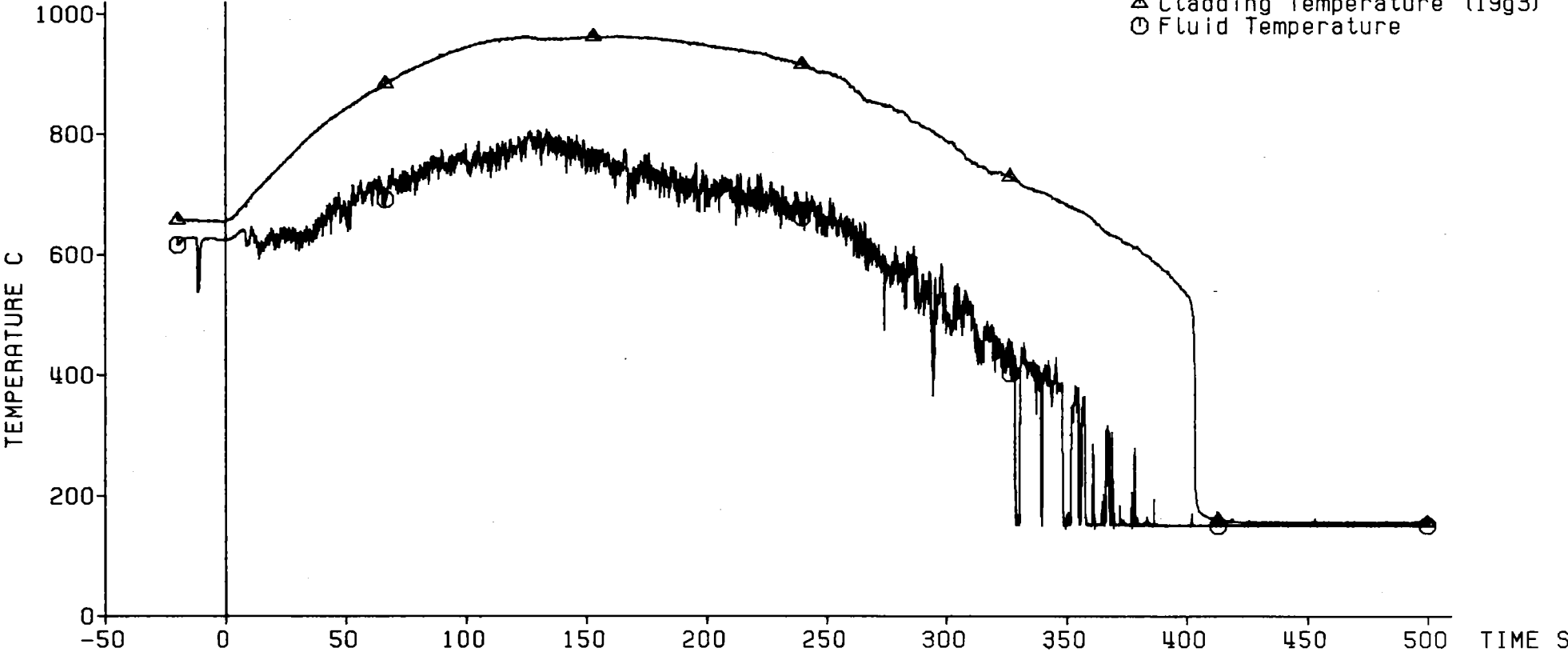

Decay Heat 120% ANS Standard
Flooding Rate (cold) 2.21 cm/s
System Pressure 3.92 bar
Feedwater Temperature 40 C

Bypass Area
=====



Fig. 28 FEBA: 5x5 ROD BUNDLE, TEST SERIES 5, TEST-No. 284

Axial Level: 1625 mm

△ Cladding Temperature (19g1)
○ Fluid Temperature
□ Housing Temperature

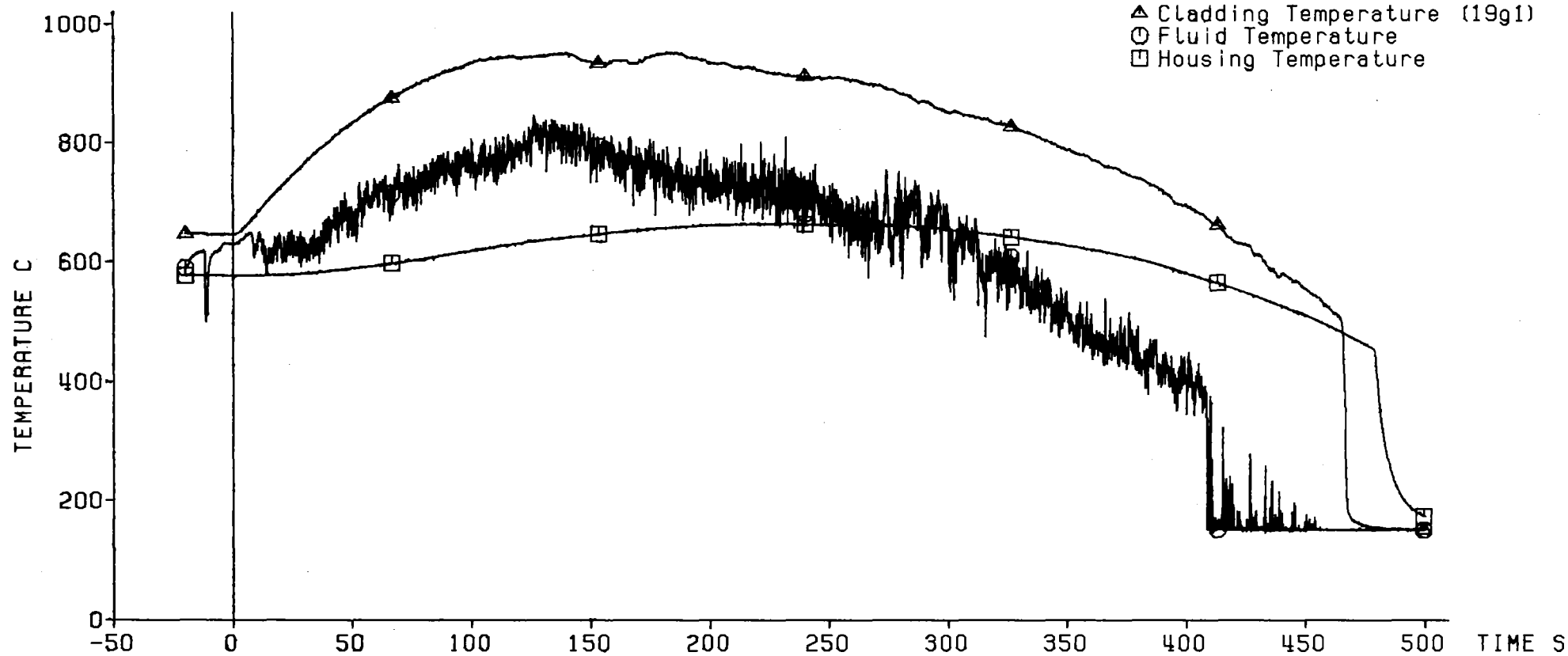

— 41 —

Decay Heat 120% ANS Standard
Flooding Rate (cold) 2.21 cm/s
System Pressure 3.92 bar
Feedwater Temperature 40 C

Bypass Area
=====



Fig. 29 FEBA: 5x5 ROD BUNDLE, TEST SERIES 5, TEST-No. 284

Axial Level: 1925 mm

▲ Cladding Temperature (17h1)
⊙ Fluid Temperature

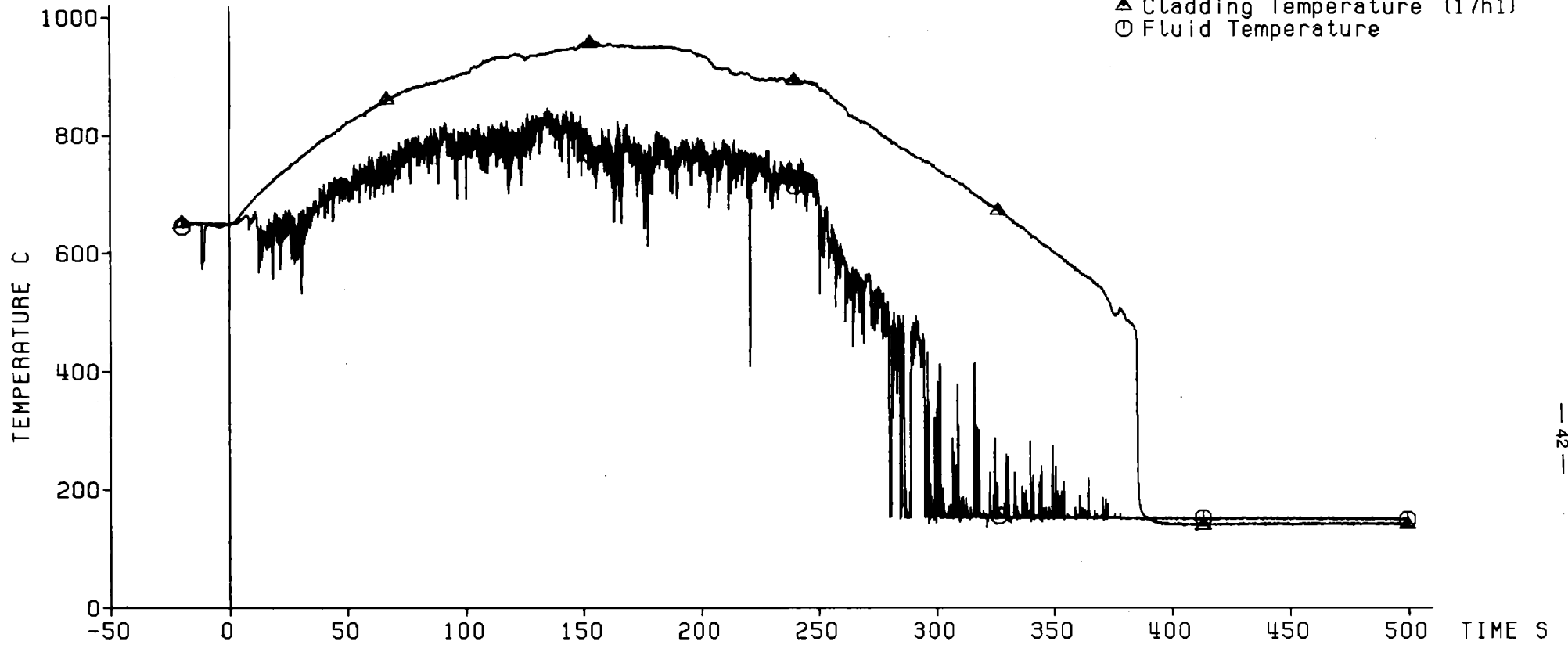

Decay Heat 120% ANS Standard
Flooding Rate (cold) 2.21 cm/s
System Pressure 3.92 bar
Feedwater Temperature 40 C

Blockage Area
=====



Fig. 30 FEBA: 5x5 ROD BUNDLE, TEST SERIES 5, TEST-No. 284

Axial Level: 1725 mm

▲ Cladding Temperature (16g2)
○ Fluid Temperature

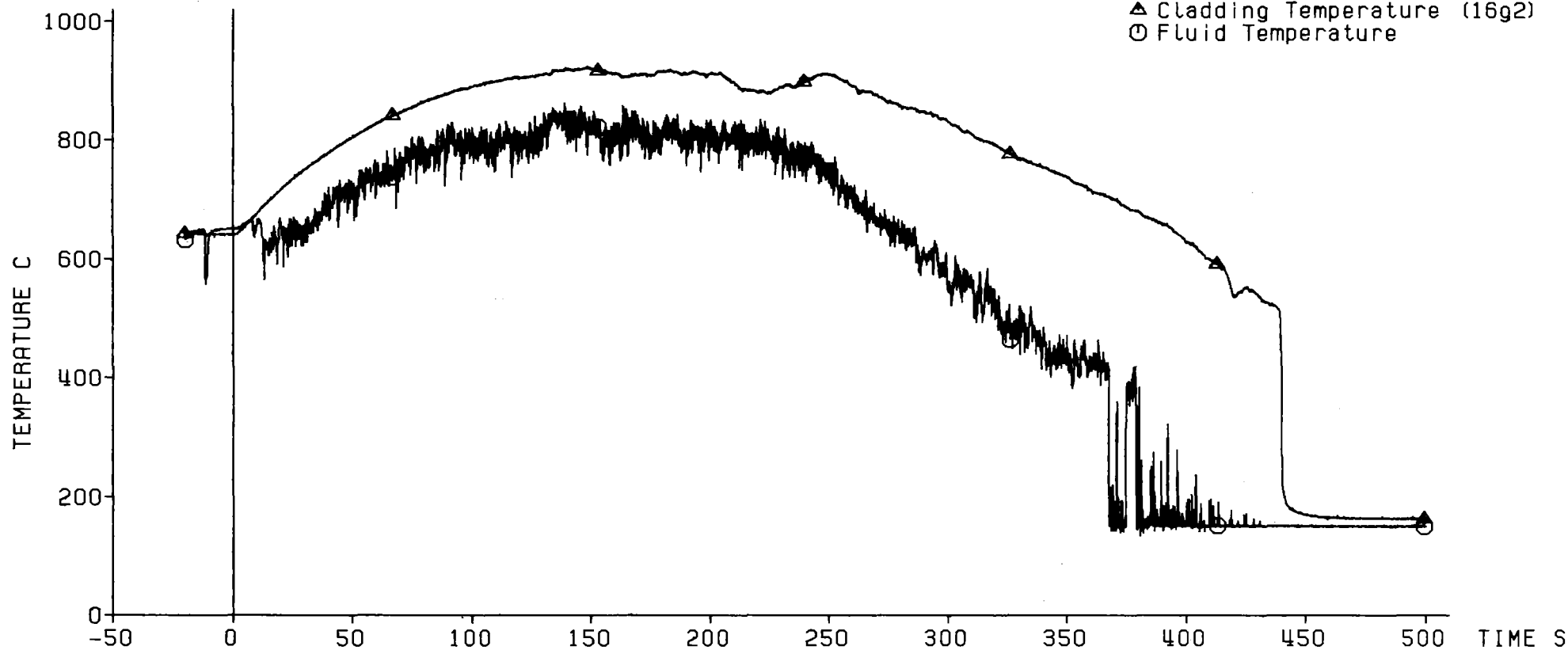

Decay Heat 120% ANS Standard
Flooding Rate (cold) 2.21 cm/s
System Pressure 3.92 bar
Feedwater Temperature 40 C

Blockage Area

KfK IRB

Fig. 31 FEBA: 5x5 ROD BUNDLE, TEST SERIES 5, TEST-No. 284

Axial Level: 1625 mm

△ Cladding Temperature (16g1)
○ Fluid Temperature
□ Housing Temperature

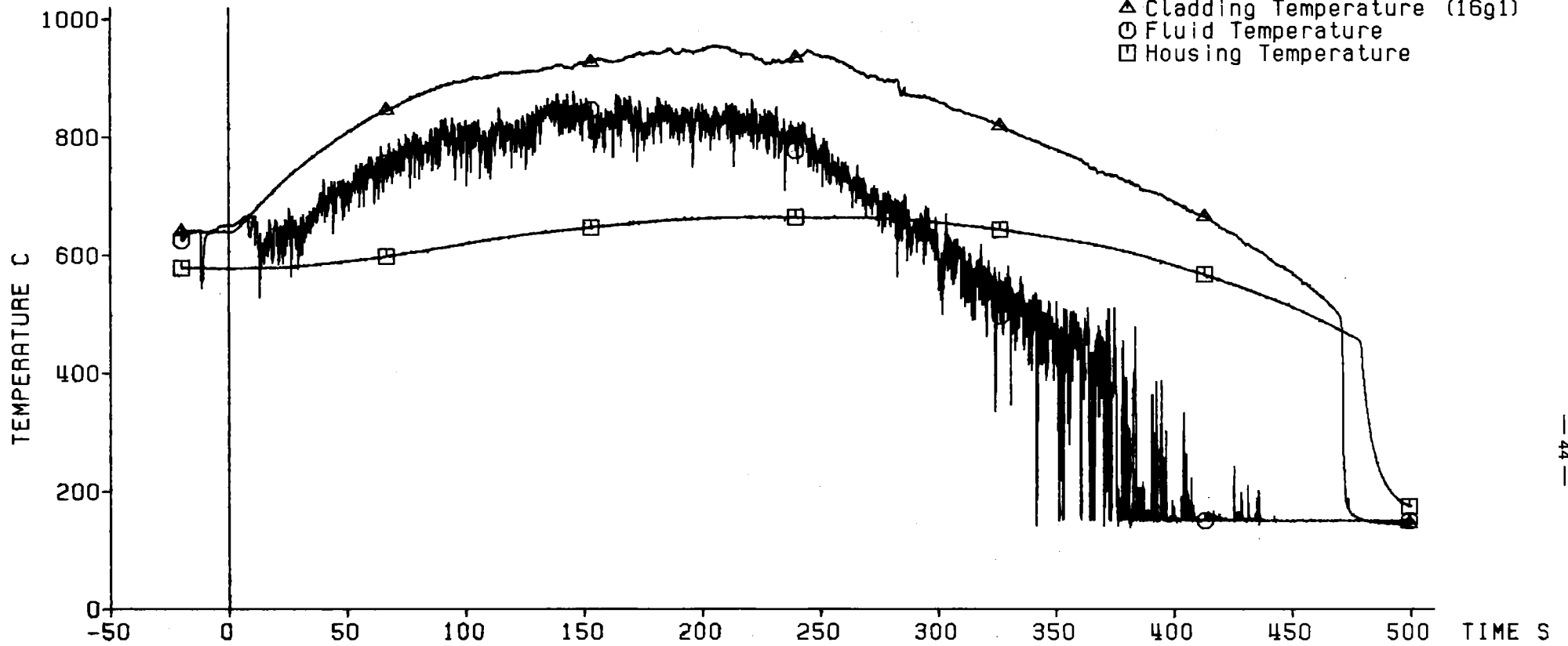

Decay Heat 120% ANS Standard
Flooding Rate (cold) 2.21 cm/s
System Pressure 3.92 bar
Feedwater Temperature 40 C

Blockage Area
=====

KJK IRB

Fig. 32 FEBA: 5x5 ROD BUNDLE, TEST SERIES 5, TEST-NO. 284

Pressure Loss
Along the Test Section:

◇ Total Length: 4196 mm
△ Lower Part: 1711 mm
○ Middle Part: 545 mm
□ Upper Part: 1940 mm

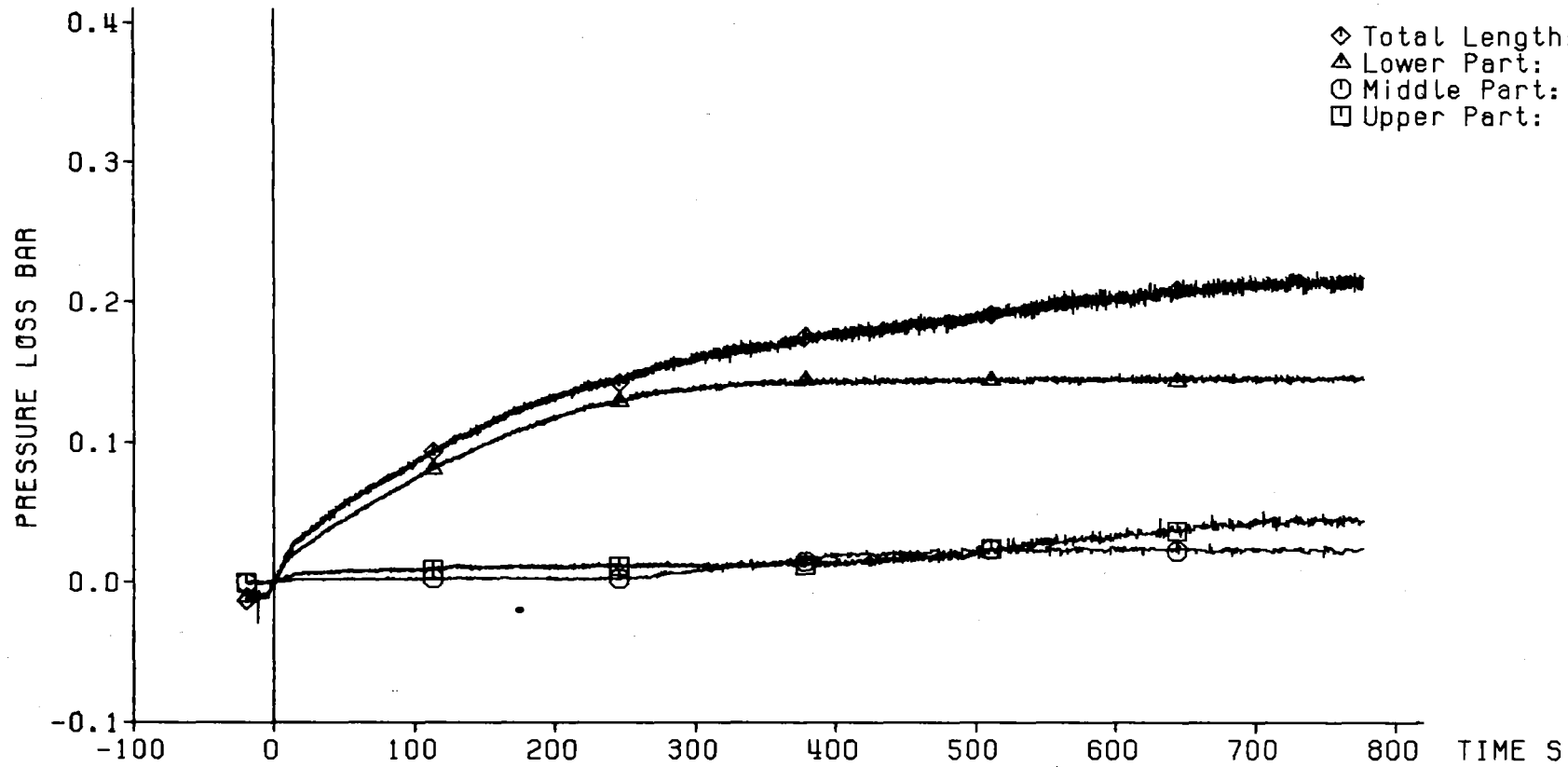

Decay Heat 120% ANS Standard
Flooding Rate (cold) 2.21 cm/s
System Pressure 3.92 bar
Feedwater Temperature 40 C

KIK IRB

Fig. 33 FEBA: 5x5 ROD BUNDLE, TEST SERIES 5, TEST-No. 284

Coolant Outlet Conditions:

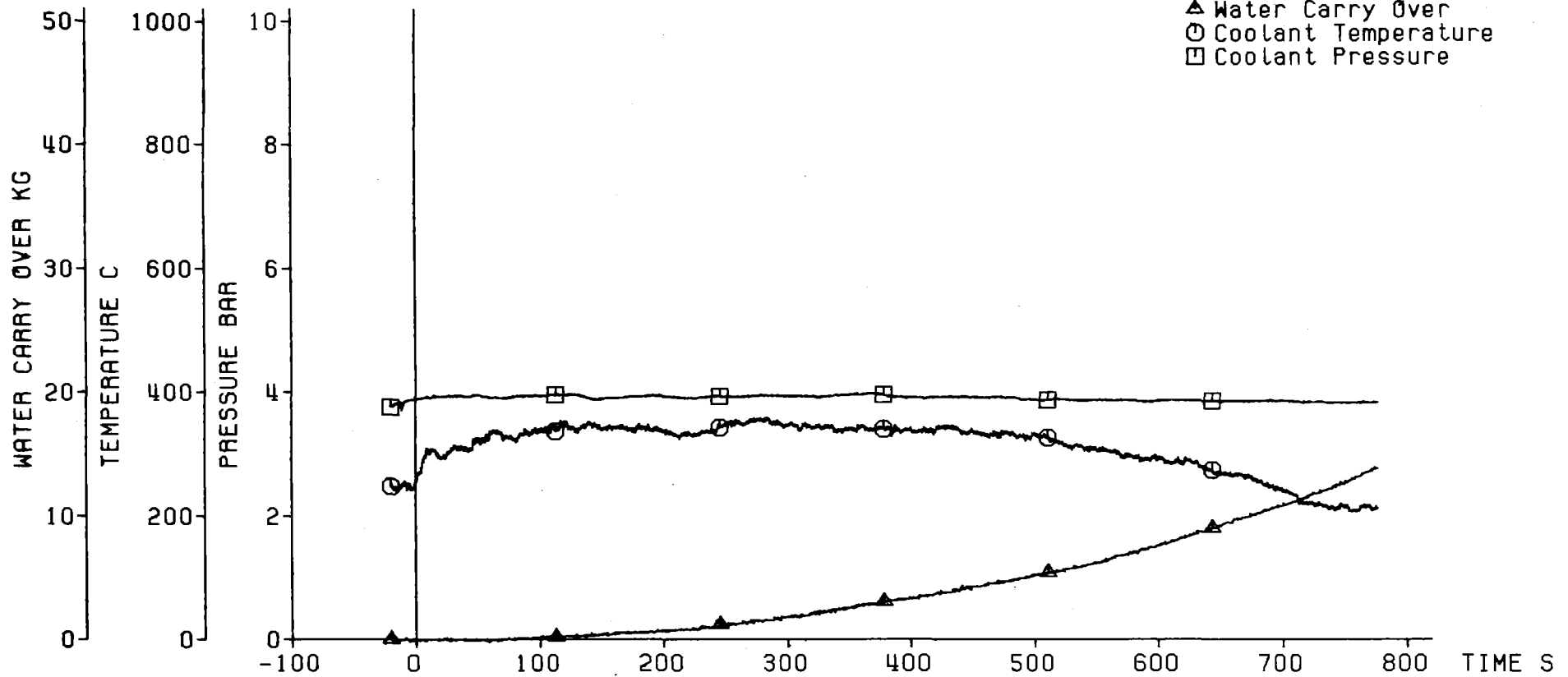

Decay Heat 120% ANS Standard
Flooding Rate (cold) 2.21 cm/s
System Pressure 3.92 bar
Feedwater Temperature 40 C

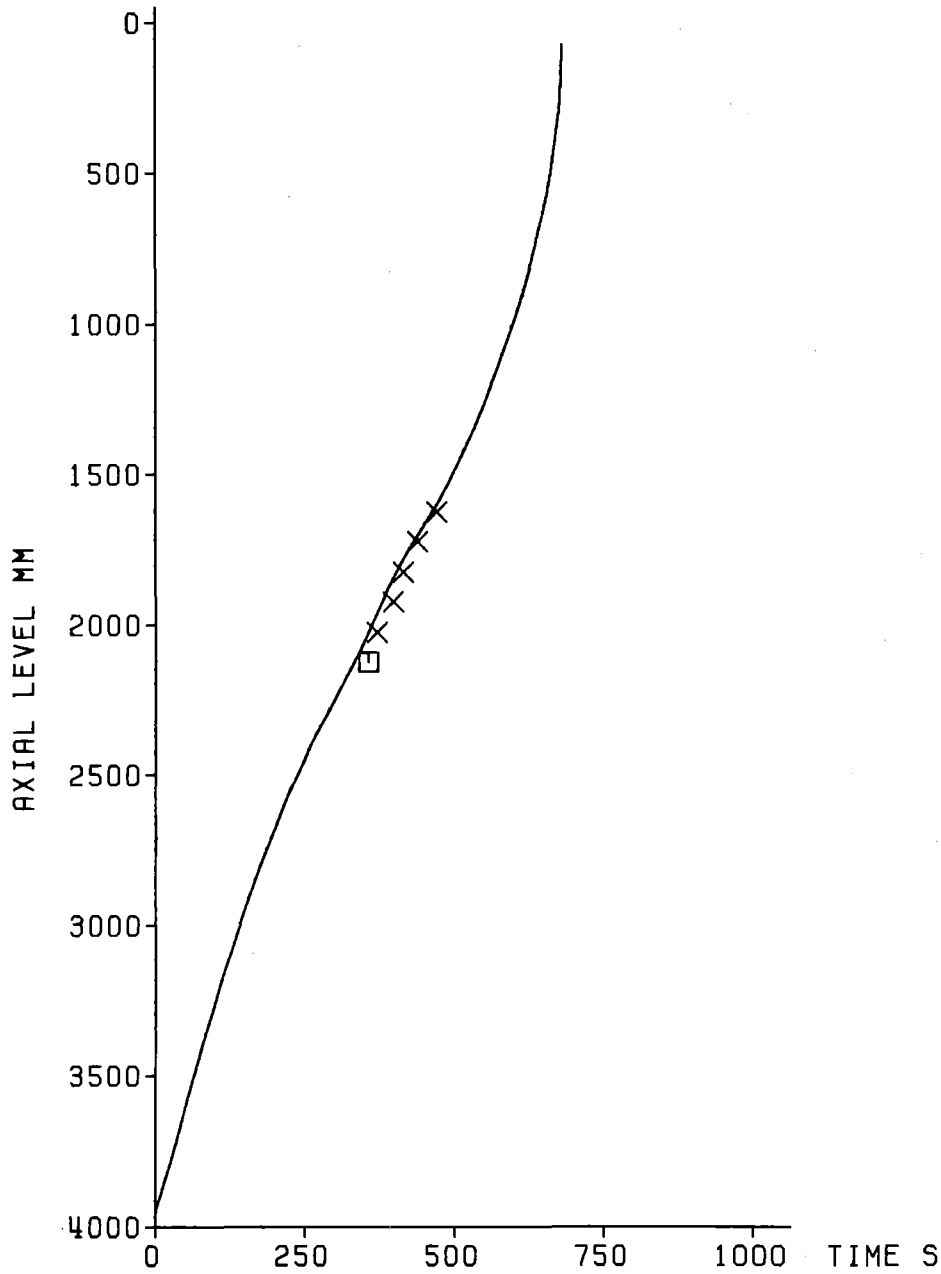

Fig. 34 FEBA: 5x5 ROD BUNDLE, TEST SERIES 5, TEST-NO. 284

Axial Position of Quench Front

□ Quenching of Sleeves

× Quenching of Claddings Downstream of Blockage Area



Decay Heat	120% ANS Standard
Flooding Rate (cold)	2.21 cm/s
System Pressure	3.92 bar
Feedwater Temperature	40 C



Fig. 35 FEBA: 5x5 ROD BUNDLE
TEST SERIES 5, TEST-No. 284

Initial Axial Temperature Profile of Claddings

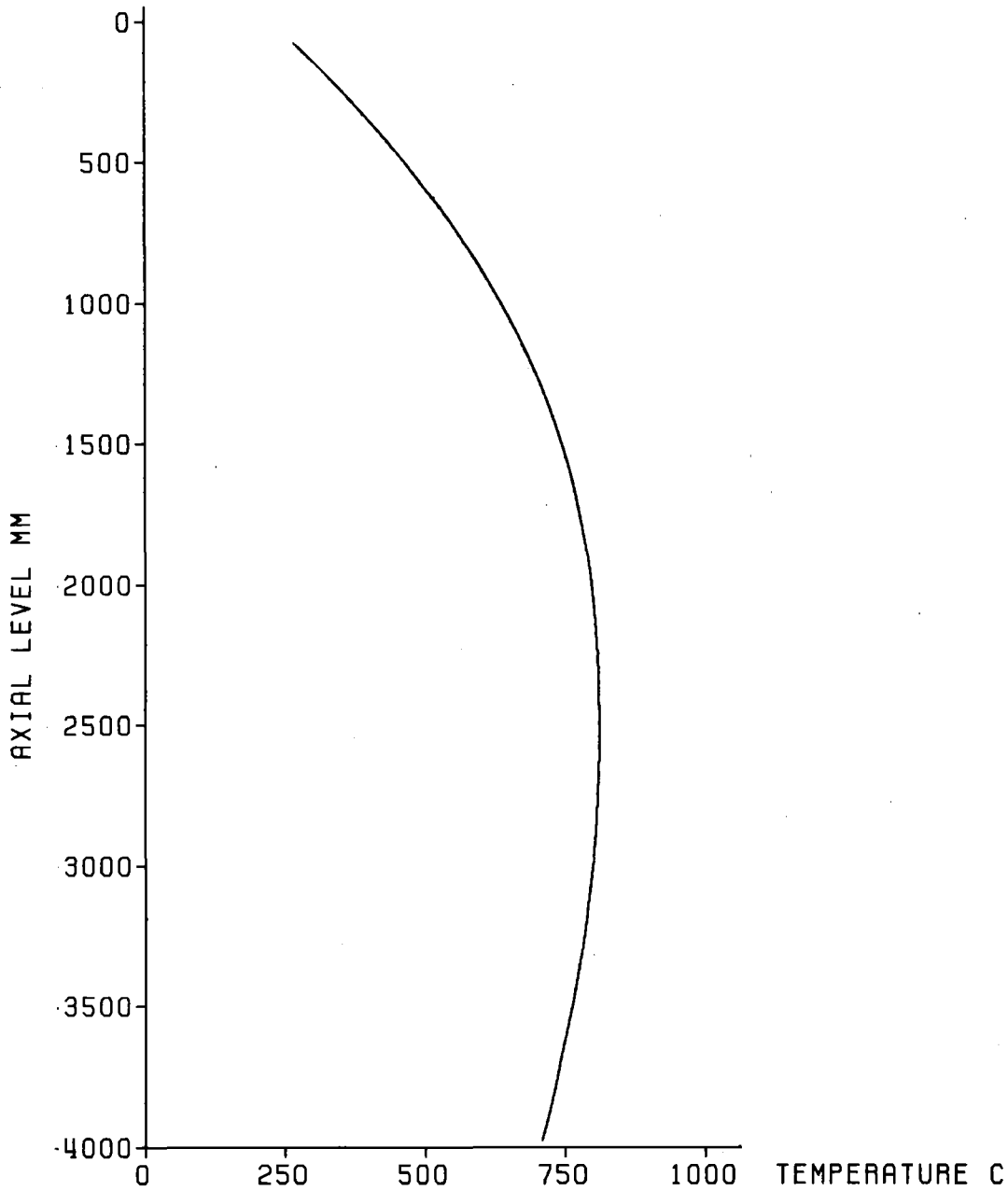

Decay Heat	120% ANS Standard
Flooding Rate (cold)	3.79 cm/s
System Pressure	3.87 bar
Feedwater Temperature	40 C



Fig. 36 FEBA: 5x5 ROD BUNDLE
TEST SERIES 5, TEST-No. 282

Test Parameters:

- ◇ Flooding Rate
- △ System Pressure
- Feedwater Temperature
- Bundle Power

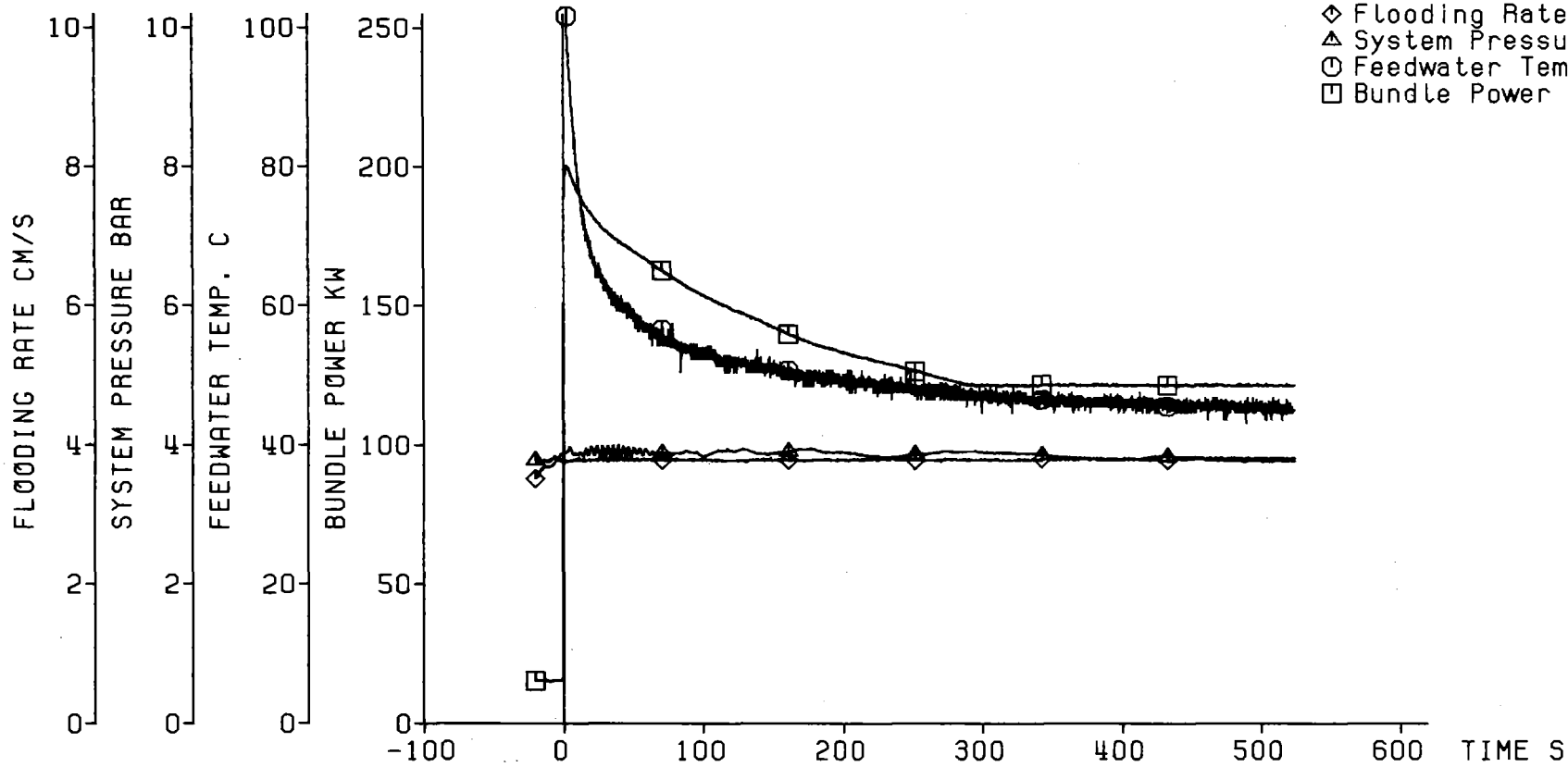

Decay Heat 120% ANS Standard
Flooding Rate (cold) 3.79 cm/s
System Pressure 3.87 bar
Feedwater Temperature 40 C



Fig. 37 FEBA: 5x5 ROD BUNDLE, TEST SERIES 5, TEST-No. 282

Cladding Temperature

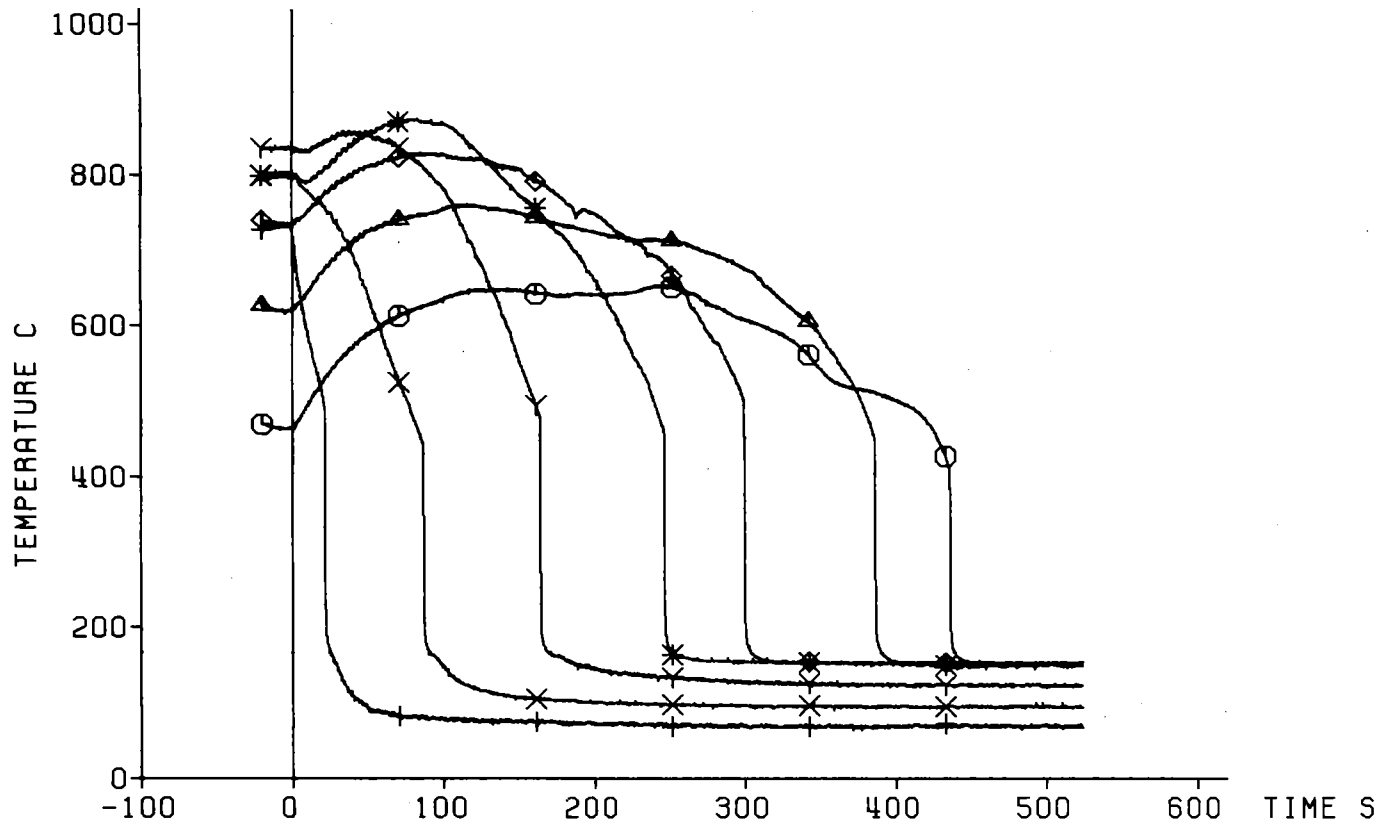

TC	Ax. Level
+	18a4 3860 mm
X	18a3 3315 mm
Y	18a2 2770 mm
*	18a1 2225 mm
◇	3b4 1680 mm
△	3b3 1135 mm
○	3b2 590 mm

Decay Heat 120% ANS Standard
 Flooding Rate (cold) 3.79 cm/s
 System Pressure 3.87 bar
 Feedwater Temperature 40 C



Fig. 38 FEBA: 5x5 ROD BUNDLE, TEST SERIES 5, TEST-No. 282

Heat Transfer Coeff.

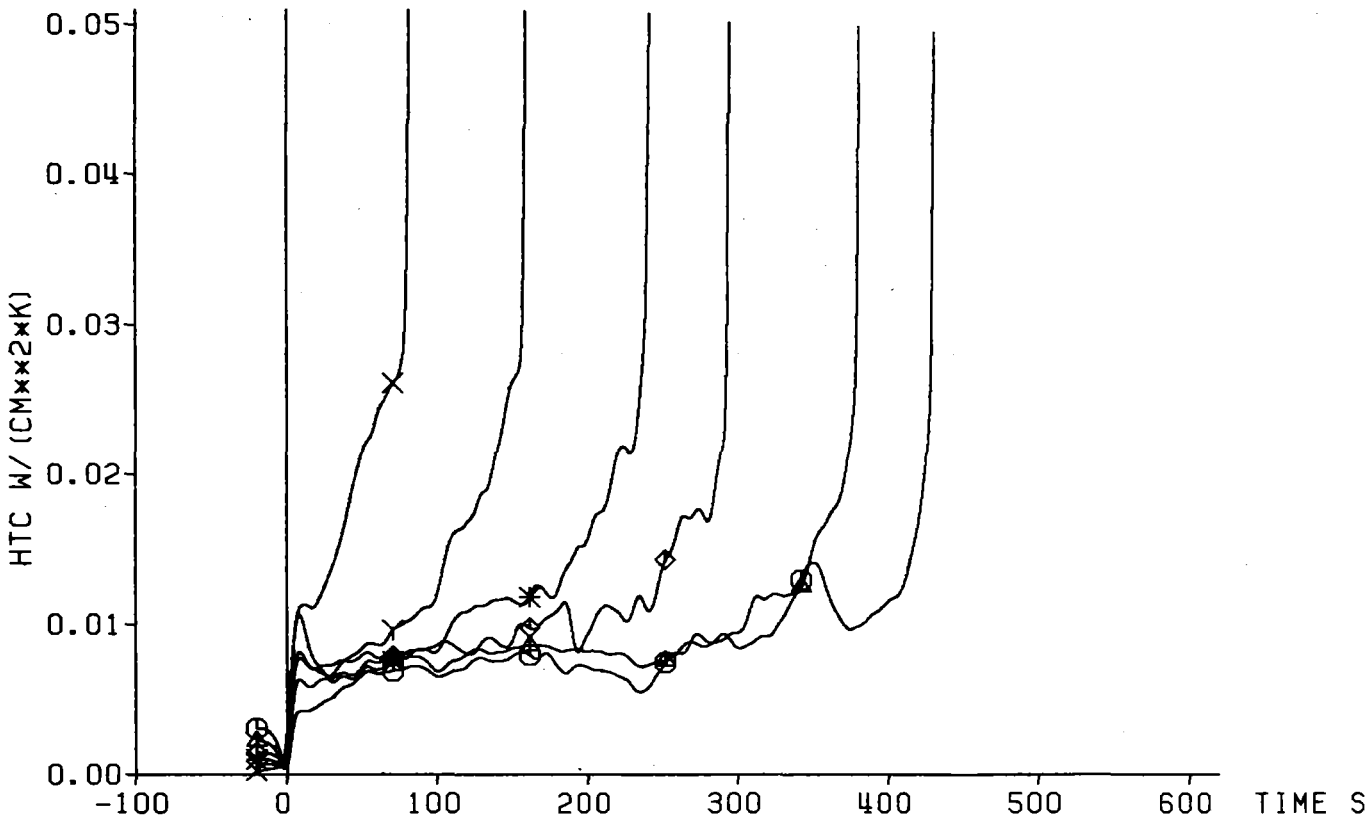

	TC	Ax. Level
X	18a3	3315 mm
Y	18a2	2770 mm
*	18a1	2225 mm
◇	3b4	1680 mm
△	3b3	1135 mm
○	3b2	590 mm

Decay Heat 120% ANS Standard
 Flooding Rate (cold) 3.79 cm/s
 System Pressure 3.87 bar
 Feedwater Temperature 40 C



Fig. 39 FEBA: 5x5 ROD BUNDLE, TEST SERIES 5, TEST-No. 282

Cladding Temperature

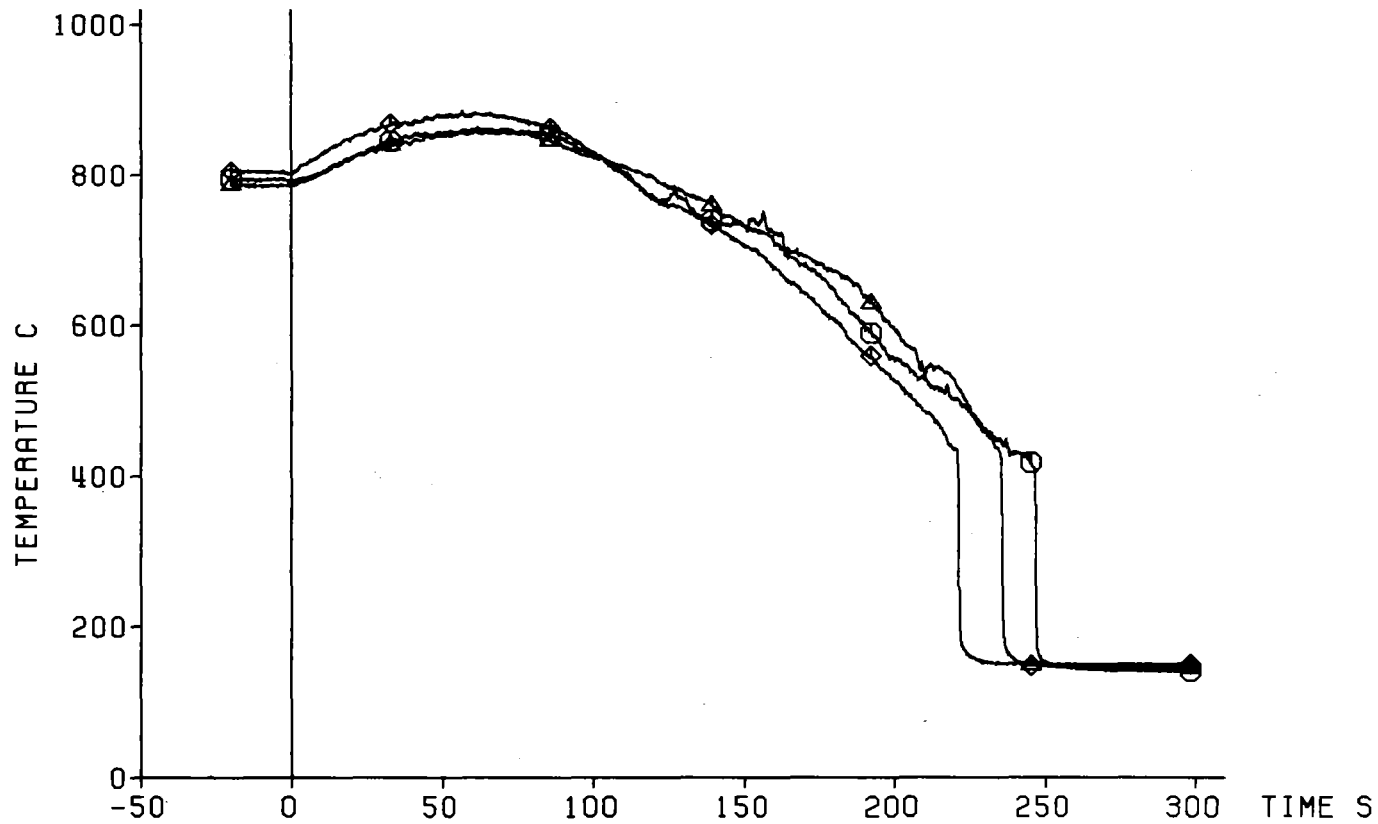

TC	Ax. Level
◇	7f4 2425 mm
△	7f3 2325 mm
○	9h4 2225 mm

Decay Heat 120% ANS Standard
 Flooding Rate (cold) 3.79 cm/s
 System Pressure 3.87 bar
 Feedwater Temperature 40 C

Bypass Area
 =====



Fig. 40 FEBA: 5x5 ROD BUNDLE, TEST SERIES 5, TEST-No. 282

Heat Transfer Coeff.

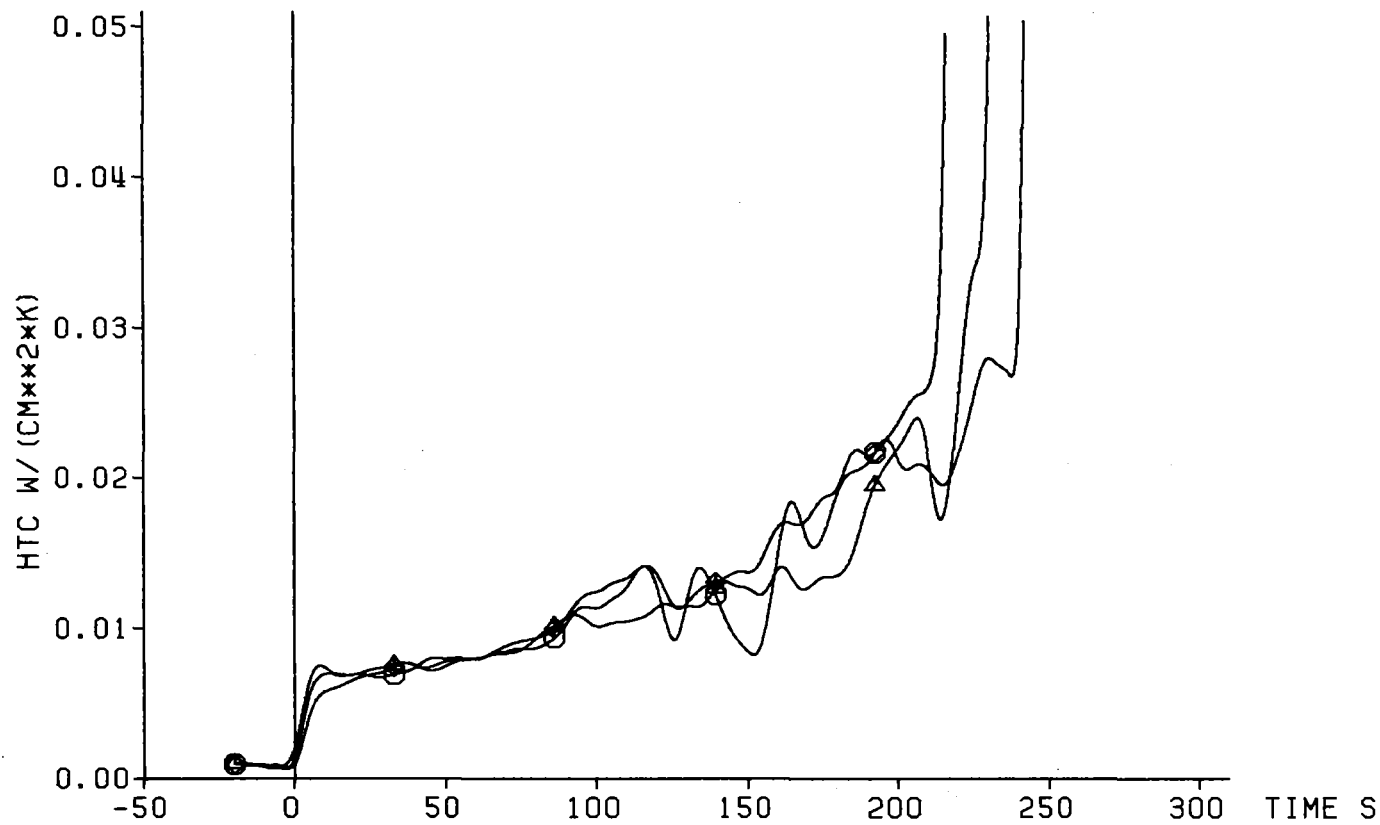

TC	Ax. Level
◇	7f4 2425 mm
△	7f3 2325 mm
○	9h4 2225 mm

Decay Heat 120% ANS Standard
 Flooding Rate (cold) 3.79 cm/s
 System Pressure 3.87 bar
 Feedwater Temperature 40 C

Bypass Area
 =====



Fig. 41 FEBA: 5x5 ROD BUNDLE, TEST SERIES 5, TEST-No. 282

Cladding Temperature

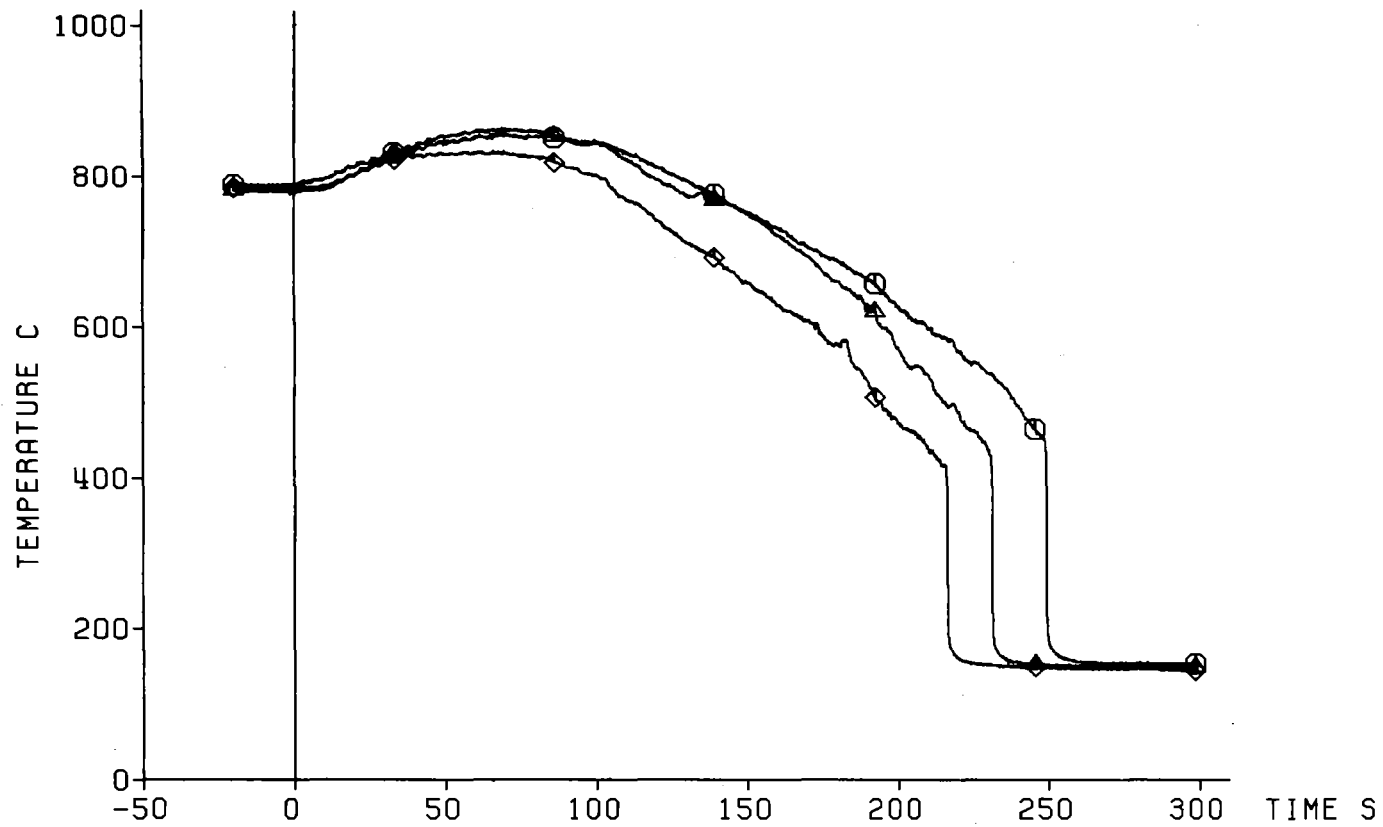

TC	Ax. Level
◇	22f4 2425 mm
△	22f3 2325 mm
○	17h4 2225 mm

Decay Heat 120% ANS Standard
 Flooding Rate (cold) 3.79 cm/s
 System Pressure 3.87 bar
 Feedwater Temperature 40 C

Blockage Area
 =====



Fig. 42 FEBA: 5x5 ROD BUNDLE, TEST SERIES 5, TEST-No. 282

Heat Transfer Coeff.

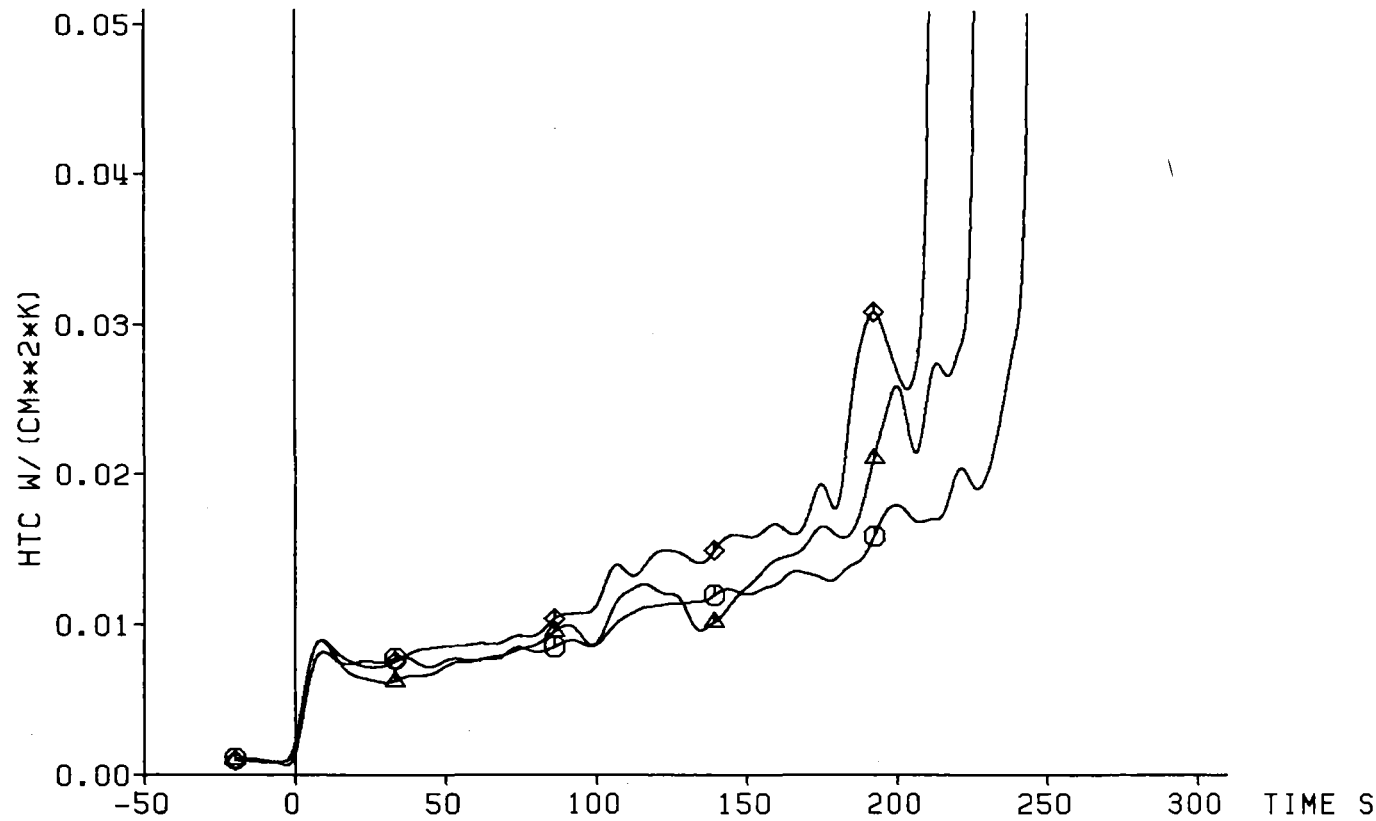

TC	Ax. Level
◇ 22f4	2425 mm
△ 22f3	2325 mm
○ 17h4	2225 mm

Decay Heat
 Flooding Rate (cold) 3.79 cm/s
 System Pressure 3.87 bar
 Feedwater Temperature 40 C

120% ANS Standard

Blockage Area
 =====



Fig. 43 FEBA: 5x5 ROD BUNDLE, TEST SERIES 5, TEST-No. 282

Cladding Temperature

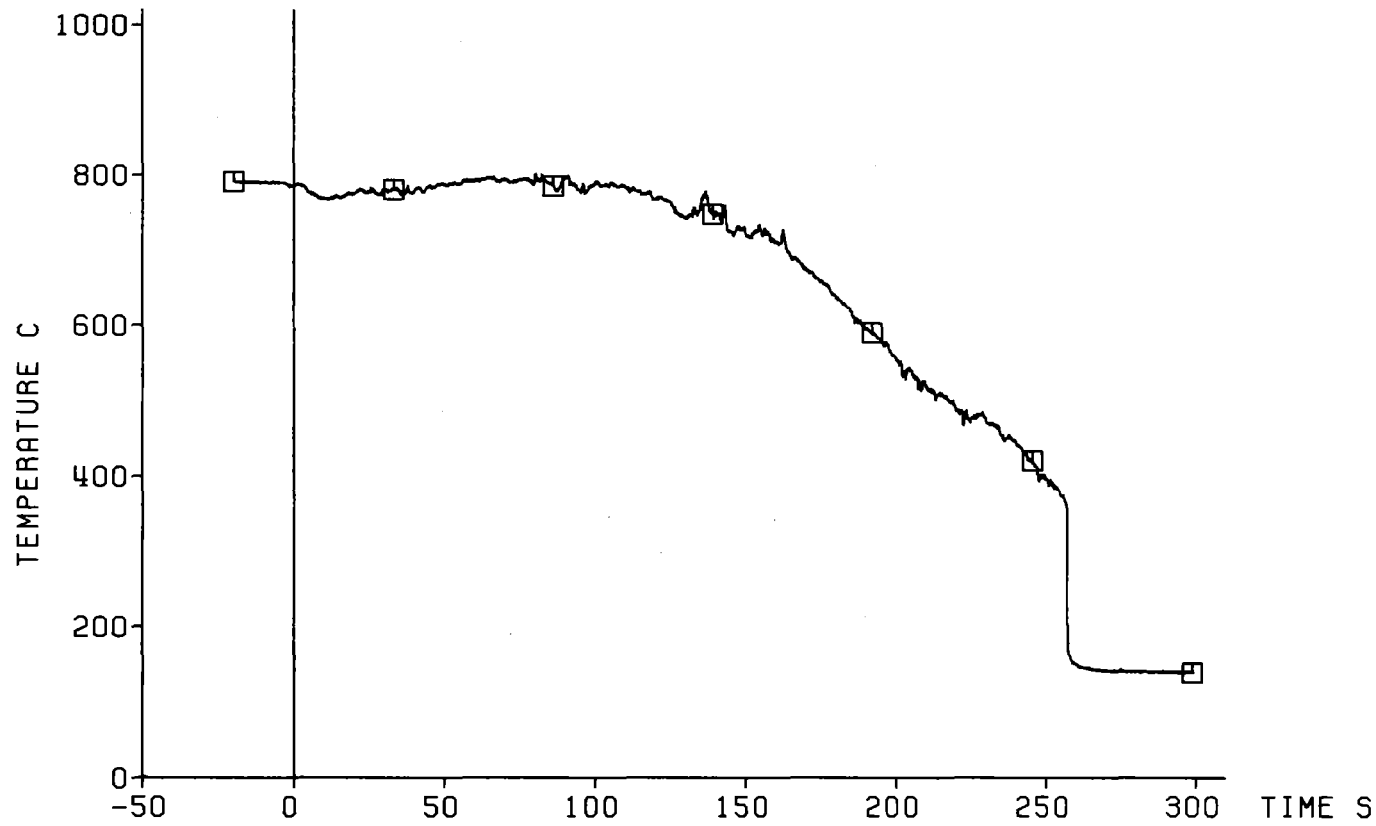

TC	Ax. Level
□	9h3 2125 mm

Decay Heat 120% ANS Standard
Flooding Rate (cold) 3.79 cm/s
System Pressure 3.87 bar
Feedwater Temperature 40 C

Bypass Area
=====



Fig. 44 FEBA: 5x5 ROD BUNDLE, TEST SERIES 5, TEST-No. 282

Heat Transfer Coeff.

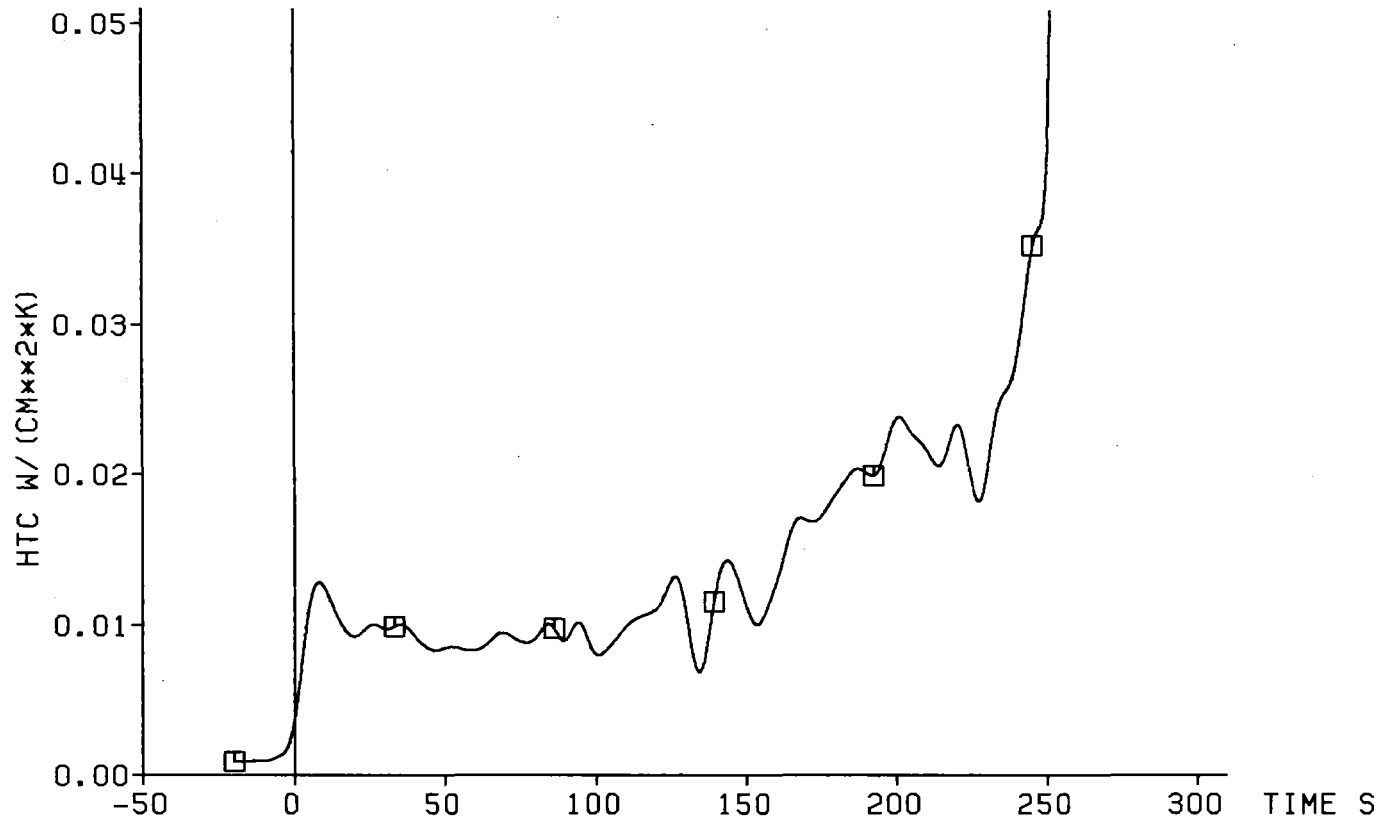

TC	Ax. Level
□	9h3 2125 mm

Decay Heat 120% ANS Standard
Flooding Rate (cold) 3.79 cm/s
System Pressure 3.87 bar
Feedwater Temperature 40 C

Bypass Area
=====



Fig. 45 FEBA: 5x5 ROD BUNDLE, TEST SERIES 5, TEST-No. 282

Cladding Temperature

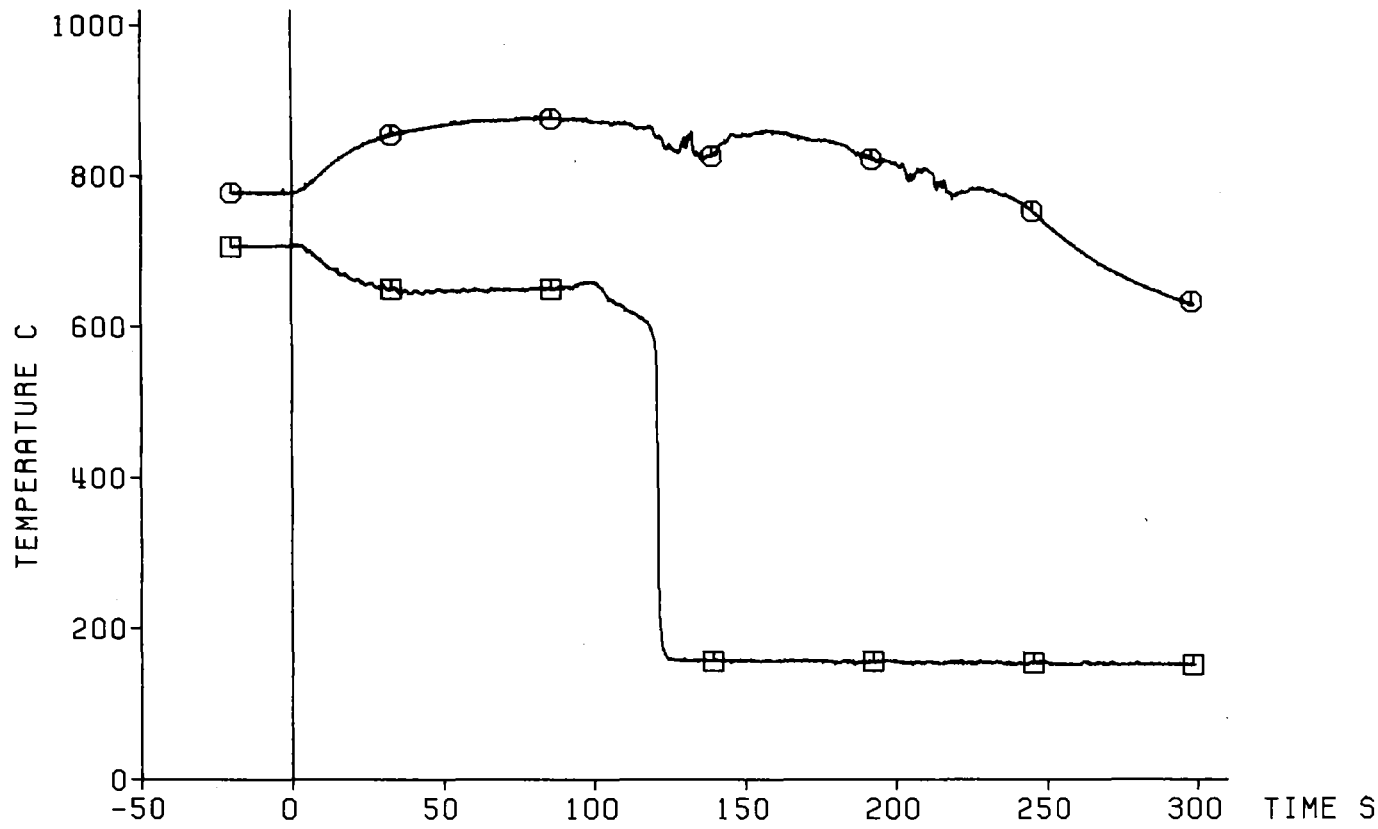

TC	Ax. Level
⊙ 17h3	2125 mm
⊠ Sleeve Rod 21	2125 mm

Decay Heat 120% ANS Standard
 Flooding Rate (cold) 3.79 cm/s
 System Pressure 3.87 bar
 Feedwater Temperature 40 C

Blockage Area
 =====



Fig. 46 FEBA: 5x5 ROD BUNDLE, TEST SERIES 5, TEST-No. 282

Cladding Temperature

TC	Ax. Level
↑ 12h3	2125 mm
× 22f1	2125 mm

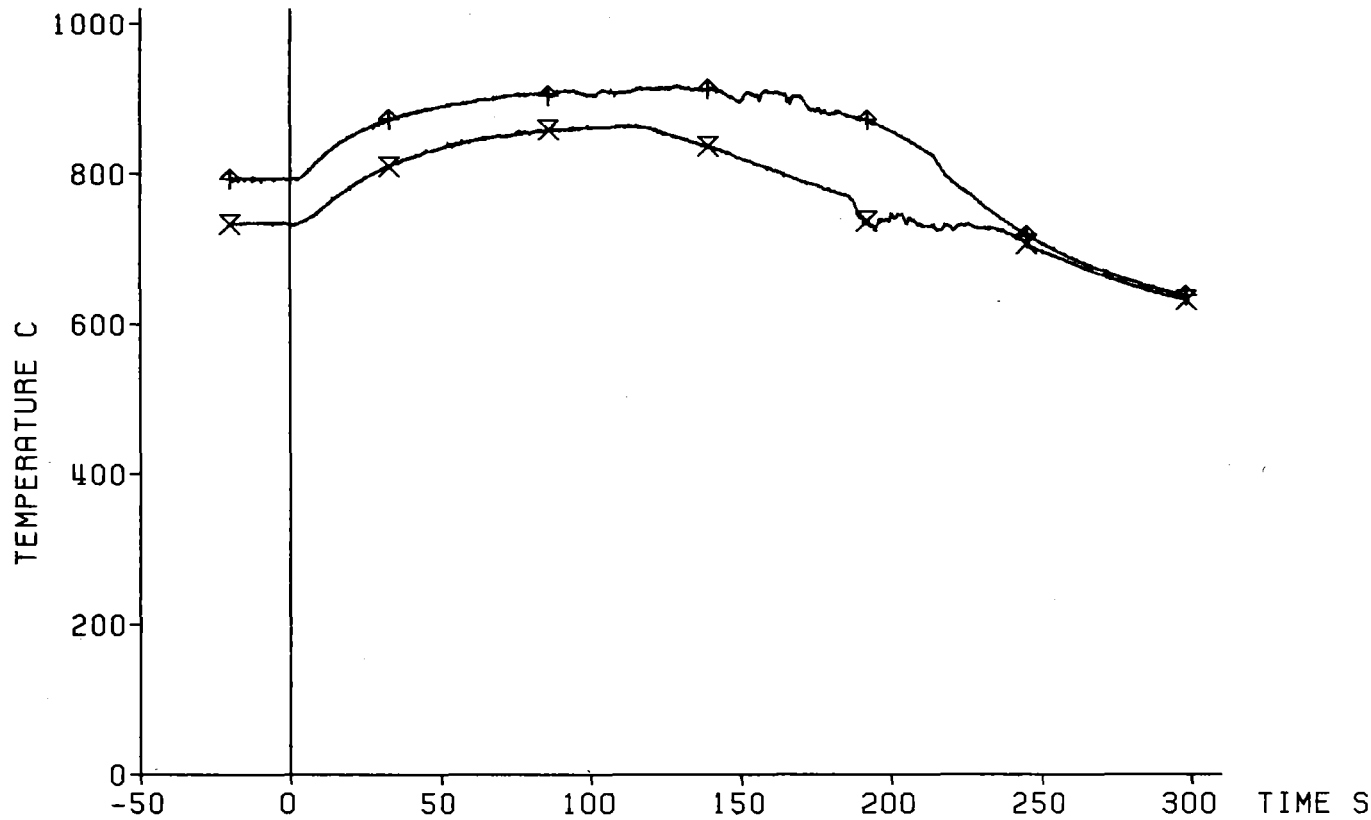

Decay Heat 120% ANS Standard
 Flooding Rate (cold) 3.79 cm/s
 System Pressure 3.87 bar
 Feedwater Temperature 40 C

Blockage Area
 =====



Fig. 47 FEBA: 5x5 ROD BUNDLE, TEST SERIES 5, TEST-No. 282

Cladding Temperature

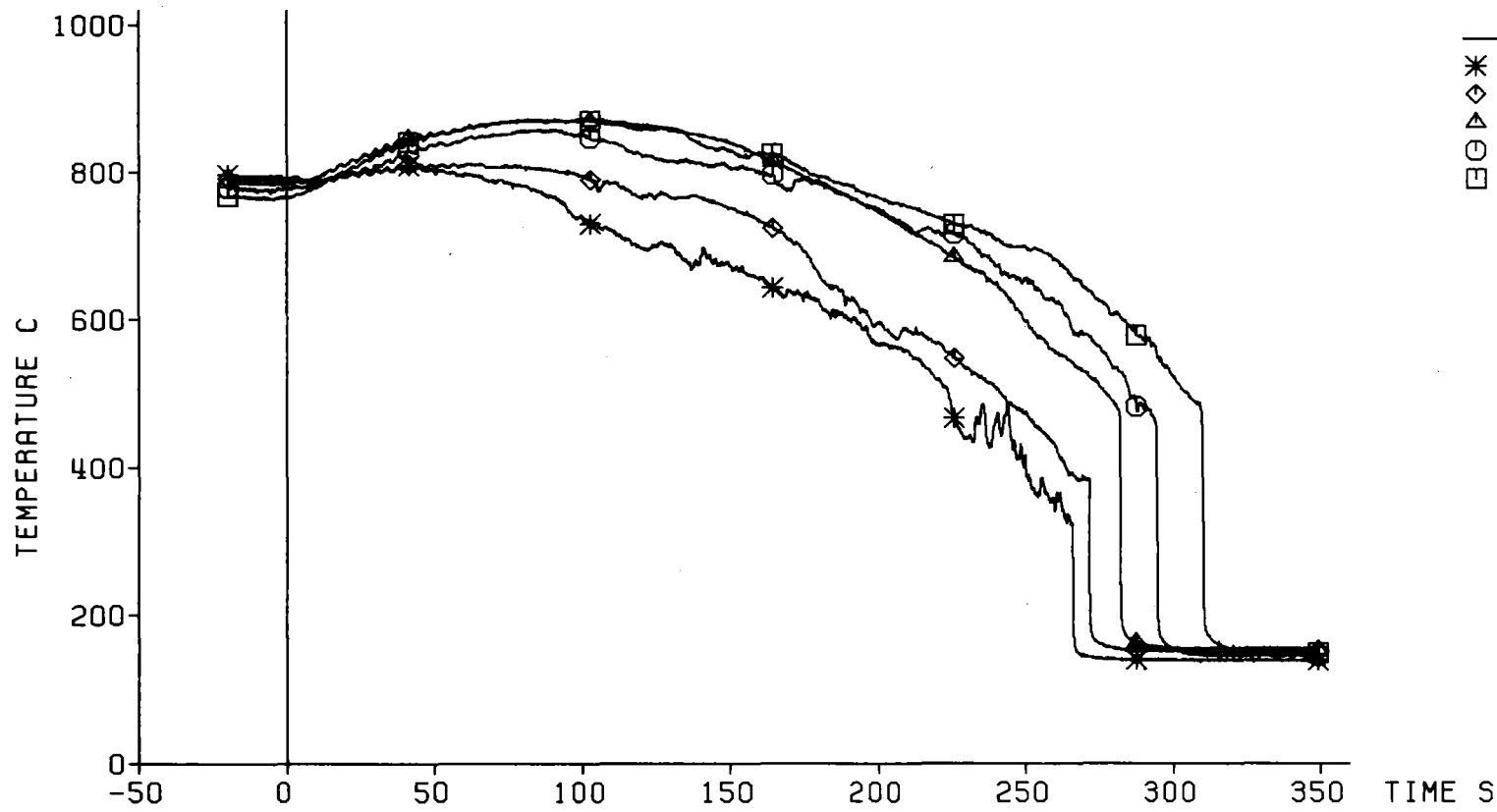

TC	Ax. Level
*	9h2 2025 mm
◇	9h1 1925 mm
△	19g3 1825 mm
○	19g2 1725 mm
□	19g1 1625 mm

Decay Heat 120% ANS Standard
 Flooding Rate (cold) 3.79 cm/s
 System Pressure 3.87 bar
 Feedwater Temperature 40 C

Bypass Area
 =====



Fig. 48 FEBA: 5x5 ROD BUNDLE, TEST SERIES 5, TEST-No. 282

Heat Transfer Coeff.

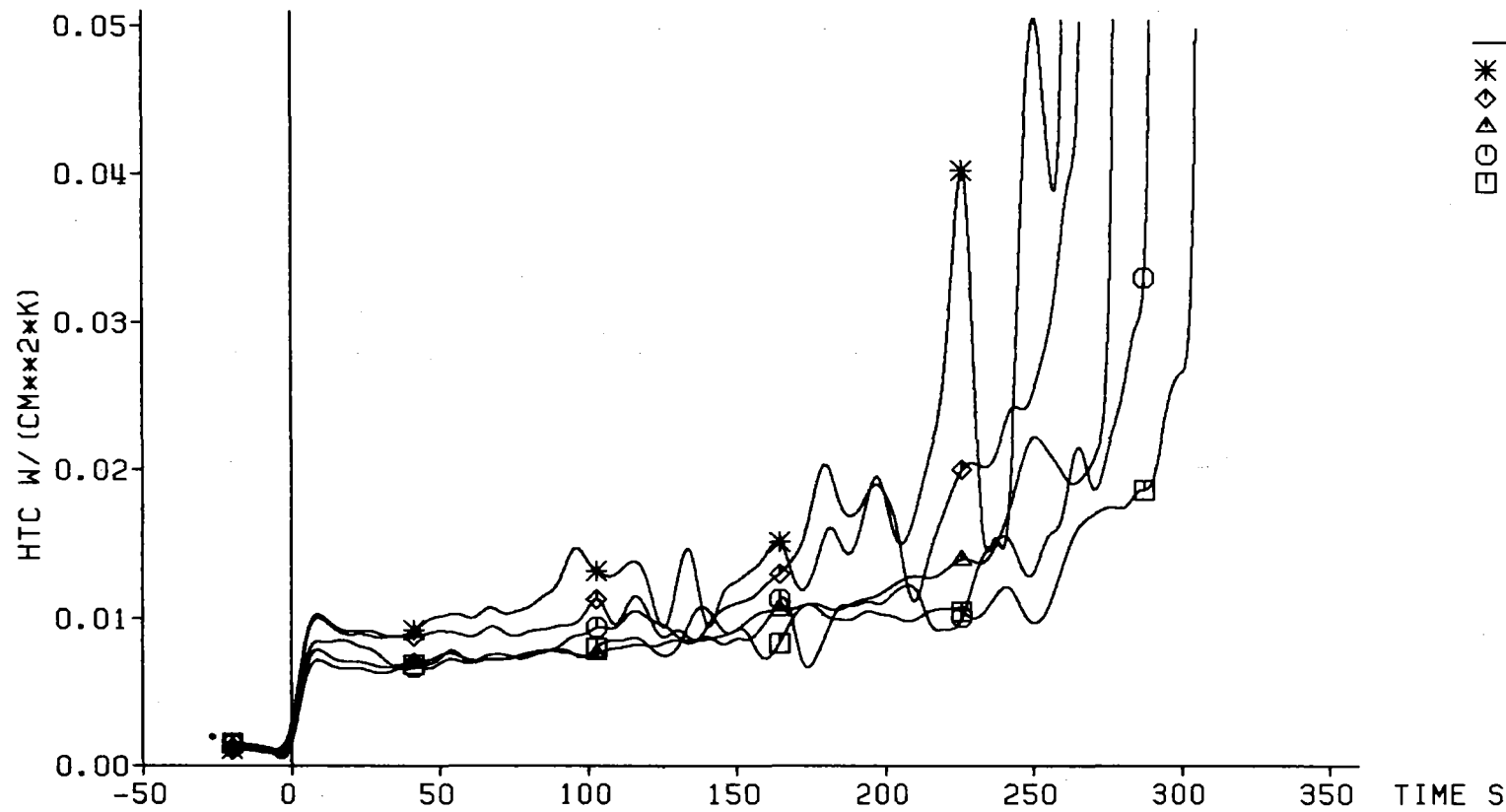

TC	Ax. Level
*	9h2 2025 mm
◇	9h1 1925 mm
△	19g3 1825 mm
○	19g2 1725 mm
□	19g1 1625 mm

Decay Heat 120% ANS Standard
 Flooding Rate (cold) 3.79 cm/s
 System Pressure 3.87 bar
 Feedwater Temperature 40 C

Bypass Area
 =====



Fig. 49 FEBA: 5x5 ROD BUNDLE, TEST SERIES 5, TEST-No. 282

Cladding Temperature

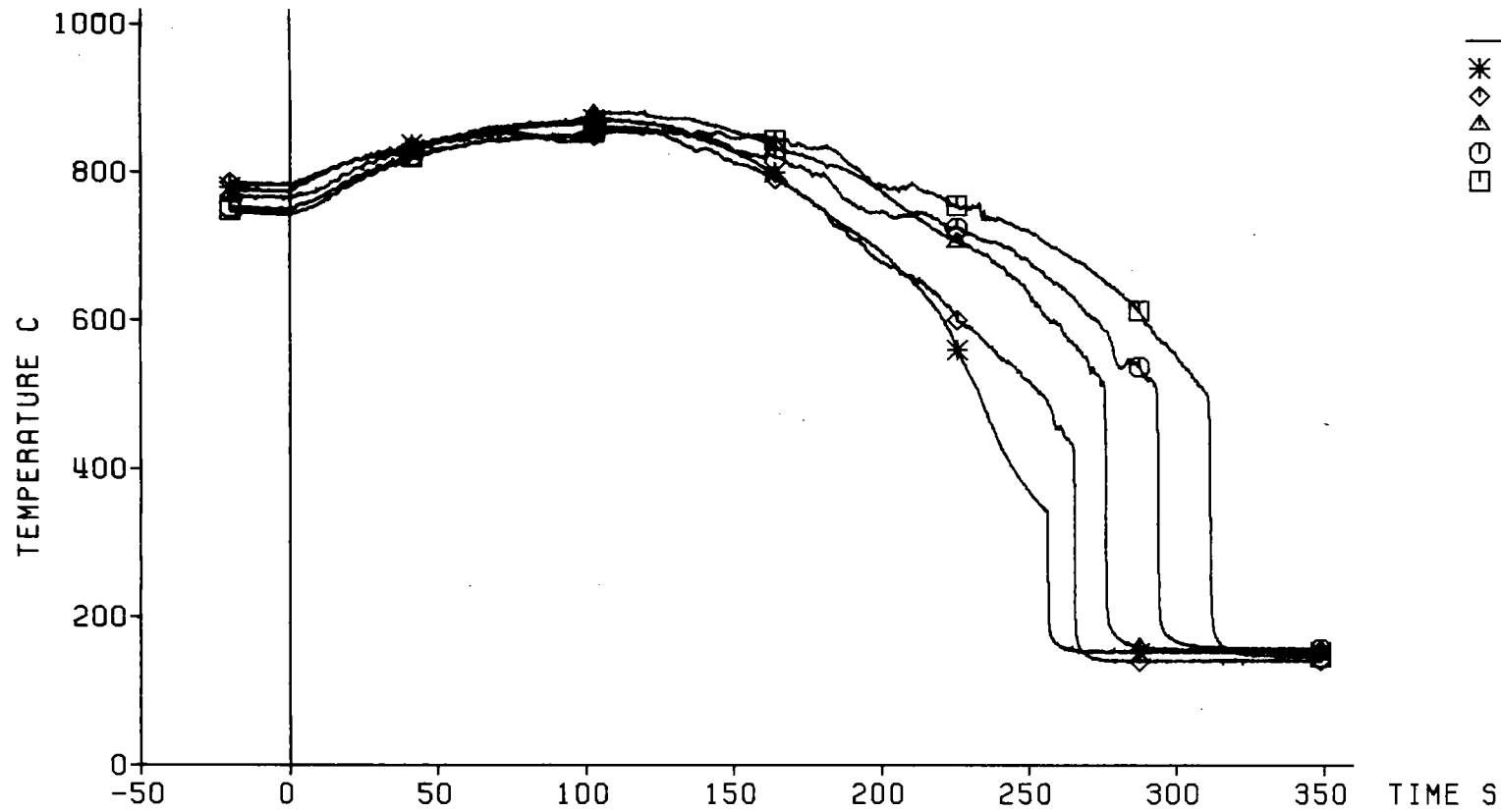

TC	Ax. Level
*	17h2 2025 mm
◇	17h1 1925 mm
△	16g3 1825 mm
○	16g2 1725 mm
□	16g1 1625 mm

Decay Heat 120% ANS Standard
 Flooding Rate (cold) 3.79 cm/s
 System Pressure 3.87 bar
 Feedwater Temperature 40 C

Blockage Area
 =====



Fig. 50 FEBA: 5x5 ROD BUNDLE, TEST SERIES 5, TEST-No. 282

Heat Transfer Coeff.

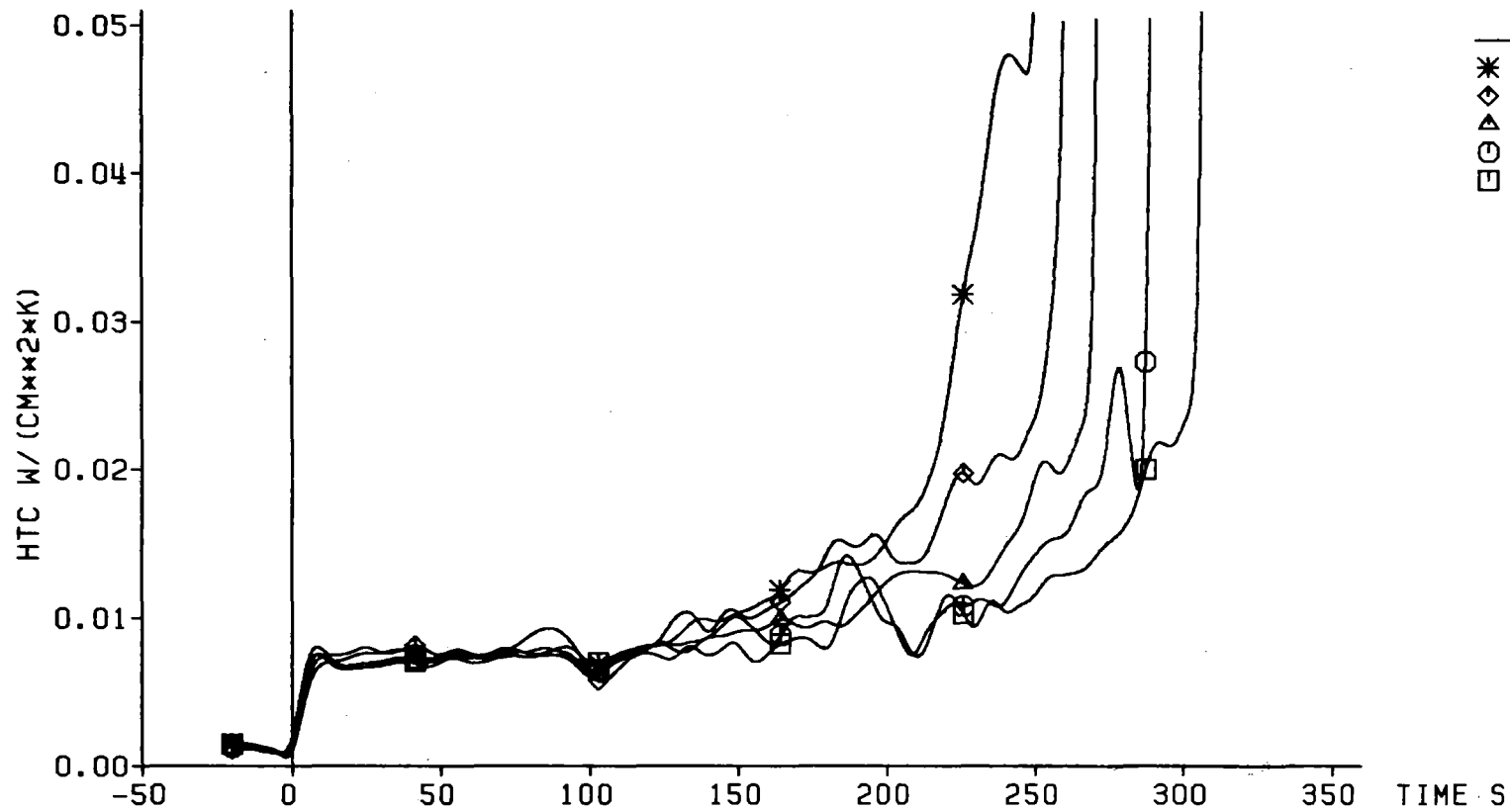

TC	Ax. Level
* 17h2	2025 mm
◇ 17h1	1925 mm
△ 16g3	1825 mm
○ 16g2	1725 mm
□ 16g1	1625 mm

Decay Heat 120% ANS Standard
 Flooding Rate (cold) 3.79 cm/s
 System Pressure 3.87 bar
 Feedwater Temperature 40 C

Blockage Area
 =====



Fig. 51 FEBA: 5x5 ROD BUNDLE, TEST SERIES 5, TEST-No. 282

Axial Level: 1825 mm

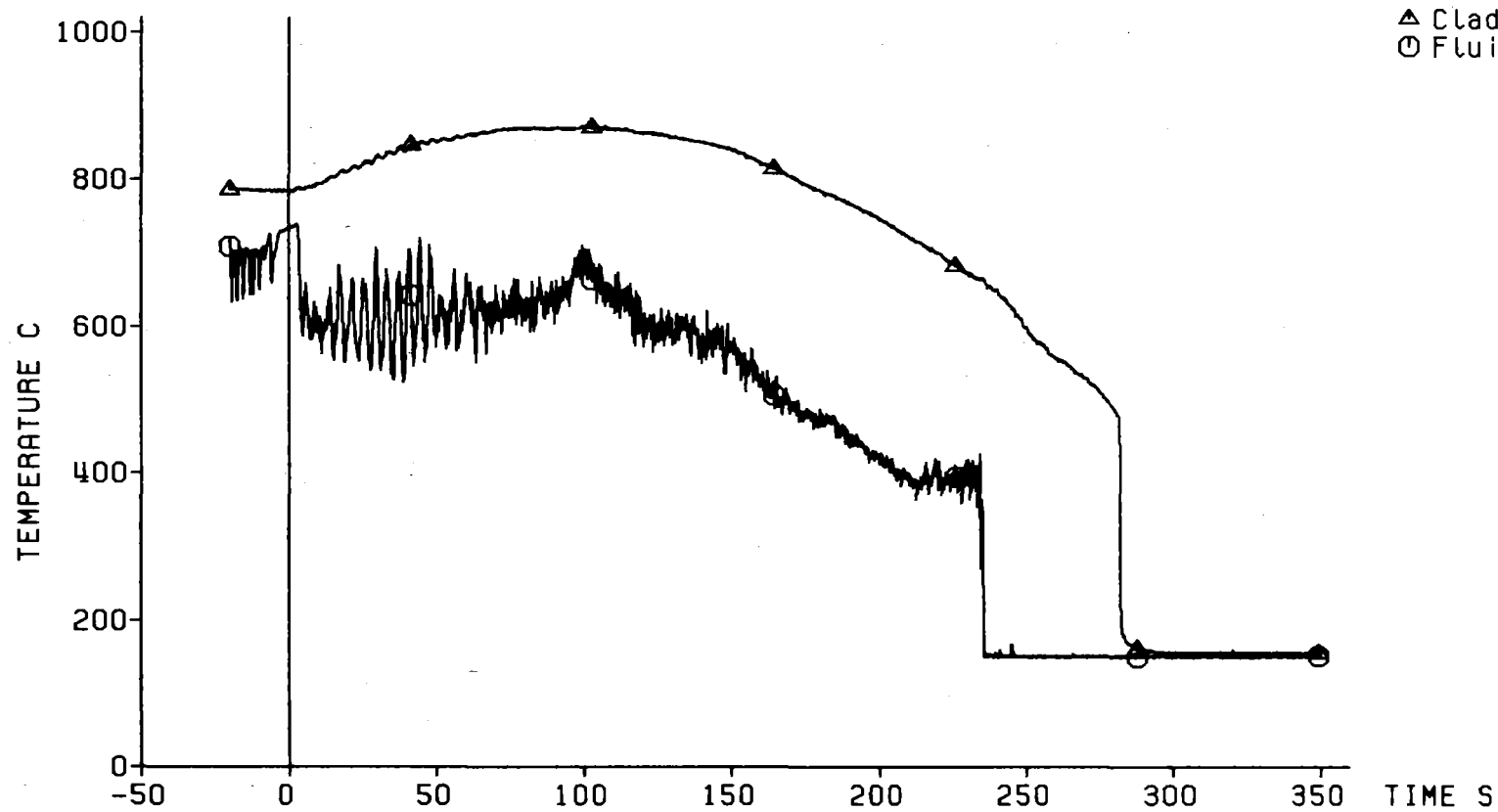

△ Cladding Temperature (19g3)
○ Fluid Temperature

— 64 —

Decay Heat 120% ANS Standard
Flooding Rate (cold) 3.79 cm/s
System Pressure 3.87 bar
Feedwater Temperature 40 C

Bypass Area
=====



Fig. 52 FEBA: 5x5 ROD BUNDLE, TEST SERIES 5, TEST-No. 282

Axial Level: 1625 mm

△ Cladding Temperature (19g1)
○ Fluid Temperature
□ Housing Temperature

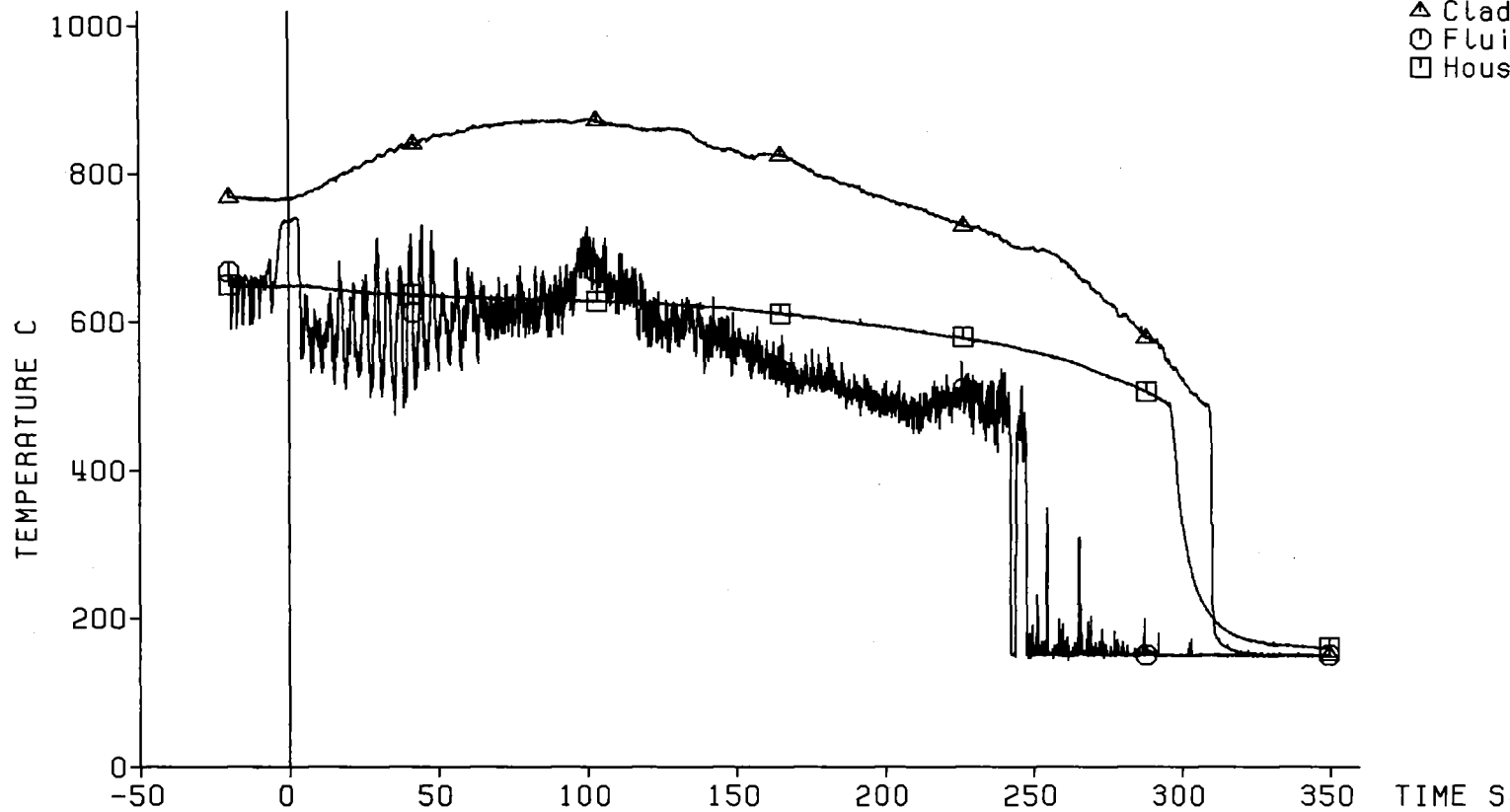

Decay Heat 120% ANS Standard
Flooding Rate (cold) 3.79 cm/s
System Pressure 3.87 bar
Feedwater Temperature 40 C

Bypass Area
=====



Fig. 53 FEBA: 5x5 ROD BUNDLE, TEST SERIES 5, TEST-NO. 282

Axial Level: 1925 mm

△ Cladding Temperature (17h1)
○ Fluid Temperature

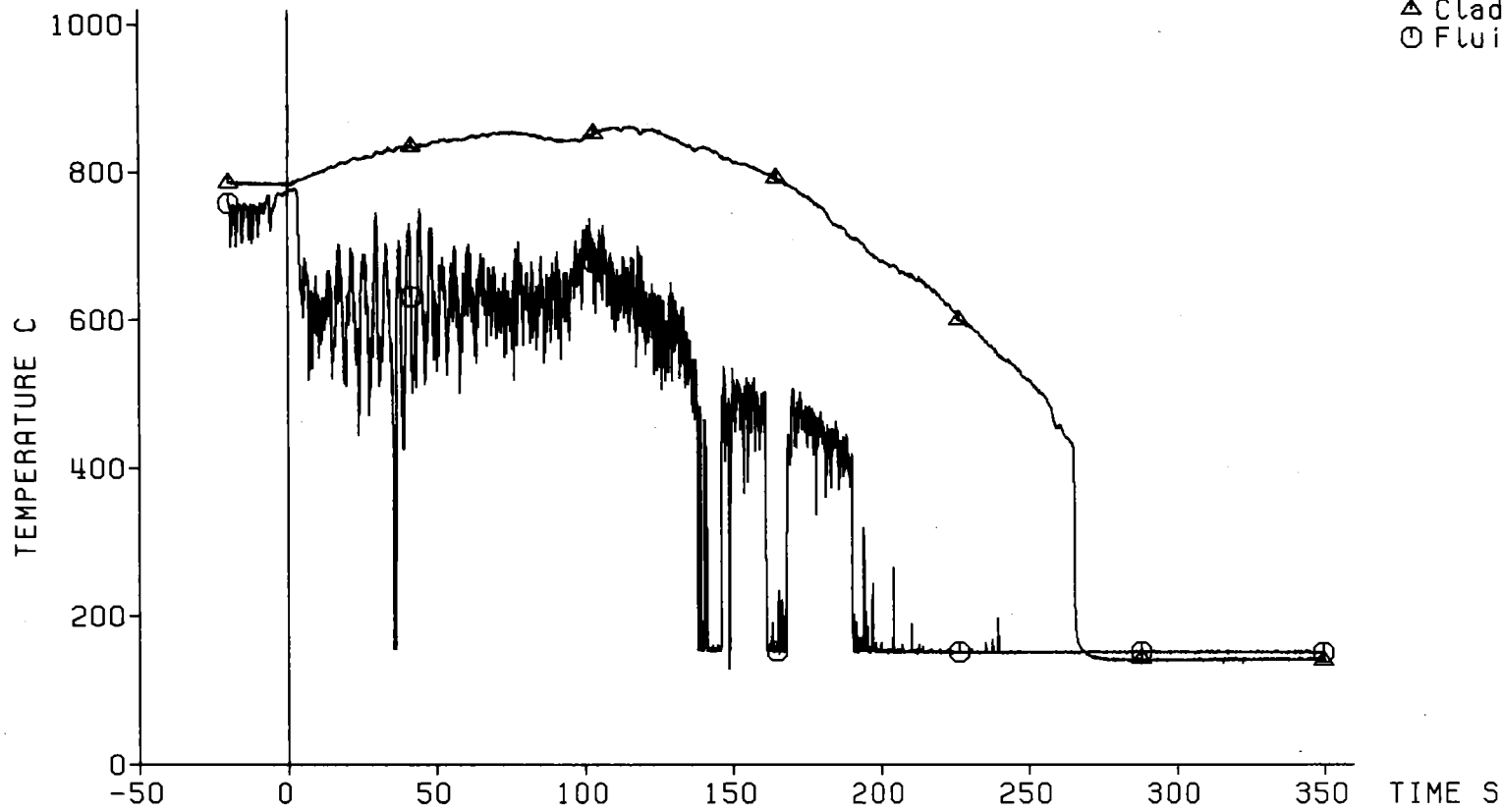

Decay Heat 120% ANS Standard
Flooding Rate (cold) 3.79 cm/s
System Pressure 3.87 bar
Feedwater Temperature 40 C

Blockage Area
=====

KIK IRB

Fig. 54 FEBA: 5x5 ROD BUNDLE, TEST SERIES 5, TEST-No. 282

Axial Level: 1725 mm

△ Cladding Temperature (16g2)
○ Fluid Temperature

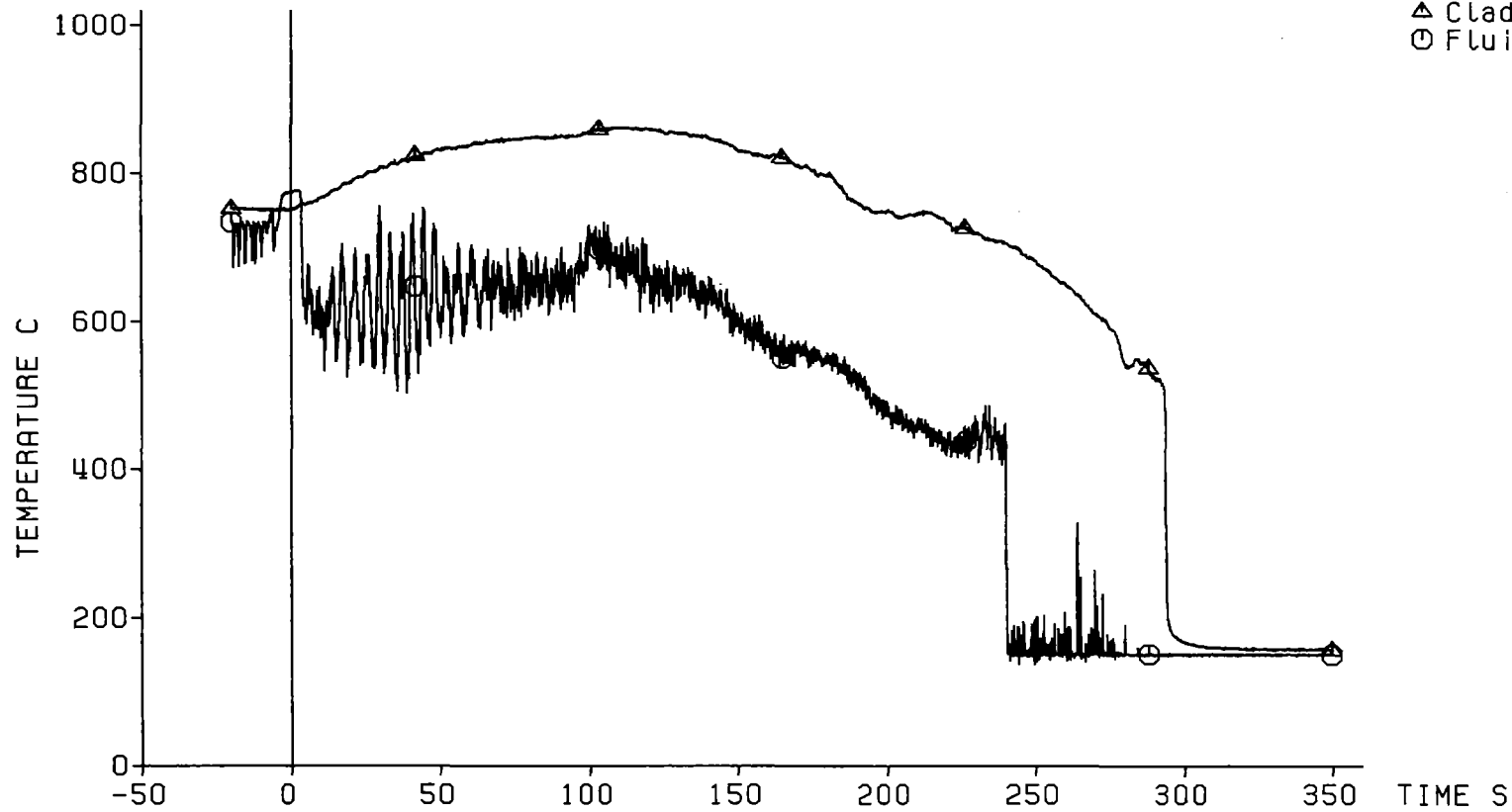

Decay Heat
Flooding Rate (cold)
System Pressure
Feedwater Temperature

120% ANS Standard
3.79 cm/s
3.87 bar
40 C

Blockage Area
=====

— 67 —



Fig. 55 FEBA: 5x5 ROD BUNDLE, TEST SERIES 5, TEST-NO. 282

Axial Level: 1625 mm

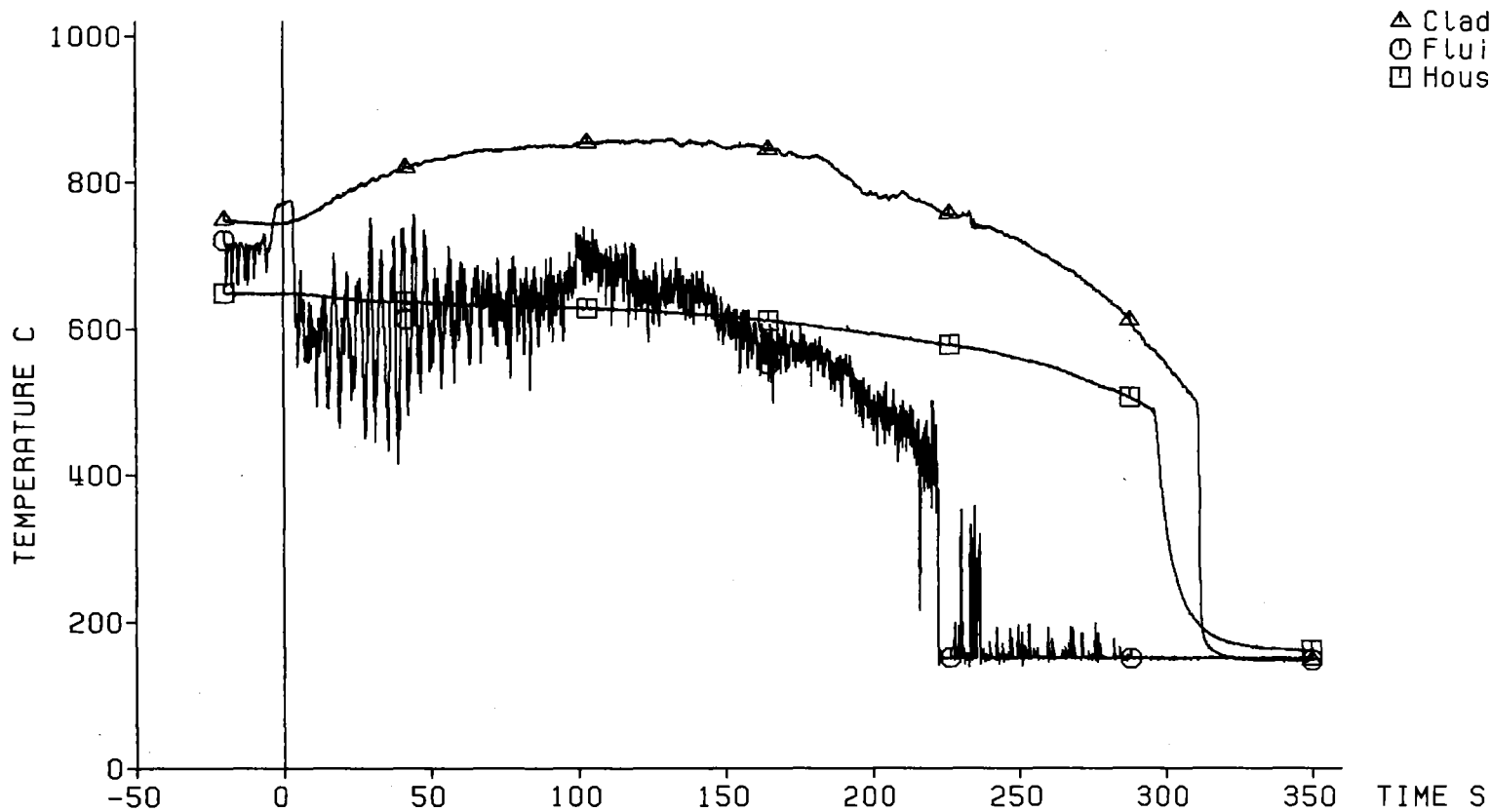

△ Cladding Temperature (16g1)
○ Fluid Temperature
□ Housing Temperature

Decay Heat 120% ANS Standard
Flooding Rate (cold) 3.79 cm/s
System Pressure 3.87 bar
Feedwater Temperature 40 C

Blockage Area
=====



Fig. 56 FEBA: 5x5 ROD BUNDLE, TEST SERIES 5, TEST-No. 282

Pressure Loss
Along the Test Section:

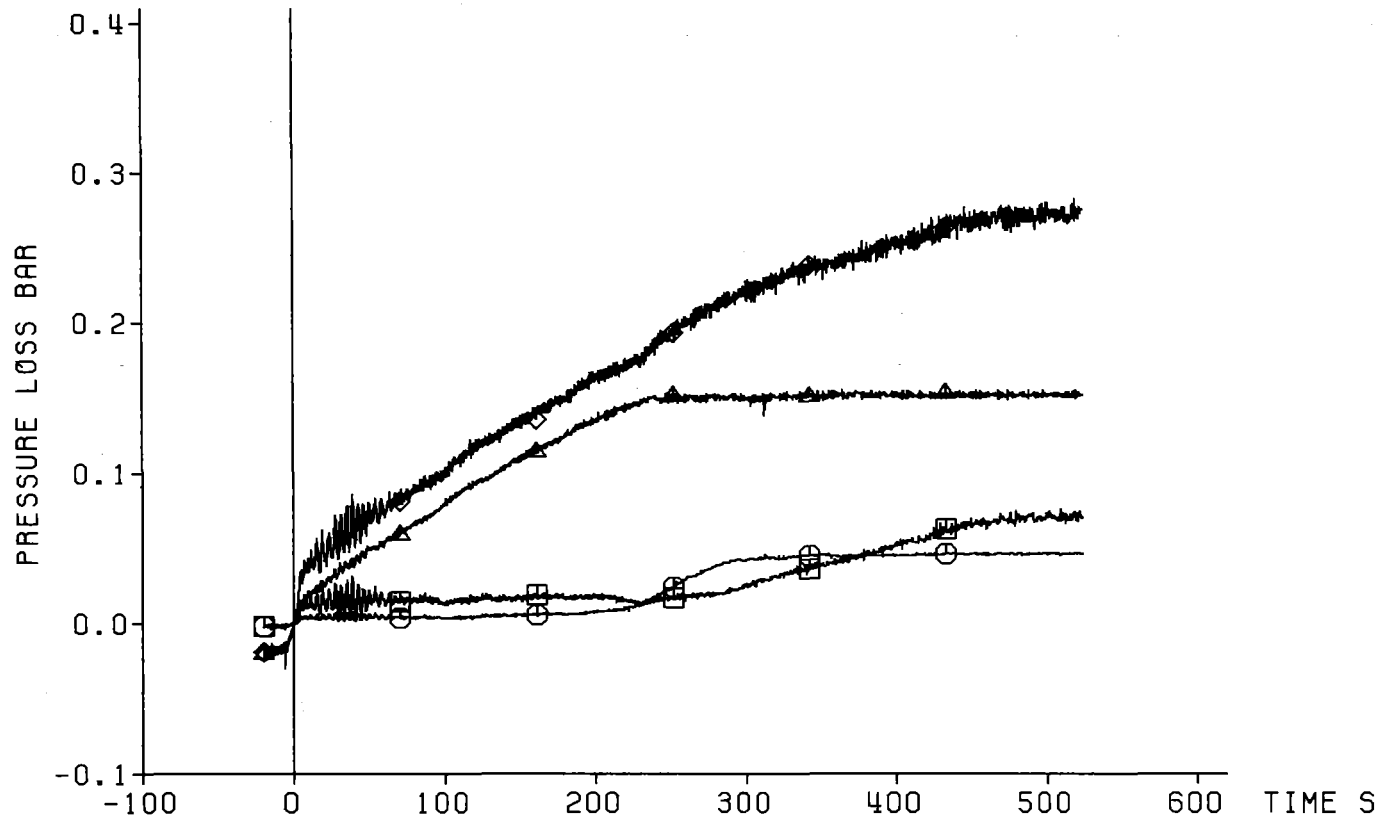

◇ Total Length: 4196 mm
△ Lower Part: 1711 mm
○ Middle Part: 545 mm
□ Upper Part: 1940 mm

Decay Heat 120% ANS Standard
Flooding Rate (cold) 3.79 cm/s
System Pressure 3.87 bar
Feedwater Temperature 40 C

KIK
IRB

Fig. 57 FEBA: 5x5 ROD BUNDLE, TEST SERIES 5, TEST-No. 282

Coolant Outlet Conditions:

△ Water Carry Over
○ Coolant Temperature
□ Coolant Pressure

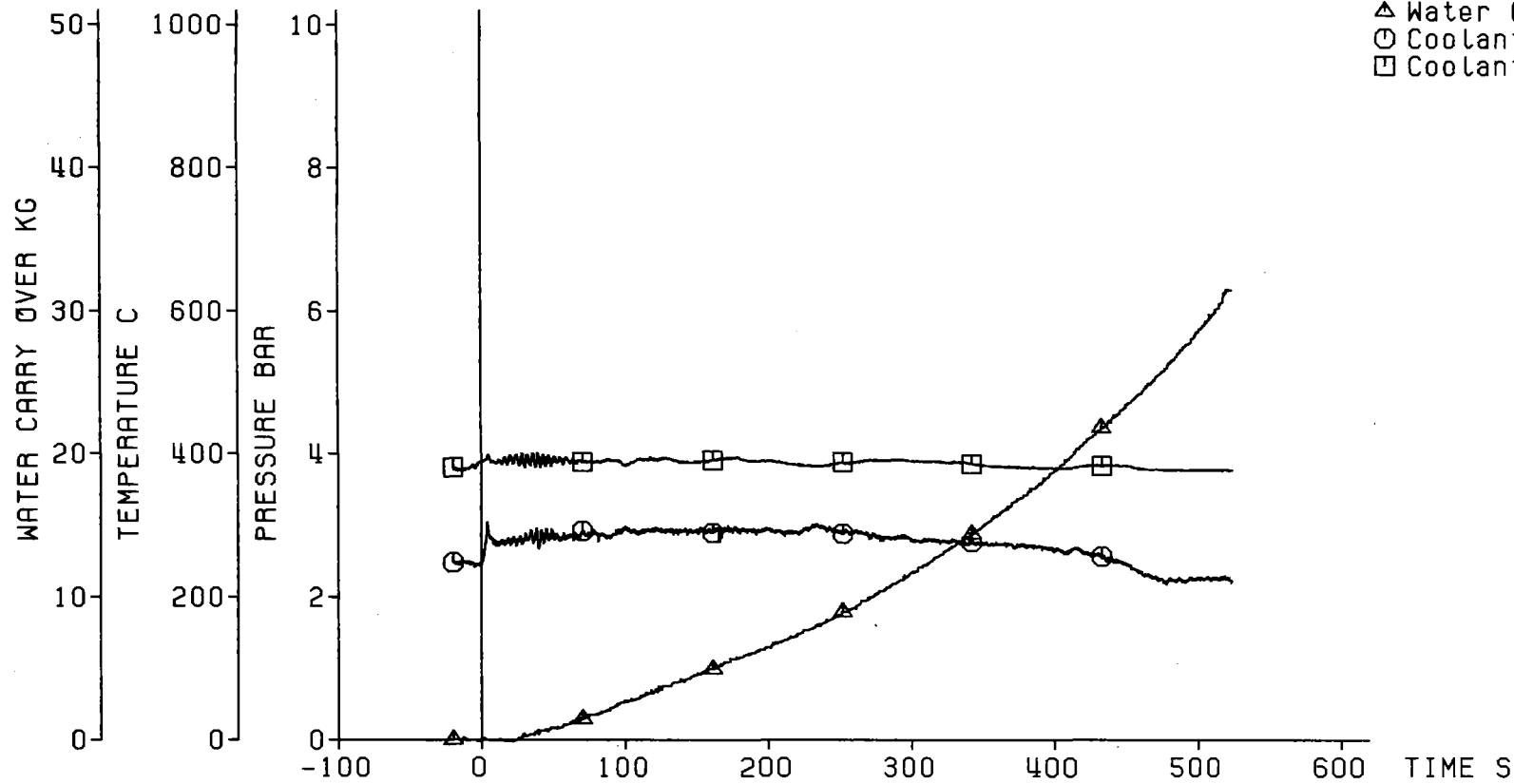

Decay Heat 120% ANS Standard
Flooding Rate (cold) 3.79 cm/s
System Pressure 3.87 bar
Feedwater Temperature 40 C

KFK IRB

Fig. 58 FEBA: 5x5 ROD BUNDLE, TEST SERIES 5, TEST-No. 282

Axial Position of Quench Front

□ Quenching of Sleeves

X Quenching of Claddings Downstream of Blockage Area

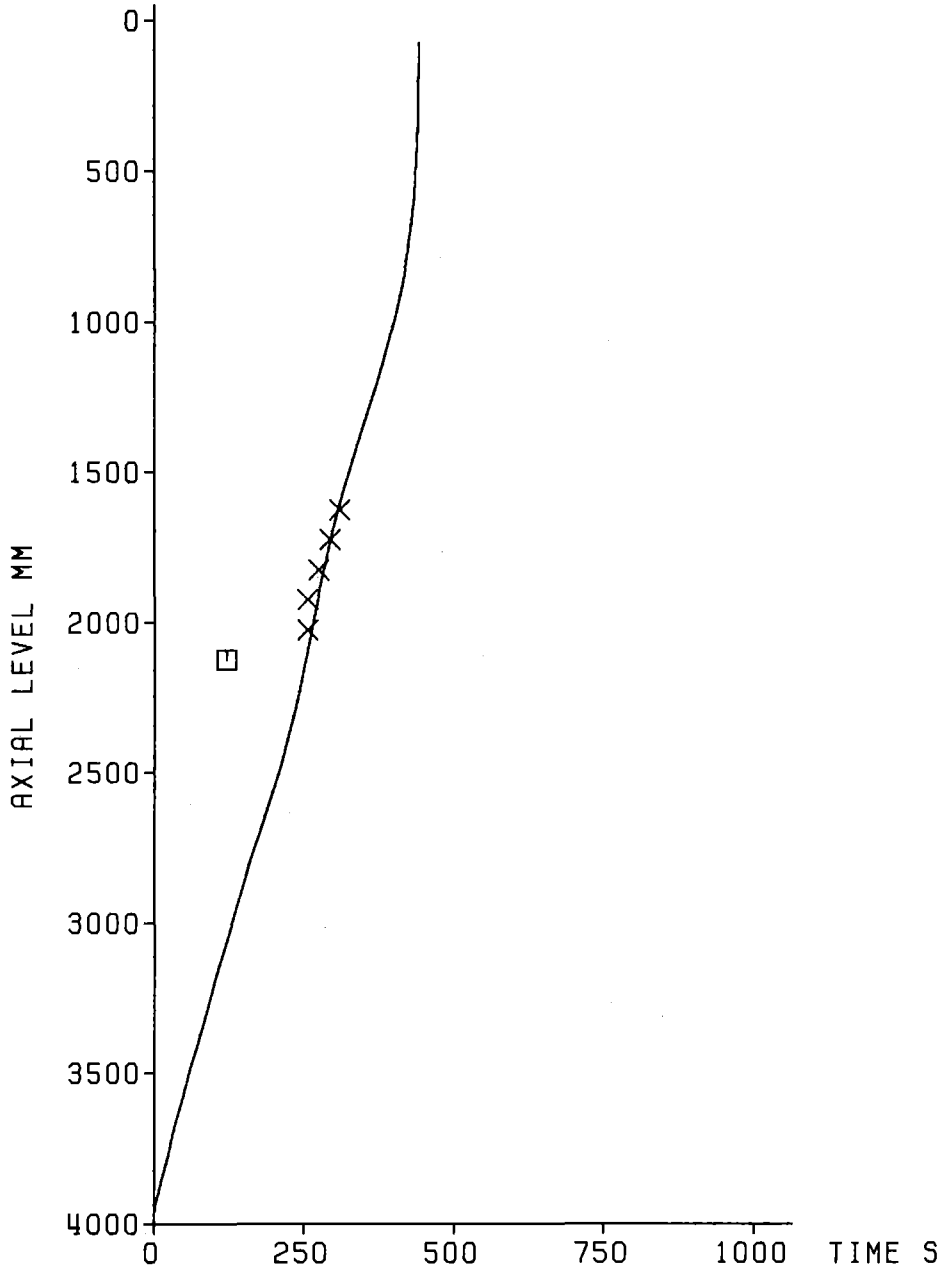

Decay Heat 120% ANS Standard
Flooding Rate (cold) 3.79 cm/s
System Pressure 3.87 bar
Feedwater Temperature 40 C



Fig. 59 FEBA: 5x5 ROD BUNDLE
TEST SERIES 5, TEST-NO. 282

Initial Axial Temperature Profile of Claddings

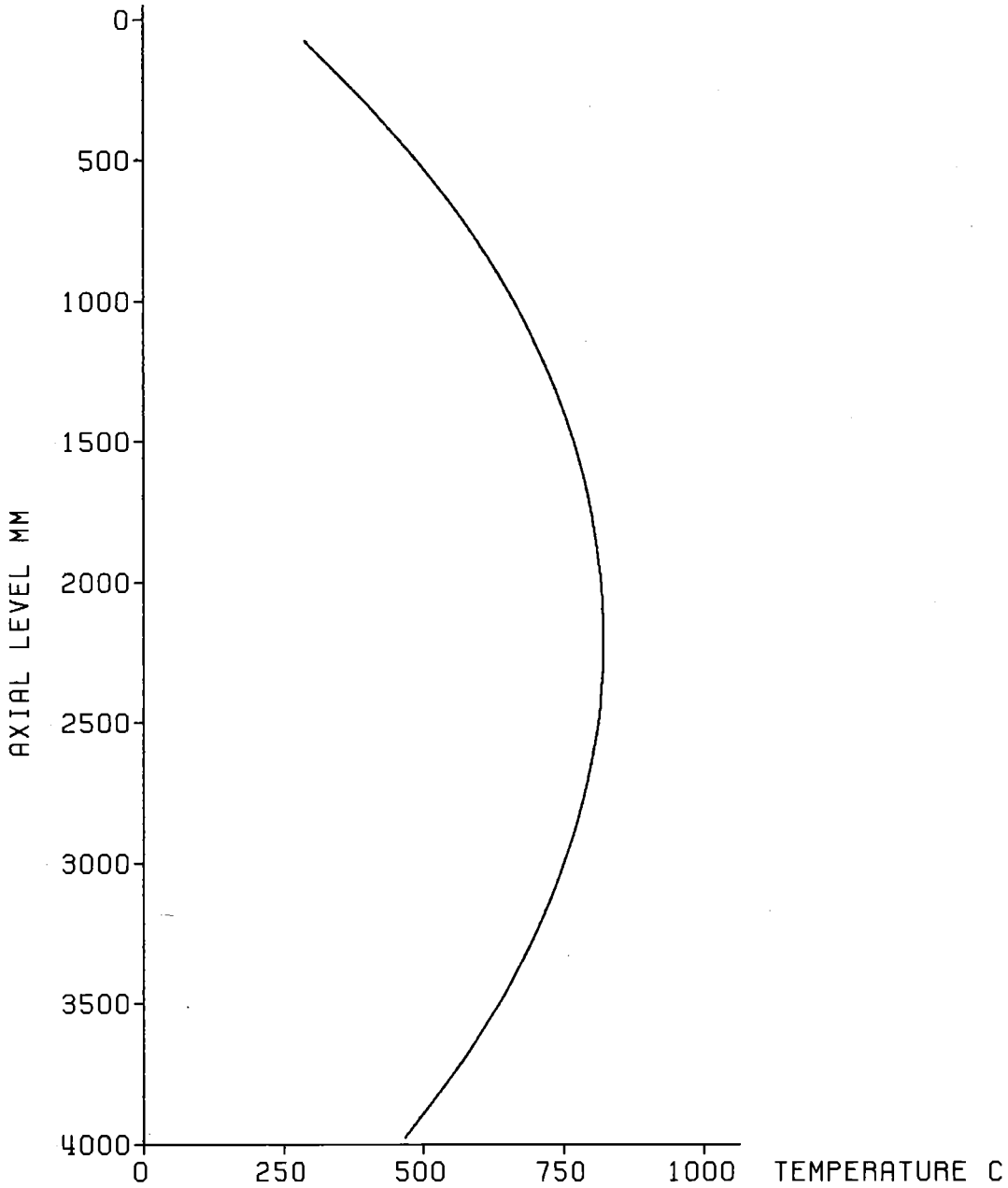

Decay Heat	120% ANS Standard
Flooding Rate (cold)	5.74 cm/s
System Pressure	3.87 bar
Feedwater Temperature	40 C



Fig. 60 FEBA: 5x5 ROD BUNDLE
TEST SERIES 5, TEST-No. 281

Test Parameters:

- ◇ Flooding Rate
- △ System Pressure
- Feedwater Temperature
- Bundle Power

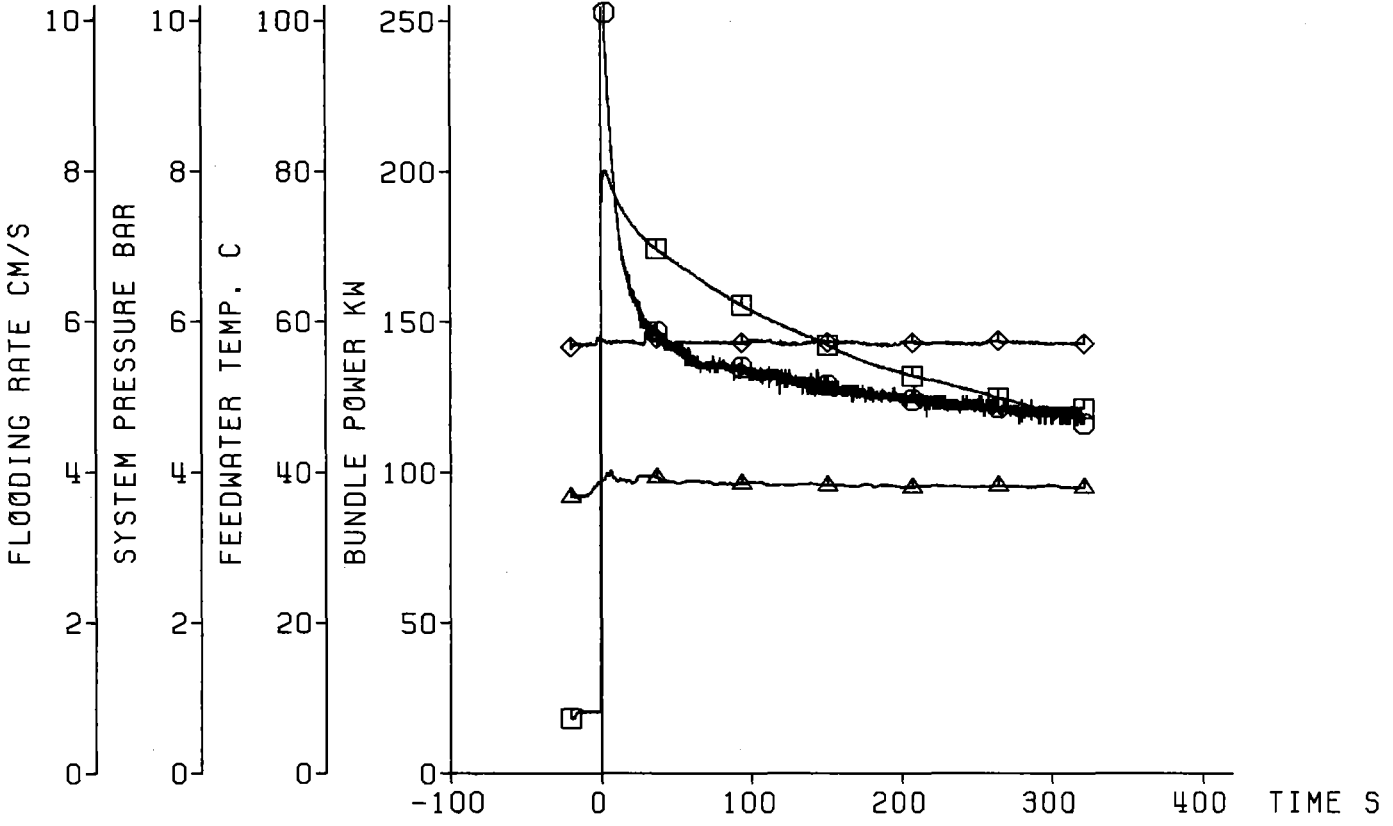

Decay Heat	120% ANS Standard
Flooding Rate (cold)	5.74 cm/s
System Pressure	3.87 bar
Feedwater Temperature	40 C



Fig. 61 FEBA: 5x5 ROD BUNDLE, TEST SERIES 5, TEST-No. 281

Cladding Temperature

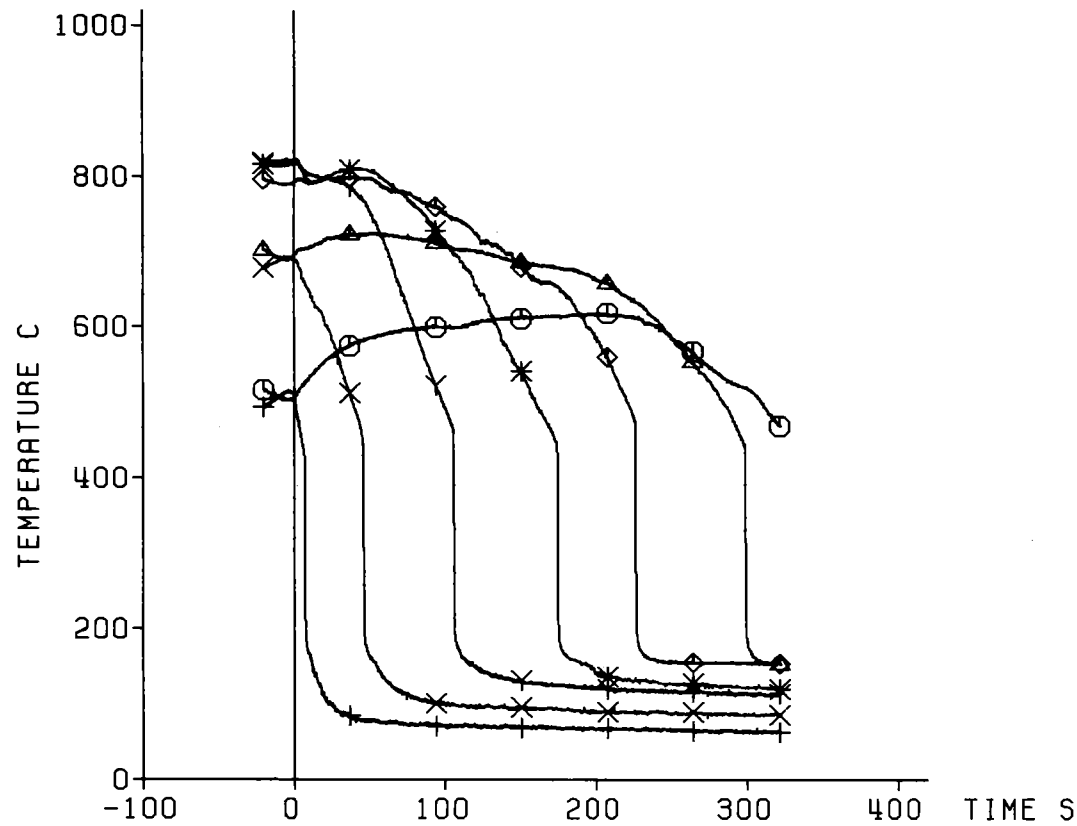

TC	Ax. Level
+	18a4 3860 mm
X	18a3 3315 mm
Y	18a2 2770 mm
*	18a1 2225 mm
◇	3b4 1680 mm
△	3b3 1135 mm
⊖	3b2 590 mm

Decay Heat 120% ANS Standard
 Flooding Rate (cold) 5.74 cm/s
 System Pressure 3.87 bar
 Feedwater Temperature 40 C



Fig. 62 FEBA: 5x5 ROD BUNDLE, TEST SERIES 5, TEST-No. 281

Heat Transfer Coeff.

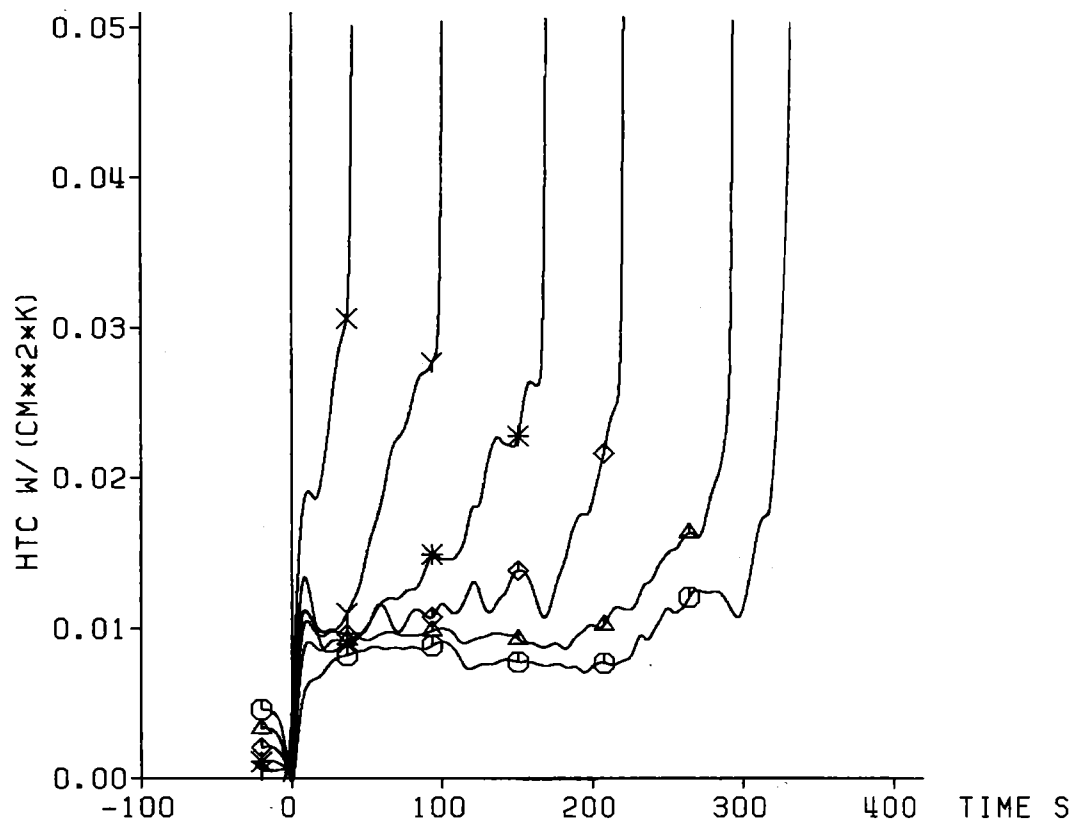

	TC	Ax. Level
X	18a3	3315 mm
Y	18a2	2770 mm
*	18a1	2225 mm
◇	3b4	1680 mm
△	3b3	1135 mm
⊙	3b2	590 mm

Decay Heat 120% ANS Standard
 Flooding Rate (cold) 5.74 cm/s
 System Pressure 3.87 bar
 Feedwater Temperature 40 C



Fig. 63 FEBA: 5x5 ROD BUNDLE, TEST SERIES 5, TEST-No. 281

Cladding Temperature

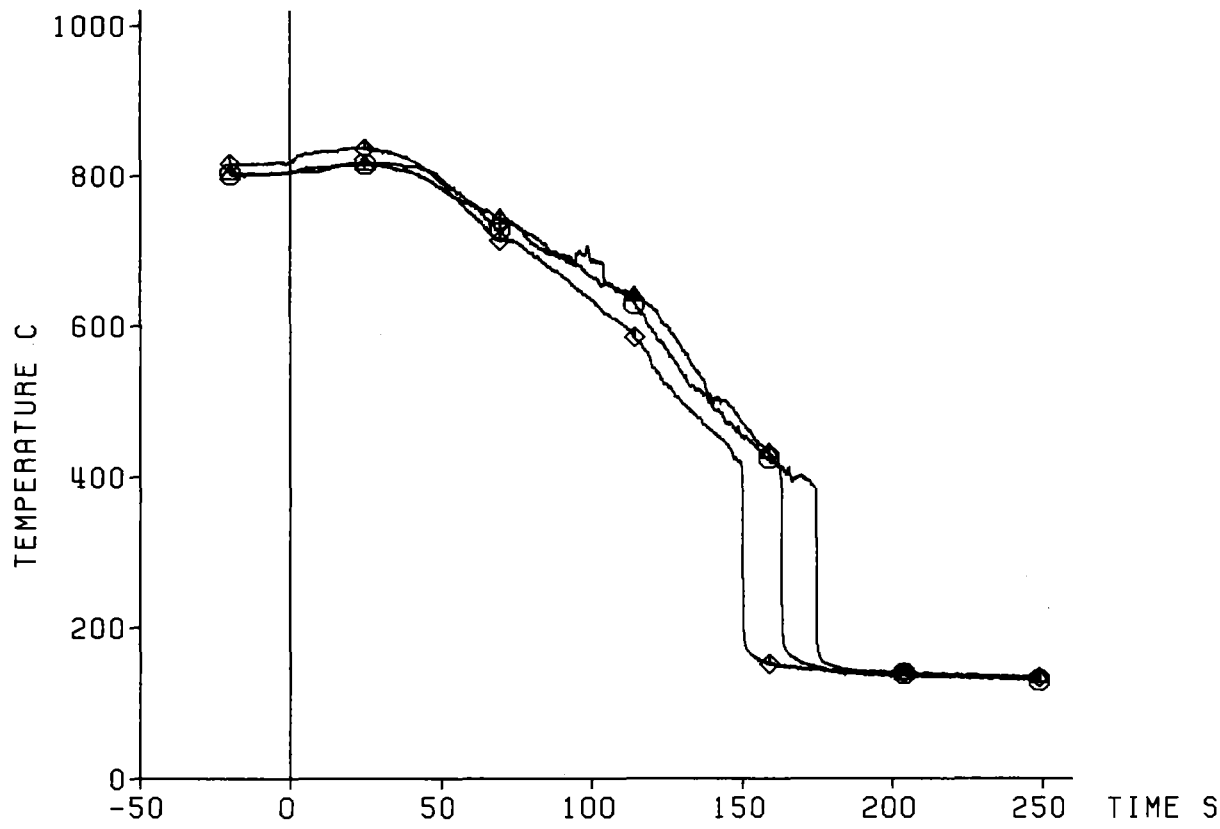

TC	Ax. Level
◇	7f4 2425 mm
△	7f3 2325 mm
○	9h4 2225 mm

Decay Heat 120% ANS Standard
 Flooding Rate (cold) 5.74 cm/s
 System Pressure 3.87 bar
 Feedwater Temperature 40 C

Bypass Area
 =====



Fig. 64 FEBA: 5x5 ROD BUNDLE, TEST SERIES 5, TEST-No. 281

Heat Transfer Coeff.

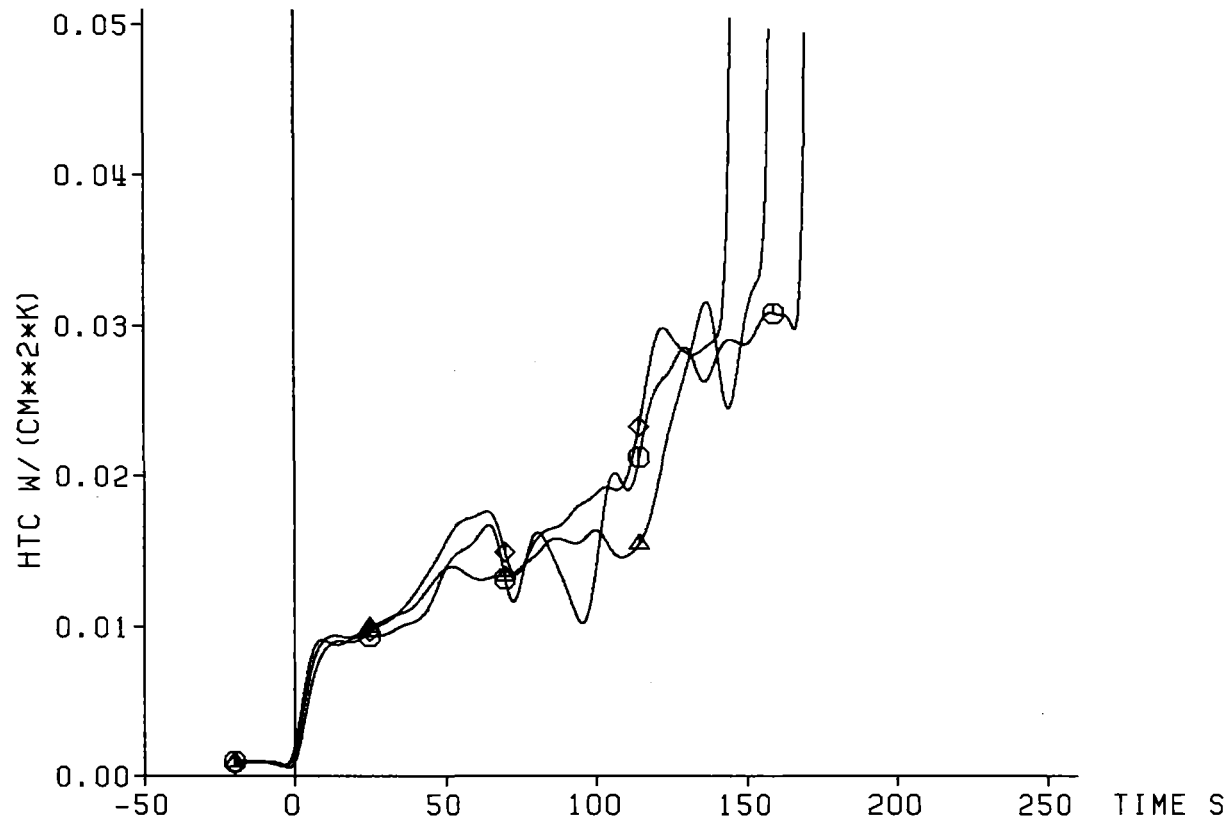

	TC	Ax. Level
◇	7f4	2425 mm
△	7f3	2325 mm
○	9h4	2225 mm

Decay Heat 120% ANS Standard
 Flooding Rate (cold) 5.74 cm/s
 System Pressure 3.87 bar
 Feedwater Temperature 40 C

Bypass Area
 =====



Fig. 65 FEBA: 5x5 ROD BUNDLE, TEST SERIES 5, TEST-No. 281

Cladding Temperature

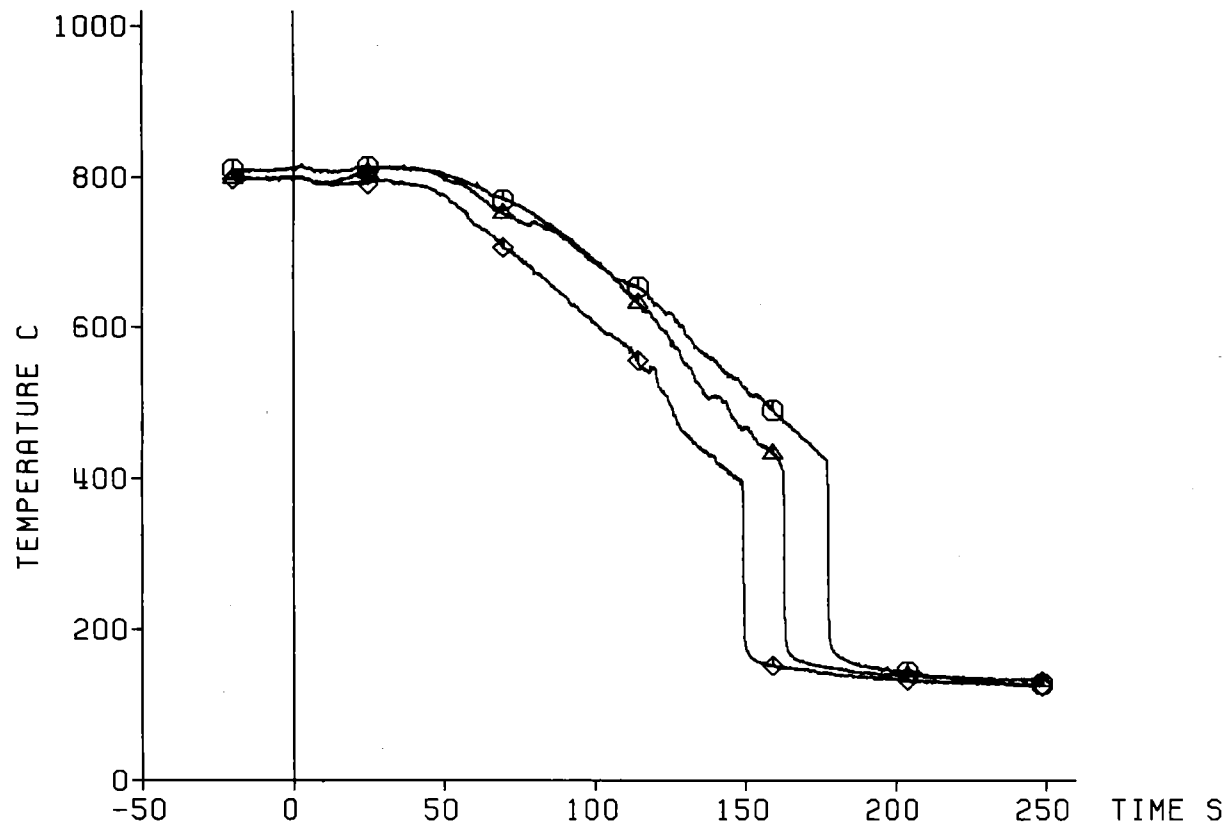

TC	Ax. Level
◇	22f4 2425 mm
△	22f3 2325 mm
○	17h4 2225 mm

Decay Heat 120% ANS Standard
 Flooding Rate (cold) 5.74 cm/s
 System Pressure 3.87 bar
 Feedwater Temperature 40 C

Blockage Area
 =====



Fig. 66 FEBA: 5x5 ROD BUNDLE, TEST SERIES 5, TEST-No. 281

Heat Transfer Coeff.

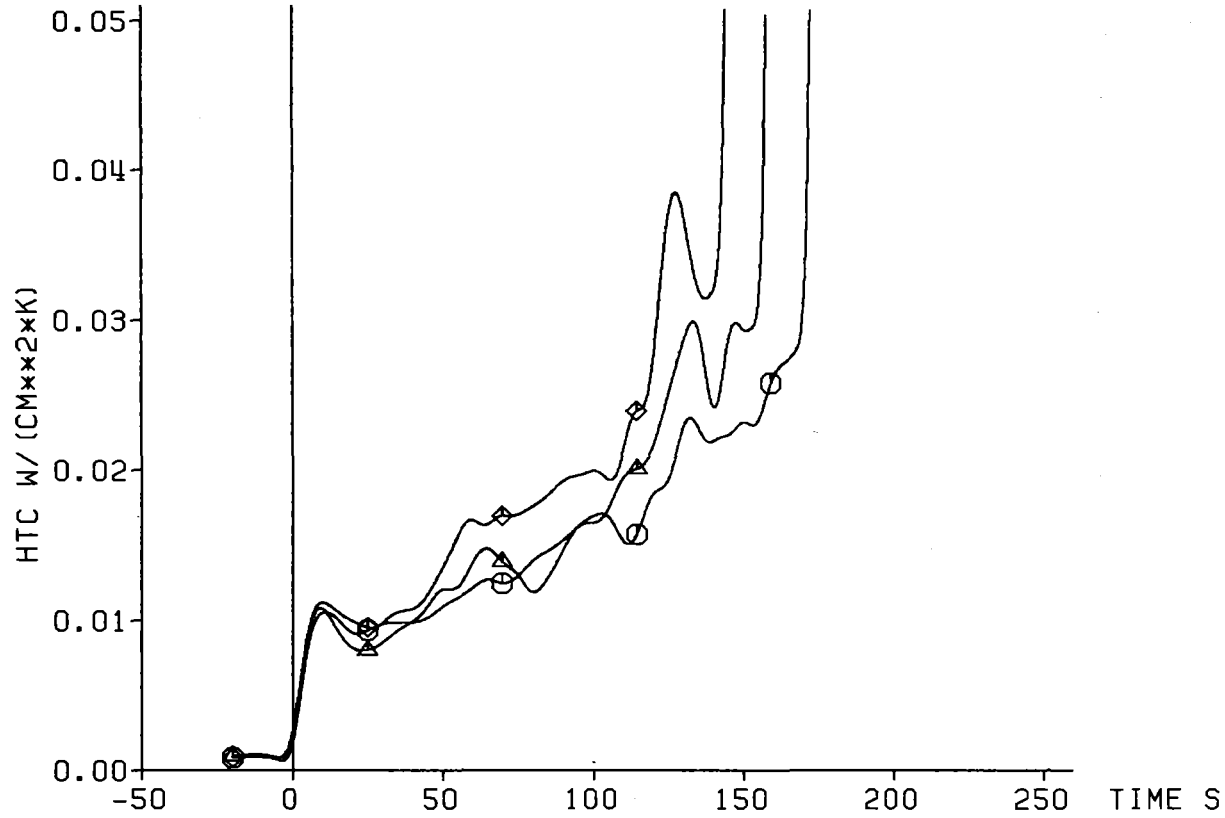

TC	Ax. Level
◇	22f4 2425 mm
△	22f3 2325 mm
○	17h4 2225 mm

Decay Heat 120% ANS Standard
 Flooding Rate (cold) 5.74 cm/s
 System Pressure 3.87 bar
 Feedwater Temperature 40 C

Blockage Area
 =====



Fig. 67 FEBA: 5x5 ROD BUNDLE, TEST SERIES 5, TEST-No. 281

Cladding Temperature

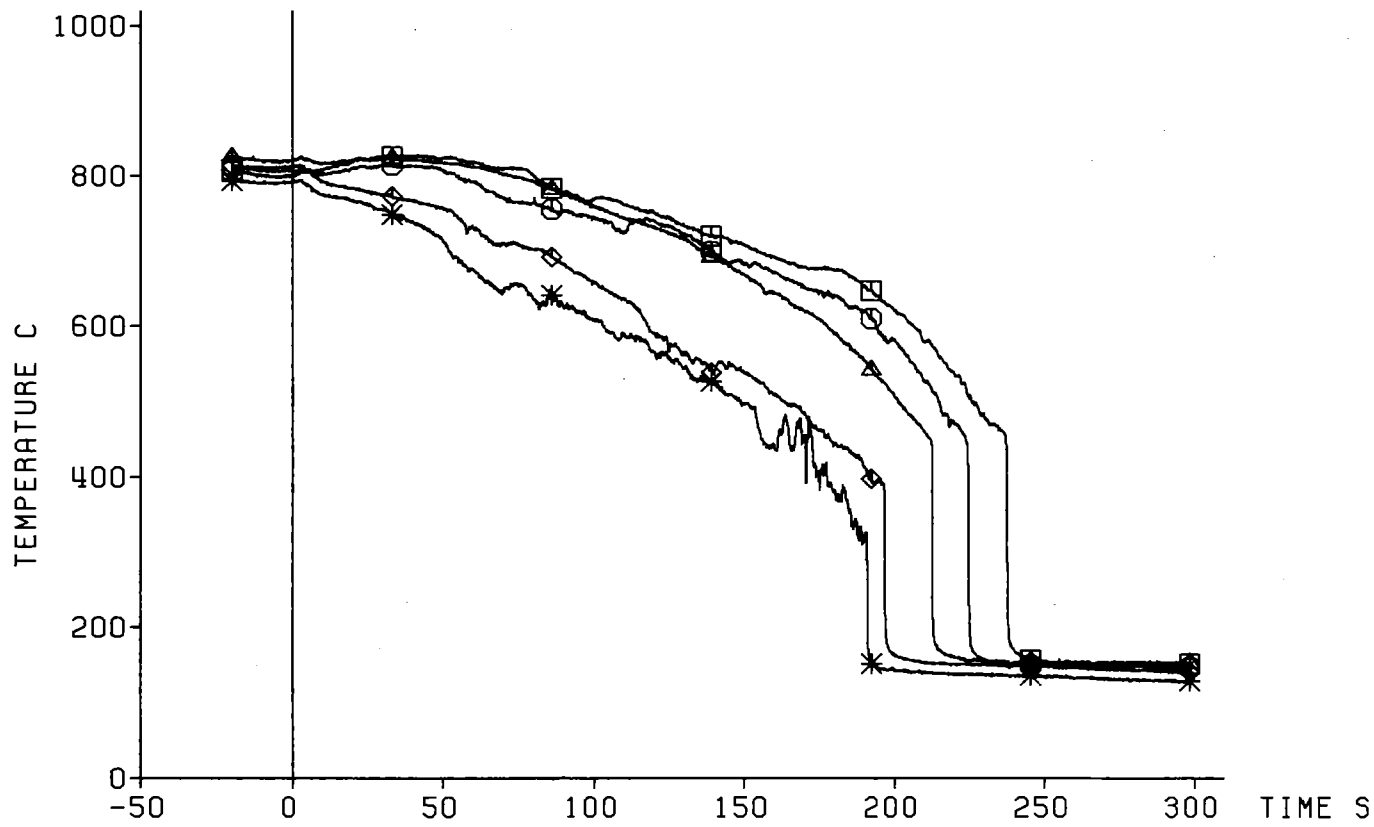

TC	Ax. Level
*	9h2 2025 mm
◇	9h1 1925 mm
△	19g3 1825 mm
○	19g2 1725 mm
□	19g1 1625 mm

Decay Heat 120% ANS Standard
 Flooding Rate (cold) 5.74 cm/s
 System Pressure 3.87 bar
 Feedwater Temperature 40 C

Bypass Area
 =====



Fig. 68 FEBA: 5x5 ROD BUNDLE, TEST SERIES 5, TEST-No. 281

Heat Transfer Coeff.

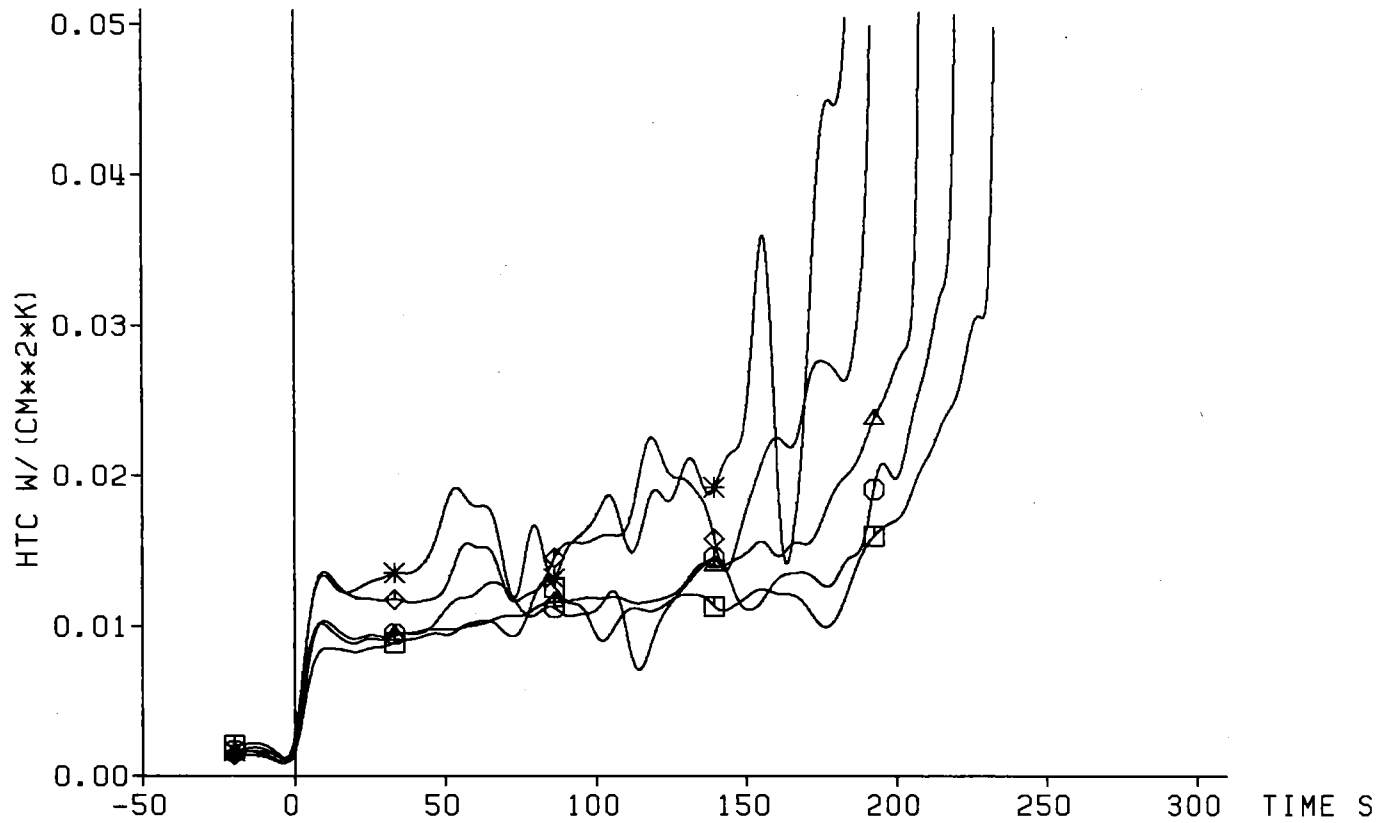

	TC	Ax. Level
*	9h2	2025 mm
◇	9h1	1925 mm
△	19g3	1825 mm
○	19g2	1725 mm
□	19g1	1625 mm

Decay Heat
 Flooding Rate (cold) 5.74 cm/s
 System Pressure 3.87 bar
 Feedwater Temperature 40 C

120% ANS Standard

Bypass Area
 =====



Fig. 69 FEBA: 5x5 R0D BUNDLE, TEST SERIES 5, TEST-No. 281

Cladding Temperature

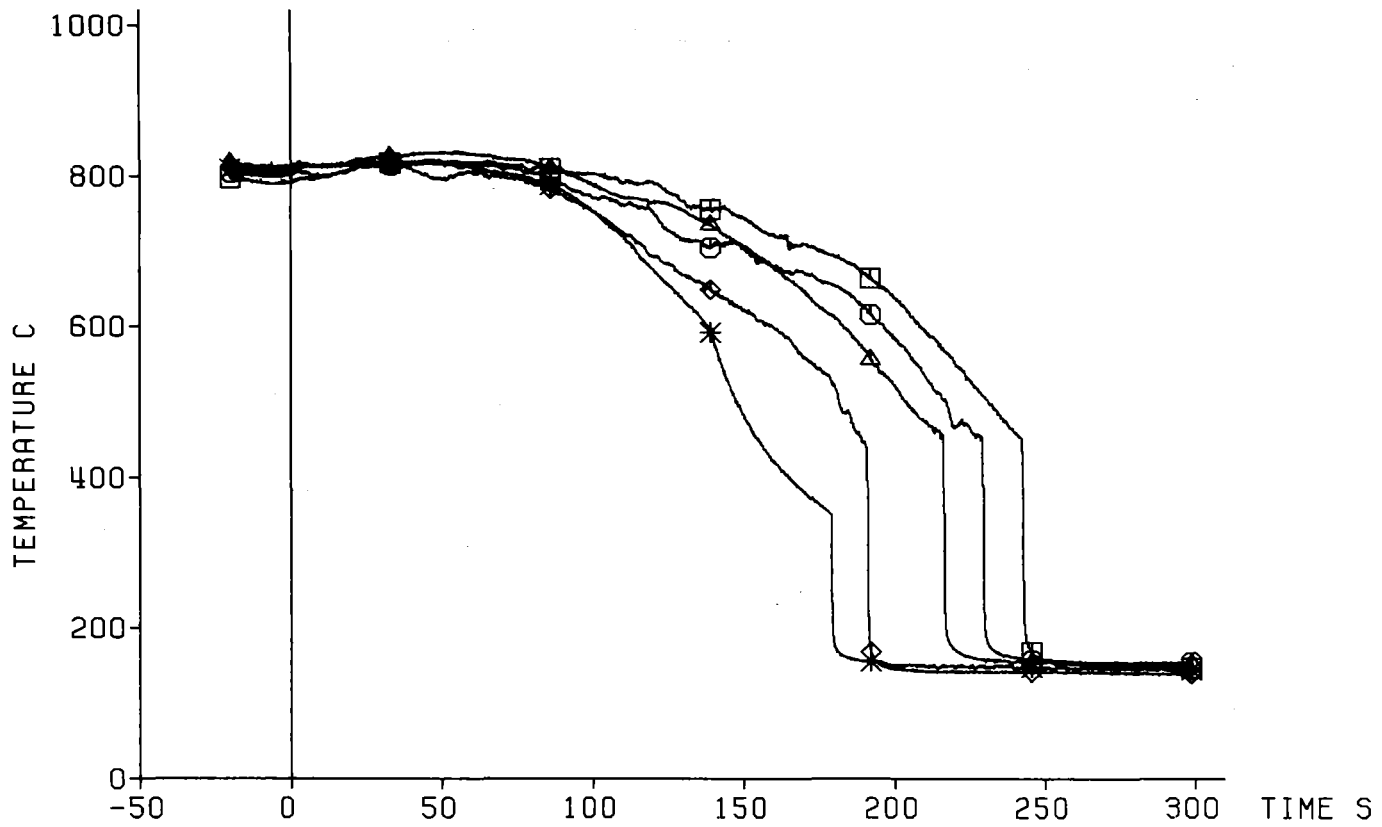

TC	Ax. Level
*	17h2 2025 mm
◇	17h1 1925 mm
△	16g3 1825 mm
○	16g2 1725 mm
□	16g1 1625 mm

Decay Heat 120% ANS Standard
 Flooding Rate (cold) 5.74 cm/s
 System Pressure 3.87 bar
 Feedwater Temperature 40 C

Blockage Area
 =====



Fig. 70 FEBA: 5x5 ROD BUNDLE, TEST SERIES 5, TEST-No. 281

Heat Transfer Coeff.

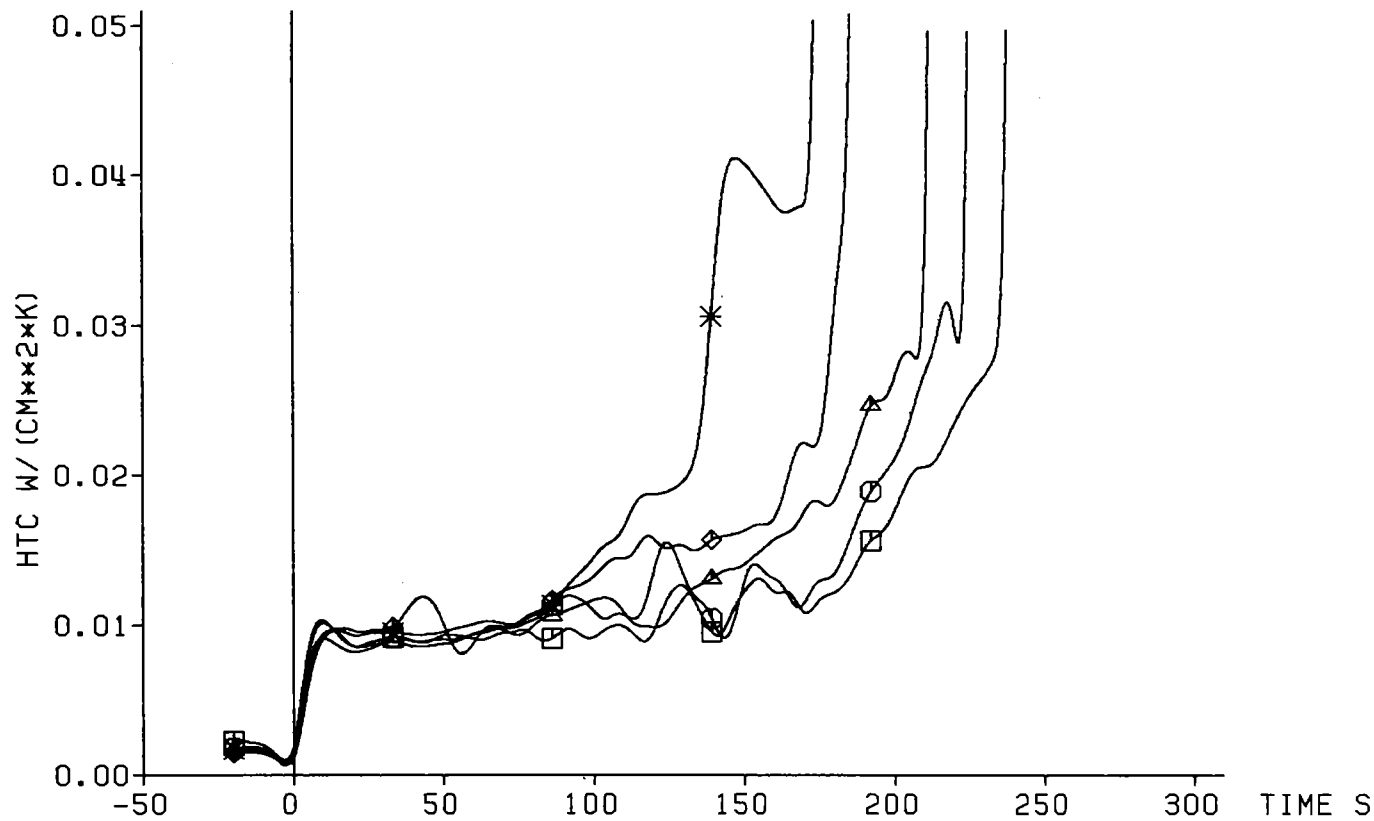

TC	Ax. Level
* 17h2	2025 mm
◇ 17h1	1925 mm
△ 16g3	1825 mm
○ 16g2	1725 mm
□ 16g1	1625 mm

Decay Heat 120% ANS Standard
 Flooding Rate (cold) 5.74 cm/s
 System Pressure 3.87 bar
 Feedwater Temperature 40 C

Blockage Area
 =====



Fig. 71 FEBA: 5x5 ROD BUNDLE, TEST SERIES 5, TEST-No. 281

Cladding Temperature

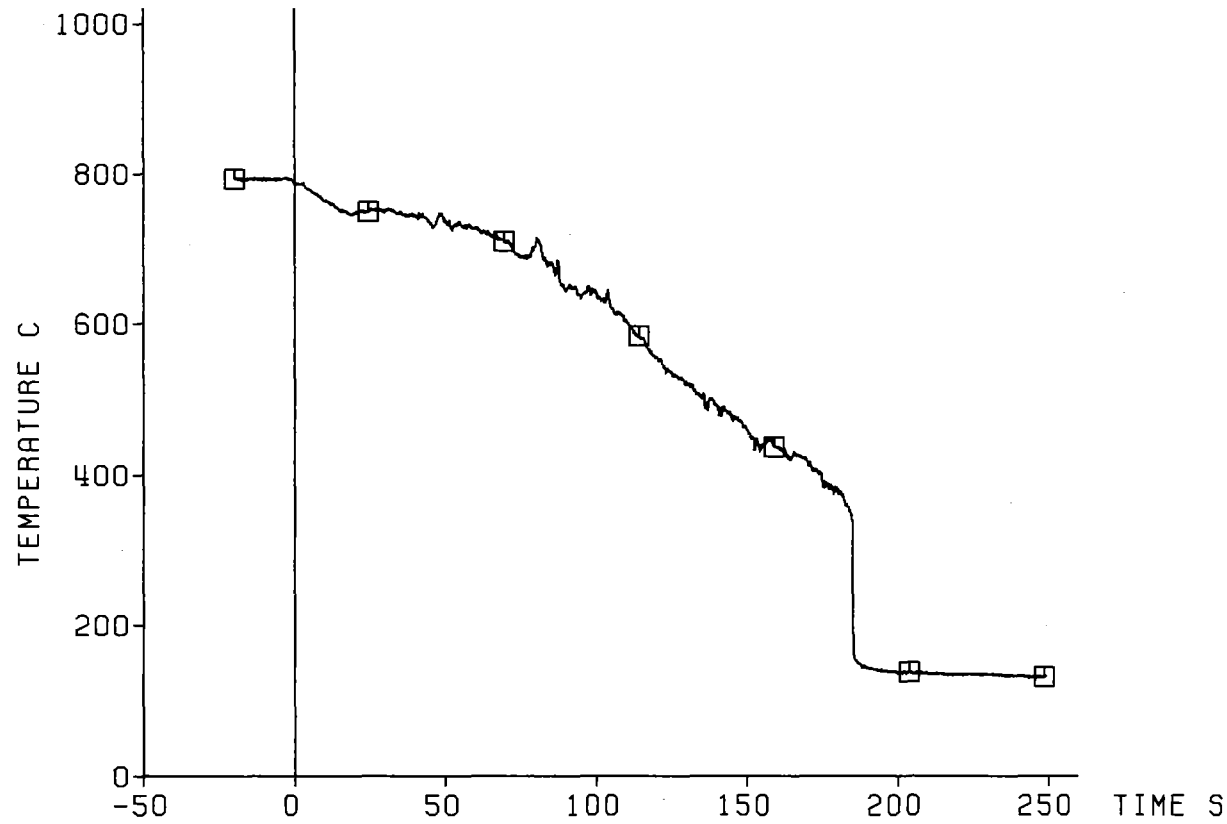

TC	Ax. Level
□ 9h3	2125 mm

Decay Heat
Flooding Rate (cold) 5.74 cm/s
System Pressure 3.87 bar
Feedwater Temperature 40 C

120% ANS Standard

Bypass Area

=====



Fig. 72 FEBA: 5x5 R0D BUNDLE, TEST SERIES 5, TEST-No. 281

Heat Transfer Coeff.

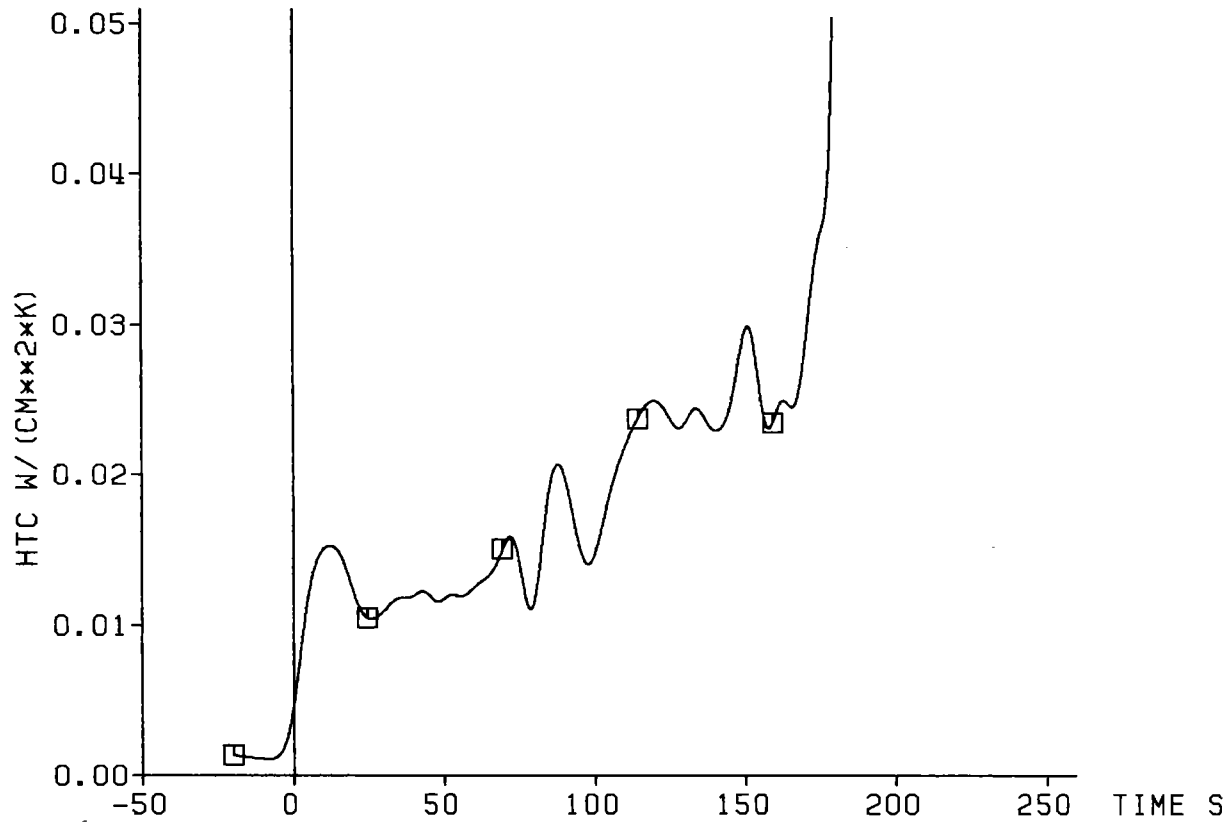

TC	Ax. Level
□	9h3 2125 mm

Decay Heat 120% ANS Standard
Flooding Rate (cold) 5.74 cm/s
System Pressure 3.87 bar
Feedwater Temperature 40 C

Bypass Area
=====



Fig. 73 FEBA: 5x5 ROD BUNDLE, TEST SERIES 5, TEST-No. 281

Cladding Temperature

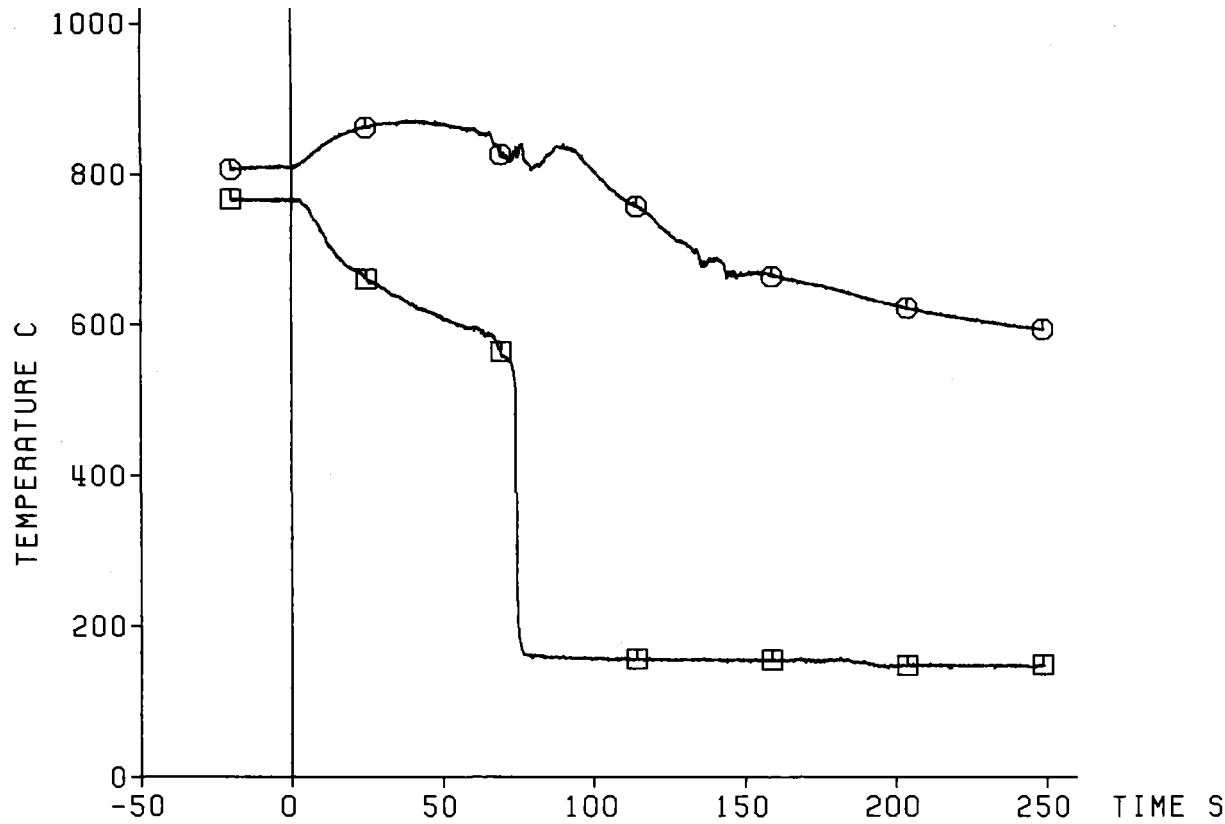

TC	Ax. Level
⊙ 17h3	2125 mm
⊠ Sleeve Rod 21	2125 mm

Decay Heat 120% ANS Standard
 Flooding Rate (cold) 5.74 cm/s
 System Pressure 3.87 bar
 Feedwater Temperature 40 C

Blockage Area
 =====



Fig. 74 FEBA: 5x5 ROD BUNDLE, TEST SERIES 5, TEST-No. 281

Cladding Temperature

TC	Ax. Level
↑ 12h3	2125 mm
× 22f1	2125 mm

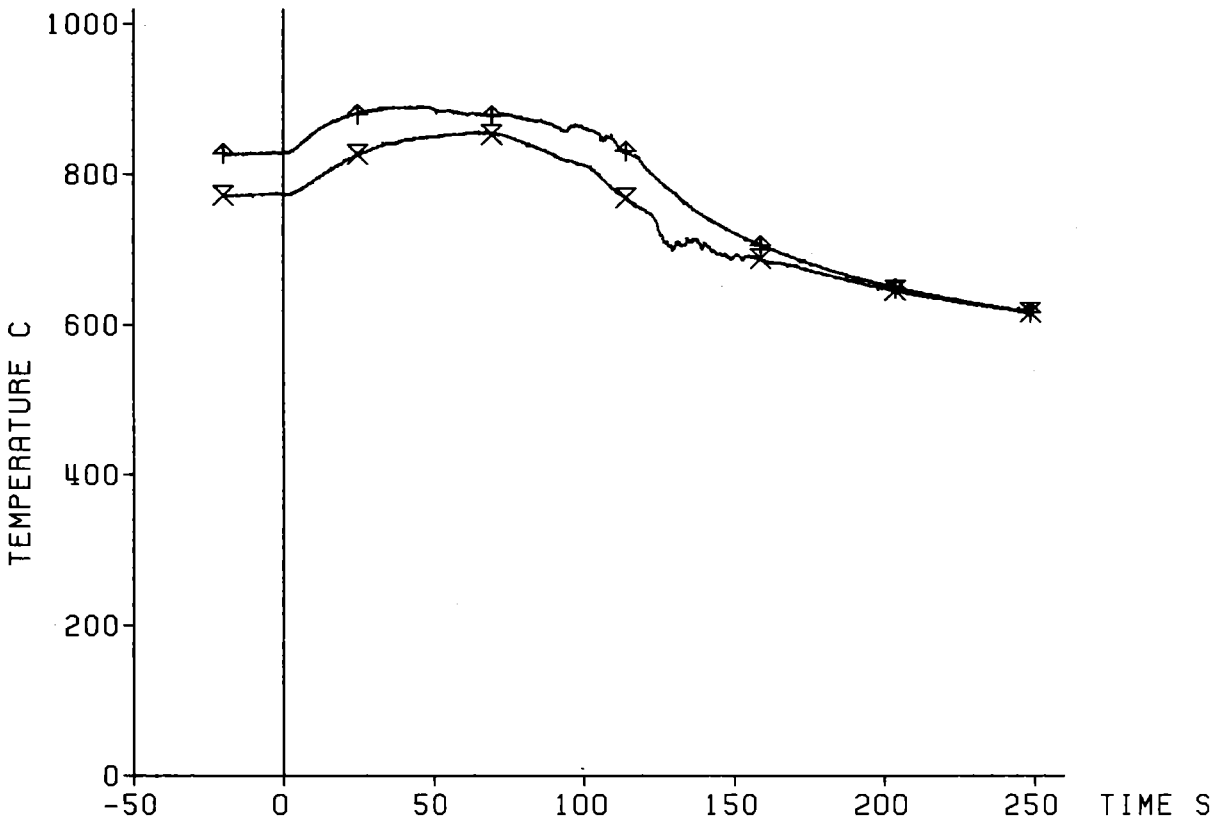

Decay Heat 120% ANS Standard
 Flooding Rate (cold) 5.74 cm/s
 System Pressure 3.87 bar
 Feedwater Temperature 40 C

Blockage Area
 =====



Fig. 75 FEBA: 5x5 ROD BUNDLE, TEST SERIES 5, TEST-No. 281

Axial Level: 1825 mm

△ Cladding Temperature (19g3)
○ Fluid Temperature

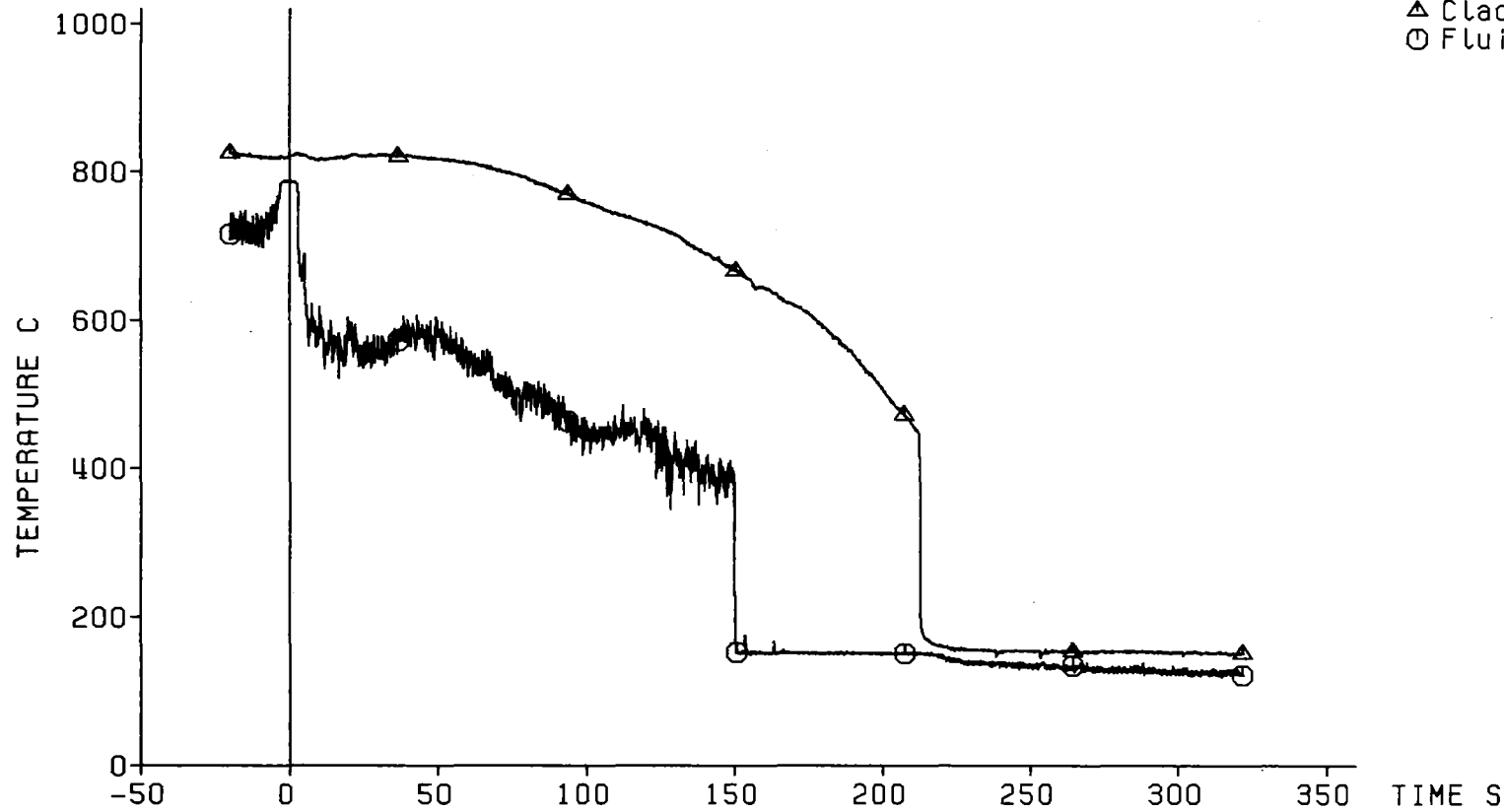

Decay Heat
Flooding Rate (cold) 5.74 cm/s
System Pressure 3.87 bar
Feedwater Temperature 40 C

120% ANS Standard

Bypass Area

=====

KfK
IRB

Fig. 76 FEBA: 5x5 ROD BUNDLE, TEST SERIES 5, TEST-No. 281

Axial Level: 1625 mm

△ Cladding Temperature (19g1)
○ Fluid Temperature
□ Housing Temperature

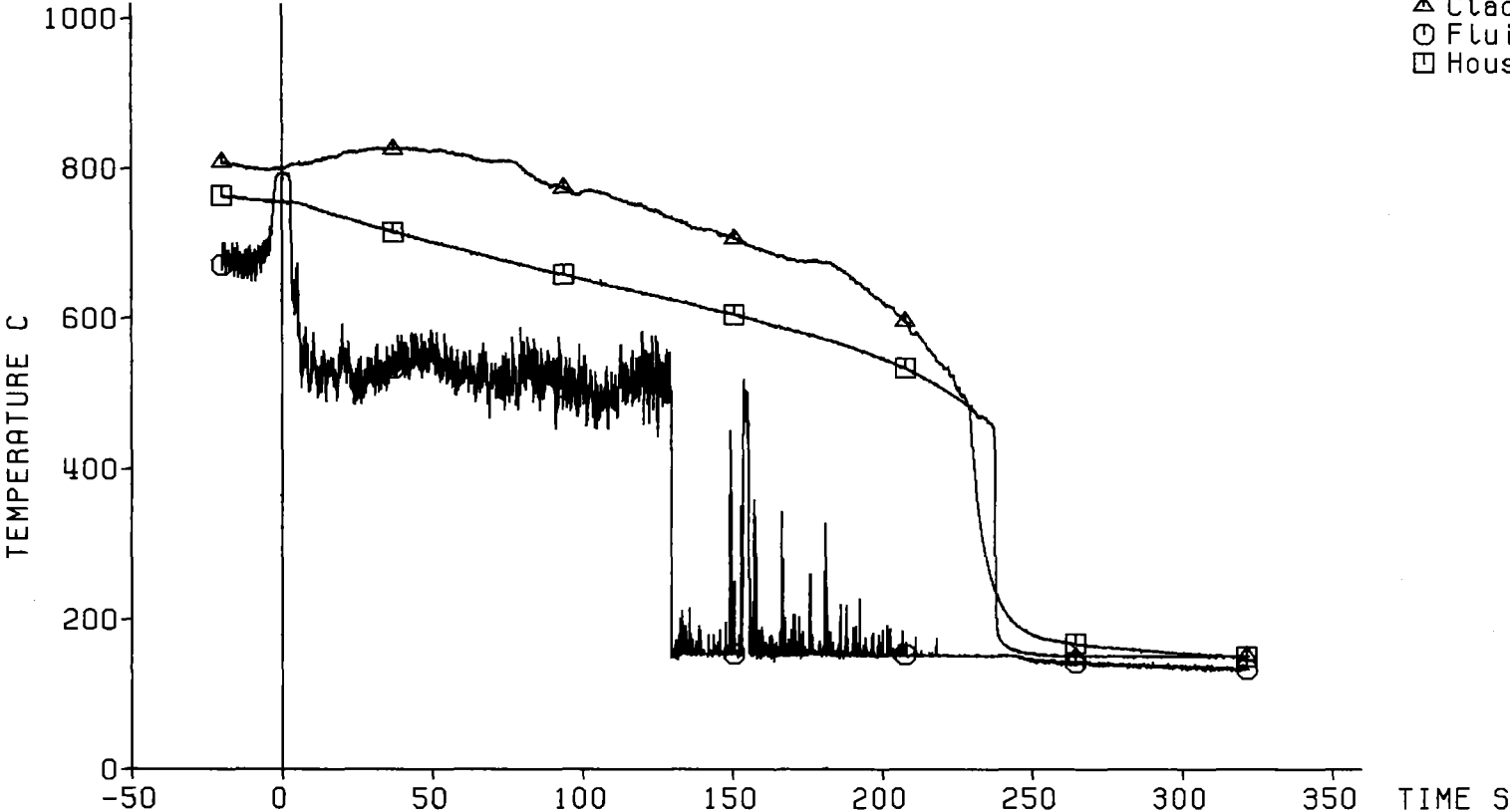

Decay Heat
Flooding Rate (cold) 5.74 cm/s
System Pressure 3.87 bar
Feedwater Temperature 40 C

120% ANS Standard

Bypass Area
=====



Fig. 77 FEBA: 5x5 ROD BUNDLE, TEST SERIES 5, TEST-No. 281

Axial Level: 1925 mm

△ Cladding Temperature (17h1)
○ Fluid Temperature

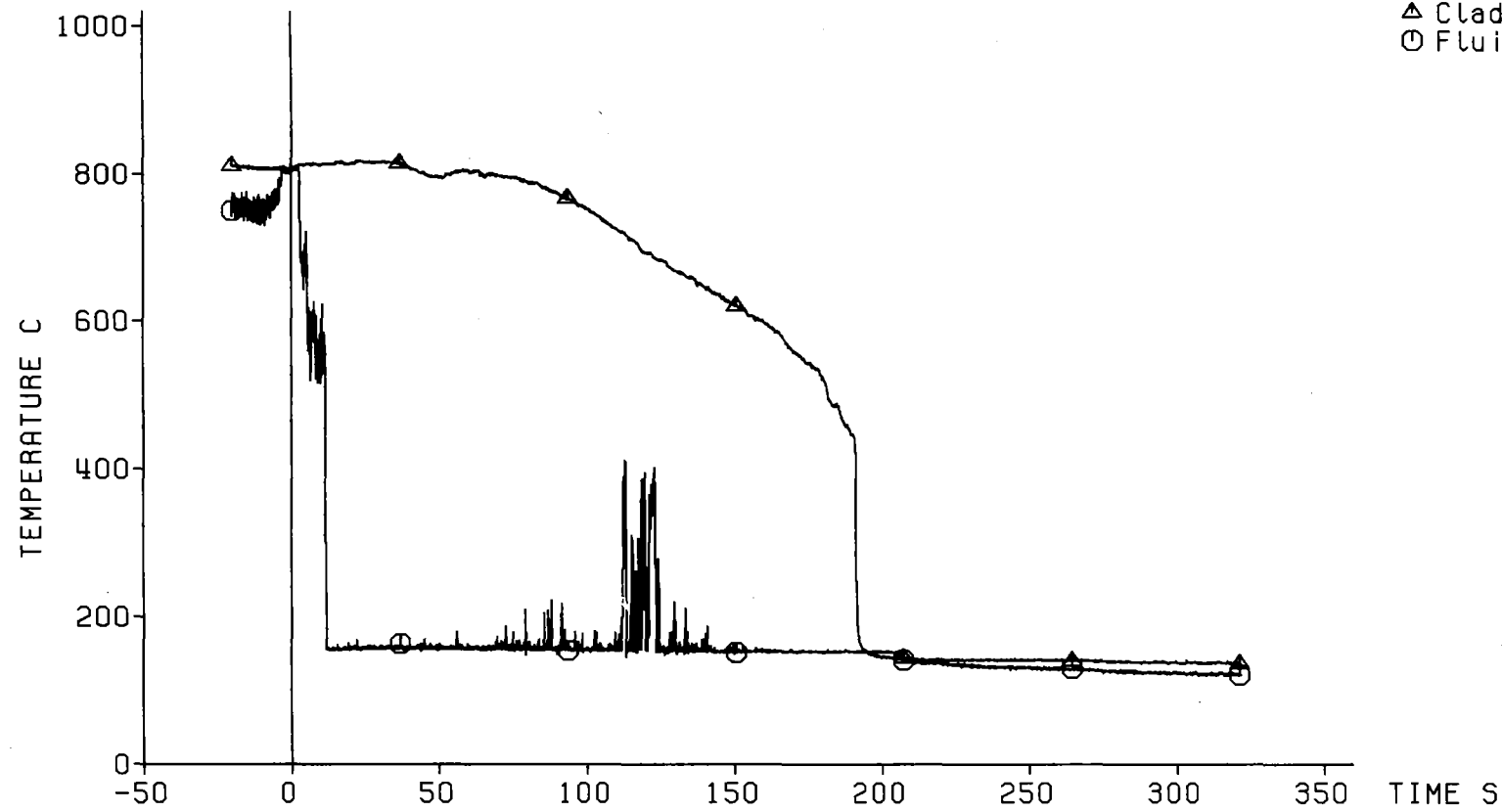

Decay Heat 120% ANS Standard
Flooding Rate (cold) 5.74 cm/s
System Pressure 3.87 bar
Feedwater Temperature 40 C

Blockage Area
=====



Fig. 78 FEBA: 5x5 ROD BUNDLE, TEST SERIES 5, TEST-No. 281

Axial Level: 1725 mm

△ Cladding Temperature (16g2)
○ Fluid Temperature

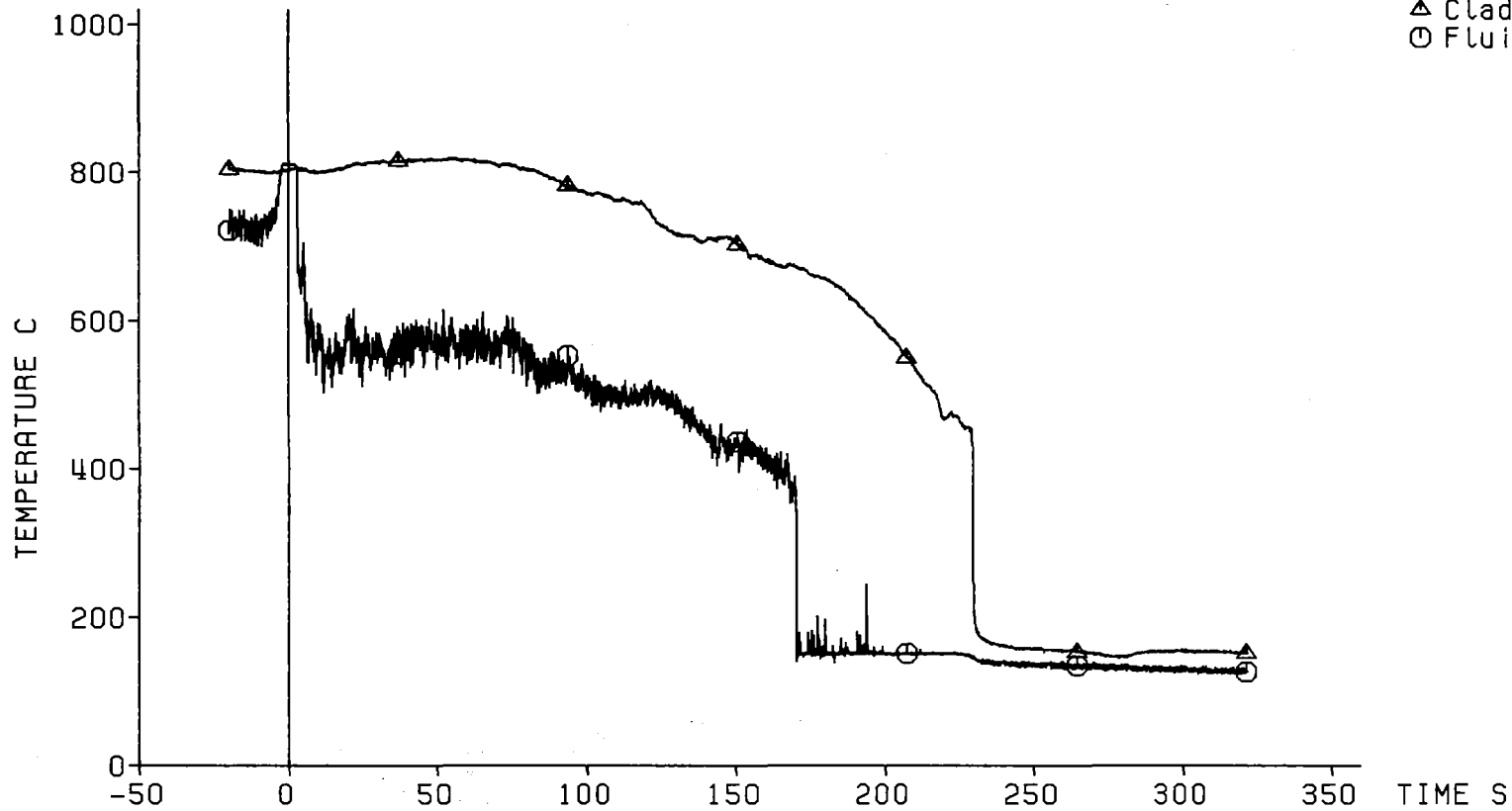

Decay Heat 120% ANS Standard
Flooding Rate (cold) 5.74 cm/s
System Pressure 3.87 bar
Feedwater Temperature 40 C

Blockage Area
=====



Fig. 79 FEBA: 5x5 ROD BUNDLE, TEST SERIES 5, TEST-No. 281

Axial Level: 1625 mm

△ Cladding Temperature (16g1)
○ Fluid Temperature
□ Housing Temperature

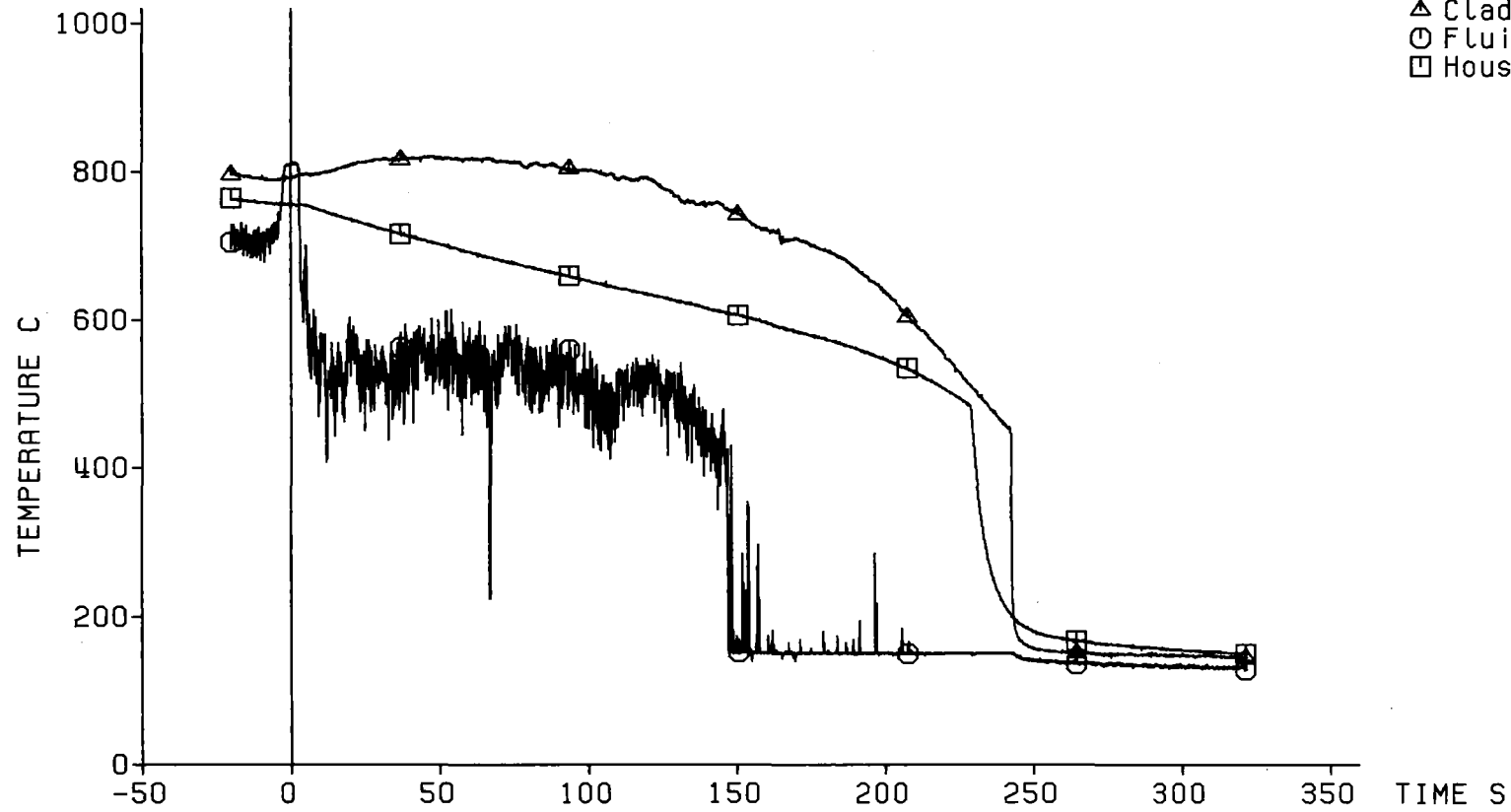

Decay Heat 120% ANS Standard
Flooding Rate (cold) 5.74 cm/s
System Pressure 3.87 bar
Feedwater Temperature 40 C

Blockage Area
=====



Fig. 80 FEBA: 5x5 ROD BUNDLE, TEST SERIES 5, TEST-No. 281

Pressure Loss
Along the Test Section:

◇ Total Length: 4196 mm
△ Lower Part: 1711 mm
○ Middle Part: 545 mm
□ Upper Part: 1940 mm

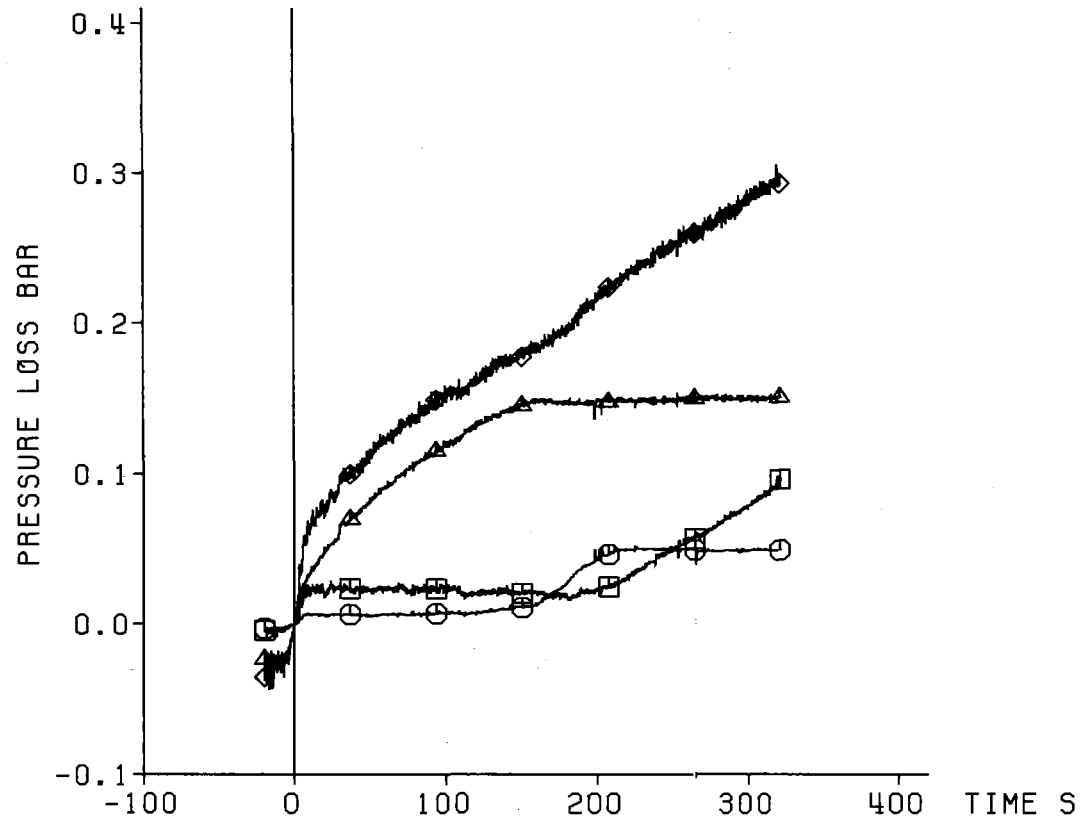

Decay Heat 120% ANS Standard
Flooding Rate (cold) 5.74 cm/s
System Pressure 3.87 bar
Feedwater Temperature 40 C



Fig. 81 FEBA: 5x5 ROD BUNDLE, TEST SERIES 5, TEST-No. 281

Coolant Outlet Conditions:

△ Water Carry Over
○ Coolant Temperature
□ Coolant Pressure

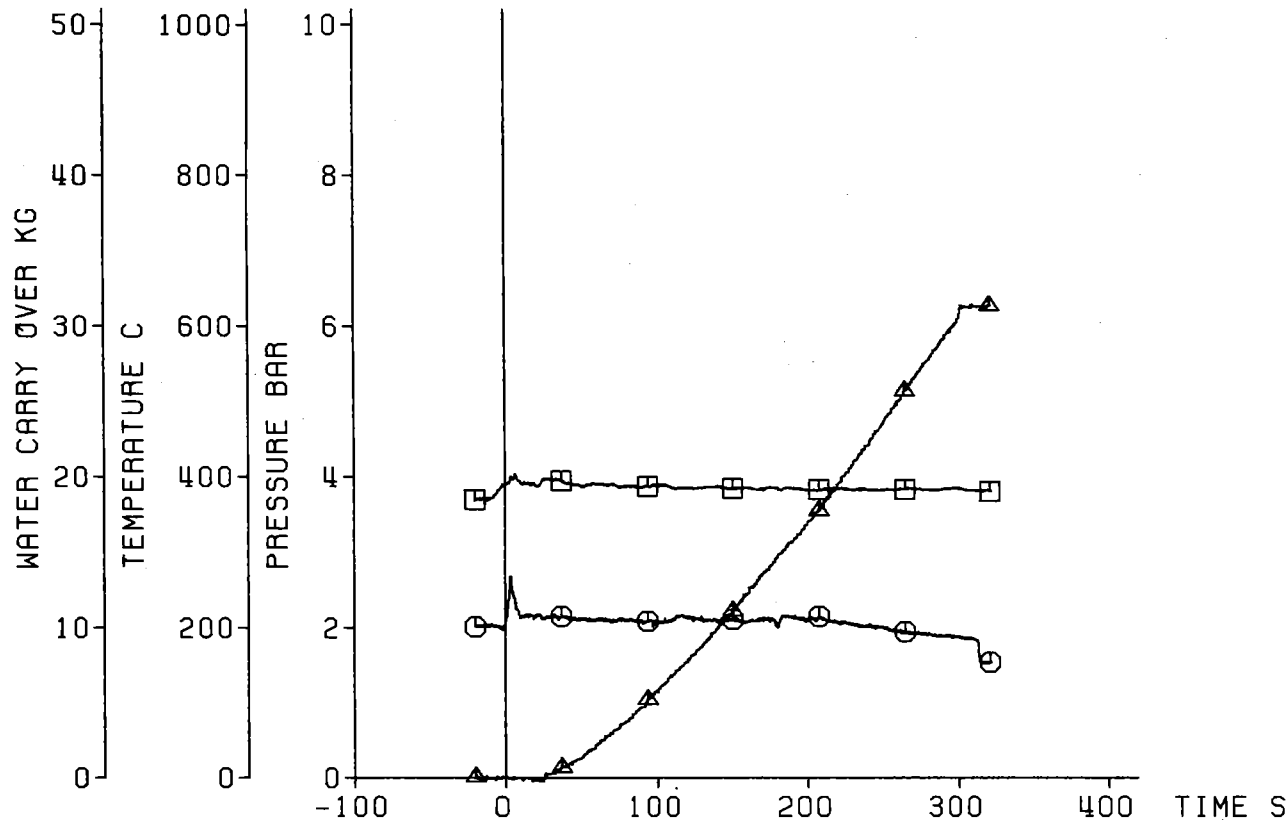

Decay Heat 120% ANS Standard
Flooding Rate (cold) 5.74 cm/s
System Pressure 3.87 bar
Feedwater Temperature 40 C

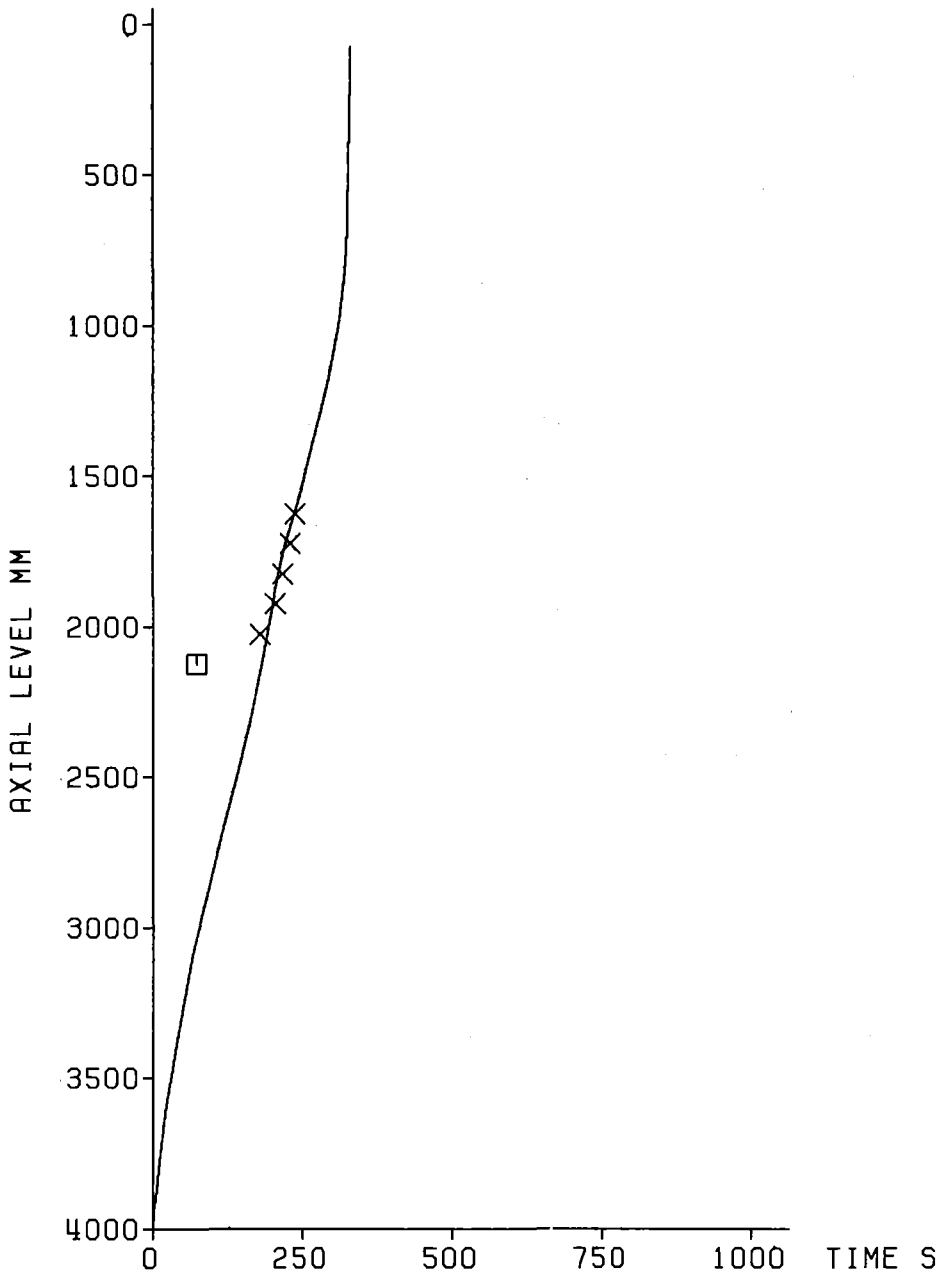

Fig. 82 FEBA: 5x5 ROD BUNDLE, TEST SERIES 5, TEST-No. 281

Axial Position of Quench Front

□ Quenching of Sleeves

X Quenching of Claddings Downstream of Blockage Area



Decay Heat	120% ANS Standard
Flooding Rate (cold)	5.74 cm/s
System Pressure	3.87 bar
Feedwater Temperature	40 C



Fig. 83 FEBA: 5x5 ROD BUNDLE
TEST SERIES 5, TEST-No. 281

TEST SERIES V

Investigation of the Effects of a 90% Flow Blockage With Bypass,
 Blockage at Axial Level 2125 mm of 3x3 Rods Placed in the Corner
 of the 5x5 Rod Bundle,
 Grid Spacer at the Bundle Midplane

Channel Listing and Data Identification for Test No. 281 Through 286

Channel No.	Data Identification		Unit	Remarks
	Type	Location		
1	Cladding Temperature	18a4.3860 ¹	°C	
2	Cladding Temperature	18a3.3315	°C	
3	Cladding Temperature	18a2.2770	°C	
4	Cladding Temperature	18a1.2225	°C	
5	Cladding Temperature	12h4.2225	°C	
6	Cladding Temperature	12h3.2125	°C	
7	Cladding Temperature	12h2.2025	°C	TC Failed
8	Cladding Temperature	12h1.1925	°C	TC Failed
9	Cladding Temperature	17h4.2225	°C	
10	Cladding Temperature	17h3.2125	°C	
11	Cladding Temperature	17h2.2025	°C	
12	Cladding Temperature	17h1.1925	°C	
13	-----		-	Open
14	-----		-	Open
15	Fluid Temperature	TF ² 1625	°C	
16	Fluid Temperature	TF ² 485	°C	
17	Housing Temperature	TK ⁵ 3315	°C	
18	Housing Temperature	TK 2025	°C	
19	Housing Temperature	TK 1625	°C	
20	Housing Temperature	TK 590	°C	
21	Fluid Temperature	Lower Plenum	°C	
22	Water Level Detector	4012	°C	Heated + Unheated TC's

TEST SERIES V

Channel No.	Data Identification		Unit	Remarks
	Type	Location		
23	Feedwater Temperature		°C	
24	Fluid Temperature	Upper Plenum	°C	
25	Room Temperature		°C	
26	Cladding Temperature	22f4.2425 ¹	°C	
27	Cladding Temperature	22f3.2325	°C	
28	Cladding Temperature	22f2.2225	°C	
29	Cladding Temperature	22f1.2125	°C	
30	Cladding Temperature	21j4.1525	°C	
31	Cladding Temperature	21j3.1425	°C	
32	Cladding Temperature	21j2.1325	°C	
33	Cladding Temperature	21j1.1225	°C	
34	Cladding Temperature	19g4.1925	°C	
35	Cladding Temperature	19g3.1825	°C	
36	Cladding Temperature	19g2.1725	°C	
37	Cladding Temperature	19g1.1625	°C	
38	Cladding Temperature	16g4.1925	°C	
39	Cladding Temperature	16g3.1825	°C	
40	Cladding Temperature	16g1.1625	°C	
41	Cladding Temperature	16g2.1725	°C	
42	Cladding Temperature	15a4.3860	°C	
43	Cladding Temperature	15a3.3315	°C	
44	Cladding Temperature	15a2.2770	°C	
45	Cladding Temperature	15a1.2225	°C	
46	Cladding Temperature	14e4.2225	°C	
47	Cladding Temperature	14e3.2175	°C	
48	Cladding Temperature	14e2.2125	°C	TC Failed
49	Cladding Temperature	14e1.2075	°C	

TEST SERIES V

Channel No.	Data Identification		Unit	Remarks
	Type	Location		
50	Cladding Temperature	13d3.2025 ¹	°C	
51	Cladding Temperature	13d2.2025	°C	
52	Cladding Temperature	13d1.2025	°C	
53	Cladding Temperature	10f4.2425	°C	
54	Cladding Temperature	10f3.2325	°C	
55	Cladding Temperature	10f2.2225	°C	
56	Cladding Temperature	10f1.2125	°C	
57	Cladding Temperature	9h4.2225	°C	
58	Cladding Temperature	9h3.2125	°C	
59	Cladding Temperature	9h2.2025	°C	
60	Cladding Temperature	9h1.1925	°C	
61	Cladding Temperature	8d4.2025	°C	
62	Cladding Temperature	8d3.2025	°C	
63	Cladding Temperature	8d2.2025	°C	
64	Cladding Temperature	8d1.2025	°C	
65	Cladding Temperature	7f4.2425	°C	
66	Cladding Temperature	7f3.2325	°C	
67	Cladding Temperature	7f2.2225	°C	
68	Cladding Temperature	7f1.2125	°C	
69	Sleeve Temperature	TH ⁶ 21.2125	°C	
70	-----		-	Open
71	-----		-	Open
72	-----		-	Open
73	Cladding Temperature	3b4.1680	°C	
74	Cladding Temperature	3b3.1135	°C	
75	Cladding Temperature	3b2. 590	°C	
76	Cladding Temperature	3b1. 45	°C	

TEST SERIES V

Channel No.	Data Identification		Unit	Remarks
	Type	Location		
77	Cladding Temperature	25k4. 400 ¹	°C	
78	Cladding Temperature	25k3. 300	°C	
79	Cladding Temperature	25k2. 200	°C	
80	Cladding Temperature	25k1. 100	°C	
81	Electrical Power Input	8 Rods	kW	Rods No. 1 Through 8
82	Electrical Power Input	8 Rods	kW	Rods No. 9 Through 16
83	Electrical Power Input	9 Rods	kW	Rods No. 17 Through 25
84	Housing Temperature	TK ⁵ 3820	°C	
85	-----		-	Open
86	Cladding Temperature	2c4.4025	°C	
87	Cladding Temperature	2c3.3925	°C	
88	Cladding Temperature	2c2.3825	°C	
89	Cladding Temperature	2c1.3725	°C	
90	Cladding Temperature	24c4.4025	°C	
91	Cladding Temperature	24c3.3925	°C	
92	Cladding Temperature	24c2.3825	°C	
93	Cladding Temperature	24c1.3725	°C	TC Failed
94	Cladding Temperature	11i4.2025	°C	
95	Housing Temperature	TK 838	°C	
96	Cladding Temperature	11i3.1975	°C	
97	Fluid Temperature	TF ² 2770	°C	
98	Fluid Temperature	TF ³ 2210	°C	
99	Fluid Temperature	TF ² 2425	°C	
100	Fluid Temperature	TF ² 1925	°C	
101	Fluid Temperature	TF ⁴ 1825	°C	

TEST SERIES V

Channel No.	Data Identification		Unit	Remarks
	Type	Location		
102	Fluid Temperature	TF ⁴ 1625	°C	
103	Fluid Temperature	TF ² 1725	°C	
104	Fluid Temperature	TF ² 685	°C	
105	Fluid Temperature	TF ² 1135	°C	
106	Fluid Temperature	TF ² 590	°C	
107	Fluid Temperature	TF ² 300	°C	
108	Cladding Temperature	11i2.1925 ¹	°C	
109	Cladding Temperature	11i1.1875	°C	
110	Time (10 Scans/s)		s	t = 0: Start of Reflooding
111	Pressure in Lower Plenum	4091	bar	
112	Pressure in Upper Plenum	-105	bar	
113	Pressure in Buffer		bar	
114	Bundle Power		kW	Channels: 81 + 82 + 83
115	Flooding Velocity (cold)		cm/s	
116	Water Carry Over Collected		kg	Downstream of Bundle Exit
117	Pressure Diff.	1835 and -105 mm	bar	
118	Measured	2380 and 1835 mm	bar	
119	Between	4091 and 2380 mm	bar	
120	Axial Level	4091 and -105 mm	bar	Values Measured Separately

- 1) TC's of 0.5 mm diameter embedded in rod cladding. Measuring position:
Example: rod No. = 18, type of rod instrumentation = a, TC No. = 4,
axial level = 3860 mm, referenced to the top flange of the bundle.
- 2) TF = TC's of 0.25 mm diameter (bare).
TC's placed in subchannel surrounded by rods No. 12, 17, 16 and 11.
- 3) TF = TC's of 0.25 mm diameter (bare).
TC's placed in subchannel surrounded by rods No. 3, 8, 7 and 2.

TEST SERIES V

- 4) TF = TC's of 0.25 mm diameter (bare).
TC's placed in subchannel surrounded by rods No. 2, 7, 6 and 1.
- 5) TK = TC's of 0.5 mm diameter placed in the wall of the bundle housing of
of 6.5 mm thickness.
- 6) TH = TC's of 0.5 mm diameter embedded in sleeve. Measuring position:
Example: rod No. 21, axial level = 2125 mm.

TEST SERIES VI

Investigation of the Effects of 90% and 62% Flow Blockages With Bypass,
 90% Blockage at Axial Level 2125 mm, 62% Blockage at Axial Level 1925 mm
 of 3x3 Rods Placed in the Corner of the 5x5 Rod Bundle,
 Grid Spacer at the Bundle Midplane

Test No.	Flooding Velocity (cold) cm/s	System Pressure bar	Feedwater Temp. ¹ °C		Bundle Power ² kW		Remarks
			0-30 s	End	0 s	Transient	
276	3.8	3.9	73	43	200	120% ANS	Figs. 86 Through 114
277	2.1	3.9	73	46	200	120% ANS	Data Not Plotted
275	3.8	3.9	61	43	200	120% ANS	Data Not Plotted
278	4.8	3.9	75	43	200	120% ANS	Data Not Plotted

Table 2 FEBA 5x5 rod bundle: Main test parameters of test series VI

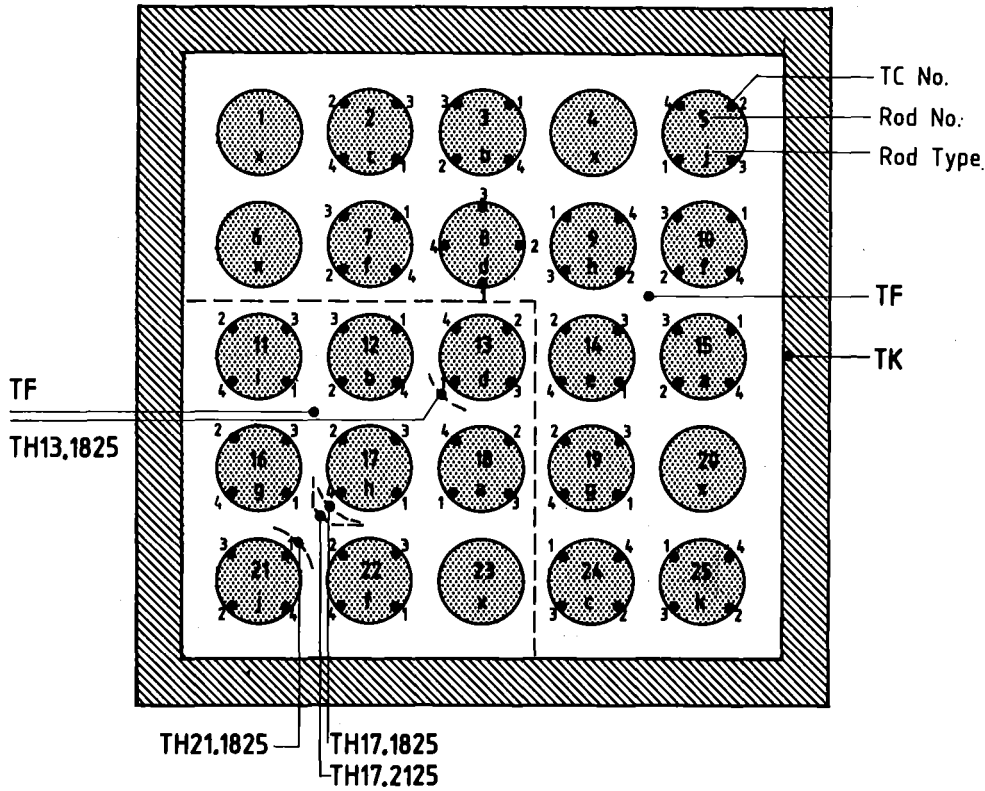

Rod Type	TC No.	Axial Level mm
a	1	2225
	2	2770
	3	3315
	4	3860
b	1	45
	2	590
	3	1135
	4	1680
c	1	3725
	2	3825
	3	3925
	4	4025
d	1	2025
	2	2025
	3	2025
	4	2025

Rod Type	TC No.	Axial Level mm
e	1	2075
	2	2125
	3	2175
	4	2225
f	1	2125
	2	2225
	3	2325
	4	2425
g	1	1625
	2	1725
	3	1825
	4	1925
h	1	1925
	2	2025
	3	2125
	4	2225

Rod Type	TC No.	Axial Level mm
i	1	1875
	2	1925
	3	1975
	4	2025
j	1	1225
	2	1325
	3	1425
	4	1525
k	1	100
	2	200
	3	300
	4	400
x	without TC's	

Fig. 84 5x5 rod bundle: Radial and axial location of cladding, sleeve, fluid and housing TC's for test series VI

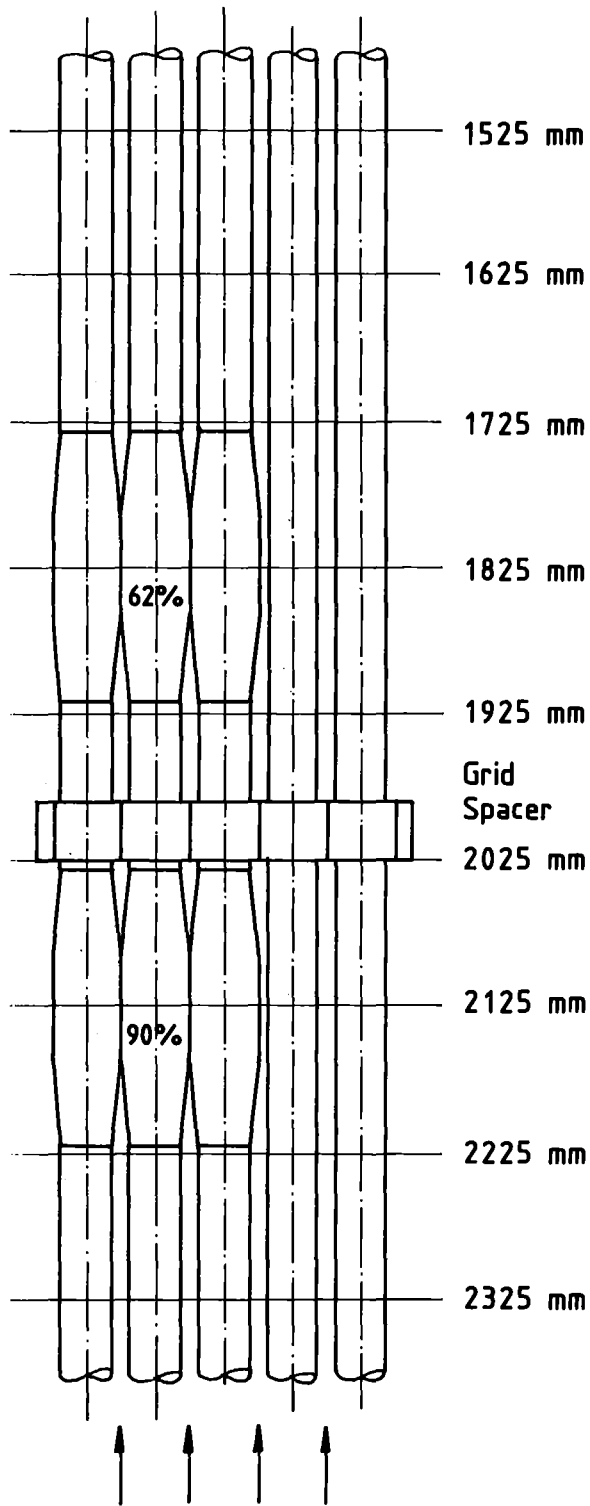
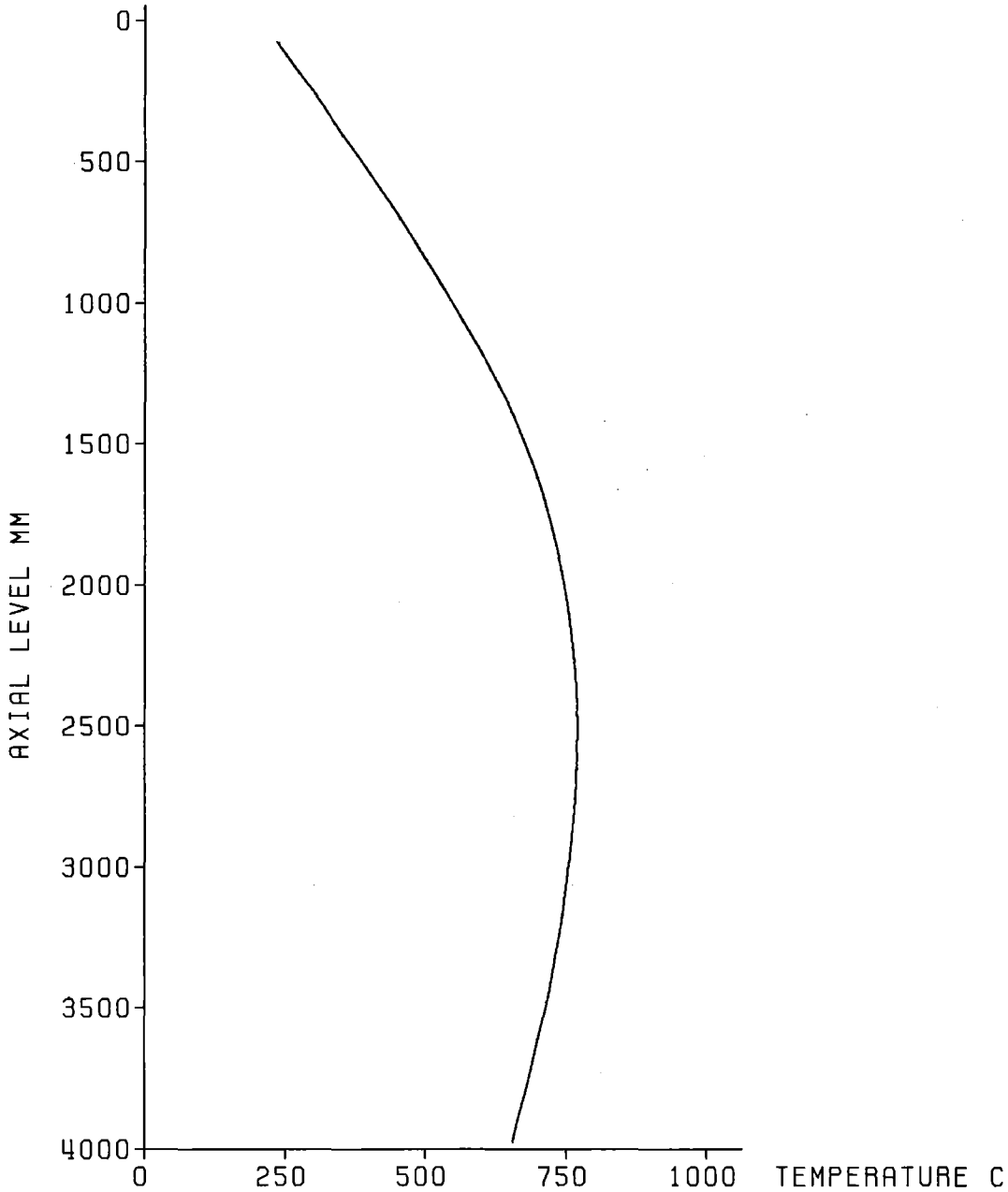

Fig. 85 5x5 rod bundle: Layout of the bundle geometry of test series VI

Initial Axial Temperature Profile of Claddings



Decay Heat 120% ANS Standard
Flooding Rate (cold) 3.77 cm/s
System Pressure 3.94 bar
Feedwater Temperature 40 C



Fig. 86 FEBA: 5x5 ROD BUNDLE
TEST SERIES 6, TEST-No. 276

Test Parameters:

- ◇ Flooding Rate
- △ System Pressure
- Feedwater Temperature
- Bundle Power

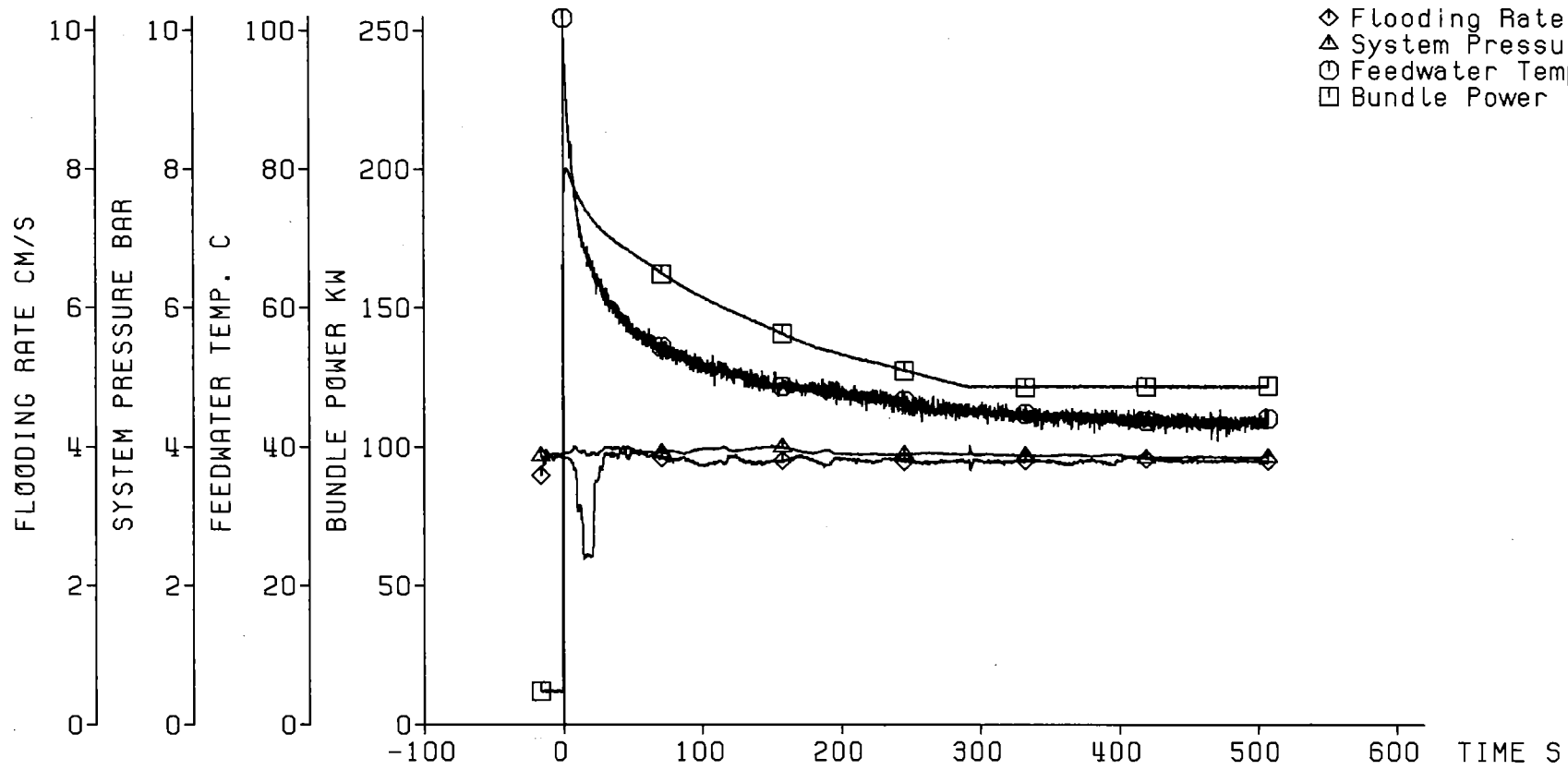

Decay Heat 120% ANS Standard
Flooding Rate (cold) 3.77 cm/s
System Pressure 3.94 bar
Feedwater Temperature 40 C



Fig. 87 FEBA: 5x5 R0D BUNDLE, TEST SERIES 6, TEST-No. 276

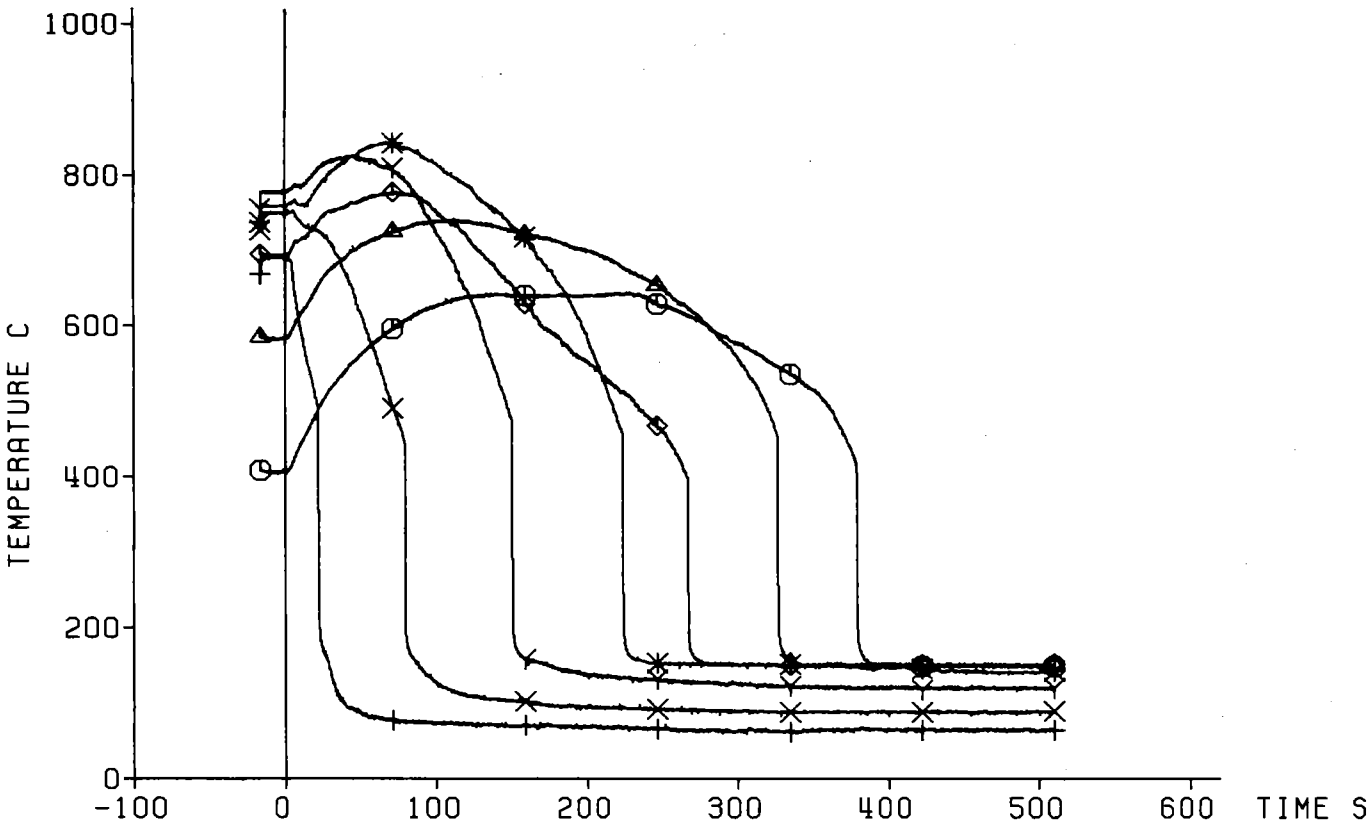

TC	Ax. Level
+	18a4 3860 mm
X	18a3 3315 mm
Y	18a2 2770 mm
*	18a1 2225 mm
◇	3b4 1680 mm
△	3b3 1135 mm
○	3b2 590 mm

Decay Heat 120% ANS Standard
Flooding Rate (cold) 3.77 cm/s
System Pressure 3.94 bar
Feedwater Temperature 40 C



Fig. 88 FEBA: 5x5 ROD BUNDLE, TEST SERIES 6, TEST-No. 276

Heat Transfer Coeff.

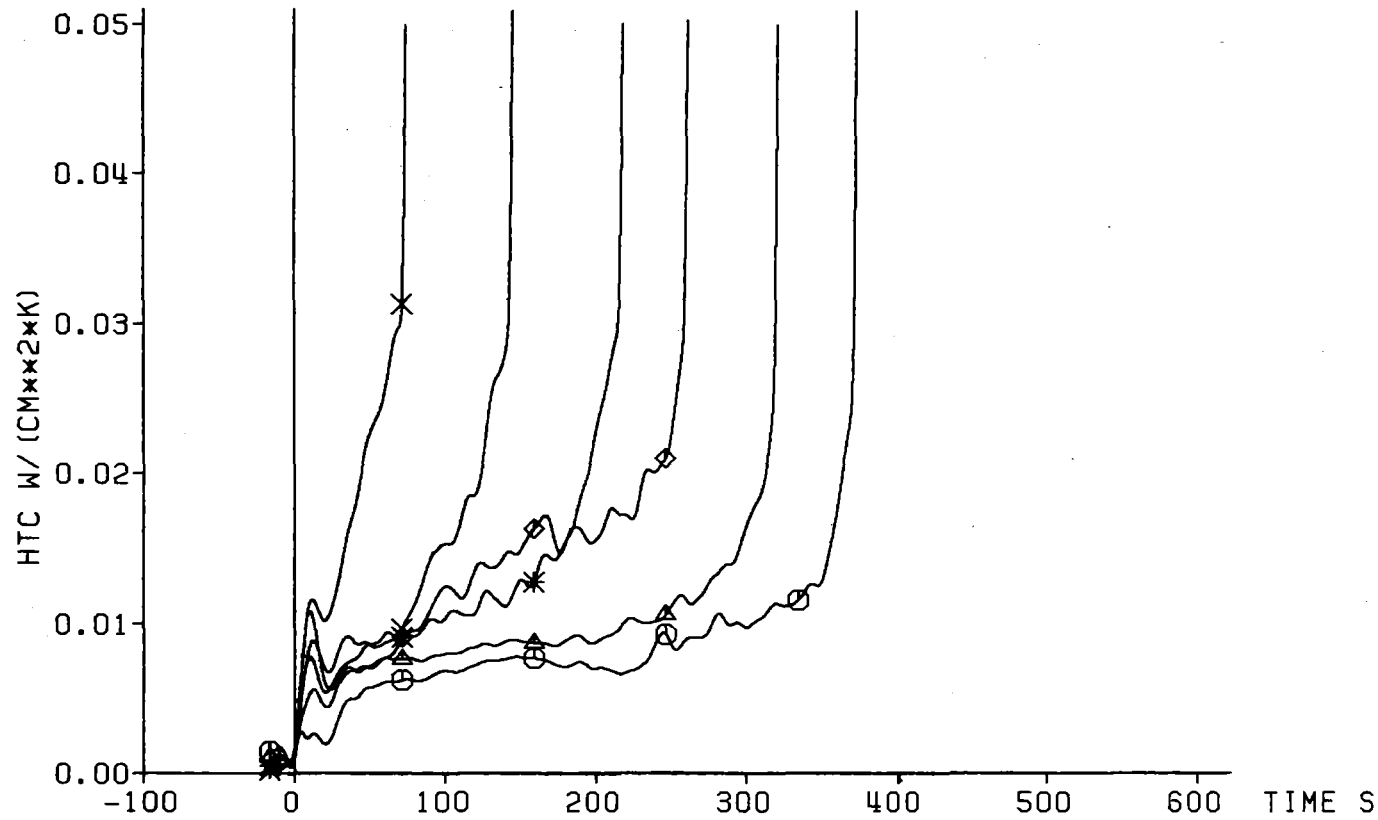

	TC	Ax. Level
X	18a3	3315 mm
Y	18a2	2770 mm
*	18a1	2225 mm
◇	3b4	1680 mm
△	3b3	1135 mm
○	3b2	590 mm

Decay Heat 120% ANS Standard
 Flooding Rate (cold) 3.77 cm/s
 System Pressure 3.94 bar
 Feedwater Temperature 40 C



Fig. 89 FEBA: 5x5 ROD BUNDLE, TEST SERIES 6, TEST-No. 276

Cladding Temperature

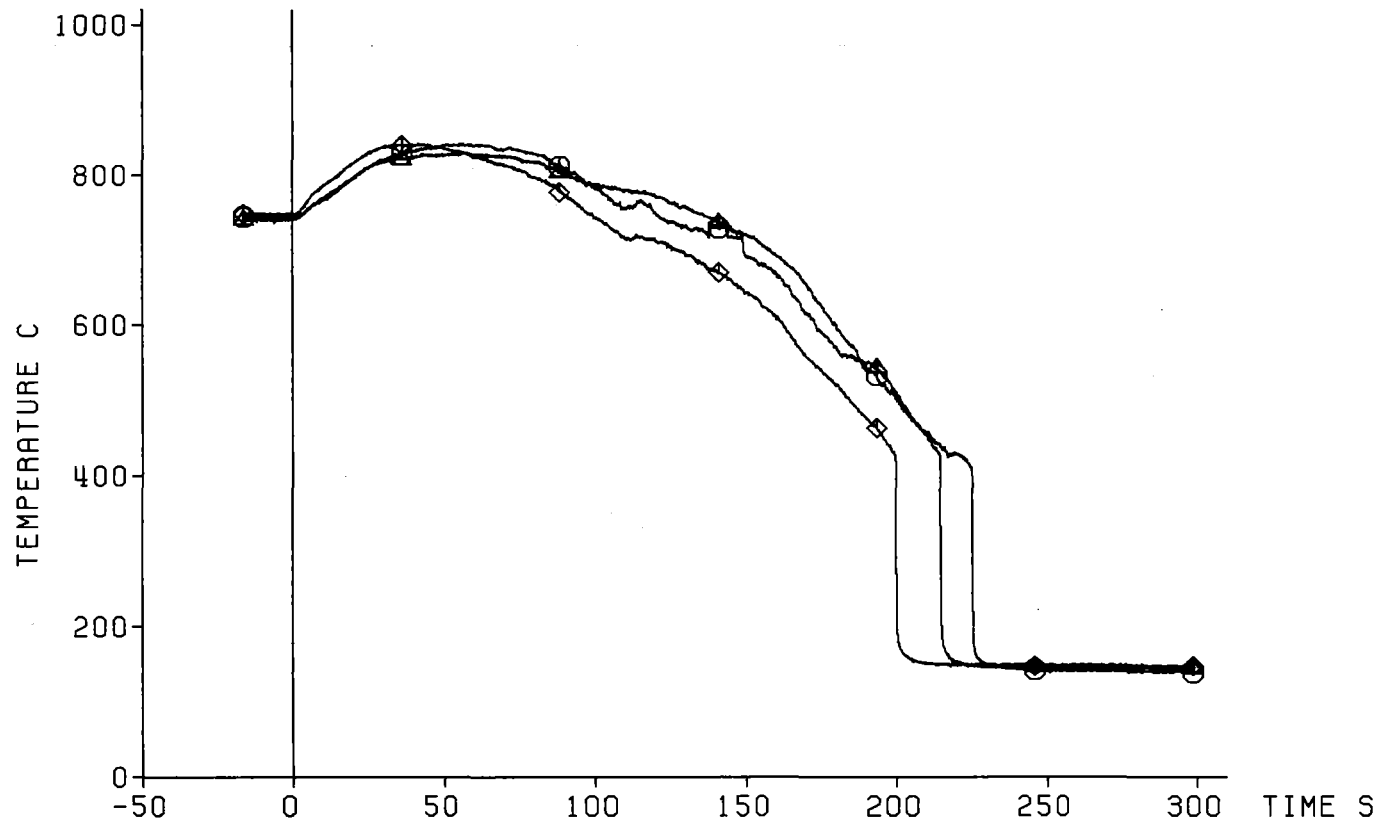

TC	Ax. Level
◇	7f4 2425 mm
△	7f3 2325 mm
○	9h4 2225 mm

Decay Heat 120% ANS Standard
 Flooding Rate (cold) 3.77 cm/s
 System Pressure 3.94 bar
 Feedwater Temperature 40 C

Bypass Area
 =====



Fig. 90 FEBA: 5x5 ROD BUNDLE, TEST SERIES 6, TEST-No. 276

Heat Transfer Coeff.

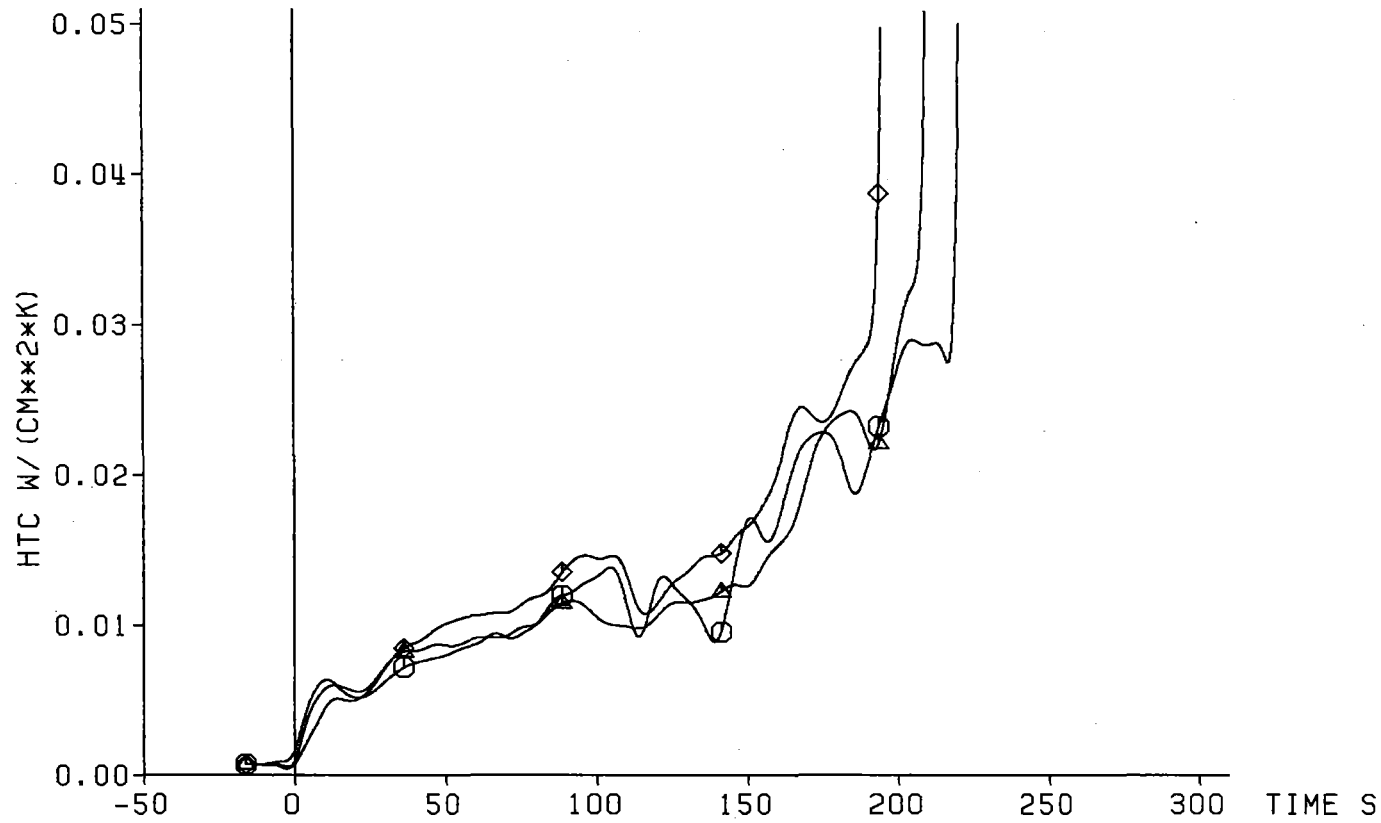

TC	Ax. Level
◇ 7f4	2425 mm
△ 7f3	2325 mm
○ 9h4	2225 mm

Decay Heat 120% ANS Standard
 Flooding Rate (cold) 3.77 cm/s
 System Pressure 3.94 bar
 Feedwater Temperature 40 C

Bypass Area
 =====



Fig. 91 FEBA: 5x5 ROD BUNDLE, TEST SERIES 6, TEST-No. 276

Cladding Temperature

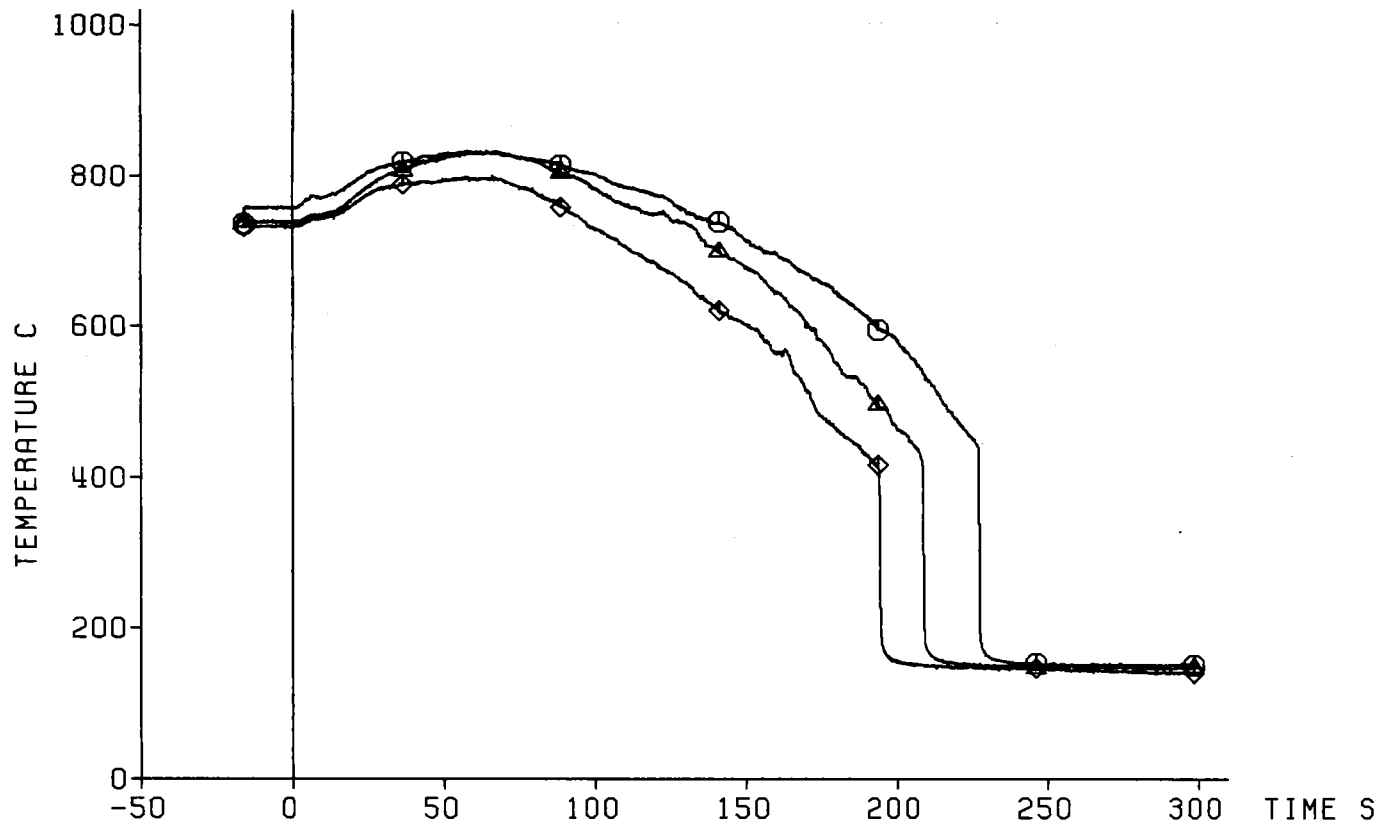

TC	Ax. Level
◇	22f4 2425 mm
△	22f3 2325 mm
○	17h4 2225 mm

Decay Heat 120% ANS Standard
 Flooding Rate (cold) 3.77 cm/s
 System Pressure 3.84 bar
 Feedwater Temperature 40 C

Blockage Area
 =====



Fig. 92 FEBA: 5x5 ROD BUNDLE, TEST SERIES 6, TEST-No. 276

Heat Transfer Coeff.

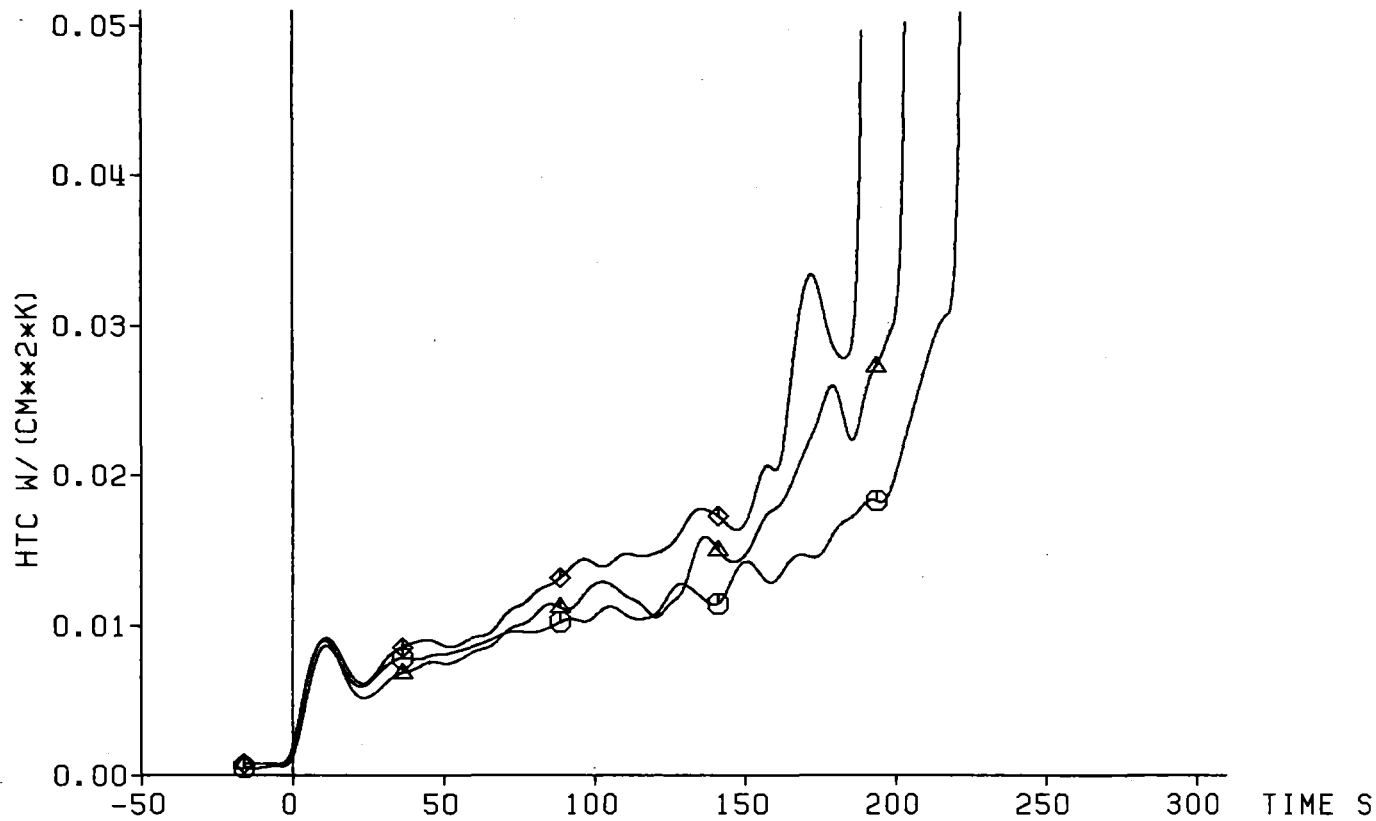

TC	Ax. Level
◇ 22f4	2425 mm
△ 22f3	2325 mm
○ 17h4	2225 mm

Decay Heat 120% ANS Standard
 Flooding Rate (cold) 3.77 cm/s
 System Pressure 3.84 bar
 Feedwater Temperature 40 C

Blockage Area
 =====



Fig. 93 FEBA: 5x5 ROD BUNDLE, TEST SERIES 6, TEST-No. 276

Cladding Temperature

TC | Ax. Level
9h3 | 2125 mm

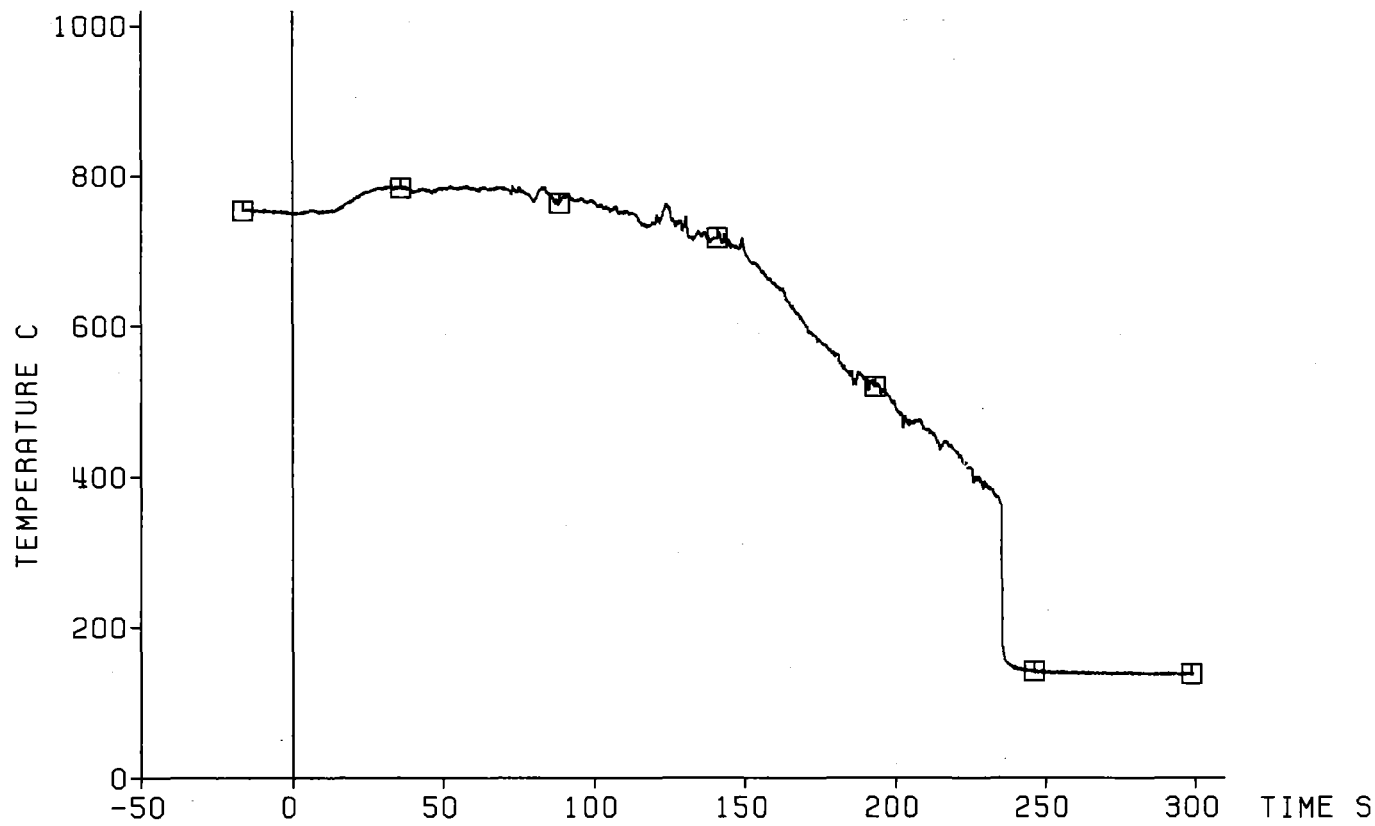

Decay Heat 120% ANS Standard
Flooding Rate (cold) 3.77 cm/s
System Pressure 3.94 bar
Feedwater Temperature 40 C

Bypass Area
=====

kfk
IRB

Fig. 94 FEBA: 5x5 ROD BUNDLE, TEST SERIES 6, TEST-No. 276

Heat Transfer Coeff.

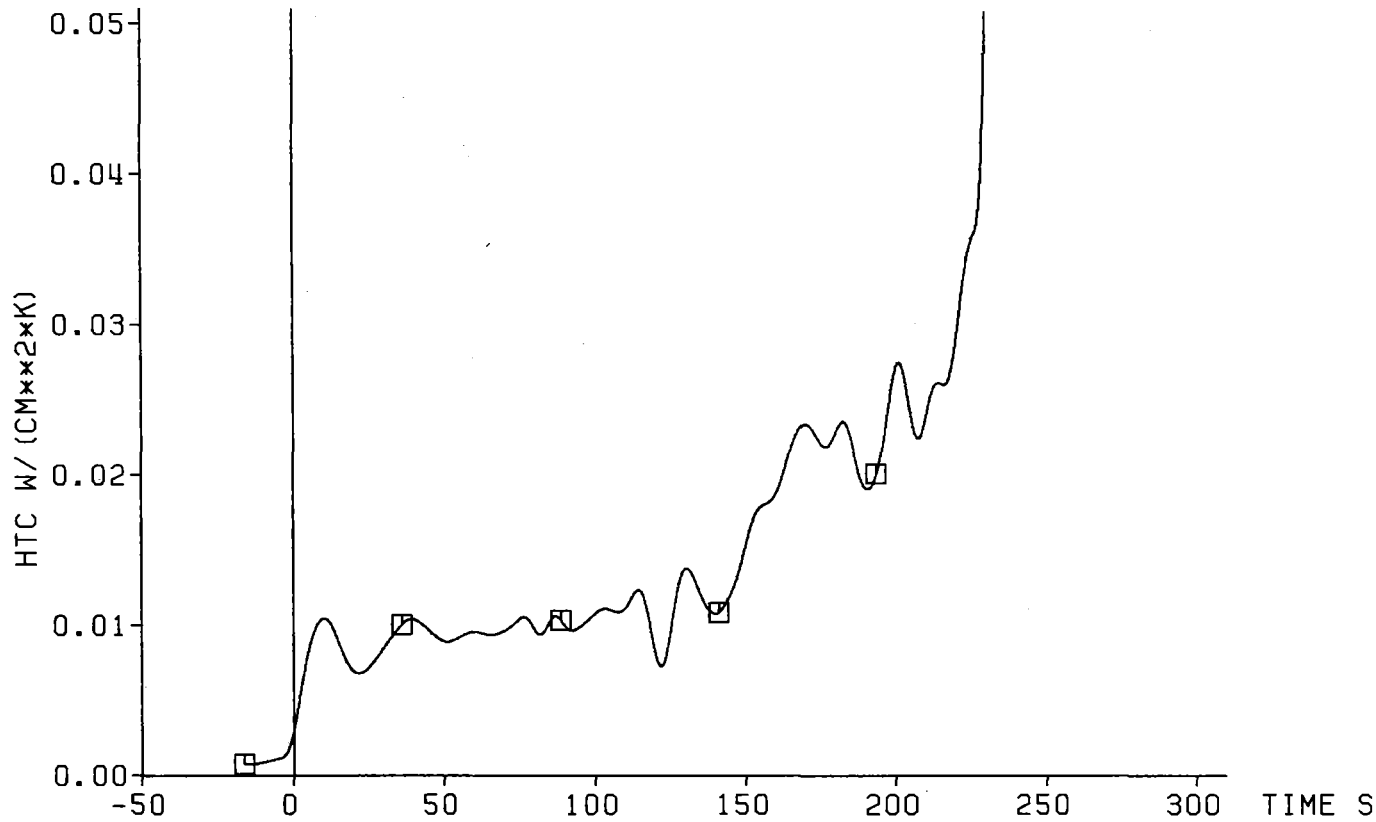

TC	Ax. Level
□ 9h3	2125 mm

Decay Heat 120% ANS Standard
Flooding Rate (cold) 3.77 cm/s
System Pressure 3.94 bar
Feedwater Temperature 40 C

Bypass Area
=====



Fig. 95 FEBA: 5x5 ROD BUNDLE, TEST SERIES 6, TEST-NO. 276

Cladding Temperature

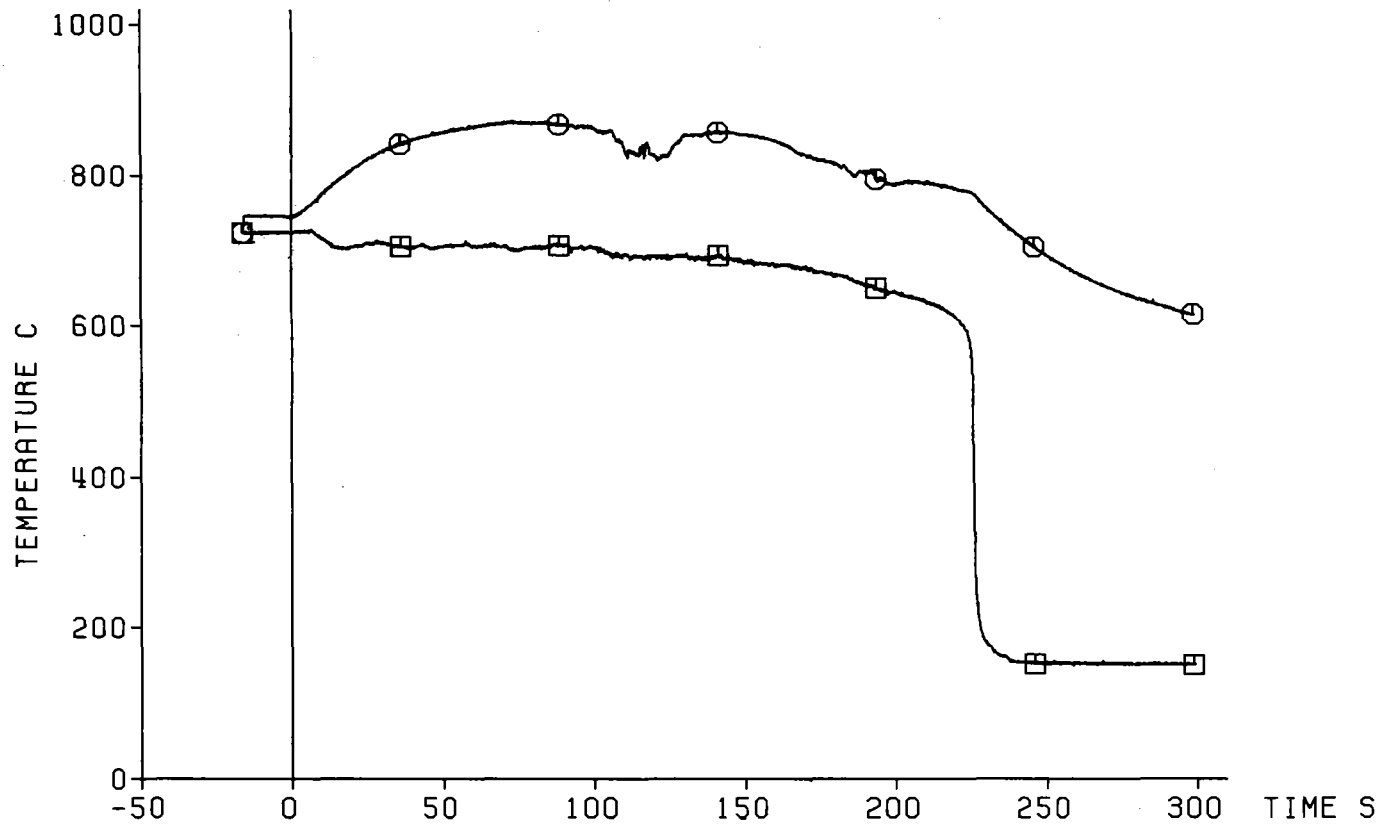

TC	Ax. Level
⊙ 17h3	2125 mm
⊠ Sleeve	2125 mm

Decay Heat 120% ANS Standard
 Flooding Rate (cold) 3.77 cm/s
 System Pressure 3.84 bar
 Feedwater Temperature 40 C

Blockage Area
 =====



Fig. 96 FEBA: 5x5 ROD BUNDLE, TEST SERIES 6, TEST-No. 276

Cladding Temperature

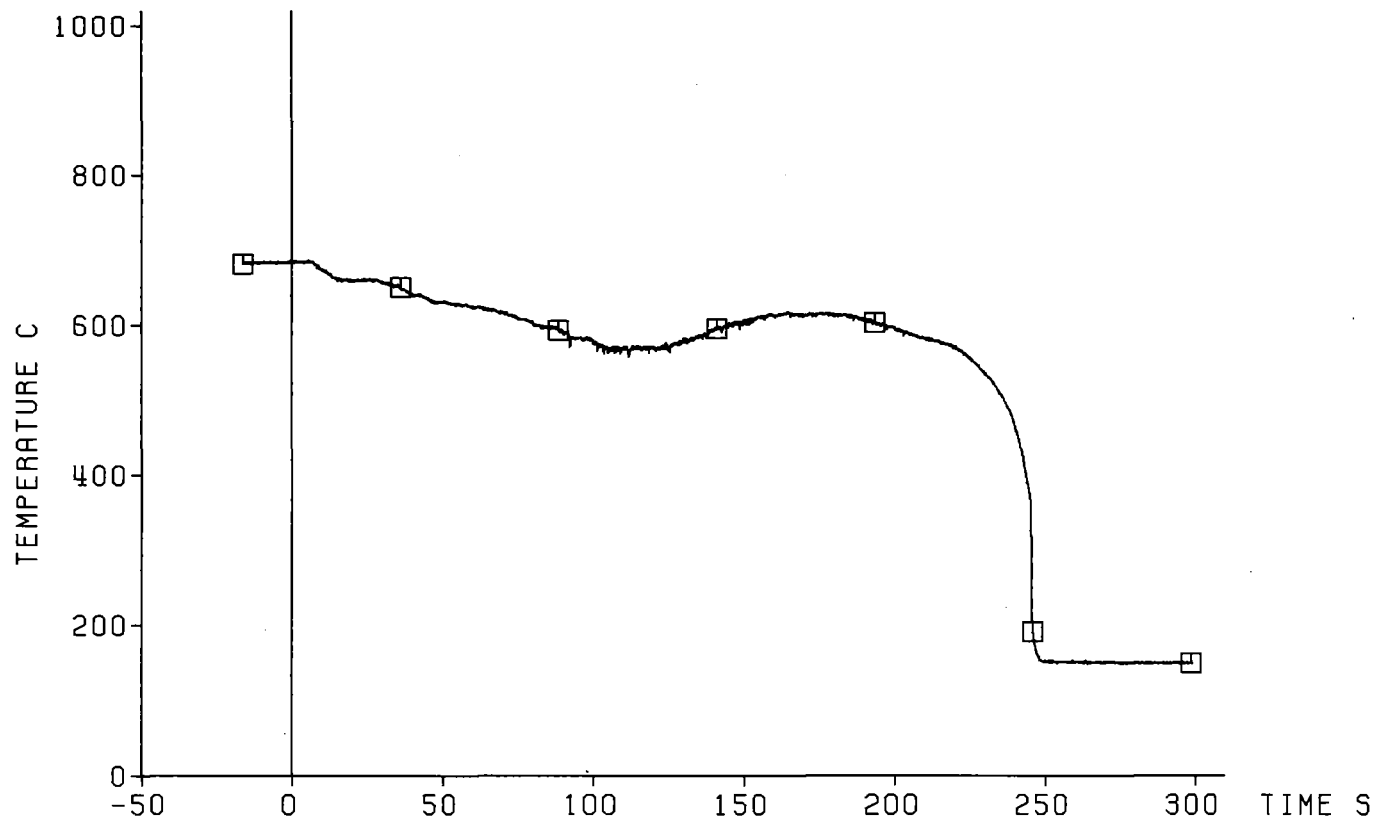

TC	Ax. Level
□ Sleeve Rod 21	2125 mm

Decay Heat 120% ANS Standard
 Flooding Rate (cold) 3.77 cm/s
 System Pressure 3.84 bar
 Feedwater Temperature 40 C

Blockage Area
 =====



Fig. 97 FEBA: 5x5 ROD BUNDLE, TEST SERIES 6, TEST-No. 276

Cladding Temperature

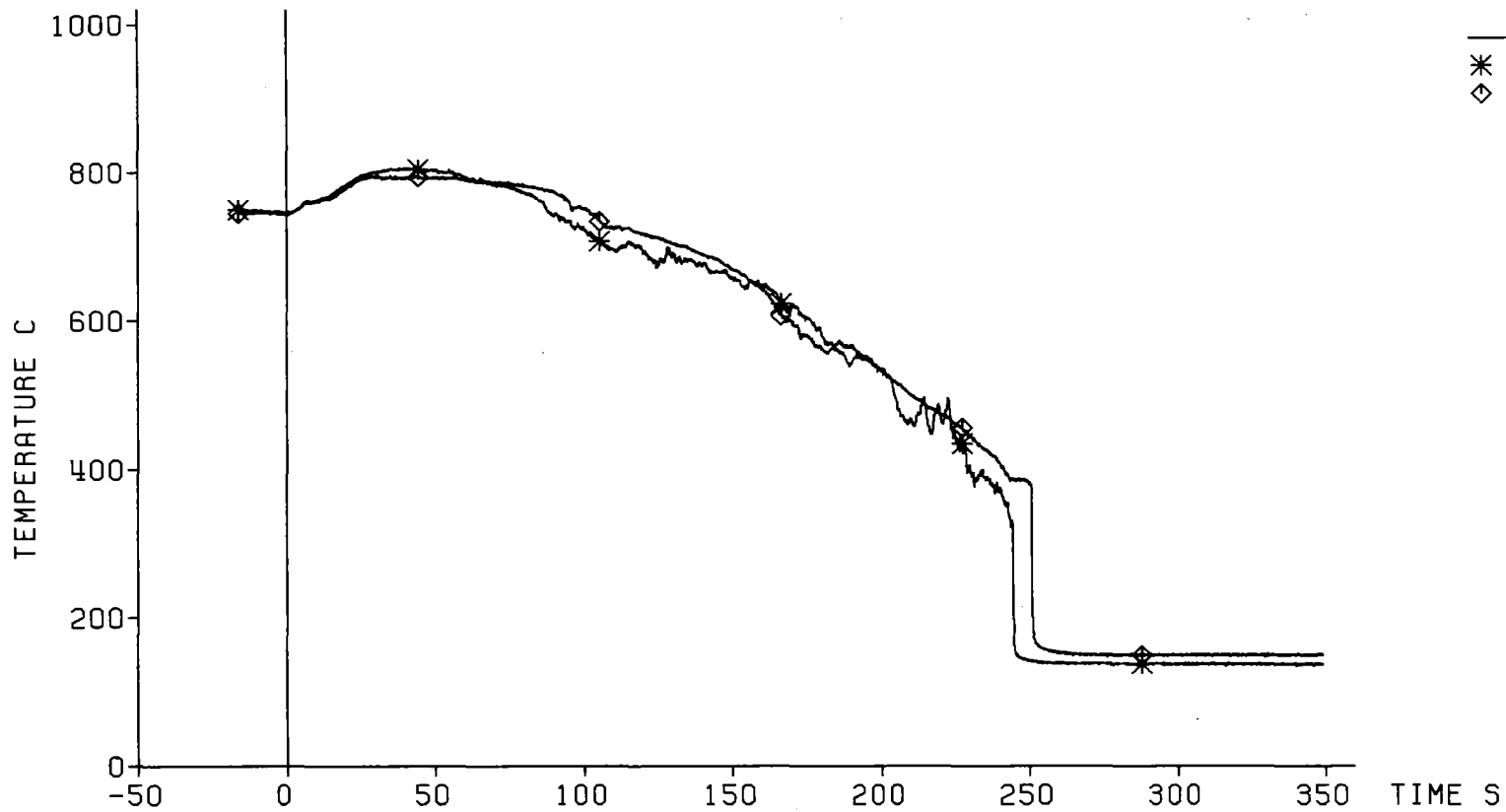

TC	Ax. Level
* 9h2	2025 mm
◇ 9h1	1925 mm

Decay Heat 120% ANS Standard
 Flooding Rate (cold) 3.77 cm/s
 System Pressure 3.94 bar
 Feedwater Temperature 40 C

Bypass Area
 =====



Fig. 98 FEBA: 5x5 ROD BUNDLE, TEST SERIES 6, TEST-No. 276

Heat Transfer Coeff.

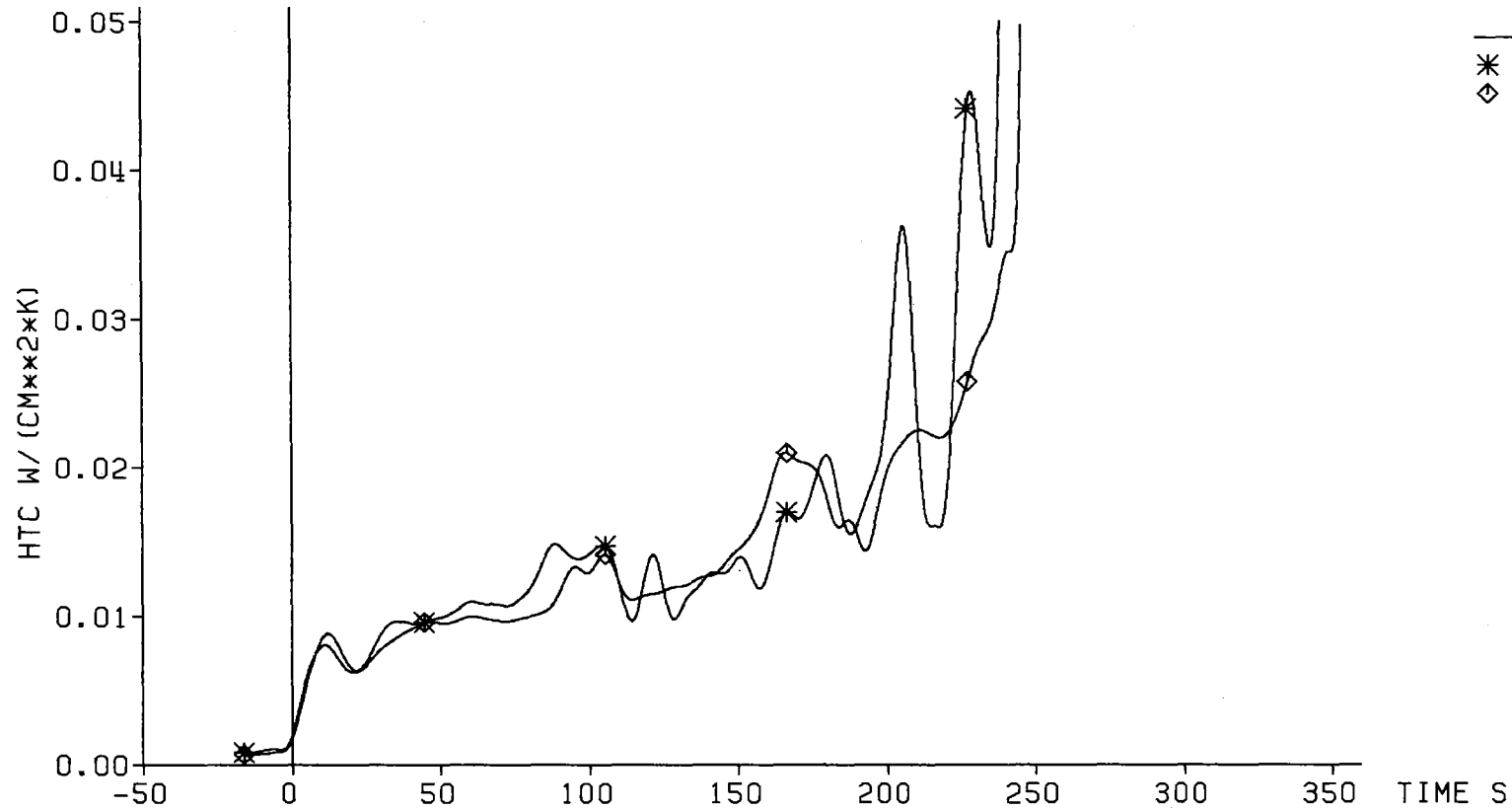

	TC	Ax. Level
*	9h2	2025 mm
◇	9h1	1925 mm

Decay Heat 120% ANS Standard
Flooding Rate (cold) 3.77 cm/s
System Pressure 3.94 bar
Feedwater Temperature 40 C

Bypass Area
=====



Fig. 99 FEBA: 5x5 ROD BUNDLE, TEST SERIES 6, TEST-No. 276

Cladding Temperature

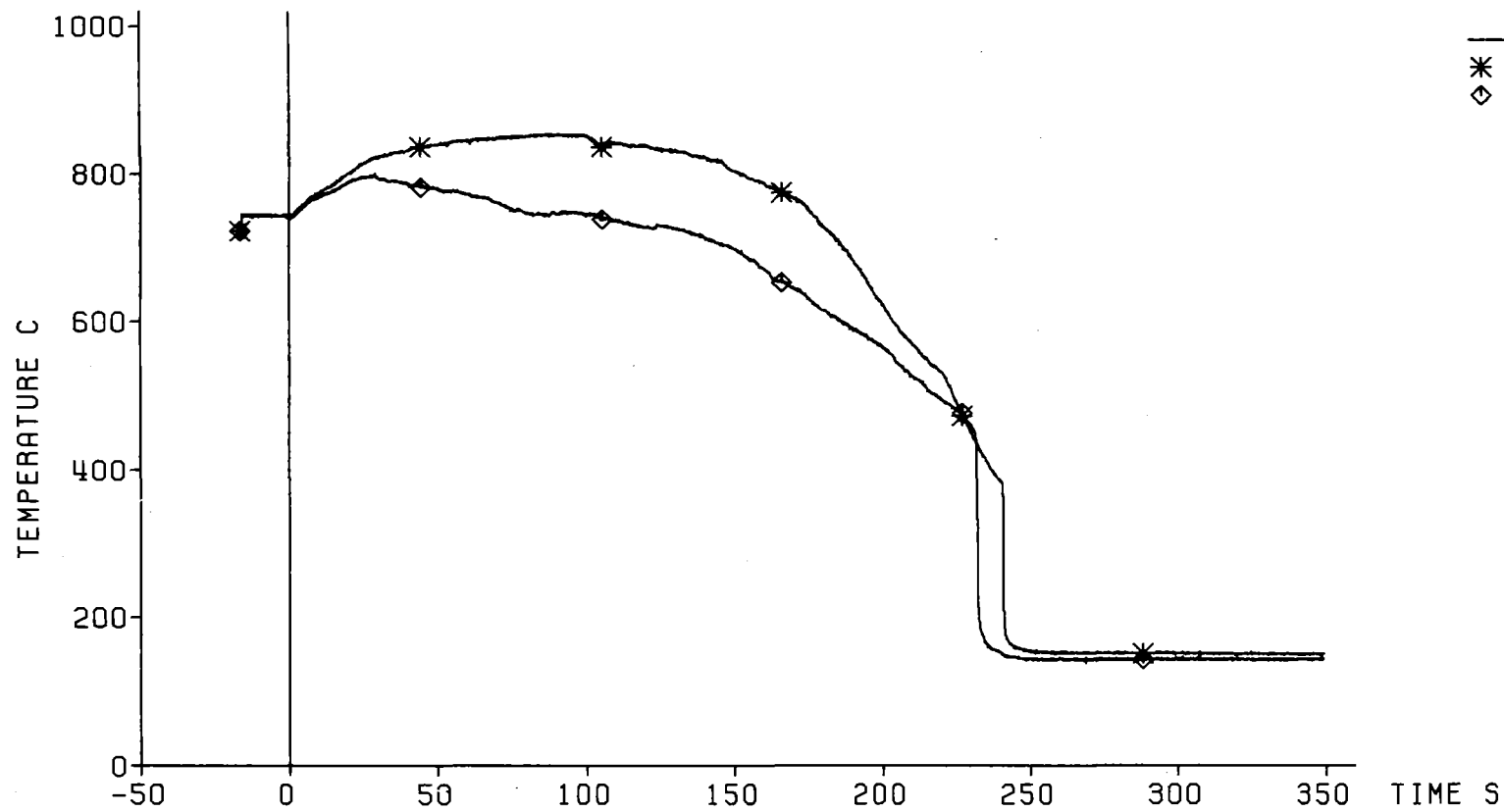

TC	Ax. Level
* 17h2	2025 mm
◇ 17h1	1925 mm

Decay Heat 120% ANS Standard
 Flooding Rate (cold) 3.77 cm/s
 System Pressure 3.84 bar
 Feedwater Temperature 40 C

Blockage Area
 =====



Fig. 100 FEBA: 5x5 ROD BUNDLE, TEST SERIES 6, TEST-No. 276

Heat Transfer Coeff.

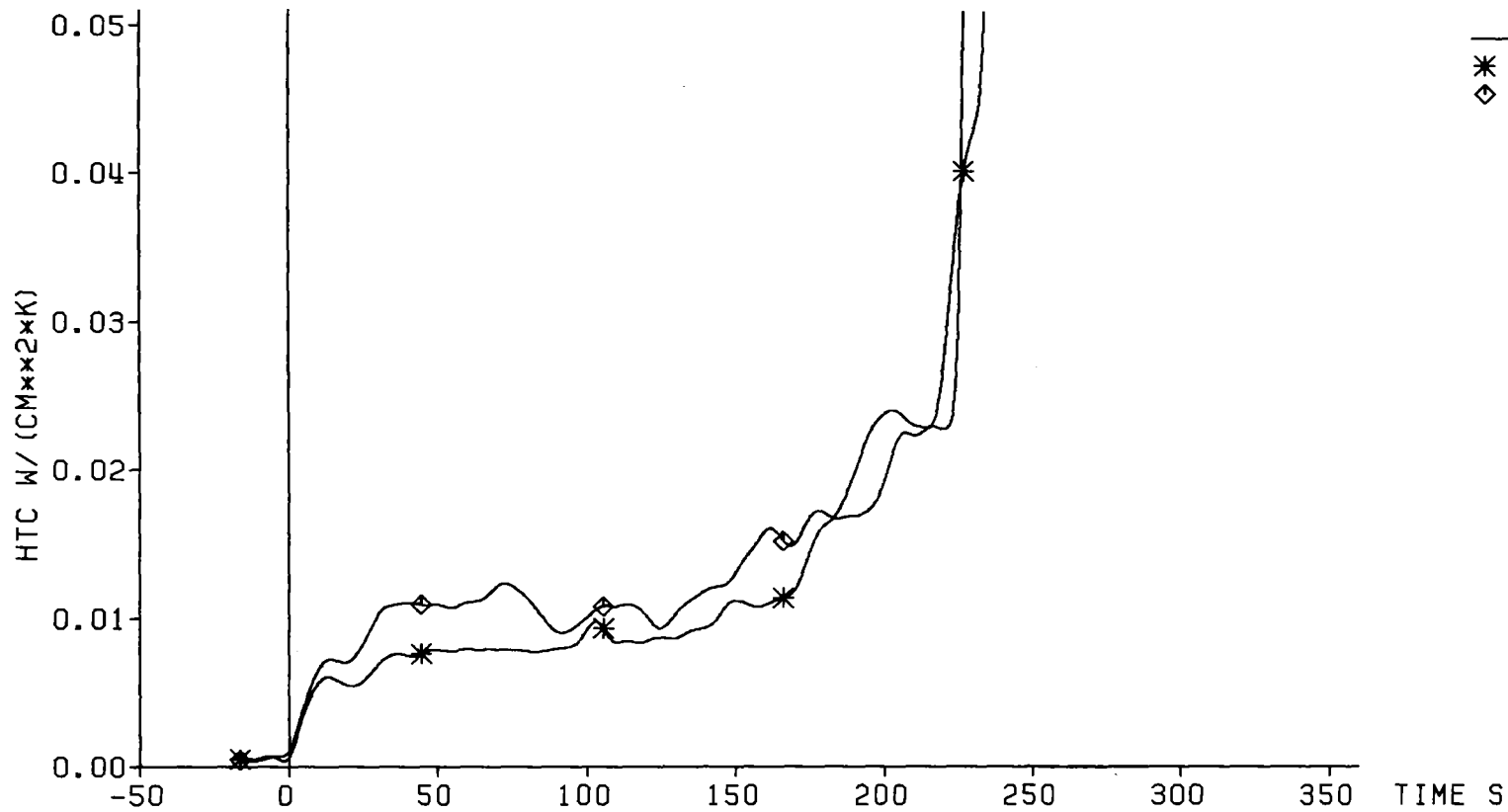

TC	Ax. Level
* 17h2	2025 mm
◇ 17h1	1925 mm

Decay Heat 120% ANS Standard
 Flooding Rate (cold) 3.77 cm/s
 System Pressure 3.84 bar
 Feedwater Temperature 40 C

Blockage Area
 =====



Fig. 101 FEBA: 5x5 ROD BUNDLE, TEST SERIES 6, TEST-No. 276

Cladding Temperature

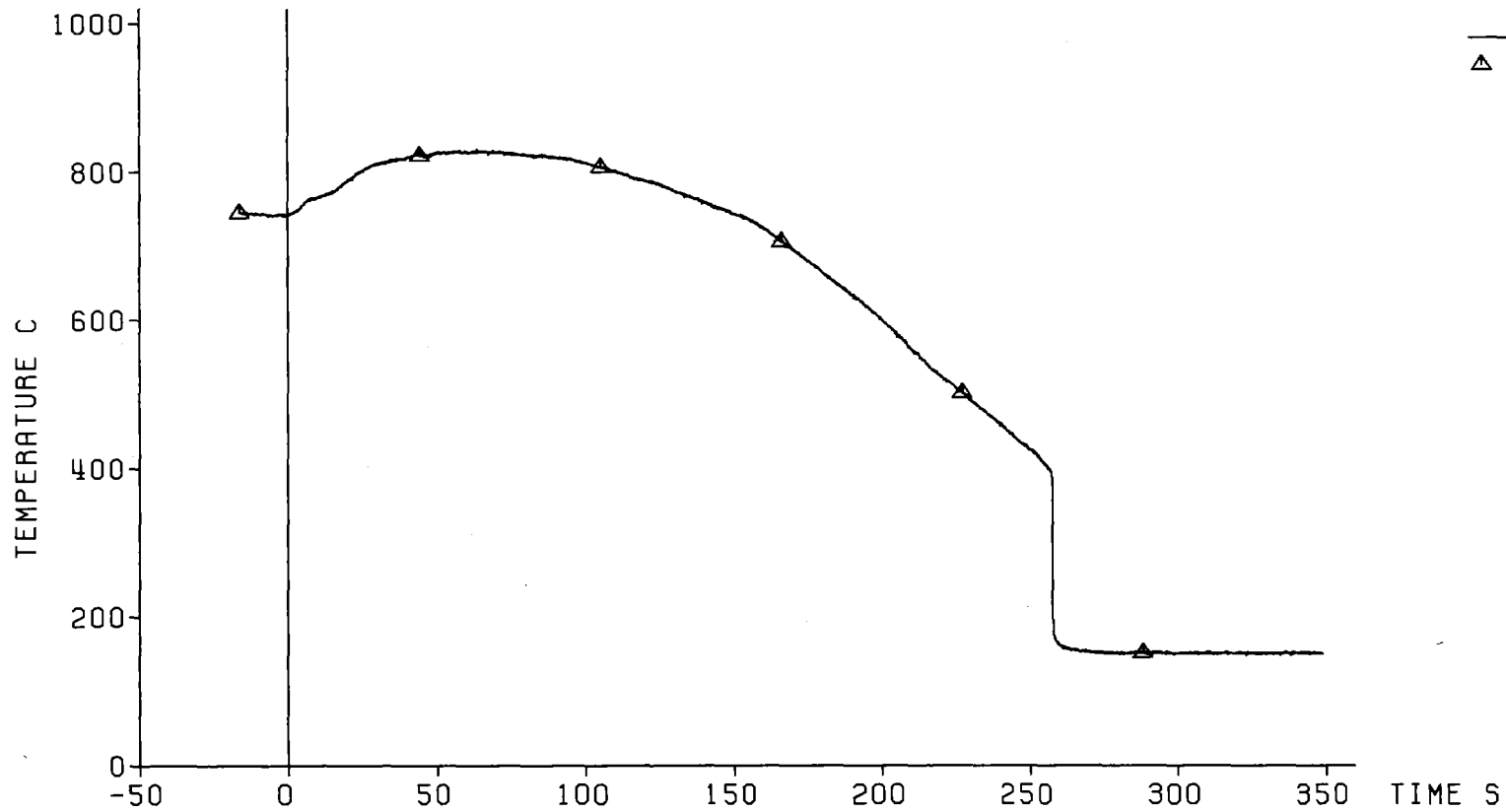

TC	Ax. Level
△ 19g3	1825 mm

Decay Heat 120% ANS Standard
Flooding Rate (cold) 3.77 cm/s
System Pressure 3.94 bar
Feedwater Temperature 40 C

Bypass Area
=====



Fig. 102 FEBA: 5x5 ROD BUNDLE, TEST SERIES 6, TEST-No. 276

Heat Transfer Coeff.

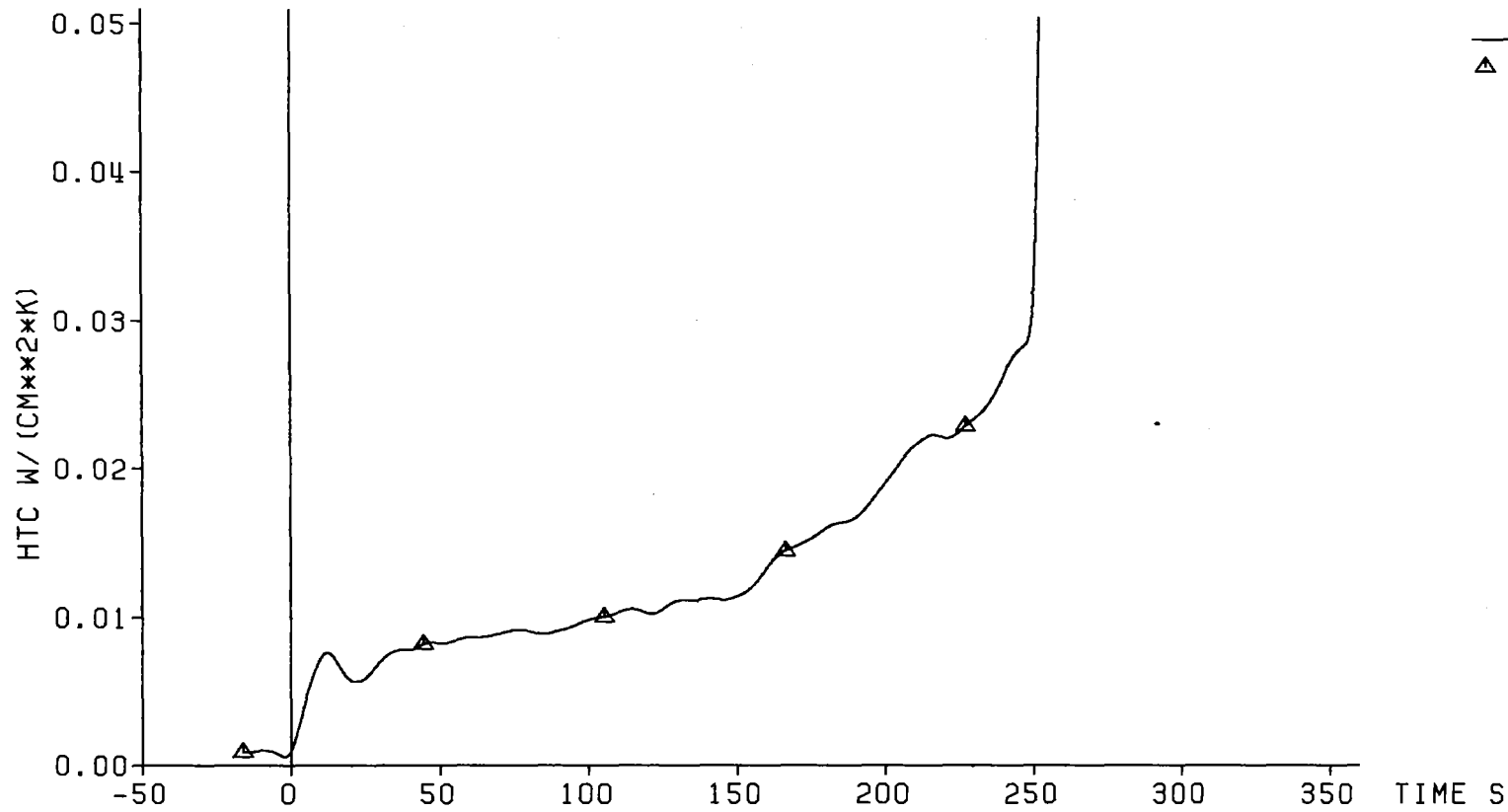

TC	Ax. Level
△ 19g3	1825 mm

Decay Heat	120% ANS Standard
Flooding Rate (cold)	3.77 cm/s
System Pressure	3.94 bar
Feedwater Temperature	40 C

Bypass Area
=====



Fig.103 FEBA: 5x5 ROD BUNDLE, TEST SERIES 6, TEST-No. 276

Cladding Temperature

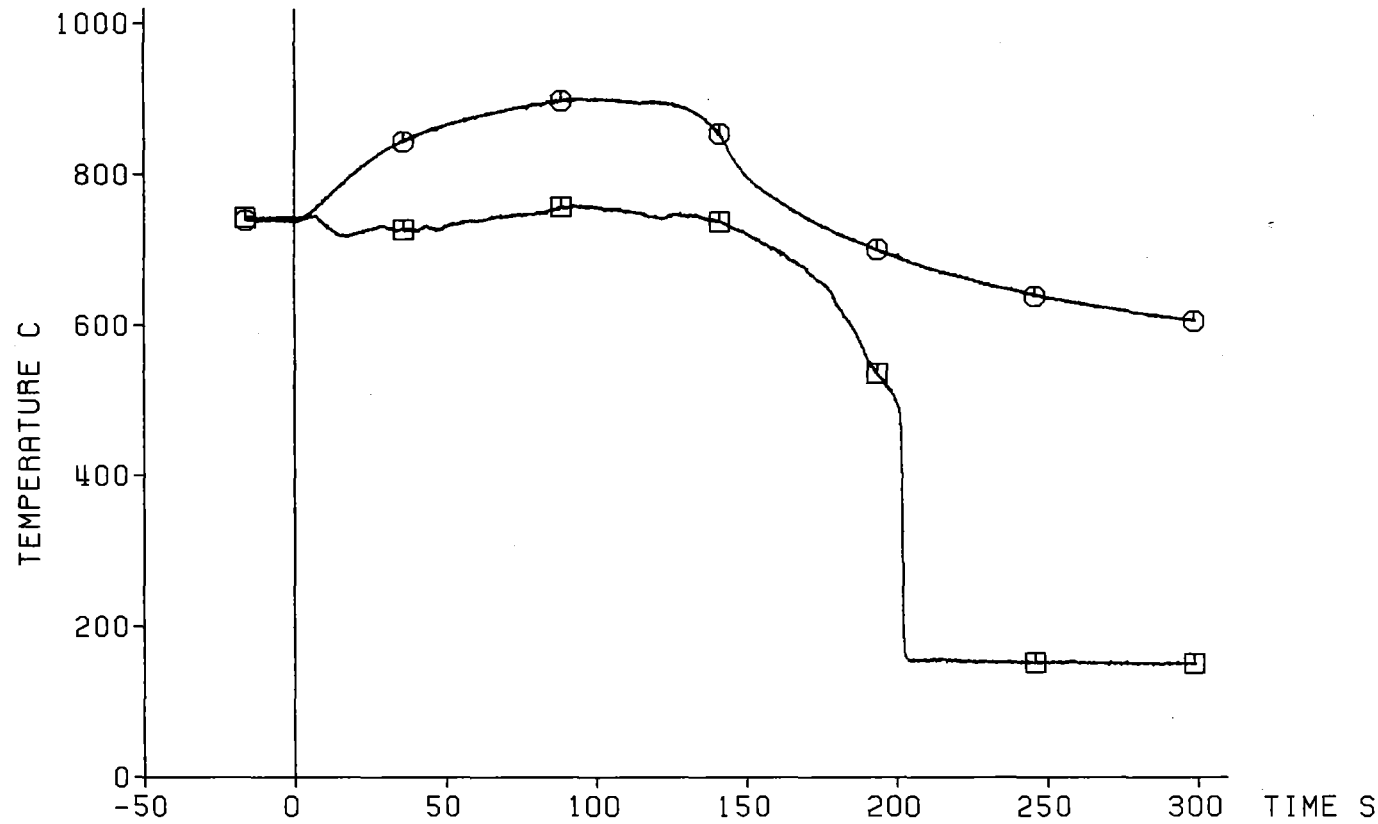

TC	Ax. Level
⊙ 16g3	1825 mm
⊠ Sleeve	1825 mm

Decay Heat 120% ANS Standard
 Flooding Rate (cold) 3.77 cm/s
 System Pressure 3.84 bar
 Feedwater Temperature 40 C

Blockage Area
 =====



Fig. 104 FEBA: 5x5 ROD BUNDLE, TEST SERIES 6, TEST-No. 276

Cladding Temperature

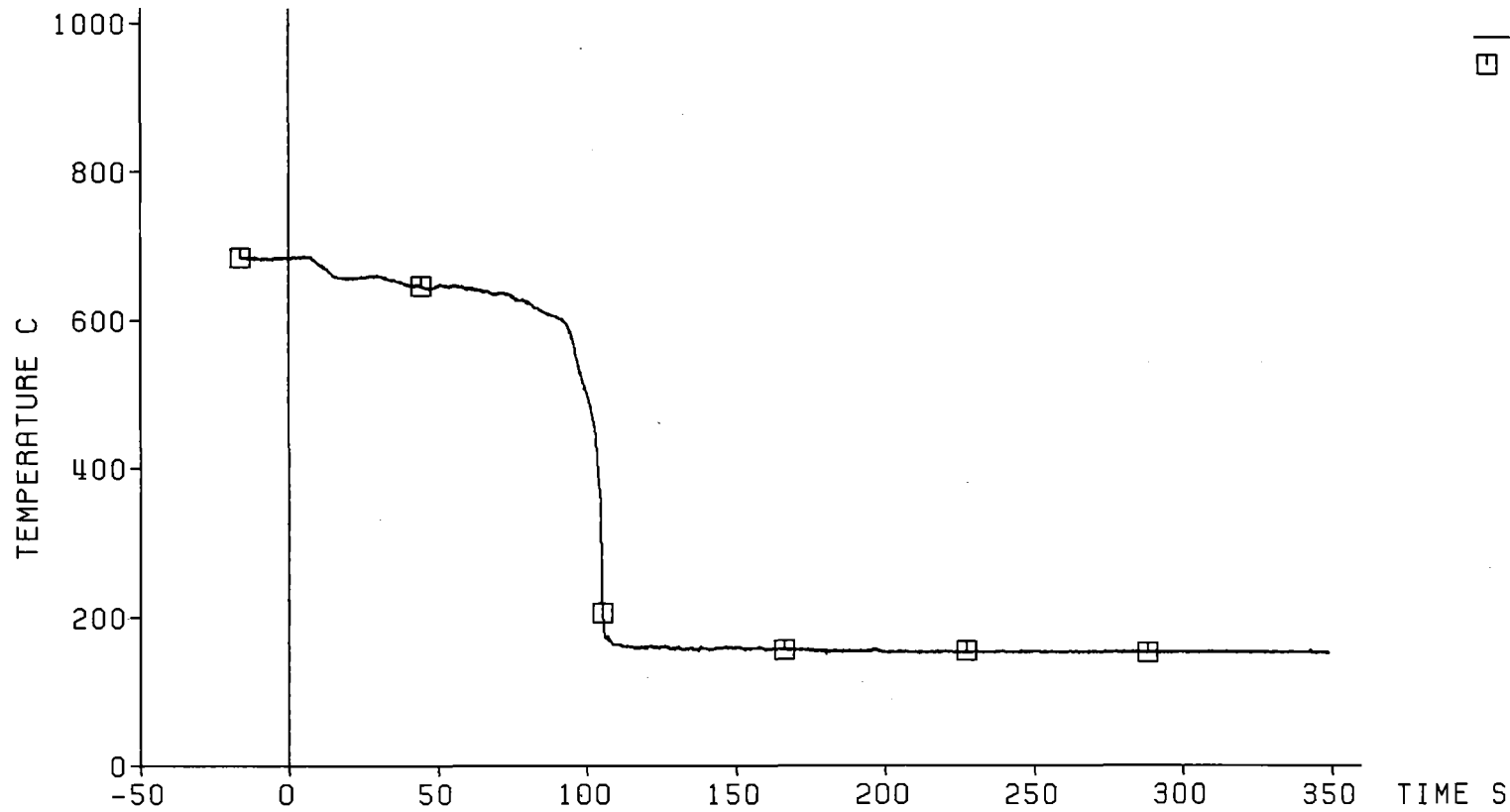

TC	Ax. Level
□ Sleeve Rod 21	1825 mm

Decay Heat 120% ANS Standard
 Flooding Rate (cold) 3.77 cm/s
 System Pressure 3.84 bar
 Feedwater Temperature 40 C

Blockage Area
 =====



Fig. 105 FEBA: 5x5 ROD BUNDLE, TEST SERIES 6, TEST-No. 276

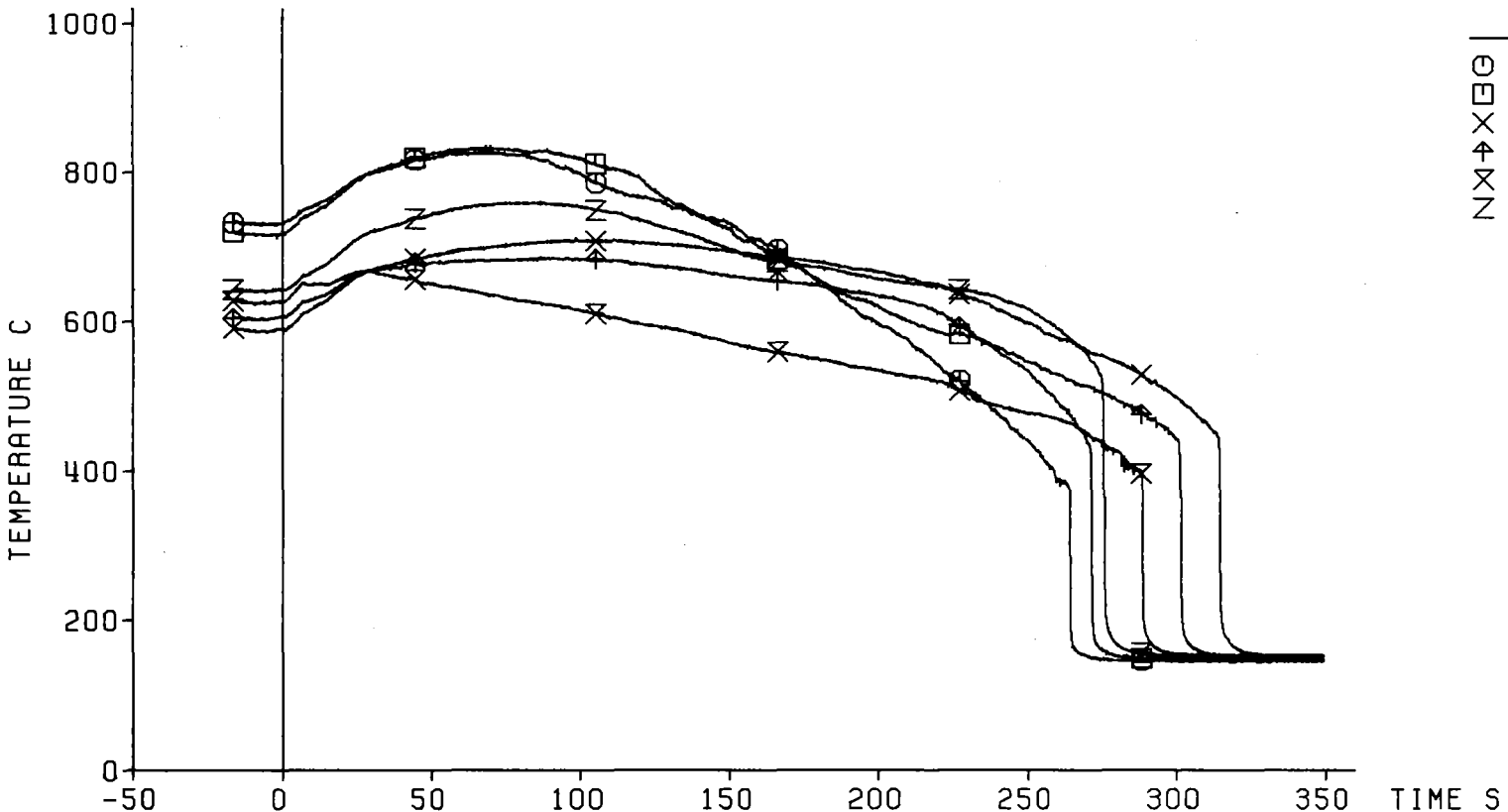

TC	Ax. Level
⊙	19g2 1725 mm
⊠	19g1 1625 mm
×	5j4 1525 mm
⊕	5j3 1425 mm
⊗	5j2 1325 mm
∇	5j1 1225 mm

Decay Heat 120% ANS Standard
 Flooding Rate (cold) 3.77 cm/s
 System Pressure 3.94 bar
 Feedwater Temperature 40 C

Bypass Area
=====



Fig. 106 FEBA: 5x5 ROD BUNDLE, TEST SERIES 6, TEST-No. 276

Heat Transfer Coeff.

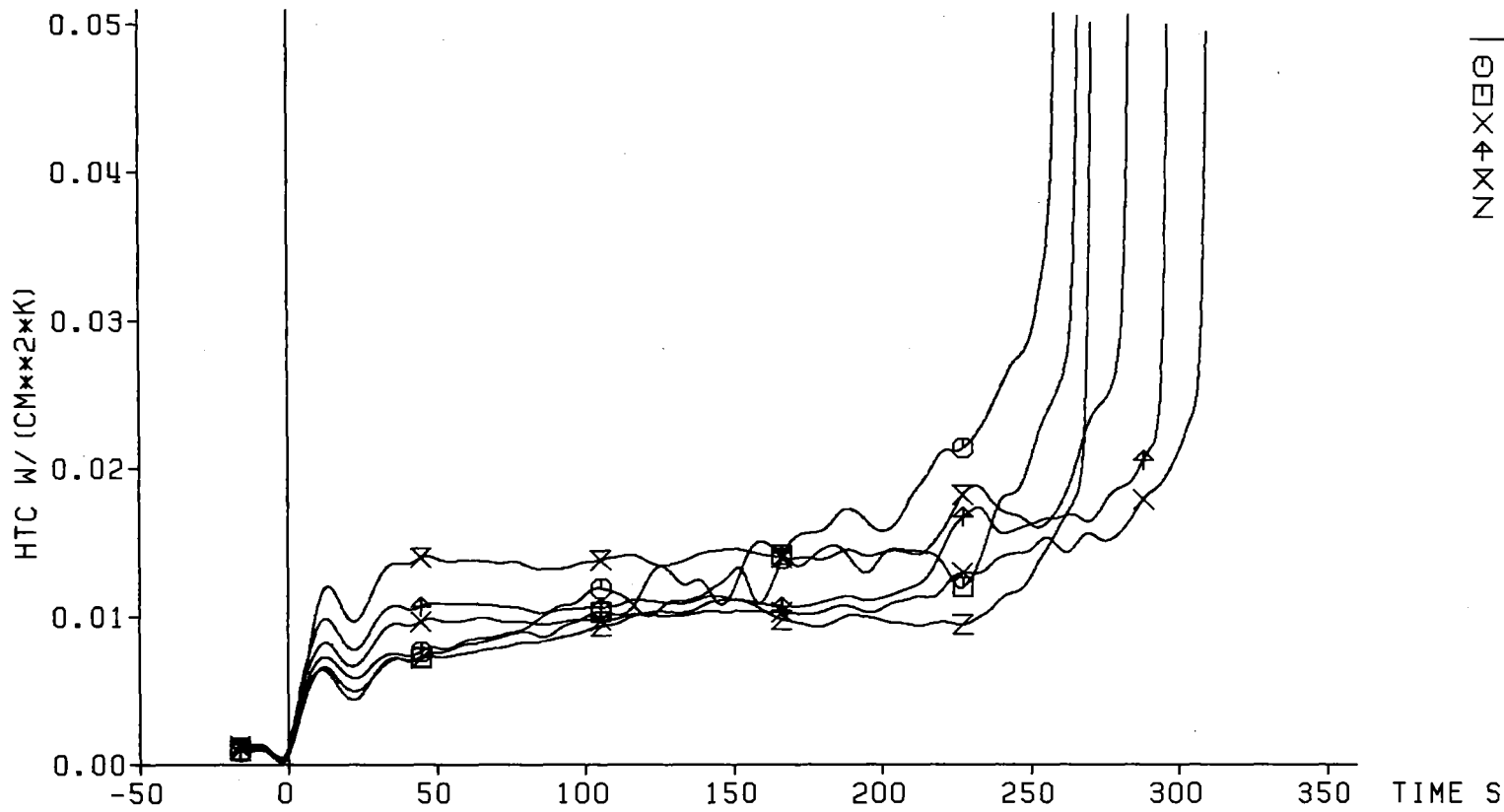

	TC	Ax. Level
○	19g2	1725 mm
□	19g1	1625 mm
X	5j4	1525 mm
△	5j3	1425 mm
⋈	5j2	1325 mm
Z	5j1	1225 mm

Decay Heat 120% ANS Standard
 Flooding Rate (cold) 3.77 cm/s
 System Pressure 3.94 bar
 Feedwater Temperature 40 C

Bypass Area
 =====



Fig. 107 FEBA: 5x5 ROD BUNDLE, TEST SERIES 6, TEST-No. 276

Cladding Temperature

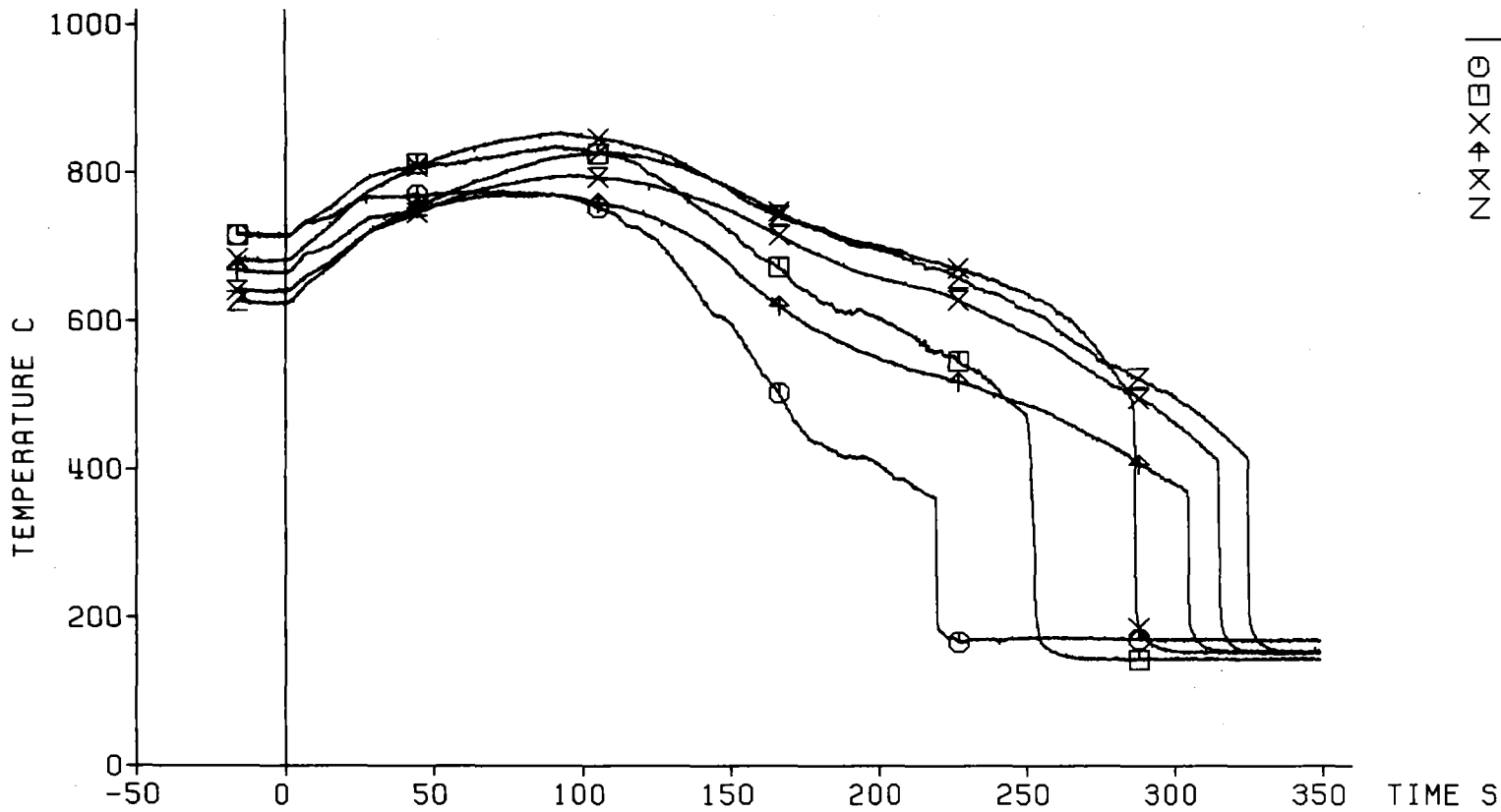

Decay Heat 120% ANS Standard
 Flooding Rate (cold) 3.77 cm/s
 System Pressure 3.84 bar
 Feedwater Temperature 40 C

Blockage Area
 =====



Fig. 108 FEBA: 5x5 ROD BUNDLE, TEST SERIES 6, TEST-No. 276

Heat Transfer Coeff.

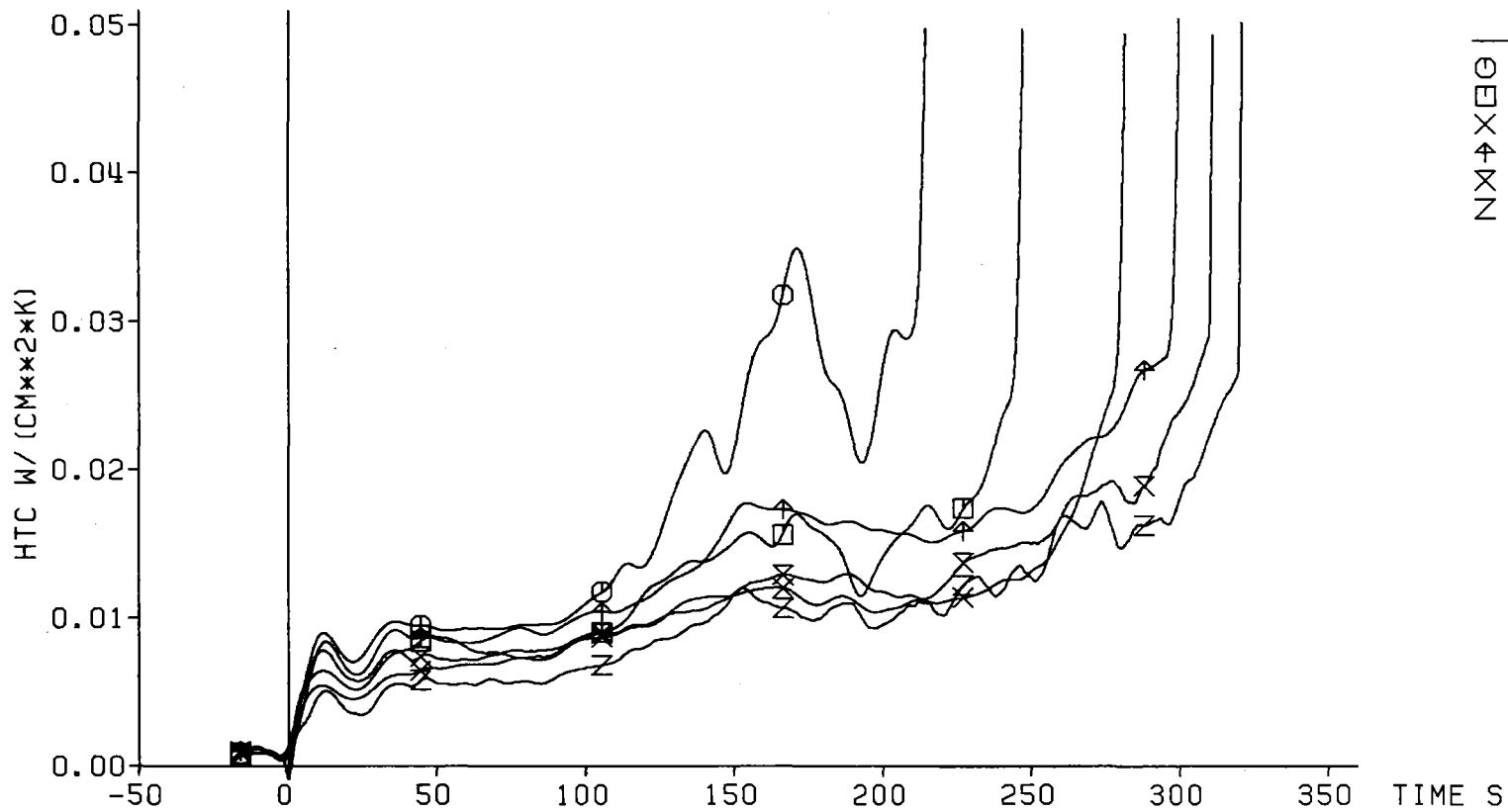

	TC	Ax. Level
○	16g2	1725 mm
□	16g1	1625 mm
×	21j4	1525 mm
△	21j3	1425 mm
×	21j2	1325 mm
▽	21j1	1225 mm

Decay Heat 120% ANS Standard
 Flooding Rate (cold) 3.77 cm/s
 System Pressure 3.84 bar
 Feedwater Temperature 40 C

Blockage Area
 =====



Fig. 109 FEBA: 5x5 ROD BUNDLE, TEST SERIES 6, TEST-No. 276

Axial Level: 1625 mm

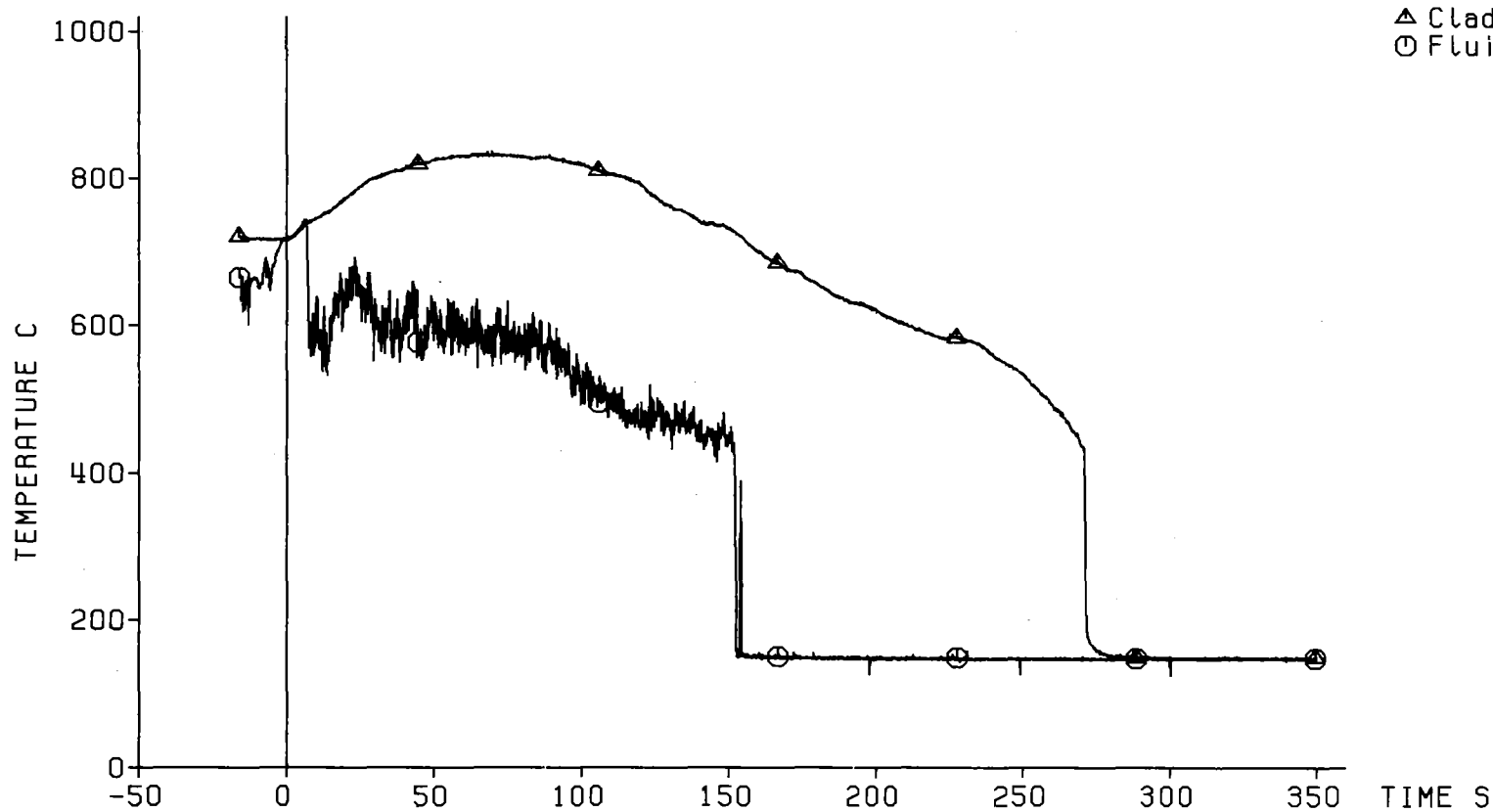

△ Cladding Temperature (19g1)
○ Fluid Temperature

Decay Heat 120% ANS Standard
Flooding Rate (cold) 3.77 cm/s
System Pressure 3.94 bar
Feedwater Temperature 40 C

Bypass Area
=====



Fig. 110 FEBA: 5x5 ROD BUNDLE, TEST SERIES 6, TEST-No. 276

Axial Level: 1625 mm

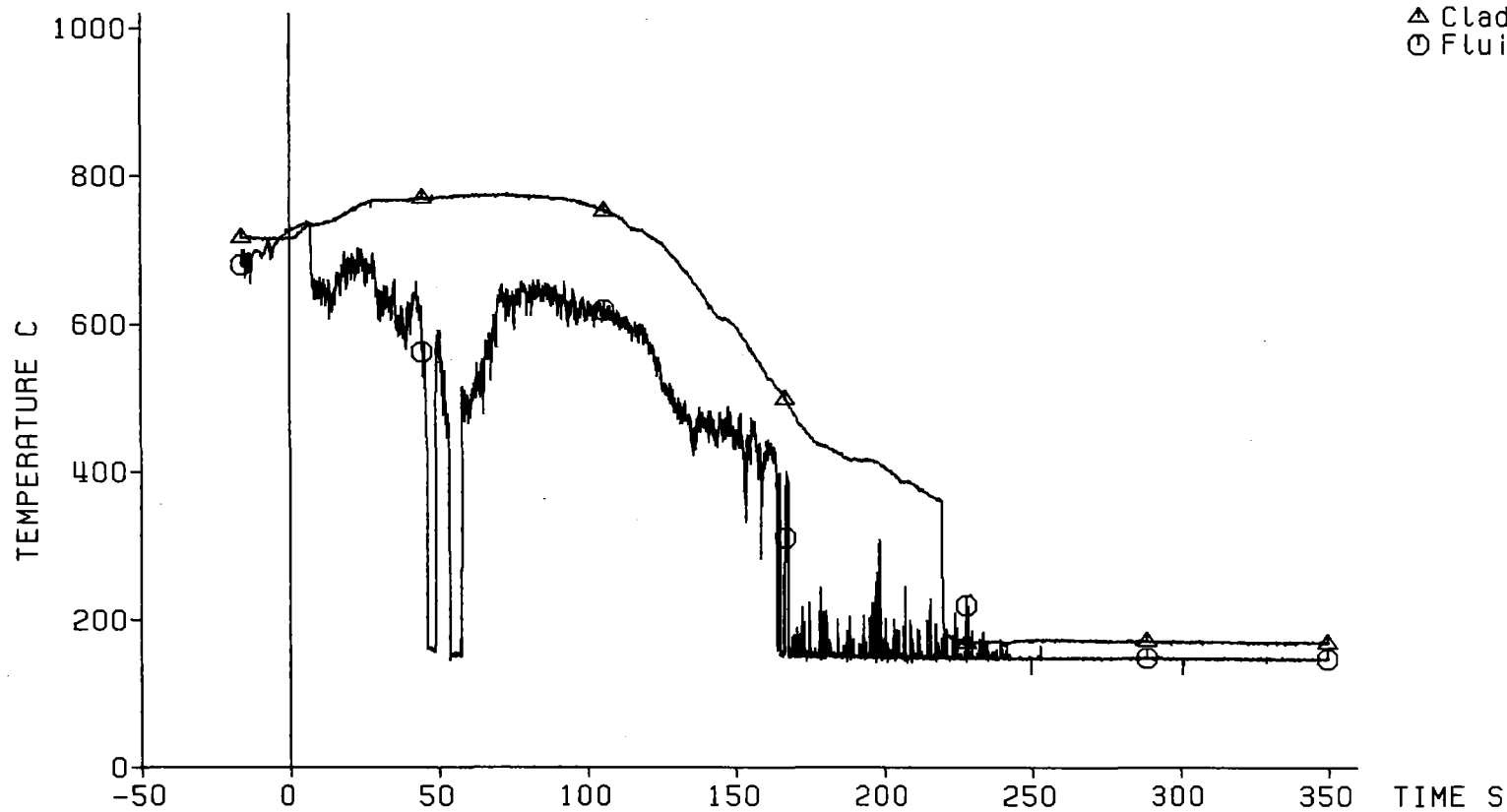

△ Cladding Temperature (16g1)
○ Fluid Temperature

Decay Heat 120% ANS Standard
Flooding Rate (cold) 3.77 cm/s
System Pressure 3.84 bar
Feedwater Temperature 40 C

Blockage Area
=====



Fig. 111 FEBA: 5x5 ROD BUNDLE, TEST SERIES 6, TEST-No. 276

Pressure Loss
Along the Test Section:

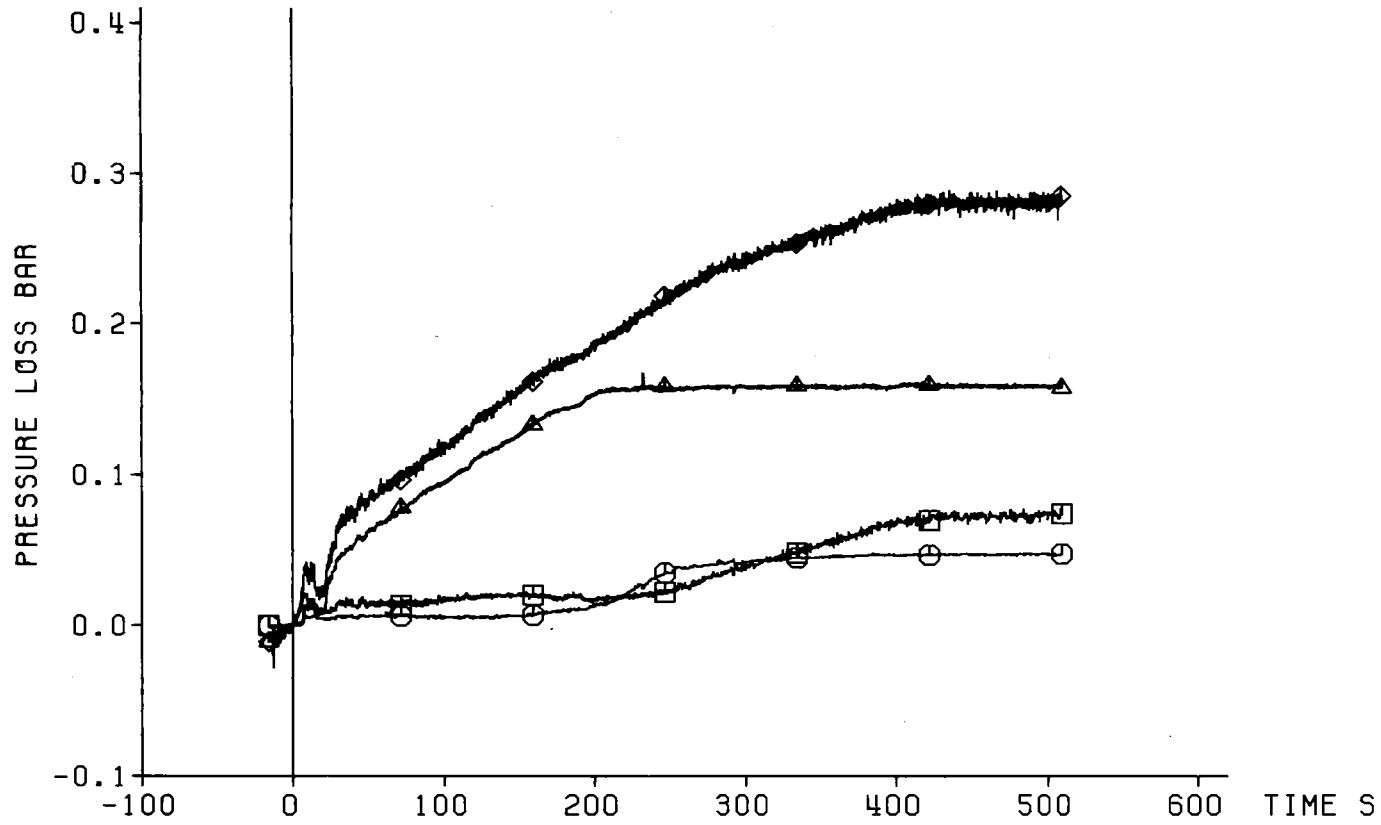

◇ Total Length: 4196 mm
△ Lower Part: 1711 mm
○ Middle Part: 545 mm
□ Upper Part: 1940 mm

Decay Heat 120% ANS Standard
Flooding Rate (cold) 3.77 cm/s
System Pressure 3.94 bar
Feedwater Temperature 40 C



Fig. 112 FEBA: 5x5 ROD BUNDLE, TEST SERIES 6, TEST-NO. 276

Coolant Outlet Conditions:

△ Water Carry Over
○ Coolant Temperature
□ Coolant Pressure

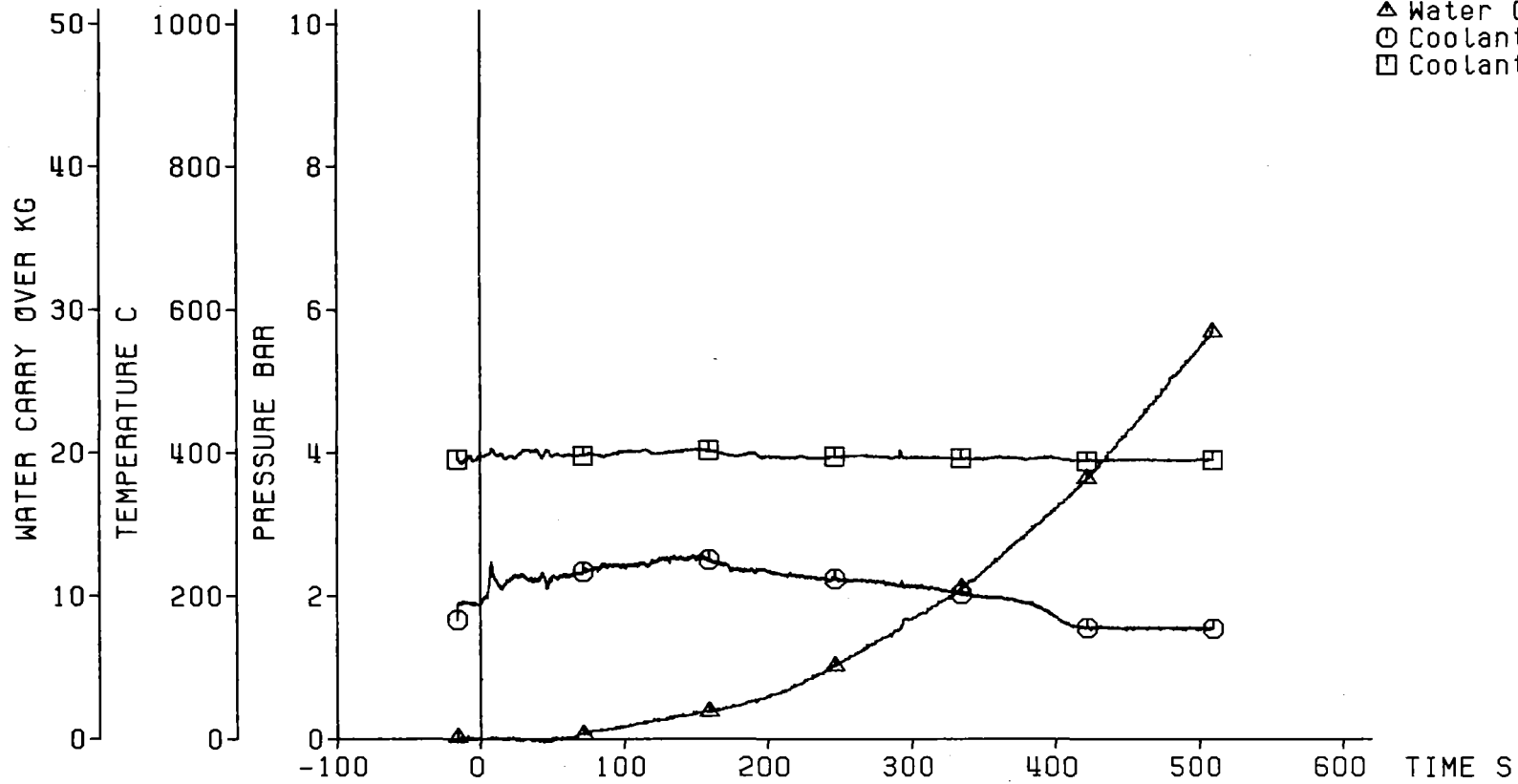

Decay Heat 120% ANS Standard
Flooding Rate (cold) 3.77 cm/s
System Pressure 3.94 bar
Feedwater Temperature 40 C

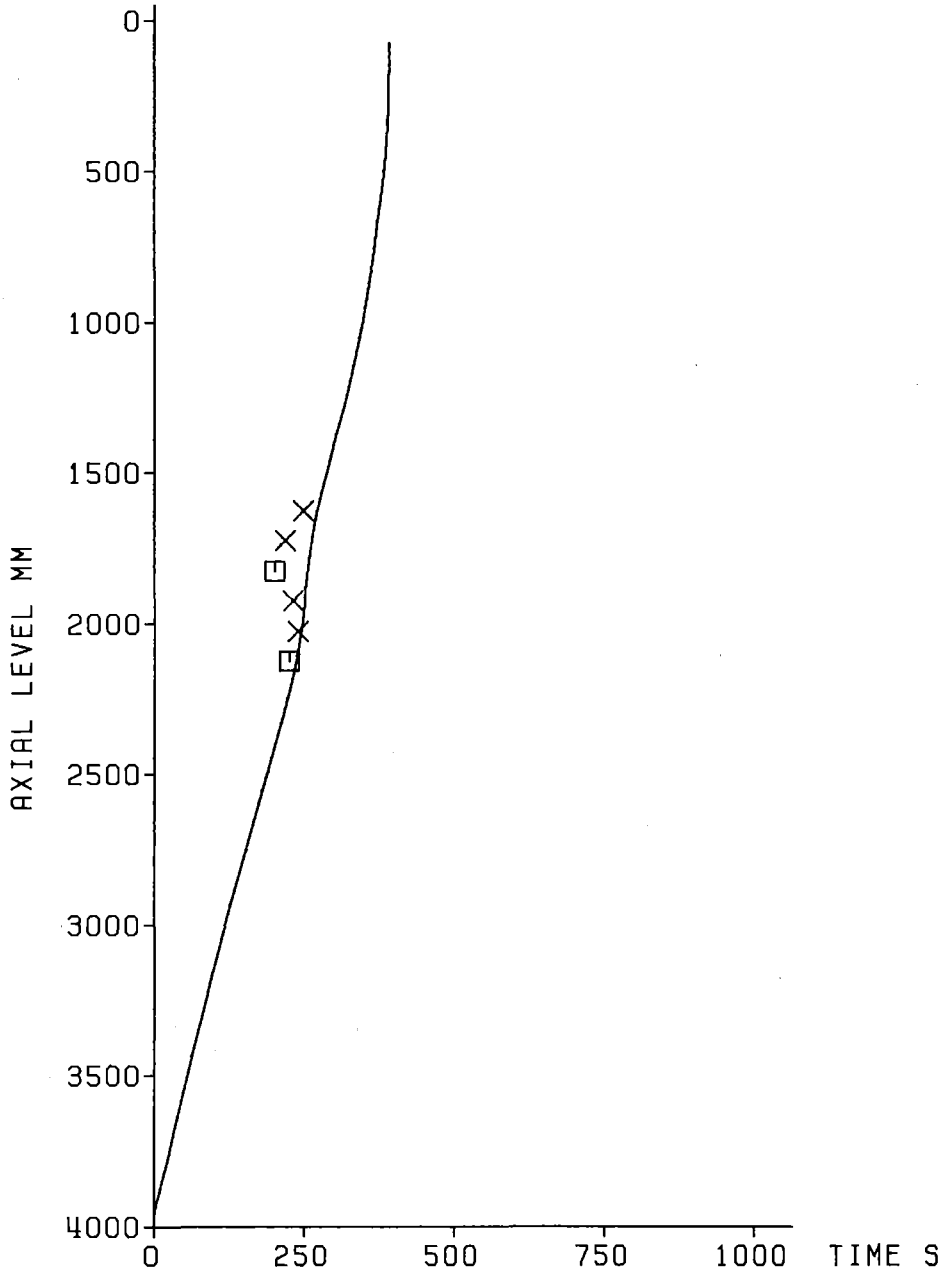

Fig. 113 FEBA: 5x5 ROD BUNDLE, TEST SERIES 6, TEST-No. 276

Axial Position of Quench Front

□ Quenching of Sleeves

X Quenching of Claddings Downstream of Blockage Area



Decay Heat	120% ANS Standard
Flooding Rate (cold)	3.77 cm/s
System Pressure	3.94 bar
Feedwater Temperature	40 C



Fig. 114 FEBA: 5x5 ROD BUNDLE
TEST SERIES 6, TEST-No. 276

TEST SERIES VI

Investigation of the Effects of 90% and 62% Flow Blockages With Bypass,
 90% Blockage at Axial Level 2125 mm, 62% Blockage at Axial Level 1925 mm
 of 3x3 Rods Placed in the Corner of the 5x5 Rod Bundle,
 Grid Spacer at the Bundle Midplane

Channel Listing and Data Identification for Test No. 274 Through 278

Channel No.	Data Identification		Unit	Remarks
	Type	Location		
1	Cladding Temperature	18a4.3860 ¹	°C	
2	Cladding Temperature	18a3.3315	°C	
3	Cladding Temperature	18a2.2770	°C	
4	Cladding Temperature	18a1.2225	°C	
5	Cladding Temperature	12b4.1680	°C	
6	Cladding Temperature	12b3.1135	°C	TC Failed During Test 278
7	Cladding Temperature	12b2.590	°C	TC Failed
8	Cladding Temperature	12b1.45	°C	TC Failed
9	Cladding Temperature	17h4.2225	°C	
10	Cladding Temperature	17h3.2125	°C	
11	Cladding Temperature	17h2.2025	°C	
12	Cladding Temperature	17h1.1925	°C	
13	Fluid Temperature	TF ² 2770	°C	
14	Fluid Temperature	TF ² 2380	°C	
15	Fluid Temperature	TF ² 1625	°C	
16	Fluid Temperature	TF ² 485	°C	
17	Housing Temperature	TK ⁴ 3564	°C	
18	Housing Temperature	TK 1925	°C	
19	Housing Temperature	TK 1383	°C	
20	Housing Temperature	TK 590	°C	
21	Fluid Temperature	Lower Plenum	°C	
22	Water Level Detector	4012	°C	Heated + Unheated TC's

TEST SERIES VI

Channel No.	Data Identification		Unit	Remarks
	Type	Location		
23	Feedwater Temperature		°C	
24	Fluid Temperature	Upper Plenum	°C	
25	Room Temperature		°C	
26	Cladding Temperature	22f4.2425 ¹	°C	
27	Cladding Temperature	22f3.2325	°C	
28	Cladding Temperature	22f2.2225	°C	
29	Cladding Temperature	22f1.2125	°C	
30	Cladding Temperature	21j4.1525	°C	
31	Cladding Temperature	21j3.1425	°C	
32	Cladding Temperature	21j2.1325	°C	
33	Cladding Temperature	21j1.1225	°C	
34	Cladding Temperature	19g4.1925	°C	
35	Cladding Temperature	19g3.1825	°C	
36	Cladding Temperature	19g2.1725	°C	
37	Cladding Temperature	19g1.1625	°C	
38	Cladding Temperature	16g4.1925	°C	
39	Cladding Temperature	16g3.1825	°C	
40	Cladding Temperature	16g1.1725	°C	
41	Cladding Temperature	16g2.1625	°C	
42	Cladding Temperature	15a4.3860	°C	
43	Cladding Temperature	15a3.3315	°C	
44	Cladding Temperature	15a2.2770	°C	
45	Cladding Temperature	15a1.2225	°C	
46	Cladding Temperature	14e4.2225	°C	TC Failed
47	Cladding Temperature	14e3.2175	°C	
48	Cladding Temperature	14e2.2125	°C	
49	Cladding Temperature	14e1.2075	°C	

TEST SERIES VI

Channel No.	Data Identification		Unit	Remarks
	Type	Location		
50	Cladding Temperature	13d3.2025 ¹	°C	
51	Cladding Temperature	13d2.2025	°C	
52	Cladding Temperature	13d1.2025	°C	
53	Cladding Temperature	10f4.2425	°C	TC Failed During Test 278
54	Cladding Temperature	10f3.2325	°C	
55	Cladding Temperature	10f2.2225	°C	
56	Cladding Temperature	10f1.2125	°C	
57	Cladding Temperature	9h4.2225	°C	
58	Cladding Temperature	9h3.2125	°C	
59	Cladding Temperature	9h2.2025	°C	
60	Cladding Temperature	9h1.1925	°C	
61	Cladding Temperature	8d4.2025	°C	
62	Cladding Temperature	8d3.2025	°C	
63	Cladding Temperature	8d2.2025	°C	
64	Cladding Temperature	8d1.2025	°C	
65	Cladding Temperature	7f4.2425	°C	
66	Cladding Temperature	7f3.2325	°C	
67	Cladding Temperature	7f2.2225	°C	
68	Cladding Temperature	7f1.2125	°C	
69	Sleeve Temperature	TH ⁵ 13.1825	°C	
70	Sleeve Temperature	TH 17.1825	°C	
71	Sleeve Temperature	TH 17.2125	°C	
72	Sleeve Temperature	TH 21.1825	°C	
73	Cladding Temperature	3b4.1680	°C	
74	Cladding Temperature	3b3.1135	°C	
75	Cladding Temperature	3b2. 590	°C	
76	Cladding Temperature	3b1. 45	°C	

TEST SERIES VI

Channel No.	Data Identification		Unit	Remarks
	Type	Location		
77	Sleeve Temperature	TH ⁵ 21.2125	°C	
78	-----	-----	-	Open
79	-----	-----	-	Open
80	Cladding Temperature	25k1. 100 ¹	°C	
81	Electrical Power Input	8 Rods	kW	Rods No. 1 Through 8
82	Electrical Power Input	8 Rods	kW	Rods No. 9 Through 16
83	Electrical Power Input	9 Rods	kW	Rods No. 17 Through 25
84	Housing Temperature	TK ⁴ 3030	°C	
85	Cladding Temperature	25k4. 400	°C	
86	Cladding Temperature	2c4.4025	°C	
87	Cladding Temperature	2c3.3925	°C	
88	Cladding Temperature	2c2.3825	°C	
89	Cladding Temperature	2c1.3725	°C	
90	Cladding Temperature	24c4.4025	°C	
91	Cladding Temperature	24c3.3925	°C	
92	Cladding Temperature	24c2.3825	°C	
93	Cladding Temperature	24c1.3725	°C	
94	Cladding Temperature	5j1.1225	°C	
95	Cladding Temperature	5j2.1325	°C	
95	Cladding Temperature	5j3.1425	°C	
97	Cladding Temperature	5j4.1525	°C	
98	Cladding Temperature	11i1.1875	°C	
99	Cladding Temperature	11i2.1925	°C	
100	Fluid Temperature	TF ³ 2245	°C	

TEST SERIES VI

Channel No.	Data Identification		Unit	Remarks
	Type	Location		
101	Fluid Temperature	TF ³ 1900	°C	
102	Fluid Temperature	TF ³ 1625	°C	
103	-----		-	Open
104	-----		-	Open
105	Fluid Temperature	TF ² 1135	°C	
106	-----		-	Open
107	-----		-	Open
108	Cladding Temperature	11i3.1975 ¹	°C	
109	Cladding Temperature	11i4.2025	°C	
110	Time (10 Scans/s)		s	t = 0: Start of Reflooding
111	Pressure in Lower Plenum	4091	bar	
112	Pressure in Upper Plenum	-105	bar	
113	Pressure in Buffer		bar	
114	Bundle Power		kW	Channels: 81 + 82 + 83
115	Flooding Velocity (cold)		cm/s	
116	Water Carry Over Collected		kg	Downstream of Bundle Exit
117	Pressure Diff.	1835 and -105 mm	bar	
118	Measured	2380 and 1835 mm	bar	
119	Between	4091 and 2380 mm	bar	
120	Axial Level	4091 and -105 mm	bar	Values Measured Separately

- 1) TC's of 0.5 mm diameter embedded in rod cladding. Measuring position:
Example: rod No. = 18, type of rod instrumentation = a, TC No. = 4,
axial level = 3860 mm, referenced to the top flange of the bundle.
- 2) TF = TC's of 0.25 mm diameter (bare).
TC's placed in subchannel surrounded by rods No. 12, 17, 16 and 11.

TEST SERIES VI

3) TF = TC's of 0.25 mm diameter (bare).

TC's placed in subchannel surrounded by rods No. 10, 15, 14 and 9.

4) TK = TC's of 0.5 mm diameter placed in the wall of the bundle housing of
of 6.5 mm thickness.

5) TH = TC's of 0.5 mm diameter embedded in sleeve. Measuring position:

Example: rod No. 13, axial level = 1825 mm.

TEST SERIES VII

Investigation of the Effects of a 62% Flow Blockage Without Bypass,
Blockage at the Bundle Midplane of all Rods of the 5x5 Rod Bundle

Test No.	Flooding Velocity (cold) cm/s	System Pressure bar	Feedwater Temp. ¹ °C		Bundle Power ² kW		Remarks
			0-30 s	End	0 s	Transient	
327	2.2	4.1	55	35	200	120% ANS	Figs. 117 Through 139
322	3.8	2.1	54	41	200	120% ANS	Figs. 140 Through 162
324	3.8	4.1	56	42	200	120% ANS	Figs. 163 Through 185
329	3.8	5.9	63	41	200	120% ANS	Figs. 186 Through 208
321	5.8	2.1	47	40	200	120% ANS	Figs. 209 Through 231
325	5.8	4.1	61	46	200	120% ANS	Figs. 232 Through 254
330	5.8	5.9	65	44	200	120% ANS	Figs. 255 Through 277
323	Steam	2.0	--	--	Low Power		Data Not Plotted
326	Steam	4.0	--	--	Low Power		Data Not Plotted
331	Steam	6.0	--	--	Low Power		Data Not Plotted

- 1) Measured in the lower plenum
- 2) Decay heat transient corresponding 120% ANS Standard 40 s after shutdown of the reactor

Table 3 FEBA 5x5 rod bundle: Main test parameters of test series VII

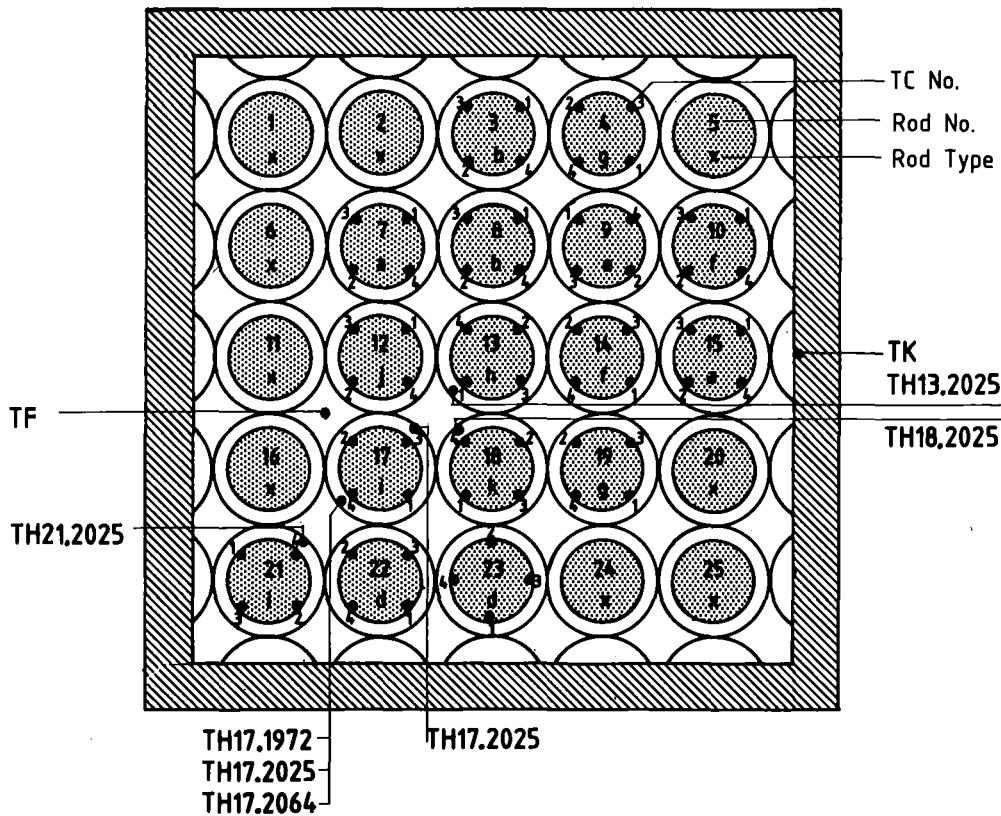

Rod Type	TC No.	Axial Level mm
a	1	2225
	2	2770
	3	3315
	4	3860
b	1	45
	2	590
	3	1135
	4	1680
c	1	3725
	2	3825
	3	3925
	4	4025
d	1	2025
	2	2025
	3	2025
	4	2025

Rod Type	TC No.	Axial Level mm
e	1	2075
	2	2125
	3	2175
	4	2225
f	1	2125
	2	2225
	3	2325
	4	2425
g	1	1625
	2	1725
	3	1825
	4	1925
h	1	1925
	2	2025
	3	2125
	4	2225

Rod Type	TC No.	Axial Level mm
i	1	1875
	2	1925
	3	1975
	4	2025
j	1	1225
	2	1325
	3	1425
	4	1525
k	1	100
	2	200
	3	300
	4	400
x	without TC's	

Fig. 115 5x5 rod bundle: Radial and axial location of cladding, sleeve, fluid and housing TC's for test series VII

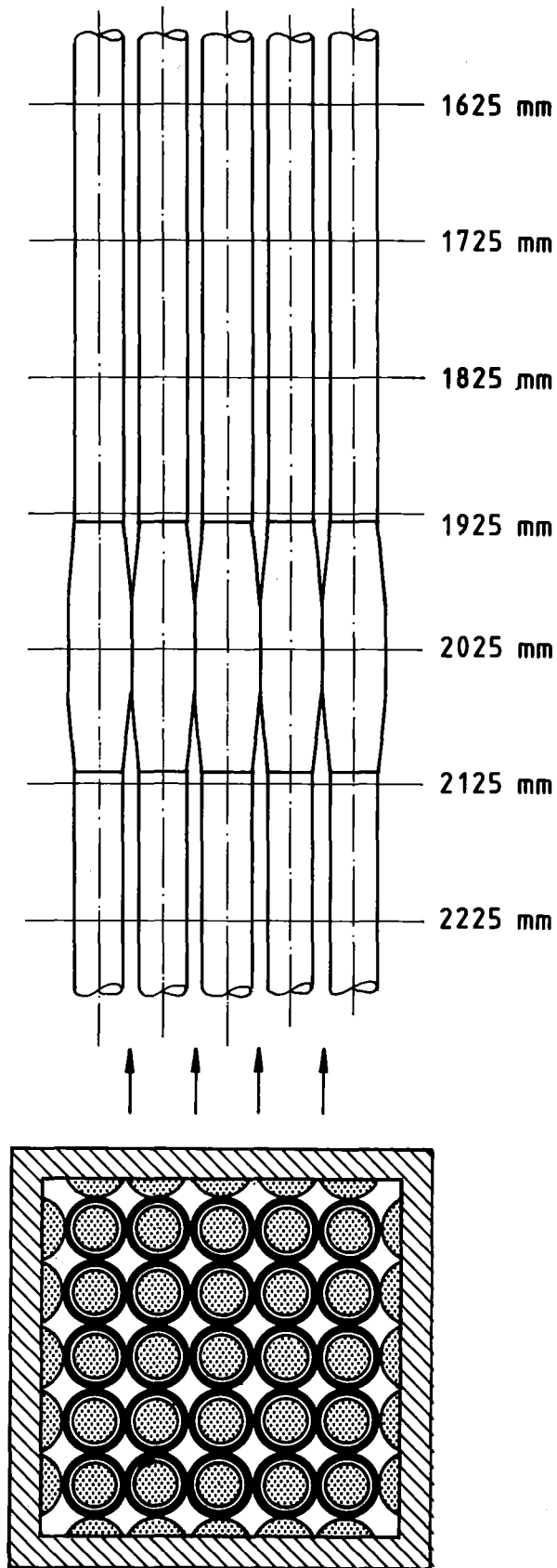
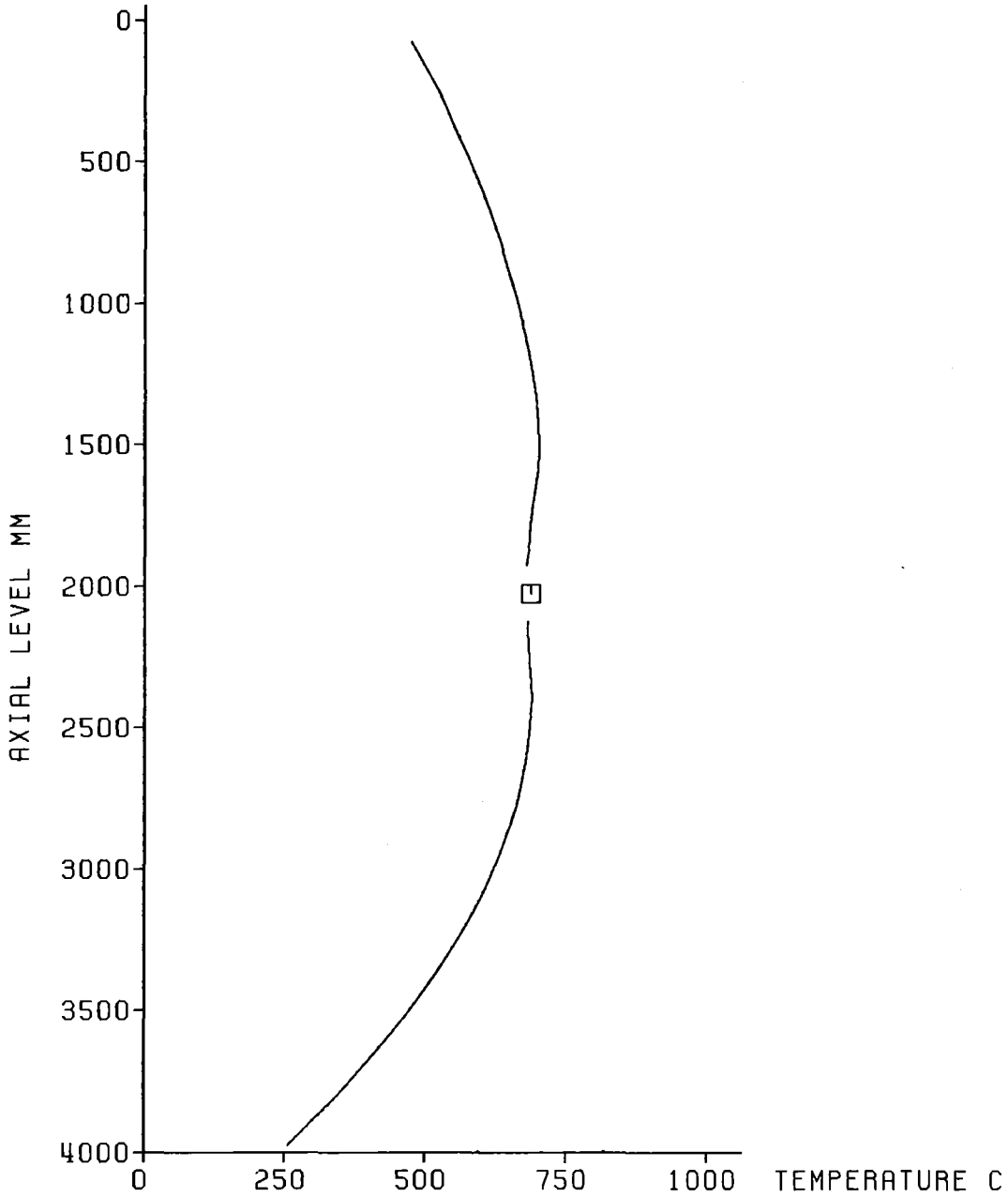

Fig. 116 5x5 rod bundle: Layout of the bundle geometry of test series VII

Initial Axial Temperature Profile of Claddings

□ Initial Temperature of Sleeves at Bundle Midplane



Decay Heat	120% ANS Standard
Flooding Rate (cold)	2.21 cm/s
System Pressure	4.15 bar
Feedwater Temperature	40 C



Fig. 117 FEBA: 5x5 ROD BUNDLE
TEST SERIES 7, TEST-No. 327

Test Parameters:

- ◇ Flooding Rate
- △ System Pressure
- Feedwater Temperature
- Bundle Power

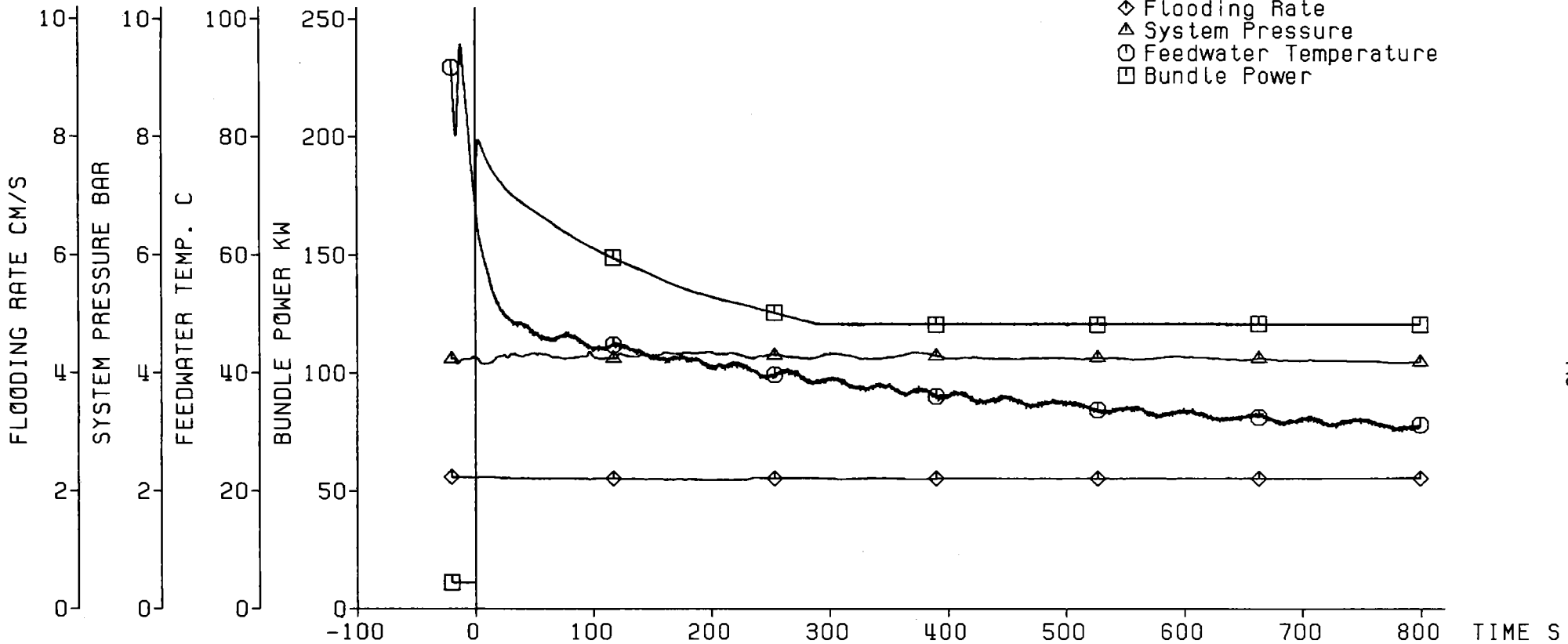

Decay Heat 120% ANS Standard
Flooding Rate (cold) 2.21 cm/s
System Pressure 4.15 bar
Feedwater Temperature 40 C



Fig. 118 FEBA: 5x5 ROD BUNDLE, TEST SERIES 7, TEST-No. 327

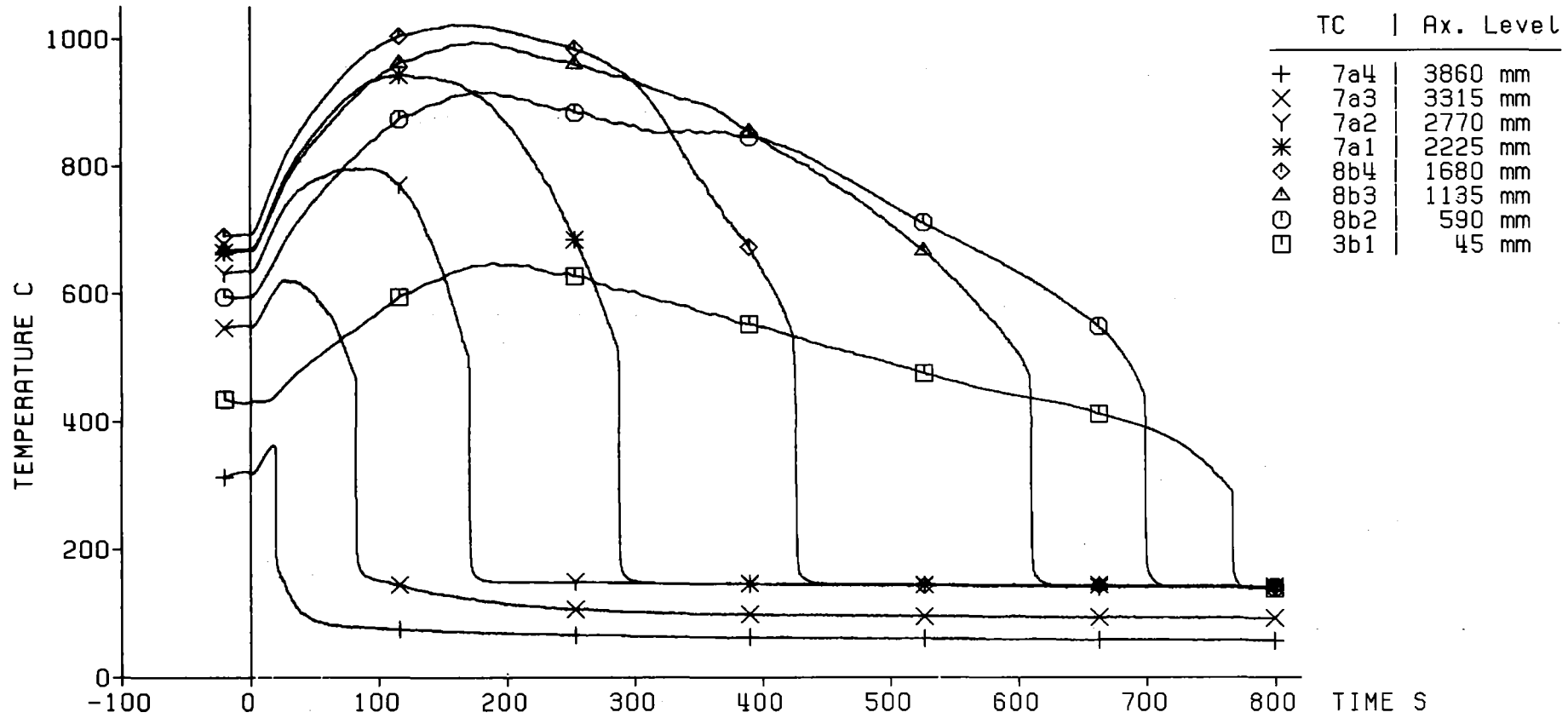

Decay Heat 120% ANS Standard
 Flooding Rate (cold) 2.21 cm/s
 System Pressure 4.15 bar
 Feedwater Temperature 40 C



Fig. 119 FEBA: 5x5 ROD BUNDLE, TEST SERIES 7, TEST-No. 327

Heat Transfer Coeff.

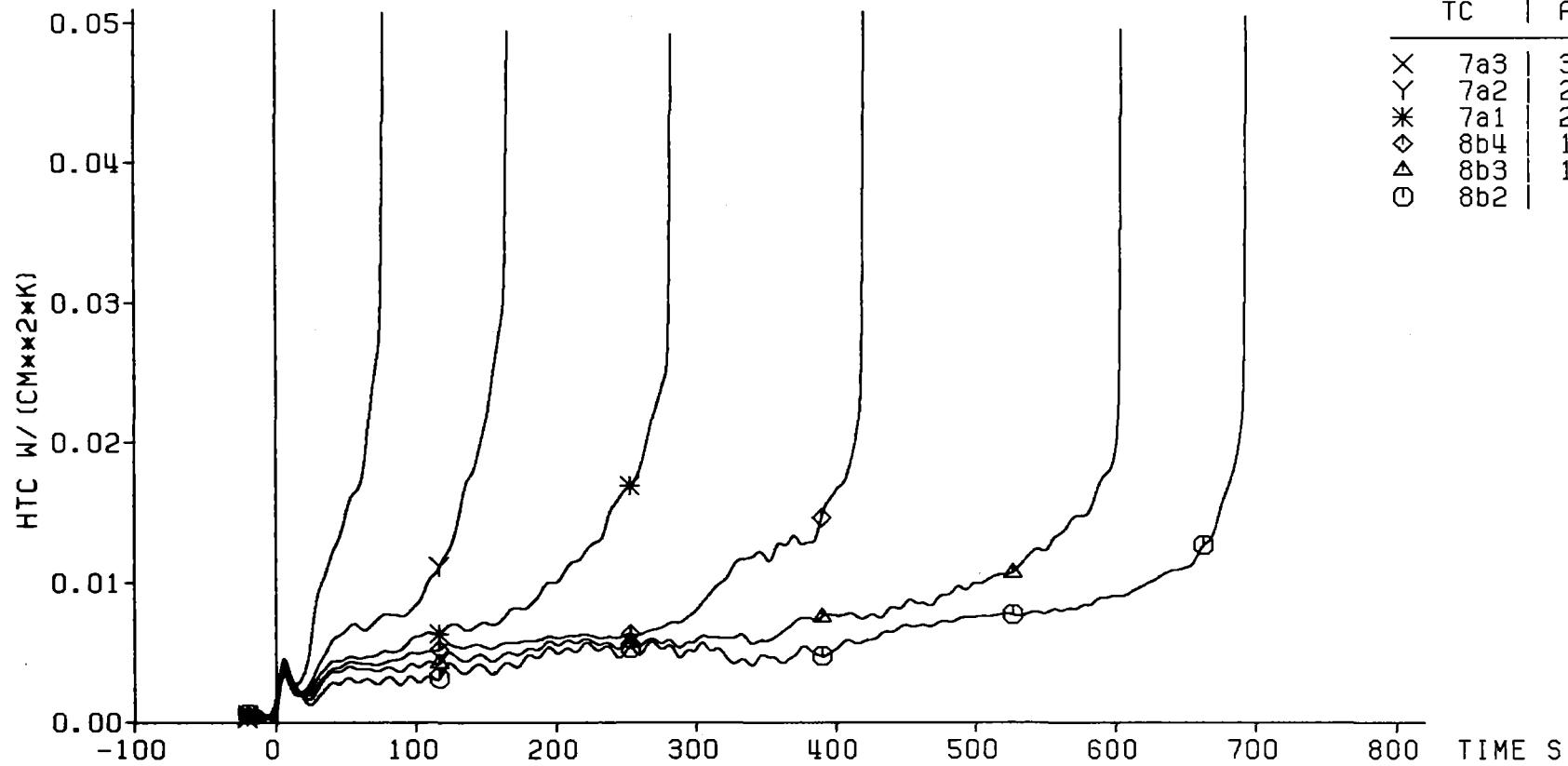

Decay Heat 120% ANS Standard
 Flooding Rate (cold) 2.21 cm/s
 System Pressure 4.15 bar
 Feedwater Temperature 40 C



Fig. 120 FEBA: 5x5 ROD BUNDLE, TEST SERIES 7, TEST-No. 327

Cladding Temperature

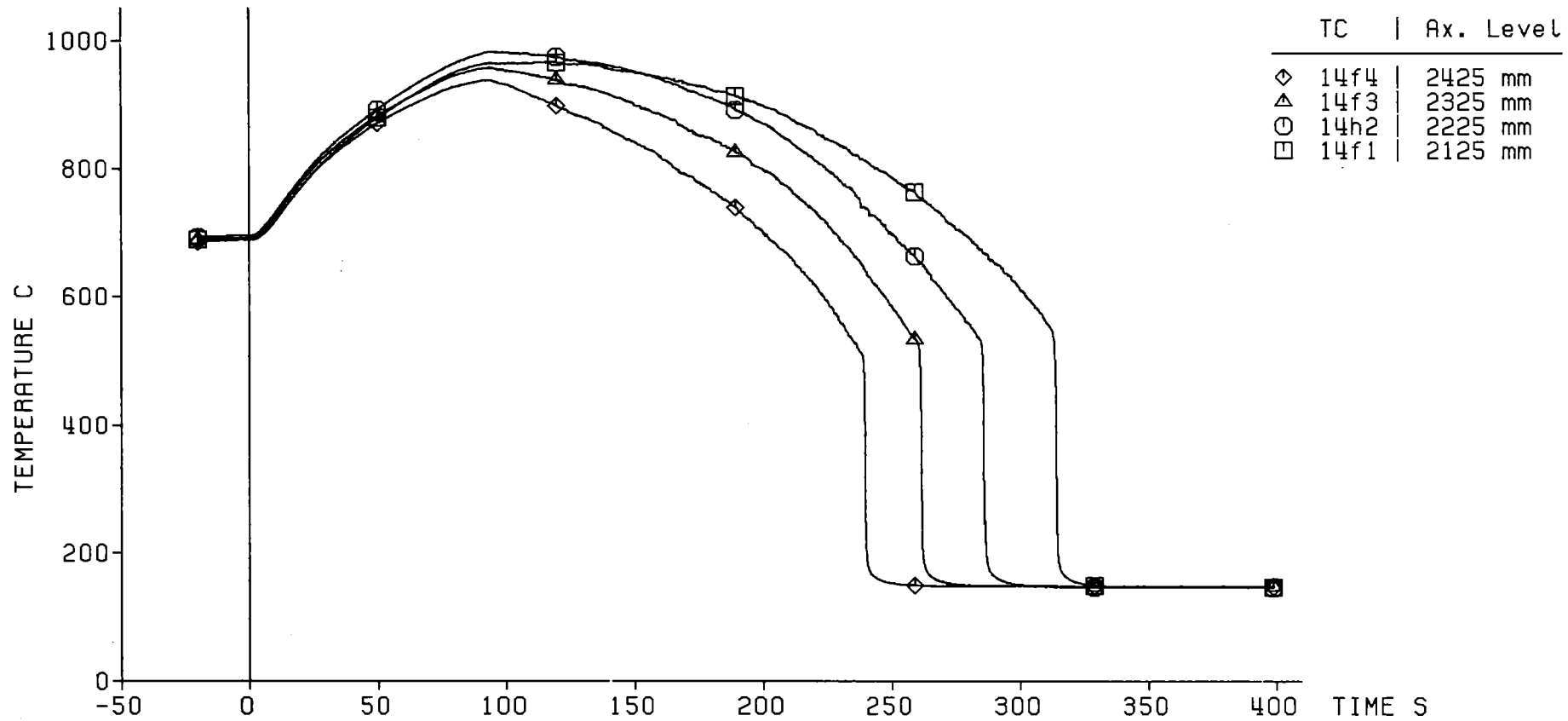

Decay Heat 120% ANS Standard
 Flooding Rate (cold) 2.21 cm/s
 System Pressure 4.15 bar
 Feedwater Temperature 40 C



Fig. 121 FEBA: 5x5 ROD BUNDLE, TEST SERIES 7, TEST-No. 327

Heat Transfer Coeff.

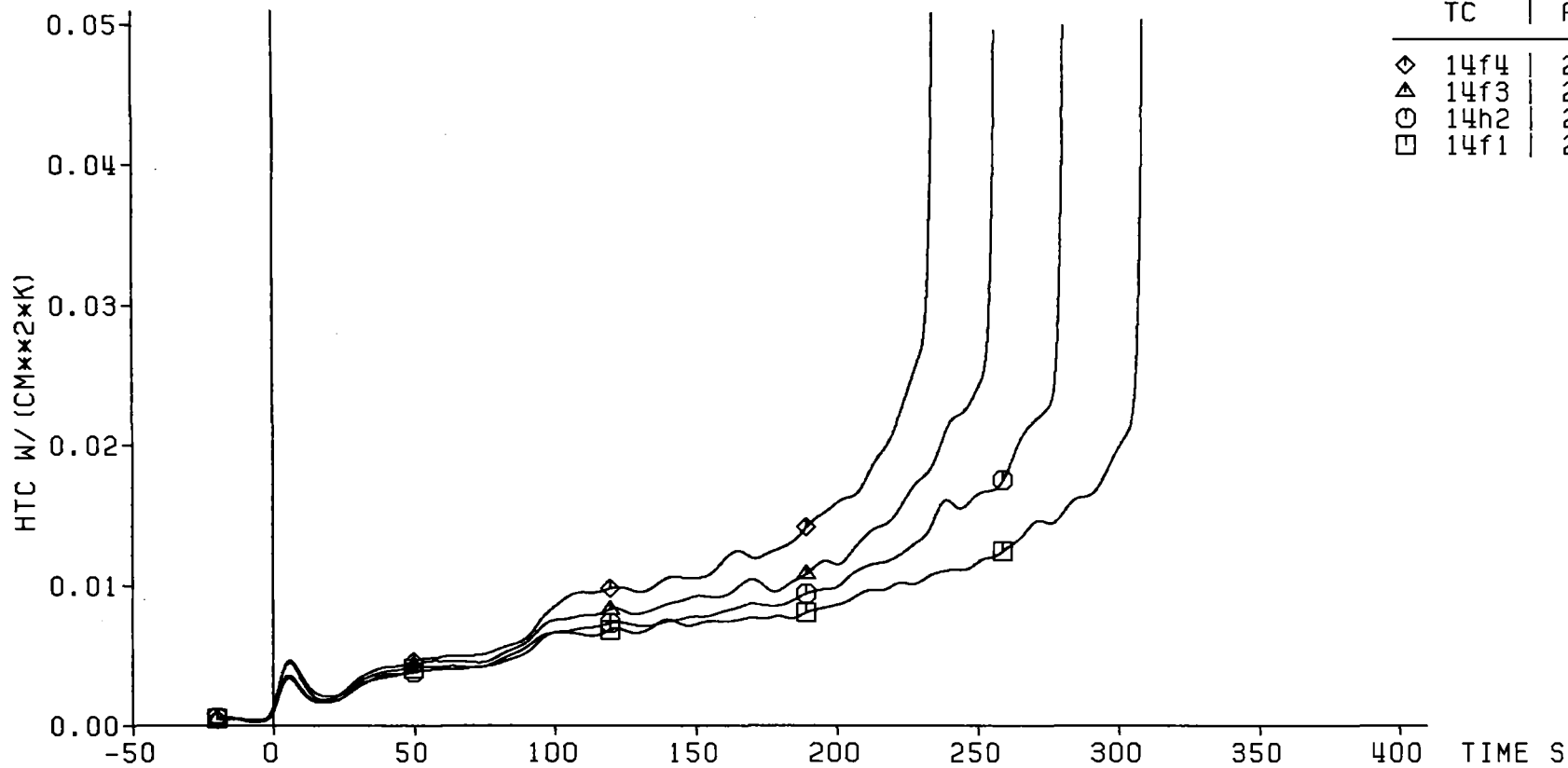

Decay Heat 120% ANS Standard
 Flooding Rate (cold) 2.21 cm/s
 System Pressure 4.15 bar
 Feedwater Temperature 40 C



Fig. 122 FEBA: 5x5 ROD BUNDLE, TEST SERIES 7, TEST-No. 327

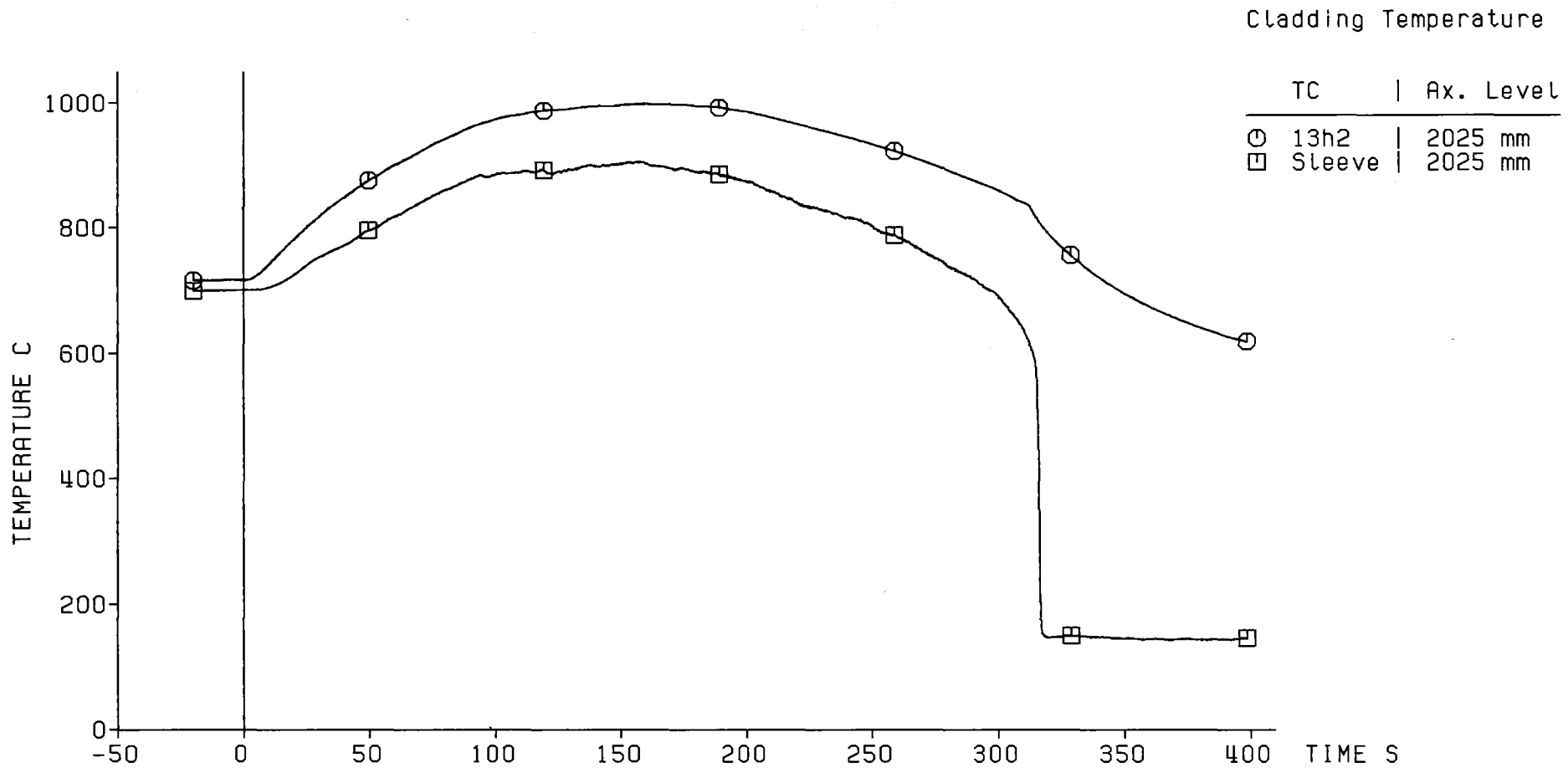

Decay Heat	120% ANS Standard
Flooding Rate (cold)	2.21 cm/s
System Pressure	4.15 bar
Feedwater Temperature	40 C

KIK IRB

Fig. 123 FEBA: 5x5 ROD BUNDLE, TEST SERIES 7, TEST-No. 327

Cladding Temperature

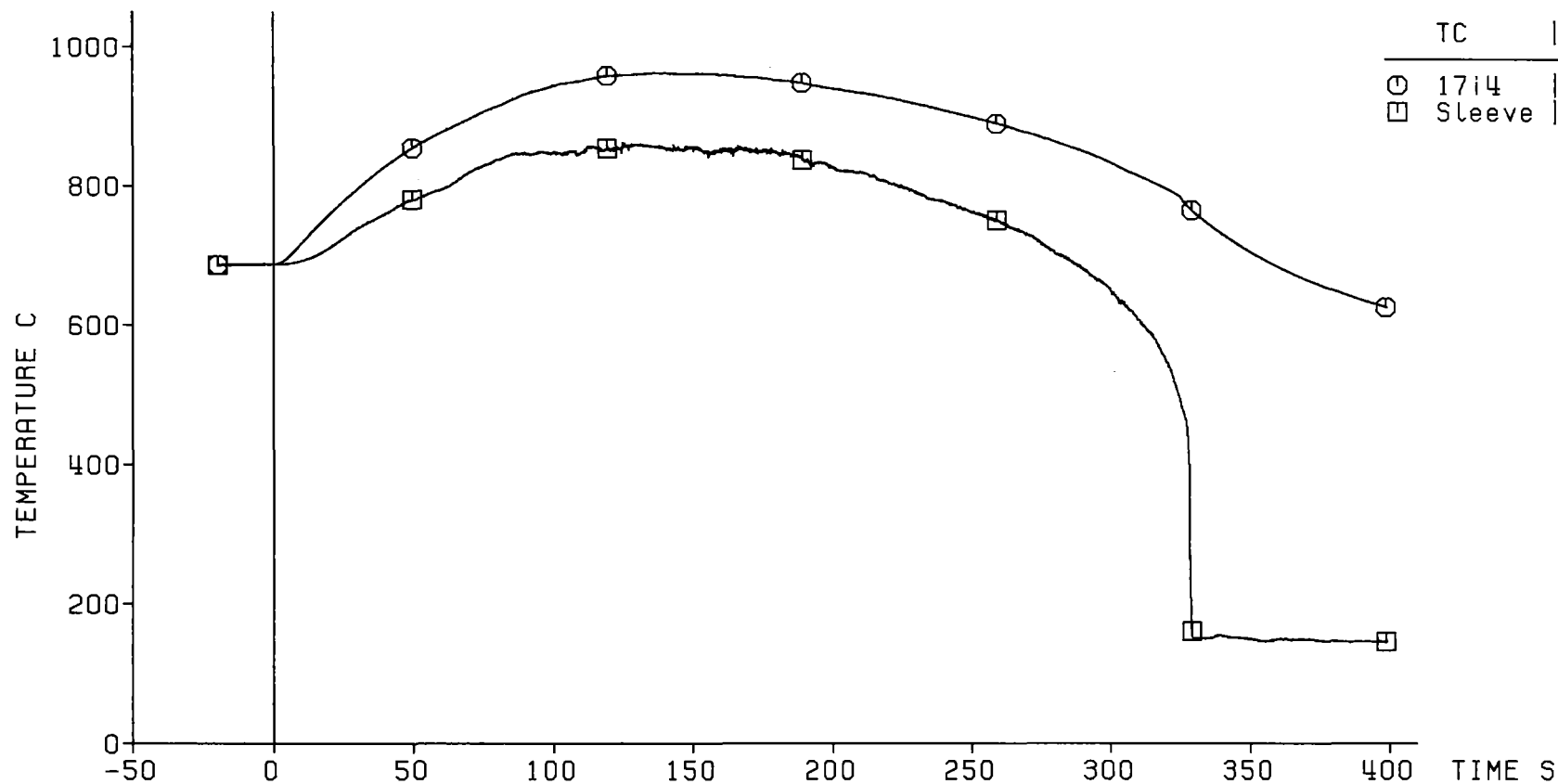

Decay Heat 120% ANS Standard
 Flooding Rate (cold) 2.21 cm/s
 System Pressure 4.15 bar
 Feedwater Temperature 40 C



Fig. 124 FEBA: 5x5 ROD BUNDLE, TEST SERIES 7, TEST-No. 327

Cladding Temperature

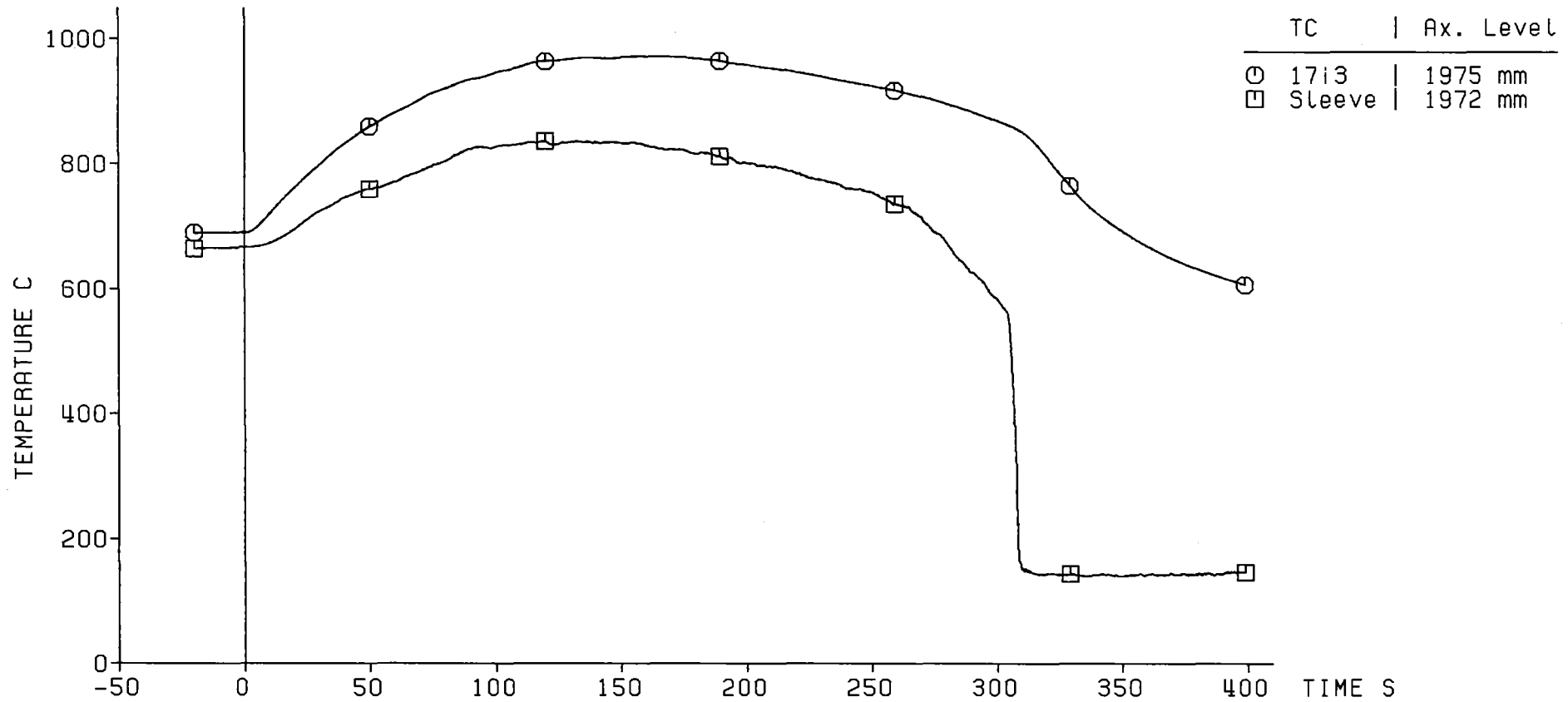

Decay Heat 120% ANS Standard
 Flooding Rate (cold) 2.21 cm/s
 System Pressure 4.15 bar
 Feedwater Temperature 40 C



Fig. 125 FEBA: 5x5 ROD BUNDLE, TEST SERIES 7, TEST-No. 327

Cladding Temperature

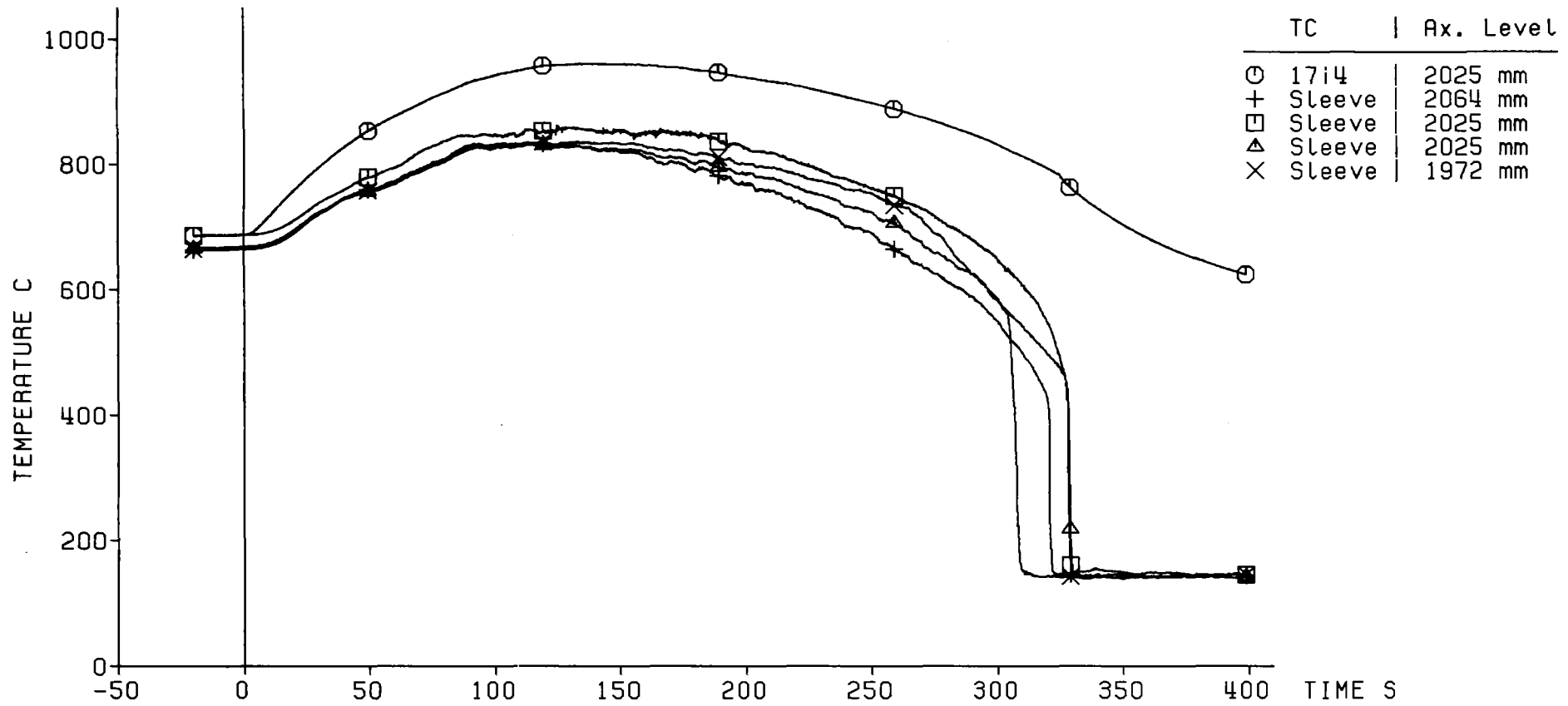

Decay Heat 120% ANS Standard
 Flooding Rate (cold) 2.21 cm/s
 System Pressure 4.15 bar
 Feedwater Temperature 40 C



Fig. 126 FEBA: 5x5 ROD BUNDLE, TEST SERIES 7, TEST-No. 327

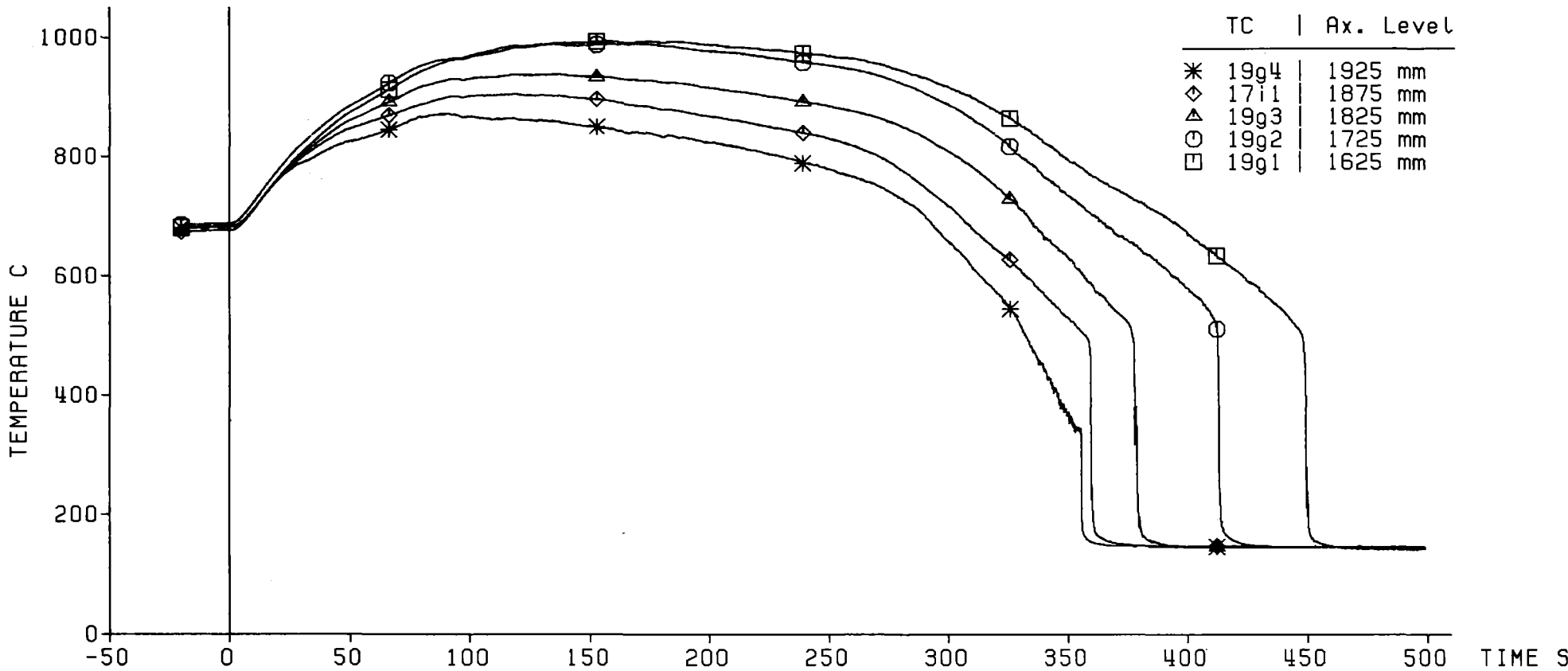

Decay Heat 120% ANS Standard
Flooding Rate (cold) 2.21 cm/s
System Pressure 4.15 bar
Feedwater Temperature 40 C



Fig. 127 FEBA: 5x5 ROD BUNDLE, TEST SERIES 7, TEST-No. 327

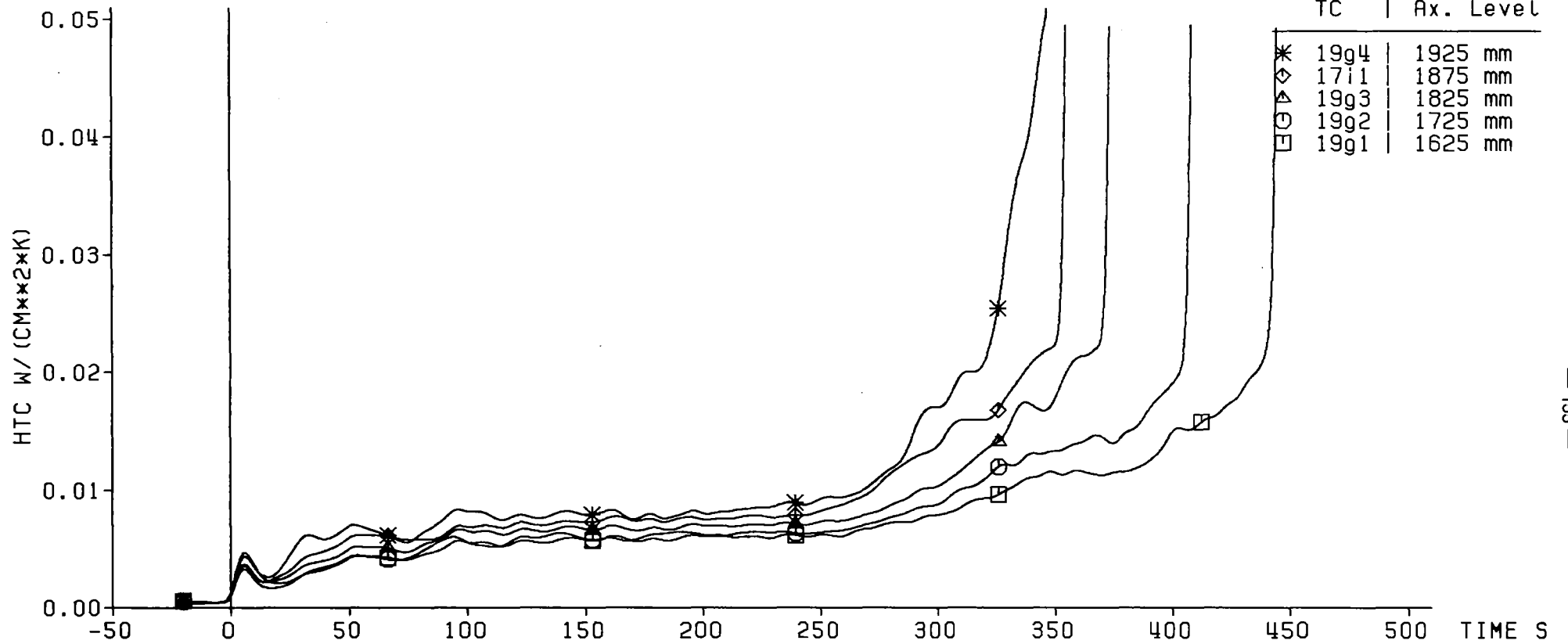

— 155 —

Decay Heat 120% ANS Standard
 Flooding Rate (cold) 2.21 cm/s
 System Pressure 4.15 bar
 Feedwater Temperature 40 C



Fig. 128 FEBA: 5x5 ROD BUNDLE, TEST SERIES 7, TEST-No. 327

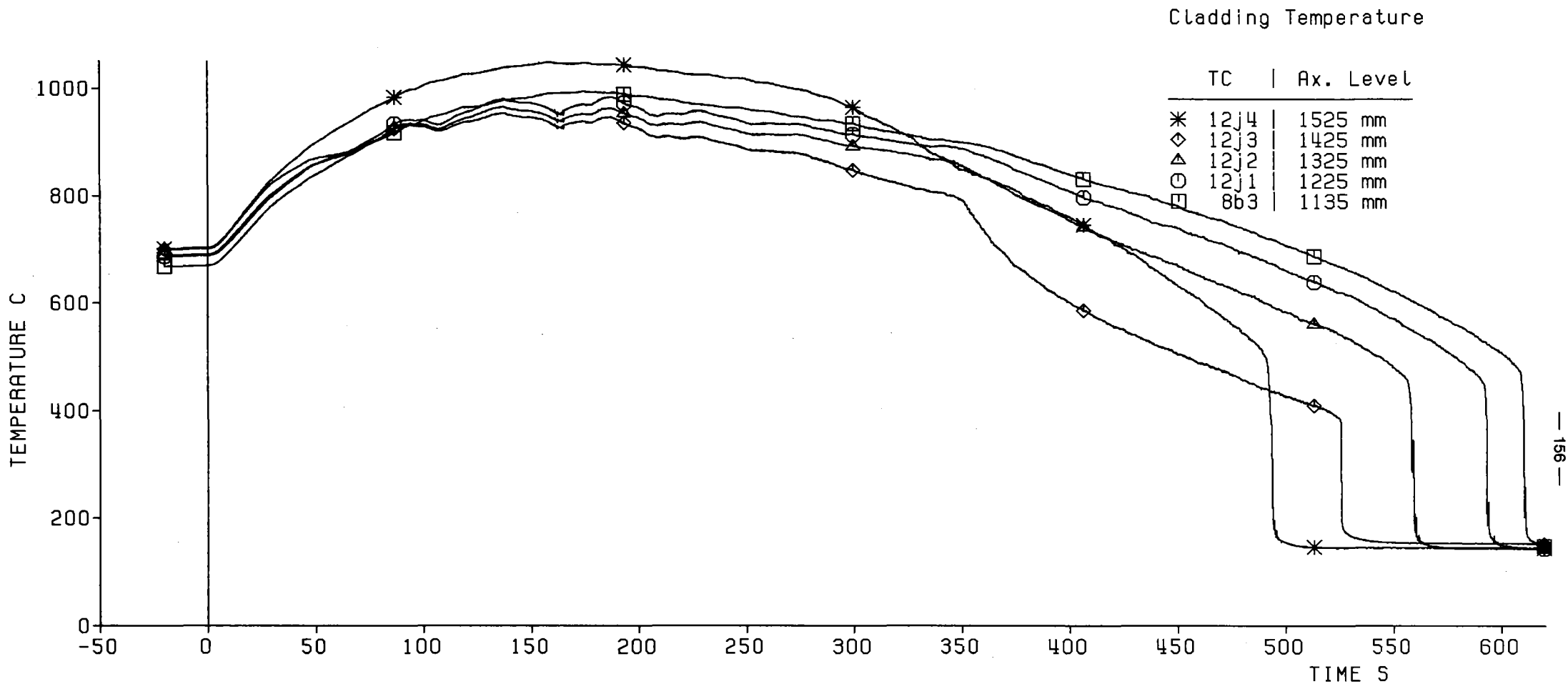

Decay Heat 120% ANS Standard
 Flooding Rate (cold) 2.21 cm/s
 System Pressure 4.15 bar
 Feedwater Temperature 40 C

KfK IRB

Fig. 129 FEBA: 5x5 ROD BUNDLE, TEST SERIES 7, TEST-No. 327

Heat Transfer Coeff.

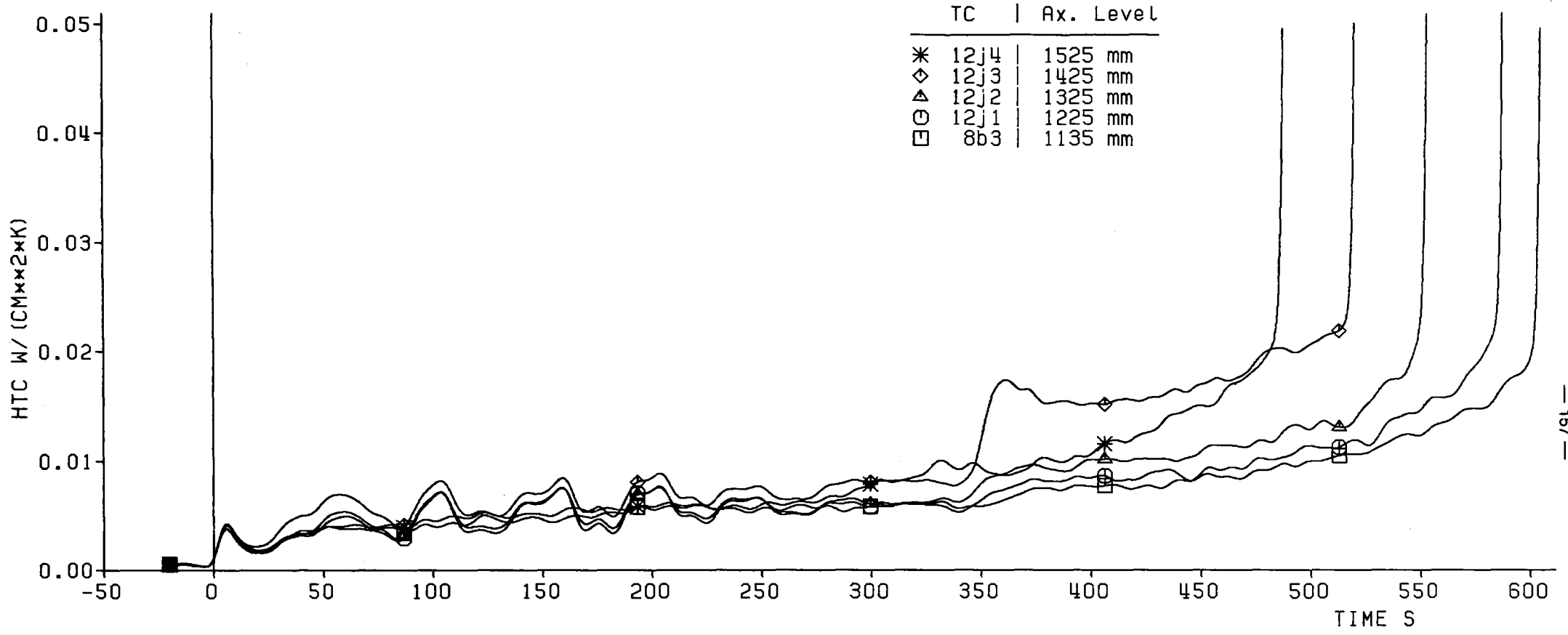

Decay Heat 120% ANS Standard
 Flooding Rate (cold) 2.21 cm/s
 System Pressure 4.15 bar
 Feedwater Temperature 40 C



Fig. 130 FEBA: 5x5 ROD BUNDLE, TEST SERIES 7, TEST-No. 327

Axial Level: 2770 mm

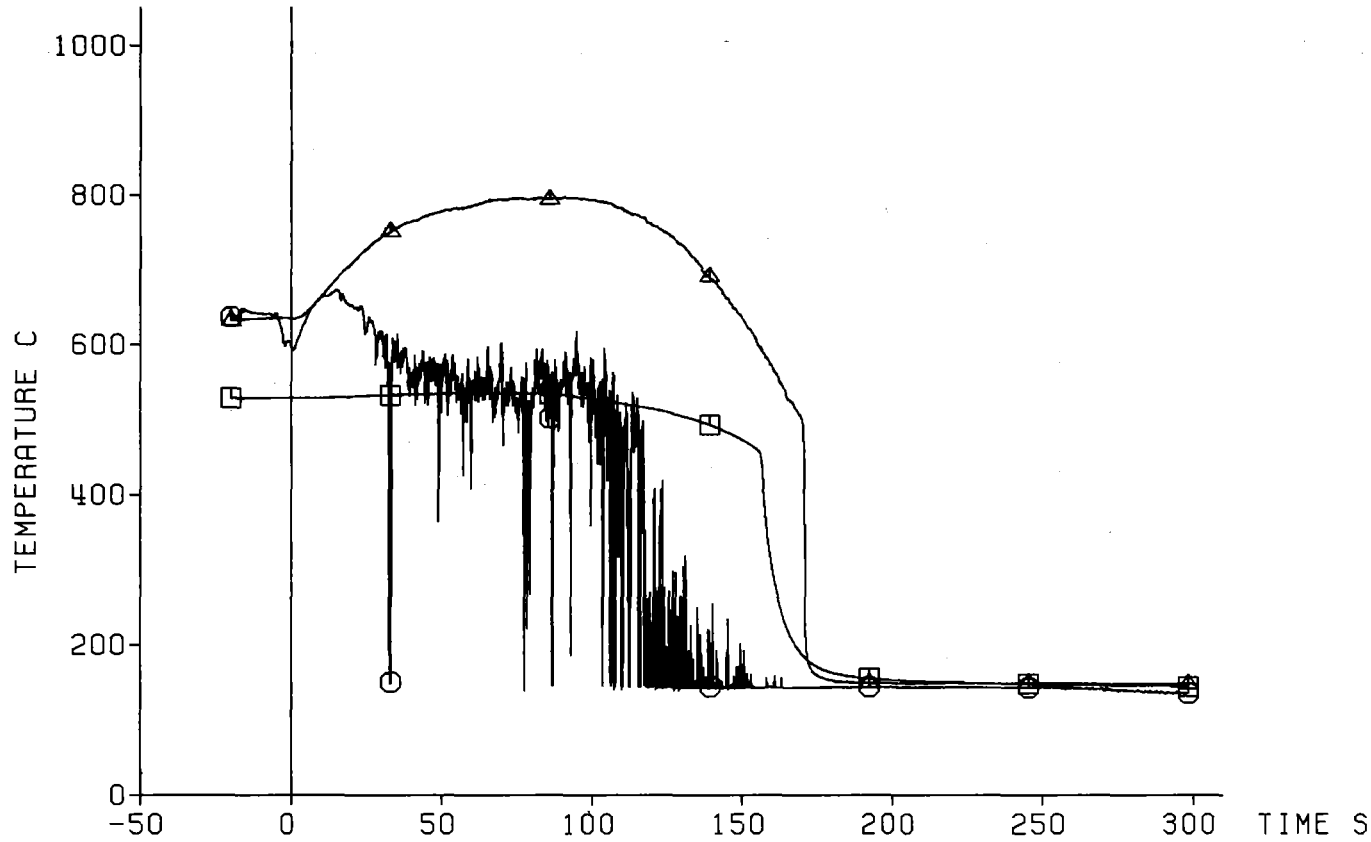

Decay Heat 120% ANS Standard
Flooding Rate (cold) 2.21 cm/s
System Pressure 4.15 bar
Feedwater Temperature 40 C



Fig. 131 FEBA: 5x5 ROD BUNDLE, TEST SERIES 7, TEST-No. 327

Axial Level: 2225 mm

△ Cladding Temperature (7a1)
○ Fluid Temperature (2240 mm)
□ Housing Temperature (2235 mm)

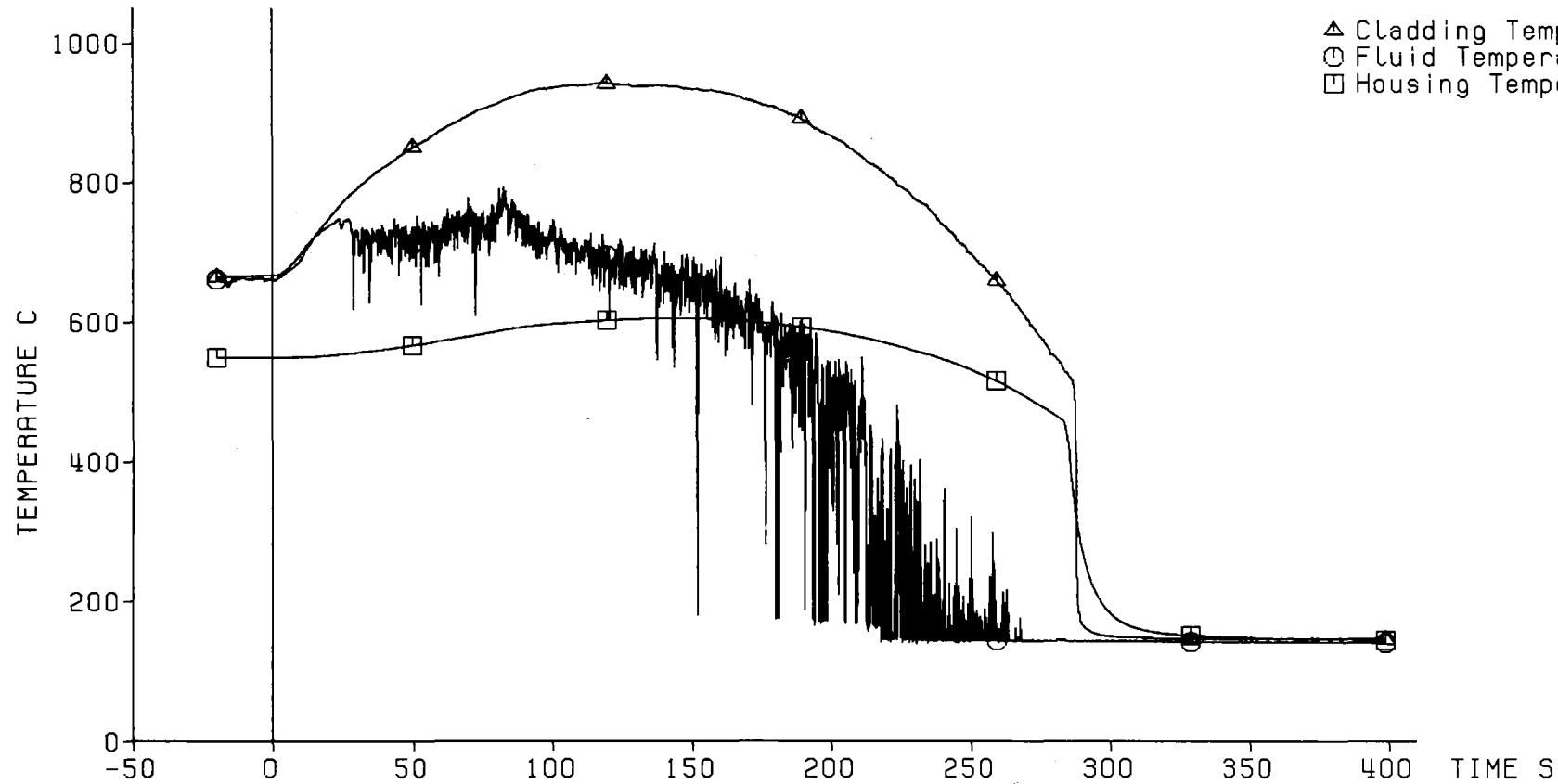

Decay Heat 120% ANS Standard
Flooding Rate (cold) 2.21 cm/s
System Pressure 4.15 bar
Feedwater Temperature 40 C

KIK IRB

Fig. 132 FEBA: 5x5 ROD BUNDLE, TEST SERIES 7, TEST-No. 327

Axial Level: 1825 mm

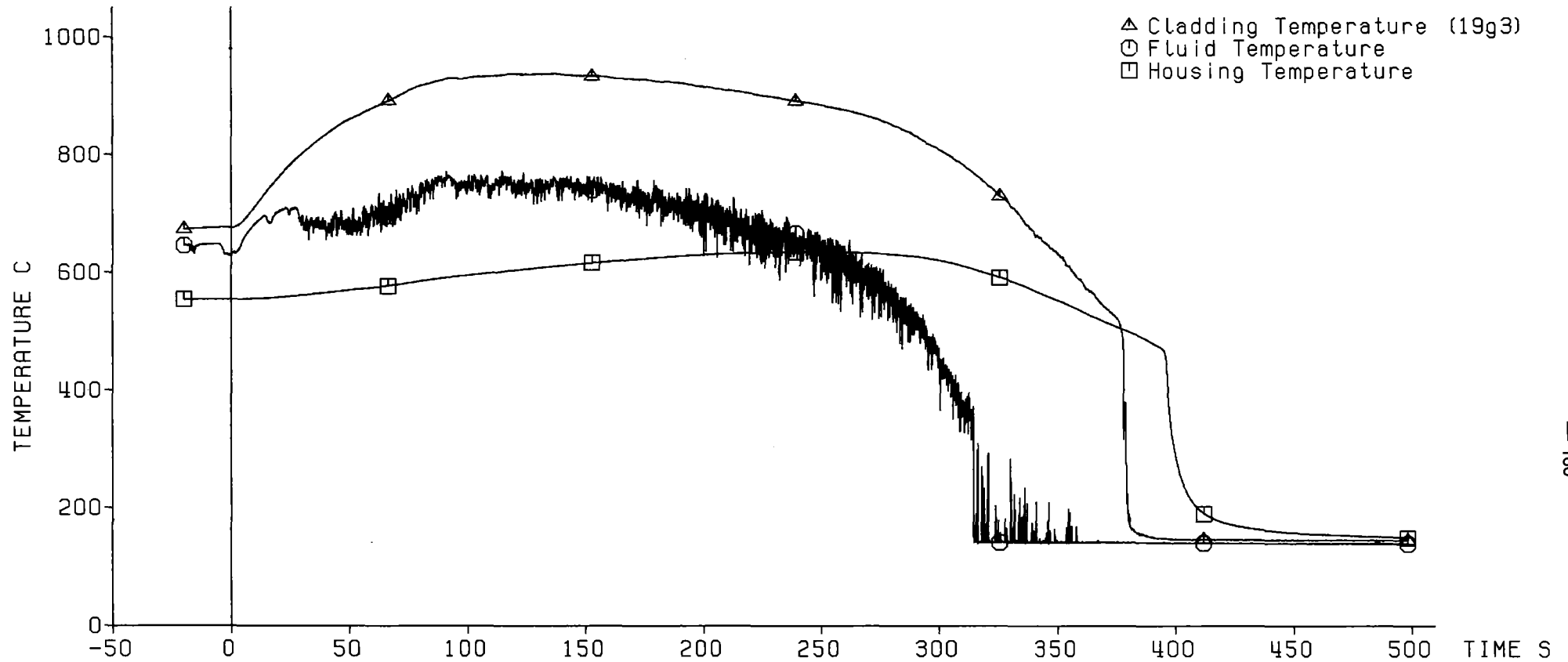

Decay Heat 120% ANS Standard
Flooding Rate (cold) 2.21 cm/s
System Pressure 4.15 bar
Feedwater Temperature 40 C



Fig. 133 FEBA: 5x5 ROD BUNDLE, TEST SERIES 7, TEST-No. 327

Axial Level: 1725 mm

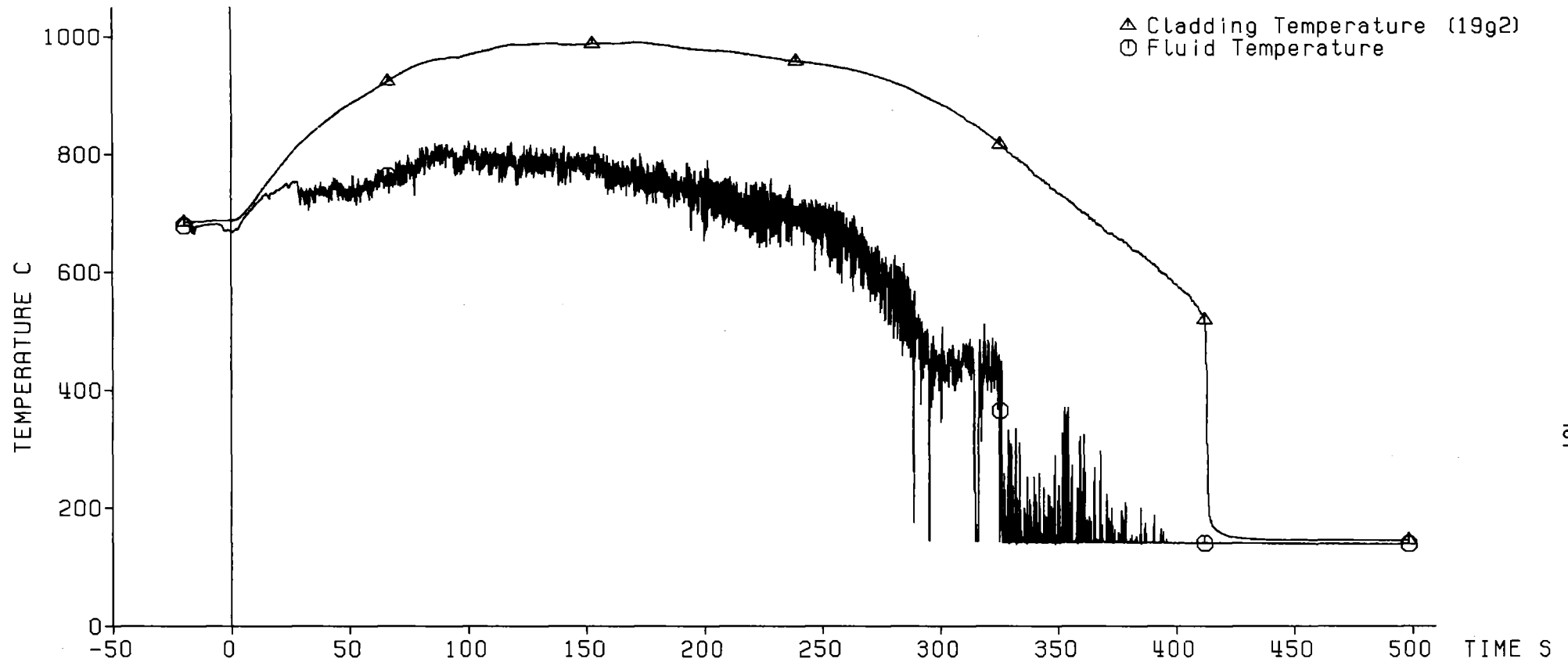

Decay Heat 120% ANS Standard
Flooding Rate (cold) 2.21 cm/s
System Pressure 4.15 bar
Feedwater Temperature 40 C



Fig. 134 FEBA: 5x5 ROD BUNDLE, TEST SERIES 7, TEST-No. 327

Axial Level: 1625 mm

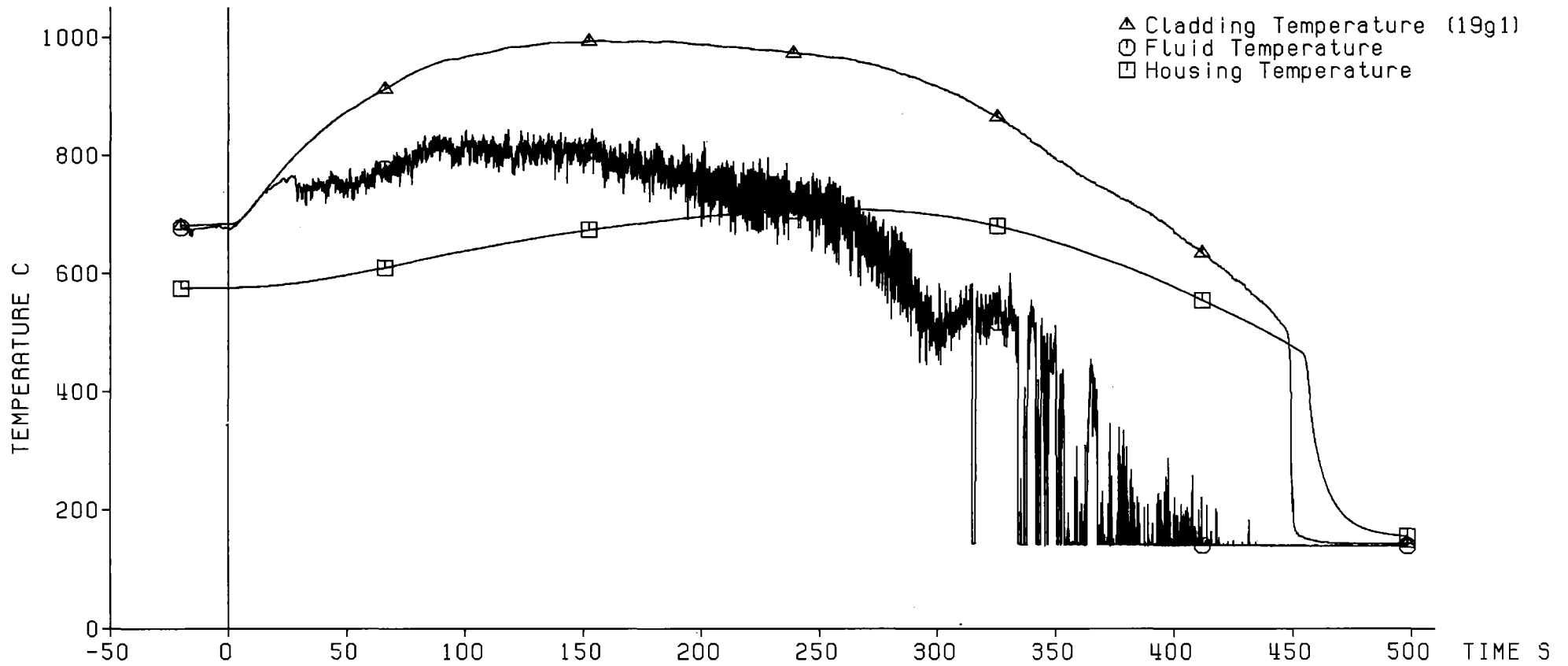

Decay Heat 120% ANS Standard
Flooding Rate (cold) 2.21 cm/s
System Pressure 4.15 bar
Feedwater Temperature 40 C

KJK IRB

Fig. 135 FEBA: 5x5 ROD BUNDLE, TEST SERIES 7, TEST-NO. 327

Axial Level: 1135 mm

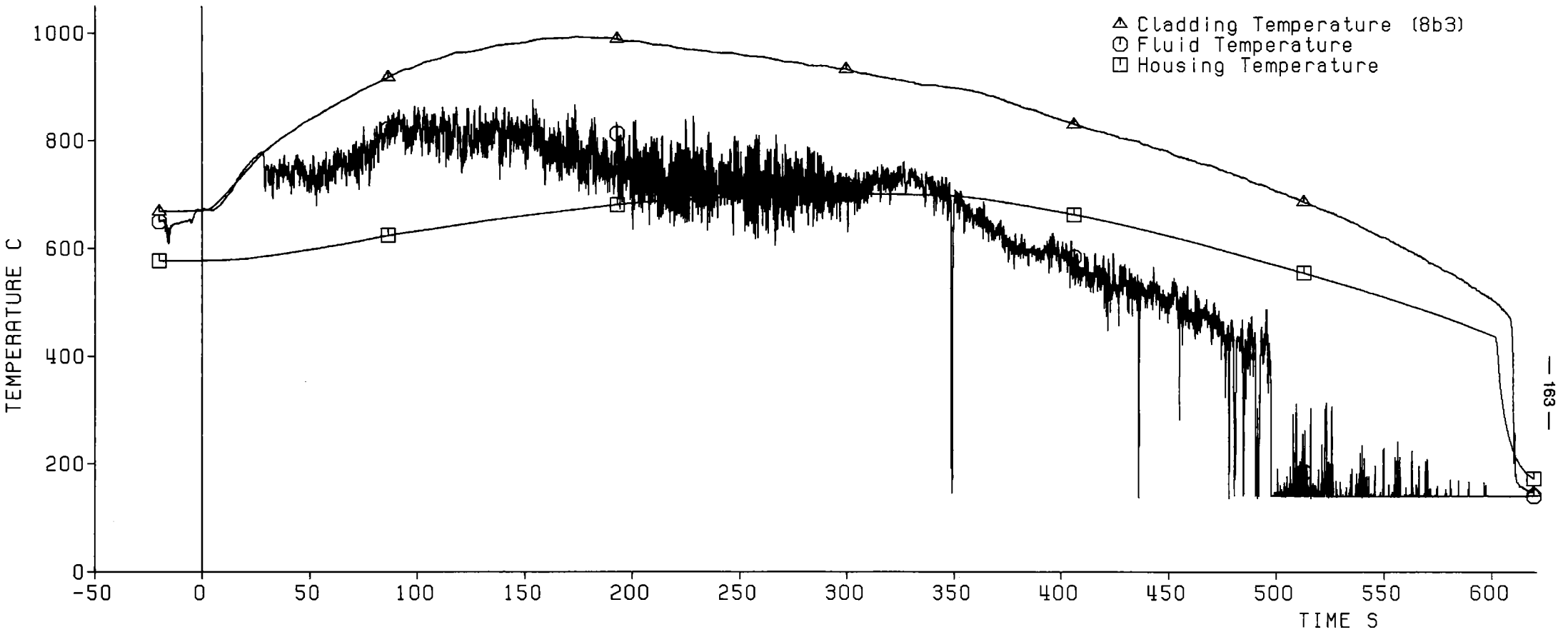

Decay Heat 120% ANS Standard
Flooding Rate (cold) 2.21 cm/s
System Pressure 4.15 bar
Feedwater Temperature 40 C



Fig. 136 FEBA: 5x5 ROD BUNDLE, TEST SERIES 7, TEST-No. 327

Pressure Loss
Along the Test Section:

◇ Total Length: 4196 mm
△ Lower Part: 1711 mm
○ Middle Part: 545 mm
□ Upper Part: 1940 mm

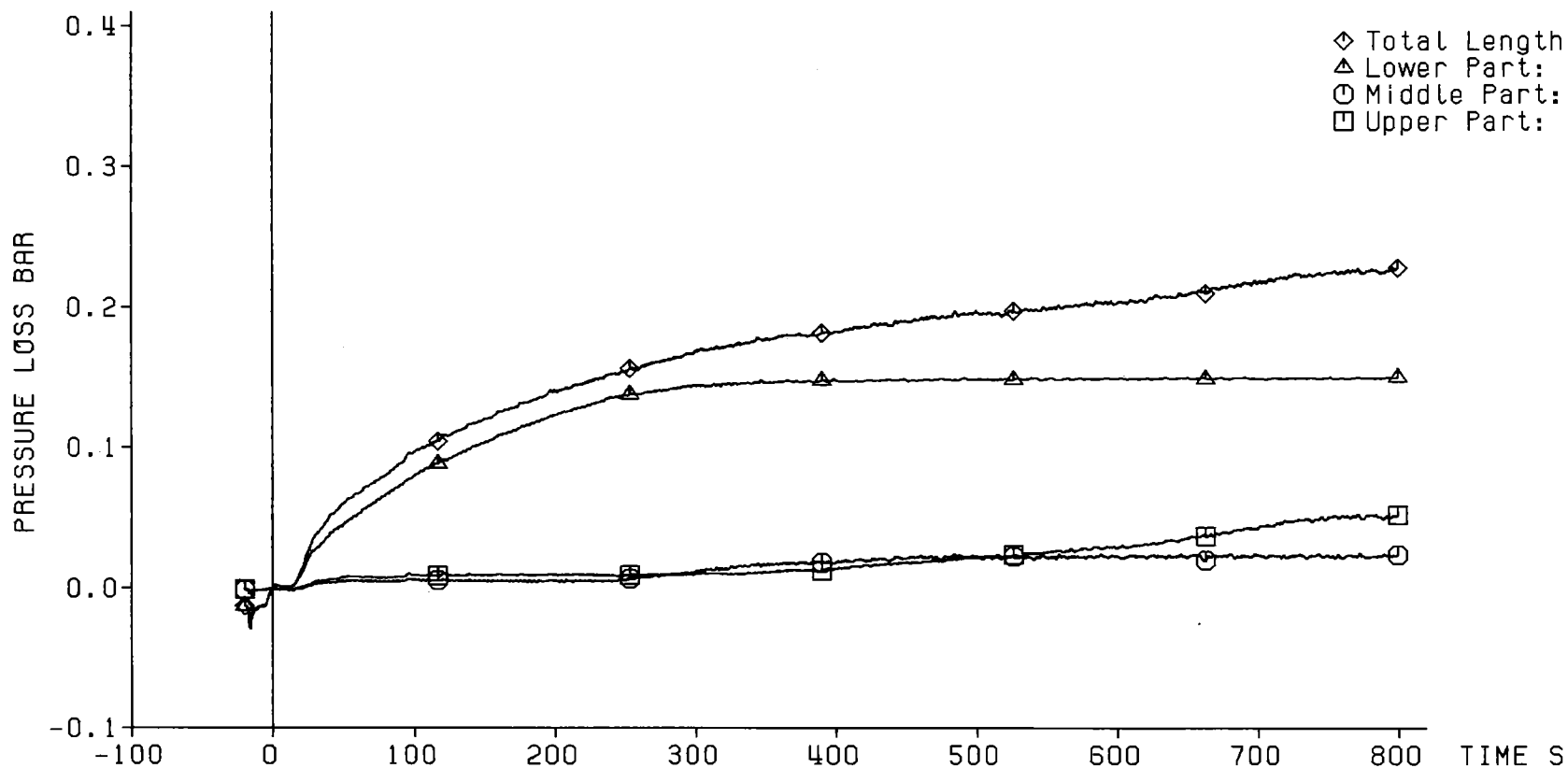

Decay Heat 120% ANS Standard
Flooding Rate (cold) 2.21 cm/s
System Pressure 4.15 bar
Feedwater Temperature 40 C



Fig. 137 FEBA: 5x5 ROD BUNDLE, TEST SERIES 7, TEST-No. 327

Coolant Outlet Conditions:

△ Water Carry Over
○ Coolant Temperature
□ Coolant Pressure

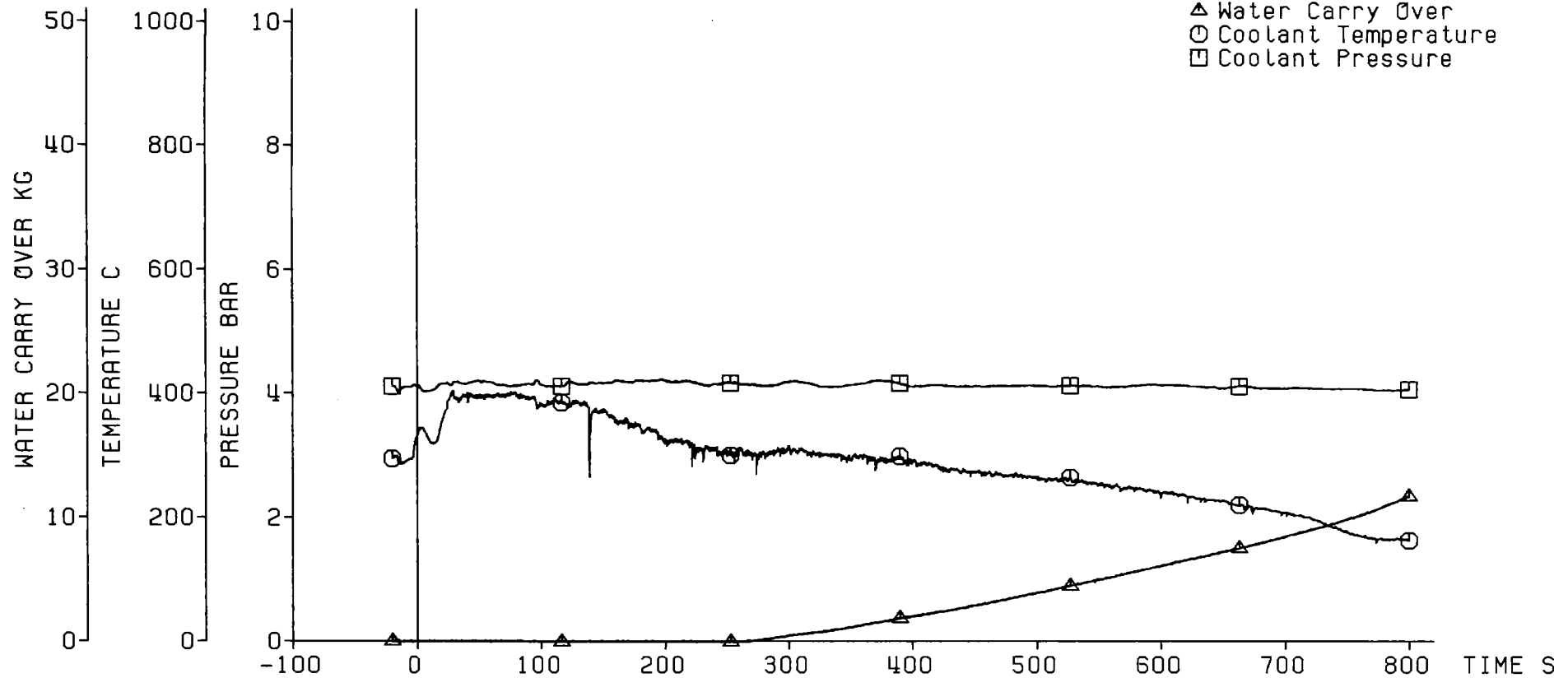

Decay Heat 120% ANS Standard
Flooding Rate (cold) 2.21 cm/s
System Pressure 4.15 bar
Feedwater Temperature 40 C



Fig. 138 FEBA: 5x5 ROD BUNDLE, TEST SERIES 7, TEST-No. 327

Axial Position of Quench Front

□ Quenching of Sleeves at Bundle Midplane

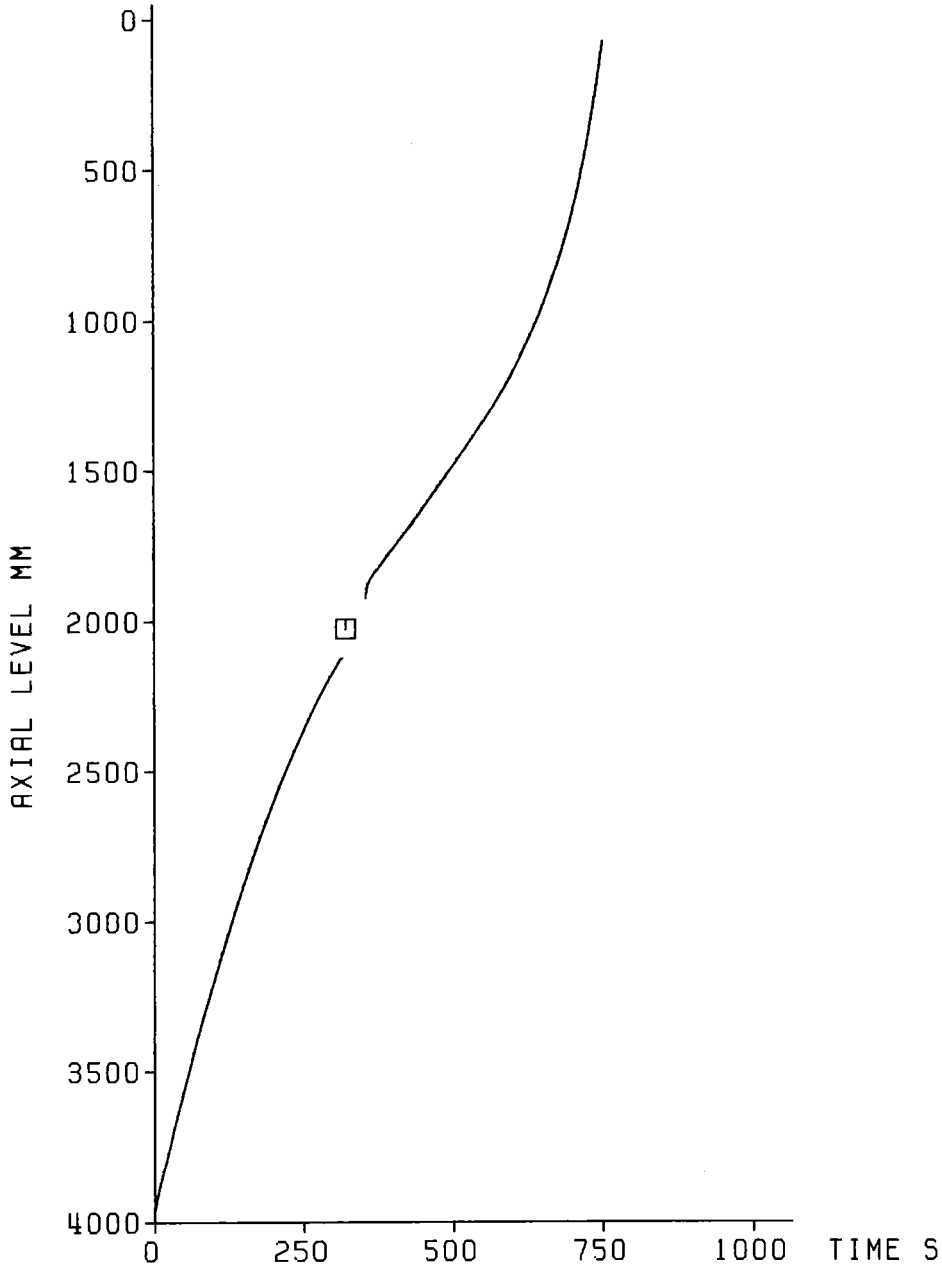

Decay Heat	120% ANS Standard
Flooding Rate (cold)	2.21 cm/s
System Pressure	4.15 bar
Feedwater Temperature	40 C



Fig. 139 FEBA: 5x5 ROD BUNDLE
TEST SERIES 7, TEST-No. 327

Initial Axial Temperature Profile of Claddings

□ Initial Temperature of Sleeves at Bundle Midplane

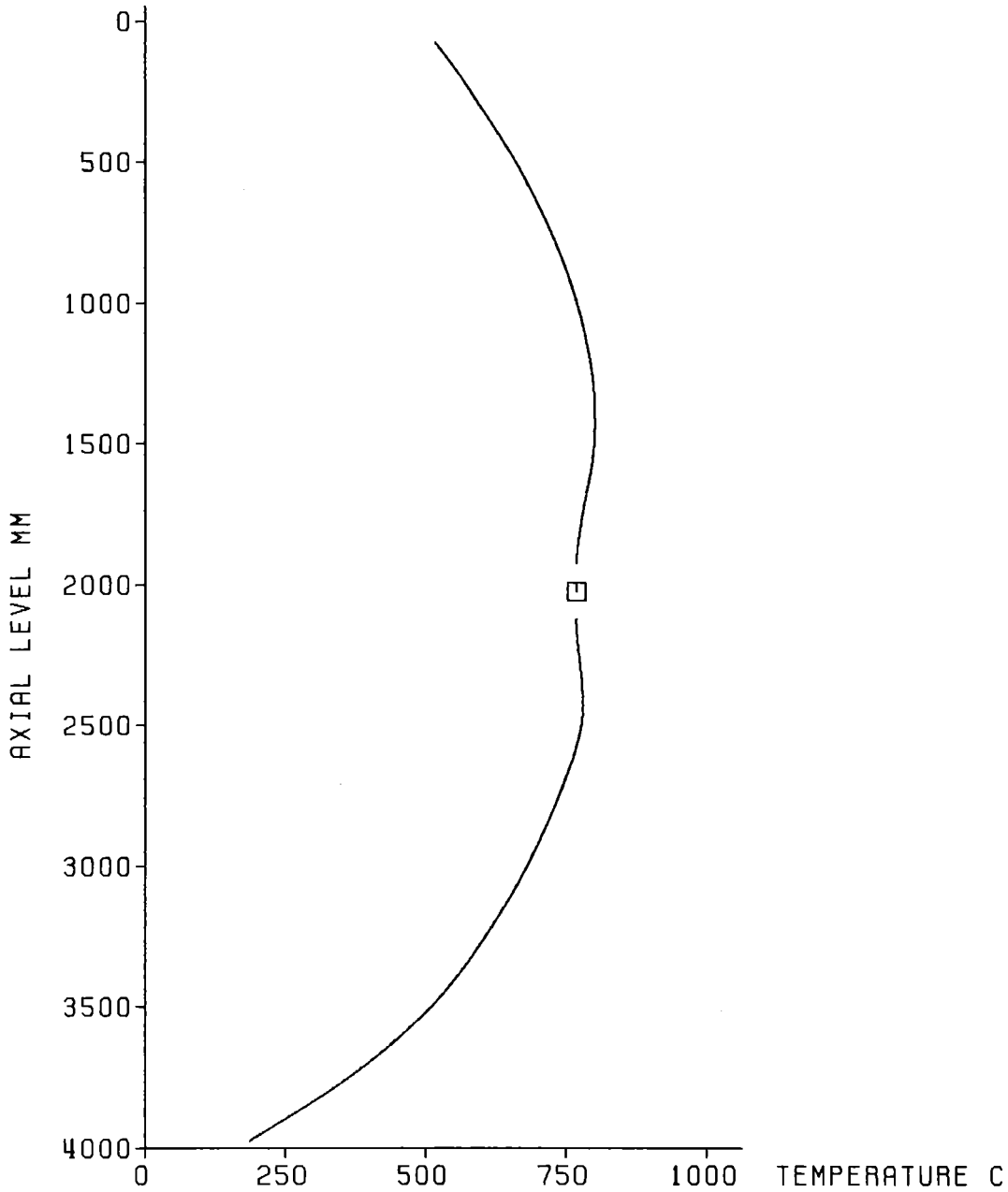

Decay Heat	120% ANS Standard
Flooding Rate (cold)	3.81 cm/s
System Pressure	2.11 bar
Feedwater Temperature	40 C



Fig. 140 FEBA: 5x5 ROD BUNDLE
TEST SERIES 7, TEST-No. 322

Test Parameters:

- ◇ Flooding Rate
- △ System Pressure
- Feedwater Temperature
- Bundle Power

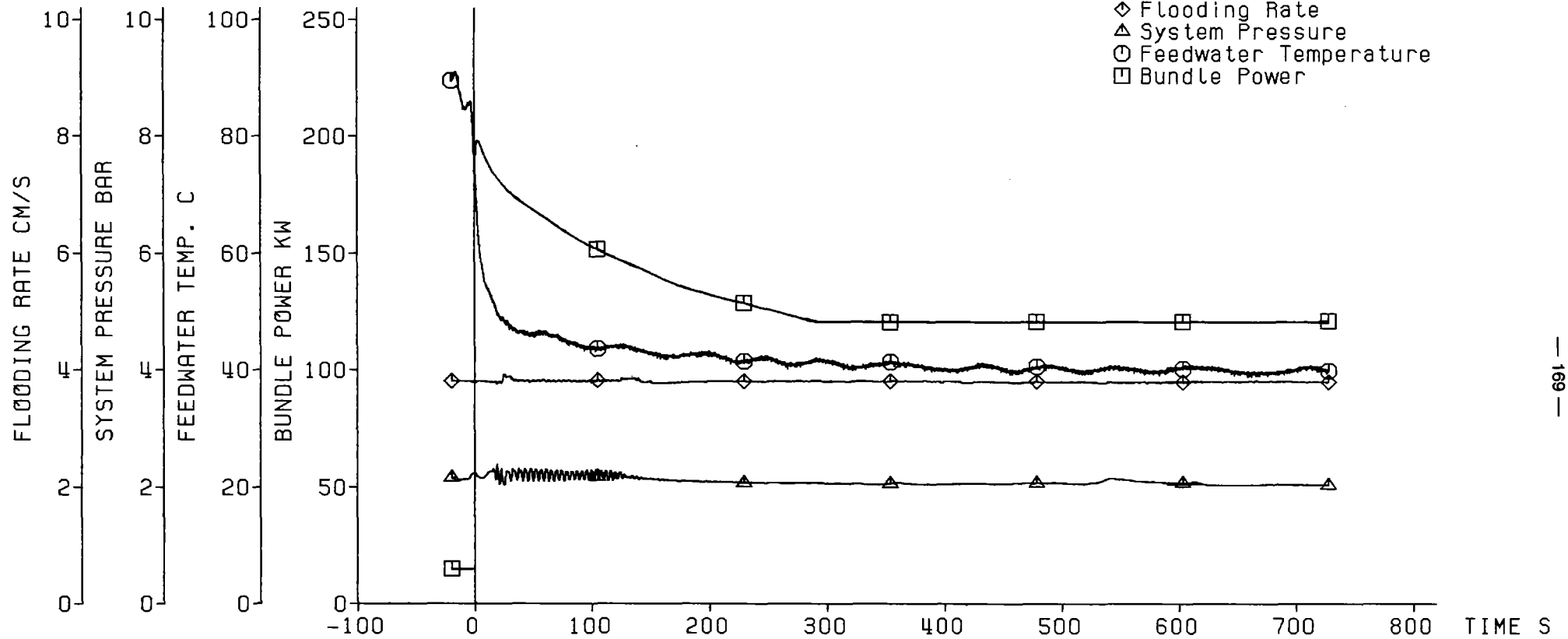

Decay Heat 120% ANS Standard
Flooding Rate (cold) 3.81 cm/s
System Pressure 2.11 bar
Feedwater Temperature 40 C



Fig. 141 FEBA: 5x5 ROD BUNDLE, TEST SERIES 7, TEST-NO. 322

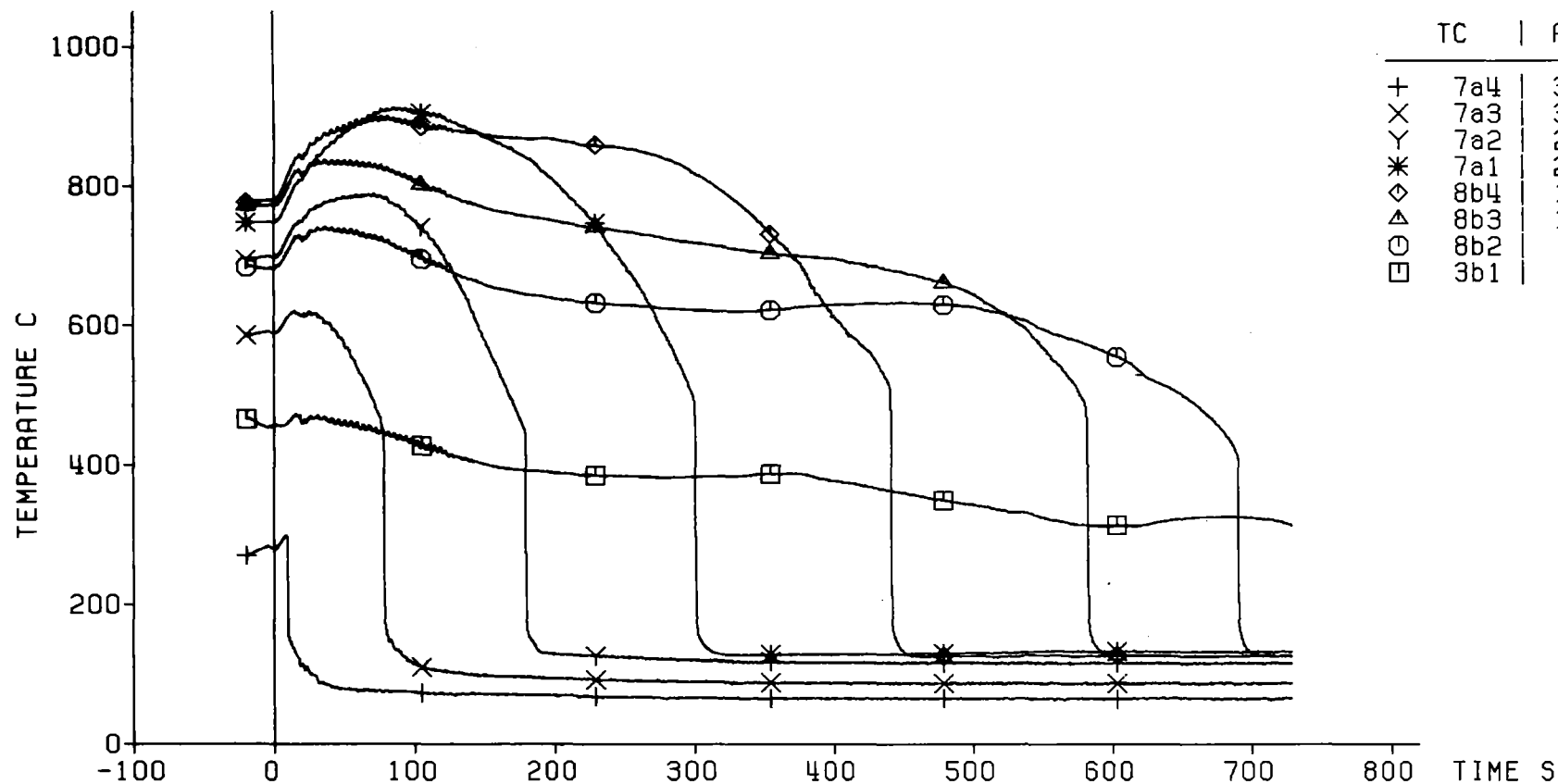

Decay Heat 120% ANS Standard
 Flooding Rate (cold) 3.81 cm/s
 System Pressure 2.11 bar
 Feedwater Temperature 40 C



Fig. 142 FEBA: 5x5 ROD BUNDLE, TEST SERIES 7, TEST-No. 322

Heat Transfer Coeff.

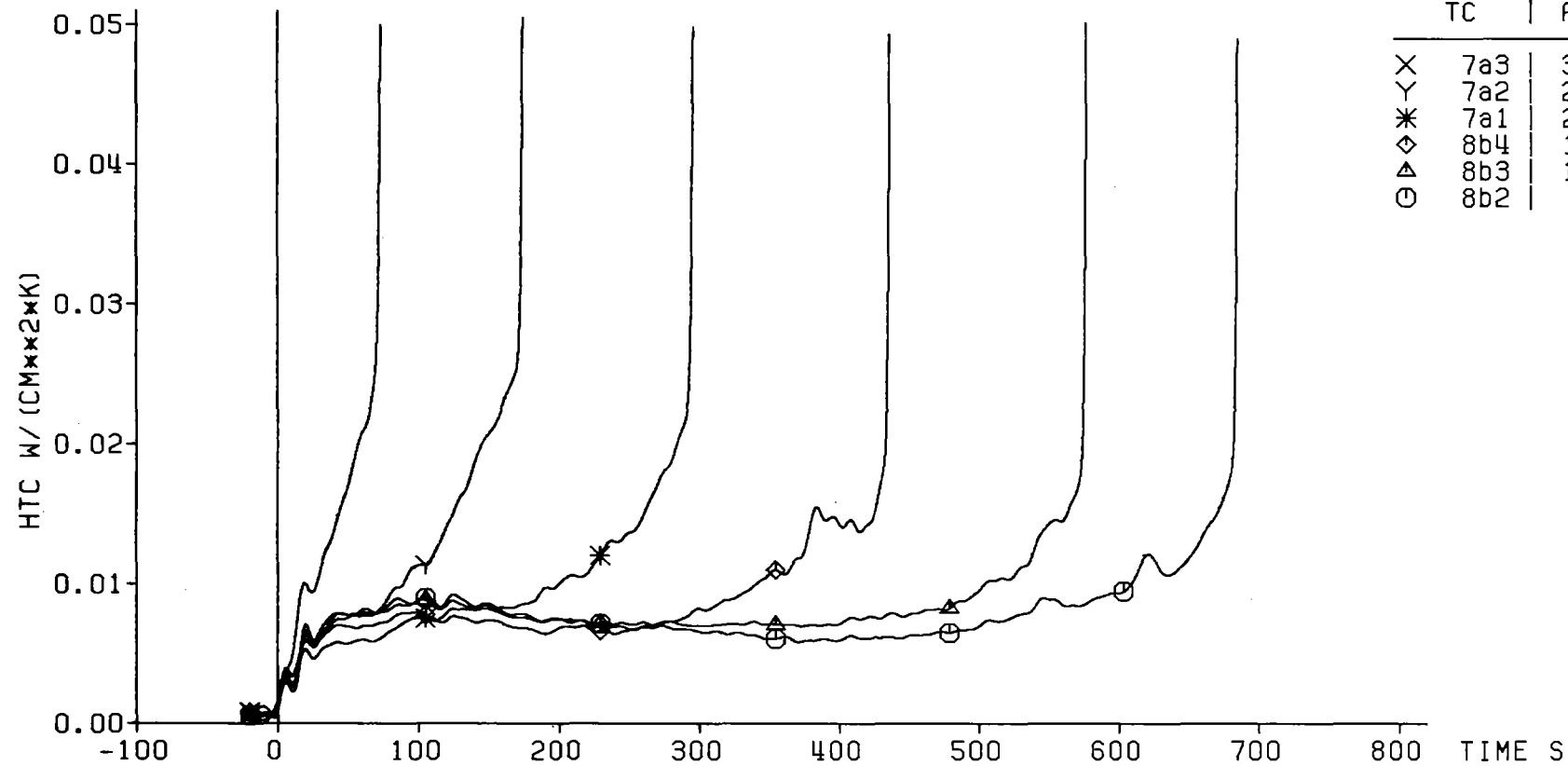

	TC	Ax. Level
X	7a3	3315 mm
Y	7a2	2770 mm
*	7a1	2225 mm
◇	8b4	1680 mm
△	8b3	1135 mm
○	8b2	590 mm

Decay Heat 120% ANS Standard
 Flooding Rate (cold) 3.81 cm/s
 System Pressure 2.11 bar
 Feedwater Temperature 40 C



Fig. 143 FEBA: 5x5 ROD BUNDLE, TEST SERIES 7, TEST-NO. 322

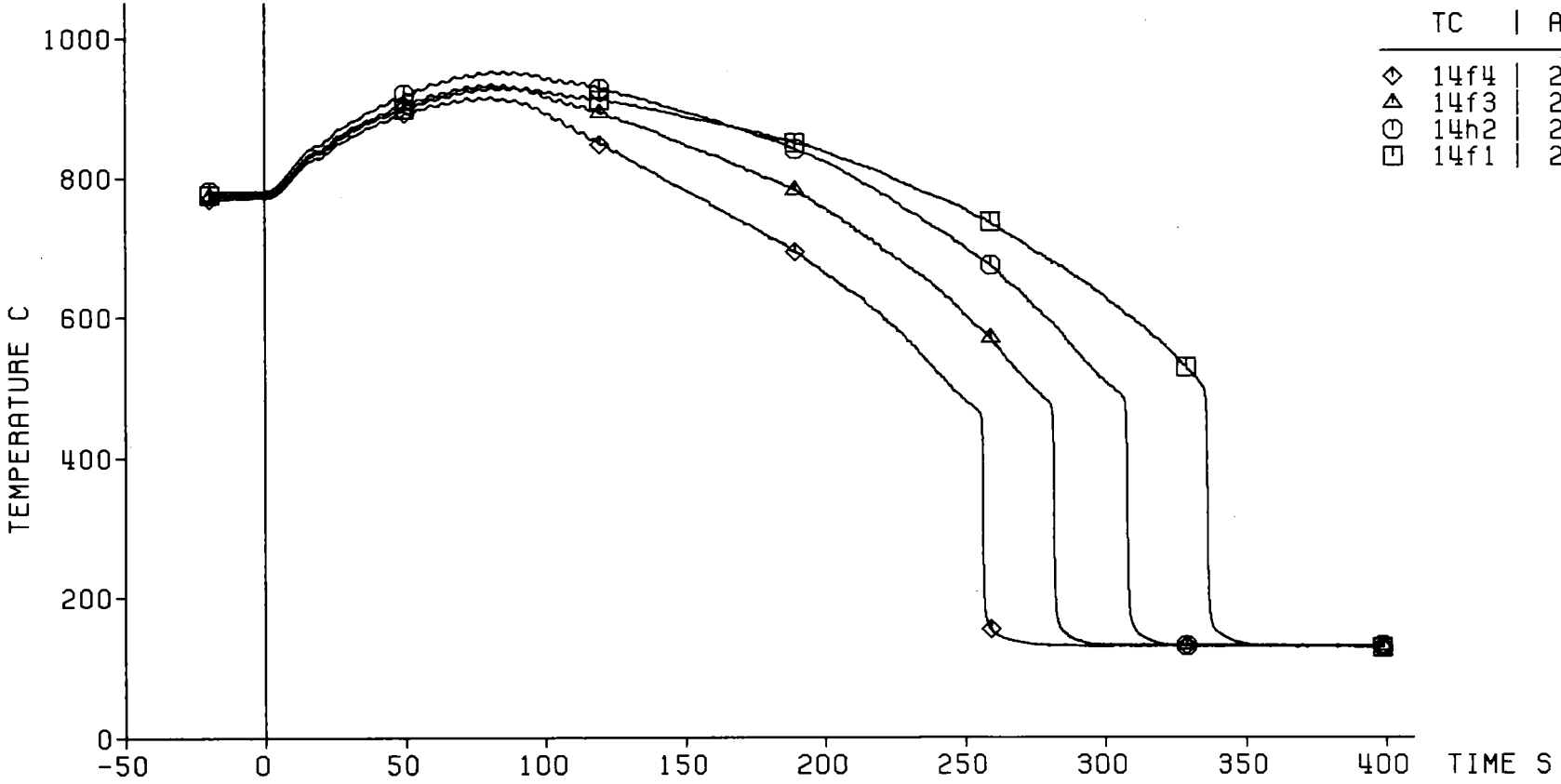

Decay Heat 120% ANS Standard
Flooding Rate (cold) 3.81 cm/s
System Pressure 2.11 bar
Feedwater Temperature 40 C



Fig. 144 FEBA: 5x5 ROD BUNDLE, TEST SERIES 7, TEST-No. 322

Heat Transfer Coeff.

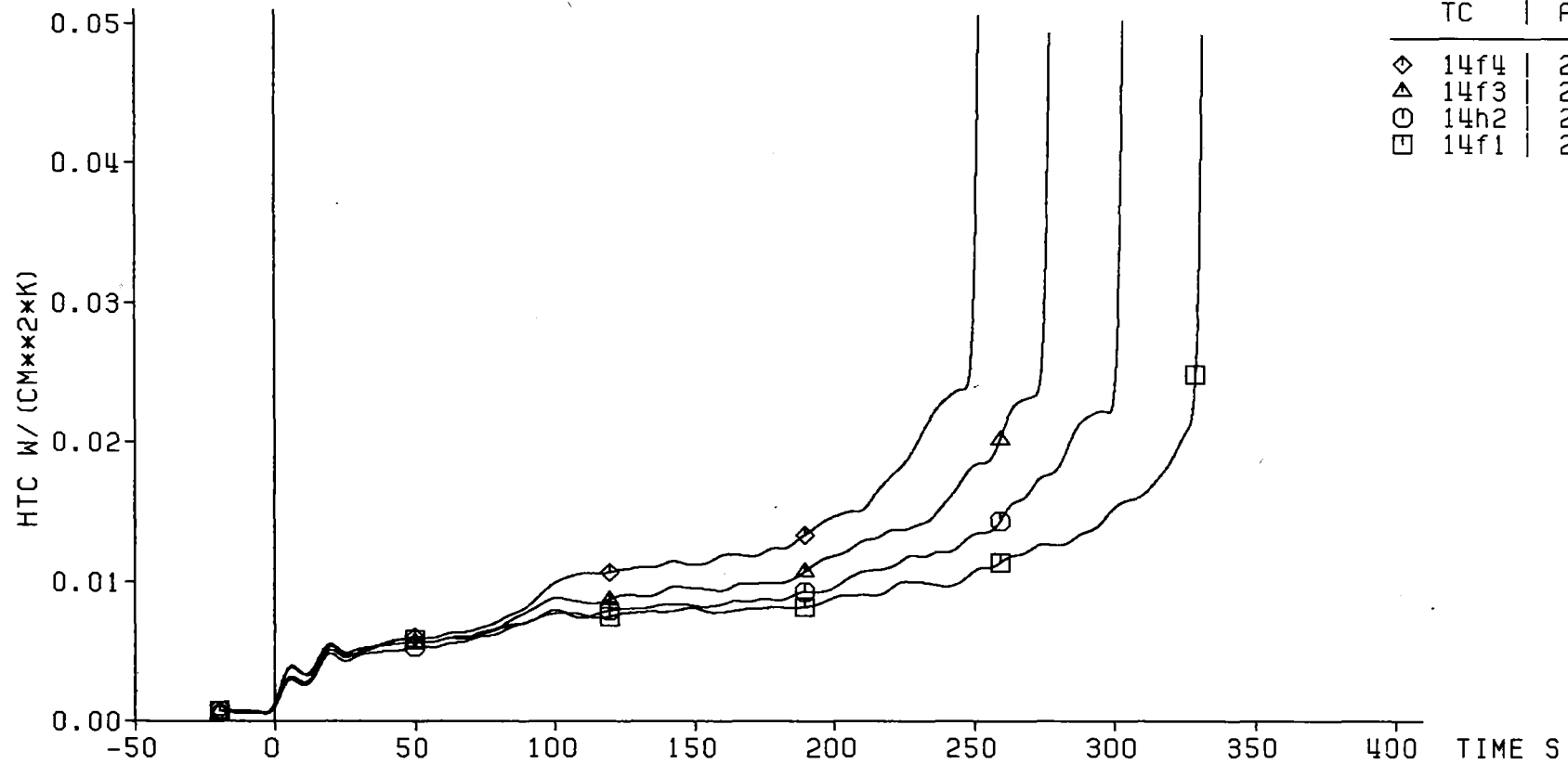

Decay Heat 120% ANS Standard
 Flooding Rate (cold) 3.81 cm/s
 System Pressure 2.11 bar
 Feedwater Temperature 40 C



Fig. 145 FEBA: 5x5 ROD BUNDLE, TEST SERIES 7, TEST-NO. 322

Cladding Temperature

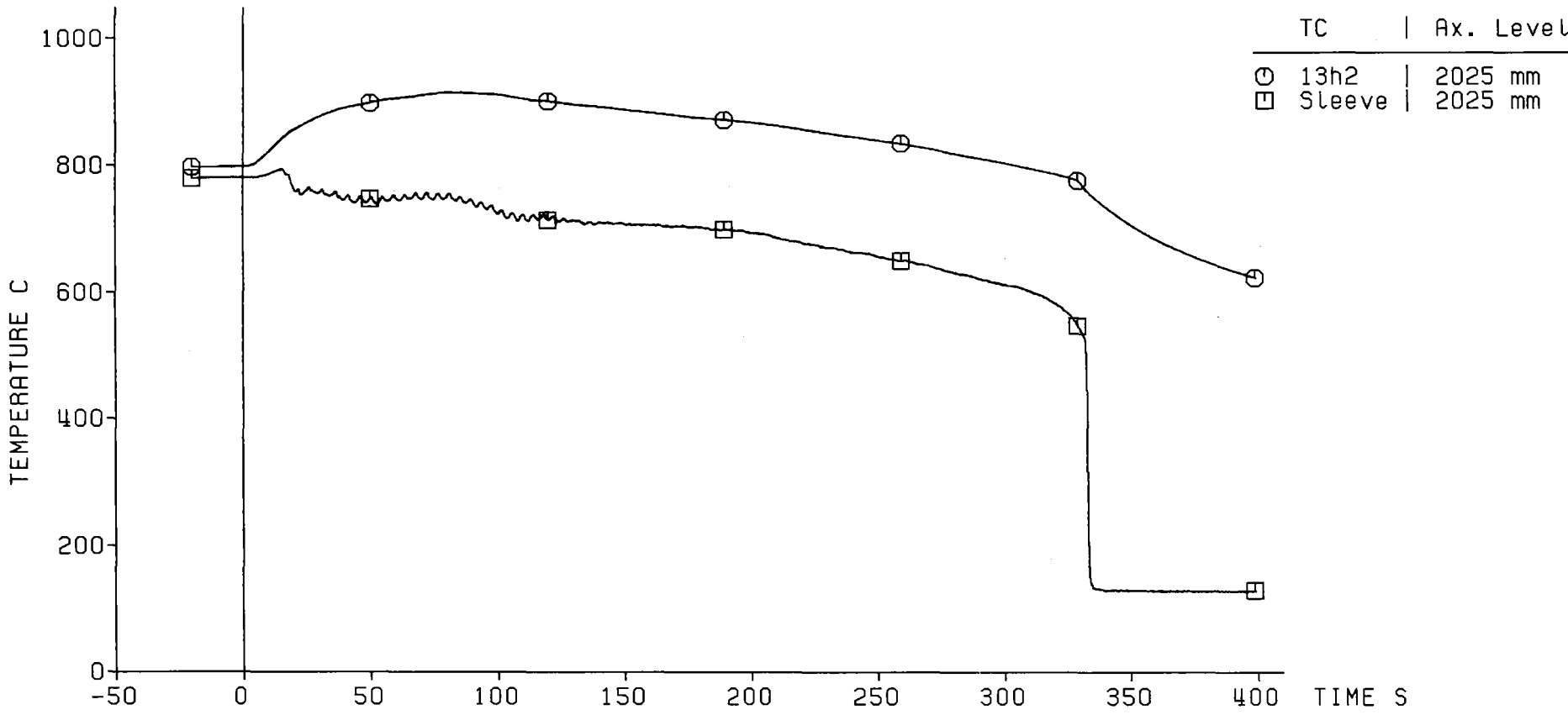

Decay Heat 120% ANS Standard
 Flooding Rate (cold) 3.81 cm/s
 System Pressure 2.11 bar
 Feedwater Temperature 40 C



Fig. 146 FEBA: 5x5 ROD BUNDLE, TEST SERIES 7, TEST-No. 322

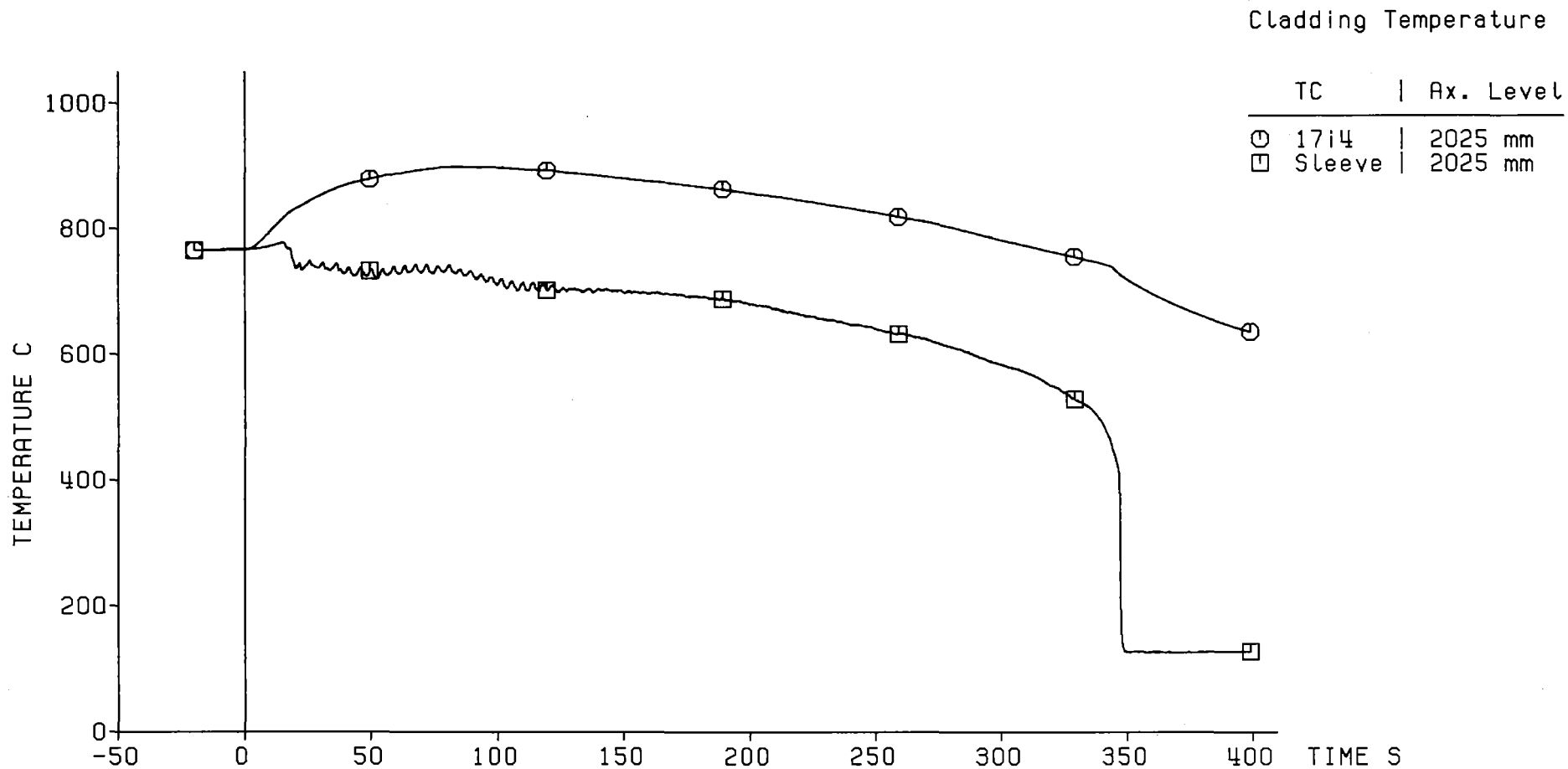

Decay Heat 120% ANS Standard
 Flooding Rate (cold) 3.81 cm/s
 System Pressure 2.11 bar
 Feedwater Temperature 40 C

KfK IRB

Fig. 147 FEBA: 5x5 ROD BUNDLE, TEST SERIES 7, TEST-No. 322

Cladding Temperature

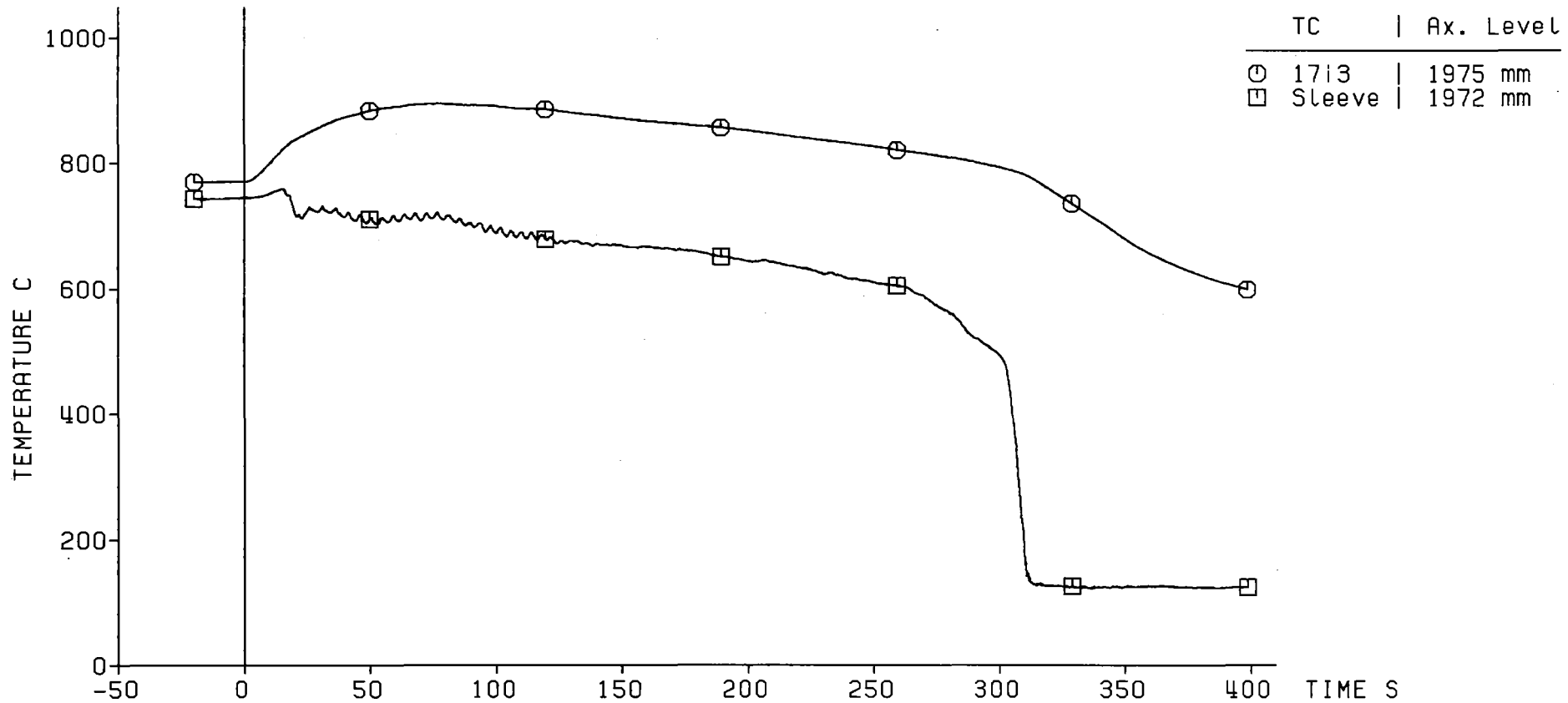

Decay Heat 120% ANS Standard
 Flooding Rate (cold) 3.81 cm/s
 System Pressure 2.11 bar
 Feedwater Temperature 40 C



Fig. 148 FEBA: 5x5 ROD BUNDLE, TEST SERIES 7, TEST-No. 322

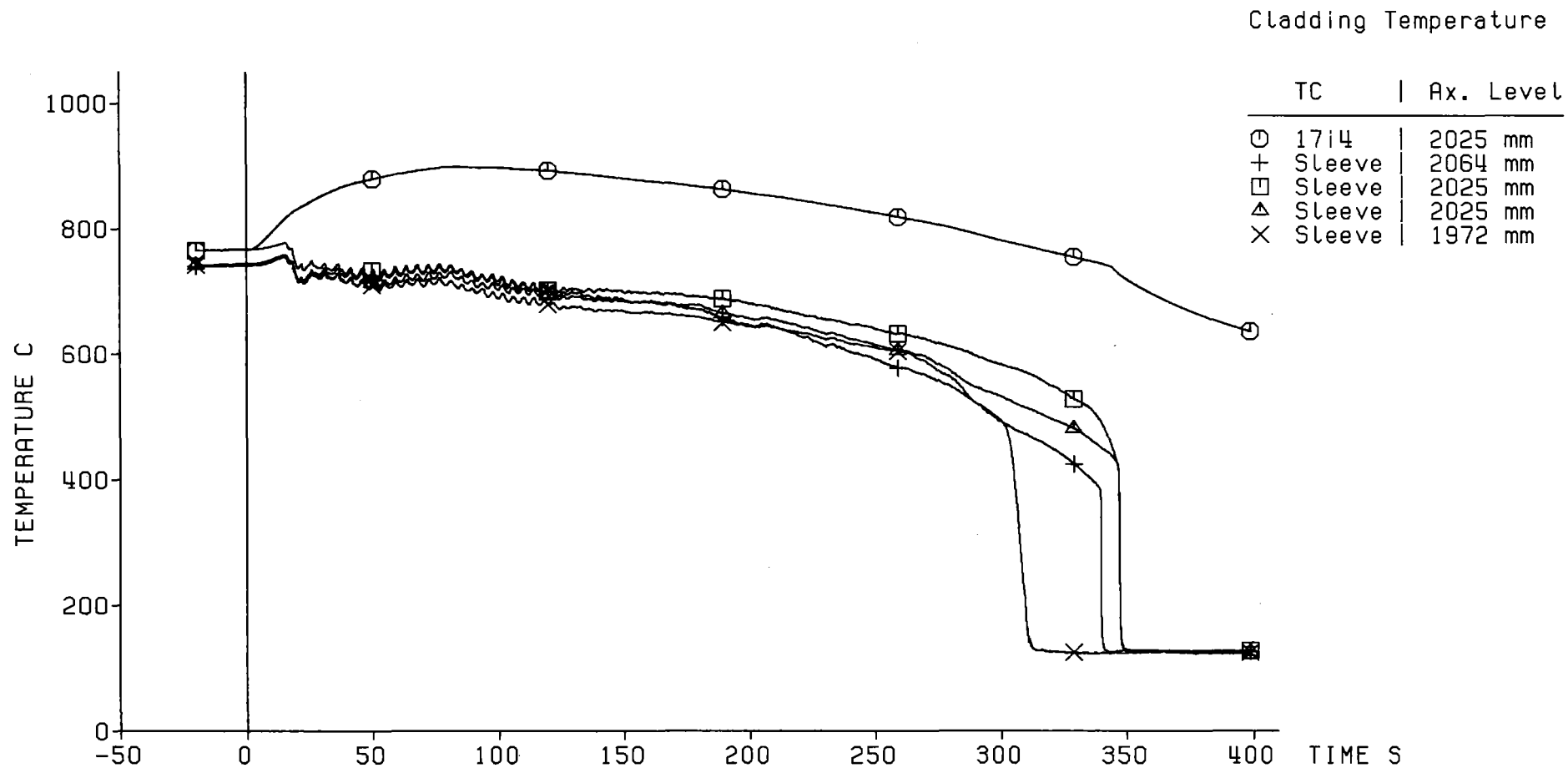

Decay Heat 120% ANS Standard
 Flooding Rate (cold) 3.81 cm/s
 System Pressure 2.11 bar
 Feedwater Temperature 40 C



Fig. 149 FEBA: 5x5 ROD BUNDLE, TEST SERIES 7, TEST-No. 322

Cladding Temperature

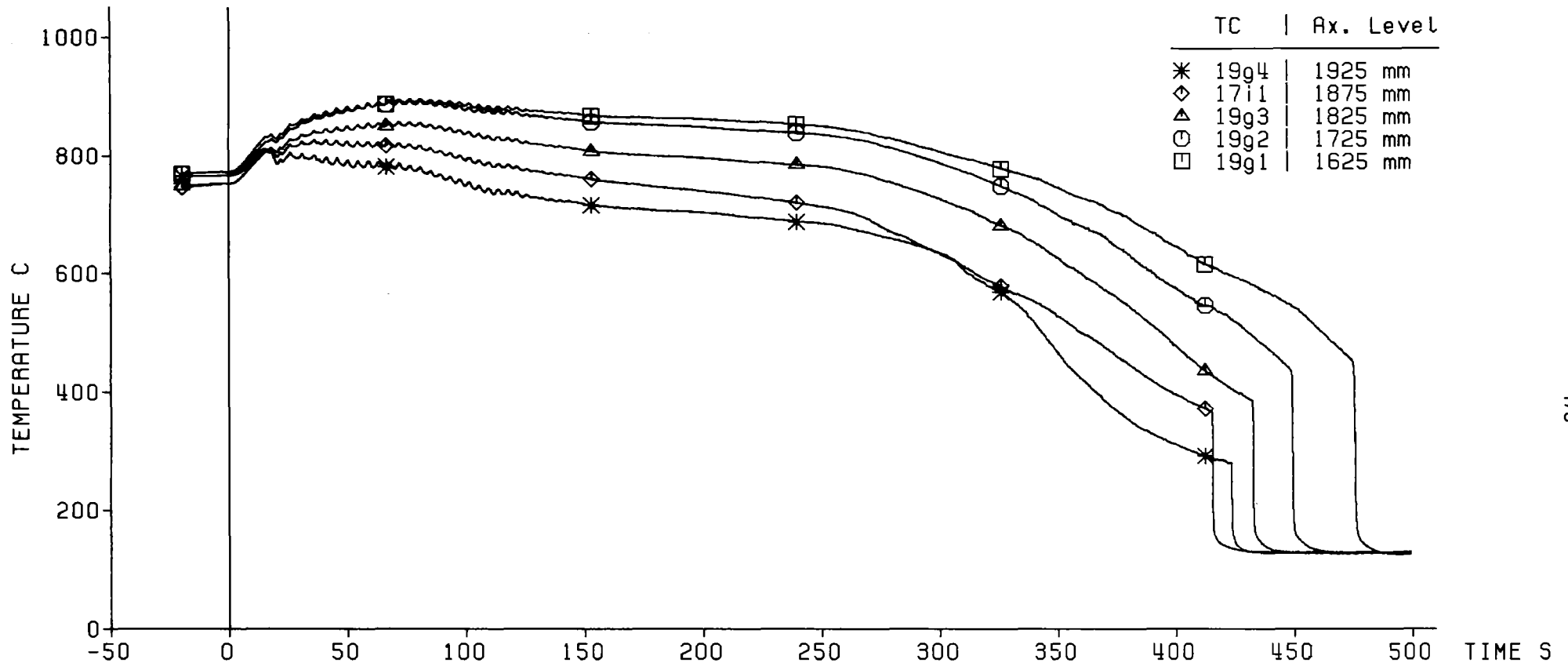

Decay Heat 120% ANS Standard
 Flooding Rate (cold) 3.81 cm/s
 System Pressure 2.11 bar
 Feedwater Temperature 40 C



Fig. 150 FEBA: 5x5 ROD BUNDLE, TEST SERIES 7, TEST-No. 322

Heat Transfer Coeff.

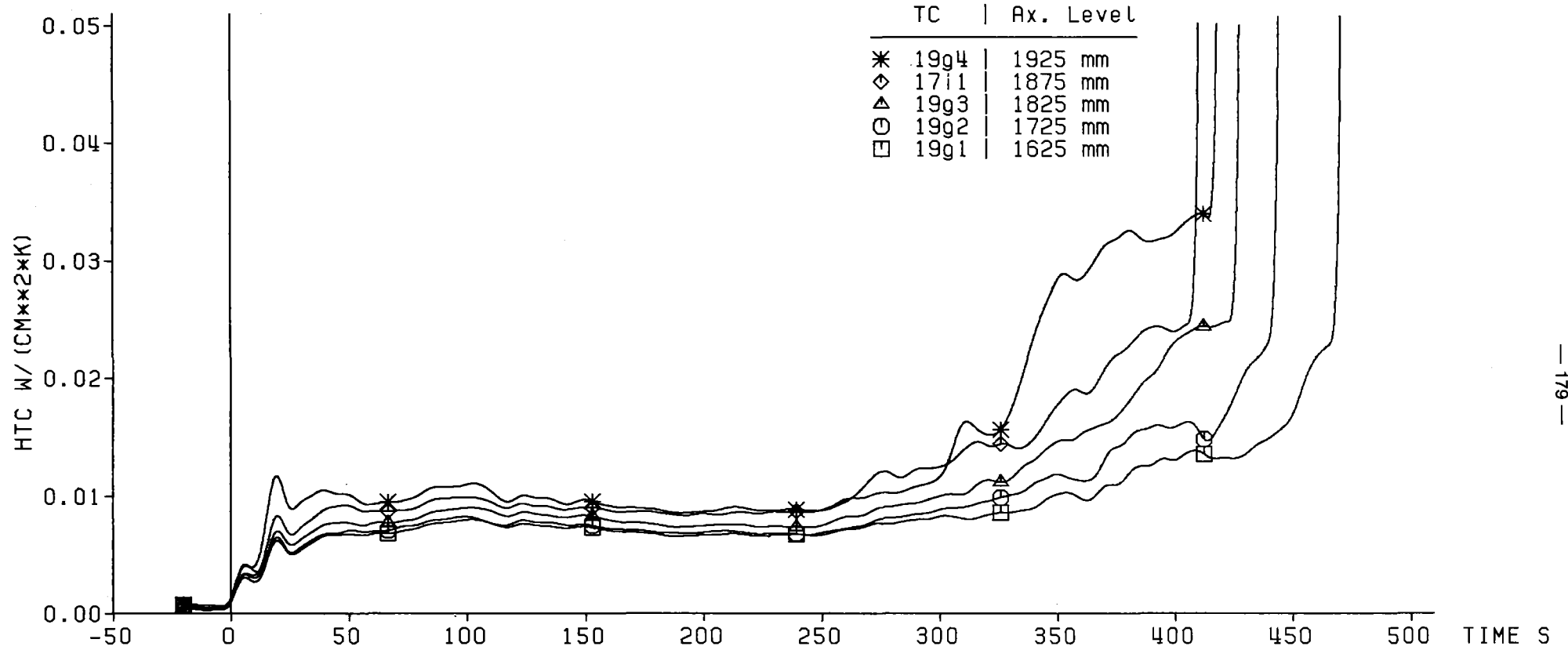

Decay Heat 120% ANS Standard
 Flooding Rate (cold) 3.81 cm/s
 System Pressure 2.11 bar
 Feedwater Temperature 40 C



Fig. 151 FEBA: 5x5 ROD BUNDLE, TEST SERIES 7, TEST-No. 322

Cladding Temperature

TC	Ax. Level
* 12j4	1525 mm
◇ 12j3	1425 mm
△ 12j2	1325 mm
○ 12j1	1225 mm
□ 8b3	1135 mm

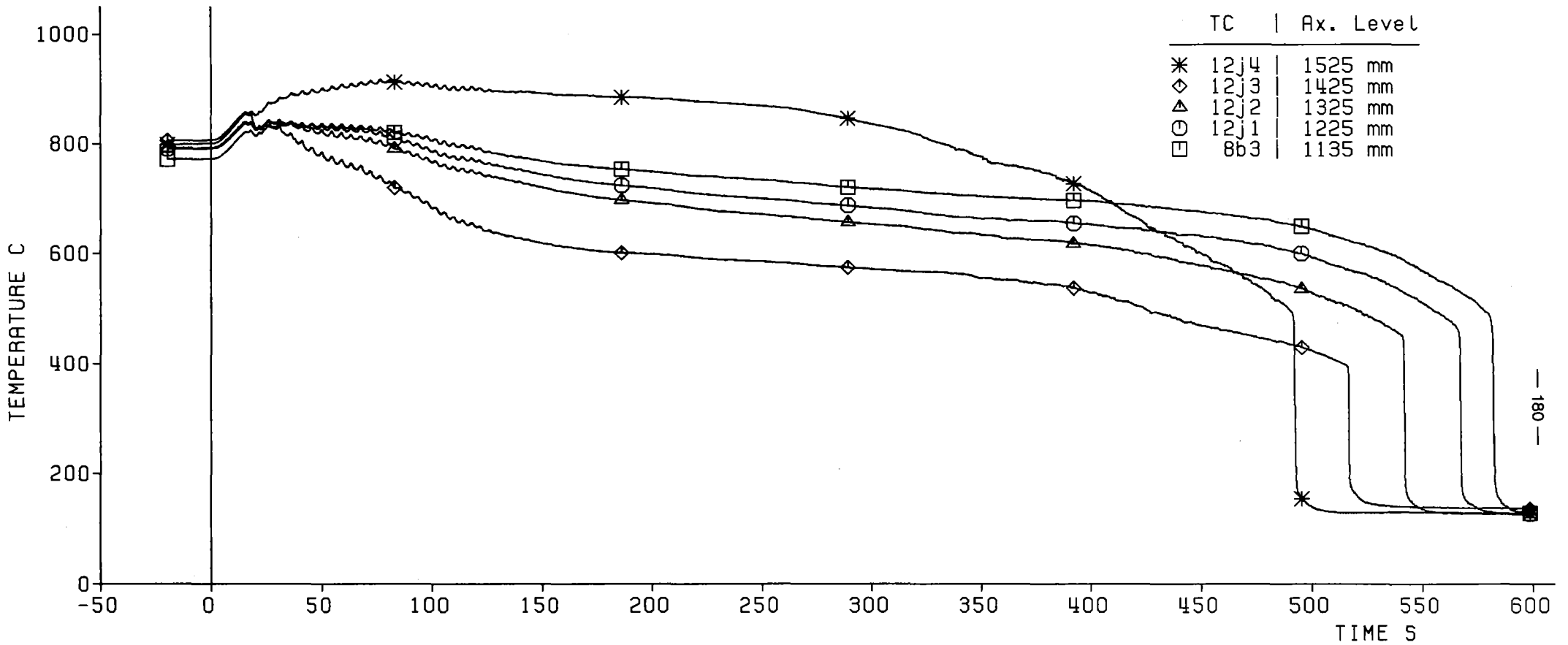

Decay Heat 120% ANS Standard
 Flooding Rate (cold) 3.81 cm/s
 System Pressure 2.11 bar
 Feedwater Temperature 40 C



Fig. 152 FEBA: 5x5 ROD BUNDLE, TEST SERIES 7, TEST-No. 322

Heat Transfer Coeff.

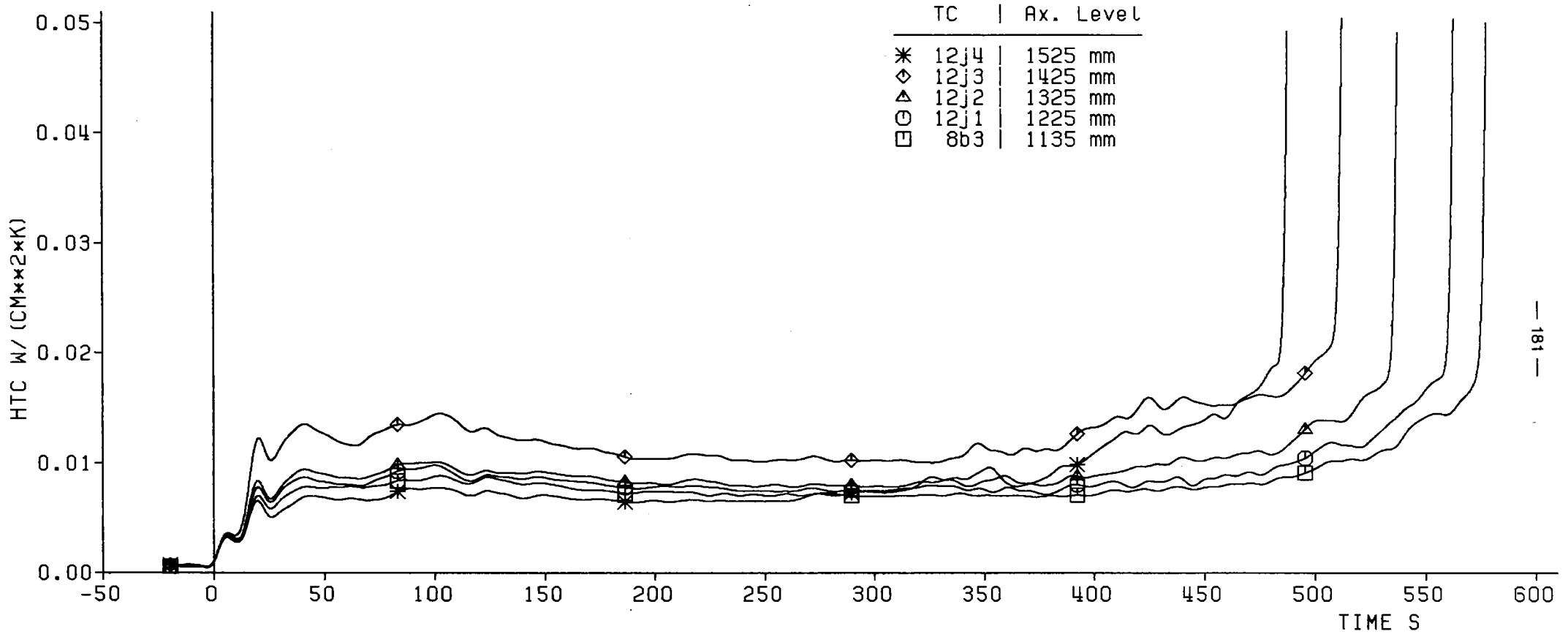

Decay Heat 120% ANS Standard
 Flooding Rate (cold) 3.81 cm/s
 System Pressure 2.11 bar
 Feedwater Temperature 40 C



Fig. 153 FEBA: 5x5 ROD BUNDLE, TEST SERIES 7, TEST-No. 322

Axial Level: 2770 mm

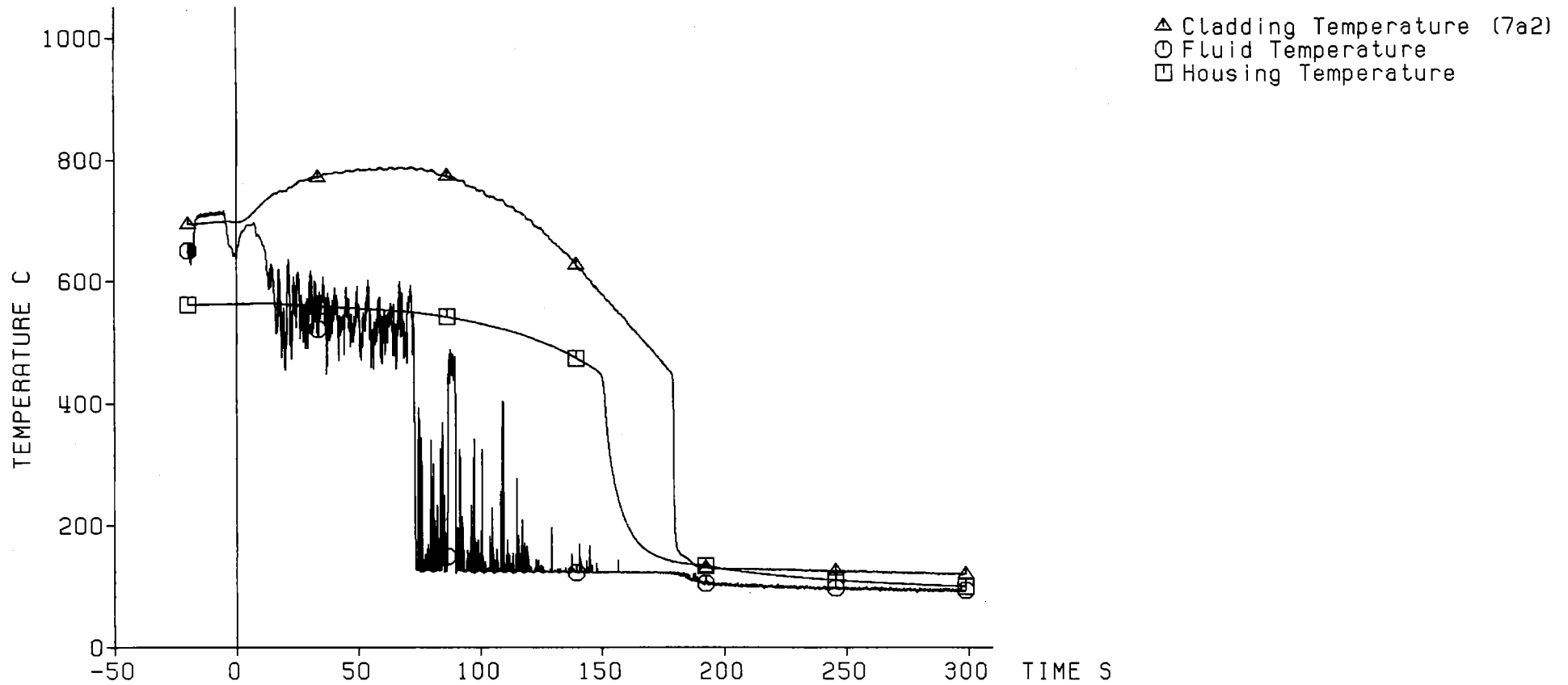

Decay Heat 120% ANS Standard
Flooding Rate (cold) 3.81 cm/s
System Pressure 2.11 bar
Feedwater Temperature 40 C

— 182 —

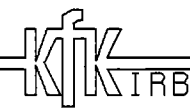
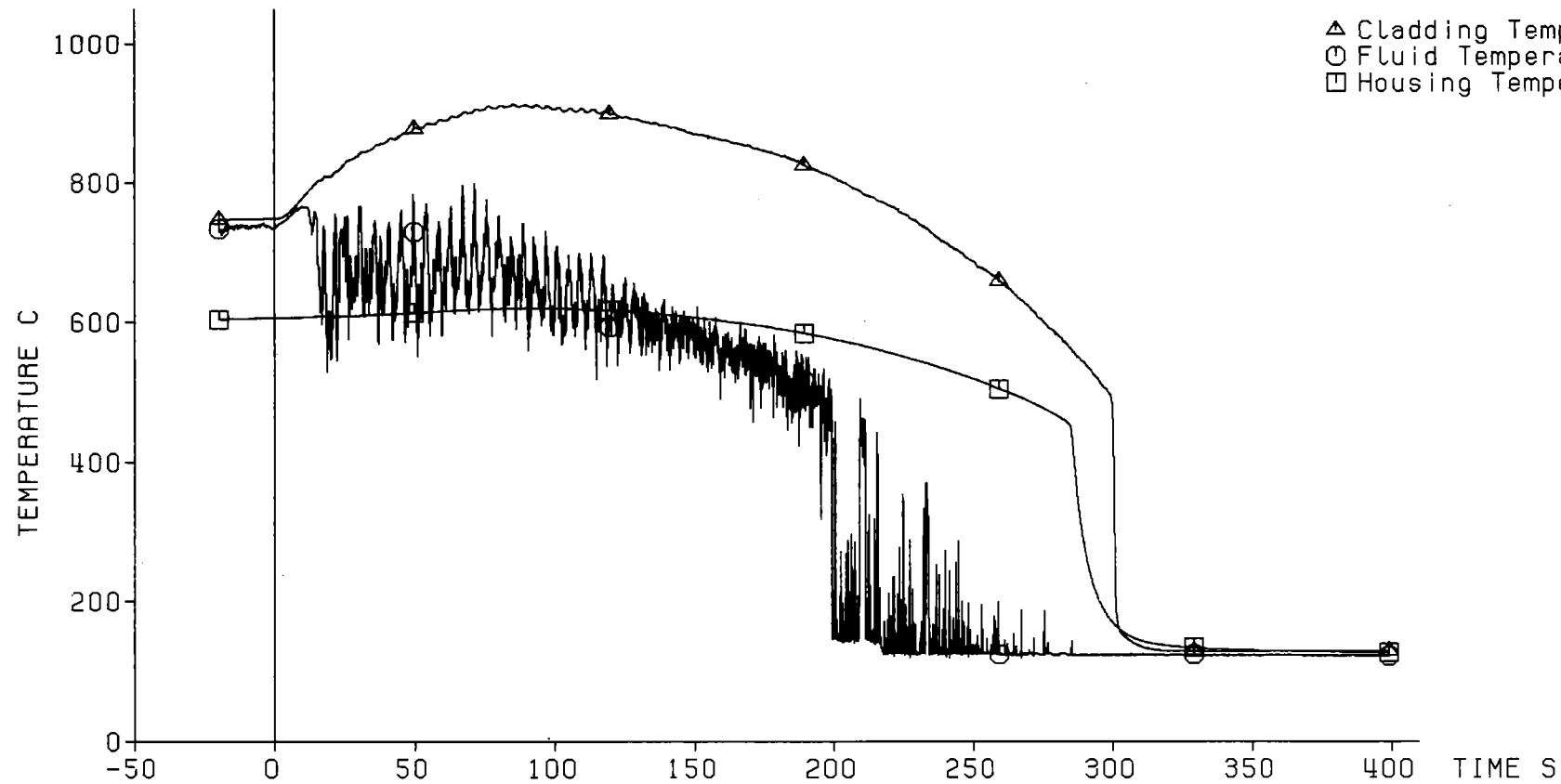

Fig. 154 FEBA: 5x5 ROD BUNDLE, TEST SERIES 7, TEST-No. 322

Axial Level: 2225 mm

△ Cladding Temperature (7a1)
○ Fluid Temperature (2240 mm)
□ Housing Temperature (2235 mm)



Decay Heat 120% ANS Standard
Flooding Rate (cold) 3.81 cm/s
System Pressure 2.11 bar
Feedwater Temperature 40 C

KIK IRB

Fig. 155 FEBA: 5x5 ROD BUNDLE, TEST SERIES 7, TEST-No. 322

Axial Level: 1825 mm

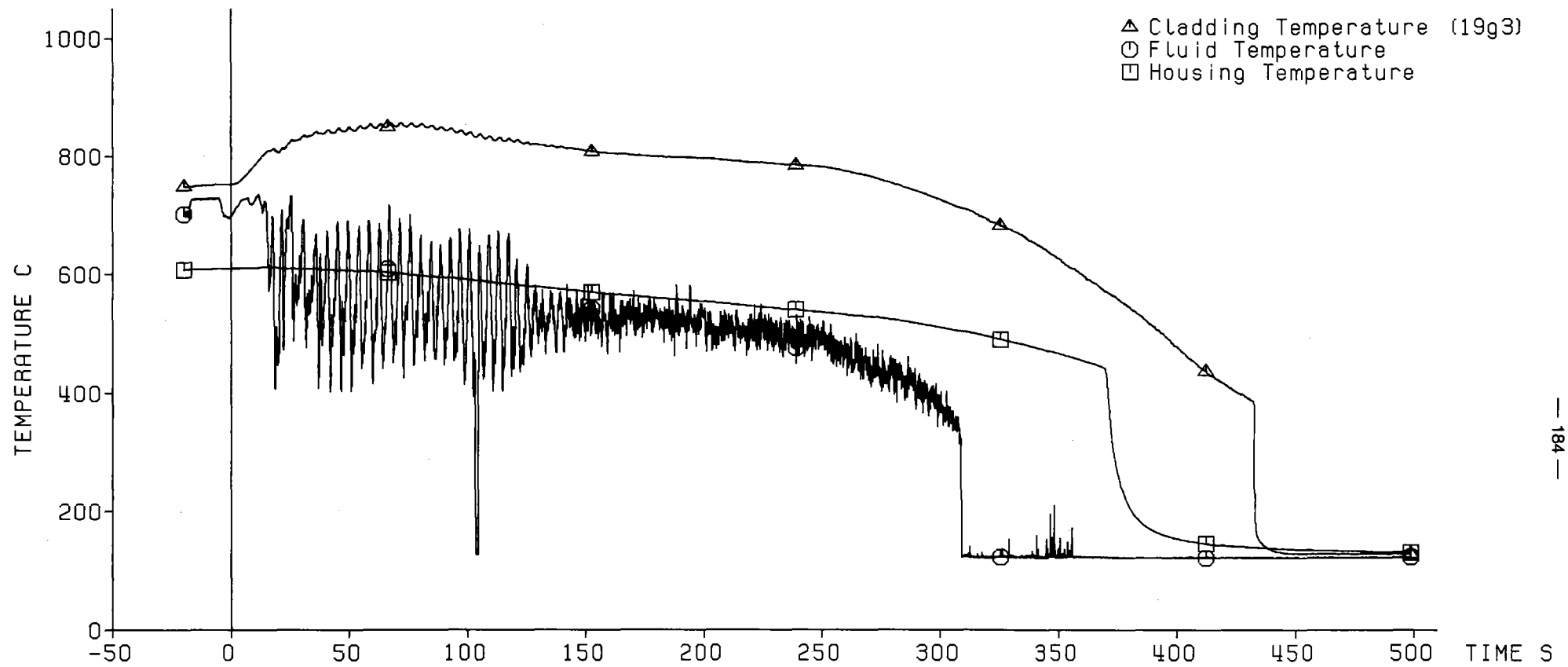

Decay Heat 120% ANS Standard
Flooding Rate (cold) 3.81 cm/s
System Pressure 2.11 bar
Feedwater Temperature 40 C



Fig. 156 FEBA: 5x5 ROD BUNDLE, TEST SERIES 7, TEST-No. 322

Axial Level: 1725 mm

△ Cladding Temperature (19g2)
○ Fluid Temperature

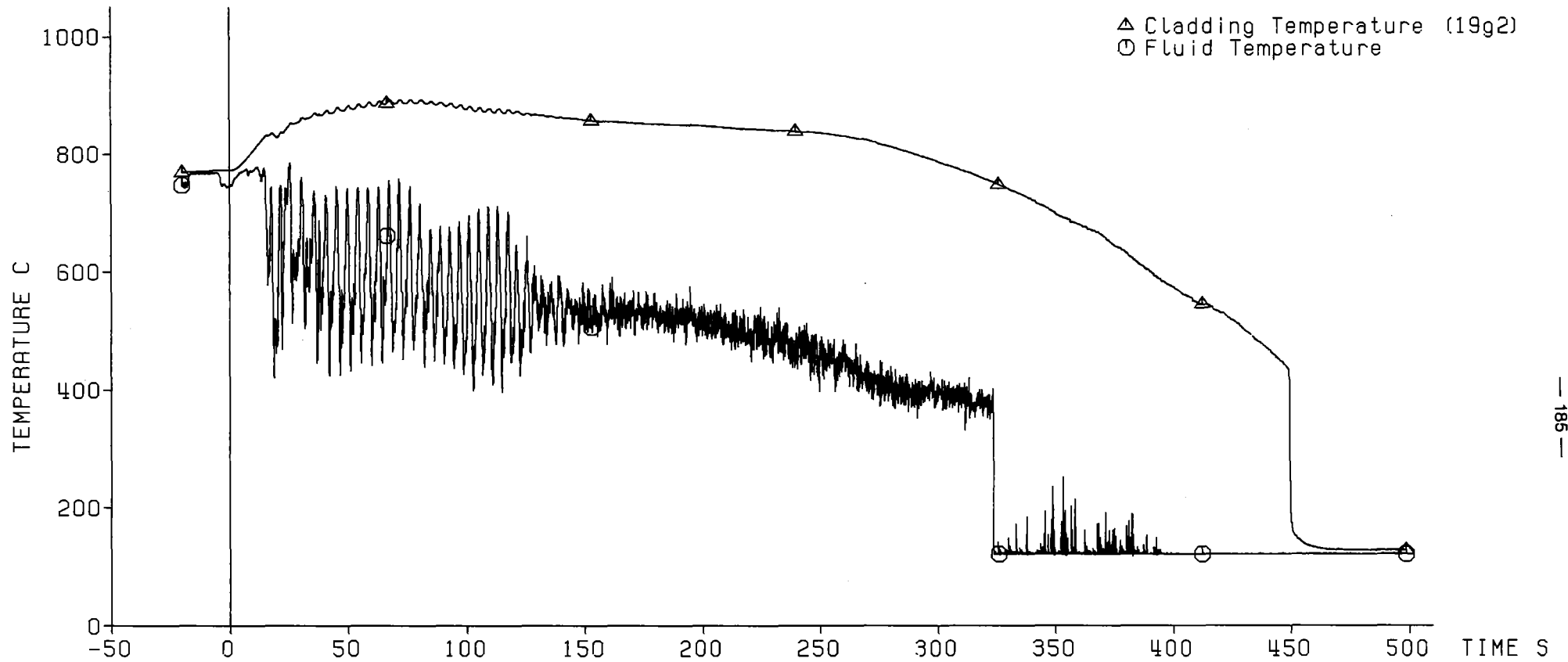

— 185 —

Decay Heat 120% ANS Standard
Flooding Rate (cold) 3.81 cm/s
System Pressure 2.11 bar
Feedwater Temperature 40 C



Fig. 157 FEBA: 5x5 ROD BUNDLE, TEST SERIES 7, TEST-No. 322

Axial Level: 1625 mm

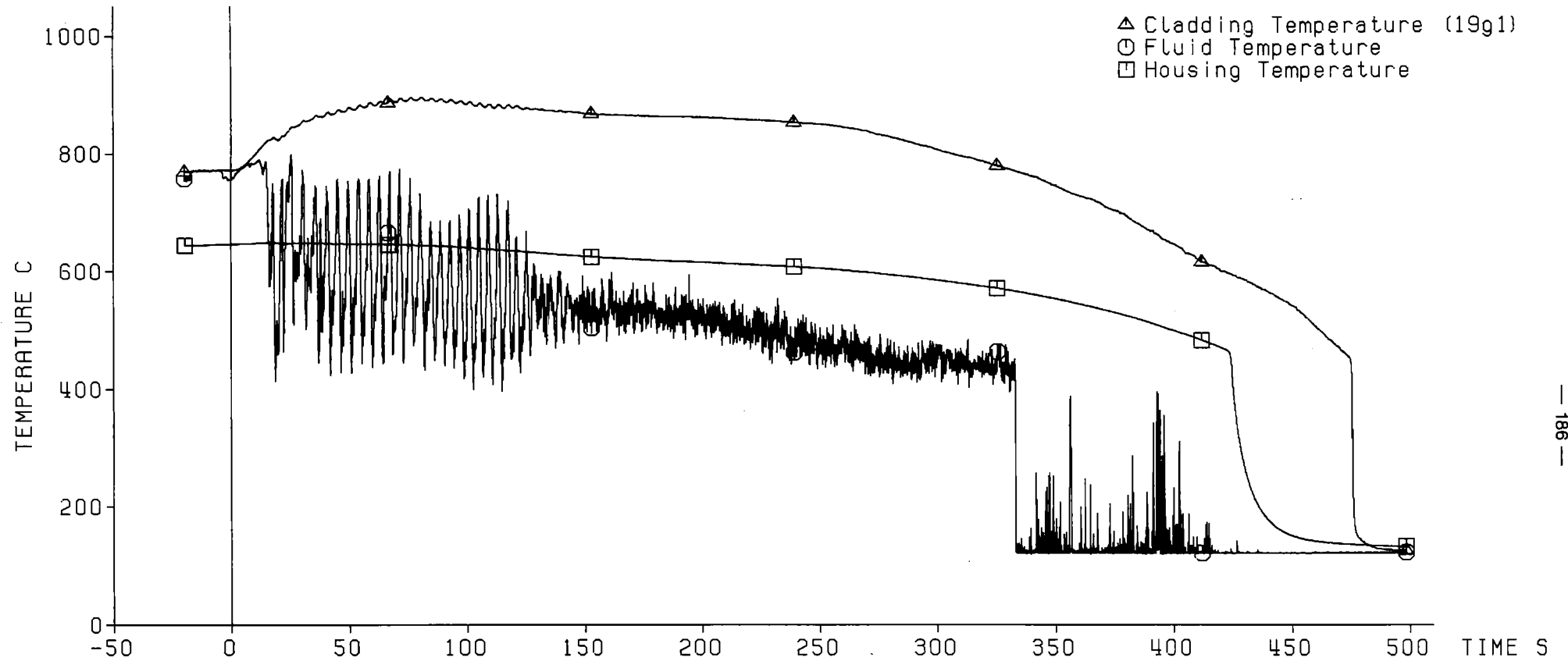

Decay Heat 120% ANS Standard
Flooding Rate (cold) 3.81 cm/s
System Pressure 2.11 bar
Feedwater Temperature 40 C



Fig. 158 FEBA: 5x5 ROD BUNDLE, TEST SERIES 7, TEST-No. 322

Axial Level: 1135 mm

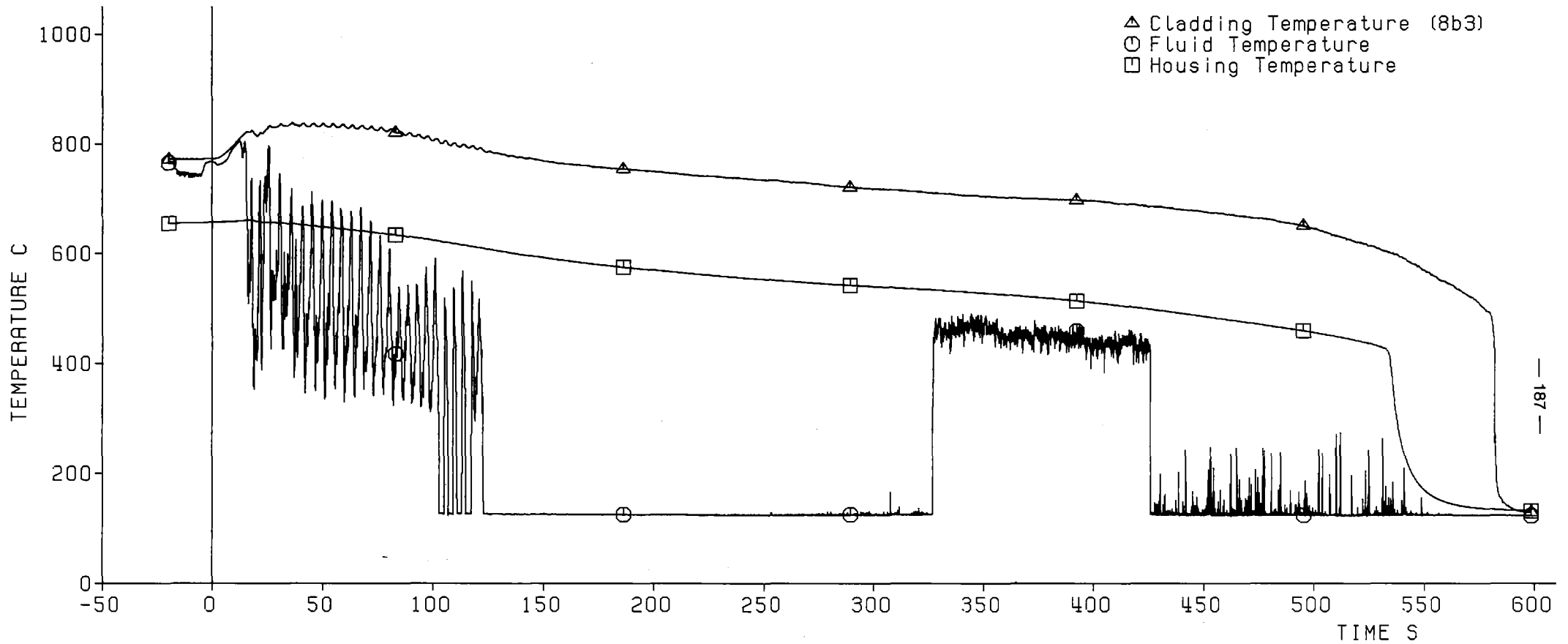

Decay Heat	120% ANS Standard
Flooding Rate (cold)	3.81 cm/s
System Pressure	2.11 bar
Feedwater Temperature	40 C

KFK IRB

Fig. 159 FEBA: 5x5 ROD BUNDLE, TEST SERIES 7, TEST-No. 322

Pressure Loss
Along the Test Section:

◇ Total Length: 4196 mm
△ Lower Part: 1711 mm
○ Middle Part: 545 mm
□ Upper Part: 1940 mm

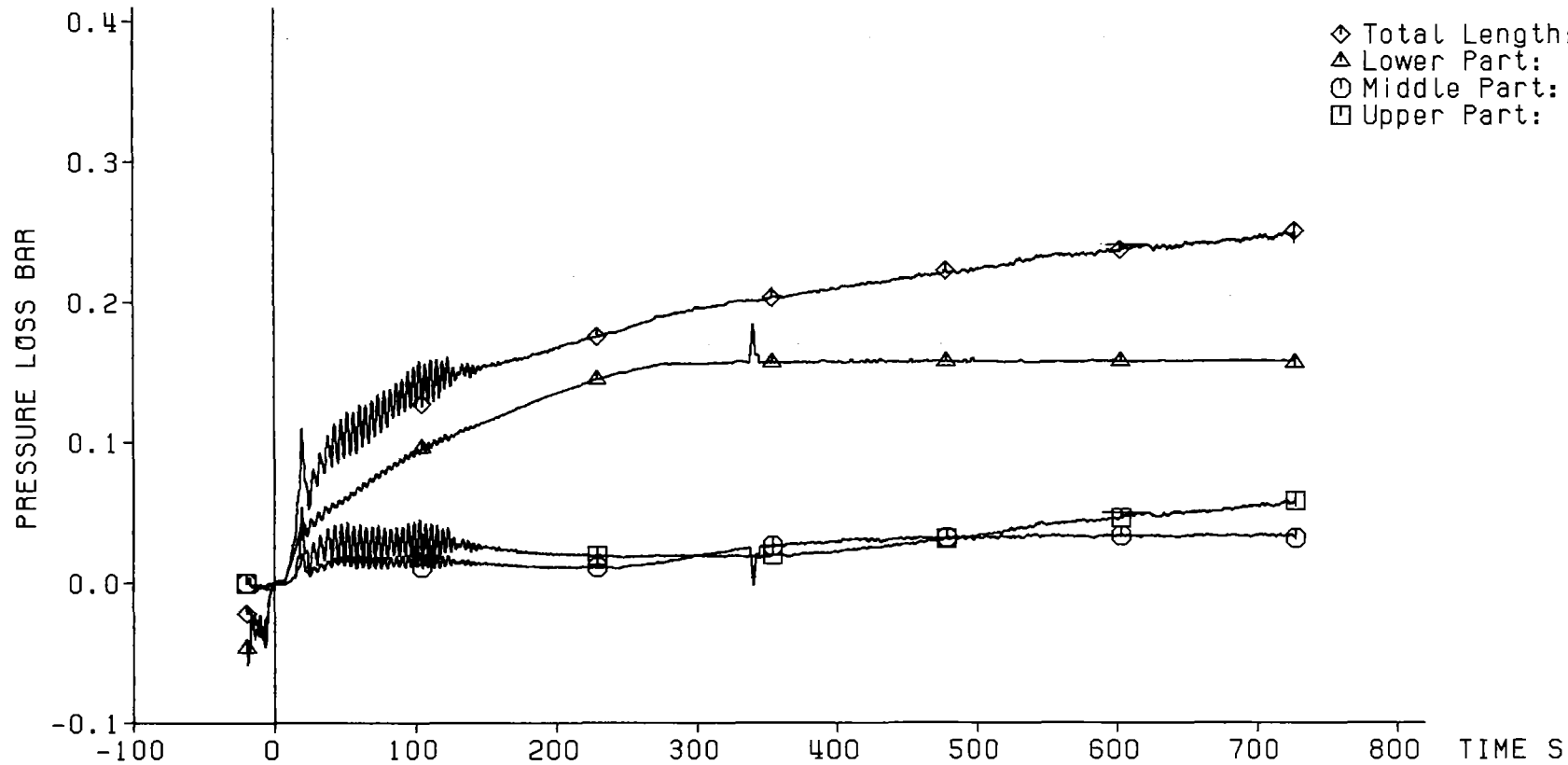

Decay Heat 120% ANS Standard
Flooding Rate (cold) 3.81 cm/s
System Pressure 2.11 bar
Feedwater Temperature 40 C

KIK
KIRB

Fig. 160 FEBA: 5x5 ROD BUNDLE, TEST SERIES 7, TEST-No. 322

Coolant Outlet Conditions:

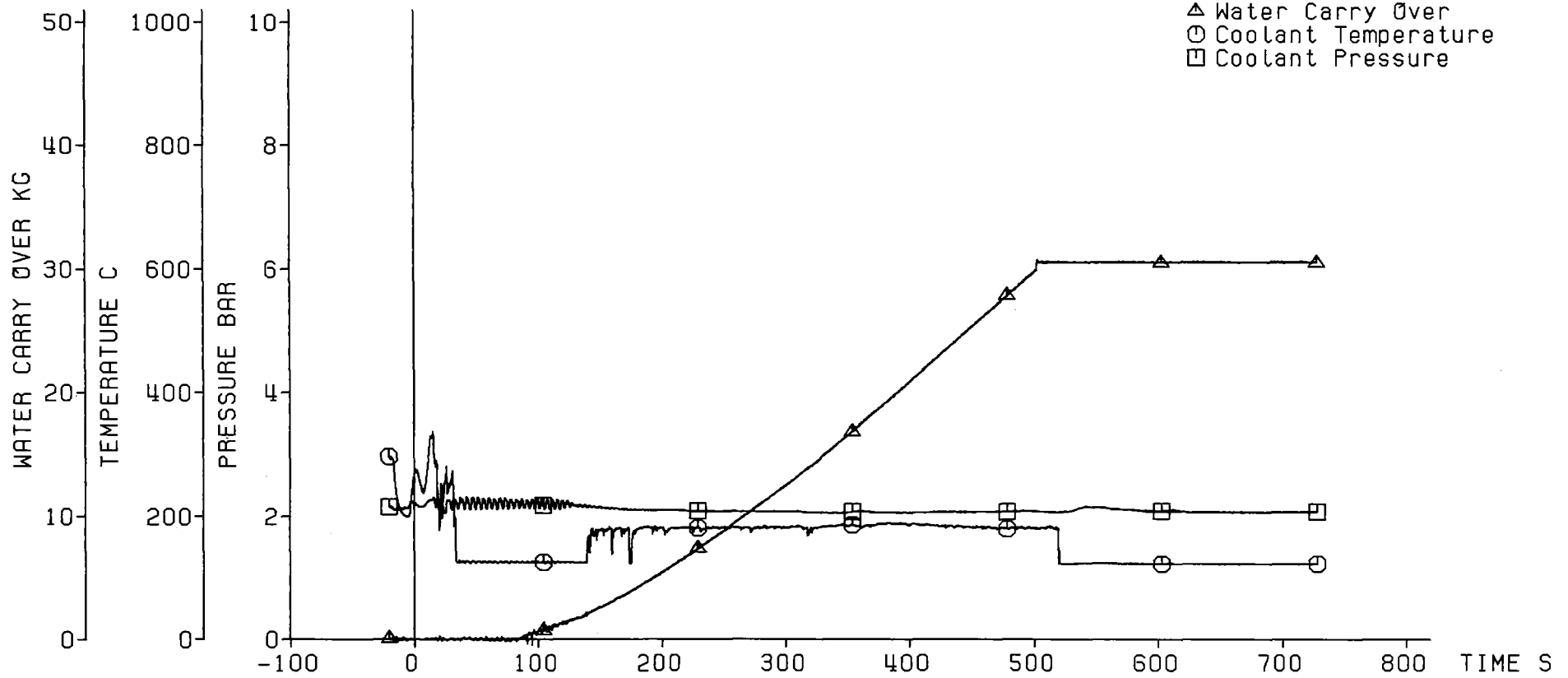

Decay Heat 120% ANS Standard
Flooding Rate (cold) 3.81 cm/s
System Pressure 2.11 bar
Feedwater Temperature 40 C



Fig. 161 FEBA: 5x5 ROD BUNDLE, TEST SERIES 7, TEST-No. 322

Axial Position of Quench Front

□ Quenching of Sleeves at Bundle Midplane

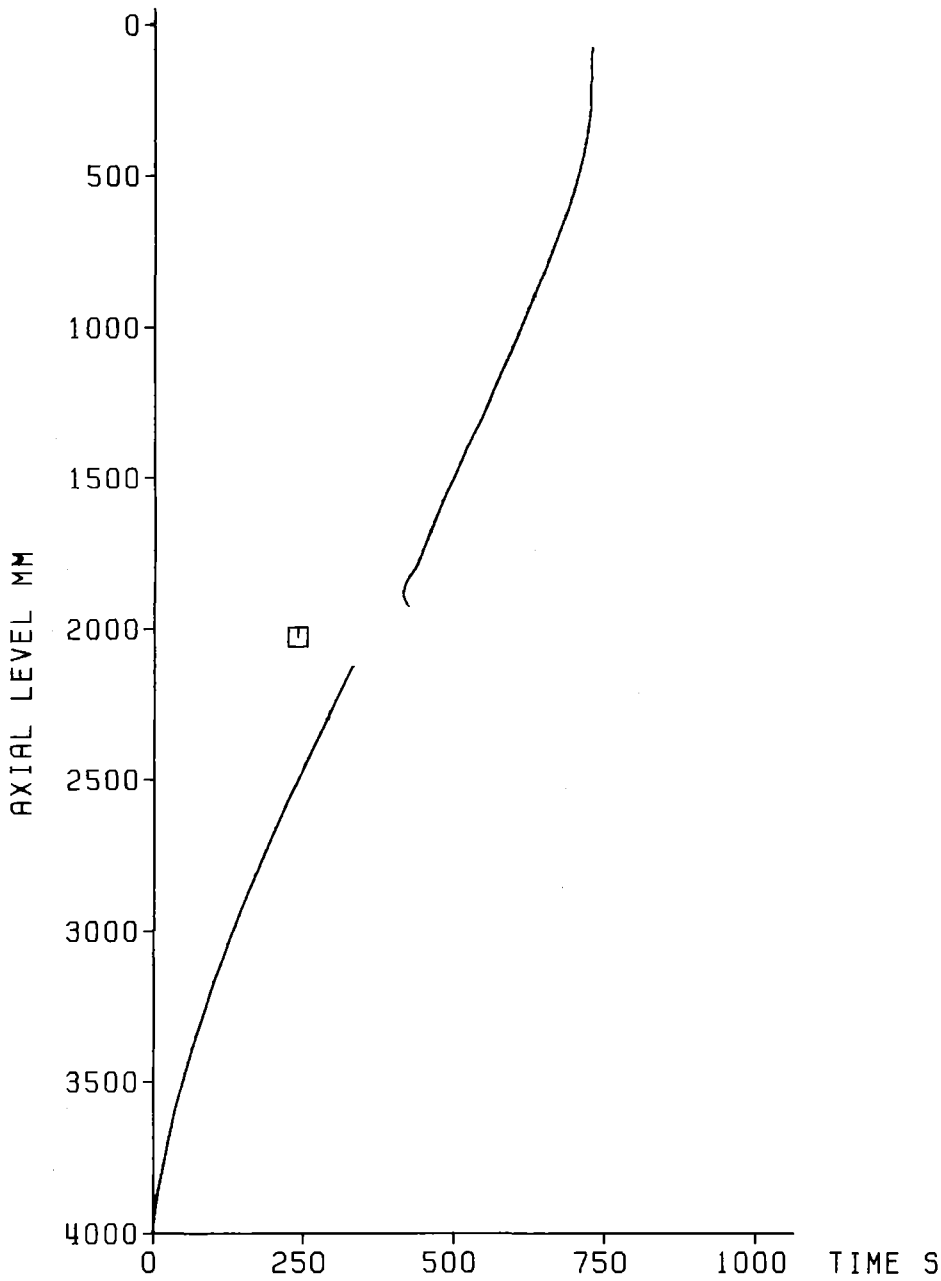

Decay Heat	120% ANS Standard
Flooding Rate (cold)	3.81 cm/s
System Pressure	2.11 bar
Feedwater Temperature	40 C

KJK IRB

Fig. 162 FEBA: 5x5 ROD BUNDLE
TEST SERIES 7, TEST-No. 322

Initial Axial Temperature Profile of Claddings

□ Initial Temperature of Sleeves at Bundle Midplane

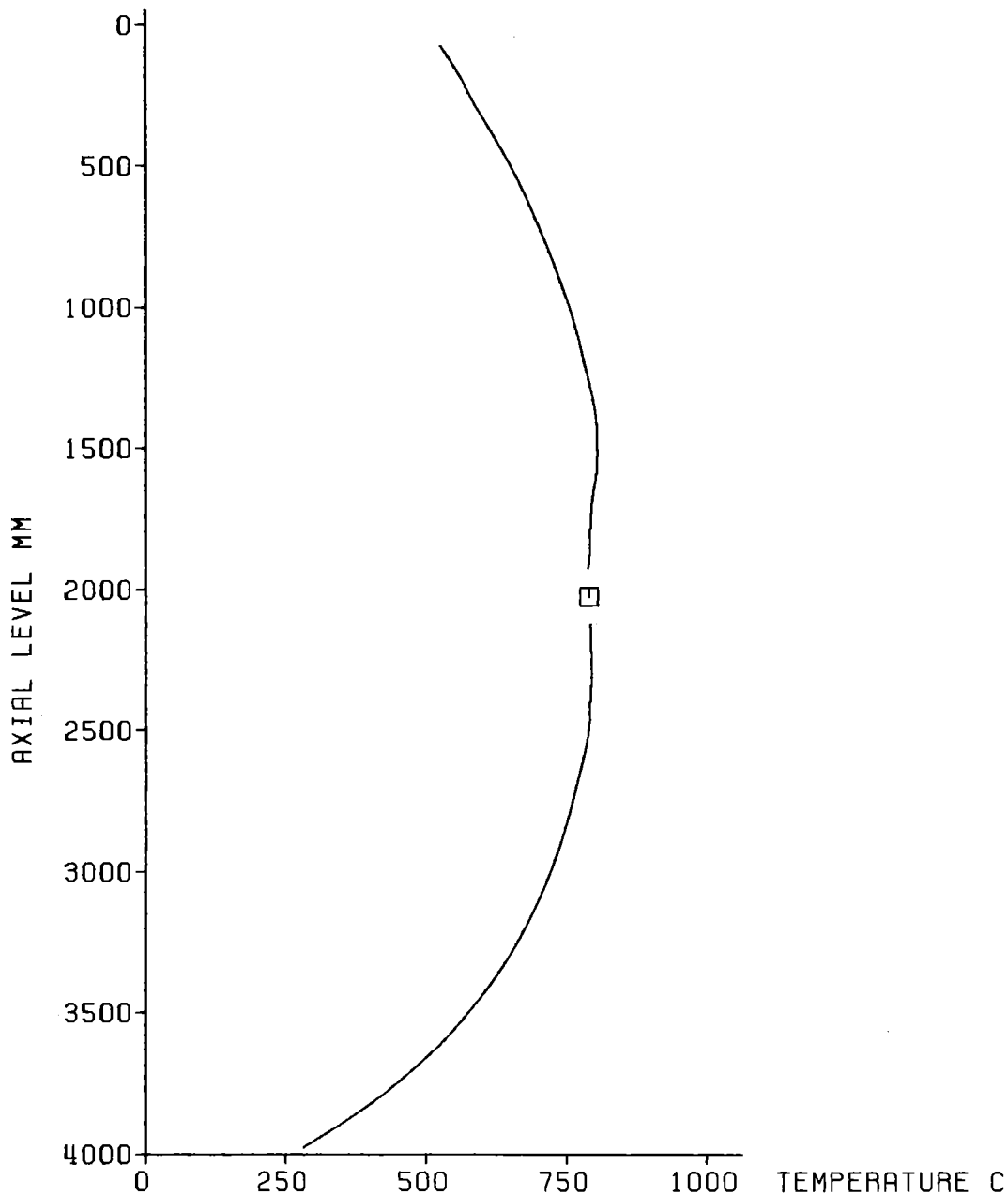

Decay Heat	120% ANS Standard
Flooding Rate (cold)	3.80 cm/s
System Pressure	4.10 bar
Feedwater Temperature	40 C



Fig. 163 FEBA: 5x5 ROD BUNDLE
TEST SERIES 7, TEST-No. 324

Test Parameters:

- ◇ Flooding Rate
- △ System Pressure
- Feedwater Temperature
- Bundle Power

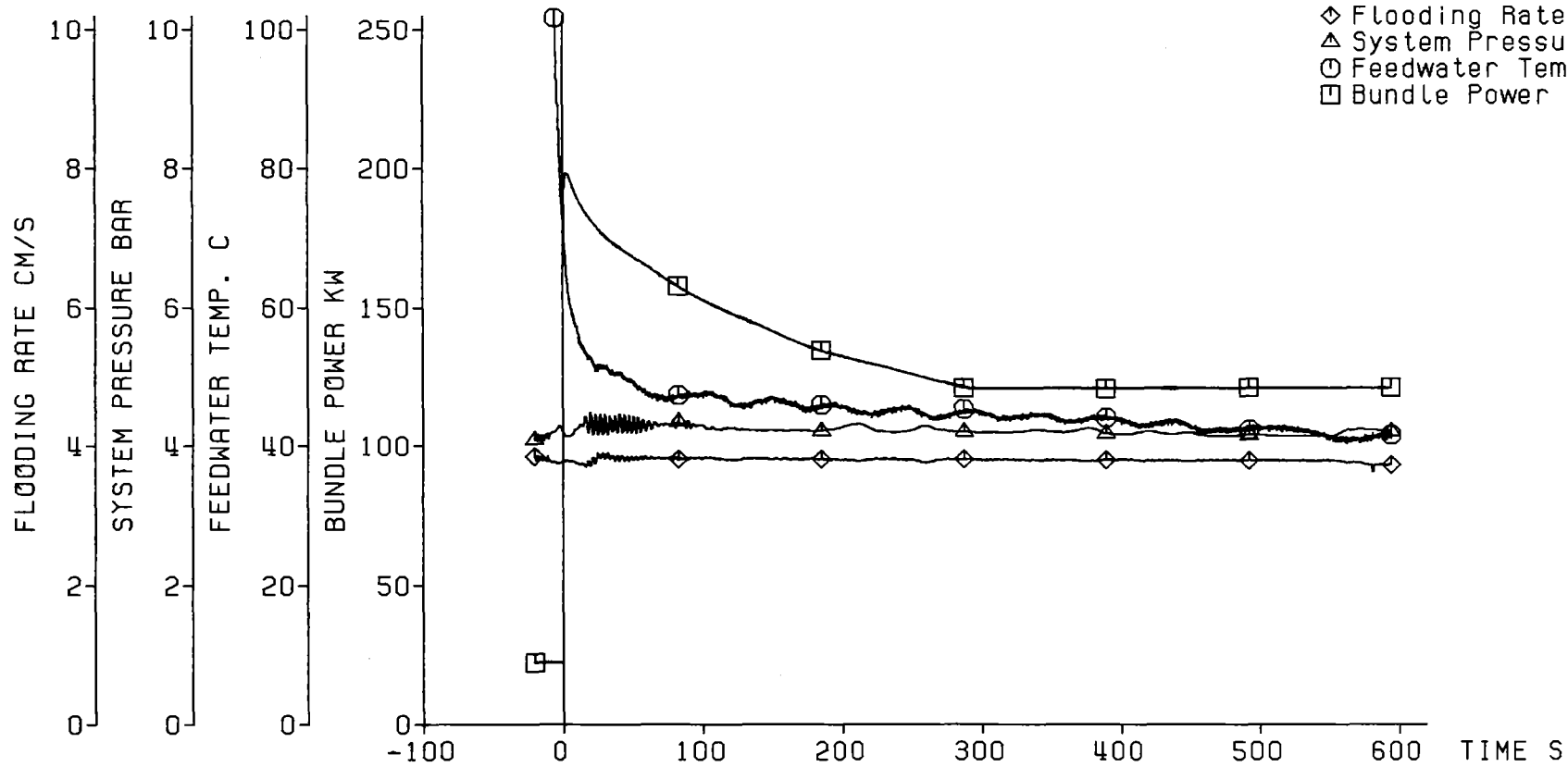

Decay Heat 120% ANS Standard
 Flooding Rate (cold) 3.80 cm/s
 System Pressure 4.10 bar
 Feedwater Temperature 40 C



Fig. 164 FEBA: 5x5 ROD BUNDLE, TEST SERIES 7, TEST-No. 324

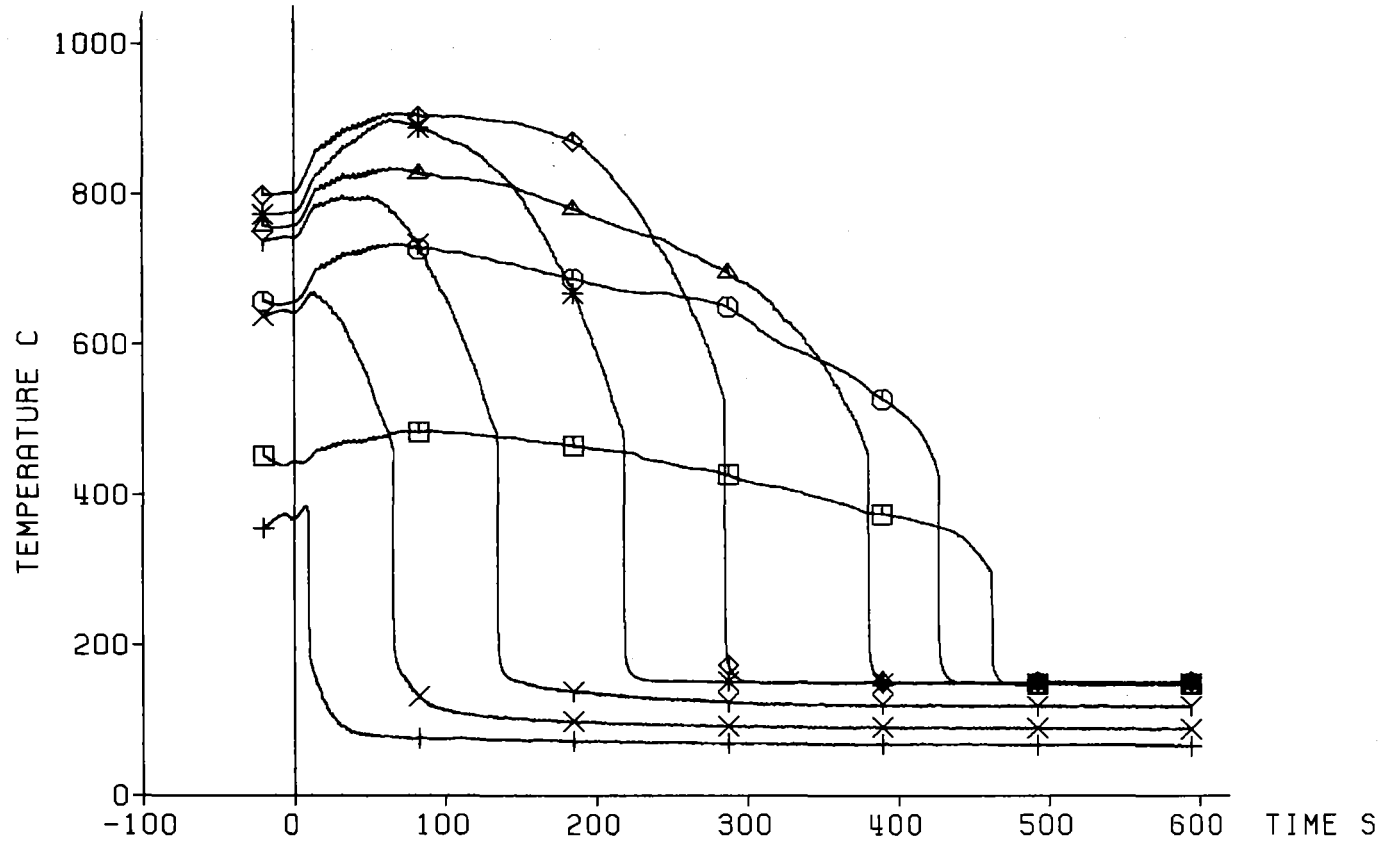

TC	Ax. Level
+	7a4 3860 mm
X	7a3 3315 mm
Y	7a2 2770 mm
*	7a1 2225 mm
◇	8b4 1680 mm
△	8b3 1135 mm
○	8b2 590 mm
□	3b1 45 mm

Decay Heat 120% ANS Standard
 Flooding Rate (cold) 3.80 cm/s
 System Pressure 4.10 bar
 Feedwater Temperature 40 C



Fig. 165 FEBA: 5x5 ROD BUNDLE, TEST SERIES 7, TEST-No. 324

Heat Transfer Coeff.

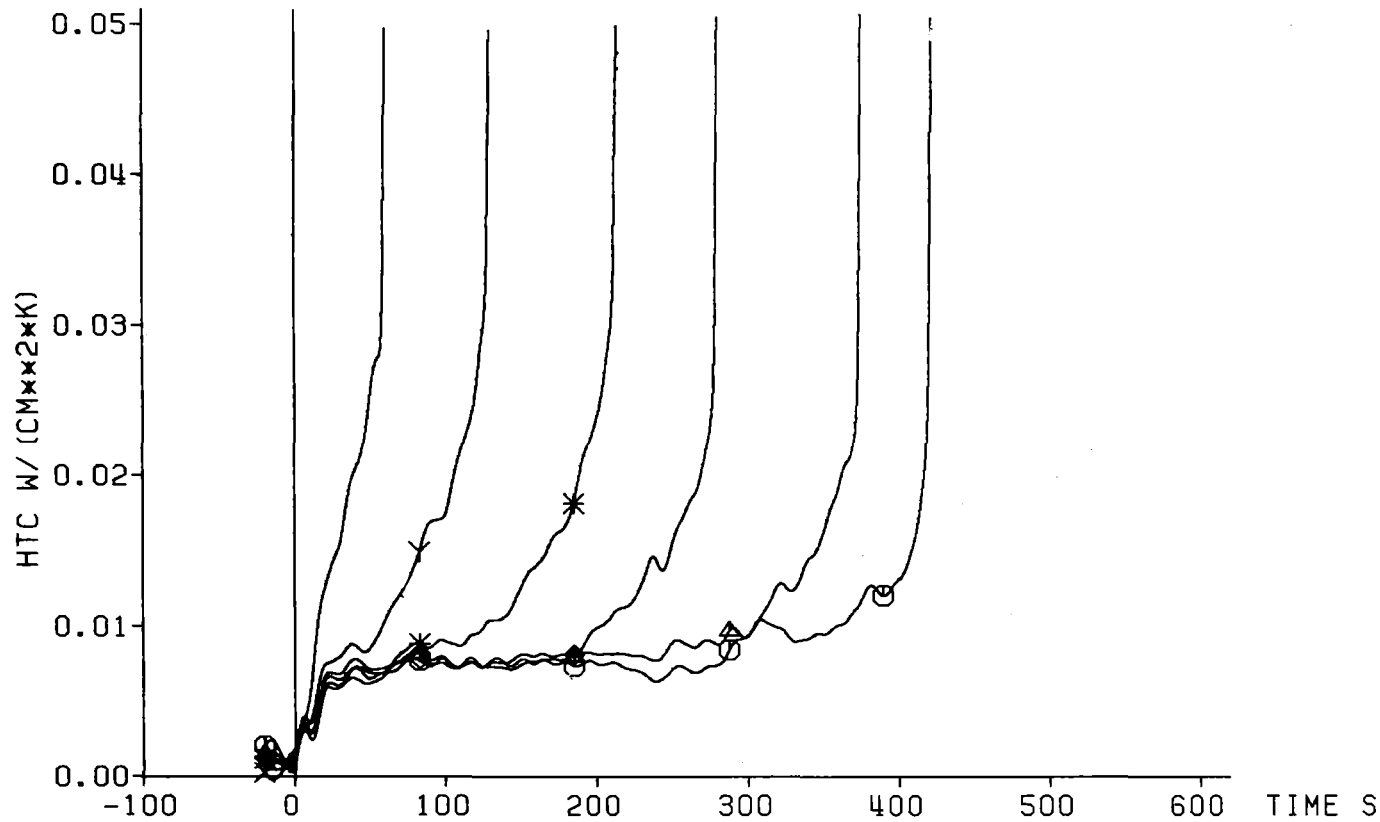

	TC	Ax. Level
X	7a3	3315 mm
Y	7a2	2770 mm
*	7a1	2225 mm
◇	8b4	1680 mm
△	8b3	1135 mm
○	8b2	590 mm

Decay Heat 120% ANS Standard
 Flooding Rate (cold) 3.80 cm/s
 System Pressure 4.10 bar
 Feedwater Temperature 40 C



Fig. 166 FEBA: 5x5 ROD BUNDLE, TEST SERIES 7, TEST-No. 324

Cladding Temperature

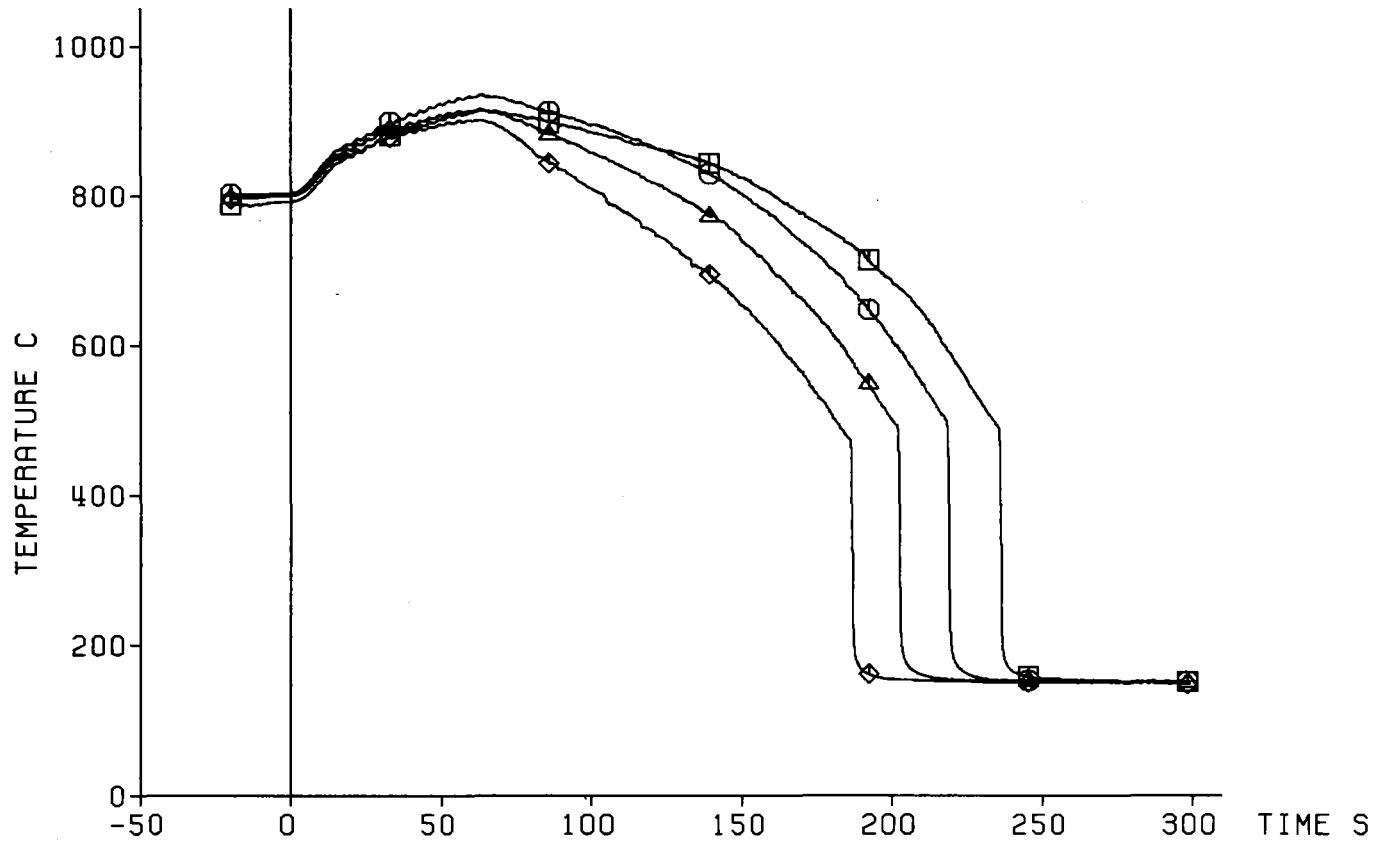

Decay Heat 120% ANS Standard
 Flooding Rate (cold) 3.80 cm/s
 System Pressure 4.10 bar
 Feedwater Temperature 40 C



Fig. 167 FEBA: 5x5 ROD BUNDLE, TEST SERIES 7, TEST-No. 324

Heat Transfer Coeff.

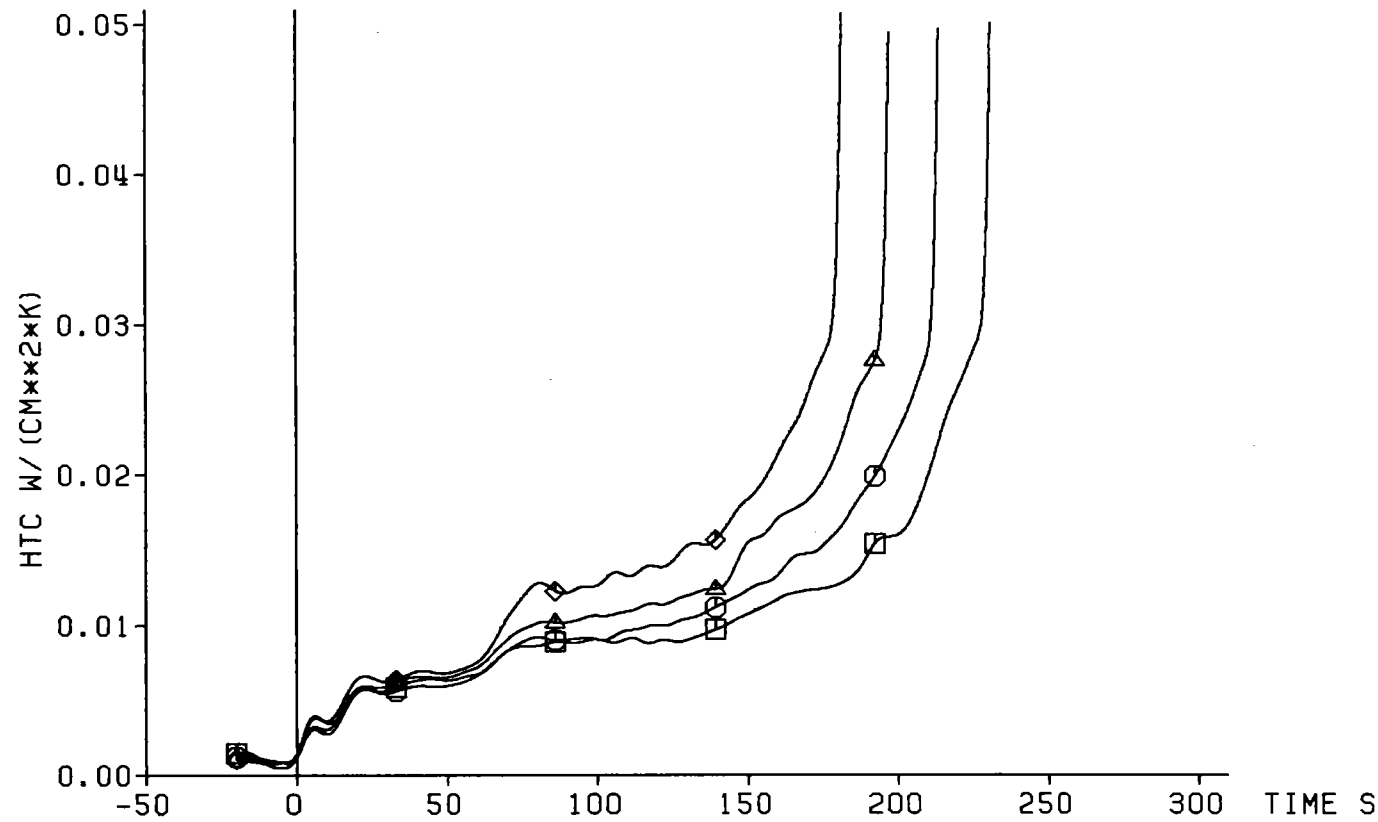

TC	Ax. Level
◇	14f4 2425 mm
△	14f3 2325 mm
○	14h2 2225 mm
□	14f1 2125 mm

Decay Heat 120% ANS Standard
 Flooding Rate (cold) 3.80 cm/s
 System Pressure 4.10 bar
 Feedwater Temperature 40 C



Fig. 168 FEBA: 5x5 ROD BUNDLE, TEST SERIES 7, TEST-No. 324

Cladding Temperature

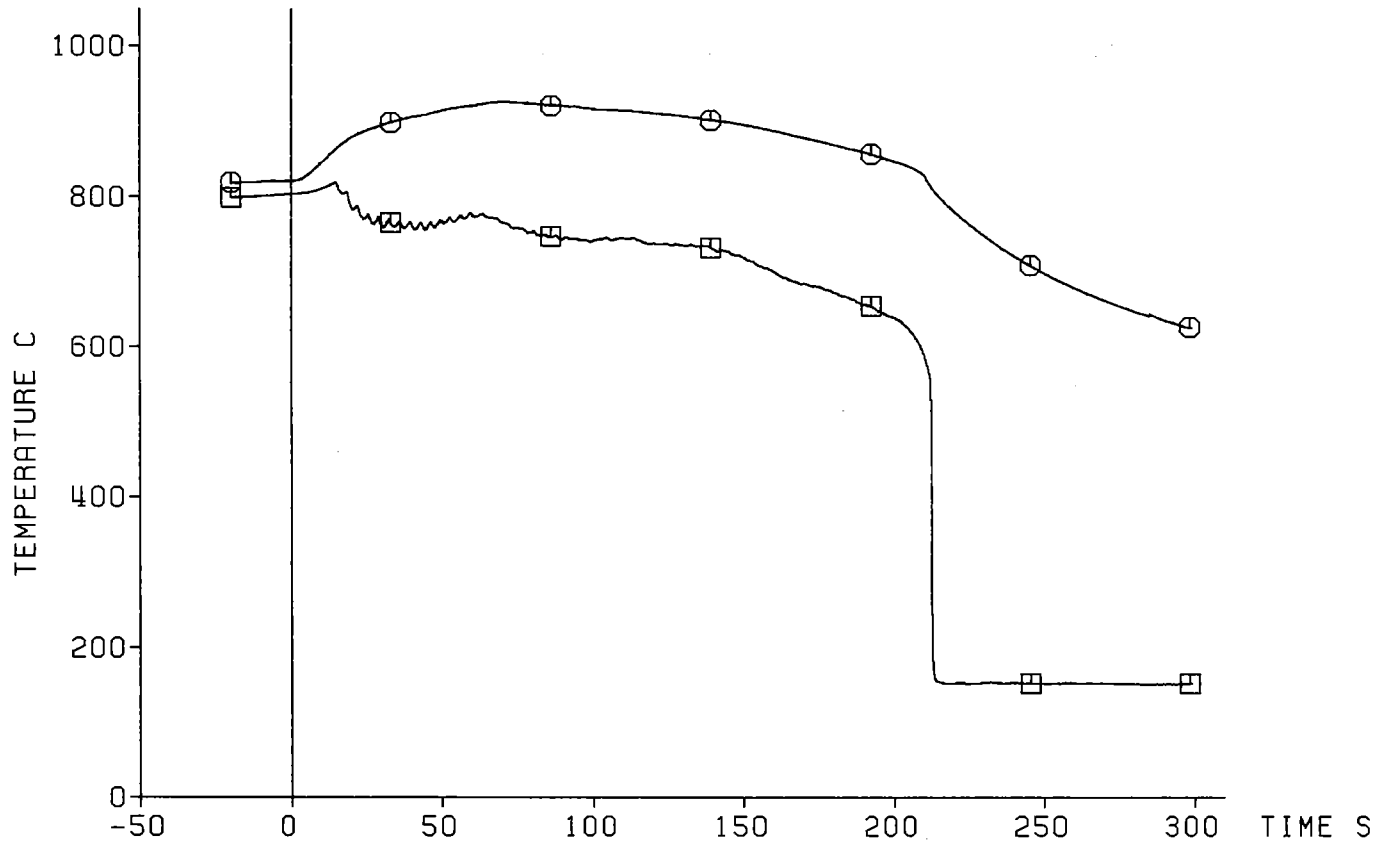

TC	Ax. Level
○ 13h2	2025 mm
□ Sleeve	2025 mm

Decay Heat 120% ANS Standard
 Flooding Rate (cold) 3.80 cm/s
 System Pressure 4.10 bar
 Feedwater Temperature 40 C



Fig. 169 FEBA: 5x5 ROD BUNDLE, TEST SERIES 7, TEST-No. 324

Cladding Temperature

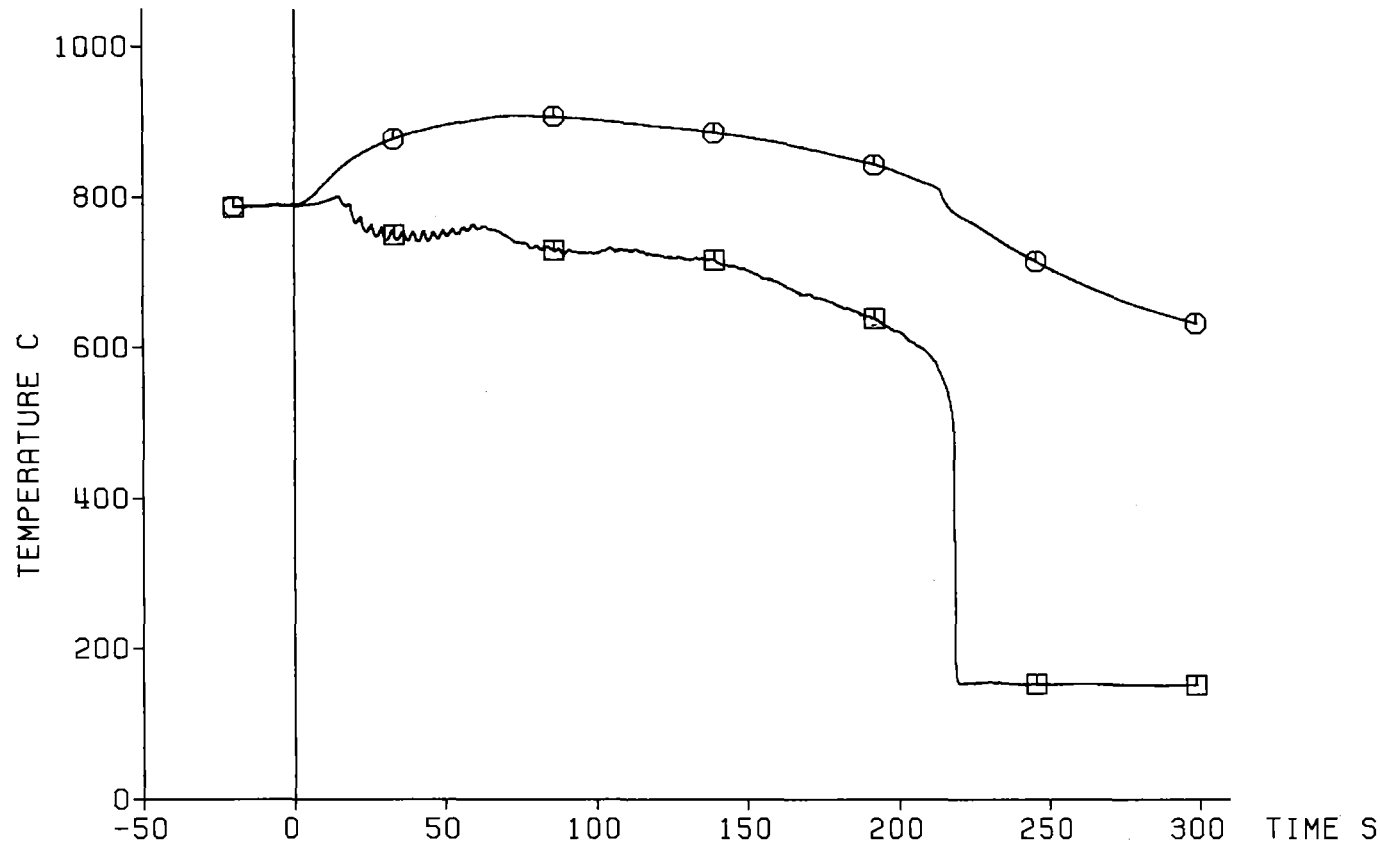

TC	Ax. Level
⊙ 17i4	2025 mm
⊠ Sleeve	2025 mm

Decay Heat 120% ANS Standard
 Flooding Rate (cold) 3.80 cm/s
 System Pressure 4.10 bar
 Feedwater Temperature 40 C



Fig. 170 FEBA: 5x5 ROD BUNDLE, TEST SERIES 7, TEST-No. 324

Cladding Temperature

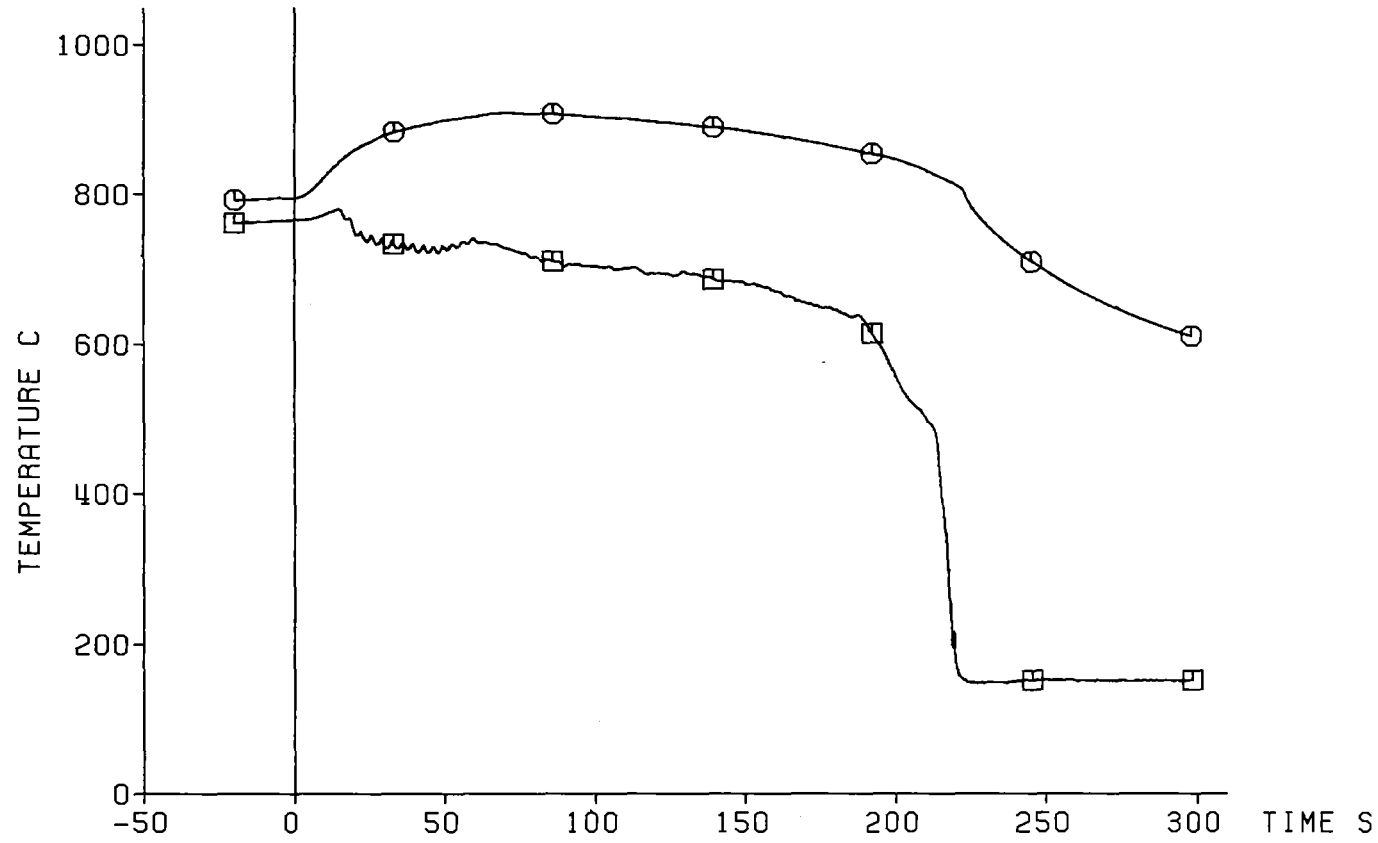

TC	Ax. Level
⊙ 1713	1975 mm
⊠ Sleeve	1972 mm

Decay Heat 120% ANS Standard
 Flooding Rate (cold) 3.80 cm/s
 System Pressure 4.10 bar
 Feedwater Temperature 40 C



Fig. 171 FEBA: 5x5 ROD BUNDLE, TEST SERIES 7, TEST-No. 324

Cladding Temperature

TC	Ax. Level
○ 1714	2025 mm
+ Sleeve	2064 mm
□ Sleeve	2025 mm
△ Sleeve	2025 mm
× Sleeve	1972 mm

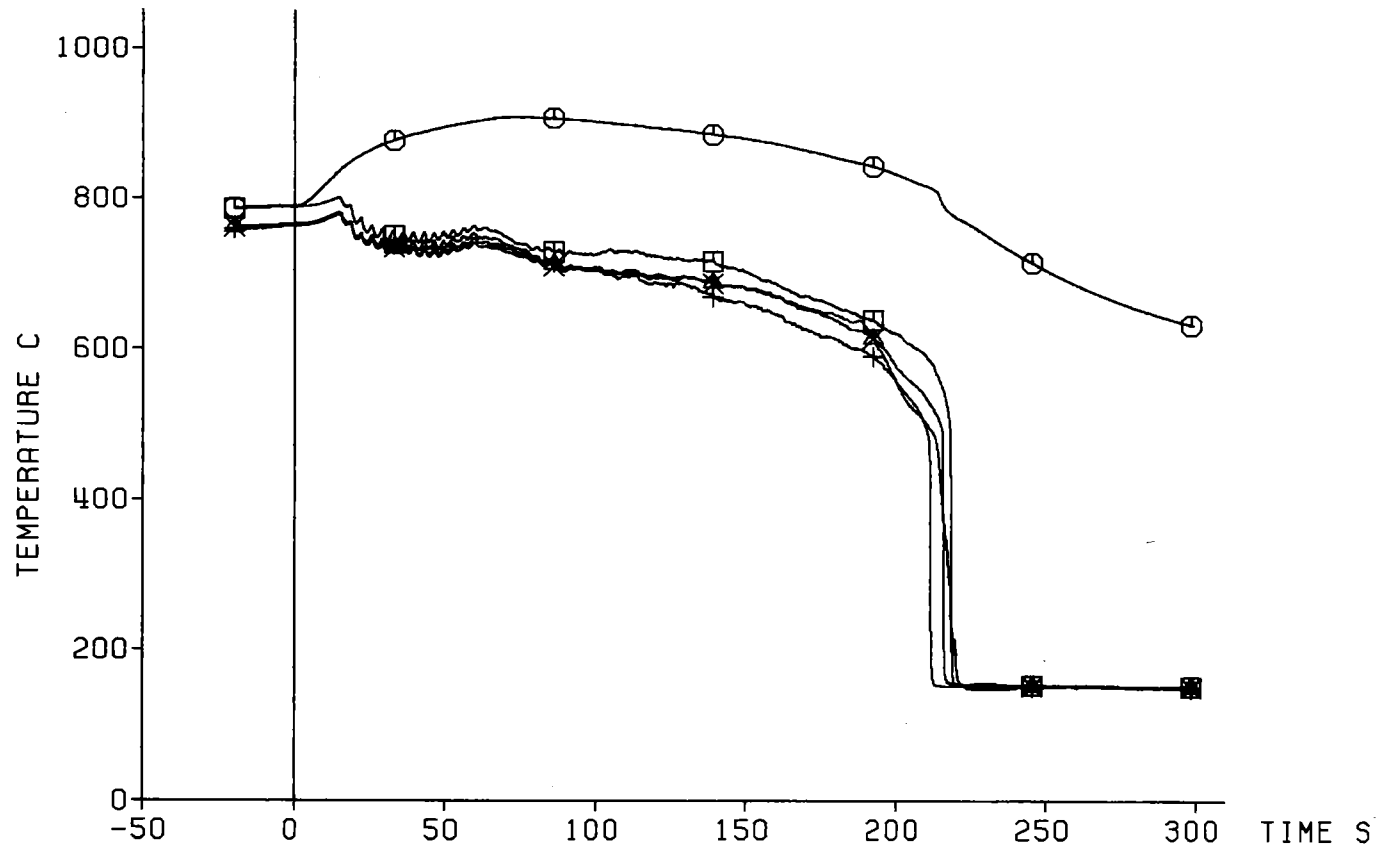

Decay Heat 120% ANS Standard
 Flooding Rate (cold) 3.80 cm/s
 System Pressure 4.10 bar
 Feedwater Temperature 40 C



Fig. 172 FEBA: 5x5 ROD BUNDLE, TEST SERIES 7, TEST-No. 324

Cladding Temperature

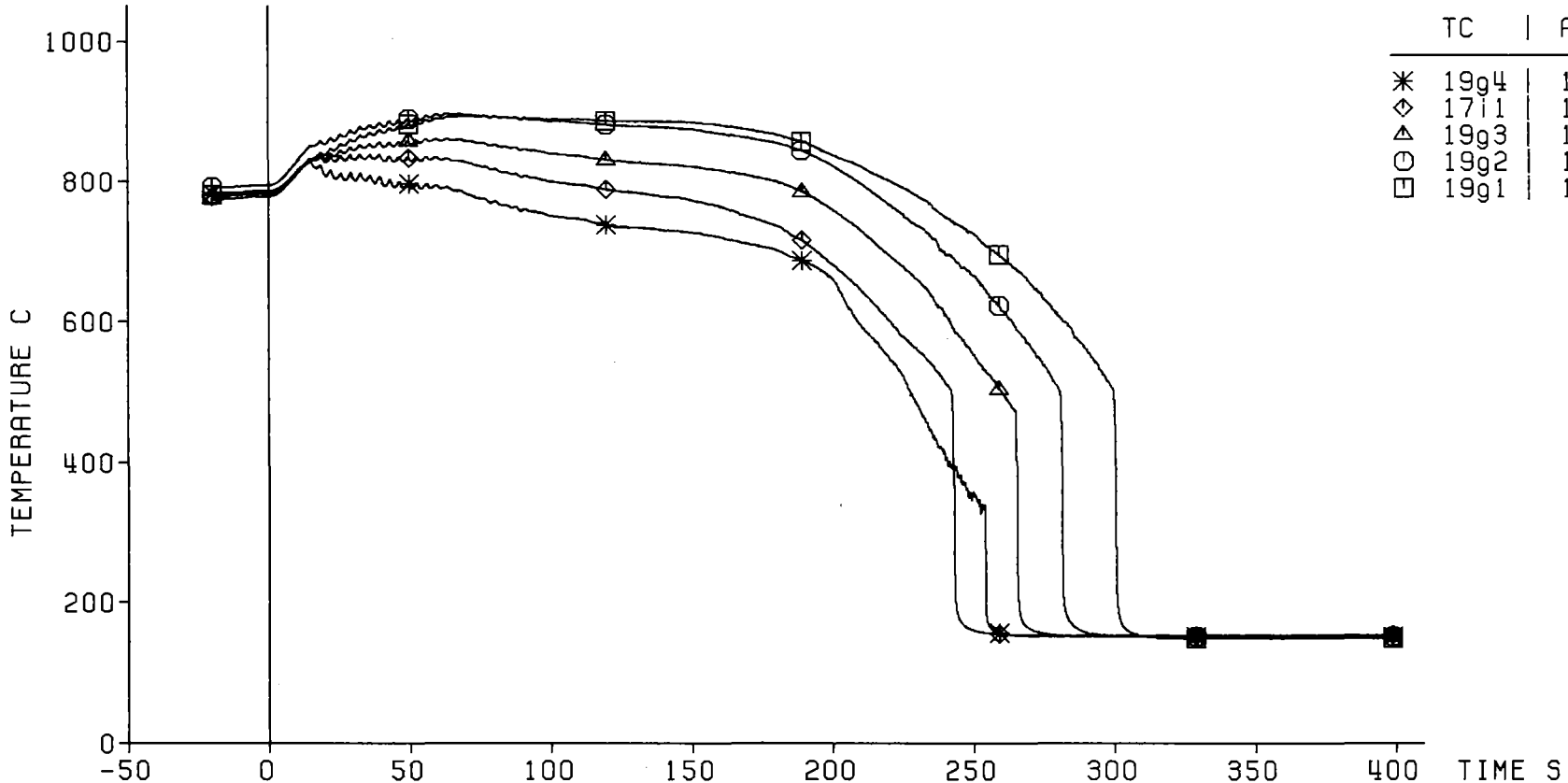

TC	Ax. Level
* 19g4	1925 mm
◇ 17i1	1875 mm
△ 19g3	1825 mm
○ 19g2	1725 mm
□ 19g1	1625 mm

Decay Heat 120% ANS Standard
 Flooding Rate (cold) 3.80 cm/s
 System Pressure 4.10 bar
 Feedwater Temperature 40 C



Fig. 173 FEBA: 5x5 ROD BUNDLE, TEST SERIES 7, TEST-No. 324

Heat Transfer Coeff.

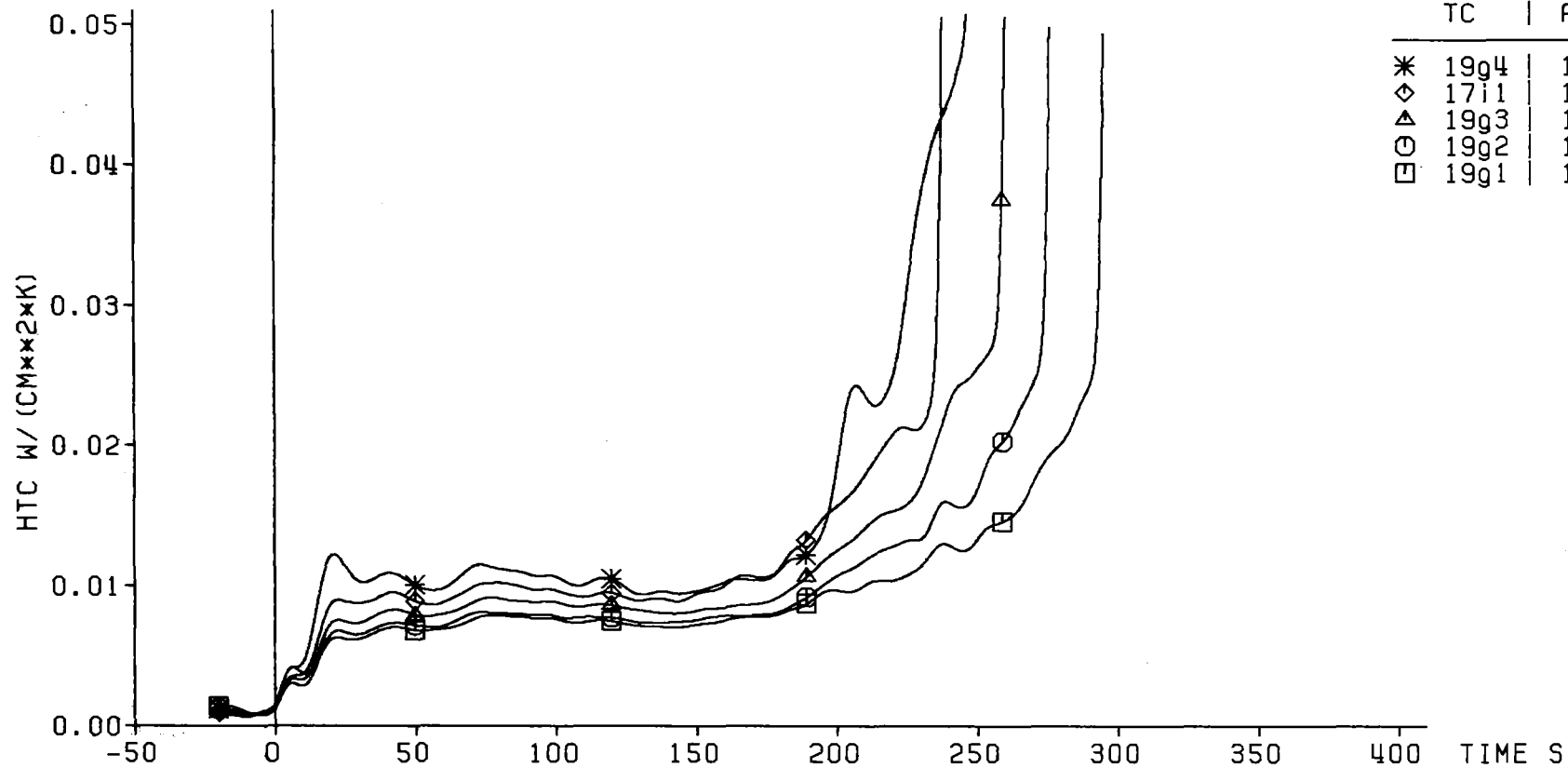

Decay Heat 120% ANS Standard
 Flooding Rate (cold) 3.80 cm/s
 System Pressure 4.10 bar
 Feedwater Temperature 40 C



Fig. 174 FEBA: 5x5 ROD BUNDLE, TEST SERIES 7, TEST-No. 324

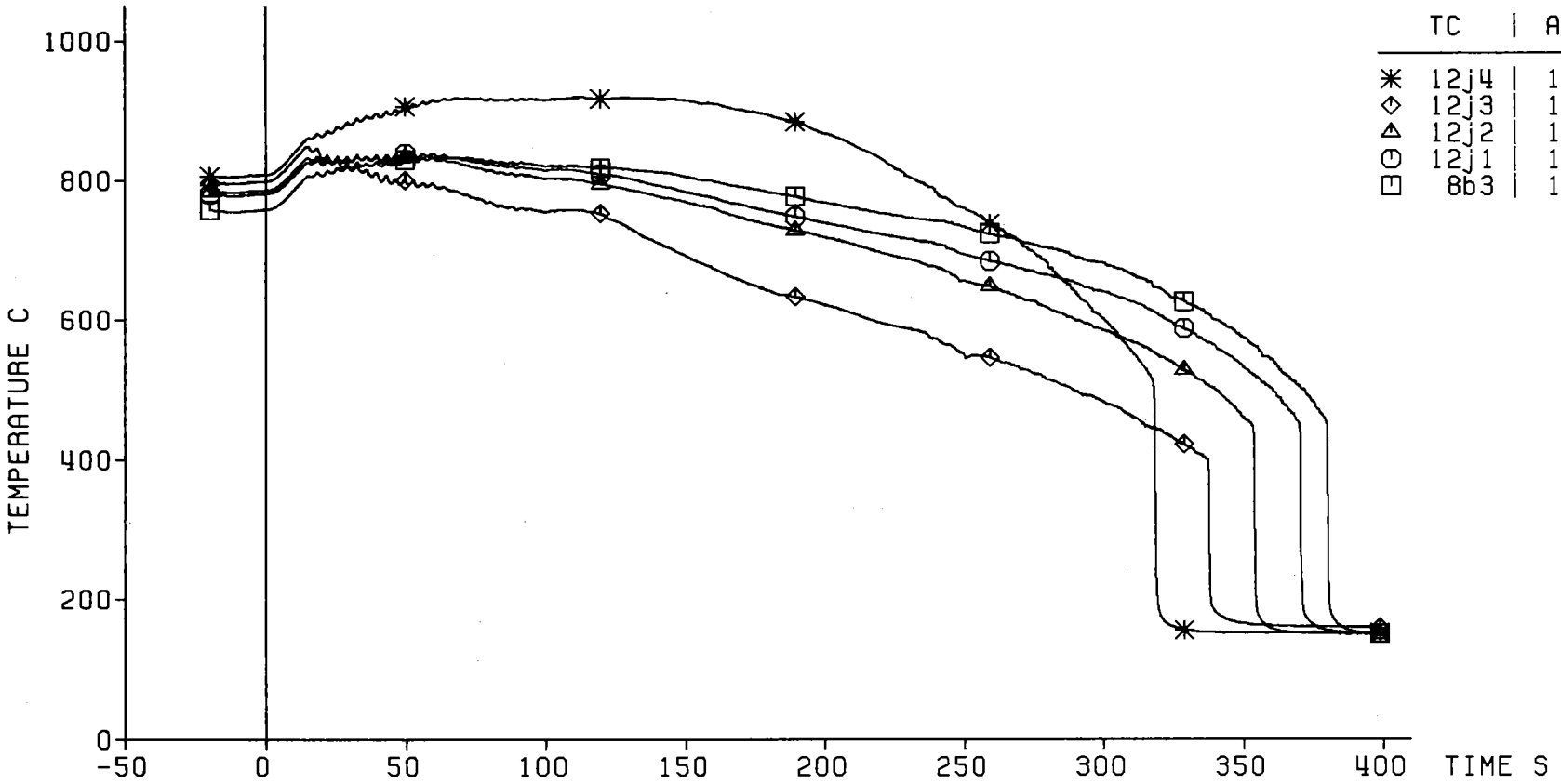

Decay Heat 120% ANS Standard
Flooding Rate (cold) 3.80 cm/s
System Pressure 4.10 bar
Feedwater Temperature 40 C



Fig. 175 FEBA: 5x5 ROD BUNDLE, TEST SERIES 7, TEST-No. 324

Heat Transfer Coeff.

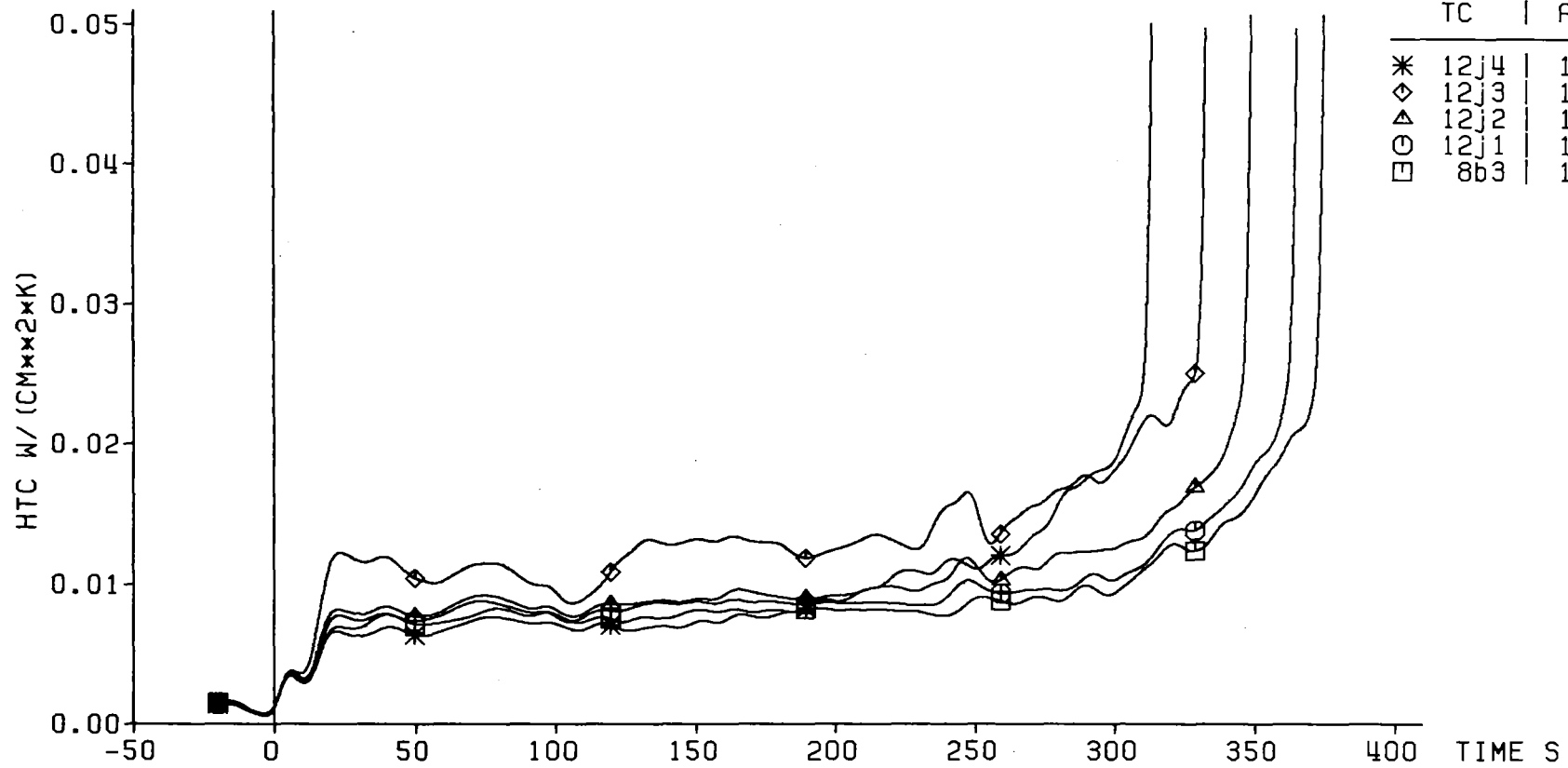

Decay Heat 120% ANS Standard
 Flooding Rate (cold) 3.80 cm/s
 System Pressure 4.10 bar
 Feedwater Temperature 40 C



Fig. 176 FEBA: 5x5 ROD BUNDLE, TEST SERIES 7, TEST-No. 324

Axial Level: 2770 mm

△ Cladding Temperature (7a2)
○ Fluid Temperature
□ Housing Temperature

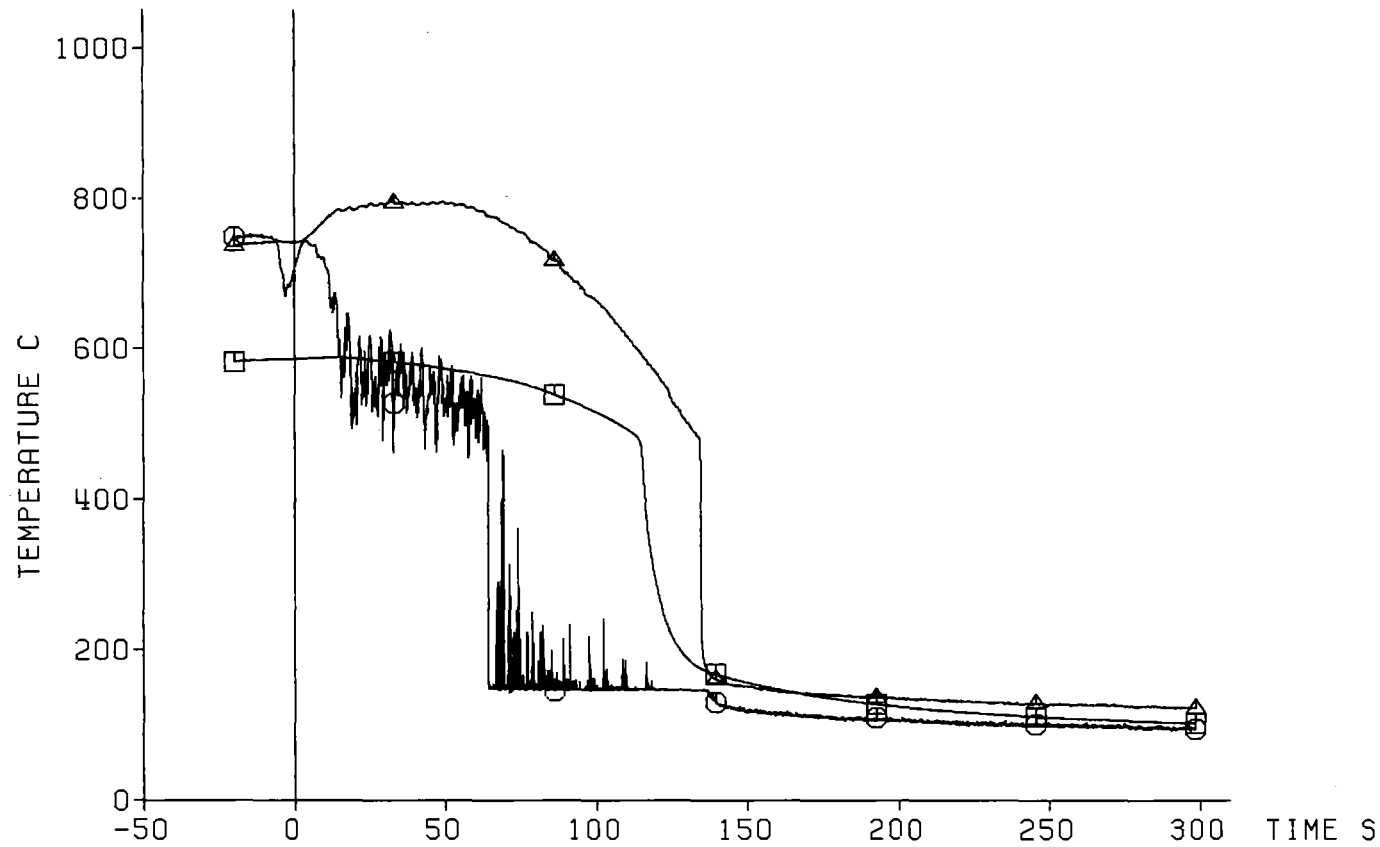

Decay Heat 120% ANS Standard
Flooding Rate (cold) 3.80 cm/s
System Pressure 4.10 bar
Feedwater Temperature 40 C



Fig. 177 FEBA: 5x5 ROD BUNDLE, TEST SERIES 7, TEST-No. 324

Axial Level: 2225 mm

△ Cladding Temperature (7a1)
○ Fluid Temperature (2240 mm)
□ Housing Temperature (2235 mm)

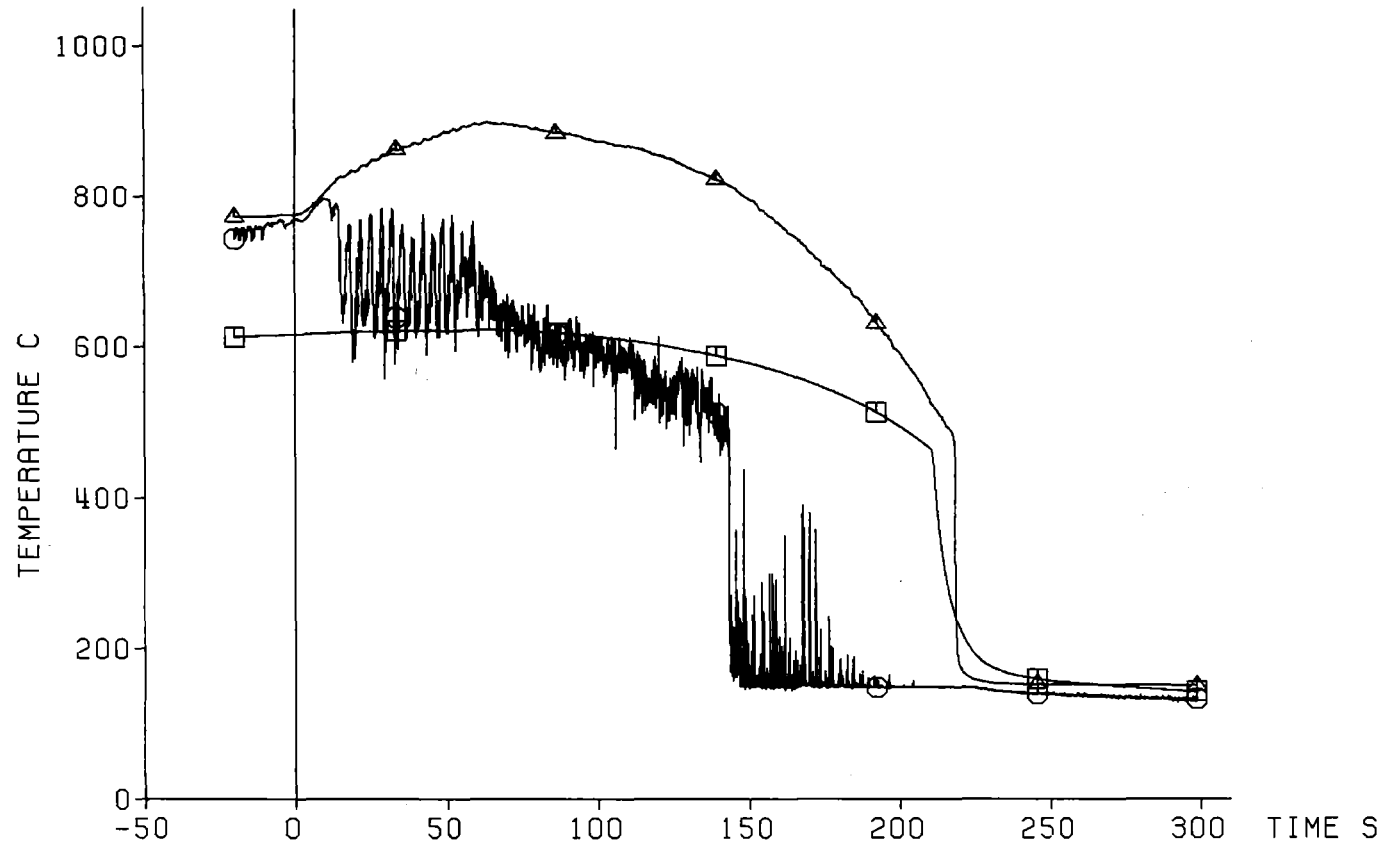

Decay Heat 120% ANS Standard
Flooding Rate (cold) 3.80 cm/s
System Pressure 4.10 bar
Feedwater Temperature 40 C

KIK
IRB

Fig. 178 FEBA: 5x5 ROD BUNDLE, TEST SERIES 7, TEST-No. 324

Axial Level: 1825 mm

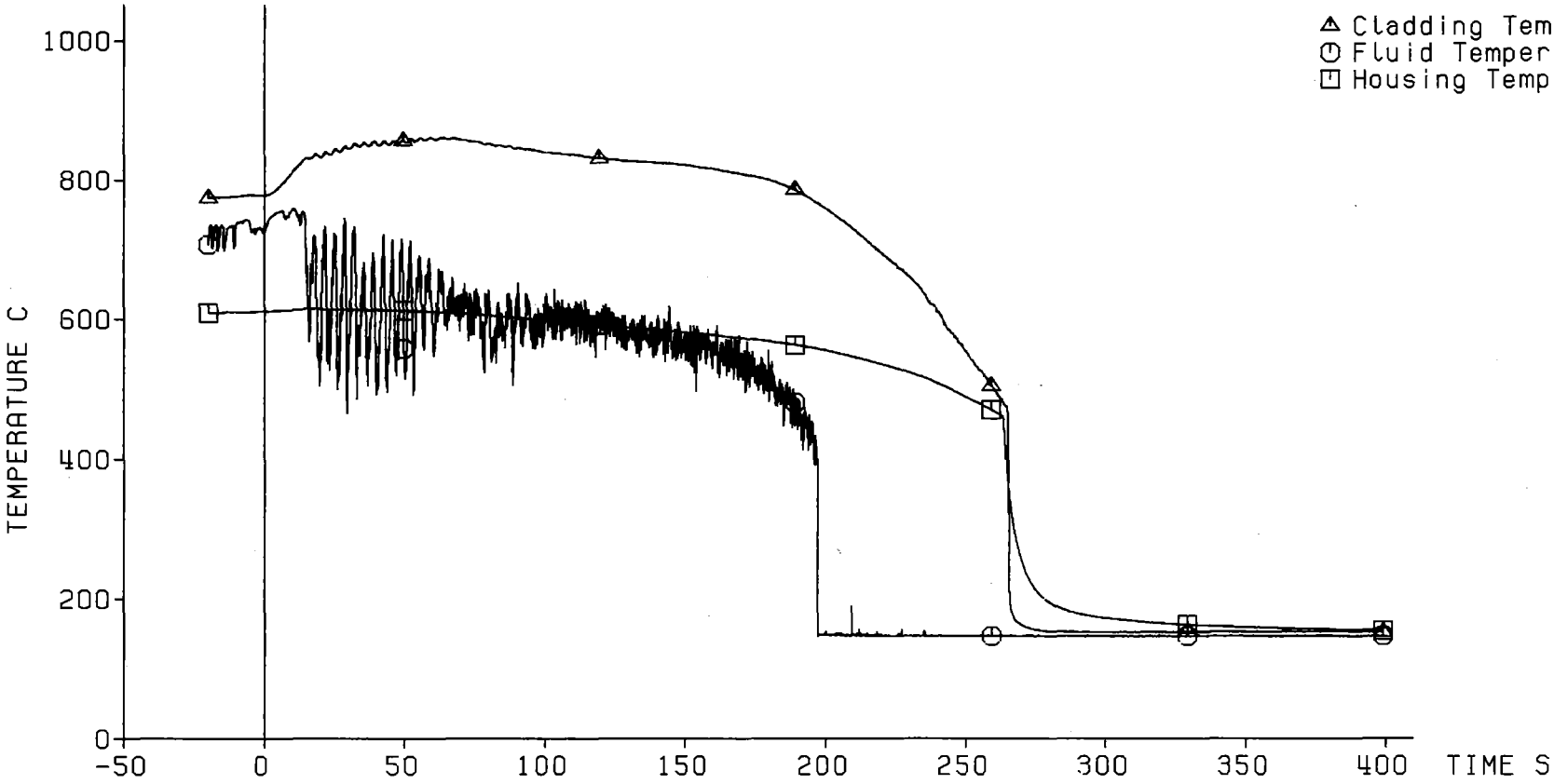

— 208 —

Decay Heat 120% ANS Standard
Flooding Rate (cold) 3.80 cm/s
System Pressure 4.10 bar
Feedwater Temperature 40 C



Fig. 179 FEBA: 5x5 ROD BUNDLE, TEST SERIES 7, TEST-No. 324

Axial Level: 1725 mm

△ Cladding Temperature (19g2)
○ Fluid Temperature

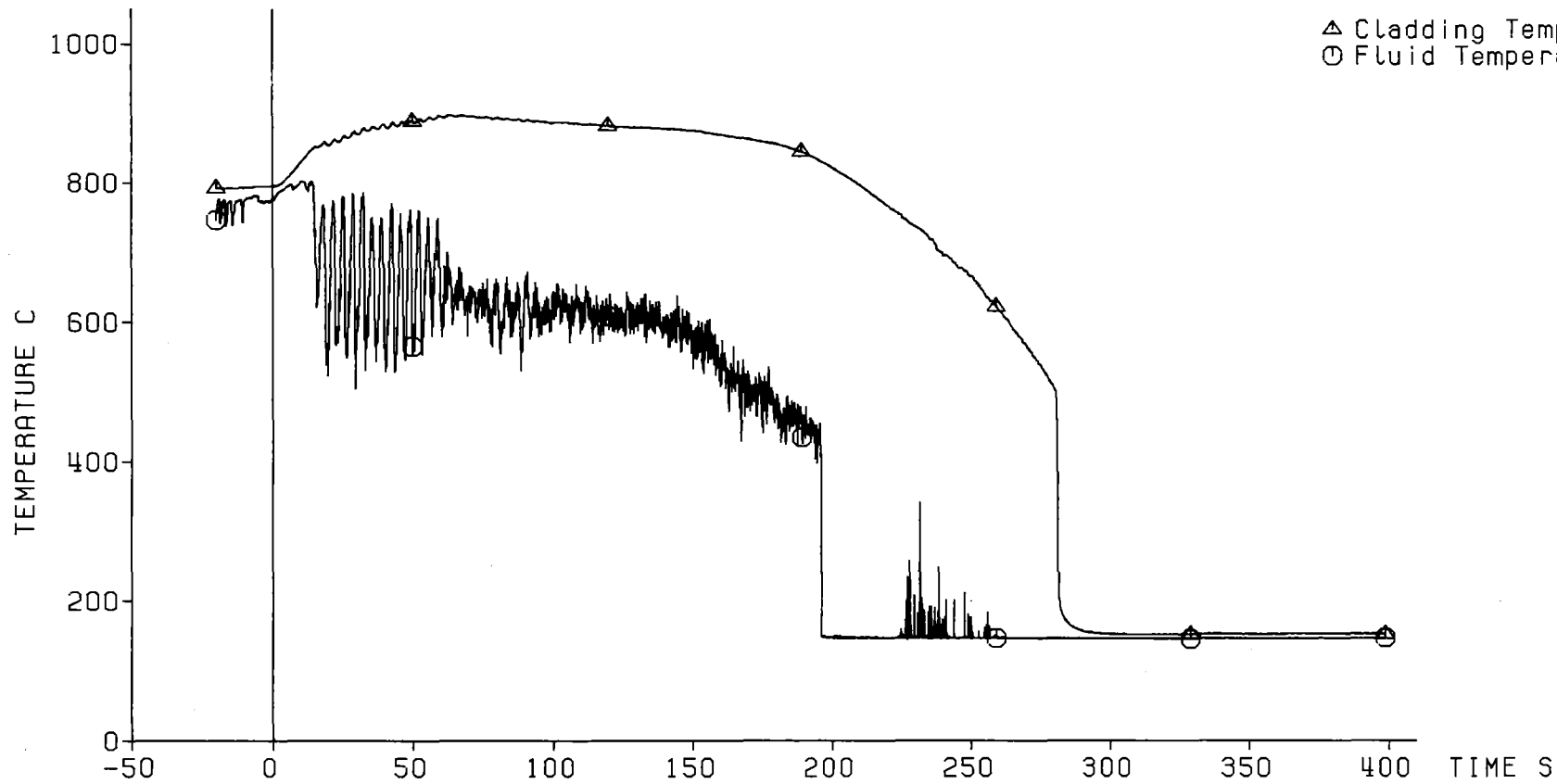

Decay Heat 120% ANS Standard
Flooding Rate (cold) 3.80 cm/s
System Pressure 4.10 bar
Feedwater Temperature 40 C

— 209 —



Fig. 180 FEBA: 5x5 ROD BUNDLE, TEST SERIES 7, TEST-No. 324

Axial Level: 1625 mm

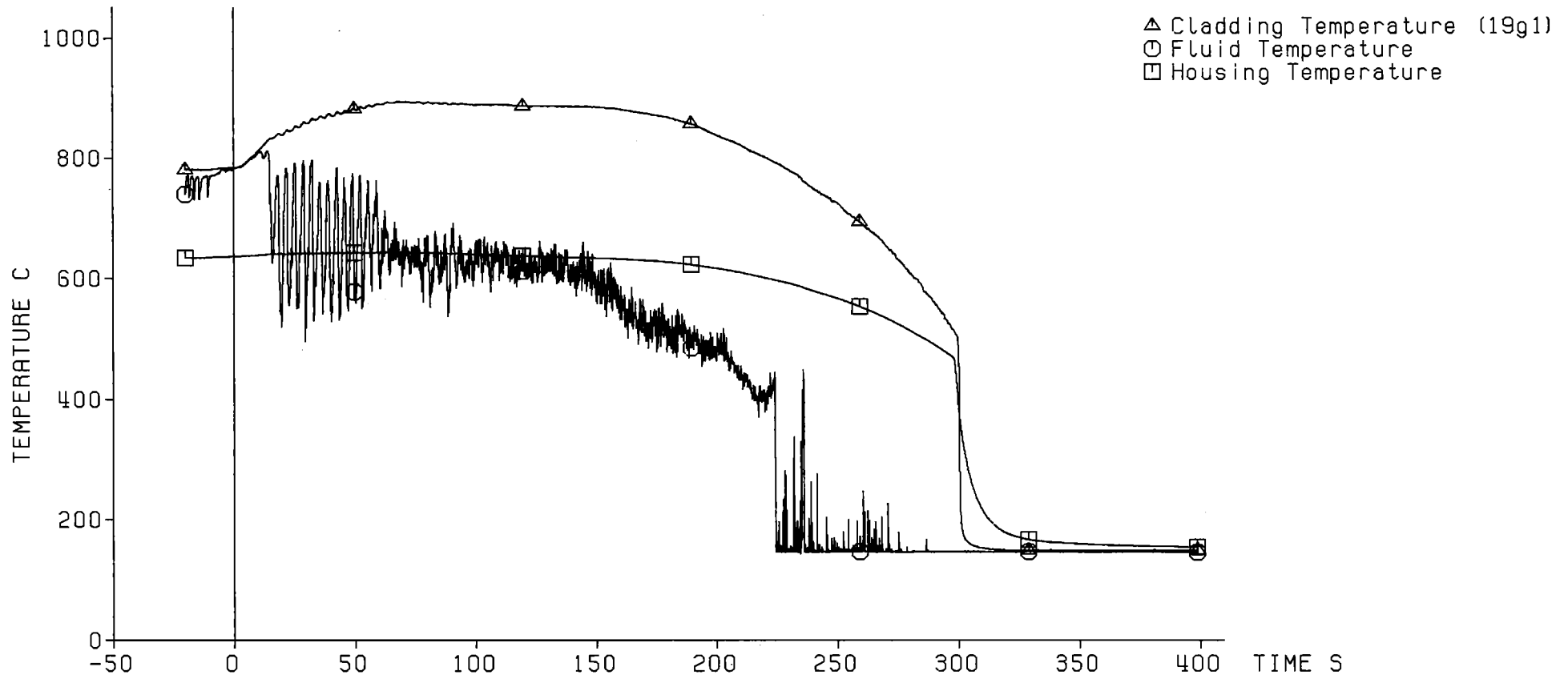

Decay Heat 120% ANS Standard
Flooding Rate (cold) 3.80 cm/s
System Pressure 4.10 bar
Feedwater Temperature 40 C

KFK IRB

Fig. 181 FEBA: 5x5 ROD BUNDLE, TEST SERIES 7, TEST-NO. 324

Axial Level: 1135 mm

△ Cladding Temperature (8b3)
○ Fluid Temperature
□ Housing Temperature

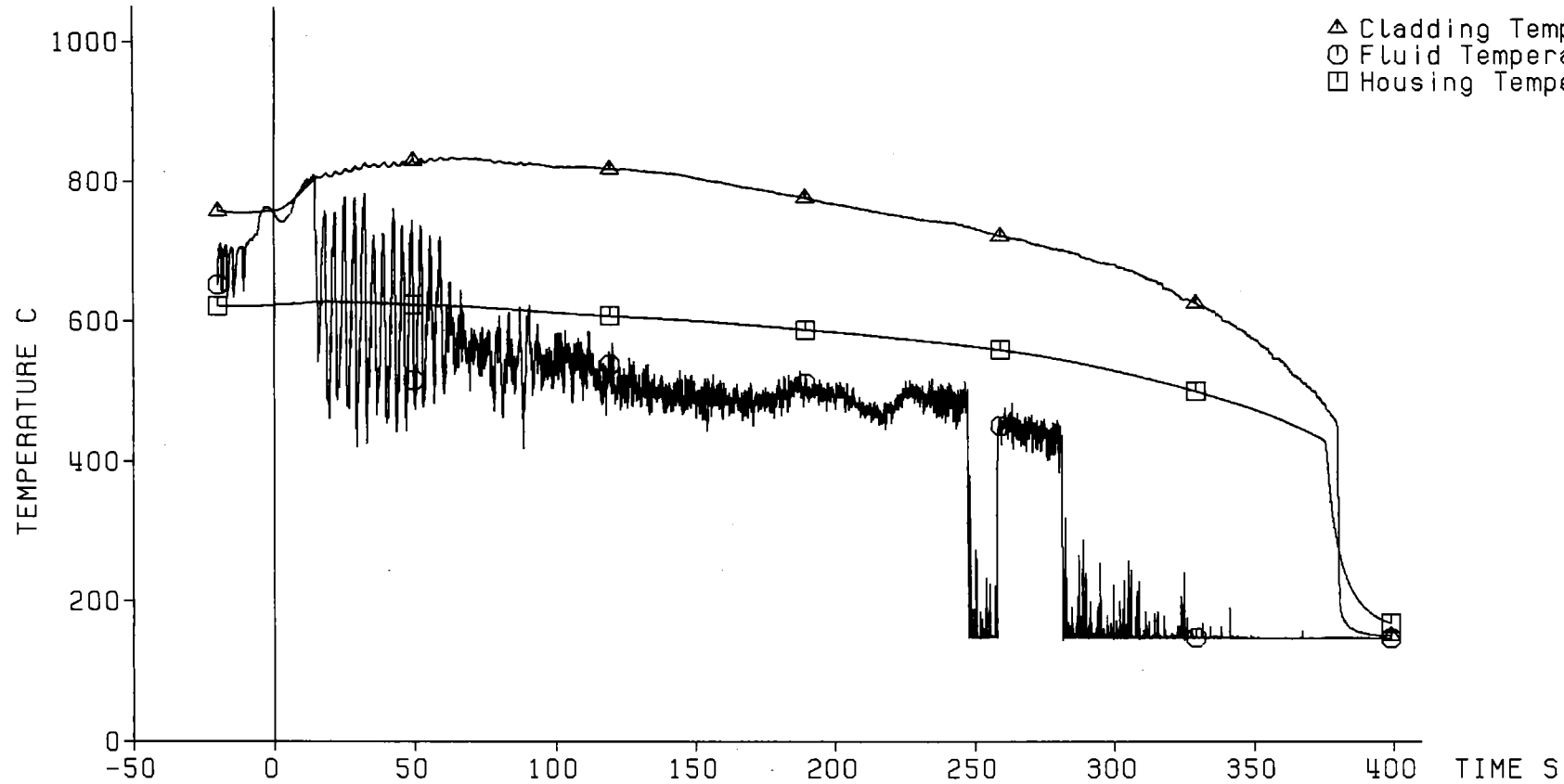

Decay Heat 120% ANS Standard
Flooding Rate (cold) 3.80 cm/s
System Pressure 4.10 bar
Feedwater Temperature 40 C



Fig. 182 FEBA: 5x5 ROD BUNDLE, TEST SERIES 7, TEST-No. 324

Coolant Outlet Conditions:

△ Water Carry Over
○ Coolant Temperature
□ Coolant Pressure

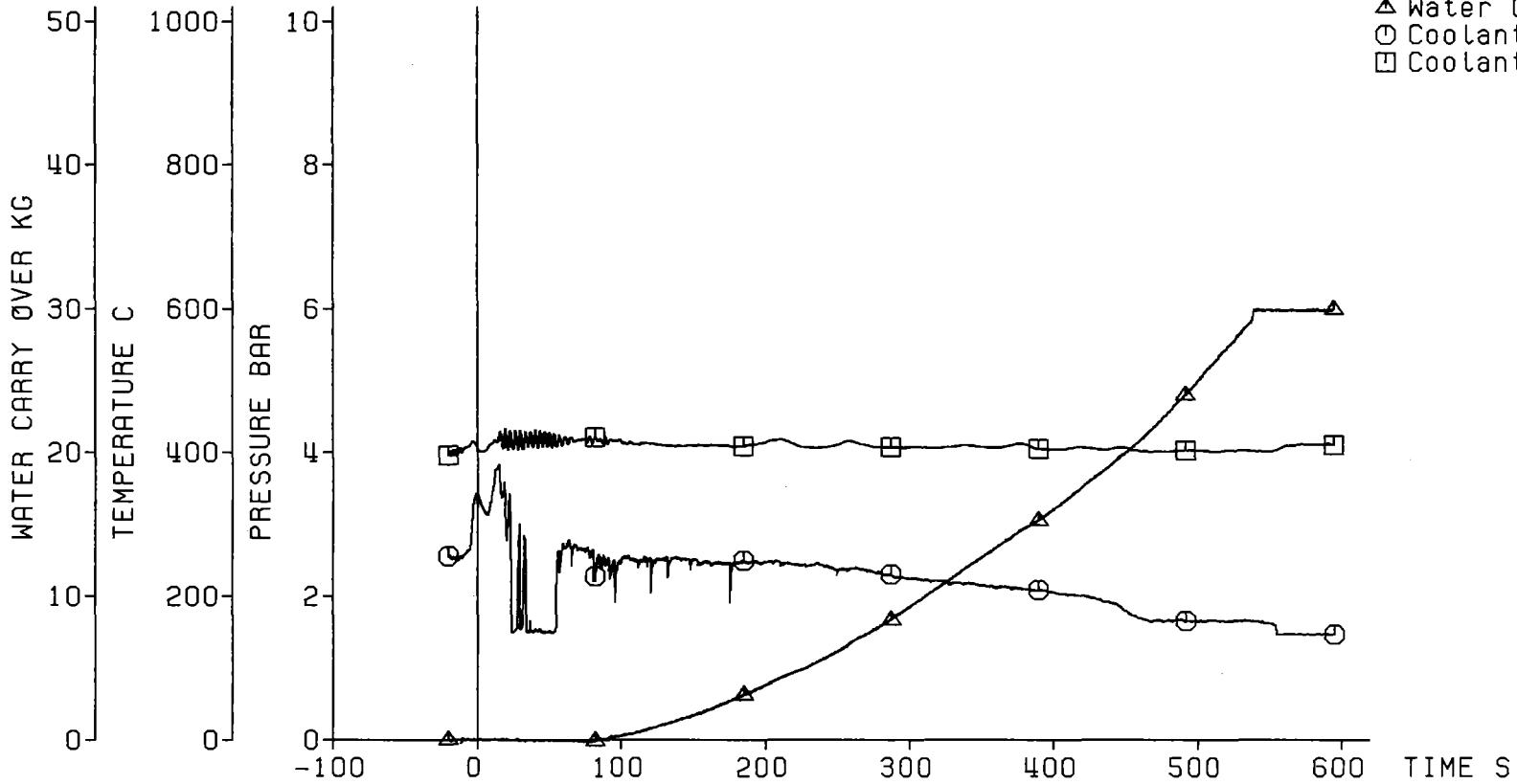

Decay Heat 120% ANS Standard
Flooding Rate (cold) 3.80 cm/s
System Pressure 4.10 bar
Feedwater Temperature 40 C

— 212 —



Fig. 183 FEBA: 5x5 ROD BUNDLE, TEST SERIES 7, TEST-No. 324

Pressure Loss
Along the Test Section:

◇ Total Length: 4196 mm
△ Lower Part: 1711 mm
○ Middle Part: 545 mm
□ Upper Part: 1940 mm

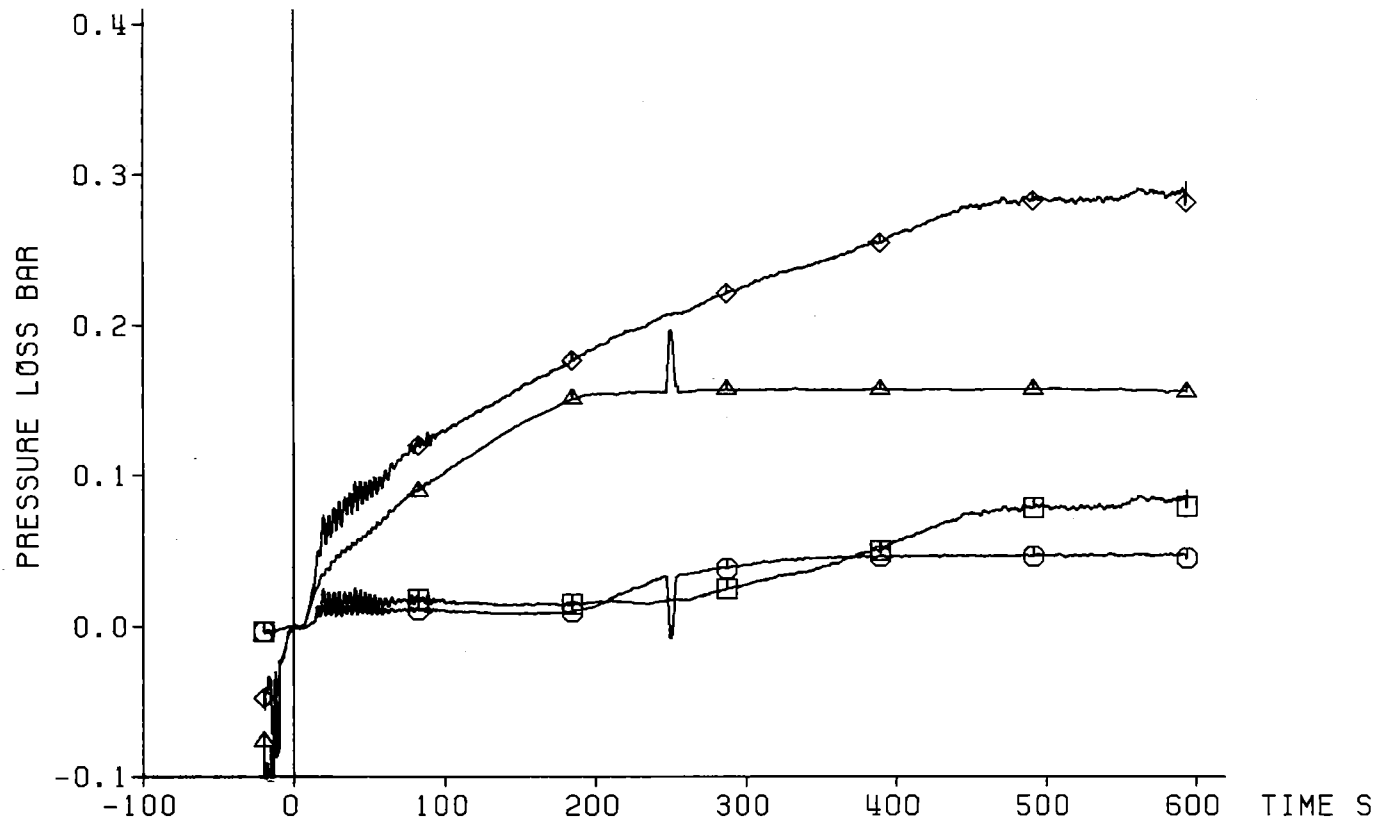

Decay Heat 120% ANS Standard
Flooding Rate (cold) 3.80 cm/s
System Pressure 4.10 bar
Feedwater Temperature 40 C

KIRB

Fig. 184 FEBA: 5x5 ROD BUNDLE, TEST SERIES 7, TEST-No. 324

Axial Position of Quench Front

□ Quenching of Sleeves at Bundle Midplane

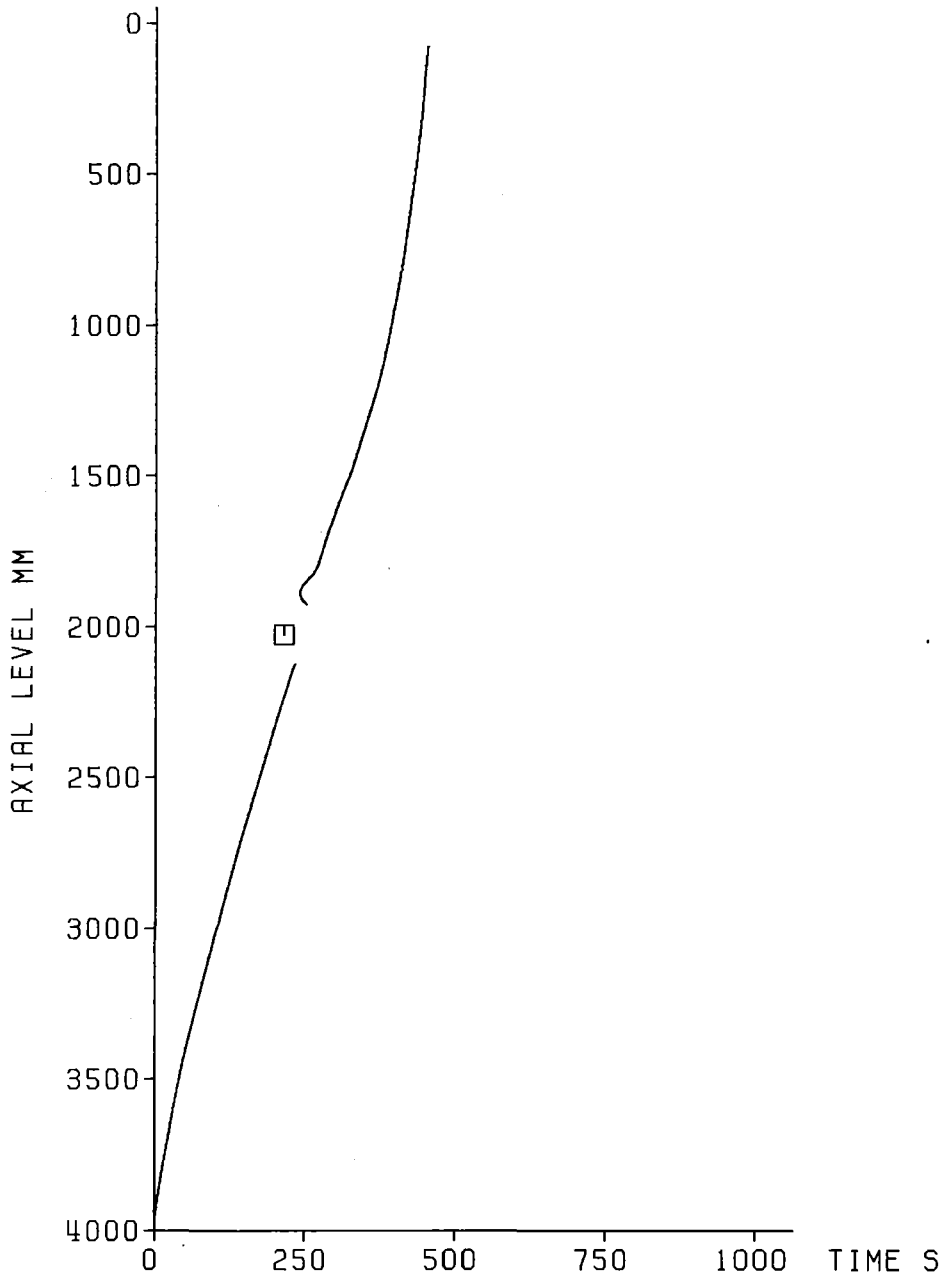

Decay Heat	120% ANS Standard
Flooding Rate (cold)	3.80 cm/s
System Pressure	4.10 bar
Feedwater Temperature	40 C



Fig. 185 FEBA: 5x5 ROD BUNDLE
TEST SERIES 7, TEST-No. 324

Initial Axial Temperature Profile of Claddings

□ Initial Temperature of Sleeves at Bundle Midplane

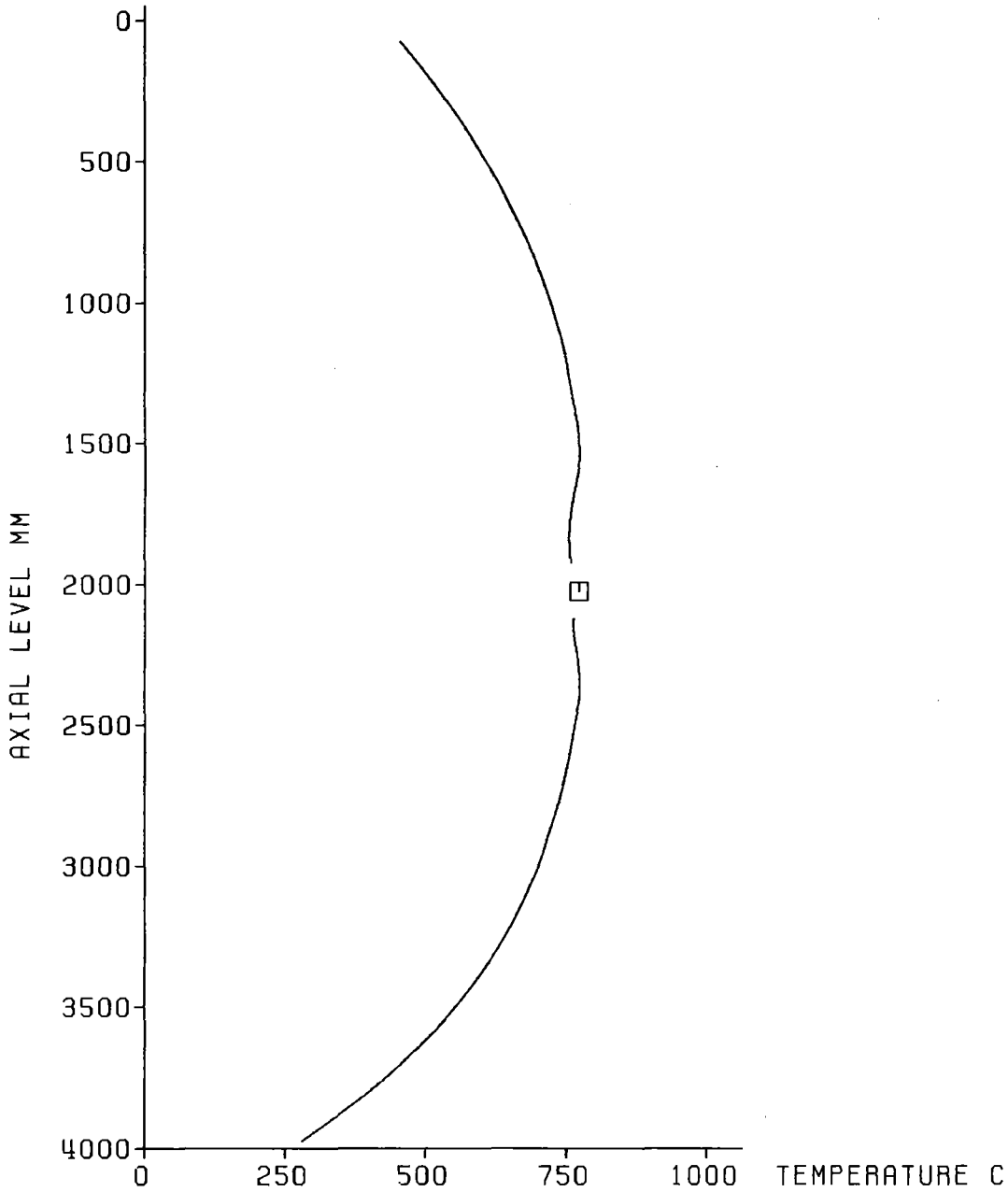

Decay Heat	120% ANS Standard
Flooding Rate (cold)	3.81 cm/s
System Pressure	5.88 bar
Feedwater Temperature	40 C

KIK IRB

Fig. 186 FEBA: 5x5 ROD BUNDLE
TEST SERIES 7, TEST-No. 329

Test Parameters:

- ◇ Flooding Rate
- △ System Pressure
- Feedwater Temperature
- Bundle Power

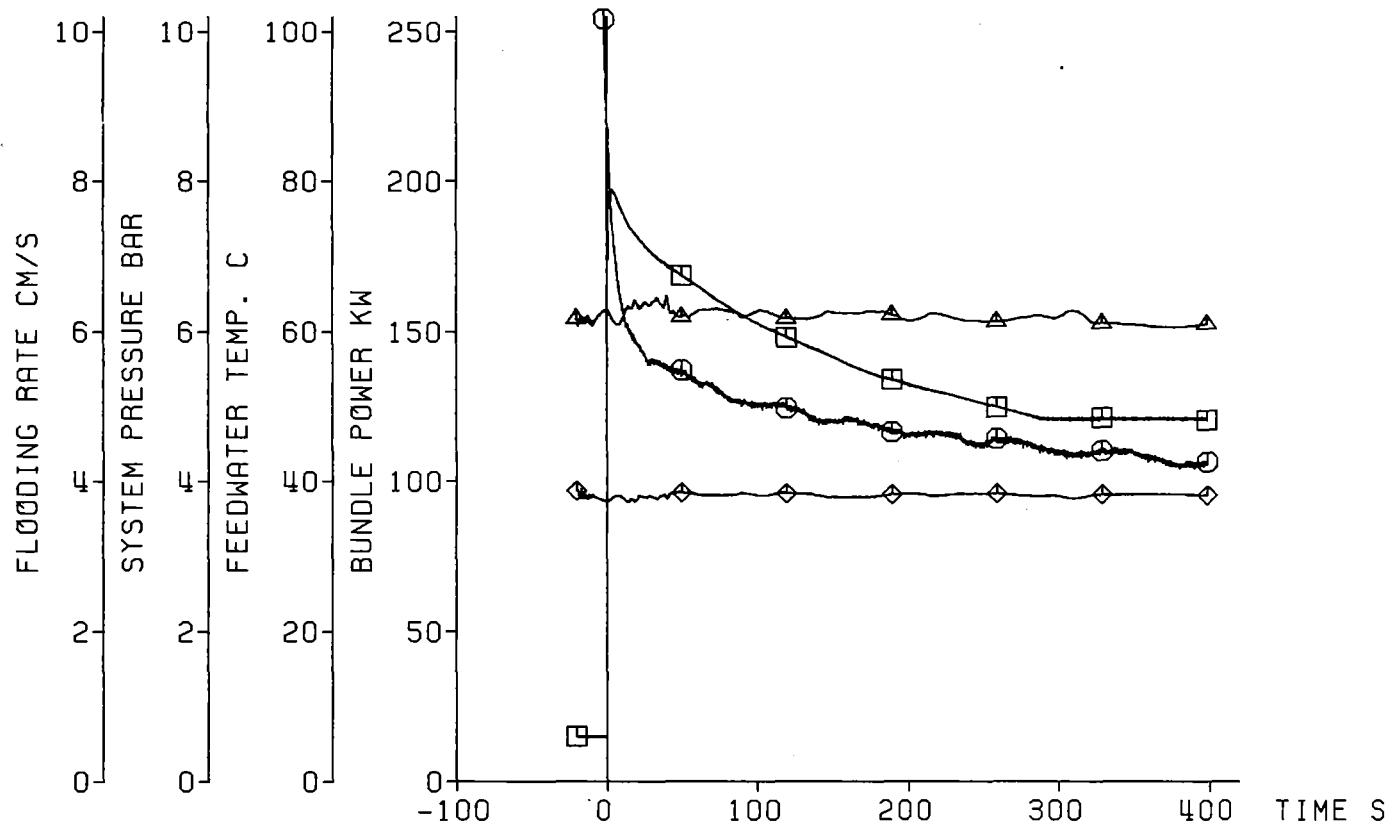

Decay Heat 120% ANS Standard
Flooding Rate (cold) 3.81 cm/s
System Pressure 5.88 bar
Feedwater Temperature 40 C



Fig. 187 FEBA: 5x5 ROD BUNDLE, TEST SERIES 7, TEST-No. 329

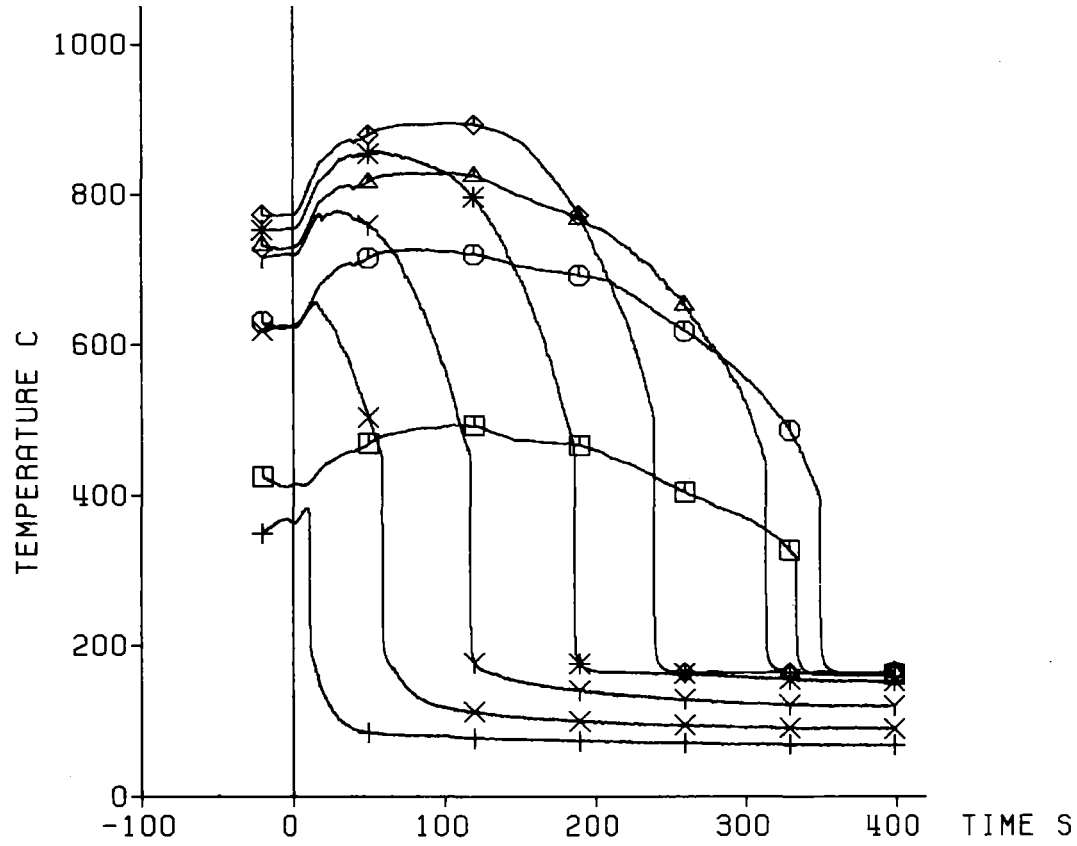

	TC	Ax. Level
+	7a4	3860 mm
X	7a3	3315 mm
Y	7a2	2770 mm
*	7a1	2225 mm
◇	8b4	1680 mm
△	8b3	1135 mm
⊙	8b2	590 mm
□	3b1	45 mm

Decay Heat 120% ANS Standard
 Flooding Rate (cold) 3.81 cm/s
 System Pressure 5.88 bar
 Feedwater Temperature 40 C



Fig. 188 FEBA: 5x5 ROD BUNDLE, TEST SERIES 7, TEST-No. 329

Heat Transfer Coeff.

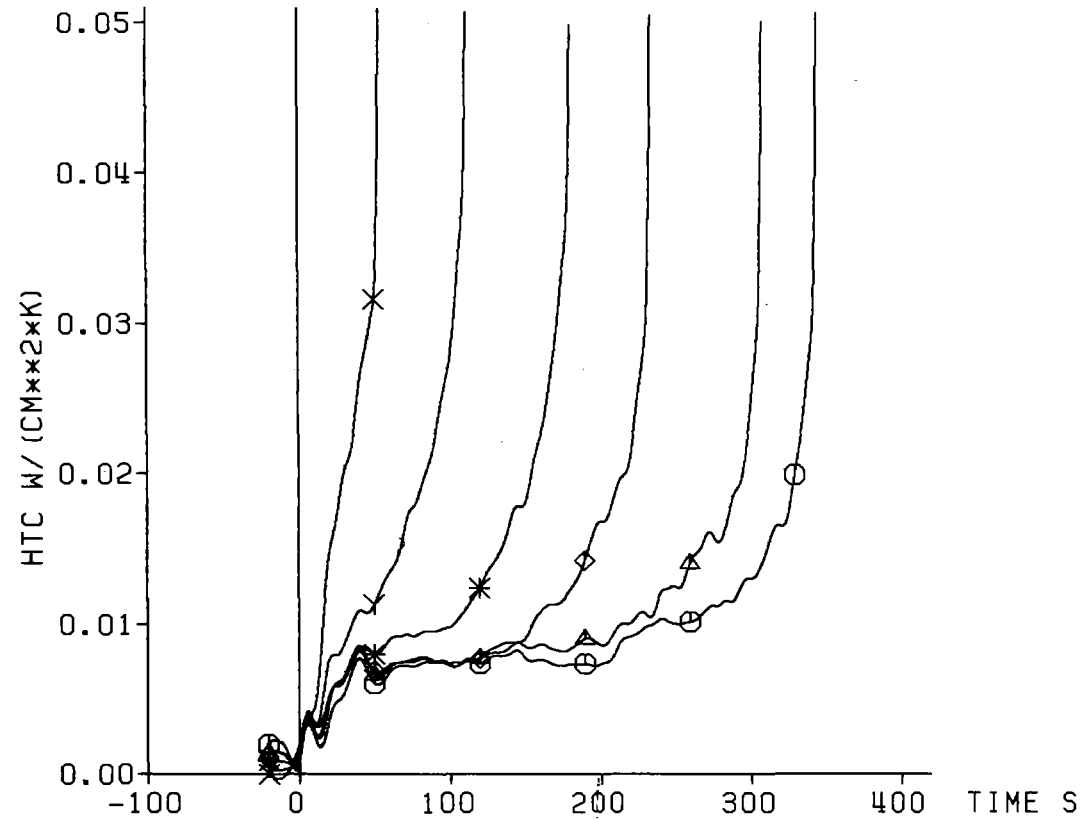

TC	Ax. Level
X	7a3 3315 mm
Y	7a2 2770 mm
*	7a1 2225 mm
◇	8b4 1680 mm
△	8b3 1135 mm
○	8b2 590 mm

Decay Heat 120% ANS Standard
 Flooding Rate (cold) 3.81 cm/s
 System Pressure 5.88 bar
 Feedwater Temperature 40 C



Fig. 189 FEBA: 5x5 ROD BUNDLE, TEST SERIES 7, TEST-No. 329

Cladding Temperature

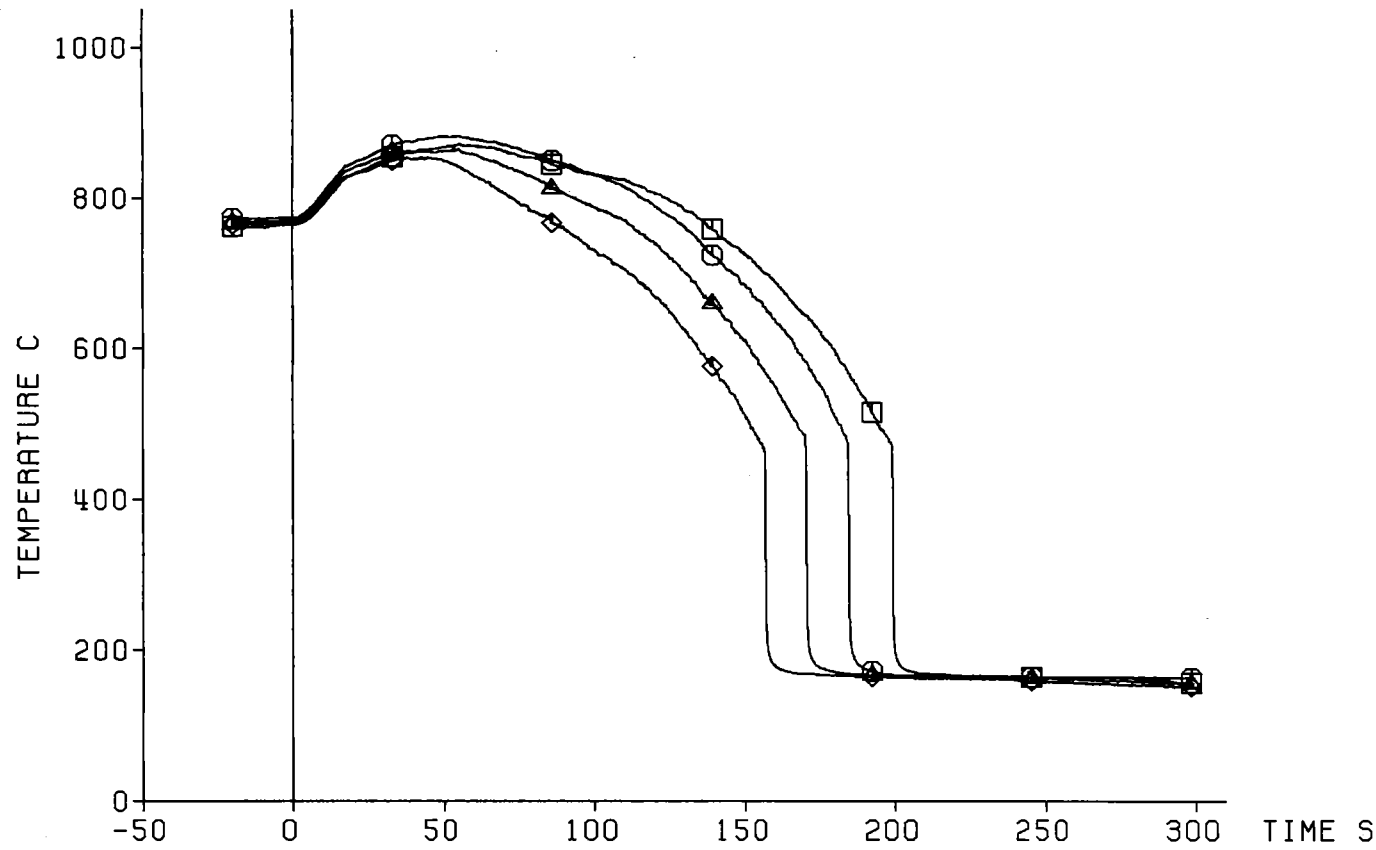

TC	Ax. Level
◇	14f4 2425 mm
△	14f3 2325 mm
○	14h2 2225 mm
□	14f1 2125 mm

Decay Heat 120% ANS Standard
 Flooding Rate (cold) 3.81 cm/s
 System Pressure 5.88 bar
 Feedwater Temperature 40 C



Fig. 190 FEBA: 5x5 ROD BUNDLE, TEST SERIES 7, TEST-No. 329

Heat Transfer Coeff.

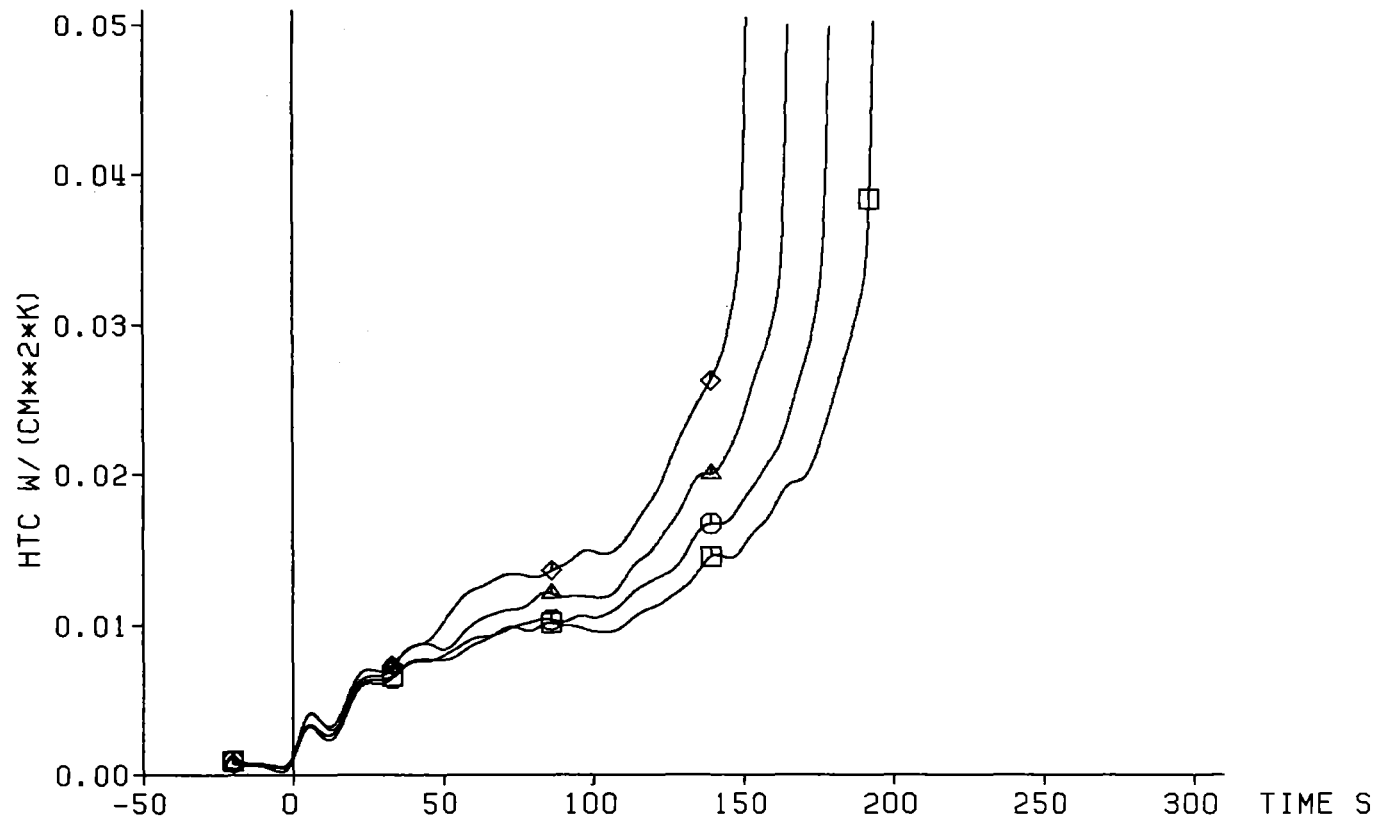

TC	Ax. Level
◇	14f4 2425 mm
△	14f3 2325 mm
⊙	14h2 2225 mm
□	14f1 2125 mm

Decay Heat 120% ANS Standard
 Flooding Rate (cold) 3.81 cm/s
 System Pressure 5.88 bar
 Feedwater Temperature 40 C



Fig. 191 FEBA: 5x5 ROD BUNDLE, TEST SERIES 7, TEST-No. 329

Cladding Temperature

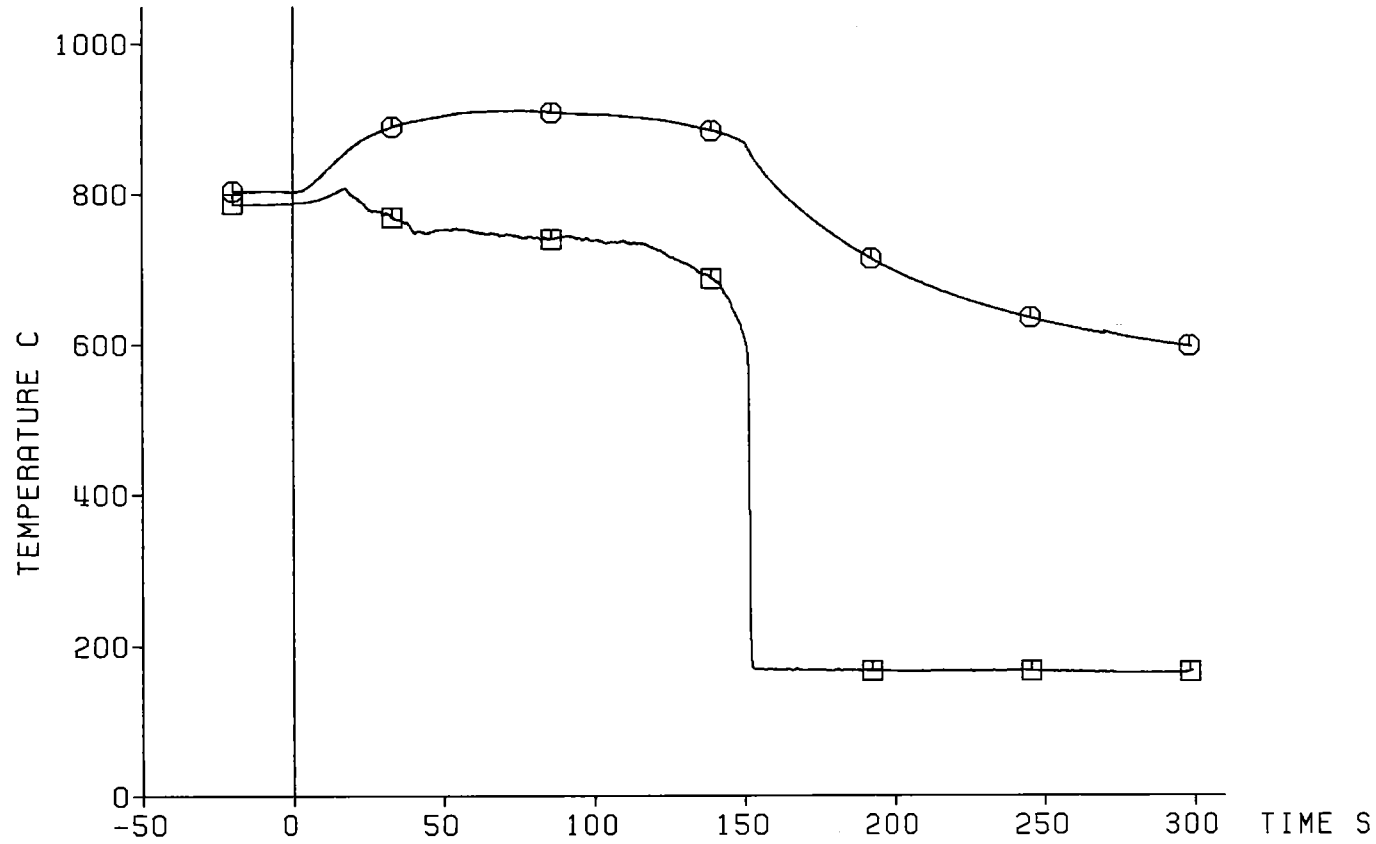

TC	Ax. Level
⊙ 13h2	2025 mm
⊠ Sleeve	2025 mm

Decay Heat 120% ANS Standard
 Flooding Rate (cold) 3.81 cm/s
 System Pressure 5.88 bar
 Feedwater Temperature 40 C



Fig. 192 FEBA: 5x5 ROD BUNDLE, TEST SERIES 7, TEST-No. 329

Cladding Temperature

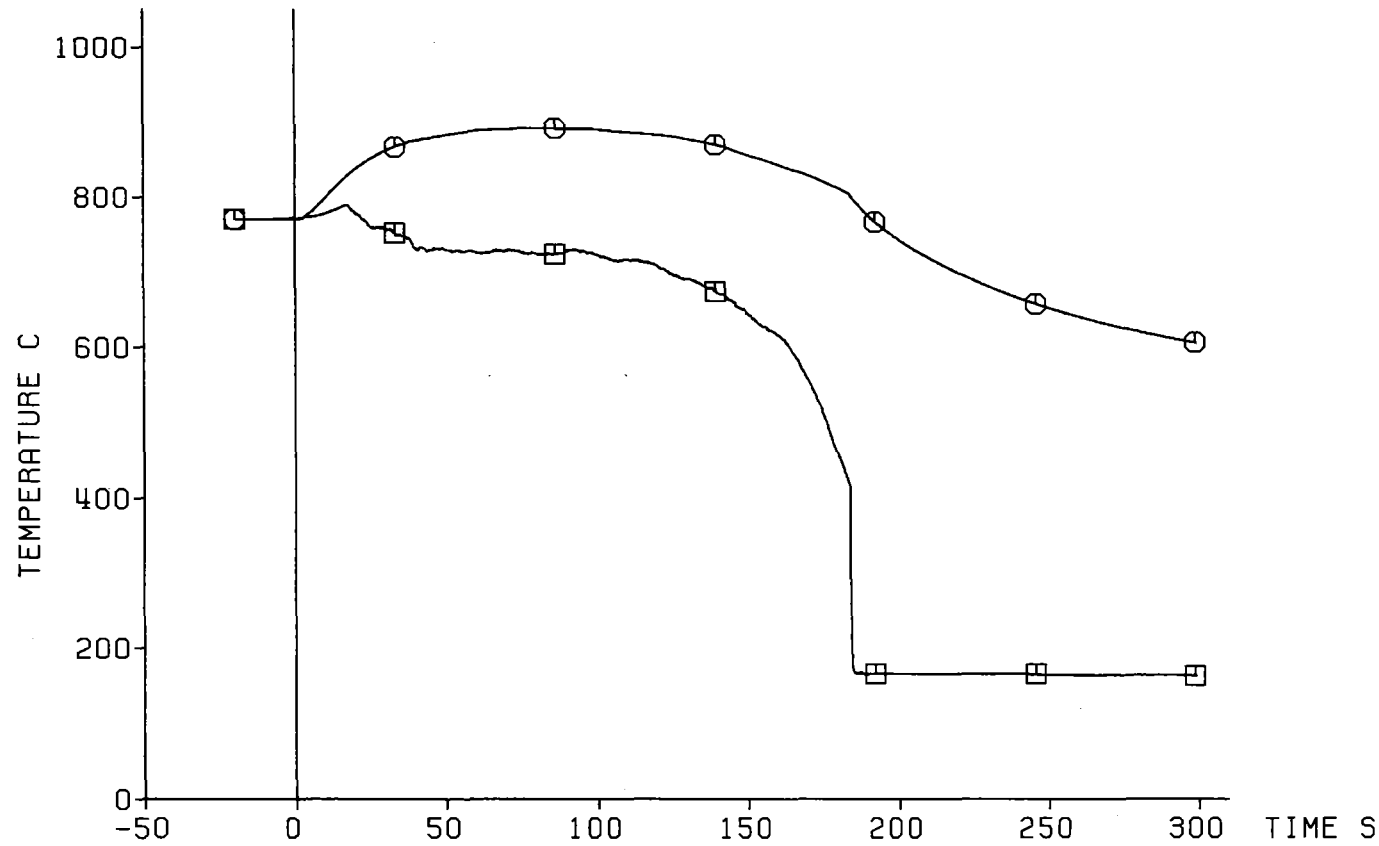

TC	Ax. Level
⊙ 17i4	2025 mm
⊠ Sleeve	2025 mm

Decay Heat 120% ANS Standard
 Flooding Rate (cold) 3.81 cm/s
 System Pressure 5.88 bar
 Feedwater Temperature 40 C



Fig. 193 FEBA: 5x5 ROD BUNDLE, TEST SERIES 7, TEST-No. 329

Cladding Temperature

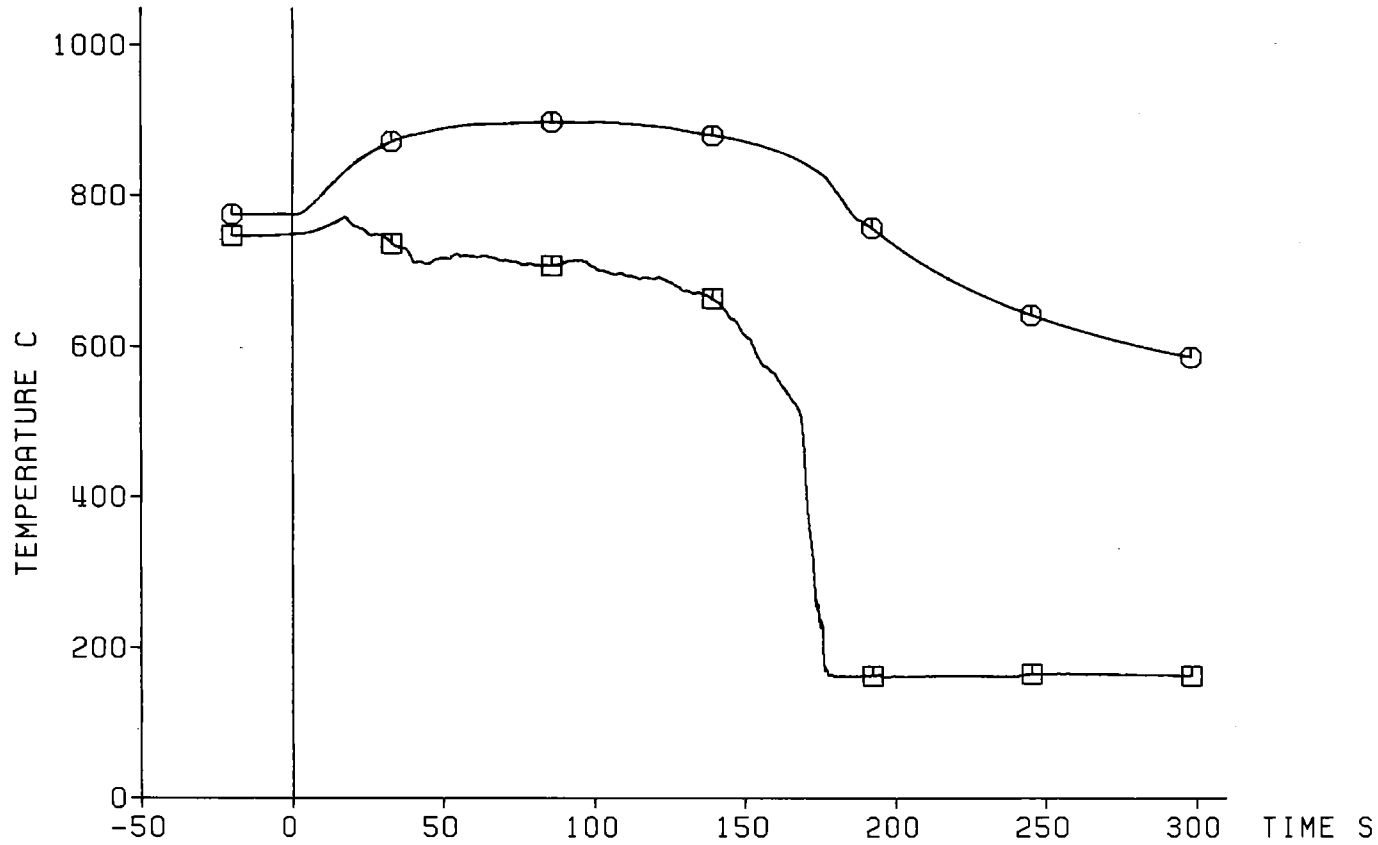

TC	Ax. Level
⊙ 17i3	1975 mm
□ Sleeve	1972 mm

Decay Heat 120% ANS Standard
 Flooding Rate (cold) 3.81 cm/s
 System Pressure 5.88 bar
 Feedwater Temperature 40 C



Fig. 194 FEBA: 5x5 ROD BUNDLE, TEST SERIES 7, TEST-No. 329

Cladding Temperature

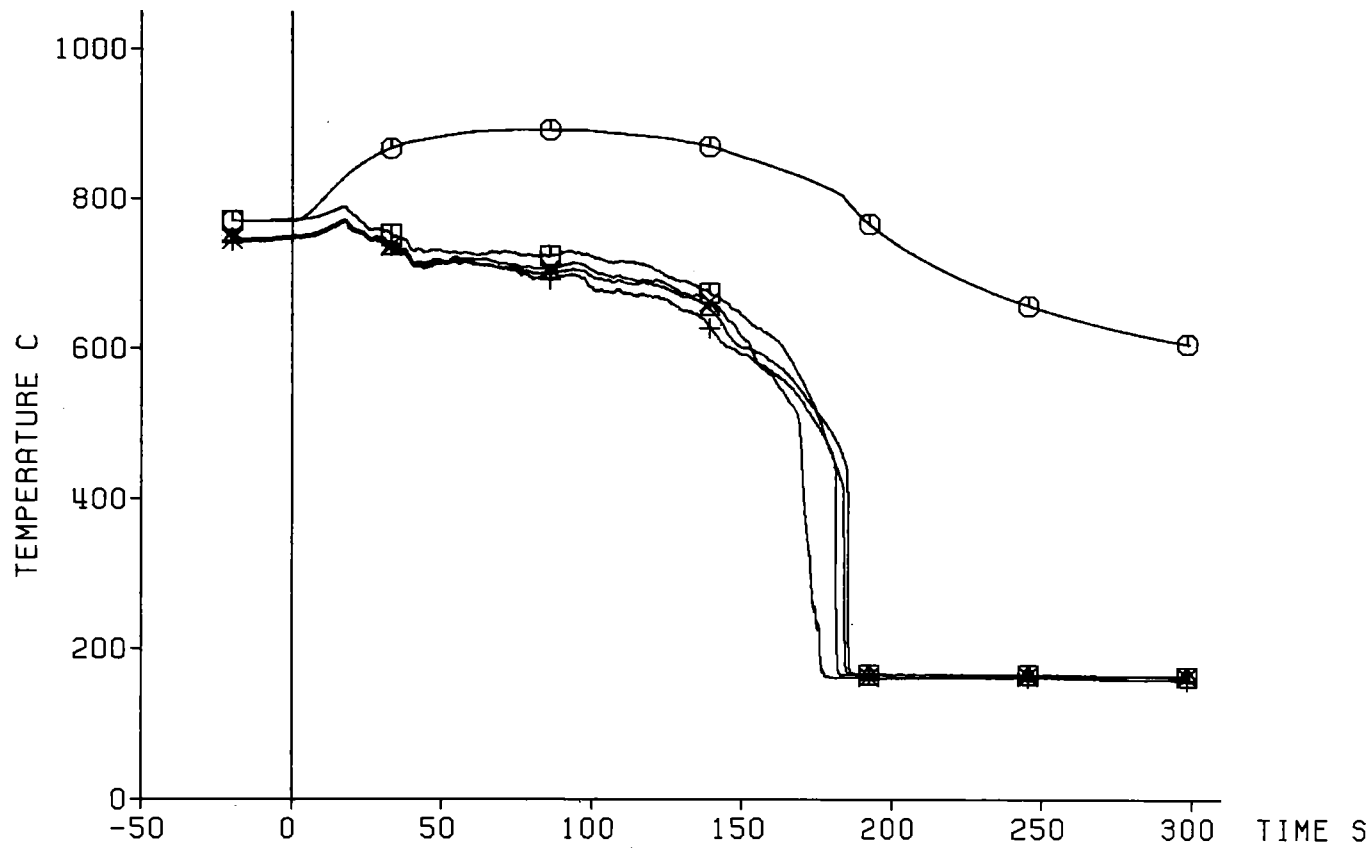

TC	Ax. Level
⊙	17i4 2025 mm
+	Sleeve 2064 mm
□	Sleeve 2025 mm
△	Sleeve 2025 mm
×	Sleeve 1972 mm

Decay Heat 120% ANS Standard
 Flooding Rate (cold) 3.81 cm/s
 System Pressure 5.88 bar
 Feedwater Temperature 40 C



Fig. 195 FEBA: 5x5 ROD BUNDLE, TEST SERIES 7, TEST-No. 329

Cladding Temperature

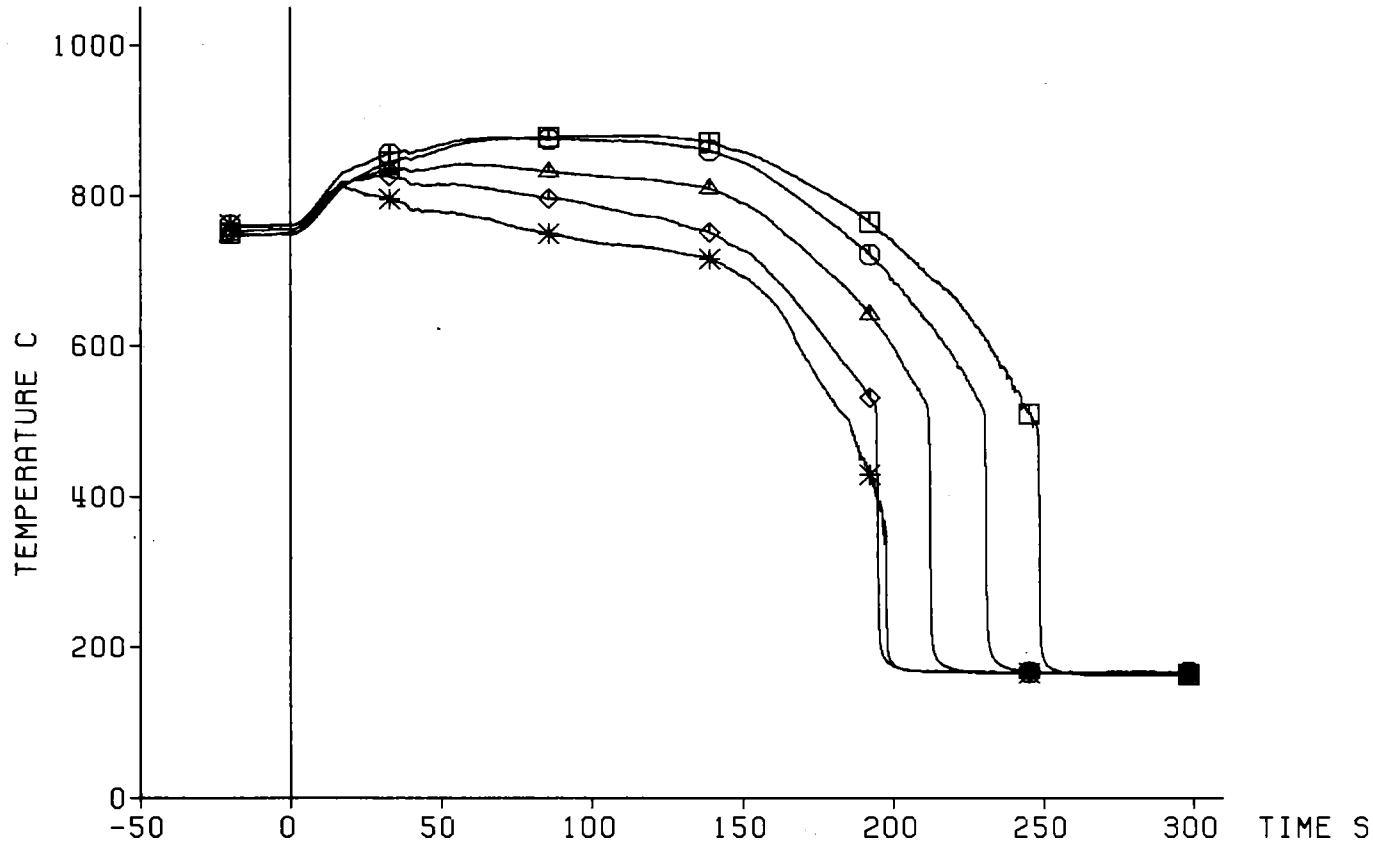

TC	Ax. Level
* 19g4	1925 mm
◇ 17i1	1875 mm
△ 19g3	1825 mm
⊙ 19g2	1725 mm
□ 19g1	1625 mm

Decay Heat 120% ANS Standard
 Flooding Rate (cold) 3.81 cm/s
 System Pressure 5.88 bar
 Feedwater Temperature 40 C



Fig. 196 FEBA: 5x5 ROD BUNDLE, TEST SERIES 7, TEST-No. 329

Heat Transfer Coeff.

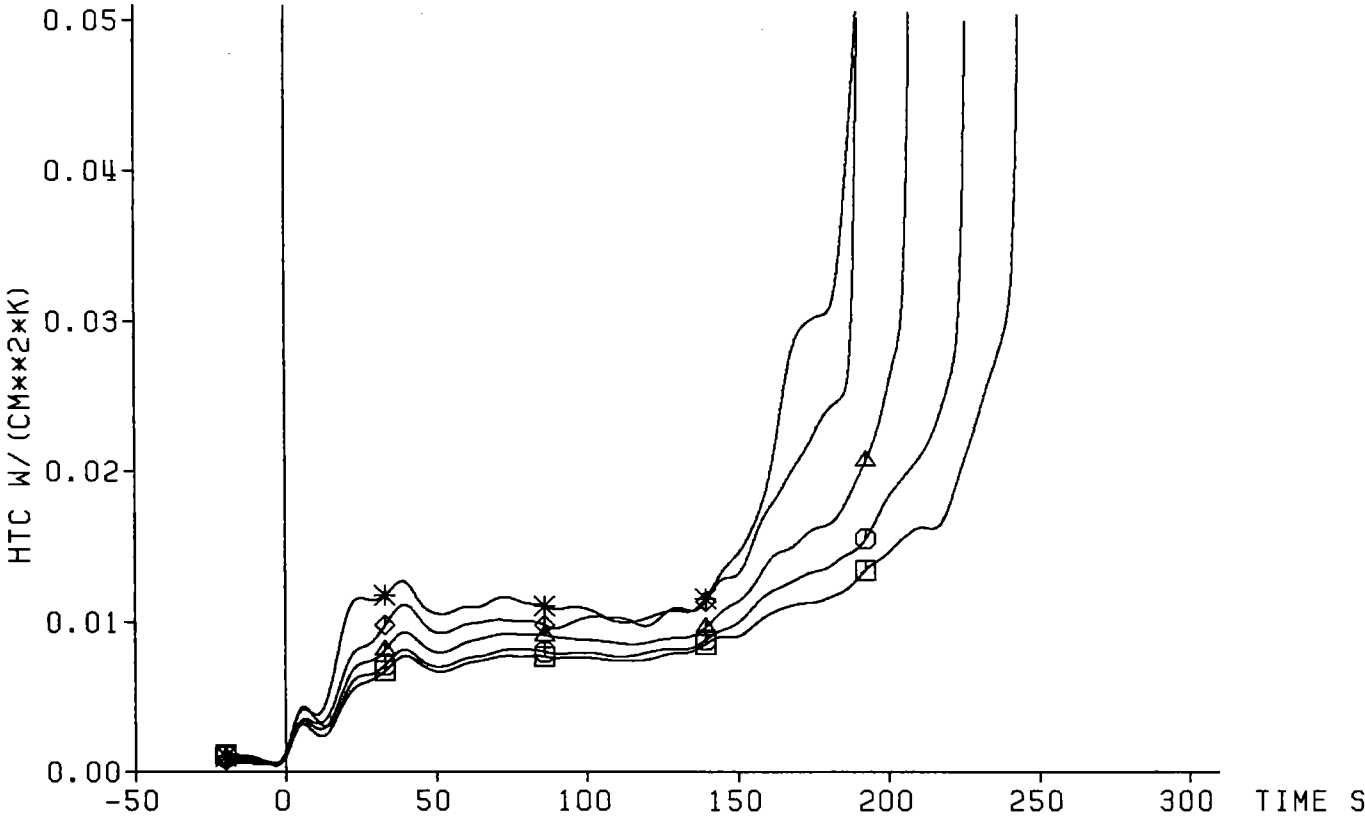

TC	Ax. Level
* 19g4	1925 mm
◇ 17i1	1875 mm
△ 19g3	1825 mm
○ 19g2	1725 mm
□ 19g1	1625 mm

Decay Heat 120% ANS Standard
 Flooding Rate (cold) 3.81 cm/s
 System Pressure 5.88 bar
 Feedwater Temperature 40 C



Fig. 197 FEBA: 5x5 ROD BUNDLE, TEST SERIES 7, TEST-No. 329

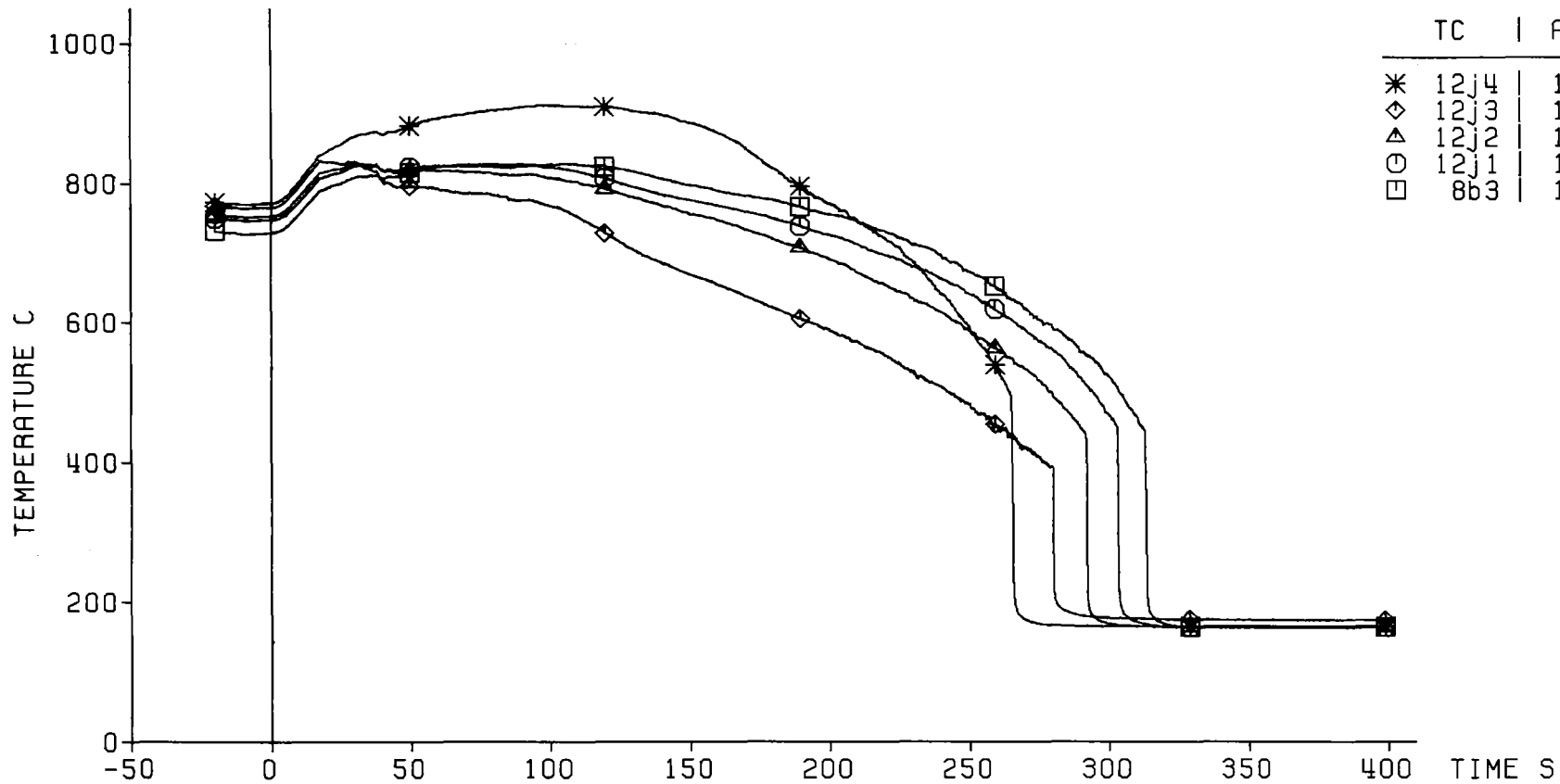

Decay Heat 120% ANS Standard
 Flooding Rate (cold) 3.81 cm/s
 System Pressure 5.88 bar
 Feedwater Temperature 40 C



Fig. 198 FEBA: 5x5 ROD BUNDLE, TEST SERIES 7, TEST-No. 329

Heat Transfer Coeff.

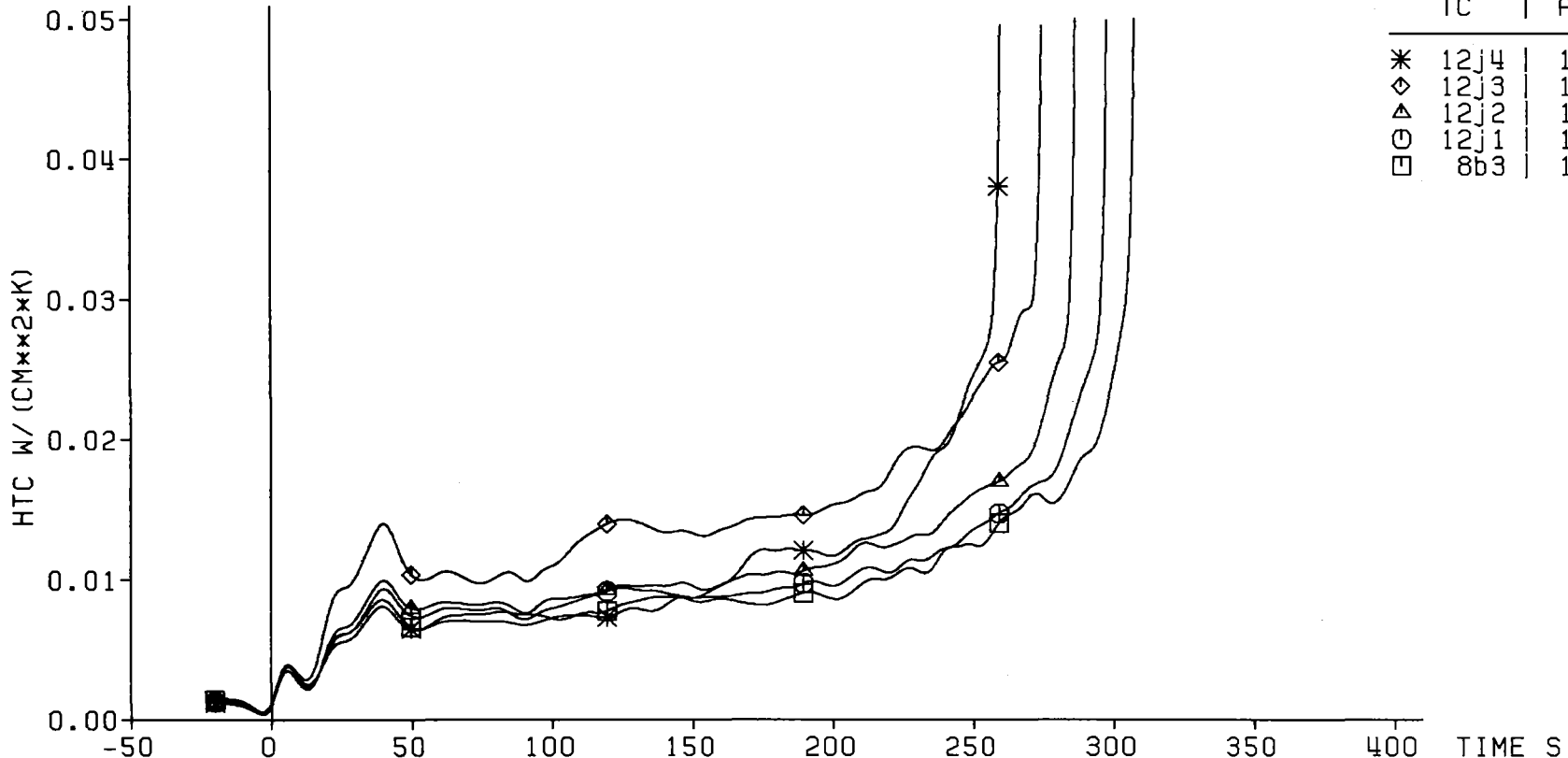

	TC	Ax. Level
*	12j4	1525 mm
◇	12j3	1425 mm
△	12j2	1325 mm
○	12j1	1225 mm
□	8b3	1135 mm

Decay Heat 120% ANS Standard
 Flooding Rate (cold) 3.81 cm/s
 System Pressure 5.88 bar
 Feedwater Temperature 40 C



Fig. 199 FEBA: 5x5 ROD BUNDLE, TEST SERIES 7, TEST-No. 329

Axial Level: 2770 mm

△ Cladding Temperature (7a2)
○ Fluid Temperature
□ Housing Temperature

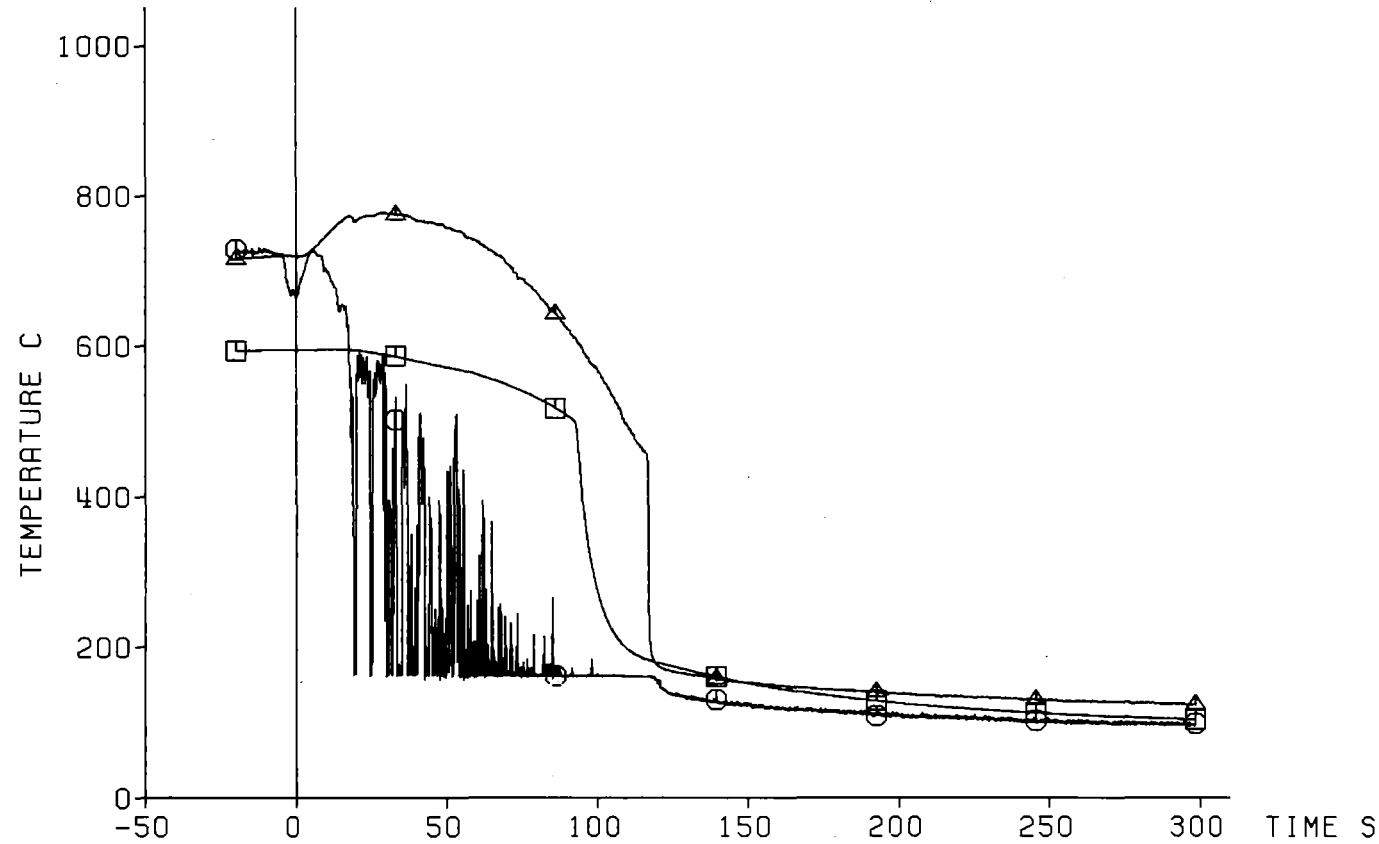

Decay Heat 120% ANS Standard
Flooding Rate (cold) 3.81 cm/s
System Pressure 5.88 bar
Feedwater Temperature 40 C

— 230 —



Fig. 200 FEBA: 5x5 ROD BUNDLE, TEST SERIES 7, TEST-No. 329

Axial Level: 2225 mm

△ Cladding Temperature (7a1)
○ Fluid Temperature (2240 mm)
□ Housing Temperature (2235 mm)

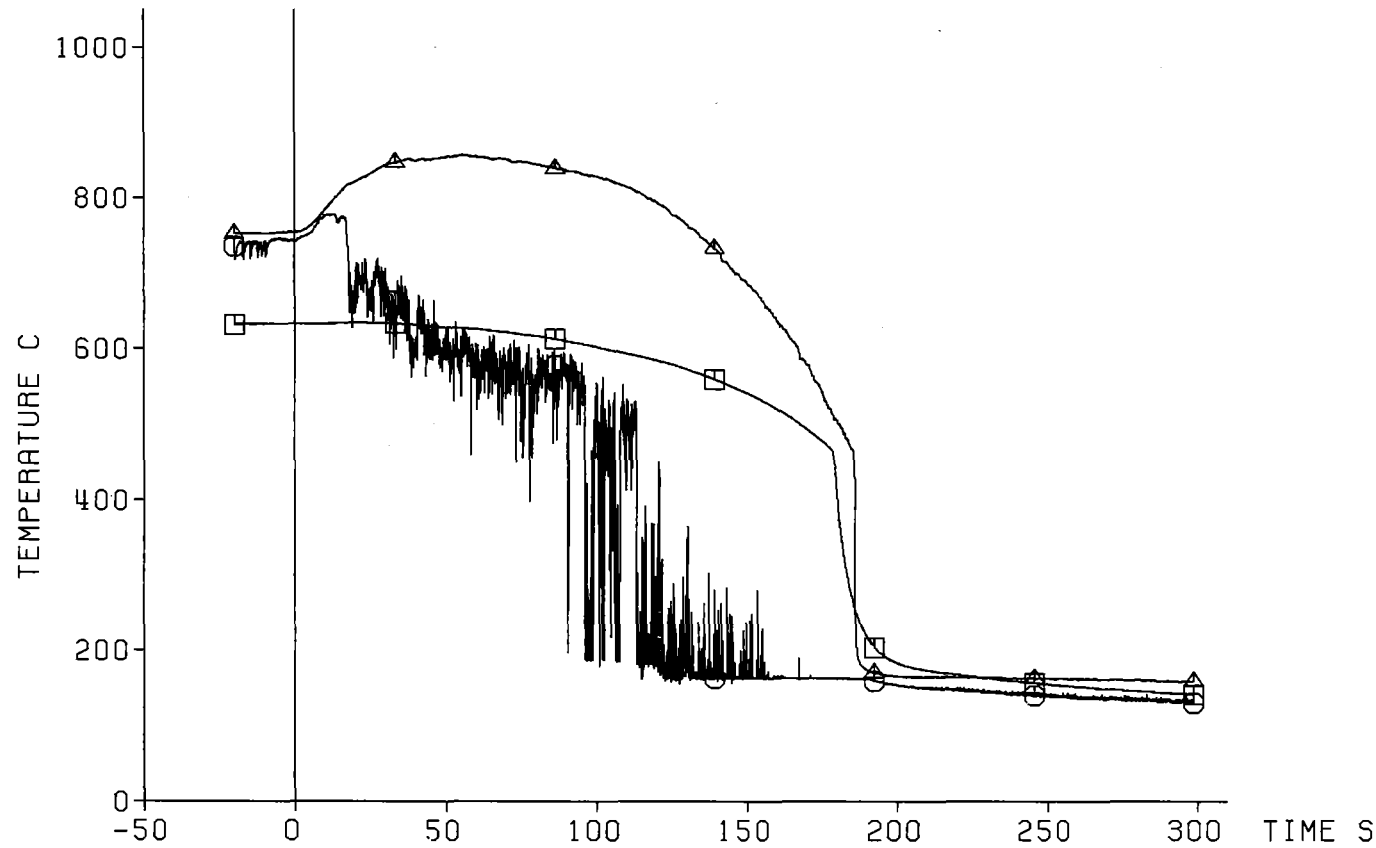

Decay Heat 120% ANS Standard
Flooding Rate (cold) 3.81 cm/s
System Pressure 5.88 bar
Feedwater Temperature 40 C



Fig. 201 FEBA: 5x5 ROD BUNDLE, TEST SERIES 7, TEST-No. 329

Axial Level: 1825 mm

△ Cladding Temperature (19g3)
○ Fluid Temperature
□ Housing Temperature

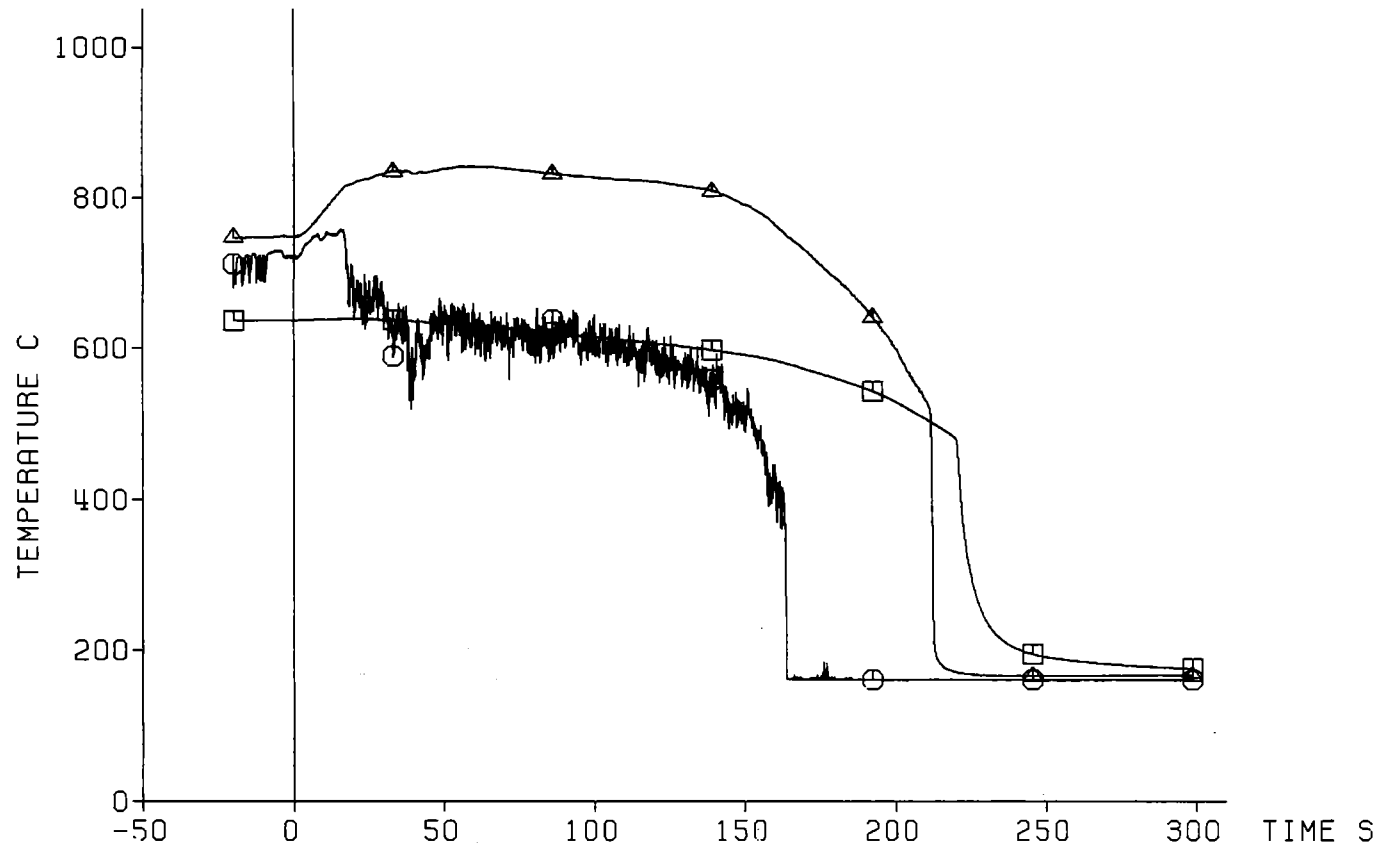

Decay Heat 120% ANS Standard
Flooding Rate (cold) 3.81 cm/s
System Pressure 5.88 bar
Feedwater Temperature 40 C

KFK
IRB

Fig. 202 FEBA: 5x5 ROD BUNDLE, TEST SERIES 7, TEST-No. 329

Axial Level: 1725 mm

△ Cladding Temperature (19g2)
○ Fluid Temperature

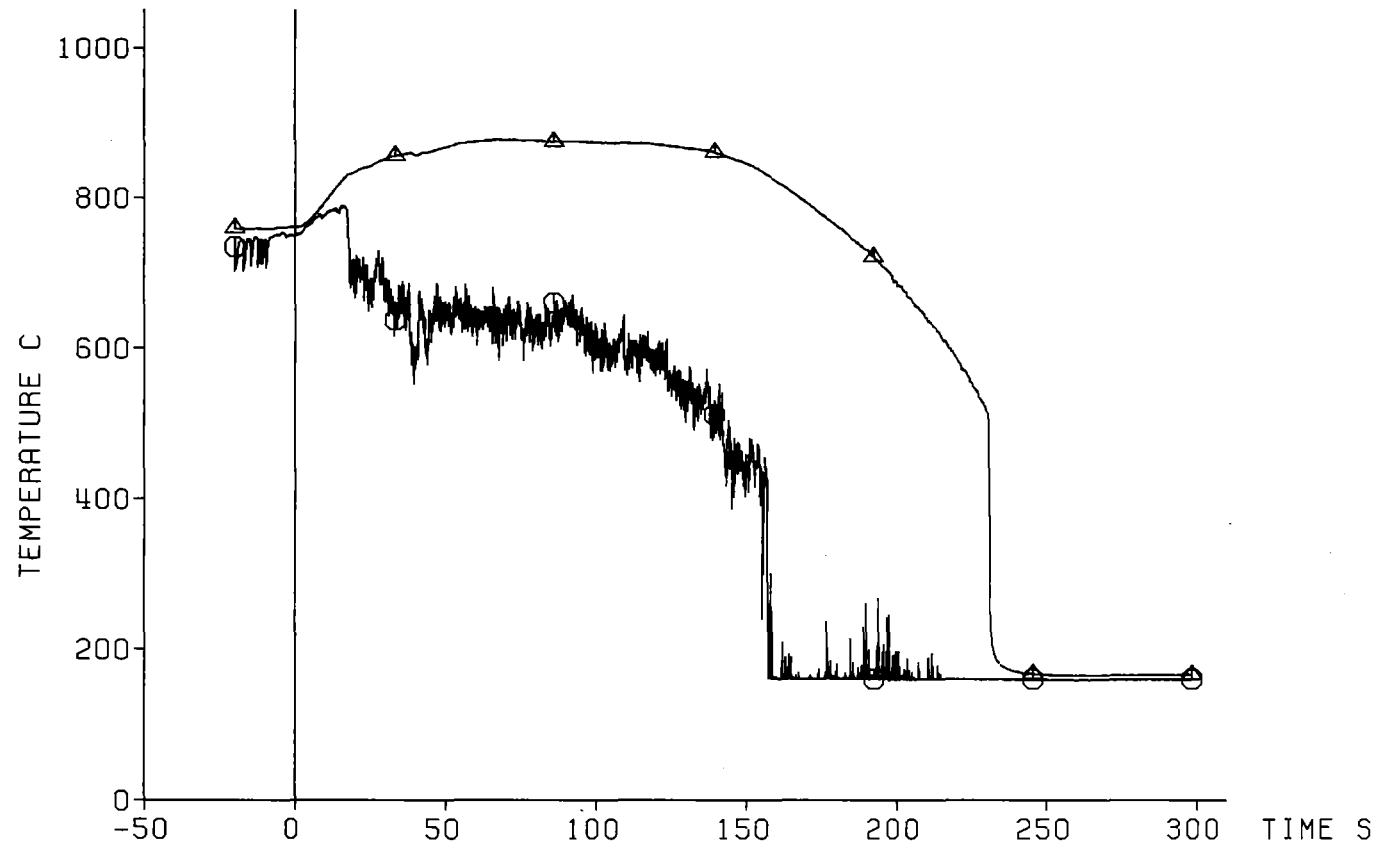

Decay Heat 120% ANS Standard
Flooding Rate (cold) 3.81 cm/s
System Pressure 5.88 bar
Feedwater Temperature 40 C



Fig. 203 FEBA: 5x5 ROD BUNDLE, TEST SERIES 7, TEST-No. 329

Axial Level: 1625 mm

△ Cladding Temperature (19g1)
○ Fluid Temperature
□ Housing Temperature

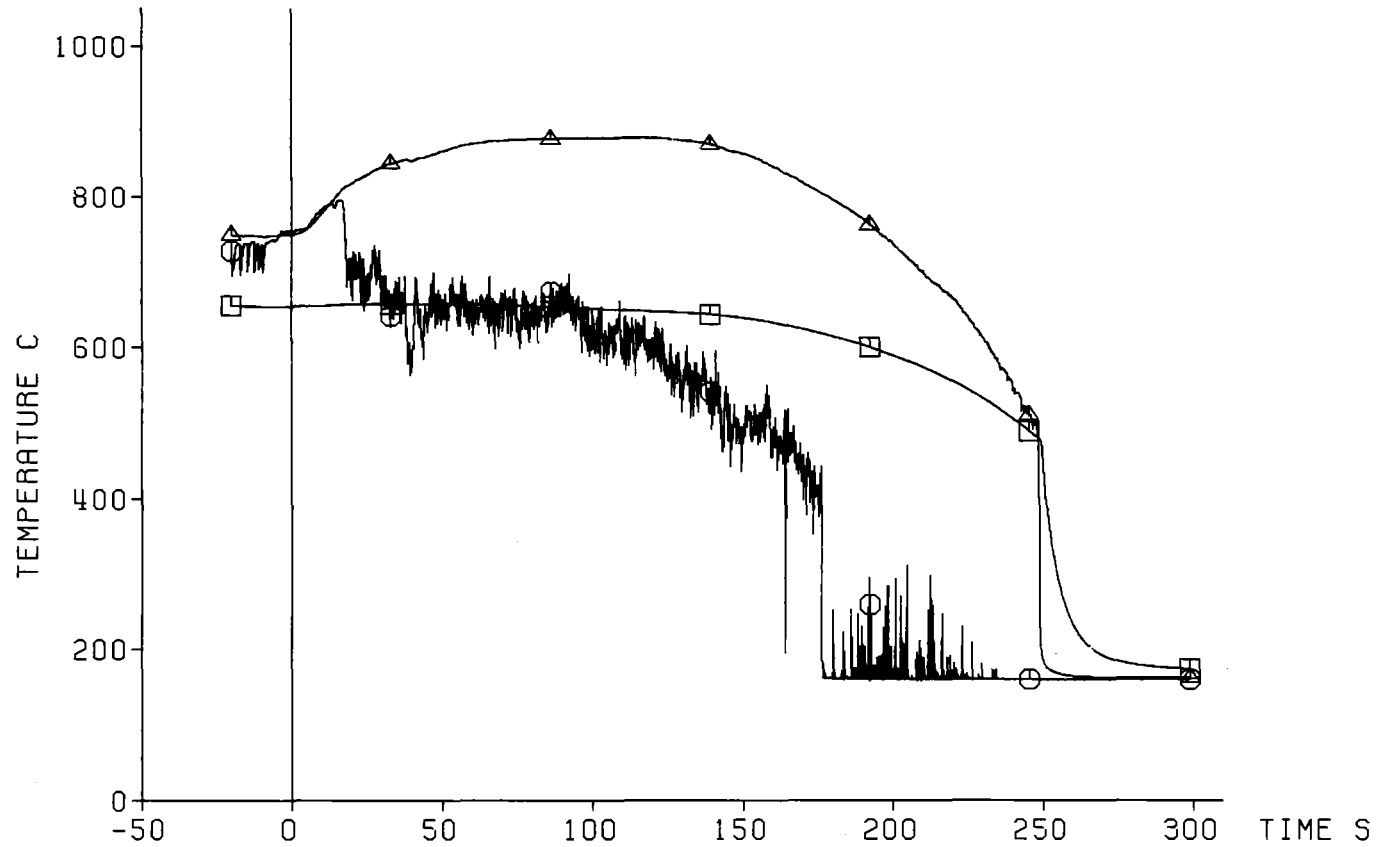

Decay Heat 120% ANS Standard
Flooding Rate (cold) 3.81 cm/s
System Pressure 5.88 bar
Feedwater Temperature 40 C



Fig. 204 FEBA: 5x5 ROD BUNDLE, TEST SERIES 7, TEST-No. 329

Axial Level: 1135 mm

△ Cladding Temperature (8b3)
○ Fluid Temperature
□ Housing Temperature

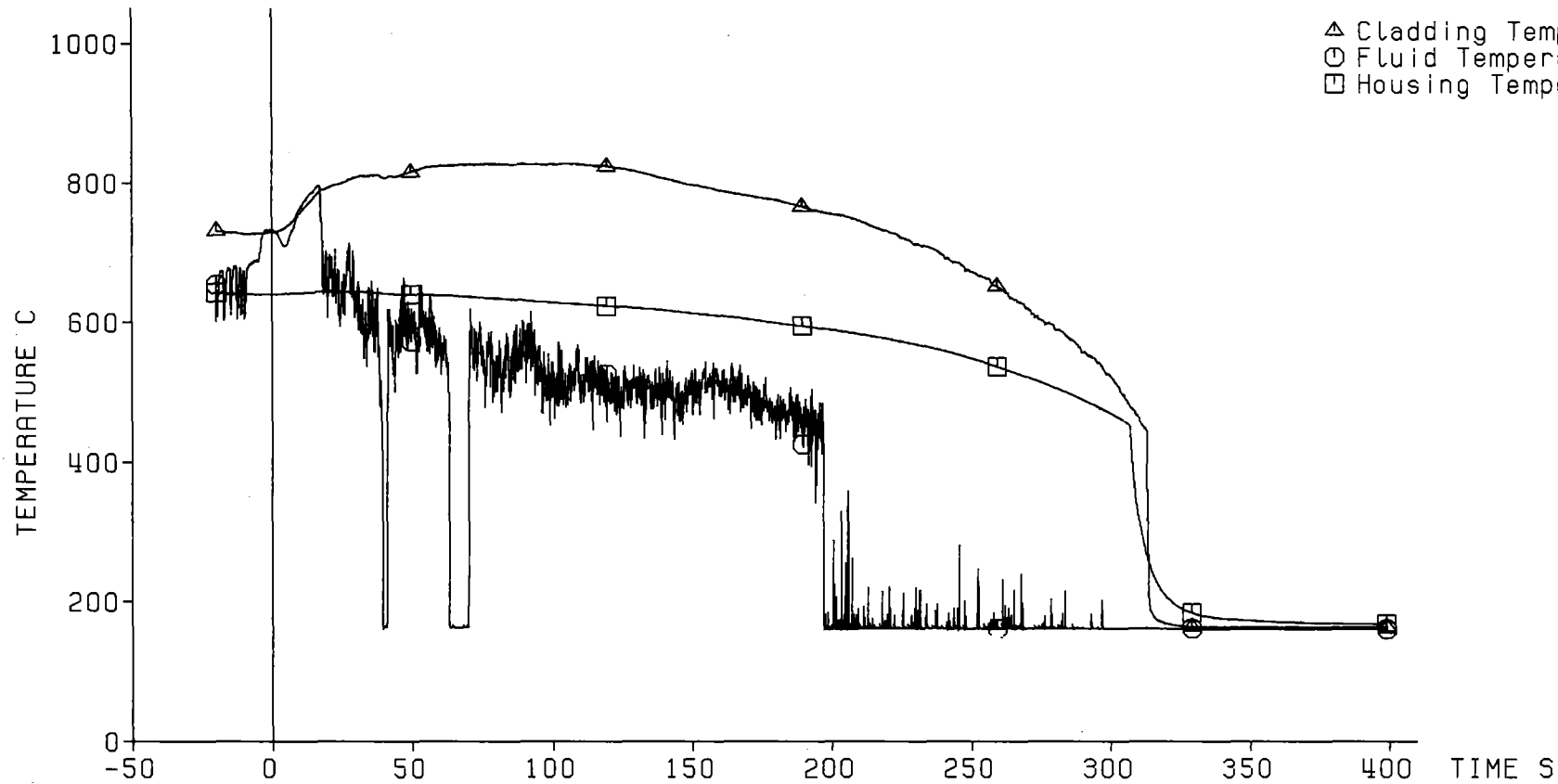

Decay Heat 120% ANS Standard
Flooding Rate (cold) 3.81 cm/s
System Pressure 5.88 bar
Feedwater Temperature 40 C

— 235 —



Fig. 205 FEBA: 5x5 ROD BUNDLE, TEST SERIES 7, TEST-No. 329

Pressure Loss
Along the Test Section:

◇ Total Length: 4196 mm
△ Lower Part: 1711 mm
○ Middle Part: 545 mm
□ Upper Part: 1940 mm

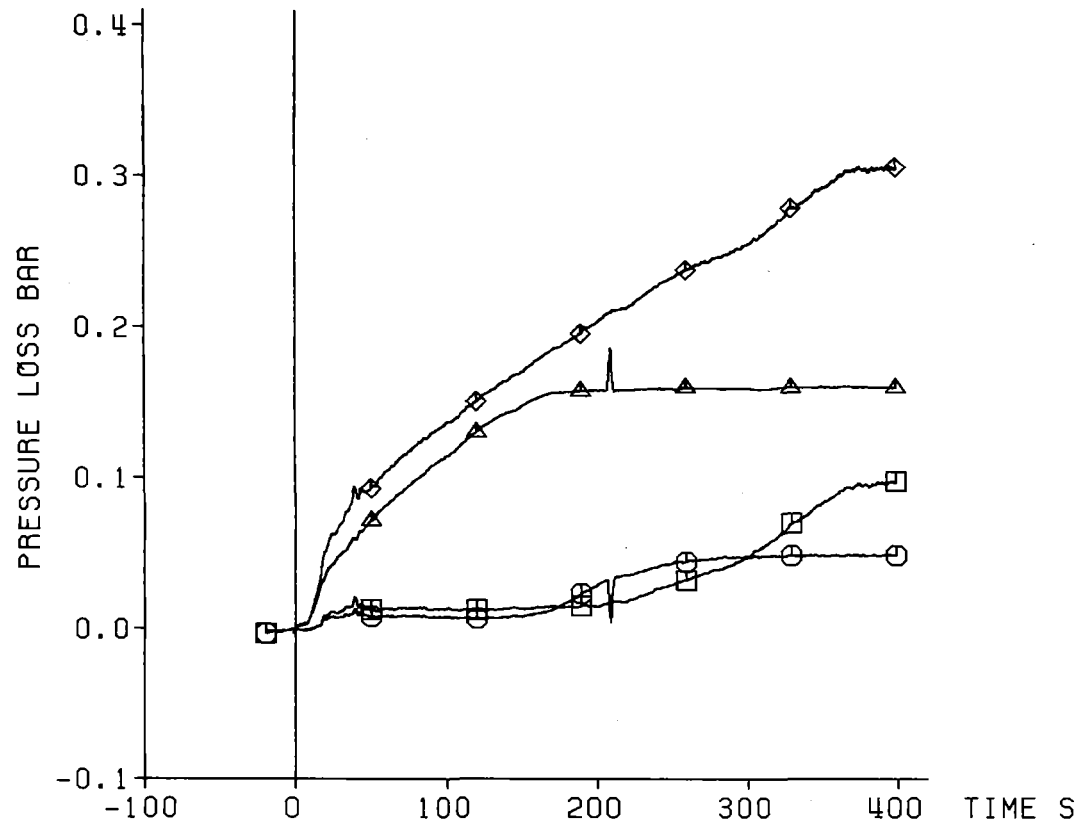

Decay Heat 120% ANS Standard
Flooding Rate (cold) 3.81 cm/s
System Pressure 5.88 bar
Feedwater Temperature 40 C

KIK
IRB

Fig. 206 FEBA: 5x5 ROD BUNDLE, TEST SERIES 7, TEST-No. 329

Coolant Outlet Conditions:

- △ Water Carry Over
- Coolant Temperature
- Coolant Pressure

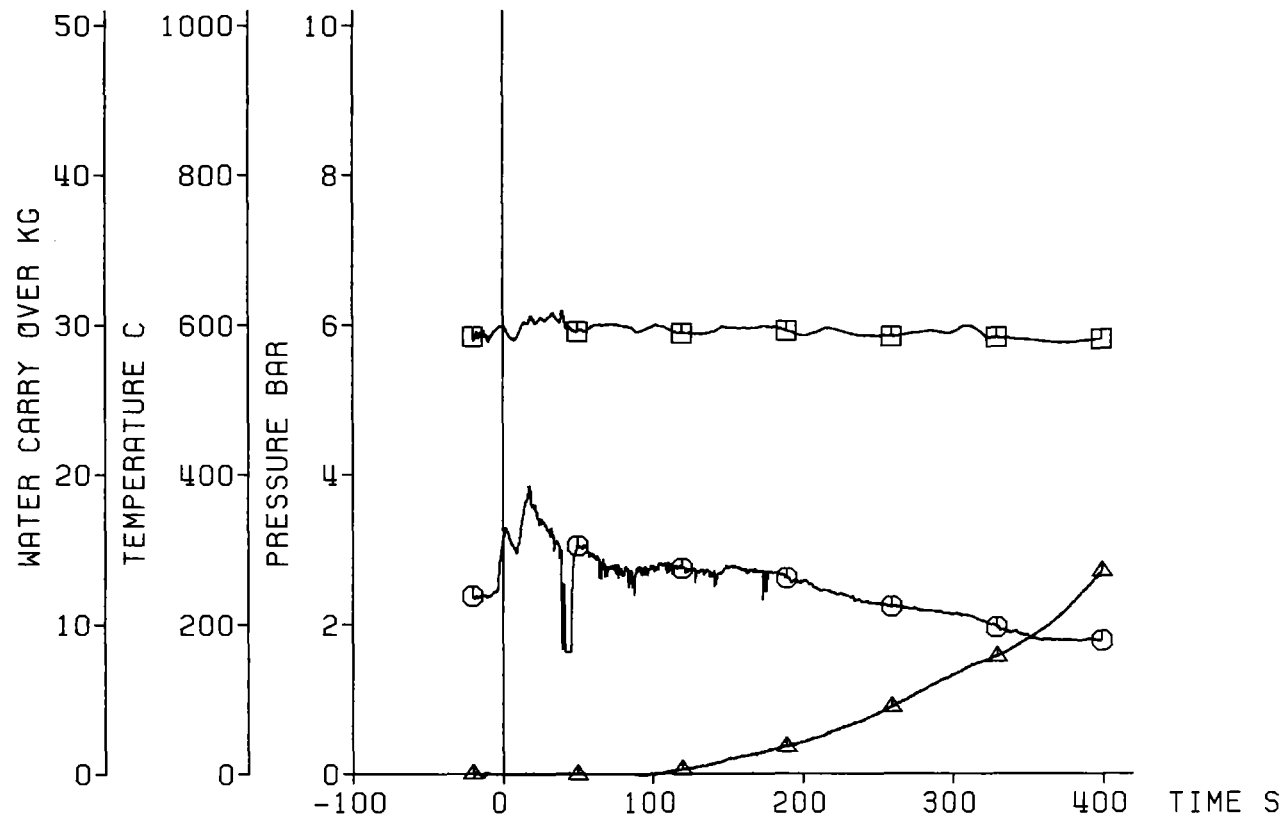

Decay Heat 120% ANS Standard
Flooding Rate (cold) 3.81 cm/s
System Pressure 5.88 bar
Feedwater Temperature 40 C



Fig. 207 FEBA: 5x5 ROD BUNDLE, TEST SERIES 7, TEST-No. 329

Axial Position of Quench Front

□ Quenching of Sleeves at Bundle Midplane

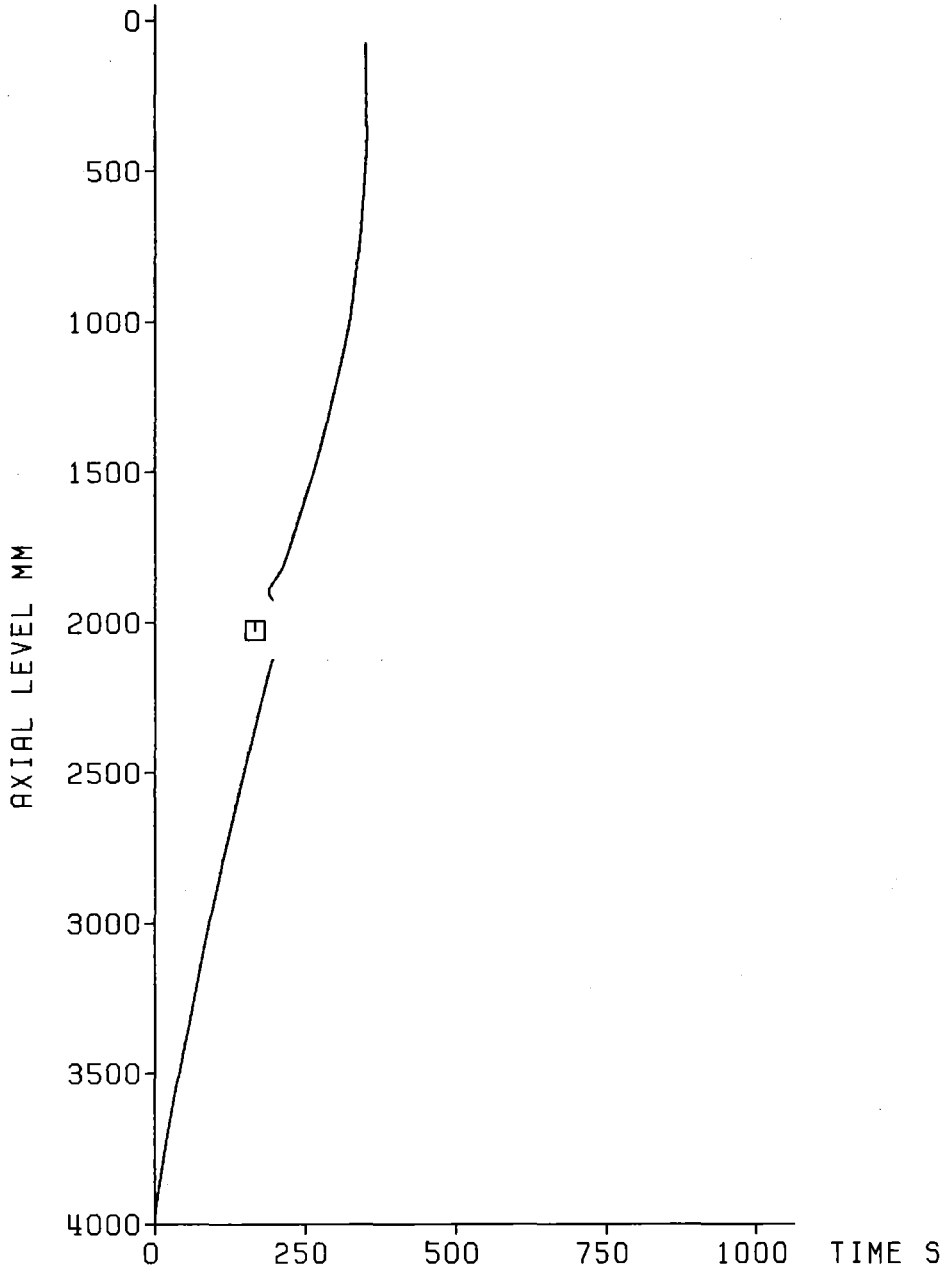

Decay Heat	120% ANS Standard
Flooding Rate (cold)	3.81 cm/s
System Pressure	5.88 bar
Feedwater Temperature	40 C



Fig. 208 FEBA: 5x5 ROD BUNDLE
TEST SERIES 7, TEST-No. 329

Initial Axial Temperature Profile of Claddings

□ Initial Temperature of Sleeves at Bundle Midplane

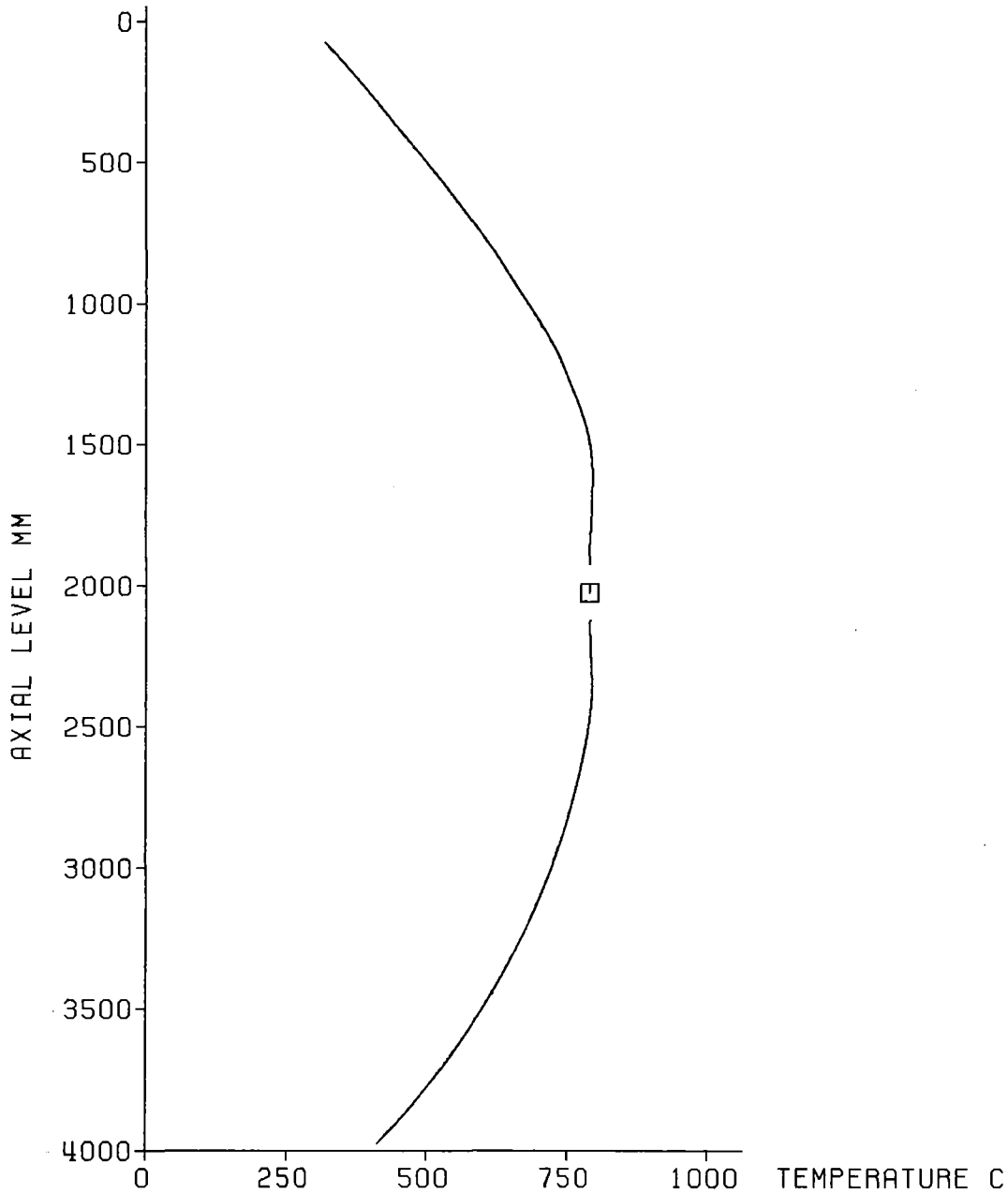

Decay Heat	120% ANS Standard
Flooding Rate (cold)	5.81 cm/s
System Pressure	2.10 bar
Feedwater Temperature	40 C



Fig. 209 FEBA: 5x5 ROD BUNDLE
TEST SERIES 7, TEST-No. 321

Test Parameters:

- ◇ Flooding Rate
- △ System Pressure
- Feedwater Temperature
- Bundle Power

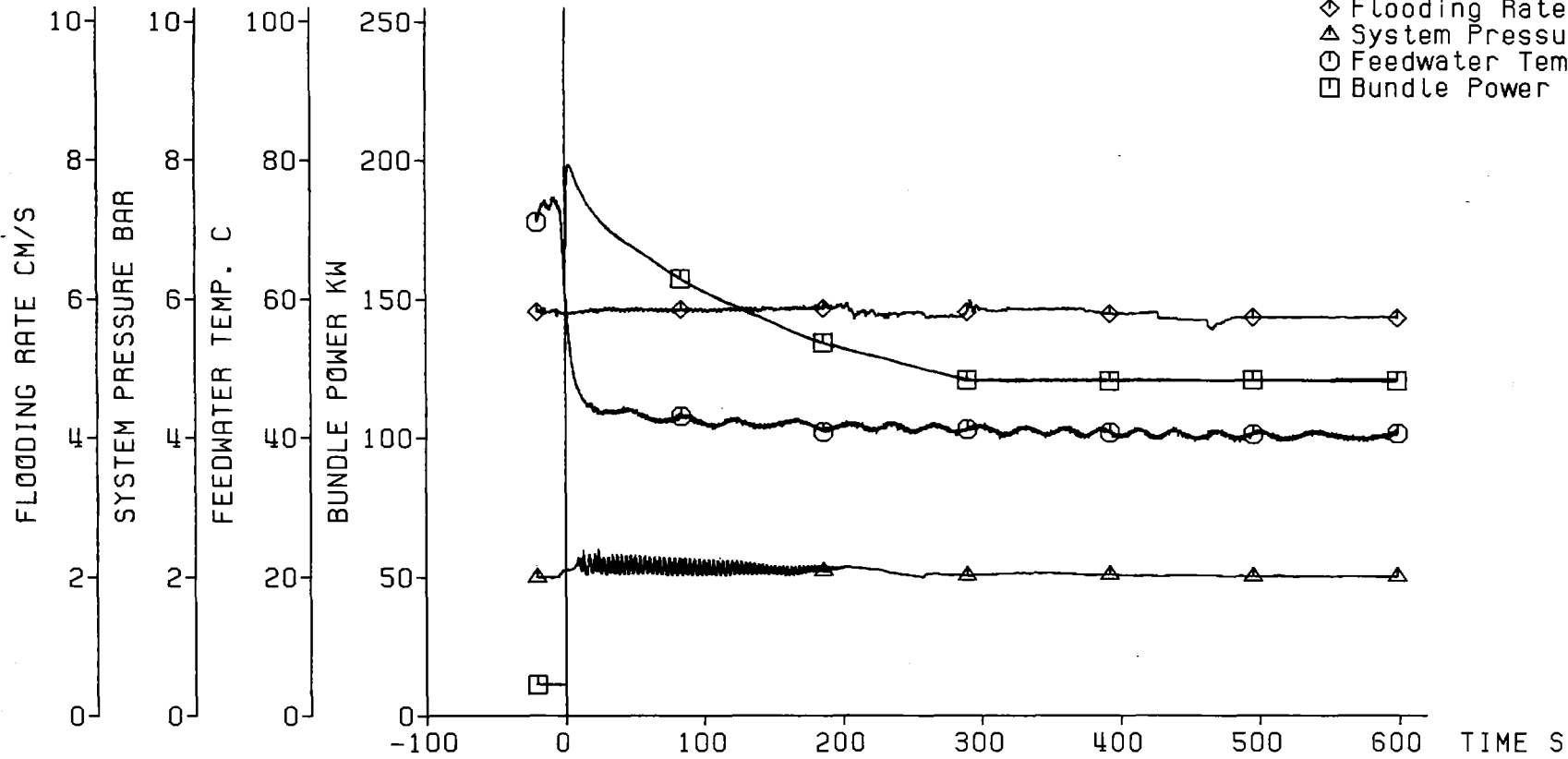

Decay Heat 120% ANS Standard
Flooding Rate (cold) 5.81 cm/s
System Pressure 2.10 bar
Feedwater Temperature 40 C



Fig. 210 FEBA: 5x5 ROD BUNDLE, TEST SERIES 7, TEST-No. 321

Cladding Temperature

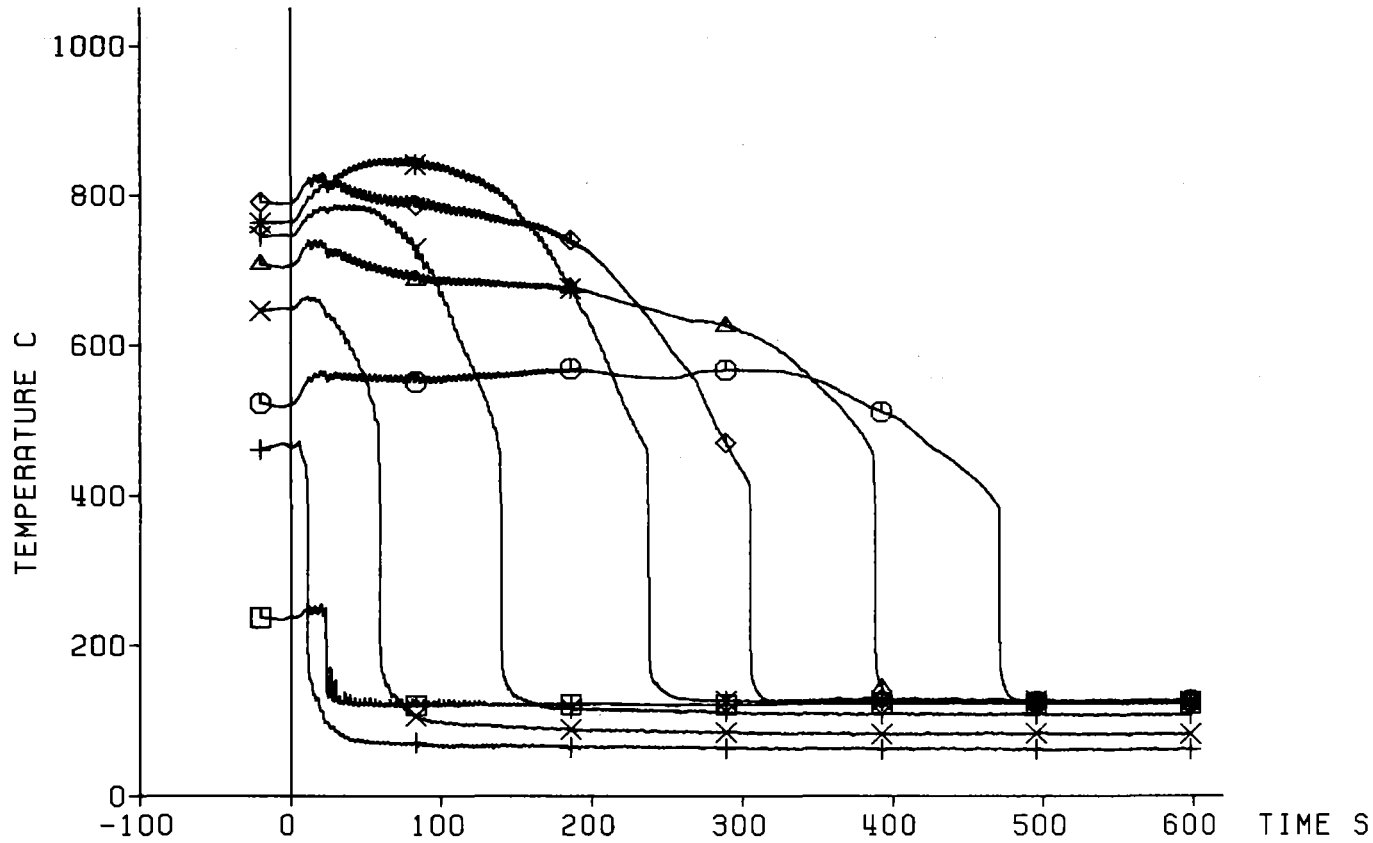

TC	Ax. Level
+	7a4 3860 mm
X	7a3 3315 mm
Y	7a2 2770 mm
*	7a1 2225 mm
◇	8b4 1680 mm
△	8b3 1135 mm
○	8b2 590 mm
□	3b1 45 mm

Decay Heat 120% ANS Standard
 Flooding Rate (cold) 5.81 cm/s
 System Pressure 2.10 bar
 Feedwater Temperature 40 C



Fig. 211 FEBA: 5x5 ROD BUNDLE, TEST SERIES 7, TEST-No. 321

Heat Transfer Coeff.

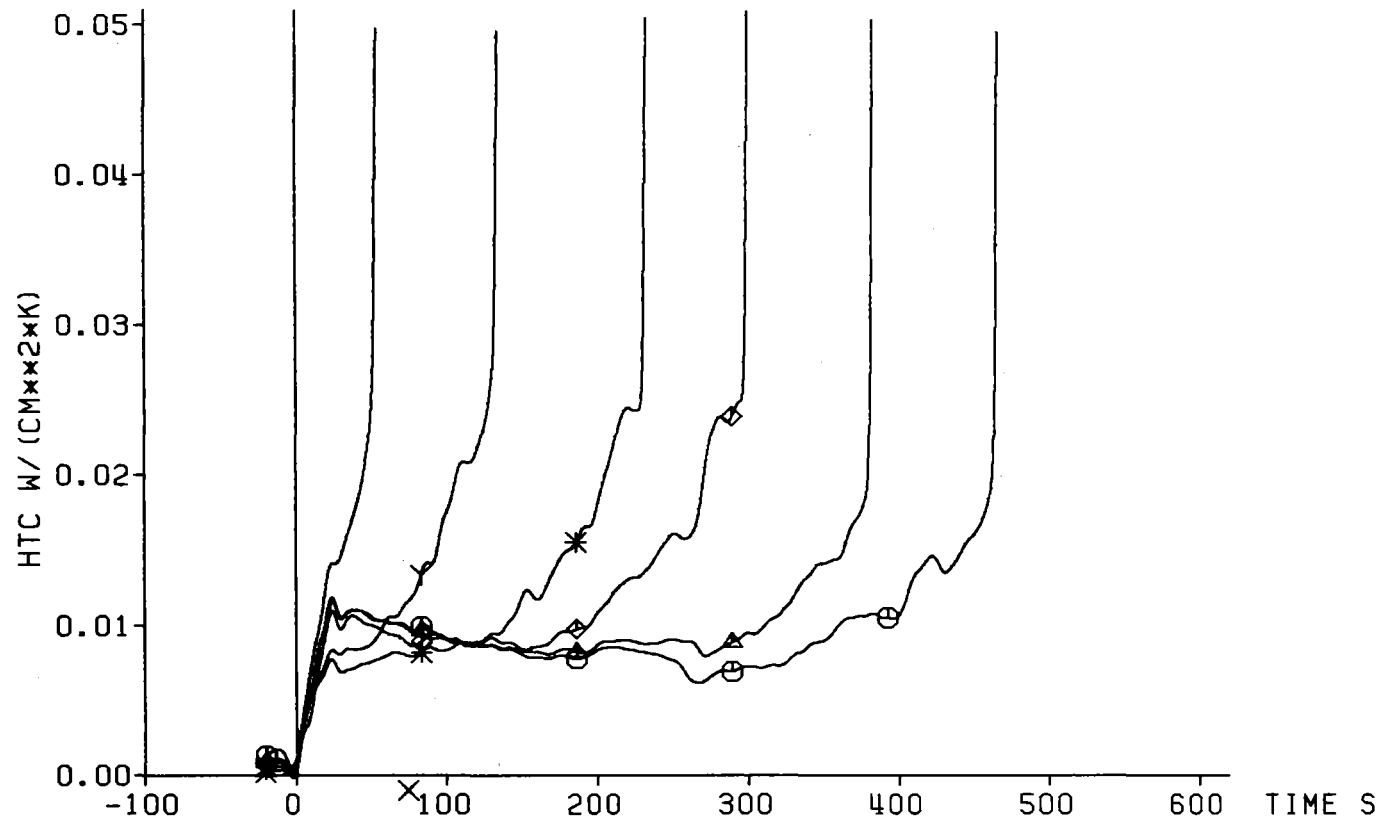

	TC	Ax. Level
X	7a3	3315 mm
Y	7a2	2770 mm
*	7a1	2225 mm
◇	8b4	1680 mm
△	8b3	1135 mm
○	8b2	590 mm

Decay Heat 120% ANS Standard
 Flooding Rate (cold) 5.81 cm/s
 System Pressure 2.10 bar
 Feedwater Temperature 40 C



Fig. 212 FEBA: 5x5 ROD BUNDLE, TEST SERIES 7, TEST-No. 321

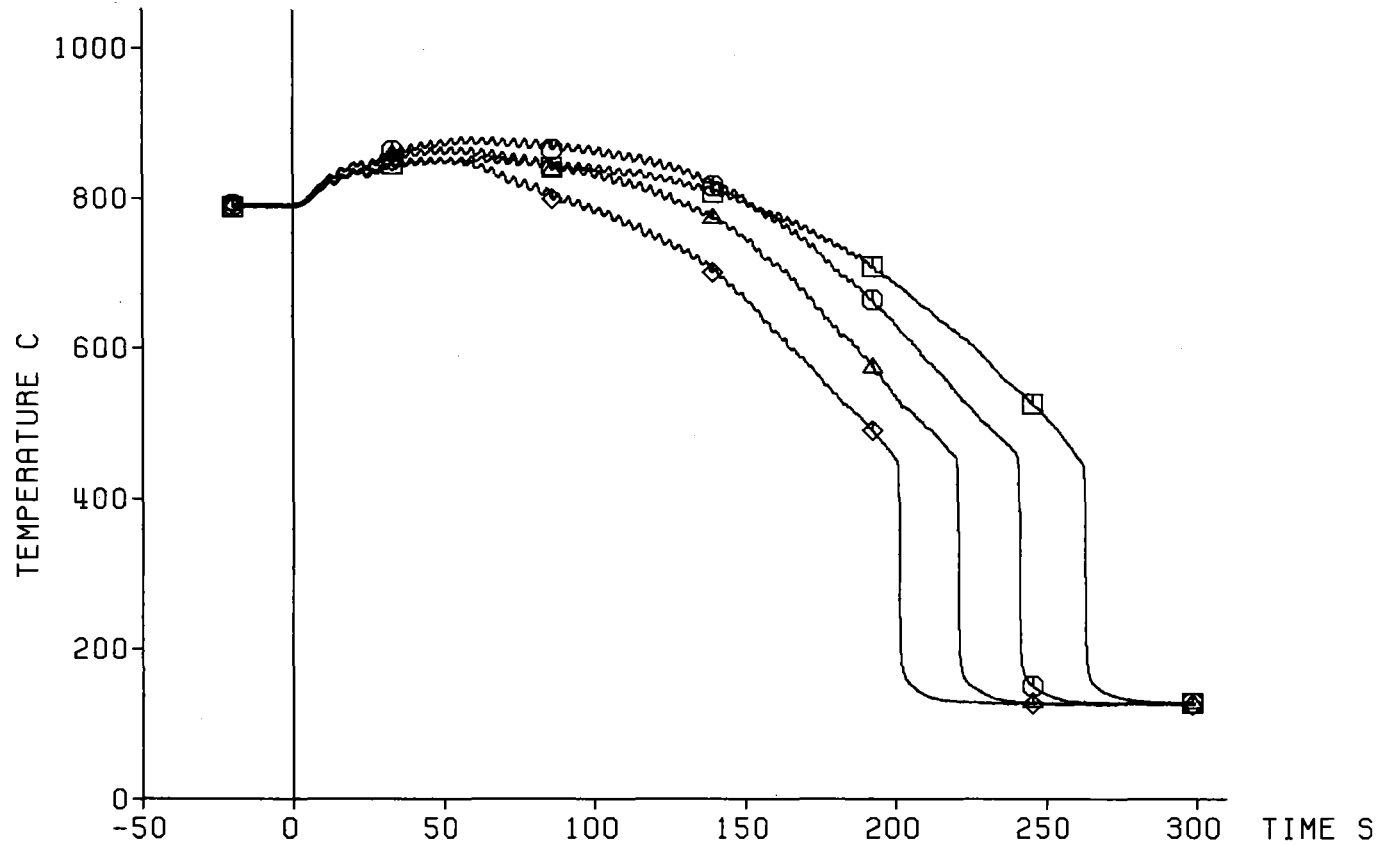

TC	Ax. Level
◇	14f4 2425 mm
△	14f3 2325 mm
⊙	14h2 2225 mm
□	14f1 2125 mm

Decay Heat 120% ANS Standard
 Flooding Rate (cold) 5.81 cm/s
 System Pressure 2.10 bar
 Feedwater Temperature 40 C



Fig. 213 FEBA: 5x5 ROD BUNDLE, TEST SERIES 7, TEST-No. 321

Heat Transfer Coeff.

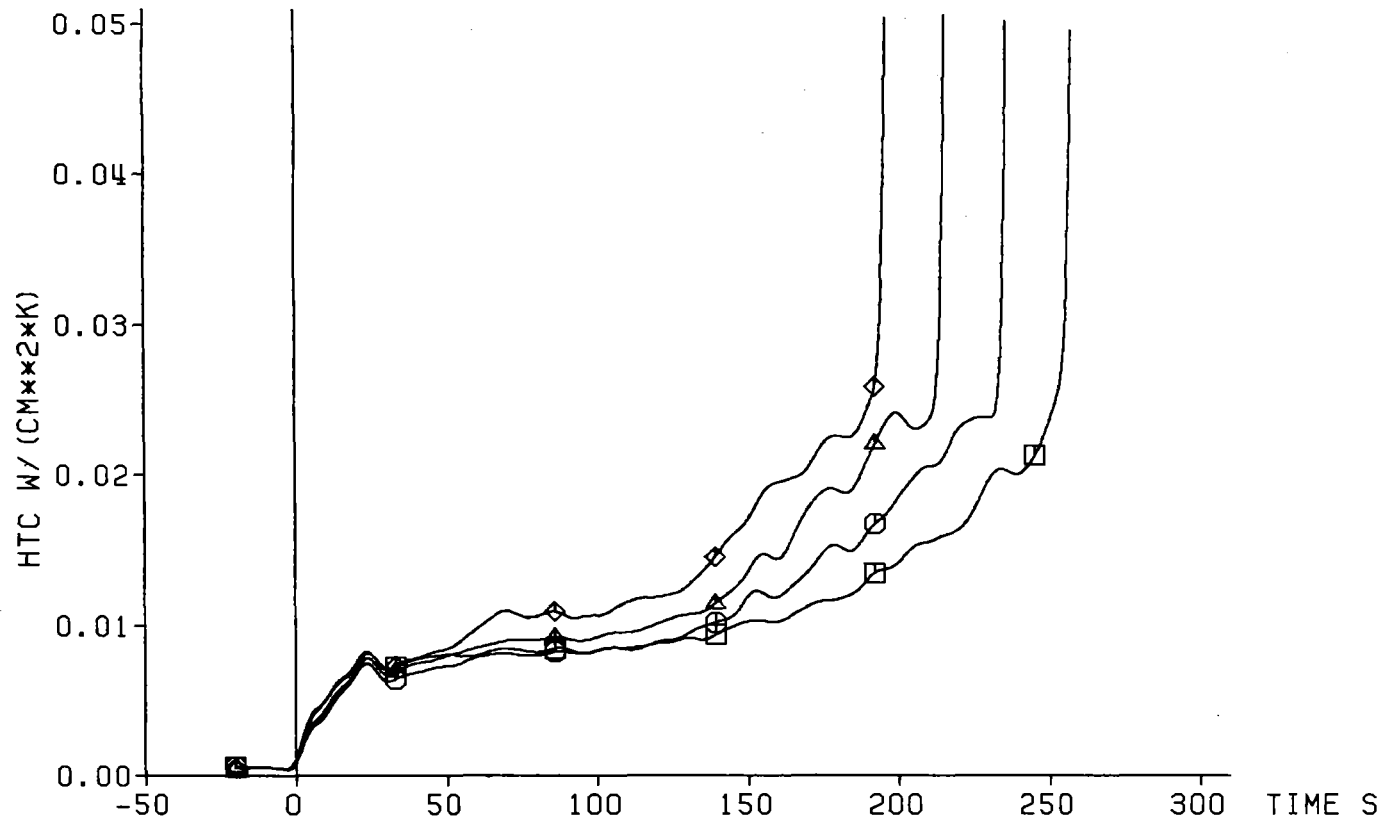

TC	Ax. Level
◇	14f4 2425 mm
△	14f3 2325 mm
○	14h2 2225 mm
□	14f1 2125 mm

Decay Heat 120% ANS Standard
 Flooding Rate (cold) 5.81 cm/s
 System Pressure 2.10 bar
 Feedwater Temperature 40 C



Fig. 214 FEBA: 5x5 ROD BUNDLE, TEST SERIES 7, TEST-No. 321

Cladding Temperature

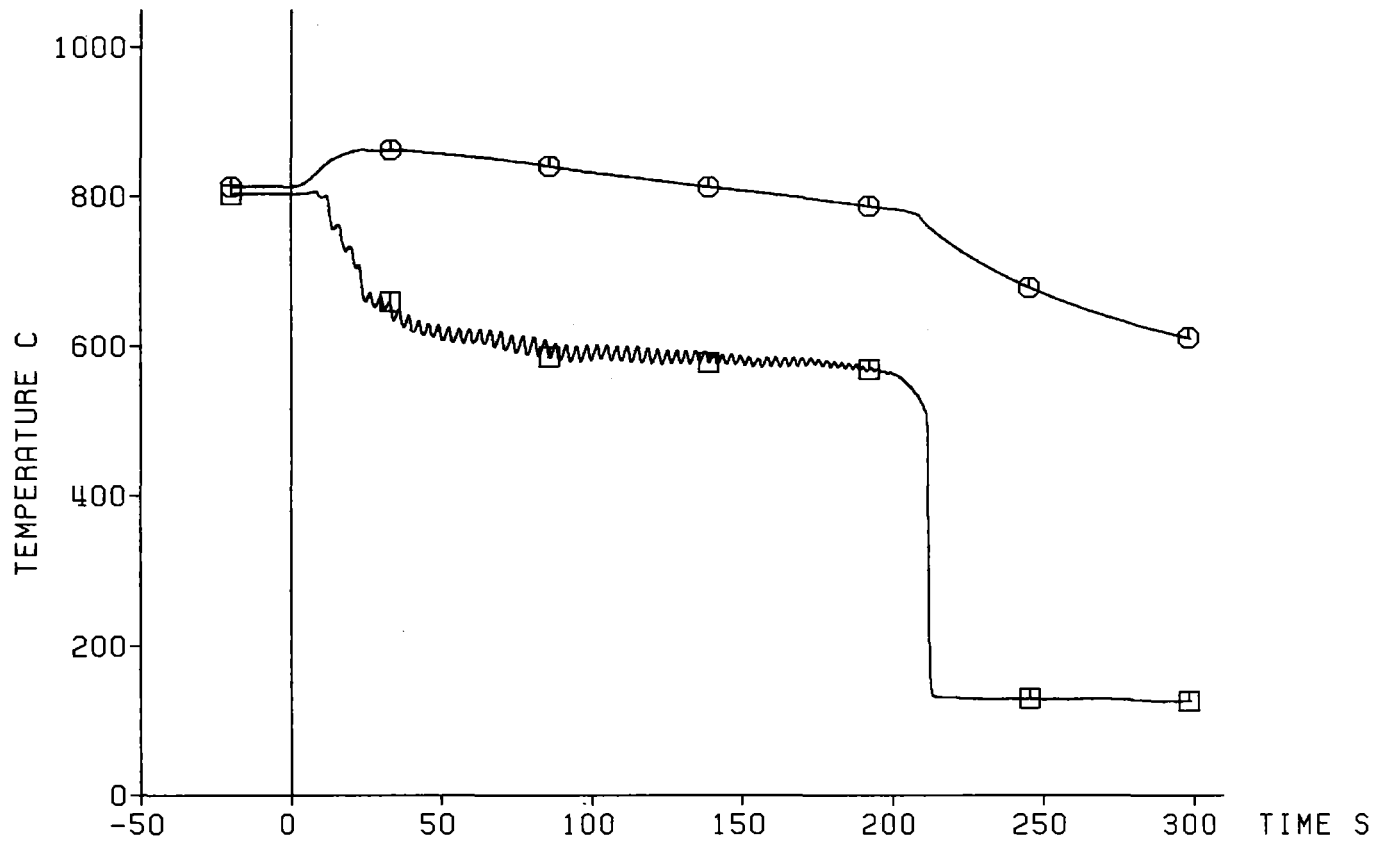

TC	Ax. Level
⊙ 13h2	2025 mm
⊠ Sleeve	2025 mm

Decay Heat 120% ANS Standard
 Flooding Rate (cold) 5.81 cm/s
 System Pressure 2.10 bar
 Feedwater Temperature 40 C



Fig. 215 FEBA: 5x5 ROD BUNDLE, TEST SERIES 7, TEST-No. 321

Cladding Temperature

TC	Ax. Level
⊙ 17i4	2025 mm
⊠ Sleeve	2025 mm

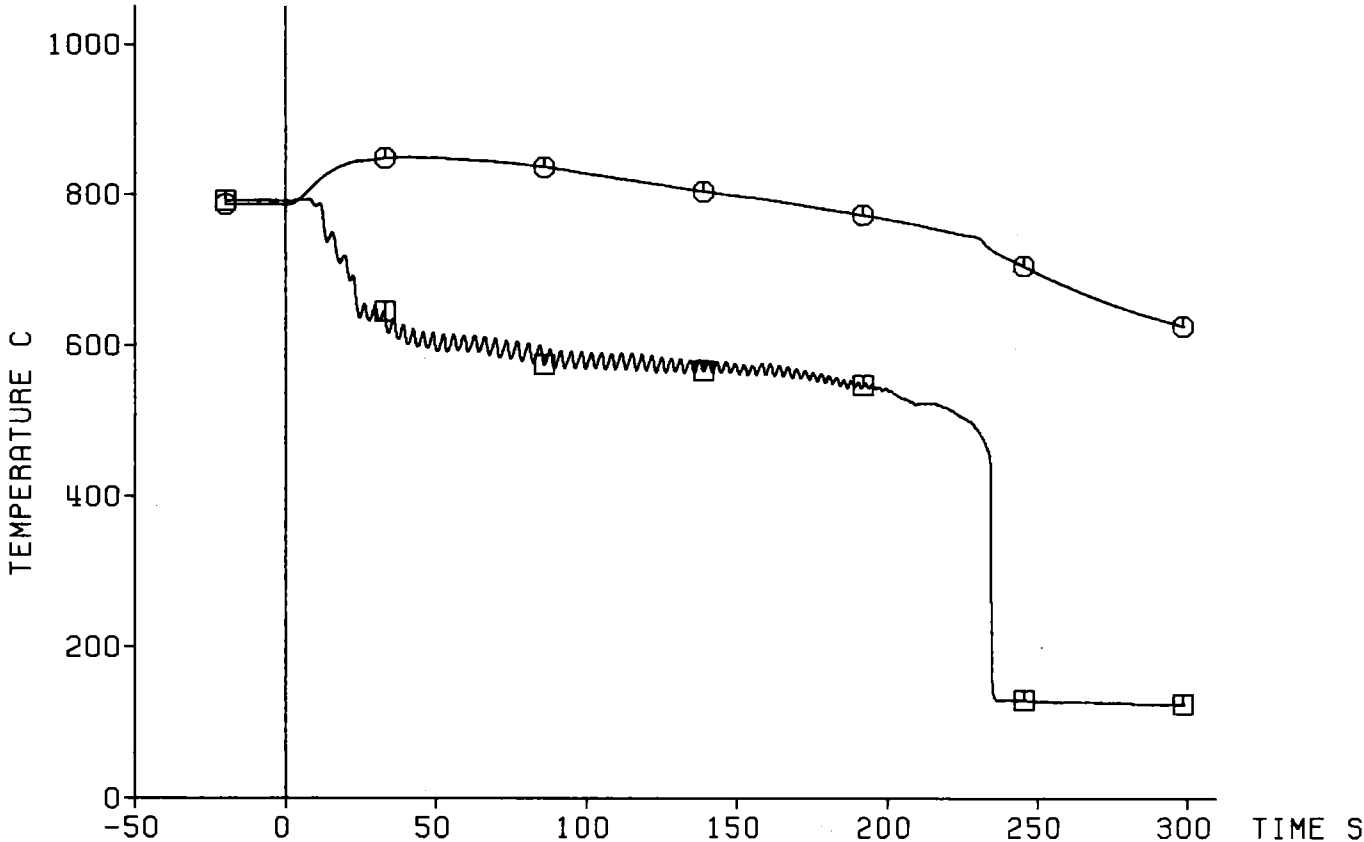

Decay Heat 120% ANS Standard
 Flooding Rate (cold) 5.81 cm/s
 System Pressure 2.10 bar
 Feedwater Temperature 40 C



Fig. 216 FEBA: 5x5 ROD BUNDLE, TEST SERIES 7, TEST-No. 321

Cladding Temperature

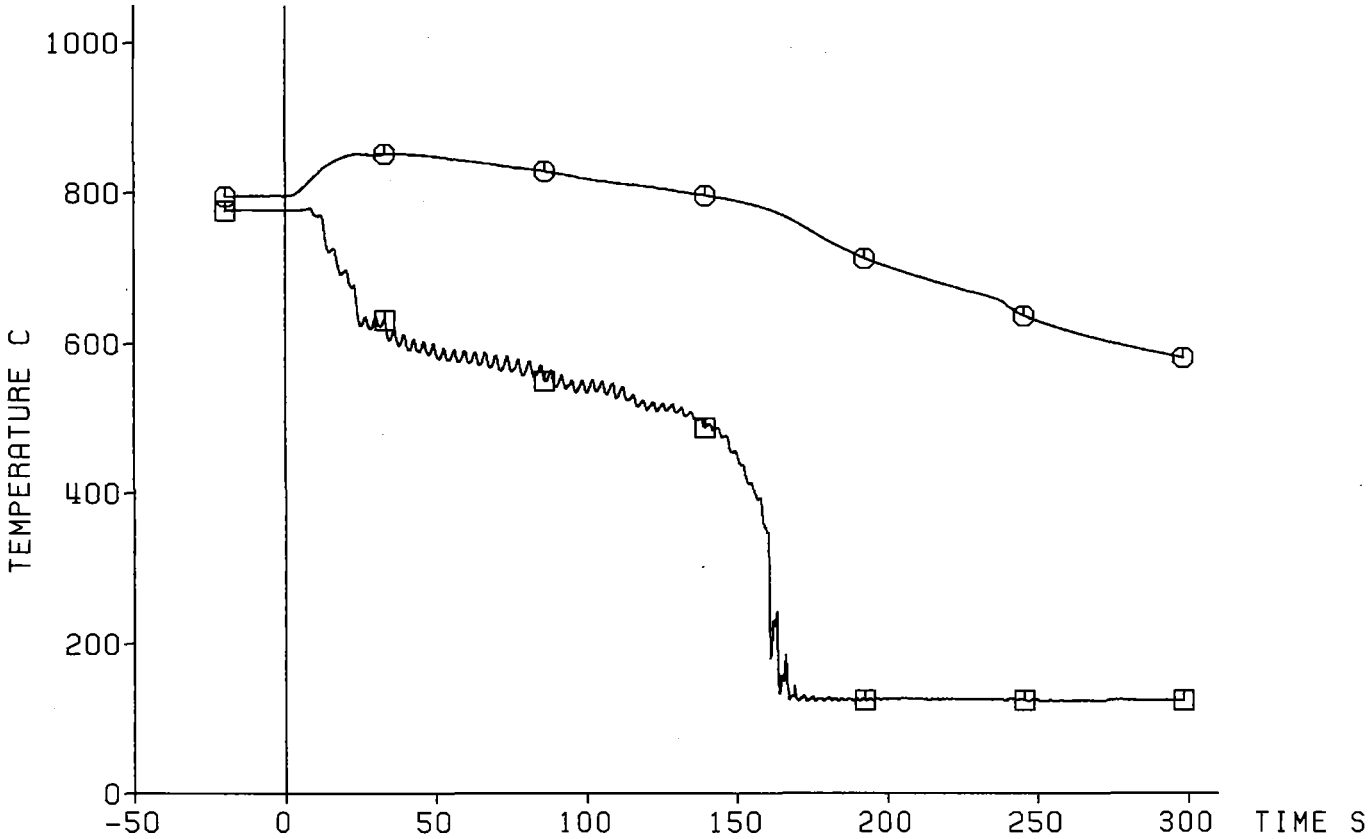

TC	Ax. Level
○ 1713	1975 mm
□ Sleeve	1972 mm

Decay Heat 120% ANS Standard
 Flooding Rate (cold) 5.81 cm/s
 System Pressure 2.10 bar
 Feedwater Temperature 40 C



Fig. 217 FEBA: 5x5 ROD BUNDLE, TEST SERIES 7, TEST-No. 321

Cladding Temperature

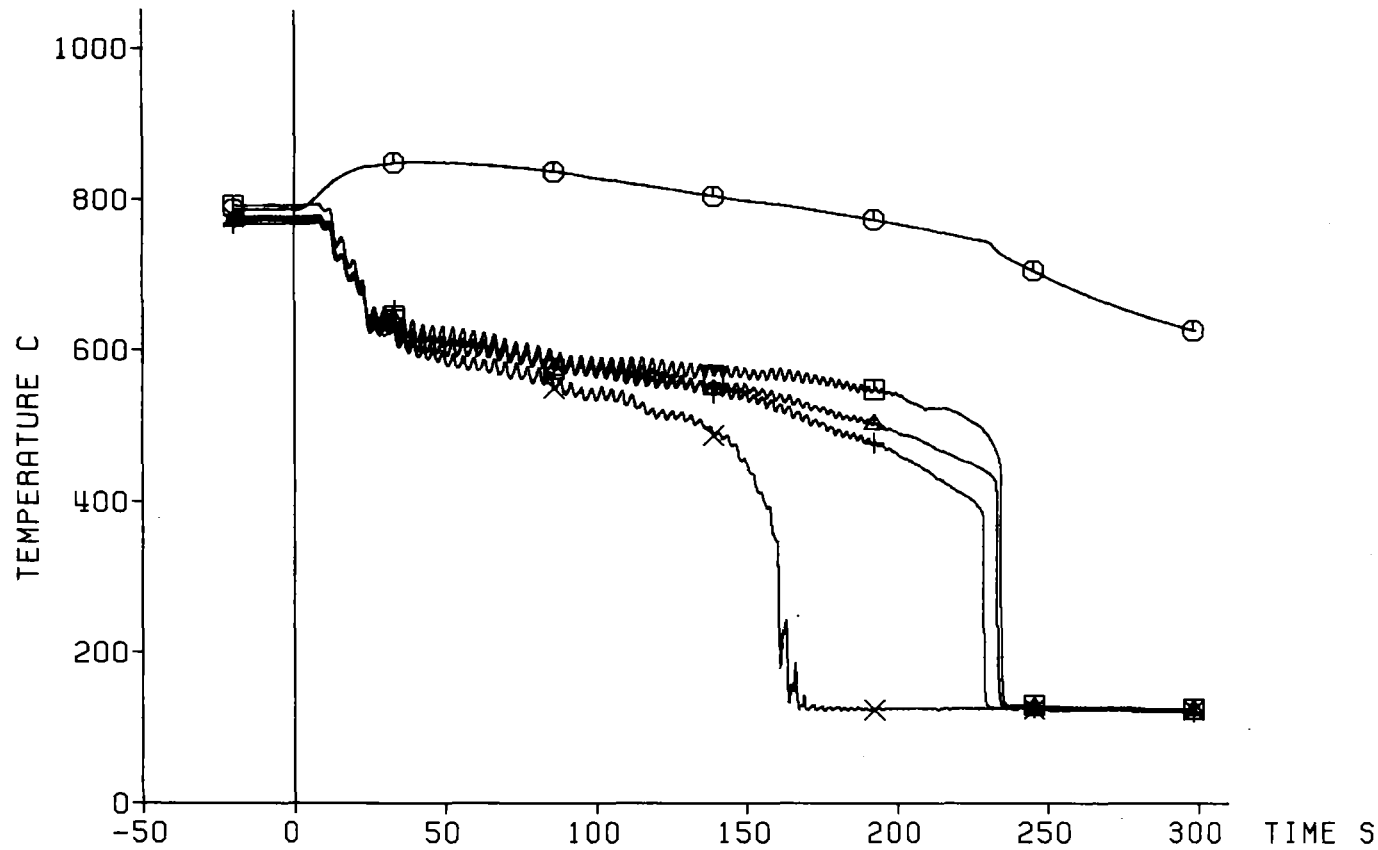

TC	Ax. Level
⊖ 1714	2025 mm
+ Sleeve	2064 mm
□ Sleeve	2025 mm
△ Sleeve	2025 mm
× Sleeve	1972 mm

Decay Heat 120% ANS Standard
 Flooding Rate (cold) 5.81 cm/s
 System Pressure 2.10 bar
 Feedwater Temperature 40 C



Fig. 218 FEBA: 5x5 ROD BUNDLE, TEST SERIES 7, TEST-No. 321

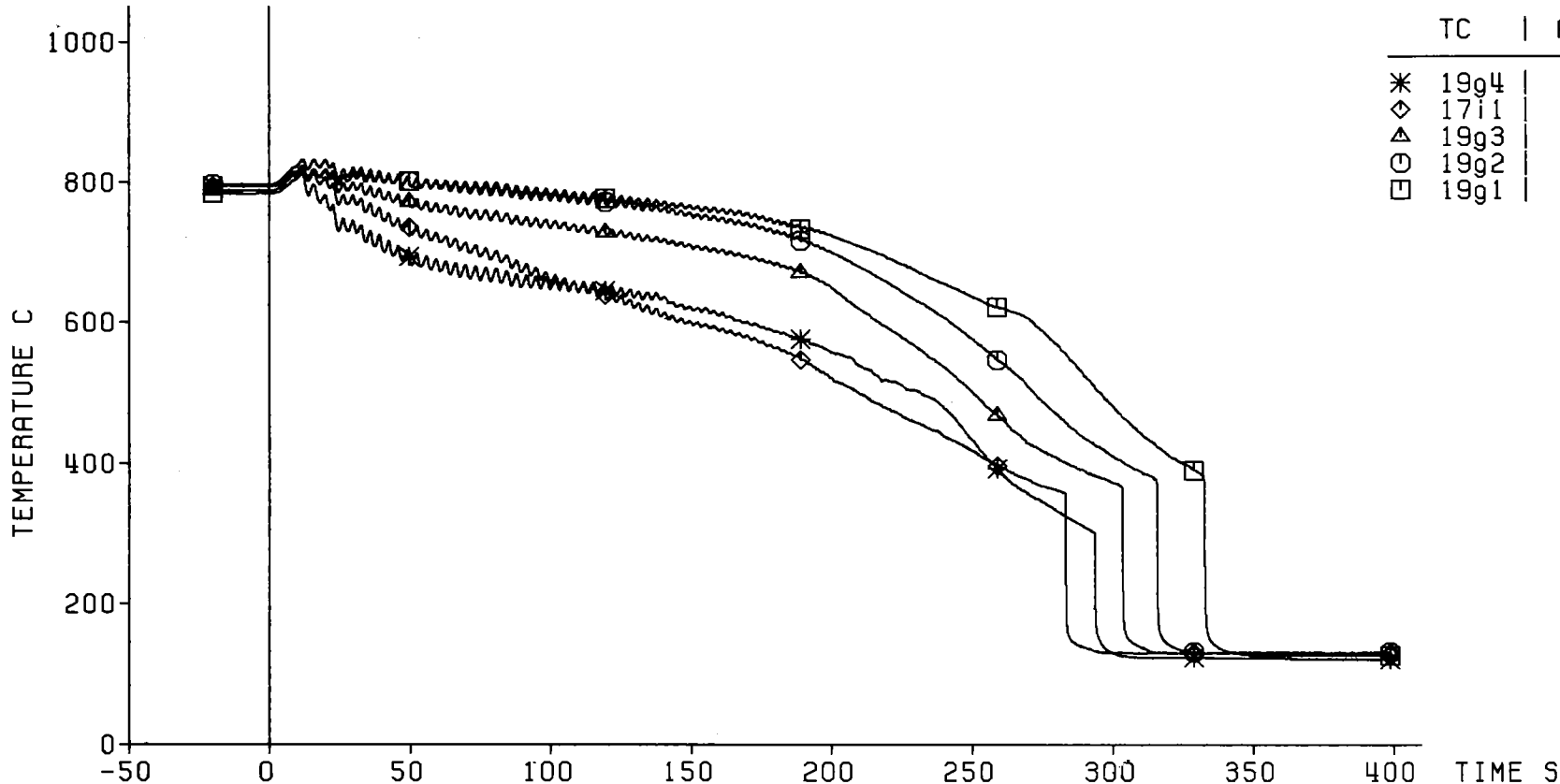

Decay Heat 120% ANS Standard
Flooding Rate (cold) 5.81 cm/s
System Pressure 2.10 bar
Feedwater Temperature 40 C



Fig. 219 FEBA: 5x5 ROD BUNDLE, TEST SERIES 7, TEST-No. 321

Heat Transfer Coeff.

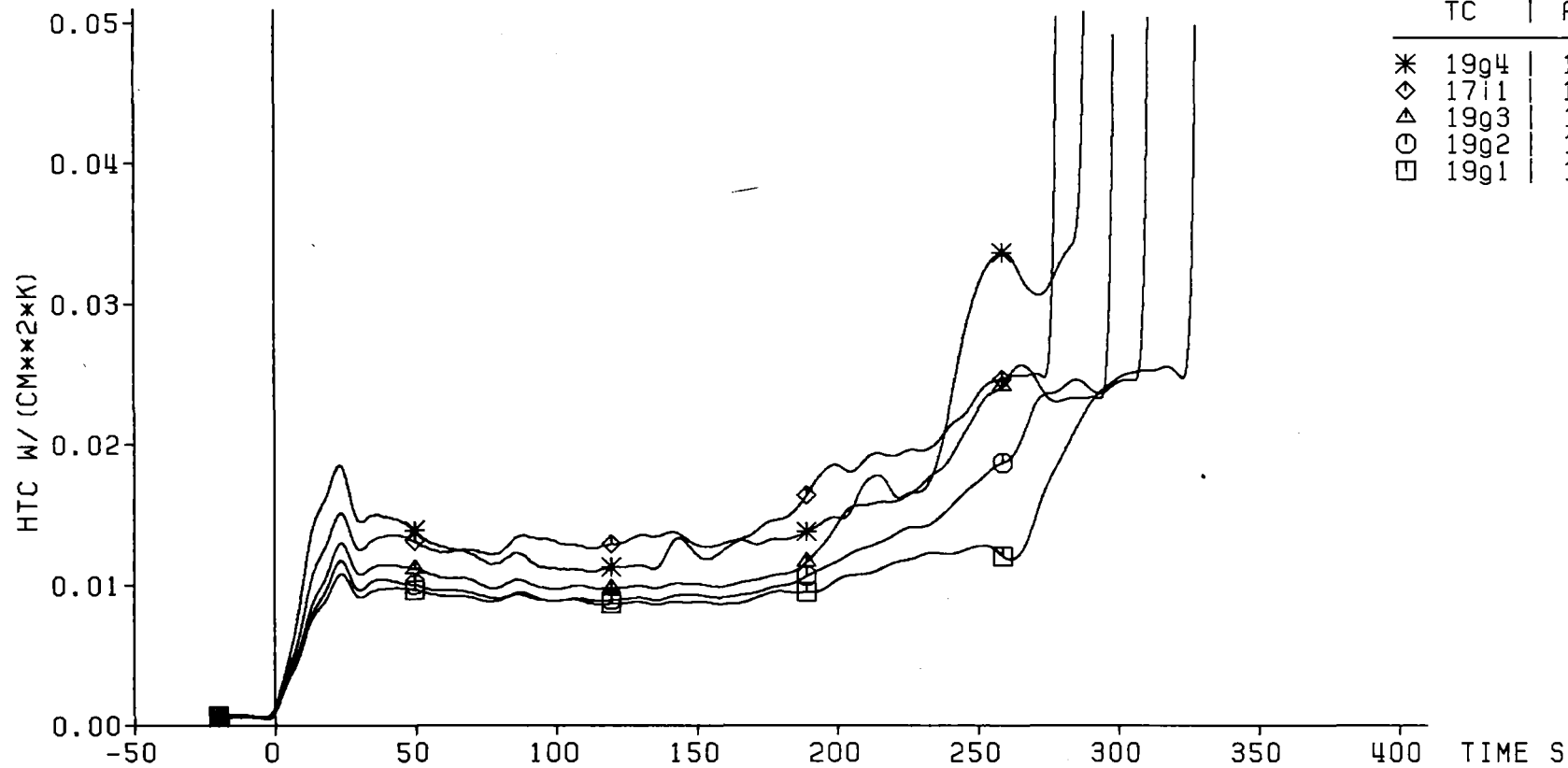

Decay Heat 120% ANS Standard
 Flooding Rate (cold) 5.81 cm/s
 System Pressure 2.10 bar
 Feedwater Temperature 40 C



Fig. 220 FEBA: 5x5 ROD BUNDLE, TEST SERIES 7, TEST-No. 321

Cladding Temperature

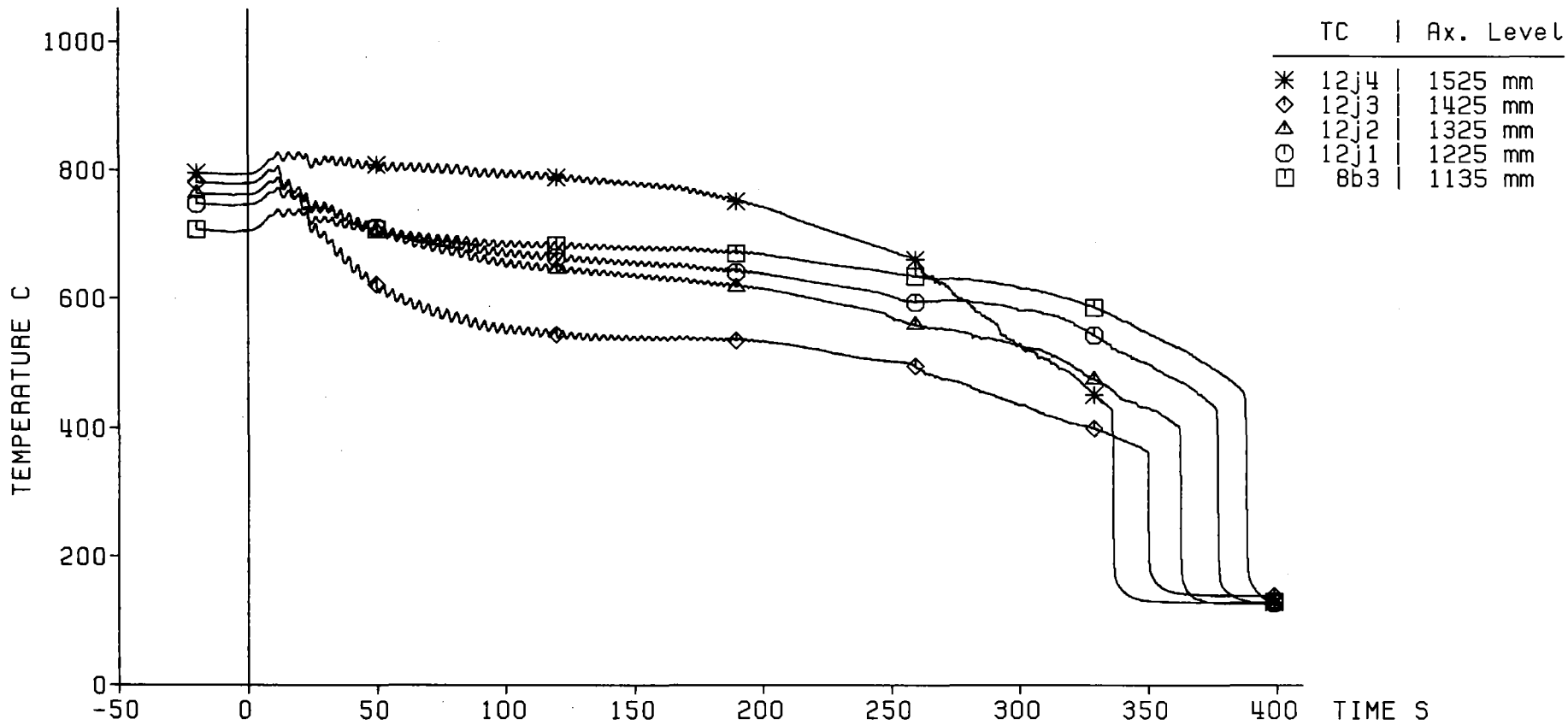

Decay Heat 120% ANS Standard
 Flooding Rate (cold) 5.81 cm/s
 System Pressure 2.10 bar
 Feedwater Temperature 40 C



Fig. 221 FEBA: 5x5 ROD BUNDLE, TEST SERIES 7, TEST-No. 321

Heat Transfer Coeff.

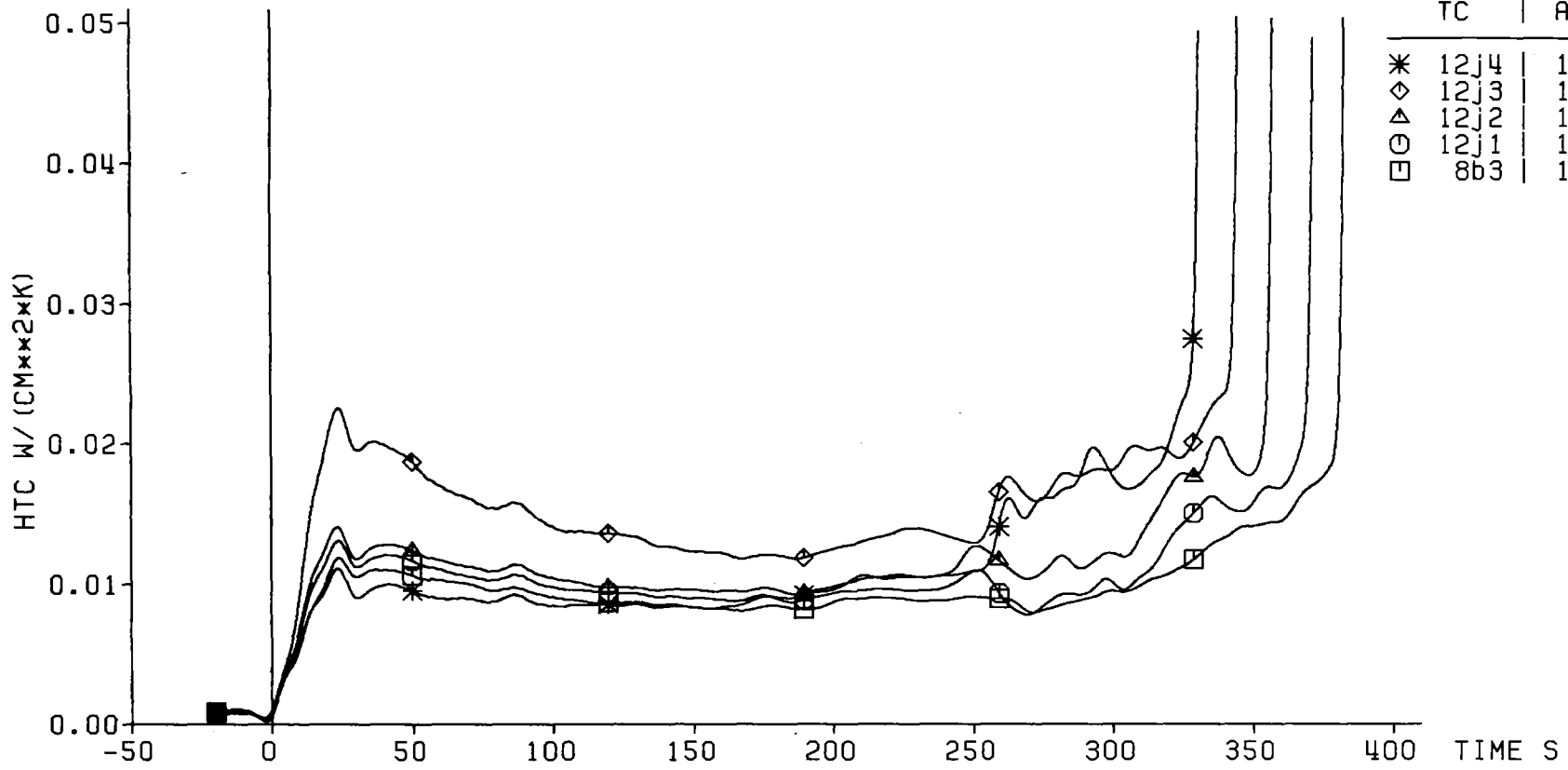

TC	Ax. Level
*	12j4 1525 mm
◇	12j3 1425 mm
△	12j2 1325 mm
○	12j1 1225 mm
□	8b3 1135 mm

Decay Heat 120% ANS Standard
 Flooding Rate (cold) 5.81 cm/s
 System Pressure 2.10 bar
 Feedwater Temperature 40 C



Fig. 222 FEBA: 5x5 ROD BUNDLE, TEST SERIES 7, TEST-No. 321

Axial Level: 2770 mm

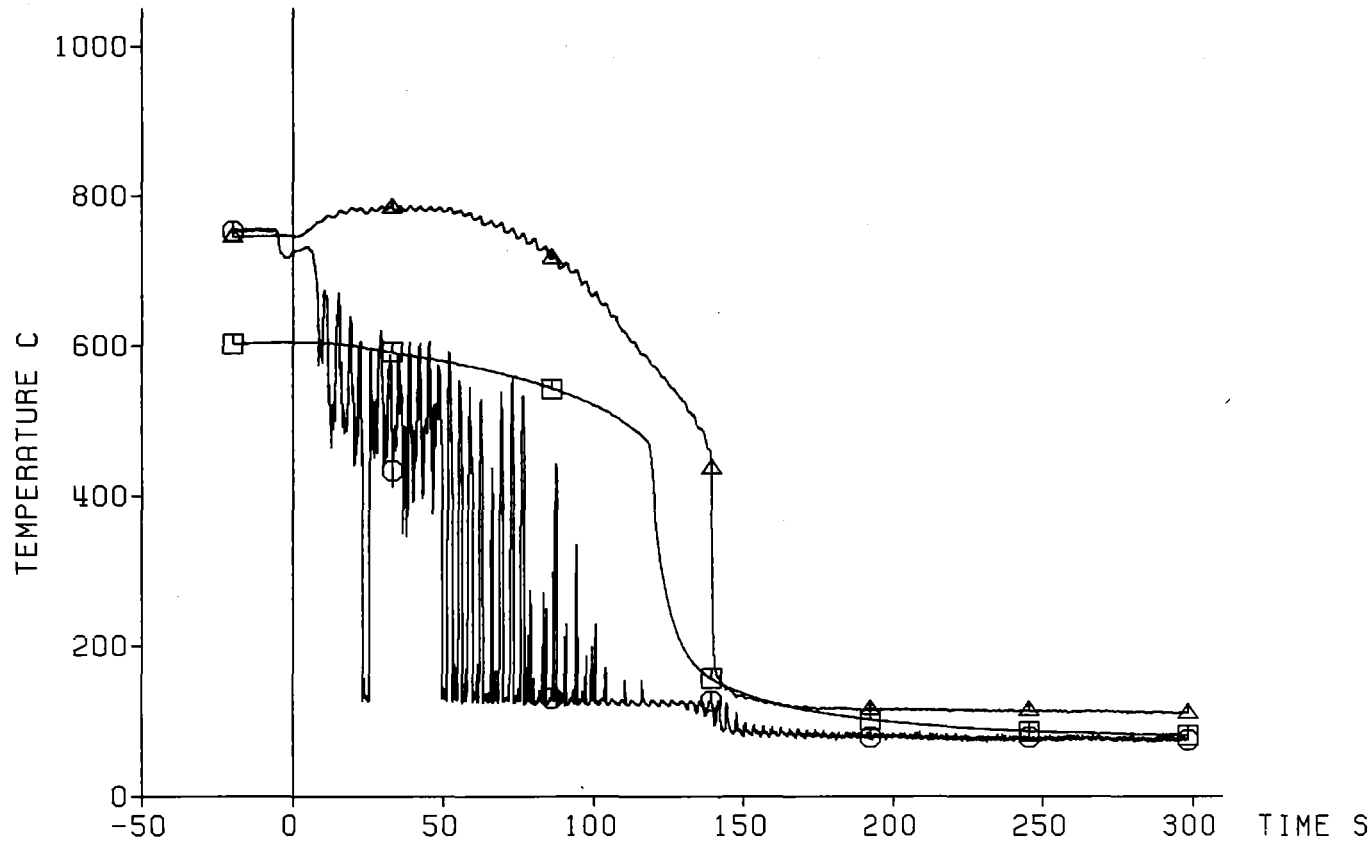

△ Cladding Temperature (7a2)
○ Fluid Temperature
□ Housing Temperature

Decay Heat 120% ANS Standard
Flooding Rate (cold) 5.81 cm/s
System Pressure 2.10 bar
Feedwater Temperature 40 C



Fig. 223 FEBA: 5x5 ROD BUNDLE, TEST SERIES 7, TEST-NO. 321

Axial Level: 2225 mm

△ Cladding Temperature (7a1)
○ Fluid Temperature (2240 mm)
□ Housing Temperature (2235 mm)

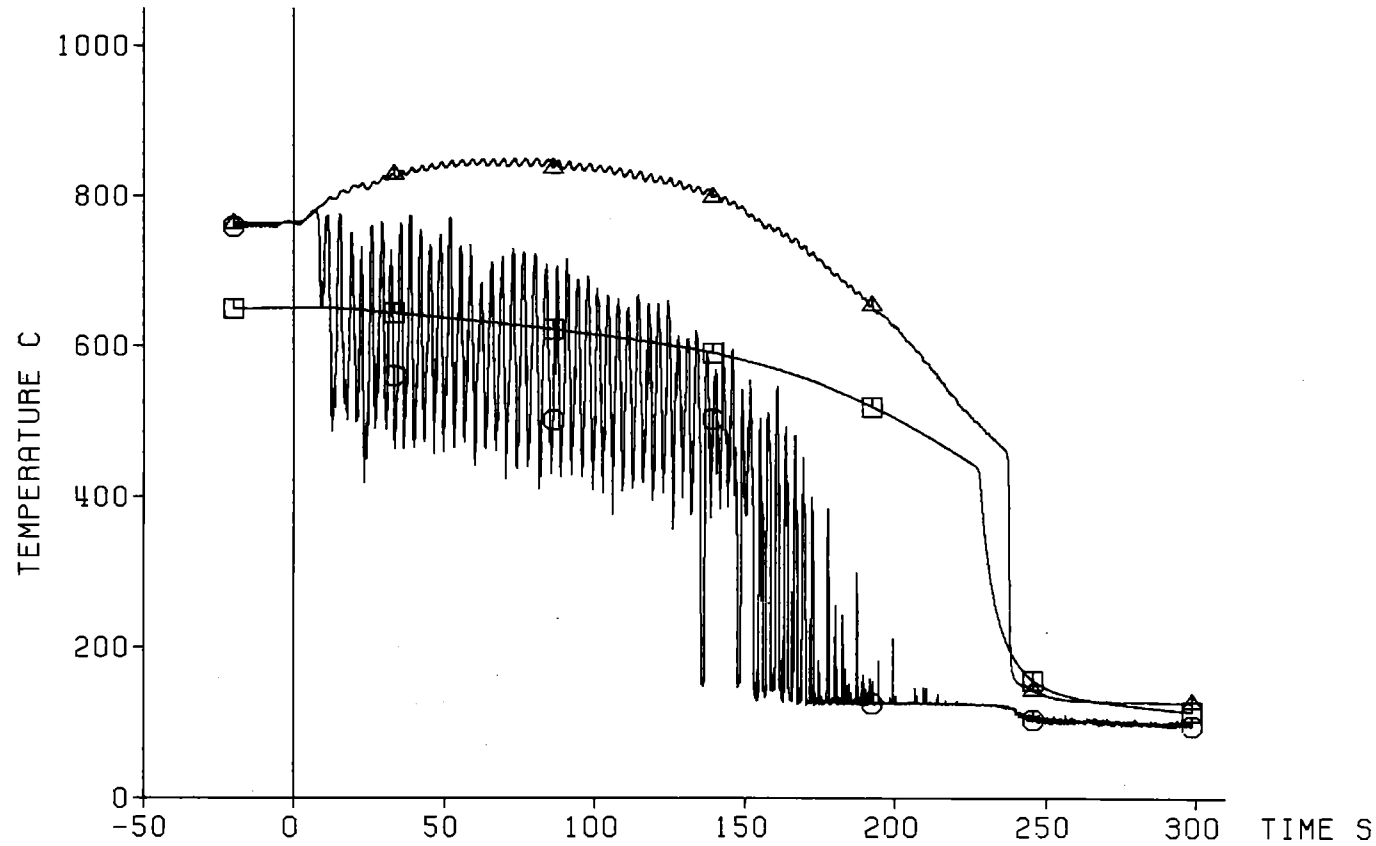

Decay Heat 120% ANS Standard
Flooding Rate (cold) 5.81 cm/s
System Pressure 2.10 bar
Feedwater Temperature 40 C

— 255 —



Fig. 224 FEBA: 5x5 ROD BUNDLE, TEST SERIES 7, TEST-NO. 321

△ Cladding Temperature (19g3)
○ Fluid Temperature
□ Housing Temperature

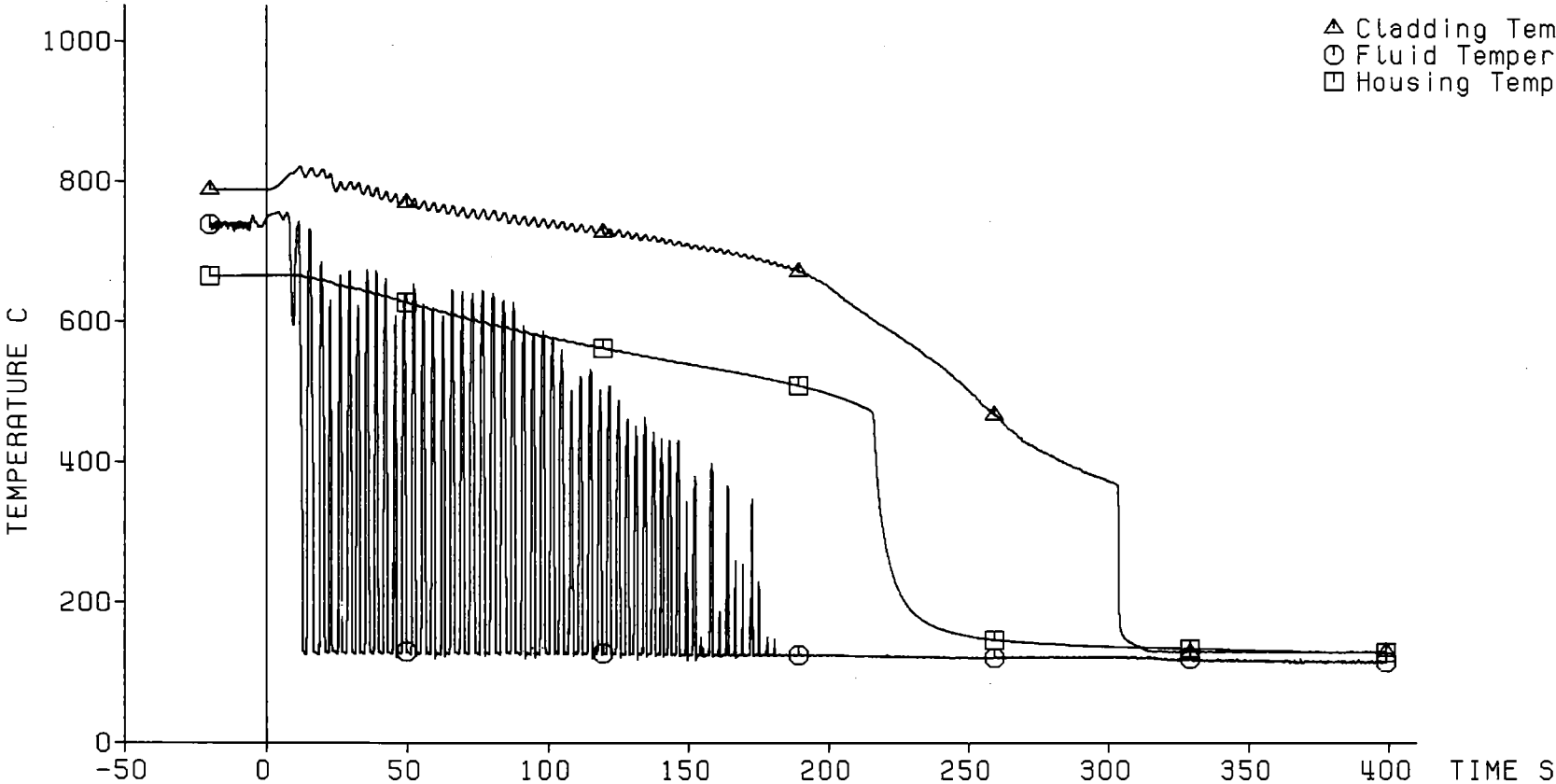

Decay Heat 120% ANS Standard
Flooding Rate (cold) 5.81 cm/s
System Pressure 2.10 bar
Feedwater Temperature 40 C



Fig. 225 FEBA: 5x5 ROD BUNDLE, TEST SERIES 7, TEST-No. 321

Axial Level: 1725 mm

△ Cladding Temperature (19g2)
○ Fluid Temperature

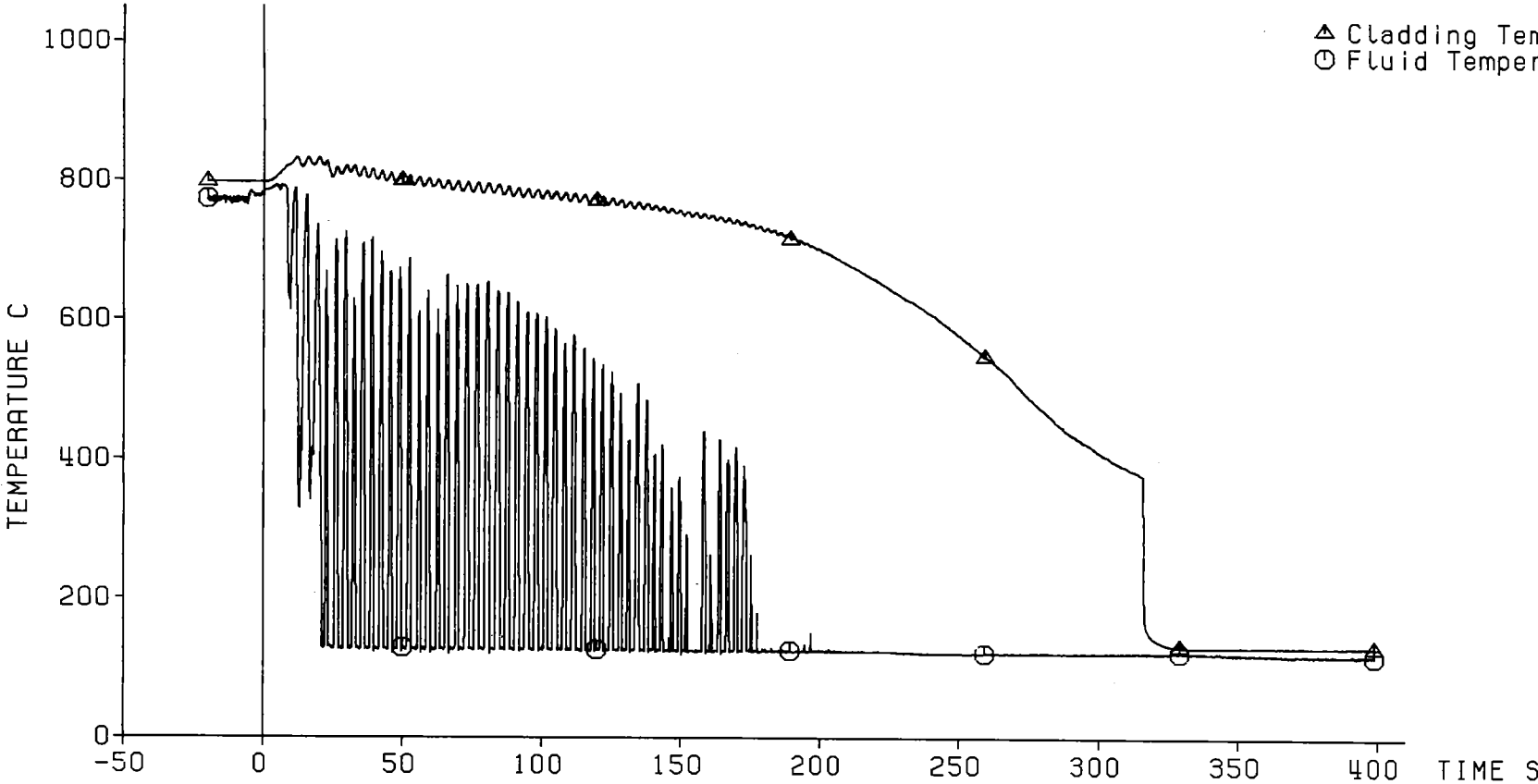

Decay Heat 120% ANS Standard
Flooding Rate (cold) 5.81 cm/s
System Pressure 2.10 bar
Feedwater Temperature 40 C



Fig. 226 FEBA: 5x5 ROD BUNDLE, TEST SERIES 7, TEST-NO. 321

Axial Level: 1625 mm

△ Cladding Temperature (19g1)
○ Fluid Temperature
□ Housing Temperature

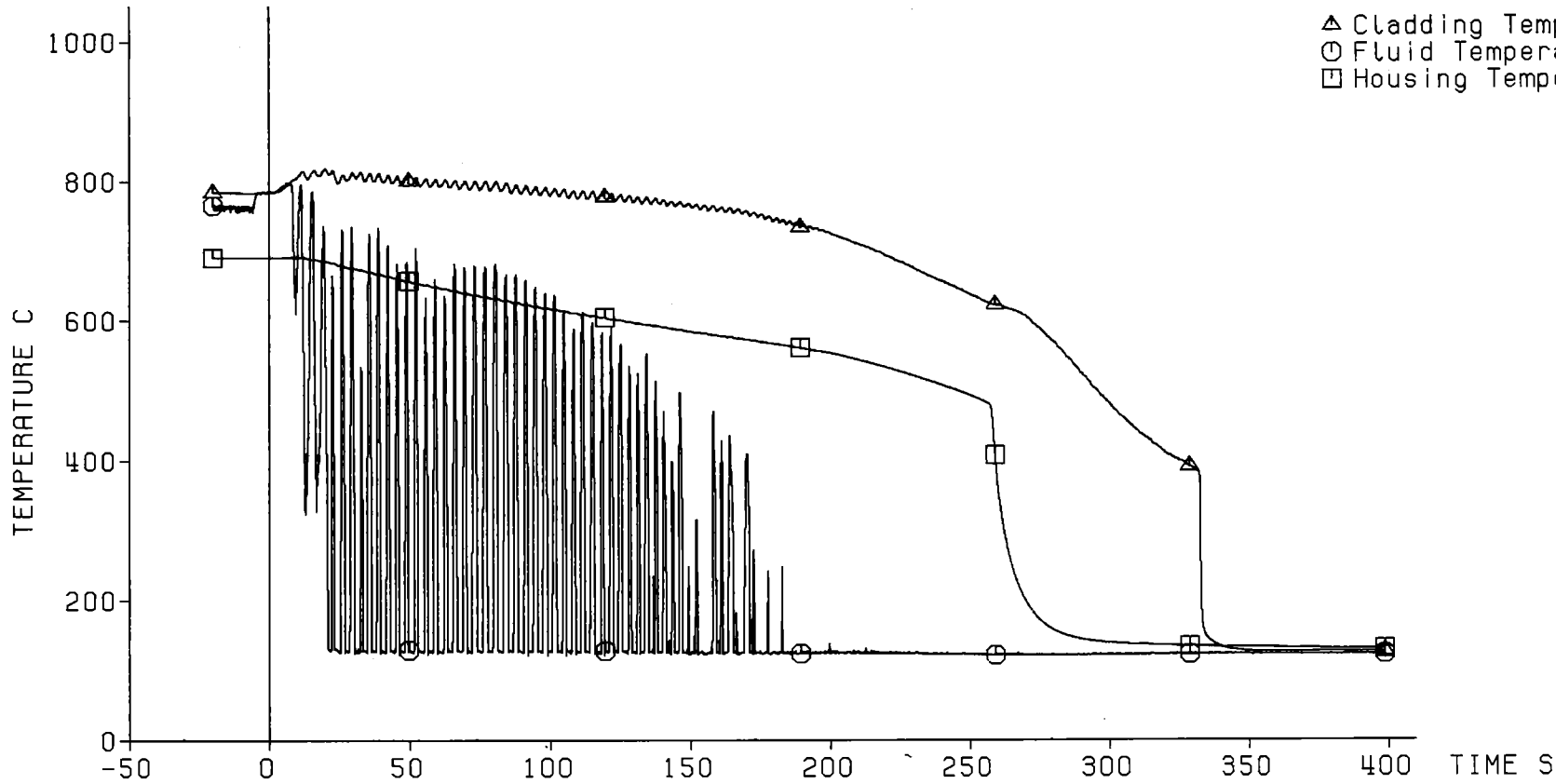

Decay Heat 120% ANS Standard
Flooding Rate (cold) 5.81 cm/s
System Pressure 2.10 bar
Feedwater Temperature 40 C

— 258 —



Fig. 227 FEBA: 5x5 ROD BUNDLE, TEST SERIES 7, TEST-No. 321

Axial Level: 1135 mm

△ Cladding Temperature (8b3)
○ Fluid Temperature
□ Housing Temperature

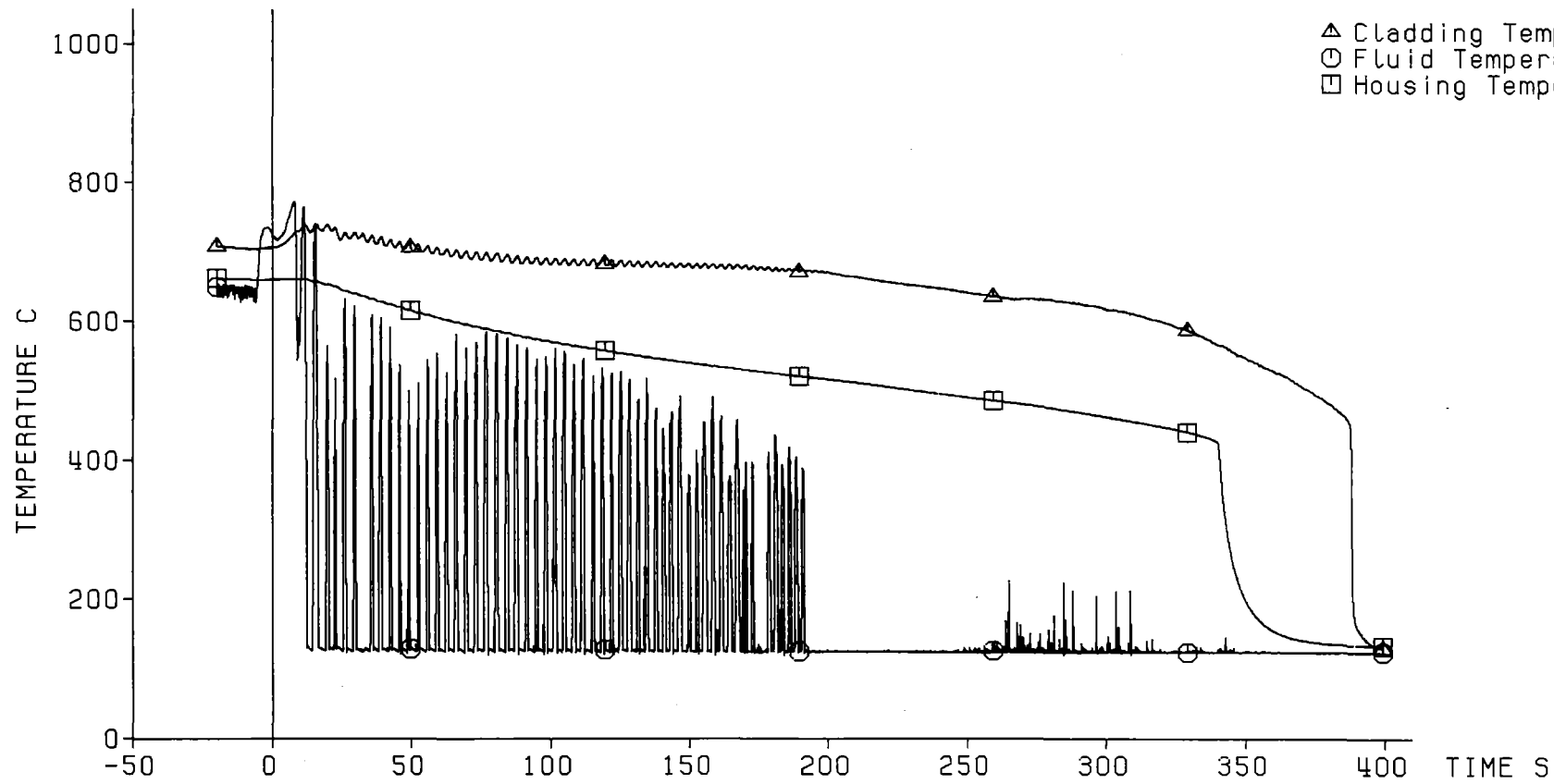

Decay Heat 120% ANS Standard
Flooding Rate (cold) 5.81 cm/s
System Pressure 2.10 bar
Feedwater Temperature 40 C



Fig. 228 FEBA: 5x5 ROD BUNDLE, TEST SERIES 7, TEST-NO. 321

Pressure Loss
Along the Test Section:

◇ Total Length: 4196 mm
△ Lower Part: 1711 mm
○ Middle Part: 545 mm
□ Upper Part: 1940 mm

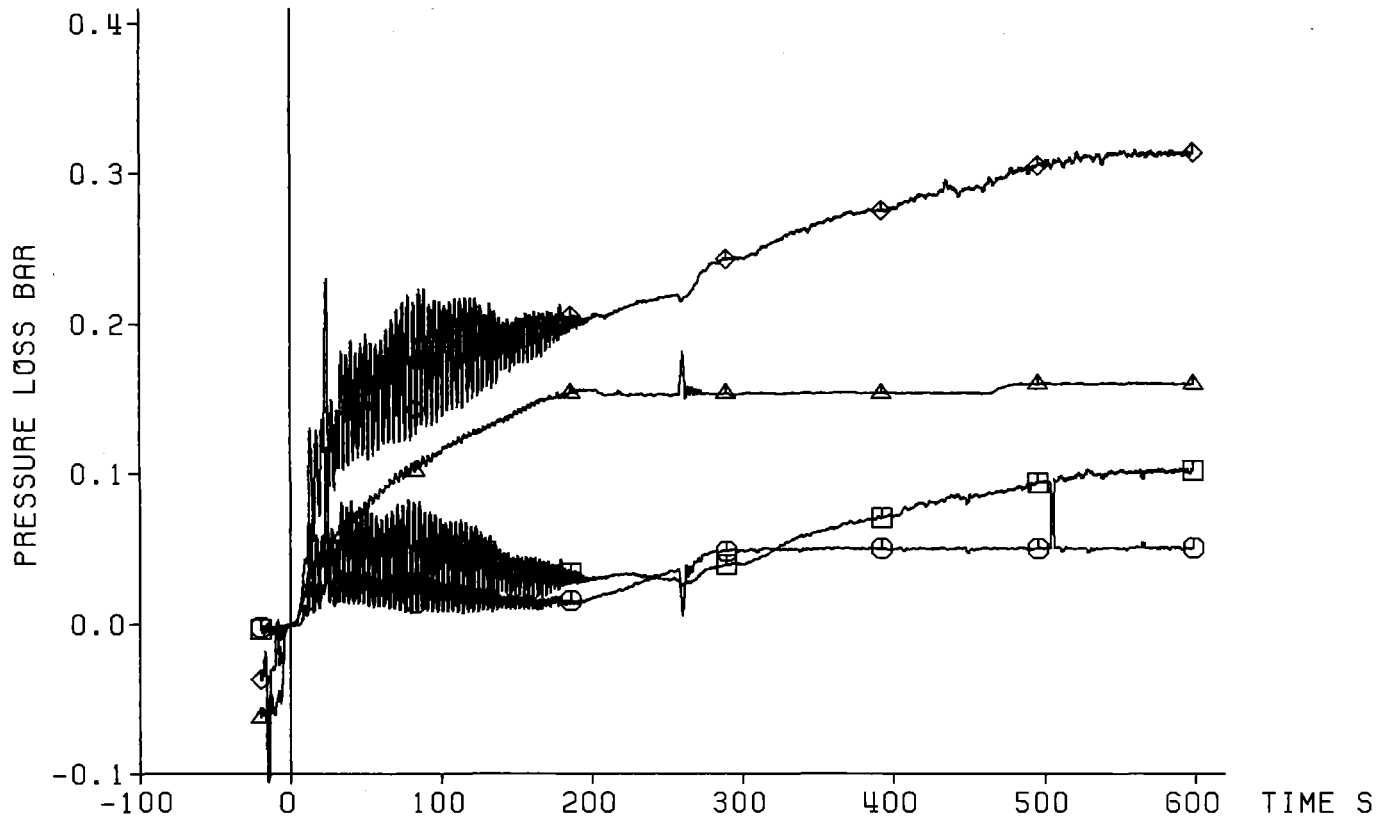

Decay Heat 120% ANS Standard
Flooding Rate (cold) 5.81 cm/s
System Pressure 2.10 bar
Feedwater Temperature 40 C

KIK IRB

Fig. 229 FEBA: 5x5 ROD BUNDLE, TEST SERIES 7, TEST-No. 321

Coolant Outlet Conditions:

△ Water Carry Over
○ Coolant Temperature
□ Coolant Pressure

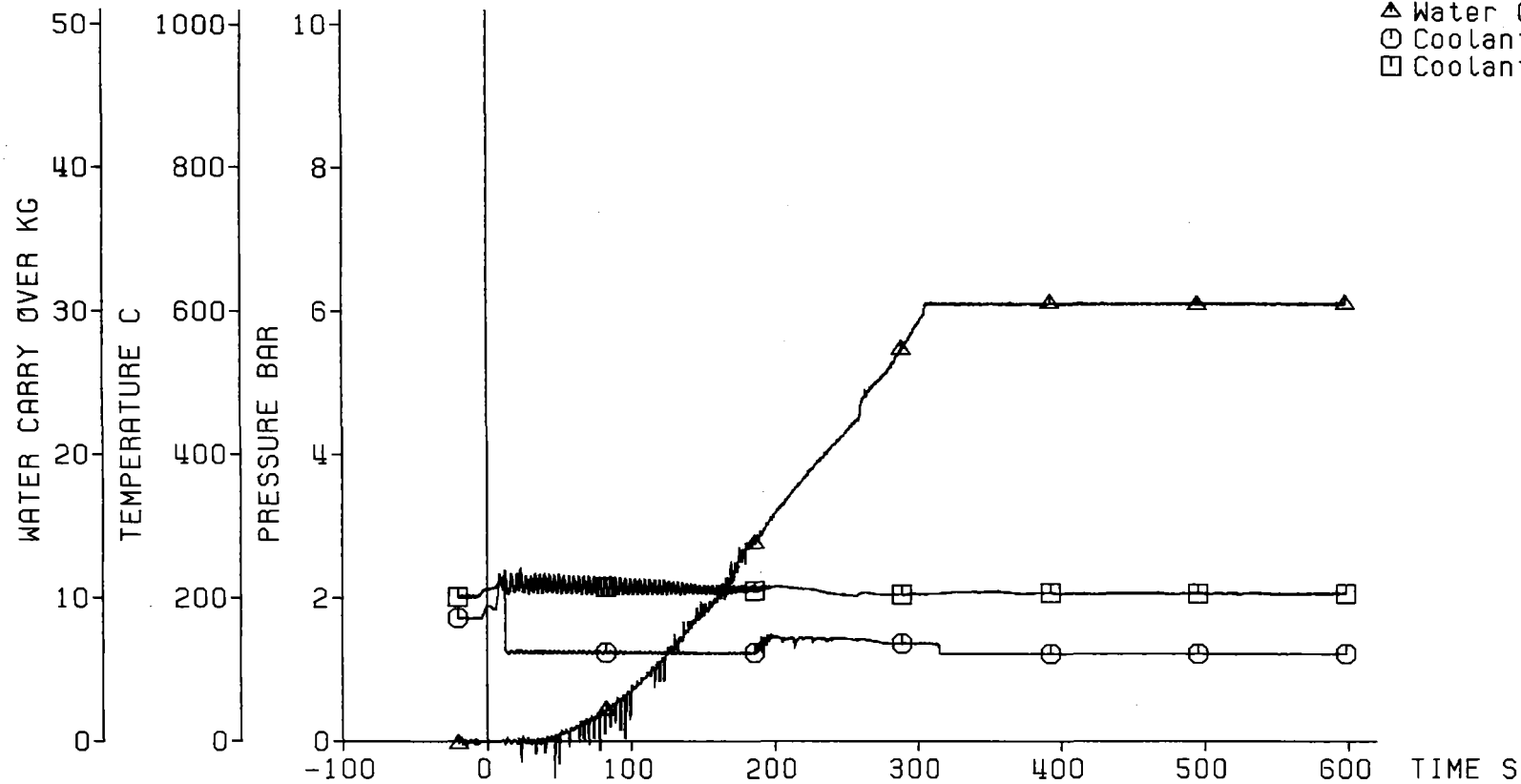

Decay Heat 120% ANS Standard
Flooding Rate (cold) 5.81 cm/s
System Pressure 2.10 bar
Feedwater Temperature 40 C



Fig. 230 FEBA: 5x5 ROD BUNDLE, TEST SERIES 7, TEST-No. 321

Axial Position of Quench Front

□ Quenching of Sleeves at Bundle Midplane

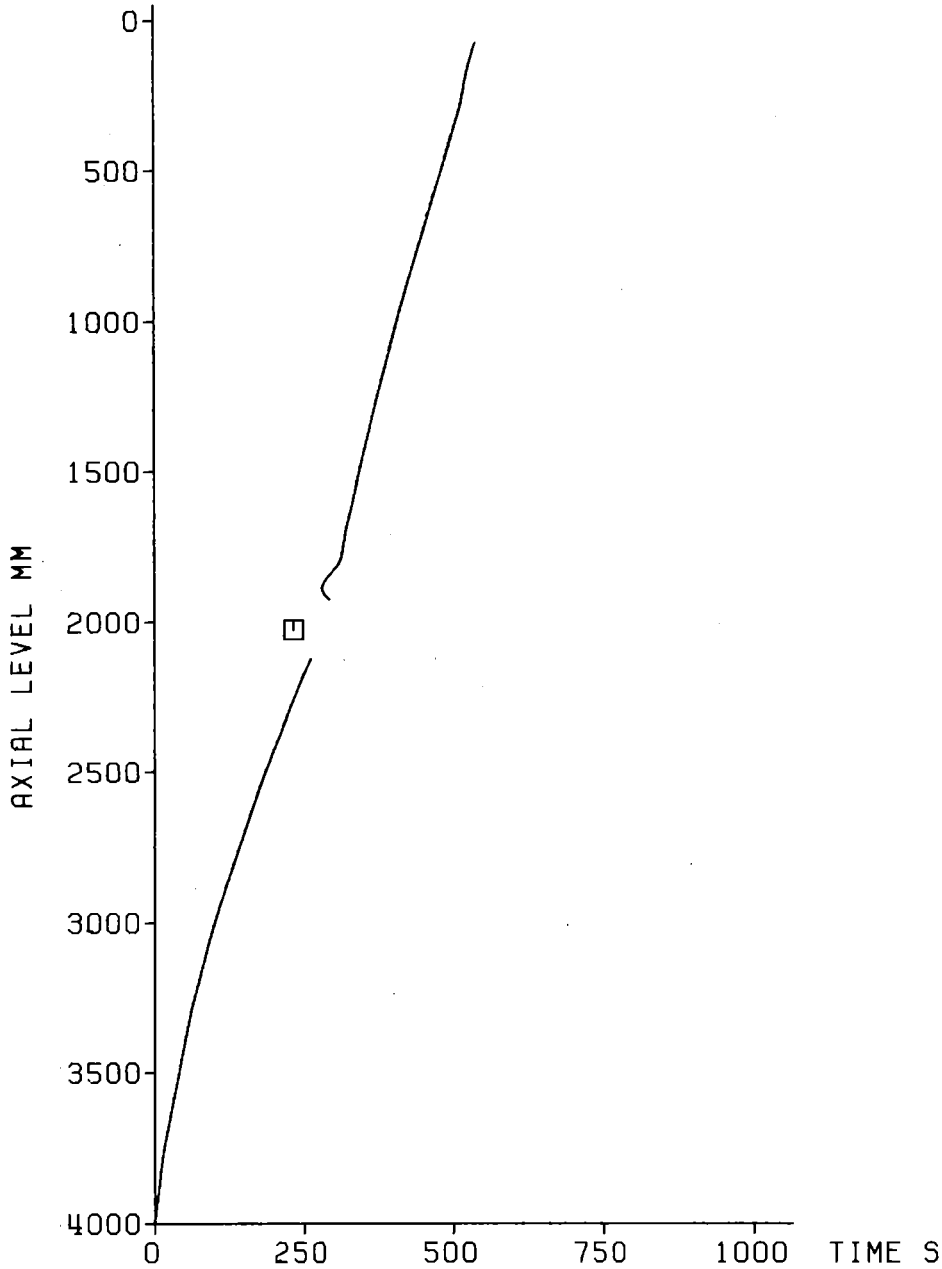

Decay Heat	120% ANS Standard
Flooding Rate (cold)	5.81 cm/s
System Pressure	2.10 bar
Feedwater Temperature	40 C



Fig. 231 FEBA: 5x5 ROD BUNDLE
TEST SERIES 7, TEST-No. 321

Initial Axial Temperature Profile of Claddings

□ Initial Temperature of Sleeves at Bundle Midplane

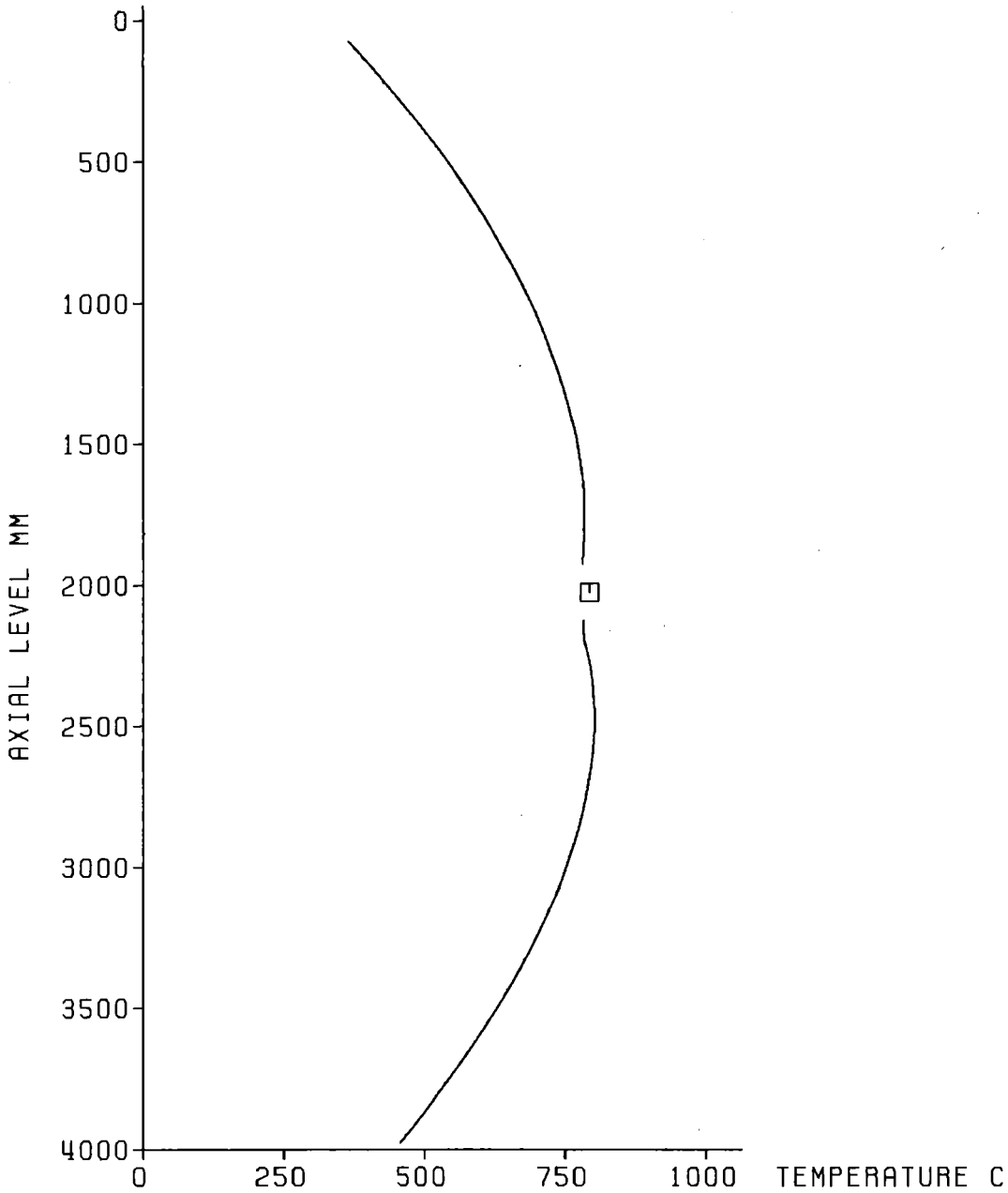

Decay Heat	120% ANS Standard
Flooding Rate (cold)	5.77 cm/s
System Pressure	4.10 bar
Feedwater Temperature	40 C



Fig. 232 FEBA: 5x5 ROD BUNDLE
TEST SERIES 7, TEST-No. 325

Test Parameters:

- ◇ Flooding Rate
- △ System Pressure
- Feedwater Temperature
- Bundle Power

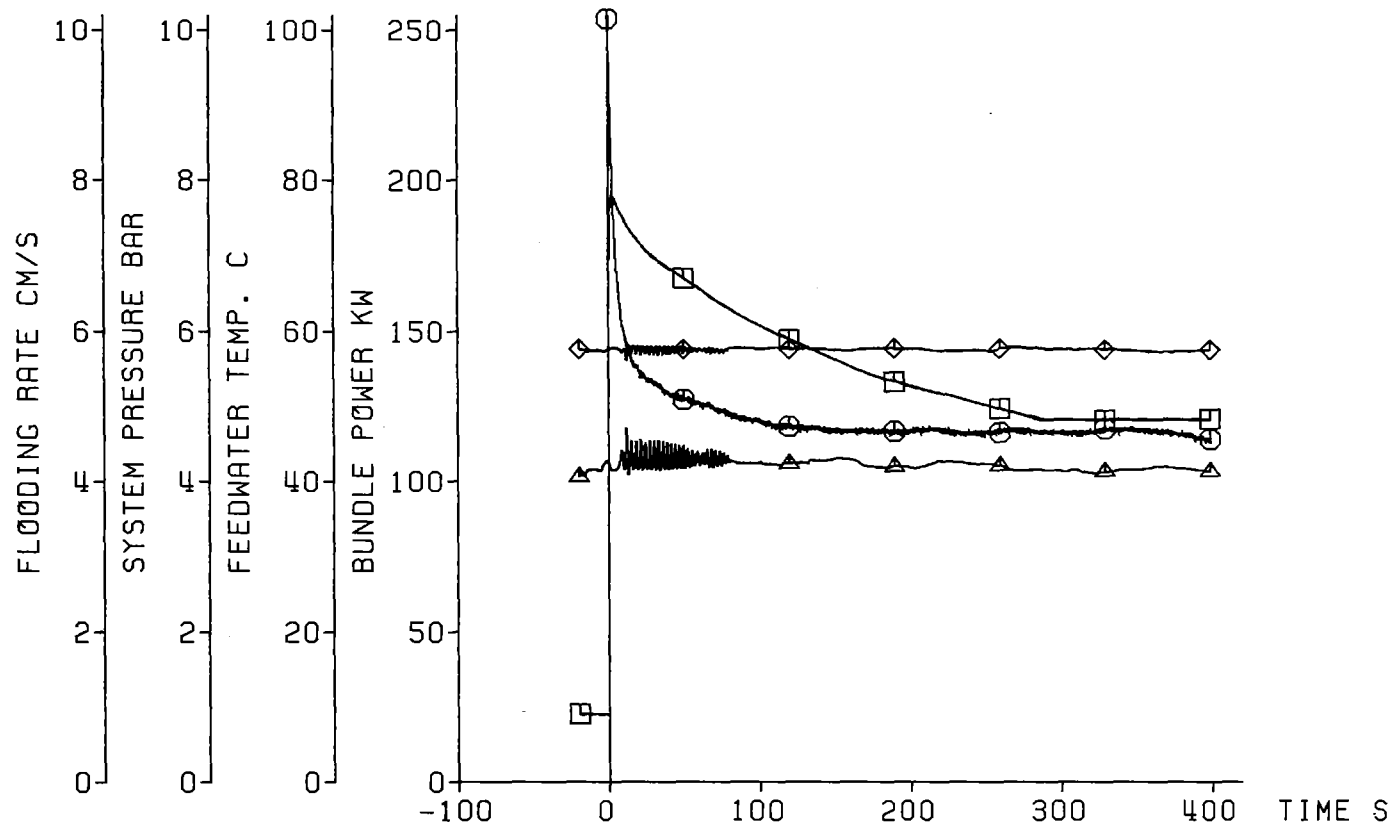

Decay Heat 120% ANS Standard
Flooding Rate (cold) 5.77 cm/s
System Pressure 4.10 bar
Feedwater Temperature 40 C



Fig. 233 FEBA: 5x5 ROD BUNDLE, TEST SERIES 7, TEST-No. 325

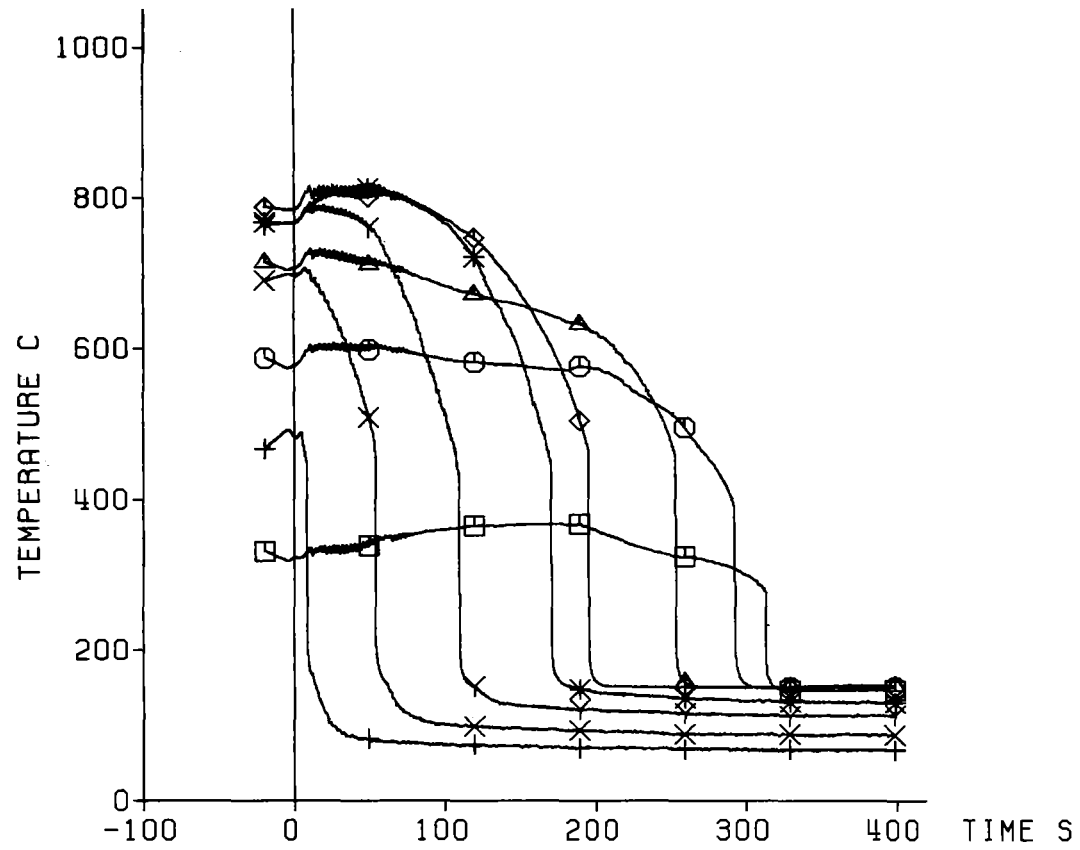

TC	Ax. Level
+	7a4 3860 mm
X	7a3 3315 mm
Y	7a2 2770 mm
*	7a1 2225 mm
◇	8b4 1680 mm
△	8b3 1135 mm
⊙	8b2 590 mm
□	3b1 45 mm

Decay Heat 120% ANS Standard
 Flooding Rate (cold) 5.77 cm/s
 System Pressure 4.10 bar
 Feedwater Temperature 40 C



Fig. 234 FEBA: 5x5 ROD BUNDLE, TEST SERIES 7, TEST-No. 325

Heat Transfer Coeff.

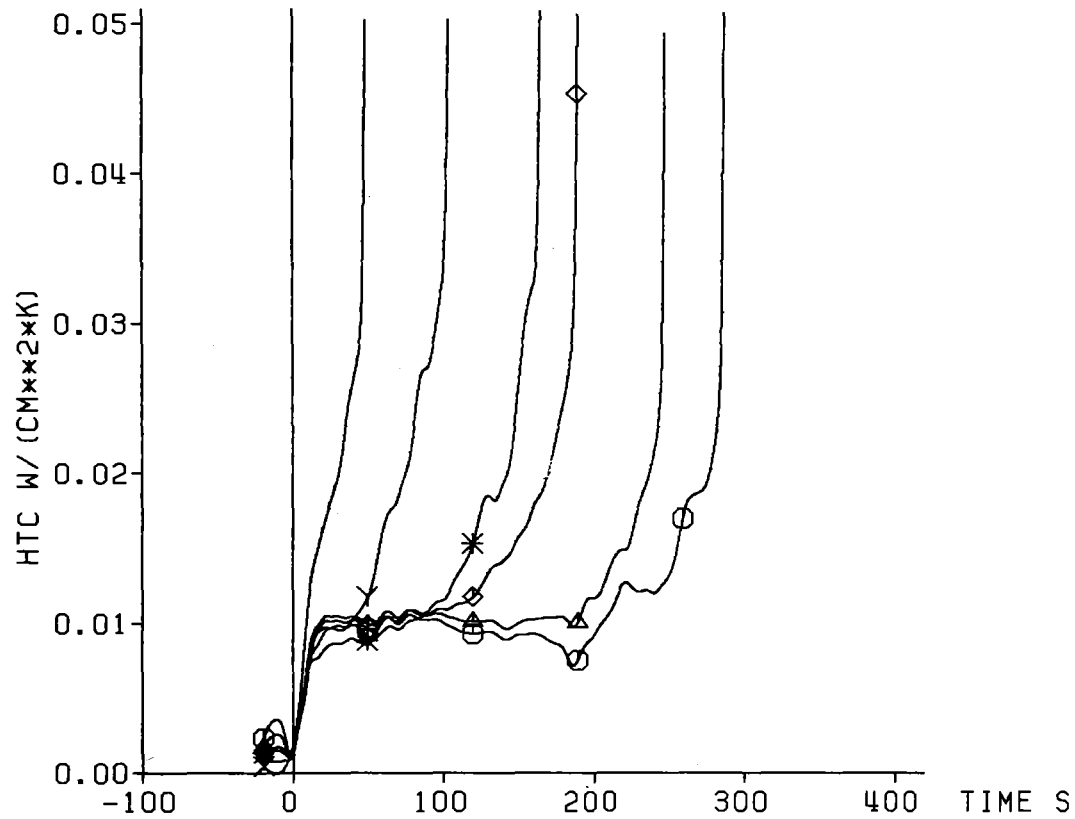

TC	Ax. Level
X	7a3 3315 mm
Y	7a2 2770 mm
*	7a1 2225 mm
◇	8b4 1680 mm
△	8b3 1135 mm
○	8b2 590 mm

Decay Heat 120% ANS Standard
 Flooding Rate (cold) 5.77 cm/s
 System Pressure 4.10 bar
 Feedwater Temperature 40 C



Fig. 235 FEBA: 5x5 ROD BUNDLE, TEST SERIES 7, TEST-No. 325

Cladding Temperature

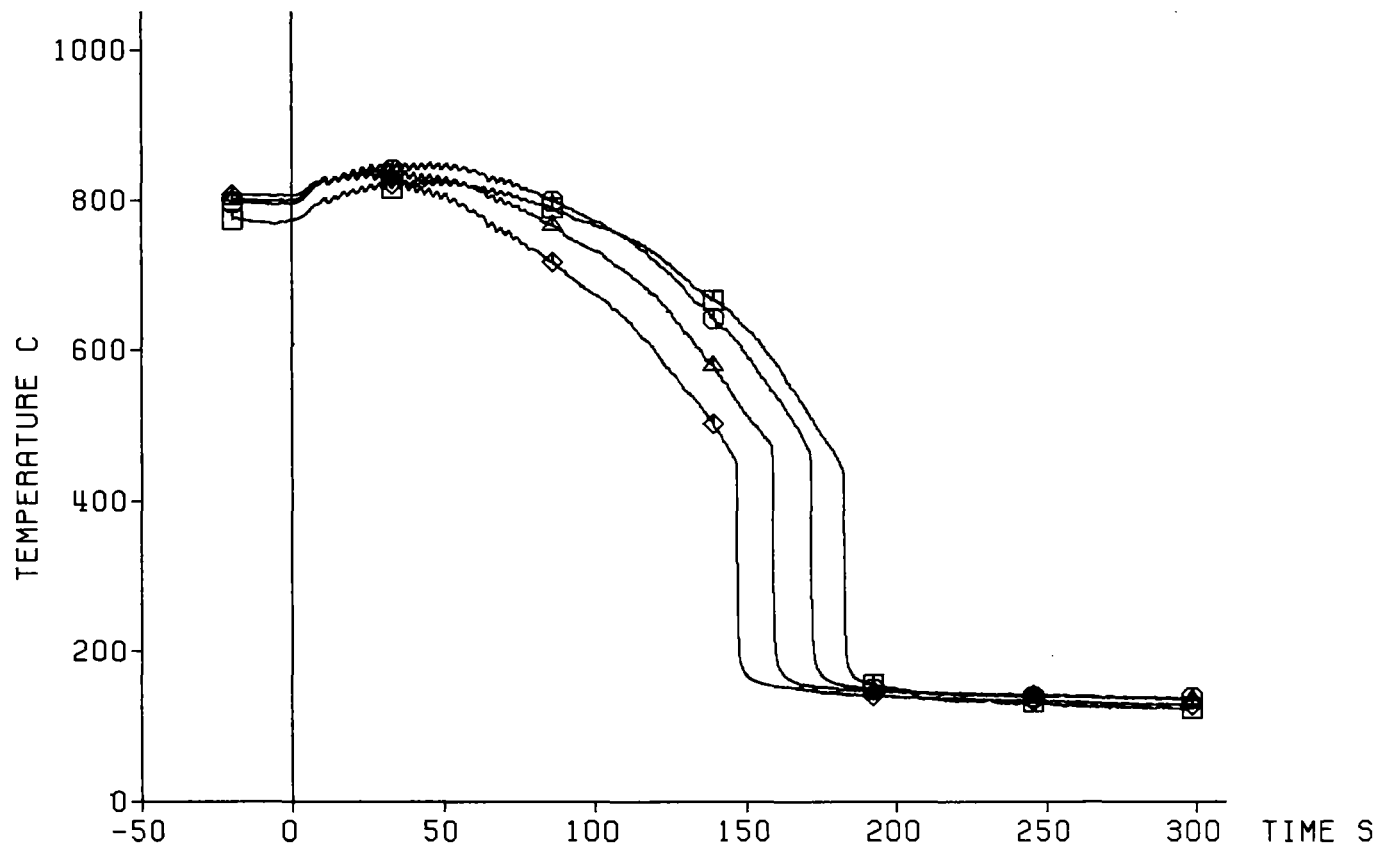

TC	Ax. Level
◇	14f4 2425 mm
△	14f3 2325 mm
○	14h2 2225 mm
□	14f1 2125 mm

Decay Heat 120% ANS Standard
 Flooding Rate (cold) 5.77 cm/s
 System Pressure 4.10 bar
 Feedwater Temperature 40 C



Fig. 236 FEBA: 5x5 ROD BUNDLE, TEST SERIES 7, TEST-NO. 325

Heat Transfer Coeff.

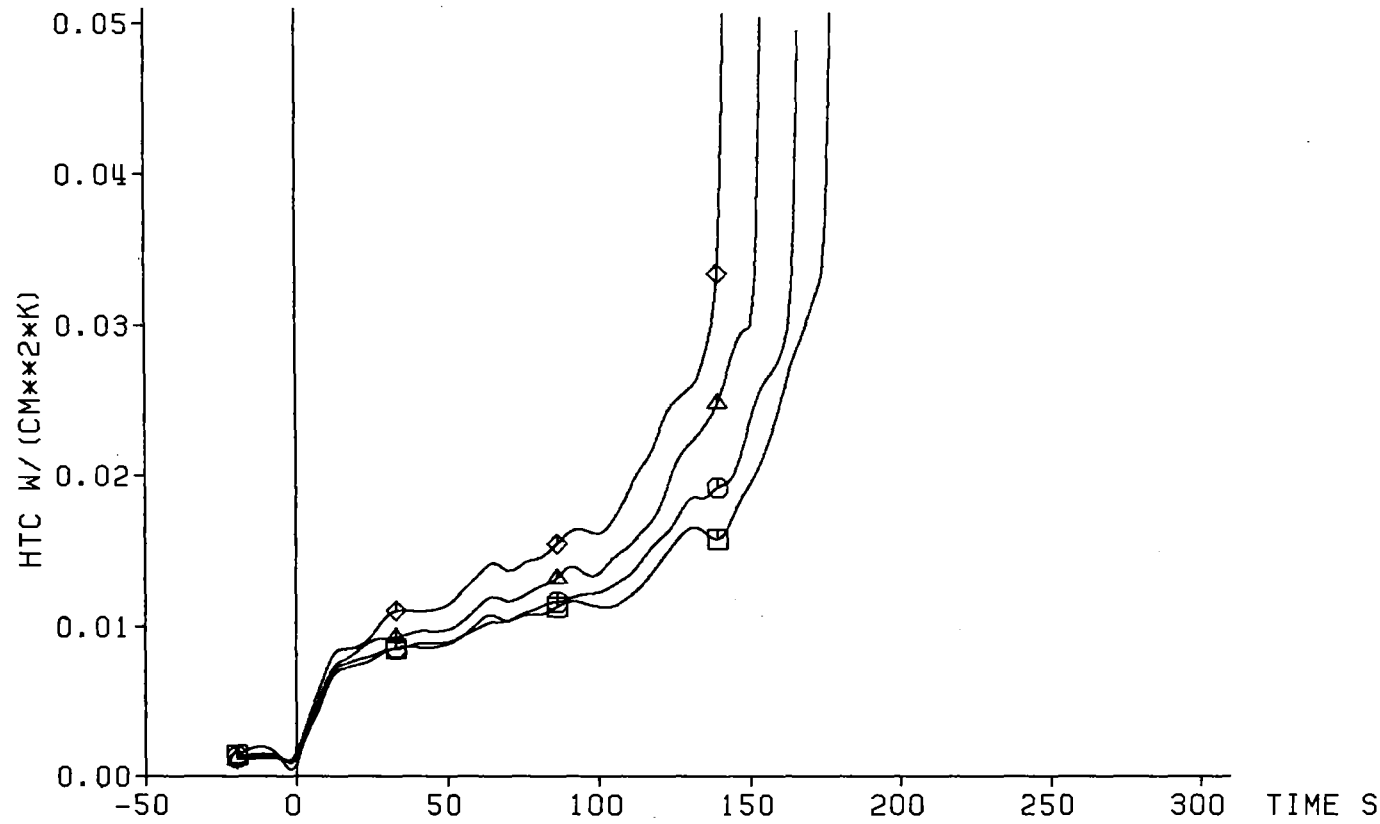

TC	Ax. Level
◇	14f4 2425 mm
△	14f3 2325 mm
○	14h2 2225 mm
□	14f1 2125 mm

Decay Heat 120% ANS Standard
 Flooding Rate (cold) 5.77 cm/s
 System Pressure 4.10 bar
 Feedwater Temperature 40 C



Fig. 237 FEBA: 5x5 ROD BUNDLE, TEST SERIES 7, TEST-No. 325

Cladding Temperature

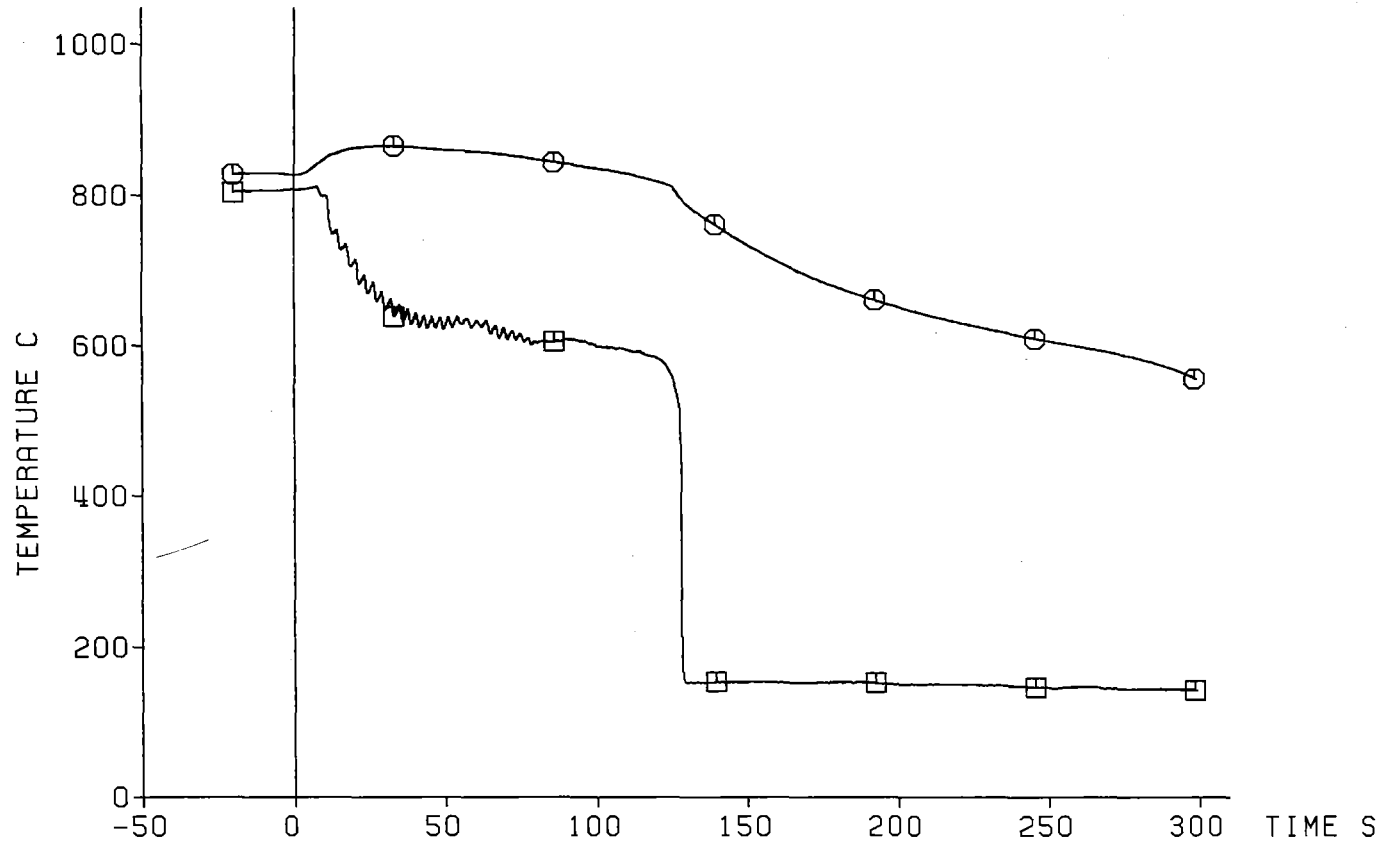

TC	Ax. Level
⊙ 13h2	2025 mm
⊠ Sleeve	2025 mm

Decay Heat 120% ANS Standard
 Flooding Rate (cold) 5.77 cm/s
 System Pressure 4.10 bar
 Feedwater Temperature 40 C



Fig. 238 FEBA: 5x5 ROD BUNDLE, TEST SERIES 7, TEST-No. 325

Cladding Temperature

TC	Ax. Level
⊙ 17i4	2025 mm
⊠ Sleeve	2025 mm

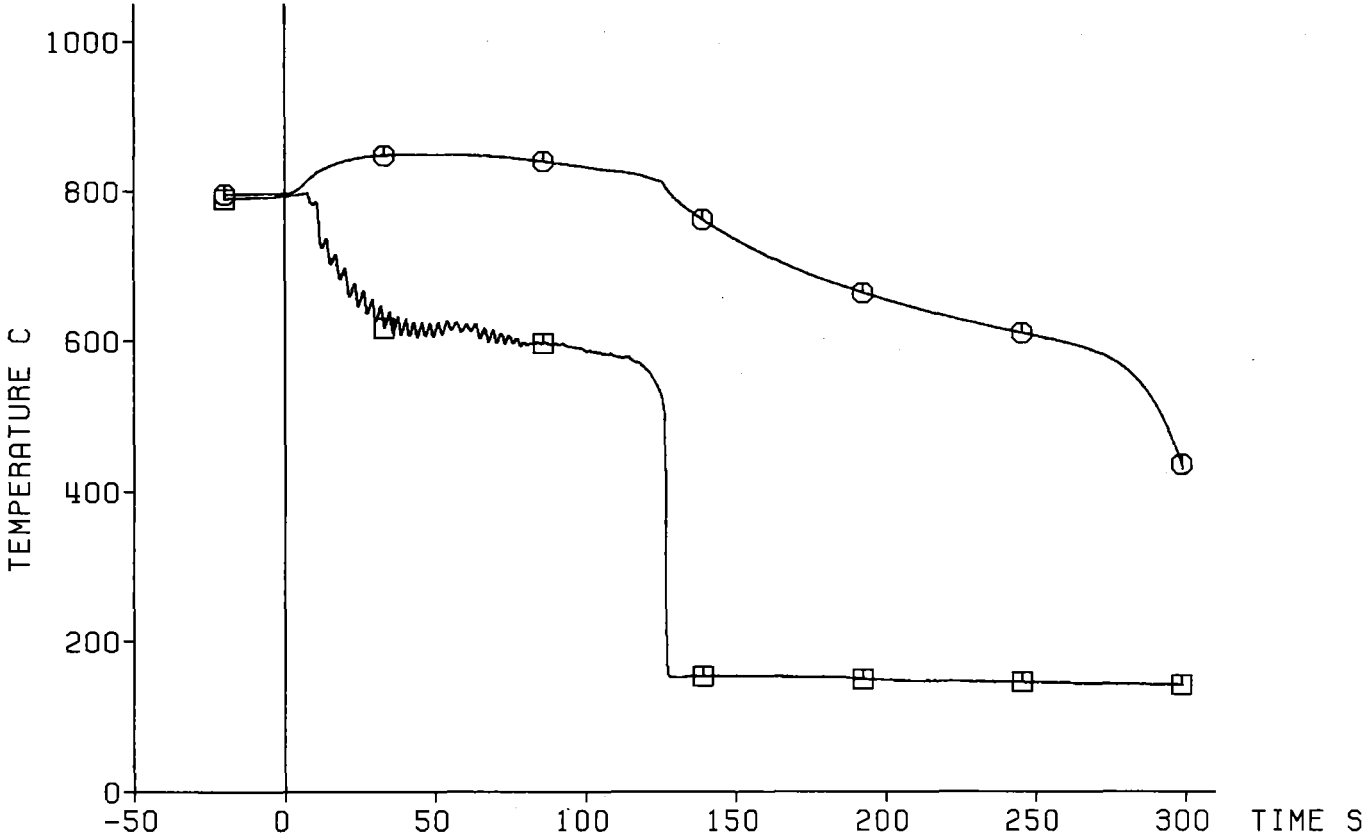

Decay Heat 120% ANS Standard
 Flooding Rate (cold) 5.77 cm/s
 System Pressure 4.10 bar
 Feedwater Temperature 40 C

- 271 -



Fig. 239 FEBA: 5x5 ROD BUNDLE, TEST SERIES 7, TEST-No. 325

Cladding Temperature

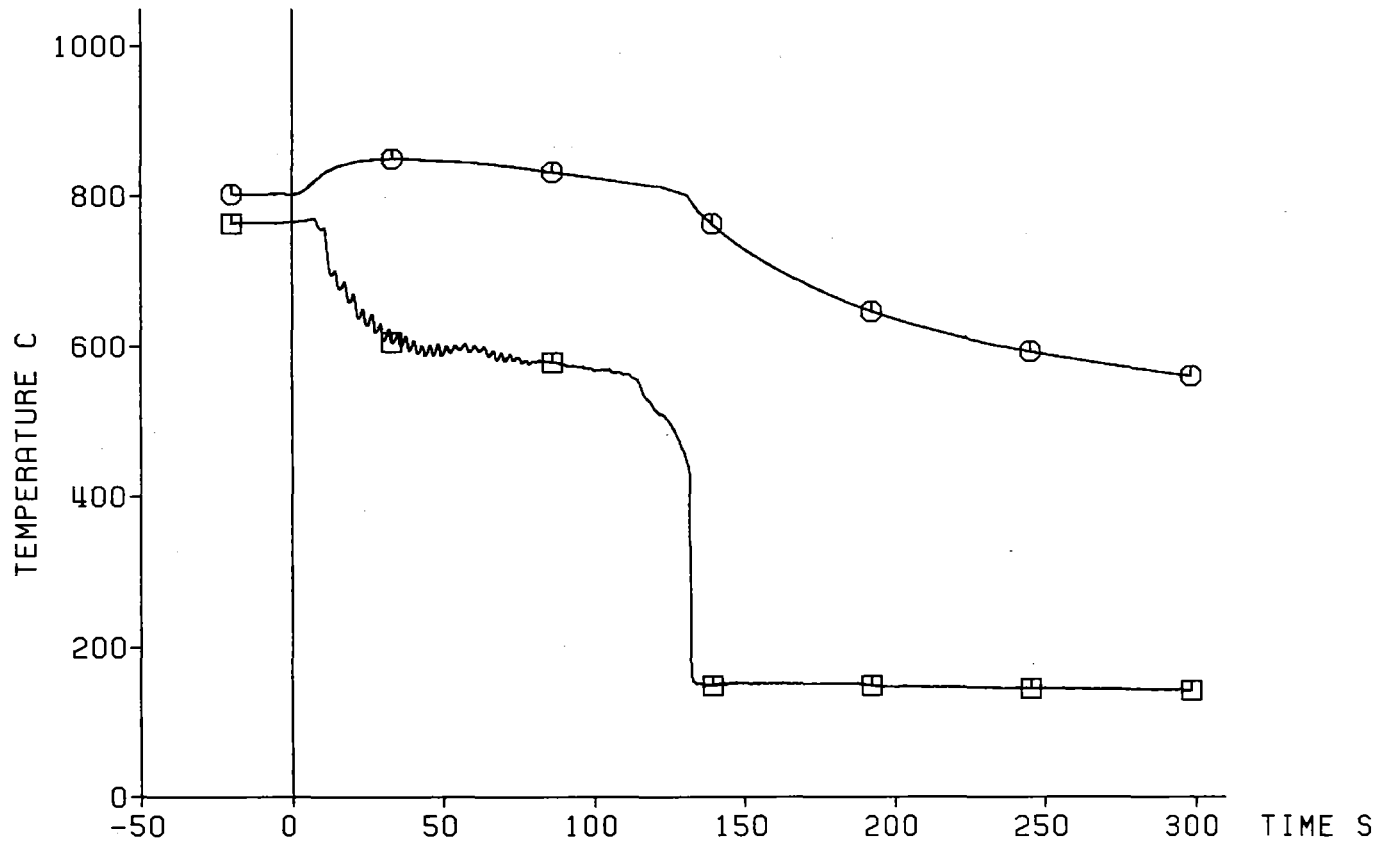

TC	Ax. Level
⊙ 17i3	1975 mm
⊠ Sleeve	1972 mm

Decay Heat 120% ANS Standard
 Flooding Rate (cold) 5.77 cm/s
 System Pressure 4.10 bar
 Feedwater Temperature 40 C



Fig. 240 FEBA: 5x5 ROD BUNDLE, TEST SERIES 7, TEST-No. 325

Cladding Temperature

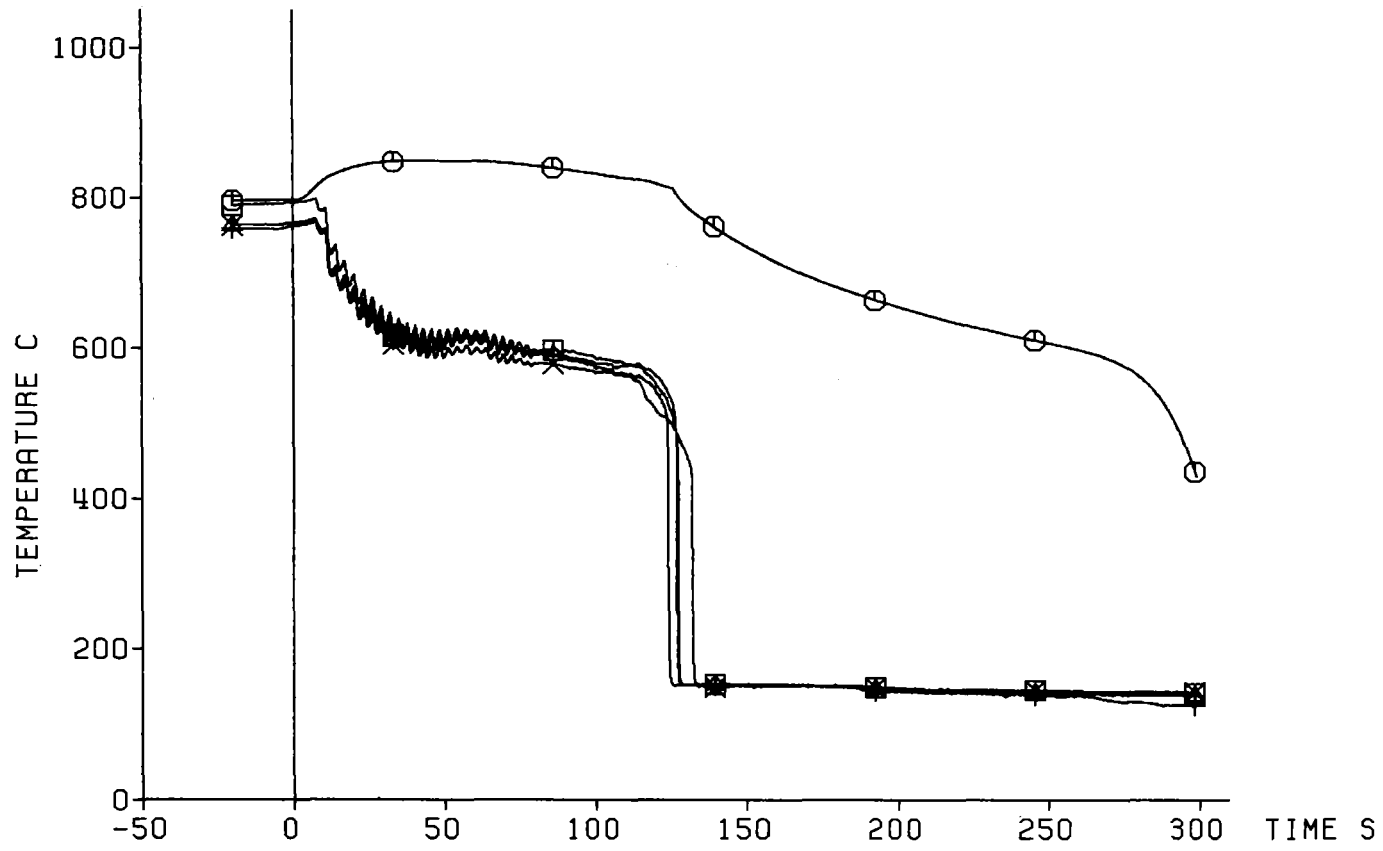

TC	Ax. Level
○	17i4 2025 mm
+	Sleeve 2064 mm
□	Sleeve 2025 mm
△	Sleeve 2025 mm
×	Sleeve 1972 mm

Decay Heat 120% ANS Standard
 Flooding Rate (cold) 5.77 cm/s
 System Pressure 4.10 bar
 Feedwater Temperature 40 C



Fig. 241 FEBA: 5x5 ROD BUNDLE, TEST SERIES 7, TEST-No. 325

Cladding Temperature

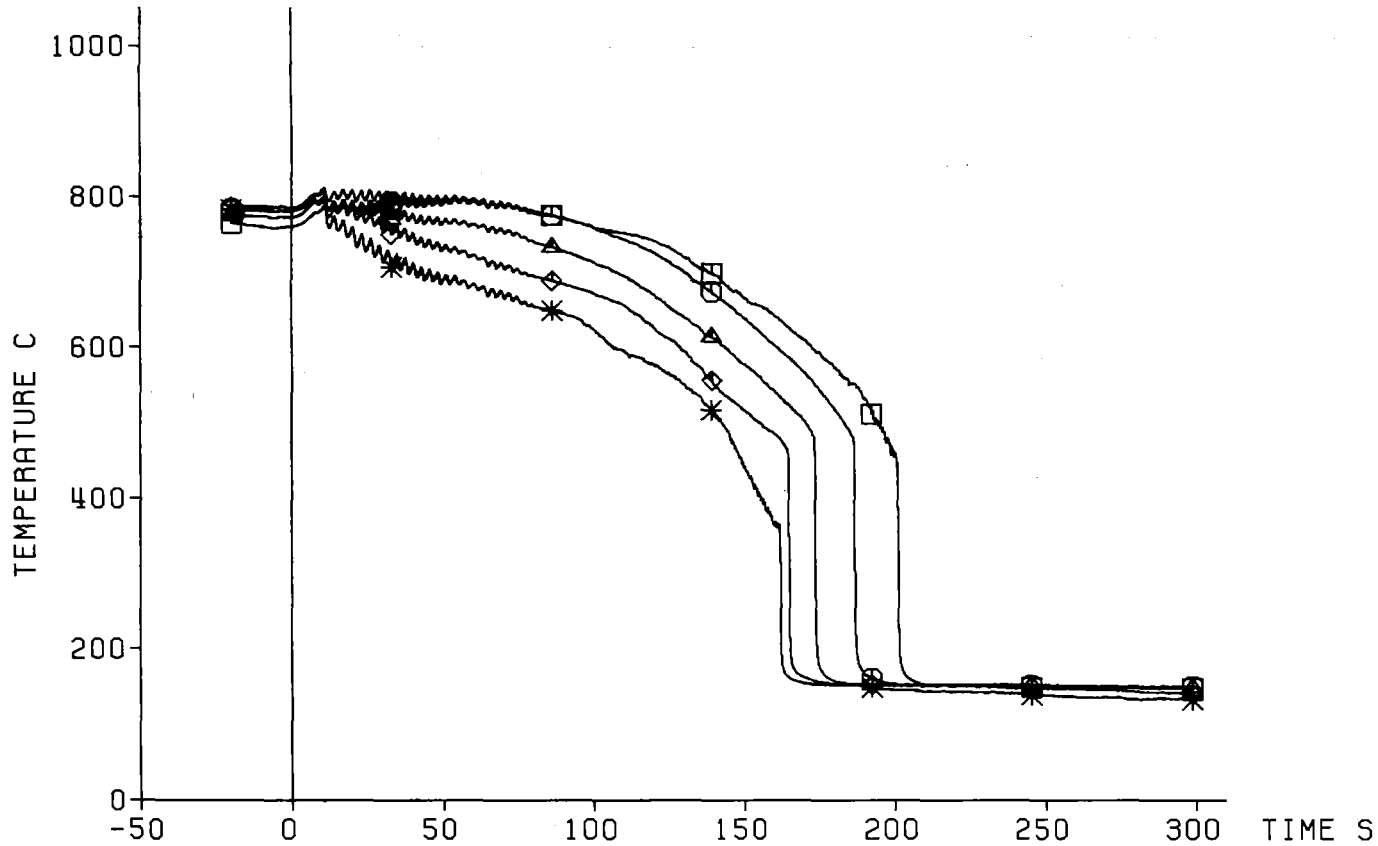

TC	Ax. Level
* 19g4	1925 mm
◇ 17i1	1875 mm
△ 19g3	1825 mm
○ 19g2	1725 mm
□ 19g1	1625 mm

Decay Heat 120% ANS Standard
 Flooding Rate (cold) 5.77 cm/s
 System Pressure 4.10 bar
 Feedwater Temperature 40 C



Fig. 242 FEBA: 5x5 ROD BUNDLE, TEST SERIES 7, TEST-No. 325

Heat Transfer Coeff.

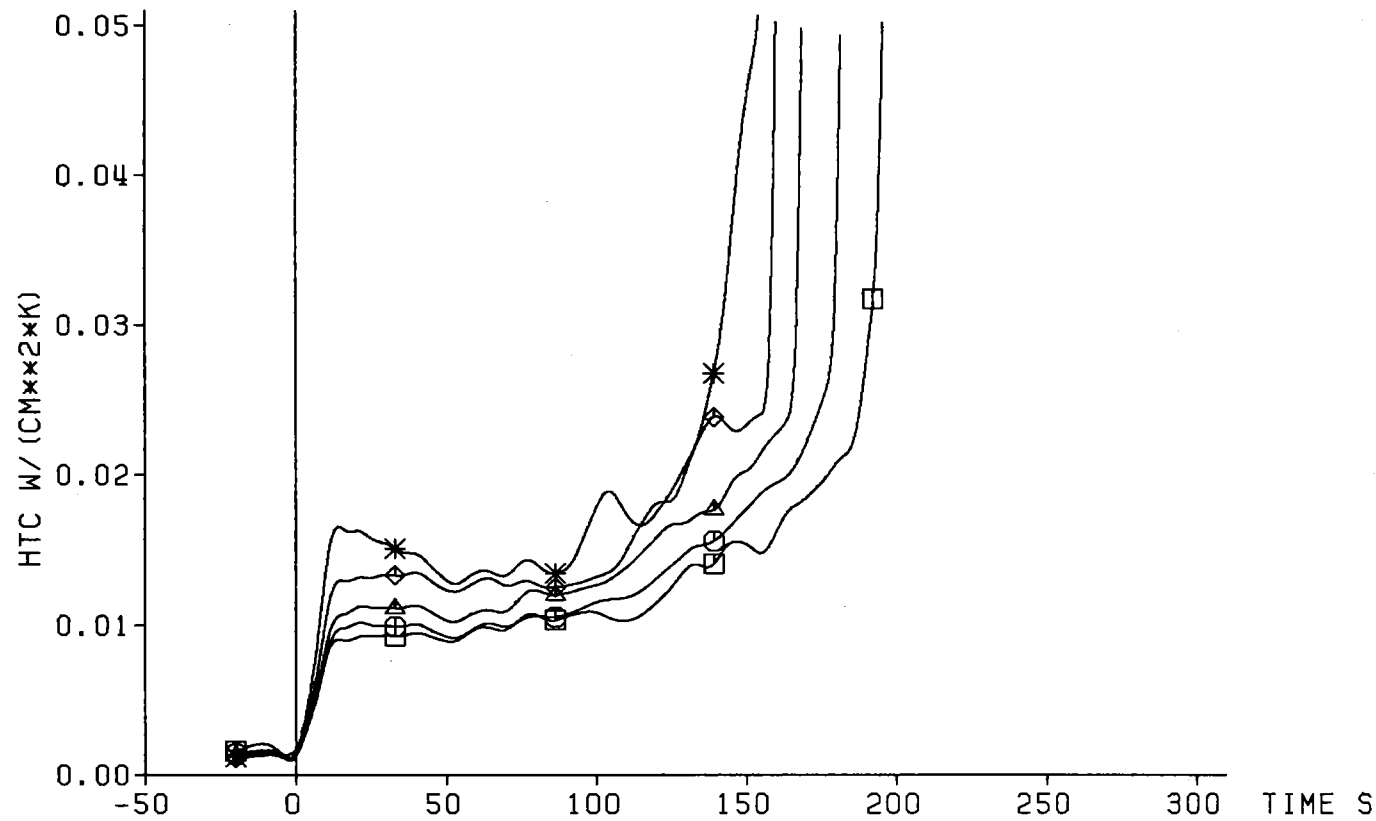

	TC	Ax. Level
*	19g4	1925 mm
◇	17i1	1875 mm
△	19g3	1825 mm
⊙	19g2	1725 mm
□	19g1	1625 mm

Decay Heat 120% ANS Standard
 Flooding Rate (cold) 5.77 cm/s
 System Pressure 4.10 bar
 Feedwater Temperature 40 C



Fig. 243 FEBA: 5x5 ROD BUNDLE, TEST SERIES 7, TEST-No. 325

Cladding Temperature

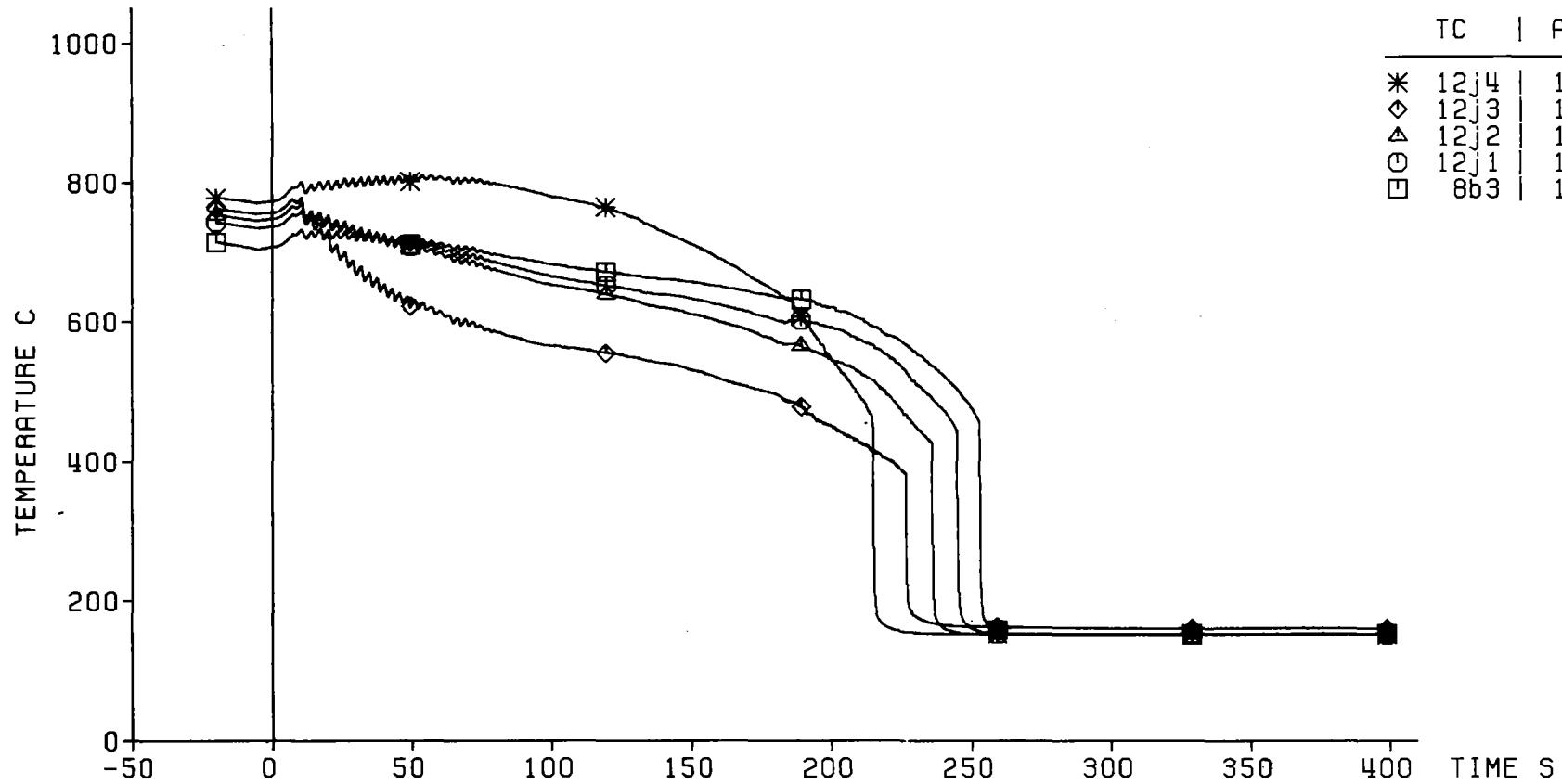

Decay Heat 120% ANS Standard
 Flooding Rate (cold) 5.77 cm/s
 System Pressure 4.10 bar
 Feedwater Temperature 40 C



Fig. 244 FEBA: 5x5 ROD BUNDLE, TEST SERIES 7, TEST-No. 325

Heat Transfer Coeff.

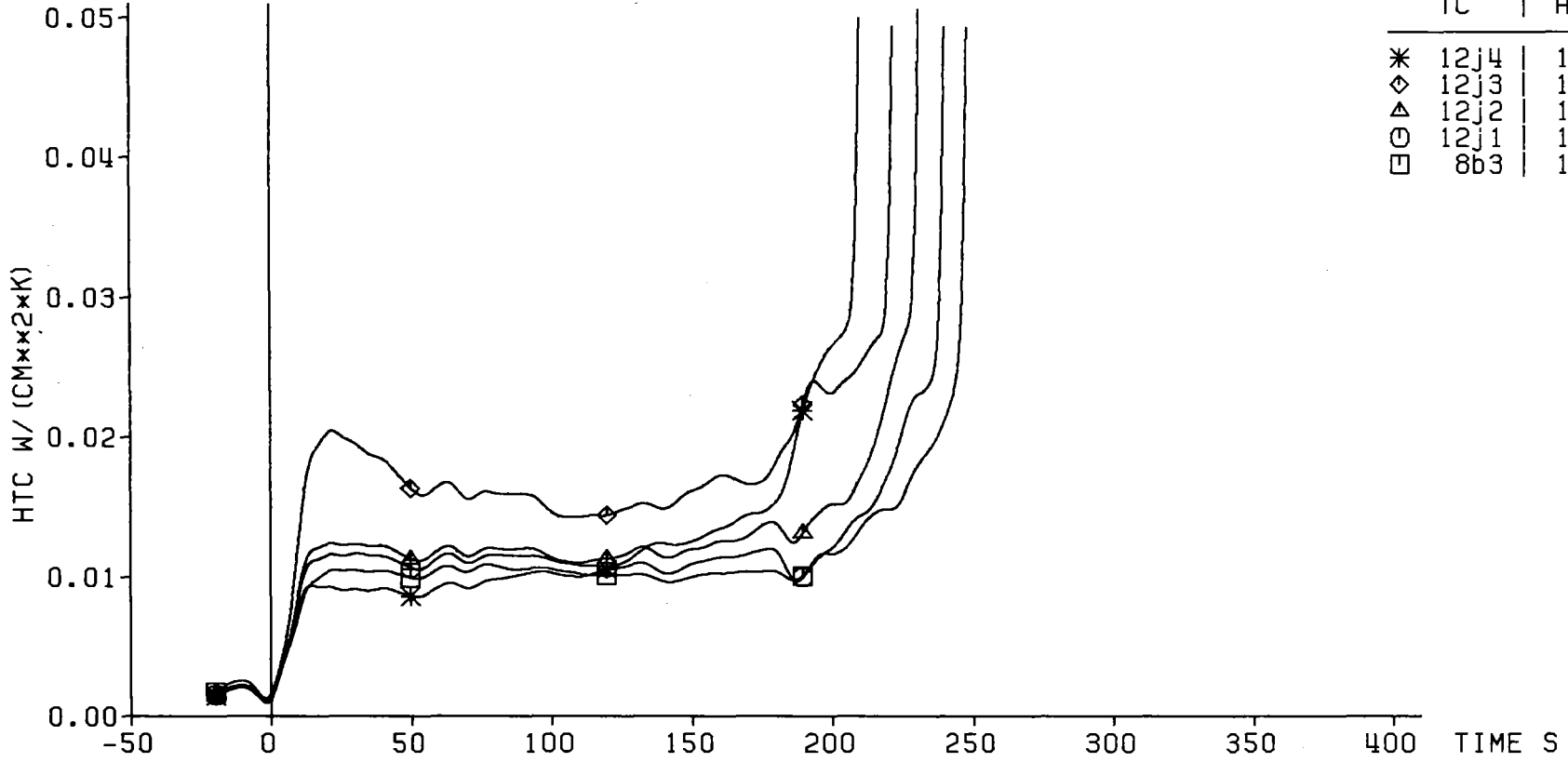

Decay Heat 120% ANS Standard
 Flooding Rate (cold) 5.77 cm/s
 System Pressure 4.10 bar
 Feedwater Temperature 40 C



Fig. 245 FEBA: 5x5 ROD BUNDLE, TEST SERIES 7, TEST-No. 325

Axial Level: 2770 mm

△ Cladding Temperature (7a2)
○ Fluid Temperature
□ Housing Temperature

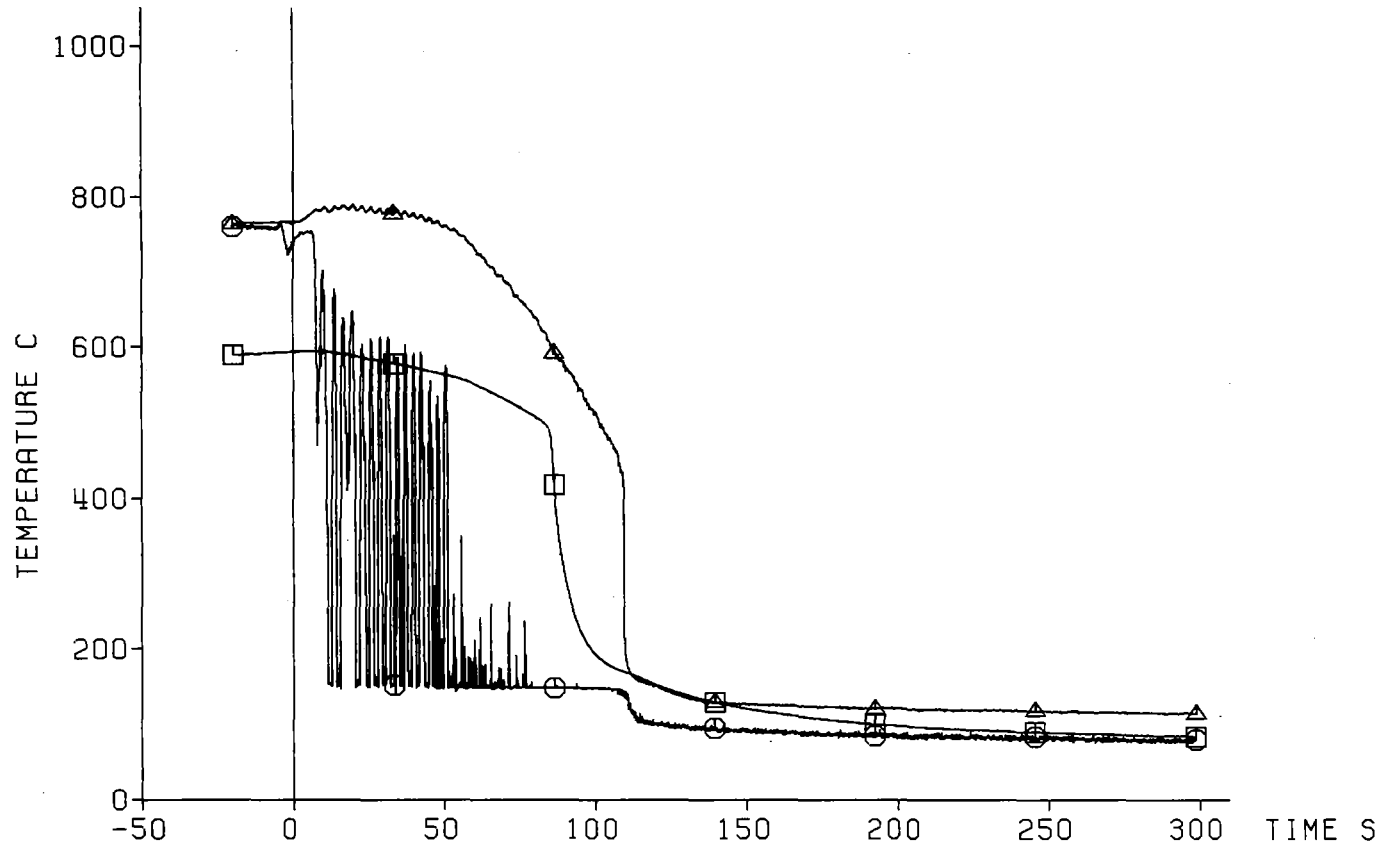

Decay Heat 120% ANS Standard
Flooding Rate (cold) 5.77 cm/s
System Pressure 4.10 bar
Feedwater Temperature 40 C

— 278 —



Fig. 246 FEBA: 5x5 ROD BUNDLE, TEST SERIES 7, TEST-No. 325

Axial Level: 2225 mm

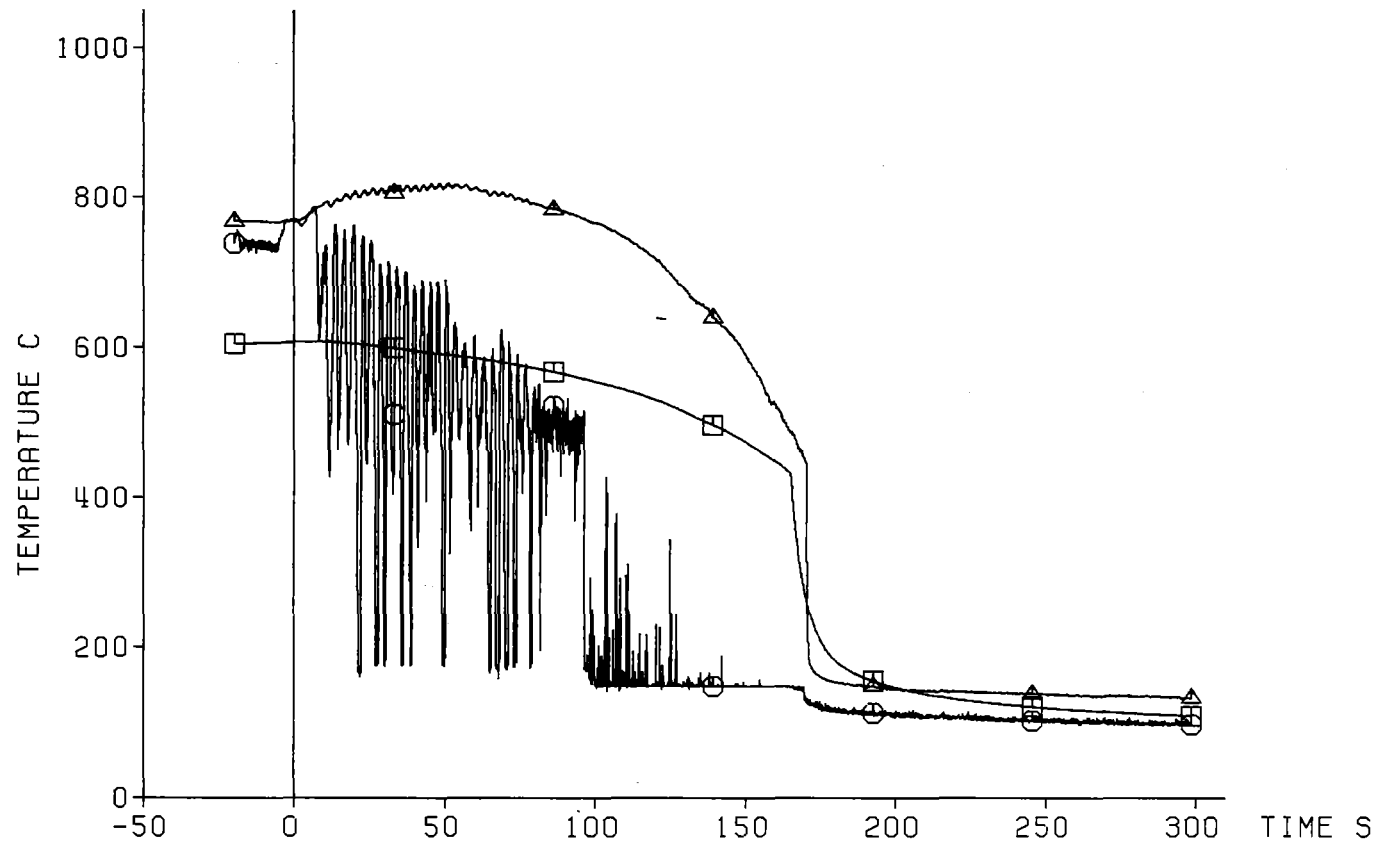

— 279 —

Decay Heat 120% ANS Standard
Flooding Rate (cold) 5.77 cm/s
System Pressure 4.10 bar
Feedwater Temperature 40 C



Fig. 247 FEBA: 5x5 ROD BUNDLE, TEST SERIES 7, TEST-No. 325

Axial Level: 1825 mm

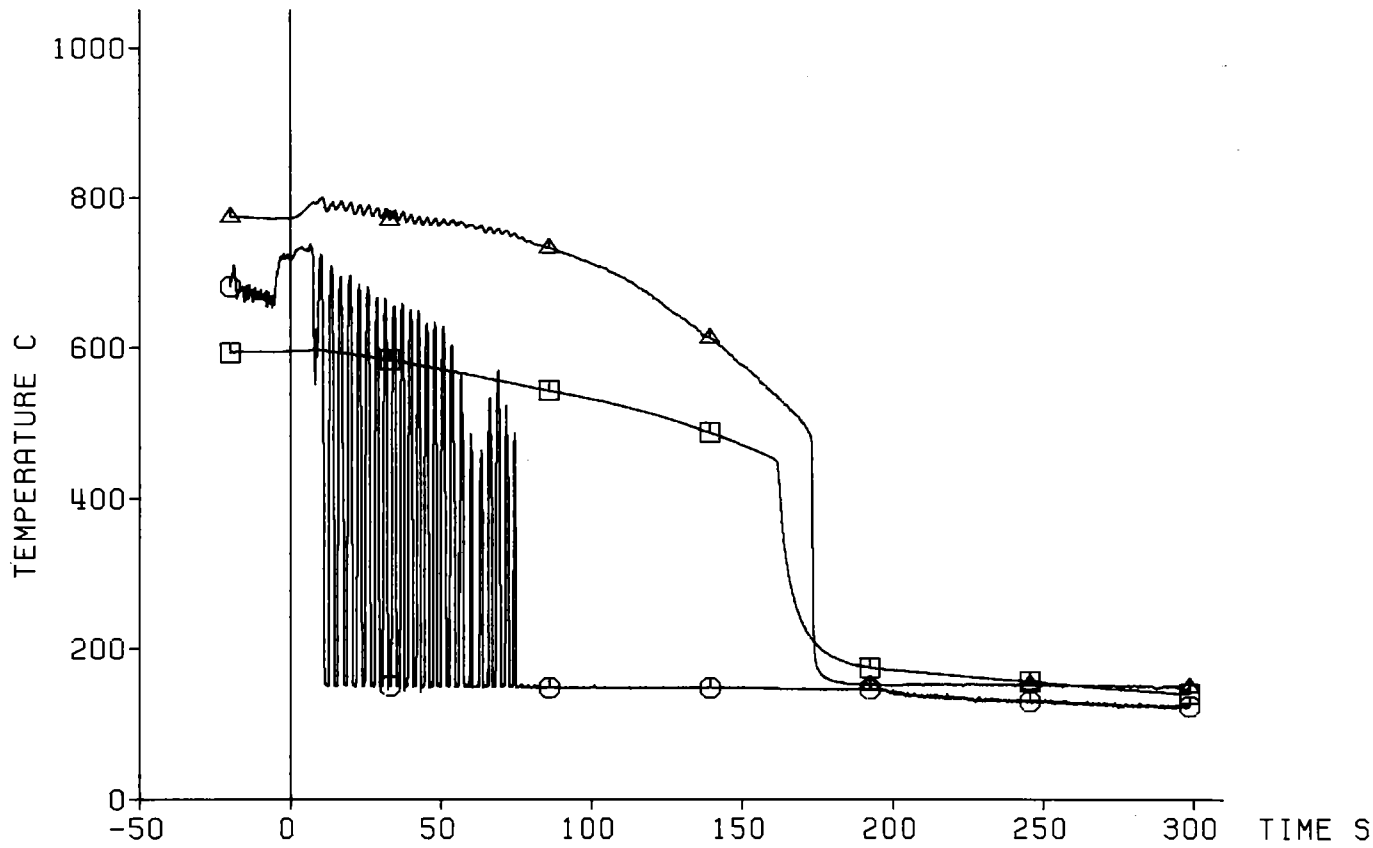

△ Cladding Temperature (19g3)
○ Fluid Temperature
□ Housing Temperature

Decay Heat 120% ANS Standard
Flooding Rate (cold) 5.77 cm/s
System Pressure 4.10 bar
Feedwater Temperature 40 C

— 280 —



Fig. 248 FEBA: 5x5 ROD BUNDLE, TEST SERIES 7, TEST-No. 325

Axial Level: 1725 mm

△ Cladding Temperature (19g2)
○ Fluid Temperature

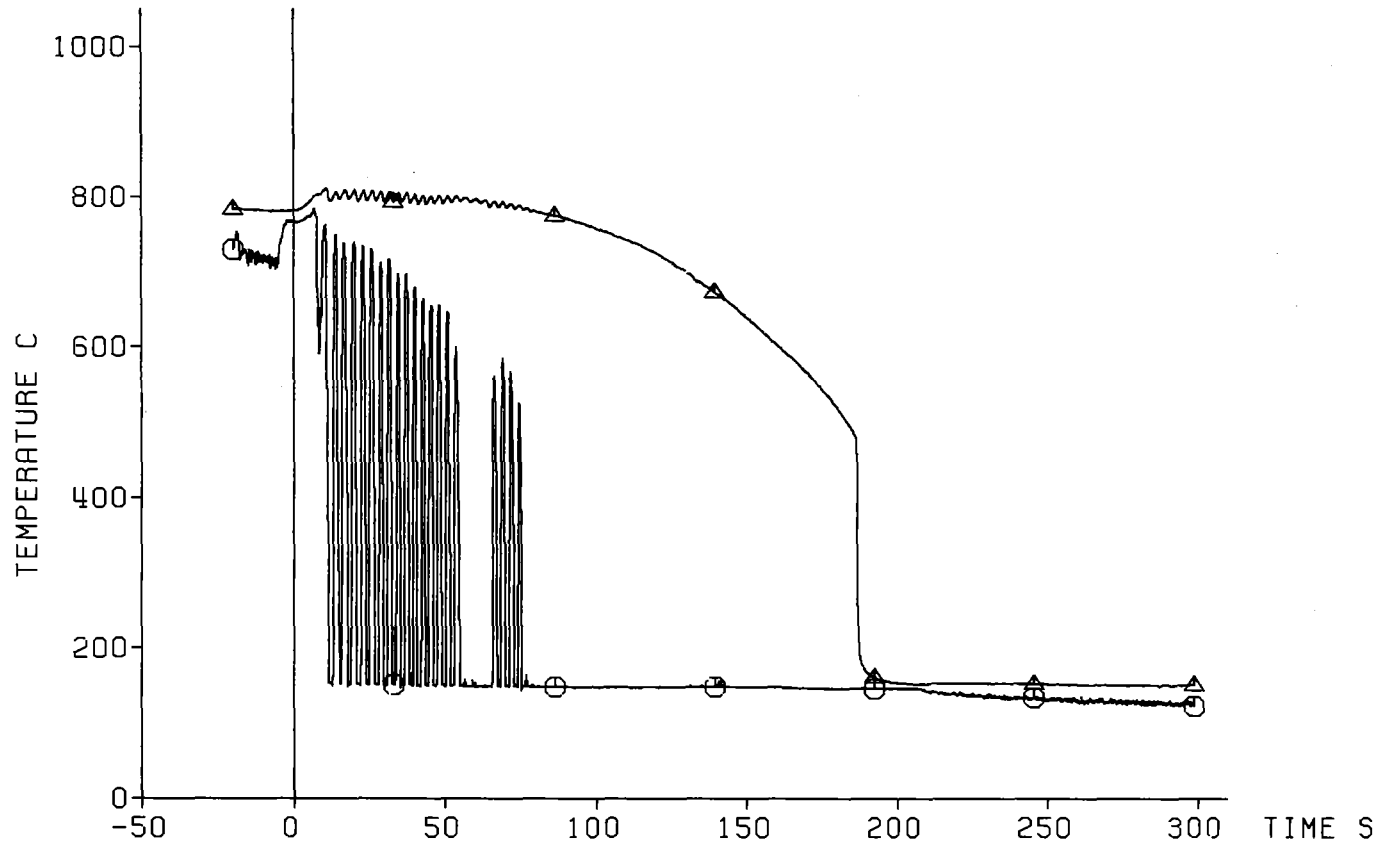

Decay Heat 120% ANS Standard
Flooding Rate (cold) 5.77 cm/s
System Pressure 4.10 bar
Feedwater Temperature 40 C



Fig. 249 FEBA: 5x5 ROD BUNDLE, TEST SERIES 7, TEST-No. 325

Axial Level: 1625 mm

△ Cladding Temperature (19g1)
○ Fluid Temperature
□ Housing Temperature

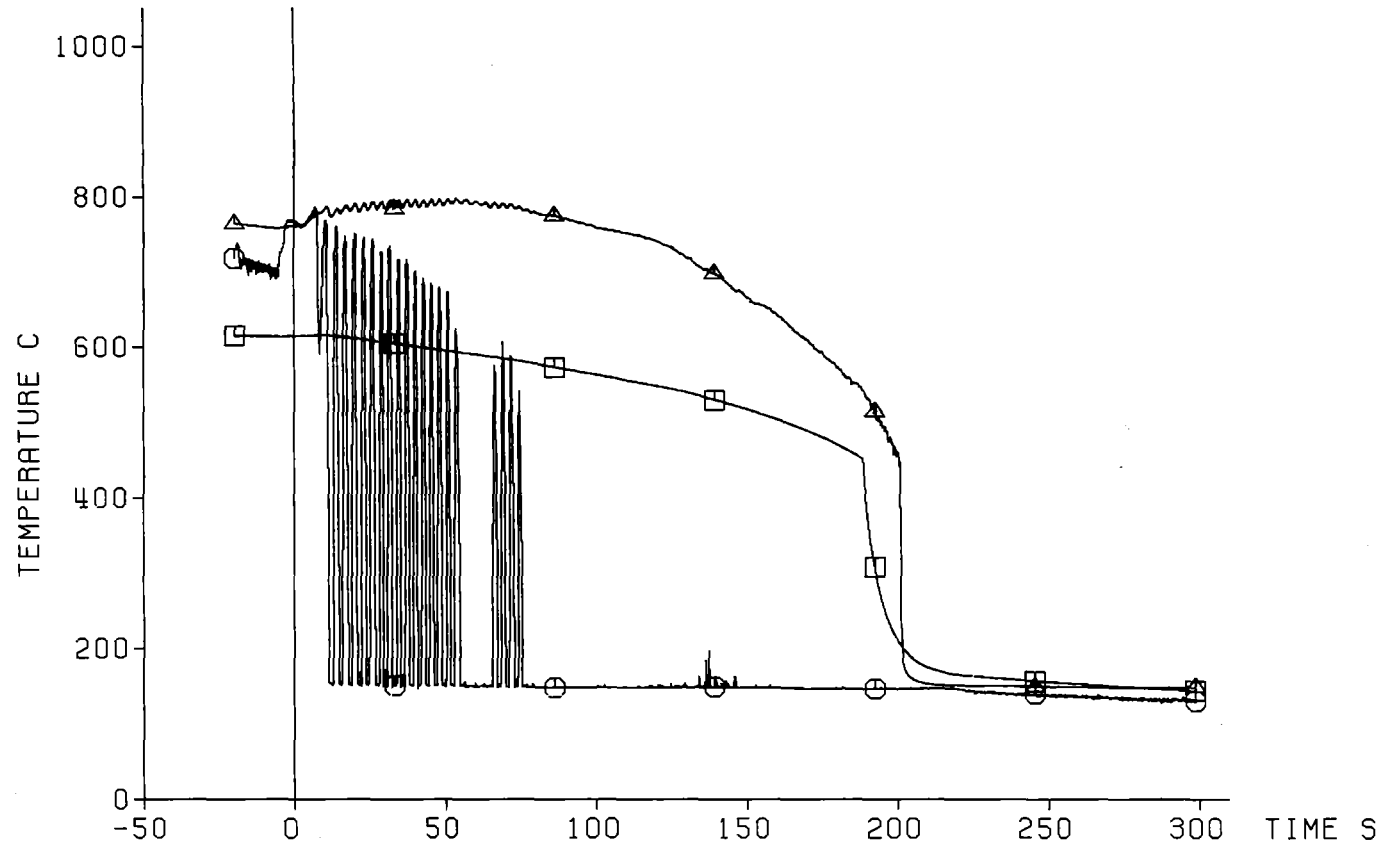

Decay Heat 120% ANS Standard
Flooding Rate (cold) 5.77 cm/s
System Pressure 4.10 bar
Feedwater Temperature 40 C



Fig. 250 FEBA: 5x5 ROD BUNDLE, TEST SERIES 7, TEST-No. 325

Axial Level: 1135 mm

△ Cladding Temperature (8b3)
○ Fluid Temperature
□ Housing Temperature

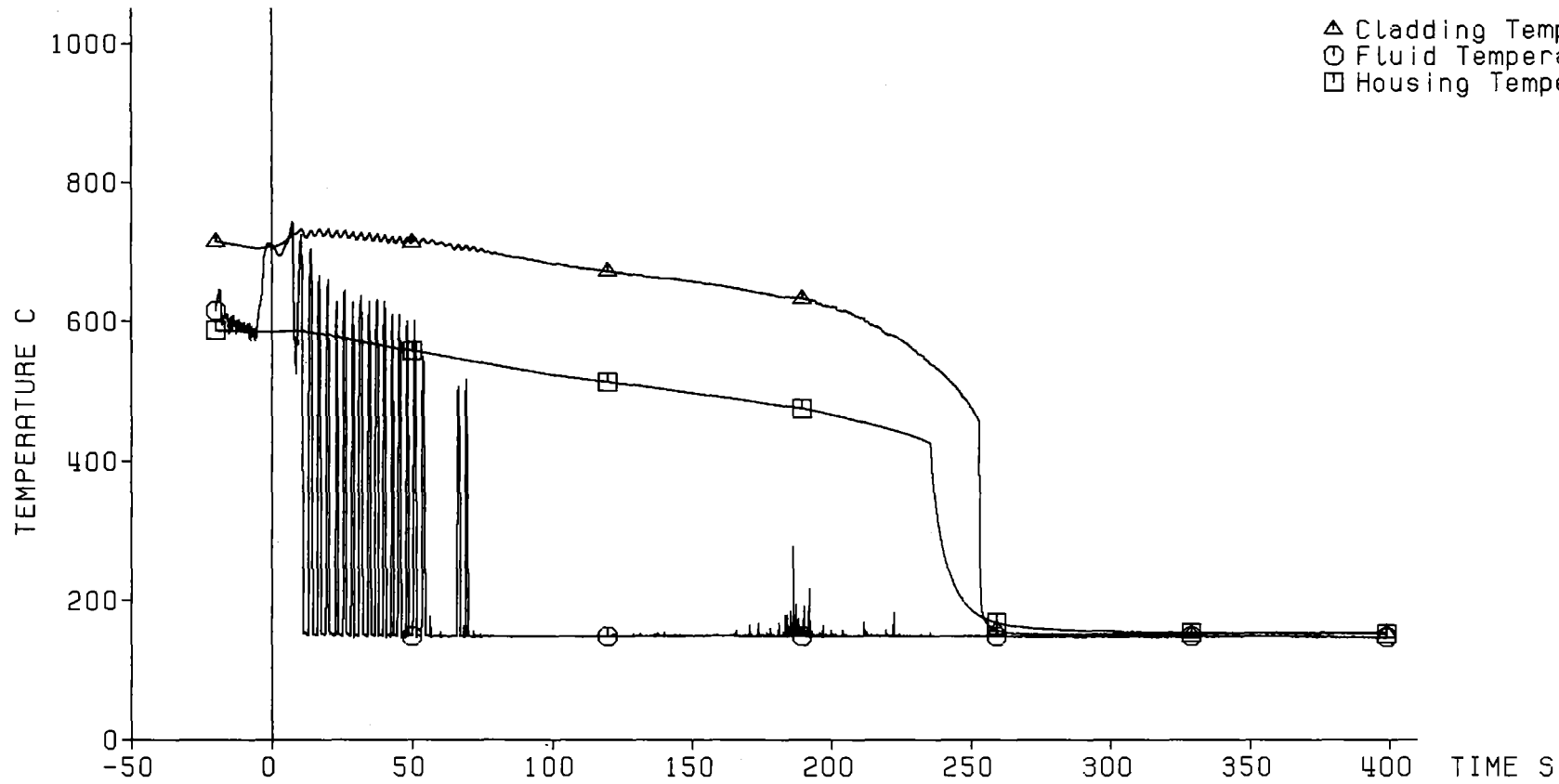

Decay Heat 120% ANS Standard
Flooding Rate (cold) 5.77 cm/s
System Pressure 4.10 bar
Feedwater Temperature 40 C

KIK IRB

Fig. 251 FEBA: 5x5 ROD BUNDLE, TEST SERIES 7, TEST-No. 325

Pressure Loss
Along the Test Section:

◇ Total Length: 4196 mm
△ Lower Part: 1711 mm
○ Middle Part: 545 mm
□ Upper Part: 1940 mm

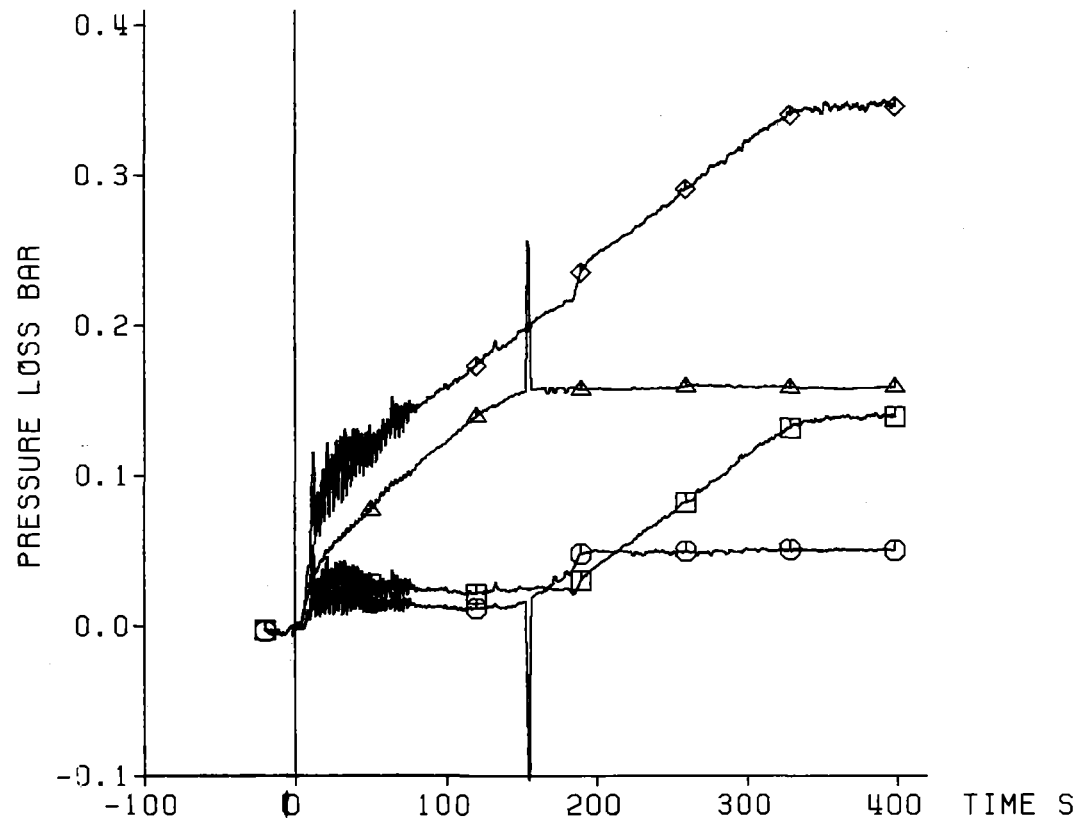

Decay Heat 120% ANS Standard
Flooding Rate (cold) 5.77 cm/s
System Pressure 4.10 bar
Feedwater Temperature 40 C

KIK
IRB

Fig. 252 FEBA: 5x5 ROD BUNDLE, TEST SERIES 7, TEST-NO. 325

Coolant Outlet Conditions:

△ Water Carry Over
○ Coolant Temperature
□ Coolant Pressure

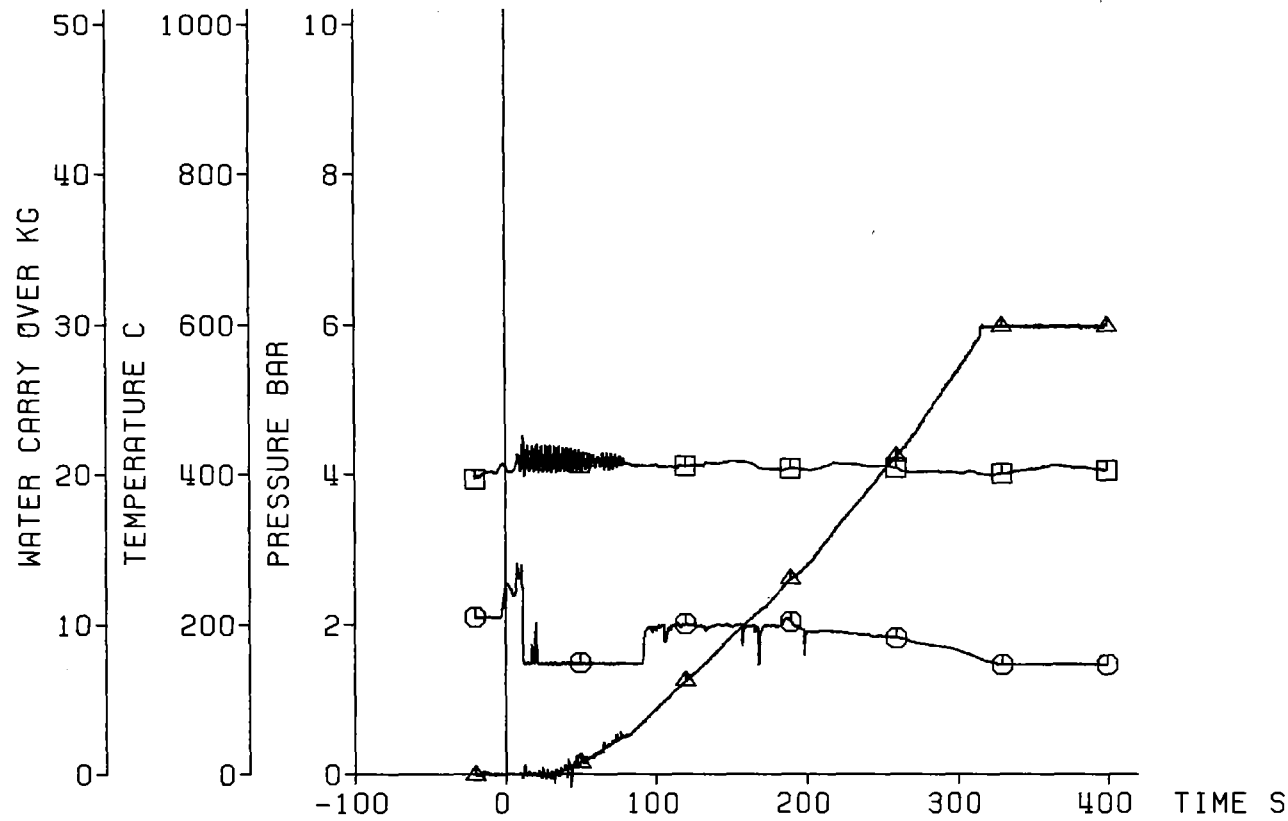

Decay Heat 120% ANS Standard
Flooding Rate (cold) 5.77 cm/s
System Pressure 4.10 bar
Feedwater Temperature 40 C



Fig. 253 FEBA: 5x5 ROD BUNDLE, TEST SERIES 7, TEST-No. 325

Axial Position of Quench Front

□ Quenching of Sleeves at Bundle Midplane

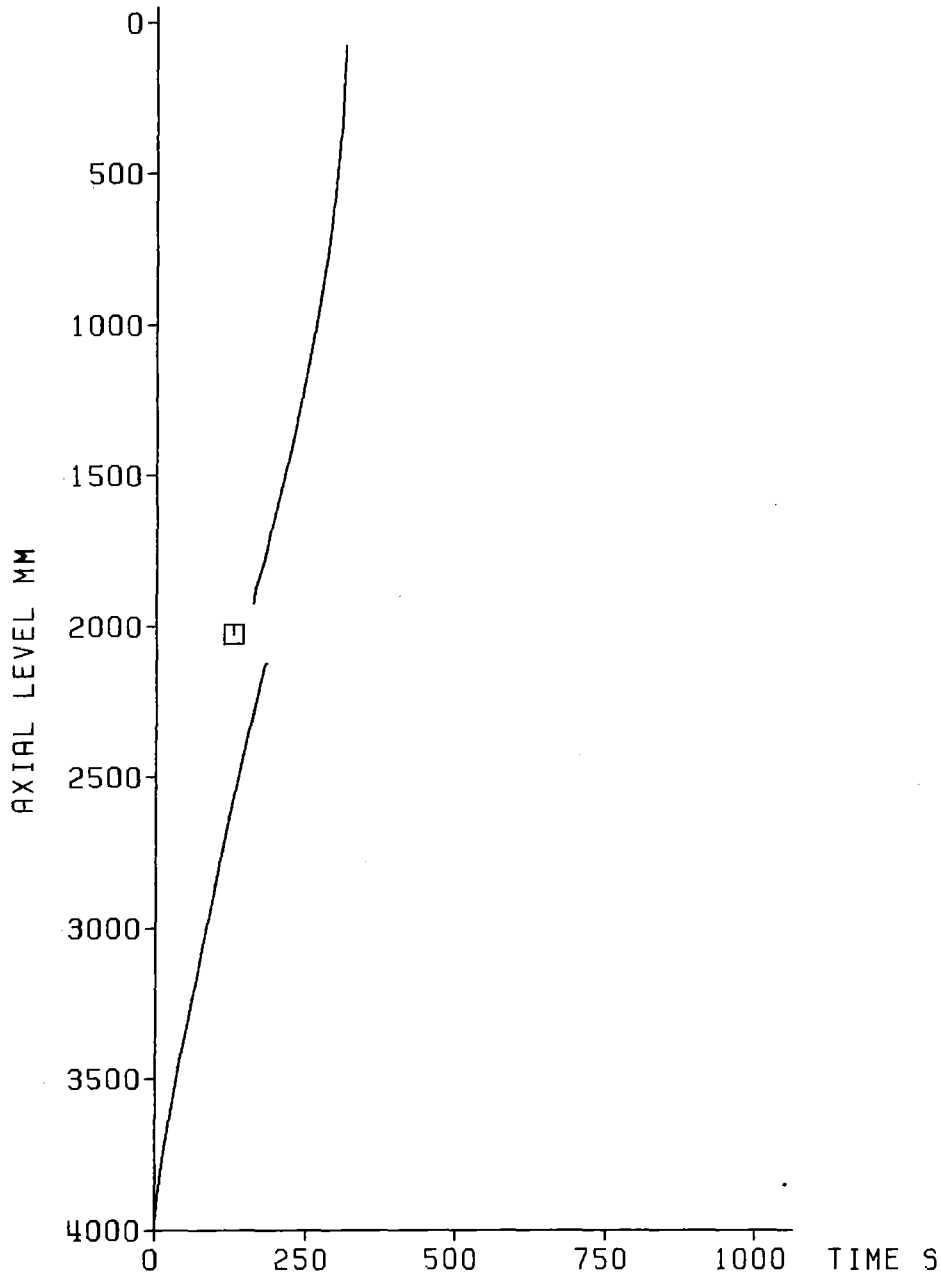

Decay Heat	120% ANS Standard
Flooding Rate (cold)	5.77 cm/s
System Pressure	4.10 bar
Feedwater Temperature	40 C

KJK IRB

Fig. 254 FEBA: 5x5 ROD BUNDLE
TEST SERIES 7, TEST-No. 325

Initial Axial Temperature Profile of Claddings

□ Initial Temperature of Sleeves at Bundle Midplane

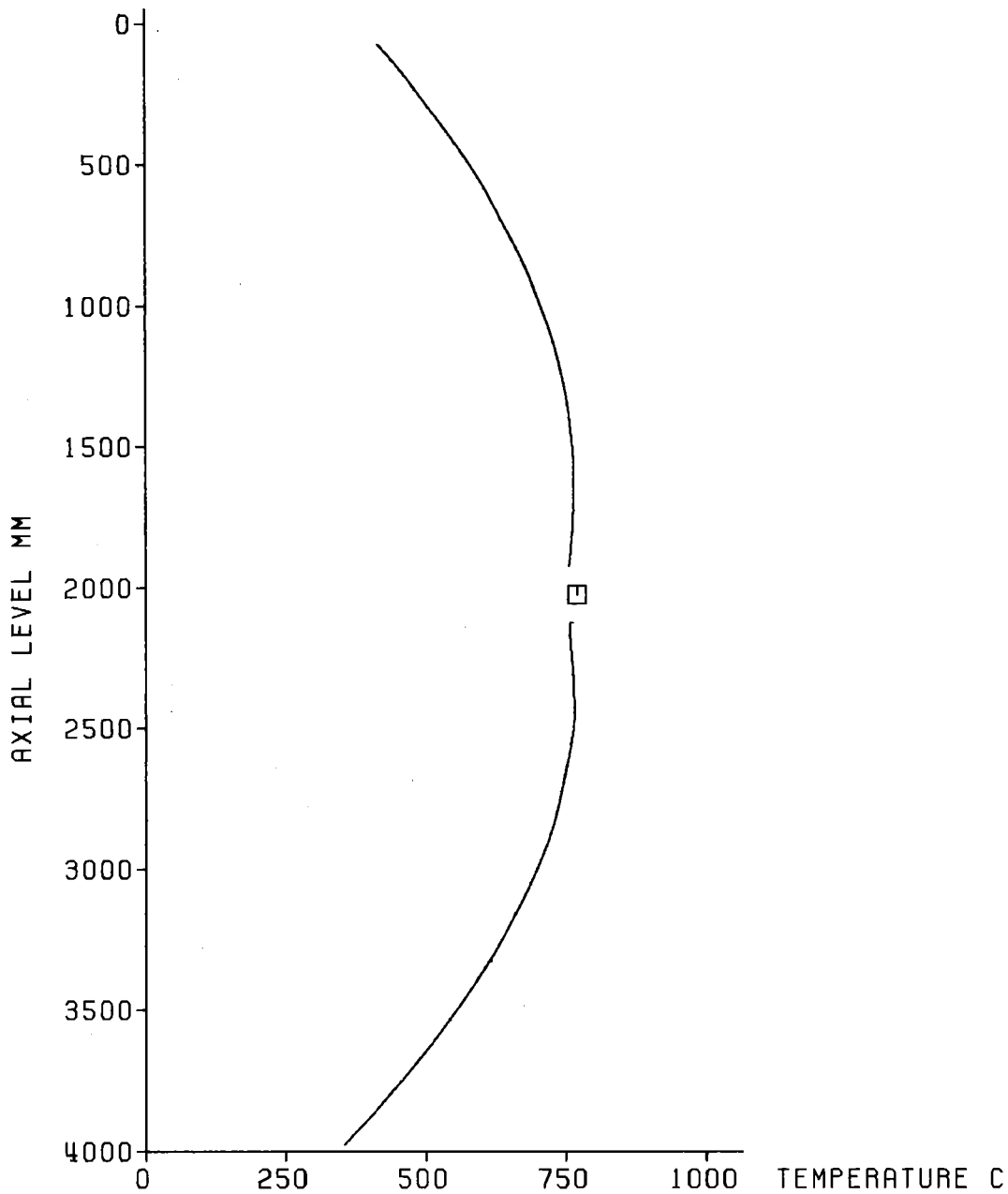

Decay Heat	120% ANS Standard
Flooding Rate (cold)	5.78 cm/s
System Pressure	5.91 bar
Feedwater Temperature	40 C

KFK IRB

Fig. 255 FEBA: 5x5 ROD BUNDLE
TEST SERIES 7, TEST-NO. 330

Cladding Temperature

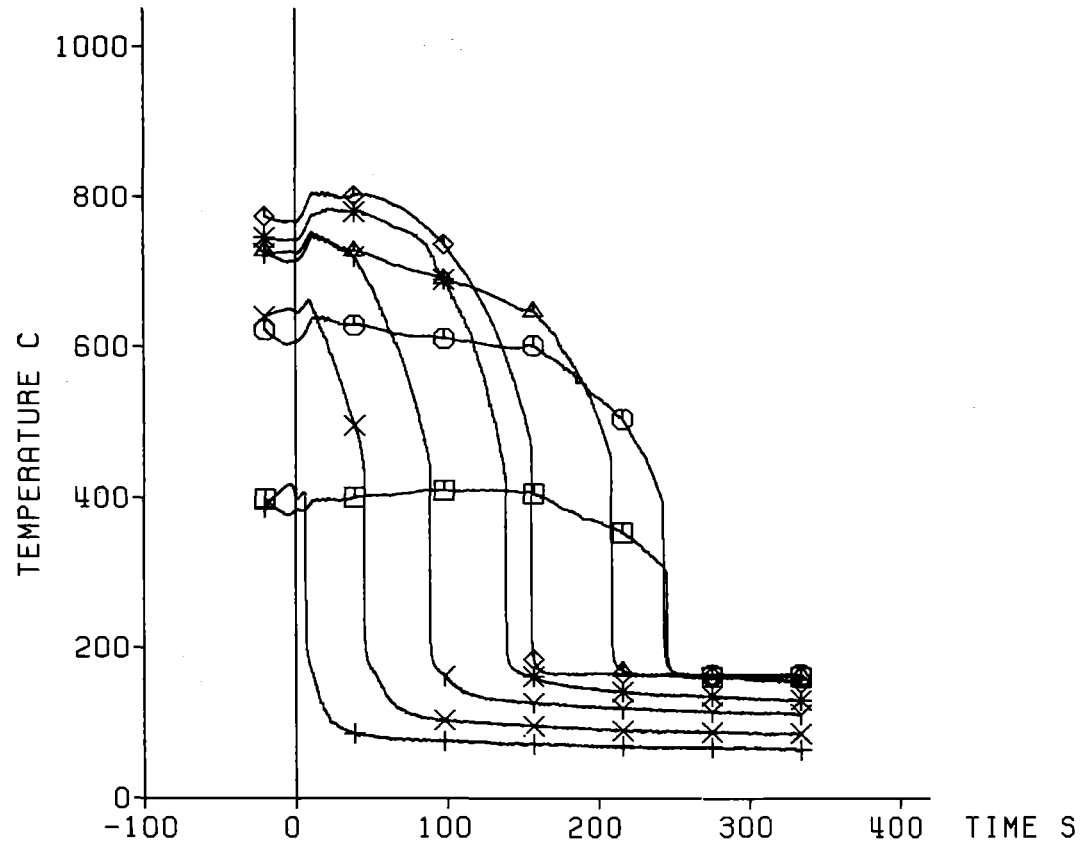

TC	Ax. Level
+	7a4 3860 mm
X	7a3 3315 mm
Y	7a2 2770 mm
*	7a1 2225 mm
◇	8b4 1680 mm
△	8b3 1135 mm
○	8b2 590 mm
□	3b1 45 mm

Decay Heat 120% ANS Standard
 Flooding Rate (cold) 5.78 cm/s
 System Pressure 5.91 bar
 Feedwater Temperature 40 C



Fig. 257 FEBA: 5x5 ROD BUNDLE, TEST SERIES 7, TEST-No. 330

Heat Transfer Coeff.

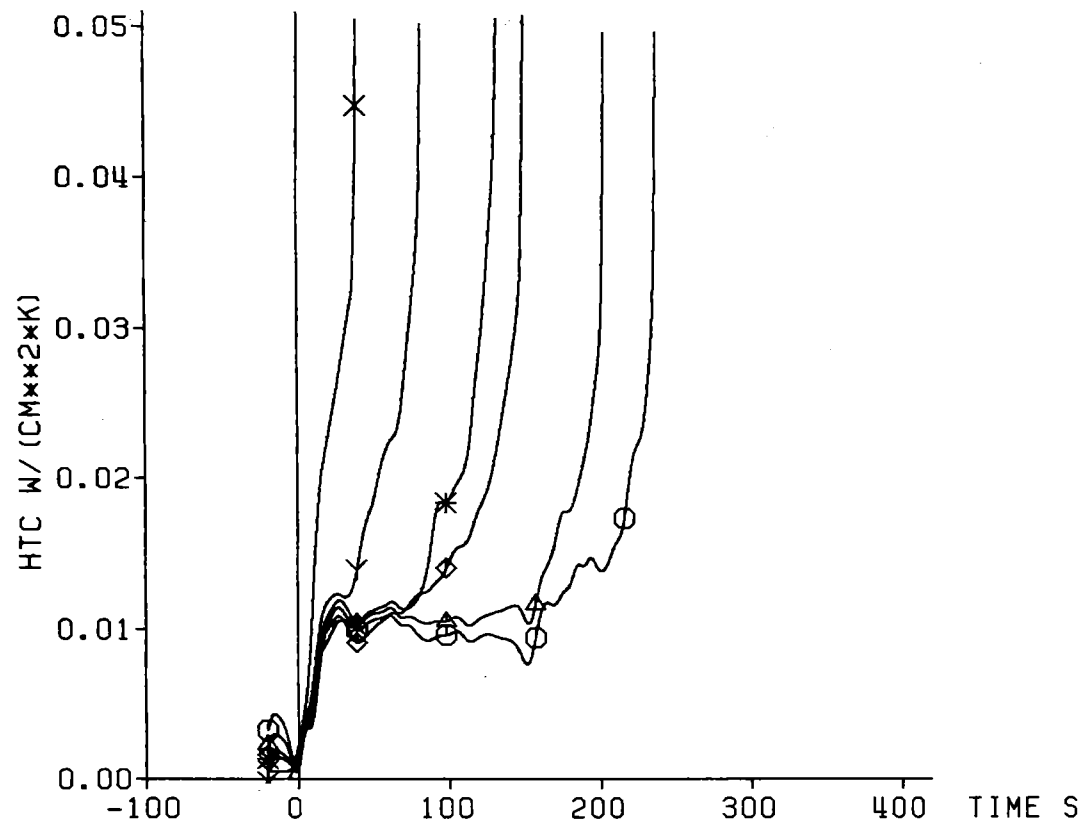

	TC	Ax. Level
X	7a3	3315 mm
Y	7a2	2770 mm
*	7a1	2225 mm
◇	8b4	1680 mm
△	8b3	1135 mm
○	8b2	590 mm

Decay Heat 120% ANS Standard
 Flooding Rate (cold) 5.78 cm/s
 System Pressure 5.91 bar
 Feedwater Temperature 40 C



Fig. 258 FEBA: 5x5 ROD BUNDLE, TEST SERIES 7, TEST-No. 330

Cladding Temperature

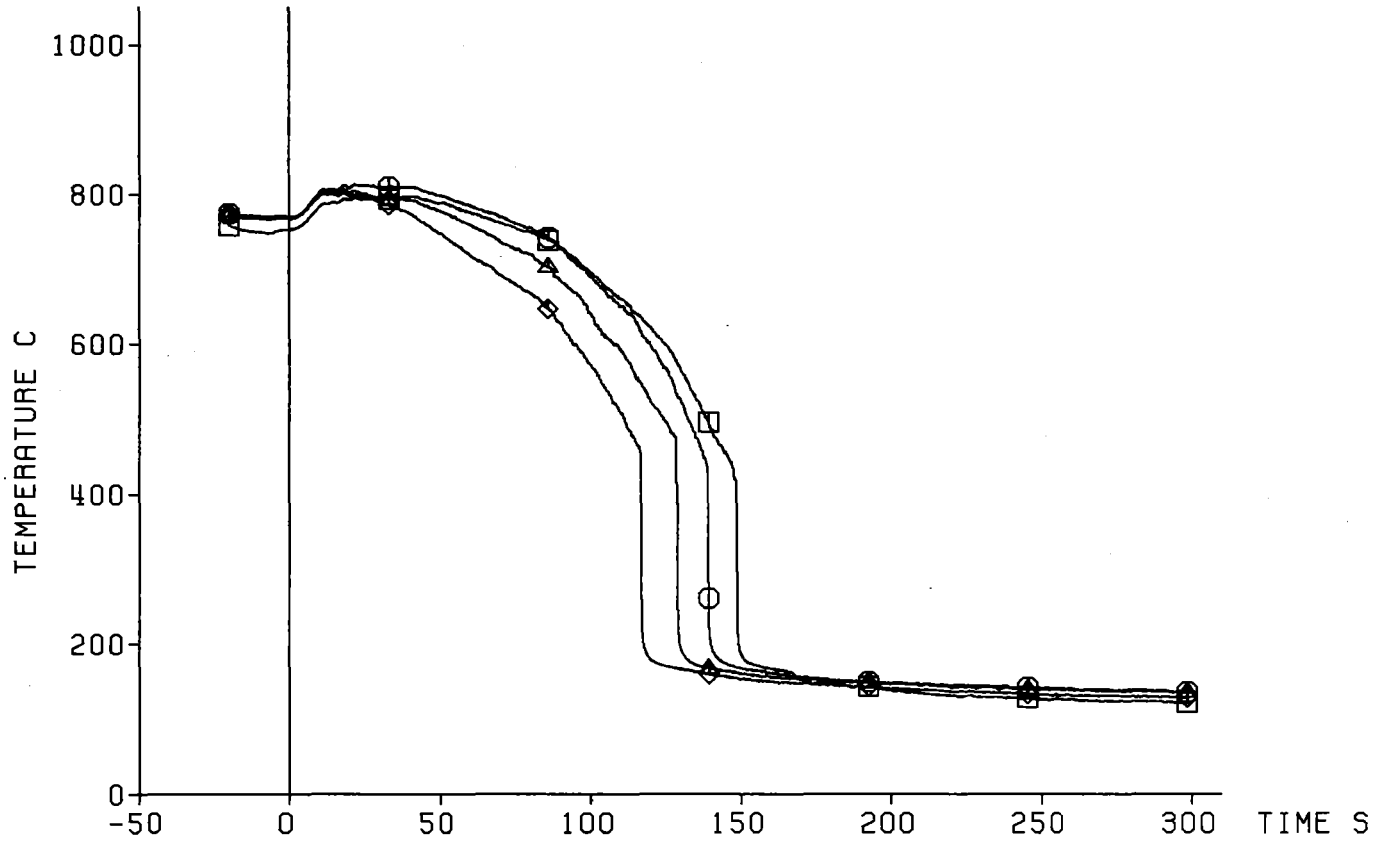

TC	Ax. Level
◇	14f4 2425 mm
△	14f3 2325 mm
○	14h2 2225 mm
□	14f1 2125 mm

Decay Heat 120% ANS Standard
 Flooding Rate (cold) 5.78 cm/s
 System Pressure 5.91 bar
 Feedwater Temperature 40 C



Fig. 259 FEBA: 5x5 ROD BUNDLE, TEST SERIES 7, TEST-No. 330

Heat Transfer Coeff.

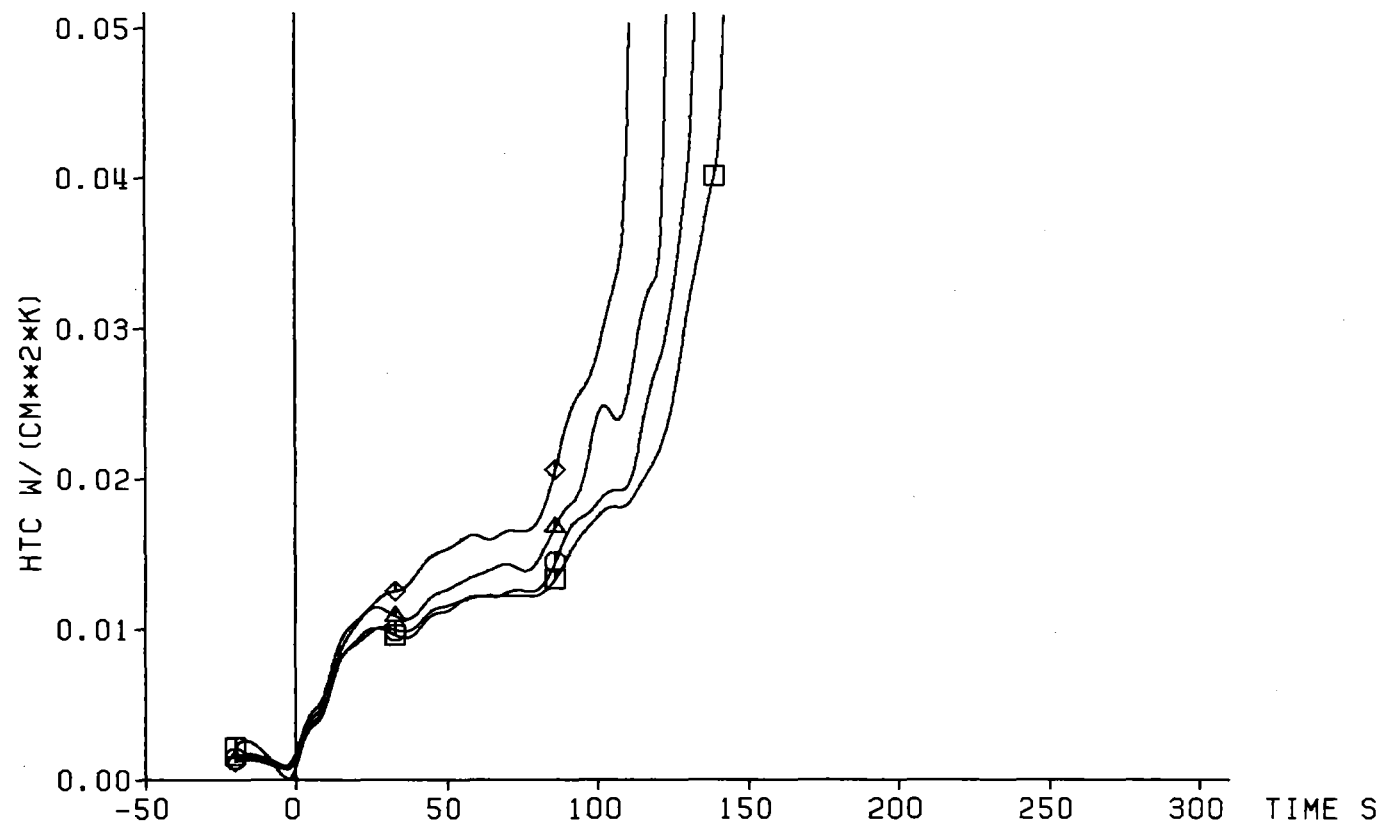

	TC	Ax. Level
◇	14f4	2425 mm
△	14f3	2325 mm
⊙	14h2	2225 mm
□	14f1	2125 mm

Decay Heat 120% ANS Standard
 Flooding Rate (cold) 5.78 cm/s
 System Pressure 5.91 bar
 Feedwater Temperature 40 C



Fig. 260 FEBA: 5x5 ROD BUNDLE, TEST SERIES 7, TEST-No. 330

Cladding Temperature

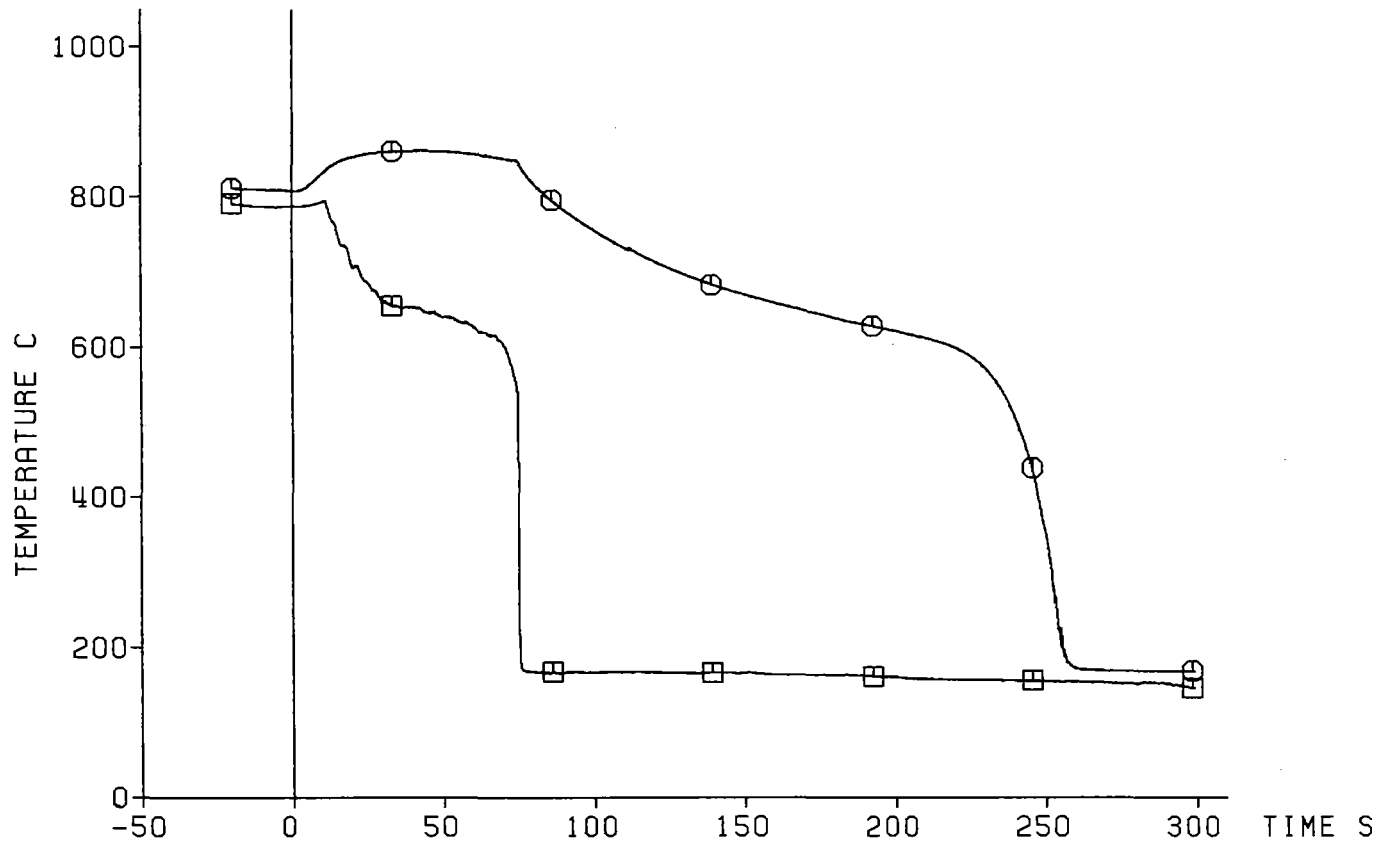

TC	Ax. Level
○ 13h2	2025 mm
□ Sleeve	2025 mm

Decay Heat 120% ANS Standard
 Flooding Rate (cold) 5.78 cm/s
 System Pressure 5.91 bar
 Feedwater Temperature 40 C



Fig. 261 FEBA: 5x5 ROD BUNDLE, TEST SERIES 7, TEST-No. 330

Cladding Temperature

TC	Ax. Level
⊙ 1714	2025 mm
⊠ Sleeve	2025 mm

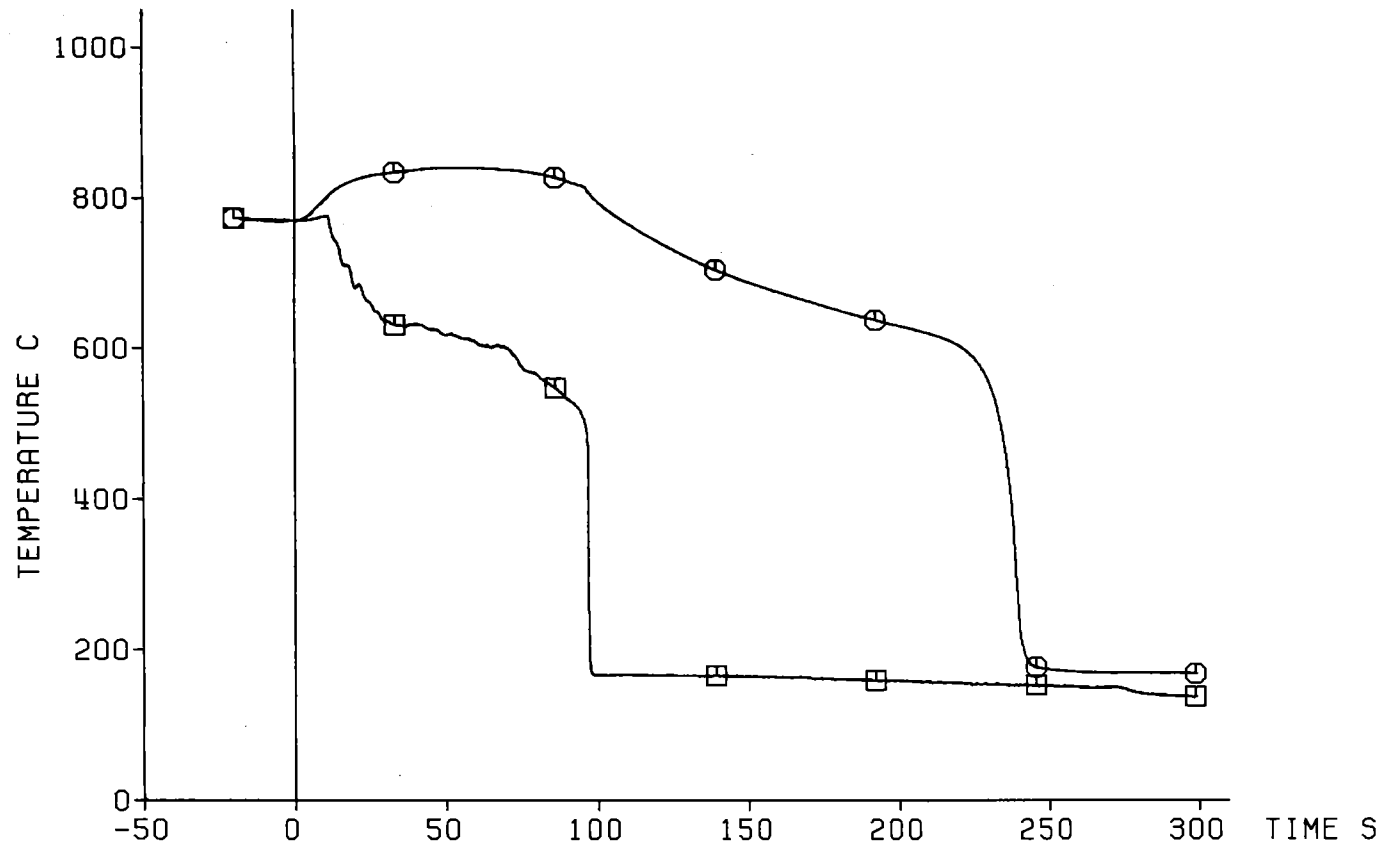

Decay Heat 120% ANS Standard
 Flooding Rate (cold) 5.78 cm/s
 System Pressure 5.91 bar
 Feedwater Temperature 40 C



Fig. 262 FEBA: 5x5 ROD BUNDLE, TEST SERIES 7, TEST-No. 330

Cladding Temperature

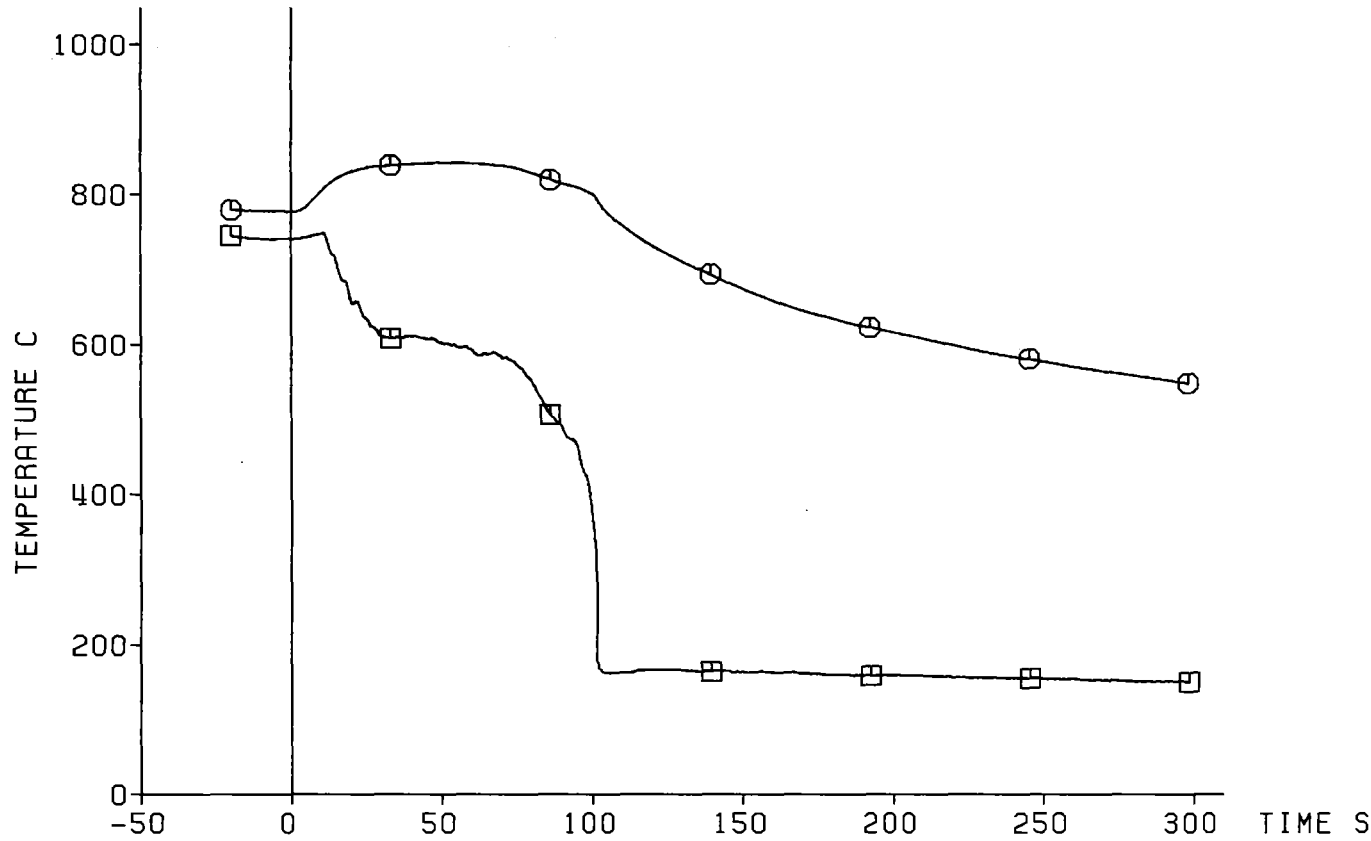

TC	Ax. Level
⊙ 17i3	1975 mm
⊠ Sleeve	1972 mm

Decay Heat 120% ANS Standard
 Flooding Rate (cold) 5.78 cm/s
 System Pressure 5.91 bar
 Feedwater Temperature 40 C



Fig. 263 FEBA: 5x5 ROD BUNDLE, TEST SERIES 7, TEST-No. 330

Cladding Temperature

TC	Ax. Level
⊙ 1714	2025 mm
+ Sleeve	2064 mm
□ Sleeve	2025 mm
△ Sleeve	2025 mm
× Sleeve	1972 mm

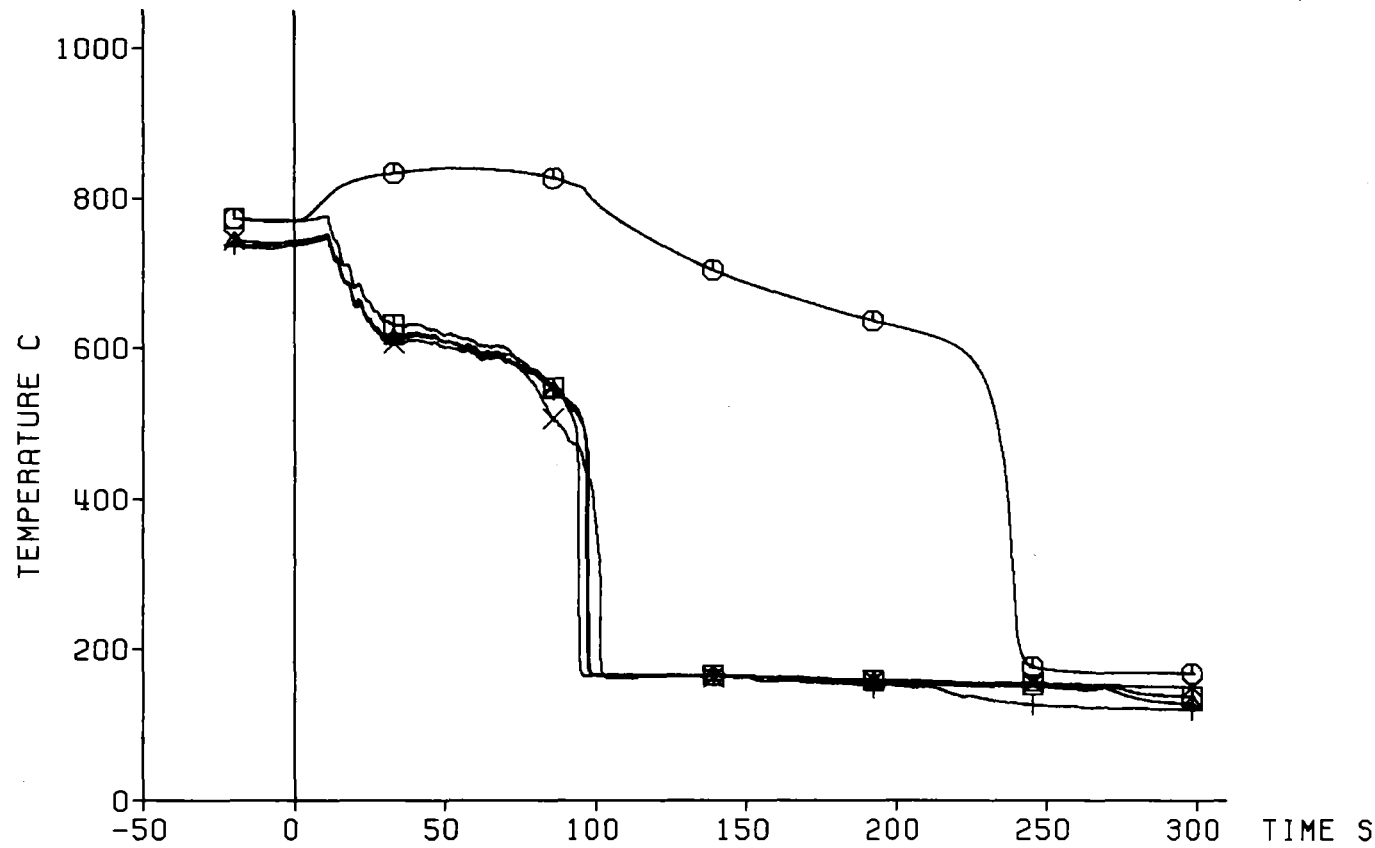

Decay Heat 120% ANS Standard
 Flooding Rate (cold) 5.78 cm/s
 System Pressure 5.91 bar
 Feedwater Temperature 40 C



Fig. 264 FEBA: 5x5 ROD BUNDLE, TEST SERIES 7, TEST-No. 330

TC	Ax. Level
* 19g4	1925 mm
◇ 17i1	1875 mm
△ 19g3	1825 mm
○ 19g2	1725 mm
□ 19g1	1625 mm

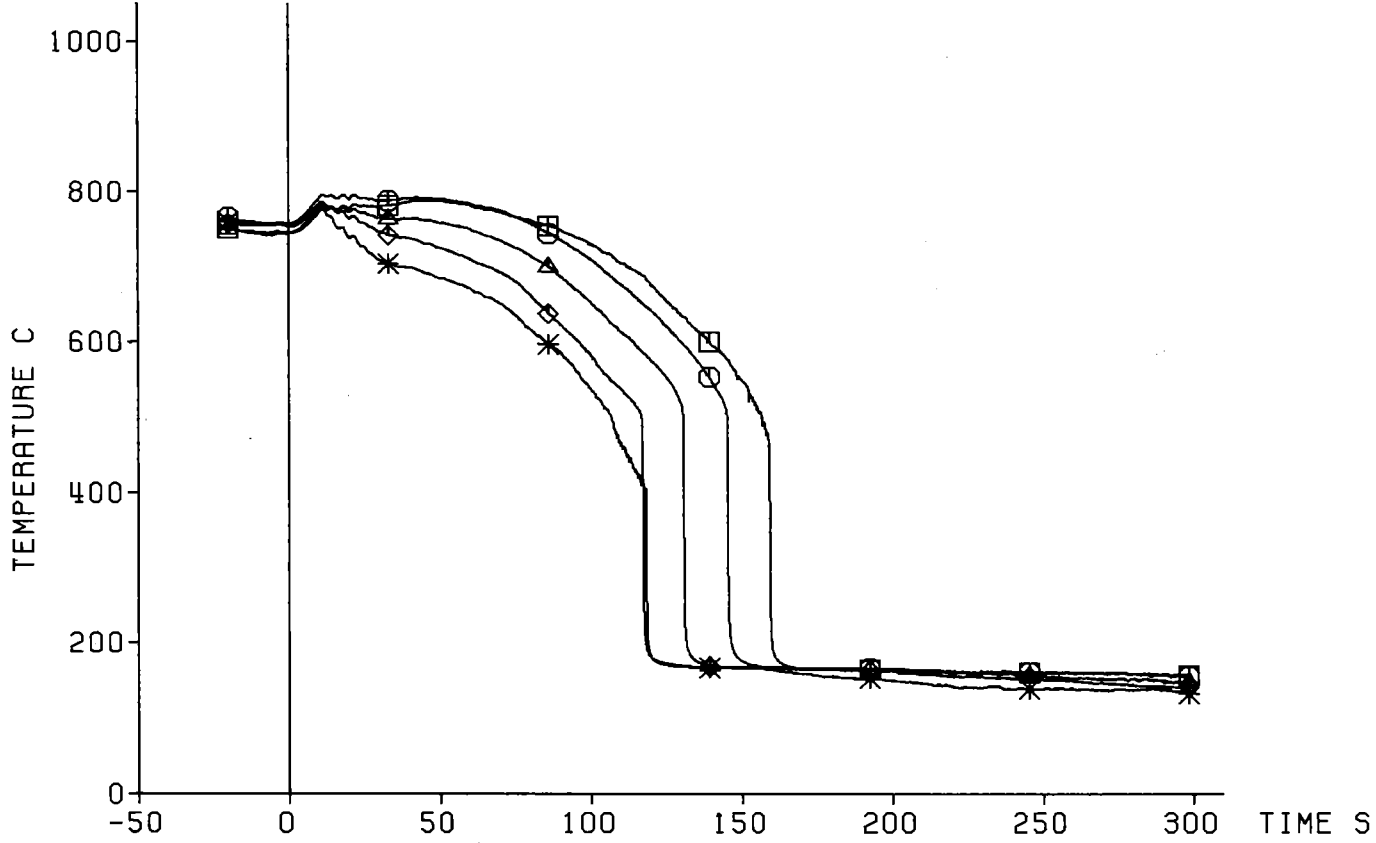

Decay Heat 120% ANS Standard
Flooding Rate (cold) 5.78 cm/s
System Pressure 5.91 bar
Feedwater Temperature 40 C



Fig. 265 FEBA: 5x5 ROD BUNDLE, TEST SERIES 7, TEST-No. 330

Heat Transfer Coeff.

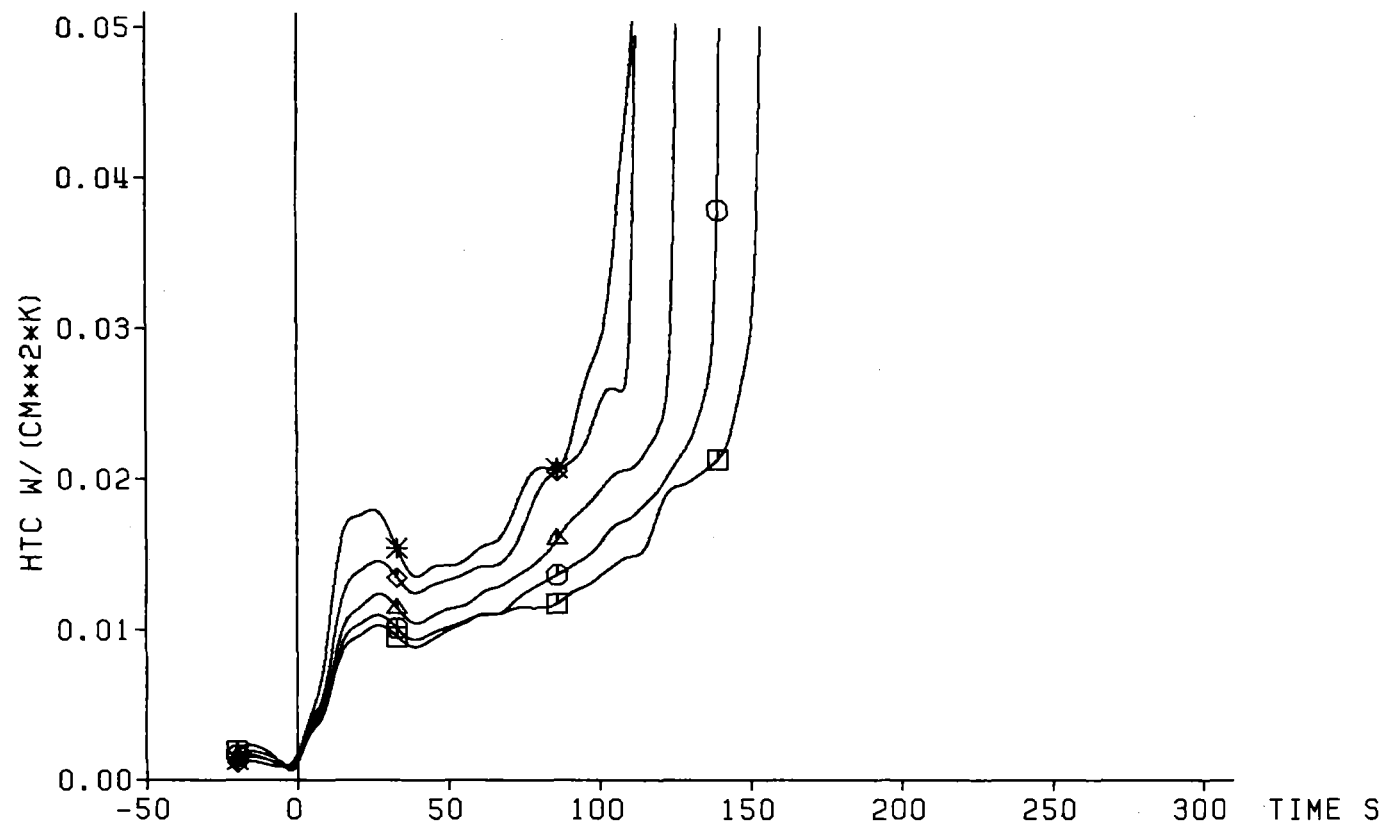

TC	Ax. Level
* 19g4	1925 mm
◇ 17i1	1875 mm
△ 19g3	1825 mm
○ 19g2	1725 mm
□ 19g1	1625 mm

Decay Heat 120% ANS Standard
 Flooding Rate (cold) 5.78 cm/s
 System Pressure 5.91 bar
 Feedwater Temperature 40 C



Fig. 266 FEBA: 5x5 ROD BUNDLE, TEST SERIES 7, TEST-No. 330

Cladding Temperature

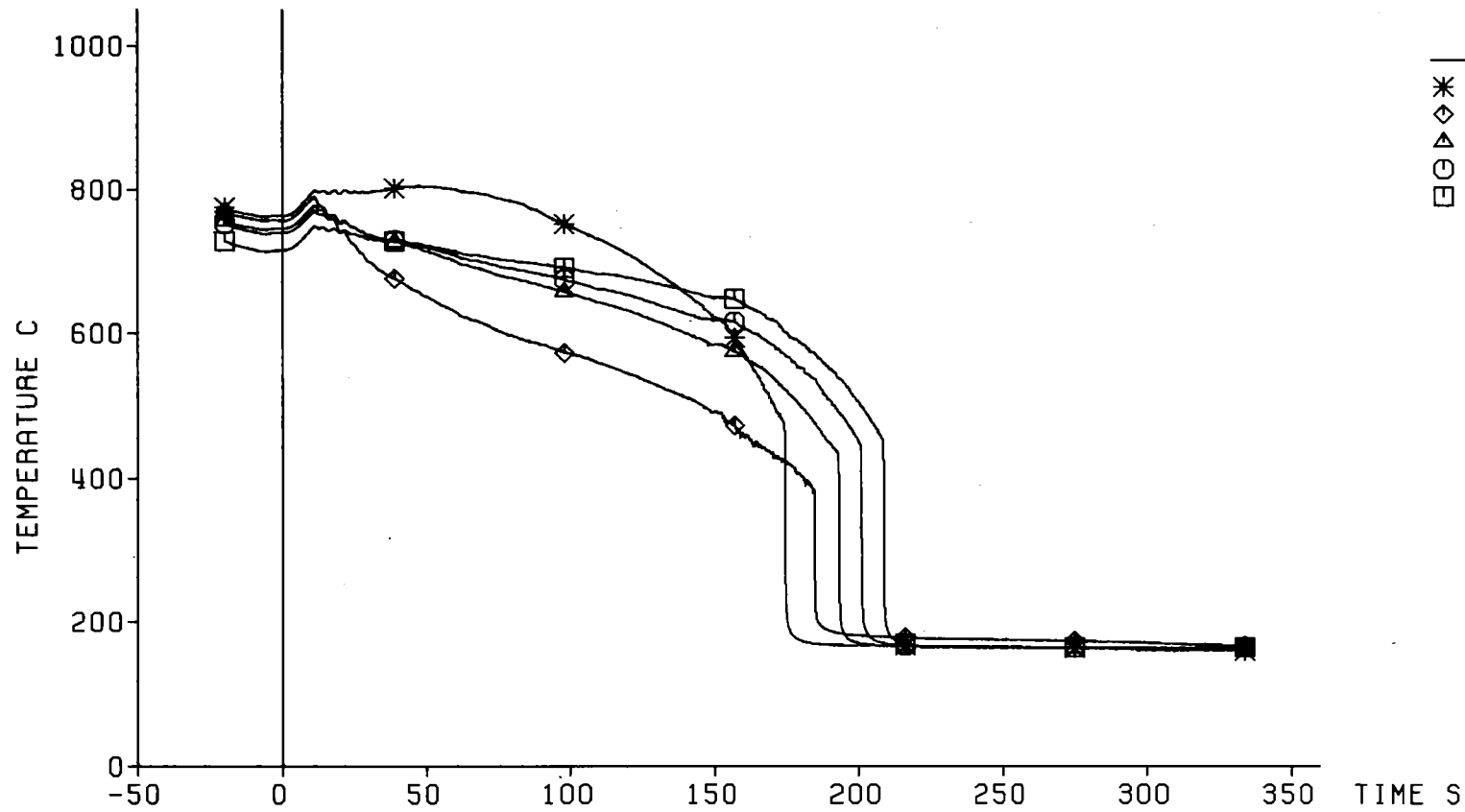

TC	Ax. Level
* 12j4	1525 mm
◇ 12j3	1425 mm
△ 12j2	1325 mm
○ 12j1	1225 mm
□ 8b3	1135 mm

Decay Heat 120% ANS Standard
 Flooding Rate (cold) 5.78 cm/s
 System Pressure 5.91 bar
 Feedwater Temperature 40 C



Fig. 267 FEBA: 5x5 ROD BUNDLE, TEST SERIES 7, TEST-No. 330

Heat Transfer Coeff.

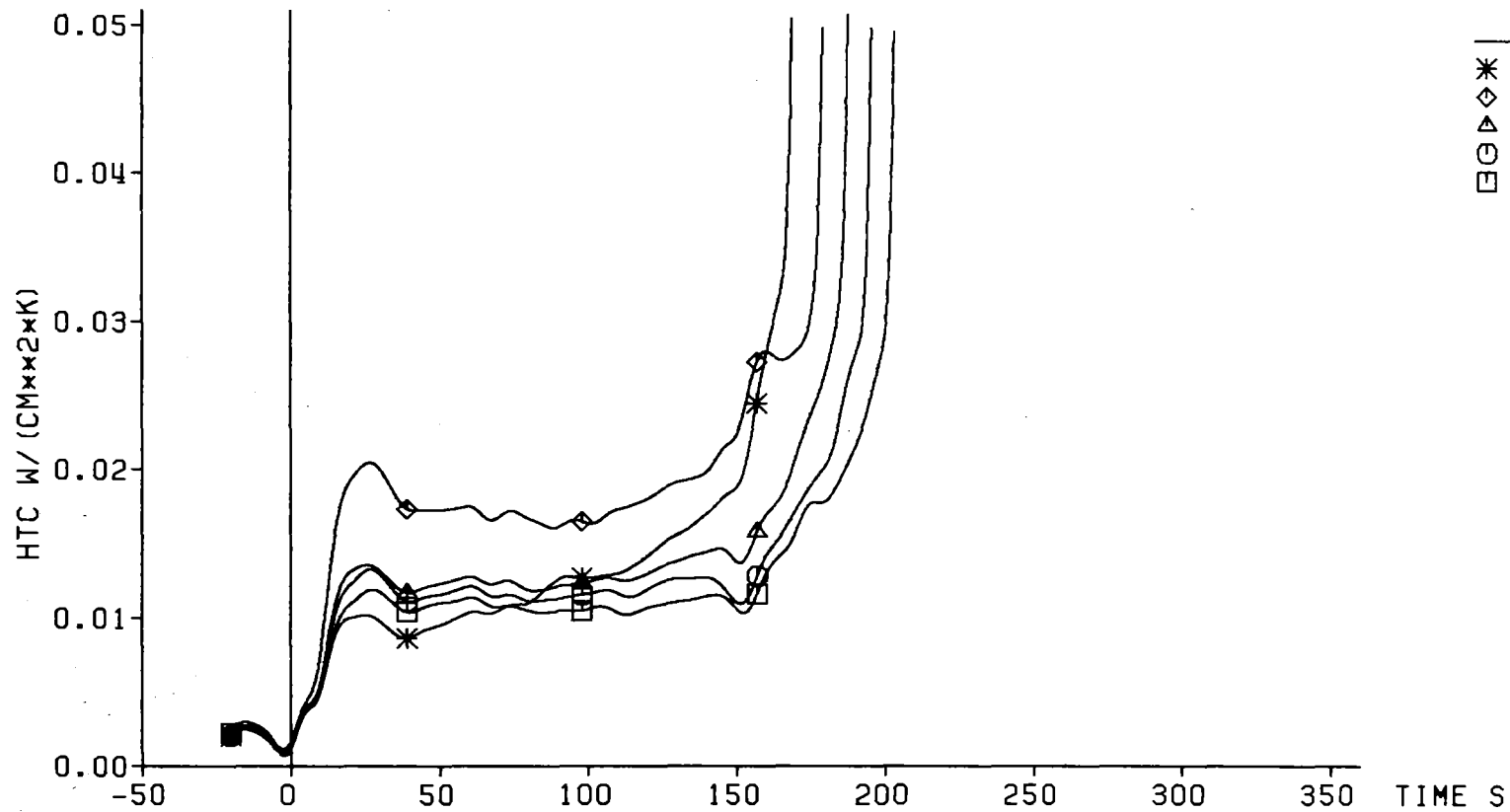

Decay Heat 120% ANS Standard
 Flooding Rate (cold) 5.78 cm/s
 System Pressure 5.91 bar
 Feedwater Temperature 40 C



Fig. 268 FEBA: 5x5 ROD BUNDLE, TEST SERIES 7, TEST-No. 330

Axial Level: 2770 mm

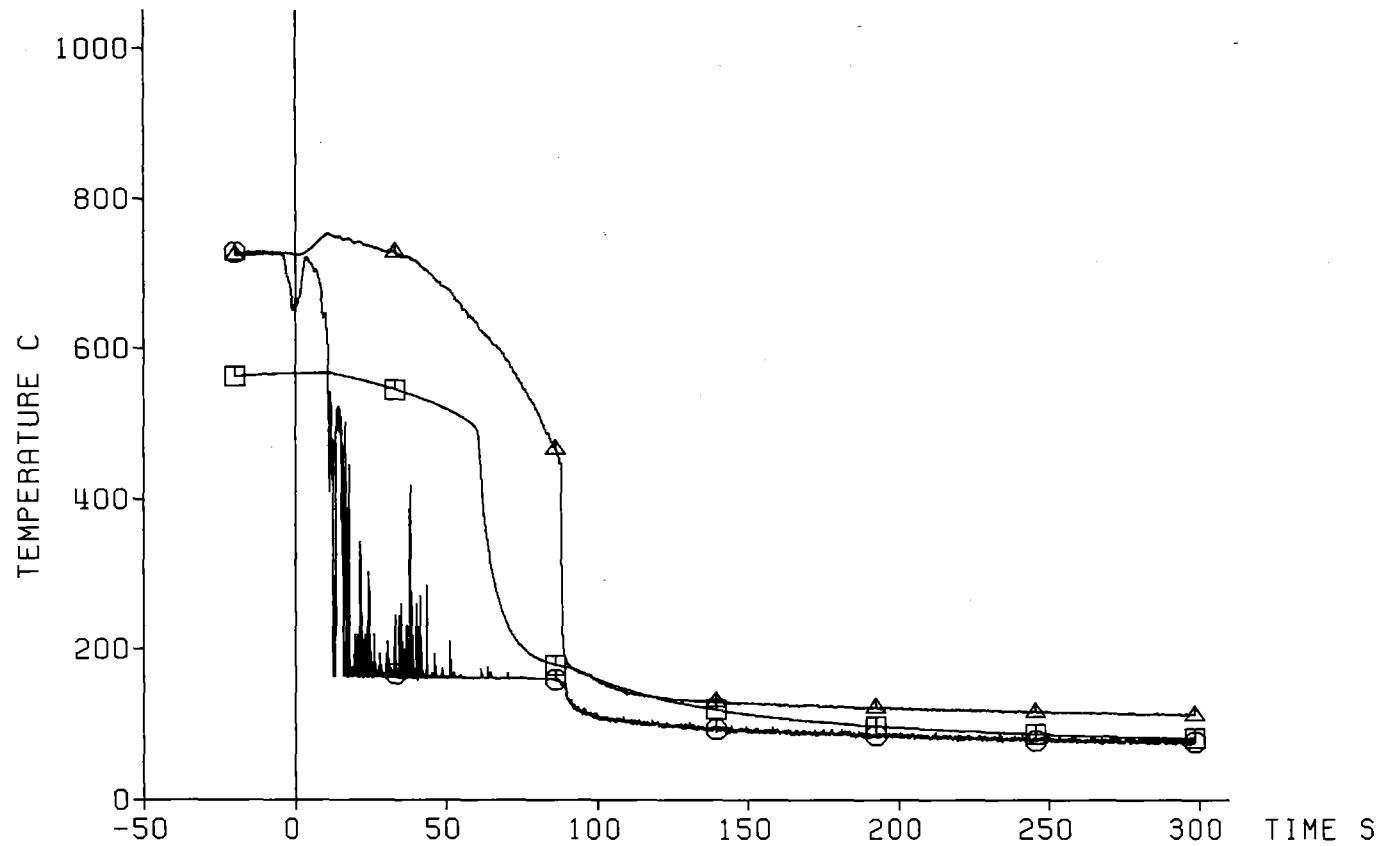

△ Cladding Temperature (7a2)
○ Fluid Temperature
□ Housing Temperature

Decay Heat 120% ANS Standard
Flooding Rate (cold) 5.78 cm/s
System Pressure 5.91 bar
Feedwater Temperature 40 C

— 302 —



Fig. 269 FEBA: 5x5 ROD BUNDLE, TEST SERIES 7, TEST-No. 330

Axial Level: 2225 mm

△ Cladding Temperature (7a1)
○ Fluid Temperature (2240 mm)
□ Housing Temperature (2235 mm)

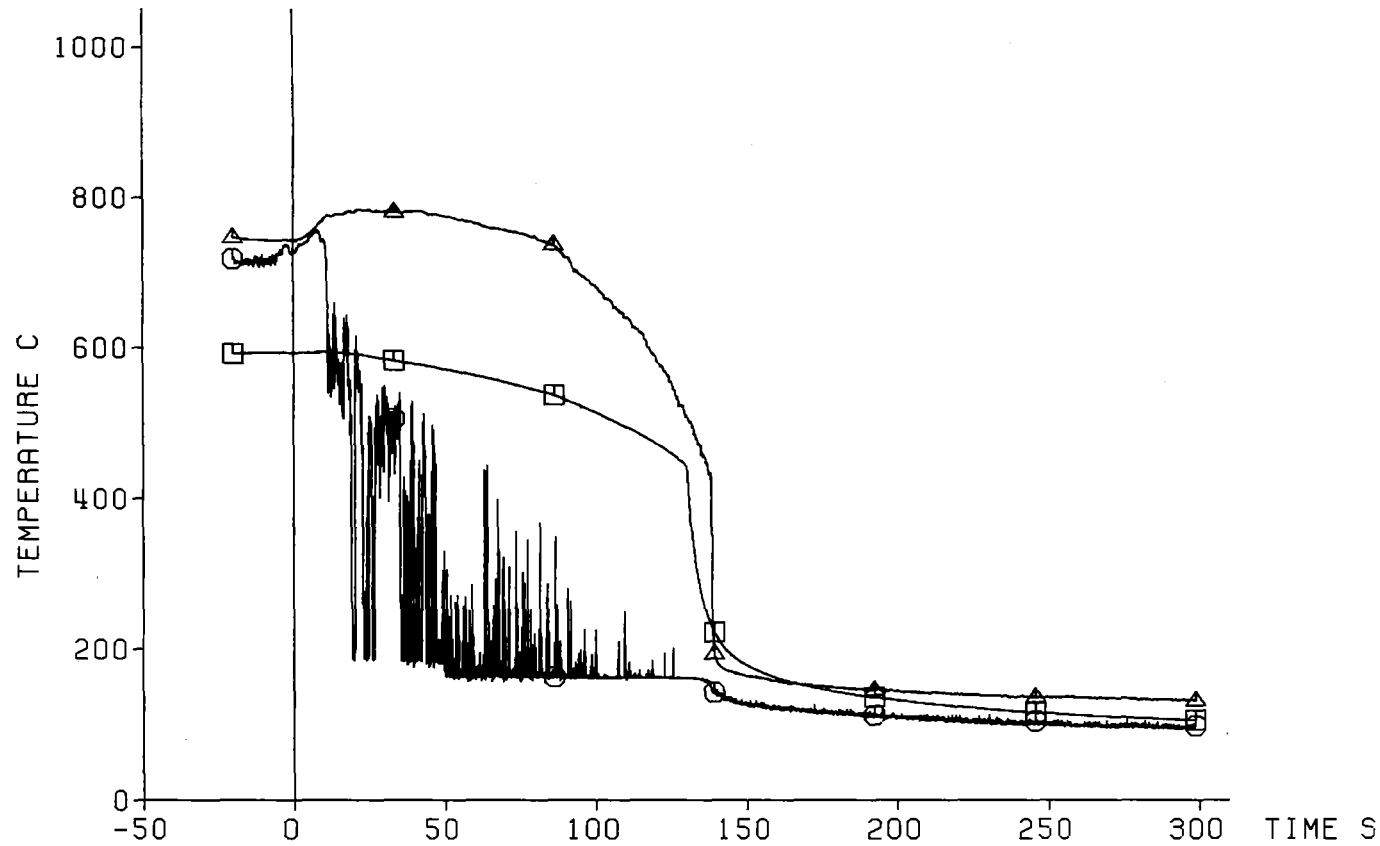

Decay Heat 120% ANS Standard
Flooding Rate (cold) 5.78 cm/s
System Pressure 5.91 bar
Feedwater Temperature 40 C



Fig. 270 FEBA: 5x5 ROD BUNDLE, TEST SERIES 7, TEST-No. 330

Axial Level: 1825 mm

△ Cladding Temperature (19g3)
○ Fluid Temperature
□ Housing Temperature

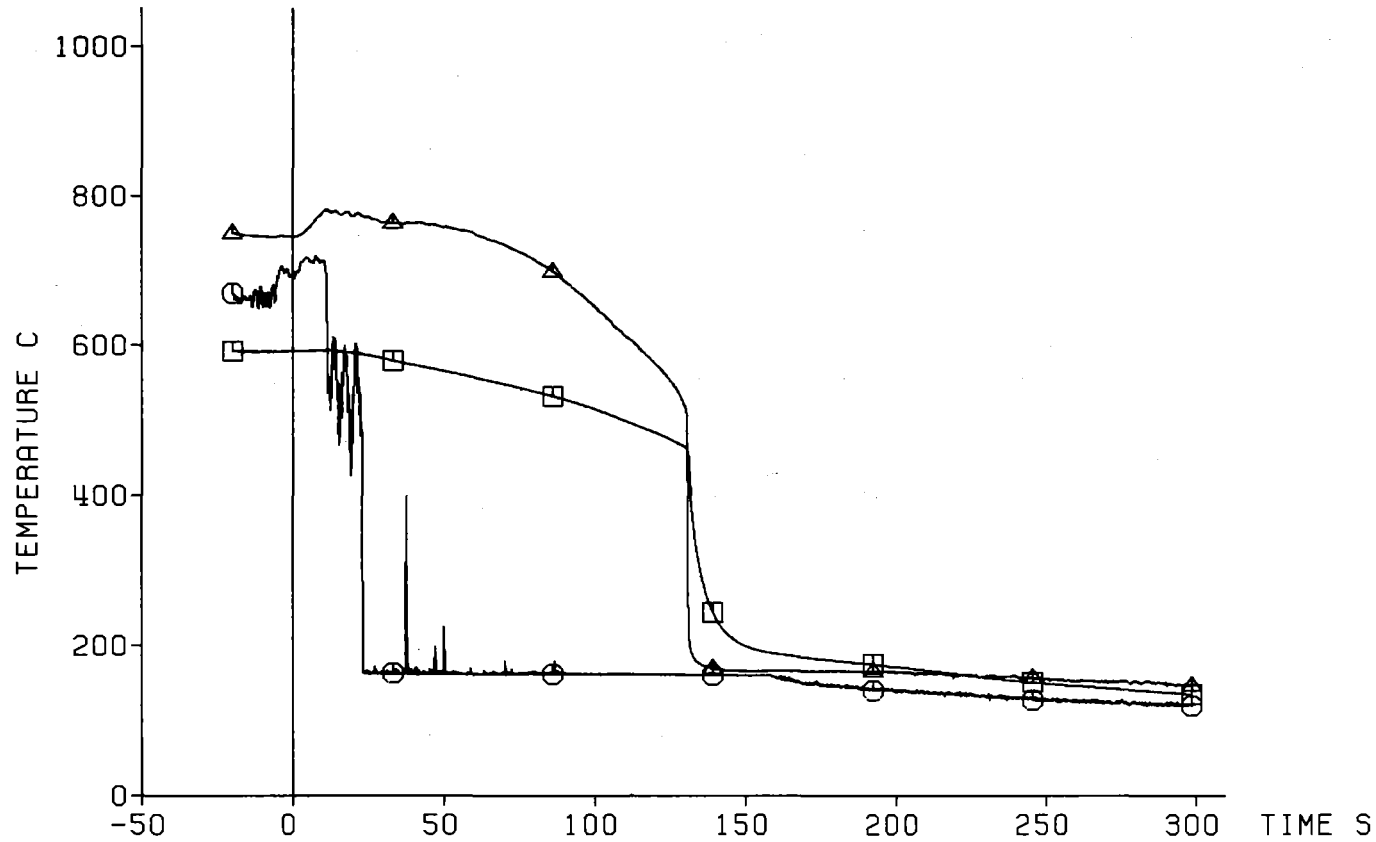

Decay Heat 120% ANS Standard
Flooding Rate (cold) 5.78 cm/s
System Pressure 5.91 bar
Feedwater Temperature 40 C

— 304 —



Fig. 271 FEBA: 5x5 ROD BUNDLE, TEST SERIES 7, TEST-NO. 330

Axial Level: 1725 mm

△ Cladding Temperature (19g2)
○ Fluid Temperature

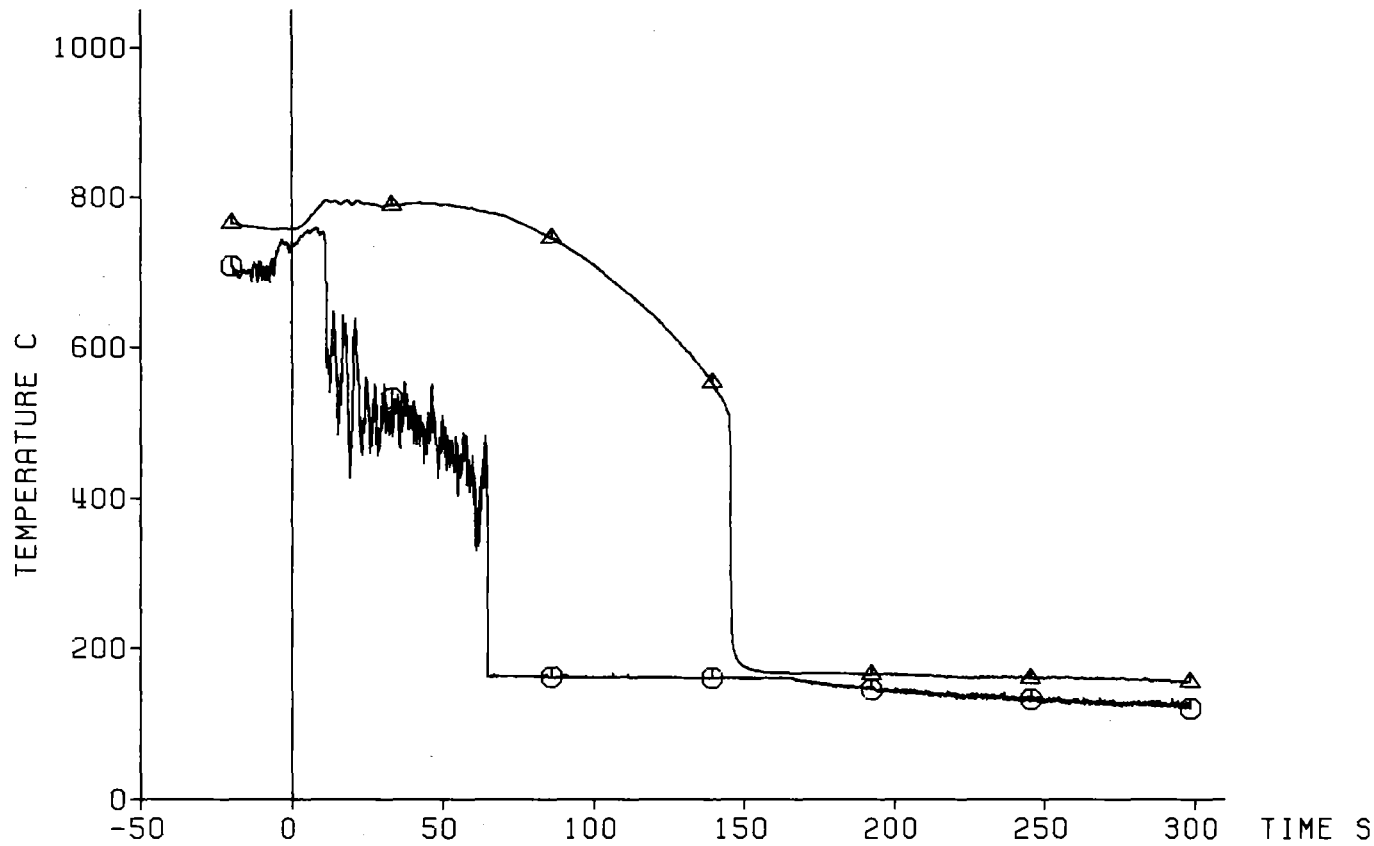

Decay Heat 120% ANS Standard
Flooding Rate (cold) 5.78 cm/s
System Pressure 5.91 bar
Feedwater Temperature 40 C

KIRB

Fig. 272 FEBA: 5x5 ROD BUNDLE, TEST SERIES 7, TEST-No. 330

Axial Level: 1625 mm

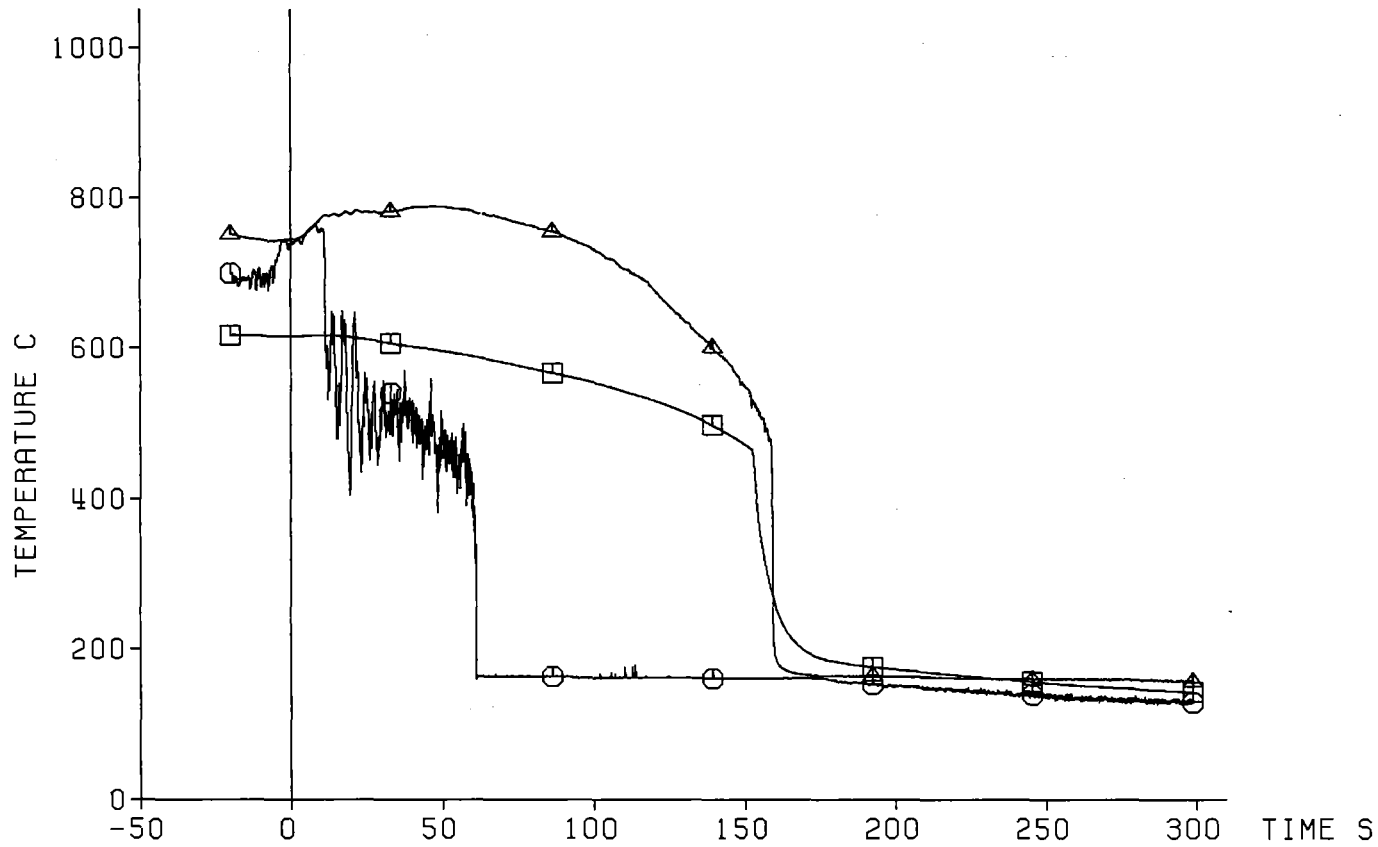

△ Cladding Temperature (19g1)
○ Fluid Temperature
□ Housing Temperature

Decay Heat 120% ANS Standard
Flooding Rate (cold) 5.78 cm/s
System Pressure 5.91 bar
Feedwater Temperature 40 C

— 306 —



Fig. 273 FEBA: 5x5 ROD BUNDLE, TEST SERIES 7, TEST-No. 330

Axial Level: 1135 mm

△ Cladding Temperature (8b3)
○ Fluid Temperature
□ Housing Temperature

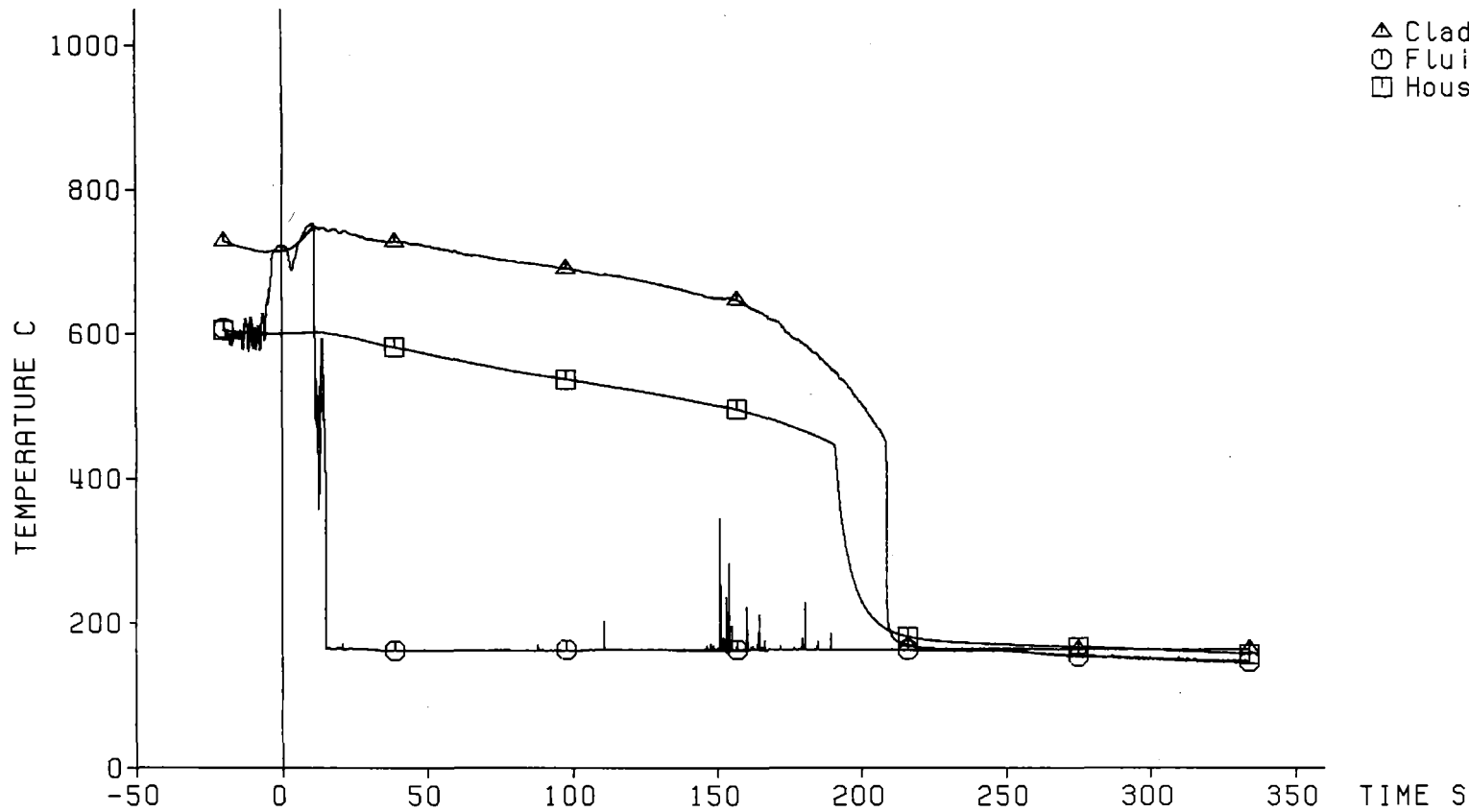

Decay Heat 120% ANS Standard
Flooding Rate (cold) 5.78 cm/s
System Pressure 5.91 bar
Feedwater Temperature 40 C

— 307 —

KIK IRB

Fig. 274 FEBA: 5x5 ROD BUNDLE, TEST SERIES 7, TEST-No. 330

Pressure Loss
Along the Test Section:

◇ Total Length: 4196 mm
△ Lower Part: 1711 mm
○ Middle Part: 545 mm
□ Upper Part: 1940 mm

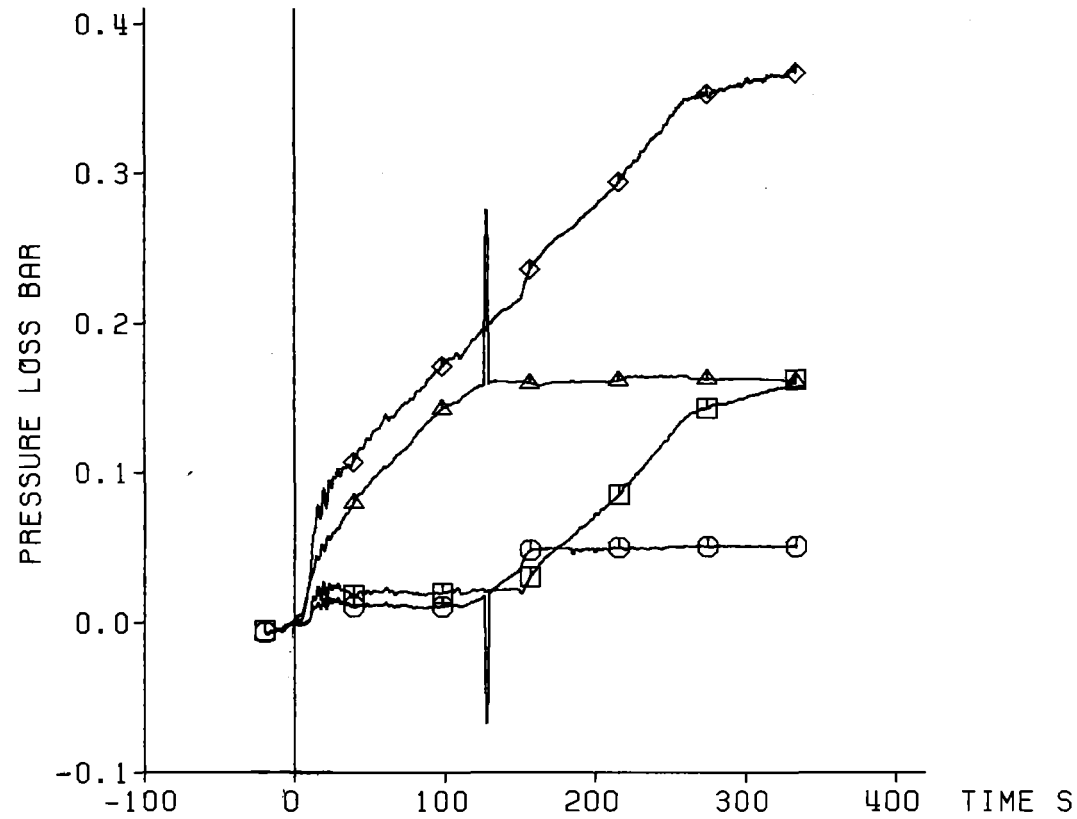

Decay Heat 120% ANS Standard
Flooding Rate (cold) 5.78 cm/s
System Pressure 5.91 bar
Feedwater Temperature 40 C

KIK IRB

Fig. 275 FEBA: 5x5 R0D BUNDLE, TEST SERIES 7, TEST-No. 330

Coolant Outlet Conditions:

△ Water Carry Over
○ Coolant Temperature
□ Coolant Pressure

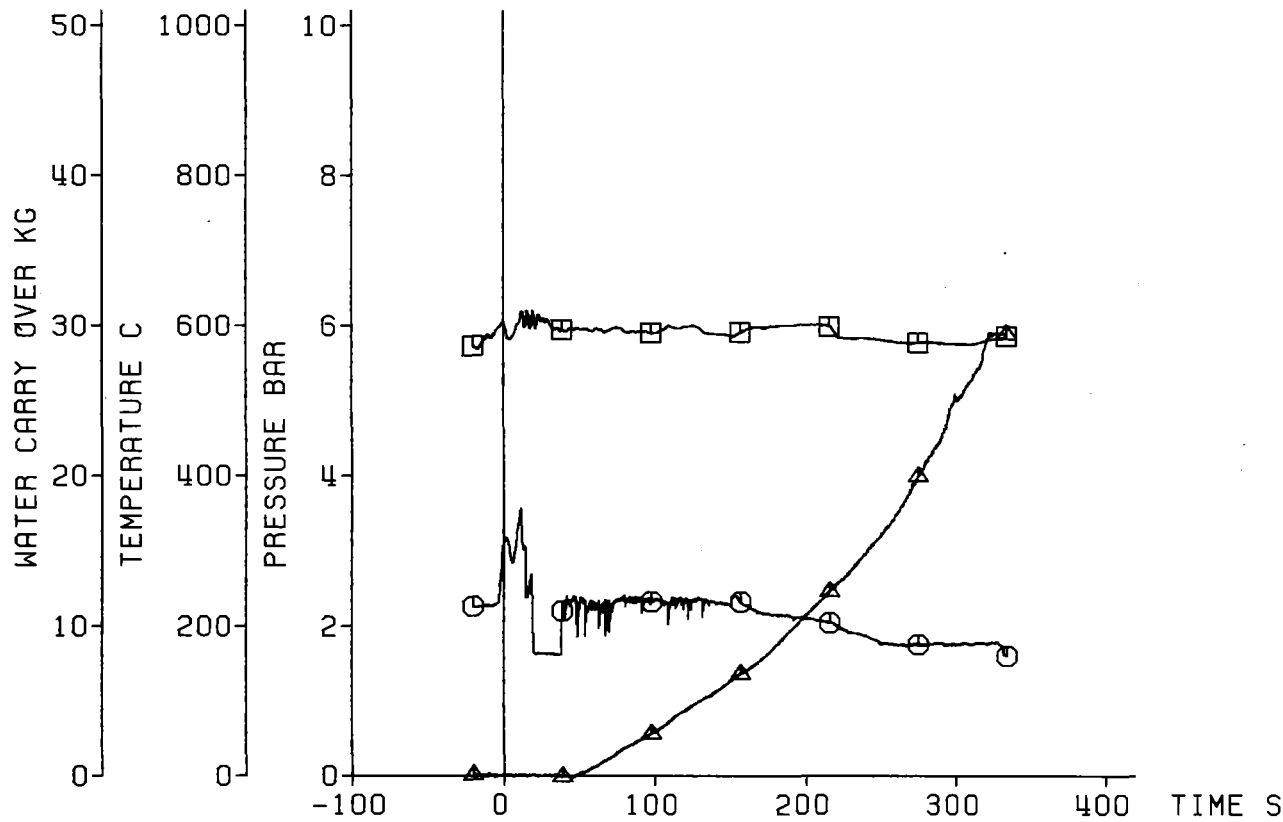

Decay Heat 120% ANS Standard
Flooding Rate (cold) 5.78 cm/s
System Pressure 5.91 bar
Feedwater Temperature 40 C



Fig. 276 FEBA: 5x5 ROD BUNDLE, TEST SERIES 7, TEST-NO. 330

Axial Position of Quench Front

□ Quenching of Sleeves at Bundle Midplane

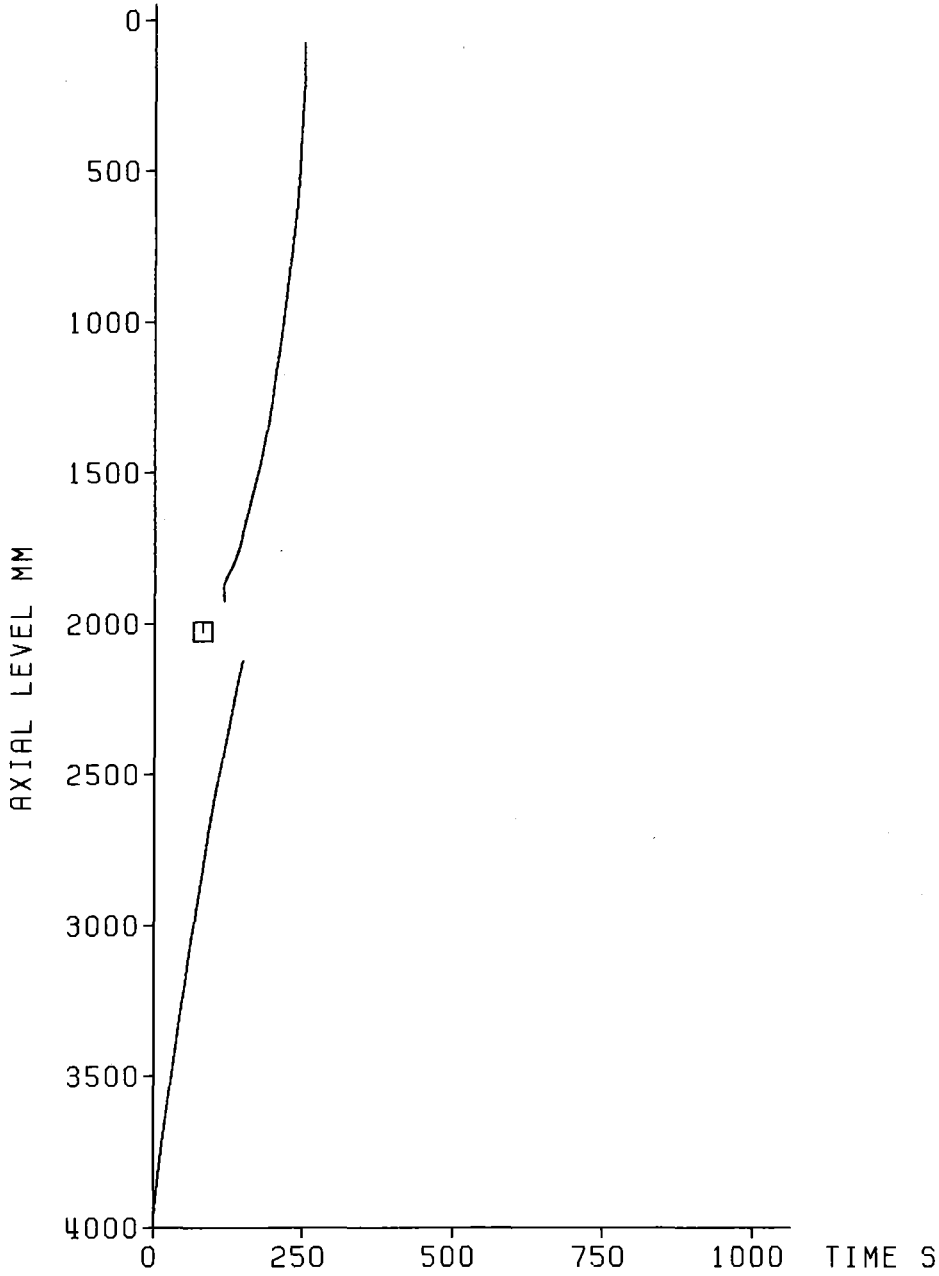

Decay Heat	120% ANS Standard
Flooding Rate (cold)	5.78 cm/s
System Pressure	5.91 bar
Feedwater Temperature	40 C



Fig. 277 FEBA: 5x5 ROD BUNDLE
TEST SERIES 7, TEST-No. 330

TEST SERIES VII

Investigation of the Effects of a 62% Flow Blockage Without Bypass,
Blockage at the Bundle Midplane of all Rods of the 5x5 Rod Bundle

Channel Listing and Data Identification for Test No. 321 Through 331

Channel No.	Data Identification		Unit	Remarks
	Type	Location		
1	Time (10 Scans/s)		s	t = 0: Start of Reflooding
2	Cladding Temperature	3b1. 45 ¹	°C	
3	Cladding Temperature	3b2. 590	°C	
4	Cladding Temperature	3b3.1135	°C	
5	Cladding Temperature	3b4.1680	°C	
6	Cladding Temperature	4b1.1625	°C	
7	Cladding Temperature	4b2.1725	°C	
8	Cladding Temperature	4b3.1825	°C	
9	Cladding Temperature	4b4.1925	°C	
10	Cladding Temperature	7a1.2225	°C	
11	Cladding Temperature	7a2.2770	°C	
12	Cladding Temperature	7a3.3315	°C	
13	Cladding Temperature	7a4.3860	°C	
14	Cladding Temperature	8b1. 45	°C	
15	Cladding Temperature	8b2. 590	°C	
16	Cladding Temperature	8b3.1135	°C	
17	Cladding Temperature	8b4.1680	°C	
18	Cladding Temperature	9e1.2075	°C	
19	Cladding Temperature	9e2.2125	°C	
20	Cladding Temperature	9e3.2175	°C	
21	Cladding Temperature	9e4.2225	°C	

TEST SERIES VII

Channel No.	Data Identification		Unit	Remarks
	Type	Location		
22	Cladding Temperature	10f1.2125 ¹	°C	
23	Cladding Temperature	10f2.2225	°C	
24	Cladding Temperature	10f3.2325	°C	
25	Cladding Temperature	10f4.2425	°C	
26	Cladding Temperature	12j1.1225	°C	
27	Cladding Temperature	12j2.1325	°C	
28	Cladding Temperature	12j3.1425	°C	
29	Cladding Temperature	12j4.1525	°C	
30	Cladding Temperature	13h1.1925	°C	
31	Cladding Temperature	13h2.2025	°C	
32	Cladding Temperature	13h3.2125	°C	
33	Cladding Temperature	13h4.2225	°C	
34	Cladding Temperature	14f1.2125	°C	
35	Cladding Temperature	14f2.2225	°C	
36	Cladding Temperature	14f3.2325	°C	
37	Cladding Temperature	14f4.2425	°C	
38	Cladding Temperature	15a1.2225	°C	
39	Cladding Temperature	15a2.2770	°C	
40	Cladding Temperature	15a3.3315	°C	
41	Cladding Temperature	15a4.3860	°C	
42	Cladding Temperature	17i1.1875	°C	
43	Cladding Temperature	17i2.1925	°C	
44	Cladding Temperature	17i3.1975	°C	
45	Cladding Temperature	17i4.2025	°C	
46	Cladding Temperature	18k1. 100	°C	
47	Cladding Temperature	18k2. 200	°C	
48	Cladding Temperature	18k3. 300	°C	
49	Cladding Temperature	18k4. 400	°C	

TEST SERIES VII

Channel No.	Data Identification		Unit	Remarks
	Type	Location		
50	Cladding Temperature	19g1.1625 ¹	°C	
51	Cladding Temperature	19g2.1725	°C	
52	Cladding Temperature	19g3.1825	°C	
53	Cladding Temperature	19g4.1925	°C	
54	Cladding Temperature	21i1.1875	°C	
55	Cladding Temperature	21i2.1925	°C	
56	Cladding Temperature	21i3.1975	°C	
57	Cladding Temperature	21i4.2025	°C	
58	Cladding Temperature	22d1.2025	°C	
59	Cladding Temperature	22d2.2025	°C	
60	Cladding Temperature	22d3.2025	°C	
61	Cladding Temperature	22d4.2025	°C	
62	Cladding Temperature	23d1.2025	°C	
63	Cladding Temperature	23d2.2025	°C	
64	Cladding Temperature	23d3.2025	°C	
65	Cladding Temperature	23d4.2025	°C	
66	Sleeve Temperature	TH ² 18.2025	°C	
67	Sleeve Temperature	TH ³ 13.2025	°C	
68	Sleeve Temperature	TH ⁴ 21.2025	°C	
69	Sleeve Temperature	TH ⁵ 17.2025	°C	
70	Sleeve Temperature	TH ⁶ 17.2064	°C	
71	Sleeve Temperature	TH ⁶ 17.1972	°C	
72	Sleeve Temperature	TH ⁶ 17.2025	°C	
73	Fluid Temperature	TF ⁷ 300	°C	
74	Fluid Temperature	TF 485	°C	
75	Fluid Temperature	TF 1135	°C	
76	Fluid Temperature	TF 1625	°C	
77	Fluid Temperature	TF 1725	°C	
78	Fluid Temperature	TF 1825	°C	

TEST SERIES VII

Channel No.	Data Identification		Unit	Remarks
	Type	Location		
79	Fluid Temperature	TF ⁷ 1925	°C	TC Failed
80	Fluid Temperature	TF 2240	°C	
81	Fluid Temperature	TF 2380	°C	
82	Fluid Temperature	TF 2770	°C	
83	Fluid Temperature	TF 3038	°C	
84	Fluid Temperature	TF 3315	°C	
85	Housing Temperature	TK ⁸ 283	°C	
86	Housing Temperature	TK 590	°C	
87	Housing Temperature	TK 1135	°C	
88	Housing Temperature	TK 1625	°C	
89	Housing Temperature	TK 1825	°C	
90	Housing Temperature	TK 2025	°C	
91	Housing Temperature	TK 2235	°C	
92	Housing Temperature	TK 2770	°C	
93	Housing Temperature	TK 3018	°C	
94	Housing Temperature	TK 3315	°C	
95	Fluid Temperature	Lower Plenum	°C	
96	Fluid Temperature	Upper Plenum	°C	
97	Feedwater Temperature		°C	
98	Room Temperature		°C	
99	Electrical Power Input	8 Rods	kW	Rods No. 1 Through 8
100	Electrical Power Input	8 Rods	kW	Rods No. 9 Through 16
101	Electrical Power Input	9 Rods	kW	Rods No. 17 Through 25
102	Water Level Detector	4012 mm	°C	Heated + Unheated TC's
103	Water Level Detector	3932 mm	°C	Heated + Unheated TC's
104	Pressure in Buffer		bar	
105	Flooding Velocity (cold)		cm/s	

TEST SERIES VII

Channel No.	Data Identification		Unit	Remarks
	Type	Location		
106	Pressure in Upper Plenum	-105 mm	bar	
107	Pressure in Lower Plenum	4091 mm	bar	
108	Bundle Power		kW	Channels: 81 + 82 + 83
109	Water Carry Over Collected		kg	Downstream of Bundle Exit
110	Pressure Diff.	1835 and -105 mm	bar	Values Measured Separately
111	Measured	2380 and 1835 mm	bar	
112	Between	4091 and 2380 mm	bar	
113	Axial Level	4091 and -105 mm	bar	

- 1) TC's of 0.5 mm diameter embedded in rod cladding. Measuring position:
Example: rod No. = 3, type of rod instrumentation = b, TC No. = 1,
axial level = 45 mm, referenced to the top flange of the bundle.
- 2) TH = TC's of 0.5 mm diameter embedded in sleeve. Measuring position:
Example: rod No. 18, axial level = 2025 mm. Corresponding subchannel
surrounded by rods No. 18, 17, 12 and 13.
- 3) TH = TC embedded in sleeve of rod No. 13. Corresponding subchannel sur-
rounded by rods No. 13, 18, 17 and 12.
- 4) TH = TC embedded in sleeve of rod No. 21. Corresponding subchannel sur-
rounded by rods No. 21, 16, 17 and 22.
- 5) TH = TC embedded in sleeve of rod No. 17. Corresponding subchannel sur-
rounded by rods No. 17, 12, 13 and 18.
- 6) TH = TC embedded in sleeve of rod No. 17. Corresponding subchannel sur-
rounded by rods No. 17, 22, 21 and 16.
- 7) TF = TC's of 0.25 mm diameter (bare) placed in subchannel surrounded by
rods No. 12, 17, 16 and 11.
- 8) TK = TC's of 0.5 mm diameter placed in the wall of the bundle housing of
of 6.5 mm thickness.

TEST SERIES VIII

Investigation of the Effects of a 90% Flow Blockage Without Bypass,
Blockage at the Bundle Midplane of all Rods of the 5x5 Rod Bundle

Test No.	Flooding Velocity (cold) cm/s	System Pressure bar	Feedwater Temp. ¹ °C		Bundle Power ² kW		Remarks
			0-30 s	End	0 s	Transient	
342	2.2	2.2	51	41	200	120% ANS	Figs. 280 Through 305
338	2.2	4.1	61	44	200	120% ANS	Figs. 306 Through 331
341	3.8	2.2	52	41	200	120% ANS	Figs. 332 Through 357
337	3.8	4.0	57	42	200	120% ANS	Figs. 358 Through 383
334	3.8	5.8	66	43	200	120% ANS	Figs. 384 Through 409
340	5.8	2.2	54	41	200	120% ANS	Figs. 410 Through 435
336	5.8	4.1	53	41	200	120% ANS	Figs. 436 Through 461
333	5.8	5.8	60	43	200	120% ANS	Figs. 462 Through 487
346	Steam	2.0	--	--	Low Power		Data Not Plotted
339	Steam	4.0	--	--	Low Power		Data Not Plotted
335	Steam	6.0	--	--	Low Power		Data Not Plotted

1) Measured in the lower plenum

2) Decay heat transient corresponding 120% ANS Standard 40 s after shutdown
of the reactor

Table 4 FEBA 5x5 rod bundle: Main test parameters of test series VIII

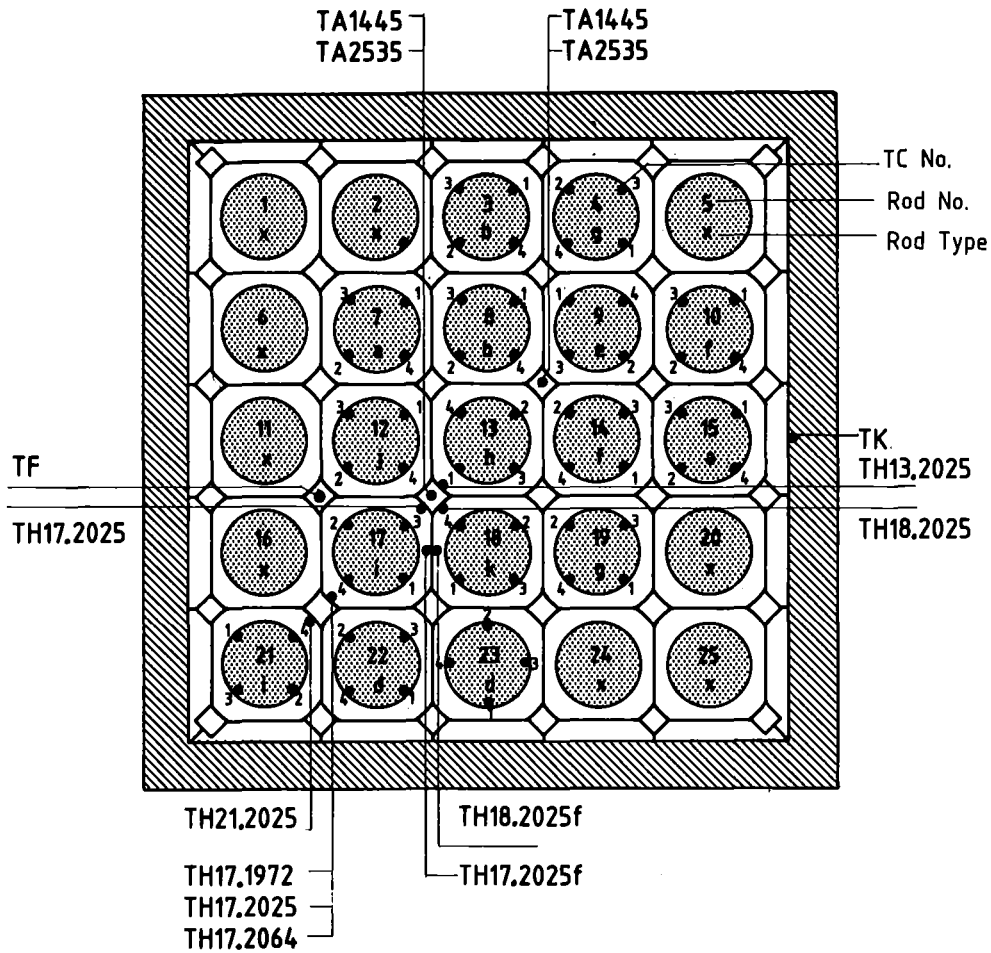

Rod Type	TC No.	Axial Level mm
a	1	2225
	2	2770
	3	3315
	4	3860
b	1	45
	2	590
	3	1135
	4	1680
c	1	3725
	2	3825
	3	3925
	4	4025
d	1	2025
	2	2025
	3	2025
	4	2025

Rod Type	TC No.	Axial Level mm
e	1	2075
	2	2125
	3	2175
	4	2225
f	1	2125
	2	2225
	3	2325
	4	2425
g	1	1625
	2	1725
	3	1825
	4	1925
h	1	1925
	2	2025
	3	2125
	4	2225

Rod Type	TC No.	Axial Level mm
i	1	1875
	2	1925
	3	1975
	4	2025
j	1	1225
	2	1325
	3	1425
	4	1525
k	1	100
	2	200
	3	300
	4	400
x	without TC's	

Fig. 278 5x5 rod bundle: Radial and axial location of cladding, sleeve, spacer, fluid and housing TC's for test series VIII

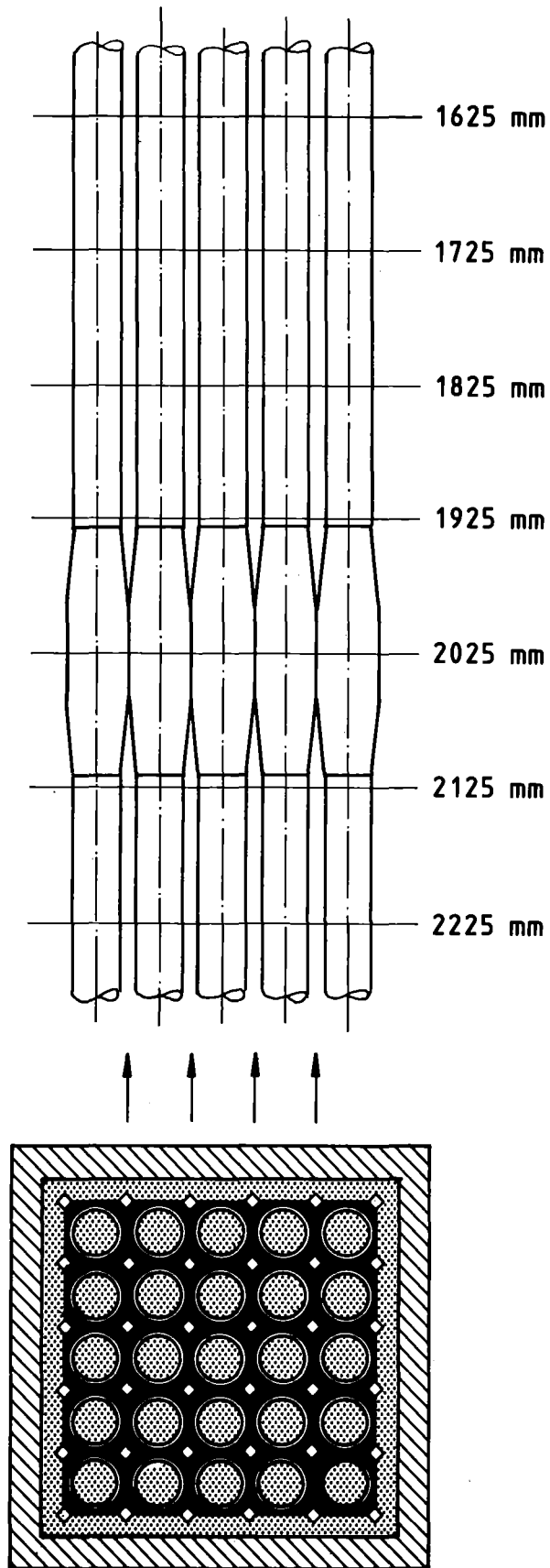
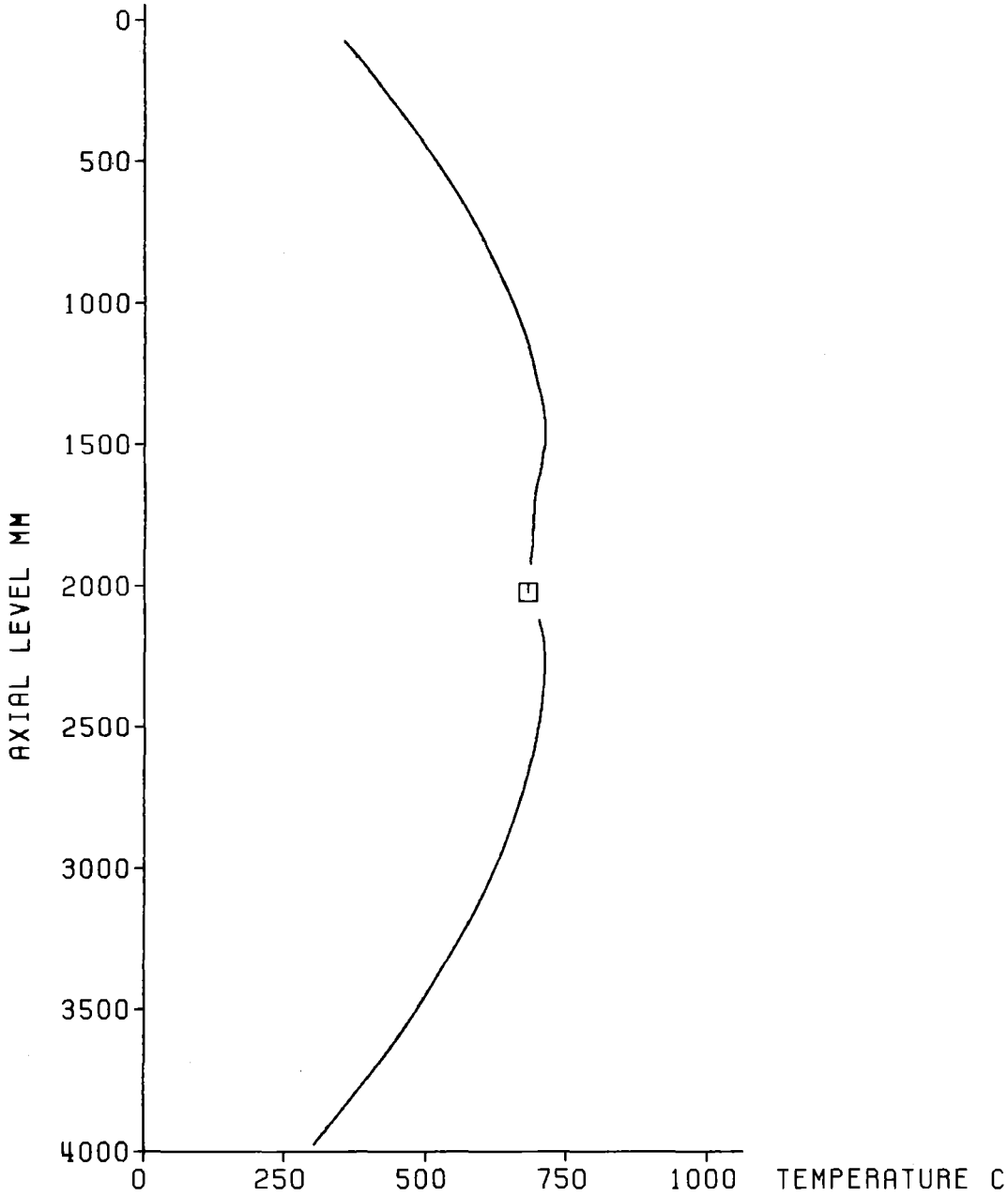

Fig. 279 5x5 rod bundle: Layout of the bundle geometry of test series VIII

Initial Axial Temperature Profile of Claddings

□ Initial Temperature of Sleeves at Bundle Midplane



Decay Heat	120% ANS Standard
Flooding Rate (cold)	2.22 cm/s
System Pressure	2.22 bar
Feedwater Temperature	40 C



Fig. 280 FEBA: 5x5 ROD BUNDLE
TEST SERIES 8, TEST-NO. 342

Test Parameters:

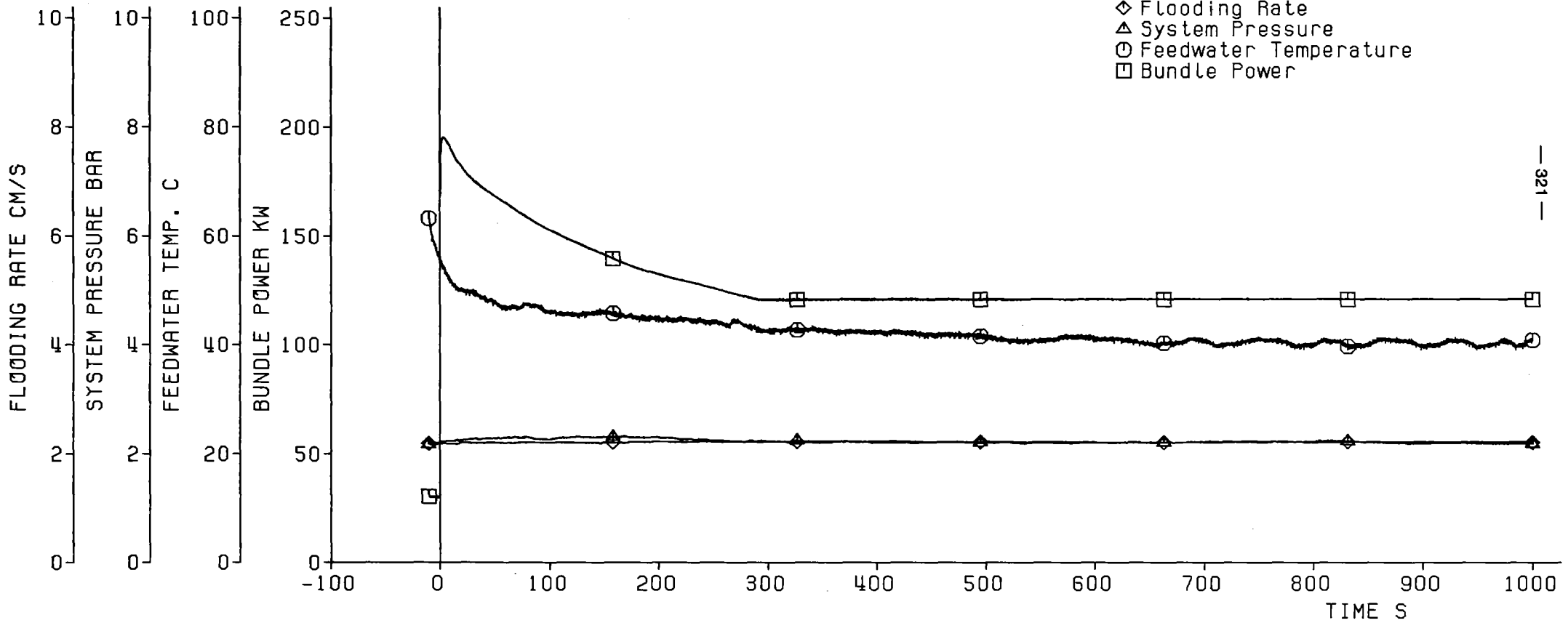

Decay Heat 120% ANS Standard
Flooding Rate (cold) 2.22 cm/s
System Pressure 2.22 bar
Feedwater Temperature 40 C



Fig. 281 FEBA: 5x5 ROD BUNDLE, TEST SERIES 8, TEST-NO. 342

Cladding Temperature

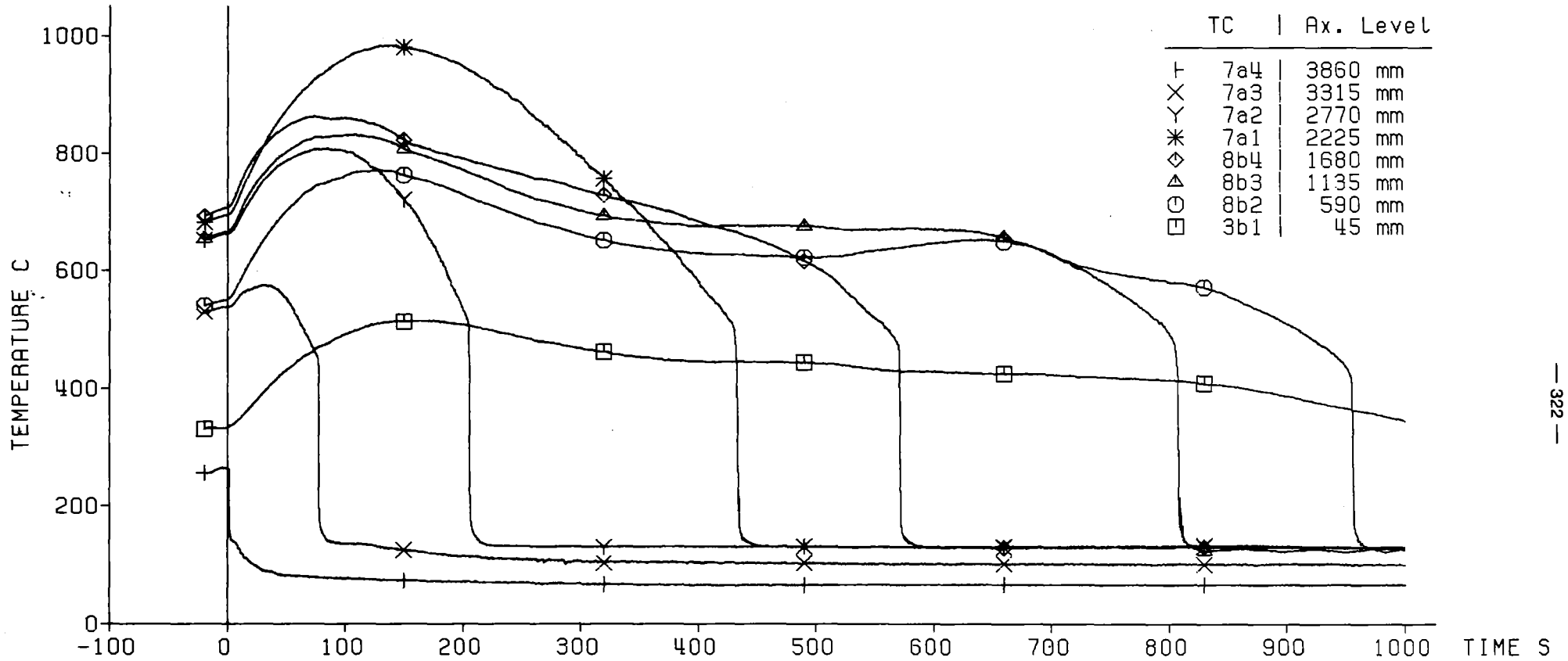

Decay Heat 120% ANS Standard
 Flooding Rate (cold) 2.22 cm/s
 System Pressure 2.22 bar
 Feedwater Temperature 40 C



Fig. 282 FEBA: 5x5 ROD BUNDLE, TEST SERIES 8, TEST-No. 342

Heat Transfer Coeff.

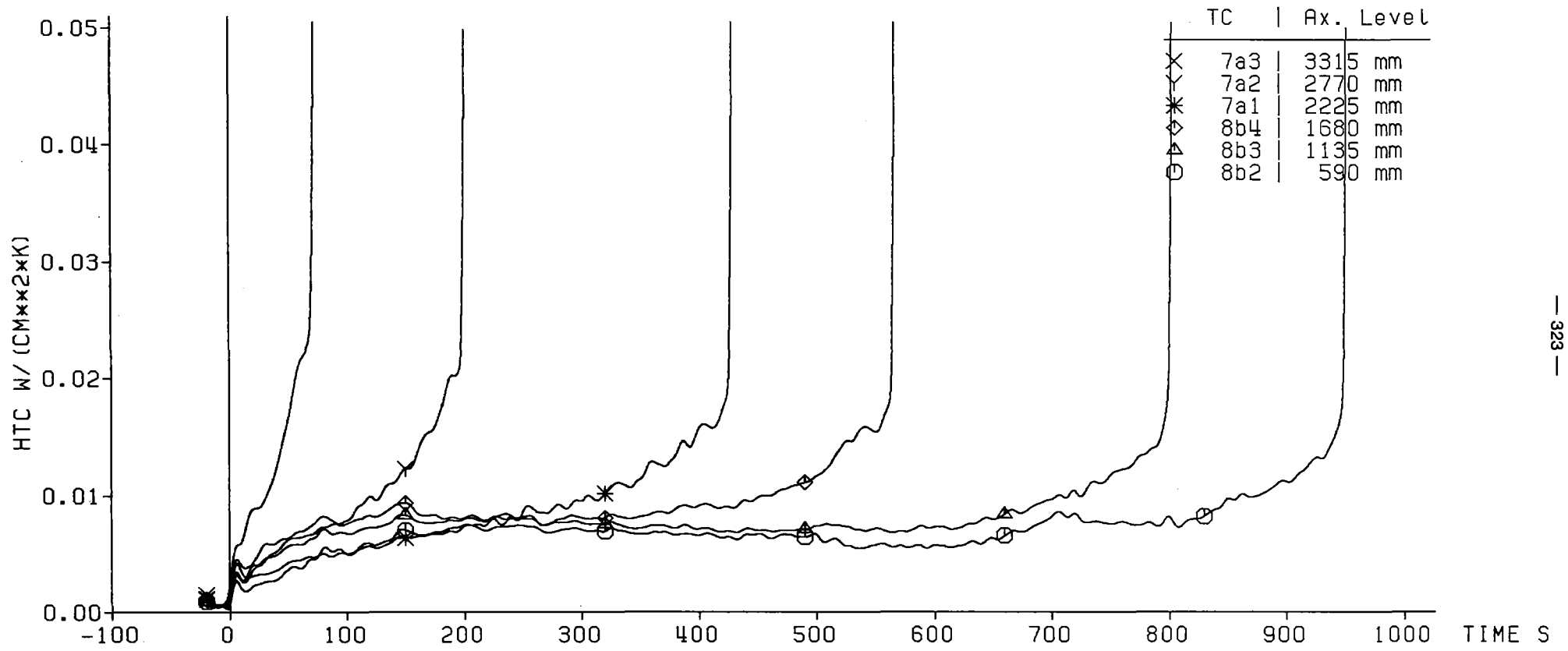

— 323 —

Decay Heat 120% ANS Standard
 Flooding Rate (cold) 2.22 cm/s
 System Pressure 2.22 bar
 Feedwater Temperature 40 C



Fig. 283 FEBA: 5x5 ROD BUNDLE, TEST SERIES 8, TEST-No. 342

Cladding Temperature

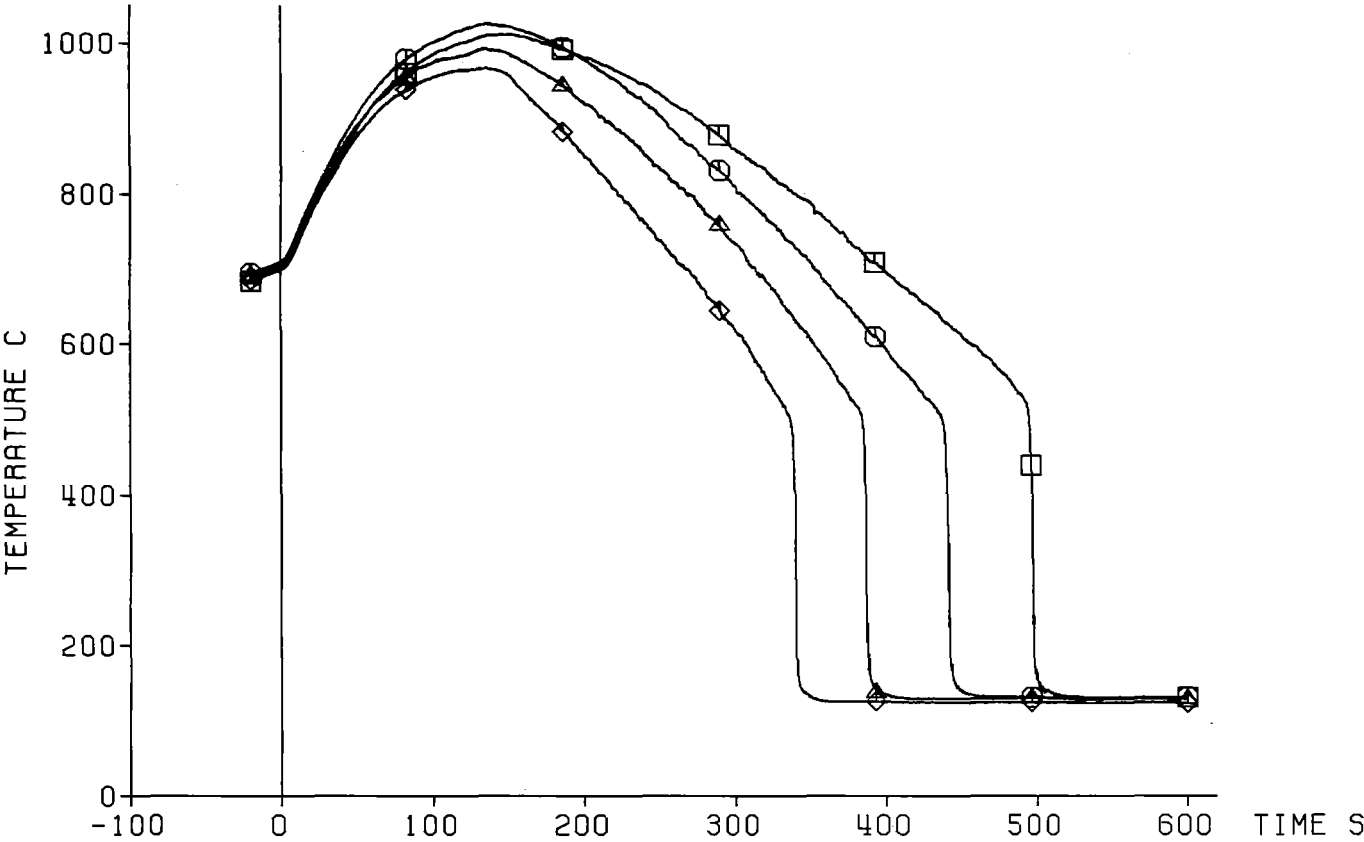

TC	Ax. Level
◇	14f4 2425 mm
△	14f3 2325 mm
○	14h2 2225 mm
□	14f1 2125 mm

Decay Heat 120% ANS Standard
 Flooding Rate (cold) 2.22 cm/s
 System Pressure 2.22 bar
 Feedwater Temperature 40 C



Fig. 284 FEBA: 5x5 ROD BUNDLE, TEST SERIES 8, TEST-No. 342

Heat Transfer Coeff.

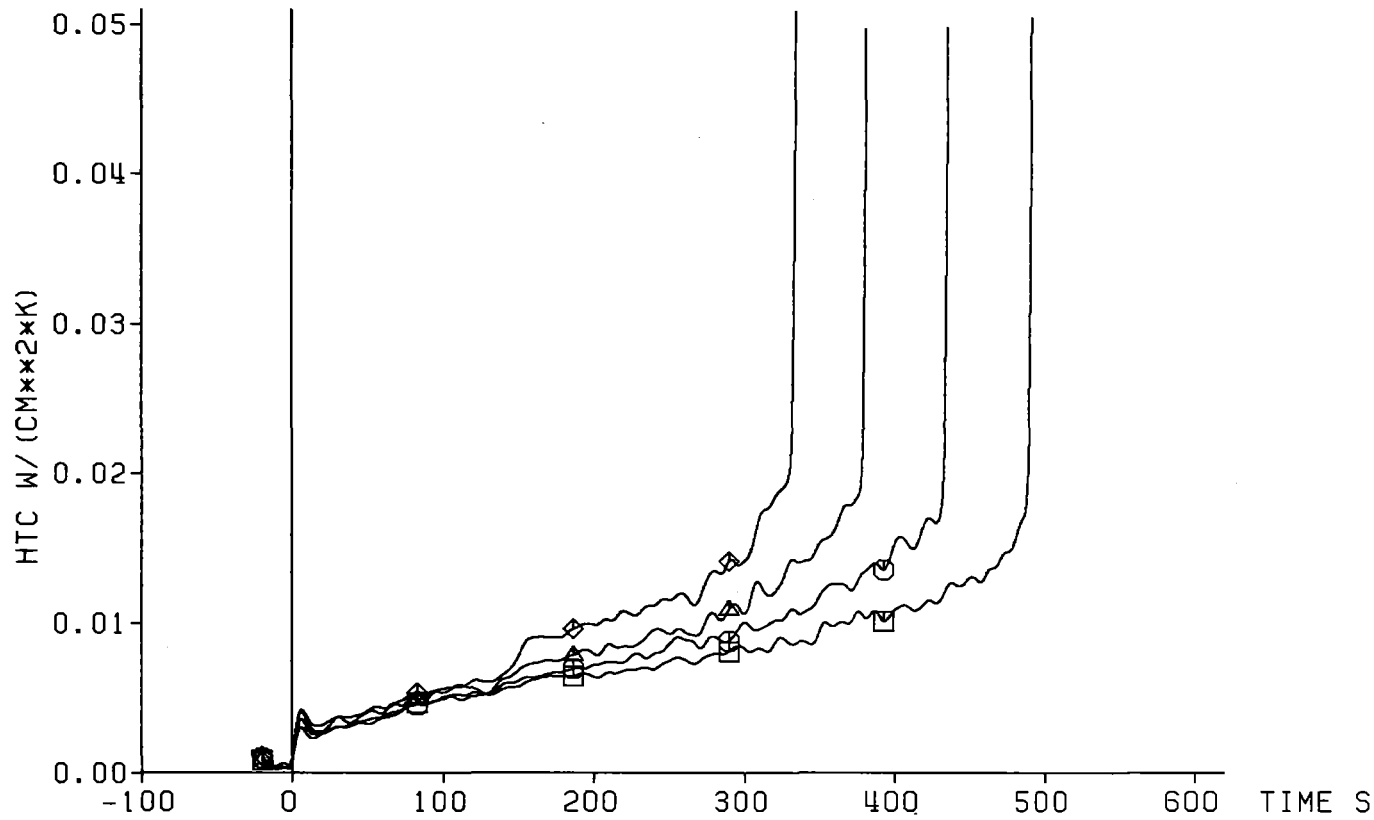

TC	Ax. Level
◇ 14f4	2425 mm
△ 14f3	2325 mm
○ 14h2	2225 mm
□ 14f1	2125 mm

Decay Heat 120% ANS Standard
 Flooding Rate (cold) 2.22 cm/s
 System Pressure 2.22 bar
 Feedwater Temperature 40 C



Fig. 285 FEBA: 5x5 ROD BUNDLE, TEST SERIES 8, TEST-NO. 342

Cladding Temperature

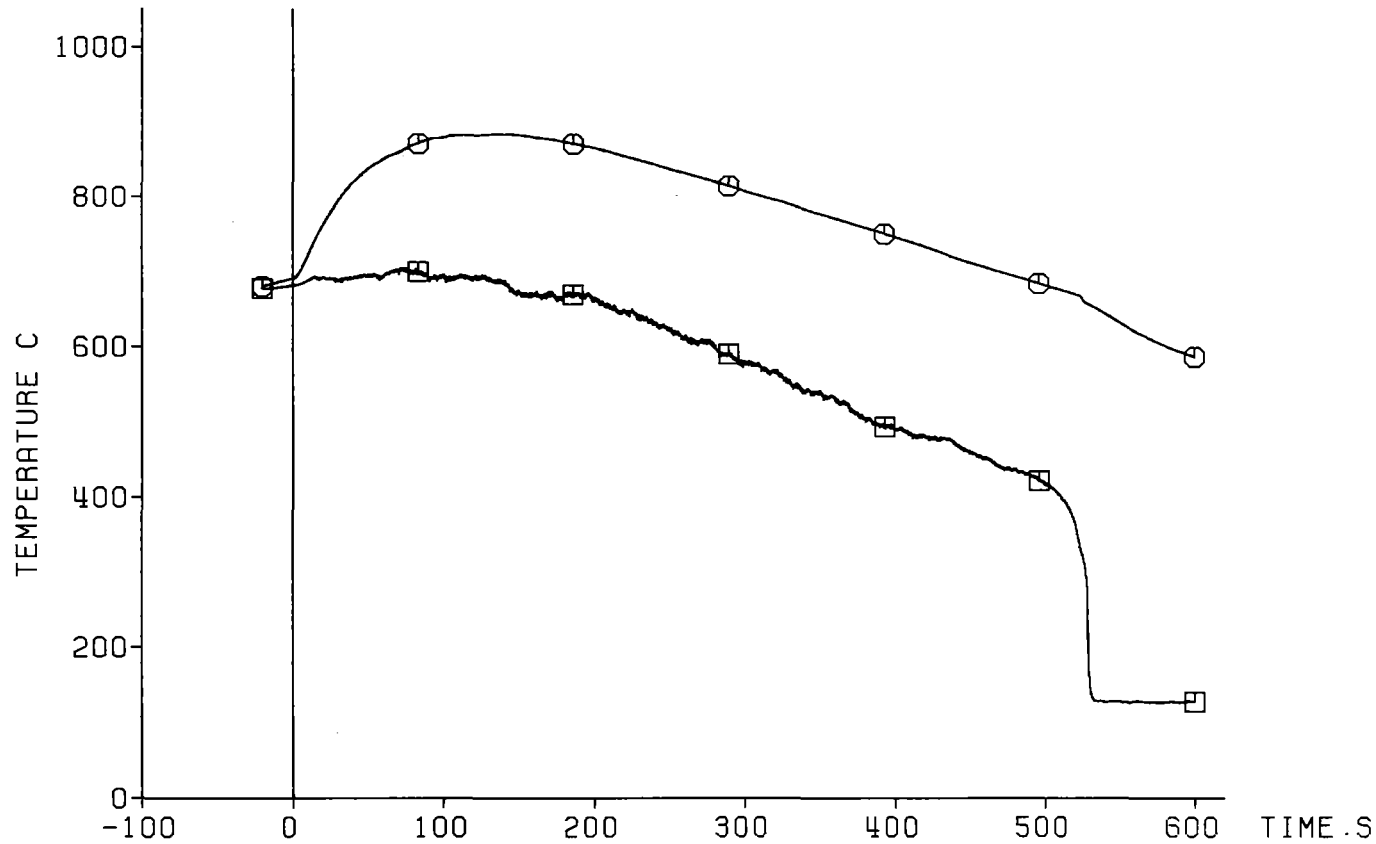

TC	Ax. Level
○ 17i4	2025 mm
□ Sleeve	2025 mm

Decay Heat 120% ANS Standard
 Flooding Rate (cold) 2.22 cm/s
 System Pressure 2.22 bar
 Feedwater Temperature 40 C



Fig. 286 FEBA: 5x5 ROD BUNDLE, TEST SERIES 8, TEST-NO. 342

Sleeve Temperature
 Contact Face: Rods 17 and 18

TC	Ax. Level
⊖	Sleeve 2025 mm (Rod 17)
⊞	Sleeve 2025 mm (Rod 18)

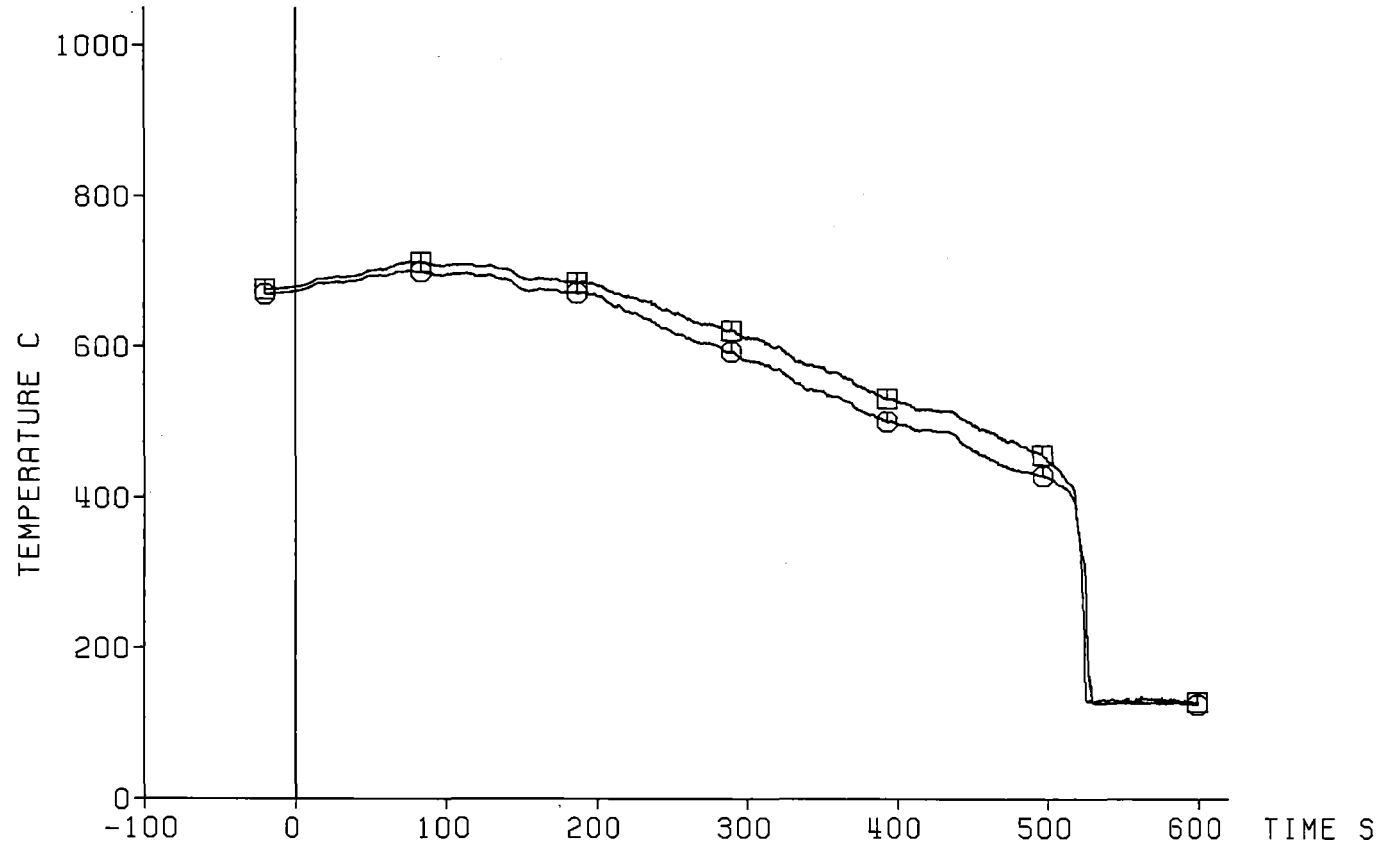

— 327 —

Decay Heat 120% ANS Standard
 Flooding Rate (cold) 2.22 cm/s
 System Pressure 2.22 bar
 Feedwater Temperature 40 C



Fig. 287 FEBA: 5x5 ROD BUNDLE, TEST SERIES 8, TEST-No. 342

Cladding Temperature

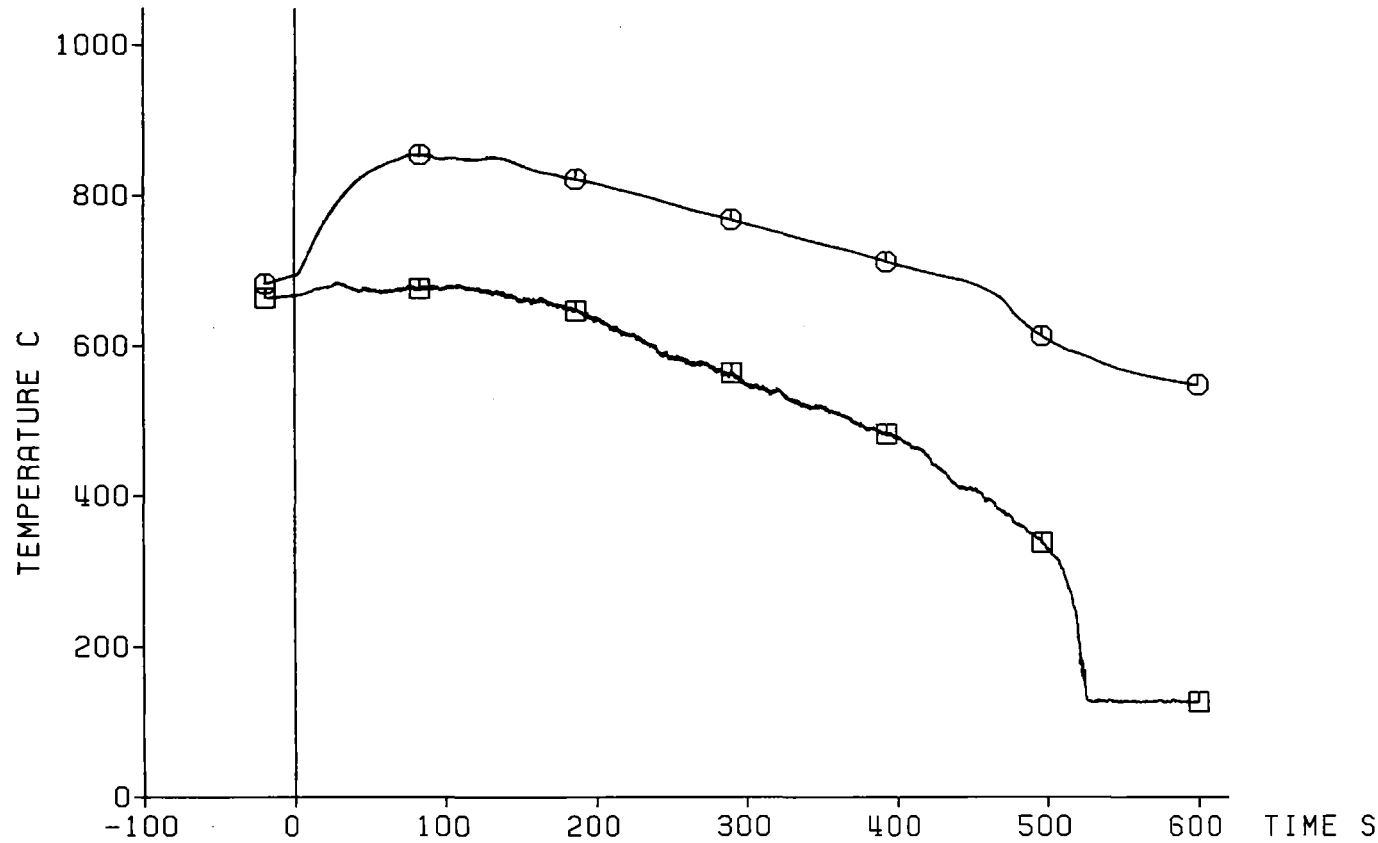

TC	Ax. Level
⊙ 17i3	1975 mm
⊠ Sleeve	1972 mm

Decay Heat 120% ANS Standard
 Flooding Rate (cold) 2.22 cm/s
 System Pressure 2.22 bar
 Feedwater Temperature 40 C



Fig. 288 FEBA: 5x5 ROD BUNDLE, TEST SERIES 8, TEST-No. 342

Cladding Temperature

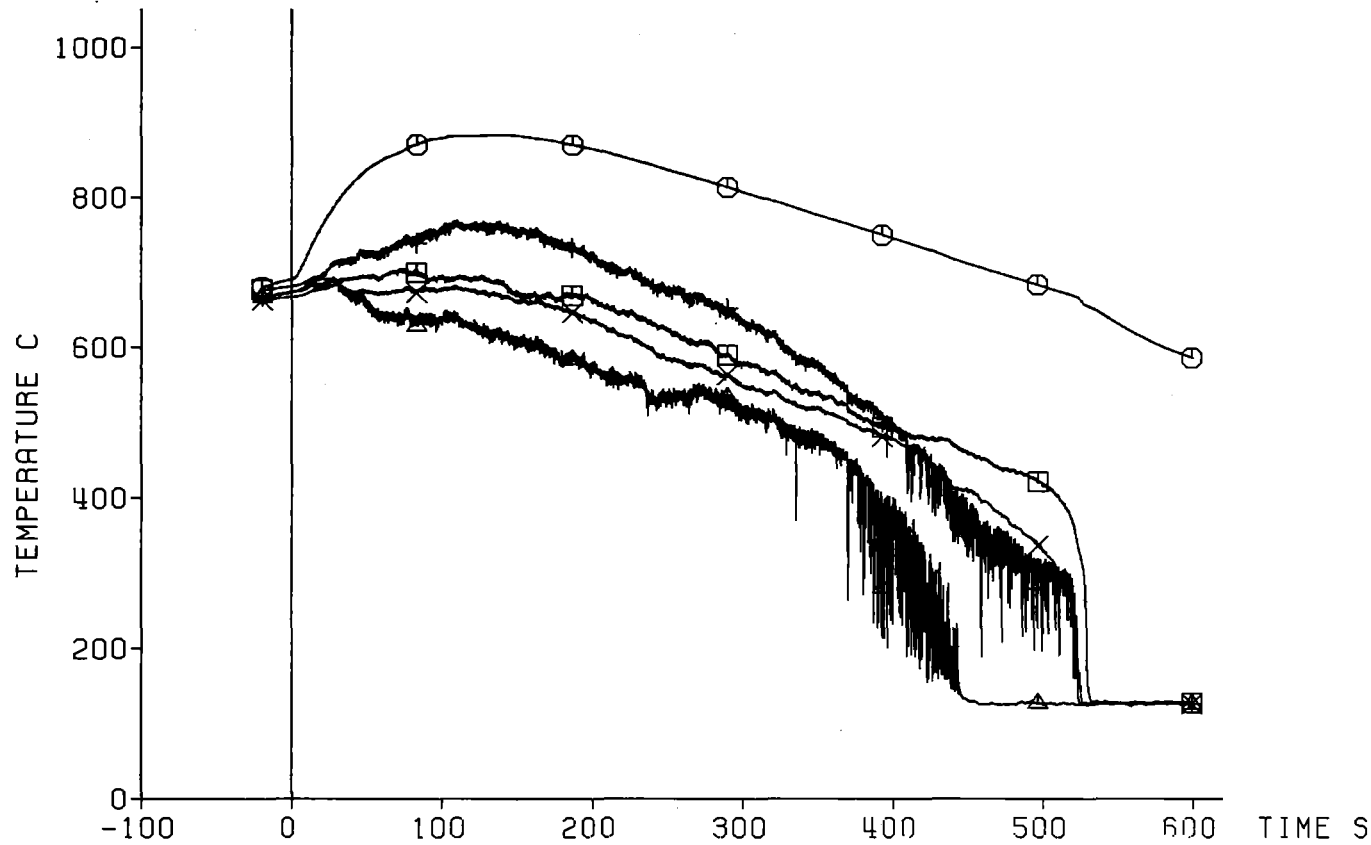

TC	Ax. Level
⊙	1714 2025 mm
+	Sleeve 2064 mm
□	Sleeve 2025 mm
△	Sleeve 2025 mm
×	Sleeve 1972 mm

Decay Heat 120% ANS Standard
 Flooding Rate (cold) 2.22 cm/s
 System Pressure 2.22 bar
 Feedwater Temperature 40 C



Fig. 289 FEBA: 5x5 ROD BUNDLE, TEST SERIES 8, TEST-No. 342

Cladding Temperature

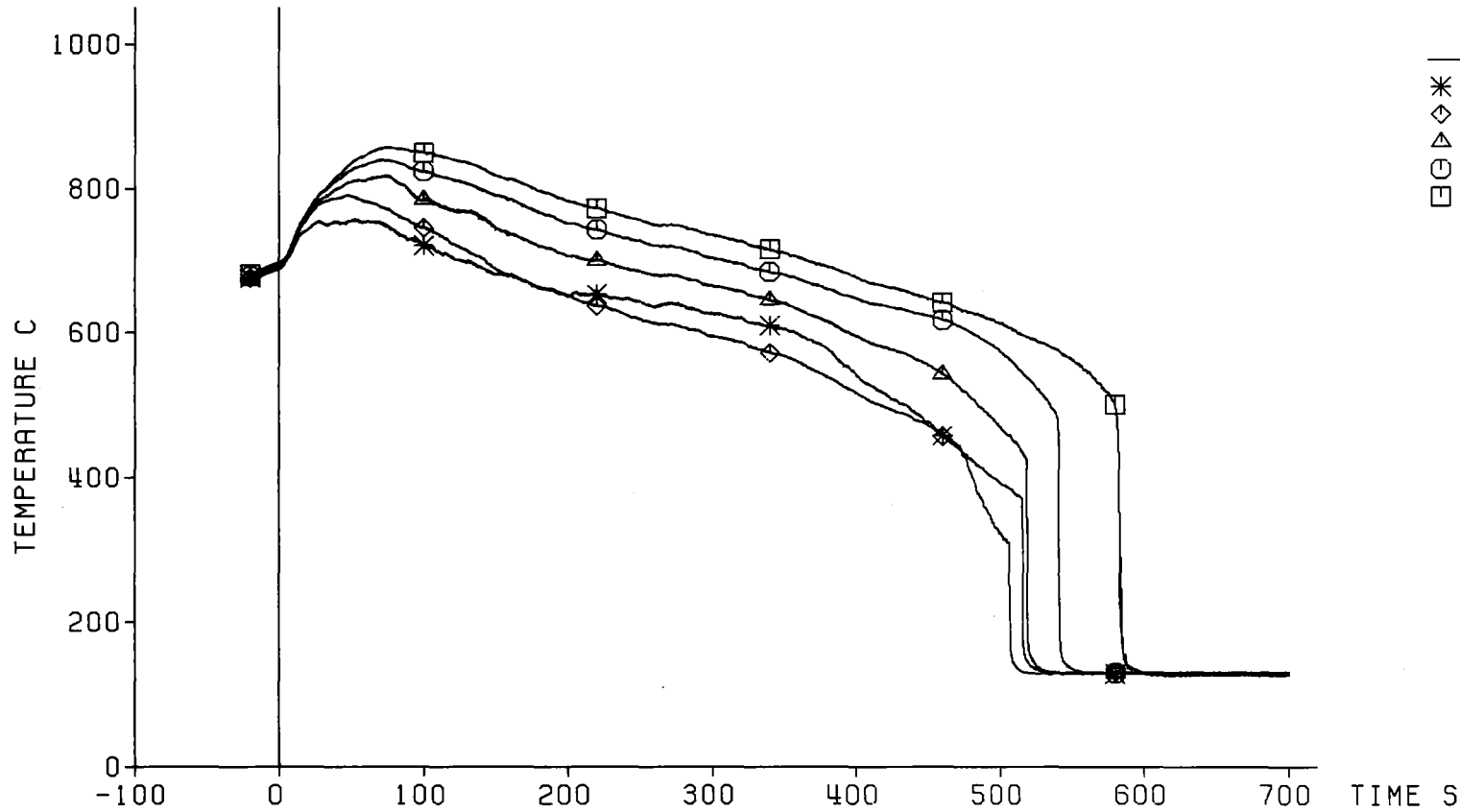

Decay Heat 120% ANS Standard
 Flooding Rate (cold) 2.22 cm/s
 System Pressure 2.22 bar
 Feedwater Temperature 40 C



Fig. 290 FEBA: 5x5 ROD BUNDLE, TEST SERIES 8, TEST-No. 342

Heat Transfer Coeff.

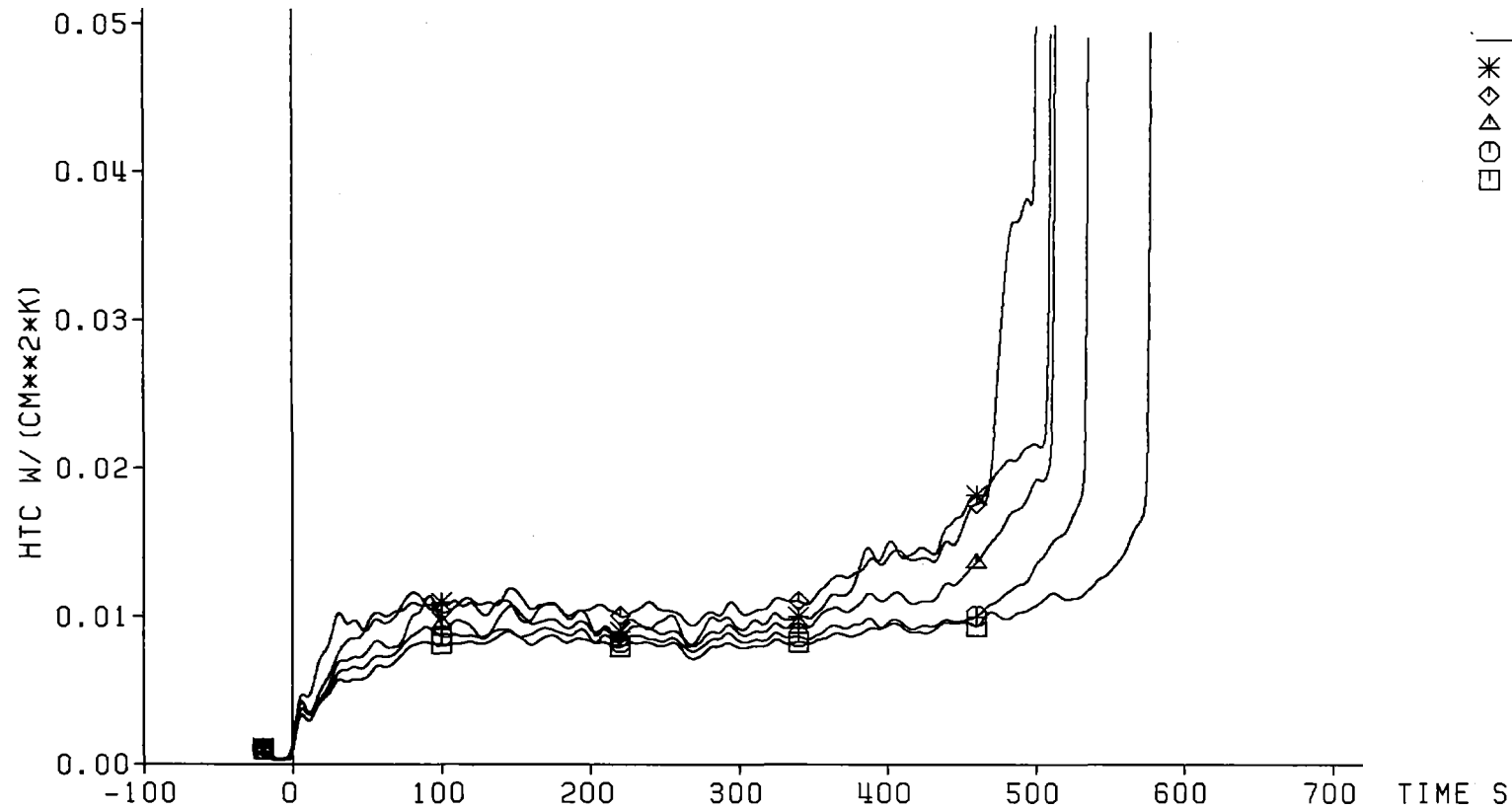

Decay Heat 120% ANS Standard
 Flooding Rate (cold) 2.22 cm/s
 System Pressure 2.22 bar
 Feedwater Temperature 40 C



Fig. 291 FEBA: 5x5 ROD BUNDLE, TEST SERIES 8, TEST-No. 342

Cladding Temperature

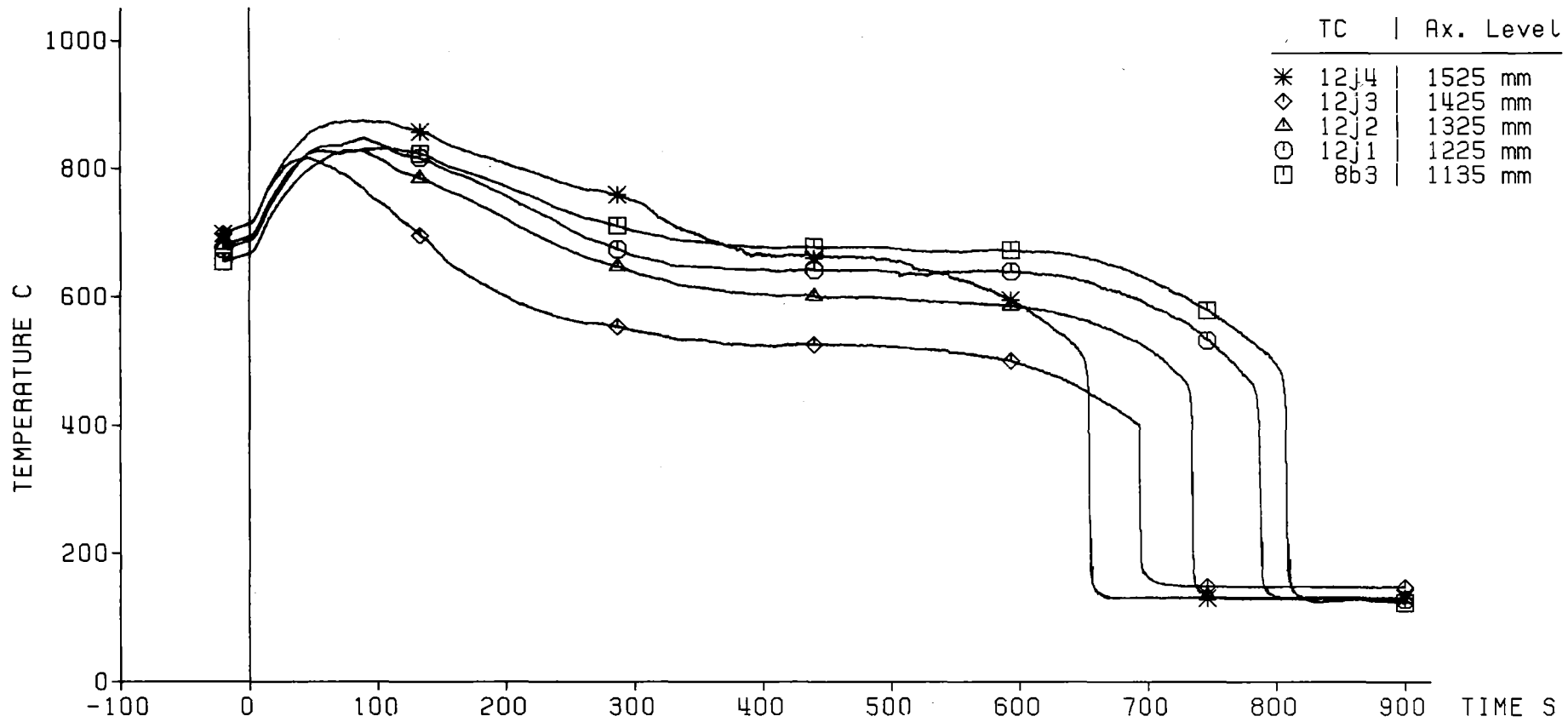

Decay Heat 120% ANS Standard
 Flooding Rate (cold) 2.22 cm/s
 System Pressure 2.22 bar
 Feedwater Temperature 40 C



Fig. 292 FEBA: 5x5 ROD BUNDLE, TEST SERIES 8, TEST-No. 342

Heat Transfer Coeff.

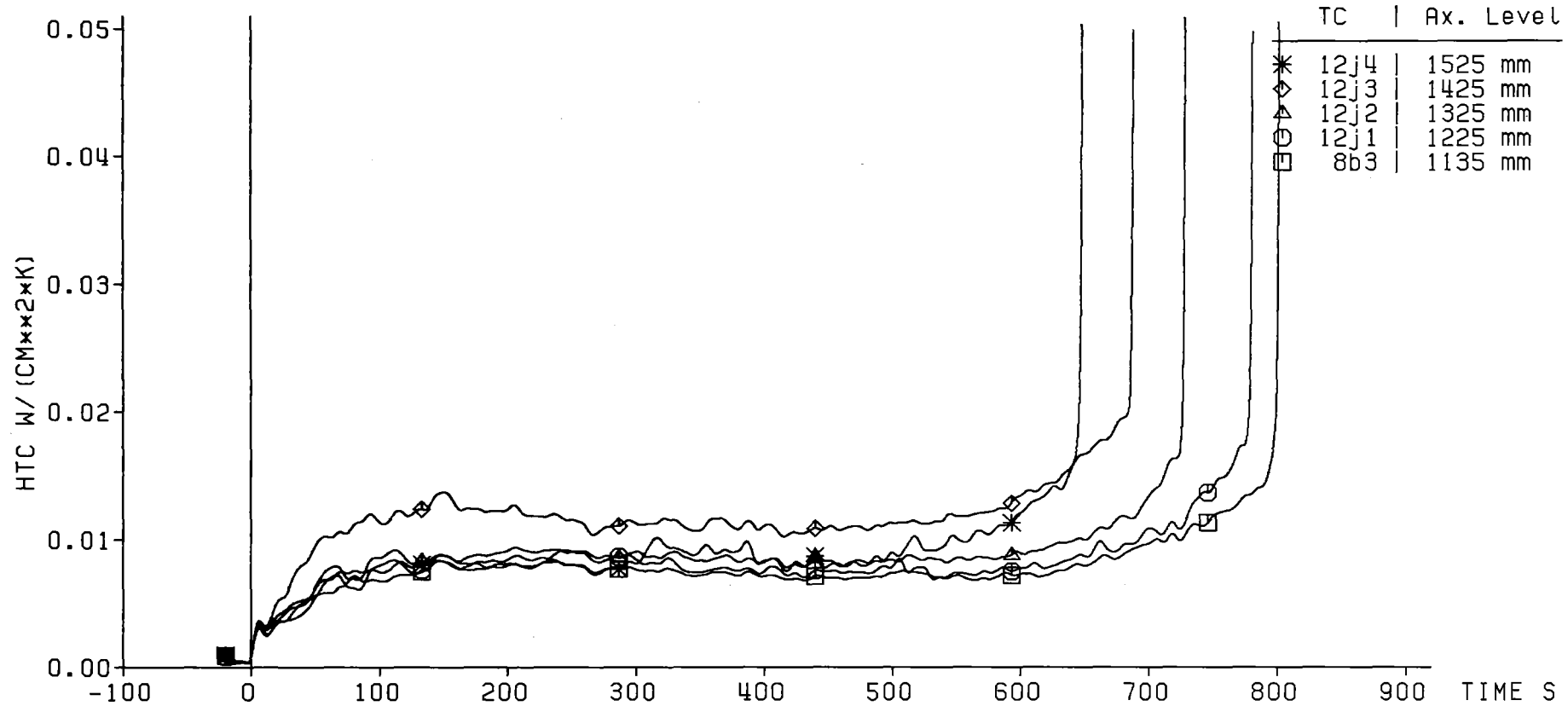

Decay Heat 120% ANS Standard
 Flooding Rate (cold) 2.22 cm/s
 System Pressure 2.22 bar
 Feedwater Temperature 40 C



Fig. 293 FEBA: 5x5 ROD BUNDLE, TEST SERIES 8, TEST-No. 342

Grid Spacer Temperature

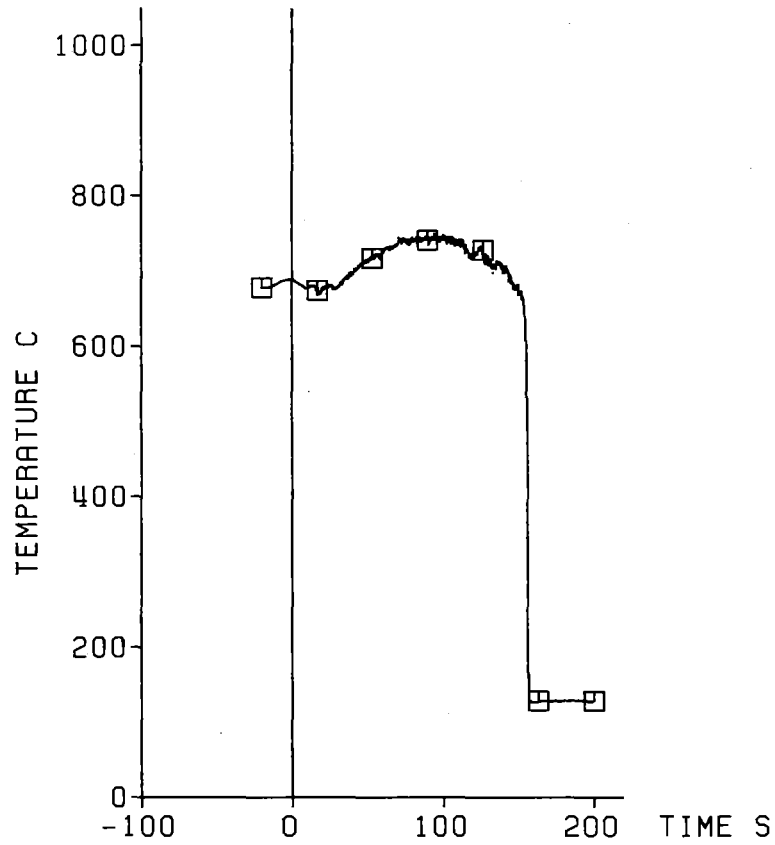

TC	Axial Level
69	2535 mm

Decay Heat 120% ANS Standard
Flooding Rate (cold) 2.22 cm/s
System Pressure 2.22 bar
Feedwater Temperature 40 C

— 334 —



Fig. 294 FEBA: 5x5 ROD BUNDLE, TEST SERIES 8, TEST-No. 342

Grid Spacer Temperature

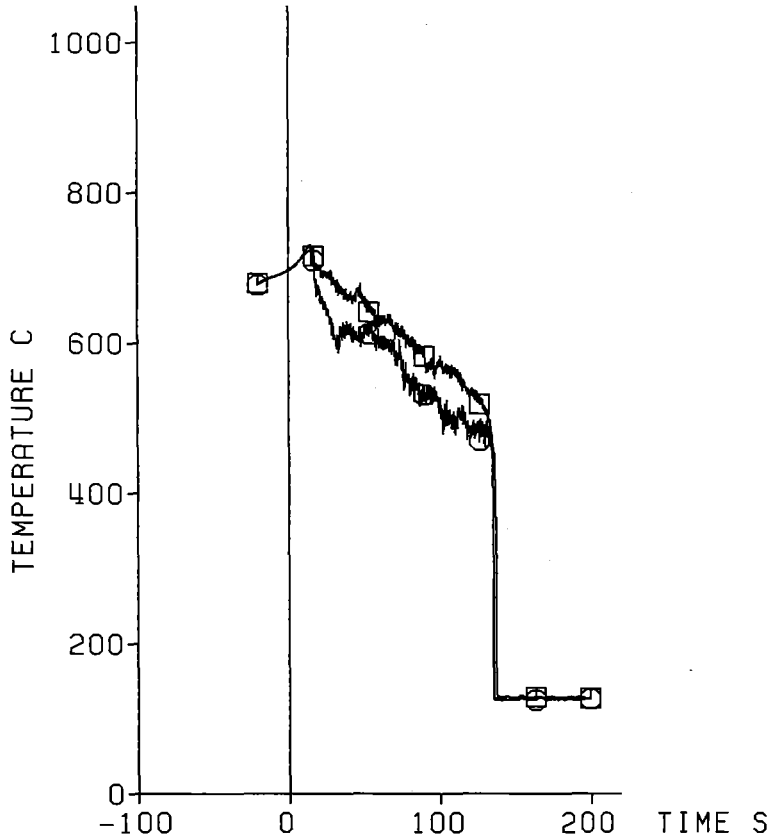

	TC	Axial Level
□	67	1425 mm
○	66	1425 mm

Decay Heat 120% ANS Standard
 Flooding Rate (cold) 2.22 cm/s
 System Pressure 2.22 bar
 Feedwater Temperature 40 C

- 335 -



Fig. 295 FEBA: 5x5 ROD BUNDLE, TEST SERIES 8, TEST-No. 342

Axial Level: 2770 mm

△ Cladding Temperature (7a2)
○ Fluid Temperature
□ Housing Temperature

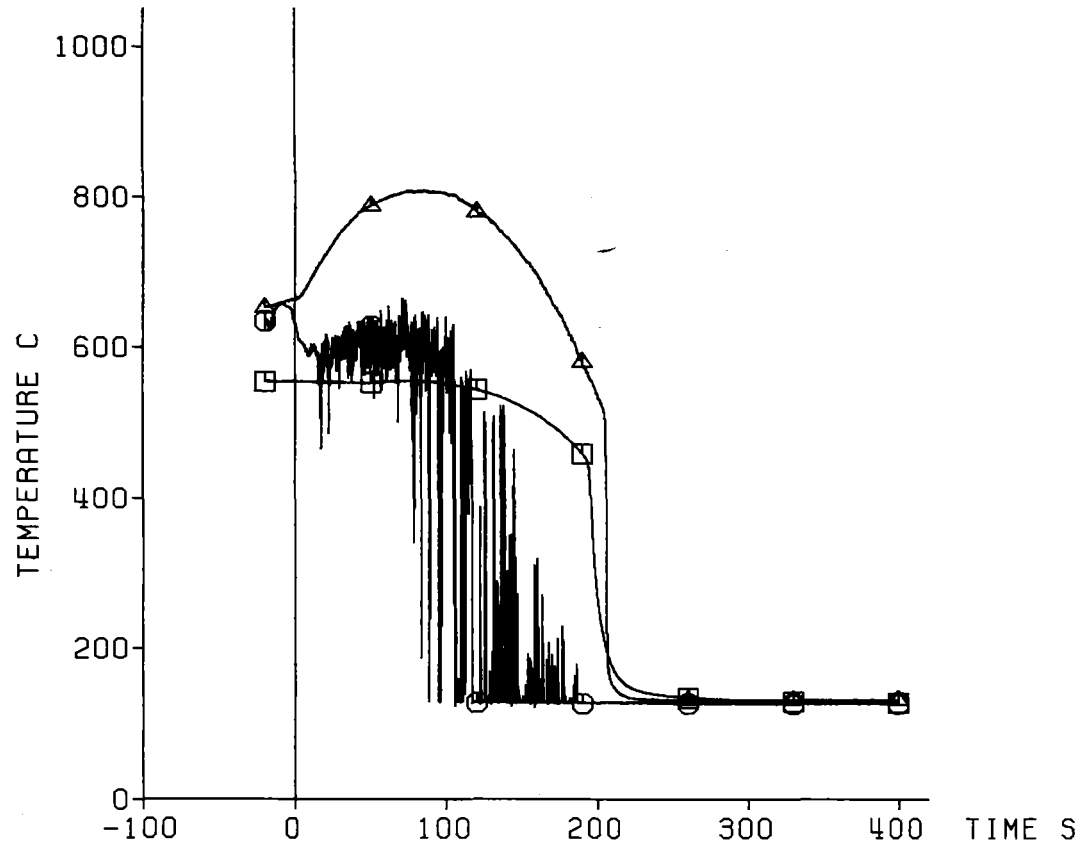

Decay Heat 120% ANS Standard
Flooding Rate (cold) 2.22 cm/s
System Pressure 2.22 bar
Feedwater Temperature 40 C

— 336 —



Fig. 296 FEBA: 5x5 ROD BUNDLE, TEST SERIES 8, TEST-No. 342

Axial Level: 2225 mm

△ Cladding Temperature (7a1)
○ Fluid Temperature (2240 mm)
□ Housing Temperature (2235 mm)

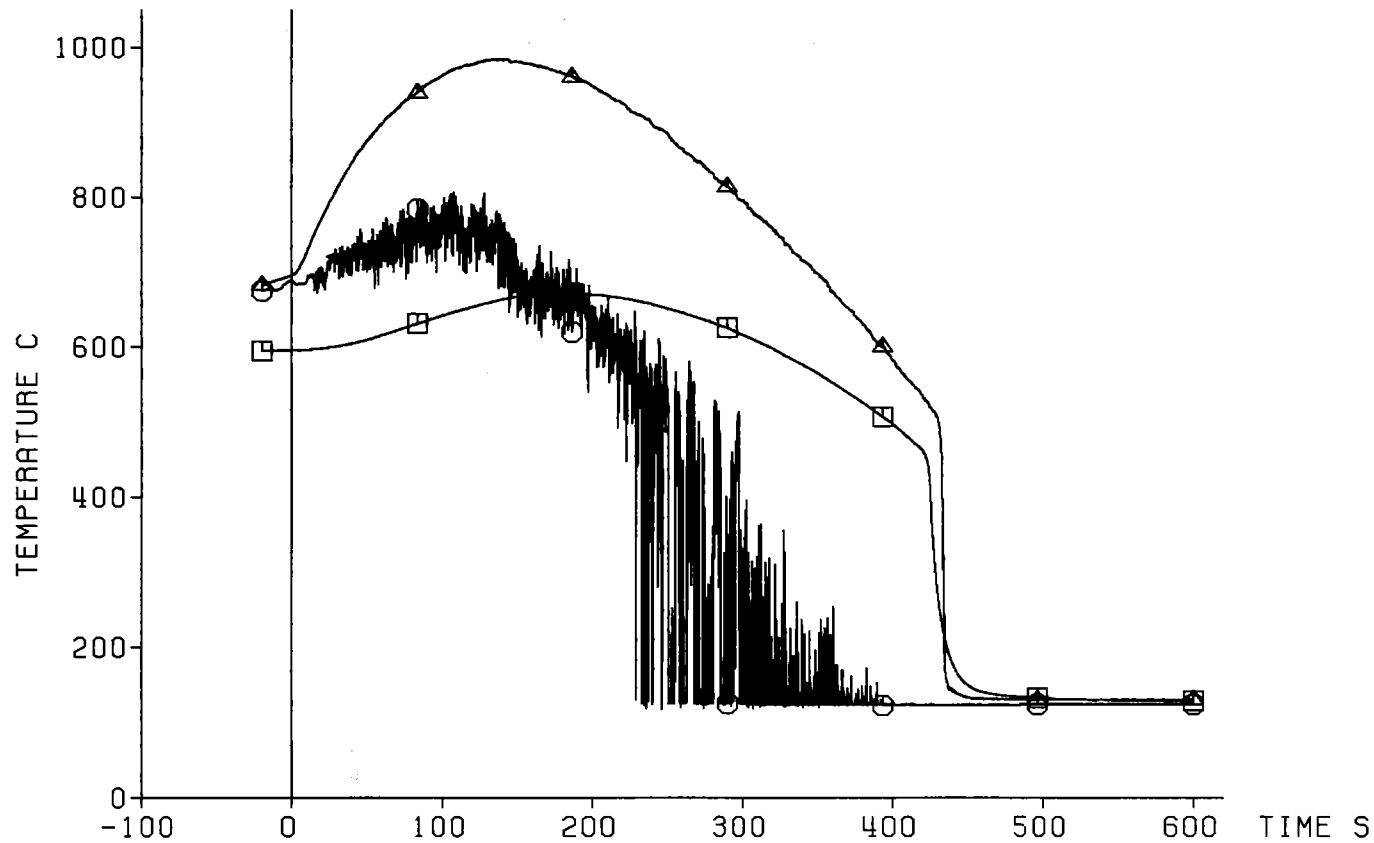

Decay Heat 120% ANS Standard
Flooding Rate (cold) 2.22 cm/s
System Pressure 2.22 bar
Feedwater Temperature 40 C

— 337 —



Fig. 297 FEBA: 5x5 ROD BUNDLE, TEST SERIES 8, TEST-NO. 342

Axial Level: 1925 mm

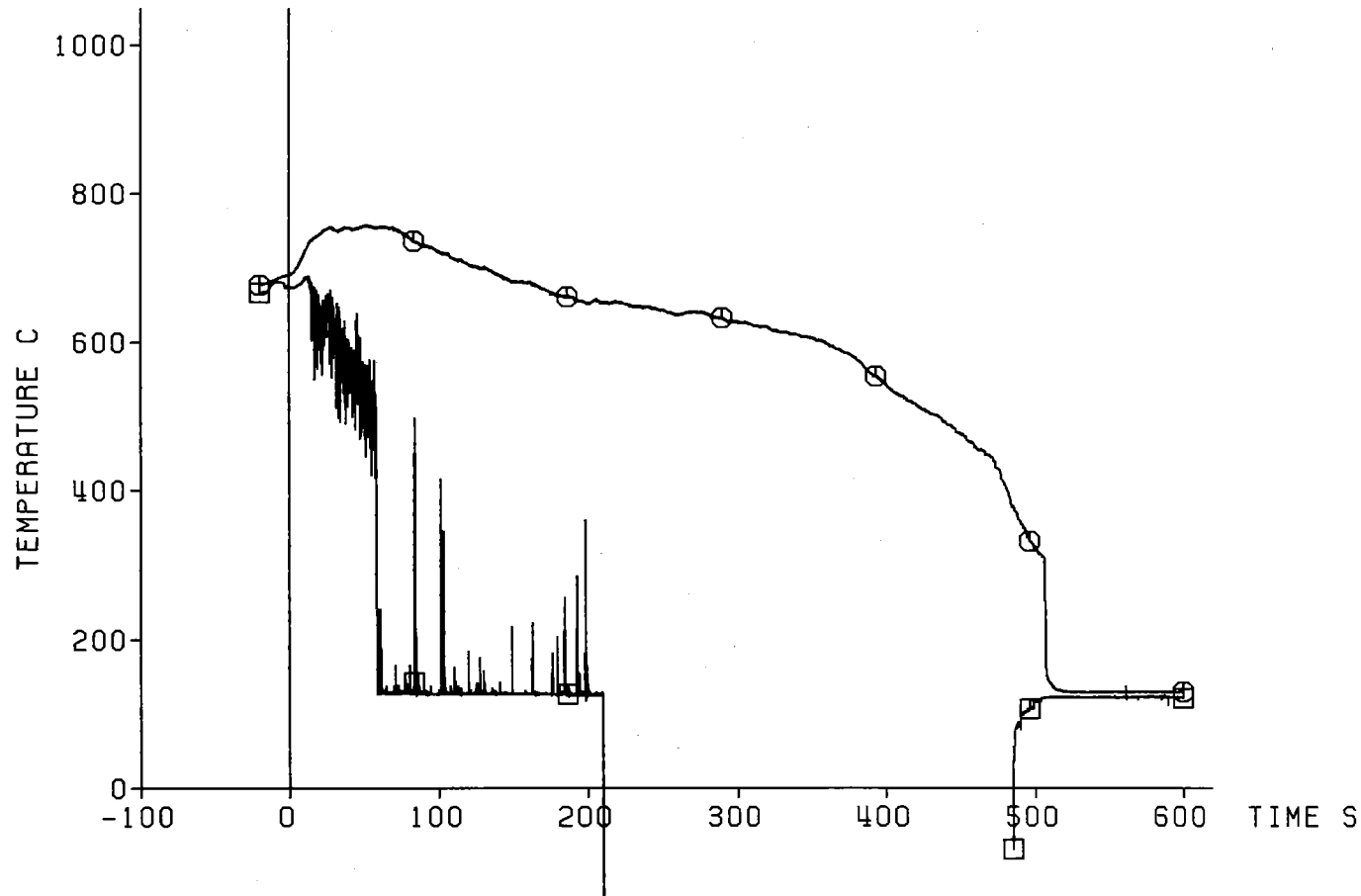

Decay Heat 120% ANS Standard
Flooding Rate (cold) 2.22 cm/s
System Pressure 2.22 bar
Feedwater Temperature 40 C

— 338 —

KfK
IRB

Fig. 298 FEBA: 5x5 ROD BUNDLE, TEST SERIES 8, TEST-No. 342

Axial Level: 1825 mm

△ Cladding Temperature (19g3)
○ Fluid Temperature
□ Housing Temperature

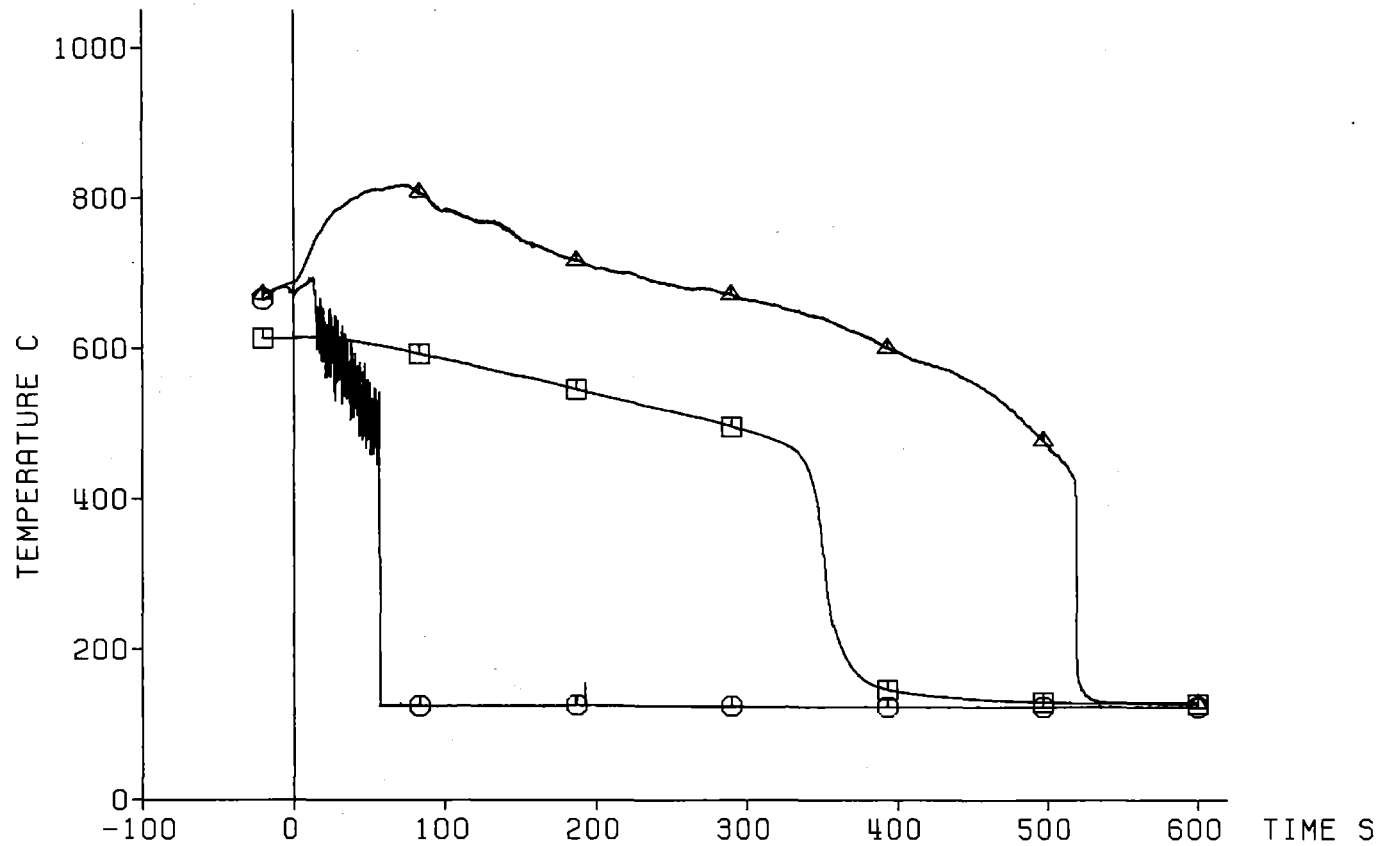

Decay Heat 120% ANS Standard
Flooding Rate (cold) 2.22 cm/s
System Pressure 2.22 bar
Feedwater Temperature 40 C

— 339 —



Fig. 299 FEBA: 5x5 ROD BUNDLE, TEST SERIES 8, TEST-No. 342

Axial Level: 1725 mm

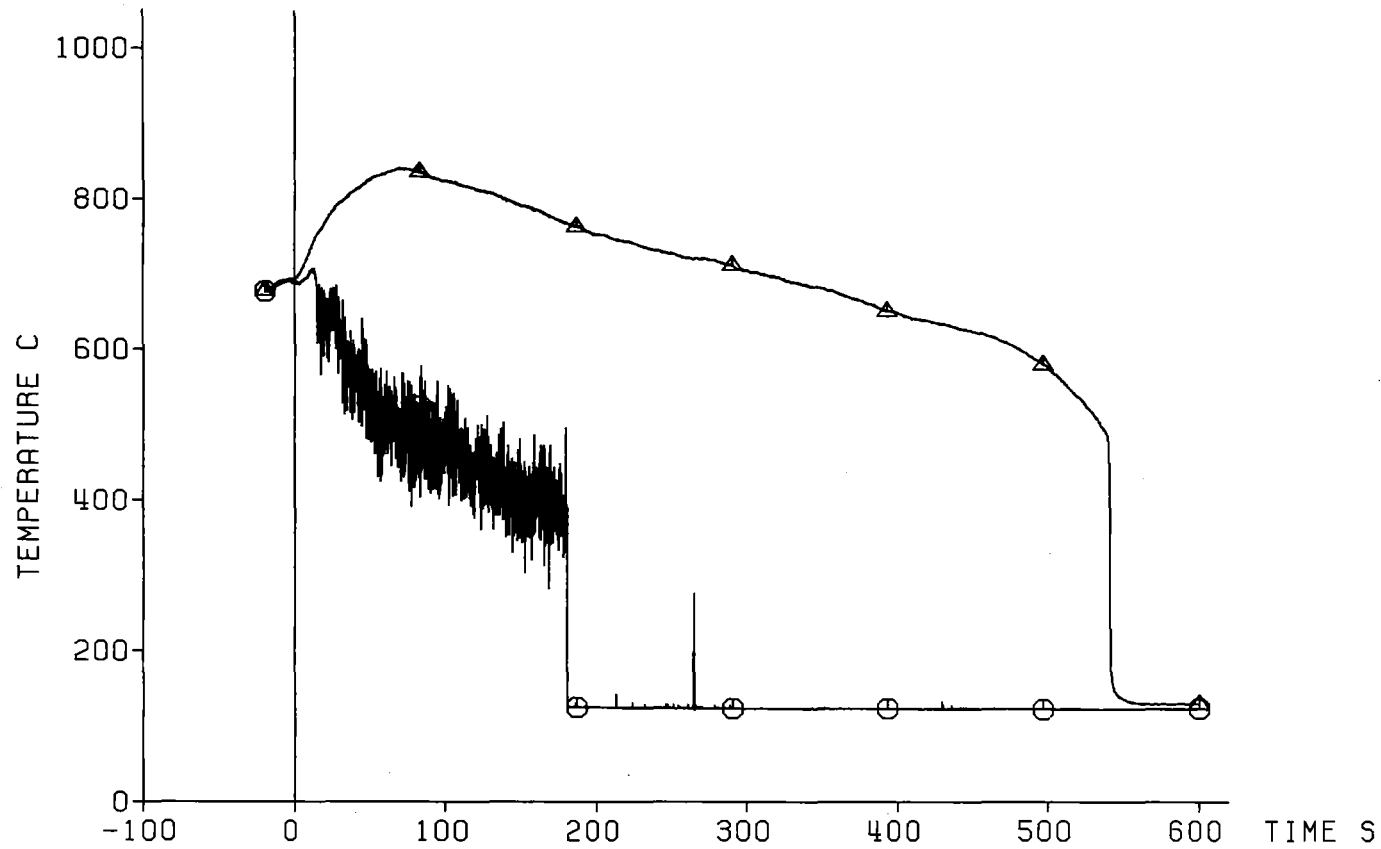

△ Cladding Temperature (19g2)
○ Fluid Temperature

Decay Heat 120% ANS Standard
Flooding Rate (cold) 2.22 cm/s
System Pressure 2.22 bar
Feedwater Temperature 40 C

KIK IRB

Fig. 300 FEBA: 5x5 ROD BUNDLE, TEST SERIES 8, TEST-NO. 342

Axial Level: 1625 mm

△ Cladding Temperature (19g1)
○ Fluid Temperature
□ Housing Temperature

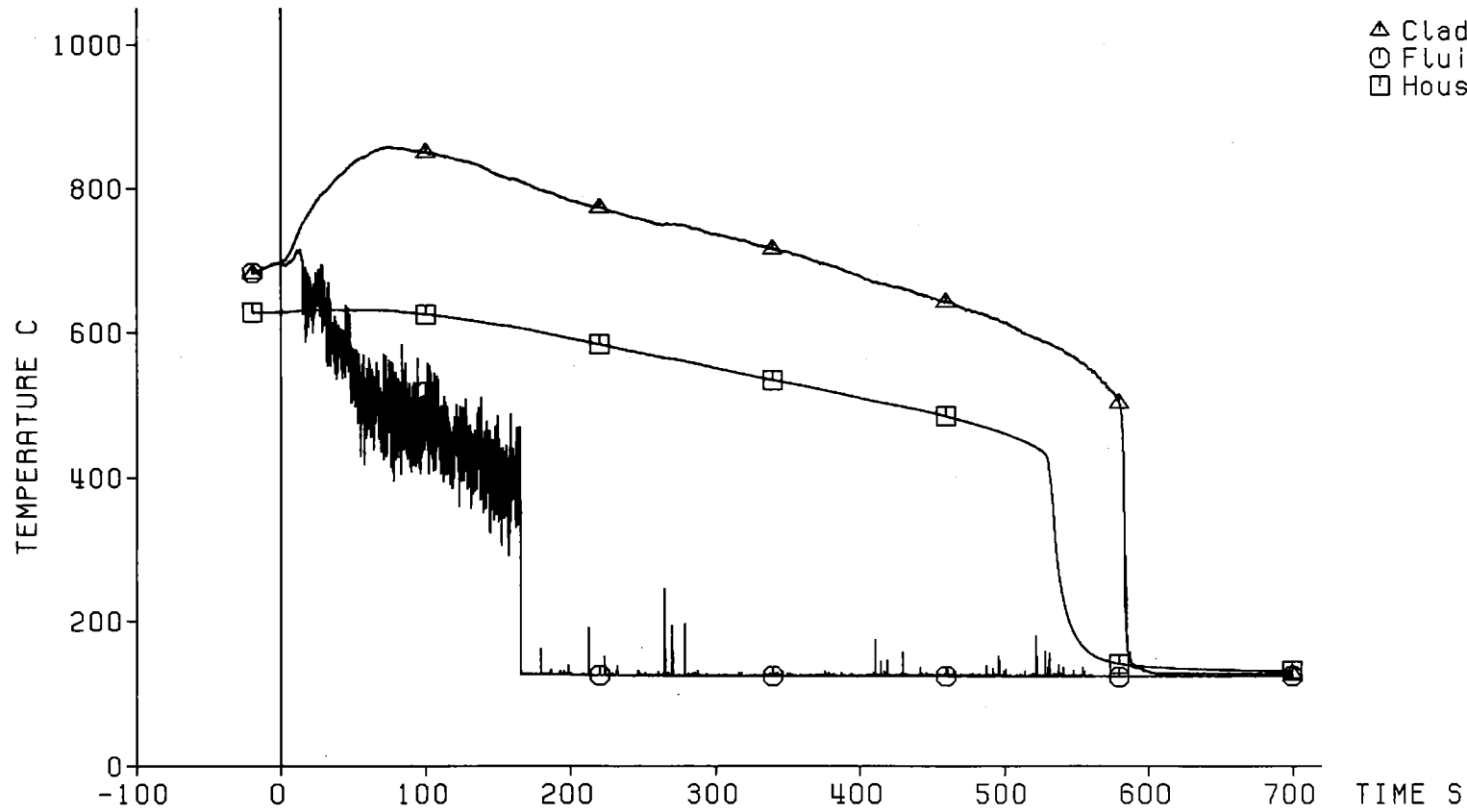

Decay Heat 120% ANS Standard
Flooding Rate (cold) 2.22 cm/s
System Pressure 2.22 bar
Feedwater Temperature 40 C

— 341 —

KIK
IRB

Fig. 301 FEBA: 5x5 ROD BUNDLE, TEST SERIES 8, TEST-NO. 342

Axial Level: 1135 mm

△ Cladding Temperature (8b3)
○ Fluid Temperature
□ Housing Temperature

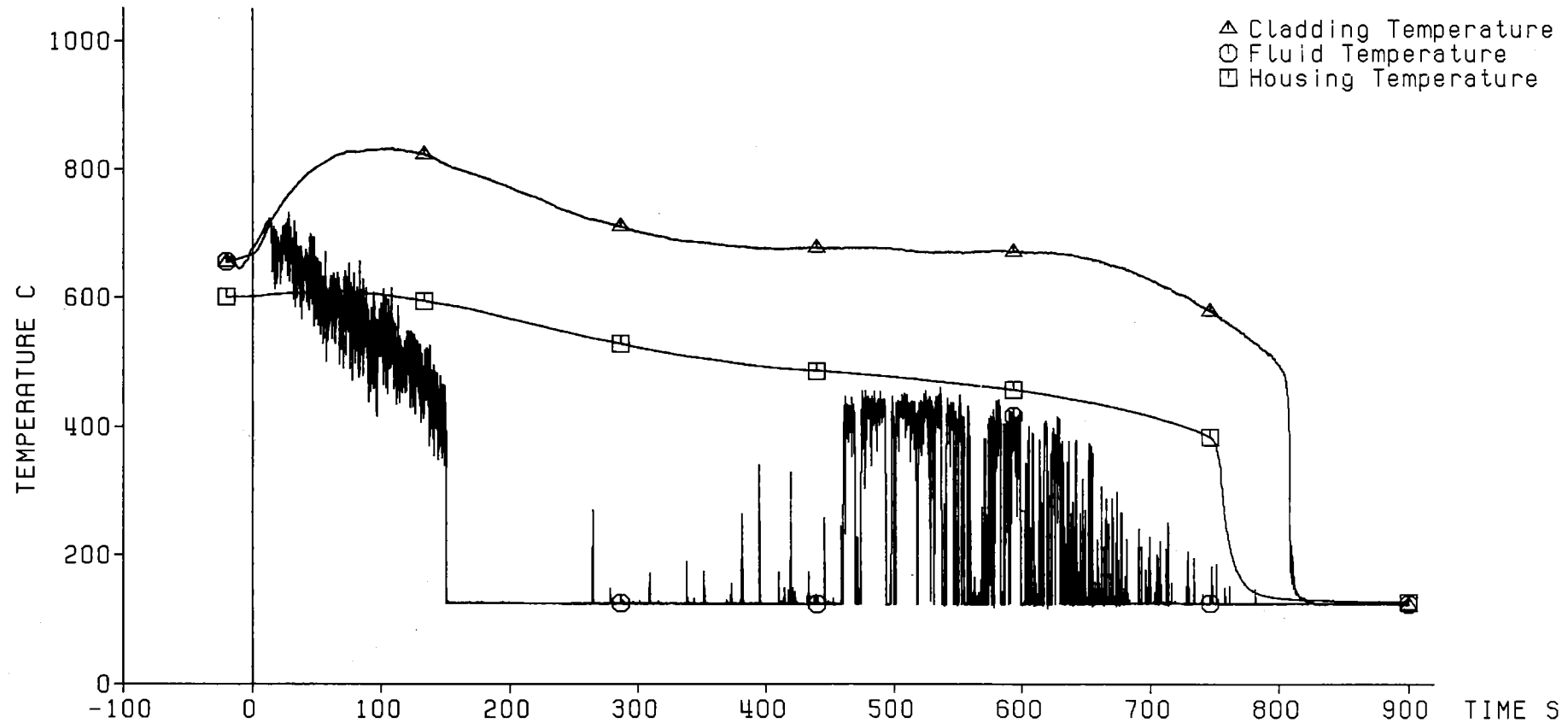

Decay Heat 120% ANS Standard
Flooding Rate (cold) 2.22 cm/s
System Pressure 2.22 bar
Feedwater Temperature 40 C



Fig. 302 FEBA: 5x5 ROD BUNDLE, TEST SERIES 8, TEST-No. 342

Pressure Loss
Along the Test Section:

◇ Total Length: 4196 mm
△ Lower Part: 1711 mm
○ Middle Part: 545 mm
□ Upper Part: 1940 mm

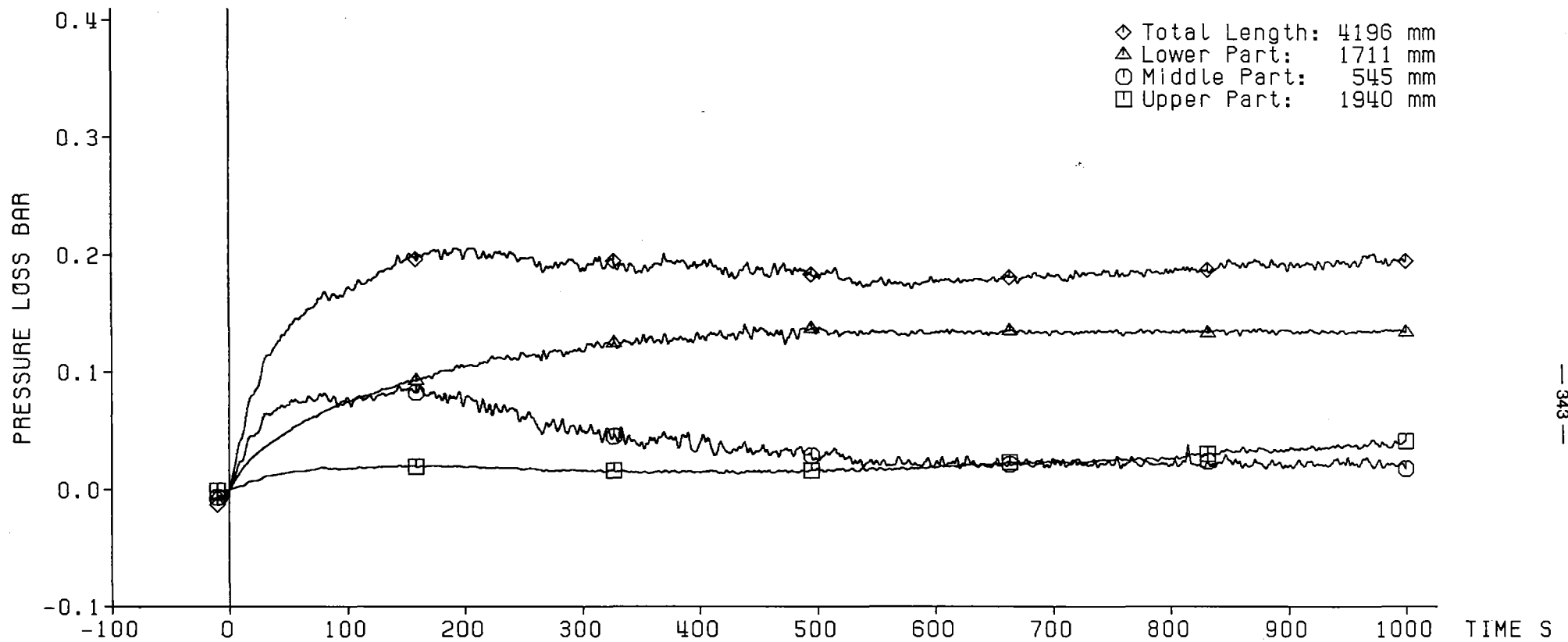

Decay Heat 120% ANS Standard
Flooding Rate (cold) 2.22 cm/s
System Pressure 2.22 bar
Feedwater Temperature 40 C



Fig. 303 FEBA: 5x5 ROD BUNDLE, TEST SERIES 8, TEST-NO. 342

Coolant Outlet Conditions:

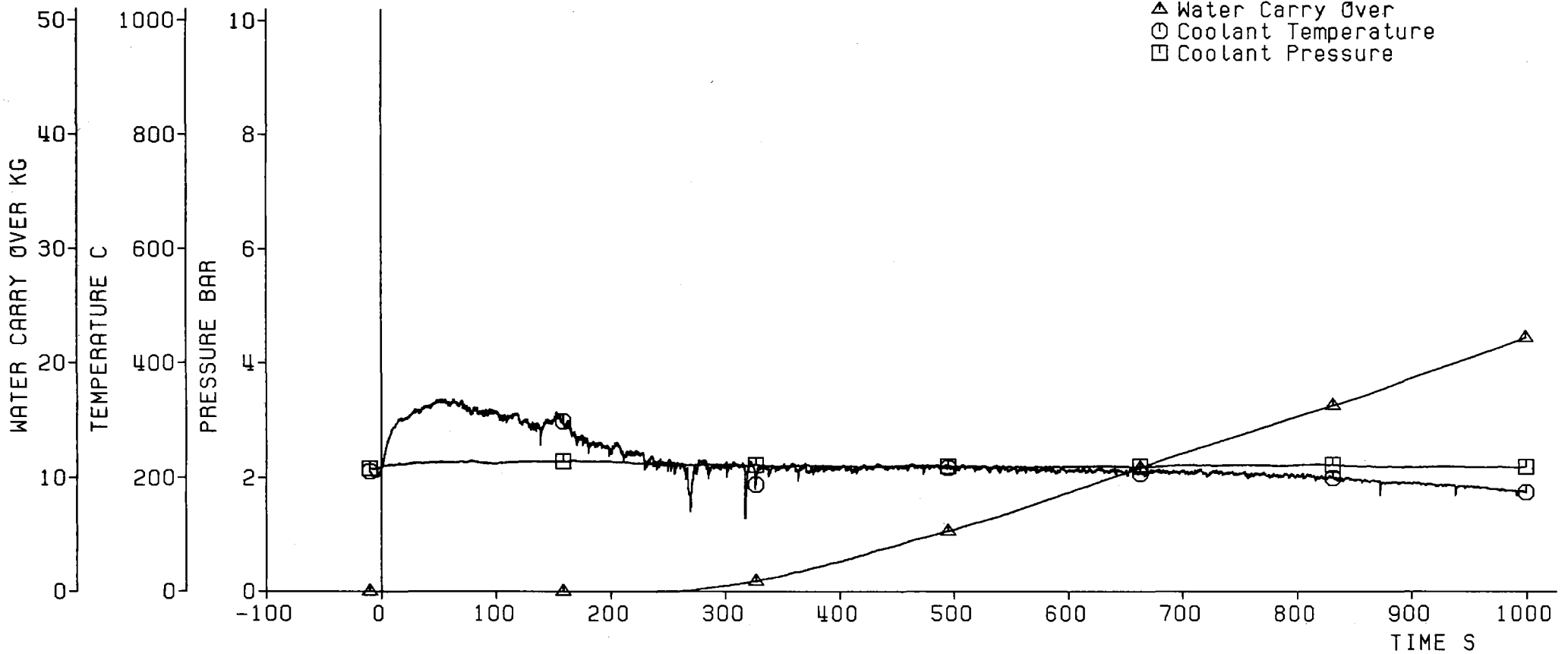

Decay Heat 120% ANS Standard
Flooding Rate (cold) 2.22 cm/s
System Pressure 2.22 bar
Feedwater Temperature 40 C



Fig. 304 FEBA: 5x5 ROD BUNDLE, TEST SERIES 8, TEST-No. 342

Axial Position of Quench Front

□ Quenching of Sleeves at Bundle Midplane

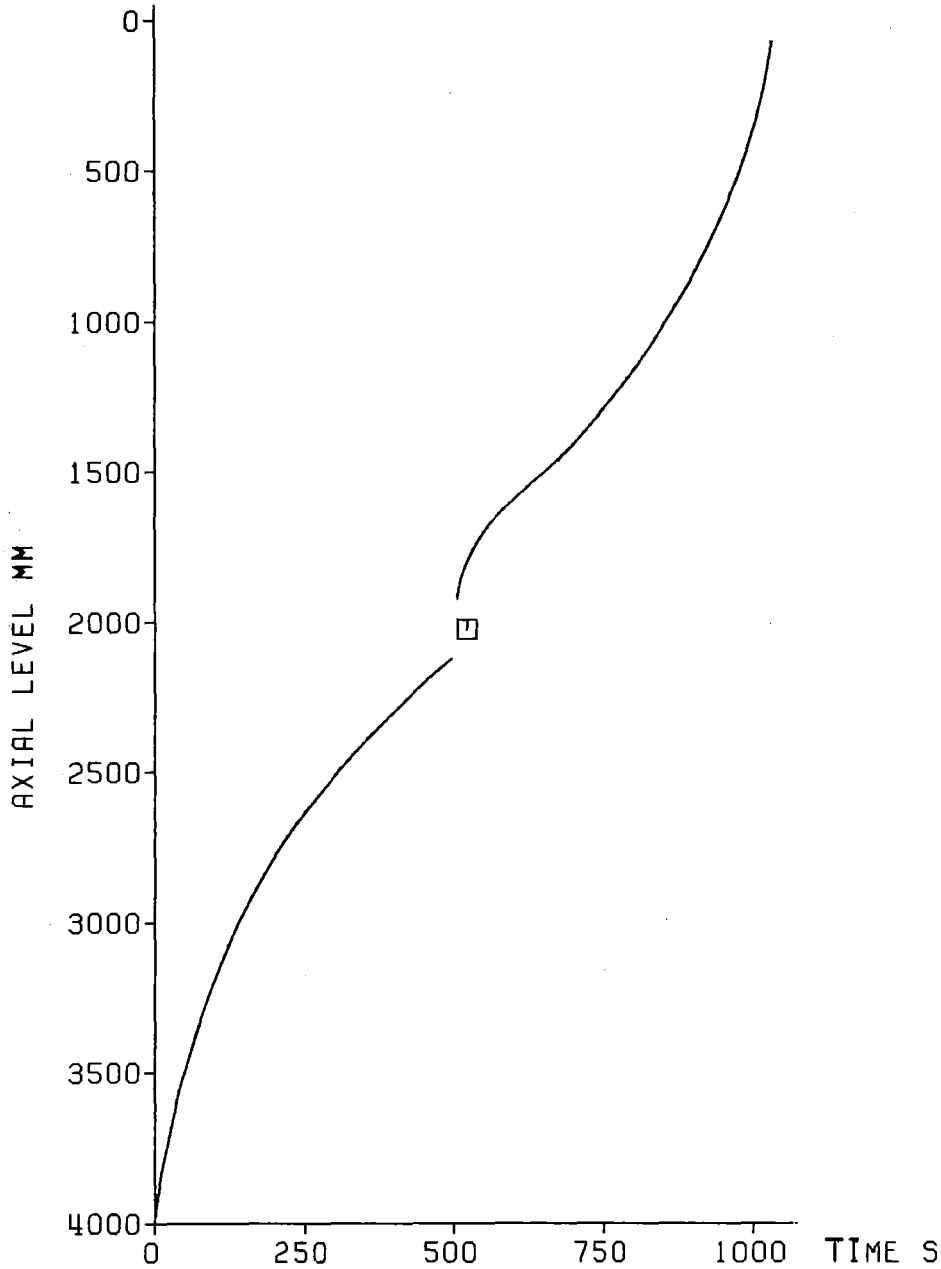

Decay Heat	120% ANS Standard
Flooding Rate (cold)	2.22 cm/s
System Pressure	2.22 bar
Feedwater Temperature	40 C



Fig. 305 FEBA: 5x5 ROD BUNDLE
TEST SERIES 8, TEST-NO. 342

Initial Axial Temperature Profile of Claddings

□ Initial Temperature of Sleeves at Bundle Midplane

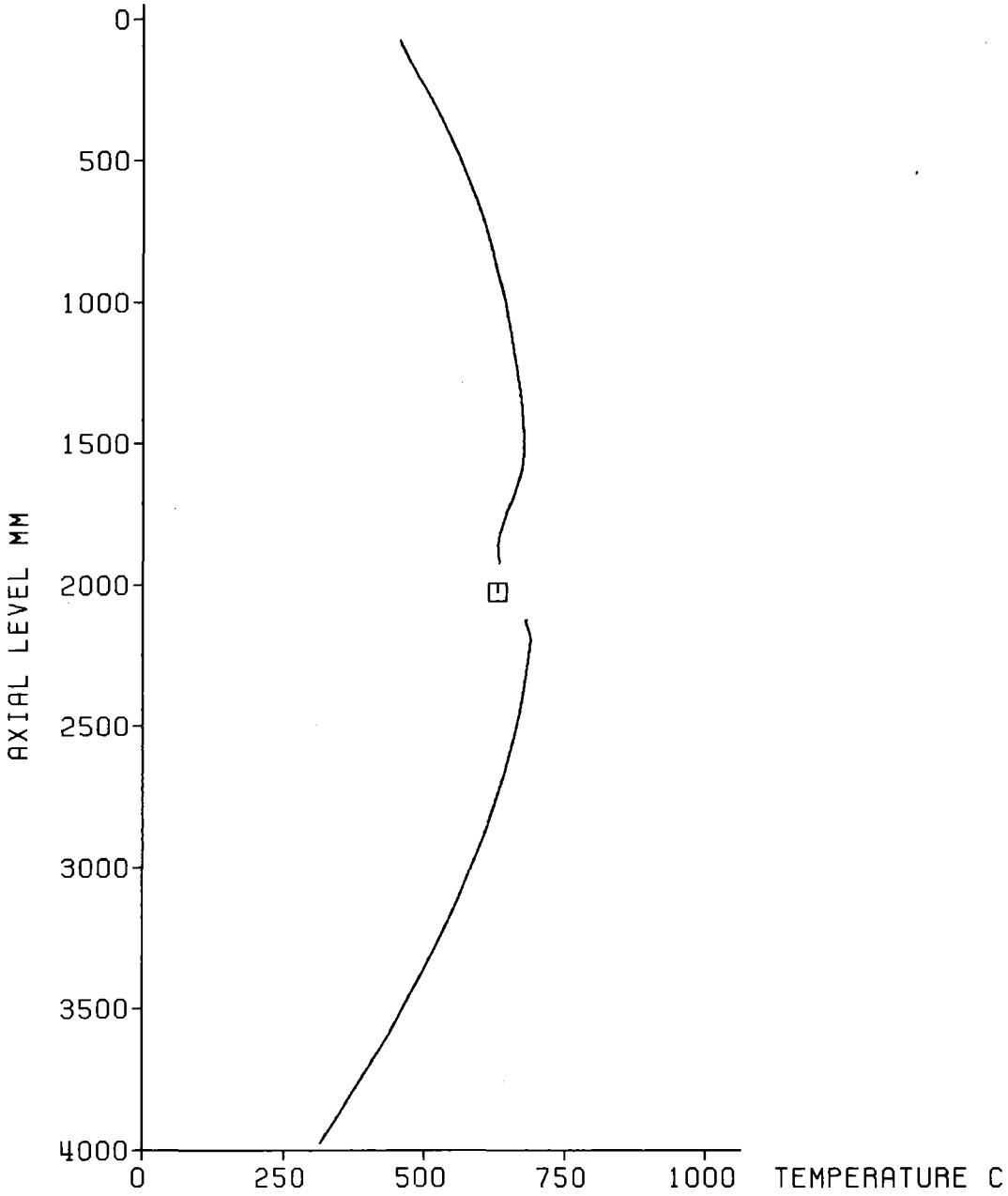

Decay Heat	120% ANS Standard
Flooding Rate (cold)	2.20 cm/s
System Pressure	4.10 bar
Feedwater Temperature	40 C



Fig. 306 FEBA: 5x5 ROD BUNDLE
TEST SERIES 8, TEST-No. 338

Test Parameters:

- ◇ Flooding Rate
- △ System Pressure
- Feedwater Temperature
- Bundle Power

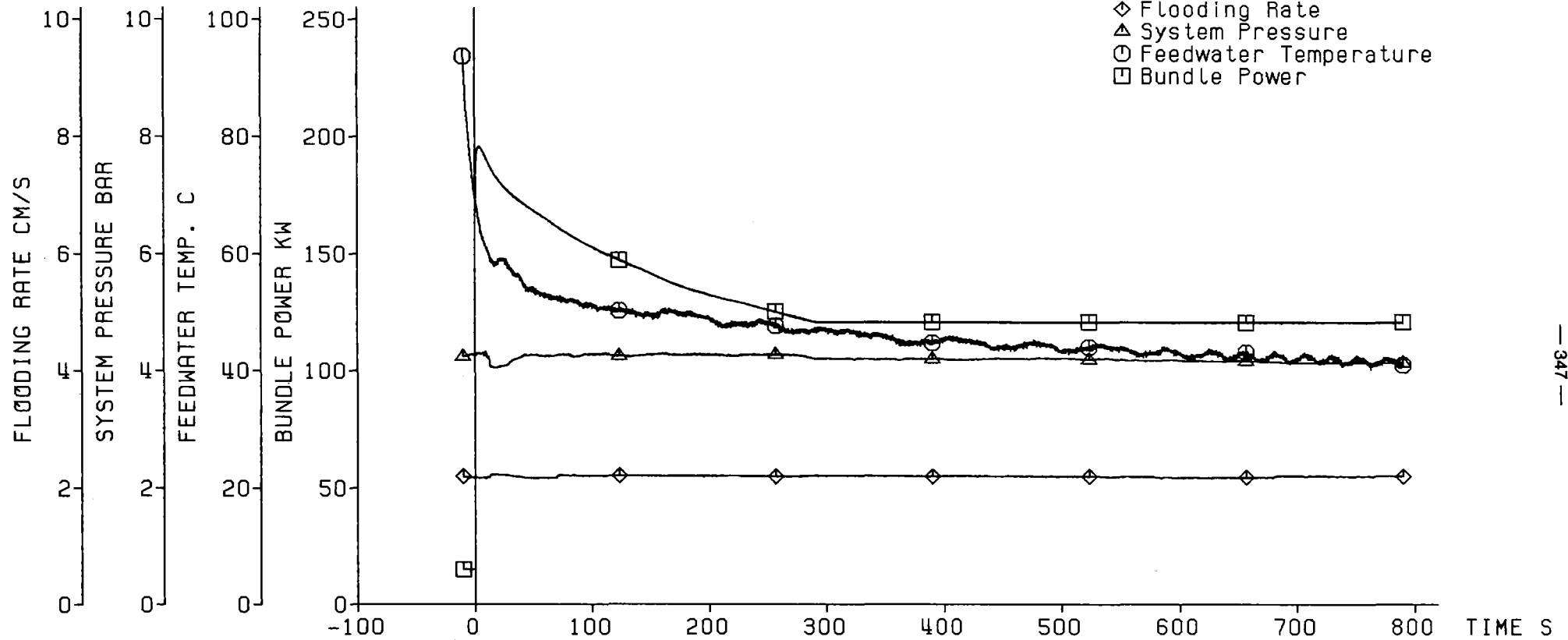

Decay Heat 120% ANS Standard
Flooding Rate (cold) 2.20 cm/s
System Pressure 4.10 bar
Feedwater Temperature 40 C



Fig. 307 FEBA: 5x5 ROD BUNDLE, TEST SERIES 8, TEST-No. 338

Heat Transfer Coeff.

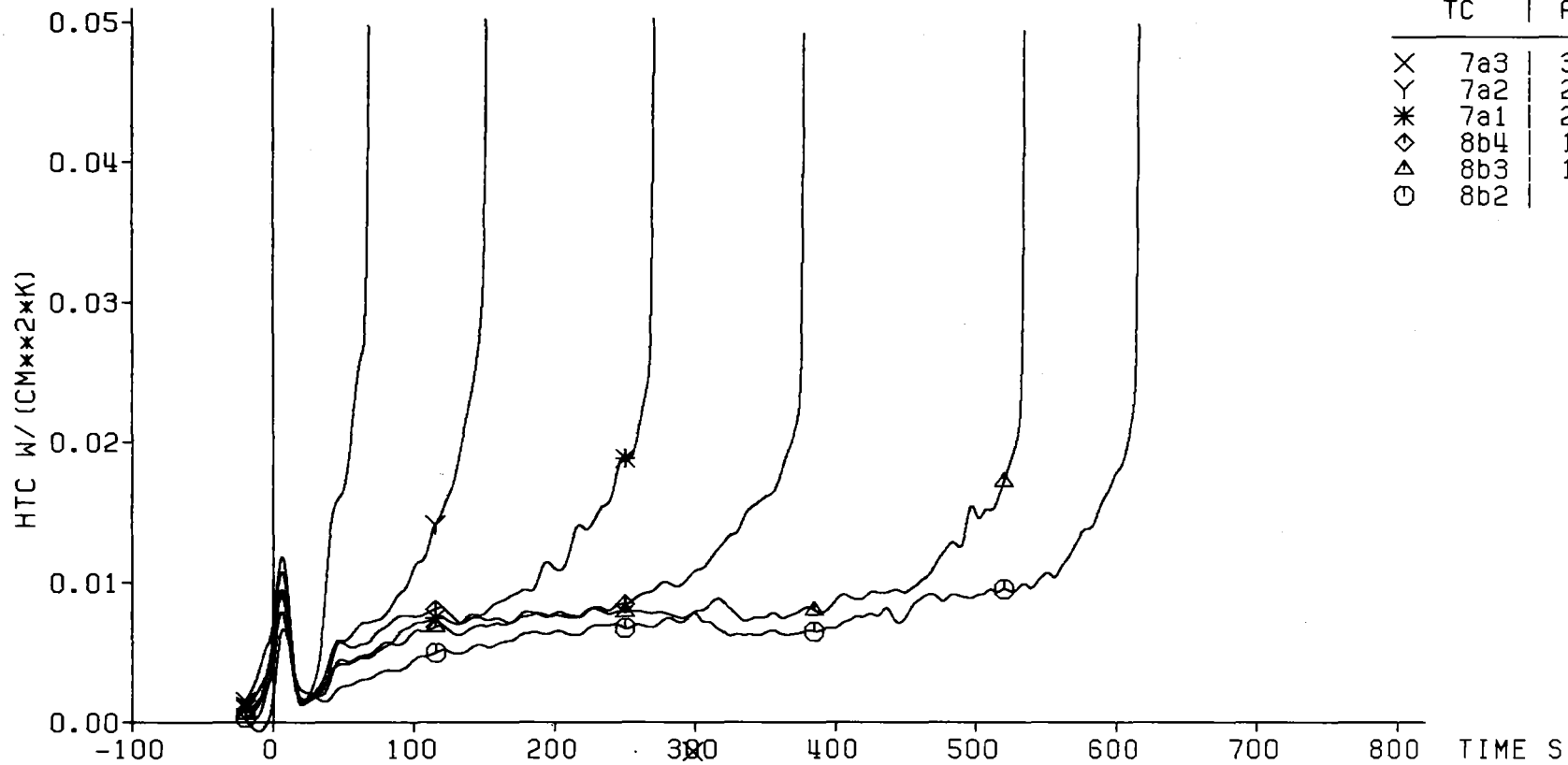

Decay Heat 120% ANS Standard
 Flooding Rate (cold) 2.20 cm/s
 System Pressure 4.10 bar
 Feedwater Temperature 40 C



Fig. 309 FEBA: 5x5 ROD BUNDLE, TEST SERIES 8, TEST-No. 338

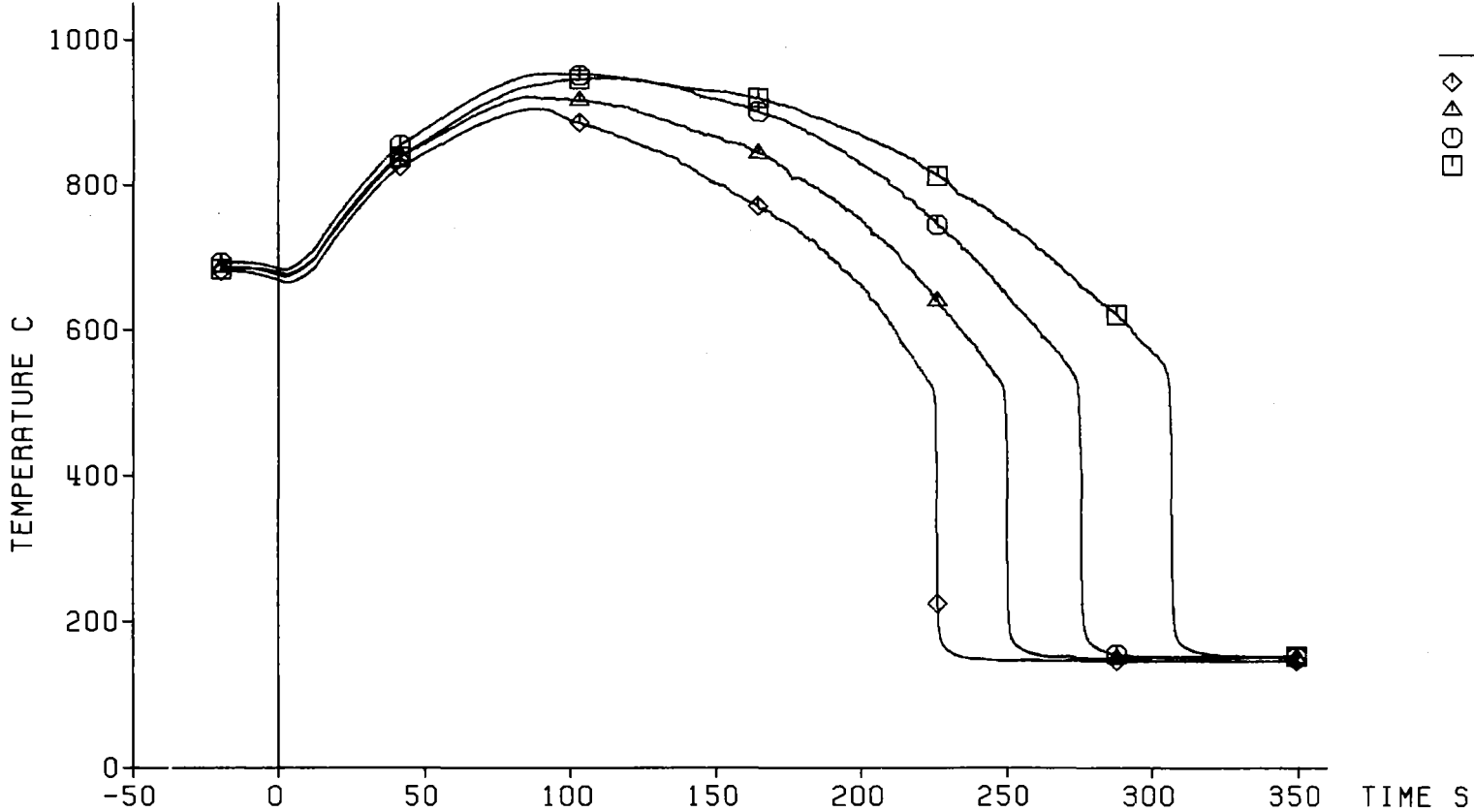

Decay Heat 120% ANS Standard
Flooding Rate (cold) 2.20 cm/s
System Pressure 4.10 bar
Feedwater Temperature 40 C



Fig. 310 FEBA: 5x5 ROD BUNDLE, TEST SERIES 8, TEST-No. 338

Heat Transfer Coeff.

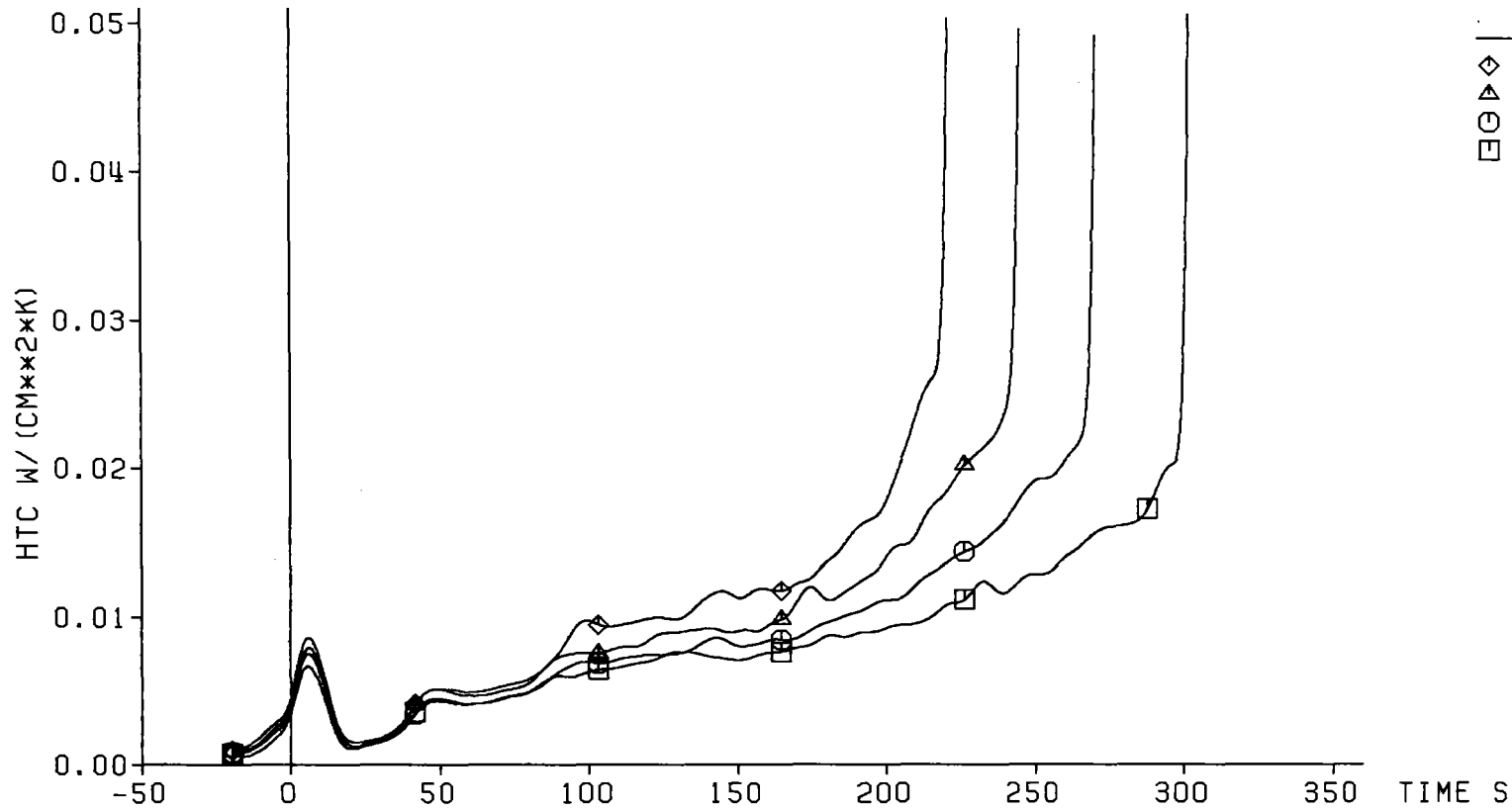

Decay Heat 120% ANS Standard
 Flooding Rate (cold) 2.20 cm/s
 System Pressure 4.10 bar
 Feedwater Temperature 40 C



Fig. 311 FEBA: 5x5 ROD BUNDLE, TEST SERIES 8, TEST-No. 338

Cladding Temperature

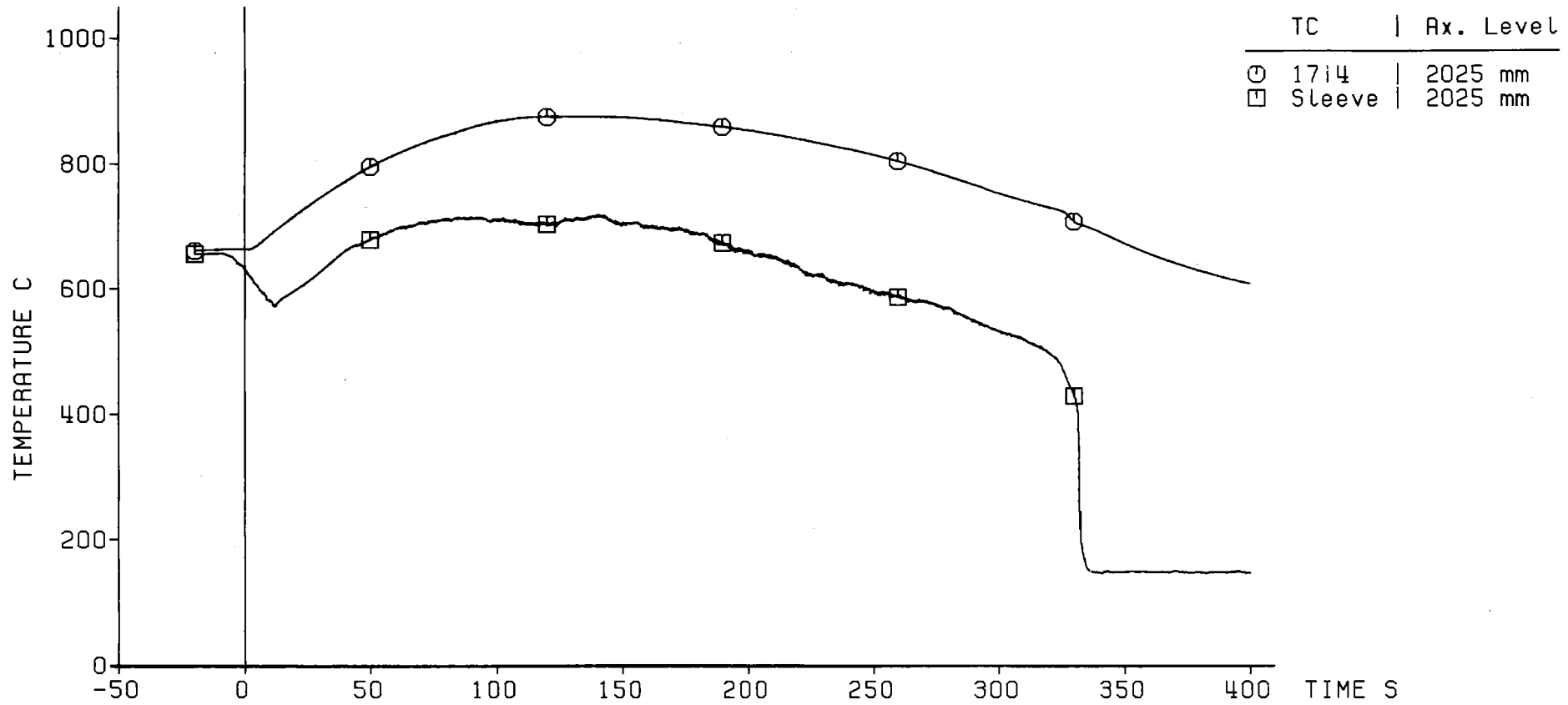

Decay Heat 120% ANS Standard
 Flooding Rate (cold) 2.20 cm/s
 System Pressure 4.10 bar
 Feedwater Temperature 40 C



Fig. 312 FEBA: 5x5 R0D BUNDLE, TEST SERIES 8, TEST-No. 338

Sleeve Temperature
Contact Face: Rods 17 and 18

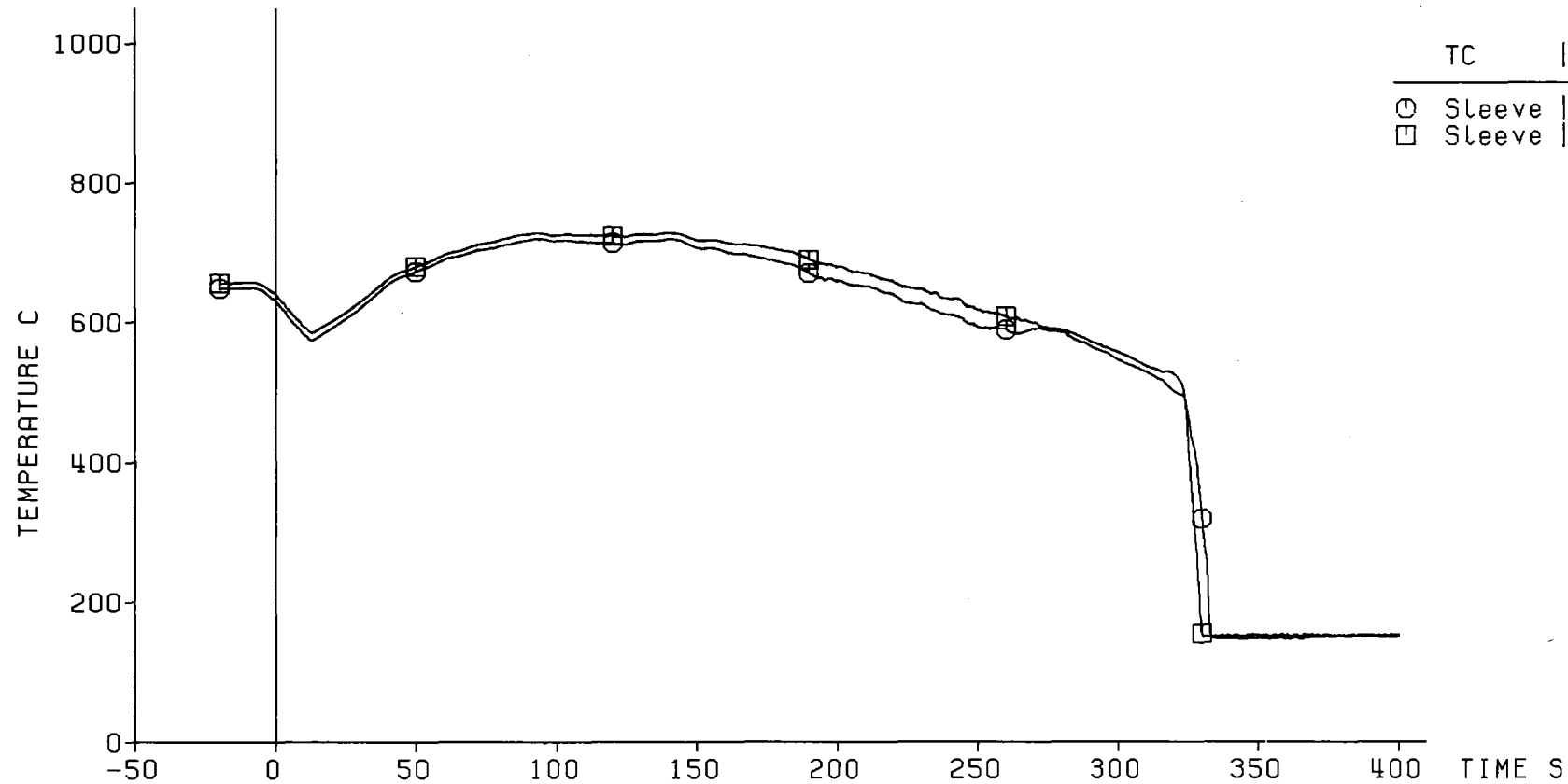

TC	Ax. Level
○ Sleeve	2025 mm (Rod 17)
□ Sleeve	2025 mm (Rod 18)

Decay Heat 120% ANS Standard
 Flooding Rate (cold) 2.20 cm/s
 System Pressure 4.10 bar
 Feedwater Temperature 40 C

— 353 —



Fig. 313 FEBA: 5x5 ROD BUNDLE, TEST SERIES 8, TEST-No. 338

Cladding Temperature

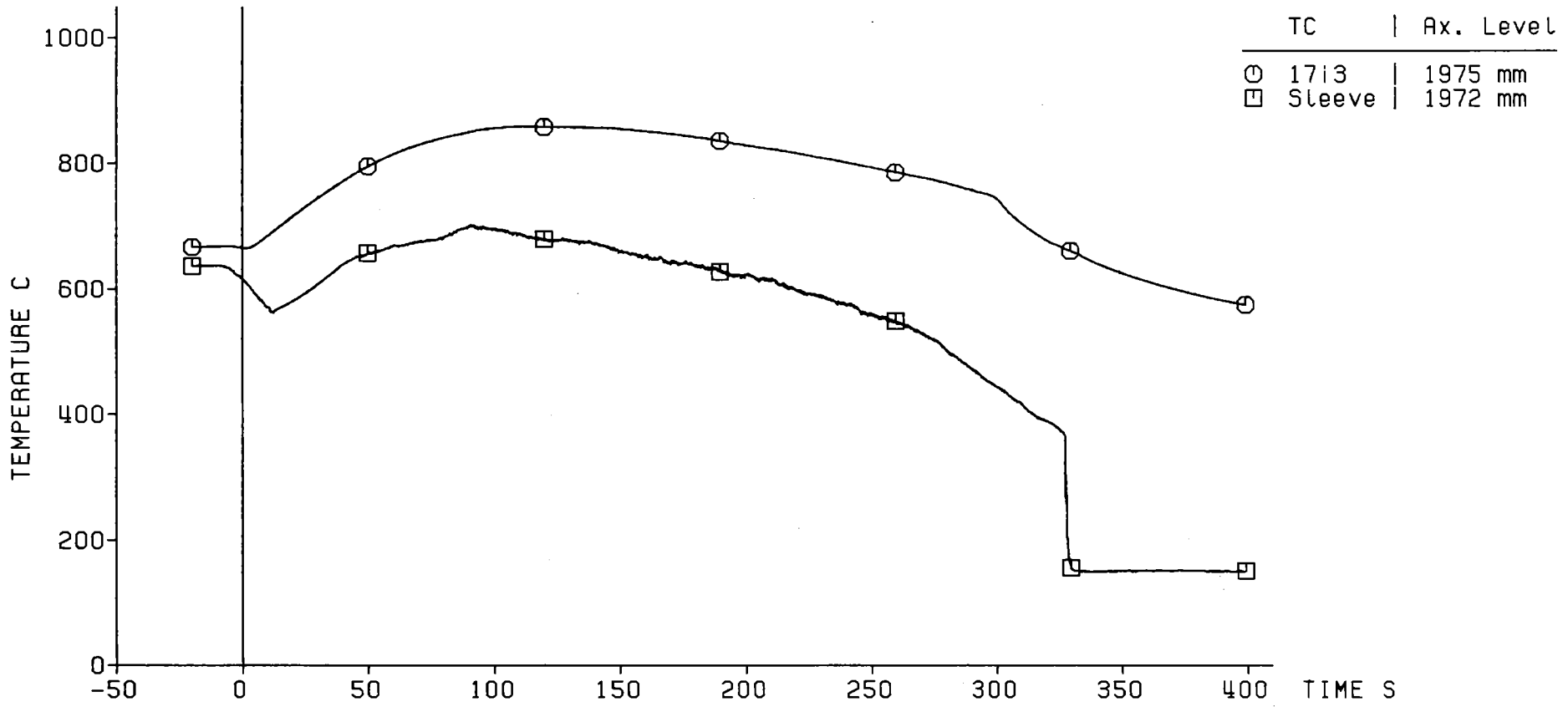

Decay Heat 120% ANS Standard
 Flooding Rate (cold) 2.20 cm/s
 System Pressure 4.10 bar
 Feedwater Temperature 40 C



Fig. 314 FEBA: 5x5 ROD BUNDLE, TEST SERIES 8, TEST-No. 338

Cladding Temperature

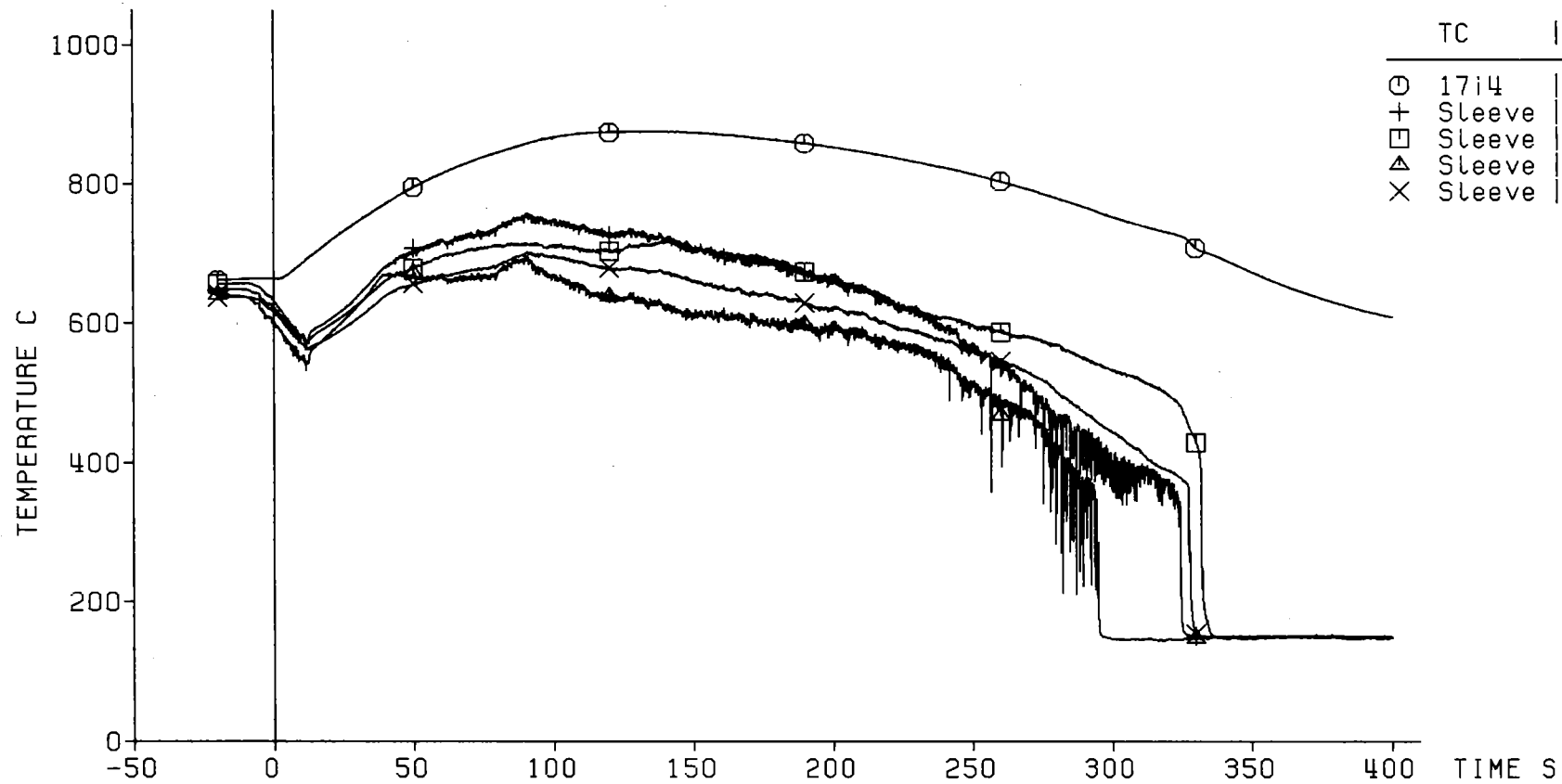

Decay Heat 120% ANS Standard
 Flooding Rate (cold) 2.20 cm/s
 System Pressure 4.10 bar
 Feedwater Temperature 40 C



Fig. 315 FEBA: 5x5 ROD BUNDLE, TEST SERIES 8, TEST-No. 338

Cladding Temperature

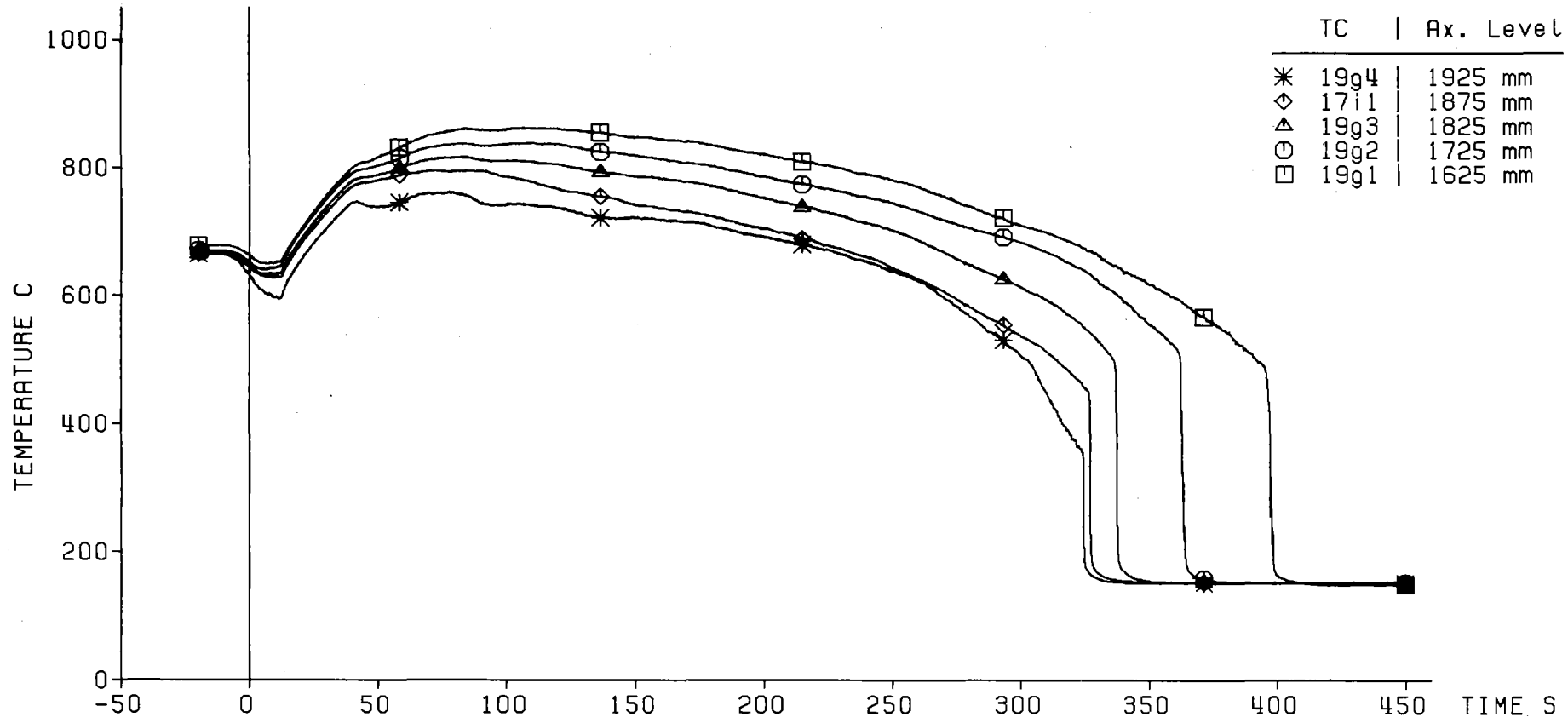

Decay Heat 120% ANS Standard
 Flooding Rate (cold) 2.20 cm/s
 System Pressure 4.10 bar
 Feedwater Temperature 40 C



Fig. 316 FEBA: 5x5 ROD BUNDLE, TEST SERIES 8, TEST-No. 338

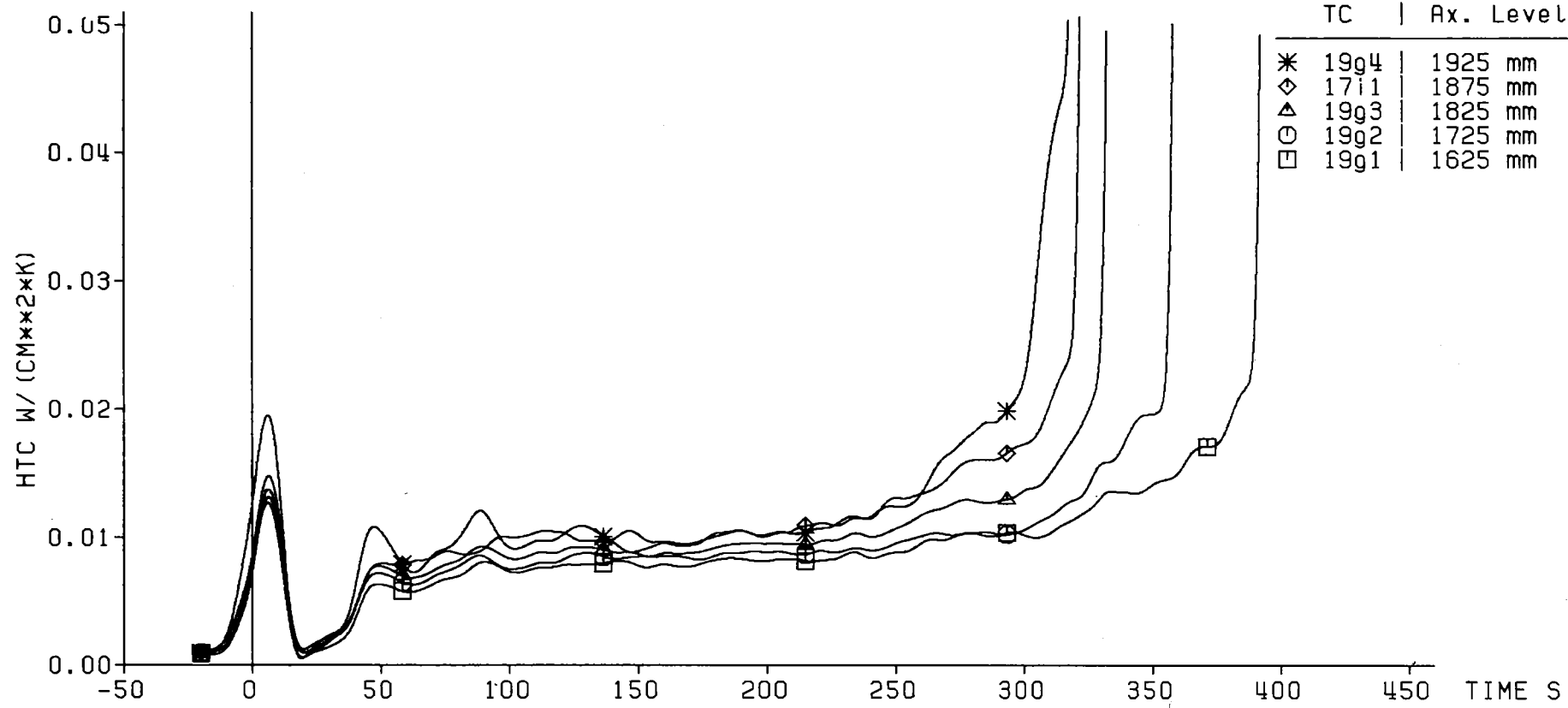

Decay Heat 120% ANS Standard
Flooding Rate (cold) 2.20 cm/s
System Pressure 4.10 bar
Feedwater Temperature 40 C



Fig. 317 FEBA: 5x5 ROD BUNDLE, TEST SERIES 8, TEST-No. 338

Cladding Temperature

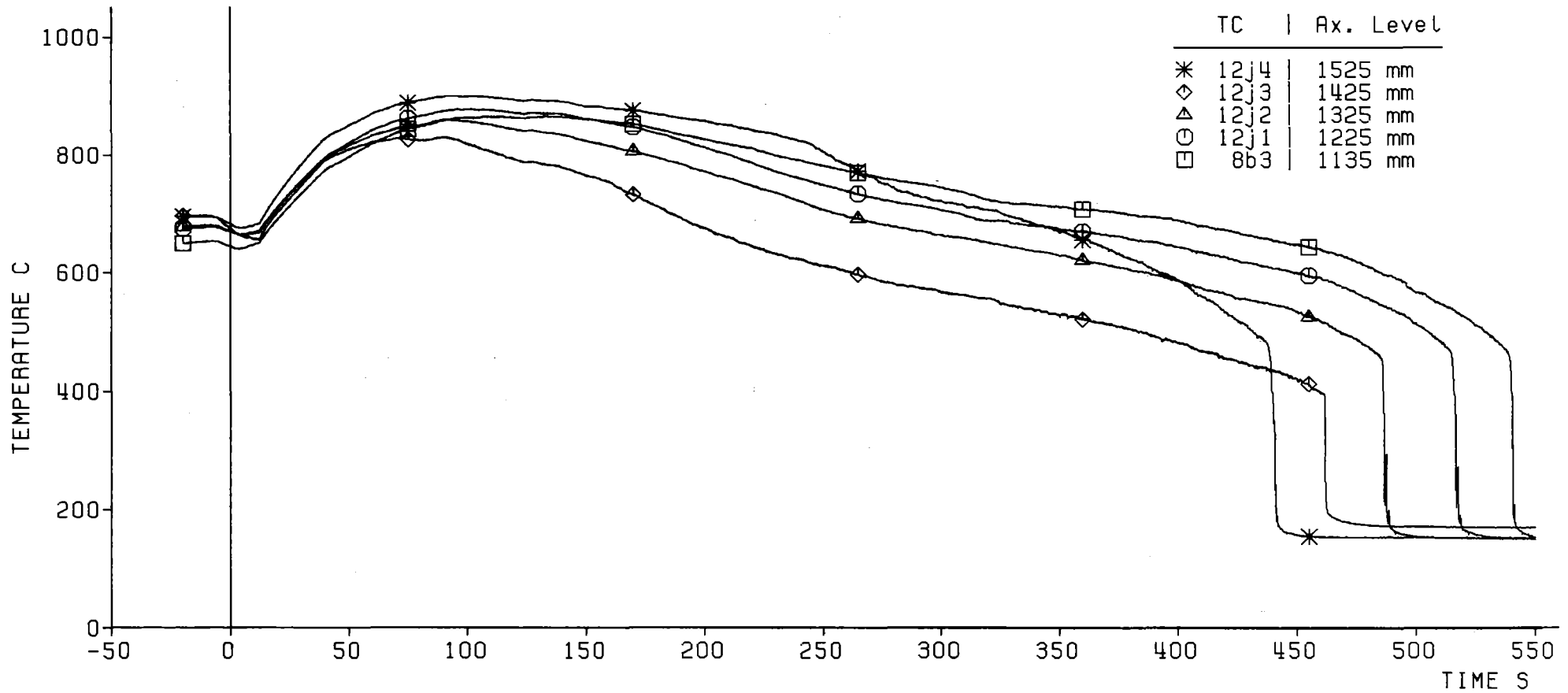

Decay Heat 120% ANS Standard
 Flooding Rate (cold) 2.20 cm/s
 System Pressure 4.10 bar
 Feedwater Temperature 40 C



Fig. 318 FEBA: 5x5 ROD BUNDLE, TEST SERIES 8, TEST-No. 338

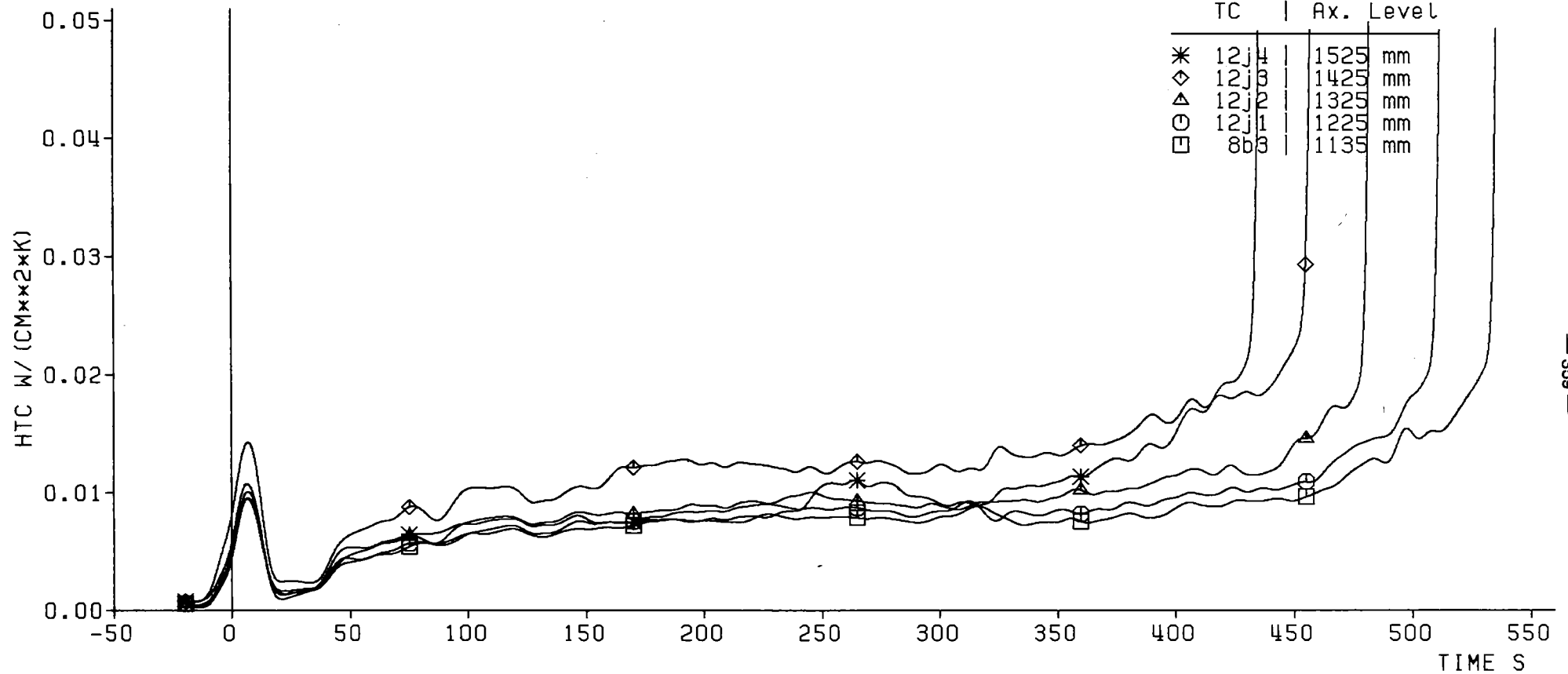

Decay Heat 120% ANS Standard
 Flooding Rate (cold) 2.20 cm/s
 System Pressure 4.10 bar
 Feedwater Temperature 40 C

KfK
 IRB

Fig. 319 FEBA: 5x5 ROD BUNDLE, TEST SERIES 8, TEST-No. 338

Grid Spacer Temperature

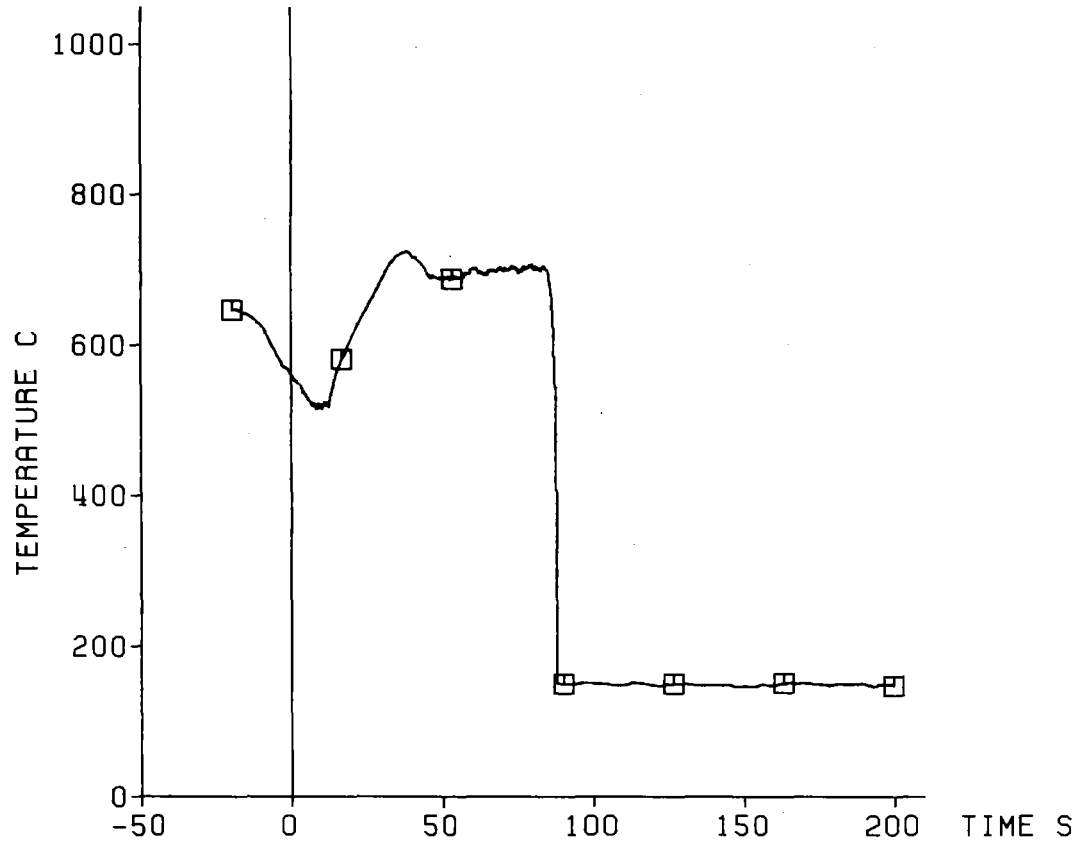

TC	Axial Level
□ 69	2535 mm

Decay Heat 120% ANS Standard
 Flooding Rate (cold) 2.20 cm/s
 System Pressure 4.10 bar
 Feedwater Temperature 40 C

— 360 —



Fig. 320 FEBA: 5x5 ROD BUNDLE, TEST SERIES 8, TEST-No. 338

Grid Spacer Temperature

	TC	Axial Level
□	67	1425 mm
○	66	1425 mm

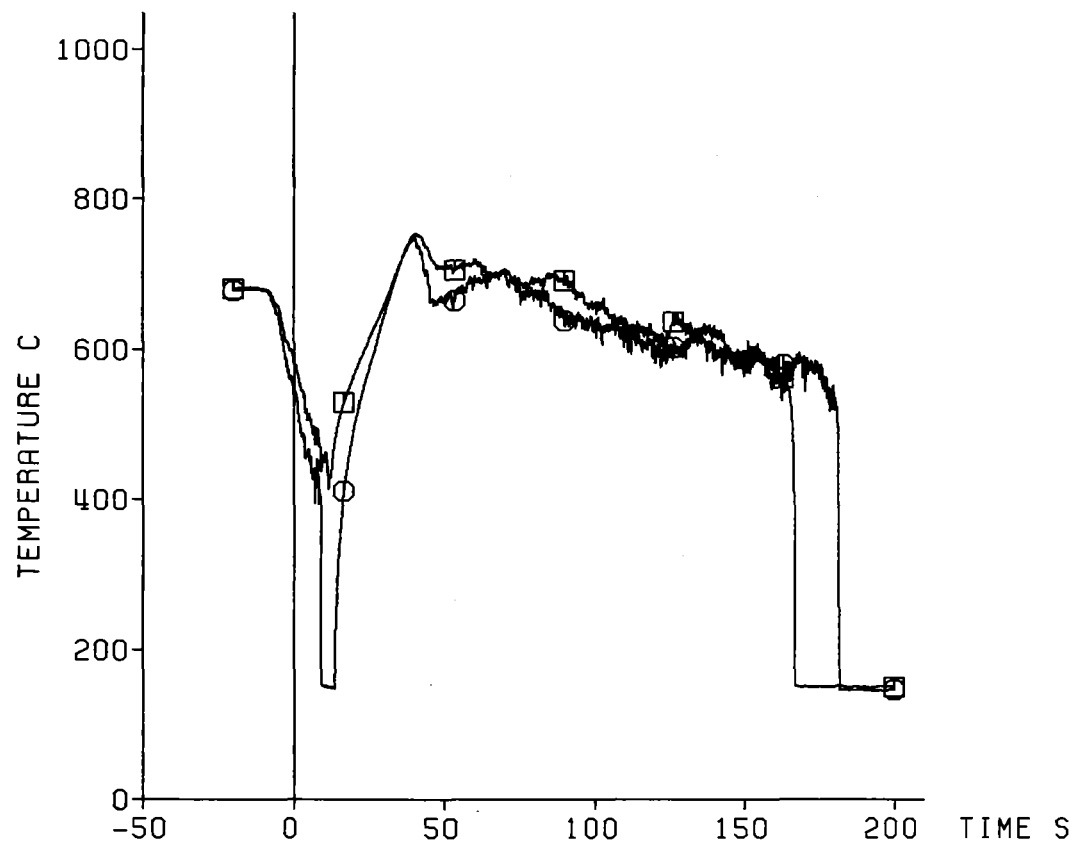

Decay Heat 120% ANS Standard
 Flooding Rate (cold) 2.20 cm/s
 System Pressure 4.10 bar
 Feedwater Temperature 40 C



Fig. 321 FEBA: 5x5 ROD BUNDLE, TEST SERIES 8, TEST-No. 338

Axial Level: 2770 mm

△ Cladding Temperature (7a2)
○ Fluid Temperature
□ Housing Temperature

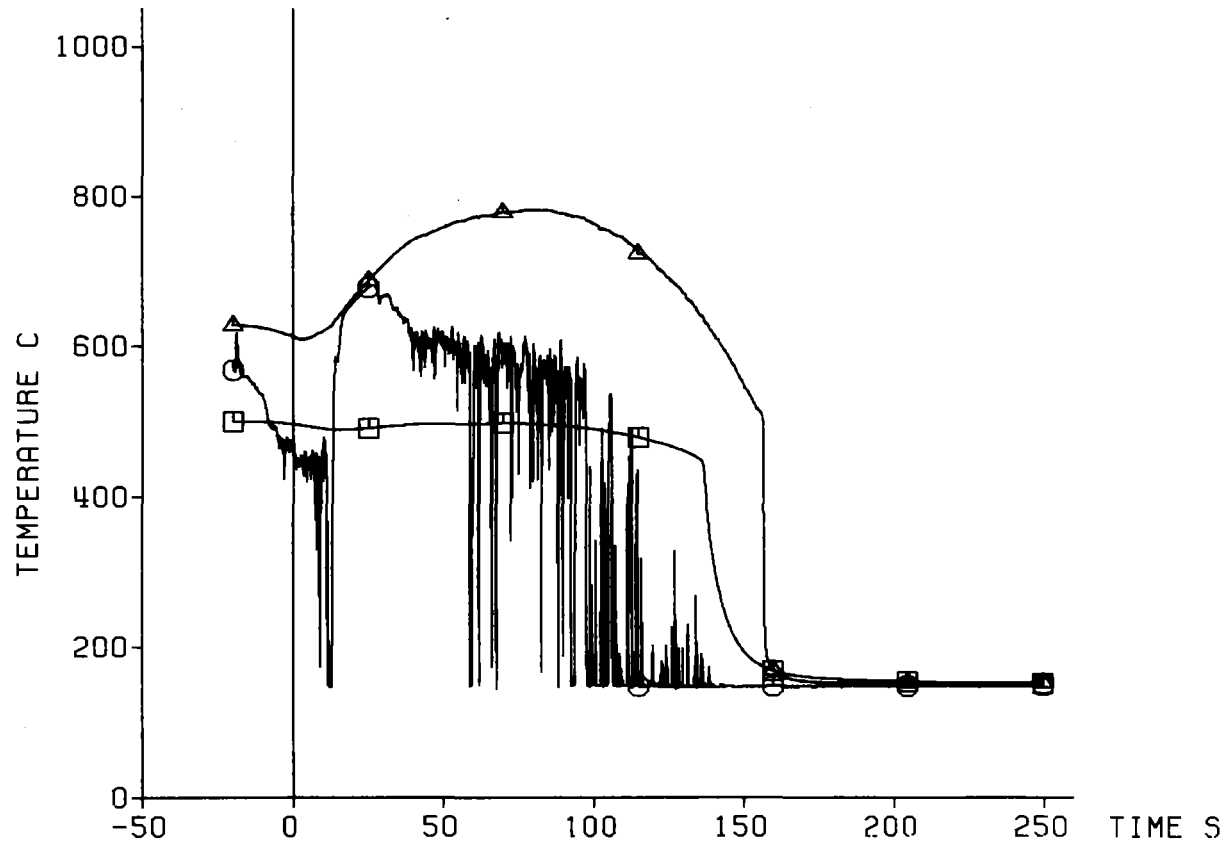

Decay Heat 120% ANS Standard
Flooding Rate (cold) 2.20 cm/s
System Pressure 4.10 bar
Feedwater Temperature 40 C

KIK IRB

Fig. 322 FEBA: 5x5 ROD BUNDLE, TEST SERIES 8, TEST-NO. 338

Axial Level: 2225 mm

△ Cladding Temperature (7a1)
○ Fluid Temperature (2240 mm)
□ Housing Temperature (2235 mm)

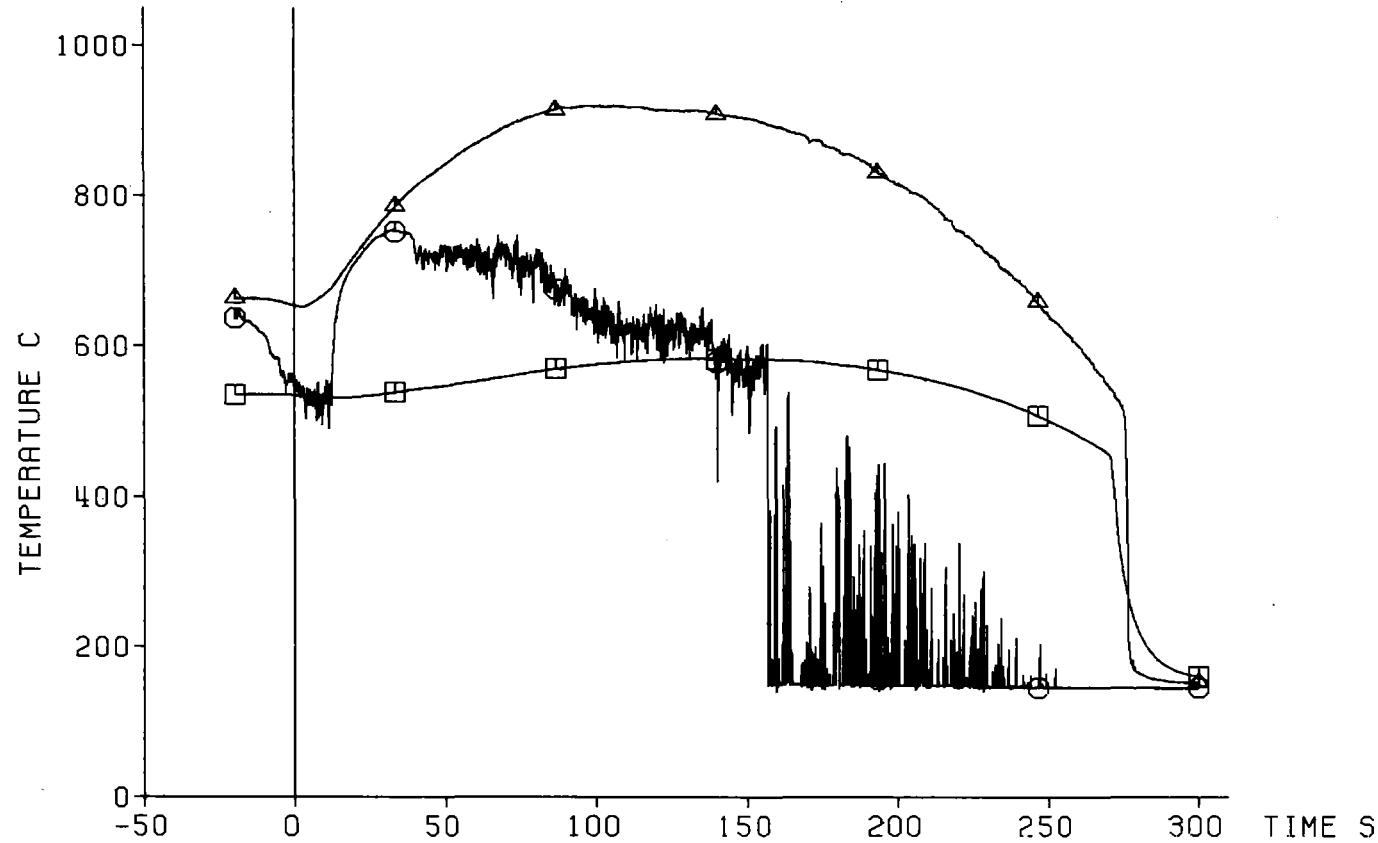

Decay Heat 120% ANS Standard
Flooding Rate (cold) 2.20 cm/s
System Pressure 4.10 bar
Feedwater Temperature 40 C

KIRB

Fig. 323 FEBA: 5x5 ROD BUNDLE, TEST SERIES 8, TEST-No. 338

Axial Level: 1925 mm

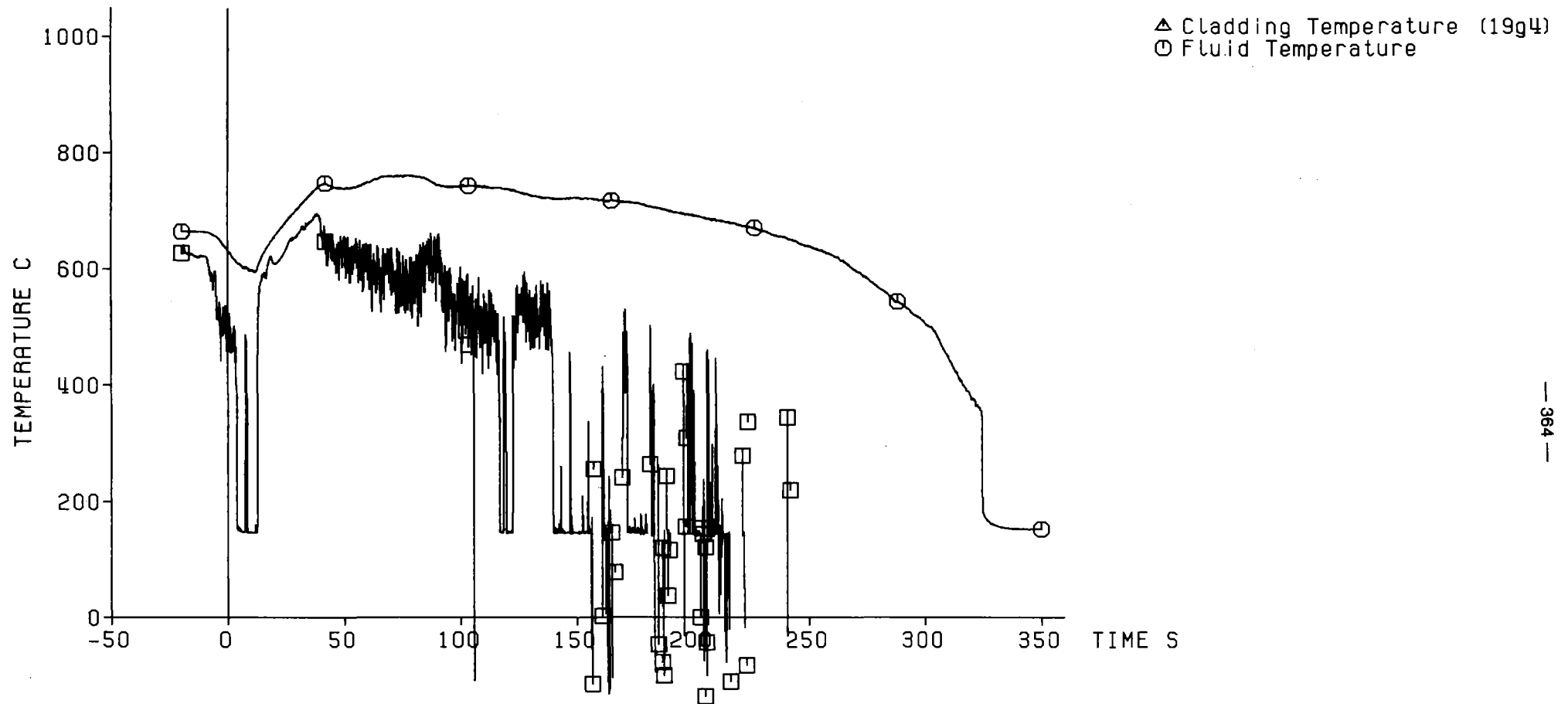

Decay Heat 120% ANS Standard
Flooding Rate (cold) 2.20 cm/s
System Pressure 4.10 bar
Feedwater Temperature 40 C



Fig. 324 FEBA: 5x5 ROD BUNDLE, TEST SERIES 8, TEST-No. 338

Axial Level: 1825 mm

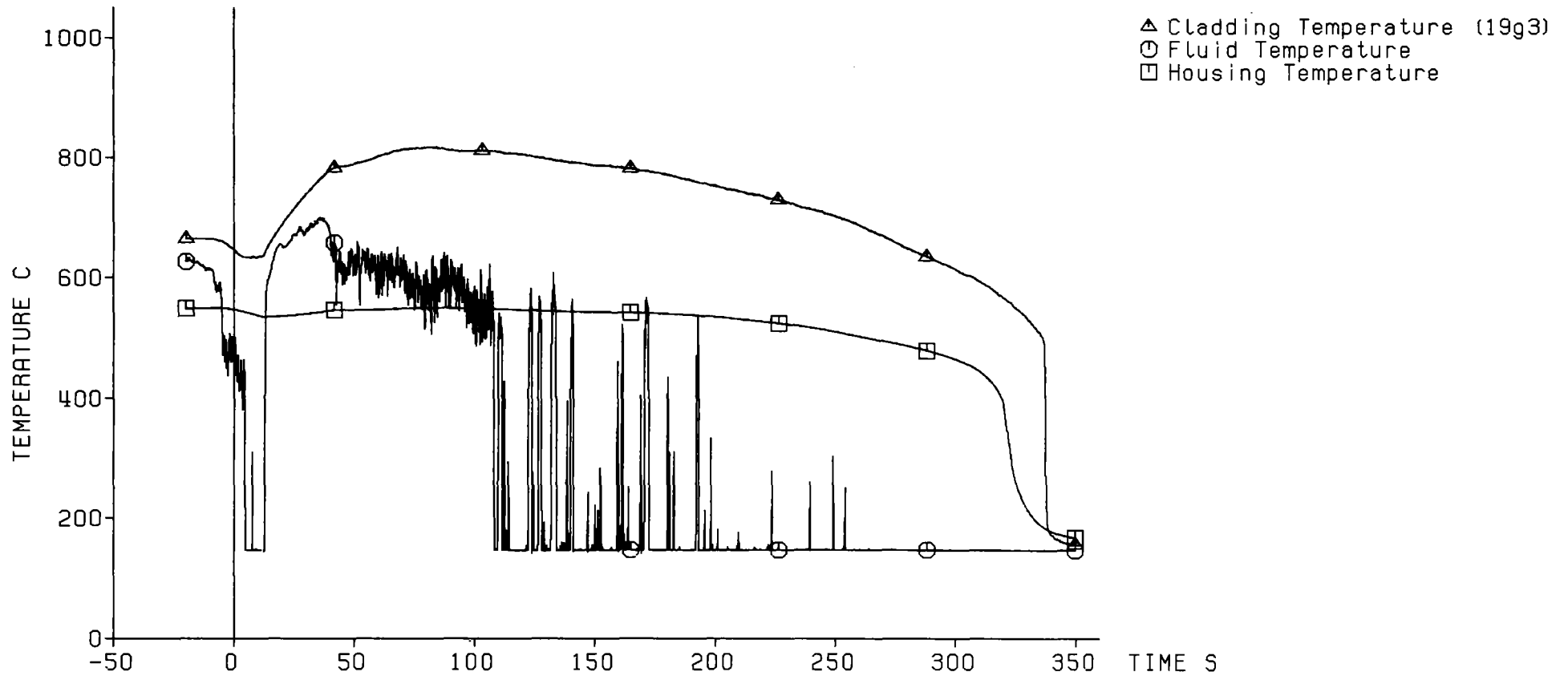

— 365 —

Decay Heat 120% ANS Standard
Flooding Rate (cold) 2.20 cm/s
System Pressure 4.10 bar
Feedwater Temperature 40 C



Fig. 325 FEBA: 5x5 ROD BUNDLE, TEST SERIES 8, TEST-No. 338

Axial Level: 1725 mm

△ Cladding Temperature (19g2)
○ Fluid Temperature

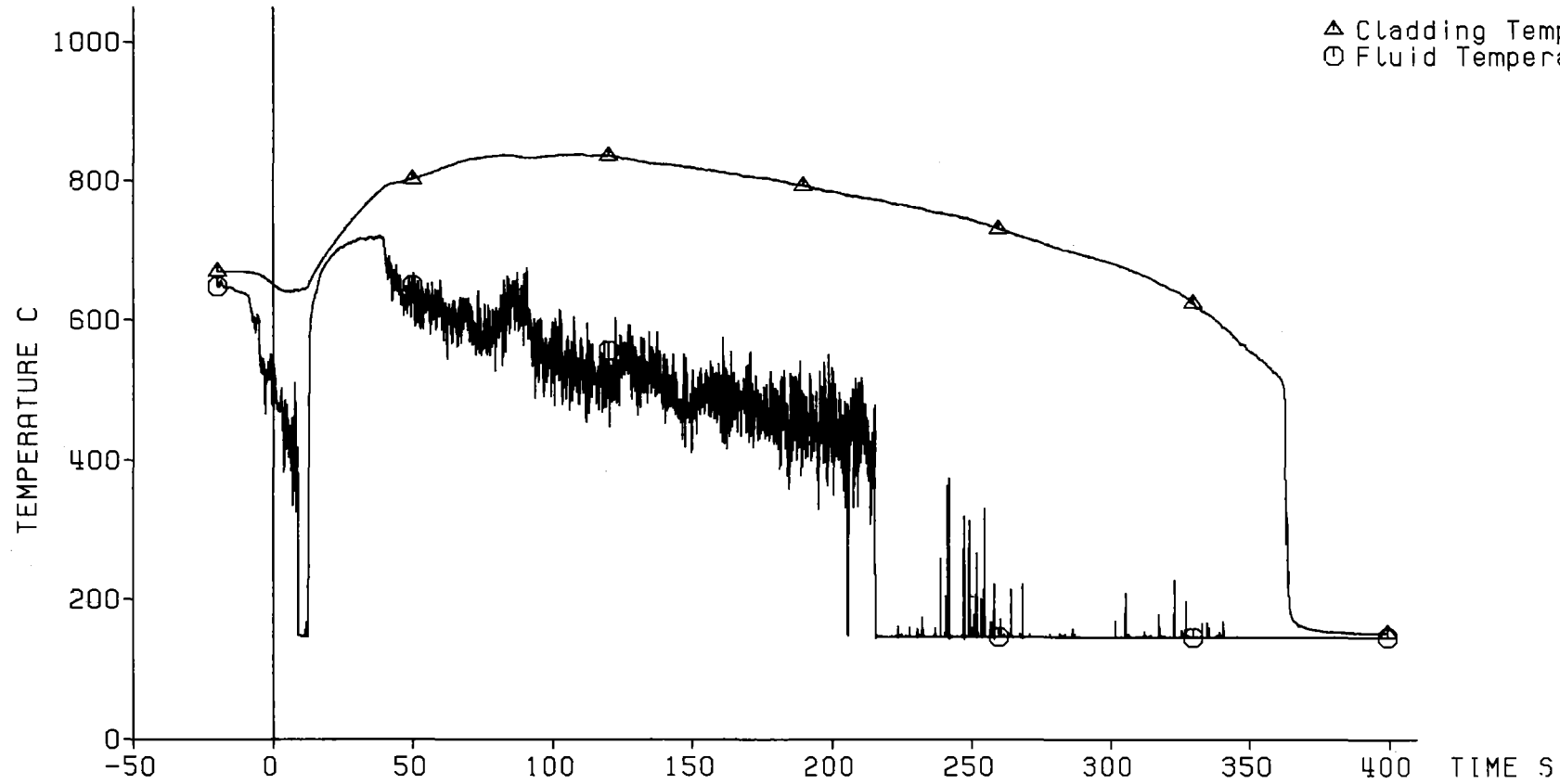

Decay Heat 120% ANS Standard
Flooding Rate (cold) 2.20 cm/s
System Pressure 4.10 bar
Feedwater Temperature 40 C

— 368 —



Fig. 326 FEBA: 5x5 ROD BUNDLE, TEST SERIES 8, TEST-NO. 338

Axial Level: 1625 mm

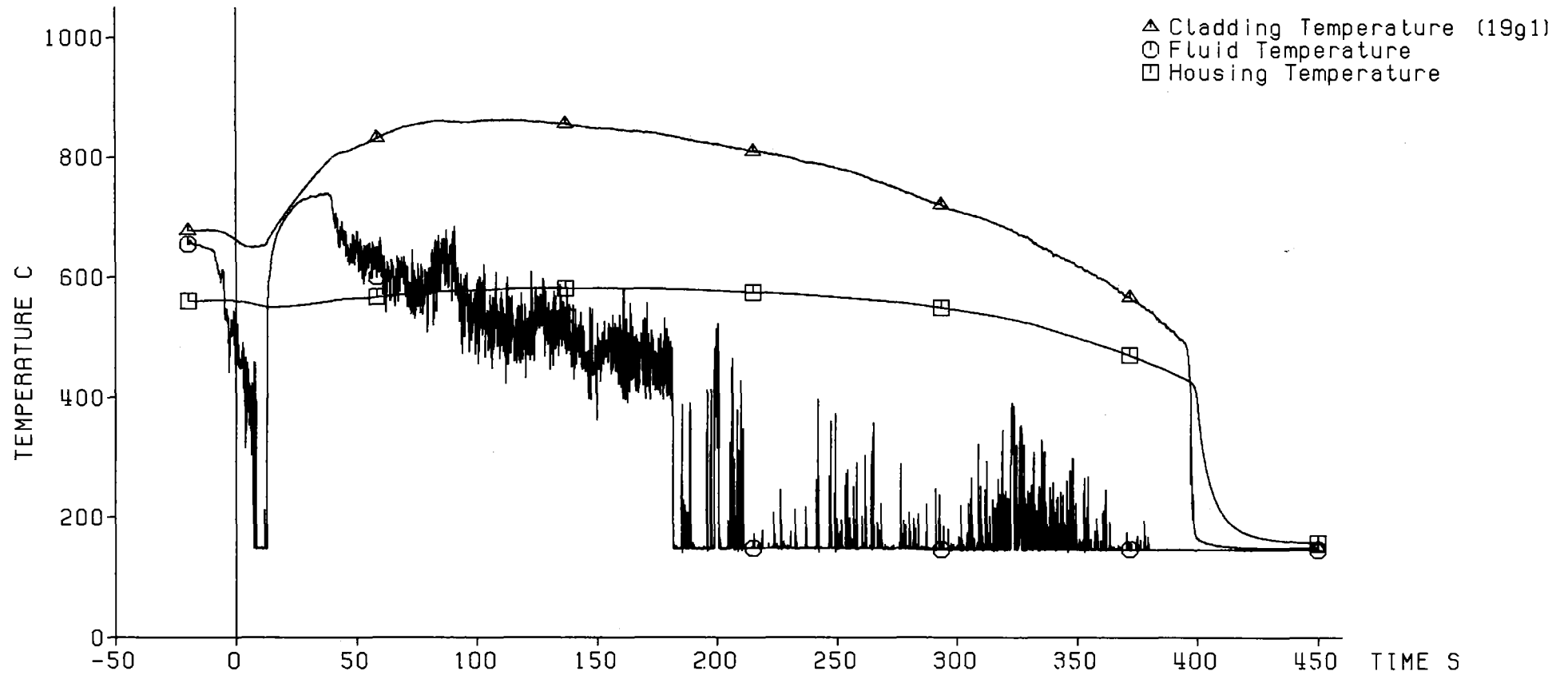

— 367 —

Decay Heat 120% ANS Standard
Flooding Rate (cold) 2.20 cm/s
System Pressure 4.10 bar
Feedwater Temperature 40 C



Fig. 327 FEBA: 5x5 ROD BUNDLE, TEST SERIES 8, TEST-No. 338

Axial Level: 1135 mm

△ Cladding Temperature (8b3)
○ Fluid Temperature
□ Housing Temperature

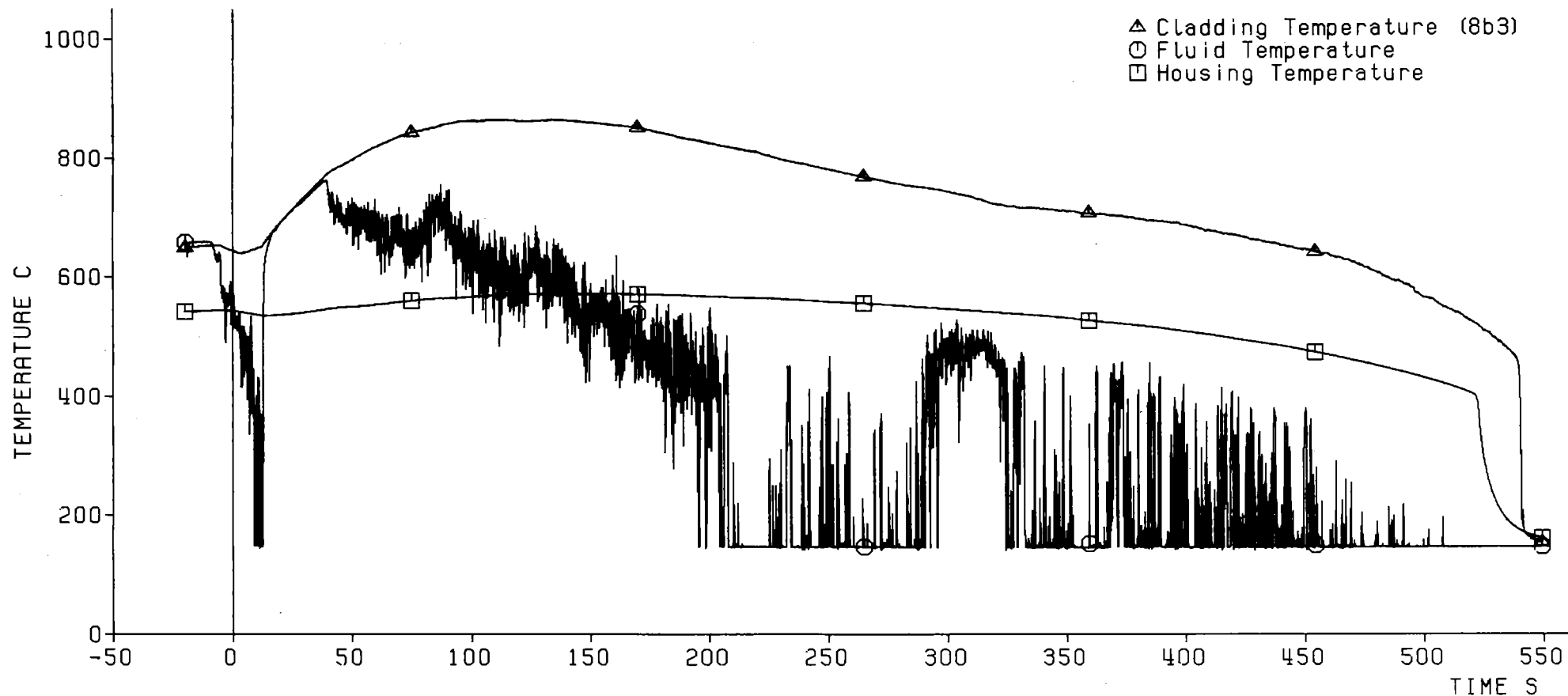

Decay Heat 120% ANS Standard
Flooding Rate (cold) 2.20 cm/s
System Pressure 4.10 bar
Feedwater Temperature 40 C

KFK IRB

Fig. 328 FEBA: 5x5 ROD BUNDLE, TEST SERIES 8, TEST-No. 338

Pressure Loss
Along the Test Section:

◇ Total Length: 4196 mm
△ Lower Part: 1711 mm
○ Middle Part: 545 mm
□ Upper Part: 1940 mm

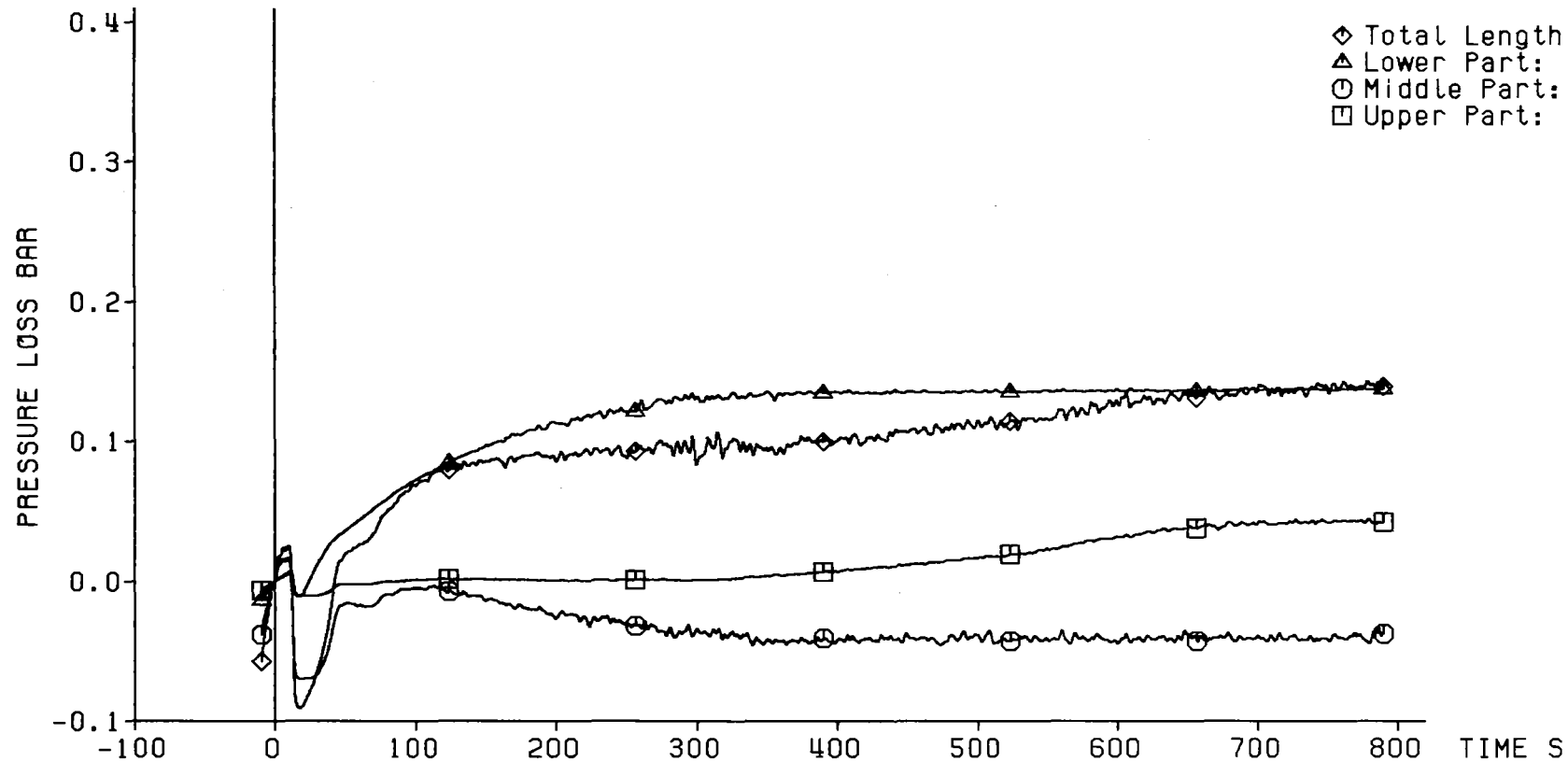

Decay Heat 120% ANS Standard
Flooding Rate (cold) 2.20 cm/s
System Pressure 4.10 bar
Feedwater Temperature 40 C

KIRB

Fig. 329 FEBA: 5x5 ROD BUNDLE, TEST SERIES 8, TEST-No. 338

Coolant Outlet Conditions:

△ Water Carry Over
○ Coolant Temperature
□ Coolant Pressure

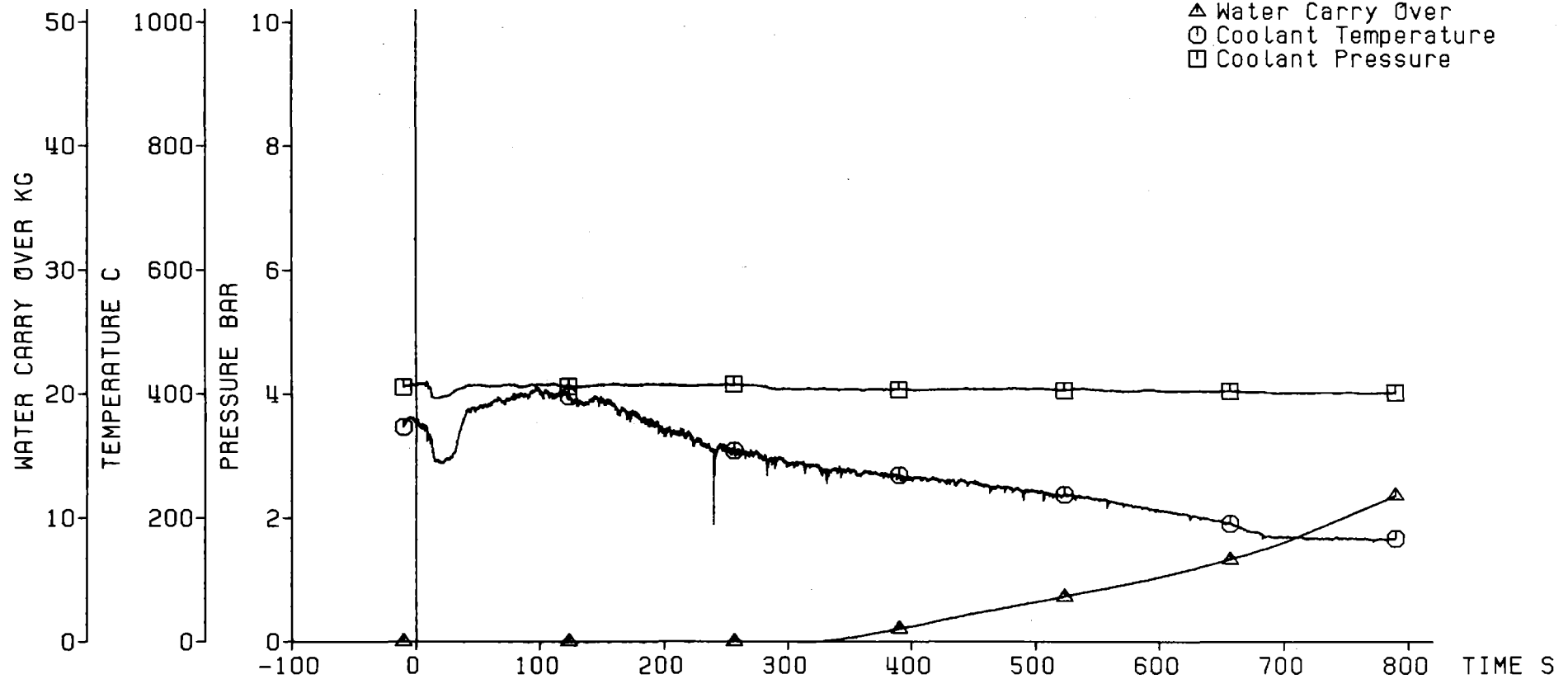

Decay Heat 120% ANS Standard
Flooding Rate (cold) 2.20 cm/s
System Pressure 4.10 bar
Feedwater Temperature 40 C

KIK IRB

Fig. 330 FEBA: 5x5 ROD BUNDLE, TEST SERIES 8, TEST-NO. 338

Axial Position of Quench Front

□ Quenching of Sleeves at Bundle Midplane

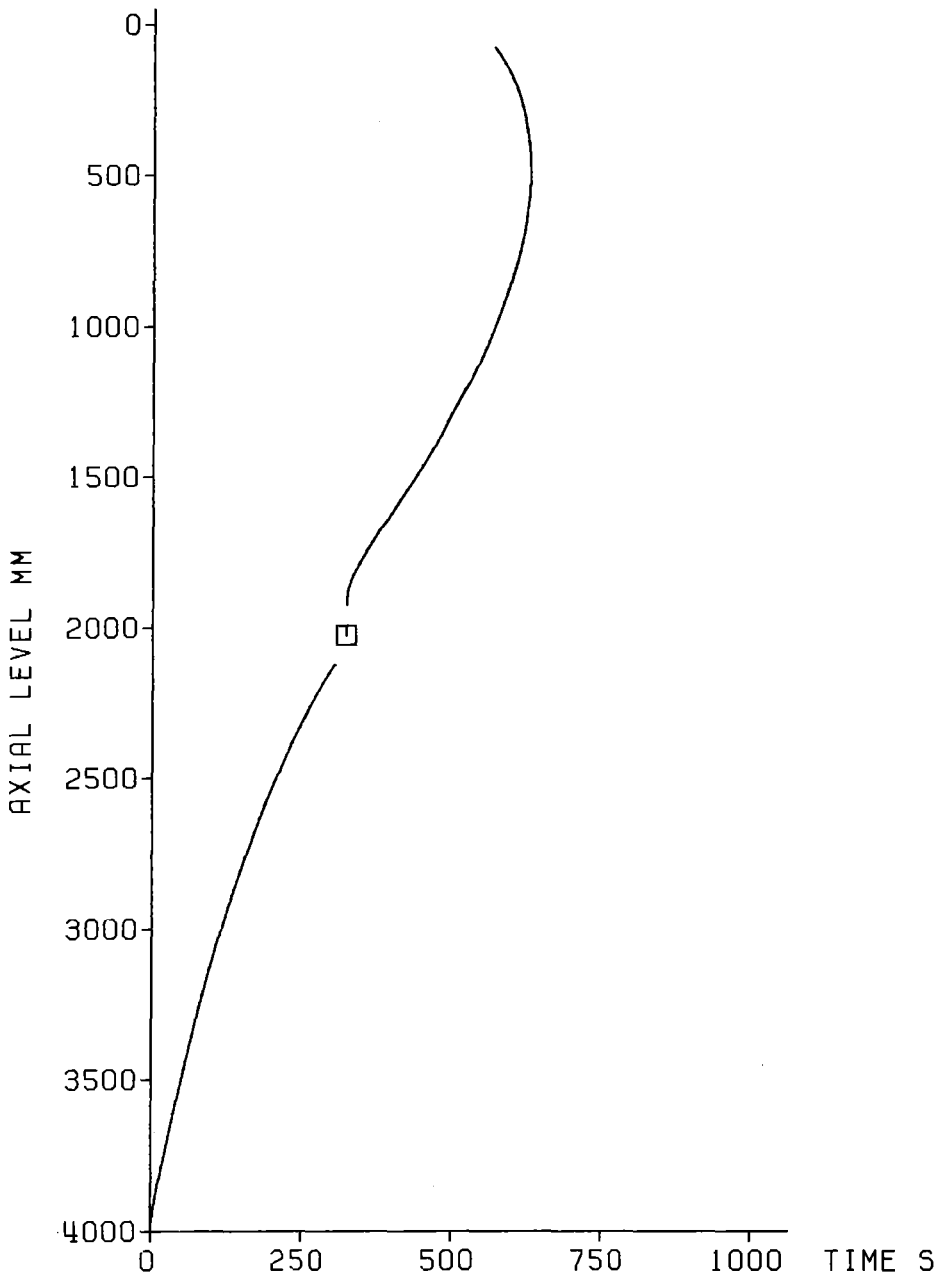

Decay Heat	120% ANS Standard
Flooding Rate (cold)	2.20 cm/s
System Pressure	4.10 bar
Feedwater Temperature	40 C



Fig. 331 FEBA: 5x5 ROD BUNDLE
TEST SERIES 8, TEST-NO. 338

Initial Axial Temperature Profile of Claddings

□ Initial Temperature of Sleeves at Bundle Midplane

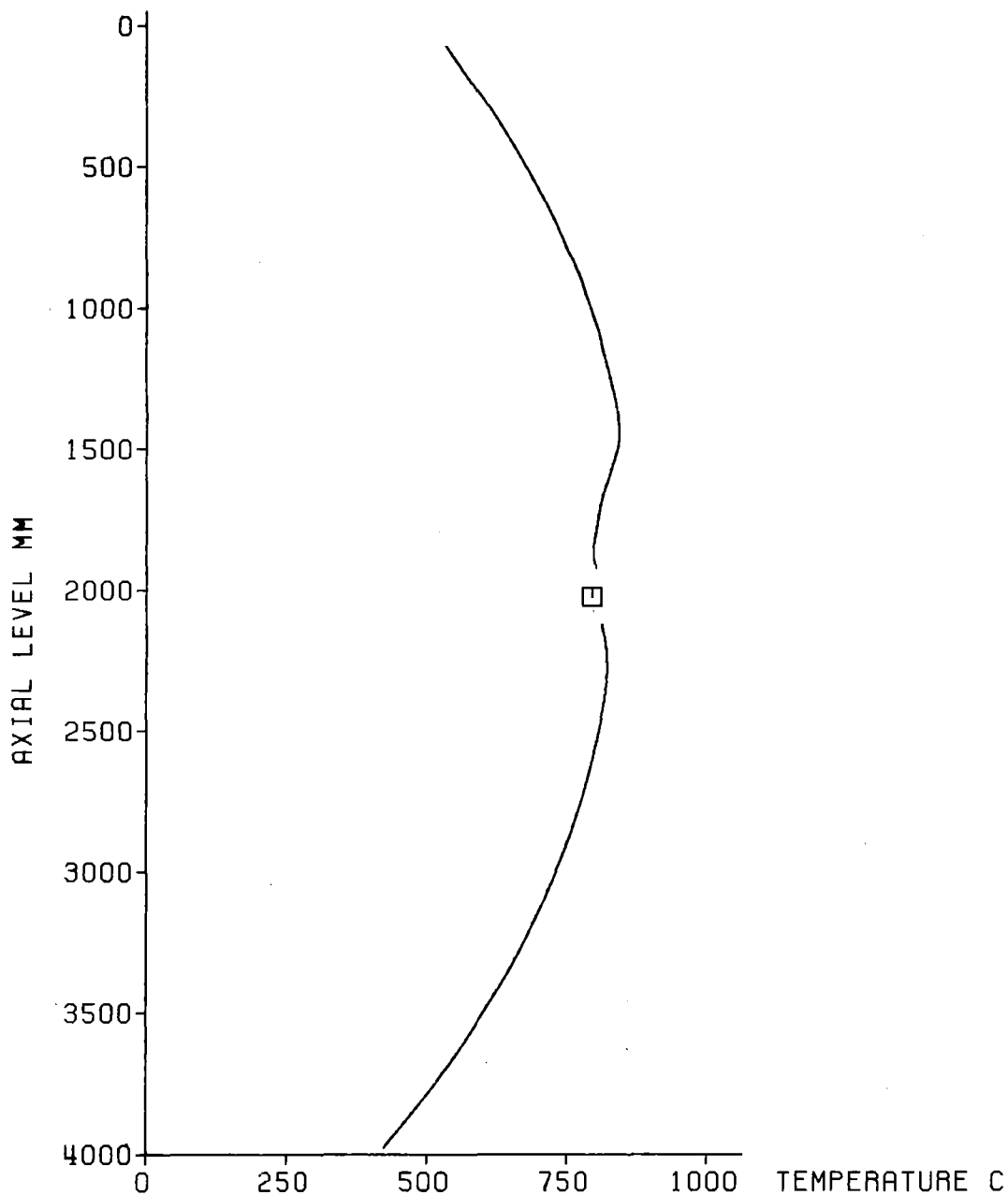

Decay Heat	120% ANS Standard
Flooding Rate (cold)	3.82 cm/s
System Pressure	2.19 bar
Feedwater Temperature	40 C



Fig. 332 FEBA: 5x5 ROD BUNDLE
TEST SERIES 8, TEST-No. 341

Test Parameters:

- ◇ Flooding Rate
- △ System Pressure
- Feedwater Temperature
- Bundle Power

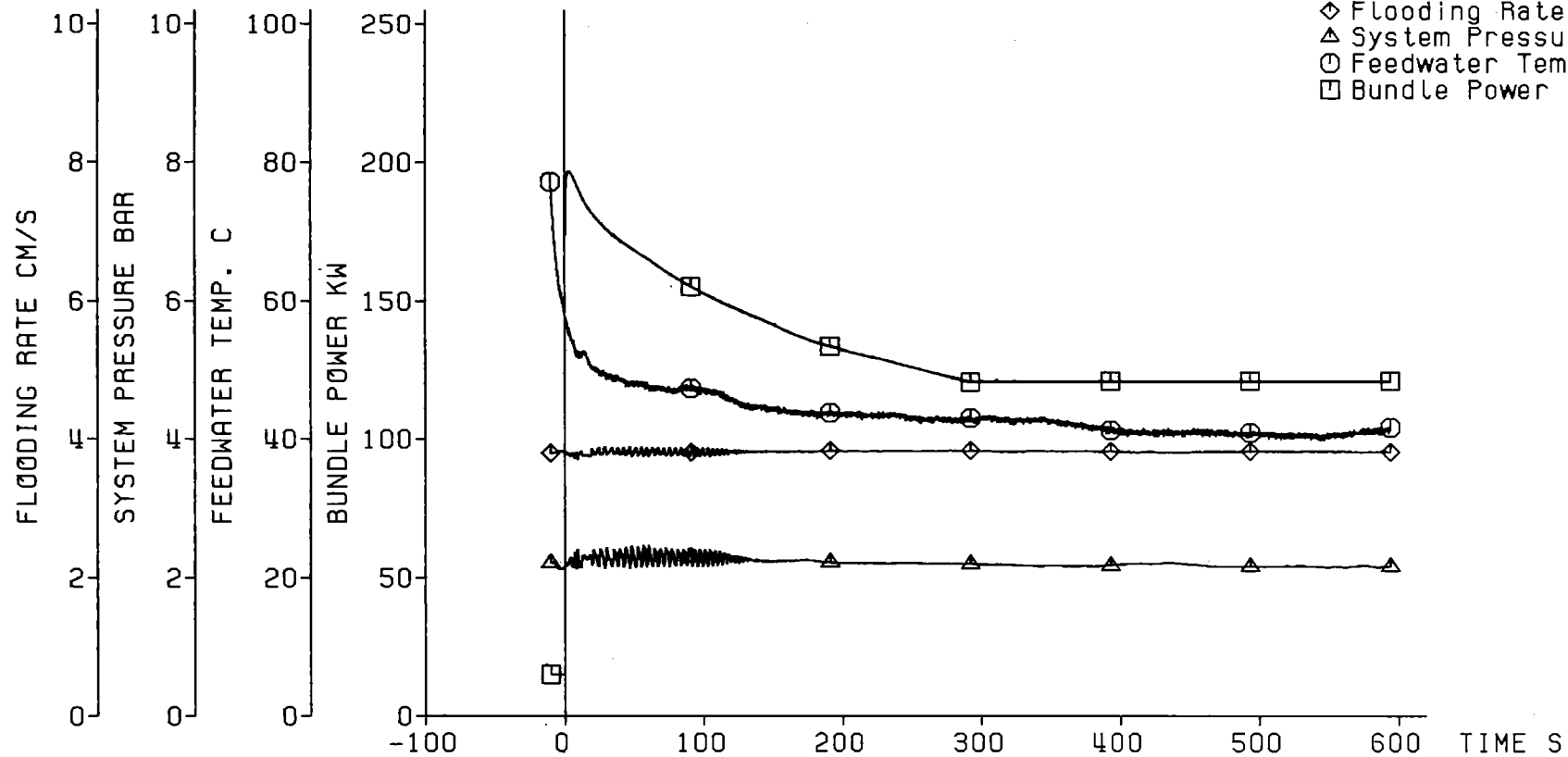

Decay Heat 120% ANS Standard
Flooding Rate (cold) 3.82 cm/s
System Pressure 2.19 bar
Feedwater Temperature 40 C



Fig. 333 FEBA: 5x5 ROD BUNDLE, TEST SERIES 8, TEST-No. 341

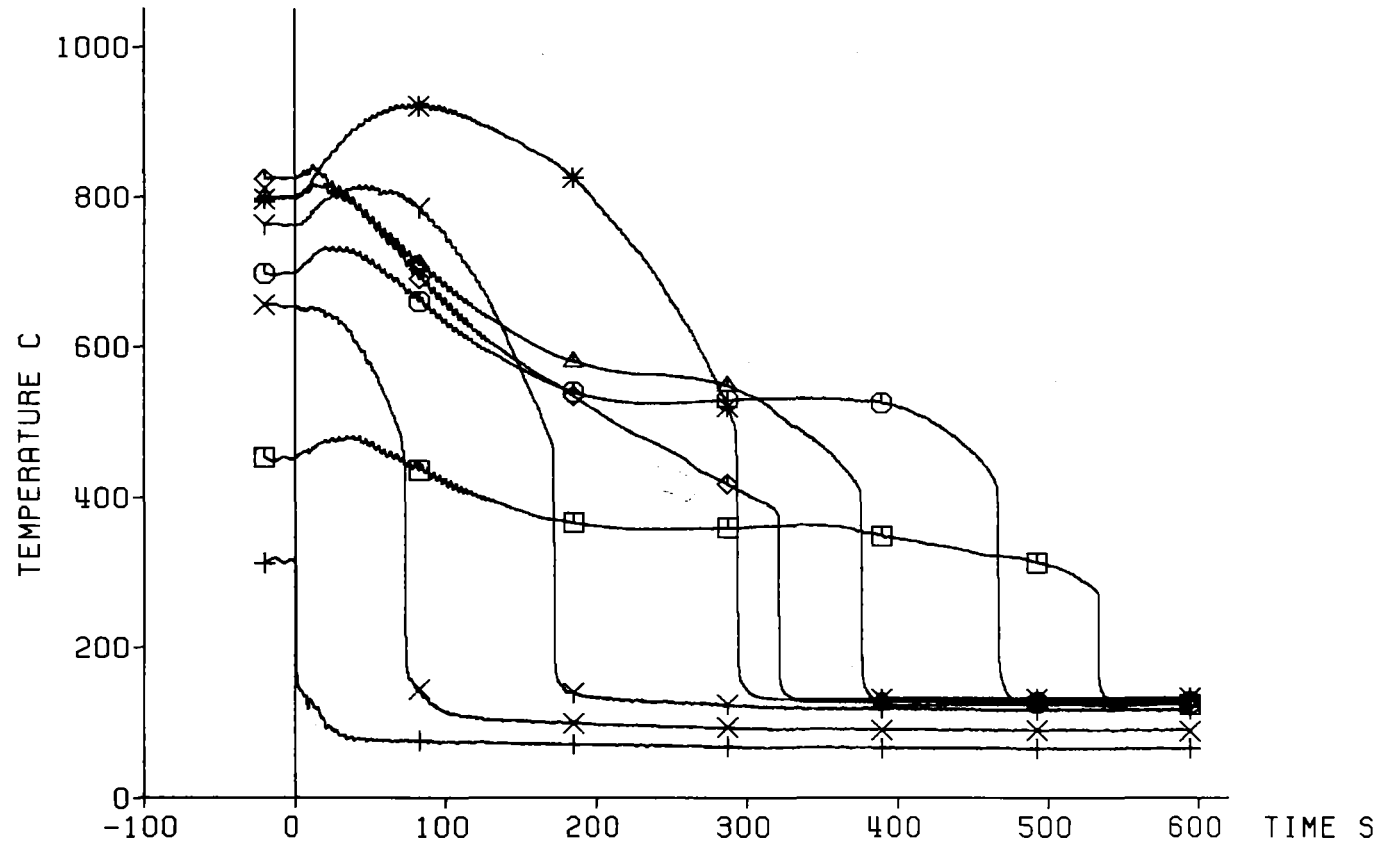

	TC	Ax. Level
+	7a4	3860 mm
X	7a3	3315 mm
Y	7a2	2770 mm
*	7a1	2225 mm
◇	8b4	1680 mm
△	8b3	1135 mm
⊙	8b2	590 mm
□	3b1	45 mm

Decay Heat 120% ANS Standard
 Flooding Rate (cold) 3.82 cm/s
 System Pressure 2.19 bar
 Feedwater Temperature 40 C



Fig. 334 FEBA: 5x5 ROD BUNDLE, TEST SERIES 8, TEST-No. 341

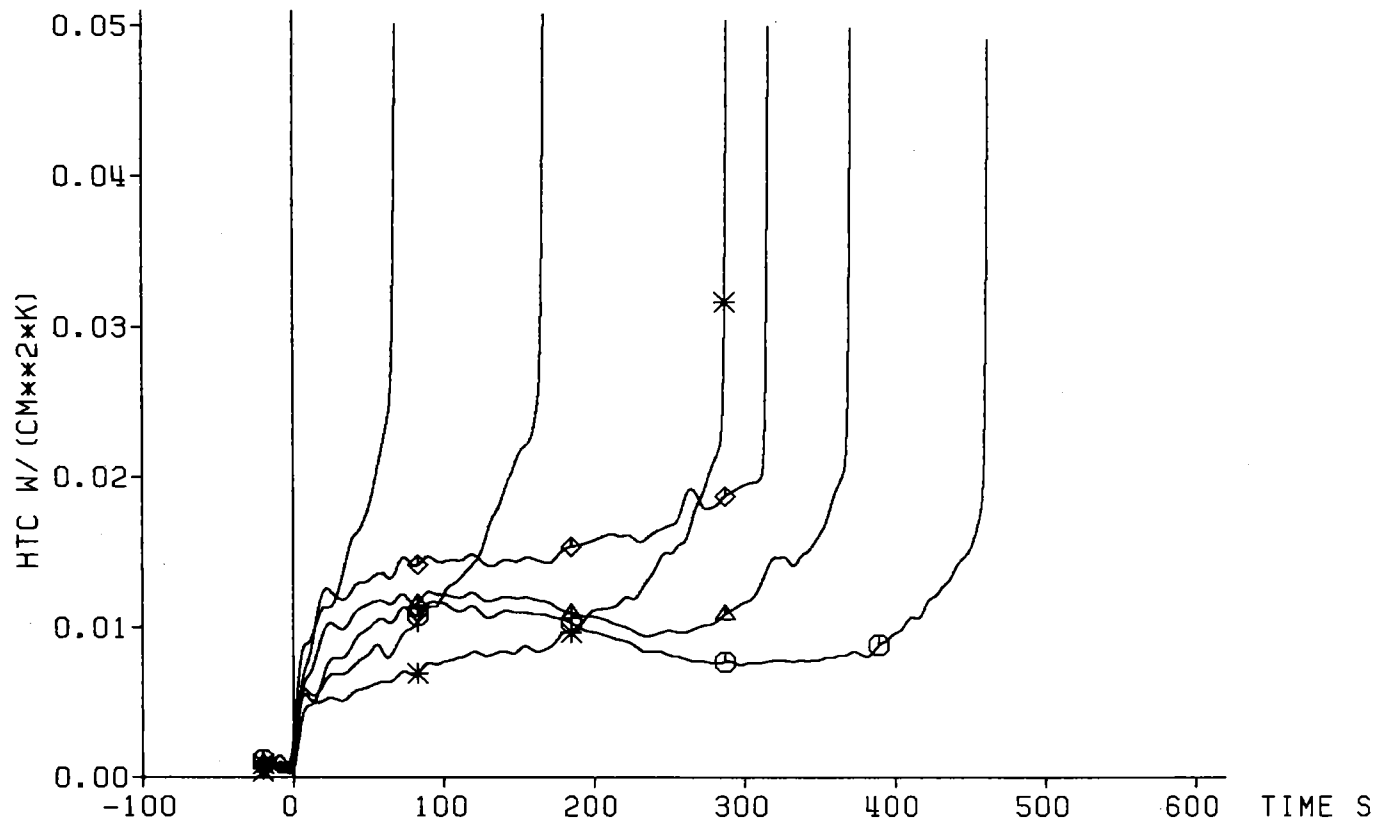

	TC	Ax. Level
X	7a3	3315 mm
Y	7a2	2770 mm
*	7a1	2225 mm
◇	8b4	1680 mm
△	8b3	1135 mm
○	8b2	590 mm

Decay Heat 120% ANS Standard
 Flooding Rate (cold) 3.82 cm/s
 System Pressure 2.19 bar
 Feedwater Temperature 40 C



Fig. 335 FEBA: 5x5 ROD BUNDLE, TEST SERIES 8, TEST-No. 341

Cladding Temperature

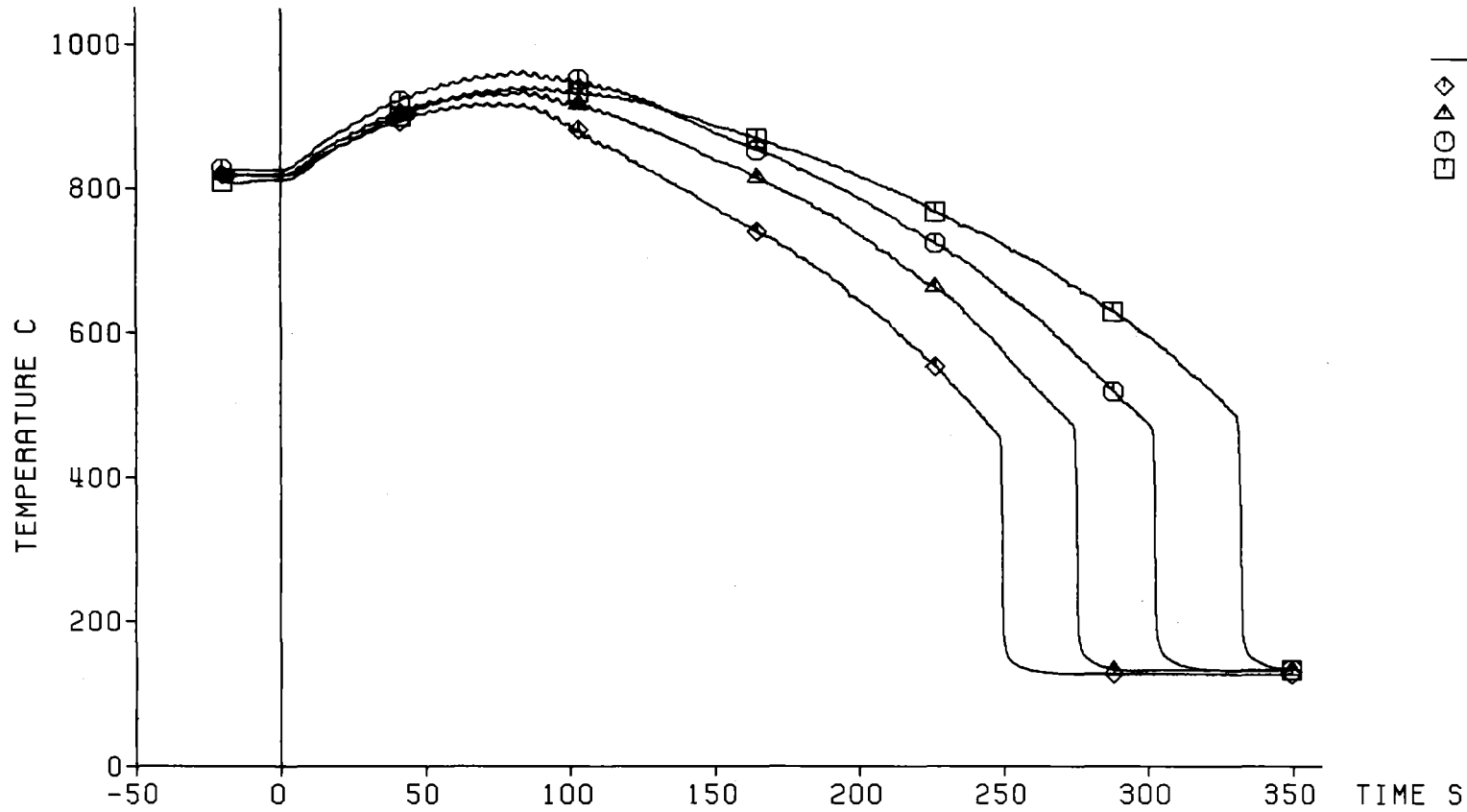

Decay Heat 120% ANS Standard
 Flooding Rate (cold) 3.82 cm/s
 System Pressure 2.19 bar
 Feedwater Temperature 40 C



Fig. 336 FEBA: 5x5 ROD BUNDLE, TEST SERIES 8, TEST-No. 341

Heat Transfer Coeff.

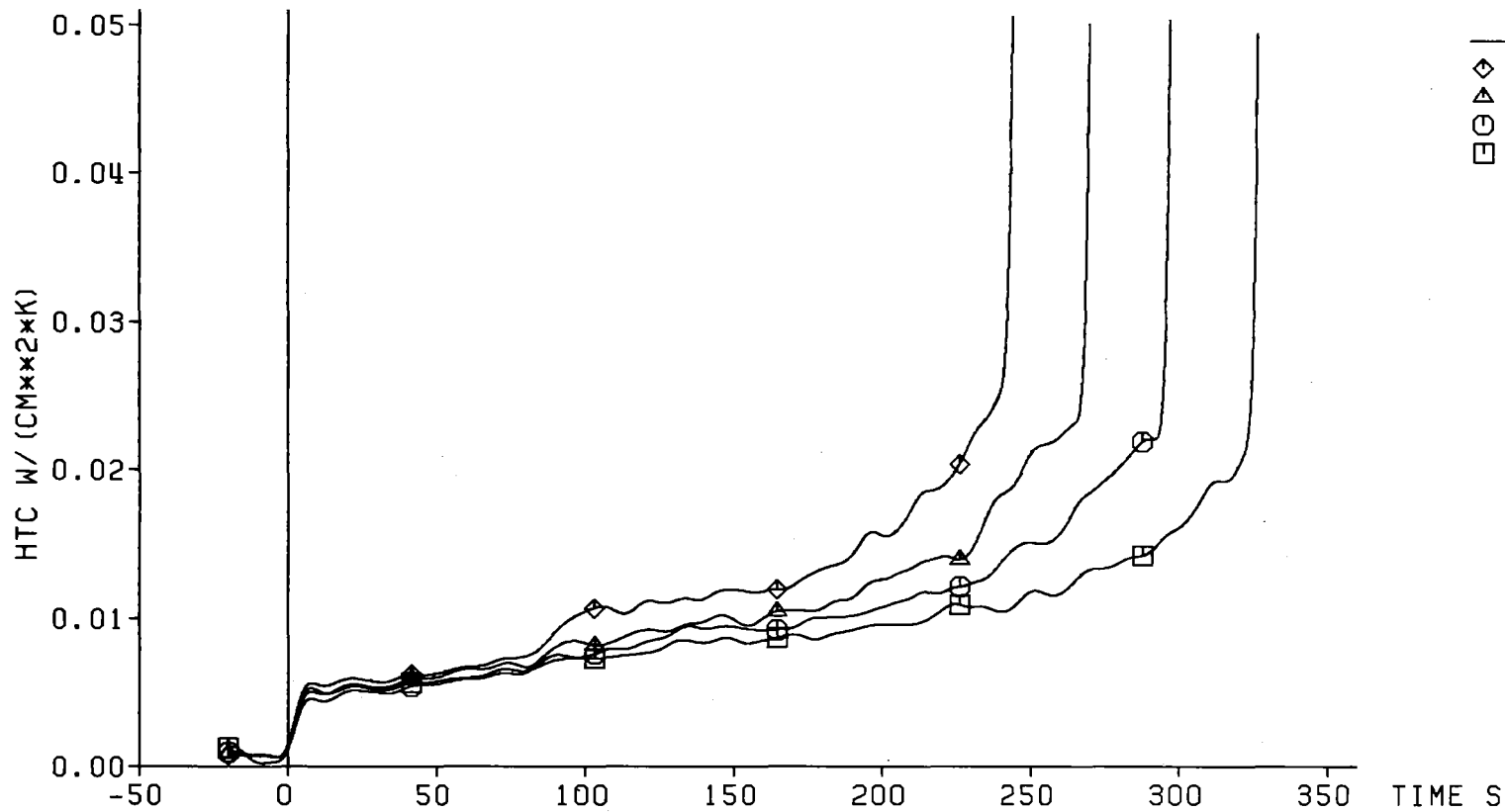

Decay Heat 120% ANS Standard
 Flooding Rate (cold) 3.82 cm/s
 System Pressure 2.19 bar
 Feedwater Temperature 40 C



Fig. 337 FEBA: 5x5 ROD BUNDLE, TEST SERIES 8, TEST-No. 341

Cladding Temperature

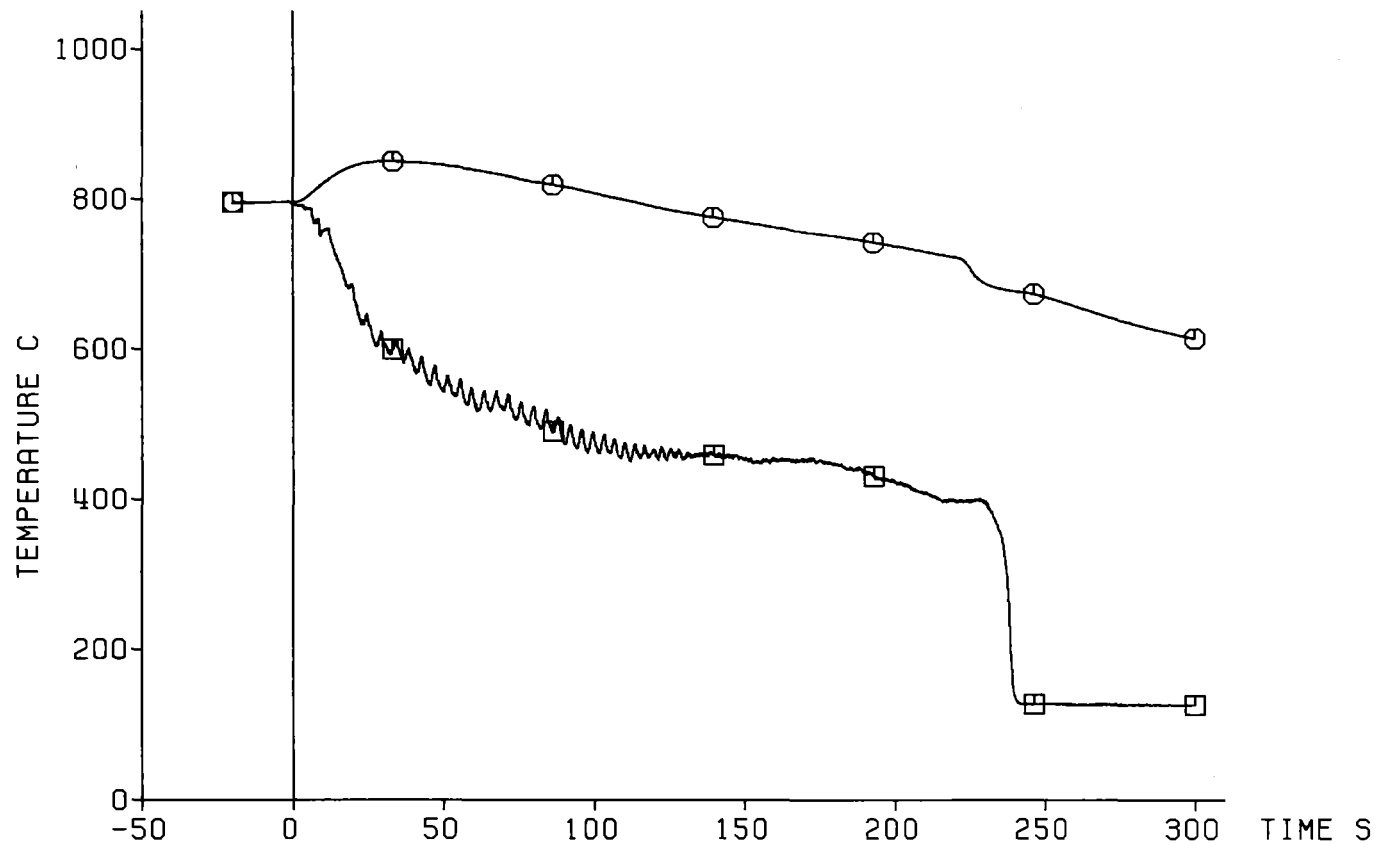

TC	Ax. Level
⊙ 1714	2025 mm
⊠ Sleeve	2025 mm

Decay Heat 120% ANS Standard
 Flooding Rate (cold) 3.82 cm/s
 System Pressure 2.19 bar
 Feedwater Temperature 40 C



Fig. 338 FEBA: 5x5 ROD BUNDLE, TEST SERIES 8, TEST-No. 341

Sleeve Temperature
Contact Face: Rods 17 and 18

TC	Ax. Level
○ Sleeve	2025 mm (Rod 17)
□ Sleeve	2025 mm (Rod 18)

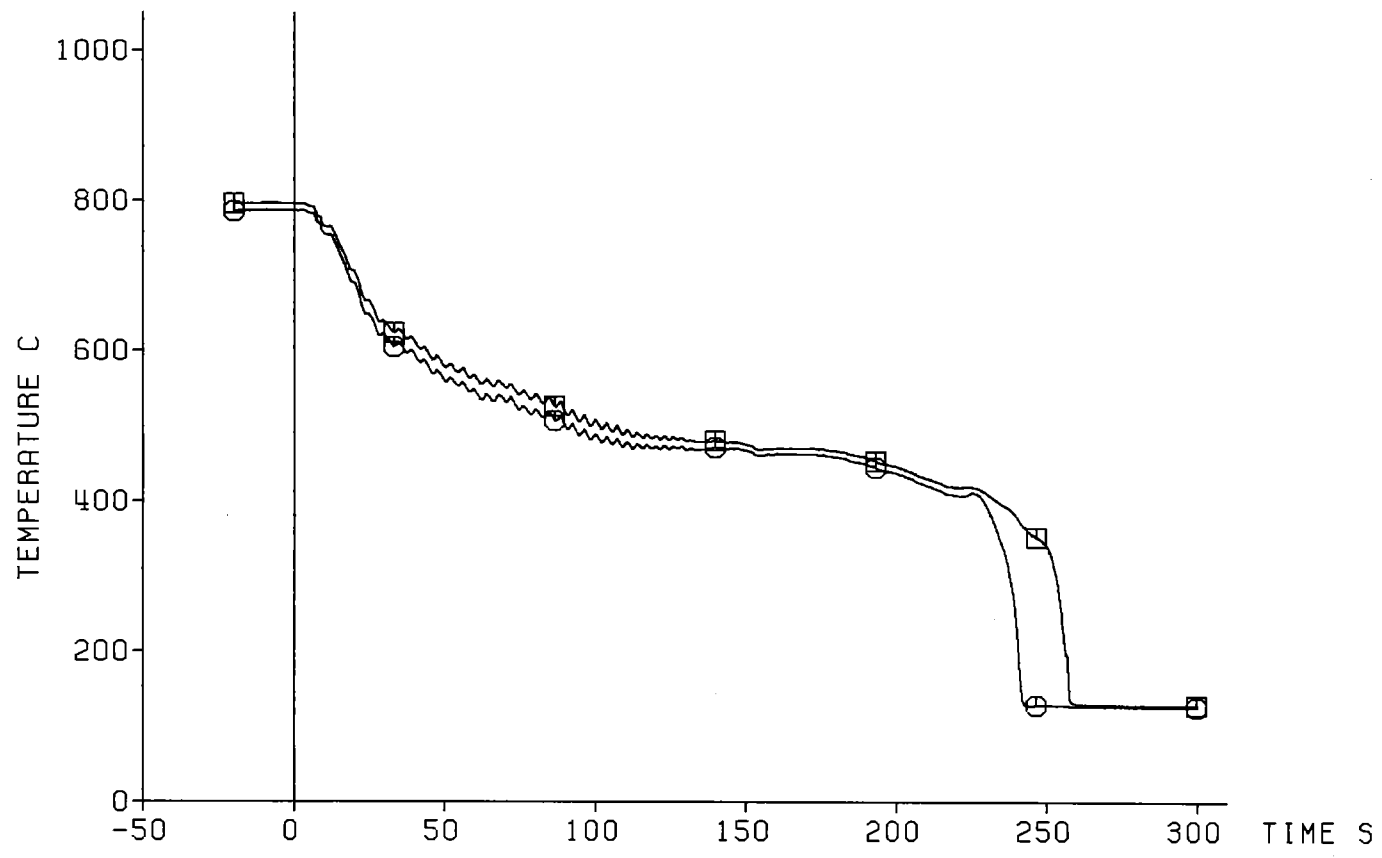

Decay Heat 120% ANS Standard
 Flooding Rate (cold) 3.82 cm/s
 System Pressure 2.19 bar
 Feedwater Temperature 40 C

— 379 —



Fig. 339 FEBA: 5x5 ROD BUNDLE, TEST SERIES 8, TEST-NO. 341

Cladding Temperature

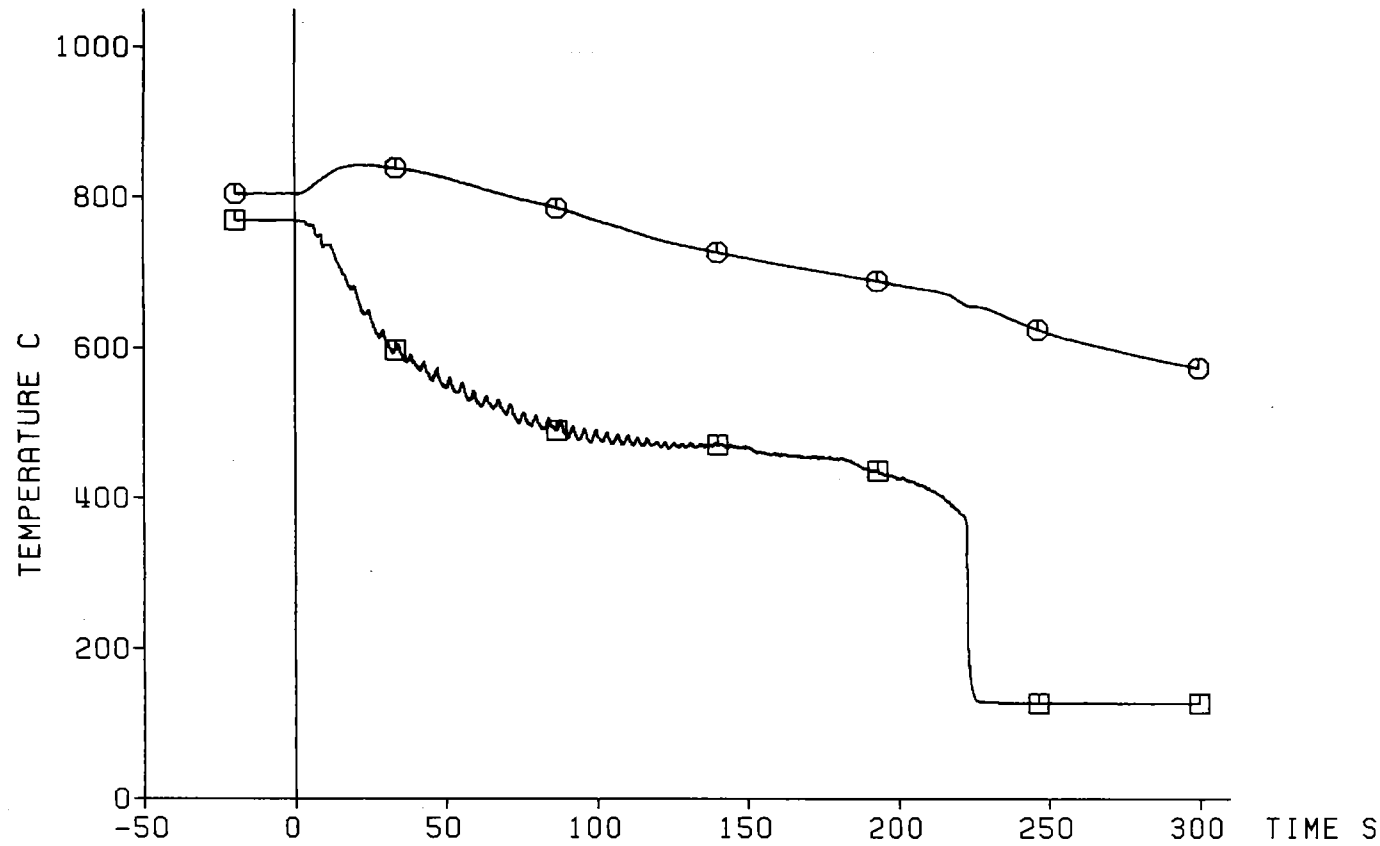

TC	Ax. Level
⊙ 17i3	1975 mm
⊠ Sleeve	1972 mm

Decay Heat 120% ANS Standard
 Flooding Rate (cold) 3.82 cm/s
 System Pressure 2.19 bar
 Feedwater Temperature 40 C



Fig. 340 FEBA: 5x5 ROD BUNDLE, TEST SERIES 8, TEST-No. 341

Cladding Temperature

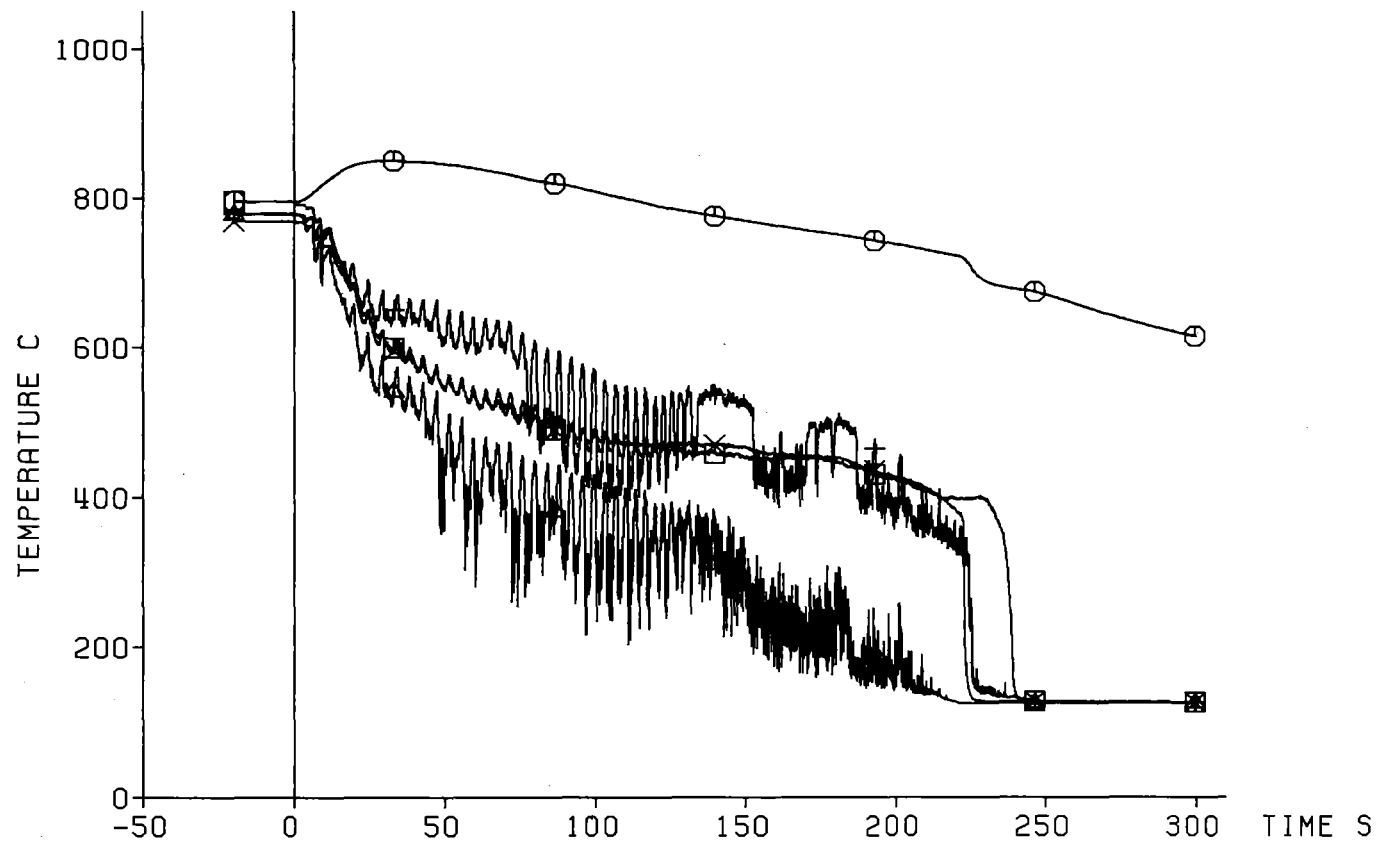

TC	Ax. Level
○ 17i4	2025 mm
+ Sleeve	2064 mm
□ Sleeve	2025 mm
△ Sleeve	2025 mm
× Sleeve	1972 mm

Decay Heat 120% ANS Standard
 Flooding Rate (cold) 3.82 cm/s
 System Pressure 2.19 bar
 Feedwater Temperature 40 C



Fig. 341 FEBA: 5x5 ROD BUNDLE, TEST SERIES 8, TEST-No. 341

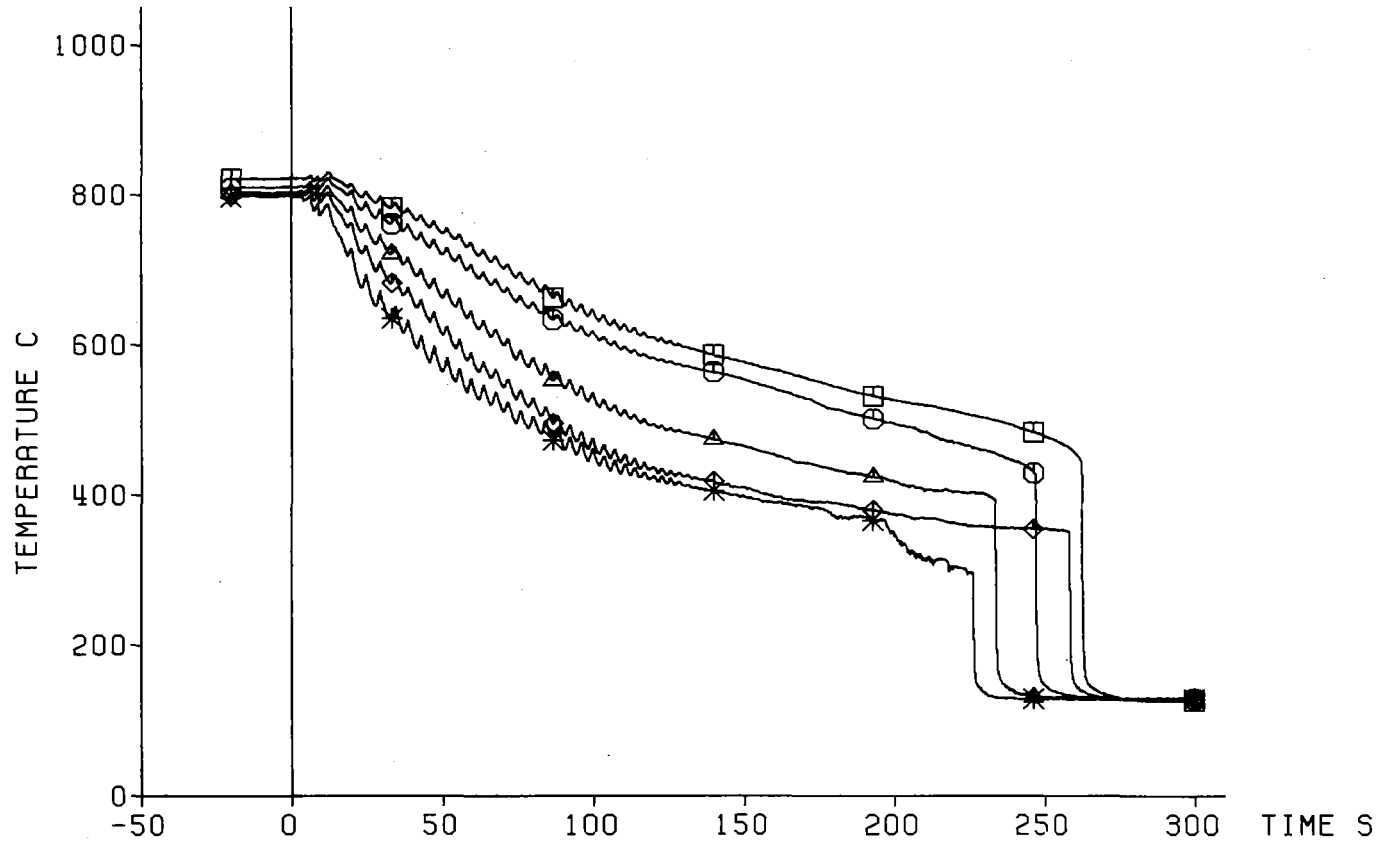

TC	Ax. Level
* 19g4	1925 mm
◇ 17i1	1875 mm
△ 19g3	1825 mm
○ 19g2	1725 mm
□ 19g1	1625 mm

Decay Heat 120% ANS Standard
 Flooding Rate (cold) 3.82 cm/s
 System Pressure 2.19 bar
 Feedwater Temperature 40 C



Fig. 342 FEBA: 5x5 ROD BUNDLE, TEST SERIES 8, TEST-No. 341

Heat Transfer Coeff.

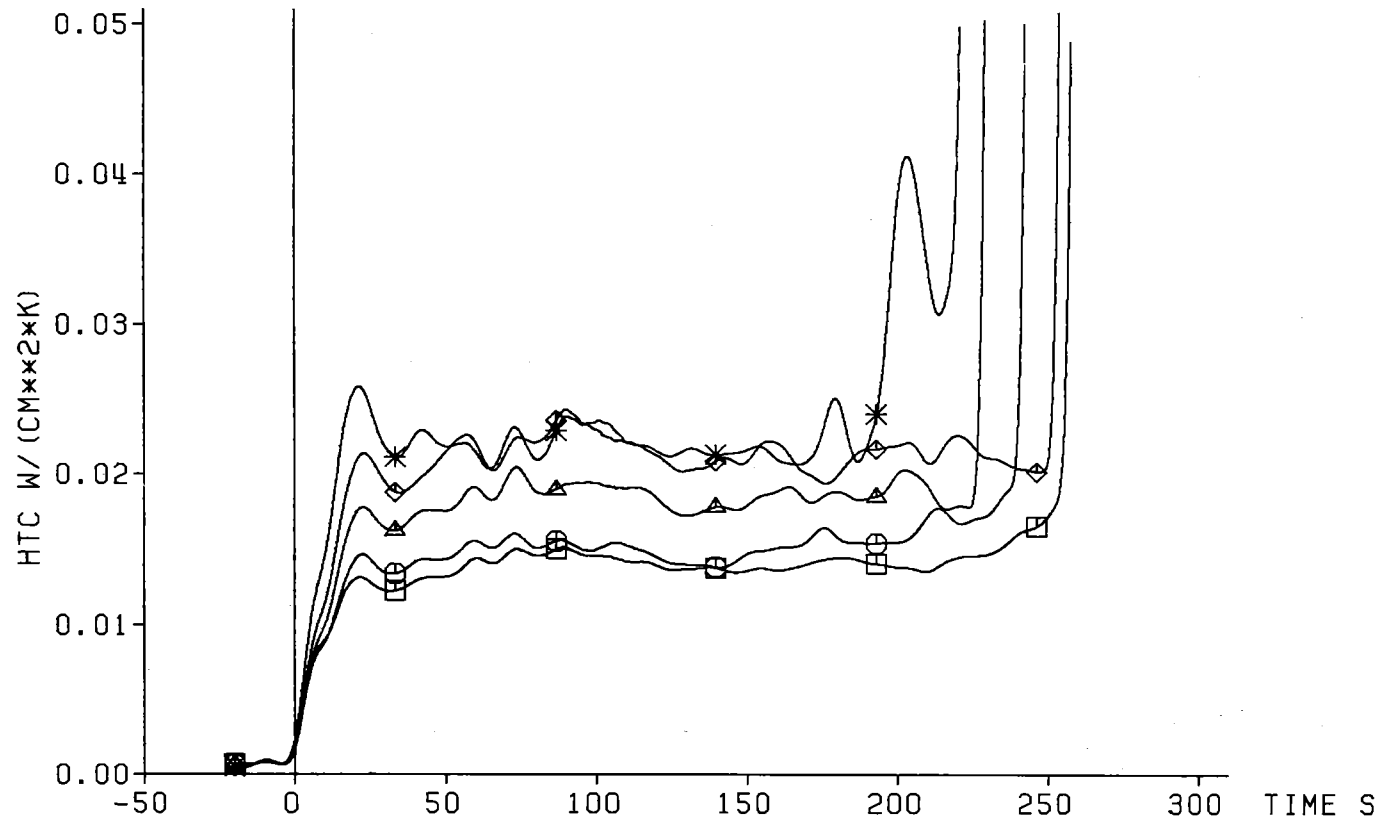

TC	Ax. Level
*	19g4 1925 mm
◇	17i1 1875 mm
△	19g3 1825 mm
⊙	19g2 1725 mm
□	19g1 1625 mm

Decay Heat 120% ANS Standard
 Flooding Rate (cold) 3.82 cm/s
 System Pressure 2.19 bar
 Feedwater Temperature 40 C



Fig. 343 FEBA: 5x5 ROD BUNDLE, TEST SERIES 8, TEST-No. 341

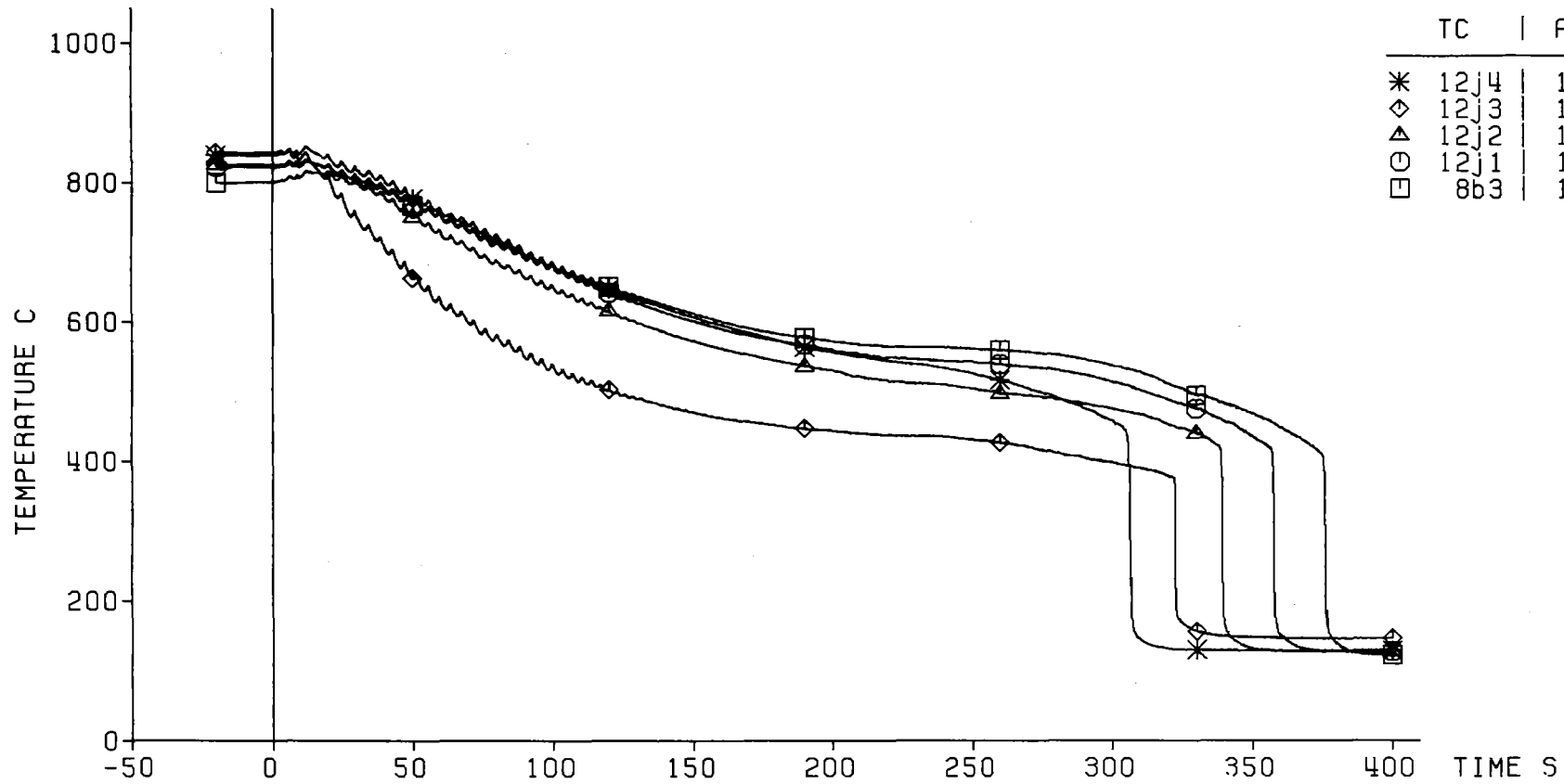

Decay Heat 120% ANS Standard
 Flooding Rate (cold) 3.82 cm/s
 System Pressure 2.19 bar
 Feedwater Temperature 40 C



Fig. 344 FEBA: 5x5 ROD BUNDLE, TEST SERIES 8, TEST-No. 341

Heat Transfer Coeff.

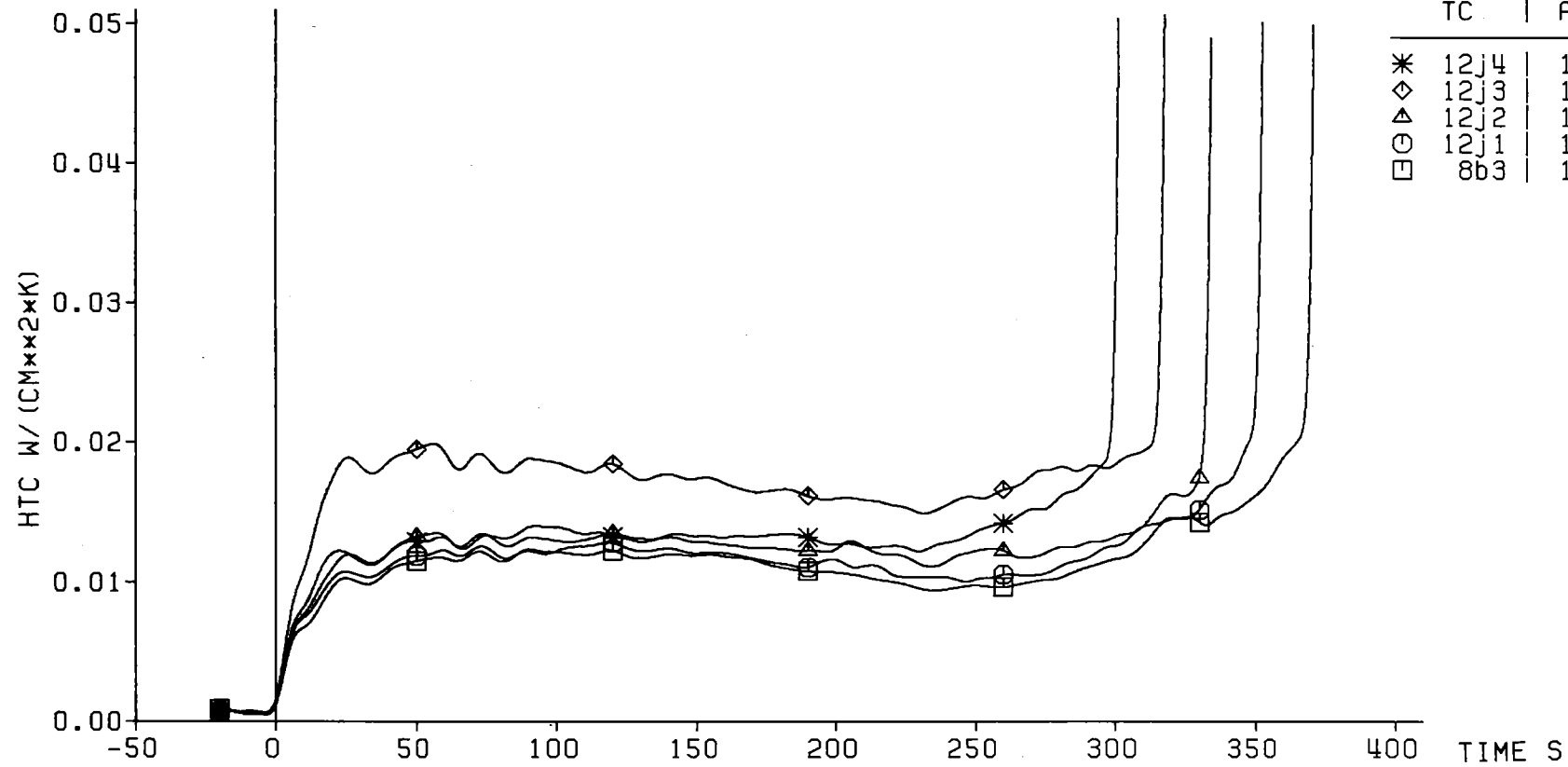

Decay Heat 120% ANS Standard
 Flooding Rate (cold) 3.82 cm/s
 System Pressure 2.19 bar
 Feedwater Temperature 40 C



Fig. 345 FEBA: 5x5 ROD BUNDLE, TEST SERIES 8, TEST-NO. 341

Grid Spacer Temperature

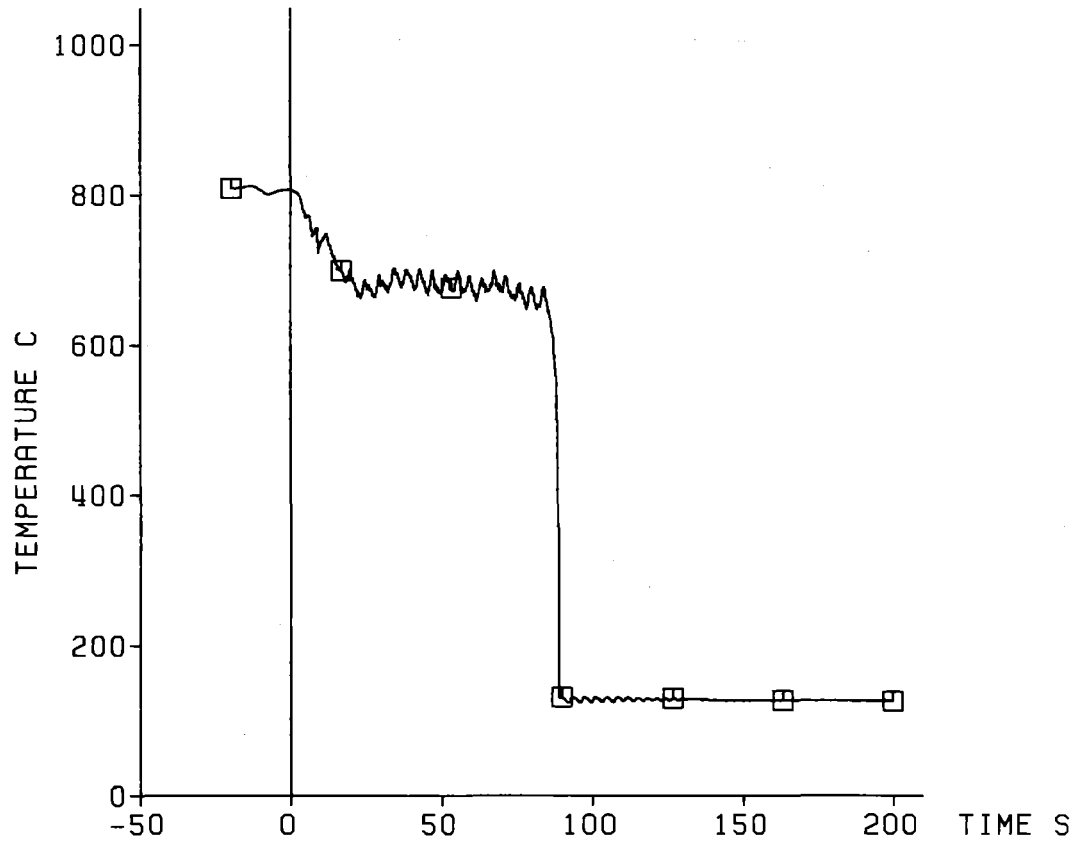

TC	Axial Level
□ 69	2535 mm

Decay Heat 120% ANS Standard
 Flooding Rate (cold) 3.82 cm/s
 System Pressure 2.19 bar
 Feedwater Temperature 40 C

— 386 —



Fig. 346 FEBA: 5x5 ROD BUNDLE, TEST SERIES 8, TEST-No. 341

Grid Spacer Temperature

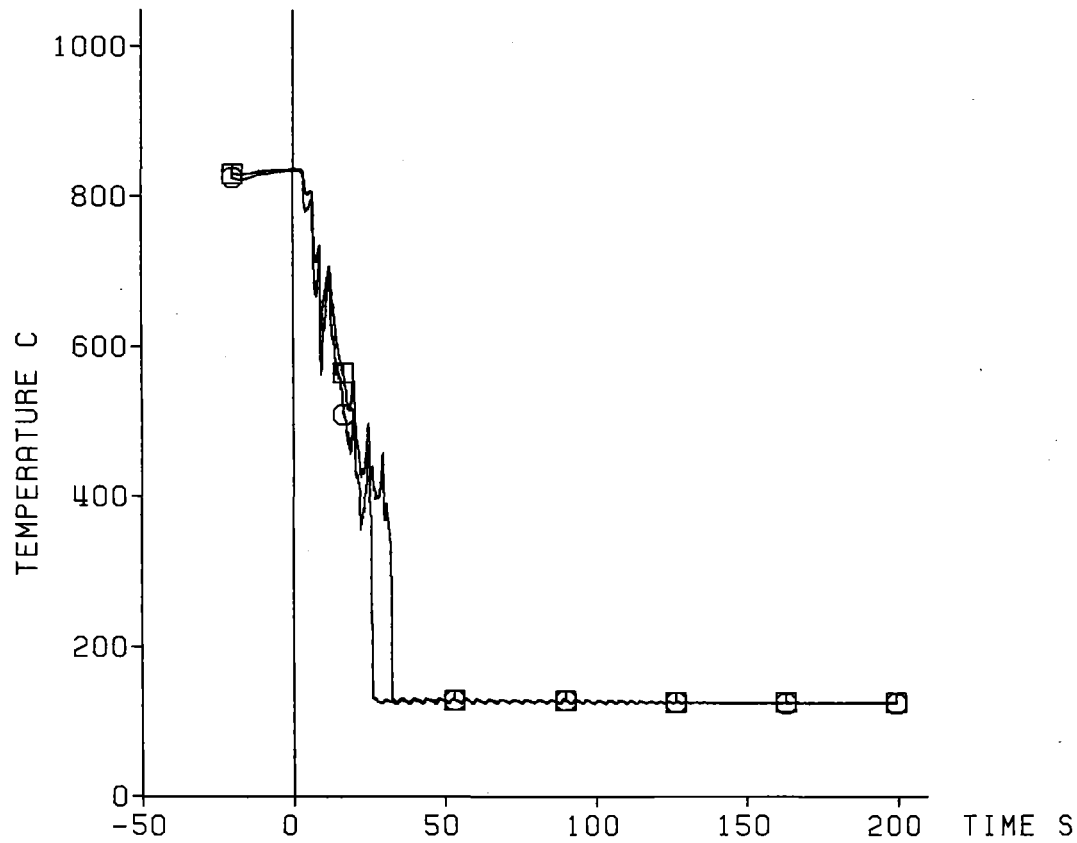

TC	Axial Level
□ 67	1425 mm
○ 66	1425 mm

Decay Heat 120% ANS Standard
 Flooding Rate (cold) 3.82 cm/s
 System Pressure 2.19 bar
 Feedwater Temperature 40 C

- 387 -



Fig. 347 FEBA: 5x5 ROD BUNDLE, TEST SERIES 8, TEST-No. 341

Axial Level: 2770 mm

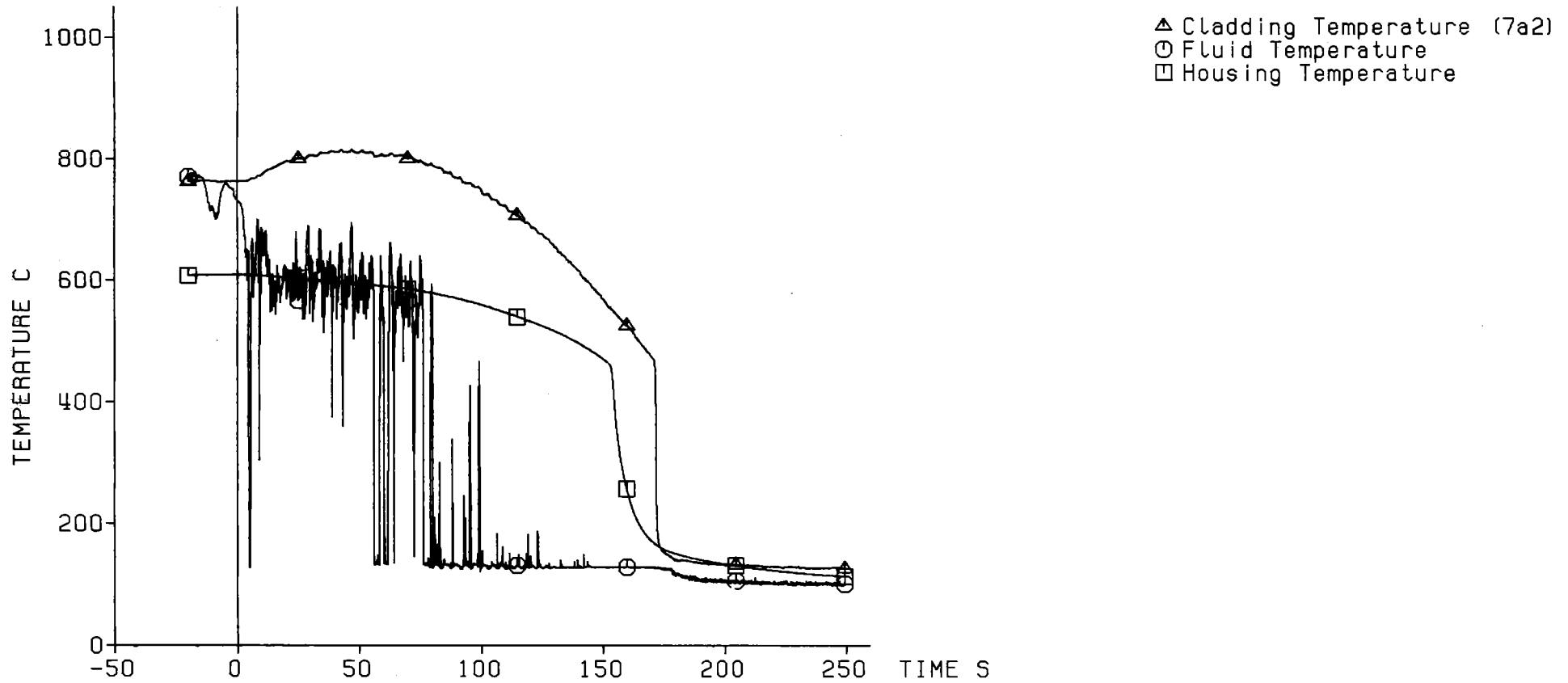

Decay Heat 120% ANS Standard
Flooding Rate (cold) 3.82 cm/s
System Pressure 2.19 bar
Feedwater Temperature 40 C

— 388 —



Fig. 348 FEBA: 5x5 ROD BUNDLE, TEST SERIES 8, TEST-NO. 341

Axial Level: 2225 mm

△ Cladding Temperature (7a1)
○ Fluid Temperature (2240 mm)
□ Housing Temperature (2235 mm)

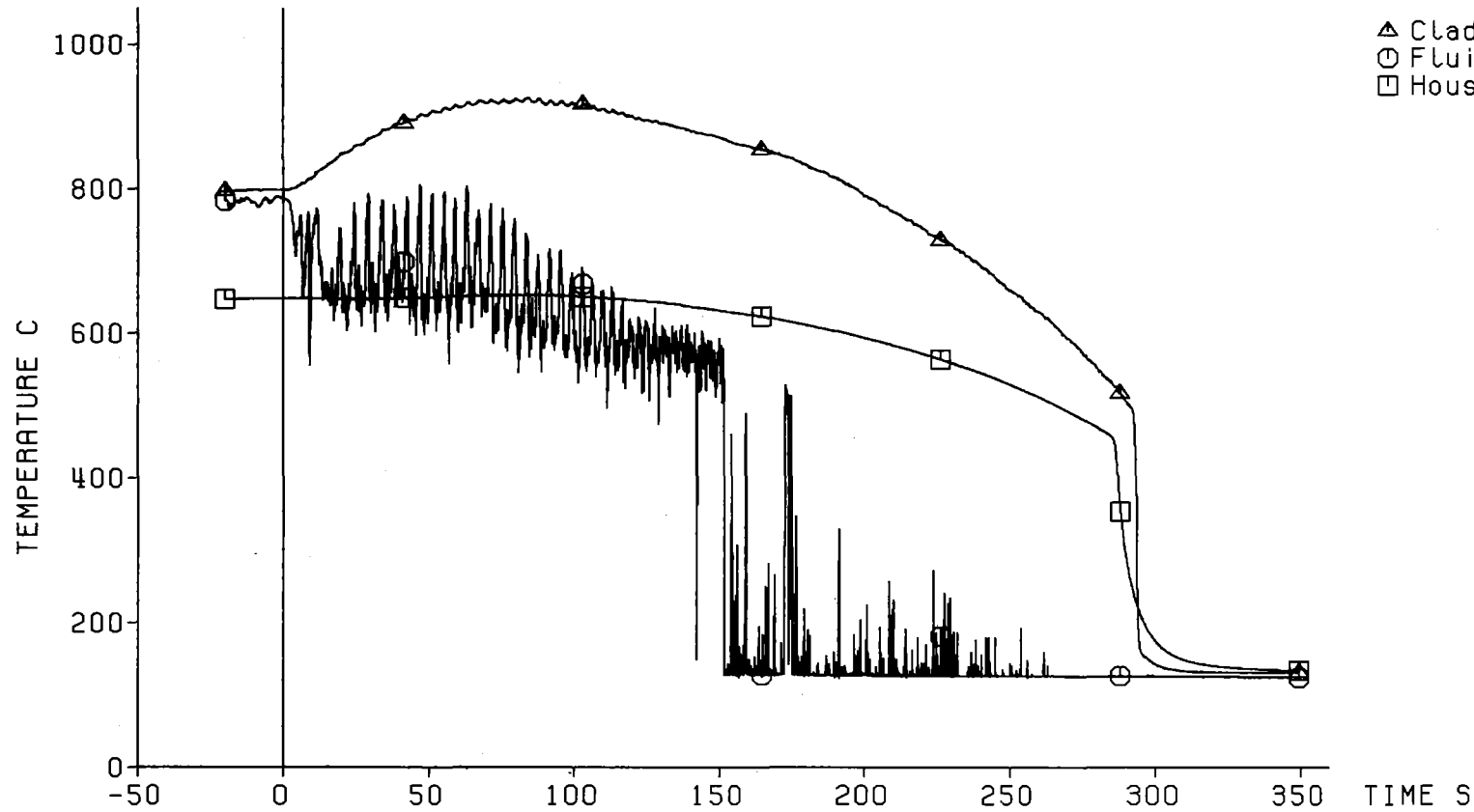

Decay Heat 120% ANS Standard
Flooding Rate (cold) 3.82 cm/s
System Pressure 2.19 bar
Feedwater Temperature 40 C

KIRB

Fig. 349 FEBA: 5x5 ROD BUNDLE, TEST SERIES 8, TEST-NO. 341

Axial Level: 1925 mm

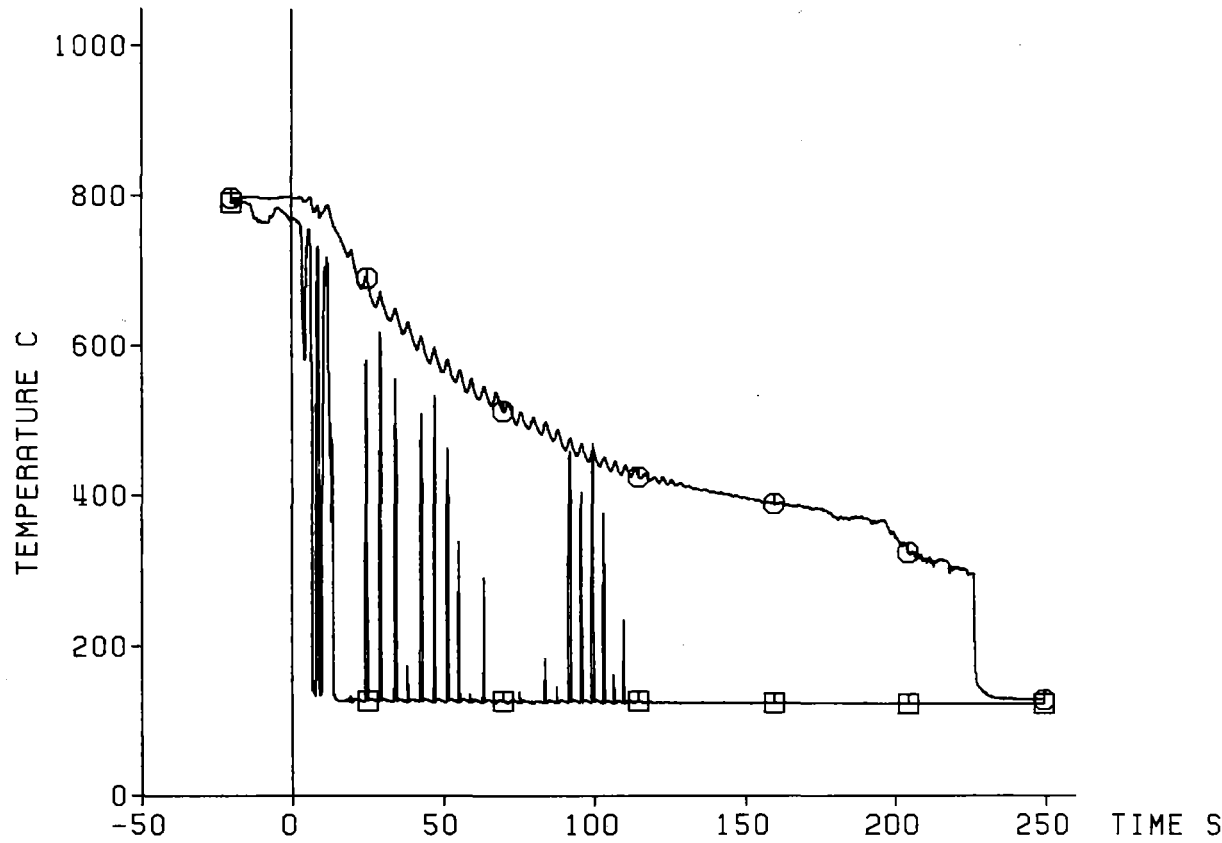

△ Cladding Temperature (19g4)
○ Fluid Temperature

Decay Heat 120% ANS Standard
Flooding Rate (cold) 3.82 cm/s
System Pressure 2.19 bar
Feedwater Temperature 40 C

— 390 —

KIK TRB

Fig. 350 FEBA: 5x5 ROD BUNDLE, TEST SERIES 8, TEST-NO. 341

Axial Level: 1825 mm

△ Cladding Temperature (19g3)
○ Fluid Temperature
□ Housing Temperature

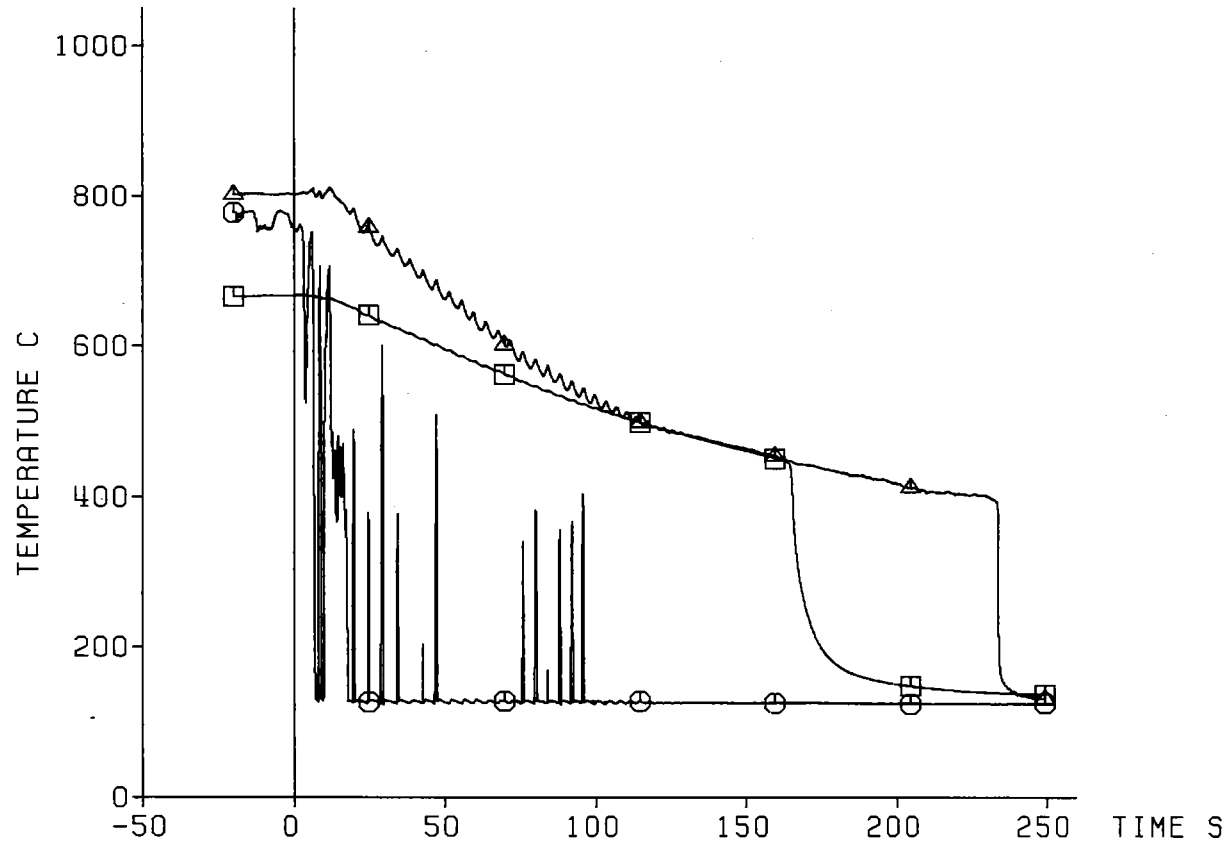

Decay Heat 120% ANS Standard
Flooding Rate (cold) 3.82 cm/s
System Pressure 2.19 bar
Feedwater Temperature 40 C

— 391 —



Fig. 351 FEBA: 5x5 ROD BUNDLE, TEST SERIES 8, TEST-No. 341

Axial Level: 1725 mm

△ Cladding Temperature (19g2)
○ Fluid Temperature

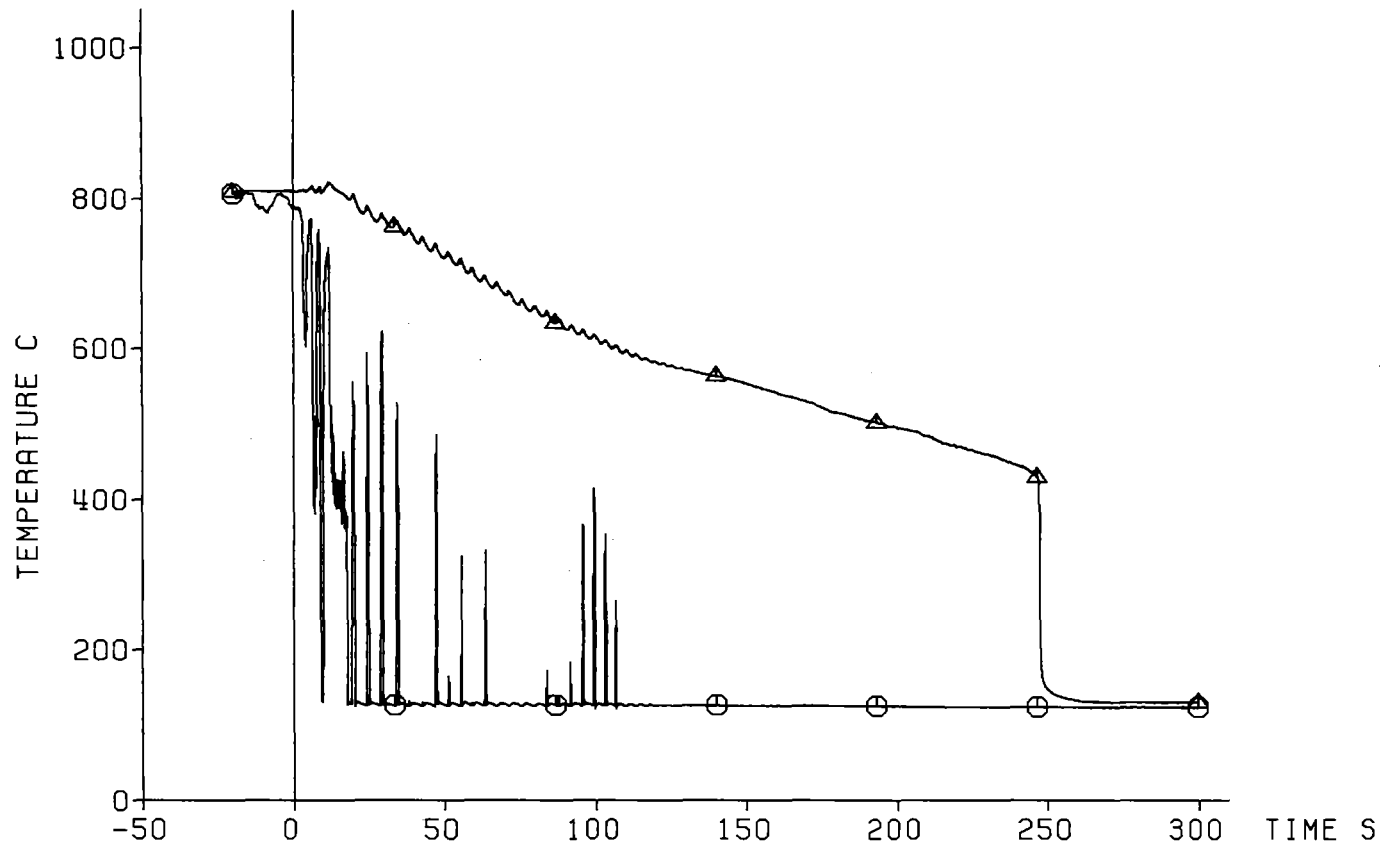

Decay Heat 120% ANS Standard
Flooding Rate (cold) 3.82 cm/s
System Pressure 2.19 bar
Feedwater Temperature 40 C

KIK IRB

Fig. 352 FEBA: 5x5 ROD BUNDLE, TEST SERIES 8, TEST-No. 341

Axial Level: 1625 mm

△ Cladding Temperature (19g1)
○ Fluid Temperature
□ Housing Temperature

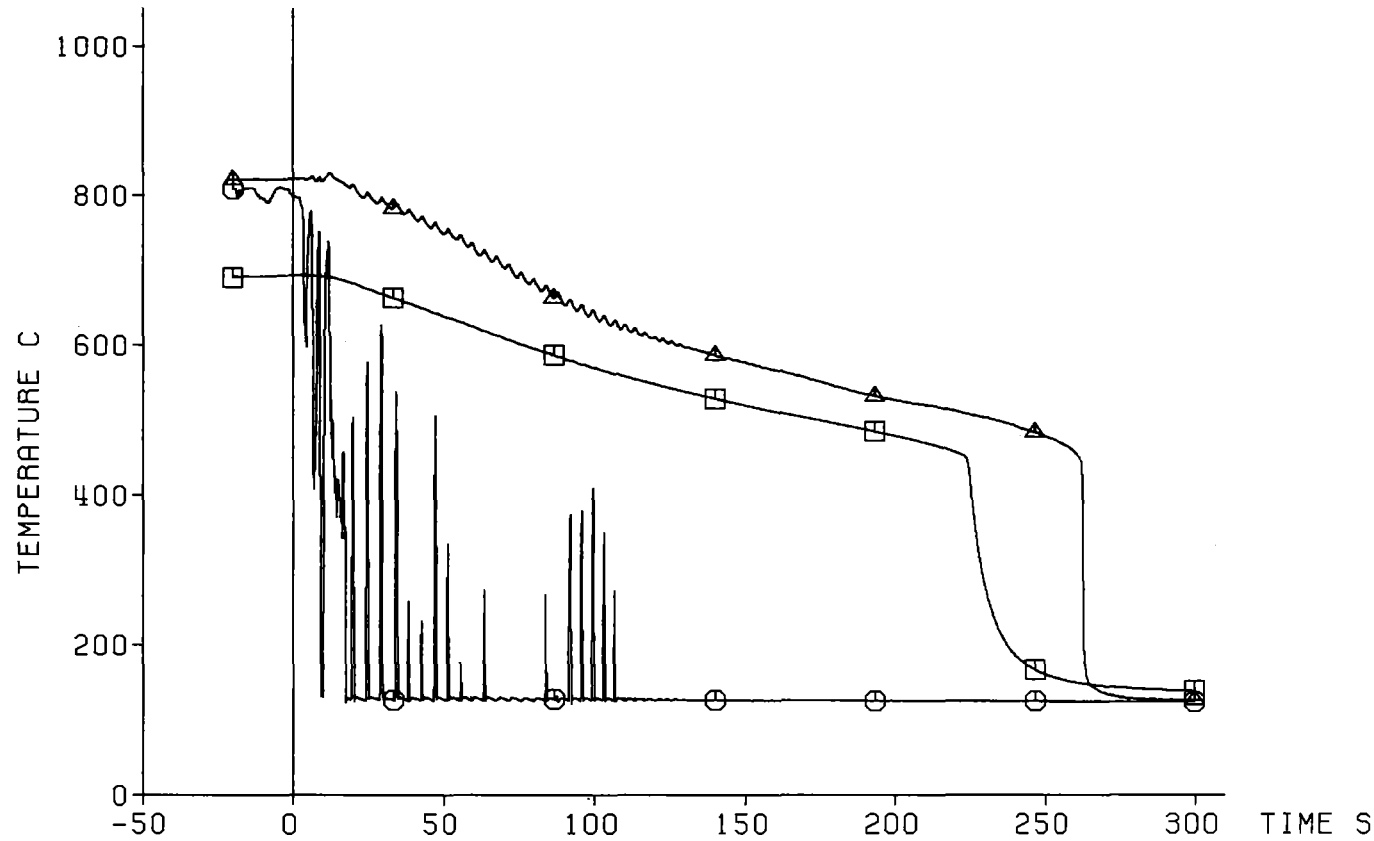

Decay Heat 120% ANS Standard
Flooding Rate (cold) 3.82 cm/s
System Pressure 2.19 bar
Feedwater Temperature 40 C

— 393 —



Fig. 353 FEBA: 5x5 ROD BUNDLE, TEST SERIES 8, TEST-No. 341

Axial Level: 1135 mm

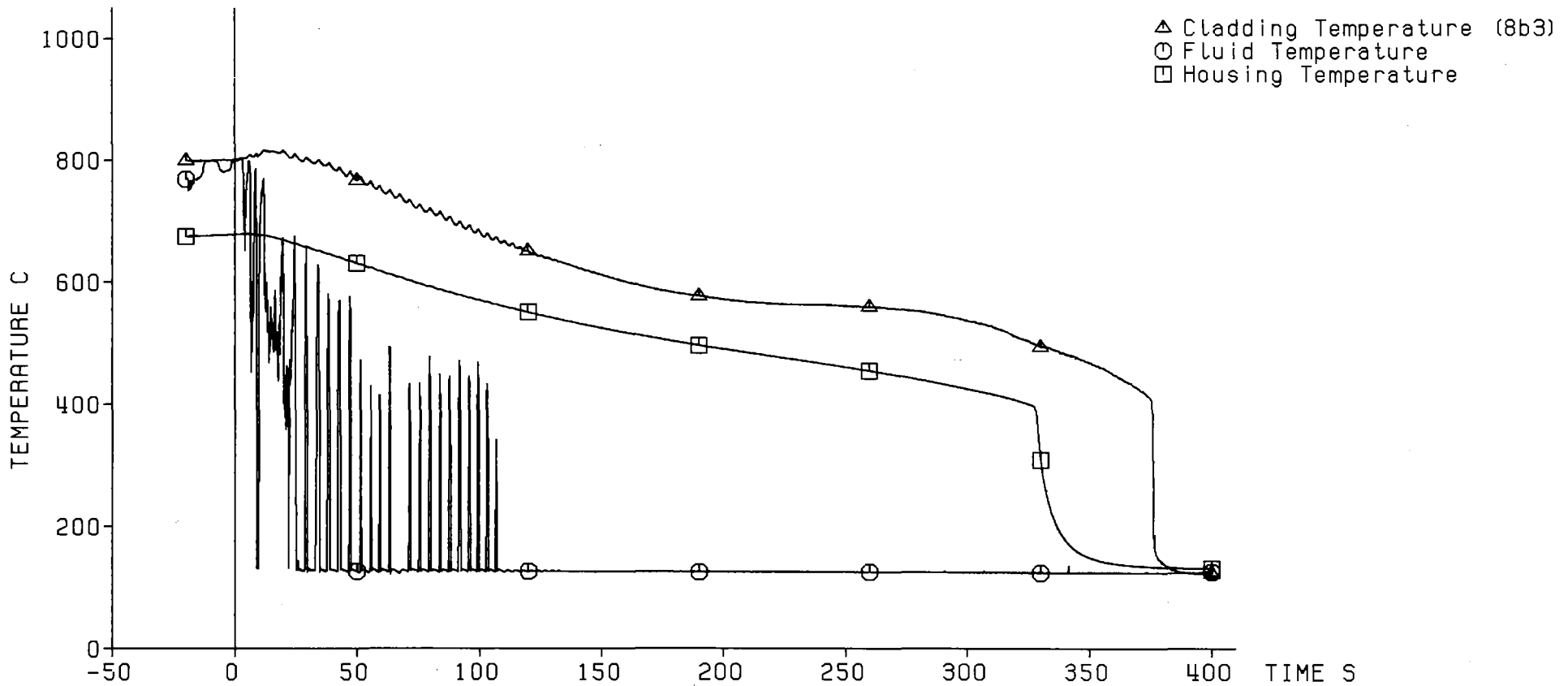

Decay Heat 120% ANS Standard
Flooding Rate (cold) 3.82 cm/s
System Pressure 2.19 bar
Feedwater Temperature 40 C

KIK IRB

Fig. 354 FEBA: 5x5 ROD BUNDLE, TEST SERIES 8, TEST-No. 341

Pressure Loss
Along the Test Section:

◇ Total Length: 4196 mm
△ Lower Part: 1711 mm
○ Middle Part: 545 mm
□ Upper Part: 1940 mm

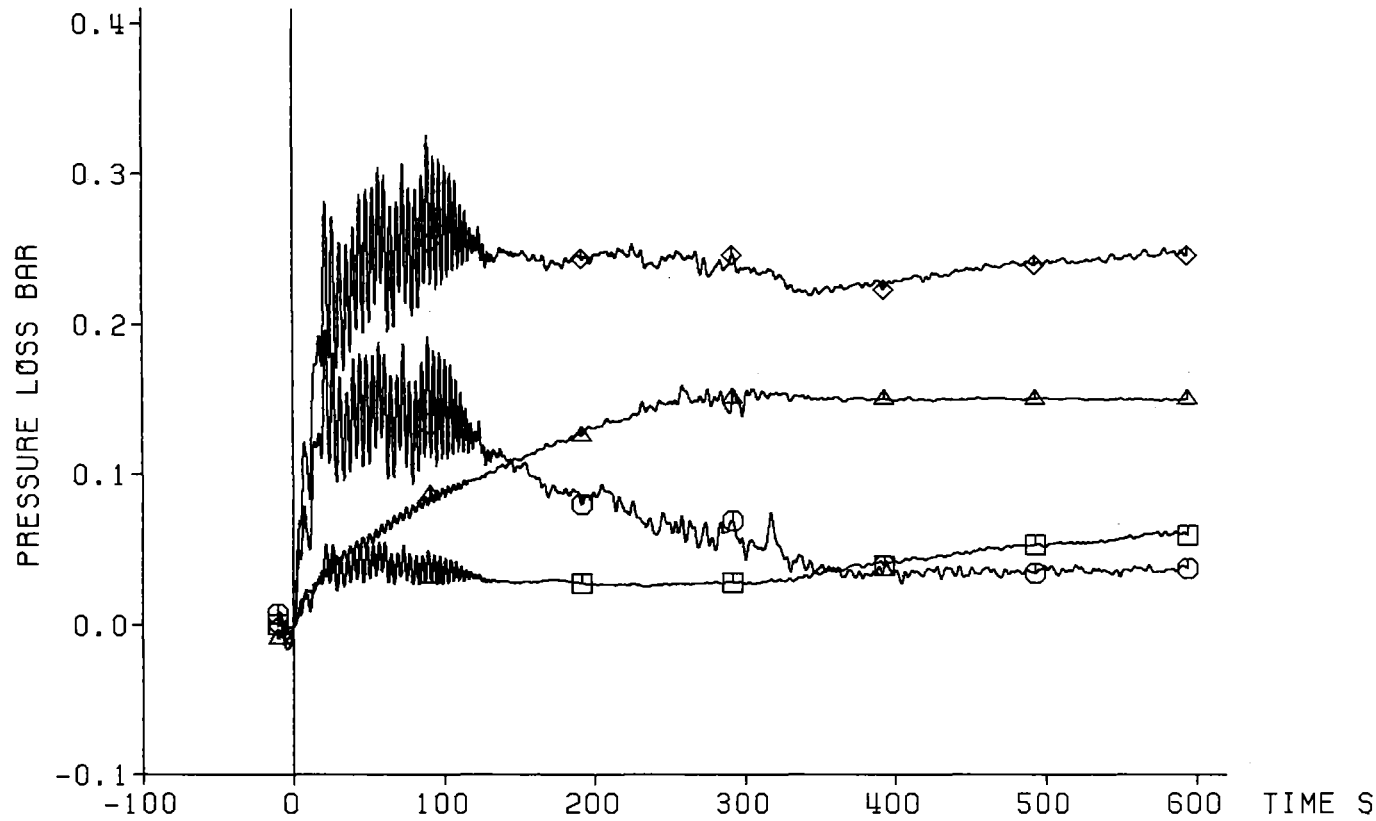

Decay Heat 120% ANS Standard
Flooding Rate (cold) 3.82 cm/s
System Pressure 2.19 bar
Feedwater Temperature 40 C

KfK
IRB

Fig. 355 FEBA: 5x5 ROD BUNDLE, TEST SERIES 8, TEST-No. 341

Coolant Outlet Conditions:

△ Water Carry Over
○ Coolant Temperature
□ Coolant Pressure

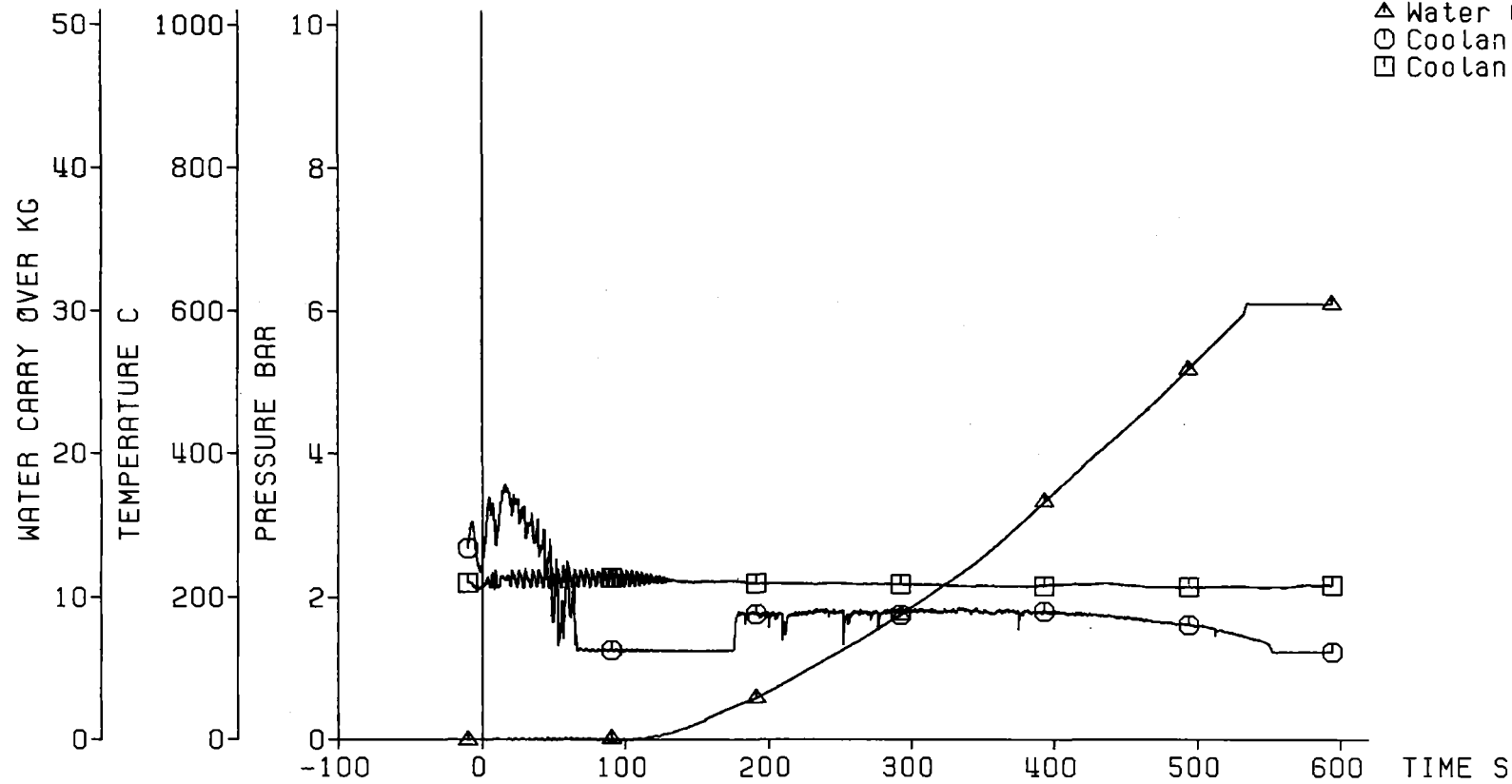

Decay Heat 120% ANS Standard
Flooding Rate (cold) 3.82 cm/s
System Pressure 2.19 bar
Feedwater Temperature 40 C



Fig. 356 FEBA: 5x5 ROD BUNDLE, TEST SERIES 8, TEST-No. 341

Axial Position of Quench Front

□ Quenching of Sleeves at Bundle Midplane

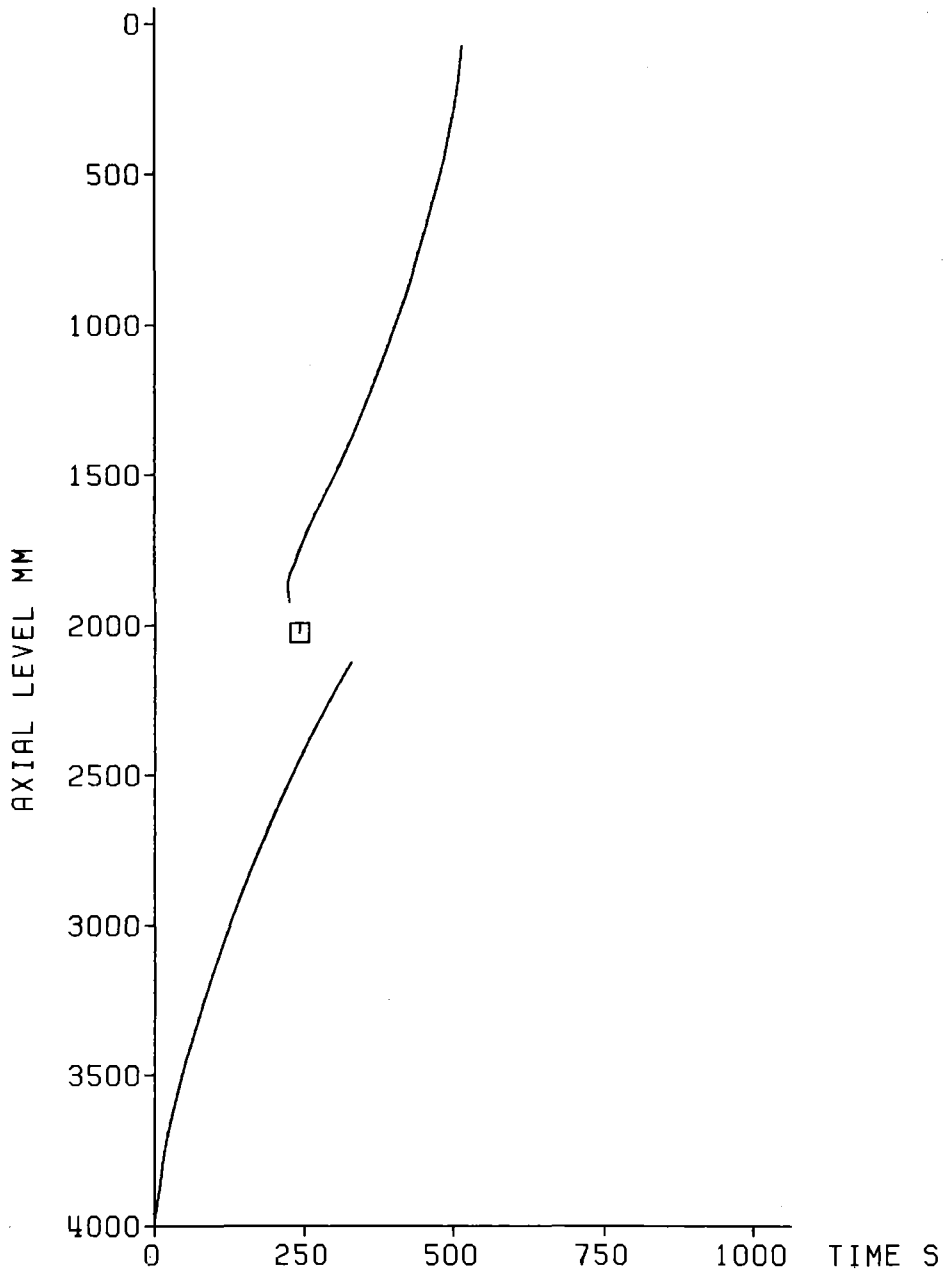

Decay Heat 120% ANS Standard
Flooding Rate (cold) 3.82 cm/s
System Pressure 2.19 bar
Feedwater Temperature 40 C



Fig. 357 FEBA: 5x5 ROD BUNDLE
TEST SERIES 8, TEST-No. 341

Initial Axial Temperature Profile of Claddings

□ Initial Temperature of Sleeves at Bundle Midplane

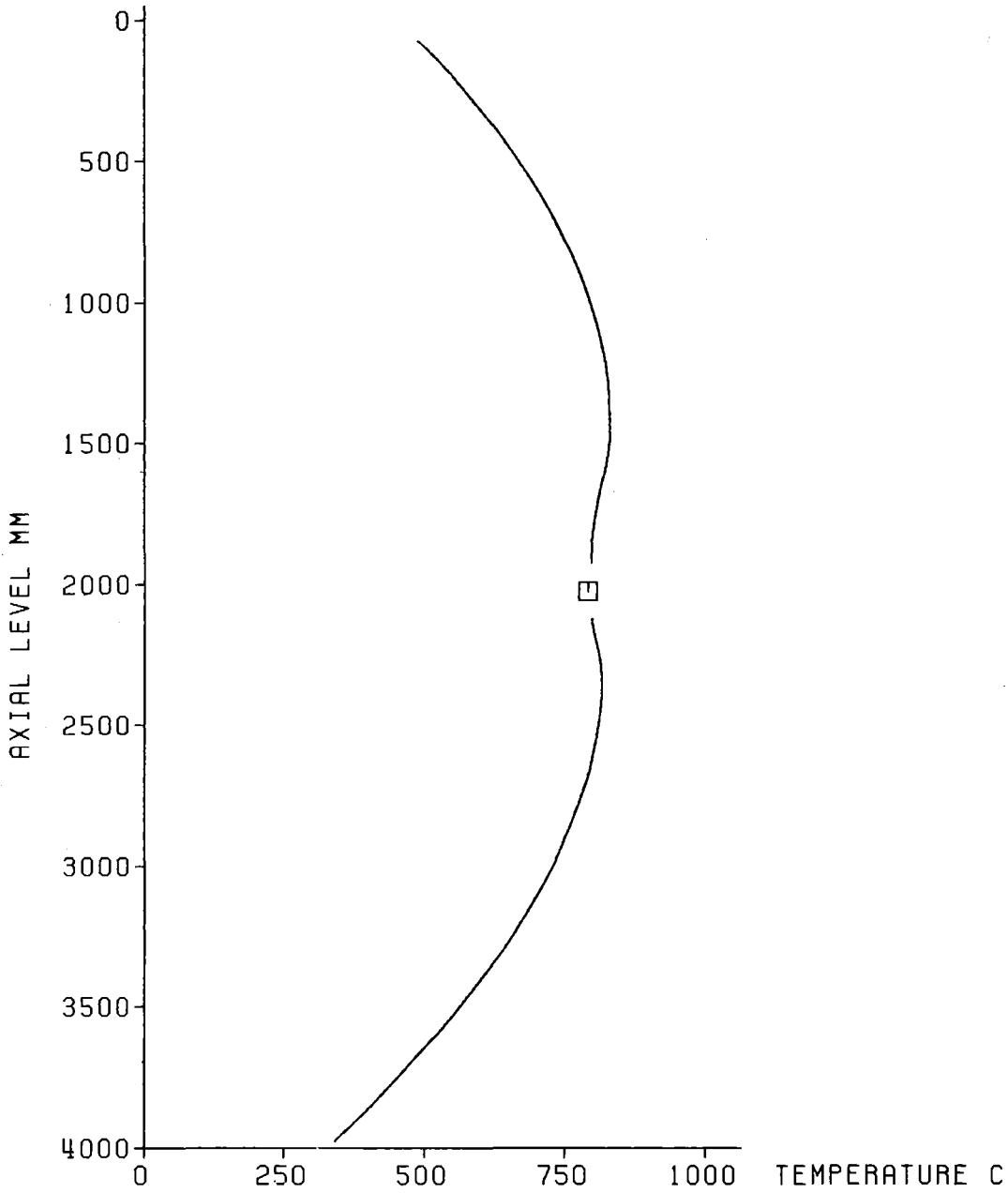

Decay Heat	120% ANS Standard
Flooding Rate (cold)	3.77 cm/s
System Pressure	4.05 bar
Feedwater Temperature	40 C



Fig. 358 FEBA: 5x5 ROD BUNDLE
TEST SERIES 8, TEST-No. 337

Test Parameters:

- ◇ Flooding Rate
- △ System Pressure
- Feedwater Temperature
- Bundle Power

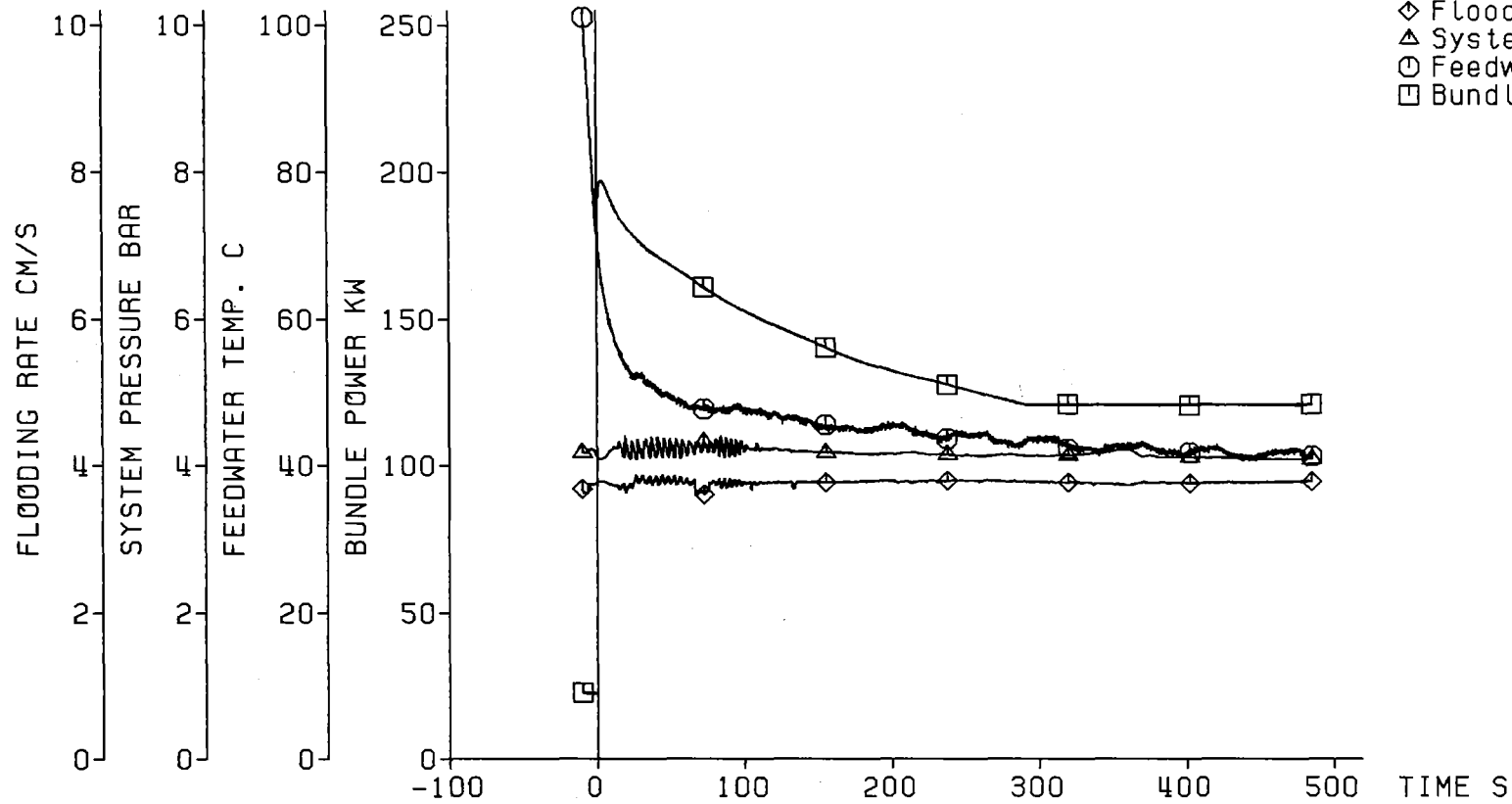

Decay Heat 120% ANS Standard
Flooding Rate (cold) 3.77 cm/s
System Pressure 4.05 bar
Feedwater Temperature 40 C



Fig. 359 FEBA: 5x5 ROD BUNDLE, TEST SERIES 8, TEST-No. 337

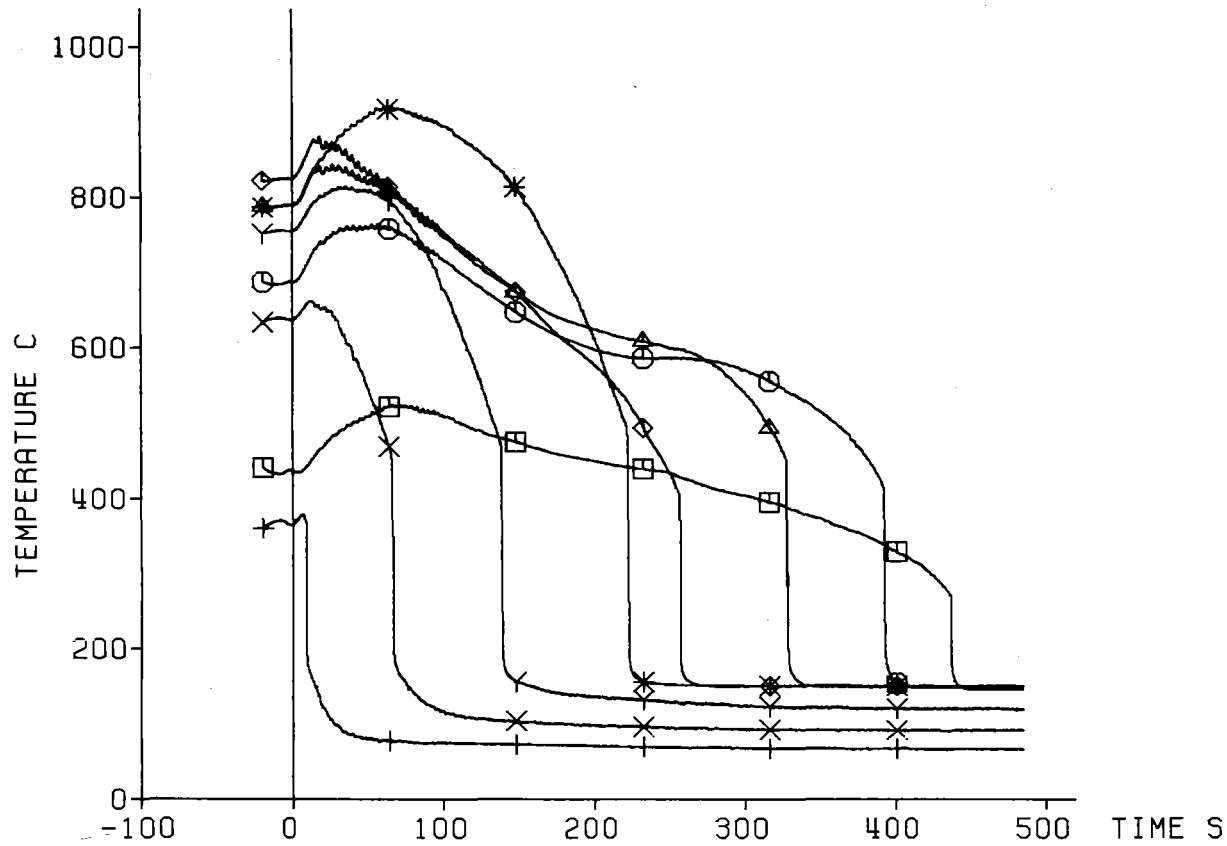

TC	Ax. Level
+	7a4 3860 mm
X	7a3 3315 mm
Y	7a2 2770 mm
*	7a1 2225 mm
◇	8b4 1680 mm
△	8b3 1135 mm
○	8b2 590 mm
□	3b1 45 mm

Decay Heat 120% ANS Standard
 Flooding Rate (cold) 3.77 cm/s
 System Pressure 4.05 bar
 Feedwater Temperature 40 C



Fig. 360 FEBA: 5x5 ROD BUNDLE, TEST SERIES 8, TEST-No. 337

Heat Transfer Coeff.

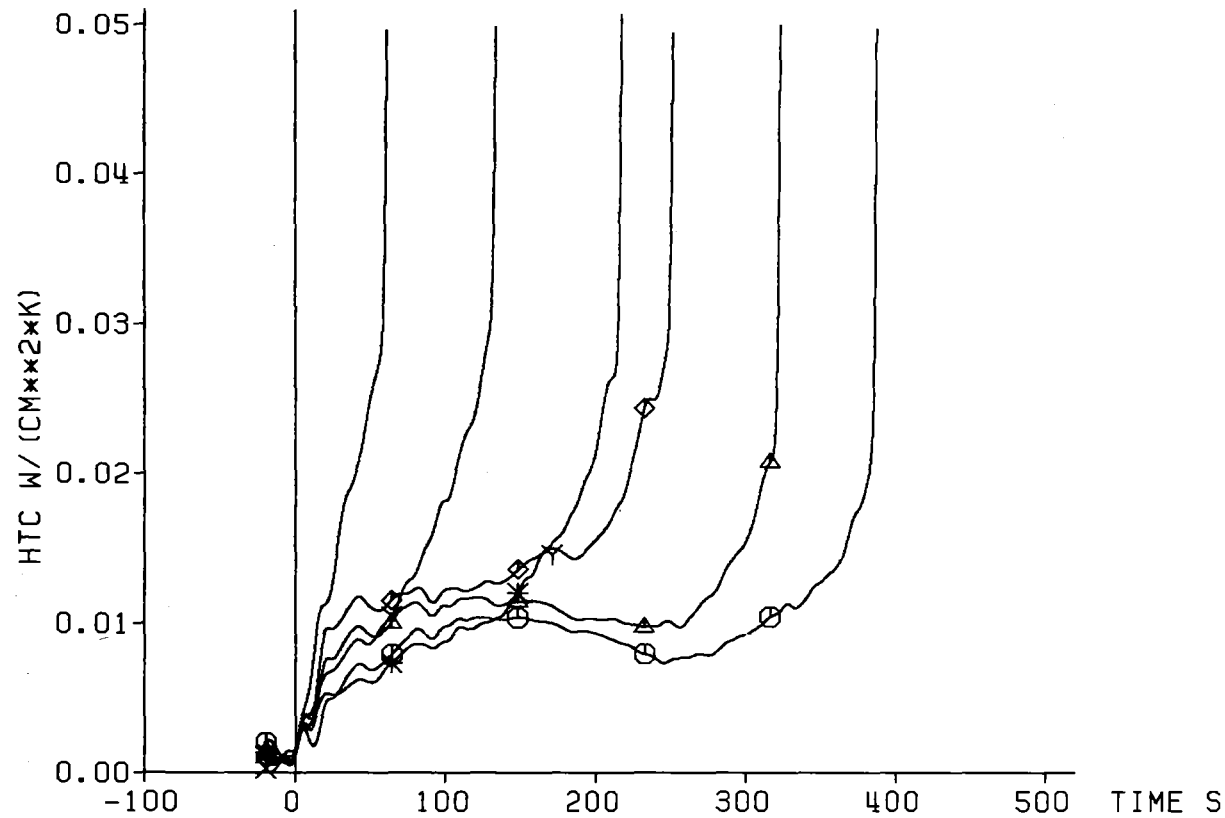

	TC	Ax. Level
X	7a3	3315 mm
Y	7a2	2770 mm
*	7a1	2225 mm
◇	8b4	1680 mm
△	8b3	1135 mm
○	8b2	590 mm

Decay Heat 120% ANS Standard
 Flooding Rate (cold) 3.77 cm/s
 System Pressure 4.05 bar
 Feedwater Temperature 40 C



Fig. 361 FEBA: 5x5 ROD BUNDLE, TEST SERIES 8, TEST-NO. 337

Cladding Temperature

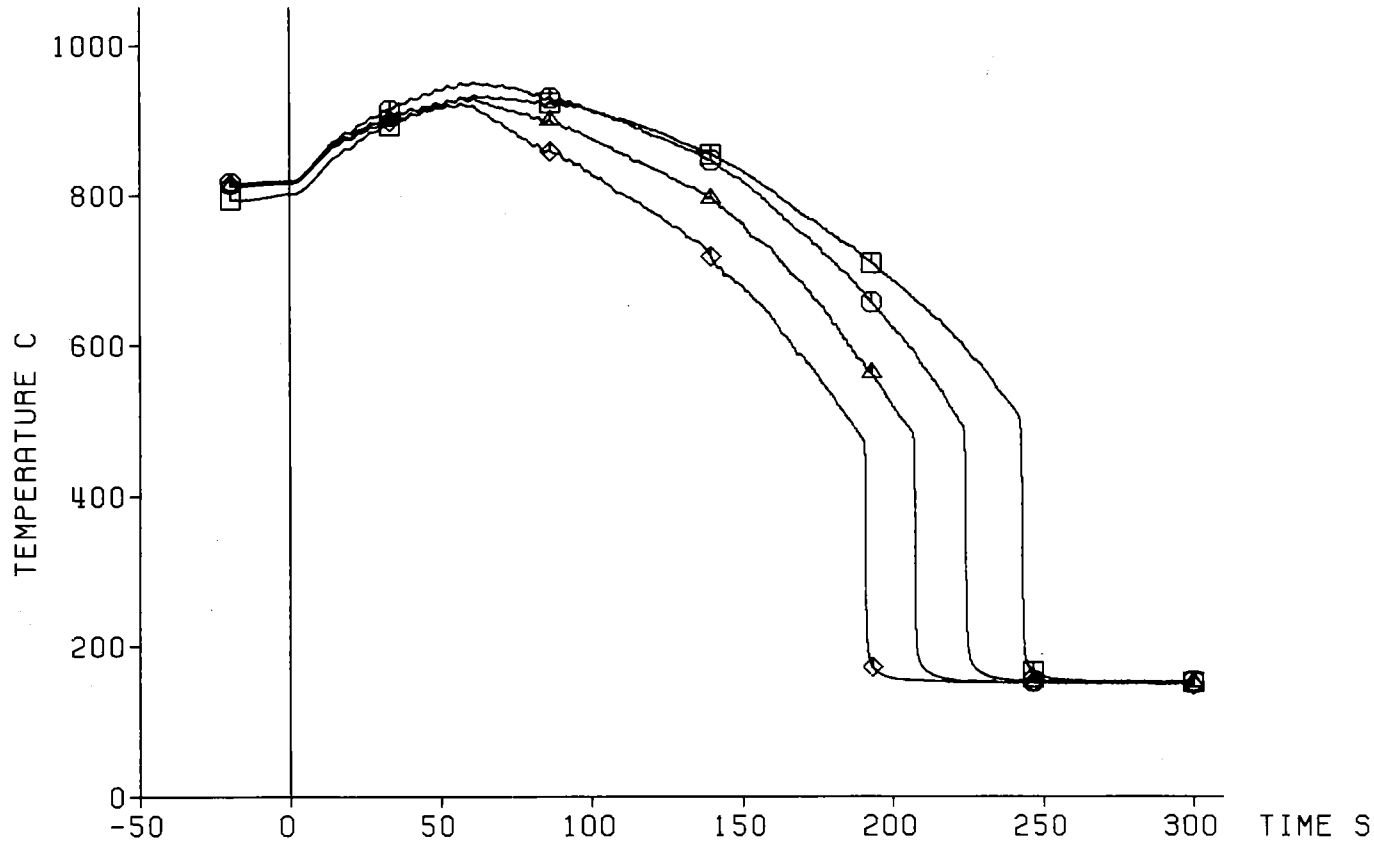

TC	Ax. Level
◇	14f4 2425 mm
△	14f3 2325 mm
○	14h2 2225 mm
□	14f1 2125 mm

Decay Heat 120% ANS Standard
 Flooding Rate (cold) 3.77 cm/s
 System Pressure 4.05 bar
 Feedwater Temperature 40 C



Fig. 362 FEBA: 5x5 ROD BUNDLE, TEST SERIES 8, TEST-No. 337

Heat Transfer Coeff.

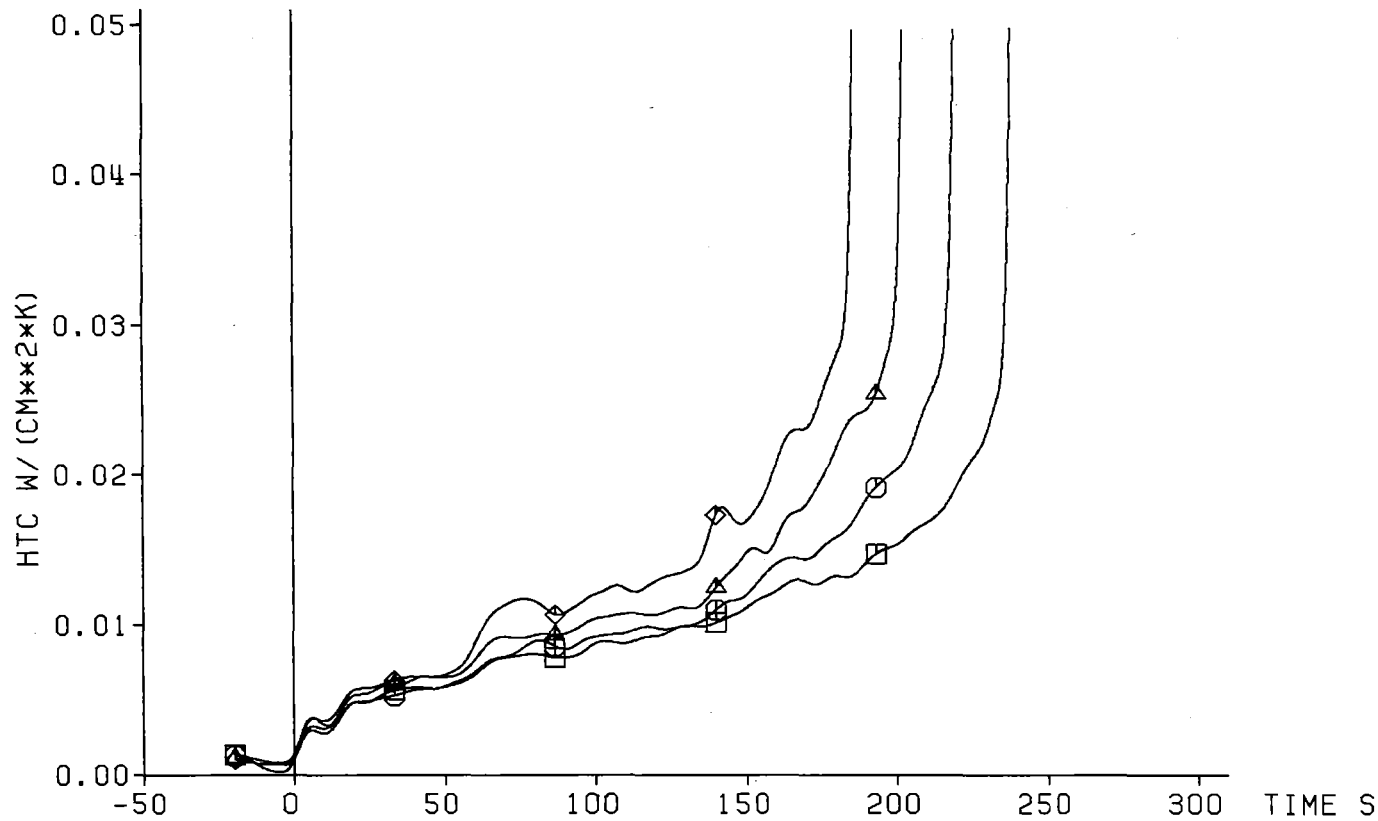

TC	Ax. Level
◇	14f4 2425 mm
△	14f3 2325 mm
○	14h2 2225 mm
□	14f1 2125 mm

Decay Heat 120% ANS Standard
 Flooding Rate (cold) 3.77 cm/s
 System Pressure 4.05 bar
 Feedwater Temperature 40 C



Fig. 363 FEBA: 5x5 ROD BUNDLE, TEST SERIES 8, TEST-No. 337

Cladding Temperature

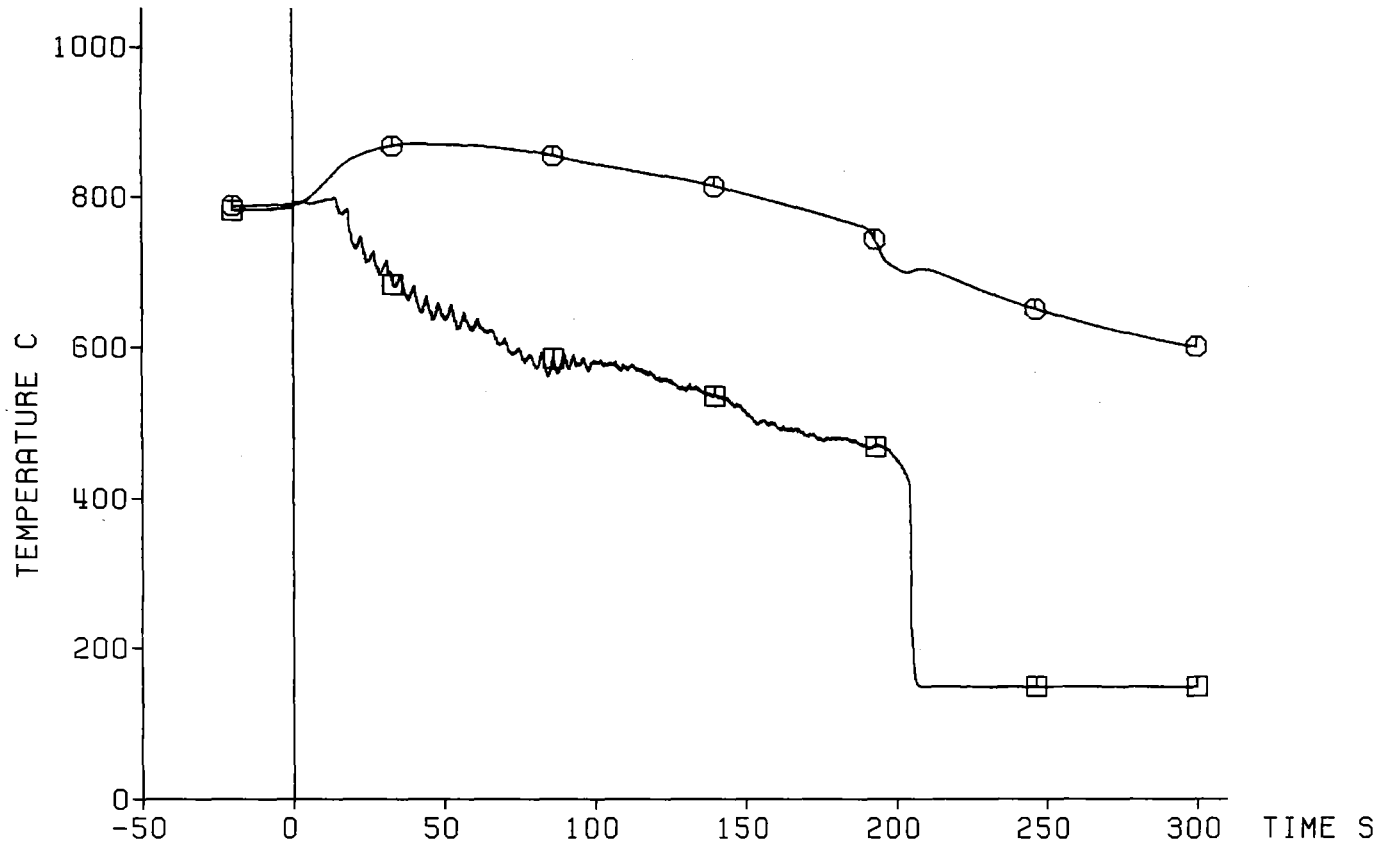

TC	Ax. Level
○ 1714	2025 mm
□ Sleeve	2025 mm

Decay Heat 120% ANS Standard
 Flooding Rate (cold) 3.77 cm/s
 System Pressure 4.05 bar
 Feedwater Temperature 40 C

— 404 —



Fig. 364 FEBA: 5x5 R0D BUNDLE, TEST SERIES 8, TEST-No. 337

Sleeve Temperature
Contact Face: Rods 17 and 18

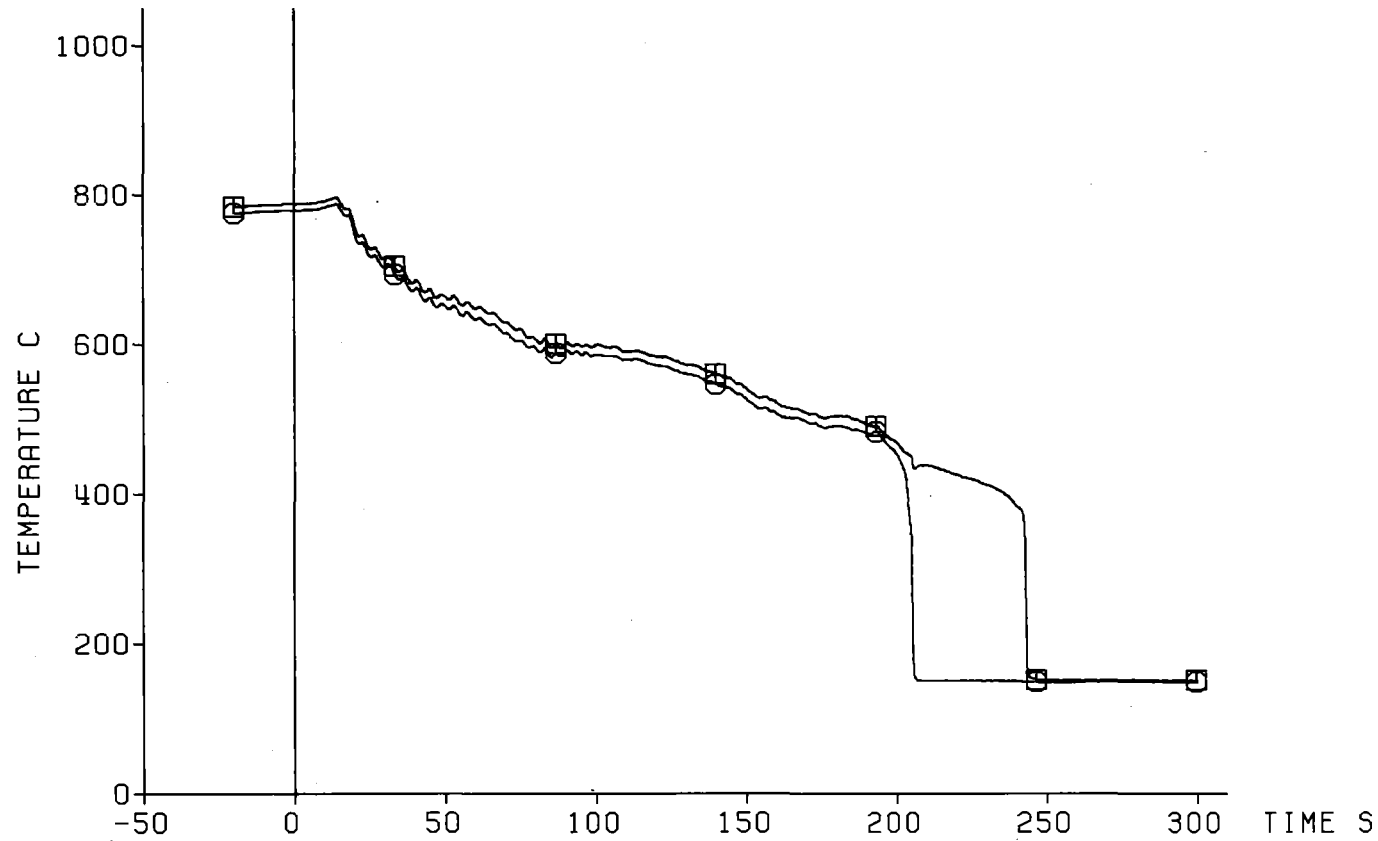

TC	Ax. Level
○ Sleeve	2025 mm (Rod 17)
□ Sleeve	2025 mm (Rod 18)

Decay Heat 120% ANS Standard
Flooding Rate (cold) 3.77 cm/s
System Pressure 4.05 bar
Feedwater Temperature 40 C

— 405 —



Fig. 365 FEBA: 5x5 ROD BUNDLE, TEST SERIES 8, TEST-NO. 337

Cladding Temperature

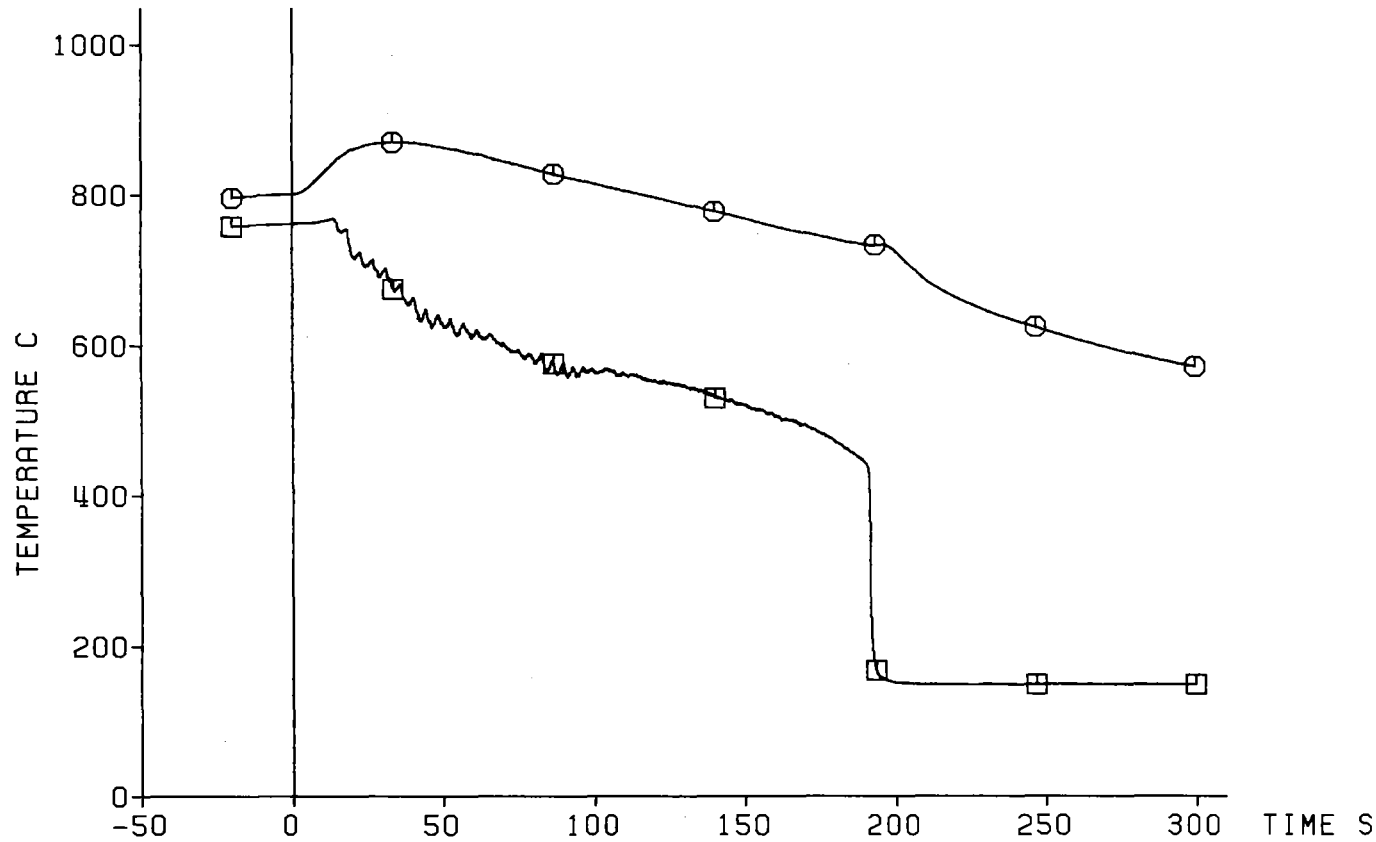

TC	Ax. Level
⊙ 17i3	1975 mm
□ Sleeve	1972 mm

Decay Heat 120% ANS Standard
 Flooding Rate (cold) 3.77 cm/s
 System Pressure 4.05 bar
 Feedwater Temperature 40 C



Fig. 366 FEBA: 5x5 ROD BUNDLE, TEST SERIES 8, TEST-No. 337

Cladding Temperature

TC	Ax. Level
⊙ 17i4	2025 mm
+ Sleeve	2064 mm
□ Sleeve	2025 mm
△ Sleeve	2025 mm
× Sleeve	1972 mm

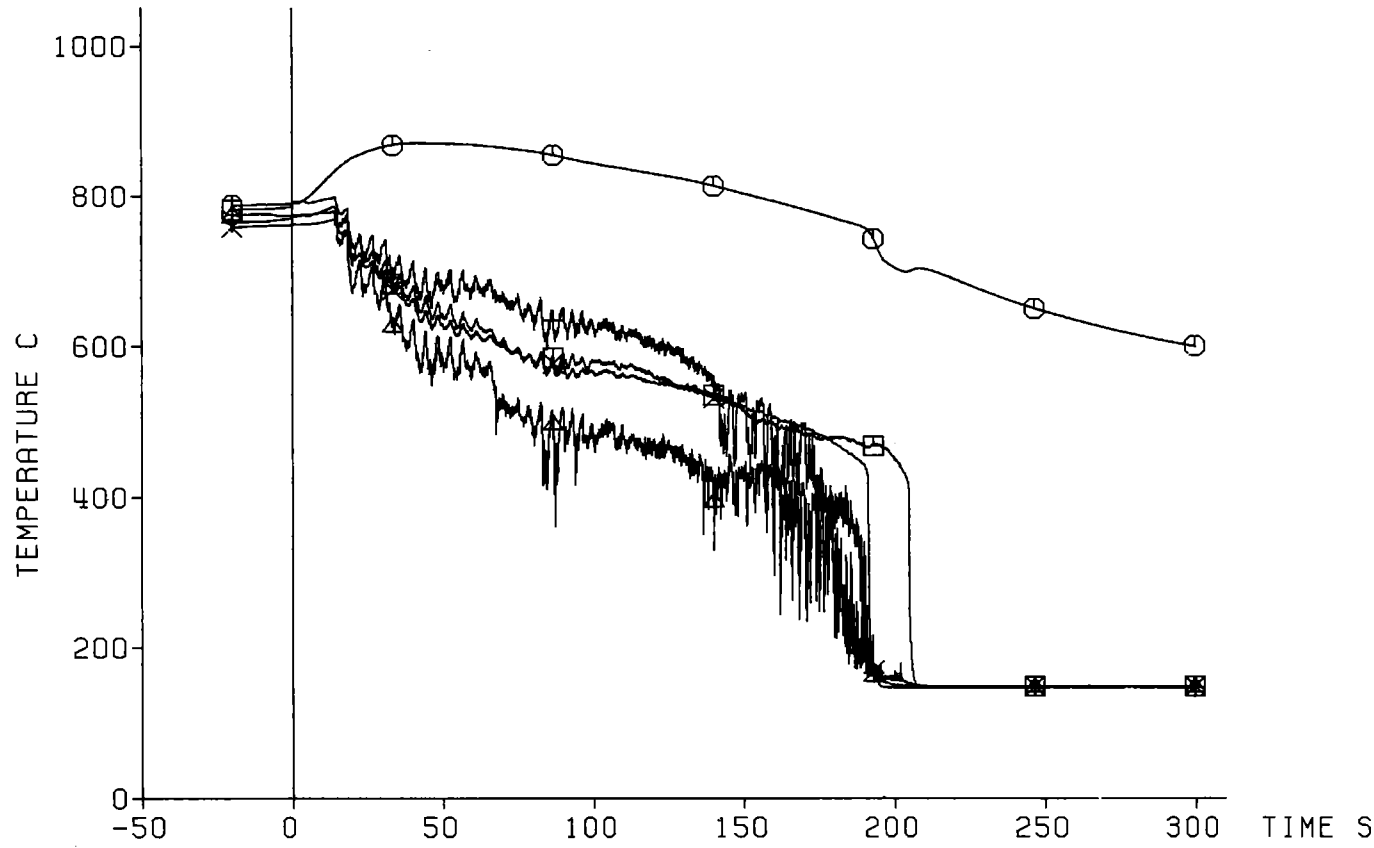

Decay Heat 120% ANS Standard
 Flooding Rate (cold) 3.77 cm/s
 System Pressure 4.05 bar
 Feedwater Temperature 40 C



Fig. 367 FEBA: 5x5 ROD BUNDLE, TEST SERIES 8, TEST-No. 337

Cladding Temperature

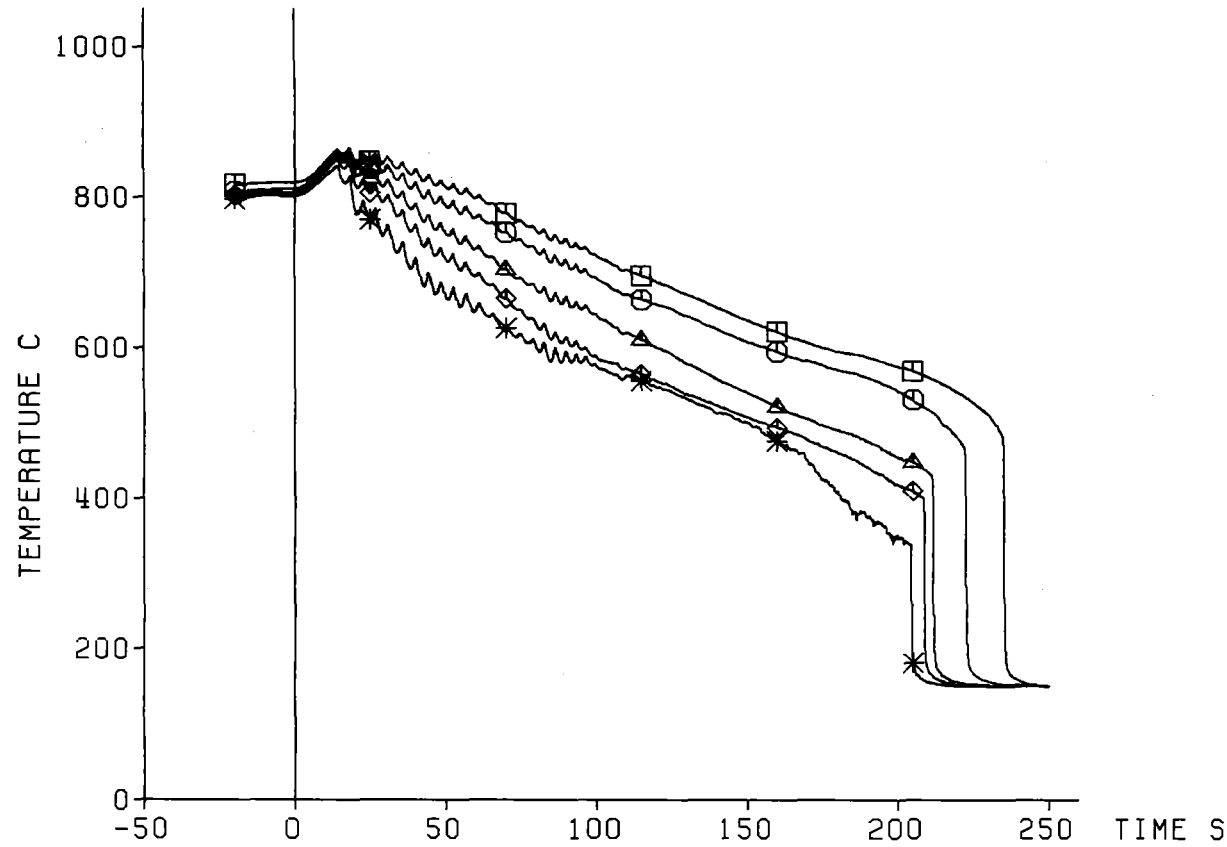

TC	Ax. Level
* 19g4	1925 mm
◇ 17i1	1875 mm
△ 19g3	1825 mm
⊙ 19g2	1725 mm
□ 19g1	1625 mm

Decay Heat 120% ANS Standard
 Flooding Rate (cold) 3.77 cm/s
 System Pressure 4.05 bar
 Feedwater Temperature 40 C



Fig. 368 FEBA: 5x5 ROD BUNDLE, TEST SERIES 8, TEST-No. 337

Heat Transfer Coeff.

	TC	Ax. Level
*	19g4	1925 mm
◇	1711	1875 mm
△	19g3	1825 mm
○	19g2	1725 mm
□	19g1	1625 mm

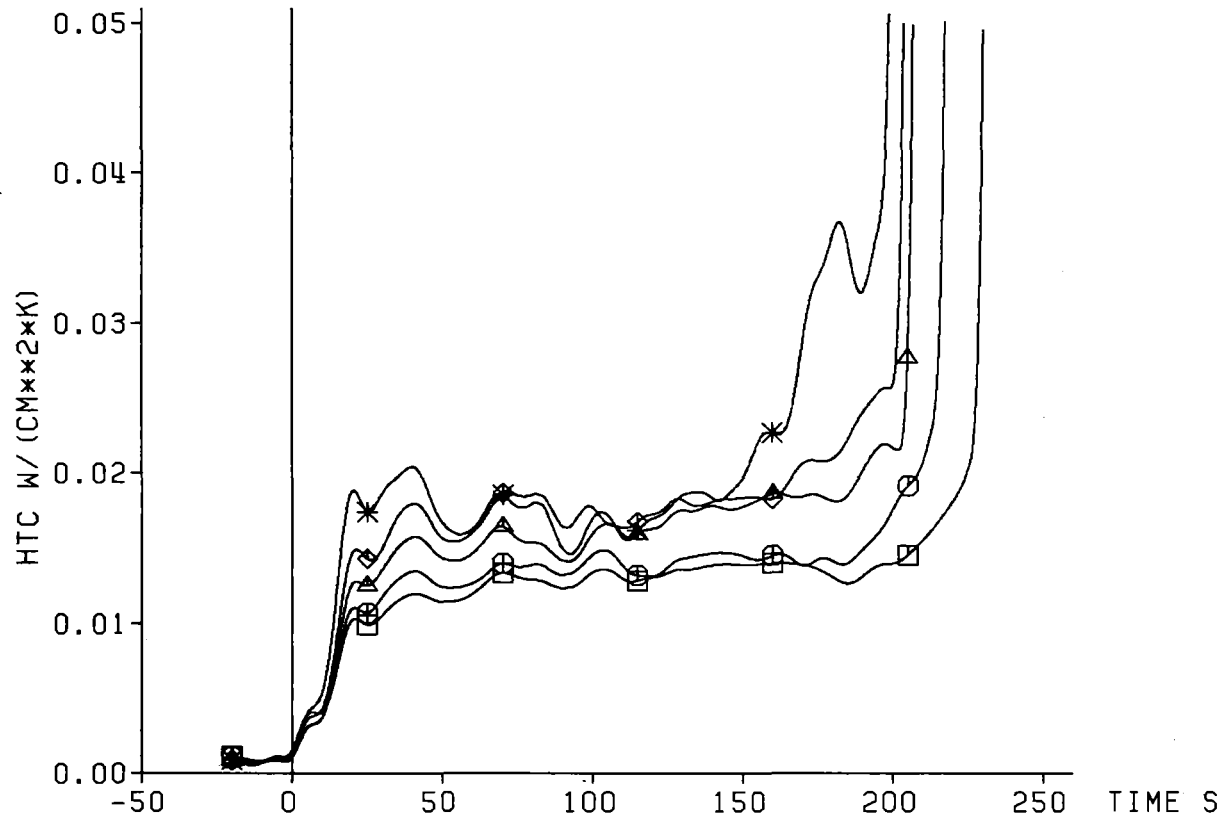

Decay Heat 120% ANS Standard
 Flooding Rate (cold) 3.77 cm/s
 System Pressure 4.05 bar
 Feedwater Temperature 40 C



Fig. 369 FEBA: 5x5 ROD BUNDLE, TEST SERIES 8, TEST-No. 337

TC	Ax. Level
* 12j4	1525 mm
◇ 12j3	1425 mm
△ 12j2	1325 mm
○ 12j1	1225 mm
□ 8b3	1135 mm

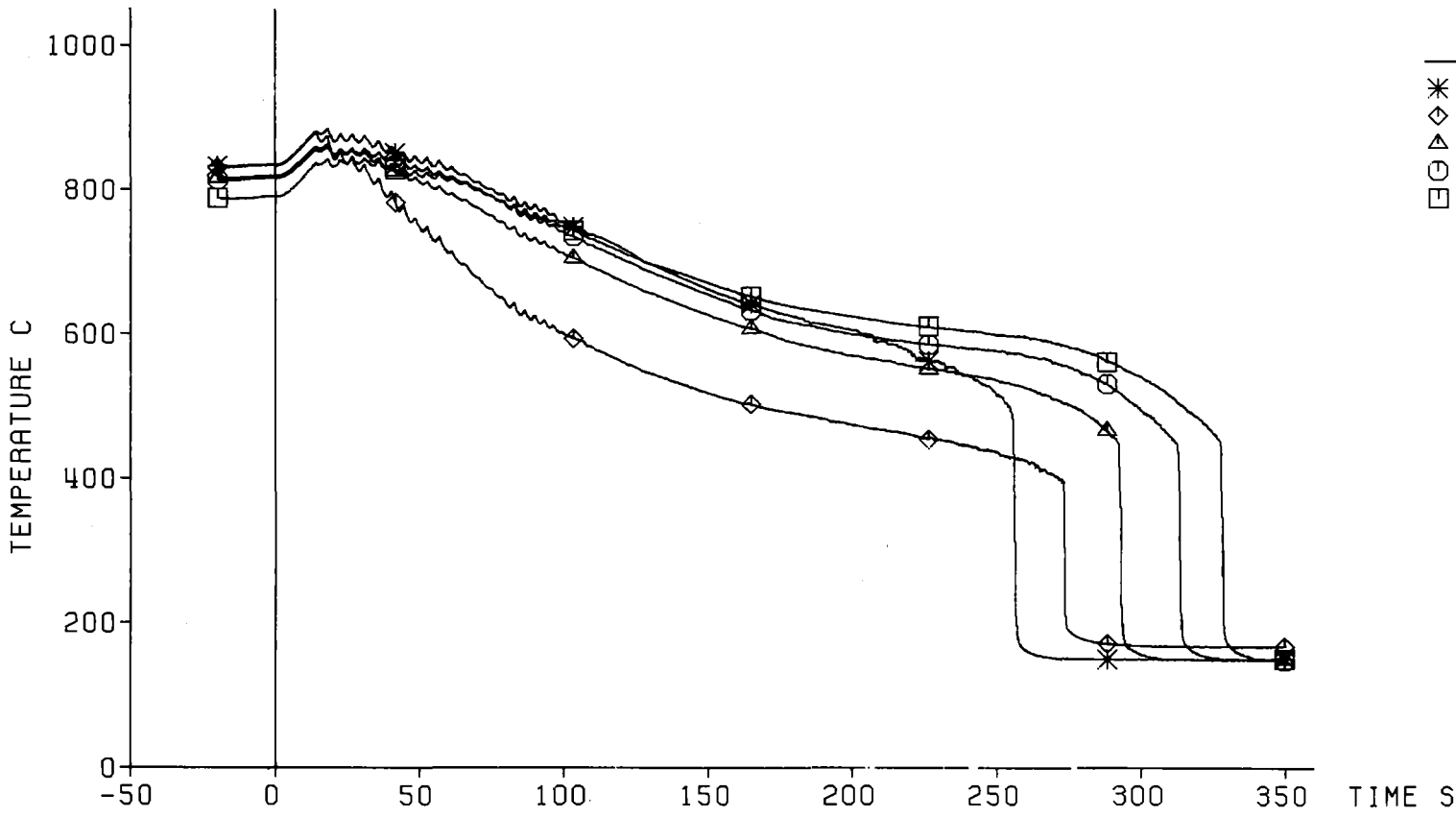

Decay Heat 120% ANS Standard
 Flooding Rate (cold) 3.77 cm/s
 System Pressure 4.05 bar
 Feedwater Temperature 40 C



Fig. 370 FEBA: 5x5 ROD BUNDLE, TEST SERIES 8, TEST-No. 337

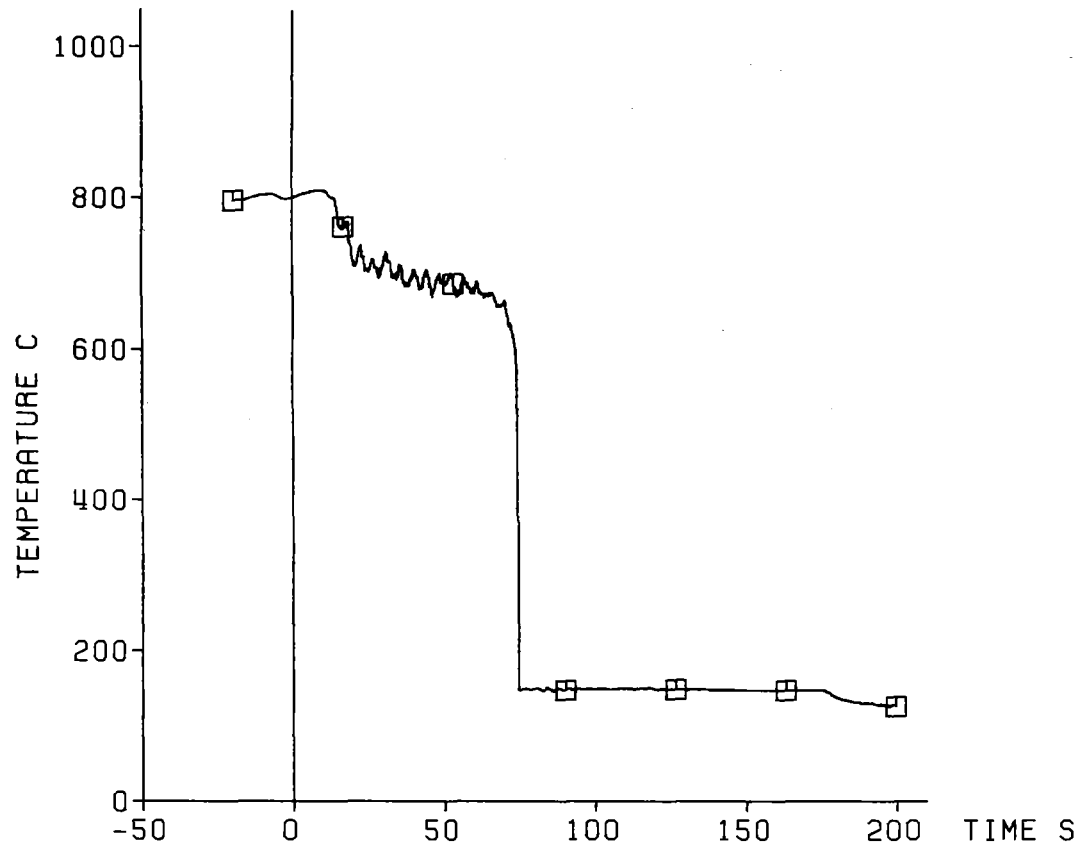

TC	Axial Level
□ 69	2535 mm

Decay Heat 120% ANS Standard
 Flooding Rate (cold) 3.77 cm/s
 System Pressure 4.05 bar
 Feedwater Temperature 40 C



Fig. 372 FEBA: 5x5 ROD BUNDLE, TEST SERIES 8, TEST-No. 337

Grid Spacer Temperature

	TC	Axial Level
□	67	1425 mm
○	66	1425 mm

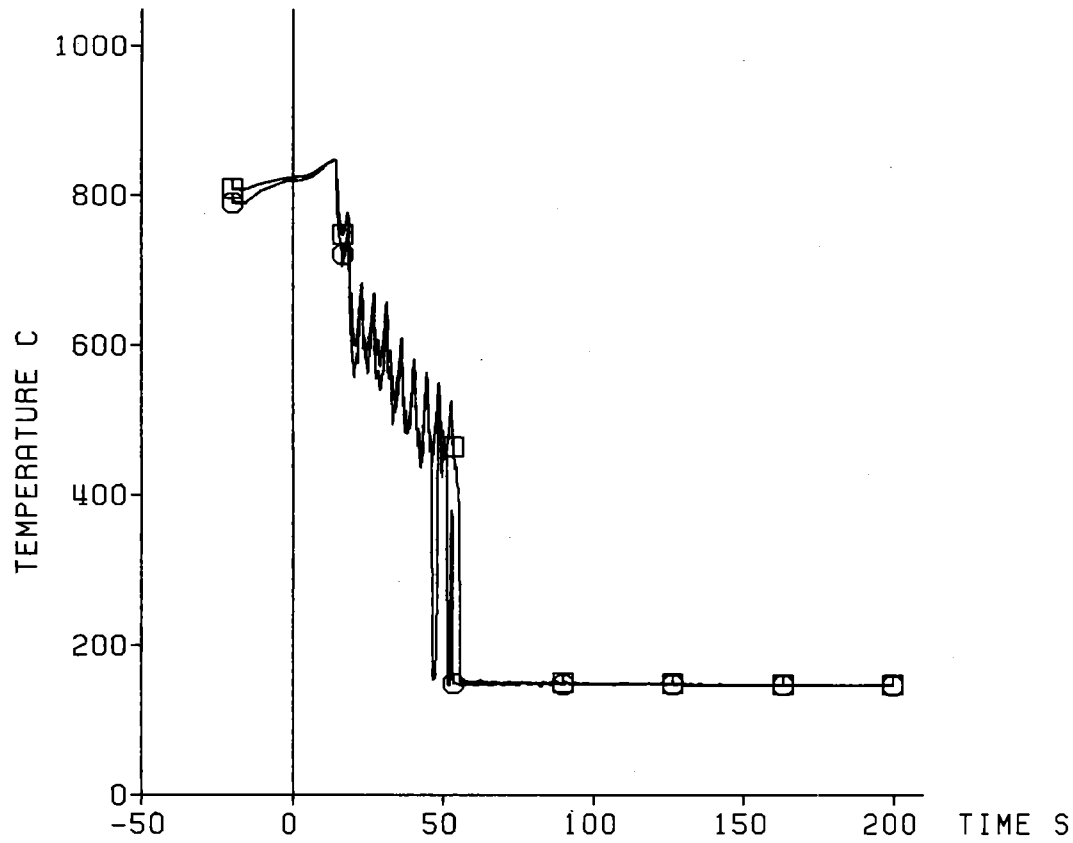

Decay Heat 120% ANS Standard
 Flooding Rate (cold) 3.77 cm/s
 System Pressure 4.05 bar
 Feedwater Temperature 40 C



Fig. 373 FEBA: 5x5 ROD BUNDLE, TEST SERIES 8, TEST-No. 337

Axial Level: 2770 mm

△ Cladding Temperature (7a2)
○ Fluid Temperature
□ Housing Temperature

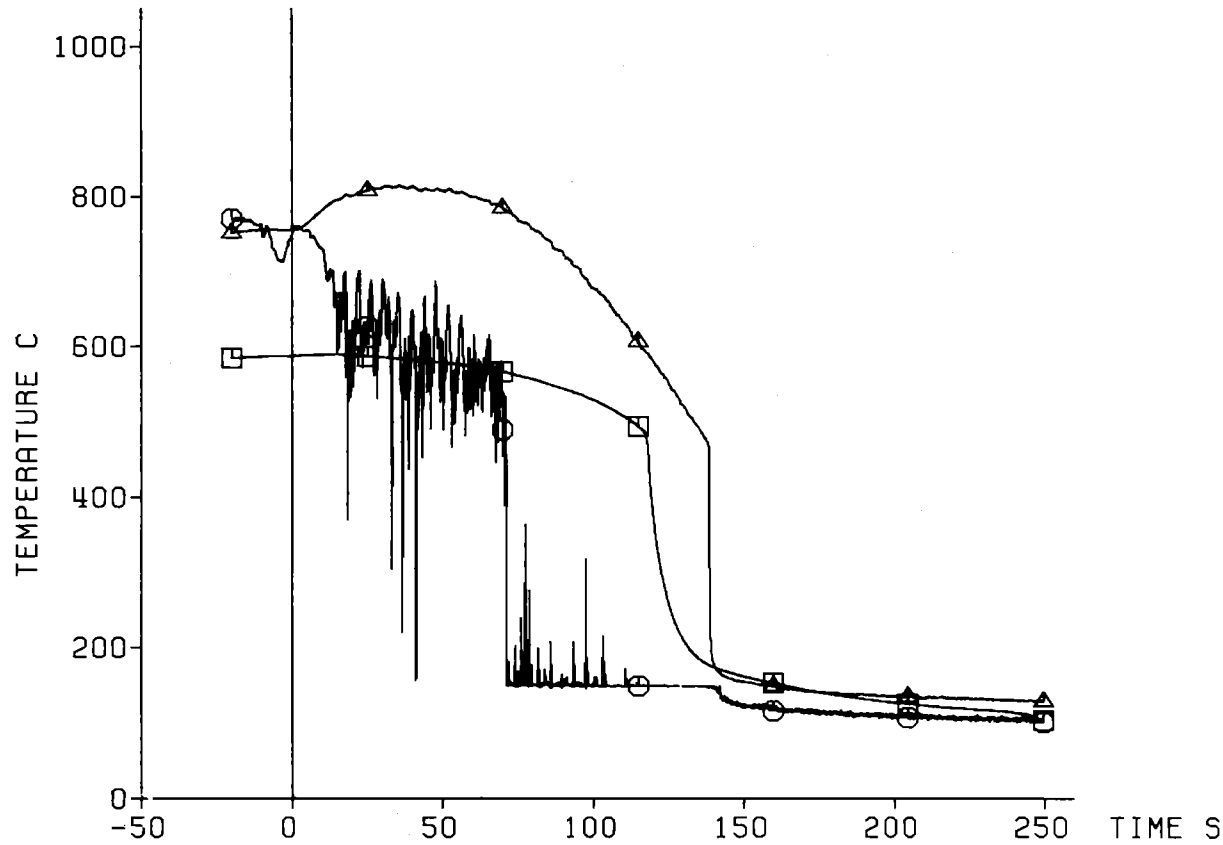

Decay Heat 120% ANS Standard
Flooding Rate (cold) 3.77 cm/s
System Pressure 4.05 bar
Feedwater Temperature 40 C

— 414 —



Fig. 374 FEBA: 5x5 ROD BUNDLE, TEST SERIES 8, TEST-NO. 337

Axial Level: 2225 mm

△ Cladding Temperature (7a1)
○ Fluid Temperature (2240 mm)
□ Housing Temperature (2235 mm)

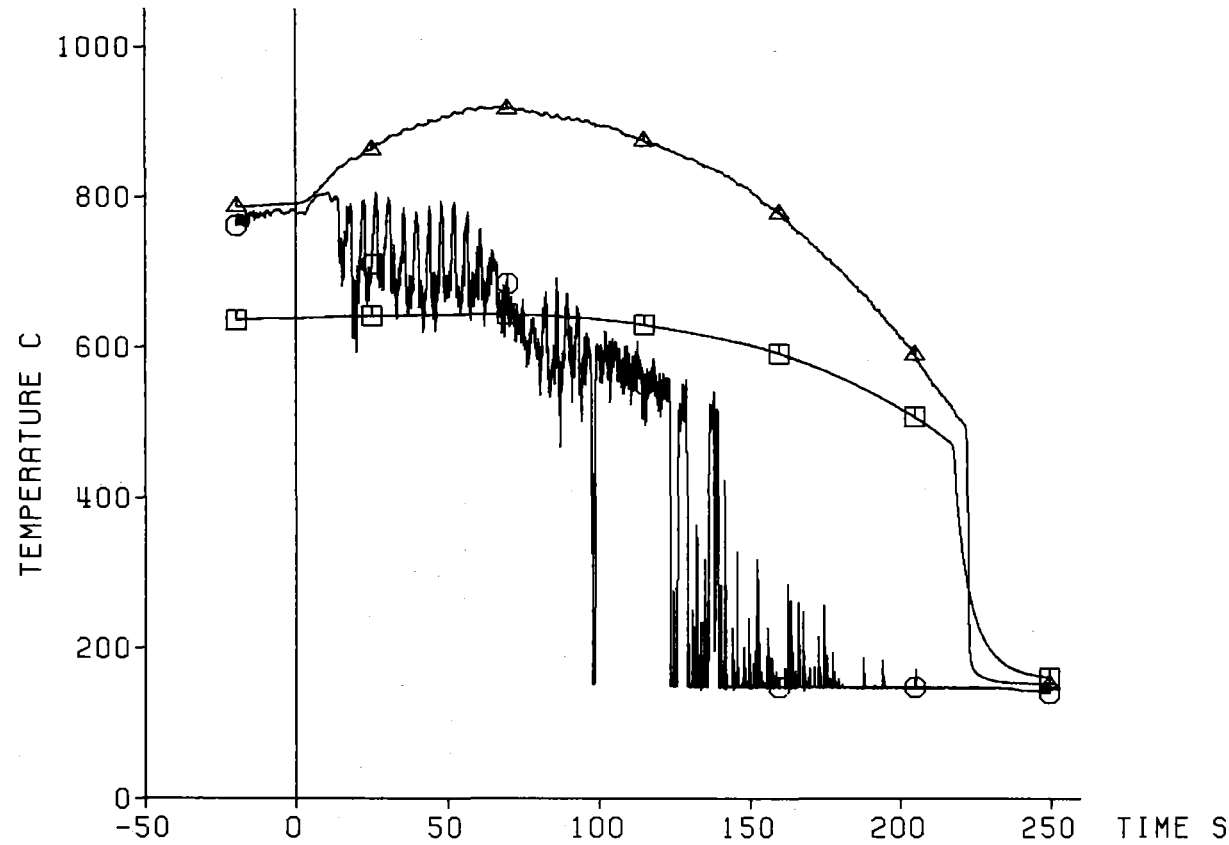

Decay Heat 120% ANS Standard
Flooding Rate (cold) 3.77 cm/s
System Pressure 4.05 bar
Feedwater Temperature 40 C

— 415 —



Fig. 375 FEBA: 5x5 ROD BUNDLE, TEST SERIES 8, TEST-No. 337

Axial Level: 1925 mm

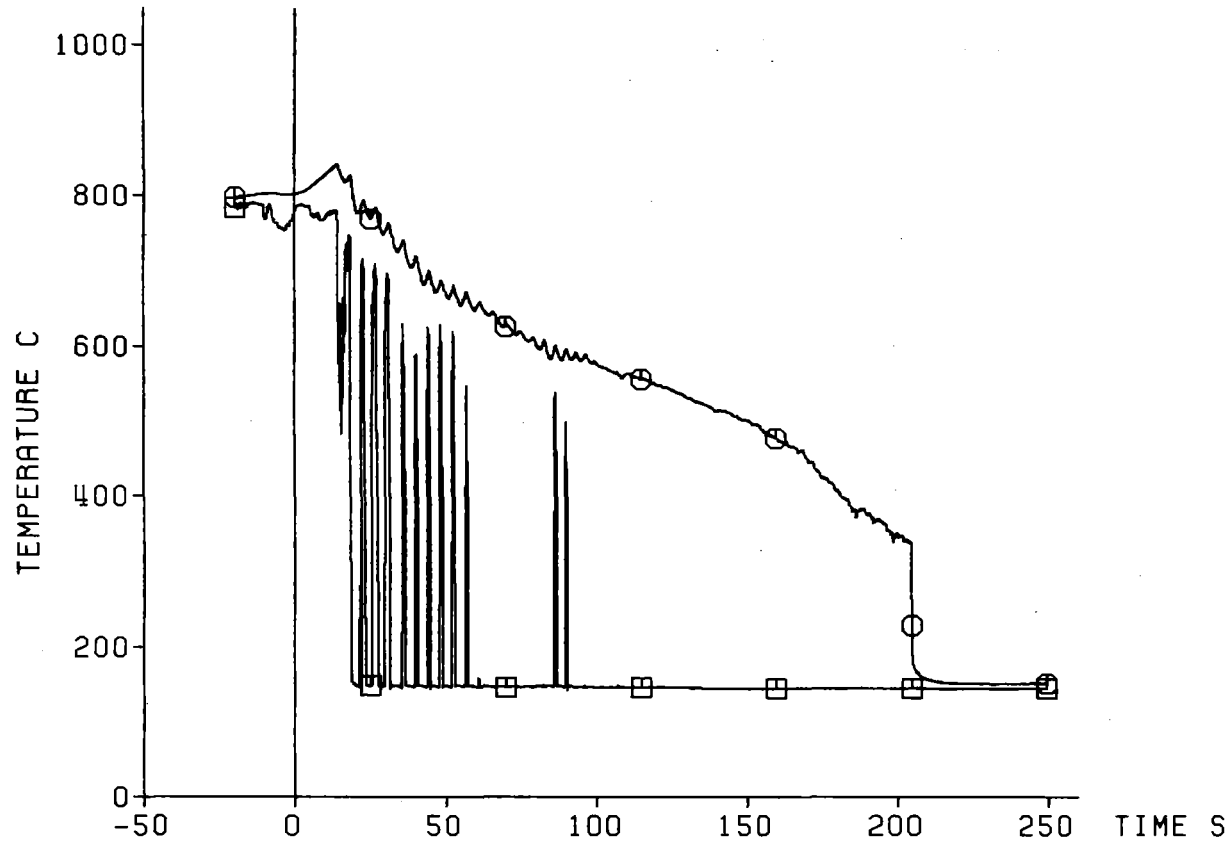

▲ Cladding Temperature (19g4)
○ Fluid Temperature

Decay Heat 120% ANS Standard
Flooding Rate (cold) 3.77 cm/s
System Pressure 4.05 bar
Feedwater Temperature 40 C

— 416 —



Fig. 376 FEBA: 5x5 ROD BUNDLE, TEST SERIES 8, TEST-No. 337

Axial Level: 1825 mm

▲ Cladding Temperature (19g3)
○ Fluid Temperature
□ Housing Temperature

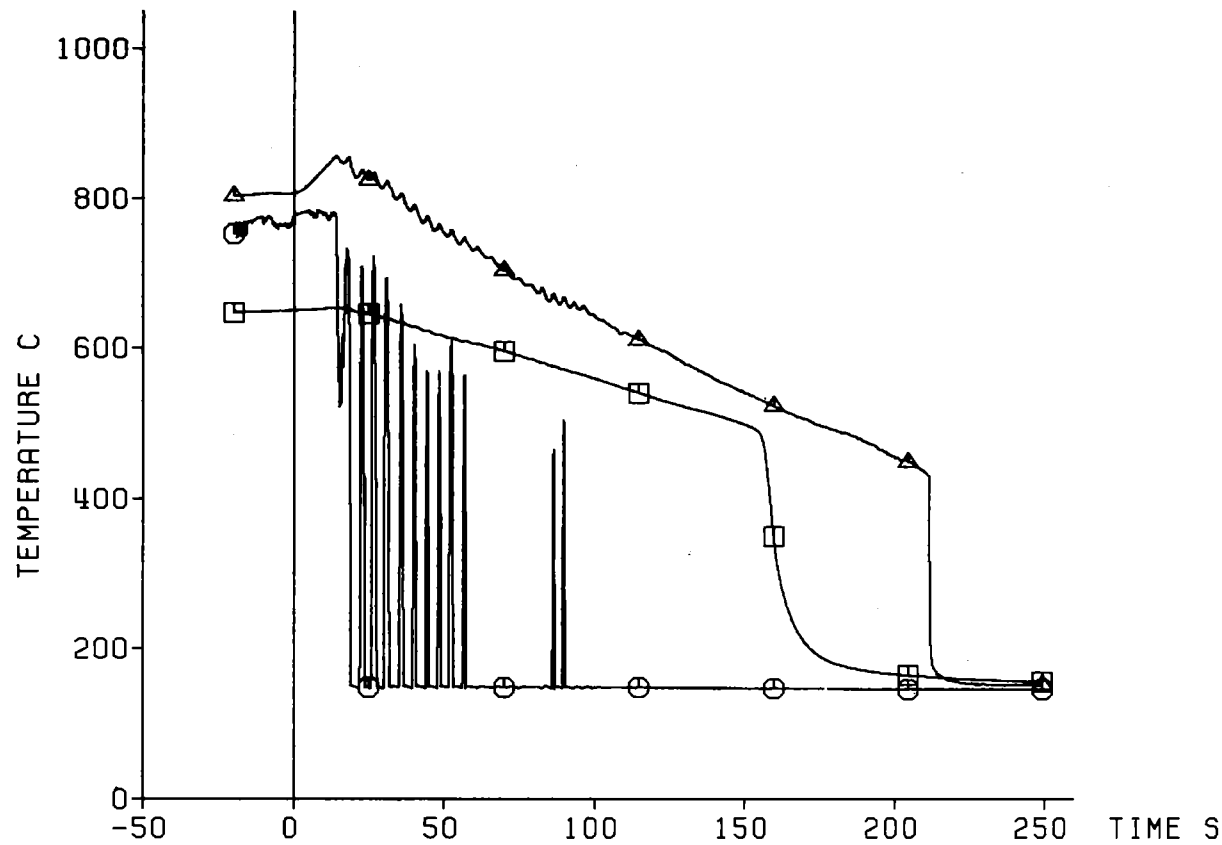

Decay Heat 120% ANS Standard
Flooding Rate (cold) 3.77 cm/s
System Pressure 4.05 bar
Feedwater Temperature 40 C

KfK
IRB

Fig. 377 FEBA: 5x5 ROD BUNDLE, TEST SERIES 8, TEST-No. 337

Axial Level: 1725 mm

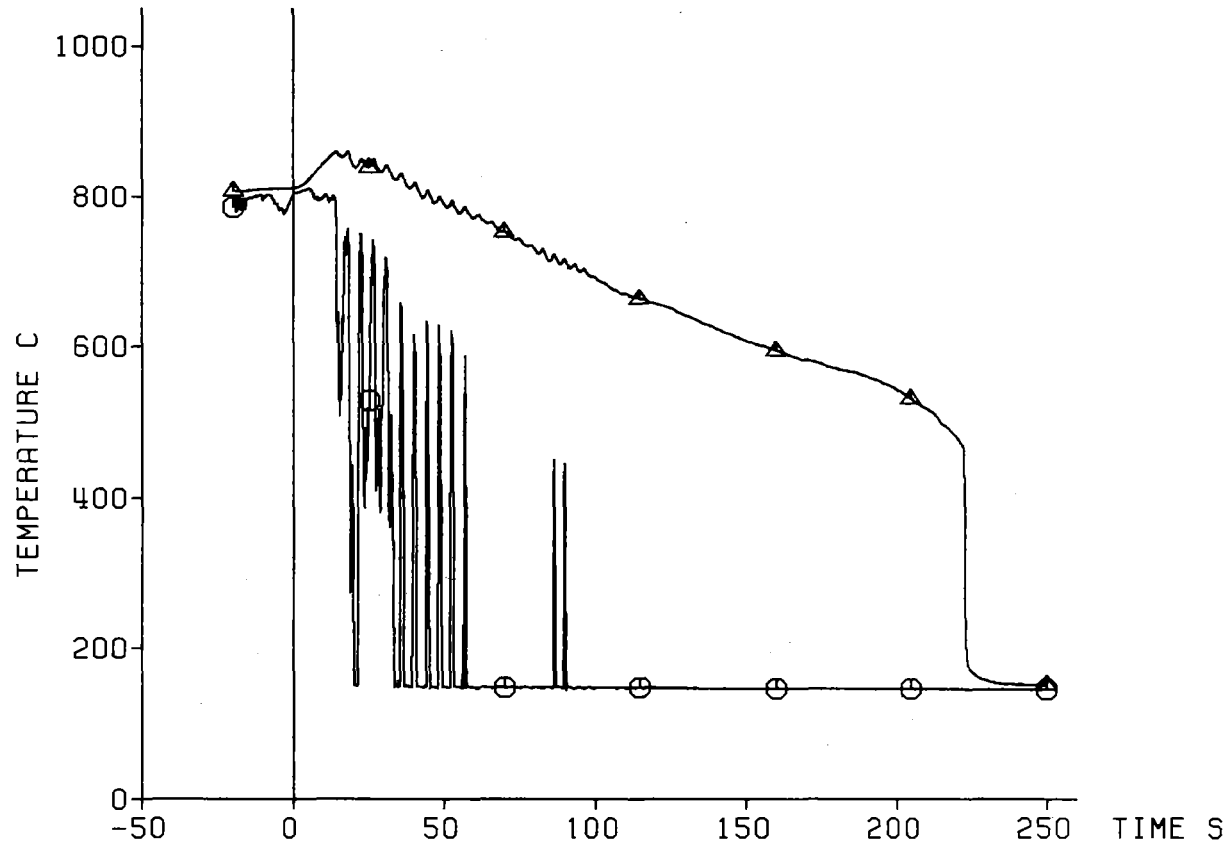

△ Cladding Temperature (19g2)
○ Fluid Temperature

Decay Heat 120% ANS Standard
Flooding Rate (cold) 3.77 cm/s
System Pressure 4.05 bar
Feedwater Temperature 40 C

— 418 —



Fig. 378 FEBA: 5x5 ROD BUNDLE, TEST SERIES 8, TEST-No. 337

Axial Level: 1625 mm

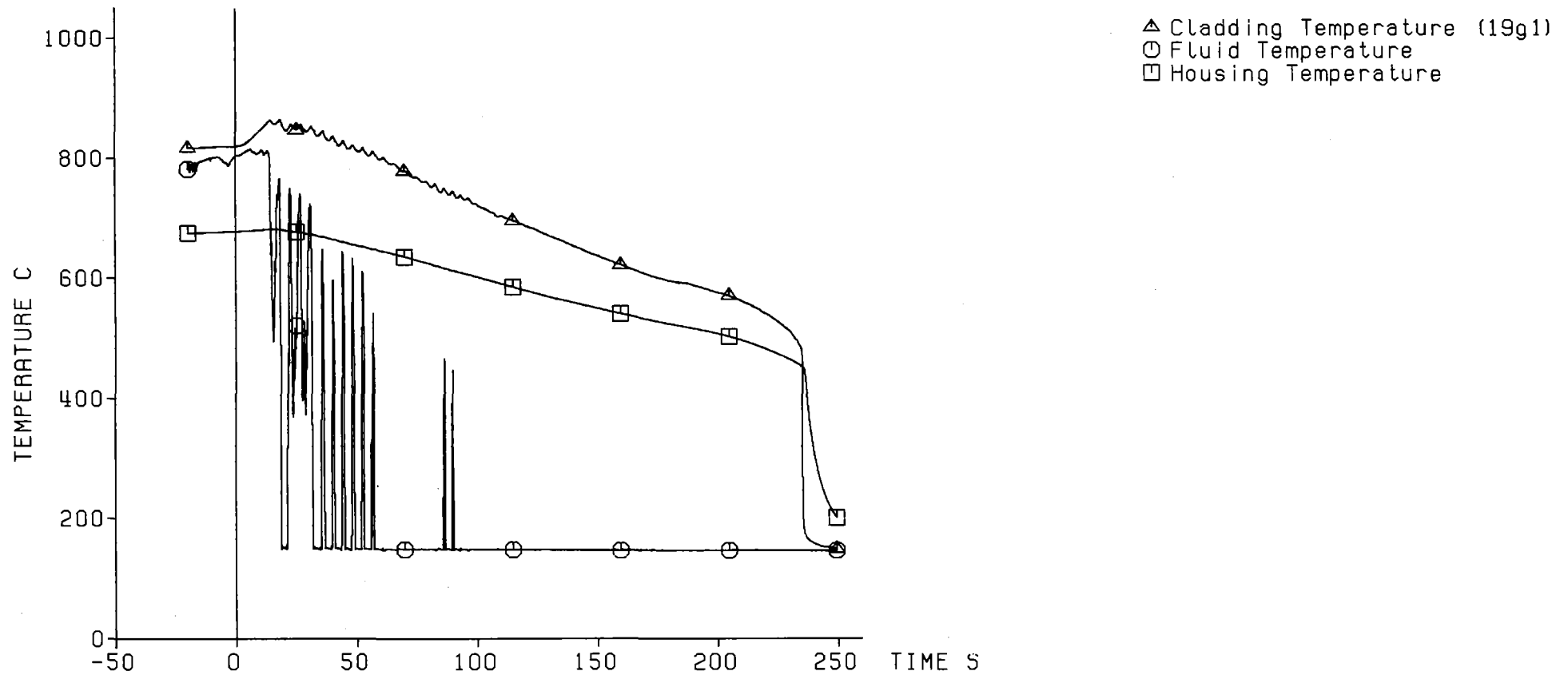

Decay Heat 120% ANS Standard
Flooding Rate (cold) 3.77 cm/s
System Pressure 4.05 bar
Feedwater Temperature 40 C



Fig. 379 FEBA: 5x5 ROD BUNDLE, TEST SERIES 8, TEST-No. 337

Axial Level: 1135 mm

△ Cladding Temperature (8b3)
○ Fluid Temperature
□ Housing Temperature

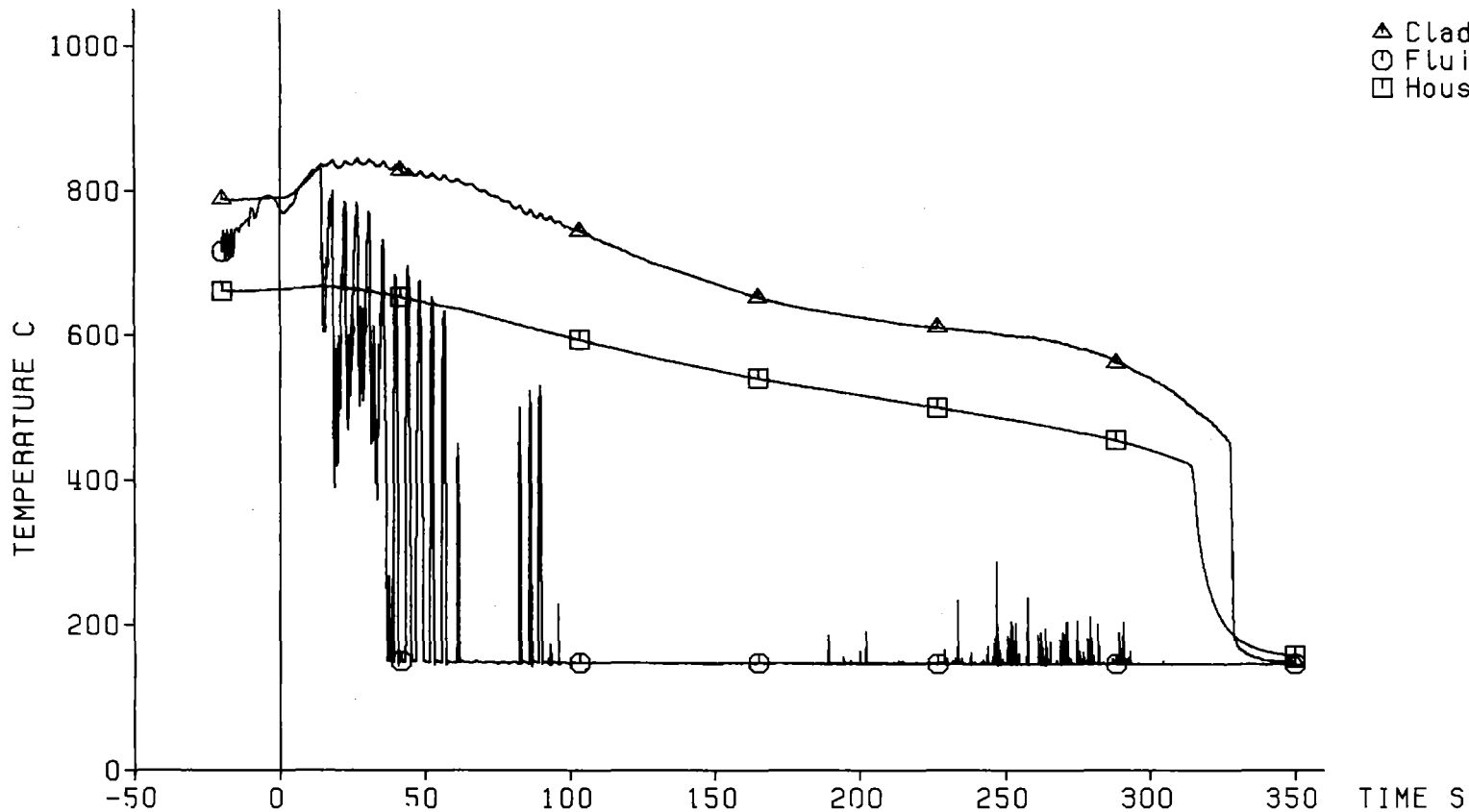

Decay Heat	120% ANS Standard
Flooding Rate (cold)	3.77 cm/s
System Pressure	4.05 bar
Feedwater Temperature	40 C

KIK IRB

Fig. 380 FEBA: 5x5 ROD BUNDLE, TEST SERIES 8, TEST-No. 337

Pressure Loss
Along the Test Section:

◇ Total Length: 4196 mm
△ Lower Part: 1711 mm
○ Middle Part: 545 mm
□ Upper Part: 1940 mm

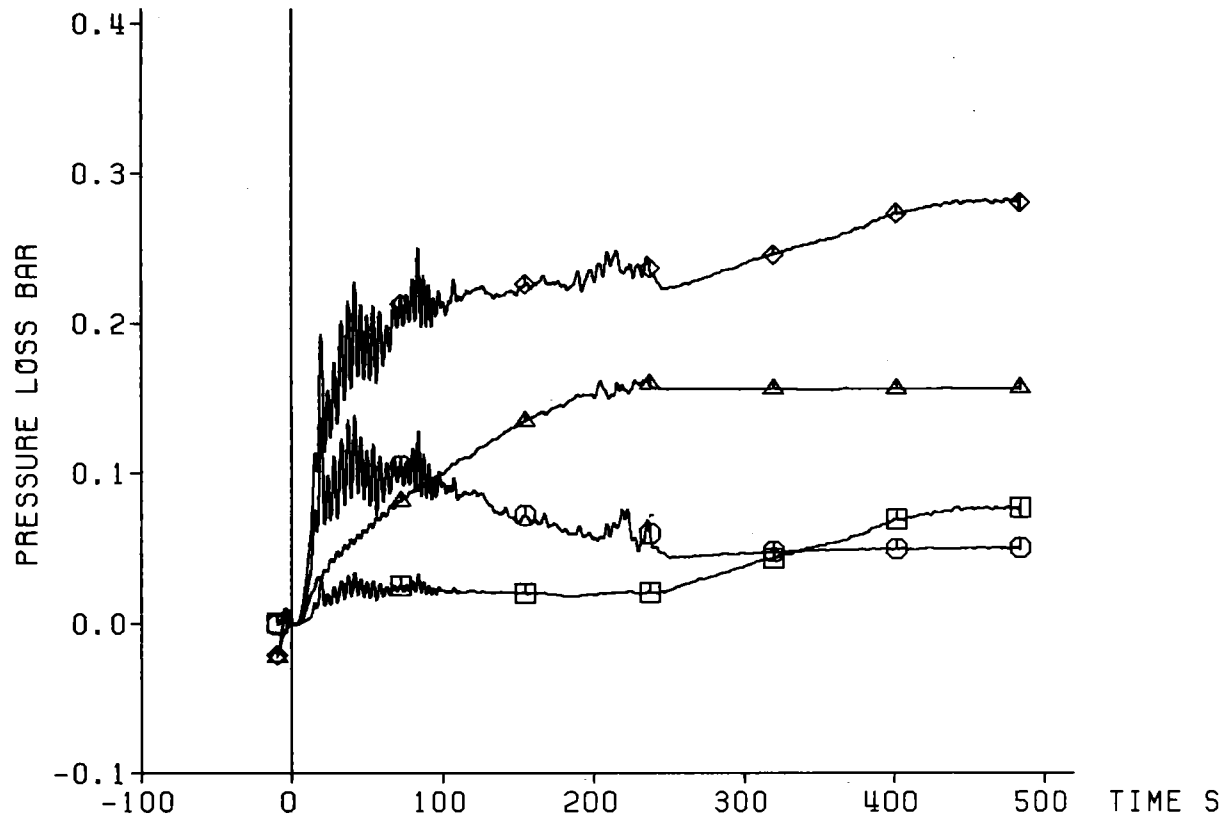

Decay Heat 120% ANS Standard
Flooding Rate (cold) 3.77 cm/s
System Pressure 4.05 bar
Feedwater Temperature 40 C

KIK
IRB

Fig. 381 FEBA: 5x5 ROD BUNDLE, TEST SERIES 8, TEST-NO. 337

Coolant Outlet Conditions:

△ Water Carry Over
○ Coolant Temperature
□ Coolant Pressure

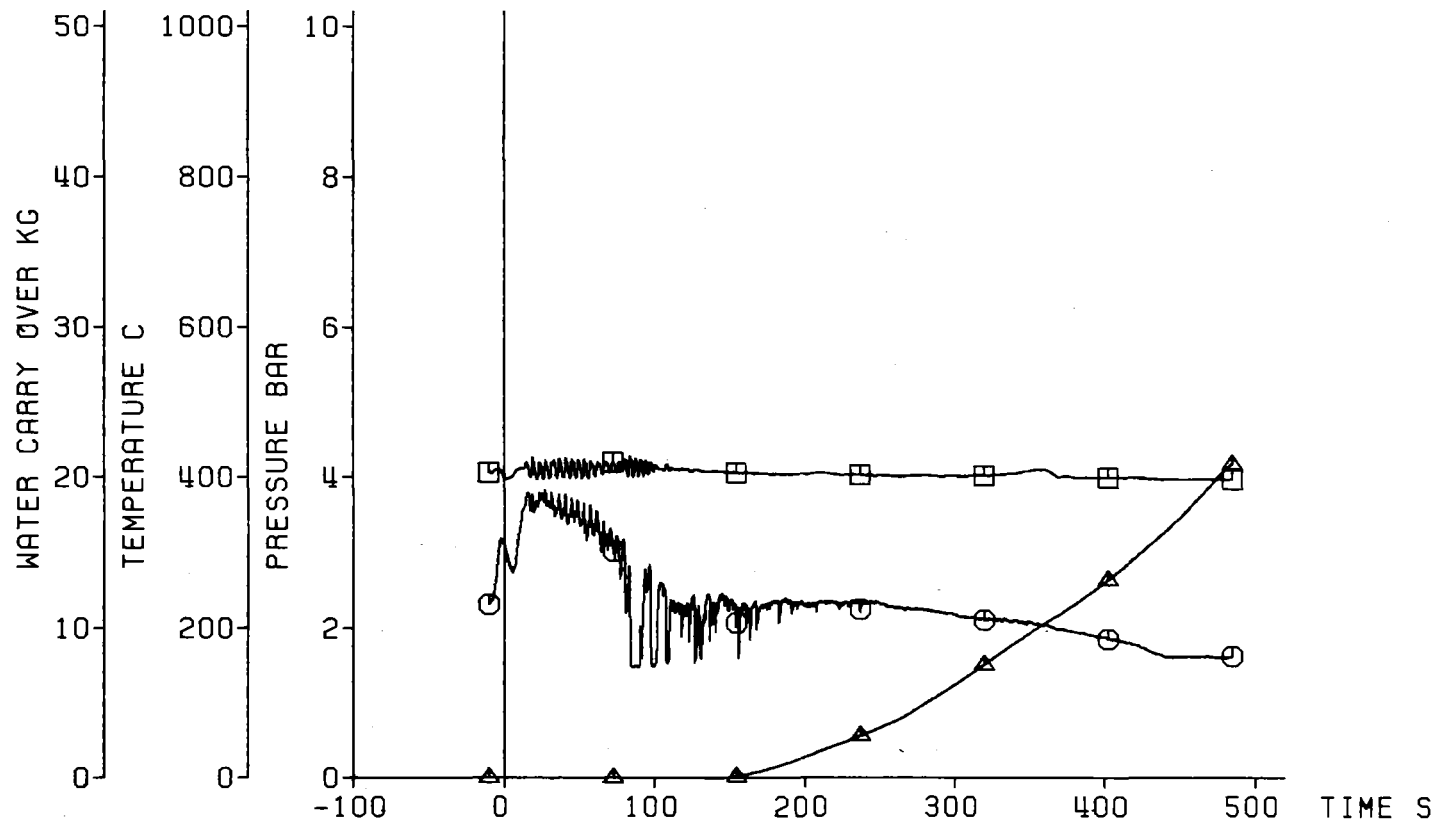

Decay Heat 120% ANS Standard
Flooding Rate (cold) 3.77 cm/s
System Pressure 4.05 bar
Feedwater Temperature 40 C

KIK IRB

Fig. 382 FEBA: 5x5 ROD BUNDLE, TEST SERIES 8, TEST-NO. 337

Axial Position of Quench Front

□ Quenching of Sleeves at Bundle Midplane

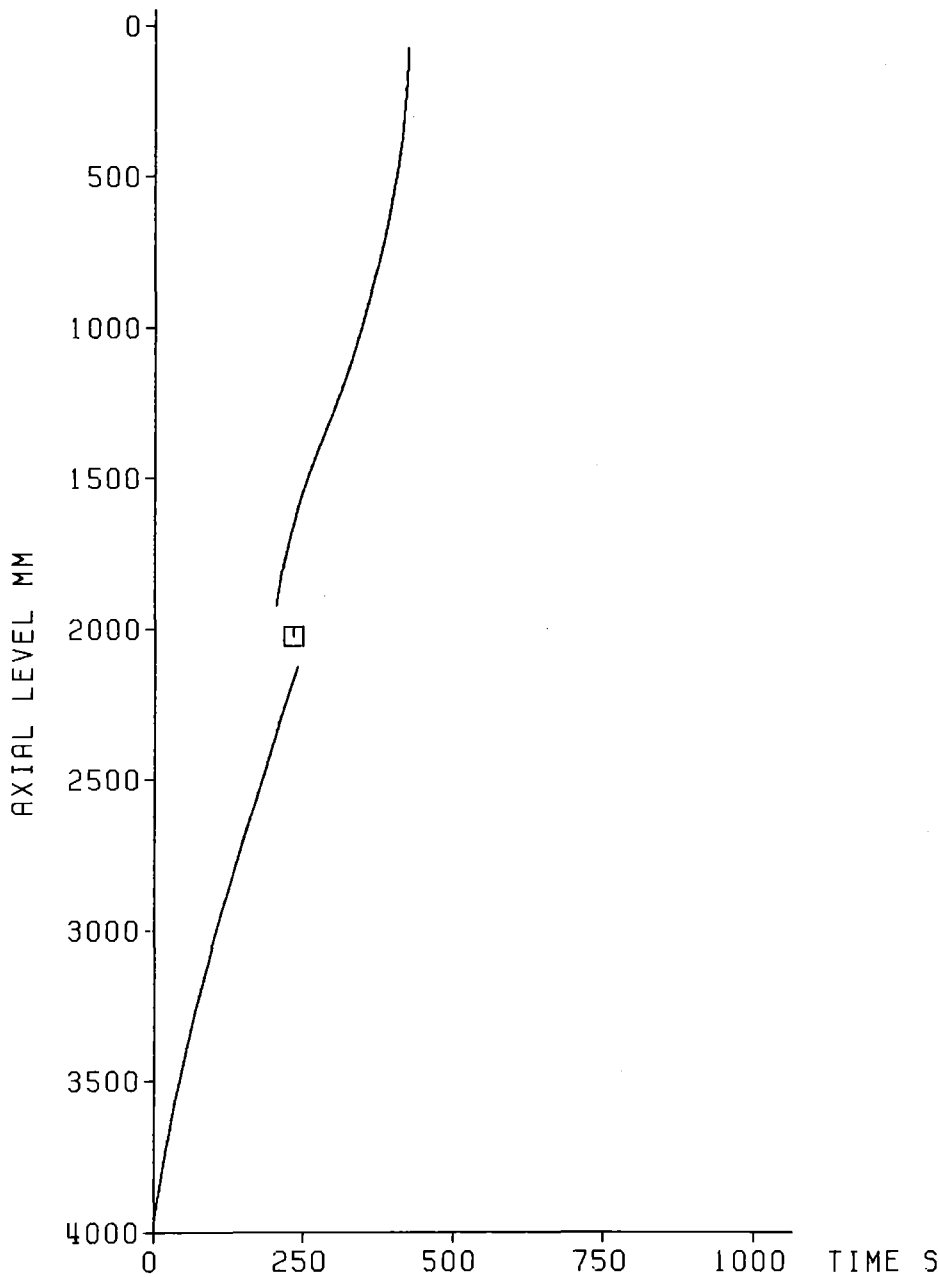

Decay Heat	120% ANS Standard
Flooding Rate (cold)	3.77 cm/s
System Pressure	4.05 bar
Feedwater Temperature	40 C



Fig. 383 FEBA: 5x5 ROD BUNDLE
TEST SERIES 8, TEST-No. 337

Initial Axial Temperature Profile of Claddings

□ Initial Temperature of Sleeves at Bundle Midplane

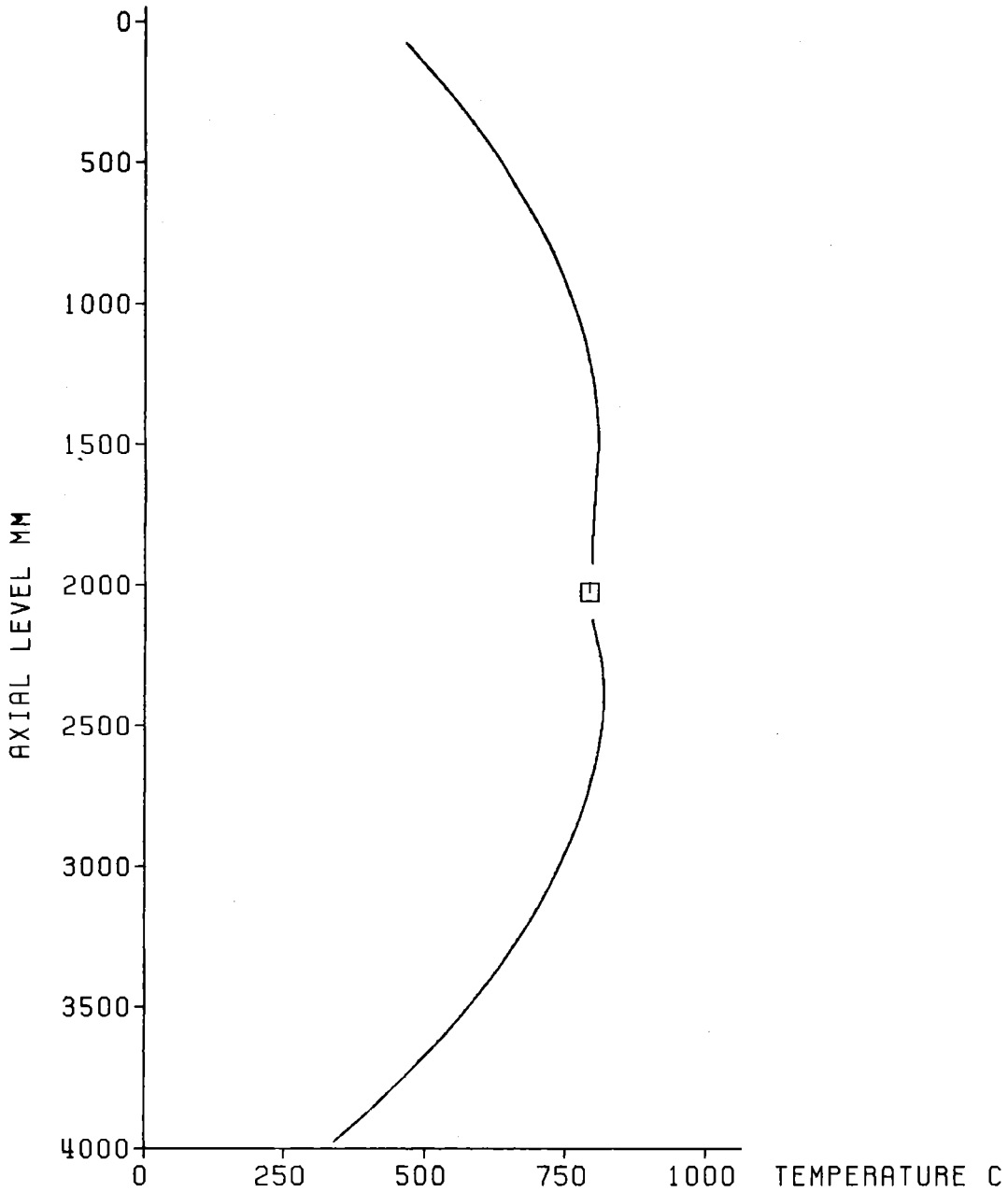

Decay Heat	120% ANS Standard
Flooding Rate (cold)	3.79 cm/s
System Pressure	5.84 bar
Feedwater Temperature	40 C



Fig. 384 FEBA: 5x5 ROD BUNDLE
TEST SERIES 8, TEST-No. 334

Test Parameters:

- ◇ Flooding Rate
- △ System Pressure
- Feedwater Temperature
- Bundle Power

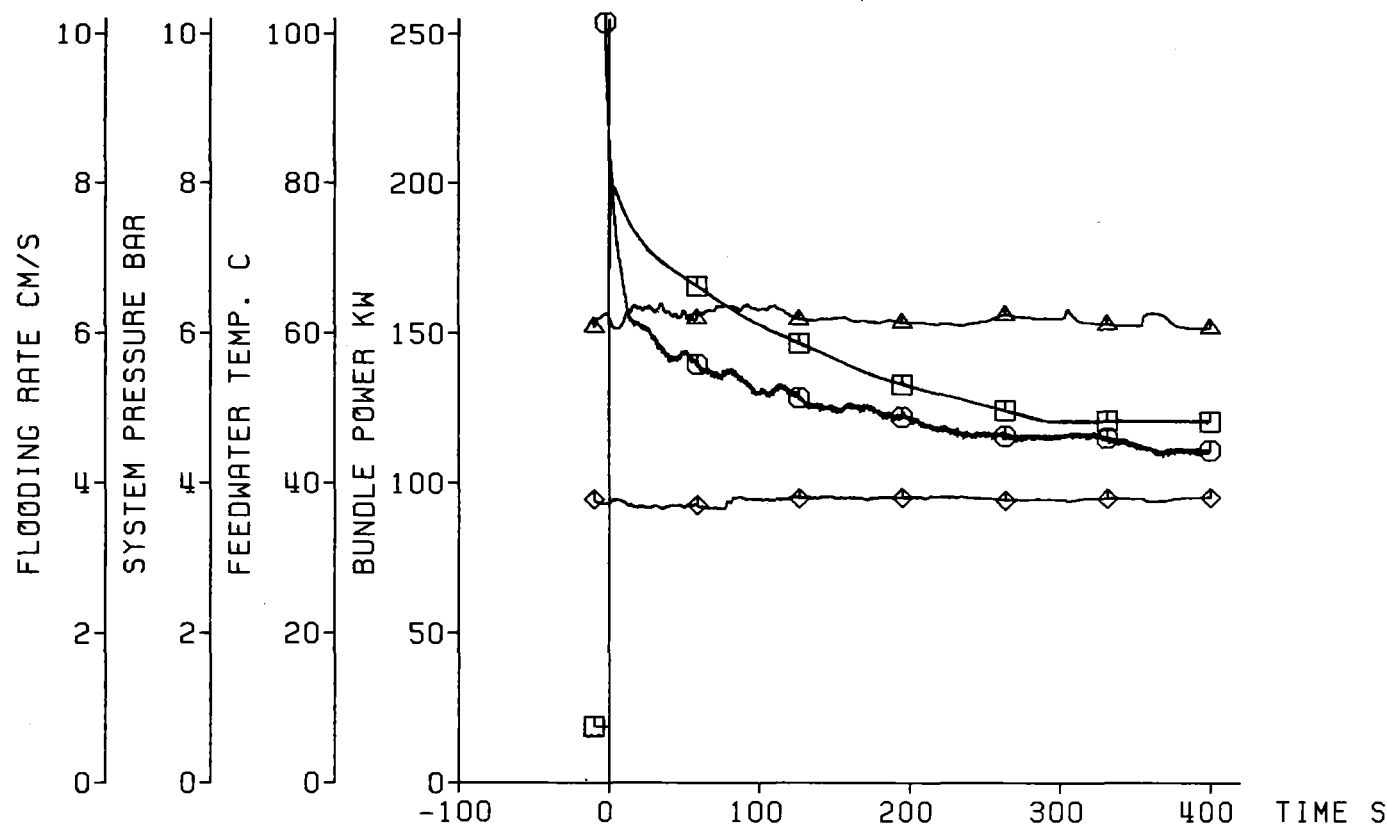

Decay Heat 120% ANS Standard
Flooding Rate (cold) 3.79 cm/s
System Pressure 5.84 bar
Feedwater Temperature 40 C



Fig. 385 FEBA: 5x5 ROD BUNDLE, TEST SERIES 8, TEST-No. 334

Cladding Temperature

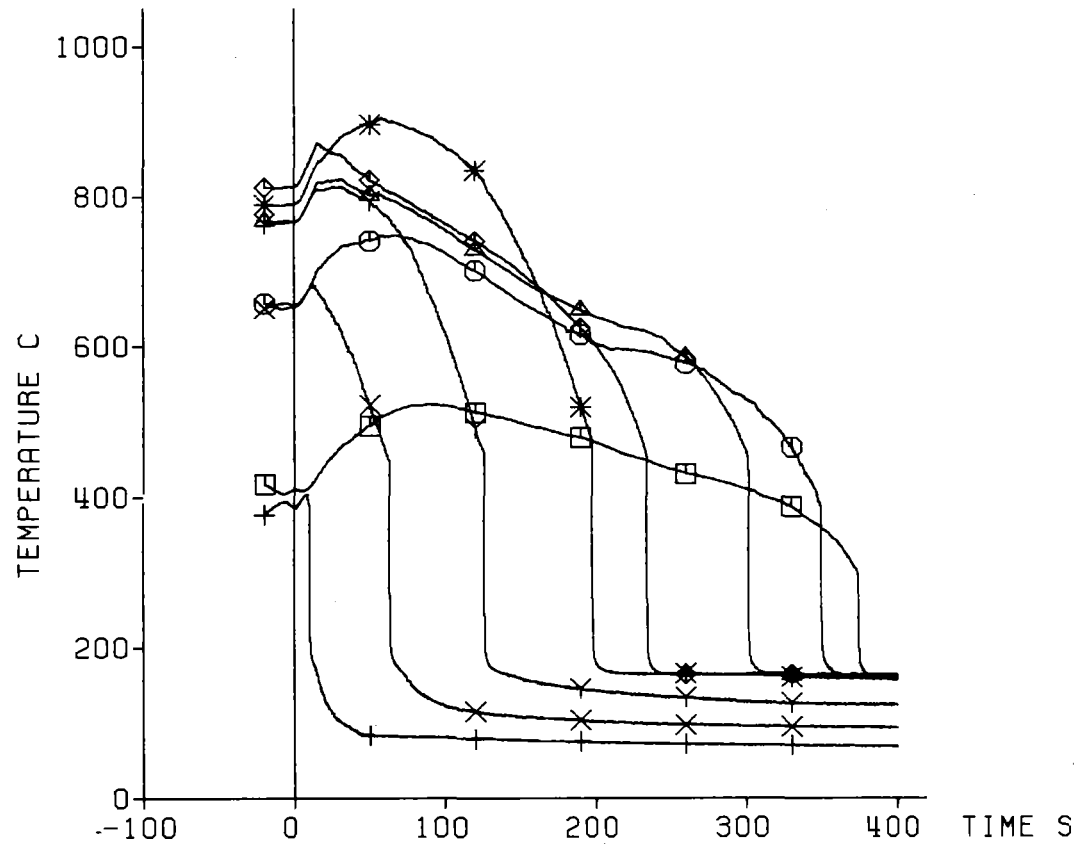

TC	Ax. Level
+	7a4 3860 mm
X	7a3 3315 mm
Y	7a2 2770 mm
*	7a1 2225 mm
◇	8b4 1680 mm
△	8b3 1135 mm
○	8b2 590 mm
□	3b1 45 mm

Decay Heat 120% ANS Standard
 Flooding Rate (cold) 3.79 cm/s
 System Pressure 5.84 bar
 Feedwater Temperature 40 C



Fig. 386 FEBA: 5x5 ROD BUNDLE, TEST SERIES 8, TEST-No. 334

Heat Transfer Coeff.

	TC	Ax. Level
X	7a3	3315 mm
Y	7a2	2770 mm
*	7a1	2225 mm
◇	8b4	1680 mm
△	8b3	1135 mm
○	8b2	590 mm

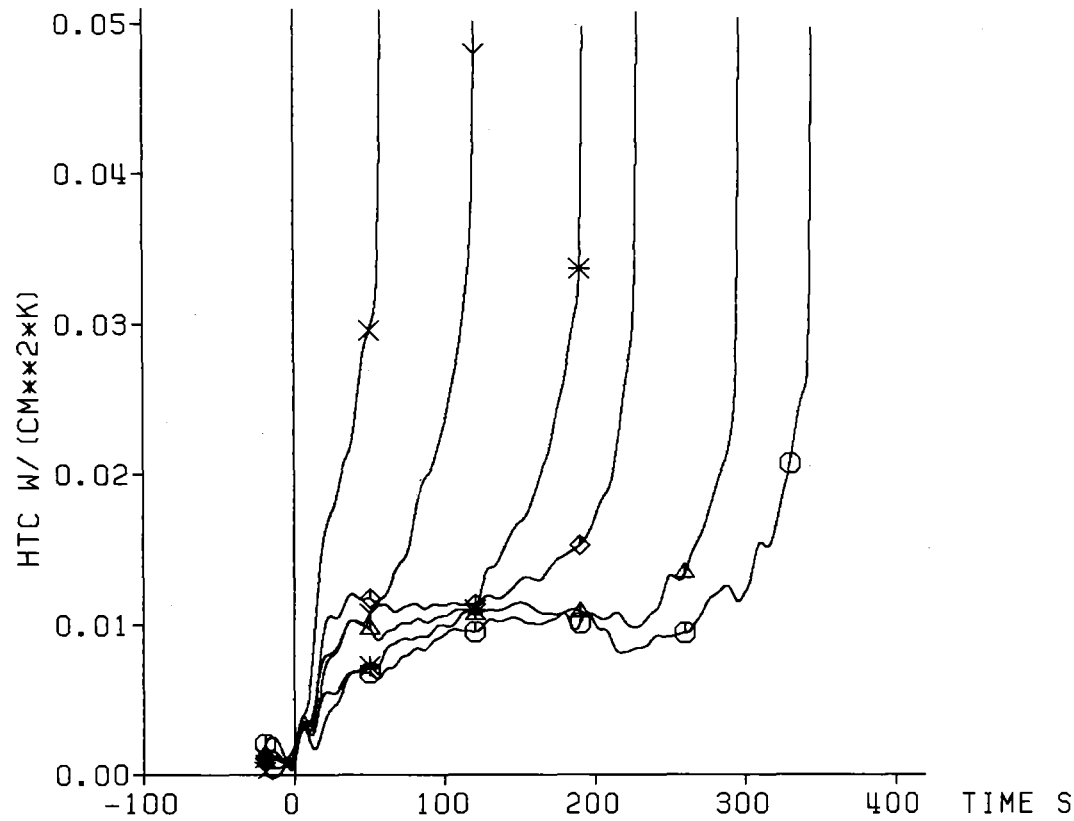

Decay Heat 120% ANS Standard
 Flooding Rate (cold) 3.79 cm/s
 System Pressure 5.84 bar
 Feedwater Temperature 40 C



Fig. 387 FEBA: 5x5 ROD BUNDLE, TEST SERIES 8, TEST-No. 334

Cladding Temperature

	TC	Ax. Level
◇	14f4	2425 mm
△	14f3	2325 mm
○	14h2	2225 mm
□	14f1	2125 mm

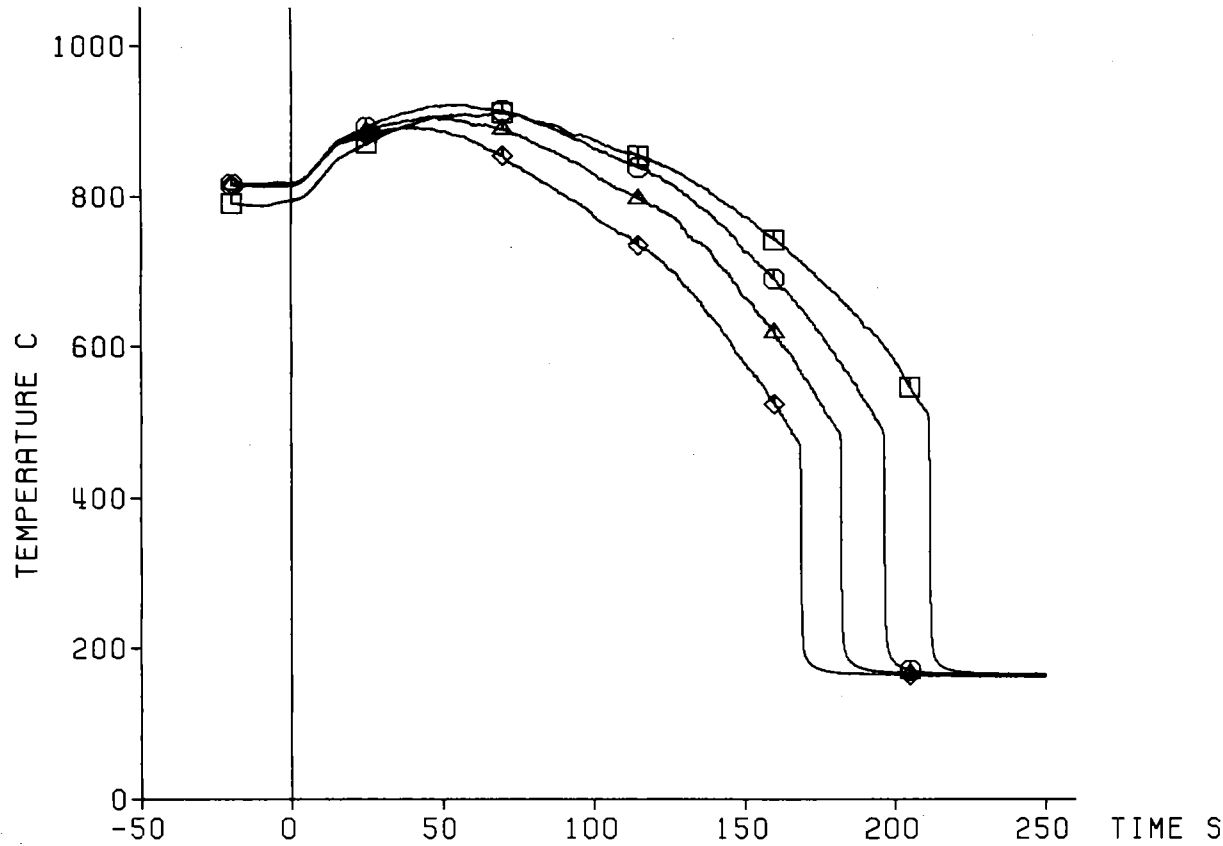

Decay Heat 120% ANS Standard
 Flooding Rate (cold) 3.79 cm/s
 System Pressure 5.84 bar
 Feedwater Temperature 40 C



Fig. 388 FEBA: 5x5 ROD BUNDLE, TEST SERIES 8, TEST-No. 334

Heat Transfer Coeff.

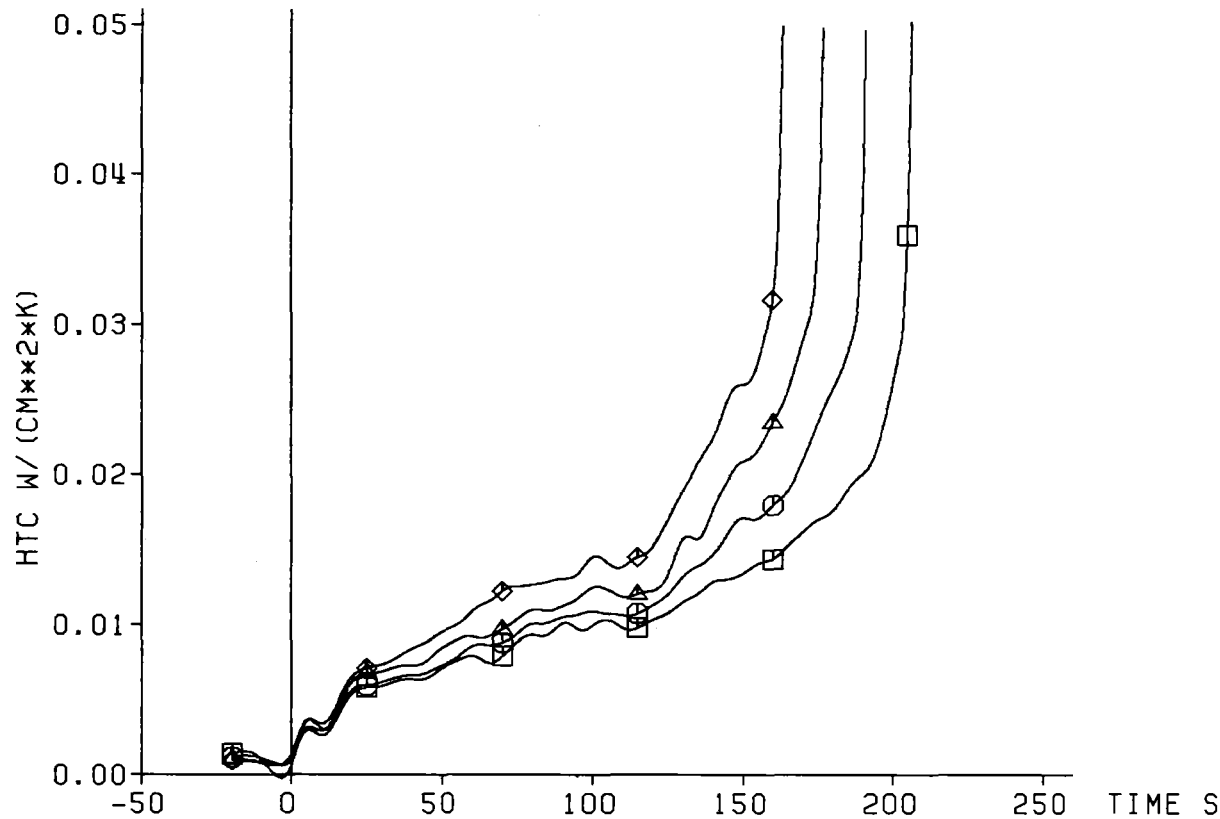

TC	Ax. Level
◇ 14f4	2425 mm
△ 14f3	2325 mm
○ 14h2	2225 mm
□ 14f1	2125 mm

Decay Heat 120% ANS Standard
 Flooding Rate (cold) 3.79 cm/s
 System Pressure 5.84 bar
 Feedwater Temperature 40 C



Fig. 389 FEBA: 5x5 ROD BUNDLE, TEST SERIES 8, TEST-No. 334

Cladding Temperature

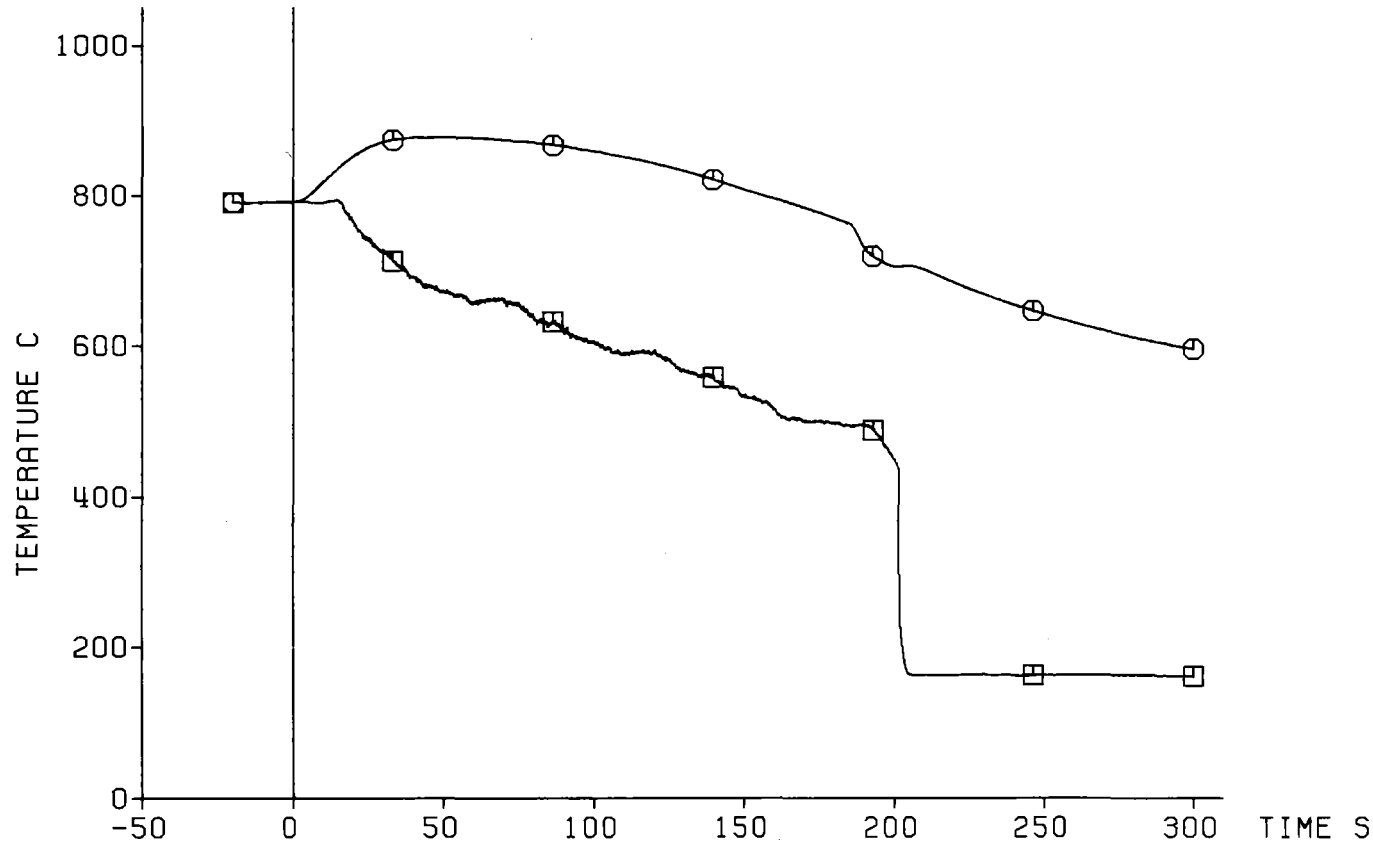

TC	Rx. Level
⊙ 1714	2025 mm
□ Sleeve	2025 mm

Decay Heat 120% ANS Standard
 Flooding Rate (cold) 3.79 cm/s
 System Pressure 5.84 bar
 Feedwater Temperature 40 C



Fig. 390 FEBA: 5x5 ROD BUNDLE, TEST SERIES 8, TEST-NO. 334

Sleeve Temperature
 Contact Face: Rods 17 and 18

TC	Ax. Level
○ Sleeve	2025 mm (Rod 17)
□ Sleeve	2025 mm (Rod 18)

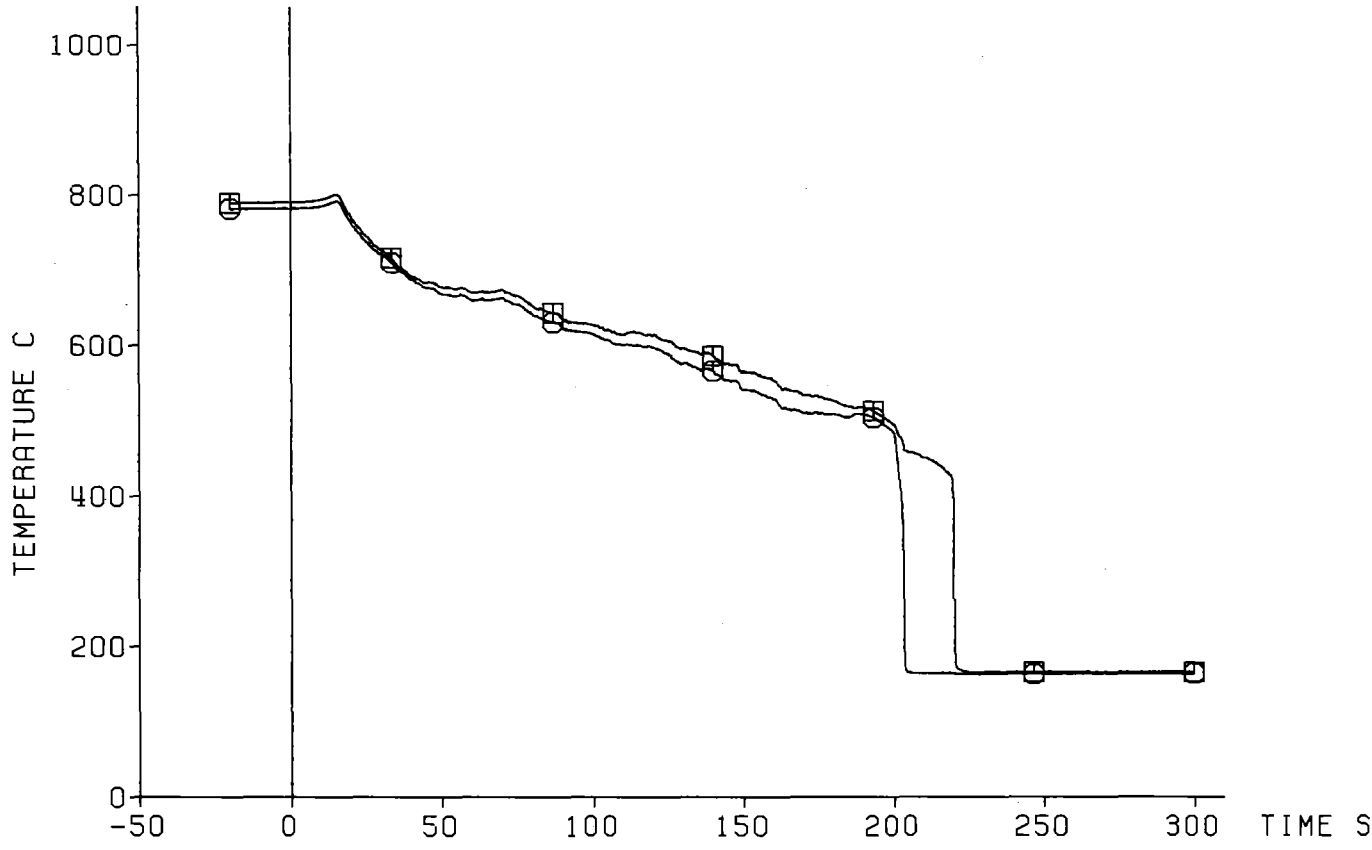

Decay Heat 120% ANS Standard
 Flooding Rate (cold) 3.79 cm/s
 System Pressure 5.84 bar
 Feedwater Temperature 40 C

— 431 —



Fig. 391 FEBA: 5x5 ROD BUNDLE, TEST SERIES 8, TEST-No. 334

Cladding Temperature

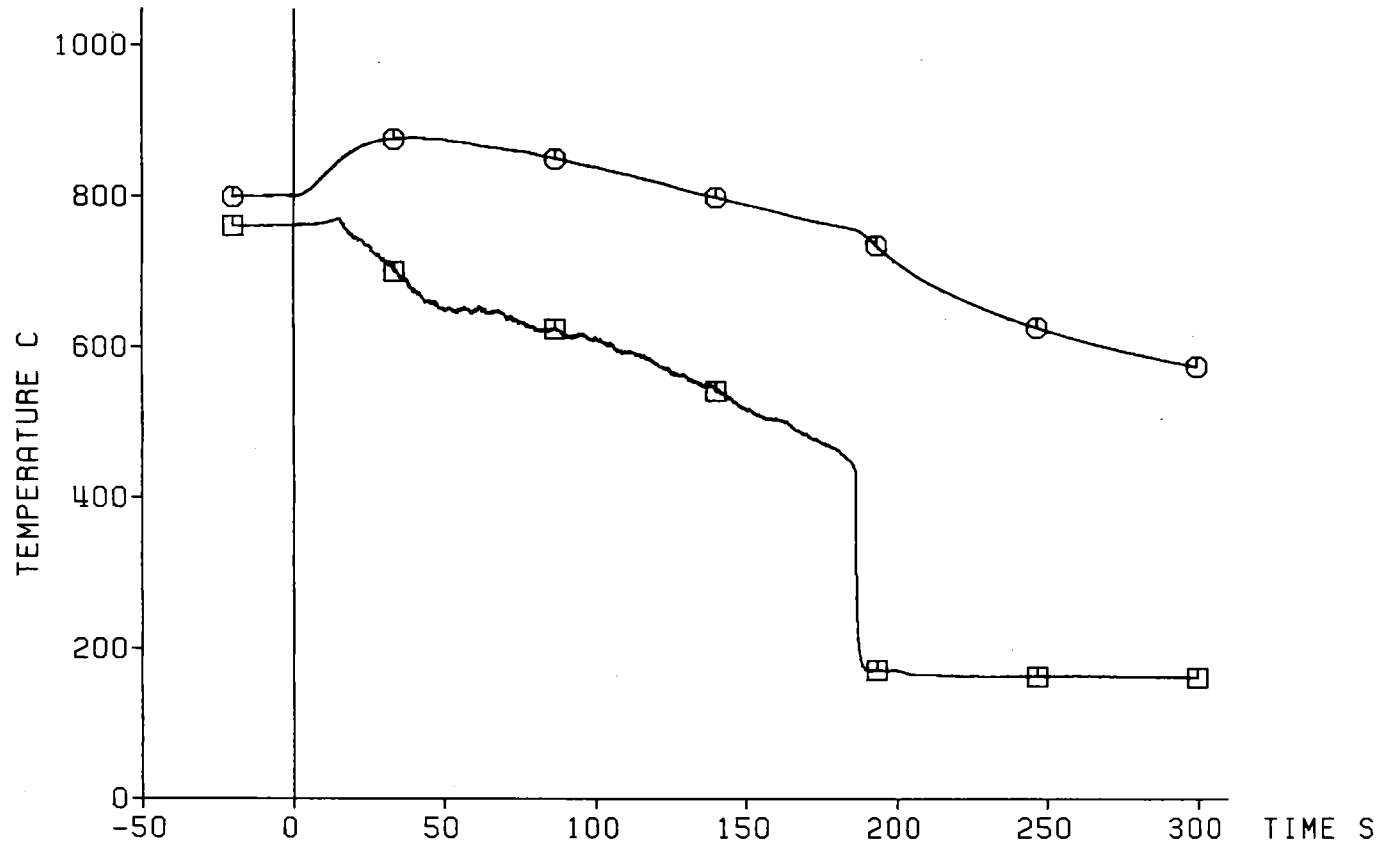

TC	Ax. Level
⊙	17i3 1975 mm
⊠	Sleeve 1972 mm

Decay Heat 120% ANS Standard
 Flooding Rate (cold) 3.79 cm/s
 System Pressure 5.84 bar
 Feedwater Temperature 40 C



Fig. 392 FEBA: 5x5 ROD BUNDLE, TEST SERIES 8, TEST-No. 334

Cladding Temperature

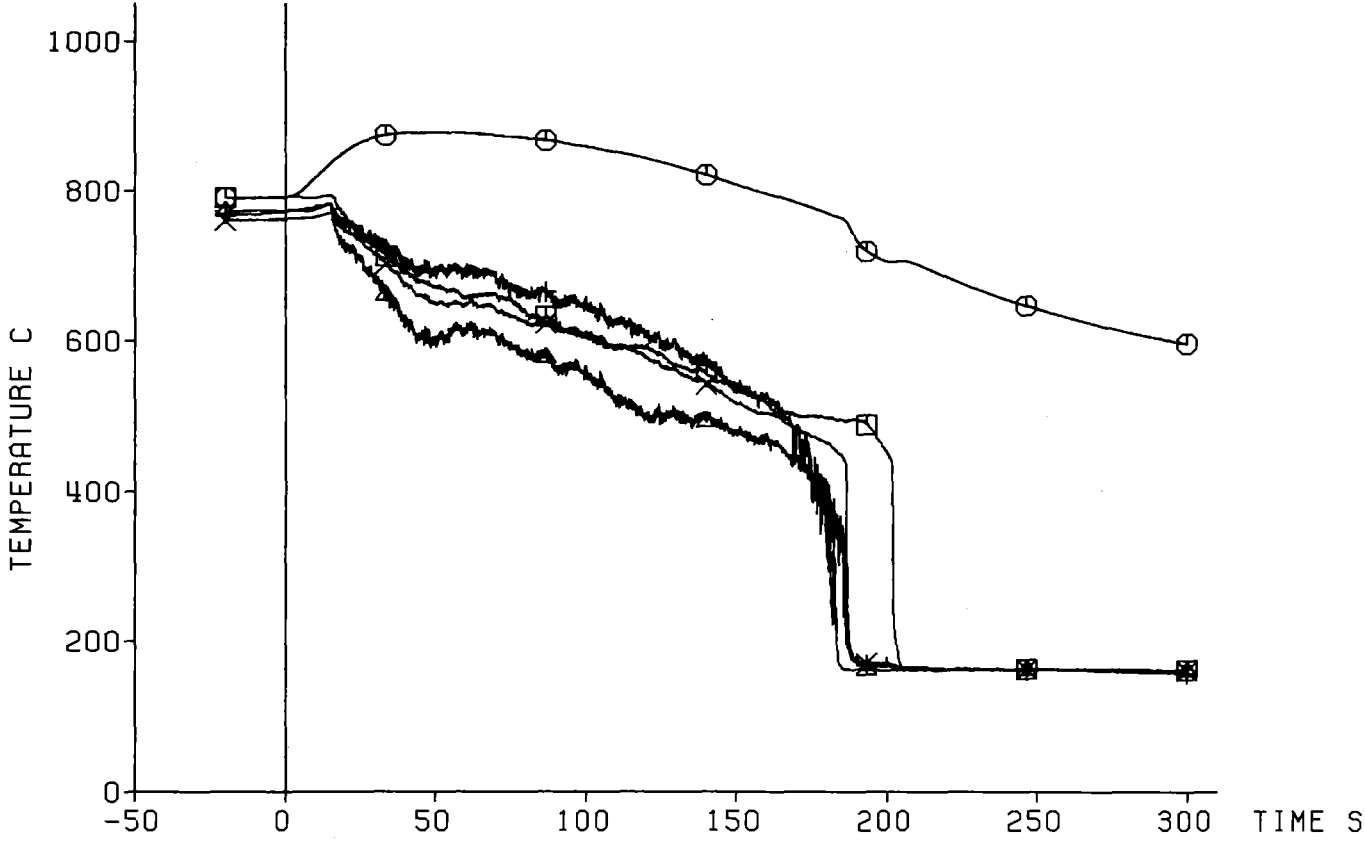

TC	Ax. Level
○	1714 2025 mm
+	Sleeve 2064 mm
□	Sleeve 2025 mm
△	Sleeve 2025 mm
×	Sleeve 1972 mm

Decay Heat 120% ANS Standard
 Flooding Rate (cold) 3.79 cm/s
 System Pressure 5.84 bar
 Feedwater Temperature 40 C



Fig. 393 FEBA: 5x5 ROD BUNDLE, TEST SERIES 8, TEST-No. 334

Cladding Temperature

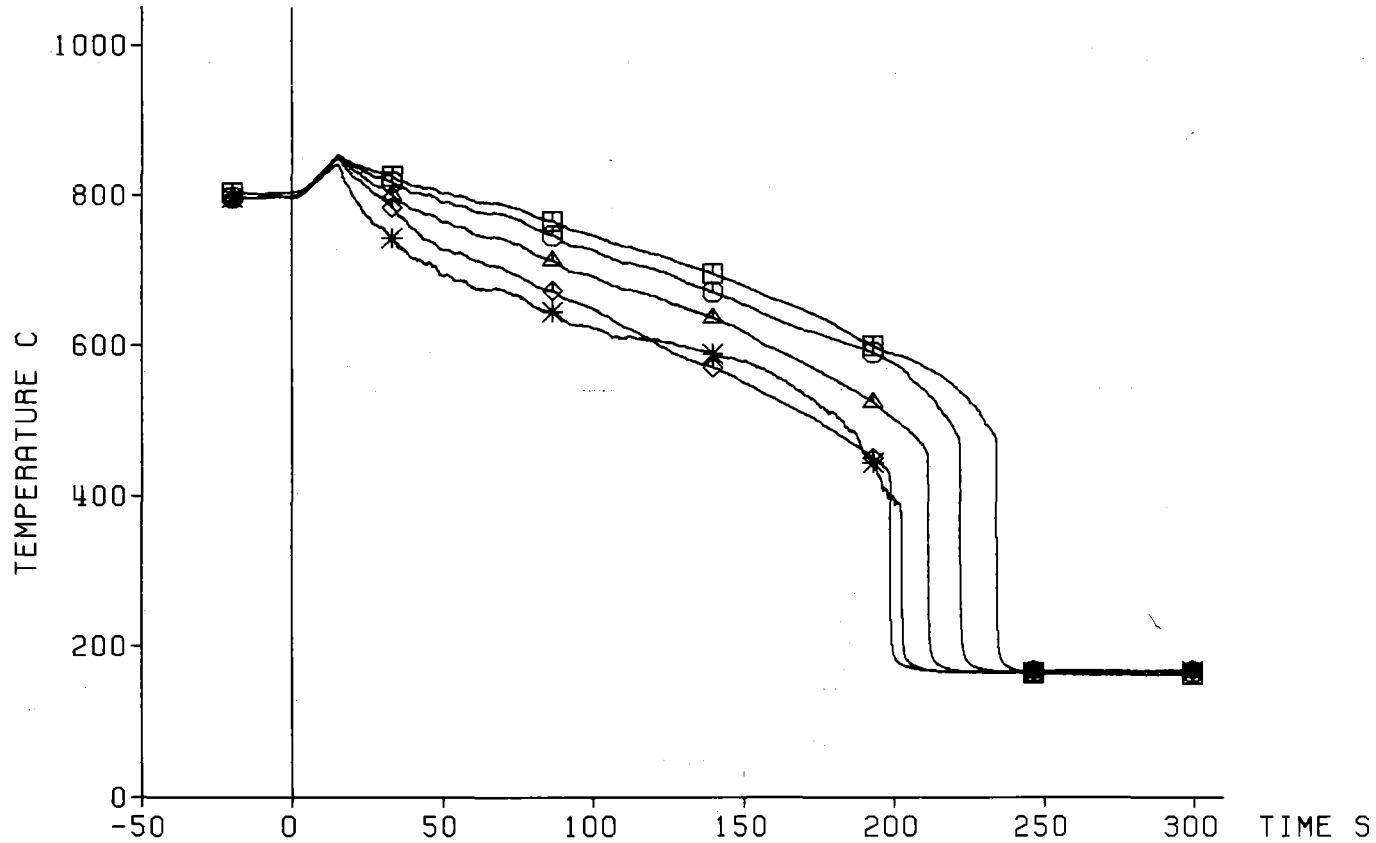

TC	Ax. Level
*	19g4 1925 mm
◇	17i1 1875 mm
△	19g3 1825 mm
○	19g2 1725 mm
□	19g1 1625 mm

Decay Heat 120% ANS Standard
 Flooding Rate (cold) 3.79 cm/s
 System Pressure 5.84 bar
 Feedwater Temperature 40 C



Fig. 394 FEBA: 5x5 ROD BUNDLE, TEST SERIES 8, TEST-No. 334

Heat Transfer Coeff.

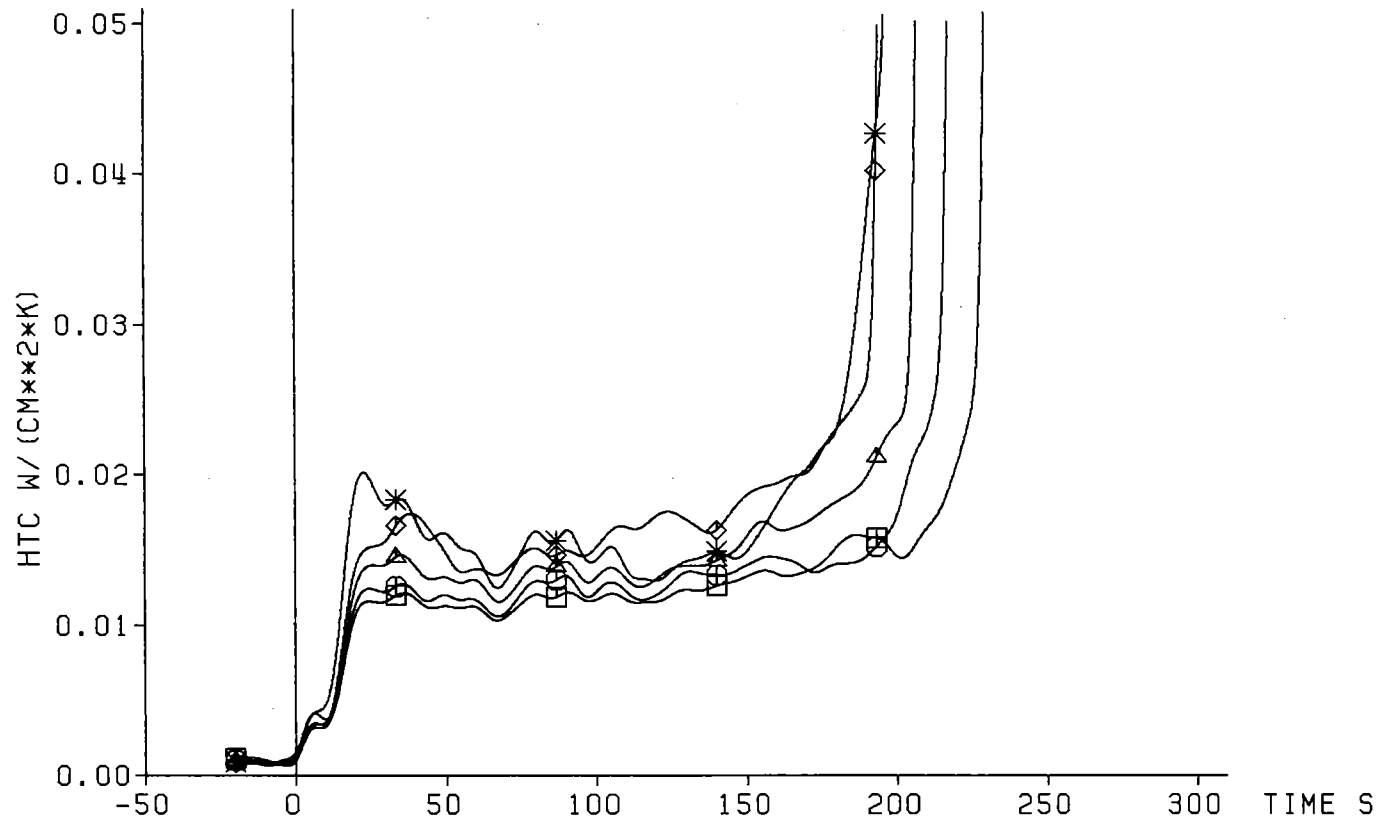

TC	Ax. Level
*	19g4 1925 mm
◇	17i1 1875 mm
△	19g3 1825 mm
⊙	19g2 1725 mm
□	19g1 1625 mm

Decay Heat 120% ANS Standard
 Flooding Rate (cold) 3.79 cm/s
 System Pressure 5.84 bar
 Feedwater Temperature 40 C



Fig. 395 FEBA: 5x5 ROD BUNDLE, TEST SERIES 8, TEST-No. 334

Cladding Temperature

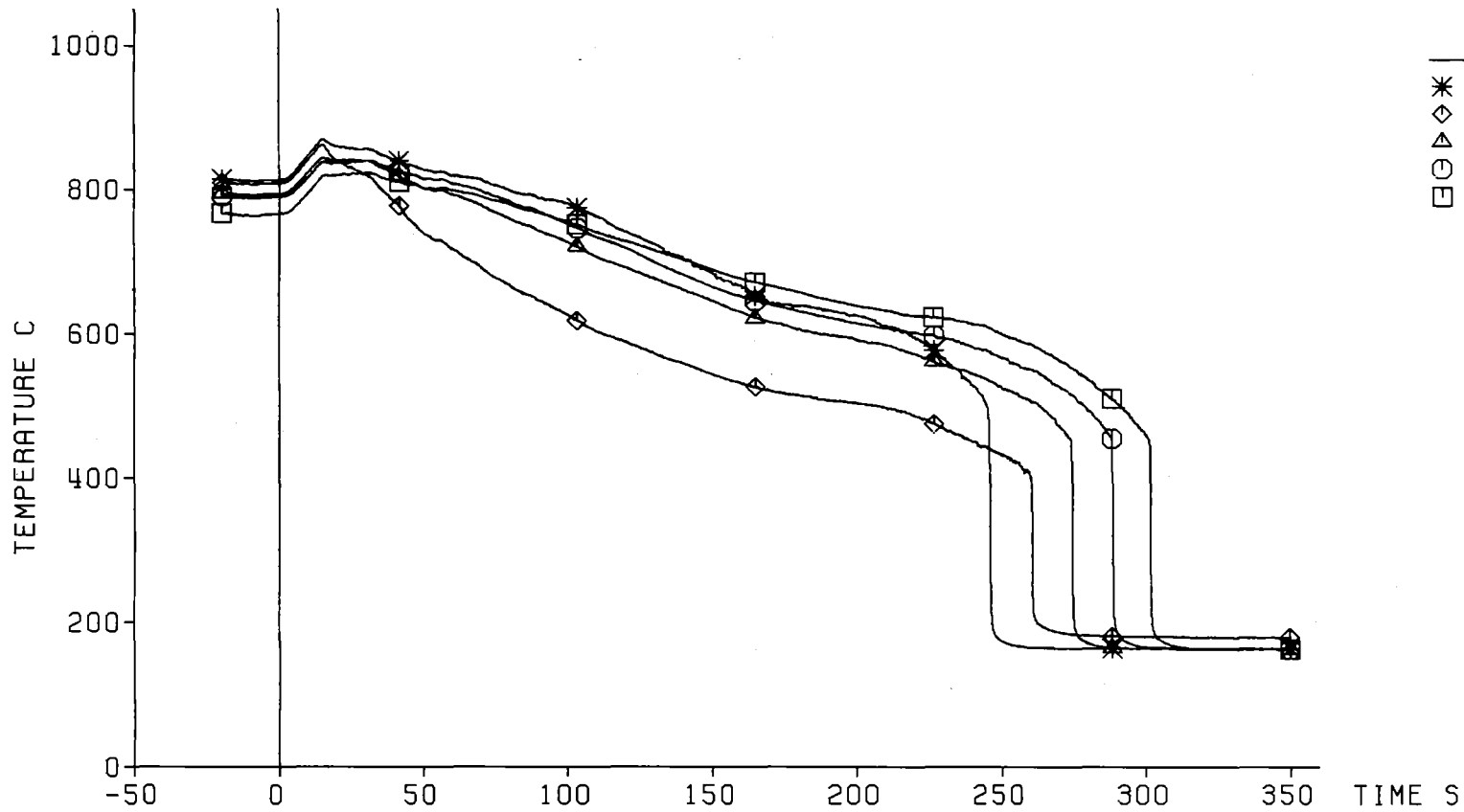

TC	Ax. Level
*	12J4 1525 mm
◇	12J3 1425 mm
△	12J2 1325 mm
○	12J1 1225 mm
□	8b3 1135 mm

Decay Heat 120% ANS Standard
 Flooding Rate (cold) 3.79 cm/s
 System Pressure 5.84 bar
 Feedwater Temperature 40 C



Fig. 396 FEBA: 5x5 ROD BUNDLE, TEST SERIES 8, TEST-No. 334

Heat Transfer Coeff.

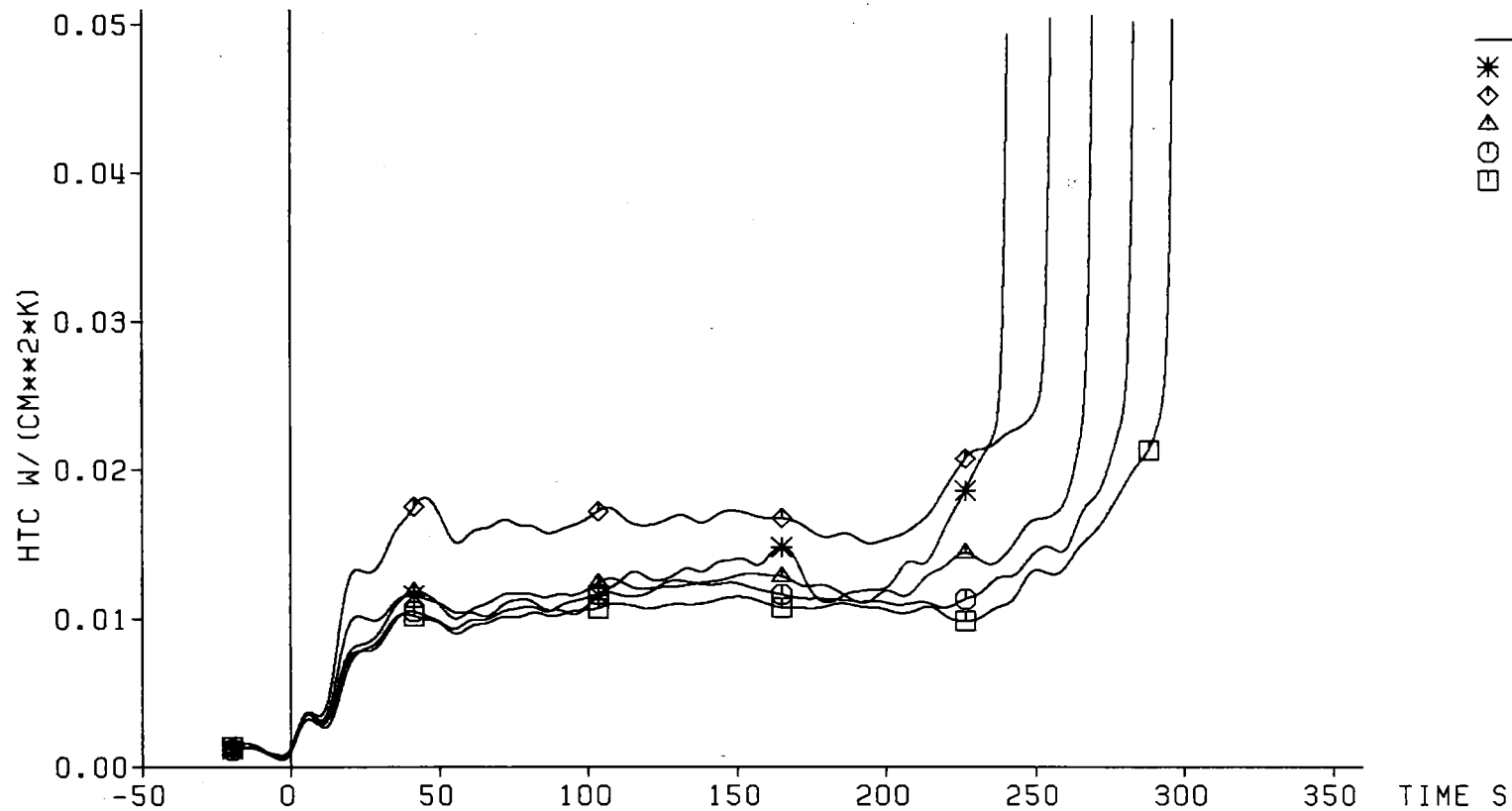

TC	Ax. Level
*	12j4 1525 mm
◇	12j3 1425 mm
△	12j2 1325 mm
○	12j1 1225 mm
□	8b3 1135 mm

Decay Heat 120% ANS Standard
 Flooding Rate (cold) 3.79 cm/s
 System Pressure 5.84 bar
 Feedwater Temperature 40 C



Fig. 397 FEBA: 5x5 ROD BUNDLE, TEST SERIES 8, TEST-No. 334

Grid Spacer Temperature

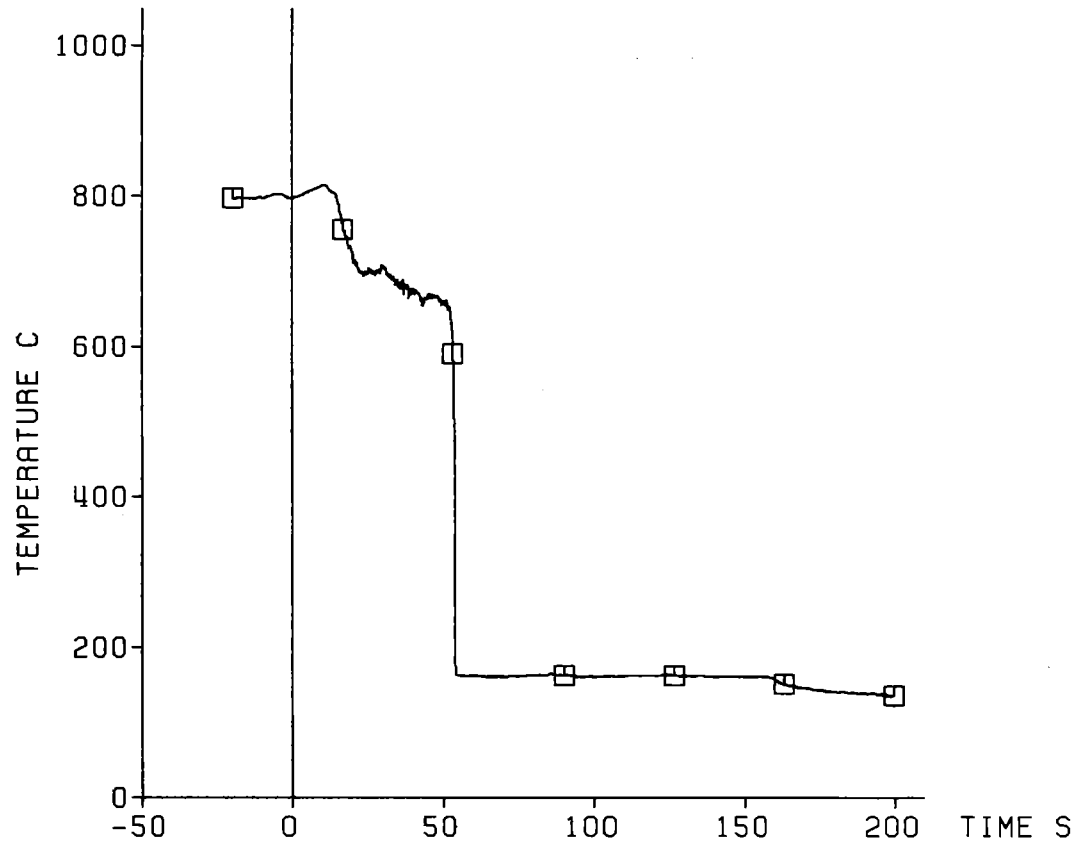

TC	Axial Level
□ 69	2535 mm

Decay Heat 120% ANS Standard
Flooding Rate (cold) 3.79 cm/s
System Pressure 5.84 bar
Feedwater Temperature 40 C

— 498 —



Fig. 398 FEBA: 5x5 ROD BUNDLE, TEST SERIES 8, TEST-NO. 334

Grid Spacer Temperature

	TC	Axial Level
□	67	1425 mm
○	66	1425 mm

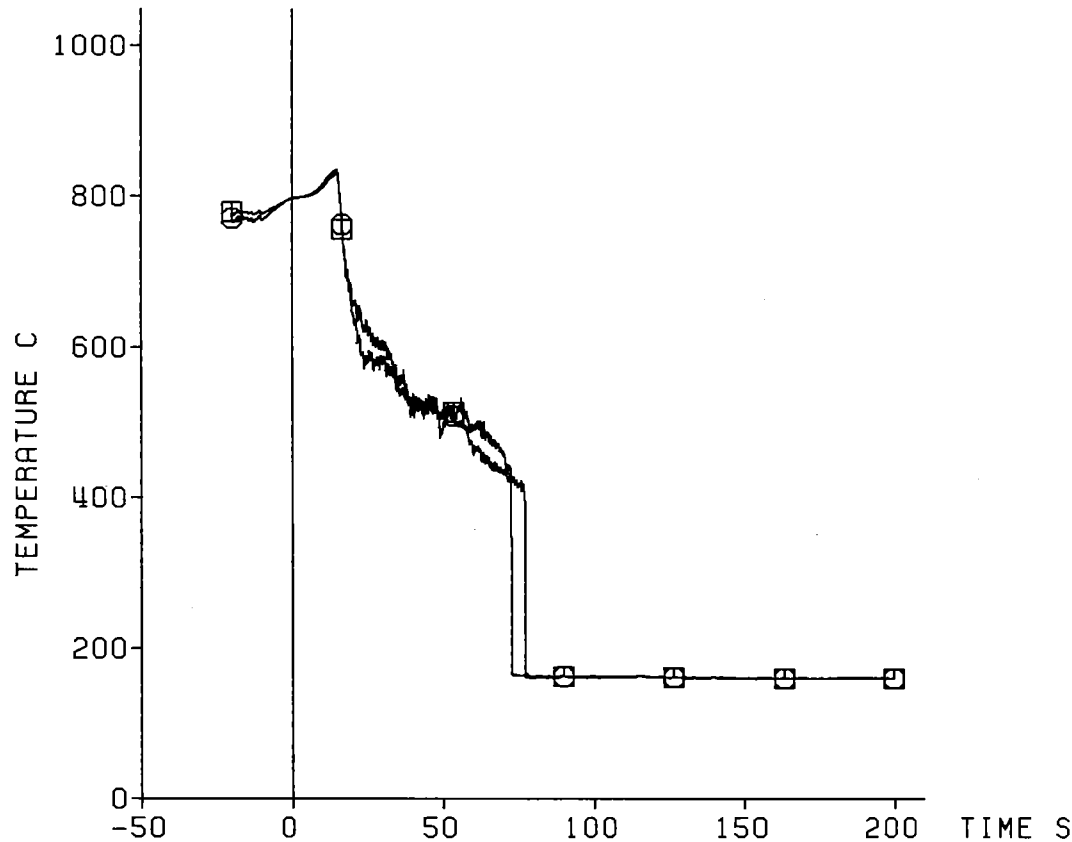

Decay Heat 120% ANS Standard
 Flooding Rate (cold) 3.79 cm/s
 System Pressure 5.84 bar
 Feedwater Temperature 40 C



Fig. 399 FEBA: 5x5 ROD BUNDLE, TEST SERIES 8, TEST-No. 334

Axial Level: 2770 mm

△ Cladding Temperature (7a2)
○ Fluid Temperature
□ Housing Temperature

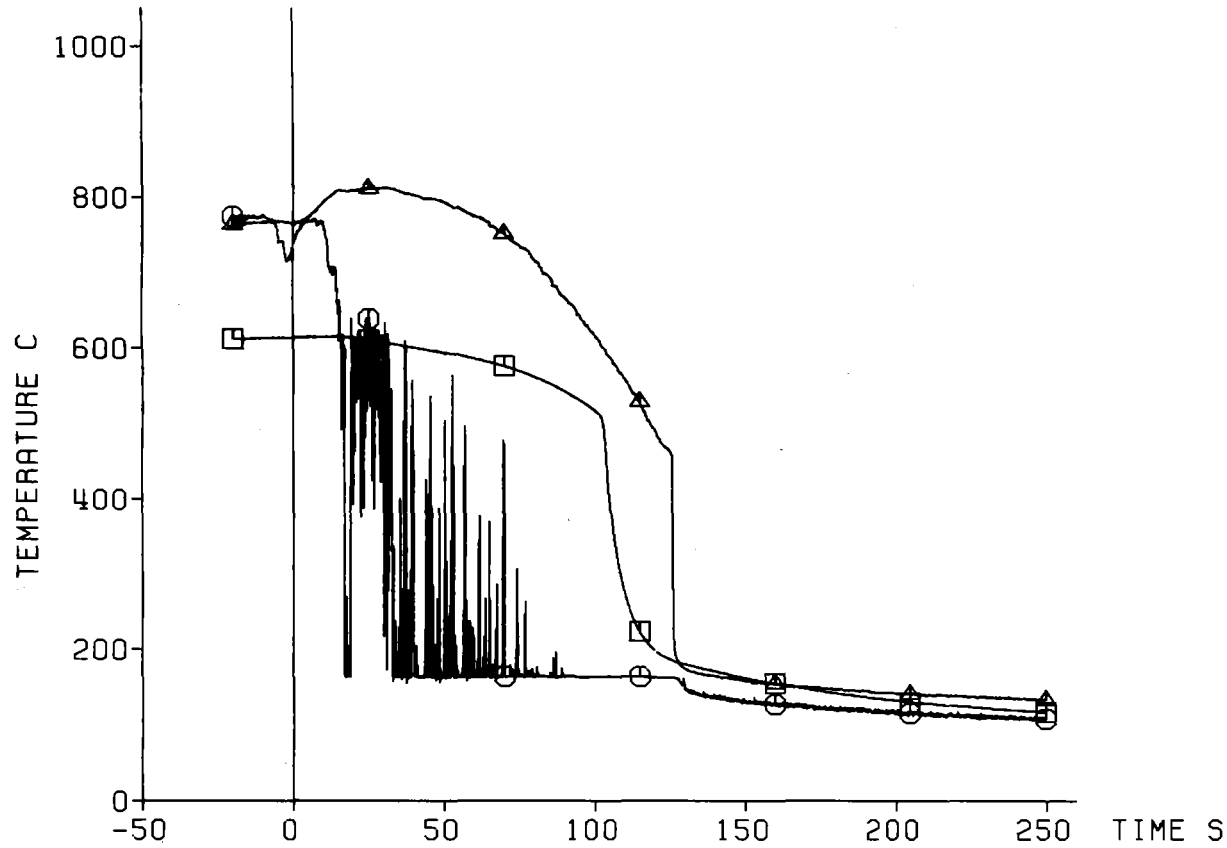

Decay Heat 120% ANS Standard
Flooding Rate (cold) 3.79 cm/s
System Pressure 5.84 bar
Feedwater Temperature 40 C

KFK IRB

Fig. 400 FEBA: 5x5 ROD BUNDLE, TEST SERIES 8, TEST-No. 334

Axial Level: 2225 mm

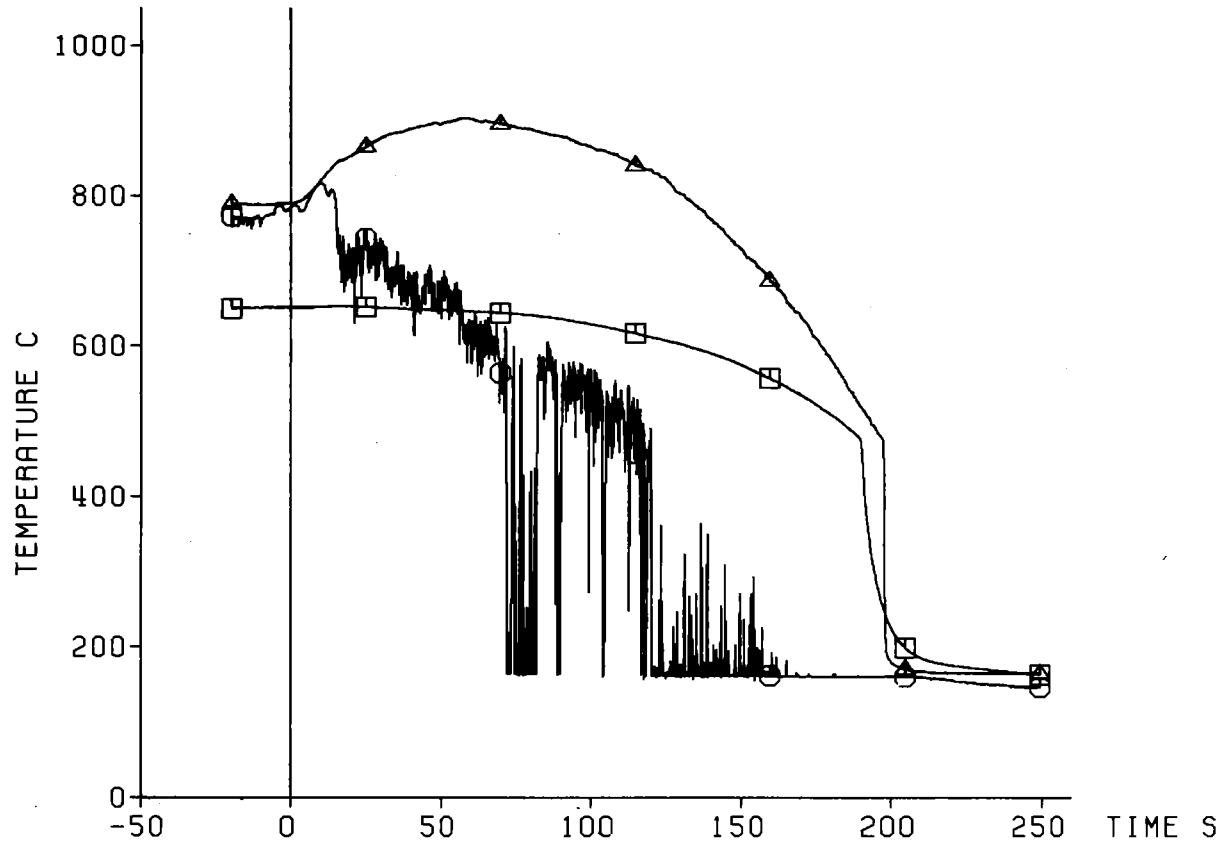

Decay Heat 120% ANS Standard
Flooding Rate (cold) 3.79 cm/s
System Pressure 5.84 bar
Feedwater Temperature 40 C

KJK IRB

Fig. 401 FEBA: 5x5 ROD BUNDLE, TEST SERIES 8, TEST-No. 334

Axial Level: 1925 mm

△ Cladding Temperature (19g4)
○ Fluid Temperature

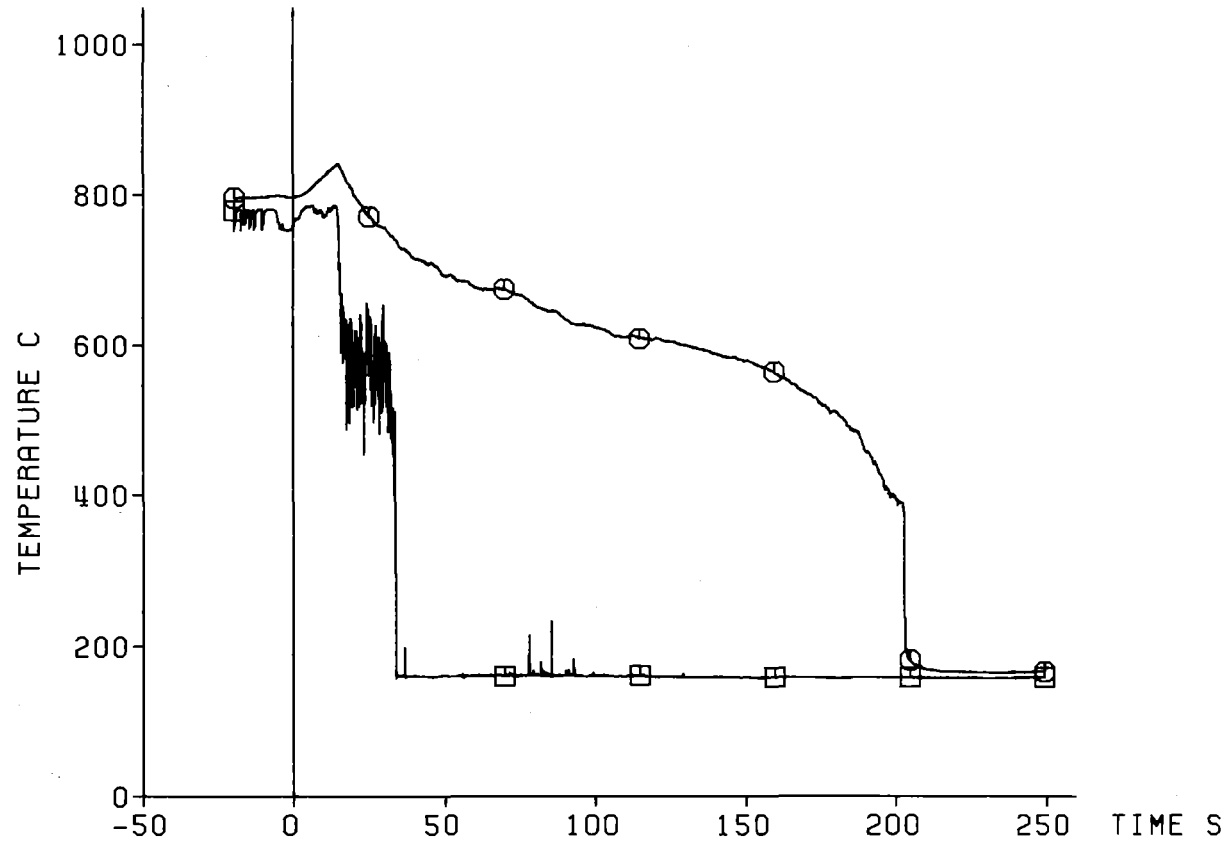

Decay Heat 120% ANS Standard
Flooding Rate (cold) 3.79 cm/s
System Pressure 5.84 bar
Feedwater Temperature 40 C

— 442 —



Fig. 402 FEBA: 5x5 ROD BUNDLE, TEST SERIES 8, TEST-No. 334

Axial Level: 1825 mm

△ Cladding Temperature (19g3)
○ Fluid Temperature
□ Housing Temperature

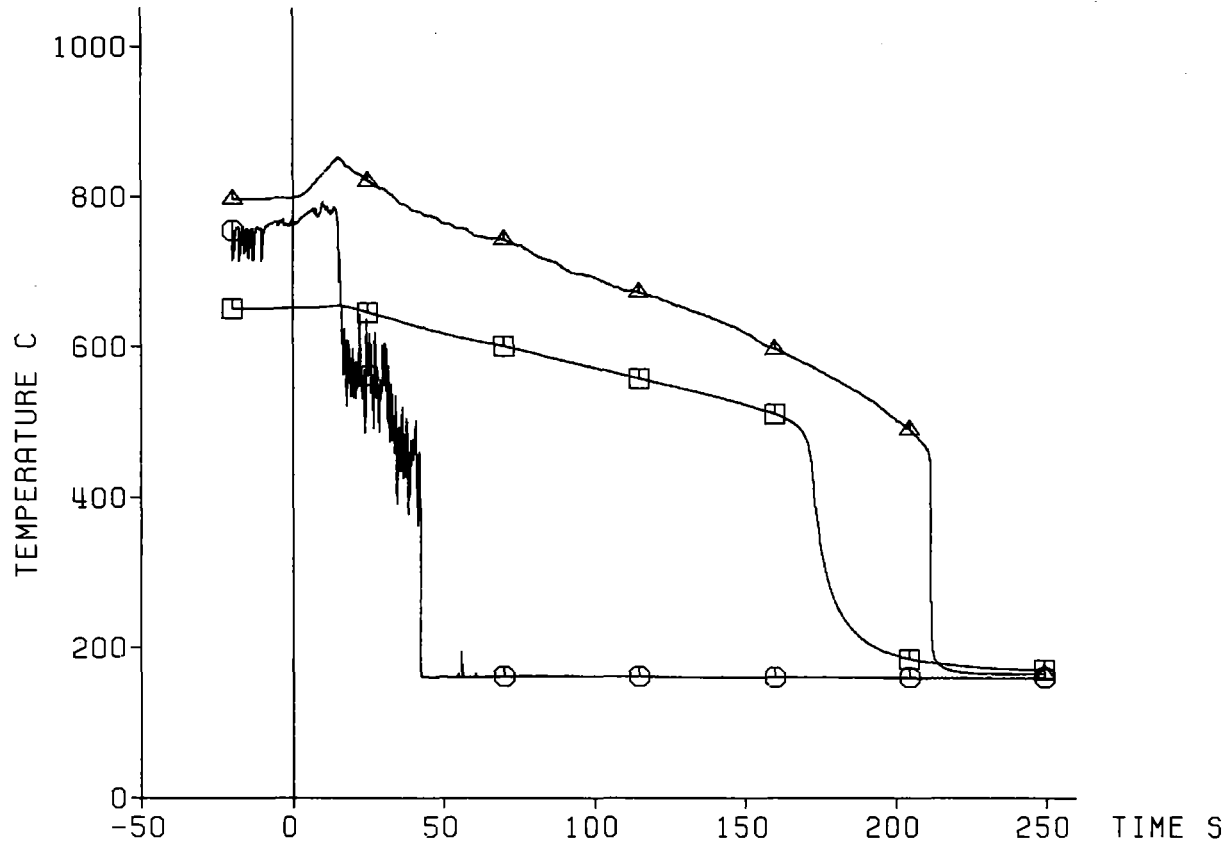

Decay Heat 120% ANS Standard
Flooding Rate (cold) 3.79 cm/s
System Pressure 5.84 bar
Feedwater Temperature 40 C



Fig. 403 FEBA: 5x5 ROD BUNDLE, TEST SERIES 8, TEST-No. 334

Axial Level: 1725 mm

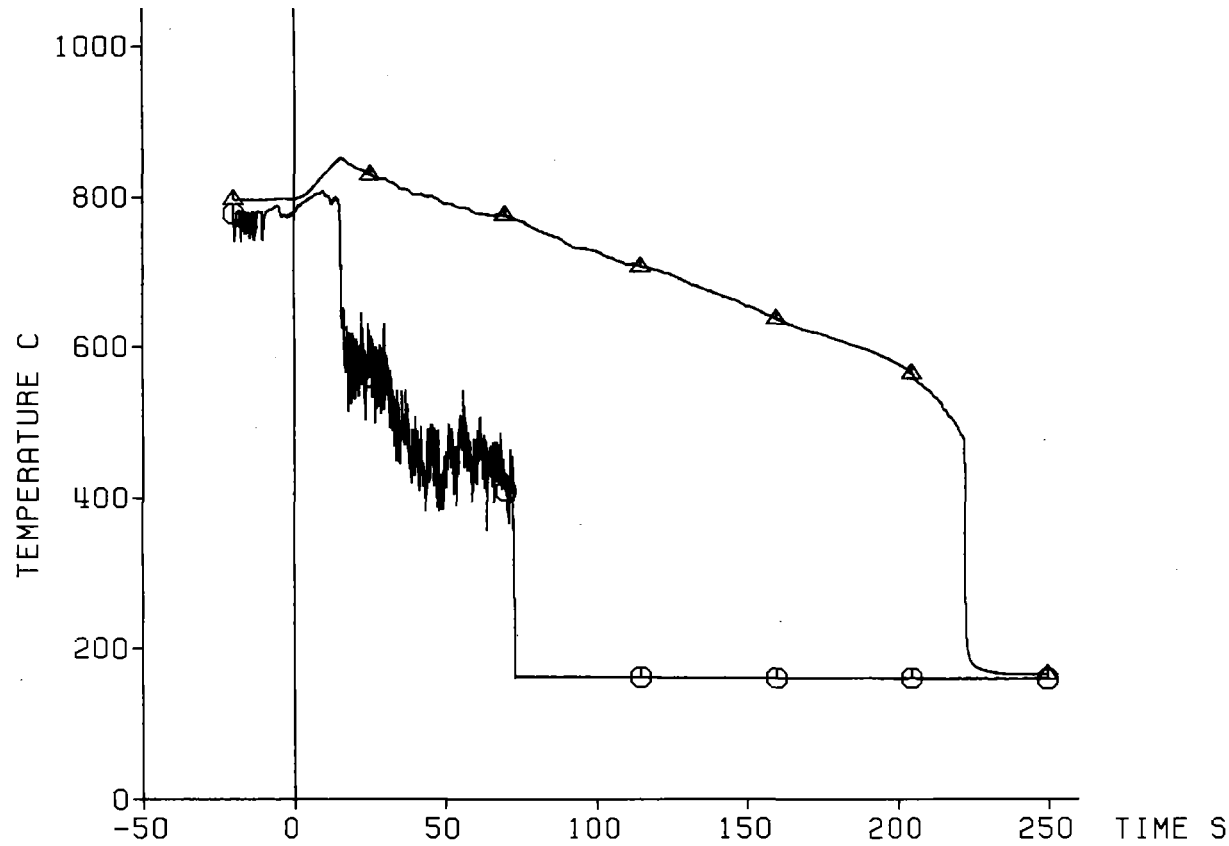

Decay Heat 120% ANS Standard
Flooding Rate (cold) 3.79 cm/s
System Pressure 5.84 bar
Feedwater Temperature 40 C



Fig. 404 FEBA: 5x5 ROD BUNDLE, TEST SERIES 8, TEST-No. 334

Axial Level: 1625 mm

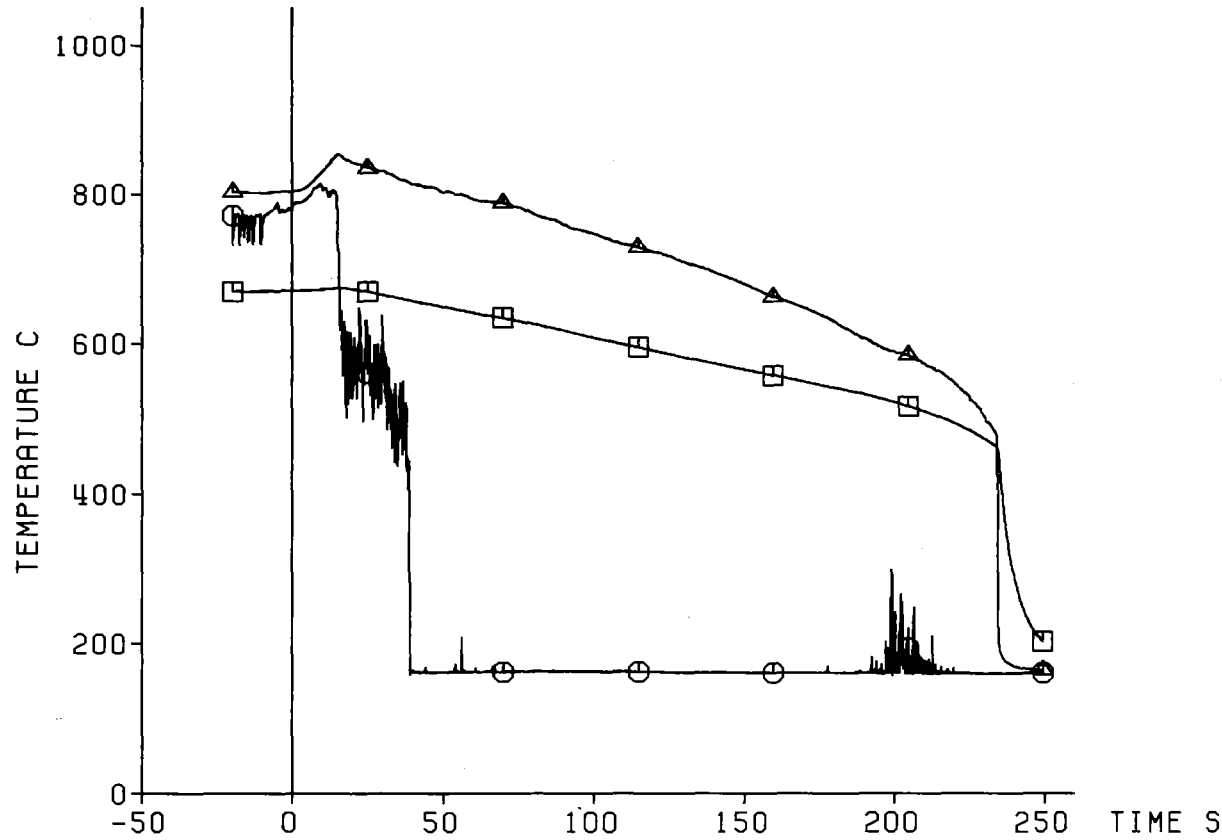

△ Cladding Temperature (19g1)
○ Fluid Temperature
□ Housing Temperature

Decay Heat 120% ANS Standard
Flooding Rate (cold) 3.79 cm/s
System Pressure 5.84 bar
Feedwater Temperature 40 C

— 445 —



Fig. 405 FEBA: 5x5 ROD BUNDLE, TEST SERIES 8, TEST-No. 334

Axial Level: 1135 mm

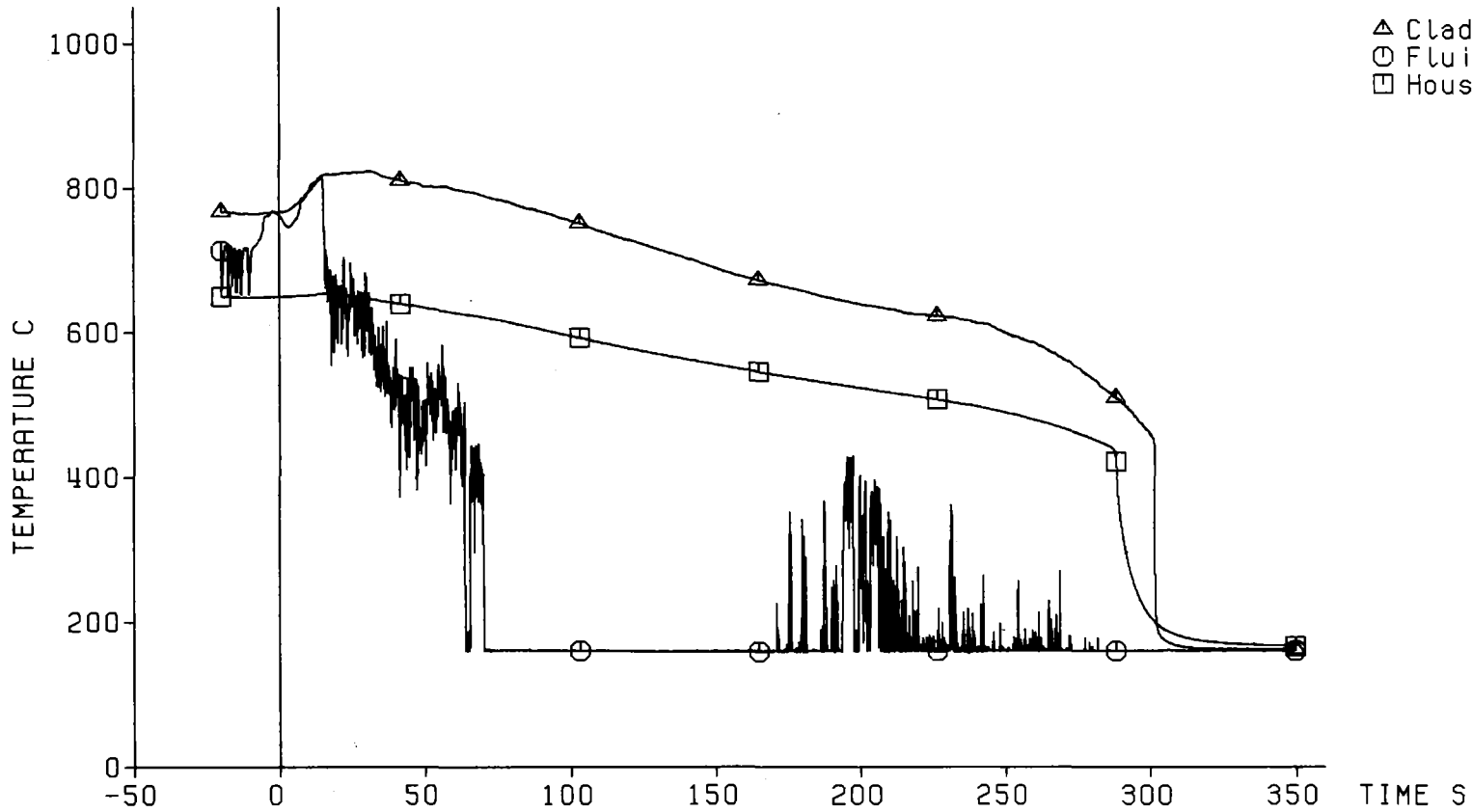

△ Cladding Temperature (8b3)
○ Fluid Temperature
□ Housing Temperature

Decay Heat 120% ANS Standard
Flooding Rate (cold) 3.79 cm/s
System Pressure 5.84 bar
Feedwater Temperature 40 C



Fig. 406 FEBA: 5x5 ROD BUNDLE, TEST SERIES 8, TEST-No. 334

Pressure Loss
Along the Test Section:

◇ Total Length: 4196 mm
△ Lower Part: 1711 mm
○ Middle Part: 545 mm
□ Upper Part: 1940 mm

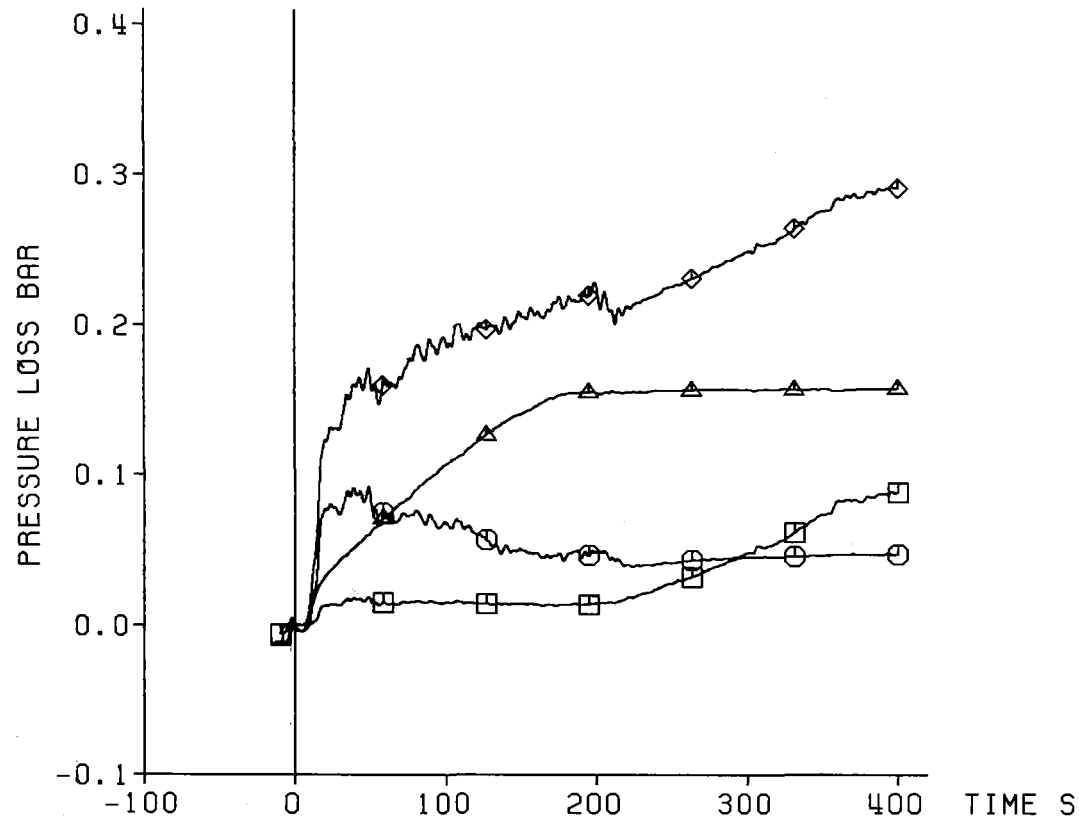

Decay Heat 120% ANS Standard
Flooding Rate (cold) 3.79 cm/s
System Pressure 5.84 bar
Feedwater Temperature 40 C

KIK IRB

Fig. 407 FEBA: 5x5 ROD BUNDLE, TEST SERIES 8, TEST-No. 334

Coolant Outlet Conditions:

△ Water Carry Over
○ Coolant Temperature
□ Coolant Pressure

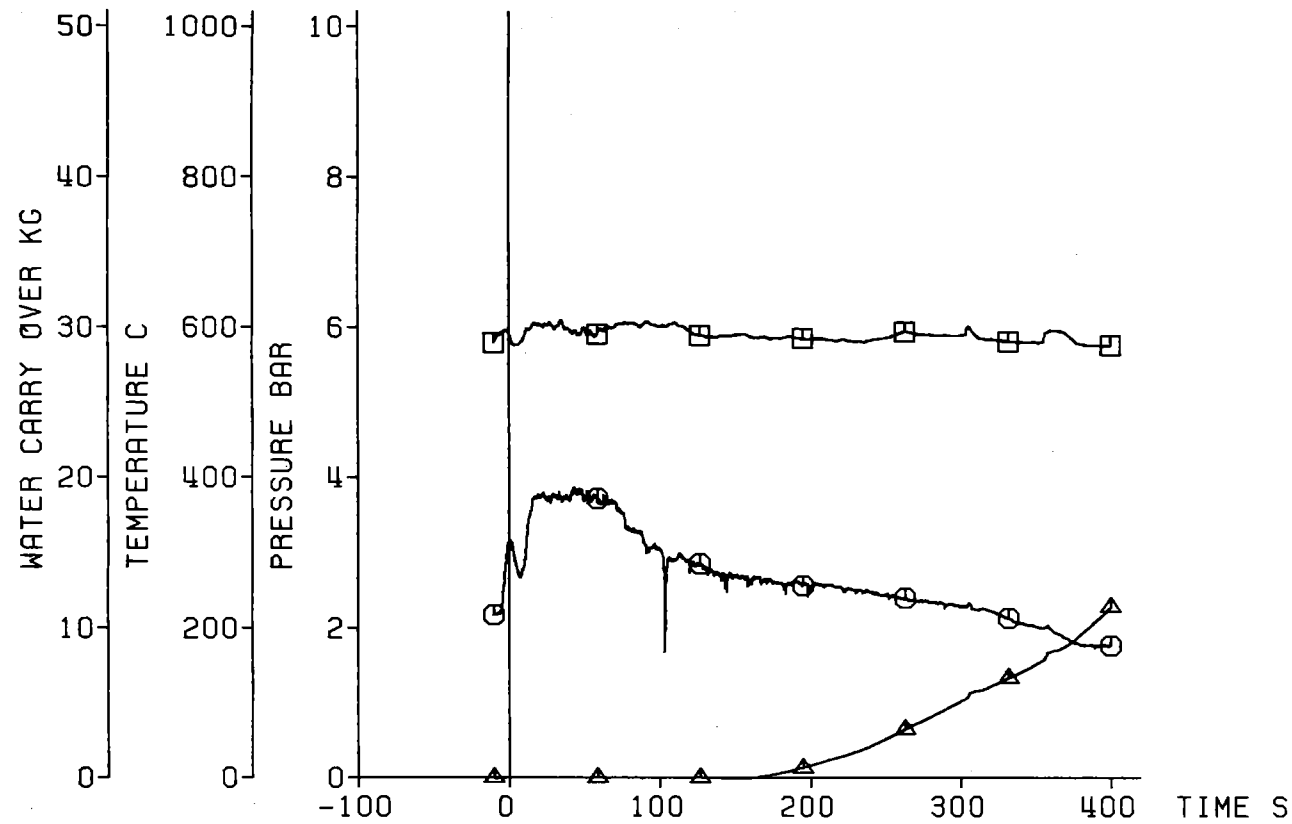

Decay Heat 120% ANS Standard
Flooding Rate (cold) 3.79 cm/s
System Pressure 5.84 bar
Feedwater Temperature 40 C



Fig. 408 FEBA: 5x5 ROD BUNDLE, TEST SERIES 8, TEST-No. 334

Axial Position of Quench Front

□ Quenching of Sleeves at Bundle Midplane

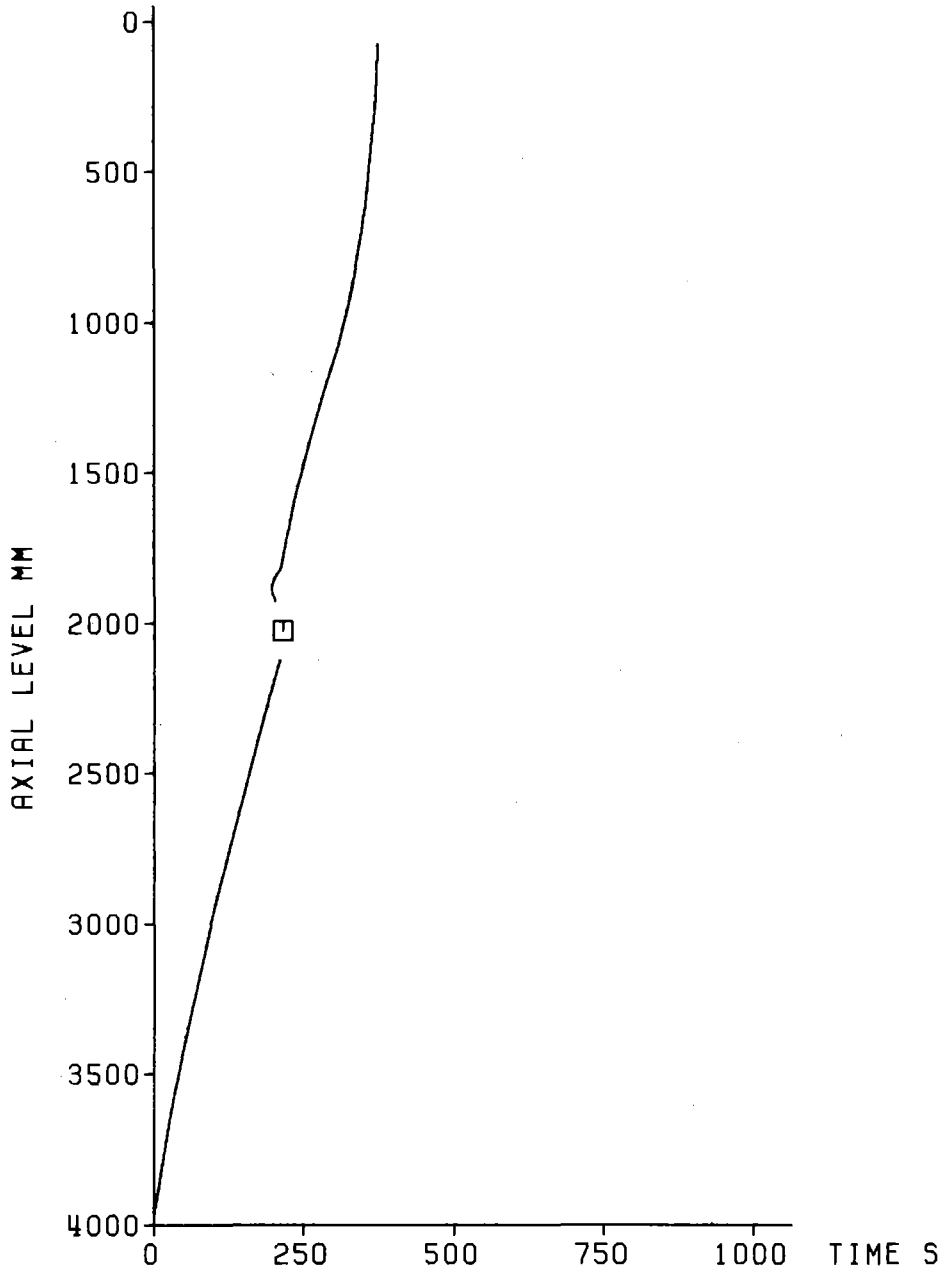

Decay Heat	120% ANS Standard
Flooding Rate (cold)	3.79 cm/s
System Pressure	5.84 bar
Feedwater Temperature	40 C



Fig. 409 FEBA: 5x5 ROD BUNDLE
TEST SERIES 8, TEST-NO. 334

Initial Axial Temperature Profile of Claddings

□ Initial Temperature of Sleeves at Bundle Midplane

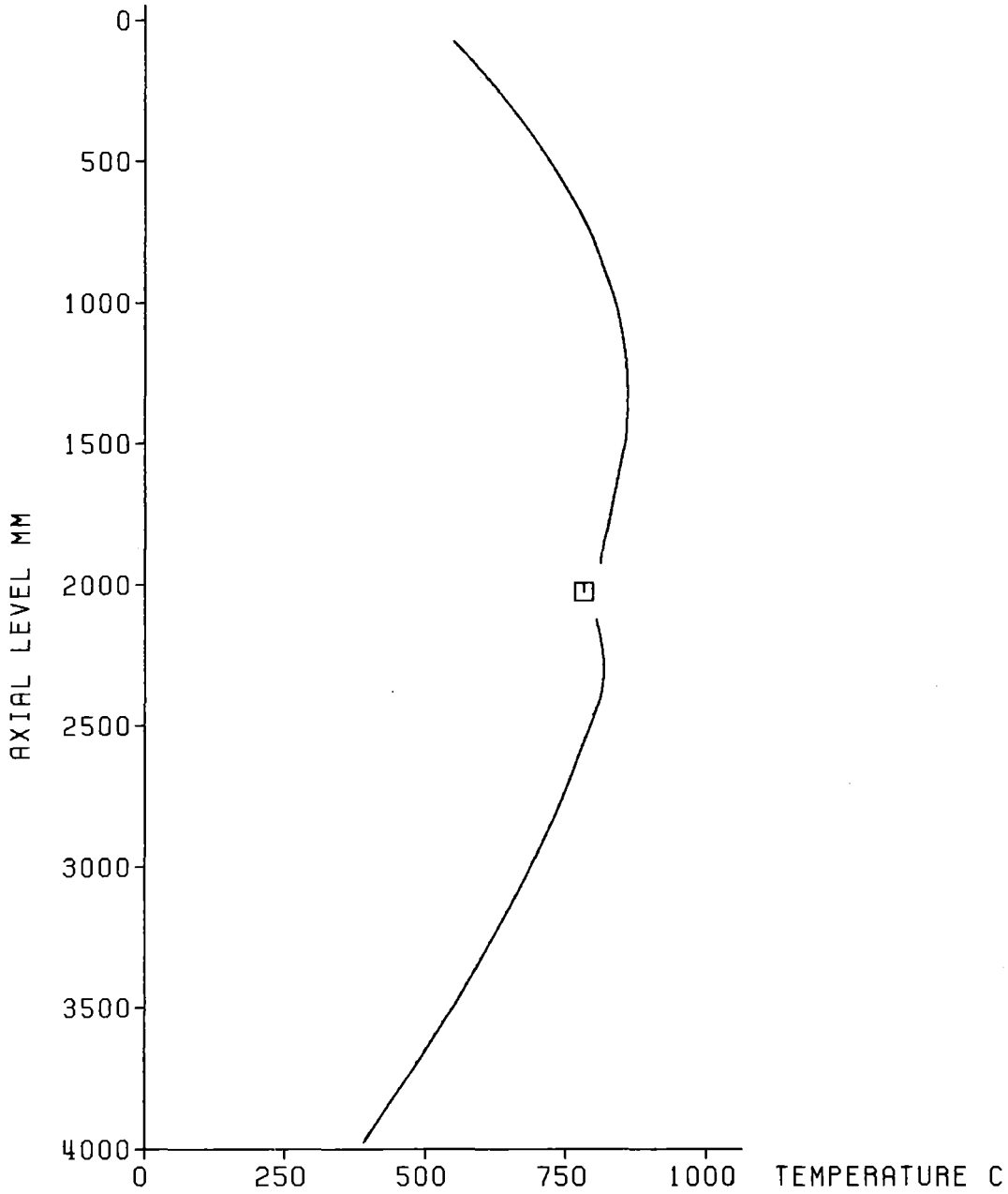

Decay Heat	120% ANS Standard
Flooding Rate (cold)	5.78 cm/s
System Pressure	2.24 bar
Feedwater Temperature	40 C



Fig. 410 FEBA: 5x5 ROD BUNDLE
TEST SERIES 8, TEST-No. 340

Test Parameters:

- ◇ Flooding Rate
- △ System Pressure
- Feedwater Temperature
- Bundle Power

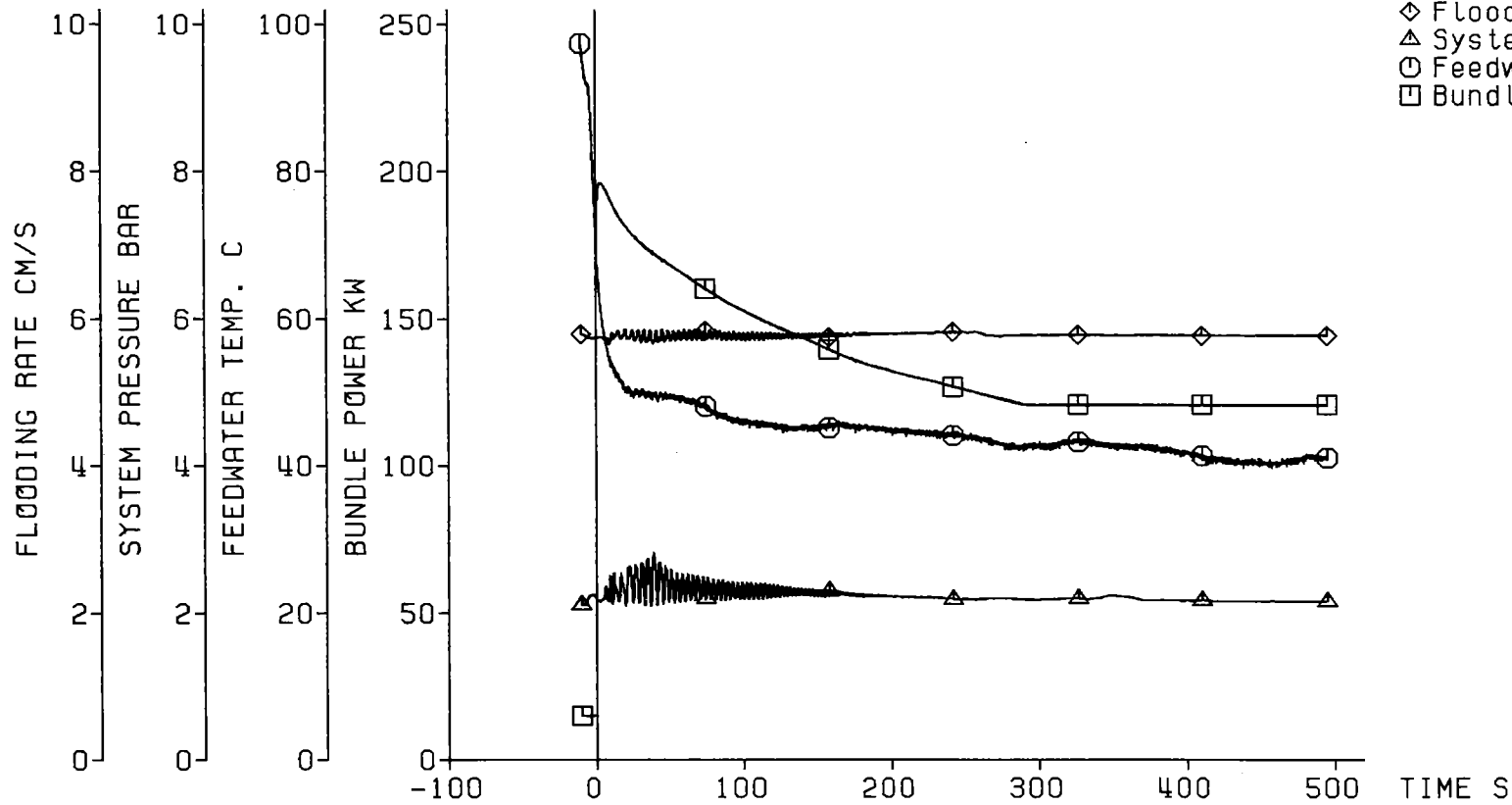

Decay Heat 120% ANS Standard
Flooding Rate (cold) 5.78 cm/s
System Pressure 2.24 bar
Feedwater Temperature 40 C



Fig. 411 FEBA: 5x5 ROD BUNDLE, TEST SERIES 8, TEST-NO. 340

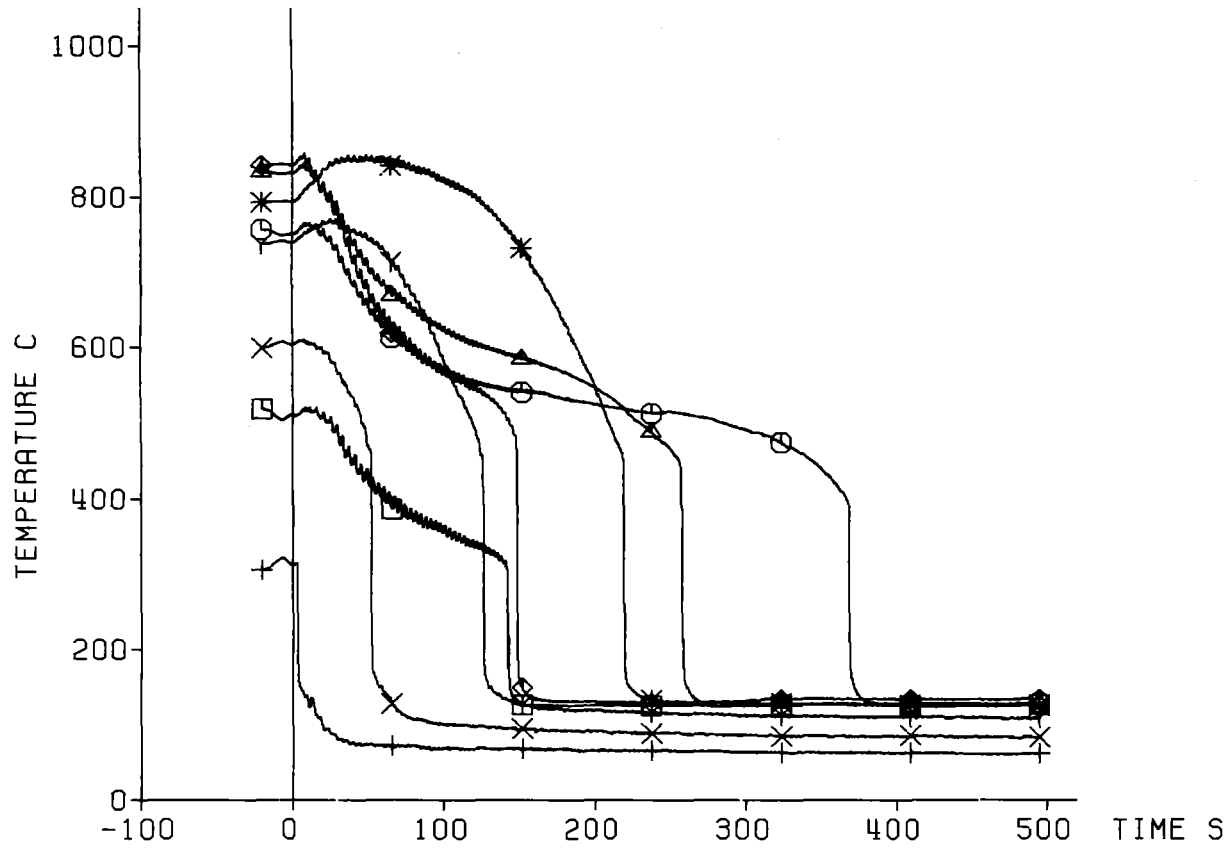

TC	Ax. Level
+	7a4 3860 mm
X	7a3 3315 mm
Y	7a2 2770 mm
*	7a1 2225 mm
◇	8b4 1680 mm
△	8b3 1135 mm
○	8b2 590 mm
□	3b1 45 mm

Decay Heat 120% ANS Standard
 Flooding Rate (cold) 5.78 cm/s
 System Pressure 2.24 bar
 Feedwater Temperature 40 C



Fig. 412 FEBA: 5x5 R0D BUNDLE, TEST SERIES 8, TEST-No. 340

Heat Transfer Coeff.

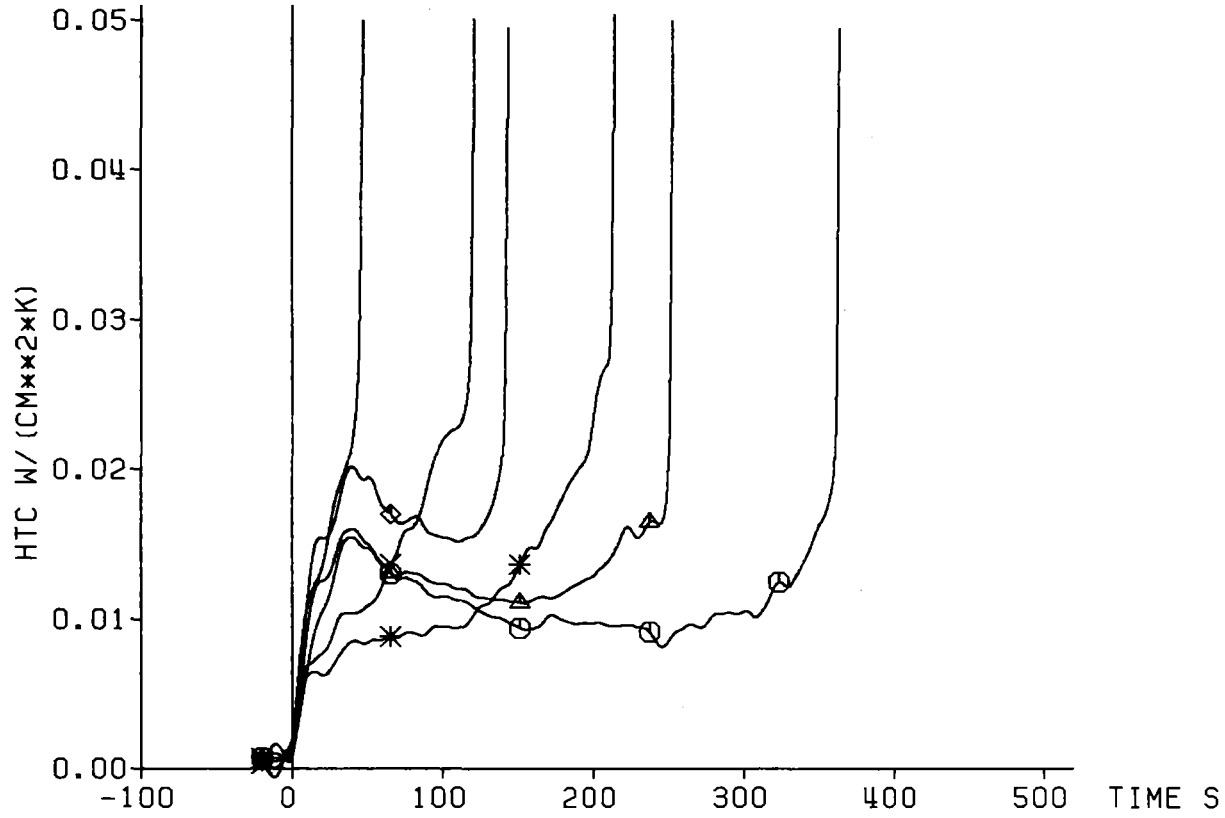

	TC	Ax. Level
X	7a3	3315 mm
Y	7a2	2770 mm
*	7a1	2225 mm
◇	8b4	1680 mm
△	8b3	1135 mm
○	8b2	590 mm

Decay Heat 120% ANS Standard
 Flooding Rate (cold) 5.78 cm/s
 System Pressure 2.24 bar
 Feedwater Temperature 40 C



Fig. 413 FEBA: 5x5 ROD BUNDLE, TEST SERIES 8, TEST-No. 340

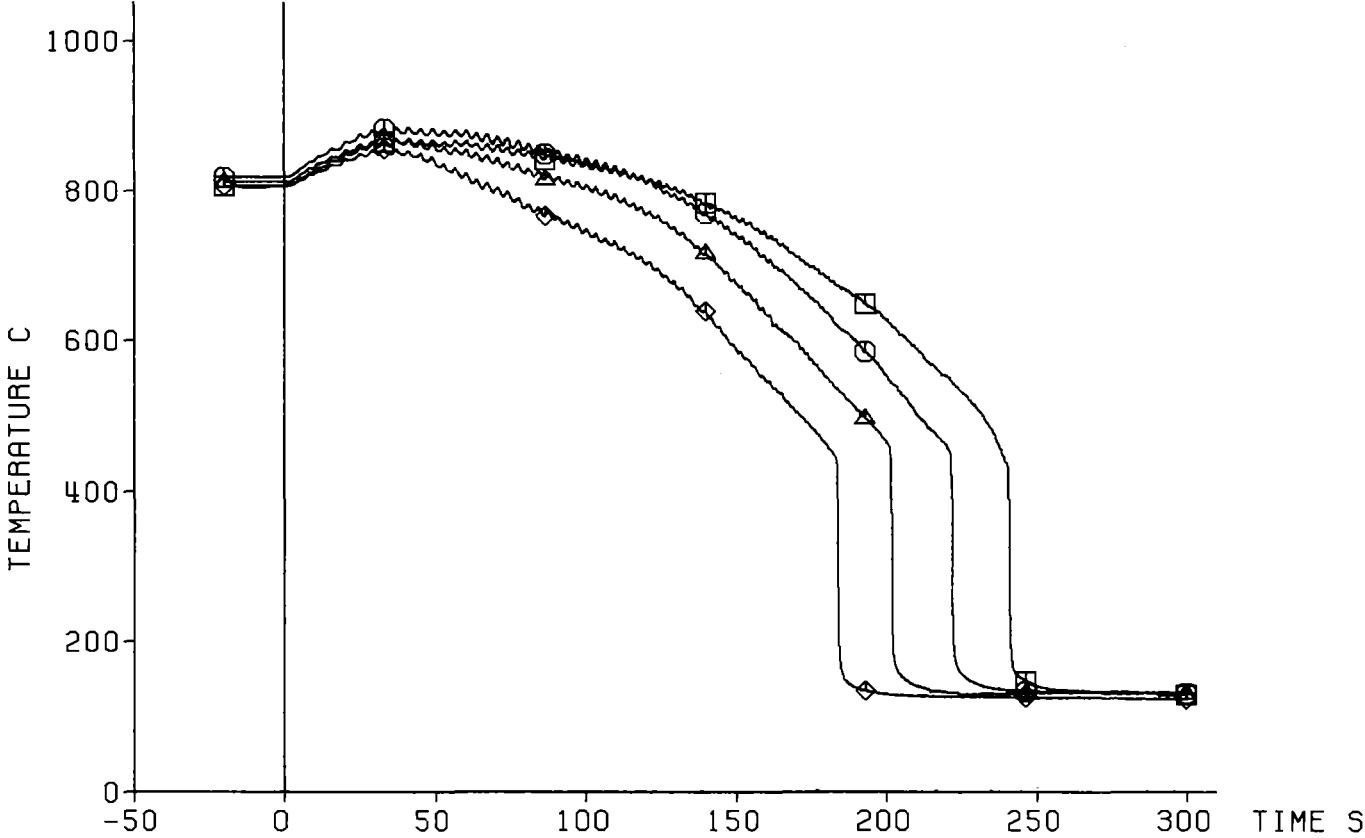

TC	Ax. Level
◇	14f4 2425 mm
△	14f3 2325 mm
○	14h2 2225 mm
□	14f1 2125 mm

Decay Heat 120% ANS Standard
Flooding Rate (cold) 5.78 cm/s
System Pressure 2.24 bar
Feedwater Temperature 40 C



Fig. 414 FEBA: 5x5 ROD BUNDLE, TEST SERIES 8, TEST-No. 340

Heat Transfer Coeff.

TC	Ax. Level
◇	14f4 2425 mm
△	14f3 2325 mm
○	14h2 2225 mm
□	14f1 2125 mm

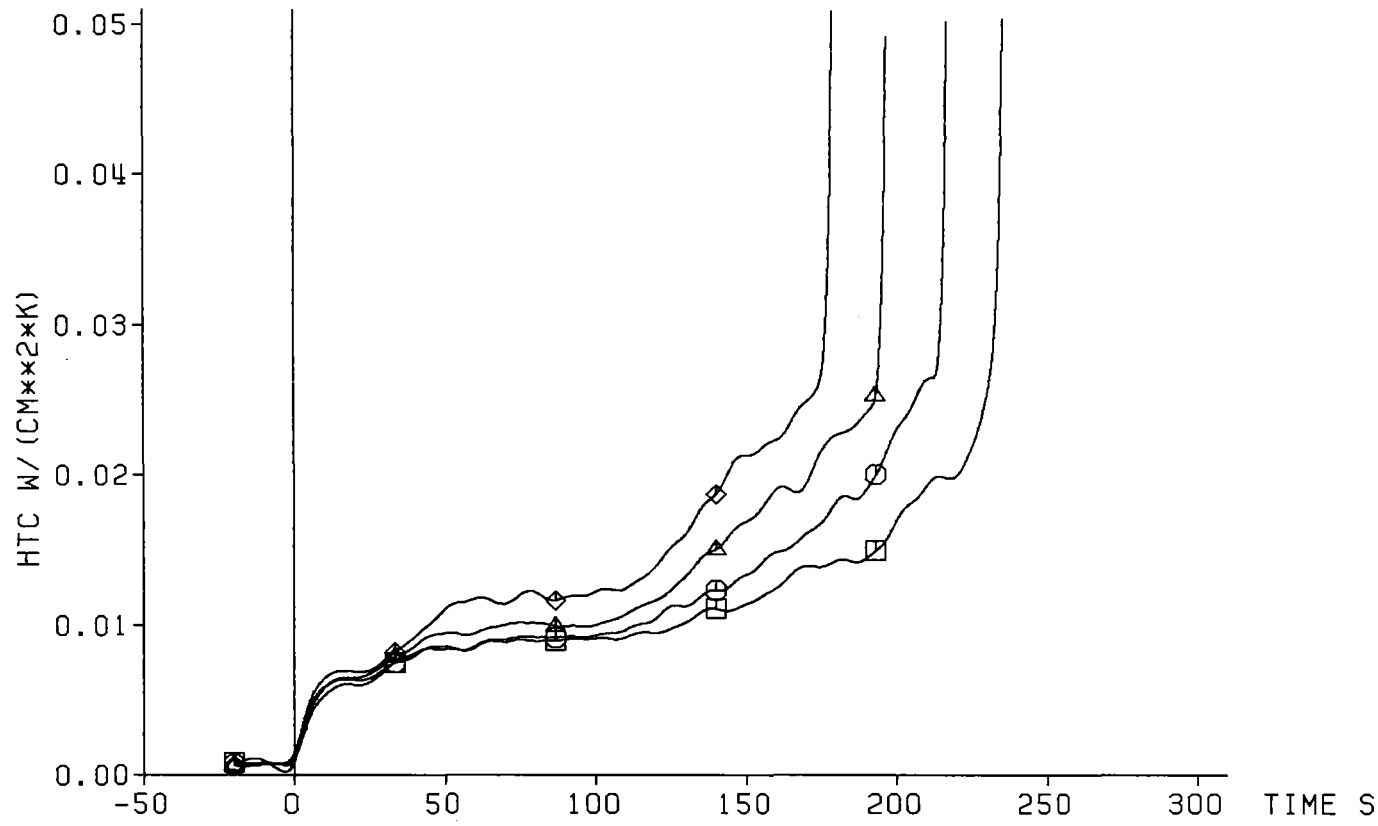

Decay Heat 120% ANS Standard
 Flooding Rate (cold) 5.78 cm/s
 System Pressure 2.24 bar
 Feedwater Temperature 40 C

— 455 —



Fig. 415 FEBA: 5x5 ROD BUNDLE, TEST SERIES 8, TEST-No. 340

Cladding Temperature

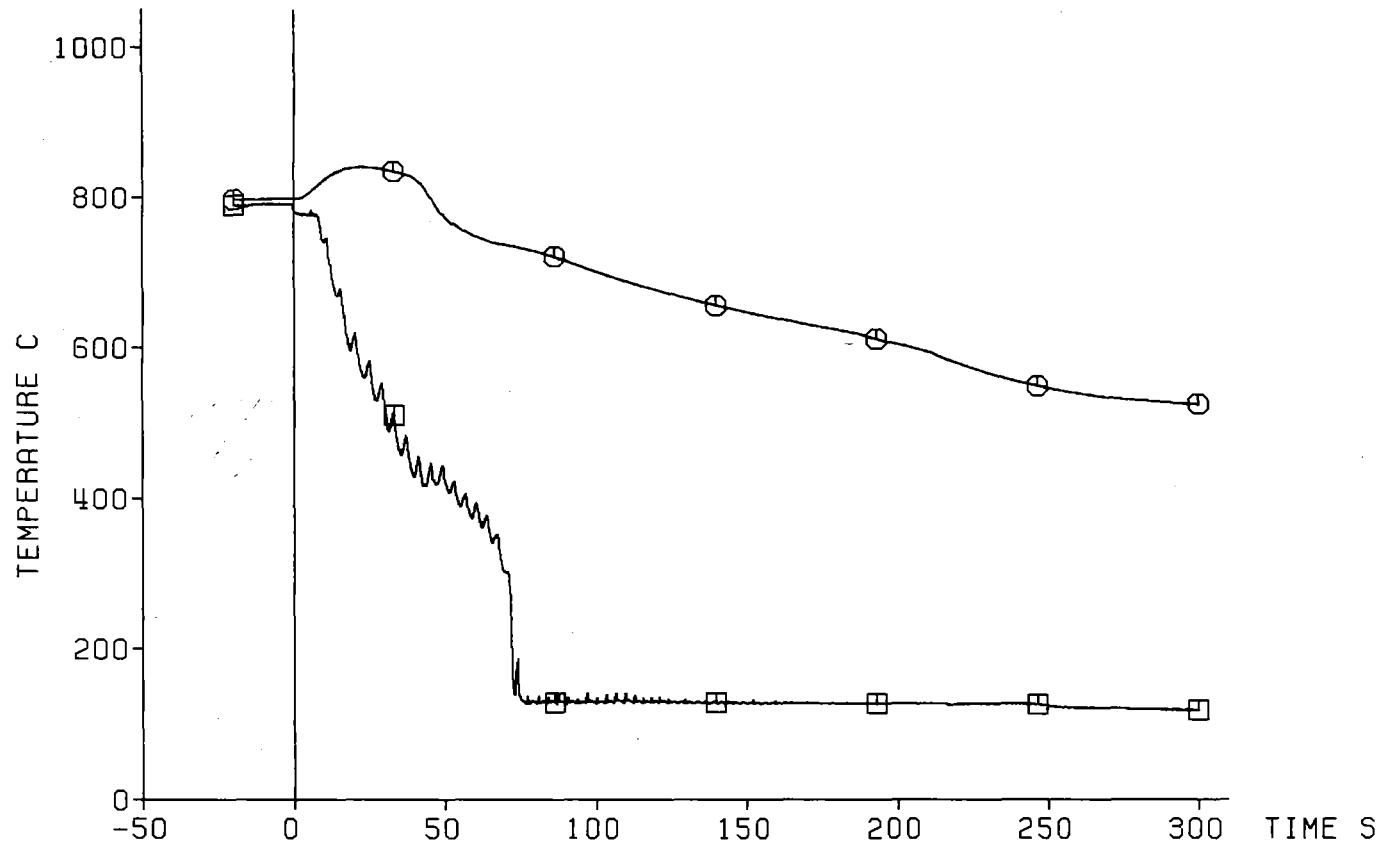

TC	Ax. Level
⊙ 1714	2025 mm
⊠ Sleeve	2025 mm

Decay Heat 120% ANS Standard
 Flooding Rate (cold) 5.78 cm/s
 System Pressure 2.24 bar
 Feedwater Temperature 40 C



Fig. 416 FEBA: 5x5 ROD BUNDLE, TEST SERIES 8, TEST-No. 340

Sleeve Temperature
Contact Face: Rods 17 and 18

TC	Ax. Level
○ Sleeve	2025 mm (Rod 17)
□ Sleeve	2025 mm (Rod 18)

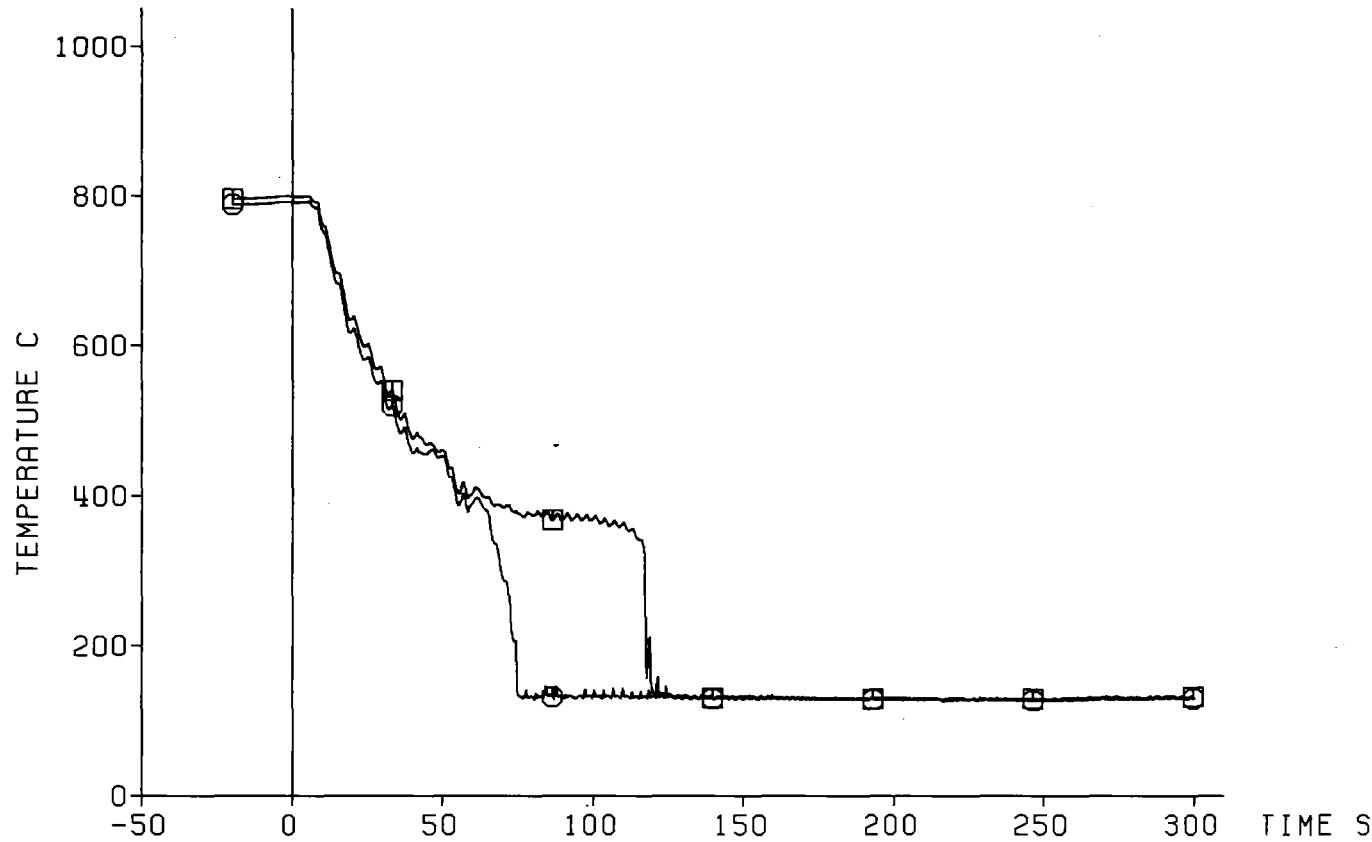

Decay Heat 120% ANS Standard
 Flooding Rate (cold) 5.78 cm/s
 System Pressure 2.24 bar
 Feedwater Temperature 40 C

— 457 —



Fig. 417 FEBA: 5x5 ROD BUNDLE, TEST SERIES 8, TEST-No. 340

Cladding Temperature

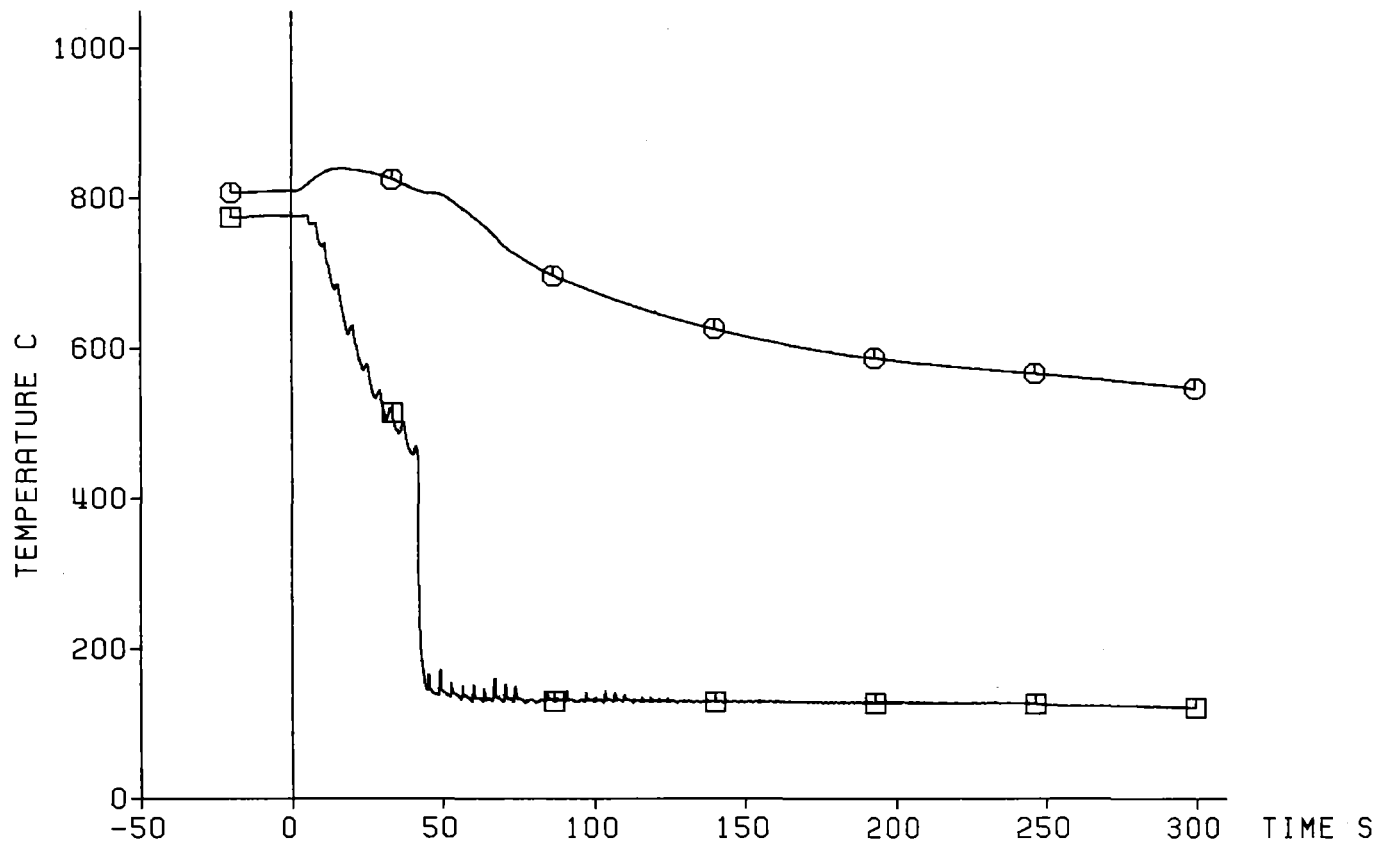

TC	Ax. Level
○ 1713	1975 mm
□ Sleeve	1972 mm

Decay Heat 120% ANS Standard
 Flooding Rate (cold) 5.78 cm/s
 System Pressure 2.24 bar
 Feedwater Temperature 40 C



Fig. 418 FEBA: 5x5 ROD BUNDLE, TEST SERIES 8, TEST-No. 340

Cladding Temperature

TC	Ax. Level
○ 1714	2025 mm
+ Sleeve	2064 mm
□ Sleeve	2025 mm
△ Sleeve	2025 mm
× Sleeve	1972 mm

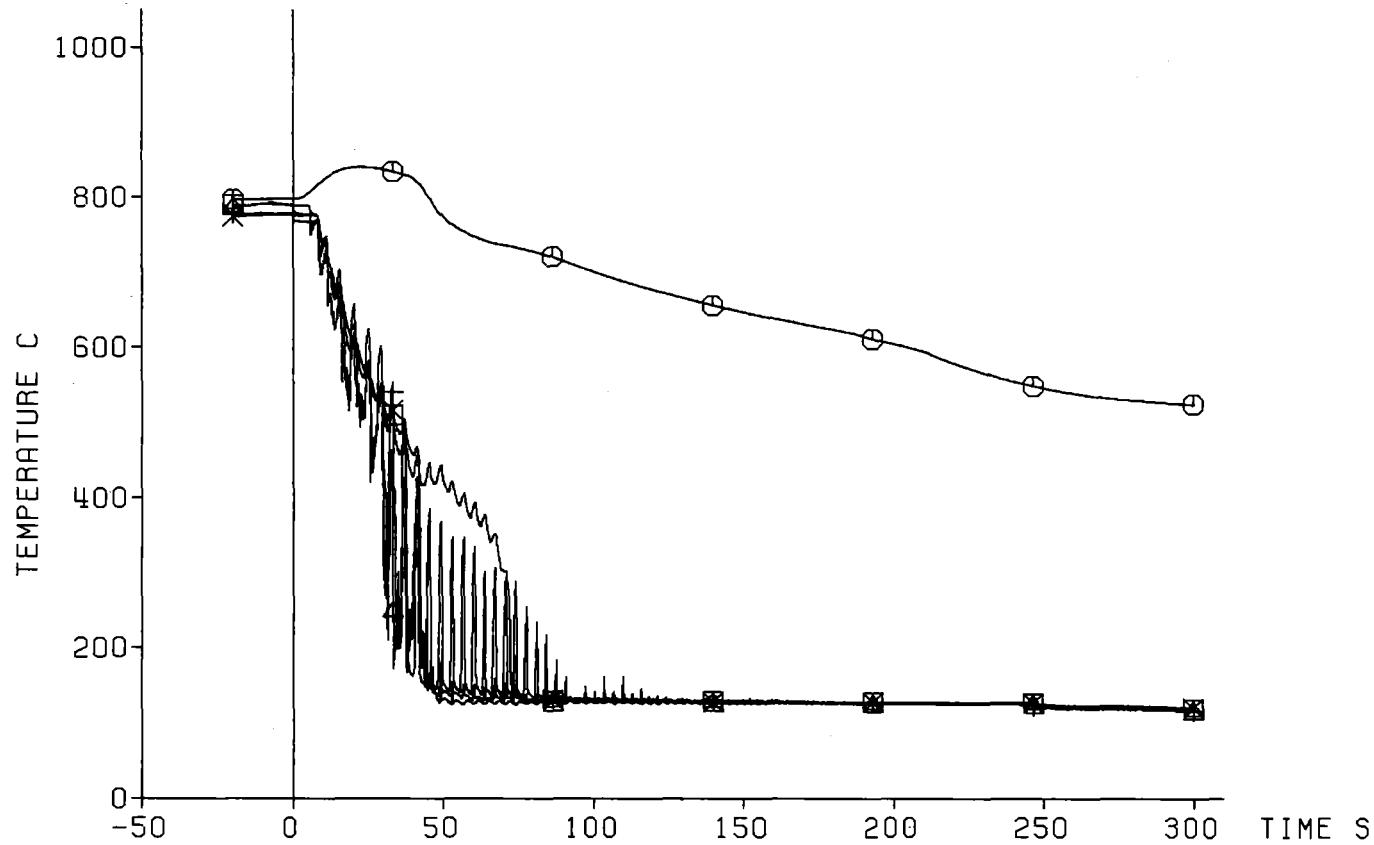

Decay Heat 120% ANS Standard
 Flooding Rate (cold) 5.78 cm/s
 System Pressure 2.24 bar
 Feedwater Temperature 40 C



Fig. 419 FEBA: 5x5 ROD BUNDLE, TEST SERIES 8, TEST-No. 340

Cladding Temperature

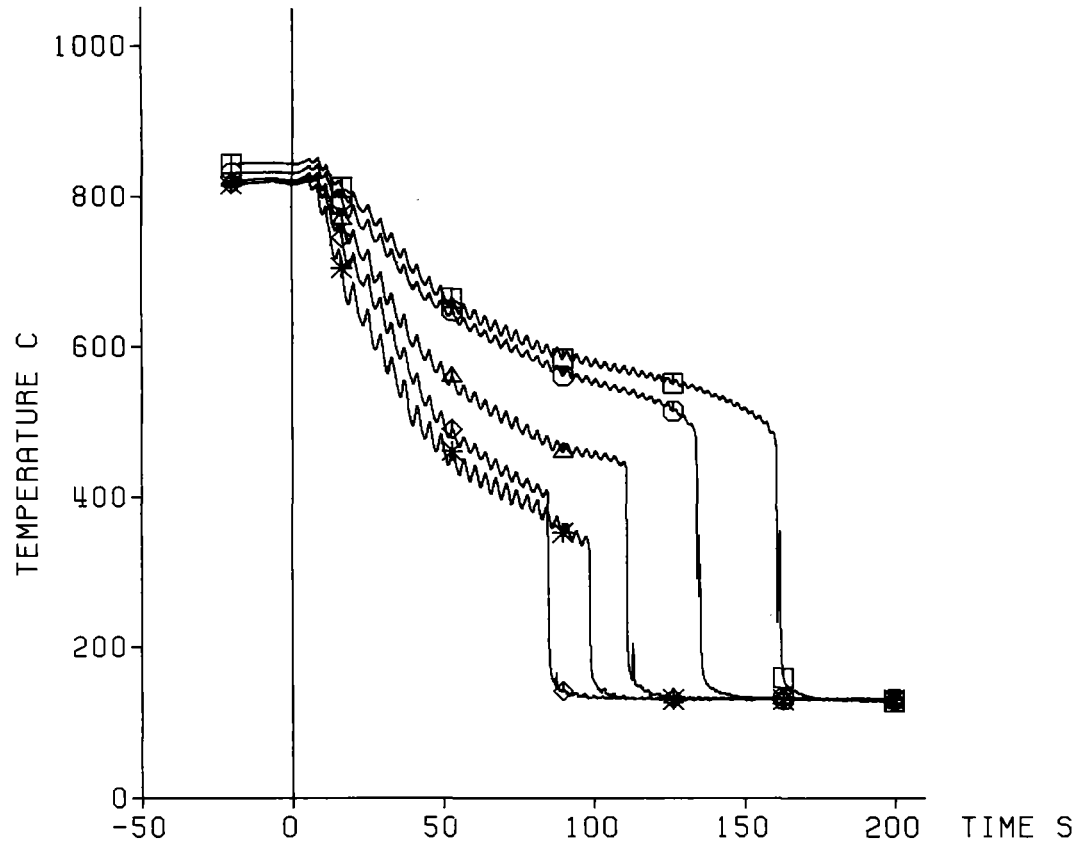

TC	Ax. Level
* 19g4	1925 mm
◇ 17i1	1875 mm
△ 19g3	1825 mm
○ 19g2	1725 mm
□ 19g1	1625 mm

Decay Heat 120% ANS Standard
 Flooding Rate (cold) 5.78 cm/s
 System Pressure 2.24 bar
 Feedwater Temperature 40 C

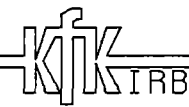
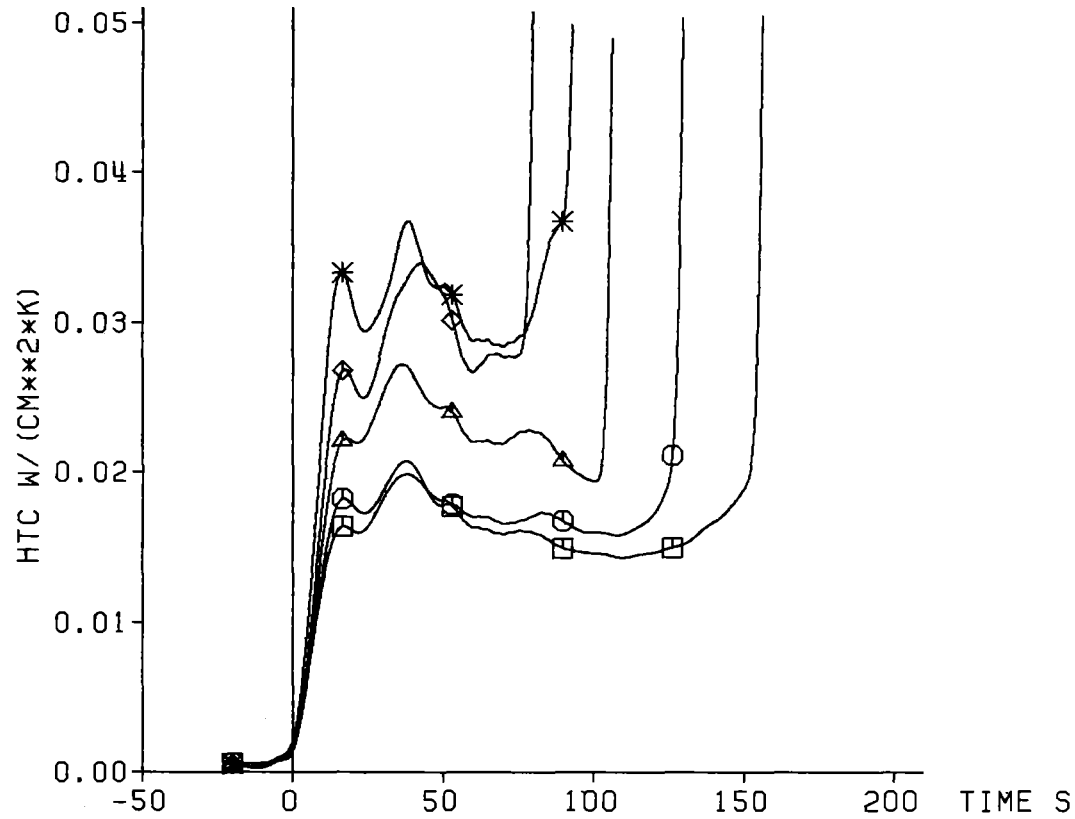

Fig. 420 FEBA: 5x5 ROD BUNDLE, TEST SERIES 8, TEST-No. 340

Heat Transfer Coeff.



	TC	Ax. Level
*	19g4	1925 mm
◇	17i1	1875 mm
△	19g3	1825 mm
⊙	19g2	1725 mm
□	19g1	1625 mm

Decay Heat 120% ANS Standard
 Flooding Rate (cold) 5.78 cm/s
 System Pressure 2.24 bar
 Feedwater Temperature 40 C

— 461 —



Fig. 421 FEBA: 5x5 ROD BUNDLE, TEST SERIES 8, TEST-No. 340

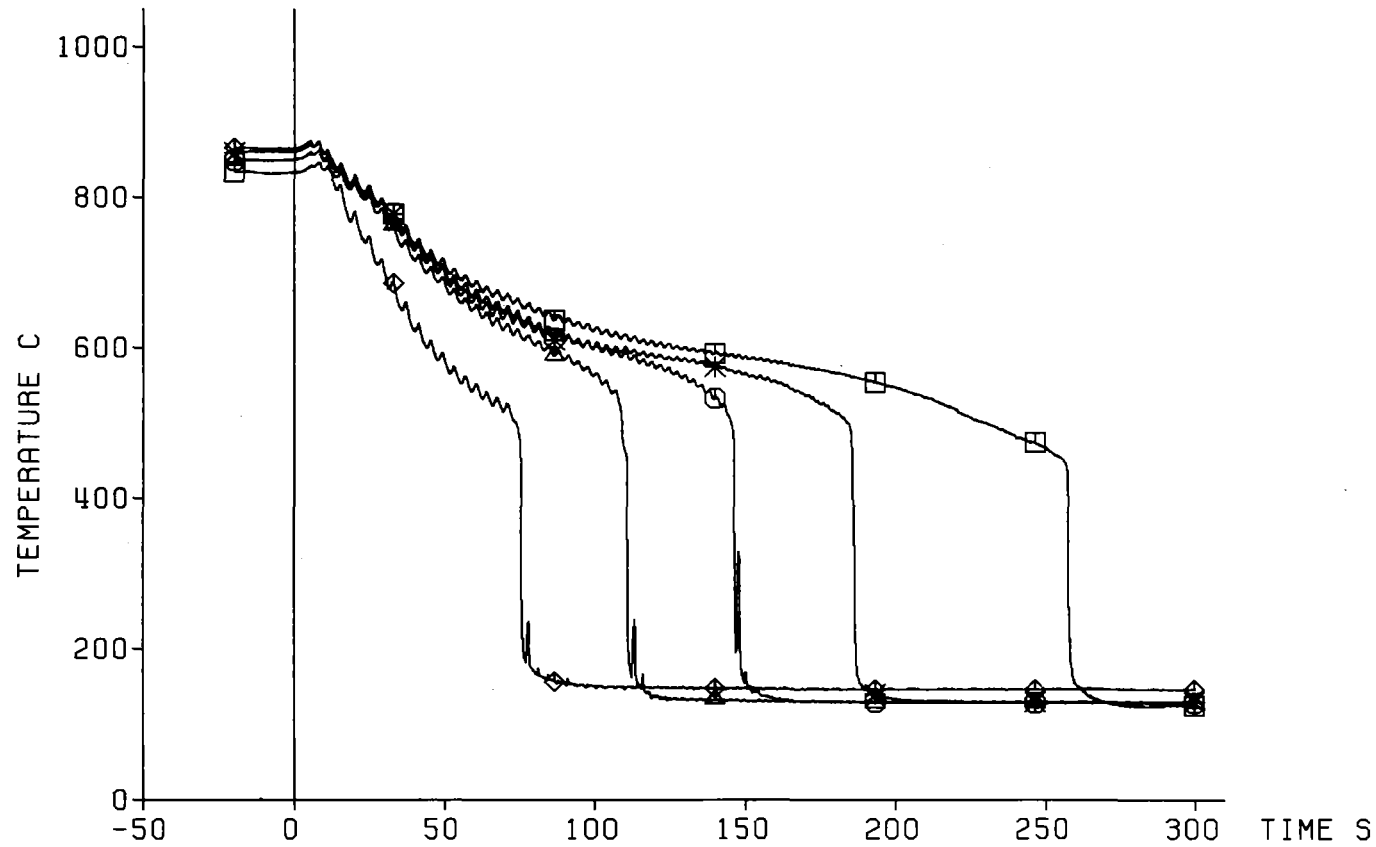

TC	Ax. Level
* 12j4	1525 mm
◇ 12j3	1425 mm
△ 12j2	1325 mm
○ 12j1	1225 mm
□ 8b3	1135 mm

Decay Heat 120% ANS Standard
 Flooding Rate (cold) 5.78 cm/s
 System Pressure 2.24 bar
 Feedwater Temperature 40 C



Fig. 422 FEBA: 5x5 ROD BUNDLE, TEST SERIES 8, TEST-No. 340

Heat Transfer Coeff.

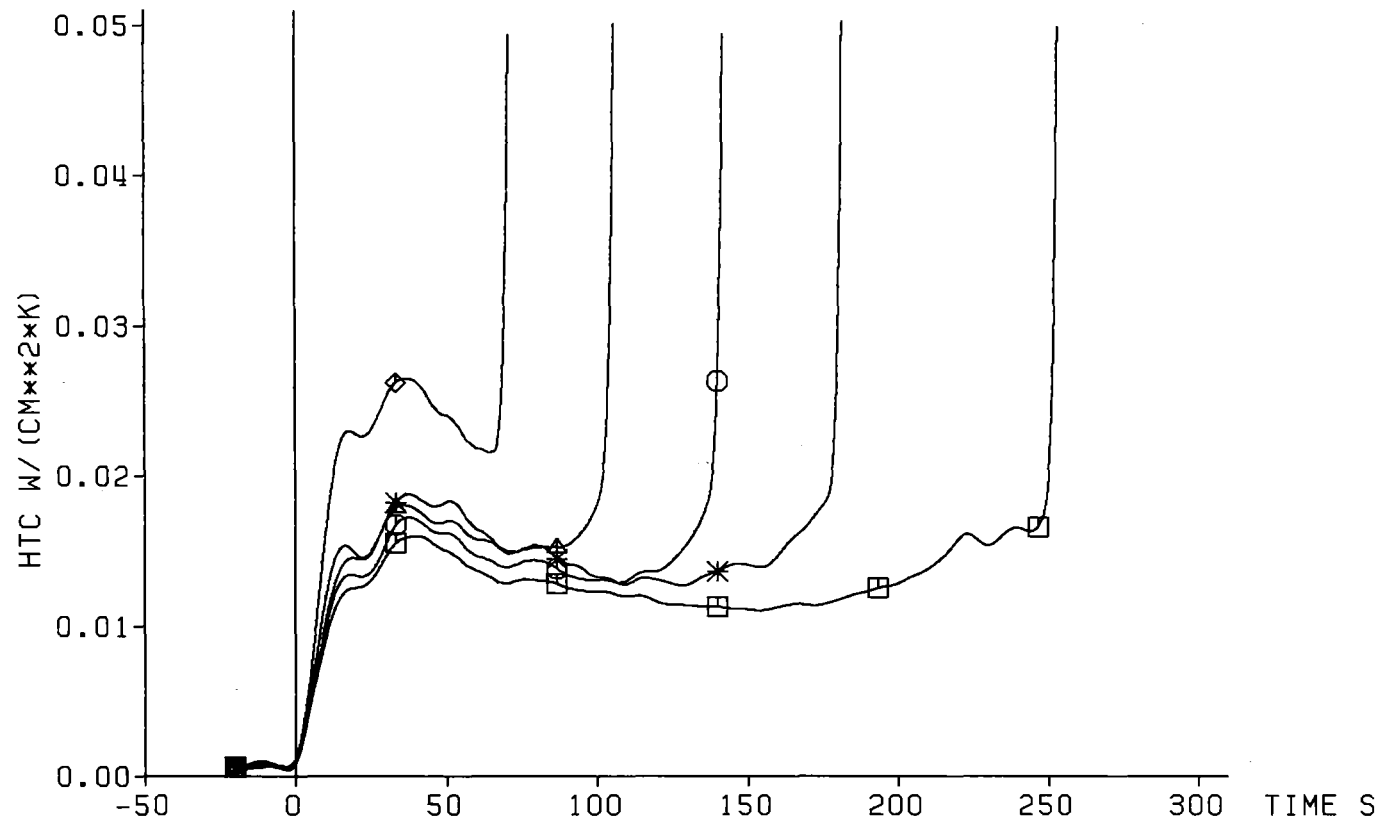

	TC	Ax. Level
*	12j4	1525 mm
◇	12j3	1425 mm
△	12j2	1325 mm
○	12j1	1225 mm
□	8b3	1135 mm

Decay Heat 120% ANS Standard
 Flooding Rate (cold) 5.78 cm/s
 System Pressure 2.24 bar
 Feedwater Temperature 40 C

— 463 —



Fig. 423 FEBA: 5x5 ROD BUNDLE, TEST SERIES 8, TEST-No. 340

Grid Spacer Temperature

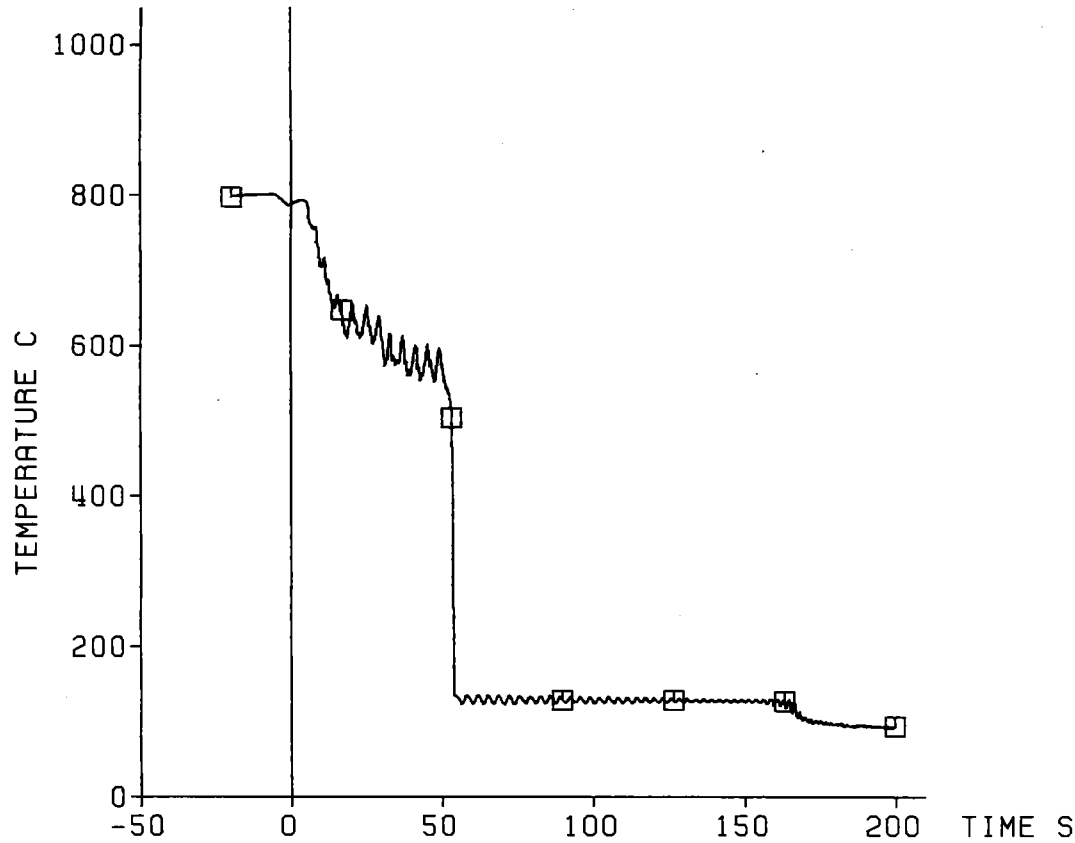

TC	Axial Level
□ 69	2535 mm

Decay Heat 120% ANS Standard
 Flooding Rate (cold) 5.78 cm/s
 System Pressure 2.24 bar
 Feedwater Temperature 40 C

— 464 —



Fig. 424 FEBA: 5x5 ROD BUNDLE, TEST SERIES 8, TEST-No. 340

Grid Spacer Temperature

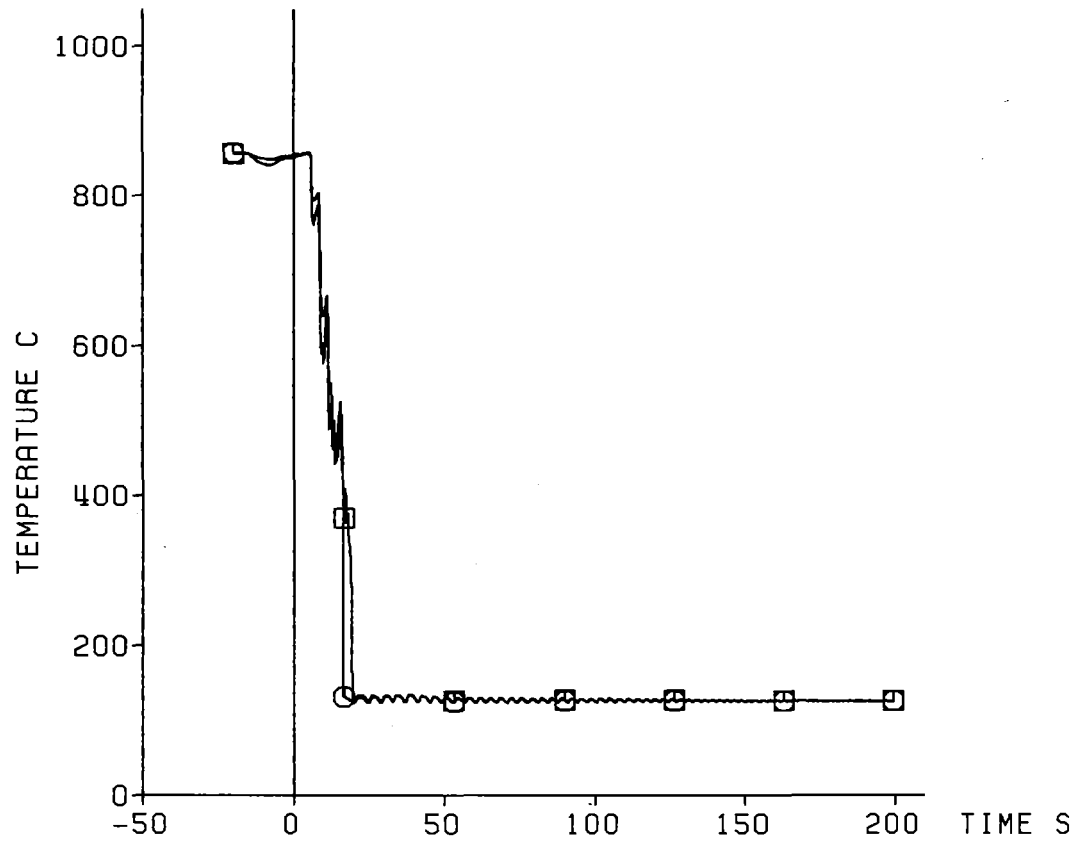

	TC	Axial Level
□	67	1425 mm
○	66	1425 mm

Decay Heat 120% ANS Standard
 Flooding Rate (cold) 5.78 cm/s
 System Pressure 2.24 bar
 Feedwater Temperature 40 C



Fig. 425 FEBA: 5x5 ROD BUNDLE, TEST SERIES 8, TEST-No. 340

Axial Level: 2770 mm

△ Cladding Temperature (7a2)
○ Fluid Temperature
□ Housing Temperature

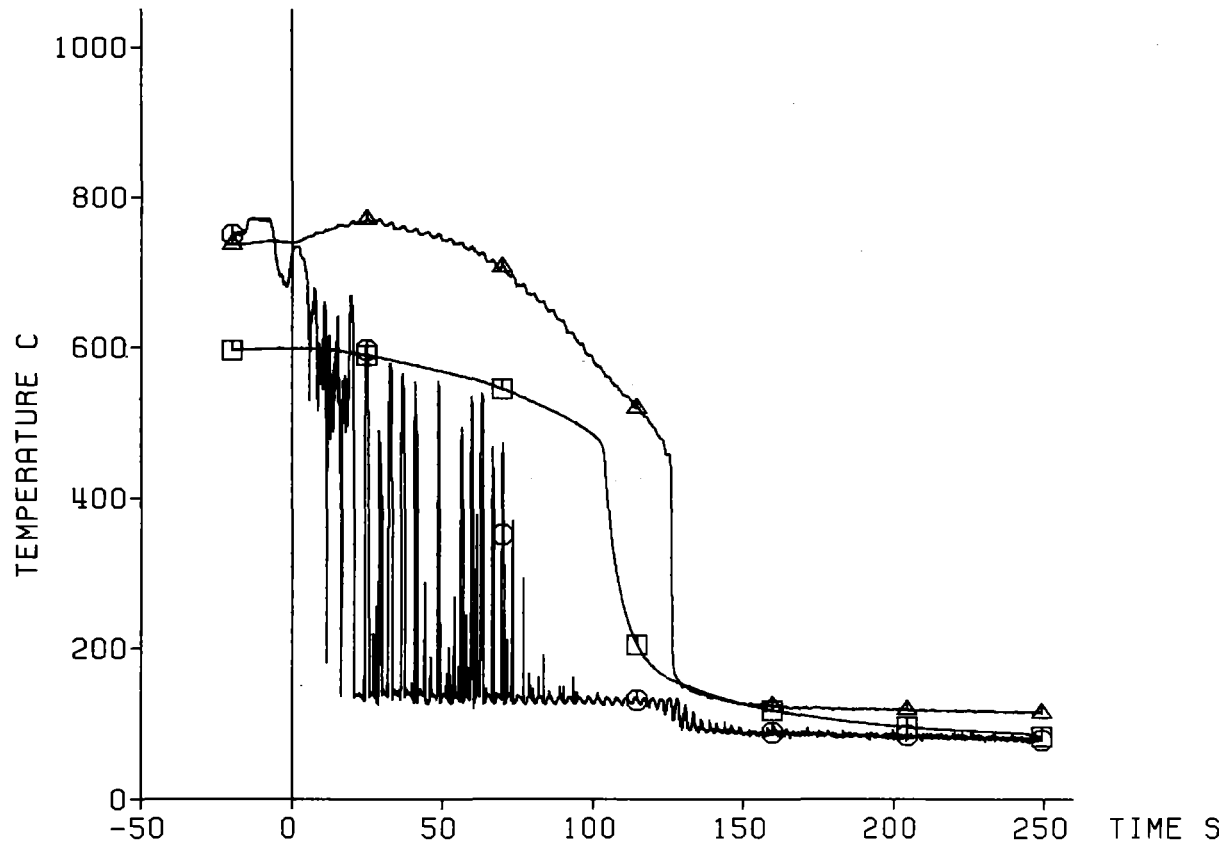

Decay Heat 120% ANS Standard
Flooding Rate (cold) 5.78 cm/s
System Pressure 2.24 bar
Feedwater Temperature 40 C

— 466 —



Fig. 426 FEBA: 5x5 ROD BUNDLE, TEST SERIES 8, TEST-No. 340

Axial Level: 2225 mm

△ Cladding Temperature (7a1)
○ Fluid Temperature (2240 mm)
□ Housing Temperature (2235 mm)

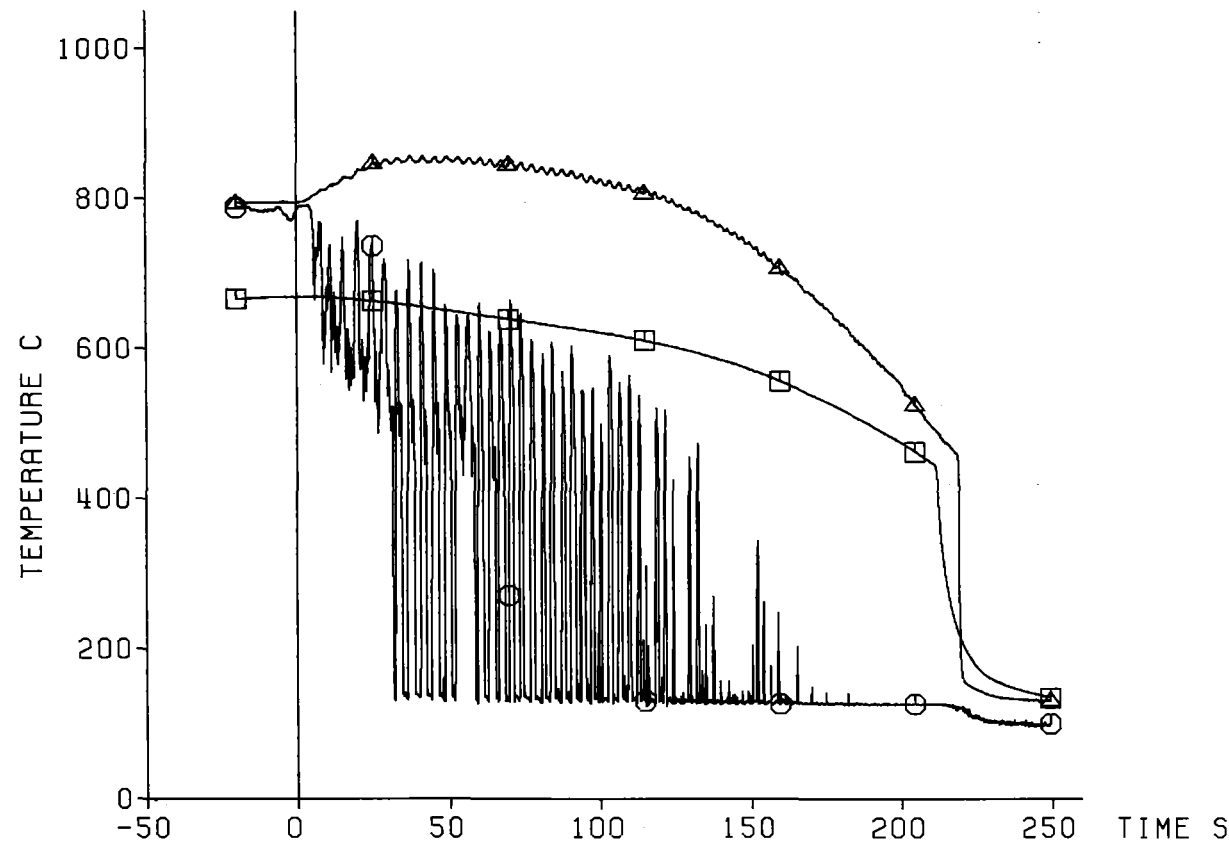

Decay Heat 120% ANS Standard
Flooding Rate (cold) 5.78 cm/s
System Pressure 2.24 bar
Feedwater Temperature 40 C

KFK IRB

Fig. 427 FEBA: 5x5 ROD BUNDLE, TEST SERIES 8, TEST-No. 340

Axial Level: 1925 mm

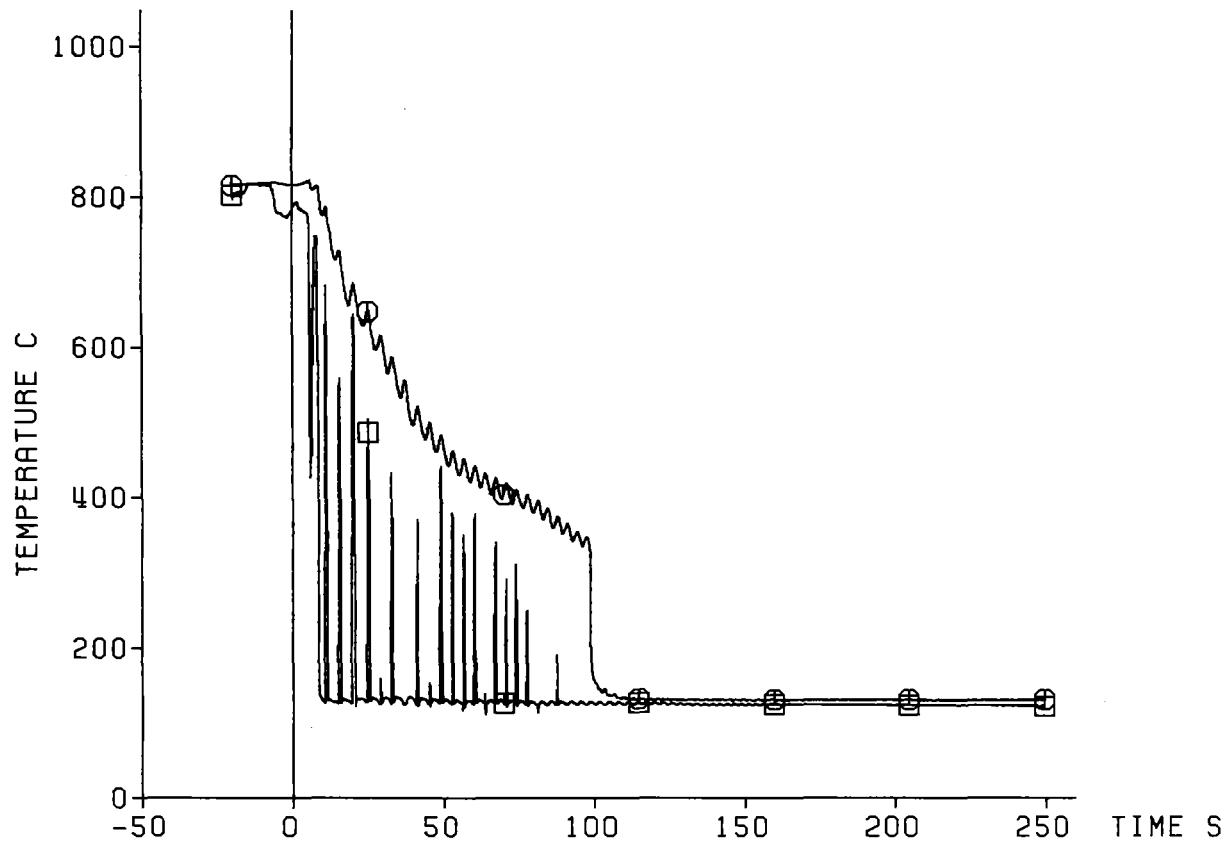

△ Cladding Temperature (19g4)
⊙ Fluid Temperature

Decay Heat 120% ANS Standard
Flooding Rate (cold) 5.78 cm/s
System Pressure 2.24 bar
Feedwater Temperature 40 C

— 468 —



Fig. 428 FEBA: 5x5 ROD BUNDLE, TEST SERIES 8, TEST-NO. 340

Axial Level: 1825 mm

△ Cladding Temperature (19g3)
○ Fluid Temperature
□ Housing Temperature

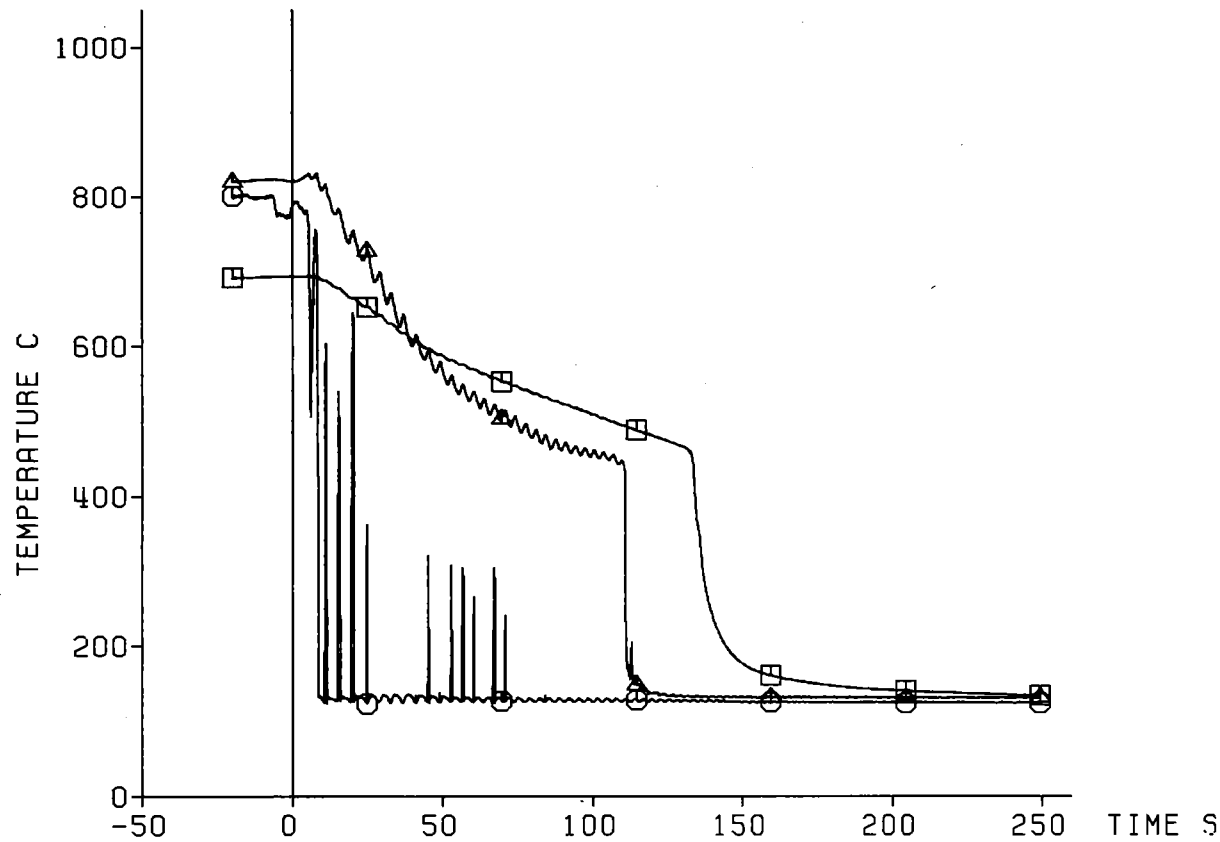

Decay Heat 120% ANS Standard
Flooding Rate (cold) 5.78 cm/s
System Pressure 2.24 bar
Feedwater Temperature 40 C



Fig. 429 FEBA: 5x5 ROD BUNDLE, TEST SERIES 8, TEST-No. 340

Axial Level: 1725 mm

△ Cladding Temperature (19g2)
○ Fluid Temperature

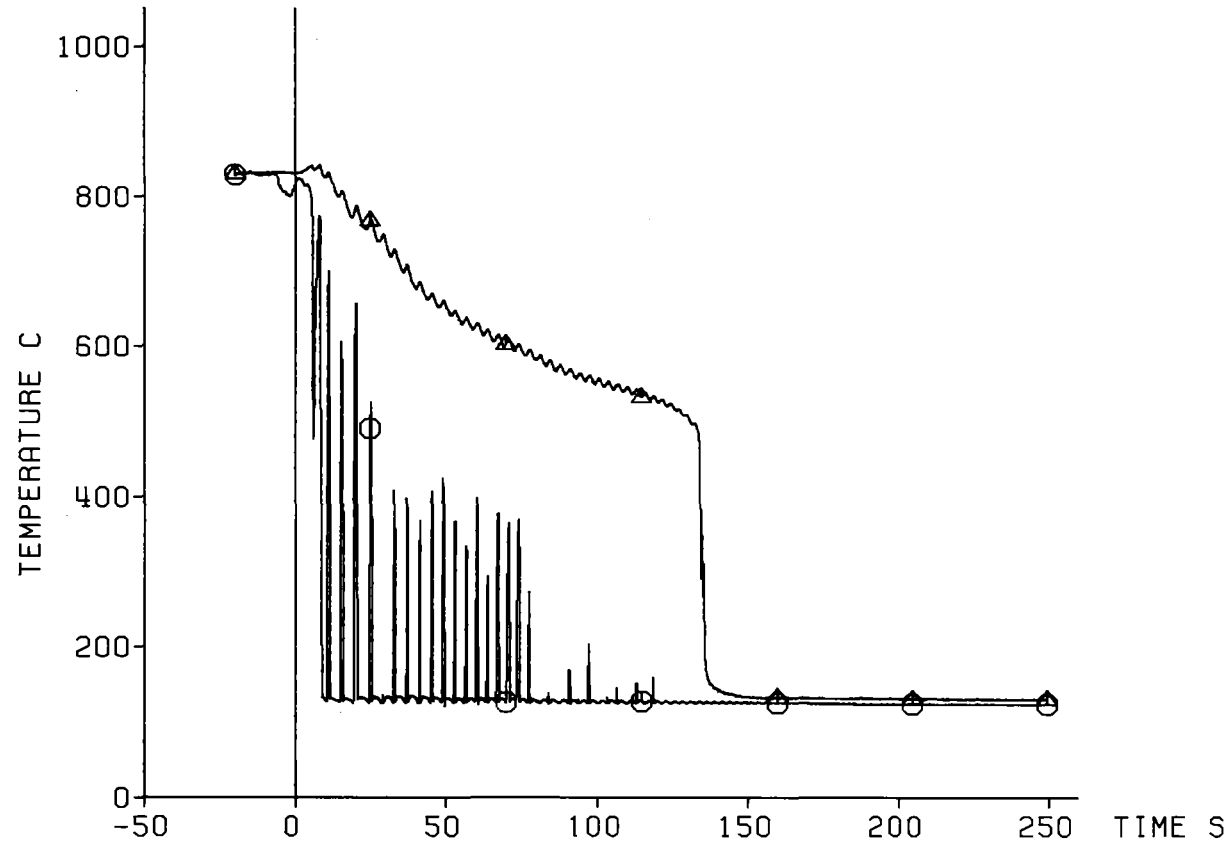

Decay Heat 120% ANS Standard
Flooding Rate (cold) 5.78 cm/s
System Pressure 2.24 bar
Feedwater Temperature 40 C

KIK IRB

Fig. 430 FEBA: 5x5 ROD BUNDLE, TEST SERIES 8, TEST-No. 340

Axial Level: 1625 mm

▲ Cladding Temperature (19g1)
○ Fluid Temperature
□ Housing Temperature

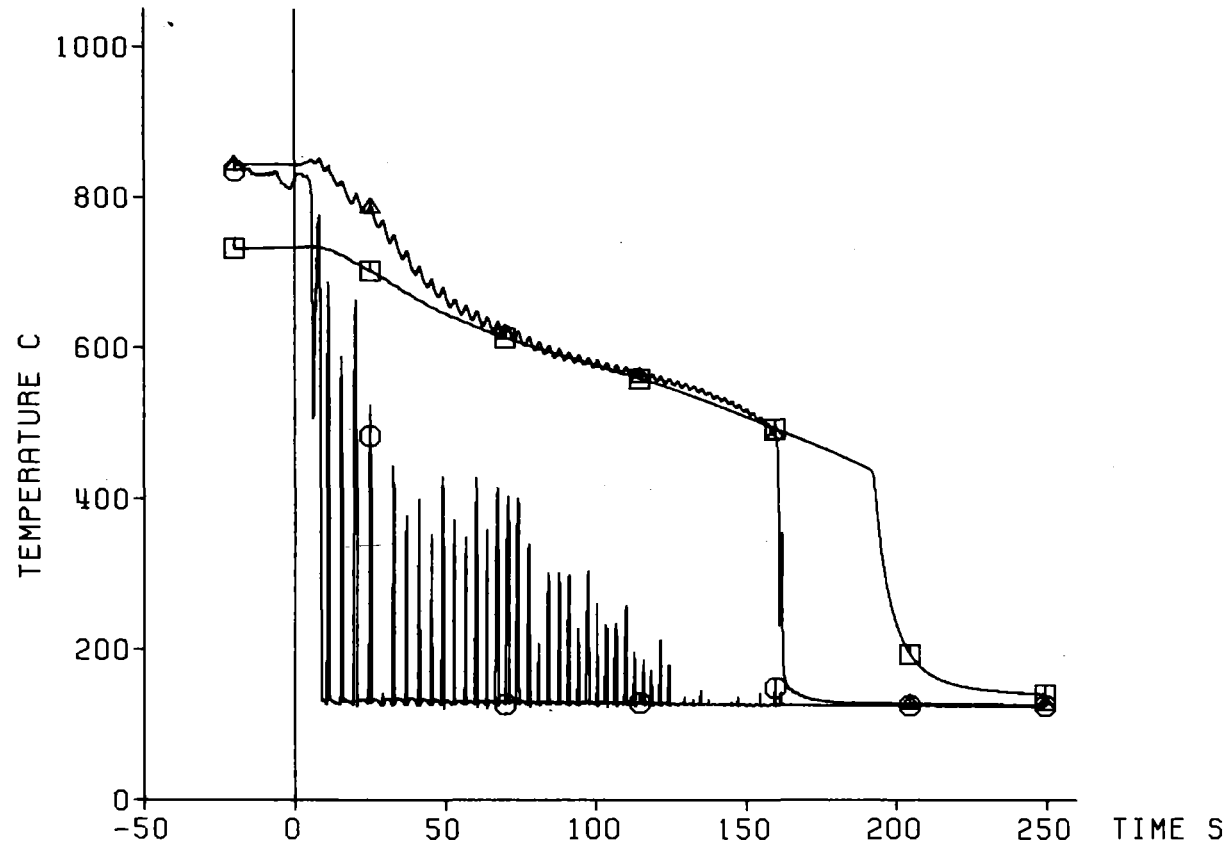

Decay Heat 120% ANS Standard
Flooding Rate (cold) 5.78 cm/s
System Pressure 2.24 bar.
Feedwater Temperature 40 C



Fig. 431 FEBA: 5x5 ROD BUNDLE, TEST SERIES 8, TEST-No. 340

Axial Level: 1135 mm

△ Cladding Temperature (8b3)
○ Fluid Temperature
□ Housing Temperature

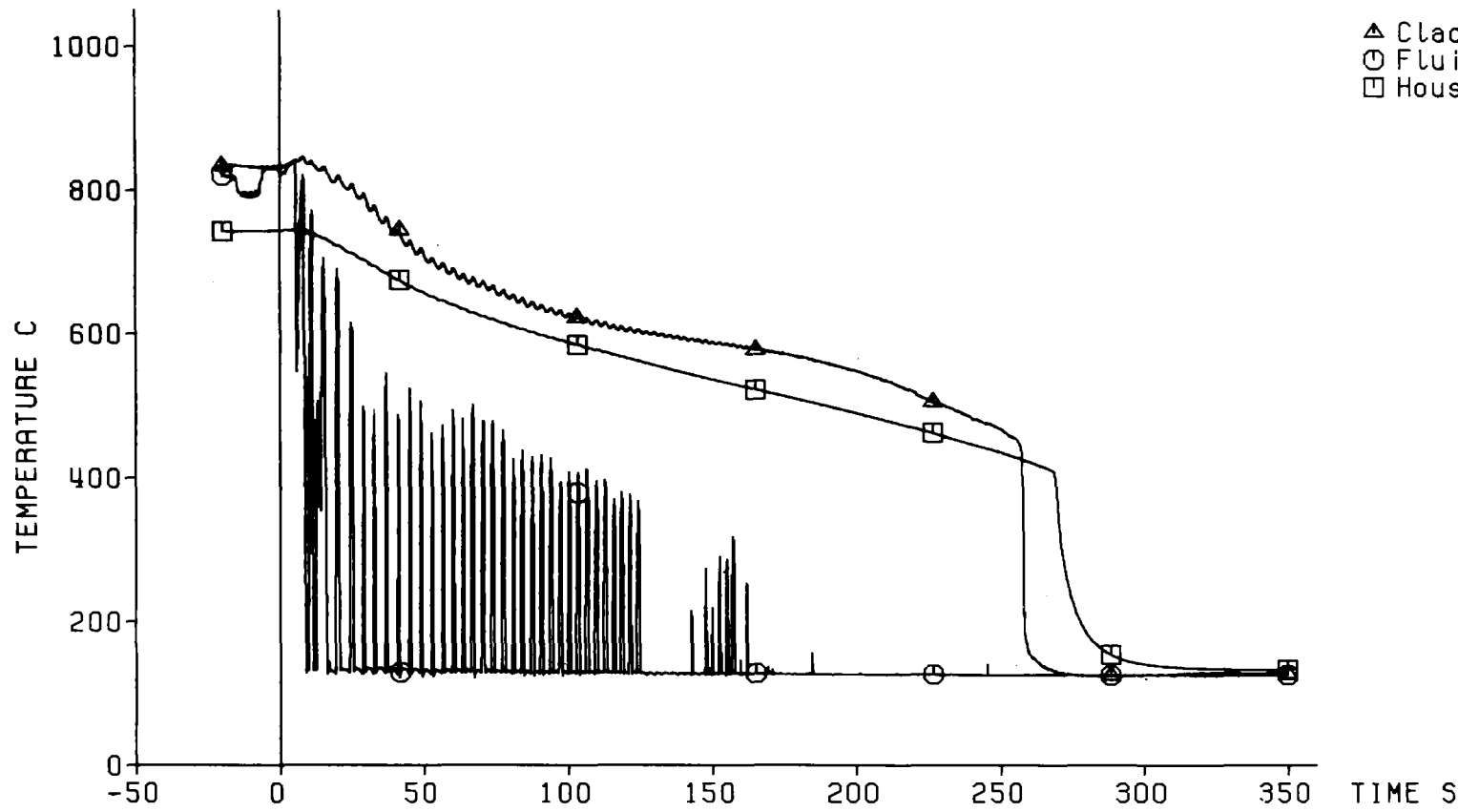

Decay Heat 120% ANS Standard
Flooding Rate (cold) 5.78 cm/s
System Pressure 2.24 bar
Feedwater Temperature 40 C

472



Fig. 432 FEBA: 5x5 ROD BUNDLE, TEST SERIES 8, TEST-No. 340

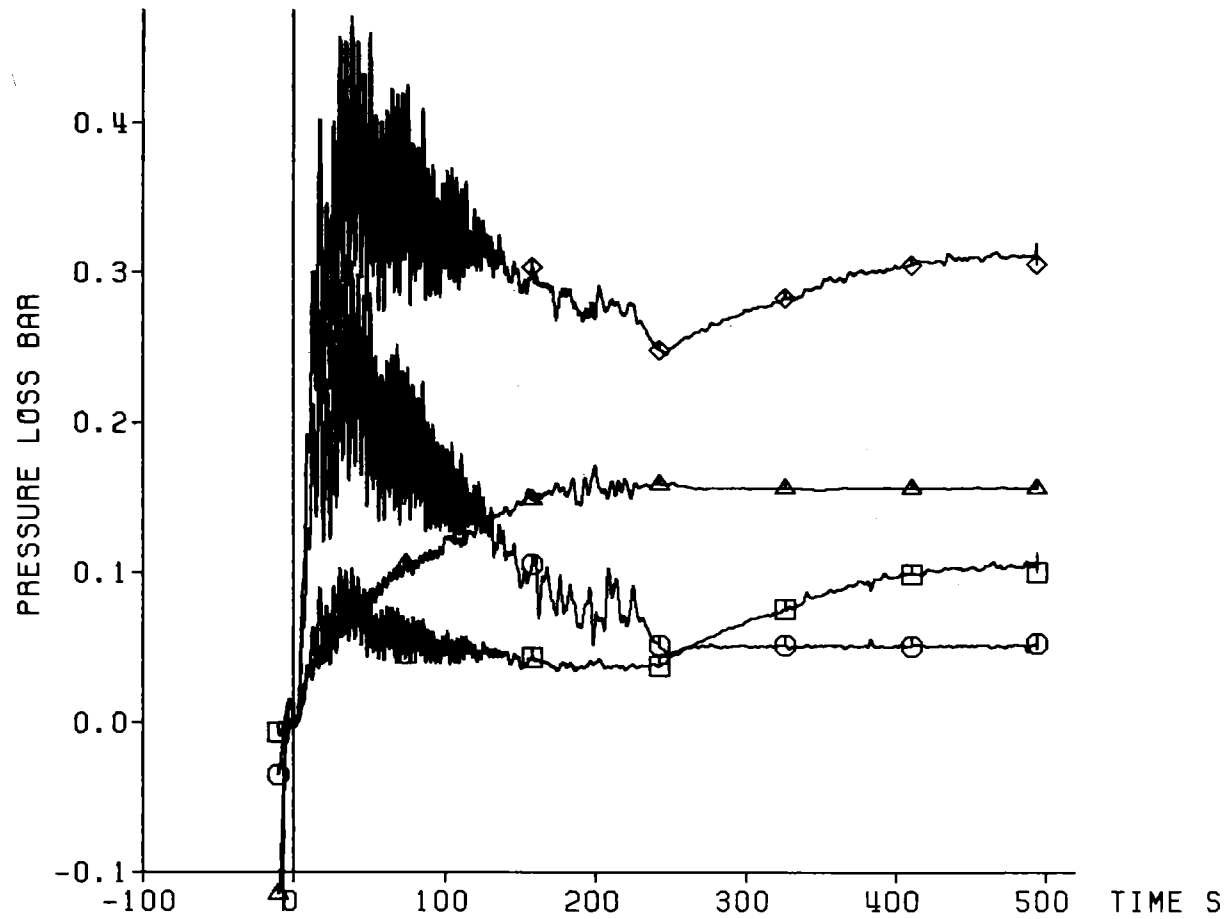

Pressure Loss
Along the Test Section:

◇ Total Length: 4196 mm
 △ Lower Part: 1711 mm
 ○ Middle Part: 545 mm
 □ Upper Part: 1940 mm

Decay Heat	120% ANS Standard
Flooding Rate (cold)	5.78 cm/s
System Pressure	2.24 bar
Feedwater Temperature	40 C



Fig. 433 FEBA: 5x5 ROD BUNDLE, TEST SERIES 8, TEST-No. 340

Coolant Outlet Conditions:

△ Water Carry Over
○ Coolant Temperature
□ Coolant Pressure

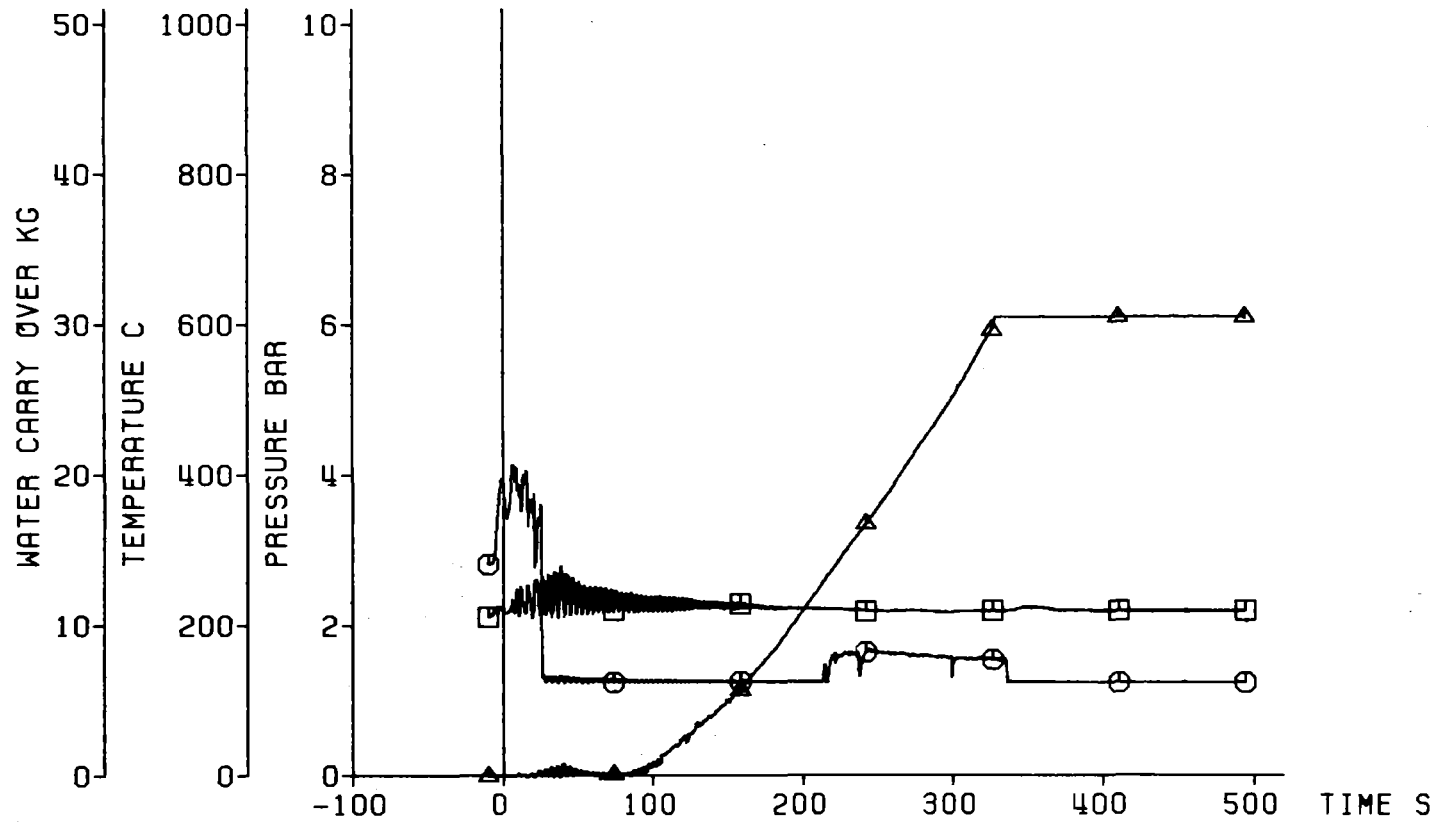

Decay Heat 120% ANS Standard
Flooding Rate (cold) 5.78 cm/s
System Pressure 2.24 bar
Feedwater Temperature 40 C



Fig. 434 FEBA: 5x5 ROD BUNDLE, TEST SERIES 8, TEST-No. 340

Axial Position of Quench Front

□ Quenching of Sleeves at Bundle Midplane

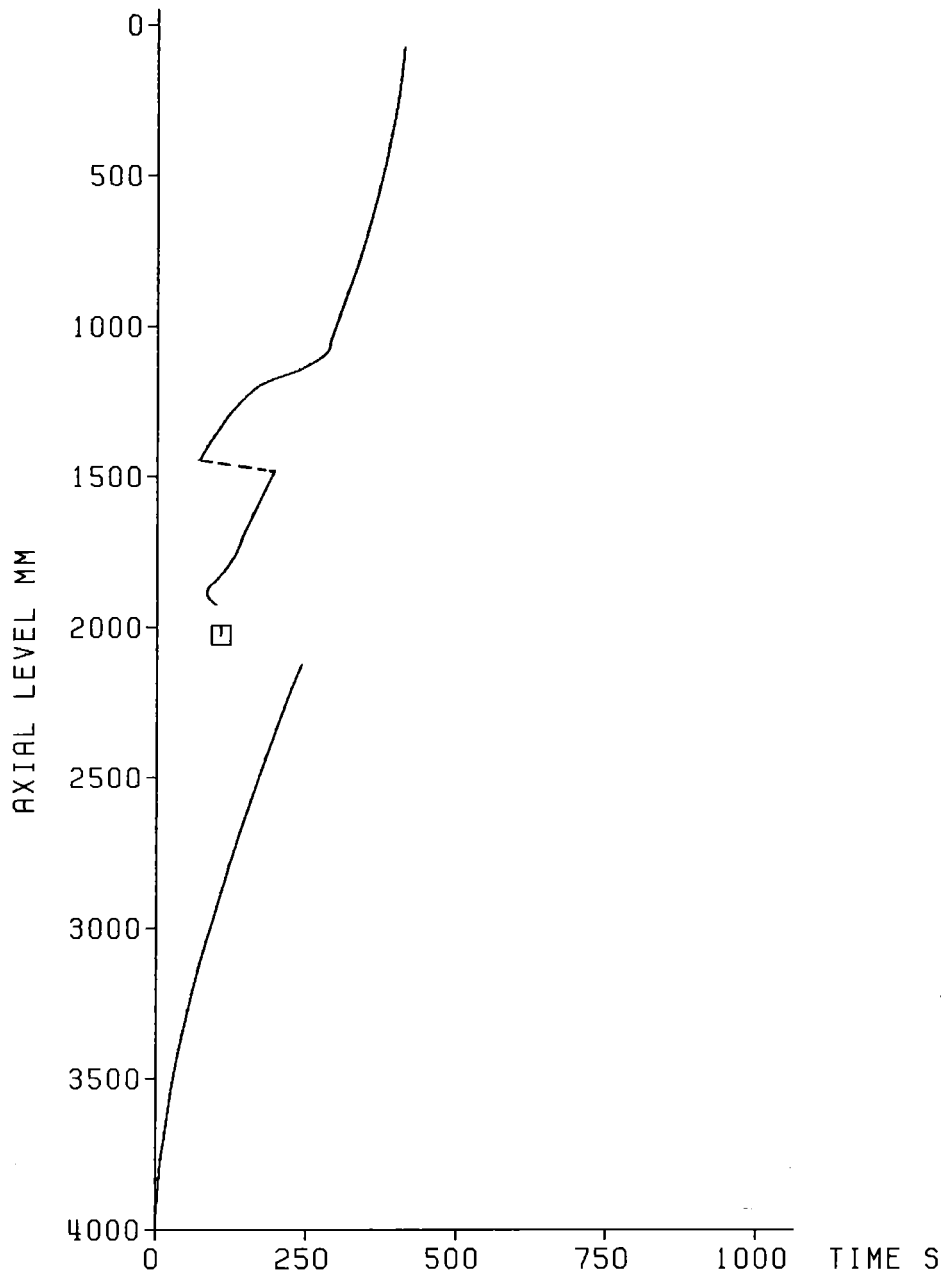

Decay Heat	120% ANS Standard
Flooding Rate (cold)	5.78 cm/s
System Pressure	2.24 bar
Feedwater Temperature	40 C



Fig. 435 FEBA: 5x5 ROD BUNDLE
TEST SERIES 8, TEST-NO. 340

Initial Axial Temperature Profile of Claddings

□ Initial Temperature of Sleeves at Bundle Midplane

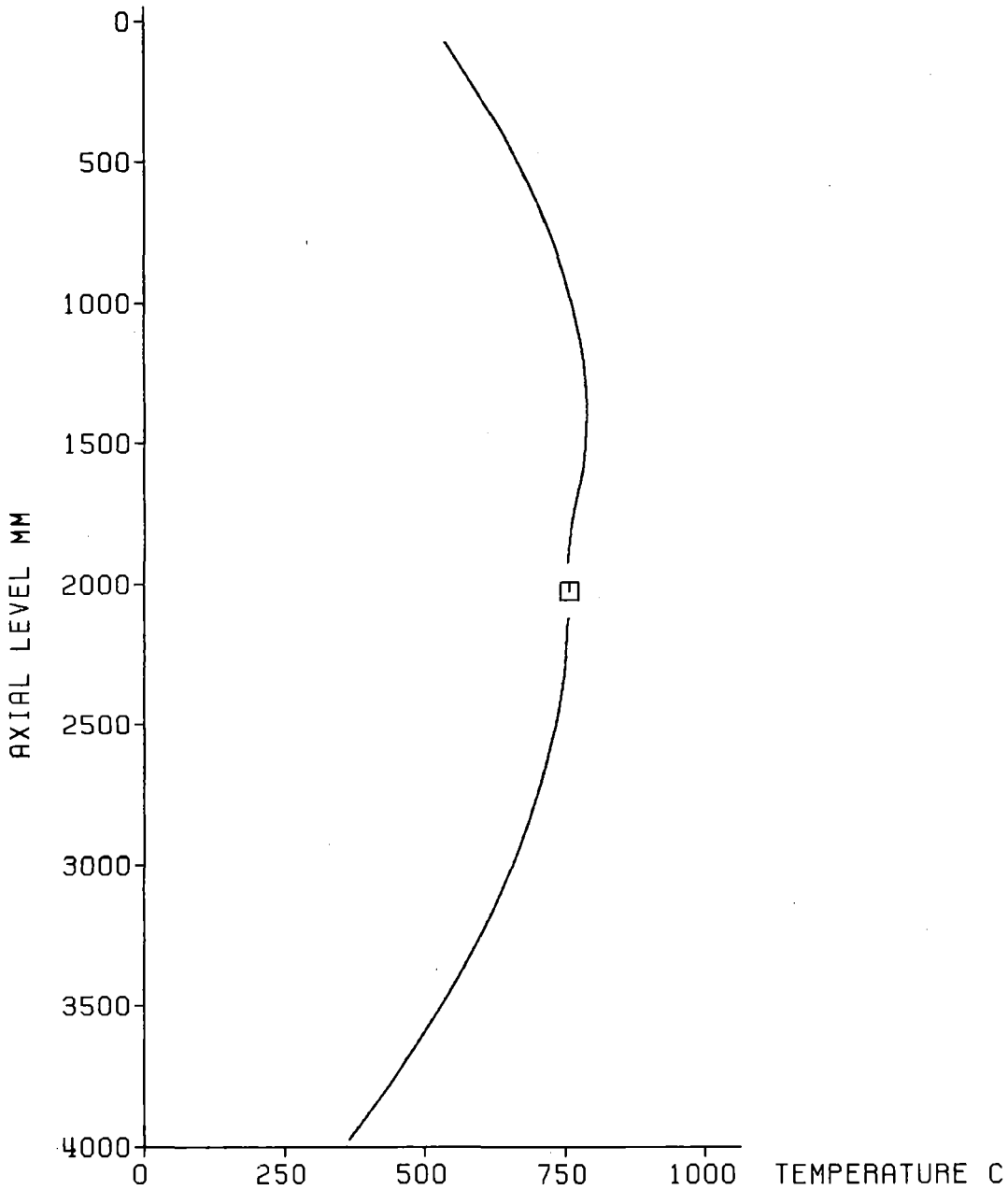

Decay Heat	120% ANS Standard
Flooding Rate (cold)	5.77 cm/s
System Pressure	4.05 bar
Feedwater Temperature	40 C



Fig. 436 FEBA: 5x5 ROD BUNDLE
TEST SERIES 8, TEST-No. 336

Test Parameters:

- ◇ Flooding Rate
- △ System Pressure
- Feedwater Temperature
- Bundle Power

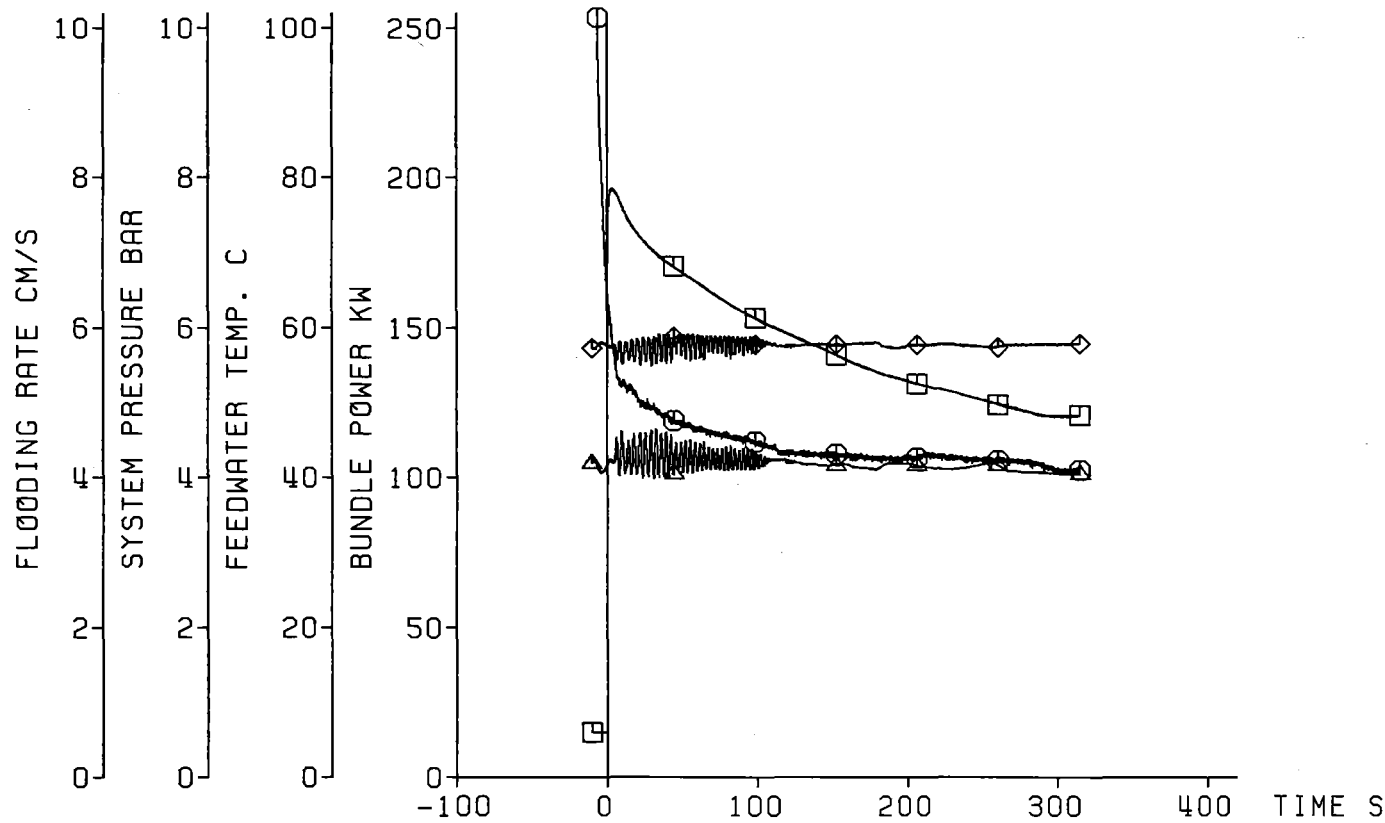

Decay Heat 120% ANS Standard
Flooding Rate (cold) 5.77 cm/s
System Pressure 4.05 bar
Feedwater Temperature 40 C



Fig. 437 FEBA: 5x5 ROD BUNDLE, TEST SERIES 8, TEST-No. 336

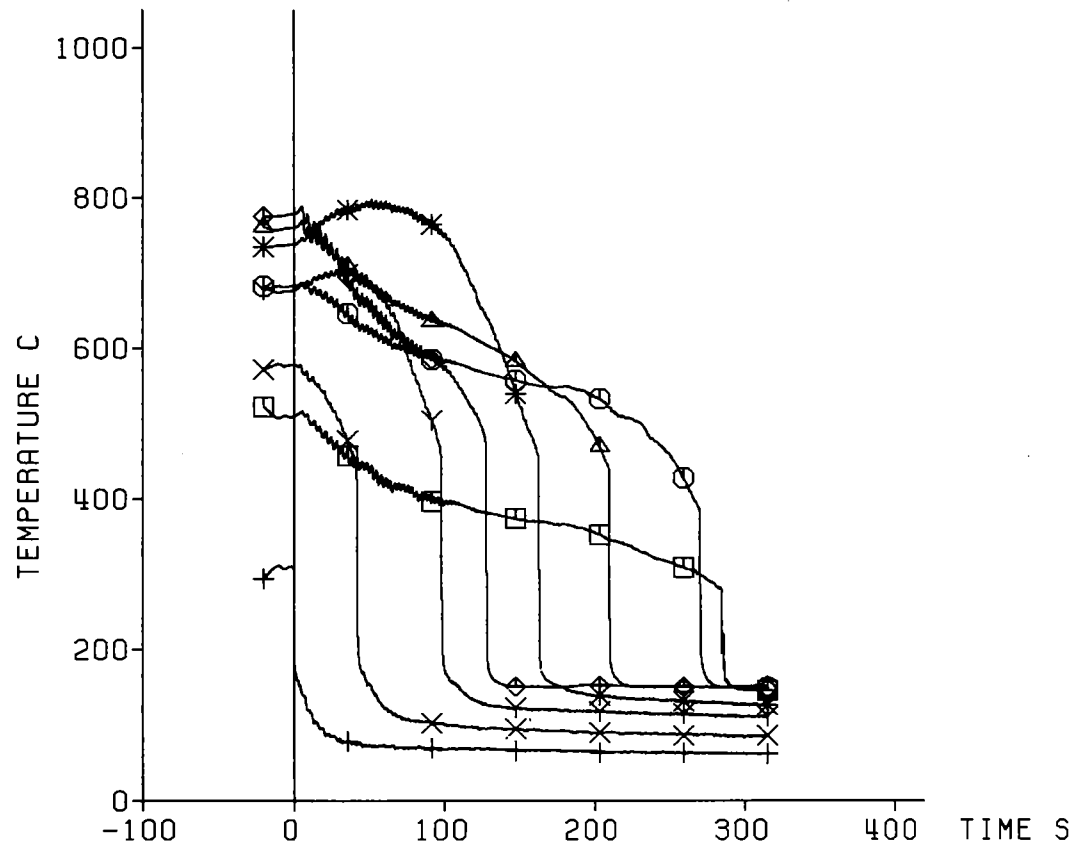

TC	Ax. Level
+	7a4 3860 mm
X	7a3 3315 mm
Y	7a2 2770 mm
*	7a1 2225 mm
◇	8b4 1680 mm
△	8b3 1135 mm
⊙	8b2 590 mm
□	3b1 45 mm

Decay Heat 120% ANS Standard
 Flooding Rate (cold) 5.77 cm/s
 System Pressure 4.05 bar
 Feedwater Temperature 40 C



Fig. 438 FEBA: 5x5 ROD BUNDLE, TEST SERIES 8, TEST-No. 336

Heat Transfer Coeff.

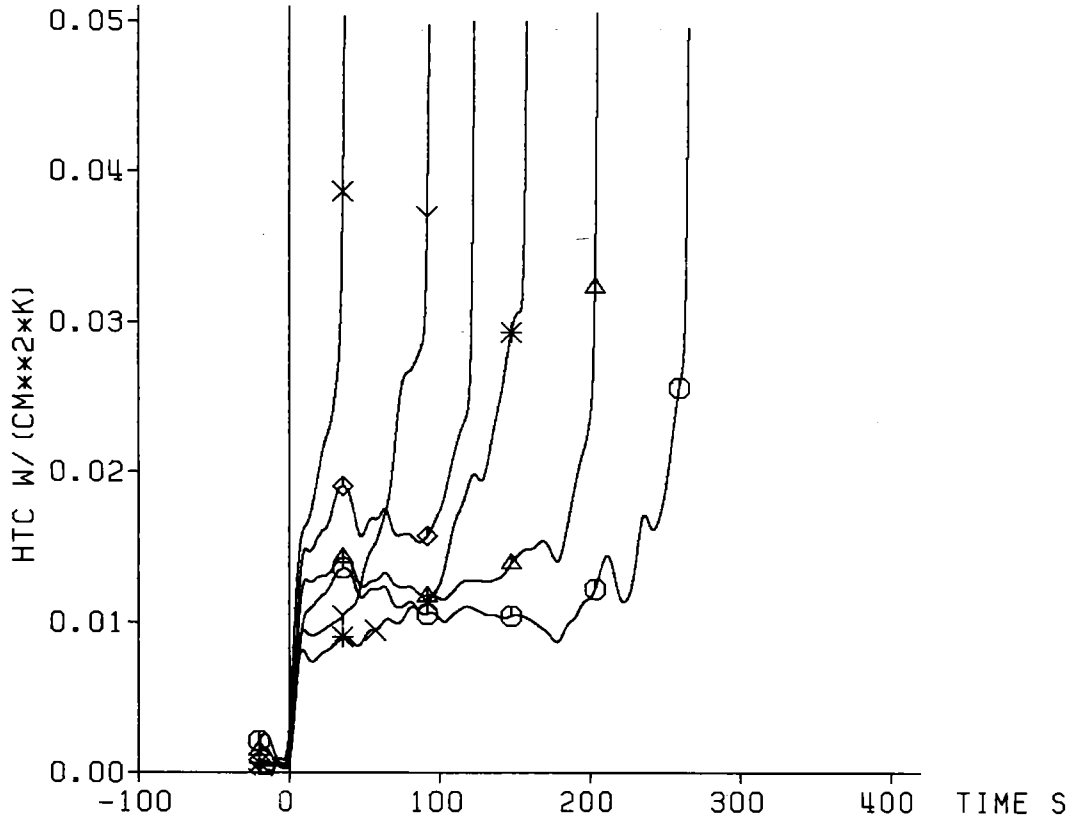

TC	Ax. Level
X	7a3 3315 mm
Y	7a2 2770 mm
*	7a1 2225 mm
◇	8b4 1680 mm
△	8b3 1135 mm
○	8b2 590 mm

Decay Heat 120% ANS Standard
 Flooding Rate (cold) 5.77 cm/s
 System Pressure 4.05 bar
 Feedwater Temperature 40 C



Fig. 439 FEBA: 5x5 ROD BUNDLE, TEST SERIES 8, TEST-NO. 336

Cladding Temperature

TC	Ax. Level
◇	14f4 2425 mm
△	14f3 2325 mm
○	14h2 2225 mm
□	14f1 2125 mm

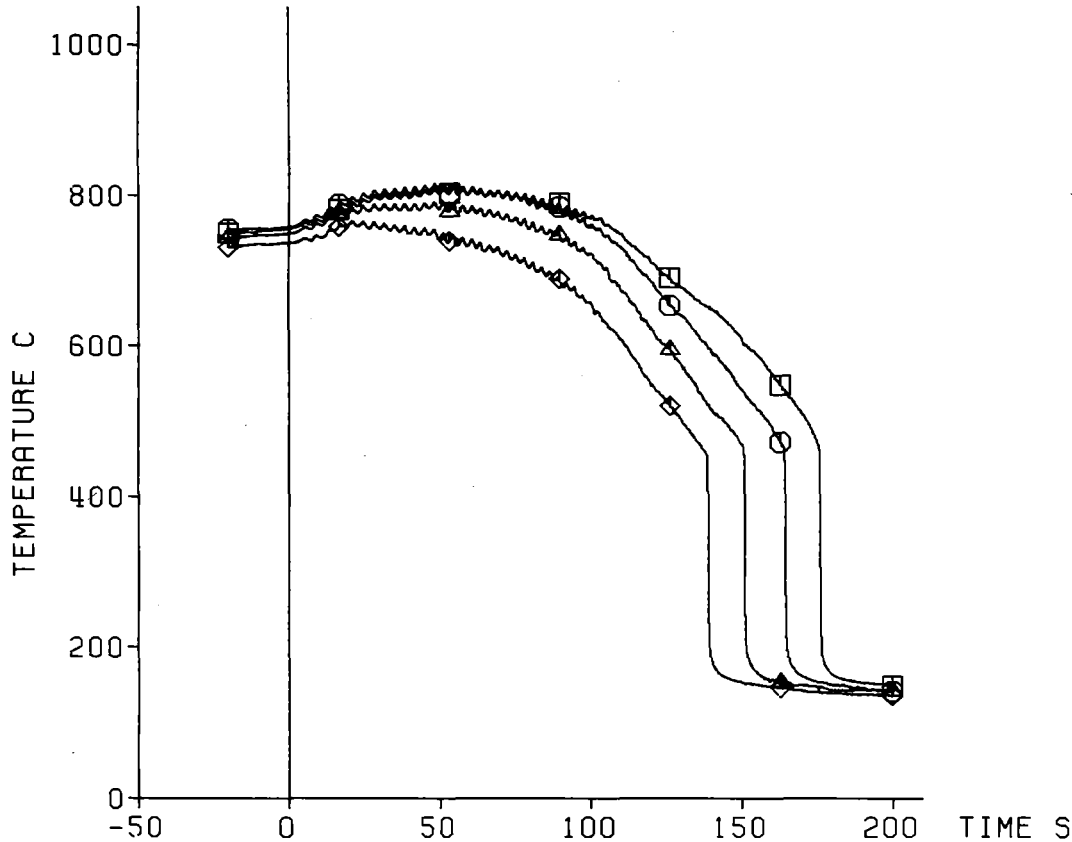

Decay Heat 120% ANS Standard
 Flooding Rate (cold) 5.77 cm/s
 System Pressure 4.05 bar
 Feedwater Temperature 40 C



Fig. 440 FEBA: 5x5 ROD BUNDLE, TEST SERIES 8, TEST-No. 336

Heat Transfer Coeff.

TC	Rx. Level
◇	14f4 2425 mm
△	14f3 2325 mm
○	14h2 2225 mm
□	14f1 2125 mm

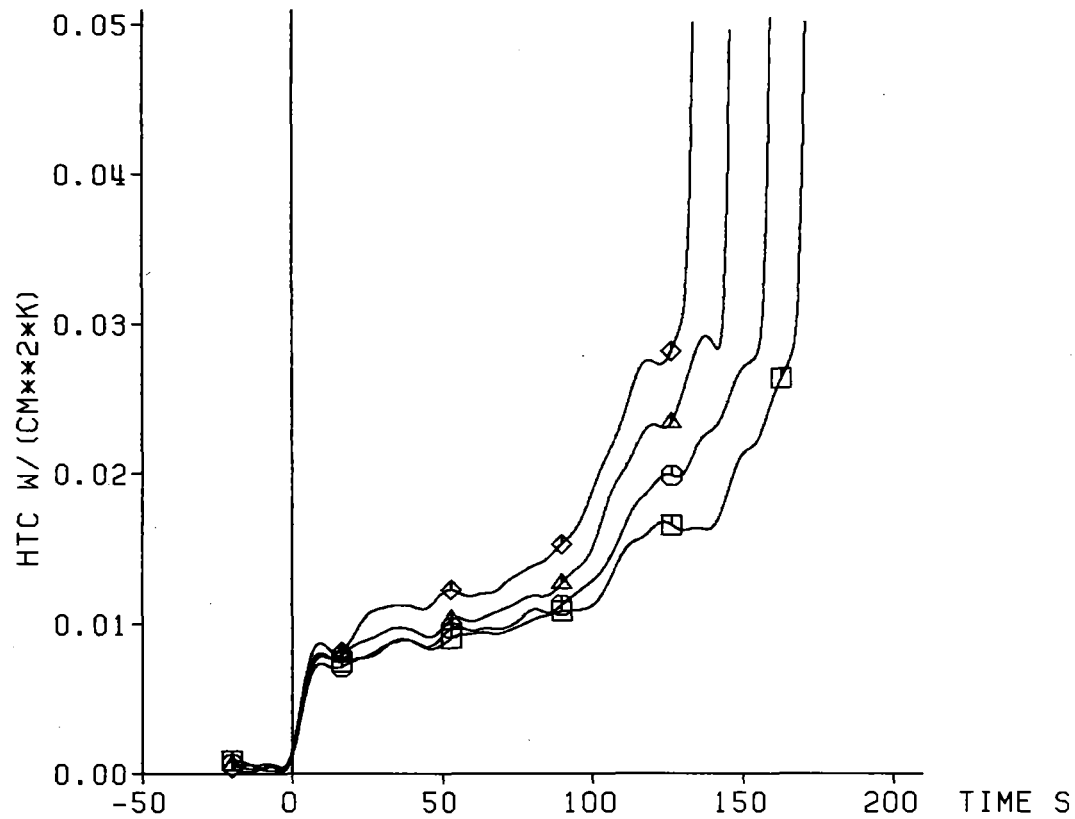

Decay Heat 120% ANS Standard
 Flooding Rate (cold) 5.77 cm/s
 System Pressure 4.05 bar
 Feedwater Temperature 40 C

— 481 —



Fig. 441 FEBA: 5x5 ROD BUNDLE, TEST SERIES 8, TEST-No. 336

Cladding Temperature

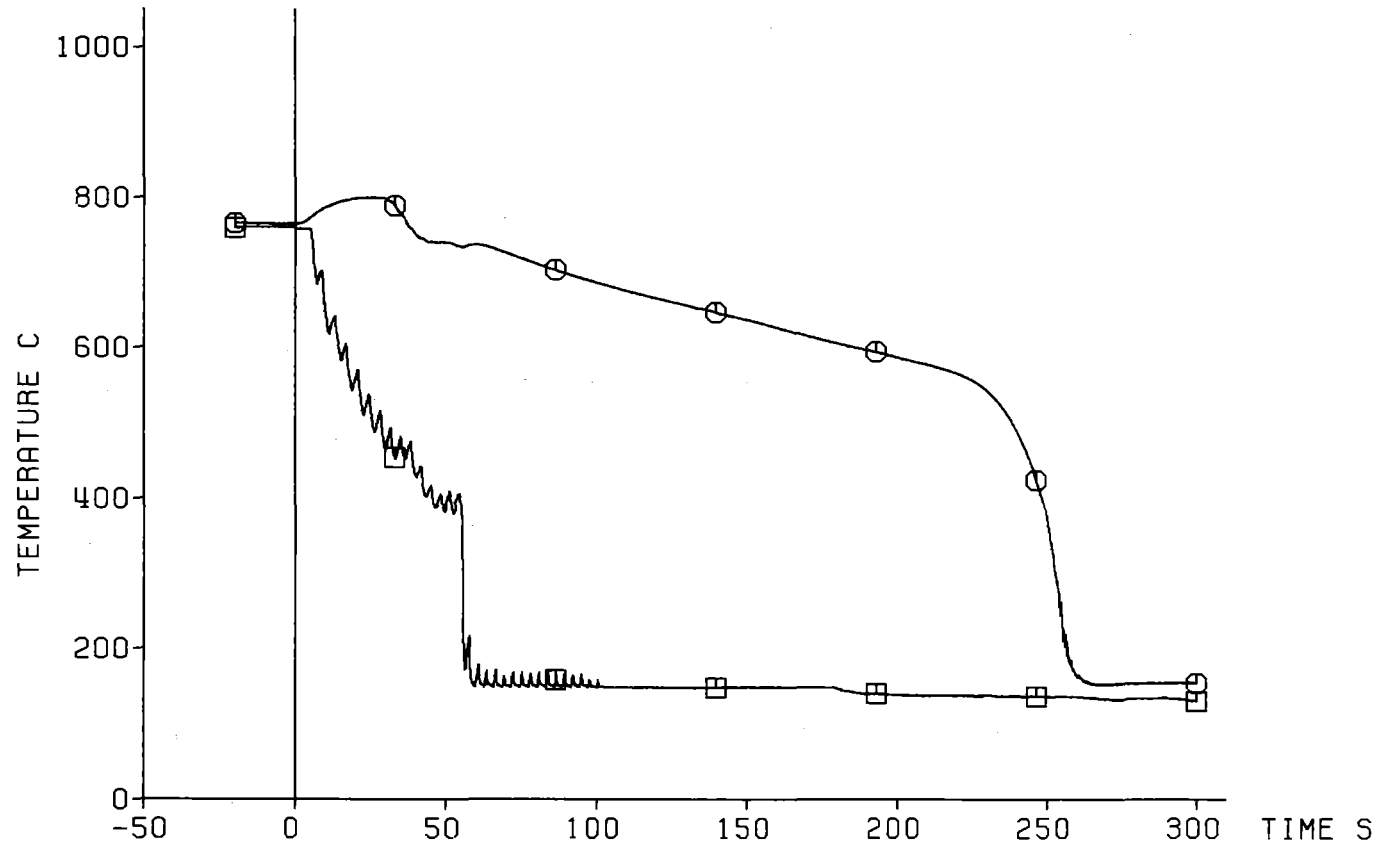

TC	Ax. Level
⊙ 17i4	2025 mm
⊠ Sleeve	2025 mm

Decay Heat 120% ANS Standard
 Flooding Rate (cold) 5.77 cm/s
 System Pressure 4.05 bar
 Feedwater Temperature 40 C



Fig. 442 FEBA: 5x5 ROD BUNDLE, TEST SERIES 8, TEST-No. 336

Sleeve Temperature
 Contact Face: Rods 17 and 18

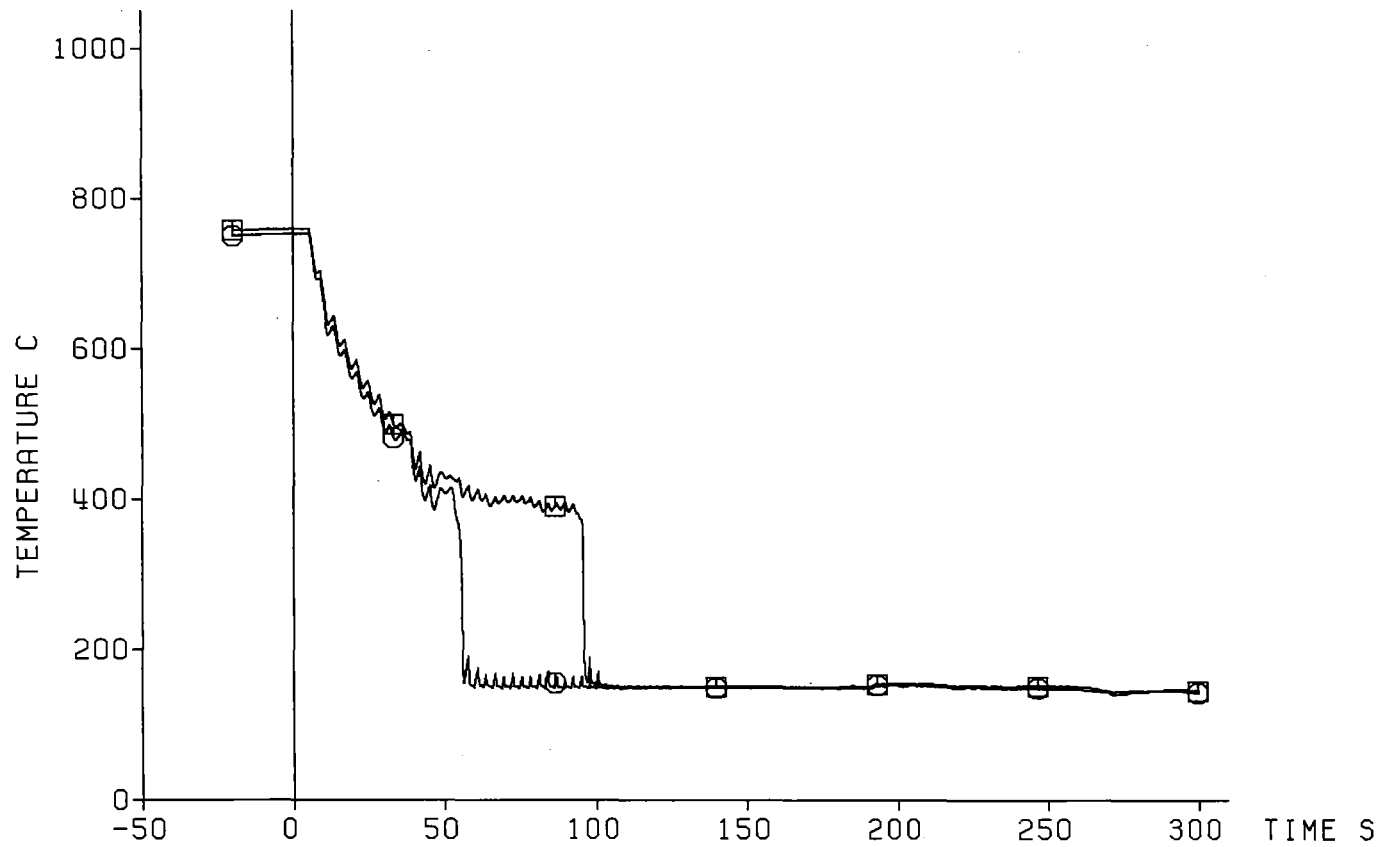

TC	Ax. Level
○ Sleeve	2025 mm (Rod 17)
□ Sleeve	2025 mm (Rod 18)

Decay Heat 120% ANS Standard
 Flooding Rate (cold) 5.77 cm/s
 System Pressure 4.05 bar
 Feedwater Temperature 40 C

— 483 —



Fig. 443 FEBA: 5x5 ROD BUNDLE, TEST SERIES 8, TEST-No. 336

Cladding Temperature

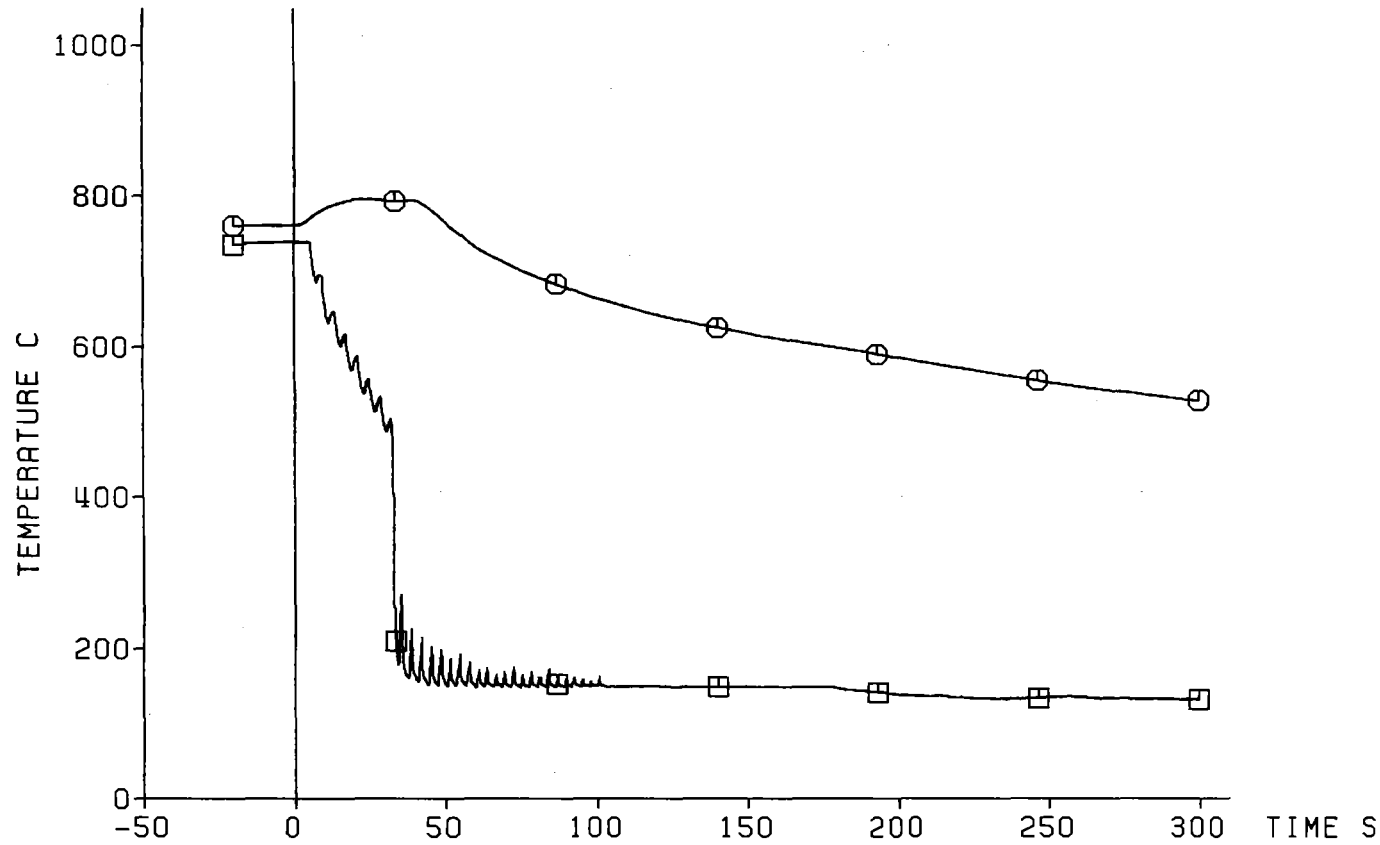

TC	Ax. Level
⊙ 1713	1975 mm
⊠ Sleeve	1972 mm

Decay Heat 120% ANS Standard
 Flooding Rate (cold) 5.77 cm/s
 System Pressure 4.05 bar
 Feedwater Temperature 40 C



Fig. 444 FEBA: 5x5 ROD BUNDLE, TEST SERIES 8, TEST-No. 336

TC	Ax. Level
* 19g4	1925 mm
◇ 17i1	1875 mm
△ 19g3	1825 mm
○ 19g2	1725 mm
□ 19g1	1625 mm

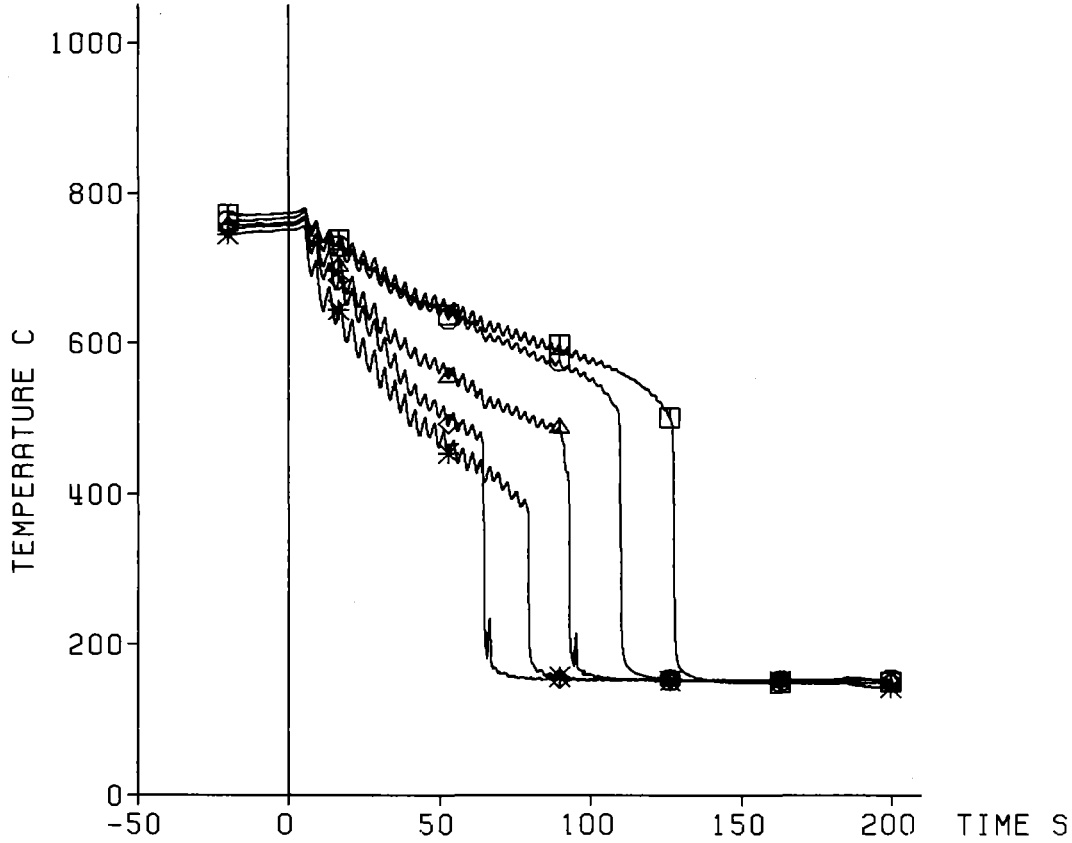

Decay Heat 120% ANS Standard
Flooding Rate (cold) 5.77 cm/s
System Pressure 4.05 bar
Feedwater Temperature 40 C



Fig. 446 FEBA: 5x5 ROD BUNDLE, TEST SERIES 8, TEST-No. 336

Cladding Temperature

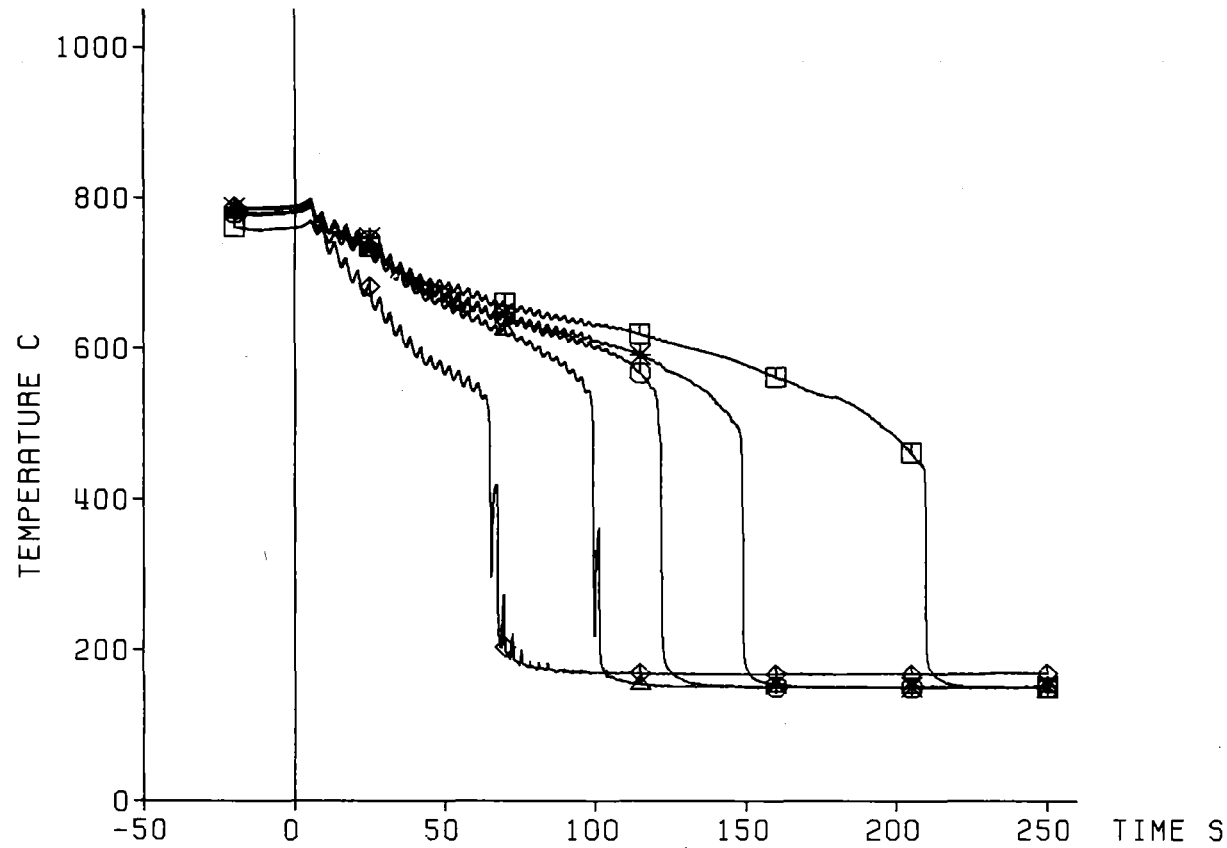

TC	Ax. Level
* 12j4	1525 mm
◇ 12j3	1425 mm
△ 12j2	1325 mm
○ 12j1	1225 mm
□ 8b3	1135 mm

Decay Heat 120% ANS Standard
 Flooding Rate (cold) 5.77 cm/s
 System Pressure 4.05 bar
 Feedwater Temperature 40 C



Fig. 448 FEBA: 5x5 ROD BUNDLE, TEST SERIES 8, TEST-No. 336

Heat Transfer Coeff.

	TC	Ax. Level
*	12j4	1525 mm
◇	12j3	1425 mm
△	12j2	1325 mm
○	12j1	1225 mm
□	8b3	1135 mm

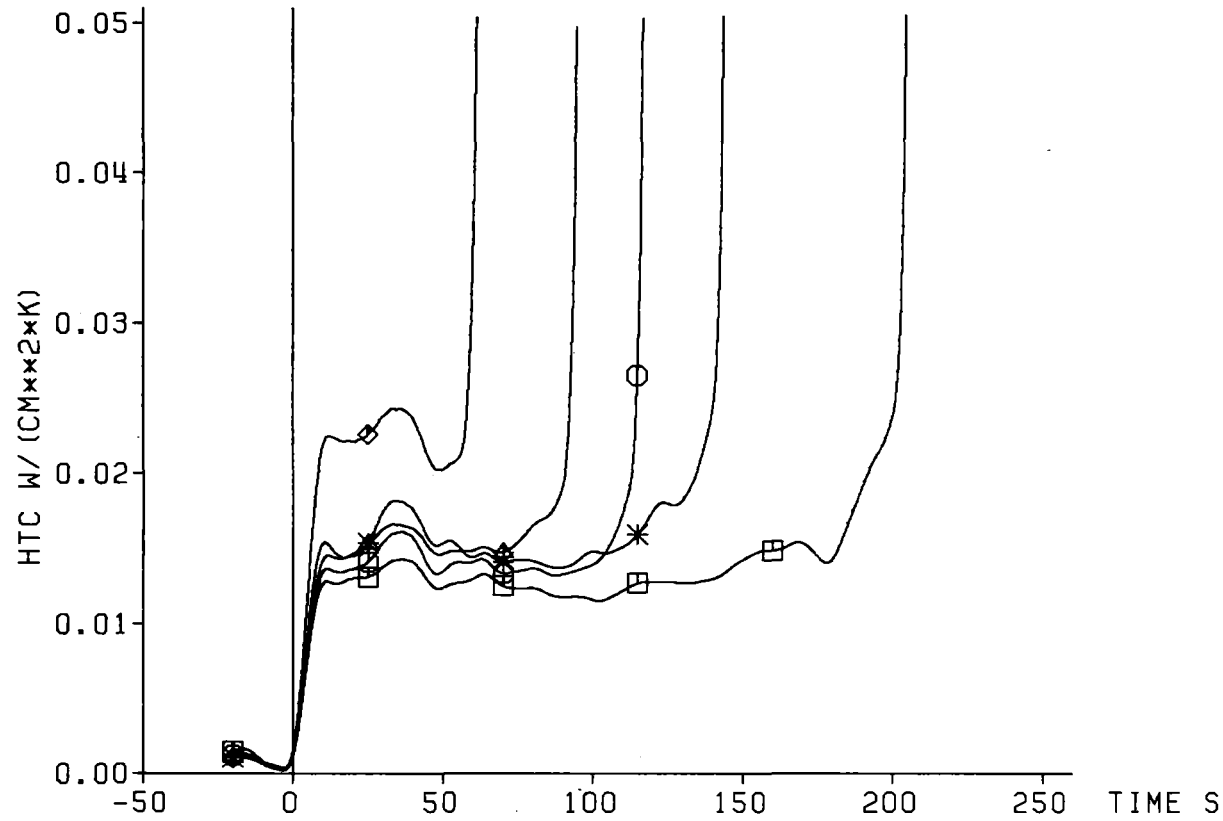

Decay Heat 120% ANS Standard
 Flooding Rate (cold) 5.77 cm/s
 System Pressure 4.05 bar
 Feedwater Temperature 40 C



Fig. 449 FEBA: 5x5 ROD BUNDLE, TEST SERIES 8, TEST-No. 336

Grid Spacer Temperature

TC	Axial Level
□ 69	2535 mm

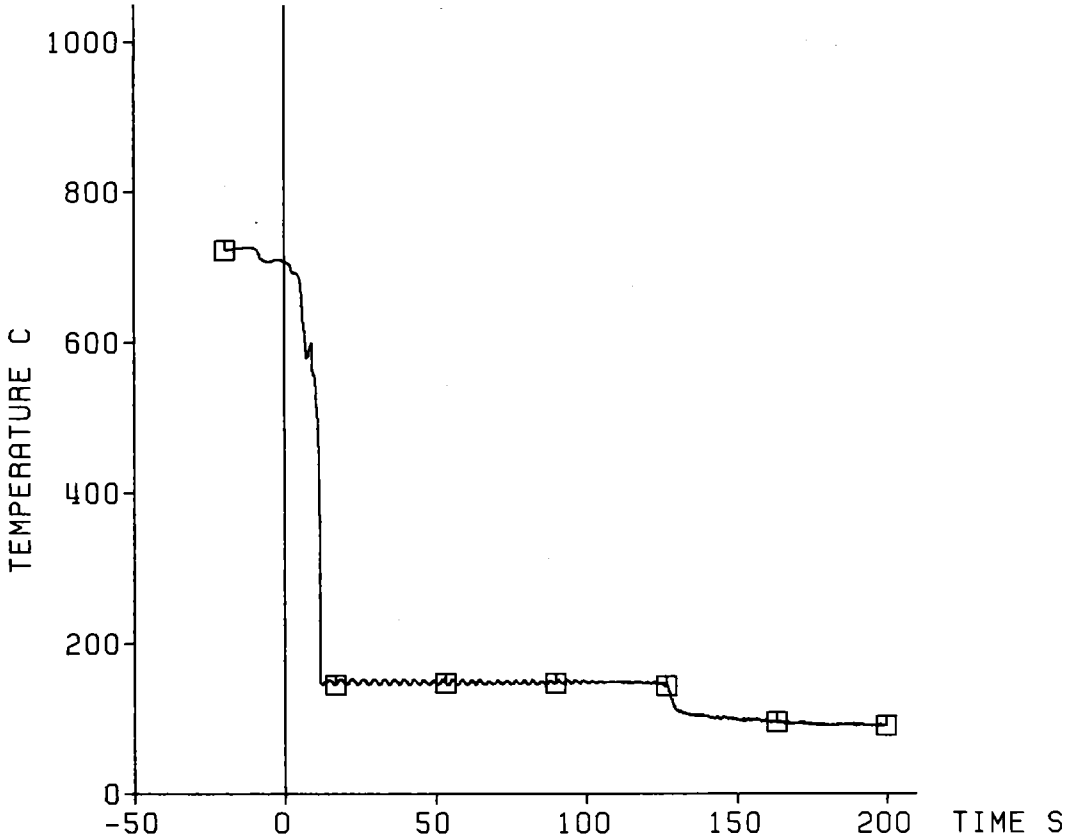

Decay Heat 120% ANS Standard
Flooding Rate (cold) 5.77 cm/s
System Pressure 4.05 bar
Feedwater Temperature 40 C



Fig. 450 FEBA: 5x5 ROD BUNDLE, TEST SERIES 8, TEST-No. 336

Grid Spacer Temperature

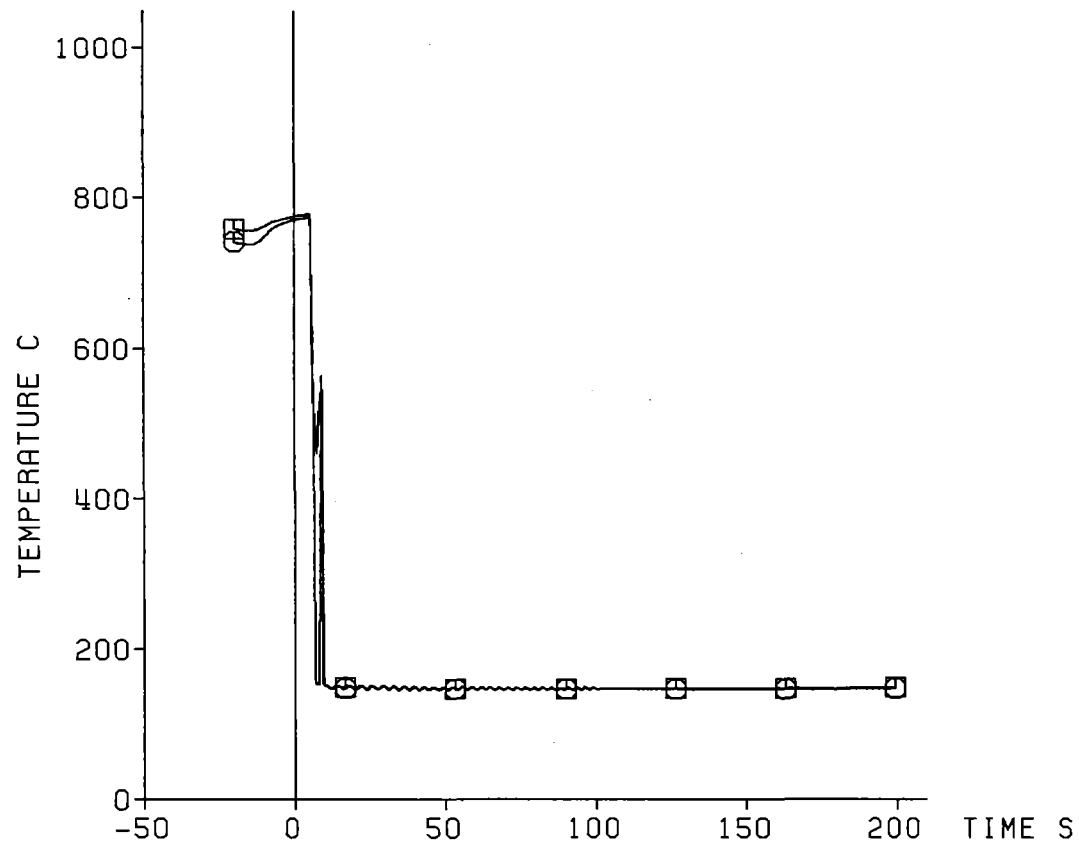

TC	Axial Level
□ 67	1425 mm
○ 66	1425 mm

Decay Heat 120% ANS Standard
 Flooding Rate (cold) 5.77 cm/s
 System Pressure 4.05 bar
 Feedwater Temperature 40 C



Fig. 451 FEBA: 5x5 ROD BUNDLE, TEST SERIES 8, TEST-No. 336

Axial Level: 2770 mm

▲ Cladding Temperature (7a2)
○ Fluid Temperature
□ Housing Temperature

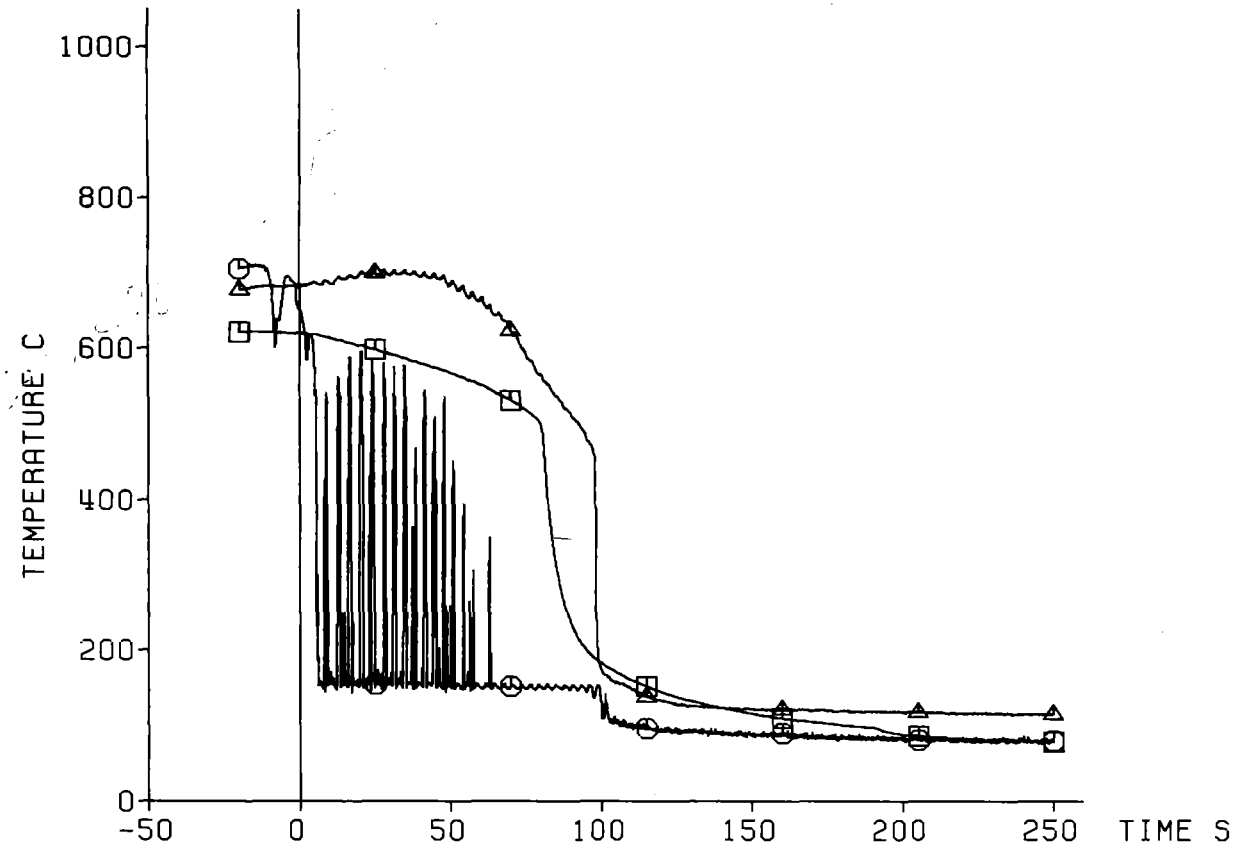

Decay Heat 120% ANS Standard
Flooding Rate (cold) 5.77 cm/s
System Pressure 4.05 bar
Feedwater Temperature 40 C



Fig. 452 FEBA: 5x5 ROD BUNDLE, TEST SERIES 8, TEST-No. 336

Axial Level: 2225 mm

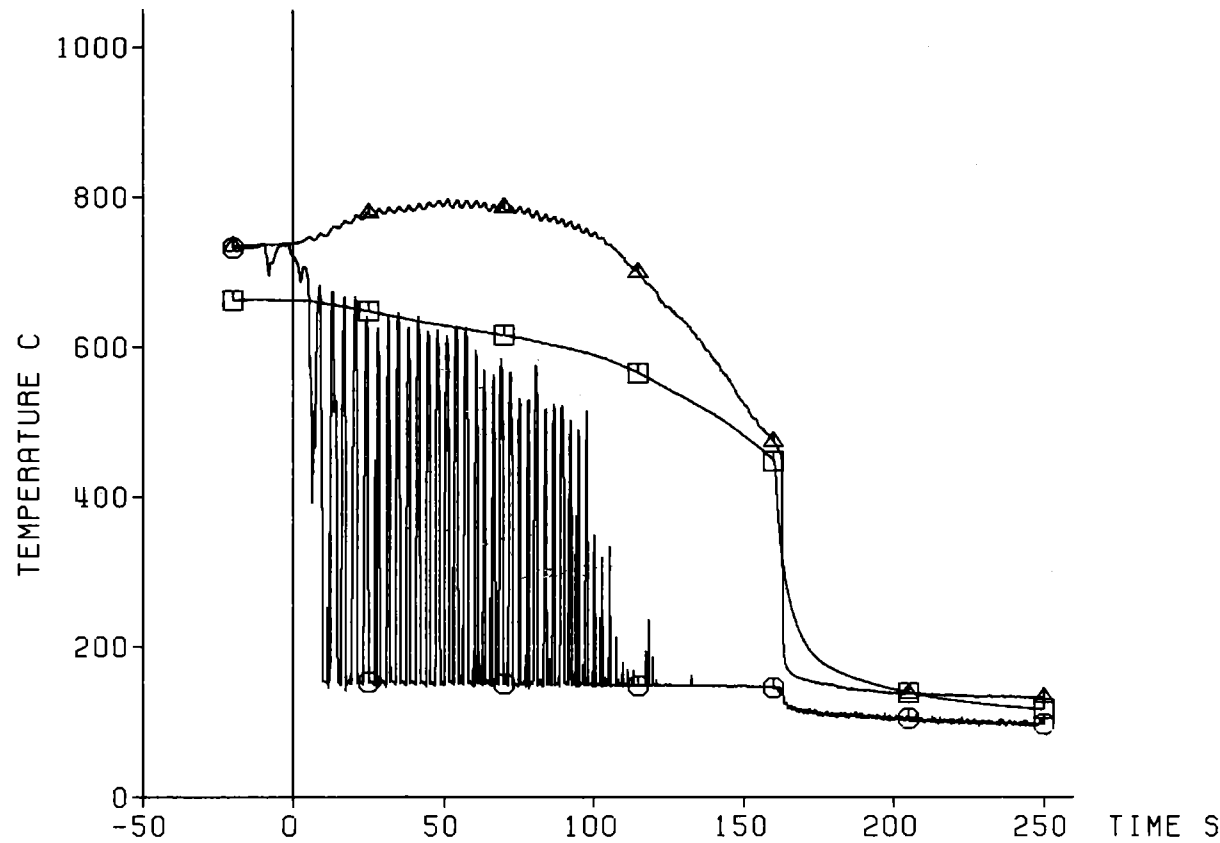

△ Cladding Temperature (7a1)
○ Fluid Temperature (2240 mm)
□ Housing Temperature (2235 mm)

Decay Heat 120% ANS Standard
Flooding Rate (cold) 5.77 cm/s
System Pressure 4.05 bar
Feedwater Temperature 40 C

— 493 —



Fig. 453 FEBA: 5x5 ROD BUNDLE, TEST SERIES 8, TEST-NO. 336

Axial Level: 1925 mm

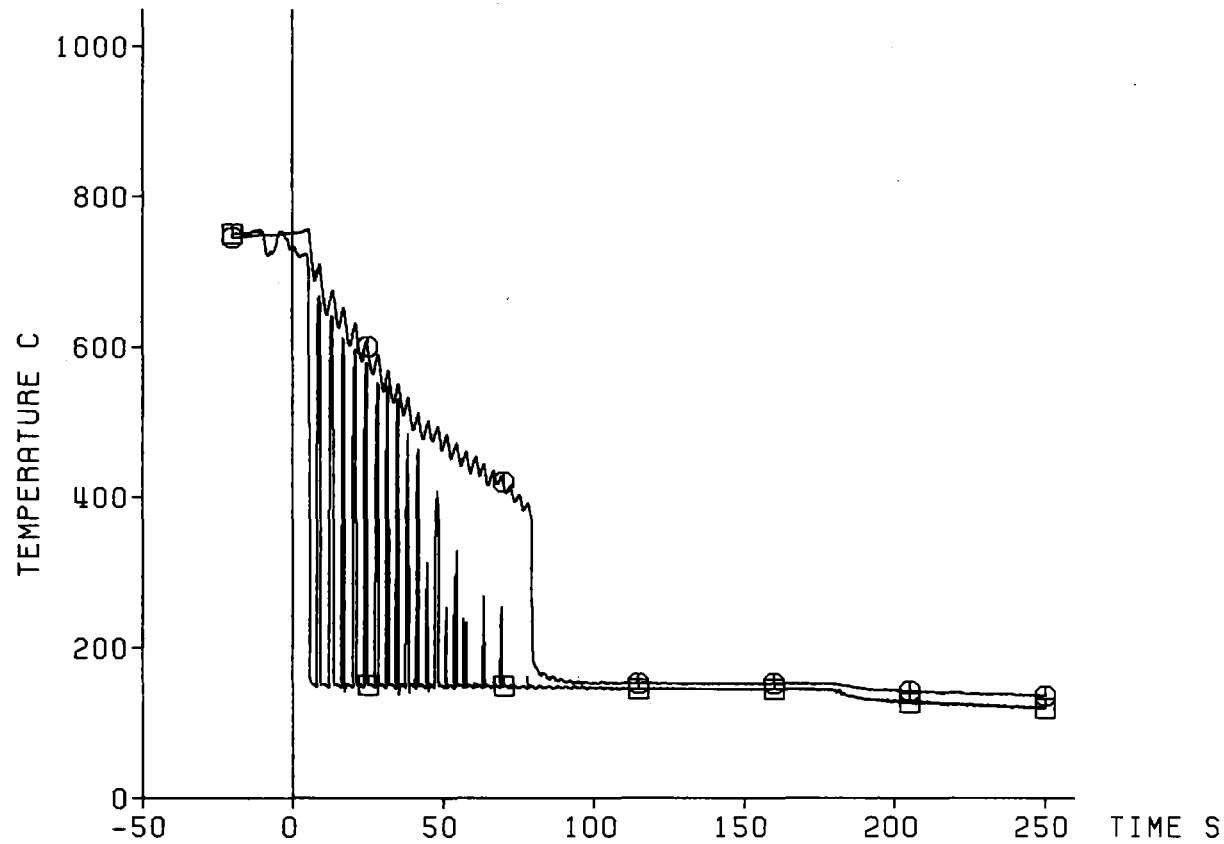

△ Cladding Temperature (19g4)
○ Fluid Temperature

Decay Heat 120% ANS Standard
Flooding Rate (cold) 5.77 cm/s
System Pressure 4.05 bar
Feedwater Temperature 40 C

— 494 —



Fig. 454 FEBA: 5x5 ROD BUNDLE, TEST SERIES 8, TEST-No. 336

Axial Level: 1825 mm

△ Cladding Temperature (19g3)
○ Fluid Temperature
□ Housing Temperature

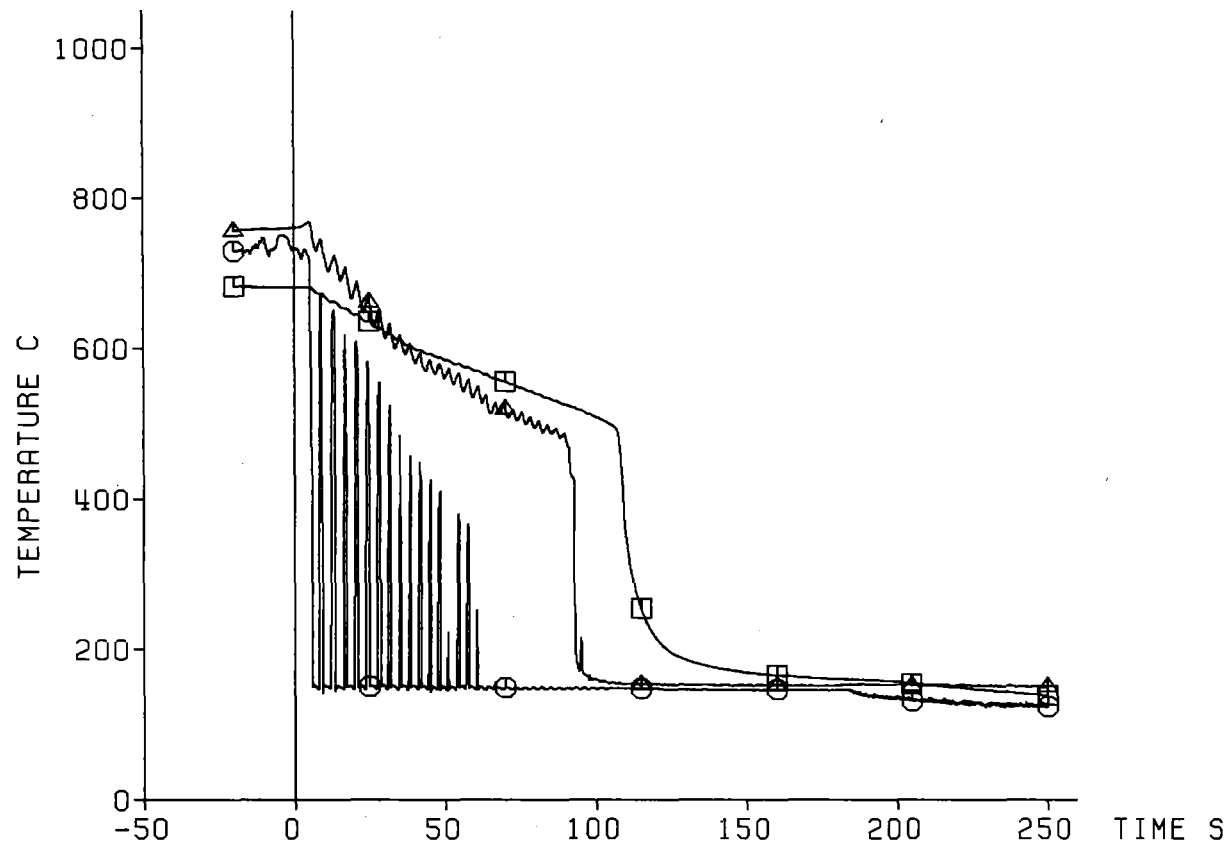

Decay Heat 120% ANS Standard
Flooding Rate (cold) 5.77 cm/s
System Pressure 4.05 bar
Feedwater Temperature 40 C

KIK
IRB

Fig. 455 FEBA: 5x5 ROD BUNDLE, TEST SERIES 8, TEST-NO. 336

Axial Level: 1725 mm

△ Cladding Temperature (19g2)
○ Fluid Temperature

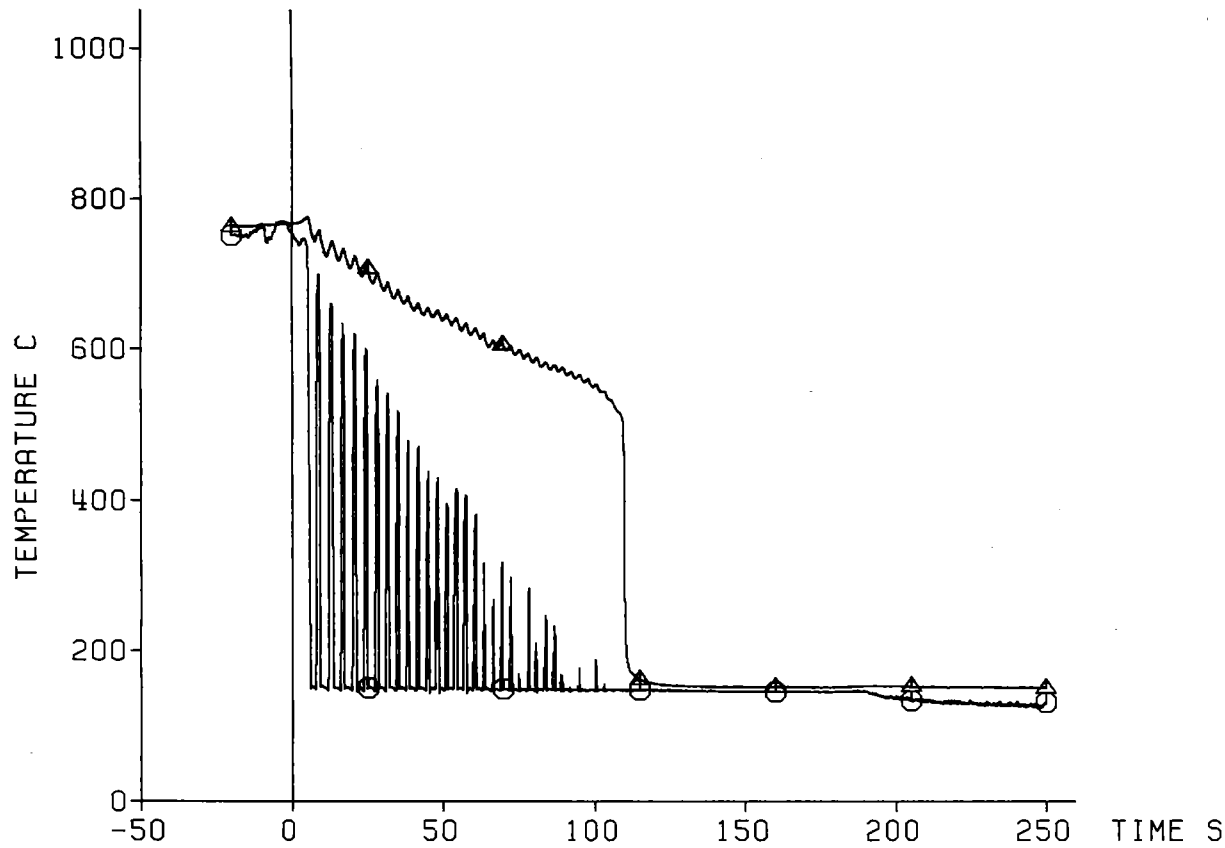

Decay Heat 120% ANS Standard
Flooding Rate (cold) 5.77 cm/s
System Pressure 4.05 bar
Feedwater Temperature 40 C

— 456 —



Fig. 456 FEBA: 5x5 ROD BUNDLE, TEST SERIES 8, TEST-NO. 336

Axial Level: 1625 mm

△ Cladding Temperature (19g1)
○ Fluid Temperature
□ Housing Temperature

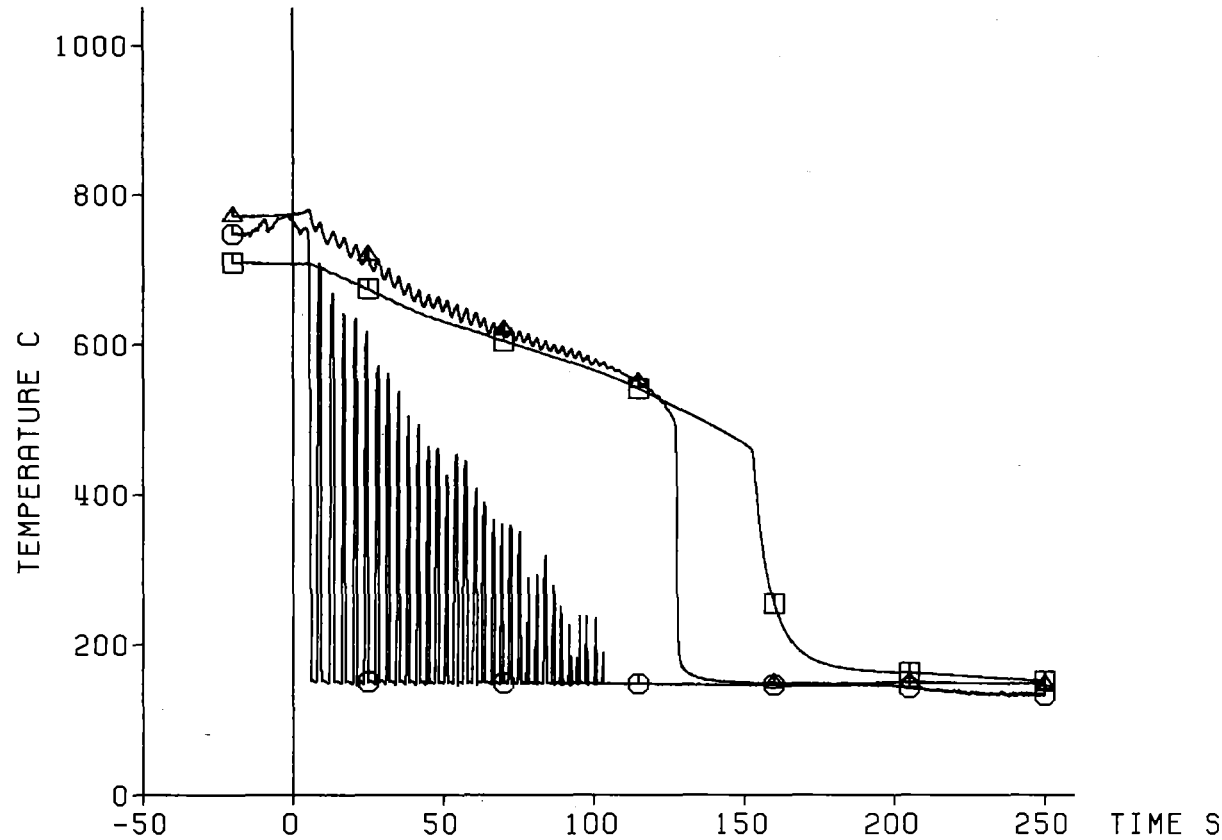

Decay Heat 120% ANS Standard
Flooding Rate (cold) 5.77 cm/s
System Pressure 4.05 bar
Feedwater Temperature 40 C

KFK IRB

Fig. 457 FEBA: 5x5 ROD BUNDLE, TEST SERIES 8, TEST-No. 336

Axial Level: 1135 mm

△ Cladding Temperature (8b3)
○ Fluid Temperature
□ Housing Temperature

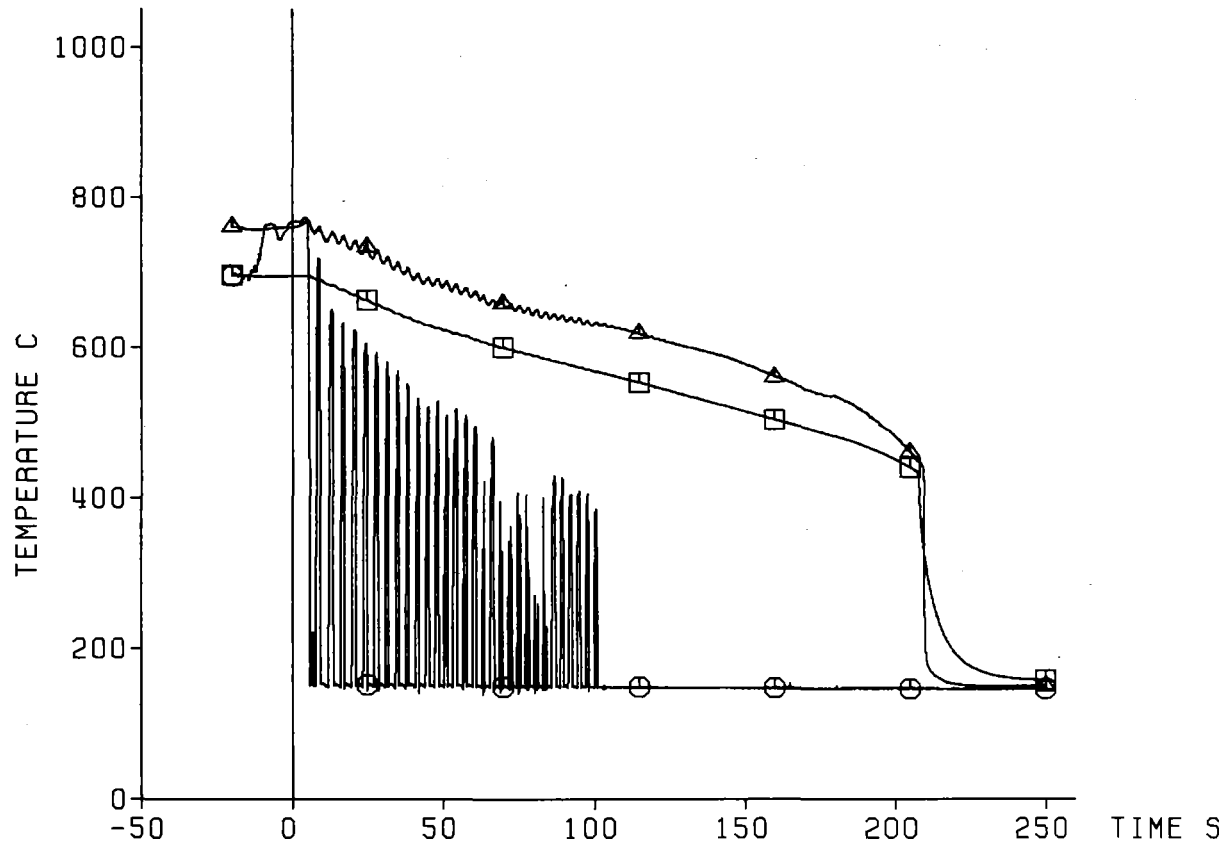

Decay Heat 120% ANS Standard
Flooding Rate (cold) 5.77 cm/s
System Pressure 4.05 bar
Feedwater Temperature 40 C

— 498 —



Fig. 458 FEBA: 5x5 ROD BUNDLE, TEST SERIES 8, TEST-NO. 336

Pressure Loss
Along the Test Section:

◇ Total Length: 4196 mm
△ Lower Part: 1711 mm
○ Middle Part: 545 mm
□ Upper Part: 1940 mm

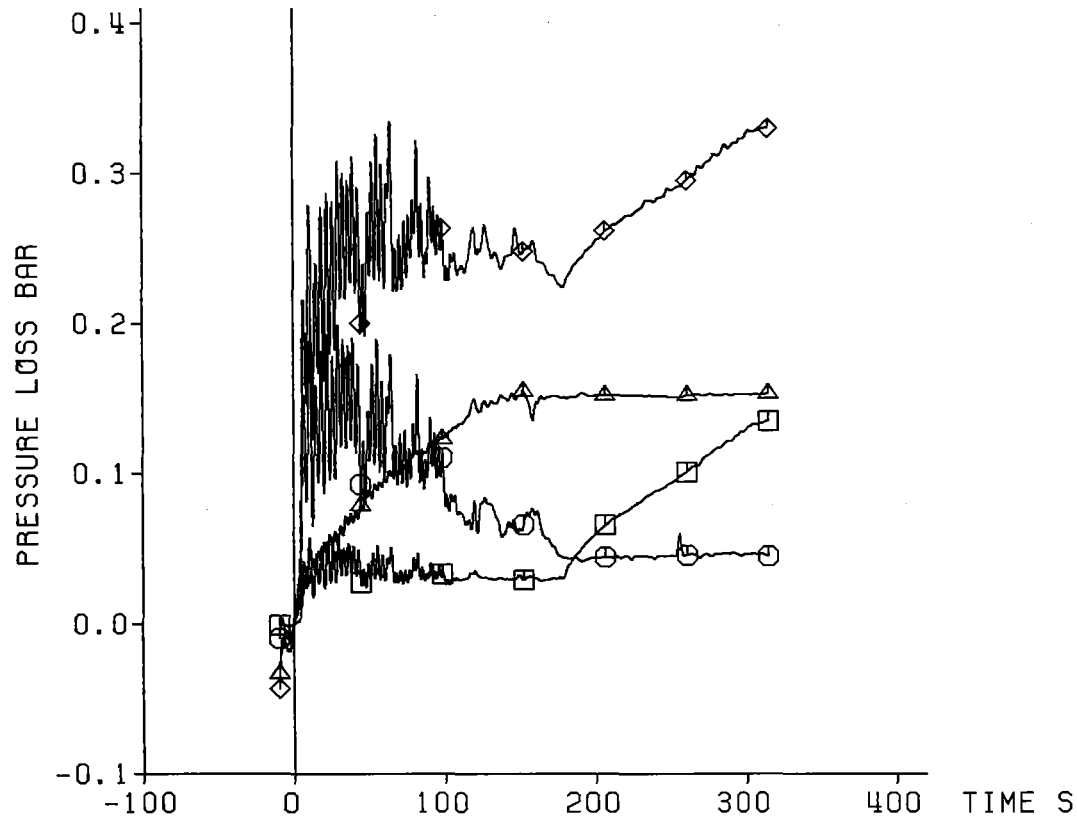

Decay Heat 120% ANS Standard
Flooding Rate (cold) 5.77 cm/s
System Pressure 4.05 bar
Feedwater Temperature 40 C



Fig. 459 FEBA: 5x5 ROD BUNDLE, TEST SERIES 8, TEST-No. 336

Coolant Outlet Conditions:

△ Water Carry Over
○ Coolant Temperature
□ Coolant Pressure

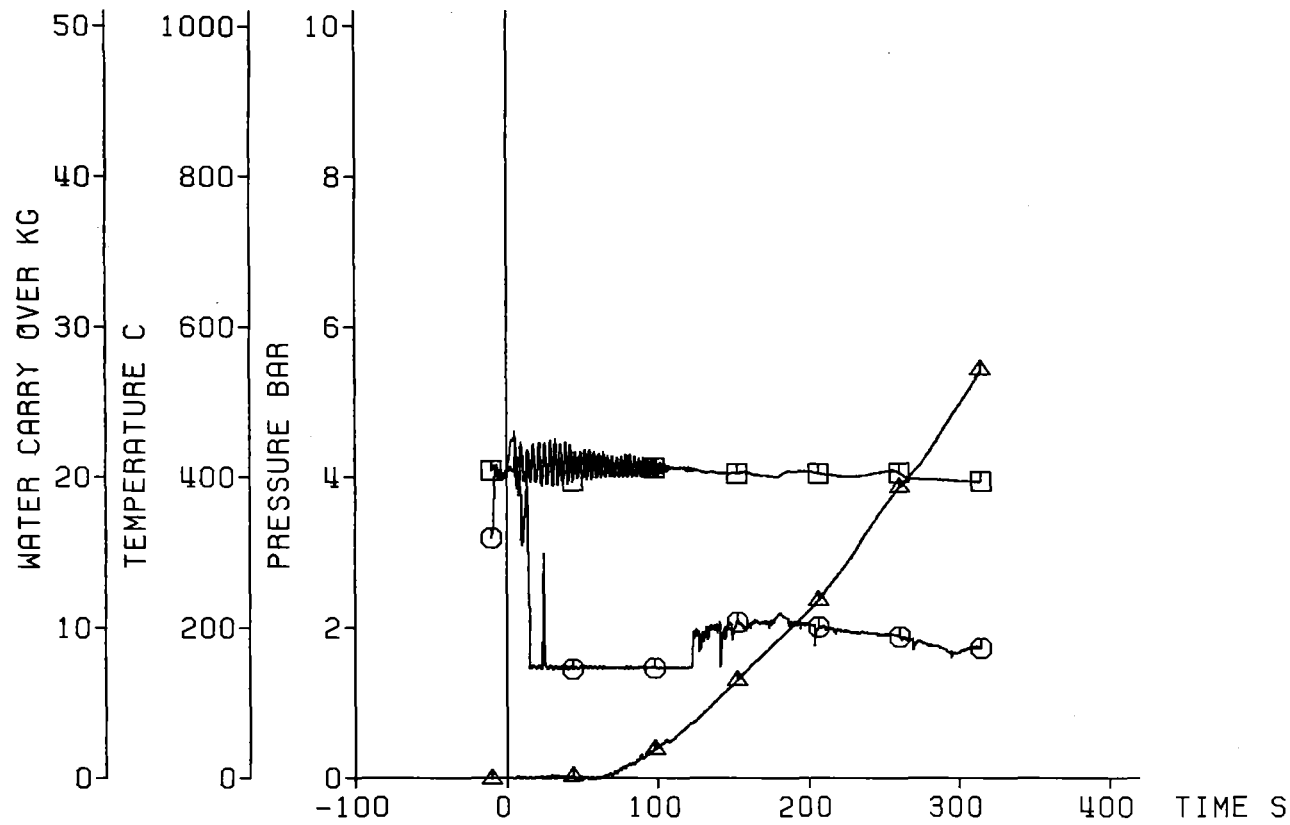

Decay Heat 120% ANS Standard
Flooding Rate (cold) 5.77 cm/s
System Pressure 4.05 bar
Feedwater Temperature 40 C

— 500 —



Fig. 460 FEBA: 5x5 ROD BUNDLE, TEST SERIES 8, TEST-NO. 336

Axial Position of Quench Front

□ Quenching of Sleeves at Bundle Midplane

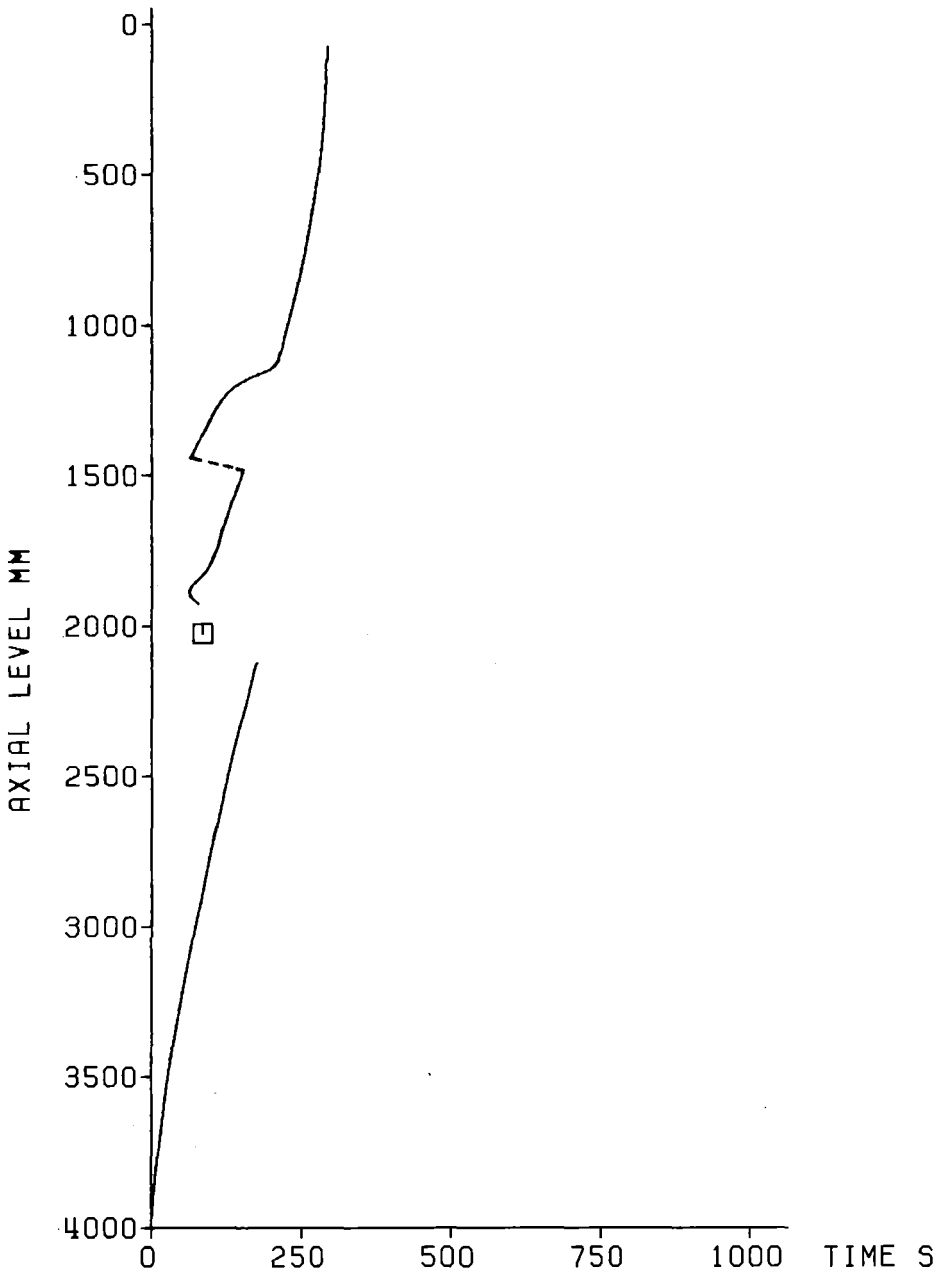

Decay Heat	120% ANS Standard
Flooding Rate (cold)	5.77 cm/s
System Pressure	4.05 bar
Feedwater Temperature	40 C



Fig. 461 FEBA: 5x5 ROD BUNDLE
TEST SERIES 8, TEST-No. 336

Initial Axial Temperature Profile of Claddings

□ Initial Temperature of Sleeves at Bundle Midplane

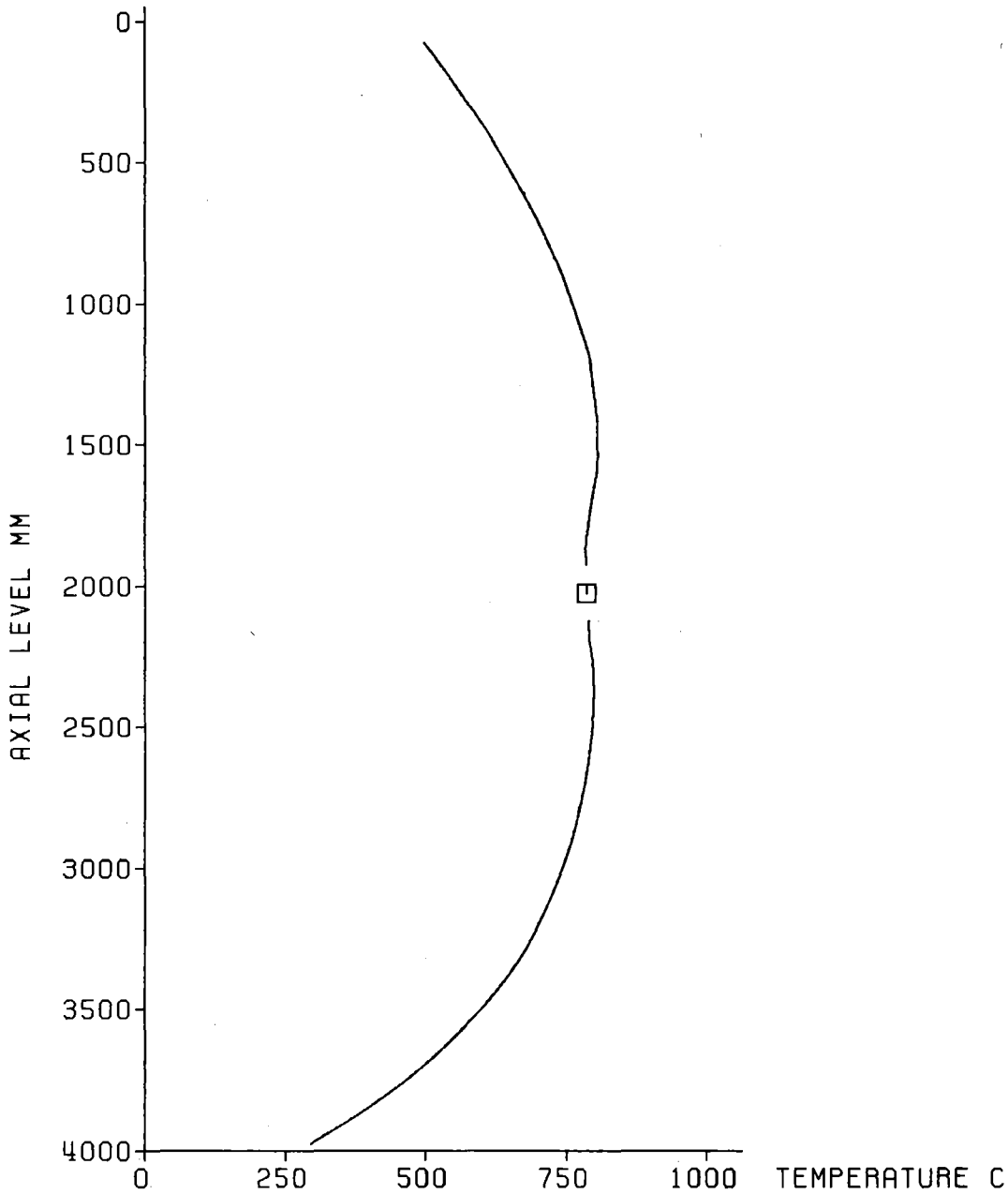

Decay Heat	120% ANS Standard
Flooding Rate (cold)	5.77 cm/s
System Pressure	5.83 bar
Feedwater Temperature	40 C



Fig. 462 FEBA: 5x5 ROD BUNDLE
TEST SERIES 8, TEST-NO. 333

Test Parameters:

- ◇ Flooding Rate
- △ System Pressure
- Feedwater Temperature
- Bundle Power

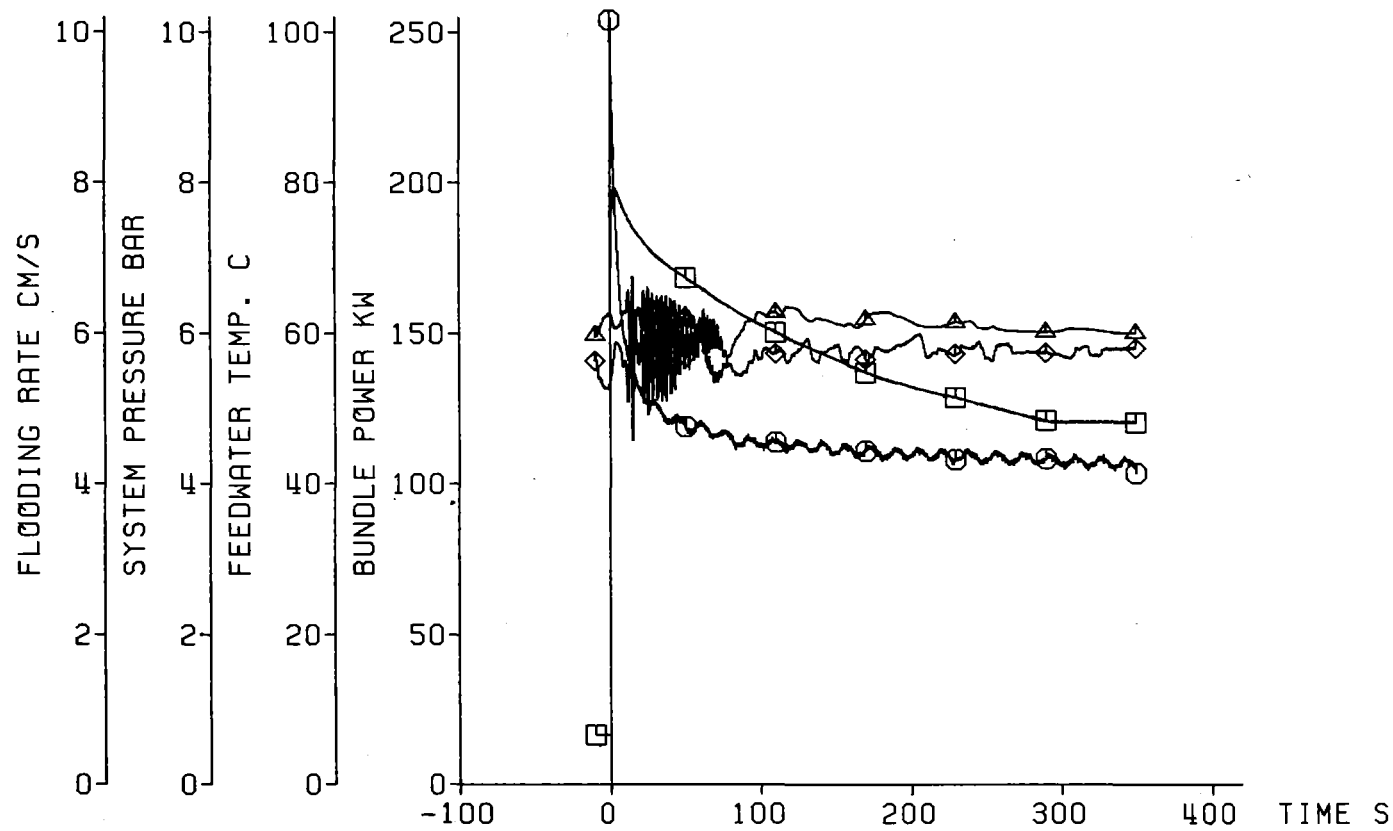

Decay Heat 120% ANS Standard
Flooding Rate (cold) 5.77 cm/s
System Pressure 5.83 bar
Feedwater Temperature 40 C



Fig. 463 FEBA: 5x5 ROD BUNDLE, TEST SERIES 8, TEST-No. 333

Cladding Temperature

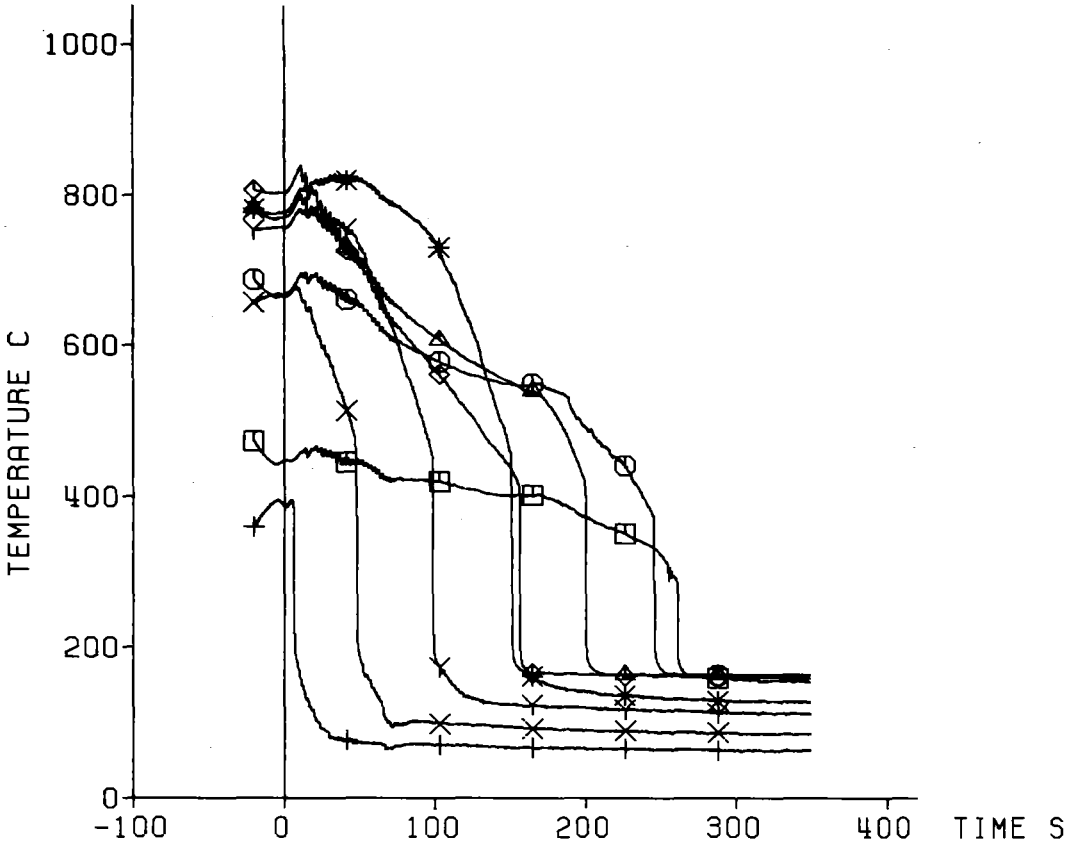

TC	Ax. Level
+	7a4 3860 mm
X	7a3 3315 mm
Y	7a2 2770 mm
*	7a1 2225 mm
◇	8b4 1680 mm
△	8b3 1135 mm
○	8b2 590 mm
□	3b1 45 mm

Decay Heat 120% ANS Standard
 Flooding Rate (cold) 5.77 cm/s
 System Pressure 5.83 bar
 Feedwater Temperature 40 C



Fig. 464 FEBA: 5x5 ROD BUNDLE, TEST SERIES 8, TEST-No. 333

Heat Transfer Coeff.

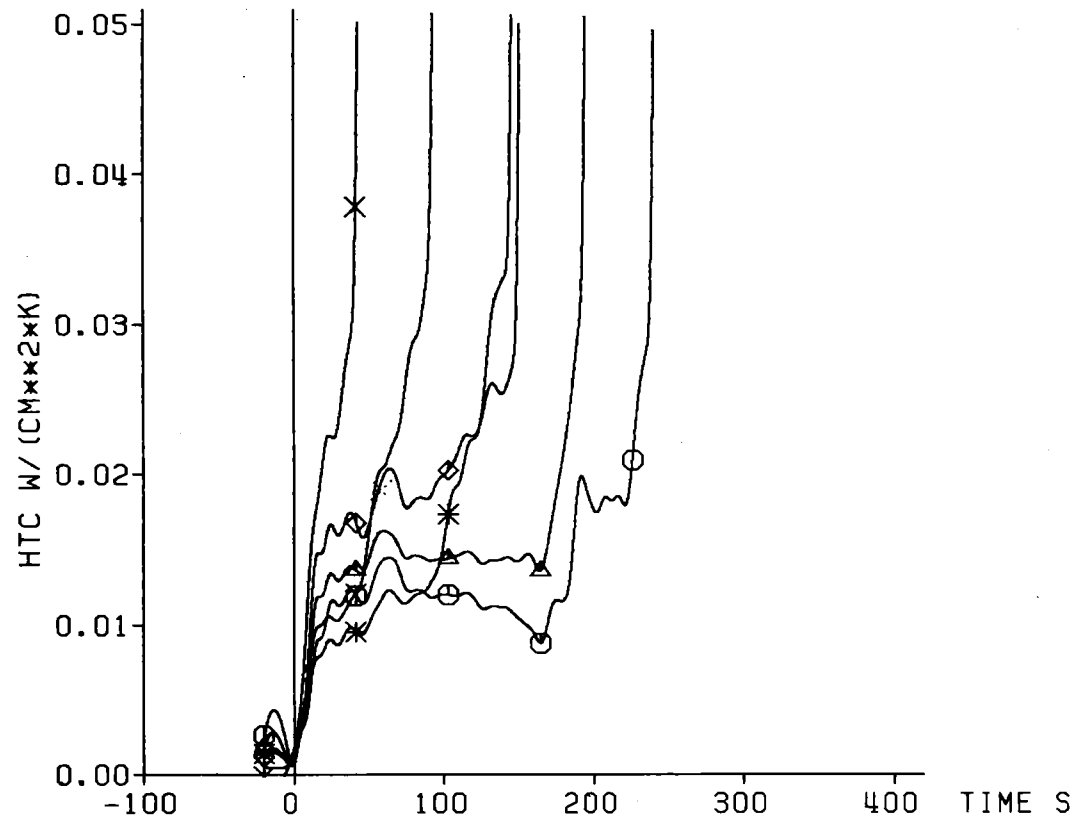

	TC	Ax. Level
X	7a3	3315 mm
Y	7a2	2770 mm
*	7a1	2225 mm
◇	8b4	1680 mm
△	8b3	1135 mm
○	8b2	590 mm

Decay Heat 120% ANS Standard
 Flooding Rate (cold) 5.77 cm/s
 System Pressure 5.83 bar
 Feedwater Temperature 40 C



Fig. 465 FEBA: 5x5 ROD BUNDLE, TEST SERIES 8, TEST-No. 333

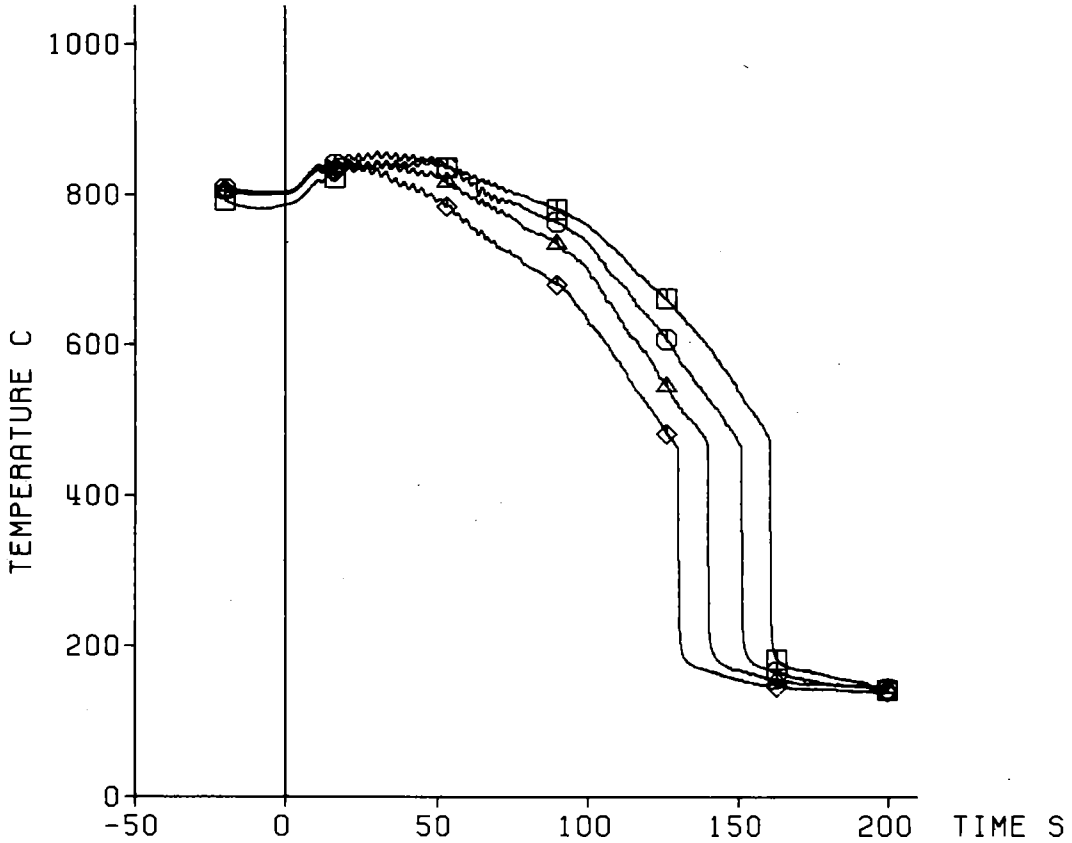

TC	Ax. Level
◇	14f4 2425 mm
△	14f3 2325 mm
○	14h2 2225 mm
□	14f1 2125 mm

Decay Heat 120% ANS Standard
Flooding Rate (cold) 5.77 cm/s
System Pressure 5.83 bar
Feedwater Temperature 40 C



Fig. 466 FEBA: 5x5 ROD BUNDLE, TEST SERIES 8, TEST-No. 333

Heat Transfer Coeff.

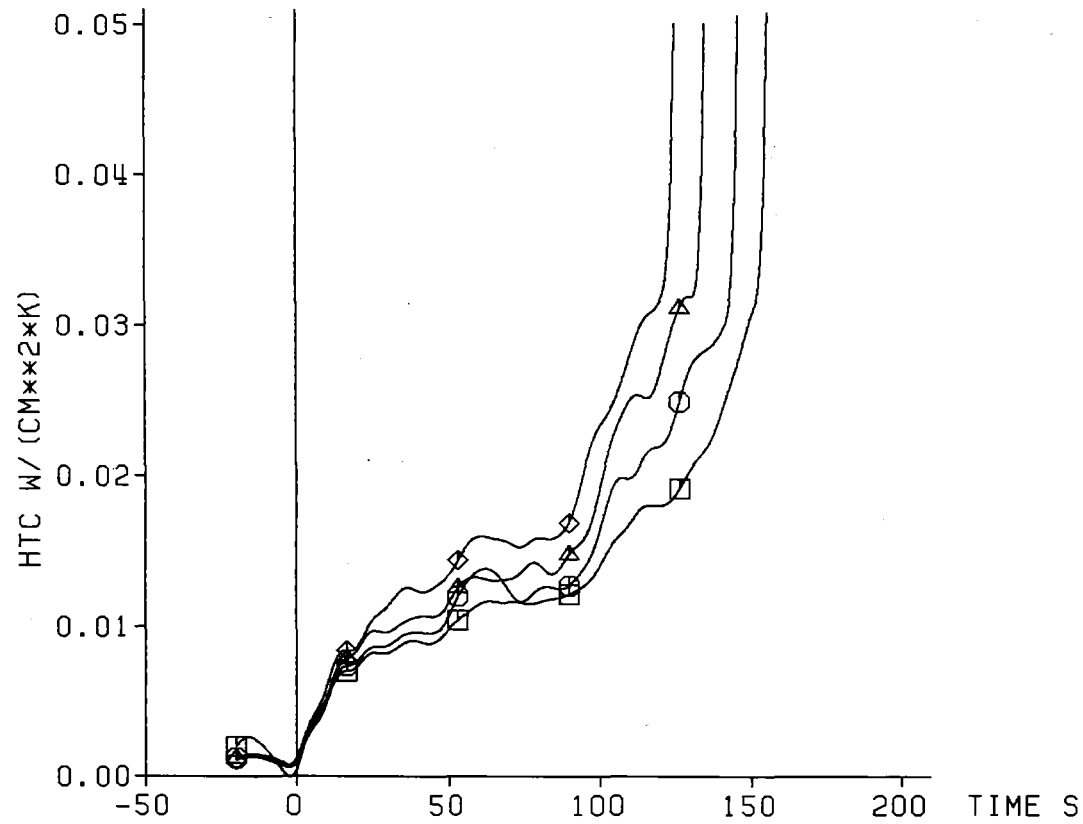

	TC	Ax. Level
◇	14f4	2425 mm
△	14f3	2325 mm
○	14h2	2225 mm
□	14f1	2125 mm

Decay Heat 120% ANS Standard
Flooding Rate (cold) 5.77 cm/s
System Pressure 5.83 bar
Feedwater Temperature 40 C



Fig. 467 FEBA: 5x5 ROD BUNDLE, TEST SERIES 8, TEST-NO. 333

Cladding Temperature

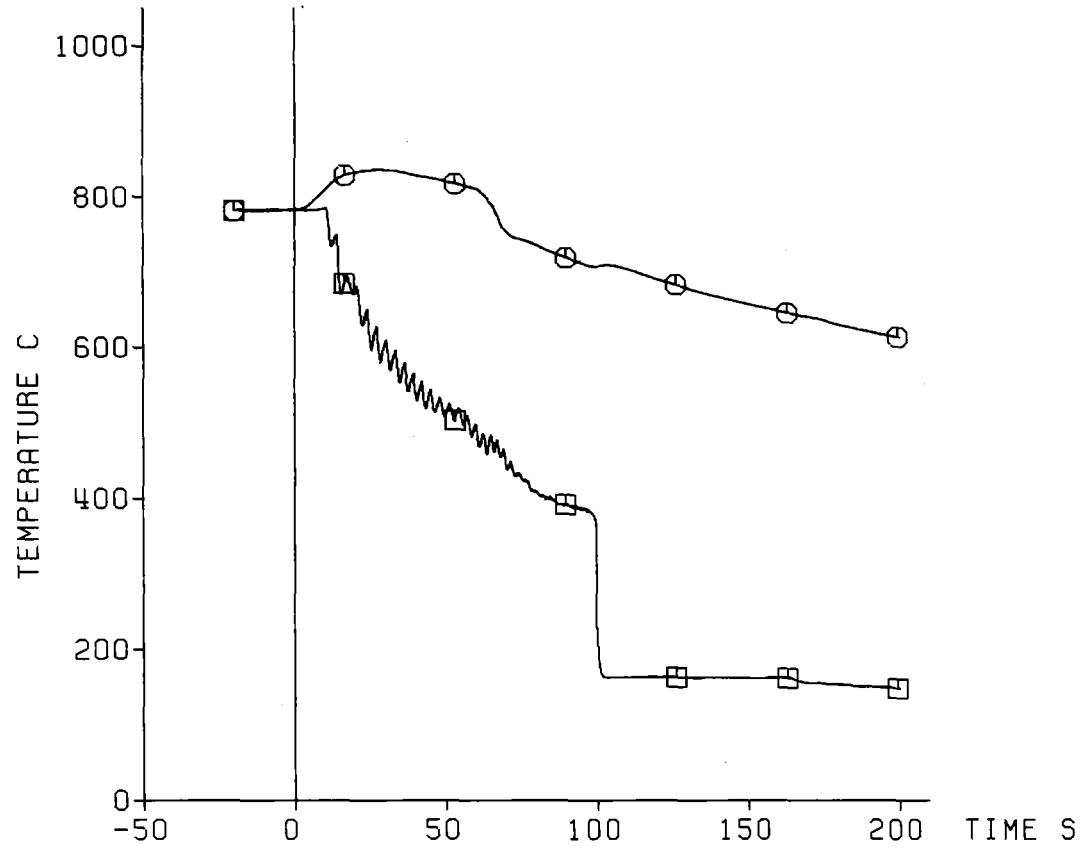

TC	Rx. Level
○ 17i4	2025 mm
□ Sleeve	2025 mm

Decay Heat 120% ANS Standard
 Flooding Rate (cold) 5.77 cm/s
 System Pressure 5.83 bar
 Feedwater Temperature 40 C



Fig. 468 FEBA: 5x5 ROD BUNDLE, TEST SERIES 8, TEST-No. 333

Sleeve Temperature
Contact Face: Rods 17 and 18

TC	Ax. Level
⊕ Sleeve	2025 mm (Rod 17)
⊞ Sleeve	2025 mm (Rod 18)

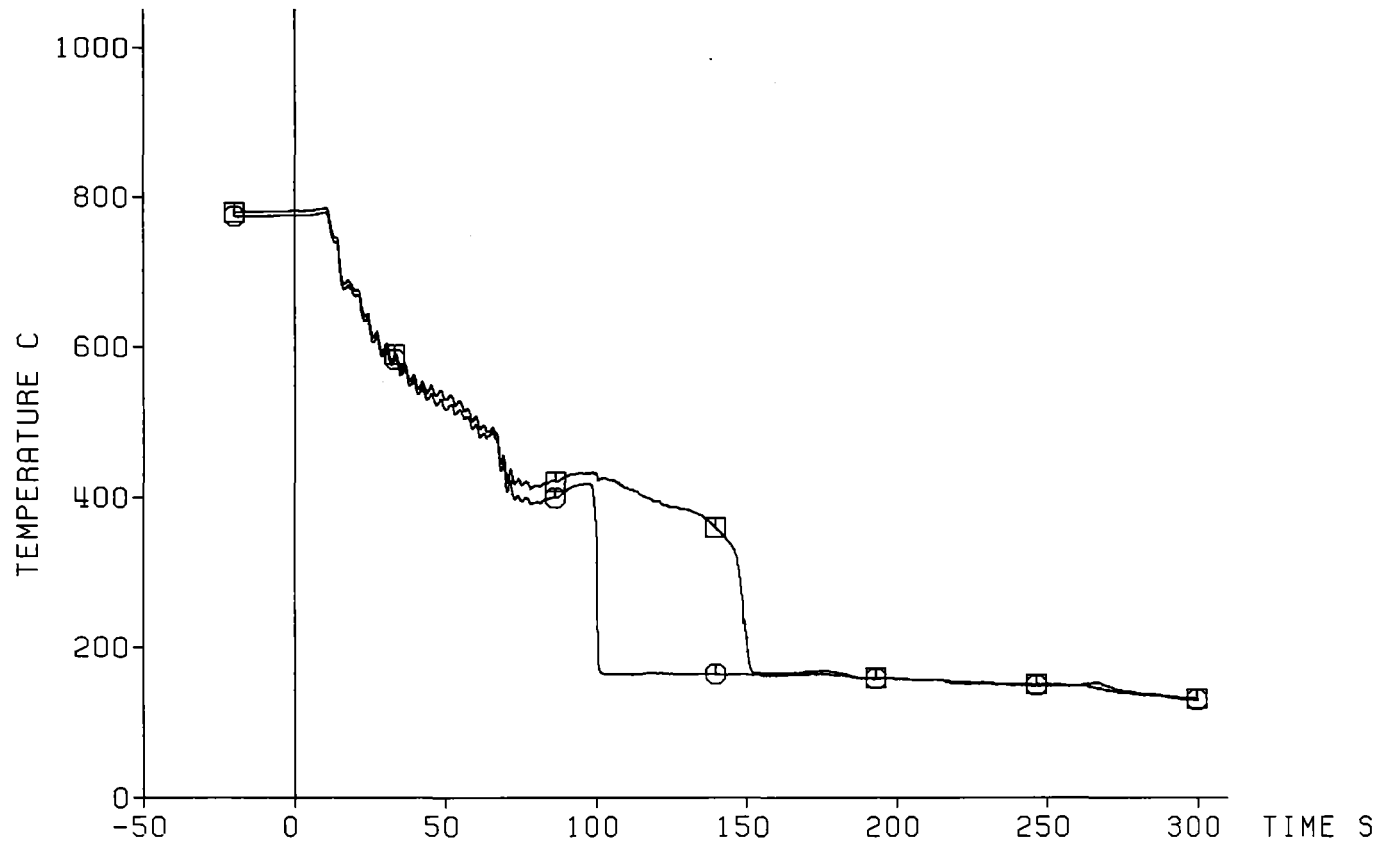

— 509 —

Decay Heat 120% ANS Standard
 Flooding Rate (cold) 5.77 cm/s
 System Pressure 5.83 bar
 Feedwater Temperature 40 C



Fig. 469 FEBA: 5x5 ROD BUNDLE, TEST SERIES 8, TEST-No. 333

Cladding Temperature

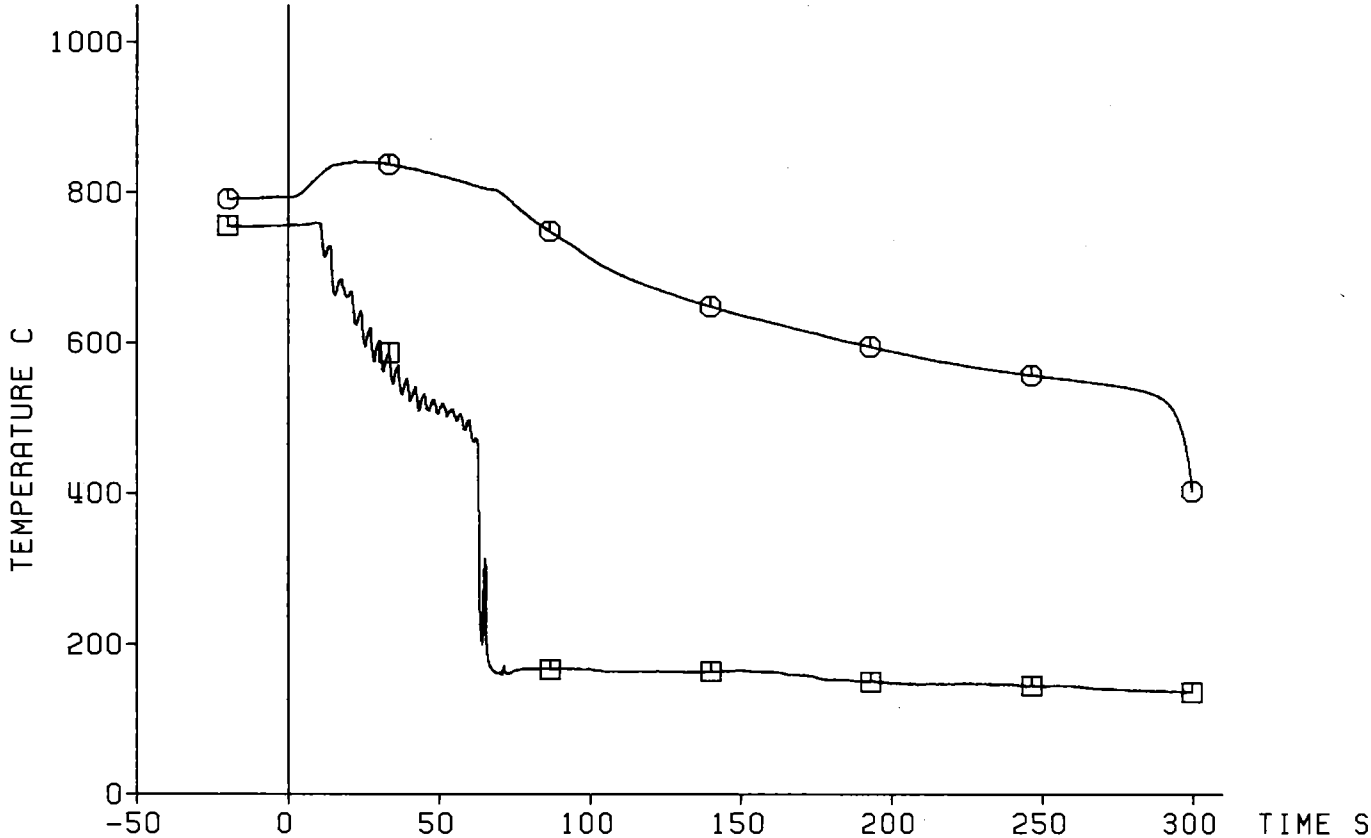

TC	Ax. Level
⊙ 1713	1975 mm
⊠ Sleeve	1972 mm

Decay Heat 120% ANS Standard
 Flooding Rate (cold) 5.77 cm/s
 System Pressure 5.83 bar
 Feedwater Temperature 40 C



Fig. 470 FEBA: 5x5 ROD BUNDLE, TEST SERIES 8, TEST-No. 333

Cladding Temperature

TC	Ax. Level
○ 1714	2025 mm
+ Sleeve	2064 mm
□ Sleeve	2025 mm
△ Sleeve	2025 mm
X Sleeve	1972 mm

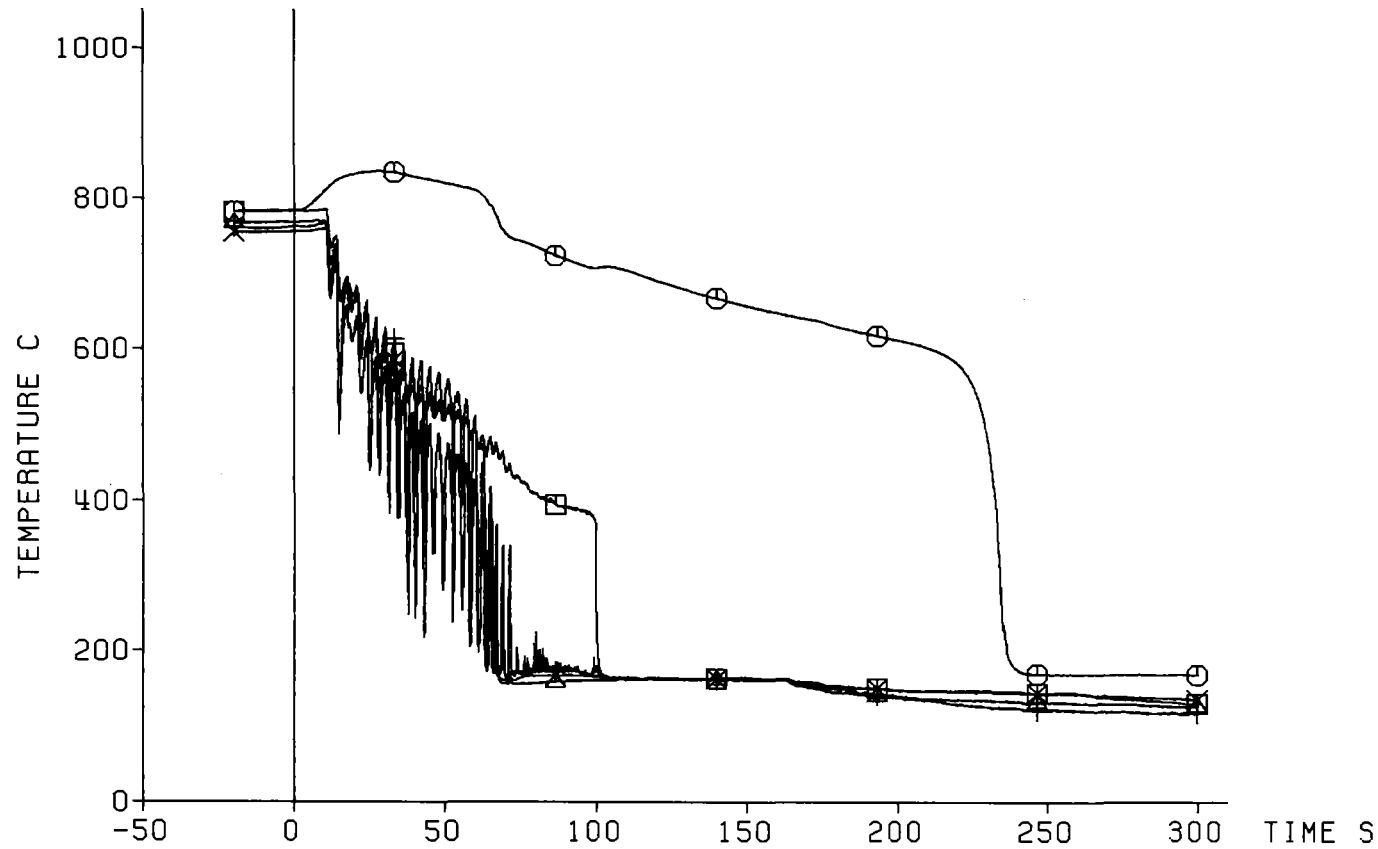

Decay Heat 120% ANS Standard
 Flooding Rate (cold) 5.77 cm/s
 System Pressure 5.83 bar
 Feedwater Temperature 40 C

— 511 —



Fig. 471 FEBA: 5x5 ROD BUNDLE, TEST SERIES 8, TEST-No. 333

Cladding Temperature

TC	Ax. Level
* 19g4	1925 mm
◇ 17i1	1875 mm
△ 19g3	1825 mm
○ 19g2	1725 mm
□ 19g1	1625 mm

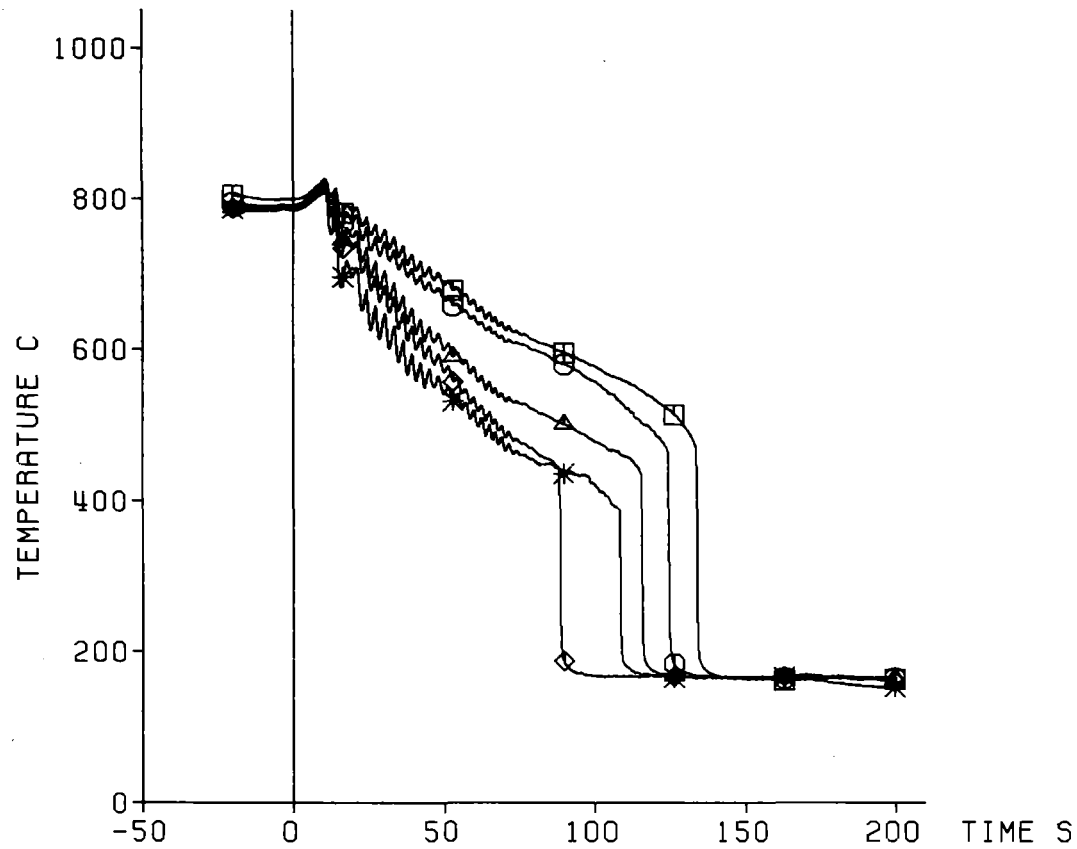

Decay Heat 120% ANS Standard
 Flooding Rate (cold) 5.77 cm/s
 System Pressure 5.83 bar
 Feedwater Temperature 40 C



Fig. 472 FEBA: 5x5 ROD BUNDLE, TEST SERIES 8, TEST-No. 333

Heat Transfer Coeff.

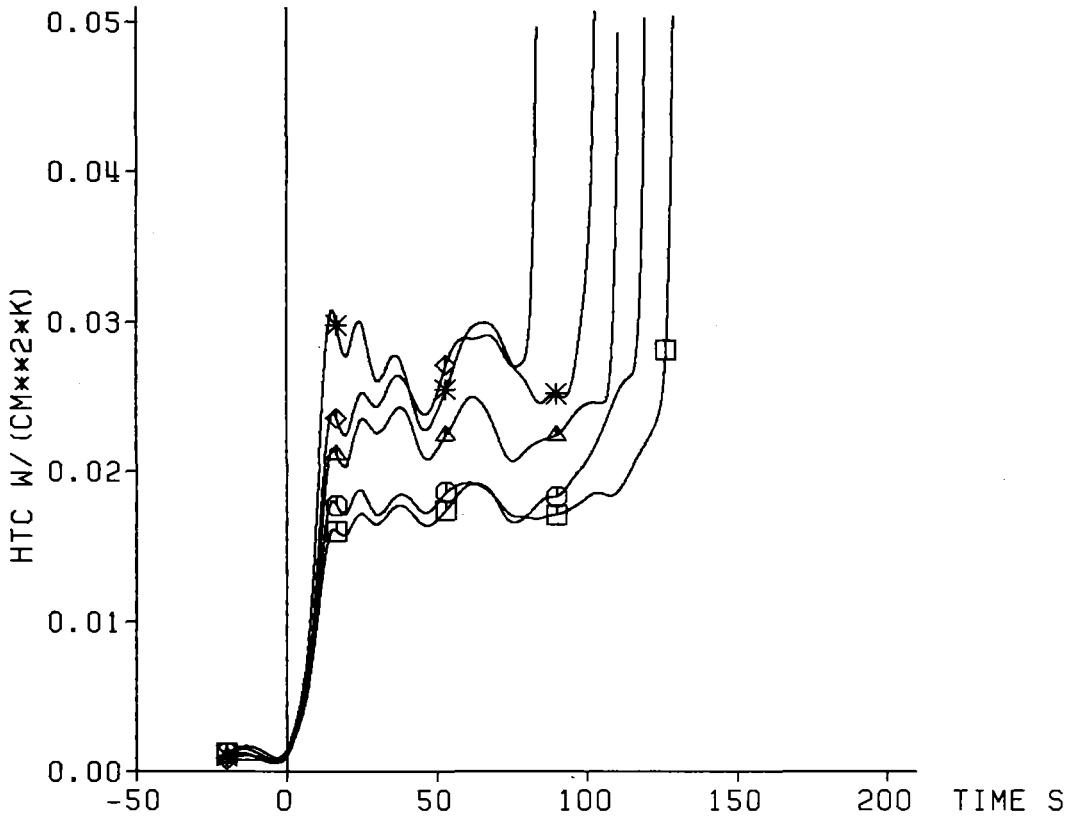

	TC	Ax. Level
*	19g4	1925 mm
◇	17i1	1875 mm
△	19g3	1825 mm
○	19g2	1725 mm
□	19g1	1625 mm

Decay Heat 120% ANS Standard
 Flooding Rate (cold) 5.77 cm/s
 System Pressure 5.83 bar
 Feedwater Temperature 40 C



Fig. 473 FEBA: 5x5 ROD BUNDLE, TEST SERIES 8, TEST-No. 333

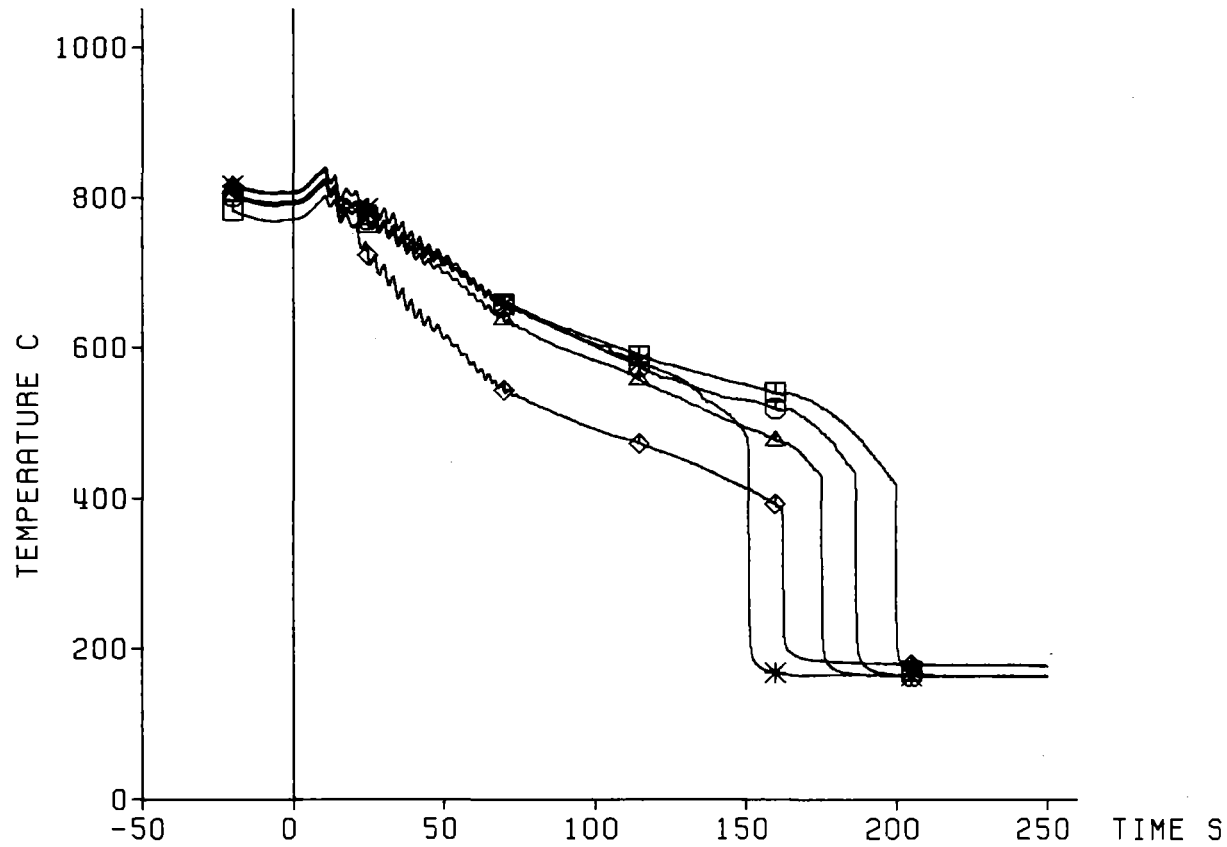

TC	Ax. Level
* 12j4	1525 mm
◇ 12j3	1425 mm
△ 12j2	1325 mm
○ 12j1	1225 mm
□ 8b3	1135 mm

Decay Heat 120% ANS Standard
 Flooding Rate (cold) 5.77 cm/s
 System Pressure 5.83 bar
 Feedwater Temperature 40 C



Fig. 474 FEBA: 5x5 ROD BUNDLE, TEST SERIES 8, TEST-No. 333

Grid Spacer Temperature

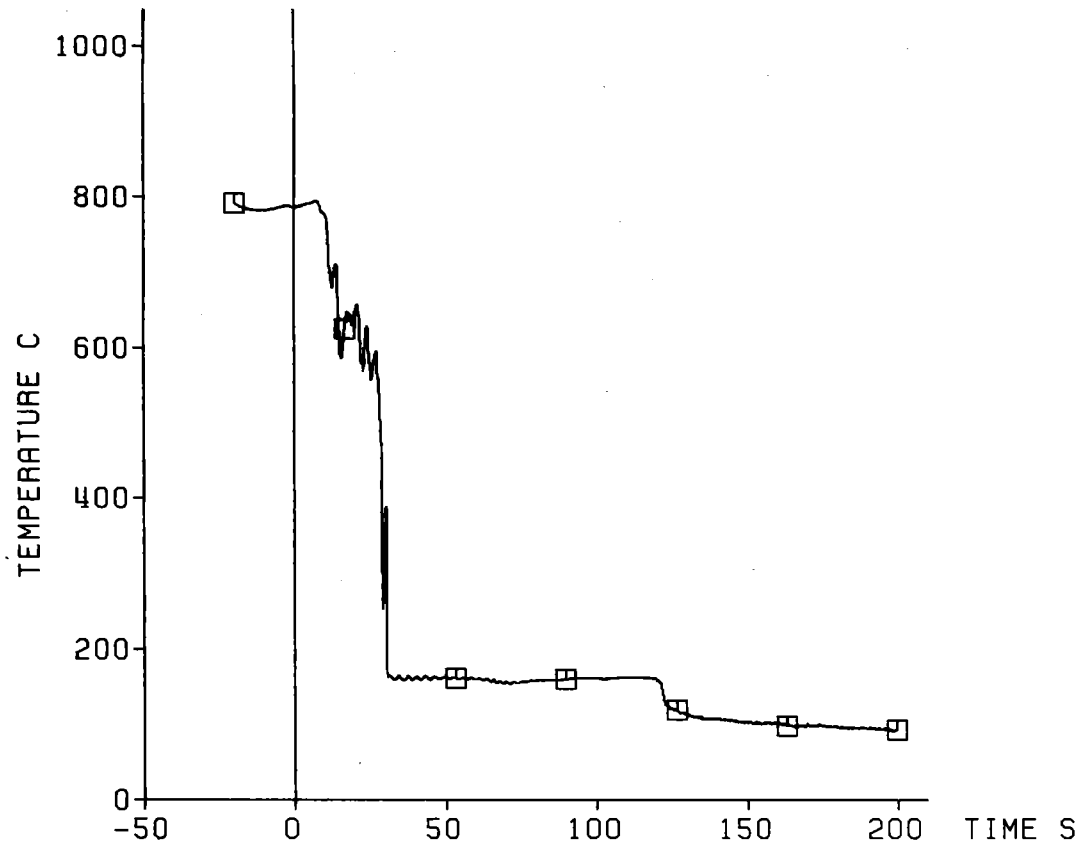

TC	Axial Level
□ 69	2535 mm

Decay Heat 120% ANS Standard
 Flooding Rate (cold) 5.77 cm/s
 System Pressure 5.83 bar
 Feedwater Temperature 40 C



Fig. 476 FEBA: 5x5 ROD BUNDLE, TEST SERIES 8, TEST-No. 333

Grid Spacer Temperature

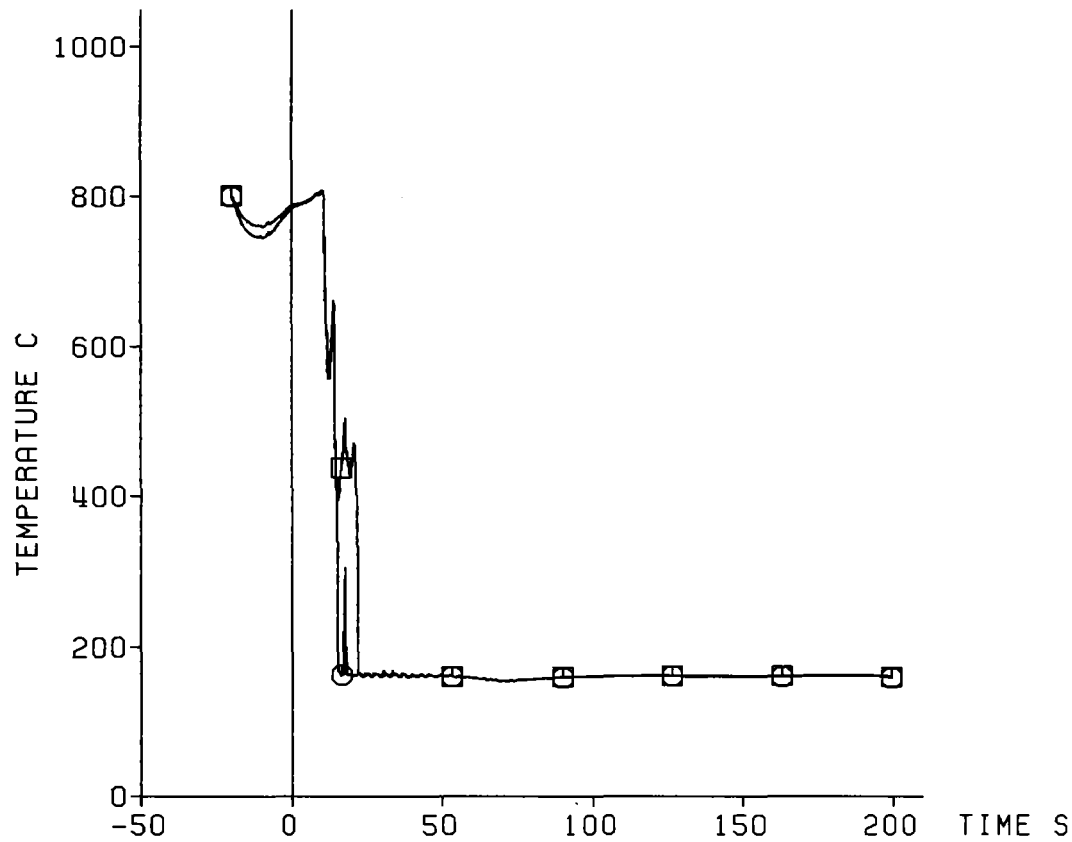

TC	Axial Level
□ 67	1425 mm
○ 66	1425 mm

Decay Heat 120% ANS Standard
 Flooding Rate (cold) 5.77 cm/s
 System Pressure 5.83 bar
 Feedwater Temperature 40 C



Fig. 477 FEBA: 5x5 ROD BUNDLE, TEST SERIES 8, TEST-No. 333

Axial Level: 2770 mm

△ Cladding Temperature (7a2)
○ Fluid Temperature
□ Housing Temperature

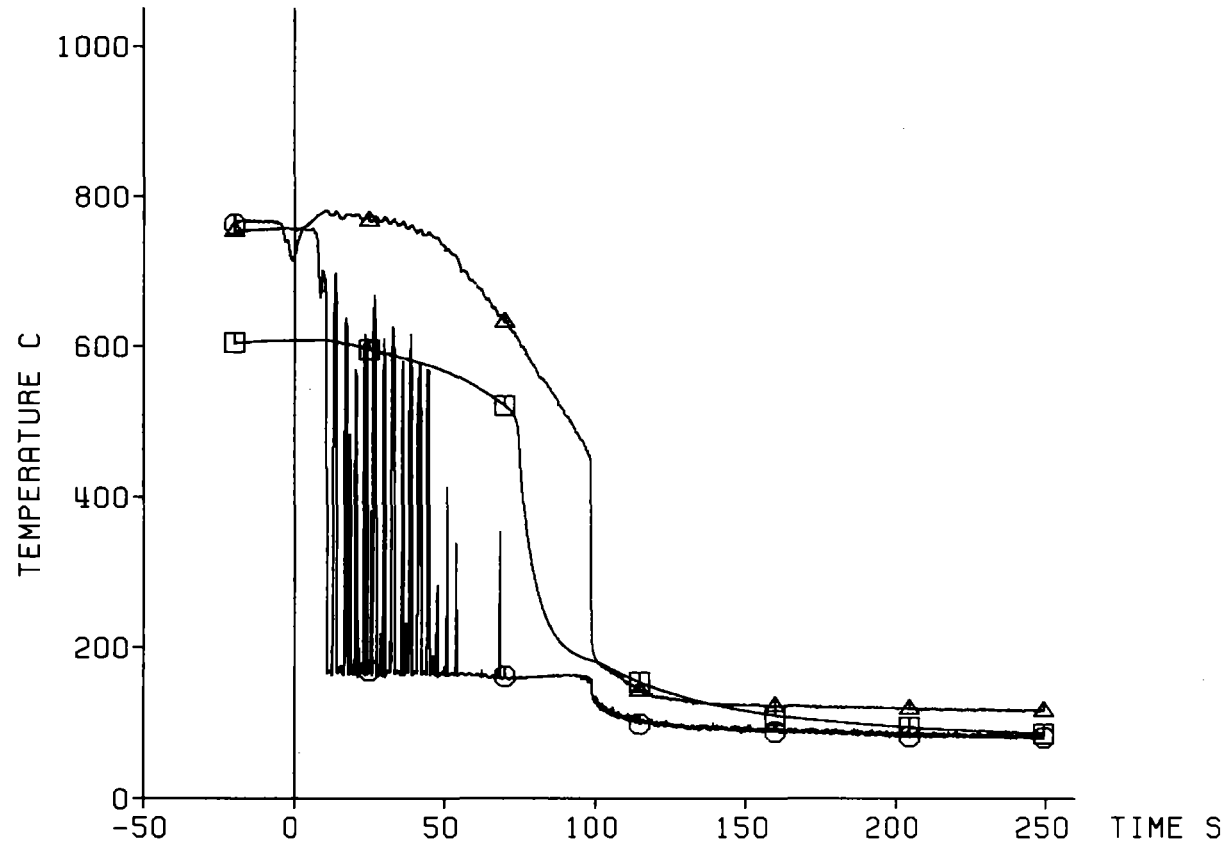

Decay Heat 120% ANS Standard
Flooding Rate (cold) 5.77 cm/s
System Pressure 5.83 bar
Feedwater Temperature 40 C



Fig. 478 FEBA: 5x5 ROD BUNDLE, TEST SERIES 8, TEST-NO. 333

Axial Level: 1925 mm

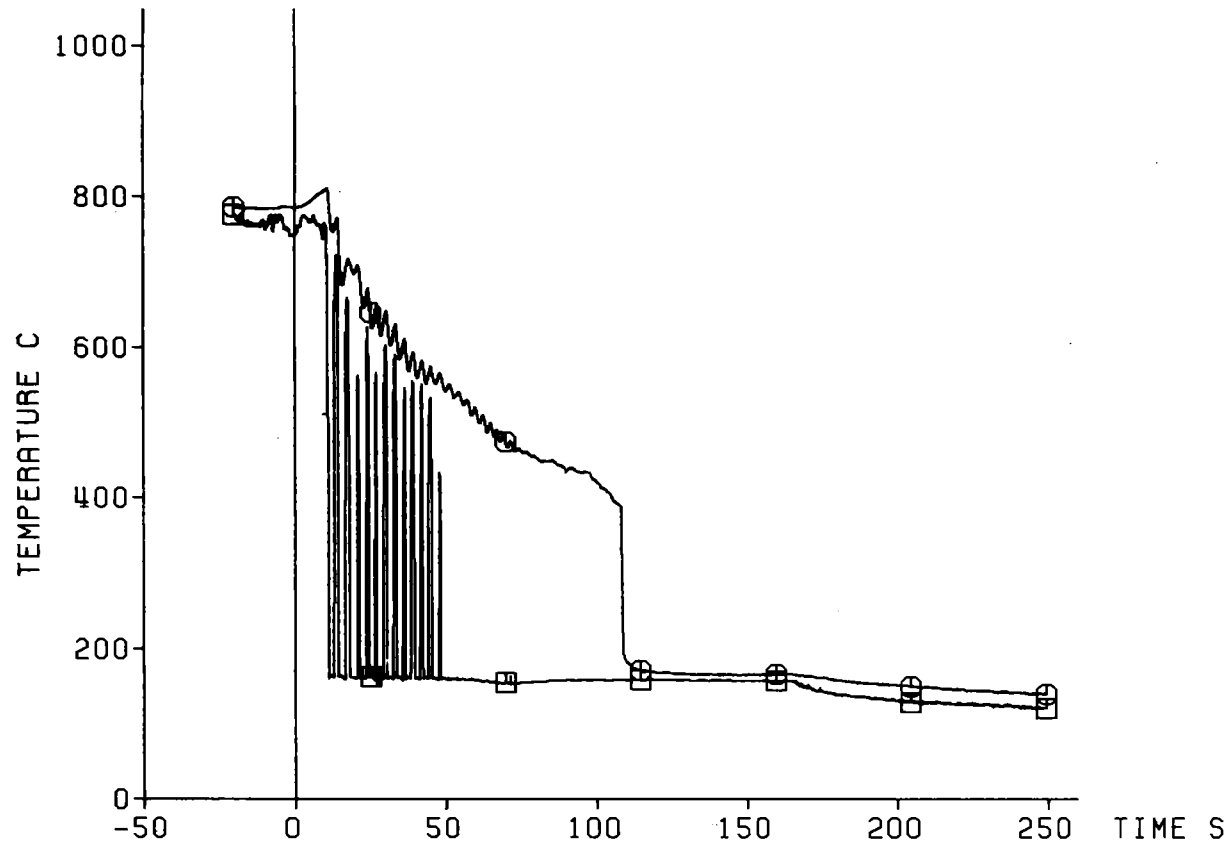

△ Cladding Temperature (19g4)
○ Fluid Temperature

Decay Heat 120% ANS Standard
Flooding Rate (cold) 5.77 cm/s
System Pressure 5.83 bar
Feedwater Temperature 40 C

— 520 —



Fig. 480 FEBA: 5x5 ROD BUNDLE, TEST SERIES 8, TEST-NO. 333

Axial Level: 1825 mm

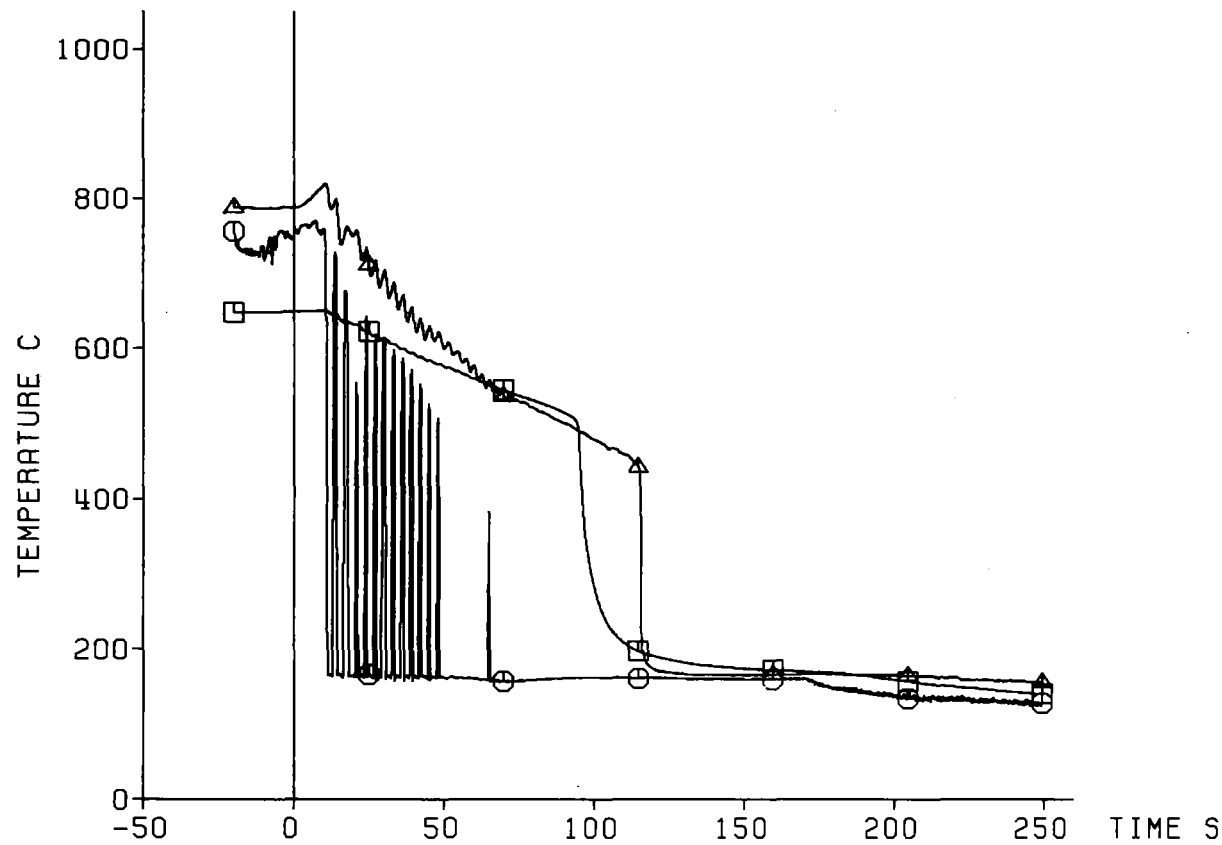

▲ Cladding Temperature (19g3)
○ Fluid Temperature
□ Housing Temperature

Decay Heat 120% ANS Standard
Flooding Rate (cold) 5.77 cm/s
System Pressure 5.83 bar
Feedwater Temperature 40 C

— 521 —



Fig. 481 FEBA: 5x5 ROD BUNDLE, TEST SERIES 8, TEST-No. 333

Axial Level: 1725 mm

△ Cladding Temperature (19g2)
○ Fluid Temperature

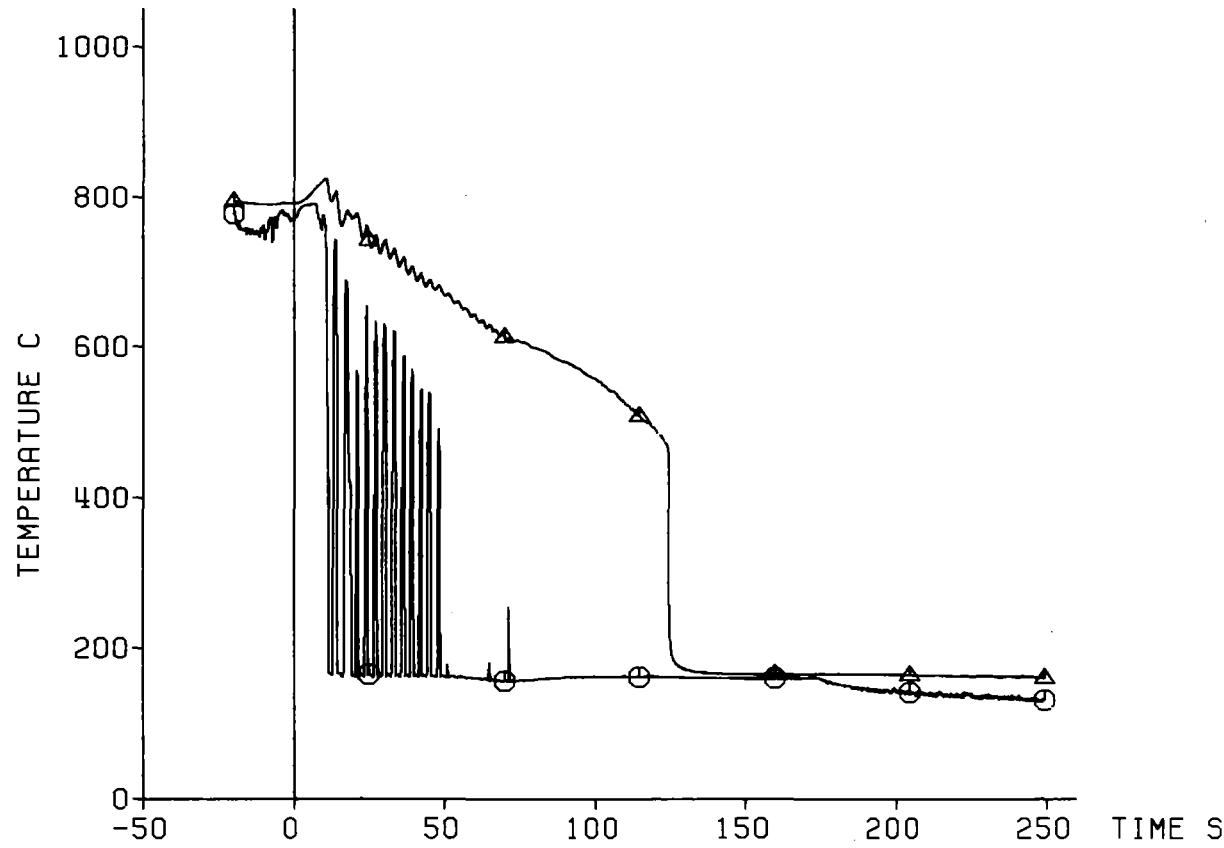

Decay Heat 120% ANS Standard
Flooding Rate (cold) 5.77 cm/s
System Pressure 5.83 bar
Feedwater Temperature 40 C

KFK IRB

Fig. 482 FEBA: 5x5 ROD BUNDLE, TEST SERIES 8, TEST-No. 333

Axial Level: 1625 mm

△ Cladding Temperature (19g1)
○ Fluid Temperature
□ Housing Temperature

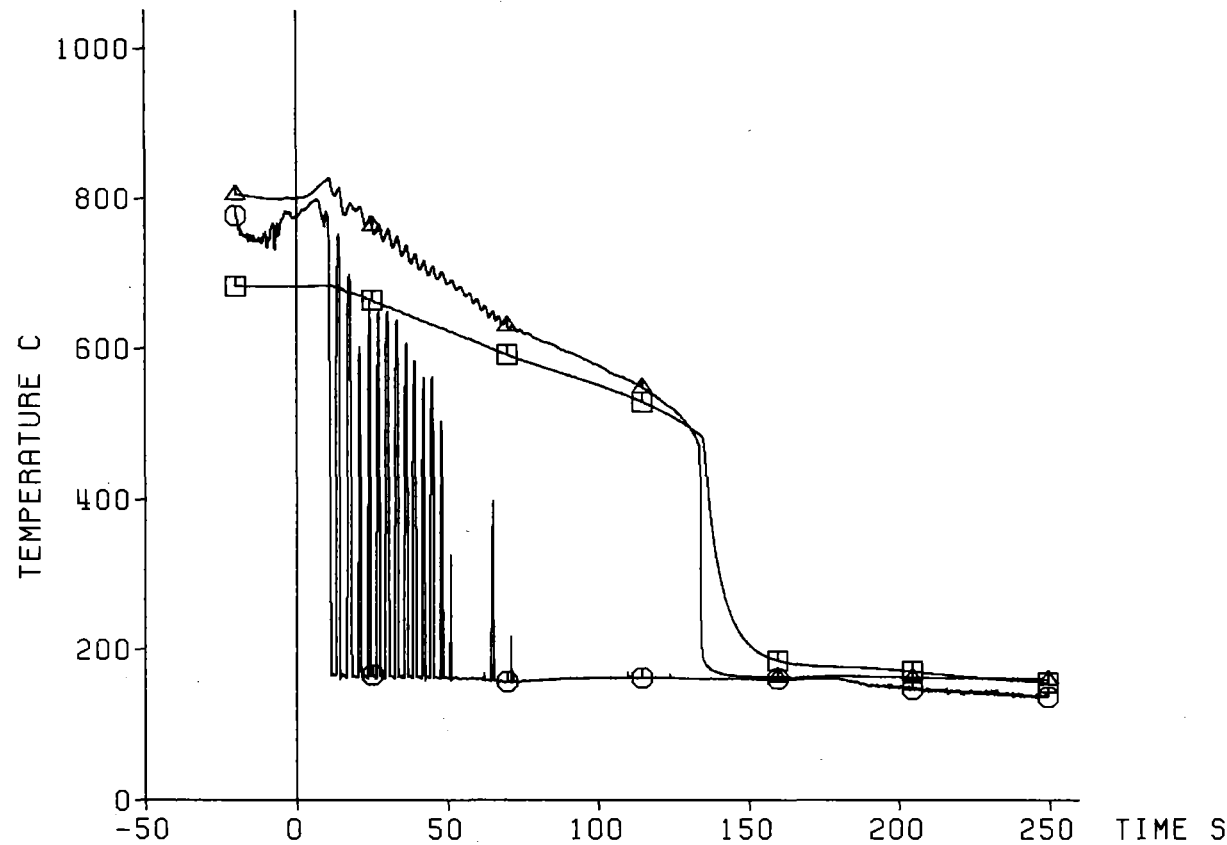

Decay Heat 120% ANS Standard
Flooding Rate (cold) 5.77 cm/s
System Pressure 5.83 bar
Feedwater Temperature 40 C

— 523 —



Fig. 483 FEBA: 5x5 ROD BUNDLE, TEST SERIES 8, TEST-No. 333

Axial Level: 1135 mm

△ Cladding Temperature (8b3)
○ Fluid Temperature
□ Housing Temperature

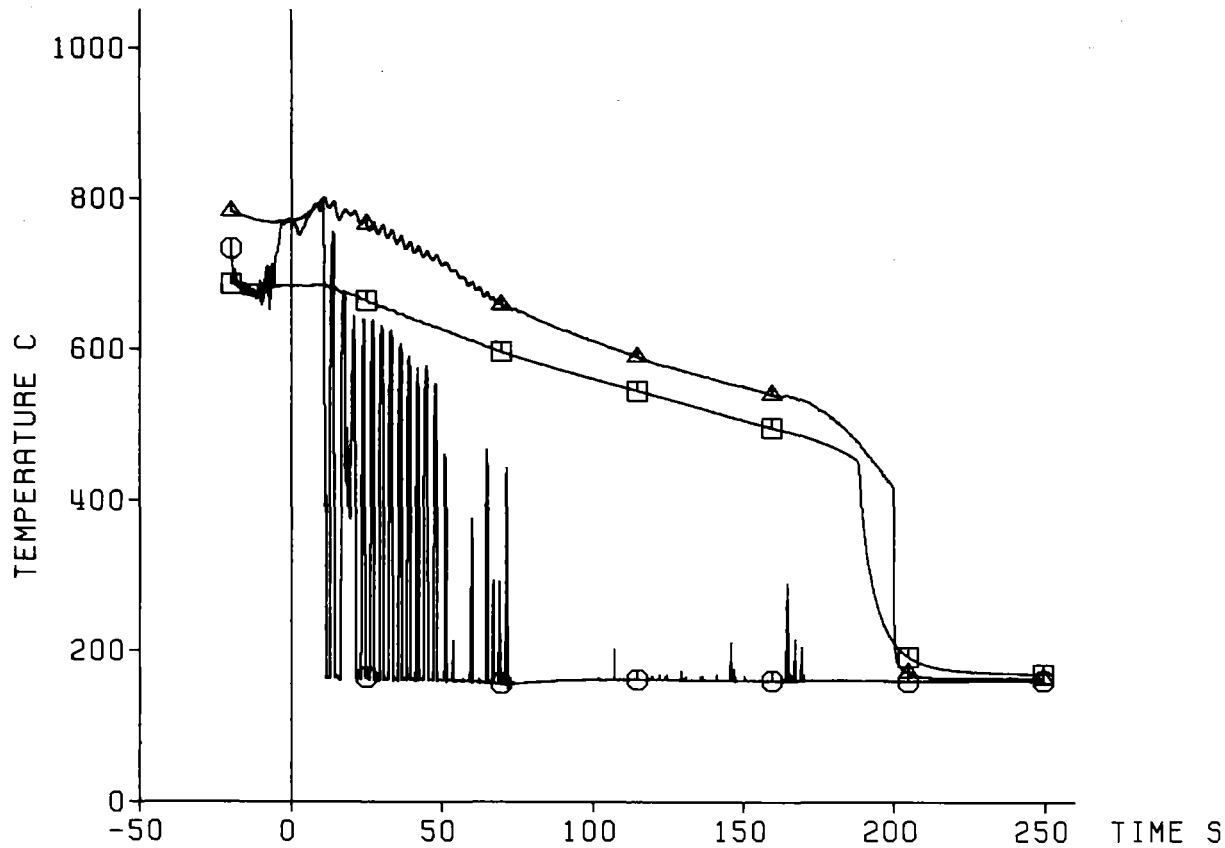

Decay Heat 120% ANS Standard
Flooding Rate (cold) 5.77 cm/s
System Pressure 5.83 bar
Feedwater Temperature 40 C

— 524 —

KIRB

Fig. 484 FEBA: 5x5 ROD BUNDLE, TEST SERIES 8, TEST-No. 333

Pressure Loss
Along the Test Section:

◇ Total Length: 4196 mm
△ Lower Part: 1711 mm
○ Middle Part: 545 mm
□ Upper Part: 1940 mm

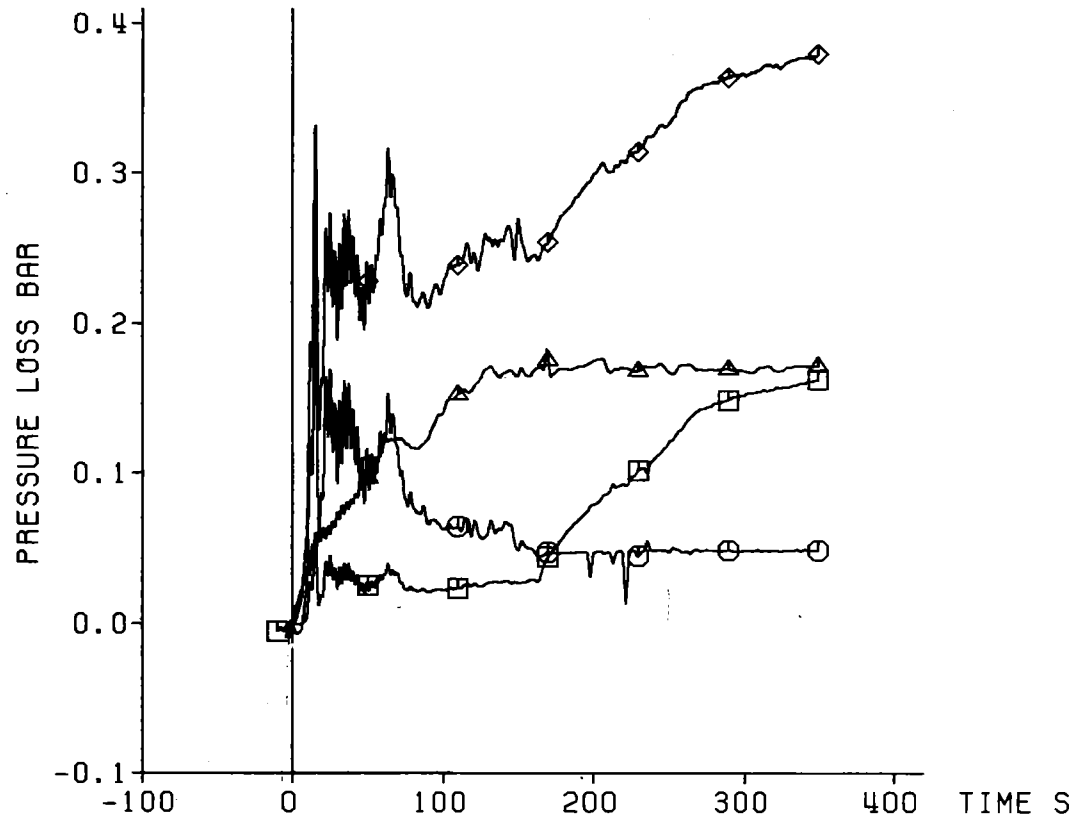

Decay Heat 120% ANS Standard
Flooding Rate (cold) 5.77 cm/s
System Pressure 5.83 bar
Feedwater Temperature 40 C

KfK
IRB

Fig. 485 FEBA: 5x5 ROD BUNDLE, TEST SERIES 8, TEST-No. 333

Coolant Outlet Conditions:

△ Water Carry Over
○ Coolant Temperature
□ Coolant Pressure

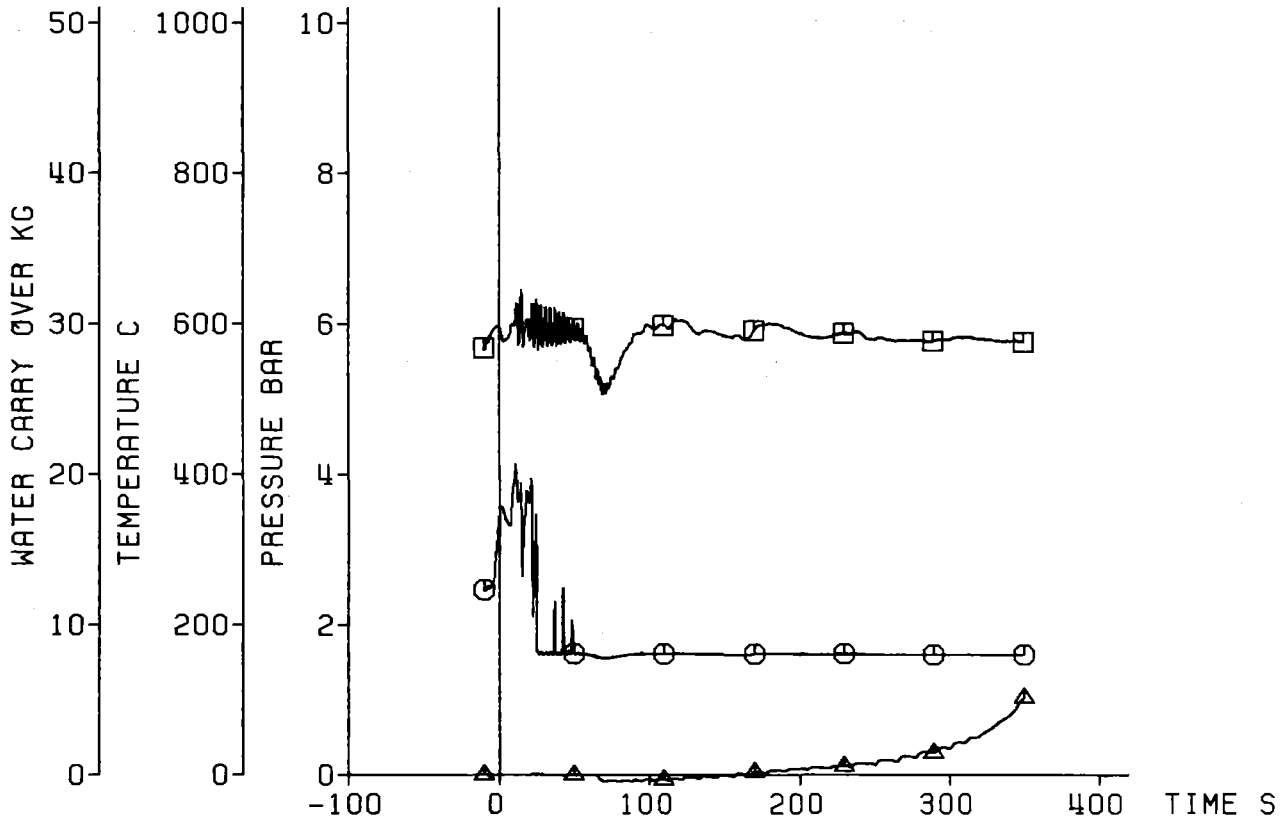

Decay Heat 120% ANS Standard
Flooding Rate (cold) 5.77 cm/s
System Pressure 5.83 bar
Feedwater Temperature 40 C

— 526 —



Fig. 486 FEBA: 5x5 ROD BUNDLE, TEST SERIES 8, TEST-NO. 333

Axial Position of Quench Front

□ Quenching of Sleeves at Bundle Midplane

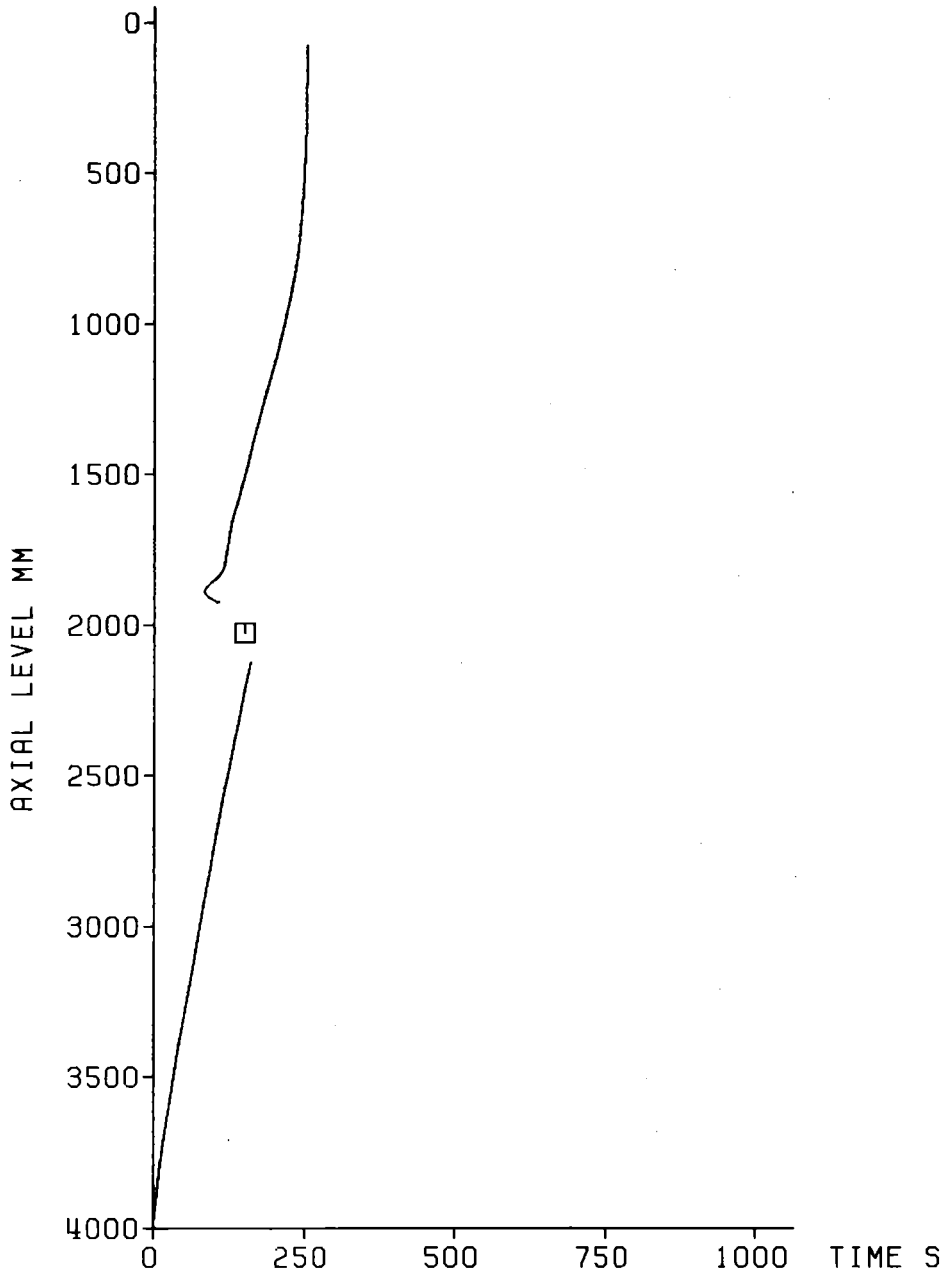

Decay Heat	120% ANS Standard
Flooding Rate (cold)	5.77 cm/s
System Pressure	5.83 bar
Feedwater Temperature	40 C



Fig. 487 FEBA: 5x5 ROD BUNDLE
TEST SERIES 8, TEST-No. 333

TEST SERIES VIII

Investigation of the Effects of a 90% Flow Blockage Without Bypass,
Blockage at the Bundle Midplane of all Rods of the 5x5 Rod Bundle

Channel Listing and Data Identification for Test No. 333 Through 342

Channel No.	Data Identification Type	Location	Unit	Remarks
1	Time (10 Scans/s)		s	t = 0: Start of Reflooding
2	Cladding Temperature	3b1. 45 ¹	°C	
3	Cladding Temperature	3b2. 590	°C	
4	Cladding Temperature	3b3.1135	°C	
5	Cladding Temperature	3b4.1680	°C	
6	Cladding Temperature	4b1.1625	°C	TC Failed
7	Cladding Temperature	4b2.1725	°C	
8	Cladding Temperature	4b3.1825	°C	
9	Cladding Temperature	4b4.1925	°C	
10	Cladding Temperature	7a1.2225	°C	
11	Cladding Temperature	7a2.2770	°C	
12	Cladding Temperature	7a3.3315	°C	
13	Cladding Temperature	7a4.3860	°C	
14	Cladding Temperature	8b1. 45	°C	
15	Cladding Temperature	8b2. 590	°C	
16	Cladding Temperature	8b3.1135	°C	
17	Cladding Temperature	8b4.1680	°C	
18	Cladding Temperature	9e1.2075	°C	
19	Cladding Temperature	9e2.2125	°C	
20	Cladding Temperature	9e3.2175	°C	
21	Cladding Temperature	9e4.2225	°C	

TEST SERIES VIII

Channel No.	Data Identification		Unit	Remarks
	Type	Location		
22	Cladding Temperature	10f1.2125 ¹	°C	
23	Cladding Temperature	10f2.2225	°C	
24	Cladding Temperature	10f3.2325	°C	
25	Cladding Temperature	10f4.2425	°C	
26	Cladding Temperature	12j1.1225	°C	
27	Cladding Temperature	12j2.1325	°C	
28	Cladding Temperature	12j3.1425	°C	
29	Cladding Temperature	12j4.1525	°C	
30	Cladding Temperature	13h1.1925	°C	TC Failed
31	Cladding Temperature	13h2.2025	°C	
32	Cladding Temperature	13h3.2125	°C	
33	Cladding Temperature	13h4.2225	°C	
34	Cladding Temperature	14f1.2125	°C	
35	Cladding Temperature	14f2.2225	°C	
36	Cladding Temperature	14f3.2325	°C	
37	Cladding Temperature	14f4.2425	°C	
38	Cladding Temperature	15a1.2225	°C	
39	Cladding Temperature	15a2.2770	°C	
40	Cladding Temperature	15a3.3315	°C	
41	Cladding Temperature	15a4.3860	°C	
42	Cladding Temperature	17i1.1875	°C	
43	Cladding Temperature	17i2.1925	°C	
44	Cladding Temperature	17i3.1975	°C	
45	Cladding Temperature	17i4.2025	°C	
46	Cladding Temperature	18k1. 100	°C	
47	Cladding Temperature	18k2. 200	°C	
48	Cladding Temperature	18k3. 300	°C	
49	Cladding Temperature	18k4. 400	°C	

TEST SERIES VIII

Channel No.	Data Identification		Unit	Remarks
	Type	Location		
50	Cladding Temperature	19g1.1625 ¹	°C	
51	Cladding Temperature	19g2.1725	°C	
52	Cladding Temperature	19g3.1825	°C	
53	Cladding Temperature	19g4.1925	°C	
54	Cladding Temperature	21i1.1875	°C	
55	Cladding Temperature	21i2.1925	°C	
56	Cladding Temperature	21i3.1975	°C	
57	Cladding Temperature	21i4.2025	°C	
58	Cladding Temperature	22d1.2025	°C	
59	Cladding Temperature	22d2.2025	°C	
60	Cladding Temperature	22d3.2025	°C	
61	Cladding Temperature	22d4.2025	°C	
62	Cladding Temperature	23d1.2025	°C	
63	Cladding Temperature	23d2.2025	°C	
64	Cladding Temperature	23d3.2025	°C	
65	Cladding Temperature	23d4.2025	°C	
66	Grid Spacer Temp.	TA ² 1425	°C	TC Failed
67	Grid Spacer Temp.	TA ³ 1425	°C	
68	Grid Spacer Temp.	TA ² 2535	°C	
69	Grid Spacer Temp.	TA ³ 2535	°C	
70	Sleeve Temperature	TH ⁴ 17.2025	°C	
71	Sleeve Temperature	TH ⁴ 18.2025	°C	
72	Sleeve Temperature	TH ⁵ 18.2025	°C	
73	Sleeve Temperature	TH ⁶ 13.2025	°C	
74	Sleeve Temperature	TH ⁷ 21.2025	°C	
75	Sleeve Temperature	TH ⁸ 17.2025	°C	
76	Sleeve Temperature	TH ⁹ 17.2064	°C	
77	Sleeve Temperature	TH ⁹ 17.2025	°C	
78	Sleeve Temperature	TH ⁹ 17.1972	°C	

TEST SERIES VIII

Channel No.	Data Identification		Unit	Remarks
	Type	Location		
79	Fluid Temperature	TF ¹⁰ 300	°C	Failed During Some Tests
80	Fluid Temperature	TF 485	°C	
81	Fluid Temperature	TF 1135	°C	
82	Fluid Temperature	TF 1625	°C	
83	Fluid Temperature	TF 1725	°C	
84	Fluid Temperature	TF 1825	°C	
85	Fluid Temperature	TF 1925	°C	
86	Fluid Temperature	TF 2240	°C	
87	Fluid Temperature	TF 2380	°C	
88	Fluid Temperature	TF 2770	°C	
89	Fluid Temperature	TF 3038	°C	
90	Fluid Temperature	TF 3315	°C	
91	Housing Temperature	TK ¹¹ 283	°C	
92	Housing Temperature	TK 590	°C	
93	Housing Temperature	TK 1135	°C	
94	Housing Temperature	TK 1625	°C	
95	Housing Temperature	TK 1825	°C	
96	Housing Temperature	TK 2025	°C	
97	Housing Temperature	TK 2235	°C	
98	Housing Temperature	TK 2770	°C	
99	Housing Temperature	TK 3018	°C	
100	Housing Temperature	TK 3315	°C	
101	Fluid Temperature	Lower Plenum	°C	
102	Fluid Temperature	Upper Plenum	°C	
103	Feedwater Temperature		°C	
104	Room Temperature		°C	
105	Electrical Power Input	8 Rods	kW	Rods No. 1 Through 8
106	Electrical Power Input	8 Rods	kW	Rods No. 9 Through 16
107	Electrical Power Input	9 Rods	kW	Rods No. 17 Through 25

TEST SERIES VIII

Channel No.	Data Identification		Unit	Remarks
	Type	Location		
108	Water Level Detector	4012 mm	°C	Heated + Unheated TC's
109	Water Level Detector	3932 mm	°C	Heated + Unheated TC's
110	Pressure in Buffer		bar	
111	Flooding Velocity (cold)		cm/s	
112	Pressure in Upper Plenum	-105 mm	bar	
113	Pressure in Lower Plenum	4091 mm	bar	
114	Bundle Power		kW	Channels: 81 + 82 + 83
115	Water Carry Over Collected		kg	Downstream of Bundle Exit
116	Pressure Diff.	1835 and -105 mm	bar	
117	Measured	2380 and 1835 mm	bar	
118	Between	4091 and 2380 mm	bar	
119	Axial Level	4091 and -105 mm	bar	Values Measured Separately

- 1) TC's of 0.5 mm diameter embedded in rod cladding. Measuring position:
Example: rod No. = 3, type of rod instrumentation = b, TC No. = 1,
axial level = 45 mm, referenced to the top flange of the bundle.
- 2) TA = TC's of 0.5 mm diameter brazed on surface of grid spacer. Measuring position: Example: axial level = 1425 mm. Subchannel surrounded by rods No. 8, 9, 14 and 13.
- 3) TA = TC's of 0.5 mm diameter brazed on surface of grid spacer. Measuring position: Example: axial level = 1425 mm. Subchannel surrounded by rods No. 12, 13, 17 and 18.
- 4) TH = TC's of 0.5 mm diameter embedded in sleeve. Measuring position:
Example: rod No. 17, axial level = 2025 mm, contact face of sleeves of rods No. 17 and 18.
- 5) TH = TC embedded in sleeve of rod No. 18. Corresponding subchannel surrounded by rods No. 18, 17, 12 and 13.

- 6) TH = TC embedded in sleeve of rod No. 13. Corresponding subchannel surrounded by rods No. 13, 18, 17 and 12.
- 7) TH = TC embedded in sleeve of rod No. 21. Corresponding subchannel surrounded by rods No. 21, 16, 17 and 22.
- 8) TH = TC embedded in sleeve of rod No. 17. Corresponding subchannel surrounded by rods No. 17, 12, 13 and 18.
- 9) TH = TC embedded in sleeve of rod No. 17. Corresponding subchannel surrounded by rods No. 17, 22, 21 and 16.
- 10) TF = TC's of 0.25 mm diameter (bare) placed in subchannel surrounded by rods No. 12, 17, 16 and 11.
- 11) TK = TC's of 0.5 mm diameter placed in the wall of the bundle housing of 6.5 mm thickness.