

Jutta Geldermann  
Martin Treitz  
Hannes Schollenberger  
Jens Ludwig  
Otto Rentz

# Integrated Process Design for the Inter-Company Plant Layout Planning of Dynamic Mass Flow Networks





Jutta Geldermann, Martin Treitz,  
Hannes Schollenberger, Jens Ludwig, Otto Rentz

**Integrated Process Design for the Inter-Company Plant  
Layout Planning of Dynamic Mass Flow Networks**



# **Integrated Process Design for the Inter-Company Plant Layout Planning of Dynamic Mass Flow Networks**

von

Jutta Geldermann

Martin Treitz

Hannes Schollenberger

Jens Ludwig

Otto Rentz



---

universitätsverlag karlsruhe

## **Impressum**

Universitätsverlag Karlsruhe  
c/o Universitätsbibliothek  
Straße am Forum 2  
D-76131 Karlsruhe  
[www.uvka.de](http://www.uvka.de)



Dieses Werk ist unter folgender Creative Commons-Lizenz  
lizenziert: <http://creativecommons.org/licenses/by-nc-nd/2.0/de/>

Universitätsverlag Karlsruhe 2007  
Print on Demand

ISBN: 978-3-86644-126-2

# Preface

Within its promotion initiative for interdisciplinary environmental research the VolkswagenStiftung provided a grant for the research project "Integrated Process Design for the Inter-Enterprise Plant Layout Planning of Dynamic Mass Flow Networks" (PepOn) proposed by the French-German Institute for Environmental Research (DFIU/IFARE). This report compiles the main outcomes of the project.

The objective of the research project is to identify cost-efficient and reliable techniques for emission abatement options, in particular in the sector of metal surface treatment and coating with organic solvents in industrializing countries under the special conditions determined by their dynamic economic growth. Whereas reduction measures for pollutants such as  $NO_x$  and  $SO_2$  have been comparatively well implemented in industrial plants via technology transfer, the pollution reduction measures for volatile organic compounds (VOC) are more problematic. Thus, the case studies of this research project focus on the reduction and avoidance of VOC in small and medium-sized enterprises. Consequently the focus of this project is the development of a methodology for optimising the inter-enterprise plant layout planning in dynamic mass flow networks, as typical in industrialising countries. This integrated approach requires a tight coupling of mass, energy, economic and ecological assessment approaches and demands an interdisciplinary research project. By simultaneously considering energy consumption, solvent reprocessing and wastewater reduction, a multi objective process design problem has to be optimised. In this case the Pinch-Analysis can be applied to heat flows, mass flows and wastewater flows. For the expected overlapping solutions Operations Research methods can be modified to create a total order and to generate recommendations. The developed MOPA (Multi Objective Pinch Analysis) is then applied to several case studies in China and Chile, in order to ensure the practical applicability of the scientific findings.

Such a research project would not have been possible without reliable and capable project partners. Our very special thanks go to our project partners:

- Marcela Zacarías M., Jens Neugebauer and Dr. Alex Berg G. (Unidad de Desarrollo Tecnológico (UDT), Universidad de Concepción, Concepción, Chile)
- Dr. Surong Guo and Prof. Yongsen Lu (College of Environmental Science and Engineering (CESE), Tongji University, Shanghai, P.R. China)
- Dr. Yinan Wang and Prof. Fengqi Zhou (Energy Research Institute (ERI), State Development and Reform Commission, Beijing, P.R. China)

We would like to express our sincerely gratitude towards the VolkswagenStiftung and especially Prof. Hagen Hof. Without that grant for young researchers, such an unusual project, spanning three continents, would not have been possible.

Jutta Geldermann, Martin Treitz, Hannes Schollenberger, Jens Ludwig, Otto Rentz

French-German Institute for Environmental Research (DFIU/IFARE)

University of Karlsruhe (TH), Germany

Karlsruhe, January 2007



# Contents

<b>List of Figures</b>	<b>vii</b>
<b>List of Tables</b>	<b>xiii</b>
<b>1 Challenges for Industrial Production</b>	<b>1</b>
1.1 Background . . . . .	1
1.2 Objectives . . . . .	5
1.3 Introduction of the Case Studies from Chile and China . . . . .	8
1.3.1 Case Studies concerning Coating of Metal Parts . . . . .	9
1.3.2 Case Studies concerning Alcohol Production . . . . .	10
1.3.3 Further Case Studies . . . . .	11
<b>2 Cleaner Production in Industrialising Countries</b>	<b>13</b>
2.1 The Example of China and Chile . . . . .	13
2.2 Environmental Protection System in China . . . . .	16
2.2.1 Prevention and Control of Industrial Pollution . . . . .	17
2.2.2 Developing a Circular Economy . . . . .	18
2.2.3 Economic and Environmental Investment Policy . . . . .	19
2.2.4 Environmental Science and Technology . . . . .	20
2.2.5 Pollution Control for Small and Medium-sized Enterprises in China	21
2.3 Adaptation Possibilities of BATs in China . . . . .	30
2.3.1 Legal Framework and Questions of Funding . . . . .	30

---

2.3.2	Status and Potentials for Environmental Protection . . . . .	33
2.3.3	Industry Structure . . . . .	35
2.3.4	Possibilities of a Technology Transfer . . . . .	36
2.4	Cleaner Production in Chile . . . . .	38
2.4.1	Financing of Cleaner Production Technologies . . . . .	40
2.4.2	Status and Potentials for Environmental Protection . . . . .	41
2.4.3	Prevailing Industry Structures in Chile . . . . .	43
2.4.4	Possibilities for Technology Transfer . . . . .	46
2.5	Discussion on Technology Transfer . . . . .	48
2.5.1	Innovation in China . . . . .	49
2.5.2	Innovation in Chile . . . . .	50
2.5.3	Prediction of Technology Innovation and Diffusion . . . . .	51
2.5.4	Technology Transfer for Sustainable Development . . . . .	53
2.5.5	Conclusions . . . . .	54
2.6	A Metric for the Determination of BAT . . . . .	55
2.6.1	Definition of a Metric for the Determination of BAT . . . . .	56
2.6.2	Example of the Application of a Metric for the Determination of BAT . . . . .	62
2.6.3	Discussion of the Application of a Metric for the determination of BAT . . . . .	69
<b>3</b>	<b>Process Integration in Production Networks</b>	<b>71</b>
3.1	Thermal Pinch Analysis . . . . .	73
3.1.1	Principles of the Pinch Analysis . . . . .	75
3.1.2	Solving the Pinch Analysis with the Transportation Algorithm . . . . .	80
3.1.3	Example of the Thermal Pinch Analysis . . . . .	85
3.1.4	Discussion of the Thermal Pinch Analysis . . . . .	92
3.2	Water Pinch Analysis . . . . .	94
3.2.1	Approach based on Water Quality . . . . .	96

---

---

3.2.2	Approaches based on Water Quantity and Stream Mapping . . . . .	101
3.2.3	Example of the Water Pinch Analysis . . . . .	106
3.2.4	Discussion of the Water Pinch Analysis . . . . .	113
3.3	Solvents Pinch Analysis . . . . .	114
3.3.1	Principles of the Condensation System . . . . .	116
3.3.2	Economic Analysis of the Recovery of VOC via Condensation . . . . .	119
3.3.3	Example of the Solvents Pinch Analysis . . . . .	120
3.4	Multi Objective Pinch Analysis (MOPA) . . . . .	129
3.4.1	Advantages and Limitations of the Pinch Analysis . . . . .	129
3.4.2	Outline of the MOPA Concept . . . . .	131
3.4.3	Discussion of the Examples of the Determination of Target Values by the Pinch Analysis Approach . . . . .	133
<b>4</b>	<b>Inter-Company Production Networks</b>	<b>135</b>
4.1	Challenges for Inter-Company Collaboration . . . . .	135
4.2	Eco-Industrial Parks in China and Chile . . . . .	139
4.3	Model of an Industrial Park . . . . .	140
4.3.1	Application of the Thermal Pinch Analysis for the Industrial Park . . . . .	142
4.3.2	Discussion of the Application of the Pinch Analysis to Inter-Company Networks . . . . .	143
<b>5</b>	<b>Using Multi-Criteria Analysis to Evaluate Resource Efficiency</b>	<b>145</b>
5.1	Introduction to Efficiency Measurement . . . . .	146
5.1.1	Relative Efficiency of Techniques . . . . .	146
5.1.2	Preference Modelling in Multi-Criteria Analysis . . . . .	149
5.2	The Approach of PROMETHEE . . . . .	152
5.2.1	Preference Modelling . . . . .	153
5.2.2	The Aggregation Model of PROMETHEE . . . . .	156

---

---

5.2.3	Sensitivity Analyses in PROMETHEE . . . . .	157
5.2.4	Sensitivity Analyses for Preferential Data . . . . .	160
5.2.5	Principal Component Analysis for Sensitivity Analyses . . . . .	166
5.2.6	Summary of the Sensitivity Analyses in PROMETHEE . . . . .	175
5.3	Example of the Application of PROMETHEE . . . . .	176
5.3.1	Results of the Analysis . . . . .	177
5.3.2	Principal Component Analysis of the Decision Problem . . . . .	181
5.3.3	Sensitivity Analysis with Respect to Data Uncertainty . . . . .	183
5.3.4	Evaluation of Inter-Criteria Preferences . . . . .	185
5.3.5	Evaluation of Intra-Criteria Preferences . . . . .	189
5.3.6	Recommendations based on the Analysis . . . . .	192
5.4	Summary . . . . .	194
<b>6</b>	<b>Dynamic Capacity Planning</b>	<b>197</b>
6.1	Introduction to Capacity Planning . . . . .	197
6.2	Challenges in Dynamic and Seasonal Markets . . . . .	200
6.3	Production Pinch Analysis . . . . .	203
6.3.1	Translation of the Thermal Pinch Analysis to Production Planning	203
6.3.2	Discussion of Production Strategies for a Case Study . . . . .	206
6.3.3	Discussion of Production Strategies for Dynamic Markets . . . . .	211
6.3.4	Conclusions on the Production Pinch Analysis . . . . .	212
<b>7</b>	<b>Summary</b>	<b>213</b>
7.1	Conclusions of the Pinch Analysis Methodology . . . . .	214
7.2	Conclusions of the Inter-Company Approach . . . . .	216
7.3	Conclusions of the Multi-Criteria Approach . . . . .	217
7.4	Conclusions of the Dynamic Capacity Planning Approach . . . . .	219
7.5	Conclusions of the Case Studies in General . . . . .	220

---

---

7.6 Outlook . . . . .	222
<b>A Case Study 1: Bicycle Production in China</b>	<b>225</b>
A.1 Background of the Case Study . . . . .	225
A.2 Process Characteristics of the Bicycle Coating Process . . . . .	227
A.2.1 The Coating of Bicycles . . . . .	228
A.2.2 Process Parameters for the Coating Step . . . . .	229
A.2.3 Process Design Options and Evaluation Criteria . . . . .	232
A.3 Parameters of the Case Study . . . . .	235
<b>B Case Study 2: Bicycle Production in Chile</b>	<b>241</b>
B.1 Background of the Case Study . . . . .	241
B.2 Process Characteristics of the Bicycle Coating Process . . . . .	244
B.2.1 Process Parameters for the Coating Step . . . . .	245
B.2.2 Process Design Options and Evaluation Criteria . . . . .	246
B.3 Calculations and Recommendations . . . . .	247
B.3.1 Calculation of the Energy Target Values . . . . .	247
B.3.2 Calculation of the VOC Target Values . . . . .	248
B.3.3 Calculation of the Water Target Values . . . . .	251
B.3.4 Results using PROMETHEE . . . . .	252
B.3.5 Discussion . . . . .	254
<b>C Case Study 3: Pisco Production in Chile</b>	<b>257</b>
C.1 Background of the Case Study . . . . .	257
C.2 Process Characteristics of the Pisco Production . . . . .	258
C.3 Calculations and Recommendations . . . . .	259
C.3.1 Process Improvements with Respect to Wastewater . . . . .	259
C.3.2 Optimisation with Respect to Energy . . . . .	260

---

---

<b>D Case Study 4: Industrial Alcohol Production in China</b>	<b>265</b>
D.1 Process Characteristics of the Industrial Alcohol Production . . . . .	266
D.2 Implementation of Cleaner Production Measures . . . . .	268
D.2.1 Integrated Use of Best Available Techniques (BATs) . . . . .	269
D.2.2 Integration of Mass and Energy Flows . . . . .	270
D.3 Simulation of Policy Incentives to Promote Cleaner Production . . . . .	272
D.4 Discussion . . . . .	274
<b>E Case Study 5: Fishery Net Impregnation in Chile</b>	<b>275</b>
E.1 Background of the Case Study . . . . .	275
E.2 Process Characteristics of the Fishery Net Impregnation . . . . .	277
E.3 Calculations and Recommendations . . . . .	279
E.4 Discussion . . . . .	280
<b>F Case Study 6: Small Series Production of Commercial Vehicles in China</b>	<b>281</b>
F.1 Background of the Case Study . . . . .	281
F.2 Process Characteristics of the Small Series Coating of Commercial Vehicles	283
F.3 Discussion . . . . .	286
<b>G Author Information</b>	<b>287</b>
G.1 French-German Institute for Environmental Research (DFIU/IFARE) . . .	287
G.2 Unidad de Desarrollo Tecnológico (UDT) . . . . .	289
G.3 College of Environmental Science and Engineering (CESE) . . . . .	290
G.4 Energy Research Institute . . . . .	290
<b>Bibliography</b>	<b>292</b>

---

# List of Figures

1.1	The Design Process . . . . .	3
2.1	Changes in the Gross Industrial Output Value of Industrial Enterprises . .	23
2.2	Changes in the Gross Profit of Industrial Enterprises . . . . .	23
2.3	The Pollution Load of Rural SMEs' Pollution . . . . .	26
2.4	The Changes of the Pollution Load of SMEs of the Whole Country . . . .	27
2.5	The Legal Framework of Spreading Key Appropriate Technologies for Environmental Protection in China . . . . .	31
2.6	Conceptual Framework for the Process Analysis Approach . . . . .	54
2.7	Domain of BAT and technologies $\Gamma^0$ , $\Gamma^{\lambda_1}$ and $\Gamma^{\lambda_2}$ for one set of limit and optimal values . . . . .	58
2.8	Comparison of $d_{BAT}$ of two countries with different preferences . . . . .	60
2.9	Process Flow Chart for the Coating of Plastic Parts . . . . .	63
2.10	BAT-domains of Germany and Chile (above) and Germany and China (below) and the positions of the evaluated techniques $\Gamma^1, \Gamma^2, \Gamma^3$ . . . . .	67
3.1	Hot and Cold Composite Curve . . . . .	76
3.2	Heat Profiles by the Grand Composite Curve . . . . .	80
3.3	Profile of the Temperature Gradient within a Concurrent (left) and Countercurrent (right) Heat Exchanger . . . . .	82
3.4	Composite Curves of the Thermal Pinch Analysis . . . . .	87
3.5	Grand Composite Curve of the <i>Thermodynamic Approach</i> of the Thermal Pinch Analysis . . . . .	88

---

3.6	Grand Composite Curve of the <i>Economic Approach</i> of the Thermal Pinch Analysis . . . . .	89
3.7	Representation of Water Using Processes . . . . .	97
3.8	Match of Limiting Composite Curve and Water Supply Line . . . . .	98
3.9	Regeneration of Water with Fixed Outlet Concentration of the Regeneration	99
3.10	Recycling of Regenerated Water . . . . .	100
3.11	Water Composite Curves . . . . .	102
3.12	Mixing Modifies the Shape of the Source Composite Curve . . . . .	103
3.13	Conceptual Example of Mixing of Source Streams with Fresh Water . . . .	104
3.14	Stream Mapping Diagram . . . . .	106
3.15	Composite Curves of the Water Pinch Analysis with Reuse . . . . .	109
3.16	Water Pinch Analysis with Regeneration - Reuse . . . . .	110
3.17	Water Pinch Analysis with Regeneration - Recycling . . . . .	111
3.18	Schematic Representation of a Saturation-Pressure Curve within the Operating Range of the VOC-Condensation System . . . . .	116
3.19	Schematic Representation of a VOC-Condensation System . . . . .	117
3.20	Hot and Cold Composite Curves of the Solvents Pinch Analysis . . . . .	121
3.21	Concentrations of the Multi-Component VOCs Based on the Saturation-Pressure Curve . . . . .	122
3.22	Total Annualised Costs Depending on the Endpoint Temperature of Condensation . . . . .	124
3.23	Sensitivity Analysis for the Value for Recovered Solvents . . . . .	125
3.24	Sensitivity Analysis of Surface Specific Costs and Operating Costs for the Coolant . . . . .	126
3.25	Sensitivity Analysis of the Concentration of Solvents in the Waste Gas . .	127
3.26	Modules of the Multi Objective Pinch Analysis . . . . .	132
4.1	Required Piping of Inter-Company Heat Exchange within an Industrial Park . . . . .	141

---



---

4.2	Hot and Cold Composite Curves of the Industrial Park . . . . .	143
5.1	Types of Preference Functions $P(d)$ . . . . .	154
5.2	Profile of an Alternative . . . . .	157
5.3	Sensitivity Analysis of the Weighting . . . . .	161
5.4	Spider Diagram of $\Phi$ of All Criteria and All Alternatives . . . . .	163
5.5	Projections on the GAIA Plane . . . . .	167
5.6	Alternatives and Criteria in the GAIA Plane . . . . .	169
5.7	Alternatives and Criteria Selection in the GAIA Plane . . . . .	170
5.8	PROMETHEE II Ranking and PROMETHEE Decision Axis . . . . .	170
5.9	PROMETHEE VI Area $\Delta$ for a Hard and Soft Decision Problem . . . . .	173
5.10	Distinguishability Analysis . . . . .	175
5.11	Positive Outranking Flow $\Phi^+(a)$ , Negative Outranking Flow $\Phi^-(a)$ and Net Outranking Flow $\Phi(a)$ of the Different Process Design Options . . . . .	178
5.12	Spider Diagram of the Different Process Design Options . . . . .	179
5.13	PROMETHEE I Ranking of the Process Design Options . . . . .	179
5.14	Profiles of all Process Design Options . . . . .	180
5.15	PROMETHEE II Ranking of the Process Design Options . . . . .	181
5.16	Principal Component Analysis of the Decision Problem . . . . .	182
5.17	Projections on the Decision Stick $\pi$ . . . . .	183
5.18	Distinguishability Analysis with an Uncertainty Level of $\pm 10\%$ . . . . .	184
5.19	Data Distribution of Attribute Value <i>Investment</i> for Alternative <i>Water-</i> <i>borne Coatings</i> with Uncertainty Level of 10% and 50% . . . . .	185
5.20	Distinguishability Analysis with an Uncertainty Level of $\pm 50\%$ . . . . .	185
5.21	Sensitivity Analysis by Walking Weights . . . . .	186
5.22	Sensitivity Analysis of the Weight for Criterion <i>Water</i> . . . . .	187
5.23	Sensitivity Analysis of the Weight for Attribute <i>Costs</i> . . . . .	187
5.24	PROMETHEE VI Area . . . . .	188

---

---

5.25	Preference Function Definition of Criterion <i>Investment</i> . . . . .	189
5.26	Sensitivity Analysis of the Preference Parameter <i>s</i> of Criterion <i>Investment</i>	190
5.27	Sensitivity Analysis of all Preference Parameter of all Criteria . . . . .	191
5.28	Sensitivity Analysis of Preference Function Types of Criterion <i>Investment</i> .	191
5.29	Sensitivity Analysis of all Preference Function Types of all Criteria . . . . .	192
6.1	Strategies of Capacity Planning . . . . .	202
6.2	Production Planning . . . . .	205
6.3	Composite and Grand Composite Curves of the Production Pinch with Strategies 1, 2 and 4 . . . . .	209
6.4	Composite and Grand Composite Curves of the Production Pinch with Strategies 3 and 5 . . . . .	210
6.5	Composite and Grand Composite Curves of the Production Pinch with Strategies 3 and 4 for a period of 5 years . . . . .	211
A.1	Process Layout of the Coating Section of the Bicycle Production . . . . .	229
A.2	Parameters of the Bicycle Coating Application . . . . .	231
A.3	Aggregated Outranking Flows with Additional Alternative <i>Thermal Incin-</i> <i>ceration</i> $T_5$ . . . . .	238
A.4	PROMETHEE I Ranking with Additional Alternative <i>Thermal Incinera-</i> <i>tion</i> ( $T_5$ ) for the Waste gas of the drying ovens only . . . . .	239
A.5	Distinguishability Analysis with Additional Alternative <i>Thermal Incin-</i> <i>ceration</i> $T_5$ . . . . .	239
B.1	Bicycle and Furniture Production between 2000 and 2005 . . . . .	242
B.2	Bicycle and Furniture Production in 2003 . . . . .	243
B.3	Process Schema of the Bicycle Coating Process . . . . .	245
B.4	Hot and Cold Composite Curves Energy . . . . .	246
B.5	Hot and Cold Composite Curves Energy . . . . .	248
B.6	Concentration of Xylene . . . . .	249

---

---

B.7	Variation of the best temperature gradient depending on the end point temperature of condensation . . . . .	251
B.8	Spider-Diagram of the abridged (left) and full (right) evaluation . . . . .	252
B.9	$\Phi_{net}$ flow of all possible preference type combinations . . . . .	253
B.10	GAIA Plane of the full (upper) and abridged (lower) evaluation . . . . .	254
C.1	Process Schema and Mass Flows of the Pisco Production . . . . .	258
C.2	Single Streams of the Heating and Cooling Requirements . . . . .	261
C.3	Composite Curves of the Pisco Production . . . . .	262
C.4	Grand Composite Curve of the Pisco Production . . . . .	262
D.1	Process Layout of the Industrial Alcohol Production . . . . .	266
D.2	Plant Layout of the Different Sections of the Alcohol Production . . . . .	267
D.3	Wastewater Treatment Section of the Alcohol Plant . . . . .	268
D.4	Primary Feedback Chart of Cleaner Production and Policy Factors . . . . .	272
E.1	Gross Annual Production of the three main salmonid species farmed in Chile	276
E.2	Process Characteristics of the Fishery Net Impregnation . . . . .	279
F.1	Annual Production of Motor Vehicles in Germany and China . . . . .	282
F.2	Chinese Automobile Industry Production . . . . .	283
F.3	Process Layout of the Coating Section of the Automobile Production . . . . .	284

---



# List of Tables

2.1	The Classification Criteria of SMEs . . . . .	22
2.2	Scale and Classification of SMEs in 1999 . . . . .	24
2.3	Industry Structure and Comparison . . . . .	35
2.4	Permissible Daily Average Limits for VOC at Workplaces . . . . .	39
2.5	Nomenclature for the Metric of BAT Definition . . . . .	56
2.6	Characterisation of the investigated technique . . . . .	64
2.7	Limit values for Chile, China and Germany . . . . .	65
2.8	Optimal values for Chile, China and Germany . . . . .	65
2.9	$d_{BAT}$ and $d_T$ for Chile, China and Germany (bold values indicate fulfilled requirements) . . . . .	66
2.10	Calculated contribution factors for Chile, China and Germany . . . . .	68
3.1	Nomenclature for the Thermal Pinch Analysis . . . . .	74
3.2	Typical Temperatures and Pressures for Utilities . . . . .	79
3.3	Data for the Thermal Pinch Analysis . . . . .	86
3.4	Heat Transfer Table of the Economic Analysis of the Thermal Pinch . . . . .	90
3.5	Characterisation of the Energy Target Values . . . . .	92
3.6	Nomenclature for the Water Pinch Analysis . . . . .	95
3.7	Characterisation of the Pre-Treatment . . . . .	107
3.8	Data for the Water Pinch Analysis . . . . .	108
3.9	Characterisation of the Water Target Values . . . . .	112

---

3.10	Nomenclature for the Solvents Pinch Analysis . . . . .	114
3.11	Characterisation of the Different Solvent Target Values . . . . .	128
5.1	Sensitivity Analyses for PROMETHEE . . . . .	159
5.2	Characterisation of the Different Process Design Options . . . . .	177
6.1	Monthly Production Rates and Estimated Costs for all Strategies . . . . .	207
6.2	Available Strategies in the Production Pinch Analysis . . . . .	208
A.1	Data of Bicycle Production and Consumption in the EU . . . . .	226
A.2	Cost Data of Bicycle Production in the EU . . . . .	227
A.3	Multi-Component Solvent Composition . . . . .	230
A.4	Settings for the Case Study . . . . .	232
A.5	Coefficients of Heat Capacity (Gas) . . . . .	236
A.6	Coefficients of Heat Capacity (Liquid) . . . . .	236
A.7	Coefficients of Vapour Pressure Curve . . . . .	236
A.8	General Process and Model Parameters for the Solvents Pinch Analysis . .	236
A.9	Preferential Parameters Multi-Criteria Analysis . . . . .	237
A.10	Parameters Production Pinch Analysis . . . . .	237
B.1	Multi-Criteria Characterisation of the Assessed Techniques . . . . .	252
D.1	Profits of Cleaner Production . . . . .	273
F.1	Characterisation of the Coating Section . . . . .	284

---

# Chapter 1

## Challenges for Industrial Production

The need to increase efficiency, improve environmental performance, comply with legislation and simultaneously preserve social responsibility are some of the key challenges to be faced by industry today and in the future. They stem from both the low costs of labour and less constrained local production in industrialising countries and the rapid development in consumer demand and questions concerning environmental and safety standards in industrialised countries [Charpentier, 2005]. In addition, globalisation has connected markets through lower trade barriers and e-commerce and because the operating environment has changed, new approaches need to be developed to meet these challenges. This results in an increased drive for process optimisation to reduce both energy and material loss in the production process and to provide non-polluting, defect-free and recyclable products and by-products.

### 1.1 Background

Industrial engineering should offer suitable tools to develop, improve, implement and evaluate production systems and their operations management. Recently, supply chain management has gained increasing awareness, as a cross-functional approach to improve resource efficiency throughout the industrial value chain. But supply chains are no longer a linear arrangement of processes ending at a final consumer: Instead, there is an increasing shift towards recycling and utilisation of by-products in other supply chains. By handling waste streams (e.g. reduction, reuse, remanufacture, recycling and disposal [Sarkis, 2003]) material cycles can be closed within the supply chain network and resource consumption can be reduced. Especially the research on industrial parks highlights synergies between co-operating companies by optimising both the material and energy flows

and the utilisation of by-products, simultaneously gaining ecological and economic benefits [Tietze-Stöckinger, 2005; Frank, 2003].

While the reuse of production scrap (mostly cuttings or defective products) is required foremost in the manufacturing industry [Fleischmann et al., 2001; Spengler et al., 2003], chemical process engineering in contrast must consider a multitude of by-products with various material properties. In particular the conversion of harmful substances into useful products is a traditional field for mass and energy flow management and process engineering in chemical supply chains. Integrated analysis of different process systems can provide valuable insight into, and also identify improvements in the financial and environmental performance of industrial global supply chain systems [Dibon, 2004; Faruk et al., 2002].

Against this background, one central aim of industrial engineering is the identification and creation of innovative production process designs by combining mathematical and chemical engineering optimisation approaches. Therefore, the quantification of effects and the systematic generation of design alternatives are necessary. In that context, process design refers to chemical plant design, industrial construction and technology management (cf. Figure 1.1). Optimisation is an ongoing task in the chemical process industry, since the operating range of mass and energy flows within a process is directly determined by the process design. The power of process design tools lies in the modelling of the relationship between the underlying chemical and physical principles of unit operations and the knowledge of which combinations lead to beneficial designs [Barnicki and Sirola, 2004]. Unit operations can be modelled by process simulation software (e.g. *Aspen Plus*, a process modelling tool for steady state simulation, design, performance monitoring, optimisation and business planning for chemicals, specialty chemicals, petrochemicals and metallurgy industries). Such process models can serve as a basis for further investigation by Operations Research approaches, like Mixed Integer Linear Programming (MILP) [Spengler et al., 1997], Goal Programming [Zhou et al., 2000] or agent-based approaches [García-Flores and Wang, 2002]. The design alternatives can be evaluated by a number of different criteria (economic, health, safety, environmental impact, energy consumption, controllability, flexibility, ease of maintenance, etc.) and future evaluation might even include further criteria, such as labour utilisation, risk minimisation and security [Barnicki and Sirola, 2004].

A central question for process optimisation are the available technical alternatives. In Europe the catalogue of *Best Available Techniques (BAT)* according to the *Directive on Integrated Pollution Prevention and Control (IPPC 96/61/EC)* is the result of an exchange of information between Member States and the industries concerned. For all relevant industrial sectors, best available techniques have been identified, without prescribing the use



of any technique or specific technology, but taking into account the technical characteristics of the installation concerned, its geographical location and the local environmental conditions, ensuring a high level of protection for the environment as a whole [Rentz et al., 1999b, 2003; Jansen, 2004; Geldermann and Rentz, 2001]. In order to investigate a process modification as the implementation of a technique out of the BAT catalogue, the expected performance of a process at hand can be modelled and simulated by indicators [Cano-Ruiz and McRae, 1998].

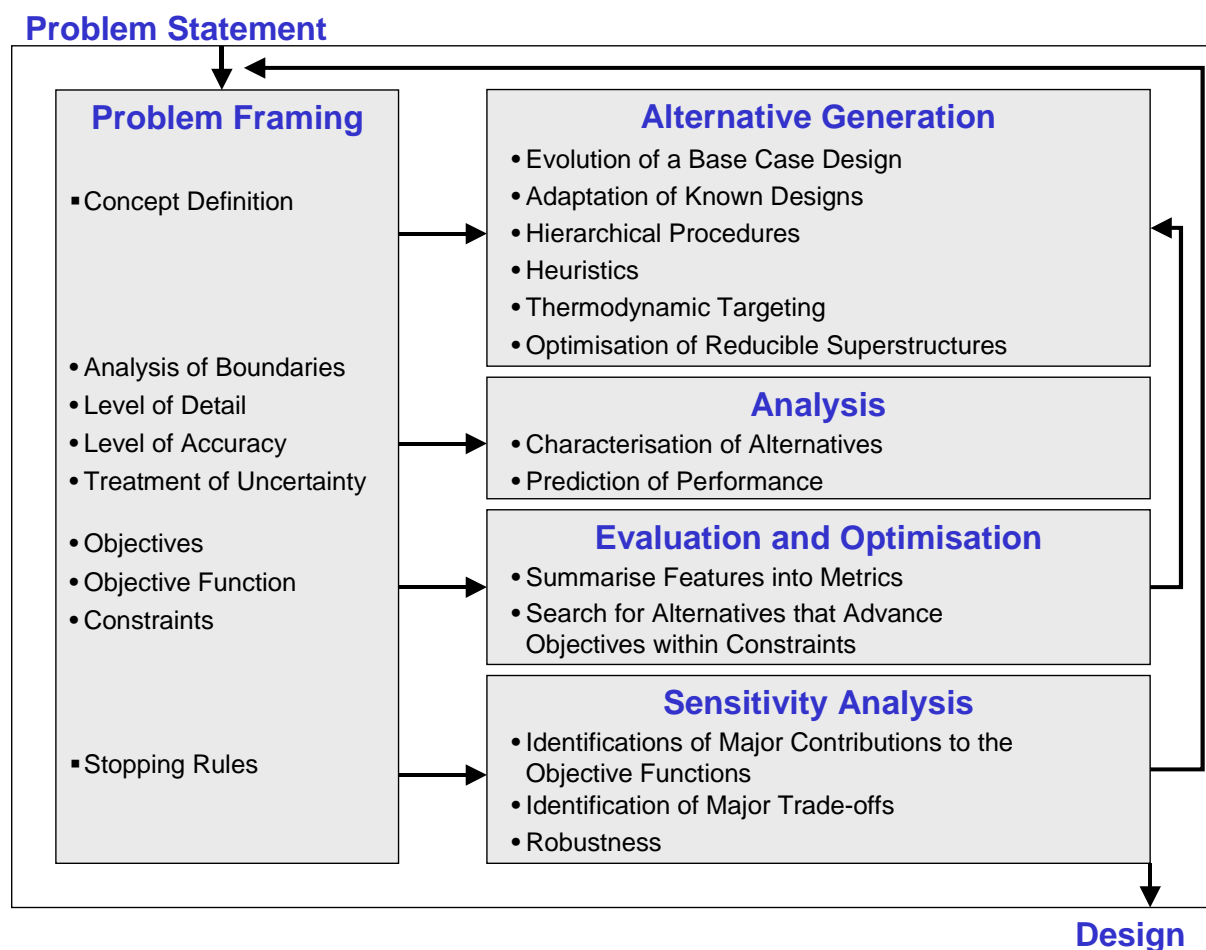

Figure 1.1: The Design Process [Cano-Ruiz and McRae, 1998]

However, the implementation of BAT may depend on the geographical locations and environmental conditions, but also on the economic conditions. Compared to Europe, Japan or North America, industrialising countries face different financial, environmental and industrial conditions. Disparity of the economic development and the scarcity of some resources in relation to the population present a challenge to the environmental policy of many emerging countries. In addition to traditional environmental problems (such

as for example deforestation, erosion, and water shortage) the generation of emissions, wastewater, solid waste, or noise contributes to the pollution of air, water and soil.

One major problem is air pollution from man-made sources, due to the increased use of fossil fuels (e.g. nitrogen oxides ( $NO_x$ ) emissions), manufacturing processes and the use of chemicals, posing a risk to both human health and the environment. Reducing air pollution is a complex task. Whereas pollution reduction measures of pollutants like  $NO_x$  and  $SO_2$  in large industrial installations have been implemented comparably well via technology transfer, the pollution reduction of *Volatile Organic Compounds (VOC)* is more problematic. Emitted VOC are precursors of ozone, which is of major concern in both urban and rural areas. Some studies indicate that for example in China the harvest of soybean crops is reduced by 10% or more and spring wheat production by 20% and 3% respectively, in comparison with the potential production [ECON, 2002]. Overall, more than 5.3 million hectares of land are estimated to be affected by air pollution in China with ozone pollution likely to increase in the years to come, due to several factors including growing numbers of motor vehicles and small and medium-sized enterprises (SME) [ECON, 2002]. In Chile for example the capital region of Santiago is especially affected by air pollution and has been declared a saturated zone in terms of ozone and several other contaminants. Thus, a decontamination plan must be executed for the region, and environmental impact assessments are obligatory for all industrial, urban or real estate projects.

Besides air quality, water pollution and the aim to provide public access to freshwater are of great importance to industrialising countries [UNEP, 2004]. Most industrialising countries need to improve their water resource management. Considerable health effects must be considered, but also significant effects to the structure of industrial applications are observed. Insufficient wastewater regulations based on a central authority vs. a demand-oriented management can be observed [UNEP, 2004]. Furthermore, in China for example, inequalities in water supply between western vs. the coastal and eastern regions lead to different water perception [ECON, 2002].

A third major concern is energy consumption. Taking into account the rising energy demand of industrialising countries, major improvements in efficiency and the incorporation of renewable energy sources are necessary. Furthermore, due to the highly regulated power supply in numerous countries the energy prices are commonly state-controlled. As a result, in most cases energy prices are below market prices and thus do not encourage energy saving measures.

Besides general differences between Europe and industrialising countries, geographical conditions and differences in infrastructure can determine unequal development within these countries. For example in China a disproportionate level of progress exists in the different regions. As it is true for the natural water and mineral resources, the economic development of the eastern and coastal provinces also outplays the underdeveloped western regions and Inner Mongolia. Therefore, the 10<sup>th</sup> five-year plan (2001-2005) contained 225 projects furthering development in these regions with tax advantages, technological innovations and development of infrastructure [Staiger et al., 2003].

Given these circumstances, in the definition of a resource efficient production concept or a technique selection of the BAT catalogue a multitude of different functions and a wide range of properties are significant for the definition and characterisation of materials. When utilising materials for their intended purposes undesired effects also occur, for example incompletely converted raw material, unavoidable by-products, spent catalysts and solvents as well as inherent contaminants in the raw material [Charpentier, 2005]. The risks to humans and the environment by the production, use and disposal of chemicals are addressed in various initiatives, e.g. the *Registration, Evaluation and Authorization of Chemicals* (REACH) in Europe or the *Toxics Substances Control Act* (TSCA) in the United States. There exists a trade-off between information on hazards and information on safer alternatives. Pollution prevention and cleaner production approaches are generally acknowledged to be superior to pollution control [Koch and Ashford, 2006]. The development of new technologies and process innovation "necessitates an integrated system approach for a multi-scale and multidisciplinary modelling of complex, simultaneous and often coupled momentum, heat and mass transfer phenomena and processes taking place at different time scales ( $10^{-15}$  to  $10^8$  s) and length scales ( $10^{-8}$  to  $10^4$  m) encountered in industrial practices" [Charpentier, 2005].

Therefore, methods for a systematic identification of resource-efficient production options are needed, taking water and energy efficiency into account. The challenge now is the optimal recovery and reuse of materials not only for single substances or energy flows in large chemical installations, but also for smaller production processes and various mass and energy flows.

## 1.2 Objectives

The economic and ecologic process optimisation considering the technical process details holds a fine tradition in the chemical process engineering field. Significant energy savings

can be realised applying the pinch point method. Instead of optimising single processes (like heat exchanger) an overlapping network optimisation is executed. By simultaneously considering energy consumption, solvent reprocessing and wastewater reduction a multi objective process design problem has to be optimised. In this case the pinch analysis can be applied to heat flows, mass flows and wastewater flows. For the expected overlapping solutions Operations Research methods can be modified to create a total order and to generate recommendations.

Since in existing approaches only single mass or energy flows of chemical plants were mapped and no simultaneous optimisation was executed, the objective of this book is an innovation in its field by combining the approach of the pinch point analysis in the process integration technology and models of Operations Research in the inter-enterprise production planning. Through the parallel reduction of energy consumption, water use and VOC emissions, a multi-criteria process design problem for intra- and inter-company facility planning must be solved in order to implement efficient recycling cascades. Resulting conflicting solutions must be evaluated based on a multi-criteria approach. This will introduce new possibilities for cleaner technologies and environmental protection by optimally combining process-integrated emission reduction measures and end-of-pipe technologies, while also creating a challenge for further research in the field of multi-criteria decision support. Special focus is on the different case studies in China and Chile (Appendix A - Appendix F). These aspects will be addressed in seven consecutive chapters within this book, reflecting the different objectives of this work:

*Chapter 2* focuses especially on industrialising countries and the special requirements and challenges to harmonise *Sustainable Development* and dynamic growth in these countries. Since the existing approaches towards integrated environmental protection in Europe cannot be directly incorporated by developing industrial nations due to different basic financial and technical conditions, new approaches are needed that can be more easily adapted to the local conditions while still satisfying the environmental objective. Especially approaches suitable for *Small and Medium Sized Enterprises* (SME) are necessary, which are the backbone of various emerging markets. Thus, the system of environmental protection and legislation in China is introduced (cf. Chapter 2.2) and possibilities for adaptation of European approaches of environmental protection in China are discussed (cf. Chapter 2.3). This is followed by an overview of the measures and legislation concerning *Cleaner Production* in Chile (cf. Chapter 2.4). Finally, possibilities of environmental technology transfer are discussed (cf. Chapter 2.5) and a metric for the evaluation of technology combinations is presented (cf. Chapter 2.6).

*Chapter 3* explains the *pinch analysis* as a process design method for integrating processes and closing material cycles. The basic idea behind the thermal pinch analysis is a systematic approach to the minimisation of lost energy in order to come as close as possible to a reversible system. First, the main features of the *thermal pinch analysis* approach (cf. Chapter 3.1) are presented and second, the *water pinch analysis* (cf. Chapter 3.2) is described as an extension of the heat exchange problem to a mass exchange problem addressing minimal fresh water consumption in a production network. Third, the *solvents pinch analysis* (cf. Chapter 3.3) is presented as a method to assess the recovery of organic solvents via condensation in a production network. Economic parameters are included in all approaches to address the trade-off between savings of operating costs and investment. Finally, the advantages and limitations of the various approaches are discussed. The combination of the different pinch analysis approaches for intra- and inter-company production networks into one integrated model is to be developed: *Multi Objective Pinch Analysis (MOPA)* provides the framework for pinch analysis combined with a subsequent multi-criteria evaluation. The optimisation and assessment methodology is demonstrated by a case study. First, based on a company in the bicycle production industry target values for the discussion of savings potentials in the context of several process design options are discussed.

*Chapter 4* addresses the question whether the inter-enterprise plant layout planning offers further potential for emission reductions and cost savings. The concept of closing mass and energy flow cycles is a well-established principle in the process industry on large industrial production sites. Focussing on SME it can be observed that not only inter-company networks and supply chain management have gained increased importance by concentrating on core competences and realising synergies, but also eco-industrial networks provide significant optimisation potential by closing material loops. Consequently, the challenges for inter-company collaboration are discussed (cf. Chapter 4.1) with a particular focus on eco-industrial parks in Chile and China (cf. Chapter 4.2). Finally, examples of a model of an industrial park summarising some of the different case studies of this book show the potentials of an holistic inter-enterprise plant layout planning (cf. Chapter 4.3).

*Chapter 5* presents an approach to address the problem to integrate the different targets determined by pinch analyses in one solution to evaluate the overall resource efficiency. The aim is the assessment of a techno-economic production process improvement based on resource efficiency. A general introduction addresses the problem of comparing different technical options (cf. Chapter 5.1). Missing preferential parameters are identified as key information to resolve incomparabilities between the different technical options. The application of the multi-criteria approach PROMETHEE is presented to resolve the

incomparabilities between alternatives by preferential information between the criteria (weighting factors) and within criteria (preference functions) (cf. Chapter 5.2). The case study shows the application of the various pinch analysis modules and a subsequent multi-criteria assessment for the coating section of the bicycle production.

*Chapter 6* addresses the problem of planning the future production capacity of a company. The traditional capacity planning problem can be analysed in numerous ways and has been extensively discussed in literature (cf. Chapter 6.1). For companies acting in a very dynamic economic environment like in industrialising countries, the problem is more challenging, as is addressed in Chapter 6.2. When companies face a seasonal demand, the problem of capacity adaptation can become even more challenging, as there may be a constant need for capacity adaptations. Forecasting such seasonal demands is possible using various statistical methods, mostly aiming at identifying a seasonal component in historical demand data. Thus, this chapter presents an approach for dynamic and seasonal capacity planning based on the pinch analysis approach (cf. Chapter 6.3). Different production strategies are discussed based on aggregate demand and supply. The application of the analysis is shown on different case studies.

*Chapter 7* compiles the main facets of industrial engineering presented in this book and shows the major contributions of this work. This is followed by an in-depth discussion of the model, which contrasts the advantages and limitations. The Multi Objective Pinch Analysis combines technical, economic and ecological aspects with a multi-criteria analysis incorporating an uncertainty analysis. This makes the assessment of the different targets operational. In addition, aspects for further research are highlighted.

### **1.3 Introduction of the Case Studies from Chile and China**

The case studies are the main focus of this book and demonstrate the features and potentials of the different evaluation aspects for industrial engineering presented in the following chapters. Special focus is set on the application of the methodology to SME. The pinch analysis approach in connection with multi-criteria analysis provides a consistent assessment method for different mass and energy flows within a company, an industrial park or even throughout a supply chain network. It consequently strives for a more comprehensive approach to optimise the system's performance than focussing on single operational units. By determining savings potentials, an assessment of possible process layout modifications

is possible. Case studies from two major emerging economies, China and Chile, are used to demonstrate the application of the methodology proposed.

By applying the methodology developed, decision support can be provided for the production process design of single companies and inter-company networks to improve resource efficiency. First, the realisation of savings potentials based on target values is discussed. Individual target values for energy, water and solvents consumption are calculated based on the pinch analysis and different unit operations are discussed concerning the realisation of the individual savings potentials. Second, an overall assessment is provided by using a multi-criteria approach combining the individual target values. Comprehensive sensitivity analyses are carried out to examine the robustness of the decision and to gain a deeper understanding of the decision problem.

### 1.3.1 Case Studies concerning Coating of Metal Parts

The analysis and optimisation of the serial coating of bicycles is the question of the first two case studies. In the focus are the different paint application steps of the production process. Even though completely assembled bikes are in general produced in these companies, the construction of the frames as well as the assembling and the packaging steps are not taken into account henceforth. The coating of bicycle frames is important for protecting the frame, for example against corrosion and chemical deterioration, and for maintaining the best possible optical quality and several coating layers are applied through a spraying process building up a sequence of layers on the frame.

- *Bicycle Production in China (Bicycle Company 1)*: The case study analyses a reference installation of a typical bicycle production facility of a middle sized firm in China (approximately 850 000 bicycles in 2004, 1 million in 2005 and estimated 1.2 million in 2006) and is one of four bicycle companies at the "bicycle road" in Ludu, a suburb of Taicang [Bao et al., 2005; Lu, 2005]. In the reference company up to 130 000 bicycles are produced per month in peak times and approx. 50 000 in low times by 800 to 1 000 employees. The main question to be answered is if it is worthwhile to modify the paint application process in order to increase the resource efficiency. The developed Multi Objective Pinch Analysis is applied to the case study, which demonstrates the features of MOPA. The use of energy, the consumption of water, and the generated solvent emissions are the major relevant mass and energy flows in the coating step of the bicycle production. A detailed analysis is provided in Appendix A.

- *Bicycle Production in Chile (Bicycle Company 2):* *Bicycle 2* produces on a smaller scale ( $< 100\,000$  bicycles per year). The production process is similar to the one of the reference company *Bicycle 1*. There exists a continuous pre-treatment section and frequently two-colour coatings are applied as a basecoat<sup>1</sup>. Furthermore, the company faces even larger seasonal changes than *Bicycle 1* and thus bed frames are welded and coated in the same facilities. A detailed analysis is provided in Appendix B.

In the coating of bicycles the use of energy, the consumption of water, and the generated solvent emissions are the major relevant mass and energy flows. The case studies show for example that there exists a demand of hot utility for drying the coating of the bicycle frames. By reusing the hot waste heat of the drying ovens to pre-heat the fresh air for the drying process the total demand of hot utility can be reduced by heat integration. A multi-criteria approach is used to integrate identified target values determined by pinch analyses and to compare several process design options. By sensitivity analyses the impact on the result is evaluated with respect to the preferences of the decision maker.

### 1.3.2 Case Studies concerning Alcohol Production

Two case studies are used to demonstrate the challenges of optimising resource efficiency in the alcohol production by using biomass. The first case study focuses on industrial liquid ethanol production from fermented sugar of the cassava root. In industrial processes ethanol is used in a wide application area as a reagents solvents. In the food sector the production of alcohol includes fermentation processes for malt beverages with malt for example from barley, wheat, rice or corn, to produce for example beer, and furthermore includes distillation processes of those fermented beverages, to produce for example whisky. In addition, wines are produced by a fermentation process of the juice of grapes or fruits and brandies are distilled secondary products of those products.

- *Pisco Production: Alcohol Distillery* is an agricultural cooperative producing Pisco, a brandy-like spirit, from a wine distillation process. In the harvest season several distributed facilities collect the grapes from the affiliated winegrowers and after

---

<sup>1</sup> Within the PepOn project several diploma thesis were carried out in Chile in cooperation with the Unidad de Desarrollo Tecnológico (UDT) in Concepción and local companies. The diploma thesis of Alexander Hercher focused on solvent emission reduction measures ("Technische und wirtschaftliche Möglichkeiten der Minderung von Lösemittlemissionen am Beispiel eines industriellen Lackierbetriebes in Chile", Institut für Industriebetriebslehre und Industrielle Produktion, Universität Karlsruhe, 2005)



removing the peduncles and maceration, the must is fermented and stored. In a second step throughout the whole year the wine is continuously distilled. The distiller's wash is the major source of emissions and is treated in an organic wastewater treatment system. A detailed analysis is provided in Appendix C.

- *Industrial Alcohol:* The industrial alcohol plant is an alcohol distillery established in 1994 in which currently 216 employees produce 45 000 tons of alcohol in different grades, 20 000 tons of by-product  $CO_2$ , and 13 million cubic meters of biogas. In general, the industrial alcohol production is one sector, which consumes a great amount of water and energy. The average consumptions of a ton of 95 % (v) alcohol are 102 tons of water and 217 kWh of electricity. Meanwhile 10 - 15 tons of distillage with a COD as high as 50 000 - 60 000 mg/l are generated. A detailed analysis is provided in Appendix D.

Major focus within the case studies is the closing of material cycles, especially using waste heat and wastewater treatment. In general the high organic concentration in the waste gas or waste water are considered. In some cases considering economic aspects closed systems already exist, such as for example for  $CO_2$  by-products or biogas plants. In addition, policy measures are discussed for the introduction of cleaner production technology.

### 1.3.3 Further Case Studies

In general the integration of mass- and energy flows has a long tradition in the process industry combining relatively homogeneous classes of industry, whereas the inter-enterprise plant layout planning is relatively new with respect to *unexpected* combinations involving heterogeneous classes of industry [Eilering and Vermeulen, 2004]. Therefore, further case studies reflection special circumstances in Chile and China are considered in the following.

- *Fishery Net Impregnation:* This company repairs, cleans and impregnates fishery nets used for salmon cultivation. The nets must be changed every four months. Because of the growing algae and mussels they become more and more heavy. In addition, fouling may be the source for bacteria or other illnesses for the salmon. After cleaning the nets with high pressure cleaners and large-scale washing machines, the nets are repaired and impregnated. The impregnation is achieved by a dip coating containing conventional solvent-based coatings. In a last step the nets are dried in a drying tower. A detailed analysis is provided in Appendix E.

- *Small Series Production of Commercial Vehicles:* The vehicle production is increasingly important in China and major challenges with respect to improving the resource efficiency of the production exist. The investigated automobile company is a middle-sized firm producing commercial vehicles in a small series production such as light off-road vehicles and trucks. 900 workers producing approx. 15 000 vehicles in 2005, but the company is increasing its capacity rapidly aiming at 100 000 units in the next years. A detailed analysis is provided in Appendix F.

Throughout the whole book *Case Study 1* is used in order to illustrate the developed methods. Chapter 4, dedicated to Industrial Parks, tries to combine the individual case studies. Especially in the inter-company application the special requirements of the specific case studies, as for example the fishery net impregnation, show new options for process integration.

## Chapter 2

# Cleaner Production in Industrialising Countries

The regional and global energy and material markets will be affected by growing economies and industrialising countries and vice versa. Thus, the world development report of 2003 "*Sustainable Development in a Dynamic World*" [Worldbank, 2002] calls for a dynamic growth in income and productivity for industrialising countries in accordance with a sustainable development. The considerable economic growth in industrialising countries in the last decades, however, has generated increasing environmental pollution. Thus, the success or failure of a resource efficient development will impact on the world's economy. Due to the rapid growth of emerging economies and their increasing demand for resources, it is essential to include these countries and their special conditions in the development of new strategies for sustainable development. Especially approaches suitable for *Small and Medium Sized Enterprises* (SME) are required, since significant changes in supply chain structures (e.g. due to market dynamics) especially challenge SME, which are the backbone of various emerging countries.

### 2.1 The Example of China and Chile

By focussing on mass and energy flow data the identified savings potentials are based on the currently used techniques of a specific country. By not considering the special circumstances of particular countries, "one-size-fits-all policies" [Steenblik and Andrew, 2002]

are less likely to succeed and a transfer of clean technologies<sup>2</sup> is limited. This aspect is also emphasised in the *Agenda 21*, which states that "environmentally sound technologies are not just individual technologies, but total systems which include know-how, procedures, goods and services, and equipment as well as organisational and managerial procedures" (UNEP [1992], chapter 34, art. 34.3)<sup>3</sup>. Therefore, country-specific data, i.e. socio-economic, cultural and environmental priorities and key financial parameters, must be considered.

China and Chile are used as representatives for other industrialising and developing countries since they face similar financial and environmental challenges as others, such as for example Guatemala, Nicaragua, Tanzania, Vietnam or Zimbabwe as an UNEP study shows [Ciccozzi et al., 2003]. However, newly introduced environmental legislation in China of the *State Environmental Protection Agency (SEPA)* by the *Cleaner Production Promotion Law* in 2003 and in Chile of the "*Comisión nacional del medio ambiente*" (*CONAMA*) by the *Environmental Framework Act* in 1994 show the ambition of these two important industrialising countries to improve their environmental performance.

Comparable to the general situation of Latin America, Chile is characterised by a structural dualism. More than 98 % of the companies are small businesses. The SME account for less than 25 % of the total sales in the non-agricultural sector, but offer more than 80 % of the employment [Troncoso, 2000]. However, the great importance of the development of SME for the economic development of a country is generally recognised [Mugler, 1998; OECD, 1999]. In addition other structural deficits stem from the distribution of the industrial activity in the different sectors as for example 80 % of the exports are based on natural resources [Giurco, 2005]. Therefore, not only is the exploitation of the natural resources a problem, but also the small ratio of value added (e.g. copper, pulp industry, fruits, wine, fish). Furthermore, the lack of skilled human resources affects the productivity of the SME in all sectors in Chile.

Several structural differences exist between China and Chile. In China State-Owned Enterprises (SOE) are the major constitutive type of enterprise and in addition the *Township and Village Enterprises (TVE)* play a significant role in the Chinese economy besides privately-owned companies. The collective enterprises TVE contributed to the stabilisation of the economic development since about 1980 and fostered the industrialisation

---

<sup>2</sup> The transfer of clean technologies refers to the application of existing technologies for a new use, or by a new user for economic gain and lower environmental impact [Geldermann et al., 2006c; Agmon and Glinow, 1991].

<sup>3</sup> The *Agenda 21* is the result of several UN-Conferences which took place between 1972 and 1992. It has been signed by 179 countries on the United Nations Conference on Environment and Development in Rio de Janeiro in 1992.

particularly within the rural areas [Schlotthauer, 2003]. TVE experienced an advantage in comparison to SOE to capture opportunities in many markets, thanks to their flexibility due to small size, diversified community economy and a less strict bureaucratic control [Perotti et al., 1998; Fu and Balasubramanyam, 2003]. A detailed analysis about the institutional framework in China is provided in [Banks, 1994; Badelt, 2005; Steger et al., 2003; Geng and Yi, 2005; Zeng et al., 2005], covering cultural, political-legal, and environmental aspects and including an analysis of the economic policy and its implication to an environmental incentive system, in particular energy efficiency.

According to the international example, China created an organisational structure in environmental protection. Environmental protection consistently accomplished means often also the close-down of enterprises of all sizes. Although such close-downs could cause an economic and social destabilisation, the modernisation goals and the health of the population would be endangered without immediate additional environmental protection measures [Betke, 2003]. Furthermore, the relevance of the different stakeholder groups, for example the State Environmental Protection Agency (SEPA), local environmental protection agencies (EPA), energy suppliers, and customers is analysed in [Badelt, 2005]. Up to now major changes of the economic system and only minor changes in the political system prevail in China since the reform and opening policy in 1978 [Zeng et al., 2005]. Consequently, there exists a tight entanglement between political, economic, and administrative sectors leading to inefficient operating control, corruption and absence of the economic principle [Badelt, 2005]. Size and ownership significantly determine for example the energy efficiency in a company because due to the higher economic pressure the demand for energy efficiency improvements in privately owned companies is stronger than in state owned. But even though the production increases annually in China leading to higher energy demand, the specific energy consumption per production unit improves since the size of the companies and the number of privately-owned companies increases [Badelt, 2005]. Major driver for the implementation of cleaner production techniques in China is the motivation to enter international markets requiring certain environmental standards [Zeng et al., 2005].

## 2.2 Environmental Protection System in China

by **Fengji Zhou, Yinan Wang**<sup>4</sup>

The State Council Information Office published a so-called White Paper on "Environmental Protection in China (1996-2005)", which gives a systematic and comprehensive introduction into environmental protection legislation in China [StateCouncilChina,2006]. The following sections give an overview of the different aspects of this report. For a detailed description please refer to the White Paper of the *State Council Information Office* of China [StateCouncilChina,2006].

The Constitution of the People's Republic of China (PRC) stipulates, "*The State protects and improves the environment in which people live and the ecological environment. It prevents and controls pollution and other public hazards.*" Since the foundation of the PRC 1949, the *National People's Congress (NPC)* and its Standing Committee have formulated nine laws on environmental protection and 15 laws on the protection of natural resources. Since 1996, the State has formulated or revised laws on environmental protection, such as those on prevention and control of water pollution, marine environment protection, prevention and control of air pollution, of noise pollution and of solid waste pollution, of radioactive pollution, and the evaluation of environmental impact. Other laws are closely related to environmental protection, such as those on water, cleaner production, renewable energy, agriculture, grassland and animal husbandry. The State Council has formulated or revised over 50 administrative regulations.<sup>5</sup>

Other documents have similar power to laws and regulations, such as the *Decision on Implementing the Idea of Taking the Scientific Outlook on Development and Strengthening Environmental Protection*, *Opinions for Quickening the Development of a Circular Economy*, and *Circular on the Recent Work of Effectively Building a Resource-efficient Society*. Relevant departments of the State Council, local people's congresses and local people's governments have promulgated over 660 central and local rules and regulations in order to implement the national laws and administrative regulations on environmental protection. Altogether, more than 800 national environmental protection standards have been promulgated by the State at both the national and local levels. National-level

---

<sup>4</sup> Energy Research Institute (ERI), National Development and Reform Commission, Beijing, China

<sup>5</sup> Examples are Regulations on Environmental Protection Management of Construction Projects, Rules for the Implementation of the Law on the Prevention and Control of Water Pollution, Regulations on the Safety Management of Dangerous Chemicals, Regulations on the Management of Collection and Use of Waste Discharge Fees, Measures on the Management of Dangerous Waste Operation Licenses, Regulations on the Protection of Wild Plants, and Regulations on the Safety Management of Agricultural Genetically-modified Organisms. More detailed information can be found at [StateCouncilChina,2006]

environmental protection standards include environmental quality standards, pollutant discharge (control) standards, and standards for environmental samples, while local environmental protection standards include environmental quality and pollutant discharge standards.

### 2.2.1 Prevention and Control of Industrial Pollution

Prevention and control of industrial pollution is the focal point of China's environmental protection endeavours. China's strategy in this regard is undergoing a major change compared with the past. There is a shift from control of the end pollution to control of the origin and the whole process of pollution, from control of the concentration of the pollutants to control of both concentration and total amount of pollutants, from control of point sources to comprehensive control of river valleys or entire regions, and from simply addressing the pollution problem of an enterprise to adjusting the industrial structure, promoting cleaner production and developing a circular economy. The amount of industrial waste water, oxygen for industrial chemicals, industrial sulphur dioxide, industrial smoke and industrial dust discharged in generating one unit of GDP in China in 2004 dropped by 58 % in comparison to 1995. Energy consumption per 10 000 RMB of GDP in 2004 declined by 45 % from 1990, equivalent to saving 700 million tons of standard coal in total. The coal consumption for generating thermal power, the comparable energy consumption for each ton of steel and the comprehensive energy consumption for cement declined by 11.2 %, 29.6 % and 21.9 %, respectively.

Enterprises with backward technologies that caused serious pollution or that wasted resources were closed down. During the Ninth Five-Year Plan period (1996-2000), the State closed down 84 000 small enterprises that had caused both serious waste of resources and pollution [StateCouncilChina,2006]. In the period 2001-2004, the State, on three occasions in a run, issued directories listing the backward production capabilities, technologies and products that should be eliminated, and more than 30 000 enterprises that had wasted resources and caused serious pollution were winnowed out [StateCouncilChina,2006]. Eight industries that consumed large amounts of resources and caused serious environmental pollution, i.e., those producing iron and steel, cement, electrolytic aluminium, iron alloy, calcium carbide, coking, saponin and chromic salt, were rectified, and the construction of over 1 900 projects was either stopped or postponed. In 2005 over 2 600 enterprises in the iron and steel, cement, iron alloy, coking, paper-making and textile printing and dyeing industries were closed down for having caused serious environmental pollution and violated industrial policies. Problems of big industrial polluters such as cement, power,

iron and steel, paper-making and chemicals were tackled in a comprehensive way, and technological transformation was carried out. As a result, the discharged amount of principal pollutants has kept declining, while the output of these sectors has increased year by year [StateCouncilChina,2006].

### **2.2.2 Developing a Circular Economy**

The development of a circular economy comprises three steps. The first step is to engage in cleaner production by making full use of resources at the beginning and throughout the whole production process in an enterprise, so as to minimise, reuse or render harmless the waste matter; to gradually establish a producer's responsibility system and extend it to cover the designing phase to promote ecologically friendly product design. So far, over 5 000 enterprises in the sectors of chemicals, light industry, power generating, coal, machinery, and building materials have passed the examination for cleaner production. More than 12 000 enterprises across China have received the ISO14000 Environmental Management system certification. More than 800 enterprises and over 18 000 products of diverse types and specifications have received environmental labelling certification. Their annual output value is worth 60 billion RMB.

The second step is that an ecological industry is being vigorously developed in industry-concentrated areas so that wastes from upstream enterprises become raw materials for enterprises downstream. This has effectively extended the production chain, minimised the amount of waste and realised zero emission. Besides, ecological industrial zones have been established and resources are being used in the most efficient way within these zones or among enterprises. At present, 17 ecological industrial parks of different kinds have been set up nationwide (see also Chapter 2.3).

The third step is to make overall plans for the development of industry and agriculture, production and consumption, city and countryside. This involves vigorously developing industries that make circular use of resources, so as to realize sustainable production and consumption. The State has conducted the first pilot circular economy program in 82 enterprises in some of the key industries, fields or industrial parks, and in concerned provinces and municipalities. A pilot scheme is being carried out in 24 cities, including Beijing and Shanghai, to establish a recycling system of renewable resources. Hainan, Jilin, Heilongjiang and six other provinces are actively engaged in building themselves into ecological provinces, and some 150 cities and counties into ecological cities and counties [StateCouncilChina,2006].



### 2.2.3 Economic and Environmental Investment Policy

The last decade has seen the largest increase ever in China's investment in its environmental protection [StateCouncilChina,2006]. A pluralistic financing system based on government support has taken initial shape after years of efforts. The government increases its input into environmental protection. During the Tenth Five-Year Plan period, 111.9 billion RMB was earmarked from the central budget for environmental protection, of which about 90% from the treasury bonds was used mainly to control the dust storm sources threatening the Beijing-Tianjin area, to protect natural forests, to turn cultivated farmland back into forests or pastures, to control pollution around the Yangtze River's Three Gorges Dam area and its upstream, as well as pollution on the Huaihe, Liaohe and Haihe rivers, Taihu, Dianchi and Chaohu lakes, to industrialise the reuse and recycling of sewage and garbage, and to reclaim waste water. Since 1998, the State has focused treasury bond investment on environmental infrastructure construction, bringing along a large amount of social investment. Between 1996 and 2004, China's investment into environmental pollution control reached 952.27 billion RMB, amounting to 1% of that period's GDP. In 2006, expenditure on environmental protection has been formally itemised in the State's financial budget [StateCouncilChina,2006].

Another important policy is the environment-related fee collection. The management and collection of discharge fees have been strengthened by strict separation of their collection and use, and channelling the fees exclusively into the prevention and control of environmental pollution. The collection of sulphur dioxide discharge fees has been expanded to include all related enterprises, public institutions and private businesses, and the rate of such fees has been raised from 0.2 to 0.63 RMB per kg. The treatment of urban sewage, garbage and hazardous wastes has also been changed, so as to channel social capital in a variety of ways into the environmental protection, infrastructure construction and operation, and to promote the market liberalisation and industrialisation of pollution control [StateCouncilChina,2006]. A concession operation system has been established and implemented for the operation of urban sewage and garbage treatment. In some places, the operation of sewage treatment plants and garbage treatment establishments set up by the government has been transferred to enterprises through public bidding/tendering and contracting. In this way, the government has strengthened its role of supervision while the economic returns of the investment in environmental protection have also been augmented.

The formulation of prices and tax policies can also be favourable to environmental protection. A mechanism to share fees for renewable energy resources has been established. The

part of the price of grid electricity generated by renewable energy is higher than that of the electricity generated by local desulphurised coal-burning generators, the difference between the expenses for maintaining the independent power system using renewable energy subsidised or funded by the government and the average power price of local provincial power grids, as well as the expenses involved in renewable-energy-generated electricity to be incorporated in power grids, will be resolved by collecting extra fees from electricity consumers. The tax rebate policies for exported products, including iron and steel, electrolytic aluminium and iron alloy, have been annulled or reduced in group form. Taxation policy has been formulated in favour of auto industry upgrading and auto pollution alleviation. The consumption tax will be reduced by 30% for auto producers if they reach the low-pollution emission standard ahead of schedule [StateCouncilChina,2006]. Tax reduction or exemption are extended to enterprises engaged in reclaiming renewable resources, making comprehensive use of resources and producing equipment for environmental protection, as well as enterprises using waste water, gas and residues as the main materials of production. The policy of collecting tax on the occupation of cultivated land is observed strictly, so as to promote the rational use of land resources, strengthen land management and protect arable land. The standards of tax collected on the production of coal, crude oil, and natural gas will be raised in steps in the future in order to protect mineral resources and promote the rational development and utilisation of resources [StateCouncilChina,2006].

#### 2.2.4 Environmental Science and Technology

China attaches great importance to and consistently seeks to enhance the support capability of science and technology for environmental protection, actively promotes the industrialisation of environmental protection, and has adopted various measures to encourage public participation in this regard [StateCouncilChina,2006].

Environmental protection scientific research. During the Tenth Five-Year Plan period, the State has organised and conducted the national key "water pollution control technology and treatment project," carried out research and development of such model programs as lake pollution control and ecological recovery, quality improvement of urban water environment, drinking water security safeguard and newly developed waste-water treatment project, thus providing practical technological plans and supportive technological systems for water pollution prevention and control [StateCouncilChina,2006]. A batch of environmental monitoring technologies and equipment has been developed, and many applied. The research and development of such pilot programs as motor-vehicle emis-

sion purification, de-sulphurisation of gas discharged by coal-fuelled boilers, disposal of solid wastes, cleaner production in key sectors and other key technologies have been conducted, and a group of high and new technologies and equipment have been developed with independent intellectual property rights. The "research on countermeasures against significant environmental issues and relevant key supportive technologies" has been listed in the State's key scientific and technological plans; research is under way regarding environmental protection strategy and technological policy, the theory of circular economy and ecological industrial technology, chemicals control technology, polluted site recovery technology, and a green GDP accounting framework have roughly taken shape. The government has carried out research on comprehensive ecological system assessment, ecological functional zoning, and the recovery and reconstruction of the frail ecological zones in the western part of the country, thus shaping up a variety of treatment technology patterns and a mechanism for large-scale demonstration and popularisation in those zones. The country has also completed its survey of alien invasive species, and set up a biodiversity database. It has formulated the *State Environment and Health Action Plan*, and conducted surveys on environment and health in key areas. It has actively conducted research on global environmental changes, and worked out the *State Assessment Report on Climate Changes*, which provides a scientific basis for the State to formulate policies to cope with global environmental changes and participate in the negotiation on relevant international conventions.

After years of practice, China has formed an industrial system of environmental protection with a basically complete category and certain economic.

### **2.2.5 Pollution Control for Small and Medium-sized Enterprises in China**

In the 2002 promulgated SMEs Promotion Law of the People's Republic of China, SMEs are defined as follows: "the SMEs in this Law refer to enterprises of different ownership and different forms, with small and medium size production and operation, legally established within the territory of the People's Republic of China, beneficial to satisfying the social need and increasing the opportunities of employment, and in compliance with the national industrial policies." According to the above definition, on February 19, 2003, the relevant authorities have released the new classification criteria according to the characteristic of different industries and based on the parameters of number of employees (Staff), sales volume (Sales) and value of assets (Capital). (cf. Table 2.1). The industrial sectors include mining, manufacturing, electricity, gas and water production and supply.

Table 2.1: The Classification Criteria of SMEs

Sectors	Small and Medium-sized Enterprises			Including Medium-sized Enterprises		
	Staff [No]	Sales [million RMB]	Capital [million RMB]	Staff [No]	Sales [million RMB]	Capital [million RMB]
Industrial Sectors	<2 000	<300	<400	>300	>30	>40
Construction	<3 000	<300	<400	>600	>30	>40
Retailing	<500	<150	-	>100	>10	-
Wholesaling	<200	<300	-	>100	>10	-
Transportation	<3 000	<300	-	>500	>30	-
Communication and Post	<1 000	<300	-	>400	>30	-
Hotels and Restaurants	<800	<150	-	>400	>30	-

### 2.2.5.1 The Overall Situation and Important Role of SMEs in China

As per China's criteria on SME classification and according to incomplete statistics, there are, at present, 29.3 million SMEs in broad sense in China with a staff of 174 million and asset value of 6 660 billion RMB. Among them, there are 25.4 million self-employed enterprises with a staff of 54 million and asset value of 560 billion. There are 3.9 million SMEs in narrow sense with a staff of 120 million and asset value of 6 100 billion.<sup>6</sup>

Not only does the number of SMEs account for a majority in all enterprises, but also the gross industrial output value of SMEs accounts for a significant proportion (cf. Figure 2.1). In the 90's, the annual growth rate of the gross industrial output value of large

<sup>6</sup> The range of SMEs in broad sense is different from that in narrow sense. In broad sense, SMEs refer to all the enterprises except for the enterprises confirmed as large enterprises according to relevant national criteria. In that sense, SMEs include not only small and medium corporate enterprises, but also self-employed enterprises. In narrow sense, SMEs refer to small and medium corporate enterprises, including small corporate enterprises and medium corporate enterprises but excluding self-employed enterprises. That is to say the SMEs in broad sense is the SMEs in narrow sense plus self-employed enterprises.

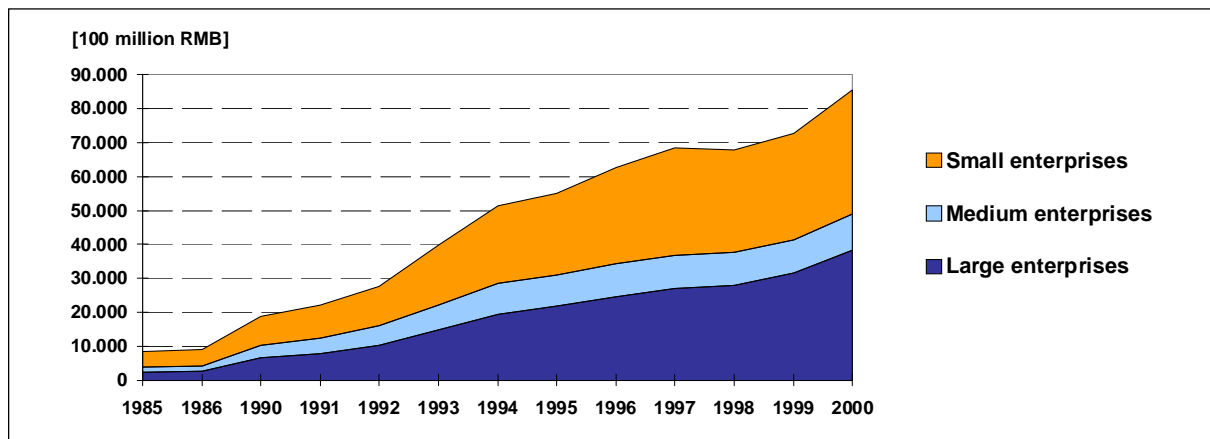

Figure 2.1: Changes in the Gross Industrial Output Value of Industrial Enterprises [ChinaStat2001]

enterprises was 13% while that of SMEs was 12%. Although there was a sharp decline in the number of SMEs in 1998 (being only one third that of 1997), their gross industrial output value increased steadily, demonstrating their market competitiveness.

Although the gross industrial output value and sales revenue of SMEs are almost equivalent to those of large industrial enterprises, the actual profit of SMEs is far smaller than that of large enterprises (cf. Figure 2.2). The reason is seen in the fact that SMEs are backward on technology and lack market competitiveness.

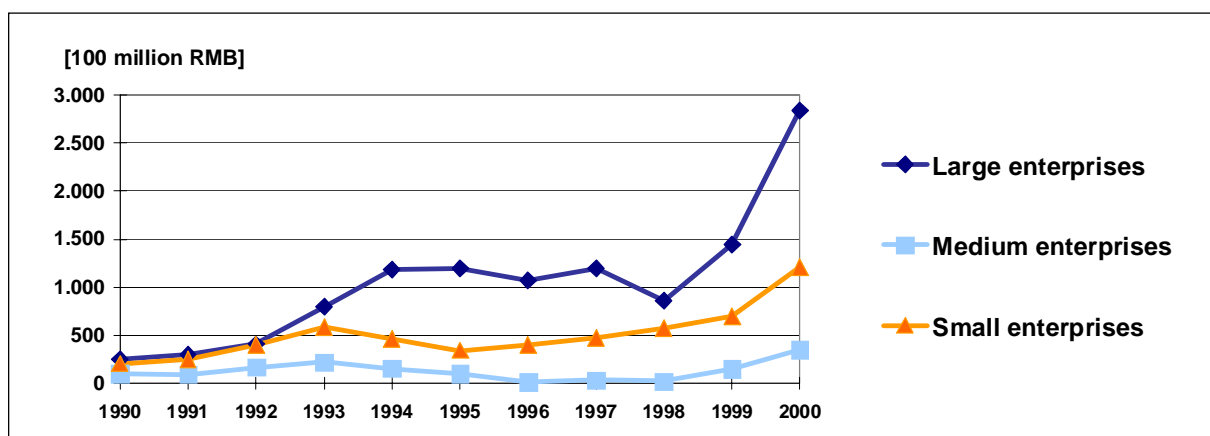

Figure 2.2: Changes in the Gross Profit of Industrial Enterprises [ChinaStat2001]

The characteristics of the distribution of SMEs are summarised as follows:

1. **Distribution in terms of ownership:** SMEs of non-public ownership occupy an absolute majority in all SMEs. According to the investigation of the State Statistics Bureau, among the 3.9 million SMEs in narrow sense in 2001, SMEs with collective ownership account for the largest proportion, which is 57%, followed by private ownership and state ownership (each about 17%). That means enterprises with public ownership occupy 74% while those with non-public ownership occupy 26%. But if the 25.4 million self-employed enterprises are taken into consideration, then the actual percentage of enterprises with public ownership will be less than 10% and the absolute majority will be the enterprises with non-public ownership.
2. **Distribution in different industries:** Among all SMEs, 45% are industrial enterprises, 35% retail and wholesale enterprises, 8% social service enterprises, 3.5% construction enterprises, 2.5% transportation, postal and communication enterprises and 6% enterprises in other business.
3. **Distribution in different regions:** The development of SMEs is not balanced among different regions with the majority of SMEs being in the east region. SMEs in the east region account for 50% of the total, those in the middle region 28% and those in the west region 22%.
4. **SMEs of different sizes:** According to their annual sales volume, SMEs can be divided into four categories, as Table 2.2 illustrates. The smallest enterprises, which have the clear majority, are usually start-up enterprises without clearly defined development direction or strong market competitiveness.

*Table 2.2: Scale and Classification of SMEs in 1999*

Classification (Annual sales [million RMB])	Number	Percentage [%]
500-200	2 127	1.8
200-100	5 269	4.4
100-50	11 192	9.4
50-5	100 245	84.4

In China, SMEs have the same great vitality as large enterprises, and with their unique nature and characteristics that are different from large enterprises, they manifest powerful

competitiveness and vast development prospect. Following is a summary of the characteristics of SMEs' development in recent years. Firstly SMEs' large number and great proportion in the total number of enterprises is a common characteristic of SMEs' development in most countries of the world. Like most other countries, SMEs in China possess an overwhelming proportion in the total number of enterprises. According to statistics, there are about 30 million SMEs in China at present, accounting for as high as 99.9% of the total number of enterprises; and even after excluding self-employed industrial and commercial enterprises, there are still 4 million SMEs, accounting for 99.4% of the total number of enterprises; and especially in the industries such as retail commerce, transportation and social services, nearly all enterprises are SMEs. According to calculations, SMEs produce 50.5% of GDP, 76.6% of industrial value added, 43.2% of tax revenue and 57.1% of commodity sales volume of the whole society. So, it can be said that SMEs possess half of the national economy.

Secondly, SMEs absorb plenty of labor force, and help to stabilize the society. Due to their small scale, simple organisation structure, flexible mechanisms and high efficiency of decision-making, they have obvious advantages in creating employment opportunities compared with larger enterprises. According to surveys, the number of people working in SMEs already accounts for over 75% of total number of people working. Thirdly, SMEs, with a flexible mechanism and innovative spirit, are the cradle of high and new technology industries. Due to their small scale, simple organisation, flexible mechanism and efficient decision-making, SMEs are inherently related with technology innovation. And finally, SMEs undertake the important export task, and is a basic force to activate the market. In recent years, SMEs have always possessed about 60% of the total export value of 200 billion dollars of China every year.

Considering the important functions SMEs play in economic development, the objectives of the government supporting SMEs' development should be: (1) to instigate potential investors to establish new SMEs, thus converting savings into practical investment and enlarging SMEs' number; (2) to stimulate existing SMEs to innovate their technologies and improve their management, expand their scale and enhance their competitiveness; (3) to encourage SMEs' merger, reorganisation and exit, in order to optimize the industrial structure.

Although the state has formulated a number of policies, laws and regulations to encourage and support SMEs' development, and relevant local departments have also issued relevant policies to support and help the SMEs of their local regions, due to the limitations in respect of the development stage, external environment, in particular insufficient policy support as well as SMEs' own development characteristics etc, SMEs still face many

problems in development, such as shortage of funds, difficulty in financing, backwardness of technology and equipments, uncompetitiveness of products, blocking of information, lack of professionals, heavy tax burden, imperfectness of SMEs' socialised service system, all of which has hindered SMEs' further development.

### 2.2.5.2 Current Situation of SMEs' Environmental Pollution

On the whole, the current situation of SMEs' environmental pollution is severe. However, existing statistics can hardly summarize the status of SMEs' pollutant emission and pollution prevention and control, because in China, the environmental statistics on industrial pollutant emission and pollution prevention and control are not classified by the scale of industrial enterprises. In order to understand the current situation of environmental pollution of SMEs in China, two approaches to estimate the pollution load of SMEs can be applied. The first approach is to estimate pollution load of the rural SMEs <sup>7</sup> and try to find a trend (Figure 2.3). The second is to estimate the pollution load of SMEs with the pollution discharge volume per production value unit coefficients (Figure 2.4).

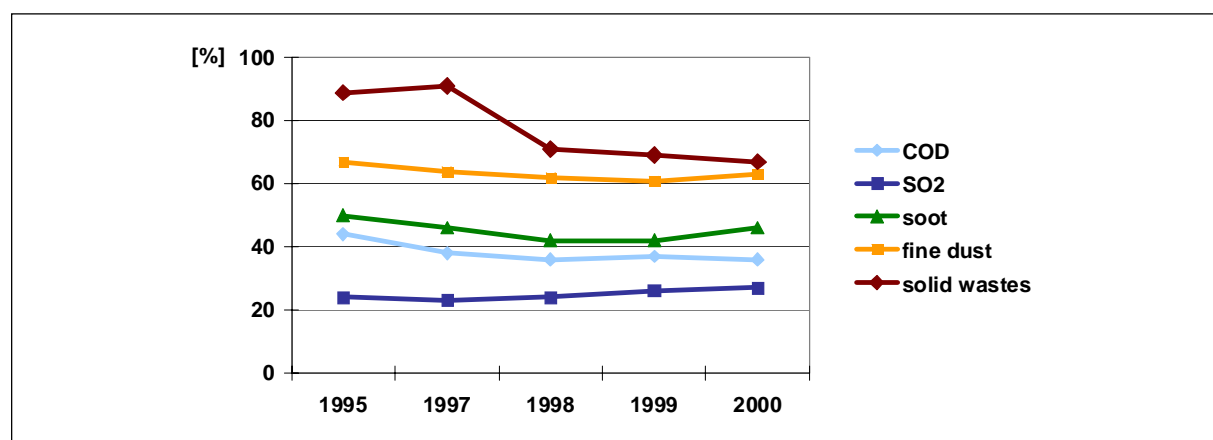

Figure 2.3: The Pollution Load of Rural SMEs' Pollution [StateCouncil]

Although the two methods are adopted to estimate SMEs' pollution discharge load, it can be seen from the calculation result that SMEs' wastewater COD discharge load calculated with the second method is somehow higher than that calculated with the first method,

<sup>7</sup> Rural SMEs are referred to *Township and Village Industrial Enterprises (TVIEs)* or *Township and Village Enterprises (TVEs)*. According to statistics (the survey result of 1998), there are about 20.04 million rural enterprises in China with the average scale of 445 900 RMB operating revenue per enterprise, and a little more than 6 400 big and medium-sized rural enterprises by relevant standards for classifying enterprises, so it is obvious that most of the rural enterprises are small enterprises.



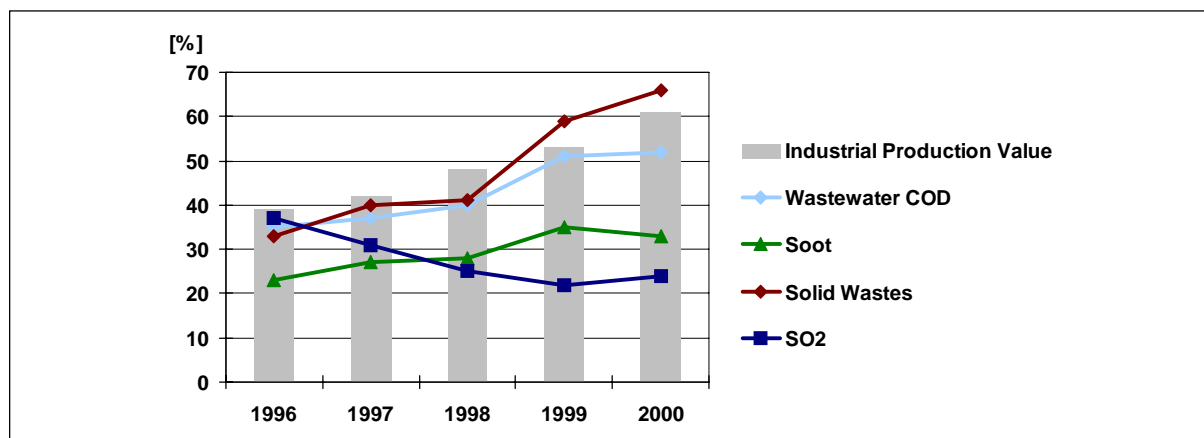

Figure 2.4: The Changes of the Pollution Load of SMEs of the Whole Country [StateCouncil]

while the percentages of SMEs' every other major pollutants discharge load in their respective total discharge loads calculated with the two methods are relatively consistent and comparable. Therefore, these two methods can be cross-checked with each other, and at the same time, it can be seen that SMEs pollution load accounts for quite a high percentage in the total discharge volume, about 50%.

From the above estimation, the SMEs' environmental pollution situation and characteristics can be summarised as follows: By carrying out the "One control and reaching double standards" campaign, the force of supervision and control has been strengthened continuously, and SMEs' pollution discharge volume per 10 000 RMB production value has declined. With SMEs' development, the percentage of their production value in the gross industrial production value of the whole country has risen continuously, resulting in the increase of their pollutant discharge load as well.

Pollution is concentrated in several industries, with water pollution being concentrated in paper making, tanning, electroplating, printing and dyeing industries, air pollution is concentrated in non-metal mineral product manufacturing industries, such as building materials (cement and bricks, for example) manufacturing industries, and solid wastes pollution is concentrated in excavating industry. These industries have low entrance thresholds both in terms of capital and in terms of technology, so small-scale enterprises are in the majority. From the economy perspective, they lack the motivation to treat pollution, from the management perspective, the supervision and control is difficult so the pressure on them to treat pollution is insufficient, and from the technology perspective, treating pollution is difficult, because these enterprises are mostly in traditional industries that do not require too much capital, technology and market.

### 2.2.5.3 The Financial Status of SMEs' Environmental Pollution Control

Enterprises' environmental pollution prevention and treatment financing mainly refers to enterprises' activities and acts of raising money for the construction and running of environmental protection treatment facilities, including the facilities for environmental pollution preventive measures such as cleaner production. At present, even the financing for SMEs' development is difficult, let alone the financing for SMEs' environmental pollution prevention and treatment. Because the construction and running costs of SMEs' pollution prevention and treatment facilities are generally high, the yield rate is low and the capital risk is high, it is very difficult for ordinary financial institutions to give financial support to SMEs' environmental pollution prevention and treatment.

In general, the main financing channels for enterprises' environmental pollution prevention and control include the following:

1. **Bank loans** are one financing channels for SMEs' pollution prevention. In 1995, the People's Bank of China stipulated in *The Notification of the People's Bank of China on Several Problems Concerning Implementing the Loan Policies and Strengthening Environmental Protection Work* that: for the projects and enterprises conducting environmental protection and pollution treatment, the financial institutions of every level should differentiate among them according to their respective economic performance and repaying ability, and select and support the excellent ones. For those emphasised environmental protection projects which have good environmental benefits and no obvious economic benefits, but are able to repay the loans, the policy banks such as China Development Bank should, on the precondition of having secured the source of repaying finances, support in arranging loans. However, SMEs are generally small in scale, poor in economic performance, and at the same time produce serious environmental pollution, and can hardly meet the condition for bank loans, so it is very difficult for them to conduct cleaner production and environmental pollution control through bank loans. At present, in order to encourage the development of SMEs, the State is actively formulating various fiscal and tax policies to broaden the financing channels, - such as demanding that the governments of various levels set aside certain amounts of finances to be mainly used in the credit guarantee, establishment support, technological innovation etc. for SMEs, and to lower the threshold for lending.
2. **The pollution Levy System: the pollution treatment subsidy**, namely the pollution emission fee, is used for subsidizing the polluting enterprises to treat pollution in the form of free appropriation or repayable loans. Previously, the finances

for pollution treatment used by enterprises needed not be repaid, but since 1988, it has gradually shifted into paid usage, the appropriation having become loans.

3. **Stock market financing** is in general one of the mechanisms for enterprises to finance various business activities, including environmental pollution control. In 1996, Shenyang Special Environmental Protection Equipment Limited Company became the first environmental protection enterprise offering shares to the public, and 30 enterprises related to environmental protection had already been listed in the stock market by 1999, forming the environmental protection sector in the stock market. For the whole environmental protection industry and environmental pollution control, the stock market financing for environmental protection companies can broaden the financing channel for environmental protection, change the previous situation whereby environmental protection finances mainly came from governmental directives and guidelines, and enable the financing for environmental protection to really go to the market, nevertheless, it is very difficult for SMEs to finance themselves from the stock market because of its very high threshold, which is hardly attainable by SMEs.

It can be concluded, that the solution to SMEs' pollution problem is constrained by the availability of finance sources. If enterprises can obtain the technological transformation loans, the technological transformation can have the effect of cleaning up the production to a considerable extent, and in combination with the strict implementation of the "Three simultaneous" system, technological transformation and extending reproduction are all conducive to enterprises' pollution treatment. But for those small-scale enterprises that cannot get fiscal and financial support, even if they have constructed environmental protection facilities, these facilities will have a very low running rate or not run at all due to the reason that market prices does not recognize pollution treatment costs.

## 2.3 Adaptation Possibilities of BATs in China

by Yongsen Lu, Cunkuan Bao, Surong Guo, Tingfei Shu<sup>8</sup>

A system with respect to Best Available Techniques (BAT) which covered two domains namely environmental protection and cleaner production was first introduced into China in the early 1990s. To promote the application of scientific and technological research achievements and accelerate the transformation of them into practical capability of pollution prevention and control, and enhance the investment benefits in environmental protection, the *State Environmental Protection Agency (SEPA)* has launched an action on the screening, evaluation and spread of national best available and appropriate technologies since 1993. The Directives of SEPA NO.12 "*Management Measures to the Spread of National Best Available-Appropriate Technologies (NBATs) for Environmental Protection*" was issued in November 1993 [SEPA12]. Later it was amended as the Directive of SEPA NO.4 "*Management Measures to the Spread of National Key Appropriate Technologies (NKATS) for Environmental Protection*" issued in June 1999 [SEPA4]. Further information on the legal framework and the implementation of environmental protection in China can for example be found in [SEPA-EnvProtection; SETC, 2002; SETC, 2000; Song, 2000; Xu, 1999].

### 2.3.1 Legal Framework and Questions of Funding

The *State Economic and Trade Commission (SETC)* and SEPA have promulgated a series of decrees, policies and measures to encourage practising cleaner production. Many best practicable and available cleaner technologies have been recommended since the early 1990s [SEPA-EnvPolicy]. Legislation especially focussing on different media were enacted before 2003 in China for example by the *Environment Protection Act* in 1989, the *Water Pollution Protection Act* in 1984 and revised in 1996, the *Air Pollution Protection Act* in 2000, the *Solid Waste Pollution Protection Act* in 1995 and the *Noise Pollution Protection Act* in 1996 [Zeng et al., 2005]. Most regulations do not contain specific emission limits [Zeng et al., 2005], but if they contain standards, most of them are unrevised limits from the Soviet Union.

Over the years, the China's government has been pursuing the *Circular Economy* as an objective. It is a common view of many officials and experts that the cleaner production is the basis of a circular economy and spreading best appropriate and available technologies either for environmental protection or cleaner production is an effective way.

---

<sup>8</sup> College of Environmental Science and Engineering, Tongji University, Shanghai, China

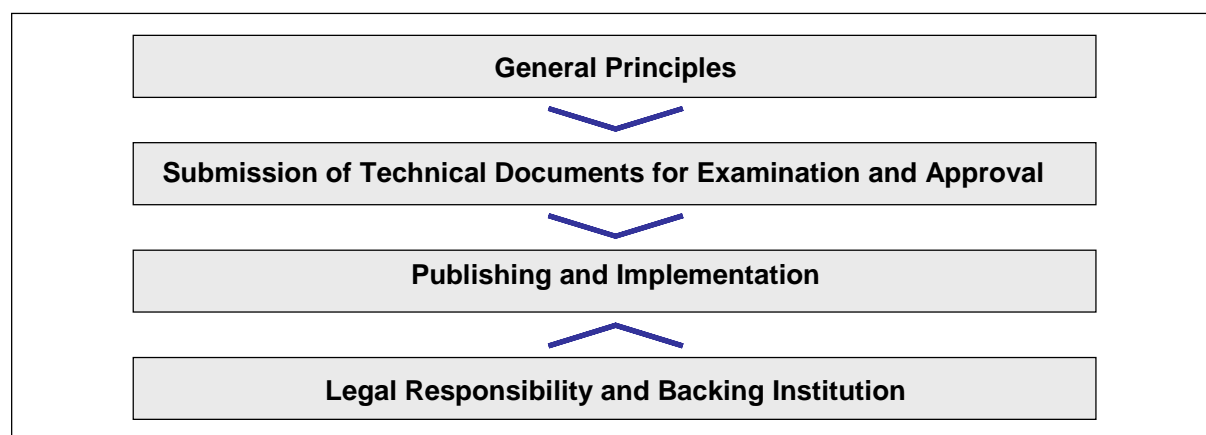

Figure 2.5: The Legal Framework of Spreading Key Appropriate Technologies for Environmental Protection in China

There has not been a legal framework compulsively to promulgate NBATs or NKATs in China. The "National Law of Promoting Cleaner Production" (enforcement since 1 January 2003) [ChinaLawPromCP] and "National Law of Energy Saving" (1 November 1997) [ChinaLawEnergy] are both based on policy guide and encouragement. The commercial administration jointly with other sector administrations under the National Council releases a guiding inventory on cleaner technologies, techniques, equipment and products to public. The obsolete system for backward technologies, equipment and products which heavily waste resources and cause environment pollution within given time limits is executed based on the Law [StateCouncil1994].

The legal framework of the "Management Measures to the spread of National Best Available-Appropriate Technologies for Environmental Protection" or the "Management Measures to the Spread of National Key Appropriate Technologies for Environmental Protection" is shown in Figure 2.5. According to these documents the main points concerning NKATs are described as follows:

The **Definition of the "National Key Appropriate Technologies" (NKATs):** denotes the advanced pollution prevention and control technology, integrated resource utilisation technology, ecosystem protection technology and cleaner production technology which are adaptive or appropriate to the state economic development level during a particular period.

SEPA is the responsible institution in overall planning, organisation, coordination and inspection management of spreading the NKATs. Its main obligations includes the following items:

- organising the collection and examination of NKAT applications, issuing and managing the approved NKATs;
- directing and coordinating the spread of NKATs;
- formulating the policies concerning NKATs and supervising their implementation;
- promoting the construction of demonstrative projects and parks of NKATs, and spreading their experiences or achievements;
- establishing a national network to spread NKATs, and bringing up market mechanism for sustainable operation and
- organising international cooperation and communication.

As regard the *Submission, Examination and Approval*, the NKATs should meet following conditions:

- conforming to the state industrial policies and technological policies;
- being mature in process, advanced in technology, and rational in economy;
- having more than two practically applied cases with longer than one year's normally successive operation;
- having strong adaptation with broad usability and spreading ability;
- possessing important roles in pollution prevention and control, improvement of environmental quality and local eco-conditions; and
- being clear in industrial and technological rights and knowledge property rights as well.

These management measures can also be applied to foreign advanced technologies which are urgently needed but could not be provided by domestic institutions or market. The owner of foreign advanced technology can submit the NKATs application directly to SEPA.

The SEPA was the responsible organisation for examining and approval of the application forms for NKATs from nationwide applicants. From 1993 to 2003 SEPA was in charge of the publication of an "*Annual Compilation of NKATs (or NBATs before 1998)*" and circulation in the country. But the legal responsibility for examination, approval and

spread of NKATs has been moved to the *China Association of Environmental Protection Industry* since 2003 [Lu et al., 2001].

SEPA encourage the users who include state-run industries, collective and private corporations to give priority to the implementation of NKATs in pollution prevention and control projects. Local governmental institutions or sectors should also take precedence of NKATs in implementing environmental plans and management actions. Some large scale NKATs with greater active effects on improvement of the national environment, reduction of pollution or circular economy may be selected and brought into the national spread plan of NKATs.

**Backing Institutions or Units** of NKATs shall conform to the conditions of:

- holding the ownership of the technology;
- having the qualification of corporation; and
- the capability to engage in research, development, design and spread of the KATs

There is no direct funding to support the application or utilisation of NBATs or NKATs. Two financial measures are legally set by the central and local governments: (1) A special fund is set to support the spread of NKATs and (2) a special pollution control fund and an environmental protection subsidy take precedence of NKATs for the construction of environmental protection or cleaner production projects.

### 2.3.2 Status and Potentials for Environmental Protection

BAT systems have had a long history of development in European countries and the U.S. since the late 1960s. It is well known that this system is effective in pollution prevention and cleaner production. The system has been introduced to China as reference in laying down emission standards for thirty years, but had not practically been used as a legal system until 1992.

Although the NBATs (or NKATs) systems have been built in China since then and played a positive and important role in environmental protection and promoting cleaner production, average quantity of published NKATs has been about 140 pieces per year. The published NKATs can be divided into two categories:

1. **Pollution Control Technologies:** This category of technologies are mainly used for waste water treatment and disposal, air pollution control and waste gas treat-

ment, solid waste treatment and disposal, noise and vibration control, and instrumentation of environmental monitoring. The number of NKATs in this category was on average accounted for 75% of the total NKATs published in one year.

2. **Cleaner Production or Pollution Prevention Technologies** includes comprehensive utilisation of resources, waste reclamation and reuse, and conservation of the national ecosystem, etc. The number of NKATs in this category on average accounted for only 25% of the total NKATs published in one year. According to experts' estimation this category of technology will gradually be the main stream in NKATs [Lu et al., 2001].

Two major potentials are identified for development of environmental protection in China in the future: The first potential stems from market mechanisms for the spreading use of BAT. External factors to drive the use of BAT include governmental policy as the first driving factor in spreading use of BAT (see also Chapter 2.2). Financing of the BAT use is mainly in the form of financial input (investment) from the government and pollution control costs from industrial corporations, which are all driven by the government's environmental policy. Over the years the central and local governments have promulgated a series of laws and regulations to guide companies on pollution control and cleaner production and encouraged them to use BATs or NKATs. Unfortunately over the years the enforcement of laws and regulations have often not been executed seriously and also the environmental monitoring has often not been able to match the requirements of the laws and regulations set, which has left loopholes for many companies to exploit. As the results the NBATs (or NKATs) are not urgently needed as was expected. The main internal driving factor in spreading BAT use is the continuous pursuing, by the backing institutions or units, of technology innovation and quality improvement of BATs or NKATs to meet the market needs. Other factors include ameliorating the companies' image in by customers, following the law and entrepreneurs' consciousness, etc.

The second major potential for development of environmental protection in China stems from potential markets of foreign BATs. Generally speaking foreign BATs are welcome and have made contribution over the years in China, market and numerous facts have demonstrated this issue. But the obstacles that a new technology must overcome to break into the environmental technology market serve to protect the technologies already in the market. The obstacles are the barriers to entry, which are a common phenomenon. Three types of entry barriers are discussed as follows: (1) *Cost Barrier*: This barrier is a kind of admission charge. For example, "inside" companies which own NKATs may possess certain advantages such as market relationship web, prior impression in official or



public pattern, specialised equipment and management expertise. Therefore foreign BAT in order to enter the Chinese market and compete effectively, must incur the cost necessary to acquire equivalent advantages. (2) *Technology Discrimination Barrier*: This barrier is related to advertising expenses for a technology entering the market, in order to convince buyers what the salient advantages of the new technology are over the competitors. (3) *Legal Barrier*: Local government through various regulations or limits, permitted zoning, limited licensing, and other barriers to protect local technologies and backing institutions or units. (4) *Barriers of Imperfect Market*: The laws and regulations of the environmental technology market are far from perfect. Enforcement of the laws and regulations is often not strictly. Overdue emphasis on market induction or profit maximisation facilitates makes companies to prefer cheaper technologies without quality assurance to BATs of high quality.

Comparing to the situation in 1990s, the potential market for foreign BATs is becoming more and more normal and open presently and will probably be much better in future.

### 2.3.3 Industry Structure

The structure of China's industry changed fundamentally during the last decades. The development of industry structure generally can be shown in Table 2.3. The table also shows the great disparity of the industry structure of China against developed countries.

*Table 2.3: Industry Structure and Comparison*

Nation	First Industry	Second Industry	Third Industry	[Year]
	(Agriculture)	(Industrial Manufacture)	(Service)	
Proportion of National Economy [%]				
China	30.1	48.5	21.4	1980
	14.8	52.9	32.3	2003
Germany	16	50	34	1935
Japan	13	45	42	1960

The pollution control and prevention especially risk management is becoming a rigorous task that SEPA and local EPB are confronting. The trend of structure transition in China is:

- the market becoming the main body to induce companies' actions;
- the concentration degree of enterprise groups in specific zones getting faster and better, in the Yangtze Delta, Pearl River Delta and some other areas;
- the development of the third industry being more sluggish than the second industry and
- development or construction of such heavy industries as iron and steel, cement, petroleum refinery and chemicals, etc. being overheated.

The essential measures the government takes to combat the malformation of the industry structure are strengthening macro-policy regulation and control, of market mechanism, pursuing circular economy, strictly enforcing laws and regulations, improving the quality of NKATs and increasing the number of users of NKATs, and introducing foreign advanced BATs to the Chinese market as well.

### 2.3.4 Possibilities of a Technology Transfer

The main bodies of research and development in environmental technology presently are the research institutes and universities in China, and the companies with higher level of R&D (Research and Development) are few. The governmental policies have been encouraging R&D and quicker technology transfer since the 1990s. However over the years environmental technology transfer from foreign companies and research institutes has been increasing and supporting central government's policies.

Domestic companies and governmental institutions usually find the information through the following approaches: Foreign and domestic handbooks on BATs, NKATs and patents are a major source for companies to obtain needed technologies. Technological exchange with foreign companies, research institutes and individual experts will accelerate the processes of transfer. Websites and Internet are rich sources to find technology owner and/or cooperation partners. Compilations of the NKATs or NBATs are good resources, but the re-verification and validation are often necessary before making a decision on transfer. Regular exhibitions or symposiums can promote technology cooperation and transfer.

Consequently, general procedures for technology transfer include the following steps [Lu et al., 2002; Qu, 2001]:

- define the scope of technology transfer;
- negotiation and costs;
- related documents and the mode of equipment and material supply;
- technology supporting service and training;
- pre-check and pre-examination;
- final check and acceptance;
- patent, trade mark and confidential; and
- taxation.

Summarising the various opportunities of technology transfer the following aspects can be identified (cf. [Lu et al., 2002; Zhang and Peng, 2000]): There have been a number of opportunities for technology transfer especially for advanced BATs. For examples, the United Nations Industry Development Organisation has been putting 3 billion USD in construction of China municipal wastewater treatment works since 2001 for ten years; the World Bank put total investment of two billion USD on 15 key pollution control projects from 2001 to 2005 [Lu et al., 2002]. Foreign corporations are encouraged to participate in the municipal infrastructure construction and building some circular economic projects through BAT mode or to be share holders through technology transfer. Technological distance exists among Chinese NKATs and foreign BATs, so that the technology transfer in these aspects are encouraged and have good prospects. The "*List of environmental equipment (technology) encouraged to be developed currently*" has been issued periodically by SEPA since middle 1990s. But many of them have not got appropriate technologies in the domestic market. That provides the opportunities for foreign technology transfer.

## 2.4 Cleaner Production in Chile

by Dr. Alex Berg, Marcela Zacarías<sup>9</sup>

During the military dictatorship of Pinochet between 1973 and 1999 the increased dynamic growth of Chile started accompanied with environmental deterioration. Starting with the democratic development of the country in 1990 and the increasing entanglement of the Chilean economy with the world markets new cleaner production strategies, in Spanish "Producción Limpia", were adopted and companies can be certified according to sector specific emission limits. Especially the rapidly increasing per capita energy consumption challenges the environmental policy in Chile. In 2002 Chile ratified the Kyoto Protocol, but as an industrialising country does not have to achieve  $CO_2$  emission reductions. However, as a ratifying country Chile can actively offer through *Joint Implementation*<sup>10</sup> and *Emission Trading*<sup>11</sup> the implementation of projects, so called *Clean Development Mechanisms (CDM)* in Chile for emission rights of developed countries<sup>12</sup>. Even though Chile achieved a considerable trade volume of salmon and wine production, the extraction of copper is still the backbone of the Chilean economy. Major environmental impact with respect to global metal cycles are site dependent and consequently it is necessary to consider local impacts from the mining stage in an overall assessment [Giurco, 2005].

Chile does not possess air quality standards for volatile organic compounds. Only limits of concentration for some VOC in the workplace are at present governed by the Supreme Decree 594 of 1999 ("Regulation on Basic Environmental and Sanitary Conditions at Workplaces"). It establishes permissible maximum concentrations for several chemical and physical agents at workplaces. VOC are among these chemical agents, Table 2.4 shows a summary of the permissible daily average limits (Límites Permisibles Ponderados, LPP) for some VOC or VOC mixtures.

---

<sup>9</sup> Unidad de Desarrollo Tecnológico (UDT), University of Concepción, Chile

<sup>10</sup> Article 6 of the Kyoto Protocol

<sup>11</sup> Article 17 of the Kyoto Protocol

<sup>12</sup> Japan, Canada and the United Kingdom are the major countries implementing CDM in Chile.

*Table 2.4: Permissible Daily Average Limits for VOC at Workplaces*

Substance or Mixture	Permissible Limit ppm	Daily Average mg/m <sup>3</sup>
Formaldehyde	0.3	0.37
Acetone	600	1 424
Methanol	160	210
Benzene	8	26
2-Butanone	160	472
Cyclohexane	240	820
Vinyl chloride	4	10
Dinitrobenzene	0.12	0.8
Ethylbenzene	80	348
Liquefied petroleum gas	800	1 400
Gasoline with less than 0.5 % of benzene	240	712
Hexane	40	141
Nitrobenzene	0.8	4
Toluene	80	300
Xylene	80	347

The National Environment Commission, called *Comisión Nacional del Medio Ambiente* (CONAMA), is the Environmental Protection Agency in Chile and has entrusted two studies at national level, related to the Volatile Organic Compounds. These studies were carried out between 1998 and 2001. The first one, whose final report was written in December 1998, was called "Preparation of Technical-Scientific Background for the Environmental Norm/Recommendation for Volatile Organic Compounds", while the second was the "Regulation of Sources Emitting Volatile Organic Compounds", which was completed in 2001. In the first study, VOC emission estimations and environmental measurements were carried out at the national level. High levels of Benzene were detected in some areas during the study and mitigation measures were recommended. Following the results of the first study, the need to carry out the second study arose; its main purpose was the preparation of a rough draft for a "Norm for the Air Quality with regard to Benzene in Chile". To the present date, this rough draft of the norm has not been concretised.

### 2.4.1 Financing of Cleaner Production Technologies

The experience of diverse organisations shows that practically all the technologies of cleaner production, including "soft technologies" (management tools) and "hard technologies" (requiring significant investments), are available in the Chilean market and by that reason, the access to them is an effort of information and adaptation of each organisation.

The Corporation of Production Promotion (Corporación de Fomento de la Producción, CORFO), has a number of technical support instruments, such as co-financing for example. Furthermore, it offers financial aid, such as long-term credits, for SME in different industrial fields. These instruments and the financial aid facilitate the technological development and the innovation, the improvement of the business management, the access to the diverse services of the financial market, as well as regional and emerging sectors' productive development.

Particularly, CORFO has defined cleaner production as a priority strategic feature and in the area of productive modernisation it has designed the course of action for support in environmental matters (Línea de Acción de Apoyo en Materia Medioambiental) that is composed of the following instruments:

- Fund of Technical Aid of Cleaner Production (Fondo de Asistencia Técnica de Especialidad Producción Limpia, FAT-PL)
- Program of Support to the Management of Businesses in Cleaner Production (Programa de Apoyo a la Gestión de Empresas en Producción Limpia, PAG-PL)
- Program of Support for Preinvestment in Environmental Protection (Programa de Apoyo a la Preinversión en Medioambiente, PIMA)

Besides, in the area of financial intermediation, CORFO counts on the "Line of Credit for the Financing of Investments in Environmental Protection in SME" (so-called Línea B-14). The other existing instruments, though not specifically meant for environmental matters, can also be adapted for applications in environmental management and cleaner production. These instruments aimed at the improvement of the general management of businesses (co-financing) include:

- Associative Projects of Promotion (PROFO)
- Suppliers Development Program (PDP)

- Program of Support to the Business Management (PAG)
- Fund of Technical Aid of (FAT)
- Program of Support to the Preinvestment in Environment (PIMA)
- Fund of Technical Aid of Cleaner Production (FAT-PL)
- Program of Support to the Management of Businesses in Cleaner Production (PAG PL)

Finally, two programs exist in the field of promotion of innovation and technological development, which are the National Fund of Productive and Technological Development (FONTEC) and the Fund of Development and Investment (Fondo de Desarrollo e Inversión, FDI).

### 2.4.2 Status and Potentials for Environmental Protection

The national politics for cleaner production are enforced by the National Council for Cleaner Production depending on the Chilean Economy Department. The council was created by mandate of CORFO and has the role of coordinating and facilitating the execution of the strategies that give impulse to the Politics of Cleaner Production defined by the government for the period 2001 - 2005. In this sense, the council has to evaluate initiatives, to be adopted by diverse public institutions that promote cleaner production and the prevention of contaminations. The council aims at collecting all the necessary information needed to monitor the advance of the theme to a national scale. It also aims at generating proposals to further develop to perfect successful initiatives. It also strives to promote and to articulate this politics among all the prominent actors of the country, and has the responsibility to evaluate its advance and to execute the changes for its improvement.

Selected Cleaner Production agreements of the investigated sectors are briefly characterised in the following as an example:

- Cleaner Production Agreement for the Sector of Pisco and Pisco-Grapes of the III and IV Region

The agreement was subscribed in August of 2004 in Vicuña (IV Region) and September of 2004 in Alto del Carmen (III Region). The signatories from the private sector are the Association of Pisco Producers (Asociación de Productores de Pisco) and

Cooperativa Agrícola Pisquera Elqui Ltda. (CAPEL). To the document adhered the following nine companies: Agrícola e Inmobiliaria San Felipe Ltda. (Horcón Quemado), Agroindustrial y Comercial El Rosario, Sociedad Agrícola Mal Paso y Compañía, Pisquera Río Elqui, Sociedad Agroindustrial Valle del Elqui, Agroproductos Bauzá y Compañía, Sucesión Ernesto Munizaga, Capel, Pisonor (CCU - Ruta Norte).

The agreements objectives are incorporating measures and technologies of cleaner production, increasing the productive efficiency and reducing the contamination at the place of origin. The implementation of good operating practices, reutilisation and recycling are also promoted.

- Cleaner Production Agreement for Management of Containers and Paintings, Chemical Sector Subscribed in January 6, 2000.

The agencies involved in this agreement are the following institutions from the private sector: "Asociación de Industrias Químicas" and "Empresas Químicas de la Región Metropolitana". It was signed by 35 chemical companies of the Metropolitan Region, the Departments of Economy and Health (Servicio de Salud Metropolitano del Ambiente, SESMA), the Corporation of Promotion to the Production (CORFO) and the Central Bank. It is supported by the Association of Chemical Industrialists (Asociación Gremial de Industriales Químicos de Chile, ASIQUIM).

The agreement's objectives cover environmental aspects that transcend the fulfilment of the environmental regulation in force that regulate the management and final disposition of containers used, of chemical products, as well as the responsible management in the production of paintings.

- Cleaner Production Agreement of Nets Wash Workshops Signed November 4, 2004.

It is signed by 21 nets wash workshop of the X and XI regions and the public agencies involved. The agreement is comprised of 37 actions divided into five general goals, the ones that are described subsequently:

- Optimisation of the Sanitary and Environmental Management
- Management of Liquid Industrial Wastes
- Management of Solid Industrial Wastes
- Management in Hygiene and Labour Security
- Integral management and Training in Cleaner Production



The agreement's objectives are to promote a growing process of productive efficiency and to prevent the contamination during the reception, making, washing, repairing, drying, impregnation and delivery phases of the nets wash workshops. It also aims at optimizing the conditions of hygiene and labour security. The involved industry associations are the Association of Net Repair Workshops (Asociación de Talleres de Redes A.G., ATARED) and the Chilean Association of the Salmon Industry (invited) (Asociación de la Industria del Salmón de Chile A.G.).

### 2.4.3 Prevailing Industry Structures in Chile

More than 98 % of the companies in Chile are small businesses. The SME account for less than 25 % of the total sales in the non-agricultural sector, but offer more than 80 % of the employment [Troncoso, 2000]. The SME in Chile are confronted with several disadvantages compared to large companies. Besides the well known absent effects of economies-of-scales, they have no access to international capital markets and must pay higher interest rates on the national market. Furthermore, the lack of skilled human resources affects the productivity of the SME in all sectors in Chile [Landerretche, 2002]. Additionally, the numerous regional integration agreements signed by Chile with other countries result in a breakdown of protection measures for certain products and activities thus also affecting the competitiveness of SMEs [Schiff, 2002].

The positive results of the domestic economy in the year 2004 (reactivation, macroeconomic equilibrium, and growth), besides the need for financial resources to develop new plans to improve the competitiveness, describe the present situation of the SME. Data from the Central Bank shows that the consumer prices index (IPC) was 2,4 %, the gross domestic product (PIB) reached 57 trillion pesos at current prices (about 127 billion EUR), with a percentage variation of 6,1 with relation to year 2003, and the exports increased by 53 % with 32.024,9 million dollars FOB exported in 2004.

Though the perspectives for the SME are encouraging, above all considering the economic joint (Estrategia, April 5, 2004), the immediate analysis says that "the gross part of the growth of the economy in 2004 is centred in the exporting sector" (Diario Financiero, April 13, 2005) and particularly in the large businesses that carry out the 95 % of the exports.

The degree of participation of SME in the productive economic system is well described considering the following data:

- They represent the 16,1 % of the total of businesses;

- They participate from the 23,7 % of the total of sales carried out;
- They give employment to 47,7 % of the labor force;
- They represent 4,8 % of total exports; (Aserta, March 2005)
- They export the 3 % of its total sales; and

These figures of Chilean SME contrast with the ones of other countries, for example Italy, where this segment exports 60 % of the PIB and provides 92 % of the employment, or with Taiwan, where SMEs represent 98 % of the businesses, provide 78 % of the employment, account for 30 % of the sales and for 20 % of the exports. (Larraín, October, 2004)

Nevertheless, the SME should be the most dynamic productive segment in the next years, thanks to the unlimited possibilities that an expanded market of 1000 million people. For Larraín (October, 2004): a small group of SME (5 % - 10 %), counts on immediate opportunities, another bigger group (25 % - 50 %) is faced with competitive challenges and threats, and another 40 % expects neither good nor bad effects.

In the study "Obstacles and opportunities of investment for the development of the small and medium businesses in Chile" [Bianchi and Parrilli, 2002], it is noted that the politics of development of the segment have to consider the normative aspects and the failures of the existing market, and that these politics should lead to the generation of a productive system that unites the economic actors in the project for competitive development based on more specialisation and complementarity of the SME (efficiency), which should be at integrated in networks that produce for the global markets (conglomeration) [Bianchi and Parrilli, 2002].

For a productive system to be competitive, it should include a number of qualities (innovative capacity, production of international quality, qualified human resources, available financial resources, cooperation among businesses, etc.) that direct it toward the technological border and the new demands of the consumers. These qualities impact directly in the following factors that determine the success of the SME. The first factor for success is the integration in a dynamic social and productive system at the local level. Another factor is the work to improve the quality of the product, process and of the human resources. Finally, their success depends on the diffusion of knowledge and competences to be able to structure the local economy [Bianchi and Parrilli, 2002].

In line with the function of these qualities, and considering the normative aspects and the failures of existing market, the government and the private sector have developed a series of initiatives, which include:

- Ley de Cooperativas (2002).
- Ley del Tribunal de la Libre Competencia (2003).
- Ley de Compras Públicas (2003).
- Ley de Factura Título Ejecutivo (2004).
- Fondo Garantía Pequeña Empresa (FOGAPE).
- Capital semilla para emprendimiento. (CORFO)
- PROFO reforzado para asociatividad (2005 - CORFO)
- Modernización del Estado (2003). [[www.modernizacion.cl](http://www.modernizacion.cl)]
- Grupo de acción digital. [[www.agendadigital.cl](http://www.agendadigital.cl)]
- Chile Calidad. [[www.cnpc.cl](http://www.cnpc.cl)]
- Chile Califica. [[www.chilecalifica.cl](http://www.chilecalifica.cl)]
- Chile Innova. [[www.innovacion.cl](http://www.innovacion.cl)]
- Sistema Nacional de Calidad. (CORFO, INN, Chile Calidad)
- Norma NCh 2909 Of. 2004 para la gestión PYME. [[www.inn.cl](http://www.inn.cl)]
- Chile Competitivo. [[www.asimet.cl](http://www.asimet.cl) - [www.cnpc.cl](http://www.cnpc.cl)]
- Innova Chile. [[www.corfo.cl](http://www.corfo.cl)]

These initiatives are designed to facilitate contribution among different social players (public agents, private companies, universities and investigation centres), and to favour the competitive capacity of the SME; through the formation of clusters (sectoral and geographical conglomeration), of spin-offs and technological consortiums. Besides they promote the quality improvement (certification), and the search for new market niches, with the objective to compete with products and services of greater aggregate value.

#### 2.4.4 Possibilities for Technology Transfer

The Chilean government has promoted the relation between companies and research institutions from the 1990's. The major aim of these initiatives is to improve productivity of companies on one hand, on the other hand there is assistance for the creation of new businesses. One example of these efforts are the business incubators created for several universities, which provide business consultancy, staff, mentoring and basic services. For existing SME, the Corporation for the Promotion of Production (Corporación de Fomento de la Producción, CORFO), through Innova Chile, offers several ways of support for the transfer of know-how and the diffusion of new technologies, two of them are described in the following.

##### *Misión Tecnológica (Technological Mission)*

This programme consists of a subsidy that covers part of the travel cost for visits to foreign countries. Such visits shall assist them in improving productivity and modernise their production, by transferring or adapting technologies of management or of production to their businesses. The program supports visits to businesses, universities or centres of research and development that may be of interest to the enterprises. Besides this, aid for organizing seminars on process modernisation and specialisation is given with the aim of spreading modern production and management technologies. The mission also finances participation in fairs and international expositions that are of technological relevance to the businesses. The programme is organised for groups of representatives from five to fifteen companies from one industry sector, from related sectors or technological institutions related to specific subject. CORFO contributes up to 70 % of the total cost of the project, with a maximum of 45 million pesos (about 100 000 Euros). This contribution within the Technological Mission covers the expenses associated to technology transfer.

##### *Chile Emprende (Chile Venture)*

The aim of Chile Emprende (Chile Venture) is to facilitate and promote the business opportunities to micro-companies and small businesses within one region of the country. Its main objective is to generate employment through the development of business opportunities for the businesses of smaller size. This shall be made possible by organising committees that include stakeholders of the private sector, of municipalities and of industry associations. Chile Emprende was created in 2005 and operates on a very local scale. In each territory projects are defined by companies and public institutions. Networks are established in each territory in order to identify common development objectives that enable the channelling of available resources in a way that optimizes the potential of the particular territory.

Some other initiatives are focused on one specific industry, like the programme INIA-CHILE ([www.inia.cl](http://www.inia.cl)) of the Chilean government, which has the aim to create or adapt scientific and technological knowledge for the agricultural sector. They use publications and courses for small groups of farmers and private companies that shall act as so-called extension agents for spreading innovations among farmers.

Additionally several international programs and cooperations exist for the promotion of innovation and technology transfer in SME. For example, the Innovation Relay Centre (IRC-Chile), created by the European Commission in 1995 in order to facilitate transnational innovation and the transfer of technology. It offers specialised consultancy services for SME, mainly in the area of technology transfer and of the creation of agreements between companies for a mutual benefit.

## 2.5 Discussion on Technology Transfer

Effective global response to climate change requires the development, transfer and utilisation of environmentally sound technologies between and within countries. For instance, there are several programs designed to operationalise the technology transfer provisions of the *United Nations Framework Convention on Climate Change (UNFCCC)*. Their goal is to demonstrate modalities for developed country parties to fulfil their obligation under the UNFCCC to support technology transfer to developing countries and to facilitate their participation in global efforts to combat climate changes [Kline et al., 2004]. For instance a "Special Report of the Intergovernmental Panel on Climate Change (IPCC)" [see e.g. Metz et al., 2000] offers information on technology transfer, such as capacity building, the promotion of an enabling environment, and mechanisms for technology transfer from developed to developing countries. Likewise, the *Clean Development Mechanism (CDM)*<sup>13</sup>, an arrangement under the Kyoto Protocol, allows industrialised countries with a greenhouse gas reduction commitment to invest in emission reducing projects in developing countries as an alternative to what is generally considered more costly emission reductions in their own countries, thus contributing to a technology transfer.

Technology transfer is defined as a process for conceiving of a new application for an existing technology. Many companies, universities, and governmental organisations have "Offices of Technology Transfer" dedicated to identifying research results of potential commercial interest, and to developing strategies for their exploitation. Such technology transfer organisations are often multidisciplinary, involving economists, engineers, lawyers, marketers and scientists.<sup>14</sup> In the scientific literature, technology transfer and innovation are closely related. The concept of "innovation" originally involved production innovation,

---

<sup>13</sup>The Clean Development Mechanism (CDM) was originally seen as an instrument with a bi- or multilateral character where an entity or fund from an industrialised country invests in a project in a developing country. In a unilateral option, the project development is planned and financed within the developing country. By doing so, transaction costs can be reduced compared to foreign investments that have to overcome bureaucratic hurdles. On the other hand, technology transfer is likely to be lower, because capacity building has to be undertaken by the host country and all risks have to be carried by host country entities. Whereas several countries from Asia and Latin America can design and implement projects autonomously, most of the Sub-Saharan countries will further rely on foreign support [Michaelowa, 2007]

<sup>14</sup>One example is the German Association for Technical Cooperation - GTZ. In 1947, the Federal Ministry for Economic Cooperation and Development (BMZ) awarded the GTZ a general contract within the framework of development cooperation. The GTZ is active in 135 countries and has branch offices in more than 50 countries. It supports the ecological planning and evaluation of country-specific environmental projects concerning e.g. energy, agriculture, or forestry. The industry-specific focus is on the recording of environmental burdens, environmental technical consultation of levels of industry,

process innovation, market innovation, use of new raw materials and getting materials in new ways, and organisational innovation [Schumpeter, 1934]. Later on, the focus of research was on effective management of R&D (Research and Development) activities [Abernathy and Utterback, 1975] and the role of the users of innovation as a key source [von Hippel, 1988; Shapiro, 2001].

Technology management has only been coined in the last two decades and originally stems from the planning and controlling of research and development. It aims to understand, shape and relate the interactions between technology, organisations, and society and their impact on the sustainable use of natural and human resources. Especially the keeping pace with technological progress is of outmost importance for industrial firms [Milling, 1974; Zahn, 1995; Hauschildt, 1997; Brockhoff, 1999; Tschirky and Koruna, 1998]. Recently, based on the system theory, some scholars (particularly from Asia) have shifted the research focus from individual components in the innovation system to their interactive relationships. This "portfolio innovation theory" comprises inter alia coordination between product innovation and process innovation, and coordination between technology innovation and organisational culture innovation [Xu et al., 1998, 2007; Coriat and Weinstein, 2002]. Thus, technology transfer has to take into consideration cultural characteristics, especially in industrialising countries having their own unique background and characteristics.

### 2.5.1 Innovation in China

Most Chinese enterprises overlooked technological innovation for a long time. By devoting themselves to technological innovation, non-technological factors were ignored, such that the technological base of the enterprises was not solid enough to improve performance [Xu et al., 2007]. Research on innovation management and technology transfer in China is in its early stages and growing rapidly, as technology is transferred to Chinese organisations and the organisations themselves create innovations [Farris, 2007]. For example, [Li et al., 2007] analyse product innovation and process innovation in Chinese state-owned enterprises (SOEs) and come to the conclusion that market forces and internal governance have the highest influence. The studies conducted to date provide promising theoretical ideas, but specific findings should be regarded as tentative, as was the case in early research on innovation in the West [Farris, 2007].

---

introduction of environmental management tools, and suitable legal and regulatory general conditions. The direct transfer of technology, is however rare.

Given the peculiarities in innovation management and in particular decision making in enterprises in industrialising countries, suitable approaches for technology and innovation management are needed. Especially decision making in Chinese innovation management differs in several aspects from western approaches, and is not yet profoundly investigated in the scientific literature [Liu et al., 2006]. Many decision makers outside the companies, such as in several consulting instances and external authorities, are for instance, involved in the implementation of innovations [Xu, 2000]. Moreover, Chinese business networks and thus the current management system are still sustained by Chinese cultural values and tradition [Xu, 2000; Badelt, 2005; Schlotthauer, 2003]. Thus, Western perceptions of innovation management cannot be directly applied to the situation in Chinese enterprises without adaptations. The rapidly developing industrial parks in China, however, call for appropriate tools for the improvement of the complex production networks.

### 2.5.2 Innovation in Chile

Research on technology transfer to Latin America has however a longer tradition and deals mainly with the following two questions [Lopes, 1994]:

1. What are the technologies most needed in the developing nations of Latin America today?
2. How can the transfer of these technologies from the developed countries be improved profitably?

It is however worth noting that an active approach needs to be backed by a conceptual knowledge exchange in order for key technologies to arrive in Latin America. Specific investigations on innovation processes in Chile, however, are rare. One example is a study on ranking cities in Latin America on their capability to create knowledge-based enterprises, where [Tiffin and Jimenez, 2006] developed an index and tested it exemplarily for its feasibility and cost-effectiveness in Santiago de Chile.

Currently, life sciences seems to be the best developed research area throughout Latin America. Commercially successful innovations are however lacking, unlike the case in many highly industrialised countries. A reason might be the historical lack of political and social legitimacy exhibited by innovation policies in underdevelopment countries [Sutz, 2007].



### 2.5.3 Prediction of Technology Innovation and Diffusion

The prediction of technology transfer and the diffusion of emission reduction techniques is of interest both for political and industrial decision makers. *Integrated Assessment Models* are being developed for the analysis of innovation and diffusion of technologies that affect emissions in certain regions. Models for the determination of national cost functions, such as ARGUS, PERSEUS, RAINS, MARKAL and others, take into account full sets of emission reduction options, including structural options related to changes in sectoral activities and production technologies [for an overview see e.g. Hordijk and Kroeze, 1997; Makowski, 2000; Geldermann et al., 2006b; Geldermann and Rentz, 2004]. They provide the "cost optimal" evolution of the production system (production technologies and abatement options in place) over a given planning horizon, which in turn allows the realisation of emission reduction ceilings and the supply of demand for products or services specified exogenously on the sectoral level. One example is the *Regional Air Pollution INFORMATION and Simulation model* RAINS, which has been developed by IIASA as a tool for the integrated assessment of alternative strategies to reduce acid deposition in Europe and Asia. The RAINS model presently consists of the following modules [Alcamo et al., 1990; Cofala et al., 2000; Klimont et al., 2000]:

- activity databases on energy use, transport, agriculture and industrial activities,
- emission projections modules for  $SO_2$ ,  $NO_x$ ,  $VOC$ ,  $NH_3$  and  $PM$ ,
- a module for abatement costs for these pollutants,
- reduced-form models representing the dispersion of pollutants in the atmosphere,
- effect-indicators (health, ecosystem effects), and
- optimisation module.

Results from the RAINS model have been used for the development of international agreements such as the 1999 Gothenburg Protocol under the United Nations Economic Commission for Europe (UN/ECE) Convention on Long-range Transboundary Air Pollution (CLRTAP) as well as for the 2001 European Community Directive on National Emission Ceilings of certain atmospheric pollutants (Directive 2001/81/EC).

RAINS Asia has been under development for several years now [Cofala et al., 2004; Streets and Waldhoff, 2000; van Aardenne et al., 1999]. As one of the few models, it covers emissions of non-methane volatile organic compounds (NMVOC) in China. The historical

activity data of more than 70 VOC emitting processes, for the years 1990 and 1995, was collected at the provincial level. By using emission factors, based on Western, Asian and Chinese experience, and growth factors derived from anticipated economic, population, and lifestyle changes, and technology improvements, future emissions could be estimated for the years 2000, 2010, and 2020. [Klimont et al., 2000] came to the conclusion, that though activity growth rates are much higher than these increases would imply, technology improvements mediate the increase.

For the realisation of the identified strategies, the feasibility of the emission reduction measures identified by the model should be considered, since some measures might, in practice, be less viable than others e.g. due to technical difficulties or due to strong lobby group pressure. In addition, the choice of a different time horizon (than 2010) for the model calculations could result in a different allocation because of the long-term potential of technological progress. Modelling the influences of endogenous technological learning, government-sponsored R&D programmes or retrofitting measures before the end of the installation lifetime would also yield different results.

The industrial sectors considered so far comprise stationary VOC emission sources. Agriculture and the natural environment have not been covered due to lack of definite information on their emission relevance and lack of emission reduction options. However, these sources have proven to be considerable in several countries especially in summer, when high ozone levels occur, and should therefore also be taken into consideration [Geldermann and Rentz, 2004].

General criticism on Integrated Assessment Models is voiced by several authors [e.g. Bhattacharya et al., 2004; Burtraw and Krupnick, 1999; DeCanio, 2006]. According to them, the models used to derive estimations of technology transfer and future emissions are based on assumptions that have largely gone untested. Engineering (bottom-up) approaches are used to model technical change as a set of price and productivity factors that change over time as a function of technology advances in the considered developing countries. S-shaped diffusion curves are generated, which demonstrate the maturity of the market for a given technology in a given region [Gallaher and Delhotal, 2004]. Thus, the main factor limiting the accuracy of the required data is the availability and quality of input data, in particular with regard to the structure of emission sources (statistics on activities, information on plants and applied processes, e.g. size and age distribution of installations and control options already in place).

## 2.5.4 Technology Transfer for Sustainable Development

Successful transfer of appropriate technologies is essential to facilitating national and community development and enhancing sustainability, especially in developing countries and countries with economies in transition. The *Agenda 21*, revealed at the United Nations Conference on Environment and Development (Rio de Janeiro, 1992), states that: "*New and efficient technologies will be essential to increase the capabilities (in particular of developing countries) to achieve sustainable development, sustain the world's economy, protect the environment, and alleviate poverty and human suffering. Inherent in these activities is the need to address the improvement of technology currently used and its replacement, when appropriate, with more accessible and more environmentally sound technology*".

Promoted by various initiatives, sustainability strategies (not limiting the quality of life or options available for future generations [WCED]) are being applied increasingly, with the aim of raising efficiency and preventing environmental damage amongst broader sustainability goals. Closed loop approaches for the whole supply chain, *Life Cycle Assessment* (LCA) criteria for products and connected processes [Hunkeler et al., 2003] and techno-economic assessment methods are used to improve performance [Geldermann et al., 2000a; Rentz et al., 2003]. For example, the research field of *Industrial Ecology* [Ruz, 2003] endeavours to study "*flows of materials and energy in industrial and consumer activities and effects of these flows on the environment and the influences of economic, political, regulatory, and social factors of the flows, and the transformation of resources*" [White, 1994]. Hence, Industrial Ecology considers different scopes of application on the firm, inter-enterprise and global level, thereby incorporating various methodological approaches (cf. Figure 2.6).

Various other approaches, apart from the *Industrial Ecology* [Graedel and Allenby, 2003; Ruz, 2003], exist for incorporating different levels of firm, process, or product assessment, such as *Cleaner Production* [Jia et al., 2006; UNEP, 1994], *Eco-Efficiency* [Fussler, 1999; Lehni, 2000; Saling et al., 2002; Geldermann et al., 2007], the *Zero-Emission* concept [Suzuki, 2000], *supply chain management* based concepts (*Green Supply Chain Management* [Sarkis, 2003], *Environmental Supply Chain Management* [Nagel, 2000] and *Integrated Chain Management* [Seuring, 2004a]). Due to varying definitions, the relationship and overlap between approaches are often unclear [Seuring, 2004b]. These approaches may be based on different objectives and levels (product, process, company, inter-company or regional level), and might differ in the application of various methods, but they share the common challenge of applying methods for identifying practically applicable solutions on

sustainability aspects, such as environmental information, waste water treatment, water supply and purification, air pollution control, waste management, recycling, soil preservation, noise protection, power generation, and energy efficiency.

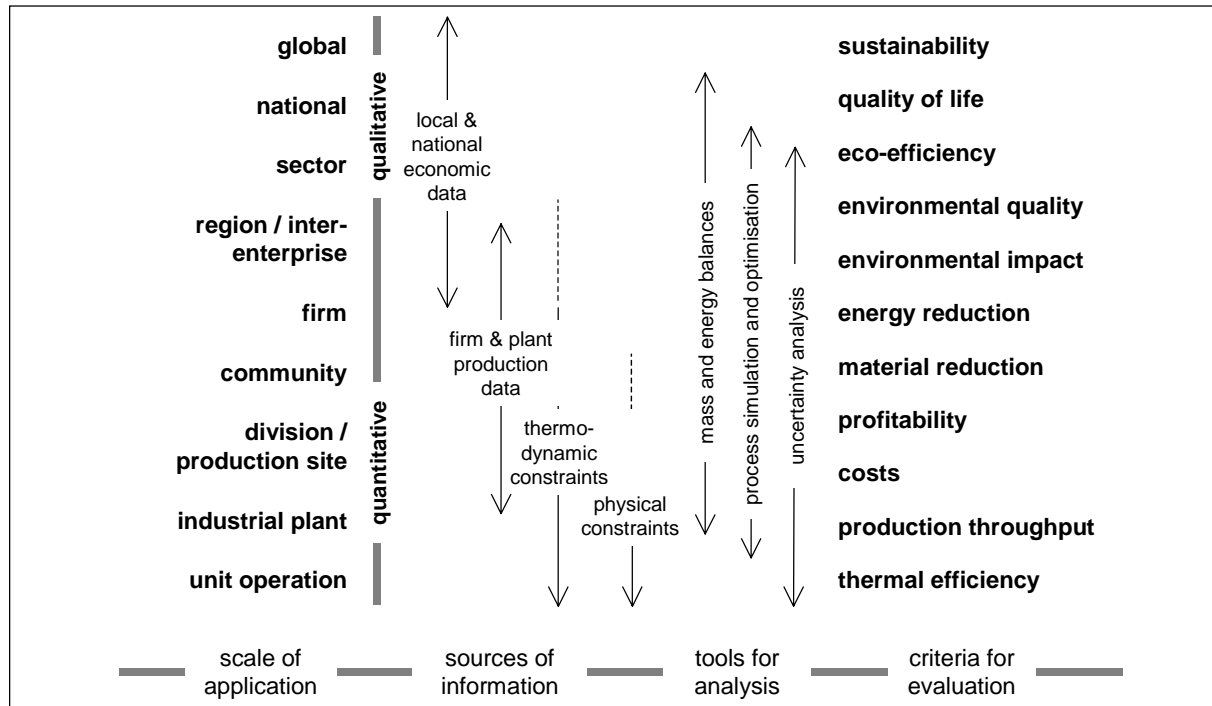

Figure 2.6: Conceptual Framework for the Process Analysis Approach, adapted from [Diwekar and Small, 2001]

While such activities towards industrial ecology are already common practice in the United States, Japan and Europe, their dissemination in Latin America and in China has just began [Ruz, 2003]. Thanks to a growing environmental awareness in the industry, academic and practical interest in exploring the opportunities of industrial ecology can be observed. However, before implementing options for industrial ecology, their environmental and economic consequences need to be quantified. Since economic motivations are especially important in developing and industrialising countries, the understanding of the economic implications is key [Chertow, 2004].

## 2.5.5 Conclusions

The aspect of effectiveness of technology transfer to developing countries still raises important questions for researchers and practitioners alike, since successful technology transfer requires inputs such as coordination between technology developers and users; a facilita-

tive environment that is supportive of entrepreneurship; and networks and collaborations that provide referral links for information, finance and other pertinent resources [Marotte and Niosi, 2000]. Technological progress provides new opportunities to improve resource efficiency in industrial production [Grossmann, 2004].

Since the portfolio of available unit operations continuously changes through innovation, re-evaluating of processes is essential. The techno-economic assessment of different production process options (new process design or modifications to existing installations) depends to a great extent on the input materials and their properties as well as the specific technical application. Different sources of information and different available methodologies exist depending on the scale of the application. Moreover, different criteria prevail depending on the research target. Broad schemes, such as sustainability on a global level, break down to more detailed criteria such as thermal efficiency on the level of unit operations. The diverse evaluation criteria on the various scales of application comprise different attributes with partially conflicting objectives. This necessitates an appropriate formal analysis of the multiple criteria for informed decisions in implementing sustainable solutions. Thus in the following a metric for the determination of BAT is suggested as a formal approach.

## 2.6 A Metric for the Determination of BAT

Generally speaking, a metric is a system of parameters that are to be measured. In mathematics a metric or distance function is a function, which defines a distance between elements of a set. Intuitive notions about the concept of distances can be used and modified. For the formal comparison of different techniques for cleaner production in industrialising countries, a metric will be introduced which illustrates the varying appraisal of technological options in different countries. More information about efficiency measurement can be found in Section 5.1. Based on the relative efficiency of different technique combinations a classification with respect to the definition of *Best Available Techniques (BAT)* is possible based on a multi-criteria approach (cf. Chapter 5). It must be pointed out that the considerations are based on a relative efficiency measure depending on the selected criteria and the selected alternatives. Consequently, both the definition of  $\Gamma^{opt}$  and  $\Gamma^0$  in combination with the weighting and the selected Euclidean norm highly influences the shape of the domain  $D_{BAT}$ . Hence, even if no statement is made concerning the technology combinations and only existing technology combinations are considered the assessment is limited by the simplified parameter and system boundary selection. Consequently, two major aspects must be pointed out:

1. The metric considers a target value for each resource. This target value compromises a minimal consumption of the resource. To a certain extent, these theoretical minimal target values can be determined using the pinch analysis approaches described in Chapter 3.
2. The metric is part of a multi-criteria decision support process. Consequently, it considers explicitly preferential information such as the relative importance of the different resources (cf. Section 5.1.2).

However, the identification of the techno-economic-environmental process improvement potential using a simple metric offers adequate possibilities in order to assess the different technologies.

### 2.6.1 Definition of a Metric for the Determination of BAT

The method introduced below to determine a country specific BAT can be applied by political decision makers and local authorities for the accreditation of BAT as well as by technology suppliers for assessing the possibilities of an environmentally sound technology transfer for a specific application. It aggregates different criteria and merges technological, economic and environmental parameters. Specific national conditions can be taken into account by using emission limit values.<sup>15</sup> Table 2.5 shows the nomenclature used for the definition of the metric.

Table 2.5: Nomenclature for the Metric of BAT Definition [Geldermann et al., 2006c]

Var	Name
$C$	set of criteria $C = \{c_1, c_2, \dots, c_n\}$
$c_i^{opt}$	value of criteria $i$ at theoretical minimum level; $i = 1, \dots, n$ ( $n \in \mathbb{N}$ )
$c_i^{limit}$	value of criteria $i$ at maximal acceptable level
$c_i^\lambda$	value of criteria $i$ for technology $\Gamma^\lambda$
$\Gamma^\lambda$	available technology within $\mathbb{R}^n$
$\ \Gamma^\lambda\ $	norm of $\Gamma^\lambda$
$\Gamma^0$	Technology fulfilling the minimum requirements for the determination of BAT

<sup>15</sup>Local and even company specific considerations can be introduced by using emission limit values stated in the granted permits. In the context of technology transfer and decision support for policy makers and technology suppliers; however, such lower-level considerations are of minor relevance.

Table 2.5: Nomenclature for the Metric of BAT Definition (cont.)

Var	Name
$\Gamma^{opt}$	Best possible technological realisation of the investigated activity
$D_{BAT}$	domain of Best Available Techniques, $D \subset \mathbb{R}^n$
$\Theta_\Gamma$	set of all available technologies $\Gamma_\lambda^\mu$
$\Theta_{BAT}$	set of all technologies classified as Best Available Techniques $\Gamma^\lambda \in D_\Gamma$
$\hat{w}_i$	country specific weighting factor of criteria $c_i$
$w_i$	country specific normalised weighting factor of criteria $c_i$
$d_{BAT}$	measure for the minimum requirements of a BAT
$d_\Gamma$	measure used for the determination of a specific technique $\Gamma^\lambda$
$\delta_\Gamma$	measure for the comparison of two techniques $\Gamma^\lambda, \Gamma_\lambda^{\tilde{\mu}} \in \Theta_\Gamma$
$f_i^\lambda$	contribution of $c_i$ to $d_\Gamma$

In general a metric  $d(\cdot, \cdot) : \mathbb{R}^n \times \mathbb{R}^n \rightarrow \mathbb{R}$  defines a distance between two points in  $\mathbb{R}^n$ . A metric  $d(x, y) = \|x - y\|$ ,  $x, y \in \mathbb{R}^n$  in the vector space  $\mathbb{R}^n$  is induced by the norm  $\|\cdot\| : \mathbb{R}^n \rightarrow \mathbb{R}$  which is equivalent to the length of a vector. The general conditions of a metric  $d(\cdot, \cdot)$  and a norm  $\|\cdot\|$  are fulfilled [Kelley, 1975].

The parameter  $n \in \mathbb{N}$  is the number of different criteria (i.e. water consumption, investment, VOC emissions etc.) used for the determination of BAT. Hence, it is equivalent to the dimension of the given problem.

An existing technique  $\Gamma^\lambda \in \Theta_\Gamma$  is described by determining a specific value  $c_i^\lambda$  for each criterion  $i$  ( $i = 1, \dots, n$ ):

$$\Gamma^\lambda = \begin{pmatrix} c_1^\lambda \\ c_2^\lambda \\ \vdots \\ c_n^\lambda \end{pmatrix} \quad (2.1)$$

For each activity (e.g. painting of plastic parts, coil coating etc.) an optimal value  $c_i^{opt}$  can be set for each criterion  $c_i$ . They can be defined by taking the minimum value of each criterion for the set of existing technologies including those, which are in a pilot state. Alternatively, they can be determined by an expert panel. These values must be kept up-to-date in accordance with the pace of the technological development of the considered sector. Depending on the criteria the optimal value can be equal to zero as is the case for example with investments. In general, the problem is formulated as a minimisation

problem. Thus, criteria where the target is a maximum must be transformed. The optimal values of all criteria  $c_i$  define  $\Gamma^{opt} \in \mathbb{R}^n$  (cf. Equation (2.2) and Figure 2.7):

$$\Gamma^{opt} = \begin{pmatrix} c_1^{opt} \\ c_2^{opt} \\ \dots \\ c_n^{opt} \end{pmatrix} \quad (2.2)$$

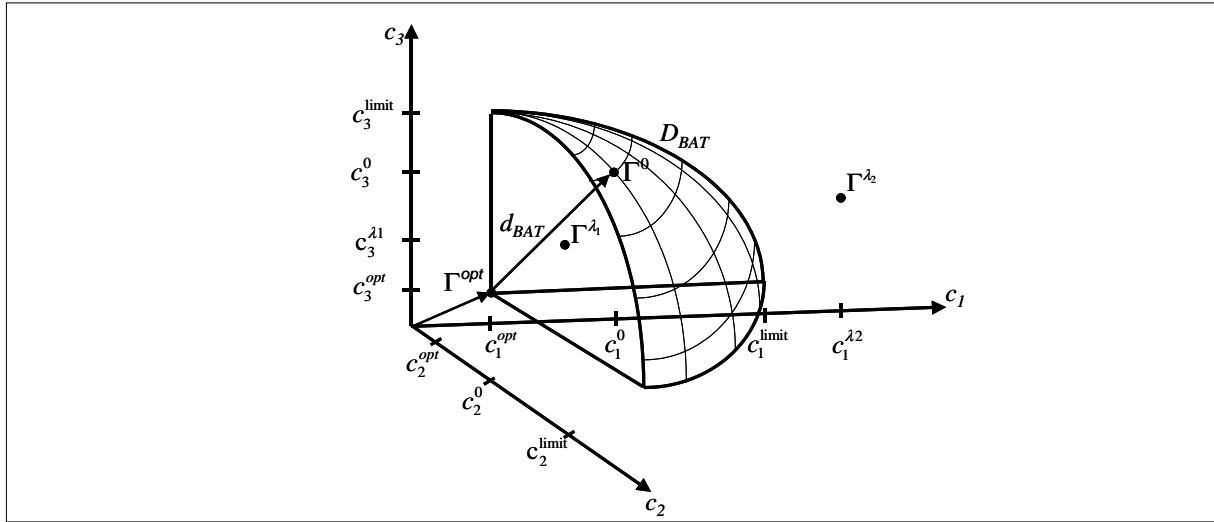

Figure 2.7: Domain of BAT and technologies  $\Gamma^0$ ,  $\Gamma^{\lambda_1}$  and  $\Gamma^{\lambda_2}$  for one set of limit and optimal values

In terms of BAT  $\Gamma^{opt}$  can be interpreted as the best possible technological realisation for the investigated activity. It is not an existing technique, but a positive reference for all techniques  $\Gamma^\lambda$  (cf. Equation (2.5)).<sup>16</sup> Furthermore, it represents the lower limit of the domain  $D_{BAT}$ . All techniques classified as BAT are an element of this domain. For the application or sector under investigation no technology exists with at least one criterion below its optimal value i.e. for each available technology  $\Gamma^\lambda \in \Theta_\Gamma$  the following expression is valid:

$$c_i^\lambda \geq c_i^{opt} \quad \forall i, \lambda \in \mathbb{N} \quad (2.3)$$

<sup>16</sup>There are several classical algorithms for multi-objective linear programming (MOLP; see, e.g. Benayoun et al. [1971], Zeleny [1982, 153-178], Steuer and Choo [1983]), where the ideal solution plays an important role. Since the ideal solution is not generally feasible in reality, traditional MOLP algorithms operate with a nondominated point or a set of nondominated points.



Following Equation (2.3), the criteria  $c_i$  must be described in such a way that for each of them the optimal value is equivalent to the lower bound of the set of all possible values. Nevertheless,  $c_i^{opt}$  need not be an element of this set. If a criterion where the optimal value is the upper bound is regarded, then the values should be transformed in such a way that the target is their minimisation. This can be achieved by subtracting the value from a constant which should be large enough to avoid negative numbers<sup>17</sup>.

The limit values  $c_i^{limit}$  (Figure 2.8) are references for the maximum acceptable value of each criterion  $i$  (e.g. energy consumption, water consumption, CO<sub>2</sub> emissions, investments etc.). When using the proposed metric for the comparison of techniques, these reference values can be set equivalent to legal requirements or be defined by political decision makers. For example, in the case of emissions or resources consumption thresholds defined by environmental legislation may be used. Economic values, instead, can be set as the maximum reasonable investment. A clear cut value, however, is difficult to define, as already the definition of BAT indicates, when mentioning "viable conditions, taking into consideration the costs and advantages" (cf. section 2).

For an easy aggregation of all criteria to one measure used for defining BAT ( $d_{BAT}$ ), the criteria can be normalised on the basis of the defined limit values country specific weighting factors  $\hat{w}_i$  for each criterion  $c_i$ :

$$\hat{w}_i = \frac{1}{c_i^{limit} - c_i^{opt}} \quad (2.4)$$

Such distance-to-target weighting methods are widely used in life cycle impact assessment and rank impacts as being more important the further away the values are from achieving the desired targets for the pollutants, as articulated by emission limit values. [Seppälä and Hämäläinen, 2001] show that the distance-to-target approach is consistent with decision theory for non-zero targets with equal importance and linear damage functions passing through the origin. [Soest et al., 1998] state that those targets are only suitable for a general prioritisation of environmental topics, but not for a company's investment decision, when local considerations are of relevance. [Soares et al., 2006] come in their comparison of various weighting methods to the conclusion, that in spite of some weaknesses, the distance-to-target method can give more emphasis to the geographic aspects of environmental impact categories. The alternative definition of weighting factors based on expert panels is much more a value-based procedure. For the general comparison of

---

<sup>17</sup>One example of such a transformed criterion is the number of employees. From a political point of view the interest lies in job creation. Thus, the more personal required, the better.

techniques by the proposed metric, weighting factors can be used to define the aggregated measure for BAT named  $d_{BAT}$ :

$$d_{BAT} = \frac{1}{\sum_{i=1}^n \hat{w}_i} \quad \forall i \quad (i = 1, \dots, n) \quad (2.5)$$

This definition has several advantages in comparison to a normalised measure which will always turn out to be equal to 1. By taking the reciprocal of the sum of weighting factors, differences in the limit values directly influence the  $d_{BAT}$ . A decrease in one criterion  $c_i$  leads to a decrease of  $d_{BAT}$ . Hence, the stricter the requirements, the smaller the scope for BAT. This allows a comparison of the country specific situation as shown exemplary in Figure 2.8.

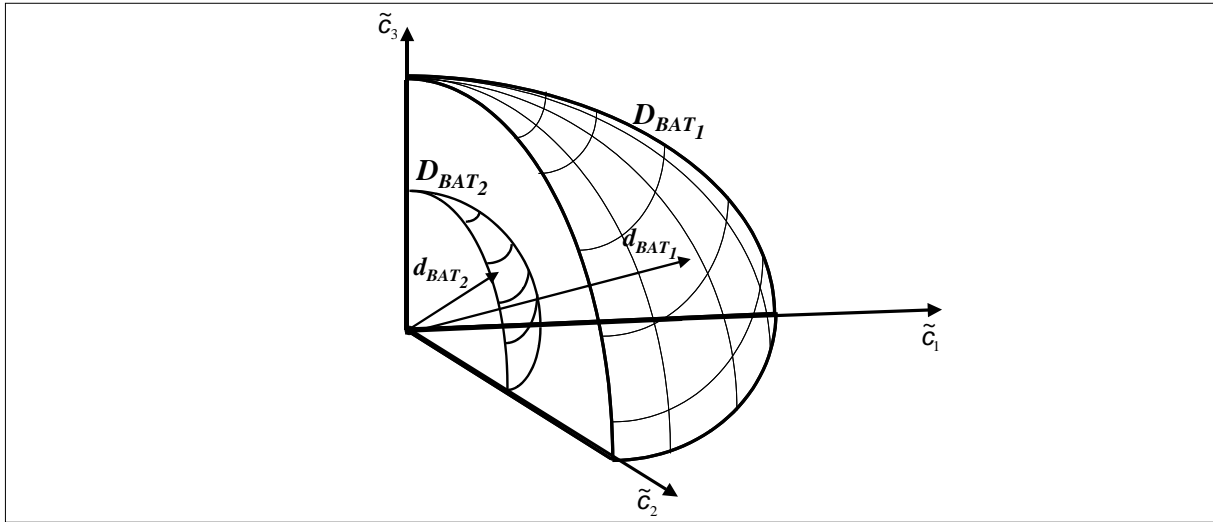

Figure 2.8: Comparison of  $d_{BAT}$  of two countries with different preferences

The weighting factors describe the trade-off between the different criteria  $c_i$  as set by the limit values. This is in contrast with the actual legislation, which sets targets mostly for each criterion independently. Hence, there is no difference between two techniques with similar values for all but one criterion as long as the value of the differing criteria of both techniques is below the limit value.

By introducing weighting factors as suggested, it is possible to ensure that if a technique has a higher value for one criterion, it must be compensated by a lower value for a second criterion as long as the technique is in  $D_{BAT}$ . For example, if a coating technique A

requires more energy per m<sup>2</sup> surface than coating technique B, it must have a lower VOC-emission value in order to be compatible.

In order to verify if a technique  $\Gamma^\lambda$  fulfils the BAT requirements, normalised weighting factors  $w_i$  can be calculated:

$$w_i = \frac{\hat{w}_i}{\sum_{i=1}^n \hat{w}_i} \quad \forall i \quad (i = 1, \dots, n) \quad (2.6)$$

Then, they are used to define a modified Euclidean norm<sup>18</sup> for calculating the length of a vector which is equivalent to the aggregated value of all criteria  $c_i$ :

$$\|\Gamma^\lambda\| = \sqrt{\sum_{i=1}^n (w_i \cdot c_i^\lambda)^2} \quad (2.7)$$

By applying this norm and taking into account the optimal values as defined by  $\Gamma^{opt}$  a distance measure for the characterisation of the technology under investigation ( $\Gamma^\lambda$ ) can be calculated:

$$d_\Gamma = d(\Gamma^\lambda, \Gamma^{opt}) = \|\Gamma^\lambda - \Gamma^{opt}\| = \sqrt{\sum_{i=1}^n [w_i \cdot (c_i^\lambda - c_i^{opt})]^2} \quad (2.8)$$

If this distance measure is lower than  $d_{BAT}$ , technique  $\Gamma^\lambda$  fulfils the minimum requirements as set by the limit values and can be classified as BAT. Thus, the catalogue of BAT ( $\Theta_{BAT}$ ) forms a subset of the set of available techniques ( $\Theta_\Gamma$ ) and of the domain  $D_{BAT}$ . Hence, a technology must be an element of this domain in order to be classified as a BAT. The following condition is valid for all techniques  $\Gamma^\lambda \in D_{BAT}$ :

$$d_\Gamma \leq d_{BAT} = d(\Gamma^0, \Gamma^{opt}) = \|\Gamma^0 - \Gamma^{opt}\| \quad (2.9)$$

Therein,  $\Gamma^0$  represents a technique that fulfils the requirements of BAT exactly. In addition to the distance measures  $d_{BAT}$  and  $d_\Gamma$  used for the determination of BAT, the performance of two techniques  $\Gamma^{\lambda_1}$  and  $\Gamma^{\lambda_2}$  within the scope of BAT in one country can be compared using  $\delta_\Gamma$ :

$$\delta_\Gamma = \|\Gamma^{\lambda_1} - \Gamma^{\lambda_2}\| \quad (2.10)$$

<sup>18</sup>The actual approach used in most legislations is that of a maximum norm.

Furthermore, contribution factors  $f_i^\lambda$  can be determined. They are a measure for the contribution of each criterion to the technology specific distance measure  $d_T$  (cf. Equation (2.8)). They can be used for indicating which parameter should be improved in case the requirements for BAT are not fulfilled:

$$f_i^\lambda = \frac{[w_i \cdot (c_i^\lambda - c_i^{opt})]^2}{\sum_{i=1}^n [w_i \cdot (c_i^\lambda - c_i^{opt})]^2} \quad (2.11)$$

Due to the fact that the absolute value of  $f_i^\lambda$  depends on the limit ( $c_i^{limit}$ ), optimal ( $c_i^{opt}$ ) and actual values ( $c_i^\lambda$ ) of each parameter, they differ between the countries. Thus, they can also be used to compare the situations in the different countries.

Finally, it should be noted that the analysis of a technique to determine if it is a BAT or not, must be carried out independently for each country due to the fact that  $d_{BAT}$  as well as  $d_T$  are country specific. Both of these depend on the limit values  $c_i^{limit}$  and the optimal values  $c_i^{opt}$  which are individually determined by each country.

## 2.6.2 Example of the Application of a Metric for the Determination of BAT

The coating of plastic components for the automotive industry is of major relevance to the environment due to the associated VOC emissions. The substitution of metal parts through plastic in recent years lead to a significant increase in the market volume of plastic parts to be coated [Estrela and Lipkova, 2003].

About 75% of the processed varnishes are applied for plastic mounting parts of vehicles (and the remaining 25% almost completely for coating of TV or hi-fi units) [Rentz et al., 2003]. The coating of plastic parts falls under the scope of the European BAT-activities within the section of *Surface Treatment using Solvents* (cf. Annex I 6.7 of the IPPC-Directive).

In this section a case study is presented, which is not included in the six major case studies of this book. The case study analyses a completely automated coating line where the parts are transported on skids. The first layer of applied coating is the primer, then the basecoat is applied in two steps. Finally, the parts are coated with clear coat. Between the application of the different layers, drying steps are necessary (c.f. Figure 2.9). The subsequent quality control is carried out manually and is therefore not considered as a part of the technique.

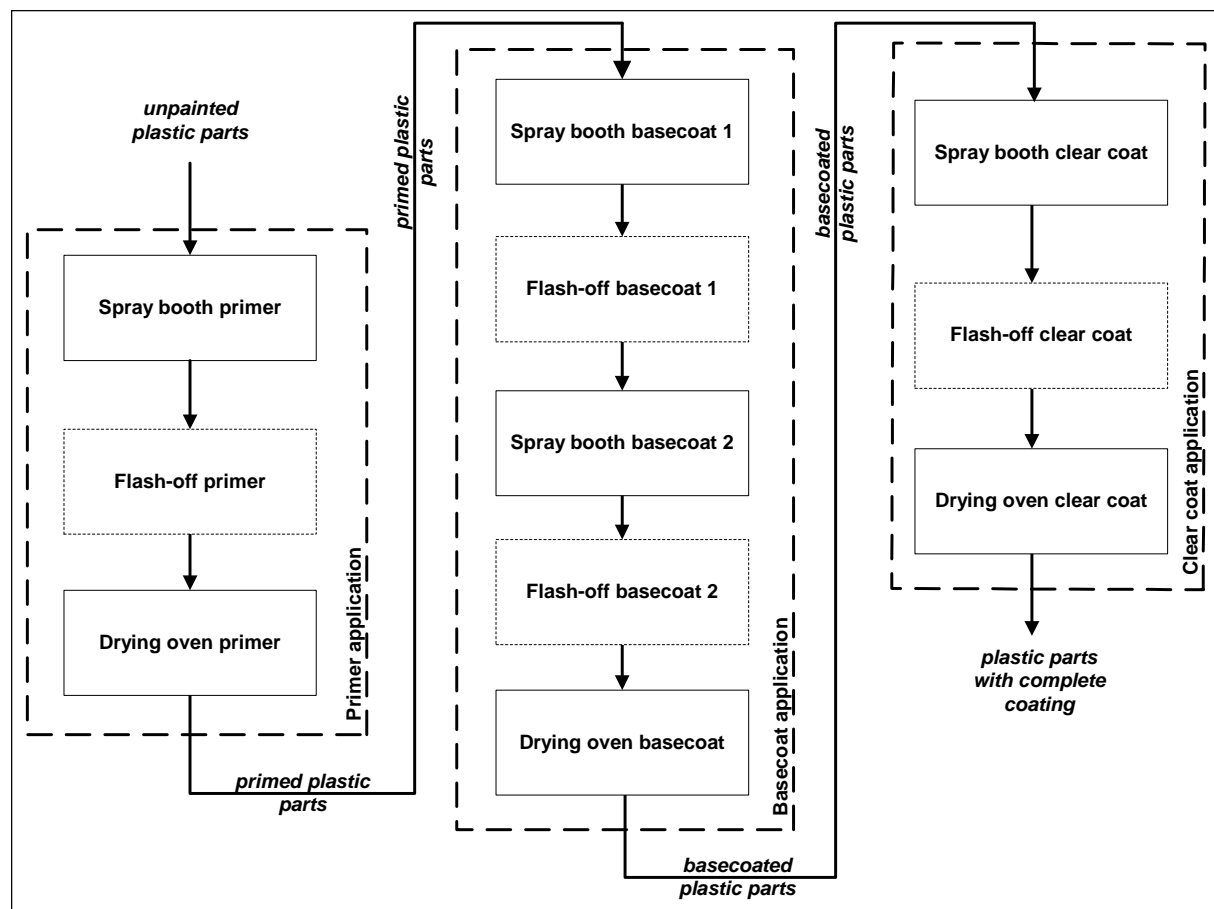

Figure 2.9: Process Flow Chart for the Coating of Plastic Parts [Geldermann et al., 2006c]

The actual spraying is carried out by robots with spray guns with air-assisted atomisation. The air of the spray booths as well as the paint overspray is conducted through a double-S Venturi washer. The paint particles coagulate and are then separated using a decanter. Most of the water from the Venturi washer is reused, the rest is discarded along with the water obtained from the drying of the coagulate. Ventilation is provided by a fresh air system. No recirculation takes place. The exhaust gas from all the devices (booths, flash-off zones and drying ovens) is collected and leaves the system as one waste gas stream. Energy is mainly used for heating and air compression. Three parameters are used to characterise the performance of the technique:

1. the Chemical Oxygen Demand (COD) in [mg/l], a measure for the organic load of the waste water,

2. the limit value for the emissions of Volatile Organic Compounds (VOC) in [mg C/m<sup>3</sup>], and
3. the energy consumption per square meter of painted surface in [kWh/m<sup>2</sup>].

Nevertheless, more parameters can be taken into account for the evaluation. Table 2.6 shows the values for the selected technique of plastic coating.

*Table 2.6: Characterisation of the investigated technique*

Parameter	$\Gamma^0$	$\Gamma^1, \Gamma^2, \Gamma^3$
	Before Treatment	After Treatment
COD [mg/l]	4,500	250
VOC [mg C/m <sup>3</sup> ]	73	43 <sup>a</sup> (1.7 <sup>b</sup> )
Energy [kWh/m <sup>2</sup> ]	950	700 <sup>c</sup>

<sup>a</sup>After complete switch to waterborne coatings.

<sup>b</sup>After installation of a thermal incinerator.

<sup>c</sup>After installation of heat exchangers.

### 2.6.2.1 Regional specific limit and optimal values

For each of the three countries under consideration (Chile, China and Germany) specific limit values  $c_i^{limit}$  can be obtained from legislation, experts or by assumptions based on information about prevailing technological standards. Consequently, the domain has a different appearance and thus different values for determining  $d_{BAT}$ . Table 2.7 gives an overview of the limit values used in this example.

They are derived from legal requirements, if available from granted permits and local or national legislation. The VOC limit values are calculated on the basis of similar thresholds in Germany by using ozone air concentrations, because until now no specific VOC emission limits have been set in Chile and China.

In addition to the limit values, the optimal values must also be determined. For this example they have been set by taking into account the local technologies and country specific concerns (cf. Table 2.8).

### 2.6.2.2 Assessment of the Coating Technique

On the basis of the limit and optimal values  $d_{BAT}$  (cf. Equation (2.5)) is calculated reflecting the minimum requirements for Best Available Techniques in Chile, China and

Table 2.7: Limit values for Chile, China and Germany

Variable	Parameter	Chile	China	Germany
$c_1^{limit}$	COD [mg/l]	400	300	300 <sup>1</sup>
$c_2^{limit}$	VOC [mg C/m <sup>3</sup> ]	67	83	50 <sup>2</sup>
$c_3^{limit}$	Energy [kWh/m <sup>2</sup> ]	1500	2000	1500 <sup>3</sup>

<sup>1</sup> Threshold for paint application companies.

<sup>2</sup> Threshold for paint application companies with more than 15t of consumed solvents. Values for Chile and China are calculated based on conversion factors derived from limit values of ozone concentrations.

<sup>3</sup> Consumption per square meter of painted surface. German values based on BAT-documents, Chilean and Chinese values are estimates.

Table 2.8: Optimal values for Chile, China and Germany

Variable	Parameter	Chile	China	Germany
$c_1^{opt}$	COD [mg/l]	80	90	50
$c_2^{opt}$	VOC [mg C/m <sup>3</sup> ]	0.1	0.1	0.1
$c_3^{opt}$	Energy [kWh/m <sup>2</sup> ]	300	600	150

Germany (cf. Table 2.9). The comparison of this measure with  $d_\Gamma$  (cf. Equation (2.8)) shows that the application technique without treatment (Technology  $\Gamma^0$ ) does not fulfil the requirements of any of the countries without the use of at least one emission reduction measure. Thus, three emission reduction measures are investigated:

- The first option is the implementation of a waste water treatment plant (Technology  $\Gamma^1$ ). Nevertheless, this improvement is insufficient in all three countries. The respective value of  $d_{\Gamma^1}$  is higher than the respective values of  $d_{BAT}$ .
- By switching to waterborne coatings (Technology  $\Gamma^2$ ) the requirements for BAT in Chile and China are fulfilled.
- The installation of an additional end-of-pipe treatment, in this case a thermal incinerator, is necessary (Technology  $\Gamma^3$ ) in order to fulfil the requirements of Germany (cf. Figure 2.10).

An additional implementation of heat exchangers is not necessary to fulfil the requirements of BAT, but it might be an economically feasible modification due to heat recovery and energy savings (and consequently cost savings). Furthermore, this option might be a possible response to stricter future requirements concerning energy consumption which is especially of interest in Chile because of occurring energy shortages (cf. Chapter 2.1).

Table 2.9:  $d_{BAT}$  and  $d_{\Gamma}$  for Chile, China and Germany (bold values indicate fulfilled requirements)

	Chile	China	Germany
$d_{BAT}$	52.89	58.88	40.35
$d_{\Gamma^0}$	733.42	1237.56	721.11
$d_{\Gamma^1}$	70.23	68.33	71.34
$d_{\Gamma^2}$	<b>52.54</b>	<b>55.44</b>	53.08
$d_{\Gamma^3}$	<b>40.15</b>	<b>47.23</b>	<b>40.20</b>

Once the relative position of a technology within the BAT domain has been identified, a technology supplier might be interested in its improvement. Here, the contribution factors  $f_i^{\lambda}$  can be employed (cf. Equation (2.11)), which measure the contribution of each criterion to the technology specific distance measure  $d_{\Gamma}$ . Table 2.10 shows that the first parameter to be improved is the COD which is mainly responsible for the high value of  $d_{\Gamma^0}$ . In a second step the VOC-emissions must be addressed ( $\Gamma^1$ ). Due to the fact that even after the application of waterborne coatings<sup>19</sup> ( $\Gamma^2$ ), the VOC emissions are the main contributor to  $d_{\Gamma}$ , the third step aims at a further reduction of VOC-emissions ( $\Gamma^3$ ). The procedure of process improvement is generally an iterative process. After each process change the new  $d_{\Gamma}$  values are calculated. After comparison with the respective  $d_{BAT}$ , the decision about the next step of improvement depends on whether or not the requirements are fulfilled.

### 2.6.2.3 Implications for technology transfer

In this case study, the second implemented measure of VOC-emission reduction (incinerator), needs only be applied according to the German legal framework, whereas in Chile and China it is not necessary. Thus, a supplier of plants and equipment serving mainly the German market can transfer the same technique to the Chilean or Chinese markets. It might even be possible to dispense the incinerator completely, which makes the technique much cheaper.

As a result, the BAT-metric can be used as a tool for assessing the suitability of a certain technique for different legal frameworks. On this basis, the technology supplier has the possibility of evaluating whether or not it is necessary to change the technique under

<sup>19</sup>Waterborne coatings are not free of solvents but have a remaining VOC concentration of about 10 %.



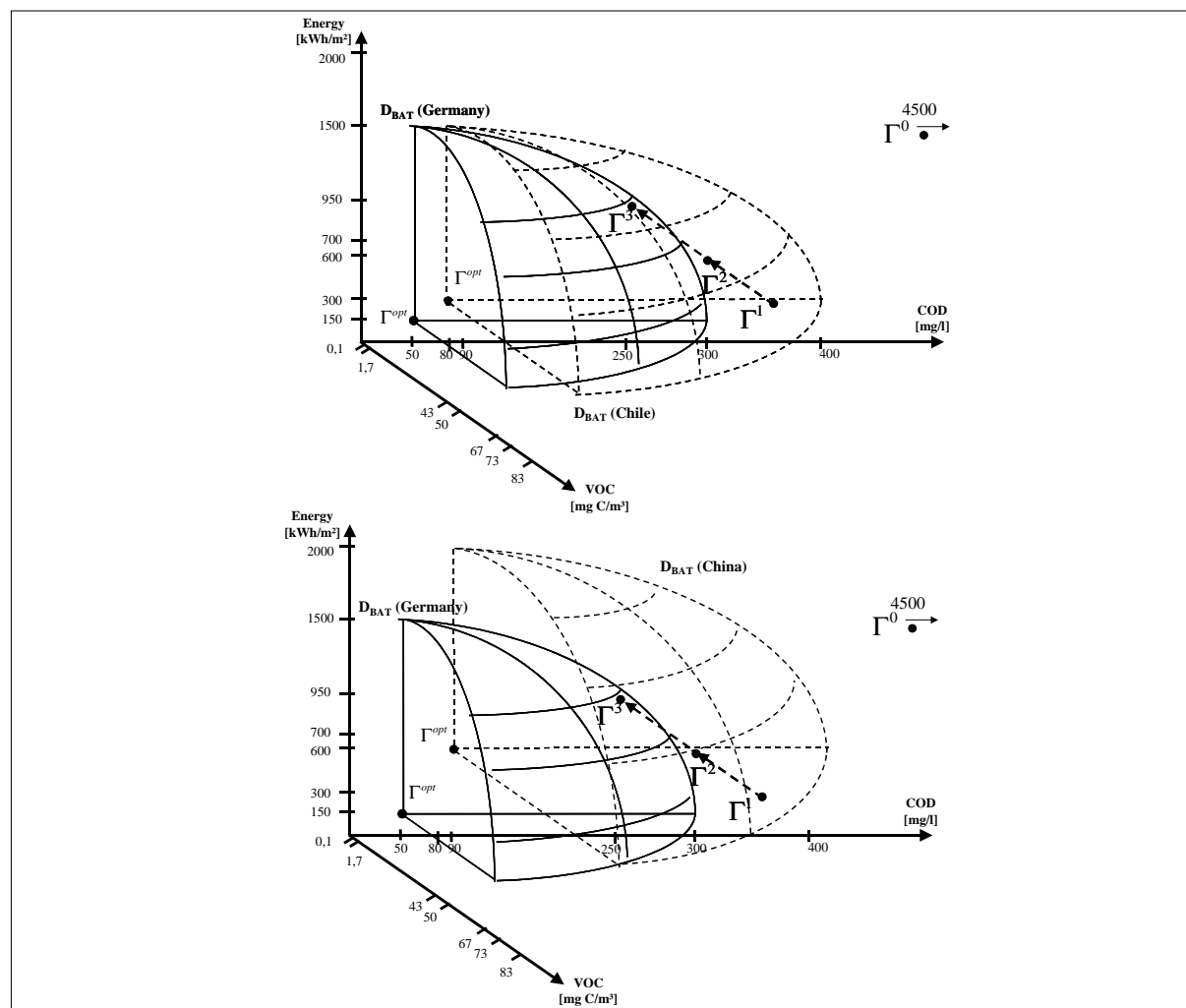

Figure 2.10: BAT-domains of Germany and Chile (above) and Germany and China (below) and the positions of the evaluated techniques  $\Gamma^1$ ,  $\Gamma^2$ ,  $\Gamma^3$

consideration. Furthermore, the contribution factors give a first indication of the possible parameter that should be improved if certain requirements are not fulfilled.

By taking into account the difference between  $d_\Gamma$  and the country specific  $d_{BAT}$  in this case study, the supplier and the plant operator of the technique might conclude that including the incinerator has an advantage due to the fact that only a small change in the legal requirements may force its installation anyway. This strategy might be supported by regarding the contribution factors, which indicate where a probable aggravation of the legal requirements can be expected.

The BAT-metric can also illustrate long-term changes. Thus, technologies that are more environmentally friendly than actually required by the existing environmental regulations at the time of technique transfer might be preferred, since the degree to which they fulfil

Table 2.10: Calculated contribution factors for Chile, China and Germany

Variable	Chile	China	Germany
$f_1^0$	0.992	0.998	0.992
$f_2^0$	0.006	0.002	0.007
$f_3^0$	0.002	0.000	0.001
$f_1^1$	0.160	0.431	0.205
$f_2^1$	0.674	0.523	0.683
$f_3^1$	0.166	0.046	0.112
$f_1^2$	0.286	0.655	0.370
$f_2^2$	0.417	0.275	0.427
$f_3^2$	0.297	0.070	0.203
$f_1^3$	0.490	0.902	0.645
$f_2^3$	0.001	0.001	0.001
$f_3^3$	0.509	0.097	0.354

the actual framework can be estimated. On this basis the trade-off between investment and 'legal lifetime' - the duration in which the technique fulfils legal requirements - can be assessed resulting in a transfer of techniques with a better environmental performance.

Broadly speaking, the BAT metric has certain similarities with the wide-spread used technology portfolios. In spite of the raised criticism as being too general, they nevertheless focus decisions on the given data and limit the influence of purely subjective impressions (STREBEL, Kotler Bliemel). The most important advantage of the presented metric can thus be seen in the systematic consideration of the different national requirements. Due to the derivation of the weighting factors on the basis of defined emission limit values, the approach is purely formal. It has to be noted, however, that the setting of emission limit values is a political process with uncountable subjective influences as well. Alternatively, the weighting factors can be defined by an expert panel according to their insights and priorities.

It has to be noted as well that the determination, if a technique is BAT or not, gives no indication for the pace of a possible technology diffusion in the various countries. Innovation in clean production systems is recently seen as a major source of economic progress, especially in industrialising countries. The relationships of dependence between determinants and willingness for sustainable production and consumption systems, however, deserve further scientific attention [Montalvo, 2003].

### 2.6.3 Discussion of the Application of a Metric for the determination of BAT

Considering the special requirements of industrialising countries, the improvement of resource efficiency is important for sustainable development. In this context BAT are a possible instrument for political decision makers, as well as a guideline for technology suppliers. In order to take into account specific local conditions and preferences concerning environmental protection, a flexible approach for the comparison of techniques with BAT is needed.

The presented metric allows an easy adaptation to different local requirements by defining specific optimal and limit values. The underlying principles of calculation and BAT determination remain unchanged. The defined measure for the determination of BAT ( $d_{BAT}$ ) allows the depiction and comparison of different regional conditions. Thus, a supplier of plants and equipment can recognise if a specific technique fulfils national requirements of BAT. Additionally, changes in the requirements which are to be expected due to a dynamic political environment and progress in technological development can be taken into account by using the contribution factors  $f_i^\lambda$ .

Contrary to other assessment methods known e.g. from Life Cycle Analysis, the presented metric is nondimensional and therefore allows the simultaneous consideration of criteria from the three dimensions discussed within the context of sustainability (environmental, economic and social). Furthermore, the considered trade-off between the different parameters allows a technique assessment that takes into account the fact that the improvement of one criterion might result in a worsening of another.



# Chapter 3

## Process Integration in Production Networks

The problem of synthesising chemical process networks attracted much attention in the 1970s (surveys are for example provided in [Furman and Sahinidis, 2002; Linnhoff, 1993]). Especially for heat recovery branch and bound techniques [Lee et al., 1970], heuristics, such as matching the hot stream of the highest supply temperature with the cold stream of highest target temperature [Ponton and Donaldson, 1974], and multi-criteria algorithms (attempting to optimise total heat transfer area, energy recovery and total costs) [Nishida et al., 1977], were discussed. Rather than concentrating on the network topology, focus can also be put on the feasibility, for example controllability, start-up procedures, safety constraints, and the flexibility of the system [Hohmann, 1971; Ram et al., 1975; Alexander et al., 2000]. By focussing on the flexibility, theoretical minimal consumption targets are identified and then the design of the network is simplified by the trade-off between those and complexity, operability and costs of additional unit operations.

The integration of processes is performed predominantly by simulation, i.e. by automatically generating design variants and selecting the best one. Hereby, simulation based approaches can explicitly consider incomplete, uncertain data, such as material properties, thermodynamic data and kinetics of partial processes [Mosberger, 2005]. Through the interpretation of the problem from a thermodynamic rather than from a combinatorial point of view, the field of *process integration* [Linnhoff and Flower, 1978; Linnhoff and Hindmarsh, 1983; Douglas, 1988; El-Halwagi, 1997; Dunn and Bush, 2001] in engineering design was established. It can be described as a "system-oriented, thermodynamics-based, and integrated approach to the analysis, synthesis, and retrofit of process plants that examines an entire process in order to develop ways of integrating materials and energy that

minimise both costs and waste production” [Mann and Liu, 1999]. Three key principles describe the process integration methodology towards more efficient production systems [Mann and Liu, 1999]:

- ”Treat the entire manufacturing process as a single integrated system of interconnected processing units and use process, utility, and waste streams for both analysis and design.
- Apply process engineering principles (e.g. thermodynamics, mass and energy balances) to key process steps in order to establish a priori attainable performance targets on the use of materials and energy and the generation of emissions and wastes.
- Finalise the details of the process design in order to realise the established performance targets.”

*Heat integration* (cf. Chapter 3.1) is one branch of process integration and it ”provides a fundamental understanding of energy utilisation within the process and employs this understanding in identifying energy targets and optimising heat recovery and energy-utility systems. ... Of particular importance are the thermal pinch techniques that can be used to identify minimum heating and cooling utility requirements for a process” [El-Halwagi, 1997]. Today, the *thermal pinch analysis* is a well established and mature design methodology in chemical engineering.

A second branch of process integration is *mass integration*. Here, the basic question is to establish a fundamental understanding of the flow of mass within the process and to employ this holistic understanding in identifying performance targets and optimising the generation and routing of types of material throughout the process [El-Halwagi, 1997]. The *water pinch analysis* (cf. Chapter 3.2) represents a specific case of mass integration. It is based on the principle of a mass transfer from a contaminant source (i.e. contaminant rich process stream) to a contaminant lean water stream. The design of processes for recovering VOC from a gaseous waste stream can be formulated via mass integration, such as with adsorption or absorption, but also as a condensation problem [Dunn and El-Halwagi, 1994]. Since the recovery of solvents can be achieved via thermal condensation, the problem can be stated as a heat transfer problem and consequently be addressed by a so-called *solvents pinch analysis* (cf. Chapter 3.3).

Objective of the PepOn Project and this book is the implementation of a generic methodology incorporating the different pinch analyses to assess the overall savings potential

applied to intra- and inter-company production networks in industrialising countries described in the Appendixes A - F. By a module-wise implementation of the different pinch analysis approaches the results of the different modules can be integrated and transferred to the multi-criteria evaluation (cf. Chapter 5). Nevertheless, by addressing a specific problem the module-wise implementation provides the flexibility for a substitution of one module with another software<sup>20</sup>.

First, each pinch analysis approach (energy, water, solvents) is described in order to present the general concept of the underlying method. Second, all different pinch analysis approaches are illustrated using the first case study *Bicycle Company 1*. The introduction of the case study and background information are presented in the Appendix A.

### 3.1 Thermal Pinch Analysis

The assessment and optimisation of process systems with an exergo-economic approach has a long tradition in the process industry [Tsatsaronis et al., 1990]. The focus thereby is on a formalised integrated approach considering energy and mass flows of an entire system instead of investigating the degree of efficiency of single energy-conversion processes, such as heat exchangers, independently [Linnhoff et al., 1979; Umeda et al., 1979; Linnhoff and Turner, 1981; Linnhoff, 2004]. In chemical processes heat is utilised for the operation of reactors and the subsequent thermal separation of the reaction products. The basic idea behind energy pinch analysis is a systematic approach to the minimisation of lost energy in order to come as close as possible to a reversible system. In its first step the pinch analysis yields the best possible heat recovery. Further recovery can only be achieved by changing the conditions or structures of the investigated system, for example flow rates, pressures or routing of flows [Parthasarathy and El-Halwagi, 2000].

In the following the very basic concepts and ideas of the pinch analysis are described. For a more detailed description and additional aspects the relevant literature is recommended [see e.g. Linnhoff and Flower, 1978; Umeda et al., 1979; Linnhoff and Hindmarsh, 1983; Linnhoff, 1998; Peters et al., 2003; Radgen, 1996; Linnhoff and Sahdev, 2005]. Case studies

---

<sup>20</sup>e.g. the *Centre for Process Integration (CPI)* within the School of Chemical Engineering and Analytical Science of *The University of Manchester* ([www.ceas.manchester.ac.uk/research/researchcentres/centreforprocessintegration](http://www.ceas.manchester.ac.uk/research/researchcentres/centreforprocessintegration)), *Aspentech* ([www.aspentech.com](http://www.aspentech.com)) and *Linnhoff March* as a division of KBC Process Technology Ltd ([www.linnhoffmarch.com](http://www.linnhoffmarch.com)) offer specialised software for specific problems, such as for example the simulation and optimisation of distillation columns, multiphase chemical reactor networks, refinery networks, or multiple feed streams in a water pinch analysis.

demonstrate the various application possibilities of the different pinch analysis approaches to small and medium-sized enterprises.

Table 3.1: Nomenclature for the Thermal Pinch Analysis

Variable	Unit	Name
$T$	$[K]$	temperature
$\Delta T_{min}$	$[K]$	minimum temperature gradient (driving force)
$STP$	$[-]$	standard temperature and pressure with $T_{STP} = 0^\circ\text{C} = 273.15\text{ K}$ and $p_{STP} = 101325\text{ Pa} = 101325\text{ N/m}^2$
$R$	$[J/mol \cdot K]$	ideal gas constant, $R = 8.314472$
$n$	$[mol]$	amount of substance
$V$	$[m^3]$	volume
$V_M$	$[m^3/mol]$	molar volume
$V_{STP}$	$[m^3/mol]$	molar volume of an ideal gas under standard conditions for temperature and pressure, $V_{STP} = 22.414\text{ [m}^3/\text{kmol}]$
$L$	$[-]$	number of temperature intervals with $k, l \in \{1, 2, \dots, L\}$
$C$	$[-]$	number of cold process and cold utility streams
$s$	$[-]$	number of cold utility streams
$C - s$	$[-]$	number of cold process streams
$H$	$[-]$	number of hot process and hot utility streams
$t$	$[-]$	number of hot utility streams
$H - t$	$[-]$	number of hot process streams
$c_{ik}$	$[-]$	cold process stream $i$ in temperature interval $k$
$h_{jl}$	$[-]$	hot process stream $j$ in temperature interval $l$
$a_{ik}$	$[kJ/h]$	enthalpy flow in interval $k$ of cold stream $i$
$b_{jl}$	$[kJ/h]$	enthalpy flow in interval $l$ of hot stream $j$
$q_{ik,jl}$	$[kJ/h]$	thermal energy transferred from source $h_{jl}$ to heat sink $c_{ik}$
$C_{ik,jl}$	$[\text{€}/kJ]$	costs of transferring a single unit of $q_{ik,jl}$
$r_{STP}$	$[m^3/h(STP)]$	flow rate under STP
$\Delta T_{ln}$	$[K]$	logarithmic mean temperature difference (LMTD)
$A$	$[m^2]$	heat transfer area
$\alpha_{ij}$	$[kW/m^2 \cdot K]$	heat transfer coefficient
$c_p$	$[kJ/kmol \cdot K]$	specific heat capacity
$n$	$[-]$	factor for economies of scale



Table 3.1: Nomenclature for the Thermal Pinch Analysis (cont.)

Variable	Unit	Name
$\kappa_{proc}$	$[\text{€}/\text{m}^2]$	specific costs for heat exchanger surface area for a match of two process streams
$\kappa_{util,s,t}$	$[\text{€}/\text{m}^2]$	specific costs for heat exchanger surface area for a match of cold utility $s$ with hot process streams $[1, H - t]$ or of hot utility $t$ with cold process streams $[1, C - s]$
$w$	$[-]$	component $w$ of a process stream ( $w = (1, 2, \dots, W)$ , $W$ as number of components ( $W \in \mathbb{N}$ ))
$\chi_w$	$[-]$	mole fraction of component $w$
$\sigma_{util}$	$[\text{€}/\text{kJ}]$	price of utility $util$

### 3.1.1 Principles of the Pinch Analysis

The starting point of the pinch analysis lies in the objective of achieving optimal energy utilisation in a process by interconnecting material flows requiring heating (cold flows) with those requiring cooling (hot flows) and therefore was originally orientated exclusively at minimising additional energy utilities. The pinch analysis requires the combination of hot and cold process streams to composite curves and the description of the respective *enthalpy-temperature* ( $\Delta H, T$ ) relationships (cf. Figure 3.1). Additionally, a minimum temperature gradient  $\Delta T_{min}$  must be set representing the driving force of the heat transfer (cf. Table 3.1).

The result of the pinch analysis is the energy savings potential for the considered set of processes and represents the target for the subsequent design process. Furthermore, information about the amount of heat exchange required between the appropriate streams is obtained, minimising the use of hot and cold utilities. Depending on the chosen design constraints, which reflect technical and chemical requirements, the actual savings are determined resulting in an economically feasible solution driven by the trade-off between investment in heat exchanger and the savings in the consumption of utilities.

The flexibility of the design is of importance too. If the layout of a standard design can be evaluated and its flexibility assessed, then modifications can be carried out using heat integration and the flexibility of the subsequent design can be compared to the original one [Alexander et al., 2000]. Consequently, layout planning is not only driven by a trade-off between equipment, such as capital for heat exchanger, and operating costs (energy

utility costs), but also by the feasibility, such as for example controllability, starting-up procedures, safety constraints, etc., and flexibility of the system.

### 3.1.1.1 Concept of Composite Curves and Determination of Target Values

The basic idea behind the pinch analysis becomes apparent in the concept of the cold and hot *composite curves*. The individual cold and hot flows are divided into temperature intervals whose limits are chosen so that one interval boundary lies on every entry and exit temperature. In each temperature interval the individual cold and hot heat flows of that interval are added and displayed together as straight lines in the  $(\Delta H, T)$  diagram (cf. Figure 3.1).

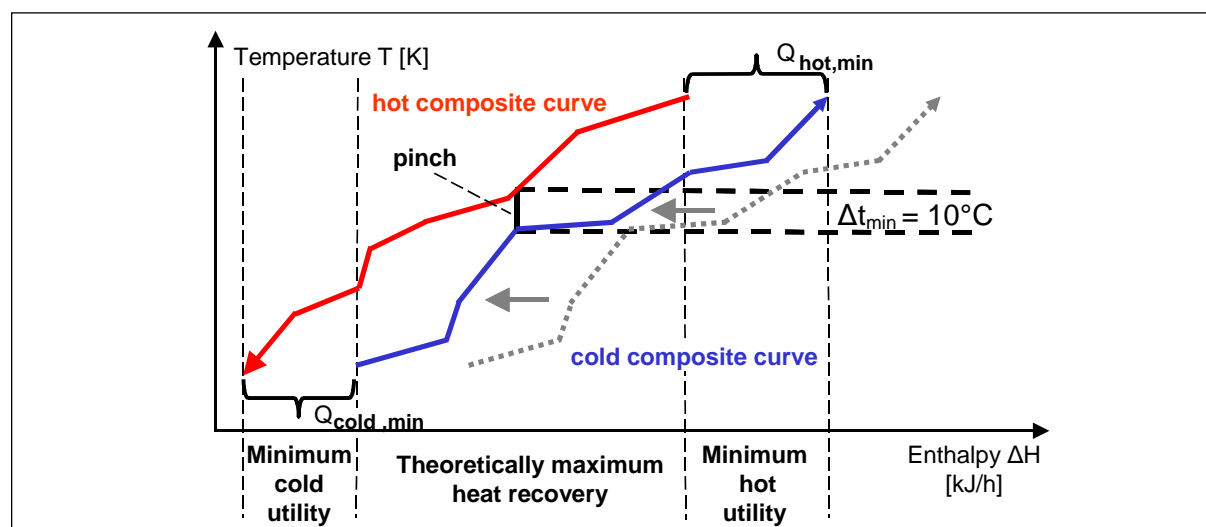

Figure 3.1: Hot and Cold Composite Curve [Linnhoff, 2004]

Since only changes of enthalpy are relevant, the curves can be moved horizontally in the diagram. Figure 3.1 shows a set of hypothetical streams. Together they represent the entire heat balance of the system. The points of a change in the slope in one of the composite curves indicate the start or the end of one flow or the onset of a phase change [Peters et al., 2003]. In order to ensure a heat transfer between cold and hot flows, the combined curves of the hot material flows must lie over those of the cold flows in all points, and thus are moved horizontally until this condition is met. The constraint set by  $\Delta T_{min}$  is defined as the minimal temperature difference between the flows. Then the pinch point, where the distance between the hot and cold curves is minimal, denotes the possible optimal internal heat transfer between the hot and cold flows. By decreasing  $\Delta T_{min}$  the composite curves can be shifted closer together, whereby the gradient must be

larger than zero to enable a heat transfer ( $\Delta T_{min} > 0$ ).  $Q_{Hot,min}^*$  is the minimal amount of hot utility demanded for heating which cannot be covered by utilising the hot flows, whereas  $Q_{Cold,min}^*$  represents the amount of heat which must be dissipated by external coolers.

The process streams on the right side of the  $(\Delta H, T)$ -diagram above the pinch temperature require heating (these streams constitute the *heat sink*), whereas the process streams below the pinch temperature would need cooling (these streams are referred to as the *heat source*). More heating than  $Q_{Hot,min}^*$  would lead to additional cooling and increase  $Q_{Cold,min}^*$  at the end of the temperature intervals. This would be an indication of suboptimal energy use or mismatched energy demand.

A surplus of heat below the pinch point cannot be balanced with heat demand above the pinch, since energy would then need to be transferred against the temperature gradient. Incorporating these insights three basic rules valid for any pinch problem can be identified [see e.g. Peters et al., 2003; Radgen, 1996; Dunn and Bush, 2001; Linnhoff et al., 1979; Linnhoff and Turner, 1981]:

- no heat dissipation above the pinch,
- no heat supply below the pinch,
- no heat transport across the pinch.

The matching of hot and cold process streams can be done graphically by plotting the composite curves or by using optimisation algorithms (cf. Section 3.1.2).

### 3.1.1.2 Determination of Enthalpy Values

If the inlet temperature  $T_{in}$ , outlet temperature  $T_{out}$ , the mean specific heat capacity  $c_m$  and the amount  $G$  of a specific flow is known, the enthalpy value  $\Delta H$  of that stream can be determined [Gregorig, 1973]:

$$\Delta H = c_m \cdot G (T_{out} - T_{in}) \quad \text{with } c_m = \frac{1}{T_{out} - T_{in}} \int_{t=T_{in}}^{T_{out}} c_p dt \quad (3.1)$$

However, in practice each process stream is characterised by a multitude of different material properties. In this case the process stream is not only characterised by inlet and outlet temperature  $T_{in}$  and  $T_{out}$  in K, but also by the flow rate  $r$  of the entire stream and the properties of its components  $w$ , such as the concentration as the mole fractions

$\chi_w$  and the coefficients for the polynomial approximation of the specific heat capacity (phase specific) ( $A^g, B^g, C^g, D^g, E^g$  kJ/molK). For example the enthalpy value can then be determined by Equation 3.2 under *standard temperature and pressure (STP)* for a gaseous stream. Hereby, the standard molar volume of an ideal gas can be determined as  $V_{STP} = 22.414 \text{ m}^3/\text{kmol}$  using the ideal gas law ( $p \cdot V = n \cdot R \cdot T$ ).

$$\Delta H = \frac{r}{V_{STP}} \cdot \sum_{w=1}^W \left( \chi_w \cdot \int_{t=T_{in}}^{T_{out}} (A_w^g + B_w^g \cdot t + C_w^g \cdot t^2 + D_w^g \cdot t^3 + E_w^g \cdot t^4) dt \right) \quad (3.2)$$

The calculations of the integrals are made by a linear approximation of the sum of the integrals (*numeric integration*) using the midpoint rule [Schwarz, 1997]. An explicit solution is not possible since a primitive (function) cannot be defined for some integrals. For questions concerning the process, analysis focussing on the enthalpy values can be determined through numerical integration of Equation 3.2 with 0.1 K steps. In case of processes where a specific temperature must be maintained, i.e.  $T_{in} = T_{out}$ , the released or absorbed heat must be modelled differently or the enthalpy requirement must be given explicitly.

### 3.1.1.3 Concept of the Grand Composite Curve for Multiple Utilities

In a first step the pinch analysis determines the theoretical minimal heating and cooling requirements ( $Q_{Hot,min}^*$  and  $Q_{Cold,min}^*$ ) by using composite curves. However, it does not give information about the temperature levels at which the various utilities are used. As a pure thermodynamic analysis it assumes that there is enough utility at the maximal/minimal heating/cooling temperature level, but in most processes the utilities are used at different temperatures and different pressures. Table 3.2 shows some typical values.

Table 3.2: Typical Temperatures and Pressures for Utilities

Utility	Temperature [K]	Pressure [bar]
high pressure steam	703	26
middle pressure steam	523	15
low pressure steam	423	3
water	293	–
sole water	273	–
mechanical cooling I	253	–
mechanical cooling II	233	–
liquid nitrogen	193	–

In order to minimise overall costs, the costs of utility consumption must be considered. "The general objective is to maximise the use of the cheaper utility levels and minimise the use of the expensive utility levels" [Linnhoff, 1998]. Hence, if possible, low pressure steam is preferred to high pressure steam and conversely cooling water is preferred to mechanical cooling whenever possible. The concept of the *grand composite curve* enables this analysis by employing a heat profile. The grand composite curve shows the enthalpy demand above the pinch and the enthalpy supply below the pinch at each temperature level [Linnhoff, 2004]. It is the difference between the hot composite curve reduced by  $\frac{1}{2}\Delta T_{min}$  and the cold composite curve increased by  $\frac{1}{2}\Delta T_{min}$ . Consequently, the heat profile touches the ordinate at the pinch temperature (cf. Figure 3.2).

Figure 3.2 (left diagram) shows schematically the heat profile of a system. The maximal distance of the heat profile above the pinch marks the minimal heating requirement  $Q_{Hot,min}^*$  and the maximal distance below the pinch marks the minimal cooling  $Q_{Cold,min}^*$ . These are identical to the minimal requirements in the analysis of the composite curves. The temperature levels of the available heating and cooling utilities are added as dotted lines in Figure 3.2. The actual utility used is marked as a bold line covering the utilities at each level.

The maximal use of low pressure instead of high pressure steam or cooling water instead of mechanical cooling can be calculated by the difference of the grand composite curve to the ordinate at the given temperature level (cf. dotted, horizontal line in the middle diagram in Figure 3.2). These points are called "utility pinch points". Depending on the costs for each utility and the specific costs for the heat exchanger it can be more economic

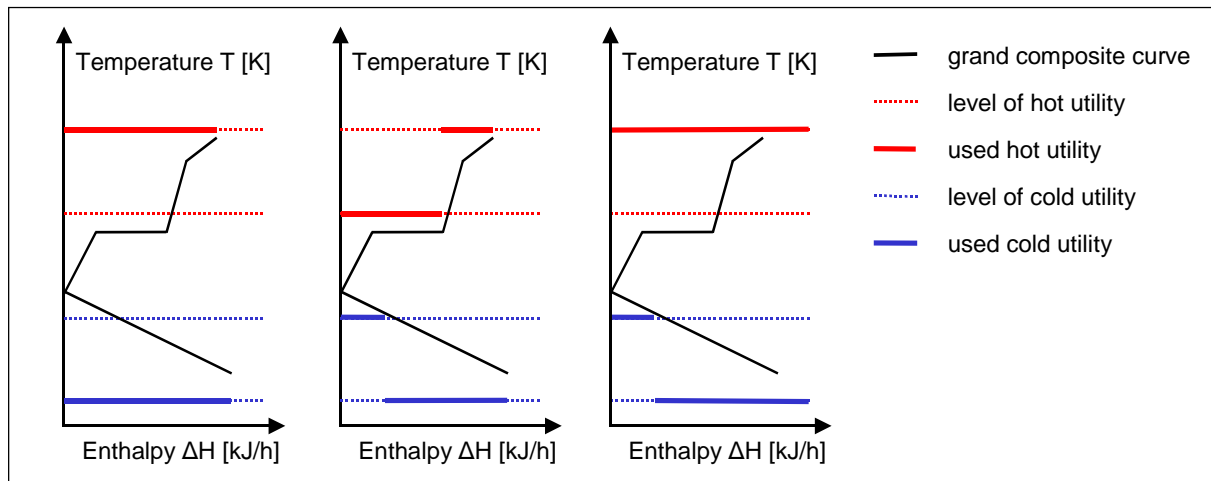

Figure 3.2: Heat Profiles by the Grand Composite Curve (adapted from [Linnhoff, 2004])

to use more than the required minimal heating or cooling (cf. right diagram in Figure 3.2). By utilising the gradient higher than  $\Delta T_{min}$  a smaller transfer area is needed in case of using heat exchanger, which could outbalance the costs of the additional utilities in contrast to the maximal integration.

### 3.1.2 Solving the Pinch Analysis with the Transportation Algorithm

The problems addressed by the pinch analysis can be solved graphically or by computer software. By linearising the hot and cold flows a transformation of the pinch problem into an automated solving routine, as a transportation problem from Operations Research where efficient algorithms exist for solving the *minimal energy input*-optimisation problem, can be demonstrated [Cerda et al., 1983]. Questions concerning the aspects of this section have been addressed in [Treitz, 2006; Geldermann et al., 2006d].

In order to solve the pinch analysis problem with a linear optimisation approach, the objective function of the general minimisation equation of the classical transportation problems is extended. The original parameter  $c_{ij}$  in the transportation problem indicates the costs per unit transported material from production site  $i$  to customer  $j$  and  $x_{ij}$  denotes the transported quantity. In an analogous manner, the extended objective function as the minimum utility problem can be stated as follows [Cerda et al., 1983]:

$$\min_{q_{ik,jl}} \sum_{i=1}^C \sum_{k=1}^L \sum_{j=1}^H \sum_{l=1}^L C_{ik,jl} \cdot q_{ik,jl} \quad (3.3)$$

The variable  $q_{ik,jl}$  (heat transferred) corresponds to  $x_{ij}$  (material transported). The transport prices  $c_{ij}$  per unit transported material are translated to the parameter  $C_{ik,jl}$ , which defines the costs associated with an possible heat exchange. In order to solve the transport algorithm with a linear optimisation algorithm it is transformed with a truncated incidence matrix into a standard linear programming problem [Neumann and Morlock, 1993]. In this way the transport algorithm can be solved with the *OptimisationToolbox* of MATLAB<sup>TM</sup>. In general, two types of analysis are possible: (1) a *thermodynamic approach* and (2) an *economic approach*. For both of these, if the temperature of the cold composite curve is already warmer than the temperature of the hot composite curve (i.e.  $l > k$ ) a heat exchange against the temperature gradient is impossible and  $C_{ik,jl}$  is allocated for a numeric determination with a large (infinitely high) value  $M$  (cf. Equation 3.4 and Equation 3.7).

### 3.1.2.1 Thermodynamic Approach

In the *thermodynamic approach* the possible heat exchanges between process flow combinations are allocated zero costs, whereas the fulfilment of heating or cooling duty by utility consumption are allocated costs of one [Cerda et al., 1983]. For the thermodynamic approach only one hot utility and only one cold utility are considered, i.e.  $s = 1$  and  $t = 1$ , since a distinction between different available utilities is not necessary.

$$C_{ik,jl} = \begin{cases} 0 & \text{for } i \text{ and } j \text{ are both process} \\ & \text{streams and a match is allowed, i.e. } k \leq l \\ 0 & \text{for } i \text{ and } j \text{ are both utility streams,} \\ & \text{i.e. } (i = C, j = H, s = 1, t = 1) \\ 1 & \text{only } i \text{ or } j \text{ is a utility stream} \\ M & \text{otherwise, where } M \text{ is a very large} \\ & \text{(infinite) number} \end{cases} \quad (3.4)$$

### 3.1.2.2 Economic Approach

In the *economic approach* the cost coefficients are specified in more detail. The driving cost factor is the heat exchange area  $A$  of the considered heat exchanger, which depends

on the heat quantity to be exchanged  $\Delta Q$ , the mean logarithmic temperature gradient  $\Delta T_{ln}$  and the overall heat transfer coefficient  $\alpha$  (cf. Equation 3.5) [Gregorig, 1973]:

$$A = \frac{\Delta Q}{\alpha \cdot \Delta T_{ln}} \quad (3.5)$$

Depending on the geometry of the heat exchanger the surface area  $A$  depends on further variables as for example for a tube and shell heat exchanger the surface area  $A$  depends in addition on the length  $l$ , the diameter  $d$ , the number  $n$  of tubes, etc. [Gregorig, 1973]. In the following Equation 3.5 is used as an estimate for  $A$ .

Whereas the temperature difference  $\Delta T$  is sufficient for a differential surface element  $dA$  of  $A$ , integration requires the calculation of a mean temperature difference  $\Delta T_{ln}$  (cf. Equation 3.6) as a mean for  $\Delta T$  since the temperature gradient is not constant within the heat exchanger<sup>21</sup> [Eastop and McConkey, 1969]:

$$\Delta T_{ln} = \frac{\Delta T_1 - \Delta T_2}{\ln \frac{\Delta T_1}{\Delta T_2}} \quad (3.6)$$

For example Figure 3.3 shows the temperature profile in a concurrent and a countercurrent heat exchanger and the schematic run of the temperature curves. In case  $\Delta T_1 = \Delta T_2$  then  $\Delta T_{ln}$  is defined as  $\Delta T_1 = \Delta T_2 = \Delta T_{ln}$ .

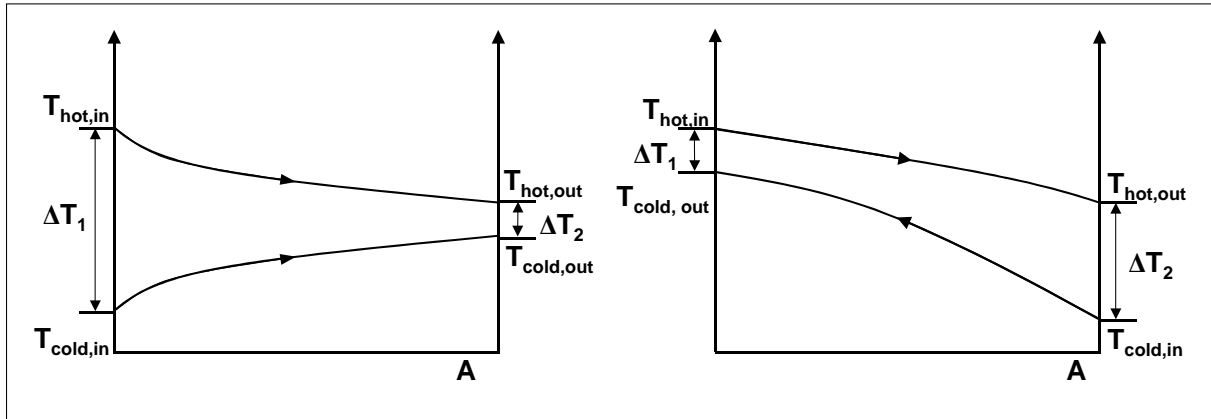

Figure 3.3: Profile of the Temperature Gradient within a Concurrent (left) and Countercurrent (right) Heat Exchanger [Eastop and McConkey, 1969]

<sup>21</sup>The definition of Equation 3.6 depends on the geometry of the heat exchanger and specific correction factors can be defined for the different heat exchanger as for example tube and shell heat exchanger [Gregorig, 1973]. In the following Equation 3.6 is used as an estimate for the mean temperature difference.



Therefore, the cost coefficients  $C_{ik,jl}$  for the economic approach can be formulated as shown in Equation 3.7:

$$C_{ik,jl} = \begin{cases} f_{proc}(A^n \cdot \kappa_{proc}) & \text{for } i \text{ and } j \text{ are both process} \\ & \text{streams and a match is allowed, i.e. } k \leq l \\ 0 & \text{for } i \text{ and } j \text{ are both utility streams,} \\ & \text{i.e. } (i = C, j = H, s = 1, t = 1) \\ f_{util}((A^n \cdot \kappa_{util,i,j}) + \sigma_{util}) & \text{only } i \text{ or } j \text{ is a utility stream} \\ M & \text{otherwise, where } M \text{ is a very large} \\ & \text{(infinite) number} \end{cases} \quad (3.7)$$

The specific costs are referred to per unit heat transferred, i.e.  $\Delta Q = 1 \text{ kJ/h}$ . In the case of integration, i.e. a heat exchange between two process streams, the costs are a function of the heat exchange area  $A$  and the specific costs  $[\text{€}/\text{m}^2]$  for the heat exchanger  $\kappa_{proc}$ . In addition further costs are generated as for example the costs for the pump energy. These costs are neglected in the following. In the case of heat transfer between a process stream and a utility, individual specific costs  $\kappa_{util,i,j} [\text{€}/\text{m}^2]$  are assumed and the price of the utility  $\sigma_{util} [\text{€}/\text{kJ}]$  is considered. Since the actual quantity of heat transferred is not known in advance of the optimisation, an iterative, for example simulation based approach, would generate more exact cost parameters using the factor  $n$  of the economies of scale. In general 0.6 is a good approximation for  $n$  and consequently  $n$  is also called the six-tenth factor. In case of heat exchangers depending on the geometry, material etc., more specific values for  $n$  can be determined (e.g. 0.82 for a plate heat exchanger).

### 3.1.2.3 Constraints

The transportation problem has several constraints, which are explained in the following. Equation 3.8 states that the heat required by cold stream  $i$  in interval  $k$  must be transferred from any hot stream. In the same manner, Equation 3.9 states that the cooling of hot stream  $j$  in interval  $l$  must come from any cold stream. The transferred heat  $q_{ik,jl}$  must be nonnegative ( $q_{ik,jl} \geq 0 \forall i, k, j, l$ ), which ensures that there is no heat moving from a cold stream to a hot stream.

$$\begin{aligned} \sum_{j=1}^H \sum_{l=1}^L q_{ik,jl} &= a_{ik} \\ i &= 1, 2, \dots, C \\ k &= 1, 2, \dots, L \end{aligned} \quad (3.8)$$

$$\begin{aligned} \sum_{i=1}^C \sum_{k=1}^L q_{ik,jl} &= b_{jl} \\ j &= 1, 2, \dots, H \\ l &= 1, 2, \dots, L \end{aligned} \quad (3.9)$$

$$a_{C-s+1,1} \geq \sum_{j=1}^{H-1} \sum_{l=1}^L b_{jl} \forall s \quad (3.10)$$

$$b_{H-t+1,L} \geq \sum_{i=1}^{C-1} \sum_{k=1}^L a_{ik} \forall t \quad (3.11)$$

Furthermore, there is the assumption that there is enough cooling (cf. Equation 3.10) and enough heating capacity (cf. Equation 3.11) of each of the utility streams to satisfy all cooling and heating requirements. Moreover, the problem stated assumes a given minimum  $\Delta T_{min}$  driving force, implicitly given by the required heat  $a_{ik}$  and the available heat  $b_{jl}$  per interval  $k$  and  $l$  respectively.

In addition, constraints can be chosen in such a way that certain energy flow combinations are excluded, for example due to excessive distances between sources and sinks. For an in-depth description of the application of the transport algorithm to the pinch point analysis see [Cerda et al., 1983].

#### 3.1.2.4 Determination of the Pinch Points

The pinch point denotes the optimal internal heat transfer between the hot and cold flows [Linnhoff and Flower, 1978]. In order to numerically calculate the position of the pinch points on the composite curves two approaches are possible based either on the table of the transportation problem [Cerda et al., 1983] or on heat balances of the individual temperature intervals [Linnhoff and Flower, 1978]. This way using the heat balances of the composite streams the pinch points can be identified efficiently.

With the linear approximation of all process streams within each temperature interval, the composite curves are a combination of straight lines aggregated from the different streams in the intervals  $k$  and  $l$  for all cold streams  $i$  and all hot streams  $j$ . It can be

shown that only corner points (points where at least one of the composite curves changes its slope) and end points can be potential pinch points [Cerda et al., 1983]. These are the boundaries of the different intervals  $k$  and  $l$  of  $L$ . In a preceding step a set of viable pinch points can be identified thus reducing the size of the initial problem significantly [Cerda et al., 1983]. Since only points with a change in the slope of either one of the composite curves can be candidate pinch points, intervals without a any change in slope of both of the composite curves can be merged. This distinction is even more precise because points on the cold composite curve are only candidates if the slope becomes flatter at this point, whereas points on the hot composite curve are only candidates if the slope is steeper above the point [Cerda et al., 1983].

Energy balances are determined for each temperature interval  $T_k = [T_{in,k}, T_{out,k}]$  of the composite curves of heat demand  $I_k$  ( $I_k = \sum_{i=1}^{C-s} a_{ik}$ ) and heat supply  $O_k$  ( $O_k = \sum_{j=1}^{H-t} b_{jk}$ ) starting at the highest temperature. A positive balance thus implies a heat demand in temperature interval  $T_k$ . Basic thermodynamics states that heat transfer can take place only from higher to lower temperatures. This means that a resulting heat supply balance from higher temperature intervals can be passed on to lower temperature intervals (i.e. there is a heat flow between the temperature intervals). Consequently, a heat oversupply can be passed on whereas a shortage must be filled by utilities. The assumption in this case is that it is irrelevant whether the utility supply takes place in every temperature interval individually or the total heat demand is supplied to the temperature interval with the highest temperature and is then distributed through the temperature intervals by a heat flow [Linnhoff and Flower, 1978]. Thus, the maximal aggregated heat demand of the heat balances must be supplied to the system. In this case the heat flow between the intervals balances generated heat demand. The pinch point lies in the temperature interval in which the remaining supplied heat is completely consumed. At this point no heat flow exists between the temperature intervals above and the temperature intervals below.

### 3.1.3 Example of the Thermal Pinch Analysis

For the determination of the energy target values the thermal pinch analysis approach based on an implementation in MATLAB<sup>TM</sup> using the transport algorithm of Operations Research as described in Section 3.1 is applied. The energy savings potentials identified for the different process design options are discussed with respect to available unit operations for realising the theoretical savings potential. A detailed introduction to the case study can be found in Appendix A. The appendix provides an overview of the background of

the case study, the description of the considered technical options and the illustration of the considered criteria. In the following the calculations are explained.

### 3.1.3.1 Application of the Thermal Pinch Analysis

The thermal pinch analysis of the reference bicycle company is based on three cold streams  $C_1, C_2, C_3$  requiring heating and two hot process streams  $H_1, H_2$  requiring cooling. In the following only the process streams of the three continuous drying ovens are used, since the process streams in the coating cabins and flash-off zones do not need heating at all and the drying step of the pre-treatment requires a special batch-wise analysis.

Table 3.3: Data for the Thermal Pinch Analysis

Stream	$T_{in}$ [K]	$T_{out}$ [K]	$r$ [m <sup>3</sup> ]	Component	CAS No	mole fraction
$C_1$	289	373	667	Oxygen	7782-44-7	0.21
				Nitrogen	7727-37-9	0.79
$C_2$	289	403	667	Oxygen	7782-44-7	0.21
				Nitrogen	7727-37-9	0.79
$C_3$	289	403	667	Oxygen	7782-44-7	0.21
				Nitrogen	7727-37-9	0.79
$H_1$	403	373	1 333	m-Xylol	95-47-6	$3.24E^{-03}$
				Ethyl Acetate	141-78-6	$1.18E^{-03}$
				Toluene	108-88-3	$1.18E^{-03}$
				Benzene	71-43-2	$2.94E^{-04}$
				Oxygen	7782-44-7	0.21
				Nitrogen	7727-37-9	0.79
$H_1$	393	300	2 000	m-Xylol	95-47-6	$1.60E^{-03}$
				Ethyl Acetate	141-78-6	$5.83E^{-04}$
				Toluene	108-88-3	$5.83E^{-04}$
				Benzene	71-43-2	$1.46E^{-04}$
				Oxygen	7782-44-7	0.21
				Nitrogen	7727-37-9	0.79

Table 3.3 shows the specific temperatures and the components of the different gaseous streams. The drying air of the processes using heating is taken from the outside air supply. 33 % of the solvents are emitted in the drying ovens and are therefore relevant for the heat integration scenario. The minimal temperature difference between the hot and the cold composite curve is assumed to be  $\Delta T_{min} = 10$  K.

The current process layout requires a heating by hot utilities of 275 MJ/h (= 76 kWh/h). All waste heat is released without being re-used. As Figure 3.4 illustrates the pinch points are situated at the bottom of the hot and cold composite curve. There exists a wide range of overlapping composite curves illustrating the theoretic possible heat integration of 249 MJ/h (= 69 kWh/h) leaving a minimal requirement of hot utility at the upper end of the composite curve of around 25 MJ/h (= 7 kWh/h). Hence, the theoretical savings potential is about 90 % and the major heating requirement for the ovens could be met by heat integration of the hot waste gas. The individual solvent components and the air flow are considered with their temperature specific parameters. However, the humidity in the air is not considered.

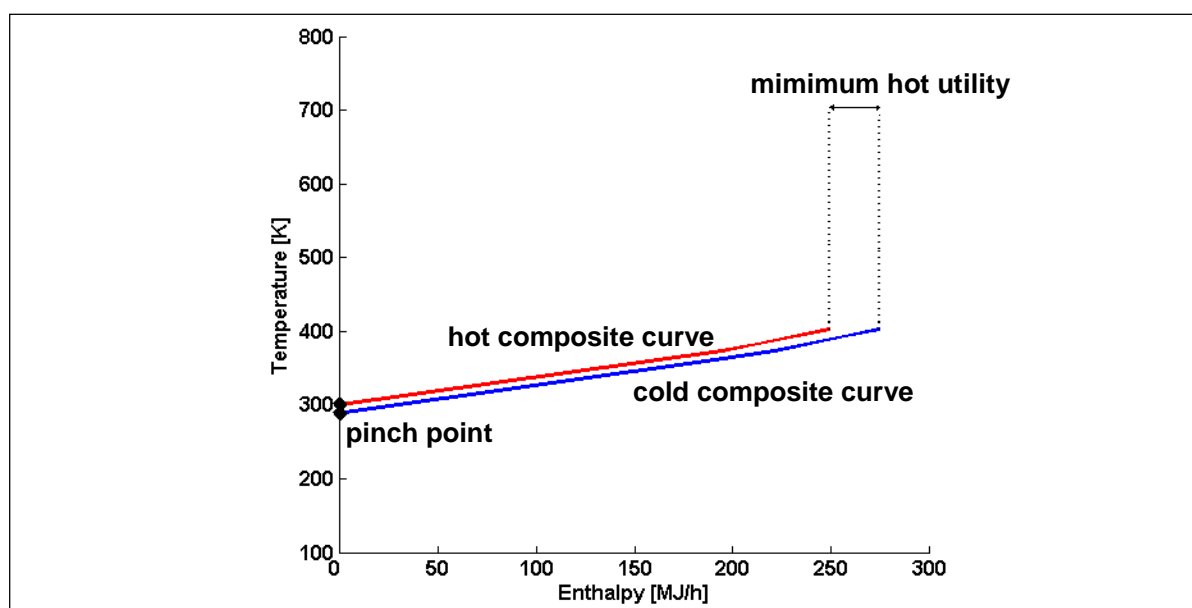

Figure 3.4: Composite Curves of the Thermal Pinch Analysis

However, as discussed in Section 3.1.2 a distinction must be made between a thermodynamic and an economic approach. As introduced in Section 3.1.1.3 the grand composite curve shows the aggregated heating and cooling requirements of the analysed system and can be used to optimise the use of additional utilities.

The thermodynamic analysis shows that there do not exist any external cooling requirements in this analysis (cf. Figure 3.5). The aggregated external heating requirements are shown with respect to the required temperatures. These energy demands cannot be covered by heat integration, but must be supplied by additional utilities.

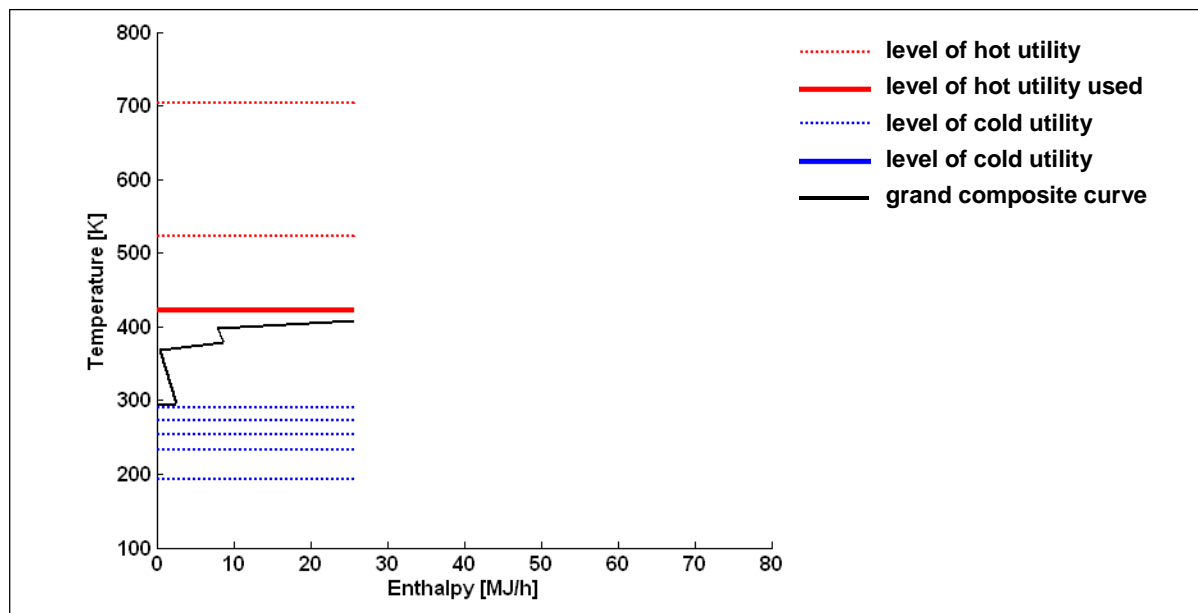

Figure 3.5: Grand Composite Curve of the Thermodynamic Approach of the Thermal Pinch Analysis

However, the economic analysis shows less heat integration of 194 MJ/h (= 54 kWh/h) and a higher demand of external heating utilities of 80 MJ/h (= 22 kWh/h). In this case external cooling requirements exist, balancing the heat demand and supply of the system. In the economic approach less heat integration is used (70% vs. 90%) and therewith taking advantage of a higher temperature gradient in the heat exchanger resulting in a smaller heat exchanger surface area and ultimately in lower costs for the heat exchanger.

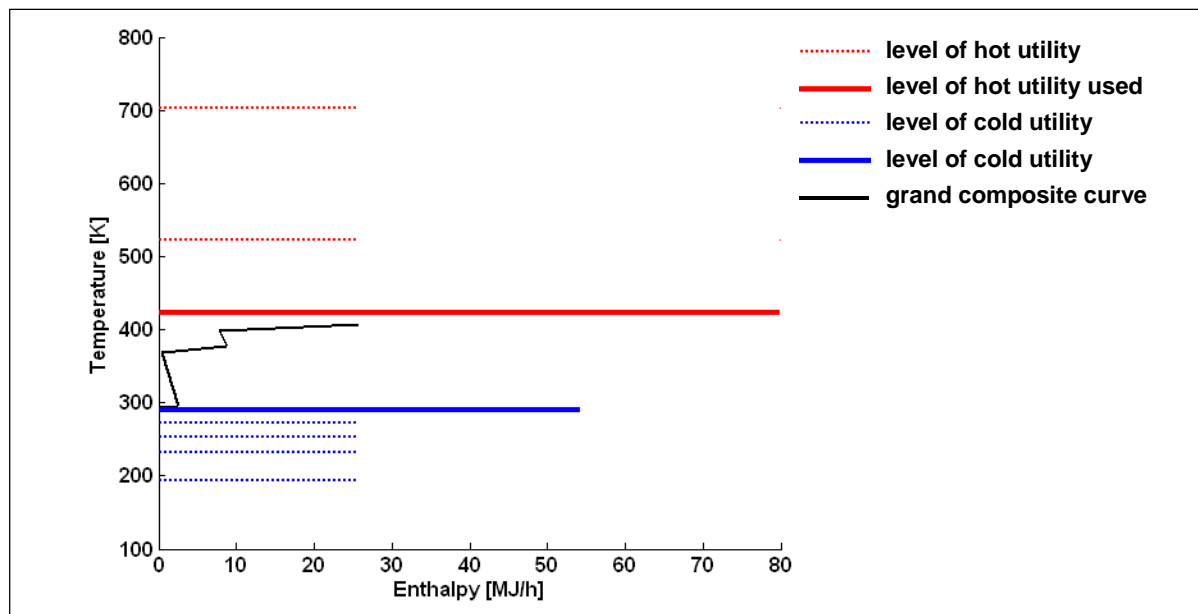

Figure 3.6: Grand Composite Curve of the Economic Approach of the Thermal Pinch Analysis

In this case an optimisation concerning the selection of different heating utilities is not reasonable, since a gas-powered heating system is available at the bicycle company and other additional alternatives do not provide potential for economic improvement. A split between different hot utilities may provide the possibility to use cheaper utilities in lower temperature ranges, but would require more heat exchanger and more equipment resulting in unreasonable effort.

### 3.1.3.2 Discussion of Unit Operations

After the determination of the thermodynamic and economic targets by using the thermal pinch analysis approach an adequate unit operation must be identified to realise the existing savings potentials. Given the economic optimal solution requiring only around 22 kWh/h heating utility, a significant energy savings potential can be identified. The heat transfer table (cf. Table 3.4) shows which flows can be connected. For example the heating duty of the cold stream  $C_1$ , which is the drying air of the filler oven at 100 °C, is completely satisfied by heat integration. The cold process streams  $C_2$  and  $C_3$  are only partially covered by heat integration and the remaining requirements are fulfilled by the hot utility.

Table 3.4: Heat Transfer Table of the Economic Analysis of the Thermal Pinch [MJ/h]

	$H_1$	$H_2$	hot utility
$C_1$	54 758	10 247	8 858
$C_2$	0	65 004	35 552
$C_3$	0	65 004	35 552
cold utility	0	54 613	-

As the heat transfer table suggests several heat exchanger would be necessary for combining the cold and hot process streams. However, in this special case the gaseous waste streams can be combined to one single stream and all the cold process streams can be combined to one single stream for pre-heating the air of the drying ovens. By considering the different temperature levels and mass flow streams the parameters for modelling the gaseous waste streams can be adjusted. Consequently, only one heat exchanger is required reducing considerably the investment of the heat exchanger and the necessary piping. Furthermore, the temperatures of the hot process streams can be adjusted for the exclusive consideration of the best heat integration resulting in no cooling requirements by specifically cooling the hot process streams down to only 48 °C. If the aim of the analysis is the calculation of the energy requirements for a condensation system for the solvents in the gaseous waste stream, different cooling utilities must be discussed (cf. Section 3.3).

A gas-gas heat exchange is characterised by low heat transfer coefficients and thus requires large heat exchange surfaces. Because of this the surface area of gas-gas heat exchanger is extended by fins within the heat exchanger [VDI]. In this case a welded, stainless steel plate heat exchanger would be suitable with an exchange surface area of 124 m<sup>2</sup> by 167 plates realising 54 kW for the 2 000 m<sup>3</sup> of all process streams [Weiler, 2005]. The heat transfer coefficient for this gas-gas heat exchanger is 0.014 kW/m<sup>2</sup>K and therewith in the range of typical values of 0.01 kW/m<sup>2</sup>K - 0.035 kW/m<sup>2</sup>K [VDI].

In a countercurrent flow arrangement of a recuperative heat exchanger the gaseous waste is cooled down from 120 °C to 48 °C and herewith it is possible to pre-heat the fresh air supply from 16 °C to 89 °C.

Total investment for the installation can be estimated by the investment for the heat exchanger plus the piping installation. The costs for the heat exchanger is assumed to be 10 000 €. This leads to a complete surface dependent costs of 115 €/m<sup>2</sup>. The costs



for the piping installation depends on the distances of the chimneys at the roof of the bicycle company. Currently, eight chimneys are at the roof of the company (two for the pre-treatment drying ovens, and two for each of the three continuous drying ovens). The fresh air supply is also taken from a channel located at the roof of the company. Consequently, it is necessary to connect the gaseous waste streams with a heat exchanger at the roof of the company and the fresh air channel. By assuming a stainless steel pipe with a diameter of 200 mm a total length of 60 m is required to connect the streams. Considering additional insulation and connecting parts, such as for example 90° bends, T-pieces and mountings, the installation of the heat exchanger would require further 9 000 € of material and 11 000 € of labour costs<sup>22</sup>. Consequently, the total investment would sum up to 30 000 €. Assuming a price for natural gas of 416 €/t savings of approx. 3 800 €/a can be achieved resulting in a positive net present value.

### 3.1.3.3 Characterisation with respect to Energy

Five different technical options are compared based on the pinch analysis results: The *Status Quo* is evaluated with respect to a switch to *Waterborne Basecoats*, the installation of a *Condensation* or *Thermal Incineration* system and a switch to *Powder Coatings*. A detailed introduction to the different technical options and evaluation criteria is provided in Appendix A. Please refer to page 225 for more information.

In the case of *Condensation* or *Waterborne Basecoats* an investment of 30 000 € is considered and energy savings of 54 kW are realised (cf. Table 3.5). In case of *Thermal Incineration* a special heat exchanger is not reasonable since temperatures of 982 °C must be reached to burn the solvents and a cooling down of the waste gas of the drying ovens is not useful. In this case a heat exchanger system within the thermal incinerator is considered realising 50 % heat recovery (cf. Section 3.3.3). Thus, the ratio of the heating of the drying ovens is considered here with 38 kW.

The option *Powder Coating* requires higher temperatures because of an higher film thickness to burn in the coatings. Thus, the investment highly depends on the existing drying ovens. If the existing drying ovens are able to reach temperatures of 150 °C, as assumed in the following, only minor changes in the investment have to be considered with respect to the heat integration compared to the proposed heat exchanger and 35 000 € are taken into account in the following for a heat exchanger installation of 75 kW of the total required

---

<sup>22</sup>For the installation an European wage level is assumed. However, the wage level in China is considerably lower, but specific data for the individual installation steps were not available for China.

Table 3.5: Characterisation of the Energy Target Values

	Status Quo	Waterborne Basecoats	Thermal Incineration	Condensation	Powder Coating
Energy [kWh/h]	76	22	38	22	25
Investment [€]	0	30 000	-	30 000	35 000

100 kW. If the drying ovens have to be renewed an investment of approx. 250 000 € would be required.

### 3.1.4 Discussion of the Thermal Pinch Analysis

The fact that an optimum is sought with respect to heat recovery rather than costs in the *thermodynamic approach* might at first appear to be a disadvantage. However, since the overall costs are dominated to large extent by the costs of energy, all different networks which feature maximum heat recovery are suitable as starting networks for the design [Linnhoff and Flower, 1978].

Numerous papers exist proposing modifications to the classical pinch analysis in order to cover unique processes not considered in the simple model. Special attention must be paid to processes where the composition of the stream changes, for example separation processes, mixing points, direct heating, etc. Furthermore, discontinuous composite curves can be modelled [Lakshmanan and Fraga, 2002]. In general the methodology assumes that at least one cold and one hot process stream within the temperature range exist. If this is not the case it is possible to acquire multiple pinch points and then determine lower and upper bounds on  $\Delta T_{min}$  in order to determine the thermodynamic optimum [Lakshmanan and Fraga, 2002].

#### 3.1.4.1 Application of the Thermal Pinch Analysis to Batch Processes

The classical pinch analysis approach only considers continuous processes and assumes the parameters to be time independent. In batch processes, however, not only temperature levels determine which processes can be combined, but also the changing availability over

time addressed in *time average models*, *time event models* and *time slice models* [Obeng and Ashton, 1988; Linnhoff, 1993], where an analysis is done for each time interval and excess heat can be transferred not only from hot to cold streams, but also from earlier to later time intervals. Thus, as for any process integration analysis the modelling of batch process requires data about mass- and energy flows. However, for the determination of target values for batch processes further information is required concerning the time aspect of the operations. Three different approaches can be identified for the modelling of batch processes [Ashton, 1992]:

- ***Time Average Models***: The heating and cooling requirements of the batch processes are "averaged" with respect to defined time intervals and the analysis is carried out analogous to the thermal pinch analysis of continuous process streams.
- ***Time Event Models***: The scheduling of the operations is the base for the analysis using Gantt Charts by determining a critical path through the different heating and cooling requirements and their specific time schedule. Focus of the analysis is the de-bottling of peak times of the system.
- ***Time Slice Models***: Similar to the temperature intervals in the classical thermal pinch analysis in time slice models starting and finishing points of all operations are ascertained a specific time interval. For each time interval the heating and cooling requirements are balanced. Nevertheless, excess heat of one time interval can be transferred to the next time interval constituting a heat source. By this proceeding a cascade of heat sources and sinks can be constructed.

Nevertheless, the models consider an intermediate heat integration is favoured over heat storage and later integration by constructing the batch cascade. In this context the type of energy with respect to storage and convertibility must be considered. An approach based primarily on a time analysis and to a lesser degree on temperature is also possible. By analysing the scheduling of the different processes an optimisation of the heat integration is targeted by re-scheduling the processes in order to reduce storage and peak loads of the utilities [Wang and Smith, 1995].

#### 3.1.4.2 Applicability of the Pinch Analysis Approach

In general the pinch analysis determines the composite curves and thus the theoretical minimal energy requirements for a fixed process layout and given process and material balances. If these parameters are altered a new iteration is necessary. However, the

pinch analysis can be used to estimate if a modification is likely to be beneficial. As a general rule, however, for optimised process design the so-called *plus-minus principle* ( $\pm$  principle) [Linnhoff, 1998] is based on the concept that no heat transfer across the pinch point exists and states:

- reducing hot utility targets by
  - increasing hot stream duty above the pinch temperature
  - decreasing cold stream duty above the pinch temperature
- reducing cold utility targets by
  - decreasing hot stream duty below the pinch temperature
  - increasing cold stream duty below the pinch temperature

By applying the  $\pm$  principle the proposed process modification can be evaluated and an approximation can be made about whether it will be beneficial or detrimental to the overall heat balance. The pinch analysis is used to evaluate a given design with respect to its heat balances and utility consumption.

## 3.2 Water Pinch Analysis

Although the pinch analysis was originally developed for the minimisation of energy consumption by effectively combining hot and cold streams, its principles can also be employed for water consumption and other auxiliary materials. The goal is always to reuse heat, water and auxiliary materials as efficiently as possible, while adhering to the requirements of the process steps. Analogous to the application of the thermal pinch analysis approach, the water pinch analysis can be used to calculate the target values based on either minimum fresh water consumption or minimum wastewater generation that maximise water reuse in a network of various water streams. Just as in the energy pinch analysis this approach focuses on the network of process streams instead of single process units: In this case reducing the demand for water by using the outlet water of one process unit to realise its own water requirements or that of other unit operations. The opposite approach would be to modify single processes or process units to reduce the overall water demand, such as using air-cooled instead of water-cooled condensers or improved blowdown rates.

The first pinch analysis based approach focussing entirely on water minimisation was a graphical methodology targeted at minimal fresh water and wastewater flow rates through the analysis of the *concentration vs. the mass load* of the different process streams [Wang and Smith, 1994]. This approach is based on a mass exchange problem between a set of contaminant rich process streams and a set of contaminant lean process streams [El-Halwagi and Manousiouthakis, 1989] and because "the amount of water required is a function of the quality of the water provided" [Polley and Polley, 2000] it is an approach based on water quality (cf. Section 3.2.1). Since unit operations with an unchanging mass load of the water stream, for example a cooling operation, can only be mapped with difficulty by the concentration vs. mass load approach different approaches were developed and coexist. The analysis on *concentration vs. flow rate* diagrams takes the water quantity (i.e. fixed flow rates) as the general basis to identify the water savings potential [Dhole et al., 1996; Polley and Polley, 2000; Sorin and Bédard, 1999; Linnhoff, 2004] (cf. Section 3.2.2.1). Further modifications used a simulation based approach considering various mixing possibilities of water source streams [Hallale, 2002]. Furthermore, a conceptually different approach used stream mapping diagrams (composition vs. flow rate) or condition mapping diagrams, for example *Chemical Oxygen Demand (COD) vs. flow rate*, focussing on identifying different recycling possibilities of single streams rather than constructing composite curves [Dunn and Bush, 2001] (cf. Section 3.2.2.2).

Table 3.6: Nomenclature for the Water Pinch Analysis

Variable	Unit	Name
$c$	[ppm]	concentration
$\Delta C_{min}$	[ppm]	minimum concentration difference (driving force)
$C_{reg}$	[ppm]	concentration where regeneration starts
$C_0$	[ppm]	outlet concentration of the regeneration process
$C_{pinch}$	[ppm]	pinch concentration
$R$	[-]	regeneration
$R_{const}$	[ppm]	constant regeneration performance
$\Delta \dot{m}$	[kg/h]	mass transfer requirements
$F_{WS}$	[m <sup>3</sup> /h]	feedstream of the fresh water supply
$\kappa_{WS}$	[€/m <sup>3</sup> ]	specific costs for fresh water supply
$\kappa_{reg}$	[€/m <sup>3</sup> ]	specific costs for regeneration
$\kappa_{WW}$	[€/m <sup>3</sup> ]	specific costs for wastewater discharge

The fundamental difference between the thermal pinch analysis and the water pinch analysis lies in the definition of the quality of a stream [Linnhoff, 2004]. The quality parameter in a heat integration analysis is the temperature. In a water pinch analysis the water quality is characterised by various parameters, for example COD, pH, suspended solids (SS) or the conductance of the water. If more than one quality parameter of the water streams is of significance to the processes they must be taken into account for the optimisation. Such "key contaminants" are defined as "any property that prevents the direct reuse of a wastewater stream" [Tainsh and Rudman, 1999]. In fact an analysis for each key contaminant has to be executed and a design must be developed iteratively. Given that graphical approaches are generally quite complex for multi-parameter cases or distributed wastewater treatment systems, the use of mathematical methods is more appropriate. A comprehensive overview of the theoretical principals, the different methodological approaches and industrial applications is provided e.g. by [Alva-Argáez et al., 1998; Mann and Liu, 1999].

### 3.2.1 Approach based on Water Quality

The water pinch analysis approach based on water quality assumes a water network with several operations using water, which have individual inlet and outlet thresholds for a certain contaminant [Wang and Smith, 1994]. It requires no fundamental change to the process network layout during the analysis, which would necessitate a new start. The aim of the analysis is the determination of minimal water flow rates. It is a quality-based approach since the driving force of the analysis is the mass load that must be transferred from the process unit by the process water, for example measured in kg/h, which means that it is basically a contamination transfer problem from process streams to water streams. In order to achieve a reduction in the water consumption three generic strategies are used [Wang and Smith, 1994]:

- **Reuse:** consumption of wastewater in other unit operations either directly or blended with other wastewater or freshwater flows (cf. Section 3.2.1.1);
- **Regeneration Reuse:** consumption of wastewater in other operations (without re-entering the previous process again) after partial treatment and possible mixing with other wastewater or freshwater flows (cf. Section 3.2.1.2);
- **Regeneration Recycling:** consumption in all operations (including re-entering the previous process again) after partial treatment and possible mixing with other wastewater or freshwater flows (cf. Section 3.2.1.3).

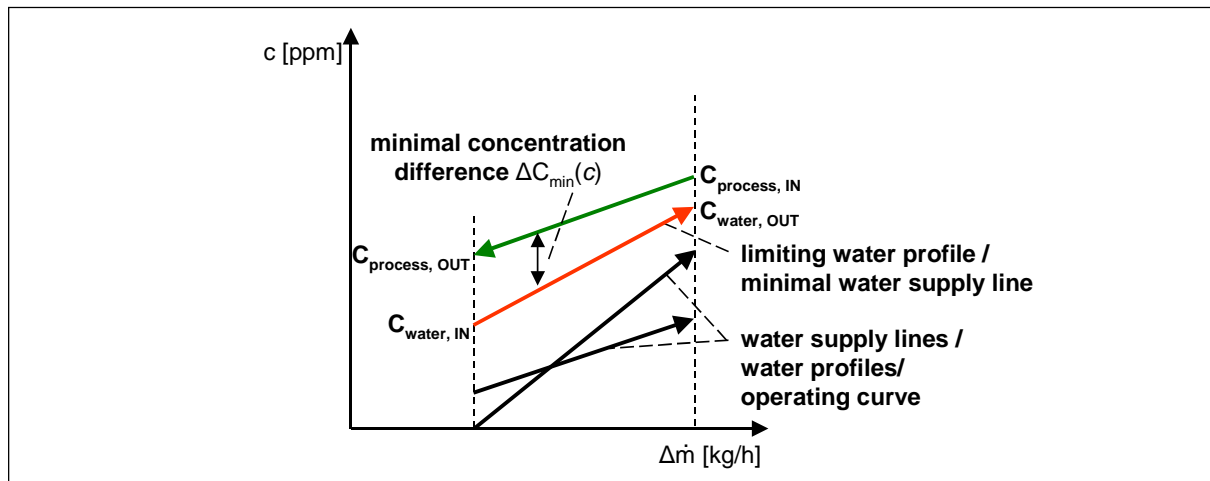

Figure 3.7: Representation of Water Using Processes [Wang and Smith, 1994]

The mass transfer requirements  $\Delta \dot{m}$  and the inlet and outlet concentrations of a specific contaminant composition are the key indicators of the analysis. A linear behaviour is assumed for the transfer which is a good approximation for diluted streams, for example water used for washing [Henßen, 2004], and the driving force is the minimal concentration difference  $\Delta C_{\text{min}}$ . The mass transfer requirements  $\Delta \dot{m}$  of a process unit are specified and in combination with the concentration requirements they determine the minimal potential water flow rate, the so-called *limiting water profile* (cf. Figure 3.7). Different operating curves, i.e. water profiles or water supply lines, can be used in the process, but the limiting water profile is based on the highest possible inlet concentration and therefore maximises the reuse possibilities.

The maximal inlet and outlet concentrations of each process unit depend for example on the (1) required minimal mass transfer driving force  $\Delta C_{\text{min}}$ , (2) maximal solubility, (3) precipitation avoidance, (4) fouling of equipment, (5) corrosion limitations, or (6) minimal flow rate that prevents the settling of solid particles [Wang and Smith, 1994].

### 3.2.1.1 Case 1: Reuse

In the case of reuse the limiting water profiles of all operations are compiled in one concentration vs. mass load diagram (cf. Figure 3.8). Inlet and outlet concentrations of the different operations define concentration intervals. Overlapping concentrations are combined to a *limiting composite curve* (also *concentration composite curve*) taking into account all mass loads of the different operations of the respective concentration interval.

The minimal freshwater supply is calculated by determining the steepest water supply line below the limiting composite curve. Assuming that the contaminant concentration of the freshwater at the inlet is zero, the water supply curve begins at the origin. The point where the water supply curve touches the limiting water profile is the pinch point. Since the mass transfer driving force is considered in the maximum inlet and outlet concentration, the driving force is not zero at the pinch point even if the water supply curve touches the limiting water profile.

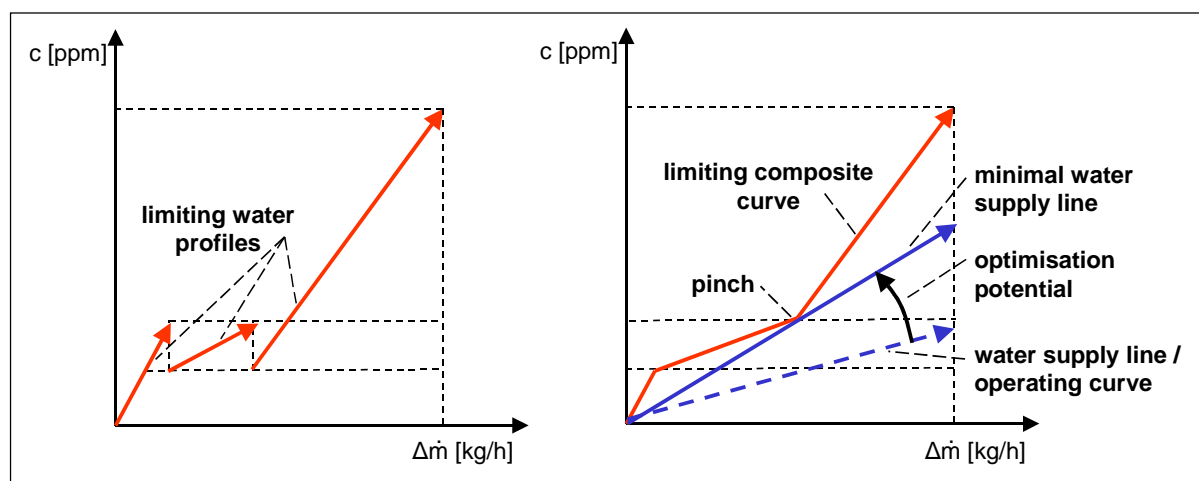

Figure 3.8: Match of Limiting Composite Curve and Water Supply Line [Wang and Smith, 1994]

The slope of the limiting water profile describes the worst water quality acceptable, and the water supply line defines the actual water flow rate in the system: A steeper straight line corresponds to a higher accumulation of the contaminant in the water which means the same mass load is collected by a smaller flow rate. Hence, the steepest possible water supply curve minimises the required flow rate and the optimisation potential can be determined by the difference in the slopes. The difference between the operating water supply line and the limiting water profile illustrates the water savings potential (cf. Figure 3.8). However, a steeper line corresponds to a lower fresh water flow rate, but since the total mass load is fixed, this leads to higher contaminant outlet concentrations.

Practical problems often require the consideration of several contaminants or parameters. If it is not possible to aggregate multiple contaminants to a single parameter, such as Chemical Oxygen Demand - COD, an iterative process must be applied by shifting the inlet and outlet concentrations of each process in order to find the overall pinch in the system. The basic assumption in this approach is an underlying correlation between the



mass transfer of the different contaminants, for example a proportional mass transfer of all contaminants to one reference contaminant.

### 3.2.1.2 Case 2: Regeneration Reuse

Furthermore, the concept of regeneration and reuse takes into account that wastewater regeneration lowers the concentration of the contaminants and consequently allows further reuse options and a reduction in fresh water demand. Using individual or combined preliminary and primary wastewater treatment operations, for example grates, filtration, settling tanks, or biological treatment operations, such as fixed bed reactor, aeration tank, the concentration of certain contaminants can be reduced. Consequently, the water can be used in processes for which the concentration was too high before regeneration. In the case of several wastewater treatment operations, all operations are combined to a single one characterised by a certain degradation rate  $R_{const}$  or outlet concentration  $C_0$ . In the analysis the same flow rate before and after the regeneration is assumed: visualised by the same slope of the water supply curve before and after regeneration (cf. Figure 3.9).

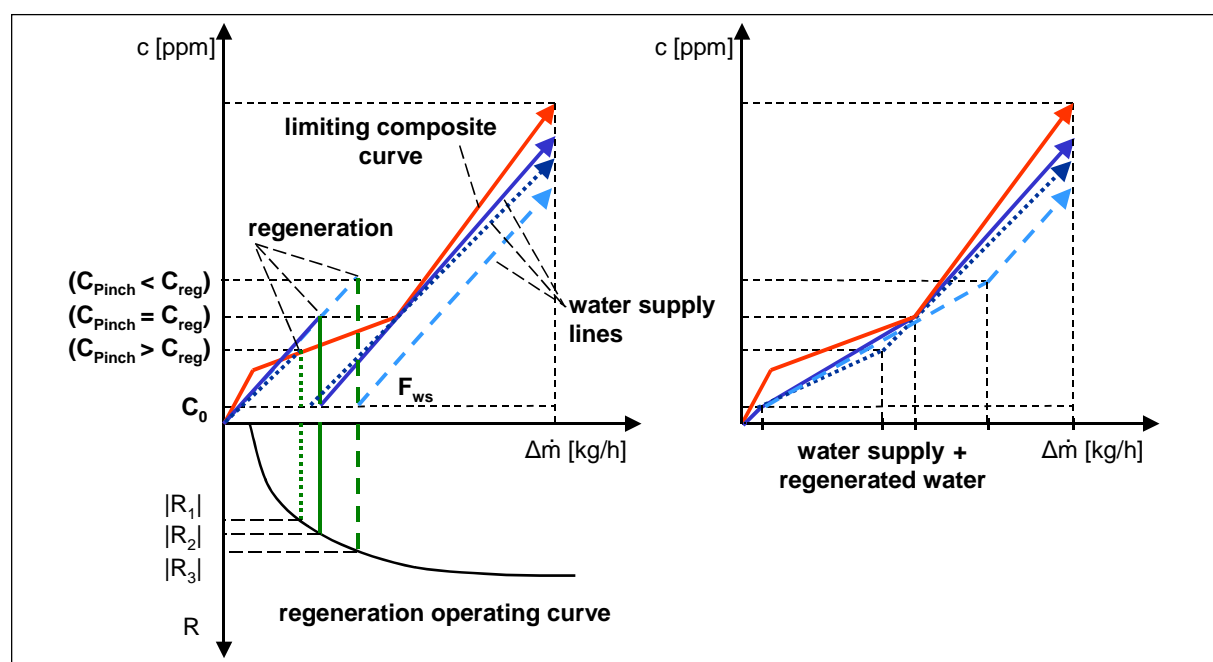

Figure 3.9: Regeneration of Water with Fixed Outlet Concentration of the Regeneration [Wang and Smith, 1994; Henßen, 2004]

In case of a constant outlet concentration, the concentration of the contaminant in the wastewater is reduced to  $C_0$  as soon as the regeneration concentration  $C_{reg}$  is reached.

Between  $C_0$  and  $C_{reg}$  the water supply curves are combined to a single composite water supply curve.  $C_{reg}$  should be chosen in such a way that the composite water supply curve is as close as possible to, and below the limiting composite curve. Assuming a constant outlet concentration  $C_0$  different performances of regeneration  $R$  can be determined for different  $C_{reg}$  (cf. Figure 3.9). It can be shown that it is optimal if  $C_{reg}$  is equal to the concentration at the pinch point  $C_{pinch}$  [Wang and Smith, 1994]. A lower regeneration concentration would stand for a larger difference between the composite curves and hence would require a higher flow rate. A higher regeneration concentration would still minimise the flow rate, but would require an unnecessary effort (cf. Section 3.2.1.4).

### 3.2.1.3 Case 3: Regeneration Recycling

In the case of regeneration operations including the possibility of recycling of water even higher reductions in the water consumption can be achieved. The processes below  $C_0$  must be fed by freshwater supply since this concentration level cannot be achieved by the regeneration process. Hence, if a circulation of the process water is possible, the flow rate is determined by the slope of the limiting composite curve below the concentration  $C_0$  (cf. Figure 3.10). In this case the water flow rate after regeneration is increased by the closed loop water and the slope after regeneration shows the amount of regenerated water.

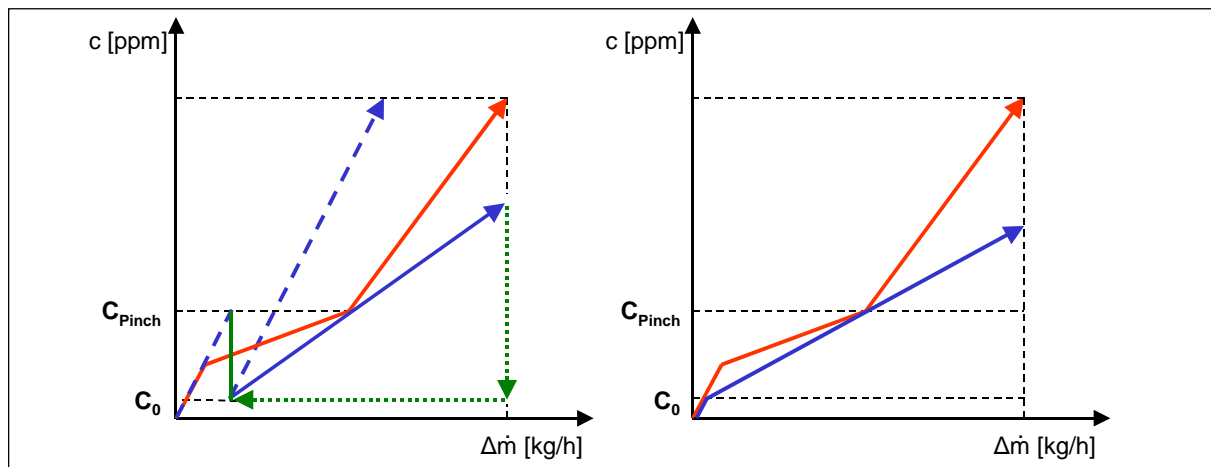

Figure 3.10: Recycling of Regenerated Water [Wang and Smith, 1994]

In the event no recycling of water would be used, but regeneration only, a constant flow rate before and after regeneration, illustrated as the grey dotted curve to the left in Figure 3.10, would result. However, the limiting composite curve would be crossed. In order to prevent this, the additional demand for water must be covered using recycling water.

### 3.2.1.4 Economic Considerations

Economic considerations have been introduced to the water pinch analysis based on water quality [El-Halwagi, 1997; Henßen, 2004]. In this thesis the trade-off between the costs of regeneration and fresh water supply is modelled by the cost coefficients  $\kappa_{WS}$  for the specific costs for fresh water supply and  $\kappa_{reg}$  for the specific costs for regeneration in €/m<sup>3</sup>. As shown in the thermal pinch analysis (cf. Section 3.1.1.3) the flow rate of the fresh water supply can vary from the minimal flow rate because of economic reasons. Furthermore, the discharge of water can be penalised by a wastewater charge  $\kappa_{WW}$

The consideration of multiple feedstreams for fresh water supply and multiple contaminants with economic considerations can be achieved by an iterative approach [Henßen, 2004]

## 3.2.2 Approaches based on Water Quantity and Stream Mapping

Different approaches for the optimisation of water networks evolved from criticism of limitations of the quality based approach. The major limitation of the quality based approach stems from the central role of mass transport [Dhole et al., 1996]:

- The mass transfer model is only suitable for fundamental operations of mass transport on the water stream, such as cleaning. Reactors, boilers or cooling towers with negligible mass transfer, where the flow rate is of crucial importance, cannot be modelled sufficiently as mass transfer operations.
- Operations consisting of several water streams containing different contamination levels can only be modelled poorly.
- Flow changes within a certain plant component, such as evaporation in a cooling tower, are difficult to take into account.

Therefore, approaches focussing on the quantity of water demand and supply of the single processes (cf. Section 3.2.2.1) and on identification of correct mixing and recycling possibilities (cf. Section 3.2.2.2) exist.

### 3.2.2.1 Approach based on Water Quantity

In the approach based on water quantity each sink is characterised by its water demand and the maximum allowable inlet contaminant concentration, and each source by its water supply and respective contaminant outlet concentration. In the case of a single quality parameter the streams can be plotted in the *purity vs. concentration profile* (cf. Figure 3.11). In contrast to the quality based approach the water quality of the streams is constant. The maximum concentration of inlet and outlet concentration is shown and consequently each stream can be expressed by a horizontal line. The length illustrates the flow rate of each stream for a given (or allowable) concentration.

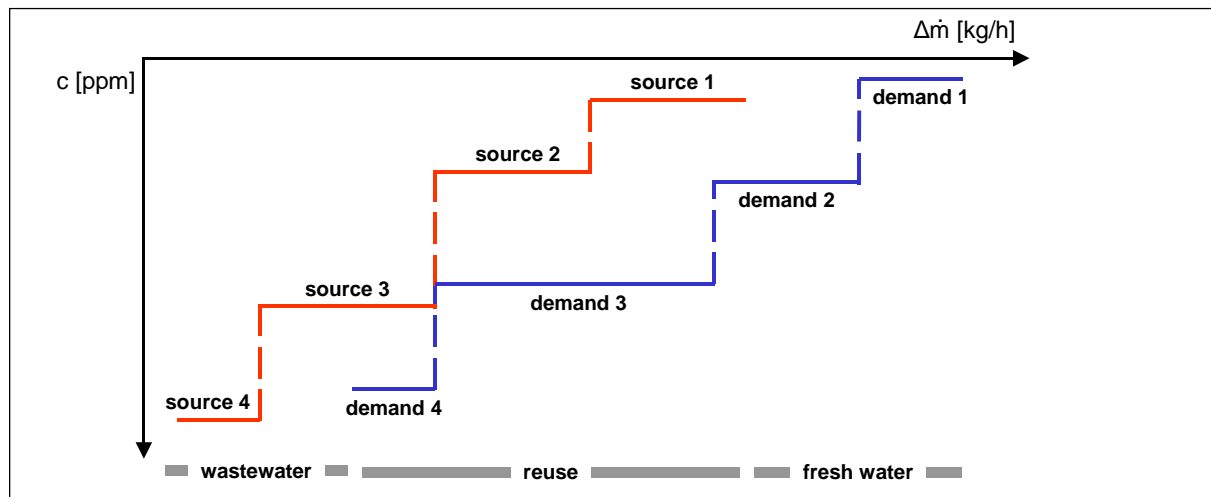

Figure 3.11: Water Composite Curves [Dhole et al., 1996]

All sources together (red line) and all sinks (blue line) constitute stepped composite curves (cf. Figure 3.11). The composite curves can be shifted horizontally, since the streams are independent of the absolute mass load requirement. The sink composite curve can thus be moved from the right towards the source composite curve until they touch. The point at which they contact is termed the pinch, analogous to the thermal pinch analysis. Sinks located beneath the source curve can reuse the water from the sources above, since the source streams have the necessary quality. Uncovered sinks located to the right of the potential reusable water area need fresh water, while those to the left produce wastewater, which means that a portion of the source streams of poor quality have no corresponding sink.

The pinch divides the streams into two subsystems of water deficit and water oversupply. As in the case of the thermal pinch analysis the optimal water transfer is governed by three rules [Linnhoff and Hindmarsh, 1983]:

- Water cannot be transferred across the pinch. Transfer from sources below the pinch to sinks above the pinch is impossible due to the contaminant concentration. If, on the contrary, water from sources above the pinch is passed to sinks below the pinch, a deficit of previously available source water above occurs, which must be compensated by additional fresh water. More water is now available below, however, it can only be discharged as wastewater since all the sinks are already completely supplied by the sources. Transport across the pinch would thus lead to more fresh water and wastewater;
- Wastewater cannot occur above the pinch since in this area of water deficit all source streams can be reused for the sinks;
- Below the pinch no fresh water can be employed because this area is characterised by a water oversupply and the water demand from all the sinks is satisfied by the source streams.

Constructing the composite curves on the basis of the source streams does not consider any changes in the source stream composition. Hence, mixing of source streams changes the shape of the source composite curve and consequently the targets (cf. Figure 3.12).

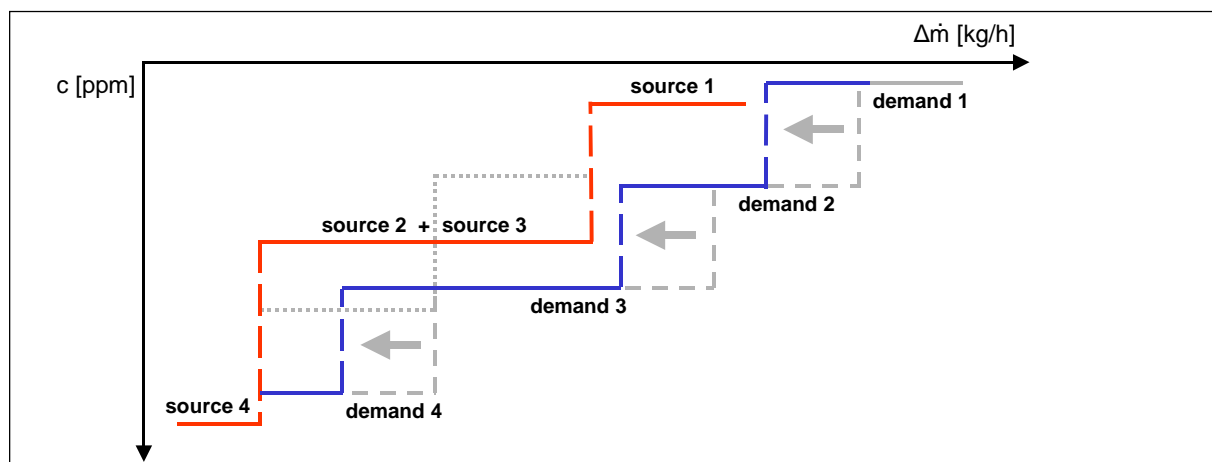

Figure 3.12: Mixing Modifies the Shape of the Source Composite Curve [Dhole et al., 1996]

In this sense the proposed methodology based on water quantity does not calculate the complete potential for reuse, but rather a too small savings potential. Therefore, the methodology does not determine the overall target detached from any network design.

Consequently, the approach was extended using systematically the key principle: "Fresh water use is minimised when the contaminant uptake of water demand is maximised" [Polley and Polley, 2000]. This means that if source streams cannot be used directly they are mixed with each other and where necessary with fresh water until they are able to meet the demand of the water using process with the highest requirements both in terms of quantity and in terms of quality. Source and sink streams are used in ascending concentration order [Polley and Polley, 2000].

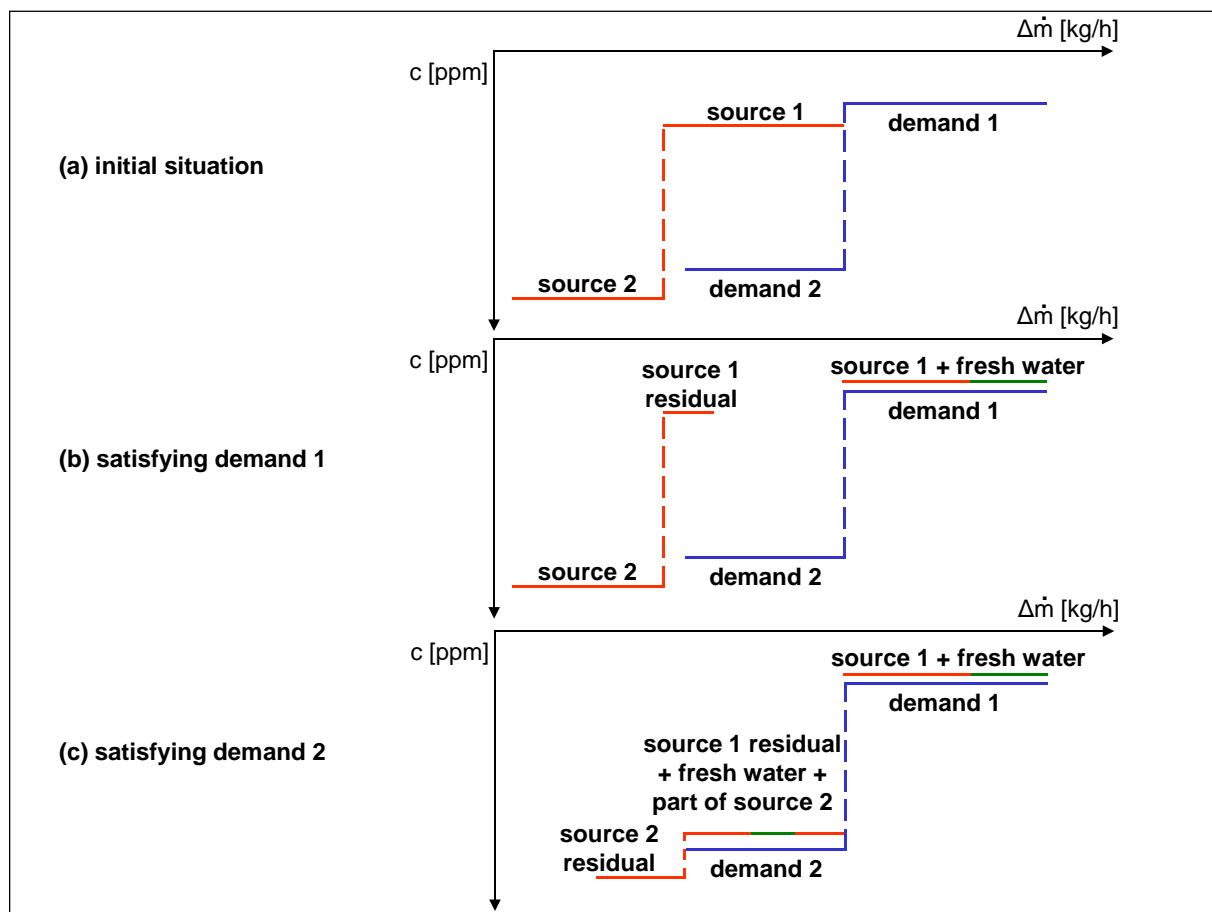

Figure 3.13: Conceptual Example of Mixing of Source Streams with Fresh Water [Polley and Polley, 2000]

This approach is visualised in Figure 3.13: In a first step the demand of stream "demand 1" is satisfied because it has the strictest water requirements. Since the quality of "source

1” does not meet the requirements of ”demand 1” it is diluted with fresh water. The residual of source stream 1 is mixed with source streams 2 until it just meets the water quality requirements of ”demand 2”. The remaining quantity is filled with fresh water.

According to the general procedure the required quantity is determined and in case of an disequilibrium a shortage is balanced by fresh water. In case of an excess supply the water quality is concentrated with other source streams of higher contaminant concentration until it just meets the demand requirements. Applying this principle guarantees a minimum fresh water supply. Instead of allowing a higher concentration difference as a driving force in the process the source streams are mixed to maximise reuse possibilities. This approach might lead to a combination of various source streams and a very complex network. Hence, a simplification of the network is necessary after the analysis increasing the fresh water demand again. A general disadvantage of this approach is that only reuse of water is considered and no regeneration or recycling processes are modelled. In order to identify reasonable recycling alternatives an approach based on stream mapping diagrams (cf. Section 3.2.2.2) can be used to identify a well selected source composite curve.

### 3.2.2.2 Approach based on Stream Mapping

In general, the same data set (*concentration vs. mass load* of the individual water streams) is used in the approach based on stream mapping to identify recycling options in a given water flow network. However, rather than constructing composite curves the outlet concentrations of the different sources are compared to the required inlet concentrations of the various sinks (cf. Figure 3.14). In this sense the approach based on stream mapping is not a water pinch analysis. Rather than systematically analysing the given process streams, different recycling possibilities can be identified by stream conditions.

By plotting existing or required flow rates of the source and sink streams against existing or required parameters different connection options. Three generic possibilities to identify connection options through the network exist [Dunn and Bush, 2001]: (1) *direct recycling* (including splitting up of sources, e. g.  $Q_1$  into  $Q_{1a}, Q_{1b}, Q_{1c}$ , (2) *mixing* of water streams and (3) *regeneration* opportunities, i. e. the source stream is regenerated to reduce the composition to an acceptable level for reuse. The general procedure begins with sinks requiring fresh water (contaminant concentration equals zero), which must be satisfied. Next the requirements of all other sinks are met by reusing the regenerated water of the process itself or by mixing it with fresh water or streams containing lower contaminant concentrations. However, by this procedure not an overall savings potential can be identified and higher gradients for reusing water are not considered. Nevertheless, the strength

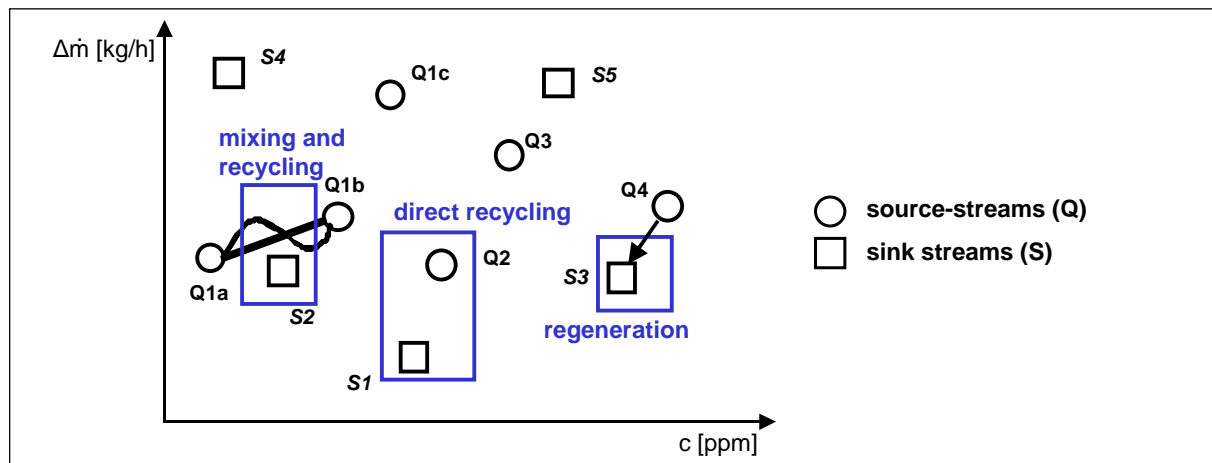

Figure 3.14: Stream Mapping Diagram [Dunn and Bush, 2001]

of this approach lies in the analysis of a complete process network illustrating the streams in the stream mapping diagram and selecting appropriate streams to be mixed.

### 3.2.3 Example of the Water Pinch Analysis

By the application of the water pinch analysis a reduction of water consumption and of wastewater generation is aimed at with reusing water in the pre-treatment step through cascading, the application of regeneration processes, such as for example ultra-filtration or ion exchanger, or the recycling of water streams by using regeneration processes, e.g. filter press, with a closed recycling loop.

In the bicycle production the water consumption can be almost solely traced back to the batch-wise pre-treatment and the coating application. In the pre-treatment of the bicycle frame and fork the adherence is improved between the bicycle parts and the subsequent coating layers by dipping the bicycle parts in different baths and rinsing them with water and deionised water (cf. Table 3.7).

The analysis revealed that it is difficult to find a common key contaminant for the different operations, since various metals, salts from the cleaning agents and solvents are used in the different operations [Leicht, 2005; Wurdack, 2006]. Nevertheless, the conductance and the  $pH$ -value seemed to be the most appropriate values for describing the pre-treatment steps, in which the phosphating is one exception since this process step can be characterised by total acid value, and the  $COD$  value is the best value to describe the water used in the coating application.



Table 3.7: Characterisation of the Pre-Treatment

Operation	Minimal <i>pH</i> -Value	Maximal <i>pH</i> -Value	Minimal Conduc- tance [ $\mu\text{S}/\text{cm}$ ]	Maximal Conduc- tance [ $\mu\text{S}/\text{cm}$ ]
degreasing	11.2	11.8	-	-
water rinsing 1	2.5	8	0	10 000
water rinsing 2	6.5	10	0	5 000
passivation	7.8	8.4	1 100	3 300
water rinsing 3	5	8	0	5 000
water rinsing 4	6	8	0	500
surface activation	8.7	9.8	-	-
phosphating	-	-	-	-
deionised water rinsing 1	5.2	7.8	0	50
deionised water rinsing 2	5.2	7.8	0	50

The pre-treatment of the bicycle parts consists of several steps: In the degreasing process contaminations are removed from the surface. The application of organic solvents is limited in that step to manual degreasing of small and/or working pieces with a complex geometry. In general the degreasing is done with water-based cleaning agents. Several rinsing operations are applied throughout the pre-treatment. The substrates proceed through an phosphatation bath to both increase the adhesion of the coating layers and prevent interferences in the coating process to failures on the surface [Rentz et al., 2003]. Here, iron and zinc phosphating processes are the most applied ones. In the last step before the actual coating a passivation is carried out in order to extend the effect of protection against corrosion and to improve adherence. After the pre-treatment the frames are dried batch-wise in an oven at 140 °C.

In the coating application large amounts of water are used as water curtains to capture the overspray in the coating application and to wash out the particles from the air in the coating cabin. High volumes of air are drawn twice through the water curtain, i.e. venturi washer, to collect the coating particles and solvents. Around 15 m<sup>3</sup>/h are required for this operation in each of the six coating cabins. However, the water is regenerated by a filter press and only 1.8 m<sup>3</sup>/h of fresh water is required.

### 3.2.3.1 Application of the Water Pinch Analysis

Table 3.8 shows the mass load and the limiting parameters of the different process steps of the pre-treatment, which are relevant for the water pinch analysis providing the base for the determination of target values [Wurdack, 2006]. The limiting fresh water flow rate is based on averaged values considering the bath volume and frequency of alteration of the different baths, such as for example the bath volume of the *water rinsing 1* is assumed to be 25 m<sup>3</sup> and must be changed four times a year, resulting in 0.058 m<sup>3</sup>/h. The  $C_{lim,out}$  corresponds to the maximal conductance in Table 3.7 and the  $C_{lim,in}$  is determined by the durability of a bath and the contamination from zero to maximal conductance during that period.

In general the water pinch analysis is based on the contaminant load, which must be removed through a washing process. Taking into account the contaminant load to be removed, the minimal water flow rate can be determined.

Table 3.8: Data for the Water Pinch Analysis

No.	Operation	$\Delta m_{i,total}$ [kg/h]	$C_{lim,in}$ [ppm]	$C_{lim,out}$ [ppm]	$r_{lim}$ [m <sup>3</sup> /h]	$fresh_{lim}$ [m <sup>3</sup> /h]
1	water rinsing 1	0.289	4 988.46	5.000	25.0	0.058
2	water rinsing 2	0.144	2 494.23	2.500	25.0	0.058
3	passivation	0.457	1 627.15	1.650	20.0	0.277
4	water rinsing 3	0.289	2 497.11	2.500	100.0	0.115
5	water rinsing 4	0.029	249.71	250	100.0	0.115
6	deionised water rinsing 1	0.002	24.94	25	30.0	0.069
7	deionised water rinsing 2	0.002	24.94	25	30.0	0.069

However, since the contaminant load varies from piece to piece and this information is in general not available, the contaminant load is calculated based on the determined minimal water flow rate. For this case study it is assumed that the minimal fresh water flow rate corresponds to the maximal duration and volume of a bath. The conductance in  $\mu\text{S}/\text{cm}$  can be transformed into ppm as a measure for the total dissolved solids, whereby the rate depends on the actual components in the water, the temperature and the concentration and no fixed conversion factor can be applied [Wiegran, 2000]. In the following an average conversion factor of  $2 \mu\text{S}/\text{cm} = 1 \text{ ppm}$  is used. Considering  $C_{lim,out}$  and the minimum

fresh water flow rate  $fresh_{lim}$ , the contamination  $\Delta m_{i,total}$  can be calculated (cf. Table 3.8).

In addition the minimal flow rate  $r_{lim}$  is determined based on the minimal amount of water at the level  $C_{lim,in}$  to remove  $\Delta m_{i,total}$ , which corresponds to the bath volume. The minimal water flow rate  $r_{lim}$  for a dipping bath means that the bath at  $C_{lim,in}$  can only be used one more hour and the contamination is raised from  $C_{lim,in}$  to  $C_{lim,out}$ . Thus, if only water at the level of  $C_{lim,in}$  is available for reuse, the complete bath must be changed to remove  $\Delta m_{i,total}$ .

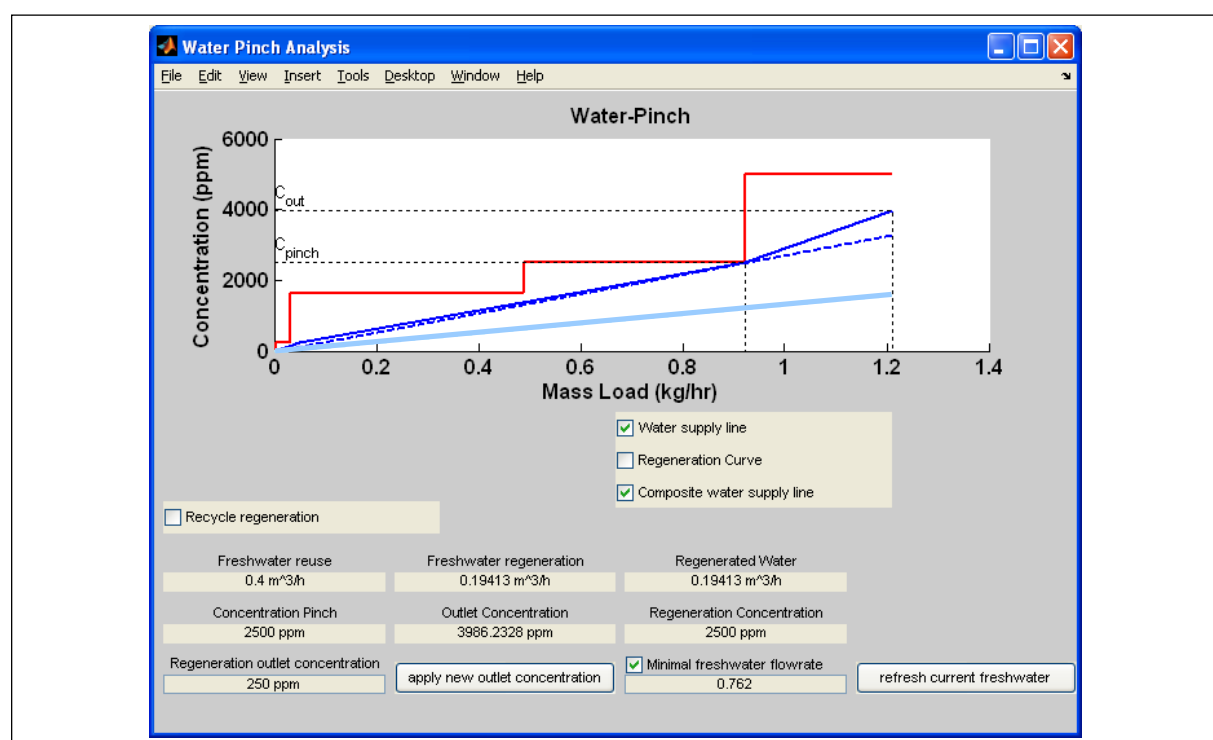

Figure 3.15: Composite Curves of the Water Pinch Analysis with Reuse

If all processes of the pre-treatment would be fed by fresh water the total water demand would be 0.762 m<sup>3</sup>/h adding up the last column in Table 3.8. By considering all limiting process parameters for each pre-treatment step the composite curve for the system's total water demand can be shown based on the mass load to be transferred within the maximum inlet and maximal outlet concentration (cf. Figure 3.15). The minimal fresh water supply, illustrated as the line with the flattest slope, defines the base to determine the possible savings potentials based on the assumption that all processes are fed by minimal fresh water and no recycling is used.

By allowing theoretical maximal reuse within the limits, the total water demand of the system would be only  $0.4 \text{ m}^3/\text{h}$  defined by the reciprocal of the slope of the water supply line, which touches the limiting composite curve at the pinch point at 2500 ppm. The water supply line defines the maximal slope without an intersection of the limiting composite curve. The limiting composite curve consists of almost horizontal lines defining the concentrations of the different pre-treatment baths. In the case of reuse of water, which means that water in baths with a lower contaminant concentration at the end of the cleaning process are moved to the first cleaning steps, with higher contaminant concentration, the overall wastewater has a concentration of  $C_{out} = 3280 \text{ ppm}$  leaving the processes if reuse is used to a maximal extend. The slope of the minimal fresh water supply line is lower than the water supply line reusing the water illustrating the higher flow rate and the savings potential through reuse.

By considering available regeneration operations, such as for example an ion exchanger or ultra-filtration reducing the concentration from  $C_{pinch} = 2500 \text{ ppm}$  to 250 ppm, the fresh water demand can be lowered to  $0.19 \text{ m}^3/\text{h}$  (cf. Figure 3.16). In the case of regeneration reuse the outlet concentration increases to 3986 ppm. In addition to the original water supply line and the minimal fresh water supply line Figure 3.16 shows the limiting composite curve of the water supply using a regeneration process. Below  $C_0$  and above  $C_{pinch}$  the composite curve illustrates the fresh water supply of  $0.19 \text{ m}^3/\text{h}$  in the middle range the composite curve has a lower slope illustrating the contaminant reduction by the regeneration process. Consequently, in the case of regeneration and reuse it is possible to reduce the fresh water flow rate compared to the case of pure reuse without cutting the limiting water profile.

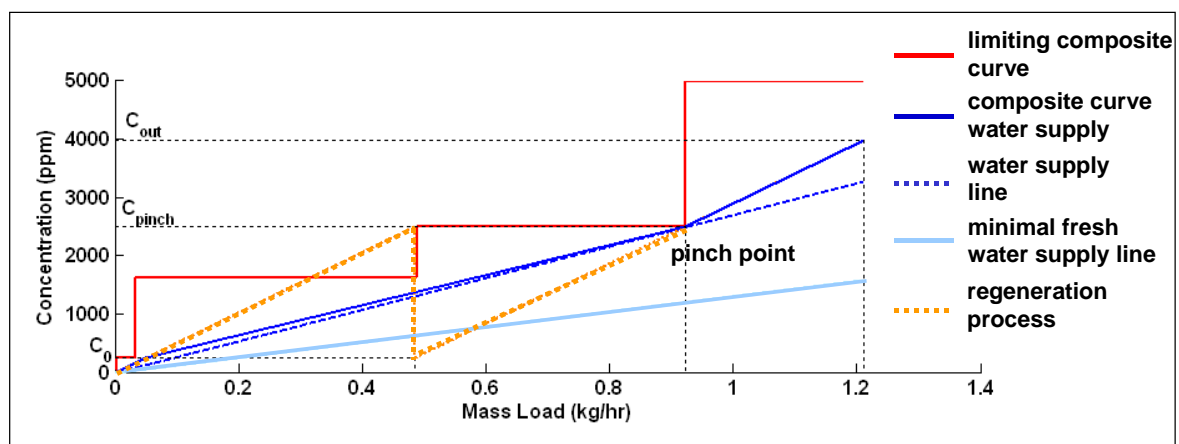

Figure 3.16: Water Pinch Analysis with Regeneration - Reuse

By introducing a recycling of the water it is possible to reduce the fresh water demand to  $0.14 \text{ m}^3/\text{h}$ , which is just the sum of the water demand of the two deionised water rinsing steps. These two steps cannot be fed by recycled water since they require lower contaminant concentration than can possibly be achieved by the recycling process. However, the outlet concentration of the water increases to 4600 ppm. The slope of the fresh water for the recycling ("recycling water" in Figure 3.17) is higher than the slope of the regenerated water within the recycling loop ("regenerated water" in Figure 3.17). Through the recycling process the inner loop has an internal water flow rate of  $0.26 \text{ m}^3/\text{h}$ , whereas the fresh water supply is only  $0.14 \text{ m}^3/\text{h}$ . The composite water supply line illustrates the sum of the profiles and stays under the limiting composite curve.

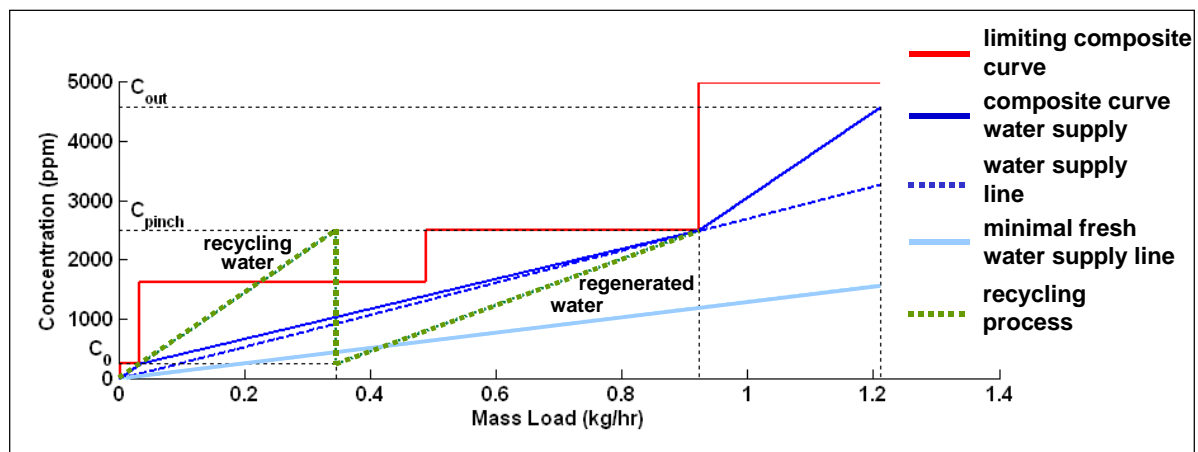

Figure 3.17: Water Pinch Analysis with Regeneration - Recycling

### 3.2.3.2 Characterisation with Respect to Water

The target values concerning the water consumption are based on the water pinch analysis for the pre-treatment steps, the minimal water supply for the water curtains due to evaporation and the process characteristics of the different techniques. The current consumption is based on the different water consuming process steps of the pre-treatment using the minimal fresh water flow rate of  $0.762 \text{ m}^3/\text{h}$  and the current consumption of the water curtains in the coating section of  $1.8 \text{ m}^3/\text{h}$ . Since no specific consumption values are available for the pre-treatment steps, the minimal fresh water flow rate is taken as a base for comparison. Thus, in the *Status Quo* a fresh water demand of  $2.562 \text{ m}^3/\text{h}$  exists. However, in general the fresh water demand of the water curtains can be reduced to 200 l/d for each of the six coating cabins to balance the loss of evaporated water resulting

in a minimal water consumption of  $0.18 \text{ m}^3/\text{h}$ . In general it is possible to neutralise the wastewater of the pre-treatment steps and reuse the wastewater in the coating section. Thereby, no wastewater is generated in the overall process since the solids are filtered out and dried resulting in solid waste. The grease separated from the water can be burned in a power station, and the sludge of the passivation and degreasing must be brought to landfill. However, further investigation is required if this is possible in the plant of the reference company and thus, this option is not considered in the following.

Through various process improvement measures (like the introduction of regeneration and recycling techniques or the extension of life-time of pre-treatment baths) the use of water can be lowered to  $0.14 \text{ m}^3/\text{h}$  for the pre-treatment section and  $0.18 \text{ m}^3/\text{h}$  for the water curtains as the target for the analysis requiring an investment of 15 000 € (cf. Table 3.9). In case of the options *Thermal Incineration* and *Condensation* this results in an overall performance of  $0.32 \text{ m}^3/\text{h}$ .

Table 3.9: Characterisation of the Water Target Values

	<b>Status Quo</b>	<b>Waterborne Basecoats</b>	<b>Thermal Incineration</b>	<b>Condensation</b>	<b>Powder Coating</b>
Water [ $\text{m}^3/\text{h}$ ]	2.56	0.46	0.32	0.32	0.28
Investment [€]	0	30 000	15 000	15 000	30 000

In the case of a change to *Waterborne Basecoats* two additional deionised water rinsing steps are required, since the waterborne paints have worse adhesion than solvent-based coatings. Thus, the water use for this option is  $0.18 \text{ m}^3/\text{h}$  for the water curtains and  $0.28 \text{ m}^3/\text{h}$  for the pre-treatment steps ( $0.46 \text{ m}^3/\text{h}$  overall). The installation of the two additional deionised water baths is considered with an additional investment of 15 000 €. In case of a switch to *Powder Coatings* the water curtains are not used any more. However, as in the case of waterborne basecoats an improved pre-treatment is required. Using an improved pre-treatment it is possible to apply a two layer coating without a filler application. Since powder coatings in general result in higher film thickness it is possible to use an integrated filler system in the basecoat powder application. Consequently the fresh water demand of the pre-treatment is  $0.28 \text{ m}^3/\text{h}$ .

### 3.2.4 Discussion of the Water Pinch Analysis

Each of the presented water pinch methodologies has its own inherent advantages and shortcomings. But the accepted and numerous applications of the water pinch approaches found in a variety of industry sectors show their impact on industrial wastewater management, for example in the pulp and paper industry [Koufos and Retsina, 2001], breweries [Linnhoff, 2004], citrus plants [Thevendiraraj et al., 2003] or beat sugar plants [Vaccari et al., 2005].

One significant advantage of the approach based on water quality is that wastewater streams of varying contaminant level can be mixed and an overall target can be determined. By characterising fresh water and wastewater streams with specific costs and associating costs to regeneration processes an economic assessment is possible.

The central role of mass transport limits this approach to fundamental mass transfer operations, such as cleaning. Operations with negligible mass transfer, such as boilers or cooling towers, where the flow rate is of crucial importance, cannot be modelled adequately. Furthermore, the application of the methodology to multi-parameter cases is quite complex even for small numbers of streams and the correlated transfer not always valid.

The approach based on water quantity can adequately present water using processes without mass transport and the optimal combination of sources and sinks can be modelled as a linear optimisation problem. However, this simple combination of streams is also the major drawback to the approach: The mixing of multiple source streams is not considered or if explicitly permitted leads to a multitude of counterproductive mixing solutions. Consequently, purity - concentration profiles only portray a certain interpretation of the total process [Hallale, 2002]. The results of the optimisation therefore need not be equivalent to the actual optimum, because a suitable mixing of the source streams can shift the pinch point and thus lead to an improved reuse of the water. The same is true for the approach based on stream mapping. The major advantage of that approach is the identification of correct mixing and recycling possibilities.

Considering the various aspects only a case specific application of the different approaches or their combination appears reasonable to identify meaningful target values.

### 3.3 Solvents Pinch Analysis

Besides pure heat integration in the classical pinch analysis and mass integration, as for example in the water pinch analysis, another application of the pinch analysis is for solvents or multi-component solvents. The recovery of organic solvents (Volatile Organic Compounds (VOC)) of a gaseous waste stream can be translated into a heat exchange problem because the solvents can be separated from the waste gas via thermal condensation [Dunn and El-Halwagi, 1994; Parthasarathy and El-Halwagi, 2000]. The reduction of VOC in gaseous waste via mass integration, for example adsorption and absorption, is not considered in this section [refer to e.g. El-Halwagi, 1997].

Table 3.10: Nomenclature for the Solvents Pinch Analysis

Variable	Unit	Name
$T$	[K]	temperature
$T_{End}$	[K]	end point temperature of condensation
$T_{LowerEnd}$	[K]	lower bound of temperature range of condensation
$T_{UpperEnd}$	[K]	upper bound of temperature range of condensation
$T^S$	[K]	supply (inlet) temperature of gaseous waste stream
$T^C$	[K]	dew temperature of VOC
$\Delta T_{min}$	[K]	minimum temperature gradient (driving force)
$\Delta T_{ln}$	[K]	logarithmic mean temperature difference (LMTD)
$h$	[kJ/kmol · K]	specific enthalpy of gaseous stream
$r_{STP}$	[m <sup>3</sup> /h (STP)]	flow rate under standard temperature and pressure (STP)
$A$	[m <sup>2</sup> ]	heat transfer area
$\alpha$	[kW/m <sup>2</sup> · K]	heat transfer coefficient
$c_{p,L}$	[kJ/kmol · K]	specific heat capacity of the VOC liquid
$c_{p,V}$	[kJ/kmol · K]	specific heat capacity of the VOC vapour
$c_{p,g}$	[kJ/kmol · K]	specific heat capacity of the VOC-free gas
$\kappa^D$	[€/m <sup>2</sup> ]	specific costs for heat exchanger surface area for dehumidification
$\kappa^C$	[€/m <sup>2</sup> ]	specific costs for heat exchanger surface area for condensation
$\kappa^I$	[€/m <sup>2</sup> ]	specific costs for heat exchanger surface area for integration



Table 3.10: Nomenclature for the Solvents Pinch Analysis (cont.)

Variable	Unit	Name
$w$	$[-]$	component $w$ of the gaseous stream ( $w = (1, 2, \dots, W)$ , $W$ as number of components ( $W \in \mathbb{N}$ ))
$\chi_w$	$[-]$	mole fraction of component $w$
$\chi^s$	$[kmol \text{ VOC} / kmol \text{ VOC free gas}]$	supply composition of gaseous waste stream
$\chi^t$	$[kmol \text{ VOC} / kmol \text{ VOC free gas}]$	target composition of gaseous waste stream
$\lambda$	$[kJ/kmol]$	latent heat of condensation
$\sigma_{util}$	$[\text{€}/kJ]$	price of utility $util$

By using phase diagrams the targeted solvents concentration can be described by the temperatures of the gaseous waste stream. Thus, the required temperature intervals for applying the pinch analysis can be obtained. When using multi-stage condensation for VOC recovery the waste gas can be pre-cooled by the cold cleaned gas stream. This approach of incorporating the cleaned gas stream can also be applied when other emission reduction measures are used, such as thermal incinerators [Geldermann et al., 2006d]. The application of the solvents pinch analysis and the subsequent integrated design are used to find the most cost-effective solution. Consequently, the quantity of solvents to be recovered can be determined [Parthasarathy and El-Halwagi, 2000]. The total costs in the case of VOC are a combination of those for purchased solvents and those for condensation. The recovered solvents can be reused in the same process or they can even be sold, for example for cleaning applications, depending on the option finally selected. The properties of the employed solvents (VOC) determine the temperature intervals used in the pinch analysis. Since a complete condensation of the VOC is theoretically possible ( $\chi^t = 0$ ), the objective is to find a feasible economic solution through a techno-economic assessment of available techniques.

### 3.3.1 Principles of the Condensation System

Fundamentally, the analysis is based on *temperature - concentration relationships* (cf. Figure 3.18) depending on the temperature-sensitive *saturation pressure curves* of the single or multi-component VOC considered in a gaseous waste stream [Schollenberger and Treitz, 2005]. By describing the concentration of VOC in the waste gas as a dependent variable of the waste gas temperature, the mass transfer problem is converted into a heat transfer problem. Consequently, each recovery target  $\chi^t$ , i.e. VOC concentration in the gaseous stream, can be translated into a required endpoint temperature  $T_{End}$  of the condensation [Richburg and El-Halwagi, 1995].

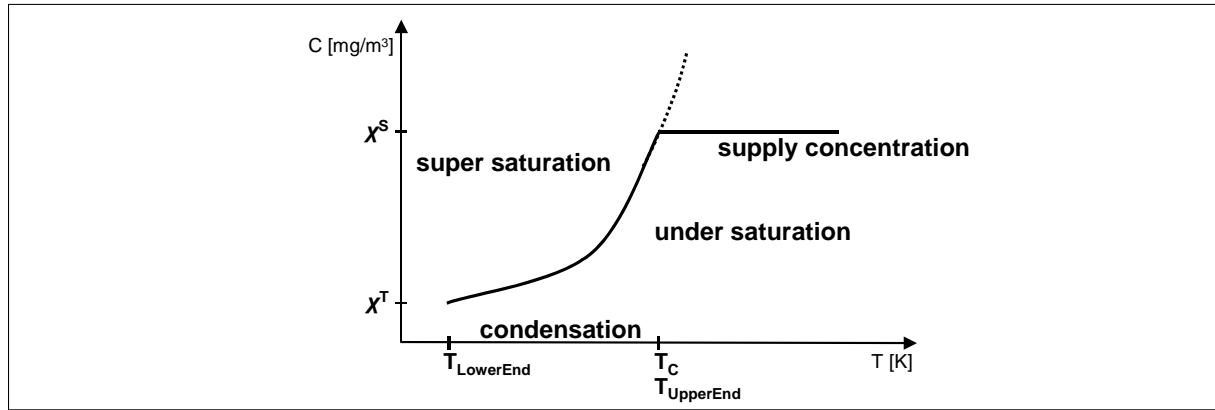

Figure 3.18: Schematic Representation of a Saturation-Pressure Curve within the Operating Range of the VOC-Condensation System

In the special case of one single organic solvent, the temperature of condensation  $T^C$ , i.e. the dew point, of the solvent depends on its partial pressure  $p_{pp}^{VOC}(T)$ . In the case of a multi-component VOC or a mixture of gases, the temperature of condensation  $T_j^C$  of one component, i.e. the  $j^{th}$  solvent, depends on the partial pressure of the component  $p_{pp}^j(T)$ . By cooling down the gaseous waste stream the concentration of VOC in a dilute system is constant, i.e.  $\chi_{VOC}(T) = \chi_{VOC}^s$  for  $T > T^C$ , until the condensation starts at  $T^C$  where the partial pressure equals the vapour pressure of VOC, i.e.  $p_{pp}^{VOC}(T^C) = p_{vp}^{VOC}(T^C)$ , and saturation is reached. In this case the concentration of VOC  $\chi_{VOC}(T)$  approximately equals the fraction of the partial pressure to the total pressure of the gaseous waste for  $T \leq T^C$  (cf. Equation 3.12) [Richburg and El-Halwagi, 1995]:

$$\chi_{VOC}(T) = \frac{p_{pp}^{VOC}(T)}{p^{total} - p_{pp}^{VOC}(T)} \approx \frac{p_{pp}^{VOC}(T)}{p^{total}} \text{ since } p_{pp}^{VOC}(T_{End}) \ll p^{total} \quad (3.12)$$

Using the equation of the saturation pressure curve (cf. Equation 3.12) the target concentration  $\chi^t$  can be determined by the end point temperature of condensation  $T_{End}$  (cf. Equation 3.13) [Richburg and El-Halwagi, 1995]:

$$\chi_{VOC}^t = \frac{p_{pp}^{VOC}(T_{End})}{p^{total}} \quad (3.13)$$

In general, a condensation system consists of at least two units (cf. Figure 3.19 [Dunn and El-Halwagi, 1994]). The first step is a dehumidification unit for eliminating the moisture in the waste gas. This step is necessary in order to prevent icing of the system during further refrigeration and it is usually operated at around 278 K (5 °C). A recuperator utilises the cold gaseous stream of the condensation system accompanied by additional cooling utilities. The heat transfer between the process streams or the utilities is modelled by the process stream specific heat-transfer coefficients. The second step consists of the condensation unit. The dehumidified waste gas is cooled further in order to condense the VOC. Depending on the objective (fulfilment of a concentration threshold of VOC in the gaseous stream vs. pure cost efficient operation of the condensation system) very low temperatures may be necessary. For the additional cooling of the waste gas in the lowest temperature range either mechanical cooling or a cryogenic cooling agent is used, such as liquid nitrogen ( $N_{2l}$ ), the quantity of which can be derived from its specific heat-transfer coefficient  $\alpha$ .

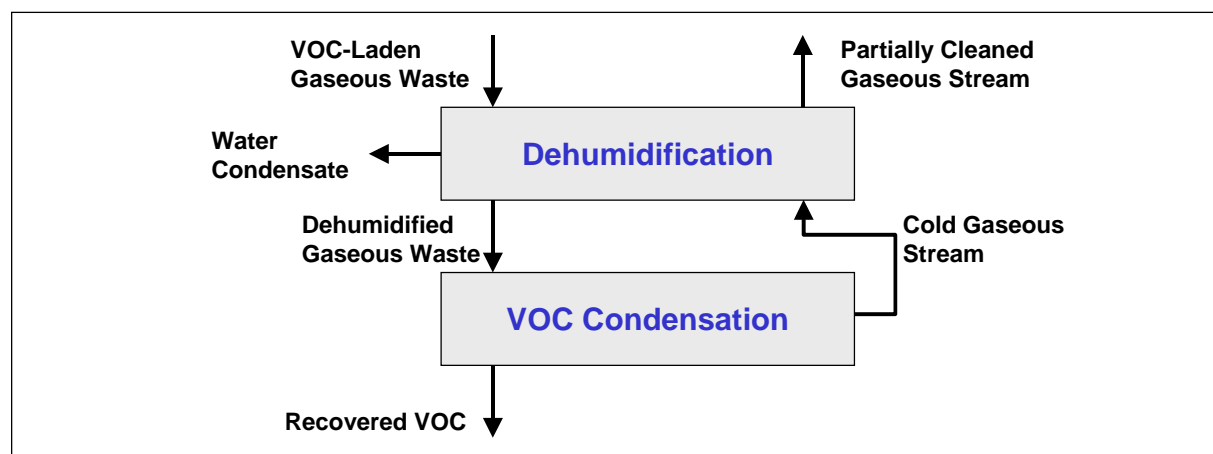

Figure 3.19: Schematic Representation of a VOC-Condensation System [Dunn and El-Halwagi, 1994]

The operating temperature range depends on the supply temperature of the VOC-laden gaseous waste stream (e.g. 20 °C (293 K) as the upper boundary (where the starting

point of condensation depends on the VOC concentration in the gaseous waste stream) (cf.  $T_{UpperEnd}$  in Figure 3.18) and on the maximum of the system dependent temperatures (freezing point of the coolant, minimal machine-dependent system temperature, freezing point of solvent, etc.) as the lower boundary (cf.  $T_{LowerEnd}$  in Figure 3.18). In practise de-icing processes (continuous vs. breaks) are used to diminish the ice caused by the remaining moisture in the waste gas. These de-icing processes are not considered in the following. Furthermore, the technical constraints that must be considered in the calculation are the maximum and minimum solvent concentration given by the process itself. For example, in order to allow quick drying and to limit the lasting effects of the solvent on the object, the concentration of the solvents in the air should not exceed a certain value. Additionally, safety requirements must be carefully followed due to the risk of explosion from the solvents [DIN 1539].

The solvents pinch analysis approach for gaseous waste streams containing VOC is implemented in a module using MATLAB<sup>TM</sup>. The integrals of the heat balance are solved in MATLAB<sup>TM</sup> by numeric integration in 0.1 K steps. The same procedure is used in the thermal pinch analysis (cf. Section 3.1.1). The calculation considers the temperature dependent heat capacities  $c_{p,V}$  of the waste gas and the gaseous stream after condensation. In addition the specific heat capacity of the VOC-free gas  $c_{p,g}$  is taken into account. Furthermore, the heat of condensation  $\lambda$  is taken into account as well as the heat capacity of the condensed liquid solvent  $c_{p,L}$  (cf. Equation 3.14) [Richburg and El-Halwagi, 1995]:

$$\Delta H = \int_{t=TS}^T c_{p,g}(t)dt + \int_{t=TS}^T \chi(t) \cdot c_{p,V}(t)dt + [\chi_s - \chi(t)] \cdot \lambda + \int_{t=TC}^T (\chi_s - \chi(t)) \cdot c_{p,L}(t)dt \quad (3.14)$$

In a first step the enthalpy supply and demand of the gas flows are determined for each given temperature step (e.g. 0.1 K). Next, the heat balances within the system are calculated depending on the chosen temperature gradient. Thereafter, imbalances are adjusted by heat integration or through utilities [Richburg and El-Halwagi, 1995]. By modifying the temperature gradient (configuring the heat transfer area) or the end point of condensation (controlling the quantity of recovered solvents) the system performance can be evaluated (cf. Section 3.3.2).

Additionally, a number of assumptions are made:

1. in the case of condensation as an abatement technique it is assumed that the temperature of the end point of the condensation is low enough to fulfil possible legal requirements concerning a threshold of VOC concentration in the gaseous stream;

2. the various gases and liquids are regarded as ideal, i.e. their thermodynamic characteristics do not affect each other;
3. the heat losses are neglected;
4. the condensate of solvents is cooled down to the end point temperature of the condensation, since locking out of the condensate is not considered thus far.

### 3.3.2 Economic Analysis of the Recovery of VOC via Condensation

Since a complete condensation of the VOC in the gaseous waste stream is theoretically possible, economic parameters are additionally taken into account in order to identify a cost-efficient solution. The objective of the analysis is to determine the economically reasonable amount of recoverable solvents which can be translated into an endpoint temperature  $T_{End}$  of the condensation at which this recovery target is reached. Thus, the optimisation objective is the minimal total annual costs of the plant. In addition to the investment and the operating costs of the condensation system, the developed model also considers possible operating income. If the recovered solvents are re-used in the same process (closed loop recycling) the quantity of recovered solvents is valued with the price for new solvents. In case the solvents are not used within the process, for example due to quality restrictions, the value equals the price for which the solvents can be sold.

The heat-transfer between the gaseous waste and the (partially) cleaned cold gaseous stream is modelled via the heat transfer coefficient  $\alpha$ , and the investment is calculated on the basis of heat exchanger surface area dependent values. Parameters such as geometry and material are considered using surface area dependent values and the operating costs of the heat exchanger, such as maintenance and repair is not considered. However, the costs of the cooling agent, due for example to constant loss through evaporation of  $N_2$ , is added to the operating cost. It must be noted, however, that the economic parameters, particularly the ratios between them, are a crucial factor for the result of the calculation.

The integrated and dissipated heat depend on the endpoint temperature of the condensation  $T_{End}$ . Hence, the solution is driven by the trade-off between the amount of recovered solvents, i.e. savings for the solvents, on the one hand, and the necessary investment in the heat exchanger and costs for the coolants on the other hand. However, the investment and the amount of coolants for a given recovery target  $\chi^t$  depend on the temperature gradient  $\Delta T_{min}$ . For example, a higher temperature gradient allows less heat integration and therefore requires less investment, but necessitates more cooling agents. For each end-

point temperature of the condensation within the condensation range and for each  $\Delta T_{min}$  within an assumed range (e.g. 2 K to 20 K) the total annual costs are determined.

### 3.3.3 Example of the Solvents Pinch Analysis

In this section the focus of the analysis is on the identification of target values of the condensation system by the solvents pinch analysis approach for the solvent emissions in the gaseous waste streams. In a first step the target values are identified followed in a second step by an economic analysis of the target values for the condensation system and in a last step unit operations are suggested to realise the proposed savings potentials.

#### 3.3.3.1 Application of the Solvents Pinch Analysis

The calculations of the thermal condensation of solvents can be described as a heat exchange problem and thus can be evaluated by the pinch analysis approach for the recovery of solvents as shown in Section 3.3. The analysis is based on temperature-concentration relationships depending on the temperature-sensitive saturation pressure curves of the considered multi-component VOC.

In the following it is assumed that the coating system would be changed to a Benzene-free coating system<sup>23</sup> by an installation of a condensation installation. Furthermore, the minor content of Ethyl Acetate would be replaced to have less different but higher concentrated solvents in the waste gas. Consequently, the Xylene content is kept constant and the mole fraction of the Toluene is increased by the former Benzene and Ethyl Acetate ratio keeping the total amount of solvents used constant (cf. also Figure A.2 on page 231).

Even though most of the solvent emissions are generated in the coating cabins and flash-off zones, the solvent concentrations in the gaseous waste streams of the coating cabins are considerably lower due to the high air flows compared to the solvent concentration in the waste gas of the drying ovens. The high air flows are necessary to speed up the sinking of the coating particles in the air resulting from the overspray. The average solvent concentration in the gaseous waste stream of the coating cabins and flash of

---

<sup>23</sup>Benzene is an important industrial solvent and is commonly used as an additive in gasoline. Since it is a human genotoxic carcinogen and "there is no identifiable threshold below which there is no risk to human health", all industrial fields are encouraged to substitute Benzene (European Parliament Directive 2000/69/EC). In industrial metal coating Benzene can be substituted by Toluene, which is basically a Benzene ring with a functional  $CH_3$ -group instead of one hydrogen or Xylene substituting two hydrogen with functional  $CH_3$ -groups.

zones is  $5.4 \cdot 10^{-5}$  kmol/kmol air and in the gaseous waste stream of the drying ovens  $2.6 \cdot 10^{-3}$  kmol/kmol air. Thus, only  $\frac{1}{3}$  of the solvents, i.e. the gaseous waste stream of the drying ovens, are considered for the condensation and the coating cabins and the flash-off zones are not relevant for the condensation because of the low solvent concentration in the waste gas.

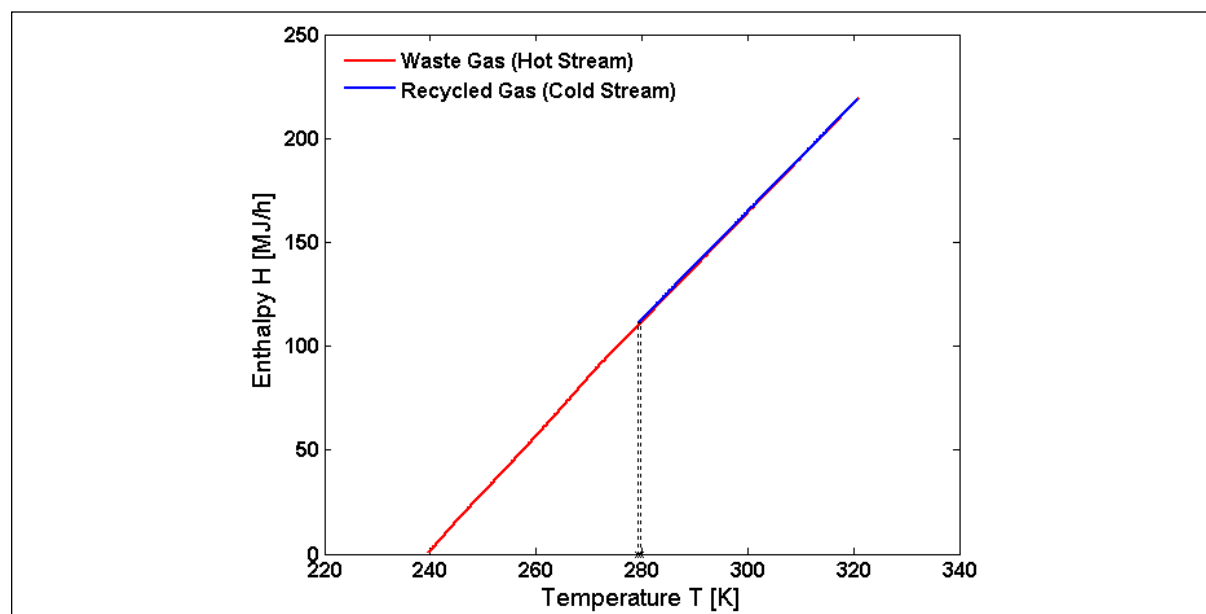

Figure 3.20: Hot and Cold Composite Curves of the Solvents Pinch Analysis

The calculation considers the temperature dependent heat capacities of the waste gas and the partly cleaned waste gas after condensation. Furthermore, the heat of condensation is taken into account as well as the heat capacity of the condensed liquid solvents. In addition to the heat integration described in Section 3.1.3 the condensation requires further cooling of the waste gas of the drying ovens. Thus, the temperature range to be considered for the calculation of the condensation is given by the supply temperature of the waste gas  $T^S$  (in this case  $48\text{ }^\circ\text{C}$  ( $= 321\text{ K}$ )) as the upper bound and the maximum of the system dependent temperatures (freezing point of the coolant, minimal system temperature, freezing point of solvent etc.) as the lower bound. Here the installation of a mechanical cooling unit is considered<sup>24</sup>. Thus, the minimal operating temperature of the mechanical cooling plus the minimal temperature difference  $\Delta T_{min}$  at  $-38\text{ }^\circ\text{C}$  ( $= 235\text{ K}$ ) defines the lower bound of the temperature range  $T_{LowerEnd}$ . Consequently, the condensation system covers the dehumidification component from supply temperature of the waste gas of  $321\text{ K}$  to  $278\text{ K}$ ,

<sup>24</sup>For a different company using the single solvent Xylene in a further case study the condensation to cryogen temperatures with liquid nitrogen ( $N_2$ ) is examined [Schollenberger and Treitz, 2005].

the condensation component from  $T_{UpperEnd} = 278$  K to the optimal endpoint temperature  $T_{End}$  (minimal 235 K) and the internal heat integration component from  $T_{End} + \Delta T_{min}$  to 321 K (cf. Figure 3.19 on page 117). Consequently, the hot and cold composite curves of the thermal condensation system summarise the cooling and heating requirements of the complete condensation system (cf. Figure 3.20).

If the waste gas is cooled down the concentration is constant until condensation starts and the solvent concentration in the waste gas sinks. The actual starting point of condensation depends on the solvent concentration of the individual solvents in the waste gas and the resulting partial pressures of the individual components. The concentration of Xylene is  $1.44 \cdot 10^{-3}$  kmol/kmol air and of Toluene is  $1.18 \cdot 10^{-3}$  kmol/kmol air which results in an overall concentration<sup>25</sup> of 9 625 mgC/m<sup>3</sup> ( $= 2.6 \cdot 10^{-3}$  kmol/kmol air). This concentration accrues from the solvents contained in the paint and the solvents used for dilution. The flow rate of the waste gas is 2 000 m<sup>3</sup>/h. The calculation shows that the condensation of Xylene in the waste gas starts at 270.9 K ( $T_{UpperEnd}$  in Figure 3.21) and of Toluene at 245.3 K. The integrals of the heat balance are solved in MATLAB<sup>TM</sup> numerically with a linear approximation in 0.1 K steps.

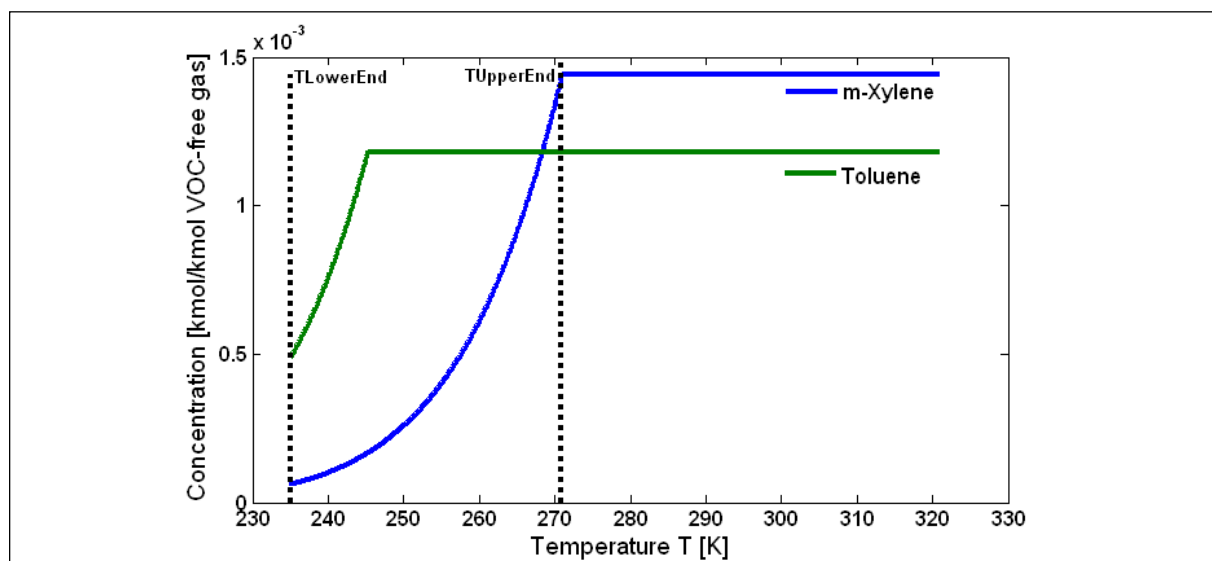

Figure 3.21: Concentrations of the Multi-Component VOCs Based on the Saturation-Pressure Curve

The endpoint temperature of condensation  $T_{End} = 239.4$  K can be translated in a remaining solvent concentration in the waste gas after condensation. At  $T_{End}$  the concentration of Xylene is  $9.5 \cdot 10^{-5}$  kmol/kmol air and of Toluene is  $7.2 \cdot 10^{-4}$  kmol/kmol air as Figure 3.21

<sup>25</sup>Xylene and Toluene have the same  $C_{org}$  ratio of 0.91.



shows. This corresponds to a  $C_{org}$  in the waste gas of the drying ovens of 3 300 mgC/m<sup>3</sup> after condensation from originally 9 625 mgC/m<sup>3</sup>. The remaining solvents in the partly cleaned cold gas lead combined with the air flows of the coating cabins to overall solvent emissions of 233 mgC/m<sup>3</sup> at an air flow of approx. 194 000 m<sup>3</sup>/h waste air. By using  $N_2$  as a coolant the minimal temperature of the condensation system would be the freezing point of Xylene at 225 K and  $C_{org}$  could be even reduced down to 844 mgC/m<sup>3</sup> for the waste gas of the drying ovens (207 mgC/m<sup>3</sup> overall).

The advantage of a condensation of VOC from a waste gas stream is that air pollution control and solvent recovery in liquid state are achieved simultaneously within one apparatus. However, complex systems and cooling temperatures<sup>26</sup> well below  $-100\text{ }^\circ\text{C}$  are required to fulfil for example German legislation, since condensation only takes places "when the temperature of a cooling surface is below the dew point of the vapour of the respective concentration" [Rinner et al., 2002]. With a decreasing concentration lower temperatures are necessary to condense the remaining solvents from the waste gas. Nevertheless, it is possible to use only a condensation system to fulfil legal requirements and emission reduction rates up to 99.8 % can be achieved [Rinner et al., 2002]. However, as the analysis showed in this case the overall limit would be 844 mgC/m<sup>3</sup>. The emission reduction rate is limited by the freezing point of Xylene. By installing a more complex system with de-icing units a cooling to even lower temperatures and higher emission reduction rates is possible.

### 3.3.3.2 Economic Evaluation of the Solvents Pinch Analysis

The objective of this analysis is to determine the economic reasonable amount of solvents to be recovered. This can be translated into an endpoint temperature of the condensation  $T_{End}$  at which this recovery target is reached. The costs for running the condensation are calculated as total annual costs comprising fixed costs for the installation of heat exchangers and operating costs for the additional cooling.

The amount of heat to be integrated and the heat to be dissipated depend on the endpoint temperature of the condensation. The costs for the heat exchanger is determined by specific surface dependent costs. For the heat exchanger of the integration unit are no operating costs considered, for example for maintenance, and no heat transfer losses are included in the analysis. In case of the cooling unit of the condensation system the use of electric power based on the specific heat transfer coefficient of the mechanical cooling unit is regarded. The condensed solvents are also cooled to  $T_{End}$  since an advance extraction

---

<sup>26</sup>These cryogenic temperatures can for example be achieved with liquid nitrogen.

is not considered. Parameters such as for example the geometry of the heat exchanger are not explicitly considered.

The minimal temperature gradient  $\Delta T_{min}$  for the use of mechanical cooling between the raw gas and the partly cleaned waste gas depends in this special case only to a limited extent on the end point of condensation. The solution is driven by the trade-off between the amount of recovered solvents and therefore the revenues for the solvents and necessary investment in heat exchanger and operating costs for the cooling. For each endpoint temperature of the condensation within the condensation range from 270.9 K down to 235 K and for each  $\Delta T_{min}$  within an assumed range (2 K - 60 K) the total annual costs are determined. The analysis reveals that the optimal temperature gradient for the heat integration is 40 K between the partly cleaned cold gas and the condensation waste gas stream.

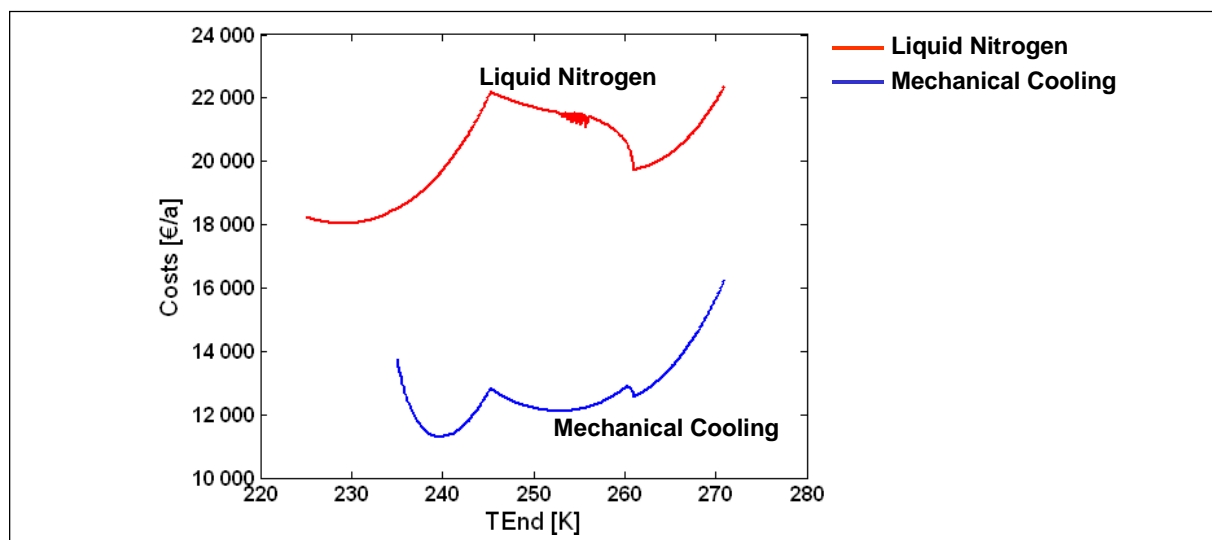

Figure 3.22: Total Annualised Costs Depending on the Endpoint Temperature of Condensation

To identify the best operating point of the condensation system the operating costs for the cooling, the annualised direct costs for the heat exchangers and the value of the recovered solvents must be determined for each condensation temperature. Thus, taking into account the operating costs of the mechanical cooling unit (12 230 €/a) and the annualised direct costs for the three heat exchangers, the total annualised costs are 27 500 €/a (assuming a 10% interest rate and an economic life time of 5 years). By assuming a value of 0.56 €/kg for the recovered solvents, i.e. this corresponds to 60% of the original price, savings of 16 000 €/a can be realised, leading to a minimum of 11 300 €/a at the best operating point of 239.4 K (cf. Figure 3.22). Thus, instead of 45 000 €/a only

29 000 €/a must be spent for solvents. The condensation with  $N_2$  is more expensive than the mechanical cooling, as Figure 3.22 illustrates, but it is possible to reach lower temperatures<sup>27</sup>.

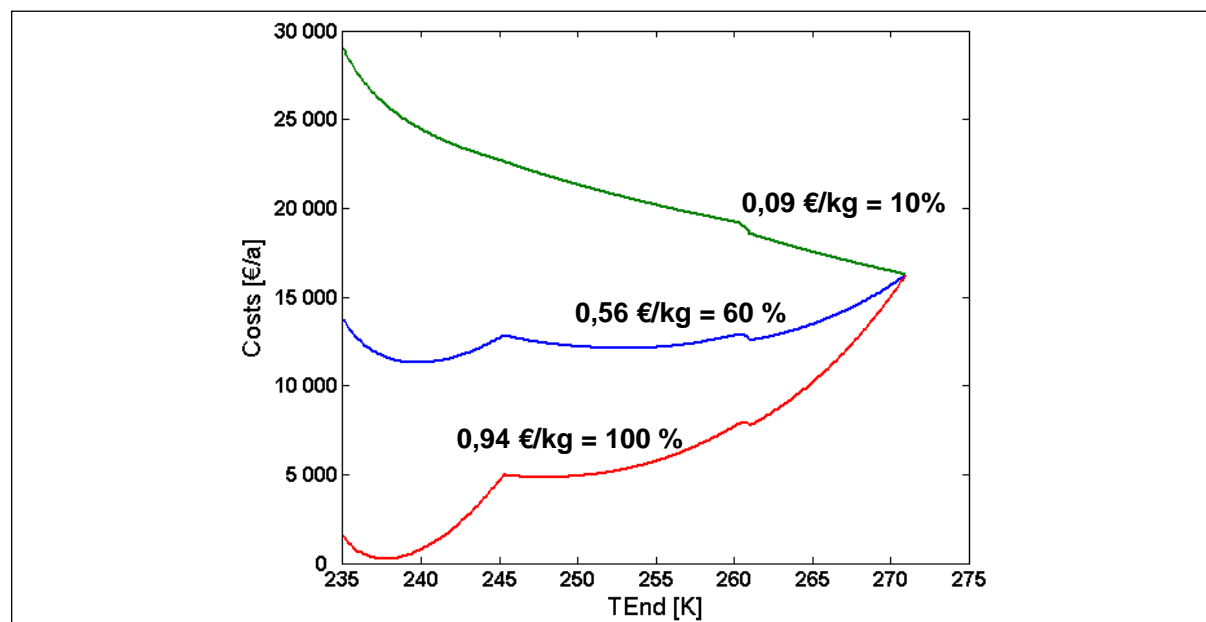

Figure 3.23: Sensitivity Analysis for the Value of Recovered Solvents

The investment for a condensation unit consists of the direct costs for the three heat exchangers (dehumidification unit 11 000 €, cooling unit 27 000 € and integration unit 16 000 €), freight (3%), taxes (5%) and the direct (foundations, piping) and indirect (engineering, start-up) installation costs. Thus, the total investment for the condensation system would be 95 000 €.

Depending on the quality requirements of the process the recovered solvents can be used either in the same process or for a different application or in a combined solution. Since the solvents from the paint can also be recovered it is possible that more solvents are recovered as are necessary for the process.

Figure 3.23 shows the sensitivity of the overall annualised costs to the value of the recovered solvents. Since the recovered solvents can be used only to a limited extent directly in the process the value of the recovered solvents is assumed to be 0.56 €/kg only 60% of the original price. But as Figure 3.23 indicates the total annualised costs are sensitive to the value of the recovered solvents. However, as the sensitivity analysis for a price of

<sup>27</sup> Assuming a de-icing unit the analysis would not be limited by the freezing point of Xylene and even lower temperatures would be possible using  $N_2$ .

0.94 €/kg (= 100 % of the original price) shows there exists no significant change in the endpoint temperature of condensation. Whereas the costs rise disproportionately high by cooling down assuming a price of only 10 % of the original price.

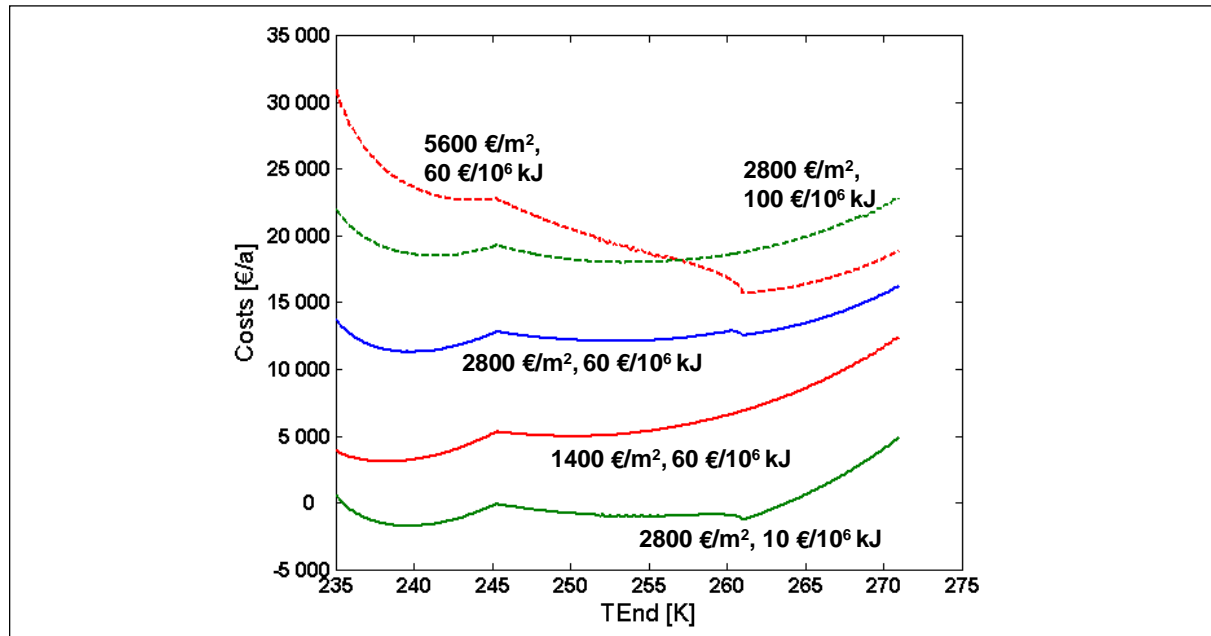

Figure 3.24: Sensitivity Analysis of Surface Specific Costs and Operating Costs for the Coolant

The sensitivity of the overall costs to the annualised costs for running the heat exchanger depends on the surface dependent price for the heat exchanger and the energy for the mechanical cooling. Figure 3.24 shows different combinations of investment and operating costs for the heat exchanger. Only by significantly reducing the costs for the heat exchanger by a given value for the recovered solvents it is possible to reach a balance of the costs and the realised savings. Figure 3.24 does not include the total investment considering all investment components, hence it is possible to reach a balanced running of the heat exchanger even though the total investment is still not cost effective.

The sensitivity of the total annualised costs with respect to the concentration of solvents in the waste gas is shown in Figure 3.25. There is a significant effect on the overall total annualised costs concerning the concentration of the solvents. Figure 3.25 shows the original solvent concentration and a 5 times higher concentration. Since the total annualised costs are very sensitive to the concentration of the solvents a combination of a condensation system of mechanical cooling, which is cheaper than a condensation system with liquid nitrogen cooling (cf. Figure 3.22), with a concentration component, for example a zeolite wheel, or a secondary measure after the condensation, for example an active

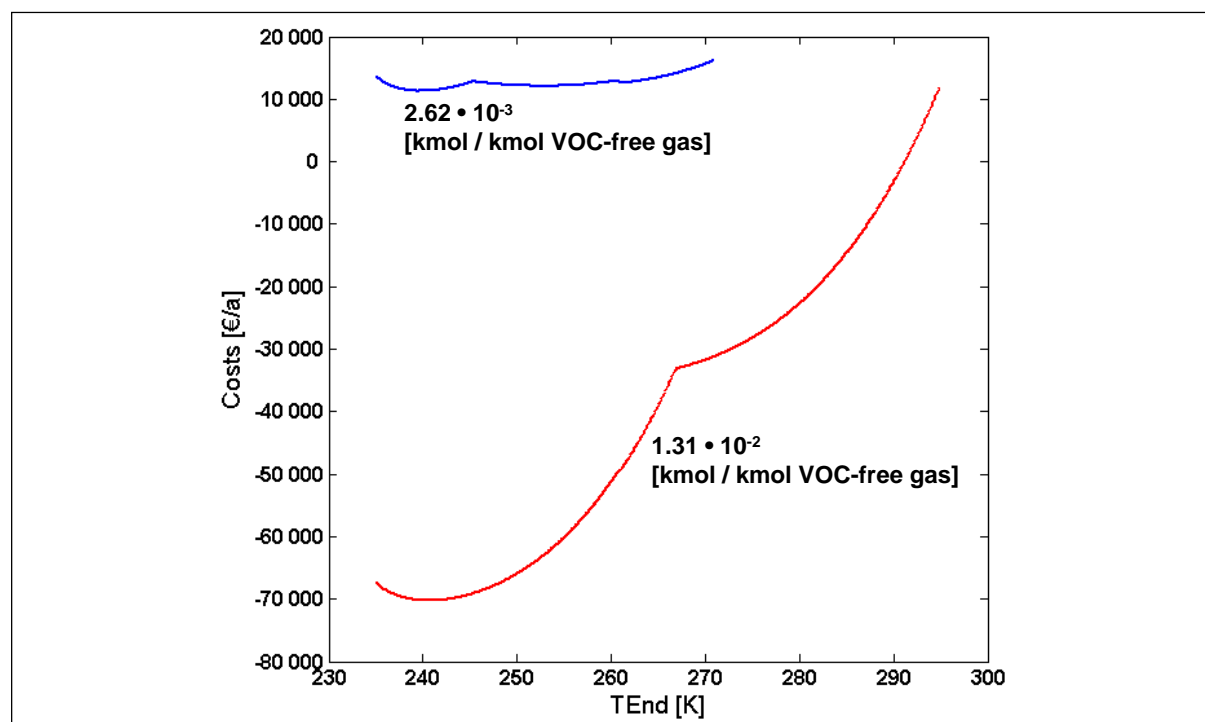

Figure 3.25: Sensitivity Analysis of the Concentration of Solvents in the Waste Gas

carbon filter, to fulfil ultimately the legal requirements may provide economic advantages compared to a sole cryogenic system. The condensation process is only economic if the solvent concentration in the exhaust gas is in the range of the saturation concentration at high temperatures and if the volume of exhaust gas is as small as possible for energy reasons [Rentz et al., 2003]. A basic problem is that the solvent proportion may exceed the emission limits for the explosion prevention. In this case the installations must be operated with inert gas (typically nitrogen) as carrier gas instead of air. For the case study the explosion limits are not relevant. If the exhaust gas contains several components with similar vapour pressure curves, a selective separation of components is often not possible [Schultes, 1996]. A limiting factor for the applicability of condensers is the energy demand that is necessary for reaching the dew point of the substances to be condensed.

### 3.3.3.3 Characterisation with Respect to Solvents

As identified in the last section, at the best operating point an reduction in the overall solvent emissions to  $233 \text{ mgC/m}^3$  can be achieved with a condensation system. The overall investment results in  $140\,000 \text{ €}$  considering the *heat integration* option ( $30\,000 \text{ €}$ )

and the *water regeneration-recycling* option (15 000 €) and the *solvents recovery* option (95 000 €) (cf. Table 3.11).

The thermal incineration is quite effective compared to the condensation leading to emission reduction rates of 99% of the initial concentration of the waste gas, but faces a high investment. The initial investment is calculated considering the incinerator, auxiliary equipment, direct installation costs, such as for example foundations and piping, indirect installation costs, such as for example engineering and start-up costs and an internal heat recovery of 50% in the incinerator installation. The price is determined according to the formula provided in [Rentz et al., 1999a]. If an incinerator is installed only for the 2 000 m<sup>3</sup>/h waste gas of the drying tunnels an investment of 186 000 € would be required. However, if an thermal incineration system is installed for the total waste gas of 194 000 m<sup>3</sup>/h the investment of an thermal oxidiser is 672 000 €. In addition to the investment of the incinerator the investment for improving the use and recycling of water of 15 000 € is required.

Table 3.11: Characterisation of the Different Solvent Target Values

	Status Quo	Waterborne Basecoats	Thermal Incineration	Condensation	Powder Coating
Solvents [mgC/m <sup>3</sup> ]	297.70	171.23	2.98	233.00	0
Investment [€]	0	75 000	687 000	140 000	245 000
Operating Costs [€/a]	45 000	24 200	45 000	29 000	30 000

Compared to thermal incineration, the switch to waterborne basecoats requires only a smaller investment. In case of a switch to waterborne basecoats 30 000 € for the realisation of the heat integration are required, additional 30 000 € for the improved pre-treatment section and 15 000 € for new spraying tools and equipment. Consequently, a total of 75 000 € must be invested to change the current coating system to waterborne basecoats. But the lower investment results in significant lower abatement efficiency leaving 171.73 mgC/m<sup>3</sup> in the total waste gas of the coating section.

The change in techniques to powder coatings shows with respect to solvent emissions the highest possible difference to the process integrated or secondary measures discussed so far. Since the powder coatings contain no solvents, a reduction to 0 mgC/m<sup>3</sup> is possible. However, the investment for the introduction of a powder coating system including training and start-up difficulties must be considered. In case of a change to powder coatings the filler application is not required any more due to the thicker coating layers. However, as discussed before, the pre-treatment must be improved in that case. An advantage of the powder coating system is that the powder can be recycled and the high overspray rate of the bicycle coating can be improved. In addition the installation of an automatic coating system with standard industrial robots is suggested. By using robots as an automatic coating tool the overspray can be reduced significantly in comparison to the currently used rotating discs. Thus, four coating robots are required for the two coating lines. Since only standard tasks are required from the robots a used, standard industrial robot is sufficient and can be obtained for 20 000 € per robot. Furthermore, the four coating booths must be reconstructed with a circulating air system for the recycling of the powder. The investment results in 245 000 € considering 35 000 € for the heat integration and 15 000 € for the improved pre-treatment.

### 3.4 Multi Objective Pinch Analysis (MOPA)

The pinch analysis approach can be used for the application and optimisation of various process streams by understanding of the important factors regulating a process and approximating meaningful targets. The advantages and limitations of the pinch analysis approaches are discussed (cf. Section 3.4.1) providing the key elements for a subsequent integration and assessment of intra and inter-company production networks. In order to combine the various approaches to facilitate a simultaneous consideration of energy, water and solvent flows in a production system, the *Multi Objective Pinch Analysis* provides a framework for the integration of the different pinch analysis approaches. It enables the development of a generic model structuring the various input data for the process optimisation via pinch analyses and provides the base for a multi-criteria decision support model to evaluate the different targets determined by pinch analysis (cf. Chapter 5).

#### 3.4.1 Advantages and Limitations of the Pinch Analysis

Feasibility, economic relevance and environmental impact of the processes are key drivers of the decision process concerning the planning or modification of a plant. Consequently,

compliance with emission limits, plant safety, maintenance of product quality, and control of start-up and both planned and unplanned shut-downs must be ensured [Mosberger, 2005]. One approach to evaluate preliminary design and process modifications are *flow sheeting* programs which, on the one hand can simulate in detail operating conditions based on construction data, and on the other hand the overall combination of the various unit operations in the process.

A different approach is based on methods of process integration. The evaluation of the process design is based on target values. Just as in the simulation, the evaluation is based on detailed process characteristics and material properties, and if a parameter is not known it must be calculated either based on measurement data, similar reactions or unit operations. With respect to the assessment it is necessary to explicitly acknowledge this uncertainty in the material properties and unknown parameters.

Other aspects not considered here in detail include the construction geometry and construction materials, e.g. corrosion and thermal requirements. These are only considered rudimentarily here - as cost surcharges dependent on operating conditions (pressure, temperature), type of material and size of equipment. Cost estimation in the context of process design, particularly with regard to heat transfer, is based on scaling effects [Peters et al., 2003]. Depending on the specific case other cost aspects are considered, e.g. costs for piping, which include not only the costs for the piping itself, but also for the labour, valves, foundations, etc. An overview of different cost estimation methods is given in [Peters et al., 2003].

The general purpose of the process evaluation based on process specific data, is to find weak points and bottlenecks in the process design. In general, however, there are reasons for not operating near the theoretical minimum (e.g. for heat integration at the thermodynamic minimum) [Vogel, 2005]:

- start-up operations often require start-up heat exchangers,
- energy utilisation only becomes possible as a result of increasing the column pressure and this means higher investment and may result in material problems (decomposition, side reactions),
- problems associated with the formation of deposits during heat transfer.

Similar statements can be made for water or solvent analyses, e.g. the solution obtained with the water pinch must be translated into a feasible process design. Therefore, strategies such as the bypassing of process water can be applied. In addition to the different



parameters being considered (single or multi parameter, water regeneration), a distinction between water as a utility (utility water pinch analysis) and water as a substance required in the process itself (process water pinch analysis) must also be made. A simulation-based approach addressing the problem of several aqueous streams relevant for one operation, including water losses, has been developed [Hallale, 2002].

Detailed chemical engineering experience is required in order to model the process streams in the detail required by integration technology for achieving meaningful results. If the process streams are inadequately modelled or oversimplified, only the very obvious results can be obtained. However, using a highly sophisticated level of detail requires complex modelling of the material and time dependencies of the reactions. Therefore, the challenge is to provide an adequate level of modelling. The pinch analysis allows a process evaluation at each stage of the process design phase, from the preliminary design to the fully operational plant, and is a useful tool for decision support where incomplete knowledge about specific details of certain unit operations exists.

Complex models and software tools are available to experts for modelling the process parameters and analysing the system. Nevertheless, the aim of the pinch analysis is [Kemp, 1991]:

- to give a rapid understanding of the important factors regulating the mass and energy consumption of a process;
- allowing approximate but meaningful mass and energy targets to be set using shortcut calculations;
- pre-optimisation to identify the most promising scheme before embarking on the costly and time-consuming detailed design phase.

The target values obtained by the different pinch analysis approaches can be used for an integrated technique assessment using a multi-criteria approach and enhance the discussion about the resource efficiency of the production network (cf. Chapter 5).

### 3.4.2 Outline of the MOPA Concept

Multi Objective Pinch Analysis (MOPA) consists of a combination of pinch analyses with different targets (energy consumption, wastewater creation, consumption of solvents, etc.) and a subsequent multi-criteria analysis [Treitz, 2006]. MOPA can be illustrated by the seven modules presented in Figure 3.26. Starting with a process analysis of the company,

the industrial park or the supply chain (depending on the system boundaries), a process model is developed mapping the various process streams and defining the data requirements. In order to calculate optimisation potentials for each selected company two kinds of information are necessary: process related information (process parameters for each identified process step, parameters of auxiliary processes) and data for the characterisation of the company (annual production figures, growth rates, etc.). The values that must be gathered are both of technical and economic nature. The basic concept, especially in case of the process parameters, is to characterise substance flows (mainly solvent, water and energy) by their absolute and their economic value through direct measurement, indirect measurement (calculations based on measurements), data derived from technical data sheets, data from identical processes of another company, and data derived from comparable processes. Information from the supply chain must be included in order to gather consistent data. For example customers who ordered coated plastic parts must be included in order to know the exact production schedule for that day in advance (especially in just in time production). The paint producer must also be included so that an analysis of the specific solvents and their concentrations used in that specific batch can be obtained.

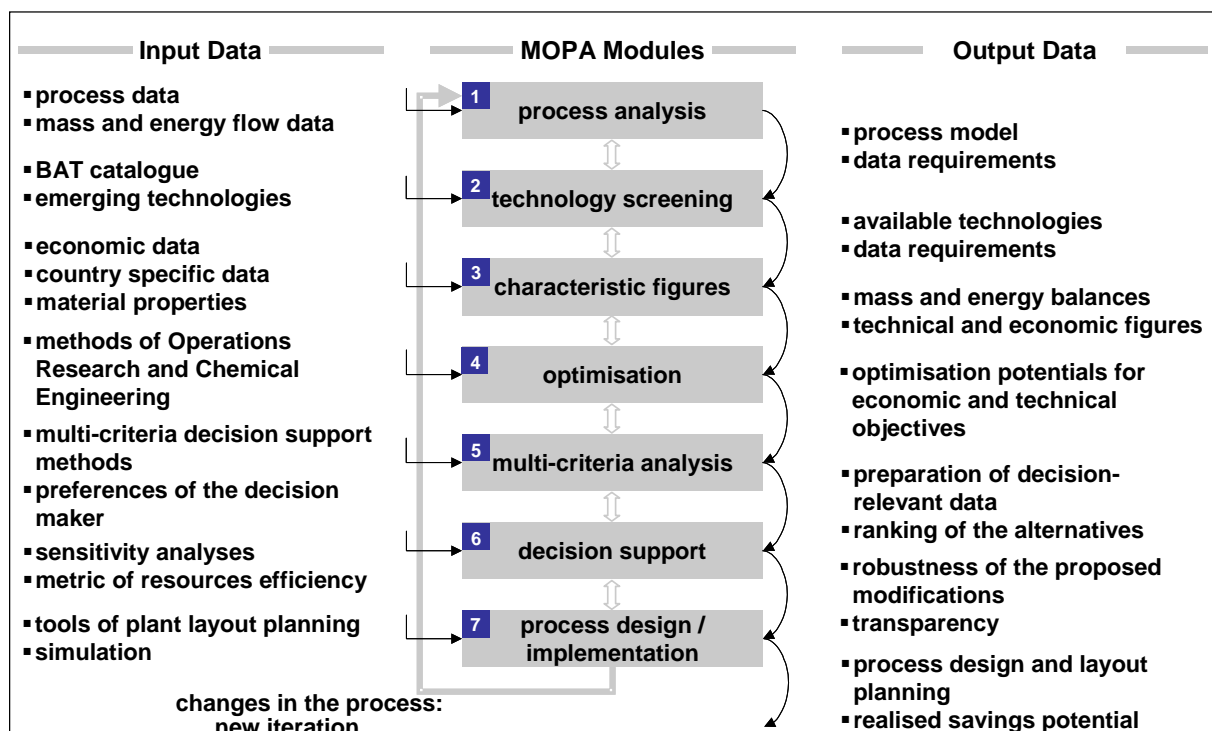

Figure 3.26: Modules of the Multi Objective Pinch Analysis [Treitz et al., 2004; Treitz, 2006]

In the second module a technology screening compiles all required information on *Best Available Techniques (BAT)* and emerging technologies in order to describe the process model and different technology options with characteristic figures (cf. module 3 in Figure 3.26 and cf. Chapter 2). The optimisation module (cf. module 4 in Figure 3.26) is based on the pinch analysis and can be solved using the transport algorithm from Operations Research. A set of optimal solutions is delivered, which spans the domain of considered technology combinations and peaks at the most current level (cf. Chapter 3). In a multi-criteria decision process the preferences, with respect to the different resources, conclusively determine the selection of a set of technologies for consideration (cf. module 5 and 6 in Figure 3.26). Additionally, further criteria such as investment, operating costs, and quality attributes extend the dimension of the given problem [Treitz et al., 2005]. From a techno-economic point of view the set of available technology combinations must be compared and assessed in a multi-criteria analysis (cf. Chapter 5). A metric for resource efficiency or a multi-criteria decision support method can be applied for this purpose. Given the characteristics of the problem (i.e. considering simultaneously quantitative and qualitative data), multi-criteria methods such as PROMETHEE [Brans et al., 1986] or the Multi Attribute Value Theory (MAVT) [Keeney, 1992] are suitable for ranking the different alternatives and to address the problem of modelling preferential information.

The specific technologies implemented in the subsequent process design (cf. module 7 in Figure 3.26) eventually define the savings that can be realised. If there are changes to the process layout (e.g. different temperature intervals, different set of process streams, etc.) the new design can be evaluated by MOPA in an iterative process.

### 3.4.3 Discussion of the Examples of the Determination of Target Values by the Pinch Analysis Approach

In this chapter target values concerning the energy, water and solvent consumption in a process are approximated and significant factors are determined in a pre-optimisation to identify meaningful savings potentials. Only generic modules calculating the target values are presented emphasising the strength of the pinch analysis approach to determine rough targets. However, a multitude of extensions and specific modules for specific processes have been developed for the pinch analysis approach enforcing a trade-off between on the one hand applicability and intention of the pinch analysis versus on the other hand accurate modelling and detailed results. The major goal of the pinch analysis is to identify optimisation potential by leaving the options for specific designs open and generating new

ideas concerning the realisation of the optimisation potential identified. In many cases not a single "best" network can be identified but a range of good ones. Detailed precision is meaningless in the definition of the target values but will be considered in the subsequent design phase [Kemp, 1991].

Here target values for the reference company of the case study are identified and specific unit operations are illustrated discussing the realisation of the savings potentials with respect to the different process design options and for the parallel reduction of energy use, water consumption and VOC emissions for the bicycle company of case study 1. The application of the pinch analysis to a SME shows the concentration of a few relevant streams. However, for the discussion of savings potentials meaningful targets and unit operations are evaluated. By considering several mass- and energy flows a multi-criteria problem is constituted since no single process design is the best alternative in all target values and identified investment and operating costs. Thus, in the following section multi-criteria methods are proposed to discuss the possible combinations of unit operations building up the different options and consolidating the presented data in one single decision table.

In Chapter 5 an approach to evaluate the target values and combine them to an overall approach is presented. In the following Chapter (Chapter 4) inter-company applications for the pinch analysis approach are discussed and illustrated using a case study of an industrial park of several SME.

# Chapter 4

## Inter-Company Production Networks

The introduction of measures for cleaner production is demanding for small and medium sized enterprises because the critical mass for the re-use and recycling of by-products is often not reached. If the mass and energy flows of several SME can be combined, however, recycling measures may become efficient. Not only have inter-company networks and supply chain management gained increased importance by concentrating on core competences and realising synergies, but also eco-industrial networks provide significant optimisation potential by closing material and energy flow loops by utilising by-products or by reusing waste from industrial sites as a valuable input within the network.

Pinch analysis can be applied in an inter-company approach considering different supply chain or industrial park structures. For this process integration as a means of improving overall resource efficiency of the production network, the combined activities can, but not necessarily must, come from one supply chain. The linking of various production sites by process streams also enables a possible connection of processes with differing outcomes, such as for example bicycle coating and spirits production.

### 4.1 Challenges for Inter-Company Collaboration

Different categories of production networks can be distinguished: Networks between companies of one value-added chain that do not necessarily require spatial proximity of the companies are the focus of Supply Chain Management. In this case, the companies closely cooperate in order to integrate supply and demand management within and across companies. Another form of production networks can be found in industrial parks. The term industrial park is often used for any kind of agglomeration of companies of the secondary

and tertiary sectors. In contrast to industrial zones or commercial districts, the notion of parks is that the (often fenced) area is owned and managed as one unit for several independent companies. A distinct form of industrial parks that unite the two aspects of production networks are those sometimes referred to as supplier parks, in which suppliers of one company are located within the premises of one focal company [Morris et al., 2004]. Industrial parks in general are characterised by the shared use of one site, where the settler companies can also share the use of infrastructure facilities like supply networks for power and water and support services [Holländer et al., 2004]. The aim of such a joint use of specific infrastructure is increasing cost efficiencies, additional savings can be realised if the companies establish a material flow network, for example by exchanging waste heat and waste water, as will be regarded in chapter 4.3.

Industrial parks aiming at increasing economic gains and at the same time at improving environmental quality by an improved resource efficiency are called eco-industrial parks, they can render possible for SMEs to reach the critical mass for the re-use and recycling of by-products to become profitable. In general, the exchange of mass and energy flows between companies is no entirely new approach and economic complexes have existed for many years in the chemical industry. However, these cooperations were typically between homogeneous classes of industry and eco-industrial parks often show unexpected combinations of heterogeneous classes of industry [Eilering and Vermeulen, 2004]. Such a type of cooperation is often referred to as an industrial symbiosis in analogy to biology, this subject is analysed as part of the emerging field of industrial ecology. Several types of these eco-industrial parks and the specific characteristics are described in [Chertow, 2000].

Cooperations between companies as found in eco-industrial parks are characterised by the two dimensions of legal autonomy of the companies that voluntarily choose to cooperate on one hand and the significant mutual interdependence and the need for co-ordination on the other hand. Generally, there is no ex-ante hierarchy between the companies, which makes a fair and consensus-oriented decision making process vital for the success of the cooperation.

Industrial parks can be organised using different operator models, each of them coming with its own allocation of investments and risks. Furthermore, the way of organizing such a shared production site entails a certain degree of flexibility for the companies, of acceptance, stability and conflict potential for the cooperation. For example shared sites can be initiated by public institutions as a means of supporting development or environmental protection. In this case, the land and shared infrastructure are often owned by regional authorities, they can be initiated and run by one focal company or can be jointly managed by the settler companies. Whereas the last form of organisation entails certain

advantages, i.e. concerning the resource efficiency due to an increased motivation for continuous improvements of processes, it also produces the most complex organisational, financial and legal challenges. These challenges are not limited to the setting up of a site used by different companies, but continue whenever the flexibility of one company concerning its processes or its production capacity is limited by the restrictions of the inter-enterprise production network. Other important factors that need consideration include the acceptance of the specific form of cooperation by all partners, their commitment to the common project (the overall goal of the project may not always be in line with the optimal solution for each partner), continuity of the involved companies, and the conflict potential of different organisational models.

These factors need consideration, as there exist hurdles to the development of environmental cooperation, which are either technical, regulatory or economical barriers, but to a similar extent also informational and motivational barriers [Gibbs, 2003]. Personal resistance to inter-company cooperation can be explained by several aspects [Fichtner et al., 2005]. Cognitive barriers relate to lacking knowledge of potential inter-company cooperations and of consequences for sustainability. Besides these, motivational barriers like inferior importance of sustainability within personal objectives and a short-term oriented thinking have to be overcome, as well as situational barriers for individuals as for example the workload by other tasks. The existence of these barriers is partly due to the fact that the potential strategies for inter-company cooperation and their positive consequences for sustainability are unknown to decision makers. On the enterprise level, obstacles for inter-company cooperation are partly due to hierarchical structures with communication barriers and strictly separated responsibilities. As there is generally no sustainability information system for controlling the overall economic and ecological performance of a company, concepts for cooperations will fail if they are not strongly promoted by individuals. Furthermore, for SMEs, resource related barriers have to be overcome, as resources are only assigned to high priority projects with short payback periods rather than to the capital-intensive interconnection of mass and energy flows. Finally, there exist barriers to inter-enterprise cooperation on the enterprise level, like legal barriers, fear of dependency on partners, different investment cycles and insufficient trust [Fichtner et al., 2005]. This last aspect, the necessity of trust between the partners is probably the major hurdle for successful cooperations, as it can on one hand prevent the creation of cooperations and on the other hand lead to high transaction cost in established networks.

In order to overcome these barriers, several political and organisational measures are possible. Political measures include campaigns for increasing the awareness of the benefits of sustainability, for promoting regional networks and creating transparency of regional

markets. Furthermore, research on organisational sustainability management and on the assessment of benefits from cooperations will help to overcome remaining obstacles for inter-enterprise cooperation concepts. Organisational measures that may help here include the promotion of sustainability within a company, but also measures for establishing trust between the different partners, for example by arranging regular meetings of decision makers. Despite the often justified fear of small companies of an asymmetric distribution of power between the partners, the largest firm involved in the network has to assume a special role in promoting the cooperation, for example by securing the financial risk for smaller partners.

In contrast to one wide-stretching company, an inter-company production network often provides specific additional technical and organisational restrictions. Changes in process parameters or input materials affect the whole production network: E.g. paints with a low solvent content newly developed by the paint producer lead to changed solvent emissions when used at the coating workshop and thus influence the investment decision of the user concerning waste gas cleaning systems. Through the analysis of process streams within a supply chain or within an industrial park, significant improvements may be realised [Wietschel, 2002]. For example a combined wastewater treatment system could have a more stable COD value and hence a more effective and economical process could be implemented. This could be a viable option especially in industrialising countries where obligations from environmental legislation might be of a lower imperative. These examples show that further optimisation potential can be identified using an inter-company approach based on an analysis of the technical applications [Frank, 2003; Tietze-Stöckinger, 2005].

For example, an analysis of an inter-company energy network in Karlsruhe shows that a positive ecological and economic impact results from different regional energy supply strategies [Frank, 2003]. In the analysis future options of a subsequent inter-connection by pipelines and the utilisation of waste heat in neighbour companies are discussed as well as the construction of a new, more efficient power generating facility. Cost savings potentials of up to 20 %/a and emission reductions of 20 % - 30 % of  $CO_2$ ,  $NO_x$  and  $SO_2$  emissions are identified. The analysis of a common solid waste system of a supplier park for an automotive company [Tietze-Stöckinger, 2005] reveals the effect on economies of scale and the utilisation of large scale technology for SME by a long-term cooperation of the companies on site. A reduction of the overall cost was mainly accomplished by a significant reduction of the required transport. In addition an analysis of regional networks is possible as shown by a study on recycling networks in the building and construction industry [Schultmann, 2003]. By modelling the transport infrastructure, the locations of



waste generation and the locations of the recycling facilities using *Petri Nets* with information from a *Geographical Information System (GIS)* regarding the impacts on costs and emissions. However, even though the inter-company analysis may provide significant savings potentials, the realisation provides additional technical and organisational restrictions in contrast to one intra-company production network.

## 4.2 Eco-Industrial Parks in China and Chile

The planning of large scale industrial parks in China had already started in the 1980s, in order to adapt the existing industrial structures of the rapid industrialisation. SME in particular are settled in certain city areas [Wang and Lu, 1993; SEPA1998; Bao et al., 2005]. Since 2003 the "*Accelerating Small and Medium Enterprise Development Law of PRC*" regulates the development of the approximately 2.6 million SME, which account for 99.6% of the enterprises and thus make an important contribution for occupation and for industrial demand and supply. Also in 2003, the "*Cleaner Production Promotion Law*" came into force. Inspired by Japanese and German recycling economy laws, a *Circular Economy (CE)* initiative has been formed by the Chinese government. It aims to integrate cleaner production and industrial ecology in a broader system encompassing industrial firms, networks or supply chains, and regional infrastructure to support resource optimisation.

One important approach to realise the Circular Economy is the concept of the "*Eco-Industrial Park*" (*EIP*), which is defined as "*a community of manufacturing and service businesses located together on a common property. Member businesses seek enhanced environmental, economic, and social performance through collaboration in managing environmental and resource issues. By working together, the community of businesses seeks a collective benefit that is greater than the sum of individual benefits each company would realise by only optimising its individual performance. ... The goal of an EIP is to improve the economic performance of the participating companies while minimizing their environmental impacts. Components of this approach include green design of park infrastructure and plants (new or retrofitted); cleaner production, pollution prevention; energy efficiency; and inter-company partnering. An EIP also seeks benefits for neighbouring communities to assure that the net impact of its development is positive.*" (cf. [Lowe, 2001; Chertow, 2004; Raymond Côté, 2004] as well as the United Nations Environmental Program [UNEP, 1998]).

Thus, the environmental management in eco-industrial parks is a challenge, since three basic levels of interaction need to be administered:

1. At the individual firm level, higher efficiency through the reduction of resource consumption and emissions, re-use of resources, and recycling of by-products.
2. The second level comprises reuse and recycling within industrial parks and clustered or chained industries.
3. The third level requires development of municipal or regional by-product collection, storage, processing, and distribution systems.

The open question is how to organise these different levels of interaction, and how to find out the most efficient process combinations for resource efficiency. These process combinations can then allow reaching the critical mass for the re-use and recycling of by-products. If the mass and energy flows of several SME can be combined, however, recycling measures may become efficient. The methodological question of coupling process streams however, easily becomes complex, since it is a combinatorial problem in the sense of mathematics. Thus, a method is needed which allows

1. for an identification of beneficial interlinkages between the numerous energy and mass flows of various production processes to be integrated, and
2. for an estimation of the savings potentials by process integration.

Based on these results, the investment volume for the necessary unit operations for the realisation of the savings potential can be estimated. Only when the techno-economic consequences of the three levels of interaction within industrial parks have been quantified, can decisions about the selection of the most suitable technological options be made. Here MOPA can help to achieve a quantification of possible savings potentials and required investments. Only if this quantification is done can the organisational planning of the realisation of the identified innovations properly start.

### 4.3 Model of an Industrial Park

The following model of an industrial park as shown in Figure 4.1 is assumed to discuss the application of the pinch analysis to inter-company networks. Thus, only the mass and energy flows relevant for heat integration are discussed and other product or solid waste

streams, such as for example packaging scrap, are neglected. The aim of the analysis is to exemplarily present the application of the thermal pinch analysis to an inter-company network based on the case studies from Chile and China presented in the Appendix A - F. However, it turned out to be difficult to find individual industrial parks in which every single company was willing to cooperate. Thus, a model of an industrial park is presented comprising a selection of companies from Chile and China to illustrate the application of the methodology to inter-company networks. It is assumed that there are four individual companies settled in the industrial park. Figure 4.1 shows a map with assumed distances and locations of the different case studies.

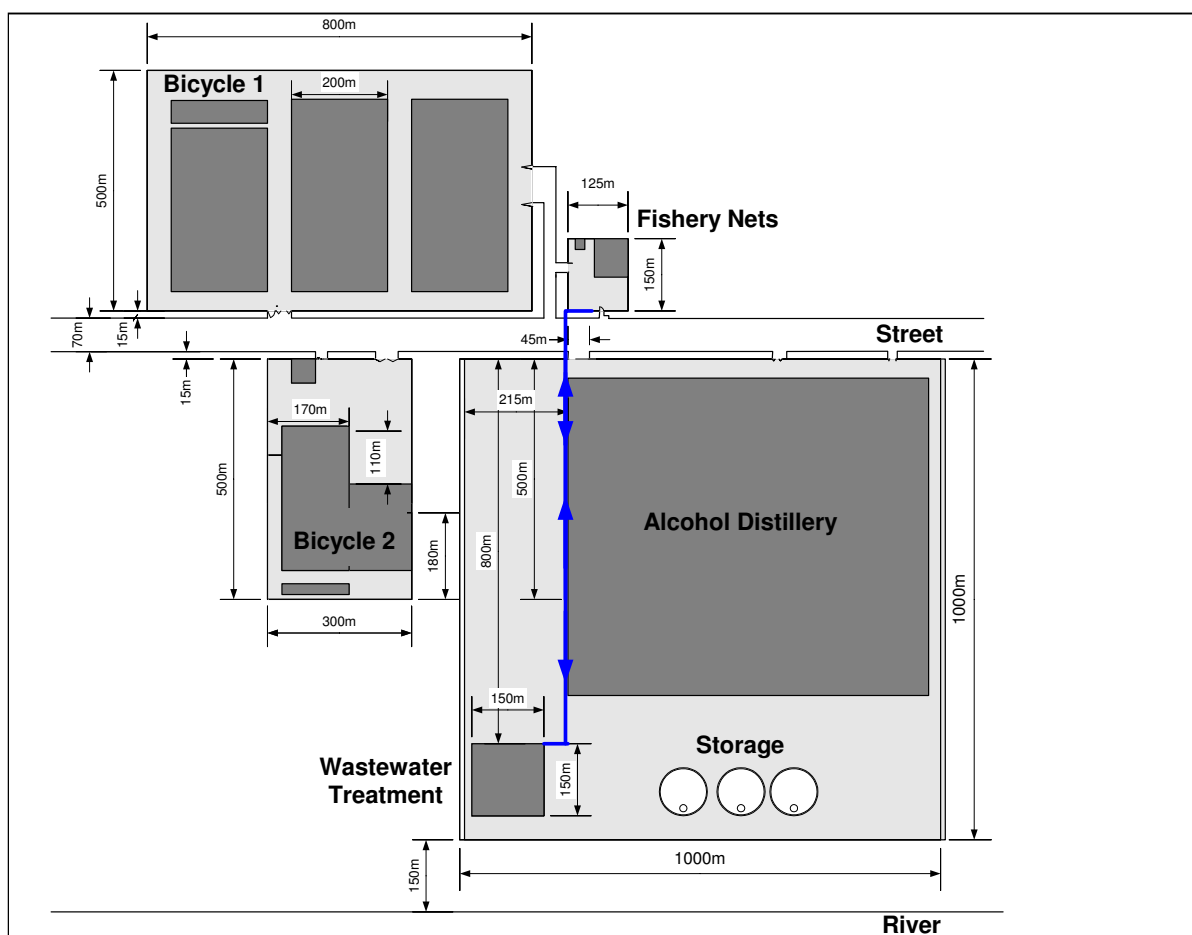

Figure 4.1: Required Piping of Inter-Company Heat Exchange within an Industrial Park

For the implementation of the pinch analysis, the considered processes must be treated as one system. The procedure for the calculation of the savings potential is the same as in the case of an intra-company problem. The result is used as a target for the process design which then results in a shared use of the utilities necessary for fulfilling the requirements

of, for example heating and cooling, and which cannot be satisfied on the basis of the available process streams. Furthermore, by linking process streams from several sites, the stream properties can be improved in order to comply with specific technical, chemical or economic requirements. For example, the combination of waste gas streams from process steps emitting organic solvents may lead to an increased volume of the combined process streams. As a consequence, other technical options for waste gas cleaning and/or solvent recovery may become economically feasible, such as for example the installation of a zeolite wheel or activated carbon filter.

### 4.3.1 Application of the Thermal Pinch Analysis for the Industrial Park

In analogy to the application of Pinch Analysis to individual processes, an overall hot and cold composite curve for the industrial park can be constructed by compiling all the heating and cooling requirements of the different companies in one single analysis (cf. Figure 4.2). The composite curves show a limited range of overlap resulting in only bounded heat integration possibilities. In total, a minimum cooling requirement by cold utilities of 2 260 MJ/h exists, compared to a minimum heating requirement by hot utilities of around 2 050 MJ/h. The overlapping range constitutes 939 MJ/h (=260 kWh/h). The major heat source is the distiller's wash of the alcohol distillery of 104 kWh/h, which is available at 92.5 °C, but which cannot be used internally due to quality restrictions of the Pisco production. In the analysis a  $\Delta T_{min}$  of 20 °C is assumed.

Since the heat is available at a relatively low temperature level, the integration possibilities are limited. But the heat is available from a liquid stream, the transportation in insulated piping is possible without significant heat loss within the short distances of the considered industrial park. Because of the wide stretching road, a culvert as an underpass of the street is necessary, increasing the costs for this option significantly.

One unit operation for the realisation of identified savings potentials is the heating of the drying air of the fishery net company. The nets are dried in a drying tower which has a temperature of 40 °C at the bottom and as low as 20 °C at the top of the drying tower using an air flow of 6 000 Nm<sup>3</sup>/h requiring 52 kWh/h. Assuming a fixed heat capacity of 4.5 kJ/kgK for the distiller's wash and no heat losses, a total of approx. 1.5 m<sup>3</sup>/h of the distiller's wash are required to reach the necessary temperature. Thus, a fluid-gas heat exchanger (with finned tube and shell) of 60 kW is recommended. By considering the cost of the heat exchanger of around 15 000 €, the cost of the rotary pump of around 1 000 € and the piping of around 160 000 €, the integration provides no economic

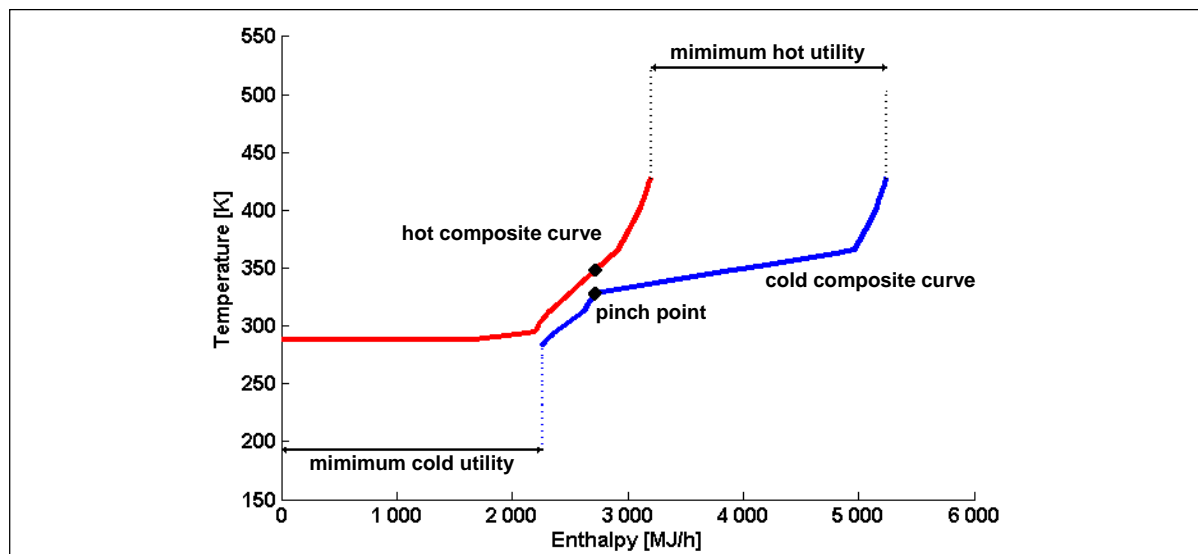

Figure 4.2: Hot and Cold Composite Curves of the Industrial Park

advantage to the current process layout of a simple gas burning heat supply considering savings of approx. 15 000 €/a (cf. Figure 4.1). For the piping, a water flow of 1.5 m<sup>3</sup>/h is considered, and thus a 40 – 50 mm pipe with insulation is required. Already in this small-scale environment the piping costs prevent an economic use of the available heat. Considering the pipe, mountings, insulation and a culvert, the piping costs sum up to 100 000 € with additional 60 000 € of labour costs for the installation. However, if no culvert would be required assuming the fishery net company was on the same side of the road, the piping costs would sum up to only around 60 000 €. Thus, with rising energy prices, the option of interconnecting the process streams may provide a good investment.

### 4.3.2 Discussion of the Application of the Pinch Analysis to Inter-Company Networks

An application of the thermal pinch analysis to a model of an industrial park is shown and the difficulties of applying the pinch analysis to an inter-company network of SME are discussed. Not only lack of information regarding the potential partners and insufficient trust concerning the dependency on the partners, but also the high degree of uncertainty concerning the benefits and costs of inter-company concepts and the risk of introducing new bottlenecks in the processes build the obstacles to inter-company networks.

Nevertheless, by using the pinch analysis approach, a rapid overall assessment of the possibilities of resource integration is possible, supporting the discussion about further cooperation with technical data. However, this integrated approach requires a tight coupling of mass, energy, economic and ecological assessment approaches based on a detailed analysis of the case at hand. Using the pinch analysis as an adequate planning tool, technical solutions can be identified and an economic and ecological evaluation of inter-company concepts is enabled. The analysis shows that a close spatial proximity of the various SME and an integration of flexibility or backup capacities are essential for building inter-company networks. Consequently, savings potentials in existing industrial parks that were not planned explicitly to facilitate the exchange of mass flows between companies will often be rather limited. In addition, the vast spectrum of possible process requirements for such an exchange of process streams, for example concerning temperature levels and water quality requirements demands a detailed ex-ante selection of suited cooperation partners. Thus the best potentials for process integration and for savings of energy and mass flows will be found in newly planned Eco-Industrial Parks. In this case, pinch analyses can provide valuable data on savings potentials, that are the foundations for all further planning of the inter-enterprise network.

Ultimately, a fair distribution of costs and revenues of the inter-company concept is required among the cooperating firms. As for the optimum configuration of the whole production network, investments and expected savings will differ for each company, it is vital not to deteriorate the overall situation for individual companies. Cooperative game theory offers several concepts that are useful for determining the optimum allocation of costs and revenues [Fichtner et al., 2004]. The aim of these concepts is to identify or create solutions, that are regarded as fair and advantageous by all participating actors in order to prevent them from leaving the cooperation or forming different coalitions.

# Chapter 5

## Using Multi-Criteria Analysis to Evaluate Resource Efficiency

The optimal allocation of resources is a core question in business economics [Koopmans, 1975]<sup>28</sup>. Since the various pinch analyses determine the theoretical optimal consumption targets for heat, water and solvents independently from each other, the question must be addressed: which is the optimal allocation for a production system, which has the resources heat, water, energy simultaneously optimised.

The definition of efficiency for an analysis of production systems is the starting point for identifying resource efficient combinations of techniques for specific techniques. In general the *degree of efficiency* is the ratio of desired output to input [Grassmann, 1950]. In the context of thermodynamic processes the input and output parameters are often limited to energy quantities, for example the transferred or converted energy compared to the employed energy, for example in a power station or wind turbine. However, this definition considers only the heat quantity and not the quality, such as temperature, which is relevant for defining its convertibility in for example refrigeration systems [see e.g. Grassmann, 1950, for a discussion]. Consequently, if it is not possible to define a single common denominator, such as the heat content or coal equivalent, the definition of the degree of efficiency is difficult.

Relative efficiency measurement is the starting point of this chapter (cf. Section 5.1). *Multi-Criteria Analysis* is discussed as an approach to resolve incomparabilities in a tech-

---

<sup>28</sup>In the explanatory statement of the *Nobel Prize Committee* in 1975 for *Leonid Kantorovich* and *Tjalling Koopmans* for their "*contributions to the theory of optimum allocation of resources*", it is said that the problem of "how available productive resources can be used to the greatest advantage in the production of goods and services" is fundamental to economics [Nobel Prize Committee, 1975].

nique assessment and especially the target values within the MOPA concept. Second, the outranking approach PROMETHEE is applied, which enables the comparison of different technological options (cf. Section 5.2). Preferential information are modelled by weighting factors and by preference functions based on pairwise comparisons. Because of the subjective assumptions that are unavoidable in decision modelling, sensitivity analyses are used to investigate the impact of value judgements to the overall results. The presented method is applied to the case study 1 of bicycle coating (cf. Section 5.3).

## 5.1 Introduction to Efficiency Measurement

The origin of the efficiency definition regarded here is the *activity analysis* [Koopmans, 1951], which also provides an overview of different allocation methods [Koopmans, 1951, 1975]. Based on the efficiency definition all non-dominated alternatives are called efficient, which is the origin of all multi-criteria problems [Brans and Mareschal, 2005].

### 5.1.1 Relative Efficiency of Techniques

The basic idea of the *activity analysis* [Koopmans, 1951] is a static model of the elements *commodity* and *activity*. A decision maker can employ commodities in activities to generate output. The quantity of each commodity is a non-negative coefficient of the activity vector and the pooled activity vectors are the technology matrix. The decision maker tries to optimally combine activities to maximise desired output for the given input. The efficiency definition states that "a possible point in the commodity space is called efficient whenever an increase in one of its coordinates (net output of one good) can be achieved only at the cost of a decrease in some other coordinate (net output of another good)" [Koopmans, 1951]. Consequently, the allocation of resources is efficient if no improvement, i.e. an addition to the output of one or more goods at no cost to the others, is possible. This relative efficiency definition is called *Pareto efficiency* and a possible improvement is referred to as a *Pareto improvement* or *Pareto optimisation* (cf. [Moffat, 1976]). Mathematically, every pareto efficient point in the commodity space is equally acceptable. Trade-offs and compromises are required by moving from one efficient point to another.

In terms of decision theory, the aim is to identify efficient alternatives. In the following,  $\{a_i(\cdot) \mid 1 \leq i \leq n, n \in \mathbb{N}\}$  denotes the finite set of all alternatives (called  $A$ ) and  $\{g_j(\cdot) \mid 1 \leq j \leq k, k \in \mathbb{N}\}$  a set of evaluation criteria (called  $C$ ). Consequently, the basic



decision problem is based on the available alternatives and the selected objectives. The objective is to maximise each attribute for a given alternative. The problem is stated e.g. as [Brans and Mareschal, 2005]:

$$\max_a \{g_1(a), g_2(a), \dots, g_j(a), \dots, g_k(a) \mid a \in A\} \quad (5.1)$$

Central for the evaluation is the *dominance relation* between the alternatives. If an alternative  $a_x$  is better in one criterion  $g_s$  than  $a_y$  and at least as good in all other criteria as  $a_y$ , then  $a_x$  dominates  $a_y$ . In terms of decision theory,  $a_x$  is preferred to  $a_y$  based on *preference relation*  $P$  (cf. Equation 5.2):

$$\begin{cases} \forall j & : g_j(a_x) \geq g_j(a_y) \\ \exists s & : g_s(a_x) > g_s(a_y) \end{cases} \iff a_x P a_y \quad (5.2)$$

If  $a_x$  and  $a_y$  are equal concerning all criteria there exists an *indifference relation*  $I$  (cf. Equation 5.3):

$$\forall j : g_j(a_x) = g_j(a_y) \iff a_x I a_y \quad (5.3)$$

If  $a_x$  is better on one criterion  $g_s$  and  $a_y$  is better on another criterion  $g_t$ , it is impossible to decide which alternative is better overall and the relation is an *incomparability relation*  $R$  (cf. Equation 5.4):

$$\begin{cases} \exists s & : g_s(a_x) > g_s(a_y) \\ \exists t & : g_t(a_x) < g_t(a_y) \end{cases} \iff a_x R a_y \quad (5.4)$$

Based on dominance relations  $P$ ,  $I$ , and  $R$  the relative efficiency definition is stated as (cf. [Koopmans, 1951]):

An alternative  $a_{eff} \in A$  is called efficient with regard to the multi-criteria problem 5.1 if no alternative  $a' \in A$  exists which dominates  $a_{eff}$  based on preference relation  $P$  (cf. Equation 5.2).

Two aspects must be pointed out (cf. [Kleine, 2001]):

1. The property of efficiency depends on the problem (cf. Equation 5.1), i.e. the available alternatives  $A$  and the selected criteria  $C$ . If the considered set of alternatives or criteria change, a previously dominated alternative can be efficient now and vice

versa. Consequently, if an alternative is said to be efficient it must be indicated with respect to which set of alternatives  $A$  and criteria  $C$ .

2. The definition states no reference concerning the comparison of alternatives, i.e. " $a_x$  is more efficient than  $a_y$ ", since no metric or measure is provided to assess the relative difference between efficient and dominated alternatives.

The definition of resource efficiency from an applicability point of view is complex since various parameters must be considered and representative ones selected. By considering a multitude of different input and output parameters the relative definition of efficiency as stated above does not help to compare a few individual technical options because most of the alternatives are called efficient based on incomparability. Hence, methodologies are required to extend the efficiency definition to reduce the incomparabilities. Therefore, various models refine or use/extend the above mentioned efficiency definition.

One approach is Data Envelopment Analysis (DEA) [Charnes et al., 1978; Cooper et al., 2004], which ex-post generates an efficiency frontier from the considered alternatives (i.e. *Decision Making Units (DMU)* such as hospitals, bank branches, public offices) on the basis of historical data and defines a distance measure as a measure for the degree of inefficiency. The origin of DEA comes from the evaluation of non-profit organisations since input and output cannot be monetarily valued with market prices and comparison is more difficult. For the purpose of monitoring and control [Belton and Stewart, 1999] one goal is the comparison of *better* and *worse* operational procedures in DMU. In the event that a DMU is identified to be inefficient, a real-valued measure or a degree of inefficiency is calculated. A crucial point of the DEA is the determination of the efficiency frontier, thus the *virtual* efficient method of production to which the real existing organisations are compared to. The parameter  $\lambda$  determines, how organisations can be scaled up and down or combined. This leads to serious problems, especially in the evaluation of a small number of techniques.

Another approach is multi-criteria analysis resolving incomparabilities by incorporating preferential information in the relative measurement of efficiency. In the evaluation of efficiency in *Multi Attribute Decision Making* problems, predominantly efficient alternatives exist according to the definition in Section 5.1.1. The field of *Multi Attribute Decision Making (MADM)* covers the assessment of a finite set of alternatives (discrete solution space) in contrast to *Multi Objective Decision Making (MODM)* focussing on alternatives restricted by constraints (continuous space). Both fields together constitute the research field of *Multi Criteria Decision Making (MCDM)*. Applications of MADM can be divided in *classical approaches*, e.g. *Multi Attribute Value Theory (MAVT)*, *Multi Attribute Utility*

*Theory (MAUT), AHP, etc., and outranking approaches, e.g. PROMETHEE, ELECTRE, ORESTE, etc..* Computer supported methods are in general referred to as *Decision Support System (DSS)* or *Multiple Criteria Decision Support System (MCDSS)*. Thus, in contrast to DEA (ex-post evaluation of many similar units for the purpose of monitoring and control) the aim of *Multi Attribute Decision Making* is the *ex-ante* assessment of a few individual options by explicitly considering the subjective preferences of a decision maker for the purpose of decision support and planning (monitoring and control vs. planning and choice [Belton and Stewart, 1999]). In selecting one final solution out of the mathematically equivalent set of Pareto optimal solutions an issue arises, which is not a mathematical question, to be addressed objectively, but a subjective element of the solution. It is the aim of multi-criteria methods to explicitly acknowledge the subjectivity of decision processes.

Concerning the efficiency definition it can be said that it provides only a partial ordering of the alternatives. *"No preference is expressed between alternatives A and B if A involves more of one desired commodity, B more of another. We can therefore not expect our model to produce a unique solution of the allocation problem"* [Koopmans, 1951]. Thus, multi-criteria methods try to reduce these incomparabilities by incorporating preference models. Preference modelling differs from outranking methods focussing on the magnitude of differences between alternatives to classical methods focussing on relating preferences to objectively measured performance. A wide range of literature about elicitation of value judgements, preference modelling and the ability of the decision maker to provide this information exists [see e.g. Belton and Stewart, 1999; Laux, 2005].

### 5.1.2 Preference Modelling in Multi-Criteria Analysis

In many decision situations, an alternative optimising all criteria simultaneously does not exist. If an alternative is better on one criterion and the other better on a different criterion, it is impossible to decide which alternative is the best without additional information [Brans and Mareschal, 2005]. Again, as discussed in the efficiency definition in Section 5.1.1, all alternatives which are not dominated by another alternative are called *efficient*. Hence, most of the alternatives given in a multi-criteria problem are efficient and incomparable. Consequently, multi-criteria methods require preferential information about relationships between the criteria, i.e. inter-criteria (cf. Section 5.1.2.1), and about each criterion, i.e. intra-criteria (cf. Section 5.1.2.2), to resolve the incomparabilities.

### 5.1.2.1 Inter-Criteria Preferences

The weighting or valuation of different criteria is a subjective element in the assessment of techniques and addresses the relative importance of the different criteria for the decision problem and thus constitutes the preferential information between criteria. The weighting factors have different meanings in different multi-criteria methodologies. In outranking methods the weighting factors represent a kind of a "voting power" [Belton and Stewart, 2002] for each criterion, rather than trade-offs or compensation ratios as in classical multi-criteria methods. In contrast to the attribute values, where a quantification is possible not only for measurable values, such as operating costs per year, but also for qualitative attributes, such as colour matching quality in the coating industry, which can be characterised by scores, benchmark tests or assigned marks, the weighting is more complex and context specific since no objective value exists to compare it to. Furthermore, behavioural aspects must be taken into account reflecting different perceptions of "gains" or "losses" [Kahneman et al., 1982] by wording a criterion in terms of losses to one reference point, in terms of gains to a different one or by biases according to the number of sub-criteria or the hierarchical level of the criteria to be valued (cf. [Hämäläinen and Salo, 1997; Pöyhönen et al., 2001; Belton and Stewart, 2002]).

Apart from the classical weighting techniques, such as direct ratio, SWING [v. Winterfeld and Edwards, 1986], SMART [Edwards, 1977; v. Winterfeld and Edwards, 1986], SMARTER [Barron and Barret, 1996; Edwards and Barron, 1994], eigenvector method [Saaty, 1980], specialised methods are discussed in the case of environmental impacts (cf. [Geldermann, 1999; v. Berkel and Lafleur, 1997; Soest et al., 1998]).

For the valuation of different ecological criteria the discussion of weighting issues leads to the fundamental questions (*i*) if there should be a weighting at all and (*ii*) if so, which weighting method should be used and (*iii*) which weights should be put on different environmental media or impact categories?

The determination of the weighting factor is difficult since it involves much technical expertise in addition to knowledge about the special requirements of the local context considered and impact caused. A first approach would be to employ similar methods to those used in *Life Cycle Analysis (LCA)* [Guinée et al., 2002] to derive the weighting factors and modify these to reflect the decision maker's preferences.

In this context well known approaches addressing the issue of valuation of potential environmental impacts exist, such as for example *Cumulative Energy Demand*, *Eco Indicator Method*, *Environmental Pressure Indicators*, *MIPS ((cradle to grave) Material Input per Unit Service)*, *Eco-tax Methods*, etc.. Some of these mentioned methods are not weighting

methods in the sense of a multi-criteria analysis, but because they contain subjective information they are dubbed "weighting factors" for example in LCA. Especially the step of *impact assessment* of a LCA both contains objective and subjective information: While the inventory table, i.e. underlying ecobalance of the mass and energy flows of the technological options, is the most objective result of a LCA study, the impact assessment is used for evaluation of the impacts, which is affected by two problems:

1. Since the impact assessment is at an early stage of development and still disputable, there is no generally accepted way of assessing, calculating or allocating the value of the damage to ecosystems [Geldermann and Rentz, 2001]. Moreover, the setting of weighting factors for the simultaneous consideration of the numerous investigated criteria will remain subjective to a certain extent. The weighting of impact categories and of mass and energy flows, which are relevant for the decision, shows the subjective assessments of the experts, permitting a structured course of action and directing the discussion to the relevant issues. As far as possible, the weighting should be oriented towards the natural science, which might be achieved by considering the ecological relevance of the impact categories and the quantitative relevance of the impact potentials [Geldermann et al., 1999; Seppälä, 2003; Tiedemann, 2001].
2. Especially in environmental assessments, the insufficient availability of exact data to calculate the damage to ecosystems causes imprecision as regards the scores. This problem is being aggravated by the complexity of the issue when considering environmental improvement in a chain perspective, which implies a large number of potential combinations and permutations for improvements. Furthermore, such an investigation requires a very broad knowledge of technical aspects, of environmental aspects, and of their relations. [Wrisberg et al., 2002].

In that context, it should be remarked, that, due to the complexity of technique assessment, any assessment method can allow only a simplified representation of the current situation by stressing individual problems. A complete interconnection of any single problem will, however, always remain an unrealistic aim. A structured procedure according to consistent rules will, however, allow more transparent and efficient decisions [Geldermann et al., 1999].

### 5.1.2.2 Intra-Criteria Preferences

Preferential information within criteria, i.e. intra-criteria preferences, create normalised data of the decision table to achieve comparability between the different criteria. The dif-

ferent attributes are measured in their respective scales, but the attribute values must be harmonised in order to reflect the perception of the different parameter values. "The purpose of all multi-criteria methods is to enrich the dominance graph" [Brans and Mareschal, 2005], i.e. to reduce the number of incomparabilities  $R$  (cf. Equation 5.4). This is done completely via *distance measures*, i.e. norms, *value functions* (*Multi Attribute Value Theory (MAVT)*) or *utility functions* (*Multi Attribute Utility Theory (MAUT)*) or partially via pairwise comparisons (*Outranking Relations*).

In contrast to methods based on value or utility functions, which associate to each individual attribute value a score between 0 and 1, the *pairwise comparisons* are based on deviations between attribute values to model the preference structure of the decision maker. An essential part of this is the extension of the pairwise dominance relations by comparisons based on preference functions. The preference functions describe the subjective view and attitude of the decision maker, i.e. his/her preferences. It is the characterisation of a preference function  $P_j(.,.) : A \times A \rightarrow [0, 1]$  for each criterion. These functions are "models describing the relative importance or desirability of achieving different levels of performance for each identified criterion" [Belton and Stewart, 2002] by incorporating value judgements about the decision makers' preferences.

## 5.2 The Approach of PROMETHEE

The problem of defining resource efficiency is discussed in this section based on the multi-criteria method PROMETHEE<sup>29</sup> [Brans et al., 1984; Brans and Vincke, 1985; Brans et al., 1986; Brans and Mareschal, 2005]. Beginning from the efficiency definition given in Section 5.1.1 the fundamental idea of PROMETHEE and its proposed approach for resolving the incomparabilities are discussed. For this purpose, PROMETHEE requires preferential information about relationships between the criteria and about each criterion. The accrued complexity requires sophisticated sensitivity analysis to guide the decision maker and to illustrate the impacts of his modelling. Especially the determination of preferential parameters is quite often underestimated. In this chapter various new sensitivity analyses for the outranking approach PROMETHEE are presented and discussed with respect to their advantages as well as their limitations.

It is well known that different decision makers prefer different decision support methods. For example, in many practical applications multi-attribute value theory (MAVT) [see e.g. Keeney and Raiffa, 1976] is suitable. However, in principle, a MAVT analysis is

---

<sup>29</sup>Preference Ranking Organization METHod for Enrichment Evaluations

subject to the same questions as an analysis in PROMETHEE addressed in this chapter. It is important both to investigate the modelling of preferential information to resolve incomparabilities and to address sources of preferential and data uncertainty.

### 5.2.1 Preference Modelling

The fundamental idea of PROMETHEE is a dominance relation based on *preference*, *indifference* and *incomparability* (cf. Equations 5.2 - 5.4) aimed at reducing the number of incomparabilities by employing preferential information to identify efficient solutions.

The PROMETHEE algorithm is based on the deviations of the attribute values. The decision table is called  $D$  and  $D_j$  is the vector of all differences of attribute values for criterion  $j$ . The goal of PROMETHEE is the identification of a ranking by resolving incomparabilities of efficient alternatives. This problem is addressed via weighting factors as inter-criteria preferential information (cf. Section 5.2.1.1) and *preference functions* as intra-criteria preferential information (cf. Section 5.2.1.2).

#### 5.2.1.1 Weighting of the Criteria

The relative importance of a criterion  $j$  is reflected in its weighting factors  $w_j$ . In the following normed weights are considered:

$$\sum_{j=1}^k w_j = 1 \quad (5.5)$$

Even so there exist specialised weighting approaches for outranking methods (e.g. cf. [Vansnick, 1986; Bana e Costa et al., 1997]) similar methods are applied as in classical approaches (cf. Section 5.1.2.1).

#### 5.2.1.2 Preference Functions

The preference function  $P_j(.,.) : A \times A \rightarrow [0, 1]$  is based on the difference in the attribute values of two alternatives  $a_1$  and  $a_2$  ( $d_j(a_1, a_2) = g_j(a_1) - g_j(a_2)$ ). In the case of a criterion that must be maximised, the alternative  $a_1$  outranks the alternative  $a_2$  if the difference  $d_j(a_1, a_2)$  is positive. Consequently, if a decision maker prefers  $a_1$  over  $a_2$  he has no preference for  $a_2$  over  $a_1$  ( $P_j(a_1, a_2) > 0 \Rightarrow P_j(a_2, a_1) = 0$ ).

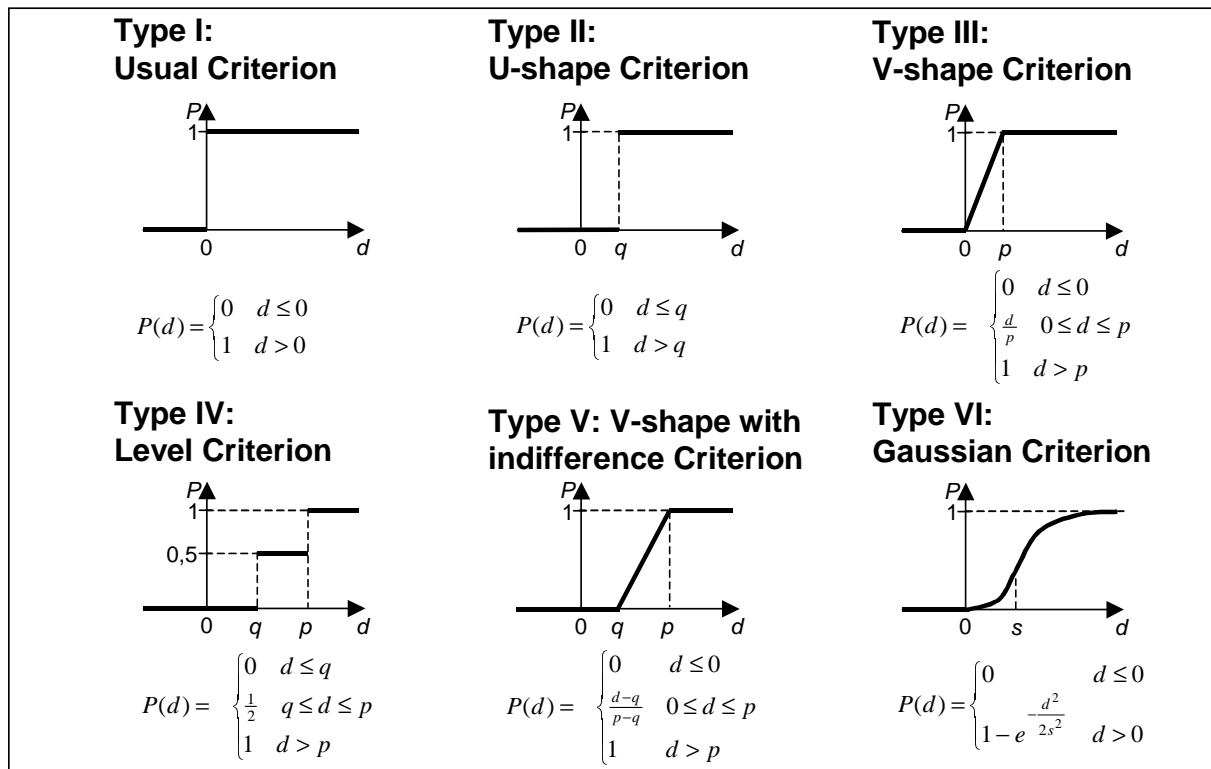

Figure 5.1: Types of Preference Functions  $P(d)$  [Brans and Mareschal, 2005]

Decision support methods such as PROMETHEE, however, are usually used in situations in which the decision makers cannot specify their preferences exactly, thus it is also the task of the applied method to formally structure and model the preferences which exist in a diffuse way. Usually six generalised preference functions are proposed and defined by threshold values of indifference ( $q$ ) and strict preference ( $p$ ), or an inflection point  $s$  as in the case of a Gaussian distribution [Brans and Mareschal, 1994]. Figure 5.1 shows the six generalised preference functions of PROMETHEE. The decision maker can choose a preference function for each criterion and depending on the selection must define certain preference parameters.

Using the generalised preference functions the indifference value  $q$  is regarded as the largest negligible difference by the decision maker. The smallest deviation, which the decision maker considers to be sufficient for a full preference, is called strict preference threshold  $p$ . Thus,  $q$  is relatively small in comparison to the attribute values of the considered criterion, whereas  $p$  is in general at the upper end of the value range. However, the inflection point  $s$  of the Gaussian preference function is located between the indifference value  $q$  and the



preference value  $p$ . Preferences are strengthened for minor differences by a small value for  $s$  near  $q$  while preferences are reduced by a value close to  $p$ .

However, both parameters  $q$  and  $p$  can also be defined and interpreted depending on the uncertainty and the quality of the attribute data [Rogers and Bruen, 1998]. The indifference value  $q$  can be interpreted for example as the minimum and correspondingly  $p$  as the maximum uncertainty value. Inaccuracies from incorrect attribute data are not clear without ambiguity up until the indifference value  $q$ , while starting from  $p$  certainly full preference exists [Maystre et al., 1994].

Specially defined or generally accepted values for the parameters  $q$ ,  $p$  and  $s$ , or methods to define them, are found extremely rarely in literature concerning multi-criteria decision theory. The reason for this is based on the understanding that there are neither "correct" values for the parameters nor is there a "correct" way to define these [Kangas et al., 2001]. The parameter values always depend on the specific decision problem as well as the preferences and assessment of the decision maker. If it is difficult for the decision maker to define such parameter values a moderator and/or an experienced analyst is of help, i.e. *homme d'étude*.

Since no objective preferences exist and value judgements are, at least partially, formed only during the modelling process, the multi-criteria method should enable the decision maker to better comprehend his underlying assumptions and model his own preferences [Belton and Stewart, 2002; Basson, 2004]. Nevertheless, it is complex to make decisions about the preference parameters and understand their effects by defining a certain value. Therefore, default values based on the attribute values are proposed if the decision maker cannot identify a starting point. However, in this case the proposed default values have a high uncertainty and sensitivity analyses are necessary in order to understand the effect of changing the proposed values [Treitz, 2006].

If no value is given by the decision maker the following default values are proposed based on the mean and the standard deviation of the attribute values concerning criterion  $j$ :

$$q = |\text{mean}\{|D_j|\} - \text{std}\{|D_j|\}| \quad (5.6)$$

$$p = \text{mean}\{|D_j|\} + \text{std}\{|D_j|\} \quad (5.7)$$

Depending on the attribute values, these methods result in relatively high limits for indifference and relatively low limits for the strict preference value  $p$ . Therefore, the

default values tolerate relatively high differences as indifferent, and on the other hand ascertain already relatively small differences a full preference.

For the parameter  $s$  the entire range of possible attribute values is considered:

$$s = \frac{1}{2}(\max\{D_j\} - \min\{D_j\}) \quad (5.8)$$

Various other parameter definitions seem reasonable (for example 5% of the minimal attribute value for  $q$  ( $q = \frac{1}{20}(\min\{|D_j|\})$ ) or the maximal difference ( $p = \max\{|D_j|\}$ ) for  $p$ ) and it is highly controversial whether proposals of parameter values should be made at all. By ascertaining default values to the preference parameters the decision maker can identify values in a meaningful range and analyse the robustness of his choice.

### 5.2.2 The Aggregation Model of PROMETHEE

The positive outranking flow  $\Phi^+(a)$  (cf. Equation 5.9) expresses how much alternative  $a$  is preferred to, i.e. outranks, all other  $(n - 1)$  alternatives  $x \in A$ . Whereas the negative outranking flow  $\Phi^-(a)$  (cf. Equation 5.9) expresses how much all the other alternatives are favoured compared to alternative  $a$ . Consequently,  $\Phi^+(a)$  and  $\Phi^-(a)$  both are positive (i.e.  $0 \leq \Phi^+(a), \Phi^-(a) \leq 1$ )

$$\Phi^+(a) = \frac{1}{n-1} \sum_{j=1}^k \sum_{x \in A} [P_j(a, x)] w_j \quad (5.9)$$

$$\Phi^-(a) = \frac{1}{n-1} \sum_{j=1}^k \sum_{x \in A} [P_j(x, a)] w_j \quad (5.10)$$

Considering  $\Phi^+(a)$  and  $\Phi^-(a)$  the net outranking flow  $\Phi(a)$  is the overall comparison (i.e.  $-1 \leq \Phi(a) \leq 1$ ):

$$\Phi(a) = \Phi^+(a) - \Phi^-(a) \quad (5.11)$$

Consequently, the PROMETHEE algorithm provides two approaches for ranking the alternatives [Brans and Mareschal, 2005]:

- The *PROMETHEE I ranking* preserves all incomparabilities and illustrates the results as a partial ranking combining the rankings induced by  $\Phi^+(a)$  or  $\Phi^-(a)$ .

- The *PROMETHEE II ranking* balances the positive and negative flows to a complete order.

The positive and negative outranking flows already consider the weighting of the different criteria. By focussing on one alternative  $a$  the single criterion net flows  $\Phi_j(a)$  express the quality of  $a$  with respect to all criteria individually:

$$\Phi_j(a) = \frac{1}{n-1} \sum_{x \in A} [P_j(a, x) - P_j(x, a)] \quad (5.12)$$

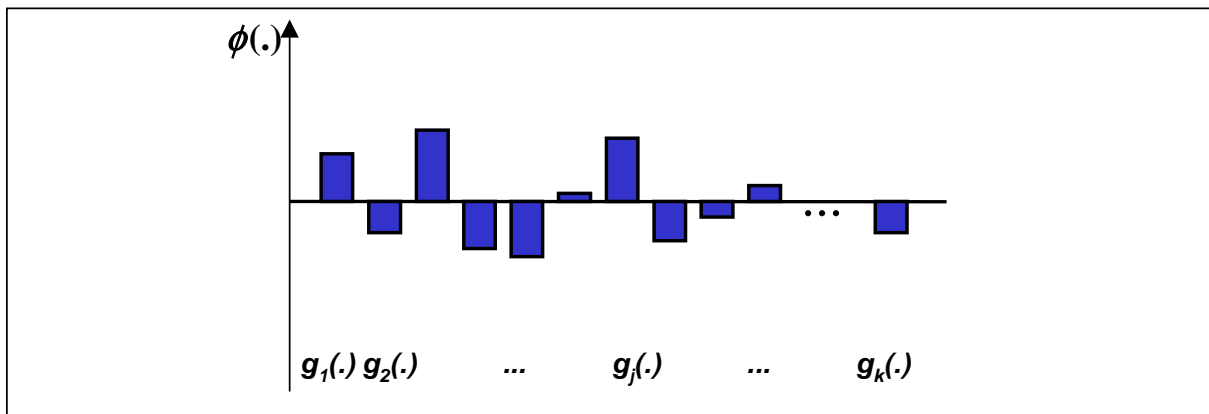

Figure 5.2: Profile of an Alternative [Brans and Mareschal, 2005]

Figure 5.2 shows the single criterion net flows  $\Phi_j(a)$  of an alternative  $a$ . It expresses the strengths and weaknesses of an alternative. All individual  $\Phi_j(a)$  are pooled in the matrix  $M$  ( $n \times k$ ). Thus, each line in  $M$  represents an alternative and each column a criterion. Different criterion scales do not affect  $M$ , since  $M$  is dimensionless, and because it is based on the values of the respective preference functions. Likewise,  $M$  is independent of the criterion weights.

### 5.2.3 Sensitivity Analyses in PROMETHEE

Sensitivity analyses play an important and relevant role in decision making and "the learning and understanding which results from engaging in the whole process of analysis is far more important than numerical results." [Belton and Stewart, 2002]. Especially in group decision making acceptance is increased by starting with preliminary results and iteratively refining the decision support model. In multi-criteria decision support sensitivity analyses are used to investigate both the data uncertainty and the preferential uncertainty

of the decision maker(s). This is done to assess how robust the results react to changes of data and parameters. When modelling value judgements especially, it is important to carry out sensitivity analyses in order to iteratively re-model the decision problem and to facilitate learning about the given problem as proposed in [ISO 14040]. Sensitivity analyses investigate how the results of a model change with respect to variations in the input parameters [French and Insua, 2000; French and Papamichail, 2003; Saltelli et al., 2000] and are therefore essential in any multi-criteria decision analysis problem. The motivation behind sensitivity analyses is amongst others to support the elicitation of judgemental inputs to an analysis; to guide the making of decisions; to explore and build consensus and to build understanding about a given problem [French, 2003].

While decision support by PROMETHEE is also available in several existing standard MCA software packages, such as Promcalc<sup>30</sup> or Decision Lab<sup>31</sup>, the major drawback of these packages is the possibility to handle the different types of uncertainties arising in a decision process in an adequate way. Therefore, the analyses are based on an implementation of PROMETHEE in MATLAB<sup>TM</sup><sup>32</sup>.

By applying the PROMETHEE technique several standard but also new sensitivity analyses can be carried out (cf. Table 5.1). On the one hand the robustness of a decision can be investigated by analysing the inter-criteria preferential information: By varying the weighting of one criterion  $j$  from zero to 100 %, by calculating sensitivity indicators  $\delta_{j,a,b}$  for the switch in the ranking position of two selected alternatives  $a$  and  $b$ , by changing all weighting factors simultaneously within certain weighting intervals, or by determining stability intervals based on  $\delta_j^-$  and  $\delta_j^+$  for a fixed ranking of a certain number of best alternatives the definition of the inter-criteria preferential parameters is supported [Zhang, 2004]. On the other hand the robustness of intra-criteria preferences, i.e. the preference function, can be investigated by evaluating all possible preference type combinations or by carrying out a *Monte Carlo Simulation (MCS)* using specific uncertainty levels, such as  $\pm 10$  %, for the parameters  $q$ ,  $p$ , and  $s$ . Furthermore, not only consideration of uncertainty in the value judgements of the decision maker but also in the process data must be addressed by evaluating the distinguishability between the different alternatives considered (cf. Table 5.1).

---

<sup>30</sup>see [Brans and Mareschal, 1994]

<sup>31</sup>see <http://www.visualdecision.com/dlab.htm>

<sup>32</sup>for further information see: <http://www.mathworks.com>

Table 5.1: Sensitivity Analyses for PROMETHEE

Variable	Fixed	Method	Output	Source
weight (one criterion)	preference parameter and type	change of weight within $[0, 1]$	$\Phi_{net}(a)$ (line plot)	[Geldermann, 1999]
weight (one criterion)	ranking of two selected alternatives $a$ and $b$	analytical determination of maximal change	sensitivity indicator $\delta_{j,a,b}$	[Zhang, 2004]
weights (all criteria)	preference parameter and type, weighting limits	convex hull of all valid weighting vectors	area in GAIA plane	[Brans and Mareschal, 1995]
weights (all criteria)	ranking of a selected number of best alternatives	maximal change of all weighting factors	stability intervals $[w_j - \delta_j^-, w_j + \delta_j^+]$	[Zhang, 2004]
preference type (one criterion)	preference parameter	variation of preference type	$\Phi_j(a)$ (line plot)	new
preference type (all criteria)	preference parameter and weighting	variation of all preference types for all criteria	$\Phi_{net}(a)$ (line plot)	new
preference parameter (one criterion)	preference type	MCS (uniform distribution)	$\Phi_j(a)$ (line plot)	new
preference parameter (all criteria)	preference type and weighting	MCS (normal distribution)	$\Phi_{net}(a)$ (box plot)	new
attribute values	preference parameter and type, weighting	MCS (normal distribution)	scatter plot	new

The introduced sensitivity analyses for the outranking approach PROMETHEE and their applicability will be discussed in detail throughout this Chapter. The consideration of preferential uncertainty and data uncertainty has been addressed for multi attribute value theory, too. Possibilities to handle and visualise data uncertainties in MAVT have for instance been proposed by [Basson and Petrie, 2007; Geldermann et al., 2006a]. Approaches that allow the use of weight intervals in MAVT instead of crisp weight values are for example described in [Mustajoki et al., 2005; Bertsch et al., 2006]. Furthermore, the variation of value function parameters (in analogy to the variation of the type of the PROMETHEE preference function) has for instance been suggested by [Mavrotas and Trifillis, 2006; Bertsch et al., 2006]. However, the literature so far is mostly limited to analyses within one MCDA approach. Having decision processes in groups in mind where different members prefer different MCDA approaches, a comparison of the results of the different "schools of thought" can be helpful to investigate the robustness of a decision with respect to the different approaches [see e.g. Stewart and Losa, 2003; Geldermann and Rentz, 2000; van Huylenbroeck, 1995; Zhang, 2004].

## 5.2.4 Sensitivity Analyses for Preferential Data

The evaluation of the inter-criteria preferences, i.e. the weighting factors, is essential for the evaluation of the uncertainty in preferential information, since the weighting highly influences the results of the multi-criteria analysis. Consequently, analytical methods for the evaluation of the weighting factors and stability intervals of the results are discussed (cf. Section 5.2.4.1). Furthermore, enumerative and simulation based approaches are applied to evaluate the uncertainty in the model parameters of the intra-criterion preferential information (cf. Section 5.2.4.2).

### 5.2.4.1 Sensitivity Analysis for the Inter-Criteria Preferences

The most frequently applied analysis technique for decision problems plots the output value, i.e.  $\Phi_{net}(a)$  in PROMETHEE, versus the weighting of a selected criterion in a two-dimensional graph [Geldermann et al., 1999]. The graph in Figure 5.3 shows the alternatives as straight lines. Thus, the effect on  $\Phi$  is illustrated for the different alternatives by a variation of the weighting from 0 to 100% of the selected criterion. Although only one parameter is explicitly changed (the weight of the selected criterion), implicitly the other criterion weights change as well.

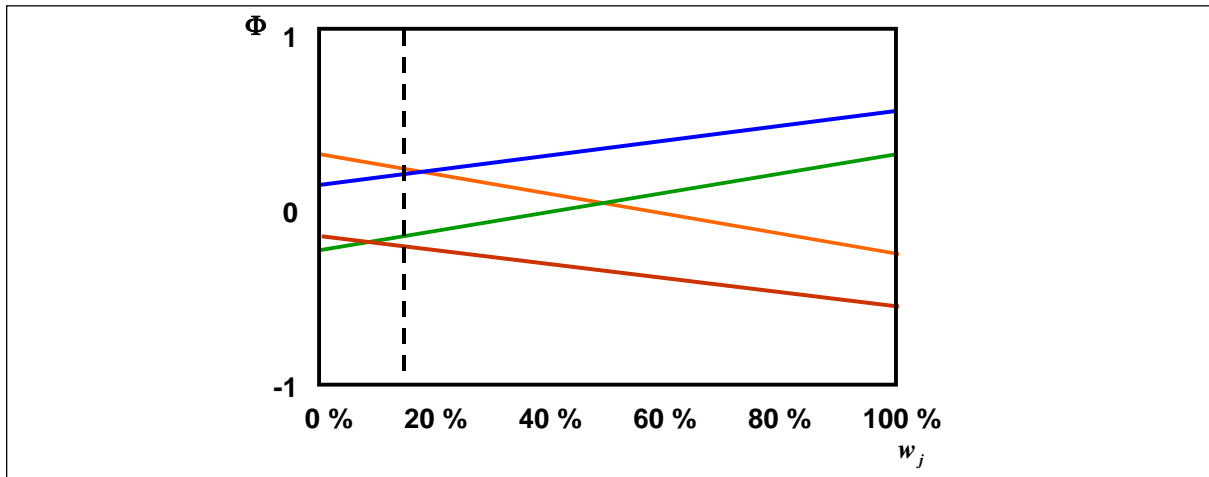

Figure 5.3: Sensitivity Analysis of the Weighting of a Selected Criterion

The gradient of the lines represents the influence of the selected criterion on the performance of the alternatives. A negative / positive gradient corresponds to negative / positive correlation on the output value  $\Phi_{net}(a)$  by the selected criterion. At the intersections of the lines a change in the ranking of the alternatives takes place. Therefore, the whole range can be divided into sections with different rankings. Within these insensitivity or stability intervals the weighting of the selected criterion can be changed and it will have no impact on the ranking [Mareschal, 1998]. The stability interval around the current weighting of the selected criterion and all possible rankings, for example up to 10 rankings within first three positions, can be calculated and used to inform the decision maker about the robustness of his weighting factor definition. Therefore, further examination of the weighting factors for an insensitive criterion can be avoided [Geldermann et al., 2003].

Furthermore, interactive software tools enable the decision maker to change the weighting of a selected criterion (i.e. *walking weights*) via a scroll bar [see e.g. Mareschal, 1998, in the case of PROMETHEE]. On the one hand the required (spare) weight can be obtained (reallocated) from (to) all other criteria, but on the other hand only from (to) selected criteria. Not only the weights of each criterion are shown in a bar chart, but simultaneously the  $\Phi_{net}(a)$  flows of the considered alternatives are shown in a bar chart with the height of each bar (i.e.  $\Phi$ ) changing with the weighting.

Additionally, sensitivity indicators  $\delta_{j,a,b}$  can analytically be calculated for each criterion  $j$ . The sensitivity indicator  $\delta_{j,a,b}$  ( $1 \leq a \leq b \leq n$  and  $1 \leq j \leq k$ ) denotes in absolute terms or as a percentage the smallest change of the current weighting  $w_j$  of criterion  $j$ , such that the ranking order of the alternative pair  $a$  and  $b$  is reversed [Zhang, 2004]. Consequently, for a  $n \times k$  decision table  $D$  a total number of  $\frac{k \cdot n(n-1)}{2}$  sensitivity indicators can be calculated and the indicator with the smallest absolute value  $|\delta_{j,a,b}|$  marks the most sensitive criterion [Geldermann et al., 2003, 2006f]. The ranking is stable concerning criterion  $j$  if no indicator  $\delta_{j,a,b}$  can be determined.

To evaluate the robustness of the ranking with respect to all weighting factors simultaneously, the sensitivity indicators  $\delta_{j,a,b}$  can be used in an optimisation model to determine stability intervals based on  $\delta_j^-$  and  $\delta_j^+$  in which the positions in the ranking order of a predetermined number of best alternatives, for example the group of the best three alternatives, remains unchanged [Zhang, 2004]. In this case the weighting  $w_j$  of criterion  $j$  can be changed within the interval  $[w_j - \delta_j^-, w_j + \delta_j^+]$  for all criteria  $j = 1, \dots, k$ . The calculation of the stability intervals is based on a linear optimisation approach maximising the stability intervals [Zhang, 2004]:

$$\max \sum_{j=1}^k (\delta_j^- + \delta_j^+) \quad (5.13)$$

The optimisation is subject to no change in the ranking position of a predetermined number of best alternatives [see Zhang, 2004, for a detailed description].

In addition to the described analytical evaluation spider diagrams are used for the visual comparison of several alternatives considering all criteria simultaneously [Vetschera, 1994]. In case of PROMETHEE the single criterion net flows  $\Phi_j(a)$  of individual attributes are shown on criterion axes, which proceed symmetrically from a common centre from -1 to 1 [Rosenau-Tornow, 2005]. Figure 5.4 shows a fictitious example. The number of axes corresponds to the number of criteria. A line for each alternative forms a polygonal traverse connecting the attribute values whose relative position shows the quality of an alternative.

The purpose of a spider diagram is less to present precise data values but more to impart a holistic, overall impression of the decision problem [Vetschera, 1994]. Depending on the decision context it can be reasonable to prefer a well-balanced alternative with average performance in all criteria than the identified best, but possibly very differentiated, alternative. Since the general overview becomes increasingly confusing with a growing



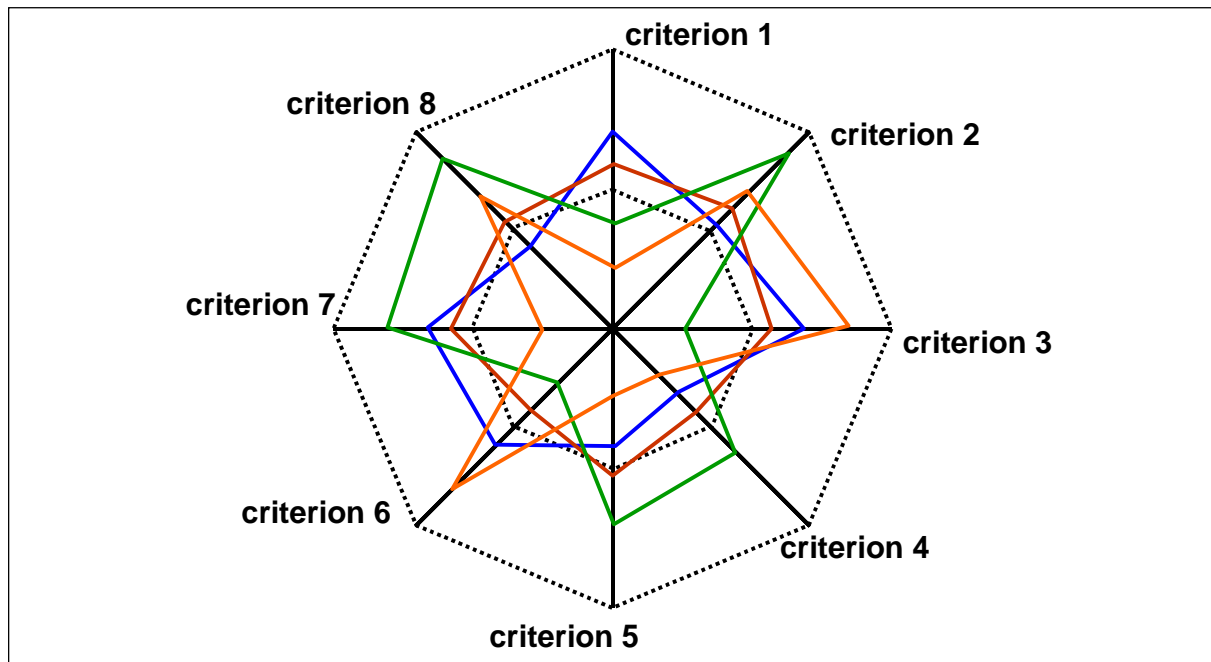

Figure 5.4: Spider Diagram of  $\Phi$  of All Criteria and All Alternatives of the Decision Problem

number of criteria or alternatives, an aggregation of the attribute values is inevitable in such cases. Here factor-analytic techniques can be employed (cf. Section 5.2.5).

#### 5.2.4.2 Sensitivity Analyses for Intra-Criterion Preferences

Extensive sensitivity analyses are necessary to capture not only the uncertainty in the inter-criteria preference values, but also in the modelling of the decision makers' preferences concerning the intra-criterion preferences. Therefore, special sensitivity analysis for preferential uncertainties within the outranking approach PROMETHEE are essential. The decision maker can define a preference function by type and depending on the type by a preference parameter. For example, the selection of preference type 1 requires no further parameter definition whereas the selection of preference type 5 requires the definition of parameters  $q$  and  $p$  (cf. Section 5.2.1.2). The differences in the attribute values can be added to the graph of the selected preference function, which clearly facilitates the determination of the preference function parameters, since the decision maker can directly see the effect of his preference type selection and parameter value definition.

The preferential uncertainties concerning the intra-criterion preferences are here addressed by a complete enumeration of all possible preference type combinations for the kind of

preference type and by *Monte Carlo Simulation (MCS)* for the evaluation of the preference parameters of the preference function in the following. Under the term Monte Carlo Simulation statistic procedures of random sampling are summarised, which approximate the effects of uncertainties of the input values onto the output values which could analytically not be regarded [see e.g. Rubinstein, 1981; Robert and Casella, 1999; Fishman, 1996; Gentle, 2003]. First, a sufficiently large number  $n$  of random numbers is drawn according to a certain distribution for one or more selected variable(s) of the decision model. Thus, it is accepted that the values distribute themselves statistically around an expected value (within an interval) which is assumed to be likely for the input data. Possible distribution types are in general for example the Normal, Uniform, Poisson, Binomial or Exponential distribution or others. Besides the simulation of the uncertainty of the regarded values, the aim is to identify potential risks and errors afflicted with the decision analysis results.

A different approach to address the uncertainty in preferential information in multi-criteria methods is carried out by fuzzy approaches [Carlsson and Fullér, 1996; Ribeiro, 1996]. Employing trapezoidal fuzzy intervals for the preference parameters, fuzzy preference flows can be used to represent the decision problem within the outranking approach PROMETHEE [Geldermann et al., 2000b]. The ranking of the alternatives is ultimately based on the defuzzified fuzzy preference flows.

However, the use of fuzzy approaches as opposed to probabilistic and Monte Carlo approaches is discussed controversially in literature. It should be emphasised that the methods described are aimed at communicating and visualising the uncertainties associated with the results of the decision analysis in contrast to the illusory preciseness of deterministic results remaining after a procedure such as the defuzzification (or after calculating expectation values in the case of probabilistic approaches). Thus, using the methods described, it is possible to explicitly illustrate the spread of the results - i.e. the ranges in which the results can vary for the spread due to preferential uncertainties or for the spread resulting from data uncertainties.

Thus, in order to address the difficulty of selecting a preference type and defining preference parameters for each criterion  $g_j(\cdot)$ , four sensitivity analyses [Treitz, 2006] are described here. The first two sensitivity analyses focus on the type of preference function and are based on preference type combinations. The second two sensitivity analyses evaluate the robustness of the decision based on the preference parameters using MCS. For each sensitivity analysis the ratio is calculated for which an alternative is ranked first.

- *Sensitivity Analysis of the Type of Preference Function of the Selected Criterion:*

A line diagram visualises the single criterion net flow  $\Phi_j$  for all alternatives by variation of all six possible preference types. In case no individual preference parameters are set the default values (cf. Section 5.2.1.2) are used. Since it is possible that in a line diagram one alternative is completely covered by another alternative warning messages are useful in a graphical representation.

- *Sensitivity Analysis of all Combinations of the Types of Preference Function for all Criteria:*

The total net flow  $\Phi$  considering all criteria is plotted as a line diagram by varying all six possible types of preference function for each alternative for all criteria.  $\Phi(a)$  is calculated for all alternatives and all  $6^k$  different combinations of preference functions. Again, in case no individual preference parameters are set the default values are used.

- *Sensitivity Analysis of the Preference Parameter(s) of the Selected Criterion:*

For this analysis the single criterion net flow  $\Phi_j(a)$  of all alternatives is calculated by variation of the preference parameter  $q$  and/or  $p$  as well as  $s$ . The uncertainty is given as a percentage, such as 10% or 90% uncertainty. Values for the parameters are generated using a Monte Carlo Simulation with a uniform distribution within the interval  $\pm$  the value of the uncertainty level around the original parameter value. In the case of preference type 1 no analysis is carried out since the preference function does not depend on a preference parameter. In the case of a preference function requiring two parameters two line plots are shown. When changing the uncertainty level the effects on  $\Phi_j(a)$  can be observed.

- *Sensitivity Analysis of the Preference Parameters of all Criteria:*

A box plot of the total net flow  $\Phi$  for all alternatives is shown for a variation of all preference parameter values using the uncertainty interval. This analysis can explore how  $\Phi$  is dependent on the preference parameters. In this case all preference parameter values are generated using a MCS approach with a normal distribution. The standard deviation is assumed to be half of the uncertainty indicated. Thus, the interval including twice the standard deviation corresponds to the uncertainty interval around the original value and covers 95.4% of all values. This interval is also called the  $2\sigma$  range.

The edges of the boxes are the lower and upper quartiles and within the box, i.e. the interquartile range, the deterministic value is visualised. The middle line of the

deterministic value is equal to the height of the bar of each alternative in the analysis using the deterministic values. The whiskers show the minimal and maximal  $\Phi(\cdot)$  of all samples. This analysis considers the selected preference type and does not vary this selection. Consequently, if preference type 1 is selected for all criteria there is no variation in the height since no parameter is used in preference type 1.

## 5.2.5 Principal Component Analysis for Sensitivity Analyses

Decision problems usually represent complex circumstances, often characterised by a multiplicity of variables. The resulting high-dimensional data sets can only be analysed and illustrated graphically using suitable statistical procedures such as the *Principal Component Analysis (PCA)* [Timm, 2002; Härdle and Simar, 2003]. In general, the principal component analysis is an attempt to obtain a reduction of the number of correlated variables. The resulting uncorrelated variables, the principal components, successively describe a maximum of variance.

### 5.2.5.1 Basics of the Principal Component Analysis in PROMETHEE

In the case of PROMETHEE the PCA is based on the matrix  $M$  of the *single criterion net flows*  $\Phi_j(a)$  in which the strengths and weaknesses of an alternative can be analysed for each criterion individually. By calculating the eigenvectors of the covariance matrix of  $M'M$  and building a matrix of all eigenvectors, sorted by the magnitude of the eigenvalues, the axes can be transformed. The transformation represents a rigid rotation of the original axes into the new principal axes based on the matrix of the sorted eigenvectors. Consequently, the new principal components span a rotated coordinate system in comparison to the original system. Both coordinate systems are  $k$ -dimensional. The desired reduction of dimension is reached by using only a subset of the principal components.

The question of how these components should be combined arises, whereby even considering the reduction of the number of dimensions, as much information as possible is preserved. It must be pointed out that the spread (i.e. the variance) of the new linear combinations is a measure for the represented information by the linear combinations [Härdle and Simar, 2003]. Therefore, it can be concluded that the eigenvector  $\nu_i$  of the largest eigenvalue (i.e.  $\lambda_1$ ) of  $cov(M'M)$  is the result of the optimisation problem for finding a representative of the maximal variance. Thus, the linear combination with the largest variance is called the 1<sup>st</sup> principal component. Perpendicular to  $\nu_1$  is the eigenvector  $\nu_2$  of the second largest eigenvalue  $\lambda_2$  (2<sup>nd</sup> principal component), representing the

largest part of the remaining total variance. By projecting the alternatives from the  $\mathbb{R}^n$  onto the plane of the 1<sup>st</sup> and 2<sup>nd</sup> principal component, the dimension is reduced while preserving the maximum information in the  $\mathbb{R}^2$  (cf. Figure 5.5).

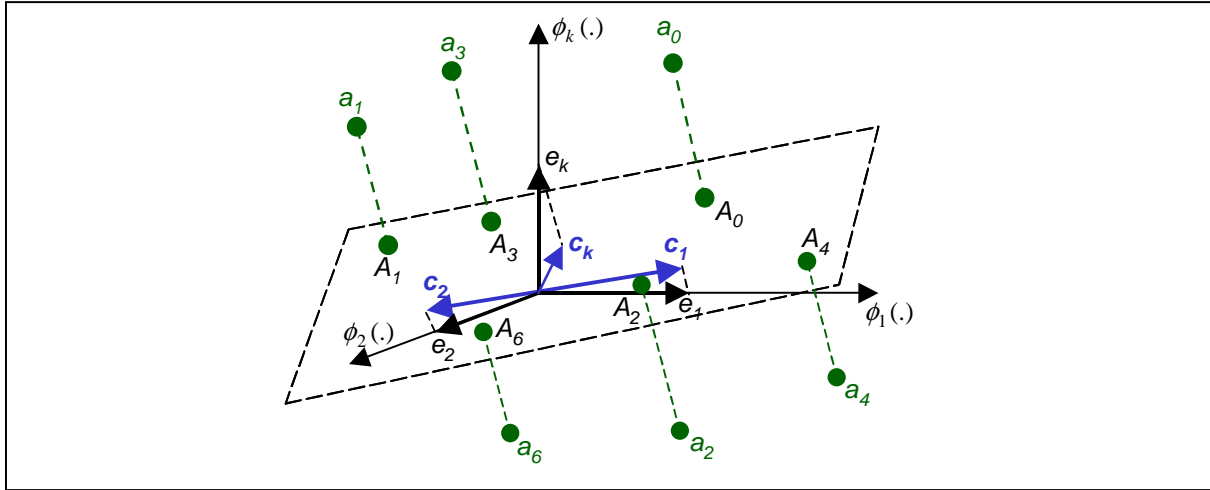

Figure 5.5: Projections on the GAIA Plane [Brans and Mareschal, 2005]

The sorted eigenvalues are therefore a measure for the ratio of the total variance, represented by the principal components. Thus, it can be calculated how much variance (and/or information) is represented by the 1<sup>st</sup> and 2<sup>nd</sup> principal component. Often, more than 60% or even 80% of the total variance is represented by the first two principal components [Brans and Mareschal, 2005] and consequently a meaningful visualisation is possible. Nevertheless, the ratio depends on the number of alternatives and number of criteria. Hence, there still exist many cases where less information is represented by the first two components and thus it is questionable whether the visual representation is meaningful enough for the decision problem [Basson, 2004].

Besides the total variance ratio the correlation of the new principal axes with the original axes is of interest. The coefficient of correlation describes how well the  $j^{\text{st}}$  variable (criterion axis) is represented by the PCA. The decision maker can use this information to ascertain how well the criterion ( $j^{\text{st}}$  variable) is represented by the 1<sup>st</sup> and 2<sup>nd</sup> principal component.

In PROMETHEE the PCA approach is incorporated and the plane of the 1<sup>st</sup> and 2<sup>nd</sup> principal component is called the *GAIA*<sup>33</sup> plane [Brans and Mareschal, 1990]. It must be pointed out that the application of the PROMETHEE algorithm to the original data

<sup>33</sup>Geometric Analysis for Interactive Aid

from matrix  $D$  compared to the single criterion net flows  $\Phi_j(a)$  of  $M$  has little influence on the representation of the decision problem on the GAIA plane [Brans and Mareschal, 1990]. The projection of  $D$  onto the GAIA plane leads only to negligibly different results than the projection of  $M$ , if one refrains from considering some unimportant reflections and the rotation of the graph.

### 5.2.5.2 Interpretation of the GAIA Plane

The alternatives are plotted as points in the GAIA plane with the unit vectors of the original coordinate axes as straight lines emanating from the origin (henceforth called *criterion axes*) (cf. Figure 5.6). Since the alternative vectors are usually longer than one, the points of alternatives are projected relatively far away from the origin for a growing number of criteria, the criterion axes appear comparatively small and the interpretation is more difficult. Therefore, the alternative vectors are optionally normalised. In this case only the end points of the unit vectors of each alternative are projected and the alternatives move toward the origin. Since the relative positions remain unchanged the meaning is unaffected. The centre of the alternatives lies in the origin of the projection, meaning that an imaginary alternative with exactly average quality aspects regarding each criterion would be projected to the new origin [Belton and Stewart, 2002].

Alternatives projected close together in the  $\mathbb{R}^2$  show likely similar characteristics, and correspondingly, strongly different alternatives are likely to be projected far from each other. Alternatives which are plotted in the direction of one criterion axis show good performance regarding this criterion. Applied to the criterion axes this implies that their length is a measure of the influence of the respective criterion on the decision problem, i.e. the longer the unit vector of the projected criterion is on the plane, the more this criterion affects the differentiation between the alternatives. Furthermore, it can be stated that criteria whose criterion axes approximately point in the same direction are positively correlated, whereas negatively correlated criteria have opposite orientations in the plane. Orthogonal criterion axes, however, mean independence of the criteria with respect to their impact [Brans and Mareschal, 1994]).

Furthermore, the GAIA plane can be used to illustrate how representative the criteria selection is and to evaluate the independence of the criteria with respect to the considered alternatives. For example in Figure 5.6 criterion axes in all directions exist, whereas in Figure 5.7 no criterion axes in favour of the alternatives  $A_2$ ,  $A_7$ ,  $A_8$  exist. Since no aspects are considered supporting  $A_2$ ,  $A_7$ ,  $A_8$ , these alternatives will come off badly, even though they might be applied technologies in practice [see e.g. Treitz et al., 2005].

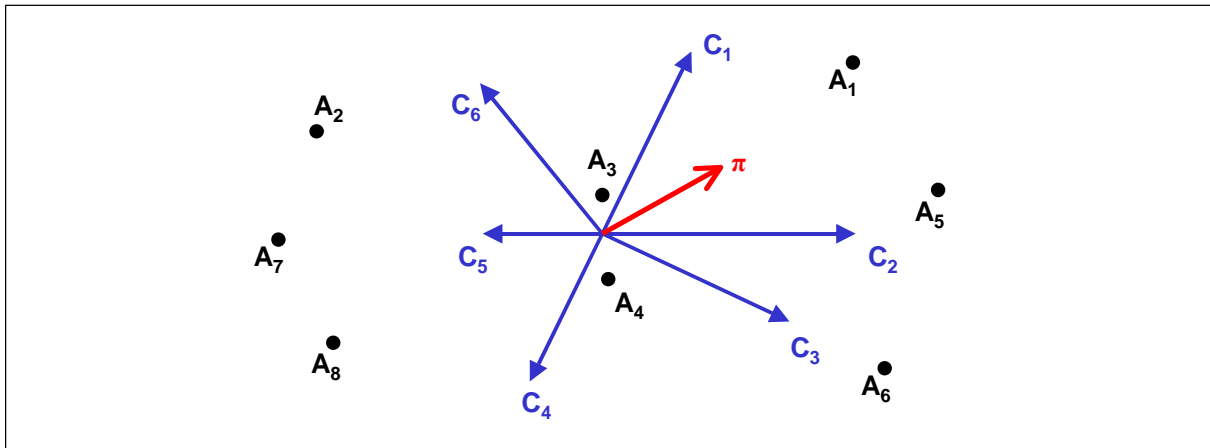

Figure 5.6: Alternatives and Criteria in the GAIA Plane [Brans and Mareschal, 2005]

Within this context it can be helpful to further consider two fictitious alternatives on the plane which facilitate the interpretation:

- *IDEAL* alternative, which achieves optimal performance regarding all criteria, as opposed to the
- *NADIR* alternative, which shows worst performance concerning each single criterion.

The worth of these two practically unattainable points lies in the fact that the decision maker can assess the quality of an alternative based on its relative position compared to the *IDEAL* and/or *NADIR*. Alternatives which are close to the *IDEAL*, have high  $\Phi$  flows and are preferred, while alternatives in the proximity of the *NADIR* do not correspond to the preferences of the decision maker.

### 5.2.5.3 Decision Axis $\pi$ in the GAIA Plane

Besides the projections of the alternatives and criterion axes the unit vector of the weighting vector  $\vec{w}$  can be projected as the *decision axis*  $\pi$  on the GAIA plane. As the name already suggests  $\pi$  is the substantial graphic decision instrument in the GAIA plane. The incorporation of the PROMETHEE preference functions into GAIA does not appear to add substantially to the geometrical representation of the alternatives, criteria and their interrelationships. The real value of GAIA lies in the idea of projecting a weighted sum of the normed flows as a direction vector in the plane in which the criteria and alternatives are plotted [Belton and Stewart, 2002].

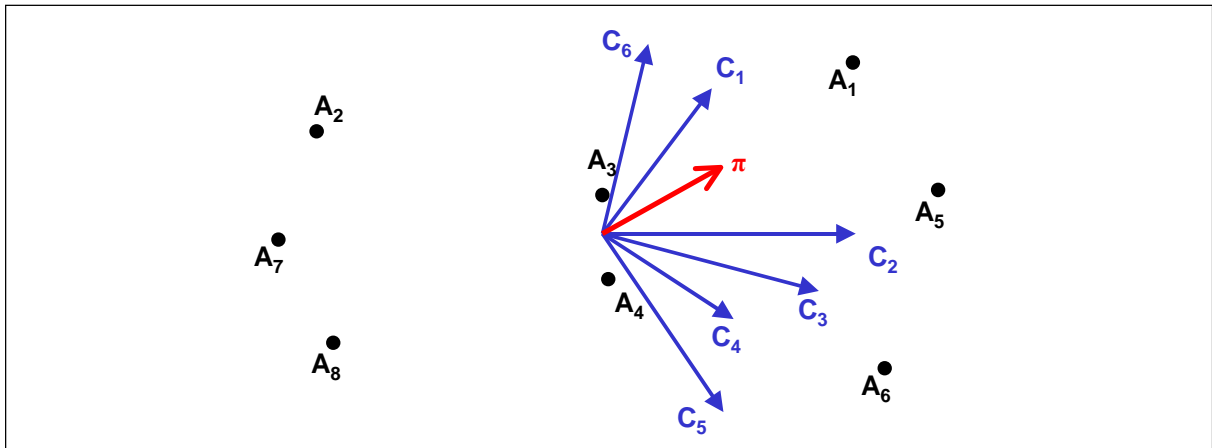

Figure 5.7: Alternatives and Criteria Selection in the GAIA Plane

$\Phi$  of an alternative can be determined by dropping a perpendicular on  $\vec{w}$ . Therefore, the ranking of the alternatives is determined by the order of the intersection points on the decision axis  $[-\pi, +\pi]$  (cf. Figure 5.8). The value of  $\Phi$  of an alternative is equal to the distance of the intersection point on  $\pi$  to the origin. Optimal performance of an alternative is equivalent to a maximal  $\Phi$  of one (worst performance of an alternative conversely is equivalent to a  $\Phi$  of -1), so that the intersection point of the projections of the IDEAL and/or NADIR on  $\pi$  lies at the two ends of  $[-\pi, +\pi]$ .

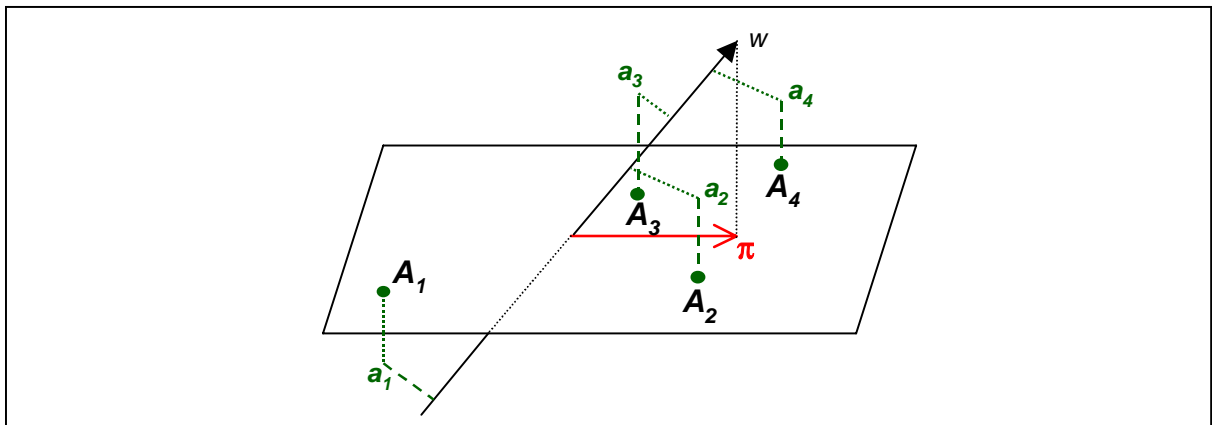

Figure 5.8: PROMETHEE II Ranking and PROMETHEE Decision Axis with Decision Stick  $\pi$  [Brans and Mareschal, 2005]

By changing the current weighting  $\vec{w}$  (for example using walking weights) the decision maker navigates  $\pi$  over the plane. Thereby the  $\Phi$  flows of the alternatives and the projec-



tions of the alternatives on  $\pi$  and possibly the ranking change. It must be stressed that the unit vector of  $\vec{w}$  by definition always has the same length, the length of its projection however changes. The position of  $\pi$  thereby determines the *decision power*: In case the unit vector of  $\vec{w}$  is relatively flat in relation to the plane and therefore  $\pi$  is relatively long, those alternatives which are on the plane far in the direction of  $\pi$  can be considered as optimal. However, if the unit vector of  $\vec{w}$  is almost orthogonal to the plane,  $\pi$  will be short. In this case the criteria probably have a strong contradictory interaction so that the determination of the preferential alternative represents a problem solvable only with difficulty.

However, projection on only two dimensions partly leads to interpretation problems: Although in general the alternatives that lie in the direction of  $\pi$  show high  $\Phi$  flows and thus are preferred by the decision maker, the relative positions of the alternatives to  $\pi$  do not necessarily match with their rank. With regard to the distance in particular, this means that far-off alternatives lying in the direction of  $\pi$  are not necessarily better than those that lie closer. The reason for this is that the perpendicular vectors of alternatives on  $\vec{w}$ , are not orthogonal on  $\pi$ . Thus, the perpendicular vectors of alternatives to  $\vec{w}$  can intersect on the projected plane. The loss of information here becomes obvious and especially for large  $k$  the plane does not represent the decision problem adequately. In order to be able to determine an unambiguous ranking of the alternatives, the projected perpendicular vectors of the alternatives are plotted into the plane.

#### 5.2.5.4 PROMETHEE VI Area $\Delta$ in the GAIA Plane

In practice multi-criteria problems are often characterised by the fact that an accurate weighting  $\vec{w}$  is difficult for the decision maker(s) [see Geldermann et al., 1998; Geldermann, 2006]. Due to the inherent degree of subjectivity contained within the weights it is often difficult for the decision maker to be precise about their values [Belton and Stewart, 1999]. Even though the PROMETHEE algorithm does not offer guidelines for the determination of the criterion weights  $w_j$ , the framework nevertheless allows the decision maker to define weighting intervals  $[w_j^-, w_j^+]$  instead of exact weighting factors  $w_j$ . The exact weighting is extended by intervals in the following way [Brans and Mareschal, 2005]:

$$0 \leq w_j^- \leq w_j \leq w_j^+ \leq 1, j = 1, \dots, k \quad (5.14)$$

Geometrically, this results in a body in the  $\mathbb{R}^n$  instead of one point (i.e. the head of the weighting vector  $\vec{w}$ ). This body is axis-parallel and its edges are limited by the weighting interval limits. By definition all components of each weighting vector  $\vec{w}$  must

always add up to one (cf. Equation 5.5), which defines a hyperplane in the  $\mathbb{R}^n$ . Again, expressed geometrically, this means that the axis-parallel body intersects with the defined hyperplane. This results in a convex polygon of the dimension  $\mathbb{R}^{n-1}$ , which contains all valid weight combinations within the given intervals representing the convex hull of all valid weighting vectors.

The calculation of this convex hull is a time-consuming problem for larger  $k$  because all intersection points of the axis-parallel body with the hyperplane must be determined. An edge of the axis-parallel body is given by  $k - 1$  interval limits and one variable component. In the calculation all possible combinations are formed whereby  $k - 1$  arbitrary elements of lower and upper interval limits are taken and one variable element, which is the remainder to one and thus not necessarily an interval limit. Each combination represents an edge of the axis-parallel body. From a geometric viewpoint, only those edges that run from a corner under the hyperplane to a corner above the hyperplane intersect with the hyperplane. All other edges run completely over (sum of the components is larger than one) or under (sum of the components is smaller than one) the hyperplane. Consequently, these edges must not be considered further. The number of all combinations that must be calculated in order to identify the number of valid combinations can become exceedingly high. Nevertheless, this appears to be the most appropriate method since other methods, such as ordering the weighting factors in advance, etc., seem to be more time-consuming in the end. Therefore, a simplified approximation of  $\Delta$  is implemented (considering all combinations of upper and lower weighting interval limits without the condition of a valid weighting vector but with normalisation of the weighting vector before projection) reducing the calculation time for large  $k$  significantly. Moreover, an evaluation of an reduced area  $\Delta$  considering only selected criteria (cf. Section 5.2.3) is possible.

The convex hull of all valid unit weighting vectors can be projected on the GAIA plane, too (cf. Figure 5.9). The generated convex polygon  $\Delta$  on the GAIA plane is called the *PROMETHEE VI Area* or even sometimes *Human Brain (HB)*, since it visualises the perceptions of the decision maker [Brans and Mareschal, 1995]. It surrounds  $\pi$  and marks the range in which  $\pi$  can move as long as it stays within the defined interval limits<sup>34</sup>.

---

<sup>34</sup>One known inadequacy concerns the representation of the PROMETHEE VI area  $\Delta$  on the GAIA plane.

In a first step all valid corner points of a convex polygon in the  $\mathbb{R}^{n-1}$  are calculated for the representation of the area. This polygon corresponds to the range within which the head of the decision stick moves in the  $k$ -dimensional space, if the criterion weights are changed only within the weight interval limits. Thus,  $\pi$  leaves the polygon only if at least one of its components lies outside of its limits. On the GAIA plane, however, it is not the decision stick but the projection of the unit vector of  $w$  that is displayed. By definition the unit vector has the length one. Accordingly, the polygon must be normalised for the projection so that the unit vector does not leave the new normalised polygon as long as all weights are within the preassigned weight intervals. Such a normalisation, however, is problematic since the

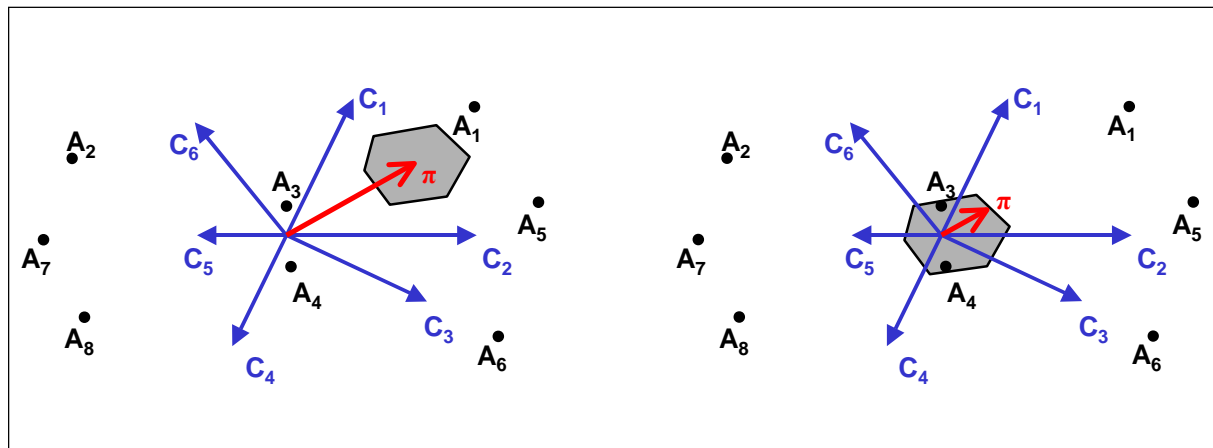

Figure 5.9: PROMETHEE VI Area  $\Delta$  for a Hard (left) and Soft (right) Decision Problem [Brans and Mareschal, 2005]

First conclusions can be drawn from the position of  $\Delta$  concerning the "difficulty" of the problem [Brans and Mareschal, 1995]:

- $\Delta$  does not include the origin of the GAIA coordinate system. Therefore, the area lies in the direction of the decision axis and in this case all valid weight combinations point approximately in the same direction. Thus, all alternatives lying in that direction are preferred and the problem can be solved relatively easy and represents a *soft problem* [Brans and Mareschal, 1995].
- $\Delta$  includes the origin of the GAIA plane. Thus the decision axis can point into each direction and preferential alternatives can lie in each direction. In this case a more precise weighting is necessary to identify a compromise solution. Consequently, it is more difficult to make a decision and therefore is called a *hard problem* [Brans and Mareschal, 1995].

---

unit vector moves concentrically around the origin. Consequently, the edges of the new normalised polygon must likewise be concentric. Due to the high complexity of such a calculation and the minor differences in comparison to the realised calculation, the modification was omitted. Consequently, only the corner points of the original polygon are normalised and projected on the GAIA plane. The edges of the normalised polygon thereby remain as straight lines and are not changed to concentric functions. Therefore, it can occur that  $\pi$  leaves  $\Delta$  even though all weights lie within the interval limits. In this case  $\Delta$  is calculated correctly, but only corner points are normalised and not the entire polygon. Possibly, the decision maker can additionally display the simplified and estimated PROMETHEE VI area, which shows better results in part than the accurately computed but insufficiently normalised area.

Nevertheless, it is questionable whether or not the PROMETHEE VI Area and the decision axis  $\pi$  provide an adequate method for decision makers to determine exactly if the variation of certain weights has an impact on the ranking of the alternatives. Consequently, it would be helpful if the stability intervals, i.e. the intervals corresponding to the simultaneous change of all criteria  $[w_j - \delta_j^-, w_j + \delta_j^+] \forall j = 1, \dots, k$ , would be projected onto the GAIA plane, too. By a comparison of the projected area of the defined weighting intervals with the projected area of the stability intervals the decision maker can assess the robustness of the ranking order. Furthermore, by allowing the assignment of general weight distributions and not "only" weight intervals to the attributes the concept of the PROMETHEE VI area could be extended and possibly allow a more accurate representation of the decision makers' preferences. However, difficulties exist concerning the practical realisation of this idea. While the convolution of the (potentially different) marginal distributions does not appear to be problematic from a theoretical point of view, an operationally applicable implementation, taking into account a constraint (i.e. the sum of the weights of all attributes is equal to one), has not been mentioned in literature up until this point [Bertsch et al., 2006].

### 5.2.5.5 Consideration of Data Uncertainties

The goal of the analysis techniques presented thus far was to evaluate the sensitivity of the output values with respect to the preferential input parameters. However, the uncertainty of the data has not yet been addressed sufficiently. All attribute values are deterministic values in the decision table  $D$  but can be characterised by an individual uncertainty. The uncertainty can be characterised by an uncertainty level as a percentage, such as 10% or 90% of the deterministic value. Instead of using deterministic attribute values for each alternative with respect to each attribute, a set of different attribute values is drawn for each alternative with respect to each attribute by MCS. Hence, when calculating the relative differences of the attribute values (also called relative *preference differences*), a set of different values is generated for each pairwise comparison instead of only one individual value.

Therefore, each alternative is not only represented by one point on the GAIA plane, but as a scatter plot. In this case attribute values are generated using a *MCS* approach with a normal distribution<sup>35</sup>. The standard deviation is assumed to be half of the uncertainty indicated like in the MCS approach for preferential uncertainties.

---

<sup>35</sup>Since no further information about the distribution of the attribute values is given a normal distribution is selected.

With this approach a *distinguishability analysis* [Basson and Petrie, 2004, 2007] can be carried out. It explores whether or not a meaningful evaluation of different alternatives is possible based on the considered criteria and considering all uncertainties in the data. The distinguishability of alternatives can be explored graphically using PCA plotted in the GAIA plane. Therefore, each alternative is not only represented by one point on the GAIA plane, but as a scatter plot (cf. Figure 5.10). Through the simulation of various parameter values for each attribute value not only one deterministic point is illustrated in the GAIA plane, but a point set reflecting the range of variation due to the underlying data uncertainty. Even though the PCA provides an adequate tool for the assessment of the distinguishability of alternatives it can only capture linear dependencies.

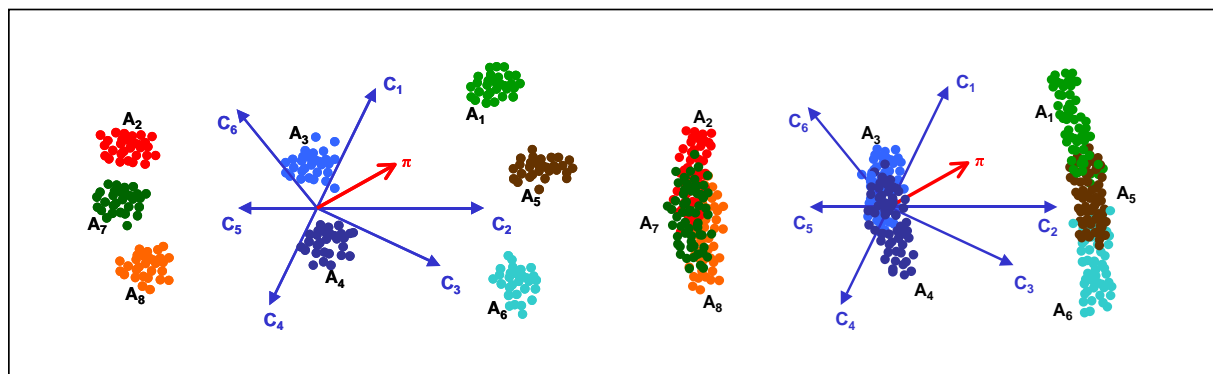

Figure 5.10: *Distinguishability Analysis (schematically)*

The distinguishability of the alternatives can be assessed depending on the extent to which the alternatives overlap on the plane. Furthermore, it is possible to identify the criteria responsible for the overlap, the range of overlap and to calculate a *distinguishability index (DI)* for decision support [Basson, 2004].

## 5.2.6 Summary of the Sensitivity Analyses in PROMETHEE

The presented approaches for sensitivity analyses allow an exploration of the impact of uncertainty in the process data as well as in the value judgements of the decision maker(s). The results of the different analyses lead to a deeper understanding of the decision problem itself. Consequently, the decision maker is able to evaluate the influence of the chosen preference parameters and to investigate the sensitivity in an uncertain data set. In particular, the extensive possibilities of analysing the effects of the preferential uncertainties are very important. By allowing the assignment of weighting intervals the

concept of *walking weights* and the PROMETHEE VI Area seem to provide a more adequate model of human preferences than sharply defined values.

Even though so it is quite discussed in decision theory to ascertain default values for preferential parameters, for example the "starting values" for the preference parameters  $p$ ,  $q$  and  $s$ , this step enables the use of extensive sensitivity analyses. In the same way, the possibility of exploring the impact of variable preference function types contributes to a facilitation of decision processes. Unfounded doubt that does not directly affect the results can be eliminated and attention can be focussed on the differences that do matter in terms of the results [French, 2003; Bertsch et al., 2006].

To summarise, it should be noted that complex decision situations usually require input from different disciplines and fields of expertise, which must be brought together in some form. The described approaches seek to enhance decision processes and consensus building. They can be applied in a straightforward way in any context where multi-criteria methods are used to support decision makers or their advisers in resolving complex decisions.

### 5.3 Example of the Application of PROMETHEE

The application of the outranking multi-criteria analysis approach PROMETHEE [Brans and Mareschal, 2005; Brans et al., 1986] is presented in this section for the case study 1 of bicycle coating (cf. Appendix A) [Schrader, 2005; Treitz, 2006]. Table 5.2 shows the decision table for the analysis summarising the findings of the different applications of the pinch analysis in Chapter 3.

Since no preferential information is available from the reference company the weighting of the environmental aspects is taken from a comparable analysis [Schollenberger and Treitz, 2005]. The exemplary weighting<sup>36</sup> reflects the included mass and energy flows of energy (30%), water (30%) and solvents (40%). The attribute regarding the solvent emissions is slightly more emphasised considering the impact of the coating to the different environmental media. However, the weighting vector must be subject to detailed sensitivity analysis to discuss the robustness of the results. The weighting reflects economic and environmental aspects each by 50%. As economic attributes the investment (20%) and the change in operating costs (30%) are included in the analysis.

---

<sup>36</sup>It is not the aim here to provide general weighting vectors, but to illustrate the impact of the weighting and the preferential parameters and how the impact on the result can be analysed by sensitivity analyses.

Table 5.2: Characterisation of the Different Process Design Options

	<b>Status Quo</b> ( $T_0$ )	<b>Waterborne Basecoats</b> ( $T_1$ )	<b>Thermal Incineration</b> ( $T_2$ )	<b>Condensation</b> ( $T_3$ )	<b>Powder Coating</b> ( $T_4$ )
Energy [kWh/h]	76	22	38	22	25
Water [m <sup>3</sup> /h]	2.56	0.46	0.32	0.32	0.28
Solvents [mgC/m <sup>3</sup> ]	297.70	171.23	2.98	233.00	0
Investment [€]	0	75 000	687 000	140 000	245 000
Operating Costs [€/a]	45 000	24 200	45 000	29 000	30 000

Furthermore, for all criteria the preference function type VI has been selected using half of the difference between the maximal and the minimal attribute value of each criterion as the inflection point  $s$  of the respective Gaussian function. Due to the significant difference of the status quo to the other process design options, the status quo is not considered for the determination of the preference parameters  $p$ ,  $q$  and  $s$ . All preferential parameters are stated in Table A.9 in the appendix and sensitivity analyses for the preference type and parameters are provided in the following.

In the next section the results of the analysis are presented applying standard available methods for PROMETHEE and in a subsequent steps the results of the new sensitivity analyses for the preference and data uncertainties for PROMETHEE are shown.

### 5.3.1 Results of the Analysis

On the basis of the decision table and the preferential parameters the switch to *Powder Coating* has the highest  $\Phi(a)$  flow compared to the other alternatives and is ranked first. Figure 5.11 shows the aggregated outranking flows of the positive outranking flow  $\Phi^+(a)$  (the strength of an alternative), the negative outranking flow  $\Phi^-(a)$  (the weakness of

an alternative, here illustrated as  $-\Phi^-(a)$  ) and the net outranking flow  $\Phi(a)$  (overall rating). The small  $\Phi^-$  for the alternative *Powder Coating* indicates, that it has a strong performance on most criteria, whereas the small  $\Phi^+$  of the *Status Quo* is a sign that this alternative is weak in most attribute values.

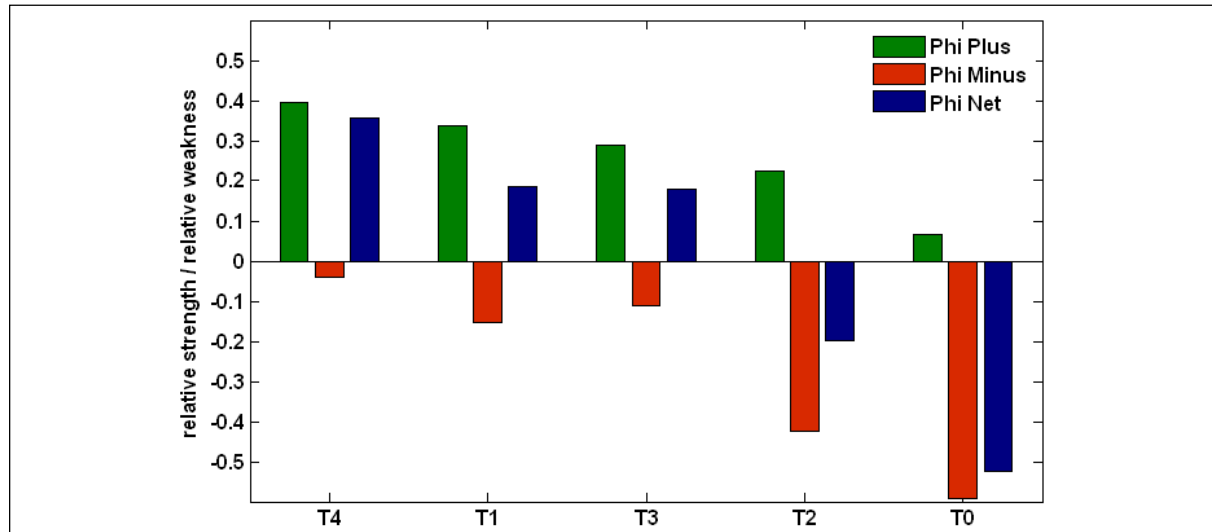

Figure 5.11: Positive Outranking Flow  $\Phi^+(a)$ , Negative Outranking Flow  $\Phi^-(a)$  and Net Outranking Flow  $\Phi(a)$  of the Process Design Options

This result is confirmed by the spider diagram of the single criterion net flows  $\Phi_j(a)$  of each criterion (cf. Figure 5.12) which shows that the *Status Quo* is outranked with respect to most criteria and only for the *Investment* criterion outranks the other alternatives. Hence, also a reasonable change of the weights of the different criteria will show the *Status Quo* as the worst alternative, which only ranks first by a weighting of *Investment* of over 92%. However, as the spider diagram shows, the decision is influenced by conflicting criteria and depending on the preference parameters and the weighting, one or the other alternative is ranked first.

All criteria contribute to the differentiation between the considered process design options as the unweighted single criterion net flows in the spider diagram illustrate. The option *Thermal Incineration* is dominated by the option *Powder Coating* since it is outranked in each single criterion. Thus, the line of the alternative *Thermal Incineration* is always inside the polygon of the option *Powder Coating*. From a theoretical point of view the alternative *Thermal Incineration* would not need to be considered further. However, the option is considered in the following since it is an effective technique for the emission reduction of solvents in the waste gas. If a switch in techniques to powder instead of liquid



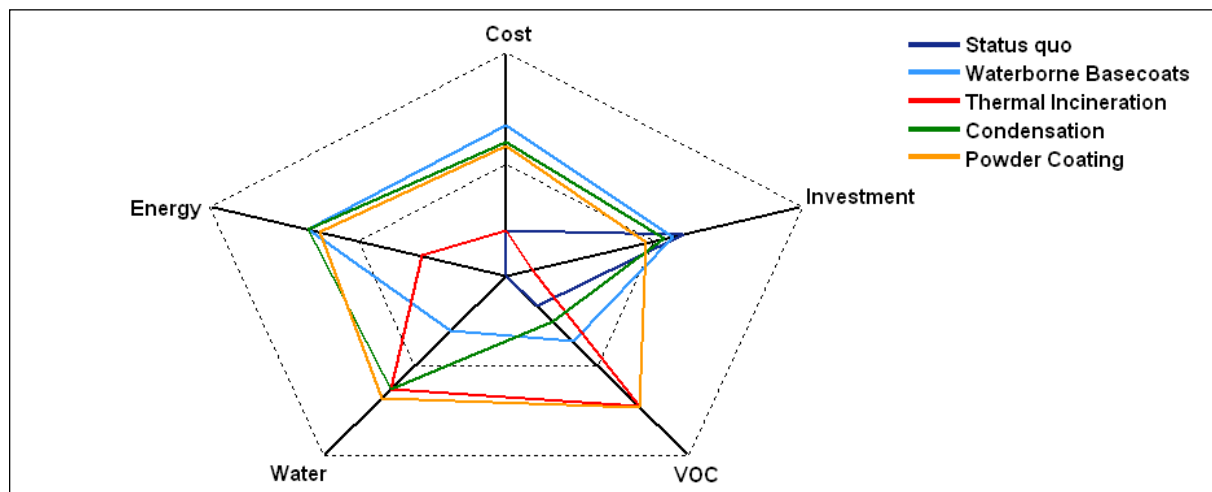

Figure 5.12: Spider Diagram of the Different Process Design Options

coatings is not favoured, the option of thermal incineration achieves the best emission reduction.

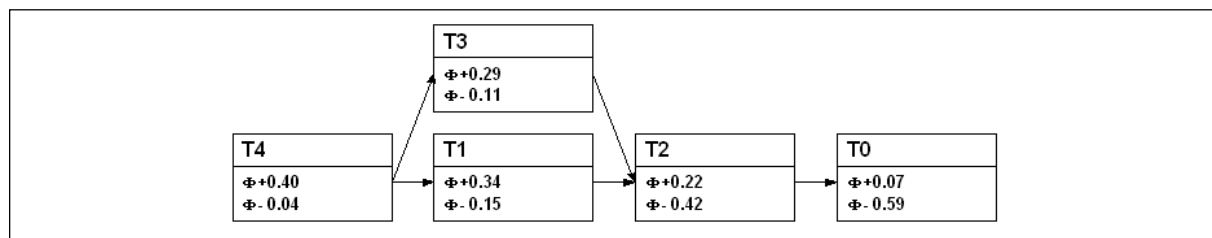

Figure 5.13: PROMETHEE I Ranking of the Process Design Options

Even though it is possible to differentiate between the alternatives in an overall assessment there exist incomparabilities as the PROMETHEE I ranking shows (cf. Figure 5.13). The switch to a powder coating based process is the preferred alternative. The outstanding performance results first from the significant reduction in water consumption since no water curtains are used and second from the elimination of solvent emissions due to the solvent-free coating. However, the alternative *Waterborne Basecoats* and *Condensation* have incomparabilities since a switch to waterborne basecoats provides more advantages, illustrated in the higher positive outranking flow ( $\Phi_{T_1}^+ = 0.34$  compared to  $\Phi_{T_3}^+ = 0.29$ ), but also faces more disadvantages, illustrated in the higher negative flow ( $\Phi_{T_1}^- = 0.15$  compared to  $\Phi_{T_3}^- = 0.11$ ).

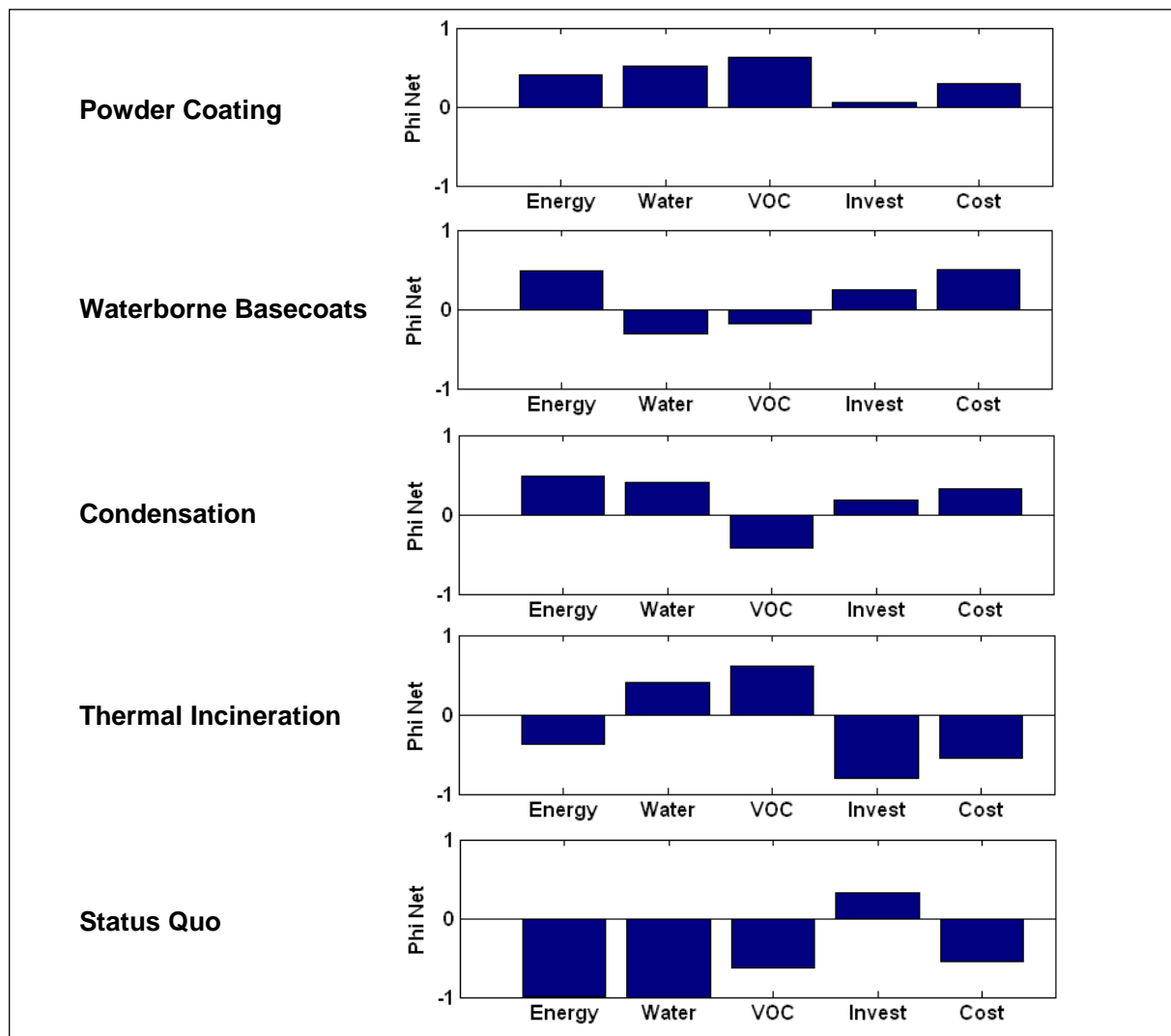

Figure 5.14: Profiles of all Process Design Options

The comparison of the profiles of the alternatives *Waterborne Basecoats* and *Condensation* reveals significant differences in the strengths and weaknesses of the alternatives (cf. Figure 5.14). The bar chart shows the quality of each process design option for each criterion  $j$  by the single criterion net flow  $\Phi_j(a)$ . Whereas the waterborne basecoats are superior in the emission reduction of solvents in the waste gas and slightly better in the initial investment (due to the smaller investment in equipment such as spray guns compared to a condensation facility), the condensation option is superior with respect to the fresh water consumption since the waterborne basecoats require additional pre-treatment steps resulting in higher water demand.

The option of a thermal incinerator has its strength in the effective reduction of solvent emissions from the gaseous waste stream. However, due to the high investment this option is outranked by the other alternatives and ranks even behind the switch to waterborne basecoats or a condensation system, which is illustrated in the PROMETHEE I and II ranking (cf. Figures 5.13 and 5.15).

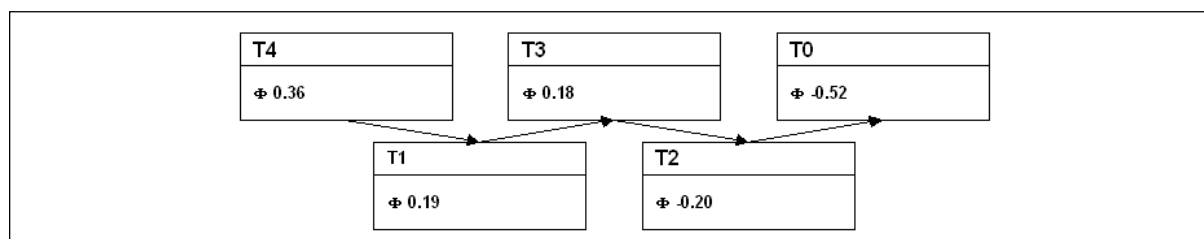

Figure 5.15: PROMETHEE I Ranking of the Process Design Options

Based on the PROMETHEE II ranking the analysis suggests a switch to powder coatings as first option before a switch to waterborne basecoats ( $T_1$ ) and the installation of a condensation system ( $T_3$ ). Nevertheless, the difference between the options  $T_1$  and  $T_3$  is very narrow. This is underlined by the fact that there exist incomparabilities between  $T_1$  and  $T_3$  in the partial PROMETHEE I ranking.

### 5.3.2 Principal Component Analysis of the Decision Problem

The *Principal Component Analysis (PCA)* is used for sensitivity analysis. By projecting the alternatives from the  $\mathbb{R}^k$  of  $k$  different criteria onto the plane of the first two principal components the so-called GAIA plane for PROMETHEE can be spanned and the decision problem can be visualised as described in Section 5.2.5 on page 166. The purpose of applying a factor-analytic technique is to aggregate the attribute information to present them in an adequate way.

In Figure 5.16 the plane of the 1<sup>st</sup> and 2<sup>nd</sup> principal component is displayed for all criteria using the preference type VI and the preference parameter  $s$  as half the difference of the maximal and minimal attribute values excluding the status quo. Apart from the alternatives and the criteria axes, the unit vector of the weighting vector can be projected on the GAIA plane as the PROMETHEE decision stick  $\pi$ .

The different criteria are shown as axes in the new coordinate system of the first two principal components. Only one half of the plane is covered by the criteria axes. Con-

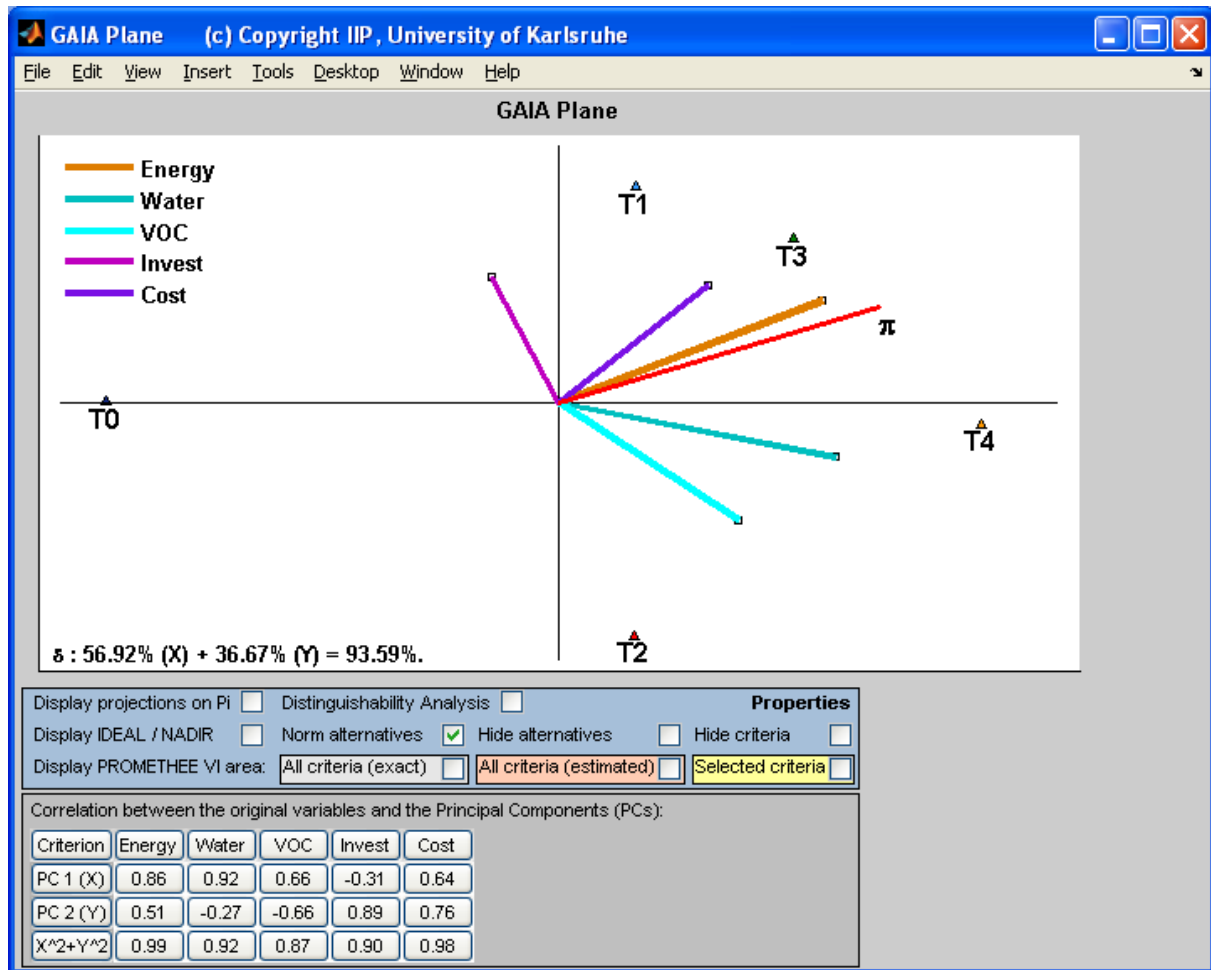

Figure 5.16: Principal Component Analysis of the Decision Problem

sequently, the question must be addressed if the chosen criteria adequately reflect the decision problem. Especially, criteria in favour of the status quo are not considered, such as for example availability of the new coating material, additional maintenance of the new installations, or required training for the new installation. Since the question of resource efficiency is the focus of the analysis, it is assumed that all different coatings and installations fulfil technical requirements and security issues since no specific data was available to model these criteria.

Roughly 93% of the total information is illustrated in the diagram (cf. Figure 5.16). The correlation between the criteria and the first two principal components is shown in the table at the bottom of Figure 5.16. It shows that the criteria *Energy*, *Water* and *VOC* are mainly represented by the first principal component and *Investment* and *Costs* mainly by the second one. Consequently, the GAIA plot can enhance the comprehension

of the given problem, but the loss of information must be considered since two distinct points in the  $\mathbb{R}^k$  of  $k$  different criteria might be projected on the same point in the plane. Consequently, the projections on the decision stick can intersect, too. For this case study no intersections can be observed (cf. Figure 5.17).

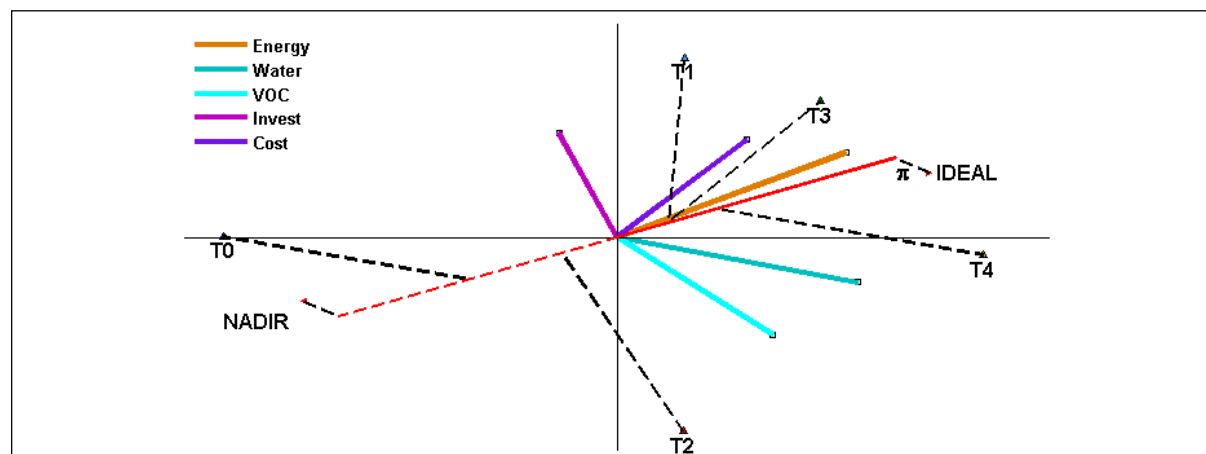

Figure 5.17: Projections on the Decision Stick  $\pi$

The projections of the alternatives intersect with the decision stick  $\pi$  at the  $\Phi$  net value of the alternative where the head of  $\pi$  is 1 (the projection of an alternative which has the best performance in all criteria, the so called IDEAL), the origin 0 and the head of the diagonally arranged line to  $\pi$  corresponds to -1 (the projection of the alternative which has the worst performance in all criteria, the so called NADIR) (cf. Figure 5.17).

The ranking of the alternatives can be seen at the order of intersections of the projections with  $\pi$ . Since the switch to waterborne basecoats ( $T_1$ ) and the installation of a condensation system ( $T_3$ ) show almost equal performance with respect to  $\Phi$ , they intersect with  $\pi$  at almost the same position.

### 5.3.3 Sensitivity Analysis with Respect to Data Uncertainty

In Table 5.2 all attribute values are deterministic values but can be characterised by an uncertainty level as a percentage, such as 10 % of the deterministic value. Instead of using deterministic attribute values for each alternative with respect to each attribute, a set of different attribute values is drawn for each alternative with respect to each attribute by Monte Carlo Simulation. Thus, when calculating the relative differences of the attribute values (also called relative *preference differences*), a set of different values is generated for

each pairwise comparison instead of only one individual value. Therefore, each alternative is not only represented by one point on the GAIA plane, but as a scatter plot. In this case attribute values are generated using a normal distribution and by assuming an uncertainty level and a normal distribution with 1000 samples<sup>37</sup>. The uncertainty level can cover a more stringent range, for example  $\pm 5\%$  -  $\pm 10\%$  for more accurate data and a broader range for criteria which are more difficult to quantify such as for example  $\pm 10\%$  -  $\pm 50\%$ .

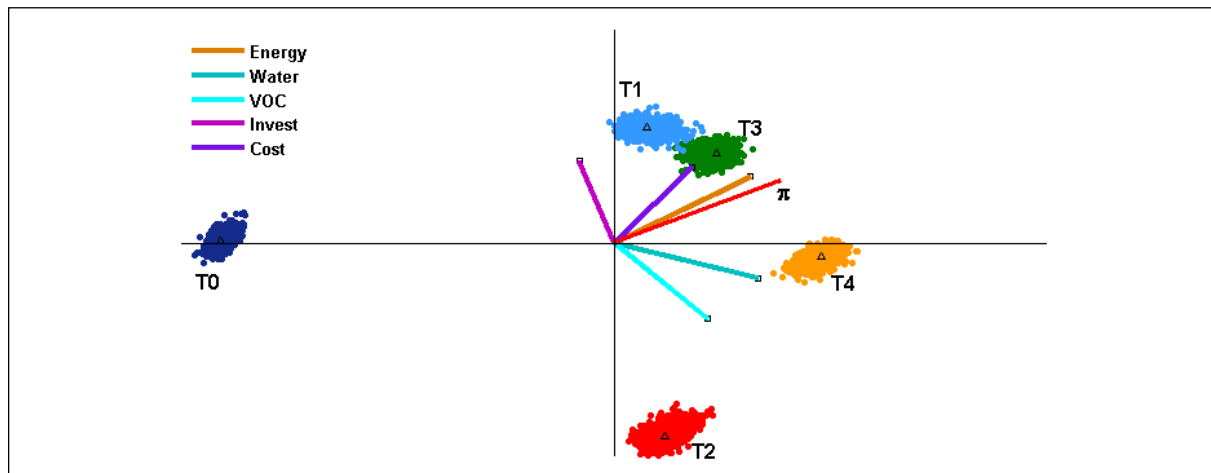

Figure 5.18: Distinguishability Analysis with an Uncertainty Level of  $\pm 10\%$

With an uncertainty level of  $\pm 10\%$  the different process design options can clearly be distinguished from each other, as Figure 5.18 illustrates. Even the options *Waterborne Basecoats* and *Condensation*, which are incomparable considering the preferences, can be distinguished since the areas of projections do not overlap.

In the first distinguishability analysis an uncertainty level of  $\pm 10\%$  is assumed for all attribute values of the alternatives, but in a second analysis  $\pm 50\%$  is taken into account to investigate the sensitivity of the attribute values. Figure 5.19 shows the data distribution for an uncertainty level of 10% and 50% of the attribute value *Investment* for the alternative *Waterborne Basecoats*.

As Figure 5.20 shows the different process design options can still be distinguished from each other by an uncertainty level of  $\pm 50\%$ . Only the options *Waterborne Basecoats* and *Condensation* do now overlap considerably. Since no design variants are considered in the analysis, such as for example different condensation systems or different thermal incinera-

<sup>37</sup>For a graphical analysis such as the distinguishability analysis a Monte Carlo Simulation with 1000 samples is in general considered to be sufficiently large.

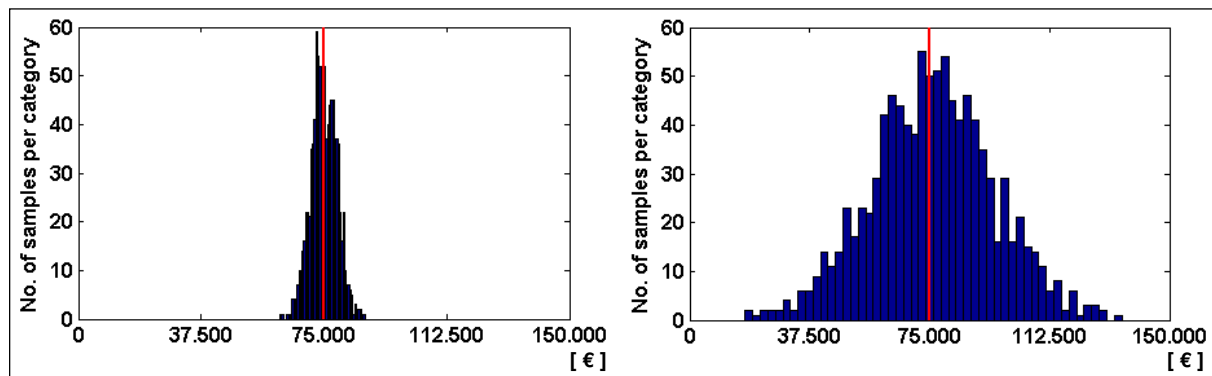

Figure 5.19: Data Distribution of Attribute Value Investment for Alternative Waterborne Coatings with Uncertainty Level of 10 % (left) and 50 % (right)

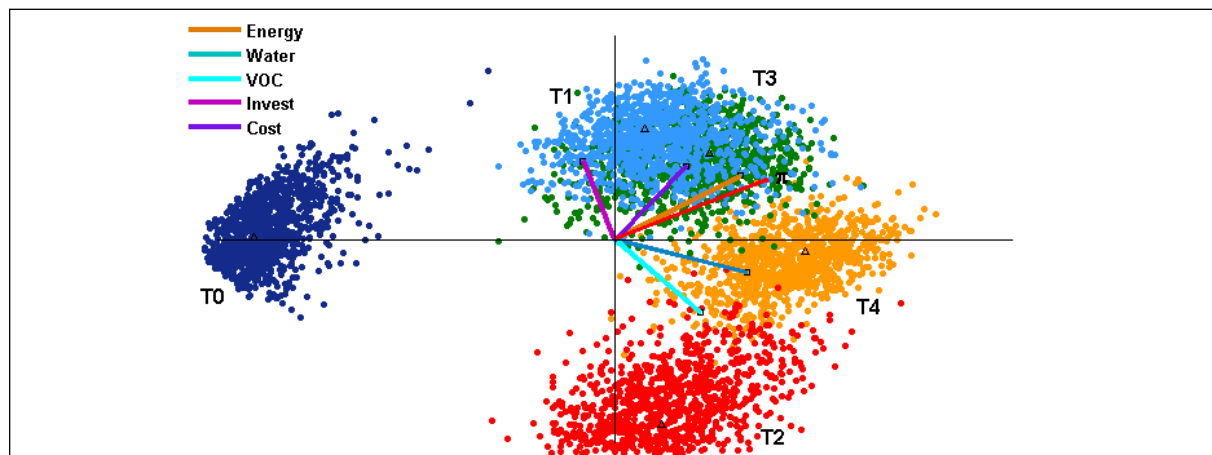

Figure 5.20: Distinguishability Analysis with an Uncertainty Level of  $\pm 50\%$

tors, the various design concepts can be distinguished by their characteristic performance and the different strengths and weaknesses.

### 5.3.4 Evaluation of Inter-Criteria Preferences

Sensitivity analyses are useful to analyse not only the uncertainty in the underlying data, but also in the modelling of the decision makers' preferences. Therefore, special sensitivity analyses for preferential uncertainties within the outranking approach PROMETHEE are applied to analyse the impact of the preference parameters to the overall result. Various sensitivity analyses (cf. Table 5.1 on page 159) can be used to facilitate modelling and

transparent depiction of the decision problem within PROMETHEE. On the one hand the robustness of a decision can be investigated by changing the weighting of one criterion from zero to 100%. On the other hand the robustness of the parameters  $q$ ,  $p$ , and  $s$  of the preference function in PROMETHEE can be investigated by carrying out a Monte Carlo Simulation using specific uncertainty levels (e.g.  $\pm 10\%$  or even  $\pm 100\%$ ) or by evaluating all possible preference type combinations.

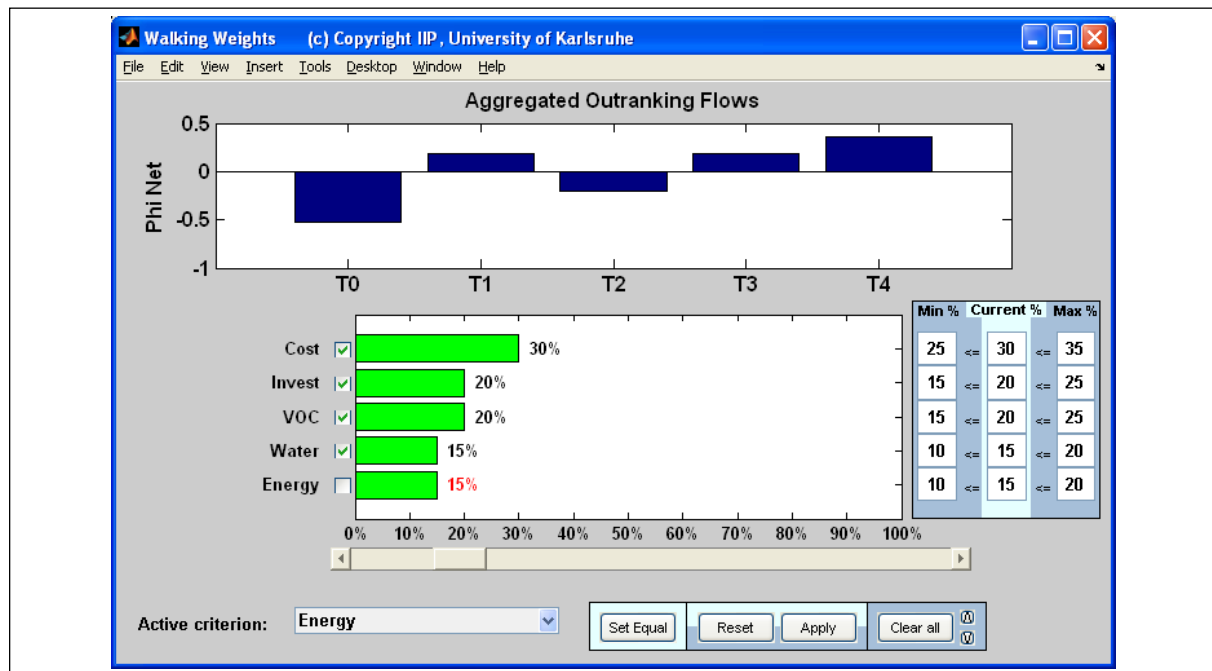

Figure 5.21: Sensitivity Analysis by Walking Weights

Enabled by an interactive decision support methodology it is useful for the decision maker to change the weighting of a selected criterion by a scroll bar and modify the current weighting (i.e. walking weights cf. Figure 5.21). On the one hand by increasing the weight of the considered criterion the required weighting factor can be obtained either from all other criteria or only from selected criteria. This depends on the selection of the decision maker using the check-box right next to each criterion (cf. Figure 5.21). On the other hand by reducing the weight of the considered criterion the spare weight can be reallocated either to all other criteria or only to selected criteria. Not only the weights of each criterion are shown in a bar chart, but simultaneously, the  $\Phi$  net flows of the considered alternatives are shown in a bar chart and the height of each bar (i.e.  $\Phi$ ) changes with the weighting.



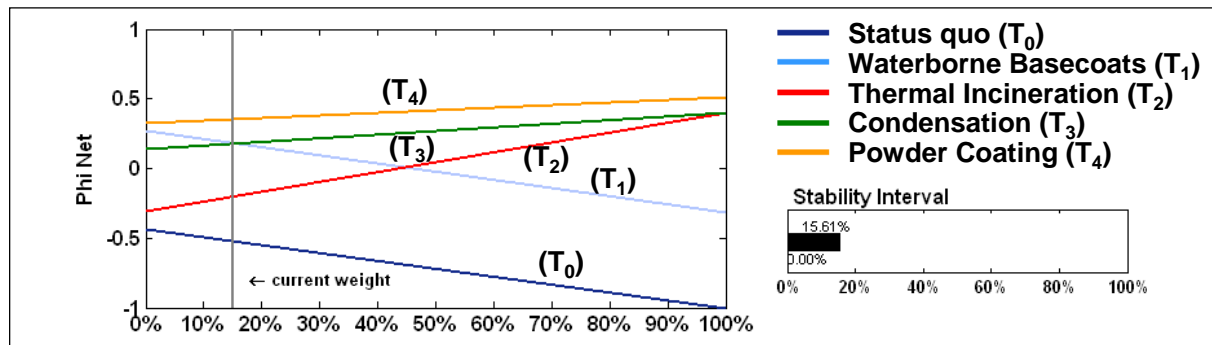

Figure 5.22: Sensitivity Analysis of the Weight for Criterion Water

Figure 5.22 shows the sensitivity analysis for the weight of the criterion *Water*. Each line represents one alternative and the gradient of the lines shows the influence of the selected criterion on the performance of the alternatives. The current weighting is 15% and the stability interval around this weighting reaches from 0% to 15.6%. Thus, the ranking changes directly if the weighting of the water criterion is changed. Even though the powder coating option is the best alternative for any weighting factor of *Water*, right above the upper limit of the stability interval the waterborne basecoats option changes positions with the condensation option. By an weighting of more than 44.6% the thermal incineration becomes third and even better than the change to waterborne basecoats.

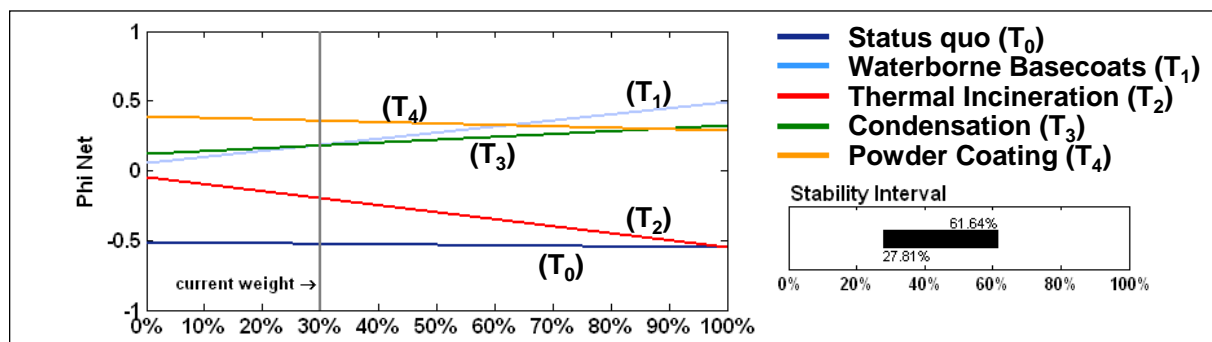

Figure 5.23: Sensitivity Analysis of the Weight for Attribute Costs

The stability interval in case of the sensitivity analysis for the criterion *Costs* is [27.8%, 61.6%], but the option *Powder Coating* is the best alternative from 0% - 61.6%. Above the stability interval the waterborne basecoats are the preferred alternative due to their lower operating cost.

The stability interval for the criterion *Energy* is [0 %, 72.1 %] and for the criterion *Solvents* covers the range of [18.2 %, 41.3 %]. However, the option *Powder Coating* is the best alternative within [3.8 %, 100 %] and only below 3.8 % the option *Condensation* would be the best alternative. Concerning the attribute *Investment* the stability interval around the current weighting is [13.2 %, 37.8 %].

By defining upper and lower bounds for each weight (cf. Figure 5.21) the convex hull of all valid weighting combinations can be projected on the GAIA plane, visualising the range of  $\pi$ , i.e. the PROMETHEE VI area  $\Delta$  visualises the area to which  $\pi$  is restricted if it stays inside the defined boundaries with an assumed absolute variation, in this case of  $\pm 5\%$ , in the weighting of each criterion simultaneously (cf. Section 5.2.5.4). The PROMETHEE VI area and the decision stick  $\pi$  illustrate the influence of different weights in the GAIA plane, since they are not taken into account in the projections of the criteria and alternatives.

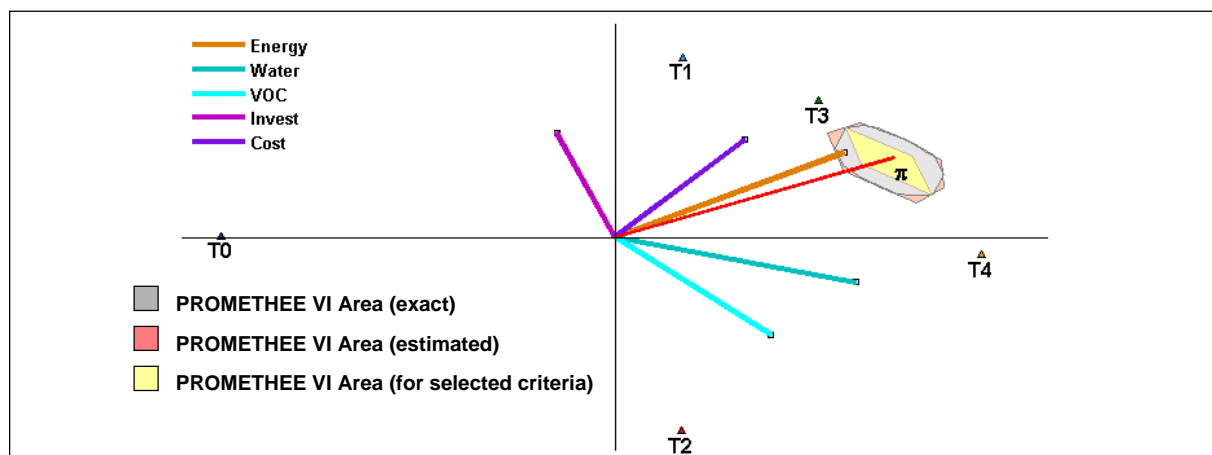

Figure 5.24: PROMETHEE VI Area

As Figure 5.24 illustrates a "soft problem" must be solved (cf. Section 5.2.5.4), since the origin is not part of  $\Delta$  and therefore good alternatives lie in the general direction of the decision stick. It is assumed, that in case of a soft problem a compromise is easier to find than in a "hard problem", where the origin belongs to  $\Delta$  and basically all alternatives may possibly be selected. In addition to the exact calculation (grey area) also an estimated PROMETHEE VI area is shown (for a detailed description of the different areas refer to

Section 5.2.5.4 on page 171). However, considering the small number of criteria, the areas do not differ considerably and the calculation time is not a problem<sup>38</sup>.

### 5.3.5 Evaluation of Intra-Criteria Preferences

Considering the difficulties in modelling value judgements it is especially important to carry out sensitivity analyses for the preference parameter and type of the preference function in PROMETHEE besides the weighting parameters. The sensitivity analysis is performed for the preference parameters by a Monte Carlo Simulation and for the preference type by an enumeration of all possible preference type combinations.

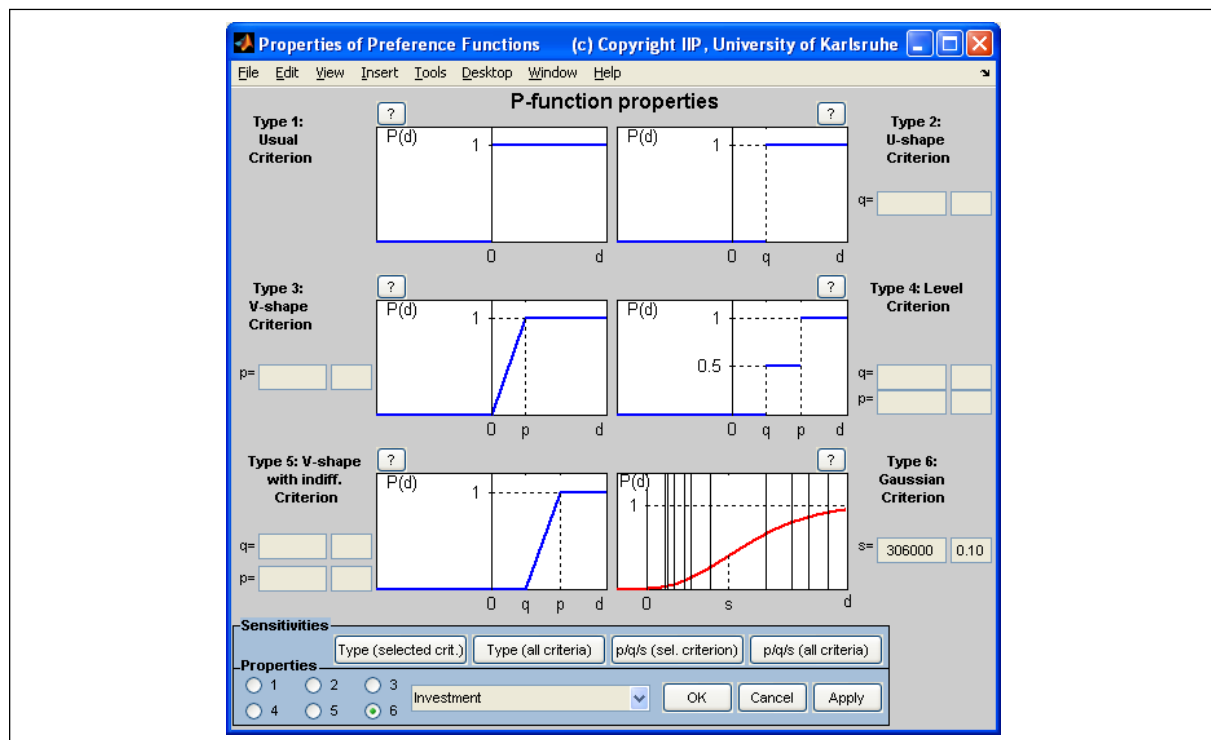

Figure 5.25: Preference Function Definition of Criterion Investment

For each criterion it is possible to define a preference function by selecting a preference type and defining the appropriate parameters (cf. Figure 5.25). The preference function is based on the differences in attribute values stemming from the pairwise comparisons. Figure 5.25 shows the selection of preference type VI for the criterion *Investment* with

<sup>38</sup>If more than ten criteria are used, the calculation time slows down considerably. However, it is possible to calculate  $\Delta$  for an example of the iron and steel industry provided in [Geldermann, 1999] with 21 criteria and 9 alternatives.

an inflection point at 306 000 € and an uncertainty level of 10 %. The Gaussian function illustrates the slope of the preference function and the vertical lines illustrate the existing differences between the attribute values. Thus, it is possible to visually identify the relevant range for the selection of preference parameters.

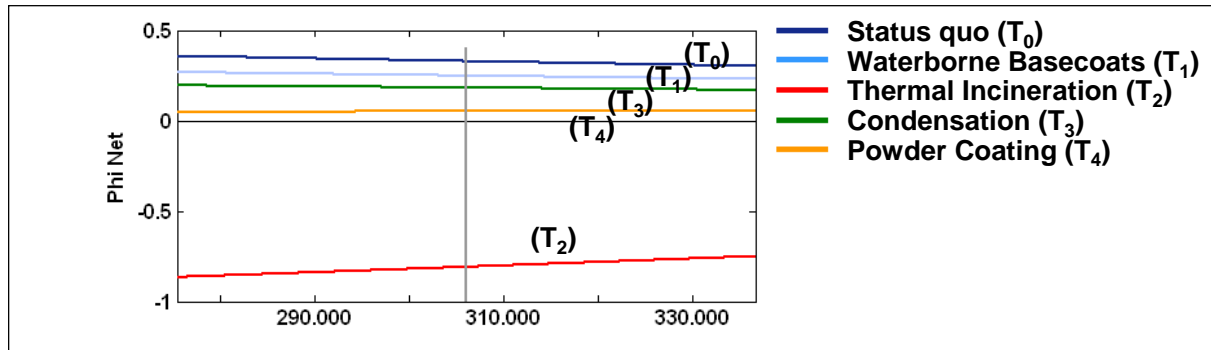

Figure 5.26: Sensitivity Analysis of the Preference Parameter of Criterion Investment

Figure 5.26 shows the sensitivity analysis for the parameter  $s$  around the proposed inflection point at 306 000 € for the single criterion net flow  $\Phi_j(a)$ . The Monte Carlo Simulation for the preference parameter is based on a uniform distribution and an uncertainty level of 10 % with 306 000 € as the mean of the distribution, which is half of the difference between the maximal attribute value (687 000 €) and the minimal attribute value (75 000 €) of the different available design options excluding the status quo.

By varying the inflection point the magnitude of the differentiation between the different investments is modelled. A higher value for  $s$  results in more indifference between the different investments whereas a smaller value for  $s$  means a higher focus on the differences in the investments and smaller difference results already in more distinct preference values. The *Status Quo* ranks first for any value of  $s$  since no investment is considered in this case and *Thermal Incineration* is outranked by all other alternatives since it requires the highest investment.

However, the overall contribution does not significantly change by varying  $s$ . Nevertheless, the analysis also shows that by for example increasing the uncertainty level of  $s$  for all criteria to 100 % there is a significant effect on the overall results (cf. Figure 5.27).

In case of an uncertainty level of 10 % there exist no overlaps between the process design option *Powder Coating* and the second and third ranked options *Waterborne Coatings* and *Condensation*. By increasing the uncertainty level to 100 % shifts exist in the overall ranking of the alternatives nevertheless the alternative *Powder Coating* is still considered

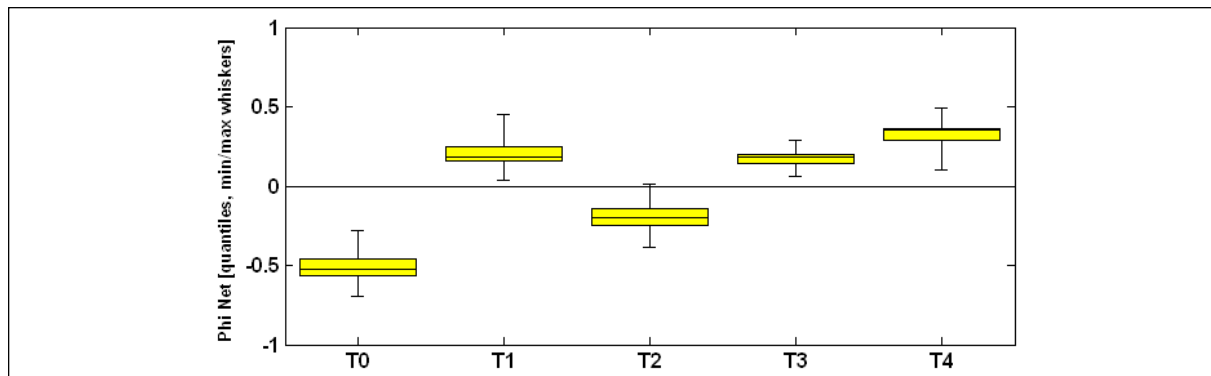

Figure 5.27: Sensitivity Analysis of all Preference Parameter of all Criteria

the best alternative in 87% of the cases. The boxplot in Figure 5.27 shows  $\Phi(a)$  of all alternatives according to the deterministic value for each alternative as the middle line within the box, and the lower and upper quartiles (25<sup>th</sup> and 75<sup>th</sup> percentiles) of the normal distributed values over the defined uncertainty interval as the edges of the boxes. The whiskers visualise the maximal and minimal  $\Phi(a)$  net for each alternative within the uncertainty interval.

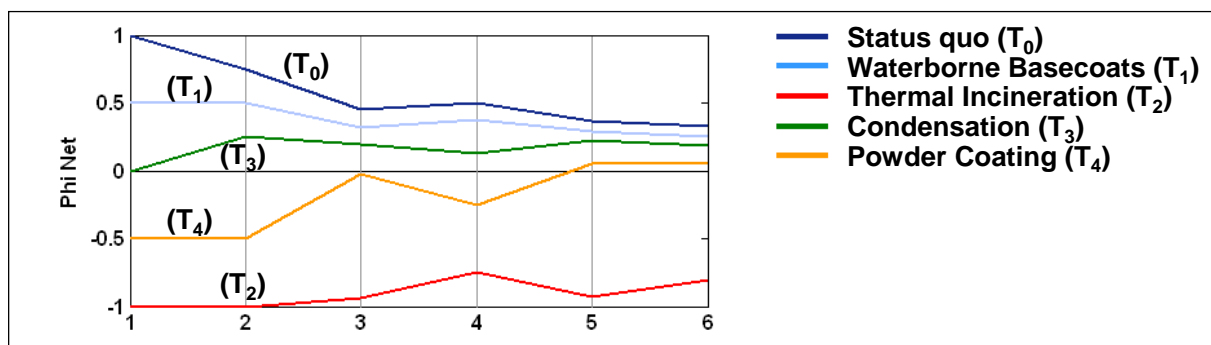

Figure 5.28: Sensitivity Analysis of Preference Function Types of Criterion Investment

Figure 5.28 shows the impact of the selection of a specific preference type for the criterion *Investment*. Since the ranking is based on the absolute differences in attribute values between the alternatives, the ranking of the alternatives does not change by changing the preference type. However, the magnitude of the preference of one alternative compared to another changes as the single criterion net flows  $\Phi_j(a)$  illustrate.

Further calculations show that in the case of the permutation of all preference types (I - VI) for all 5 criteria, the alternative *Powder Coating* is only the best alternative in 52%

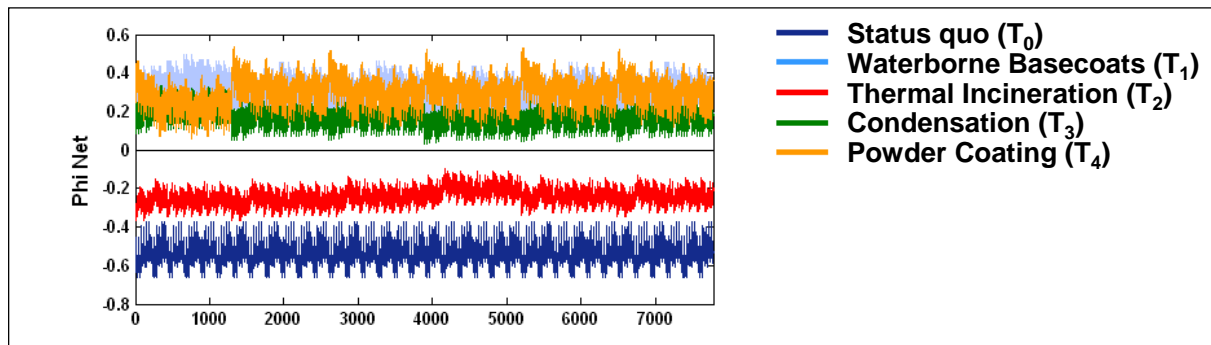

Figure 5.29: Sensitivity Analysis of all Preference Function Types of all Criteria

of all  $6^5 = 7776$  possible combinations of preference type functions (cf. Figure 5.29). In 48 % the option *Waterborne Basecoats* is ranked first. In this case the weights and the preference parameters are fixed and only the effect on the overall result is analysed by changing the type of preference function for each criterion. Herewith, the low robustness of the decision is demonstrated and emphasises the need of a high transparency of the decision problem to be able to interpret the obtained results in the best possible way. To summarise, the analyses reveal that no clear preference for one alternative is obvious, since the option *Powder Coating* shows the best performance of most criteria, but both the option *Waterborne Basecoats* and *Condensation* of solvents show comparable performances depending on the preference modelling.

### 5.3.6 Recommendations based on the Analysis

This section shows the application of the multi-criteria approach PROMETHEE to the evaluation of process design options for the process of industrial bicycle coating. Four process design modifications ( $T_1$ : the switch to waterborne basecoats,  $T_2$ : the installation of a thermal incineration system,  $T_3$ : application of a condensation system, and  $T_4$ : the switch to powder coatings) are discussed and compared to the status quo. The analysis revealed that the result depends highly on the modelling of the preferential parameters. For the assumed preferential parameters the analysis suggests a switch to powder coatings and thereby provides the same result as the metric presented before.

Since powder coatings are solvent-free and particularly suitable for metal parts, such as bicycles, due to the electrostatic application and do not require water curtains to absorb the coating particles in the cabins and provide a low waste generation by using the possible recycling of the coating particles, various technical, economic and environmental aspects

give reasons to favour a switch to powder coatings. Especially, the improvement of the application efficiency by using a standard industrial robot and the reduced overall energy demand favour the option  $T_4$  compared to the other alternatives. In the case study only the heat integration of the waste gas of the drying ovens of the powder coating system is considered resulting in a higher energy demand as the status quo because of the higher drying temperatures. However, a reduction of operating costs is considered due to a changeover from conventional three layer coating processes to a two layer powder coating installation.

The general disadvantage of powder coatings however is the limited control of the layer thickness [Ondratschek, 2002]. However, by changing from a three to a two layer coating higher film thickness is taken into account and future developments will decrease this limitation. Thus, the switch to powder coatings is a change in techniques and leaving the company well prepared for future challenges.

The switch to waterborne basecoats is the simplest way to achieve a reduction in the solvent emissions. For example, the implementation of solvent emission reduction measure, such as for example the switch to waterborne basecoats results in an exemption of the emission threshold limits with respect to the European Solvents Directive [EC 99/13]. Even though the reduction is only based on a switch in the basecoat application, since no waterborne clearcoats are currently available for this application, the measure is quite effective considering the small required investment. The option of a condensation system turned out to be incomparable to the switch to waterborne basecoats. The installation of a condensation system would be considered as a secondary measure with respect to the European Solvents Directive [EC 99/13] and in this case an emission threshold of  $150 \text{ mgC/m}^3$  must be complied with. However, in the case study an overall emission limit by installation of a condensation system of  $233 \text{ mgC/m}^3$  was determined. As shown in the economic evaluation of the condensation system the operating costs highly depend on the value of the recovered solvents. If the recovered solvents can be used directly in the same process by a closed loop recycling the condensation is a noteworthy option for the waste gas cleaning of industrial bicycle coating. Since the concentration of the solvents in the waste gas determines the investment in heat exchanger a concentration unit by a zeolite wheel is suggested leading to a higher concentration of the solvents in a reduced air flow. However, if the solvents cannot be reused the operating costs of a condensation system does not justify the achieved solvent emission reduction.

The option of a thermal incineration turned out to be too expensive as a waste gas cleaning technique. Even if only the waste gas of the drying ovens is considered and a considerably lower gaseous waste stream must be treated, this results in an investment

of 201 000 € compared to 687 000 € for the installation of an incinerator for the total waste air. However, the overall emission reduction efficiency is considerably lower<sup>39</sup> and the option of thermal incineration only for the waste gas of the drying ovens (referred to as option  $T_5$ ) is incomparable to the thermal incineration of the total waste gas stream, but still outranked by the option *Waterborne Basecoats and Condensation*<sup>40</sup>.

The application of several sensitivity analyses for the underlying data and value judgement uncertainty proves that the results highly depend on the modelling of the preferential parameters and consequently a transparent modelling of the decision problem furthers the communication of preferential information and a compromise solution. The data uncertainty has only a limited effect on the distinguishability since the different concepts can well be differentiated. Even though the weighting, i.e. inter-criteria preferences, of the different criteria has a considerable impact on the overall results the influence of the intra-criteria preferences, such as the preference type and the parameter of the preference function, may be more relevant in this case than the impact of the uncertainty of the weighting factors. By applying the simulation techniques an evaluation of the robustness of the decision is enabled and an adjustment of the model is possible.

## 5.4 Summary

It is necessary to acknowledge in a multi-criteria analysis the subjectivity and uncertainty in the selection process of criteria, alternatives and distance measure in order to transparently model the assessment process. Hence, when considering the assessment and evaluation of different technological options it can be concluded that the exact definition of efficiency, considering for example recycling etc., is of minor importance. However, the selection of appropriate criteria and alternatives and the modelling of the decision makers' values is of major importance.

The techno-economic assessment of a process design by determination of the various targets by pinch analyses simultaneously including country specific economic parameters and perceptions is achieved in the multi-criteria evaluation. The combination of the different pinch analysis approaches for intra- and inter-company production networks in one integrated comprehensive model, the *Multi Objective Pinch Analysis (MOPA)*

---

<sup>39</sup>In Europe the installation of a thermal waste gas treatment, like a thermal incinerator, results in an overall emission limit of 20 mgC/m<sup>3</sup> with respect to the European Solvents Directive [EC 99/13].

<sup>40</sup>The aggregated outranking flows (cf. Figure A.3), the PROMETHEE I ranking (cf. Figure A.4) and a distinguishability analysis (cf. Figure A.5) including  $T_5$  are provided in the Appendix A (starting from page 238).



provides the framework to address the trade-off between a full and adequate level of integration. The application of the multi-criteria approach PROMETHEE is presented to resolve the incomparabilities between alternatives by preferential information between the criteria (weighting factors) and within criteria (preference functions).

The developed sensitivity analyses allow an exploration of the impact of uncertainty in the process data as well as in the value judgements of the decision maker(s). The assessment methodology is demonstrated in this chapter with a case study. In Chapter 3 target values and characteristic figures describing different process design options are identified and economic operating parameters of certain technology combinations, such as for example the condensation of solvents, are evaluated and consolidated in this chapter.

The single parameters can be investigated by a multi-criteria analysis using PROMETHEE offering the possibility of carrying out several sensitivity analyses. The sensitivity analyses provide a good understanding of the effects of the different modelling parameters and the application of the Monte Carlo Simulation offers the possibility of an analysis including several parameters simultaneously. Consequently, the application of the Monte Carlo Simulation in combination with a Principal Component Analysis can help to understand the impact of the uncertainties of the raw data on the overall results. Additionally, decision makers should be aware of the influence of the selected criteria and the chosen weighting factors as demonstrated by the effect of different preference function parameters or weighting vectors.



# Chapter 6

## Dynamic Capacity Planning

Cooperations between several SME are often economically and ecologically beneficial, however the mutual dependency resulting from process integration entails new risks and reduced flexibility for each company. Especially production capacities influence the optimal settings for inter-enterprise mass and energy exchanges. Therefore reliable predictions of future production capacities of the individual companies are essential for such types of cooperations to be successful. Such planning is equally necessary with regard to the environmental impacts of a company, i.e. its resource consumption and emissions as they depend on the characteristics of the used processes on one hand and on the other hand on the temporal development of its production output. In the following a selection of classical approaches for strategic capacity planning is presented. All these approaches show certain limitations when confronted with real conditions, especially with the dynamic economical development found in emerging markets. Furthermore, a special form of capacity planning is needed when a company faces a seasonal demand. One recent approach for this problem is the transfer of pinch analysis to production planning, which is described in the last section of this chapter.

### 6.1 Introduction to Capacity Planning

Planning the expansion of a company's production capacity is a vital managerial task, as it involves the commitment of large capital resources over a long period of time. The basic reason for capacity planning is the principle of economies-of-scale, which means that in general large installations are able to produce at lower costs per unit produced than small installations [Peters et al., 2003; Rentz, 1979]. Furthermore, capacity increases are generally not arbitrarily scalable, reducing the company's options to stepwise increases

or decreases of their production capacity. As investments in new capacity are generally not fully reversible and lead to financing costs, capacity changes always involve a certain amount of risk, especially when demand is fluctuating.

The term production capacity can be defined as the ability or power of a company to produce its outputs, with the limitations of this power being the installations and means of production as well as the labour. The term is sometimes used synonymously for the maximum output [Giglio, 1970], while other authors distinguish between quantitative and qualitative capacity or subdivide quantitative capacity into the minimal capacity of a company or installation, the optimal capacity and the maximum capacity [Küpper, 1992; Corsten, 1994]. These kinds of capacity are especially relevant in the area of energy supply, as these parameters differ as well as start-up times of power plants and hot and cold reserves are necessary [see Frank, 2003]. The focus of this chapter is strategic capacity planning as a long term strategy for adapting the maximum output of a company to given demand rather than on other capacity-related issues of location planning, production scheduling and supply chain planning.

The problem of planning the future production capacity of a company can be addressed in numerous ways and has been extensively discussed in literature. A good overview of standard methods is given in [Luss, 1982]. For more recent approaches, the reviews of [Mieghem, 2003; Wu et al., 2005] are recommended, with the latter focusing on high-tech industries. Since the late 1950s, various solution approaches have been developed and delivered insights into the planning problem. However, these works often analyse very specific planning situations and the vast multitude of company or industry specific requirements can not be addressed by one single unified approach. A classification of approaches can be done regarding exact versus heuristic methods, hard versus soft capacity constraints or by the general scope of the problem.

The approaches found in Operations Research literature can be grouped into exact and heuristic methods. Whereas exact approaches deliver optimal (based on the assumptions) results to the formulated problem. They are limited by the modelling step itself, as a complete representation of relevant factors and interdependencies is normally impossible. Additionally, such exact approaches are limited to the special cases they were designed for and are limited by a number of constraints. Heuristic approaches use techniques like optimising a series of individual periods with a subsequent combination [Tempelmeier and Helber, 1994; Franca et al., 1997] or solving an unconstrained problem and regarding capacities in a second step. In the latter approaches, demand is shifted to previous or following periods in case it cannot be satisfied due to capacity restrictions [Clark and Armentano, 1995; Franca et al., 1997]. Some models for simultaneous optimisation deal

with planning locations, investment, labour and logistics simultaneously [Kern, 1962]. However, these integer or mixed integer linear optimisation models are too complex and are applied in a very simplified way for analysing the relations between different planning areas [Küpper, 1980]. More relevant in practice are simulation models applied for investigating interdependencies for alternative parameter values in order to find compromise solutions for conflicting goals [Küpper, 1992].

The complexity of capacity planning directly depends on the kind of capacity constraint, i.e. if they are hard or soft [Balachandran et al., 1997]. If short-term capacity increases are economically justifiable whenever there is a shortfall for some product, the capacity constraints are termed to be soft. In this case, the problem can be solved on individual resource levels by using the expected demand distribution and the ratio of the resource acquisition costs and its opportunity costs to optimise capacity utilisation [Balachandran et al., 1997]. For hard capacity constraints, where augmenting capacity in the short run whenever there is a shortfall is not economical, the opportunity costs for a resource has to be determined at the product portfolio level. In this case the opportunity costs of a resource is a function of shadow prices associated with the constraints for the whole product-mix problem in the following periods. This problem can either be solved by linear programming or the solution can be approximated. Capacity expansion problems are often solved using constrained stochastic programming, however such optimising approaches are limited by the complexity of the problem. The need to model the stochastic process underlying product demand and to include all production and marketing constraints, as well as the scale of the problem itself result in high informational and computational complexities [Balachandran et al., 1997]. Thus, there is need for simple rules offering reasonable approximations of the optimum strategy.

The typical objective of standard capacity planning is to minimise the discounted costs by choosing the optimal expansion sizes, expansion times and sometimes the locations or capacity types (flexible or dedicated) [Luss, 1982]. The factors influencing the decision are mainly the discount rate of the money and economies-of-scale. The size of the capacity expansion is sometimes assumed to be continuous, which is often assumed to be a good approximation that reduces the complexity of the problem. In general, there are three kinds of standard types of capacity expansion models. The first group includes those, which assume a concave or linear investment function. They mainly try to resolve the conflict between possible economies of scale and the interest charge resulting from large investments. A second group describes the capacity expansion problem as a pure sequencing problem. In this case, a certain number of extension possibilities is predefined

and their optimal order is sought for. The last group includes those models that try to optimise replacement investments at the same time as expansion investments.

One of the first and best known works are those by Manne, who developed a capacity expansion model for heavy industries in India, as well as several subsequent extensions [Manne, 1961, 1967]. In the basic approach, a linear growth of demand is assumed, which can only be satisfied by own production (no imports). This approach determines regeneration points for constant capacity expansions by minimising the net present value of overall costs. Several extensions include the analysis of several production sites and with the possibility to import [Manne, 1967].

An important factor for planning production capacity is the strategy concerning unfulfilled demand. For resource-based capacity planning, the utilisation of installations is the main criterion, with unfulfilled demand being considered to be lost forever, but without associating penalty costs [Balachandran et al., 1997]. When such penalties are considered, they can be compared to the constraints concerning expansion costs, in order to determine if augmenting installed capacity in the short run to accommodate demand peaks is economically justifiable. Such calculations are of special interest for multiproduct installations, where capacity has to be apportioned to the product-mix and augmenting the production of one product may reduce those of others. Such changes of the product-mix, as well as other reversible measures like subcontracting or adapting labour time or size are suited for small random or cyclical demand changes, while expansions of aggregate capacity are required for continuously growing demand rates (affected by uncertainties about the product life cycle).

## 6.2 Challenges in Dynamic and Seasonal Markets

Capacity planning is of special interest in industrialising countries, since they are characterised by a strong economic growth that offers great business opportunities for companies that can satisfy this demand. However, a dynamic economy is also characterised by more significant uncertainties and downturns than industrialised countries. Thus, the planning of production capacity is a more difficult, but also a more relevant issue for companies doing business in these regions.

Besides economic opportunities, producing in newly industrialising countries can involve several handicaps especially for smaller enterprises. Access to credit is normally difficult and lending terms and conditions are especially strict for small companies. They are often characterised by high interest rates, short repayment periods and requests for guarantees

[Ciccozzi et al., 2003]. The special conditions concerning environmental questions in industrialising countries are described in Chapter 2.

Capacity planning is a complex exercise, partly due to demand uncertainties which are especially relevant in a dynamic economic environment as found in industrialising countries. Two components of uncertainty can be distinguished here according to [Chen et al., 2002]. The first is a random component that can represent seasonal or cyclic effects, mostly modelled as an additive or multiplicative term that can vary with time. Its time horizon can be one year for seasonal effects, but is clearly shorter than the whole product life cycle. The second component is the uncertainty of the demand pattern over the whole product life cycle or planning horizon, representing the success or failure of the product. Whereas the latter is relevant for making investments in capacity expansion, the first kind of uncertainties mentioned are easiest to deal with using reversible capacity adjustments like subcontracting or an increase of working time or labour [Khmelnitsky and Kogan, 1996]. One approach for modelling the total demand is to assume these two components to be mutually independent. This approach is often found in literature, as it allows a facile stochastic modelling of the demand with demand history not providing any additional information for planning. In contrast, Chen et al. [Chen et al., 2002] propose a scenario approach to capture demand uncertainty and its evolution, which is especially relevant when demand is highly influenced by past product success. In the first step, they use a tree structure to capture the evolution of demand over time. In this scenario based approach, each arc in the tree structure represents a set of possible demand outcomes in a given period and the complete evolution of demand are represented by the paths from the root to the respective level, i.e. period. Using the probabilities of individual paths, the strategic decisions like flexible versus dedicated capacity or the product mix for multiproduct companies can be investigated by means of standard stochastic programming. Such an explicit consideration of different kinds of uncertainties in demand and capacity planning seems to be very suited for SME in dynamic regions.

Figure 6.1 sketches several aspect of the capacity planning problem in a dynamic environment. Whereas several standard approaches exist for determining the ideal size and time of capacity expansion for a given demand growth rate, these predictions are much more uncertain in the case of industrialising countries. Demand growth may vary widely in a funnel-shaped area between the assumed upper and lower limit, influenced by general macroeconomic data on one hand and by the life-cycle uncertainty of the specific product on the other hand. The sketch shows that temporal distances and sizes of capacity expansions normally can vary; when old aggregates are to be retrofitted, this often allows for gradual capacity expansions, too.

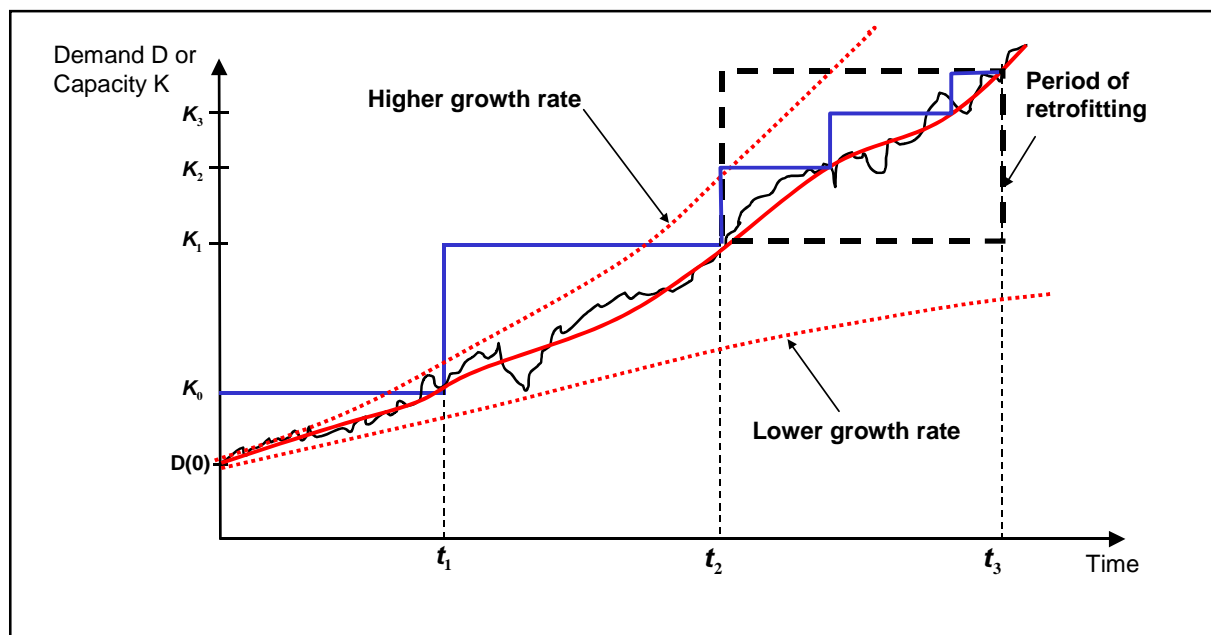

Figure 6.1: Strategies of Capacity Planning

A special case is the planning for a seasonal demand requiring constant capacity adaptations. Strategies for adapting the production rate to seasonally changing demands are discussed in Chapter 6.3 using the example of a bicycle company, another business influenced seasonal by demand or supply is for example the agricultural sector (cf. Case study on Pisco production in Appendix C).

For long term planning in industrialising countries and emerging economies, forecasting market's development is essential. For quantifying technological progress and for predicting technological change, growth and diffusion curves can be applied [Lakhani, 1979; Dekimpe et al., 1998; Miller et al., 2003]. The most common way of displaying market diffusion of technologies is using *S curves*, which are an analogy to biological growth processes. The basis of this approach is that the market for one product will eventually reach saturation and that all technologies will reach certain performance limits [Griliches, 1957; Wolfrum, 1991]. These models strongly depend on the quality of estimations used as input data. They can also be criticised as an overly simplified representation of reality. The curves developed by Pearl (assuming that the future diffusion depends on past evolution) and Gompertz (assuming that the future diffusion is independent of past evolution) are most commonly used for predicting innovation adaptation rates. However their application is not suited for modelling disruptive technologies, i.e. those, which eventually will overturn the existing dominant technology [Brockhoff, 1999]. These tech-



nologies may radically change the diffusion patterns or start a new *S curve*. New kinds of diffusion curves have been recently developed [Perkins and Neumayer, 2004], however their appropriateness for predicting technology diffusion in emerging economies remains to be verified. Especially for analysing the diffusion of technologies related to emission reduction technologies, *Integrated Assessment Models* exist, for example the model RAINS [Alcamo et al., 1990], as described in Chapter 2.5. These models use the evolution of emissions and the costs of abatement technologies for setting emission limit values. They are based on assumptions of technology transfer for example derived from technology diffusion curves. Concerning the problem of capacity planning in dynamic regions, it can be concluded that no universally applicable method exists and that the prediction of future demand remains a challenging problem especially for industrialising countries.

## 6.3 Production Pinch Analysis

Recently, a transfer of pinch analysis to production planning has been suggested [Singhvi and Shenoy, 2002; Singhvi et al., 2004]. In chemical engineering, the pinch analysis as presented in Chapter 3 holds a long tradition as a method for determining optimal target values for heat or mass exchanger networks by calculating an optimal alignment of available flows. A graphical representation of the time-material production relationship derived from the original pinch analysis can be used for aggregate production planning when facing a seasonal demand. This can deliver insights in the production planning problem as several production strategies can be compared. The application of this approach to a case studies on bicycle coating in China (cf. AppendixA) is shown in the following section. The production pinch analysis does not deliver theoretical optimal results as the classical pinch analysis, but it offers a simple analysis of different production strategies and gives the planners deeper insights in the planning situation. The application of the analysis is shown for a Chinese bicycle company (for more details see Appendix A) facing seasonal demand changes throughout the year and different production planning strategies are compared based on cost criteria.

### 6.3.1 Translation of the Thermal Pinch Analysis to Production Planning

The planning of future production capacities can be formally addressed in numerous ways, as was mentioned in the previous section. When companies face a seasonal demand, the problem of capacity adaptation can become even more challenging, as there may be a

constant need for capacity adaptations. Forecasting such seasonal demands is possible using various statistical methods, mostly aiming at identifying a seasonal component in historical demand data (see for example [Winters, 1960]). Given a prediction of the upcoming seasonal demand, a company still has to choose its production strategy, i.e. when to operate at which production rate. [Singhvi and Shenoy, 2002; Singhvi et al., 2004] propose a graphical method that represents demand and supply data as composite curves and deriving inspiration from pinch analysis (see Chapter 3).

In this context, aggregated production planning is defined as the identification of an overall level of production for an individual company. The focus of the analysis is the evaluation of seasonal changes on the demand side and its consequences for setting the level of production during the whole period considered. The central issue in this case is how to choose and adapt the production rate during the period in order to avoid stock-outs and minimise inventory and capacity changes. Several production strategies are possible, the following section (cf. Section 6.3.2) shows selected strategies that are compared with the pinch approach.

The *time-material production* relationship can be used for a pinch analysis approach for aggregate production planning in analogy to the classical pinch analysis [Singhvi and Shenoy, 2002; Singhvi et al., 2004]. Based on material balances, a time versus material quantity plot can be derived, based on the original thermal pinch analysis. The quality parameter in the production planning pinch is the time of production (in analogy to the temperature level  $T$ ). The quantity parameter is the demand of units to a certain time (in analogy to the enthalpy  $\Delta H$ , describing the supply and demand of the hot and cold composite curve). One demand composite curve and one production composite curve can be constructed on a time basis (cf. Figure 6.2). Whereas a sorting of the individual streams is a basic part of the classical pinch analysis, the demand composite curve is inalterable in this approach. Similar to the modelling of re-use and re-generation processes in the water pinch analysis reducing the overall fresh water flow rate but generating costs, the adjustment of the production level at the production pinch point reduces the overall level of production resulting in a steeper slope of the production composite curve.

The adaptation of a straight minimum supply line to the demand composite also draws inspiration from the water pinch analysis as presented in Chapter 3.2. The idea to introduce a time-dependent representation in the pinch diagram is inspired by the pinch analysis for batch processes that proposes a scheduling of batch processes in time slice or time event models (see Chapter 3.1). In the graphical representation of the production pinch approach, the vertical distance between the demand and the supply line shows the lead time, which corresponds to the minimal temperature difference  $\Delta T_{min}$  as the gradi-

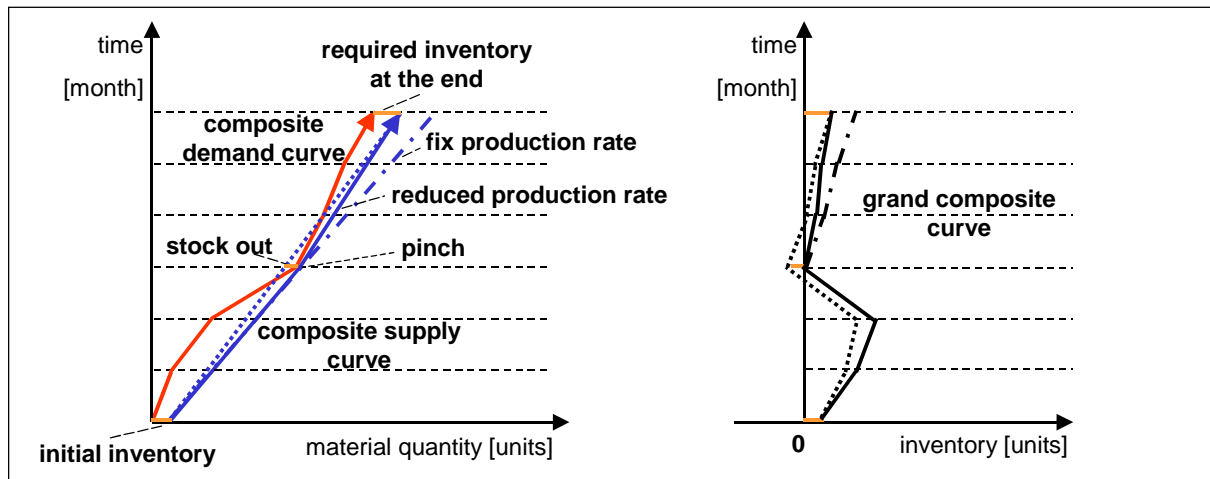

Figure 6.2: Production Pinch Analysis [Singhvi and Shenoy, 2002]

ent or driving force of the system. This lead time is normally set to be zero at the pinch point, with the supply exactly fulfilling the demand. The horizontal distance of the two composite curves represents the inventory, which in general has to be positive in order to avoid stock-outs. The grand composite curve (displaying the difference between the composite curves at each point of the qualitative scale) displays the inventory level of the analysed production process for each time interval and can be used to quickly compare the suitability of different production strategies for a given demand curve. Thus, additional strategies for setting the level of production can be discussed based on costs, such as investment dependent costs, labour costs, material costs, inventory costs, stock-out penalty costs and costs for capacity adjustments. The assumption is based on the original production pinch analysis [Singhvi and Shenoy, 2002] that an increase in the production rate requires a larger workforce (capacity is only determined by the workforce in this simplified approach) and hence results in hiring costs, these include for example administration and training and were assumed to be equal to the costs of one man month per worker. Correspondingly, a decrease in production results in layoff costs (for example assumed equal to the costs of two man month per worker). While these costs favour a constant production rate, those for keeping an inventory or for unsatisfied demand require the opposite. Taking into account these effects, the pinch-inspired setting of the production rate is used to find a compromise, however without explicitly regarding the specific amounts of these costs.

The fact, that the production pinch approach does not regard the magnitude of different costs shows how it is rather an simple strategy for finding quick solutions or starting solution for further analyses. However, the concept can used as a basis for a more detailed

computer based modelling with more detailed and realistic cost data and further constraints. The underlying view of employees to be removable as needed by the company is certainly a critical point of the production pinch analysis, however such a view was found for the company of the case study as well as for the data used by [Singhvi and Shenoy, 2002; Singhvi et al., 2004]. However, the method is rather flexible and allows for more social views, for example by including additional constraints to the planning, higher costs for laid-off workers, etc. Based on the different options in the thermal and water pinch analysis, several strategies (cf. Table 6.2) for the evaluation of the production planning of a production network can be formulated, as will be shown for a case study in the next section. In this application, the dependence of the planning outcome on the starting season and the occurrence of stock-out using the pinch planning method were identified as shortcomings of the method for which solutions are proposed.

### 6.3.2 Discussion of Production Strategies for a Case Study

The application of the analysis is shown for a Chinese bicycle company (for a more detailed description see Appendix A) facing seasonal changes throughout the year [Treitz, 2006; Brosi, 2006]. Since the demand of bicycles varies throughout the year, the question of how the level of production should be chosen to address seasonal changes arises. Also when considering dynamic growth the problem of how to adjust the production accordingly must be addressed. There are several options available for the reference company: One possibility could be the production of a second product without seasonal changes requiring similar operations as the main product. In an example of a Chilean bicycle company that welds, coats and assembles bicycles, the production of metal bed frames was chosen as they also require welding and coating cf. Appendix B, [Schollenberger and Treitz, 2005]. A second option would be to produce bicycles for different markets with shifted seasons. For example the Chinese bicycle company of this case study produces bicycles in the summer (June, July, August) for the Chilean market, as it is the low season of the US, European and Chinese market. Assuming that the shipment takes one to two month, the bicycles are available at peak times in spring in the southern hemisphere (October, November, December) especially before Christmas.

However, such substitution of products or markets are not always possible and companies have to choose their production planning strategies based on cost criteria. Table 6.1 shows the distribution of the demand for bicycles throughout the year. Five basic strategies for production planning are discussed (cf. Table 6.2) [Brosi, 2006]. Since the seasonal increase of demand starts in October, it is the starting month of the evaluation. All real

and estimated cost parameters are provided in the Appendix (cf. Table A.10 on page 237).

Table 6.1: Monthly Production Rates and Estimated Costs for all Strategies

Demand		Production Rates [Bikes/Month]					
		Fixed Production with one Pinch-Point	Variable Production with one Pinch-Point	Variable Production, multiple Pinch-Points	Average Production	Max-Zero Strategy	Chase Strategy
October	90.000	108.000	108.000	108.000	83.333	166.667	90.000
November	90.000						90.000
December	110.000						110.000
January	130.000						130.000
February	120.000						120.000
March	90.000						90.000
April	80.000		48.800	50.000	0	0	80.000
May	60.000						60.000
June	50.000						50.000
July	50.000						50.000
August	60.000	60.000					
September	70.000	70.000	70.000				
<b>Annual Cost [Thousands €]</b>		<b>30.918</b>	<b>22.539</b>	<b>21.702</b>	<b>23.465*</b>	<b>37.892</b>	<b>22.816</b>
<b>Ending Inventory [Bikes]</b>		<b>296.000</b>	<b>0</b>	<b>0</b>	<b>0</b>	<b>0</b>	<b>0</b>

Table 6.1 shows the demand for each regarded month and the corresponding production rate according to the five applied strategies discussed below. The costs of each production strategy are calculated using estimated values for material, labour and inventory. This calculation is done in a similar way as in [Singhvi and Shenoy, 2002; Singhvi et al., 2004], however they use these assumed costs for a linear optimisation and compare the result to the pinch strategy, whereas here the resulting costs of different strategies are compared. The relevant costs for choosing the production strategy in this basic calculation are hiring and layoff costs on one hand and inventory and stock-out costs on the other hand. As the latter two costs favour frequent changes in the production rate (only determined by the workforce in this case) and the first two punish such changes of the production rate (equal to the production capacity in this case), the pinch-inspired setting of the production rate is used to find a compromise. In this example, the strategies inspired by pinch analysis result in minimal costs, meaning they offer the best compromise between the objectives of low inventory/stock-out and a small number of costly capacity adaptations.

Different options for the level of production can be discussed based on costs, such as investment dependent costs, labour costs, material costs, inventory costs, stock-out penalty costs and costs for capacity adjustments (hiring and layoff costs). The strategies illustrate different ways based on flexibility and costs to comply with the demand composite curve

and to supply the required aggregated demand (cf. Table 6.2). Strategy *Fixed Production Level with one Pinch Point* represents the minimum constant production rate, which ensures that demand is permanently fulfilled by the current production. As it is an extension of the production rate needed in high demand periods to all periods, it leads to significant undesired ending inventories and is only used as a benchmark here. *Variable Production Level with one Pinch Point* is the one strategy derived from pinch analysis by [Singhvi and Shenoy, 2002; Singhvi et al., 2004]. It consists of choosing the minimal production rate from the starting point that does not create stock-outs. The point where this straight line is tangent to the demand composite curve is called pinch point and the production rate is adapted here in a break. The following production rate segment is rotated from this pivotal point until its end is at the point required by the demand composite curve and a possible ending inventory.

Table 6.2: Available Strategies in the Production Pinch Analysis [Brosi, 2006]

No.	Strategy	Pinch Points	Capacity Adjustments	Possibility Stock-Out
1	Fixed Production Level with one Pinch Point	1	0	no
2	Variable Production Level with one Pinch Point	1	1	no
3	Variable Production Level with multiple Pinch Points	var.	var.	no
4	Average Production	0	0	yes
5	Max-Zero Strategy	0	1	no
6	Chase Strategy	0	var.	no

However, the *Variable Production Level with one Pinch Point* strategy generated stock-outs for some demand patterns, especially if no ending inventory is planned. In case such stock-outs occur, we propose two corrective strategies: Firstly, the higher production rate before the pinch point could be maintained for as many periods, as are needed in order to build up sufficient inventory levels. This solution increases inventory costs, but does not require additional adjustments of the production rate.

As a further solution to eliminate the problem of stock-outs for the pinch strategy we propose a strategy called *Variable Production Level with multiple Pinch Points*, which is based on adapting the production rate in several pinch points, determined as the point of contact of the minimal production rate below the demand composite curve, starting from the last pinch point. This strategy may entail several adaptations to the production rate,

however only in cases where the one pinch point strategy leads to stock-outs. As this strategy is viable for most given demand patterns, it was superior to the other strategies in most cases. This strategy could be further enhanced, for example by considering the trade-off between stock-outs, inventory and capacity adaptations for every pinch point.

The first three strategies illustrate different ways based on compromising between flexibility and costs to comply with the demand composite curve. The remaining strategies are analysed here as benchmarks for the evaluation of the trade-off between penalties for stock-outs on one hand and the inventory costs on the other. These strategies include the *Average Production* strategy, which leads to stock-outs and which is only optimal, when changing the production rate is prohibitively costly. Applying the so-called *Max-Zero* strategy, all goods are produced in the first months and none in the later months. This strategy may be useful, if keeping inventory is inexpensive and if there is a second product, which can be produced in the remaining periods after retooling the installation. The last one of these extreme strategies is the *Chase* Strategy, which always exactly fulfils demand without delay. This strategy might be sound if costs for capacity adjustments are low. All these are analysed as benchmarks for the evaluation of the trade-off of the penalty for stock-outs on one hand and the inventory costs on the other.

Figure 6.3 shows the demand composite curve of the production pinch analysis illustrating the aggregated demand in accordance to Table 6.1 with October as the starting month. Furthermore, both strategies with one single pinch point (Strategies 1 and 2) and the average production rate (Strategy 4) are shown.

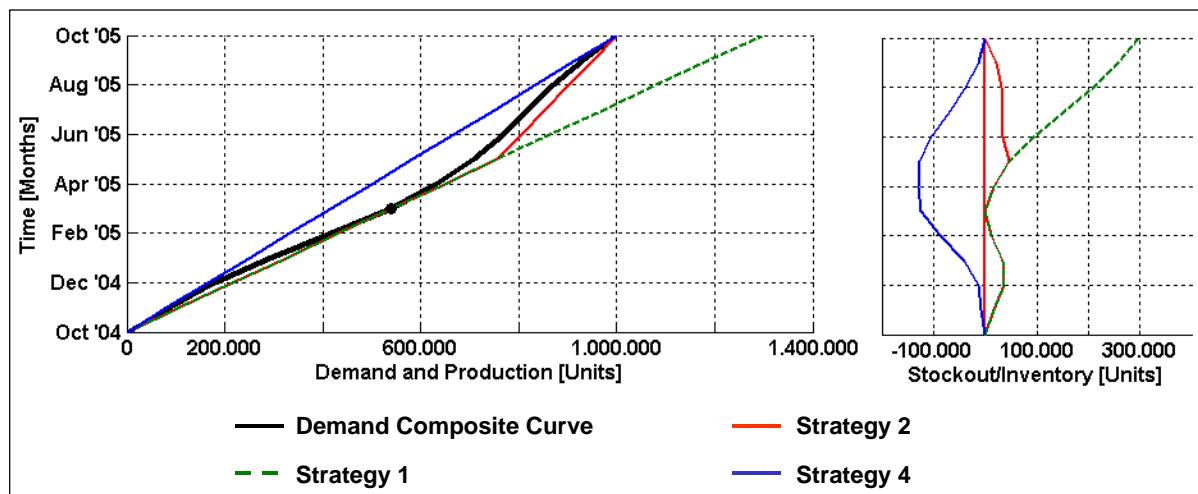

Figure 6.3: Composite and Grand Composite Curves of the Production Pinch with Strategies 1, 2 and 4

Strategy 1 with a fixed level of production requires a monthly production rate of 108 000 bicycles to prevent any stock-outs and total costs of 30.9 million € arise. In Strategy 2 with one capacity adjustment a production rate of 108 000 is suggested in the peak season from October to March and a production rate of 48 000 in the low season from March to September. In this case Strategy 2 generates costs of 22.7 million € and is preferred to Strategy 1 due to the total annual costs of production including the costs of storage and capacity adjustments, i.e. hiring or layoff costs. However, based on the analysis the costs differ significantly due to the high number of units stored in Strategy 1. In addition Strategy 4 is illustrated as an average production rate of 83 334 bicycles per month to fulfil the annual demand of 1 million bicycles. In this case stock-outs are allowed, but are valued as lost business. In this case less equipment is required but due to lost business the overall cost accumulates to 23.5 million € and ultimately this strategy is more expensive in the long run than Strategy 2 distinguishing between high and low season.

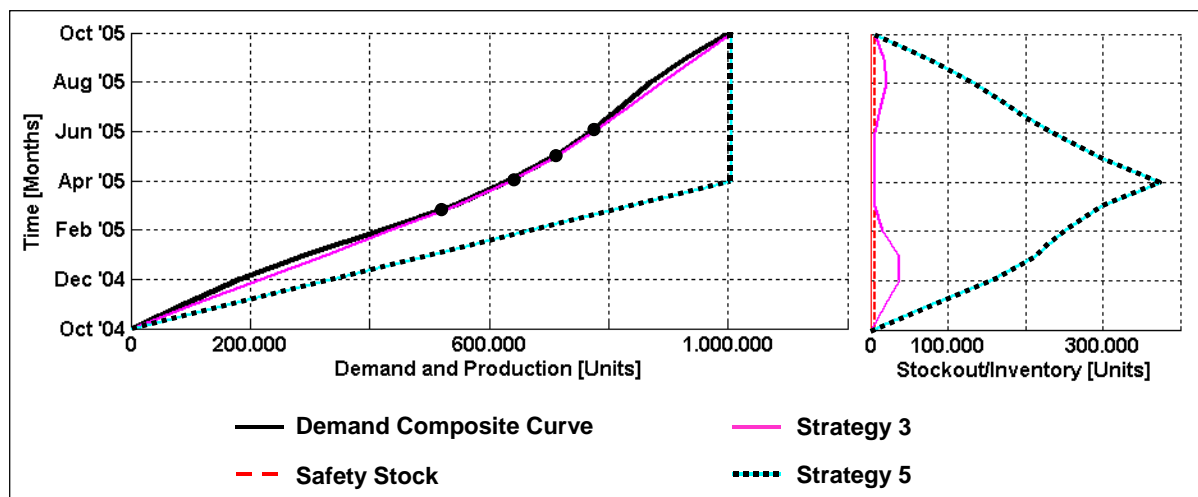

Figure 6.4: Composite and Grand Composite Curves of the Production Pinch with Strategies 3 and 5

*Variable Production Level with multiple Pinch Points* (Strategy 3, lowest costs) and *Max-Zero* (Strategy 5, highest costs) are shown in Figure 6.4 taking into account a safety stock  $\Delta I_{min}$  of 5 000 units. In Strategy 3, multiple capacity adjustments are allowed compared to Strategy 2, which has only one capacity adjustment. As Figure 6.4 illustrates, the production curve closely follows the demand curve by identifying four pinch points. Thus, as in *Variable Production Level with one Pinch Point*, in the multiple pinch point case (Strategy 3) the production rate would be 108 000 bicycles per month from October to February. However, starting in March the production rate would decrease continuously until the start of the new peak season. Strategy 3 would generate costs of 22.1 million €. In order to analyse the influence of inventory costs, Strategy 5 not only differs between



the high and low seasons, but also only operates at either full or zero production for each month. Consequently, in Strategy 5, the production rate in the first half of the analysis period is 166 667 bicycles per month from October to March and zero in the second half.

### 6.3.3 Discussion of Production Strategies for Dynamic Markets

The whole planning, including that of growth rates of the demand and capacity limits, can be extended to multiple periods, i.e. years. In this way, the analysis can support the aggregated capacity planning of a company in a dynamic market. Since the way of visualising and choosing production strategies shown in this chapter can be used for any kind of specific dynamic situations, only one scenario is regarded here as an outlook for an individual multiperiod planning. Of course numerous other and more formal planning approaches, like for example an optimisation based on linear programming exist and may be better suited for such problems. However, the visual representation and the simple production strategies analysed here offer a quick understanding of the situation without cumbersome modelling and thus are suited for all kind of companies.

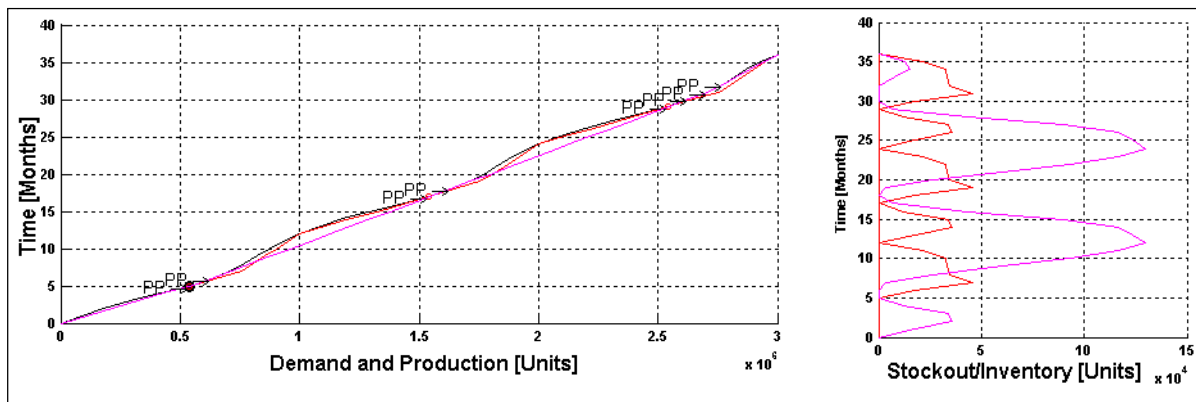

Figure 6.5: Composite and Grand Composite Curves of the Production Pinch with Strategies 3 and 4 for a period of 5 years

In the following example, a simple linear growth rate of 10% per year is assumed, however with all growth occurring in the high season (worst case). The bicycle company has a maximal production capacity of 150 000 bicycles per month. Following Strategy 2 with two different production rates, one for the peak and one for the low season, in 2008 the maximal capacity is reached in the peak season, assuming an effective production of 90% of the maximal capacity. In this case the production rate in the low season can be increased, the production rate of the peak season can be extended by one month, or a capacity extension requiring investment can be realised. By including outsourced

production, the existing capacity may be sufficient if there exists uncertainty concerning the stability of the growth rates in the coming years.

Figure 6.5 shows the production rates and the resulting inventory levels for this example. A comparison based on cost data is equally possible. This small example shows how numerous the different options for the company can be and how difficult a comprehensive optimisation can become. The production pinch approach and a visualisation of the whole planning situation, as well as simple comparisons of costs can support the planners in their decision-making. It could also be further extended to include a cost-based optimisation.

### 6.3.4 Conclusions on the Production Pinch Analysis

The application of the pinch analysis methodology to production planning provides a simple but effective tool for analysing production strategies of a company in a seasonal market. Based on the cost parameters the different production strategies can be evaluated. Those based on pinch analysis provide a good compromise between inventory costs and capacity adaptation costs. By using estimated growth rates and including several periods, the analysis supports the aggregated capacity planning of a company in a dynamic market. The idea to transfer concepts of engineering and physics to economy seems promising, a similar transfer using the concept of momentum for measuring the performance of supply chains has recently been proposed by [Cho and Lee, 2007].

A challenge for the analysis is the determination of the starting time interval for the analysis. In contrast to the thermal pinch analysis in which all heating and cooling requirements are sorted according to their quality parameter temperature and resulting in a theoretical minimal utility target, the sorting of the demand in the production pinch analysis is infeasible. Consequently, the analysis can result in sub-optimal solutions and the results may vary significantly depending on the selected starting interval. The basic idea by [Singhvi and Shenoy, 2002; Singhvi et al., 2004] can be improved by introducing an opening step for choosing a suitable beginning period. Here, we propose the beginning of the peak season, which means the highest growth rates, as the starting point of the evaluation. The idea to select a strategy with multiple pinch points can be used to overcome stock-outs possible in the one pinch point strategy. Especially this strategy seems to be promising. However, more comprehensive research is needed concerning the time-variance of the results, as reasonable results are not guaranteed for arbitrary demand lines.

# Chapter 7

## Summary

Improving the resource efficiency of a production network based on detailed process characteristics has a long tradition in industrial engineering.

One approach to support the analysis of resource efficiency in industrial engineering is the pinch analysis. Originally developed for studies on heat integration it can also be applied to water and wastewater networks, to the recovery of solvents or to analysing product streams for production planning. Using pinch analysis, theoretical consumption target values for the process streams under consideration can be calculated based on the maximal heat, water and solvent reuse. In addition, unit operations are discussed with respect to the realisation of savings potentials considering the trade-off between operating costs and investment.

Combining pinch analyses with different objectives, a Multi Objective Pinch Analysis (MOPA) takes into consideration economic, environmental and technical process details to identify a resource efficient production method including the development of a process model, the determination of characteristic figures by applying pinch analysis and a subsequent evaluation. For the comparison of different technological options, the out-ranking multi-criteria analysis method PROMETHEE is applied. By using Monte Carlo Simulation together with Principal Component Analysis, the uncertainty associated with the decision can be evaluated in a comprehensive sensitivity analysis. The multi-criteria decision support model is applied to different case studies.

## 7.1 Conclusions of the Pinch Analysis Methodology

The field of process integration aims at assessing entire production processes with an integrated approach to the analysis, synthesis, and retrofit of process plants by integrating mass and energy flows that minimise both costs and waste. Pinch analysis is a mature design and optimisation approach within process integration based on mass and energy flows. The characteristic principle of the approach is to view a production network as one interconnected system of unit operations which aims at optimising the overall performance by including new unit operations, introducing new connections between streams and closing material cycles. Thus, it is possible to define theoretical optimal target values based on physical laws and chemical engineering principles.

The details of process designs that would realise the established performance targets are however addressed by the pinch analysis approach only to a limited extent. The pinch analysis is useful for conceptual process evaluation and for definition of performance targets before the next step of more detailed analysis using flow sheeting and simulation. Whilst specific extensions to the original pinch analysis are available to consider the special requirements of certain operations (for example mixing and interception of water and wastewater process streams or the scheduling of batch processes) the strength of the pinch analysis is to leave the specific design and thus determine theoretical target values.

There exist several applications of the pinch analysis methodology to mass and energy flows. Three different major applications are identified:

- *Thermal Pinch Analysis:* The basic idea of the thermal pinch analysis is a systematic approach to the minimisation of lost energy in order to come as close as possible to a reversible system. In its first step the pinch analysis yields the best possible heat recovery at the thermodynamic optimum. Further recovery can only be achieved by changing conditions or structures of the investigated system. Thus, the pinch analysis requires the combination of hot and cold process streams to composite curves and the description of the respective temperature-enthalpy relationships. Additionally, a minimum temperature gradient  $\Delta T_{min}$  must be set representing the driving force of the heat transfer. The result of the pinch analysis is the energy savings potential for the considered set of processes.
- *Water Pinch Analysis:* Furthermore, pinch analysis can also be applied to calculate water and wastewater savings. Instead of considering temperature-enthalpy relationships the water pinch regards concentration-mass load curves. All streams of the investigated system are combined to a limiting composite curve describing the

”worst” water quality acceptable. The freshwater curve describes the water supply of the system. The slope of the curve is a measure for the flow rate. The water supply and limiting curve match at the pinch point and the resulting slope defines the minimum water flow rate needed.

- *Solvents Pinch Analysis:* Besides heat exchange and water management, another application of the pinch analysis is for solvents or multi-component solvents since their separation from waste gas is usually carried out via thermal condensation. This permits a translation of organic solvent reclamation into a heat exchange problem. By using phase diagrams the targeted VOC concentration can be described by temperatures of the gaseous waste stream. The application of solvents pinch analysis is used to find the most cost-effective solution for the condensation of solvents from gaseous emissions.

The key question, however, is the realisation of the identified target values. The catalogue of Best Available Techniques (BAT) provides a pool of available unit operations and technology combinations to suggest unit operations to realise the identified savings potentials or emission reductions. These descriptions comprise key figures on energy and material consumption, as well as information about the caused impact. Additionally, economic aspects, for example operating costs and investment, have to be taken into account considering country-specific parameters and pay-off periods.

The presented pinch analyses are applied to individual energy and material flows in large technical production facilities of the process industry, without simultaneous optimisation of material and energy flows. Thus, the extension of these methods for inter-company mass and energy flow networks for small to medium sized companies as described in this book expands the field of application of the pinch analysis. In particular, the pinch analysis provides insights in the growing number of industrial parks especially for developing and industrialising countries. By combining the three pinch analysis approaches with multi-criteria analysis design recommendations for intra- and inter-company production networks can be systematically evaluated, negative environmental effects can be reduced permanently and critical points in the production network can be identified.

The different case studies demonstrate the application of the methodology. Individual target values for the use of energy, consumption of water and recovery of solvents are determined based on the pinch analysis and different unit operations are discussed concerning the realisation of the individual savings potentials. In this way different process design options are characterised by several criteria, such as for example the available possibilities for heat integration or water reuse for the different options.

With the advent of more advanced process models and computational power, process integration technologies have gained in importance. The advantage of the pinch analysis can be seen in the determination of the theoretical optimum for a given set of heat and material streams.

## 7.2 Conclusions of the Inter-Company Approach

Pinch analyses can identify significant savings of resource consumption. Its realisation, however, requires a sufficiently large number of processes with matching supply and demand profiles for heat and mass flows. Thus the savings potential for SME is limited, as they often do not reach the critical mass for the re-use and recycling of by-products. Thus a combination of mass and energy flows of several SME within an eco-industrial park is regarded as an approach for overcoming these limitations. Such eco-industrial parks are designed for increasing economic gains and at the same time at improving environmental quality by an improved resource efficiency. The optimisation potential, which can be identified using an inter-company approach, can be even larger when additional synergies as for example by using shared installations for wastewater treatment or power supply can be realised.

Industrial parks in general are agglomerations of independent companies on one shared production site, which is owned and managed as one unit. The site is owned and managed either by local authorities, by one focal company, by a special service company or jointly by all tenant companies. The choice of this operator model strongly influences the success of such cooperations through various aspects like the distribution of investment and financial risk, the motivation of individual partners to join or stay in the cooperation, the flexibility and continuity of the cooperation etc. The choice of an appropriate operator model as well as other organisational measures can help to overcome hurdles to the development of environmental cooperation, which can be legal barriers, informational and motivational barriers, or lacking trust.

Industrial parks are especially common in China, where they developed as a means for adapting the existing industrial structures to the rapid industrialisation. Recently, special legislation has been passed regulating the development of the vast number of SME as well as the realisation of a circular economy, for example by creating eco-industrial parks. Three levels of interaction within industrial parks are addressed here: a higher efficiency through the reduction of resource consumption and emissions on individual firm level, improved reuse and recycling within industrial parks and finally the development of mu-

municipal or regional by-product collection, storage, processing, and distribution systems. As the techno-economic consequences of the three levels of interaction within industrial parks have to be quantified, in order to make decisions about the selection of the most suitable technological options, MOPA can be a useful tool here for achieving a quantification of possible savings potentials and required investments.

The application of pinch analyses for a possible industrial park of four SME is shown in Chapter 4. The linking of various production sites by process streams is analysed for companies from different sectors, such as for example bicycle coating, and spirits production. Only the mass and energy flows relevant for heat integration are discussed in this example for the application of the pinch analysis to inter-company networks. The whole park is regarded as one system here, the overall hot and cold composite curve for the industrial park is constructed by compiling all the heating and cooling requirements of the different companies in one single analysis. Since the heat is available at a relatively low temperature level, the integration possibilities are limited and in this specific configuration the piping costs prevent an economic use of the available heat. However, MOPA allows for a rapid overall assessment of the possibilities of resource integration, thus supporting the discussion about further cooperation with technical data.

### 7.3 Conclusions of the Multi-Criteria Approach

One of the main challenges following the determination of the target values is the evaluation of alternative techniques taking into account strengths and weaknesses according to their environmental and economic performance. However, since no single alternative may be the best in all criteria there exist incomparabilities. In this context multi-criteria analysis aims at identifying efficient alternatives and reducing incomparabilities, since a comprehensive evaluation of different technological options requires the simultaneous consideration of different mass and energy flows and economic performance.

The definition of resource efficiency from an applicability point of view is complex because various parameters must be considered and representative ones must be selected. This is especially true for environmental resources, in which the market prices do not reflect full costs. Therefore, the idea is to understand waste not as material to be discarded, but as a potential future resource. Thus, the material properties and available processing and recycling technologies determine the value of a resource.

Resource efficiency as the overall objective for the assessment is broken down into a multi attribute optimisation problem for energy-, water- and solvent-streams. The target values

for these resources are identified using pinch analyses and the weighting parameters for the resources are chosen according to the decision maker's preferences. Consequently, various aspects of the definition of value judgements in a multi-criteria analysis must be discussed.

A relative efficiency measurement by multi-criteria analysis is used in this book to resolve incomparabilities and to compare different techniques. The outranking approach PROMETHEE is applied for an integrated technique assessment and preferential information is modelled by weighting factors and preference functions based on pairwise comparisons. PROMETHEE is applied to discuss the ranking of the alternatives and the relative strengths and weaknesses of the alternatives reflected in their profiles. Furthermore, comprehensive sensitivity analyses for preferential and data uncertainties are the major contribution of the Multi Objective Pinch Analysis.

The potentials and driving forces, i.e. gradients, in the material and energy system are taken into account, and the decision support system helps to transparently model the attribute data for the comparison and the involved subjective preferences of policy makers or business managers. There is always a subjective element in the decision, which especially becomes obvious not only with respect to the weighting factors, both in the application of the metric and of PROMETHEE, but also in the definition of the norm in the metric or the definition of a preference function in PROMETHEE. This book concentrates on the production processes and not on the personal / psychological side of decision making in SME as investigated in organisational theory. The influence of the uncertainty in the preferential parameter on the results is investigated by comprehensive sensitivity analyses.

Parametric sensitivity analyses are used to investigate the influence of the preferential parameters of PROMETHEE to the overall results and Monte Carlo Simulation (MCS) is used to investigate simultaneous changes in all parameters. The Principal Component Analysis is expanded by MCS, in order to investigate uncertainties in all attributes. However, the analysis of the principal components not only furthers the evaluation of the current decision problem and helps to assess if the selection of criteria sufficiently describes the decision problem, but furthermore supports a technology management by illustrating potentials for unit operations or gaps in available technologies. Like in the concept of ecological product development a design for environment is stipulated for process innovation by multi-criteria analysis.



## 7.4 Conclusions of the Dynamic Capacity Planning Approach

As the application of pinch analyses is regarded for companies and groups of companies from industrialising countries, the dynamic development of the economic environment in these regions has to be considered too. Especially the mutual dependency resulting from process integration entails new risks and reduced flexibility for each company, thus the planning of future production capacity for each company is vital for the cooperation.

The reason why capacity planning is an important issue for companies is the principle of economies-of-scale and often the non-existence of fully scalable installations which both favour large installations. However, these require the nonreversible commitment of large capital resources and involve a high risk, especially for uncertain fluctuating demand.

A large number of approaches for capacity planning exist, however they often analyse very specific planning situations and there is no single unified approach for all the vast multitude of company or industry specific requirements. Exact methods often comprise a linear programming problem for a specific simplified model of a company. Heuristic approaches often solve partial problems first before combining the solutions. More comprehensive approaches include the planning for multiple products or multiple locations. Especially for dynamic regions, the aspects of how to include uncertainties in the planning and how to plan for unfulfilled demand are relevant. Some approaches for capacity planning that include these aspects seem to be especially suited for a dynamic environment.

In industrialising countries, companies often face a strong economic growth, however including a high risk of economic downturns and a difficult lending terms especially for SME. Long-term predictions for individual companies or industrial sectors are especially challenging in newly industrialising countries. Rough predictions can be obtained using methods for predicting technology diffusion, for example using S curves derived from the modelling of biological growth processes. However, these models are rather simplified approaches and as all methods proposed by literature for capacity planning show certain limitations when confronted with real conditions.

When facing a seasonal demand, the problem of capacity adaptation can become even more challenging, as besides the need for forecasting such seasonal demands, there may be a constant need for capacity adaptations. One approach for this problem is proposed transfer of pinch analysis to production planning. In analogy to the pinch analyses for heat and water integration, this approach uses a graphical representation of the time-material production relationship. While not delivering theoretical optimal results as the classical

pinch analysis, this approach offers a simple analysis of different production strategies and can deliver insights in the production planning problem. The aim is to avoid stock-outs and minimize inventory on one hand and to avoid changes in the production rate (equals capacity in this simple approach) that lead to hiring and layoff costs.

The basic pinch inspired approach as well as several other strategies are applied to the production data of a Chinese bicycle company. This application shows how the approach can be useful to obtain quick results, but it also shows several shortcomings of the method. A modified strategy with several pinch points is proposed to avoid stock-outs and an initial step for finding a suited starting point for the analysis are proposed. An extension of the analysis to several years allows including dynamic growth. However, the approach is not suited for all kinds of demand lines and being a simple graphical method does not explicitly consider the relation different types of cost. It is a very simple approach to identify compromises between a constant production rate and continuous adaptations to demand.

## 7.5 Conclusions of the Case Studies in General

The proposed methodology MOPA is being illustrated in detail at hand of the exemplar case study on bicycle coating throughout this book. In course of the research project PepOn a series of different case studies has been conducted in China and in Chile of which six are described in the Appendices of this book. The most comprehensive case study evaluates the overall optimisation potential by applying the new methodology to a bicycle company in China. Bicycle production is an important industry sector in China and for the determination of available savings potentials, target values for the this company are identified by the various pinch analysis approaches and an overall performance evaluation is demonstrated.

In the case study, target values were identified for heat integration, water management and solvents recovery using the pinch analysis approach. In addition, the analysis showed how the identified theoretical target values can partly be realised by taking into account basic unit operations. For example, in the case of heat integration a specific heat exchanger is suggested to use the waste heat of the drying ovens to pre-heat the fresh air flow of the drying process of the coating section of the bicycle production. In the case of the water pinch analysis, an ion exchanger or a filter is suggested to regenerate the water of the pre-treatment steps of the bicycle coating. The recovery of the solvents used in the coating application from the gaseous waste stream is evaluated by thermal condensation

following the pinch analysis procedure. An detailed economic analysis of the condensation system showed, that an installation highly depends on the possibility to recycle the recovered solvents. For the economic analysis the pinch analysis approach provides figures characterising the fundamental dependencies based on the heat exchanger surface. In a subsequent step a more accurate economic evaluation can be achieved by applying flow sheeting and simulation techniques for the single unit operation. For example, the effect of different temperature gradients within the heat exchanger can be evaluated in more detail. Consequently, by including material properties and unit operations in the analysis of the total system's performance the economic analysis is based on the characteristic mass and energy flows of the system providing an adequate level of detail to inform the selection of a preferred option.

Multi-criteria analysis facilitates the selection of a preferred option by combining the different target values and investigating the overall optimisation potential of different process design options. In addition, the multi-criteria analysis supports the transparent modelling of the decision process by explicitly including preferential information. By clearly visualising the different technology combinations and their relative positions it is possible to evaluate trade-offs and the effect of different environmental priorities. For the case study the analysis by PROMETHEE suggests a switch to powder coating instead of the existing solvent-based liquid coating process. In addition to eliminating the solvent emissions in the coating step, the material efficiency can also be improved significantly by recycling the coating powder and using a circulating air system. Because of the geometry of a bicycle frame, large amounts of overspray are generated by using high rotating discs as occurs for the status quo. By using a standard industrial robot the material efficiency can be improved significantly and the manual touch-up is not required any more.

The sensitivity analyses in PROMETHEE reveal that there does not exist a robust solution. The realisation of a specific process design depends in this case highly on the preferential parameters. To evaluate the impact of the different modelling parameters and the uncertainty with respect to the data and even more with respect to the value judgements of the decision maker various new sensitivity analysis have been introduced using Monte Carlo Simulation for the preference parameter and an enumeration of all possible preference type combinations of the preference function.

A further advantage of the methodology developed in this thesis stems from the capability to embrace additional considerations as the case study shows. Depending on the special focus of the analysis new elements can be integrated as for example specialised modules for modelling mass transfer processes by the pinch analysis approach or to integrate the capacity or production planning in the assessment. In this way individual technology

combinations can be compared based on the results of the pinch analysis approaches and in addition different types of data and preferential uncertainties are addressed in the framework of a multi-criteria analysis.

## 7.6 Outlook

The topics of sustainability, resource efficiency and cleaner production are currently receiving increasing attention. Reaching further than just pollution prevention, they aim for a holistic approach. Therefore, a multi-scale, consistent and systematic approach is necessary to analyse industrial production networks. In this book an approach combining pinch analyses with multi-criteria analysis is developed and applied to a series of different case studies from Chile and China on intra- and inter-company scale with the focus on VOC-emission reduction. Since Multi Objective Pinch Analysis is a novel approach to a systematic assessment of production networks, many potential fields for future research are opened:

The fundamental idea of the pinch analysis approach is to identify target values in a system's assessment. New fields of application for the methodology based on the engineering principles to other fields of research will further the interdisciplinary research. So far, economies of scale prevent from the use of process integration in SME. But with the advent of micro-devices, new possibilities are being created, such as biomass heating or energy conversion facilities. The economic and environmental evaluation of techniques is highly complex and systematic tools are required. Thus, the pinch analysis can provide the base for incorporating different fields of expertise thereby generating new insights.

The problem of planning the future production capacity of a company can be addressed in numerous ways. When companies face a seasonal demand, the problem of capacity adaptation can become even more challenging, as there may be a constant need for capacity adaptations. For example, in contrast to conventional chemical processes, the use of biomass has several distinct characteristics: Raw materials differ in quality, have a time dependent availability, come from decentralised sources and require adjusted logistics operations. Consequently, the consideration of renewable energy sources with their special characteristics requires suitable planning tools that take into account the dynamics of the production system (for example by following the seasons and the yearly changes). In this research, the dependence of the planning outcome on the starting season and the occurrence of stock-out using the pinch planning method were identified as shortcomings of the method for which solutions are needed. Furthermore, the control of the single unit

operations in the context of renewables with respect to the overall systems performance is more complex than in classical mass and energy flow management systems.

Therefore, new aspects in the planning process must be considered, such as the opportunity to reduce  $CO_2$  emissions, the decentralised structure within the process chain (requiring low transport distances) and the economic development of urban areas and even Mega-Cities. However, the biomass potential is limited by forest and agricultural crop land and the plant size (due to the transport costs) limiting the economies of scale. This tends to result in a competition between acreage and biomass (food production, material use of biomass, different energetic biomass paths) requiring a multi-criteria assessment identifying the best utilisation of a given area.

It is necessary to overlay the approach of process integration and network design with the multi-criteria assessment to gain sustainable improvements and to understand environmental dynamics in an intra- and inter-company production network in a systematic way. Improved computational modelling will enable this progress and information will be available to the entire enterprise for the resource planning. The performance of a process is modelled and simulated by indicators and the design alternatives are evaluated by a number of different criteria. In this field new attributes can be included, such as flexibility of the process design, labour utilisation or risk minimisation in order to reflect various aspects of a cleaner production strategy. Thus for example in the case of biomass utilisation the environmental impacts can be regarded in a more holistic way by considering consequences for soil quality and water pollution, emissions and efficiency of different ways to use biomass and the availability of biomass.

In addition the aggregation procedure in multi-criteria analyses can be further evaluated based on the impact of different norms on the performance indication of different alternatives and by incorporating additional sensitivity analyses concerning rank stability regarding limit values for value functions or the uncertainty level for the distinguishability analysis. For example, it would be useful to know up to which uncertainty level the alternatives can be distinguished from each other and which criterion is the most sensitive with respect to data uncertainty and requires more accurate data. Furthermore, aspects concerning group decision making must be addressed in the context of process design and how a common understanding can be enhanced in an inter-company setting, as common in industrial parks.

Cleaner production and resource efficiency are key elements of global environmental policy and the question must be addressed how economic growth and environmental performance can be harmonised. Based on the experiences from the case studies in China and Chile

a first understanding of the problems encountered in emerging and developing industrial nations is achieved and as a result, specific suggestions for the modification or further development of Best Available Techniques for utilisation in the other countries can be derived.

# Appendix A

## Case Study 1: Bicycle Production in China

The case study analyses a reference installation of a typical bicycle production facility of a middle sized firm in China (approximately 850 000 bicycles in 2004, 1 million in 2005 and estimated 1.2 million in 2006) and is one of four bicycle companies at the "bicycle road" in Ludu, a suburb of Taicang. Around 3.6 million bicycles and bicycle parts and components were produced in 2004 along a nine kilometre long road by four bicycle companies and approximately 60 bicycle components producers in Ludu [Lu, 2005]. The development of an eco-design concept for the *Ludu Bicycle Park* is one of the exemplary projects of the *Taicang Eco-City Development Plan* of the College of Environmental Science and Engineering of the Tongji University in Shanghai [Bao et al., 2005; Lu, 2005]. In the reference company up to 130 000 bicycles are produced per month in peak times and approx. 50 000 in low times by 800 to 1 000 employees.

### A.1 Background of the Case Study

The production capacity for bicycles in China is over 80 million bicycles per year by actually producing around 66 million in 2004. The bicycle producers in China face a considerable decline in domestic sales from around 40 million per year in the past to only 22 million bicycles in 2004.<sup>41</sup> Nevertheless, the production of bicycle and parts and components for bicycles considerably increased in the last years with worldwide 55 % – 60 % of all bicycles being produced in China. However, there are considerable regional

---

<sup>41</sup>China Business Information, Ein Informationsportal des Deutsch-Chinesischen Zentrums in Leipzig (DCZL),<http://www.china-business-information.de>

differences: In the USA 96 % of the bicycles sold today are coming from China, whereas in the EU the market share of Chinese bicycles was only around 4 % in 2003/2004 (cf. Table A.1). In new markets, e.g. electric powered bicycles, bicycle producers in China created a significant market share globally.

Table A.1: Data of Bicycle Production and Consumption in the EU in [units] [EC 2005/1095]

Indicator	2000	2001	2002	2003	04/2003 03/2004
consumption in EU	17 348 000	15 236 000	15 695 000	17 336 000	18 037 000
production in EU	12 700 000	11 028 000	10 083 000	10 165 000	10 160 000
sales EU products	11 718 000	10 035 000	9 175 000	9 100 000	9 300 000
market share EU	67 %	66 %	58 %	52 %	51 %
imports from PRC	128 091	257 728	561 706	707 351	733 901
market share PRC	0.73 %	1.68 %	3.58 %	4.08 %	4.07 %

Some of the bicycle producing companies in China are situated in *Export Processing Zones (EPZ)* and face a binding export obligation included in their investment licenses and furthermore, all exporting producers face significant state interference concerning export prices and quantities [EC 2005/1095]. This resulted in price-dumping accusations and an investigation of the European Council, which finally imposed anti-dumping duties of 30.6 % on bicycle imports originating in China into the EU in the year 1993. Following an anti-circumvention investigation in 1997 this regulation was extended to certain bicycle parts. In 2000 the anti-dumping duty was confirmed according to a new review. The last review for bicycles originating from China was in 2005 considering an investigation period (IP) in 2003/2004. In that review the export prices of China were compared to *normal values* of Mexico and a dumping margin of 48.5 % was identified<sup>42</sup> and became effective as an anti-dumping duty<sup>43</sup> [EC 2005/1095]. However, the import of bicycles and bicycle

<sup>42</sup>The weighted average duty rate of the sample was 36.8 %, but because of a low level of cooperation no exceptions for sample companies were made and all companies were assigned the maximal value of 48.5 %.

<sup>43</sup>The same regulation imposes anti-dumping duties of 34.5 % on companies in Vietnam with the exception of one cooperating company with an anti-dumping duty of 15.8 %. Furthermore, the regulation (EC) No 397/1999 of the European Council imposes anti-dumping duty on imports of bicycles originating in Taiwan with rates ranging from 2.4 % to 18.2 % (weighted average duty rate of 5.4 %). There were also



parts from China into the European Union plays only an underpart. Major importing country for the EU is Taiwan with a total market share of 14.5 % of the total sales in the EU.

One reason for imposing anti-dumping duties was the low profitability of 3.6 % of the European bicycles producing sector with respect to a minimum assumed profitability of 8 % during the investigation period (IP) in 2003/2004 <sup>44</sup> [EC 2005/1095]. The anti-dumping duty was increased in 2005, even though the average profitability of existing European bicycle producers increased in comparison to the investigation in 2000. This increase was mainly caused by both restructuring and closing of businesses and a higher share of imported bicycle parts, such as coated frames, which are frequently cheaper than in-house production (cf. Table A.2).

*Table A.2: Cost Data of Bicycle Production in the EU [EC 2005/1095]*

<b>Indicator</b>	<b>2000</b>	<b>2001</b>	<b>2002</b>	<b>2003</b>	<b>04/2003 03/2004</b>
sales price [€/per unit]	124	127	120	115	122
cost of production [€/per unit]	119	122	115	110	117
wage costs per employee [€/a]	23 575	25 846	27 130	27 593	28 153

Consequently, with a production of over 100 million bicycles per year worldwide and the share of about 66 million bicycles produced in China, this sector represents an important part in the economic development of China as the second leading trading partner of the European Union.

## **A.2 Process Characteristics of the Bicycle Coating Process**

As implied in the introduction, the paint application steps of the production process are in the focus of the analysis even though the company produces completely assembled

---

anti-dumping duties effective in the sector of bicycle production for Indonesia, Malaysia and Thailand in the years 1996 - 2002.

<sup>44</sup>Investigation Period (IP) for the anti-dumping regulation was 1 April 2003 to 31 March 2004

bikes. Since the coating of bicycle frames is important for protecting the frame and for maintaining the best possible optical quality several coating steps are usually applied.

### A.2.1 The Coating of Bicycles

In order to fulfil these requirements the following sequence of process steps is widely established:

- pre-treatment (degreasing, passivation, several water cleaning steps and phosphating);
- filler application;
- topcoat application:
  - single layer application (rare),
  - double (basecoat and clearcoat) layer application (primarily),
  - special coatings (metallic) (rare).

Several coating layers are applied through a spraying process building up a sequence of layers on the frame. Only if two or more different colours are used the basecoat application is split in different chromophoric steps, which are applied primarily in wet-wet application. Consequently, this requires the application of at least three co-ordinated coating layers. After the pre-treatment and each coating application step, forced drying is necessary. Thus, energy input is required and solvent emissions are generated if liquid paints are used. Basically, a trade-off between reduced VOC-input and energy consumption can be observed. Therefore, the drying process following the coating of the bicycle frame and fork is central to the application of the pinch analysis and the setting of minimal costs and energy targets [Geldermann et al., 2006d].

In the reference company the bicycle frames and forks go through several batch-wise pre-treatment steps and a discontinuous drying process in an oven. Next, the frames pass on a conveyer band through three coating steps (filler application, basecoat application and clearcoat application) each followed by a drying step (cf. Figure A.1). As shown in Figure A.1 each coating step consists of an automatic application step with a high-speed rotating disc in an  $\Omega$ -loop and a manual application step. A maximum of four workers can stand simultaneously in the touch-up zone of the coating cabin to spray individual parts of the frame, which might not have coated properly by the disc. In the reference



capacity of the component depending on the temperature, come from the ChERIC<sup>45</sup> database according to their CAS No.<sup>46</sup>

Table A.3: Multi-component Solvent Composition

Solvent	CAS No	mole fraction	formula	$C_{org}$	molar weight [kg/kmol]
m-Xylene	95-47-6	55 %	$C_8H_{10}$	0.91	106.16
Ethyl Acetate	141-78-6	20 %	$C_4H_8O_2$	0.55	88.10
Toluene	108-88-3	20 %	$C_7H_8$	0.91	92.14
Benzene	71-43-2	5 %	$C_6H_6$	0.92	78.11
Solvent Mix	-	-	-	0.84	98.35

The solvents used are Xylene, Ethyl Acetate, Toluene, and Benzene. The temperature dependent properties (heat capacity, saturation pressure etc.) are assumed to be similar to an ideal gas and are approximated by pure component specific parameters. The mass flow stream in kmol/h is considered to be constant throughout the whole drying process. Relevant for emission limits is the total organic carbon,  $C_{org}$ , which is easier to measure technically than individual solvent concentrations. Itemisation of individual solvent concentrations would require enormous effort and high costs. Thus, flame ionisation detector (FID) instruments or silica gel is used for analysing the waste gas composition by determining the total carbon content. Therefore,  $C_{org}$  in mgC/m<sup>3</sup> is primarily used as a threshold reference, as for example in German legislation [BMU-31.BImSchV].

The quantities of released solvents are calculated based on annual consumption averages (cf. Table A.4) and are verified using measurement data of the lasting dried paint on the frame and the respective solvent content based on a total surface of one bicycle set of 39.7 dm<sup>2</sup> (surface frame: 33.8 dm<sup>2</sup>; surface fork: 5.9 dm<sup>2</sup>) of a comparable case study [Schollenberger and Treitz, 2005]. Another important aspect in spray coating is the application efficiency. Depending on the geometry of the object in regular spray coating the application efficiency is 30 % – 50 %, by support of HVLP spray guns the efficiency

<sup>45</sup>CHemical Engineering Research Information Center, Korea Thermophysical Properties Data Bank, <http://www.cheric.org/>

<sup>46</sup>All chemical elements can be identified by a CAS No. The Chemical Abstracts Service registry numbers are copyright by the American Chemical Society and uniquely identify each chemical component.



	<b>1</b>	<b>2</b>	<b>3</b>	<b>4</b>	<b>5</b>	<b>6</b>
	Filler	Drying 1	Paint	Drying 2	Clear Coat	Drying 3
T [°C]	16	100	16	130	16	130
Air [Nm <sup>3</sup> /h]	64 000	600	64 000	600	64 000	600
VOC [kg/h]	14.86	7.65	24.06	12.39	6.54	3.37
VOC [mgC/Nm <sup>3</sup> ]	197	9 438	318	15 282	86	4 157

Figure A.2: Parameters of the Bicycle Coating Application

can be improved to 50 % – 70 %. With electro-static support the application efficiency can even be as high as 60 % – 85 % [Ondratschek, 2002]. However, these values seem to be too high for the coating of bicycle frames. As specified by the coating company  $\frac{2}{3}$  of the solvent emissions emerge in the coating cabin and flash off zones and  $\frac{1}{3}$  of the solvent emissions emerge in the drying oven. However, the proportion of solvent emissions in the drying oven seems to be quite high compared to other studies<sup>47</sup> where 92 % – 96 % of the solvent emissions emerge in the coating cabins and flash-off zones and only 8 % – 4 % in the drying ovens (cf. Appendix B).

The major environmental impacts during the drying process are caused by energy consumption and volatile organic compound emissions from solvents in the coating material. In the current process layout each stream is heated up separately and is released after the drying tunnel using independent fresh air sources<sup>48</sup> for each oven.

This current production process layout is compared to a new process layout using the waste heat of the drying process being released. In the new process layout the air flows of the drying ovens are preheated using the released heat and consequently the overall energy consumption is reduced. Further measures for improving the general energy efficiency such as for example improved insulation may be possible, but are not included in this case study. For example delays resulting from malfunctions and downtimes in the production facilities

<sup>47</sup> Within the PepOn project several case studies were investigated on-site in close cooperation with companies in Chile, China and Germany. A special focus was put on the estimation of solvents emission within the diploma thesis by Robert Kolotilo ("Untersuchung der Sensitivität der Lösemittlemissionen bei Änderung der Massenbilanz am Beispiel einer Lackierstraße für Plastikanbauteile", Institut für Industriebetriebslehre und Industrielle Produktion, Universität Karlsruhe, 2005) and Alexander Hercher ("Technische und wirtschaftliche Möglichkeiten der Minderung von Lösemittlemissionen am Beispiel eines industriellen Lackierbetriebes in Chile", Institut für Industriebetriebslehre und Industrielle Produktion, Universität Karlsruhe, 2005)

<sup>48</sup> Annual average daytime temperature for Shanghai is 15.8 °C, German Weather Service, www.dwd.de

Table A.4: Settings for the Case Study

Indicator	Amount	Unit
Effective working time	400	min/d
Working days	260	d/a
Filler consumption	50 220	l/a
Basecoat consumption	84 240	l/a
Clearcoat consumption	27 540	l/a
Additional solvent consumption	54 000	l/a
Solid content undiluted filler	47 %	%
Solid content undiluted paint	50 %	%
Solid content undiluted clear coat	64 %	%
Mixing ratio additional solvent/filler	1: 3	-
Mixing ratio additional solvent/paint	1: 3	-
Mixing ratio additional solvent/clear coat	1: 3	-
Density undiluted filler	1.20	kg/dm <sup>3</sup>
Density undiluted paint	0.98	kg/dm <sup>3</sup>
Density undiluted clear coat	0.94	kg/dm <sup>3</sup>
Density additional solvent	0.9	kg/dm <sup>3</sup>

cause an automated shut-down of the heating in the drying ovens and an ensuing cooling these down, which might be slowed down with appropriate insulation. Increased energy consumption due to these downtimes, which might be substantial, is not considered in the following model. Furthermore, auxiliary processes such as the preheating of drying ovens, the cleaning of tools, or the mixing of the filler or paint do exist in addition to the main painting process, but are not regarded in the following. Nevertheless, they may also provide significant potential for the conservation of resources [Neugebauer et al., 2005].

### A.2.3 Process Design Options and Evaluation Criteria

Modifications in the processes of various SME and TVE in China are necessary within the next years in order to increase efficiency, to improve environmental performance, and to comply with existing and new legislation. In its resolution on *Prospects for EU-China Trade Relations* the European Parliament "recognises that many of China's environmen-

tal problems stem not from lack of laws but from lack of law enforcement”, and addresses “the many outstanding areas of concern ... in the field of Intellectual Property Rights (IPR) enforcement, ..., transparency and environmental, social and health standards” and additionally calls on the European Commission “to make use of the EU countries’ political and economic influence in order to bring about a change in China’s attitude towards compliance with international trade rules.” ... Addressing inter alia the worker’s rights, social dumping and the high levels of pollution the European Parliament “urges the Chinese government, under pain of seeing trade with the EU being severely restricted, to play a full and positive role in promoting sustainable development, both inside China and globally”. (European Parliament Resolution on Prospects for Trade Relations between the EU and China (2005/2015(INI)), 13.10.2005, European Parliament Public Register of Documents, Document P6\_TA(2005)0381, <http://www.europarl.eu.int>). Considering various design modifications and variants (Thermal Oxidiser vs. Regenerative Thermal Oxidiser (RTO)) four different generic process design options aiming at emission reduction can be identified to be compared to the *Status Quo*: a complete shift to waterborne coatings concerning the basecoat as a process integrated measure and the two additive measures of thermal incineration, i.e. thermal oxidation, and the recovery of the solvents by condensation. Additionally, the complete technique shift to powder coatings is discussed as a separate measure:

- Status Quo ( $T_0$ )
- Waterborne Basecoats ( $T_1$ )
- Thermal Incineration ( $T_2$ )
- Condensation ( $T_3$ )
- Powder Coating ( $T_4$ )

The status quo represents the current process layout and has no solvent emission reduction measure installed. The development of new coatings, for example waterborne, high solid or powder coatings, and new coating application tools, for example HVLP<sup>49</sup> spray guns or high-speed rotating discs, were caused by more stringent environmental legislation concerning solvent emissions in the serial coating of metal parts [Rentz et al., 2003; Geldermann et al., 2004] and in the sector of vehicle refinishing [Schollenberger, 2006]. Waterborne coating systems for bicycles are state-of-the-art for filler and basecoat systems, but are not available for clearcoat systems. The waterborne coatings still contain

---

<sup>49</sup>High Volume Low Pressure

solvents, but have a considerably lower solvent content (10 % - 15 % compared to 50 % - 80 % of regular coatings). However, waterborne coating systems often contain biocides for long-term stability and therefore may represent a potential health risk during application and handling<sup>50</sup>. The second option as a proven technology is thermal incineration, which offers a safe, reliable, and efficient method for the removal of a wide range of VOC (except halogenated hydrocarbons) [Rentz et al., 2003]. They undergo oxidation in a combustion chamber at temperatures between 700 °C and 1 000 °C, to a certain extent with the addition of fuel. Removal efficiencies up to 99 % and even above can be achieved [Rentz et al., 2003]. The third option considered is a condensation system. The advantage of a condensation system is the recovery of the solvents used in the application and reuse resulting in a potential economic benefit [Geldermann et al., 2006e]. The last option is a switch of techniques to powder coatings, which are solvent-free systems that require electrostatic application procedures and are therefore primarily suitable for metal bodies, such as bicycle frames. Powder coating systems provide some inherent positive properties: Since they are free of solvent emissions, no water is necessary in order to absorb coating particles in the coating cabins and less waste is generated compared to liquid spray coatings since a recycling of the coating material is possible (up to 95 %) [Rentz et al., 2003]. Even though there exists a high application efficiency and the high proportion of circulating air in the coating booth results in a reduction of energy consumption, the investment for a change to powder coatings must be considered.

Further process design alternatives, such as for example catalytical incineration, a biofilter, a bioactive scrubber, or a zeolite wheel<sup>51</sup> are not considered in the following [see e.g. Rentz et al., 2003; Geldermann et al., 2004, for further information and a techno-economic assessment].

Following the procedures of a techno-economic assessment [Geldermann, 1999] various criteria are taken into account in the evaluation of the process design options to be assessed. For an evaluation in reference to a sustainable development a whole range of different criteria from various perspectives can be considered with respect to functionality, economy, environmental quality, safety and societal quality [VDI 3780]. With respect to a selection of an appropriate process design in the context of emission abatement techniques,

---

<sup>50</sup>The use of biocidal products as preservatives is regulated by the European Parliament Directive 98/8/EC concerning the placing of biocidal products on the market.

<sup>51</sup>A zeolite wheel can be used as a concentrating system to purify low loaded waste streams. The cleaning of the gaseous waste stream is accomplished by a adsorption of the VOC in the hydrophobic zeolites and the continuous or discontinuous release by a smaller air stream at high release temperature. However, due to the moisture in the gaseous waste stream caused by the water curtains in the coating cabins and the coating particles caused by the overspray, filters have to be installed.



major criteria are amongst others the required efficiency of the VOC emission reduction, the characteristics of the waste gas (composition, volume flow, VOC concentration), the technical-economic service life and the quality requirements of recovered solvents [Rentz et al., 2003].

For the following case study the criteria for the evaluation consider the mass and energy flows of the company and the evaluation is based on a relative assessment of the alternatives compared to target values for each criterion which are calculated using the pinch analysis approaches. The criteria represent only a selection of relevant criteria for the evaluation of the resource efficiency of the different production process design options and are specifically:

- Energy [kWh/h] (Energy)
- Water [m<sup>3</sup>/h] (Water)
- Solvents [mgC/m<sup>3</sup>] (VOC)
- Investment [€] (Invest)
- Operating Costs [€/a] (Costs)

Since the criteria cover only the decision relevant aspects of the design options, only differences between the options are taken into account. Unchanged process steps for all options, for example the welding before the coating and the assembling and packaging after the coating, and all the involved parameters, such as the energy use of these process steps, are neglected. The change in operating costs considers for example the amount and value of the recovered solvents and include the operating cooling costs for the condensation installation. In case of a switch to powder coatings the decision relevant operating costs and the investment in comparison to the status quo are taken into account.

### A.3 Parameters of the Case Study

In the following different parameters used in the calculations are presented. They build the base for the calculations of optimisation potentials based on heat, water or solvent integration. In addition, further results are presented complementing the case study of industrial bicycle coating in China.

Table A.5: Coefficients of Heat Capacity (Gas)

solvent name	$A_g$	$B_g$	$C_g$	$D_g$	$E_g$
m-Xylene	$-1.26 \cdot 10^{01}$	$5.66 \cdot 10^{-01}$	$-2.80 \cdot 10^{-04}$	$2.03 \cdot 10^{-08}$	$1.72 \cdot 10^{-11}$
Ethyl Acetate	$7.24 \cdot 10^{00}$	$4.07 \cdot 10^{-01}$	$-2.09 \cdot 10^{-04}$	$2.85 \cdot 10^{-08}$	0
Toluene	$-2.05 \cdot 10^{01}$	$4.80 \cdot 10^{-01}$	$-1.64 \cdot 10^{-04}$	$-8.87 \cdot 10^{-08}$	$5.44 \cdot 10^{-11}$
Benzene	$-6.07 \cdot 10^{01}$	$6.33 \cdot 10^{-01}$	$5.80 \cdot 10^{-04}$	$2.80 \cdot 10^{-07}$	$-5.49 \cdot 10^{-11}$

Table A.6: Coefficients of Heat Capacity (Liquid)

solvent name	$A_l$	$B_l$	$C_l$	$D_l$
m-Xylene	$-2.00 \cdot 10^{02}$	$3.06 \cdot 10^{00}$	$-8.26 \cdot 10^{-03}$	$7.93 \cdot 10^{-06}$
Toluene	$-5.63 \cdot 10^{01}$	$1.77 \cdot 10^{00}$	$-5.19 \cdot 10^{-03}$	$5.49 \cdot 10^{-06}$

Table A.7: Coefficients of Vapour Pressure Curve

solvent name	A	B	C	D
m-Xylene	$-1.01 \cdot 10^{01}$	$-7.95 \cdot 10^{03}$	$8.33 \cdot 10^{01}$	$5.94 \cdot 10^{-06}$
Toluene	$-8.80 \cdot 10^{00}$	$-6.92 \cdot 10^{03}$	$7.41 \cdot 10^{01}$	$5.75 \cdot 10^{-06}$

Table A.8: General Process and Model Parameters for the Solvents Pinch Analysis

Variable	Value	Remarks
lower bound of temperature range	150 K	end point for the calculation of concentration diagram etc.
upper bound of temperature range	321 K	equivalent to the supply temperature of the waste gas stream
approximation temperature interval	0.1 K	control parameter for linearisation
system pressure	0.1 kPa	required for the calculation of saturated concentrations
flow rate	0.1 Nm <sup>3</sup> /h	used for the calculation of energy flows per unit time

Table A.8: General Process and Model Parameter for the Solvents Pinch Analysis (cont.)

Variable	Value	Remarks
minimum $\Delta T_{min}$	2 K	minimal driving force for heat exchange
maximum $\Delta T_{min}$	20 K	maximal driving force for heat exchange
$T_{humid}$	278 K	end temperature for the dehumidification
VOC-emission	1 kgC/Nm <sup>3</sup>	threshold of VOC emission (upper bound of condensation temperature)
$T_{sysmin}$	278 K	minimal operating temperature of the whole system

Table A.9: Preferential Parameters Multi-Criteria Analysis (Uncertainty Level: ? Columns)

Criterion	$w_j^-$	$w_j$	$w_j^+$	t	p	?	q	?	s	?
Energy	10 %	15 %	20 %	6	17.47	10 %	3.86	10 %	8	10 %
Water	10 %	15 %	20 %	6	0.19	10 %	0.05	10 %	0.09	10 %
Solvents	15 %	20 %	25 %	6	237.83	10 %	51.42	10 %	116.50	10 %
Investment	15 %	20 %	25 %	6	563 635	10 %	81 698	10 %	306 000	10 %
Costs	25 %	30 %	35 %	6	18 337	10 %	2 809	10 %	10 406	10 %

Table A.10: Parameters Economic Evaluation Production Pinch Analysis (data partly from [Singhvi et al., 2004])

Variable	Value
production time per bicycle	1.03 h/unit
labour cost	435 €/month
material cost	9.50 €/unit
production cost	27 €/unit
stock-keeping cost rate	20 %
selling price	33 €/unit
hiring cost	206 €/worker

Table A.10: Parameter Economic Evaluation Production Pinch Analysis (cont.)

Variable	Value
layoff cost	340 €/worker
capital demand	450 €/unit
ratio investment depended cost	17 %

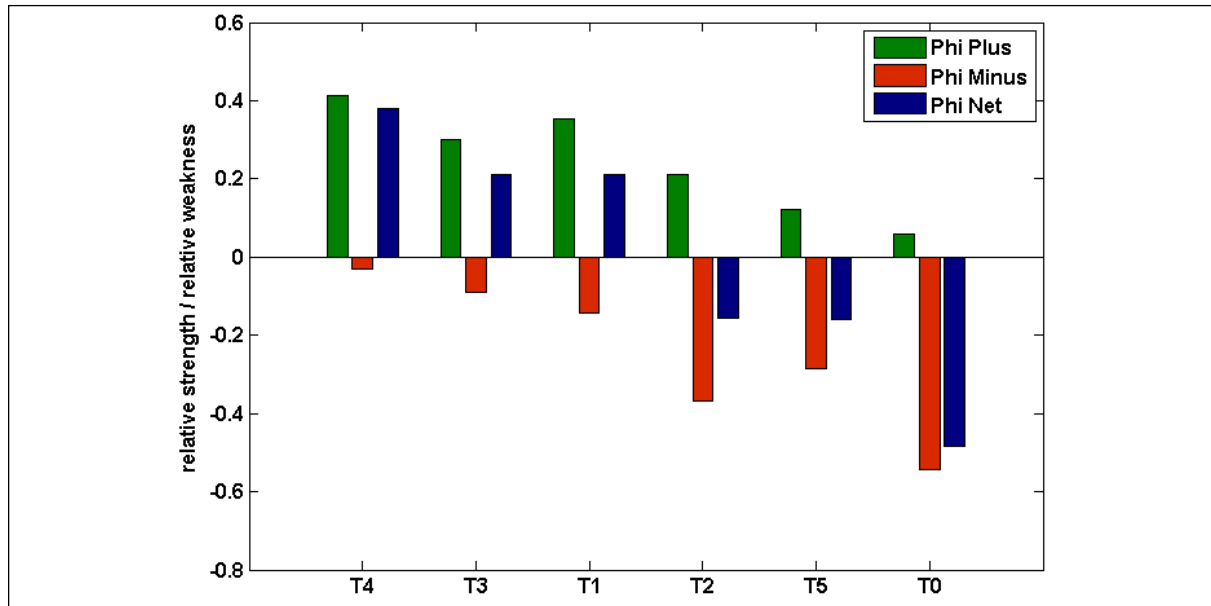
Figure A.3: Aggregated Outranking Flows with Additional Alternative Thermal Incineration  $T_5$

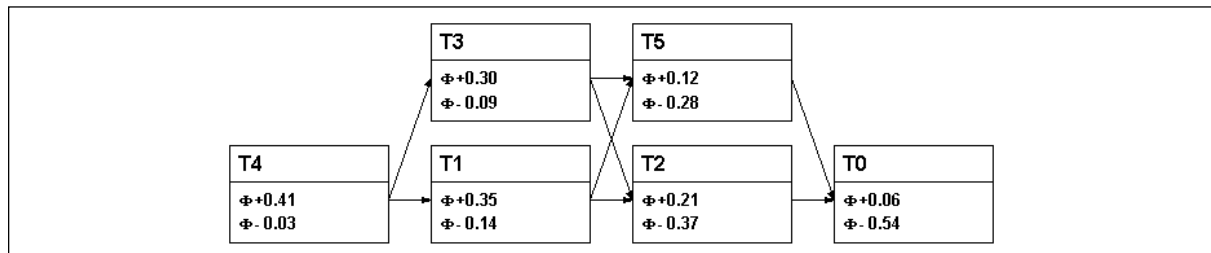

Figure A.4: PROMETHEE I Ranking with Additional Alternative Thermal Incineration ( $T_5$ )

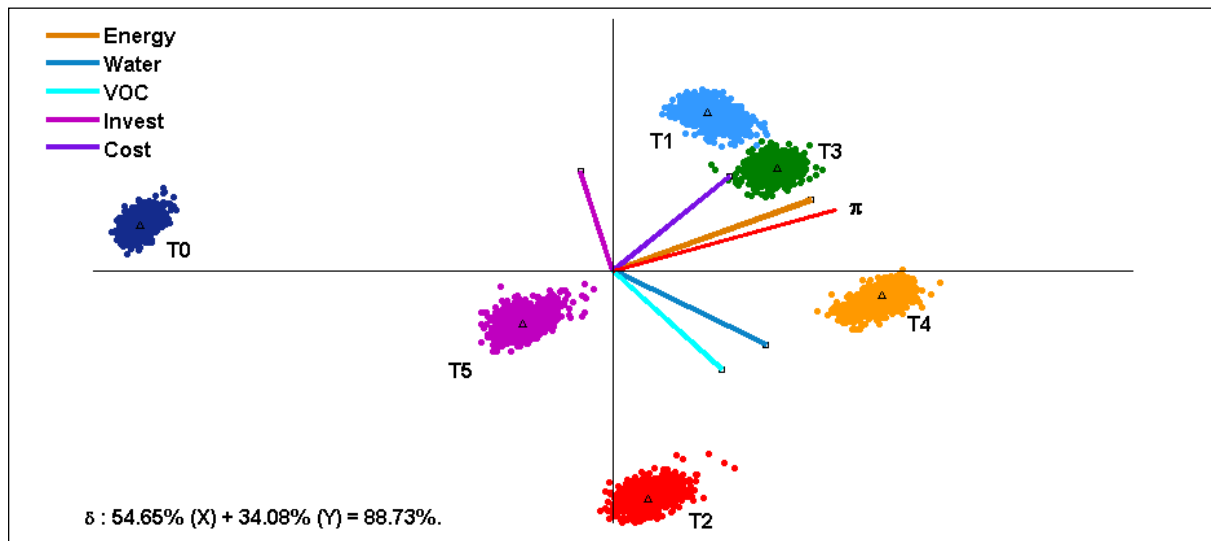

Figure A.5: Distinguishability Analysis with Additional Alternative Thermal Incineration  $T_5$



# Appendix B

## Case Study 2: Bicycle Production in Chile

contribution by **Jens Neugebauer, Marcela Zacarías, Alexander Hercher, Alex Berg**, Unidad de Desarrollo Tecnológico (UDT), Concepción, Chile

The investigated company is a middle sized firm in Chile producing bicycles (approx. 80 000 per year with an average surface area of 40 dm<sup>2</sup> of the bicycle frame) and beds (approx. 12 000 pieces per year with an average surface area of 361 dm<sup>2</sup> of the various parts) [Hercher, 2005]. The focus of the analysis are the paint application steps of the production process, which are technically similar for both products, henceforth called frames generalised. The construction of the frames as well as assembling and packaging steps are not taken into account.

### B.1 Background of the Case Study

The latest evaluation of Chilean Cycling Federation in the year 2000 counted some 530 000 bicycles per year sold in the country, of those about 330 000 were classified as mountain bikes. The most important brands in the Chilean market are *Bianchi*, *Oxford* and *Lahsen*. Presently, the total market capacity is estimated to be about 450 000 bicycles. Unlike other sectors, such as for example vehicle serial coating, the sector of general industrial metal coating is characterised by a multitude of different requirements, coating materials and application methods. Apart from mechanical engineering and the finish of household appliances, the series coating of bicycle frames and metal furniture represents a typical area of application of this sector.

The production plant of *Bicycle 2* with a total surface of 16 000 m<sup>2</sup> is situated in the west of the city of Santiago de Chile. The company is the exclusive producer for bicycles of a special brand for South and Central America. More than 400 employees manufacture up to 200 000 bicycles each year. The production of *Bicycle 2* may be divided into three different product groups, of which the total bicycle production amounts some 50 %:

1. Branded Bicycles: 70 % of total annual bicycle production; high season from September to February, low season from March to August
2. Other bicycle types (e.g. for department stores or special marketing activities): 30 % of total annual bicycle production; high season from September to February, low season from March to August
3. Furniture production: approx. 50 % of annual capacity; high season from March to August, low season from September to February.

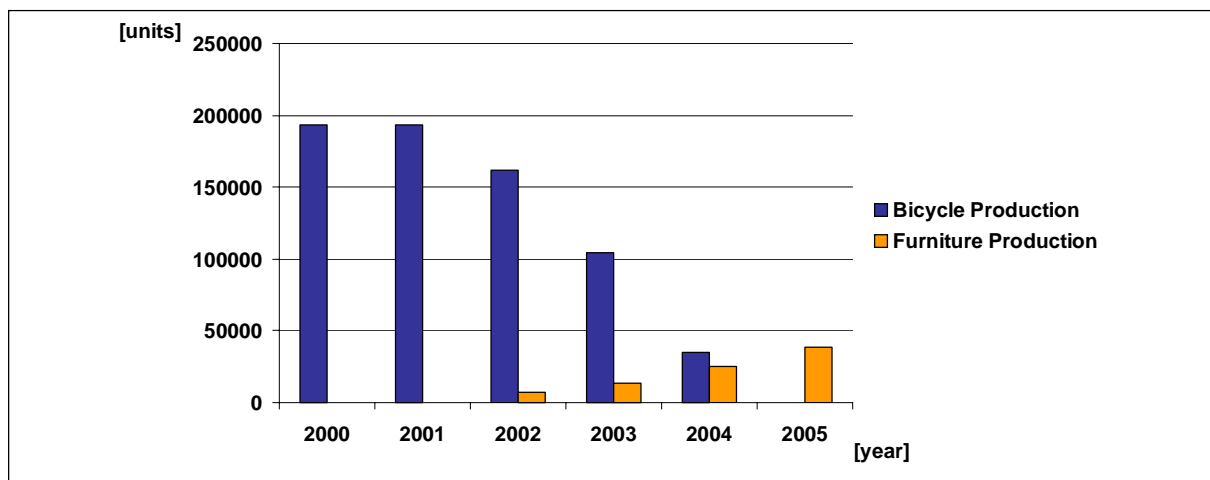

Figure B.1: *Bicycle and Furniture Production between 2000 and 2005*

Until 2003, in high season were only bicycle frames produced up to the total capacity of approx. 900 frames per day. In bicycle's low season, approx. 250 bicycle and approx. 120 furniture frames are produced each day (for examples see Figure B.1). The constant reduction in the bicycle production as well as the simultaneous continuous increase in the furniture production are particularly remarkable. The reason for this development is that *Bicycle 2* has been importing prefabricated and painted bicycle frames from China since the year 2000 to save on costs. In the year 2005 all frames were supplied for the first time in the firm's history completely from the Far East. The metal furniture production,



which was originally taken up into the program, in order to fully and uniformly use up all the available production capacity, was able to constantly expand in the last years and has transformed itself into a very important pillar of *Bicycle 2*. Particularly caused by the Chinese competition of low budget pre-assembled bicycle frames, the low season production model might persist in the future.

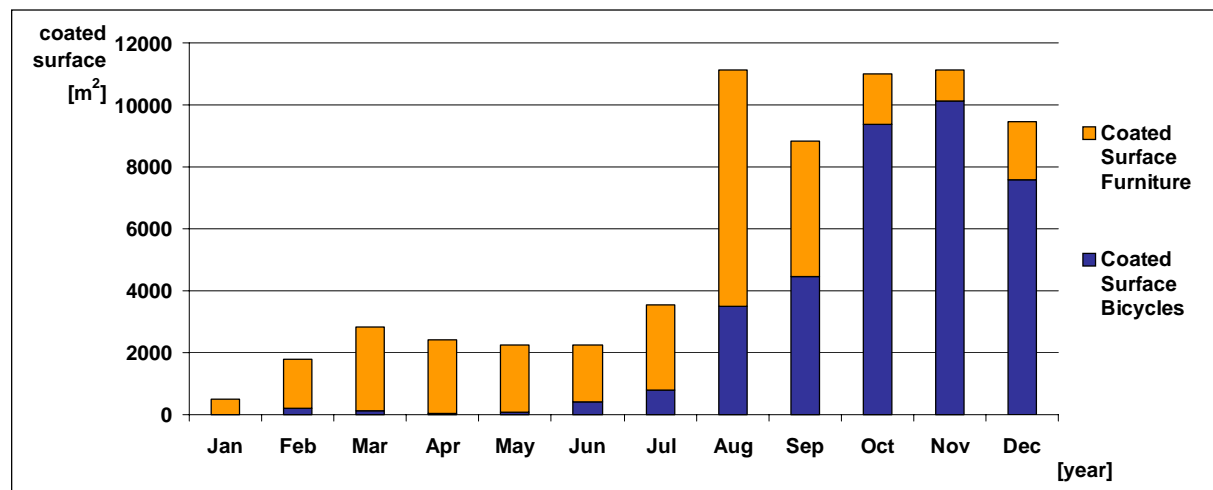

Figure B.2: *Bicycle and Furniture Production in 2003*

The monthly production figures of the year 2003 are marked by strong fluctuations in bicycle production (cf. Figure B.2). Despite the compensatory influence of furniture production, strong seasonal fluctuations still arise with regard to the monthly coated surface. Altogether in the year 2003 a total surface of 67 078 m<sup>2</sup> was painted. Bicycle frames accounted for 55 % while metal furniture took up 45 %.

Due to significant differences in production cost, more and more enterprises are actually outsourcing manual labour based processes to low-wage countries. Being formerly characteristic of central European countries, this phenomenon nowadays also affects emerging nations like Chile, whose GDP of 6 057 USD per capita in 2004 is only 20 % that of Germany [la Rubia et al., 2005]. One industry particularly being affected in Chile is the production of bicycles, as the import of pre-painted frames tends to be cheaper than maintaining existing coating facilities. Since various technologies and guidelines for the optimisation of industrial coating processes already exist, the main challenge lies in the adaptation of the available information. Therefore, material and energy flows as well as cost parameters have to be specifically analysed, and possible solutions have to be recalculated in order to meet the needs of the plant operator. On this very basis, the evaluation of technological alternatives can be conducted by means of material flow management

[Spengler et al., 1997; Terazono and Moriguchi, 2004], environmental assessment methodologies [Eyerer, 1996] or multi-criteria approaches [Seppälä et al., 2002; Treitz, 2006]. Beside typical parameters like operational cost or environmental impacts, the ranking of all results may as well consider individual decision restrictions such as social development indices, investment or local legislative and emission standards.

## B.2 Process Characteristics of the Bicycle Coating Process

In general, the coating process of this case study is very similar to the case study of *Bicycle 1* described in Appendix A. Summarising, the production facility of *Bicycle 2* can be divided into eight different plant sections:

- Stock for Metal Tubes and semi-finished Metal Parts
- Mechanical Workshop (batch treatment)
- Surface Treatment of intermediate Metal Parts (batch treatment)
- Welding of Frames (batch treatment)
- Frame Pre-Treatment (continuous treatment)
- Frame Coating (continuous treatment)
- Final Assembly (batch treatment)
- Storage and Delivery

After the pre-treatment steps (degreasing, passivation, water cleaning and phosphating), the frames pass through four coating steps (filler application, two paint applications and finally a clear coat application) followed by a drying step. Figure B.3 describes the processes belonging to the three main parts that are connected with the use of solvents and paint. Bicycle and furniture frames pass the total process chain described with one exception: the bicolour painting process is only used for the branded bicycles and the furniture frames.

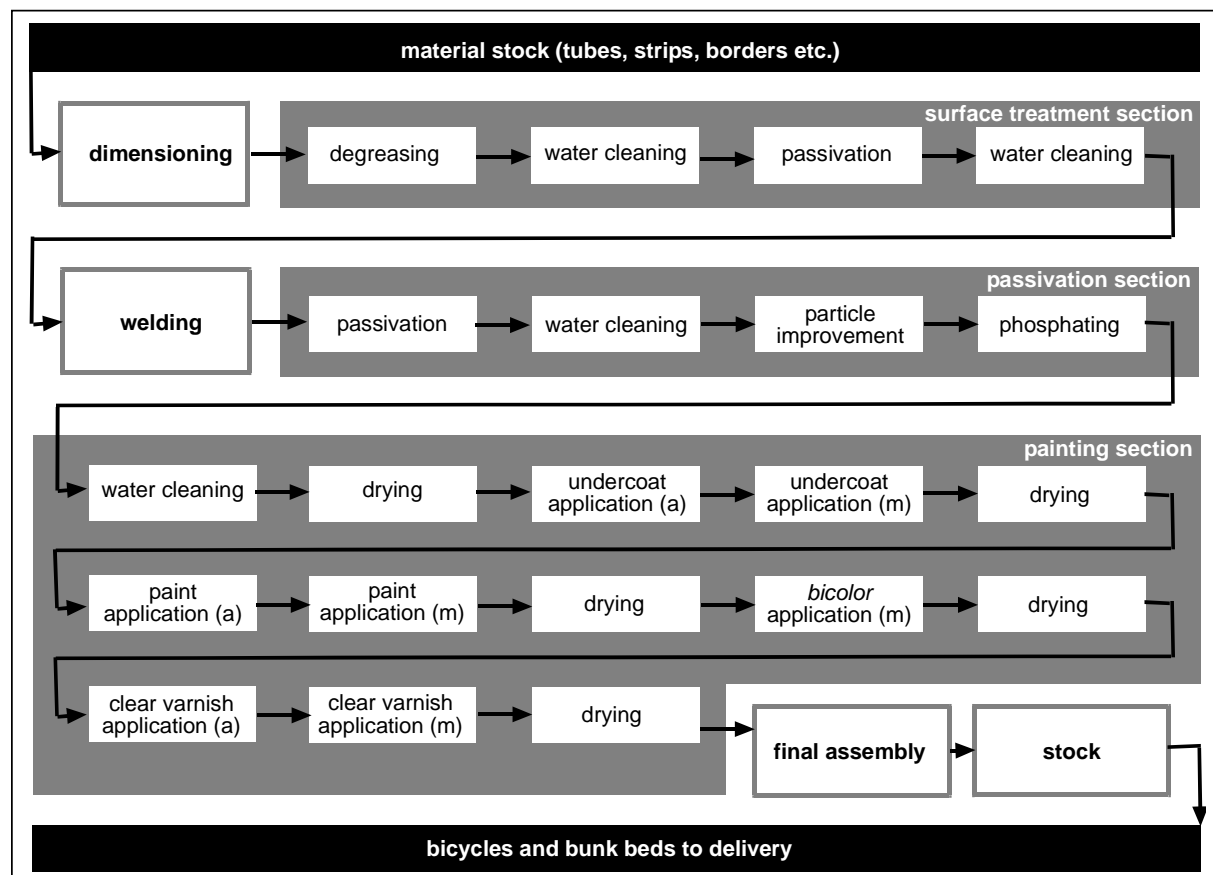

Figure B.3: Process Schema of the Bicycle Coating Process

### B.2.1 Process Parameters for the Coating Step

The spray booths and flash-off zones and the drying oven have a separate waste gas system (around 96% of the solvents are emitted in the booths and flash-off zones and the rest in the drying oven). The solvent used is Xylene (CAS No 95-47-6) (cf. Tables A.5 - A.7) with a molecular weight of 106.167 kg/kmol. Some share of the overall solvents used are in the paint and some are bought extra to dilute the paint and adjust the spraying parameters such as viscosity. The temperature dependent properties (heat capacity, saturation pressure, etc.) are assumed to be similar to an ideal gas and are approximated by pure component specific parameters as described in the *Bicycle 1* case study.

The gaseous emissions of each painting cabin within the painting section (7 measurements, see Figure 4) and of the emergency power generator outside (driven by diesel) are determined once a year; there is no treatment facility existing. Although the frames,

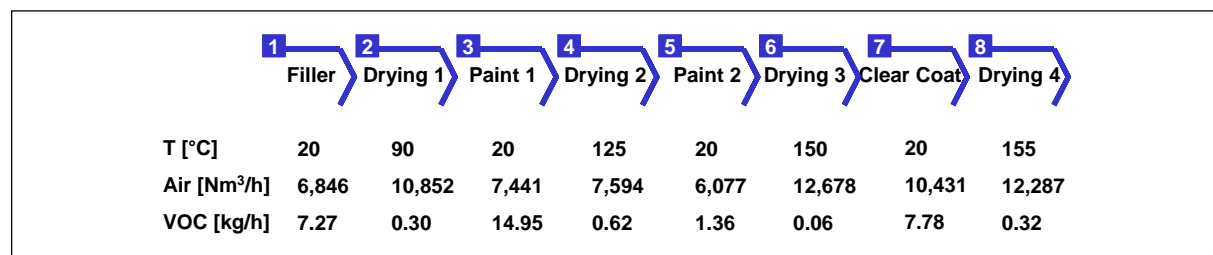

Figure B.4: Hot and Cold Composite Curves Energy

leaving each painting cabin, pass a short distance before getting into the ovens, it can be assumed that no solvent is emitted in these zones.

In the current process layout each stream is heated up separately and released after the drying tunnel using independent fresh air sources for each oven (*baseline scenario*). This baseline scenario is compared to a scenario using the heat of the production process being released during the cooling down of the waste gas to 40 °C. The air flows of the drying ovens are preheated using the released heat and the overall energy consumption is reduced (*heat integration scenario*). Further measures for improving the general energy efficiency are discussed in literature, but not included in this case study.

## B.2.2 Process Design Options and Evaluation Criteria

Except of the option *Powder Coating*, the same emission abatement options as in the *Bicycle 1* case study are used to be compared to the *Status Quo* (abbr.  $T_0$ ) of the *Bicycle 2* case study: a complete shift to *Waterborne Coatings* ( $T_1$ ) as process integrated measure and the two additive measures of *Thermal Incineration* ( $T_2$ ) and the recovery of the solvents with a *Condensation* ( $T_3$ ). The evaluation is based on a relative assessment of the alternatives compared to target values for each criterion ( $S_{pinch}$ ), which are calculated using inter alia the pinch analysis approach. The selected criteria for the evaluation are:

- Energy Consumption [kWh/h] (Energy)
- Fresh Water Consumption [m<sup>3</sup>/h] (Water)
- VOC Emissions [mgC/m<sup>3</sup>] (VOC)
- Investment for Abatement Installation as annualised costs [€/a] (InvDep)
- Change in Operating Costs due to Purchased Solvents [€/a] (Costs)

The last criterion (Costs) covers the change in operating cost pertaining purchased solvents. In industrial coating fillers and paints are in general bought not ready for application but with a lower solvent content than required (e.g. solvent content of filler bought: 53%). Thus, additional solvents are bought to adjust the viscosity of the paint right before the application (e.g. solvent content of filler ready for application: 76.5%). Furthermore, additional solvents are required for cleaning equipments such as spray guns. Hence, the amount of solvents recovered determines the amount of additional solvents that have to be bought.

Since the level of VOC emissions is not really an evaluation criteria because all abatement options have to fulfil the emission threshold for VOC, two separate analyses are carried out: One multi-criteria evaluation using all five criteria (*full criteria set*) and one analysis using all criteria but VOC Emissions since it is assumed to be a knock-out criterion and fulfilled by all alternatives (*abridged criteria set*).

## **B.3 Calculations and Recommendations**

In this section the target values for heat integration, water reuse and solvents recovery are calculated using the pinch analysis approaches as described in Chapter 3. The target values are discussed in comparison to current resource consumption in terms of the savings potential they provide and the possibilities how they could be realised by installation of specific unit operations. The individual savings potential constitute the base for the multi-criteria assessment integrating the various targets in one overall assessment as described in Chapter 5.

### **B.3.1 Calculation of the Energy Target Values**

Calculations of the energy pinch analysis are done using the classical transport algorithm as described in Chapter 3.1. Both, the drying air of the process requiring heating and the cooling air of the counter-current flow are taken from the outside air supply (assumed to be 20 °C). Auxiliary processes such as the preheating of drying ovens, the cleaning of tools, or the mixing of the filler or paint exist in addition to the main painting process, but are not included in the investigation of this case study. Nevertheless they may also provide significant potential for the conservation of re-sources. Furthermore, the air flows of the spraying booths and the flash-off zones are not considered as they do not need any heating at all. 4% of the solvents are emitted in the drying ovens and are therefore

relevant for the heat integration scenario. The minimal temperature difference between the hot and the cold composite curve is assumed to be  $\Delta T_{min} = 10$  K.

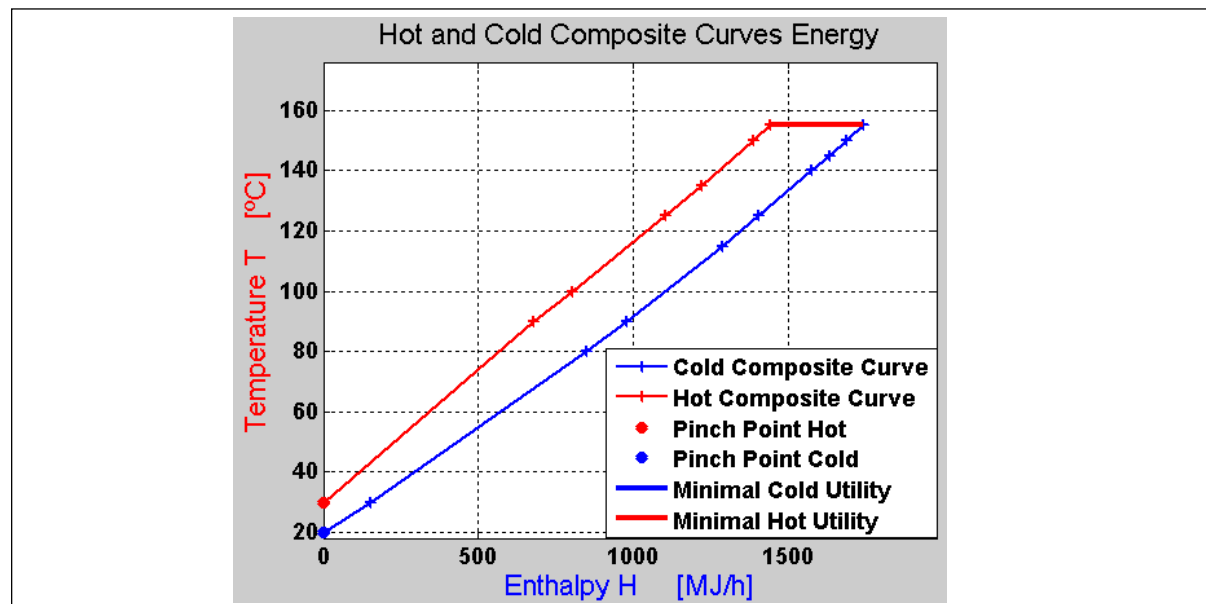

Figure B.5: Hot and Cold Composite Curves Energy

The baseline scenario requires a heating of 5 063 MJ/h (= 1 406.3 kWh/h), which is lost during the cooling down of the air flows. As Figure B.5 illustrates, in the heat integration scenario the pinch points are situated at the bottom of the hot and cold composite curve leaving a requirement of hot utility at the upper end of the composite curve of around 300 MJ/h (= 83.5 kWh/h). Hence, the theoretical savings potential is about 94% and the major heating requirements for the ovens could be met by heat integration of the hot waste gas.

### B.3.2 Calculation of the VOC Target Values

The thermal condensation of solvents can be described as a heat exchanger problem and thus be evaluated by the pinch analysis approach (cf. Chapter 3.3). The analysis is based on temperature - concentration relationships depending on the temperature-sensitive saturation pressure curves of the considered pure or multi-component VOC. The calculation also considers the temperature dependent heat capacities of the waste gas and the partly cleaned waste gas after condensation. Furthermore, the heat of condensation is taken into account as well as the heat capacity of the condensed liquid solvent.

In contrast to the heat integration scenario, discussed in the last section, the condensation is applied to the 96% of the solvent emissions of the booths. The flash-off zones are relevant to the condensation. Since the warmer air stream of the drying ovens has a significant lower solvent concentration it is unreasonable to mix the streams and cool down the higher volume of air afterwards. Hence, the streams of the drying ovens are not used for the condensation.

The temperature range to be considered for the calculation of the condensation is given by the supply temperature of the air flow (in this case 20 °C (293 K)) as the upper bound and the maximum of system dependent temperatures (freezing point of the coolant, minimal system temperature, freezing point of solvent, etc.) as the lower bound. In this case study the freezing point of Xylene at −48 °C (225 K) defines the lower bound of the temperature range. The starting point of condensation depends on the solvent concentration in the air which is 1 001 mg/m<sup>3</sup>. This concentration accrues from the solvents contained in the paint and the solvents used for dilution. The flow rate of the air is 30 800 Nm<sup>3</sup>/h. Both data are calculated on the basis of air quality measurements.

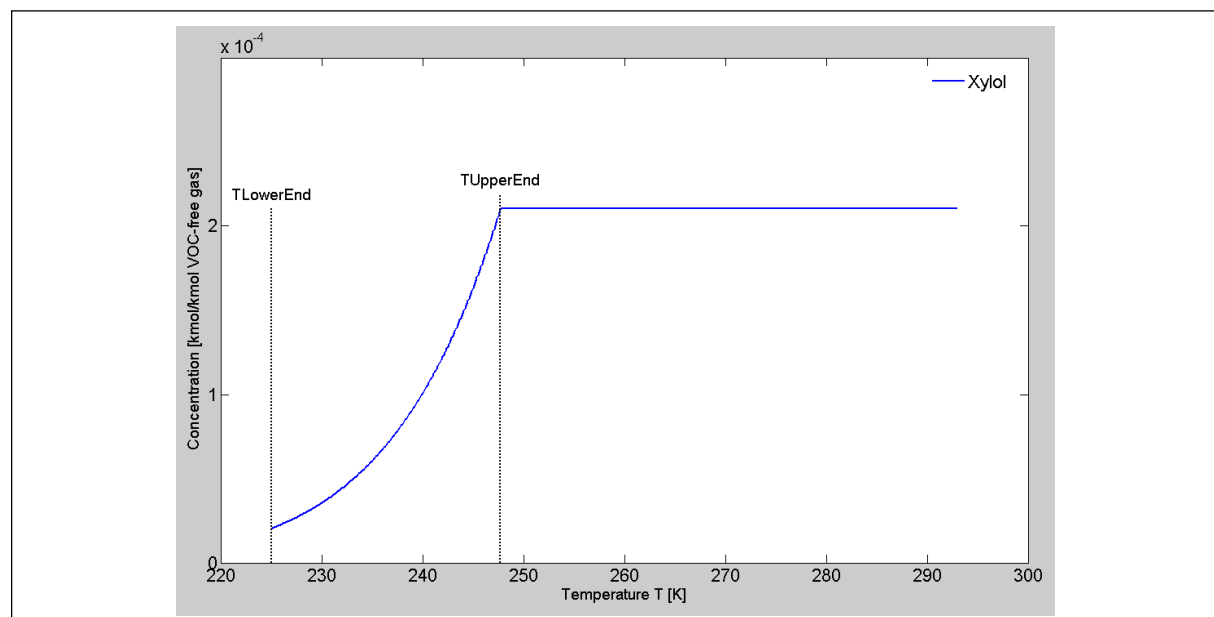

Figure B.6: Concentration of Xylene

The condensation of Xylene in the waste gas starts at 247.7 K ( $T_{UpperEnd}$  in Figure B.6). The objective of the analysis is to determine the economic reasonable amount of solvents to be recovered, which can be translated into an endpoint temperature ( $T_{End}$ ) of the condensation at which this recovery target is reached. The costs for running the conden-

sation are calculated as total annual costs comprising fixed costs for the installation of heat exchangers and operating costs for the additional cooling by liquid nitrogen.

The heat to be integrated and the heat to be dissipated depend on the endpoint temperature of the condensation. The heat exchanger between the waste gas and the full or partly cleaned cold gas is characterised by surface dependent investment without considering possible operating (e.g. for maintenance) costs and heat transfer losses. The heat exchanger in the lower temperature range considers not only the investment of the heat exchanger, but also the consumption of coolant based on their specific heat transfer coefficient. The condensed solvents are also cooled to  $T_{End}$  since an advance extraction is not considered. Parameters such as geometry and material are not explicitly considered.

The integrals of the heat balance are solved in MATLAB<sup>TM</sup> numerically with a linear approximation in 0.1 °K steps. The solution is driven by the trade-off between the amount of recovered solvents and therefore the revenues for the solvents and necessary investment in heat exchanger and coolants (e.g. liquid nitrogen). For each endpoint temperature of the condensation within the condensation range (247.9 K to 225 K) and for each  $\Delta T_{min}$  within an assumed range (2 K to 20 K) the total annual costs are determined. Depending on the quality requirements of the process the recovered solvents can be used either in the same process or in a different application or both since the solvents within the paint can also be recovered it is possible that more solvents are recovered than are necessary in the process.

Figure B.7 shows that the minimal temperature gradient  $\Delta T_{min}$  for the use of liquid nitrogen as a coolant between the raw gas and the partly cleaned waste gas depends on the end point of condensation.

The analysis reveals that the optimal temperature gradient is 8.5 °K and at an end temperature of condensation at the minimal possible temperature of 225 K. The annualised costs for the heat exchanger would be 38 214 €/a (assuming a 4% interest rate and economic life time of 10 years) and together with the residual value of the current plant resulting in 107 214 €/a. Since more solvents are recovered than have to be purchased additionally, due to the solvents delivered with the paints directly, savings of 7 785 €/a can be realised instead of spending 38 461 €/a. The calculated end point temperature of condensation leads mixed together with the air flows of the ovens to overall solvent emissions of 57.5 mgC/m<sup>3</sup> and an air flow of approx. 75 000 Nm<sup>3</sup>/h waste air.

The thermal incineration is quite effective compared to the condensation leading to emission values of 99% of the initial concentration (in this case the stream of the booths, flash-off zones and the drying tunnel are lead through the thermal oxidizer). But is has a



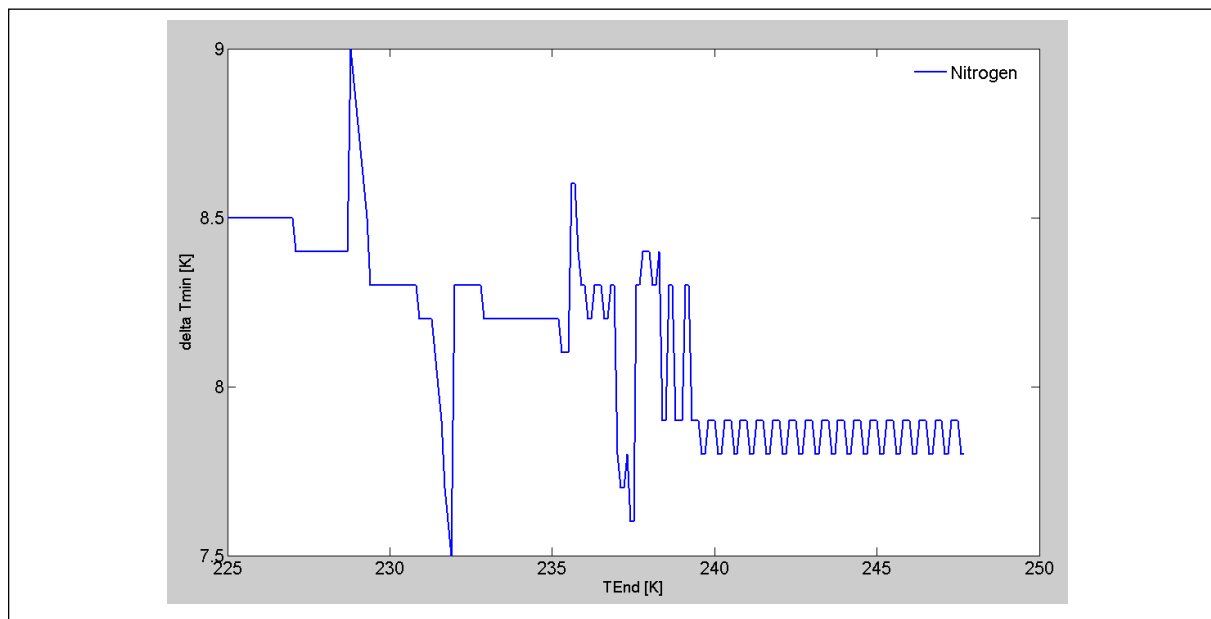

Figure B.7: Variation of the best temperature gradient depending on the end point temperature of condensation

quite high initial investment of around 460 000 € (assuming a specific economic life-time of 20 years, an interest rate of 4% and an residual value of 75 000 € results in annual costs of over 30 000 €/a) and also high operating costs since all burned solvents have to be replaced by new ones. Compared thereto, the switch to waterborne basecoats shows a smaller investment and lower operating costs (10 000 €/a), but also significant lower abatement efficiency (227 mgC/m<sup>3</sup>).

### B.3.3 Calculation of the Water Target Values

The target values concerning the water consumption are based on the process characteristics of the different techniques in relative comparison to the current consumption. The current consumption is based on the different water consuming process steps, their absolute consumption and relative frequency (e.g. cleaning of painting booth 1 m<sup>3</sup> per week or change of 46 m<sup>3</sup> acid passivation bath twice a year) resulting in an water consumption of 0.28 m<sup>3</sup>/h. Through various process improvement measures (like the extension of life-time of pretreatment baths) this consumption can be lowered to 0.15 m<sup>3</sup>/h as the target for the analysis.

### B.3.4 Results using PROMETHEE

In this case study, the data-set is used for the evaluation with the multi-criteria method PROMETHEE [Brans and Vincke, 1985; Brans and Mareschal, 2005]. Table B.1) shows the relative differences to the pinch values and also the weighting for all five criteria and an abridged criteria set.

Table B.1: Multi-Criteria Characterisation of the Assessed Techniques

Criterion	Unit	Weight	( $T_0$ )	( $T_1$ )	( $T_2$ )	( $T_3$ )
Energy	[kWh/h]	0.150 (0.189)	1 322.73	1 297.73	1 393.04	1 364.92
Water	[m <sup>3</sup> /h]	0.150 (0.189)	0.13	0.13	0.05	0.15
VOC Emissions	[mgC/m <sup>3</sup> ]	0.200 (-)	393.9	227.2	3.9	57.5
Inv. dependent	[€/a]	0.200 (0.252)	69 000	78 000	99 575	107 214
Operating Costs	[€/a]	0.300 (0.378)	38 461	20 672	38 461	-7 785

The analysis with the full set of criteria suggests an implementation of condensation as emission abatement option. Nevertheless, the difference between this alternative and a switch to waterborne coatings is very narrow. This is underlined by the fact that the switch to waterborne basecoats is ranked first in the abridged approach, again with only a small difference to condensation.

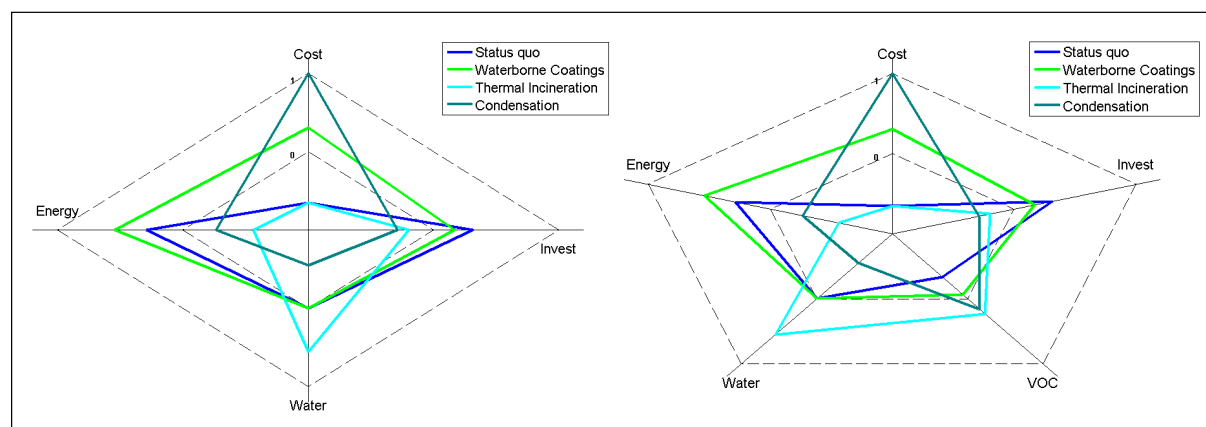

Figure B.8: Spider-Diagram of the abridged (left) and full (right) evaluation

The strength of condensation are the operating costs, whereas the strength of a switch to waterborne lies in the lower energy consumption and the smaller investment dependent costs. However, as the spider diagram (cf. Figure B.8) shows, the decision is influenced by conflicting criteria and depending on the preference parameters and the weighting, one or the other alternative is ranked first.

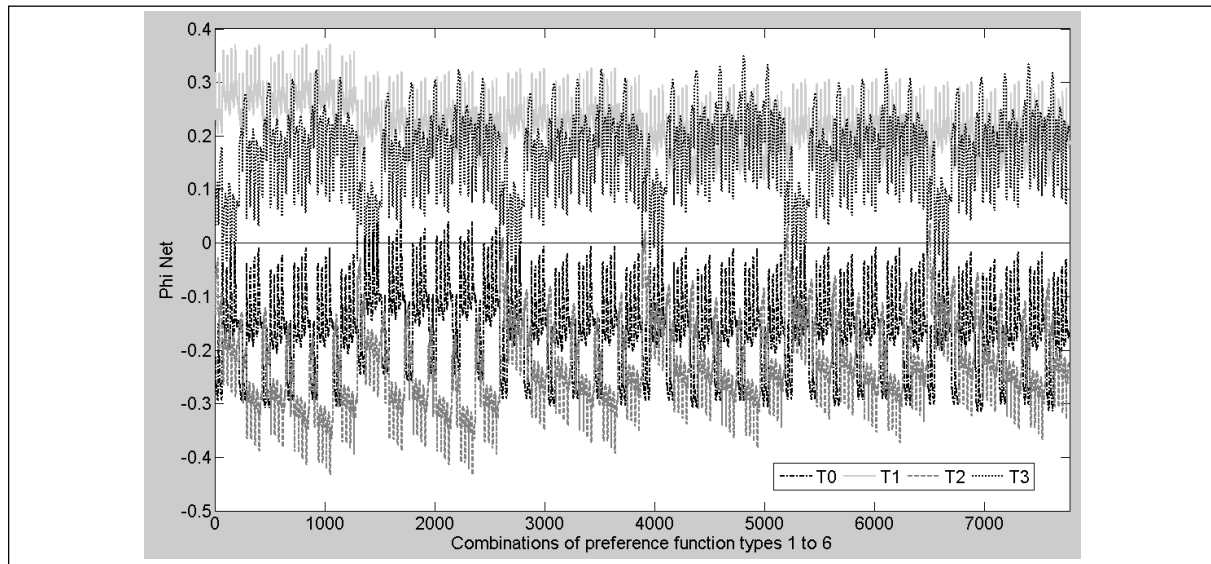

Figure B.9:  $\Phi_{net}$  flow of all possible preference type combinations

Further calculations show that in the case of the permutation of all preference types I through VI for all five criteria, alternative  $T_1$  and  $T_3$  change position depending on the final combination of preference type functions (cf. Figure B.9). In this sensitivity analysis the weights and the preference parameters are fixed and the effect on the overall result is analysed by only changing the type of preference function for each criterion. Herewith, the low robustness of the decision is demonstrated and emphasizes the need of a high transparency of the decision problem to be able to interpret the obtained results in the best possible way.

Another approach used for sensitivity analysis is the *Principal Component Analysis (PCA)* as described in Section 5.2.5 projecting the alternatives, criteria axes and the weighting vector (the PROMETHEE decision stick  $\pi$ ) on the GAIA plane. The GAIA plane is displayed for all criteria using the preference type VI and the parameter  $s$  as half the difference of the maximal and minimal attribute values. In addition, the PROMETHEE VI area can be visualised illustrating the range of  $\pi$ .

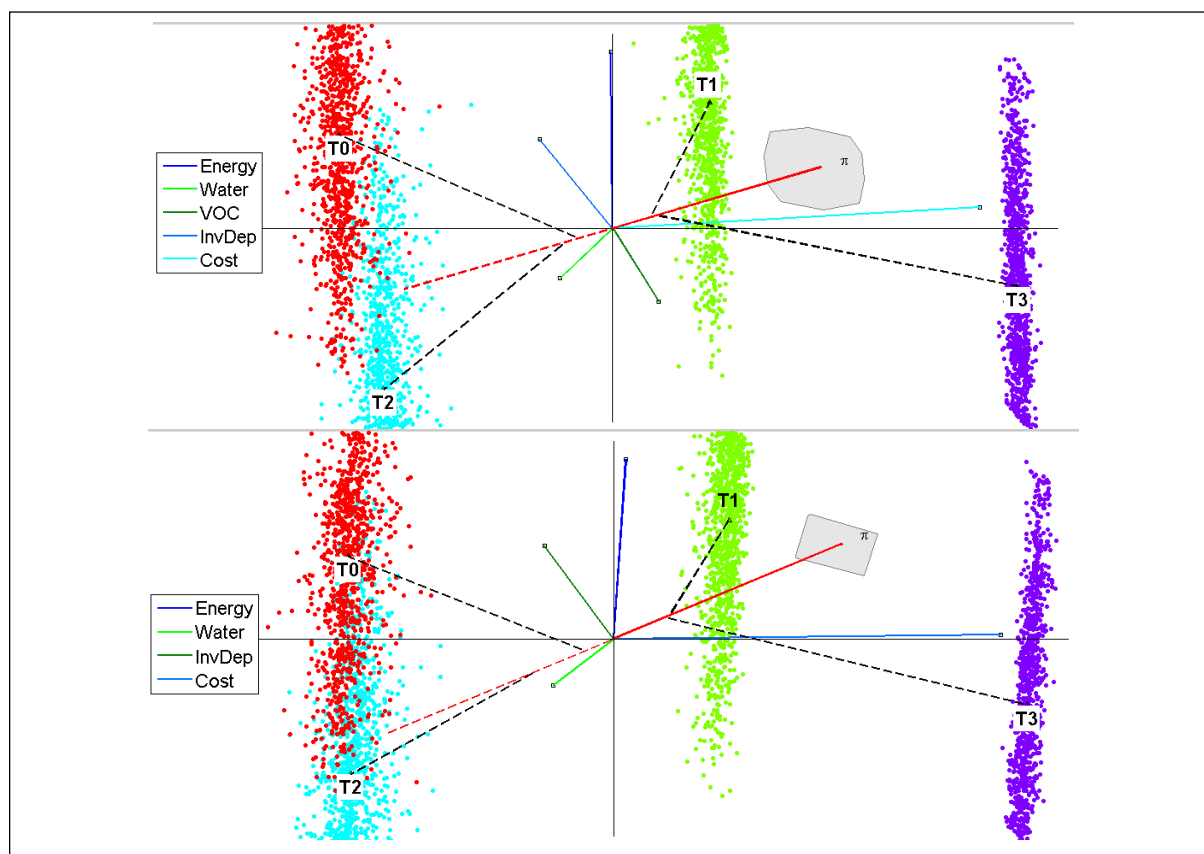

Figure B.10: GAIA Plane of the full (upper) and abridged (lower) evaluation

Furthermore, if attribute values are characterised by a specific uncertainty level, a scatter plot based on a *Monte Carlo Simulation* (uncertainty level of  $\pm 10\%$  and normal distribution) can be displayed that visualises the distinguishability between all alternatives [Basson, 2004]. To summarise, the analyses reveal that no clear preference for one alternative is obvious, since both condensation of solvents and a switch to waterborne basecoats show comparable performances.

### B.3.5 Discussion

The case study *Bicycle 2* shows the application of the MOPA to the process of industrial coating of bicycle and bed frames. Target values of optimisation as well as economically feasible operating parameters of certain techniques are evaluated and calculated using pinch analysis for energy, water and VOC.

Furthermore, the single parameters can be investigated by a multi-criteria analysis offering the possibility of carrying out several sensitivity analyses. They can provide a good understanding of the effects of the different modelling parameters. The use of a Monte Carlo Simulation offers the possibility of an analysis comprised of several parameters simultaneously. Additionally, decision makers should be aware of the influence of the selected criteria and the chosen weighting factors as demonstrated by the rank reversal obtained in this case study due to the elimination of one criterion.



# Appendix C

## Case Study 3: Pisco Production in Chile

The company of the case study is a producer of Pisco, a brandy like spirit, in the northern part of Chile. It has an overall processing capacity of over 200 000 t grapes per year on several factory sites for grape collection and processing, the larger factory sites also do the distillation using alembics and storage [Richers, 2006; Jungkurth, 2006; Frey, 2007]. Finally, all the distilled alcohols are brought to the main factory site, where they are bottled and packed.

### C.1 Background of the Case Study

Pisco is the most widely consumed spirit in Chile, Bolivia and Peru. The liquor is distilled from grapes like a brandy and is made in the wine-producing regions of South America. The right to produce Pisco as an exclusive cultural commodity has been the centre of a dispute between Chile and Peru. Although Chile produces, markets and exports Chilean Pisco in larger quantities, the city of Pisco lies in Peru. In Chile the name "Pisco" enjoys the protection of an indication of origin. The appropriate standards were outlined in December 1999 in the "*Decreto NO. 521 Denominación de Origen Pisco*", which specifies the manufacture regions, the permitted grapes and the assigned production processes.

The Pisco industry is increasingly interested in exporting overseas because of the limited sales market in Chile. In order to guarantee the environmental standards necessary for the market entrance into other countries, the large Pisco producers are focusing on self-commitment. Following the example of the wine producing companies an agreement on

cleaner production in the Pisco industry, i.e. *"Acuerdo de Producción Limpia - Productores de Pisco y Procesadores de Uva Pisquera III y IV Región"*, was adopted in 2004 in Chile. By signing the agreement the companies committed themselves to implement, within a period of up to 30 months numerous measures for the reduction of the environmental impact and the increase of the industrial safety. In return the enterprises received a certification enabling the entrance into international markets. The largest part of the improvement measures involves the decrease and control of liquid industrial wastes and the water consumption. A special emphasis is thereby on the disposal of the resulting distiller's wash. In addition, possibilities of the energy conservation and improving the efficiency are included in the agreement.

## C.2 Process Characteristics of the Pisco Production

The Pisco production can be roughly arranged into the three sections of (i) wine preparation, (ii) distillation and (iii) maturing and filling. These three sections differ both temporally and structurally. The wine production is limited to the harvesting months running from February until April. The harvested grapes/clusters must be converted immediately to wine, since they would otherwise decay within a very short time. Therefore there are smaller, remote locations, whose only purpose is the preparation of grape juice. Subsequently, the grape juice produced there is immediately supplied to the locations equipped for the fermentation step. Thus the larger locations are relieved from the grape juice preparation and the transportation distances for the farmers are shortened.

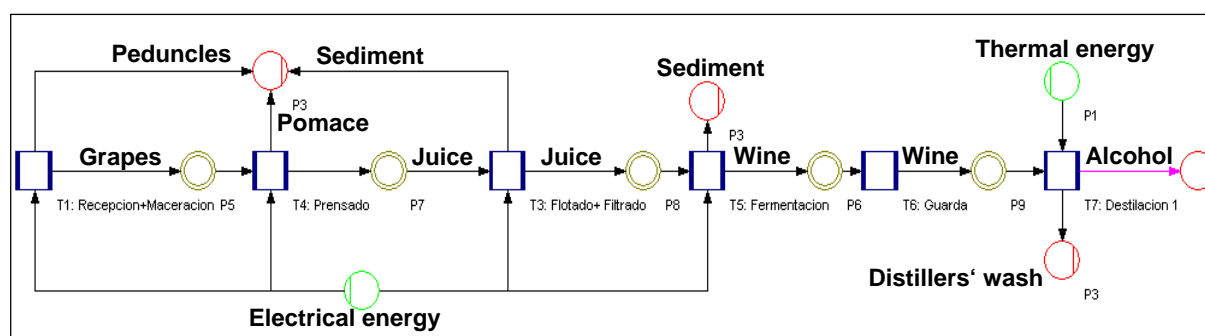

Figure C.1: Process Schema and Mass Flows of the Pisco Production

The wine can easily be stored without problems for several months after the fermentation. Therefore even wine from smaller, decentralised locations, which have wine production facilities but lack distillation mechanisms, is supplied to the distillation locations, in which



the period of distillation is between the months May and December. The bottling of the matured alcohol takes place, depending on the demand, during the entire year.

Figure C.1 shows the individual steps of the Pisco production. It consists of a set of processes, which are made up of different procedures of the grape juice extraction, grape juice clarifying, wine preparation and distillation. The sequence of the subprocesses orients itself at the mass flow of production, beginning with the grapes up to the distilled alcohol. The process representation is limited to the processes from grape receipt to distillation, since no relevant material or energy flows are observed during the storing, maturing, and filling processes. About 4 kg of grapes are needed to produce a litre of Pisco. And about 2.7 kg of distiller's wash is the main waste product. Other wastes are the pomace, the peduncles and the sediment.

### C.3 Calculations and Recommendations

In the Pisco production the sources of energy used are fuel oil and electricity. These are regarded and analysed separately, since substitution possibilities hardly exist in the production process. The copper alembics used for the distillation of the wine are heated indirectly with steam. The steam is produced in a boiler plant in two large water boilers. The feed water is heated up to the boiling temperature by heating the boiler with fuel oil. The dried saturated steam has high specific thermal capacity and a good heat transmission coefficient.

The two boilers offer an overall capacity of 5 400 kg/h. The produced steam is used exclusively for the heating of the copper blisters. 885 000 l of fuel oil are used yearly to produce about 12 000 t of steam. With the price of oil at 0.02 \$ per bottle of Pisco produced, it is clear that it only constitutes a small portion of the overall production costs.

#### C.3.1 Process Improvements with Respect to Wastewater

The substantial emission problem in the Pisco production is the distiller's wash which develops during the wine's distillation. The distiller's wash has a low pH value, a high chemical and biochemical oxygen requirement and a strong tendency to anaerobic sour decomposition. Thus it is not suitable, in contrast to the distiller's wash from the grain and potato distilleries, for use as feed in the animal husbandry [Weller, 1979]. However the following are some of the possibilities for disposal:

- Evaporation by sprinkling.
- Concentration of the distiller's wash and later use of the firm residue as fertilizer [Torrijos and Moletta, 2000].
- Use as irrigation water.
- Fermentation gas production by anaerobic decomposition [Borja et al., 1993].
- Aerobic biological treatment.
- Employment for the stabilisation of crushed stone roads (due to the strengthening and sticking characteristics of the distiller's wash) [Beltrán et al., 1999].

At present the distiller's wash is disposed off, by mixing it with cool water and using it to irrigate green pastures. Investigations have confirmed its positive fertilising characteristics when employment in vineyard irrigation [Tano et al., 2005]. The deployment of the untreated distiller's wash on the soil is however problematic. The danger of infiltration of the soil and straining the groundwater also exists [Marfull, 2005]. In addition the decomposition of the distiller's wash results in unpleasant smells, which could trouble the citizen living in the proximity of the irrigation schemes. Anaerobic decomposition or aerobic treatment in plant purification plants for the production of fermentation gas are some possibilities for the pollution free disposal of the distiller's wash.

### **C.3.2 Optimisation with Respect to Energy**

During the fermentation of the juice, a high energy demand for cooling requirements during the fermentation process, illustrated by a horizontal line in Figure C.3, characterises the production process. The juice has to be constantly cooled to the optimum fermentation temperature of 15°C, with heat being created by the fermentation process and the average ambient air temperature being higher. Consequently, this cooling of uninsulated steel tanks by external cooling pipes causes more than half of the total electricity consumption of the plants. Measures to reduce this consumption include an insulation of the fermentation tanks and cooling pipes within the tanks.

The distillation of the wine in the batch procedure can be improved in terms of the energy needed [Ficarella and Laforgia, 1999]. By a continuous counter-current distillation the energy can be used for heat integration. Consequently, continuous distillation provides substantial energy savings potential [Stichlmair and Fair, 1998]. However the general

production rules for Pisco prescribe the distillation for the Pisco in the batch procedure. The use of the continuous distillation method is therefore not possible.

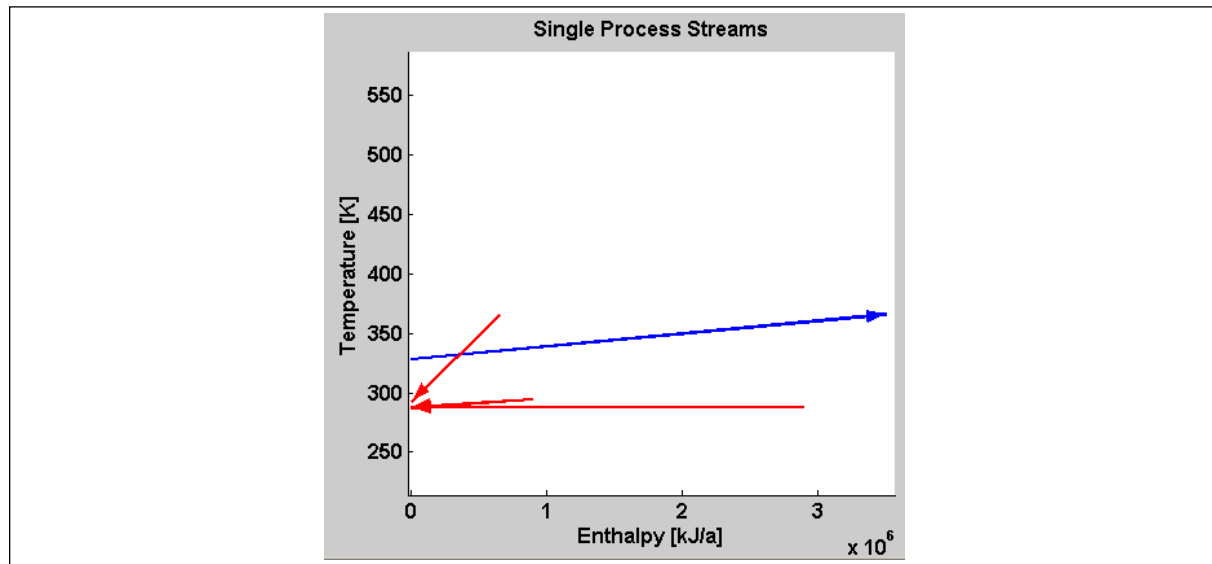

Figure C.2: Single Streams of the Heating and Cooling Requirements

The distillation of the wine is carried out between the months April and December. The wine is pumped for distillation from the outdoor storage tanks into the fuel blisters. The wine temperature corresponds to the average outside temperature during the distillation months of 14°C. In the case of a direct filling of the fuel blisters with the cold wine, a substantial energy input is necessary in order to heating up the wine to the distillation temperature.

Wine pre-heaters are used for example in the traditional Cognac production. The wine pre-heater is a tank installed above the fuel blister with the same volume as the fuel blister. In the Cognac production for example, the pre-heater is filled at the beginning of distillation with the wine for the next fuel blister filling. Hot alcohol steam ascending from the fuel blister passes by the wine pre-heater and warms up the wine contained in it, before it is led into the condenser. As soon as the wine's temperature in the pre-heater rises to about 70°C, the steam is rerouted directly into the condenser in order to avoid overheating the wine. Thus, the wine is pre-heated to its ideal initial temperature during the current distillation and the fuel that would have otherwise been used for the purpose is saved. Figure C.3 shows all single heating and cooling requirements of the case study.

Although the fuel blisters are equipped with a wine pre-heater in the company of the case study, it is not used for the wine's preliminary heating, since the quality of the wine

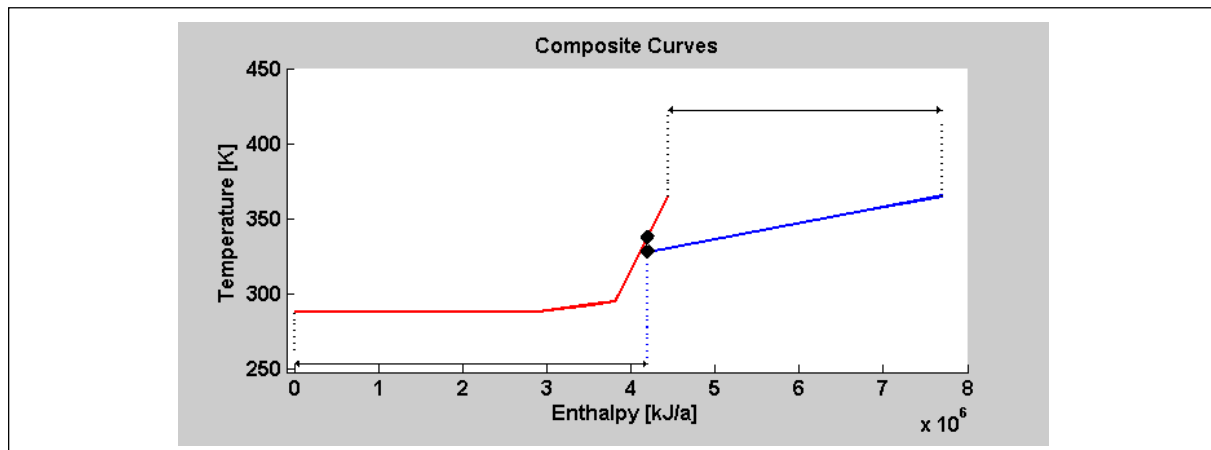

Figure C.3: Composite Curves of the Pisco Production

would suffer from the prolonged exposure to heat. Instead plate heat exchangers are used in order to preheat the wine with the counter current flow of the distiller's wash.

For an efficient heat transfer, the heat exchanger needs to be thoroughly cleaned to remove the residue build up that results from the wine heating process. The plate-type heat exchanger is preferable because of its high heat transmission coefficient and the simple decomposability and cleaning.

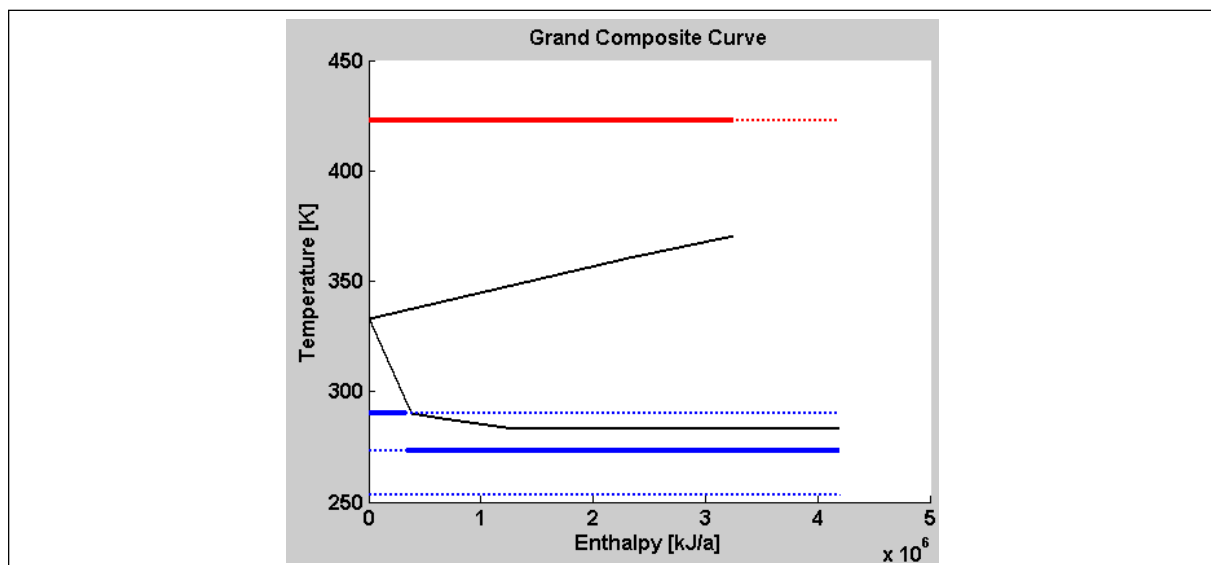

Figure C.4: Grand Composite Curve of the Pisco Production

Figure C.4 shows the overall grand composite curve with the aggregated heating and cooling requirements. The heating steam is produced in a central boiler plant. Two parallel fire-tube boilers heated with fuel oil are installed for this steam generation. The biggest heat losses are generated due to high exhaust gas temperatures in the form of exhaust gas losses. The exhaust gas temperature can be lowered by the installation of a waste-gas heat exchanger for feed water preliminary heating, also known as the "Economizer" [Ganapathy, 2003]. The Economizer can be installed between the exhaust and fire-place.

In general, the main environmental impacts of this production process are the high chemical and biochemical oxygen requirement of the of the distiller's wash and its disposal, as well as the high energy demand. Whereas the first problem is rather easily solved and the waste can even become an input for biogas power production, a considerable energy demand is inherent in the process. Optimisations that do not completely change the production process include a reduction of energy losses here, for example by an insulation of the cooled fermentation tanks or by preheating the wine using waste heat.



# Appendix D

## Case Study 4: Industrial Alcohol Production in China

by **Yongsen Lu, Surong Guo, Wei Zheng, Cunkuan Bao, Tingfei Shu**<sup>52</sup>

Cleaner production and environmental protection challenge SME of diverse origin in China. However, with respect to the significant disparities in socio-economic development, technical level, natural resources, and weather conditions among the different regions in China only approaches considering these local aspects seem to be adequate [Worldbank, 2004]. Therefore, it is difficult to define state-wide regulations and scenarios for cleaner production initiatives incorporating market situations, business performance and technical risks.

Energy and wastewater utilisation and discharge of organic pollutants play a significant role in the industrial alcohol production. Even though cleaner production measures have been implemented in the alcohol industry in China, new approaches are required to integrate and optimise the cleaner production technologies within the company [Guo et al., 2006]. The objective of this case study is to present different types of available technologies to improve the resource efficiency in the industrial alcohol production and to show the impact of environmental policy measures to this industry.

---

<sup>52</sup>College of Environmental Science and Engineering, Tongji University, Shanghai, China

## D.1 Process Characteristics of the Industrial Alcohol Production

In the case study the industrial alcohol production is analysed. 150 000 t/a of cassava are used as a raw material for the brewing process. Cassava is a woody shrub whose tuberous root is reaped. One part of the cassava is cultivated in South of China and the other part is imported from Southeast Asia (mostly Thailand). Further production inputs are water, electricity and coal. Coal is needed for the co-generation power station, which produces electricity and steam for the distillation processes. 20 000 t/a of coal are burnt and 83 000 m<sup>3</sup>/a of fresh water are needed for the distillation process.

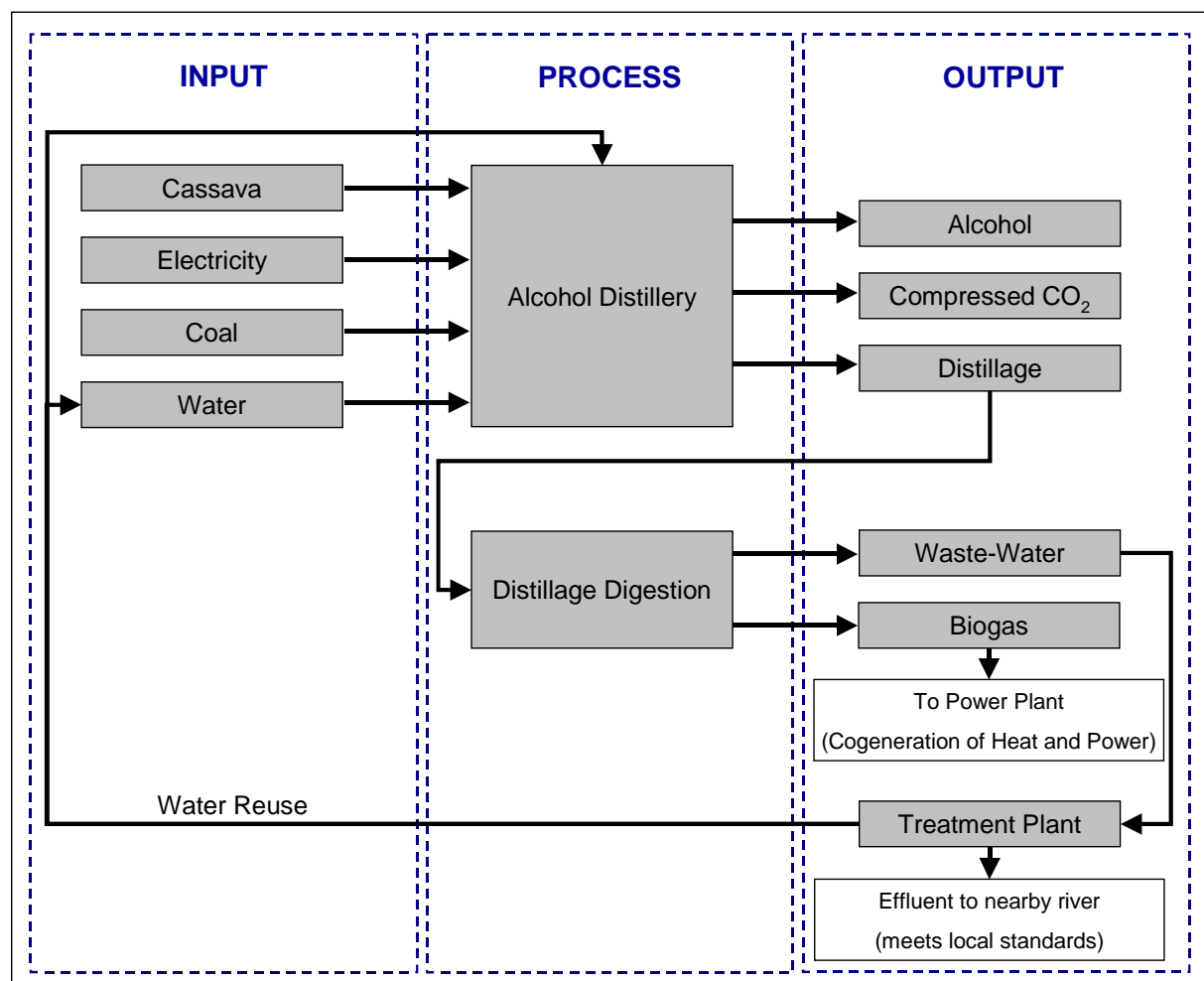

Figure D.1: Process Layout of the Industrial Alcohol Production [Lu, 2005]



The reference company of the case study produces 50 000 t/a of alcohol (the unevenness coefficient of alcohol production:  $K = \text{maximum turnout/average turnout}$  is 1.5) and 20 000 t/a of  $CO_2$  which is compressed and sold as a by-product (cf. Figure D.1).

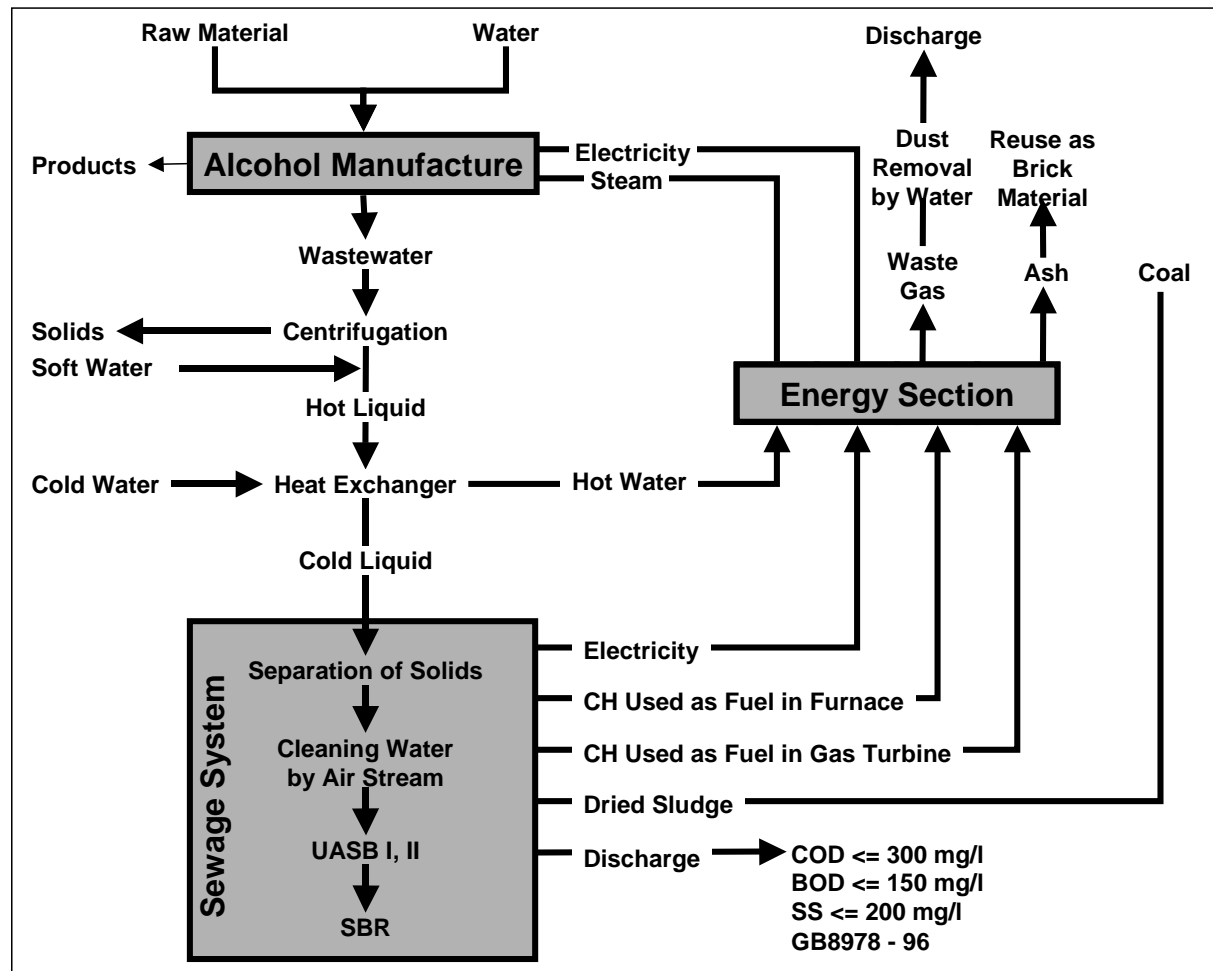

Figure D.2: Plant Layout of the Different Sections of the Alcohol Production [Lu, 2005]

750 000 t/a of distillage, which has a temperature of more than 90 °C after the distillation process, are further processed: The organic parts of the distillage are fermented and thus digested into biogas. This anaerobic process takes place at around 35 °C (heat spent in keeping digester temperature:  $1.16 \cdot 10^9$  kJ/a) and results in 18 200 000 m<sup>3</sup>/a of biogas (lower heating value of 22 400 kJ/m<sup>3</sup>) which is burned in the power station and hence used for the combined heat and power generation. The total energy provided by biogas is around  $6.3 \cdot 10^{10}$  kJ/a. The wastewater is treated and 360 000 m<sup>3</sup>/a are reused in the distillation process or in the boiler station. As a positive side-effect, the fermentation of the distillage reduces the COD and thus improves the water quality.

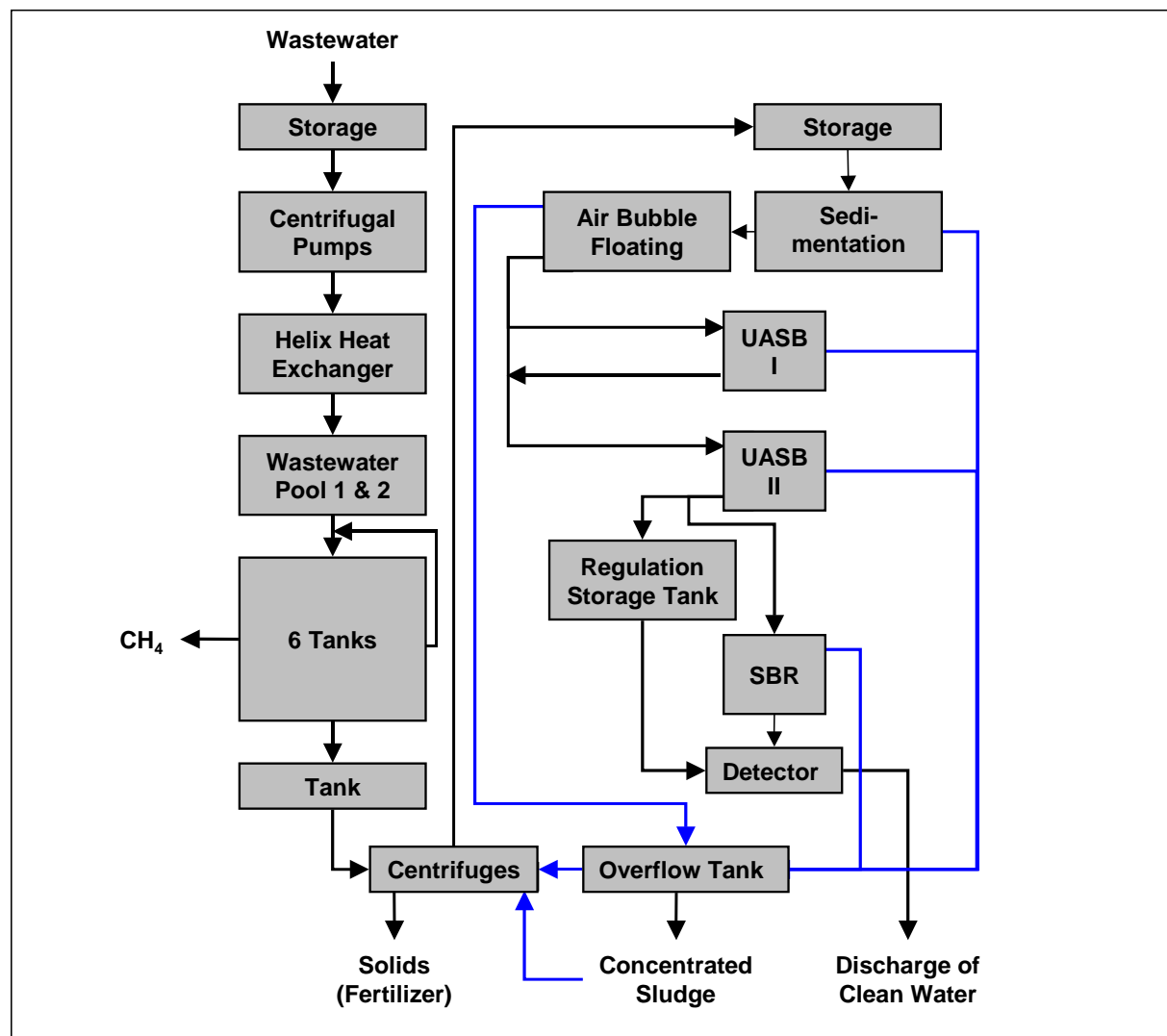

Figure D.3: Wastewater Treatment Section of the Alcohol Plant [Lu, 2005]

## D.2 Implementation of Cleaner Production Measures

One of the essential elements of cleaner production is *3R*, i.e. *reduction, recycle* and *reuse* of materials and energy [Qian, 2004]. Being contrary to linear material-flow of the conventional process, i.e. "*resource consumption*  $\rightarrow$  *product*  $\rightarrow$  *waste discharge*", the recycling material-flow of the circular pattern is closed with the feedback as "*resource consumption*  $\rightarrow$  *product*  $\rightarrow$  *regenerative resource*". In another way, it is an integrated process that includes both production and consumption in all levels of the society, enforcing laws and regulations and emphasising to use kinds of advanced techniques. To combine *3R* principles with the industrial alcohol production of this case study several techniques can be

incorporated in the production process (an detailed analysis of this section is provided in [Guo et al., 2005]).

### D.2.1 Integrated Use of Best Available Techniques (BATs)

Since the last two decades a series of laws and regulations have been enacted, and played two roles in environmental protection [Wang, 2004] (cf. Chapter 2): On the one hand they put the pressure on enterprises; on the other hand they enhance the competitiveness and enlarge the market opportunities for enterprises that have done well in environmental protection for a variety of reasons: benefited from preference polices of getting loans in low interest and derating sales tax; the appreciation and encouragement from society and government to gain advantages over competitors though improving environmental performances, and to protect and enhance their reputation. The company of the case study has taken the advantage of all the supports of available environmental polices since 1998. Step by step it has changed its image from a serious polluter into an environmental friend, and won a great deal of recognitions from its customers and the society. Recently it has not only sold more products but also won more appreciations. The following *Best Available Techniques* have been introduced:

1. *BAT I: Integrated Mode of Combining UASB and SBR:* For the case study a distillage utilisation and wastewater treatment consisting of two steps is used combining an *Upflow Anaerobic Sludge Bed (UASB)* and a *Sequence Batch Reaktor (SBR)*. UASB, the step one, is used to ferment organic compounds of the distillage into biogas and decrease the COD from 50 000 mg/l to 2 000 mg/l; and SBR, the steps two, further reduces the COD to less than 150 mg/l, which meets the local secondary effluent standards. Optimising the reaction parameters, it yields 33 m<sup>3</sup> biogas per cubic metre of distillage, which is much higher than the average amount of 23 m<sup>3</sup>/m<sup>3</sup> in China [Xia et al., 1999].
2. *BAT II: Using More Effective Yeast:* The fermentation level was improved by using more effective yeast to increase the concentration of alcohol in the fermented liquid from 7.5 %(v/v) to 10.5 %(v/v). In this way 25 % distillage was reduced, and roughly 38 000 t vapour (P=0.25 MPa abs, T=280 °C) was saved because the feedstock of the distillation process was decreased sharply; and the investment could be reduced because the sizes of the distilling towers and other auxiliaries were reduced. In addition, the distillage load of UASB-SBR system was reduced from 580 000 to 400 000 t.

3. *BAT III: Installation of a Co-Generation Power Plant:* The co-generation has been used in the case study and showed remarkable energy savings in comparison with a system producing electricity and vapour separately. The co-generation saved 25 % - 30 % of energy in comparison to a conventional process [Gorsek and Glavic, 2003], and the energy efficiency of the boiler increased 60 % - 80 % [Castier and Pajagopal, 1988]. According to local statistics about 10 000 t/a of coal were saved.
4. *BAT IV: Installation of a Wet Separation Process:* In general, there exist several methods to remove particles in gas. In the industrial alcohol production usually a dry process is applied to separate the cassava powder from the gas. In a next step it is brewed with water in the ratio of 1:3 (wt/wt). Thus, a wet separation method is suggested to collect the cassava powder directly by water. Generally, the drawback of wet separation methods is secondary pollution in the wastewater. Therefore, dry methods still dominate separating solids from gas. However, the innovative wet process made the cassava powder absorbed by water for cooking, and the discharged air was cleaner. In addition, the power of the exhaust fan can be reduced resulting in decreasing costs.
5. *BAT V: Installation of Helix-Plate Heat Exchanger:* The type of heat exchangers were changed from *showering* to helix-plate so that two flows in the helix-plate heat exchanger always flowed adversely in turbulent status when the number of Reynolds reached 1 800 or higher. A Comparison to the *direct showering type*, the later needed less cooling water to exchange the same thermal energy and it turned out that it is easier to recycle and reuse the used-up cooling water. The transport power to transfer the cooling water can be reduced, too.

Most of the BATs suggested above are not new technologies and have been effectively used in other sectors, but they are newly used in this combination within the case study of the described alcohol distillery. It is well known that technological progress is one of the pillar stones of cleaner production in order to improve manufacturing processes and to save materials and energy. However, the challenge remains how to address economic, social and environmental issues simultaneously.

## D.2.2 Integration of Mass and Energy Flows

Several measures for the integration of mass and energy flows have been taken: *Integrated Use of Cassava as Source of Mass and Energy:* As only a small ratio of carbon contained in the cassava is transformed into alcohol, most of the carbon is converted into various

kinds of organic substances and remains in the distillage [Saha et al., 2005]. But in the case study the carbon in the distillage is reused and most of the carbon is changed into biogas, which is burned in furnace of the co-generation power plant to generate electricity and vapour.

*Energy Cascading:* An energy cascading system [EMCENTRE] was built in the reference company of the case study based on exergy levels of the resources [Gaggioli et al., 1991]. In the co-generation system (refer to *BAT III*), the high pressure and superheated vapour ( $P \approx 2.6$  MPa abs,  $T \approx 480$  °C) was used to generate electricity. The exergy of tail vapour ( $P \approx 0.453$  MPa,  $T \approx 300$  °C) was used in the process of cooking ( $P \approx 0.45$  MPa abs,  $T \approx 280$  °C) and distillation ( $P \approx 0.25$  MPa abs,  $T \approx 260$  °C).

In addition, the thermal energy of vapour on the top of the distillation tower was used to heat the feed of the stripping tower. A part of cooling water (70 °C) was used as brewing water. In this way not only the water but also its exergy was used. In the process of fermentation, cooling water ( $< 17$  °C) from underground was firstly used in fermentation ( $T \approx 33$  °C), and then continually used in saccharification ( $T \approx 65$  °C). The distillage ( $T \approx 80$  °C) was used to heat the soft water before the UASB-SBR wastewater treatment system. The energy cascading system made a great amount of energy from heating and cooling process saved.

*Water Integration:* The reference company of the case study enabled water integration by designing a water-net including an inner circle within the company, and an outer circle linking to the local river. Two connections can be observed: First, the river is the sink of the wastewater after the wastewater treatment and second, the cooling water is pumped directly from the river and afterwards discharged into the river again with two or three degree of temperature increment. Owing to the circular pattern and cleaner production, the local river has sufficient assimilation capability to tolerate small pollution loads from the reference company based on an impact assessment. In addition, the river water is also used directly as process water, for example as boiler water after an ion exchange treatment. A small part of the cooling water is used as brewing water saving not only tap water but also energy.

### D.3 Simulation of Policy Incentives to Promote Cleaner Production

A simulation of policy incentives is made by a three-level modelling using *System Dynamics* [see e.g. Forrester, 1961; Sterman, 2000] for a *Cleaner Production (CP)* system of the reference company of an alcohol distillery. An detailed analysis of this section is provided in [Zheng et al., 2005]. The different mass and energy flows are modelled in several sub-systems, for example *cooling water (CWT)*, *processing wastewater (WT)*, *sludge (WS)*. Each subsystem interacts through coupling to form a feedback loop. The main feedback chart of the model is shown in Figure D.4.

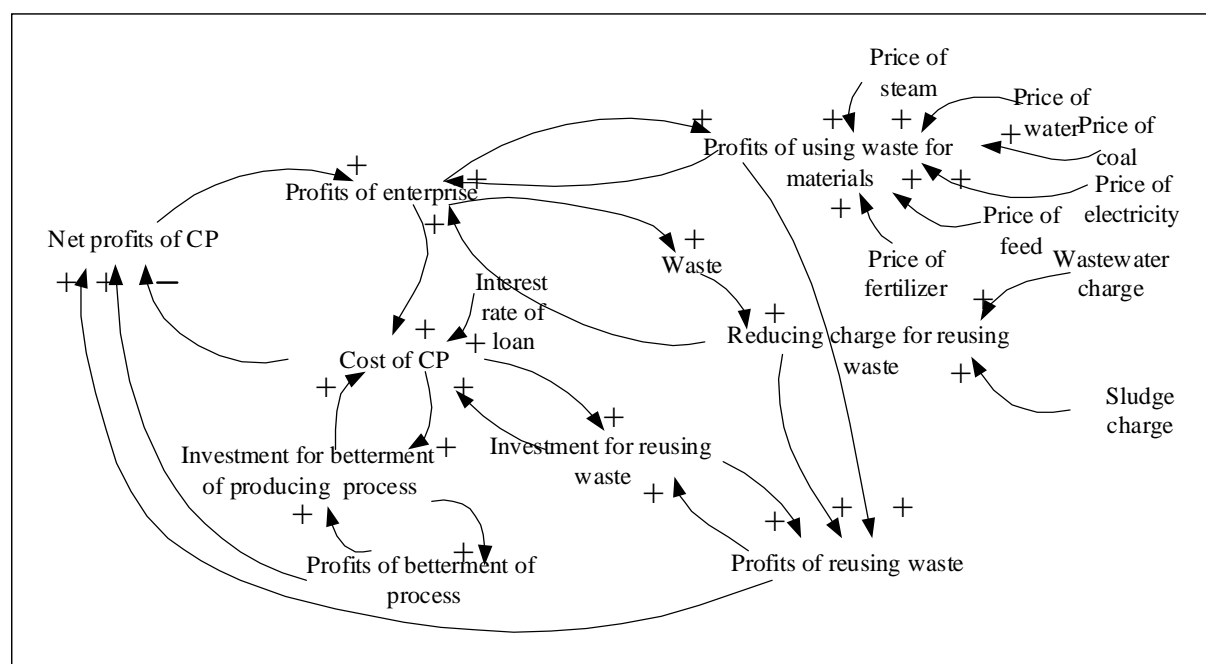

Figure D.4: Primary Feedback Chart of Cleaner Production (CP) and Policy Factors [Zheng et al., 2005]

The cost to bring about the regulatory environmental objectives by means of administrative order usually is much higher than that of economic leverage because the environmental administration has to collect and analyses detail information on the lost of abiding in enterprises. On contrary government establishes economic policies based on motivating cleaner production in enterprises, which may not only protect the environment but also decrease the cost of governmental management.

The reference company of the case study invested in construction of technology innovation and waste to energy projects respectively 30 million RMB and 55 million RMB. The depreciation time is 10 years, net depreciation rate is 5%, corresponding depreciation expenses of each year are 2.85 million RMB and 5.225 million RMB, and running cost are 4 million RMB and 5 million RMB. The results of the simulation based on the system dynamics model are shown in Table D.1.

*Table D.1: Profits of Cleaner Production (CP) in [10 000 RMB/a] [Zheng et al., 2005]*

<b>Year</b>	<b>Profits of CP</b>	<b>Net profits of CP</b>	<b>Profits of reusing waste</b>	<b>Profits of investment</b>
2006	3 276	1 568	593	2 682
2007	3 877	2 169	1 194	2 682
2008	4 501	2 794	1 819	2 682
2009	4 970	3 263	2 268	2 702
2010	5 773	4 065	2 968	2 707
2011	6 041	4 333	3 254	2 707
2012	6 312	4 605	3 525	2 707
2013	6 333	4 625	3 545	2 707
2014	6 352	4 645	3 565	2 707
2015	7 412	5 705	4 549	2 863

If all the funds were raised independently by the reference company, the refund period would be by the year of 2008. The huge investment of capital construction and equipment is always the main obstacle of practising CP in an enterprise. The government subsidies, such as low interest loans or accelerated depreciation, could help the reference company more easily to construct the project and to earlier obtain economic and environmental benefits.

In addition, the reference company consumes a great quantity of water and discharges wastewater and sludge. In the future, the government may change the water fees and pollution charges to promote CP. Raising the fee of cooling water intake and discharge can encourage to increase the recycling rate of cooling water in the reference company. Furthermore, plenty of lees and sludge is generated in which a lot of microzyme, edible fibre and starch exist. Consequently, dried lees could be converted into feedstuff, and other solid wastes could be burned as fuel.

In general, the industrial alcohol production uses great amounts of electricity. The biogas produced in the lees liquid digestion could generate electricity. Thus, raising the electricity price by the government will encourage enterprises to take full advantage of CP. Based on different energy prices (0.76 RMB/kWh or 1.52 RMB/kWh for electricity and 30 or 60 RMB/m<sup>3</sup> for steam) different scenarios can be evaluated [see e.g. Zheng et al., 2005].

## D.4 Discussion

High economic benefits and emission reduction can be gained through the material recycling, energy cascading or improving production process and reusing by-products in the industrial alcohol production. In alcohol production process the best level of cassava input was attained with efficiency of carbon use. The distillage digested into methane and hydrogen which are the fuel for co-generation power station and equal to 20 000 t of coal equivalent saved per year. The sequenced batch reactor (SBR) of activated sludge process was used for further treatment of the effluent from distillage digester. Meantime 20 000 t of compressed  $CO_2$  in food grade were supplied to the market.

With the help of the circular production patterns it is possible for the industrial alcohol production to change the conventional linear economy into a closed loop of circular economy. If all alcohol enterprises in China would implement similar patterns, the water environment would be improved immensely, since the total ratio of COD and BOD discharged by alcohol distilleries in the country is 18.0% and 12.5% respectively of all different industrial sectors [Guo et al., 2006].

Furthermore, the case study shows that it is feasible and effective to use system dynamics to simulate the effect of policy impacts on the profits of cleaner production in the investigated company. This can be a reference for the government and stakeholders to formulate policies on promoting cleaner production in various manufacturing sectors. The results show that government subsidies or low interest loans to support enterprise's huge investment on CP facility, and the regulation of water fees, provide incentives for cleaner production.



# Appendix E

## Case Study 5: Fishery Net Impregnation in Chile

The reference company is a small sized firm that does the maintenance of different types of nets for salmon cultivation in the Los Lagos region in southern Chile. When placed in the sea over several months, such nets are affected by fouling, meaning the accumulation of marine organism deposits that reduce the oxygen level in the cages and can cause diseases. In order to prevent this, the maintenance includes the washing of the nets using large drums or high pressure cleaners, the reparation of nets where needed and an impregnation of the nets with antifouling paint. The reference company washes about ten nets per day, which means an annual throughput of about 600 tons of dry nets [Benz, 2007]. The company is steadily growing at about 15 % leading to increasing environmental concerns about the consumption of fresh water and energy and about wastewater and organic waste with a high load of copper from the antifouling.

### E.1 Background of the Case Study

The once expensive salmon delicacy is affordable to most people today. This change was made possible by the cultivation of salmon in fish plantations. The primary suppliers on the world market are Chile and Norway. While the cultivation of salmon in Chile could hardly be spoken of in the 70's, the emergence of this industry became visible in the 80's, before stabilizing and expanding in the 90's. New production methods were necessary for the cultivation of the salmon and different ones were developed. The use of fishnets for confining the aquacultures a common feature to all.

The salmon farming industry exists in Chile for about 15 years and in this time the value of the exports has increased by around 1 000 percent. In 1991 the total exports amounted to 150 million USD, whereas the year the 2004 total exports of Chilean salmon surpassed 1 400 million USD, which shows its vital relevance to the national economy.

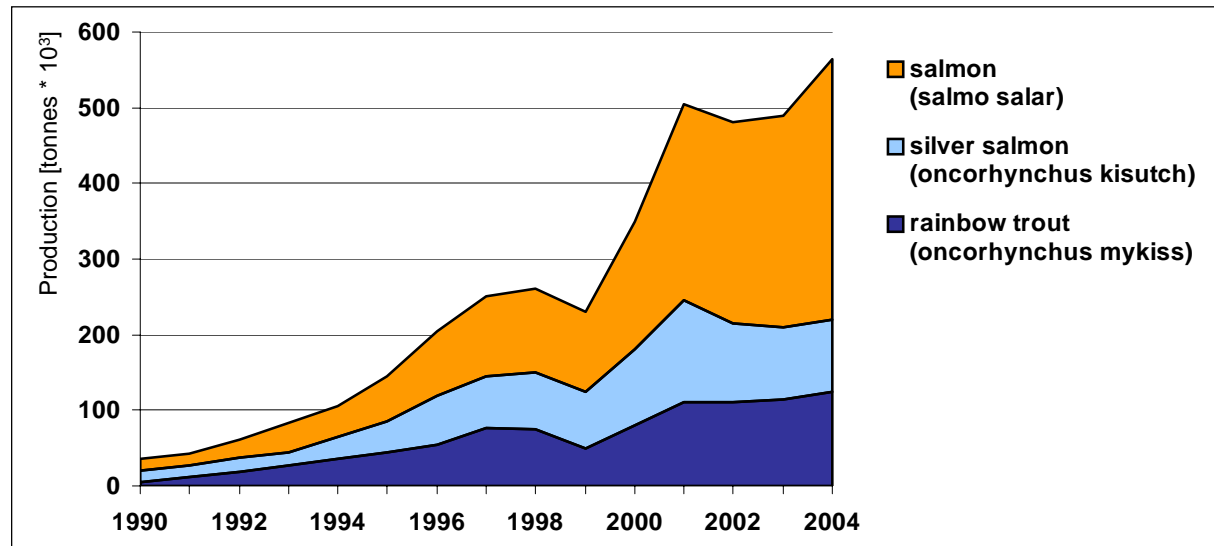

Figure E.1: Gross Annual Production of the three main salmonid species farmed in Chile [Buschmann et al., 2006]

In order to diminish mortality in the cages of cultures of salmons, it is essential to maintain the nets of the cages clean to allow the renovation of the water in the cages and a sufficient oxygen level. Originally, these nets had to be washed every two weeks to a month (depending on the sea currents and the time of the year) due to the great amount of organisms that adhered to them (fouling). Later, in order to increase the period of washing of the nets (with the purpose of avoiding stress to the fish by handlings and transfers), was begun to impregnate the nets with antifouling paintings based of copper oxide. The used copper oxide and the organic waste resulting from the washing process are important environmental aspects of the net washing sector, which includes about 200 washing installations.

## E.2 Process Characteristics of the Fishery Net Impregnation

Four different kinds of net are generally used for the salmon production, of which two are permanently in water. The fishnet, which is finely woven in appearance, serves to hold a group of fish together in an area. Several fishnets are usually used side-by-side in a salmon cultivation; they are then encased in a larger, coarse-meshed, protective net. The protective net serves to protect the salmon against seals and other fish robbers of the sea.

In the most common form of cultivation, box shaped fishnets, which are open at the top, are arranged in two rows of six and surrounded by a large protective net. Each fishnet is at the same time stretched by means of a rigid floating device. The protective net is then fastened to the fishnets, at approximately 5 metre intervals, with wire ropes and to the bottom with corner concrete anchors. In addition, on the floating devices used to stretch the fishnets, a kind of veranda is found, which facilitates the stretching of protective nets against the sun or birds. Shady nets are particularly needed to protect the skin of young fish. Otherwise bird protective nets are used, which, due to their mesh size, lie between the fishnets and the protective net and protect the fish from fish-robbing birds.

Both the sun and the bird protective nets are usually not impregnated, as they are normally not immersed in water and therefore don't accumulate algae or mussels. They however become porous due to the solar radiation and weather influence and must be replaced within one year.

In contrast, fishnets and the fish protective nets are in constant contact with the sea and thereby offer a growth surface for algae and mussels. These afflict the nets in the long run making it difficult and finally preventing water exchange between the surrounding sea and the salmon culture. As this water exchange is indispensable for the salmon to live and grow, two options remain to guarantee a successful cultivation. Either the accumulation on the nets is prevented by technical means or there has to be a constant replacement of the nets.

A weighed decision must be made on whether to apply a coating, which comes with higher material and expenditure costs, or to undertake regular replacement of the nets. Each net replacement also means disturbing the fish, which reduces their fodder intake compared to undisturbed ones. Each net replacement therefore leads to a delay in their development. Some fish plantations nevertheless forgo the net coating. In some places, this is practised on grounds of environmental protection, since a certain amount of colour separation is unavoidable, which in turn translates into sea pollution.

In the summer months, a non-treated net accumulates so much algae and mussels that a net replacement is necessary within 15 to 20 days in order to avoid endangering the fish. Through treatment and coating of the nets, this period can be extended to half a year. Two different processes are used for the coating of nets in salmonid farming.

The first coating process uses waterborne colours. This procedure appears to be more expensive when considering the input costs, it is however gentler on the nets and is regarded as being more compatible since it results in less sea pollution. The life expectancy of a net coated with water-based colours lies on the average at approximately 5 years. The other procedure uses solvent-based colours, which reduce the net's life expectancy on the average to 3 years.

In general the process of washing of the nets originating of the salmon cages can be divided in seven stages:

1. **Reception:** The nets are transported by trucks to the plant, where they are unloaded and ordered in the reception area. This ordering is made such that the nets of a same client are together to avoid crossed contamination.
2. **Washing:** In this stage the adhesions (clams, seeds of clams, seaweed, etc.) are washed of the nets. All the heavy solids generated in this stage are collected and deposited temporarily in drums; the liquids are treated and then disposed to the sewage system, the sea or to underground water.
3. **Drying 1:** This stage of the process tries to extract to the maximum the humidity of the net. This process step is carried out in a heated drying tower at controlled temperature.
4. **Repair:** The nets are repaired to prepare them for an iterative use in the cages of the culture centres. The repair activities contemplate a general overhaul of the net, the damaged sectors are marked and later repaired.
5. **Impregnating:** In this stage the nets are painted with antifouling painting (waterborne or solvent based) in order to prevent the adhesion of organisms to the nets.
6. **Dripping-off and Drying 2:** The nets are hanged up so that the excess of painting drips and can be recovered.
7. **Packing and Shipping:** In the last step, the nets are packed, generally in polyethylene bags and dispatched in trucks to the salmon farms.

### E.3 Calculations and Recommendations

The following graphic gives an overview of the different process steps used in the software UMBERTO<sup>®</sup> to analyse the mass and energy flows. The main environmental impacts of the company are the copper content in the solid organic waste and in the wastewater and the high freshwater and energy consumption. As the company has to fulfil the needs of its customers concerning antifouling protection for the nets, a substitution of these products seems not possible on company level. The company has to rely on the suppliers efforts for product innovations and can only change its processes to reduce the environmental impact.

One example for such small process innovation steps is collecting the rainwater of the uncovered storage area for dirty nets. This firstly prevents the contamination of the surrounding nature with sewage and secondly the collected rainwater can be reused in the washing process, thus reducing the freshwater consumption.

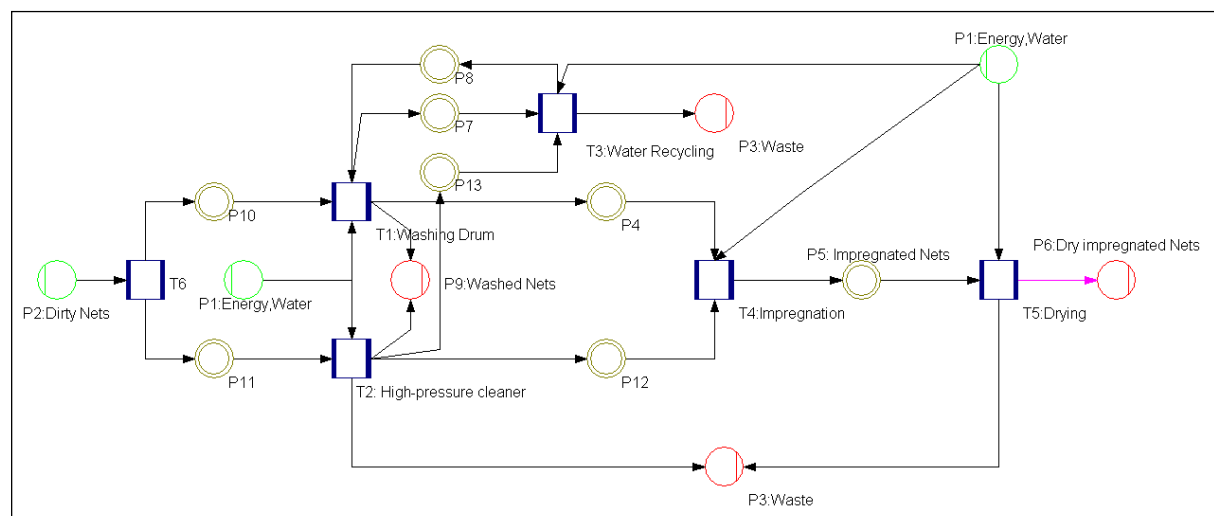

Figure E.2: Process Characteristics of the Fishery Net Impregnation

Another important environmental aspect is the energy consumption for the drying of the nets. This is done by hanging the nets in a drying tower about 20 m high and circulating hot air within the tower. Gas burners are used for this heating, when the air in the tower reaches a certain level of humidity, a flap at the tower's top is opened for the humid air to exhaust. Depending on the type of antifouling paintings used, the drying step is carried out only before the impregnation (for solvent based paints) or also after impregnating the nets (for waterborne paints).

The drying tower is made from corrugated iron, which leads to significant heat losses due to the lack of insulation. With an average drying time of four hours per net and an assumed constant temperature of 35 °C, up to 50 % of the heating energy are lost, with the exact figure depending on several variables, mostly the exact rate of the hot air effluence. This energy loss could be reduced to insignificance using insulation panels with a PUR hard foam core. Whereas such building materials provide very low heat conductivity, the price for retrofitting the drying tower may be prohibitive for the company. However, considering an increase in the gas price of 35 % from 2003 to 2004 (according to company data) and the steady increase of the company's processing capacity, such investments should be considered for capacity expansions.

## E.4 Discussion

While the insulation of the cooling tower would lead to significant reductions of the energy consumption, the energy demand for drying the nets at different process steps stays high in this type of company. As heat at a rather low temperature level of about 30 degreecelsius-50 degreecelsius, which is often found as waste heat in industrial processes, is required for this process, this company is very suited for process integration measures.

As shown in Chapter 4 the introduction of cleaner production technologies is demanding for small and medium sized enterprises because the critical mass for the re-use and recycling of mass and energy flows. But considering the special requirements of the fishery net impregnation in combination with the Pisco production presented in Appendix C new inter-company savings potential can be identified.

# Appendix F

## Case Study 6: Small Series Production of Commercial Vehicles in China

contribution by **Yinan Wang and Fengji Zhou**<sup>53</sup>

The reference company is a middle sized firm producing commercial vehicles in a small series production in a district next to Beijing City on two factory sites. The case study considers the new factory site, which was built in 2003 and started formally to operate in June 2004. It comprises welding, coating and assembling workshops and in addition a testing and a R&D centre. The total site occupies 100 000 m<sup>2</sup> and the production capacity is 15 000 units per year. However, the reference company plans an enlargement of the factory site to 310 000 m<sup>2</sup> with an overall production capacity of 100 000 units per year.

### F.1 Background of the Case Study

The vehicle production is an important industrial sector in China and increased in the last decade significantly. In 2005 China reached almost the same vehicle production as Germany with 5.7 million cars and will probably overtake Germany in 2006 since an increase in production by 15 % to 20 % is expected [BFAI-China] (cf. Figure F.1). Thus, China will rank third after the United States (12 million units) and Japan (11 million units). In 2010 the annual production is expected to be about 9 to 10 million motor

---

<sup>53</sup>Energy Research Institute (ERI), National Development and Reform Commission, Beijing, China

vehicles. However, there exist major challenges in the resource and energy conservation in the production and use of vehicles.

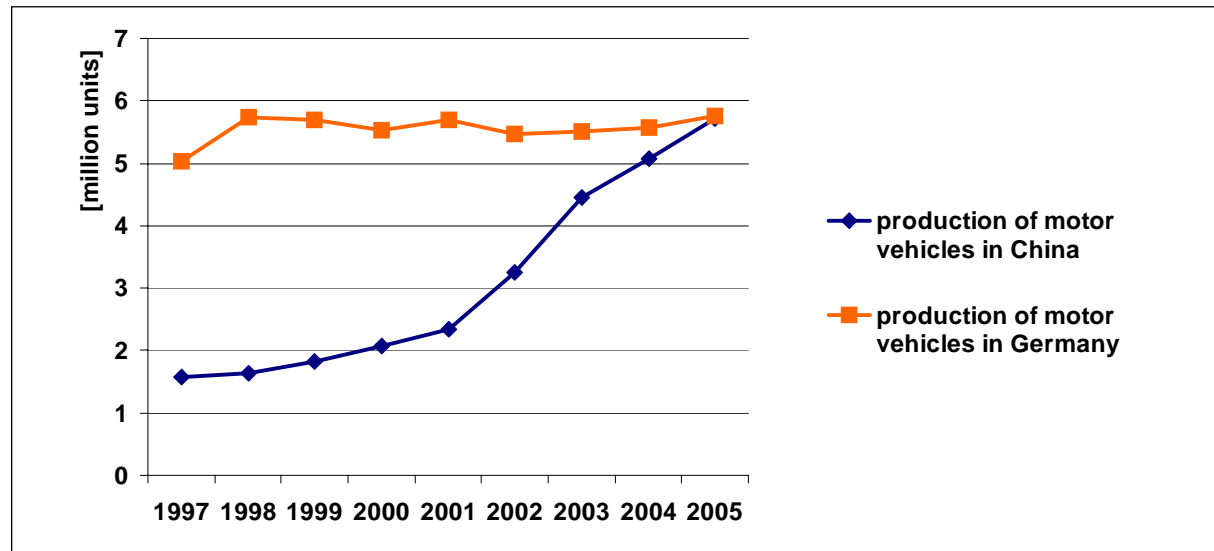

Figure F.1: Annual Production of Motor Vehicles in Germany and China [Noble, 2006]

With a long history of manufacturing light off-road vehicles and trucks, the company of the case study is engaged in developing and manufacturing cross-country and light cross-country jeeps. Though a small percentage, it can export low-class and middle-class vehicles, such as for example minivans or trucks, to East Europe and Southeast Asia. Consequently, main products in the case study are (1) light off-road vehicle / sport-utility vehicles (SUV), (2) pick-up trucks and (3) mini vans.

The production is organised with 900 workers in a two shift operation (each shift is six hours) matching the production target of 50 units per day. The main raw materials are steel, paints and solvents (Xylene). The energy (mainly electricity and natural gas) is taken from the public network according to governmentally regulated prices. In the last year 4.77 Million RMB (=477 000 €) have been invested for the environmental protection in the company, which is 2% of the total investment of the company.



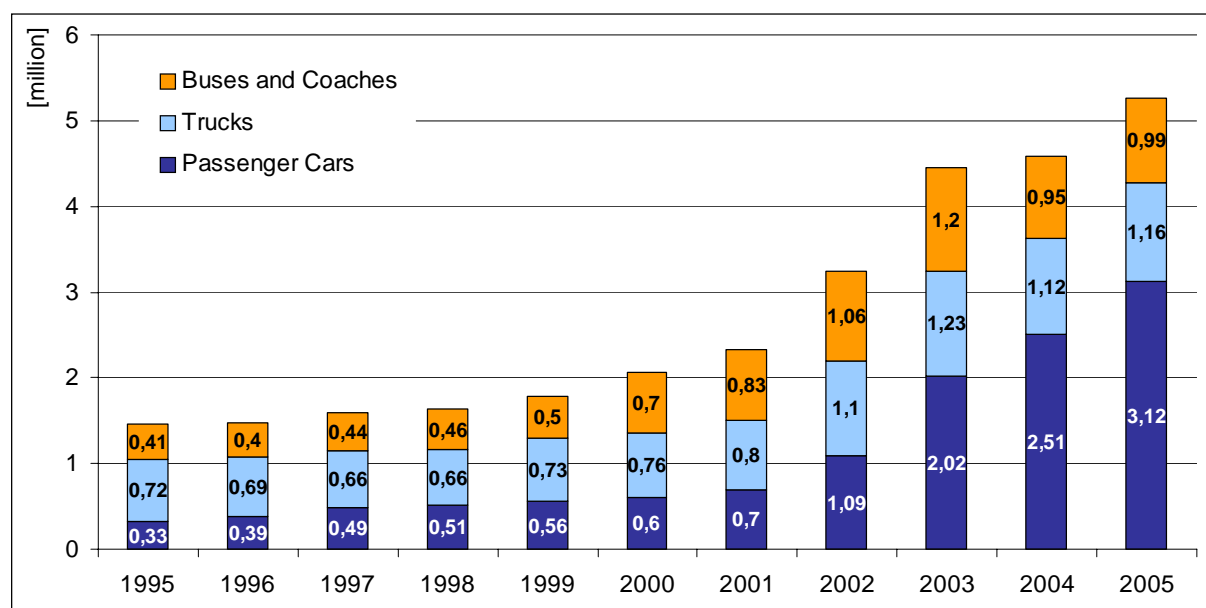

Figure F.2: Chinese Automobile Industry Production [Chi]

## F.2 Process Characteristics of the Small Series Coating of Commercial Vehicles

The coating workshop on the factory site is constructed using light steel mesh enforced by a brick wall at the bottom of 1.2 m in height. At the top of the wall there is compound thermal structure for the heat preservation. Furthermore, the roof is also made of the same material as of the wall. The roof top's fans are designed for air circulation. The workshop's total area is 21 744 m<sup>2</sup>, the height is 8.8 m, width of 24 m and 180 m for the length. Daylight from the roof and the wall is combined with electricity light for the lighting.

The task of this workshop is for the coating of vehicles including *Luba*, *Luling*, *Qiling*, and *Flagship*. The process consists of a pre-treatment prior coating, electrophoresis, inner coating and surface coating. The waste gas is directly emitted which has to meet the requirements of second level of related norms of SEPA. The waste water produced in the factory meets the requirements of third level of related norms of SEPA, then it is transmitted to the centralised waste water disposal factory in the district in which the second level of norms has to be met.

Table F.1: Characterisation of the Coating Section

Application Step	Air Flow Booth [m <sup>3</sup> /h]	Air Flow Oven [m <sup>3</sup> /h]	Temperature Oven [°C]
Primer	320 000	300 000	140±5
Basecoat	540 000	300 000	140±5
Clearcoat	540 000	300 000	140±5

The coating procedure is different for high-class and low-class products in the new factories. Generally speaking, there are four layers for high-class cars which include base coating, first layer painting, second layer painting and polishing coating, while there are only two layers for the low-class cars which are base coating and one layer painting (cf. Figure F.3).

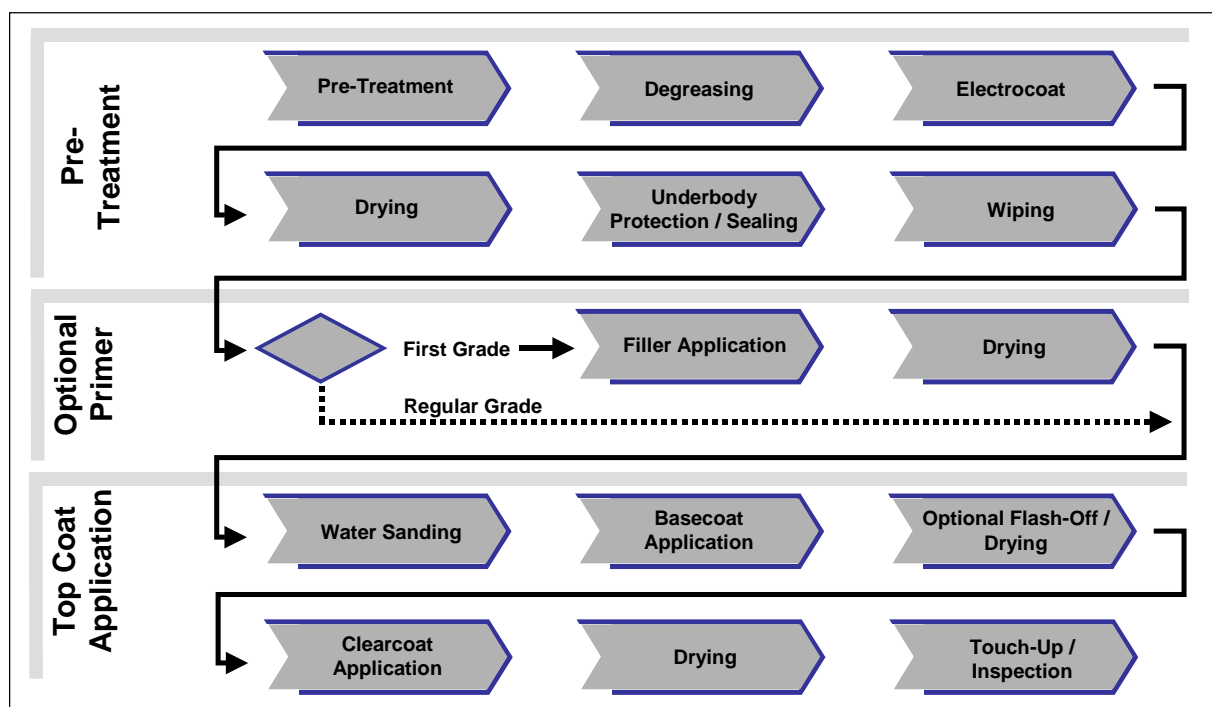

Figure F.3: Process Layout of the Coating Section of the Automobile Production

In order to fulfil current legislation, the factory has installed three sets of waste water disposing equipment with more than 1 million RMB for each. Additionally, there are equipments installed in gas pipes to deal with waste gas with the rough cost of 2 million RMB over all. The standards adopted in the effluent treatment specifically are:

1. The standards for the treatment of polluted water in the city of Beijing
2. The standards for the air-pollution, GB16297-1996
3. The standards for noise pollution in the industry, GB12348-90
4. The standards for air pollution due to industrial oven, GB9078-1996

The pollution sources to the environment of this workshop are mainly: noise, effluent water, effluent gases and waste solid residues. The factory has applied the following measures for the treatments:

- **Noise:** Precaution measures have been taken in the designing stage to minimise the noise. The requirements have been stressed for the noise reduction during equipment purchasing; the workshop has built-in insulation foundation and wall absorption boards; soft connections are used between the piping and equipment for the reduction of vibration; the heavy noised equipments, e.g., cooling pumps, chilling system, etc. are installed in the enclosure of special rooms. After the above measures, it has proved that the No.1 specification of the standards for the air-pollution, GB16297-1996 has been complied.
- **Effluent Water:** The effluent water is mainly generated in the pre-treatment of the coating by degreasing, phosphating and final water cleaning. Main characteristics of the water can be described by the following indicators:  $pH = 8 - 9$ ,  $BOD_5 = 74$  mg/l,  $COD = 274$  mg/l, Suspended Solids  $SS = 73$  mg/l, mineral oil = 16 mg/l,  $Z_n = 0.145$  mg/l (Zinc and its inorganic compounds). The effluent water is drained to the waste water station in the factory. The waste water treatment includes a pH-fitting, deposition bath, air floating and sand filtering. After this first treatment the waste water is drained to public sewerage system.
- **Effluent Gas:** The effluent gas stems from the burning of natural gas for the drying oven, from the polluted air due to the coating and polluted air emitted from the dryer. On average the waste gas from the chimney of the dryer and the oven results in smoke  $7.6$  mg/m<sup>3</sup>,  $SO_2 = 17$  mg/m<sup>3</sup>,  $NO_x = 168$  mg/m<sup>3</sup>, blackness of the dust is less than *Level 1*. It is confirmed that the air pollution of the coating workshop complies with the standards of DB11/139-2002 in Beijing area. The special treatment has been taken for the air pollution produced by the coating process. The effluent gas is treated by water spraying using spinning method. The effectiveness of removing the painting dust may reach 98% or above. The treated gas is exhausted through a 25 m chimney to the open. The organic effluent gas produced

from the dryers is lead to the oven to mix with natural gas for the burning. There is a 15 m chimney for each dryer to exhaust the treated effluent gas in the chamber. The treatment complies with the relevant regulation.

- **Solid Waste:** The solid residues mainly consist of paint residues, phosphorous residues, used sand paper, used cotton wool, mud from sewerage station. Among them, phosphorous residues and paint residues are collected to the solid residues treatment centre in Beijing for special treatment. The rest of the solid residues are treated through the normal standard channel.

### F.3 Discussion

Since the appearance of a car is of major concern to customers, great importance is attached to the coating process in the automotive industry. The application of high quality coating is important for protecting the car from corrosion, chemical deterioration, weathering, chipping etc., and for maintaining optimal optical characteristics as well as faultless and even application. Consequently, surface treatment technologies in the European automotive industry are innovative: driven to a high standard of quality by customers on the one side and to a high environmental standard by the IPPC directive on the other. The coating process described in this case study showed as special characteristic less demanding requirements on both sides. Due to trade secrets specific results concerning this case study are omitted in this book. For the general application of the methodology to the serial coating of passenger cars please refer to [Geldermann et al., 2006d].

In general, surface treatment technologies using solvents, such as the serial coating of cars, can cause a substantial environmental hazard due to the generation of volatile organic compounds (VOCs) and their neurotoxic properties. But basically, a trade-off between reduced VOC-input and energy consumption can be observed. Consequently, the drying process after coating the car body is central to the application of the pinch analysis and the setting of minimal cost and energy targets. Thus, the connection of the different drying tunnels and modelling of the different flows delivers a good insight into the serial coating of raw chassis. Heat could not only transferred within each drying tunnel, but also between the different drying tunnels [see Geldermann et al., 2006d].

# Appendix G

## Author Information

### G.1 French-German Institute for Environmental Research (DFIU/IFARE)

The *French-German Institute for Environmental Research (DFIU/IFARE)* within the University of Karlsruhe (TH) is a joint effort of the French government, the Regional Council of Alsace (France) and the State of Baden-Württemberg (Germany) and aims at supporting transboundary co-operation in the field of environmental research.

Its research activities include primarily the techno-economic analysis and evaluation of emission reduction techniques (especially for dust,  $SO_2$ ,  $NO_x$  and VOC), the development of regional/national emission reduction strategies as well as the techno-economic evaluation of emission reduction measures. The DFIU/IFARE aims at supporting transboundary co-operation in the field of environmental research, in order to provide scientific support to environmental policy making, to produce readily applicable scientific information for decision makers confronted with environmental issues and to initiate co-operation with international organisations (EU, Council of Europe, UN, OECD, ...).

The research group "*Technique Assessment and Risk Management*" applies and develops further modern approaches for the techno-economic and environmental assessment of emission reduction strategies in order to meet new environmental requirements. Thus, an investigation of the technical and economic viability of innovative, environmentally sound production processes is essential employing interdisciplinary methodologies for production planning and technology management.

**Jutta Geldermann** holds a diploma in Industrial Engineering and a PhD in Business Administration, both from the University of Karlsruhe (TH). While heading the interdisciplinary research team on "Technique Assessment and Risk Management" at (DFIU/IFARE), her major research areas are multi-criteria decision support systems and assessment and optimisation of the economic performance of emission reduction strategies on regional, national and supranational levels. In December 2006, she was appointed Professor for Production and Logistics at the Georg-August-University of Goettingen (Germany).

**Martin Treitz** holds a diploma in Industrial Engineering and a PhD in Business Administration, both from the University of Karlsruhe (TH). He is a scientific research assistant in the interdisciplinary research team on "Technique Assessment and Risk Management" at the Institute for Industrial Production (IIP), University of Karlsruhe (TH), Germany. His major research interests include multi-criteria decision making, production process design, resource efficiency and risk management.

**Hannes Schollenberger** holds a Diploma in Geoecology (University of Bayreuth) and a Ph.D. in Business Administration (University of Karlsruhe). He was a scientific research assistant in the working group "Technique Assessment and Risk Management" at DFIU/IFARE. Main research areas are metal coating, time and motion studies, substance flow analysis, techno-economic assessment of process changes under new environmental legislation. Actually, he works for Henkel Ltda. in São Paulo, Brazil.

**Jens Ludwig** holds a diploma in Industrial Engineering from the University of Karlsruhe (TH). He is a scientific research assistant in the interdisciplinary research team on "Technique Assessment and Risk Management" at the Institute for Industrial Production (IIP), University of Karlsruhe (TH), Germany. His major research interests include capacity planning in dynamic environments, the evaluation of emission reduction measures by multi-criteria analyses, the consequences of such legislation for different stakeholder groups and inter-company applications with a special focus on eco-industrial parks.

**Otto Rentz** is professor for Industrial Production and Economics at the University of Karlsruhe (TH) where he also received his diploma in Economics and his PhD in Industrial Chemistry concluding his studies in France and Germany. He is director of the Institute for Industrial Production and the French-German Institute for Environmental Research, University of Karlsruhe (TH), Germany. From 1981 to 1982 he was Director of the Fraunhofer Institute for Systems Analysis and Innovation Research. From 1999 to 2001 he was Director of the Asia-Europe Environmental Technology Centre (AEETC) in Bangkok. His major research interests include energy systems, state of the art of

environmental protection technologies, concepts for the reduction and recycling of waste and technology transfer as well as environmental economics and policies.

## G.2 Unidad de Desarrollo Tecnológico (UDT)

*Unidad de Desarrollo Tecnológico (UDT)* of the University of Concepción was founded in 1996 as an institution for the development of technology. Its goal is the supplementation of scientific research work with practical experiences from operating pilot plants and industry studies. The working areas include environmental engineering, advanced materials and new uses of forest biomass. UDT is financed principally through industry contracts and employs 36 scientists and technicians.

**Alex Berg** Berg holds a chemical engineering degree from the University of Concepción and a PhD in Natural Sciences of the University of Hamburg. He is the Executive Director of UDT since its beginning in 1996. Before, he worked for 6 years for the German companies Kunz Holding GmbH & Co KG and Veba Oel AG developing a new process for the pulping of wood with organic solvents. His areas of competence are the scaling up of chemical processes, especially those related with the use of biomass as a source of chemicals, fuels and new materials.

**Jens Neugebauer** holds a diploma in chemical engineering from the University of Dortmund and will finish his PhD studies in industrial engineering at the RWTH Aachen University in 2007. After an appointment as project manager at the Fraunhofer UMSICHT in Oberhausen, he joined the UDT in Concepción as a co-ordinator for international R&D projects in environmental engineering. His research activities comprise mass and cost flow analysis for waste management systems as well as the interdisciplinary assessment of environmental technologies.

**Marcela Zacarías**, a Chemical Engineer from the University of Concepción, works for UDT since 1997. She has a long year experience in environmental technologies, especially regarding waste water treatment, odour removal and measurement and air pollution control, which has been acquired in projects performed together with companies from the fishing, food and wood processing industries and refineries. Her major interests are industrial implementation of cutting age technologies with the aim of diminishing the environmental impacts of industrial processes.

### G.3 College of Environmental Science and Engineering (CESE)

The *College of Environmental Science and Engineering (CESE)* and the *UNDP-Tongji Institute of Environment for Sustainable Development* are research institutes within the Tongji University in Shanghai. The Tongji University is one of the leading universities in the Peoples Republic of China founded in 1907 as a German medical university. Presently there are over 41 000 students registered as well as approximately 4 200 employees in research and teaching. As one of the key research centres in the Peoples Republic of China, the university maintains eight research laboratories and engineering centres. The College of Environmental Science and Engineering of the Tongji University, of which the research centre "State Key Laboratory of Pollution Control and Resources Reuse" is a part, has over 100 employees, 18 of whom are professors and 30 are assistant professors. The research centre for "Cleaner Production and Environmental Assessment" of the School of Environmental Science and Engineering provides important contributions in policy and industry projects. The research focusses on environmental city planning, eco-industrial park planning and integrated environmental assessment.

**Yongsen Lu** is professor for environmental assessment and planning at the *College of Environmental Science and Engineering (CESE)*, Tongji University, and *UNDP-Tongji Institute of Environment for Sustainable Development*. He received Bachelor Degree in Sanitary Engineering, Tsinghua University in 1959. He has been the visiting scholar at the University of Toronto, Canada from 1981 to 1983. He has had long term experiences in environmental engineering design and research at industrial sectors and won awards and prizes of invention and technology development. Over the years his research interests has been in the areas of innovative environmental technology and management, and integrated environmental assessment and planning.

**Surong Guo** received a PhD from Tongji University where she worked as a researcher in the field of Environmental Science and Engineering. She studied Chemical Engineering at Zhejiang University where she got Bachelor and Master Degree. In addition, she worked at Qingdao University as Assistant Professor for many years.

### G.4 Energy Research Institute

The *Energy Research Institute (ERI)* of the National Development and Reform Commission (NDRC) was established in 1980. It is a national research organisation con-



ducting comprehensive studies on China's energy issues. Since its establishment, it has been affiliated with the former State Energy Commission and the former State Economy Commission and former State Planning Commission. Since 2003, ERI is under the National Development and Reform Commission. ERI employs 100 staff, with one director-general and three deputy directors. Apart from this, there are 33 senior research posts. ERI is divided into 4 research centers with 3 function divisions and offices. They are:

- Center for Energy Economy and Development Strategy Research
- Energy Efficiency Center
- Center for Renewable Energy Development
- Center for Energy, Environment and Climate Change Research
- Research Management and International Collaboration Division
- Administration Office
- Human Resource Division

**Fengqi Zhou** graduated from the Electrical Engineering Department, Tsinghua University in 1959, became Deputy Director General of Energy Research Institute in 1981 and Director General in 1987 till 1999. Now he is Senior Adviser of Energy Research Institute of National Development and Reform Commission and Advisor of China Energy Research Society, Vice President of China Energy Conservation Society, and China Energy Investment Society, and a member of the Energy Committee of Chinese Academy of Science, and a member of Energy Expert Group of "National Key Basic Research Development Planning (973)" Program, and Executive Director of GOC/World Bank/GEF China Renewable Energy Scale up Program Office, Former Senior Consultant of Ministry of Electrical Power Industry and Ministry of Energy Industry. Internationally, Professor Zhou is a member of Advisor Board of Asia Pacific Energy Research Center (Japan) and a member of the Working Group on Energy Strategies and Technologies, China Council for International Cooperation on Environment and Development. He was a member of the Energy and Environment Steering Committee of the World Bank, and a member of the Prototype Carbon Fund Technical Advisory Group of the World Bank, and The lead author of Working Group 3 of IPCC 2nd,3rd , and 4th Assessment Report and IPCC Special Report for Technology Transfer from 1996-2007, and The lead author of World Energy Assessment 2000 (WEC, UNDP, UNDESA).

***Yin Nan Wang*** gained a degree Bachelor Degree on Industrial Electrical Automation in Hebei Institute of Technology in 1993, and a Master Degree on High-Voltage Engineering and Communication in Tsinghua University in 1996, and a PhD of Science and Technology in Beijing University in 2001. She was a Lecturer of Hebei Institute of Technology in 1996-1997, and a Project Manager of Clever Software Company and XuJi Electrical Company in 2000 and 2001. Since December 2001 to February 2004 she became an Assistant Researcher of the Institute of Electrical Engineering of Chinese Academy of Science. Since March 2004 she is an Associate Professor and Deputy Executive Director of GOC /WB/ GEF China Renewable Energy Scale-up Program Management Office.

# Bibliography

- W. J. Abernathy and J. M. Utterback. A dynamic model of process and product innovation. *Omega*, 3(6):639–656, 1975.
- T. Agmon and M. A. Glinow. *Technology Transfer in International Business*. Oxford University Press, New York, 1991.
- J. Alcamo, R. Shaw, and L. Hordijk. *The RAINS Model of Acidification. Science and Strategies in Europe*. Kluwer, Dordrecht, 1990.
- B. Alexander, G. Barton, J. Petrie, and J. A. Romagnoli. Process synthesis and optimisation tools for environmental design: methodology and structure. *Computers and Chemical Engineering*, 24(2-7):1195–1200, 2000.
- A. Alva-Argáez, A. C. Kokossis, and R. Smith. Wastewater minimisation of industrial systems using an integrated approach. *Computers and Chemical Engineering*, 22(Supplements):S741–S744, 1998.
- G. Ashton. Design of Energy Efficient Batch Processes. In P. A. Pilavachi, editor, *Energy Efficiency in Process Technology*, Proceedings of the International Conference on Energy Efficiency in Process Technology, pages 1050–1062. Elsevier, 1992.
- G. Badelt. *Anreizsysteme zur Verbesserung der industriellen Energieeffizienz in Transformationsländern am Beispiel der VR China*. Shaker, Aachen, 2005.
- B. V. Balachandran, R. Balakrishnan, and K. Sivaramakrishnan. Capacity Planning with Demand Uncertainty. *The Engineering Economist*, 43(1):49–72, 1997.
- C. A. Bana e Costa, T. J. Stewart, and J. C. Vansnick. Multicriteria decision analysis: Some thoughts based on the tutorial and discussion sessions of the ESIGMA meetings. *European Journal of Operational Research*, 99(1):28–37, 1997.
- R. D. Banks. How to Spur the "Greening" of Industry in Rapidly Industrializing Countries. *Industry and Environment (UNEP IE)*, 17(3):42–44, 1994.

- C. Bao, S. Wang, S. Guo, and Y. Lu. The Challenges of Building Eco-Industrial Parks through Inter- Enterprise Planning of Dynamic Mass Flow Networks in China. In J. Geldermann, M. Treitz, H. Schollenberger and O. Rentz, editor, *Challenges for Industrial Production*, Proceedings of the Workshop within the PepOn Project on "Integrated Process Design for the Inter-Enterprise Plant Layout Planning of Dynamic Mass Flow Networks", 7. - 8. Nov., pages 9–20. Universitätsverlag Karlsruhe, 2005.
- S. D. Barnicki and J. Siirola. Process synthesis prospective. *Computers and Chemical Engineering*, 28:441–446, 2004.
- F. H. Barron and B. E. Barret. Decision Quality Used Ranked Attribute Weights. *Management Science*, 42:1515–1523, 1996.
- L. Basson. *Context, Compensation and Uncertainty in Environmental Decision Making*. Thesis/dissertation, Department of Chemical Engineering, University of Sydney, Australia, 2004.
- L. Basson and J. G. Petrie. An Integrated Approach for the Management of Uncertainty in Decision Making Supported by LCA-Based Environmental Performance Information. In *Transactions of the 2nd Biennial Meeting of the International Environmental Modelling and Software Society*. iEMSS, 2004.
- L. Basson and J. G. Petrie. An Integrated Approach for the Consideration of Uncertainty in Decision Making Supported by Life Cycle Assessment. *Environmental Modelling & Software*, 22(2):167–176, 2007. Special Issue on Environmental Decision Support Systems.
- V. Belton and T. Stewart. DEA and MCDA: Competing or Complementary Approaches. In N. Meskens and M. Roubens, editors, *Advances in Decision Analysis*, Mathematical Modelling: Theory and Applications, chapter 6, pages 87–104. Kluwer Academic Publishers, 1999.
- V. Belton and T. Stewart. *Multiple Criteria Decision Analysis - An integrated approach*. Kluwer Academic Press, Boston, 2002.
- F. Beltrán, J. García-Araya, and P. Álvares. Wine Distillery Wastewater Degradation - Oxidative Treatment Using Ozone and its Effect on the Wastewater Biodegradability. *Journal of Agriculture and Food Chemistry*, 47:3911 – 3918, 1999.
- A. Benz. Untersuchung der Beschichtung von Fischereinetzen in der Lachsproduktion in Chile. Technical report, Studienarbeit am Institut für Industriebetriebslehre und Industrielle Produktion, Universität Karlsruhe (TH), 2007.

- V. Bertsch, J. Geldermann, and O. Rentz. Multidimensional Monte Carlo Sensitivity Analysis in Multi-Criteria Decision Support. In F. Mayer and J. Stahre, editors, *9th IFAC Symposium on Automated Systems Based on Human Skill And Knowledge*, page (submitted), Nancy, France, 2006.
- D. Betke. Umweltschutz. In B. Staiger, H.-W. Schulte, and S. Friedrich, editors, *Das große China-Lexikon*, pages 774–776. Wissenschaftliche Buchgesellschaft, 2003.
- BFAI-China. *Automarkt der VR China weist wieder Rekordwachstum auf*. BFAI - Bundesagentur für Außenwirtschaft, 22.09.2006 . URL <http://www.bfai.de>. Datenbank "Länder und Märkte":China.
- A. Bhattacharya, R. Mudgal, and A. Taneja. Acid deposition and critical load analysis in Agra, India. *Journal of Hazardous Materials*, 106(2-3):157–160, 2004.
- P. Bianchi and M. Parrilli. Obstáculos y oportunidades de inversión para el desarrollo de las pequeñas y medianas empresas en Chile. Report, 2002.
- R. Borja, A. Martin, R. Maestro, M. Luque, and M. Durán. Enhancement of the Anaerobic Digestion of Distillery Wastewater by the Removal of Phenolic Inhibitors. *Bioresource Technology*, 45:99 – 104, 1993.
- J.-P. Brans and B. Mareschal. The PROMETHEE methods for MCDM; the PROMCALC, GAIA and BANKADVISOR software. In C. A. Bana e Costa, editor, *Readings in multiple criteria decision aid*. Springer-Verlag, 1990.
- J.-P. Brans and B. Mareschal. The PROMCALC and GAIA decision support system for Multi-criteria decision aid. *Decision Support System*, 12:297–310, 1994.
- J.-P. Brans and B. Mareschal. The PROMETHEE VI procedure: How to differentiate hard from soft multicriteria problems. *Journal of Decision Systems*, 4:213–223, 1995.
- J.-P. Brans and B. Mareschal. PROMETHEE Methods. In J. Figueira and S. Greco and M. Ehrgott, editor, *Multiple Criteria Decision Analysis - State of the Art Surveys*, pages 163–195. Springer, 2005.
- J.-P. Brans and P. Vincke. A Preference Ranking Organisation Method: The PROMETHEE Method for Multi Criteria Decision Making. *Management Science*, 31: 647 – 656, 1985.
- J.-P. Brans, B. Mareschal, and P. Vincke. PROMETHEE: a new family of outranking methods in multicriteria analysis. In J. P. Brans, editor, *Operational Research, IFORS 84*, pages 477–490. North-Holland, 1984.

- J.-P. Brans, P. Vincke, and B. Mareschal. How to select and how to rank projects: The PROMETHEE method. *European Journal of Operational Research*, 24:228–238, 1986.
- K. Brockhoff. *Forschung und Entwicklung: Planung und Kontrolle*. Oldenbourg, München, 5 edition, 1999.
- P. Brosi. Die Übertragung der Pinch-Analyse auf das Supply Chain Management. Technical report, Diplomarbeit am Institut für Industriebetriebslehre und Industrielle Produktion, Universität Karlsruhe (TH), 2006.
- D. Burtraw and A. J. Krupnick. RAINS-ASIA: A critique and guide to future research. Report, 1999.
- A. H. Buschmann, V. A. Riquelme, M. C. Hernandez-Gonzalez, D. Varela, J. E. Jimenez, L. A. Henriquez, P. A. Vergara, R. Guinez, and L. Filun. A review of the impacts of salmonid farming on marine coastal ecosystems in the southeast pacific. *ICES Journal of Marine Science*, 63:1338–1345, 2006.
- J. A. Cano-Ruiz and G. J. McRae. Environmentally Conscious Chemical Process Design. *Annual Review of Energy and Environment*, 23:499–536, 1998.
- C. Carlsson and R. Fullér. Fuzzy multiple criteria decision making: recent developments. *Fuzzy Sets and Systems*, 78:139–153, 1996.
- M. Castier and K. Pajagopal. Thermodynamic analysis of an distillery. *Energy*, 13:455 – 459, 1988.
- J. Cerda, A. Westerberg, D. Manson, and B. Linnhoff. Minimum utility usage in heat exchanger network synthesis - A transportation problem. *Chemical Engineering Science*, 38(3):373–387, 1983.
- A. Charnes, W. W. Cooper, and E. Rhodes. Measuring the efficiency of decision making units. *European Journal of Operational Research*, 2(6):429–444, 1978.
- J.-C. Charpentier. Four main objectives for the future of chemical and process engineering mainly concerned by the science and technologies of new materials production. *Chemical Engineering Journal*, 107:3–17, 2005.
- H. Chen, Y. Wen, M. Waters, and D. Shonnard. Design guidance for chemical processes using environmental and economic assessments. *Industrial and Engineering Chemistry Research*, 41(18):4503–4513, 2002.

- M. Chertow. Industrial Symbiosis: Literature and Taxonomy. *Annual Review of Energy & Environment*, 25:313 – 337, 2000.
- M. Chertow. Industrial Symbiosis and Eco-Industrial Parks. In E.-I. E. A. Network, editor, *Partnership for the Future: 2nd Annual Conference and Workshop for Eco-Industrial Development*, Bangkok, 2004.
- Jahresbericht Auto 2006*. China Association of Automobile Manufacturers in Verband der Automobilindustrie (VDA). URL <http://www.vda.de/de/service/jahresbericht/index.html>.
- ChinaLawEnergy. *National Law of Energy Saving*, 1997.
- ChinaLawPromCP. *National Law of Promoting Cleaner Production*, 2003.
- M. K. Cho and Y. H. Lee. Development of a new performance measure for the Supply Chain using the concept of momentum. *International Journal of Production Economics* (submitted), 2007.
- E. Ciccozzi, R. Checkenya, and A. V. Rodriguez. Recent experiences and challenges in promoting cleaner production investments in developing countries. *Journal of Cleaner Production*, 11:629–638, 2003.
- A. Clark and V. Armentano. A heuristic for a resource-capacitated multi-stage lot-sizing problem with lead times. *Journal of Operations Management*, 46:1208–1222, 1995.
- J. Cofala, M. Amann, and Z. Klimont. Calculating Emission Control Scenarios and their Costs in the RAINS Model: Recent Experience and Future Needs. *Pollution Atmosphérique*, 4-5:37–48, 2000.
- J. Cofala, M. Amann, F. Gyarfas, W. Schoepp, J. C. Boudri, L. Hordijk, C. Kroeze, J. Li, D. Lin, T. S. Panwar, and S. Gupta. Cost-effective control of SO<sub>2</sub> emissions in Asia. *Journal of Environmental Management*, 72(3):149–161, 2004.
- W. W. Cooper, L. M. Seiford, and J. Zhu. Data Envelopment Analysis: History, Models and Interpretations. In W. W. Cooper, L. M. Seiford, and J. Zhu, editors, *Handbook on Data Envelopment Analysis*, International Series in Operations Research and Management Science, chapter 1, pages 1–40. Kluwer, 2004.
- B. Coriat and O. Weinstein. Organizations, firms and institutions in the generation of innovation. *Research Policy*, 31(2):273–290, 2002.

- H. Corsten. *Handbuch Produktionsmanagement: Strategie - Führung -Technologie - Schnittstelle*. Gabler, Wiesbaden, 1994.
- S. J. DeCanio. *Economic Models of Climate Change: A Critique*. Palgrave Macmillan, Hampshire, 2006.
- M. G. Dekimpe, P. M. Parker, and M. Sarvary. Staged estimation of international diffusion models: An application to global cellular telephone adoption. *Technological Forecasting and Social Change*, 57:105–132, 1998.
- SEPA-EnvPolicy. *Encyclopedia of China Environmental Policy towards Market Economy*. Department of Policy and Regulation, State Environmental Protection Agency (SEPA), Beijing, 2002. Chemical Industry Press.
- SEPA-EnvProtection. *The Tenth Five-Year Plan of the National Environmental Protection*. Department of Policy and Regulation, State Environmental Protection Agency (SEPA), Beijing. URL [www.sepa.gov.cn](http://www.sepa.gov.cn).
- DIN 1539. *Tockner und Öfen, in denen brennbare Stoffe freigesetzt werden; Sicherheitsanforderungen*. Deutsches Institut für Normung (DIN).
- V. R. Dhole, N. Ramchandi, R. A. Tainsh, and M. Wasilewski. Make your process water pay for itself. *Chemical Engineering*, 103(1):100–103, 1996.
- A. Dibon. New Inline Coil-Coating facilities: A Breakthrough in New Curing and Exhaust Air Purification Technologies. In J. G. Hannes Schollenberger Isabelle Hubert Otto Rentz, editor, , *Integrated Scenario Analysis and Decision Support for the Modern Factory*, pages 111–118. French-German Institute for Environmental Research (DFIU/IFARE), 2004.
- U. Diwekar and M. J. Small. Process analysis approach to industrial ecology. In R. U. Ayres and L. W. Ayres, editors, *A handbook of industrial ecology*, chapter 11, pages 114–137. Edward Elgar, 2001.
- J. M. Douglas. *Conceptual design of chemical processes*. McGraw-Hill, New York, 1988.
- R. F. Dunn and G. E. Bush. Using process integration technology for CLEANER production. *Journal of Cleaner Production*, 9:1–23, 2001.
- R. F. Dunn and M. El-Halwagi. Selection of optimal VOC-condensation systems. *Waste Management*, 14(2):103–113, 1994.



- T. D. Eastop and A. McConkey. *Applied Thermodynamics for Engineering Technologists*. Longman, Green and Co LTD, London, 2nd edition, 1969.
- ECON. Environmental challenges in China: determinants of success and failure. Background Report for the World Development Report 2003, 2002. URL <http://econ.worldbank.org/>.
- W. Edwards. How to use Multiattribute Utility Measurement for Social Decision Making. *IEEE Transactions on Systems, Man, and Cybernetics*, SMC-7:326–340, 1977.
- W. Edwards and F. H. Barron. SMARTS and SMARTER: Improved Simple Methods for Multiattribute Utility Measurement. *Organizational Behaviour and Human Decision Processes*, 60:306–325, 1994.
- J. A. Eilering and W. J. Vermeulen. Eco-Industrial parks: towards industrial symbiosis and utility sharing in practice. *Progress in Industrial Ecology*, 1:245 – 270, 2004.
- M. El-Halwagi. *Pollution prevention through process integration: systematic design tools*. Academic Press, San Diego, 1997.
- M. El-Halwagi and V. Manousiouthakis. Synthesis of Mass-Exchange Networks. *AIChE J.*, 35(8):1233–1244, 1989.
- EMCENTRE. *Saving Water, Energy and Raw Materials in Fermentation (in Chinese)*. EMCENTRE (Environmental Management Center). URL [http://www.emcentre.com/unepweb/tec\\_case/food\\_15/house/casename.shtml](http://www.emcentre.com/unepweb/tec_case/food_15/house/casename.shtml).
- M. Estrela and A. Lipkova. Condition, technical limitations, industrial and environmental costs in passing from metal to plastic. Generic, 2003.
- EC 99/13. *Council Directive 99/13/EC on the limitation of emissions of volatile organic compounds due to the use of organic solvents in certain activities and installations*. European Commission (EC). URL <http://europa.eu.int/eur-lex/en/>.
- EC 2005/1095. *Council Regulation imposing a definitive anti-dumping duty on imports of bicycles originating in Vietnam and amending Regulation (EC) No 1524/2000 imposing a definitive anti-dumping duty on imports of bicycles originating in the People's Republic of China*. European Commission (EC). URL <http://europa.eu.int/eur-lex/en/>.
- P. Eyerer. *Ganzheitliche Bilanzierung*. Springer, Berlin, 1996.
- G. F. Farris. Research on innovation management and technology transfer in China. *The Journal of Technology Transfer*, 32(1-2):123 – 126, 2007.

- A. C. Faruk, R. C. Lamming, P. D. Cousins, and F. E. Bowen. Analyzing, Mapping and Managing Environmental Impacts along Supply Chains. *Journal of Industrial Ecology*, 5(2):13–36, 2002.
- BMU-31.BImSchV. 31. *Verordnung zur Durchführung des Bundes-Immissionsschutzgesetzes (Verordnung zur Begrenzung der Emissionen flüchtiger organischer Verbindungen bei der Verwendung organischer Lösemittel in bestimmten Anlagen)*. Federal Ministry for the Environment, Nature Conservation and Nuclear Safety (BMU), 2001.
- A. Ficarella and D. Laforgia. Energy conservation in alcohol distillery with the application of pinch technology. *Energy Conversion & Management*, 40:1495 – 1514, 1999.
- W. Fichtner, M. Frank, and O. Rentz. Inter-firm energy supply concepts: an option for cleaner energy production. *Journal of Cleaner Production*, 12:891–899, 2004.
- W. Fichtner, I. Tietze-Stöckinger, M. Frank, and O. Rentz. Barriers of inter-organisational environmental management: Two case studies on industrial symbiosis. *Progress in Industrial Ecology*, 2(1):73 – 88, 2005.
- G. Fishman. *Monte Carlo - Concepts, Algorithms, and Application*. Springer Series in Operation Research. Springer, New York, Berlin, Heidelberg, 1996.
- M. Fleischmann, P. Beullens, J. M. Bloemhof, and L. N. V. Wassenhove. The Impact of Product Recovery on Logistics Network Design. *Production and Operations Management*, 10(2):156–173, 2001.
- J. W. Forrester. *Industrial Dynamics*. MIT Press, Cambridge, 1961.
- P. Franca, V. Armentano, R. Beretta, and A. Clark. A heuristic method for lot-sizing in multi-stage systems. *Computers in Operations Research*, 24:861–874, 1997.
- M. Frank. *Entwicklung und Anwendung einer integrierten Methode zur Analyse von betriebsübergreifenden Energieversorgungskonzepten*. Dissertation, Universität Karlsruhe (TH), 2003.
- S. French. Modelling, making inferences and making decisions: the roles of sensitivity analysis. *TOP*, 11(2):229–252, 2003.
- S. French and D. R. Insua. *Statistical Decision Theory*. Edward Arnold, London, 2000.
- S. French and N. Papamichail. Decision Behaviour, Analysis and Support - Decision making and how computers and analysis may support this. Report, 2003.

- A. Frey. Material und Stoffstrommanagement in der Piscoproduktion. Technical report, Diplomarbeit am Institut für Industriebetriebslehre und Industrielle Produktion, Universität Karlsruhe (TH), 2007.
- X. Fu and V. N. Balasubramanyam. Township and Village Enterprises in China. *The Journal of Development Studies*, 39(4):27–46, 2003.
- K. C. Furman and N. V. Sahinidis. A Critical Review and Annotated Bibliography for Heat Exchanger Network Synthesis in the 20th Century. *Industrial and Engineering Chemistry Research*, 41(10):2335–2370, 2002.
- C. Fussler. Neue Wege zur Ökoeffizienz. In E. Weizsäcker and J. Seiler-Hausmann, editors, *Ökoeffizienz - Management der Zukunft*. Birkhäuser Verlag, 1999.
- R. A. Gaggioli, D. A. Sama, S. Quian, and Y. M. El-Sayed. Integration of a new process into an existing site: a case study in the application of exergy analysis. *Journal of Engineering for Gas Turbine and Power*, 113:170 – 183, 1991.
- M. Gallaher and K. C. Delhotal. Modeling the Impact of Technical Change on Emissions Abatement Investments in Developing Countries. *The Journal of Technology Transfer*, 30 Michael Gallaher<sup>1</sup> and K. Casey Delhotal<sup>2</sup> (1) RTI International, 3040 Cornwallis Road, Research Triangle Park, NC, 27709, U.S.A (2) U.S. Environmental Protection Agency, 1200 Pennsylvania Avenue NW, 6202J, Washington, DC, 20460, U.S.A(1-2): 211–225, 2004.
- V. Ganapathy. *Industrial Boilers and Heat Recovery Steam Generators - Design, Applications and Calculations*. Marcel Dekker, Inc., New York, 2003.
- R. García-Flores and X. Z. Wang. A multi-agent system for chemical supply chain simulation and management support. *OR Spectrum*, 24:343–370, 2002.
- J. Geldermann. *Entwicklung eines multikriteriellen Entscheidungsunterstützungssystems zur integrierten Technikbewertung*. Fortschrittsberichte VDI, Reihe 16, Nr. 105, Dissertation, Universität Karlsruhe (TH). VDI Verlag, Düsseldorf, 1999.
- J. Geldermann. *Mehrzielentscheidungen in der industriellen Produktion*. Habilitation, Universität Karlsruhe (TH). Universitätsverlag Karlsruhe, Karlsruhe, 2006.
- J. Geldermann and O. Rentz. Bridging the gap between american and european MADM-approaches? In , Madrid, 2000. Madrid, 51st Meeting of the European Working Group Multicriteria Aid for Decisions.

- J. Geldermann and O. Rentz. Integrated technique assessment with imprecise information as a support for the identification of Best Available Techniques (BAT). *OR Spectrum*, 23:137–157, 2001.
- J. Geldermann and O. Rentz. Techno-economic assessment of VOC-emission reduction strategies based on the ARGUS model. *Environmental Modelling & Software*, 2004.
- J. Geldermann, C. Jahn, T. Spengler, and O. Rentz. Proposal for an integrated approach for the assessment of cross-media aspects relevant for the determination of 'Best Available Techniques' BAT in the European Union. In *Workshop on the assessment of cross media aspects relevant for the determination of "Best Available Techniques" in the frame of the implementation of Article 16(2) of the IPPC Directive*, 1998.
- J. Geldermann, C. Jahn, T. Spengler, and O. Rentz. Proposal for an Integrated Approach for the Assessment of Cross-Media Aspects Relevant for the Determination of "Best Available Techniques" BAT in the European Union. *International Journal of Life Cycle Assessment*, 4(2):94–106, 1999.
- J. Geldermann, S. Nunge, N. Avci, and O. Rentz. The Reference Installation Approach for the Techno-Economic Assessment of Emission Abatement Options and the Determination of BAT According to the IPPC-Directive. *International Journal of Life Cycle Assessment*, 5 LCA(4):S194, 2000a.
- J. Geldermann, T. Spengler, and O. Rentz. Fuzzy Outranking for Environmental Assessment, Case Study: Iron and Steel Making Industry. *Fuzzy Sets and Systems - Special Issue on Soft Decision Analysis*, 115:45–65, 2000b.
- J. Geldermann, K. Zhang, and O. Rentz. Sensitivitätsanalysen für das Outranking-Verfahren PROMETHEE. In W. Habenicht, B. Scheubrein, and R. Scheubrein, editors, *Multicriteria- und Fuzzy-Systeme in Theorie und Praxis*. Deutscher Universitätsverlag, 2003.
- J. Geldermann, H. Schollenberger, and O. Rentz. Integrated Scenario Analysis for Metal Surface Treatment . *International Journal of Integrated Supply Management*, 1(2): 219–235, 2004.
- J. Geldermann, V. Bertsch, and O. Rentz. Multi-Criteria Decision Support and Uncertainty Handling, Propagation and Visualisation for Emergency and Remediation Management. In H.-D. Haasis, H. Kopfer, and J. Schönberger, editors, *Operations Research Proceedings 2005*, pages 755–760, Heidelberg, 2006a. Springer.

- J. Geldermann, V. Bertsch, M. Treitz, S. French, K. N. Papamichail, and R. P. Hämäläinen. Multi-criteria Decision Support and Evaluation of Strategies for Nuclear Remediation Management. *OMEGA - The International Journal of Management Science (accepted)*, 2006b.
- J. Geldermann, H. Schollenberger, M. Treitz, and O. Rentz. Adapting the European Approach of Best Available Techniques: Case Studies from Chile and China. *Journal of Cleaner Production (accepted)*, 2006c.
- J. Geldermann, M. Treitz, and O. Rentz. Integrated technique assessment based on the pinch analysis approach for the design of production networks. *European Journal of Operational Research*, 171(3):1020–1032, 2006d.
- J. Geldermann, M. Treitz, H. Schollenberger, and O. Rentz. Evaluation of VOC recovery strategies: Multi Objective Pinch Analysis (MOPA) for the evaluation of VOC recovery strategies. *OR Spectrum*, 28 Special Issue on Product Recovery(1):3–20, 2006e.
- J. Geldermann, K. Zhang, and O. Rentz. Sensitivity Analyses for the Outranking Approach PROMETHEE. *Decision Support Systems*, (submitted), 2006f.
- J. Geldermann, M. Treitz, and O. Rentz. Comparison of Eco-Efficiency with Multi-Criteria Analysis to Evaluate Resource Efficiency. *Ecological Economics*, accepted, 2007.
- Y. Geng and J. Yi. Eco-Industrial Development in China. In R. H. Tiina Salonen Wu Chunyou Geng Yong, editor, , Sustainable Management of Industrial Parks: Proceedings of the German - Chinese Workshop from October 12 - 16 2004 in Leipzig, Germany, pages 51–68. Logos Verlag, 2005.
- J. E. Gentle. *Random Number Generation and Monte Carlo Methods*. Statistics and Computing. Springer, New York, Berlin, Heidelberg, 2003.
- D. Gibbs. Trust and networking in inter-firm relations: the case of eco-industrial development. *Local Economy*, 18(3):222–236, 2003.
- R. J. Giglio. Stochastic capacity models. *Management Science*, 17(3):174 – 188, 1970.
- D. Giurco. *Towards sustainable metal cycles: the case of copper*. Thesis/dissertation, University of Sydney, 2005.
- A. Gorsek and P. Glavic. Process integration of a steam turbine. *Applied Thermal Engineering*, 23:1227 – 1234, 2003.

- T. Graedel and B. R. Allenby. *Industrial Ecology*. Prentice Hall, Upper Saddle River, 2 edition, 2003.
- P. Grassmann. Zur allgemeinen Definition des Wirkungsgrades. *Chemie Ingenieur Technik*, 22(4):77–96, 1950.
- R. Gregorig. *Wärmeaustausch und Wärmeaustauscher : Konstruktionssystematik, Serienproduktion, Rohrschwingungen, fertigungsgerechte wirtschaftliche Optimierung aufgrund von Exergieverlusten*. Sauerländer, Aarau, 2 edition, 1973.
- Z. Griliches. Hybrid Corn: An Exploration in the Economics of Technological Change. *Econometrica*, 25:630–653, 1957.
- I. E. Grossmann. Challenges in the new millennium: product discovery and design, enterprise and supply chain optimization, global life cycle management. *Computers and Chemical Engineering*, 29:29–39, 2004.
- J. B. Guinée, M. Gorrée, R. Heijungs, G. Huppes, R. Kleijn, A. de Koning, L. van Oers, A. W. Sleeswijk, S. Suh, H. A. U. de Haes, H. de Bruijn, R. V. Duin, and M. A. J. Huijbregts. *Handbook on Life Cycle Assessment - Operational Guide to the ISO Standards*. Kluwer Academic Publishers, Dordrecht, 2002.
- H. Guo, B. Chen, X. Yu, G. Huang, L. Liu, and X. Nie. Assessment of cleaner production options for alcohol industry of china: a study in the shouguang alcohol factory. *Journal of Cleaner Production*, 14(1):94 – 103, 2006.
- S. Guo, Y. Lu, D. Jiang, and C. Bao. Study on the eco-industrial model for alcohol distillery. In J. Geldermann, M. Treitz, H. Schollenberger and O. Rentz, editor, *Challenges for Industrial Production*, Proceedings of the Workshop within the PepOn Project on ”Integrated Process Design for the Inter-Enterprise Plant Layout Planning of Dynamic Mass Flow Networks”, 7. - 8. Nov., pages 145–152, 2005.
- N. Hallale. A new graphical targeting method for water minimisation. *Advances in Environmental Research*, 6:377–390, 2002.
- J. Hauschildt. *Innovationsmanagement*. Vahlen, München, 2 edition, 1997.
- G. Henßen. *Kostenoptimale Gestaltung von Stoffaustauschernetzwerken mit Hilfe der erweiterten Wasser-Pinch-Methode*. Thesis/dissertation, Dissertation, University of Aachen, 2004.

- A. Hercher. Technische und wirtschaftliche Möglichkeiten der Minderung von Lösemittelmissionen am Beispiel eines industriellen Lackierbetriebes in Chile. Technical report, Diplomarbeit am Institut für Industriebetriebslehre und Industrielle Produktion, Universität Karlsruhe (TH), 2005.
- R. Hämäläinen and A. Salo. The issue is understanding the weights. *Journal of Multi-Criteria Decision Analysis*, 6:340 – 343, 1997.
- E. Hohmann. *Optimum Networks for Heat Exchange*. Thesis/dissertation, University of South California, 1971.
- R. Holländer, T. Salonen, W. Chunyou, and G. Yong. *Sustainable Management of Industrial Parks*. 2004.
- L. Hordijk and C. Kroeze. Integrated assessment models for acid rain. *European Journal of Operational Research*, 102:405–417, 1997.
- W. Härdle and L. Simar. *Applied Multivariate Statistical Analysis*. Springer-Verlag, Berlin; Heidelberg, 2003.
- D. Hunkeler, K. Saur, M. Finkbeiner, W.-P. Schmidt, A. A. Jensen, H. Strandorf, and K. Christiansen. *Life Cycle Management*. SETAC Publications, Pensacola, 2003.
- ISO 14040. *Environmental Management - Life Cycle Assessment - Principles and Framework*. International Organization for Standardization (ISO).
- I. Jansen. The "Sevilla Process" - Best Available Techniques in surface treatment using organic solvents. In *Integrated Scenario Analysis and Decision Support for the Modern Factory*, pages 127–136. French-German Institute for Environmental Research (DFIU/IFARE), 2004.
- X. Jia, T. Zhang, F. Wang, and F. Han. Multi-objective modeling and optimization for cleaner production processes. *Journal of Cleaner Production*, 14 JIA2006(2):146–151, 2006.
- M. Jungkurth. Einsatz erneuerbarer Energien bei einem mittelständischem Unternehmen in Chile. Technical report, Diplomarbeit am Institut für Industriebetriebslehre und Industrielle Produktion, Universität Karlsruhe (TH), 2006.
- D. Kahneman, P. Slovic, and A. Tversky. *Judgment under uncertainty: heuristics and biases*. Cambridge University Press, Cambridge, 1982.

- A. Kangas, J. Kangas, and J. Pykäläinen. Outranking methods as tools in strategic natural resources planning. *Silva Fennica*, 35(2):215–227, 2001.
- R. L. Keeney. *Value-Focused Thinking: A Path to Creative Decision Making*. Harvard University Press, 1992.
- R. L. Keeney and H. Raiffa. *Decisions with multiple objectives: Preferences and value tradeoffs*. John Wiley, New York, 1976.
- J. L. Kelley. *General topology*. Springer, New York, 1975.
- I. C. Kemp. Some Aspects of the practical application of the pinch technology methods. *Transaction of the Institution of Chemical Engineers*, 69a:471–479, 1991.
- W. Kern. *Die Messung industrieller Fertigungskapazitäten und ihrer Ausnutzung: Grundlagen u. Verfahren*. Westdeutscher Verlag, Köln, 1962.
- E. Khmelnitsky and K. Kogan. Optimal policies for aggregate production and capacity planning under rapidly changing demand conditions. *Int. J. Prod. Res.*, 34(7):1929–1941, 1996.
- A. Kleine. Data Envelopment Analysis aus entscheidungstheoretischer Sicht. *OR Spectrum*, 23(2):223–242, 2001.
- Z. Klimont, J. Cofala, and M. Amann. Estimating Costs for Controlling Emissions of Volatile Organic Compounds (VOC) from Stationary Sources in Europe. Report, 2000.
- D. Kline, L. Vimmerstedt, and R. Benioff. Clean energy technology transfer: A review of programs under the UNFCCC. *Mitigation and Adaptation Strategies for Global Change*, 9 KLINE2004(1):1–35, 2004.
- L. Koch and N. A. Ashford. Rethinking the role of information in chemicals policy: implications for TSCA and REACH. *Journal of Cleaner Production*, 14:31–46, 2006.
- T. C. Koopmans. Analysis of Production as an Efficient Combination of Activities. In T. C. Koopmans, editor, *Activity Analysis of Production and Allocation*, pages 33–97. John Wiley and Sons, 1951.
- T. C. Koopmans. Concepts of optimality and their uses. Lex Prix Nobel en 1975 - Lecture at the Nobel Price Ceremony, 1975. URL <http://www.jstor.org>.
- D. Koufos and T. Retsina. Practical energy and water management through pinch analysis for the pulp and paper industry. *Water Science and Technology*, 43(2):327–332, 2001.



- H.-U. Küpper. *Interdependenzen zwischen Produktionstheorie und der Organisation des Produktionsprozesses*. Duncker Humblot, Berlin, 1980.
- H.-U. Küpper. Kapazität und Investition als Gegenstand der Investitions-Controlling. In H. Corsten, R. Köhler, H. Müller-Merbach, and H. H. Schröder, editors, *Kapazitätsmessung, Kapazitätsgestaltung, Kapazitätsoptimierung: eine betriebswirtschaftliche Kernfrage*, pages 115 – 132. Schäffer-Poeschel, 1992.
- C. D. la Rubia, T. Rülle, and W. Schäfer. *Perspektiven Lateinamerika. Dresdner Bank Lateinamerika*, 2005.
- H. Lakhani. Empirical Implications of Mathematical Functions Used to Analyze Market Penetration of New Products. *Technological Forecasting and Social Change*, 15, 1979.
- R. Lakshmanan and E. S. Fraga. Pinch location and minimum temperature approach for discontinuous composite curves. *Computers and Chemical Engineering*, 26(6):779–783, 2002.
- O. Landerretche. *El Fomento de la Pequeña y Mediana Empresa y los Desafíos de la Globalización*. Serial (Book, Monograph), 2002.
- H. Laux. *Entscheidungstheorie*. Springer, Heidelberg, 6 edition, 2005.
- K. F. Lee, A. H. Masso, and D. F. Rudd. Branch and Bound Synthesis of Integrated Process Design. *Industrial and Engineering Chemistry Fundamentals*, 9(1):48–58, 1970.
- M. Lezni. *eco-efficiency - creating more value with less impact*. Report, 2000.
- A. Leicht. *Anwendung von Methoden des Operations Research zur Optimierung des Wassereinsatzes in der Industrie*. Technical report, Diplomarbeit am Institut für Industriebetriebslehre und Industrielle Produktion, Universität Karlsruhe (TH), 2005.
- Y. Li, Y. Liu, and F. Ren. Product innovation and process innovation in SOEs: evidence from the Chinese transition. *The Journal of Technology Transfer*, 32 Yuan Li1 Contact Information, Yi Liu2 Contact Information and Feng Ren1 LI2007(1-2):63–85, 2007.
- B. Linnhoff. Pinch Analysis - A state of the art overview. *Transaction of the Institution of Chemical Engineers*, 71(A):503–522, 1993.
- B. Linnhoff. Introduction to Pinch Technology. Linnhoff March, 1998. URL <http://www.linnhoffmarch.com/pdfs/PinchIntro.pdf>.

- B. Linnhoff. Mit der Pinch-Technologie Prozesse und Anlagen optimieren - Eine Methode des betrieblichen Energie- und Stoffstrommanagements. Landesamt für Umwelt, Messungen und Naturschutz, 2004. URL <http://www2.lfu.baden-wuerttemberg.de>.
- B. Linnhoff and J. R. Flower. Synthesis of Heat Exchanger Networks: I, Systematic Generation of Networks with Various Criteria of Optimality. *AIChE J.*, 24:633, 1978.
- B. Linnhoff and E. Hindmarsh. The pinch design method for heat exchanger networks. *Chemical Engineering Science*, 38(5):745–763, 1983.
- B. Linnhoff and V. Sahdev. Pinch Technology. In Ullmann's, editor, *Chemical Engineering and Plant Design*, chapter Volume 2, pages 1075–1081. Wiley, 2005.
- B. Linnhoff and J. A. Turner. Heat-recovery networks: new insights yield big savings. *Chemical Engineering*, 1981.
- B. Linnhoff, D. Manson, and I. Wardle. Understanding heat exchanger networks. *Computers and Chemical Engineering*, 3:295–302, 1979.
- J. J. Liu, J. Y. Qian, and J. Chen. Technological learning and firm-level technological capability building: analytical framework and evidence from Chinese manufacturing firms. *International Journal of Technology Management*, 36(1/2/3):190–208, 2006.
- S. Lopes. Technology transfer in the americas. *The Journal of Technology Transfer*, 19 LOPES1994(2):25–33, 1994.
- E. A. Lowe. Eco-Industrial Handbook for Asian Developing Countries. Technical report, Asian Development Bank, 2001. URL <http://www.indigodev.com/ADBHBdownloads.html>.
- Y. Lu. The Challenges of Building Eco-Industrial Parks through Inter-Enterprise Planning of Dynamic Mass Flow Networks in China. In *Challenges for Industrial Production*, Presentation at the Workshop "Challenges for Industrial Production", November 7-8, 2005.
- Y. Lu, C. Bao, and Y. Wang. Research Report of Quality Management, R&D and Economic Instruments for the Development of Environmental Technology Manufacture Sector (ETMS) in Jiangsu Province in China. Technical report, College of Environmental Science and Engineering, Tongji University, Shanghai, 2001.
- Y. Lu, C. Bao, and Y. Wang. Research Report of the Assessment of Technology Transfer Opportunity for ETMS in Jiangsu Province and China. Technical report, College of Environmental Science and Engineering, Tongji University, Shanghai, 2002.

- H. Luss. Operations research and capacity expansion problems: A survey. *Operations Research*, 30(5):907–947, 1982.
- M. Makowski. Modeling paradigms applied to the analysis of European air quality. *European Journal of Operational Research*, 122:219–241, 2000.
- J. G. Mann and Y. A. Liu. *Industrial Water Reuse and Wastewater Minimization*. McGraw-Hill, New York, 1999.
- A. S. Manne. Capacity expansion and probabilistic growth. *Econometrica*, 29(4):632 – 649, 1961.
- A. S. Manne. *Investments for capacity expansion : size, location and time-phasing*. Allen and Unwin, London, 1967.
- B. Mareschal. Weight stability intervals in multicriteria decision aid. *European Journal of Operational Research*, 33:54–64, 1998.
- P. Marfull. Pisqueros Buscan la Mejor Forma de Tratar sus Riles. URL [www.hannachile.com](http://www.hannachile.com). Hanna Instruments, Santiago de Chile, 2005.
- C. Marotte and J. Niosi. Technology Transfer to China The Issues of Knowledge and Learning. *The Journal of Technology Transfer*, 25 Claude Marcotte<sup>1</sup> and Jorge Niosi<sup>2</sup> Contact Information (1) Faculty of Commerce and Administration, Concordia University, Montreal, 1455 Boul Maisonneuve, Canada, H3G 1M8 (2) Department of Management and Technology, Université du Québec à Montréal, Station Center-Ville, Montreal, Qc, Canada, H3C 3P8 MAROTTE2000(1):43–57, 2000.
- G. Mavrotas and P. Trifillis. Multicriteria decision analysis with minimum information: combining DEA with MAVT. *Computers and Operations Research*, 33:2083–2098, 2006.
- J. Maystre, J. Pictet, and J. Simos. *Méthodes multicritères ELECTRE - Description, conseils pratiques et cas d'application à la gestion environnementale*. Presse Polytechniques et Universitaires Romandes, Lausanne, 1994.
- B. Metz, O. R. Davidson, J.-W. Martens, S. N. M. van Rooijen, and L. van Wie McGrory. *Methodological and Technological Issues in Technology Transfer: A Special Report of the Intergovernmental Panel on Climate Change*. Cambridge University Press, Cambridge, 2000.
- A. Michaelowa. Unilateral CDM - can developing countries finance generation of greenhouse gas emission credits on their own? *International Environmental Agreements: Politics, Law and Economics*, (online first / in press), 2007.

- J. V. Miegheem. Capacity Management, Investment, and Hedging: Review and Recent Developments. *Manufacturing & Service Operations Management*, 5(4):269–302, 2003.
- N. Miller, L. Snyder, and R. Stavins. The Effects of Environmental Regulation on Technology Diffusion: The Case of Chlorine Manufacturing. Report, 2003.
- P. Milling. *Der technische Fortschritt beim Produktionsprozeß : ein dynamisches Modell für innovative Industrieunternehmen*. Gabler, Wiesbaden, 1974.
- D. W. Moffat. *Economics Dictionary*. Elsevier Scientific Publishing, New York, 1976.
- C. C. Montalvo. Sustainable production and consumption systems-cooperation for change: assessing and simulating the willingness of the firm to adopt/develop cleaner technologies. The case of the In-Bond industry in northern Mexico. *Journal of Cleaner Production*, 11(4):411–426, 2003.
- D. Morris, T. Donnelly, and T. Donnelly. Supplier parks in the automotive industry. *Supply Chain Management*, 9(2):129–133, 2004.
- E. Mosberger. Chemical Plant Design and Construction. In Ullmann's, editor, *Chemical Engineering and Plant Design*, chapter Volume 2, pages 987–1073. Wiley, 2005.
- J. Mugler. *Betriebswirtschaftslehre der Klein- und Mittelbetriebe*, volume 1. Springer, 1998.
- J. Mustajoki, R. P. Hämäläinen, and A. Salo. Decision Support by Interval SMART/SWING - Incorporating Imprecision in the SMART and SWING Methods. *Decision Sciences*, 36(2), 2005.
- R. N. Nagel. Environmental Supply Chain Management versus Life Cycle Analysis Method Eco-Indicator '95: a Relative Business Perspective versus an Absolute Environmental Perspective. Report, 2000.
- ChinaStat2001. *China Statistical Yearbook*. National Bureau of Statistics of China. URL <http://www.stats.gov.cn/english/>.
- J. Neugebauer, M. Zacarás, A. Hercher, and A. Berg. Optimisation of a bicycle production plant in Chile using Integrated Environmental Management Approaches. In *Challenges for Industrial Production*, Presentation at the Workshop "Challenges for Industrial Production", November 7-8, 2005.
- K. Neumann and M. Morlock. *Operations Research*. Hanser, München, Wien, 1993.

- N. Nishida, Y. A. Liu, and L. Lapidus. Studies in Chemical Process Design and Synthesis: III. A Simple and Practical Approach to the Optimal Synthesis of Heat Exchanger Networks. *AIChE J.*, 23(1):77–93, 1977.
- Nobel Prize Committee. The Bank of Sweden Prize in Economic Sciences in Memory of Alfred Nobel 1975: Award to Prof. Kantorovich and Prof. Koopmans for their contributions to the theory of optimum allocation of resources. Press Release, 1975. URL <http://nobelprize.org/economics/laureates/1975/index.html>.
- G. W. Noble. The emergence of the chinese and indian automobile industries and implications for other developing countries. Technical report, Institute of Social Science, University of Tokyo, 2006. URL <http://siteresources.worldbank.org/>.
- E. D. Obeng and G. J. Ashton. On pinch technology based procedures for the design of batch processes. *Chemical Engineering Research and Design*, 66:255–259, 1988.
- OECD. *Financing newly emerging private enterprises in transition economies*. Paris, 1999.
- D. Ondratschek. *Jahrbuch "Besser Lackieren"*. Vinzenz, Hannover, 2002.
- G. Parthasarathy and M. El-Halwagi. Optimum mass integration strategies for condensation and allocation of multicomponent VOCs. *Chemical Engineering Science*, 55: 881–895, 2000.
- R. Perkins and E. Neumayer. The international diffusion of new technologies: a multi-technology analysis of latecomer advantage and global economic integration. Report, 2004.
- E. C. Perotti, L. Sun, and L. Zou. State-Owned versus Township and Village Enterprises in China. Report, 1998.
- M. S. Peters, K. D. Timmerhaus, and R. E. West. *Plant design and economics for chemical engineers*. McGraw-Hill, New York, 5 edition, 2003.
- G. T. Polley and H. L. Polley. Design better water networks. *Chemical Engineering Progress*, 96(2):47–52, 2000.
- J. W. Ponton and R. A. Donaldson. A fast method for the synthesis of optimal heat exchanger networks. *Chemical Engineering Science*, 29(12):2375–2377, 1974.

- M. Pöyhönen, H. Vrolijk, and R. P. Hämäläinen. Behavioral and procedural consequences of structural variation in value trees. *European Journal of Operational Research*, 134: 216–227, 2001.
- Y. Qian. Cleaner production and circular economy: New strategy for environment and development. In *Proceedings of the World Engineer's Convention*, volume D: Environment, Production and Disaster Mitigation, pages 215 – 218, Beijing, 2004. China Association for Science and Technology, China Science and Technology Press.
- G. Qu. Enhancement of Market Mechanism, Promotion of Environmental Industry. *China Environmental Industry*, 2:5–8, 2001.
- P. Radgen. *Energiesystemanalyse eines Düngemittelkomplexes*. Dissertation, Universität Duisburg. VDI-Verlag, Düsseldorf, 1996.
- N. S. Ram, R. N. Rathore, and G. J. Powers. A Forward Branching Scheme for the Synthesis of Energy Recovery Systems. *Industrial and Engineering Chemistry Process Design and Development*, 14(2):175–181, 1975.
- Raymond Côté. The Industrial Park as an Ecosystem. Technical report, Industrial Ecology Research Group, Dalhousie University, Nova Scotia, Canada, 2004.
- O. Rentz. *Techno-Ökonomie betrieblicher Emissionsminderungsmaßnahmen*. Technological Economics, Band 4. Erich Schmidt Verlag, Berlin, 1979.
- O. Rentz, S. Nunge, M. Laforsch, and T. Holtmann. Technical Background Document for the Actualisation and Assessment of UN/ECE Protocols related to the Abatement of the transboundary Transport of Volatile Organic Compounds from Stationary Sources. Report, 1999a.
- O. Rentz, S. Nunge, M. Laforsch, and T. Holtmann. BAT Background Document of the Task Force on the Assessment of Abatement Options/techniques for Nitrogen Oxides (NOx). Report, 1999b.
- O. Rentz, N.-H. Peters, S. Nunge, and J. Geldermann. *Report on the Best Available Techniques (BAT) in the Sectors of Paint and Adhesive Application in Germany*. VDI-Verlag, Düsseldorf, 2003.
- R. A. Ribeiro. Fuzzy multiple attribute decision making: a review and new preference elicitation techniques. *Fuzzy Sets and Systems*, 78:155–181, 1996.

- A. Richburg and M. El-Halwagi. A graphical approach to the optimal design of heat-induced separation networks for VOC recovery. *AIChE Symposium Series*, 91(304): 256–259, 1995.
- C. Richers. Optimierung der Energie- und Stoffströme in der chilenischen Pisco Production. Technical report, Diplomarbeit am Institut für Industriebetriebslehre und Industrielle Produktion, Universität Karlsruhe (TH), 2006.
- M. Rinner, M. Kind, and E.-U. Schlünder. Separated solvent recovery from waste gas with cryo-condensation. *Separation and Purification Technology*, 29:95–104, 2002.
- C. P. Robert and G. Casella. *Monte Carlo Statistical Methods*. Springer Texts in Statistics. Springer, New York, Berlin, Heidelberg, 1999.
- M. Rogers and M. Bruen. A new system for weighting environmental criteria for use within ELECTRE III. *European Journal of Operational Research*, 107:552–563, 1998.
- D. Rosenau-Tornow. *Ganzheitlich prozessorientierte Entscheidungsunterstützung am Beispiel der Automobillackierung - Ein Beitrag zum industriellen Stoffstrommanagement*. PhD thesis, Technische Universität Braunschweig, 2005.
- R. Rubinstein. *Simulation and the Monte Carlo Method*. Wiley series in probability and mathematical statistics. Wiley, New York, 1981.
- A. M. Ruz. Problems for Applying Industrial Ecology Concepts. In *Second International Society for Industrial Ecology Conference*, 2003.
- T. L. Saaty. *The Analytic Hierarchy Process*. McGraw Hill, New York, 1980.
- N. K. Saha, M. Balakrishnan, and V. S. Batra. Improving industrial water use: Case study for an indian distillery. *Resources, Conservation and Recycling*, 43:163 – 174, 2005.
- P. Saling, A. Kircherer, B. Dittrich-Krämer, R. Wittlinger, W. Zombik, I. Schmidt, W. Schrott, and S. Schmidt. Eco-Efficiency Analysis by BASF: The Method. *International Journal of Life Cycle Assessment*, 7(4):203–218, 2002.
- A. Saltelli, K. Chan, and E. M. Scott. *Sensitivity Analysis*. John Wiley and Sons, Chichester, 2000.
- J. Sarkis. A strategic decision framework for green supply chain management. *Journal of Cleaner Production*, 11:379–409, 2003.

- M. Schiff. Chile's Trade and Regional Integration: An Assessment. *The World Economy*, 25:973–990, 2002.
- N. Schlotthauer. *Unternehmens- und Bankenreform in China*. Peter Lang, Frankfurt am Main, 2003.
- H. Schollenberger. *Analyse und Verbesserung der Arbeitsabläufe in Betrieben der Reparaturlackierung*. Dissertation, Universität Karlsruhe (TH). Universitätsverlag Karlsruhe, Karlsruhe, 2006.
- H. Schollenberger and M. Treitz. Application of Multi Objective Pinch Analysis. In J. Geldermann, M. Treitz, H. Schollenberger and O. Rentz, editor, *Challenges for Industrial Production*, Proceedings of the Workshop within the PepOn Project on "Integrated Process Design for the Inter-Enterprise Plant Layout Planning of Dynamic Mass Flow Networks", 7. - 8. Nov., pages 117–126. Universitätsverlag Karlsruhe, 2005.
- B. Schrader. Strategische Entscheidungsunterstützung: Implementierung und beispielhafte Anwendung eines Software Tools zur Evaluierung von Mehrzielentscheidungsproblemen. Technical report, Diplomarbeit am Institut für Industriebetriebslehre und Industrielle Produktion, Universität Karlsruhe (TH), 2005.
- M. Schultes. *Abgasreinigung: Verfahrensprinzipien, Berechnungsgrundlagen, Verfahrensvergleich*. Springer, Heidelberg, 1996.
- F. Schultmann. *Stoffstrombasiertes Produktionsmanagement: betriebswirtschaftliche Planung und Steuerung industrieller Kreislaufwirtschaftssysteme*. Habilitation, Universität Karlsruhe (TH). Erich Schmidt, Berlin, 2003.
- J. A. Schumpeter. *The theory of economic development*. Harvard University Press, Cambridge, MA, 1934.
- H. R. Schwarz. *Numerische Mathematik*. B.G. Teubner, Stuttgart, 1997.
- SEPA12. *Management Measures to the Spread of National Key Appropriate Technologies*. SEPA, no.4 edition, 1999.
- SEPA4. *Management Measures to the Spread of National Best Available-Appropriate Technologies*. SEPA, no. 12 edition, 1993.
- J. Seppälä. *Life cycle impact assessment based on decision analysis*. Helsinki, 2003.



- J. Seppälä and R. P. Hämäläinen. On the meaning of the distance-to-target weighting method and normalisation in life cycle impact assessment. *International Journal of Life Cycle Assessment*, 6(4):211–218, 2001.
- J. Seppälä, L. Basson, and G. A. Norris. Decision analysis frameworks for life-cycle impact assessment. *Journal of Industrial Ecology*, 5(4):45–68, 2002.
- S. Seuring. Integrated chain management and supply chain management comparative analysis and illustrative cases. *Journal of Cleaner Production*, 12:1059–1071, 2004a.
- S. Seuring. Industrial Ecology, Life Cycles, Supply Chains: Differences and Interrelations. *Business Strategy and the Environment*, 13:306–319, 2004b.
- S. M. Shapiro. *24/7 Innovation: A blueprint for surviving and thriving in an age of change*. McGraw Hill, New York, 2001.
- A. Singhvi and U. V. Shenoy. Aggregate Planning in Supply Chains by Pinch Analysis. *Transaction of the Institution of Chemical Engineers*, 80 (A), 2002.
- A. Singhvi, K. P. Madhavan, and U. V. Shenoy. Pinch analysis for aggregate production planning in supply chains. *Computers and Chemical Engineering*, 28:993–999, 2004.
- S. R. Soares, L. Toffoletto, and L. Deschênes. Development of weighting factors in the context of LCIA. *Journal of Cleaner Production*, 14(6-7):649–660, 2006.
- J. P. V. Soest, H. Sas, and G. D. Witt. Apples, Oranges and the Environment: Prioritising Environmental Measures on the Basis of their Cost-effectiveness. Report - Centre for Energy Conservation and Environmental Technology (Delft), 1998. URL <http://www.cedelft.nl>.
- A. Song. Promoting the spread of major practicable environmental technologies based on market mechanism. *China Environmental Protection Industry*, 2000.
- M. Sorin and S. Bédard. The global pinch point in water networks. *Process Safety and Environmental Protection : Transactions of the Institution of Chemical Engineers: Part B*, 77:305–308, 1999.
- T. Spengler, H. Püchert, T. Penkuhn, and O. Rentz. Environmental integrated production and recycling management. *European Journal of Operational Research*, 97(2):308–327, 1997.

- T. Spengler, M. Ploog, and M. Schröter. Integrated planning of acquisition, disassembly and bulk recycling: a case study on electronic scrap recovery. *OR Spectrum*, 25(3): 413–442, 2003.
- B. Staiger, S. Friedrich, and H.-W. Schütte. *Das große China Lexikon*. Primus Verlag, Darmstadt, 2003.
- StateCouncil1994. *Outlines of The National Industry Policies*. State Council, Document Guofa No. 33 edition, 1994.
- StateCouncilChina,2006. *Environmental Protection in China (1996 - 2005)*. State Council Information Office of China, 2006. URL <http://www.china.org.cn/english/2006/Jun/170355.htm>.
- StateCouncil. *Estimation Results of the Research Reports by the Development Research Center of the State Council*. State Council of China.
- SETC, 2002. *The Tenth Five-Year Plan on the Development of the National Environmental Protection Industry*. State Economic and Trade Commission, 2002. URL [www.setc.gov.cn](http://www.setc.gov.cn).
- SETC, 2000. *Development of Environmental Technologies Currently Encouraged by the State*. State Economic and Trade Commission and State Administration of Taxation, 2002. URL [www.setc.gov.cn](http://www.setc.gov.cn).
- SEPA1998. *Audit Handbook of Cleaner Production for Enterprises*. State Environmental Protection Agency (SEPA), 1998.
- R. Steenblik and D. Andrew. Trade and environment. *Observer*, 233, 2002.
- U. Steger, F. Zhaoben, and L. Wei. *Greening Chinese Business: Barriers, Trends and Opportunities for Environmental Management*. Greenleaf Publishing, Sheffield, 2003.
- J. D. Sterman. *Business Dynamics - Systems Thinking and Modeling for a Complex World*. McGraw Hill, 2000.
- J. T. Stewart and F. B. Losa. Towards reconciling outranking and value measurement practice. *European Journal of Operational Research*, 145:645–659, 2003.
- J. Stichlmair and J. Fair. *Distillation - Principles and Practices*. Wiley-VCH, New York, 1998.
- D. G. Streets and S. T. Waldhoff. Present and future emissions of air pollutants in China: SO<sub>2</sub>, NO<sub>x</sub>, and CO. *Atmospheric Environment*, 34 STREETS2000(3):363–374, 2000.

- J. Sutz. Strong life sciences in innovative weak contexts: a "developmental" approach to a tantalizing mismatch. *The Journal of Technology Transfer*, Online first: 10.1007/s10961-006-9022-y Judith Sutz Universidad de la República, Montevideo, Uruguay SUTZ2007, 2007.
- M. Suzuki. Realisation of a Sustainable Society - Zero Emissions Approaches. In *GRATAMA Workshop*. The United Nations University, 2000.
- R. A. Tainsh and A. R. Rudman. Practical techniques and methods to develop an efficient water management strategy. In *IQPC Conference: "Water Recycling and Effluent Re-Use"*, 1999.
- F. Tano, L. Valenti, O. Failla, and E. Beltrame. Effects of Distillery Vinasses on Vineyard Yield and Quality in the D.O.C. "Oltrepò Pavese Pinot Nero" - Lombardy, Italy. *Water Science and Technology*, 51:199 – 204, 2005.
- H. Tempelmeier and S. Helber. A heuristic for dynamic multi-item multi-level capacitated lotsizing for general product structures. *European Journal of Operational Research*, 75: 296–311, 1994.
- A. Terazono and Y. Moriguchi. International Secondary Material Flows within Asia. *Journal of Industrial Ecology*, 8(4):10–12, 2004.
- S. Thevendiraraj, J. Klemes, D. Paz, G. Aso, and G. Cardenas. Water and wastewater minimisation study of a citrus plant. *Resources, Conservation and Recycling*, 37:227–250, 2003.
- A. Tiedemann. Life Cycle Assessments for Graphic Papers. Technical report, Umweltbundesamt, 2001.
- I. Tietze-Stöckinger. *Kosteneinsparpotenziale durch Erweiterung der Systemgrenzen*. Dissertation, Universität Karlsruhe (TH). Universitätsverlag Karlsruhe, Karlsruhe, 2005.
- S. Tiffin and G. Jimenez. Design and Test of an Index to Measure the Capability of Cities in Latin America to Create Knowledge-Based Enterprises. *The Journal of Technology Transfer*, 31 Scott Tiffin<sup>1</sup> Contact Information and Gonzalo Jimenez<sup>2</sup>, TIFFIN2006(1): 61–76, 2006.
- N. H. Timm. *Applied multivariate analysis*. Springer, New York, 2002.
- M. Torrijos and R. Moletta. *Efluentes vinícolas y procedimientos de tratamiento*, pages 769 – 783. AMV Ediciones-Mundi Prensa, Madrid, 2000.

- M. Treitz. *Production Process Design Using Multi-Criteria Analysis*. Dissertation, Universität Karlsruhe (TH). Universitätsverlag Karlsruhe, Karlsruhe, 2006.
- M. Treitz, H. Schollenberger, V. Bertsch, J. Geldermann, and O. Rentz. Process Design based on Operations Research: A Metric for Resource Efficiency. In *Clean Environment for All: 2nd International Conference on Environmental Concerns: Innovative Technologies and Management Options*, pages 842–853, Xiamen, China, 2004.
- M. Treitz, H. Schollenberger, B. Schrader, J. Geldermann, and O. Rentz. Multi-Criteria Decision Support for Integrated Technique Assessment. In *RADTECH Europe 05: UV/EB - Join the Winning Technology*, pages 153–160. Vincentz, 2005.
- J. Troncoso. CORFO: The Chilean Economic Development Agency. *Economic Development Review*, 2000(Spring):45–48, 2000.
- G. Tsatsaronis, J. J. Pisa, and L. Lin. The effect of assumptions on the detailed exergoeconomic analysis of a steam power plant design configuration, Part 1: Theoretical Development. In *A Future for energy - Flowers '90: Proceedings of the Florence World Energy Research Symposium*, 1990.
- H. Tschirky and S. Koruna. *Technologie-Management : Idee und Praxis / Hugo Tschirky ; . - : , 1998*. Verlag Industrielle Organisation, Zürich, 1998.
- T. Umeda, T. Harada, and K. Shiroko. A Thermodynamic Approach to the Synthesis of Heat Integration Systems in Chemical Processes. *Computers and Chemical Engineering*, 3:273–282, 1979.
- UNEP. Agenda 21.: United Nations Environment Program: UN Conference on Environment and Development (Earth Summit), 1992. URL <http://www.unep.org/resources/gov/keydocuments.asp>.
- UNEP. International Declaration on Cleaner Production. United Nations Environment Program, 1994. <http://www.uneptie.org/pc/declaration/translations/english.htm>.
- UNEP. International Declaration on Cleaner Production. In *United Nations Environment Program*. UNEP, Paris, 1998.
- UNEP. Water for the future. In *2003 Annual Report*. United Nations Environment Program, 2004.
- R. v. Berkel and M. Laffleur. Application of an industrial ecology toolbox for the introduction of industrial ecology in enterprises - II. *Journal of Cleaner Production*, 5(1-2): 27–37, 1997.

- D. v. Winterfeld and D. Edwards. *Decision Analysis and Behavioral Research*. Cambridge University Press, Cambridge, 1986.
- G. Vaccari, E. Tamburini, G. Sgualdino, K. Urbaniec, and J. Klemes. Overview of the environmental problems in beet sugar processing: possible solutions. *Journal of Cleaner Production*, 13(5):499–507, 2005.
- J. A. van Aardenne, G. R. Carmichael, H. Levyl, D. Streets, and L. Hordijk. Anthropogenic NO<sub>x</sub> emissions in Asian next term in the period 1990 - 2020. *Atmospheric Environment*, 33(4):633–646, 1999.
- G. van Huylenbroeck. The Conflict Analysis Method: bridging the gap between ELECTRE, PROMETHEE and ORESTE. *European Journal of Operational Research*, 82(3): 490–502, 1995.
- J. C. Vansnick. On the problem of weights in multi-criteria decision making (the non-compensatory approach). *European Journal of Operational Research*, 24:288–294, 1986.
- VDI. *VDI- Wärmesatlas*. Verein Deutscher Ingenieure (VDI), Heidelberg, 2004.
- VDI 3780. *Technikbewertung: Begriffe und Grundlagen (Technology Assessment: Concepts and Foundations)*. Verein Deutscher Ingenieure (VDI). guideline 3780.
- R. Vetschera. Visualisierungstechniken in Entscheidungsproblemen bei mehrfacher Zielsetzung. *OR Spektrum*, 16:227–241, 1994.
- H. Vogel. Process Development. In Ullmann's, editor, *Chemical Engineering and Plant Design*, chapter Volume 2, pages 873–913. Wiley, 2005.
- E. von Hippel. *The sources of innovation*. Oxford University Press, New York, 1988.
- J. Wang and Y. Lu. *Countermeasure Studies of Environmental Pollution Prevention in China*. Jiangsu People Publisher, Nanjing, 1993.
- Y. P. Wang and R. Smith. Wastewater Minimisation. *Chemical Engineering Science*, 49 (7):981–1006, 1994.
- Y. P. Wang and R. Smith. Time Pinch Analysis. *Transaction of the Institution of Chemical Engineers*, 73A:905–914, 1995.
- Y. Q. Wang. How to promote development of circular economy environmental protection department. *Environment Protection*, 9:3–7, 2004.

- S. Weiler. Optimierung von Stoff- und Energieströmen am Beispiel eines Industrieparks in China. Technical report, Diplomarbeit am Institut für Industriebetriebslehre und Industrielle Produktion, Universität Karlsruhe (TH), 2005.
- G. Weller. *Abwasserbeseitigung in Brennereien und Winzerbetrieben*, chapter 31, pages 107 – 137. Münchner Beiträge zur Abwasser- und Fischerei- und Flussbiologie, Bayerische Landesanstalt für Wasserforschung, 1979.
- R. White. Preface. In B. R. Allenby and D. Richards, editors, *The Greening of Industrial Ecosystems*, chapter 0, pages 5–6. National Academic Press, 1994.
- K. Wiegand. *Entwicklung elektrochemischer Sensoren zur Bestimmung von Carbonatspezies in Meerwasser*. Thesis/dissertation, Analytische Chemie, Mathematisch-Naturwissenschaftliche Fakultät, Wilhelms Universität Münster, 2000.
- M. Wietschel. *Stoffstrommanagement*. Verlag Peter Lang, Frankfurt (Main), 2002.
- P. Winters. Forecasting sales by exponentially weighted moving averages. *Management Science*, 6:324 – 342, 1960.
- B. Wolfrum. *Strategisches Technologiemanagement*. Gabler, Wiesbaden, 2 edition, 1991.
- WCED. *Our Common Future*. World Commission on Environment and Development (WCED), Oxford, 1987.
- Worldbank. World Development Report 2003: Sustainable Development in a Dynamic World. Report, 2002. URL [www.worldbank.org/wdr/](http://www.worldbank.org/wdr/).
- Worldbank. World Development Indicators 2004. World Bank, 2004.
- N. Wrisberg, H. A. U. de Haes, U. Triebswetter, P. Eder, and R. Clift. *Analytical Tools for Environmental Design and Management in a Systems Perspective*. Kluwer Academic Publishers, Dordrecht, 2002.
- S. Wu, M. Erkoc, and S. Karabuk. Managing Capacity in the High-Tech Industry: A Review of Literature. *Engineering Economist*, 50(2):125 – 158, 2005.
- M. Wurdack. Techno-ökonomische Bewertung von Einsparpotentialen am Beispiel von Wasserströmen in einem Industriepark. Technical report, Diplomarbeit am Institut für Industriebetriebslehre und Industrielle Produktion, Universität Karlsruhe (TH), 2006.
- C. F. Xia, W. D. Zhang, H. C. Song, J. Xie, and Z. Zhao. The technological & economic and environmental assessment of biogas engineering in chinese distillery. *New Energy*, 21(3):35 – 40, 1999.

- J. Xu. *Entscheidungsstrukturen und Entscheidungsfindung für ein Innovationsmanagement in großen und mittelgroßen chinesischen Staatsunternehmen*. Thesis/dissertation, RWTH Aachen, 2000.
- Q. Xu, J. Chen, and B. Guo. Perspective of technology innovation and technology management in China. *IEEE Transactions on Engineering Management*, 45 XU1998(4): 381–387, 1998.
- Q. Xu, L. Zhu, G. Zhang, and F. Wang. Haier's Tao of innovation: a case study of the emerging Total Innovation Management model. *The Journal of Technology Transfer*, 32 Qingrui Xu<sup>1</sup> Contact Information, Ling Zhu<sup>2</sup>, Gang Zheng<sup>1</sup> and Fangrui Wang<sup>1</sup> XU2007(1-2):27–47, 2007.
- S. Xu. Improvement of the market system for environmental protection industry. *China Environmental Protection Industry*, 1999.
- E. Zahn. *Handbuch Technologiemanagement*. Schäffer-Poeschel, Stuttgart, 1995.
- S. X. Zeng, C. M. Tam, V. W. Tam, and Z. M. Deng. Towards implementation of ISO 14001 environmental management system in selected industries in China. *Journal of Cleaner Production*, 13:645–656, 2005.
- K. Zhang. *Entwicklung eines integrierten multikriteriellen Gruppenentscheidungsunterstützungssystems (MGDSS)*. Dissertation, Universität Karlsruhe (TH). Shaker, Aachen, 2004.
- Y. Zhang and B. Peng. Development of the Market for Environmental Technology and Products. *Environmental Protection*, 9:40–42, 2000.
- W. Zheng, C. Bao, S. Guo, and Y. Lu. Simulation of Policy Incentives to Promote Cleaner Production in an Alcohol Distillery. In J. Geldermann, M. Treitz, H. Schollenberger and O. Rentz, editor, *Challenges for Industrial Production*, Proceedings of the Workshop within the PepOn Project on "Integrated Process Design for the Inter-Enterprise Plant Layout Planning of Dynamic Mass Flow Networks", 7. - 8. Nov., pages 199 – 205, 2005.
- Z. Zhou, S. Cheng, and B. Hua. Supply chain optimization of continuous process industries with sustainability considerations. *Computers and Chemical Engineering*, 24(2-7):1151–1158, 2000.

Improving the resource efficiency of production processes and reducing their environmental impact is a challenge, especially in dynamic regions for industrialising countries. This is partly due to the growing number of Small and Medium-Sized Enterprises (SME), which often have high resource consumption and contribute significantly to certain emissions, like those of volatile organic compounds (VOC).

Inter-company production networks that allow the closing of material cycles are one possibility for reducing their environmental impact. The basis for such efforts is a detailed mapping of the mass and energy flows for identifying process characteristics that are the main drivers for resource efficiency. Thus, the aim of this book is to present the results of the research project Integrated Process Design for the Inter-Company Plant Layout Planning of Dynamic Mass Flow Networks (PepOn) and to offer a systematic approach to support the decisions in process design striving for the best utilisation of process streams considering multiple criteria.

This approach is based on multiple pinch analyses and aims at using this established method of chemical engineering for a holistic evaluation of process alternatives on one hand and for determining savings potentials for production networks of several companies on the other hand. The use of energy, the consumption of water and the generated solvent emissions as well as operating costs and investment are the factors used for comparing different emission reduction technologies. Several case studies in China and Chile are used to illustrate the application of the methodology.