

Operad groups

Zur Erlangung des akademischen Grades eines

Doktors der Naturwissenschaften

von der Fakultät für Mathematik des
Karlsruher Instituts für Technologie (KIT)
genehmigte

Dissertation

von
Werner Thumann
aus Regensburg
– 2014 –

Tag der mündlichen Prüfung: 28.01.2015
Referent: Prof. Dr. Roman Sauer
Korreferent: Prof. Dr. Enrico Leuzinger
Korreferent: Prof. Dr. Andreas Thom

Contents

Introduction	3
Notation and Conventions	6
Acknowledgements	7
Chapter 1. Preliminaries on categories	9
1. Comma categories	9
2. The classifying space of a category	9
3. The fundamental groupoid of a category	10
4. Coverings of categories	11
5. Contractibility and homotopy equivalences	12
6. Smashing isomorphisms in categories	14
7. Calculus of fractions and cancellation properties	15
8. Monoidal categories and string diagrams	17
9. Cones and joins	21
10. The Morse method for categories	23
Chapter 2. Operad groups	29
1. Basic definitions	29
2. Normal forms	35
3. Calculus of fractions and cancellation properties	36
4. Operads with transformations	37
5. Examples	40
Chapter 3. A topological finiteness result	49
1. The Brown criterion	49
2. Three types of arc complexes	51
3. Statement of the main theorem	56
4. A contractible complex	57
5. Isotropy groups	61
6. Finite type filtration	64
7. Connectivity of the filtration	65
8. Applications	75
Chapter 4. A group homological result	77
1. Statement of the main theorem	77
2. Proof of the main theorem	78
3. Non-amenability and infiniteness	89
4. Applications	92
Bibliography	97

Introduction

In unpublished notes of 1965, Richard Thompson defined three interesting groups F, T, V . For example, F is the group of all piecewise linear homeomorphisms of the unit interval with breakpoints lying in the dyadic rationals and with slopes being powers of 2. It has the presentation

$$F = \langle x_0, x_1, x_2, \dots \mid x_k^{-1} x_n x_k = x_{n+1} \text{ for } k < n \rangle$$

In the subsequent years until the present days, hundreds of papers have been devoted to the study of these groups and to related groups. The reason for this is that they have the ability to unite seemingly incompatible properties. For example, Thompson showed that V is an infinite finitely-presented simple group. Even more is true: Brown showed in [8] that V is of type F_∞ . For F , this has been shown by Brown and Geoghegan in [9] by constructing a classifying space for F with two cells in each positive dimension. They also showed that $H^k(F, \mathbb{Z}F) = 0$ for every $k \geq 0$. This implies in particular that all homotopy groups of F at infinity vanish and that F has infinite cohomological dimension. Thus, they produced the first example of an infinite dimensional torsion-free group of type F_∞ . In [6], Brin and Squier showed that F is a free group free group, i.e. contains no free group of rank at least 2. Geoghegan conjectured in 1979 that F is non-amenable, thus being a counterexample to the von Neumann conjecture. Ol'shanskii disproved the von Neumann conjecture around 1980 (see [35] and the references therein). On the other hand, despite several attempts of various authors, the amenability question for F still seems to be open at the time of writing.

Later, Thompson's group F was rediscovered in homotopy theory: Freyd and Heller [23] showed that there is an unsplitable homotopy idempotent on the Eilenberg–MacLane space $K(F, 1)$ which is universal in some sense. This is probably where the letter F comes from: Freyd and Heller considered so-called *free-homotopies* which do not necessarily fix the base point. Independently, F reappeared in the context of a problem in shape theory [14]. Other contexts in which the Thompson groups have arisen include Teichmüller theory and mapping class groups (work of Robert C. Penner) and dynamic data storage in trees (work of Daniel D. Sleator, Robert E. Tarjan and William P. Thurston).

Since the introduction of the classical Thompson groups F, T and V , a lot of generalizations have appeared in the literature which have a “Thompson-esque” feeling to them. Among them are the so-called diagram or picture groups [28], various groups of piecewise linear homeomorphisms of the unit interval [43], groups acting on ultrametric spaces via local similarities [29], higher dimensional Thompson groups nV [4] and the braided Thompson group BV [5]. A recurrent theme in the study of these groups are topological finiteness properties, most notably property F_∞ which means that the group admits a classifying space with compact skeleta. The proof of this property is very similar in each case, going back to a method of Brown, the Brown criterion [8], and a technique of Bestvina and Brady, the discrete Morse Lemma for affine complexes [2]. This program has been conducted in all the above mentioned classes of groups: For diagram or picture groups

in [16, 17], for the piecewise linear homeomorphisms in [43], for local similarity groups in [18], for the higher dimensional Thompson groups in [22] and for the braided Thompson group in [10].

The main motivation to define the class of operad groups, which are the central objects in this thesis, was to find a framework in which a lot of the Thompson-like groups in the existing literature could be recovered and in which the established techniques could be performed to show property F_∞ , thus unifying and extending existing proofs in the literature. The main device to define these groups are operads in the category of sets. Operads are well established objects whose importance in mathematics and physics has steadily increased during the last decades. Representations of operads constitute algebras of various types and consequently find applications in such diverse areas as Lie-Theory, Noncommutative Geometry, Algebraic Topology, Differential Geometry, Field Theories and many more. To apply our F_∞ theorem to a given Thompson-like group, one has to find the operadic structure underlying the group. Then one has to check whether this operad satisfies certain finiteness conditions. In a lot of cases, the proofs of these conditions are either trivial or straightforward.

The second motivation was to extend the results previously obtained with my PhD adviser Roman Sauer in [39] to other Thompson-like groups. There, we showed that dually contracting local similarity groups are l^2 -invisible, meaning that group homology with group von Neumann algebra coefficients vanishes in every dimension, i.e.

$$H_k(G, \mathcal{N}(G)) = 0$$

for all $k \geq 0$ where $\mathcal{N}(G)$ denotes the group von Neumann algebra of G . If G is of type F_∞ , then this is equivalent to

$$H_k(G, l^2(G)) = 0$$

for all $k \geq 0$. We will extend this result to the setting of operad groups. More precisely, we show a homological result implying that under certain conditions, group (co)homology of such groups with certain coefficients vanishes in all dimensions provided it vanishes in dimension 0. This can be applied not only to l^2 -homology but also to cohomology with coefficients in the group ring. As a corollary, we reobtain and extend the results of Brown and Geoghegan that $H^k(G, \mathbb{Z}G) = 0$ for each $k \geq 0$ and $G = F, V$ [8, 9].

As in [39], we briefly want to discuss the relationship between the results on l^2 -homology and Gromov's *zero-in-the-spectrum* conjecture (see [27]). The algebraic version of this conjecture states that if $\Gamma = \pi_1(M)$ is the fundamental group of a closed aspherical Riemannian manifold, then there exists always a dimension $p \geq 0$ such that $H_p(\Gamma, \mathcal{N}\Gamma) \neq 0$ or equivalently $H_p(\Gamma, l^2\Gamma) \neq 0$. Conjecturally, the fundamental groups of closed aspherical manifolds are precisely the Poincaré duality groups G of type F , i.e. the groups G such that there is a compact classifying space and a natural number $n \geq 0$ such that

$$H^i(G, \mathbb{Z}G) = \begin{cases} 0 & \text{if } i \neq n \\ \mathbb{Z} & \text{if } i = n \end{cases}$$

(see [12]). Dropping Poincaré duality and relaxing type F to type F_∞ , we arrive at a more general question which has been posed by Lück in [32, Remark 12.4 on p. 440]: If G is a group of type F_∞ , does there always exist a p with $H_p(G, \mathcal{N}G) \neq 0$? Combining the topological finiteness and the l^2 -homology results of this thesis, we obtain a lot of counterexamples to this question. Unfortunately, all these groups G are neither of type F nor satisfy Poincaré duality since, as already mentioned above, we can also show $H^k(G, \mathbb{Z}G) = 0$ for all $k \geq 0$.

The present work is an updated version of the material in the articles [47–49] which have been electronically published as preprints.

We now want to describe the structure and the results of this thesis in more detail.

Our language will be strongly category theory flavoured. Although we assume the basics of category theory, we collect and recall in Chapter 1 all the tools we will need for the definitions of operad groups and for our two main results. We lay a particular emphasis on topological aspects of categories by considering categories as topological objects via the nerve functor. This can be made precise by endowing the category of (small) categories with a model structure Quillen equivalent to the usual homotopy category of spaces, but we won't use this fact. In Section 10 of this chapter, we will discuss a tool which is probably not so well-known as the others. There, we introduce the discrete Morse method for categories in analogy to the one for simplicial complexes: With the help of a Morse function, a category can be filtered by a nested sequence of full subcategories. The relative connectivity of such a filtration is controlled by the connectivity of certain categories associated to each filtration step, the so-called descending links. This can be used to compute lower bounds for the connectivity of categories.

In Chapter 2, we will introduce the main objects of this thesis, the so-called operad groups. Before we do this, we recall the notion of operads (internal to the category of sets). This is an abstract algebraic structure generalizing that of a monoid. It comes with an associative multiplication and with identity elements. However, elements in an operad, which are called operations, can be of higher arity (or degree): An operation possesses several inputs and one output. If we have an operation with n inputs, then we can plug the outputs of n other operations into the inputs of the first one, yielding composition maps for the operad. This concept can be generalized even more: Just as one proceeds from monoids to categories by introducing further objects, we can introduce colors to operads and label the inputs and outputs of operations with these colors. Then we require that the composition maps respect this coloring. Furthermore, we can introduce actions of the symmetric or braid groups on the inputs of the operations and obtain symmetric or braided operads.

We then attach, in a very natural way, a category to each operad, called the category of operators. When taking fundamental groups of these categories, we arrive at the concept of operad groups. In Section 5 of Chapter 2, we then discuss some examples of operads and corresponding operad groups. We see that all of the Thompson-like groups discussed in the first part of the introduction can be realized as operad groups. Furthermore, we give new examples and even a procedure how to generate a lot of these Thompson-like groups as operad groups associated to suboperads of endomorphism operads.

We will also discuss so-called operads with transformations which are operads with invertible degree 1 operations. In this context, we will introduce very elementary and elementary operations. These model in some sense the generators and relations in such an operad with transformations. In particular, we can define what it means for such an operad to be finitely generated or of finite type. This will become important in Chapter 3 where we prove the following

THEOREM. *Let \mathcal{O} be a finite type (symmetric/braided) operad with transformations which is color-tame and such that there are only finitely many colors and degree 1 operations. Assume further that \mathcal{O} is either free or satisfies the cancellative calculus of fractions. Then the operad groups associated to \mathcal{O} are of type F_∞ .*

The conditions are explained in the text and are usually not hard to verify in practice. The proof proceeds roughly as follows and the ideas are mainly inspired by [2, 8, 10, 22, 43]. Denote by \mathcal{S} the category of operators of \mathcal{O} . We then can look at the universal covering category \mathcal{U} of \mathcal{S} which is contractible due to the conditions in the theorem. We mod out the isomorphisms in \mathcal{U} and obtain the quotient category \mathcal{U}/\mathcal{G} which is still contractible. The operad group Γ , which is the fundamental group of \mathcal{S} , acts on \mathcal{U} by deck transformations. This induces an action on \mathcal{U}/\mathcal{G} . Brown's criterion applied to this action yields that Γ is of type F_∞ if we show that the isotropy groups of the action are of finite type and if we find a filtration by invariant finity type subcategories with relative connectivity tending to infinity. The latter is shown by appealing to the discrete Morse method for categories mentioned earlier. Thus, we have to inspect the connectivity of certain descending links. This is the hardest part of the proof. We filter each descending link by two subcategories, the core and the corona. The core is related to certain arc complexes in \mathbb{R}^d with $d = 1, 2, 3$. A lower bound for the connectivity of these complexes is given in Theorem 3.4. The connectivity for the corona and for the whole descending link is then deduced from the connectivity of the core by using again the discrete Morse method.

Let us turn to the last Chapter 4 where we prove the following

THEOREM. *Let \mathcal{O} be a (symmetric) operad satisfying the calculus of fractions. Let \mathcal{M} be a coefficient system which is Künneth and inductive. Let Γ be the operad group of \mathcal{O} based at a split and progressive object. Then group homology $H_k(\Gamma, \mathcal{M}\Gamma)$ vanishes in all degrees $k \geq 0$ provided it vanishes in degree 0.*

The proof is an adaption of the proof in [39] in the case of local similarity groups, but it is not straightforward. The proof in [39] consisted of constructing a suitable simplicial complex on which the group in question acts and then applying a spectral sequence associated to this action which computes the homology of the group in terms of the homology of the stabilizer subgroups. The proof in the case of operad groups goes the same way. However, it is a priori unclear how to construct the simplicial complex. The reason is the following: A local similarity group is defined as a representation, i.e. as a group of homeomorphisms of a compact ultrametric space. This space is used to construct the simplicial complex as a poset of partitions of this space. The case of operad groups is more abstract. A priori, there is no canonical space comparable to these ultrametric spaces on which an operad group acts. However, these spaces, called limit spaces, are conjectured to exist if the operad satisfies the calculus of fractions. We don't use these limit spaces here. Instead, we will take the conjectured correspondence between calculus of fractions operads and their limit spaces as a motivation to mimic the necessary notions for the construction of the desired simplicial complex in terms of the operad itself.

I believe that the above mentioned limit space for calculus of fractions operads could be a usefull tool to study the dynamics of operad groups. For example, it could be used to obtain simplicity results, to find finite factor representations or to apply Rubin's Theorem. This is a possible direction for further research.

Notation and Conventions

Usually, the definition of a category comes with a notion of composition in the form of a map of sets

$$\mathrm{Hom}(B, C) \times \mathrm{Hom}(A, B) \rightarrow \mathrm{Hom}(A, C) \quad (f, g) \mapsto f \circ g$$

which implicitly encodes how the composition of two morphisms is notated. I like to think of categories where this is not the case so that one can choose any notation

which best fits to the situation. For example, we could write $f \triangleright g$ or $g \triangleleft f$ for the composition of two morphisms $f: A \rightarrow B$ and $g: B \rightarrow C$. If the objects have elements which can be plugged into functions, then we could write $x \triangleright f$ or $f \triangleleft x$. The usual notation is $f(x)$. After all, it doesn't matter which notation we use since it should always be clear from the context which symbol denotes the function or the argument.

In the following, we almost exclusively use the notation $f * g$ or just fg for the composition $f \triangleright g$ of two composable arrows $f: A \rightarrow B$ and $g: B \rightarrow C$. It is then often convenient to write $x \triangleright f$ for the evaluation of f at x . However, we will still use the usual $f(x)$ since otherwise we would have to write $(X, x_0) \triangleright \pi_1$ instead of $\pi_1(X, x_0)$ for example.

There is, however, an important thing to keep in mind. As a consequence of our preferred left to right notation, notions which involve "right" or "left" are different when using the right to left notation. For example, consider an object X . Then $\text{Aut}(X)$ is a group with multiplication defined as $f \cdot g := f * g$. If we had defined $f \cdot g := f \circ g$, we would have obtained the opposite group. Thus, with our convention, a homomorphism $\rho: G \rightarrow \text{Aut}(X)$ gives a *right* action on X (assuming X has elements) via $x \cdot g := x \triangleright (g \triangleright \rho)$ instead of a *left* action via $g \cdot x := \rho(g)(x)$.

Another example is as follows: Consider a monoid M with multiplication $a \cdot b$. It can be seen as a category with one object and with composition $a * b := a \cdot b$. If we had defined $a \circ b := a \cdot b$ we would have obtained the opposite category. Thus, a functor $\lambda: G \rightarrow \mathcal{C}$ with G a group and \mathcal{C} a category of sets and maps of sets induces a *right* action on the object X in the image of λ via $x \cdot g := x \triangleright (g \triangleright \lambda)$ for $g \in G$ and $x \in X$ instead of a *left* action via $g \cdot x := \lambda(g)(x)$.

One more example: If a category satisfies $(f \circ g = f' \circ g) \Rightarrow (f = f')$, it is usually called *right* cancellative. However, using our convention, this property reads $(g * f = g * f') \Rightarrow (f = f')$ and consequently, we will call it *left* cancellative.

Acknowledgements

I want to thank my adviser Roman Sauer for the opportunity to pursue mathematics, for his guidance, encouragement and support over the last few years. I also gratefully acknowledge financial support by the DFG grants 1661/3-1 and 1661/3-2. Last but not least, I want to thank my parents who supported me invaluable during my time as a PhD student.

CHAPTER 1

Preliminaries on categories

In this chapter, we review some aspects of category theory which we need for later considerations. In particular, we want to emphasize the concept of seeing categories as topological objects. We refer to the first chapter of Quillen's seminal paper [37] for another exposition in that direction. Also note that everything, except the Morse method for categories explained in Section 10, should be mathematical folklore and we make no claim of originality.

1. Comma categories

Let $\mathcal{A} \xrightarrow{f} \mathcal{C} \xleftarrow{g} \mathcal{B}$ be two functors. Then the comma category $f \downarrow g$ has as objects all the triples (A, B, γ) where A resp. B is an object in \mathcal{A} resp. \mathcal{B} and $\gamma: f(A) \rightarrow g(B)$ is an arrow in \mathcal{C} . An arrow from (A, B, γ) to (A', B', γ') is a pair (α, β) of arrows $\alpha: A \rightarrow A'$ in \mathcal{A} and $\beta: B \rightarrow B'$ in \mathcal{B} such that the diagram

$$\begin{array}{ccc} f(A) & \xrightarrow{\gamma} & g(B) \\ f(\alpha) \downarrow & & \downarrow g(\beta) \\ f(A') & \xrightarrow{\gamma'} & g(B') \end{array}$$

commutes. Composition is given by composing the components.

If f is the inclusion of a subcategory, we write $\mathcal{A} \downarrow g$ for the comma category $f \downarrow g$. Furthermore, if \mathcal{A} is just a subcategory with one object A and its identity arrow, we write $A \downarrow g$. In this case, the objects of the comma category are pairs (B, γ) where B is an object in \mathcal{B} and $\gamma: A \rightarrow g(B)$ is an arrow. An arrow from (B, γ) to (B', γ') is an arrow $\beta: B \rightarrow B'$ such that the triangle

$$\begin{array}{ccc} & & g(B) \\ & \nearrow \gamma & \downarrow g(\beta) \\ A & & \\ & \searrow \gamma' & \\ & & g(B') \end{array}$$

commutes. Of course, there are analogous abbreviations for the right factor. For example, if g is the inclusion of a subcategory and \mathcal{A} is the terminal category as above, the symbol $A \downarrow \mathcal{B}$ makes sense.

2. The classifying space of a category

We assume that the reader is familiar with the basics of simplicial sets (see e.g. [26]). The nerve $N(\mathcal{C})$ of a category \mathcal{C} is a simplicial set defined as follows: A k -simplex is a sequence

$$A_0 \xrightarrow{\alpha_0} A_1 \xrightarrow{\alpha_1} \dots \xrightarrow{\alpha_{k-1}} A_k$$

of composable arrows. The i 'th face map $d_i: N(\mathcal{C})_k \rightarrow N(\mathcal{C})_{k-1}$ is given by composing the arrows at the object A_i . When i is 0 or k , then the object A_i is removed from the sequence instead. The i 'th degeneracy map $s_i: N(\mathcal{C})_k \rightarrow N(\mathcal{C})_{k+1}$ is given by inserting the identity at the object A_i .

The geometric realization $|N(\mathcal{C})|$ of $N(\mathcal{C})$ is a CW-complex which we call the classifying space $B(\mathcal{C})$ of \mathcal{C} . See [50] for the reason why this is called a classifying space. If the category \mathcal{C} is a group, then $B(\mathcal{C})$ is the usual classifying space of the group which is defined as the unique space (up to homotopy equivalence) with fundamental group the given group and with higher homotopy groups vanishing.

Since we can view any category as a space via the above construction, any topological notion or concept can be transported to the world of categories. For example, if we say that the category \mathcal{C} is connected, then we mean that $B(\mathcal{C})$ is connected. Of course, one can easily think of an intrinsic definition of connectedness for categories and we will give some for other topological concepts below. But there are also concepts for which a combinatorial description is at least unknown, for example higher homotopy groups.

Transporting topological concepts to the category \mathbf{CAT} of (small) categories via the nerve functor can be made precise: The Thomason model structure on \mathbf{CAT} [11, 45] is a model structure Quillen equivalent to the usual model structure on \mathbf{SSET} , the category of simplicial sets.

Every simplicial complex is homeomorphic to the classifying space of some category: A simplicial complex can be seen as a partially ordered set of simplices with the order relation given by the face relation. Moreover, a partially ordered set (poset) is just a category with at most one arrow between any two objects. The classifying space of a poset coming from a simplicial complex is exactly the barycentric subdivision of the simplicial complex.

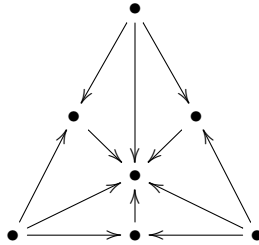

Even more is true: McDuff showed in [34] that for each connected simplicial complex there is a monoid (i.e. a category with only one object) with classifying space homotopy equivalent to the given complex. Thus, every path-connected space has the weak homotopy type of some monoid. For example, observe the monoid consisting of the identity element and elements x_{ij} with multiplication rules $x_{ij}x_{kl} = x_{il}$. In [19] it is shown that its classifying space is homotopy equivalent to the 2-sphere.

3. The fundamental groupoid of a category

Following the philosophy of transporting topological concepts to categories via the nerve functor, we define the fundamental groupoid $\pi_1(\mathcal{C})$ of a category \mathcal{C} to be the fundamental groupoid of its classifying space. There is also an intrinsic description of the fundamental groupoid of \mathcal{C} in terms of the category itself which we will describe now (see e.g. [26, Chapter III, Corollary 1.2] that these two notions are indeed the same). The objects of $\pi_1(\mathcal{C})$ are the objects of \mathcal{C} and the arrows of $\pi_1(\mathcal{C})$ are paths modulo homotopy. Here, a path in \mathcal{C} from an object A to an object B is a zig-zag of morphisms from A to B , i.e. starting from A , one travels from

object to object over the arrows of \mathcal{C} , regardless of the direction of the arrows. For example, the following zig-zag is a path in \mathcal{C}

$$A \leftarrow C_1 \rightarrow C_2 \leftarrow C_3 \leftarrow C_4 \rightarrow C_5 \rightarrow B$$

Paths can be concatenated in the obvious way. The homotopy relation on paths is the smallest equivalence relation respecting the operation of concatenation of paths generated by the following elementary relations:

$$\begin{aligned} A \xrightarrow{\alpha} B \xrightarrow{\beta} C &\sim A \xrightarrow{\alpha\beta} C \\ A \xleftarrow{\alpha} B \xleftarrow{\beta} C &\sim A \xleftarrow{\beta\alpha} C \\ A \xrightarrow{\alpha} B \xleftarrow{\alpha} A &\sim A \\ A \xleftarrow{\alpha} B \xrightarrow{\alpha} A &\sim A \\ A \xrightarrow{\text{id}} A &\sim A \\ A \xleftarrow{\text{id}} A &\sim A \end{aligned}$$

where the A 's on the right represent the empty path at A . Composition in $\pi_1(\mathcal{C})$ is given by concatenating representatives. The identities are represented by the empty paths. If A is an object of \mathcal{C} then we denote by $\pi_1(\mathcal{C}, A)$ the automorphism group of $\pi_1(\mathcal{C})$ at A and call it the fundamental group of \mathcal{C} at A .

The fundamental groupoid of \mathcal{C} has two further descriptions: First, denote by G the left adjoint functor to the inclusion functor from groupoids to categories. Then we have $\pi_1(\mathcal{C}) = G(\mathcal{C})$. Second, it is the localization $\mathcal{C}[\mathcal{C}^{-1}]$ of \mathcal{C} (at all its morphisms) since it comes with a canonical functor $\varphi: \mathcal{C} \rightarrow \pi_1(\mathcal{C})$ satisfying the following universal property: Having any other functor $\eta: \mathcal{C} \rightarrow \mathcal{A}$ with the property that $\eta(f)$ is an isomorphism in \mathcal{A} for every arrow f in \mathcal{C} , then there is a unique functor $\epsilon: \pi_1(\mathcal{C}) \rightarrow \mathcal{A}$ such that $\varphi\epsilon = \eta$.

$$\begin{array}{ccc} \mathcal{C} & \xrightarrow{\varphi} & \pi_1(\mathcal{C}) \\ & \searrow \eta & \vdots \epsilon \\ & & \mathcal{A} \end{array}$$

4. Coverings of categories

Let $P: \mathcal{D} \rightarrow \mathcal{C}$ be a functor. We say that P is a covering if for every arrow a in \mathcal{C} and every object X in \mathcal{D} which projects via P onto the domain or the codomain of a , there exists exactly one arrow b in \mathcal{D} with domain resp. codomain X and projecting onto a via P . In other words, arrows can be lifted uniquely provided that the lift of the domain or codomain is given. Of course, P yields a map on the classifying spaces. To justify the definition of covering functor, we have the following:

PROPOSITION 1.1. *Let $P: \mathcal{D} \rightarrow \mathcal{C}$ be a functor. Then P is a covering functor if and only if $BP: B\mathcal{D} \rightarrow B\mathcal{C}$ is a covering map of spaces.*

PROOF. By [24, Appendix I, 3.2], $BP = |NP|: |N\mathcal{D}| \rightarrow |N\mathcal{C}|$ is a covering map if and only if $NP: N\mathcal{D} \rightarrow N\mathcal{C}$ is a covering of simplicial sets as defined in [24, Appendix I, 2.1]. This means that every n -simplex in $N\mathcal{C}$ uniquely lifts to $N\mathcal{D}$ provided that the lift of a vertex of the simplex is given. The lifting property for P as defined above says that this is true for 1-simplices. So it is clear that P is a covering functor provided that BP is a covering map of spaces. For the converse implication, one exploits special properties of nerves of categories. Not every simplicial set arises as the nerve of a category. The Segal condition gives a necessary and sufficient condition for a simplicial set to come from a category:

Every horn Λ_n^i for $0 < i < n$ can be uniquely filled by an n -simplex. Using this, the lifting property for 1-simplices implies the lifting property for n -simplices. \square

Now let \mathcal{C} be a category and X an object in \mathcal{C} . Observe the canonical functor $\varphi: \mathcal{C} \rightarrow \pi_1(\mathcal{C})$. Define $\mathcal{U}_X(\mathcal{C})$ to be the category $X \downarrow \varphi$. The canonical projection $\mathcal{U}_X(\mathcal{C}) \rightarrow \mathcal{C}$ sending an object (B, γ) to B is a covering. Furthermore, $\mathcal{U}_X(\mathcal{C})$ is simply connected, i.e. connected and its fundamental groupoid is equivalent to the terminal category (see [36]). So it deserves the name universal covering category. More precisely, it is the universal covering of the component of \mathcal{C} which contains the object X .

There is a canonical functor $\pi_1(\mathcal{C}) \rightarrow \mathbf{CAT}$ taking objects X to the category $\mathcal{U}_X(\mathcal{C})$ and an arrow $f: X \rightarrow Y$ to a functor $\mathcal{U}_X(\mathcal{C}) \rightarrow \mathcal{U}_Y(\mathcal{C})$ which is given by precomposition with f^{-1} . Fixing the object X , this functor restricts to a functor $\pi_1(\mathcal{C}, X) \rightarrow \mathbf{CAT}$ sending the unique object of the group $\pi_1(\mathcal{C}, X)$ to the universal covering $\mathcal{U}_X(\mathcal{C})$. This is the same as a representation of $\pi_1(\mathcal{C}, X)$ in \mathbf{CAT} , i.e. a group homomorphism $\rho: \pi_1(\mathcal{C}, X) \rightarrow \text{Aut}(\mathcal{U}_X(\mathcal{C}))$ into the group of invertible functors with multiplication given by $f \cdot g := f * g$. Equivalently, this is a right action of the group $\pi_1(\mathcal{C}, X)$ on $\mathcal{U}_X(\mathcal{C})$ given by the formula $\alpha \cdot \gamma := \alpha \triangleright (\gamma \triangleright \rho)$ for $\gamma \in \pi_1(\mathcal{C}, X)$ and arrows α in $\mathcal{U}_X(\mathcal{C})$. This gives the usual deck transformations on the universal covering.

5. Contractibility and homotopy equivalences

We say that a category is contractible if its classifying space is contractible and we say that a functor $F: \mathcal{C} \rightarrow \mathcal{D}$ is a homotopy equivalence if $BF: BC \rightarrow BD$ is one. There are some standard conditions which assure that a category is contractible or a functor is a homotopy equivalence. These will be recalled below.

A non-empty category \mathcal{C} is contractible if

- i) \mathcal{C} has an initial object.
- ii) \mathcal{C} has binary products.
- iii) \mathcal{C} is a poset, i.e. there is at most one arrow between any two objects, and there is an object X_0 together with a functor $F: \mathcal{C} \rightarrow \mathcal{C}$ such that for each object X there exist arrows $X \rightarrow F(X) \leftarrow X_0$ (compare with [38, Subsection 1.5]).
- iv) \mathcal{C} is filtered which means that for every two objects X, Y there is an object Z with arrows $X \rightarrow Z, Y \rightarrow Z$ and for every two arrows $f, g: A \rightarrow B$ there is an arrow $h: B \rightarrow C$ such that $fh = gh$.

Of course, the dual statements are also true. It is instructive to sketch the arguments for these four claims:

- i) Let \mathcal{I} be the category with two objects and one non-identity arrow from the first to the second object. The classifying space of \mathcal{I} is the unit interval I . A natural transformation of two functors $f, g: \mathcal{C} \rightarrow \mathcal{D}$ can be interpreted as a functor $\mathcal{C} \times \mathcal{I} \rightarrow \mathcal{D}$. On the level of spaces, this gives a homotopy $BC \times I \rightarrow BD$. If \mathcal{C} is a category with initial object X_0 , then there is a unique natural transformation from the functor const_{X_0} (sending every arrow of \mathcal{C} to id_{X_0}) to the identity functor $\text{id}_{\mathcal{C}}$. On the level of spaces, this yields a homotopy between id_{BC} and the constant map $BC \rightarrow BC$ with value the point X_0 .
- ii) Choose an object X_0 in \mathcal{C} . Let $F: \mathcal{C} \rightarrow \mathcal{C}$ be the functor $Y \mapsto X_0 \times Y$. Projection onto the first factor yields a natural transformation $F \rightarrow \text{const}_{X_0}$ and projection onto the second factor yields a natural transformation $F \rightarrow \text{id}_{\mathcal{C}}$. This gives two homotopies which together give the desired contraction of BC .

- iii) First note that, if $F, G: \mathcal{C} \rightarrow \mathcal{C}$ are two functors with the property that there is an arrow $F(X) \rightarrow G(X)$ for each object X , then this already defines a natural transformation $F \rightarrow G$ by uniqueness of arrows in the poset. Now the conditions on X_0 and F yield that there are natural transformations $\text{id}_{\mathcal{C}} \rightarrow F$ and $\text{const}_{X_0} \rightarrow F$. On the level of spaces this gives the desired contraction of BC .
- iv) First, let \mathcal{D} be a finite subcategory of \mathcal{C} . We claim that there exists a cocone over \mathcal{D} in \mathcal{C} , i.e. there is an object Z in \mathcal{C} and for each object Y in \mathcal{D} an arrow $Y \rightarrow Z$ which commute with the arrows in \mathcal{D} . This cocone is contractible because Z is a terminal object. A cocone can be constructed as follows: First pick two objects Y_1, Y_2 in \mathcal{D} and find an object Z' with arrows $Y_1 \rightarrow Z'$ and $Y_2 \rightarrow Z'$. Pick another object Y_3 and find an object Z'' with arrows $Y_3 \rightarrow Z''$ and $Z' \rightarrow Z''$. Repeating this with all objects of \mathcal{D} , we obtain an object Q together with arrows $f_Y: Y \rightarrow Q$ for every object Y in \mathcal{D} . The f_Y probably won't commute with the arrows in \mathcal{D} yet, but we can repair this by repeatedly applying the second property of filteredness. Pick an arrow $d: Y \rightarrow Y'$ in \mathcal{D} and observe the parallel arrows $df_{Y'}$ and f_Y . Apply the second property to find an arrow $\omega: Q \rightarrow Q'$ with $df_{Y'}\omega = f_Y\omega$. Replace Q by Q' and all the arrows f_D for objects D of \mathcal{D} by $f_D\omega$. Repeat this with all the other arrows in \mathcal{D} .

Now to finish the proof of this item, take a map $S^n \rightarrow BC$. Since S^n is compact, it can be homotoped to a map such that the image is covered by the geometric realization of a finite subcategory. The cocone over this subcategory then gives the desired null-homotopy. To obtain the first homotopy, one could use Kan's fibrant replacement functor Ex^∞ and argue as follows: Since $\text{Ex}^\infty(NC)$ is fibrant and weakly homotopy equivalent to NC , an element in $\pi_n(BC) = \pi_n(NC)$ can be represented by a morphism of simplicial sets $\partial\Delta_n \rightarrow \text{Ex}^\infty(NC)$. Since $\partial\Delta_n$ has only finitely many non-degenerate simplices, this map factors through $\text{Ex}^k(NC)$ for some k and we obtain a map $\partial\Delta_n \rightarrow \text{Ex}^k(NC)$. By adjointness, this gives a morphism $\text{Sd}^k(\partial\Delta^n) \rightarrow NC$ where Sd is the barycentric subdivision functor. This representative can now be null-homotoped in a cocone as above.

We recall Quillen's famous Theorem A from [37] which gives a sufficient but in general not necessary condition for a functor to be a homotopy equivalence.

THEOREM 1.2. *Let $f: \mathcal{C} \rightarrow \mathcal{D}$ be a functor. If for each object Y in \mathcal{D} the category $Y \downarrow f$ is contractible, then the functor f is a homotopy equivalence. Similarly, if the category $f \downarrow Y$ is contractible for each object Y in \mathcal{D} , then f is a homotopy equivalence.*

REMARK 1.3. When applying this theorem to an inclusion $f: \mathcal{A} \rightarrow \mathcal{B}$ of a full subcategory, it suffices to check $Y \downarrow f = Y \downarrow \mathcal{A}$ for objects Y not in \mathcal{A} . If Y is an object in \mathcal{A} , the comma category $Y \downarrow \mathcal{A}$ has the object (Y, id_Y) as initial object and thus is automatically contractible. Similar remarks apply to the comma categories $f \downarrow Y = \mathcal{A} \downarrow Y$.

REMARK 1.4. If \mathcal{D} is a groupoid, then for $Y, Y' \in \mathcal{D}$ the comma categories $Y \downarrow f$ and $Y' \downarrow f$ are isomorphic. Thus one has to check contractibility only for one Y . The same remarks apply to the comma categories $f \downarrow Y$.

6. Smashing isomorphisms in categories

Recall that a connected groupoid is equivalent, as a category, to any of its automorphism groups. Consequently, a connected groupoid is contractible if and only if its automorphism groups are trivial. This is the case if and only if there is exactly one isomorphism between any two objects.

Let \mathcal{C} be a category and $\mathcal{G} \subset \mathcal{C}$ a subcategory which is a disjoint union of contractible groupoids. We define the quotient category \mathcal{C}/\mathcal{G} as follows: The objects of \mathcal{C}/\mathcal{G} are equivalence classes of objects of \mathcal{C} where we say that $X \sim Y$ are equivalent if there is an isomorphism $X \rightarrow Y$ in \mathcal{G} . Note that such an isomorphism is unique since each component of \mathcal{G} is contractible. We define

$$\mathrm{Hom}_{\mathcal{C}/\mathcal{G}}([X], [Y]) := \{A \rightarrow B \text{ in } \mathcal{C} \mid A \in [X], B \in [Y]\} / \sim$$

where two elements $(A \rightarrow B) \sim (A' \rightarrow B')$ in the set are defined to be equivalent if the diagram

$$\begin{array}{ccc} A & \longrightarrow & B \\ \downarrow & & \downarrow \\ \mathcal{G} \ni \downarrow & & \downarrow \in \mathcal{G} \\ A' & \longrightarrow & B' \end{array}$$

commutes. Let $[\alpha: A \rightarrow B]$ and $[\beta: C \rightarrow D]$ be two composable arrows, i.e. $[B] = [C]$, then there is a unique isomorphism $\gamma: B \rightarrow C$ in \mathcal{G} and one defines

$$[\alpha: A \rightarrow B] * [\beta: C \rightarrow D] := [\alpha\gamma\beta: A \rightarrow D]$$

Set $\mathrm{id}_{[X]} = [\mathrm{id}_X]$. One easily checks that \mathcal{C}/\mathcal{G} is a well-defined category.

REMARK 1.5. Observe that if $\mathcal{X} \rightarrow \mathcal{Y}$ is an arrow in \mathcal{C}/\mathcal{G} and representatives X and Y have been chosen for \mathcal{X} and \mathcal{Y} , then there is a unique arrow $X \rightarrow Y$ representing $\mathcal{X} \rightarrow \mathcal{Y}$.

REMARK 1.6. If \mathcal{C} is a poset, then every subgroupoid \mathcal{G} is a disjoint union of contractible groupoids and \mathcal{C}/\mathcal{G} is a poset as well.

REMARK 1.7. Let \mathcal{X} and \mathcal{Y} be two objects in \mathcal{C}/\mathcal{G} . Fix some object X_0 representing \mathcal{X} . Then the arrows $\mathcal{X} \rightarrow \mathcal{Y}$ in \mathcal{C}/\mathcal{G} are in one to one correspondence with arrows $X_0 \rightarrow Y$ in \mathcal{C} modulo isomorphisms in \mathcal{G} on the right. Likewise, if we fix some object Y_0 representing \mathcal{Y} , then arrows $\mathcal{X} \rightarrow \mathcal{Y}$ in \mathcal{C}/\mathcal{G} are in one to one correspondence with arrows $X \rightarrow Y_0$ in \mathcal{C} modulo isomorphisms in \mathcal{G} on the left.

PROPOSITION 1.8. *The canonical projection $p: \mathcal{C} \rightarrow \mathcal{C}/\mathcal{G}$ is a homotopy equivalence.*

PROOF. For each object in \mathcal{C}/\mathcal{G} choose a representing object in \mathcal{C} . By Remark 1.5, this already defines a functor $f: \mathcal{C}/\mathcal{G} \rightarrow \mathcal{C}$. We have $f * p = \mathrm{id}_{\mathcal{C}/\mathcal{G}}$ and we will show that f is a homotopy equivalence. It then follows that also p is a homotopy equivalence.

Let Y be an object in \mathcal{C} . We show that $Y \downarrow f$ has an initial object and thus is contractible. It then follows from Quillen's Theorem A (Theorem 1.2) that f is a homotopy equivalence. There is a unique isomorphism $\gamma: Y \rightarrow [Y] \triangleright f$ in \mathcal{G} and the data $([Y], \gamma)$ is an object in $Y \downarrow f$. We want to show that it is initial. Let $([Z], \alpha)$ be another object in $Y \downarrow f$. Then $\mu := [\gamma^{-1}\alpha]: [Y] \rightarrow [Z]$ gives an arrow

$([Y], \gamma) \rightarrow ([Z], \alpha)$ because $\mu \triangleright f = \gamma^{-1} \alpha$ and thus the triangle

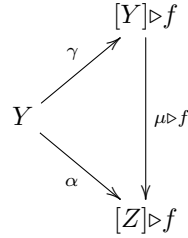

commutes. Furthermore, since γ is an isomorphism, $\mu \triangleright f$ is the only arrow such that the triangle commutes. Since f is faithful, also μ is the unique arrow such that the triangle commutes and thus represents the unique arrow $([Y], \gamma) \rightarrow ([Z], \alpha)$. \square

7. Calculus of fractions and cancellation properties

The next definition is very classical and due to Gabriel and Zisman [24].

DEFINITION 1.9. Let \mathcal{C} be a category. It satisfies the calculus of fractions if the following two conditions are satisfied:

- (*Square filling*) For every pair of arrows $f: B \rightarrow A$ and $g: C \rightarrow A$ there are arrows $a: D \rightarrow B$ and $b: D \rightarrow C$ such that $af = bg$.

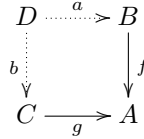

- (*Equalization*) Whenever we have arrows $f, g: A \rightarrow B$ and $a: B \rightarrow C$ such that $fa = ga$, then there exists an arrow $b: D \rightarrow A$ with $bf = bg$.

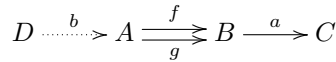

More precisely, this is called the *right* calculus of fractions. There is also a dual *left* calculus of fractions. Since we are mainly interested in the right calculus of fractions, we omit the word “right”.

REMARK 1.10. The existence of binary pullbacks in \mathcal{C} trivially implies the square filling property but it also implies the equalization property [1, Lemma 1.2]. So a category with binary pullbacks satisfies the calculus of fractions.

The calculus of fractions has positive effects on the complexity of the fundamental groupoid $\pi_1(\mathcal{C})$: One can show (see e.g. [24] or [3]) that each class in $\pi_1(\mathcal{C})$ can be represented by a *span* which is a zig-zag of the form



Furthermore, two spans

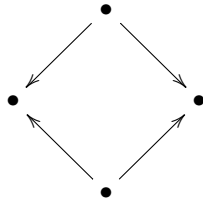

are homotopic if and only if the diagram can be filled in the following way:

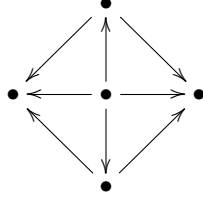

In other words, the elements in the localization can be described as fractions and this explains the name of the calculus of fractions. We will frequently write (α, β) for a span consisting of arrows α and β where the first arrow α points to the left (i.e. is the denominator) and the second arrow β points to the right (i.e. is the nominator). Two spans are composed by concatenating representatives to a zig-zag and then transforming the zig-zag into a span by choosing a square filling of the middle cospan.

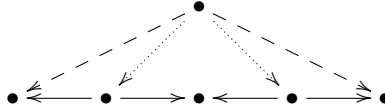

The canonical functor $\varphi: \mathcal{C} \rightarrow \pi_1(\mathcal{C})$ is given by sending an arrow α to the class represented by the span

$$\bullet \xleftarrow{\text{id}} \bullet \xrightarrow{\alpha} \bullet$$

Using the special form of the homotopy relation from above, we see that two arrows $\alpha, \beta: X \rightarrow Y$ are homotopic (i.e. $\varphi(\alpha)$ and $\varphi(\beta)$ are homotopic) if and only if there is an arrow $\omega: A \rightarrow X$ such that $\omega\alpha = \omega\beta$. Using this, one can reobtain the following classical result:

LEMMA 1.11. *A connected groupoid \mathcal{G} is aspherical.*

PROOF. Let X be some object in \mathcal{G} and look at the universal covering category $\mathcal{U}_X(\mathcal{G})$. It is also a connected groupoid. We show that the automorphism group of $\mathcal{U}_X(\mathcal{G})$ at some object is trivial. Consequently, $\mathcal{U}_X(\mathcal{G})$ is equivalent to the terminal category and therefore contractible. The lemma then follows from elementary covering theory.

So let $A = (Y, \alpha)$ be an object in $\mathcal{U}_X(\mathcal{G})$ where $\alpha: X \rightarrow Y$ is an arrow in $\pi_1(\mathcal{G})$. An automorphism $A \rightarrow A$ is an arrow $\gamma: Y \rightarrow Y$ in \mathcal{G} such that $\alpha\gamma = \alpha$ in $\pi_1(\mathcal{G})$. It follows $\gamma = \text{id}_Y$ in $\pi_1(\mathcal{G})$, i.e. γ is homotopic to id_Y in \mathcal{G} . Since \mathcal{G} satisfies the calculus of fractions, there must be an arrow β with $\beta\gamma = \beta$ in \mathcal{G} . It follows $\gamma = \text{id}_Y$ in \mathcal{G} . \square

We now turn to cancellation properties in categories.

DEFINITION 1.12. Let \mathcal{C} be a category. It is called right cancellative if $fa = ga$ for arrows f, g, a implies $f = g$. It is called left cancellative if $af = ag$ implies $f = g$. It is called cancellative if it is left and right cancellative.

REMARK 1.13. Note that we have the following implications:

$$\begin{aligned} \text{right cancellation} &\implies \text{equalization} \\ \text{equalization} + \text{left cancellation} &\implies \text{right cancellation} \end{aligned}$$

We will use the following result in Chapter 3 to prove finiteness properties for operad groups:

PROPOSITION 1.14. *Let \mathcal{C} be a category satisfying the cancellative calculus of fractions. Then the canonical functor $\varphi: \mathcal{C} \rightarrow \pi_1(\mathcal{C})$ is faithful and a homotopy equivalence. In particular, \mathcal{C} is aspherical if it is connected and satisfies the cancellative calculus of fractions.*

PROOF. Injectivity is easy: Let f, g be arrows in \mathcal{C} which are mapped to the same arrow in $\pi_1(\mathcal{C})$. This means that f, g are homotopic. Since \mathcal{C} satisfies the calculus of fractions, this implies that there is an arrow ω with $\omega f = \omega g$. From the cancellation property it follows that $f = g$.

For showing that the functor is a homotopy equivalence, we apply Quillen's Theorem A (Theorem 1.2) to the functor $\varphi: \mathcal{C} \rightarrow \pi_1(\mathcal{C})$. Let X be an object in $\pi_1(\mathcal{C})$, i.e. an object in \mathcal{C} . We have to check that the comma category $X \downarrow \varphi$ is contractible. Note that this is the universal covering category $\mathcal{U}_X(\mathcal{C})$. First we claim that this category is a poset: Let (Z, a) and (Z', a') be objects in $X \downarrow \varphi$ and γ_1, γ_2 be two arrows from (Z, a) to (Z', a') . This means that Z, Z' are objects in \mathcal{C} , $a: X \rightarrow Z \triangleright \varphi$ and $a': X \rightarrow Z' \triangleright \varphi$ are arrows in $\pi_1(\mathcal{C})$ and $\gamma_1, \gamma_2: Z \rightarrow Z'$ are arrows in \mathcal{C} such that $a * (\gamma_1 \triangleright \varphi) = a' = a * (\gamma_2 \triangleright \varphi)$ in $\pi_1(\mathcal{C})$. It follows $\gamma_1 \triangleright \varphi = \gamma_2 \triangleright \varphi$ and therefore $\gamma_1 = \gamma_2$ by injectivity.

Now we want to show that this poset is cofiltered. Then we can apply item iv) of Section 5. We have to show that for each two objects A, A' in $X \downarrow \varphi$ there is another object B and arrows $B \rightarrow A$ and $B \rightarrow A'$. Let $A = (Z, a)$ and $A' = (Z', a')$ with arrows $a: X \rightarrow Z \triangleright \varphi$ and $a': X \rightarrow Z' \triangleright \varphi$ which can be represented by spans (α, β) and (α', β') respectively. Choose a square filling (γ, γ') of the cospan (α, α') .

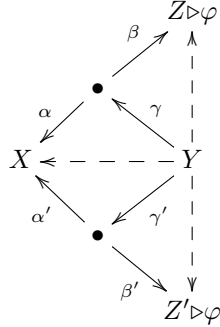

Then the arrow $\omega := \gamma\alpha = \gamma'\alpha'$ can be interpreted as the denominator of a span representing an arrow in $\pi_1(\mathcal{C})$ which we denote by ω^{-1} . Furthermore, since $\varphi: \mathcal{C} \rightarrow \pi_1(\mathcal{C})$ is the identity on objects, we can write $Y = Y \triangleright \varphi$. Thus, we can define the object $B := (Y, \omega^{-1})$ in $X \downarrow \varphi$. Finally, the arrows $\gamma\beta$ and $\gamma'\beta'$ give arrows $B \rightarrow A$ and $B \rightarrow A'$ respectively. \square

REMARK 1.15. The functor $\varphi: \mathcal{C} \rightarrow \pi_1(\mathcal{C})$ in Proposition 1.14 is still a homotopy equivalence if we drop the cancellation property from the hypothesis. This is proved in [13, Section 7].

8. Monoidal categories and string diagrams

We first recall the notion of (symmetric/braided) monoidal categories.

DEFINITION 1.16. A (strict) monoidal category $(\mathcal{C}, \otimes, I)$ is a category \mathcal{C} with a functor

$$\otimes: \mathcal{C} \times \mathcal{C} \rightarrow \mathcal{C}$$

and a distinguished object I such that

$$\begin{aligned} (X \otimes Y) \otimes Z &= X \otimes (Y \otimes Z) \\ (f \otimes g) \otimes h &= f \otimes (g \otimes h) \end{aligned}$$

and

$$\begin{aligned} I \otimes X &= X = X \otimes I \\ \text{id}_I \otimes f &= f = f \otimes \text{id}_I \end{aligned}$$

for objects X, Y, Z and arrows f, g, h . It is called *braided* if there is an isomorphism $\gamma_{X,Y}: X \otimes Y \rightarrow Y \otimes X$ which is natural in X and Y and satisfies the first and second hexagon identity, i.e. the following two diagrams commute

$$\begin{array}{ccc} & A \otimes (B \otimes C) \xrightarrow{\gamma} (B \otimes C) \otimes A & \\ \parallel & & \parallel \\ (A \otimes B) \otimes C & & B \otimes (C \otimes A) \\ \searrow \gamma \otimes 1 & & \nearrow 1 \otimes \gamma \\ & (B \otimes A) \otimes C = B \otimes (A \otimes C) & \end{array}$$

$$\begin{array}{ccc} & (A \otimes B) \otimes C \xrightarrow{\gamma} C \otimes (A \otimes B) & \\ \parallel & & \parallel \\ A \otimes (B \otimes C) & & (C \otimes A) \otimes B \\ \searrow 1 \otimes \gamma & & \nearrow \gamma \otimes 1 \\ & A \otimes (C \otimes B) = (A \otimes C) \otimes B & \end{array}$$

for objects A, B, C . One can visualize the two hexagon identities as follows:

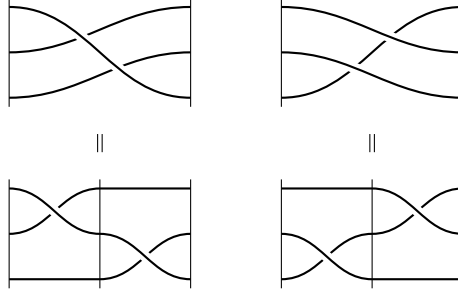

If the natural isomorphism also satisfies $\gamma_{X,Y} * \gamma_{Y,X} = \text{id}_{X \otimes Y}$, then we call the monoidal category *symmetric*. Note that in a symmetric monoidal category the second hexagon identity follows from the first one and vice versa. So in this case only one of them has to be included in the definition. Sometimes, we call a monoidal category *planar* in order to stress that it's neither symmetric nor braided.

Joyal and Street introduced the notion of braided monoidal categories in [30]. It is designed such that the braided monoidal category freely generated by a single object is the groupoid with components the braid groups B_n . More precisely, we have an object for each natural number n , there are no morphisms $n \rightarrow m$ with $n \neq m$ and $\text{Hom}(n, n) = B_n$. More generally, they introduced the braided monoidal category $\mathfrak{Braid}(\mathcal{C})$ freely generated by another category \mathcal{C} [30, page 37]: The objects are free words in the objects of \mathcal{C} , i.e. finite sequences of objects of \mathcal{C} . A morphism consists of a braid $\beta \in B_n$ where the strands are labelled with morphisms $\alpha_i: A_i \rightarrow B_i$ of \mathcal{C} , yielding an arrow

$$(\beta, \alpha_1, \dots, \alpha_n): (A_{1 \triangleright \beta}, \dots, A_{n \triangleright \beta}) \rightarrow (B_1, \dots, B_n)$$

in $\mathfrak{Braid}(\mathcal{C})$. Composition is performed by composing the braids and applying composition in \mathcal{C} to every strand. The tensor product is given by juxtaposition. A set C can be viewed as a discrete category, so we also obtain the notion of a braided monoidal category $\mathfrak{Braid}(C)$ freely generated by a set. The arrows are just braids with strands labelled by the elements of C , i.e. are colored.

The same remarks apply to the symmetric version. In particular, a category \mathcal{C} freely generates a symmetric monoidal category $\mathfrak{Sym}(\mathcal{C})$.

Even simpler, we can form the free monoidal category $\mathfrak{Mon}(\mathcal{C})$ generated by a category \mathcal{C} . The strands are decorated by arrows in \mathcal{C} but they are not allowed to braid or cross each other.

If \mathcal{C} is a (symmetric/braided) monoidal category, then there is exactly one tensor structure on $\pi_1(\mathcal{C})$ making it into a (symmetric/braided) monoidal category and such that the canonical functor $\varphi: \mathcal{C} \rightarrow \pi_1(\mathcal{C})$ respects that structure, i.e.

$$\begin{aligned}\varphi(X \otimes Y) &= \varphi(X) \otimes \varphi(Y) \\ \varphi(\alpha \otimes \beta) &= \varphi(\alpha) \otimes \varphi(\beta) \\ \varphi(I) &= I \\ \varphi(\gamma_{X,Y}) &= \gamma_{\varphi(X),\varphi(Y)}\end{aligned}$$

for objects X, Y and arrows α, β . The tensor product on the level of arrows can be constructed as follows: Let one arrow be represented by the zig-zag

$$A_0 \xleftarrow{\alpha_1} A_1 \xrightarrow{\alpha_2} \dots \xrightarrow{\alpha_k} A_k$$

and the other arrow by the zig-zag

$$B_0 \xrightarrow{\beta_1} B_1 \xleftarrow{\beta_2} \dots \xrightarrow{\beta_l} B_l$$

Then the tensor product may be represented by the zig-zag

$$\begin{array}{cccccccccccccccc} A_0 & \xleftarrow{\alpha_1} & A_1 & \xrightarrow{\alpha_2} & \dots & \xrightarrow{\alpha_k} & A_k & \xrightarrow{\text{id}} & A_k & \xleftarrow{\text{id}} & \dots & \xrightarrow{\text{id}} & A_k \\ \otimes & \otimes & \otimes & \otimes & \dots & \otimes & \otimes & \otimes & \otimes & \otimes & \dots & \otimes & \otimes \\ B_0 & \xleftarrow{\text{id}} & B_0 & \xrightarrow{\text{id}} & \dots & \xrightarrow{\text{id}} & B_0 & \xrightarrow{\beta_1} & B_1 & \xleftarrow{\beta_2} & \dots & \xrightarrow{\beta_l} & B_l \end{array}$$

We now review (in an informal manner) the notion of string diagrams for (symmetric/braided) monoidal categories. They were first used by Roger Penrose and later formally introduced by Joyal and Street [31] (see also [40] for a survey on string diagrams for monoidal categories of various sorts).

In a category \mathcal{C} , objects X can be visualized as labelled strings and arrows $f: X \rightarrow Y$ can be visualized as labelled nodes or boxes between strings. We call these boxes transistors. Composition $f * g$ with $f: X \rightarrow Y$ and $g: Y \rightarrow Z$ is visualized by connecting the strings of two transistors.

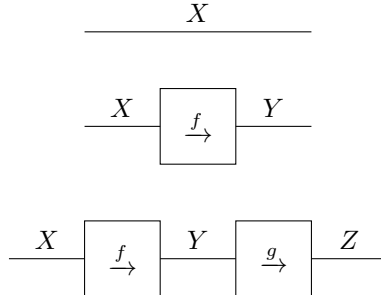

In order to model composition correctly, we have to identify the following string diagrams:

$$\begin{array}{c} X \\ \hline \boxed{f} \\ \hline Y \end{array} \begin{array}{c} \boxed{g} \\ \hline Z \end{array} = \begin{array}{c} X \\ \hline \boxed{fg} \\ \hline Z \end{array}$$

A transistor labelled with the identity morphism of an object X is identified with a string labelled X .

If \mathcal{C} is monoidal, the tensor functor \otimes is visualized by writing strings and transistors side by side. For example, the following diagrams represent the tensor product $X \otimes Y$ of objects X, Y and the tensor product $f \otimes g: X \otimes A \rightarrow Y \otimes B$ of morphisms $f: X \rightarrow Y$ and $g: A \rightarrow B$.

$$\begin{array}{c} X \\ \hline \\ \hline Y \end{array} \quad \begin{array}{c} X \\ \hline \boxed{f} \\ \hline Y \end{array} \quad \begin{array}{c} A \\ \hline \boxed{g} \\ \hline B \end{array}$$

A morphism of the form $f: X_1 \otimes \dots \otimes X_k \rightarrow Y_1 \otimes \dots \otimes Y_l$ is visualized by a transistor with k entering strings labelled X_1, \dots, X_k and l outgoing strings labelled Y_1, \dots, Y_l . For example, the following diagram represents an arrow $f: X \otimes A \rightarrow Y \otimes B$.

$$\begin{array}{c} X \\ \hline \boxed{f} \\ \hline A \end{array} \begin{array}{c} Y \\ \hline \\ \hline B \end{array}$$

Just as in the case of composition, we have to make identifications in order to model the tensor operation correctly:

$$\begin{array}{c} X \\ \hline \boxed{f} \\ \hline Y \end{array} \quad \begin{array}{c} A \\ \hline \boxed{g} \\ \hline B \end{array} = \begin{array}{c} X \\ \hline \boxed{f \otimes g} \\ \hline A \end{array} \begin{array}{c} Y \\ \hline \\ \hline B \end{array} = \begin{array}{c} X \otimes A \\ \hline \boxed{f \otimes g} \\ \hline Y \otimes B \end{array}$$

Strings labelled with the unit object I are identified with empty diagrams.

If \mathcal{C} is braided, we have the natural braiding isomorphisms $\gamma_{X,Y}: X \otimes Y \rightarrow Y \otimes X$. These are visualized by the diagrams

$$\begin{array}{c} X \\ \hline \\ \hline Y \end{array} \begin{array}{c} \\ \hline \\ \hline \end{array}$$

If \mathcal{C} is symmetric, $\gamma_{X,Y}$ takes the form

$$\begin{array}{c} X \\ \hline \\ \hline Y \end{array} \begin{array}{c} \\ \hline \\ \hline \end{array}$$

The crucial observation for this graphical language is the coherence between it and the axioms of monoidal categories (compare with [40, Theorems 3.1, 3.7 and 3.12]):

THEOREM 1.17. *A well-formed equation between morphism terms in the language of planar resp. braided resp. symmetric monoidal categories follows from the axioms of planar resp. braided resp. symmetric monoidal categories if and only if it holds, up to isotopy in 2 resp. 3 resp. 4 dimensions, in the graphical language.*

These dimensions also reflect the position of planar resp. braided resp. symmetric monoidal categories in the periodic table of higher categories: Planar monoidal categories are 2-categories with one object, braided monoidal categories are 3-categories with one object and one arrow, symmetric monoidal categories are 4-categories with one object, one arrow and one 2-cell.

Above, we have seen that the fundamental groupoid $\pi_1(\mathcal{C})$ of a monoidal category \mathcal{C} of some type inherits the structure of a monoidal category of the same type. To model this fundamental groupoid via string diagrams, we also allow to connect outgoing strings of transistors to outgoing strings of other transistors and ingoing strings to ingoing strings.

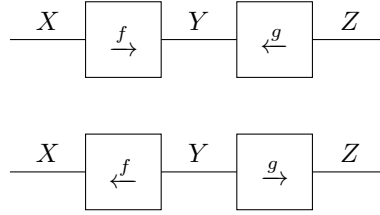

The homotopy relations

$$\begin{aligned} A \xrightarrow{\alpha} B \xrightarrow{\beta} C &\sim A \xrightarrow{\alpha\beta} C \\ A \xleftarrow{\alpha} B \xleftarrow{\beta} C &\sim A \xleftarrow{\beta\alpha} C \\ A \xrightarrow{\text{id}} A &\sim A \\ A \xleftarrow{\text{id}} A &\sim A \end{aligned}$$

already become identities in the graphical language. To correctly model the homotopy relations

$$\begin{aligned} A \xrightarrow{\alpha} B \xleftarrow{\alpha} A &\sim A \\ A \xleftarrow{\alpha} B \xrightarrow{\alpha} A &\sim A \end{aligned}$$

we introduce identifications for string diagrams as follows:

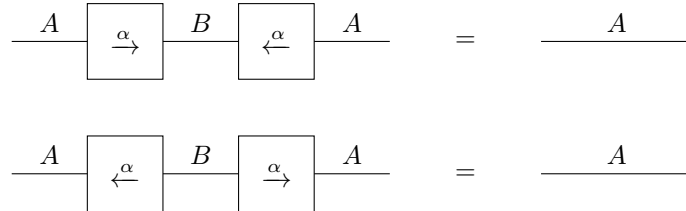

We call the left hand sides dipoles which cancel each other.

With these modifications, we obtain the same coherence Theorem 1.17 for the fundamental groupoids of (symmetric/braided) monoidal categories. This will help us later to handle paths up to homotopy more easily and will establish a connection of operad groups with diagram groups.

9. Cones and joins

Let \mathcal{C}, \mathcal{D} be two categories. We define the join $\mathcal{C} * \mathcal{D}$. The set of objects of $\mathcal{C} * \mathcal{D}$ is the disjoint union of the objects of \mathcal{C} and \mathcal{D} . The set of arrows is the disjoint union of the arrows of \mathcal{C} and \mathcal{D} together with exactly one arrow $C \rightarrow D$ for each pair (C, D) of objects C of \mathcal{C} and D of \mathcal{D} . The composition rules are the unique ones extending the compositions in \mathcal{C} and \mathcal{D} . The classifying space of the join is homotopy equivalent to the join of the classifying spaces $B(\mathcal{C} * \mathcal{D}) \simeq BC * BD$.

Now we define the cone over a category. The objects of $\text{Cone}(\mathcal{C})$ are the objects of \mathcal{C} plus another object called \mathfrak{tip} . The arrows are the arrows of \mathcal{C} together with

exactly one arrow from \mathbf{tip} to every object in \mathcal{C} . Dually, there is a $\mathbf{Cocone}(\mathcal{C})$ over \mathcal{C} . In the cocone, the extra arrows go from the objects of \mathcal{C} to the extra object \mathbf{tip} . Last but not least, when we have a join $\mathcal{C} * \mathcal{D}$ of two categories, there is a mixed version $\mathbf{Coone}(\mathcal{C} * \mathcal{D})$ which we call the coone over the join. Again, there is one extra object \mathbf{tip} and for every object in $\mathcal{C} * \mathcal{D}$ we have an extra arrow. When we have an object in \mathcal{C} , the extra arrow *goes to tip*. When we have an arrow in \mathcal{D} , the extra arrow *comes from tip*. The composition of an arrow $C \rightarrow \mathbf{tip}$ with an arrow $\mathbf{tip} \rightarrow D$ is the unique arrow $C \rightarrow D$ from the definition of the join. All three coning versions give the usual conings on the topological level:

$$\begin{aligned} B(\mathbf{Cone}(\mathcal{C})) &\cong \mathbf{Cone}(B(\mathcal{C})) \\ B(\mathbf{Cocone}(\mathcal{C})) &\cong \mathbf{Cone}(B(\mathcal{C})) \\ B(\mathbf{Coone}(\mathcal{C} * \mathcal{D})) &\cong \mathbf{Cone}(B(\mathcal{C} * \mathcal{D})) \end{aligned}$$

The join of two spaces X and Y is defined to be the homotopy pushout of the two projections $X \leftarrow X \times Y \rightarrow Y$. Thus, it is defined only up to homotopy and there is some freedom to choose models of a join. Indeed, there is another construction giving the join of two categories. For this, we need to recall the Grothendieck construction: Let \mathcal{J} be some indexing category and $F: \mathcal{J} \rightarrow \mathbf{CAT}$ a diagram in \mathbf{CAT} . The objects of the Grothendieck construction $\int F$ are pairs (J, X) of objects J in \mathcal{J} and X in $J \triangleright F$. An arrow from (J, X) to (J', X') is a pair (f, α) consisting of an arrow $f: J \rightarrow J'$ and an arrow $\alpha: X \triangleright (f \triangleright F) \rightarrow X'$. Composition is given by

$$(f, \alpha) * (f', \alpha') := (f * f', \alpha \triangleright (f' \triangleright F) * \alpha')$$

In [45] it is shown that there is a model structure on \mathbf{CAT} Quillen equivalent to \mathbf{SSET} , nowadays called the Thomason model structure, and in [46] it is shown that the nerve of the Grothendieck construction $\int F$ is homotopy equivalent to the homotopy pushout of the diagram $F * N$ which is obtained from the diagram F by applying the nerve functor. In fact, $\int F$ realizes the homotopy pushout of F with respect to the Thomason model structure on \mathbf{CAT} [21, Section 3].

Now let \mathcal{C}, \mathcal{D} be categories. We call the Grothendieck construction of the diagram

$$\mathcal{C} \xleftarrow{\mathbf{pr}_{\mathcal{C}}} \mathcal{C} \times \mathcal{D} \xrightarrow{\mathbf{pr}_{\mathcal{D}}} \mathcal{D}$$

the Grothendieck join of \mathcal{C} and \mathcal{D} and denote it by $\mathcal{C} \circ \mathcal{D}$. From [46] we know that $B(\mathcal{C} \circ \mathcal{D})$ is homotopy equivalent to the homotopy pushout of the diagram

$$BC \xleftarrow{\mathbf{pr}_{BC}} BC \times BD \xrightarrow{\mathbf{pr}_{BD}} BD$$

But the latter is the join $BC * BD$ by definition. So we have $B(\mathcal{C} \circ \mathcal{D}) \simeq BC * BD$.

One can show that the Grothendieck join is associative and thus we can write $\mathcal{C}_1 \circ \dots \circ \mathcal{C}_k$ for a finite collection \mathcal{C}_i of categories. The objects of such an iterated Grothendieck join are elements of the set

$$\mathbf{obj}(\mathcal{C}_1 \circ \dots \circ \mathcal{C}_k) = \coprod_{S \subset \{1, \dots, k\}} \prod_{s \in S} \mathbf{obj}(\mathcal{C}_s)$$

Whenever we have $S \subset T \subset \{1, \dots, k\}$, objects $(Y_t)_{t \in T}$ and $(X_s)_{s \in S}$ and arrows $\alpha_s: Y_s \rightarrow X_s$ in \mathcal{C}_s for each $s \in S$, then there is an arrow

$$(\alpha_s)_{s \in S}: (Y_t)_{t \in T} \rightarrow (X_s)_{s \in S}$$

For $R \subset S \subset T$ the composition is given by

$$(\alpha_s)_{s \in S} * (\beta_r)_{r \in R} = (\alpha_r * \beta_r)_{r \in R}$$

There is also a dual notion of the Grothendieck join which we define as

$$\mathcal{C} \bullet \mathcal{D} := (\mathcal{C}^{op} \circ \mathcal{D}^{op})^{op}$$

Since $B(\mathcal{A}^{op}) = B(\mathcal{A})$ for any category, we still have $B(\mathcal{C} \bullet \mathcal{D}) \simeq BC * BD$. Furthermore, it is still associative, so that we can write $\mathcal{C}_1 \bullet \dots \bullet \mathcal{C}_k$ for a finite collection \mathcal{C}_i of categories. The objects of such an iterated dual Grothendieck join are elements of the set

$$\text{obj}(\mathcal{C}_1 \bullet \dots \bullet \mathcal{C}_k) = \coprod_{S \subset \{1, \dots, k\}} \prod_{s \in S} \text{obj}(\mathcal{C}_s)$$

Whenever we have $S \subset T \subset \{1, \dots, k\}$, objects $(X_s)_{s \in S}$ and $(Y_t)_{t \in T}$ and arrows $\alpha_s: X_s \rightarrow Y_s$ in \mathcal{C}_s for each $s \in S$, then there is an arrow

$$(\alpha_s)_{s \in S}: (X_s)_{s \in S} \rightarrow (Y_t)_{t \in T}$$

For $R \subset S \subset T$ the composition is given by

$$(\beta_r)_{r \in R} * (\alpha_s)_{s \in S} = (\beta_r * \alpha_r)_{r \in R}$$

10. The Morse method for categories

We review a well-known technique to study the connectivity of spaces. We first describe the method in the case of simplicial complexes which has been used in [2] to prove finiteness properties of certain groups. We then explain the same method in the context of categories.

Let \mathcal{C} be a simplicial complex. Let v be a vertex in \mathcal{C} . Denote by \mathcal{C}^{-v} the full subcomplex spanned by the vertices of \mathcal{C} except v . Define the *descending link*

$$lk_{\downarrow}(v) := lk_{\mathcal{C}}(v) \cap \mathcal{C}^{-v}$$

to be the intersection of the ordinary link of v in \mathcal{C} with the subcomplex \mathcal{C}^{-v} . We then have a canonical pushout diagram

$$\begin{array}{ccc} lk_{\downarrow}(v) & \longrightarrow & \text{Cone}(lk_{\downarrow}(v)) \\ \downarrow & & \downarrow \\ \mathcal{C}^{-v} & \longrightarrow & \mathcal{C} \end{array}$$

where $\text{Cone}(lk_{\downarrow}(v))$ denotes the simplicial cone over $lk_{\downarrow}(v)$. The following lemma expresses the connectivity of the pair $(\mathcal{C}, \mathcal{C}^{-v})$ in terms of the connectivity of $lk_{\downarrow}(v)$.

LEMMA 1.18. *Let X and L be two spaces and $L \rightarrow C$ a cofibration into a contractible space C . Let*

$$\begin{array}{ccc} L & \longrightarrow & C \\ \downarrow & & \downarrow \\ X & \longrightarrow & Z \end{array}$$

be a pushout of spaces. If L is $(n-1)$ -connected, then the pair (Z, X) is n -connected.

PROOF. Choose a base point $a \in L$ and denote by a also the corresponding points in the spaces C, X, Z of the pushout. We prove the claim by induction over n . First we treat the cases $n = 0$ and $n = 1$. For $n = 0$ the assumption is that L is (-1) -connected, i.e. we only know that L is non-empty. It is easy to see in this case that $\pi_0(X, a) \rightarrow \pi_0(Z, a)$ is surjective which means that $\pi_0(Z, X) = 1$, i.e. (Z, X) is 0-connected. For $n = 1$ the assumption is that L is 0-connected, i.e. path connected. Seifert–van Kampen applied to the pushout of spaces yields a pushout of groups

$$\begin{array}{ccc} \pi_1(L, a) & \longrightarrow & 1 \\ \downarrow & & \downarrow \\ \pi_1(X, a) & \longrightarrow & \pi_1(Z, a) \end{array}$$

since $\pi_1(C, a) = 1$. It follows that $\pi_1(X, a) \rightarrow \pi_1(Z, a)$ is surjective. From the 0-connectedness of L it also follows easily that $\pi_0(X, a) \rightarrow \pi_0(Z, a)$ is a bijection. From the long exact homotopy sequence of the pair (Z, X) it follows that $\pi_0(Z, X) = 1$ and $\pi_1(Z, X) = 1$, i.e. (Z, X) is 1-connected.

Now we assume that the statement is true for $n \geq 1$ and we want to derive it for $n + 1$. So we assume that L is n -connected. By the Hurewicz Theorem, we get $H_k(L) = 0$ for $1 \leq k \leq n$. Observe the long exact homology sequence of the pair (C, L) . Since $H_k(C) = 0$ for $k \geq 1$ we obtain $H_k(C, L) = 0$ for $2 \leq k \leq n + 1$. Excision applied to the pushout of spaces yields isomorphisms

$$H_k(C, L) \cong H_k(Z, X)$$

for each k . So we obtain $H_k(Z, X) = 0$ for $2 \leq k \leq n + 1$. By induction hypothesis, we have that (Z, X) is n -connected. So by the relative Hurewicz Theorem, we have an isomorphism

$$H_{n+1}(Z, X) \cong \pi_{n+1}(Z, X)$$

Consequently, we also have $\pi_{n+1}(Z, X) = 0$ and (Z, X) is $(n + 1)$ -connected. \square

More generally, let \mathcal{X}_0 be the full subcomplex of the simplicial complex \mathcal{X} spanned by a subset of vertices. Then \mathcal{X} can be built up from \mathcal{X}_0 by successively adding vertices. If all the descending links appearing this way are highly connected, then also the pair $(\mathcal{X}, \mathcal{X}_0)$ will be highly connected and, using the long exact homotopy sequence, we obtain the following:

PROPOSITION 1.19. *Let $x_0 \in \mathcal{X}_0$ be a point. Assume that each descending link is n -connected. Then, we have*

$$\pi_k(\mathcal{X}_0, x_0) \cong \pi_k(\mathcal{X}, x_0)$$

for $k = 0, \dots, n$.

Note that, in general, the descending links depend on the order in which the vertices are added. We call two vertices v_1, v_2 in $\mathcal{X} \setminus \mathcal{X}_0$ *independent* if they are not joined by an edge in \mathcal{X} . Assume now that we want to add v_1 and then v_2 at some step of the process. The independence condition ensures that the descending links of v_1 and v_2 do *not* depend on the order in which v_1 and v_2 are added.

The adding order is often encoded in a Morse function. This is a function f assigning to each vertex in $\mathcal{X} \setminus \mathcal{X}_0$ an element in a totally ordered set, e.g. \mathbb{N} . We require that vertices with the same f -value are pairwise independent. We then add vertices in order of ascending f -values. Because of the independence property, the adding order of vertices with the same f -value can be chosen arbitrarily. Alternatively, we can add vertices with the same f -value all at once.

We now give a version of this concept for categories. Let \mathcal{C} be a category and X an object in \mathcal{C} with $\text{Hom}_{\mathcal{C}}(X, X) = \{\text{id}_X\}$. Define \mathcal{C}^{-X} to be the full subcategory of \mathcal{C} spanned by the objects of \mathcal{C} except X . We define

$$\overline{lk}_{\downarrow}(X) := \mathcal{C}^{-X} \downarrow X$$

to be the *descending up link* of X and

$$lk_{\downarrow}(X) := X \downarrow \mathcal{C}^{-X}$$

to be the *descending down link* of X . Furthermore, define

$$lk_{\downarrow}(X) := \overline{lk}_{\downarrow}(X) * lk_{\downarrow}(X)$$

to be the *descending link* of X .

We have a commutative diagram \mathfrak{D} as follows:

$$\begin{array}{ccc} lk_{\downarrow}(X) & \longrightarrow & \text{Coone}(\overline{lk}_{\downarrow}(X) * \underline{lk}_{\downarrow}(X)) \\ \downarrow & & \downarrow \\ \mathcal{C}^{-X} & \longrightarrow & \mathcal{C} \end{array}$$

The horizontal arrows are the obvious inclusions. We explain the vertical arrows, starting with

$$\overline{lk}_{\downarrow}(X) * \underline{lk}_{\downarrow}(X) \rightarrow \mathcal{C}^{-X}$$

An object either comes from $\overline{lk}_{\downarrow}(X)$ and thus is a pair $(Y, Y \rightarrow X)$ with Y an object in \mathcal{C}^{-X} or comes from $\underline{lk}_{\downarrow}(X)$ and thus is a pair $(Y, X \rightarrow Y)$ with Y an object in \mathcal{C}^{-X} . In both cases, the object will be sent to Y . Similarly, on the level of arrows, it is also the canonical projection from $\overline{lk}_{\downarrow}(X)$ or $\underline{lk}_{\downarrow}(X)$ to \mathcal{C}^{-X} . However, for each object $(Y, Y \rightarrow X)$ in $\overline{lk}_{\downarrow}(X)$ and each object $(Y', X \rightarrow Y')$ in $\underline{lk}_{\downarrow}(X)$, there is another unique arrow in the join. Send this arrow to the composition $Y \rightarrow X \rightarrow Y'$. Next, we will define the arrow

$$\text{Coone}(\overline{lk}_{\downarrow}(X) * \underline{lk}_{\downarrow}(X)) \rightarrow \mathcal{C}$$

Of course, in order to make the diagram commutative, this functor restricted to the base $lk_{\downarrow}(X)$ of the coone is the one already defined above. So we have to define the images of the extra object **tip** and the extra arrows. Send **tip** to X . Let $(Y, Y \rightarrow X)$ be an object of $\overline{lk}_{\downarrow}(X)$. The arrow from this object to **tip** is sent to the arrow $Y \rightarrow X$. Similarly, let $(Y, X \rightarrow Y)$ be an object of $\underline{lk}_{\downarrow}(X)$. Then the arrow from **tip** to this object is sent to the arrow $X \rightarrow Y$.

Our goal is to show that the diagram \mathfrak{D} becomes a pushout on the level of classifying spaces. Unfortunately, this is not always the case. Consider for example the groupoid $\bullet \rightrightarrows \bullet$ with two objects and two non-identity arrows which are inverse to each other. In all these cases, however, the situation is even better:

LEMMA 1.20. *Assume that there is an object $A \neq X$ and arrows $\alpha: X \rightarrow A$ and $\beta: A \rightarrow X$. Then the inclusion $\mathcal{C}^{-X} \rightarrow \mathcal{C}$ is a homotopy equivalence.*

PROOF. We show that $\mathcal{C}^{-X} \downarrow X$ is filtered and thus contractible. The lemma then follows from Theorem 1.2 and Remark 1.3. Let (Y, γ) be an object in $\mathcal{C}^{-X} \downarrow X$, i.e. $\gamma: Y \rightarrow X$ is an arrow in \mathcal{C} with Y an object in \mathcal{C}^{-X} . Set $\epsilon := \gamma\alpha$. Because of the assumption $\text{Hom}_{\mathcal{C}}(X, X) = \{\text{id}_X\}$, the arrow $\alpha\beta: X \rightarrow X$ must be the identity. Then we calculate

$$\gamma = \gamma(\alpha\beta) = (\gamma\alpha)\beta = \epsilon\beta$$

This shows that ϵ represents an arrow $(Y, \gamma) \rightarrow (A, \beta)$ in $\mathcal{C}^{-X} \downarrow X$. In particular, for every two objects in the comma category, there are arrows to the object (A, β) . This shows the first property of a filtered category.

For the second property, we have to show that any two parallel arrows are co-equalized by another arrow. So let (Z, ν) and (Y, γ) be two objects and $\epsilon, \epsilon': (Z, \nu) \rightarrow (Y, \gamma)$ be two arrows, i.e. $\epsilon, \epsilon': Z \rightarrow Y$ are arrows in \mathcal{C}^{-X} and we have $\epsilon\gamma = \nu = \epsilon'\gamma$. Set $\mu = \gamma\alpha$ which is an arrow $(Y, \gamma) \rightarrow (A, \beta)$ as already pointed out. Then we calculate

$$\epsilon\mu = \epsilon\gamma\alpha = \nu\alpha = \epsilon'\gamma\alpha = \epsilon'\mu$$

and we are done. \square

In all other cases, diagram \mathfrak{D} is indeed a pushout on the level of classifying spaces:

LEMMA 1.21. *Assume that for any object $A \neq X$ either there are only arrows from X to A or there are only arrows from A to X , but never both. Then the diagram $B(\mathfrak{D})$*

$$\begin{array}{ccc} B(lk_{\downarrow}X) & \longrightarrow & \text{Cone}(B(lk_{\downarrow}X)) \\ \downarrow & & \downarrow \\ B(\mathcal{C}^{-X}) & \longrightarrow & B(\mathcal{C}) \end{array}$$

is a pushout of spaces.

PROOF. We claim that the nerve functor applied to the diagram \mathfrak{D}

$$\begin{array}{ccc} N(lk_{\downarrow}X) & \longrightarrow & N(\text{Coone}(\overline{lk}_{\downarrow}X * \underline{lk}_{\downarrow}X)) \\ \downarrow & & \downarrow \\ N(\mathcal{C}^{-X}) & \longrightarrow & N(\mathcal{C}) \end{array}$$

yields a pushout in **SSET**. Since the geometric realization functor $|\cdot|: \mathbf{SSET} \rightarrow \mathbf{TOP}$ is left adjoint to the singular simplex functor, it preserves all colimits and in particular all pushouts. Therefore, applying the geometric realization functor $|\cdot|$ to the diagram $N(\mathfrak{D})$, we obtain a pushout in **TOP**, as claimed in the lemma.

A simplex in $N(\mathcal{C})$ is just a string of composable arrows $A_0 \rightarrow \dots \rightarrow A_k$. One can easily deduce from the assumption that whenever there are two occurrences of X in such a string of composable arrows, then there cannot be objects different from X in between. In other words, if X occurs at all, then all the X in the string are contained in a maximal substring of the form $X \rightarrow X \rightarrow \dots \rightarrow X$ where all the arrows are (necessarily) id_X .

Assume now that we have a commutative diagram as follows:

$$\begin{array}{ccc} N(lk_{\downarrow}X) & \longrightarrow & N(\text{Coone}(\overline{lk}_{\downarrow}X * \underline{lk}_{\downarrow}X)) \\ \downarrow & & \downarrow \\ N(\mathcal{C}^{-X}) & \longrightarrow & N(\mathcal{C}) \end{array} \begin{array}{l} \nearrow f \\ \dashrightarrow h \\ \searrow g \end{array} \rightarrow Z$$

We will show that h is uniquely determined by f and g . Assume σ is a simplex in $N(\mathcal{C})$ given by a string of composable arrows $A_0 \rightarrow \dots \rightarrow A_k$. If all the A_i are contained in the full subcategory \mathcal{C}^{-X} then σ is a simplex in the simplicial subset $N(\mathcal{C}^{-X})$ and then necessarily $h(\sigma) = g(\sigma)$. On the other hand, assume that not all the A_i are objects of \mathcal{C}^{-X} , i.e. at least one $A_i = X$. As pointed out above, σ must be of the form

$$B_0 \rightarrow \dots \rightarrow B_r \rightarrow X \rightarrow \dots \rightarrow X \rightarrow C_0 \rightarrow \dots \rightarrow C_s$$

where $B_i \neq X$ for all $i = 0, \dots, r$ and $C_j \neq X$ for all $j = 0, \dots, s$. All the B_i are in the image of $\overline{lk}_{\downarrow}(X)$ because, after composing, we get an arrow $B_i \rightarrow X$. Analogously, all the C_j are in the image of $\underline{lk}_{\downarrow}(X)$. Such a simplex σ always lifts to unique simplex $\bar{\sigma}$ along the map

$$N(\text{Coone}(\overline{lk}_{\downarrow}X * \underline{lk}_{\downarrow}X)) \rightarrow N(\mathcal{C})$$

Thus we have $h(\sigma) = f(\bar{\sigma})$. This proves uniqueness of h . Showing that h actually defines a map of simplicial sets is left to the reader. \square

We combine Lemmas 1.18, 1.20 and 1.21 to get:

PROPOSITION 1.22. *If the descending link $lk_{\downarrow}(X)$ is $(n-1)$ -connected, then the pair $(\mathcal{C}, \mathcal{C}^{-X})$ is n -connected.*

More generally, let \mathcal{X}_0 be a full subcategory of the category \mathcal{X} spanned by a collection of objects in \mathcal{X} . Assume that $\text{Hom}_{\mathcal{X}}(X, X) = \{\text{id}_X\}$ for all objects X in $\mathcal{X} \setminus \mathcal{X}_0$. Then \mathcal{X} can be built up from \mathcal{X}_0 by successively adding objects. If all the descending links appearing this way are highly connected, then also the pair $(\mathcal{X}, \mathcal{X}_0)$ will be highly connected and, using the long exact homotopy sequence, we obtain the following:

THEOREM 1.23. *Let $x_0 \in \mathcal{X}_0$ be an object. Assume that each descending link is n -connected. Then, we have*

$$\pi_k(\mathcal{X}_0, x_0) \cong \pi_k(\mathcal{X}, x_0)$$

for $k = 0, \dots, n$.

We say that two objects x_1 and x_2 in $\mathcal{X} \setminus \mathcal{X}_0$ are independent if there are no arrows $x_1 \rightarrow x_2$ or $x_2 \rightarrow x_1$ in \mathcal{X} . This guarantees independence of $lk_{\downarrow}(x_1)$ and $lk_{\downarrow}(x_2)$ from the adding order of x_1 and x_2 .

Again, we can encode the adding order with the help of a Morse function f which assigns to each object in $\mathcal{X} \setminus \mathcal{X}_0$ an element in a totally ordered set, e.g. \mathbb{N} . We require that objects with the same f -value are pairwise independent and we add objects in order of increasing f -values.

CHAPTER 2

Operad groups

In this chapter, we want to introduce our main objects of study, the operad groups. We first define the types of operads we will be working with. We will then define operad groups to be the fundamental groups of the category of operators naturally associated to operads. It will be important for later considerations that the category of operators satisfies the (cancellative) calculus of fractions. We will therefore formulate these properties in terms of the operad itself. Operads with invertible degree 1 operations will be called operads with transformations and for these we introduce the important concepts of (very) elementary transformation classes which model in some sense the generators and relations in such an operad. In the last section, we will discuss examples of operads which lead to well-known operad groups and methods to generate operads to which the main theorems in Chapters 3 and 4 will be applicable.

1. Basic definitions

DEFINITION 2.1. An operad \mathcal{O} consists of a set of colors C and sets of operations $\mathcal{O}(a_1, \dots, a_n; b)$ for each finite ordered sequence a_1, \dots, a_n, b of colors in C (the a_i are the input colors and b is the output color) with $n \geq 1$ (allowing operations with no inputs is possible, but we won't consider such operads). See Figure 1 for a visualization of operations. There are composition maps (Figure 1)

$$\begin{array}{c} \mathcal{O}(c_{11}, \dots, c_{1k_1}; a_1) \times \dots \times \mathcal{O}(c_{n1}, \dots, c_{nk_n}; a_n) \times \mathcal{O}(a_1, \dots, a_n; b) \\ \downarrow \\ \mathcal{O}(c_{11}, \dots, c_{1k_1}, c_{21}, \dots, c_{nk_n}; b) \end{array}$$

denoted by $(\phi_1, \dots, \phi_n, \theta) \mapsto (\phi_1, \dots, \phi_n) * \theta$. Composition is associative (Figure 2):

$$\begin{array}{c} ((\psi_{11}, \dots, \psi_{1k_1}) * \phi_1, \dots, (\psi_{n1}, \dots, \psi_{nk_n}) * \phi_n) * \theta \\ \parallel \\ (\psi_{11}, \dots, \psi_{1k_1}, \psi_{21}, \dots, \psi_{nk_n}) * ((\phi_1, \dots, \phi_n) * \theta) \end{array}$$

For each color a there are distinguished unit elements $1_a \in \mathcal{O}(a; a)$ such that

$$(1_{a_1}, \dots, 1_{a_n}) * \theta = \theta = \theta * 1_b$$

for each operation θ . Sometimes we call such an operad planar in order to distinguish it from the symmetric or braided versions below.

A symmetric/braided operad comes with additional maps (Figure 3)

$$x \cdot _ : \mathcal{O}(a_1, \dots, a_n; b) \rightarrow \mathcal{O}(a_{1 \triangleright x}, \dots, a_{n \triangleright x}; b)$$

for each x in the symmetric group S_n or in the braid group B_n respectively. Here, $i \triangleright x$ for $x \in S_n$ means plugging the element i into the permutation x which is considered as a bijection of the set $\{1, \dots, n\}$. There is a canonical projection $B_n \rightarrow$

S_n , so this makes sense also in the braided case. These maps are assumed to be actions:

$$x \cdot (y \cdot \theta) = (xy) \cdot \theta \quad 1 \cdot \theta = \theta$$

They also have to be equivariant with respect to composition (Figures 4 and 5):

$$\begin{aligned} (\phi_{1 \triangleright x}, \dots, \phi_{n \triangleright x}) * (x \cdot \theta) &= \bar{x} \cdot ((\phi_1, \dots, \phi_n) * \theta) \\ (y_1 \cdot \phi_1, \dots, y_n \cdot \phi_n) * \theta &= (y_1, \dots, y_n) \cdot ((\phi_1, \dots, \phi_n) * \theta) \end{aligned}$$

Here, \bar{x} is obtained from x by replacing the i 'th strand of x by n_i strands and n_i is the number of inputs of $\phi_{i \triangleright x}$. Furthermore, (y_1, \dots, y_n) is the concatenation of the permutations resp. braidings y_i .

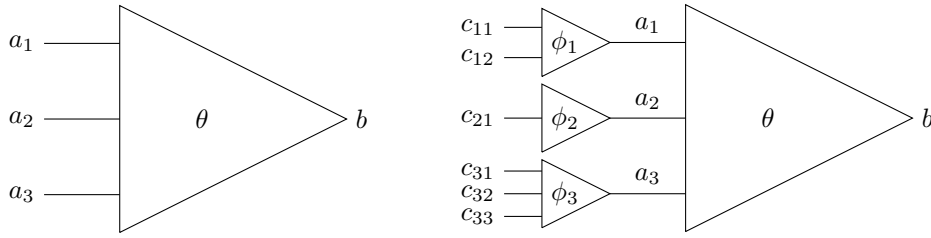

FIGURE 1. Visualization of an operation and composition of operations.

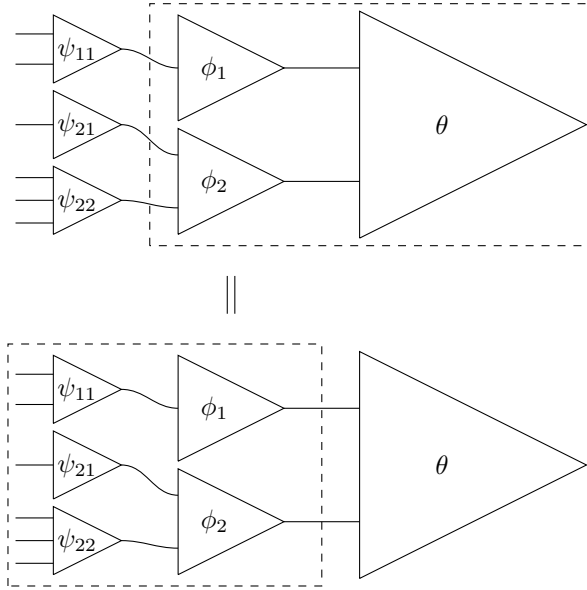

FIGURE 2. Associativity.

REMARK 2.2. There is an equivalent way of writing the composition, namely with so-called partial compositions. The i 'th partial compositions

$$*_i : \mathcal{O}(c_1, \dots, c_k; a_i) \times \mathcal{O}(a_1, \dots, a_n; b) \rightarrow \mathcal{O}(a_1, \dots, a_{i-1}, c_1, \dots, c_k, a_{i+1}, \dots, a_n; b)$$

are defined as

$$\phi *_i \theta := (1_{a_1}, \dots, 1_{a_{i-1}}, \phi, 1_{a_{i+1}}, \dots, 1_{a_n}) * \theta$$

Conversely, one could define operads via partial compositions and obtain the usual composition from a product of several partial compositions.

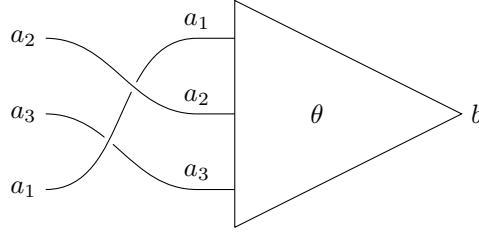

FIGURE 3. Action of the braid groups on the operations.

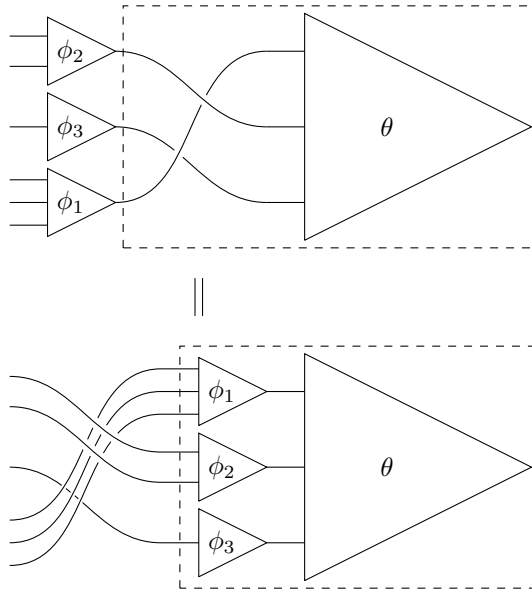

FIGURE 4. First equivariance property.

The planar operads, symmetric operads and braided operads can be organized into categories **OP**, **SYM.OP** and **BRA.OP** respectively. Denote by **MON**, **SYM.MON** and **BRA.MON** the categories of monoidal categories, symmetric monoidal categories and braided monoidal categories respectively. There are functors

$$\text{End: MON} \longrightarrow \text{OP}$$

$$\text{End: SYM.MON} \longrightarrow \text{SYM.OP}$$

$$\text{End: BRA.MON} \longrightarrow \text{BRA.OP}$$

assigning to each (symmetric/braided) monoidal category \mathcal{C} an operad $\text{End}(\mathcal{C})$, called the endomorphism operad. The colors of $\text{End}(\mathcal{C})$ are the objects of \mathcal{C} and the sets of operations are given by

$$\text{End}(\mathcal{C})(a_1, \dots, a_n; b) = \text{Hom}_{\mathcal{C}}(a_1 \otimes \dots \otimes a_n, b)$$

Composition in $\text{End}(\mathcal{C})$ is induced by the composition in \mathcal{C} in the obvious way. The unit element in $\text{End}(\mathcal{C})(a; a)$ is the identity $\text{id}_a: a \rightarrow a$ in \mathcal{C} . In the symmetric or braided case, \mathcal{C} comes with additional natural isomorphisms $\gamma_{X,Y}: X \otimes Y \rightarrow Y \otimes X$. These can be used to define the action of the symmetric resp. braid groups on the sets of operations. In the theory of operads, these endomorphism operads play an

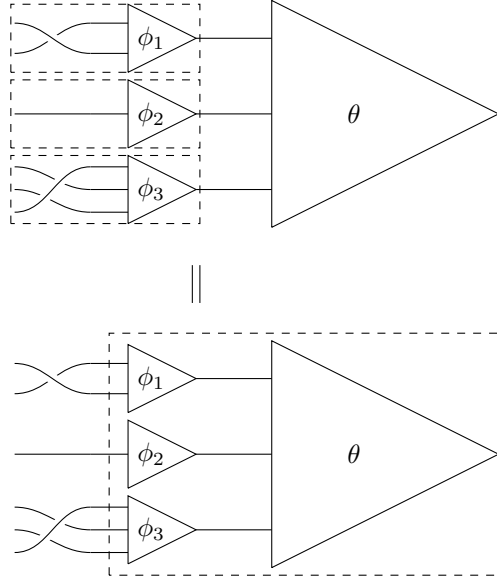
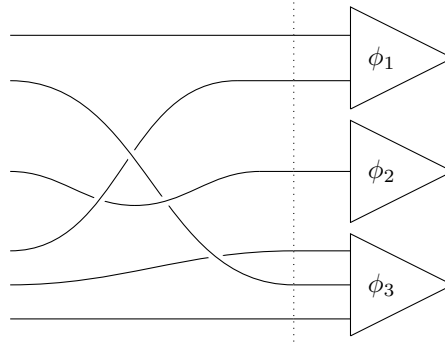

FIGURE 5. Second equivariance property.

FIGURE 6. Arrow in $\mathcal{S}(\mathcal{O})$.

important role since morphisms of operads

$$\mathcal{O} \rightarrow \text{End}(\mathcal{C})$$

are representations of or algebras over the operad \mathcal{O} .

The functors End have left adjoints

$$\mathcal{S}: \text{OP} \longrightarrow \text{MON}$$

$$\mathcal{S}: \text{SYM.OP} \longrightarrow \text{SYM.MON}$$

$$\mathcal{S}: \text{BRA.OP} \longrightarrow \text{BRA.MON}$$

The (symmetric/braided) monoidal category $\mathcal{S}(\mathcal{O})$ is called the category of operators. We will define these categories explicitly. We start with the planar case and then use it to define the braided case. The symmetric case is then similar to the braided case.

So let \mathcal{O} be a planar operad with a set of colors C . The objects of $\mathcal{S}(\mathcal{O})$ are free words in the colors, i.e. finite sequences of colors in C . An arrow in $\mathcal{S}(\mathcal{O})$ is a finite sequence of operations in \mathcal{O} : If X_1, \dots, X_n are operations in \mathcal{O} , the (ordered)

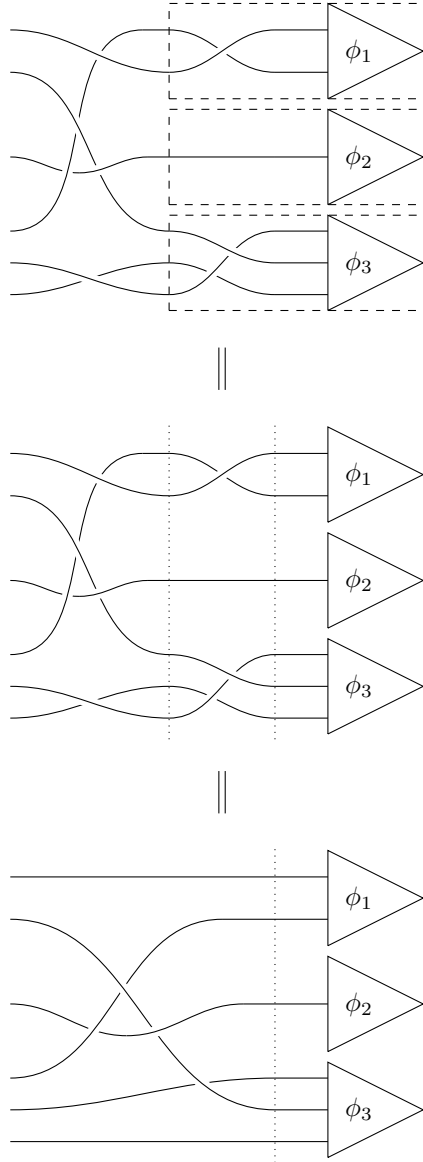
FIGURE 7. Equivalence in $\mathcal{S}(\mathcal{O})$.

input colors of X_i are $(c_i^1, \dots, c_i^{k_i})$ and the output color of X_i is d_i , then the X_i give an arrow

$$(X_1, \dots, X_n): (c_1^1, \dots, c_1^{k_1}, c_2^1, \dots, c_n^{k_n}) \rightarrow (d_1, \dots, d_n)$$

of $\mathcal{S}(\mathcal{O})$. Composition is induced by the composition in the operad \mathcal{O} and the identities are given by the identity operations in \mathcal{O} . The tensor product is given by juxtaposition.

Now let \mathcal{O} be a braided operad with set of colors C . By forgetting the action of the braid groups, we get a planar operad \mathcal{O}_{pl} . The braided monoidal category $\mathcal{S}(\mathcal{O})$ is a certain product $\mathfrak{Braid}(C) \boxtimes \mathcal{S}(\mathcal{O}_{\text{pl}})$. The objects of $\mathcal{S}(\mathcal{O})$ are once more finite sequences of colors in C . Arrows in $\mathcal{S}(\mathcal{O})$ are equivalence classes of pairs $(\beta, X) \in \mathfrak{Braid}(C) \times \mathcal{S}(\mathcal{O}_{\text{pl}})$ consisting of a C -colored braid β and a sequence $X = (X_1, \dots, X_n)$ of operations of \mathcal{O} where the codomain of β equals the domain of

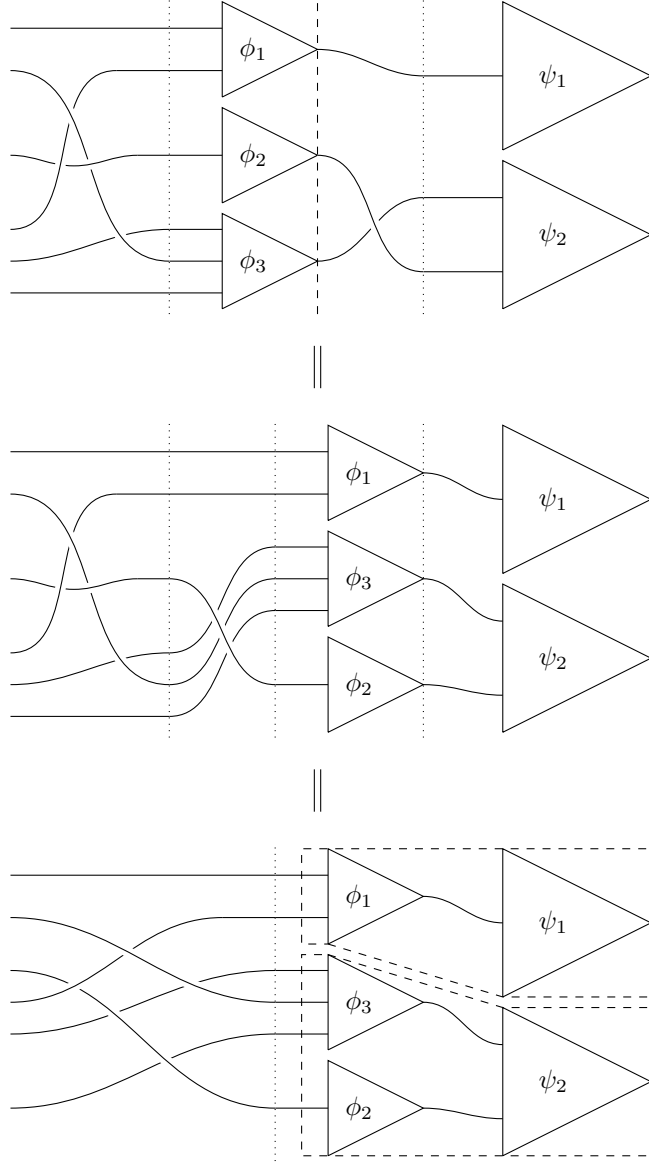
FIGURE 8. Composition in $\mathcal{S}(\mathcal{O})$.

X (Figure 6). The equivalence relation on such pairs is the following: Let (β, X) be such a pair with $X = (X_1, \dots, X_n)$. For each $i = 1, \dots, n$ let σ_i be a C -colored braid such that $\sigma_i \cdot X_i$ is defined. Let $\sigma := \sigma_1 \otimes \dots \otimes \sigma_n$ and define

$$\sigma \cdot (\beta, X) := (\beta * \sigma^{-1}, (\sigma_1 \cdot X_1, \dots, \sigma_n \cdot X_n))$$

We require (β, X) and (β', X') to be equivalent if there exists a σ as above such that $(\beta', X') = \sigma \cdot (\beta, X)$. Roughly speaking, parts of the braid β can be used to act on the operations X_i or, conversely, braids acting on the operations X_i can be merged into β . This is visualized in Figure 7.

Composition in $\mathcal{S}(\mathcal{O})$ is defined on representatives (β, X) and (δ, Y) . Loosely speaking, we push the sequence X of operations through the colored braid δ just as in the definition of equivariance for operads, obtain another colored braid $X \curvearrowright \delta$

which is obtained from δ by multiplying the strands according to X and another sequence of operations $X \curvearrowright \delta$ which is obtained from X by permuting the operations according to δ , and finally compose the left and right side in $\mathfrak{Braid}(C)$ and $\mathcal{S}(\mathcal{O}_{\text{pl}})$ respectively:

$$(\beta, X) * (\delta, Y) := (\beta * X \curvearrowright \delta, X \curvearrowright \delta * Y)$$

See Figure 8 for a visualization of this procedure. That this definition is independent of the chosen representatives follows from the equivariance properties of operads.

Last but not least, the tensor product is defined on representatives (β, X) and (δ, Y) via juxtaposition, i.e. $(\beta, X) \otimes (\delta, Y) := (\beta \otimes \delta, X \otimes Y)$. The identity arrows are those represented by a pair of identities.

DEFINITION 2.3. The degree of an operation is its number of inputs. The degree of an object in $\mathcal{S}(\mathcal{O})$ is the length of the corresponding color word. The degree of an arrow in $\mathcal{S}(\mathcal{O})$ is the degree of its domain. A higher degree operation resp. object resp. arrow is one with degree at least 2.

DEFINITION 2.4. Let \mathcal{O} be a planar, symmetric or braided operad and let X be an object in $\mathcal{S}(\mathcal{O})$. Then the group

$$\pi_1(\mathcal{O}, X) := \pi_1(\mathcal{S}(\mathcal{O}), X)$$

is called the operad group associated to \mathcal{O} based at X .

2. Normal forms

In case \mathcal{O} is a planar operad, arrows in $\mathcal{S}(\mathcal{O})$ are just tensor products of operations. In the symmetric and braided case, however, arrows are equivalence classes of pairs (β, X) . In this section, we want to give a normal form of such arrows, i.e. canonical representatives (β, X) . We will treat the braided case, the symmetric case is similar and simpler.

Consider a colored braid β with n strands. The i 'th strand is the strand starting from the node with index $i \in \{1, \dots, n\}$. Let S be a subset of the index set $\{1, \dots, n\}$. Deleting all strands in β other than those with an index in S yields another colored braid $\beta|_S$. We say that β is unbraided on S if $\beta|_S$ is trivial.

Let (n_1, \dots, n_k) be a sequence of natural numbers with $1 = n_1 < n_2 < \dots < n_k = n + 1$. A sequence like this is called a partition of n , denoted by $[n_1, \dots, n_k]$, because the sets $S_i := \{n_i, \dots, n_{i+1} - 1\}$ form a partition of the set $\{1, \dots, n\}$. We say β is unbraided with respect to the partition $[n_1, \dots, n_k]$ if it is unbraided on the sets S_i .

LEMMA 2.5. *Let $[n_1, \dots, n_k]$ be a partition of n and β a colored braid with n strands. Then there is a unique decomposition $\beta = \beta_p * \beta_u$ into colored braids β_p and β_u such that $\beta_p = \beta_p^1 \otimes \dots \otimes \beta_p^{k-1}$ is a tensor product of colored braids β_p^i with $|S_i|$ strands and β_u is unbraided with respect to $[n_1, \dots, n_k]$.*

PROOF. Define $\beta_p^i := \beta|_{S_i}$ and

$$\beta_u := \left(\beta|_{S_1}^{-1} \otimes \dots \otimes \beta|_{S_{k-1}}^{-1} \right) * \beta$$

Then we have $\beta = \beta_p * \beta_u$ and β_u is unbraided with respect to $[n_1, \dots, n_k]$. The uniqueness statement is left to the reader. \square

Now let $[\beta, X]$ be an arrow in $\mathcal{S}(\mathcal{O})$ with $X = (X_1, \dots, X_k)$. Assume $\deg(X_i) = d_i$ and $d_1 + \dots + d_k = n$. Define $n_i = 1 + \sum_{j=1}^{i-1} d_j$ for $i = 1, \dots, k + 1$ and observe the partition $[n_1, \dots, n_{k+1}]$. Decompose the colored braid β^{-1} as in the previous lemma to obtain $\beta = \tau * \rho$ where τ^{-1} is unbraided with respect to $[n_1, \dots, n_{k+1}]$ and

$\rho = \rho_1 \otimes \dots \otimes \rho_k$ is a tensor product of colored braids ρ_i with d_i strands. Define $Y_i = \rho_i \cdot X_i$. Then from the definition of arrows in $\mathcal{S}(\mathcal{O})$ it follows that

$$[\beta, X] = [\tau, Y]$$

with $Y = (Y_1, \dots, Y_k)$. So each arrow has a representative (τ, Y) such that τ^{-1} is unbraided in the ranges defined by the domains of the operations in the second component. It is easy to see that there is at most one such pair.

Similarly, in the symmetric case, for each arrow in $\mathcal{S}(\mathcal{O})$, there is a unique representative (τ, Y) such that the colored permutation τ^{-1} is unpermuted on the domains of the operations in the second component.

DEFINITION 2.6. The unique representative (τ, Y) of an arrow in $\mathcal{S}(\mathcal{O})$ with τ^{-1} unpermuted resp. unbraided on the domains of the operations in Y is called the normal form of that arrow.

3. Calculus of fractions and cancellation properties

In the following, we write $\theta \approx \psi$ if two operations θ, ψ in an operad are equivalent modulo the action of the symmetric resp. braid groups, i.e. there exists a permutation resp. braid γ such that $\theta = \gamma \cdot \psi$. Of course, in the planar case, this just means equality of operations.

DEFINITION 2.7. Let \mathcal{O} be a (symmetric/braided) operad. We say that \mathcal{O} satisfies the calculus of fractions if the following two conditions are satisfied:

- (*Square filling*) For every pair of operations θ_1 and θ_2 with the same output color, there are sequences of operations $\Psi_1 = (\psi_1^1, \dots, \psi_1^{k_1})$ and $\Psi_2 = (\psi_2^1, \dots, \psi_2^{k_2})$ such that $\Psi_i * \theta_i$ is defined for $i = 1, 2$ and such that $\Psi_1 * \theta_1 \approx \Psi_2 * \theta_2$.
- (*Equalization*) Assume we have an operation θ and sequences of operations $\Psi_1 = (\psi_1^1, \dots, \psi_1^k)$ and $\Psi_2 = (\psi_2^1, \dots, \psi_2^k)$ such that $\Psi_1 * \theta \approx \Psi_2 * \theta$, i.e. there is a γ with $\Psi_1 * \theta = \gamma \cdot (\Psi_2 * \theta)$. Then γ is already of the form $\gamma = \gamma_1 \otimes \dots \otimes \gamma_k$ such that $\gamma_j \cdot \psi_2^j$ is defined for each $j = 1, \dots, k$ and there is a sequence of operations Ξ_j for each $j = 1, \dots, k$ such that $\Xi_j * \psi_1^j = \Xi_j * (\gamma_j \cdot \psi_2^j)$.

PROPOSITION 2.8. \mathcal{O} satisfies the calculus of fractions if and only if $\mathcal{S}(\mathcal{O})$ does.

PROOF. It is easy to see that the square filling property for $\mathcal{S}(\mathcal{O})$ implies the square filling property for \mathcal{O} .

Conversely, assume $[\beta, X]$ and $[\sigma, Y]$ are arrows in $\mathcal{S}(\mathcal{O})$ with common codomain. Let $X = (X_1, \dots, X_k)$ and $Y = (Y_1, \dots, Y_k)$. For showing the square filling property for this pair of arrows, it suffices to consider the case $\beta = \text{id}$ and $\sigma = \text{id}$. But under this assumption, we can use the square filling property of \mathcal{O} for each pair of operations X_i and Y_i .

Now assume equalization for \mathcal{O} . Let $[\beta, X], [\sigma, Y], [\delta, Z]$ be arrows in $\mathcal{S}(\mathcal{O})$ such that $[\beta, X] * [\delta, Z] = [\sigma, Y] * [\delta, Z]$. For showing the equalization property in this situation, it suffices to consider the case $\delta = \text{id}$. Moreover, we can then assume without loss of generality that $\beta = \text{id}$. By assumption, we have that the pairs $(\text{id}, X * Z)$ and $(\sigma, Y * Z)$ are equivalent. When writing $X * Z = (R_1, \dots, R_l)$ and $Y * Z = (S_1, \dots, S_l)$, this implies that σ has to split as a tensor product $\sigma = \sigma_1 \otimes \dots \otimes \sigma_l$ such that $\sigma_i \cdot S_i = R_i$. We therefore can assume without loss of generality that $l = 1$. Setting $\Psi_1 := X$ and $\Psi_2 := Y$, we see that the hypothesis of the equalization property for \mathcal{O} is satisfied with $\gamma := \sigma$. The resulting sequences of operations Ξ_j can be juxtaposed to yield an arrow which equalizes the arrows $[\text{id}, X]$ and $[\sigma, Y]$.

Conversely, assume equalization for $\mathcal{S}(\mathcal{O})$ and assume we have $\theta, \Psi_1, \Psi_2, \gamma$ as in the hypothesis of the equalization property for \mathcal{O} . The arrow $[\text{id}, \theta]$ then coequalizes

the arrows $[\text{id}, \Psi_1]$ and $[\gamma, \Psi_2]$. We therefore get an arrow $[\delta, Z]$ which equalizes the last two arrows. We can assume without loss of generality that $\delta = \text{id}$. But then it follows that γ has to split as required and the Ξ_j can be obtained by splitting the sequence Z . \square

DEFINITION 2.9. Let \mathcal{O} be a (symmetric/braided) operad. We define right cancellativity and left cancellativity for \mathcal{O} as follows:

- (*Right cancellativity*) Assume we have an operation θ and sequences of operations $\Psi_1 = (\psi_1^1, \dots, \psi_1^k)$ and $\Psi_2 = (\psi_2^1, \dots, \psi_2^k)$ such that $\Psi_1 * \theta \approx \Psi_2 * \theta$, i.e. there is a γ with $\Psi_1 * \theta = \gamma \cdot (\Psi_2 * \theta)$. Then γ is already of the form $\gamma = \gamma_1 \otimes \dots \otimes \gamma_k$ such that $\gamma_j \cdot \psi_2^j$ is defined and equal to ψ_1^j for each $j = 1, \dots, k$.
- (*Left cancellativity*) Assume we have operations θ_1 and θ_2 and a sequence of operations Ψ such that $\Psi * \theta_1 = \Psi * \theta_2$. Then $\theta_1 = \theta_2$.

We say that \mathcal{O} is cancellative if it is both left and right cancellative.

PROPOSITION 2.10. \mathcal{O} satisfies the left resp. right cancellation property if and only if $\mathcal{S}(\mathcal{O})$ does.

PROOF. The equivalence of right cancellativity of \mathcal{O} with that of $\mathcal{S}(\mathcal{O})$ is proven similarly as in the case of the equalization property in Proposition 2.8.

It is easy to prove the left cancellativity of \mathcal{O} using the one of $\mathcal{S}(\mathcal{O})$.

Conversely, assume we have left cancellativity for \mathcal{O} and let $[\beta, X], [\sigma, Y]$ and $[\delta, Z]$ be arrows in $\mathcal{S}(\mathcal{O})$ with $[\delta, Z] * [\beta, X] = [\delta, Z] * [\sigma, Y]$. For showing left cancellativity in this situation, we can assume without loss of generality that $\beta = \text{id}$. Moreover, we can then assume without loss of generality that also $\delta = \text{id}$. By assumption, we have that the pairs $(\text{id}, Z * X)$ and $(\bar{\sigma}, \bar{Z} * Y)$ are equivalent where $\bar{\sigma} = Z \curvearrowright \sigma$ and $\bar{Z} = Z \curvearrowleft \sigma$. When writing $Z * X = (R_1, \dots, R_l)$ and $\bar{Z} * Y = (S_1, \dots, S_l)$, this implies that $\bar{\sigma}$ has to split as a tensor product $\bar{\sigma} = \bar{\sigma}_1 \otimes \dots \otimes \bar{\sigma}_l$ such that $\bar{\sigma}_i \cdot S_i = R_i$. When writing $X = (K_1, \dots, K_l)$ and $Y = (T_1, \dots, T_l)$, it follows that also σ has to split as a tensor product $\sigma = \sigma_1 \otimes \dots \otimes \sigma_l$ such that $\sigma_i \cdot T_i$ is defined and, using left cancellativity of \mathcal{O} , we obtain $\sigma_i \cdot T_i = K_i$. This implies $[\text{id}, X] = [\sigma, Y]$. \square

REMARK 2.11. Just as in the case of categories, we have:

$$\begin{aligned} \text{right cancellation} &\implies \text{equalization} \\ \text{equalization} + \text{left cancellation} &\implies \text{right cancellation} \end{aligned}$$

4. Operads with transformations

Observe that the colors of an operad \mathcal{O} together with the degree 1 operations form a category $\mathcal{I}(\mathcal{O})$. In general, this category could be any category. Thus, to prove certain theorems, it is often necessary to impose restrictions on the degree 1 operations.

DEFINITION 2.12. A planar resp. symmetric resp. braided operad \mathcal{O} is called a *planar resp. symmetric resp. braided operad with transformations* if the category $\mathcal{I}(\mathcal{O})$ is a groupoid. In other words, all the degree 1 operations are invertible.

For such an operad, a transformation is an arrow in $\mathcal{S}(\mathcal{O})$ of the form $[\sigma, X]$ where $X = (X_1, \dots, X_n)$ is a sequence of operations of degree 1. The transformations form a groupoid which we call $\mathcal{T}(\mathcal{O})$.

We say that two operations θ_1 and θ_2 are transformation equivalent if there is a transformation α such that $\theta_2 = \alpha * \theta_1$. We denote by $\mathcal{TC}(\mathcal{O})$ the set of equivalence

classes of operations modulo transformation. Note that two transformation equivalent operations have the same degree. Thus, we also have a notion of degree for elements in $\mathcal{TC}(\mathcal{O})$. We define a partial order on the set $\mathcal{TC}(\mathcal{O})$ as follows: Write $\Theta_1 \leq \Theta_2$ if there is an operation θ_1 with $[\theta_1] = \Theta_1$ and operations ψ_1, \dots, ψ_n such that $(\psi_1, \dots, \psi_n) * \theta_1 \in \Theta_2$. Then, for every θ_1 with $[\theta_1] = \Theta_1$ there are operations ψ_1, \dots, ψ_n such that $(\psi_1, \dots, \psi_n) * \theta_1 \in \Theta_2$. It is not hard to prove that this relation is indeed a partial order. Note that the degree function on $\mathcal{TC}(\mathcal{O})$ strictly respects this order relation which means

$$\Theta_1 < \Theta_2 \implies \deg(\Theta_1) < \deg(\Theta_2)$$

The following observation, which easily follows from the definitions, reinterprets the square filling property of Definition 2.7 in terms of the poset $\mathcal{TC}(\mathcal{O})$ of transformation classes:

OBSERVATION 2.13. Let \mathcal{O} be a (symmetric/braided) operad with transformations. Then \mathcal{O} satisfies the square filling property if and only if for each pair Θ_1, Θ_2 of transformation classes with the same codomain color there is another transformation class Θ with $\Theta_1 \leq \Theta \geq \Theta_2$.

QUESTION 2.14. Is it enough to find a class Θ with $\Theta_1 \leq \Theta \geq \Theta_2$ for each pair Θ_1, Θ_2 of *very* elementary classes with the same codomain? For the definition of “very elementary” see Definition 2.18 below.

4.1. Spines in graded posets. We call a poset P graded if there is degree function $\deg: P \rightarrow \mathbb{N}$ such that $\deg(x) < \deg(y)$ whenever $x < y$. For example, $\mathcal{TC}(\mathcal{O})$ above is graded.

DEFINITION 2.15. Let P be a graded poset and $M \subset P$ be the subset of minimal elements in P . The spine S of P is the smallest subset $S \subset P$ such that $M \subset S$ and which satisfies the following property: Whenever $v \in P \setminus S$ then there is a greatest element $g \in S$ such that $g < v$.

We want to prove that the spine of a graded poset always exists.

CONSTRUCTION 2.16. We define $S_i \subset P$ for $i \in \{0, 1, 2, \dots\}$ inductively. Set $S_0 = M$. Assume that S_i has been constructed. If $|S_i| \leq 1$, set $S_{i+1} = \emptyset$. Else, for each pair $x, y \in S_i$ with $x \neq y$, define $M_{i+1}(x, y) \subset P$ as follows: If $x < y$ or $x > y$, set $M_{i+1}(x, y) = \{\max\{x, y\}\}$. Else, let $M_{i+1}(x, y)$ be the set consisting of all the minimal elements z with the property $x < z > y$. Now, let S_{i+1} be the union of all the $M_{i+1}(x, y)$. Finally, define $S = \bigcup_{i=0}^{\infty} S_i$.

OBSERVATION 2.17. Let $A \subset P$. Assume that $v \in P$ satisfies $a < v$ for all $a \in A$. We claim that there is a minimal element p in the set $\{z \in P \mid \forall a \in A \ a < z\}$ which also satisfies $p \leq v$. If v is already minimal, then we can set $p = v$. If it is not minimal, there must be another element $v' \in P$ with $a < v' < v$ for all $a \in A$. Then v' has strictly smaller degree than v . If we repeat this argument with v' , we have to end up with a minimal element p at some time, because the degree function is bounded below. This p surely satisfies $p \leq v$.

Let $v \in P \setminus S$. We want to find the greatest element in the set

$$V := \{z \in S \mid z < v\}$$

For each i , set $S_i^\downarrow = S_i \cap V$. We claim: There exists exactly one i_0 such that $|S_j^\downarrow| > 1$ for $j < i_0$, $|S_{i_0}^\downarrow| = 1$ and $S_j^\downarrow = \emptyset$ for $j > i_0$ and the unique element in $S_{i_0}^\downarrow$ is the greatest element in V .

Observation 2.17 applied to $A = \emptyset$ reveals that $S_0^\downarrow \neq \emptyset$. Note that either all but finitely many of the S_i are empty or the sequence of numbers

$$d_i := \min\{\deg(z) \mid z \in S_i\}$$

tends to infinity. But the degree of all the elements in all the S_i^\downarrow is bounded by $\deg(v)$. It follows that in any case there must be an i_0 such that $S_j^\downarrow = \emptyset$ for all $j > i_0$. Choose the i_0 which is minimal with respect to this property, i.e. $S_{i_0}^\downarrow \neq \emptyset$. Assume $|S_{i_0}^\downarrow| > 1$ and let $x \neq y$ be two elements in this set. If x and y are comparable, e.g. $x < y$, then $y \in S_{i_0+1}^\downarrow$, a contradiction. Else, write $A = \{x, y\}$ and recall that $x, y < v$. Thus, by Observation 2.17, we know that there must be a $p \in M_{i_0+1}(x, y)$ with $p \leq v$. Since $v \notin S$, we have indeed $p < v$. Consequently, $p \in S_{i_0+1}^\downarrow$, a contradiction again. So we have indeed $|S_{i_0}^\downarrow| = 1$. Next, observe that for any j , if $S_j \neq \emptyset$, then S_{j-1} consists of at least two elements. This follows directly from the definitions. Consequently, the same holds for the S_j^\downarrow . From this, it easily follows $|S_j^\downarrow| > 1$ for $j < i_0$.

We now use this to prove that the unique element $g \in S_{i_0}^\downarrow$ is the greatest element in V , i.e. $x \leq g$ whenever $x \in S$ with $x < v$. Let x be such an element. If $x \neq g$, then there must be some $j < i_0$ such that $x \in S_j^\downarrow$. There is another element x' in this S_j^\downarrow . If x and x' are comparable, then set $p = \max\{x, x'\}$. We then have $p \in S_{j+1}^\downarrow$ and $x \leq p$. Else, Observation 2.17 applied to $A = \{x, x'\}$ shows that there is $p \in S_{j+1}^\downarrow$ with $x < p$. In both cases, if $j + 1 = i_0$, that p must be g and we are done. Else, we repeat this process with p in place of x until we reach level i_0 . This completes the proof that S satisfies the property in Definition 2.15.

Remains to prove that S is the smallest subset containing M and satisfying this property. So let $S' \subset P$ be another subset containing M and satisfying this property. We have to prove $S \subset S'$. We will prove $S_i \subset S'$ by induction over i . The induction start is trivial because $S_0 = M$. For the induction step, assume $S_i \subset S'$. Let $v \in S_{i+1}$. Assume that $v \notin S'$. Then there is a greatest element $p \in S'$ with $p < v$. Furthermore, there must be $x, y \in S_i$ with $x \neq y$ and $v \in M_{i+1}(x, y)$. First assume $x < y$. Then we have $v = y$ and thus $v \in S_i \subset S'$, a contradiction. Now assume that x and y are incomparable. Then v is minimal with respect to $x < v > y$. Since $x, y \in S'$ and p is the greatest element in S' with $p < v$, we obtain $x \leq p \geq y$. Indeed, we must have $x < p > y$, because x and y are incomparable. This contradicts the minimality of v . So we must have $v \in S'$ and thus $S_{i+1} \subset S'$.

4.2. Elementary and very elementary operations. Denote by $\mathcal{TC}^*(\mathcal{O})$ the full subposet of $\mathcal{TC}(\mathcal{O})$ spanned by the higher degree classes (i.e. the elements of degree at least 2).

DEFINITION 2.18. Let \mathcal{O} be a (symmetric/braided) operad with transformations. The minimal elements in $\mathcal{TC}^*(\mathcal{O})$ are called very elementary transformation classes. Denote the set of very elementary classes by VE .

Let $\Theta, \Theta_1, \dots, \Theta_k \in \mathcal{TC}(\mathcal{O})$ be (not necessarily distinct) transformation classes. We say that Θ is decomposable into the classes Θ_i if we find operations $\theta_i \in \Theta_i$ for $i = 1, \dots, k$ which can be partially composed (see Remark 2.2) in a certain way to an operation in Θ . It can be shown that any class in $\mathcal{TC}^*(\mathcal{O})$ decomposes into very elementary classes.

DEFINITION 2.19. Let \mathcal{O} be a (symmetric/braided) operad with transformations. The elements in the spine of $\mathcal{TC}^*(\mathcal{O})$ are called elementary transformation classes. Denote the set of elementary classes by E .

An operation in \mathcal{O} is called (very) elementary if it is contained in a (very) elementary transformation class. We will call the elementary but not very elementary classes resp. operations strictly elementary.

DEFINITION 2.20. \mathcal{O} is finitely generated if there are only finitely many very elementary transformation classes. It is of finite type if there are only finitely many elementary transformation classes.

The following proposition states that the subsets VE and E are invariant under the right action of degree 1 operations.

PROPOSITION 2.21. *Let \mathcal{O} be a (symmetric/braided) operad with transformations. Let θ be a higher degree operation and γ be a degree 1 operation. Then the transformation class $[\theta]$ is (very) elementary if and only if the class $[\theta] * \gamma := [\theta * \gamma]$ is (very) elementary. In particular, the operation θ is (very) elementary if and only if $\theta * \gamma$ is (very) elementary.*

PROOF. The main observation is that if Θ, Θ' are two transformation classes, then $\Theta < \Theta'$ holds if and only if $\Theta * \gamma < \Theta' * \gamma$ holds. This implies that $\Theta \in VE$ if and only if $\Theta * \gamma \in VE$ or, in other words, $VE * \gamma = VE$. Now write $E' = E * \gamma$. We then have $VE \subset E'$. Let $\Theta \in \mathcal{TC}^*(\mathcal{O}) \setminus E'$. Then $\Theta * \gamma^{-1} \in \mathcal{TC}^*(\mathcal{O}) \setminus E$. Thus, by the definition of E as the spine of $\mathcal{TC}^*(\mathcal{O})$, we have that there is a greatest element $\Psi \in E$ with $\Psi < \Theta * \gamma^{-1}$. Then $\Psi * \gamma \in E'$ is the greatest element with $\Psi * \gamma < \Theta$. Consequently, E' satisfies the defining properties of the spine E . It follows $E \subset E' = E * \gamma$. Since this holds for arbitrary γ , we obtain $E = E * \gamma$. \square

5. Examples

In this section, we want to present some examples of operads leading to already well-known operad groups as well as to new groups to which the main theorems of Chapters 3 and 4 are applicable.

5.1. Free operads. When specifying a set of colors C and, for each $(n+1)$ -tuple $(a_1, \dots, a_n; b)$ of colors, a set of operations where the inputs are labelled with the colors a_1, \dots, a_n and where the output is labelled with the color b , then we may form the free planar resp. the free braided resp. the free symmetric operad generated by this data. This construction can be described as the left adjoint of a functor forgetting all the data of an operad except the colors and the sets of operations.

Consider for example the free planar operad \mathcal{O} generated by one color and a single binary operation. The operations in this operad are in one to one correspondence with binary trees. Composition is modelled by grafting the roots of trees to leaves of other trees. It is an easy exercise to prove that \mathcal{O} satisfies the cancellative calculus of fractions. For example, we can obtain a square filling of two binary trees by taking the “union” of the two trees. This union is the pullback of the two trees. Consequently, elements in the operad group $\pi_1(\mathcal{O}, 1)$ are represented by spans of binary trees, usually known under the name of tree pair diagrams. The product of two such spans is obtained by concatenating them and forming a square filling of the middle cospan:

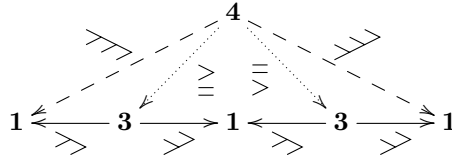

This models the well-known Thompson group F . If we consider the free symmetric operad generated by one color and one binary operation, we obtain the Thompson

group V . If we consider the free braided operad generated by one color and one binary operation, we obtained the braided Thompson group BV defined in [5]. In the case of F , this has first been observed in [20].

More generally, the operad groups of free planar operads generated by higher degree operations correspond exactly to the so-called diagram groups defined in [28]. When considering free symmetric operads, we get symmetric versions of diagram groups which are called “braided” in [28, Definition 16.2]. The truly braided diagram groups are the ones arising from free braided operads. Let $\langle S|R \rangle$ be a semigroup presentation with generators S and relations R which gives rise to (symmetric/braided) diagram groups. For example, we could have the presentation $\langle a, b \mid aa = ab \rangle$. Call a relation in R tree-like if one side of that relation consists of a single generator only. If a relation in R is not tree-like, we introduce another generator and split this relation into two using this new generator. For example, we split $aa = ab$ into $aa = c$ and $c = ab$. The associated diagram groups do not change if we split relations this way, so we can assume without loss of generality that the relations in R are tree-like. Consider the (symmetric/braided) operad \mathcal{O} freely generated by the colors S and one operation for each relation in R . Let X be a word in the alphabet S . Then the (symmetric/braided) diagram group associated to $\langle S|R \rangle$ and based at X is the operad group $\pi_1(\mathcal{O}, X)$. This correspondence is not hard to see if we use string diagrams (see Subsection 8 in Chapter 1) for representing elements in the fundamental groupoid of $\mathcal{S}(\mathcal{O})$ and compare them with so-called pictures in [28, Definitions 4.1 and 16.2].

We can also freely generate (symmetric/braided) operads *with transformations*. The generating data in this case is a groupoid specifying the colors and the degree 1 operations and a set of higher degree operations. More precisely, if we start with a set C of colors, for each $n \geq 2$ and $(n + 1)$ -tuple $(a_1, \dots, a_n; b)$ of colors a certain set of operations $S(a_1, \dots, a_n; b)$ and a groupoid \mathcal{G} with objects in one to one correspondence with the colors in C , then we may form the free (symmetric/braided) operad with transformations \mathcal{O} having C as its set of colors and such that $S(a_1, \dots, a_n; b) \subset \mathcal{O}(a_1, \dots, a_n; b)$ as well as $\mathcal{I}(\mathcal{O}) = \mathcal{G}$. If \mathcal{G} is a discrete groupoid, i.e. a groupoid with objects and identities, then we reobtain the free (symmetric/braided) operad generated by a set of higher degree operations.

Let \mathcal{O} be a free (symmetric/braided) operad with transformations generated by its groupoid of degree 1 operations and a set S of higher degree operations. Then the very elementary transformation classes in such an operad are in one to one correspondence with operations of the form $\theta * \gamma$ where $\theta \in S$ and γ is a degree 1 operation. Note also that $\theta * \gamma = \theta' * \gamma'$ if and only if $\theta = \theta'$ and $\gamma = \gamma'$. Thus, \mathcal{O} is finitely generated in the sense of Definition 2.20 if and only if S is finite and there are only finitely many degree 1 operations with domain equal to the codomain of some operation in S . In particular, it is finitely generated if S and $\mathcal{I}(\mathcal{O})$ are finite. There are no strictly elementary transformation classes in \mathcal{O} .

5.2. Suboperads of endomorphism operads. Recall that there is a (symmetric/braided) operad $\text{End}(\mathcal{C})$ naturally associated to each (symmetric/braided) monoidal category \mathcal{C} , called the endomorphism operad. The colors of $\text{End}(\mathcal{C})$ are the objects in \mathcal{C} and the sets of operations are given by

$$\text{End}(\mathcal{C})(a_1, \dots, a_n; b) = \text{Hom}_{\mathcal{C}}(a_1 \otimes \dots \otimes a_n, b)$$

Let \mathcal{G} be a subgroupoid of \mathcal{C} and S be a set of higher degree operations in $\mathcal{E} := \text{End}(\mathcal{C})$ with outputs and inputs being objects of \mathcal{G} . Then we can look at the suboperad of \mathcal{E} generated by this data: It is the smallest suboperad \mathcal{O} such that $\mathcal{I}(\mathcal{O}) = \mathcal{G}$ and such that the elements in S are operations in \mathcal{O} . These suboperads

are in general not free in the sense of Subsection 5.1 though we have only specified generators. The relations are automatically modelled by the ambient category \mathcal{C} .

Not always is the map $S \rightarrow \mathcal{TC}(\mathcal{O})$ sending an operation to its transformation class a bijection onto the set of very elementary classes. However, this is true if the following conditions are satisfied:

- (\mathcal{V}_1) If $\theta, \theta' \in S$ with $\theta \neq \theta'$, then $[\theta]$ and $[\theta']$ are incomparable, i.e. $[\theta] \not\leq [\theta']$ and $[\theta] \not\geq [\theta']$. In particular, they are not equal.
- (\mathcal{V}_2) The set of transformation classes represented by operations in S is closed under right multiplication with operations in \mathcal{G} , i.e. for each $\theta \in S$ and $\gamma \in \mathcal{G}$ there is $\theta' \in S$ with $[\theta * \gamma] = [\theta']$.

We want to be a bit more explicit now and observe suboperads of the endomorphism operad \mathcal{E} of the symmetric monoidal category (\mathbf{TOP}, \sqcup) where \sqcup is the coproduct (i.e. the disjoint union) of topological spaces. We call an operation (f_1, \dots, f_k) in \mathcal{E} *mono* if the images of the maps $f_i: X_i \rightarrow X$ are pairwise disjoint in X and the f_i are injective. We call it *epi* if the images cover X . It is not hard to prove that if all operations in a suboperad of \mathcal{E} are mono, then it satisfies the right cancellation property. Likewise, if all the operations are epi, then it satisfies the left cancellation property.

We give an explicit example to illustrate the above procedure. Consider the unit square and the right angled triangle obtained by halving the unit square:

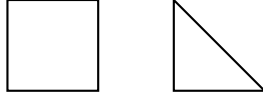

Consider all isometries of the square and the triangle, i.e. the dihedral group D_4 and $\mathbb{Z}/2\mathbb{Z}$. The disjoint union of these isometry groups forms a groupoid \mathcal{G} lying in \mathbf{TOP} . Consider the following subdivisions, called very elementary subdivisions:

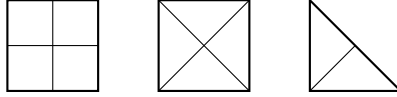

The set S has three elements, one for each subdivision: The first one maps four squares to each square in the first subdivision via coordinate-wise linear transformations. The second one maps four triangles to each triangle in the second subdivision via orientation preserving similarities. The third one maps two triangles to each triangle in the third subdivision via orientation preserving similarities. As above, the groupoid \mathcal{G} together with the set S generate a suboperad \mathcal{O} of the symmetric operad $\mathcal{E} = \text{End}(\mathbf{TOP}, \sqcup)$.

The transformation classes are in one to one correspondence with subdivisions of the square or the triangle which can be obtained by iteratively applying the three subdivisions above. We have $\Theta_1 \leq \Theta_2$ if and only if Θ_2 can be obtained from Θ_1 by performing further subdivisions. For example, we have

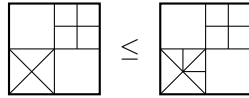

From this it follows easily that the transformation classes represented by the very elementary subdivisions are not comparable, i.e. (\mathcal{V}_1) is satisfied. Furthermore, when applying an isometry of the square or the triangle to one of the operations in S , we obtain the same operation with a transformation precomposed. Thus, also (\mathcal{V}_2) is satisfied. It follows that the very elementary subdivisions correspond exactly to the very elementary classes of \mathcal{O} .

To find all the elementary transformation classes, we have to follow the construction in 2.16. There is exactly one minimal subdivision of the square which refines the two very elementary subdivisions of the square:



Thus, this subdivision represents the only elementary class which is not very elementary.

All the operations in \mathcal{O} are clearly epi, so it satisfies the left cancellation property. Not all of them are mono, but we can change the definitions a little bit and obtain an isomorphic operad where all operations are mono: Instead of the closed square and triangle, we can consider the open square and triangle and also subdivisions into open squares and triangles. Thus, \mathcal{O} also satisfies the right cancellation property. Moreover, we claim that it satisfies square filling. To see this, consider the following chains of subdivisions:

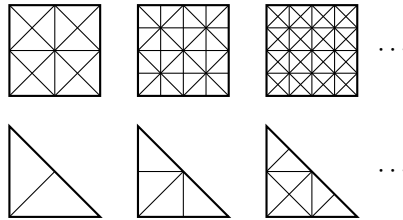

These are cofinal in the sense that every subdivision of the square resp. triangle is smaller than or equal to one of the subdivisions of the first resp. second chain. From Observation 2.13 it follows that \mathcal{O} satisfies square filling. All in all, \mathcal{O} satisfies the cancellative calculus of fractions.

5.2.1. *Cube cutting operads.* Let N be a finite set of natural numbers greater than or equal to 2. Denote by $\langle N \rangle$ the multiplicative submonoid of \mathbb{N} generated by the numbers in N . We say that the numbers in N are independent if, whenever a natural number n can be written as a product $n_1^{r_1} \cdots n_k^{r_k}$ of pairwise distinct numbers $n_i \in N$, then the exponents r_i are already uniquely determined by n . In other words, N is a basis for $\langle N \rangle$. This is satisfied for example if the numbers in N are pairwise coprime or, even stronger, if they are prime. For later reference, we record the following two trivial observations:

- (\mathcal{B}_1) No number $n \in N$ is a product of other numbers in N .
- (\mathcal{B}_2) Whenever $n_1, \dots, n_k \in N$ are pairwise distinct numbers and $n \in \langle N \rangle$ is divisible by each n_i in $\langle N \rangle$, i.e. there is $m_i \in \langle N \rangle$ with $n = n_i m_i$, then n is also divisible by the product $n_1 \cdots n_k$ in $\langle N \rangle$.

There are non-bases N which satisfy (\mathcal{B}_1) but not (\mathcal{B}_2), for example $N = \{2, 6, 7, 21\}$. For this N we have $6 \cdot 7 = 42 = 2 \cdot 21$.

In the same vein as above, we now construct cube cutting operads. For $d \geq 1$, consider the d -dimensional unit cube and a subgroup if its group of isometries. Define this group to be the groupoid \mathcal{G} lying in \mathbf{TOP} . Next, we want to specify very elementary subdivisions of the cube. For each $j \in \{1, \dots, d\}$, let $N_j \subset \mathbb{N}$ be a set of natural numbers as in the preceding paragraph. For each such j and $n \in N_j$, there is a very elementary subdivision of the cube given by cutting it, perpendicularly to the j 'th coordinate axis, into n congruent subbricks. The following are the very elementary subdivisions in the case $d = 2$, $N_1 = \{2\}$ and $N_2 = \{3\}$:

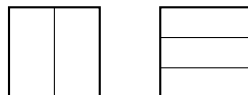

There is one operation in S for each such very elementary subdivision: Cubes are coordinate-wise linearly rescaled to fit into the subbricks of the subdivisions. The groupoid \mathcal{G} together with the set S generate a suboperad \mathcal{O} of $\mathcal{E} = \text{End}(\text{TOP}, \sqcup)$ which we call a symmetric cube cutting operad since we will also define planar cube cutting operads below.

The transformation classes are in one to one correspondence with subdivisions of the cube obtained by iteratively applying n -cuts in direction j as above. Two transformation classes are comparable if and only if one is a subdivision of the other. From (\mathcal{B}_1) it follows that two very elementary subdivisions are not comparable. Consequently, (\mathcal{V}_1) is satisfied. It is not always true that right multiplication of elements in \mathcal{G} with operations in S yields another operation in S up to transformation. For example, a rotation of a vertically cutted square by an angle of $\pi/2$ yields a horizontally cutted square. Whether (\mathcal{V}_2) is satisfied or not depends on the interplay between the isometries in \mathcal{G} and the sets N_j . For example, it is satisfied if $\mathcal{G} = 1$ or if $N_1 = \dots = N_d$. Let us always assume that \mathcal{G} and the N_j are compatible in a way such that (\mathcal{V}_2) is satisfied. Then the very elementary subdivisions are in one to one correspondence with the very elementary transformation classes.

We want to identify the elementary transformation classes. For each element $T = (T_1, \dots, T_d) \in 2^{N_1} \times \dots \times 2^{N_d}$ of the product of the power sets such that $T \neq (\emptyset, \dots, \emptyset)$, there is a transformation class Θ_T which is obtained by iteratively performing, for each $j \in \{1, \dots, d\}$ and each $n \in T_j$, an n -cut in direction j on every subbrick. The result is independent of the order of the cuts. These classes are exactly the elementary classes. To see this, we make the following claim: If Θ_T and $\Theta_{T'}$ are two such classes with $T \not\subset T'$ and $T \not\supset T'$, then $\Theta_{T \cup T'}$ is the smallest class Θ satisfying $\Theta_T < \Theta > \Theta_{T'}$. Here, the inclusion $T \subset T'$ and the union $T \cup T'$ is meant to be coordinate-wise. The figure below pictures the elementary operations in the case $d = 2$, $N_1 = \{2, 3\}$ and $N_2 = \{2, 3\}$.

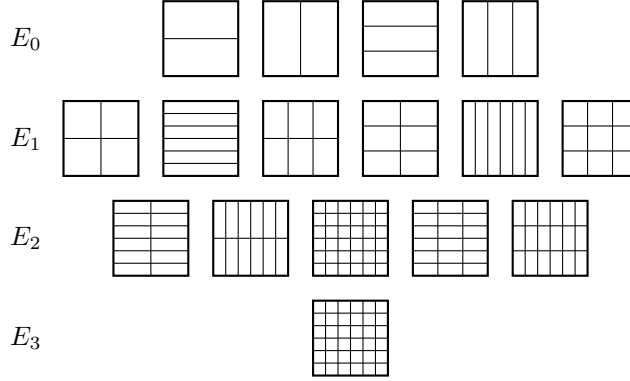

To see the above claim, we consider the case $d = 1$ and set $N := N_1$. The case $d > 1$ can be derived by applying the following observations coordinate-wise. Call a transformation class regular if all the subintervals in the corresponding subdivision of the unit interval have the same length. Now, let Θ be a transformation class with $\Theta_T < \Theta > \Theta_{T'}$. It is not hard to find the greatest regular class Θ_r with $\Theta_r \leq \Theta$. Since Θ_T and $\Theta_{T'}$ are regular, we have $\Theta_T \leq \Theta_r \geq \Theta_{T'}$. There is a unique $n \in \langle N \rangle$ such that $\frac{1}{n}$ is the length of the subintervals in the subdivision of Θ_r . Then $\Theta_T \leq \Theta_r$ means that the product of the numbers in T divides n in $\langle N \rangle$. In particular, each $t \in T$ divides n in $\langle N \rangle$. Likewise, each $t' \in T'$ divides n in $\langle N \rangle$. It follows from (\mathcal{B}_2) that the product of the numbers in $T \cup T'$ divides n in $\langle N \rangle$. This implies $\Theta_{T \cup T'} \leq \Theta_r$ and it follows $\Theta_{T \cup T'} \leq \Theta$, q.e.d.

All the operations in \mathcal{O} are epi and \mathcal{O} is isomorphic to a suboperad of \mathcal{E} where all operations are mono by considering open cubes instead of closed ones. Consequently, \mathcal{O} satisfies the left and right cancellation property. We also find a cofinal chain of subdivisions: The first subdivision in this chain is obtained by iteratively applying, for each $j \in \{1, \dots, d\}$ and each $n \in N_j$, an n -cut in direction j on every subbrick. Then the whole chain is obtained by iterating this with every subbrick. For example, in the case $d = 2$, $N_1 = \{2\}$ and $N_2 = \{3\}$, we can take the following chain:

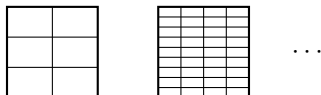

Thus, \mathcal{O} satisfies the square filling property. All in all, it satisfies the cancellative calculus of fractions.

Note that the symmetric cube cutting operads are symmetric operads with transformations. When forgetting the symmetric structure on \mathcal{E} , we obtain a planar operad \mathcal{E}_{pl} and we can define suboperads, which are then planar operads with transformations and which we call planar cube cutting operads, as follows: Consider the case $d = 1$. Set $\mathcal{G} = 1$. Let $N \subset \mathbb{N}$ be a set of natural numbers as in the first paragraph. There is one very elementary subdivision of the unit interval for each $n \in N$, cutting it into n pieces of equal length. The operations in S linearly map unit intervals to the subintervals of very elementary subdivisions. This time, however, we specify the order of these maps. We require that they are ordered by their images via the natural ordering on the unit interval. Denote by \mathcal{O} the suboperad of \mathcal{E}_{pl} generated by this data. Note that \mathcal{O} is a planar operad with transformations which is degenerate in the sense that there are no degree 1 operations besides the identities. Thus, a transformation class is the same as an operation. Operations in \mathcal{O} are in one to one correspondence with subdivision of the unit interval which are obtained by iteratively applying n -cuts for various $n \in N$. Two operations are related if and only if one is a subdivision of the other. The very elementary operations are in one to one correspondence with the very elementary subdivisions and the elementary operations can be described just as in the case of symmetric cube cutting operads. Furthermore, \mathcal{O} satisfies the cancellative calculus of fractions because of the same reasons as above.

We now look at the operad groups associated to these planar resp. symmetric cube cutting operads. Using the fact that arrows in the fundamental groupoid of a category satisfying the calculus of fractions can be represented by spans, it is easy to identify the following operad groups (where $\mathcal{G} = 1$ in each case):

- The Higman-Thompson groups $F_{n,r}$ resp. $V_{n,r}$ arise as the operad groups based at r associated to the planar resp. symmetric cube cutting operads with $d = 1$ and $N = \{n\}$.
- The groups of piecewise linear homeomorphisms of the (Cantor) unit interval $F(r, \mathbb{Z}[\frac{1}{n_1 \dots n_k}], \langle n_1, \dots, n_k \rangle)$ resp. $G(r, \mathbb{Z}[\frac{1}{n_1 \dots n_k}], \langle n_1, \dots, n_k \rangle)$ considered in [43] arise as the operad groups based at r associated to the planar resp. symmetric cube cutting operads with $d = 1$ and $N = \{n_1, \dots, n_k\}$.
- The higher dimensional Thompson groups nV (see [4]) arise as the operad groups associated to the symmetric cube cutting operads with $d = n$ and $N_1 = \dots = N_d = \{2\}$.

5.2.2. *Local similarity operads.* In [29] groups were defined which act in a certain way on compact ultrametric spaces. We recall the definition of a finite similarity structure:

DEFINITION 2.22. Let X be a compact ultrametric space. A finite similarity structure Sim_X on X consists of a finite set $\text{Sim}_X(B_1, B_2)$ of similarities $B_1 \rightarrow B_2$ for every ordered pair of balls (B_1, B_2) such that the following axioms are satisfied:

- (*Identities*) Each $\text{Sim}_X(B, B)$ contains the identity.
- (*Inverses*) If $\gamma \in \text{Sim}_X(B_1, B_2)$, then also $\gamma^{-1} \in \text{Sim}_X(B_2, B_1)$.
- (*Compositions*) If $\gamma_1 \in \text{Sim}_X(B_1, B_2)$ and $\gamma_2 \in \text{Sim}_X(B_2, B_3)$, then also $\gamma_1\gamma_2 \in \text{Sim}_X(B_1, B_3)$.
- (*Restrictions*) If $\gamma \in \text{Sim}_X(B_1, B_2)$ and $B_3 \subset B_1$ is a subball, then also $\gamma|_{B_3} \in \text{Sim}_X(B_3, \gamma(B_3))$.

Here, a similarity $\gamma: X \rightarrow Y$ of metric spaces is a homeomorphism such that there is a $\lambda > 0$ with $d(\gamma(x_1), \gamma(x_2)) = \lambda d(x_1, x_2)$ for all $x_1, x_2 \in X$. Let Sim_X be a finite similarity structure on the compact ultrametric space X . A homeomorphism $\gamma: X \rightarrow X$ is said to be locally determined by Sim_X if for every $x \in X$ there is a ball $x \in B \subset X$ such that $\gamma(B)$ is a ball and $\gamma|_B \in \text{Sim}_X(B, \gamma(B))$. The set of all such homeomorphisms forms a group which we denote by $\Gamma(\text{Sim}_X)$.

To a finite similarity structure Sim_X , we can associate a symmetric operad with transformations \mathcal{O} , a suboperad of $\mathcal{E} = \text{End}(\text{TOP}, \sqcup)$, and reobtain the groups $\Gamma(\text{Sim}_X)$ as operad groups. We do this by appealing to the procedure above. Two balls B_1, B_2 in X are called Sim_X -equivalent if $\text{Sim}_X(B_1, B_2) \neq \emptyset$. Choose one ball in each Sim_X -equivalence class (the isomorphism class of the operad we will define does not depend on this choice). Consider the groupoid \mathcal{G} lying in TOP which is the disjoint union of the groups $\text{Sim}_X(B, B)$ with B a chosen ball. The set S contains one operation in \mathcal{E} for each chosen ball B : Consider the maximal proper subballs A_1, \dots, A_k of B . For each $i = 1, \dots, k$ choose a similarity γ_i in $\text{Sim}_X(B_i, A_i)$ where B_i is the unique chosen ball equivalent to A_i . Now the operation associated to B maps the chosen balls B_i to A_i using the similarities γ_i . The data (\mathcal{G}, S) generates a suboperad \mathcal{O} of \mathcal{E} .

Each transformation class in \mathcal{O} is uniquely determined by a chosen ball together with a subdivision into subballs. Two such subdivisions are related if and only if one can be obtained from the other by further subdividing the subballs. Condition (\mathcal{V}_1) is trivially true since the operations in S have different codomains. A similarity in $\text{Sim}_X(B, B)$ is an isometry $\gamma: B \rightarrow B$ which permutes the maximal proper subballs and the restriction of γ to a maximal proper subball is again a similarity in Sim_X . It follows that right multiplication of an element in \mathcal{G} with an operation in S gives the same operation modulo transformation. In particular, (\mathcal{V}_2) is satisfied. Thus, the very elementary classes of \mathcal{O} are in one to one correspondence with the chosen balls together with their subdivisions into the proper maximal subballs. Since every two very elementary classes have different colors as codomains, there are no elementary classes which are not very elementary.

All the operations in \mathcal{O} are both mono and epi. Thus, it satisfies both left and right cancellation. It also satisfies square filling and thus the cancellative calculus of fractions since we again find a cofinal sequence of subdivisions for each chosen ball B : Define the chain inductively by subdividing each subball by their maximal proper subballs.

Using the fact that arrows in the fundamental groupoid of a category satisfying the calculus of fractions can be represented by spans, it is not hard to establish an isomorphism $\pi_1(\mathcal{O}, X) \cong \Gamma(\text{Sim}_X)$ where we assume that X is the chosen ball of its Sim_X -equivalence class.

5.3. Ribbon Thompson group. To close this section, we briefly want to discuss an operad yielding an operad group RV which naturally fits into the sequence

of well-known groups F, V, BV . First observe the free braided operad with transformations generated by a single color, the group \mathbb{Z} as groupoid of degree 1 operations and a single binary operation. The components of the corresponding groupoid of transformations are the groups $B_n \times \mathbb{Z}^n$. Think of elements of these groups as ribbons which can braid and twist. A single twist corresponds to a generator in \mathbb{Z} . Then we impose the following relation on this operad:

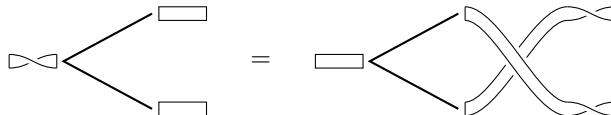

The caret corresponds to the generating binary operation. The operations in this braided operad with transformations are in one to one correspondence with binary trees together with braiding and twisting ribbons attached to the leaves. The transformation classes are in one to one correspondence with binary trees. The only very elementary class is represented by the binary tree with two leaves (the caret). There are no strictly elementary classes. It satisfies the cancellative calculus of fractions. Consequently, elements in the associated operad group based at 1 can be represented by pairs of binary trees where the leaves are connected by braiding and twisting ribbons. Composition is modelled by concatenating two such tree pair diagrams, removing all dipoles formed by carets and then applying the above relation in order to obtain another tree pair diagram.

A topological finiteness result

In this chapter we want to discuss sufficient conditions on a (symmetric/braided) operad with transformations which imply that the associated operad groups are of type F_∞ . The proof is an adaption of methods which have been developed by various authors, most notably in [2, 8, 10, 22, 43]. We construct a contractible category on which the operad group acts with finite type isotropy groups. We then filter this category by invariant subcategories and show that the connectivity of this filtration tends to infinity. Then the Brown criterion, which we recall in Section 1, yields the desired result. To show the connectivity statement, we use the Morse method for categories and show that the connectivity of the descending links tends to infinity. We do so by filtering each descending link by two subcategories, the core and the corona. The core can be identified with a certain arc complex. These arc complexes are treated separately in Section 2.

1. The Brown criterion

In this section, we want to recall a special case of Brown's criterion [8]. We give a different, more geometric proof using a construction of Lück [33, Lemma 4.1]. Let Γ be a discrete group and X be a Γ -CW-complex. Let I_n be the indexing set for the equivariant n -dimensional cells. For $i \in I_n$ denote by H_i the isotropy group of the i 'th cell. When choosing explicit H_i -CW-complex models EH_i for the universal covers of the classifying spaces of the isotropy groups H_i , then one can construct a free Γ -CW-complex $\mathcal{F}(X)$ which is (non-equivariantly) homotopy equivalent to X . The space $\mathcal{F}(X)$ is the colimit over a nested sequence of spaces F_n which are inductively defined by

$$F_0 = \coprod_{i \in I_0} \Gamma \times_{H_i} EH_i$$

and the Γ -pushouts

$$\begin{array}{ccc} \coprod_{i \in I_n} (\Gamma \times_{H_i} EH_i) \times S^{n-1} & \longrightarrow & F_{n-1} \\ \downarrow & & \downarrow \\ \coprod_{i \in I_n} (\Gamma \times_{H_i} EH_i) \times D^n & \longrightarrow & F_n \end{array}$$

for $n \geq 1$. In other words, the equivariant cell $\Gamma/H_i \times D^n$ in X is replaced by the Γ -CW-complex $(\Gamma \times_{H_i} EH_i) \times D^n$. More details can be found in the proofs of [33, Lemma 4.1 and Theorem 3.1]. The crucial observation is that if X is of finite type (i.e. there are only finitely many equivariant cells in each dimension) and if each chosen EH_i is of finite type, then also $\mathcal{F}(X)$ is of finite type.

THEOREM 3.1. *Let Γ be a discrete group and X be a (not necessarily equivariantly) contractible Γ -CW-complex with isotropy groups of type F_∞ . Assume we have a filtration $(X_n)_{n \in \mathbb{N}}$ of X such that each X_n is a Γ -CW-subcomplex of finite type and such that the connectivity of the pairs (X_n, X_{n-1}) tends to infinity as $n \rightarrow \infty$. Then Γ is of type F_∞ .*

PROOF. Choose models EH_i of finite type. Using these models we can construct the blow-ups $\mathcal{F}(X)$ and $\mathcal{F}(X_n)$ for each n . These are *free* Γ -CW-complexes, each $\mathcal{F}(X_n)$ is of finite type and $(\mathcal{F}(X_n))_{n \in \mathbb{N}}$ is a filtration of $\mathcal{F}(X)$. Furthermore, each $\mathcal{F}(X_n)$ is homotopy equivalent to X_n and $\mathcal{F}(X)$ is homotopy equivalent to X . We have a commutative diagram

$$\begin{array}{ccccccc} \cdots & \longrightarrow & X_n & \longrightarrow & X_{n+1} & \longrightarrow & \cdots \\ & & \downarrow & & \downarrow & & \\ \cdots & \longrightarrow & \mathcal{F}(X_n) & \longrightarrow & \mathcal{F}(X_{n+1}) & \longrightarrow & \cdots \end{array}$$

where the vertical arrows are homotopy equivalences and the horizontal arrows are inclusions. The naturality of the long exact homotopy sequence of a pair of spaces and the five lemma imply

$$\pi_k(\mathcal{F}(X_{n+1}), \mathcal{F}(X_n)) \cong \pi_k(X_{n+1}, X_n)$$

Thus, also the connectivity of the pairs $(\mathcal{F}(X_{n+1}), \mathcal{F}(X_n))$ tends to infinity. These considerations imply that we can assume without loss of generality that the action of Γ on X is free.

Under this assumption, we now prove that Γ is of type F_∞ . Set $Y := X/\Gamma$ and $Y_n := X_n/\Gamma$ and let y be some point in Y_0 . We have $\pi_1(Y, y) \cong \Gamma$ since we assumed that Γ acts freely on X . The projections $p_n: X_n \rightarrow X_n/\Gamma = Y_n$ and $p: X \rightarrow X/\Gamma = Y$ are covering maps, i.e. fiber bundles with discrete fibers. Applying the long exact homotopy sequence of a fibration and using that X is assumed to be contractible, we obtain that Y is aspherical, i.e. all higher homotopy groups of Y vanish. Furthermore, we have (see e.g. [44, Theorem 4.6])

$$\pi_k(Y_{n+1}, Y_n) \cong \pi_k(X_{n+1}, X_n)$$

Consequently, the connectivity of the pairs (Y_{n+1}, Y_n) goes to infinity as well. Spelled out, this means

$$\forall m \exists n \forall k \geq n (Y_{k+1}, Y_k) \text{ is } m\text{-connected}$$

Note that for a triple of spaces $B \subset A \subset Z$, if (A, B) and (Z, A) are k -connected, then also (Z, B) is k -connected. This follows from the long exact homotopy sequence of that triple. Furthermore, if $Z_1 \subset Z_2 \subset \dots$ is a nested sequence of spaces with colimit Z and each (Z_{i+1}, Z_i) is k -connected, then also (Z, Z_1) is k -connected. This follows from the previous remark and the fact that each map $K \rightarrow Z$ from a compact space K (e.g. $K = S^n$) factors through some Z_i . Applying this observation to our situation above, we obtain

$$\forall m \exists n \forall k \geq n (Y, Y_k) \text{ is } m\text{-connected}$$

and this means

$$\forall m \exists n \forall k \geq n \forall i < m \pi_i(Y, Y_k) = 0$$

Using the long exact homotopy sequence of the pair (Y, Y_k) , this is equivalent to

$$\forall m \exists n \forall k \geq n (\forall i < m \pi_i(Y_k, y) \cong \pi_i(Y, y) \text{ and } \pi_m(Y_k, y) \twoheadrightarrow \pi_m(Y, y))$$

For some fixed m , we now know that there is a k large enough such that

$$\begin{aligned} \pi_1(Y_k, y) &\cong \pi_1(Y, y) \cong \Gamma \\ \pi_2(Y_k, y) &\cong \pi_2(Y, y) = 0 \\ &\vdots \\ \pi_m(Y_k, y) &\cong \pi_m(Y, y) = 0 \end{aligned}$$

We now can take that Y_k (which has only finitely many cells in each dimension by assumption) and attach cells in dimension $m+2$ and higher to kill all the homotopy groups above dimension m . Call this space Y_k^+ . The isomorphisms above then tell us that Y_k^+ is a classifying space for Γ with compact $(m+1)$ -skeleton. Thus, Y_k^+ is a witness that Γ is of type F_{m+1} . Since m was arbitrary, it follows that Γ is of type F_∞ (see e.g. [25, Proposition 7.2.2]). \square

2. Three types of arc complexes

Let $d \in \{1, 2, 3\}$ and C be a set of colors. Let $X = (c_1, \dots, c_n)$ be a word in the colors of C . An archetype consists of a unique identifier together with a word in the colors of C of length at least 2. Let A be a set of archetypes. To this data, we will associate a simplicial complex $\mathcal{AC}_d(C, A; X)$.

Consider the points $1, \dots, n \in \mathbb{R}$ and embed them into \mathbb{R}^d via the first component embedding $\mathbb{R} \rightarrow \mathbb{R}^d$. Color these points with the colors in the word X (i.e. the point i is colored with the color c_i) and call them nodes. Denote the set of nodes by N . A link is the image of an embedding $\gamma: [0, 1] \rightarrow \mathbb{R}^d$ such that $\gamma(0)$ and $\gamma(1)$ are nodes. Note that a link may contain more than two nodes. Two links connecting the same set of nodes are equivalent if there is an isotopy of $\mathbb{R}^d \setminus N$ which takes one link to the other. An equivalence class of links is called an arc. Note that in the case $d = 1$, arcs and links are the same since each arc is represented by a unique link. We say that two arcs are disjoint if there are representing links which are disjoint. In the cases $d = 2, 3$, we can choose representing links of a collection of arcs such that the links are in minimal position:

LEMMA 3.2. *Assume $d = 2$ or $d = 3$. Let $\mathbf{a}_0, \dots, \mathbf{a}_k$ be arcs with $\mathbf{a}_i \neq \mathbf{a}_j$ for each $i \neq j$. Then there are representing links $\alpha_0, \dots, \alpha_k$ such that $|\alpha_i \cap \alpha_j|$ is finite and minimal for each $i \neq j$.*

PROOF. In the case $d = 3$, we can always find representing links which only intersect at nodes, if at all. The case $d = 2$ is a bit more complicated. We use the ideas from [10, Lemma 3.2]: Consider the nodes as punctures in the plane \mathbb{R}^2 . Then we can find a hyperbolic metric on that punctured plane. Now define α_i to be the geodesic within the class \mathbf{a}_i . \square

A link connecting a set of nodes M is called admissible if there is an isotopy of $\mathbb{R}^d \setminus M$ taking the link into the image of the first component embedding $\mathbb{R} \rightarrow \mathbb{R}^d$. In the case $d = 1$, this is vacuous. In the case $d = 2$, this implies in particular that, when travelling the link starting from the lowest node, the nodes are visited in ascending order. This last property is even equivalent to being admissible in the case $d = 3$. An arc is called admissible if one and consequently all of its links are admissible. Now label an admissible arc with the identifier of an archetype in A . We require that the word formed by the colors of the connected nodes (in ascending order) equals the color word of the archetype. Call such a labelled admissible arc an archetypal arc.

The vertices of $\mathcal{AC}_d(C, A; X)$ are the archetypal arcs. Two vertices are joined by an edge if the corresponding arcs are disjoint. This determines the complex as a flag complex. A k -simplex is therefore a set of $k+1$ pairwise disjoint archetypal arcs. We call this an archetypal arc system. It follows from Lemma 3.2 above that if $\{\mathbf{a}_0, \dots, \mathbf{a}_k\}$ is an archetypal arc system, then we always find representing links α_i of \mathbf{a}_i such that the α_i are pairwise disjoint. The following are examples of 2-simplices in the cases $d = 1, 2, 3$ (where we have omitted the labels on the arcs).



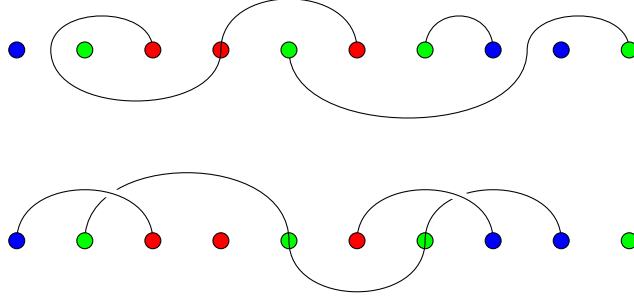

The following are *non-examples* of simplices in the case $d = 2$. In the first diagram, the two arcs are not disjoint and in the second diagram, the arc is not admissible. However, the second diagram would represent an admissible arc in the case $d = 3$.



DEFINITION 3.3. Let C be a set of colors and A be a set of archetypes. A word in the colors of C is called reduced if it admits no archetypal arc on it. The set of archetypes A is called tame if the length of all reduced words is bounded from above. The length of an archetype is the length of its color word. The set of archetypes A is of finite type if the length of all archetypes is bounded from above.

THEOREM 3.4. Let $d \in \{1, 2, 3\}$. Let C be a set of colors and A be a set of archetypes. Assume that A is tame and of finite type. Let m_r be the smallest natural number greater than the length of any reduced color word and m_a be the maximal length of archetypes in A . Define

$$\nu_\kappa(l) := \left\lfloor \frac{l - m_r}{\kappa} \right\rfloor - 1$$

Let X be a word in the colors of C and denote by lX the length of X . Then the complex $\mathcal{AC}_d(C, A; X)$ is $\nu_{\kappa_d}(lX)$ -connected where

$$\begin{aligned} \kappa_1 &:= 2m_a + m_r - 2 \\ \kappa_2 &:= 2m_a - 1 \\ \kappa_3 &:= 2m_a - 1 \end{aligned}$$

For the proof in the case $d = 2$ we have to pass to a slightly larger class of complexes: Instead of \mathbb{R}^2 we consider links and arcs in the punctured plane $S = \mathbb{R}^2 \setminus \{p_1, \dots, p_l\}$ with finitely many punctures $p_i \in \mathbb{R}^2$ disjoint from the nodes. Here, we define two links connecting the same set of nodes to be equivalent if they differ by an isotopy of $S \setminus N$ and a link connecting a set of nodes M to be admissible if there is an isotopy of $\mathbb{R}^2 \setminus M$ taking the link into the image of the first component embedding $\mathbb{R} \rightarrow \mathbb{R}^2$. Note that in the latter case, we require an isotopy of $\mathbb{R}^2 \setminus M$ and not of $S \setminus M$, i.e. we allow the links to be pulled over punctures. We denote the corresponding complex of archetypal arc systems again by $\mathcal{AC}_d(C, A; X)$, suppressing the additional data of punctures since, as we will see, the punctures do not affect the connectivity of the complexes. In other words, Theorem 3.4 is also valid for this larger class of complexes.

2.1. Proof of the connectivity theorem. The proof essentially consists of slightly modified ideas from [10, Subsection 3.3].

We induct over the length lX of X . The induction start is $lX \geq m_r$. This implies that X is not reduced and thus admits an archetypal arc on it. It follows that

$\mathcal{AC}_d(C, A; X)$ is non-empty, i.e. (-1) -connected. For the induction step, assume $lX \geq m_r + \kappa_d$. We look at the cases $d = 1, 2, 3$ separately, starting with the case $d = 2$ since it is the hardest one.

2.1.1. *The two-dimensional case.* Choose a vertex of $\mathcal{AC}_2 := \mathcal{AC}_2(C, A; X)$ represented by an archetypal arc \mathbf{b} . Let $v_1 < \dots < v_t$ be the nodes connected by \mathbf{b} . Let \mathcal{AC}_2^0 be the full subcomplex of \mathcal{AC}_2 spanned by the archetypal arcs which do not meet the nodes v_i .

We want to estimate the connectivity of the pair $(\mathcal{AC}_2, \mathcal{AC}_2^0)$ using the Morse method for simplicial complexes (see e.g. Section 10 in Chapter 1). Let \mathbf{a} be an archetypal arc. Define

$$s_i(\mathbf{a}) := \begin{cases} 1 & \text{if } \mathbf{a} \text{ meets } v_i \\ 0 & \text{else} \end{cases}$$

for each $i = 1, \dots, t$. Now set

$$h(\mathbf{a}) := (s_1(\mathbf{a}), \dots, s_t(\mathbf{a}))$$

Note that the right side is a sequence of t numbers in $\{0, 1\}$. Interpret these sequences as binary numbers read from left to right and order them accordingly. For example, 000 corresponds to 0, 100 corresponds to 1, 010 corresponds to 2, 110 corresponds to 3 and so on. Then h is a Morse function building up \mathcal{AC}_2 from \mathcal{AC}_2^0 since archetypal arcs with h -value equal to $(0, \dots, 0)$ are exactly the archetypal arcs in \mathcal{AC}_2^0 and two archetypal arcs with the same h -value different from $(0, \dots, 0)$ are not connected by an edge.

We want to inspect the descending links with respect to this Morse function h . Let \mathbf{a} be an archetypal arc with Morse height greater than $(0, \dots, 0)$. Find the greatest $\tau \in \{1, \dots, t\}$ such that $s_\tau(\mathbf{a}) = 1$. It is not hard to prove that $lk_\downarrow(\mathbf{a})$ is the full subcomplex of \mathcal{AC}_2 spanned by archetypal arcs disjoint from \mathbf{a} and not meeting any v_i with $i > \tau$. Let X' be the color word which is obtained from X by removing the colors corresponding to nodes which are contained in \mathbf{a} and to the nodes v_i with $i > \tau$. Then we see that $lk_\downarrow(\mathbf{a})$ is isomorphic to $\mathcal{AC}_2(C, A; X')$ with an additional puncture corresponding to \mathbf{a} and further additional punctures corresponding to the nodes v_i with $i > \tau$. By induction, it follows that $lk_\downarrow(\mathbf{a})$ is $\nu_{\kappa_2}(lX')$ -connected. Denote by $l\mathbf{a}$ the length of \mathbf{a} , i.e. the number of nodes it meets. Then we can estimate

$$\begin{aligned} lX' &= lX - l\mathbf{a} - (t - \tau) \\ &= lX - l\mathbf{a} - t + \tau \\ &\geq lX - m_a - t + \tau \\ &\geq lX - m_a - t + 1 \\ &\geq lX - 2m_a + 1 \end{aligned}$$

Thus, $lk_\downarrow(\mathbf{a})$ is $\nu_{\kappa_2}(lX - 2m_a + 1)$ -connected. Consequently, by the Morse method, the connectivity of the pair $(\mathcal{AC}_2, \mathcal{AC}_2^0)$ is

$$\nu_{\kappa_2}(lX - 2m_a + 1) + 1 = \nu_{\kappa_2}(lX)$$

because of $\kappa_2 = 2m_a - 1$.

The second step of the proof consists of showing that the inclusion $\iota: \mathcal{AC}_2^0 \rightarrow \mathcal{AC}_2$ induces the trivial map in π_m for $m \leq \nu_{\kappa_2}(lX)$. It then follows from the long exact homotopy sequence of the pair $(\mathcal{AC}_2, \mathcal{AC}_2^0)$ that \mathcal{AC}_2 is $\nu_{\kappa_2}(lX)$ -connected which completes the proof in the case $d = 2$.

Let $\varphi: S^m \rightarrow \mathcal{AC}_2^0$ be a map with $m \leq \nu_{\kappa_2}(lX)$. We have to show that $\psi := \varphi * \iota: S^m \rightarrow \mathcal{AC}_2$ is homotopic to a constant map. Think of S^m as the boundary of a $(m + 1)$ -simplex. By simplicial approximation [41, Theorem 3.4.8]

we can subdivide S^m and homotope φ to a simplicial map. So we will assume in the following that φ is simplicial. Next, we want to apply [10, Lemma 3.9] in order to subdivide S^m further and homotope ψ to a simplexwise injective map. This means that whenever vertices $v \neq w$ in S^m are joined by an edge, then $\psi(v) \neq \psi(w)$. To apply the lemma, we have to show that the link of every k -simplex σ in \mathcal{AC}_2 is $(m - 2k - 2)$ -connected. So let $\mathbf{a}_0, \dots, \mathbf{a}_k$ be pairwise disjoint archetypal arcs representing a k -simplex σ . The link of this simplex is the full subcomplex spanned by the archetypal arcs which are disjoint from every \mathbf{a}_i . Deleting every color corresponding to nodes which are contained in one of the \mathbf{a}_i from X , we obtain a color word X' and it is easy to see that the link of σ is isomorphic to $\mathcal{AC}_2(C, A; X')$ with one additional puncture for each \mathbf{a}_i . By induction, we obtain that $lk(\sigma)$ is $\nu_{\kappa_2}(lX')$ -connected. We have the estimate $lX' \geq lX - (k + 1)m_a$ and thus

$$\begin{aligned} \nu_{\kappa_2}(lX') &\geq \nu_{\kappa_2}(lX - (k + 1)m_a) \\ &= \left\lfloor \frac{lX - (k + 1)m_a - m_r}{2m_a - 1} \right\rfloor - 1 \\ &= \left\lfloor \frac{lX - m_r}{2m_a - 1} - \frac{(k + 1)m_a}{2m_a - 1} \right\rfloor - 1 \\ &\geq \left\lfloor \frac{lX - m_r}{2m_a - 1} - \frac{(2k + 2)(2m_a - 1)}{2m_a - 1} \right\rfloor - 1 \\ &= \nu_{\kappa_2}(lX) - (2k + 2) \\ &\geq m - 2k - 2 \end{aligned}$$

So the hypothesis of the lemma is satisfied and we will assume in the following that ψ is simplexwise injective.

We now want to show that ψ can be homotoped so that the image is contained in the star of \mathbf{b} . Since the star of a vertex is always contractible, this will finish the proof. We will homotope ψ by moving single vertices of S^m step by step, eventually landing in the star of \mathbf{b} . Consider the vertices $\mathbf{a}_1, \dots, \mathbf{a}_l$ of $\psi(S^m)$ which do not yet lie in the star of \mathbf{b} , i.e. which are not disjoint to \mathbf{b} . Choose representing links α_i of \mathbf{a}_i and β of \mathbf{b} such that the system of links $(\beta, \alpha_1, \dots, \alpha_l)$ is in minimal position as in Lemma 3.2. Note the little subtlety that archetypal arcs may have the same underlying arc but are different because they have different labels. In this case, homotope the corresponding links a little bit so that they intersect only at nodes. Note also that each α_i intersects β , but not at nodes since each \mathbf{a}_i comes from \mathcal{AC}_2^0 . Last but not least, we can assume that whenever p is an intersection point of β with one of the α_i , then there is at most one α_i meeting the point p .

Now look at the intersection point p of one of the α_i with β which is closest to v_1 along β . Write α for the link which intersects β at this point and \mathbf{a} for the corresponding arc.

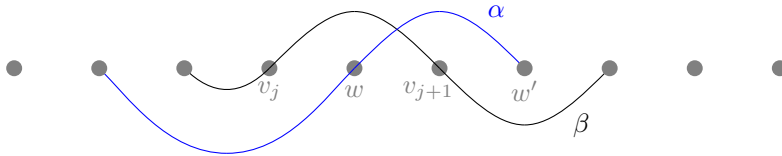

Choose a vertex x in S^m which maps to \mathbf{a} via ψ . Define another link α' as follows: Let j be such that the intersection point p lies on the segment of β connecting v_j with v_{j+1} . Denote by $w < w'$ the nodes such that p lies on the segment of α connecting w with w' . Now push this segment of α along β over the node v_j such that α and α' bound a disk whose interior does not contain any puncture or node other than v_j .

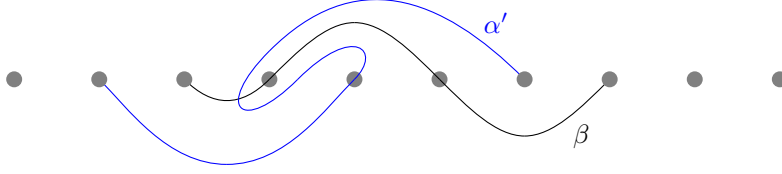

Note that α' is still admissible. Denote by \mathbf{a}' the archetypal arc with link α' and the same label as \mathbf{a} . Our goal is now to homotope ψ to a simplicial map ψ' such that $\psi'(x) = \mathbf{a}'$ and $\psi'(y) = \psi(y)$ for all other vertices y . Iterating this procedure often enough, we arrive at a map ψ^* homotopic to ψ such that $\psi^*(y) \in st(\mathbf{b})$ for each vertex y . For example, the next step would be to move x to the vertex α'' :

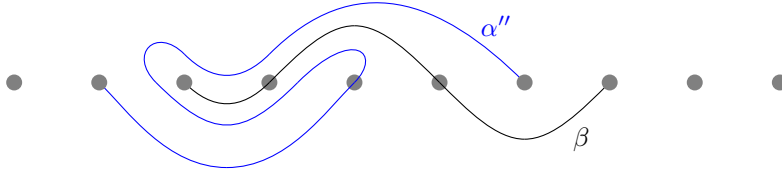

By simplexwise injectivity, no vertex of $lk(x)$ is mapped to \mathbf{a} . Furthermore, a vertex of \mathcal{AC}_2 in the image of ψ disjoint to \mathbf{a} must also be disjoint to \mathbf{a}' because we have chosen α such that no other α_i intersects β between p and v_1 . From these observations, it follows that

$$\psi(lk(x)) \subset lk(\mathbf{a}) \cap lk(\mathbf{a}')$$

This inclusion enables us to define a simplicial map $\psi': S^m \rightarrow \mathcal{AC}_2$ with $\psi'(x) = \mathbf{a}'$ and $\psi'(y) = \psi(y)$ for all other vertices y . Let X' be the color word obtained from X by removing all colors corresponding to nodes which are contained in \mathbf{a} or to the node v_j . Then $lk(\mathbf{a}) \cap lk(\mathbf{a}')$ is isomorphic to $\mathcal{AC}_2(C, A; X')$ with an additional puncture corresponding to the disk bounded by $\alpha \cup \alpha'$. Thus, by induction, it is $\nu_{\kappa_2}(lX')$ -connected. We have the estimate $lX' \geq lX - m_a - 1$ and therefore

$$\begin{aligned} \nu_{\kappa_2}(lX') &\geq \nu_{\kappa_2}(lX - m_a - 1) \\ &= \left\lfloor \frac{lX - m_a - 1 - m_r}{2m_a - 1} \right\rfloor - 1 \\ &= \left\lfloor \frac{lX - m_r}{2m_a - 1} - \frac{m_a + 1}{2m_a - 1} \right\rfloor - 1 \\ &\geq \left\lfloor \frac{lX - m_r}{2m_a - 1} - \frac{2m_a - 1}{2m_a - 1} \right\rfloor - 1 \\ &= \nu_{\kappa_2}(lX) - 1 \\ &\geq m - 1 \end{aligned}$$

Since $lk(x)$ is an $(m - 1)$ -sphere, this connectivity bound for $lk(\mathbf{a}) \cap lk(\mathbf{a}')$ implies that the map $\psi|_{lk(x)}: lk(x) \rightarrow lk(\mathbf{a}) \cap lk(\mathbf{a}')$ can be extended to the star $st(x)$ of x which is an m -disk. So we obtain a map $\vartheta: st(x) \rightarrow lk(\mathbf{a}) \cap lk(\mathbf{a}')$ coinciding with ψ on the boundary $lk(x)$. We can now homotope $\psi|_{st(x)} \text{ rel } lk(x)$ to ϑ within $st(\mathbf{a})$ and further to ψ' within $st(\mathbf{a}')$. This finishes the proof of the theorem in the case $d = 2$.

2.1.2. The three-dimensional case. Choose an archetypal arc \mathbf{b} connecting the nodes $v_1 < \dots < v_i$ and let \mathcal{AC}_3^0 be the full subcomplex of $\mathcal{AC}_3 := \mathcal{AC}_3(C, A; X)$ spanned by the archetypal arcs which do not meet the nodes v_i .

With a very similar Morse argument as in the case $d = 2$ above, we can show that the pair $(\mathcal{AC}_3, \mathcal{AC}_3^0)$ is $\nu_{\kappa_3}(lX)$ -connected.

Again, the second step consists of showing that the inclusion $\iota: \mathcal{AC}_3^0 \rightarrow \mathcal{AC}_3$ induces the trivial map in π_m for $m \leq \nu_{\kappa_3}(lX)$. This is much easier in the case $d = 3$: Let $\varphi: S^m \rightarrow \mathcal{AC}_3^0$ be a map and assume without loss of generality that it is simplicial. But then the map $\psi := \varphi * \iota: S^m \rightarrow \mathcal{AC}_3$ already lies in the star $st(\mathfrak{b})$ of \mathfrak{b} since an archetypal arc not meeting any of the nodes v_i is already disjoint to \mathfrak{b} . Consequently, ψ can be homotoped to a constant map and this concludes the proof in the case $d = 3$.

2.1.3. The one-dimensional case. Choose an archetypal arc \mathfrak{b} connecting the nodes $v_1 < \dots < v_t$ such that the color word formed by the first r nodes $w < v_1$ is reduced. Let \mathcal{AC}_1^0 be the full subcomplex of $\mathcal{AC}_1 := \mathcal{AC}_1(C, A; X)$ spanned by the archetypal arcs which do not meet the nodes v_i . This condition is equivalent to not meeting any nodes $w \leq v_t$. These are simply the first s nodes $w_1 < \dots < w_s$ where $s = r + t$. In other words, w_i is the point $i \in \mathbb{R}$ colored with the color c_i from X .

For each archetypal arc \mathfrak{a} not contained in \mathcal{AC}_1^0 there exists a unique $1 \leq q \leq s$ such that \mathfrak{a} meets w_q but not w_1, \dots, w_{q-1} . In this case, define $h(\mathfrak{a}) = -q$. Then h is a Morse function building up \mathcal{AC}_1 from \mathcal{AC}_1^0 . So let \mathfrak{a} be such an archetypal arc. Let X' be the color word obtained from X by removing all colors corresponding to the nodes contained in \mathfrak{a} and to the nodes w_1, \dots, w_{q-1} . Then the descending link $lk_{\downarrow}(\mathfrak{a})$ is isomorphic to $\mathcal{AC}_1(C, A; X')$ and by induction, it is $\nu_{\kappa_1}(lX')$ -connected. We can estimate

$$\begin{aligned} lX' &= lX - l\mathfrak{a} - (q - 1) \\ &= lX - l\mathfrak{a} - q + 1 \\ &\geq lX - m_a - q + 1 \\ &\geq lX - m_a - (m_a + m_r - 1) + 1 \\ &= lX - 2m_a - m_r + 2 \end{aligned}$$

Thus, $lk_{\downarrow}(\mathfrak{a})$ is $\nu_{\kappa_1}(lX - 2m_a - m_r + 2)$ -connected. Consequently, by the Morse method, the connectivity of the pair $(\mathcal{AC}_1, \mathcal{AC}_1^0)$ is

$$\nu_{\kappa_1}(lX - 2m_a - m_r + 2) + 1 = \nu_{\kappa_1}(lX)$$

because of $\kappa_1 = 2m_a + m_r - 2$.

Just as in the case $d = 3$, one can show that the inclusion $\iota: \mathcal{AC}_1^0 \rightarrow \mathcal{AC}_1$ induces the trivial map in π_m for $m \leq \nu_{\kappa_1}(lX)$. This proves the theorem in the case $d = 1$.

REMARK 3.5. The method used in the proof of [16, Proposition 4.11] yields the better connectivity $\nu_{\kappa}(lX)$ with $\kappa = m_a + m_r - 1$ for the case $d = 1$.

3. Statement of the main theorem

We say that a group G is of type F_{∞}^+ if G and all of its subgroups are of type F_{∞} . For example, all finite groups and \mathbb{Z} are of type F_{∞}^+ . We then say that a groupoid is of type F_{∞}^+ (or F_{∞}) if its automorphism groups are of type F_{∞}^+ (or F_{∞}).

DEFINITION 3.6. Let \mathcal{O} be a (symmetric/braided) operad with transformations. An object X in $\mathcal{S}(\mathcal{O})$ is called reduced if no non-transformation arrow in $\mathcal{S}(\mathcal{O})$ has X as its domain. We call \mathcal{O} color-tame if the degree of all reduced objects is bounded from above.

Note that if \mathcal{O} is monochromatic and there exists at least one higher degree operation, then it is automatically color-tame.

THEOREM 3.7. *Let \mathcal{O} be a planar or symmetric or braided operad with transformations. Assume that \mathcal{O} has only finitely many colors and is color-tame. Assume further that at least one of the following holds:*

- A) \mathcal{O} is free as a (symmetric/braided) operad with transformations, is finitely generated and $\mathcal{I}(\mathcal{O})$ is a groupoid of type F_∞ .
- B) \mathcal{O} satisfies the cancellative calculus of fractions, is of finite type and $\mathcal{I}(\mathcal{O})$ is a groupoid of type F_∞^+ .

Then for every object X in $\mathcal{S}(\mathcal{O})$ the operad group $\pi_1(\mathcal{O}, X)$ is of type F_∞ .

QUESTION 3.8. Can the requirement color-tameness be dropped?

The next four sections will be devoted to the proof of this theorem. By abuse of notation, the connected component of $\mathcal{S} := \mathcal{S}(\mathcal{O})$ containing the object X will again be denoted by \mathcal{S} . Furthermore, we abbreviate $\Gamma := \pi_1(\mathcal{O}, X)$.

4. A contractible complex

As usual, the strategy to proof Theorem 3.7 is to apply Brown's criterion 3.1 to a suitable contractible complex on which the group in question acts. In our case, this will be the following category: Consider the universal covering category $\mathcal{U} := \mathcal{U}_X(\mathcal{S})$ of \mathcal{S} based at X . In Lemmas 3.9 and 3.12 below we will show that the subgroupoid \mathcal{G} of \mathcal{U} consisting of the transformations in \mathcal{S} (lifted to \mathcal{U}) is a disjoint union of contractible groupoids. We therefore can apply Section 6 of Chapter 1 and consider the quotient category \mathcal{U}/\mathcal{G} . Recall that Γ acts on \mathcal{U} which is encoded in a functor $\Gamma \rightarrow \mathbf{CAT}$ sending the unique object of Γ to \mathcal{U} . One can easily see that this functor induces a functor $\Gamma \rightarrow \mathbf{CAT}$ sending the unique object to \mathcal{U}/\mathcal{G} . In other words, Γ also acts on \mathcal{U}/\mathcal{G} . More concretely, an arrow $f: X \rightarrow X$ in Γ acts on an object $[g: X \rightarrow Y]$ of \mathcal{U}/\mathcal{G} from the right via $[g] \cdot f := [f^{-1}g]$. Moreover, we will see in Propositions 3.10 and 3.13 below that \mathcal{U} and therefore \mathcal{U}/\mathcal{G} is contractible. So the first condition in Brown's criterion will be satisfied.

To prove the above claims, we start with case B) of Theorem 3.7. Let \mathcal{O} be a (symmetric/braided) operad with transformations. We say that the degree 1 operations are *right free* if, whenever θ is an operation and γ a degree 1 operation with $\theta * \gamma = \theta$, then $\gamma = \text{id}$. Note that this property is automatically satisfied if \mathcal{O} is left cancellative.

LEMMA 3.9. *Let \mathcal{O} be a (symmetric/braided) operad with transformations. If \mathcal{O} satisfies the calculus of fractions and the degree 1 operations are right free, then the transformations in the universal covering $\mathcal{U}_X(\mathcal{S})$ of $\mathcal{S} := \mathcal{S}(\mathcal{O})$ based at any object X form a disjoint union of contractible groupoids.*

PROOF. We have to show that each transformation in \mathcal{U} with the same domain and codomain is trivial. In other words, we have to show that each null-homotopic transformation $\gamma: Y \rightarrow Y$ in \mathcal{S} is trivial.

So assume that $\gamma: Y \rightarrow Y$ is such a null-homotopic transformation in \mathcal{S} . Since \mathcal{S} satisfies the calculus of fractions, this means that there is an arrow α with $\alpha\gamma = \alpha$. By precomposing with a suitable colored permutation or colored braiding, we can assume that α is just a sequence of operations. By pulling the operations of α through the permutation resp. braiding part of γ , one can see that the latter must be trivial. Then, using right freeness of degree 1 operations, one deduces that also the degree 1 operations in γ must be trivial. \square

PROPOSITION 3.10. *If \mathcal{O} is a (symmetric/braided) operad satisfying the calculus of fractions, then the universal covering $\mathcal{U}_X(\mathcal{S})$ of $\mathcal{S} := \mathcal{S}(\mathcal{O})$ based at any object X is contractible.*

PROOF. This follows from Remark 1.15. \square

REMARK 3.11. Lemma 3.9 and Proposition 3.10 are more general than we really need. Since we require in Theorem 3.7 B) that \mathcal{O} satisfies the *cancellative* calculus of fractions, it follows from the proof of Proposition 1.14 that \mathcal{U} is a contractible poset. Remark 1.6 and Proposition 1.8 then yield that \mathcal{U}/\mathcal{G} is a contractible poset as well.

Now we turn to case A) of Theorem 3.7. So let \mathcal{O} be a free (symmetric/braided) operad with transformations which is generated by a set C of colors, a set S of higher degree operations and a groupoid \mathcal{I} of degree 1 operations with object set C . It is very helpful to view arrows in $\pi_1(\mathcal{S})$, i.e. paths in \mathcal{S} modulo homotopy, as string diagrams (see Section 8 in Chapter 1): Every arrow in $\pi_1(\mathcal{S})$ can be represented by a string diagram with higher degree operations in S or degree 1 operations in \mathcal{I} as transistors and with strings labelled with the colors in C . The transistors may point in any direction (left or right). String diagrams where the transistors only point to the right (from the domain to the codomain) represent arrows in \mathcal{S} . Note that we have the following homotopy

$$\bullet \xrightarrow{\gamma} \bullet \sim \bullet \xleftarrow{\gamma^{-1}} \bullet \xrightarrow{\gamma^{-1}} \bullet \xrightarrow{\gamma} \bullet \sim \bullet \xleftarrow{\gamma^{-1}} \bullet \xrightarrow{\gamma^{-1}\gamma} \bullet \sim \bullet \xleftarrow{\gamma^{-1}} \bullet$$

for isomorphisms γ in categories. Consequently, we can assume that all degree 1 operations point to the right and that no degree 1 operation in the diagram is connected to another degree 1 operation.

For example, let $S = \{\theta, \psi\}$ with θ, ψ operations of degree 2, $|C| = 1$ and $\mathcal{I} = \mathbb{Z}/2\mathbb{Z}$ the group with 2 elements. Then a string diagram representing an arrow $1 \rightarrow 5$ in $\pi_1(\mathcal{S})$ could look like the following one:

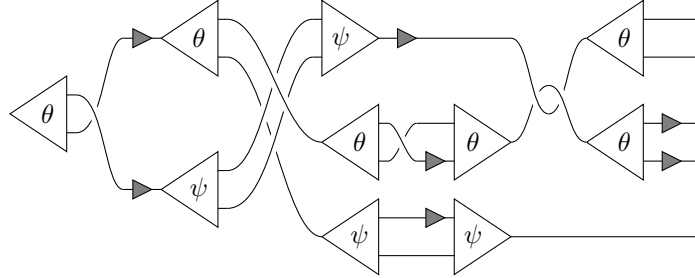

We can delete all the dipoles formed by higher degree operations in S from the diagram and afterwards combine all the degree 1 operations in \mathcal{I} which then are connected by strings:

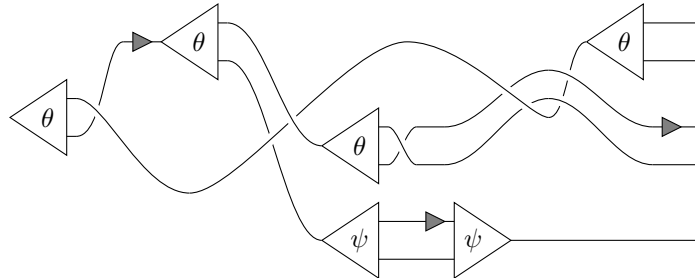

Repeating this procedure, we end up with a unique (up to isotopy in the appropriate dimension) string diagram which contains no dipoles, where all degree 1 operations point to the right and where no two degree 1 operations are connected by strings. We call this the reduced string diagram representing the given arrow in $\pi_1(\mathcal{S})$. The above diagram already is in reduced form.

An arrow in $\pi_1(\mathcal{S})$ is trivial if and only if its reduced string diagram is the trivial one (i.e. contains no operations and no non-trivial permutations or braidings). Equivalently, two arrows in $\pi_1(\mathcal{S})$ are equal if and only if their reduced string diagrams are equal (up to isotopy in the appropriate dimension). In particular, two arrows in \mathcal{S} are homotopic if and only if they are equal. This implies the following:

LEMMA 3.12. *Let \mathcal{O} be a free (symmetric/braided) operad with transformations. Then the universal covering $\mathcal{U}_X(\mathcal{S})$ of $\mathcal{S} := \mathcal{S}(\mathcal{O})$ based at any object X is a poset. In particular, the transformations in \mathcal{U} form a disjoint union of contractible groupoids.*

A similar result as in the next proposition (with different terminology) can be found in [15, Theorem 4.4] or [16, Theorem 3.10].

PROPOSITION 3.13. *Let \mathcal{O} be a free (symmetric/braided) operad with transformations. Then the universal covering $\mathcal{U}_X(\mathcal{S})$ of $\mathcal{S} := \mathcal{S}(\mathcal{O})$ based at any object X is contractible.*

PROOF. Denote by \mathcal{G} the subgroupoid of $\mathcal{U} := \mathcal{U}_X(\mathcal{S})$ consisting of all the transformations. Then, as pointed out above (Lemma 3.12), we can form the quotient \mathcal{U}/\mathcal{G} which is homotopy equivalent to \mathcal{U} . We will show that \mathcal{U}/\mathcal{G} is contractible to prove the proposition.

We do so by introducing a Morse function on \mathcal{U}/\mathcal{G} and apply the Morse method for categories. Let S be the set of higher degree operations which generates \mathcal{O} freely (together with a groupoid of degree 1 operations). An object in \mathcal{U} is a path from X to some other object modulo homotopy. As explained above, such an object is represented by a unique reduced string diagram having operations in S or operations in $\mathcal{I}(\mathcal{O})$ as transistors. An object in \mathcal{U}/\mathcal{G} is an object in \mathcal{U} modulo transformations. They are thus also represented by reduced string diagrams but two such diagrams are considered to be equal if they differ by a permutation or a braiding and by degree 1 operations in $\mathcal{I}(\mathcal{O})$ on the right. For a reduced string diagram D , denote by $\#_l(D)$ the number of higher degree operations in S pointing to the left and by $\#_r(D)$ the number of higher degree operations pointing to the right. These numbers are of course invariant under attaching transformations on the right, so we get well-defined numbers $\#_l(A)$ and $\#_r(A)$ for an object A in \mathcal{U}/\mathcal{G} . Now define

$$f(A) := (\#_l(A), \#_r(A))$$

on the objects of \mathcal{U}/\mathcal{G} and order the pairs on the the right lexicographically. Note that we have $\text{Hom}_{\mathcal{U}/\mathcal{G}}(A, A) = \{\text{id}_A\}$ for each object A and that no two objects with the same f -value are connected by an arrow. Thus, we can indeed apply the Morse method for categories with f as a Morse function. For example, the following reduced string diagram

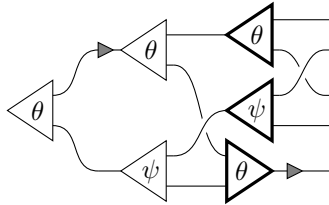

has Morse height $(5, 1)$. There is exactly one object with Morse height $(0, 0)$. Thus, we are building up \mathcal{U}/\mathcal{G} from a point. If we prove that each descending link $lk_{\downarrow}(A)$ is contractible, it follows that \mathcal{U}/\mathcal{G} is contractible.

So let A be an object in \mathcal{U}/\mathcal{G} represented by a reduced diagram as above. Assume $f(A) > (0, 0)$, so there must be at least one operation of S in A . We call such a higher degree operation in A exposed if there is no other higher degree

operation connected to that operation on the right. For example, the thick bordered operations in the above diagram are the exposed operations. Assume that there is at least one exposed operation pointing to the left (in the above diagram we have two). In this case, we will show that $\underline{lk}_\downarrow(A)$ is contractible. In case there are only right pointing exposed operations, we observe that $\overline{lk}_\downarrow(A)$ is contractible using similar arguments. Since A is an object in the quotient \mathcal{U}/\mathcal{G} , we can assume that there are no permutations or braidings and no degree 1 operations acting on the exposed operations from the right:

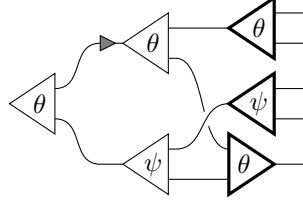

Fix such a representative of A and denote by Y the codomain of that representative. Arrows $A \rightarrow B$ in \mathcal{U}/\mathcal{G} are in one to one correspondence with arrows $Y \rightarrow Z$ in \mathcal{S} modulo transformations acting from the right (Remark 1.7). We will represent these as reduced string diagrams with transistors in \mathcal{S} or $\mathcal{I}(\mathcal{O})$ which all point to the right.

We now want to show that $\underline{lk}_\downarrow(A)$ is homotopy equivalent to a $(k-1)$ -simplex where k is the number of left pointing exposed operations in A . First consider the full subcategory \mathcal{Z} in $\underline{lk}_\downarrow(A)$ spanned by the classes $[\beta]$ modulo right transformations where $\beta: Y \rightarrow Z$ is a tensor product of identities and higher degree operations in \mathcal{S} which all form dipoles with the left pointing exposed operations.

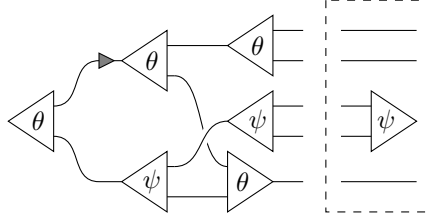

This subposet apparently realizes a $(k-1)$ -simplex with top face represented by the class $[\beta_0]$ where β_0 contains all the left pointing exposed operations.

The proof is finished by showing that the inclusion $\mathcal{Z} \rightarrow \underline{lk}_\downarrow(A)$ is a homotopy equivalence using Quillen's Theorem A. An object in $\underline{lk}_\downarrow(A)$ is an arrow $\beta: Y \rightarrow Z$ modulo right transformations such that at least one left pointing exposed operation forms a dipole with one of the operations in the string diagram representation of β . Let $\gamma: Y \rightarrow Z'$ be the arrow which is obtained from β by removing all operations in the string diagram representation of β which do not form dipoles with the left pointing exposed operations.

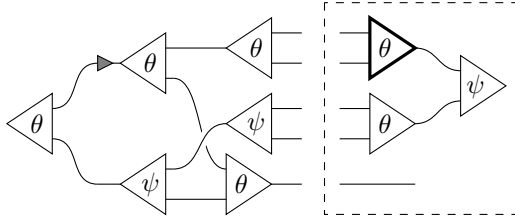

In $\underline{lk}_\downarrow(A)$, there is exactly one arrow $[\gamma] \rightarrow [\beta]$, adding the removed operations, which represents an object in the comma category $\mathcal{Z} \downarrow [\beta]$. This object is the terminal

object in $\mathcal{Z}\downarrow[\beta]$. Consequently, $\mathcal{Z}\downarrow[\beta]$ is contractible. It follows from Quillen's Theorem A that the inclusion $\mathcal{Z} \rightarrow \mathit{lk}_1(A)$ is a homotopy equivalence. \square

To summarize the results of this section, we note that under the assumptions of the main theorem, \mathcal{U} and therefore also \mathcal{U}/\mathcal{G} is a contractible poset.

5. Isotropy groups

We continue to verify the conditions in Brown's criterion for the action of Γ on \mathcal{U}/\mathcal{G} . In this section, we prove that \mathcal{U}/\mathcal{G} is indeed a Γ -CW-complex by showing that group elements fixing a cell already fix it pointwise. Furthermore, we show that cell stabilizers are of type F_∞ . In the following, we abbreviate $\mathcal{T} := \mathcal{T}(\mathcal{O})$ and $\mathcal{I} := \mathcal{I}(\mathcal{O})$.

LEMMA 3.14. *The groupoid \mathcal{T} formed by the transformations in \mathcal{S} is of type F_∞ , i.e. all the components of \mathcal{T} are equivalent to groups of type F_∞ .*

PROOF. By assumption, the groupoid \mathcal{I} formed by the degree 1 operations is of type F_∞ . The groupoid \mathcal{T} is $\mathcal{M}\text{on}(\mathcal{I})$ in the planar case, $\mathfrak{S}\eta\text{m}(\mathcal{I})$ in the symmetric case and $\mathfrak{B}\text{raid}(\mathcal{I})$ in the braided case (see Section 8 in Chapter 1 for the definitions of these categories).

Choose a color in each component of \mathcal{I} . Let Y be an object in \mathcal{T} . We have to show that $\text{Aut}_{\mathcal{T}}(Y)$ is of type F_∞ . We can assume without loss of generality that Y decomposes as a tensor product of chosen colors: $Y = c_1 \otimes \dots \otimes c_k$. In the planar case we have

$$\text{Aut}_{\mathcal{M}\text{on}(\mathcal{I})}(Y) = \text{Aut}_{\mathcal{I}}(c_1) \times \dots \times \text{Aut}_{\mathcal{I}}(c_k)$$

and the claim follows because the $\text{Aut}_{\mathcal{I}}(c_i)$ are of type F_∞ . For the symmetric and braided case, first assume that all the colors c_i are equal to one chosen color c . In the symmetric case, we then have

$$\text{Aut}_{\mathfrak{S}\eta\text{m}(\mathcal{I})}(Y) = S_k \ltimes \text{Aut}_{\mathcal{I}}(c)^k$$

where S_k , the symmetric group on k strands, acts by permutation of the factors. More precisely, we have the group homomorphism

$$\varphi: S_k \rightarrow \text{Aut}(G^k) \quad \sigma \mapsto [(g_1, \dots, g_k) \mapsto (g_{1 \triangleright \sigma^{-1}}, \dots, g_{k \triangleright \sigma^{-1}})]$$

which gives a right action of S_k on G^k by the definition $g \cdot \sigma = g \triangleright (\sigma \triangleright \varphi)$. The multiplication in the semidirect product $S_k \ltimes G^k$ is then given by

$$(\sigma, g) * (\sigma', g') := (\sigma * \sigma', (g \cdot \sigma') * g')$$

Since S_k is a finite group, it is also of type F_∞ . Since semidirect products of type F_∞ groups are of type F_∞ [25, Exercise 1 on page 176 and Proposition 7.2.2], it follows that $\text{Aut}_{\mathfrak{S}\eta\text{m}(\mathcal{I})}(Y)$ is of type F_∞ . In the braided case we have

$$\text{Aut}_{\mathfrak{B}\text{raid}(\mathcal{I})}(Y) = B_k \ltimes \text{Aut}_{\mathcal{I}}(c)^k$$

where B_k , the braid group on k strands, acts via permutation of the factors through the projection $B_k \rightarrow S_k$. The braid groups B_k are of type F_∞ [42, Theorem A]. As above, it follows that $\text{Aut}_{\mathfrak{B}\text{raid}(\mathcal{I})}(Y)$ is of type F_∞ .

Remains to handle the case where not all the colors c_i lie in the same component of \mathcal{I} . Denote by B'_k the finite index subgroup of B_k consisting of the elements σ with the property $c_{i \triangleright \sigma} = c_i$. Since different c_i are not connected by an isomorphism in \mathcal{I} , we now have

$$\text{Aut}_{\mathfrak{B}\text{raid}(\mathcal{I})}(Y) = B'_k \ltimes (\text{Aut}_{\mathcal{I}}(c_1) \times \dots \times \text{Aut}_{\mathcal{I}}(c_k))$$

where B'_k still acts by permuting the factors. This action is well-defined due to the definition of B'_k . Recall that a group is of type F_∞ if and only if a finite

index subgroup is of type F_∞ [25, Corollary 7.2.4]. It follows that B'_k and thus $\text{Aut}_{\mathfrak{B}\text{-raid}(\mathcal{I})}(Y)$ is of type F_∞ . The symmetric case can be treated similarly. \square

LEMMA 3.15. *Let \mathcal{P} be an object in \mathcal{U}/\mathcal{G} . Then the stabilizer subgroup $\text{Stab}_\Gamma(\mathcal{P})$ is of type F_∞ .*

PROOF. Fix an arrow $p: X \rightarrow Y$ in $\pi_1(\mathcal{S})$ which represents the object \mathcal{P} in \mathcal{U}/\mathcal{G} , i.e. $[p] = \mathcal{P}$. Let $\gamma \in \Gamma$ fix the point \mathcal{P} . This means $[\gamma^{-1}p] = [p] \cdot \gamma = [p]$. It follows that there is some transformation $t: Y \rightarrow Y$ such that $\gamma^{-1}p = pt$. This is equivalent to $p^{-1}\gamma p = t^{-1}$ which implies that $p^{-1}\gamma p$ is an element in $\text{Aut}_\mathcal{T}(Y)$. Conversely, for τ a transformation in $\text{Aut}_\mathcal{T}(Y)$, the element $p\tau p^{-1}$ is contained in $\text{Stab}_\Gamma(\mathcal{P})$. Thus, the map

$$\text{Stab}_\Gamma(\mathcal{P}) \rightarrow \text{Aut}_\mathcal{T}(Y) \quad \gamma \mapsto p^{-1}\gamma p$$

is an isomorphism with inverse given by $\tau \mapsto p\tau p^{-1}$. Since $\text{Aut}_\mathcal{T}(Y)$ is of type F_∞ by the previous lemma, the claim follows. Note that this isomorphism depends on the choice of p . However, two such choices differ by a transformation τ and the two corresponding isomorphisms differ by conjugation with τ . \square

In the following, the degree of an object \mathcal{P} in \mathcal{U}/\mathcal{G} is the degree of the object Y when $p: X \rightarrow Y$ is an arrow in $\pi_1(\mathcal{S})$ representing \mathcal{P} .

LEMMA 3.16. *Consider a cell σ in the geometric realization of \mathcal{U}/\mathcal{G} and $\gamma \in \Gamma$. Then the following are equivalent:*

- *The element γ fixes σ set-wise.*
- *The element γ fixes σ point-wise.*
- *The element γ fixes all the vertices of σ .*

In particular, \mathcal{U}/\mathcal{G} is indeed a Γ -CW-complex and the stabilizer subgroup of a cell σ is the subgroup which fixes all the vertices of σ .

PROOF. A non-degenerate cell σ in the geometric realization of \mathcal{U}/\mathcal{G} is a sequence of composable, non-trivial arrows in \mathcal{U}/\mathcal{G}

$$\mathcal{P}_0 \xrightarrow{\epsilon_0} \mathcal{P}_1 \xrightarrow{\epsilon_1} \dots \xrightarrow{\epsilon_{k-1}} \mathcal{P}_k$$

Note that the degree of the objects \mathcal{P}_i decreases strictly because the arrows are assumed to be non-trivial (i.e. are not represented by transformations). Let $\gamma \in \Gamma$ be an element which fixes σ set-wise. Assume $\gamma \in \Gamma$ permutes the vertices \mathcal{P}_i in this cell non-trivially. Then there must be a j such that $\mathcal{P}_j \cdot \gamma = \mathcal{P}_{j'}$ and $\mathcal{P}_{j-1} \cdot \gamma = \mathcal{P}_{j''}$ with $j' < j''$. The arrow $\epsilon_{j-1} \cdot \gamma: \mathcal{P}_{j''} \rightarrow \mathcal{P}_{j'}$ is non-trivial which implies $\deg(\mathcal{P}_{j''}) > \deg(\mathcal{P}_{j'})$, a contradiction. Thus, each vertex \mathcal{P}_i is fixed by γ . We then obtain $\epsilon_i \cdot \gamma = \epsilon_i$ for each i since \mathcal{U}/\mathcal{G} is a poset. This proves the lemma. \square

We say that two operations θ_1 and θ_2 are *two-sided* transformation equivalent if there are transformations α, γ such that $\theta_2 = \alpha * \theta_1 * \gamma$.

PROPOSITION 3.17. *The stabilizer subgroups of cells are of type F_∞ .*

PROOF. In the following, we restrict ourselves to the braided case. The planar and symmetric cases are similar and simpler.

We first choose a color in each connected component of \mathcal{I} . Next, we choose an operation in each two-sided transformation class such that the output of the chosen operation is a chosen color.

Consider a cell as in the proof of Lemma 3.16. Let $p_k: X \rightarrow Y_k$ be a representing path of \mathcal{P}_k such that $Y_k = c_1 \otimes \dots \otimes c_l$ is a tensor product of chosen colors. In the proofs of Lemmas 3.14 and 3.15, we have seen that p_k induces an isomorphism

$$\varphi: \text{Stab}_\Gamma(\mathcal{P}_k) \rightarrow B'_l \times (\text{Aut}_\mathcal{I}(c_1) \times \dots \times \text{Aut}_\mathcal{I}(c_l))$$

Choose some $\mathcal{P}_i =: \mathcal{P}$ different from \mathcal{P}_k and observe the arrow $\epsilon: \mathcal{P} \rightarrow \mathcal{P}_k$ which is the composition of the ϵ_j in between. Choose a representing path $p: X \rightarrow Y$ of \mathcal{P} . Then there is exactly one arrow $e: Y \rightarrow Y_k$ representing ϵ . One can compose p and p_k with transformations η and λ such that $\lambda: Y_k \rightarrow Y_k$ is a tensor product of degree 1 operations $\lambda_i: c_i \rightarrow c_i$ and e is a tensor product of chosen operations. Write $p'_k = p_k \lambda$ for the new representative of \mathcal{P}_k . To p'_k corresponds another isomorphism

$$\varphi': \text{Stab}_\Gamma(\mathcal{P}_k) \rightarrow B'_l \times (\text{Aut}_{\mathcal{I}}(c_1) \times \dots \times \text{Aut}_{\mathcal{I}}(c_l))$$

which differs from φ by conjugation with λ . Denote the new representative $p\eta$ of \mathcal{P} again by p .

Now let $\gamma \in \text{Stab}_\Gamma(\mathcal{P}_k)$. Then γ fixes also \mathcal{P} , i.e. $\mathcal{P} \cdot \gamma = \mathcal{P}$, if and only if

$$\begin{aligned} [p'_k e^{-1}] &= [p] = [p] \cdot \gamma \\ &= [\gamma^{-1} p] \\ &= [\gamma^{-1} p'_k e^{-1}] \\ &= [p'_k p'_k{}^{-1} \gamma^{-1} p'_k e^{-1}] \\ &= [p'_k t_\gamma^{-1} e^{-1}] \end{aligned}$$

where we have set $t_\gamma := p'_k{}^{-1} \gamma p'_k$, an element in the image of the isomorphism φ' . Therefore, we have to identify all such t_γ which satisfy this equation. In other words, we look for all t_γ such that there is a transformation τ with

$$e t_\gamma = \tau e$$

Roughly speaking, we look for all t_γ which can be pulled through e from the codomain to the domain.

For better readability, we assume without loss of generality that the colors c_i are all equal to one color c . In particular, the codomains of φ and φ' are of the form $B_l \times \text{Aut}_{\mathcal{I}}(c)^l$. Then write $e = \theta_1 \otimes \dots \otimes \theta_l$ where the θ_i are chosen operations with codomain the chosen color c . Define H_i to be the subgroup of $\text{Aut}_{\mathcal{I}}(c)$ consisting of elements h which can be pulled through the operation θ_i , i.e. there exists a transformation τ with $\theta_i h = \tau \theta_i$. Furthermore, let B_l^* be the finite index subgroup of B_l consisting of the elements σ with the property $\theta_i \circ \sigma = \theta_i$. Denote by $\text{Stab}_\Gamma(\mathcal{P}, \mathcal{P}_k)$ the subgroup of $\text{Stab}_\Gamma(\mathcal{P}_k)$ which also fixes \mathcal{P} . Then the isomorphism φ' restricts to an isomorphism

$$\varphi'_{\mathcal{P}}: \text{Stab}_\Gamma(\mathcal{P}, \mathcal{P}_k) \rightarrow B_l^* \times (H_1 \times \dots \times H_l) =: \Omega_{\mathcal{P}}$$

where the subgroup B_l^* still acts via permutation of the factors and this is well-defined due to the definition of B_l^* . The proof of this is straightforward and uses the fact that two two-sided transformation equivalent θ_i must be equal.

Recall that φ' differs from φ by conjugation with λ . So the image of $\text{Stab}_\Gamma(\mathcal{P}, \mathcal{P}_k)$ under φ is its image under φ' conjugated with λ . More precisely, φ restricts to an isomorphism

$$\varphi_{\mathcal{P}}: \text{Stab}_\Gamma(\mathcal{P}, \mathcal{P}_k) \rightarrow \lambda \Omega_{\mathcal{P}} \lambda^{-1} =: \Omega_{\mathcal{P}}$$

Consider the pure braid group P_l which is a finite index subgroup of B_l . It is also a finite index subgroup of B_l^* . Recall that we have $\lambda = \lambda_1 \otimes \dots \otimes \lambda_l$ where the λ_i are degree 1 operations. We have

$$\begin{aligned} \lambda(P_l \times (H_1 \times \dots \times H_l)) \lambda^{-1} &= \lambda(P_l \times (H_1 \times \dots \times H_l)) \lambda^{-1} \\ &= P_l \times (\lambda_1 H_1 \lambda_1^{-1} \times \dots \times \lambda_l H_l \lambda_l^{-1}) \\ &= P_l \times (H_1^{\mathcal{P}} \times \dots \times H_l^{\mathcal{P}}) \end{aligned}$$

where $H_i^{\mathcal{P}} := \lambda_i H_i \lambda_i^{-1}$ is isomorphic to H_i . This is a finite index subgroup of $\Omega_{\mathcal{P}}$.

Remains to consider the case when $\gamma \in \text{Stab}_\Gamma(\mathcal{P}_k)$ fixes more than one additional vertex \mathcal{P}_i . For this we have to show that the intersection

$$\Omega_{\mathcal{P}_0} \cap \dots \cap \Omega_{\mathcal{P}_{k-1}} \subset B_l \rtimes \text{Aut}_{\mathcal{I}}(c)^l$$

is of type F_∞ . For better readability, we assume without loss of generality that $k = 2$. Then the last statement is equivalent to

$$\begin{aligned} \left(P_l \times (H_1^{\mathcal{P}_0} \times \dots \times H_l^{\mathcal{P}_0}) \right) \cap \left(P_l \times (H_1^{\mathcal{P}_1} \times \dots \times H_l^{\mathcal{P}_1}) \right) = \\ P_l \times \left((H_1^{\mathcal{P}_0} \cap H_1^{\mathcal{P}_1}) \times \dots \times (H_l^{\mathcal{P}_0} \cap H_l^{\mathcal{P}_1}) \right) \end{aligned}$$

being of type F_∞ since it is a finite index subgroup. This is true because P_l is of type F_∞ and all the groups $H_i^{\mathcal{P}_0} \cap H_i^{\mathcal{P}_1}$ are of type F_∞ . The latter statement is true because of the following: In case A) of the main theorem, each subgroup H_i is either trivial or the whole group $\text{Aut}_{\mathcal{I}}(c)$ which is of type F_∞ . In case B) of the main theorem, $\text{Aut}_{\mathcal{I}}(c)$ is even of type F_∞^+ . This completes the proof of the proposition. \square

6. Finite type filtration

To apply Brown's criterion to the Γ -CW-complex \mathcal{U}/\mathcal{G} , we need a filtration by Γ -CW-subcomplexes $(\mathcal{U}/\mathcal{G})_n$ which are of finite type. Recall that the degree function on \mathcal{S} induces degree functions on \mathcal{U} and \mathcal{U}/\mathcal{G} . Define \mathcal{S}_n resp. \mathcal{U}_n resp. $(\mathcal{U}/\mathcal{G})_n$ to be the full subcategories spanned by the objects of degree at most n . Note that we have $\mathcal{U}_n/\mathcal{G}_n = (\mathcal{U}/\mathcal{G})_n$ where $\mathcal{G}_n = \mathcal{G} \cap \mathcal{U}_n$. In the following, we want to show that $(\mathcal{U}/\mathcal{G})_n$ only has finitely many Γ -equivariant cells in each dimension.

Choose one operation in each very elementary transformation class and denote the resulting set of operations by S . By the assumptions in Theorem 3.7, S is a finite set.

OBSERVATION 3.18. Let $\theta \in S$ and γ be a degree 1 operation such that $\theta * \gamma$ is defined. Then, by Proposition 2.21, $\theta * \gamma$ is again very elementary and there is a $\theta' \in S$ and a transformation τ with $\theta * \gamma = \tau * \theta'$.

Denote by Ω the set of all identity operations together with all operations of degree at most n which are obtained by partially composing operations in S . Note that Ω is finite because S is finite and there are only finitely many colors by assumption. Denote by Λ the set of arrows in \mathcal{S}_n which are obtained by taking tensor products of operations in Ω . Again, the set Λ is finite.

Let $\Lambda^{*p} \subset \Lambda^p$ be the subset of p -tuples of composable arrows in Λ . We claim that there is a surjective function

$$\Lambda^{*p} \twoheadrightarrow \{p\text{-cells in } (\mathcal{U}/\mathcal{G})_n\} / \Gamma$$

which proves that there are only finitely many Γ -equivariant cells in $(\mathcal{U}/\mathcal{G})_n$. Let $(e_0, \dots, e_{p-1}) \in \Lambda^{*p}$. Choose a path $p_0: X \rightarrow \text{dom}(e_0)$. Define paths $p_k: X \rightarrow \text{dom}(e_k)$ by the composite $p_k := p_0 e_0 \dots e_{k-1}$. The p_i represent objects \mathcal{P}_i and the e_i represent arrows $\epsilon_i: \mathcal{P}_i \rightarrow \mathcal{P}_{i+1}$ in $(\mathcal{U}/\mathcal{G})_n$. Thus, the sequence $\epsilon_0, \dots, \epsilon_{p-1}$ gives a p -cell in $(\mathcal{U}/\mathcal{G})_n$. This p -cell surely depends on the choice of p_0 but two such choices give equivalent p -cells modulo the action of Γ . So we get a well-defined function as above.

Remains to show that this function is indeed surjective. Consider a p -cell in $(\mathcal{U}/\mathcal{G})_n$ in the form of a string

$$\mathcal{P}_0 \xrightarrow{\epsilon_0} \mathcal{P}_1 \xrightarrow{\epsilon_1} \dots \xrightarrow{\epsilon_{p-1}} \mathcal{P}_p$$

of composable arrows in $(\mathcal{U}/\mathcal{G})_n$. For each \mathcal{P}_i we can choose representatives P_i in \mathcal{U}_n . Then each ϵ_i is represented by a unique arrow $e_i: P_i \rightarrow P_{i+1}$ in \mathcal{U}_n . We now want to change these representatives so that each e_i lies in Λ .

Start with the last arrow $e_{p-1} = [\sigma, \Theta]$. Let T be the set of operations of the form $\tau * \theta$ where τ is a transformation and $\theta \in S$. In other words, T is the union of all the very elementary transformation classes. Each higher degree operation θ in the sequence Θ can be written, up to transformation, as a partial composition of operations in T (see the remarks after Definition 2.18). It follows $\theta = s * \psi$ where s is a transformation and ψ is an operation decomposable into operations of the form $(\gamma_1, \dots, \gamma_k) * \xi$ with $\xi \in S$ and γ_i of degree 1. Using Observation 3.18, we can pull the degree 1 operations to the domain of ψ , starting with the rightmost degree 1 operations, and obtain $\theta = s * \psi$ where s is a transformation and ψ is an operation decomposable into operations of S . We now have $e_{p-1} = \tau * \Psi$ where τ is some transformation and Ψ is simply a tensor product of identities or higher degree operations decomposable into operations of S . By changing the representatives P_{p-1} , e_{p-1} and e_{p-2} in their respective classes modulo the subgroupoid \mathcal{G} , we can assume $\tau = \text{id}$ and thus that e_{p-1} lies in Λ . We can now repeat this argument with e_{p-2} and then with e_{p-3} and so forth until we have changed each e_i to lie in Λ . This proves surjectivity.

7. Connectivity of the filtration

It remains to show the connectivity statement in Brown's criterion, i.e. we have to show that the connectivity of the pair $((\mathcal{U}/\mathcal{G})_n, (\mathcal{U}/\mathcal{G})_{n-1})$ tends to infinity as $n \rightarrow \infty$. To show this, we apply the Morse method for categories. The degree function on \mathcal{U}/\mathcal{G} is a Morse function and the corresponding filtration is exactly $(\mathcal{U}/\mathcal{G})_n$. Thus, we have to prove that the connectivity of the descending link $lk_{\downarrow}(\mathcal{K})$ tends to infinity as the degree of the object \mathcal{K} tends to infinity. Note that the descending up link $\overline{lk}_{\downarrow}(\mathcal{K})$ is always empty, so we have $lk_{\downarrow}(\mathcal{K}) = \underline{lk}_{\downarrow}(\mathcal{K})$.

DEFINITION 3.19. An arrow $[\sigma, \Theta]$ in \mathcal{S} is called (very) elementary if it is not a transformation and every higher degree operation in Θ is (very) elementary. An arrow in \mathcal{U} is called (very) elementary if the corresponding arrow in \mathcal{S} is (very) elementary. An arrow in \mathcal{U}/\mathcal{G} is called (very) elementary if there is a (very) elementary representative in \mathcal{U} .

It follows from Proposition 2.21 that the number of (very) elementary operations in an arrow $a \in \mathcal{U}$ does not change if we replace a by another representative in the class $[a] \in \mathcal{U}/\mathcal{G}$. In particular, if the arrow $\alpha \in \mathcal{U}/\mathcal{G}$ is (very) elementary, then *all* representing arrows $a \in \mathcal{U}$ of α are (very) elementary.

The data of an object in $\underline{lk}_{\downarrow}(\mathcal{K})$ consists of an object \mathcal{Y} in \mathcal{U}/\mathcal{G} with $\text{deg}(\mathcal{Y}) < \text{deg}(\mathcal{K})$ and an arrow $\alpha: \mathcal{K} \rightarrow \mathcal{Y}$ in \mathcal{U}/\mathcal{G} . Now we define $\text{Core}(\mathcal{K})$ to be the full subcategory of $\underline{lk}_{\downarrow}(\mathcal{K})$ spanned by the objects (\mathcal{Y}, α) where α is a very elementary arrow. Denote by $\text{Corona}(\mathcal{K})$ the full subcategory of $\underline{lk}_{\downarrow}(\mathcal{K})$ spanned by the objects (\mathcal{Y}, α) with α an elementary arrow. So we have

$$\text{Core}(\mathcal{K}) \subset \text{Corona}(\mathcal{K}) \subset \underline{lk}_{\downarrow}(\mathcal{K})$$

and we will study the connectivity of these spaces successively.

7.1. The core. In this subsection, we adopt the normal form point of view of Section 2 in Chapter 2: Arrows in \mathcal{S} are always represented by a unique pair (σ, Θ) such that σ^{-1} is unpermuted resp. unbraided on the domains of the operations in the sequence Θ .

We say that two operations θ_1 and θ_2 are *right transformation equivalent* if there is a transformation γ such that $\theta_2 = \theta_1 * \gamma$. Recall from Proposition 2.21 that being elementary or very elementary is invariant under right transformations.

The object \mathcal{K} in \mathcal{U}/\mathcal{G} is a class of objects in \mathcal{U} modulo transformations. Fix some representing object K . Then the objects in $\text{Core}(\mathcal{K})$ are in one to one correspondence with pairs (Y, a) where Y is an object in \mathcal{U} with $\deg(Y) < \deg(K)$ and $a: K \rightarrow Y$ is a very elementary arrow in \mathcal{U} modulo transformations on the codomain (compare with Remark 1.7). Choose one operation in each right transformation equivalence class and denote the resulting set of operations by R . We choose the identity for a class of degree 1 operations so that the degree 1 operations in R are identities. Now define a very elementary R -arrow to be a very elementary arrow (σ, Θ) in \mathcal{S} such that the operations in Θ are elements of R . Thus, Θ is a tensor product of identities and at least one very elementary operation lying in R . This notion of very elementary R -arrows can be lifted to arrows in \mathcal{U} . Now the objects in $\text{Core}(\mathcal{K})$ are in one to one correspondence with pairs (Y, a) where Y is an object with $\deg(Y) < \deg(K)$ and $a: K \rightarrow Y$ is

- (planar case) a very elementary R -arrow.
- (symmetric case) a very elementary R -arrow modulo colored permutations on the codomain.
- (braided case) a very elementary R -arrow modulo colored braidings on the codomain.

The equivalence relation modulo braidings on the codomain is called “dangling” in [10] because these objects may be visualized as a braiding where some strands at one end are connected by very elementary operations in R , called “feet”, and these are allowed to dangle freely (see [10, Figure 9]).

Now let C be the set of colors of the operad \mathcal{O} . We define a set of archetypes A as follows: For each operation in R , form an archetype with identifier this operation and with color word the domain of that operation. The object K in \mathcal{U} is a path of arrows in \mathcal{S} modulo homotopy. It starts at the color word X and ends at some other color word T . Consider the simplicial complex $\mathcal{AC}_d(C, A; T)$ from Section 2. It can be seen as a poset of simplices with an arrow from a simplex σ to another simplex σ' if and only if σ is a face of σ' .

PROPOSITION 3.20. *The category $\text{Core}(\mathcal{K})$ is a poset and isomorphic, as a poset, to $\mathcal{AC}_d(C, A; T)$ where $d = 1$ in the planar case, $d = 2$ in the braided case and $d = 3$ in the symmetric case.*

PROOF. We restrict our attention to the braided case, i.e. $d = 2$. The other two cases are much simpler.

First, it is clear that $\text{Core}(\mathcal{K})$ is a poset since \mathcal{U}/\mathcal{G} is a poset. We want to understand the poset structure a bit better: Let Λ be an object of $\text{Core}(\mathcal{K})$ in the form of a very elementary R -arrow $K \rightarrow Y$ modulo dangling. Fix some very elementary R -arrow λ representing this class with the property that the colored braiding of that arrow is unbraided not only on the sets of strands connected to single operations but also on the set of strands connected to identity operations. Then arrows in $\text{Core}(\mathcal{K})$ with domain Λ are in one to one correspondence with very elementary R -arrows α in \mathcal{U} , modulo dangling, such that the very elementary operations of α only connect to identity operations of λ in the composition $\lambda * \alpha$ (since compositions of very elementary operations are not very elementary anymore). The following diagram, in which the gray triangles are identity operations, illustrates such a situation:

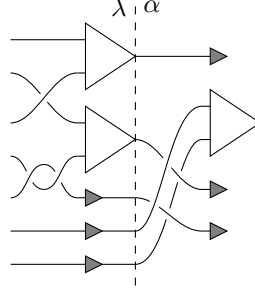

These considerations yield the following interpretation of the poset structure: We have $\Lambda \rightarrow \Lambda'$ if and only if there is a very elementary R -arrow λ representing the dangling class Λ such that adding very elementary operations of R to loose strands of λ (i.e. strands connected to identity operations) gives a very elementary R -arrow representing the dangling class Λ' .

We will consider an isomorphism of posets

$$\text{comb}: \text{Core}(\mathcal{K}) \rightarrow \mathcal{AC}_2(C, A; T)$$

called “combing” as in [10, Section 4] and its inverse

$$\text{weave}: \mathcal{AC}_2(C, A; T) \rightarrow \text{Core}(\mathcal{K})$$

which we call “weaving”.

To define the first map, start with an object Λ in $\text{Core}(\mathcal{K})$. As above, it is a very elementary R -arrow in normal form modulo dangling. Thus, it is represented by a colored braid with unbraided strands connected by very elementary operations in R . Think of the domain of the braid as being fixed on the line

$$L_1 := \{(x, 0, 1) \mid x \in \mathbb{R}\} \subset \mathbb{R}^3$$

the codomain as being fixed on the line

$$L_0 := \{(x, 0, 0) \mid x \in \mathbb{R}\} \subset \mathbb{R}^3$$

and visualize the operations as straight lines in L_0 connecting the ends of the corresponding strands. Now “combing straight” the braid means moving around the ends of the braid in the plane $P := \mathbb{R}^2 \times \{0\} \subset \mathbb{R}^3$ such that the whole braid becomes unbraided. The segments representing the operations get deformed in P this way and in fact become the archetypal arcs in $\text{comb}(\Lambda)$. They are admissible because the braid was required to be unbraided on the domains of the operations. This process is visualized in [10, Figure 17]. Note that combing does not depend on the representative under dangling, so it is a well-defined map on the objects of $\text{Core}(\mathcal{K})$. It also respects the poset structures, so it is a map of posets.

To define the second map, start with an archetypal arc system \mathcal{A} . This is a priori embedded in \mathbb{R}^2 but embed it in \mathbb{R}^3 via the embedding $\mathbb{R}^2 \times \{0\} \subset \mathbb{R}^3$. Connect the nodes of the archetypal arc system with the line L_1 by straight lines parallel to the third component axis. The process of weaving first tries to separate the archetypal arcs by moving the nodes in the plane P . Here, being separate means being separated by a straight line in P parallel to the second component axis. Also, the set of nodes which are not contained in an arc should be separated from the arcs. By doing these moves, the vertical strands connecting the nodes with the line L_1 become braided in a certain way. The separation process is always possible but the resulting braid is not unique (think of two nodes connected by an arc and turn around the arc several times). To make the resulting braid unique (up to dangling), we additionally require that the subbraid determined by an archetypal arc never becomes braided during the separation process. This can be achieved for

example by the following additional movement rule: The nodes of an archetypal arc always have to stay on the same line L in P parallel to the first component axis. This line L may move up and down and the nodes of the archetypal arc may move left and right on L but they must never cross each other on L . Then, when the archetypal arcs are separated from each other and from the isolated nodes, the property admissible of the archetypal arcs ensures that they can be homotoped to straight lines lying in L_0 . The following figure visualizes this process:

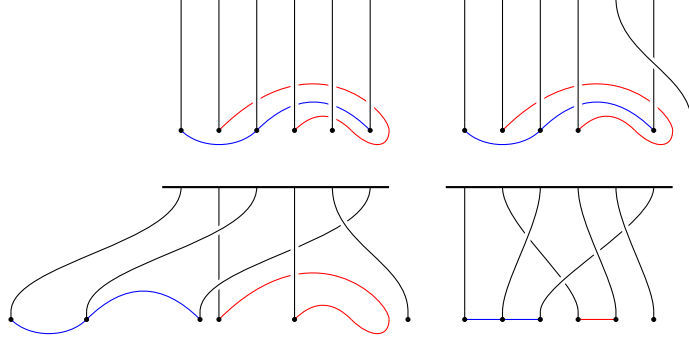

Replacing the archetypal arcs by the identifier operations of the corresponding archetype yields a representative of $\text{weave}(\mathcal{A})$ and the class modulo dangling does not depend on the weaving process. Thus, we get a well-defined map on the objects of $\mathcal{AC}_2(C, A; T)$. It also respects the poset structures, so it is a map of posets. \square

It follows from the finiteness of VE that the set of archetypes A is of finite type (though not finite in general) and from the color-tameness of \mathcal{O} that it is tame. More precisely, let m_V be the largest degree of very elementary classes and m_C be the smallest natural number greater than the degree of any reduced object in \mathcal{S} . Then we can set $m_a = m_V$ and $m_r = m_C$ in Theorem 3.4. We thus get the following

COROLLARY 3.21. *Core(\mathcal{K}) is $\nu_d(\deg \mathcal{K})$ -connected where*

$$\begin{aligned}\nu_1(l) &:= \left\lfloor \frac{l - m_C}{2m_V + m_C - 2} \right\rfloor - 1 \\ \nu_2(l) &:= \left\lfloor \frac{l - m_C}{2m_V - 1} \right\rfloor - 1 \\ \nu_3(l) &:= \left\lfloor \frac{l - m_C}{2m_V - 1} \right\rfloor - 1\end{aligned}$$

Here, $d = 1$ corresponds to the planar case, $d = 2$ to the braided case and $d = 3$ to the symmetric case.

7.2. The corona. First note that, in case A) of the main theorem, we have $VE = E$ and therefore $\text{Core}(\mathcal{K}) = \text{Corona}(\mathcal{K})$. So this subsection only applies to case B).

We build up $\text{Corona}(\mathcal{K})$ from $\text{Core}(\mathcal{K})$ using again the Morse method for categories. We then get a connectivity result for the corona from the connectivity result for the core. The idea is attributed to [22].

We assumed \mathcal{O} to be of finite type, i.e. the set of elementary classes E is finite. Let m_E be the largest degree of elementary classes. An object in $\text{Corona}(\mathcal{K})$ is a pair $(\mathcal{Y}, \alpha: \mathcal{K} \rightarrow \mathcal{Y})$ where $\deg(\mathcal{Y}) < \deg(\mathcal{K})$ and α is an elementary arrow in \mathcal{U}/\mathcal{G} . For $2 \leq k \leq m_E$ denote by $\#_{se}^k(\alpha)$ the number of strictly elementary operations of

degree k in any representative of α . Define

$$f((\mathcal{Y}, \alpha)) := (\#_{se}^{m_E}(\alpha), \#_{se}^{m_E-1}(\alpha), \dots, \#_{se}^2(\alpha), \deg(\mathcal{Y}))$$

Order the values of f lexicographically. Then f becomes a Morse function building up $\text{Corona}(\mathcal{K})$ from $\text{Core}(\mathcal{K})$. Define

$$\begin{aligned} \mu_1(l) &:= \left\lfloor \frac{l - m_C}{2m_V + m_C + m_E} \right\rfloor - 2 \\ \mu_2(l) &:= \left\lfloor \frac{l - m_C}{2m_V + m_E} \right\rfloor - 1 \\ \mu_3(l) &:= \left\lfloor \frac{l - m_C}{2m_V + m_E} \right\rfloor - 1 \end{aligned}$$

PROPOSITION 3.22. *For each object (\mathcal{Y}, α) in $\text{Corona}(\mathcal{K})$ which is not an object in $\text{Core}(\mathcal{K})$, the descending link $lk_{\downarrow}(\mathcal{Y}, \alpha)$ with respect to the Morse function f above is $\mu_d(\deg \mathcal{K})$ -connected.*

From Theorem 1.23 we get that $\text{Core}(\mathcal{K})$ and $\text{Corona}(\mathcal{K})$ share the same homotopy groups up to dimension $\mu_d(\deg \mathcal{K})$. We already know that $\text{Core}(\mathcal{K})$ is $\nu_d(\deg \mathcal{K})$ -connected. Furthermore, we have $\nu_d(l) \geq \mu_d(l)$. Consequently, we get the following

COROLLARY 3.23. *$\text{Corona}(\mathcal{K})$ is $\mu_d(\deg \mathcal{K})$ -connected. In particular, its connectivity tends to infinity as $\deg(\mathcal{K}) \rightarrow \infty$.*

In the rest of this subsection, we give a proof of Proposition 3.22. We distinguish between two sorts of objects (\mathcal{Y}, α) in $\text{Corona}(\mathcal{K})$ which are not objects in $\text{Core}(\mathcal{K})$: Such an object is called *mixed* if there is at least one very elementary operation in α . It is called *pure* if there is no very elementary operation in α .

LEMMA 3.24. *Let (\mathcal{Y}, α) be mixed. Then $\overline{lk}_{\downarrow}(\mathcal{Y}, \alpha)$ and therefore $lk_{\downarrow}(\mathcal{Y}, \alpha)$ is contractible. In particular, Proposition 3.22 is true for mixed objects.*

PROOF. The data of an object in $\overline{lk}_{\downarrow}(\mathcal{Y}, \alpha)$ is $\Omega = ((\mathcal{L}, \beta_1), \beta_2)$ where \mathcal{L} is an object in \mathcal{U}/\mathcal{G} , β_1 is an elementary arrow in \mathcal{U}/\mathcal{G} , β_2 is an arrow in \mathcal{U}/\mathcal{G} such that $\beta_1\beta_2 = \alpha$ and (\mathcal{L}, β_1) forms an object in $\text{Corona}(\mathcal{K})$ of strictly smaller Morse height than (\mathcal{Y}, α) . Let $\Omega' = ((\mathcal{L}', \beta'_1), \beta'_2)$ be another such object. An arrow $\Omega \rightarrow \Omega'$ is represented by an arrow $\delta: \mathcal{L} \rightarrow \mathcal{L}'$ such that $\beta_1\delta = \beta'_1$ and $\delta\beta_2 = \beta'_2$.

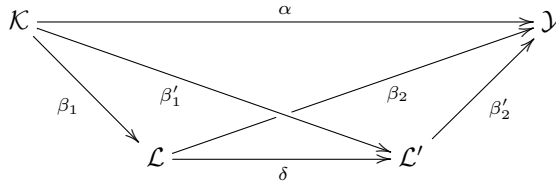

It follows that $\overline{lk}_{\downarrow}(\mathcal{Y}, \alpha)$ is a poset since \mathcal{U}/\mathcal{G} is a poset.

Choose representatives K and Y of \mathcal{K} and \mathcal{Y} . Then α is represented by a unique arrow $a: K \rightarrow Y$. We can choose K such that a is a tensor product of higher degree operations and identities. Let $a^v: K \rightarrow Y^v$ be the arrow obtained from a by replacing all strictly elementary operations θ with $\deg(\theta)$ identity operations. Let $a^{se}: Y^v \rightarrow Y$ be the arrow obtained from a by replacing all very elementary operations by one identity operation each. We have $a^v a^{se} = a$. An example of a, a^v, a^{se} is pictured below. There, a white triangle is a placeholder for a strictly elementary operation. A black triangle indicates a very elementary operation. A straight horizontal line represents an identity operation.

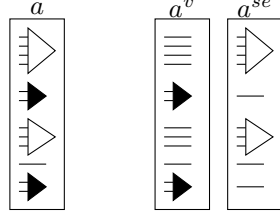

Set $\mathcal{Y}^v := [Y^v]$ and $\alpha^v := [a^v]$ as well as $\alpha^{se} := [a^{se}]$. Then $(\mathcal{Y}^v, \alpha^v)$ is an object in $\text{Core}(\mathcal{K})$ and α^{se} represents an arrow $(\mathcal{Y}^v, \alpha^v) \rightarrow (\mathcal{Y}, \alpha)$ in $\text{Corona}(\mathcal{K})$. Moreover, the pair $\Xi := ((\mathcal{Y}^v, \alpha^v), \alpha^{se})$ is an object in $\overline{\text{lk}}_{\downarrow}(\mathcal{Y}, \alpha)$.

Let $\Omega = ((\mathcal{L}, \beta_1), \beta_2)$ be an object in $\overline{\text{lk}}_{\downarrow}(\mathcal{Y}, \alpha)$. We define another object $F(\Omega) = ((\mathcal{M}, \gamma_1), \gamma_2)$ of $\overline{\text{lk}}_{\downarrow}(\mathcal{Y}, \alpha)$ as follows: Choose a representative L of \mathcal{L} such that β_2 is represented by $b_2: L \rightarrow Y$ which is a tensor product of identities and higher degree operations. Then β_1 is represented by a unique $b_1: K \rightarrow L$. Note that $b_1 b_2 = a$. Think of b_1 as splitting higher degree operations of a into operations of smaller degree and of b_2 as merging them back to their original form. Now define the arrows $g_1: K \rightarrow M$ and $g_2: M \rightarrow Y$ to be the same splitting of a with the only exception that no very elementary operation of a is splitted. An example fitting to the example above is pictured below. There, a gray triangle is a placeholder for an elementary operation or a degree 1 operation, a blue triangle can be any operation and a dot on a straight horizontal line indicates a possibly non-trivial degree 1 operation.

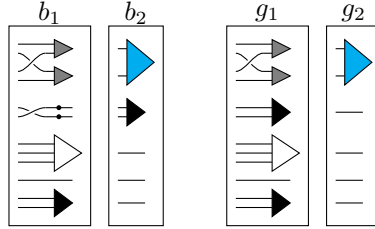

Now set $\mathcal{M} := [M]$ and $\gamma_1 := [g_1]$ as well as $\gamma_2 = [g_2]$.

It is not hard to see that $\Omega \mapsto F(\Omega)$ extends to a functor $\overline{\text{lk}}_{\downarrow}(\mathcal{Y}, \alpha) \rightarrow \overline{\text{lk}}_{\downarrow}(\mathcal{Y}, \alpha)$ which means that whenever we have an arrow $\delta: \Omega \rightarrow \Omega'$, then there is an arrow $\Delta: F(\Omega) \rightarrow F(\Omega')$.

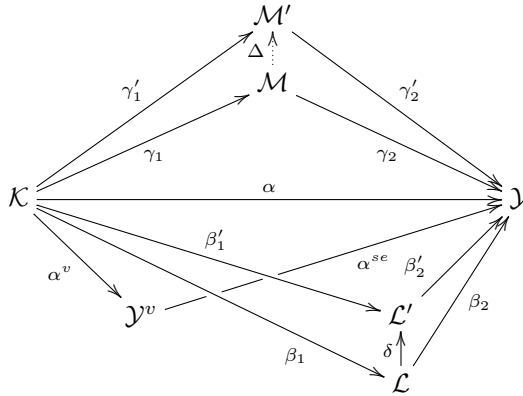

We also have arrows $\xi_\Omega: \Xi \rightarrow F(\Omega)$ and $\iota_\Omega: \Omega \rightarrow F(\Omega)$.

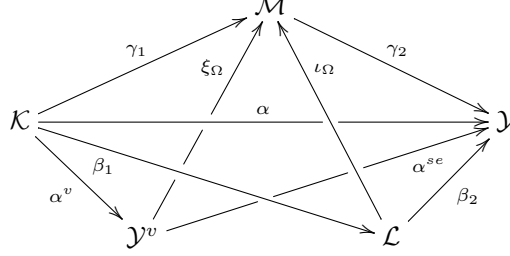

The arrow ξ_Ω is represented by an arrow $x_\Omega: Y^v \rightarrow M$ which satisfies $a^v x_\Omega = g_1$ and $x_\Omega g_2 = a^{se}$. The arrow ι_Ω is represented by $i_\Omega: L \rightarrow M$ which satisfies $b_1 i_\Omega = g_1$ and $i_\Omega g_2 = b_2$. In the example from above, these arrows look as follows:

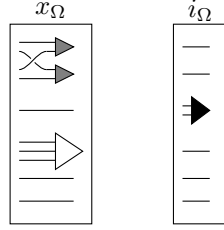

The claim of the proposition now follows from item iii) in Section 5 of Chapter 1 applied to the functor F and the object Ξ . \square

LEMMA 3.25. *Let (\mathcal{Y}, α) be pure. Then $lk_\downarrow(\mathcal{Y}, \alpha)$ is $\mu_d(\deg \mathcal{K})$ -connected and Proposition 3.22 is true for pure objects.*

PROOF. Choose representatives K and Y of \mathcal{K} and \mathcal{Y} such that $a: K \rightarrow Y$ representing α is a tensor product of higher degree operations and identities.

First observe the descending up link $\overline{lk}_\downarrow(\mathcal{Y}, \alpha)$. An object in $\overline{lk}_\downarrow(\mathcal{Y}, \alpha)$ is a pair $((\mathcal{L}, \beta_1), \beta_2)$ with $f(\mathcal{L}, \beta_1) < f(\mathcal{Y}, \alpha)$ and $\beta_1 \beta_2 = \alpha$. When choosing a representative L of \mathcal{L} , we get unique representatives $b_1: K \rightarrow L$ of β_1 and $b_2: L \rightarrow Y$ of β_2 such that $b_1 b_2 = a$. As in the proof of the previous lemma, b_1 can be interpreted as splitting higher degree operations of a into operations of smaller degree and b_2 as merging them back to their original form. Denote by \mathcal{A}_i the full subcategory of $\overline{lk}_\downarrow(\mathcal{Y}, \alpha)$ spanned by the objects which only split the i 'th higher degree operation in a . Denote by \mathbf{n} the number of higher degree operations in a . Observe now that when splitting operations in a one by one, then we can also split all that operations at once. This observation reveals that

$$\overline{lk}_\downarrow(\mathcal{Y}, \alpha) = \mathcal{A}_1 \circ \dots \circ \mathcal{A}_\mathbf{n}$$

is the Grothendieck join of the \mathcal{A}_i explained in Section 9 of Chapter 1. Note that the categories \mathcal{A}_i are all non-empty since all the higher degree operations in a are elementary but not very elementary and splitting such a strictly elementary operation decreases the Morse height. Thus, $\overline{lk}_\downarrow(\mathcal{Y}, \alpha)$ is $(\mathbf{n} - 2)$ -connected.

Now look at the descending down link $lk_\downarrow(\mathcal{Y}, \alpha)$. Objects are pairs $((\mathcal{L}, \beta_1), \beta_2)$ with $f(\mathcal{L}, \beta_1) < f(\mathcal{Y}, \alpha)$ and $\alpha \beta_2 = \beta_1$. When choosing a representative L of \mathcal{L} , we get representatives $b_1: K \rightarrow L$ of β_1 and $b_2: Y \rightarrow L$ of β_2 such that $ab_2 = b_1$. Looking at the Morse function f for the corona, one sees that the higher degree operations of b_2 must be very elementary operations which only compose with identity operations of a . At this point, we have to distinguish between the planar case on the one hand and the braided resp. symmetric case on the other.

We start with the braided resp. symmetric case: The arguments in the proof of Proposition 3.20 reveal that $\underline{lk}_\downarrow(\mathcal{Y}, \alpha)$ is isomorphic to $\mathcal{AC}_d(C, A; T')$ where T' is the color word obtained from the codomain of a after deleting the higher degree operations. Denote by \mathfrak{l} the length of T' , i.e. the number of identity operations in a . Then we already know that $\mathcal{AC}_d(C, A; T')$ is $\nu_d(\mathfrak{l})$ -connected (compare with Corollary 3.21). Consequently, the connectivity of the descending link $lk_\downarrow(\mathcal{Y}, \alpha) = \overline{lk}_\downarrow(\mathcal{Y}, \alpha) * \underline{lk}_\downarrow(\mathcal{Y}, \alpha)$ is

$$\begin{aligned} \mathfrak{n} + \nu_d(\mathfrak{l}) &= \mathfrak{n} + \left\lfloor \frac{\mathfrak{l} - m_C}{2m_V - 1} \right\rfloor - 1 \\ &\geq \mathfrak{n} + \left\lfloor \frac{\deg \mathcal{K} - \mathfrak{n}m_E - m_C}{2m_V - 1} \right\rfloor - 1 \\ &\geq \mathfrak{n} + \left\lfloor \frac{\deg \mathcal{K} - \mathfrak{n}m_E - m_C}{2m_V + m_E} \right\rfloor - 1 \\ &= \left\lfloor \frac{\deg \mathcal{K} - m_C + 2m_V \mathfrak{n}}{2m_V + m_E} \right\rfloor - 1 \\ &\geq \left\lfloor \frac{\deg \mathcal{K} - m_C}{2m_V + m_E} \right\rfloor - 1 \\ &= \mu_d(\deg \mathcal{K}) \end{aligned}$$

where we have used that $\mathfrak{n}m_E + \mathfrak{l} \geq \deg \mathcal{K}$.

Now we turn to the planar case: An identity component in a is a maximal subsequence of identity operations. Let \mathfrak{m} be the number of identity components and denote by \mathfrak{l}_i for $i = 1, \dots, \mathfrak{m}$ the length of the i 'th identity component. Denote by \mathfrak{l} the total number of identity operations in a , i.e. the sum of the \mathfrak{l}_i . Define \mathcal{B}_i to be the full subcategory of $\underline{lk}_\downarrow(\mathcal{Y}, \alpha)$ spanned by the objects which only add very elementary operations into the i 'th identity component. Observe now that when adding very elementary operations into different identity components one by one, then we can also add all that operations at once. This reveals that $\underline{lk}_\downarrow(\mathcal{Y}, \alpha)$ is the Grothendieck join of the \mathcal{B}_i . Note, though, when inspecting the direction of the arrows in $\underline{lk}_\downarrow(\mathcal{Y}, \alpha)$, one sees that it is in fact the dual Grothendieck join. So we have

$$\underline{lk}_\downarrow(\mathcal{Y}, \alpha) = \mathcal{B}_1 \bullet \dots \bullet \mathcal{B}_\mathfrak{m}$$

Similarly as in the braided resp. symmetric case, \mathcal{B}_i is isomorphic to $\mathcal{AC}_1(C, A; T_i)$ where T_i is the color word obtained from the codomain of a after deleting all operations except the identity operations of the i 'th identity component. The length of T_i is \mathfrak{l}_i . Then we already know that $\mathcal{AC}_1(C, A; T_i)$ is $\nu_1(\mathfrak{l}_i)$ -connected. Therefore, the connectivity of $\underline{lk}_\downarrow(\mathcal{Y}, \alpha)$ is at least

$$2\mathfrak{m} - 2 + \sum_{j=1}^{\mathfrak{m}} \nu_1(\mathfrak{l}_j)$$

Thus, the connectivity of $lk_\downarrow(\mathcal{Y}, \alpha)$ is

$$\begin{aligned} \mathfrak{n} + 2\mathfrak{m} - 2 + \sum_{j=1}^{\mathfrak{m}} \nu_1(\mathfrak{l}_j) &\geq \mathfrak{n} + \mathfrak{m} - 2 + \sum_{j=1}^{\mathfrak{m}} \left\lfloor \frac{\mathfrak{l}_j - m_C}{2m_V + m_C} \right\rfloor \\ &\geq \mathfrak{n} - 2 + \sum_{j=1}^{\mathfrak{m}} \frac{\mathfrak{l}_j - m_C}{2m_V + m_C} \\ &= \mathfrak{n} - 2 + \frac{\mathfrak{l} - \mathfrak{m}m_C}{2m_V + m_C} \end{aligned}$$

$$\begin{aligned}
&\geq \mathbf{n} - 2 + \frac{\deg \mathcal{K} - \mathbf{n}m_E - (\mathbf{n} + 1)m_C}{2m_V + m_C} \\
&\geq \mathbf{n} + \frac{\deg \mathcal{K} - \mathbf{n}m_E - \mathbf{n}m_C - m_C}{2m_V + m_C + m_E} - 2 \\
&= \frac{\deg \mathcal{K} - m_C + 2m_V \mathbf{n}}{2m_V + m_C + m_E} - 2 \\
&\geq \frac{\deg \mathcal{K} - m_C}{2m_V + m_C + m_E} - 2 \\
&\geq \mu_1(\deg \mathcal{K})
\end{aligned}$$

where we have used in the fourth step that $\mathbf{m} \leq \mathbf{n} + 1$ and $\mathbf{n}m_E + \mathbf{l} \geq \deg \mathcal{K}$. \square

7.3. The whole link. In this last step, we show that the inclusion

$$\text{Corona}(\mathcal{K}) \subset \underline{lk}_\downarrow(\mathcal{K})$$

is a homotopy equivalence. It then follows from Corollary 3.23 that the connectivity of $\underline{lk}_\downarrow(\mathcal{K})$ tends to infinity as $\deg(\mathcal{K}) \rightarrow \infty$ which is what we wanted to show in order to finish the proof of Theorem 3.7. This step is analogous to the reduction to the Stein space of elementary intervals in [43]. We again apply the Morse method for categories to build $\underline{lk}_\downarrow(\mathcal{K})$ up from $\text{Corona}(\mathcal{K})$. The Morse function on objects of $\underline{lk}_\downarrow(\mathcal{K})$ which do not lie in $\text{Corona}(\mathcal{K})$ is given by

$$f((\mathcal{Y}, \alpha)) := -\deg(\mathcal{Y})$$

We have $\underline{lk}_\downarrow(\mathcal{Y}, \alpha) = \emptyset$ and thus $lk_\downarrow(\mathcal{Y}, \alpha) = \overline{lk}_\downarrow(\mathcal{Y}, \alpha)$ with respect to this Morse function. Similarly as in the proofs of Lemmas 3.24 and 3.25, we obtain

$$\overline{lk}_\downarrow(\mathcal{Y}, \alpha) = \mathcal{A}_1 \circ \dots \circ \mathcal{A}_n$$

where the \mathcal{A}_i are full subcategories of $\overline{lk}_\downarrow(\mathcal{Y}, \alpha)$ spanned by the objects which correspond to splitting exactly one of the \mathbf{n} higher degree operations in a representative a of α . At least one of these operations must be non-elementary since (\mathcal{Y}, α) is not an object in $\text{Corona}(\mathcal{K})$. Without loss of generality, assume that \mathcal{A}_1 corresponds to such a non-elementary higher degree operation. If we show that \mathcal{A}_1 is contractible, it follows that $\overline{lk}_\downarrow(\mathcal{Y}, \alpha)$ is contractible. Thus, we are building $\underline{lk}_\downarrow(\mathcal{K})$ up from $\text{Corona}(\mathcal{K})$ along contractible descending links and it follows from Theorem 1.23 that the inclusion $\text{Corona}(\mathcal{K}) \subset \overline{lk}_\downarrow(\mathcal{K})$ is a homotopy equivalence. That \mathcal{A}_1 is contractible follows from Proposition 3.27 below.

First, we want to reinterpret the defining property of E as the spine of $\mathcal{T}\mathcal{C}^*(\mathcal{O})$ in terms of the category \mathcal{U}/\mathcal{G} .

LEMMA 3.26. *Let $\alpha: \mathcal{K} \rightarrow \mathcal{Y}$ be a non-elementary arrow in \mathcal{U}/\mathcal{G} such that $\deg(\mathcal{K}) = n > 1$ and $\deg(\mathcal{Y}) = 1$. Then there is a unique pair (α_1, α_2) of arrows in \mathcal{U}/\mathcal{G} (called the maximal elementary factorization of α) such that α_2 is elementary, $\alpha_1\alpha_2 = \alpha$ and such that the following universal property is satisfied: Whenever (β_1, β_2) is another pair with β_2 elementary and $\beta_1\beta_2 = \alpha$ (called an elementary factorization of α), then there is a unique arrow γ with $\alpha_1\gamma = \beta_1$ and $\gamma\beta_2 = \alpha_2$.*

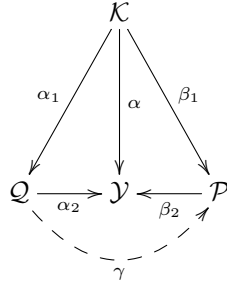

PROOF. Recall that \mathcal{U}/\mathcal{G} is a poset. So there is at most one such γ . If also (β_1, β_2) satisfies the universal property, then we must have $\mathcal{Q} = \mathcal{P}$ and consequently $\alpha_1 = \beta_1$ as well as $\alpha_2 = \beta_2$. This shows the uniqueness statements.

Remains to prove the existence of such a pair: Choose representatives K, Y of \mathcal{K}, \mathcal{Y} . Then α is represented by a unique arrow $a: K \rightarrow Y$. Note that a is just an operation since $\deg(Y) = 1$. Denote the transformation class of a by Ω . Its degree is $\deg(K) = n > 1$ and it is non-elementary by assumption. Thus, by the definition of E as the spine, there is a greatest elementary class Θ with the property $\Theta < \Omega$. This implies that there is an operation $\theta \in \Theta$ and an arrow q in \mathcal{S} such that $q * \theta = a$ in \mathcal{S} . Define $Q := K * q$ as an object in \mathcal{U} and further $\mathcal{Q} := [Q]$ as an object in \mathcal{U}/\mathcal{G} . The arrows $q: K \rightarrow Q$ resp. $\theta: Q \rightarrow Y$ in \mathcal{U} represent arrows α_1 resp. α_2 in \mathcal{U}/\mathcal{G} such that $\alpha_1 \alpha_2 = \alpha$ and α_2 is elementary.

These two arrows satisfy the universal property: Let $b_1: K \rightarrow P$ and $b_2: P \rightarrow Y$ be representatives of $\beta_1: \mathcal{K} \rightarrow \mathcal{P}$ and $\beta_2: \mathcal{P} \rightarrow \mathcal{Y}$. Obviously, the transformation class $[b_2]$ of b_2 is elementary and satisfies $[b_2] < [a] = \Omega$. Since $\Theta = [\theta]$ is the greatest such class, we obtain $[b_2] \leq [\theta]$. This means that there is an arrow g in \mathcal{S} such that $g * b_2 = \theta$ in \mathcal{S} . If g is interpreted as an arrow $Q \rightarrow P$ in \mathcal{U} , then it represents an arrow $\gamma: \mathcal{Q} \rightarrow \mathcal{Y}$ in \mathcal{U}/\mathcal{G} which satisfies $\gamma \beta_2 = \alpha_2$. We then also have $\alpha_1 \gamma = \beta_1$ since \mathcal{U}/\mathcal{G} is a poset. \square

We now turn to the announced proposition which concludes the proof of the main theorem.

PROPOSITION 3.27. *Let $\alpha: \mathcal{K} \rightarrow \mathcal{Y}$ be a non-elementary arrow in \mathcal{U}/\mathcal{G} such that $\deg(\mathcal{K}) = n > 1$ and $\deg(\mathcal{Y}) = 1$. Let \mathcal{M} be the full subcategory of $\mathcal{K}\downarrow(\mathcal{U}/\mathcal{G})_{n-1}$ spanned by the objects $(\mathcal{Z}, \beta: \mathcal{K} \rightarrow \mathcal{Z})$ with $\deg(\mathcal{Z}) > 1$ and*

$$\mathcal{L} := \mathcal{M}\downarrow(\mathcal{Y}, \alpha)$$

the descending up link of (\mathcal{Y}, α) with respect to the Morse function f above. Then \mathcal{L} is contractible.

PROOF. Note that the data of an object of \mathcal{L} is a non-trivial factorization of α , i.e. a pair (α_1, α_2) of arrows in \mathcal{U}/\mathcal{G} such that $\alpha_1 \neq \text{id} \neq \alpha_2$ and $\alpha_1 \alpha_2 = \alpha$. An arrow from (α_1, α_2) to (β_1, β_2) is an arrow γ such that $\alpha_1 \gamma = \beta_1$ and $\gamma \beta_2 = \alpha_2$. Clearly, \mathcal{L} is a poset.

Apply Lemma 3.26 above to obtain a maximal elementary factorization (α_1, α_2) of α . Note that (α_1, α_2) is an object of \mathcal{L} and the universal property says that this object is initial among the objects (β_1, β_2) of \mathcal{L} with β_2 elementary.

More generally, for an object (ϵ_1, ϵ_2) of \mathcal{L} with ϵ_2 non-elementary, we can apply the lemma to obtain a maximal elementary factorization $(\epsilon_1^*, \epsilon_2^*)$ of ϵ_2 . Then define $F(\epsilon_1, \epsilon_2) := (\epsilon_1 \epsilon_1^*, \epsilon_2^*)$ which is again an object in \mathcal{L} . If ϵ_2 is already elementary, we set $\epsilon_1^* = \text{id}$ and $\epsilon_2^* = \epsilon_2$ so that $F(\epsilon_1, \epsilon_2) = (\epsilon_1, \epsilon_2)$.

We claim that F extends to a functor $\mathcal{L} \rightarrow \mathcal{L}$. So let (ϵ_1, ϵ_2) and (β_1, β_2) be two objects of \mathcal{L} and $\gamma: (\epsilon_1, \epsilon_2) \rightarrow (\beta_1, \beta_2)$ an arrow in \mathcal{L} . We have to show that there is an arrow $\varphi: F(\epsilon_1, \epsilon_2) \rightarrow F(\beta_1, \beta_2)$.

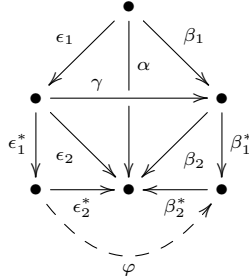

Observe first that if $\epsilon_1^* = \text{id}$, then $\gamma\beta_1^*$ is an arrow $F(\epsilon_1, \epsilon_2) \rightarrow F(\beta_1, \beta_2)$ as required. Else, observe that the pair $(\gamma\beta_1^*, \beta_2^*)$ is another elementary factorization of ϵ_2 . Thus, by the universal property, we get a unique arrow φ such that $\varphi\beta_2^* = \epsilon_2^*$ and $\epsilon_1^*\varphi = \gamma\beta_1^*$. This amounts to an arrow $F(\epsilon_1, \epsilon_2) \rightarrow F(\beta_1, \beta_2)$.

Since $F(\epsilon_1, \epsilon_2)$ is an elementary factorization of α , we get an arrow $(\alpha_1, \alpha_2) \rightarrow F(\epsilon_1, \epsilon_2)$ for each object (ϵ_1, ϵ_2) in \mathcal{L} . Furthermore, ϵ_1^* clearly gives an arrow $(\epsilon_1, \epsilon_2) \rightarrow F(\epsilon_1, \epsilon_2)$. The claim of the proposition now follows from item iii) in Section 5 of Chapter 1 applied to the functor F and the object (α_1, α_2) . \square

8. Applications

In this section, we want to apply Theorem 3.7 to the examples in Section 5 of Chapter 2.

8.1. Free operads. Let \mathcal{O} be a free (symmetric/braided) operad with transformations generated by a groupoid \mathcal{G} of degree 1 operations and a set S of higher degree operations with inputs and outputs colored with the objects in \mathcal{G} . Assume that \mathcal{G} and S are finite. Then the only thing to check in order to apply Theorem 3.7 A) is the color-tameness condition.

The special case where there are no degree 1 operations besides the identities has been treated in [16, 17]: In [16, Theorem 4.4] it is shown that the planar diagram groups associated to a finite complete presentation of a finite semigroup are of type F_∞ . Assume without loss of generality that the relations in this presentation are tree-like and let \mathcal{O} be the corresponding free planar operad (with transformations) as explained in Subsection 5.1 of Chapter 2. The finiteness of the presentation then corresponds to finitely many colors and finitely many free generators in \mathcal{O} . Furthermore, if we have a finite complete presentation of a finite semigroup, then there are only finitely many reduced words (see [16, Subsection 4.2]). This implies color-tameness of \mathcal{O} . Thus, also the conditions of our main theorem are satisfied. In [17, Theorem 1] it is shown that the symmetric diagram groups associated to a finite semigroup presentation with terminating rewrite system having only finitely many reduced objects is of type F_∞ . Assume again without loss of generality that each relation in this presentation is tree-like and let \mathcal{O} be the corresponding free symmetric operad (with transformations). Then \mathcal{O} obviously satisfies the conditions of our main theorem.

Note that Theorem 3.7 A) extends the results from [16, 17] since it also allows braidings and degree 1 isomorphisms in \mathcal{O} .

8.2. Suboperads of endomorphism operads. Consider the example with squares and triangles, the cube cutting operads (planar or symmetric) and the local similarity operads from Subsection 5.2 in Chapter 2. There, we have seen that they all satisfy the cancellative calculus of fractions. The squares and triangles operad and the cube cutting operads are of finite type. The local similarity operads are of finite type if and only if there are only finitely many Sim_X -equivalence classes of balls, so we will assume this in the following. Then, in all three cases, the groupoid $\mathcal{I}(\mathcal{O})$ is finite.

In order to apply Theorem 3.7 B), it therefore remains to check color-tameness. The cube cutting operads are monochromatic, so color-tameness is trivially satisfied here. The squares and triangles operad has two colors (the square and the triangle). It is easy to check that any sequence of at least five squares and triangles is the domain of a very elementary arrow in $\mathcal{S}(\mathcal{O})$. Thus, it also is color-tame. In general, a local similarity operad is not color-tame.

As a special case, we obtain that the higher dimensional Thompson groups nV are of type F_∞ . This has been shown before in [22].

The one dimensional cube cutting operads (planar or symmetric) with trivial groupoid of degree 1 operations yield the groups of piecewise linear homeomorphisms of the unit (Cantor) interval studied in [43] and from the main theorem, it follows that they are of type F_∞ . This has already been shown in [43].

The finiteness result for the local similarity groups has also been obtained in [18, Theorem 6.5]. The hypothesis in this theorem consists of demanding that the finite similarity structure possesses only finitely many Sim_X -equivalence classes of balls and of the property rich in simple contractions which is implied by the easier to state property rich in ball contractions [18, Definition 5.12]. It is not hard to see that the latter property exactly means that \mathcal{O} , the local similarity operad associated to Sim_X , is color-tame.

8.3. Ribbon Thompson group. The braided operad \mathcal{O} with transformations discussed in Subsection 5.3 of Chapter 2 satisfies the cancellative calculus of fractions. It is monochromatic and therefore color-tame. There is only one very elementary transformation class and thus, \mathcal{O} is of finite type. The groupoid $\mathcal{I}(\mathcal{O})$ is the group \mathbb{Z} which is of type F_∞^+ . Part B) of the main theorem yields that the Ribbon Thompson group is of type F_∞ .

A group homological result

Let \mathcal{O} be a planar or symmetric operad satisfying the calculus of fractions and $\Gamma = \pi_1(\mathcal{O}, X)$. The main theorem of this chapter states that if group homology of Γ vanishes in dimension 0, then it already vanishes in every dimension, provided some conditions are fulfilled for the coefficient Γ -modules and for the basepoint X . In particular, these conditions are fulfilled by group ring and von Neumann algebra coefficients. As an application, this enables us to show that a lot of symmetric operad groups are l^2 -invisible, i.e. group homology with von Neumann algebra coefficients vanishes in every dimension. Combining this with the finiteness results from Chapter 3, we obtain a large class of groups which are both l^2 -invisible and of type F_∞ . This has some relationship with the *zero-in-the-spectrum* question by Gromov (see Subsection 4.1). The results in this chapter generalize the results previously obtained in [39].

1. Statement of the main theorem

DEFINITION 4.1. Let $\mathcal{M}G$ be a $\mathbb{Z}G$ -module for every group G . We call \mathcal{M}

- *Künneth* if for every two groups G_1, G_2 and $n_1, n_2 \in \mathbb{Z}$ with $n_i \geq -1$ the following is satisfied:

$$\left. \begin{array}{l} \forall_{k \leq n_1} H_k(G_1, \mathcal{M}G_1) = 0 \\ \forall_{k \leq n_2} H_k(G_2, \mathcal{M}G_2) = 0 \end{array} \right\} \implies \forall_{k \leq n} H_k(G, \mathcal{M}G) = 0$$

where $G := G_1 \times G_2$ and $n := n_1 + n_2 + 1$.

- *inductive* if whenever H and G are groups with H a subgroup of G and $k \geq 0$, then we have that

$$H_k(H, \mathcal{M}H) = 0 \quad \text{implies} \quad H_k(H, \mathcal{M}G) = 0$$

Let \mathfrak{P} be a property of groups. Then we say that \mathcal{M} is \mathfrak{P} -Künneth if the property Künneth has to be satisfied only for \mathfrak{P} -groups G_1, G_2 . We say that \mathcal{M} is \mathfrak{P} -inductive if the property inductive has to be satisfied only for \mathfrak{P} -subgroups H of the arbitrary group G . Furthermore, one can formulate these two properties also in the cohomological case.

DEFINITION 4.2. Let \mathcal{O} be a planar or symmetric or braided operad and X an object in $\mathcal{S}(\mathcal{O})$. We say that X is

- *split* if there are objects A_1, A_2, A_3 and an arrow $A_1 \otimes X \otimes A_2 \otimes X \otimes A_3 \rightarrow X$ in $\mathcal{S}(\mathcal{O})$.
- *progressive* if for every arrow $Y \rightarrow X$ there are objects A_1, A_2 and an arrow $A_1 \otimes X \otimes A_2 \rightarrow Y$ such that the coordinates of X are connected to only one operation in this arrow (see Figure 1).

REMARK 4.3. If X is just a single color, then X is split if and only if there is an operation with output color X and at least two inputs of color X . If \mathcal{O} is monochromatic and $X \neq I$ is an object of $\mathcal{S}(\mathcal{O})$, then X is split if and only if there is at least one operation in \mathcal{O} with at least two inputs. So in the monochromatic case, the condition split is in fact a property of \mathcal{O} .

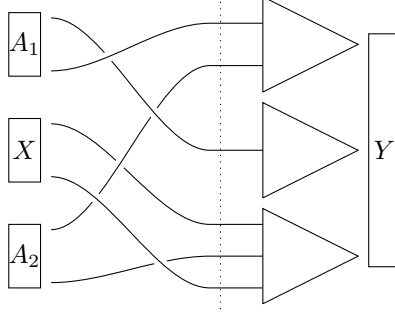

FIGURE 1. An arrow $A_1 \otimes X \otimes A_2 \rightarrow Y$ such that X is only connected to one operation.

REMARK 4.4. If X is just a single color, then X is progressive if and only if for every operation θ with output color X there is another operation ϕ with at least one input of color X and at least one input of θ has the same color as the output of ϕ . Now assume that \mathcal{O} is monochromatic. Then an object $X \neq I$ in $\mathcal{S}(\mathcal{O})$ (which is just a natural number $X > 0$, e.g. $X = 3$) is progressive if and only if there is an operation in \mathcal{O} with at least X inputs (e.g. 3 inputs). Note that $X = 1$ is always progressive in the monochromatic case.

THEOREM 4.5. *Let \mathcal{O} be a planar or symmetric operad which satisfies the calculus of fractions. Let \mathcal{M} be a coefficient system which is Künneth and inductive. Let X be a split progressive object of $\mathcal{S}(\mathcal{O})$. Set $\Gamma := \pi_1(\mathcal{O}, X)$. Then*

$$H_0(\Gamma, \mathcal{M}\Gamma) = 0 \quad \implies \quad \forall_{k \geq 0} H_k(\Gamma, \mathcal{M}\Gamma) = 0$$

The same is true for cohomology.

More generally, let \mathfrak{P} be a property of groups which is closed under taking products. Then the statement is true also for coefficient systems \mathcal{M} which are only \mathfrak{P} -Künneth and \mathfrak{P} -inductive, provided that Γ satisfies \mathfrak{P} .

REMARK 4.6. Let X, Y be objects in $\mathcal{S}(\mathcal{O})$. Generalizing the notion of progressiveness, we say that X is Y -progressive if for every arrow $Z \rightarrow X$ there is an arrow $A_1 \otimes Y \otimes A_2 \rightarrow Z$ and the coordinates of Y are connected to only one operation in this arrow (call this the *link condition*). In particular, there is an arrow $A_1 \otimes Y \otimes A_2 \rightarrow X$.

With this notion, we can formulate a slightly more general version of Theorem 4.5: Let $\mathcal{O}, \mathfrak{P}, \mathcal{M}$ be as in the theorem. Let X be an object of $\mathcal{S}(\mathcal{O})$ and set $\Gamma = \pi_1(\mathcal{O}, X)$. Assume there is a split object Y such that X is Y -progressive, $\Upsilon := \pi_1(\mathcal{O}, Y)$ satisfies \mathfrak{P} and $H_0(\Upsilon, \mathcal{M}\Upsilon) = 0$. Then $H_k(\Gamma, \mathcal{M}\Gamma) = 0$ for each $k \geq 0$. The same is true for cohomology.

2. Proof of the main theorem

We start with two general lemmas concerning the calculus of fractions.

LEMMA 4.7. *Let \mathcal{C} be a category satisfying the calculus of fractions. Then two square fillings of a given span can be combined to a common square filling. This means: Let x, y be two arrows with the same codomain and assume having two*

square fillings as in the diagram

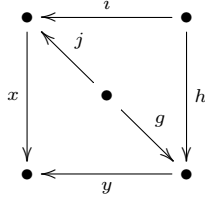

then we can complete this diagram to the commutative diagram

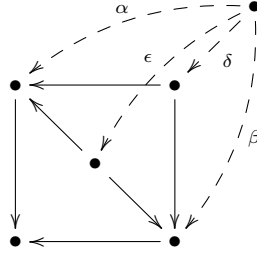

PROOF. Let c, d be a square filling of $a := ix = hy, b := jx = gy$, i.e. $ca = db$. Then ch and dg are two parallel arrows which are coequalized by y , i.e. $(ch)y = (dg)y$. By the equalization property we find an equalizing arrow k with $k(ch) = k(dg)$. By the same reasoning we find an arrow l with $l(ci) = l(dj)$. Let m, n be a square filling of l, k , i.e. $ml = nk =: p$. Then one can easily calculate that the arrows

$$\delta = pc \quad \alpha = pci \quad \beta = pch \quad \epsilon = pd$$

fill the diagram as required. \square

LEMMA 4.8. Let \mathcal{C} be a category satisfying the calculus of fractions. Let \bar{x} and \bar{y} be two arrows $A \rightarrow C$. Assume that there are arrows $x, y: A \rightarrow B$ and $a: B \rightarrow C$ such that $xa = \bar{x}$ and $ya = \bar{y}$.

$$C \xleftarrow{\bar{x}} B \xleftarrow{x} A \xrightarrow{y} B \xrightarrow{a} C$$

Then the span $C \xleftarrow{\bar{x}} A \xrightarrow{\bar{y}} C$ is null-homotopic if and only if the span $B \xleftarrow{x} A \xrightarrow{y} B$ is null-homotopic.

PROOF. First note that a span like $B \xleftarrow{x} A \xrightarrow{y} B$ is null-homotopic if and only if the parallel arrows x and y are homotopic. Since \mathcal{C} satisfies the calculus of fractions, this is the case if and only if there is an equalizing arrow, i.e. an arrow $d: D \rightarrow A$ with $dx = dy$. Now if x and y are homotopic then clearly also \bar{x} and \bar{y} are homotopic. On the other hand, assume that \bar{x} and \bar{y} are homotopic and $d: D \rightarrow A$ equalizes \bar{x} and \bar{y} . Then we have

$$(dx)a = d(xa) = d\bar{x} = d\bar{y} = d(ya) = (dy)a$$

Then by the equalization property we find an arrow $e: E \rightarrow D$ with $e(dx) = e(dy)$. Consequently, the arrow ed equalizes x and y and thus, x and y are homotopic. \square

We now turn to the proof of Theorem 4.5. In the following, let \mathcal{O} be a planar or symmetric operad satisfying the calculus of fractions with set of colors C and let $\mathcal{S} := \mathcal{S}(\mathcal{O})$.

2.1. Marked objects. Let $c = (c_1, \dots, c_n)$ be an object of \mathcal{S} , i.e. c_1, \dots, c_n are colors in C . First we define a marking on c in the symmetric case. It assigns to each coordinate of c a symbol. A symbol can be assigned several times and not every coordinate has to be marked by a symbol. More precisely, a marking of c is a set S of symbols together with a subset $I \subset \{1, \dots, n\}$ and a surjective function $f: I \rightarrow S$. In the planar case, we additionally require the marking to be ordered. This means that whenever $i \triangleright f = j \triangleright f$ for $i < j$ then also $i \triangleright f = k \triangleright f = j \triangleright f$ for $i < k < j$.

Let m_1, m_2 be two markings of c with symbol sets S_1, S_2 . We say $m_1 \subset m_2$ if there is a function $i: S_1 \rightarrow S_2$ and every coordinate which is marked with $s_1 \in S_1$ is also marked with $s_1 \triangleright i \in S_2$. We say m_1 and m_2 are equivalent if $m_1 \subset m_2$ and $m_2 \subset m_1$. This means that there is a bijection $i: S_1 \rightarrow S_2$ and a coordinate is marked with $s_1 \in S_1$ if and only if it is marked with $s_1 \triangleright i \in S_2$. By slight abuse of notation, we identify equivalent markings and write $m_1 = m_2$ if they are equivalent. Then \subset becomes a partial order on the set of markings on c (see the first paragraph of Subsection 2.3).

2.2. Marked arrows. Let $\alpha: c \rightarrow d$ be an arrow in \mathcal{S} with objects $c = (c_1, \dots, c_n)$ and $d = (d_1, \dots, d_m)$. A marking on α is a marking on the domain c . A comarking on α is a marking on the codomain d . A comarking on α induces a marking on α : Let (σ, X) be a representative of α where σ is either an identity or a colored permutation, depending on whether \mathcal{O} is planar or symmetric. Write $X = (X_1, \dots, X_m)$. The comarking yields a marking on the operations X_i . Mark each input of X_i with the same symbol. Now push the markings through σ to obtain a marking on the domain c . Figure 2 illustrates this procedure. If m is the comarking, then we denote this pull-backed marking by $\alpha^*(m)$. Observe that this pull-back is functorial, i.e. we have

$$(\alpha\beta)^*(m) = \alpha^*(\beta^*(m))$$

Furthermore, we have

$$m_1 \subset m_2 \iff \alpha^*(m_1) \subset \alpha^*(m_2)$$

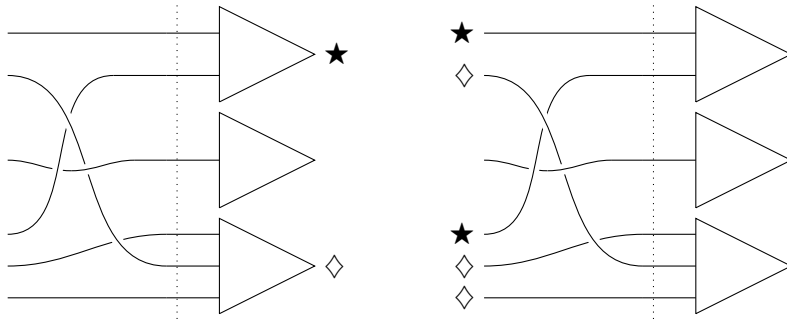

FIGURE 2. A comarking (left) and the pull-backed marking (right).

Now fix an object x in \mathcal{S} .

Let (α_1, m_1) and (α_2, m_2) be two marked arrows with codomain x , i.e. $\alpha_i: c_i \rightarrow x$ is an arrow and m_i is a marking on c_i . We write

$$(\alpha_1, m_1) \subset (\alpha_2, m_2)$$

if there is a square filling

$$\begin{array}{ccc} d & \xrightarrow{\beta_2} & c_2 \\ \beta_1 \downarrow & & \downarrow \alpha_2 \\ c_1 & \xrightarrow{\alpha_1} & x \end{array}$$

with $\beta_1^*(m_1) \subset \beta_2^*(m_2)$. Observe that then *every* square filling satisfies this: Let (γ_1, γ_2) be another square filling of (α_1, α_2) . Then choose a common square filling (δ_1, δ_2) as in Lemma 4.7. It is not hard to see that the property $\delta_1^*(m_1) \subset \delta_2^*(m_2)$ is inherited from the square filling (β_1, β_2) . On the other hand, this forces the property onto the square filling (γ_1, γ_2) , i.e. we have $\gamma_1^*(m_1) \subset \gamma_2^*(m_2)$.

REMARK 4.9. This observation implies also the following: Let $(\alpha_1, m_1) \subset (\alpha_2, m_2)$ and assume that $\alpha_1 = \alpha_2$. Then we have necessarily $m_1 \subset m_2$. Indeed, we can choose $\beta_1 = \text{id} = \beta_2$ in the above square filling.

PROPOSITION 4.10. *The relation \subset on the set of marked arrows is reflexive and transitive.*

PROOF. Reflexivity is clear. For transitivity assume $(\alpha_1, m_1) \subset (\delta, m)$ and $(\delta, m) \subset (\alpha_2, m_2)$. Choose two square fillings

$$\begin{array}{ccccc} a_1 & \xrightarrow{\delta_1} & d & \xleftarrow{\delta_2} & a_2 \\ \beta_1 \downarrow & & \downarrow \delta & & \downarrow \beta_2 \\ c_1 & \xrightarrow{\alpha_1} & x & \xleftarrow{\alpha_2} & c_2 \end{array}$$

with $\beta_1^*(m_1) \subset \delta_1^*(m)$ and $\delta_2^*(m) \subset \beta_2^*(m_2)$. Choose a square filling of (δ_1, δ_2)

$$\begin{array}{ccccc} & & e & & \\ & \swarrow \gamma_1 & \downarrow \eta & \searrow \gamma_2 & \\ a_1 & \xrightarrow{\delta_1} & d & \xleftarrow{\delta_2} & a_2 \\ \beta_1 \downarrow & & \downarrow \delta & & \downarrow \beta_2 \\ c_1 & \xrightarrow{\alpha_1} & x & \xleftarrow{\alpha_2} & c_2 \end{array}$$

Now we have

$$\begin{aligned} (\gamma_1 \beta_1)^*(m_1) &= \gamma_1^*(\beta_1^*(m_1)) \\ &\subset \gamma_1^*(\delta_1^*(m)) \\ &= (\gamma_1 \delta_1)^*(m) \\ &= \eta^*(m) \\ &= (\gamma_2 \delta_2)^*(m) \\ &= \gamma_2^*(\delta_2^*(m)) \\ &\subset \gamma_2^*(\beta_2^*(m_2)) \\ &= (\gamma_2 \beta_2)^*(m_2) \end{aligned}$$

This proves $(\alpha_1, m_1) \subset (\alpha_2, m_2)$. \square

2.3. Balls and partitions. A transitive and reflexive relation \preceq on a set Z is not a poset in general since $a \preceq b$ together with $b \preceq a$ does not imply $a = b$ in general. We can repair this in the following way: Define $a, b \in Z$ to be equivalent if $a \preceq b$ and $b \preceq a$. This is indeed an equivalence relation because \preceq is assumed to be reflexive and transitive. Now if \mathbf{a} and \mathbf{b} are two equivalence classes, we write

$\mathbf{a} \leq \mathbf{b}$ if there are representatives a and b respectively with $a \preceq b$. One can easily show that then *any* two representatives satisfy this. Using this, it is not hard to see that \leq is indeed a partial order on the set of equivalence classes. In particular, we have $\mathbf{a} = \mathbf{b}$ if and only if $\mathbf{a} \leq \mathbf{b}$ and $\mathbf{b} \leq \mathbf{a}$.

We want to apply this observation to the reflexive and transitive relation \subset on the set of marked arrows. We say that two marked arrows (α_1, m_1) and (α_2, m_2) with common codomain x are equivalent if both $(\alpha_1, m_1) \subset (\alpha_2, m_2)$ and $(\alpha_2, m_2) \subset (\alpha_1, m_1)$ hold. We remark that this is equivalent to the existence of a square filling

$$\begin{array}{ccc} d & \xrightarrow{\beta_2} & c_2 \\ \beta_1 \downarrow & & \downarrow \alpha_2 \\ c_1 & \xrightarrow{\alpha_1} & x \end{array}$$

with $\beta_1^*(m_1) = \beta_2^*(m_2)$ and moreover that *every* square filling satisfies this.

- A *semi-partition* is an equivalence class of marked arrows.
- A *partition* is a semi-partition with fully marked domain for some (and therefore for every) representative of the semi-partition. Here, an object in \mathcal{S} is fully marked if every coordinate is marked.
- A *multiball* is a semi-partition with an uni-marked domain for some (and therefore for every) representative of the semi-partition. Here, an object in \mathcal{S} is uni-marked if there is only one symbol in the marking.
- A *ball* is a semi-partition such that there is a single-marked representative. Here, an object in \mathcal{S} is single-marked if only one coordinate is marked.

Note that these definitions depend on the base point x . Following the remarks in the first paragraph, we write $\mathcal{P} \subset \mathcal{Q}$ for two semi-partitions \mathcal{P} and \mathcal{Q} if there are representatives p of \mathcal{P} and q of \mathcal{Q} satisfying $p \subset q$. Then for *all* such representatives p, q we have $p \subset q$. It follows that \subset is a partial order on the set of semi-partitions. In particular, we have $\mathcal{P} = \mathcal{Q}$ if and only if $\mathcal{P} \subset \mathcal{Q}$ and $\mathcal{Q} \subset \mathcal{P}$.

We now investigate the relationship between semi-partitions and multiballs. Let \mathcal{P} be a semi-partition with representative (α, m) . Picking out a symbol s of m and removing all markings except those with the chosen symbol s gives a uni-marked arrow (α, m^s) . The corresponding equivalence class is a multiball and is independent of the chosen representative (α, m) in the following sense: If we choose another representative (β, n) , then $(\alpha, m) \sim (\beta, n)$ and to the chosen symbol s of m corresponds a unique symbol r of n . Deleting all markings in n except those with the symbol r gives a uni-marked arrow (β, n^r) which is equivalent to (α, m^s) . Multiballs arising in this way are called submultiballs of \mathcal{P} and we write $P \in \mathcal{P}$ for submultiballs. Note that Remark 4.9 implies that two submultiballs P_1, P_2 coming from a representative of \mathcal{P} by choosing two different symbols satisfy $P_1 \not\subset P_2$ and $P_2 \not\subset P_1$, in particular $P_1 \neq P_2$. It follows that there is a canonical bijection between the set $\{P \in \mathcal{P}\}$ of submultiballs of \mathcal{P} and the set of symbols of \mathcal{P} (which is, by definition, the set of symbols of the marking of any representative for \mathcal{P}). Moreover, any two submultiballs $P_1, P_2 \in \mathcal{P}$ with $P_1 \neq P_2$ satisfy the stronger property $(P_1 \not\subset P_2) \wedge (P_2 \not\subset P_1)$. Equivalently, whenever $P_1 \subset P_2$ or $P_2 \subset P_1$, then already $P_1 = P_2$.

PROPOSITION 4.11. *Let \mathcal{P}, \mathcal{Q} be semi-partitions, then*

$$\mathcal{Q} \subset \mathcal{P} \iff \forall Q \in \mathcal{Q} \exists P \in \mathcal{P} Q \subset P$$

In particular, $\mathcal{P} = \mathcal{Q}$ if and only if $\{Q \in \mathcal{Q}\} = \{P \in \mathcal{P}\}$.

PROOF. We first prove the last statement since it is a formal consequence of the previous statement and the remarks preceding the proposition. First recall that $\mathcal{P} = \mathcal{Q}$ is equivalent to $\mathcal{P} \subset \mathcal{Q}$ and $\mathcal{Q} \subset \mathcal{P}$. The first statement of the proposition says that there is a function $i: \{Q \in \mathcal{Q}\} \rightarrow \{P \in \mathcal{P}\}$ with the property that $Q \subset Q \triangleright i$ for each $Q \in \mathcal{Q}$. Since we also have $\mathcal{P} \subset \mathcal{Q}$, there is another function $j: \{P \in \mathcal{P}\} \rightarrow \{Q \in \mathcal{Q}\}$ with the property that $P \subset P \triangleright j$ for each $P \in \mathcal{P}$. We have

$$Q \subset Q \triangleright i \subset (Q \triangleright i) \triangleright j = Q \triangleright (ij)$$

for all $Q \in \mathcal{Q}$. Since both the left and right side are submultiballs of \mathcal{Q} , the remarks preceding the proposition imply $Q = Q \triangleright (ij)$ for all $Q \in \mathcal{Q}$. We then have

$$Q \subset Q \triangleright i \subset Q$$

and therefore also $Q = Q \triangleright i$ for all $Q \in \mathcal{Q}$. This shows $\{Q \in \mathcal{Q}\} \subset \{P \in \mathcal{P}\}$. With a similar argument applied to ji , we also obtain $\{Q \in \mathcal{Q}\} \supset \{P \in \mathcal{P}\}$. So we have indeed $\{Q \in \mathcal{Q}\} = \{P \in \mathcal{P}\}$. The converse implication also follows easily from the first statement of this proposition.

Now let's turn to the first statement: Assume $\mathcal{Q} \subset \mathcal{P}$. By the square filling technique, we know that we can choose a common arrow $\alpha: c \rightarrow x$ with markings $m_{\mathcal{Q}} \subset m_{\mathcal{P}}$ such that $[\alpha, m_{\mathcal{Q}}] = \mathcal{Q}$ and $[\alpha, m_{\mathcal{P}}] = \mathcal{P}$. If $Q \in \mathcal{Q}$, then we find a symbol $s_{\mathcal{Q}}$ of the marking $m_{\mathcal{Q}}$ which corresponds to Q . But since $m_{\mathcal{Q}} \subset m_{\mathcal{P}}$, there is a unique symbol $s_{\mathcal{P}}$ of the marking $m_{\mathcal{P}}$ such that the coordinates of c marked by $s_{\mathcal{Q}}$ are also marked by $s_{\mathcal{P}}$. The submultiball obtained from $(\alpha, m_{\mathcal{P}})$ corresponding to the symbol $s_{\mathcal{P}}$ is the one we are looking for.

Conversely, assume that there is a function $i: \{Q \in \mathcal{Q}\} \rightarrow \{P \in \mathcal{P}\}$ such that $Q \subset Q \triangleright i$ for every $Q \in \mathcal{Q}$. Using the square filling technique, we find a common arrow $\alpha: c \rightarrow x$ with markings $m_{\mathcal{Q}}, m_{\mathcal{P}}$ such that $[\alpha, m_{\mathcal{Q}}] = \mathcal{Q}$ and $[\alpha, m_{\mathcal{P}}] = \mathcal{P}$. We want to show $m_{\mathcal{Q}} \subset m_{\mathcal{P}}$. Let s be any symbol of $m_{\mathcal{Q}}$. To this symbol corresponds exactly one submultiball $Q \in \mathcal{Q}$ such that $Q = [\alpha, m_{\mathcal{Q}}^s]$ where $m_{\mathcal{Q}}^s$ is the submarking of $m_{\mathcal{Q}}$ with all markings removed except those with the symbol s . To the submultiball $Q \triangleright i \in \mathcal{P}$ corresponds exactly one symbol r of $m_{\mathcal{P}}$ such that $Q \triangleright i = [\alpha, m_{\mathcal{P}}^r]$. Since $Q \subset Q \triangleright i$ we have $(\alpha, m_{\mathcal{Q}}^s) \subset (\alpha, m_{\mathcal{P}}^r)$ and therefore $m_{\mathcal{Q}}^s \subset m_{\mathcal{P}}^r$ by Remark 4.9. It follows $m_{\mathcal{Q}} \subset m_{\mathcal{P}}$ and thus $\mathcal{Q} \subset \mathcal{P}$. \square

2.4. The action on the set of semi-partitions. Here we will define an action of $\Gamma = \pi_1(\mathcal{S}, x)$ on the set of semi-partitions over x . So let $\gamma \in \Gamma$ and \mathcal{P} be a semi-partition over x . We will define another semi-partition $\gamma \cdot \mathcal{P}$ over x . Recall that γ is represented by a span $x \xleftarrow{\gamma_d} a \xrightarrow{\gamma_n} x$ (the d refers to *denominator* and the n refers to *nominator*) and that \mathcal{P} is represented by a marked arrow $(\alpha: c \rightarrow x, m)$. First choose a square filling of (γ_n, α)

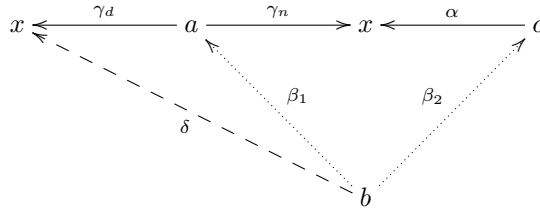

and then define $\delta := \beta_1 \gamma_d: b \rightarrow x$. Endow this arrow with the marking $\mu := \beta_2^*(m)$. Finally, define $\gamma \cdot \mathcal{P} := [\delta, \mu]$. We have to show that this is well-defined, i.e. we have to show that the resulting class is independent of

1. the square filling (β_1, β_2)
2. the marked arrow (α, m) as a representative of \mathcal{P}
3. the span (γ_d, γ_n) as a representative of γ

We now prove these points one by one.

1. Assume we have two square fillings of (γ_n, α) as in the following diagram:

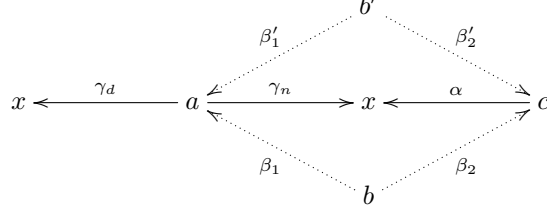

Choose a common square filling as in Lemma 4.7:

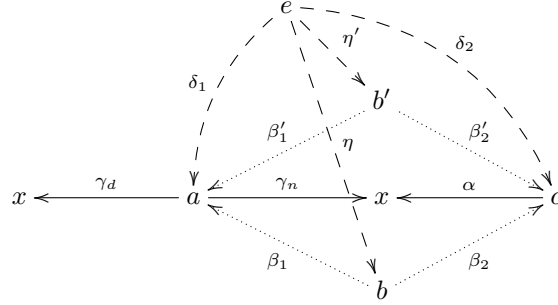

Now the marked arrow $(\beta_1\gamma_d, \beta_2^*(m))$ is equivalent to the marked arrow $(\delta_1\gamma_d, \delta_2^*(m))$ via η . Analogously, the marked arrow $(\beta'_1\gamma_d, \beta'_2^*(m))$ is equivalent to $(\delta_1\gamma_d, \delta_2^*(m))$ via η' and therefore equivalent to $(\beta_1\gamma_d, \beta_2^*(m))$, q.e.d.

2. Let (α', m') be another marked arrow equivalent to (α, m) and choose a square filling (β, β') such that $\beta^*(m) = \beta'^*(m') =: \mu$ as in the following diagram:

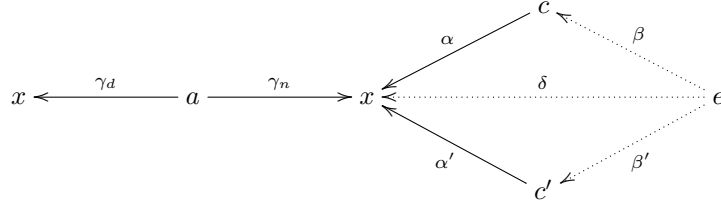

First choose a square filling (η_1, η_2) of (γ_n, α) and then a square filling (ν_1, ν_2) of (η_2, β) . Analogously, choose a square filling (η'_1, η'_2) of (γ_n, α') and then a square filling (ν'_1, ν'_2) of (η'_2, β')

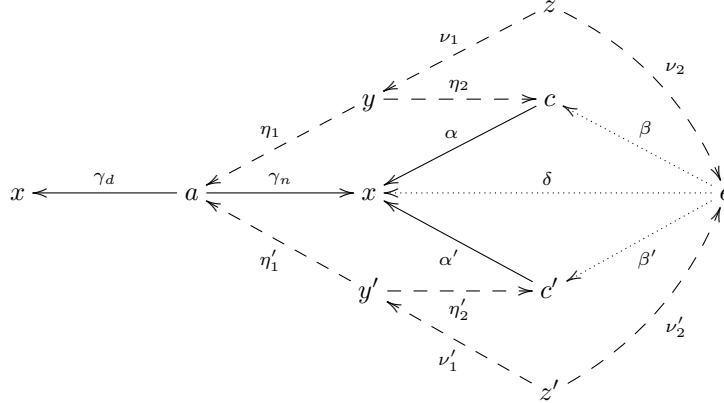

The marked arrow $(\eta_1\gamma_d, \eta_2^*(m))$ is equivalent to $\Lambda := (\nu_1\eta_1\gamma_d, \nu_2^*(\mu))$ via ν_1 . On the other side, the marked arrow $(\eta'_1\gamma_d, \eta'_2^*(m'))$ is equivalent to $\Lambda' := (\nu'_1\eta'_1\gamma_d, \nu'_2^*(\mu))$

via ν'_1 . The marked arrows Λ and Λ' are both constructed from the same marked arrow (δ, μ) and so are equivalent by **1**. Consequently, $(\eta_1 \gamma_d, \eta_2^*(m))$ and $(\eta'_1 \gamma_d, \eta_2^*(m'))$ are equivalent, q.e.d.

3. Let (γ'_d, γ'_n) be another representing span of γ homotopic to the span (γ_d, γ_n) . Then recall that the two spans can be filled by a diagram as follows:

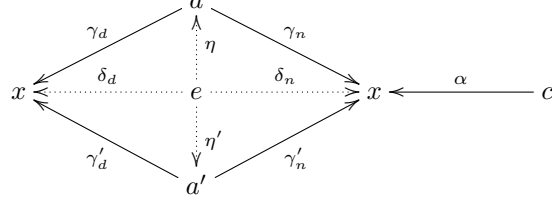

Now choose a square filling (ν_1, ν_2) of (δ_n, α) and note that (ϵ, ν_2) , where $\epsilon := \nu_1 \eta$, gives square filling of (γ_n, α) .

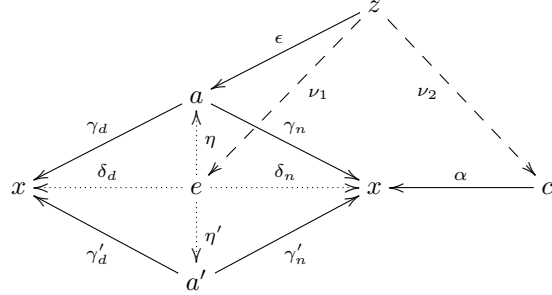

The marked arrow $(\epsilon \gamma_d, \nu_2^*(m))$ is equivalent to $(\nu_1 \delta_d, \nu_2^*(m))$. Similarly, define $\epsilon' = \nu_1 \eta'$ and note that (ϵ', ν_2) gives a square filling of (γ'_n, α) . Again, the marked arrow $(\epsilon' \gamma'_d, \nu_2^*(m))$ is equivalent to $(\nu_1 \delta_d, \nu_2^*(m))$. Therefore, $(\epsilon \gamma_d, \nu_2^*(m))$ and $(\epsilon' \gamma'_d, \nu_2^*(m))$ are equivalent, q.e.d.

Now we want to show that this is indeed an action, i.e. $1 \cdot \mathcal{P} = \mathcal{P}$ and $\gamma^1 \cdot (\gamma^2 \cdot \mathcal{P}) = (\gamma^1 \gamma^2) \cdot \mathcal{P}$. The first property is easy to see. The second property is not entirely trivial but straightforward. We will be explicit for completeness. Choose two representing spans (γ_d^1, γ_n^1) and (γ_d^2, γ_n^2) for γ^1 and γ^2 respectively. Let (α, m) represent \mathcal{P} . To get a representing span for the composition $\gamma_1 \gamma_2$, choose a square filling (β_1, β_2) of (γ_n^1, γ_d^2) and take the span $(\beta_1 \gamma_d^1, \beta_2 \gamma_n^2)$. This span acts on (α, m) as before and is sketched diagrammatically as follows:

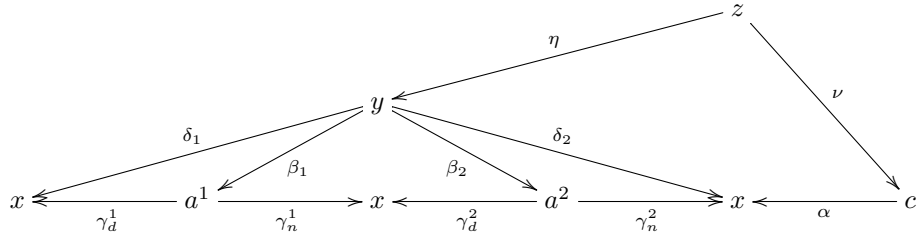

So a representative of $(\gamma^1 \gamma^2) \cdot \mathcal{P}$ is given by $(\eta \delta_1, \nu^*(m))$. Now a representative for $\gamma^2 \cdot \mathcal{P}$ is given by $(\eta \beta_2 \gamma_d^2, \nu^*(m))$ because $(\eta \beta_2, \nu)$ is a square filling for (γ_n^2, α) . Since $(\eta \beta_1, \text{id}_z)$ is a square filling for $(\gamma_n^1, \eta \beta_2 \gamma_d^2)$, we obtain that $(\eta \beta_1 \gamma_d^1, \text{id}_z^*(\nu^*(m)))$ is a representative of $\gamma^1 \cdot (\gamma^2 \cdot \mathcal{P})$. But this last marked arrow is equal to $(\eta \delta_1, \nu^*(m))$, q.e.d.

REMARK 4.12. It is not hard to see that $\mathcal{P} \subset \mathcal{Q}$ implies $\gamma \cdot \mathcal{P} \subset \gamma \cdot \mathcal{Q}$.

REMARK 4.13. The submultiballs of $\gamma \cdot \mathcal{P}$ are the multiballs $\gamma \cdot P$ with $P \in \mathcal{P}$.

2.5. Pointwise stabilizers of partitions. Let \mathcal{P} be a partition over x . By the pointwise stabilizer of \mathcal{P} we mean the subgroup

$$\Lambda := \{\gamma \in \pi_1(\mathcal{S}, x) \mid \gamma \cdot P = P \text{ for all } P \in \mathcal{P}\}$$

Fix some representative (α, m) of \mathcal{P} . We can assume without loss of generality that the marking m on the domain c of α is ordered. That means that if $f: I \rightarrow S$ is the marking function of m and whenever $i \triangleright f = j \triangleright f$ for $i < j$, then also $i \triangleright f = k \triangleright f = j \triangleright f$ for every k with $i < k < j$. This is true in the planar case by definition. In the symmetric case, we can choose a colored permutation $\sigma \in \mathfrak{Sym}(C)$ with $\sigma^*(m)$ ordered and replace (α, m) by the equivalent marked arrow $(\sigma\alpha, \sigma^*(m))$.

PROPOSITION 4.14. *Each symbol of the marking m determines a subword of the word $c = \text{dom}(\alpha)$. Denote these subwords by c_1, \dots, c_k and order them such that $c = c_1 \otimes \dots \otimes c_k$. Then we have a well-defined isomorphism of groups*

$$\Xi: \pi_1(\mathcal{S}, c_1) \times \dots \times \pi_1(\mathcal{S}, c_k) \rightarrow \Lambda$$

which is given by applying the tensor product of paths and then conjugating with the arrow α . More explicitly, it is given by sending representing spans p_1, \dots, p_k to the homotopy class represented by the path

$$\begin{array}{ccccccc}
 & & c_1 & \xleftarrow{p_1^\leftarrow} & a_1 & \xrightarrow{p_1^\rightarrow} & c_1 \\
 & & \otimes & \otimes & \otimes & \otimes & \otimes \\
 x & \xleftarrow{\alpha} & \vdots & \vdots & \vdots & \vdots & \vdots & \xrightarrow{\alpha} & x \\
 & & \otimes & \otimes & \otimes & \otimes & \otimes \\
 & & c_k & \xleftarrow{p_k^\leftarrow} & a_k & \xrightarrow{p_k^\rightarrow} & c_k
 \end{array}$$

where p_i^\leftarrow is the arrow pointing to the left and p_i^\rightarrow the arrow pointing to the right in the span p_i .

PROOF. It is not hard to see that the map is independent of the chosen representing spans p_i and that it is a group homomorphism. Injectivity follows from Lemma 4.8 and Lemma 4.15 below. Before we prove surjectivity, we want to see that the image really lies in the subgroup Λ . We can use the representative (α, m) to extract representatives of submultiballs $P \in \mathcal{P}$. The subwords c_i are in one to one correspondence with the submultiballs $P \in \mathcal{P}$. A representative (α, m_i) of $P \in \mathcal{P}$ corresponding to c_i is obtained from (α, m) by removing all markings except the markings on the subword c_i . The representing span of $\Xi(p_1, \dots, p_k)$ pictured above can be written as $(p^\leftarrow \alpha, p^\rightarrow \alpha)$ where $p^\leftarrow = p_1^\leftarrow \otimes \dots \otimes p_k^\leftarrow$ and $p^\rightarrow = p_1^\rightarrow \otimes \dots \otimes p_k^\rightarrow$. Letting this span act on (α, m_i) , we can choose $(\text{id}, p^\rightarrow)$ as a square filling and the resulting representative is $(p^\leftarrow \alpha, p^\rightarrow^*(m_i))$. But this is equivalent to (α, m_i) because $p^\leftarrow^*(m_i) = p^\rightarrow^*(m_i)$.

Now we prove surjectivity. Let $\gamma \in \Lambda$ which can be represented by a path of the form

$$x \xleftarrow{\alpha} c \xleftarrow{z^\leftarrow} a \xrightarrow{z^\rightarrow} c \xrightarrow{\alpha} x$$

Observe the representatives (α, m_i) of the submultiballs $P \in \mathcal{P}$ from above. A representative of $\gamma \cdot [\alpha, m_i]$ is given by $(z^\leftarrow \alpha, z^\rightarrow^*(m_i))$. So we have $(\alpha, m_i) \sim (z^\leftarrow \alpha, z^\rightarrow^*(m_i))$. Of course, $(z^\leftarrow, \text{id})$ is a square filling of $(\alpha, z^\leftarrow \alpha)$ and thus

$$z^\leftarrow^*(m_i) = z^\rightarrow^*(m_i)$$

Now assume for the moment that the operad \mathcal{O} is planar. Then it follows easily from these equalities that the span $(z^\leftarrow, z^\rightarrow)$ splits as a product according to the decomposition $c = c_1 \otimes \dots \otimes c_k$, i.e. there are $z_i^\leftarrow: a_i \rightarrow c_i$ and $z_i^\rightarrow: a_i \rightarrow c_i$ with $z^\leftarrow = z_1^\leftarrow \otimes \dots \otimes z_k^\leftarrow$ and $z^\rightarrow = z_1^\rightarrow \otimes \dots \otimes z_k^\rightarrow$. By construction, the spans $(z_i^\leftarrow, z_i^\rightarrow)$ give a preimage of γ under Ξ . If, on the other hand, \mathcal{O} is symmetric, then there is colored

permutation $\sigma \in \mathfrak{Sym}(C)$ such that the span $(\sigma z^\prec, \sigma z^\succ)$, which is homotopic to (z^\prec, z^\succ) , splits as above and we can finish the proof also in this case. \square

LEMMA 4.15. *Let $a \xleftarrow{q} b \xrightarrow{p} a$ be a span in \mathcal{S} which is a tensor product of k spans $a_i \xleftarrow{q_i} b_i \xrightarrow{p_i} a_i$ for $i = 1, \dots, k$, i.e. $q = q_1 \otimes \dots \otimes q_k$ and $p = p_1 \otimes \dots \otimes p_k$. Then the span (q, p) is null-homotopic if and only if each (q_i, p_i) is null-homotopic.*

PROOF. It is clear that if each (q_i, p_i) is null-homotopic, then (q, p) is null-homotopic. So we prove the converse. We can assume without loss of generality that $q_i \neq \text{id}_I \neq p_i$ where I is the monoidal unit in \mathcal{S} , i.e. the empty word. First observe that p, q are parallel arrows and since \mathcal{S} satisfies the calculus of fractions, they are homotopic if and only if there is an arrow $r: c \rightarrow b$ with $rq = rp$. Now, by precomposing with an arrow in $\mathfrak{Sym}(C)$ if necessary, we can assume that r is an arrow in $\mathcal{S}(\mathcal{O}_{\text{pl}})$, i.e. a tensor product of operations in \mathcal{O} . Observe that in \mathcal{S} we have $\alpha_1 \otimes \dots \otimes \alpha_l = \beta_1 \otimes \dots \otimes \beta_m$ for arrows $\alpha_i \neq \text{id}_I \neq \beta_i$ if and only if $l = m$ and $\alpha_i = \beta_i$ for each $i = 1, \dots, l$. Now it follows easily that r gives arrows r_1, \dots, r_k such that $r_i q_i = r_i p_i$ for each $i = 1, \dots, k$. Thus, q_i is homotopic to p_i for each $i = 1, \dots, k$. \square

2.6. The poset of partitions. From now on, fix some base object x which is split and progressive. More generally, in view of Remark 4.6:

Let y be a split object such that x is y -progressive.

Furthermore, let $n \in \mathbb{N}$.

Two objects a, b in \mathcal{S} are called equivalent if they are isomorphic in $\pi_1(\mathcal{S})$, i.e. there is a path (equivalently, a span) between them in \mathcal{S} . Of course, $\pi_1(\mathcal{S}, a) \cong \pi_1(\mathcal{S}, b)$ in this case.

Let $c = (c_1, \dots, c_k)$ with $c_i \in C$ an object in \mathcal{S} and m be a uni-marking on c , i.e. there is only one symbol in m . Then m determines another object $\mathfrak{c}(m)$ by deleting all c_i 's which are not marked by m . If $\alpha: a \rightarrow c$ is an arrow, then $\mathfrak{c}(\alpha^*(m)) \sim \mathfrak{c}(m)$ in the above sense.

Let B be a multiball. If (α, m) and (α', m') are representatives, then $\mathfrak{c}(m) \sim \mathfrak{c}(m')$. Thus, each multiball B gives an equivalence class $\mathfrak{cc}(B)$ of objects.

We say that a partition \mathcal{P} (over x) satisfies the n -condition with respect to y if at least n submultiballs $P \in \mathcal{P}$ satisfy $y \in \mathfrak{cc}(P)$. The n -condition with respect to y is preserved by the action of $\Gamma = \pi_1(\mathcal{S}, x)$ on the partitions: If \mathcal{P} satisfies the n -condition with respect to y , then also $\gamma \cdot \mathcal{P}$ satisfies it.

We define a poset (\mathbb{P}, \leq) : The objects of \mathbb{P} are partitions over x and $\mathcal{P} \leq \mathcal{Q}$ if and only if $\mathcal{P} \supset \mathcal{Q}$. The group $\Gamma = \pi_1(\mathcal{S}, x)$ acts on this poset via the action on partitions. Because of Remark 4.12, the action indeed respects the relation \leq .

Since the n -condition with respect to y is invariant under the action of Γ , we can define the invariant subposet (\mathbb{P}_n, \leq) to be the full subposet consisting of partitions satisfying the n -condition with respect to y . Next, we want to show that

1. $\mathbb{P}_n \neq \emptyset$ and
2. (\mathbb{P}_n, \leq) is filtered.

From item iv) in Section 5 of Chapter 1, it follows that the poset \mathbb{P}_n is *contractible*.

1. Since x is y -progressive, there is an arrow $a_1 \otimes y \otimes a_2 \rightarrow x$. Apply y 's split condition $(n-1)$ times to find an arrow $z \rightarrow x$ where z has a tensor product decomposition with at least n factors equal to y . Mark each of these factors with a different symbol and the rest with yet another symbol. This yields a partition $\mathcal{P} \in \mathbb{P}_n$.

2. Let $\mathcal{P}, \mathcal{Q} \in \mathbb{P}_n$. We have to find $\mathcal{R} \in \mathbb{P}_n$ with $\mathcal{P}, \mathcal{Q} \leq \mathcal{R}$. First we find one in \mathbb{P} . Let $(\alpha_{\mathcal{P}}, m_{\mathcal{P}})$ and $(\alpha_{\mathcal{Q}}, m_{\mathcal{Q}})$ be representatives of \mathcal{P} and \mathcal{Q} respectively.

Choose a square filling $(\beta_{\mathcal{P}}, \beta_{\mathcal{Q}})$ of $(\alpha_{\mathcal{P}}, \alpha_{\mathcal{Q}})$ and set $\delta = \beta_{\mathcal{P}}\alpha_{\mathcal{P}} = \beta_{\mathcal{Q}}\alpha_{\mathcal{Q}}$. Now find a full marking $\mu \subset \beta_{\mathcal{P}}^*(m_{\mathcal{P}}), \beta_{\mathcal{Q}}^*(m_{\mathcal{Q}})$, for example by marking each coordinate of $\text{dom}(\delta)$ with a different symbol. Then $\mathcal{R} = [\delta, \mu]$ is a common refinement of \mathcal{P} and \mathcal{Q} . Now use that x is y -progressive to find an arrow $\eta: z \rightarrow \text{dom}(\delta)$ where z has a tensor product decomposition with at least one factor equal to y . Then apply y 's split condition $(n-1)$ times to obtain an arrow $\nu: w \rightarrow z$ where w has a tensor product decomposition with at least n factors equal to y . Observe the marked arrow $(\nu\eta\delta, (\nu\eta)^*(\mu))$. The so-called link condition in Remark 4.6 ensures that the n factors of w equal to y are marked with the same symbol in the marking $(\nu\eta)^*(\mu)$. Refine this marking such that these factors are marked with new different symbols. This gives a representative of a partition satisfying the n -condition with respect to y , refining \mathcal{R} and thus refining both \mathcal{P} and \mathcal{Q} .

A simplex σ in the poset \mathbb{P}_n is a finite ascending sequence of objects, written $[\mathcal{P}_0 < \mathcal{P}_1 < \dots < \mathcal{P}_p]$. We now observe the stabilizer subgroup Γ_{σ} of such a simplex. By definition, an element γ is in this stabilizer subgroup if and only if $\{\mathcal{P}_0, \dots, \mathcal{P}_p\} = \{\gamma \cdot \mathcal{P}_0, \dots, \gamma \cdot \mathcal{P}_p\}$. But since the action of γ respects \leq , this is equivalent to $\gamma \cdot \mathcal{P}_i = \mathcal{P}_i$ for each $i = 0, \dots, p$. So each $\gamma \in \Gamma_{\sigma}$ fixes σ vertex-wise. Observe the subgroup

$$\Lambda_{\sigma} := \{\gamma \in \Gamma \mid \gamma \cdot P = P \text{ for all } P \in \mathcal{P}_p\} < \Gamma$$

By Proposition 4.14, we know that $\Lambda_{\sigma} \cong \pi_1(\mathcal{S}, c_1) \times \dots \times \pi_1(\mathcal{S}, c_k)$ for appropriate objects c_i . Since \mathcal{P}_p satisfies the n -condition with respect to y , at least n of these objects are equivalent to y and thus at least n of the factors in the product decomposition of Λ_{σ} are isomorphic to $\Upsilon := \pi_1(\mathcal{S}, y)$. So we find a normal subgroup $\Lambda'_{\sigma} \triangleleft \Lambda_{\sigma}$ with $\Lambda'_{\sigma} \cong \Upsilon^n$. Below, we will show that Λ_{σ} is a normal subgroup of Γ_{σ} . So we arrive at the following situation

$$\boxed{\Upsilon^n \cong \Lambda'_{\sigma} \triangleleft \Lambda_{\sigma} \triangleleft \Gamma_{\sigma}}$$

LEMMA 4.16. *Let $\mathcal{R}_1, \mathcal{R}_2$ be semi-partitions and \mathcal{P} be a partition with $\mathcal{P} \subset \mathcal{R}_1$. Assume*

$$\forall_{R_1 \in \mathcal{R}_1} \exists_{R_2 \in \mathcal{R}_2} \forall_{P \in \mathcal{P}} P \subset R_1 \implies P \subset R_2$$

Then we have $\mathcal{R}_1 \subset \mathcal{R}_2$.

PROOF. By applying the square filling technique twice, we find an arrow δ with three markings $m_{\mathcal{P}}, m_{\mathcal{R}_1}, m_{\mathcal{R}_2}$ on its domain such that $(\delta, m_{\mathcal{P}})$ represents \mathcal{P} and $(\delta, m_{\mathcal{R}_i})$ represents \mathcal{R}_i . Since $\mathcal{P} \subset \mathcal{R}_1$ we have $(\delta, m_{\mathcal{P}}) \subset (\delta, m_{\mathcal{R}_1})$ and therefore $m_{\mathcal{P}} \subset m_{\mathcal{R}_1}$. Note that \mathcal{P} is a partition and therefore $m_{\mathcal{P}}$ is a full marking. Now the assumption of the statement implies $m_{\mathcal{R}_1} \subset m_{\mathcal{R}_2}$ and thus $\mathcal{R}_1 \subset \mathcal{R}_2$. \square

We first show that Λ_{σ} is contained in Γ_{σ} . So let $\gamma \in \Lambda_{\sigma}$, i.e. $\gamma \cdot P = P$ for all $P \in \mathcal{P}_p$. In particular, we have $\gamma \cdot \mathcal{P}_p = \mathcal{P}_p$ (Proposition 4.11 and Remark 4.13). We have to show $\gamma \cdot \mathcal{P}_i = \mathcal{P}_i$ also for the other i 's. Write $\mathcal{P} := \mathcal{P}_p$ and $\mathcal{R} := \mathcal{P}_i$ for some other i . Then we have $\mathcal{P} \subset \mathcal{R}$. We want to apply the above lemma to $\mathcal{R}_1 = \mathcal{R}$ and $\mathcal{R}_2 = \gamma \cdot \mathcal{R}$ and deduce $\mathcal{R} \subset \gamma \cdot \mathcal{R}$. So let $R \in \mathcal{R}$ and observe $\gamma \cdot R \in \gamma \cdot \mathcal{R}$. Let $P \in \mathcal{P}$ with $P \subset R$. Then $P = \gamma \cdot P \subset \gamma \cdot R$ and the assumption of the lemma is satisfied. Similarly, we get $\mathcal{R} \subset \gamma^{-1} \cdot \mathcal{R}$ and thus $\gamma \cdot \mathcal{R} \subset \mathcal{R}$. This yields $\gamma \cdot \mathcal{R} = \mathcal{R}$, q.e.d.

Now we show that Λ_{σ} is normal in Γ_{σ} . Let $\gamma \in \Gamma_{\sigma}$ and $\alpha \in \Lambda_{\sigma}$. We have to show $\gamma^{-1}\alpha\gamma \in \Lambda_{\sigma}$, i.e. $\gamma^{-1}\alpha\gamma \cdot P = P$ for all $P \in \mathcal{P}_p =: \mathcal{P}$ or equivalently $\alpha \cdot (\gamma \cdot P) = \gamma \cdot P$ for all $P \in \mathcal{P}$. Since $\gamma \cdot \mathcal{P} = \mathcal{P}$, we have a bijection $f: \{P \in \mathcal{P}\} \rightarrow \{P \in \mathcal{P}\}$ such that $\gamma \cdot P = P \triangleright f$ for all $P \in \mathcal{P}$ (Proposition 4.11). Consequently, if $P \in \mathcal{P}$, $\alpha \cdot (\gamma \cdot P) = \alpha \cdot (P \triangleright f) = P \triangleright f = \gamma \cdot P$, q.e.d.

2.7. End of the proof. Let \mathfrak{P} be a property of groups which is closed under taking products and let \mathcal{M} be a coefficient system which is \mathfrak{P} -Künneth and \mathfrak{P} -inductive. We will only give the proof for homology. Using analogous devices for cohomology, we obtain a proof of the cohomological version of the statement.

Our main tool will be a spectral sequence explained in Brown's book [8, Chapter VII.7] (see also [39, Subsection 4.1]). If we plug in our Γ -complex (\mathbb{P}_n, \leq) and the $\mathbb{Z}\Gamma$ -module $\mathcal{M}\Gamma$, we obtain a spectral sequence E_{pq}^k with

$$E_{pq}^1 = \bigoplus_{\sigma \in \Sigma_p} H_q(\Gamma_\sigma, \mathcal{M}\Gamma) \Rightarrow H_{p+q}(\Gamma, \mathcal{M}\Gamma)$$

where Σ_p is set of p -cells representing the Γ -orbits of (\mathbb{P}_n, \leq) . This uses that the poset \mathbb{P}_n is contractible and that the cell stabilizers fix the cells pointwise.

We assumed that Υ satisfies \mathfrak{P} and that $H_0(\Upsilon, \mathcal{M}\Upsilon) = 0$. Applying the \mathfrak{P} -Künneth property $(n-1)$ times, we obtain $H_k(\Upsilon^n, \mathcal{M}\Upsilon^n) = 0$ for $k \leq n-1$. So we have $H_k(\Lambda'_\sigma, \mathcal{M}\Lambda'_\sigma) = 0$ for $k \leq n-1$. The property \mathfrak{P} -inductive yields $H_k(\Lambda'_\sigma, \mathcal{M}\Gamma) = 0$ for $k \leq n-1$. Since $\Lambda'_\sigma \triangleleft \Lambda_\sigma \triangleleft \Gamma_\sigma$, we can apply the Hochschild-Serre spectral sequence twice to obtain $H_k(\Gamma_\sigma, \mathcal{M}\Gamma) = 0$ for $k \leq n-1$. The above spectral sequence now yields $H_k(\Gamma, \mathcal{M}\Gamma) = 0$ for $k \leq n-1$. Since n was arbitrary, the result follows.

3. Non-amenability and infiniteness

In this section we use the techniques from Section 2 to prove non-amenability and infiniteness of some operad groups. Note that semi-partitions and the action on the set of semi-partitions can also be defined in the braided case.

LEMMA 4.17. *If \mathcal{O} satisfies the calculus of fractions, then the action of the colored permutations in $\text{Aut}_{\mathfrak{Sym}(C)}(X)$ or the colored braids in $\text{Aut}_{\mathfrak{Braid}(C)}(X)$ on the set of arrows $\text{Hom}_{\mathcal{S}(\mathcal{O})}(X, Y)$ is free. In particular, in the operad \mathcal{O} , the action of the symmetric groups or the braid groups on the sets of operations is free.*

PROOF. Let $[\alpha, \Theta]$ be an element in $\text{Hom}_{\mathcal{S}(\mathcal{O})}(X, Y)$ and $\sigma \in \text{Aut}_{\mathfrak{Sym}(C)}(X)$ or $\sigma \in \text{Aut}_{\mathfrak{Braid}(C)}(X)$. We have to show that $[\sigma, \text{id}] * [\alpha, \Theta] = [\alpha, \Theta]$ implies that σ is trivial. From this equality and the equalization property of $\mathcal{S}(\mathcal{O})$, we obtain an arrow $z := [\delta, \Psi]$ with $z * [\sigma, \text{id}] = z$. We can assume without loss of generality that $\delta = \text{id}$. We then have $z * [\sigma, \text{id}] = [\bar{\sigma}, \bar{\Psi}]$ with $\bar{\sigma} = \Psi \frown \sigma$ and $\bar{\Psi} = \Psi \frown \sigma$. Consequently, the pairs $(\bar{\sigma}, \bar{\Psi})$ and (id, Ψ) are equivalent in $\mathfrak{Sym}(C) \times \mathcal{S}(\mathcal{O}_{\text{pl}})$ or $\mathfrak{Braid}(C) \times \mathcal{S}(\mathcal{O}_{\text{pl}})$. This is only possible if σ is trivial. \square

Let \mathcal{O} be a symmetric or braided operad. Let α be an arrow in $\mathcal{S}(\mathcal{O})$. For any colored permutation $\sigma \in \mathfrak{Sym}(C)$ or colored braid $\sigma \in \mathfrak{Braid}(C)$ with suitable domain and codomain, we can form the group element γ represented by the span $(\alpha, [\sigma, \text{id}] * \alpha)$. Recall that the first arrow always denotes the denominator, i.e. points to the left.

LEMMA 4.18. *Assume \mathcal{O} satisfies the calculus of fractions. Then*

$$\sigma \neq 1 \implies \gamma \neq 1$$

PROOF. First consider the symmetric case. Observe the semi-partition \mathcal{R} represented by the marked arrow (α, m) where m is a marking on the domain of α with only one marked coordinate and this coordinate is non-trivially permuted by σ^{-1} . It is easy to see that $\gamma \cdot \mathcal{R}$ is represented by $(\alpha, [\sigma, \text{id}] * (m))$. The marking $m' := [\sigma, \text{id}] * (m)$ is different from m because σ^{-1} maps the only marked coordinate of m to a different coordinate by assumption. From Remark 4.9 it follows that the marked arrow (α, m) cannot be equivalent to (α, m') and thus $\gamma \cdot \mathcal{R} \neq \mathcal{R}$. Consequently $\gamma \neq 1$.

Now if \mathcal{O} is braided we can apply the above argument verbatim if we require that the braid σ has a non-trivial permutation part. But there are of course non-trivial braids which are trivial as permutations (so-called pure braids). Assume that σ is such a pure braid and that $\gamma = 1$. Note that the latter means that the parallel arrows $\sigma\alpha := [\sigma, \text{id}] * \alpha$ and α are homotopic. Since $\mathcal{S}(\mathcal{O})$ satisfies the calculus of fractions, this means that there is an arrow δ with $\delta * \sigma\alpha = \delta * \alpha$. We can assume without loss of generality that $\delta \in \mathcal{S}(\mathcal{O}_{\text{pl}})$, i.e. that $\delta = [\text{id}, \Theta]$. Composing in $\mathcal{S}(\mathcal{O})$, we get $\delta * [\sigma, \text{id}] = [\bar{\sigma}, \bar{\Theta}]$ where $\bar{\sigma} = \Theta \circ \sigma$ and $\bar{\Theta} = \Theta \circ \sigma$. Using that σ is pure we immediately see $\bar{\Theta} = \Theta$. So we have

$$[\bar{\sigma}, \text{id}] * ([\text{id}, \Theta] * \alpha) = (\delta * [\sigma, \text{id}]) * \alpha = [\text{id}, \Theta] * \alpha$$

Lemma 4.17 now gives $\bar{\sigma} = 1$ and thus $\sigma = 1$. \square

Denoting the element γ suggestively by $\overleftarrow{\alpha} \sigma \overrightarrow{\alpha}$, the lemma implies that two such group elements $\overleftarrow{\alpha} \sigma \overrightarrow{\alpha}$ and $\overleftarrow{\alpha'} \sigma' \overrightarrow{\alpha'}$ are equal if and only if $\sigma = \sigma'$. We will use this now to give a proof of the following proposition.

PROPOSITION 4.19. *Let \mathcal{O} be a symmetric operad satisfying the calculus of fractions and let X be a split object of $\mathcal{S}(\mathcal{O})$. Then $\Gamma = \pi_1(\mathcal{O}, X)$ contains a non-abelian free subgroup and is therefore non-amenable.*

PROOF. Using the split condition on X , we will explicitly construct two non-trivial elements $\gamma_1, \gamma_2 \in \Gamma$ of order 2 and 3 respectively. Then we will define two disjoint subsets A_1, A_2 of the set of semi-partitions over X such that $\gamma_1 \cdot A_2 \subset A_1$ and $\gamma_2^n \cdot A_1 \subset A_2$ for $n = 1, 2$. The Ping-Pong Lemma then shows that the subgroup $\langle \gamma_1, \gamma_2 \rangle$ generated by the two elements γ_1 and γ_2 is isomorphic to the free product $\langle \gamma_1 \rangle * \langle \gamma_2 \rangle$. So we have found a subgroup which is isomorphic to $\mathbb{Z}_2 * \mathbb{Z}_3$. Since $\mathbb{Z}_2 * \mathbb{Z}_3$ contains a free non-abelian subgroup, the proof of the proposition is then complete.

We now give the constructions. Because X is split, there is an arrow

$$\varpi: A_1 \otimes X \otimes A_2 \otimes X \otimes A_3 \rightarrow X$$

For better readability, we assume that X is a single color and $A_1 = A_2 = A_3 = I$. The construction goes the same way in the general case (with obvious modifications). So we assume that ϖ is just an operation with two inputs of color X and an output of color X . Define γ_1 to be the following element

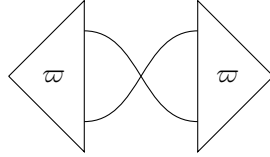

and γ_2 to be the following element

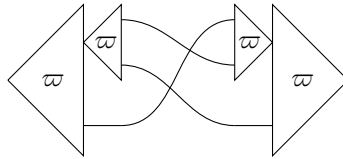

Lemma 4.18 implies that γ_1 is of order 2 and γ_2 is of order 3. Let B_1 be the ball represented by the marked arrow

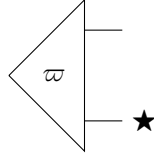

and let B_2 be the ball represented by the marked arrow

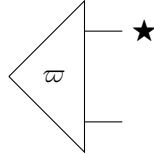

Composing the operation ϖ several times, one gets operations that look like binary trees. Call them ϖ -tree operations. Now define A_1 to be the set of all balls $B \subset B_1$ which are represented by ϖ -tree operations. Similarly, define A_2 to be the set of all balls $B \subset B_2$ which are represented by ϖ -tree operations. For example, the following marked arrows represent balls in A_1

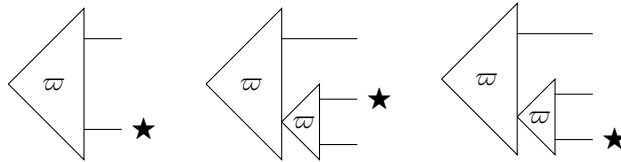

and the following marked arrows represent balls in A_2

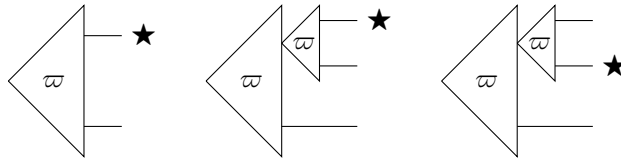

It is straightforward to check $\gamma_1 \cdot A_2 \subset A_1$ and $\gamma_2 \cdot A_1 \subset A_2$ and $\gamma_2^2 \cdot A_1 \subset A_2$, so the proof is completed. \square

Next we give sufficient conditions for infiniteness of operad groups.

PROPOSITION 4.20. *Let \mathcal{O} be a planar, symmetric or braided operad satisfying the calculus of fractions and let X be a split object of $\mathcal{S}(\mathcal{O})$. Then $\Gamma := \pi_1(\mathcal{O}, X)$ contains an infinite cyclic subgroup and is therefore infinite.*

PROOF. Because X is split, there is an arrow

$$\varpi: A_1 \otimes X \otimes A_2 \otimes X \otimes A_3 \rightarrow X$$

For better readability, we assume that X is a single color and $A_1 = A_2 = A_3 = I$. The construction goes the same way in the general case (with obvious modifications). So we assume that ϖ is just an operation with two inputs of color X and an output of color X . Define γ to be the following element

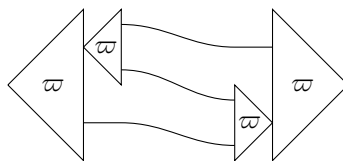

Formally, γ is represented by the span $((\varpi, \text{id}) * \varpi, (\text{id}, \varpi) * \varpi)$. We claim that γ has infinite order. The element γ^n is represented by the span (for better readability, we use the same symbol id for different identities)

$$((\varpi, \text{id}) * \dots * (\varpi, \text{id}) * \varpi, (\text{id}, \varpi) * \dots * (\text{id}, \varpi) * \varpi)$$

By Lemma 4.8, this span is null-homotopic if and only if the span (remove the last ϖ in both arrows)

$$((\varpi, \text{id}) * \dots * (\varpi, \text{id}), (\text{id}, \varpi) * \dots * (\text{id}, \varpi)) =: (\varpi_1, \varpi_2)$$

is null-homotopic. This is true if and only if there is an arrow r with $r\varpi_1 = r\varpi_2$. The arrow r can be chosen to lie in $\mathcal{S}(\mathcal{O}_{\text{pl}})$. But note that ϖ_1 splits as

$$\varpi_1 = ((\varpi, \text{id}) * \dots * (\varpi, \text{id}) * \varpi) \otimes \text{id}_X$$

and ϖ_2 splits as

$$\varpi_2 = \text{id}_X \otimes ((\text{id}, \varpi) * \dots * (\text{id}, \varpi) * \varpi)$$

It can easily be seen that such an arrow r cannot exist because otherwise operations with a different number of inputs must be equal. Consequently, each γ^n is non-trivial and therefore γ has infinite order. \square

4. Applications

Observe the 1-dimensional planar cube cutting operads and the d -dimensional symmetric cube cutting operads from Subsection 5.2 of Chapter 2. They all satisfy the (cancellative) calculus of fractions. Furthermore, they are monochromatic and possess operations of arbitrarily high degree. From Remarks 4.3 and 4.4 it follows that all objects (except the uninteresting unit object) are split and progressive. So Theorem 4.5 is applicable to these operads. Furthermore, the corresponding operad groups are all infinite by Proposition 4.20 and non-amenable in the symmetric case by Proposition 4.19.

Observe now the local similarity operads. Let Sim_X be a finite similarity structure on the compact ultrametric space X . When choosing a ball in each Sim_X -equivalence of balls, we obtain a symmetric operad with transformations \mathcal{O} . The colors of \mathcal{O} are the chosen balls. We choose X for the Sim_X -equivalence class $[X]$. We already know that \mathcal{O} satisfies the (cancellative) calculus of fractions. In [39, Definition 3.1] we called Sim_X dually contracting if there are two disjoint proper subballs B_1, B_2 of X together with similarities $X \rightarrow B_i$ in Sim_X . This easily implies that X is split.

LEMMA 4.21. *The color X is progressive provided Sim_X is dually contracting.*

PROOF. Let $\theta = (f_1, \dots, f_l)$ be an operation with output X . This means that the $f_i: B_i \rightarrow X$ are Sim_X -embeddings (i.e. f_i yields a similarity in Sim_X when the codomain is restricted to the image) such that the images of the f_i are pairwise disjoint and their union is X . So the images $\text{im}(f_i)$ form a partition \mathcal{P} of X into balls. If we apply [39, Lemma 3.7] to this partition, we find a j and a small ball B which is Sim_X -equivalent to X and such that $B \subset \text{im}(f_j)$. Using this, we can construct an operation $\psi = (g_1, \dots, g_k)$ with codomain B_j such that $g_1: X \rightarrow B_j$. From Remark 4.4 it now follows that X is progressive. \square

Consequently, Theorem 4.5 is applicable to dually contracting local similarity operads. Furthermore, the corresponding operad groups are all infinite by Proposition 4.20 and non-amenable by Proposition 4.19.

4.1. L^2 -homology. For a group G , let l^2G be the Hilbert space with Hilbert base G . Thus, elements in l^2G are formal sums $\sum_{g \in G} \lambda_g g$ with $\lambda_g \in \mathbb{C}$ such that $\sum_{g \in G} |\lambda_g|^2 < \infty$. Left multiplication with elements in G induces an isometric G -action on l^2G . Denote the set of G -equivariant linear bounded operators $l^2G \rightarrow l^2G$ by $\mathcal{B}^G(l^2G)$, a subalgebra of the algebra of all bounded linear operators $\mathcal{B}(l^2G)$. Right multiplication with an element $\gamma \in G$ induces a G -equivariant linear bounded operator $\gamma \triangleright \rho: l^2G \rightarrow l^2G$. This induces a homomorphism $\rho: \mathbb{C}G \rightarrow \mathcal{B}(l^2G)$ from the group ring into the algebra of bounded linear operators, i.e. $1 \triangleright \rho = \text{id}$ and $(\gamma_1 \gamma_2) \triangleright \rho = (\gamma_1 \triangleright \rho) * (\gamma_2 \triangleright \rho)$. The closure of the image of this map with respect to the weak or strong operator topology is called the von Neumann algebra $\mathcal{N}G$ associated to G . It is equal to the subalgebra of all G -equivariant bounded linear operators $\mathcal{B}^G(l^2G) \subset \mathcal{B}(l^2G)$ [32, Example 9.7].

We will cite some known results about this von Neumann algebra in order to deduce a corollary for l^2 -homology.

- (\mathcal{N} is inductive) Let H be a subgroup of G and $A \in \mathcal{B}^H(l^2H)$. Then $\mathbb{C}G \otimes_{\mathbb{C}H} l^2H \subset l^2G$ is a dense G -invariant subspace and

$$\text{id}_{\mathbb{C}G} \otimes_{\mathbb{C}H} A: \mathbb{C}G \otimes_{\mathbb{C}H} l^2H \rightarrow \mathbb{C}G \otimes_{\mathbb{C}H} l^2H$$

is a G -equivariant linear map which is bounded with respect to the norm coming from l^2G . Consequently, it can be extended to an element in $\mathcal{B}^G(l^2G)$. We obtain a map $\mathcal{N}H \rightarrow \mathcal{N}G$ which is an injective ring homomorphism. So if $H < G$, then $\mathcal{N}H$ is a subring of $\mathcal{N}G$. Even more is true: It is a faithfully flat ring extension [32, Theorem 6.29]. From this, it follows easily that the coefficient system \mathcal{N} is inductive.

- (\mathcal{N} is Künneth) If H_1, H_2 are two subgroups of G which commute in G , i.e. $h_1 h_2 = h_2 h_1$ for all $h_1 \in H_1$ and $h_2 \in H_2$, then $\mathcal{N}H_1$ and $\mathcal{N}H_2$ commute in $\mathcal{N}G$. In particular, $\mathcal{N}H_1 \otimes_{\mathbb{C}} \mathcal{N}H_2$ is a subring of $\mathcal{N}G$. This implies, using a standard homological algebraic argument [32, Lemma 12.11(3)], that \mathcal{N} is Künneth.
- (H_0 and amenability) Going back to a result of Kesten, the 0'th group homology of a group G with coefficients in the von Neumann algebra $\mathcal{N}G$ vanishes if and only if G is non-amenable [32, Lemma 6.36]. So we have

$$H_0(G, \mathcal{N}G) = 0 \quad \iff \quad G \text{ non-amenable}$$

- (*Relationship with l^2 -homology*) From [32, Lemma 6.97] or [32, Theorem 6.24(3)] we get for groups G of type F_∞ and every $k \geq 0$

$$H_k(G, \mathcal{N}G) = 0 \quad \iff \quad H_k(G, l^2G) = 0$$

Applying Theorem 4.5 to these observations, we get the following corollary.

COROLLARY 4.22. *Let \mathcal{O} be a planar or symmetric operad which satisfies the calculus of fractions. Let X be a split progressive object of $\mathcal{S}(\mathcal{O})$. Set $\Gamma := \pi_1(\mathcal{O}, X)$ and assume that Γ is non-amenable. Then*

$$H_k(\Gamma, \mathcal{N}\Gamma) = 0$$

for all $k \geq 0$. If Γ is also of type F_∞ (e.g. if the conditions in Theorem 3.7 are satisfied), we also have

$$H_k(\Gamma, l^2\Gamma) = 0$$

for all $k \geq 0$.

From Proposition 4.19, we get the following corollary.

COROLLARY 4.23. *Let \mathcal{O} be a symmetric operad which satisfies the calculus of fractions. Let X be a split progressive object of $\mathcal{S}(\mathcal{O})$. Set $\Gamma := \pi_1(\mathcal{O}, X)$. Then*

$$H_k(\Gamma, \mathcal{N}\Gamma) = 0$$

for all $k \geq 0$. If Γ is also of type F_∞ , we have

$$H_k(\Gamma, l^2\Gamma) = 0$$

for all $k \geq 0$.

From the remarks at the beginning of this section and from Subsection 8.2 of Chapter 3, we get the following corollary.

COROLLARY 4.24. *Let \mathcal{O} be a symmetric cube cutting operad or a local similarity operad coming from a dually contracting finite similarity structure Sim_X . In the first case, let A be any object in $\mathcal{S}(\mathcal{O})$ different from the monoidal unit I . In the second case, let A be the object X . Set $\Gamma = \pi_1(\mathcal{O}, A)$. Then*

$$H_k(\Gamma, \mathcal{N}\Gamma) = 0$$

for all $k \geq 0$. Assume furthermore that Sim_X is rich in ball contractions, i.e. the associated operad \mathcal{O} is color-tame in the sense of Definition 3.6. Then we also have

$$H_k(\Gamma, l^2\Gamma) = 0$$

for all $k \geq 0$. In particular, we have

$$H_k(V, \mathcal{N}V) = 0 \quad \text{and} \quad H_k(V, l^2V) = 0$$

for all $k \geq 0$.

This answers a question posed by Lück [32, Remark 12.4]. The *zero-in-the-spectrum* conjecture by Gromov says that whenever M is an aspherical closed Riemannian manifold, then there is always a dimension p such that zero is contained in the spectrum of the minimal closure of the Laplacian acting on smooth p -forms on the universal covering of M :

$$\exists_{p \geq 0} \quad 0 \in \text{spec}(\text{cl}(\Delta_p): D \subset L^2\Omega^p(\widetilde{M}) \rightarrow L^2\Omega^p(\widetilde{M}))$$

By [32, Lemma 12.3], this is equivalent to

$$\exists_{p \geq 0} \quad H_p(G, \mathcal{N}G) \neq 0$$

for $G = \pi_1(M)$. Dropping Poincaré duality from the assumptions, we arrive at the following question: If G is a group of type F (i.e. there exists a compact classifying space for G), then is there a p with $H_p(G, \mathcal{N}G) \neq 0$? Relaxing the assumption on the finiteness property, we arrive at the following question: If G is a group of type F_∞ , then is there a p with $H_p(G, \mathcal{N}G) \neq 0$? Corollary 4.24 together with the finiteness results obtained in Subsection 8.2 of Chapter 3 gives explicit counterexamples to this question.

4.2. Cohomology with coefficients in the group ring. We want to apply the cohomological version of Theorem 4.5 to $\mathcal{M}G := \mathbb{Z}G$. To this end, we want to show that $\mathbb{Z}G$ is FP_∞ -Künneth and FP_∞ -inductive (in cohomology). The first property follows from [39, Proposition 4.3]. The second property follows from the observation that $\mathbb{Z}G$ is a free $\mathbb{Z}H$ -module if $H < G$ and that group cohomology of groups of type FP_∞ commutes with direct limits in the coefficients [7, Theorem VIII.4.8]. From Theorem 4.5, Proposition 4.20 and $H^0(G, \mathbb{Z}G) = (\mathbb{Z}G)^G = 0$ for infinite G , we obtain:

COROLLARY 4.25. *Let \mathcal{O} be a planar or symmetric operad which satisfies the calculus of fractions. Let X be a split progressive object of $\mathcal{S}(\mathcal{O})$. Set $\Gamma := \pi_1(\mathcal{O}, X)$ and assume that Γ is of type FP_∞ (e.g. if the conditions in Theorem 3.7 are satisfied). Then*

$$H^k(\Gamma, \mathbb{Z}\Gamma) = 0$$

for all $k \geq 0$.

Recall that type F_∞ implies type FP_∞ and note that $H^k(\Gamma, \mathbb{Z}\Gamma) = 0$ for all $k \geq 0$ implies that Γ has infinite cohomological dimension [7, Propositions VIII.6.1 and VIII.6.7]. Unfortunately, this tells us that none of these groups can be of type F and consequently, we cannot find a counterexample to the above question whether there is always a dimension p with $H_p(G, \mathcal{N}G) \neq 0$, provided G is of type F .

From the remarks at the beginning of this section and from Subsection 8.2 of Chapter 3, we get the following corollary.

COROLLARY 4.26. *Let \mathcal{O} be a planar or symmetric cube cutting operad or a local similarity operad coming from a dually contracting finite similarity structure Sim_X which is also rich in ball contractions. In the first two cases, let A be any object in $\mathcal{S}(\mathcal{O})$ different from the monoidal unit I . In the last case, let A be the object X . Set $\Gamma = \pi_1(\mathcal{O}, A)$. Then*

$$H^k(\Gamma, \mathbb{Z}\Gamma) = 0$$

for all $k \geq 0$.

In particular, we obtain $H^k(F, \mathbb{Z}F) = 0$ and $H^k(V, \mathbb{Z}V) = 0$ for all $k \geq 0$. This has been shown before in [9, Theorem 7.2] and in [8, Theorem 4.21].

Bibliography

- [1] J. Bénabou, *Some remarks on 2-categorical algebra. I*, Bull. Soc. Math. Belg. Sér. A **41** (1989), no. 2, 127–194.
- [2] M. Bestvina and N. Brady, *Morse theory and finiteness properties of groups*, Invent. Math. **129** (1997), no. 3, 445–470.
- [3] F. Borceux, *Handbook of categorical algebra. 1*, Encyclopedia of Mathematics and its Applications, vol. 50, Cambridge University Press, Cambridge, 1994.
- [4] M. G. Brin, *Higher dimensional Thompson groups*, Geom. Dedicata **108** (2004), 163–192.
- [5] ———, *The algebra of strand splitting. I. A braided version of Thompson’s group V* , J. Group Theory **10** (2007), no. 6, 757–788.
- [6] M. G. Brin and C. C. Squier, *Groups of piecewise linear homeomorphisms of the real line*, Invent. Math. **79** (1985), no. 3, 485–498.
- [7] K. S. Brown, *Cohomology of groups*, Graduate Texts in Mathematics, vol. 87, Springer-Verlag, New York, 1994.
- [8] ———, *Finiteness properties of groups*, Proceedings of the Northwestern conference on cohomology of groups (Evanston, Ill., 1985), 1987, pp. 45–75.
- [9] K. S. Brown and R. Geoghegan, *An infinite-dimensional torsion-free FP_∞ group*, Invent. Math. **77** (1984), no. 2, 367–381.
- [10] K.-U. Bux, M. G. Fluch, M. Marschler, S. Witzel, and M. C. B. Zaremsky, *The braided Thompson’s groups are of type F_∞* , [arXiv:1210.2931 \[math.GR\]](#) (2012).
- [11] D.-C. Cisinski, *La classe des morphismes de Dwyer n’est pas stable par retractes*, Cahiers Topologie Géom. Différentielle Catég. **40** (1999), no. 3, 227–231 (French, with English summary).
- [12] M. W. Davis, *Poincaré duality groups*, Surveys on surgery theory, Vol. 1, Ann. of Math. Stud., vol. 145, Princeton Univ. Press, Princeton, NJ, 2000, pp. 167–193.
- [13] W. G. Dwyer and D. M. Kan, *Calculating simplicial localizations*, J. Pure Appl. Algebra **18** (1980), no. 1, 17–35.
- [14] J. Dydak, *A simple proof that pointed $FANR$ -spaces are regular fundamental retracts of ANR ’s*, Bull. Acad. Polon. Sci. Sér. Sci. Math. Astronom. Phys. **25** (1977), no. 1, 55–62 (English, with Russian summary).
- [15] D. S. Farley, *Actions of picture groups on $CAT(0)$ cubical complexes*, Geom. Dedicata **110** (2005), 221–242.
- [16] ———, *Finiteness and $CAT(0)$ properties of diagram groups*, Topology **42** (2003), no. 5, 1065–1082.
- [17] ———, *Homological and finiteness properties of picture groups*, Trans. Amer. Math. Soc. **357** (2005), no. 9, 3567–3584 (electronic).
- [18] D. S. Farley and B. Hughes, *Finiteness properties of some groups of local similarities*, [arXiv:1206.2692 \[math.GR\]](#) (2012).
- [19] Z. Fiedorowicz, *A counterexample to a group completion conjecture of J. C. Moore*, Algebr. Geom. Topol. **2** (2002), 33–35 (electronic).
- [20] M. Fiore and T. Leinster, *An abstract characterization of Thompson’s group F* , Semigroup Forum **80** (2010), no. 2, 325–340.
- [21] T. M. Fiore, W. Lück, and R. Sauer, *Euler characteristics of categories and homotopy colimits*, Doc. Math. **16** (2011), 301–354.
- [22] M. G. Fluch, M. Marschler, S. Witzel, and M. C. B. Zaremsky, *The Brin-Thompson groups sV are of type F_∞* , Pacific J. Math. **266** (2013), no. 2, 283–295.
- [23] P. Freyd and A. Heller, *Splitting homotopy idempotents. II*, J. Pure Appl. Algebra **89** (1993), no. 1-2, 93–106.
- [24] P. Gabriel and M. Zisman, *Calculus of fractions and homotopy theory*, Ergebnisse der Mathematik und ihrer Grenzgebiete, Band 35, Springer-Verlag New York, Inc., New York, 1967.
- [25] R. Geoghegan, *Topological methods in group theory*, Graduate Texts in Mathematics, vol. 243, Springer, New York, 2008.

- [26] P. G. Goerss and J. F. Jardine, *Simplicial homotopy theory*, Modern Birkhäuser Classics, Birkhäuser Verlag, Basel, 2009.
- [27] M. Gromov, *Large Riemannian manifolds*, Curvature and topology of Riemannian manifolds (Katata, 1985), Lecture Notes in Math., vol. 1201, Springer, Berlin, 1986, pp. 108–121.
- [28] V. Guba and M. Sapir, *Diagram groups*, Mem. Amer. Math. Soc. **130** (1997), no. 620.
- [29] B. Hughes, *Local similarities and the Haagerup property*, Groups Geom. Dyn. **3** (2009), no. 2, 299–315. With an appendix by Daniel S. Farley.
- [30] A. Joyal and R. Street, *Braided tensor categories*, Adv. Math. **102** (1993), no. 1, 20–78.
- [31] ———, *The geometry of tensor calculus. I*, Adv. Math. **88** (1991), no. 1, 55–112.
- [32] W. Lück, *L^2 -invariants: theory and applications to geometry and K -theory*, Ergebnisse der Mathematik und ihrer Grenzgebiete. 3. Folge. A Series of Modern Surveys in Mathematics, vol. 44, Springer-Verlag, Berlin, 2002.
- [33] ———, *The type of the classifying space for a family of subgroups*, J. Pure Appl. Algebra **149** (2000), no. 2, 177–203.
- [34] D. McDuff, *On the classifying spaces of discrete monoids*, Topology **18** (1979), no. 4, 313–320.
- [35] N. Monod, *Groups of piecewise projective homeomorphisms*, Proc. Natl. Acad. Sci. USA **110** (2013), no. 12, 4524–4527.
- [36] R. Paré, *Universal covering categories*, Rend. Istit. Mat. Univ. Trieste **25** (1993), no. 1-2, 391–411 (1994).
- [37] D. Quillen, *Higher algebraic K -theory. I*, Springer, Berlin, 1973, pp. 85–147. Lecture Notes in Math., Vol. 341.
- [38] ———, *Homotopy properties of the poset of nontrivial p -subgroups of a group*, Adv. in Math. **28** (1978), no. 2, 101–128.
- [39] R. Sauer and W. Thumann, *l^2 -invisibility and a class of local similarity groups*, Compos. Math. **150** (2014), no. 10, 1742–1754.
- [40] P. Selinger, *A survey of graphical languages for monoidal categories*, New structures for physics, Lecture Notes in Phys., vol. 813, Springer, Heidelberg, 2011, pp. 289–355.
- [41] E. H. Spanier, *Algebraic topology*, McGraw-Hill Book Co., New York-Toronto, Ont.-London, 1966.
- [42] C. C. Squier, *The homological algebra of Artin groups*, Math. Scand. **75** (1994), no. 1, 5–43.
- [43] M. Stein, *Groups of piecewise linear homeomorphisms*, Trans. Amer. Math. Soc. **332** (1992), no. 2, 477–514.
- [44] R. M. Switzer, *Algebraic topology—homotopy and homology*, Classics in Mathematics, Springer-Verlag, Berlin, 2002. Reprint of the 1975 original.
- [45] R. W. Thomason, *Cat as a closed model category*, Cahiers Topologie Géom. Différentielle **21** (1980), no. 3, 305–324.
- [46] ———, *Homotopy colimits in the category of small categories*, Math. Proc. Cambridge Philos. Soc. **85** (1979), no. 1, 91–109.
- [47] W. Thumann, *A topological finiteness result for operad groups*, arXiv:1409.1085 [math.GR] (2014).
- [48] ———, *L^2 -invisibility of symmetric operad groups*, arXiv:1407.7450 [math.AT] (2014).
- [49] ———, *Operad groups as a unified framework for Thompson-like groups*, arXiv:1407.5171 [math.GR] (2014).
- [50] M. Weiss, *What does the classifying space of a category classify?*, Homology Homotopy Appl. **7** (2005), no. 1, 185–195.