

**SVEUČILIŠTE U SPLITU**  
**FAKULTET GRAĐEVINARSTVA, ARHITEKTURE I GEODEZIJE**

# **DIPLOMSKI RAD**

**Viljan Didović**

**Split, 2017.**

**SVEUČILIŠTE U SPLITU  
FAKULTET GRAĐEVINARSTVA, ARHITEKTURE I GEODEZIJE**

**Viljan Didović**

**Projekt konstrukcije Kongresnog centra Žnjan**

**Diplomski rad**

**Split, 2017.**

*Zahvaljujem se mentoru Prof. dr. sc. Ivici Boki  
na pomoći pri izradi ovog rada i ugodnoj suradnji.*

*Hvala roditeljima koji su mi bili potpora kroz  
cijelo moje školovanje.*

**SVEUČILIŠTE U SPLITU  
FAKULTET GRAĐEVINARSTVA, ARHITEKTURE I GEODEZIJE**

**STUDIJ: DIPLOMSKI SVEUČILIŠNI STUDIJ GRAĐEVINARSTVA**  
**KANDIDAT: Viljan Didović**  
**BROJ INDEKSA: 602**  
**KATEDRA: Katedra za drvene i metalne konstrukcije**  
**PREDMET: Metalne konstrukcije**

**ZADATAK ZA DIPLOMSKI RAD**

Tema: Projekt konstrukcije Kongresnog centra Žnjan

Opis zadatka: Zadatak diplomskog rada je projektiranje čelične konstrukcije Kongresnog centra Žnjan smještenog u Splitu, s geometrijom 70,09 m x 75,60 m. Visina konstrukcije je 16,20 m.

Potrebno je izraditi model konstrukcije te izvršiti proračun i dimenzioniranje elemenata konstrukcije u skladu s HRN EN 1993, HRN EN 1992 i HRN EN 1994.

Također je potrebno proračunati spojeve konstrukcije te izraditi pripadajuće nacрте.

U Splitu, 07.03.2017.

Voditelj Diplomskog rada:

Prof. dr. sc. Ivica Boko

Predsjednik Povjerenstva  
za završne i diplomske ispite:

Doc. dr. sc. Veljko Srzić

## **Projekt konstrukcije Kongresnog centra Žnjan**

### ***Sažetak:***

Imajući kao predložak idejno rješenje Kongresnog centra Žnjan izrađen je projekt konstrukcije. Napravljen je numerički model na kojem je izvršeno dimenzioniranje elemenata konstrukcije u skladu s HRN EN 1993, HRN EN 1992 i HRN EN 1994. U finalnoj fazi su proračunati spojevi te izrađeni nacrti konstrukcije.

### ***Ključne riječi:***

Kongresni centar Žnjan, čelik, spojevi, numerički model

## **Construction project of the Congress center Žnjan**

### ***Abstract:***

Considering the conceptual design of the Congress Center Žnjan as a template, a construction project was created. The numerical model has been made on which the dimension of the structural elements was performed in accordance with HRN EN 1993, HRN EN 1992 and HRN EN 1994. In the final phase the compounds are calculated and constructed design drawings are made.

### ***Keywords:***

Žnjan Congress Center, steel, compounds, numerical model

## SADRŽAJ

1. TEHNIČKI OPIS .....	1
1.1. Opis konstrukcije .....	1
1.2. O proračunu konstrukcije.....	2
1.3. Materijal za izradu konstrukcije.....	3
1.4. Opis montaže konstrukcije.....	3
1.5. Primjenjeni propisi.....	4
1.6. Antikorozivna zaštita .....	4
1.7. Protupožarna zaštita .....	6
2. NUMERIČKI MODEL KNSTRUKCIJE.....	7
3. ANALIZA OPTEREĆENJA .....	10
3.1. Stalno opterećenje.....	10
3.2. Dodatno stalno opterećenje.....	10
3.3. Promjenjivo (pokretno) opterećenje .....	16
3.4. Opterećenje snijegom .....	21
3.5. Opterećenje vjetrom.....	24
4. KOMBINACIJE DJELOVANJA .....	37
4.1. Granično stanje uporabe (GSU).....	37
4.2. Granično stanje nosivosti (GSN) .....	38
5. PRORAČUN SPREGNUTE KROVNE KONSTRUKCIJE - POZ 400 .....	40
5.1. Pomaci spregnute krovne konstrukcije - gredni dio .....	40
5.2. Dimenziniranje spregnute krovne konstrukcije - gredni dio .....	41
5.2.1. Rezne sile – gredni nosač.....	41
5.2.2. Dimenzioniranje – gredni nosač .....	42
5.3. Pomaci spregnute krovne konstrukcije – krov velike dvorane .....	49
5.4. Dimenziniranje spregnute krovne konstrukcije – krov velike dvorane .....	50

5.4.1. Rezne sile – gornja pojasnica glavnog rešetkastog nosača.....	50
5.4.2. Dimenzioniranje – gornja pojasnica glavnog rešetkastog nosača.....	51
5.4.3. Rezne sile – donja pojasnica glavnog rešetkastog nosača .....	58
5.4.4. Dimenzioniranje – donja pojasnica glavnog rešetkastog nosača .....	59
5.4.5. Rezne sile – ispuna glavnog rešetkastog nosača.....	62
5.4.6. Dimenzioniranje – ispuna glavnog rešetkastog nosača .....	63
5.4.7. Rezne sile – podupora glavnog rešetkastog nosača .....	64
5.4.8. Dimenzioniranje – podupora glavnog rešetkastog nosača.....	65
5.4.9. Rezne sile – sekundarni gredni nosač .....	66
5.4.10. Dimenzioniranje – sekundarni gredni nosač.....	67
5.4.11. Rezne sile – spregovi .....	74
5.4.12. Dimenzioniranje – spregovi.....	75
5.5. Pomaci spregnute krovne konstrukcije – krov srednje dvorane .....	76
5.6. Dimenzioniranje spregnute krovne konstrukcije – krov srednje dvorane .....	77
5.6.1. Rezne sile – gornja pojasnica glavnog rešetkastog nosača.....	77
5.6.2. Dimenzioniranje – gornja pojasnica glavnog rešetkastog nosača.....	78
5.6.3. Rezne sile – donja pojasnica glavnog rešetkastog nosača .....	85
5.6.4. Dimenzioniranje – donja pojasnica glavnog rešetkastog nosača .....	86
5.6.5. Rezne sile – ispuna glavnog rešetkastog nosača.....	88
5.6.6. Dimenzioniranje – ispuna glavnog rešetkastog nosača .....	89
5.6.7. Rezne sile – sekundarni gredni nosača .....	90
5.6.8. Dimenzioniranje – sekundarni gredni nosača .....	91
5.6.9. Rezne sile – podupora donje pojasnice glavnog rešetkastog nosača .....	99
5.6.10. Dimenzioniranje – podupora donje pojasnice glavnog rešetkastog nosača	
5.6.11. Rezne sile – spregovi .....	101
5.6.12. Dimenzioniranje – spregovi.....	102

6. PRORAČUN SPREGNUTE MEĐUKATNE KONSTRUKCIJE-POZ 300.....	103
6.1. Pomaci spregnute međukatne konstrukcije – poz 300.....	103
6.2. Dimenziniranje spregnute međukatne konstrukcije – poz 300.....	104
6.2.1. Rezne sile – gredni nosača 1 .....	104
6.2.2. Dimenzioniranje – gredni nosača 1 .....	105
6.2.3. Rezne sile – gredni nosača 2 .....	113
6.2.4. Dimenzioniranje – gredni nosača 2 .....	114
7. PRORAČUN SPREGNUTE MEĐUKATNE KONSTRUKCIJE-POZ 200.....	121
7.1. Pomaci spregnute međukatne konstrukcije – poz 200.....	121
7.2. Dimenziniranje spregnute međukatne konstrukcije – poz 200.....	122
7.2.1. Rezne sile – gredni nosača 1 .....	122
7.2.2. Dimenzioniranje – gredni nosača 1 .....	123
7.2.3. Rezne sile – gredni nosača 2 .....	131
7.2.4. Dimenzioniranje – gredni nosača 2 .....	132
8. PRORAČUN SPREGNUTE MEĐUKATNE KONSTRUKCIJE-POZ 100.....	139
8.1. Pomaci spregnute međukatne konstrukcije – poz 100.....	139
8.2. Dimenziniranje spregnute međukatne konstrukcije – poz 100.....	140
8.2.1. Rezne sile – gredni nosača 1 .....	140
8.2.2. Dimenzioniranje – gredni nosača 1 .....	141
9. PRORAČUN SPREGNUTE MEĐUKATNE KONSTRUKCIJE – TRIBINA VELIKE DVORANE.....	149
9.1. Pomaci spregnute međukatne konstrukcije – tribina velike dvorane .....	149
9.2. Dimenziniranje spregnute međukatne konstrukcije – tribina velike dvorane....	150
9.2.1. Rezne sile – gornja pojasnica glavnog rešetkastog nosača.....	150
9.2.2. Dimenzioniranje – gornja pojasnica glavnog rešetkastog nosača.....	151
9.2.3. Rezne sile – donja pojasnica glavnog rešetkastog nosača .....	158



9.2.4. Dimenzioniranje – donja pojasnica glavnog rešetkastog nosača.....	159
9.2.5. Rezne sile – ispuna glavnog rešetkastog nosača.....	162
9.2.6. Dimenzioniranje – ispuna glavnog rešetkastog nosača .....	163
9.2.7. Rezne sile – gornja pojasnica sekundarnog rešetkastog nosača .....	164
9.2.8. Dimenzioniranje – gornja pojasnica sekundarnog rešetkastog nosača.....	165
9.2.9. Rezne sile – donja pojasnica sekundarnog rešetkastog nosača.....	172
9.2.10. Dimenzioniranje – donja pojasnica sekundarnog rešetkastog nosača .....	173
9.2.11. Rezne sile – ispuna sekundarnog rešetkastog nosača .....	176
9.2.12. Dimenzioniranje – ispuna sekundarnog rešetkastog nosača.....	177
10. PRORAČUN SPREGNUTE MEĐUKATNE KONSTRUKCIJE – TRIBINA SREDNJE DVORANE .....	178
10.1. Pomaci spregnute međukatne konstrukcije – tribina srednje dvorane.....	178
10.2. Dimenzioniranje spregnute međukatne konstrukcije–tribina srednje dvorane..	179
10.2.1. Rezne sile – gornja pojasnica glavnog rešetkastog nosača.....	179
10.2.2. Dimenzioniranje – gornja pojasnica glavnog rešetkastog nosača.....	180
10.2.3. Rezne sile – donja pojasnica glavnog rešetkastog nosača .....	187
10.2.4. Dimenzioniranje – donja pojasnica glavnog rešetkastog nosača.....	188
10.2.5. Rezne sile – ispuna glavnog rešetkastog nosača.....	191
10.2.6. Dimenzioniranje – ispuna glavnog rešetkastog nosača .....	192
10.2.7. Rezne sile – podupora glavnog rešetkastog nosača .....	193
10.2.8. Dimenzioniranje – podupora glavnog rešetkastog nosača.....	194
10.2.9. Rezne sile – gornja pojasnica sekundarnog rešetkastog nosača .....	195
10.2.10. Dimenzioniranje – gornja pojasnica sekundarnog rešetkastog nosača...	196
10.2.11. Rezne sile – donja pojasnica sekundarnog rešetkastog nosača.....	204
10.2.12. Dimenzioniranje – donja pojasnica sekundarnog rešetkastog nosača ....	205
10.2.13. Rezne sile – ispuna sekundarnog rešetkastog nosača .....	208

10.2.14. Dimenzioniranje – ispuna sekundarnog rešetkastog nosača.....	209
<b>11. PRORAČUN SPREGNUTE MEĐUKATNE KONSTRUKCIJE KONZOLNI DIO</b>	
11.1. Pomaci spregnute međukatne konstrukcije – konzolni dio .....	210
11.2. Dimenzioniranje spregnute međukatne konstrukcije–tribina srednje dvorane..	211
11.2.1. Rezne sile – gornja pojasnica glavnog rešetkastog nosača.....	211
11.2.2. Dimenzioniranje – gornja pojasnica glavnog rešetkastog nosača.....	212
11.2.3. Rezne sile – gornja pojasnica glavnog rešetkastog nosača.....	219
11.2.4. Dimenzioniranje – gornja pojasnica glavnog rešetkastog nosača.....	220
11.2.5. Rezne sile – ispuna glavnog rešetkastog nosača.....	222
11.2.6. Dimenzioniranje – ispuna glavnog rešetkastog nosača .....	223
11.2.7. Rezne sile – gornja pojasnica sekundarnog rešetkastog nosača .....	224
11.2.8. Dimenzioniranje – gornja pojasnica sekundarnog rešetkastog nosača .....	225
11.2.9. Rezne sile – donja pojasnica sekundarnog rešetkastog nosača.....	232
11.2.10. Dimenzioniranje – donja pojasnica sekundarnog rešetkastog nosača ....	233
11.2.11. Rezne sile – ispuna sekundarnog rešetkastog nosača .....	236
11.2.12. Dimenzioniranje – ispuna sekundarnog rešetkastog nosača.....	237
<b>12. PRORAČUN REŠETKASTOG NOSAČA - KONZOLNI NOSAČ 1 .....</b>	<b>238</b>
12.1. Vertikalni pomak rešetkastog nosača – konzolni nosač 1 .....	238
12.2. Dimenzioniranje rešetkastog nosača – konzolni nosač 1.....	239
12.2.1. Rezne sile – gornja pojasnica konzolnog rešetkastog nosača 1 .....	239
12.2.2. Dimenzioniranje – gornja pojasnica glavnog rešetkastog nosača 1 .....	240
12.2.3. Rezne sile – donja pojasnica konzolnog rešetkastog nosača 1 .....	242
12.2.4. Dimenzioniranje – donja pojasnica konzolnog rešetkastog nosača 1 .....	243
12.2.5. Rezne sile – vertikalna ispuna 1 konzolnog rešetkastog nosača 1 .....	246
12.2.6. Dimenzioniranje – vertikalna ispuna 1 konzolnog rešetkastog nosača 1 ..	248
12.2.7. Rezne sile – vertikalna ispuna 2 konzolnog rešetkastog nosača 1 .....	251

12.2.8. Dimenzioniranje – vertikalna ispuna 2 konzolnog rešetkastog nosača 1 .	253
12.2.9. Rezne sile – dijagonalna ispuna 1 konzolnog rešetkastog nosača 1 .....	256
12.2.10. Dimenzioniranje – dijagonalna ispuna 1 konzolnog rešetkastog nosača 1	
12.2.11. Rezne sile – dijagonalna ispuna 2 konzolnog rešetkastog nosača 1 .....	258
12.2.12. Dimenzioniranje – dijagonalna ispuna 2 konzolnog rešetkastog nosača 1	
13. PRORAČUN REŠETKASTOG NOSAČA - KONZOLNI NOSAČ 2 .....	260
13.1. Vertikalni pomak rešetkastog nosača – konzolni nosač 2 .....	260
13.2. Dimenzioniranje rešetkastog nosača – konzolni nosač 2.....	261
13.2.1. Rezne sile – gornja pojasnica konzolnog rešetkastog nosača 2.....	261
13.2.2. Dimenzioniranje – gornja pojasnica glavnog rešetkastog nosača 2.....	262
13.2.3. Rezne sile – donja pojasnica konzolnog rešetkastog nosača 2 .....	265
13.2.4. Dimenzioniranje – donja pojasnica konzolnog rešetkastog nosača 2 .....	266
13.2.5. Rezne sile – vertikalna ispuna 1 konzolnog rešetkastog nosača 2.....	269
13.2.6. Dimenzioniranje – vertikalna ispuna 1 konzolnog rešetkastog nosača 2 .	271
13.2.7. Rezne sile – vertikalna ispuna 2 konzolnog rešetkastog nosača 2.....	274
13.2.8. Dimenzioniranje – vertikalna ispuna 2 konzolnog rešetkastog nosača 2 .	276
13.2.9. Rezne sile – dijagonalna ispuna 1 konzolnog rešetkastog nosača 2 .....	279
13.2.10. Dimenzioniranje – dijagonalna ispuna 1 konzolnog rešetkastog nosača 2	
13.2.11. Rezne sile – dijagonalna ispuna 2 konzolnog rešetkastog nosača 2 .....	281
13.2.12. Dimenzioniranje – dijagonalna ispuna 2 konzolnog rešetkastog nosača 2	
14. PRORAČUN REŠETKASTOG NOSAČA - KONZOLNI NOSAČ 3 .....	283
14.1. Vertikalni pomak rešetkastog nosača – konzolni nosač 3 .....	283
14.2. Dimenzioniranje rešetkastog nosača – konzolni nosač 3.....	284
14.2.1. Rezne sile – gornja pojasnica konzolnog rešetkastog nosača 3 .....	284
14.2.2. Dimenzioniranje – gornja pojasnica glavnog rešetkastog nosača 3.....	285
14.2.3. Rezne sile – donja pojasnica konzolnog rešetkastog nosača 3 .....	288

14.2.4. Dimenzioniranje – donja pojasnica konzolnog rešetkastog nosača 3 .....	289
14.2.5. Rezne sile – vertikalna ispuna 1 konzolnog rešetkastog nosača 3 .....	292
14.2.6. Dimenzioniranje – vertikalna ispuna 1 konzolnog rešetkastog nosača 3 .	294
14.2.7. Rezne sile – vertikalna ispuna 2 konzolnog rešetkastog nosača 3 .....	297
14.2.8. Dimenzioniranje – vertikalna ispuna 2 konzolnog rešetkastog nosača 3 .	299
14.2.9. Rezne sile – dijagonalna ispuna 1 konzolnog rešetkastog nosača 3 .....	302
14.2.10. Dimenzioniranje – dijagonalna ispuna 1 konzolnog rešetkastog nosača 3	
14.2.11. Rezne sile – dijagonalna ispuna 2 konzolnog rešetkastog nosača 3 .....	304
14.2.12. Dimenzioniranje – dijagonalna ispuna 2 konzolnog rešetkastog nosača 3	
15. PRORAČUN GLAVNIH NOSAČA UNUTARNJIH STUBIŠTA.....	306
15.1. Vertikalni pomak glavnog nosača – stubište 1 (1. etaža).....	306
15.2. Dimenziniranje glavnog nosača – stubište 1 (1. etaža).....	307
15.2.1. Rezne sile – glavni gredni nosač stubišta 1 (1. etaža) .....	307
15.2.2. Dimenzioniranje – glavni gredni nosač stubišta 1 (1. etaža) .....	309
15.3. Vertikalni pomak glavnog nosača – stubište 1 (2. etaža).....	311
15.4. Dimenziniranje glavnog nosača – stubište 1 (2. etaža).....	312
15.4.1. Rezne sile – glavni gredni nosač stubišta 1 (2. etaža) .....	312
15.4.2. Dimenzioniranje – glavni gredni nosač stubišta 1 (2. etaža) .....	314
15.5. Vertikalni pomak glavnog nosača – stubište 2 (2. etaža).....	317
15.6. Dimenziniranje glavnog nosača – stubište 2 (2. etaža).....	318
15.6.1. Rezne sile – glavni gredni nosač stubišta 2 (2. etaža) .....	318
15.6.2. Dimenzioniranje – glavni gredni nosač stubišta 2 (2. etaža) .....	320
15.7. Vertikalni pomak glavnog nosača – stubište 3 (2. etaža).....	323
15.8. Dimenziniranje glavnog nosača – stubište 3 (2. etaža).....	324
15.8.1. Rezne sile – glavni gredni nosač stubišta 3 (2. etaža) .....	324
15.8.2. Dimenzioniranje – glavni gredni nosač stubišta 3 (2. etaža) .....	326

15.9. Vertikalni pomak glavnog nosača – ulazno stubište.....	328
15.10. Dimenzioniranje glavnog nosača – ulazno stubište.....	329
15.10.1. Rezne sile – glavni gredni nosač (ulazno stubište).....	329
15.10.2. Dimenzioniranje – glavni gredni nosač (ulazno stubište).....	331
15.11. Dimenzioniranje sekundarnog nosača – ulazno stubište .....	338
15.11.1. Rezne sile – sekundarni gredni nosač (ulazno stubište).....	338
15.11.2. Dimenzioniranje – sekundarni gredni nosač (ulazno stubište) .....	340
16. PRORAČUN STUPOVA .....	347
16.1. Horizontalni pomak stupova.....	347
16.2. Dimenzioniranje - stupovi prizemlja .....	348
16.2.1. Rezne sile – stup 1 (prizemlje).....	348
16.2.2. Dimenzioniranje – stup 1 (prizemlje) .....	349
16.2.3. Rezne sile – stup 2 (prizemlje).....	353
16.2.4. Dimenzioniranje – stup 2 (prizemlje) .....	354
16.2.5. Rezne sile – stup 1 (1. etaža) .....	358
16.2.6. Dimenzioniranje – stup 1 (1.etaža) .....	359
16.2.7. Rezne sile – stup 1 (2. etaža) .....	363
16.2.8. Dimenzioniranje – stup 1 (2.etaža) .....	364
16.2.9. Rezne sile – stup 1 (3. etaža) .....	368
16.2.10. Dimenzioniranje – stup 1 (3.etaža) .....	369
16.2.11. Rezne sile – stup 1 (velika dvorana) .....	373
16.2.12. Dimenzioniranje – stup 1 (3.etaža) .....	374
16.2.13. Rezne sile – krajnji stup konzolnog nosača .....	378
16.2.14. Dimenzioniranje – krajnji stup konzolnog nosača.....	379
17. DINAMIČKA ANALIZA .....	382
18. SPOJEVI.....	387

18.1. Proračun spoja stupa s temeljom .....	387
18.2. Proračun spoja stup - greda.....	391
18.3. Proračun spoja – montažni nastavak gornje pojasnice rešetkastog nosača.....	394
18.4. Proračun spoja – montažni nastavak donje pojasnice rešetkastog nosača.....	397
18.5. Proračun spoja - montažni nastavak dijagonalne ispune rešetkastog nosača ..	399
19. DIMENZIONIRANJE TEMELJA SAMCA .....	401
19.1. Dimenzioniranje temelja samca za stup 1.....	401
19.2. Dimenzioniranje temelja samca za stup 2.....	402
20. NACRTI.....	403
21. LITERATURA .....	404

# 1. TEHNIČKI OPIS

## 1.1. Opis konstrukcije

Predmet ovog projekta je čelična konstrukcija Kongresnog centara Žnjan smještena na području Splita. Parcela predviđena za izgradnju objekta nalazi se u gradskom predijelu Žnjan na ravnom terenu, a postavljena je u smjeru sjever – jug. Pristupni put za vozila smješten je na zapadnoj strani parcele gdje se nalazi i ulaz za garažu. Sa istočne strane se nalazi šetnica koja vodi do objekta. Dio slobodne neizgrađene površine služiti će za pješačku komunikaciju, a sa južne strane objekta osmišljen je Kongresni trg.

Objekt je planiran kao višetažna konstrukcija sa višenamjenskim sadržajem koji uključuju četiri male, jednu srednju i jednu veliku kongresnu dvoranu. Objekt još sadržava garažu sa 95 parkirnih mjesta, administracijski prostor, salone i caffè barove.

Vertikalnu nosivu konstrukciju čine čelični stupovi oblika poprečnog presjeka „I“. Krovna konstrukcija se sastoji dijelom od čeličnih greda koje su spregnute sa betonskom pločom, a drugim dijelom od čeličnih rešetkastih nosača spregnutih sa betonskom pločom. Međukatnu nosivu konstrukciju čine čelične grede spregnute sa betonskom pločom, a tribine srednje i velike dvorane čine čelični rešetkasti nosači koji su također spregnuti sa betonskom pločom.

Konzolni dio konstrukcije se sastoji od dva rešetkasta nosača u x smjeru te jednog rešetkastog nosača u y smjeru. Vertikalnu nosivu konstrukciju „betonske jezgre“ čine armirani betonski zidovi, a međukatnu nosivu konstrukciju armirano betonske ploče.

Vertikalna komunikacija je ostvarena liftom te sa četiri čelična montažna stubišta. Ulazno stubište u objekt čine čelični gredni nosači spregnuti sa betonskom pločom. Temelji su armirano betonski, izvedeni kao temelji samci, kvadratnog tlocrtnog oblika, a iznad temelja je postavljena temeljena armirano betonska ploča.

Ukupna širina objekta je 70,09 metara, dok duljina iznosi 75,6 m. Ukupna površina krovne plohe je cca 5300 m<sup>2</sup>, a visina objekta je 16,20 m.

## 1.2. O proračunu konstrukcije

Proračun konstrukcije izveden je uz korištenje programskog paketa Scia Engineer 2016. Proračun reznih sila, te dimenzioniranje konstruktivnih elemenata, provedeno je korištenjem programa Scia Engineer 2016, dok je za grafički dio projekta korišten program AutoCAD 2014.

Proračun reznih sila izvršen je po linearnoj teoriji elastičnosti prvog reda. Proračunom su obuhvaćena sva djelovanja na konstrukciju, a to su vlastita težina, dodatno stalno opterećenje, pokretno opterećenje, opterećenje snijegom kao i opterećenje vjetrom.

S obzirom na lokaciju objekta napravljena je analiza opterećenja koja obuhvaća djelovanje snijega i vjetra. Objekat se nalazi na području Splita, gradski predjel Žnjan te prema karti snijega za Republiku Hrvatsku ova građevina upada u 1. Područje – priobalje i otoci, što daje karakterističnu vrijednost opterećenja snijegom na tlu. U obzir je uzeta i nadmorska visina na kojoj se nalazi objekat. Za opterećenje vjetrom uzeta je zona III, kategorija zemljišta 0, te je u obzir uzeta visina objekta i njegova zaštićenost.

Pošto je vjetar dominantno opterećenje za ovakav tip objekta, posvećena mu je velika pažnja te je promatrano samo tlačno djelovanje vjetra pošto je cijeli objekt zatvorene te se nejavlja podtlačno djelovanje. Za stupove je također izvršena analiza opterećenja vjetrom, a opterećenje je zadano kao jednoliko kontinuirano djelovanje po dužini stupa.

Za svaki element konstrukcije određena je mjerodavna kombinacija opterećenja za provjeru krajnjeg graničnog stanja i graničnog stanja uporabljivosti. Za svaku granično stanje napravljene su posebne kombinacije uz poštivanje parcijalnih faktora sigurnosti prema EN 1991.

Rezultati prikazani u grafičkom dijelu ovog projekta uključuju rezne sile i pomake određenih djelova konstrukcije. Rezne sile su dane u jedinicama kN za poprečne i uzdužne sile, kNm za momente, te u mm za pomake konstrukcije. Uzete su sve mjerodavne kombinacije opterećenja u obzir, te je svaki element dimezioniran sukladno njegovim reznim silama.



### 1.3. Materijal za izradu konstrukcije

Materijal za izradu glavne nosive konstrukcije, kao i stupova je čelik S 355. Konstruktivni elementi će međusobno biti vezani vijčanim spojevima. Vijci korišteni za izvedbu ove konstrukcije su M 16, M20 i M27, svi kvalitete 10.9 . Spojevi i nastavci elemenata konstrukcije uključuju dodatne ploče i ukrute, također iste kvalitete čelika.

Za oblogu objekta predviđeni su paneli od pleksiglasa, koji imaju malu vlastitu težinu i omogućuju prolazak dnevnog svjetla. Za spregnutu konstrukciju korišten je beton klase C 30/37. Temelji su armirano betonski, klasa betona C 25/30, armatura je B 500 B.

### 1.4. Opis montaže konstrukcije

Izvedba konstrukcije je montažna. Svi elementi konstrukcije predgotovljeni stižu na gradilište te se međusobno vežu vijcima.

Nulta faza montaže, nakon izvedenih svih prethodno potrebnih radova, je montaža stupova. Kada se stup postavi na ankere koji su postavljeni u temelje, stup se pridržaje dizalicom dok se ne postigne vertikalnost pomoću dvostrukih vijaka. Nakon provjere vertikalnosti, vrši se ispunjenje prostora ispod spojne ploče i temelja ekspanzirajućim mortom.

Nakon toga se na stupove vežu glavne međukatne grede te glavni rešetkasti nosači koji tvore utazu konstrukcije. Sljedeći korak je postavljanje sekundarnih međukatnih greda kao isekundarnih rešetkastih nosača. Nakon toga se betonira betonska ploča koja nakon očvršćavanja tvori spregnutu konstrukciju.

Svi elementi konstrukcije se dovode na gradilište duljine do 12 m zbog transporta. Na gradilištu se poslje spajaju u veće segmente i takvi podižu dizalicom na predviđenu poziciju te vijčano spajaju na ostatak konstrukcije.

## 1.5. Primjenjeni propisi

Proračun i dimenzioniranje svih elemenata čelične konstrukcije provedeni su u skladu sa EUROCODE 3, a analiza djelovanja na konstrukciju napravljena je u skladu sa EUROCODE 1. Proračun i dimenzioniranje betonskih elemenata konstrukcije te spregnute konstrukcije provedeno je u skladu sa EUROCODE 2 i EUROCODE 4. Posebno je provedn proračun zavarenih spojeva prema EN 1993, dio 1-8.

## 1.6. Antikorozivna zaštita

Kod čelika pod korozijom se podrazumijeva oksidacija željeza pri djelovanju vlage i raznih nečistoća. Agensi koji ubrzavaju hrđanje su zagađena atmosfera, industrijsko područje zagađeno sumporom, sol itd.

Zaštita čeličnih konstrukcija od hrđanja vrši se:

- premazima
- zaštita cinkom
- metalizacijom
- uporabom specijalnih čelika
- katodnom zaštitom

Zaštita premazima obavlja se u svrhu spriječavanja da kisik i vlaga dođu u dodir s čelikom. Premazivanje se obično vrši bojanjem u dva sloja: osnovni premaz i zaštitni premaz. Osnovni premaz neposredno štiti čelik, a potrebno je da bude izrađen od tvari koje nisu štetne po ljudsko zdravlje. Zaštitni sloj služi za zaštitu osnovog premaza.

Prerano propadanje konstrukcije najčešće nastaje usljed loših detalja u konstrukciji (nepristupačna mjesta za bojenje, mjesta gdje se zadržava voda, oštri bridovi gdje se nemože nanijeti zahtjevana debljina premaza i sl.) koje treba nastojati izbjegavati.

Sistem zaštite bojenjem sastoji se iz:

- Priprema površine – trajnost premaza ovisi o prionjivosti boje za metalnu površinu, što ovisi o čistoći površine prije bojanja. Čišćenje se vrši četkama, pjeskarenjem, plamenikom ili kemijskim sredstvima.

- Nanošenje boje – bojenje se vrši četkom, valjkom ili prskanjem. Treba paziti na ograničenja za pojedine boje. Broj slojeva premaza obično se sastoji od dva a specifično od četiri ili više slojeva. Novi premaz može se vršiti tek kad je prethodni potpuno suh. Debljini premaza potrebno je posvetiti posebnu pažnju. Općenito, deblji premaz povećava trajnost zaštite. Ukupna debljina suhih premaza treba se kretati između 0,1-0,4 mm.

Dobro izvedeni premazi traju:

- do 30 godina u zatvorenoj prostoriji
- do 20 godina kod konstrukcija zaštićenih od kiše
- do 10 godina u prirodi
- 2-3 godine u zagađenom okolišu

Zaštita pocinčavanjem podrazumijeva vrste zaštite koje se ostvaruju nanošenjem prevlake cinka i po toplom postupku. Mase i debljine prevlaka cinka za pojedine elemente određene su prema Pravilniku o tehničkim mjerama i uvjetima za zaštitu čeličnih konstrukcija od korozije i ne mogu biti manje od 500g/m<sup>2</sup> elementa debljine 5 mm. Sve čelične konstrukcije prethodno treba odmastiti, očistiti razblaženom otopinom klorovodične kiseline te isprati hladnom vodom. Neposredno prije pocinčavanja čelična konstrukcija se stavlja u taljevinu ili otopinu za flusiranje.

Toplo pocinčavanje se izvodi stavljanjem tekućine u rastopljeni cink. Cink mora biti kvaliteta Zn 97,5 do Zn 99,5 prema HRN EN ISO 14713:2001. Prevlaka cinka dobivena toplim postupkom mora biti homogena i mora prekrivati osnovicu. Prevlaka cinka mora čvrsto prianjati za čeličnu površinu i ne smije se ljuštiti niti pucati pri uporabi.

Prije montaže potrebno je izvršiti kontrolu prevlake cinka prema HRN C.A1. 558, odnosno mase prevlake cinka prema HRN A6.021.

### **1.7. Protupožarna zaštita**

Pri izvedbi osigurat će se provedba svih propisa o zaštiti od požara. Pristup i intervencija vatrogasnog vozila omogućit će se sa zapadne strane parcele. Zahtijevana vatrootpornost elemenata čelične konstrukcije F30. Osiguranje vatrootpornosti osiguravamo specijalnim ekspandirajućim premazima.

## 2. NUMERIČKI MODEL KONSTRUKCIJE

Numerički 3D render modela konstrukcije je izrađen u Scia Engineer 2016.

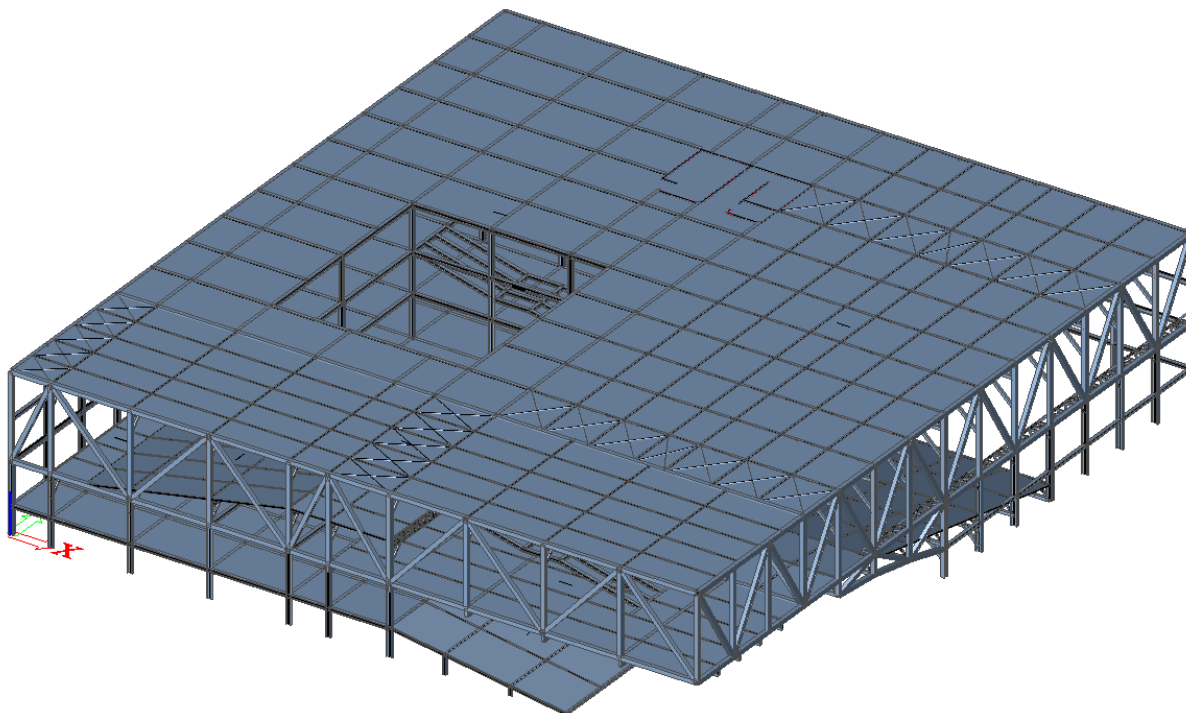

*Slika 2.1. Izometrijski prikaz 3D modela*

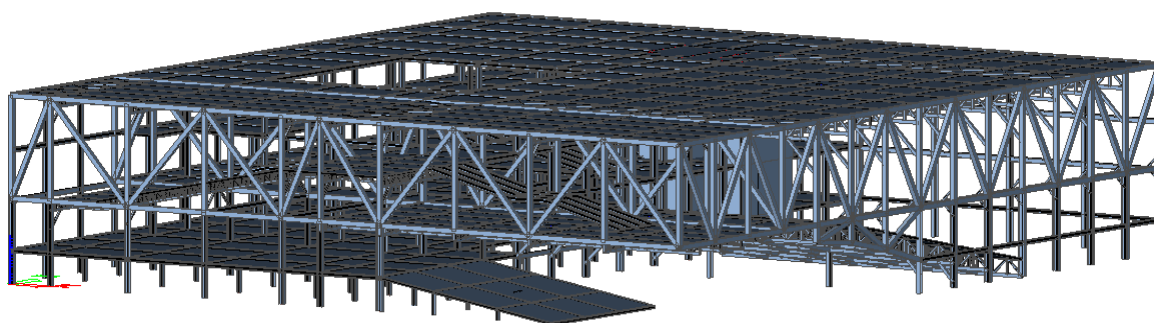

*Slika 2.2. Izometrijski prikaz 3D modela*

Tlocrt krova konstrukcije

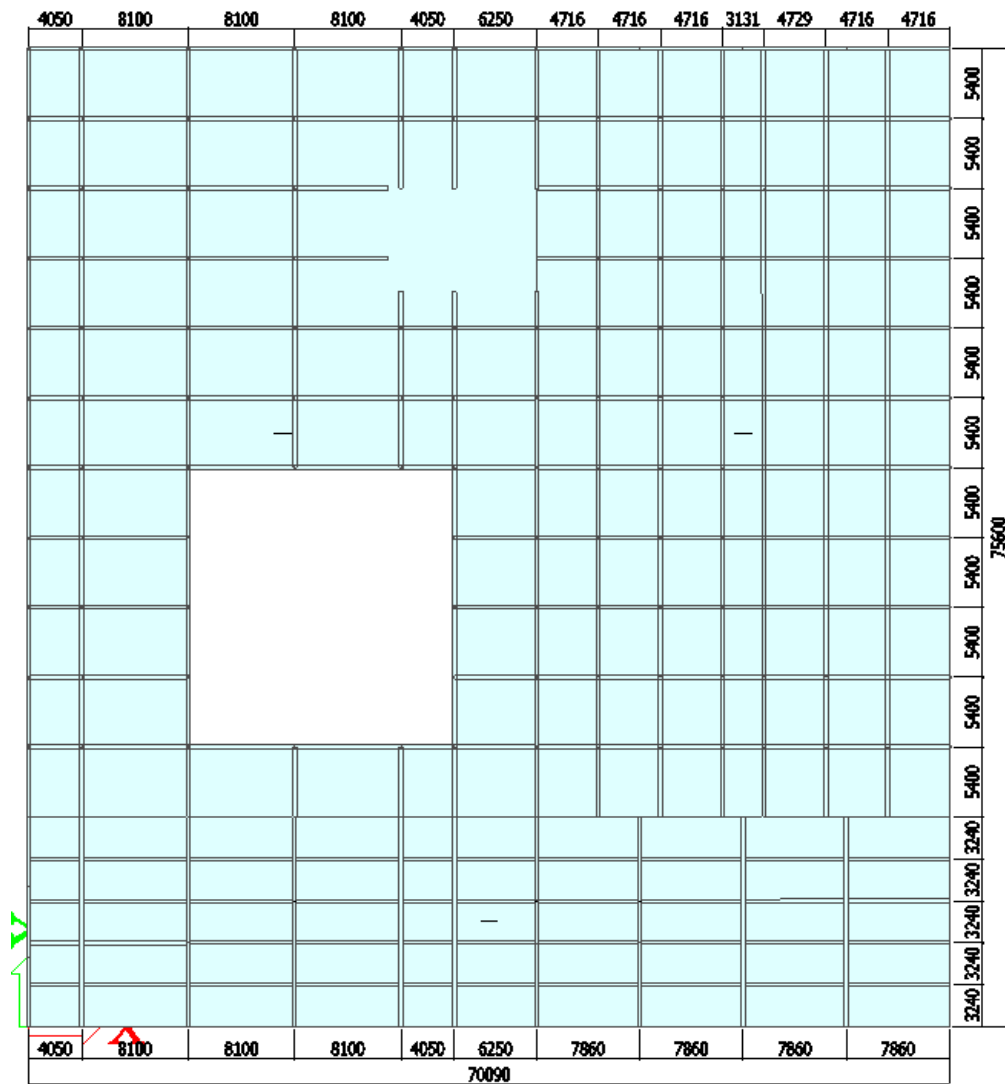

Slika 2.3. Tlocrtni prikaz rastera u numeričom modelu

Pročelja konstrukcije

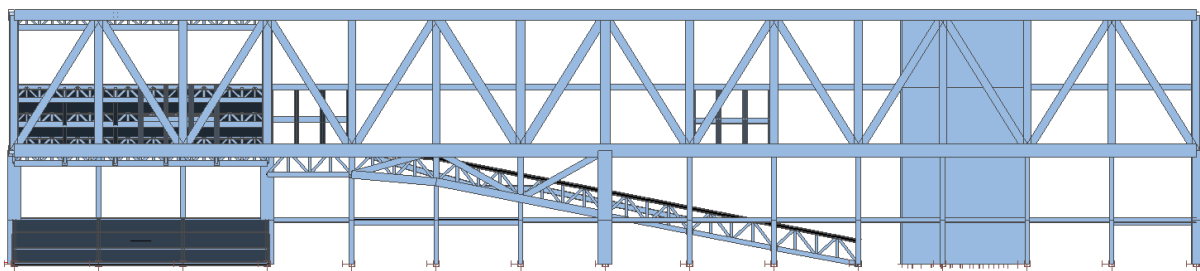

Slika 2.4. Prikaz istočnog pročelja

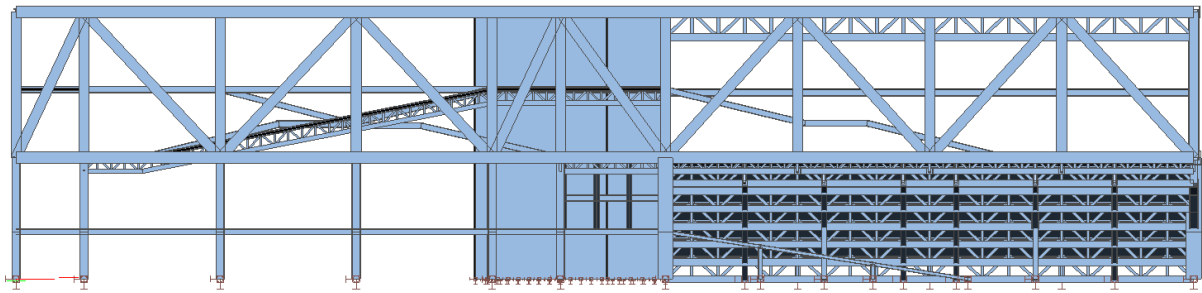

*Slika 2.3. Prikaz južnog pročelja*

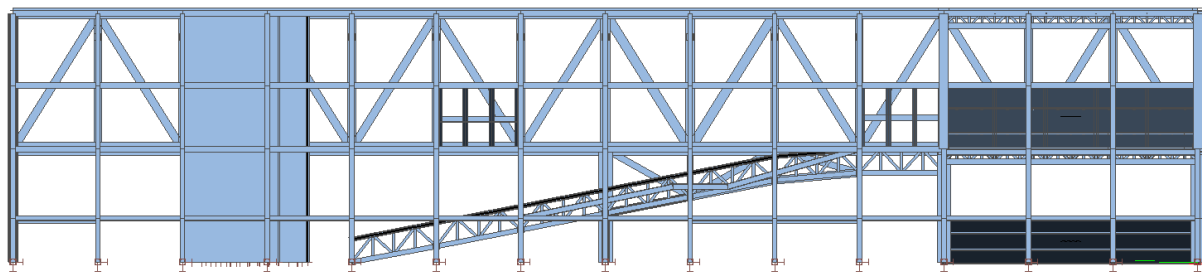

*Slika 2.4. Prikaz zapadnog pročelja*

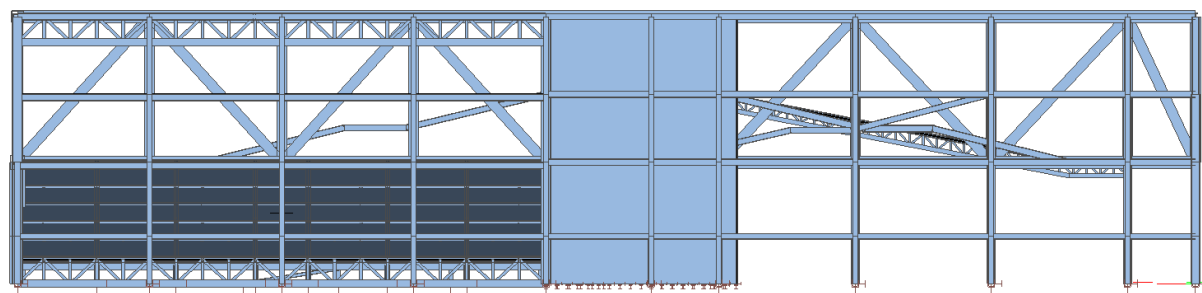

*Slika 2.5. Prikaz sjevernog pročelja*

### 3. ANALIZA OPTEREĆENJA

#### 3.1. Stalno opterećenje

Stalno opterećenje uključeno je kroz numerički model.

#### 3.2. Dodatno stalno opterećenje

a) pozicija 400 - krov

Pod dodatnim stalnim opterećenjem podrazumijevamo slojeve krovne konstrukcije. Naravno, ovdje nije uključena težina ab ploče jer je ona već zadana u numeričkom modelu.

Slojevi krovne konstrukcije	d (m)	$\gamma$ (kN/m <sup>3</sup> )	d· $\gamma$ (kN/m <sup>2</sup> )
Betonske ploče na plastičnim podloščima	0,05	25,0	1,25
Hidroizolacija + parna brana	0,01	20,0	0,20
Toplinska izolacija	0,08	5,0	0,40
Beton za pad	0,08	24,0	1,92

Ukupno dodatno stalno opterećenje:  $g_{400}=3,80$  kN/m<sup>2</sup>

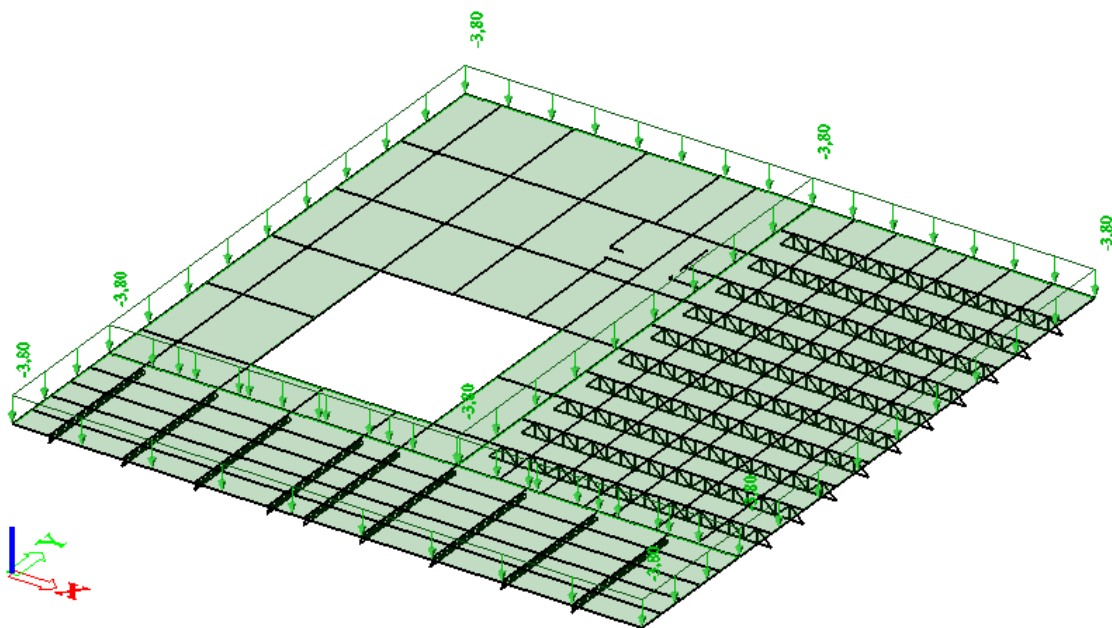

Slika 3.1. Prikaz raspodjele dodatnog stalnog opterećenja - pozicija 400



## b) pozicija 300

Pod dodatnim stalnim opterećenjem podrazumijevamo slojeve podne konstrukcije. Naravno, ovdje nije uključena težina AB ploče jer je ona već zadana u numeričkom modelu.

Slojevi međukatne konstrukcije	d (m)	$\gamma$ (kN/m <sup>3</sup> )	$d \cdot \gamma$ (kN/m <sup>2</sup> )
Pregrade			1,00
Završna obrada poda - keramika	0,01	24,0	0,24
AB estrih	0,05	25,0	1,25
Toplinska izolacija	0,04	5,0	0,20
Hidroizolacija	0,005	20,0	0,10

Ukupno dodato stalno opterećenje:  $g_{300}=2,80$  (kN/m<sup>2</sup>)

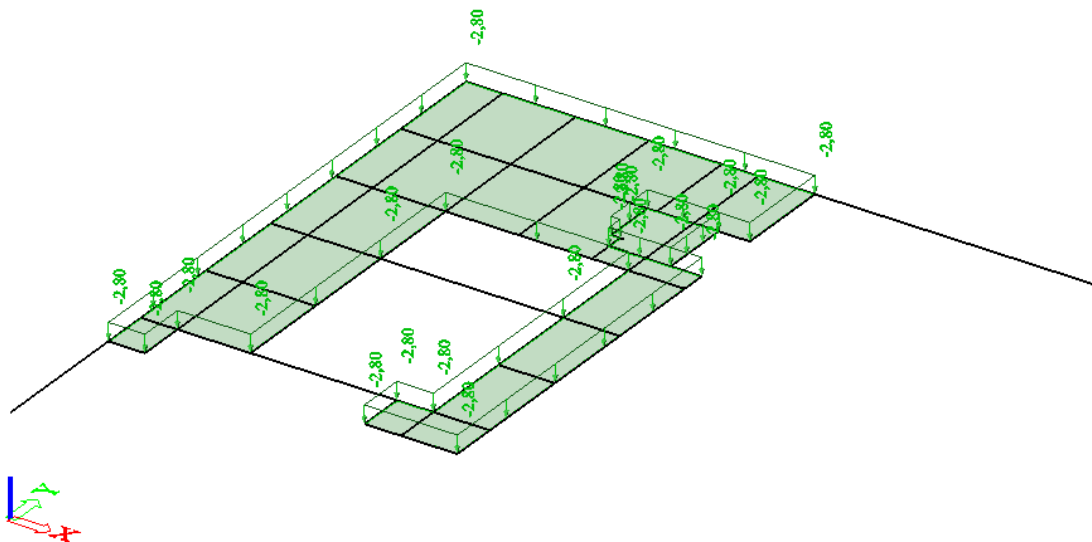

Slika 3.2. Prikaz raspodjele dodatnog stalnog opterećenja - pozicija 300

## c) pozicija 200

Pod dodatnim stalnim opterećenjem podrazumijevamo slojeve podne konstrukcije. Naravno, ovdje nije uključena težina AB ploče jer je ona već zadana u numeričkom modelu.

Slojevi međukatne konstrukcije	d (m)	$\gamma$ (kN/m <sup>3</sup> )	$d \cdot \gamma$ (kN/m <sup>2</sup> )
Pregrade			1,00
Završna obrada poda - keramika	0,01	24,0	0,24
AB estrih	0,05	25,0	1,25
Toplinska izolacija	0,04	5,0	0,20
Hidroizolacija	0,005	20,0	0,10

Ukupno dodato stalno opterećenje:  $g_{200}=2,80$  (kN/m<sup>2</sup>)

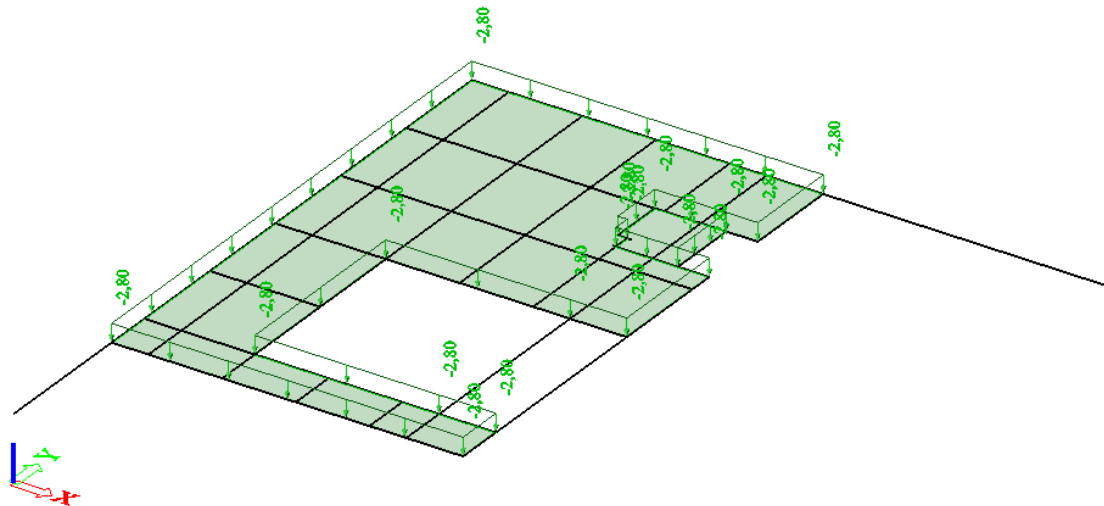

Slika 3.3. Prikaz raspodjele dodatnog stalnog opterećenja - pozicija 200

d) pozicija 200 – konzolni dio

Pod dodatnim stalnim opterećenjem podrazumijevamo slojeve podne konstrukcije. Naravno, ovdje nije uključena težina AB ploče jer je ona već zadana u numeričkom modelu.

Slojevi međukatne konstrukcije	d (m)	$\gamma$ (kN/m <sup>3</sup> )	$d \cdot \gamma$ (kN/m <sup>2</sup> )
Završna obrada poda - keramika	0,01	24,0	0,24
AB estrih	0,05	25,0	1,25
Toplinska izolacija	0,08	5,0	0,40
Hidroizolacija	0,005	20,0	0,10

Ukupno dodato stalno opterećenje:  $g_{200}=2,0$  (kN/m<sup>2</sup>)

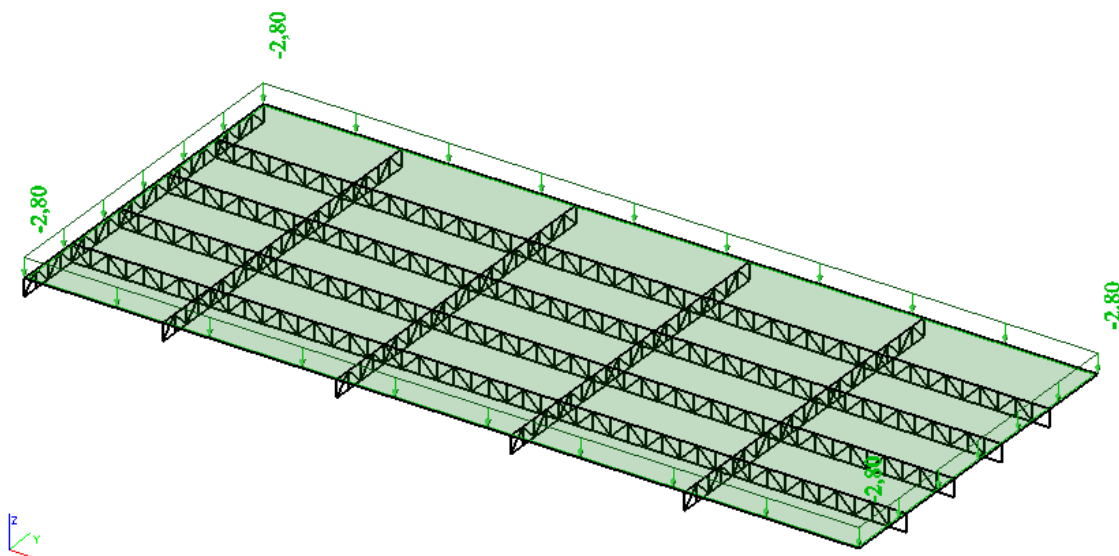

Slika 3.4. Prikaz raspodjele dodatnog stalnog opterećenja - pozicija 200 (konzolni dio)

e) pozicija 100

Pod dodatnim stalnim opterećenjem podrazumijevamo slojeve podne konstrukcije. Naravno, ovdje nije uključena težina AB ploče jer je ona već zadana u numeričkom modelu.

Slojevi međukatne konstrukcije	d (m)	$\gamma$ (kN/m <sup>3</sup> )	$d \cdot \gamma$ (kN/m <sup>2</sup> )
Pregrade			1,00
Završna obrada poda - keramika	0,01	24,0	0,24
AB estrih	0,05	25,0	1,25
Toplinska izolacija	0,04	5,0	0,20
Hidroizolacija	0,005	20,0	0,10

Ukupno dodato stalno opterećenje:  $g_{100}=2,80$  (kN/m<sup>2</sup>)

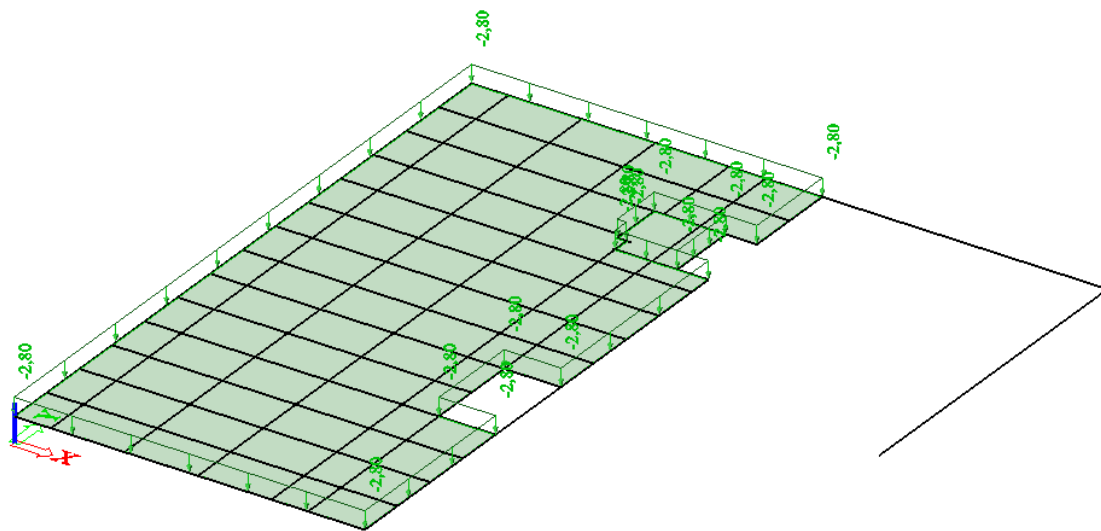

Slika 3.5. Prikaz raspodjele dodatnog stalnog opterećenja - pozicija 100

f) pozicija (000 – 200) - tribina velike dvorane

Pod dodatnim stalnim opterećenjem podrazumijevamo slojeve podne konstrukcije. Naravno, ovdje nije uključena težina AB ploče jer je ona već zadana u numeričkom modelu.

Slojevi međukatne konstrukcije	d (m)	$\gamma$ (kN/m <sup>3</sup> )	$d \cdot \gamma$ (kN/m <sup>2</sup> )
Stolovi i stolice			0,40
Završna obrada poda	0,01	25,0	0,25
AB stepenice	0,09	25,0	2,25
Toplinska izolacija	0,04	5,0	0,20
Hidroizolacija	0,005	20,0	0,10

Ukupno dodato stalno opterećenje:  $g_{(000-200)}=3,20$  (kN/m<sup>2</sup>)

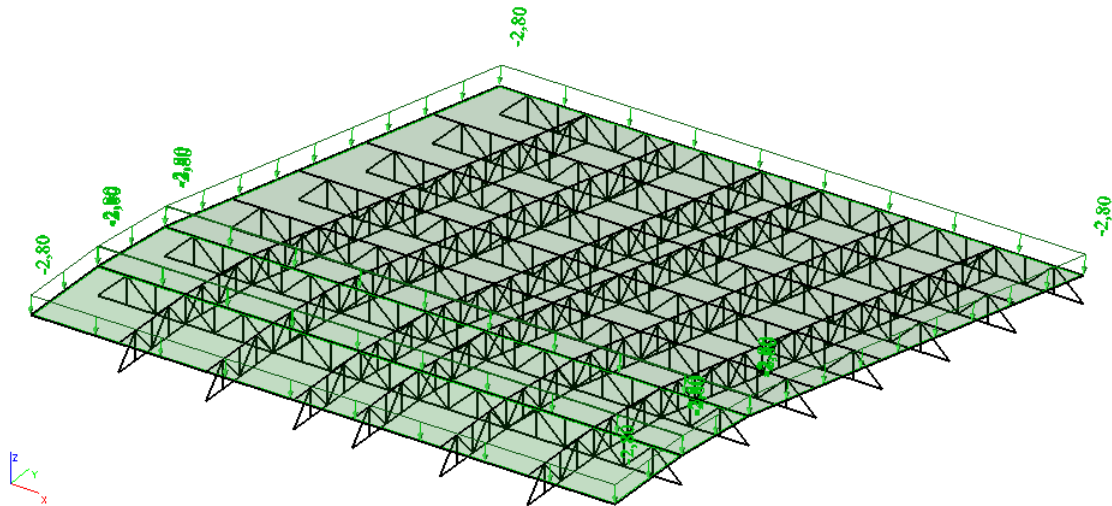

Slika 3.6. Prikaz raspodjele dodatnog stalnog opterećenja - tribina velike dvorane

g) pozicija (200 – 300) - tribina srednje dvorane

Pod dodatnim stalnim opterećenjem podrazumijevamo slojeve podne konstrukcije. Naravno, ovdje nije uključena težina AB ploče jer je ona već zadana u numeričkom modelu.

Slojevi međukatne konstrukcije	d (m)	$\gamma$ (kN/m <sup>3</sup> )	d· $\gamma$ (kN/m <sup>2</sup> )
Stolovi i stolice			0,40
Završna obrada poda	0,01	25,0	0,24
AB stepenice	0,09	25,0	2,25
Toplinska izolacija	0,04	5,0	0,20
Hidroizolacija	0,005	20,0	0,10

Ukupno dodato stalno opterećenje:  $g_{(200-300)}=3,20$  (kN/m<sup>2</sup>)

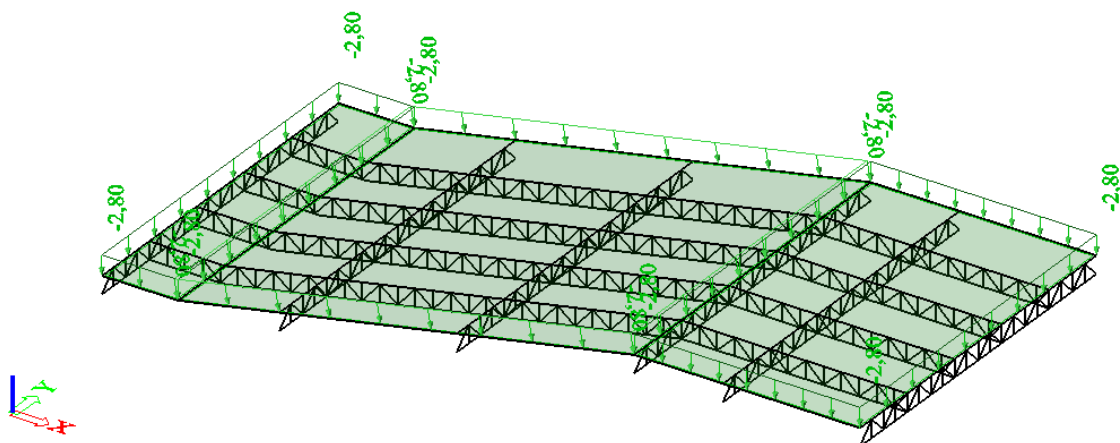

Slika 3.7. Prikaz raspodjele dodatnog stalnog opterećenja - tribina srednje dvorane

h) pozicija (100 – 300) – unutarnje stubište

Pod dodatnim stalnim opterećenjem podrazumijevamo čelično gazište stepenica koje je ujedno i poprečna (sekundarna) konstrukcija. Naravno, ovdje nije uključena težina glavnih čeličnih nosača jer je ona već zadana u numeričkom modelu.

Ukupno dodato stalno opterećenje:  $g_{\text{(stepenice)}}=1,50 \text{ (kN/m}^2\text{)}$

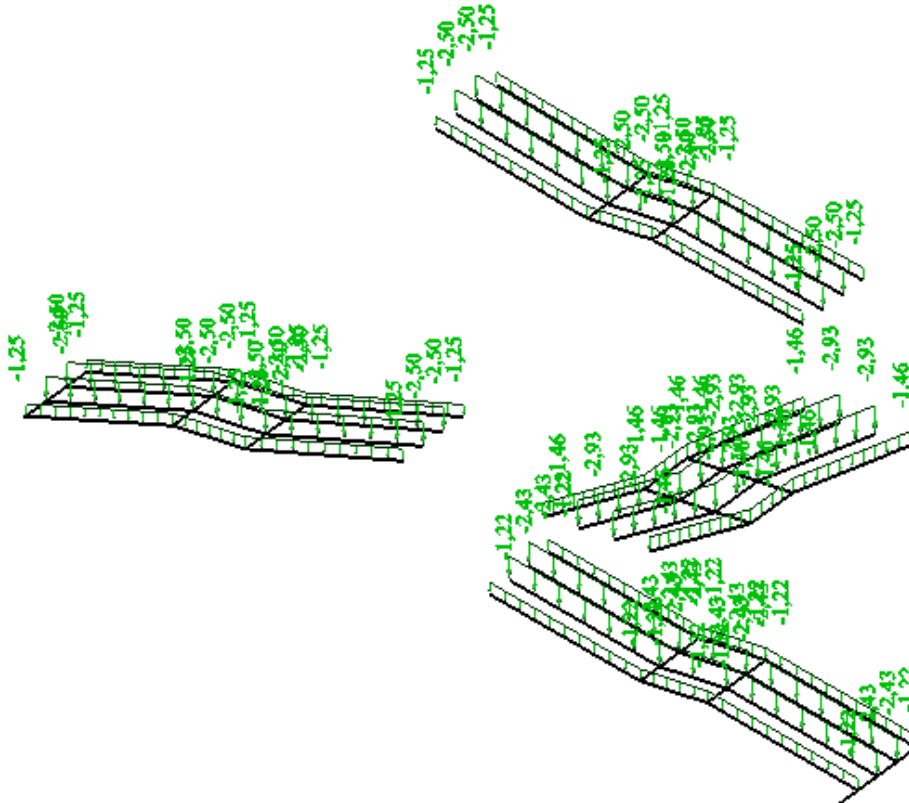

*Slika 3.8. Prikaz raspodjele dodatnog stalnog opterećenja - unutarnje stubište*

i) pozicija (000 – 100) – ulazno stubište

Pod dodatnim stalnim opterećenjem podrazumijevamo slojeve podne konstrukcije stepenica. Naravno, ovdje nije uključena težina AB ploče jer je ona već zadana u numeričkom modelu.

Slojevi konstrukcije stepenica	d (m)	$\gamma \text{ (kN/m}^3\text{)}$	$d \cdot \gamma \text{ (kN/m}^2\text{)}$
Završna obrada poda	0,03	25,0	0,75
AB stepenice	0,08	25,0	2,0

Ukupno dodato stalno opterećenje:  $g_{\text{(000-100)}}=2,75 \text{ (kN/m}^2\text{)}$

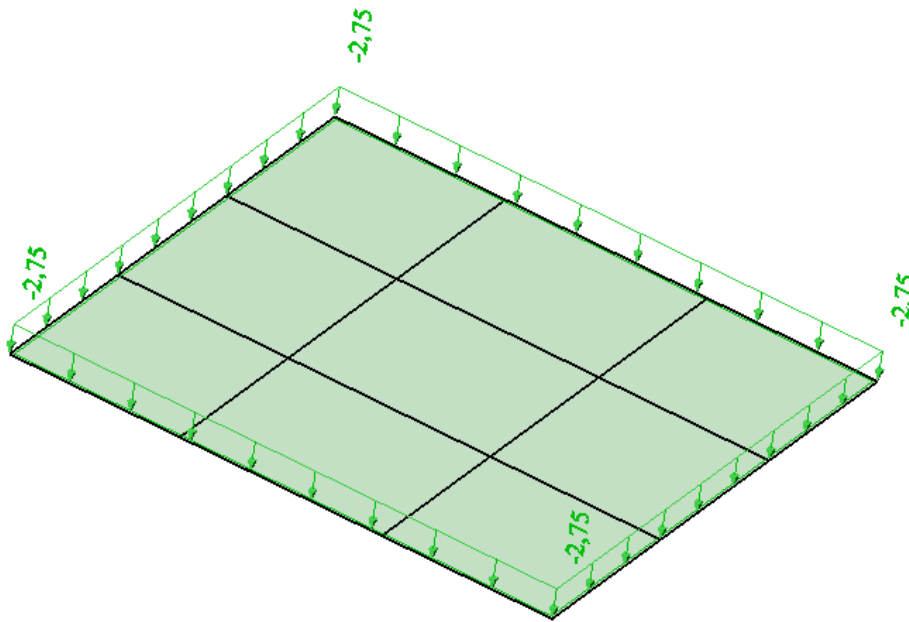

*Slika 3.9. Prikaz raspodjele dodatnog stalnog opterećenja – ulazno stubište*

### 3.3. Promjenjivo (pokretno) opterećenje

a) pozicija 400 - krov

Za pokretno opterećenje na krovu uzima se opterećenje snijegom i vjetrom koje je obrađeno u zasebnim stavkama.

b) pozicija 300

- uredi, prostorije sa stolovima, kavane, restorani i recepcije –  $3.0 \text{ kN/m}^2$

- prostorije s nepomičnim sjedalima, kina, predavaonice, čekaonice, koferencijske dvorane –  $4.0 \text{ kN/m}^2$

- prostorije bez prepreka za kretanje ljudi, izložbeni prostori, pristupi u javnim i državnim zgradama –  $5.0 \text{ kN/m}^2$

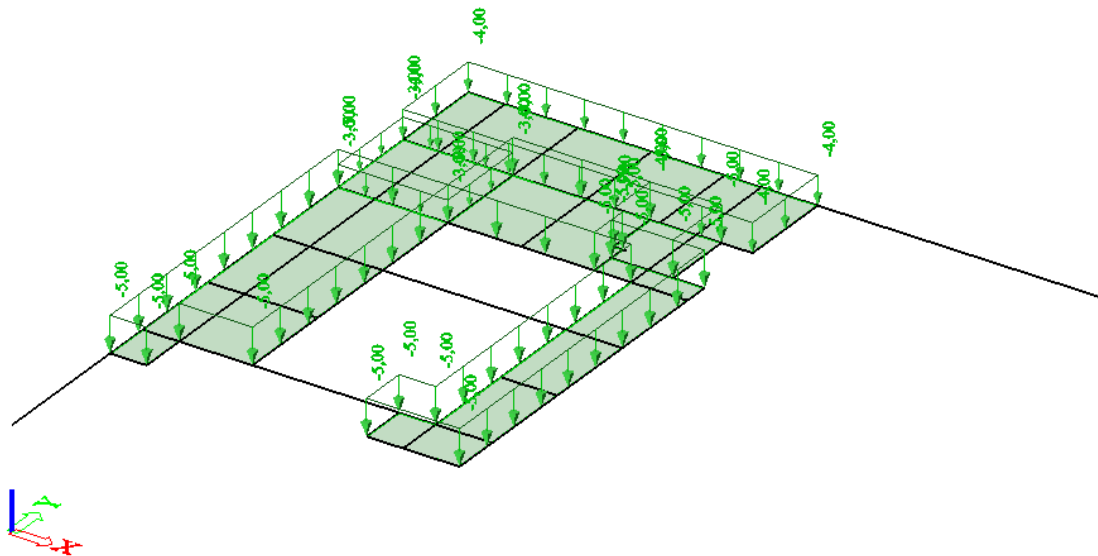

Slika 3.10. Prikaz raspodjele pokretnog opterećenja - pozicija 300

c) pozicija 200

- uredi, prostorije sa stolovima, kavane, restorani i recepcije –  $3.0 \text{ kN/m}^2$
- prostorije s nepomičnim sjedalima, kina, predavaonice, čekaonice, konferencijske dvorane –  $4.0 \text{ kN/m}^2$
- prostorije bez prepreka za kretanje ljudi, izložbeni prostori, pristupi u javnim i državnim zgradama –  $5.0 \text{ kN/m}^2$

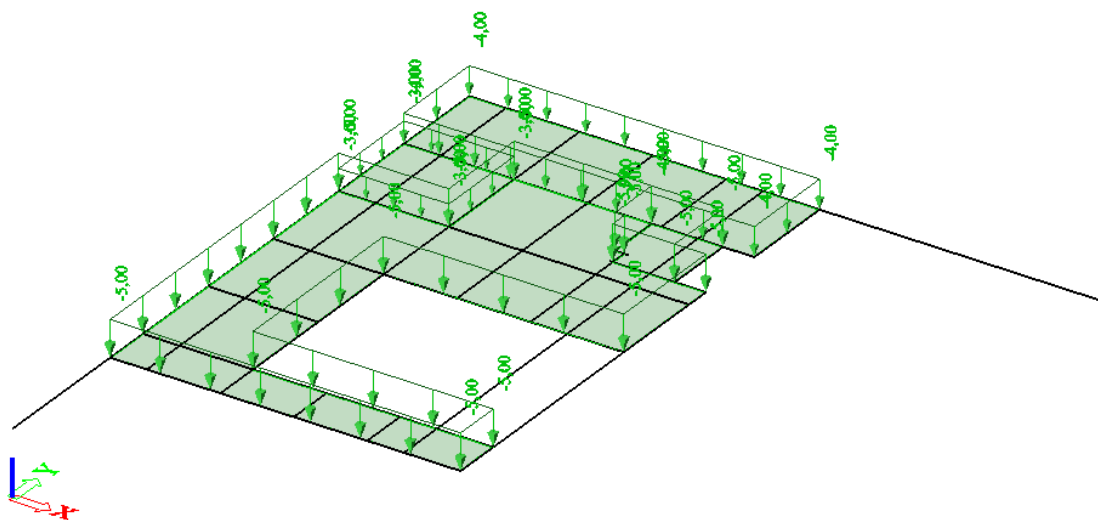

Slika 3.11. Prikaz raspodjele pokretnog opterećenja - pozicija 200

## d) pozicija 200 – konzolni dio

- prostorije bez prepreka za kretanje ljudi, izložbeni prostori, pristupi u javnim i državnim zgradama –  $5.0 \text{ kN/m}^2$

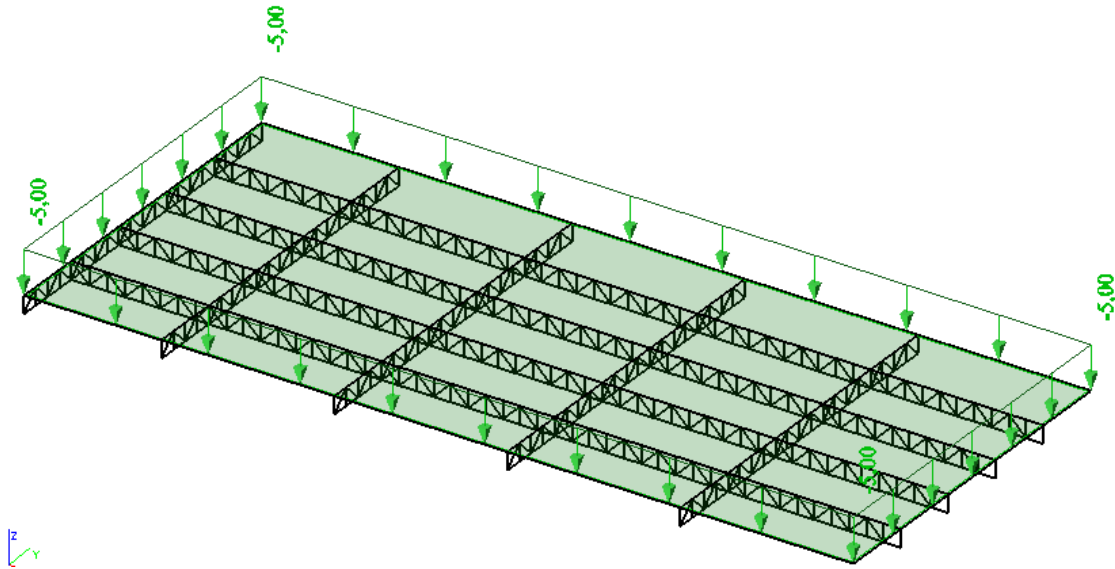

*Slika 3.12. Prikaz raspodjele pokretnog opterećenja - pozicija 200 (konzolni dio)*

## e) pozicija 100

- uredi, prostorije sa stolovima, kavane, restorani i recepcije –  $3.0 \text{ kN/m}^2$
- prostorije s nepomičnim sjedalima, kina, predavaonice, konferencijske dvorane –  $4.0 \text{ kN/m}^2$
- prostorije bez prepreka za kretanje ljudi, pristupi u javnim i državnim zgradama –  $5.0 \text{ kN/m}^2$

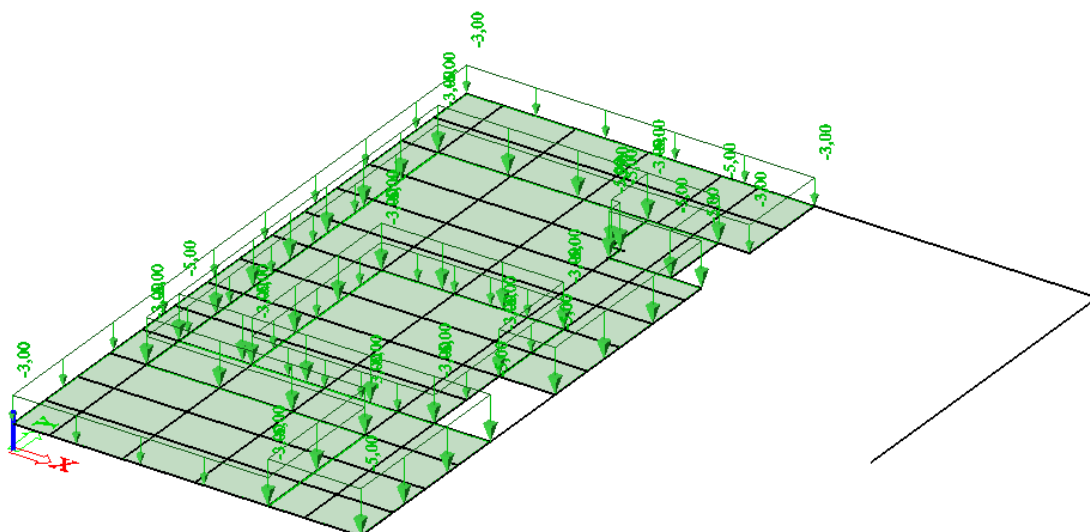

*Slika 3.13. Prikaz raspodjele pokretnog opterećenja - pozicija 100*



f) pozicija (000 – 200) - tribina velike dvorane

- prostorije s nepomičnim sjedalima, kina, predavaonice, konferencijske dvorane –  $4.0 \text{ kN/m}^2$

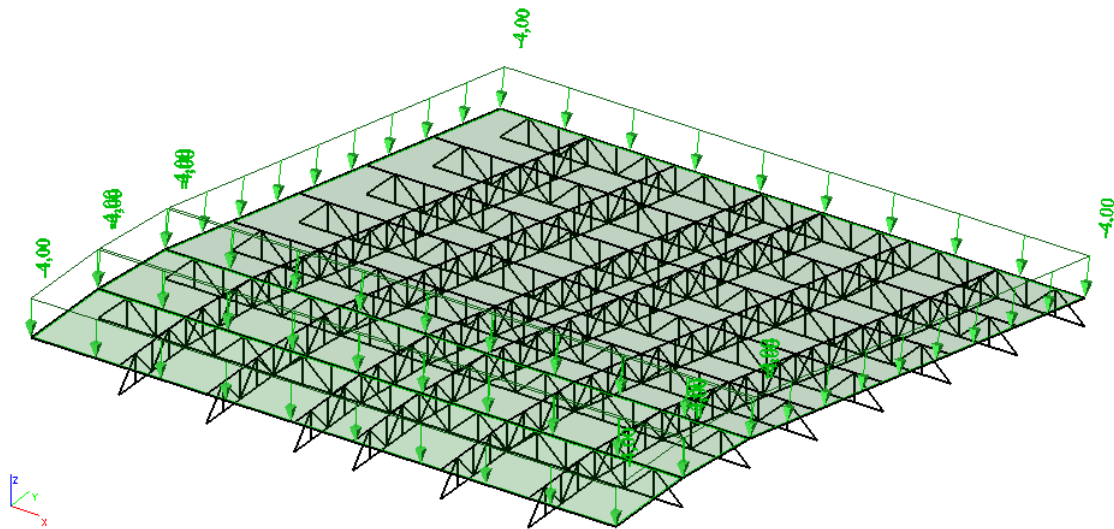

*Slika 3.14. Prikaz raspodjele pokretnog opterećenja - tribina velike dvorane*

g) pozicija (100 – 300) - tribina srednje dvorane

- prostorije s nepomičnim sjedalima, kina, predavaonice, čekaonice, konferencijske dvorane –  $4.0 \text{ kN/m}^2$

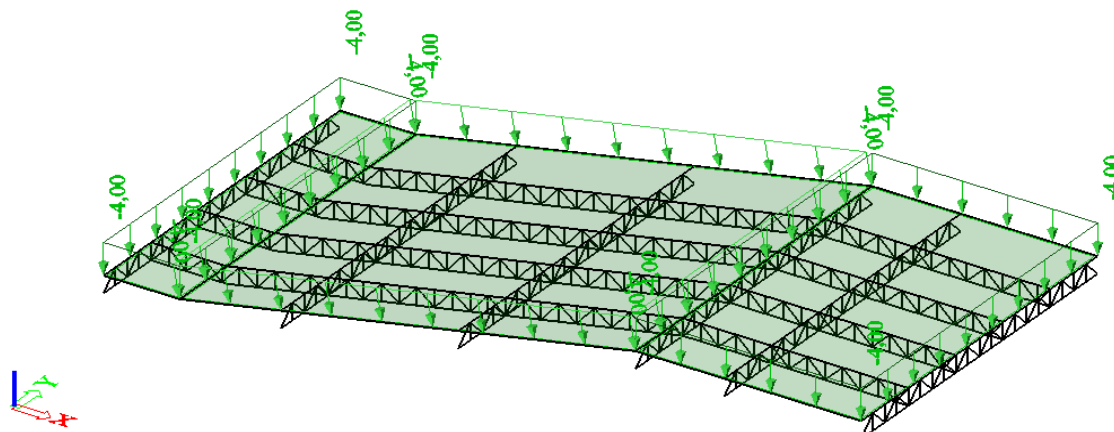

*Slika 3.15. Prikaz raspodjele pokretnog opterećenja - tribina srednje dvorane*

h) pozicija (100 – 300) – unutarnje stubište

- prostorije bez prepreka za kretanje ljudi, izložbeni prostori, pristupi u javnim i državnim zgradama –  $5.0 \text{ kN/m}^2$

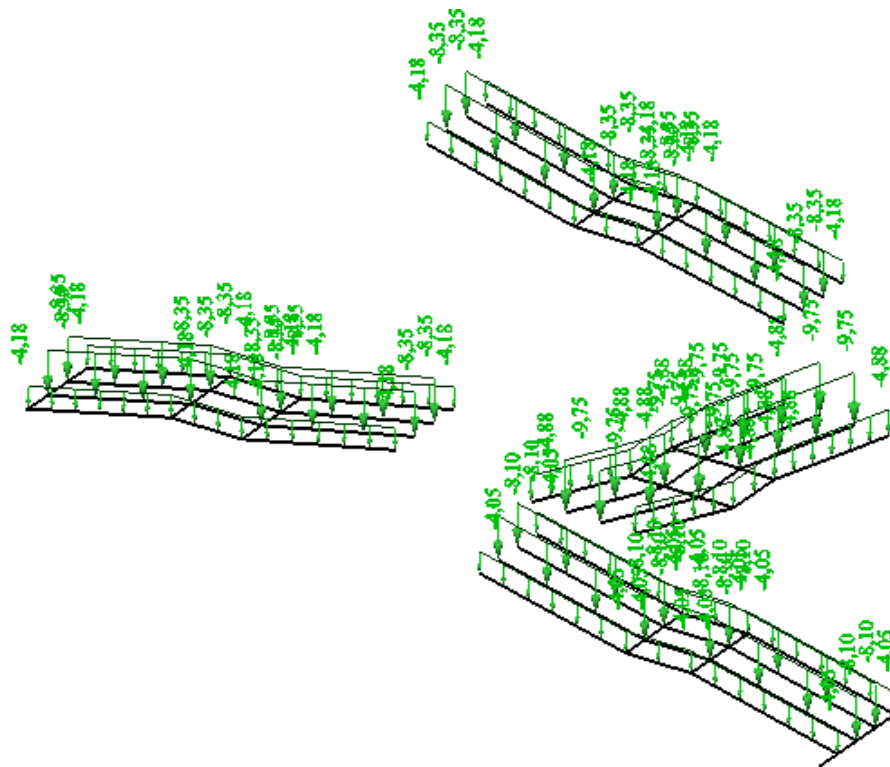

Slika 3.16. Prikaz raspodjele pokretnog opterećenja - unutarnje stubište

i) pozicija (000 – 100) – ulazno stubište

- prostorije bez prepreka za kretanje ljudi, izložbeni prostori, pristupi u javnim i državnim zgradama –  $5.0 \text{ kN/m}^2$

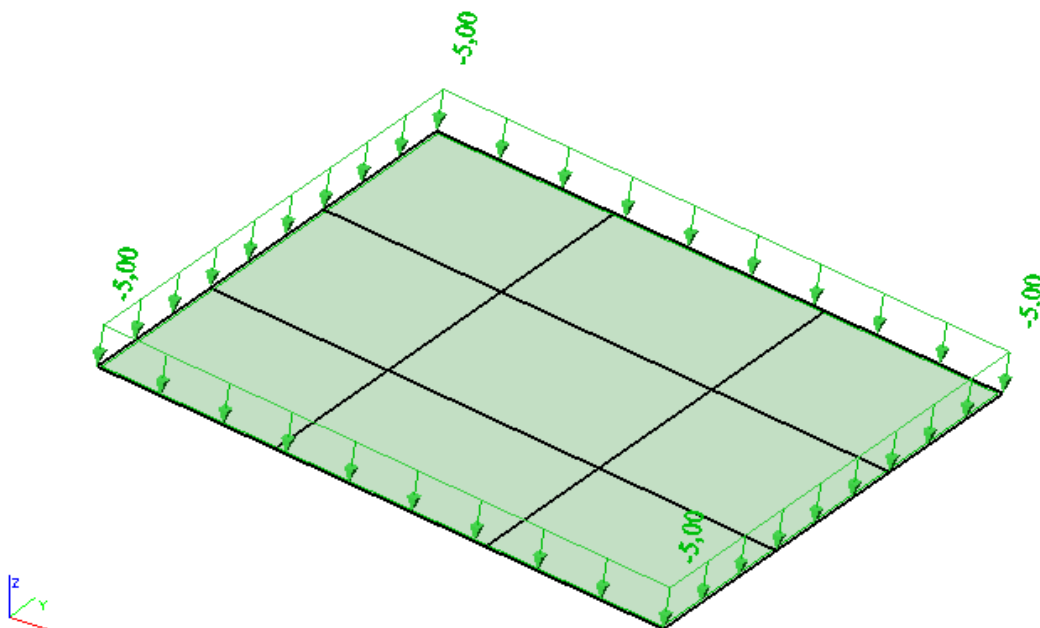

Slika 3.17. Prikaz raspodjele pokretnog opterećenja – ulazno stubište

### 3.4. Opterećenje snijegom

Opterećenje snijegom na krovu

$$s = \mu_1 \cdot C_e \cdot C_t \cdot s_k$$

$\mu_1$  - koeficijent oblika opterećenja snijegom

$C_e$  - koeficijent izloženosti (obično se usvaja vrijednost 1,0)

$C_t$  - toplinski koeficijent (obično se usvaja vrijednost 1,0)

$s_k$  - karakteristična vrijednost opterećenja snijegom na tlu

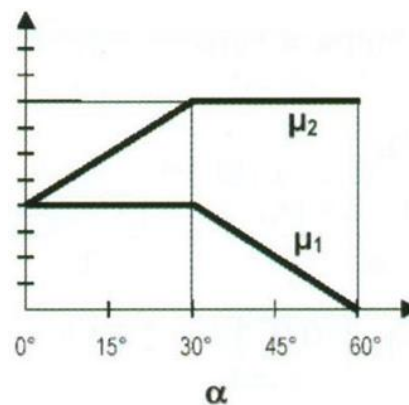

*Slika 3.18. Koeficijenti oblika opterećenja snijegom*

- za krov nagiba  $\alpha = 0^\circ$  očitana vrijednost  $\Rightarrow \mu_1 = 0,8$

Prema karti snijega za Republiku Hrvatsku ova građevina upada u 1. Područje – priobalje i otoci te prema nadmorskoj visini očitana je vrijednost  $s_k$  (karakteristična vrijednost opterećenja snijegom na tlu)  $\Rightarrow s_k = 0,5$



Slika 3.19. Karta snijega za Republiku Hrvatsku

Nadmorska visina do [m]	1. područje – priobalje i otoci [kN/m <sup>2</sup> ]	2. područje – zaleđe Dalmacije, Primorja i Istre [kN/m <sup>2</sup> ]	3. područje – kontinentalna Hrvatska [kN/m <sup>2</sup> ]	4. područje – gorska Hrvatska [kN/m <sup>2</sup> ]
100	0,50	0,75	1,00	1,25
200	0,50	0,75	1,25	1,50
300	0,50	0,75	1,50	1,75
400	0,50	1,00	1,75	2,00
500	0,50	1,25	2,00	2,50
600	0,50	1,50	2,25	3,00
700	0,50	2,00	2,50	3,50
800	0,50	2,50	2,75	4,00
900	1,00	3,00	3,00	4,50
1 000	2,00	4,00	3,50	5,00
1 100	3,00	5,00	4,00	5,50
1 200	4,00	6,00	4,50	6,00
1 300	5,00	7,00		7,00
1 400	6,00	8,00		8,00
1 500		9,00		9,00
1 600		10,00		10,00
1 700		11,00		11,00
1 800		12,00		

Tablica 3.1. Karakteristične vrijednosti opterećenja snijegom za pojedina područja i nadmorske visine

$$s = \mu_1 \cdot C_e \cdot C_t \cdot s_k$$

$\mu_1$  - koeficijent oblika  $\Rightarrow \mu_1 = 0,8$

$C_e$  - koeficijent izloženosti  $\Rightarrow C_e = 1,0$

$C_t$  - toplinski koeficijent  $\Rightarrow C_t = 1,0$

$s_k$  - karakteristična vrijednost opterećenja snijegom na tlu

$$s = 0,8 \cdot 1,0 \cdot 1,0 \cdot 0,5 = 0,4 \left[ \text{kN} / \text{m}^2 \right]$$

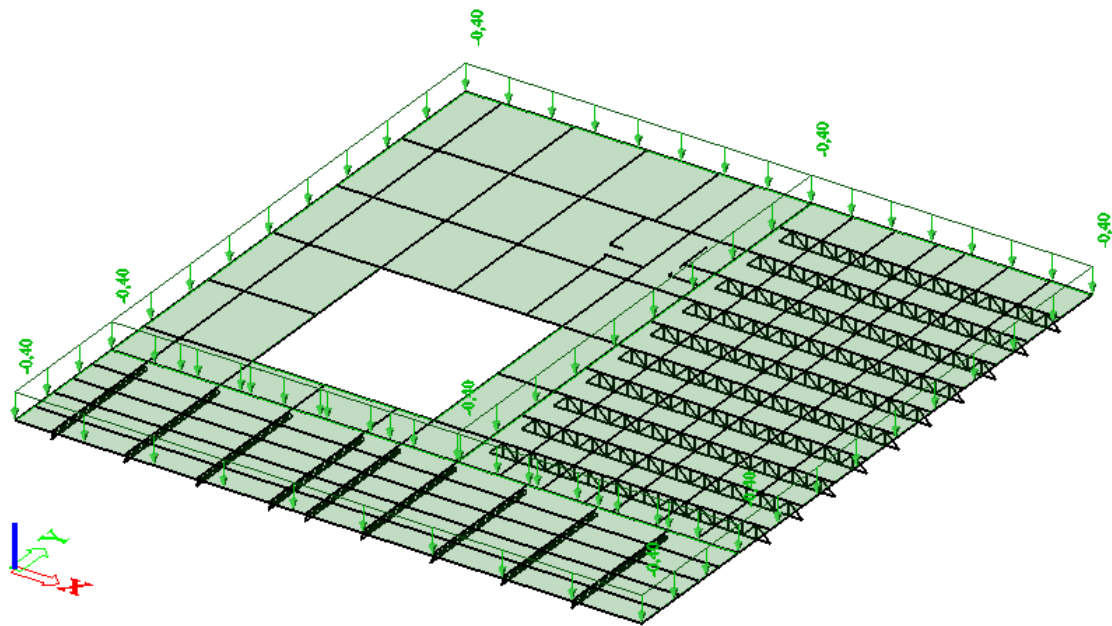

Slika 3.20. Prikaz raspodjele opterećenja snijegom - pozicija 400 (krov)

### 3.5. Opterećenje vjetrom

Opterećenje vjetrom (okomito na površinu) definira se izrazom:

- pritisak vjetra na vanjske površine:  $w_e = q_p(z_e) \cdot c_{pe}$  [kN/m<sup>2</sup>]

- pritisak vjetra na unutarnje površine:  $w_i = q_p(z_i) \cdot c_{pi}$  [kN/m<sup>2</sup>]

gdje je:

$q_p(z_{e(i)})$  – pritisak brzine vjetra pri udaru

$z_{e(i)}$  – referentna visina za vanjski (unutarnji) pritisak

$c_{pe}$  – koeficijent pritiska za vanjski vjetar

$c_{pi}$  – koeficijent pritiska za unutarnji vjetar

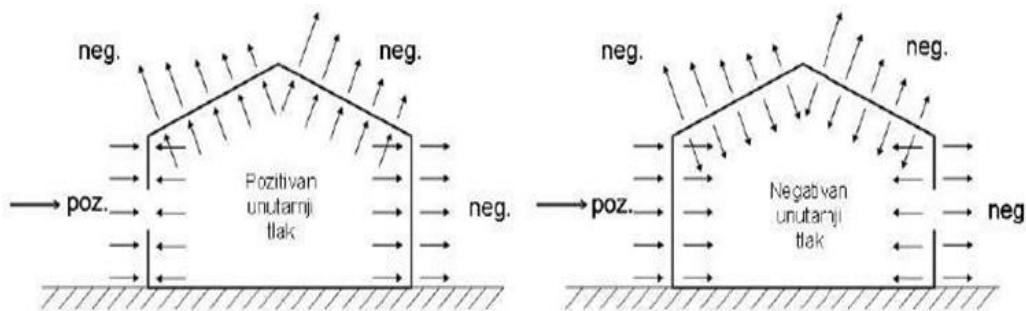

Slika 3.21. Pozitivni i negativni koeficijent pritiska vjetra

Određivanje pritiska brzine vjetra pri udaru

- osnovni pritisak vjetra  $q_b$  određuje se prema formuli

$$q_b = \frac{1}{2} \cdot \rho \cdot v_b^2 \text{ [kN/m}^2\text{]}$$

gdje je:

$\rho$  – gustoća zraka (usvaja se vrijednost iz propisa 1,25 kg/m<sup>3</sup>)

$v_b$  – osnovna brzina vjetra

- osnovna brzina vjetra  $v_b$  računa se dalje prema izrazu:

$$V_b = C_{dir} \cdot C_{season} \cdot V_{bo} \text{ (m/s)}$$

gdje je:

$v_b$  – fundamentalna vrijednost osnovne brzine vjetra (očitava se iz karte)

$c_{dir}$  – faktor smjera vjetra (obično se uzima 1,0)

$c_{season}$  – faktor doba godine (obično se uzima 1,0)



Slika 3.22. Zemljovid područja opterećenja vjetrom

$v_{bo} = 30(\text{m/s})$  – očitano sa zemljovida za područje opterećenja vjetrom – Split (Žnjan)

$c_{dir} = 1,0$

$c_{season} = 1,0$

$$v_b = c_{dir} \cdot c_{season} \cdot v_{bo} \text{ (m/s)}$$

$$v_b = 1,0 \cdot 1,0 \cdot 30,0 \text{ (m/s)}$$

$$v_b = 30,0 \text{ (m/s)}$$

$$q_b = \frac{1}{2} \cdot \rho \cdot v_b^2 [\text{kN/m}^2]$$

$$q_b = \frac{1}{2} \cdot 1,25 \cdot 30,0^2 [\text{kN/m}^2]$$

$$q_b = 0,56 [\text{kN/m}^2]$$

Nakon dobivenih vrijednosti  $v_b$  i  $v_{bo}$ , definira se srednja brzina vjetra  $v_m(z)$  iznad terena:

$$v_m(z) = v_b \cdot C_r(z) \cdot C_o(z) \text{ (m/s)}$$

gdje je:

$c_r(z)$  – faktor hrapavosti terena

$c_o(z)$  – faktor orografije ili opisivanje brežuljaka ili gora (obično se uzima 1,0)

Faktor hrapavosti  $c_r(z)$  određuje se prema:

$$c_r(z) = k_r \cdot \ln\left(\frac{z}{z_0}\right) \quad \text{za} \quad z_{\min} \leq z \leq z_{\max}$$

$$c_r(z) = c_r(z_{\min}) \quad \text{za} \quad z \leq z_{\min}$$

gdje je:

$z_0$  – duljina hrapavosti

$k_r$  – faktor terena ovisan o duljini hrapavosti

$z_{\min}$  – minimalna visina hrapavosti

$z_{\max}$  – maksimalna visina hrapavost (usvaja se vrijednost 200m)

Faktor terena  $k_r$  određuje se prema:

$$k_r = 0,19 \cdot \left(\frac{z_0}{z_{0,II}}\right)^{0,07}$$

gdje je:

$z_{0,II}$  – duljina hrapavosti za kategoriju terena 0 (prema tablici iznosi 0,003 m)

Vrijednosti  $z_0$  i  $z_{\min}$  za pojedinu kategoriju terena očitavaju se iz sljedeće tablice.

Kategorija terena		$z_0$ [m]	$z_{\min}$ [m]
0	More ili priobalna područja izložena otvorenom moru	0,003	1
I	Jezeru ili ravna i horizontalno položena područja sa zanemarivom vegetacijom i bez prepreka	0,01	1
II	Područja s niskom vegetacijom, npr. travom, i izoliranim preprekama (drveće, zgrade) s razmakom najmanje 20 visina prepreke	0,05	2
III	Područja sa stalnim pokrovom od vegetacije ili zgrade ili područja s izoliranim preprekama s razmakom najviše 20 visina prepreke (npr. sela, predgrađa, stalna šuma)	0,3	5
IV	Područja s najmanje 15 % površine pokriveno zgradama čija prosječna visina premašuje 15 m	1,0	10

**Tablica 3.2.** Vrijednosti  $z_0$  i  $z_{\min}$  za različite kategorije terena



$$k_r = 0,19 \cdot \left(\frac{0,003}{0,003}\right)^{0,07}$$

$$k_r = 0,19$$

$$c_{r(z)} = k_r \cdot \ln\left(\frac{z}{z_0}\right) \quad \text{za} \quad z_{\min} \leq z \leq z_{\max} \quad 1m \leq 17,2m \leq 200m$$

$$c_{r(z)} = 0,19 \cdot \ln\left(\frac{17,2}{0,003}\right)$$

$$c_{r(z)} = 1,64$$

$$c_0(z) = 1,0$$

$$v_m(z) = v_b \cdot C_r(z) \cdot C_o(z) (m/s)$$

$$v_m(z) = 30 \cdot 1,64 \cdot 1,0 (m/s)$$

$$v_m(z) = 49,2 (m/s)$$

Intezitet turbulencije  $I_v(z)$  računa se prema izrazu:

$$I_v(z) = \frac{k_I}{C_0(z) \cdot \ln\left(\frac{z}{z_0}\right)}$$

gdje je:

$k_I$  – faktor turbulencije (obično se uzima vrijednost 1,0, ukoliko nije drugačije definirano Nacionalnim dodatkom)

$$I_v(z) = \frac{1,0}{1,0 \cdot \ln\left(\frac{17,3}{0,003}\right)}$$

$$I_v(z) = 0,12$$

Pritisak brzine vjetra pri udaru  $q_p(z)$  se računaprema sljedećem izrazu:

$$q_p(z) = c_e(z) \cdot q_b = [1 + 7 \cdot I_v(z)] \cdot \frac{1}{2} \cdot \rho \cdot v_m^2(z)$$

gdje je:

$c_e(z)$  – faktor izloženosti i odnosi se na pritisak te ovisi o visini iznad terena  $z$  i kategoriji terena (može se očitati iz slike 3.)

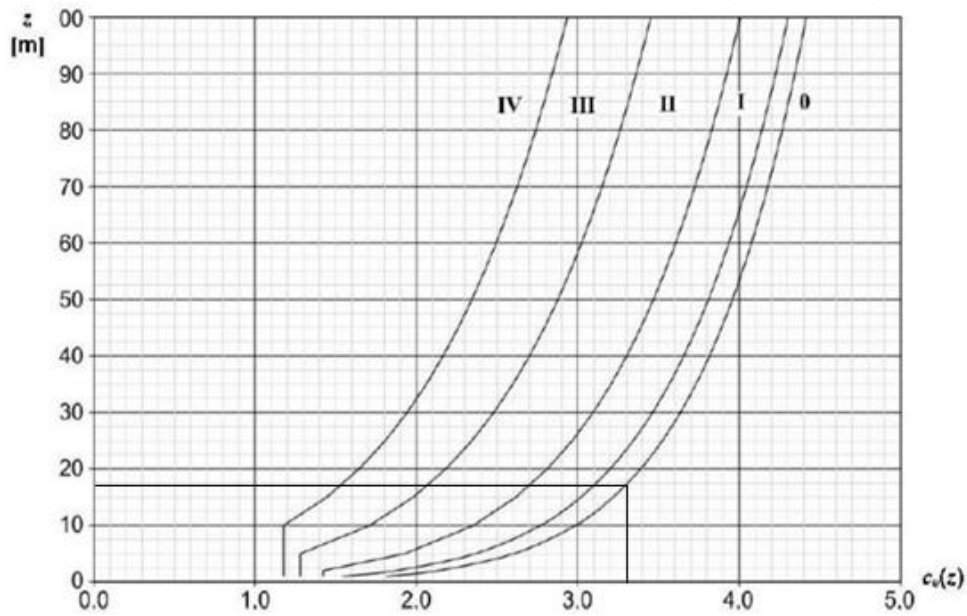

Slika 3.23. Grafički prikaz faktora izloženosti

$$q_p(z) = c_e(z) \cdot q_b = [1 + 7 \cdot 0,12] \cdot \frac{1}{2} \cdot 1,25 \cdot 49,2^2 =$$

$$q_{p(17,2m)} = 2,78(kN / m^2)$$

$c_e(z) = 3,3$  – očitano iz slike 3.23.

Određivanje koeficijenta pritiska vjetra – vjetar iz smjera x

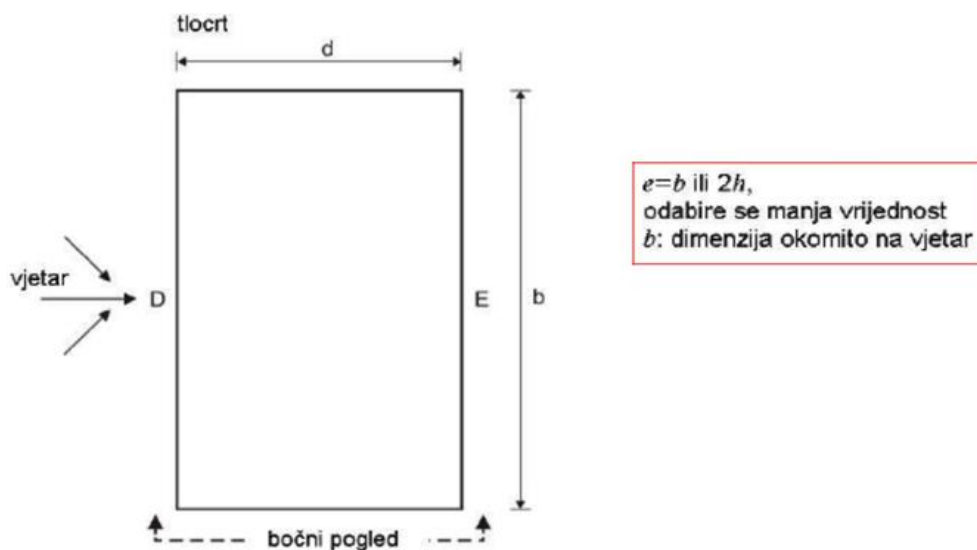

Slika 3.24. Definiranje područja vjetra za vertikalne zidove

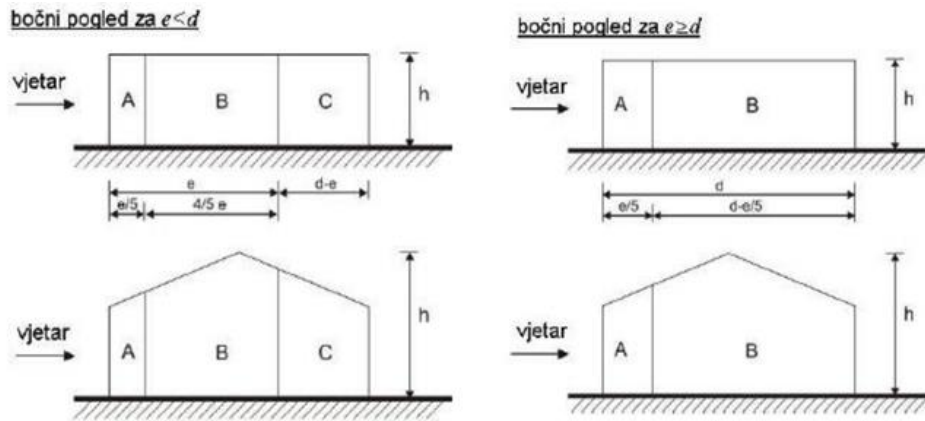

Slika 3.25. Prikaz područja vjetra za vertikalne zidove – bočni pogledi

$$b = 75,6m \quad 2h = 2 \cdot 17,2m = 34,4m = e$$

$$e = 34,4m \quad e/5 = 6,88m \quad 4/5e = 27,52m$$

$$d - e = 70,5 - 34,4 = 36,1m$$

Koeficijent vanjskog pritiska  $c_{pe}$  za vertikalne zidove

Područje	A		B		C		D		E	
	$c_{pe,10}$	$c_{pe,1}$	$c_{pe,10}$	$c_{pe,1}$	$c_{pe,10}$	$c_{pe,1}$	$c_{pe,10}$	$c_{pe,1}$	$c_{pe,10}$	$c_{pe,1}$
$\geq 5$	-1,4	-1,7	-0,8	-1,1	-0,5	-0,7	+0,8	+1,0	-0,5	-0,7
1	-1,2	-1,4	-0,8	-1,1	-0,5		+0,8	+1,0	-0,5	
$\leq 0,25$	-1,2	-1,4	-0,8	-1,1	-0,5		+0,7	+1,0	-0,3	-0,5

NAPOMENA: Za pojedinačne zgrade na otvorenome terenu u područjima u zavjetrini mogu nastupiti i veće sile. Međuvrijednosti se smiju linearno interpolirati. Za zgrade čiji je omjer  $h/d > 5$ , ukupno opterećenje vjetrom smije se temeljiti na odredbama iz točaka od 7.6 do 7.8 i 7.9.2.

Tablica 3.3. Vrijednosti koeficijenta vanjskog pritiska za vertikalne zidove

Pritiska vjetra na vanjske površine  $w_{pe}$  za vertikalne zidove

Područje	A	B	C	D	E
$q_p(z)(kN/m^2)$	2,78	2,78	2,78	2,78	2,78
$c_e(z_e)$	3,3	3,3	3,3	3,3	3,3
$c_{pe}$	-1,2	-0,8	-0,5	0,7	-0,3
$w_e(kN/m^2)$	-11,0	-7,34	-4,59	6,42	-2,75

Tablica 3.4. Izračunata vrijednost pritiska vjetra na vanjske površine zidova

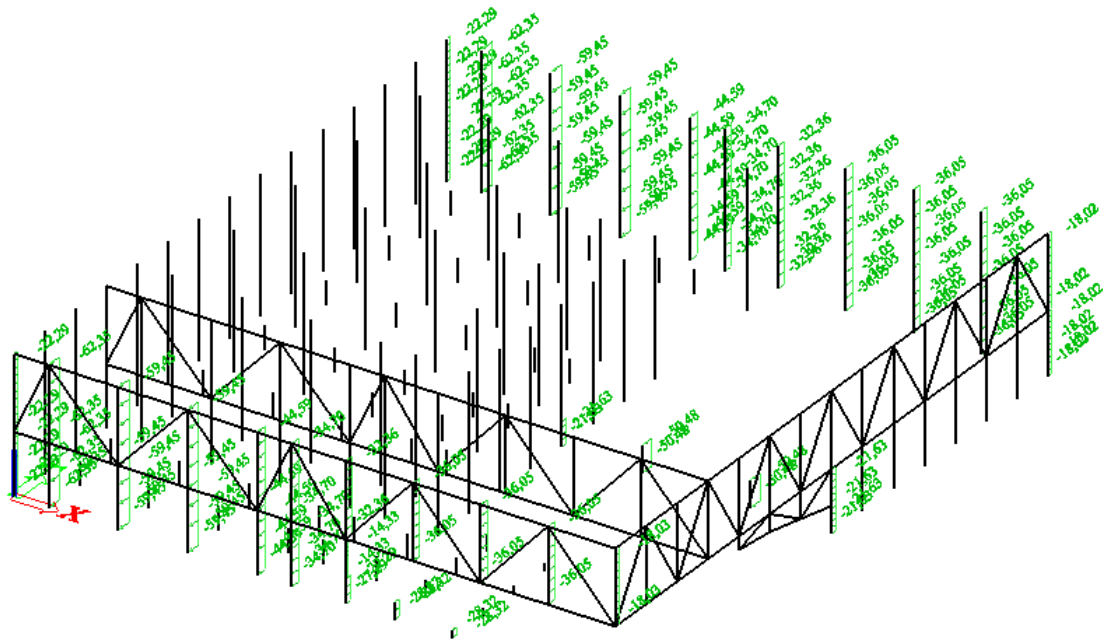

Slika 3.26. Prikaz raspodjele opterećenja vjetrom - vjetar iz smjera x - područje A, B i C

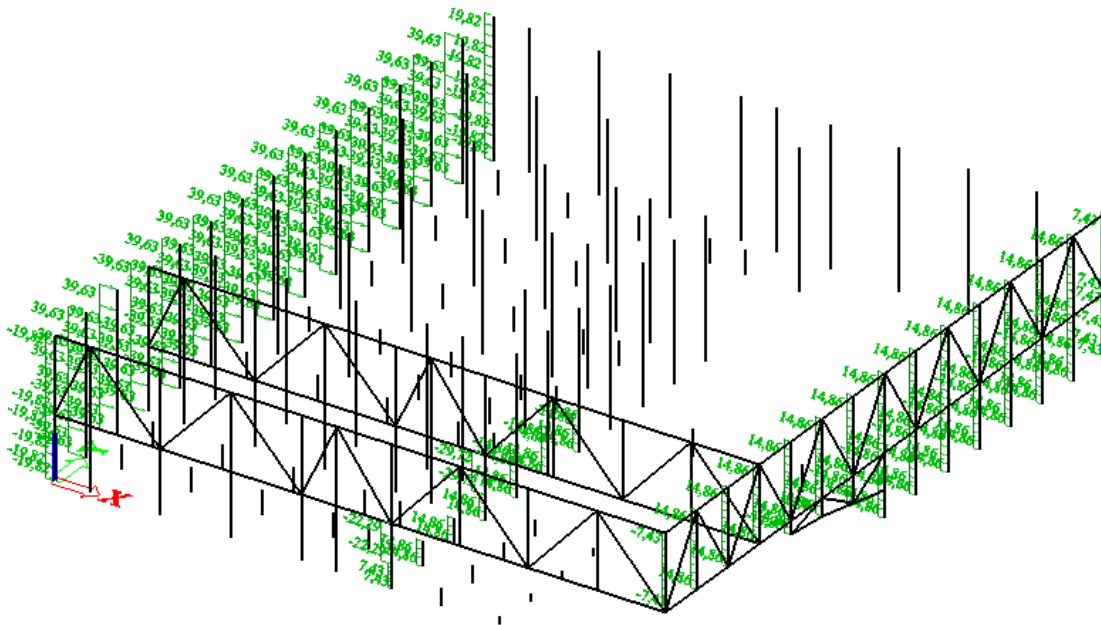

Slika 27. Prikaz raspodjele opterećenja vjetrom - vjetar iz smjera x - područje D i E

Određivanje koeficijenta pritiska vjetra - vjetar iz smjera x

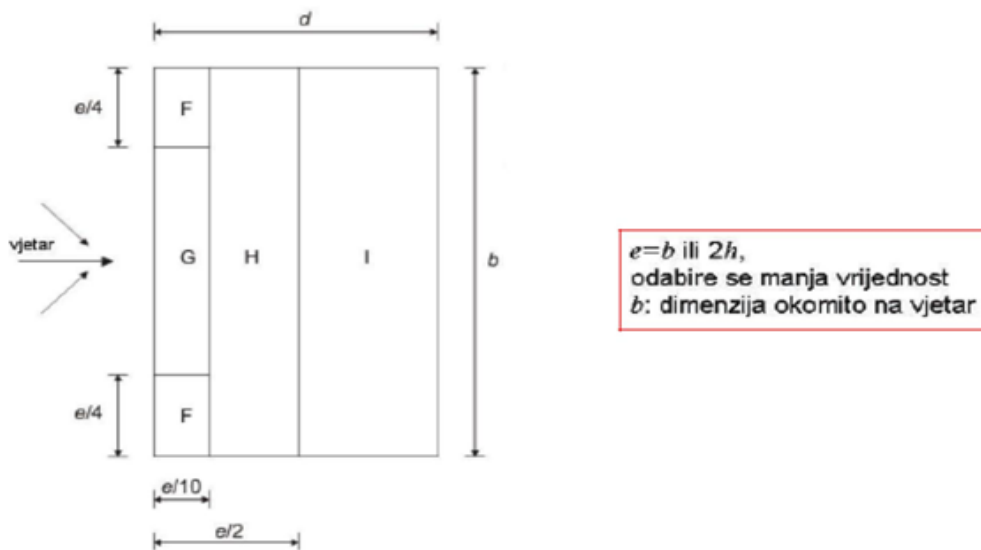

Slika 3.28. Prikaz područja vjetra za ravni krov

$$b = 75,6m \quad 2h = 2 \cdot 17,2m = 34,4m = e \quad e = 34,4m$$

$$e/2 = 17,2m \quad e/4 = 8,6m \quad e/10 = 3,44m$$

Vrsta krova	Područje								
	F		G		H		I		
	$c_{pe,10}$	$c_{pe,1}$	$c_{pe,10}$	$c_{pe,1}$	$c_{pe,10}$	$c_{pe,1}$	$c_{pe,10}$	$c_{pe,1}$	
Oštri zabati	-1,8	-2,5	-1,2	-2,0	-0,7	-1,2	+0,2	-0,2	
S nadozidima	$h_p/h = 0,025$	-1,6	-2,2	-1,1	-1,8	-0,7	-1,2	+0,2	-0,2
	$h_p/h = 0,05$	-1,4	-2,0	-0,9	-1,6	-0,7	-1,2	+0,2	-0,2
	$h_p/h = 0,10$	-1,2	-1,8	-0,8	-1,4	-0,7	-1,2	+0,2	-0,2
Zaobljeni zabati	$r/h = 0,05$	-1,0	-1,5	-1,2	-1,8	-0,4	+0,2	-0,2	
	$r/h = 0,10$	-0,7	-1,2	-0,8	-1,4	-0,3	+0,2	-0,2	
	$r/h = 0,20$	-0,5	-0,8	-0,5	-0,8	-0,3	+0,2	-0,2	
Izlomljeni zabati	$\alpha = 30^\circ$	-1,0	-1,5	-1,0	-1,5	-0,3	+0,2	-0,2	
	$\alpha = 45^\circ$	-1,2	-1,8	-1,3	-1,9	-0,4	+0,2	-0,2	
	$\alpha = 60^\circ$	-1,3	-1,9	-1,3	-1,9	-0,5	+0,2	-0,2	

NAPOMENA 1: Za krovove s nadozidima ili zaobljenim zabatima, smije se upotrebljavati linearna interpolacija za međuvrijednosti  $h_p/h$  i  $r/h$ .

NAPOMENA 2: Za krovove s izlomljenim zabatima, smije se upotrebljavati linearna interpolacija između vrijednosti za  $\alpha = 30^\circ$ ,  $45^\circ$  i  $60^\circ$ . Za  $\alpha > 60^\circ$  smije se upotrebljavati linearna interpolacija između vrijednosti za  $\alpha = 60^\circ$  i vrijednosti za ravne krovove s oštrim (izlomljenim) zabatima.

NAPOMENA 3: U području I, gdje su dane i pozitivne i negativne vrijednosti, u obzir treba uzeti obje vrijednosti.

NAPOMENA 4: Za sami izlomljeni zabat, koeficijenti vanjskog tlaka dani su u tablici 7.4a „Koeficijenti vanjskog tlaka za dvostrešne krovove; smjer vjetra 0°“, područje F i G, ovisno o nagibu izlomljenog zabata.

NAPOMENA 5: Za sami zaobljeni zabat, koeficijent vanjskog tlaka dani su linearnom interpolacijom duž krivulje, između vrijednosti na zidu i na krovu.

NAPOMENA 6: Za mansardne strehe čije su horizontalne dimenzije manje od  $e/10$  treba uzeti vrijednosti za oštre strehe. Za definiciju  $e$  vidjeti sliku 7.5.

Tablica 3.5. Vrijednosti koeficijenta vanjskog pritiska za područje ravnog krova

Pritiska vjetra na vanjske površine krova  $w_e$

Područje	F	G	H	I
$q_p(z)(\text{kN/m}^2)$	2,78	2,78	2,78	2,78
$c_e(z_e)$	3,3	3,3	3,3	3,3
$c_{pe}$	-1,8	-1,2	-0,7	(0,2) (-0,2)
$w_e(\text{kN/m}^2)$	-16,51	-13,21	-6,42	(1,83) (-1,83)

Tablica 3.6. Izračunata vrijednost pritiska vjetra na vanjske površine krova

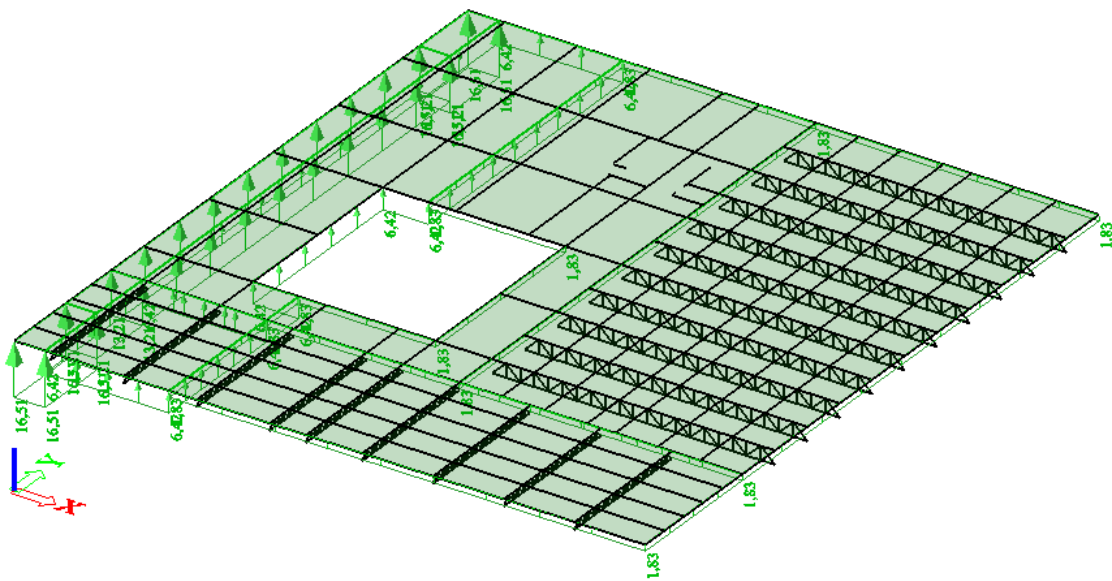

Slika 3.29. Prikaz raspodjele opterećenja vjetrom - vjetar iz smjera x - područje F, G, H i I

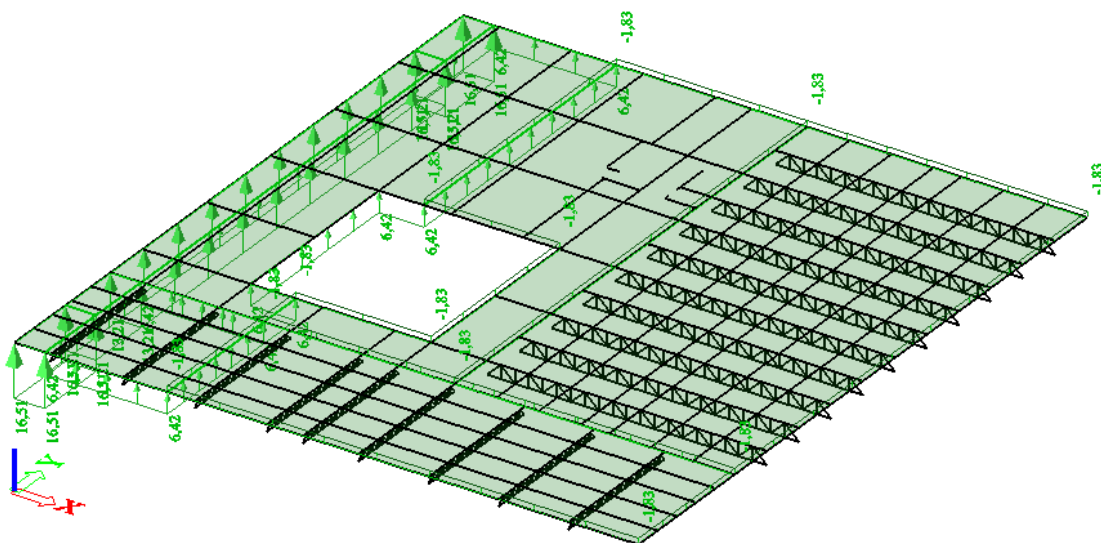

Slika 3.30. Prikaz raspodjele opterećenja vjetrom - vjetar iz smjera x - područje F, G, H i I

Određivanje koeficijenta pritiska vjetra – vjetar iz smjera y

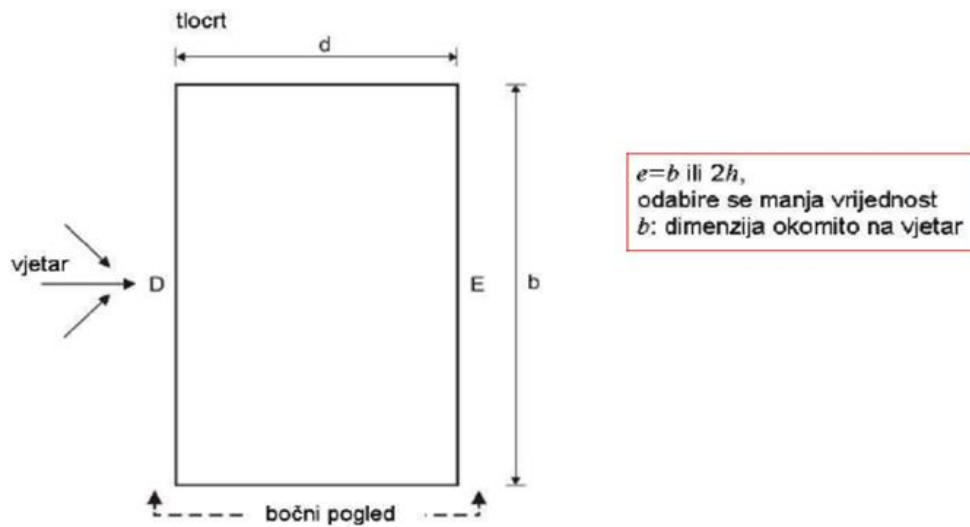

Slika 3.31. Definiranje područja vjetra za vertikalne zidove

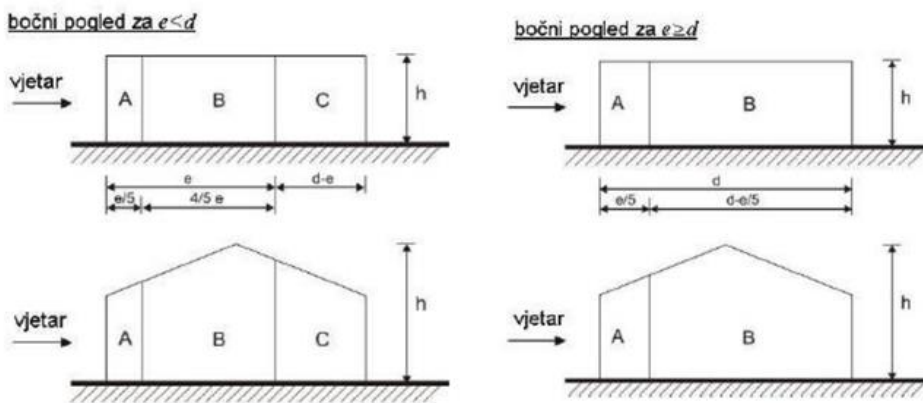

Slika 3.32. Prikaz područja vjetra za vertikalne zidove – bočni pogledi

$b = 70,5m$        $2h = 2 \cdot 17,2m = 34,4m = e$

$e = 34,4m$        $e/5 = 6,88m$        $4/5e = 27,52m$        $d - e = 75,6 - 34,4 = 42,1m$

Područje	A		B		C		D		E	
$h/d$	$c_{pe,10}$	$c_{pe,1}$	$c_{pe,10}$	$c_{pe,1}$	$c_{pe,10}$	$c_{pe,1}$	$c_{pe,10}$	$c_{pe,1}$	$c_{pe,10}$	$c_{pe,1}$
$\geq 5$	-1,4	-1,7	-0,8	-1,1	-0,5	-0,7	+0,8	+1,0	-0,5	-0,7
1	-1,2	-1,4	-0,8	-1,1	-0,5		+0,8	+1,0	-0,5	
$\leq 0,25$	-1,2	-1,4	-0,8	-1,1	-0,5		+0,7	+1,0	-0,3	-0,5

NAPOMENA: Za pojedinačne zgrade na otvorenome terenu u područjima u zavjetrini mogu nastupiti i veće sile. Međuvrijednosti se smiju linearno interpolirati. Za zgrade čiji je omjer  $h/d > 5$ , ukupno opterećenje vjetrom smije se temeljiti na odredbama iz točaka od 7.6 do 7.8 i 7.9.2.

Tablica 3.7. Vrijednosti koeficijenta vanjskog pritiska za vertikalne zidove

Pritiska vjetra na vanjske površine zidova  $w_e$

Područje	A	B	C	D	E
$q_p(z)(\text{kN/m}^2)$	2,78	2,78	2,78	2,78	2,78
$c_e(z_e)$	3,3	3,3	3,3	3,3	3,3
$c_{pe}$	-1,2	-0,8	-0,5	0,7	-0,3
$w_e(\text{kN/m}^2)$	-11,0	-7,34	-4,59	6,42	-2,75

Tablica 3.8. Izračunata vrijednost pritiska vjetra na vanjske površine zidova

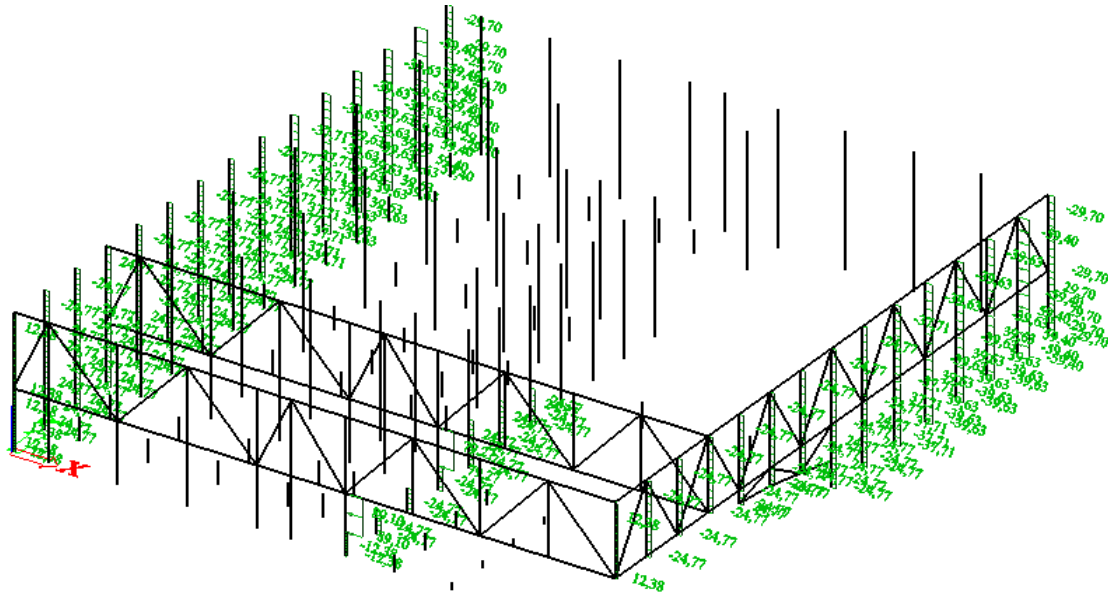

Slika 3.33. Prikaz raspodjele opterećenja vjetrom - vjetar iz smjera y - područje A, B i C

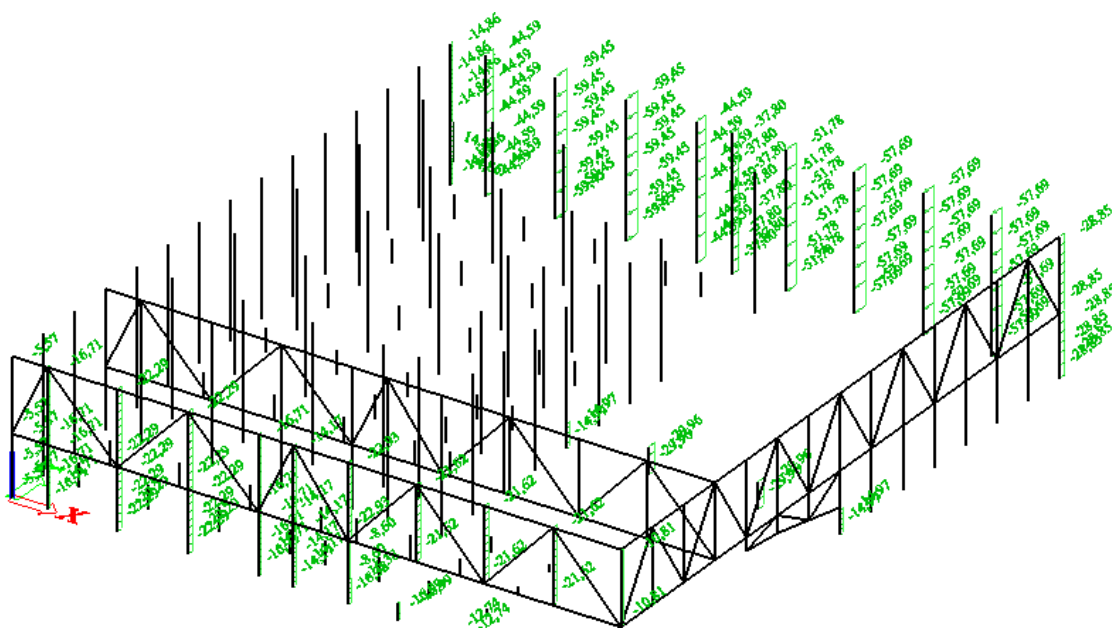

Slika 3.34. Prikaz raspodjele opterećenja vjetrom - vjetar iz smjera y - područje D i E



Određivanje koeficijenta pritiska vjetra – vjetar iz smjera y

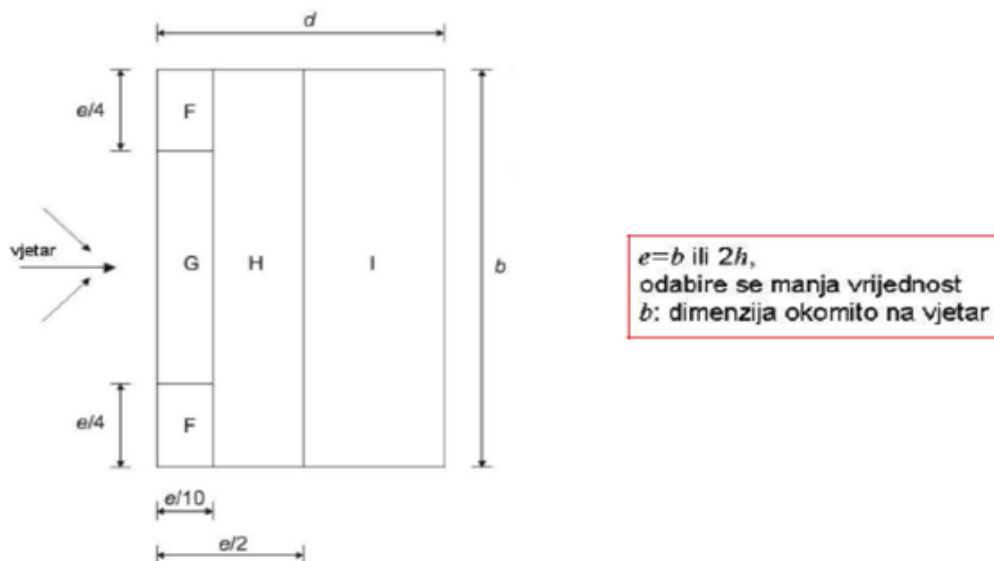

Slika 3.35. Prikaz područja vjetra za ravni krov

$$b = 70,5m \quad 2h = 2 \cdot 17,2m = 34,4m = e \quad e = 34,4m$$

$$e / 2 = 17,2m \quad e / 4 = 8,6m \quad e / 10 = 3,44m$$

Vrsta krova	Područje								
	F		G		H		I		
	$c_{pe,10}$	$c_{pe,1}$	$c_{pe,10}$	$c_{pe,1}$	$c_{pe,10}$	$c_{pe,1}$	$c_{pe,10}$	$c_{pe,1}$	
Oštri zabati	-1,8	-2,5	-1,2	-2,0	-0,7	-1,2	+0,2	-0,2	
S nadodžidima	$\lambda_{p,r/h} = 0,025$	-1,6	-2,2	-1,1	-1,8	-0,7	-1,2	+0,2	-0,2
	$\lambda_{p,r/h} = 0,05$	-1,4	-2,0	-0,9	-1,6	-0,7	-1,2	+0,2	-0,2
	$\lambda_{p,r/h} = 0,10$	-1,2	-1,8	-0,8	-1,4	-0,7	-1,2	+0,2	-0,2
Zaobljeni zabati	$r/h = 0,05$	-1,0	-1,5	-1,2	-1,8	-0,4		+0,2	-0,2
	$r/h = 0,10$	-0,7	-1,2	-0,8	-1,4	-0,3		+0,2	-0,2
	$r/h = 0,20$	-0,5	-0,8	-0,5	-0,8	-0,3		+0,2	-0,2
Izlomljeni zabati	$\alpha = 30^\circ$	-1,0	-1,5	-1,0	-1,5	-0,3		+0,2	-0,2
	$\alpha = 45^\circ$	-1,2	-1,8	-1,3	-1,9	-0,4		+0,2	-0,2
	$\alpha = 60^\circ$	-1,3	-1,9	-1,3	-1,9	-0,5		+0,2	-0,2

NAPOMENA 1: Za krovove s nadodžidima ili zaobljenim zabatima, smije se upotrebljavati linearna interpolacija za međuvrijednosti  $\lambda_{p,r/h}$  i  $r/h$ .  
 NAPOMENA 2: Za krovove s izlomljenim zabatima, smije se upotrebljavati linearna interpolacija između  $\alpha = 30^\circ$ ,  $45^\circ$  i  $60^\circ$ . Za  $\alpha > 60^\circ$  smije se upotrebljavati linearna interpolacija između vrijednosti za  $\alpha = 60^\circ$  i vrijednosti za ravne krovove s oštrim (izlomljenim) zabatima.  
 NAPOMENA 3: U području I, gdje su dane i pozitivne i negativne vrijednosti, u obzir  treba  uzeti oboje vrijednosti.  
 NAPOMENA 4: Za same izlomljene zabate, koeficijenti vanjskog tiska dani su u tablici 7.4a „Koeficijenti vanjskog tiska za dvoslojne krovove; smjer vjetra 0°“, područje F i G, ovisno o nagibu izlomljenog zabata.  
 NAPOMENA 5: Za same zaobljene zabate, koeficijenti vanjskog tiska dani su linearnom interpolacijom duž krivulje, između vrijednosti na zidu i na krovu.  
 NAPOMENA 6: Za mansardne strehe čije su horizontalne dimenzije manje od  $e/10$  treba uzeti vrijednosti za oštre strehe. Za definiciju  $e$  vidjeti sliku 7.5

Tablica 3.9. Vrijednosti koeficijenta vanjskog pritiska za područje ravnog krova

Pritiska vjetra na vanjske površine krova  $w_e$

Područje	F	G	H	I
$q_p(z)(\text{kN/m}^2)$	2,78	2,78	2,78	2,78
$c_e(z_e)$	3,3	3,3	3,3	3,3
$c_{pe}$	-1,8	-1,2	-0,7	(0,2) (-0,2)
$w_e(\text{kN/m}^2)$	-16,51	-13,21	-6,42	(1,83) (-1,83)

Tablica 3.10. Izračunata vrijednost pritiska vjetra na vanjske površine krova

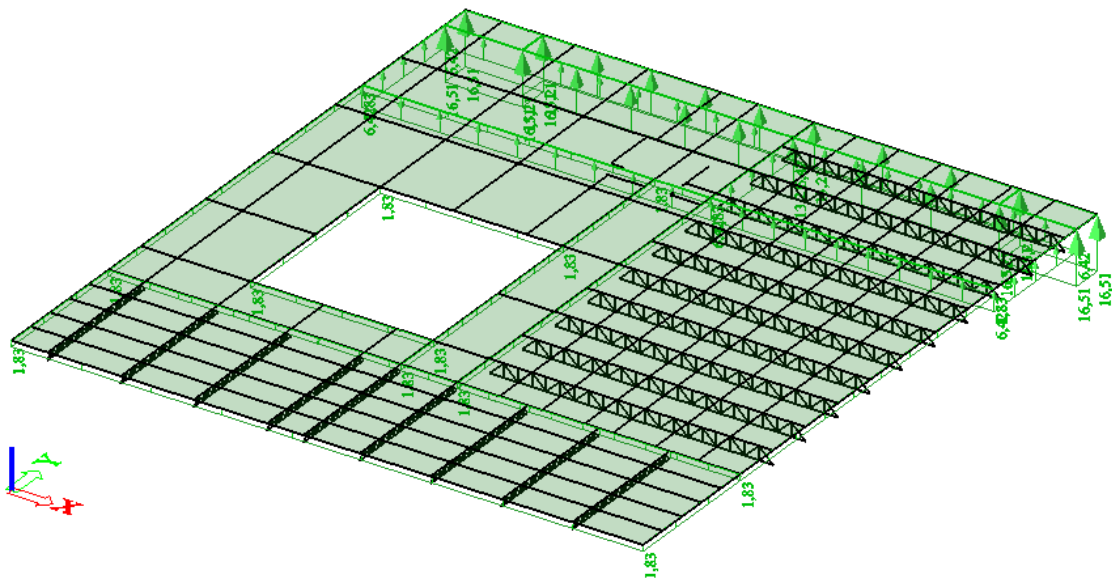

Slika 3.36. Prikaz raspodjele opterećenja vjetrom - vjetar iz smjera y - područje F, G, H i I

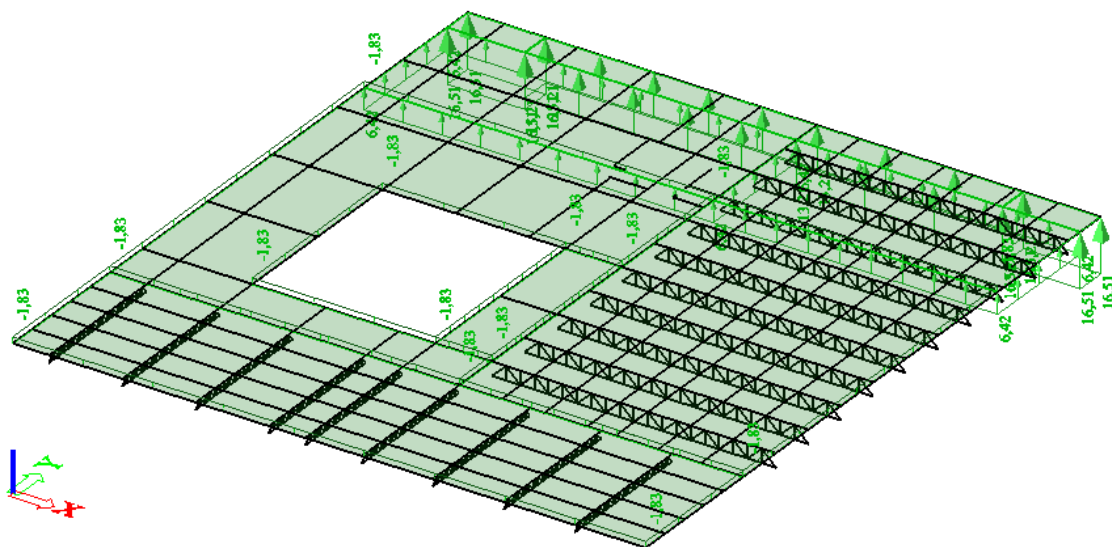

Slika 3.37. Prikaz raspodjele opterećenja vjetrom - vjetar iz smjera y - područje F, G, H i I

## 4. KOMBINACIJE DJELOVANJA

### 4.1. Granično stanje uporabe (GSU)

Prikaz kombinacija za granično stanje uporabe

#### Combinations

Name	Type	Load cases	Coeff. [-]
<small>*Student version* *Student version* *Student version* *Student version* *Student version* *Student version* *Student version* *Student version*</small>			
GSU 1	Envelope - ultimate	g - vlastita težina	1,00
		dg - dodatno stalno	1,00
GSU 2	Envelope - ultimate	g - vlastita težina	1,00
		dg - dodatno stalno	1,00
		q - promjenjivo opterećenje	1,00
GSU 3	Envelope - ultimate	g - vlastita težina	1,00
		dg - dodatno stalno	1,00
		s - opterećenje snijegom	1,00
GSU 4	Envelope - ultimate	g - vlastita težina	1,00
		dg - dodatno stalno	1,00
		Wx - opterećenje vjetrom - smjer x	1,00
		Wz - opterećenje vjetrom - smjer z - negativan	1,00
GSU 5	Envelope - ultimate	g - vlastita težina	1,00
		dg - dodatno stalno	1,00
		Wy - opterećenje vjetrom - smjer y	1,00
		Wz - opterećenje vjetrom - smjer z - negativan	1,00
GSU 6	Envelope - ultimate	g - vlastita težina	1,00
		dg - dodatno stalno	1,00
		Wx - opterećenje vjetrom - smjer x	1,00
		Wz - opterećenje vjetrom - smjer z - pozitivan	1,00
GSU 7	Envelope - ultimate	g - vlastita težina	1,00
		dg - dodatno stalno	1,00
		Wy - opterećenje vjetrom - smjer y	1,00
		Wz - opterećenje vjetrom - smjer z - pozitivan	1,00
GSU 8	Envelope - ultimate	g - vlastita težina	1,00
		dg - dodatno stalno	1,00
		q - promjenjivo opterećenje	1,00
		s - opterećenje snijegom	1,00
GSU 9	Envelope - ultimate	g - vlastita težina	1,00
		dg - dodatno stalno	1,00
		q - promjenjivo opterećenje	1,00
		Wz - opterećenje vjetrom - smjer z - negativan	1,00
GSU 10	Envelope - ultimate	g - vlastita težina	1,00
		dg - dodatno stalno	1,00
		q - promjenjivo opterećenje	1,00
		Wz - opterećenje vjetrom - smjer z - pozitivan	1,00
GSU 11	Envelope - ultimate	g - vlastita težina	1,00
		dg - dodatno stalno	1,00
		Wy - opterećenje vjetrom - smjer y	1,00
		Wz - opterećenje vjetrom - smjer z - negativan	1,00
GSU 12	Envelope - ultimate	g - vlastita težina	1,00
		dg - dodatno stalno	1,00
		q - promjenjivo opterećenje	1,00
		Wz - opterećenje vjetrom - smjer z - pozitivan	1,00
GSU 13	Envelope - ultimate	g - vlastita težina	1,00
		dg - dodatno stalno	1,00
		s - opterećenje snijegom	1,00
		Wz - opterećenje vjetrom - smjer z - negativan	1,00
GSU 14	Envelope - ultimate	g - vlastita težina	1,00
		dg - dodatno stalno	1,00
		s - opterećenje snijegom	1,00
		Wz - opterećenje vjetrom - smjer z - pozitivan	1,00
GSU 15	Envelope - ultimate	g - vlastita težina	1,00
		dg - dodatno stalno	1,00
		q - promjenjivo opterećenje	1,00
		s - opterećenje snijegom	1,00
		Wz - opterećenje vjetrom - smjer z - negativan	1,00
GSU 16	Envelope - ultimate	dg - dodatno stalno	1,00
		q - promjenjivo opterećenje	1,00
		s - opterećenje snijegom	1,00
		Wy - opterećenje vjetrom - smjer y	1,00
		Wz - opterećenje vjetrom - smjer z - pozitivan	1,00

## 4.2 Graično stanje nosivosti (GSN)

### Prikaz kombinacija za granično stanje nosivosti

#### Combinations

Name	Type	Load cases	Coeff. [-]
<i>*Student version* *Student version* *Student version* *Student version* *Student version* *Student version* *Student version* *Student version*</i>			
GSN 2	Linear - ultimate	g - vlastita težina	1,35
		dg - dodatno stalno	1,35
		q - promjenjivo opterećenje	1,80
		g - vlastita težina_dry concrete - dry concrete	1,35
GSN 3	Linear - ultimate	g - vlastita težina	1,35
		dg - dodatno stalno	1,35
		g - vlastita težina_dry concrete - dry concrete	1,35
		s - opterećenje snijegom - dry concrete	1,50
GSN 4	Linear - ultimate	g - vlastita težina	1,35
		dg - dodatno stalno	1,35
		g - vlastita težina_dry concrete - dry concrete	1,35
		Wx - 1kom. - Wz-neg - dry concrete	1,50
GSN 5	Linear - ultimate	g - vlastita težina	1,35
		dg - dodatno stalno	1,35
		g - vlastita težina_dry concrete - dry concrete	1,35
		Wx - 1kom. - Wz-poz - dry concrete	1,50
GSN 6	Linear - ultimate	g - vlastita težina	1,35
		dg - dodatno stalno	1,35
		g - vlastita težina_dry concrete - dry concrete	1,35
		Wy - 1kom. - Wz-neg - dry concrete	1,50
GSN 7	Linear - ultimate	g - vlastita težina	1,35
		dg - dodatno stalno	1,35
		g - vlastita težina_dry concrete - dry concrete	1,35
		Wy - 1kom. - Wz-poz - dry concrete	1,50
GSN 8	Linear - ultimate	g - vlastita težina	1,35
		dg - dodatno stalno	1,35
		g - vlastita težina_dry concrete - dry concrete	1,35
		Wx - 2kom. - Wz-neg - dry concrete	1,50
GSN 9	Linear - ultimate	g - vlastita težina	1,35
		dg - dodatno stalno	1,35
		g - vlastita težina_dry concrete - dry concrete	1,35
		Wx - 2kom. - Wz-poz - dry concrete	1,50
GSN 10	Linear - ultimate	g - vlastita težina	1,35
		dg - dodatno stalno	1,35
		g - vlastita težina_dry concrete - dry concrete	1,35
		Wy - 2kom. - Wz-neg - dry concrete	1,50
GSN 11	Linear - ultimate	g - vlastita težina	1,35
		dg - dodatno stalno	1,35
		g - vlastita težina_dry concrete - dry concrete	1,35
		Wy - 2kom. - Wz-poz - dry concrete	1,50
GSN 12	Linear - ultimate	g - vlastita težina	1,35
		dg - dodatno stalno	1,35
		q - promjenjivo opterećenje	1,62
		g - vlastita težina_dry concrete - dry concrete	1,35
		s - opterećenje snijegom - dry concrete	1,35
GSN 13	Linear - ultimate	g - vlastita težina	1,35
		dg - dodatno stalno	1,35
		q - promjenjivo opterećenje	1,62
		g - vlastita težina_dry concrete - dry concrete	1,35
		Wx - 1kom. - Wz-neg - dry concrete	1,35
GSN 14	Linear - ultimate	g - vlastita težina	1,35
		dg - dodatno stalno	1,35
		q - promjenjivo opterećenje	1,62
		g - vlastita težina_dry concrete - dry concrete	1,35
		Wx - 1kom. - Wz-poz - dry concrete	1,35
GSN 15	Linear - ultimate	g - vlastita težina	1,35
		dg - dodatno stalno	1,35
		q - promjenjivo opterećenje	1,62
		g - vlastita težina_dry concrete - dry concrete	1,35
		Wy - 1kom. - Wz-neg - dry concrete	1,35
GSN 16	Linear - ultimate	g - vlastita težina	1,35
		dg - dodatno stalno	1,35
		q - promjenjivo opterećenje	1,62
		g - vlastita težina_dry concrete - dry concrete	1,35
		Wy - 1kom. - Wz-poz - dry concrete	1,35
GSN 17	Ultimate	q - promjenjivo opterećenje	1,62
		g - vlastita težina_dry concrete - dry concrete	1,35
		Wx - 2kom. - Wz-neg - dry concrete	1,35
GSN 18	Linear - ultimate	g - vlastita težina	1,35
		dg - dodatno stalno	1,35
		q - promjenjivo opterećenje	1,62
		g - vlastita težina_dry concrete - dry concrete	1,35
		Wx - 2kom. - Wz-poz - dry concrete	1,35

GSN 19	Linear - ultimate	g - vlastita težina	1,35
		dg - dodatno stalno	1,35
		q - promjenjivo opterećenje	1,62
		g - vlastita težina_dry concrete - dry concrete	1,35
		Wy - 2kom. - Wz-neg - dry concrete	1,35
GSN 20	Linear - ultimate	g - vlastita težina	1,35
		dg - dodatno stalno	1,35
		q - promjenjivo opterećenje	1,62
		g - vlastita težina_dry concrete - dry concrete	1,35
		Wy - 2kom. - Wz-poz - dry concrete	1,35
GSN 21	Linear - ultimate	g - vlastita težina	1,35
		dg - dodatno stalno	1,35
		q - promjenjivo opterećenje	1,62
		g - vlastita težina_dry concrete - dry concrete	1,35
		Wx - 1kom. - Wz-neg - dry concrete	1,35
GSN 22	Linear - ultimate	g - vlastita težina	1,35
		dg - dodatno stalno	1,35
		q - promjenjivo opterećenje	1,62
		g - vlastita težina_dry concrete - dry concrete	1,35
		Wx - 1kom. - Wz-poz - dry concrete	1,35
GSN 23	Linear - ultimate	g - vlastita težina	1,35
		dg - dodatno stalno	1,35
		q - promjenjivo opterećenje	1,62
		g - vlastita težina_dry concrete - dry concrete	1,35
		Wy - 1kom. - Wz-neg - dry concrete	1,35
GSN 24	Linear - ultimate	g - vlastita težina	1,35
		dg - dodatno stalno	1,35
		q - promjenjivo opterećenje	1,62
		g - vlastita težina_dry concrete - dry concrete	1,35
		Wy - 1kom. - Wz-poz - dry concrete	1,35
GSN 25	Linear - ultimate	g - vlastita težina	1,35
		dg - dodatno stalno	1,35
		q - promjenjivo opterećenje	1,62
		g - vlastita težina_dry concrete - dry concrete	1,35
		Wx - 2kom. - Wz-neg - dry concrete	1,35
GSN 26	Linear - ultimate	g - vlastita težina	1,35
		dg - dodatno stalno	1,35
		q - promjenjivo opterećenje	1,62
		g - vlastita težina_dry concrete - dry concrete	1,35
		Wx - 2kom. - Wz-poz - dry concrete	1,35
GSN 27	Linear - ultimate	g - vlastita težina	1,35
		dg - dodatno stalno	1,35
		q - promjenjivo opterećenje	1,62
		g - vlastita težina_dry concrete - dry concrete	1,35
		Wy - 2kom. - Wz-neg - dry concrete	1,35
GSN 28	Linear - ultimate	g - vlastita težina	1,35
		dg - dodatno stalno	1,35
		q - promjenjivo opterećenje	1,62
		g - vlastita težina_dry concrete - dry concrete	1,35
		Wy - 2kom. - Wz-poz - dry concrete	1,35
		s - opterećenje snijegom - dry concrete	1,35

- parcijalni faktor za stalna opterećenja – 1,35

- parcijalni faktor za promjenjiva opterećenja – 1,5

- parcijalni faktor za promjenjivo (pokretno) opterećenje –  $1,5 \times 1,2 = 1,80$  (nije vršena kombinacija opterećenja tj. postavljanje pokretnog opterećenja u najkritičnije položaje, već je pokretno opterećenje uvećano za 20%)

- parcijalni faktor za istodobno djelovanje više promjenjivih opterećenja –  $0,9 \times 1,5 = 1,35$

## 5. PRORAČUN SPREGNUTE KROVNE KONSTRUKCIJE - POZ 400

### 5.1. Pomaci spregnute krovne konstrukcije - gredni dio

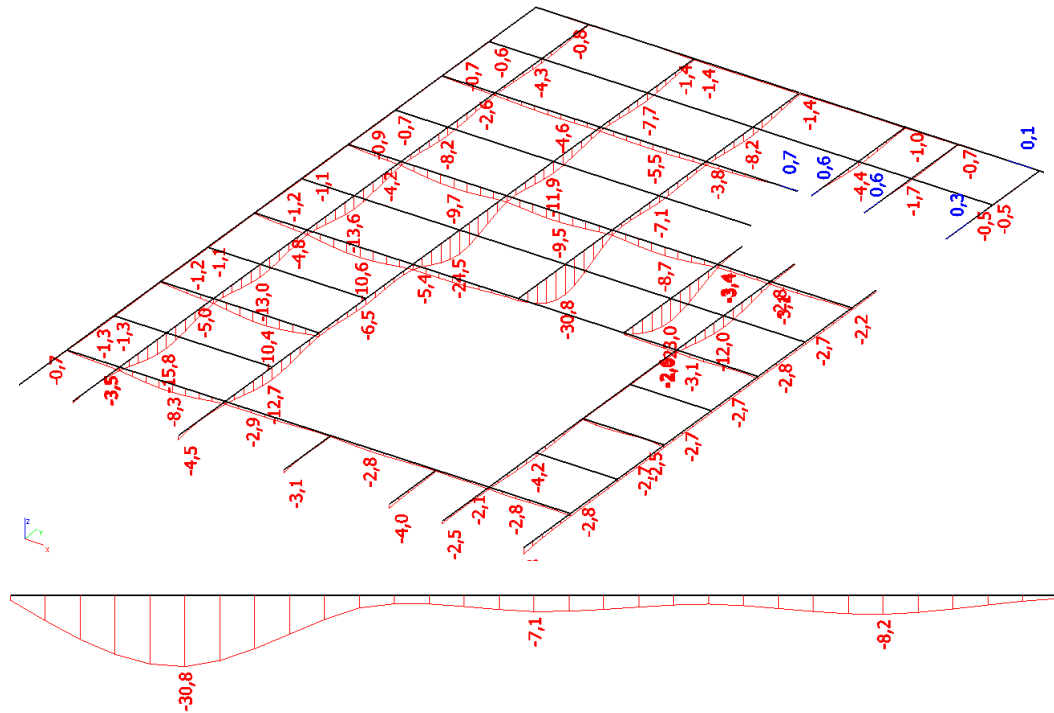

Slika 5.1. Prikaz vertikalnog pomaka grednog nosača – poz 400

Dopušteni vertikalni pomak (progib):

$$u_{dop} = \frac{l}{300} = \frac{10.8 \cdot 1000}{300} = 36.0 \text{ mm}$$

$$u_z = 30.8 \text{ mm} < u_{z,dop} = 36.0 \text{ mm} \quad \text{Zadovoljava}$$

-iskoristivost na GSU -  $30.8 \text{ mm} / 36.0 \text{ mm} = 0,856 = 86\%$

## 5.2. Dimenziniranje spregnute krovne konstrukcije - gredni dio

### 5.2.1. Rezne sile – gredni nosač

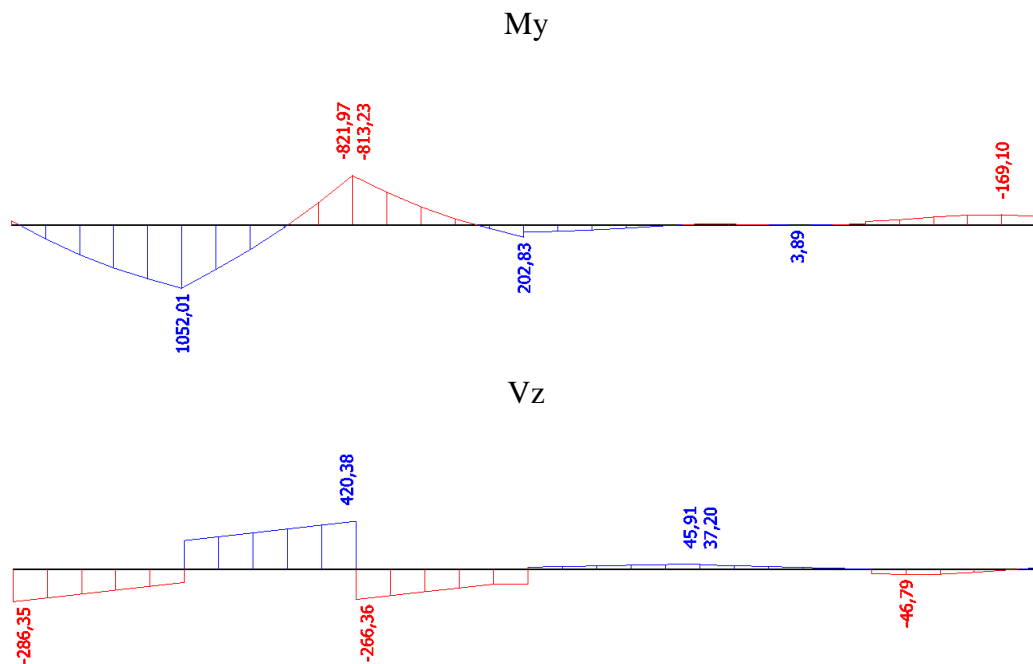

Slika 5.2.. Prikaz reznih sila grednog nosača – poz 400

-poprečni presjek nosača

Name	Gredni nosač - poz 400	
Type	HEB450	
Source description	Profil Arbed / Structural shapes / Edition Octobre 1995	
Item material	S 355	
Fabrication	rolled	
Flexural buckling y-y	a	
Flexural buckling z-z	b	
Lateral torsional buckling	Default	
Use 2D FEM analysis	*	
A [m <sup>2</sup> ]	2,1800e-02	
A y, z [m <sup>2</sup> ]	1,5015e-02	6,5456e-03
I y, z [m <sup>4</sup> ]	7,9890e-04	1,1720e-04
I w [m <sup>3</sup> ], t [m <sup>4</sup> ]	5,2584e-06	4,4050e-06
W <sub>el</sub> y, z [m <sup>3</sup> ]	3,5510e-03	7,8140e-04
W <sub>pl</sub> y, z [m <sup>3</sup> ]	3,9820e-03	1,1980e-03
d y, z [mm]	0	0
c YUCS, ZUCS [mm]	150	225
α [deg]	0,00	
A L, D [m <sup>2</sup> /m]	2,0300e+00	2,0254e+00
M <sub>ply</sub> +, - [Nm]	1,41e+06	1,41e+06
M <sub>piz</sub> +, - [Nm]	4,25e+05	4,25e+05

Slika 5.3.. Prikaz geometrijskih karakteristika nosača – poz 400

## 5.2.2. Dimenzioniranje – gredni nosač

SCIAENGINEER

### Composite Beam - Final stage

Linear calculation  
 Class: All ULS  
 Extreme 1D: Member  
 Selection: B2574

### Composite beam verification

for beam B2574 at section 5.4 m, in accordance with EC EN 1994-1-1

#### 1. Geometry data

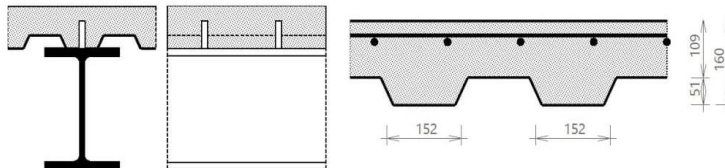

#### Continuous beam

Length of the current span	$L = 10.8 \text{ m}$
Length of previous span	$L_{\text{previous}} = 10.8 \text{ m}$
Beam spacing at the left	$L_{\text{left}} = 8.1 \text{ m}$
Beam spacing at the right	$L_{\text{right}} = 8.1 \text{ m}$
Checked section	$d_x = 5.4 \text{ m}$

Warning: For a continuous beam, intermediate buckling supports y-y are ignored in both the calculation of the effective width for the analysis model and the check.

#### 2. Cross-section & materials

##### 2.1 Steel section properties

##### 2.1.1 Cross-section

Cross-section	HEB450
Height	$h_a = 450 \text{ mm}$
Width	$b = 300 \text{ mm}$
Web thickness	$t_w = 14 \text{ mm}$
Flange thickness	$t_f = 26 \text{ mm}$
Radius	$r = 27 \text{ mm}$
Area	$A_a = 21800 \text{ mm}^2$
Moment of inertia	$I_y = 799 \cdot 10^6 \text{ mm}^4$
Radius of gyration	$i_z = 73 \text{ mm}$
Plastic section modulus	$W_{\text{ply}} = 3.982 \cdot 10^6 \text{ mm}^3$

##### 2.1.2 Material

Steel grade	S 355
Yield strength	$f_{yb} = 355 \text{ MPa}$
Ultimate strength	$f_{ub} = 490 \text{ MPa}$
E modulus	$E_b = 210000 \text{ MPa}$

##### 2.1.3 Cross-section classification

$$\epsilon = \sqrt{\frac{235}{355}} = 0.814$$

(EN 1993-1-1 §5.6 Tab. 5.2)

##### 2.1.3.1 Flange in compression

$$c_f = \frac{b - t_w - 2 \cdot r}{2} = \frac{300 \text{ mm} - 14 \text{ mm} - 2 \cdot 27 \text{ mm}}{2} = 116 \text{ mm}$$

$$\frac{c_f}{t_f} \leq 9 \cdot \epsilon$$

$$\frac{116 \text{ mm}}{26 \text{ mm}} \leq 9 \cdot 0.814$$

$$4.46 \leq 7.32$$

OK

Flange classified as Class 1.

Student version



**2.1.3.2 Web in bending**

$$c_w = h_a - 2 \cdot t_f - 2 \cdot r = 450 \text{ mm} - 2 \cdot 26 \text{ mm} - 2 \cdot 27 \text{ mm} = 344 \text{ mm}$$

$$\alpha_d = 0.5$$

$$\frac{c_w}{t_w} \leq \frac{36 \cdot \epsilon}{\alpha_d}$$

$$\frac{344 \text{ mm}}{14 \text{ mm}} \leq \frac{36 \cdot 0.814}{0.5}$$

$$24.6 \leq 58.6$$

OK

Web classified as Class 1.

**Cross-section classified as Class 1**

Cross-section Class OK.

**2.2 Concrete slab with profiled sheeting**

**2.2.1 Concrete slab**

**2.2.1.1 Slab**

Total height of the slab  $h_s = 160 \text{ mm}$

**2.2.1.2 Material**

Concrete class C30/37  
 Characteristic strength  $f_{ck} = 30 \text{ MPa}$   
 E modulus  $E_{cm} = 32800 \text{ MPa}$

**2.2.2 Profiled steel sheeting**

Sheeting with ribs parallel to the supporting beams

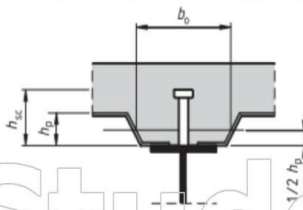

Name	Vulcraft 2 VU 20
Depth of the ribs	$h_p = 50.8 \text{ mm}$
Height of full concrete	$h_c = 109.2 \text{ mm}$
Height of the re-entrant stiffener	$h_d = 0 \text{ mm}$
Spacing of the ribs	$b_s = 304.8 \text{ mm}$
Top width of the rib	$b_r = 127 \text{ mm}$
Bottom width of the rib	$b_b = 127 \text{ mm}$
Mean width of the ribs	$b_{0,rib} = 152.4 \text{ mm}$
Thickness of the sheeting	$t_p = 0.9093 \text{ mm}$

**2.2.3 Shear connectors**

**2.2.3.1 Geometry**

Name	H110
Diameter	$d_s = 25 \text{ mm}$
Nominal height	$h_{nom} = 110 \text{ mm}$
As-welded height	$h_{sc} = 105 \text{ mm}$
Amount per trough or section	$n_r = 1$

**2.2.3.2 Material**

Steel grade	S 355
Ultimate strength	$f_{us} = 490 \text{ MPa}$

**2.2.4 Reinforcement**

**2.2.4.1 Geometry**

Longitudinal bar diameter	$d_l = 16 \text{ mm}$
Longitudinal bar spacing	$s_l = 150 \text{ mm}$
Longitudinal bar cover	$c_l = 30 \text{ mm}$
Transverse bar diameter	$d_t = 16 \text{ mm}$
Transverse bar spacing	$s_t = 150 \text{ mm}$
Transverse bar cover	$c_t = 46 \text{ mm}$

**2.2.4.2 Material**

Material	B 500A
Characteristic yield strength	$f_{yk,r} = 500 \text{ MPa}$

**3. Design values of loads**

Load Name : GSN 26

Content of combination : 1.35\*g-vlastitežina+1.35\*dg-dodatnostalno+  
1.62\*q-promjenjivoopterećenije+1.35\*g-vlastitežina\_dryconcrete+  
1.35\*Wx-2kom.-Wz-poz+1.35\*s-opterećenjesnijegom

Bending moment  $M_{Ed,comp} = 1052.300 \text{ kNm}$

Shear force  $V_{Ed,comp} = -116.558 \text{ kN}$

**4. Partial safety factors**

Steel section  $\gamma_{M0} = 1$   
 $\gamma_{M1} = 1$   
Shear connectors  $\gamma_V = 1.25$   
Concrete  $\gamma_C = 1.5$   
Reinforcement  $\gamma_S = 1.15$

**5. ULS check of the Final stage**

**5.1 Shear connection**

**5.1.1 Design resistance of shear connectors**

**5.1.1.1 Shear connector in a solid slab**

$$\frac{h_{sc}}{d_s} > 4$$

$$4.2 > 4$$

$$\alpha = 1$$

$$f_{us} = \min(490; 500) \text{ MPa}$$

$$P_{Rd,solid,1} = \frac{0.8 \cdot f_{us} \cdot \left(\frac{\pi \cdot d_s^2}{4}\right)}{\gamma_V} = \frac{0.8 \cdot 490 \text{ MPa} \cdot \left(\frac{3.14 \cdot 25 \text{ mm}^2}{4}\right)}{1.25} = 154 \text{ kN}$$

$$P_{Rd,solid,2} = \frac{0.29 \cdot \alpha \cdot d_s^2 \cdot \sqrt{f_{ck} \cdot E_{cm}}}{\gamma_V} = \frac{0.29 \cdot 1 \cdot 25 \text{ mm}^2 \cdot \sqrt{30 \text{ MPa} \cdot 32800 \text{ MPa}}}{1.25} = 144 \text{ kN}$$

$$P_{Rd,solid} = \min(P_{Rd,solid,1}; P_{Rd,solid,2}) = \min(154 \text{ kN}; 144 \text{ kN}) = 144 \text{ kN}$$

**5.1.1.2 Shear connector in profiled sheeting**

Sheeting with ribs parallel to the supporting beams

$$k_t = \frac{0.6 \cdot b_{0,rib}}{h_p} \cdot \left(\frac{h_{sc}}{h_p} - 1\right) = \frac{0.6 \cdot 152 \text{ mm}}{50.8 \text{ mm}} \cdot \left(\frac{105 \text{ mm}}{50.8 \text{ mm}} - 1\right) = 1.92$$

$$k_t = 1$$

$$P_{Rd} = k_t \cdot P_{Rd,solid} = 1 \cdot 144 \text{ kN} = 144 \text{ kN}$$

**5.1.2 Degree of shear connection**

**5.1.2.1 Determination of  $b_{eff}$  of the concrete flange and length  $L_e$**

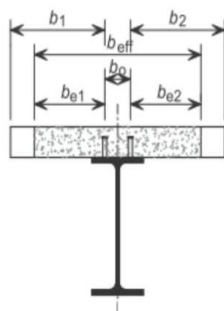

The effective width in the interval <0.25;0.75>

$$L_{e1} = 0.85 \cdot L_2 = 0.85 \cdot 10.8 \text{ m} = 9.18 \text{ m}$$

$$L_{e2} = 0.25 \cdot (L_1 + L_2) = 0.25 \cdot (10.8 \text{ m} + 10.8 \text{ m}) = 5.4 \text{ m}$$

**Left side of the beam**

$$b_1 = \frac{L_{\text{perp, left}}}{2} - \frac{b_0}{2} = \frac{8.1 \text{ m}}{2} - \frac{0 \text{ mm}}{2} = 4.05 \text{ m}$$

$$b_{e10} = \min\left(\frac{L_{e0}}{8}; b_1\right) = \min\left(\frac{0 \text{ m}}{8}; 4.05 \text{ m}\right) = 0 \text{ m}$$

$$b_{e11} = \min\left(\frac{L_{e1}}{8}; b_1\right) = \min\left(\frac{9.18 \text{ m}}{8}; 4.05 \text{ m}\right) = 1.15 \text{ m}$$

$$b_{e12} = \min\left(\frac{L_{e2}}{8}; b_1\right) = \min\left(\frac{5.4 \text{ m}}{8}; 4.05 \text{ m}\right) = 0.675 \text{ m}$$

**Right side of the beam**

$$b_2 = \frac{L_{\text{perp, right}}}{2} - \frac{b_0}{2} = \frac{8.1 \text{ m}}{2} - \frac{0 \text{ mm}}{2} = 4.05 \text{ m}$$

$$b_{e20} = \min\left(\frac{L_{e0}}{8}; b_2\right) = \min\left(\frac{0 \text{ m}}{8}; 4.05 \text{ m}\right) = 0 \text{ m}$$

$$b_{e21} = \min\left(\frac{L_{e1}}{8}; b_2\right) = \min\left(\frac{9.18 \text{ m}}{8}; 4.05 \text{ m}\right) = 1.15 \text{ m}$$

$$b_{e22} = \min\left(\frac{L_{e2}}{8}; b_2\right) = \min\left(\frac{5.4 \text{ m}}{8}; 4.05 \text{ m}\right) = 0.675 \text{ m}$$

**Calculation of  $b_{\text{eff},1}$**

$$b_{\text{eff},1} = b_0 + b_{e11} + b_{e21} = 0 \text{ mm} + 1.15 \text{ m} + 1.15 \text{ m} = 2.3 \text{ m}$$

**Calculation of  $b_{\text{eff}}$**

$$b_{\text{eff}} = b_{\text{eff},1} = 2.3 \text{ m}$$

**Determination of  $L_e$**

$$L_e = L_{e1} = 9.18 \text{ m}$$

**5.1.2.2 Minimum degree of shear connection**

Warning: Conditions given by EN 1994-1-1 Art. 6.6.1.2 (3) are not fulfilled.

$$\eta_{\text{min,calc}} = 1 - \frac{355}{f_{yb}} \cdot (0.75 - 0.03 \cdot L_e)$$

$$\eta_{\text{min,calc}} = 1 - \frac{355}{355} \cdot (0.75 - 0.03 \cdot 9.18 \text{ m}) = 0.53$$

$$\eta_{\text{min}} = \max(\eta_{\text{min,calc}}; 0.4) = \max(0.53; 0.4) = 0.53$$

**5.1.2.3 Degree of shear connection present**

**5.1.2.3.1 Compression resistance of the concrete flange**

$$f_{cd} = \frac{\alpha_{cc} \cdot f_{ck}}{\gamma_c} = \frac{1 \cdot 30 \text{ MPa}}{1.5} = 20 \text{ MPa}$$

$$N_{c,Rd} = 0.85 \cdot f_{cd} \cdot b_{\text{eff}} \cdot (h_c - h_d) = 0.85 \cdot 20 \text{ MPa} \cdot 2.3 \text{ m} \cdot (109 \text{ mm} - 0 \text{ mm}) = 4260.44 \text{ kN}$$

**5.1.2.3.2 Tension resistance of the steel member**

$$N_{pl,a} = f_{yb} \cdot A_a = 355 \text{ MPa} \cdot 21800 \text{ mm}^2 = 7739.00 \text{ kN}$$

$$N_{c,t} = \min(N_{c,Rd}; N_{pl,a}) = \min(4260.44 \text{ kN}; 7739.00 \text{ kN}) = 4260.44 \text{ kN}$$

**5.1.2.3.3 Resistance of the shear connectors**

$$l_s = \frac{L}{n_{\text{row}}} = \frac{10.8}{43} = 251 \text{ mm}$$

Number of shear studs available per length  $L_e/2$

$$n_{sp} = \frac{0.5 \cdot L_e}{l_s} \cdot n_r$$

$$n_{sp} = 18 \cdot 1 = 18$$

$$N_c = n_{sp} \cdot P_{Rd} = 18 \cdot 143835 = 2589.04 \text{ kN}$$

$$\eta = \min\left(\frac{N_c}{N_{c,t}}; 1\right) = \min\left(\frac{2589.04 \text{ kN}}{4260.44 \text{ kN}}; 1\right) = 0.61$$

$$\eta \geq \eta_{\text{min}} \\ 0.61 \geq 0.53$$

OK  
The shear connection degree is adequate.

## 5.2 Cross-sectional resistance of the composite beam

### 5.2.1 Shear buckling

$$h_w = h_s - 2 \cdot t_f = 450 \text{ mm} - 2 \cdot 26 \text{ mm} = 398 \text{ mm}$$

$$\eta_{sb} = 1.2$$

$$\frac{h_w}{t_w} \leq \frac{72 \cdot \epsilon}{\eta_{sb}}$$

$$\frac{398 \text{ mm}}{14 \text{ mm}} \leq \frac{72 \cdot 0.814}{1.2}$$

$$28.4 \leq 48.8$$

OK

The shear buckling resistance of the web does not need to be verified.

### 5.2.2 Vertical shear

The resistance to vertical shear should be taken as the resistance of the structural steel section.

$$A_v = A_s - 2 \cdot b \cdot t_f + (t_w + 2 \cdot r) \cdot t_f$$

$$= 0.0218 - 2 \cdot 0.3 \cdot 0.026 + (0.014 + 2 \cdot 0.027) \cdot 0.026 = 7968 \text{ mm}^2$$

$$A_{v,\min} = \eta_{sb} \cdot h_w \cdot t_w = 1.2 \cdot 0.398 \cdot 0.014 = 6686 \text{ mm}^2$$

$$A_v \geq A_{v,\min}$$

$$7968 \text{ mm}^2 \geq 6686 \text{ mm}^2$$

$$V_{pl,Rd} = \frac{A_v \cdot f_{yb}}{\sqrt{3} \cdot \gamma_{M0}} = \frac{7968 \text{ mm}^2 \cdot 355 \cdot 10^6}{\sqrt{3} \cdot 1} = 1633 \text{ kN}$$

$$UC_{\text{comp}_V} = \frac{\text{abs}(V_{Ed,\text{comp}})}{V_{pl,Rd}} = \frac{\text{abs}(-116.558 \text{ kN})}{1633 \text{ kN}} = 0.07$$

The shear resistance of the section is adequate.

### 5.2.3 Bending moment

#### 5.2.3.1 Longitudinal reinforcement

##### 5.2.3.1.1 Centre of composite section

For buildings not intended mainly for storage the effects of creep in concrete beams may be taken into account by using an effective E modulus  $E_{\text{ceff}} = E_{\text{cm}} / 2$ .

$$E_{\text{ceff}} = \frac{E_{\text{cm}}}{2} = \frac{32800 \text{ MPa}}{2} = 16400 \text{ MPa}$$

$$\eta_E = \frac{E_b}{E_{\text{ceff}}} = \frac{21000 \text{ MPa}}{16400 \text{ MPa}} = 12.8$$

$$y_d = \frac{A_a \cdot \left( \frac{h_a}{2} \right) + \left( \frac{1}{\eta_E} \right) \cdot b_{\text{eff}} \cdot (h_c - h_d) \cdot \left( h_a + h_s - \frac{h_c - h_d}{2} \right)}{A_a + \left( \frac{1}{\eta_E} \right) \cdot b_{\text{eff}} \cdot (h_c - h_d)}$$

$$= \frac{0.0218 \cdot \left( \frac{0.45}{2} \right) + \left( \frac{1}{12.8} \right) \cdot 2.3 \cdot (0.109 - 0) \cdot \left( 0.45 + 0.16 - \frac{0.109 - 0}{2} \right)}{0.0218 + \left( \frac{1}{12.8} \right) \cdot 2.3 \cdot (0.109 - 0)} = 381 \text{ mm}$$

##### 5.2.3.1.2 Degree of reinforcement

$$A_s = \frac{b_{\text{eff}}}{s_l} \cdot \left( \frac{d_l^2}{4} \right) \cdot \pi = \frac{2.3 \text{ m}}{150 \text{ mm}} \cdot \left( \frac{16 \text{ mm}^2}{4} \right) \cdot 3.14 = 3076 \text{ mm}^2$$

$$A_c = b_{\text{eff}} \cdot (h_c - h_d) = 2.3 \cdot (0.109 - 0) = 250614 \text{ mm}^2$$

$$z_0 = \left( h_a + h_s - \frac{h_c - h_d}{2} \right) - y_d = \left( 0.45 + 0.16 - \frac{0.109 - 0}{2} \right) - 0.381 = 174 \text{ mm}$$

$$k_c = \min \left( \frac{1}{1 + \left( \frac{h_c - h_d}{2 \cdot z_0} \right)} + 0.3; 1 \right) = \min \left( \frac{1}{1 + \left( \frac{0.109 - 0}{2 \cdot 0.174} \right)} + 0.3; 1 \right) = 1$$

$$\rho_s = \delta \cdot \left( \frac{f_{yb}}{235} \right) \cdot \left( \frac{f_{ctm}}{f_{yk,r}} \right) \cdot \sqrt{k_c} = 1.1 \cdot \left( \frac{355}{235} \right) \cdot \left( \frac{2.9 \cdot 10^6}{500 \cdot 10^6} \right) \cdot \sqrt{1} = 0.964 \%$$

$$A_s \geq \rho_s \cdot A_c$$

$$3076 \text{ mm}^2 \geq 9.64 \cdot 10^{-3} \cdot 250614 \text{ mm}^2$$

$$3076 \text{ mm}^2 \geq 2415 \text{ mm}^2$$

OK

The longitudinal reinforcement of the section is adequate.

5.2.3.2 Moment resistance

Moment resistance of a steel cross-section

$$M_{pl,Rd,a} = \frac{W_{ply} \cdot f_{yb}}{Y_{MO}} = \frac{3.98 \cdot 10^6 \text{ mm}^3 \cdot 355 \text{ MPa}}{1} = 1414 \text{ kNm}$$

Influence of shear

$$\frac{V_{pl,Rd}}{2} > \text{abs}(V_{Ed,comp})$$

$$\frac{1633 \text{ kN}}{2} > 117 \text{ kN}$$

$$817 \text{ kN} > 117 \text{ kN} \quad \text{OK}$$

The influence of the vertical shear on the bending moment resistance may be neglected.

$$f_{yb,w} = f_{yb} = 355 \text{ MPa}$$

Modified tension resistance of the steel member

$$r = 0 \text{ mm}$$

$$A_s = 2 \cdot t_f \cdot b + t_w \cdot (h_a - 2 \cdot t_f) = 2 \cdot 26 \text{ mm} \cdot 300 \text{ mm} + 14 \text{ mm} \cdot (450 \text{ mm} - 2 \cdot 26 \text{ mm}) = 21172 \text{ mm}^2$$

$$N_{pl,a} = A_s \cdot f_{yb} = 21172 \text{ mm}^2 \cdot 355 \text{ MPa} = 7516.06 \text{ kN}$$

Note: Roundings of the steel cross-section are neglected in bending resistance calculation.

$$N_{c,f} = \min(N_{c,Rd}, N_{pl,a}) = \min(4260.44 \text{ kN}; 7516.06 \text{ kN}) = 4260.44 \text{ kN}$$

Positive bending moment resistance calculation

$$N_{pl,a} > N_{c,Rd}$$

The plastic neutral axis is located within the flange of the steel section.

$$N_{pl,a} - N_{ac,f} = N_{c,f} + N_{ac,f}$$

$$x = \frac{(N_{pl,a} - N_{c,f})}{(2 \cdot b \cdot f_{yb})} = \frac{(7516.06 \text{ kN} - 4260.44 \text{ kN})}{(2 \cdot 300 \text{ mm} \cdot 355 \text{ MPa})} = 15.3 \text{ mm}$$

$$N_{ac,f} = b \cdot x \cdot f_{yb} = 300 \text{ mm} \cdot 15.3 \text{ mm} \cdot 355 \text{ MPa} = 1627.81 \text{ kN}$$

$$N_{a,t} = N_{pl,a} - N_{ac,f} = 7516.06 \text{ kN} - 1627.81 \text{ kN} = 5888.25 \text{ kN}$$

Leverage arm of the tension part of the steel section calculated to the PNA.

$$h_{ts} = \frac{b \cdot (t_f - x)^2 \cdot 0.5 + t_w \cdot (h_a - 2 \cdot t_f) \cdot \left(\frac{h_a}{2} - x\right) + t_f \cdot b \cdot \left(h_a - \frac{t_f}{2} - x\right)}{b \cdot (t_f - x) + t_w \cdot (h_a - 2 \cdot t_f) + t_f \cdot b}$$

$$= \frac{300 \cdot (26 - 15.3)^2 \cdot 0.5 + 14 \cdot (450 - 2 \cdot 26) \cdot \left(\frac{450}{2} - 15.3\right) + 26 \cdot 300 \cdot \left(450 - \frac{26}{2} - 15.3\right)}{300 \cdot (26 - 15.3) + 14 \cdot (450 - 2 \cdot 26) + 26 \cdot 300}$$

$$h_{ts} = 270 \text{ mm}$$

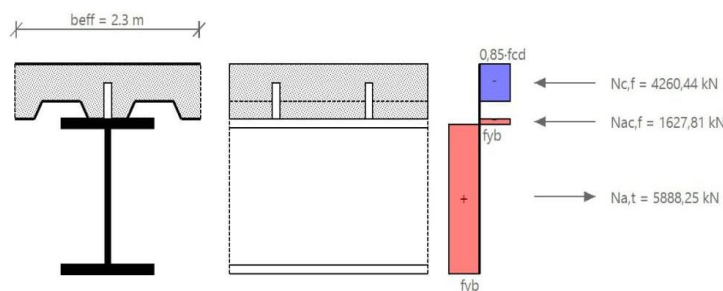

$$M_{pl,Rd} = N_{c,f} \cdot \left(x + h_s - \frac{h_c - h_d}{2}\right) + N_{ac,f} \cdot \left(\frac{x}{2}\right) + N_{a,t} \cdot h_{ts}$$

$$= 4260.44 \cdot \left(15.3 + 160 - \frac{109 - 0}{2}\right) + 1627.81 \cdot \left(\frac{15.3}{2}\right) + 5888.25 \cdot 270 = 2115 \text{ kNm}$$

Design moment resistance according to simplified method given by EN 1994-1-1 Art.6.2.1.3 (5)

$$M_{Rd} = M_{pl,Rd,a} + (M_{pl,Rd} - M_{pl,Rd,a}) \cdot \eta = 1414 \text{ kNm} + (2115 \text{ kNm} - 1414 \text{ kNm}) \cdot 0.61 = 1840 \text{ kNm}$$

$$UC_{comp,M} = \frac{\text{abs}(M_{Ed,comp})}{M_{Rd}} = \frac{\text{abs}(1052.300 \text{ kNm})}{1840 \text{ kNm}} = 0.57$$

The bending moment resistance of the section is adequate.

5.3 LTB resistance

The shear connectors are rigidly connected with the concrete slab, which provides continuous restraint to the top flange of the steel beam, so the beam is not susceptible to lateral torsional buckling.

**5.4 Longitudinal shear**

**5.4.1 Transverse reinforcement**

Design shear flow

$$h_f = h_c = 109 \text{ mm}$$

$$V_{Ed} = \frac{n_r \cdot P_{Rd}}{2 \cdot l_s \cdot h_f} = \frac{1 \cdot 144 \text{ kN}}{2 \cdot 251 \text{ mm} \cdot 109 \text{ mm}} = 2.62 \text{ MPa}$$

Transverse reinforcement

$$\frac{A_{st} \cdot f_{yk,r}}{y_s \cdot s_f} \geq \frac{V_{Ed} \cdot h_f}{\cotg(\theta)}$$

$$A_t = A_{st}/s_f$$

$$A_t = \frac{V_{Ed} \cdot h_f}{\left( \frac{\cotg(\theta) \cdot f_{yk,r}}{y_s} \right)} = \frac{2.62 \cdot 10^6 \cdot 0.109}{\left( \frac{\cotg(26.5) \cdot 500 \cdot 10^6}{1.15} \right)} = 328 \text{ mm}^2/\text{m}$$

$$A_{t,prov} = \frac{1}{s_f} \cdot \left( \frac{d_t^2}{4} \right) \cdot 3.14 = \frac{1}{0.15} \cdot \left( \frac{0.016^2}{4} \right) \cdot 3.14 = 1340 \text{ mm}^2/\text{m}$$

$$A_{t,prov} \geq A_t$$

$$1340 \text{ mm}^2/\text{m} \geq 328 \text{ mm}^2/\text{m} \quad \text{OK}$$

The transverse reinforcement of the section is adequate.

**5.4.2 Crushing of the concrete flange**

$$v = 0.6 \cdot \left( 1 - \frac{f_{ck}}{250} \right) = 0.6 \cdot \left( 1 - \frac{30}{250} \right) = 0.528 \quad (6.6N)$$

$$f_{cd} = \frac{\alpha_{cc} \cdot f_{ck}}{\gamma_c} = \frac{1 \cdot 30 \text{ MPa}}{1.5} = 20 \text{ MPa}$$

$$V_{Ed} \leq v \cdot f_{cd} \cdot \sin(\theta) \cdot \cos(\theta)$$

$$V_{Ed} \leq 0.528 \cdot 20 \text{ MPa} \cdot \sin(26.5 \text{ deg}) \cdot \cos(26.5 \text{ deg})$$

$$2.62 \text{ MPa} \leq 4.22 \text{ MPa} \quad \text{OK}$$

The crushing resistance of the concrete is adequate.

**ULS check of Final stage is OK.**

$$UC_{comp} = \max(0.07; 0.57; 0.00) = 0.57$$

-iskoristivost elementa na GSN – 57%

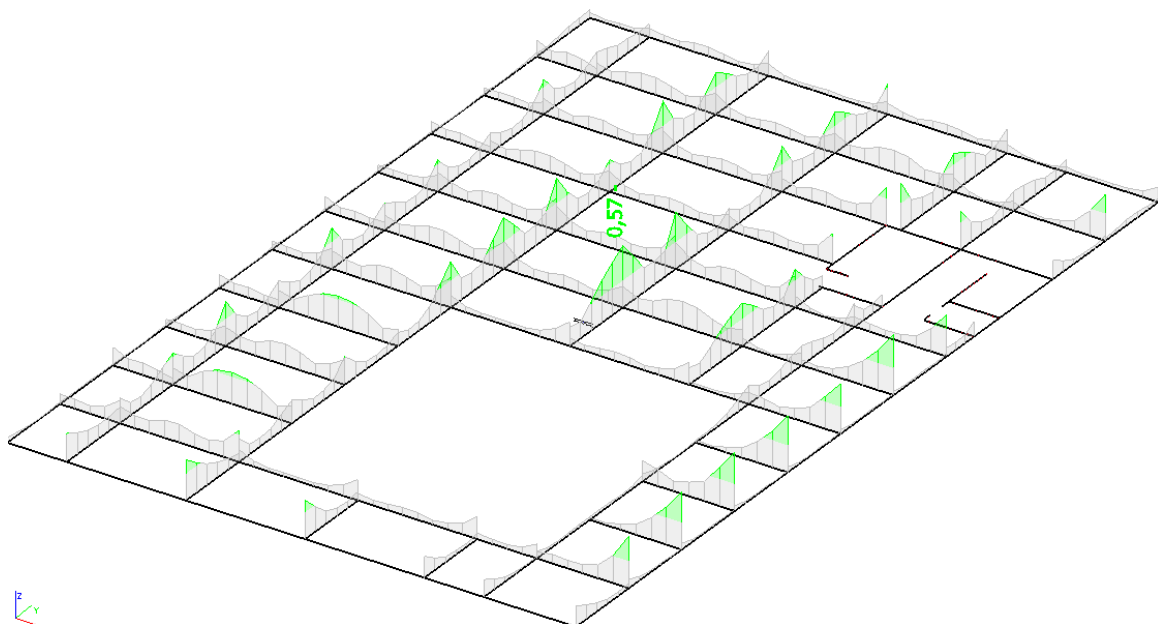

Slika 5.4.. Prikaz iskoristivosti grednih nosača – poz 400

### 5.3. Pomaci spregnute krovne konstrukcije – krov velike dvorane

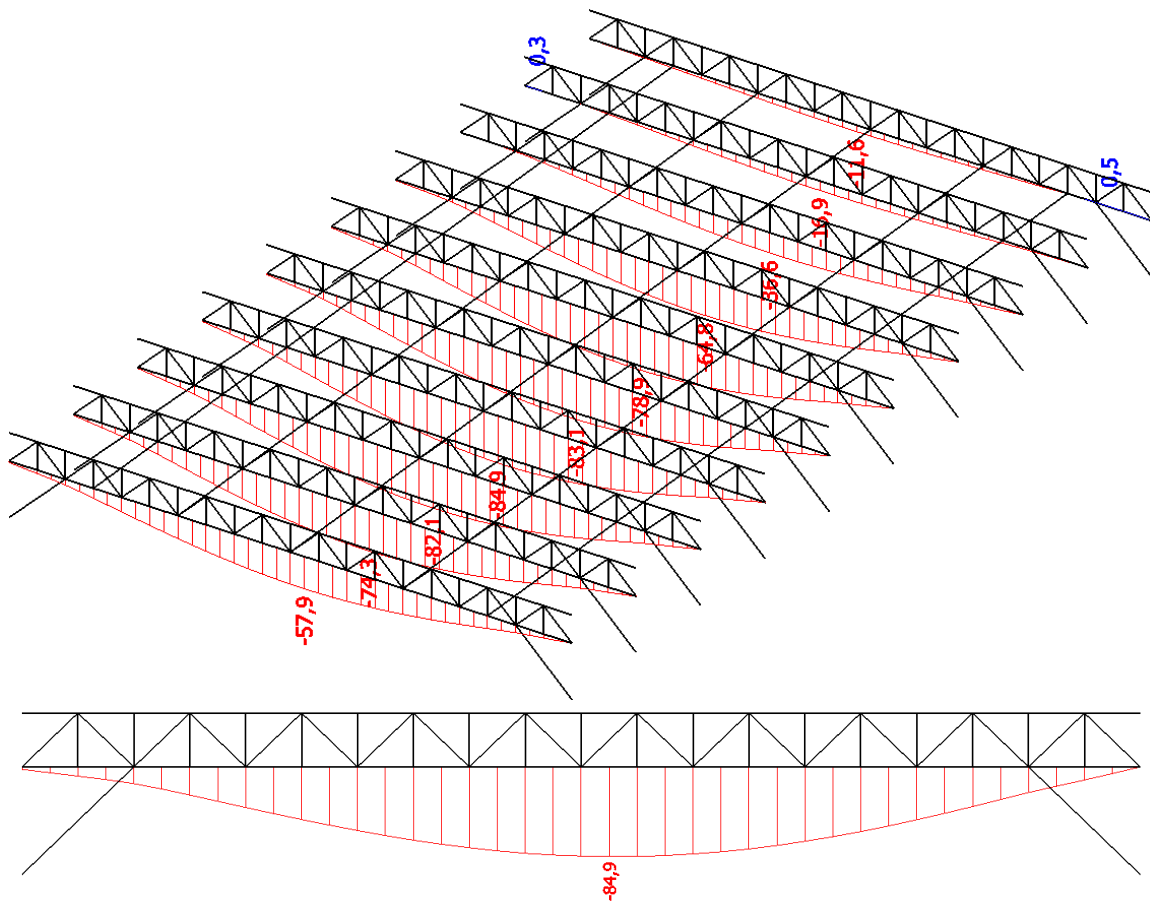

*Slika 5.5. Prikaz progiba glavnog rešetkastog nosača – krov velike dvorane*

Dopušteni vertikalni pomak (krovnna konstrukcija):

$$u_{dop} = \frac{l}{300} = \frac{30,44 \cdot 1000}{300} = 104,8 \text{ mm}$$

$$u_z = 84,9 \text{ mm} < u_{z,dop} = 104,8 \text{ mm} \quad \text{Zadovoljava}$$

-iskoristivost na GSU -  $84,9 \text{ mm} / 104,8 \text{ mm} = 0,81 = 81\%$

## 5.4. Dimenziniranje spregnute krovne konstrukcije – krov velike dvorane

### 5.4.1. Rezne sile – gornja pojasnica glavnog rešetkastog nosača

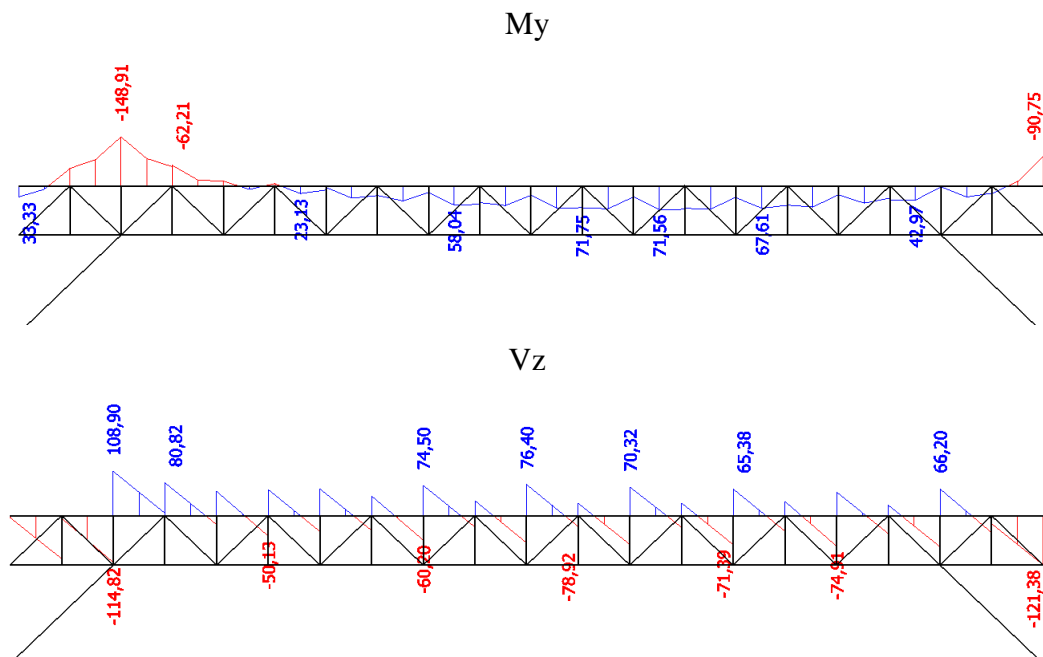

Slika 5.6.. Prikaz reznih sila - gornja pojasnica glavnog rešetkastog nosača

-poprečni presjek nosača

Name	Gornja pojasnica glavnog rešetkastog nosača - krov velike dvorane	
Type	HEB240	
Source description	Profil Arbed / Structural shapes / Edition Octobre 1995	
Item material	S 355	
Fabrication	rolled	
Flexural buckling y-y	b	
Flexural buckling z-z	c	
Lateral torsional buckling	Default	
Use 2D FEM analysis	x	
A [m <sup>2</sup> ]	1,0600e-02	
A y, z [m <sup>2</sup> ]	7,8218e-03	2,5536e-03
I y, z [m <sup>4</sup> ]	1,1260e-04	3,9230e-05
I w [m <sup>6</sup> ], t [m <sup>4</sup> ]	4,8695e-07	1,0270e-06
Wey y, z [m <sup>3</sup> ]	9,3830e-04	3,2690e-04
Wpl y, z [m <sup>3</sup> ]	1,0530e-03	4,9840e-04
d y, z [mm]	0	0
c YUCS, ZUCS [mm]	120	120
α [deg]	0,00	
A L, D [m <sup>2</sup> /m]	1,3800e+00	1,3838e+00
Mply +, - [Nm]	3,74e+05	3,74e+05
Mplz +, - [Nm]	1,77e+05	1,77e+05

Slika 5.7.. Prikaz geometrijskih karakteristika nosača – poz 400



### 5.4.2. Dimenzioniranje – gornja pojasnica glavnog rešetkastog nosača

SCIAENGINEER

#### Composite Beam - Final stage

Linear calculation  
 Class: All ULS  
 Extreme 1D: Global  
 Selection: B2671

#### Composite beam verification

for beam B2671 at section 3.14 m, in accordance with EC EN 1994-1-1

##### 1. Geometry data

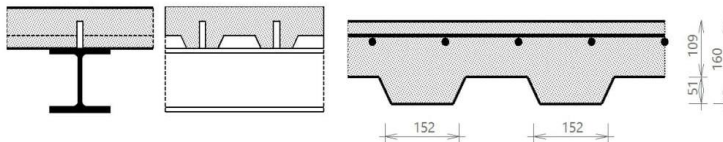

##### Continuous beam

Length of the current span	L = 4.716 m
Length of next span	L <sub>next</sub> = 4.716 m
Beam spacing at the left	L <sub>left</sub> = 0 m
Beam spacing at the right	L <sub>right</sub> = 0 m
Checked section	d <sub>x</sub> = 3.144 m

Warning: For a continuous beam, intermediate buckling supports y-y are ignored in both the calculation of the effective width for the analysis model and the check.

##### 2. Cross-section & materials

###### 2.1 Steel section properties

###### 2.1.1 Cross-section

Cross-section	HEB240
Height	h <sub>a</sub> = 240 mm
Width	b = 240 mm
Web thickness	t <sub>w</sub> = 10 mm
Flange thickness	t <sub>f</sub> = 17 mm
Radius	r = 21 mm
Area	A <sub>a</sub> = 10600 mm <sup>2</sup>
Moment of inertia	I <sub>y</sub> = 113·10 <sup>6</sup> mm <sup>4</sup>
Radius of gyration	i <sub>z</sub> = 61 mm
Plastic section modulus	W <sub>ply</sub> = 1.053·10 <sup>6</sup> mm <sup>3</sup>

###### 2.1.2 Material

Steel grade	S 355
Yield strength	f <sub>yk</sub> = 355 MPa
Ultimate strength	f <sub>tk</sub> = 490 MPa
E modulus	E <sub>b</sub> = 210000 MPa

###### 2.1.3 Cross-section classification

$$\epsilon = \sqrt{\frac{235}{355}} = 0.814 \quad (\text{EN 1993-1-1 §5.6 Tab. 5.2})$$

###### 2.1.3.1 Flange in compression

$$c_f = \frac{b - t_w - 2 \cdot r}{2} = \frac{240 \text{ mm} - 10 \text{ mm} - 2 \cdot 21 \text{ mm}}{2} = 94 \text{ mm}$$

$$\frac{c_f}{t_f} \leq 9 \cdot \epsilon$$

$$\frac{94 \text{ mm}}{17 \text{ mm}} \leq 9 \cdot 0.814$$

$$5.53 \leq 7.32$$

OK

Flange classified as Class 1.

Student version

2.1.3.2 Web in bending

$$c_w = h_s - 2 \cdot t_f - 2 \cdot r = 240 \text{ mm} - 2 \cdot 17 \text{ mm} - 2 \cdot 21 \text{ mm} = 164 \text{ mm}$$

$$\alpha_{cl} = 0.5$$

$$\frac{c_w}{t_w} \leq \frac{36 \cdot \epsilon}{\alpha_{cl}}$$

$$\frac{164 \text{ mm}}{10 \text{ mm}} \leq \frac{36 \cdot 0.814}{0.5}$$

$$16.4 \leq 58.6$$

OK

Web classified as Class 1.

**Cross-section classified as Class 1**

Cross-section Class OK.

**2.2 Concrete slab with profiled sheeting****2.2.1 Concrete slab**2.2.1.1 SlabTotal height of the slab  $h_s = 160 \text{ mm}$ 2.2.1.2 Material

Concrete class C30/37  
 Characteristic strength  $f_{ck} = 30 \text{ MPa}$   
 E modulus  $E_{cm} = 32800 \text{ MPa}$

**2.2.2 Profiled steel sheeting**

Sheeting with ribs transverse to the supporting beams

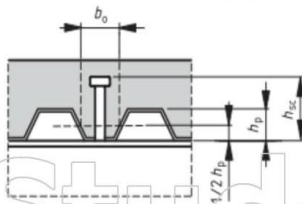

Name	Vulcraft 2 VLI 20
Depth of the ribs	$h_p = 50.8 \text{ mm}$
Height of full concrete	$h_c = 109.2 \text{ mm}$
Height of the re-entrant stiffener	$h_d = 0 \text{ mm}$
Spacing of the ribs	$b_s = 304.8 \text{ mm}$
Top width of the rib	$b_r = 127 \text{ mm}$
Bottom width of the rib	$b_b = 127 \text{ mm}$
Mean width of the ribs	$b_{0,rib} = 152.4 \text{ mm}$
Thickness of the sheeting	$t_p = 0.9093 \text{ mm}$

**2.2.3 Shear connectors**2.2.3.1 Geometry

Name	H110
Diameter	$d_s = 25 \text{ mm}$
Nominal height	$h_{nom} = 110 \text{ mm}$
As-welded height	$h_{sc} = 105 \text{ mm}$
Amount per trough or section	$n_r = 1$

2.2.3.2 Material

Steel grade	S 355
Ultimate strength	$f_{us} = 490 \text{ MPa}$

**2.2.4 Reinforcement**2.2.4.1 Geometry

Longitudinal bar diameter	$d_l = 16 \text{ mm}$
Longitudinal bar spacing	$s_l = 150 \text{ mm}$
Longitudinal bar cover	$c_l = 30 \text{ mm}$
Transverse bar diameter	$d_t = 16 \text{ mm}$
Transverse bar spacing	$s_t = 150 \text{ mm}$
Transverse bar cover	$c_t = 46 \text{ mm}$

2.2.4.2 Material

Material	B 500A
Characteristic yield strength	$f_{ykr} = 500 \text{ MPa}$

### 3. Design values of loads

Load Name : GSN 22

Content of combination : 1.35\*g-vlastitežina+1.35\*dg-dodatnostalno+  
1.62\*q-promjenjivoopterećenje+1.35\*g-vlastitežina\_dryconcrete+  
1.35\*Wx-1kom.-Wz-poz+1.35\*s-opterećenjesnijegom

Bending moment  $M_{Ed,comp} = -148.864$  kNm  
Shear force  $V_{Ed,comp} = -114.951$  kN

### 4. Partial safety factors

Steel section  $\gamma_{M0} = 1$   
 $\gamma_{M1} = 1$   
Shear connectors  $\gamma_V = 1.25$   
Concrete  $\gamma_C = 1.5$   
Reinforcement  $\gamma_S = 1.15$

### 5. ULS check of the Final stage

#### 5.1 Shear connection

##### 5.1.1 Design resistance of shear connectors

###### 5.1.1.1 Shear connector in a solid slab

$$\frac{h_{sc}}{d_s} > 4$$

$$4.2 > 4$$

$$\alpha = 1$$

$$f_{us} = \min(490; 450) \text{ MPa}$$

$$f_{us} = 450 \text{ MPa}$$

$$P_{Rd,solid,1} = \frac{0.8 \cdot f_{us} \cdot \left(\frac{\pi \cdot d_s^2}{4}\right)}{\gamma_V} = \frac{0.8 \cdot 450 \text{ MPa} \cdot \left(\frac{3.14 \cdot 25 \text{ mm}^2}{4}\right)}{1.25} = 141 \text{ kN}$$

$$P_{Rd,solid,2} = \frac{0.29 \cdot \alpha \cdot d_s^2 \cdot \sqrt{f_{ck} \cdot E_{cm}}}{\gamma_V} = \frac{0.29 \cdot 1 \cdot 25 \text{ mm}^2 \cdot \sqrt{30 \text{ MPa} \cdot 32800 \text{ MPa}}}{1.25} = 144 \text{ kN}$$

$$P_{Rd,solid} = \min(P_{Rd,solid,1}; P_{Rd,solid,2}) = \min(141 \text{ kN}; 144 \text{ kN}) = 141 \text{ kN}$$

###### 5.1.1.2 Shear connector in profiled sheeting

Sheeting with ribs transverse to the supporting beams

$$k_t = \frac{0.7}{\sqrt{n_r}} \cdot \left(\frac{b_{0,rib}}{h_p}\right) \cdot \left(\frac{h_{sc}}{h_p} - 1\right) = \frac{0.7}{\sqrt{1}} \cdot \left(\frac{152 \text{ mm}}{50.8 \text{ mm}}\right) \cdot \left(\frac{105 \text{ mm}}{50.8 \text{ mm}} - 1\right) = 2.24$$

$$k_{t,max} = 0.85$$

$$k_t = \max(0; \min(k_t; k_{t,max})) = \max(0; \min(2.24; 0.85)) = 0.85$$

$$P_{Rd} = k_t \cdot P_{Rd,solid} = 0.85 \cdot 141 \text{ kN} = 120 \text{ kN}$$

Warning: The conditions given by EN 1994-1-1 Art.6.6.4.2 (3) are not fulfilled.

##### 5.1.2 Degree of shear connection

###### 5.1.2.1 Determination of $b_{eff}$ of the concrete flange and length $L_e$

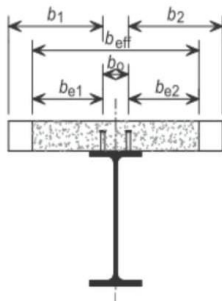

The effective width in the interval <0.25;0.75>

$$L_{e1} = 0.85 \cdot L_1 = 0.85 \cdot 4.72 \text{ m} = 4.01 \text{ m}$$

$$L_{e2} = 0.25 \cdot (L_1 + L_2) = 0.25 \cdot (4.72 \text{ m} + 4.72 \text{ m}) = 2.36 \text{ m}$$

**Left side of the beam**

No adjacent member or slab edge was found on the side.

$$b_{e10} = \frac{L_{e0}}{8} = \frac{0 \text{ m}}{8} = 0 \text{ m}$$

$$b_{e11} = \frac{L_{e1}}{8} = \frac{4.01 \text{ m}}{8} = 0.501 \text{ m}$$

$$b_{e12} = \frac{L_{e2}}{8} = \frac{2.36 \text{ m}}{8} = 0.295 \text{ m}$$

**Right side of the beam**

No adjacent member or slab edge was found on the side.

$$b_{e20} = \frac{L_{e0}}{8} = \frac{0 \text{ m}}{8} = 0 \text{ m}$$

$$b_{e21} = \frac{L_{e1}}{8} = \frac{4.01 \text{ m}}{8} = 0.501 \text{ m}$$

$$b_{e22} = \frac{L_{e2}}{8} = \frac{2.36 \text{ m}}{8} = 0.295 \text{ m}$$

**Calculation of  $b_{eff,1}$** 

$$b_{eff,1} = b_0 + b_{e11} + b_{e21} = 0 \text{ mm} + 0.501 \text{ m} + 0.501 \text{ m} = 1 \text{ m}$$

**Calculation of  $b_{eff}$** 

$$b_{eff} = b_{eff,1} = 1 \text{ m}$$

**Determination of  $L_e$** 

$$L_e = L_{e1} = 4.01 \text{ m}$$

**5.1.2.2 Minimum degree of shear connection**

Warning: Conditions given by EN 1994-1-1 Art. 6.6.1.2 (3) are not fulfilled.

$$\eta_{min,calc} = 1 - \frac{355}{f_{yb}} \cdot (0.75 - 0.03 \cdot L_e)$$

$$\eta_{min,calc} = 1 - \frac{355}{355} \cdot (0.75 - 0.03 \cdot 4.01 \text{ m}) = 0.37$$

$$\eta_{min} = \max(\eta_{min,calc}; 0.4) = \max(0.37; 0.4) = 0.4$$

**5.1.2.3 Degree of shear connection present****5.1.2.3.1 Tension resistance of the reinforcement**

$$A_s = \frac{b_{eff}}{s_l} \cdot \left(\frac{d_l^2}{4}\right) \cdot \pi = \frac{1 \text{ m}}{150 \text{ mm}} \cdot \left(\frac{16 \text{ mm}^2}{4}\right) \cdot 3.14 = 1343 \text{ mm}^2$$

$$F_s = \frac{A_s \cdot f_{yk,r}}{\gamma_s} = \frac{1.34 \cdot 10^{-3} \cdot 500 \cdot 10^6}{1.15} = 584 \text{ kN}$$

**5.1.2.3.2 Tension resistance of the steel member**

$$N_{pl,a} = f_{yb} \cdot A_a = 355 \text{ MPa} \cdot 10600 \text{ mm}^2 = 3763.00 \text{ kN}$$

$$N_{c,f} = \min(F_s; N_{pl,a}) = \min(584 \text{ kN}; 3763.00 \text{ kN}) = 584.04 \text{ kN}$$

**5.1.2.3.3 Resistance of the shear connectors**Number of full ribs available per length  $L_e$ 

$$n_{rib} = \frac{L_e}{b_s} = \frac{4.01 \text{ m}}{305 \text{ mm}}$$

$$n_{rib} = 13$$

$$l_s = b_s \cdot \text{trough} = 305 \text{ mm} \cdot 1 = 305 \text{ mm}$$

Number of shear studs available per length  $L_e/2$ 

$$n_{sp} = \frac{0.5 \cdot n_{rib} \cdot n_r}{\text{trough}} = \frac{0.5 \cdot 13 \cdot 1}{1} = 6.5$$

$$N_c = n_{sp} \cdot P_{Rid} = 6.5 \cdot 120166 = 781.08 \text{ kN}$$

$$\eta = \min\left(\frac{N_c}{N_{c,f}}; 1\right) = \min\left(\frac{781.08 \text{ kN}}{584.04 \text{ kN}}; 1\right) = 1$$

$$\eta \geq \eta_{min}$$

$$1 \geq 0.4$$

The shear connection degree is adequate. OK

## 5.2 Cross-sectional resistance of the composite beam

### 5.2.1 Shear buckling

$$h_w = h_s - 2 \cdot t_f = 240 \text{ mm} - 2 \cdot 17 \text{ mm} = 206 \text{ mm}$$

$$\eta_{sb} = 1.2$$

$$\frac{h_w}{t_w} \leq \frac{72 \cdot \varepsilon}{\eta_{sb}}$$

$$\frac{206 \text{ mm}}{10 \text{ mm}} \leq \frac{72 \cdot 0.814}{1.2}$$

$$20.6 \leq 48.8$$

OK

The shear buckling resistance of the web does not need to be verified.

### 5.2.2 Vertical shear

The resistance to vertical shear should be taken as the resistance of the structural steel section.

$$A_v = A_s - 2 \cdot b \cdot t_f + (t_w + 2 \cdot r) \cdot t_f$$

$$= 0.0106 - 2 \cdot 0.24 \cdot 0.017 + (0.01 + 2 \cdot 0.021) \cdot 0.017 = 3324 \text{ mm}^2$$

$$A_{v,\min} = \eta_{sb} \cdot h_w \cdot t_w = 1.2 \cdot 0.206 \cdot 0.01 = 2472 \text{ mm}^2$$

$$A_v \geq A_{v,\min}$$

$$3324 \text{ mm}^2 \geq 2472 \text{ mm}^2$$

$$V_{pl,Rd} = \frac{A_v \cdot f_{yb}}{\sqrt{3} \cdot \gamma_{M0}} = \frac{3324 \text{ mm}^2 \cdot 355 \cdot 10^6}{\sqrt{3} \cdot 1} = 681 \text{ kN}$$

$$UC_{\text{comp}_V} = \frac{\text{abs}(V_{Ed,\text{comp}})}{V_{pl,Rd}} = \frac{\text{abs}(-114.951 \text{ kN})}{681 \text{ kN}} = 0.17$$

The shear resistance of the section is adequate.

### 5.2.3 Bending moment

#### 5.2.3.1 Longitudinal reinforcement

##### 5.2.3.1.1 Centre of composite section

For buildings not intended mainly for storage the effects of creep in concrete beams may be taken into account by using an effective E modulus  $E_{s,\text{eff}} = E_{cm} / 2$ .

$$E_{\text{ceff}} = \frac{E_{cm}}{2} = \frac{32800 \text{ MPa}}{2} = 16400 \text{ MPa}$$

$$\eta_{\varepsilon} = \frac{E_b}{E_{\text{ceff}}} = \frac{210000 \text{ MPa}}{16400 \text{ MPa}} = 12.8$$

$$y_d = \frac{A_a \cdot \left( \frac{h_a}{2} \right) + \left( \frac{1}{\eta_{\varepsilon}} \right) \cdot b_{\text{eff}} \cdot (h_c - h_d) \cdot \left( h_a + h_s - \frac{h_c - h_d}{2} \right)}{A_a + \left( \frac{1}{\eta_{\varepsilon}} \right) \cdot b_{\text{eff}} \cdot (h_c - h_d)}$$

$$= \frac{0.0106 \cdot \left( \frac{0.24}{2} \right) + \left( \frac{1}{12.8} \right) \cdot 1 \cdot (0.109 - 0) \cdot \left( 0.24 + 0.16 - \frac{0.109 - 0}{2} \right)}{0.0106 + \left( \frac{1}{12.8} \right) \cdot 1 \cdot (0.109 - 0)} = 221 \text{ mm}$$

##### 5.2.3.1.2 Degree of reinforcement

$$A_s = \frac{b_{\text{eff}}}{s_l} \cdot \left( \frac{d_l^2}{4} \right) \cdot \pi = \frac{1 \text{ m}}{150 \text{ mm}} \cdot \left( \frac{16 \text{ mm}^2}{4} \right) \cdot 3.14 = 1343 \text{ mm}^2$$

$$A_c = b_{\text{eff}} \cdot (h_c - h_d) = 1 \cdot (0.109 - 0) = 109435 \text{ mm}^2$$

$$z_0 = \left( h_a + h_s - \frac{h_c - h_d}{2} \right) - y_d = \left( 0.24 + 0.16 - \frac{0.109 - 0}{2} \right) - 0.221 = 125 \text{ mm}$$

$$k_c = \min \left( \frac{1}{\left( 1 + \frac{h_c - h_d}{2 \cdot z_0} \right)} + 0.3; 1 \right) = \min \left( \frac{1}{\left( 1 + \frac{0.109 - 0}{2 \cdot 0.125} \right)} + 0.3; 1 \right) = 0.996$$

$$\rho_s = \delta \cdot \left( \frac{f_{yb}}{235} \right) \cdot \left( \frac{f_{ctm}}{f_{yk,r}} \right) \cdot \sqrt{k_c} = 1.1 \cdot \left( \frac{355}{235} \right) \cdot \left( \frac{2.9 \cdot 10^6}{500 \cdot 10^6} \right) \cdot \sqrt{0.996} = 0.962 \%$$

$$A_s \geq \rho_s \cdot A_c$$

$$1343 \text{ mm}^2 \geq 9.62 \cdot 10^{-3} \cdot 109435 \text{ mm}^2$$

$$1343 \text{ mm}^2 \geq 1052 \text{ mm}^2 \quad \text{OK}$$

The longitudinal reinforcement of the section is adequate.

5.2.3.2 Moment resistance

Moment resistance of a steel cross-section

$$M_{pl,Rd,a} = \frac{W_{ply} \cdot f_{yb}}{Y_{M0}} = \frac{1.05 \cdot 10^6 \text{ mm}^3 \cdot 355 \text{ MPa}}{1} = 374 \text{ kNm}$$

Influence of shear

$$\frac{V_{pl,Rd}}{2} > \text{abs}(V_{ed,comp})$$

$$\frac{681 \text{ kN}}{2} > 115 \text{ kN}$$

$$341 \text{ kN} > 115 \text{ kN} \quad \text{OK}$$

The influence of the vertical shear on the bending moment resistance may be neglected.

$$f_{yb,w} = f_{yb} = 355 \text{ MPa}$$

Modified tension resistance of the steel member

$$r = 0 \text{ mm}$$

$$A_s = 2 \cdot t_f \cdot b + t_w \cdot (h_a - 2 \cdot t_f) = 2 \cdot 17 \text{ mm} \cdot 240 \text{ mm} + 10 \text{ mm} \cdot (240 \text{ mm} - 2 \cdot 17 \text{ mm}) = 10220 \text{ mm}^2$$

$$N_{pl,a} = A_s \cdot f_{yb} = 10220 \text{ mm}^2 \cdot 355 \text{ MPa} = 3628.10 \text{ kN}$$

Note: Roundings of the steel cross-section are neglected in bending resistance calculation.

$$N_{c,f} = \min(F_s; N_{pl,a}) = \min(584 \text{ kN}; 3628.10 \text{ kN}) = 584.04 \text{ kN}$$

Negative bending moment resistance calculation

The plastic neutral axis is located within the web of the steel section.

$$N_{at,f} = b \cdot t_f \cdot f_{yb} = 0.24 \cdot 0.017 \cdot 355 \cdot 10^6 = 1448.40 \text{ kN}$$

$$N_{pl,a} - N_{at,f} - N_{at,w} = F_s + N_{at,f} + N_{at,w}$$

$$x = \frac{(N_{pl,a} - 2 \cdot N_{at,f} - F_s)}{(2 \cdot t_w \cdot f_{yb,w})} = \frac{(3628.10 \text{ kN} - 2 \cdot 1448.40 \text{ kN} - 584 \text{ kN})}{(2 \cdot 10 \text{ mm} \cdot 355 \text{ MPa})} = 20.7 \text{ mm}$$

Verification of the steel web classification.

$$\alpha_{cl} = \frac{c_w - x}{c_w} = \frac{164 - 20.7}{164} = 0.874$$

$$\frac{c_w}{t_w} \leq \frac{396 \cdot \epsilon}{13 \cdot \alpha_{cl} - 1}$$

$$\frac{164 \text{ mm}}{10 \text{ mm}} \leq \frac{396 \cdot 0.814}{13 \cdot 0.874 - 1}$$

$$16.4 \leq 31.1 \quad \text{OK}$$

Web classified as Class 1.

$$N_{at,w} = t_w \cdot x \cdot f_{yb,w} = 10 \text{ mm} \cdot 20.7 \text{ mm} \cdot 355 \text{ MPa} = 73.63 \text{ kN}$$

$$N_{a,c} = N_{pl,a} - N_{at,f} - N_{at,w} = 3628.10 \text{ kN} - 1448.40 \text{ kN} - 73.63 \text{ kN} = 2106.07 \text{ kN}$$

Leverage arm of the compression part of the steel section calculated to the PNA.

$$h_{cs} = \frac{(t_w \cdot (h_a - 2 \cdot t_f - x)^2 \cdot 0.5 + t_f \cdot b \cdot (h_a - 1.5 \cdot t_f - x))}{t_w \cdot (h_a - 2 \cdot t_f - x) + t_f \cdot b}$$

$$= \frac{(10 \cdot (240 - 2 \cdot 17 - 20.7)^2 \cdot 0.5 + 17 \cdot 240 \cdot (240 - 1.5 \cdot 17 - 20.7))}{10 \cdot (240 - 2 \cdot 17 - 20.7) + 17 \cdot 240} = 162 \text{ mm}$$

$$h_1 = x + t_f + h_s - c_1 + \frac{d_1}{2} = 0.0207 + 0.017 + 0.16 - 0.03 + \frac{0.016}{2} = 160 \text{ mm}$$

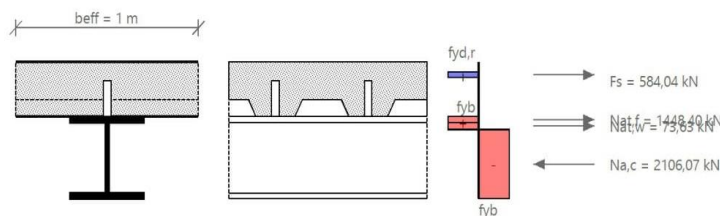

$$M_{pl,Rd} = F_s \cdot h_1 + N_{at,f} \cdot \left(\frac{t_f}{2} + x\right) + \frac{N_{at,w} \cdot x}{2} + N_{a,c} \cdot h_{cs}$$

$$= 584 \cdot 160 + 1448.40 \cdot \left(\frac{17}{2} + 20.7\right) + \frac{73.63 \cdot 20.7}{2} + 2106.07 \cdot 162 = 478 \text{ kNm}$$

Design moment resistance according to EN 1994-1-1 Art.6.2.1.2

$$M_{Rd} = M_{pl,Rd} = 478 \text{ kNm}$$

$$UC_{comp,M} = \frac{\text{abs}(M_{ed,comp})}{M_{Rd}} = \frac{\text{abs}(-148.864 \text{ kNm})}{478 \text{ kNm}} = 0.31$$

The bending moment resistance of the section is adequate.

**5.3 LTB resistance**

$$F = \left( 1 + \frac{t_w \cdot (h_a - t_f)}{4 \cdot b \cdot t_f} \right) \left( \frac{h_a - t_f}{t_w} \right)^{0.75} \left( \frac{t_f}{b} \right)^{0.25} = \left( 1 + \frac{10 \cdot (240 - 17)}{4 \cdot 240 \cdot 17} \right) \left( \frac{240 - 17}{10} \right)^{0.75} \left( \frac{17}{240} \right)^{0.25} = 6.02$$

$F_{lim} = 12.3$

$F \leq F_{lim}$

$6.02 \leq 12.3$

OK

The cross-section is qualified for verification of LTB by the simplified method.

$C_4 = 25$

$$\lambda_{LT,rel} = 5 \cdot \left( 1 + \frac{t_w \cdot (h_a - t_f)}{4 \cdot b \cdot t_f} \right) \left( \frac{h_a - t_f}{t_w} \right)^{0.75} \left( \frac{t_f}{b} \right)^{0.25} \cdot \left( \frac{f_{yb}}{E_b \cdot C_4} \right)^{0.5}$$

$$= 5 \cdot \left( 1 + \frac{0.01 \cdot (0.24 - 0.017)}{4 \cdot 0.24 \cdot 0.017} \right) \left( \frac{0.24 - 0.017}{0.01} \right)^{0.75} \left( \frac{0.017}{0.24} \right)^{0.25} \cdot \left( \frac{355 \cdot 10^6}{210 \cdot 10^9 \cdot 25} \right)^{0.5} = 0.247$$

$h_a/b <= 2 \rightarrow$  Buckling curve 'a'

$\alpha_{LT} = 0.21$

$\Phi_{LT} = 0.5 \cdot \left( 1 + \alpha_{LT} \cdot (\lambda_{LT,rel} - 0.2) + \lambda_{LT,rel}^2 \right) = 0.5 \cdot \left( 1 + 0.21 \cdot (0.247 - 0.2) + 0.247^2 \right) = 0.536$

$X_{LT} = \frac{1}{\Phi_{LT} + \sqrt{\Phi_{LT}^2 - \lambda_{LT,rel}^2}} = \frac{1}{0.536 + \sqrt{0.536^2 - 0.247^2}} = 0.99$

$X_{LT} = \min(X_{LT}, 1) = \min(0.99; 1) = 0.99$

$M_{b,Rd} = X_{LT} \cdot M_{Rd} = 0.99 \cdot 477972 = 472.959 \text{ kNm}$

$UC_{comp\_LTB} = \frac{abs(M_{Ed,comp})}{M_{b,Rd}} = \frac{abs(-148.864 \text{ kNm})}{472.959 \text{ kNm}} = 0.31$

The later torsional buckling resistance of the section is adequate.

**5.4 Longitudinal shear**

**5.4.1 Transverse reinforcement**

Design shear flow

$h_f = h_c = 109 \text{ mm}$

$v_{Ed} = \frac{F_{T,r} \cdot P_{Rd}}{I_y \cdot h_f} = \frac{1 \cdot 120 \text{ kN}}{305 \text{ mm} \cdot 109 \text{ mm}} = 3.61 \text{ MPa}$

Transverse reinforcement

$\frac{A_t \cdot f_{yk,r}}{y_s \cdot s_f} \geq \frac{v_{Ed} \cdot h_f}{\cot(\theta)}$

$A_t = A_{st}/s_f$

$A_t = \frac{v_{Ed} \cdot h_f}{\cot(\theta) \cdot f_{yk,r}} = \frac{3.61 \cdot 10^6 \cdot 0.109}{\cot(26.5) \cdot 500 \cdot 10^6} = 452 \text{ mm}^2/\text{m}$

$A_{t,prov} = \frac{1}{s_f} \cdot \left( \frac{d_t^2}{4} \right) \cdot 3.14 = \frac{1}{0.15} \cdot \left( \frac{0.016^2}{4} \right) \cdot 3.14 = 1340 \text{ mm}^2/\text{m}$

$A_{t,prov} \geq A_t$

$1340 \text{ mm}^2/\text{m} \geq 452 \text{ mm}^2/\text{m} \quad \text{OK}$

The transverse reinforcement of the section is adequate.

ULS check of Final stage is OK.

$UC_{comp} = \max(0.17; 0.31; 0.31) = 0.31$

-iskoristivost nosača na GSN – 31%

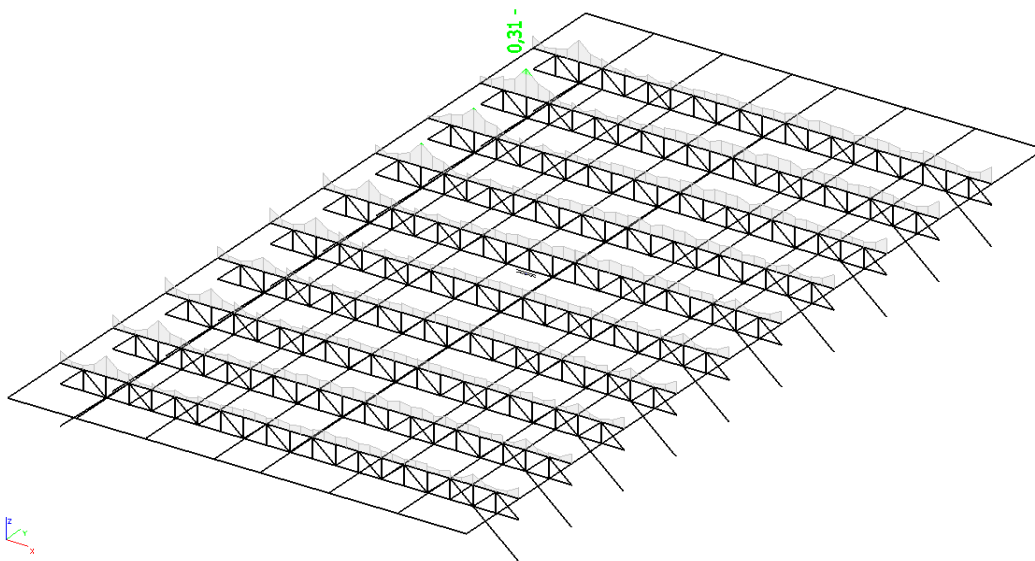

Slika 5.8.. Prikaz iskoristivosti gornje pojasnice rešetkastog nosača – poz 400

### 5.4.3. Rezne sile – donja pojasnica glavnog rešetkastog nosača

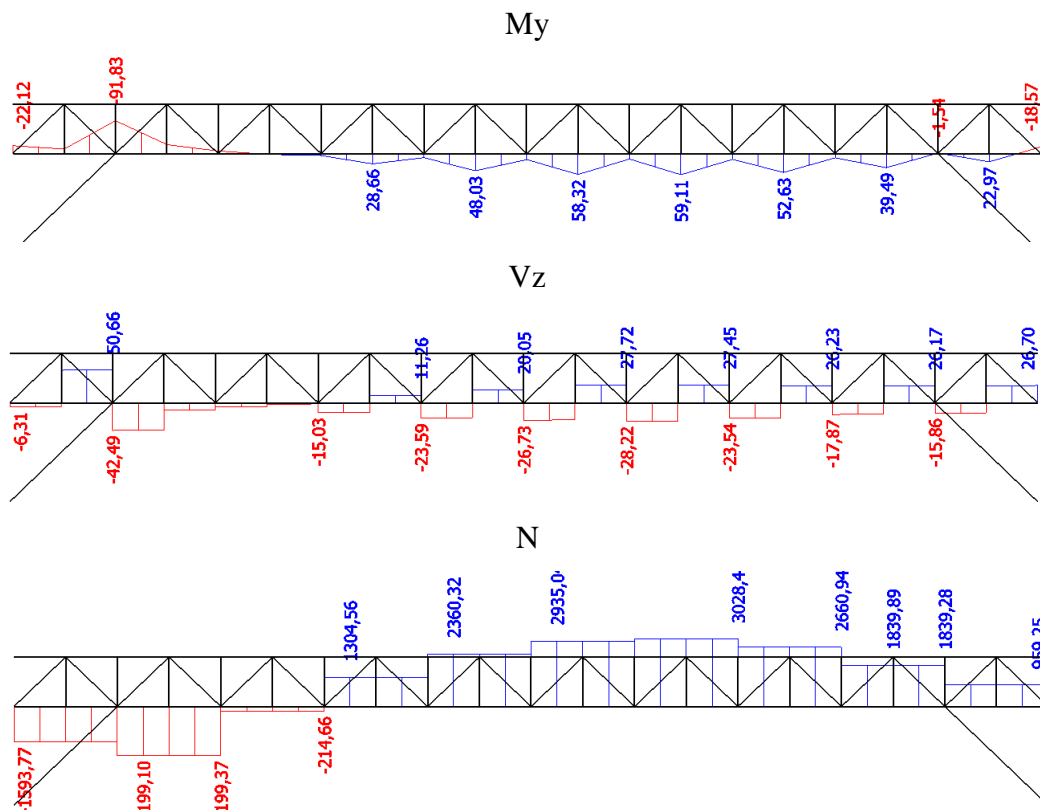

Slika 5.9. Prikaz reznih sila - donja pojasnica glavnog rešetkastog nosača

-poprečni presjek nosača

Name	Donja pojasnica glavnog rešetkastog nosača - krov velike dvorane	
Type	F280X10	
Source description	Chinese Standard / GB 6728-2002	
Item material	S 355	
Fabrication	cold formed	
Flexural buckling y-y	c	
Flexural buckling z-z	c	
Lateral torsional buckling	Default	
Use 2D FEM analysis	*	
A [m²]	1,0460e-02	
A <sub>y, z</sub> [m²]	5,2251e-03	5,2251e-03
I <sub>y, z</sub> [m⁴]	1,2479e-04	1,2479e-04
I <sub>w</sub> [m⁶], I <sub>t</sub> [m⁴]	1,4342e-06	2,0173e-04
W <sub>el y, z</sub> [m³]	8,9100e-04	8,9100e-04
W <sub>pl y, z</sub> [m³]	1,0463e-03	1,0463e-03
d <sub>y, z</sub> [mm]	0	0
c <sub>YUCS, ZUCS</sub> [mm]	140	140
α [deg]	0,00	
A <sub>L, D</sub> [m²/m]	1,0771e+00	2,0910e+00
M <sub>pl y, z</sub> [Nm]	3,71e+05	3,71e+05
M <sub>pl z, y</sub> [Nm]	3,71e+05	3,71e+05

Slika 5.10.. Prikaz geometrijskih karakteristika nosača – poz 400



### 5.4.4. Dimenzioniranje – donja pojasnica glavnog rešetkastog nosača

Member B2714	31,440 m	F280X10	S 355	GSN 5	0,91 -
--------------	----------	---------	-------	-------	--------

Note: EN 1993-1-3 article 1.1(3) specifies that this part does not apply to cold formed CHS and RHS sections. The default EN 1993-1-1 code check is executed instead of the EN 1993-1-3 code check.

Partial safety factors	
Gamma M0 for resistance of cross-sections	1,00
Gamma M1 for resistance to instability	1,00
Gamma M2 for resistance of net sections	1,25

Material		
Yield strength $f_y$	355,0	MPa
Ultimate strength $f_u$	510,0	MPa
Fabrication	Cold formed	

.....SECTION CHECK:.....

The critical check is on position 26.724 m

Internal forces	Calculated	Unit
N,Ed	-2199,10	kN
Vy,Ed	3,63	kN
Vz,Ed	-41,95	kN
T,Ed	-0,08	kNm
My,Ed	-25,46	kNm
Mz,Ed	-6,08	kNm

Classification for cross-section design

According to EN 1993-1-1 article 5.5.2

Classification of Internal Compression parts

According to EN 1993-1-1 Table 5.2 Sheet 1

Maximum width-to-thickness ratio	25,00
Class 1 Limit	26,85
Class 2 Limit	30,92
Class 3 Limit	36,88

=> Section classified as Class 1 for cross-section design

Compression check

According to EN 1993-1-1 article 6.2.4 and formula (6.9)

A	1,0460e-02	m <sup>2</sup>
Nc,Rd	3713,30	kN
Unity check	0,59	-

Bending moment check for My

According to EN 1993-1-1 article 6.2.5 and formula (6.12), (6.13)

Wpl,y	1,0463e-03	m <sup>3</sup>
Mpl,y,Rd	371,45	kNm
Unity check	0,07	-

Bending moment check for Mz

According to EN 1993-1-1 article 6.2.5 and formula (6.12), (6.13)

Wpl,z	1,0463e-03	m <sup>3</sup>
Mpl,z,Rd	371,45	kNm
Unity check	0,02	-

Shear check for Vy

According to EN 1993-1-1 article 6.2.6 and formula (6.17)

Eta	1,20	
Av	5,2300e-03	m <sup>2</sup>
Vpl,y,Rd	1071,94	kN
Unity check	0,00	-

Shear check for Vz

According to EN 1993-1-1 article 6.2.6 and formula (6.17)

Eta	1,20	
Av	5,2300e-03	m <sup>2</sup>
Vpl,z,Rd	1071,94	kN
Unity check	0,04	-

Torsion check

According to EN 1993-1-1 article 6.2.7 and formula (6.23)

Tau,t,Ed	0,1	MPa
Tau,Rd	205,0	MPa
Unity check	0,00	-

Note: The unity check for torsion is lower than the limit value of 0,05. Therefore torsion is considered as

Alpha	2,75	
MN,z,Rd	197,31	kNm
Beta	2,75	

Unity check (6.41) = 0,00 + 0,00 = 0,00 -

**Note:** Since the shear forces are less than half the plastic shear resistances their effect on the moment resistances is neglected.

The member satisfies the section check.

....:STABILITY CHECK:....

**Classification for member buckling design**

Decisive position for stability classification: 26,724 m

**Classification of Internal Compression parts**

According to EN 1993-1-1 Table 5.2 Sheet 1

Maximum width-to-thickness ratio	25,00
Class 1 Limit	26,85
Class 2 Limit	30,92
Class 3 Limit	36,88

=> Section classified as Class 1 for member buckling design

**Flexural Buckling check**

According to EN 1993-1-1 article 6.3.1.1 and formula (6.46)

Buckling parameters	yy	zz	
Sway type	sway	non-sway	
System length L	1,572	4,716	m
Buckling factor k	1,00	1,00	
Buckling length L <sub>cr</sub>	1,572	4,716	m
Critical Euler load N <sub>cr</sub>	104663,14	11629,24	kN
Slenderness Lambda	14,39	43,18	
Relative slenderness Lambda <sub>rel</sub>	0,19	0,57	
Limit slenderness Lambda <sub>rel,0</sub>	0,20	0,20	
Buckling curve	c	c	
Imperfection Alpha	0,49	0,49	
Reduction factor Chi	1,00	0,81	
Buckling resistance N <sub>b,Rd</sub>	3713,30	2992,50	kN

Flexural Buckling verification		
Cross-section area A	1,0460e-02	m <sup>2</sup>
Buckling resistance N <sub>b,Rd</sub>	2992,50	kN
Unity check	0,73	-

**Torsional(-Flexural) Buckling check**

According to EN 1993-1-1 article 6.3.1.1 and formula (6.46)

**Note:** The cross-section concerns a RHS section which is not susceptible to Torsional(-Flexural) Buckling.

**Lateral Torsional Buckling check**

According to EN 1993-1-1 article 6.3.2.1

**Note:** The cross-section concerns a RHS section with 'h / b < 10 / Lambda<sub>rel,z</sub>'.

This section is thus not susceptible to Lateral Torsional Buckling.

**Bending and axial compression check**

According to EN 1993-1-1 article 6.3.3 and formula (6.61),(6.62)

Bending and axial compression check parameters		
Interaction method	alternative method 1	
Cross-section area A	1,0460e-02	m <sup>2</sup>
Cross-section plastic modulus W <sub>pl,y</sub>	1,0463e-03	m <sup>3</sup>
Cross-section plastic modulus W <sub>pl,z</sub>	1,0463e-03	m <sup>3</sup>
Design compression force N <sub>Ed</sub>	2199,10	kN
Design bending moment (maximum) M <sub>y,Ed</sub>	-91,83	kNm
Design bending moment (maximum) M <sub>z,Ed</sub>	11,02	kNm
Characteristic compression resistance N <sub>Rk</sub>	3713,30	kN
Characteristic moment resistance M <sub>y,Rk</sub>	371,45	kNm
Characteristic moment resistance M <sub>z,Rk</sub>	371,45	kNm
Reduction factor Chi <sub>y</sub>	1,00	
Reduction factor Chi <sub>z</sub>	0,81	
Reduction factor Chi <sub>LT</sub>	1,00	
Interaction factor k <sub>yy</sub>	0,94	
Interaction factor k <sub>yz</sub>	0,62	
Interaction factor k <sub>zy</sub>	0,58	
Interaction factor k <sub>zz</sub>	0,93	

Maximum moment M<sub>y,Ed</sub> is derived from beam B2714 position 28,296 m.

Maximum moment M<sub>z,Ed</sub> is derived from beam B2714 position 31,440 m.

Interaction method 1 parameters		
Critical Euler load N <sub>cr,y</sub>	104663,14	kN
Critical Euler load N <sub>cr,z</sub>	11629,24	kN
Elastic critical load N <sub>cr,T</sub>	688471,95	kN
Cross-section plastic modulus W <sub>pl,y</sub>	1,0463e-03	m <sup>3</sup>
Cross-section elastic modulus W <sub>el,y</sub>	8,9100e-04	m <sup>3</sup>
Cross-section plastic modulus W <sub>pl,z</sub>	1,0463e-03	m <sup>3</sup>
Cross-section elastic modulus W <sub>el,z</sub>	8,9100e-04	m <sup>3</sup>

\*Student version\* \*Student version\* \*Student version\* \*Student version\* \*Student version\* \*Student version\* \*Student version\* \*Student version\* \*S

Interaction method 1 parameters		
*Student version*	*Student version*	*Student version*
Second moment of area Iy	1,2479e-04	m <sup>4</sup>
Second moment of area Iz	1,2479e-04	m <sup>4</sup>
Torsional constant It	2,0173e-04	m <sup>4</sup>
Method for equivalent moment factor C,my,0	Table A.2 Line 2 (General)	
Design bending moment (maximum) My,Ed	-91,83	kNm
Maximum relative deflection delta,z	0,7	mm
Equivalent moment factor C,my,0	1,00	
Method for equivalent moment factor C,mz,0	Table A.2 Line 2 (General)	
Design bending moment (maximum) Mz,Ed	11,02	kNm
Maximum relative deflection delta,y	-0,3	mm
Equivalent moment factor C,mz,0	0,87	
Factor mu,y	1,00	
Factor mu,z	0,96	
Factor epsilon,y	0,49	
Factor a,LT	0,00	
Critical moment for uniform bending Mcr,0	13821,58	kNm
Relative slenderness Lambda,rel,0	0,16	
Limit relative slenderness Lambda,rel,0,lim	0,21	
Equivalent moment factor C,my	1,00	
Equivalent moment factor C,mz	0,87	
Equivalent moment factor C,mLT	1,00	
Factor b,LT	0,00	
Factor c,LT	0,00	
Factor d,LT	0,00	
Factor e,LT	0,00	
Factor w,y	1,17	
Factor w,z	1,17	
Factor n,pl	0,59	
Maximum relative slenderness Lambda,rel,max	0,57	
Factor C,yy	1,08	
Factor C,yz	1,05	
Factor C,zy	1,00	
Factor C,zz	1,11	

Unity check (6.61) = 0,59 + 0,23 + 0,02 = 0,84 -

Unity check (6.62) = 0,73 + 0,14 + 0,03 = 0,91 -

The member satisfies the stability check.

-iskoristivost elementa na GSN – 91%

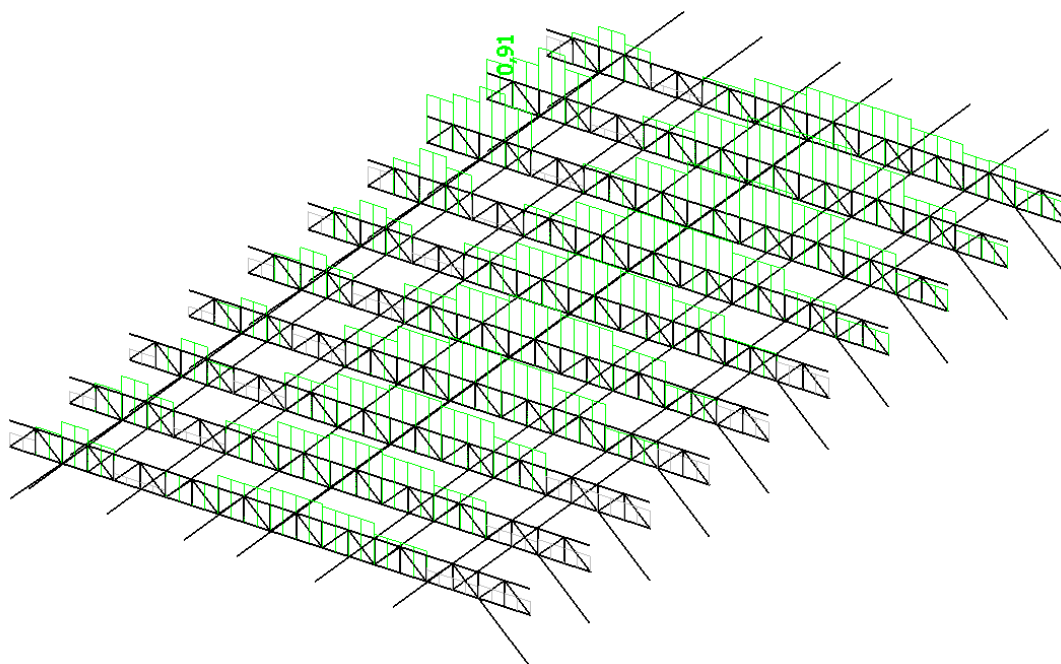

Slika 5.11.. Prikaz iskoristivosti donje pojasnice rešetkastog nosača – poz 400

### 5.4.5. Rezne sile – ispunjena glavniog rešetkastog nosača

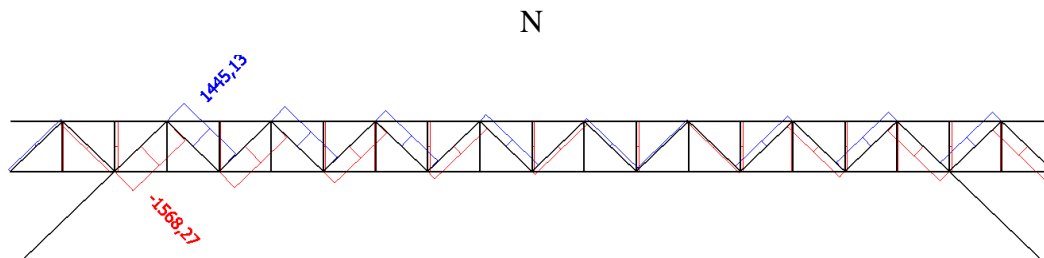

Slika 5.12.. Prikaz reznih sila - ispunjena glavniog rešetkastog nosača

Name	Ispuna glavniog rešetkastog nosača - krov velike dvorane	
Type	CFRHS180X180X8	
Source description	Rautaruukki Oyj / Structural Hollow Sections EN10219 / Ed 2007	
Item material	S 355	
Fabrication	cold formed	
Flexural buckling y-y	c	
Flexural buckling z-z	c	
Lateral torsional buckling	Default	
Use 2D FEM analysis	*	
A [m²]	5,2840e-03	
A <sub>y, z</sub> [m²]	2,6401e-03	2,6401e-03
I <sub>y, z</sub> [m⁴]	2,6459e-05	2,6459e-05
I <sub>w</sub> [m⁶], I <sub>t</sub> [m⁶]	1,2597e-07	4,1886e-05
W <sub>el y, z</sub> [m³]	2,8287e-04	2,8287e-04
W <sub>pl y, z</sub> [m³]	3,3570e-04	3,3570e-04
d <sub>y, z</sub> [mm]	0	0
c <sub>YUCS, ZUCS</sub> [mm]	90	90
α [deg]	0,00	
A <sub>L, D</sub> [m²/m]	6,8600e-01	1,3208e+00
M <sub>ply +, -</sub> [Nm]	1,19e+05	1,19e+05
M <sub>plz +, -</sub> [Nm]	1,19e+05	1,19e+05

Slika 5.13. Prikaz geometrijskih karakteristika nosača – poz 400

-iskoristivost elementa na GSN – 94%

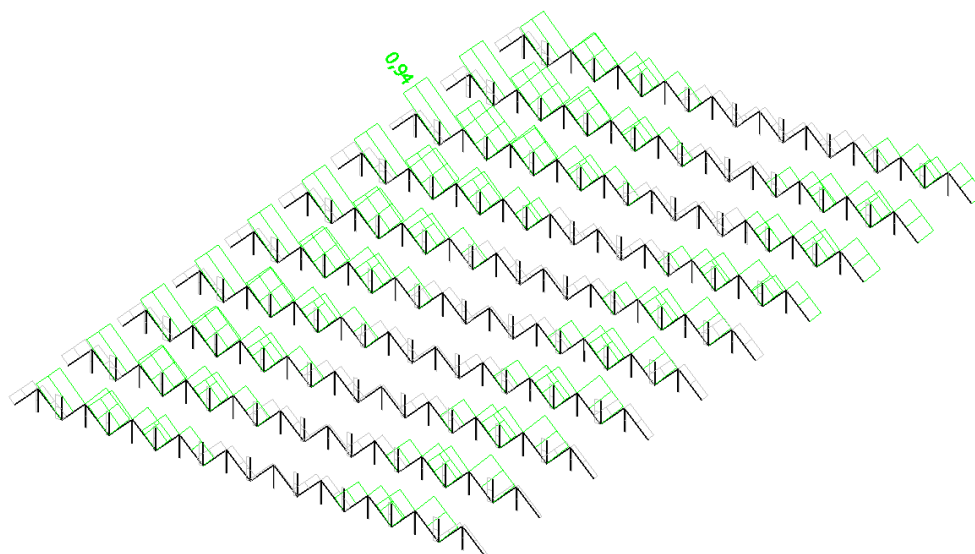

Slika 5.14. Prikaz iskoristivosti ispunjene rešetkastog nosača – poz 400

### 5.4.6. Dimenzioniranje – ispuna glavnog rešetkastog nosača

Member B2729	2,173 m	CFRHS180X180X8	S 355	GSN 22	0,94 -
--------------	---------	----------------	-------	--------	--------

Note: EN 1993-1-3 article 1.1(3) specifies that this part does not apply to cold formed CHS and RHS sections. The default EN 1993-1-1 code check is executed instead of the EN 1993-1-3 code check.

Partial safety factors	
Gamma M0 for resistance of cross-sections	1,00
Gamma M1 for resistance to instability	1,00
Gamma M2 for resistance of net sections	1,25

Material		
Yield strength fy	355,0	MPa
Ultimate strength fu	510,0	MPa
Fabrication	Cold formed	

...:SECTION CHECK:...

The critical check is on position 0.000 m

Internal forces	Calculated	Unit
N,Ed	-1568,27	kN
Vy,Ed	0,00	kN
Vz,Ed	0,00	kN
T,Ed	0,00	kNm
My,Ed	0,00	kNm
Mz,Ed	0,00	kNm

**Classification for cross-section design**

According to EN 1993-1-1 article 5.5.2

**Classification of Internal Compression parts**

According to EN 1993-1-1 Table 5.2 Sheet 1

Maximum width-to-thickness ratio	19,50
Class 1 Limit	26,85
Class 2 Limit	30,92
Class 3 Limit	34,17

=> Section classified as Class 1 for cross-section design

**Compression check**

According to EN 1993-1-1 article 6.2.4 and formula (6.9)

A	5,2840e-03	m <sup>2</sup>
Nc,Rd	1875,82	kN
Unity check	0,84	-

The member satisfies the section check.

...:STABILITY CHECK:...

**Classification for member buckling design**

Decisive position for stability classification: 0,000 m

**Classification of Internal Compression parts**

According to EN 1993-1-1 Table 5.2 Sheet 1

Maximum width-to-thickness ratio	19,50
Class 1 Limit	26,85
Class 2 Limit	30,92
Class 3 Limit	34,17

=> Section classified as Class 1 for member buckling design

**Flexural Buckling check**

According to EN 1993-1-1 article 6.3.1.1 and formula (6.46)

Buckling parameters	yy	zz	
Sway type	sway	non-sway	
System length L	2,173	2,173	m
Buckling factor k	1,00	1,00	
Buckling length Lcr	2,173	2,173	m
Critical Euler load Ncr	11176,42	11176,98	kN
Slenderness Lambda	31,30	31,30	
Relative slenderness Lambda,rel	0,41	0,41	
Limit slenderness Lambda,rel,0	0,20	0,20	
Buckling curve	c	c	
Imperfection Alpha	0,49	0,49	
Reduction factor Chi	0,89	0,89	
Buckling resistance Nb,Rd	1673,59	1673,60	kN

**Flexural Buckling verification**

Cross-section area A	5,2840e-03	m <sup>2</sup>
Buckling resistance Nb,Rd	1673,59	kN
Unity check	0,94	-

**Note:** The cross-section concerns a RHS section which is not susceptible to Torsional(-Flexural) Buckling.

The member satisfies the stability check.

### 5.4.7. Rezne sile – podupora glavnog rešetkastog nosača

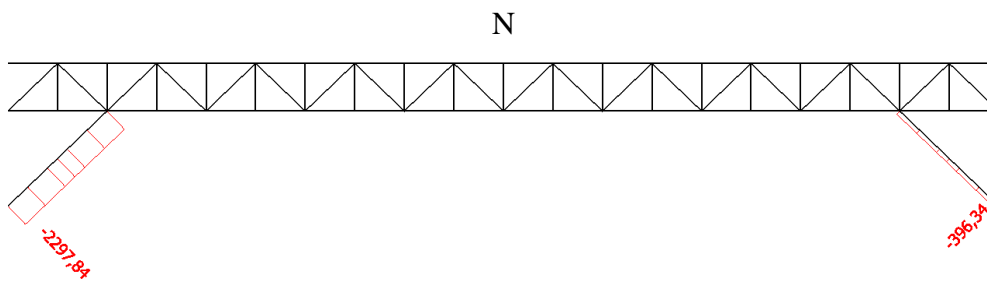

Slika 5.16. Prikaz reznih sila - podupora glavnog rešetkastog nosača

Name	Podupora donjeg pojasa glavnog rešetkastog nosača -krov velike dvorane		
Type	F250X10		
Source description	Chinese Standard / GB 6728-2002		
Item material	S 355		
Fabrication	cold formed		
Flexural buckling y-y	c		
Flexural buckling z-z	c		
Lateral torsional buckling	Default		
Use 2D FEM analysis	x		
A [m <sup>2</sup> ]	9,2600e-03		
A <sub>y, z</sub> [m <sup>2</sup> ]	4,6251e-03		4,6251e-03
I <sub>y, z</sub> [m <sup>4</sup> ]	8,7070e-05		8,7070e-05
I <sub>w</sub> [m <sup>6</sup> ], I <sub>t</sub> [m <sup>4</sup> ]	8,1380e-07		1,4197e-04
W <sub>el y, z</sub> [m <sup>3</sup> ]	6,9700e-04		6,9700e-04
W <sub>pl y, z</sub> [m <sup>3</sup> ]	8,2200e-04		8,2200e-04
d <sub>y, z</sub> [mm]	0		0
e <sub>YUCS, ZUCS</sub> [mm]	125		125
α [deg]	0,00		
A <sub>L, D</sub> [m <sup>2</sup> /m]	9,5708e-01		1,8510e+00
M <sub>pl y, z</sub> [Nm]	2,92e+05		2,92e+05
M <sub>pl z, y</sub> [Nm]	2,92e+05		2,92e+05

Slika 5.17. Prikaz geometrijskih karakteristika nosača – poz 400

-iskoristivost elementa na GSN – 88%

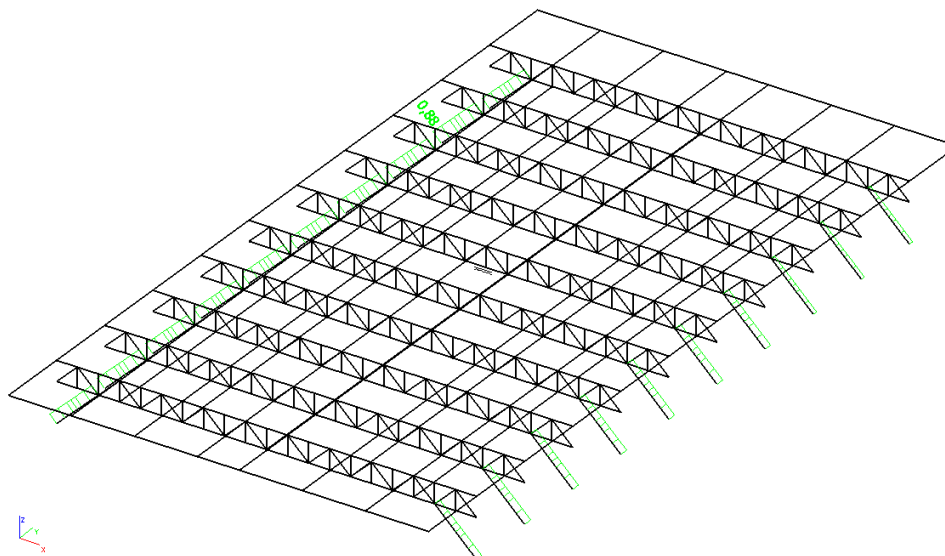

Slika 5.18. Prikaz iskoristivosti ispune rešetkastog nosača – poz 400

### 5.4.8. Dimenzioniranje – podupora glavnog rešetkastog nosača

Member B5380	4,346 m	F250X10	S 355	GSN 22	0,88 -
--------------	---------	---------	-------	--------	--------

Note: EN 1993-1-3 article 1.1(3) specifies that this part does not apply to cold formed CHS and RHS sections. The default EN 1993-1-1 code check is executed instead of the EN 1993-1-3 code check.

Partial safety factors	
Gamma M0 for resistance of cross-sections	1,00
Gamma M1 for resistance to instability	1,00
Gamma M2 for resistance of net sections	1,25

Material		
Yield strength fy	355,0	MPa
Ultimate strength fu	510,0	MPa
Fabrication	Cold formed	

....:SECTION CHECK:....

The critical check is on position 4.346 m

Internal forces	Calculated	Unit
N,Ed	-2297,84	kN
Vy,Ed	0,00	kN
Vz,Ed	0,00	kN
T,Ed	0,00	kNm
My,Ed	0,00	kNm
Mz,Ed	0,00	kNm

**Classification for cross-section design**

According to EN 1993-1-1 article 5.5.2

**Classification of Internal Compression parts**

According to EN 1993-1-1 Table 5.2 Sheet 1

Maximum width-to-thickness ratio	22,00
Class 1 Limit	26,85
Class 2 Limit	30,92
Class 3 Limit	34,17

=> Section classified as Class 1 for cross-section design

**Compression check**

According to EN 1993-1-1 article 6.2.4 and formula (6.9)

A	9,2600e-03	m <sup>2</sup>
Nc,Rd	3287,30	kN
Unity check	0,70	-

The member satisfies the section check.

....:STABILITY CHECK:....

**Classification for member buckling design**

Decisive position for stability classification: 0,000 m

**Classification of Internal Compression parts**

According to EN 1993-1-1 Table 5.2 Sheet 1

Maximum width-to-thickness ratio	22,00
Class 1 Limit	26,85
Class 2 Limit	30,92
Class 3 Limit	34,17

=> Section classified as Class 1 for member buckling design

**Flexural Buckling check**

According to EN 1993-1-1 article 6.3.1.1 and formula (6.46)

Buckling parameters	yy	zz	
Sway type	sway	non-sway	
System length L	4,346	4,346	m
Buckling factor k	1,00	1,00	
Buckling length Lcr	4,346	4,346	m
Critical Euler load Ncr	9556,01	9556,49	kN
Slenderness Lambda	44,82	44,81	
Relative slenderness Lambda,rel	0,59	0,59	
Limit slenderness Lambda,rel,0	0,20	0,20	
Buckling curve	c	c	
Imperfection Alpha	0,49	0,49	
Reduction factor Chi	0,79	0,79	
Buckling resistance Nb,Rd	2607,97	2608,00	kN

Flexural Buckling verification		
Cross-section area A	9,2600e-03	m <sup>2</sup>
Buckling resistance Nb,Rd	2607,97	kN
Unity check	0,88	-

The member satisfies the stability check.

### 5.4.9. Rezne sile – sekundarni gredni nosač

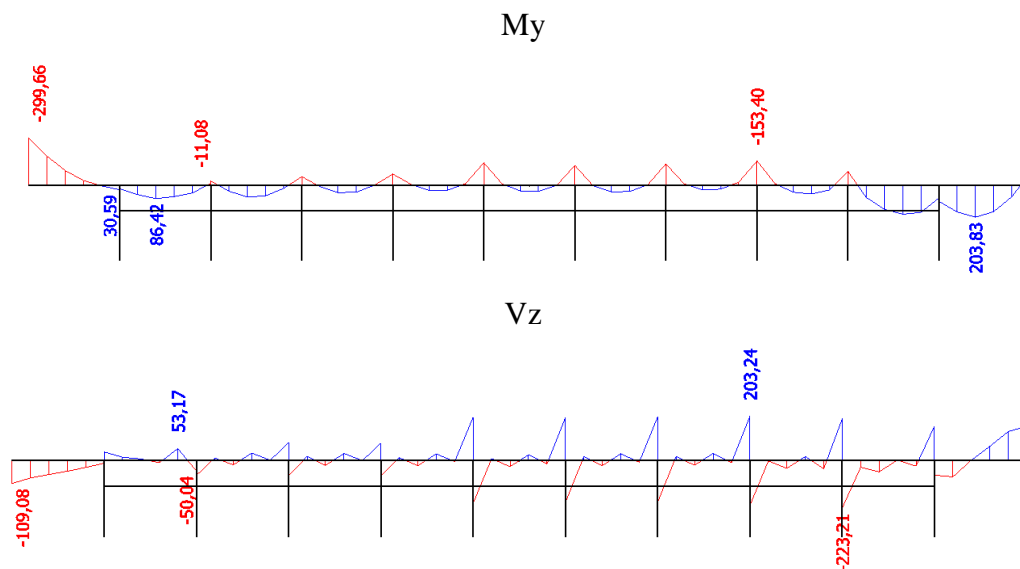

Slika 5.19. Prikaz reznih sila – sekundarni gredni nosač – poz 400

-poprečni presjek nosača

Name	Sekundarni gredni nosač - krov velike dvorane	
Type	HEB240	
Source description	Profil Arbed / Structural shapes / Edition Octobre 1995	
Item material	S 355	
Fabrication	rolled	
Flexural buckling y-y	b	
Flexural buckling z-z	c	
Lateral torsional buckling	Default	
Use 2D FEM analysis	x	
A [m <sup>2</sup> ]	1,0600e-02	
A y, z [m <sup>2</sup> ]	7,8218e-03	2,5536e-03
I y, z [m <sup>4</sup> ]	1,1260e-04	3,9230e-05
I w [m <sup>6</sup> ], t [m <sup>4</sup> ]	4,8695e-07	1,0270e-06
Wey, z [m <sup>3</sup> ]	9,3830e-04	3,2690e-04
Wply, z [m <sup>3</sup> ]	1,0530e-03	4,9840e-04
d y, z [mm]	0	0
c YUCS, ZUCS [mm]	120	120
α [deg]	0,00	
A L, D [m <sup>2</sup> /m]	1,3800e+00	1,3838e+00
Mply +, - [Nm]	3,74e+05	3,74e+05
Mplz +, - [Nm]	1,77e+05	1,77e+05

Slika 5.20. Prikaz geometrijskih karakteristika nosača – poz 400



## 5.4.10. Dimenzioniranje – sekundarni gredni nosač

SCIAENGINEER

## Composite Beam - Final stage

Linear calculation  
 Class: All ULS  
 Extreme 1D: Global  
 Selection: B5051

## Composite beam verification

for beam B5051 at section 5.4 m, in accordance with EC EN 1994-1-1

## 1. Geometry data

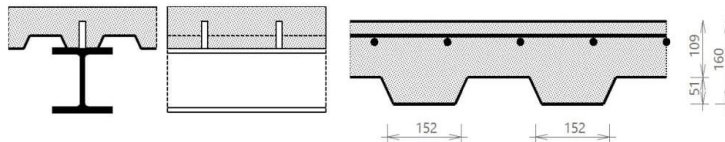

## Simply supported beam

Length of the current span	$L = 5.4 \text{ m}$
Beam spacing at the left	$L_{\text{left}} = 3.14 \text{ m}$
Beam spacing at the right	$L_{\text{right}} = 4.72 \text{ m}$
Checked section	$d_x = 5.4 \text{ m}$

## 2. Cross-section &amp; materials

## 2.1 Steel section properties

## 2.1.1 Cross-section

Cross-section	HEB240
Height	$h_a = 240 \text{ mm}$
Width	$b = 240 \text{ mm}$
Web thickness	$t_w = 10 \text{ mm}$
Flange thickness	$t_f = 17 \text{ mm}$
Radius	$r = 21 \text{ mm}$
Area	$A_a = 10600 \text{ mm}^2$
Moment of inertia	$I_y = 113 \cdot 10^6 \text{ mm}^4$
Radius of gyration	$i_z = 61 \text{ mm}$
Plastic section modulus	$W_{\text{ply}} = 1.053 \cdot 10^6 \text{ mm}^3$

## 2.1.2 Material

Steel grade	S 355
Yield strength	$f_{yb} = 355 \text{ MPa}$
Ultimate strength	$f_{ub} = 490 \text{ MPa}$
E modulus	$E_b = 210000 \text{ MPa}$

## 2.1.3 Cross-section classification

$$\varepsilon = \sqrt{\frac{235}{355}} = 0.814$$

(EN 1993-1-1 §5.6 Tab. 5.2)

## 2.1.3.1 Flange in compression

$$c_f = \frac{b - t_w - 2 \cdot r}{2} = \frac{240 \text{ mm} - 10 \text{ mm} - 2 \cdot 21 \text{ mm}}{2} = 94 \text{ mm}$$

$$\frac{c_f}{t_f} \leq 9 \cdot \varepsilon$$

$$\frac{94 \text{ mm}}{17 \text{ mm}} \leq 9 \cdot 0.814$$

$$5.53 \leq 7.32$$

OK

Flange classified as Class 1.

## 2.1.3.2 Web in bending

$$c_w = h_a - 2 \cdot t_f - 2 \cdot r = 240 \text{ mm} - 2 \cdot 17 \text{ mm} - 2 \cdot 21 \text{ mm} = 164 \text{ mm}$$

$$\alpha_{cl} = 0.5$$

$$\frac{c_w}{t_w} \leq \frac{36 \cdot \varepsilon}{\alpha_{cl}}$$

$$\frac{164 \text{ mm}}{10 \text{ mm}} \leq \frac{36 \cdot 0.814}{0.5}$$

$$16.4 \leq 58.6$$

OK

Web classified as Class 1.

## Cross-section classified as Class 1

Cross-section Class OK.

**2.2 Concrete slab with profiled sheeting****2.2.1 Concrete slab****2.2.1.1 Slab**Total height of the slab  $h_s = 160$  mm**2.2.1.2 Material**

Concrete class	C30/37
Characteristic strength	$f_{ck} = 30$ MPa
E modulus	$E_{cm} = 32800$ MPa

**2.2.2 Profiled steel sheeting**

Sheeting with ribs parallel to the supporting beams

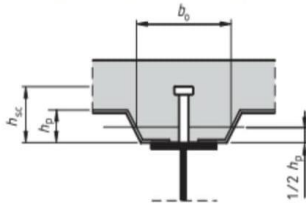

Name	Vulcraft 2 VLI 20
Depth of the ribs	$h_p = 50.8$ mm
Height of full concrete	$h_c = 109.2$ mm
Height of the re-entrant stiffener	$h_d = 0$ mm
Spacing of the ribs	$b_s = 304.8$ mm
Top width of the rib	$b_r = 127$ mm
Bottom width of the rib	$b_b = 127$ mm
Mean width of the ribs	$b_{0,rib} = 152.4$ mm
Thickness of the sheeting	$t_p = 0.9093$ mm

**2.2.3 Shear connectors****2.2.3.1 Geometry**

Name	H110
Diameter	$d_s = 25$ mm
Nominal height	$h_{nom} = 110$ mm
As-welded height	$h_{sc} = 105$ mm
Amount per trough or section	$n_r = 1$

**2.2.3.2 Material**

Steel grade	S 355
Ultimate strength	$f_{us} = 490$ MPa

**2.2.4 Reinforcement****2.2.4.1 Geometry**

Longitudinal bar diameter	$d_l = 16$ mm
Longitudinal bar spacing	$s_l = 150$ mm
Longitudinal bar cover	$c_l = 30$ mm
Transverse bar diameter	$d_t = 16$ mm
Transverse bar spacing	$s_t = 150$ mm
Transverse bar cover	$c_t = 46$ mm

**2.2.4.2 Material**

Material	B 500A
Characteristic yield strength	$f_{ykr} = 500$ MPa

**3. Design values of loads**

Load Name : GSN 7

Content of combination :  $1.35 \cdot g$ -vlastitatežina+ $1.35 \cdot dg$ -dodatnostalno+  
 $1.35 \cdot g$ -vlastitatežina\_dryconcrete+ $1.50 \cdot Wy$ -1kom.-Wz-pozBending moment  $M_{Ed,comp} = -299.657$  kNmShear force  $V_{Ed,comp} = -109.078$  kN

4. Partial safety factors

Steel section	$\gamma_{M0} = 1$
	$\gamma_{M1} = 1$
Shear connectors	$\gamma_V = 1.25$
Concrete	$\gamma_C = 1.5$
Reinforcement	$\gamma_S = 1.15$

5. ULS check of the Final stage

5.1 Shear connection

5.1.1 Design resistance of shear connectors

5.1.1.1 Shear connector in a solid slab

$$\frac{h_{sc}}{d_s} > 4$$

$$4.2 > 4$$

$$\alpha = 1$$

$$f_{us} = \min(490; 500) \text{ MPa}$$

$$P_{Rd,solid,1} = \frac{0.8 \cdot f_{us} \cdot \left(\frac{\pi \cdot d_s^2}{4}\right)}{\gamma_V} = \frac{0.8 \cdot 490 \text{ MPa} \cdot \left(\frac{3.14 \cdot 25 \text{ mm}^2}{4}\right)}{1.25} = 154 \text{ kN}$$

$$P_{Rd,solid,2} = \frac{0.29 \cdot \alpha \cdot d_s^2 \cdot \sqrt{f_{ck} \cdot E_{cm}}}{\gamma_V} = \frac{0.29 \cdot 1 \cdot 25 \text{ mm}^2 \cdot \sqrt{30 \text{ MPa} \cdot 32800 \text{ MPa}}}{1.25} = 144 \text{ kN}$$

$$P_{Rd,solid} = \min(P_{Rd,solid,1}; P_{Rd,solid,2}) = \min(154 \text{ kN}; 144 \text{ kN}) = 144 \text{ kN}$$

5.1.1.2 Shear connector in profiled sheeting

Sheeting with ribs parallel to the supporting beams

$$k_1 = \frac{0.6 \cdot b_{0,rib}}{h_p} \cdot \left(\frac{h_{sc}}{h_p} - 1\right) = \frac{0.6 \cdot 152 \text{ mm}}{50.8 \text{ mm}} \cdot \left(\frac{105 \text{ mm}}{50.8 \text{ mm}} - 1\right) = 1.92$$

$$k_1 = 1$$

$$P_{Rd} = k_1 \cdot P_{Rd,solid} = 1 \cdot 144 \text{ kN} = 144 \text{ kN}$$

5.1.2 Degree of shear connection

5.1.2.1 Determination of  $b_{eff}$  of the concrete flange and length  $L_e$

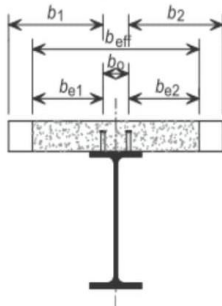

The effective width at the end support

$$L_{e0} = L_1 = 5.4 \text{ m}$$

Left side of the beam

$$b_1 = \frac{L_{perp, left}}{2} - \frac{b_0}{2} = \frac{3.14 \text{ m}}{2} - \frac{0 \text{ mm}}{2} = 1.57 \text{ m}$$

$$b_{e10} = \min\left(\frac{L_{e0}}{8}; b_1\right) = \min\left(\frac{5.4 \text{ m}}{8}; 1.57 \text{ m}\right) = 0.675 \text{ m}$$

$$b_{e11} = \min\left(\frac{L_{e1}}{8}; b_1\right) = \min\left(\frac{0 \text{ m}}{8}; 1.57 \text{ m}\right) = 0 \text{ m}$$

$$b_{e12} = \min\left(\frac{L_{e2}}{8}; b_1\right) = \min\left(\frac{0 \text{ m}}{8}; 1.57 \text{ m}\right) = 0 \text{ m}$$

$$\beta_{1, calc} = 0.55 + \frac{0.025 \cdot L_{e0}}{b_{e10}} = 0.55 + \frac{0.025 \cdot 5.4 \text{ m}}{0.675 \text{ m}} = 0.75$$

$$\beta_{1, calc} \leq 1.0$$

$$0.75 \leq 1.0$$

$$\beta_1 = \beta_{1, calc} = 0.75$$

OK

**Right side of the beam**

$$b_2 = \frac{L_{\text{perp, right}}}{2} - \frac{b_0}{2} = \frac{4.72 \text{ m}}{2} - \frac{0 \text{ mm}}{2} = 2.36 \text{ m}$$

$$b_{e20} = \min\left(\frac{L_{e0}}{8}; b_2\right) = \min\left(\frac{5.4 \text{ m}}{8}; 2.36 \text{ m}\right) = 0.675 \text{ m}$$

$$b_{e21} = \min\left(\frac{L_{e1}}{8}; b_2\right) = \min\left(\frac{0 \text{ m}}{8}; 2.36 \text{ m}\right) = 0 \text{ m}$$

$$b_{e22} = \min\left(\frac{L_{e2}}{8}; b_2\right) = \min\left(\frac{0 \text{ m}}{8}; 2.36 \text{ m}\right) = 0 \text{ m}$$

$$\beta_{2, \text{calc}} = 0.55 + \frac{0.025 \cdot L_{e0}}{b_{e20}} = 0.55 + \frac{0.025 \cdot 5.4 \text{ m}}{0.675 \text{ m}} = 0.75$$

$$\beta_{2, \text{calc}} \leq 1.0$$

$$0.75 \leq 1.0 \quad \text{OK}$$

$$\beta_2 = \beta_{2, \text{calc}} = 0.75$$

**Calculation of  $b_{\text{eff},0}$**

$$b_{\text{eff},0} = b_0 + b_{e10} \cdot \beta_1 + b_{e20} \cdot \beta_2 = 0 \text{ mm} + 0.675 \text{ m} \cdot 0.75 + 0.675 \text{ m} \cdot 0.75 = 1.01 \text{ m}$$

**Calculation of  $b_{\text{eff}}$**

$$b_{\text{eff}} = b_{\text{eff},0} = 1.01 \text{ m}$$

**Determination of  $L_e$**

$$L_e = L_{e0} = 5.4 \text{ m}$$

**5.1.2.2 Minimum degree of shear connection**

Warning: Conditions given by EN 1994-1-1 Art. 6.6.1.2 (3) are not fulfilled.

$$\eta_{\text{min, calc}} = 1 - \frac{355}{f_{yb}} \cdot (0.75 - 0.03 \cdot L_e)$$

$$\eta_{\text{min, calc}} = 1 - \frac{355}{355} \cdot (0.75 - 0.03 \cdot 5.4 \text{ m}) = 0.41$$

$$\eta_{\text{min}} = \max(\eta_{\text{min, calc}}; 0.4) = \max(0.41; 0.4) = 0.41$$

**5.1.2.3 Degree of shear connection present**

**5.1.2.3.1 Tension resistance of the reinforcement**

$$A_s = \frac{b_{\text{eff}}}{s_l} \cdot \left(\frac{d_l}{4}\right)^2 \cdot \pi = \frac{1.01 \text{ m}}{150 \text{ mm}} \cdot \left(\frac{16 \text{ mm}}{4}\right)^2 \cdot 3.14 = 1357 \text{ mm}^2$$

$$F_s = \frac{A_s \cdot f_{yk,r}}{\gamma_s} = \frac{1.36 \cdot 10^{-3} \cdot 500 \cdot 10^6}{1.15} = 590 \text{ kN}$$

**5.1.2.3.2 Tension resistance of the steel member**

$$N_{pl,a} = f_{yb} \cdot A_a = 355 \text{ MPa} \cdot 10600 \text{ mm}^2 = 3763.00 \text{ kN}$$

$$N_{c,r} = \min(F_s; N_{pl,a}) = \min(590 \text{ kN}; 3763.00 \text{ kN}) = 590.07 \text{ kN}$$

**5.1.2.3.3 Resistance of the shear connectors**

$$l_s = \frac{L}{n_{\text{row}}} = \frac{5.4}{18} = 300 \text{ mm}$$

Number of shear studs available per length  $L_e/2$

$$n_{sp} = \frac{0.5 \cdot L_e}{l_s} \cdot n_r$$

$$n_{sp} = 9 \cdot 1 = 9$$

$$N_c = n_{sp} \cdot P_{Rd} = 9 \cdot 143835 = 1294.52 \text{ kN}$$

$$\eta = \min\left(\frac{N_c}{N_{c,r}}; 1\right) = \min\left(\frac{1294.52 \text{ kN}}{590.07 \text{ kN}}; 1\right) = 1$$

$$\eta \geq \eta_{\text{min}}$$

$$1 \geq 0.41 \quad \text{OK}$$

The shear connection degree is adequate.

Student version

## 5.2 Cross-sectional resistance of the composite beam

### 5.2.1 Shear buckling

$$h_w = h_s - 2 \cdot t_f = 240 \text{ mm} - 2 \cdot 17 \text{ mm} = 206 \text{ mm}$$

$$\eta_{sb} = 1.2$$

$$\frac{h_w}{t_w} \leq \frac{72 \cdot \epsilon}{\eta_{sb}}$$

$$\frac{206 \text{ mm}}{10 \text{ mm}} \leq \frac{72 \cdot 0.814}{1.2}$$

$$20.6 \leq 48.8$$

OK

The shear buckling resistance of the web does not need to be verified.

### 5.2.2 Vertical shear

The resistance to vertical shear should be taken as the resistance of the structural steel section.

$$A_v = A_s - 2 \cdot b \cdot t_f + (t_w + 2 \cdot r) \cdot t_f$$

$$= 0.0106 - 2 \cdot 0.24 \cdot 0.017 + (0.01 + 2 \cdot 0.021) \cdot 0.017 = 3324 \text{ mm}^2$$

$$A_{v,min} = \eta_{sb} \cdot h_w \cdot t_w = 1.2 \cdot 0.206 \cdot 0.01 = 2472 \text{ mm}^2$$

$$A_v \geq A_{v,min}$$

$$3324 \text{ mm}^2 \geq 2472 \text{ mm}^2$$

$$V_{pl,Rd} = \frac{A_v \cdot f_{yb}}{\sqrt{3} \cdot \gamma_{M0}} = \frac{3324 \text{ mm}^2 \cdot 355 \cdot 10^6}{\sqrt{3} \cdot 1} = 681 \text{ kN}$$

$$UC_{comp,V} = \frac{\text{abs}(V_{Ed,comp})}{V_{pl,Rd}} = \frac{\text{abs}(-109.078 \text{ kN})}{681 \text{ kN}} = 0.16$$

The shear resistance of the section is adequate.

### 5.2.3 Bending moment

#### 5.2.3.1 Longitudinal reinforcement

##### 5.2.3.1.1 Centre of composite section

For buildings not intended mainly for storage the effects of creep in concrete beams may be taken into account by using an effective E modulus  $E_{eff} = E_{cm} / 2$ .

$$E_{eff} = \frac{E_{cm}}{2} = \frac{32800 \text{ MPa}}{2} = 16400 \text{ MPa}$$

$$\eta_{\epsilon} = \frac{E_b}{E_{eff}} = \frac{210000 \text{ MPa}}{16400 \text{ MPa}} = 12.8$$

$$y_d = \frac{A_a \cdot \left( \frac{h_a}{2} \right) + \left( \frac{1}{\eta_{\epsilon}} \right) \cdot b_{eff} \cdot (h_c - h_d) \cdot \left( h_a + h_s - \frac{h_c - h_d}{2} \right)}{A_a + \left( \frac{1}{\eta_{\epsilon}} \right) \cdot b_{eff} \cdot (h_c - h_d)}$$

$$= \frac{0.0106 \cdot \left( \frac{0.24}{2} \right) + \left( \frac{1}{12.8} \right) \cdot 1.01 \cdot (0.109 - 0) \cdot \left( 0.24 + 0.16 - \frac{0.109 - 0}{2} \right)}{0.0106 + \left( \frac{1}{12.8} \right) \cdot 1.01 \cdot (0.109 - 0)} = 221 \text{ mm}$$

##### 5.2.3.1.2 Degree of reinforcement

$$A_s = \frac{b_{eff}}{s_l} \cdot \left( \frac{d_l^2}{4} \right) \cdot \pi = \frac{1.01 \text{ m}}{150 \text{ mm}} \cdot \left( \frac{16 \text{ mm}^2}{4} \right) \cdot 3.14 = 1357 \text{ mm}^2$$

$$A_c = b_{eff} \cdot (h_c - h_d) = 1.01 \cdot (0.109 - 0) = 110565 \text{ mm}^2$$

$$z_0 = \left( h_a + h_s - \frac{h_c - h_d}{2} \right) - y_d = \left( 0.24 + 0.16 - \frac{0.109 - 0}{2} \right) - 0.221 = 124 \text{ mm}$$

$$k_{\epsilon} = \min \left( \frac{1}{\left( 1 + \frac{h_c - h_d}{2 \cdot z_0} \right)} + 0.3; 1 \right) = \min \left( \frac{1}{\left( 1 + \frac{0.109 - 0}{2 \cdot 0.124} \right)} + 0.3; 1 \right) = 0.995$$

$$\rho_s = \delta \cdot \left( \frac{f_{yb}}{235} \right) \cdot \left( \frac{f_{ctm}}{f_{yk,r}} \right) \cdot \sqrt{k_{\epsilon}} = 1.1 \cdot \left( \frac{355}{235} \right) \cdot \left( \frac{2.9 \cdot 10^6}{500 \cdot 10^6} \right) \cdot \sqrt{0.995} = 0.961 \%$$

$$A_s \geq \rho_s \cdot A_c$$

$$1357 \text{ mm}^2 \geq 9.61 \cdot 10^{-3} \cdot 110565 \text{ mm}^2$$

$$1357 \text{ mm}^2 \geq 1063 \text{ mm}^2 \quad \text{OK}$$

The longitudinal reinforcement of the section is adequate.

5.2.3.2 Moment resistance

Moment resistance of a steel cross-section

$$M_{pl,Rd,a} = \frac{W_{ply} \cdot f_{yb}}{Y_{MO}} = \frac{1.05 \cdot 10^6 \text{ mm}^3 \cdot 355 \text{ MPa}}{1} = 374 \text{ kNm}$$

Influence of shear

$$\frac{V_{pl,Rd}}{2} > \text{abs}(V_{Ed,comp})$$

$$\frac{681 \text{ kN}}{2} > 109 \text{ kN}$$

$$341 \text{ kN} > 109 \text{ kN}$$

OK

The influence of the vertical shear on the bending moment resistance may be neglected.

$$f_{y,b,w} = f_{y,b} = 355 \text{ MPa}$$

Modified tension resistance of the steel member

$$r = 0 \text{ mm}$$

$$A_a = 2 \cdot t_f \cdot b + t_w \cdot (h_a - 2 \cdot t_f) = 2 \cdot 17 \text{ mm} \cdot 240 \text{ mm} + 10 \text{ mm} \cdot (240 \text{ mm} - 2 \cdot 17 \text{ mm}) = 10220 \text{ mm}^2$$

$$N_{pl,a} = A_a \cdot f_{y,b} = 10220 \text{ mm}^2 \cdot 355 \text{ MPa} = 3628.10 \text{ kN}$$

Note: Roundings of the steel cross-section are neglected in bending resistance calculation.

$$N_{c,f} = \min(F_s; N_{pl,a}) = \min(590 \text{ kN}; 3628.10 \text{ kN}) = 590.07 \text{ kN}$$

Negative bending moment resistance calculation

The plastic neutral axis is located within the web of the steel section.

$$N_{at,f} = b \cdot t_f \cdot f_{y,b} = 0.24 \cdot 0.017 \cdot 355 \cdot 10^6 = 1448.40 \text{ kN}$$

$$N_{pl,a} - N_{at,f} - N_{at,w} = F_s + N_{at,f} + N_{at,w}$$

$$x = \frac{(N_{pl,a} - 2 \cdot N_{at,f} - F_s)}{(2 \cdot t_w \cdot f_{y,b,w})} = \frac{(3628.10 \text{ kN} - 2 \cdot 1448.40 \text{ kN} - 590 \text{ kN})}{(2 \cdot 10 \text{ mm} \cdot 355 \text{ MPa})} = 19.9 \text{ mm}$$

Verification of the steel web classification.

$$\alpha_{cl} = \frac{c_w - x}{c_w} = \frac{164 - 19.9}{164} = 0.879$$

$$\frac{c_w}{t_w} \leq \frac{396 \cdot \epsilon}{13 \cdot \alpha_{cl} - 1}$$

$$\frac{164 \text{ mm}}{10 \text{ mm}} \leq \frac{396 \cdot 0.814}{13 \cdot 0.879 - 1}$$

$$16.4 \leq 30.9$$

OK

Web classified as Class 1.

$$N_{at,w} = t_w \cdot x \cdot f_{y,b,w} = 10 \text{ mm} \cdot 19.9 \text{ mm} \cdot 355 \text{ MPa} = 70.61 \text{ kN}$$

$$N_{a,c} = N_{pl,a} - N_{at,f} - N_{at,w} = 3628.10 \text{ kN} - 1448.40 \text{ kN} - 70.61 \text{ kN} = 2109.09 \text{ kN}$$

Leverage arm of the compression part of the steel section calculated to the PNA.

$$h_{cs} = \frac{(t_w \cdot (h_a - 2 \cdot t_f - x)^2 \cdot 0.5 + t_f \cdot b \cdot (h_a - 1.5 \cdot t_f - x))}{t_w \cdot (h_a - 2 \cdot t_f - x) + t_f \cdot b}$$

$$= \frac{(10 \cdot (240 - 2 \cdot 17 - 19.9)^2 \cdot 0.5 + 17 \cdot 240 \cdot (240 - 1.5 \cdot 17 - 19.9))}{10 \cdot (240 - 2 \cdot 17 - 19.9) + 17 \cdot 240} = 163 \text{ mm}$$

$$h_1 = x + t_f + h_s - c_1 + \frac{d_1}{2} = 0.0199 + 0.017 + 0.16 - 0.03 + \frac{0.016}{2} = 159 \text{ mm}$$

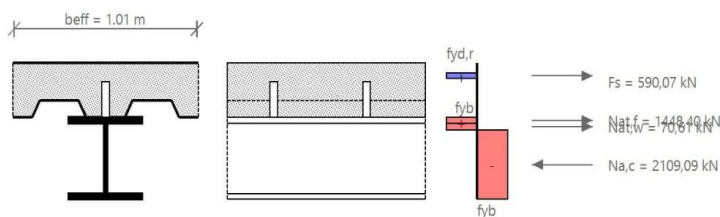

$$M_{pl,Rd} = F_s \cdot h_1 + N_{at,f} \cdot \left( \frac{t_f}{2} + x \right) + \frac{N_{at,w} \cdot x}{2} + N_{a,c} \cdot h_{cs}$$

$$= 590 \cdot 159 + 1448.40 \cdot \left( \frac{17}{2} + 19.9 \right) + \frac{70.61 \cdot 19.9}{2} + 2109.09 \cdot 163 = 479 \text{ kNm}$$

Design moment resistance according to EN 1994-1-1 Art.6.2.1.2

$$M_{Rd} = M_{pl,Rd} = 479 \text{ kNm}$$

$$UC_{comp,M} = \frac{\text{abs}(M_{Ed,comp})}{M_{Rd}} = \frac{\text{abs}(-299.657 \text{ kNm})}{479 \text{ kNm}} = 0.63$$

The bending moment resistance of the section is adequate.

**5.3 LTB resistance**

$$F = \left( 1 + \frac{t_w \cdot (h_a - t_f)}{4 \cdot b \cdot t_f} \right) \left( \frac{h_a - t_f}{t_w} \right)^{0.75} \cdot \left( \frac{t_f}{b} \right)^{0.25} = \left( 1 + \frac{10 \cdot (240 - 17)}{4 \cdot 240 \cdot 17} \right) \left( \frac{240 - 17}{10} \right)^{0.75} \cdot \left( \frac{17}{240} \right)^{0.25} = 6.02$$

$F_{lim} = 12.3$   
 $F \leq F_{lim}$

$6.02 \leq 12.3$  OK

The cross-section is qualified for verification of LTB by the simplified method.

$C_4 = 25$

$$\lambda_{LT,rel} = 5 \cdot \left( 1 + \frac{t_w \cdot (h_a - t_f)}{4 \cdot b \cdot t_f} \right) \left( \frac{h_a - t_f}{t_w} \right)^{0.75} \cdot \left( \frac{t_f}{b} \right)^{0.25} \cdot \left( \frac{f_{yb}}{E_b \cdot C_4} \right)^{0.5}$$

$$= 5 \cdot \left( 1 + \frac{0.01 \cdot (0.24 - 0.017)}{4 \cdot 0.24 \cdot 0.017} \right) \cdot \left( \frac{0.24 - 0.017}{0.01} \right)^{0.75} \cdot \left( \frac{0.017}{0.24} \right)^{0.25} \cdot \left( \frac{355 \cdot 10^6}{210 \cdot 10^9 \cdot 25} \right)^{0.5} = 0.247$$

$h_w/b < 2 \rightarrow$  Buckling curve 'a'

$\alpha_{LT} = 0.21$

$$\Phi_{LT} = 0.5 \cdot \left( 1 + \alpha_{LT} \cdot (\lambda_{LT,rel} - 0.2) + \lambda_{LT,rel}^2 \right) = 0.5 \cdot \left( 1 + 0.21 \cdot (0.247 - 0.2) + 0.247^2 \right) = 0.536$$

$$X_{LT} = \frac{1}{\Phi_{LT} + \sqrt{\Phi_{LT}^2 - \lambda_{LT,rel}^2}} = \frac{1}{0.536 + \sqrt{0.536^2 - 0.247^2}} = 0.99$$

$X_{LT} = \min(X_{LT}, 1) = \min(0.99; 1) = 0.99$

$M_{b,Rd} = X_{LT} \cdot M_{Rd} = 0.99 \cdot 478933 = 473.910 \text{ kNm}$

$UC_{comp\_LTB} = \frac{abs(M_{Ed,comp})}{M_{b,Rd}} = \frac{abs(-299.657 \text{ kNm})}{473.910 \text{ kNm}} = 0.63$

The later torsional buckling resistance of the section is adequate.

**5.4 Longitudinal shear**

**5.4.1 Transverse reinforcement**

Design shear flow

$h_f = h_c = 109 \text{ mm}$

$$v_{Ed} = \frac{N_{Rd} \cdot P_{Rd}}{2 \cdot I_s \cdot h_f} = \frac{1 \cdot 144 \text{ kN}}{2 \cdot 300 \text{ mm} \cdot 109 \text{ mm}} = 2.2 \text{ MPa}$$

Transverse reinforcement

$$\frac{A_{st} \cdot f_{yk,r}}{Y_s \cdot S_f} \geq \frac{v_{Ed} \cdot h_f}{\cotg(\theta)}$$

$A_t = A_{st}/S_f$

$$A_t = \frac{v_{Ed} \cdot h_f}{\left( \frac{\cotg(\theta)}{Y_s} \cdot f_{yk,r} \right)} = \frac{2.2 \cdot 10^6 \cdot 0.109}{\left( \frac{\cotg(26.5)}{1.15} \cdot 500 \cdot 10^6 \right)} = 275 \text{ mm}^2/\text{m}$$

$$A_{t,prov} = \frac{1}{S_f} \cdot \left( \frac{d_t^2}{4} \right) \cdot 3.14 = \frac{1}{0.15} \cdot \left( \frac{0.016^2}{4} \right) \cdot 3.14 = 1340 \text{ mm}^2/\text{m}$$

$A_{t,prov} \geq A_t$

$1340 \text{ mm}^2/\text{m} \geq 275 \text{ mm}^2/\text{m}$  OK

The transverse reinforcement of the section is adequate.

**ULS check of Final stage is OK.**

$UC_{comp} = \max(0.16; 0.63; 0.63) = 0.63$

-iskoristivost elementa na GSN – 63%

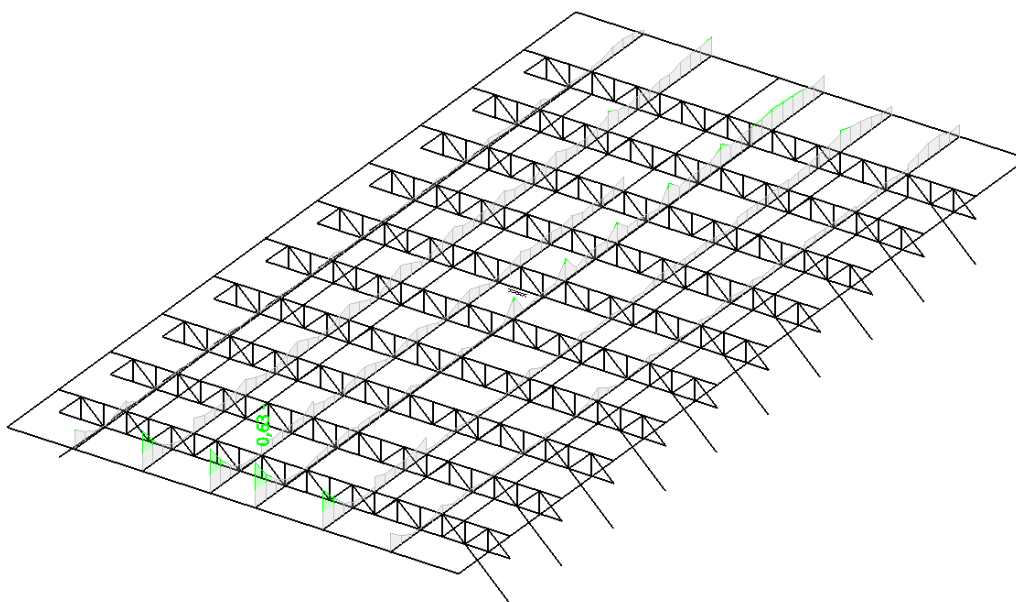

Slika 5.21. Prikaz iskoristivosti sekundarnog grednog nosača – poz 400

### 5.4.11. Rezne sile – spregovi

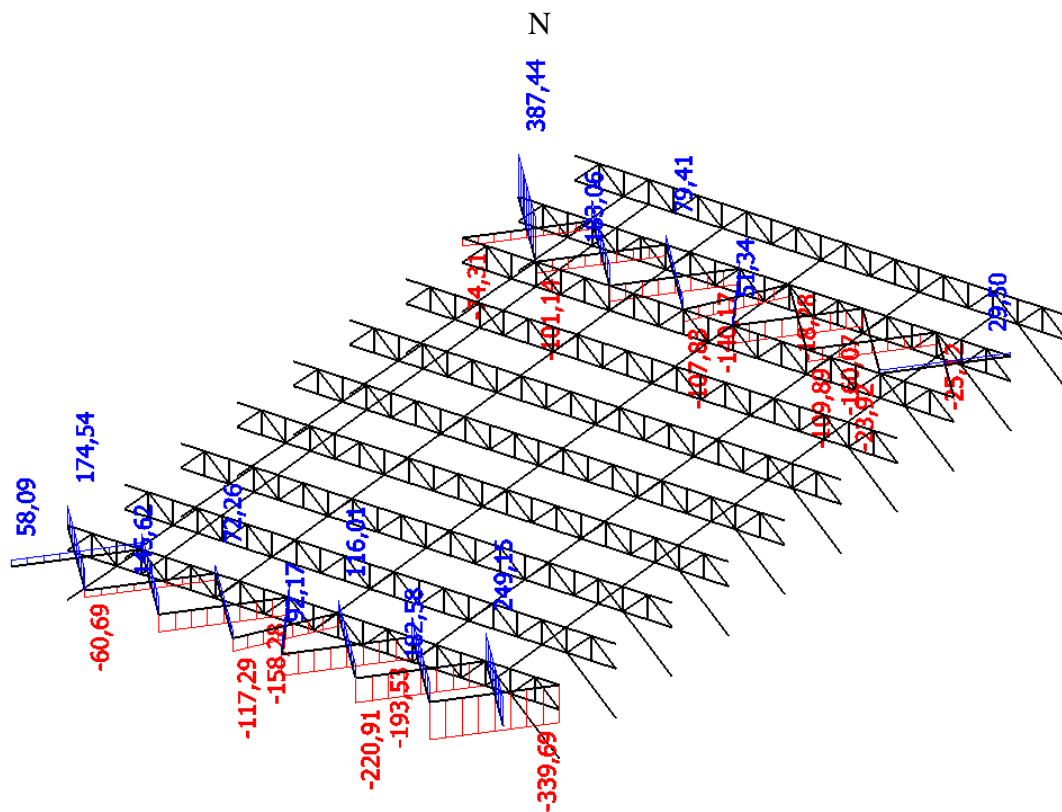

Slika 5.22. Prikaz reznih sila – spregovi – poz 400

-poprečni presjek nosača

Name	Spregovi - krov velike dvorane	
Type	RD55	
Source description	Stahl im Hochbau / 14.Auflage Band I / Teil 1	
Item material	S 355	
Fabrication	rolled	
Flexural buckling y-y	c	
Flexural buckling z-z	c	
Lateral torsional buckling	Default	
Use 2D FEM analysis	<input checked="" type="checkbox"/>	
A [m²]	2,3746e-03	
A <sub>y, z</sub> [m²]	2,1391e-03	2,1391e-03
I <sub>y, z</sub> [m⁴]	4,3977e-07	4,3977e-07
I <sub>w</sub> [m⁶], I <sub>t</sub> [m⁴]	1,6886e-20	9,0013e-07
W <sub>el y, z</sub> [m³]	1,5992e-05	1,5992e-05
W <sub>pl y, z</sub> [m³]	2,7292e-05	2,7292e-05
d <sub>y, z</sub> [mm]	0	0
c <sub>YUCS, ZUCS</sub> [mm]	28	28
α [deg]	0,00	
A <sub>L, D</sub> [m²/m]	1,7233e-01	1,7278e-01
M <sub>ply +, -</sub> [Nm]	9,84e+03	9,84e+03
M <sub>piz +, -</sub> [Nm]	9,84e+03	9,84e+03

Slika 5.23. Prikaz geometrijskih karakteristika nosača – poz 400



#### 5.4.12. Dimenzioniranje – spregovi

Dimenzioniranje elementa

$$N_{c,Rd} = N_{pl,Rd} = \frac{A \cdot f_y}{\gamma_{M_0}} = \frac{23,74 \cdot 35,5}{1,25} = 674,22(kN)$$

Uvjet nosivosti  $N_{c,Rd} \geq N_{Ed}$

$$674,22(kN) \geq 249,15 + 339,69 = 588,84(kN)$$

uvjet zadovoljen

-iskoristivost na GSN -  $588,84 kN / 674,22 kN = 0,87 = 87\%$

### 5.5. Pomaci spregnute krovne konstrukcije – krov srednje dvorane

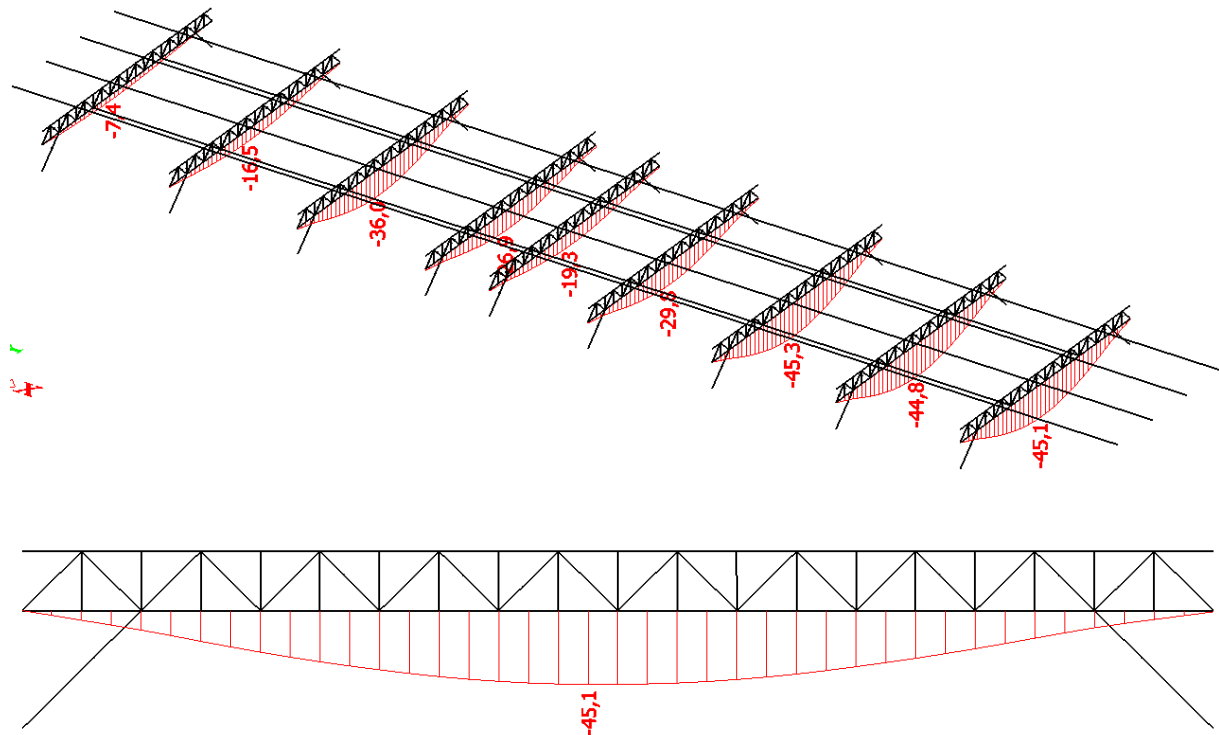

Slika 5.22. Prikaz progiba glavnog rešetkastog nosača – krov srednje dvorane

Dopušteni vertikalni pomak (progib):

$$u_{dop} = \frac{l}{300} = \frac{16.2 \cdot 1000}{300} = 54.0 \text{ mm}$$

$$u_z = 45.1 \text{ mm} < u_{z,dop} = 54.0 \text{ mm} \quad \text{Zadovoljava}$$

-iskoristivost na GSU -  $45.1 \text{ mm} / 54.0 \text{ mm} = 0,69 = 69\%$

## 5.6. Dimenziniranje spregnute krovne konstrukcije – krov srednje dvorane

### 5.6.1. Rezne sile – gornja pojasnica glavnog rešetkastog nosača

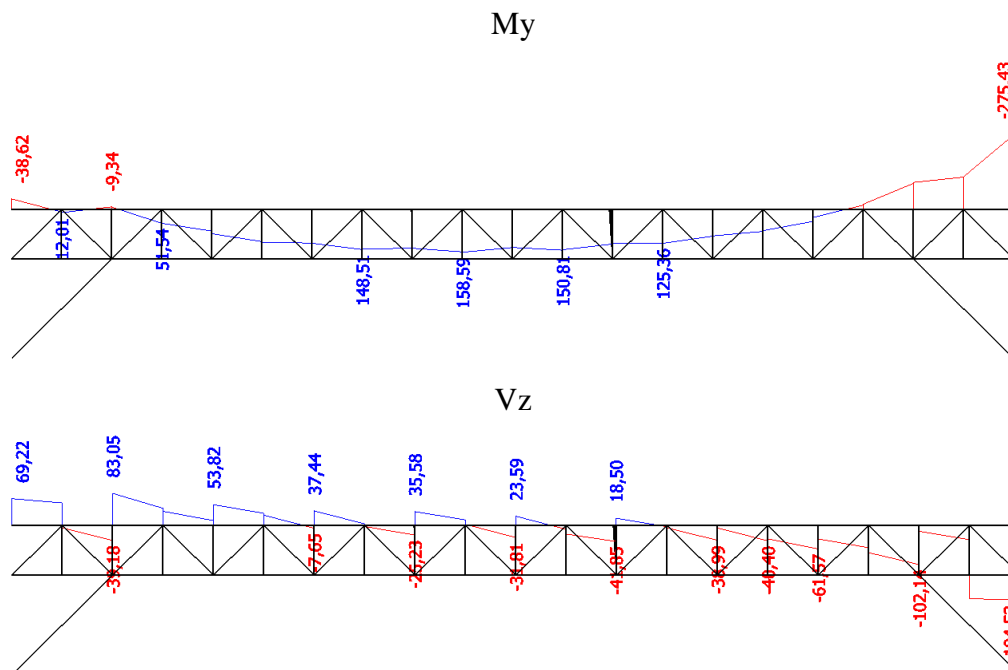

Slika 5.22. Prikaz reznih sila - gornja pojasnica glavnog rešetkastog nosača

-poprečni presjek nosača

Name	Gornja pojasnica glavnog rešetkastog nosača - krov srednje dvorane	
Type	HEB200	
Source description	Profil Arbed / Structural shapes / Edition Octobre 1995	
Item material	S 355	
Fabrication	rolled	
Flexural buckling y-y	b	
Flexural buckling z-z	c	
Lateral torsional buckling	Default	
Use 2D FEM analysis	x	
A [m <sup>2</sup> ]	7,8080e-03	
A <sub>y</sub> , z [m <sup>2</sup> ]	5,7750e-03	1,9112e-03
I <sub>y</sub> , z [m <sup>4</sup> ]	5,6960e-05	2,0030e-05
I <sub>w</sub> [m <sup>6</sup> ], t [m <sup>4</sup> ]	1,7112e-07	5,9280e-07
W <sub>el</sub> y, z [m <sup>3</sup> ]	5,6960e-04	2,0030e-04
W <sub>pl</sub> y, z [m <sup>3</sup> ]	6,4250e-04	3,0580e-04
d <sub>y</sub> , z [mm]	0	0
c YUCS, ZUCS [mm]	100	100
α [deg]	0,00	
A <sub>L</sub> , D [m <sup>2</sup> /m]	1,1500e+00	1,1510e+00
M <sub>ply</sub> +, - [Nm]	2,28e+05	2,28e+05
M <sub>plz</sub> +, - [Nm]	1,09e+05	1,09e+05

Slika 5.23.. Prikaz geometrijskih karakteristika nosača – poz 400

### 5.6.2. Dimenzioniranje – gornja pojasnica glavnog rešetkastog nosača

SCIAENGINEER

#### Composite Beam - Final stage

Linear calculation  
Class: All ULS  
Extreme 1D: Global  
Selection: B3329

#### Composite beam verification

for beam B3329 at section 16.2 m, in accordance with EC EN 1994-1-1

##### 1. Geometry data

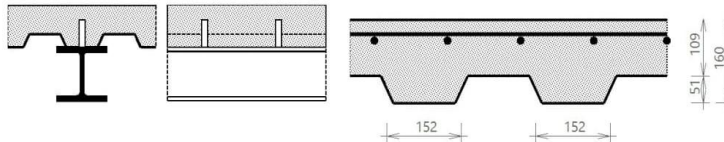

##### Simply supported beam

Length of the current span  $L = 16.2 \text{ m}$   
Beam spacing at the left  $L_{\text{left}} = 7.86 \text{ m}$   
Beam spacing at the right  $L_{\text{right}} = 7.86 \text{ m}$   
Checked section  $d_x = 16.2 \text{ m}$

Warning: For a continuous beam, intermediate buckling supports  $y$ -y are ignored in both the calculation of the effective width for the analysis model and the check.

##### 2. Cross-section & materials

###### 2.1 Steel section properties

###### 2.1.1 Cross-section

Cross-section HEB200  
Height  $h_a = 200 \text{ mm}$   
Width  $b = 200 \text{ mm}$   
Web thickness  $t_w = 9 \text{ mm}$   
Flange thickness  $t_f = 15 \text{ mm}$   
Radius  $r = 18 \text{ mm}$   
Area  $A_a = 7808 \text{ mm}^2$   
Moment of inertia  $I_y = 57 \cdot 10^6 \text{ mm}^4$   
Radius of gyration  $i_z = 51 \text{ mm}$   
Plastic section modulus  $W_{\text{ply}} = 642500 \text{ mm}^3$

###### 2.1.2 Material

Steel grade S 355  
Yield strength  $f_{yb} = 355 \text{ MPa}$   
Ultimate strength  $f_{ub} = 490 \text{ MPa}$   
E modulus  $E_b = 210000 \text{ MPa}$

###### 2.1.3 Cross-section classification

$$\epsilon = \sqrt{\frac{235}{355}} = 0.814$$

(EN 1993-1-1 §5.6 Tab. 5.2)

###### 2.1.3.1 Flange in compression

$$c_f = \frac{b - t_w - 2 \cdot r}{2} = \frac{200 \text{ mm} - 9 \text{ mm} - 2 \cdot 18 \text{ mm}}{2} = 77.5 \text{ mm}$$

$$\frac{c_f}{t_f} \leq 9 \cdot \epsilon$$

$$\frac{77.5 \text{ mm}}{15 \text{ mm}} \leq 9 \cdot 0.814$$

$$5.17 \leq 7.32$$

OK

Flange classified as Class 1.

Student version

**2.1.3.2 Web in bending**

$$c_w = h_a - 2 \cdot t_f - 2 \cdot r = 200 \text{ mm} - 2 \cdot 15 \text{ mm} - 2 \cdot 18 \text{ mm} = 134 \text{ mm}$$

$$\alpha_{cd} = 0.5$$

$$\frac{c_w}{t_w} \leq \frac{36 \cdot \epsilon}{\alpha_{cd}}$$

$$\frac{134 \text{ mm}}{9 \text{ mm}} \leq \frac{36 \cdot 0.814}{0.5}$$

$$14.9 \leq 58.6 \quad \text{OK}$$

Web classified as Class 1.

**Cross-section classified as Class 1**

Cross-section Class OK.

**2.2 Concrete slab with profiled sheeting**

**2.2.1 Concrete slab**

2.2.1.1 Slab

Total height of the slab  $h_s = 160 \text{ mm}$

2.2.1.2 Material

Concrete class C30/37  
 Characteristic strength  $f_{ck} = 30 \text{ MPa}$   
 E modulus  $E_{cm} = 32800 \text{ MPa}$

**2.2.2 Profiled steel sheeting**

Sheeting with ribs parallel to the supporting beams

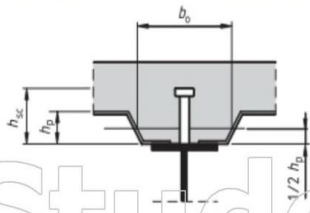

Name	Vulcraft 2 VLI 20
Depth of the ribs	$h_p = 50.8 \text{ mm}$
Height of full concrete	$h_c = 109.2 \text{ mm}$
Height of the re-entrant stiffener	$h_d = 0 \text{ mm}$
Spacing of the ribs	$b_s = 304.8 \text{ mm}$
Top width of the rib	$b_t = 127 \text{ mm}$
Bottom width of the rib	$b_b = 127 \text{ mm}$
Mean width of the ribs	$b_{0,rib} = 152.4 \text{ mm}$
Thickness of the sheeting	$t_p = 0.9093 \text{ mm}$

**2.2.3 Shear connectors**

2.2.3.1 Geometry

Name	H110
Diameter	$d_s = 25 \text{ mm}$
Nominal height	$h_{nom} = 110 \text{ mm}$
As-welded height	$h_{sc} = 105 \text{ mm}$
Amount per trough or section	$n_r = 1$

2.2.3.2 Material

Steel grade	S 355
Ultimate strength	$f_{us} = 490 \text{ MPa}$

**2.2.4 Reinforcement**

2.2.4.1 Geometry

Longitudinal bar diameter	$d_l = 16 \text{ mm}$
Longitudinal bar spacing	$s_l = 150 \text{ mm}$
Longitudinal bar cover	$c_l = 30 \text{ mm}$
Transverse bar diameter	$d_t = 16 \text{ mm}$
Transverse bar spacing	$s_t = 150 \text{ mm}$
Transverse bar cover	$c_t = 46 \text{ mm}$

2.2.4.2 Material

Material	B 500A
Characteristic yield strength	$f_{yk,r} = 500 \text{ MPa}$

**3. Design values of loads**

Load Name : GSN 7

Content of combination : 1.35\*g-vlastitežina+1.35\*dg-dodatnostalno+  
1.35\*g-vlastitežina\_dryconcrete+1.50\*Wy-1kom.-Wz-poz

Bending moment  $M_{Ed,comp} = -275.434 \text{ kNm}$   
Shear force  $V_{Ed,comp} = -194.528 \text{ kN}$

**4. Partial safety factors**

Steel section  $\gamma_{M0} = 1$   
 $\gamma_{M1} = 1$   
Shear connectors  $\gamma_V = 1.25$   
Concrete  $\gamma_C = 1.5$   
Reinforcement  $\gamma_S = 1.15$

**5. ULS check of the Final stage**

**5.1 Shear connection**

**5.1.1 Design resistance of shear connectors**

**5.1.1.1 Shear connector in a solid slab**

$$\frac{h_{sc}}{d_s} > 4$$

$$4.2 > 4$$

$$\alpha = 1$$

$$f_{us} = \min(490; 500) \text{ MPa}$$

$$P_{Rd,solid,1} = \frac{0.8 \cdot f_{us} \cdot \left(\frac{\pi \cdot d_s^2}{4}\right)}{\gamma_V} = \frac{0.8 \cdot 490 \text{ MPa} \cdot \left(\frac{3.14 \cdot 25 \text{ mm}^2}{4}\right)}{1.25} = 154 \text{ kN}$$

$$P_{Rd,solid,2} = \frac{0.29 \cdot \alpha \cdot d_s^2 \cdot \sqrt{f_{ck} \cdot E_{cm}}}{\gamma_V} = \frac{0.29 \cdot 1 \cdot 25 \text{ mm}^2 \cdot \sqrt{30 \text{ MPa} \cdot 32800 \text{ MPa}}}{1.25} = 144 \text{ kN}$$

$$P_{Rd,solid} = \min(P_{Rd,solid,1}; P_{Rd,solid,2}) = \min(154 \text{ kN}; 144 \text{ kN}) = 144 \text{ kN}$$

**5.1.1.2 Shear connector in profiled sheeting**

Sheeting with ribs parallel to the supporting beams

$$k_t = \frac{0.6 \cdot b_{0,rib}}{h_p} \cdot \left(\frac{h_{sc}}{h_p} - 1\right) = \frac{0.6 \cdot 152 \text{ mm}}{50.8 \text{ mm}} \cdot \left(\frac{105 \text{ mm}}{50.8 \text{ mm}} - 1\right) = 1.92$$

$$k_t = 1$$

$$P_{Rd} = k_t \cdot P_{Rd,solid} = 1 \cdot 144 \text{ kN} = 144 \text{ kN}$$

**5.1.2 Degree of shear connection**

**5.1.2.1 Determination of  $b_{eff}$  of the concrete flange and length  $L_e$**

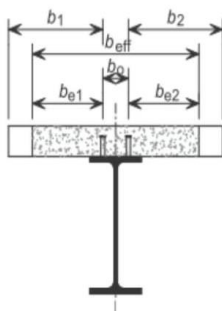

The effective width at the end support

$$L_{e0} = L_1 = 16.2 \text{ m}$$

**Left side of the beam**

$$b_1 = \frac{L_{\text{perp, left}}}{2} - \frac{b_0}{2} = \frac{7,86 \text{ m}}{2} - \frac{0 \text{ mm}}{2} = 3,93 \text{ m}$$

$$b_{e10} = \min\left(\frac{L_{e0}}{8}; b_1\right) = \min\left(\frac{16,2 \text{ m}}{8}; 3,93 \text{ m}\right) = 2,03 \text{ m}$$

$$b_{e11} = \min\left(\frac{L_{e1}}{8}; b_1\right) = \min\left(\frac{0 \text{ m}}{8}; 3,93 \text{ m}\right) = 0 \text{ m}$$

$$b_{e12} = \min\left(\frac{L_{e2}}{8}; b_1\right) = \min\left(\frac{0 \text{ m}}{8}; 3,93 \text{ m}\right) = 0 \text{ m}$$

$$\beta_{1, \text{calc}} = 0,55 + \frac{0,025 \cdot L_{e0}}{b_{e10}} = 0,55 + \frac{0,025 \cdot 16,2 \text{ m}}{2,03 \text{ m}} = 0,75$$

$$\beta_{1, \text{calc}} \leq 1,0$$

$$0,75 \leq 1,0 \quad \text{OK}$$

$$\beta_1 = \beta_{1, \text{calc}} = 0,75$$

**Right side of the beam**

$$b_2 = \frac{L_{\text{perp, right}}}{2} - \frac{b_0}{2} = \frac{7,86 \text{ m}}{2} - \frac{0 \text{ mm}}{2} = 3,93 \text{ m}$$

$$b_{e20} = \min\left(\frac{L_{e0}}{8}; b_2\right) = \min\left(\frac{16,2 \text{ m}}{8}; 3,93 \text{ m}\right) = 2,03 \text{ m}$$

$$b_{e21} = \min\left(\frac{L_{e1}}{8}; b_2\right) = \min\left(\frac{0 \text{ m}}{8}; 3,93 \text{ m}\right) = 0 \text{ m}$$

$$b_{e22} = \min\left(\frac{L_{e2}}{8}; b_2\right) = \min\left(\frac{0 \text{ m}}{8}; 3,93 \text{ m}\right) = 0 \text{ m}$$

$$\beta_{2, \text{calc}} = 0,55 + \frac{0,025 \cdot L_{e0}}{b_{e20}} = 0,55 + \frac{0,025 \cdot 16,2 \text{ m}}{2,03 \text{ m}} = 0,75$$

$$\beta_{2, \text{calc}} \leq 1,0$$

$$0,75 \leq 1,0 \quad \text{OK}$$

$$\beta_2 = \beta_{2, \text{calc}} = 0,75$$

**Calculation of  $b_{\text{eff},0}$**

$$b_{\text{eff},0} = b_0 + b_{e10} \cdot \beta_1 + b_{e20} \cdot \beta_2 = 0 \text{ mm} + 2,03 \text{ m} \cdot 0,75 + 2,03 \text{ m} \cdot 0,75 = 3,04 \text{ m}$$

**Calculation of  $b_{\text{eff}}$**

$$b_{\text{eff}} = b_{\text{eff},0} = 3,04 \text{ m}$$

**Determination of  $L_e$**

$$L_e = L_{e0} = 16,2 \text{ m}$$

**5.1.2.2 Minimum degree of shear connection**

Warning: Conditions given by EN 1994-1-1 Art. 6.6.1.2 (3) are not fulfilled.

$$\eta_{\text{min, calc}} = 1 - \frac{355}{f_{yb}} \cdot (0,75 - 0,03 \cdot L_e)$$

$$\eta_{\text{min, calc}} = 1 - \frac{355}{355} \cdot (0,75 - 0,03 \cdot 16,2 \text{ m}) = 0,74$$

$$\eta_{\text{min}} = \max(\eta_{\text{min, calc}}; 0,4) = \max(0,74; 0,4) = 0,74$$

**5.1.2.3 Degree of shear connection present**

**5.1.2.3.1 Tension resistance of the reinforcement**

$$A_s = \frac{b_{\text{eff}}}{s_l} \cdot \left(\frac{d_l^2}{4}\right) \cdot \pi = \frac{3,04 \text{ m}}{150 \text{ mm}} \cdot \left(\frac{16 \text{ mm}^2}{4}\right) \cdot 3,14 = 4072 \text{ mm}^2$$

$$F_s = \frac{A_s \cdot f_{yk,r}}{\gamma_s} = \frac{4,07 \cdot 10^{-3} \cdot 500 \cdot 10^6}{1,15} = 1770 \text{ kN}$$

**5.1.2.3.2 Tension resistance of the steel member**

$$N_{pl,a} = f_{yb} \cdot A_a = 355 \text{ MPa} \cdot 7808 \text{ mm}^2 = 2771,84 \text{ kN}$$

$$N_{c1} = \min(F_s; N_{pl,a}) = \min(1770 \text{ kN}; 2771,84 \text{ kN}) = 1770,22 \text{ kN}$$

Student version

**5.1.2.3.3 Resistance of the shear connectors**

$$l_s = \frac{L}{n_{row}} = \frac{16,2}{8} = 2,025 \text{ m} \approx 200 \text{ mm}$$

Number of shear studs available per length  $L_e/2$

$$n_{sp} = \frac{0,5 \cdot L_e}{l_s} \cdot n_r$$

$$n_{sp} = 40 \cdot 1 = 40$$

$$N_c = n_{sp} \cdot P_{Rd} = 40 \cdot 143835 = 5753.41 \text{ kN}$$

$$\eta = \min\left(\frac{N_c}{N_{cf}}, 1\right) = \min\left(\frac{5753.41 \text{ kN}}{1770.22 \text{ kN}}, 1\right) = 1$$

$$\eta \geq \eta_{min}$$

$$1 \geq 0.74 \quad \text{OK}$$

The shear connection degree is adequate.

**5.2 Cross-sectional resistance of the composite beam**

**5.2.1 Shear buckling**

$$h_w = h_a - 2 \cdot t_f = 200 \text{ mm} - 2 \cdot 15 \text{ mm} = 170 \text{ mm}$$

$$\eta_{sb} = 1.2$$

$$\frac{h_w}{t_w} \leq \frac{72 \cdot \epsilon}{\eta_{sb}}$$

$$\frac{170 \text{ mm}}{9 \text{ mm}} \leq \frac{72 \cdot 0.814}{1.2}$$

$$18.9 \leq 48.8 \quad \text{OK}$$

The shear buckling resistance of the web does not need to be verified.

**5.2.2 Vertical shear**

The resistance to vertical shear should be taken as the resistance of the structural steel section.

$$A_v = A_s - 2 \cdot b \cdot t_f + (t_w + 2 \cdot r) \cdot t_f$$

$$= 7.81 \cdot 10^{-3} - 2 \cdot 0.2 \cdot 0.015 + (9 \cdot 10^{-3} + 2 \cdot 0.018) \cdot 0.015 = 2483 \text{ mm}^2$$

$$A_{v,min} = \eta_{sb} \cdot h_w \cdot t_w = 1.2 \cdot 0.17 \cdot 9 \cdot 10^{-3} = 1836 \text{ mm}^2$$

$$A_v \geq A_{v,min}$$

$$2483 \text{ mm}^2 \geq 1836 \text{ mm}^2$$

$$V_{pl,Rd} = \frac{A_v \cdot f_{yb}}{\sqrt{3} \cdot \gamma_{M0}} = \frac{2483 \text{ mm}^2 \cdot 355 \cdot 10^6}{\sqrt{3} \cdot 1} = 509 \text{ kN}$$

$$UC_{comp,V} = \frac{abs(V_{Ed,comp})}{V_{pl,Rd}} = \frac{abs(-194.528 \text{ kN})}{509 \text{ kN}} = 0.38$$

The shear resistance of the section is adequate.

**5.2.3 Bending moment**

**5.2.3.1 Longitudinal reinforcement**

**5.2.3.1.1 Centre of composite section**

For buildings not intended mainly for storage the effects of creep in concrete beams may be taken into account by using an effective E modulus  $E_{eff} = E_{cm} / 2$ .

$$E_{eff} = \frac{E_{cm}}{2} = \frac{32800 \text{ MPa}}{2} = 16400 \text{ MPa}$$

$$\eta_E = \frac{E_b}{E_{eff}} = \frac{210000 \text{ MPa}}{16400 \text{ MPa}} = 12.8$$

$$y_d = \frac{A_a \cdot \left(\frac{h_a}{2}\right) + \left(\frac{1}{\eta_E}\right) \cdot b_{eff} \cdot (h_c - h_d) \cdot \left(h_a + h_s - \frac{h_c - h_d}{2}\right)}{A_a + \left(\frac{1}{\eta_E}\right) \cdot b_{eff} \cdot (h_c - h_d)}$$

$$= \frac{7.81 \cdot 10^{-3} \cdot \left(\frac{0.2}{2}\right) + \left(\frac{1}{12.8}\right) \cdot 3.04 \cdot (0.109 - 0) \cdot \left(0.2 + 0.16 - \frac{0.109 - 0}{2}\right)}{7.81 \cdot 10^{-3} + \left(\frac{1}{12.8}\right) \cdot 3.04 \cdot (0.109 - 0)} = 258 \text{ mm}$$

Student version



5.2.3.1.2 Degree of reinforcement

$$A_s = \frac{b_{eff} \cdot \left( \frac{d_l^2}{4} \right) \cdot \pi}{s_l} = \frac{3.04 \text{ m} \cdot \left( \frac{16 \text{ mm}^2}{4} \right)}{150 \text{ mm}} \cdot \pi = 3.14 = 4072 \text{ mm}^2$$

$$A_c = b_{eff} \cdot (h_c - h_d) = 3.04 \cdot (0.109 - 0) = 331695 \text{ mm}^2$$

$$z_0 = \left( h_a + h_s - \frac{h_c - h_d}{2} \right) - y_d = \left( 0.2 + 0.16 - \frac{0.109 - 0}{2} \right) - 0.258 = 47.6 \text{ mm}$$

$$k_c = \min \left( \frac{1}{1 + \frac{h_c - h_d}{2 \cdot z_0}} + 0.3; 1 \right) = \min \left( \frac{1}{1 + \frac{0.109 - 0}{2 \cdot 0.0476}} + 0.3; 1 \right) = 0.766$$

$$\rho_s = \delta \cdot \left( \frac{f_{yb}}{235} \right) \cdot \left( \frac{f_{ctm}}{f_{yk,r}} \right) \cdot \sqrt{k_c} = 1.1 \cdot \left( \frac{355}{235} \right) \cdot \left( \frac{2.9 \cdot 10^6}{500 \cdot 10^6} \right) \cdot \sqrt{0.766} = 0.843 \%$$

$$A_s \geq \rho_s \cdot A_c$$

$$4072 \text{ mm}^2 \geq 8.43 \cdot 10^{-3} \cdot 331695 \text{ mm}^2$$

$$4072 \text{ mm}^2 \geq 2797 \text{ mm}^2 \quad \text{OK}$$

The longitudinal reinforcement of the section is adequate.

5.2.3.2 Moment resistance

Moment resistance of a steel cross-section

$$M_{pl,Rd,a} = \frac{W_{ply} \cdot f_{yb}}{Y_{MO}} = \frac{642500 \text{ mm}^3 \cdot 355 \text{ MPa}}{1} = 228 \text{ kNm}$$

Influence of shear

$$\frac{V_{pl,Rd}}{2} > \text{abs}(V_{Ed,comp})$$

$$\frac{509 \text{ kN}}{2} > 195 \text{ kN}$$

$$254 \text{ kN} > 195 \text{ kN} \quad \text{OK}$$

The influence of the vertical shear on the bending moment resistance may be neglected.

$$f_{yb,w} = f_{yb} = 355 \text{ MPa}$$

Modified tension resistance of the steel member

$$r = 0 \text{ mm}$$

$$A_s = 2 \cdot t_f \cdot b + t_w \cdot (h_a - 2 \cdot t_f) = 2 \cdot 15 \text{ mm} \cdot 200 \text{ mm} + 9 \text{ mm} \cdot (200 \text{ mm} - 2 \cdot 15 \text{ mm}) = 7530 \text{ mm}^2$$

$$N_{pl,a} = A_s \cdot f_{yb} = 7530 \text{ mm}^2 \cdot 355 \text{ MPa} = 2673.15 \text{ kN}$$

Note: Roundings of the steel cross-section are neglected in bending resistance calculation.

$$N_{c,f} = \min(F_s; N_{pl,a}) = \min(1770 \text{ kN}; 2673.15 \text{ kN}) = 1770.22 \text{ kN}$$

Negative bending moment resistance calculation

The plastic neutral axis is located within the flange of the steel section.

$$N_{pl,a} - N_{a,f} = F_s + N_{a,f}$$

$$x = \frac{(N_{pl,a} - F_s)}{(2 \cdot b \cdot f_{yb})} = \frac{(2673.15 \text{ kN} - 1770 \text{ kN})}{(2 \cdot 200 \text{ mm} \cdot 355 \text{ MPa})} = 6.36 \text{ mm}$$

Verification of the steel web classification.

$$\alpha_{cl} = 1$$

$$\frac{c_w}{t_w} \leq \frac{396 \cdot \epsilon}{13 \cdot \alpha_{cl} - 1}$$

$$\frac{134 \text{ mm}}{9 \text{ mm}} \leq \frac{396 \cdot 0.814}{13 \cdot 1 - 1}$$

$$14.9 \leq 26.8 \quad \text{OK}$$

Web classified as Class 1.

$$N_{a,f} = b \cdot x \cdot f_{yb} = 200 \text{ mm} \cdot 6.36 \text{ mm} \cdot 355 \text{ MPa} = 451.47 \text{ kN}$$

$$N_{a,c} = N_{pl,a} - N_{a,f} = 2673.15 \text{ kN} - 451.47 \text{ kN} = 2221.68 \text{ kN}$$

Leverage arm of the compression part of the steel section calculated to the PNA.

$$h_{cs} = \frac{\left( b \cdot (t_f - x)^2 \cdot 0.5 + t_w \cdot (h_a - 2 \cdot t_f) \cdot \left( \frac{h_a}{2} - x \right) + t_f \cdot b \cdot \left( h_a - \frac{t_f}{2} - x \right) \right)}{b \cdot (t_f - x) + t_w \cdot (h_a - 2 \cdot t_f) + t_f \cdot b}$$

$$= \frac{\left( 200 \cdot (15 - 6.36)^2 \cdot 0.5 + 9 \cdot (200 - 2 \cdot 15) \cdot \left( \frac{200}{2} - 6.36 \right) + 15 \cdot 200 \cdot \left( 200 - \frac{15}{2} - 6.36 \right) \right)}{200 \cdot (15 - 6.36) + 9 \cdot (200 - 2 \cdot 15) + 15 \cdot 200}$$

$$h_{cs} = 113 \text{ mm}$$

$$h_1 = x + h_s - c + \frac{d_l}{2} = 6.36 \cdot 10^{-3} + 0.16 - 0.03 + \frac{0.016}{2} = 128 \text{ mm}$$

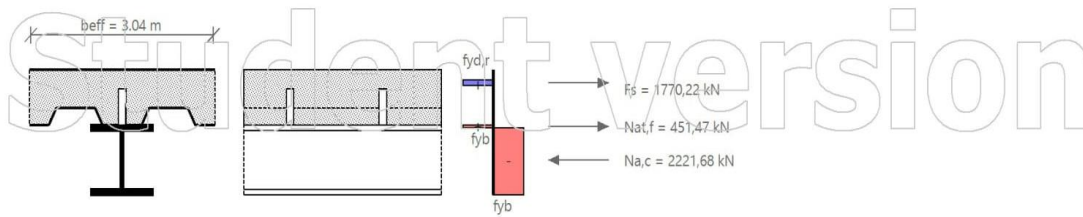

$$M_{pl,Rd} = F_s \cdot h_l + \frac{N_{at,f} \cdot X}{2} + N_{a,c} \cdot h_{cs} = 1770 \cdot 128 + \frac{451.47 \cdot 6.36}{2} + 2221.68 \cdot 113 = 480 \text{ kNm}$$

**Design moment resistance according to EN 1994-1-1 Art.6.2.1.2**

$$M_{Rd} = M_{pl,Rd} = 480 \text{ kNm}$$

$$UC_{comp,M} = \frac{abs(M_{Ed,comp})}{M_{Rd}} = \frac{abs(-275.434 \text{ kNm})}{480 \text{ kNm}} = 0.57$$

The bending moment resistance of the section is adequate.

**5.3 LTB resistance**

$$F = \left( 1 + \frac{t_w \cdot (h_a - t_f)}{4 \cdot b \cdot t_f} \right) \cdot \left( \frac{h_a - t_f}{t_w} \right)^{0.75} \cdot \left( \frac{t_f}{b} \right)^{0.25} = \left( 1 + \frac{9 \cdot (200 - 15)}{4 \cdot 200 \cdot 15} \right) \cdot \left( \frac{200 - 15}{9} \right)^{0.75} \cdot \left( \frac{15}{200} \right)^{0.25} = 5.75$$

$$F_{lim} = 12.3$$

$$F \leq F_{lim}$$

$$5.75 \leq 12.3$$

OK

The cross-section is qualified for verification of LTB by the simplified method.

$$C_4 = 25$$

$$\lambda_{LT,rel} = 5 \cdot \left( 1 + \frac{t_w \cdot (h_a - t_f)}{4 \cdot b \cdot t_f} \right) \cdot \left( \frac{h_a - t_f}{t_w} \right)^{0.75} \cdot \left( \frac{t_f}{b} \right)^{0.25} \cdot \left( \frac{f_{yb}}{E_b \cdot C_4} \right)^{0.5}$$

$$= 5 \cdot \left( 1 + \frac{9 \cdot 10^{-3} \cdot (0.2 - 0.015)}{4 \cdot 0.2 \cdot 0.015} \right) \cdot \left( \frac{0.2 - 0.015}{9 \cdot 10^{-3}} \right)^{0.75} \cdot \left( \frac{0.015}{0.2} \right)^{0.25} \cdot \left( \frac{355 \cdot 10^6}{210 \cdot 10^9 \cdot 25} \right)^{0.5} = 0.237$$

$h_a/b < 2 \rightarrow$  Buckling curve 'a'

$$\alpha_{LT} = 0.21$$

$$\Phi_{LT} = 0.5 \cdot \left( 1 + \alpha_{LT} \cdot (\lambda_{LT,rel} - 0.2) + \lambda_{LT,rel}^2 \right) = 0.5 \cdot \left( 1 + 0.21 \cdot (0.237 - 0.2) + 0.237^2 \right) = 0.532$$

$$X_{LT} = \frac{1}{\Phi_{LT} + \sqrt{\Phi_{LT}^2 - \lambda_{LT,rel}^2}} = \frac{1}{0.532 + \sqrt{0.532^2 - 0.237^2}} = 0.992$$

$$X_{LT} = \min(X_{LT}, 1) = \min(0.992; 1) = 0.992$$

$$M_{b,Rd} = X_{LT} \cdot M_{Rd} = 0.992 \cdot 480.411 = 476.540 \text{ kNm}$$

$$UC_{comp\_LTB} = \frac{abs(M_{Ed,comp})}{M_{b,Rd}} = \frac{abs(-275.434 \text{ kNm})}{476.540 \text{ kNm}} = 0.58$$

The later torsional buckling resistance of the section is adequate.

**5.4 Longitudinal shear**

**5.4.1 Transverse reinforcement**

Design shear flow

$$h_f = h_c = 109 \text{ mm}$$

$$v_{Ed} = \frac{\eta_r \cdot P_{Rd}}{2 \cdot l_s \cdot h_f} = \frac{1 \cdot 144 \text{ kN}}{2 \cdot 200 \text{ mm} \cdot 109 \text{ mm}} = 3.29 \text{ MPa}$$

Transverse reinforcement

$$\frac{A_{st} \cdot f_{yk,r}}{y_s \cdot s_f} \geq \frac{v_{Ed} \cdot h_f}{\cotg(\theta)}$$

$$A_t = A_{st}/s_f$$

$$A_t = \frac{v_{Ed} \cdot h_f}{\left( \frac{\cotg(\theta) \cdot f_{yk,r}}{y_s} \right)} = \frac{3.29 \cdot 10^6 \cdot 0.109}{\left( \frac{\cotg(26.5) \cdot 500 \cdot 10^6}{1.15} \right)} = 412 \text{ mm}^2/\text{m}$$

$$A_{t,prov} = \frac{1}{s_f} \cdot \left( \frac{d_t^2}{4} \right) \cdot 3.14 = \frac{1}{0.15} \cdot \left( \frac{0.016^2}{4} \right) \cdot 3.14 = 1340 \text{ mm}^2/\text{m}$$

$$A_{t,prov} \geq A_t$$

$$1340 \text{ mm}^2/\text{m} \geq 412 \text{ mm}^2/\text{m} \quad \text{OK}$$

The transverse reinforcement of the section is adequate.

**ULS check of Final stage is OK.**

$$UC_{comp} = \max(0.38; 0.57; 0.58) = 0.58$$

-iskoristivost elementa na GSN – 58%

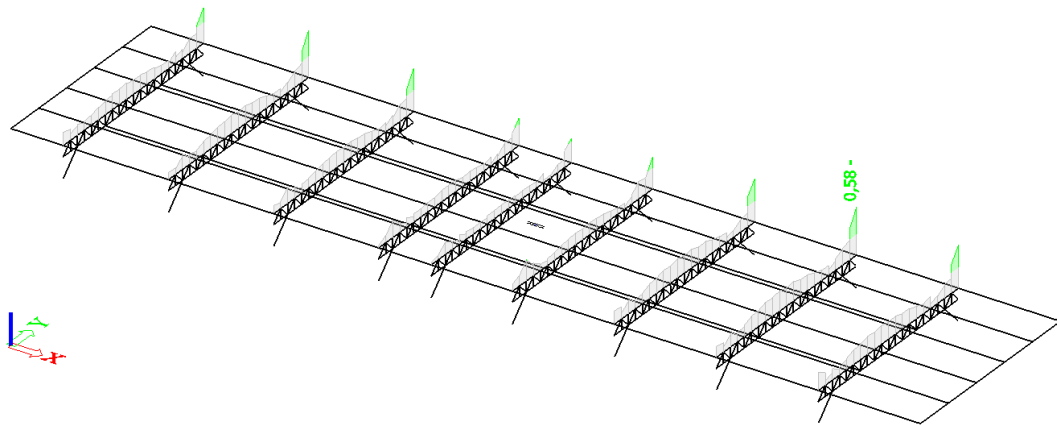

Slika 5.24. Prikaz iskoristivosti gornje pojasnice rešetkastog nosača – poz 400

### 5.6.3. Rezne sile – donja pojasnica glavnog rešetkastog nosača

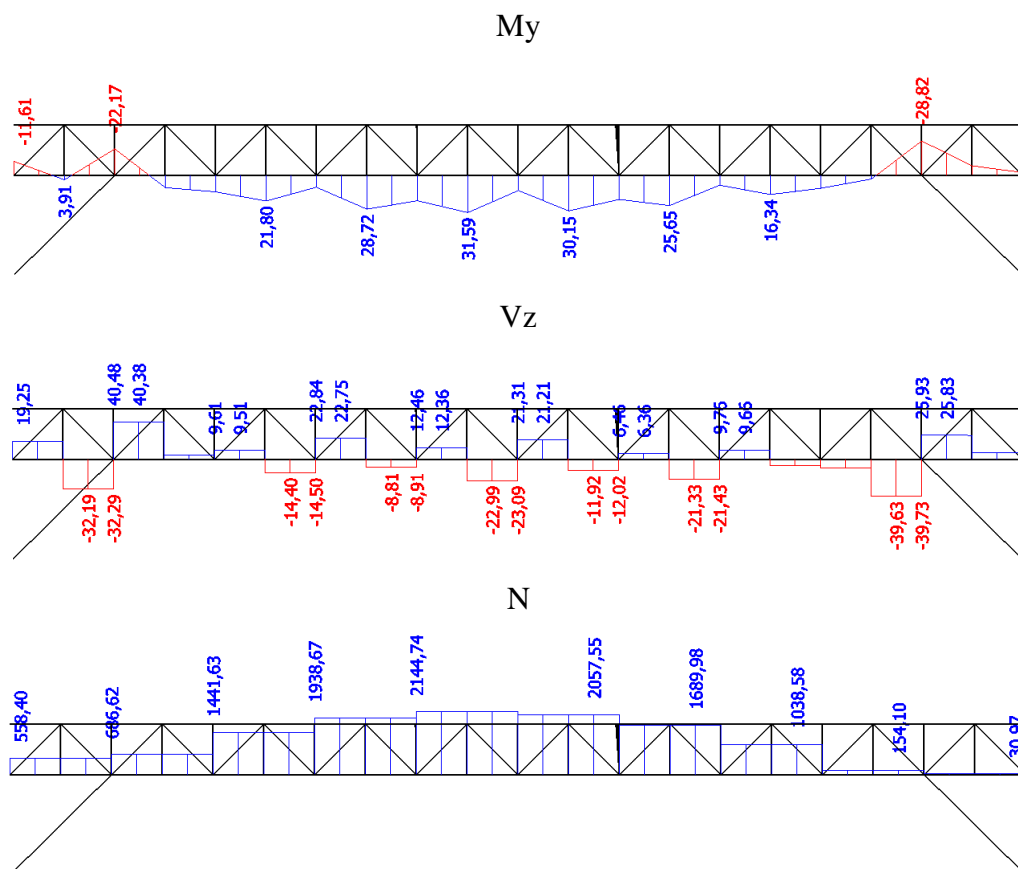

Slika 5.25. Prikaz reznih sila - donja pojasnica glavnog rešetkastog nosača

-poprečni presjek nosača

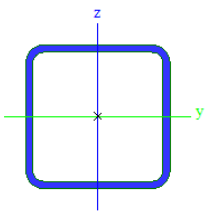
Name	Donja pojasnica glavnog rešetkastog nosača - krov srednje dvorane		
Type	F200X10		
Source description	Chinese Standard / GB 6728-2002		
Item material	S 355		
Fabrication	cold formed		
Flexural buckling y-y	c		
Flexural buckling z-z	c		
Lateral torsional buckling	Default		
Use 2D FEM analysis	x		
			
A [m <sup>2</sup> ]	7,2600e-03		
A y, z [m <sup>2</sup> ]	3,6251e-03		3,6251e-03
I y, z [m <sup>4</sup> ]	4,2510e-05		4,2510e-05
I w [m <sup>6</sup> ], t [m <sup>4</sup> ]	2,6667e-07		7,0720e-05
W <sub>el</sub> y, z [m <sup>3</sup> ]	4,2500e-04		4,2500e-04
W <sub>pl</sub> y, z [m <sup>3</sup> ]	5,0808e-04		5,0808e-04
d y, z [mm]	0		0
c YUCS, ZUCS [mm]	100		100
α [deg]	0,00		
A L, D [m <sup>2</sup> /m]	7,5708e-01		1,4510e+00
M <sub>ply</sub> +, - [Nm]	1,80e+05		1,80e+05
M <sub>plz</sub> +, - [Nm]	1,80e+05		1,80e+05

Slika 5.26. Prikaz geometrijskih karakteristika nosača – poz 400

5.6.4. Dimenzioniranje – donja pojasnica glavnog rešetkastog nosača

Member B3371	16,200 m	F200X10	S 355	GSN 7	0,83 -
--------------	----------	---------	-------	-------	--------

Note: EN 1993-1-3 article 1.1(3) specifies that this part does not apply to cold formed CHS and RHS sections. The default EN 1993-1-1 code check is executed instead of the EN 1993-1-3 code check.

Partial safety factors	
Gamma M0 for resistance of cross-sections	1,00
Gamma M1 for resistance to instability	1,00
Gamma M2 for resistance of net sections	1,25

Material		
Yield strength f <sub>y</sub>	355,0	MPa
Ultimate strength f <sub>u</sub>	510,0	MPa
Fabrication	Cold formed	

.....SECTION CHECK:.....

The critical check is on position 6.480 m

Internal forces	Calculated	Unit
N <sub>Ed</sub>	2144,74	kN
V <sub>y,Ed</sub>	0,33	kN
V <sub>z,Ed</sub>	12,46	kN
T <sub>Ed</sub>	0,63	kNm
M <sub>y,Ed</sub>	21,58	kNm
M <sub>z,Ed</sub>	-1,48	kNm

Tension check

According to EN 1993-1-1 article 6.2.3 and formula (6.5)

A	7,2600e-03	m <sup>2</sup>
N <sub>pl,Rd</sub>	2577,30	kN
N <sub>u,Rd</sub>	2665,87	kN
N <sub>t,Rd</sub>	2577,30	kN
Unity check	0,83	-

**Bending moment check for My**

According to EN 1993-1-1 article 6.2.5 and formula (6.12),(6.13)

Wpl,y	5,0808e-04	m <sup>3</sup>
Mpl,y,Rd	180,37	kNm
Unity check	0,12	-

**Bending moment check for Mz**

According to EN 1993-1-1 article 6.2.5 and formula (6.12),(6.13)

Wpl,z	5,0808e-04	m <sup>3</sup>
Mpl,z,Rd	180,37	kNm
Unity check	0,01	-

**Shear check for Vy**

According to EN 1993-1-1 article 6.2.6 and formula (6.17)

Eta	1,20	
Av	3,6300e-03	m <sup>2</sup>
Vpl,y,Rd	744,00	kN
Unity check	0,00	-

**Shear check for Vz**

According to EN 1993-1-1 article 6.2.6 and formula (6.17)

Eta	1,20	
Av	3,6300e-03	m <sup>2</sup>
Vpl,z,Rd	744,00	kN
Unity check	0,02	-

**Torsion check**

According to EN 1993-1-1 article 6.2.7 and formula (6.23)

Tau,t,Ed	0,9	MPa
Tau,Rd	205,0	MPa
Unity check	0,00	-

**Note:** The unity check for torsion is lower than the limit value of 0,05. Therefore torsion is considered as insignificant and is ignored in the combined checks.

**Combined bending, axial force and shear force check**

According to EN 1993-1-1 article 6.2.9.1 and formula (6.41)

MN,y,Rd	39,04	kNm
Alpha	6,00	
MN,z,Rd	39,04	kNm
Beta	6,00	

**....:STABILITY CHECK:....**

**Lateral Torsional Buckling check**

According to EN 1993-1-1 article 6.3.2.1

**Note:** The cross-section concerns an RHS section with  $h / b < 10 / \text{Lambda}_{rel,z}$ .

This section is thus not susceptible to Lateral Torsional Buckling.

**Bending and axial tension check**

According to EN 1993-1-3 article 6.3

Design tension force N,Ed	2144,74	kN
Design bending moment My,Ed	21,58	kNm
Design bending moment Mz,Ed	-1,48	kNm
Tension resistance Nt,Rd	2577,30	kN
Bending resistance Mb,y,Rd	162,78	kNm
Bending resistance Mc,z,Rd,com	180,37	kNm

Unity check =  $0,13 + 0,01 - 0,83 = 0,69$  -

The member satisfies the stability check.

-iskoristivost elementa na GSN – 83%

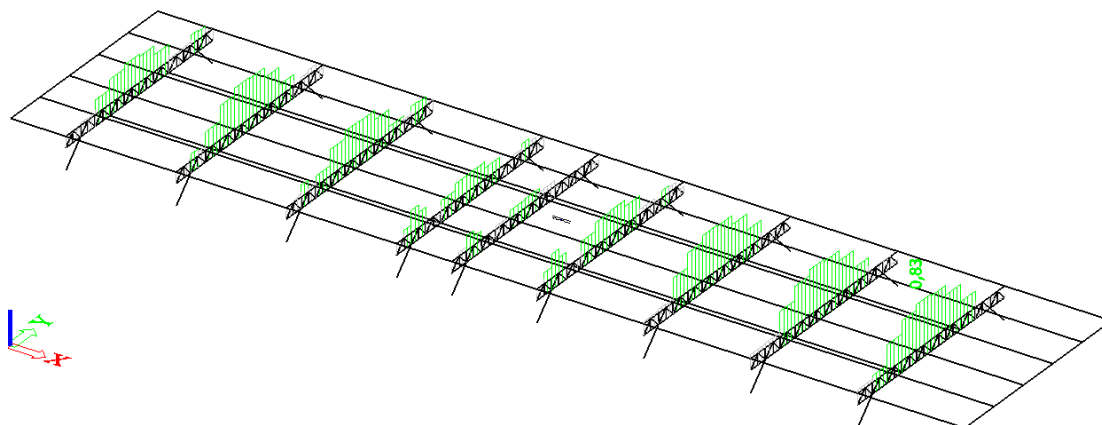

Slika 5.27.. Prikaz iskoristivosti donje pojasnice rešetkastog nosača – poz 400

### 5.6.5. Rezne sile – ispuna glavnog rešetkastog nosača

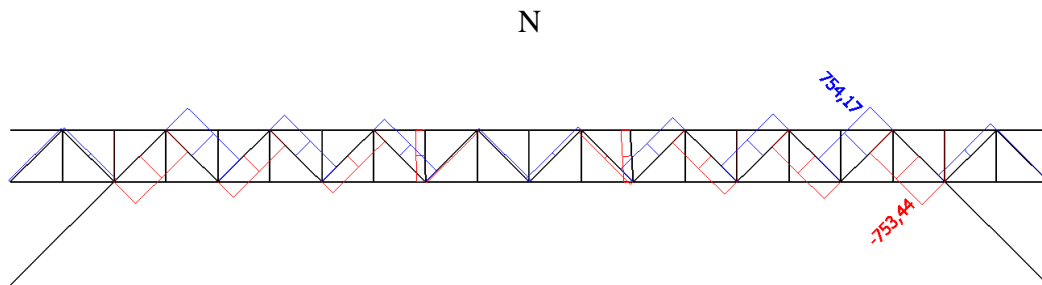

Slika 5.28. Prikaz reznih sila - ispuna glavnog rešetkastog nosača

Name	Ispuna glavnog rešetkastog nosača - krov srednje dvorane	
Type	CFRHS120X120X6	
Source description	Rautaruukki Oyj / Structural Hollow Sections EN10219 / Ed.2007	
Item material	S 355	
Fabrication	cold formed	
Flexural buckling y-y	c	
Flexural buckling z-z	c	
Lateral torsional buckling	Default	
Use 2D FEM analysis	*	
A [m <sup>2</sup> ]	2,6430e-03	
A <sub>y, z</sub> [m <sup>2</sup> ]	1,3208e-03	1,3208e-03
I <sub>y, z</sub> [m <sup>4</sup> ]	5,6216e-06	5,6216e-06
I <sub>w</sub> [m <sup>6</sup> ], t [m <sup>4</sup> ]	1,2442e-08	9,1346e-06
W <sub>el y, z</sub> [m <sup>3</sup> ]	9,3690e-05	9,3690e-05
W <sub>pl y, z</sub> [m <sup>3</sup> ]	1,1161e-04	1,1161e-04
d <sub>y, z</sub> [mm]	0	0
c YUCS, ZUCS [mm]	60	60
α [deg]	0,00	
A <sub>L, D</sub> [m <sup>2</sup> /m]	4,5900e-01	8,8095e-01
M <sub>ply +, -</sub> [Nm]	3,96e+04	3,96e+04
M <sub>plz +, -</sub> [Nm]	3,96e+04	3,96e+04

Slika 5.29. Prikaz geometrijskih karakteristika nosača – poz 400

-iskoristivost elementa na GSN - 86%

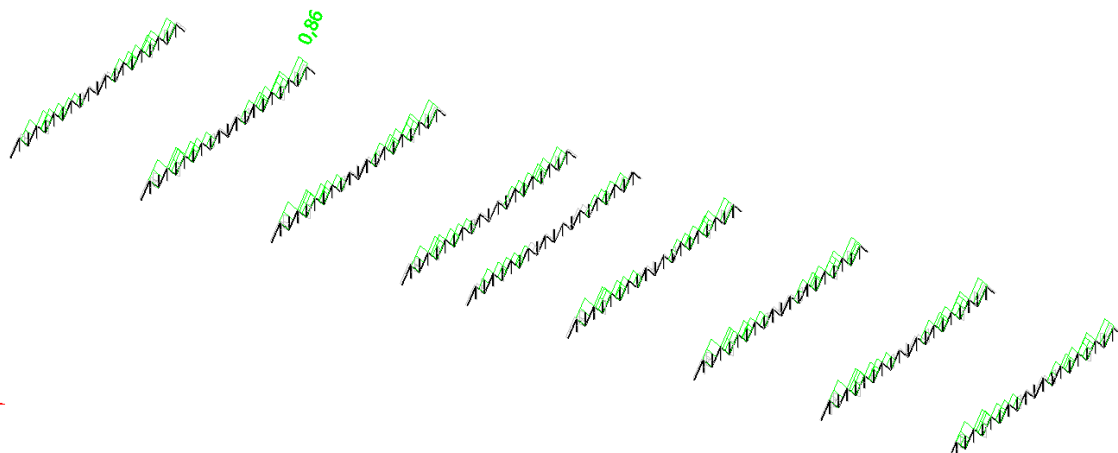

Slika 5.30. Prikaz iskoristivosti ispune rešetkastog nosača – poz 400

### 5.6.6. Dimenzioniranje – ispuna glavnog rešetkastog nosača

Member B3119	1,138 m	CFRHS120X120X6	S 355	GSN 28	0,86 -
--------------	---------	----------------	-------	--------	--------

Note: EN 1993-1-3 article 1.1(3) specifies that this part does not apply to cold formed CHS and RHS sections. The default EN 1993-1-1 code check is executed instead of the EN 1993-1-3 code check.

Partial safety factors	
Gamma M0 for resistance of cross-sections	1,00
Gamma M1 for resistance to instability	1,00
Gamma M2 for resistance of net sections	1,25

Material		
Yield strength $f_y$	355,0	MPa
Ultimate strength $f_u$	510,0	MPa
Fabrication	Cold formed	

....SECTION CHECK:....

The critical check is on position 1.138 m

Internal forces	Calculated	Unit
N,Ed	-753,44	kN
V <sub>y</sub> ,Ed	0,00	kN
V <sub>z</sub> ,Ed	0,00	kN
T,Ed	0,00	kNm
M <sub>y</sub> ,Ed	0,00	kNm
M <sub>z</sub> ,Ed	0,00	kNm

**Classification for cross-section design**

According to EN 1993-1-1 article 5.5.2

**Classification of Internal Compression parts**

According to EN 1993-1-1 Table 5.2 Sheet 1

Maximum width-to-thickness ratio	17,00
Class 1 Limit	26,85
Class 2 Limit	30,92
Class 3 Limit	34,17

=> Section classified as Class 1 for cross-section design

**Compression check**

According to EN 1993-1-1 article 6.2.4 and formula (6.9)

A	2,6430e-03	m <sup>2</sup>
N <sub>c,Rd</sub>	938,26	kN
Unity check	0,80	-

The member satisfies the section check.

....STABILITY CHECK:....

**Classification for member buckling design**

**Note:** For this section the classification for cross-section design is also used for member buckling design.

=> Section classified as Class 1 for member buckling design

**Flexural Buckling check**

According to EN 1993-1-1 article 6.3.1.1 and formula (6.46)

Buckling parameters	yy	zz
Sway type	sway	non-sway
System length L	1,138	3,415
Buckling factor k	1,00	0,33
Buckling length L <sub>cr</sub>	1,138	1,138
Critical Euler load N <sub>cr</sub>	8989,60	8991,40
Slenderness Lambda	24,69	24,68
Relative slenderness Lambda <sub>rel</sub>	0,32	0,32
Limit slenderness Lambda <sub>rel,0</sub>	0,20	0,20
Buckling curve	c	c
Imperfection Alpha	0,49	0,49
Reduction factor Chi	0,94	0,94
Buckling resistance N <sub>b,Rd</sub>	879,48	879,49

Flexural Buckling verification		
Cross-section area A	2,6430e-03	m <sup>2</sup>
Buckling resistance N <sub>b,Rd</sub>	879,48	kN
Unity check	0,86	-

**Torsional(-Flexural) Buckling check**

According to EN 1993-1-1 article 6.3.1.1 and formula (6.46)

**Note:** The cross-section concerns a RHS section which is not susceptible to Torsional(-Flexural) Buckling.

The member satisfies the stability check.

### 5.6.7. Rezne sile – sekundarni gredni nosača

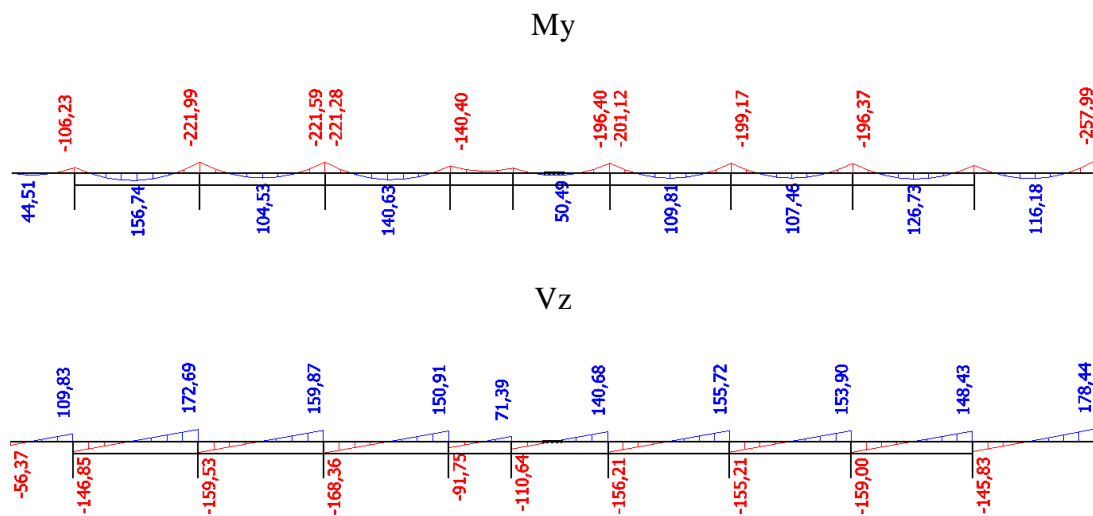

Slika 5.31. Prikaz reznih sila – sekundarni gredni nosač – poz 400

-poprečni presjek nosača

Name	Sekundarni gredni nosač - krov srednje dvorane	
Type	HEB200	
Source description	Profil Arbed / Structural shapes / Edition Octobre 1995	
Item material	S 355	
Fabrication	rolled	
Flexural buckling y-y	b	
Flexural buckling z-z	c	
Lateral torsional buckling	Default	
Use 2D FEM analysis	*	
A [m <sup>2</sup> ]	7,8080e-03	
A y, z [m <sup>2</sup> ]	5,7750e-03	1,9112e-03
I y, z [m <sup>4</sup> ]	5,6960e-05	2,0030e-05
I w [m <sup>5</sup> ], t [m <sup>4</sup> ]	1,7112e-07	5,9280e-07
W <sub>el</sub> y, z [m <sup>3</sup> ]	5,6960e-04	2,0030e-04
W <sub>pl</sub> y, z [m <sup>3</sup> ]	6,4250e-04	3,0580e-04
d y, z [mm]	0	0
c YUCS, ZUCS [mm]	100	100
α [deg]	0,00	
A L, D [m <sup>2</sup> /m]	1,1500e+00	1,1510e+00
M <sub>ply</sub> +, - [Nm]	2,28e+05	2,28e+05
M <sub>plz</sub> +, - [Nm]	1,09e+05	1,09e+05

Slika 5.32. Prikaz geometrijskih karakteristika nosača – poz 400



### 5.6.8. Dimenzioniranje – sekundarni gredni nosača

SCIAENGINEER

#### Composite Beam - Final stage

Linear calculation  
 Class: All ULS  
 Extreme 1D: Global  
 Selection: B3044

#### Composite beam verification

for beam B3044 at section 0 m, in accordance with EC EN 1994-1-1

##### 1. Geometry data

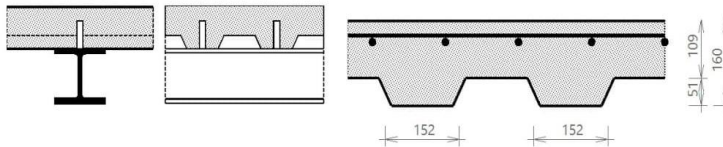

##### Continuous beam

Length of the current span	L = 7.86 m
Length of next span	L <sub>next</sub> = 7.86 m
Beam spacing at the left	L <sub>left</sub> = 3.24 m
Beam spacing at the right	L <sub>right</sub> = 3.24 m
Checked section	d <sub>x</sub> = 0 m

##### 2. Cross-section & materials

###### 2.1 Steel section properties

###### 2.1.1 Cross-section

Cross-section	HEB200
Height	h <sub>a</sub> = 200 mm
Width	b = 200 mm
Web thickness	t <sub>w</sub> = 9 mm
Flange thickness	t <sub>f</sub> = 15 mm
Radius	r = 18 mm
Area	A <sub>g</sub> = 7808 mm <sup>2</sup>
Moment of inertia	I <sub>y</sub> = 57·10 <sup>6</sup> mm <sup>4</sup>
Radius of gyration	i <sub>z</sub> = 51 mm
Plastic section modulus	W <sub>ply</sub> = 642500 mm <sup>3</sup>

###### 2.1.2 Material

Steel grade	S 355
Yield strength	f <sub>yb</sub> = 355 MPa
Ultimate strength	f <sub>ub</sub> = 490 MPa
E modulus	E <sub>b</sub> = 210000 MPa

###### 2.1.3 Cross-section classification

$$\epsilon = \sqrt{\frac{235}{355}} = 0.814 \quad (\text{EN 1993-1-1 §5.6 Tab. 5.2})$$

###### 2.1.3.1 Flange in compression

$$c_f = \frac{b - t_w - 2 \cdot r}{2} = \frac{200 \text{ mm} - 9 \text{ mm} - 2 \cdot 18 \text{ mm}}{2} = 77.5 \text{ mm}$$

$$\frac{c_f}{t_f} \leq 9 \cdot \epsilon$$

$$\frac{77.5 \text{ mm}}{15 \text{ mm}} \leq 9 \cdot 0.814$$

$$5.17 \leq 7.32$$

OK

Flange classified as Class 1.

Student version

2.1.3.2 Web in bending

$$c_w = h_a - 2 \cdot t_f - 2 \cdot r = 200 \text{ mm} - 2 \cdot 15 \text{ mm} - 2 \cdot 18 \text{ mm} = 134 \text{ mm}$$

$$\alpha_d = 0.5$$

$$\frac{c_w}{t_w} \leq \frac{36 \cdot \epsilon}{\alpha_d}$$

$$\frac{134 \text{ mm}}{9 \text{ mm}} \leq \frac{36 \cdot 0.814}{0.5}$$

$$14.9 \leq 58.6$$

OK

Web classified as Class 1.

**Cross-section classified as Class 1**

Cross-section Class OK.

**2.2 Concrete slab with profiled sheeting****2.2.1 Concrete slab**2.2.1.1 SlabTotal height of the slab  $h_s = 160 \text{ mm}$ 2.2.1.2 Material

Concrete class	C30/37
Characteristic strength	$f_{ck} = 30 \text{ MPa}$
E modulus	$E_{cm} = 32800 \text{ MPa}$

**2.2.2 Profiled steel sheeting**

Note: The angle between the direction perpendicular to the member and the ribs of profiled steel sheeting is smaller than  $10^\circ$  thus the ribs are considered as transverse to the beam.

Sheeting with ribs transverse to the supporting beams

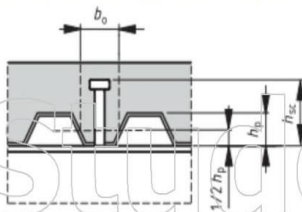

Name	Vulcraft 2 VLI 20
Depth of the ribs	$h_p = 50.8 \text{ mm}$
Height of full concrete	$h_c = 109.2 \text{ mm}$
Height of the re-entrant stiffener	$h_d = 0 \text{ mm}$
Spacing of the ribs	$b_s = 304.8 \text{ mm}$
Top width of the rib	$b_t = 127 \text{ mm}$
Bottom width of the rib	$b_b = 127 \text{ mm}$
Mean width of the ribs	$b_{0,rib} = 152.4 \text{ mm}$
Thickness of the sheeting	$t_p = 0.9093 \text{ mm}$

**2.2.3 Shear connectors**2.2.3.1 Geometry

Name	H110
Diameter	$d_s = 25 \text{ mm}$
Nominal height	$h_{nom} = 110 \text{ mm}$
As-welded height	$h_{sc} = 105 \text{ mm}$
Amount per trough or section	$n_r = 1$

2.2.3.2 Material

Steel grade	S 355
Ultimate strength	$f_{us} = 490 \text{ MPa}$

Student version

**2.2.4 Reinforcement****2.2.4.1 Geometry**

Longitudinal bar diameter	$d_l = 16 \text{ mm}$
Longitudinal bar spacing	$s_l = 150 \text{ mm}$
Longitudinal bar cover	$c_l = 30 \text{ mm}$
Transverse bar diameter	$d_t = 16 \text{ mm}$
Transverse bar spacing	$s_t = 150 \text{ mm}$
Transverse bar cover	$c_t = 46 \text{ mm}$

**2.2.4.2 Material**

Material	B 500A
Characteristic yield strength	$f_{ykr} = 500 \text{ MPa}$

**3. Design values of loads**

Load Name : GSN 26

Content of combination :  $1.35 \cdot g$ -vlastitežina+ $1.35 \cdot dg$ -dodatnostalno+  
 $1.62 \cdot q$ -promjenjivoopterećenje+ $1.35 \cdot g$ -vlastitežina\_dryconcrete+  
 $1.35 \cdot Wx$ -2kom.-Wz-poz+ $1.35 \cdot s$ -opterećenjesnijegom

Bending moment	$M_{Ed,comp} = -257.990 \text{ kNm}$
Shear force	$V_{Ed,comp} = 178.443 \text{ kN}$

**4. Partial safety factors**

Steel section	$\gamma_{M0} = 1$
	$\gamma_{M1} = 1$
Shear connectors	$\gamma_V = 1.25$
Concrete	$\gamma_C = 1.5$
Reinforcement	$\gamma_S = 1.15$

**5. ULS check of the Final stage****5.1 Shear connection****5.1.1 Design resistance of shear connectors****5.1.1.1 Shear connector in a solid slab**

$$\frac{h_{sc}}{d_s} > 4$$

$$4.2 > 4$$

$$\alpha = 1$$

$$f_{us} = \min(490; 450) \text{ MPa}$$

$$f_{us} = 450 \text{ MPa}$$

$$P_{Rd,solid,1} = \frac{0.8 \cdot f_{us} \cdot \left( \frac{\pi \cdot d_s^2}{4} \right)}{\gamma_V} = \frac{0.8 \cdot 450 \text{ MPa} \cdot \left( \frac{3.14 \cdot 25 \text{ mm}^2}{4} \right)}{1.25} = 141 \text{ kN}$$

$$P_{Rd,solid,2} = \frac{0.29 \cdot \alpha \cdot d_s^2 \cdot \sqrt{f_{ck} \cdot E_{cm}}}{\gamma_V} = \frac{0.29 \cdot 1 \cdot 25 \text{ mm}^2 \cdot \sqrt{30 \text{ MPa} \cdot 32800 \text{ MPa}}}{1.25} = 144 \text{ kN}$$

$$P_{Rd,solid} = \min(P_{Rd,solid,1}; P_{Rd,solid,2}) = \min(141 \text{ kN}; 144 \text{ kN}) = 141 \text{ kN}$$

**5.1.1.2 Shear connector in profiled sheeting**

Sheeting with ribs transverse to the supporting beams

$$k_t = \frac{0.7}{\sqrt{n_r}} \cdot \left( \frac{b_{0,rib}}{h_p} \right) \cdot \left( \frac{h_{sc}}{h_p} - 1 \right) = \frac{0.7}{\sqrt{1}} \cdot \left( \frac{152 \text{ mm}}{50.8 \text{ mm}} \right) \cdot \left( \frac{105 \text{ mm}}{50.8 \text{ mm}} - 1 \right) = 2.24$$

$$k_{t,max} = 0.85$$

$$k_t = \max(0; \min(k_t; k_{t,max})) = \max(0; \min(2.24; 0.85)) = 0.85$$

$$P_{Rd} = k_t \cdot P_{Rd,solid} = 0.85 \cdot 141 \text{ kN} = 120 \text{ kN}$$

Warning: The conditions given by EN 1994-1-1 Art.6.6.4.2 (3) are not fulfilled.

Student version

5.1.2 Degree of shear connection

5.1.2.1 Determination of  $b_{eff}$  of the concrete flange and length  $L_e$

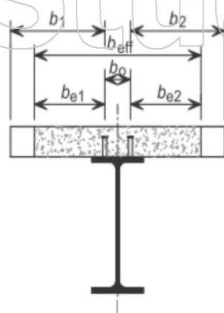

The effective width at the end support

$$L_{e0} = 0.85 \cdot L_1 = 0.85 \cdot 7.86 \text{ m} = 6.68 \text{ m}$$

Left side of the beam

$$b_1 = \frac{L_{perp\_left}}{2} - \frac{b_0}{2} = \frac{3.24 \text{ m}}{2} - \frac{0 \text{ mm}}{2} = 1.62 \text{ m}$$

$$b_{e10} = \min\left(\frac{L_{e0}}{8}; b_1\right) = \min\left(\frac{6.68 \text{ m}}{8}; 1.62 \text{ m}\right) = 0.835 \text{ m}$$

$$b_{e11} = \min\left(\frac{L_{e1}}{8}; b_1\right) = \min\left(\frac{0 \text{ m}}{8}; 1.62 \text{ m}\right) = 0 \text{ m}$$

$$b_{e12} = \min\left(\frac{L_{e2}}{8}; b_1\right) = \min\left(\frac{0 \text{ m}}{8}; 1.62 \text{ m}\right) = 0 \text{ m}$$

$$\beta_{1,calc} = 0.55 + \frac{0.025 \cdot L_{e0}}{b_{e10}} = 0.55 + \frac{0.025 \cdot 6.68 \text{ m}}{0.835 \text{ m}} = 0.75$$

$$\beta_{1,calc} \leq 1.0$$

$$0.75 \leq 1.0 \quad \text{OK}$$

$$\beta_1 = \beta_{1,calc} = 0.75$$

Right side of the beam

$$b_2 = \frac{L_{perp\_right}}{2} - \frac{b_0}{2} = \frac{3.24 \text{ m}}{2} - \frac{0 \text{ mm}}{2} = 1.62 \text{ m}$$

$$b_{e20} = \min\left(\frac{L_{e0}}{8}; b_2\right) = \min\left(\frac{6.68 \text{ m}}{8}; 1.62 \text{ m}\right) = 0.835 \text{ m}$$

$$b_{e21} = \min\left(\frac{L_{e1}}{8}; b_2\right) = \min\left(\frac{0 \text{ m}}{8}; 1.62 \text{ m}\right) = 0 \text{ m}$$

$$b_{e22} = \min\left(\frac{L_{e2}}{8}; b_2\right) = \min\left(\frac{0 \text{ m}}{8}; 1.62 \text{ m}\right) = 0 \text{ m}$$

$$\beta_{2,calc} = 0.55 + \frac{0.025 \cdot L_{e0}}{b_{e20}} = 0.55 + \frac{0.025 \cdot 6.68 \text{ m}}{0.835 \text{ m}} = 0.75$$

$$\beta_{2,calc} \leq 1.0$$

$$0.75 \leq 1.0 \quad \text{OK}$$

$$\beta_2 = \beta_{2,calc} = 0.75$$

Calculation of  $b_{eff,0}$

$$b_{eff,0} = b_0 + b_{e10} \cdot \beta_1 + b_{e20} \cdot \beta_2 = 0 \text{ mm} + 0.835 \text{ m} \cdot 0.75 + 0.835 \text{ m} \cdot 0.75 = 1.25 \text{ m}$$

Calculation of  $b_{eff}$

$$b_{eff} = b_{eff,0} = 1.25 \text{ m}$$

Determination of  $L_e$

$$L_e = L_{e0} = 6.68 \text{ m}$$

5.1.2.2 Minimum degree of shear connection

Warning: Conditions given by EN 1994-1-1 Art. 6.6.1.2 (3) are not fulfilled.

$$\eta_{min,calc} = 1 - \frac{355}{f_{yb}} \cdot (0.75 - 0.03 \cdot L_e)$$

$$\eta_{min,calc} = 1 - \frac{355}{355} \cdot (0.75 - 0.03 \cdot 6.68 \text{ m}) = 0.45$$

$$\eta_{min} = \max(\eta_{min,calc}; 0.4) = \max(0.45; 0.4) = 0.45$$

**5.1.2.3 Degree of shear connection present**

**5.1.2.3.1 Tension resistance of the reinforcement**

$$A_{s1} = \frac{b_{eff}}{s_1} \cdot \left( \frac{d_1^2}{4} \right) \cdot \pi = \frac{1.25 \text{ m}}{150 \text{ mm}} \cdot \left( \frac{16 \text{ mm}^2}{4} \right) \cdot 3.14 = 1679 \text{ mm}^2$$

$$F_s = \frac{A_{s1} \cdot f_{yk,r}}{\gamma_s} = \frac{1.68 \cdot 10^{-3} \cdot 500 \cdot 10^6}{1.15} = 730 \text{ kN}$$

**5.1.2.3.2 Tension resistance of the steel member**

$$N_{pl,a} = f_{yb} \cdot A_a = 355 \text{ MPa} \cdot 7808 \text{ mm}^2 = 2771.84 \text{ kN}$$

$$N_{c,r} = \min(F_s; N_{pl,a}) = \min(730 \text{ kN}; 2771.84 \text{ kN}) = 730.05 \text{ kN}$$

**5.1.2.3.3 Resistance of the shear connectors**

Number of full ribs available per length  $L_e$

$$n_{rib} = \frac{L_e}{b_s} = \frac{6.68 \text{ m}}{305 \text{ mm}}$$

$$n_{rib} = 21$$

$$l_s = b_s \cdot \text{trough} = 305 \text{ mm} \cdot 1 = 305 \text{ mm}$$

Number of shear studs available per length  $L_e/2$

$$n_{sp} = \frac{0.5 \cdot n_{rib} \cdot n_r}{\text{trough}} = \frac{0.5 \cdot 21 \cdot 1}{1} = 10.5$$

$$N_c = n_{sp} \cdot P_{Rd} = 10.5 \cdot 120166 = 1261.74 \text{ kN}$$

$$\eta = \min\left(\frac{N_c}{N_{c,r}}; 1\right) = \min\left(\frac{1261.74 \text{ kN}}{730.05 \text{ kN}}; 1\right) = 1$$

$$\eta \geq \eta_{min}$$

$$1 \geq 0.45 \quad \text{OK}$$

The shear connection degree is adequate.

**5.2 Cross-sectional resistance of the composite beam**

**5.2.1 Shear buckling**

$$h_w = h_b - 2 \cdot t_f = 200 \text{ mm} - 2 \cdot 15 \text{ mm} = 170 \text{ mm}$$

$$\eta_{sb} = 1.2$$

$$\frac{h_w}{t_w} \leq \frac{72 \cdot \epsilon}{\eta_{sb}}$$

$$\frac{170 \text{ mm}}{9 \text{ mm}} \leq \frac{72 \cdot 0.814}{1.2}$$

$$18.9 \leq 48.8 \quad \text{OK}$$

The shear buckling resistance of the web does not need to be verified.

**5.2.2 Vertical shear**

The resistance to vertical shear should be taken as the resistance of the structural steel section.

$$A_v = A_s - 2 \cdot b \cdot t_f + (t_w + 2 \cdot r) \cdot t_f = 7.81 \cdot 10^{-3} - 2 \cdot 0.2 \cdot 0.015 + (9 \cdot 10^{-3} + 2 \cdot 0.018) \cdot 0.015 = 2483 \text{ mm}^2$$

$$A_{v,min} = \eta_{sb} \cdot h_w \cdot t_w = 1.2 \cdot 0.17 \cdot 9 \cdot 10^{-3} = 1836 \text{ mm}^2$$

$$A_v \geq A_{v,min}$$

$$2483 \text{ mm}^2 \geq 1836 \text{ mm}^2$$

$$V_{pl,Rd} = \frac{A_v \cdot f_{yb}}{\sqrt{3} \cdot \gamma_{M0}} = \frac{2483 \text{ mm}^2 \cdot 355 \cdot 10^6}{\sqrt{3} \cdot 1} = 509 \text{ kN}$$

$$UC_{comp,V} = \frac{abs(V_{Ed,comp})}{V_{pl,Rd}} = \frac{abs(178.443 \text{ kN})}{509 \text{ kN}} = 0.35$$

The shear resistance of the section is adequate.

5.2.3 Bending moment

5.2.3.1 Longitudinal reinforcement

5.2.3.1.1 Centre of composite section

For buildings not intended mainly for storage the effects of creep in concrete beams may be taken into account by using an effective E modulus  $E_{ceff} = E_{cm} / 2$ .

$$E_{ceff} = \frac{E_{cm}}{2} = \frac{32800 \text{ MPa}}{2} = 16400 \text{ MPa}$$

$$n_E = \frac{E_b}{E_{ceff}} = \frac{210000 \text{ MPa}}{16400 \text{ MPa}} = 12.8$$

$$y_d = \frac{A_a \cdot \left( \frac{h_a}{2} \right) + \left( \frac{1}{n_E} \right) \cdot b_{eff} \cdot (h_c - h_d) \cdot \left( h_a + h_s - \frac{h_c - h_d}{2} \right)}{A_a + \left( \frac{1}{n_E} \right) \cdot b_{eff} \cdot (h_c - h_d)}$$

$$= \frac{7.81 \cdot 10^{-3} \cdot \left( \frac{0.2}{2} \right) + \left( \frac{1}{12.8} \right) \cdot 1.25 \cdot (0.109 - 0) \cdot \left( 0.2 + 0.16 - \frac{0.109 - 0}{2} \right)}{7.81 \cdot 10^{-3} + \left( \frac{1}{12.8} \right) \cdot 1.25 \cdot (0.109 - 0)} = 219 \text{ mm}$$

5.2.3.1.2 Degree of reinforcement

$$A_s = \frac{b_{eff}}{s_l} \cdot \left( \frac{d_l^2}{4} \right) \cdot \pi = \frac{1.25 \text{ m}}{150 \text{ mm}} \cdot \left( \frac{16 \text{ mm}^2}{4} \right) \cdot 3.14 = 1679 \text{ mm}^2$$

$$A_c = b_{eff} \cdot (h_c - h_d) = 1.25 \cdot (0.109 - 0) = 136793 \text{ mm}^2$$

$$z_0 = \left( h_a + h_s - \frac{h_c - h_d}{2} \right) - y_d = \left( 0.2 + 0.16 - \frac{0.109 - 0}{2} \right) - 0.219 = 86.7 \text{ mm}$$

$$k_c = \min \left( \frac{1}{1 + \frac{h_c - h_d}{2 \cdot z_0}} + 0.3; 1 \right) = \min \left( \frac{1}{1 + \frac{0.109 - 0}{2 \cdot 0.0867}} + 0.3; 1 \right) = 0.914$$

$$\rho_s = \delta \cdot \left( \frac{f_{yb}}{235} \right) \cdot \left( \frac{f_{ctm}}{f_{ykr}} \right) \cdot \sqrt{k_c} = 1.1 \cdot \left( \frac{355}{235} \right) \cdot \left( \frac{2.9 \cdot 10^6}{500 \cdot 10^6} \right) \cdot \sqrt{0.914} = 0.92\%$$

$$A_s \geq \rho_s \cdot A_c$$

$$1679 \text{ mm}^2 \geq 9.21 \cdot 10^{-3} \cdot 136793 \text{ mm}^2$$

$$1679 \text{ mm}^2 \geq 1260 \text{ mm}^2 \quad \text{OK}$$

The longitudinal reinforcement of the section is adequate.

5.2.3.2 Moment resistance

Moment resistance of a steel cross-section

$$M_{pl,Rd,s} = \frac{W_{ply} \cdot f_{yb}}{YMO} = \frac{642500 \text{ mm}^3 \cdot 355 \text{ MPa}}{1} = 228 \text{ kNm}$$

Influence of shear

$$\frac{V_{pl,Rd}}{2} > \text{abs}(V_{Ed,comp})$$

$$\frac{509 \text{ kN}}{2} > 178 \text{ kN}$$

$$254 \text{ kN} > 178 \text{ kN}$$

OK

The influence of the vertical shear on the bending moment resistance may be neglected.

$$f_{yb,w} = f_{yb} = 355 \text{ MPa}$$

Modified tension resistance of the steel member

$$r = 0 \text{ mm}$$

$$A_s = 2 \cdot t_f \cdot b + t_w \cdot (h_a - 2 \cdot t_f) = 2 \cdot 15 \text{ mm} \cdot 200 \text{ mm} + 9 \text{ mm} \cdot (200 \text{ mm} - 2 \cdot 15 \text{ mm}) = 7530 \text{ mm}^2$$

$$N_{pl,a} = A_s \cdot f_{yb} = 7530 \text{ mm}^2 \cdot 355 \text{ MPa} = 2673.15 \text{ kN}$$

Note: Roundings of the steel cross-section are neglected in bending resistance calculation.

$$N_{c,f} = \min(F_s; N_{pl,a}) = \min(730 \text{ kN}; 2673.15 \text{ kN}) = 730.05 \text{ kN}$$

**Negative bending moment resistance calculation**

The plastic neutral axis is located within the flange of the steel section.

$$N_{pl,a} - N_{a,f} = F_s + N_{a,f}$$

$$x = \frac{(N_{pl,a} - F_s)}{(2 \cdot b \cdot f_{yb})} = \frac{(2673.15 \text{ kN} - 730 \text{ kN})}{(2 \cdot 200 \text{ mm} \cdot 355 \text{ MPa})} = 13.7 \text{ mm}$$

Verification of the steel web classification.

$$\alpha_{cl} = 1$$

$$\frac{c_w}{t_w} \leq \frac{396 \cdot \epsilon}{13 \cdot \alpha_{cl} - 1}$$

$$\frac{134 \text{ mm}}{9 \text{ mm}} \leq \frac{396 \cdot 0.814}{13 \cdot 1 - 1}$$

$$14.9 \leq 26.8$$

OK

Web classified as Class 1.

$$N_{a,f} = b \cdot x \cdot f_{yb} = 200 \text{ mm} \cdot 13.7 \text{ mm} \cdot 355 \text{ MPa} = 971.55 \text{ kN}$$

$$N_{a,c} = N_{pl,a} - N_{a,f} = 2673.15 \text{ kN} - 971.55 \text{ kN} = 1701.60 \text{ kN}$$

Leverage arm of the compression part of the steel section calculated to the PNA.

$$h_{cs} = \frac{\left( b \cdot (t_f - x)^2 \cdot 0.5 + t_w \cdot (h_a - 2 \cdot t_f) \cdot \left( \frac{h_a}{2} - x \right) + t_f \cdot b \cdot \left( h_a - \frac{t_f}{2} - x \right) \right)}{b \cdot (t_f - x) + t_w \cdot (h_a - 2 \cdot t_f) + t_f \cdot b}$$

$$= \frac{\left( 200 \cdot (15 - 13.7)^2 \cdot 0.5 + 9 \cdot (200 - 2 \cdot 15) \cdot \left( \frac{200}{2} - 13.7 \right) + 15 \cdot 200 \cdot \left( 200 - \frac{15}{2} - 13.7 \right) \right)}{200 \cdot (15 - 13.7) + 9 \cdot (200 - 2 \cdot 15) + 15 \cdot 200}$$

$$h_{cs} = 140 \text{ mm}$$

$$h_1 = x + h_s - c_1 + \frac{d_1}{2} = 0.0137 + 0.16 - 0.03 + \frac{0.016}{2} = 136 \text{ mm}$$

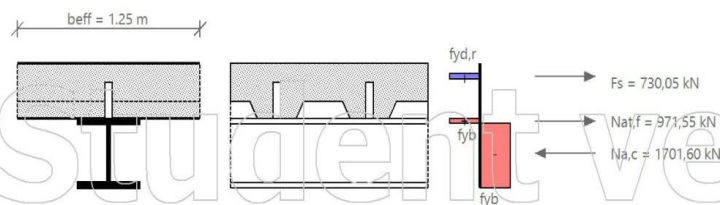

$$M_{pl,Rd} = F_s \cdot h_1 + \frac{N_{a,f} \cdot x}{2} + N_{a,c} \cdot h_{cs} = 730 \cdot 136 + \frac{971.55 \cdot 13.7}{2} + 1701.60 \cdot 140 = 343 \text{ kNm}$$

**Design moment resistance according to EN 1994-1-1 Art.6.2.1.2**

$$M_{Rd} = M_{pl,Rd} = 343 \text{ kNm}$$

$$UC_{comp,M} = \frac{abs(M_{Ed,comp})}{M_{Rd}} = \frac{abs(-257.990 \text{ kNm})}{343 \text{ kNm}} = 0.75$$

The bending moment resistance of the section is adequate.

**5.3 LTB resistance**

$$F = \left( 1 + \frac{t_w \cdot (h_a - t_f)}{4 \cdot b \cdot t_f} \right) \left( \frac{h_a - t_f}{t_w} \right)^{0.75} \cdot \left( \frac{t_f}{b} \right)^{0.25} = \left( 1 + \frac{9 \cdot (200 - 15)}{4 \cdot 200 \cdot 15} \right) \cdot \left( \frac{200 - 15}{9} \right)^{0.75} \cdot \left( \frac{15}{200} \right)^{0.25} = 5.75$$

$F_{lim} = 12.3$

$F \leq F_{lim}$

$5.75 \leq 12.3$

OK

The cross-section is qualified for verification of LTB by the simplified method.

$C_4 = 25$

$$\lambda_{LT,rel} = 5 \cdot \left( 1 + \frac{t_w \cdot (h_a - t_f)}{4 \cdot b \cdot t_f} \right) \left( \frac{h_a - t_f}{t_w} \right)^{0.75} \cdot \left( \frac{t_f}{b} \right)^{0.25} \cdot \left( \frac{f_{yb}}{E_b \cdot C_4} \right)^{0.5}$$

$$= 5 \cdot \left( 1 + \frac{9 \cdot 10^{-3} \cdot (0.2 - 0.015)}{4 \cdot 0.2 \cdot 0.015} \right) \cdot \left( \frac{0.2 - 0.015}{9 \cdot 10^{-3}} \right)^{0.75} \cdot \left( \frac{0.015}{0.2} \right)^{0.25} \cdot \left( \frac{355 \cdot 10^6}{210 \cdot 10^9 \cdot 25} \right)^{0.5} = 0.237$$

$h_a/b <= 2 \rightarrow$  Buckling curve 'a'

$\alpha_{LT} = 0.21$

$\Phi_{LT} = 0.5 \cdot (1 + \alpha_{LT} \cdot (\lambda_{LT,rel} - 0.2) + \lambda_{LT,rel}^2) = 0.5 \cdot (1 + 0.21 \cdot (0.237 - 0.2) + 0.237^2) = 0.532$

$X_{LT} = \frac{1}{\Phi_{LT} + \sqrt{\Phi_{LT}^2 - \lambda_{LT,rel}^2}} = \frac{1}{0.532 + \sqrt{0.532^2 - 0.237^2}} = 0.992$

$X_{LT} = \min(X_{LT}, 1) = \min(0.992; 1) = 0.992$

$M_{b,Rd} = X_{LT} \cdot M_{Rd} = 0.992 \cdot 343087 = 340.322 \text{ kNm}$

$UC_{comp\_LTB} = \frac{abs(M_{Ed,comp})}{M_{b,Rd}} = \frac{abs(-257.990 \text{ kNm})}{340.322 \text{ kNm}} = 0.76$

The later torsional buckling resistance of the section is adequate.

**5.4 Longitudinal shear**

**5.4.1 Transverse reinforcement**

Design shear flow

$h_f = h_c = 109 \text{ mm}$

$v_{Ed} = \frac{n_{r1} \cdot P_{Rd}}{2 \cdot l_s \cdot h_f} = \frac{1 \cdot 120 \text{ kN}}{2 \cdot 305 \text{ mm} \cdot 109 \text{ mm}} = 1.81 \text{ MPa}$

Transverse reinforcement

$\frac{A_t \cdot f_{yk,r}}{s_t} \geq \frac{v_{Ed} \cdot h_f}{\cotg(\theta)}$

$A_t = A_{st}/s_t$

$A_t = \frac{v_{Ed} \cdot h_f}{\cotg(\theta) \cdot f_{yk,r}} = \frac{1.81 \cdot 10^6 \cdot 0.109}{\cotg(26.5) \cdot 500 \cdot 10^6} = 226 \text{ mm}^2/\text{m}$

$A_{t,prov} = \frac{1}{s_t} \cdot \left( \frac{d_t^2}{4} \right) \cdot 3.14 = \frac{1}{0.15} \cdot \left( \frac{0.016^2}{4} \right) \cdot 3.14 = 1340 \text{ mm}^2/\text{m}$

$A_{t,prov} \geq A_t$

$1340 \text{ mm}^2/\text{m} \geq 226 \text{ mm}^2/\text{m} \quad \text{OK}$

The transverse reinforcement of the section is adequate.

**ULS check of Final stage is OK.**

$UC_{comp} = \max(0.35; 0.75; 0.76) = 0.76$

-iskoristivost elementa na GSN – 76%

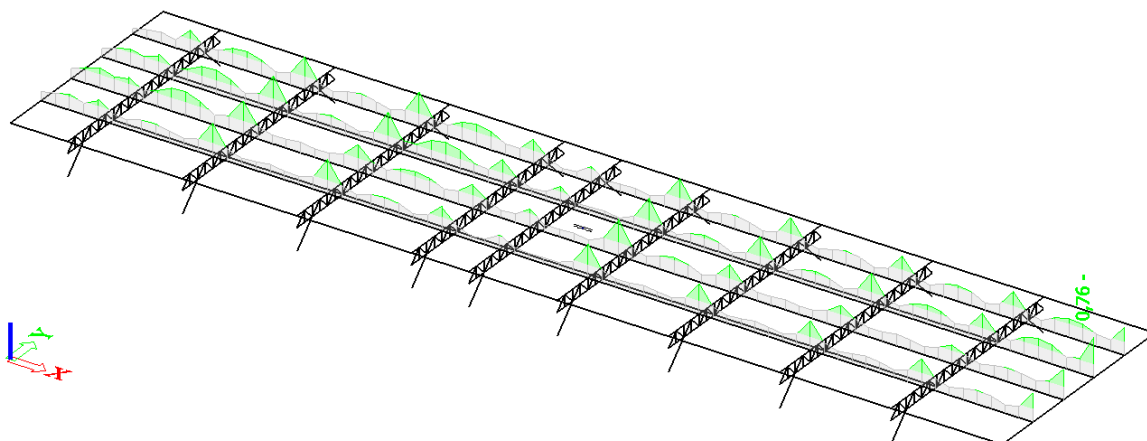

Slika 5.33. Prikaz iskoristivosti sekundarnog grednog nosača – poz 400



### 5.6.9. Rezne sile – podupora donje pojasnice glavnog rešetkastog nosača

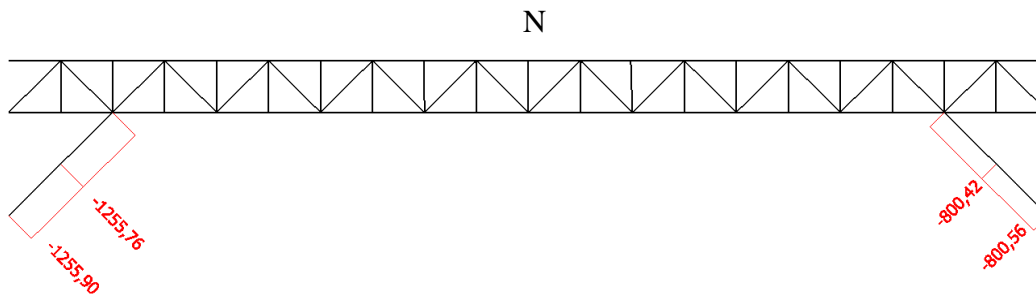

Slika 5.34. Prikaz reznih sila - podupora glavnog rešetkastog nosača

Name		Podupora donje pojasnice glavnog rešetkastog nosača - krov srednje dvorane	
Type		F180X8	
Source description		Chinese Standard / GB 6728-2002	
Item material		S 355	
Fabrication		cold formed	
Flexural buckling y-y		c	
Flexural buckling z-z		c	
Lateral torsional buckling		Default	
Use 2D FEM analysis		x	
A [m <sup>2</sup> ]		5,2800e-03	
A y, z [m <sup>2</sup> ]		2,6401e-03	2,6401e-03
I y, z [m <sup>4</sup> ]		2,5460e-05	2,5460e-05
I w [m <sup>3</sup> ], t [m <sup>3</sup> ]		1,2597e-07	4,1890e-05
Wey, z [m <sup>3</sup> ]		2,8300e-04	2,8300e-04
Wpl y, z [m <sup>3</sup> ]		3,3570e-04	3,3570e-04
d y, z [mm]		0	0
c YUCS, ZUCS [mm]		90	90
α [deg]		0,00	
A L, D [m <sup>2</sup> /m]		6,8566e-01	1,3208e+00
Mply +, - [Nm]		1,19e+05	1,19e+05
Mplz +, - [Nm]		1,19e+05	1,19e+05

Slika 5.35. Prikaz geometrijskih karakteristika nosača – poz 400

-iskoristivost elementa na GSN – 76%

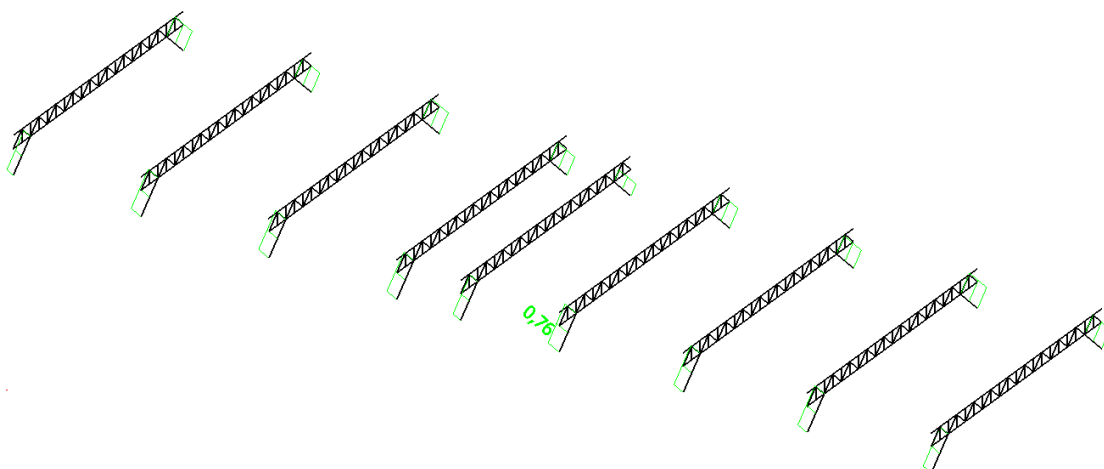

Slika 5.36. Prikaz iskoristivosti podupore rešetkastog nosača – poz 400

### 5.6.10. Dimenzioniranje – podupora donje pojasnice glavnog rešetkastog nosača

Member B5343	2,277 m	F180X8	S 355	GSN 28	0,76 -
--------------	---------	--------	-------	--------	--------

Note: EN 1993-1-3 article 1.1(3) specifies that this part does not apply to cold formed CHS and RHS sections. The default EN 1993-1-1 code check is executed instead of the EN 1993-1-3 code check.

Partial safety factors	
Gamma M0 for resistance of cross-sections	1,00
Gamma M1 for resistance to instability	1,00
Gamma M2 for resistance of net sections	1,25

Material		
Yield strength fy	355,0	MPa
Ultimate strength fu	510,0	MPa
Fabrication	Cold formed	

....:SECTION CHECK:....

The critical check is on position 2.277 m

Internal forces	Calculated	Unit
N,Ed	-1255,90	kN
Vy,Ed	0,00	kN
Vz,Ed	0,00	kN
T,Ed	0,00	kNm
My,Ed	0,00	kNm
Mz,Ed	0,00	kNm

**Classification for cross-section design**

According to EN 1993-1-1 article 5.5.2

**Classification of Internal Compression parts**

According to EN 1993-1-1 Table 5.2 Sheet 1

Maximum width-to-thickness ratio	19,50
Class 1 Limit	26,85
Class 2 Limit	30,92
Class 3 Limit	34,17

=> Section classified as Class 1 for cross-section design

**Compression check**

According to EN 1993-1-1 article 6.2.4 and formula (6.9)

A	5,2800e-03	m <sup>2</sup>
Nc,Rd	1874,40	kN
Unity check	0,67	-

The member satisfies the section check.

....:STABILITY CHECK:....

**Classification for member buckling design**

Decisive position for stability classification: 0,000 m

**Classification of Internal Compression parts**

According to EN 1993-1-1 Table 5.2 Sheet 1

Maximum width-to-thickness ratio	19,50
Class 1 Limit	26,85
Class 2 Limit	30,92
Class 3 Limit	34,17

=> Section classified as Class 1 for member buckling design

**Flexural Buckling check**

According to EN 1993-1-1 article 6.3.1.1 and formula (6.46)

Buckling parameters	yy	zz	
Sway type	sway	non-sway	
System length L	2,277	2,277	m
Buckling factor k	1,00	1,00	
Buckling length Lcr	2,277	2,277	m
Critical Euler load Ncr	10178,39	10178,90	kN
Slenderness Lambda	32,79	32,79	
Relative slenderness Lambda,rel	0,43	0,43	
Limit slenderness Lambda,rel,0	0,20	0,20	
Buckling curve	c	c	
Imperfection Alpha	0,49	0,49	
Reduction factor Chi	0,88	0,88	
Buckling resistance Nb,Rd	1652,85	1652,86	kN

Flexural Buckling verification		
Cross-section area A	5,2800e-03	m <sup>2</sup>
Buckling resistance Nb,Rd	1652,85	kN
Unity check	0,76	-

The member satisfies the stability check.

### 5.6.11. Rezne sile – spregovi

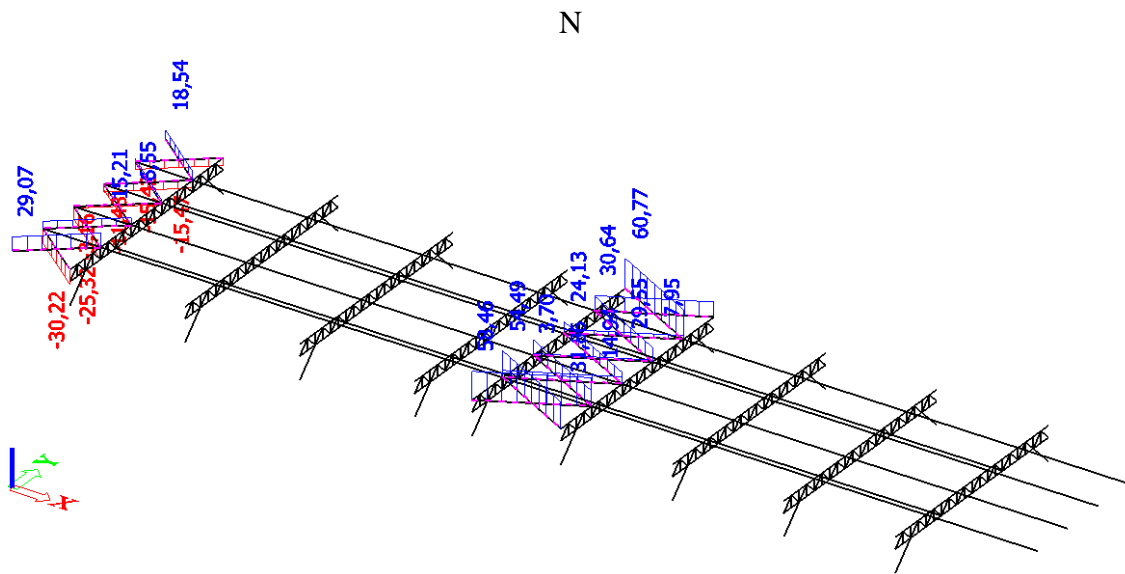

Slika 5.37. Prikaz reznih sila – spregovi – poz 400

-poprečni presjek nosača

Name	Spregovi - krov srednje dvorane	
Type	RND30	
Source description	Stahlbau Zentrum Schweiz / Konstruktionstabellen / 9.Ausgabe 2005	
Item material	S 355	
Fabrication	rolled	
Flexural buckling y-y	c	
Flexural buckling z-z	c	
Lateral torsional buckling	Default	
Use 2D FEM analysis	<input checked="" type="checkbox"/>	
A [m <sup>2</sup> ]	7,0700e-04	
A <sub>y, z</sub> [m <sup>2</sup> ]	6,3704e-04	6,3704e-04
I <sub>y, z</sub> [m <sup>4</sup> ]	3,9800e-08	3,9800e-08
I <sub>w</sub> [m <sup>6</sup> ], I <sub>t</sub> [m <sup>4</sup> ]	8,0801e-36	7,9722e-08
W <sub>el y, z</sub> [m <sup>3</sup> ]	2,6500e-06	2,6500e-06
W <sub>pl y, z</sub> [m <sup>3</sup> ]	4,5000e-06	4,5000e-06
d <sub>y, z</sub> [mm]	0	0
c <sub>YUCS, ZUCS</sub> [mm]	15	15
α [deg]	0,00	
A <sub>L, D</sub> [m <sup>2</sup> /m]	9,4200e-02	9,4243e-02
M <sub>ply +, -</sub> [Nm]	1,60e+03	1,60e+03
M <sub>plz +, -</sub> [Nm]	1,60e+03	1,60e+03

Slika 5.38. Prikaz geometrijskih karakteristika nosača – poz 400

**5.6.12. Dimenzioniranje – spregovi**

Dimenzioniranje elementa

$$N_{c,Rd} = N_{pl,Rd} = \frac{A \cdot f_y}{\gamma_{M_0}} = \frac{7,07 \cdot 35,5}{1,25} = 200,79(kN)$$

Uvjet nosivosti  $N_{c,Rd} \geq N_{Ed}$

$$200,79(kN) \geq 60,77(kN)$$

uvjet zadovoljen

-iskoristivost na GSN -  $60,77 kN / 200,79 kN = 0,30 = 30\%$

## 6. PRORAČUN SPREGNUTE MEĐUKATNE KONSTRUKCIJE-POZ 300

### 6.1. Pomaci spregnute međukatne konstrukcije – poz 300

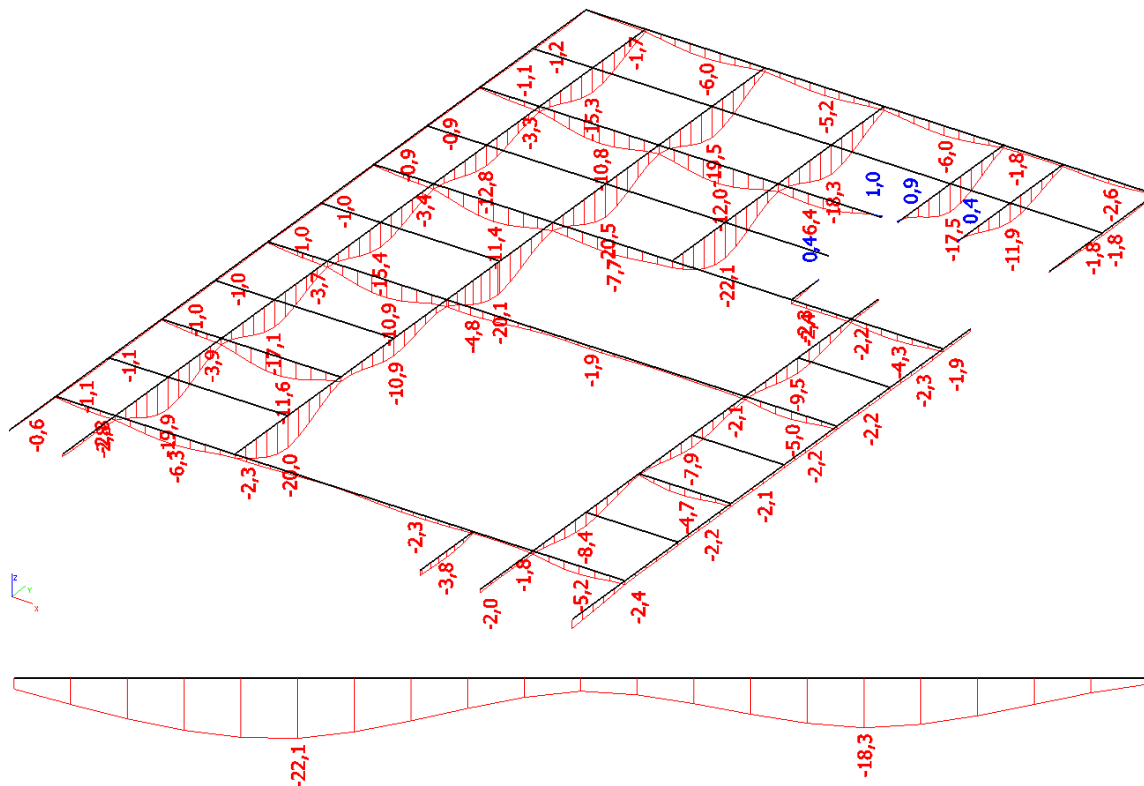

Slika 6.1. Prikaz vertikalnog pomaka gređnog nosača – poz 300

Dopušteni vertikalni pomak (progib):

$$u_{dop} = \frac{l}{300} = \frac{10,8 \cdot 1000}{300} = 36,0 \text{ mm}$$

$$u_z = 22,1 \text{ mm} < u_{z,dop} = 36,0 \text{ mm} \quad \text{Zadovoljava}$$

-iskoristivost na GSU -  $22,1 \text{ mm} / 36,0 \text{ mm} = 0,61 = 61\%$

## 6.2. Dimenziniranje spregnute međukatne konstrukcije – poz 300

### 6.2.1. Rezne sile – gredni nosača 1

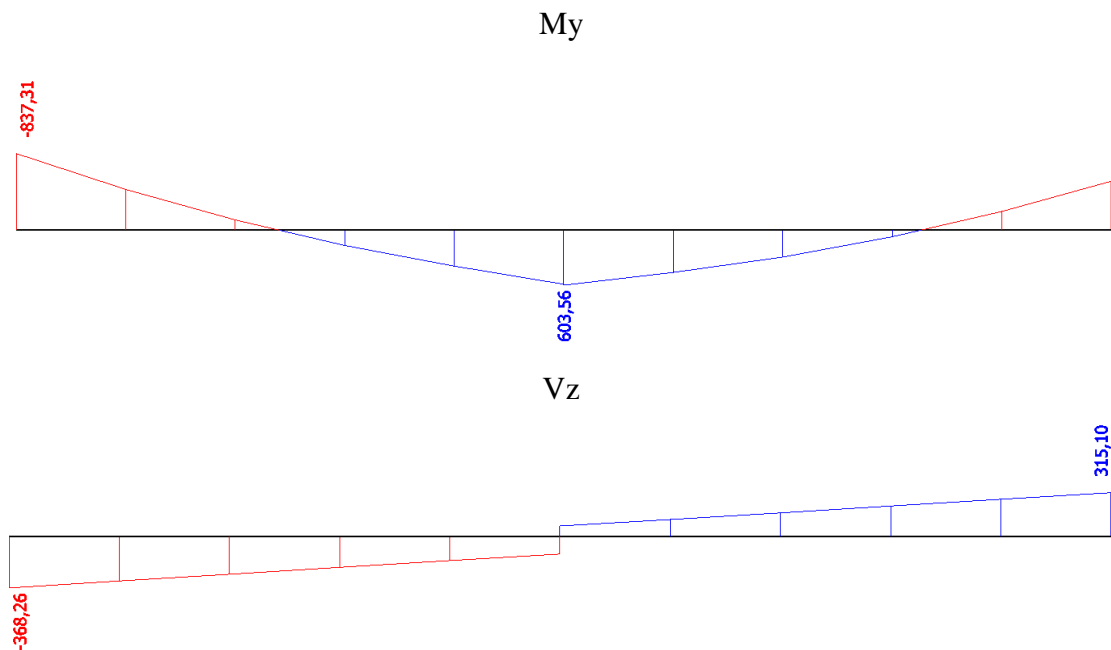

Slika 6.2.. Prikaz reznih sila grednog nosača 1 – poz 300

-poprečni presjek nosača

Name	Gredni nosač 1 - poz 300	
Type	HEA400	
Source description	Profil Arbed / Structural shapes / Edition Octobre 1995	
Item material	S 355	
Fabrication	rolled	
Flexural buckling y-y	a	
Flexural buckling z-z	b	
Lateral torsional buckling	Default	
Use 2D FEM analysis	*	
A [m²]	1,5900e-02	
A y, z [m²]	1,1006e-02	4,4726e-03
I y, z [m⁴]	4,5100e-04	8,5600e-05
I w [m³], t [m²]	2,9421e-06	1,8900e-06
Wey, z [m³]	2,3100e-03	5,7100e-04
Wply, z [m³]	2,5625e-03	8,7083e-04
d y, z [mm]	0	0
c YUCS, ZUCS [mm]	150	195
α [deg]	0,00	
A L, D [m²/m]	1,9100e+00	1,9114e+00
Mply +, - [Nm]	9,10e+05	9,10e+05
Mplz +, - [Nm]	3,10e+05	3,10e+05

Slika 6.3.. Prikaz geometrijskih karakteristika nosača – poz 300

## 6.2.2. Dimenzioniranje – gredni nosača 1

SCIAENGINEER

### Composite Beam - Final stage

Linear calculation  
Class: All ULS  
Extreme 1D: Global  
Selection: B2390

### Composite beam verification

for beam B2390 at section 10.8 m, in accordance with EC EN 1994-1-1

#### 1. Geometry data

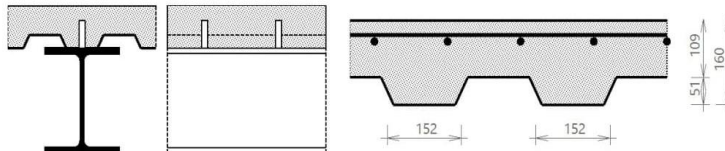

#### Simply supported beam

Length of the current span	$L = 10.8 \text{ m}$
Beam spacing at the left	$L_{\text{left}} = 8.1 \text{ m}$
Beam spacing at the right	$L_{\text{right}} = 4.05 \text{ m}$
Checked section	$d_x = 10.8 \text{ m}$

*Warning: For a continuous beam, intermediate buckling supports y-y are ignored in both the calculation of the effective width for the analysis model and the check.*

#### 2. Cross-section & materials

##### 2.1 Steel section properties

###### 2.1.1 Cross-section

Cross-section	HEA400
Height	$h_a = 390 \text{ mm}$
Width	$b = 300 \text{ mm}$
Web thickness	$t_w = 11 \text{ mm}$
Flange thickness	$t_f = 19 \text{ mm}$
Radius	$r = 27 \text{ mm}$
Area	$A_a = 15900 \text{ mm}^2$
Moment of inertia	$I_y = 451 \cdot 10^6 \text{ mm}^4$
Radius of gyration	$i_z = 73 \text{ mm}$
Plastic section modulus	$W_{\text{ply}} = 2.563 \cdot 10^6 \text{ mm}^3$

###### 2.1.2 Material

Steel grade	S 355
Yield strength	$f_{yb} = 355 \text{ MPa}$
Ultimate strength	$f_{ub} = 490 \text{ MPa}$
E modulus	$E_b = 210000 \text{ MPa}$

##### 2.1.3 Cross-section classification

$$\epsilon = \sqrt{\frac{235}{355}} = 0.814 \quad (\text{EN 1993-1-1 §5.6 Tab. 5.2})$$

###### 2.1.3.1 Flange in compression

$$c_f = \frac{b - t_w - 2 \cdot r}{2} = \frac{300 \text{ mm} - 11 \text{ mm} - 2 \cdot 27 \text{ mm}}{2} = 118 \text{ mm}$$

$$\frac{c_f}{t_f} \leq 9 \cdot \epsilon$$

$$\frac{118 \text{ mm}}{19 \text{ mm}} \leq 9 \cdot 0.814$$

$$6.18 \leq 7.32$$

OK

Flange classified as Class 1.

Student version

2.1.3.2 Web in bending

$$c_w = h_a - 2 \cdot t_f - 2 \cdot r = 390 \text{ mm} - 2 \cdot 19 \text{ mm} - 2 \cdot 27 \text{ mm} = 298 \text{ mm}$$

$$\alpha_{cd} = 0.5$$

$$\frac{c_w}{t_w} \leq \frac{36 \cdot \epsilon}{\alpha_{cd}}$$

$$\frac{298 \text{ mm}}{11 \text{ mm}} \leq \frac{36 \cdot 0.814}{0.5}$$

$$27.1 \leq 58.6 \quad \text{OK}$$

Web classified as Class 1.

**Cross-section classified as Class 1**

Cross-section Class OK.

**2.2 Concrete slab with profiled sheeting****2.2.1 Concrete slab**2.2.1.1 Slab

Total height of the slab  $h_s = 160 \text{ mm}$

2.2.1.2 Material

Concrete class C30/37  
 Characteristic strength  $f_{ck} = 30 \text{ MPa}$   
 E modulus  $E_{cm} = 32800 \text{ MPa}$

**2.2.2 Profiled steel sheeting**

Sheeting with ribs parallel to the supporting beams

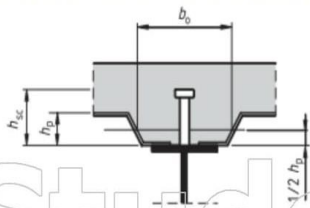

Name	Vulcraft 2 VU 20
Depth of the ribs	$h_p = 50.8 \text{ mm}$
Height of full concrete	$h_c = 109.2 \text{ mm}$
Height of the re-entrant stiffener	$h_d = 0 \text{ mm}$
Spacing of the ribs	$b_s = 304.8 \text{ mm}$
Top width of the rib	$b_r = 127 \text{ mm}$
Bottom width of the rib	$b_b = 127 \text{ mm}$
Mean width of the ribs	$b_{0,rib} = 152.4 \text{ mm}$
Thickness of the sheeting	$t_p = 0.9093 \text{ mm}$

**2.2.3 Shear connectors**2.2.3.1 Geometry

Name	H110
Diameter	$d_s = 25 \text{ mm}$
Nominal height	$h_{nom} = 110 \text{ mm}$
As-welded height	$h_{sc} = 105 \text{ mm}$
Amount per trough or section	$n_r = 1$

2.2.3.2 Material

Steel grade	S 355
Ultimate strength	$f_{us} = 490 \text{ MPa}$

**2.2.4 Reinforcement**2.2.4.1 Geometry

Longitudinal bar diameter	$d_l = 16 \text{ mm}$
Longitudinal bar spacing	$s_l = 150 \text{ mm}$
Longitudinal bar cover	$c_l = 30 \text{ mm}$
Transverse bar diameter	$d_t = 16 \text{ mm}$
Transverse bar spacing	$s_t = 150 \text{ mm}$
Transverse bar cover	$c_t = 46 \text{ mm}$

2.2.4.2 Material

Material	B 500A
Characteristic yield strength	$f_{ykr} = 500 \text{ MPa}$



**3. Design values of loads**

Load Name : GSN 24

Content of combination : 1.35\*g-vlastitežina+1.35\*dg-dodatnostalno+  
 1.62\*q-promjenjivoopterećenje+1.35\*g-vlastitežina\_dryconcrete+  
 1.35\*Wy-1kom.-Wz-poz+1.35\*s-opterećenjesnijegom

Bending moment  $M_{Ed,comp} = -837.309 \text{ kNm}$   
 Shear force  $V_{Ed,comp} = -368.263 \text{ kN}$

**4. Partial safety factors**

Steel section  $\gamma_{M0} = 1$   
 $\gamma_{M1} = 1$   
 Shear connectors  $\gamma_V = 1.25$   
 Concrete  $\gamma_C = 1.5$   
 Reinforcement  $\gamma_S = 1.15$

**5. ULS check of the Final stage**

**5.1 Shear connection**

**5.1.1 Design resistance of shear connectors**

**5.1.1.1 Shear connector in a solid slab**

$$\frac{h_{sc}}{d_s} > 4$$

$$4.2 > 4$$

$$\alpha = 1$$

$$f_{us} = \min(490; 500) \text{ MPa}$$

$$P_{Rd,solid,1} = \frac{0.8 \cdot f_{us} \cdot \left( \frac{\pi \cdot d_s^2}{4} \right)}{\gamma_V} = \frac{0.8 \cdot 490 \text{ MPa} \cdot \left( \frac{3.14 \cdot 25 \text{ mm}^2}{4} \right)}{1.25} = 154 \text{ kN}$$

$$P_{Rd,solid,2} = \frac{0.29 \cdot \alpha \cdot d_s^2 \cdot \sqrt{f_{ck} \cdot E_{cm}}}{\gamma_V} = \frac{0.29 \cdot 1 \cdot 25 \text{ mm}^2 \cdot \sqrt{30 \text{ MPa} \cdot 32800 \text{ MPa}}}{1.25} = 144 \text{ kN}$$

$$P_{Rd,solid} = \min(P_{Rd,solid,1}; P_{Rd,solid,2}) = \min(154 \text{ kN}; 144 \text{ kN}) = 144 \text{ kN}$$

**5.1.1.2 Shear connector in profiled sheeting**

Sheeting with ribs parallel to the supporting beams

$$k_l = \frac{0.6 \cdot b_{0,rib}}{h_p} \cdot \left( \frac{h_{sc}}{h_p} - 1 \right) = \frac{0.6 \cdot 152 \text{ mm}}{50.8 \text{ mm}} \cdot \left( \frac{105 \text{ mm}}{50.8 \text{ mm}} - 1 \right) = 1.92$$

$$k_l = 1$$

$$P_{Rd} = k_l \cdot P_{Rd,solid} = 1 \cdot 144 \text{ kN} = 144 \text{ kN}$$

**5.1.2 Degree of shear connection**

**5.1.2.1 Determination of  $b_{eff}$  of the concrete flange and length  $L_e$**

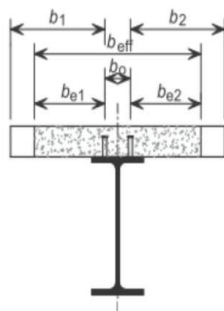

The effective width at the end support

$$L_{e0} = L_1 = 10.8 \text{ m}$$

**Left side of the beam**

$$b_1 = \frac{L_{\text{perp, left}}}{2} - \frac{b_0}{2} = \frac{8,1 \text{ m}}{2} - \frac{0 \text{ mm}}{2} = 4,05 \text{ m}$$

$$b_{e10} = \min\left(\frac{L_{e0}}{8}; b_1\right) = \min\left(\frac{10,8 \text{ m}}{8}; 4,05 \text{ m}\right) = 1,35 \text{ m}$$

$$b_{e11} = \min\left(\frac{L_{e1}}{8}; b_1\right) = \min\left(\frac{0 \text{ m}}{8}; 4,05 \text{ m}\right) = 0 \text{ m}$$

$$b_{e12} = \min\left(\frac{L_{e2}}{8}; b_1\right) = \min\left(\frac{0 \text{ m}}{8}; 4,05 \text{ m}\right) = 0 \text{ m}$$

$$\beta_{1, \text{calc}} = 0,55 + \frac{0,025 \cdot L_{e0}}{b_{e10}} = 0,55 + \frac{0,025 \cdot 10,8 \text{ m}}{1,35 \text{ m}} = 0,75$$

$$\beta_{1, \text{calc}} \leq 1,0$$

$$0,75 \leq 1,0 \quad \text{OK}$$

$$\beta_1 = \beta_{1, \text{calc}} = 0,75$$

**Right side of the beam**

$$b_2 = \frac{L_{\text{perp, right}}}{2} - \frac{b_0}{2} = \frac{4,05 \text{ m}}{2} - \frac{0 \text{ mm}}{2} = 2,03 \text{ m}$$

$$b_{e20} = \min\left(\frac{L_{e0}}{8}; b_2\right) = \min\left(\frac{10,8 \text{ m}}{8}; 2,03 \text{ m}\right) = 1,35 \text{ m}$$

$$b_{e21} = \min\left(\frac{L_{e1}}{8}; b_2\right) = \min\left(\frac{0 \text{ m}}{8}; 2,03 \text{ m}\right) = 0 \text{ m}$$

$$b_{e22} = \min\left(\frac{L_{e2}}{8}; b_2\right) = \min\left(\frac{0 \text{ m}}{8}; 2,03 \text{ m}\right) = 0 \text{ m}$$

$$\beta_{2, \text{calc}} = 0,55 + \frac{0,025 \cdot L_{e0}}{b_{e20}} = 0,55 + \frac{0,025 \cdot 10,8 \text{ m}}{1,35 \text{ m}} = 0,75$$

$$\beta_{2, \text{calc}} \leq 1,0$$

$$0,75 \leq 1,0 \quad \text{OK}$$

$$\beta_2 = \beta_{2, \text{calc}} = 0,75$$

**Calculation of  $b_{\text{eff},0}$** 

$$b_{\text{eff},0} = b_0 + b_{e10} \cdot \beta_1 + b_{e20} \cdot \beta_2 = 0 \text{ mm} + 1,35 \text{ m} \cdot 0,75 + 1,35 \text{ m} \cdot 0,75 = 2,03 \text{ m}$$

**Calculation of  $b_{\text{eff}}$** 

$$b_{\text{eff}} = b_{\text{eff},0} = 2,03 \text{ m}$$

**Determination of  $L_e$** 

$$L_e = L_{e0} = 10,8 \text{ m}$$

**5.1.2.2 Minimum degree of shear connection**

Warning: Conditions given by EN 1994-1-1 Art. 6.6.1.2 (3) are not fulfilled.

$$\eta_{\text{min, calc}} = 1 - \frac{355}{f_{yb}} \cdot (0,75 - 0,03 \cdot L_e)$$

$$\eta_{\text{min, calc}} = 1 - \frac{355}{355} \cdot (0,75 - 0,03 \cdot 10,8 \text{ m}) = 0,57$$

$$\eta_{\text{min}} = \max(\eta_{\text{min, calc}}; 0,4) = \max(0,57; 0,4) = 0,57$$

**5.1.2.3 Degree of shear connection present****5.1.2.3.1 Tension resistance of the reinforcement**

$$A_s = \frac{b_{\text{eff}}}{s_l} \cdot \left(\frac{d_l^2}{4}\right) \cdot \pi = \frac{2,03 \text{ m}}{150 \text{ mm}} \cdot \left(\frac{16 \text{ mm}^2}{4}\right) \cdot 3,14 = 2714 \text{ mm}^2$$

$$F_s = \frac{A_s \cdot f_{yk,r}}{\gamma_s} = \frac{2,71 \cdot 10^{-3} \cdot 500 \cdot 10^6}{1,15} = 1180 \text{ kN}$$

**5.1.2.3.2 Tension resistance of the steel member**

$$N_{pl,a} = f_{yb} \cdot A_a = 355 \text{ MPa} \cdot 15900 \text{ mm}^2 = 5644,50 \text{ kN}$$

$$N_{c,t} = \min(F_s; N_{pl,a}) = \min(1180 \text{ kN}; 5644,50 \text{ kN}) = 1180,15 \text{ kN}$$

Student version

**5.1.2.3.3 Resistance of the shear connectors**

$$l_s = \frac{L}{n_{row}} = \frac{10.8}{43} = 251 \text{ mm}$$

Number of shear studs available per length  $L_w/2$

$$n_{sp} = \frac{0.5 \cdot L_w}{l_s} \cdot n_r$$

$$n_{sp} = 21 \cdot 1 = 21$$

$$N_c = n_{sp} \cdot P_{Rd} = 21 \cdot 143835 = 3020.54 \text{ kN}$$

$$\eta = \min\left(\frac{N_c}{N_{cf}}; 1\right) = \min\left(\frac{3020.54 \text{ kN}}{1180.15 \text{ kN}}; 1\right) = 1$$

$$\eta \geq \eta_{min}$$

$$1 \geq 0.57 \quad \text{OK}$$

The shear connection degree is adequate.

**5.2 Cross-sectional resistance of the composite beam**

**5.2.1 Shear buckling**

$$h_w = h_a - 2 \cdot t_f = 390 \text{ mm} - 2 \cdot 19 \text{ mm} = 352 \text{ mm}$$

$$\eta_{sb} = 1.2$$

$$\frac{h_w}{t_w} \leq \frac{72 \cdot \epsilon}{\eta_{sb}}$$

$$\frac{352 \text{ mm}}{11 \text{ mm}} \leq \frac{72 \cdot 0.814}{1.2}$$

$$32 \leq 48.8 \quad \text{OK}$$

The shear buckling resistance of the web does not need to be verified.

**5.2.2 Vertical shear**

The resistance to vertical shear should be taken as the resistance of the structural steel section.

$$A_v = A_s - 2 \cdot b \cdot t_f + (t_w + 2 \cdot r) \cdot t_f$$

$$= 0.0159 - 2 \cdot 0.3 \cdot 0.019 + (0.011 + 2 \cdot 0.027) \cdot 0.019 = 5735 \text{ mm}^2$$

$$A_{v,min} = \eta_{sb} \cdot h_w \cdot t_w = 1.2 \cdot 0.352 \cdot 0.011 = 4646 \text{ mm}^2$$

$$A_v \geq A_{v,min}$$

$$5735 \text{ mm}^2 \geq 4646 \text{ mm}^2$$

$$V_{pl,Rd} = \frac{A_v \cdot f_{yb}}{\sqrt{3} \cdot \gamma_{M0}} = \frac{5735 \text{ mm}^2 \cdot 355 \cdot 10^6}{\sqrt{3} \cdot 1} = 1175 \text{ kN}$$

$$UC_{comp,V} = \frac{abs(V_{Ed,comp})}{V_{pl,Rd}} = \frac{abs(-368.263 \text{ kN})}{1175 \text{ kN}} = 0.31$$

The shear resistance of the section is adequate.

**5.2.3 Bending moment**

**5.2.3.1 Longitudinal reinforcement**

**5.2.3.1.1 Centre of composite section**

For buildings not intended mainly for storage the effects of creep in concrete beams may be taken into account by using an effective E modulus  $E_{ceff} = E_{cm} / 2$ .

$$E_{ceff} = \frac{E_{cm}}{2} = \frac{32800 \text{ MPa}}{2} = 16400 \text{ MPa}$$

$$n_E = \frac{E_b}{E_{ceff}} = \frac{210000 \text{ MPa}}{16400 \text{ MPa}} = 12.8$$

$$y_d = \frac{A_a \cdot \left(\frac{h_a}{2}\right) + \left(\frac{1}{n_E}\right) \cdot b_{eff} \cdot (h_c - h_d) \cdot \left(h_a + h_s - \frac{h_c - h_d}{2}\right)}{A_a + \left(\frac{1}{n_E}\right) \cdot b_{eff} \cdot (h_c - h_d)}$$

$$= \frac{0.0159 \cdot \left(\frac{0.39}{2}\right) + \left(\frac{1}{12.8}\right) \cdot 2.03 \cdot (0.109 - 0) \cdot \left(0.39 + 0.16 - \frac{0.109 - 0}{2}\right)}{0.0159 + \left(\frac{1}{12.8}\right) \cdot 2.03 \cdot (0.109 - 0)} = 351 \text{ mm}$$

Student version

## 5.2.3.1.2 Degree of reinforcement

$$A_s = \frac{b_{\text{eff}}}{s_j} \left( \frac{d_l^2}{4} \right) \cdot \pi = \frac{2.03 \text{ m}}{150 \text{ mm}} \left( \frac{16 \text{ mm}^2}{4} \right) 3.14 = 2714 \text{ mm}^2$$

$$A_c = b_{\text{eff}} \cdot (h_c - h_d) = 2.03 \cdot (0.109 - 0) = 221130 \text{ mm}^2$$

$$z_0 = \left( h_a + h_s - \frac{h_c - h_d}{2} \right) - y_d = \left( 0.39 + 0.16 - \frac{0.109 - 0}{2} \right) - 0.351 = 144 \text{ mm}$$

$$k_c = \min \left( \frac{1}{1 + \frac{h_c - h_d}{2 \cdot z_0}} + 0.3; 1 \right) = \min \left( \frac{1}{1 + \frac{0.109 - 0}{2 \cdot 0.144}} + 0.3; 1 \right) = 1$$

$$\rho_s = \delta \cdot \left( \frac{f_{yb}}{235} \right) \cdot \left( \frac{f_{ctm}}{f_{yk,r}} \right) \cdot \sqrt{k_c} = 1.1 \cdot \left( \frac{355}{235} \right) \cdot \left( \frac{2.9 \cdot 10^6}{500 \cdot 10^6} \right) \cdot \sqrt{1} = 0.964 \%$$

$$A_s \geq \rho_s \cdot A_c$$

$$2714 \text{ mm}^2 \geq 9.64 \cdot 10^{-3} \cdot 221130 \text{ mm}^2$$

$$2714 \text{ mm}^2 \geq 2131 \text{ mm}^2 \quad \text{OK}$$

The longitudinal reinforcement of the section is adequate.

## 5.2.3.2 Moment resistance

## Moment resistance of a steel cross-section

$$M_{pl,Rd,a} = \frac{W_{ply} \cdot f_{yb}}{Y_{MO}} = \frac{2.56 \cdot 10^6 \text{ mm}^3 \cdot 355 \text{ MPa}}{1} = 910 \text{ kNm}$$

## Influence of shear

$$\frac{V_{pl,Rd}}{2} > \text{abs}(V_{Ed,comp})$$

$$\frac{1175 \text{ kN}}{2} > 368 \text{ kN}$$

$$588 \text{ kN} > 368 \text{ kN} \quad \text{OK}$$

The influence of the vertical shear on the bending moment resistance may be neglected.

$$f_{yb,w} = f_{yb} = 355 \text{ MPa}$$

## Modified tension resistance of the steel member

$$r = 0 \text{ mm}$$

$$A_s = 2 \cdot t_f \cdot b + t_w \cdot (h_a - 2 \cdot t_f) = 2 \cdot 19 \text{ mm} \cdot 300 \text{ mm} + 11 \text{ mm} \cdot (390 \text{ mm} - 2 \cdot 19 \text{ mm}) = 15272 \text{ mm}^2$$

$$N_{pl,a} = A_s \cdot f_{yb} = 15272 \text{ mm}^2 \cdot 355 \text{ MPa} = 5421.56 \text{ kN}$$

Note: Roundings of the steel cross-section are neglected in bending resistance calculation.

$$N_{c,f} = \min(F_s; N_{pl,a}) = \min(1180 \text{ kN}; 5421.56 \text{ kN}) = 1180.15 \text{ kN}$$

## Negative bending moment resistance calculation

The plastic neutral axis is located within the web of the steel section.

$$N_{at,f} = b \cdot t_f \cdot f_{yb} = 0.3 \cdot 0.019 \cdot 355 \cdot 10^6 = 2023.50 \text{ kN}$$

$$N_{pl,a} - N_{at,f} - N_{at,w} = F_s + N_{at,f} + N_{at,w}$$

$$x = \frac{(N_{pl,a} - 2 \cdot N_{at,f} - F_s)}{(2 \cdot t_w \cdot f_{yb,w})} = \frac{(5421.56 \text{ kN} - 2 \cdot 2023.50 \text{ kN} - 1180 \text{ kN})}{(2 \cdot 11 \text{ mm} \cdot 355 \text{ MPa})} = 24.9 \text{ mm}$$

Verification of the steel web classification.

$$\alpha_{cl} = \frac{c_w - x}{c_w} = \frac{298 - 24.9}{298} = 0.916$$

$$\frac{c_w}{t_w} \leq \frac{396 \cdot \epsilon}{13 \cdot \alpha_{cl} - 1}$$

$$\frac{298 \text{ mm}}{11 \text{ mm}} \leq \frac{396 \cdot 0.814}{13 \cdot 0.916 - 1}$$

$$27.1 \leq 29.5 \quad \text{OK}$$

Web classified as Class 1.

$$N_{at,w} = t_w \cdot x \cdot f_{yb,w} = 11 \text{ mm} \cdot 24.9 \text{ mm} \cdot 355 \text{ MPa} = 97.21 \text{ kN}$$

$$N_{a,c} = N_{pl,a} - N_{at,f} - N_{at,w} = 5421.56 \text{ kN} - 2023.50 \text{ kN} - 97.21 \text{ kN} = 3300.85 \text{ kN}$$

Leverage arm of the compression part of the steel section calculated to the PNA.

$$h_{cs} = \frac{\left( t_w \cdot (h_a - 2 \cdot t_f - x)^2 \cdot 0.5 + t_f \cdot b \cdot (h_a - 1.5 \cdot t_f - x) \right)}{t_w \cdot (h_a - 2 \cdot t_f - x) + t_f \cdot b}$$

$$= \frac{\left( 11 \cdot (390 - 2 \cdot 19 - 24.9)^2 \cdot 0.5 + 19 \cdot 300 \cdot (390 - 1.5 \cdot 19 - 24.9) \right)}{11 \cdot (390 - 2 \cdot 19 - 24.9) + 19 \cdot 300} = 270 \text{ mm}$$

$$h_1 = x + t_f + h_s - c_1 + \frac{d_l}{2} = 0.0249 + 0.019 + 0.16 - 0.03 + \frac{0.016}{2} = 166 \text{ mm}$$

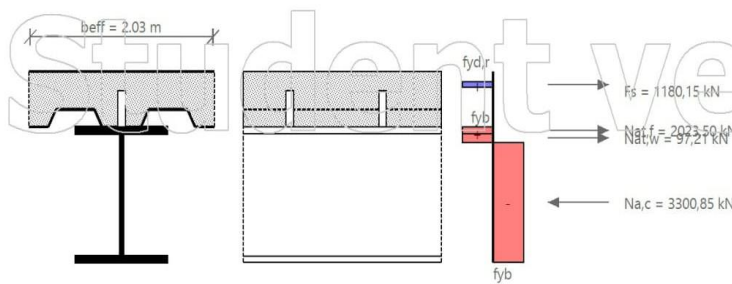

$$M_{pl,Rd} = F_s \cdot h_1 + N_{at,f} \cdot \left( \frac{t_f}{2} + x \right) + \frac{N_{at,w} \cdot x}{2} + N_{a,c} \cdot h_{cs}$$

$$= 1180 \cdot 166 + 2023.50 \cdot \left( \frac{19}{2} + 24.9 \right) + \frac{97.21 \cdot 24.9}{2} + 3300.85 \cdot 270 = 1157 \text{ kNm}$$

**Design moment resistance according to EN 1994-1-1 Art.6.2.1.2**

$$M_{Rd} = M_{pl,Rd} = 1157 \text{ kNm}$$

$$UC_{comp,M} = \frac{abs(M_{Ed,comp})}{M_{Rd}} = \frac{abs(-837.309 \text{ kNm})}{1157 \text{ kNm}} = 0.72$$

The bending moment resistance of the section is adequate.

**5.3 LTB resistance**

$$F = \left( 1 + \frac{t_w \cdot (h_a - t_f)}{4 \cdot b \cdot t_f} \right) \left( \frac{h_a - t_f}{t_w} \right)^{0.75} \left( \frac{t_f}{b} \right)^{0.25} = \left( 1 + \frac{11 \cdot (390 - 19)}{4 \cdot 300 \cdot 19} \right) \left( \frac{390 - 19}{11} \right)^{0.75} \left( \frac{19}{300} \right)^{0.25} = 8.28$$

$$F_{lim} = 12.3$$

$$F \leq F_{lim}$$

$$8.28 \leq 12.3 \quad \text{OK}$$

The cross-section is qualified for verification of LTB by the simplified method.

$$C_4 = 25$$

$$\lambda_{LT,rel} = 5 \cdot \left( 1 + \frac{t_w \cdot (h_a - t_f)}{4 \cdot b \cdot t_f} \right) \left( \frac{h_a - t_f}{t_w} \right)^{0.75} \left( \frac{t_f}{b} \right)^{0.25} \left( \frac{f_{yb}}{E_p \cdot C_4} \right)^{0.5}$$

$$= 5 \cdot \left( 1 + \frac{0.011 \cdot (0.39 - 0.019)}{4 \cdot 0.3 \cdot 0.019} \right) \left( \frac{0.39 - 0.019}{0.011} \right)^{0.75} \left( \frac{0.019}{0.3} \right)^{0.25} \left( \frac{355 \cdot 10^6}{210 \cdot 10^9 \cdot 25} \right)^{0.5} = 0.34$$

$h_a/b \leq 2 \rightarrow$  Buckling curve 'a'

$$\alpha_{LT} = 0.21$$

$$\Phi_{LT} = 0.5 \cdot \left( 1 + \alpha_{LT} \cdot (\lambda_{LT,rel} - 0.2) + \lambda_{LT,rel}^2 \right) = 0.5 \cdot \left( 1 + 0.21 \cdot (0.34 - 0.2) + 0.34^2 \right) = 0.573$$

$$X_{LT} = \frac{1}{\Phi_{LT} + \sqrt{\Phi_{LT}^2 - \lambda_{LT,rel}^2}} = \frac{1}{0.573 + \sqrt{0.573^2 - 0.34^2}} = 0.968$$

$$X_{LT} = \min(X_{LT}, 1) = \min(0.968, 1) = 0.968$$

$$M_{b,Rd} = X_{LT} \cdot M_{Rd} = 0.968 \cdot 1.16 \cdot 10^6 = 1119.465 \text{ kNm}$$

$$UC_{comp,LTB} = \frac{abs(M_{Ed,comp})}{M_{b,Rd}} = \frac{abs(-837.309 \text{ kNm})}{1119.465 \text{ kNm}} = 0.75$$

The later torsional buckling resistance of the section is adequate.

**5.4 Longitudinal shear****5.4.1 Transverse reinforcement**

Design shear flow

$$h_f = h_c = 109 \text{ mm}$$

$$V_{Ed} = \frac{\eta_f \cdot P_{Rid}}{2 \cdot l_s \cdot h_f} = \frac{1 \cdot 144 \text{ kN}}{2 \cdot 251 \text{ mm} \cdot 109 \text{ mm}} = 2.62 \text{ MPa}$$

Transverse reinforcement

$$\frac{A_{st} \cdot f_{ykr}}{(\gamma_s \cdot s_f)} \geq \frac{V_{Ed} \cdot h_f}{\cotg(\theta)}$$

$$A_t = A_{st}/s_f$$

$$A_t = \frac{V_{Ed} \cdot h_f}{\left( \frac{\cotg(\theta) \cdot f_{ykr}}{\gamma_s} \right)} = \frac{2.62 \cdot 10^6 \cdot 0.109}{\left( \frac{\cotg(26.5) \cdot 500 \cdot 10^6}{1.15} \right)} = 328 \text{ mm}^2/\text{m}$$

$$A_{t,prov} = \frac{1}{s_f} \cdot \left( \frac{d_t^2}{4} \right) \cdot 3.14 = \frac{1}{0.15} \cdot \left( \frac{0.016^2}{4} \right) \cdot 3.14 = 1340 \text{ mm}^2/\text{m}$$

$$A_{t,prov} \geq A_t$$

$$1340 \text{ mm}^2/\text{m} \geq 328 \text{ mm}^2/\text{m} \quad \text{OK}$$

The transverse reinforcement of the section is adequate.

**ULS check of Final stage is OK.**

$$UC_{comp} = \max(0.31; 0.72; 0.75) = 0.75$$

-iskoristivost elementa na GSN – 75%

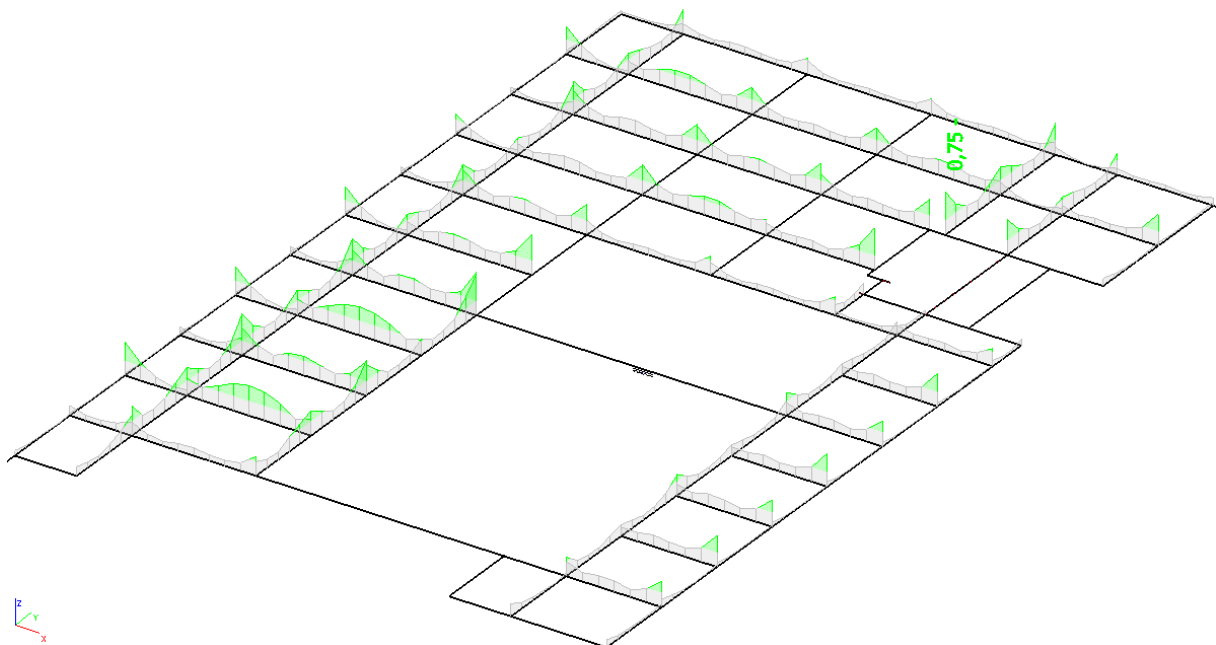

Slika 6.4. Prikaz iskoristivosti grednih nosača – poz 300

### 6.2.3. Rezne sile – gredni nosača 2

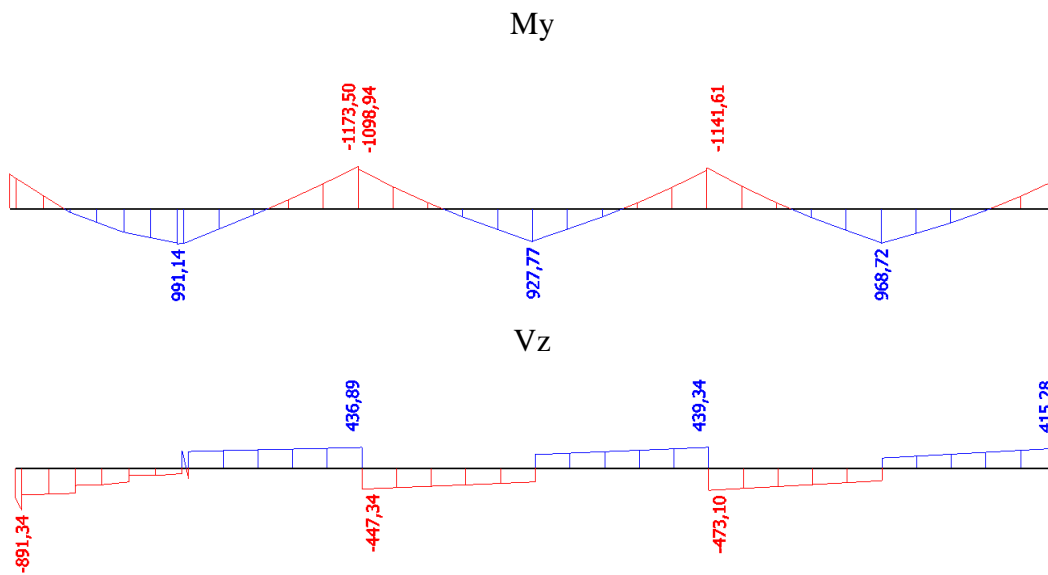

Slika 6.5. Prikaz reznih sila grednog nosača 2 – poz 300

-poprečni presjek nosača

Name	Gredni nosač 2 - poz 300	
Type	HEB450	
Source description	Profil Arbed / Structural shapes / Edition Octobre 1995	
Item material	S 355	
Fabrication	rolled	
Flexural buckling y-y	a	
Flexural buckling z-z	b	
Lateral torsional buckling	Default	
Use 2D FEM analysis	x	
A [m <sup>2</sup> ]	2,1800e-02	
A <sub>y</sub> , z [m <sup>2</sup> ]	1,5015e-02	6,5456e-03
I <sub>y</sub> , z [m <sup>4</sup> ]	7,9890e-04	1,1720e-04
I <sub>w</sub> [m <sup>6</sup> ], t [m <sup>4</sup> ]	5,2584e-06	4,4050e-06
W <sub>el</sub> y, z [m <sup>3</sup> ]	3,5510e-03	7,8140e-04
W <sub>pl</sub> y, z [m <sup>3</sup> ]	3,9820e-03	1,1980e-03
d y, z [mm]	0	0
c YUCS, ZUCS [mm]	150	225
α [deg]	0,00	
A <sub>L</sub> , D [m <sup>2</sup> /m]	2,0300e+00	2,0254e+00
M <sub>ply</sub> +, - [Nm]	1,41e+06	1,41e+06
M <sub>plz</sub> +, - [Nm]	4,25e+05	4,25e+05

Slika 6.6.. Prikaz geometrijskih karakteristika nosača – poz 300

## 6.2.4. Dimenzioniranje – gredni nosača 2

SCIAENGINEER

## Composite Beam - Final stage

Linear calculation  
 Class: All ULS  
 Extreme 1D: Global  
 Selection: B2379

## Composite beam verification

for beam B2379 at section 0 m, in accordance with EC EN 1994-1-1

## 1. Geometry data

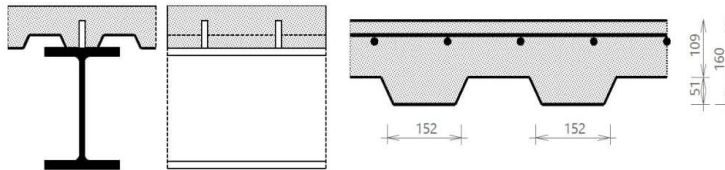

## Continuous beam

Length of the current span	$L = 10.8 \text{ m}$
Length of previous span	$L_{\text{previous}} = 10.8 \text{ m}$
Length of next span	$L_{\text{next}} = 10.8 \text{ m}$
Beam spacing at the left	$L_{\text{left}} = 8.1 \text{ m}$
Distance to the slab edge at the right	$L_{\text{right}} = 0 \text{ m}$
Checked section	$d_x = 0 \text{ m}$

Warning: For a continuous beam, intermediate buckling supports y-y are ignored in both the calculation of the effective width for the analysis model and the check.

## 2. Cross-section &amp; materials

## 2.1 Steel section properties

## 2.1.1 Cross-section

Cross-section	HEB450
Height	$h_a = 450 \text{ mm}$
Width	$b = 300 \text{ mm}$
Web thickness	$t_w = 14 \text{ mm}$
Flange thickness	$t_f = 26 \text{ mm}$
Radius	$r = 27 \text{ mm}$
Area	$A_a = 21800 \text{ mm}^2$
Moment of inertia	$I_y = 799 \cdot 10^6 \text{ mm}^4$
Radius of gyration	$i_z = 73 \text{ mm}$
Plastic section modulus	$W_{\text{ply}} = 3.982 \cdot 10^6 \text{ mm}^3$

## 2.1.2 Material

Steel grade	S 355
Yield strength	$f_{yb} = 355 \text{ MPa}$
Ultimate strength	$f_{ub} = 490 \text{ MPa}$
E modulus	$E_b = 210000 \text{ MPa}$

## 2.1.3 Cross-section classification

$$\varepsilon = \sqrt{\frac{235}{355}} = 0.814 \quad (\text{EN 1993-1-1 §5.6 Tab. 5.2})$$

## 2.1.3.1 Flange in compression

$$c_f = \frac{b - t_w - 2 \cdot r}{2} = \frac{300 \text{ mm} - 14 \text{ mm} - 2 \cdot 27 \text{ mm}}{2} = 116 \text{ mm}$$

$$\frac{c_f}{t_f} \leq 9 \cdot \varepsilon$$

$$\frac{116 \text{ mm}}{26 \text{ mm}} \leq 9 \cdot 0.814$$

$$4.46 \leq 7.32 \quad \text{OK}$$

Flange classified as Class 1.

Student version



**2.1.3.2 Web in bending**

$$c_w = h_a - 2 \cdot t_f - 2 \cdot r = 450 \text{ mm} - 2 \cdot 26 \text{ mm} - 2 \cdot 27 \text{ mm} = 344 \text{ mm}$$

$$\alpha_{cl} = 0.5$$

$$\frac{c_w}{t_w} \leq \frac{36 \cdot \epsilon}{\alpha_{cl}}$$

$$\frac{344 \text{ mm}}{14 \text{ mm}} \leq \frac{36 \cdot 0.814}{0.5}$$

$$24.6 \leq 58.6$$

OK

Web classified as Class 1.

**Cross-section classified as Class 1**

Cross-section Class OK.

**2.2 Concrete slab with profiled sheeting**

**2.2.1 Concrete slab**

**2.2.1.1 Slab**

Total height of the slab  $h_s = 160 \text{ mm}$

**2.2.1.2 Material**

Concrete class C30/37  
 Characteristic strength  $f_{ck} = 30 \text{ MPa}$   
 E modulus  $E_{cm} = 32800 \text{ MPa}$

**2.2.2 Profiled steel sheeting**

Sheeting with ribs parallel to the supporting beams

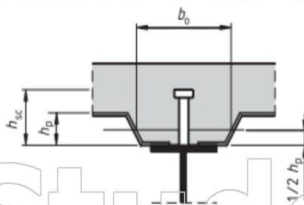

Name	Vulcraft 2 VU 20
Depth of the ribs	$h_p = 50.8 \text{ mm}$
Height of full concrete	$h_c = 109.2 \text{ mm}$
Height of the re-entrant stiffener	$h_d = 0 \text{ mm}$
Spacing of the ribs	$b_s = 304.8 \text{ mm}$
Top width of the rib	$b_t = 127 \text{ mm}$
Bottom width of the rib	$b_b = 127 \text{ mm}$
Mean width of the ribs	$b_{0,rib} = 152.4 \text{ mm}$
Thickness of the sheeting	$t_p = 0.9093 \text{ mm}$

**2.2.3 Shear connectors**

**2.2.3.1 Geometry**

Name	H110
Diameter	$d_s = 25 \text{ mm}$
Nominal height	$h_{nom} = 110 \text{ mm}$
As-welded height	$h_{sc} = 105 \text{ mm}$
Amount per trough or section	$n_r = 1$

**2.2.3.2 Material**

Steel grade	S 355
Ultimate strength	$f_{us} = 490 \text{ MPa}$

**2.2.4 Reinforcement**

**2.2.4.1 Geometry**

Longitudinal bar diameter	$d_l = 16 \text{ mm}$
Longitudinal bar spacing	$s_l = 150 \text{ mm}$
Longitudinal bar cover	$c_l = 30 \text{ mm}$
Transverse bar diameter	$d_t = 16 \text{ mm}$
Transverse bar spacing	$s_t = 150 \text{ mm}$
Transverse bar cover	$c_t = 46 \text{ mm}$

**2.2.4.2 Material**

Material	B 500A
Characteristic yield strength	$f_{ykr} = 500 \text{ MPa}$

**3. Design values of loads**

Load Name : GSN 2

Content of combination : 1.35·g-vlastitetežina+1.35·cg-dodatnosialno+  
1.80·q-promjenjivoopterećenje+1.35·g-vlastitetežina\_dryconcrete

Bending moment  $M_{Ed,comp} = -1173.500 \text{ kNm}$   
Shear force  $V_{Ed,comp} = 436.889 \text{ kN}$

**4. Partial safety factors**

Steel section  $\gamma_{M0} = 1$   
 $\gamma_{M1} = 1$   
Shear connectors  $\gamma_V = 1.25$   
Concrete  $\gamma_C = 1.5$   
Reinforcement  $\gamma_S = 1.15$

**5. ULS check of the Final stage**

**5.1 Shear connection**

**5.1.1 Design resistance of shear connectors**

**5.1.1.1 Shear connector in a solid slab**

$$\frac{h_{sc}}{d_s} > 4$$

$$4.2 > 4$$

$$\alpha = 1$$

$$f_{us} = \min(490; 500) \text{ MPa}$$

$$P_{Rd,solid,1} = \frac{0.8 \cdot f_{us} \cdot \left(\frac{\pi \cdot d_s^2}{4}\right)}{\gamma_V} = \frac{0.8 \cdot 490 \text{ MPa} \cdot \left(\frac{3.14 \cdot 25 \text{ mm}^2}{4}\right)}{1.25} = 154 \text{ kN}$$

$$P_{Rd,solid,2} = \frac{0.29 \cdot \alpha \cdot d_s^2 \cdot \sqrt{f_{ck} \cdot E_{cm}}}{\gamma_V} = \frac{0.29 \cdot 1 \cdot 25 \text{ mm}^2 \cdot \sqrt{30 \text{ MPa} \cdot 32800 \text{ MPa}}}{1.25} = 144 \text{ kN}$$

$$P_{Rd,solid} = \min(P_{Rd,solid,1}; P_{Rd,solid,2}) = \min(154 \text{ kN}; 144 \text{ kN}) = 144 \text{ kN}$$

**5.1.1.2 Shear connector in profiled sheeting**

Sheeting with ribs parallel to the supporting beams

$$k_t = \frac{0.6 \cdot b_{0,rib}}{h_p} \cdot \left(\frac{h_{sc}}{h_p} - 1\right) = \frac{0.6 \cdot 152 \text{ mm}}{50.8 \text{ mm}} \cdot \left(\frac{105 \text{ mm}}{50.8 \text{ mm}} - 1\right) = 1.92$$

$$k_t = 1$$

$$P_{Rd} = k_t \cdot P_{Rd,solid} = 1 \cdot 144 \text{ kN} = 144 \text{ kN}$$

**5.1.2 Degree of shear connection**

**5.1.2.1 Determination of  $b_{eff}$  of the concrete flange and length  $L_e$**

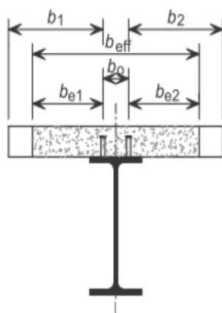

**The effective width at the internal support**

$$L_{e2} = 0.25 \cdot (L_1 + L_2) = 0.25 \cdot (10.8 \text{ m} + 10.8 \text{ m}) = 5.4 \text{ m}$$

**Left side of the beam**

$$b_1 = \frac{L_{\text{perp, left}}}{2} - \frac{b_0}{2} = \frac{8,1 \text{ m}}{2} - \frac{0 \text{ mm}}{2} = 4,05 \text{ m}$$

$$b_{e10} = \min\left(\frac{L_{e0}}{8}; b_1\right) = \min\left(\frac{0 \text{ m}}{8}; 4,05 \text{ m}\right) = 0 \text{ m}$$

$$b_{e11} = \min\left(\frac{L_{e1}}{8}; b_1\right) = \min\left(\frac{0 \text{ m}}{8}; 4,05 \text{ m}\right) = 0 \text{ m}$$

$$b_{e12} = \min\left(\frac{L_{e2}}{8}; b_1\right) = \min\left(\frac{5,4 \text{ m}}{8}; 4,05 \text{ m}\right) = 0,675 \text{ m}$$

**Right side of the beam**

$$b_2 = L_{\text{perp, right}} - \frac{b_0}{2} = 0 \text{ m}$$

$$b_{e20} = \min\left(\frac{L_{e0}}{8}; b_2\right) = \min\left(\frac{0 \text{ m}}{8}; 0 \text{ m}\right) = 0 \text{ m}$$

$$b_{e21} = \min\left(\frac{L_{e1}}{8}; b_2\right) = \min\left(\frac{0 \text{ m}}{8}; 0 \text{ m}\right) = 0 \text{ m}$$

$$b_{e22} = \min\left(\frac{L_{e2}}{8}; b_2\right) = \min\left(\frac{5,4 \text{ m}}{8}; 0 \text{ m}\right) = 0 \text{ m}$$

**Calculation of  $b_{\text{eff},2}$** 

$$b_{\text{eff},2} = b_0 + b_{e12} + b_{e22} = 0 \text{ mm} + 0,675 \text{ m} + 0 \text{ m} = 0,675 \text{ m}$$

**Calculation of  $b_{\text{eff}}$** 

$$b_{\text{eff}} = b_{\text{eff},2} = 0,675 \text{ m}$$

**Determination of  $L_e$** 

$$L_e = L_{e2} = 5,4 \text{ m}$$

**5.1.2.2 Minimum degree of shear connection**

Warning: Conditions given by EN 1994-1-1 Art. 6.6.1.2 (3) are not fulfilled.

$$\eta_{\text{min,calc}} = 1 - \frac{355}{f_{yb}} \cdot (0,75 - 0,03 \cdot L_e)$$

$$\eta_{\text{min,calc}} = 1 - \frac{355}{355} \cdot (0,75 - 0,03 \cdot 5,4 \text{ m}) = 0,41$$

$$\eta_{\text{min}} = \max(\eta_{\text{min,calc}}; 0,4) = \max(0,41; 0,4) = 0,41$$

**5.1.2.3 Degree of shear connection present****5.1.2.3.1 Tension resistance of the reinforcement**

$$A_s = \frac{b_{\text{eff}}}{s_l} \cdot \left(\frac{d_l^2}{4}\right) \cdot \pi = \frac{0,675 \text{ m}}{150 \text{ mm}} \cdot \left(\frac{16 \text{ mm}^2}{4}\right) \cdot 3,14 = 905 \text{ mm}^2$$

$$F_s = \frac{A_s \cdot f_{yk,r}}{\psi_s} = \frac{905 \cdot 10^{-6} \cdot 500 \cdot 10^6}{1,15} = 393 \text{ kN}$$

**5.1.2.3.2 Tension resistance of the steel member**

$$N_{pl,a} = f_{yb} \cdot A_a = 355 \text{ MPa} \cdot 21800 \text{ mm}^2 = 7739,00 \text{ kN}$$

$$N_{c,r} = \min(F_s; N_{pl,a}) = \min(393 \text{ kN}; 7739,00 \text{ kN}) = 393,38 \text{ kN}$$

**5.1.2.3.3 Resistance of the shear connectors**

$$l_s = \frac{L}{n_{\text{row}}} = \frac{10,8}{43} = 251 \text{ mm}$$

Number of shear studs available per length  $L_e/2$

$$n_{sp} = \frac{0,5 \cdot L_e}{l_s} \cdot n_r$$

$$n_{sp} = 10 \cdot 1 = 10$$

$$N_c = n_{sp} \cdot P_{Rd} = 10 \cdot 143835 = 1438,35 \text{ kN}$$

$$\eta = \min\left(\frac{N_c}{N_{c,r}}; 1\right) = \min\left(\frac{1438,35 \text{ kN}}{393,38 \text{ kN}}; 1\right) = 1$$

$$\eta \geq \eta_{\text{min}}$$

$$1 \geq 0,41$$

The shear connection degree is adequate. OK

## 5.2 Cross-sectional resistance of the composite beam

### 5.2.1 Shear buckling

$$h_w = h_s - 2 \cdot t_f = 450 \text{ mm} - 2 \cdot 26 \text{ mm} = 398 \text{ mm}$$

$$\eta_{sb} = 1.2$$

$$\frac{h_w}{t_w} \leq \frac{72 \cdot \varepsilon}{\eta_{sb}}$$

$$\frac{398 \text{ mm}}{14 \text{ mm}} \leq \frac{72 \cdot 0.814}{1.2}$$

$$28.4 \leq 48.8$$

OK

The shear buckling resistance of the web does not need to be verified.

### 5.2.2 Vertical shear

The resistance to vertical shear should be taken as the resistance of the structural steel section.

$$A_v = A_s - 2 \cdot b \cdot t_f + (t_w + 2 \cdot r) \cdot t_f$$

$$= 0.0218 - 2 \cdot 0.3 \cdot 0.026 + (0.014 + 2 \cdot 0.027) \cdot 0.026 = 7968 \text{ mm}^2$$

$$A_{v,min} = \eta_{sb} \cdot h_w \cdot t_w = 1.2 \cdot 0.398 \cdot 0.014 = 6686 \text{ mm}^2$$

$$A_v \geq A_{v,min}$$

$$7968 \text{ mm}^2 \geq 6686 \text{ mm}^2$$

$$V_{pl,Rd} = \frac{A_v \cdot f_{yb}}{\sqrt{3} \cdot \gamma_{M0}} = \frac{7968 \text{ mm}^2 \cdot 355 \cdot 10^6}{\sqrt{3} \cdot 1} = 1633 \text{ kN}$$

$$UC_{comp,V} = \frac{abs(V_{Ed,comp})}{V_{pl,Rd}} = \frac{abs(436.889 \text{ kN})}{1633 \text{ kN}} = 0.27$$

The shear resistance of the section is adequate.

### 5.2.3 Bending moment

#### 5.2.3.1 Longitudinal reinforcement

##### 5.2.3.1.1 Centre of composite section

For buildings not intended mainly for storage the effects of creep in concrete beams may be taken into account by using an effective E modulus  $E_{eff} = E_{cm} / 2$ .

$$E_{eff} = \frac{E_{cm}}{2} = \frac{32800 \text{ MPa}}{2} = 16400 \text{ MPa}$$

$$\eta_E = \frac{E_b}{E_{eff}} = \frac{210000 \text{ MPa}}{16400 \text{ MPa}} = 12.8$$

$$y_d = \frac{A_a \cdot \left( \frac{h_a}{2} \right) + \left( \frac{1}{\eta_E} \right) \cdot b_{eff} \cdot (h_c - h_d) \cdot \left( h_a + h_s - \frac{h_c - h_d}{2} \right)}{A_a + \left( \frac{1}{\eta_E} \right) \cdot b_{eff} \cdot (h_c - h_d)}$$

$$= \frac{0.0218 \cdot \left( \frac{0.45}{2} \right) + \left( \frac{1}{12.8} \right) \cdot 0.675 \cdot (0.109 - 0) \cdot \left( 0.45 + 0.16 - \frac{0.109 - 0}{2} \right)}{0.0218 + \left( \frac{1}{12.8} \right) \cdot 0.675 \cdot (0.109 - 0)} = 294 \text{ mm}$$

##### 5.2.3.1.2 Degree of reinforcement

$$A_s = \frac{b_{eff}}{s_l} \cdot \left( \frac{d_l^2}{4} \right) \cdot \pi = \frac{0.675 \text{ m}}{150 \text{ mm}} \cdot \left( \frac{16 \text{ mm}^2}{4} \right) \cdot 3.14 = 905 \text{ mm}^2$$

$$A_c = b_{eff} \cdot (h_c - h_d) = 0.675 \cdot (0.109 - 0) = 73710 \text{ mm}^2$$

$$z_0 = \left( h_a + h_s - \frac{h_c - h_d}{2} \right) - y_d = \left( 0.45 + 0.16 - \frac{0.109 - 0}{2} \right) - 0.294 = 261 \text{ mm}$$

$$k_c = \min \left( \frac{1}{\left( 1 + \frac{h_c - h_d}{2 \cdot z_0} \right)} + 0.3; 1 \right) = \min \left( \frac{1}{\left( 1 + \frac{0.109 - 0}{2 \cdot 0.261} \right)} + 0.3; 1 \right) = 1$$

$$\rho_s = \delta \cdot \left( \frac{f_{yb}}{235} \right) \cdot \left( \frac{f_{ctm}}{f_{yk,r}} \right) \cdot \sqrt{k_c} = 1.1 \cdot \left( \frac{355}{235} \right) \cdot \left( \frac{2.9 \cdot 10^6}{500 \cdot 10^6} \right) \cdot \sqrt{1} = 0.964 \%$$

$$A_s \geq \rho_s \cdot A_c$$

$$905 \text{ mm}^2 \geq 9.64 \cdot 10^{-3} \cdot 73710 \text{ mm}^2$$

$$905 \text{ mm}^2 \geq 710 \text{ mm}^2$$

OK

The longitudinal reinforcement of the section is adequate.

5.2.3.2 Moment resistance

Moment resistance of a steel cross-section

$$M_{pl,Rd,a} = \frac{W_{ply} \cdot f_{yb}}{Y_{MO}} = \frac{3.98 \cdot 10^6 \text{ mm}^3 \cdot 355 \text{ MPa}}{1} = 1414 \text{ kNm}$$

Influence of shear

$$\frac{V_{pl,Rd}}{2} > \text{abs}(V_{ed,comp})$$

$$\frac{1633 \text{ kN}}{2} > 437 \text{ kN}$$

$$817 \text{ kN} > 437 \text{ kN} \quad \text{OK}$$

The influence of the vertical shear on the bending moment resistance may be neglected.

$$f_{yb,w} = f_{yb} = 355 \text{ MPa}$$

Modified tension resistance of the steel member

$$r = 0 \text{ mm}$$

$$A_w = 2 \cdot t_f \cdot b + t_w \cdot (h_a - 2 \cdot t_f) = 2 \cdot 26 \text{ mm} \cdot 300 \text{ mm} + 14 \text{ mm} \cdot (450 \text{ mm} - 2 \cdot 26 \text{ mm}) = 21172 \text{ mm}^2$$

$$N_{pl,a} = A_w \cdot f_{yb} = 21172 \text{ mm}^2 \cdot 355 \text{ MPa} = 7516.06 \text{ kN}$$

Note: Roundings of the steel cross-section are neglected in bending resistance calculation.

$$N_{c,f} = \min(F_s, N_{pl,a}) = \min(393 \text{ kN}; 7516.06 \text{ kN}) = 393.38 \text{ kN}$$

Negative bending moment resistance calculation

The plastic neutral axis is located within the web of the steel section.

$$N_{at,f} = b \cdot t_f \cdot f_{yb} = 0.3 \cdot 0.026 \cdot 355 \cdot 10^6 = 2769.00 \text{ kN}$$

$$N_{pl,a} - N_{at,f} - N_{at,w} = F_s + N_{at,f} + N_{at,w}$$

$$x = \frac{(N_{pl,a} - 2 \cdot N_{at,f} - F_s)}{(2 \cdot t_w \cdot f_{yb,w})} = \frac{(7516.06 \text{ kN} - 2 \cdot 2769.00 \text{ kN} - 393 \text{ kN})}{(2 \cdot 14 \text{ mm} \cdot 355 \text{ MPa})} = 159 \text{ mm}$$

Verification of the steel web classification.

$$\alpha_{cl} = \frac{c_w - x}{c_w} = \frac{344 - 159}{344} = 0.537$$

$$\frac{c_w}{t_w} \leq \frac{396 \cdot \epsilon}{12 \cdot \alpha_{cl} + 1}$$

$$\frac{344 \text{ mm}}{14 \text{ mm}} \leq \frac{396 \cdot 0.814}{12 \cdot 0.537 - 1}$$

$$24.6 \leq 53.9 \quad \text{OK}$$

Web classified as Class 1.

$$N_{at,w} = t_w \cdot x \cdot f_{yb,w} = 14 \text{ mm} \cdot 159 \text{ mm} \cdot 355 \text{ MPa} = 792.34 \text{ kN}$$

$$N_{a,c} = N_{pl,a} - N_{at,f} - N_{at,w} = 7516.06 \text{ kN} - 2769.00 \text{ kN} - 792.34 \text{ kN} = 3954.72 \text{ kN}$$

Leverage arm of the compression part of the steel section calculated to the PNA.

$$h_{cs} = \frac{(t_w \cdot (h_a - 2 \cdot t_f - x)^2 \cdot 0.5 + t_f \cdot b \cdot (h_a - 1.5 \cdot t_f - x))}{t_w \cdot (h_a - 2 \cdot t_f - x) + t_f \cdot b}$$

$$= \frac{(14 \cdot (450 - 2 \cdot 26 - 159)^2 \cdot 0.5 + 26 \cdot 300 \cdot (450 - 1.5 \cdot 26 - 159))}{14 \cdot (450 - 2 \cdot 26 - 159) + 26 \cdot 300} = 212 \text{ mm}$$

$$h_l = x + t_f + h_s - c_1 + \frac{d_l}{2} = 0.159 + 0.026 + 0.16 - 0.03 + \frac{0.016}{2} = 307 \text{ mm}$$

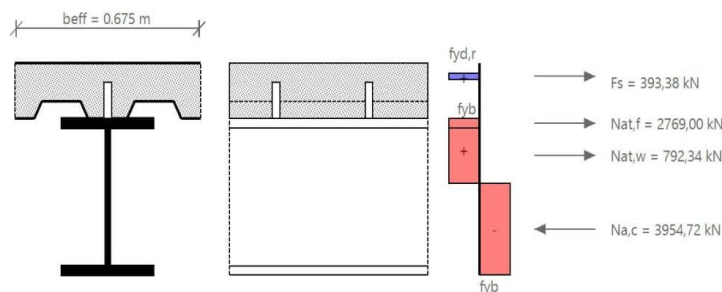

$$M_{pl,Rd} = F_s \cdot h_l + N_{at,f} \cdot \left(\frac{t_f}{2} + x\right) + \frac{N_{at,w} \cdot x}{2} + N_{a,c} \cdot h_{cs}$$

$$= 393 \cdot 307 + 2769.00 \cdot \left(\frac{26}{2} + 159\right) + \frac{792.34 \cdot 159}{2} + 3954.72 \cdot 212 = 1500 \text{ kNm}$$

**Design moment resistance according to EN 1994-1-1 Art.6.2.1.2**

$$M_{Rd} = M_{p,Rd} = 1500 \text{ kNm}$$

$$UC_{comp,M} = \frac{abs(M_{Ed,comp})}{M_{Rd}} = \frac{abs(-1173.500 \text{ kNm})}{1500 \text{ kNm}} = 0.78$$

The bending moment resistance of the section is adequate.

**5.3 LTB resistance**

$$F = \left(1 + \frac{t_w \cdot (h_a - t_f)}{4 \cdot b \cdot t_f}\right) \left(\frac{h_a - t_f}{t_w}\right)^{0.75} \cdot \left(\frac{t_f}{b}\right)^{0.25} = \left(1 + \frac{14 \cdot (450 - 26)}{4 \cdot 300 \cdot 26}\right) \cdot \left(\frac{450 - 26}{14}\right)^{0.75} \cdot \left(\frac{26}{300}\right)^{0.25} = 8.34$$

$$F_{lim} = 12.3$$

$$F \leq F_{lim}$$

$$8.34 \leq 12.3$$

OK

The cross-section is qualified for verification of LTB by the simplified method.

$$C_4 = 25$$

$$\lambda_{LT,rel} = 5 \cdot \left(1 + \frac{t_w \cdot (h_a - t_f)}{4 \cdot b \cdot t_f}\right) \left(\frac{h_a - t_f}{t_w}\right)^{0.75} \cdot \left(\frac{t_f}{b}\right)^{0.25} \cdot \left(\frac{f_{yb}}{E_b \cdot C_4}\right)^{0.5}$$

$$= 5 \cdot \left(1 + \frac{0.014 \cdot (0.45 - 0.026)}{4 \cdot 0.3 \cdot 0.026}\right) \cdot \left(\frac{0.45 - 0.026}{0.014}\right)^{0.75} \cdot \left(\frac{0.026}{0.3}\right)^{0.25} \cdot \left(\frac{355 \cdot 10^6}{210 \cdot 10^9 \cdot 25}\right)^{0.5} = 0.343$$

$h_a/b \leq 2 \rightarrow$  Buckling curve 'a'

$$\alpha_{LT} = 0.21$$

$$\Phi_{LT} = 0.5 \cdot \left(1 + \alpha_{LT} \cdot (\lambda_{LT,rel} - 0.2) + \lambda_{LT,rel}^2\right) = 0.5 \cdot \left(1 + 0.21 \cdot (0.343 - 0.2) + 0.343^2\right) = 0.574$$

$$X_{LT} = \frac{1}{\Phi_{LT} + \sqrt{\Phi_{LT}^2 - \lambda_{LT,rel}^2}} = \frac{1}{0.574 + \sqrt{0.574^2 - 0.343^2}} = 0.967$$

$$X_{LT} = \min(X_{LT}, 1) = \min(0.967, 1) = 0.967$$

$$M_{b,Rd} = X_{LT} \cdot M_{Rd} = 0.967 \cdot 1.5 \cdot 10^6 = 1450.517 \text{ kNm}$$

$$UC_{comp\_LTB} = \frac{abs(M_{Ed,comp})}{M_{b,Rd}} = \frac{abs(-1173.500 \text{ kNm})}{1450.517 \text{ kNm}} = 0.81$$

The later torsional buckling resistance of the section is adequate.

**5.4 Longitudinal shear**

**5.4.1 Transverse reinforcement**

Design shear flow

$$h_f = h_c = 109 \text{ mm}$$

$$V_{Ed} = \frac{n_r \cdot P_{Rd}}{l_s \cdot h_f} = \frac{1 \cdot 144 \text{ kN}}{251 \text{ mm} \cdot 109 \text{ mm}} = 5.24 \text{ MPa}$$

Transverse reinforcement

$$\frac{A_{st} \cdot f_{yk,r}}{y_s \cdot s_f} \geq \frac{V_{Ed} \cdot h_f}{\cotg(\theta)}$$

$$A_t = A_{st}/s_f$$

$$A_t = \frac{V_{Ed} \cdot h_f}{\left(\frac{\cotg(\theta) \cdot f_{yk,r}}{y_s}\right)} = \frac{5.24 \cdot 10^6 \cdot 0.109}{\left(\frac{\cotg(26.5) \cdot 500 \cdot 10^6}{1.15}\right)} = 657 \text{ mm}^2/\text{m}$$

$$A_{t,prov} = \frac{1}{s_t} \cdot \left(\frac{d_t^2}{4}\right) \cdot 3.14 = \frac{1}{0.15} \cdot \left(\frac{0.016^2}{4}\right) \cdot 3.14 = 1340 \text{ mm}^2/\text{m}$$

$$A_{t,prov} \geq A_t$$

$$1340 \text{ mm}^2/\text{m} \geq 657 \text{ mm}^2/\text{m} \quad \text{OK}$$

The transverse reinforcement of the section is adequate.

**ULS check of Final stage is OK.**

$$UC_{comp} = \max(0.27; 0.78; 0.81) = 0.81$$

-iskoristivost elementa na GSN – 81%

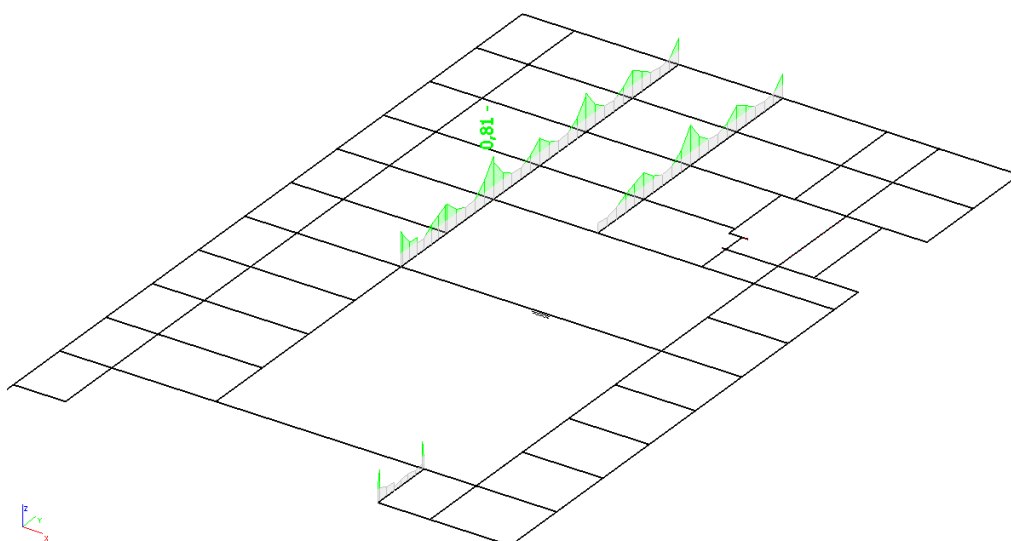

Slika 6.7. Prikaz iskoristivosti grednih nosača – poz. 300

## 7. PRORAČUN SPREGNUTE MEĐUKATNE KONSTRUKCIJE-POZ 200

### 7.1. Pomaci spregnute međukatne konstrukcije – poz 200

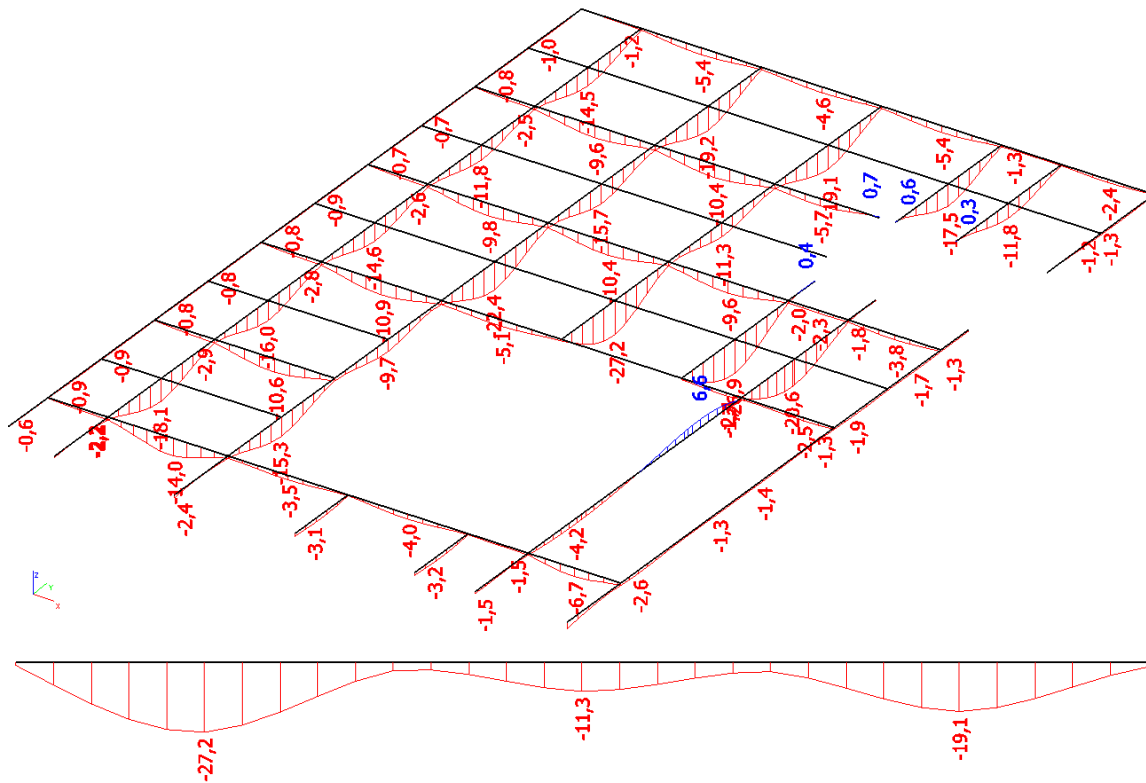

Slika 7.1. Prikaz vertikalnog pomaka grednog nosača – poz 200

Dopušteni vertikalni pomak (progib):

$$u_{dop} = \frac{l}{300} = \frac{10,8 \cdot 1000}{300} = 36,0 \text{ mm}$$

$$u_z = 27,2 \text{ mm} < u_{z,dop} = 36,0 \text{ mm} \quad \text{Zadovoljava}$$

-iskoristivost na GSU -  $27,2 \text{ mm} / 36,0 \text{ mm} = 0,75 = 75\%$

## 7.2. Dimenziniranje spregnute međukatne konstrukcije – poz 200

### 7.2.1. Rezne sile – gredni nosača 1

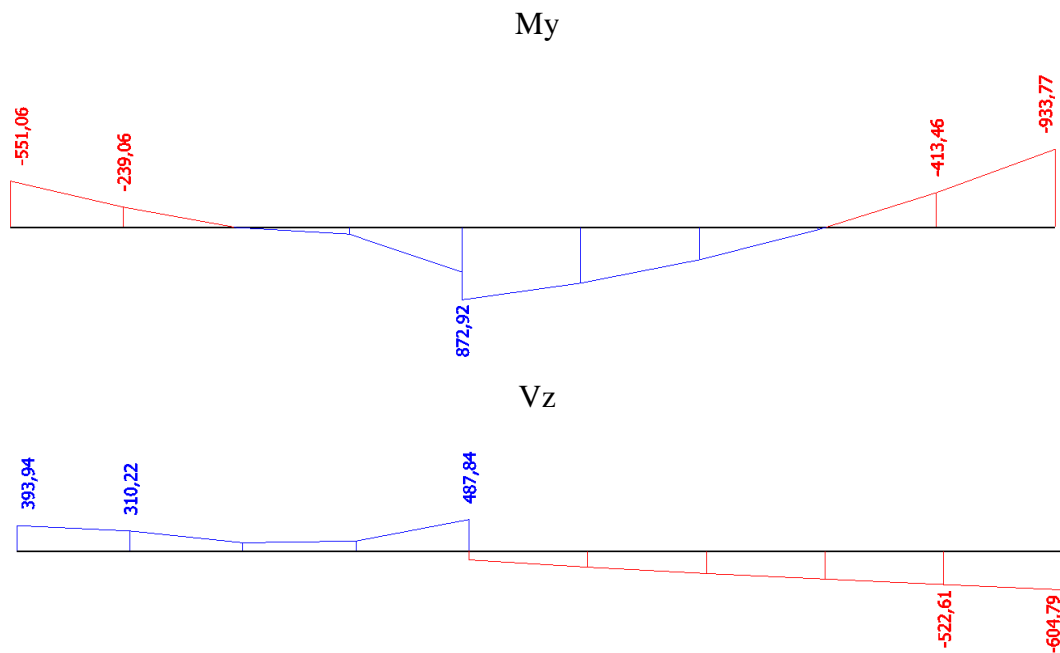

Slika 7.2.. Prikaz reznih sila grednog nosača 1 - poz 200

-poprečni presjek nosača

Name	Gredni nosač 1 - poz 200	
Type	HEA400	
Source description	Profil Arbed / Structural shapes / Edition Octobre 1995	
Item material	S 355	
Fabrication	rolled	
Flexural buckling y-y	a	
Flexural buckling z-z	b	
Lateral torsional buckling	Default	
Use 2D FEM analysis	*	
A [m <sup>2</sup> ]	1,5900e-02	
A <sub>y</sub> , z [m <sup>2</sup> ]	1,1006e-02	4,4726e-03
I <sub>y</sub> , z [m <sup>4</sup> ]	4,5100e-04	8,5600e-05
I <sub>w</sub> [m <sup>6</sup> ], t [m <sup>4</sup> ]	2,9421e-06	1,8900e-06
W <sub>el</sub> y, z [m <sup>3</sup> ]	2,3100e-03	5,7100e-04
W <sub>pl</sub> y, z [m <sup>3</sup> ]	2,5625e-03	8,7083e-04
d y, z [mm]	0	0
c YUCS, ZUCS [mm]	150	195
α [deg]	0,00	
A <sub>L</sub> , D [m <sup>2</sup> /m]	1,9100e+00	1,9114e+00
M <sub>ply</sub> +, - [Nm]	9,10e+05	9,10e+05
M <sub>piz</sub> +, - [Nm]	3,10e+05	3,10e+05

Slika 7.3.. Prikaz geometrijskih karakteristika nosača - poz 200



## 7.2.2. Dimenzioniranje – gredni nosača 1

SCIAENGINEER

### Composite Beam - Final stage

Linear calculation  
Class: All ULS  
Extreme 1D: Global  
Selection: B935

### Composite beam verification

for beam B935 at section 8.1 m, in accordance with EC EN 1994-1-1

#### 1. Geometry data

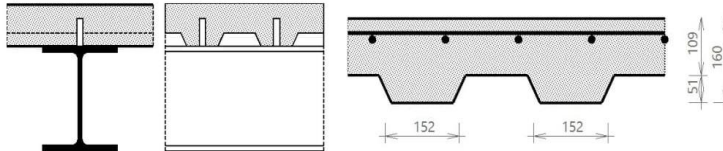

#### Continuous beam

Length of the current span	$L = 8.1 \text{ m}$
Length of previous span	$L_{\text{previous}} = 4.05 \text{ m}$
Length of next span	$L_{\text{next}} = 8.1 \text{ m}$
Distance to the slab edge at the left	$L_{\text{left}} = 5.4 \text{ m}$
Beam spacing at the right	$L_{\text{right}} = 5.4 \text{ m}$
Checked section	$d_x = 8.1 \text{ m}$

Warning: For a continuous beam, intermediate buckling supports  $y$ - $y$  are ignored in both the calculation of the effective width for the analysis model and the check.

#### 2. Cross-section & materials

##### 2.1 Steel section properties

##### 2.1.1 Cross-section

Cross-section	HEA400
Height	$h_a = 390 \text{ mm}$
Width	$b = 300 \text{ mm}$
Web thickness	$t_w = 11 \text{ mm}$
Flange thickness	$t_f = 19 \text{ mm}$
Radius	$r = 27 \text{ mm}$
Area	$A_a = 15900 \text{ mm}^2$
Moment of inertia	$I_y = 451 \cdot 10^6 \text{ mm}^4$
Radius of gyration	$i_z = 73 \text{ mm}$
Plastic section modulus	$W_{ply} = 2.563 \cdot 10^6 \text{ mm}^3$

##### 2.1.2 Material

Steel grade	S 355
Yield strength	$f_{yb} = 355 \text{ MPa}$
Ultimate strength	$f_{ub} = 490 \text{ MPa}$
E modulus	$E_b = 210000 \text{ MPa}$

##### 2.1.3 Cross-section classification

$$\varepsilon = \sqrt{\frac{235}{355}} = 0.814$$

(EN 1993-1-1 §5.6 Tab. 5.2)

##### 2.1.3.1 Flange in compression

$$c_f = \frac{b - t_w - 2 \cdot r}{2} = \frac{300 \text{ mm} - 11 \text{ mm} - 2 \cdot 27 \text{ mm}}{2} = 118 \text{ mm}$$

$$\frac{c_f}{t_f} \leq 9 \cdot \varepsilon$$

$$\frac{118 \text{ mm}}{19 \text{ mm}} \leq 9 \cdot 0.814$$

$$6.18 \leq 7.32$$

OK

Flange classified as Class 1.

Student version

**2.1.3.2 Web in bending**

$$c_w = h_a - 2 \cdot t_f - 2 \cdot r = 390 \text{ mm} - 2 \cdot 19 \text{ mm} - 2 \cdot 27 \text{ mm} = 298 \text{ mm}$$

$$\alpha_{cl} = 0.5$$

$$\frac{c_w}{t_w} \leq \frac{36 \cdot \epsilon}{\alpha_{cl}}$$

$$\frac{298 \text{ mm}}{11 \text{ mm}} \leq \frac{36 \cdot 0.814}{0.5}$$

$$27.1 \leq 58.6 \quad \text{OK}$$

Web classified as Class 1.

**Cross-section classified as Class 1**

Cross-section Class OK.

**2.2 Concrete slab with profiled sheeting**

**2.2.1 Concrete slab**

2.2.1.1 Slab

Total height of the slab  $h_s = 160 \text{ mm}$

2.2.1.2 Material

Concrete class C30/37  
 Characteristic strength  $f_{ck} = 30 \text{ MPa}$   
 E modulus  $E_{cm} = 32800 \text{ MPa}$

**2.2.2 Profiled steel sheeting**

Sheeting with ribs transverse to the supporting beams

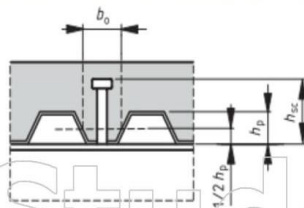

Name	Vulcraft 2 VLI 20
Depth of the ribs	$h_p = 50.8 \text{ mm}$
Height of full concrete	$h_c = 109.2 \text{ mm}$
Height of the re-entrant stiffener	$h_d = 0 \text{ mm}$
Spacing of the ribs	$b_s = 304.8 \text{ mm}$
Top width of the rib	$b_r = 127 \text{ mm}$
Bottom width of the rib	$b_b = 127 \text{ mm}$
Mean width of the ribs	$b_{0,rib} = 152.4 \text{ mm}$
Thickness of the sheeting	$t_p = 0.9093 \text{ mm}$

**2.2.3 Shear connectors**

2.2.3.1 Geometry

Name	H110
Diameter	$d_s = 25 \text{ mm}$
Nominal height	$h_{nom} = 110 \text{ mm}$
As-welded height	$h_{sc} = 105 \text{ mm}$
Amount per trough or section	$n_r = 1$

2.2.3.2 Material

Steel grade	S 355
Ultimate strength	$f_{us} = 490 \text{ MPa}$

**2.2.4 Reinforcement**

2.2.4.1 Geometry

Longitudinal bar diameter	$d_l = 16 \text{ mm}$
Longitudinal bar spacing	$s_l = 150 \text{ mm}$
Longitudinal bar cover	$c_l = 30 \text{ mm}$
Transverse bar diameter	$d_t = 16 \text{ mm}$
Transverse bar spacing	$s_t = 150 \text{ mm}$
Transverse bar cover	$c_t = 46 \text{ mm}$

2.2.4.2 Material

Material	B 500A
Characteristic yield strength	$f_{yk,r} = 500 \text{ MPa}$

**3. Design values of loads**

Load Name : GSN 22

Content of combination : 1.35\*g-vlastitežina+1.35\*dg-dodatnostalno+  
1.62\*q-promjenjivoopterećenje+1.35\*g-vlastitežina\_dryconcrete+  
1.35\*Wx-1kom.-Wz-poz+1.35\*s-opterećenjesnijegom

Bending moment  $M_{Ed,comp} = -931.833 \text{ kNm}$   
Shear force  $V_{Ed,comp} = -603.388 \text{ kN}$

**4. Partial safety factors**

Steel section  $\gamma_{M0} = 1$   
 $\gamma_{M1} = 1$   
Shear connectors  $\gamma_V = 1.25$   
Concrete  $\gamma_C = 1.5$   
Reinforcement  $\gamma_S = 1.15$

**5. ULS check of the Final stage**

**5.1 Shear connection**

**5.1.1 Design resistance of shear connectors**

**5.1.1.1 Shear connector in a solid slab**

$$\frac{h_{sc}}{d_s} > 4$$

$$4.2 > 4$$

$$\alpha = 1$$

$$f_{us} = \min(490; 450) \text{ MPa}$$

$$f_{us} = 450 \text{ MPa}$$

$$P_{Rd,solid,1} = \frac{0.8 \cdot f_{us} \cdot \left(\frac{\pi \cdot d_s^2}{4}\right)}{\gamma_V} = \frac{0.8 \cdot 450 \text{ MPa} \cdot \left(\frac{3.14 \cdot 25 \text{ mm}^2}{4}\right)}{1.25} = 141 \text{ kN}$$

$$P_{Rd,solid,2} = \frac{0.29 \cdot \alpha \cdot d_s^2 \cdot \sqrt{f_{ck} \cdot E_{cm}}}{\gamma_V} = \frac{0.29 \cdot 1 \cdot 25 \text{ mm}^2 \cdot \sqrt{30 \text{ MPa} \cdot 32800 \text{ MPa}}}{1.25} = 144 \text{ kN}$$

$$P_{Rd,solid} = \min(P_{Rd,solid,1}; P_{Rd,solid,2}) = \min(141 \text{ kN}; 144 \text{ kN}) = 141 \text{ kN}$$

**5.1.1.2 Shear connector in profiled sheeting**

Sheeting with ribs transverse to the supporting beams

$$k_t = \frac{0.7}{\sqrt{n_r}} \cdot \left(\frac{b_{0,rib}}{h_p}\right) \cdot \left(\frac{h_{sc}}{h_p} - 1\right) = \frac{0.7}{\sqrt{1}} \cdot \left(\frac{152 \text{ mm}}{50.8 \text{ mm}}\right) \cdot \left(\frac{105 \text{ mm}}{50.8 \text{ mm}} - 1\right) = 2.24$$

$$k_{t,max} = 0.85$$

$$k_t = \max(0; \min(k_t; k_{t,max})) = \max(0; \min(2.24; 0.85)) = 0.85$$

$$P_{Rd} = k_t \cdot P_{Rd,solid} = 0.85 \cdot 141 \text{ kN} = 120 \text{ kN}$$

Warning: The conditions given by EN 1994-1-1 Art.6.6.4.2 (3) are not fulfilled.

**5.1.2 Degree of shear connection**

**5.1.2.1 Determination of  $b_{eff}$  of the concrete flange and length  $L_e$**

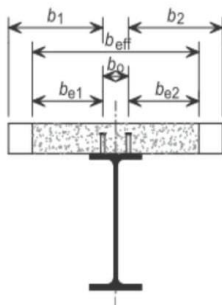

The effective width at the internal support

$$L_{e2} = 0.25 \cdot (L_2 + L_3) = 0.25 \cdot (8.1 \text{ m} + 8.1 \text{ m}) = 4.05 \text{ m}$$

**Left side of the beam**

$$b_1 = L_{\text{perp, left}} - \frac{b_0}{2} = 5.4 \text{ m} - \frac{0 \text{ mm}}{2} = 5.4 \text{ m}$$

$$b_{e10} = \min\left(\frac{L_{e0}}{8}; b_1\right) = \min\left(\frac{0 \text{ m}}{8}; 5.4 \text{ m}\right) = 0 \text{ m}$$

$$b_{e11} = \min\left(\frac{L_{e1}}{8}; b_1\right) = \min\left(\frac{0 \text{ m}}{8}; 5.4 \text{ m}\right) = 0 \text{ m}$$

$$b_{e12} = \min\left(\frac{L_{e2}}{8}; b_1\right) = \min\left(\frac{4.05 \text{ m}}{8}; 5.4 \text{ m}\right) = 0.506 \text{ m}$$

**Right side of the beam**

$$b_2 = \frac{L_{\text{perp, right}}}{2} - \frac{b_0}{2} = \frac{5.4 \text{ m}}{2} - \frac{0 \text{ mm}}{2} = 2.7 \text{ m}$$

$$b_{e20} = \min\left(\frac{L_{e0}}{8}; b_2\right) = \min\left(\frac{0 \text{ m}}{8}; 2.7 \text{ m}\right) = 0 \text{ m}$$

$$b_{e21} = \min\left(\frac{L_{e1}}{8}; b_2\right) = \min\left(\frac{0 \text{ m}}{8}; 2.7 \text{ m}\right) = 0 \text{ m}$$

$$b_{e22} = \min\left(\frac{L_{e2}}{8}; b_2\right) = \min\left(\frac{4.05 \text{ m}}{8}; 2.7 \text{ m}\right) = 0.506 \text{ m}$$

**Calculation of  $b_{\text{eff},2}$**

$$b_{\text{eff},2} = b_0 + b_{e12} + b_{e22} = 0 \text{ mm} + 0.506 \text{ m} + 0.506 \text{ m} = 1.01 \text{ m}$$

**Calculation of  $b_{\text{eff}}$**

$$b_{\text{eff}} = b_{\text{eff},2} = 1.01 \text{ m}$$

**Determination of  $L_e$**

$$L_e = L_{e2} = 4.05 \text{ m}$$

**5.1.2.2 Minimum degree of shear connection**

Warning: Conditions given by EN 1994-1-1 Art. 6.6.1.2 (3) are not fulfilled.

$$\eta_{\text{min,calc}} = 1 - \frac{355}{f_{yb}} \cdot (0.75 - 0.03 \cdot L_e)$$

$$\eta_{\text{min,calc}} = 1 - \frac{355}{355} \cdot (0.75 - 0.03 \cdot 4.05 \text{ m}) = 0.37$$

$$\eta_{\text{min}} = \max(\eta_{\text{min,calc}}; 0.4) = \max(0.37; 0.4) = 0.4$$

**5.1.2.3 Degree of shear connection present**

**5.1.2.3.1 Tension resistance of the reinforcement**

$$A_s = \frac{b_{\text{eff}}}{s_l} \cdot \left(\frac{d_l^2}{4}\right) \cdot \pi = \frac{1.01 \text{ m}}{150 \text{ mm}} \cdot \left(\frac{16 \text{ mm}^2}{4}\right) \cdot 3.14 = 1357 \text{ mm}^2$$

$$F_s = \frac{A_s \cdot f_{yk,r}}{\gamma_s} = \frac{1.36 \cdot 10^{-3} \cdot 500 \cdot 10^6}{1.15} = 590 \text{ kN}$$

**5.1.2.3.2 Tension resistance of the steel member**

$$N_{pl,a} = f_{yb} \cdot A_a = 355 \text{ MPa} \cdot 15900 \text{ mm}^2 = 5644.50 \text{ kN}$$

$$N_{c,t} = \min(F_s; N_{pl,a}) = \min(590 \text{ kN}; 5644.50 \text{ kN}) = 590.07 \text{ kN}$$

**5.1.2.3.3 Resistance of the shear connectors**

Number of full ribs available per length  $L_e$

$$n_{rib} = \frac{L_e}{b_s} = \frac{4.05 \text{ m}}{305 \text{ mm}}$$

$$n_{rib} = 13$$

$$l_s = b_s \cdot \text{trough} = 305 \text{ mm} \cdot 1 = 305 \text{ mm}$$

Number of shear studs available per length  $L_e/2$

$$n_{sp} = \frac{0.5 \cdot n_{rib} \cdot n_r}{\text{trough}} = \frac{0.5 \cdot 13 \cdot 1}{1} = 6.5$$

$$N_c = n_{sp} \cdot P_{Rd} = 6.5 \cdot 120166 = 781.08 \text{ kN}$$

$$\eta = \min\left(\frac{N_c}{N_{cf}}; 1\right) = \min\left(\frac{781.08 \text{ kN}}{590.07 \text{ kN}}; 1\right) = 1$$

$$\eta \geq \eta_{min}$$

$$1 \geq 0.4 \quad \text{OK}$$

The shear connection degree is adequate.

**5.2 Cross-sectional resistance of the composite beam**

**5.2.1 Shear buckling**

$$h_w = h_a - 2 \cdot t_f = 390 \text{ mm} - 2 \cdot 19 \text{ mm} = 352 \text{ mm}$$

$$\eta_{sb} = 1.2$$

$$\frac{h_w}{t_w} \leq \frac{72 \cdot \epsilon}{\eta_{sb}}$$

$$\frac{352 \text{ mm}}{11 \text{ mm}} \leq \frac{72 \cdot 0.814}{1.2}$$

$$32 \leq 48.8$$

OK

The shear buckling resistance of the web does not need to be verified.

**5.2.2 Vertical shear**

The resistance to vertical shear should be taken as the resistance of the structural steel section.

$$A_v = A_s - 2 \cdot b \cdot t_f + (t_w + 2 \cdot r) \cdot t_f$$

$$= 0.0159 - 2 \cdot 0.3 \cdot 0.019 + (0.011 + 2 \cdot 0.027) \cdot 0.019 = 5735 \text{ mm}^2$$

$$A_{v,min} = \eta_{sb} \cdot h_w \cdot t_w = 1.2 \cdot 0.352 \cdot 0.011 = 4646 \text{ mm}^2$$

$$A_v \geq A_{v,min}$$

$$5735 \text{ mm}^2 \geq 4646 \text{ mm}^2$$

$$V_{pl,Rd} = \frac{A_v \cdot f_{yb}}{\sqrt{3} \cdot \gamma_{M0}} = \frac{5735 \text{ mm}^2 \cdot 355 \cdot 10^6}{\sqrt{3} \cdot 1} = 1175 \text{ kN}$$

$$UC_{comp,V} = \frac{\text{abs}(V_{Ed,comp})}{V_{pl,Rd}} = \frac{\text{abs}(-603.388 \text{ kN})}{1175 \text{ kN}} = 0.51$$

The shear resistance of the section is adequate.

**5.2.3 Bending moment**

**5.2.3.1 Longitudinal reinforcement**

**5.2.3.1.1 Centre of composite section**

For buildings not intended mainly for storage the effects of creep in concrete beams may be taken into account by using an effective E modulus  $E_{ceff} = E_{cm} / 2$ .

$$E_{ceff} = \frac{E_{cm}}{2} = \frac{32800 \text{ MPa}}{2} = 16400 \text{ MPa}$$

$$n_E = \frac{E_b}{E_{ceff}} = \frac{210000 \text{ MPa}}{16400 \text{ MPa}} = 12.8$$

$$y_d = \frac{A_a \cdot \left(\frac{h_a}{2}\right) + \left(\frac{1}{n_E}\right) \cdot b_{eff} \cdot (h_c - h_d) \cdot \left(h_a + h_s - \frac{h_c - h_d}{2}\right)}{A_a + \left(\frac{1}{n_E}\right) \cdot b_{eff} \cdot (h_c - h_d)}$$

$$= \frac{0.0159 \cdot \left(\frac{0.39}{2}\right) + \left(\frac{1}{12.8}\right) \cdot 1.01 \cdot (0.109 - 0) \cdot \left(0.39 + 0.16 - \frac{0.109 - 0}{2}\right)}{0.0159 + \left(\frac{1}{12.8}\right) \cdot 1.01 \cdot (0.109 - 0)} = 301 \text{ mm}$$

Student version

5.2.3.1.2 Degree of reinforcement

$$A_s = \frac{b_{eff} \cdot \left(\frac{d_f^2}{4}\right) \cdot \pi}{s_l} = \frac{1.01 \text{ m} \cdot \left(\frac{16 \text{ mm}^2}{4}\right) \cdot 3.14}{150 \text{ mm}} = 1357 \text{ mm}^2$$

$$A_c = b_{eff} \cdot (h_c - h_d) = 1.01 \cdot (0.109 - 0) = 110565 \text{ mm}^2$$

$$z_0 = \left(h_a + h_s - \frac{h_c - h_d}{2}\right) - y_d = \left(0.39 + 0.16 - \frac{0.109 - 0}{2}\right) - 0.301 = 195 \text{ mm}$$

$$k_c = \min\left(\frac{1}{\left(1 + \frac{h_c - h_d}{2 \cdot z_0}\right)} + 0.3; 1\right) = \min\left(\frac{1}{\left(1 + \frac{0.109 - 0}{2 \cdot 0.195}\right)} + 0.3; 1\right) = 1$$

$$\rho_s = \delta \cdot \left(\frac{f_{yb}}{235}\right) \cdot \left(\frac{f_{ctm}}{f_{ykr}}\right) \cdot \sqrt{k_c} = 1.1 \cdot \left(\frac{355}{235}\right) \cdot \left(\frac{2.9 \cdot 10^6}{500 \cdot 10^6}\right) \cdot \sqrt{1} = 0.964 \%$$

$$A_s \geq \rho_s \cdot A_c$$

$$1357 \text{ mm}^2 \geq 9.64 \cdot 10^{-3} \cdot 110565 \text{ mm}^2$$

$$1357 \text{ mm}^2 \geq 1066 \text{ mm}^2 \quad \text{OK}$$

The longitudinal reinforcement of the section is adequate.

5.2.3.2 Moment resistance

Moment resistance of a steel cross-section

$$M_{pl,Rd,a} = \frac{W_{ply} \cdot f_{yb}}{\gamma_{M0}} = \frac{2.56 \cdot 10^6 \text{ mm}^3 \cdot 355 \text{ MPa}}{1} = 910 \text{ kNm}$$

Influence of shear

$$\frac{V_{pl,Rd}}{2} > \text{abs}(V_{Ed,comp})$$

$$\frac{1175 \text{ kN}}{2} > 603 \text{ kN}$$

$$588 \text{ kN} > 603 \text{ kN} \quad \text{NOT OK.}$$

Yield strength reduction due to the vertical shear according to EN 1994-1-1 Art. 6.2.2.4 (2).

$$\rho = \left(\frac{2 \cdot \text{abs}(V_{Ed,comp})}{V_{pl,Rd}} - 1\right)^2 = \left(\frac{2 \cdot \text{abs}(-603.388 \text{ kN})}{1175 \text{ kN}} - 1\right)^2 = 711 \cdot 10^{-6}$$

Note: The bending moment resistance is reduced due to the influence of the vertical shear

$$f_{yb,w} = (1 - \rho) \cdot f_{yb}$$

$$f_{yb,w} = \left(1 - 711 \cdot 10^{-6}\right) \cdot 355 \text{ MPa} = 355 \text{ MPa}$$

Modified tension resistance of the steel member

$$N_{pl,a} = 2 \cdot t_f \cdot b \cdot f_{yb} + (h_a - 2 \cdot t_f) \cdot t_w \cdot f_{yb,w}$$

$$= 2 \cdot 19 \text{ mm} \cdot 300 \text{ mm} \cdot 355 \text{ MPa} + (390 \text{ mm} - 2 \cdot 19 \text{ mm}) \cdot 11 \text{ mm} \cdot 355 \text{ MPa} = 5420.58 \text{ kN}$$

Note: Roundings of the steel cross-section are neglected in bending resistance calculation.

$$N_{c,f} = \min(F_s; N_{pl,a}) = \min(590 \text{ kN}; 5420.58 \text{ kN}) = 590.07 \text{ kN}$$

**Negative bending moment resistance calculation**

The plastic neutral axis is located within the web of the steel section.

$$N_{at,f} = b \cdot t_f \cdot f_{yb} = 0.3 \cdot 0.019 \cdot 355 \cdot 10^6 = 2023.50 \text{ kN}$$

$$N_{pla} - N_{at,f} - N_{at,w} = F_s + N_{at,f} + N_{at,w}$$

$$x = \frac{(N_{pla} - 2 \cdot N_{at,f} - F_s)}{(2 \cdot t_w \cdot f_{yb,w})} = \frac{(5420.58 \text{ kN} - 2 \cdot 2023.50 \text{ kN} - 590 \text{ kN})}{(2 \cdot 11 \text{ mm} \cdot 355 \text{ MPa})} = 100 \text{ mm}$$

Verification of the steel web classification.

$$\alpha_{cl} = \frac{c_w - x}{c_w} = \frac{298 - 100}{298} = 0.663$$

$$\frac{c_w}{t_w} \leq \frac{396 \cdot \epsilon}{13 \cdot \alpha_{cl} - 1}$$

$$\frac{298 \text{ mm}}{11 \text{ mm}} \leq \frac{396 \cdot 0.814}{13 \cdot 0.663 - 1}$$

$$27.1 \leq 42.3 \quad \text{OK}$$

Web classified as Class 1.

$$N_{at,w} = t_w \cdot x \cdot f_{yb,w} = 11 \text{ mm} \cdot 100 \text{ mm} \cdot 355 \text{ MPa} = 391.76 \text{ kN}$$

$$N_{a,c} = N_{pla} - N_{at,f} - N_{at,w} = 5420.58 \text{ kN} - 2023.50 \text{ kN} - 391.76 \text{ kN} = 3005.33 \text{ kN}$$

Leverage arm of the compression part of the steel section calculated to the PNA.

$$h_{cs} = \frac{((1 - \rho) \cdot t_w \cdot (h_a - 2 \cdot t_f - x)^2 \cdot 0.5 + t_f \cdot b \cdot (h_a - 1.5 \cdot t_f - x))}{(1 - \rho) \cdot t_w \cdot (h_a - 2 \cdot t_f - x) + t_f \cdot b}$$

$$= \frac{((1 - 711 \cdot 10^{-6}) \cdot 11 \cdot (390 - 2 \cdot 19 - 100)^2 \cdot 0.5 + 19 \cdot 300 \cdot (390 - 1.5 \cdot 19 - 100))}{(1 - 711 \cdot 10^{-6}) \cdot 11 \cdot (390 - 2 \cdot 19 - 100) + 19 \cdot 300} = 217 \text{ mm}$$

$$h_l = x + t_f + h_s - c_l + \frac{d_l}{2} = 0.1 + 0.019 + 0.16 - 0.03 + \frac{0.016}{2} = 241 \text{ mm}$$

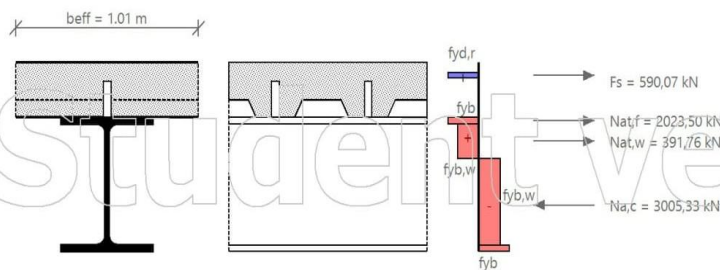

$$M_{pl,Rd} = F_s \cdot h_l + N_{at,f} \cdot \left(\frac{t_f}{2} + x\right) + \frac{N_{at,w} \cdot x}{2} + N_{a,c} \cdot h_{cs}$$

$$= 590 \cdot 241 + 2023.50 \cdot \left(\frac{19}{2} + 100\right) + \frac{391.76 \cdot 100}{2} + 3005.33 \cdot 217 = 1036 \text{ kNm}$$

**Design moment resistance according to EN 1994-1-1 Art.6.2.1.2**

$$M_{Rd} = M_{pl,Rd} = 1036 \text{ kNm}$$

$$UC_{comp,M} = \frac{abs(M_{Ed,comp})}{M_{Rd}} = \frac{abs(-931.833 \text{ kNm})}{1036 \text{ kNm}} = 0.90$$

The bending moment resistance of the section is adequate.

**5.3 LTB resistance**

$$F = \left( 1 + \frac{t_w \cdot (h_a - t_f)}{4 \cdot b \cdot t_f} \right) \cdot \left( \frac{h_a - t_f}{t_w} \right)^{0.75} \cdot \left( \frac{t_f}{b} \right)^{0.25} = \left( 1 + \frac{11 \cdot (390 - 19)}{4 \cdot 300 \cdot 19} \right) \cdot \left( \frac{390 - 19}{11} \right)^{0.75} \cdot \left( \frac{19}{300} \right)^{0.25} = 8.28$$

$F_{lim} = 12.3$

$F \leq F_{lim}$

$8.28 \leq 12.3$

OK

The cross-section is qualified for verification of LTB by the simplified method.

$C_4 = 25$

$$\lambda_{LT,rel} = 5 \cdot \left( 1 + \frac{t_w \cdot (h_a - t_f)}{4 \cdot b \cdot t_f} \right) \cdot \left( \frac{h_a - t_f}{t_w} \right)^{0.75} \cdot \left( \frac{t_f}{b} \right)^{0.25} \cdot \left( \frac{f_{yb}}{E_b \cdot C_4} \right)^{0.5}$$

$$= 5 \cdot \left( 1 + \frac{0.011 \cdot (0.39 - 0.019)}{4 \cdot 0.3 \cdot 0.019} \right) \cdot \left( \frac{0.39 - 0.019}{0.011} \right)^{0.75} \cdot \left( \frac{0.019}{0.3} \right)^{0.25} \cdot \left( \frac{355 \cdot 10^6}{210 \cdot 10^9 \cdot 25} \right)^{0.5} = 0.34$$

$h_a/b \leq 2 \rightarrow$  Buckling curve 'a'

$\alpha_{LT} = 0.21$

$\Phi_{LT} = 0.5 \cdot \left( 1 + \alpha_{LT} \cdot (\lambda_{LT,rel} - 0.2) + \lambda_{LT,rel}^2 \right) = 0.5 \cdot \left( 1 + 0.21 \cdot (0.34 - 0.2) + 0.34^2 \right) = 0.573$

$\chi_{LT} = \frac{1}{\Phi_{LT} + \sqrt{\Phi_{LT}^2 - \lambda_{LT,rel}^2}} = \frac{1}{0.573 + \sqrt{0.573^2 - 0.34^2}} = 0.968$

$\chi_{LT} = \min(\chi_{LT}, 1) = \min(0.968, 1) = 0.968$

$M_{b,Rd} = \chi_{LT} \cdot M_{Rd} = 0.968 \cdot 1.04 \cdot 10^6 = 1003.047 \text{ kNm}$

$UC_{comp\_LTB} = \frac{abs(M_{Ed,comp})}{M_{b,Rd}} = \frac{abs(-931.833 \text{ kNm})}{1003.047 \text{ kNm}} = 0.93$

The later torsional buckling resistance of the section is adequate.

**5.4 Longitudinal shear**

**5.4.1 Transverse reinforcement**

Design shear flow

$h_f = h_c = 109 \text{ mm}$

$V_{Ed} = \frac{n_r \cdot P_{Rd}}{l_s \cdot h_f} = \frac{1 \cdot 120 \text{ kN}}{305 \text{ mm} \cdot 109 \text{ mm}} = 3.61 \text{ MPa}$

Transverse reinforcement

$\frac{A_{st} \cdot f_{yk,r}}{V_s \cdot s_f} \geq \cotg(\theta)$

$A_t = A_{st}/s_f$

$A_t = \frac{V_{Ed} \cdot h_f}{\cotg(\theta) \cdot f_{yk,r}} = \frac{3.61 \cdot 10^6 \cdot 0.109}{\cotg(26.5) \cdot 500 \cdot 10^6} = 452 \text{ mm}^2/\text{m}$

$A_{t,prov} = \frac{1}{s_t} \cdot \left( \frac{d_t^2}{4} \right) \cdot 3.14 = \frac{1}{0.15} \cdot \left( \frac{0.016^2}{4} \right) \cdot 3.14 = 1340 \text{ mm}^2/\text{m}$

$A_{t,prov} \geq A_t$

$1340 \text{ mm}^2/\text{m} \geq 452 \text{ mm}^2/\text{m}$  OK

The transverse reinforcement of the section is adequate.

**ULS check of Final stage is OK.**

$UC_{comp} = \max(0.51; 0.90; 0.93) = 0.93$

-iskoristivost elementa na GSN – 93%

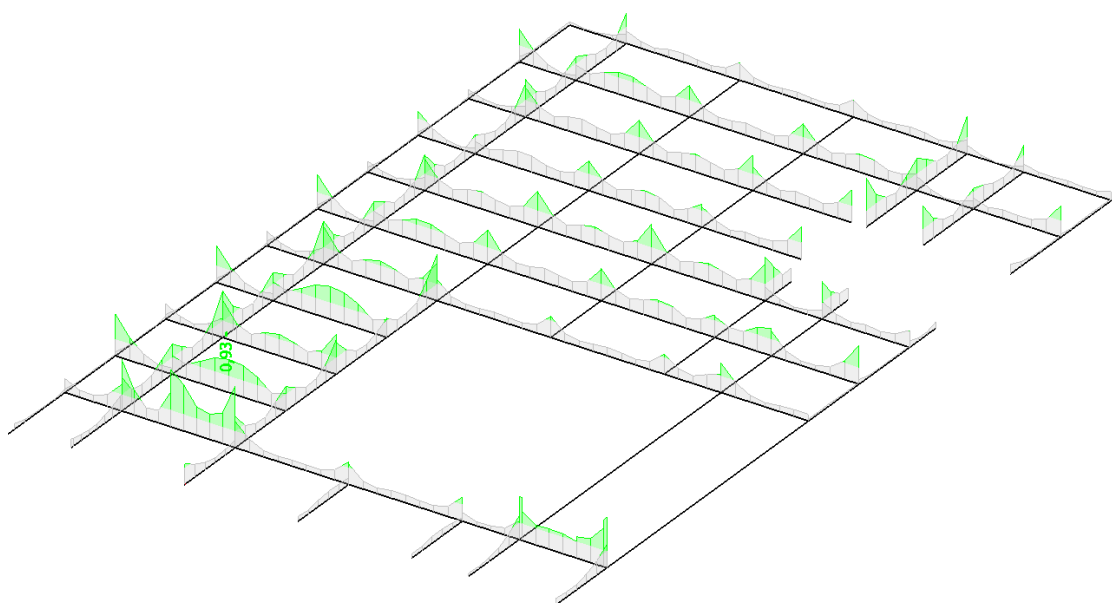

Slika 7.4. Prikaz iskoristivosti grednih nosača – poz 200



### 7.2.3. Rezne sile – gredni nosača 2

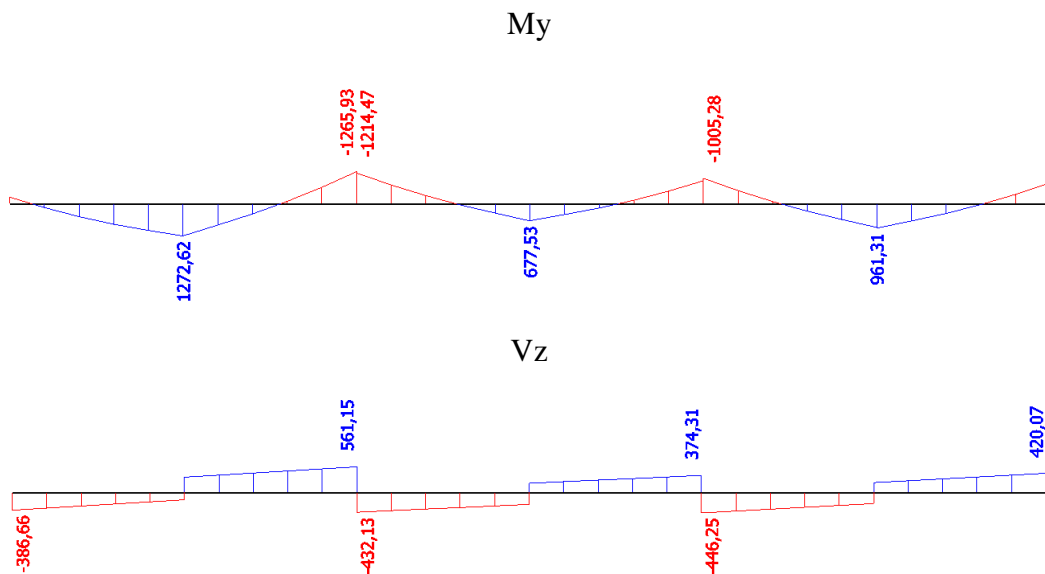

Slika 7.5.. Prikaz reznih sila grednog nosača 2 - poz 200

-poprečni presjek nosača

Name	Gredni nosač 2 - poz 200	
Type	HEB450	
Source description	Profil Arbed / Structural shapes / Edition Octobre 1995	
Item material	S 355	
Fabrication	rolled	
Flexural buckling y-y	a	
Flexural buckling z-z	b	
Lateral torsional buckling	Default	
Use 2D FEM analysis	x	
A [m <sup>2</sup> ]	2,1800e-02	
A <sub>y</sub> , z [m <sup>2</sup> ]	1,5015e-02	6,5456e-03
I <sub>y</sub> , z [m <sup>4</sup> ]	7,9890e-04	1,1720e-04
I <sub>w</sub> [m <sup>6</sup> ], t [m <sup>4</sup> ]	5,2584e-06	4,4050e-06
W <sub>el</sub> y, z [m <sup>3</sup> ]	3,5510e-03	7,8140e-04
W <sub>pl</sub> y, z [m <sup>3</sup> ]	3,9820e-03	1,1980e-03
d y, z [mm]	0	0
c YUCS, ZUCS [mm]	150	225
α [deg]	0,00	
A <sub>L</sub> , D [m <sup>2</sup> /m]	2,0300e+00	2,0254e+00
M <sub>ply</sub> +, - [Nm]	1,41e+06	1,41e+06
M <sub>plz</sub> +, - [Nm]	4,25e+05	4,25e+05

Slika 7.6.. Prikaz geometrijskih karakteristika nosača - poz 200

## 7.2.4. Dimenzioniranje – gredni nosača 2

SCIAENGINEER

## Composite Beam - Final stage

Linear calculation  
 Class: All ULS  
 Extreme 1D: Global  
 Selection: B921

## Composite beam verification

for beam B921 at section 0 m, in accordance with EC EN 1994-1-1

## 1. Geometry data

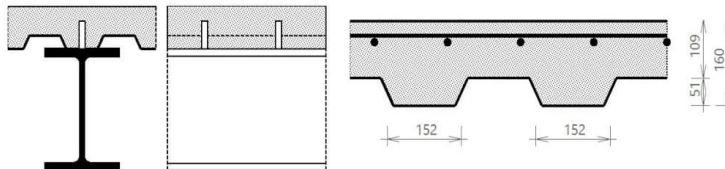

## Continuous beam

Length of the current span	$L = 10.8 \text{ m}$
Length of previous span	$L_{\text{previous}} = 10.8 \text{ m}$
Beam spacing at the left	$L_{\text{left}} = 8.1 \text{ m}$
Beam spacing at the right	$L_{\text{right}} = 8.1 \text{ m}$
Checked section	$d_x = 0 \text{ m}$

Warning: For a continuous beam, intermediate buckling supports  $y$ - $y$  are ignored in both the calculation of the effective width for the analysis model and the check.

## 2. Cross-section &amp; materials

## 2.1 Steel section properties

## 2.1.1 Cross-section

Cross-section	HEB450
Height	$h_a = 450 \text{ mm}$
Width	$b = 300 \text{ mm}$
Web thickness	$t_w = 14 \text{ mm}$
Flange thickness	$t_f = 26 \text{ mm}$
Radius	$r = 27 \text{ mm}$
Area	$A_s = 21800 \text{ mm}^2$
Moment of inertia	$I_y = 799 \cdot 10^6 \text{ mm}^4$
Radius of gyration	$i_z = 73 \text{ mm}$
Plastic section modulus	$W_{\text{ply}} = 3.982 \cdot 10^6 \text{ mm}^3$

## 2.1.2 Material

Steel grade	S 355
Yield strength	$f_{yb} = 355 \text{ MPa}$
Ultimate strength	$f_{ub} = 490 \text{ MPa}$
E modulus	$E_b = 210000 \text{ MPa}$

## 2.1.3 Cross-section classification

$$\varepsilon = \sqrt{\frac{235}{355}} = 0.814$$

(EN 1993-1-1 §5.6 Tab. 5.2)

## 2.1.3.1 Flange in compression

$$c_f = \frac{b - t_w - 2 \cdot r}{2} = \frac{300 \text{ mm} - 14 \text{ mm} - 2 \cdot 27 \text{ mm}}{2} = 116 \text{ mm}$$

$$\frac{c_f}{t_f} \leq 9 \cdot \varepsilon$$

$$\frac{116 \text{ mm}}{26 \text{ mm}} \leq 9 \cdot 0.814$$

$$4.46 \leq 7.32$$

OK

Flange classified as Class 1.

Student version

2.1.3.2 Web in bending

$$c_w = h_a - 2 \cdot t_f - 2 \cdot r = 450 \text{ mm} - 2 \cdot 26 \text{ mm} - 2 \cdot 27 \text{ mm} = 344 \text{ mm}$$

$$\alpha_d = 0.5$$

$$\frac{c_w}{t_w} \leq \frac{36 \cdot \epsilon}{\alpha_d}$$

$$\frac{344 \text{ mm}}{14 \text{ mm}} \leq \frac{36 \cdot 0.814}{0.5}$$

$$24.6 \leq 58.6$$

OK

Web classified as Class 1.

**Cross-section classified as Class 1**

Cross-section Class OK.

**2.2 Concrete slab with profiled sheeting****2.2.1 Concrete slab**2.2.1.1 SlabTotal height of the slab  $h_s = 160 \text{ mm}$ 2.2.1.2 Material

Concrete class C30/37  
 Characteristic strength  $f_{ck} = 30 \text{ MPa}$   
 E modulus  $E_{cm} = 32800 \text{ MPa}$

**2.2.2 Profiled steel sheeting**

Sheeting with ribs parallel to the supporting beams

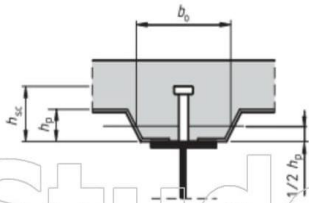

Name	Vulcraft 2 VLI 20
Depth of the ribs	$h_p = 50.8 \text{ mm}$
Height of full concrete	$h_c = 109.2 \text{ mm}$
Height of the re-entrant stiffener	$h_d = 0 \text{ mm}$
Spacing of the ribs	$b_s = 304.8 \text{ mm}$
Top width of the rib	$b_r = 127 \text{ mm}$
Bottom width of the rib	$b_b = 127 \text{ mm}$
Mean width of the ribs	$b_{0,rib} = 152.4 \text{ mm}$
Thickness of the sheeting	$t_p = 0.9093 \text{ mm}$

**2.2.3 Shear connectors**2.2.3.1 Geometry

Name	H110
Diameter	$d_s = 25 \text{ mm}$
Nominal height	$h_{nom} = 110 \text{ mm}$
As-welded height	$h_{sc} = 105 \text{ mm}$
Amount per trough or section	$n_r = 1$

2.2.3.2 Material

Steel grade	S 355
Ultimate strength	$f_{us} = 490 \text{ MPa}$

**2.2.4 Reinforcement**2.2.4.1 Geometry

Longitudinal bar diameter	$d_l = 16 \text{ mm}$
Longitudinal bar spacing	$s_l = 150 \text{ mm}$
Longitudinal bar cover	$c_l = 30 \text{ mm}$
Transverse bar diameter	$d_t = 16 \text{ mm}$
Transverse bar spacing	$s_t = 150 \text{ mm}$
Transverse bar cover	$c_t = 46 \text{ mm}$

2.2.4.2 Material

Material	B 500A
Characteristic yield strength	$f_{yk,r} = 500 \text{ MPa}$

**3. Design values of loads**

Load Name : GSN 2

Content of combination : 1.35·g-vlastitetežina+1.35·cg-dodatnos:alno+  
1.80·q-promjenjivoopterećenje+1.35·g-vlastitetežina\_dryconcrete

Bending moment  $M_{Ed,comp} = -1265.930 \text{ kNm}$   
Shear force  $V_{Ed,comp} = 561.151 \text{ kN}$

**4. Partial safety factors**

Steel section  $\gamma_{M0} = 1$   
 $\gamma_{M1} = 1$   
Shear connectors  $\gamma_V = 1.25$   
Concrete  $\gamma_C = 1.5$   
Reinforcement  $\gamma_S = 1.15$

**5. ULS check of the Final stage**

**5.1 Shear connection**

**5.1.1 Design resistance of shear connectors**

**5.1.1.1 Shear connector in a solid slab**

$$\frac{h_{sc}}{d_s} > 4$$

$$4.2 > 4$$

$$\alpha = 1$$

$$f_{us} = \min(490; 500) \text{ MPa}$$

$$P_{Rd,solid,1} = \frac{0.8 \cdot f_{us} \cdot \left(\frac{\pi \cdot d_s^2}{4}\right)}{\gamma_V} = \frac{0.8 \cdot 490 \text{ MPa} \cdot \left(\frac{3.14 \cdot 25 \text{ mm}^2}{4}\right)}{1.25} = 154 \text{ kN}$$

$$P_{Rd,solid,2} = \frac{0.29 \cdot \alpha \cdot d_s^2 \cdot \sqrt{f_{ck} \cdot E_{cm}}}{\gamma_V} = \frac{0.29 \cdot 1 \cdot 25 \text{ mm}^2 \cdot \sqrt{30 \text{ MPa} \cdot 32800 \text{ MPa}}}{1.25} = 144 \text{ kN}$$

$$P_{Rd,solid} = \min(P_{Rd,solid,1}; P_{Rd,solid,2}) = \min(154 \text{ kN}; 144 \text{ kN}) = 144 \text{ kN}$$

**5.1.1.2 Shear connector in profiled sheeting**

Sheeting with ribs parallel to the supporting beams

$$k_1 = \frac{0.6 \cdot b_{0,rib}}{h_p} \cdot \left(\frac{h_{sc}}{h_p} - 1\right) = \frac{0.6 \cdot 152 \text{ mm}}{50.8 \text{ mm}} \cdot \left(\frac{105 \text{ mm}}{50.8 \text{ mm}} - 1\right) = 1.92$$

$$k_1 = 1$$

$$P_{Rd} = k_1 \cdot P_{Rd,solid} = 1 \cdot 144 \text{ kN} = 144 \text{ kN}$$

**5.1.2 Degree of shear connection**

**5.1.2.1 Determination of  $b_{eff}$  of the concrete flange and length  $L_e$**

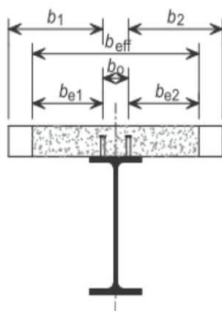

**The effective width at the internal support**

$$L_{e2} = 0.25 \cdot (L_1 + L_2) = 0.25 \cdot (10.8 \text{ m} + 10.8 \text{ m}) = 5.4 \text{ m}$$

**Left side of the beam**

$$b_1 = \frac{L_{\text{perp, left}}}{2} - \frac{b_0}{2} = \frac{8.1 \text{ m}}{2} - \frac{0 \text{ mm}}{2} = 4.05 \text{ m}$$

$$b_{e10} = \min\left(\frac{L_{e0}}{8}; b_1\right) = \min\left(\frac{0 \text{ m}}{8}; 4.05 \text{ m}\right) = 0 \text{ m}$$

$$b_{e11} = \min\left(\frac{L_{e1}}{8}; b_1\right) = \min\left(\frac{0 \text{ m}}{8}; 4.05 \text{ m}\right) = 0 \text{ m}$$

$$b_{e12} = \min\left(\frac{L_{e2}}{8}; b_1\right) = \min\left(\frac{5.4 \text{ m}}{8}; 4.05 \text{ m}\right) = 0.675 \text{ m}$$

**Right side of the beam**

$$b_2 = \frac{L_{\text{perp, right}}}{2} - \frac{b_0}{2} = \frac{8.1 \text{ m}}{2} - \frac{0 \text{ mm}}{2} = 4.05 \text{ m}$$

$$b_{e20} = \min\left(\frac{L_{e0}}{8}; b_2\right) = \min\left(\frac{0 \text{ m}}{8}; 4.05 \text{ m}\right) = 0 \text{ m}$$

$$b_{e21} = \min\left(\frac{L_{e1}}{8}; b_2\right) = \min\left(\frac{0 \text{ m}}{8}; 4.05 \text{ m}\right) = 0 \text{ m}$$

$$b_{e22} = \min\left(\frac{L_{e2}}{8}; b_2\right) = \min\left(\frac{5.4 \text{ m}}{8}; 4.05 \text{ m}\right) = 0.675 \text{ m}$$

**Calculation of  $b_{\text{eff},2}$**

$$b_{\text{eff},2} = b_0 + b_{e12} + b_{e22} = 0 \text{ mm} + 0.675 \text{ m} + 0.675 \text{ m} = 1.35 \text{ m}$$

**Calculation of  $b_{\text{eff}}$**

$$b_{\text{eff}} = b_{\text{eff},2} = 1.35 \text{ m}$$

**Determination of  $L_e$**

$$L_e = L_{e2} = 5.4 \text{ m}$$

**5.1.2.2 Minimum degree of shear connection**

Warning: Conditions given by EN 1994-1-1 Art. 6.6.1.2 (3) are not fulfilled.

$$\eta_{\text{min,calc}} = 1 - \frac{355}{f_{yb}} \cdot (0.75 - 0.03 \cdot L_e)$$

$$\eta_{\text{min,calc}} = 1 - \frac{355}{355} \cdot (0.75 - 0.03 \cdot 5.4 \text{ m}) = 0.41$$

$$\eta_{\text{min}} = \max(\eta_{\text{min,calc}}; 0.4) = \max(0.41; 0.4) = 0.41$$

**5.1.2.3 Degree of shear connection present**

**5.1.2.3.1 Tension resistance of the reinforcement**

$$A_s = \frac{b_{\text{eff}}}{s_l} \cdot \left(\frac{d_l^2}{4}\right) \cdot \pi = \frac{1.35 \text{ m}}{150 \text{ mm}} \cdot \left(\frac{16 \text{ mm}^2}{4}\right) \cdot 3.14 = 1810 \text{ mm}^2$$

$$F_s = \frac{A_s \cdot f_{yk,r}}{\gamma_s} = \frac{1.81 \cdot 10^{-3} \cdot 500 \cdot 10^6}{1.15} = 787 \text{ kN}$$

**5.1.2.3.2 Tension resistance of the steel member**

$$N_{pl,a} = f_{yb} \cdot A_a = 355 \text{ MPa} \cdot 21800 \text{ mm}^2 = 7739.00 \text{ kN}$$

$$N_{c,f} = \min(F_s; N_{pl,a}) = \min(787 \text{ kN}; 7739.00 \text{ kN}) = 786.76 \text{ kN}$$

**5.1.2.3.3 Resistance of the shear connectors**

$$l_s = \frac{L}{n_{\text{row}}} = \frac{10.8}{43} = 251 \text{ mm}$$

Number of shear studs available per length  $L_e/2$

$$n_{\text{sp}} = \frac{0.5 \cdot L_e}{l_s} \cdot n_r$$

$$n_{\text{sp}} = 10 \cdot 1 = 10$$

$$N_c = n_{\text{sp}} \cdot P_{Rd} = 10 \cdot 143835 = 1438.35 \text{ kN}$$

$$\eta = \min\left(\frac{N_c}{N_{c,f}}; 1\right) = \min\left(\frac{1438.35 \text{ kN}}{786.76 \text{ kN}}; 1\right) = 1$$

$$\eta \geq \eta_{\text{min}}$$

$$1 \geq 0.41$$

The shear connection degree is adequate. OK

## 5.2 Cross-sectional resistance of the composite beam

### 5.2.1 Shear buckling

$$h_w = h_s - 2 \cdot t_f = 450 \text{ mm} - 2 \cdot 26 \text{ mm} = 398 \text{ mm}$$

$$\eta_{sb} = 1.2$$

$$\frac{h_w}{t_w} \leq \frac{72 \cdot \epsilon}{\eta_{sb}}$$

$$\frac{398 \text{ mm}}{14 \text{ mm}} \leq \frac{72 \cdot 0.814}{1.2}$$

$$28.4 \leq 48.8$$

OK

The shear buckling resistance of the web does not need to be verified.

### 5.2.2 Vertical shear

The resistance to vertical shear should be taken as the resistance of the structural steel section.

$$A_v = A_s - 2 \cdot b \cdot t_f + (t_w + 2 \cdot r) \cdot t_f \\ = 0.0218 - 2 \cdot 0.3 \cdot 0.026 + (0.014 + 2 \cdot 0.027) \cdot 0.026 = 7968 \text{ mm}^2$$

$$A_{v,min} = \eta_{sb} \cdot h_w \cdot t_w = 1.2 \cdot 0.398 \cdot 0.014 = 6686 \text{ mm}^2$$

$$A_v \geq A_{v,min}$$

$$7968 \text{ mm}^2 \geq 6686 \text{ mm}^2$$

$$V_{pl,Rd} = \frac{A_v \cdot f_{yb}}{\sqrt{3} \cdot \gamma_{M0}} = \frac{7968 \text{ mm}^2 \cdot 355 \cdot 10^6}{\sqrt{3} \cdot 1} = 1633 \text{ kN}$$

$$UC_{comp,V} = \frac{\text{abs}(V_{Ed,comp})}{V_{pl,Rd}} = \frac{\text{abs}(561.151 \text{ kN})}{1633 \text{ kN}} = 0.34$$

The shear resistance of the section is adequate.

### 5.2.3 Bending moment

#### 5.2.3.1 Longitudinal reinforcement

##### 5.2.3.1.1 Centre of composite section

For buildings not intended mainly for storage the effects of creep in concrete beams may be taken into account by using an effective E modulus  $E_{c,eff} = E_{cm} / 2$ .

$$E_{ceff} = \frac{E_{cm}}{2} = \frac{32800 \text{ MPa}}{2} = 16400 \text{ MPa}$$

$$n_E = \frac{E_b}{E_{ceff}} = \frac{210000 \text{ MPa}}{16400 \text{ MPa}} = 12.8$$

$$y_d = \frac{A_a \cdot \left( \frac{h_a}{2} \right) + \left( \frac{1}{n_E} \right) \cdot b_{eff} \cdot (h_c - h_d) \cdot \left( h_a + h_s - \frac{h_c - h_d}{2} \right)}{A_a + \left( \frac{1}{n_E} \right) \cdot b_{eff} \cdot (h_c - h_d)} \\ = \frac{0.0218 \cdot \left( \frac{0.45}{2} \right) + \left( \frac{1}{12.8} \right) \cdot 1.35 \cdot (0.109 - 0) \cdot \left( 0.45 + 0.16 - \frac{0.109 - 0}{2} \right)}{0.0218 + \left( \frac{1}{12.8} \right) \cdot 1.35 \cdot (0.109 - 0)} = 339 \text{ mm}$$

##### 5.2.3.1.2 Degree of reinforcement

$$A_s = \frac{b_{eff}}{s_l} \cdot \left( \frac{d_l^2}{4} \right) \cdot \pi = \frac{1.35 \text{ m}}{150 \text{ mm}} \cdot \left( \frac{16 \text{ mm}^2}{4} \right) \cdot 3.14 = 1810 \text{ mm}^2$$

$$A_c = b_{eff} \cdot (h_c - h_d) = 1.35 \cdot (0.109 - 0) = 147420 \text{ mm}^2$$

$$z_0 = \left( h_a + h_s - \frac{h_c - h_d}{2} \right) - y_d = \left( 0.45 + 0.16 - \frac{0.109 - 0}{2} \right) - 0.339 = 216 \text{ mm}$$

$$k_c = \min \left( \frac{1}{\left( 1 + \frac{h_c - h_d}{2 \cdot z_0} \right)} + 0.3; 1 \right) = \min \left( \frac{1}{\left( 1 + \frac{0.109 - 0}{2 \cdot 0.216} \right)} + 0.3; 1 \right) = 1$$

$$\rho_s = \delta \cdot \left( \frac{f_{yb}}{235} \right) \cdot \left( \frac{f_{ctm}}{f_{yk,r}} \right) \cdot \sqrt{k_c} = 1.1 \cdot \left( \frac{355}{235} \right) \cdot \left( \frac{2.9 \cdot 10^6}{500 \cdot 10^6} \right) \cdot \sqrt{1} = 0.964 \%$$

$$A_s \geq \rho_s \cdot A_c$$

$$1810 \text{ mm}^2 \geq 9.64 \cdot 10^{-3} \cdot 147420 \text{ mm}^2$$

$$1810 \text{ mm}^2 \geq 1421 \text{ mm}^2$$

OK

The longitudinal reinforcement of the section is adequate.

5.2.3.2 Moment resistance

Moment resistance of a steel cross-section

$$M_{pl,Rd,a} = \frac{W_{ply} \cdot f_{yb}}{Y_{MO}} = \frac{3.98 \cdot 10^6 \text{ mm}^3 \cdot 355 \text{ MPa}}{1} = 1414 \text{ kNm}$$

Influence of shear

$$\frac{V_{pl,Rd}}{2} > \text{abs}(V_{Ed,comp})$$

$$\frac{1633 \text{ kN}}{2} > 561 \text{ kN}$$

817 kN > 561 kN OK

The influence of the vertical shear on the bending moment resistance may be neglected.

$$f_{yb,w} = f_{yb} = 355 \text{ MPa}$$

Modified tension resistance of the steel member

$$r = 0 \text{ mm}$$

$$A_a = 2 \cdot t_f \cdot b + t_w \cdot (h_a - 2 \cdot t_f) = 2 \cdot 26 \text{ mm} \cdot 300 \text{ mm} + 14 \text{ mm} \cdot (450 \text{ mm} - 2 \cdot 26 \text{ mm}) = 21172 \text{ mm}^2$$

$$N_{pl,a} = A_a \cdot f_{yb} = 21172 \text{ mm}^2 \cdot 355 \text{ MPa} = 7516.06 \text{ kN}$$

Note: Roundings of the steel cross-section are neglected in bending resistance calculation.

$$N_{c,f} = \min(F_s; N_{pl,a}) = \min(787 \text{ kN}; 7516.06 \text{ kN}) = 786.76 \text{ kN}$$

Negative bending moment resistance calculation

The plastic neutral axis is located within the web of the steel section.

$$N_{at,f} = b \cdot t_f \cdot f_{yb} = 0.3 \cdot 0.026 \cdot 355 \cdot 10^6 = 2769.00 \text{ kN}$$

$$N_{pl,a} - N_{at,f} - N_{at,w} = F_s + N_{at,f} + N_{at,w}$$

$$x = \frac{(N_{pl,a} - 2 \cdot N_{at,f} - F_s)}{(2 \cdot t_w \cdot f_{yb,w})} = \frac{(7516.06 \text{ kN} - 2 \cdot 2769.00 \text{ kN} - 787 \text{ kN})}{(2 \cdot 14 \text{ mm} \cdot 355 \text{ MPa})} = 120 \text{ mm}$$

Verification of the steel web classification.

$$\alpha_{cl} = \frac{c_w - x}{c_w} = \frac{344 - 120}{344} = 0.652$$

$$\frac{c_w}{t_w} \leq \frac{396 \cdot \epsilon}{13 \cdot \alpha_{cl} + 1}$$

$$\frac{344 \text{ mm}}{14 \text{ mm}} \leq \frac{396 \cdot 0.814}{13 \cdot 0.652 - 1}$$

$$24.6 \leq 43.1 \quad \text{OK}$$

Web classified as Class 1.

$$N_{at,w} = t_w \cdot x \cdot f_{yb,w} = 14 \text{ mm} \cdot 120 \text{ mm} \cdot 355 \text{ MPa} = 595.65 \text{ kN}$$

$$N_{a,c} = N_{pl,a} - N_{at,f} - N_{at,w} = 7516.06 \text{ kN} - 2769.00 \text{ kN} - 595.65 \text{ kN} = 4151.41 \text{ kN}$$

Leverage arm of the compression part of the steel section calculated to the PNA.

$$h_{cs} = \frac{(t_w \cdot (h_a - 2 \cdot t_f - x)^2 \cdot 0.5 + t_f \cdot b \cdot (h_a - 1.5 \cdot t_f - x))}{t_w \cdot (h_a - 2 \cdot t_f - x) + t_f \cdot b}$$

$$= \frac{(14 \cdot (450 - 2 \cdot 26 - 120)^2 \cdot 0.5 + 26 \cdot 300 \cdot (450 - 1.5 \cdot 26 - 120))}{14 \cdot (450 - 2 \cdot 26 - 120) + 26 \cdot 300} = 241 \text{ mm}$$

$$h_l = x + t_f + h_s - c_1 + \frac{d_l}{2} = 0.12 + 0.026 + 0.16 - 0.03 + \frac{0.016}{2} = 268 \text{ mm}$$

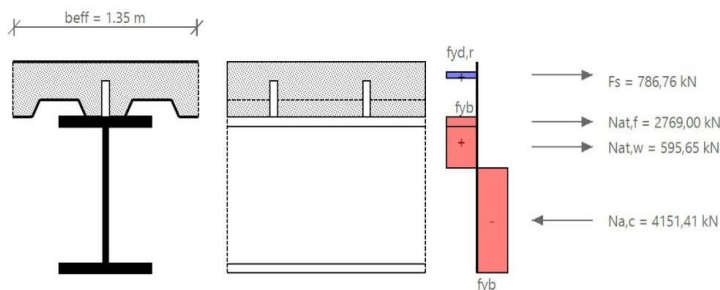

$$M_{pl,Rd} = F_s \cdot h_l + N_{at,f} \cdot \left(\frac{t_f}{2} + x\right) + \frac{N_{at,w} \cdot x}{2} + N_{a,c} \cdot h_{cs}$$

$$= 787 \cdot 268 + 2769.00 \cdot \left(\frac{26}{2} + 120\right) + \frac{595.65 \cdot 120}{2} + 4151.41 \cdot 241 = 1613 \text{ kNm}$$

**Design moment resistance according to EN 1994-1-1 Art.6.2.1.2**

$$M_{Rd} = M_{p,Rd} = 1613 \text{ kNm}$$

$$UC_{comp,M} = \frac{abs(M_{Ed,comp})}{M_{Rd}} = \frac{abs(-1265.930 \text{ kNm})}{1613 \text{ kNm}} = 0.78$$

The bending moment resistance of the section is adequate.

**5.3 LTB resistance**

$$F = \left(1 + \frac{t_w \cdot (h_a - t_f)}{4 \cdot b \cdot t_f}\right) \left(\frac{h_a - t_f}{t_w}\right)^{0.75} \cdot \left(\frac{t_f}{b}\right)^{0.25} = \left(1 + \frac{14 \cdot (450 - 26)}{4 \cdot 300 \cdot 26}\right) \left(\frac{450 - 26}{14}\right)^{0.75} \cdot \left(\frac{26}{300}\right)^{0.25} = 8.34$$

$$F_{lim} = 12.3$$

$$F \leq F_{lim}$$

$$8.34 \leq 12.3$$

OK

The cross-section is qualified for verification of LTB by the simplified method.

$$C_4 = 25$$

$$\lambda_{LT,rel} = 5 \cdot \left(1 + \frac{t_w \cdot (h_a - t_f)}{4 \cdot b \cdot t_f}\right) \left(\frac{h_a - t_f}{t_w}\right)^{0.75} \cdot \left(\frac{t_f}{b}\right)^{0.25} \cdot \left(\frac{f_{yb}}{E_b \cdot C_4}\right)^{0.5}$$

$$= 5 \cdot \left(1 + \frac{0.014 \cdot (0.45 - 0.026)}{4 \cdot 0.3 \cdot 0.026}\right) \left(\frac{0.45 - 0.026}{0.014}\right)^{0.75} \cdot \left(\frac{0.026}{0.3}\right)^{0.25} \cdot \left(\frac{355 \cdot 10^6}{210 \cdot 10^9 \cdot 25}\right)^{0.5} = 0.343$$

$h_a/b < 2 \rightarrow$  Buckling curve 'a'

$$\alpha_{LT} = 0.21$$

$$\Phi_{LT} = 0.5 \cdot \left(1 + \alpha_{LT} \cdot (\lambda_{LT,rel} - 0.2) + \lambda_{LT,rel}^2\right) = 0.5 \cdot \left(1 + 0.21 \cdot (0.343 - 0.2) + 0.343^2\right) = 0.574$$

$$\chi_{LT} = \frac{1}{\Phi_{LT} + \sqrt{\Phi_{LT}^2 - \lambda_{LT,rel}^2}} = \frac{1}{0.574 + \sqrt{0.574^2 - 0.343^2}} = 0.967$$

$$\chi_{LT} = \min(\chi_{LT}, 1) = \min(0.967, 1) = 0.967$$

$$M_{b,Rd} = \chi_{LT} \cdot M_{Rd} = 0.967 \cdot 1.61 \cdot 10^6 = 1559.965 \text{ kNm}$$

$$UC_{comp\_LTB} = \frac{abs(M_{Ed,comp})}{M_{b,Rd}} = \frac{abs(-1265.930 \text{ kNm})}{1559.965 \text{ kNm}} = 0.81$$

The later torsional buckling resistance of the section is adequate.

**5.4 Longitudinal shear**

**5.4.1 Transverse reinforcement**

Design shear flow

$$h_f = h_c = 109 \text{ mm}$$

$$V_{Ed} = \frac{\eta_r \cdot P_{Rd}}{2 \cdot I_s \cdot h_f} = \frac{1 \cdot 144 \text{ kN}}{2 \cdot 251 \text{ mm} \cdot 109 \text{ mm}} = 2.62 \text{ MPa}$$

Transverse reinforcement

$$\frac{A_{st} \cdot f_{yk,r}}{Y_s \cdot s_f} \geq \frac{V_{Ed} \cdot \eta_f}{\cotg(\theta)}$$

$$A_t = A_{st}/s_f$$

$$A_t = \frac{V_{Ed} \cdot \eta_f}{\left(\frac{\cotg(\theta) \cdot f_{yk,r}}{Y_s}\right)} = \frac{2.62 \cdot 10^6 \cdot 0.109}{\left(\frac{\cotg(26.5) \cdot 500 \cdot 10^6}{1.15}\right)} = 328 \text{ mm}^2/\text{m}$$

$$A_{t,prov} = \frac{1}{s_f} \cdot \left(\frac{d_t^2}{4}\right) \cdot 3.14 = \frac{1}{0.15} \cdot \left(\frac{0.016^2}{4}\right) \cdot 3.14 = 1340 \text{ mm}^2/\text{m}$$

$$A_{t,prov} \geq A_t$$

$$1340 \text{ mm}^2/\text{m} \geq 328 \text{ mm}^2/\text{m} \quad \text{OK}$$

The transverse reinforcement of the section is adequate.

**ULS check of Final stage is OK.**

$$UC_{comp} = \max(0.34; 0.78; 0.81) = 0.81$$

-iskoristivost elementa na GSN – 81%

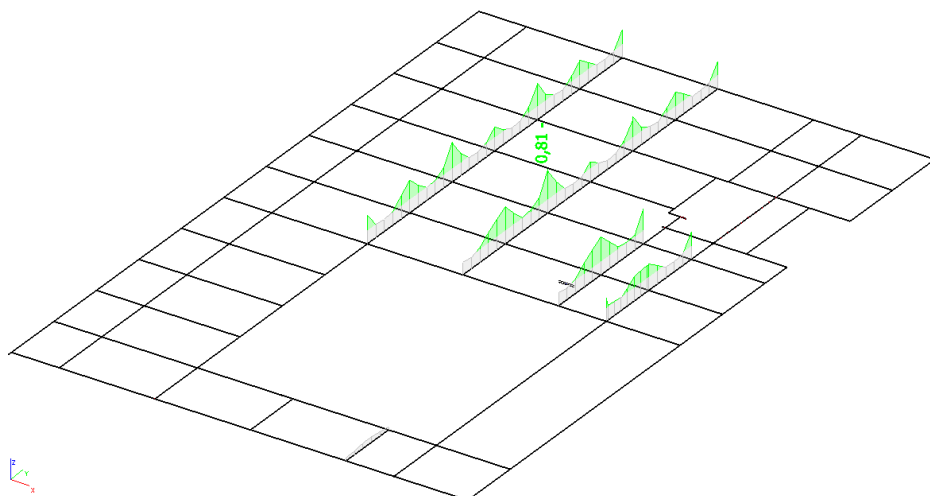

Slika 7.7. Prikaz iskoristivosti grednih nosača – poz 200



## 8. PRORAČUN SPREGNUTE MEĐUKATNE KONSTRUKCIJE-POZ 100

### 8.1. Pomaci spregnute međukatne konstrukcije – poz 100

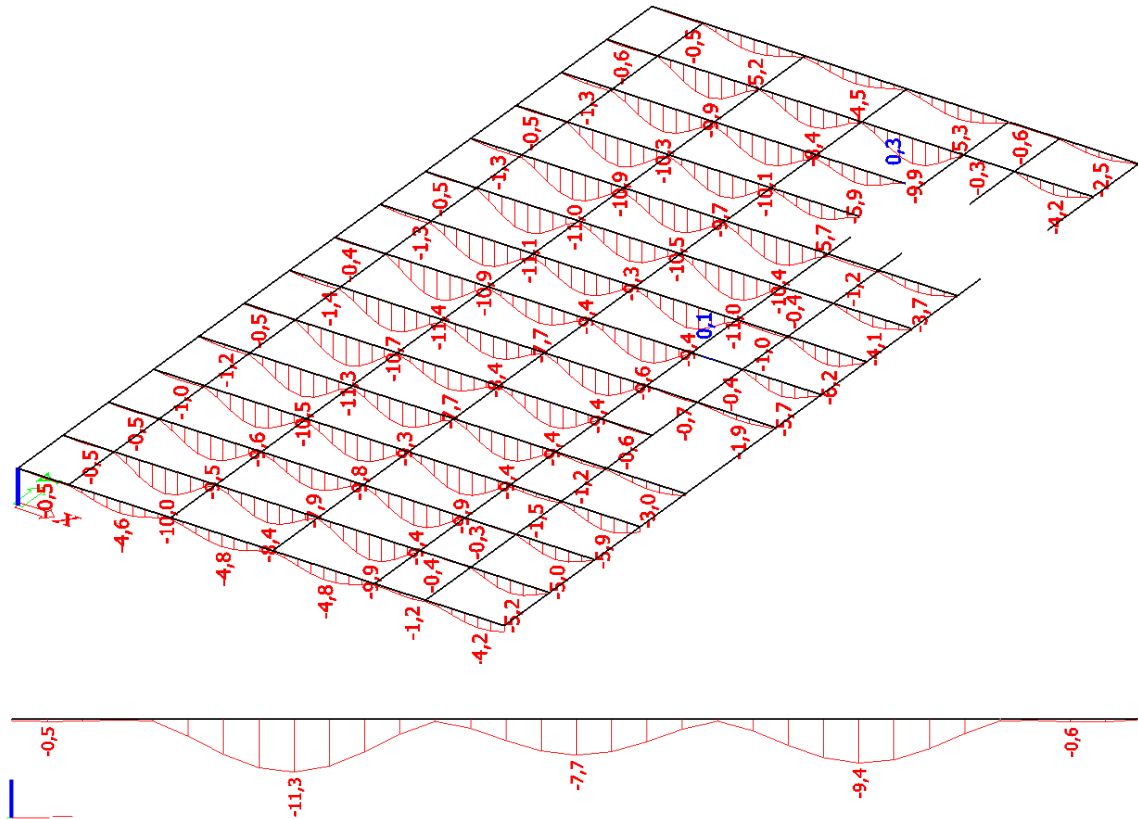

Slika 8.1. Prikaz vertikalnog pomaka grednog nosača – poz 100

Dopušteni vertikalni pomak (progib):

$$u_{dop} = \frac{l}{300} = \frac{8,1 \cdot 1000}{300} = 27,0 \text{ mm}$$

$$u_z = 11,3 \text{ mm} < u_{z,dop} = 27,0 \text{ mm} \quad \text{Zadovoljava}$$

-iskoristivost na GSU -  $11,3 \text{ mm} / 27,0 \text{ mm} = 0,42 = 42\%$

## 8.2. Dimenziniranje spregnute međukatne konstrukcije – poz 100

### 8.2.1. Rezne sile – gredni nosača 1

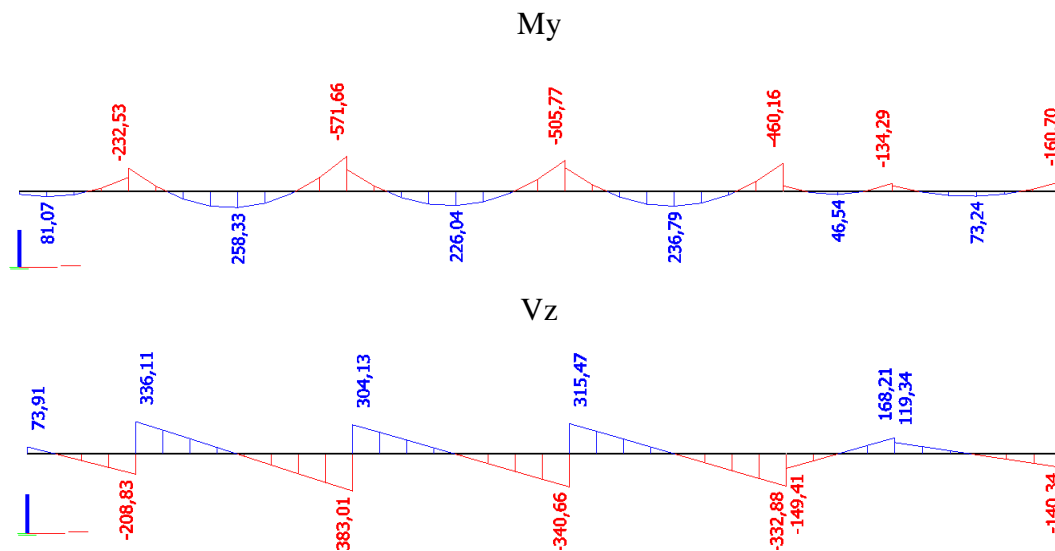

Slika 8.2.. Prikaz reznih sila grednog nosača 1 - poz 100

-poprečni presjek nosača

Name	Gredni nosač - poz 100	
Type	HEA340	
Source description	Profil Arbed / Structural shapes / Edition Octobre 1995	
Item material	S 355	
Fabrication	rolled	
Flexural buckling y-y	b	
Flexural buckling z-z	c	
Lateral torsional buckling	Default	
Use 2D FEM analysis	*	
A [m <sup>2</sup> ]	1,3400e-02	
A y, z [m <sup>2</sup> ]	9,5495e-03	3,3201e-03
I y, z [m <sup>4</sup> ]	2,7700e-04	7,4400e-05
I w [m <sup>3</sup> ], t [m <sup>4</sup> ]	1,8244e-06	1,2700e-06
W <sub>el</sub> y, z [m <sup>3</sup> ]	1,6800e-03	4,9600e-04
W <sub>pl</sub> y, z [m <sup>3</sup> ]	1,8500e-03	7,5417e-04
d y, z [mm]	0	0
c YUCS, ZUCS [mm]	150	165
α [deg]	0,00	
A L, D [m <sup>2</sup> /m]	1,8000e+00	1,7944e+00
M <sub>ply</sub> +, - [Nm]	6,57e+05	6,57e+05
M <sub>plz</sub> +, - [Nm]	2,68e+05	2,68e+05

Slika 8.3.. Prikaz geometrijskih karakteristika nosača - poz 100

## 8.2.2. Dimenzioniranje – gredni nosača 1

SCIAENGINEER

### Composite Beam - Final stage

Linear calculation  
Class: All ULS  
Extreme 1D: Global  
Selection: B3517

### Composite beam verification

for beam B3517 at section 8.1 m, in accordance with EC EN 1994-1-1

#### 1. Geometry data

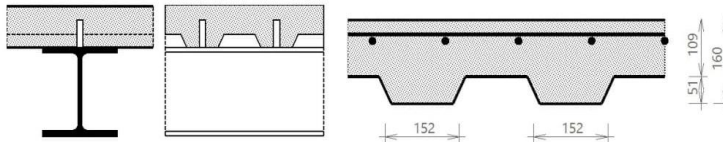

#### Continuous beam

Length of the current span	$L = 8.1 \text{ m}$
Length of previous span	$L_{\text{previous}} = 4.05 \text{ m}$
Length of next span	$L_{\text{next}} = 8.1 \text{ m}$
Beam spacing at the left	$L_{\text{left}} = 5.4 \text{ m}$
Beam spacing at the right	$L_{\text{right}} = 5.4 \text{ m}$
Checked section	$d_x = 8.1 \text{ m}$

#### 2. Cross-section & materials

##### 2.1 Steel section properties

##### 2.1.1 Cross-section

Cross-section	HEA340
Height	$h_a = 330 \text{ mm}$
Width	$b = 300 \text{ mm}$
Web thickness	$t_w = 9.5 \text{ mm}$
Flange thickness	$t_f = 16.5 \text{ mm}$
Radius	$r = 27 \text{ mm}$
Area	$A_a = 13400 \text{ mm}^2$
Moment of inertia	$I_y = 277 \cdot 10^6 \text{ mm}^4$
Radius of gyration	$i_z = 75 \text{ mm}$
Plastic section modulus	$W_{\text{ply}} = 1.85 \cdot 10^6 \text{ mm}^3$

##### 2.1.2 Material

Steel grade	S 355
Yield strength	$f_{yb} = 355 \text{ MPa}$
Ultimate strength	$f_{ub} = 490 \text{ MPa}$
E modulus	$E_b = 210000 \text{ MPa}$

##### 2.1.3 Cross-section classification

$$\varepsilon = \sqrt{\frac{235}{355}} = 0.814$$

(EN 1993-1-1 §5.6 Tab. 5.2)

##### 2.1.3.1 Flange in compression

$$c_f = \frac{b - t_w - 2 \cdot r}{2} = \frac{300 \text{ mm} - 9.5 \text{ mm} - 2 \cdot 27 \text{ mm}}{2} = 118 \text{ mm}$$

$$\frac{c_f}{t_f} \leq 9 \cdot \varepsilon$$

$$\frac{118 \text{ mm}}{16.5 \text{ mm}} \leq 9 \cdot 0.814$$

$$7.17 \leq 7.32$$

OK

Flange classified as Class 1.

Student version

2.1.3.2 Web in bending

$$c_w = h_a - 2 \cdot t_f - 2 \cdot r = 330 \text{ mm} - 2 \cdot 16.5 \text{ mm} - 2 \cdot 27 \text{ mm} = 243 \text{ mm}$$

$$\alpha_{cl} = 0.5$$

$$\frac{c_w}{t_w} \leq \frac{36 \cdot \epsilon}{\alpha_{cl}}$$

$$\frac{243 \text{ mm}}{9.5 \text{ mm}} \leq \frac{36 \cdot 0.814}{0.5}$$

$$25.6 \leq 58.6$$

OK

Web classified as Class 1.

**Cross-section classified as Class 1**

Cross-section Class OK.

**2.2 Concrete slab with profiled sheeting**

**2.2.1 Concrete slab**

2.2.1.1 Slab

Total height of the slab  $h_s = 160 \text{ mm}$

2.2.1.2 Material

Concrete class C30/37  
 Characteristic strength  $f_{ck} = 30 \text{ MPa}$   
 E modulus  $E_{cm} = 32800 \text{ MPa}$

**2.2.2 Profiled steel sheeting**

Sheeting with ribs transverse to the supporting beams

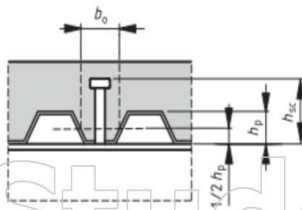

Name	Vulcraft 2 VLI 20
Depth of the ribs	$h_r = 50.8 \text{ mm}$
Height of full concrete	$h_c = 109.2 \text{ mm}$
Height of the re-entrant stiffener	$h_d = 0 \text{ mm}$
Spacing of the ribs	$b_s = 304.8 \text{ mm}$
Top width of the rib	$b_r = 127 \text{ mm}$
Bottom width of the rib	$b_b = 127 \text{ mm}$
Mean width of the ribs	$b_{0,rib} = 152.4 \text{ mm}$
Thickness of the sheeting	$t_p = 0.9093 \text{ mm}$

**2.2.3 Shear connectors**

2.2.3.1 Geometry

Name	H110
Diameter	$d_s = 25 \text{ mm}$
Nominal height	$h_{nom} = 110 \text{ mm}$
As-welded height	$h_{sc} = 105 \text{ mm}$
Amount per trough or section	$n_r = 1$

2.2.3.2 Material

Steel grade	S 355
Ultimate strength	$f_{us} = 490 \text{ MPa}$

**2.2.4 Reinforcement**

2.2.4.1 Geometry

Longitudinal bar diameter	$d_l = 16 \text{ mm}$
Longitudinal bar spacing	$s_l = 150 \text{ mm}$
Longitudinal bar cover	$c_l = 30 \text{ mm}$
Transverse bar diameter	$d_t = 16 \text{ mm}$
Transverse bar spacing	$s_t = 150 \text{ mm}$
Transverse bar cover	$c_t = 46 \text{ mm}$

2.2.4.2 Material

Material	B 500A
Characteristic yield strength	$f_{ykr} = 500 \text{ MPa}$

**3. Design values of loads**

Load Name : GSN 13  
 Content of combination : 1.35\*g-vlastitežina+1.35\*dg-dodatnostalno+  
 1.62\*q-promjenjivoopterećenije+1.35\*g-vlastitežina\_dryconcrete+  
 1.35\*Wx-1kom.-Wz-neg

Bending moment  $M_{Ed,comp} = -570.885 \text{ kNm}$   
 Shear force  $V_{Ed,comp} = -381.942 \text{ kN}$

**4. Partial safety factors**

Steel section  $\gamma_{M0} = 1$   
 $\gamma_{M1} = 1$   
 Shear connectors  $\gamma_V = 1.25$   
 Concrete  $\gamma_C = 1.5$   
 Reinforcement  $\gamma_S = 1.15$

**5. ULS check of the Final stage**

**5.1 Shear connection**

**5.1.1 Design resistance of shear connectors**

**5.1.1.1 Shear connector in a solid slab**

$$\frac{h_{sc}}{d_s} > 4$$

$$4.2 > 4$$

$$\alpha = 1$$

$$f_{us} = \min(490; 450) \text{ MPa}$$

$$f_{us} = 450 \text{ MPa}$$

$$P_{Rd,solid,1} = \frac{0.8 \cdot f_{us} \cdot \left(\frac{\pi \cdot d_s^2}{4}\right)}{\gamma_V} = \frac{0.8 \cdot 450 \text{ MPa} \cdot \left(\frac{3.14 \cdot 25 \text{ mm}^2}{4}\right)}{1.25} = 141 \text{ kN}$$

$$P_{Rd,solid,2} = \frac{0.29 \cdot \alpha \cdot d_s^2 \cdot \sqrt{f_{ck} \cdot E_{cm}}}{\gamma_V} = \frac{0.29 \cdot 1 \cdot 25 \text{ mm}^2 \cdot \sqrt{30 \text{ MPa} \cdot 32800 \text{ MPa}}}{1.25} = 144 \text{ kN}$$

$$P_{Rd,solid} = \min(P_{Rd,solid,1}; P_{Rd,solid,2}) = \min(141 \text{ kN}; 144 \text{ kN}) = 141 \text{ kN}$$

**5.1.1.2 Shear connector in profiled sheeting**

Sheeting with ribs transverse to the supporting beams

$$k_t = \frac{0.7}{\sqrt{n_r}} \cdot \left(\frac{b_{0,rib}}{h_p}\right) \cdot \left(\frac{h_{sc}}{h_p} - 1\right) = \frac{0.7}{\sqrt{1}} \cdot \left(\frac{152 \text{ mm}}{50.8 \text{ mm}}\right) \cdot \left(\frac{105 \text{ mm}}{50.8 \text{ mm}} - 1\right) = 2.24$$

$$k_{t,max} = 0.85$$

$$k_t = \max(0; \min(k_t; k_{t,max})) = \max(0; \min(2.24; 0.85)) = 0.85$$

$$P_{Rd} = k_t \cdot P_{Rd,solid} = 0.85 \cdot 141 \text{ kN} = 120 \text{ kN}$$

Warning: The conditions given by EN 1994-1-1 Art.6.6.4.2 (3) are not fulfilled.

**5.1.2 Degree of shear connection**

**5.1.2.1 Determination of  $b_{eff}$  of the concrete flange and length  $L_e$**

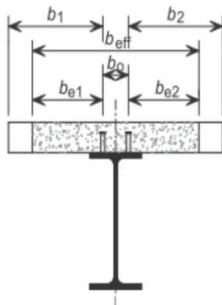

The effective width at the internal support

$$L_{e2} = 0.25 \cdot (L_2 + L_3) = 0.25 \cdot (8.1 \text{ m} + 8.1 \text{ m}) = 4.05 \text{ m}$$

**Left side of the beam**

$$b_1 = \frac{L_{\text{perp\_left}}}{2} - \frac{b_0}{2} = \frac{5,4 \text{ m}}{2} - \frac{0 \text{ mm}}{2} = 2,7 \text{ m}$$

$$b_{e10} = \min\left(\frac{L_{e0}}{8}; b_1\right) = \min\left(\frac{0 \text{ m}}{8}; 2,7 \text{ m}\right) = 0 \text{ m}$$

$$b_{e11} = \min\left(\frac{L_{e1}}{8}; b_1\right) = \min\left(\frac{0 \text{ m}}{8}; 2,7 \text{ m}\right) = 0 \text{ m}$$

$$b_{e12} = \min\left(\frac{L_{e2}}{8}; b_1\right) = \min\left(\frac{4,05 \text{ m}}{8}; 2,7 \text{ m}\right) = 0,506 \text{ m}$$

**Right side of the beam**

$$b_2 = \frac{L_{\text{perp\_right}}}{2} - \frac{b_0}{2} = \frac{5,4 \text{ m}}{2} - \frac{0 \text{ mm}}{2} = 2,7 \text{ m}$$

$$b_{e20} = \min\left(\frac{L_{e0}}{8}; b_2\right) = \min\left(\frac{0 \text{ m}}{8}; 2,7 \text{ m}\right) = 0 \text{ m}$$

$$b_{e21} = \min\left(\frac{L_{e1}}{8}; b_2\right) = \min\left(\frac{0 \text{ m}}{8}; 2,7 \text{ m}\right) = 0 \text{ m}$$

$$b_{e22} = \min\left(\frac{L_{e2}}{8}; b_2\right) = \min\left(\frac{4,05 \text{ m}}{8}; 2,7 \text{ m}\right) = 0,506 \text{ m}$$

**Calculation of  $b_{\text{eff},2}$**

$$b_{\text{eff},2} = b_0 + b_{e12} + b_{e22} = 0 \text{ mm} + 0,506 \text{ m} + 0,506 \text{ m} = 1,01 \text{ m}$$

**Calculation of  $b_{\text{eff}}$**

$$b_{\text{eff}} = b_{\text{eff},2} = 1,01 \text{ m}$$

**Determination of  $L_e$**

$$L_e = L_{e2} = 4,05 \text{ m}$$

**5.1.2.2 Minimum degree of shear connection**

Warning: Conditions given by EN 1994-1-1 Art. 6.6.1.2 (3) are not fulfilled.

$$\eta_{\text{min,calc}} = 1 - \frac{355}{f_{yb}} \cdot (0,75 - 0,03 \cdot L_e)$$

$$\eta_{\text{min,calc}} = 1 - \frac{355}{355} \cdot (0,75 - 0,03 \cdot 4,05 \text{ m}) = 0,37$$

$$\eta_{\text{min}} = \max(\eta_{\text{min,calc}}; 0,4) = \max(0,37; 0,4) = 0,4$$

**5.1.2.3 Degree of shear connection present**

**5.1.2.3.1 Tension resistance of the reinforcement**

$$A_s = \frac{b_{\text{eff}}}{s_l} \cdot \left(\frac{d_l^2}{4}\right) \cdot \pi = \frac{1,01 \text{ m}}{150 \text{ mm}} \cdot \left(\frac{16 \text{ mm}^2}{4}\right) \cdot 3,14 = 1357 \text{ mm}^2$$

$$F_s = \frac{A_s \cdot f_{yk,r}}{\gamma_s} = \frac{1,36 \cdot 10^{-3} \cdot 500 \cdot 10^6}{1,15} = 590 \text{ kN}$$

**5.1.2.3.2 Tension resistance of the steel member**

$$N_{pl,a} = f_{yb} \cdot A_a = 355 \text{ MPa} \cdot 13400 \text{ mm}^2 = 4757,00 \text{ kN}$$

$$N_{c,r} = \min(F_s; N_{pl,a}) = \min(590 \text{ kN}; 4757,00 \text{ kN}) = 590,07 \text{ kN}$$

**5.1.2.3.3 Resistance of the shear connectors**

Number of full ribs available per length  $L_s$

$$n_{rib} = \frac{L_s}{b_s} = \frac{4.05 \text{ m}}{305 \text{ mm}}$$

$$n_{rib} = 13$$

$$l_s = b_s \cdot \text{trough} = 305 \text{ mm} \cdot 1 = 305 \text{ mm}$$

Number of shear studs available per length  $L_s/2$

$$n_{sp} = \frac{0.5 \cdot n_{rib} \cdot n_r}{\text{trough}} = \frac{0.5 \cdot 13 \cdot 1}{1} = 6.5$$

$$N_c = n_{sp} \cdot P_{Rd} = 6.5 \cdot 120166 = 781.08 \text{ kN}$$

$$\eta = \min\left(\frac{N_c}{N_{c,f}}; 1\right) = \min\left(\frac{781.08 \text{ kN}}{590.07 \text{ kN}}; 1\right) = 1$$

$$\eta \geq \eta_{min}$$

$$1 \geq 0.4 \quad \text{OK}$$

The shear connection degree is adequate.

**5.2 Cross-sectional resistance of the composite beam**

**5.2.1 Shear buckling**

$$h_w = h_a - 2 \cdot t_f = 330 \text{ mm} - 2 \cdot 16.5 \text{ mm} = 297 \text{ mm}$$

$$\eta_{sb} = 1.2$$

$$\frac{h_w}{t_w} \leq \frac{72 \cdot \varepsilon}{\eta_{sb}}$$

$$\frac{297 \text{ mm}}{9.5 \text{ mm}} \leq \frac{72 \cdot 0.814}{1.2}$$

$$31.3 \leq 48.8$$

OK

The shear buckling resistance of the web does not need to be verified.

**5.2.2 Vertical shear**

The resistance to vertical shear should be taken as the resistance of the structural steel section.

$$A_v = A_s = 2 \cdot b \cdot t_f + (t_w + 2 \cdot r) \cdot t_f$$

$$= 0.0134 - 2 \cdot 0.3 \cdot 0.0165 + (9.5 \cdot 10^{-3} + 2 \cdot 0.027) \cdot 0.0165 = 4548 \text{ mm}^2$$

$$A_{v,min} = \eta_{sb} \cdot h_w \cdot t_w = 1.2 \cdot 0.297 \cdot 9.5 \cdot 10^{-3} = 3386 \text{ mm}^2$$

$$A_v \geq A_{v,min}$$

$$4548 \text{ mm}^2 \geq 3386 \text{ mm}^2$$

$$V_{pl,Rd} = \frac{A_v \cdot f_{yb}}{\sqrt{3} \cdot \gamma_{M0}} = \frac{4548 \text{ mm}^2 \cdot 355 \cdot 10^6}{\sqrt{3} \cdot 1} = 932 \text{ kN}$$

$$UC_{comp,V} = \frac{abs(V_{Ed,comp})}{V_{pl,Rd}} = \frac{abs(-381.942 \text{ kN})}{932 \text{ kN}} = 0.41$$

The shear resistance of the section is adequate.

**5.2.3 Bending moment**

**5.2.3.1 Longitudinal reinforcement**

**5.2.3.1.1 Centre of composite section**

For buildings not intended mainly for storage the effects of creep in concrete beams may be taken into account by using an effective E modulus  $E_{ceff} = E_{cm} / 2$ .

$$E_{ceff} = \frac{E_{cm}}{2} = \frac{32800 \text{ MPa}}{2} = 16400 \text{ MPa}$$

$$n_E = \frac{E_b}{E_{ceff}} = \frac{210000 \text{ MPa}}{16400 \text{ MPa}} = 12.8$$

$$y_d = \frac{A_a \cdot \left(\frac{h_a}{2}\right) + \left(\frac{1}{n_E}\right) \cdot b_{eff} \cdot (h_c - h_d) \cdot \left(h_a + h_s - \frac{h_c - h_d}{2}\right)}{A_a + \left(\frac{1}{n_E}\right) \cdot b_{eff} \cdot (h_c - h_d)}$$

$$= \frac{0.0134 \cdot \left(\frac{0.33}{2}\right) + \left(\frac{1}{12.8}\right) \cdot 1.01 \cdot (0.109 - 0) \cdot \left(0.33 + 0.16 - \frac{0.109 - 0}{2}\right)}{0.0134 + \left(\frac{1}{12.8}\right) \cdot 1.01 \cdot (0.109 - 0)} = 271 \text{ mm}$$

Student version

## 5.2.3.1.2 Degree of reinforcement

$$A_s = \frac{b_{\text{eff}}}{s_j} \left( \frac{d_l^2}{4} \right) \cdot \pi = \frac{1.01 \text{ m}}{150 \text{ mm}} \left( \frac{16 \text{ mm}^2}{4} \right) 3.14 = 1357 \text{ mm}^2$$

$$A_c = b_{\text{eff}} \cdot (h_c - h_d) = 1.01 \cdot (0.109 - 0) = 110565 \text{ mm}^2$$

$$z_0 = \left( h_a + h_s - \frac{h_c - h_d}{2} \right) - y_d = \left( 0.33 + 0.16 - \frac{0.109 - 0}{2} \right) - 0.271 = 164 \text{ mm}$$

$$k_c = \min \left( \frac{1}{\left( 1 + \frac{h_c - h_d}{2 \cdot z_0} \right)} + 0.3; 1 \right) = \min \left( \frac{1}{\left( 1 + \frac{0.109 - 0}{2 \cdot 0.164} \right)} + 0.3; 1 \right) = 1$$

$$\rho_s = \delta \cdot \left( \frac{f_{yb}}{235} \right) \cdot \left( \frac{f_{ctm}}{f_{yk,r}} \right) \cdot \sqrt{k_c} = 1.1 \cdot \left( \frac{355}{235} \right) \cdot \left( \frac{2.9 \cdot 10^6}{500 \cdot 10^6} \right) \cdot \sqrt{1} = 0.964 \%$$

$$A_s \geq \rho_s \cdot A_c$$

$$1357 \text{ mm}^2 \geq 9.64 \cdot 10^{-3} \cdot 110565 \text{ mm}^2$$

$$1357 \text{ mm}^2 \geq 1066 \text{ mm}^2 \quad \text{OK}$$

The longitudinal reinforcement of the section is adequate.

## 5.2.3.2 Moment resistance

## Moment resistance of a steel cross-section

$$M_{pl,Rd,a} = \frac{W_{ply} \cdot f_{yb}}{Y_{MO}} = \frac{1.85 \cdot 10^6 \text{ mm}^3 \cdot 355 \text{ MPa}}{1} = 657 \text{ kNm}$$

## Influence of shear

$$\frac{V_{pl,Rd}}{2} > \text{abs}(V_{Ed,comp})$$

$$\frac{932 \text{ kN}}{2} > 382 \text{ kN}$$

$$466 \text{ kN} > 382 \text{ kN} \quad \text{OK}$$

The influence of the vertical shear on the bending moment resistance may be neglected.

$$f_{yb,w} = f_{yb} = 355 \text{ MPa}$$

## Modified tension resistance of the steel member

$$r = 0 \text{ mm}$$

$$A_s = 2 \cdot t_f \cdot b + t_w \cdot (h_a - 2 \cdot t_f) = 2 \cdot 16.5 \text{ mm} \cdot 300 \text{ mm} + 9.5 \text{ mm} \cdot (330 \text{ mm} - 2 \cdot 16.5 \text{ mm}) = 12722 \text{ mm}^2$$

$$N_{pl,a} = A_s \cdot f_{yb} = 12722 \text{ mm}^2 \cdot 355 \text{ MPa} = 4516.13 \text{ kN}$$

Note: Roundings of the steel cross-section are neglected in bending resistance calculation.

$$N_{c,f} = \min(F_s; N_{pl,a}) = \min(590 \text{ kN}; 4516.13 \text{ kN}) = 590.07 \text{ kN}$$

## Negative bending moment resistance calculation

The plastic neutral axis is located within the web of the steel section.

$$N_{at,f} = b \cdot t_f \cdot f_{yb} = 0.3 \cdot 0.0165 \cdot 355 \cdot 10^6 = 1757.25 \text{ kN}$$

$$N_{pl,a} - N_{at,f} - N_{at,w} = F_s + N_{at,f} + N_{at,w}$$

$$x = \frac{(N_{pl,a} - 2 \cdot N_{at,f} - F_s)}{(2 \cdot t_w \cdot f_{yb,w})} = \frac{(4516.13 \text{ kN} - 2 \cdot 1757.25 \text{ kN} - 590 \text{ kN})}{(2 \cdot 9.5 \text{ mm} \cdot 355 \text{ MPa})} = 61 \text{ mm}$$

Verification of the steel web classification.

$$\alpha_{cl} = \frac{c_w - x}{c_w} = \frac{243 - 61}{243} = 0.749$$

$$\frac{c_w}{t_w} \leq \frac{396 \cdot \epsilon}{13 \cdot \alpha_{cl} - 1}$$

$$\frac{243 \text{ mm}}{9.5 \text{ mm}} \leq \frac{396 \cdot 0.814}{13 \cdot 0.749 - 1}$$

$$25.6 \leq 36.9 \quad \text{OK}$$

Web classified as Class 1.

$$N_{at,w} = t_w \cdot x \cdot f_{yb,w} = 9.5 \text{ mm} \cdot 61 \text{ mm} \cdot 355 \text{ MPa} = 205.78 \text{ kN}$$

$$N_{ac} = N_{pl,a} - N_{at,f} - N_{at,w} = 4516.13 \text{ kN} - 1757.25 \text{ kN} - 205.78 \text{ kN} = 2553.10 \text{ kN}$$

Leverage arm of the compression part of the steel section calculated to the PNA.

$$h_{cs} = \frac{\left( t_w \cdot (h_a - 2 \cdot t_f - x)^2 \cdot 0.5 + t_f \cdot b \cdot (h_a - 1.5 \cdot t_f - x) \right)}{t_w \cdot (h_a - 2 \cdot t_f - x) + t_f \cdot b}$$

$$= \frac{\left( 9.5 \cdot (330 - 2 \cdot 16.5 - 61)^2 \cdot 0.5 + 16.5 \cdot 300 \cdot (330 - 1.5 \cdot 16.5 - 61) \right)}{9.5 \cdot (330 - 2 \cdot 16.5 - 61) + 16.5 \cdot 300} = 205 \text{ mm}$$

$$h_l = x + t_f + h_s - c_l + \frac{d_l}{2} = 0.061 + 0.0165 + 0.16 - 0.03 + \frac{0.016}{2} = 200 \text{ mm}$$



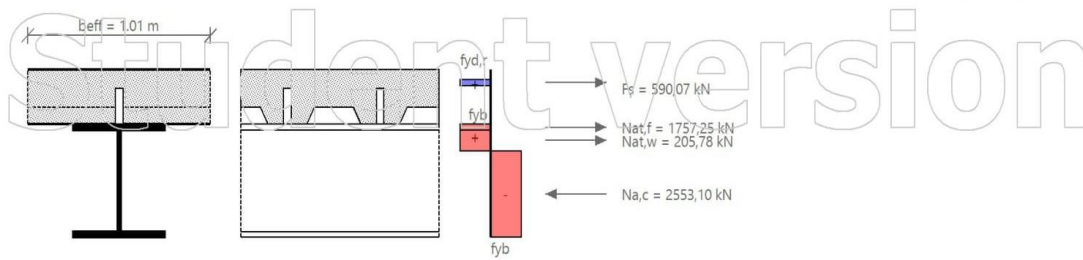

$$M_{pl,Rd} = F_d \cdot h_f + N_{at,f} \cdot \left( \frac{t_f}{2} + x \right) + \frac{N_{at,w} \cdot x}{2} + N_{a,c} \cdot h_{cs}$$

$$= 590 \cdot 200 + 1757.25 \cdot \left( \frac{16.5}{2} + 61 \right) + \frac{205.78 \cdot 61}{2} + 2553.10 \cdot 205 = 769 \text{ kNm}$$

**Design moment resistance according to EN 1994-1-1 Art.6.2.1.2**

$M_{Rd} = M_{pl,Rd} = 769 \text{ kNm}$

$UC_{comp\_M} = \frac{abs(M_{Ed,comp})}{M_{Rd}} = \frac{abs(-570.885 \text{ kNm})}{769 \text{ kNm}} = 0.74$

The bending moment resistance of the section is adequate.

**5.3 LTB resistance**

$$F = \left( 1 + \frac{t_w \cdot (h_a - t_f)}{4 \cdot b \cdot t_f} \right) \left( \frac{h_a - t_f}{t_w} \right)^{0.75} \cdot \left( \frac{t_f}{b} \right)^{0.25} = \left( 1 + \frac{9.5 \cdot (330 - 16.5)}{4 \cdot 300 \cdot 16.5} \right) \cdot \left( \frac{330 - 16.5}{9.5} \right)^{0.75} \cdot \left( \frac{16.5}{300} \right)^{0.25} = 7.67$$

$F_{lim} = 12.3$

$F \leq F_{lim}$

$7.67 \leq 12.3$  OK

The cross-section is qualified for verification of LTB by the simplified method.

$C_4 = 25$

$$\lambda_{LT,rel} = 5 \cdot \left( 1 + \frac{t_w \cdot (h_a - t_f)}{4 \cdot b \cdot t_f} \right) \left( \frac{h_a - t_f}{t_w} \right)^{0.75} \cdot \left( \frac{t_f}{b} \right)^{0.25} \cdot \left( \frac{f_{yb}}{E_b \cdot C_4} \right)^{0.5}$$

$$= 5 \cdot \left( 1 + \frac{9.5 \cdot 10^{-3} \cdot (0.33 - 0.0165)}{4 \cdot 0.3 \cdot 0.0165} \right) \cdot \left( \frac{0.33 - 0.0165}{9.5 \cdot 10^{-3}} \right)^{0.75} \cdot \left( \frac{0.0165}{0.3} \right)^{0.25} \cdot \left( \frac{355 \cdot 10^6}{210 \cdot 10^9 \cdot 25} \right)^{0.5} = 0.315$$

$h_a/b \leq 2 \rightarrow$  Buckling curve 'a'

$\alpha_{LT} = 0.21$

$\Phi_{LT} = 0.5 \cdot \left( 1 + \alpha_{LT} \cdot (\lambda_{LT,rel} - 0.2) + \lambda_{LT,rel}^2 \right) = 0.5 \cdot \left( 1 + 0.21 \cdot (0.315 - 0.2) + 0.315^2 \right) = 0.562$

$X_{LT} = \frac{1}{\Phi_{LT} + \sqrt{\Phi_{LT}^2 - \lambda_{LT,rel}^2}} = \frac{1}{0.562 + \sqrt{0.562^2 - 0.315^2}} = 0.974$

$X_{LT} = \min(X_{LT}, 1) = \min(0.974, 1) = 0.974$

$M_{b,Rd} = X_{LT} \cdot M_{Rd} = 0.974 \cdot 768809 = 748.722 \text{ kNm}$

$UC_{comp\_LTB} = \frac{abs(M_{Ed,comp})}{M_{b,Rd}} = \frac{abs(-570.885 \text{ kNm})}{748.722 \text{ kNm}} = 0.76$

The later torsional buckling resistance of the section is adequate.

**5.4 Longitudinal shear**

**5.4.1 Transverse reinforcement**

Design shear flow

$h_f = h_c = 109 \text{ mm}$

$V_{Ed} = \frac{\eta_r \cdot P_{Rd}}{2 \cdot I_s \cdot h_f} = \frac{1 \cdot 120 \text{ kN}}{2 \cdot 305 \text{ mm} \cdot 109 \text{ mm}} = 1.81 \text{ MPa}$

Transverse reinforcement

$\frac{A_{st} \cdot f_{yk,t}}{Y_s \cdot S_f} \geq \frac{V_{Ed} \cdot h_f}{\cotg(\theta)}$

$A_t = A_{st}/S_f$

$A_t = \frac{V_{Ed} \cdot h_f}{\frac{\cotg(\theta) \cdot f_{yk,t}}{Y_s}} = \frac{1.81 \cdot 10^6 \cdot 0.109}{\left( \frac{\cotg(26.5) \cdot 500 \cdot 10^6}{1.15} \right)} = 226 \text{ mm}^2/\text{m}$

$A_{t,prov} = \frac{1}{S_t} \left( \frac{d_t^2}{4} \right) \cdot 3.14 = \frac{1}{0.15} \left( \frac{0.016^2}{4} \right) \cdot 3.14 = 1340 \text{ mm}^2/\text{m}$

$A_{t,prov} \geq A_t$   
 $1340 \text{ mm}^2/\text{m} \geq 226 \text{ mm}^2/\text{m}$  OK

The transverse reinforcement of the section is adequate.

SCIAENGINEER

ULS check of Final stage is OK.  
UC\_comp = max(0.41;0.74;0.76) = 0.76

Student version

-iskoristivost elementa na GSN – 74%

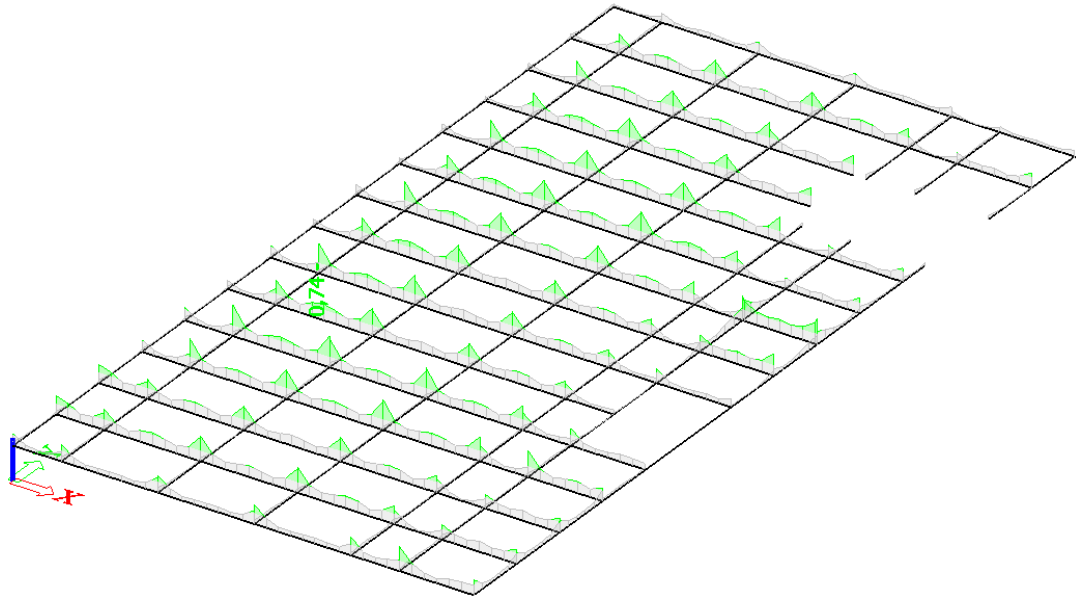

**Slika 8.4.** Prikaz iskoristivosti grednih nosača – poz 100

## 9. PRORAČUN SPREGNUTE MEĐUKATNE KONSTRUKCIJE – TRIBINA VELIKE DVORANE

### 9.1. Pomaci spregnute međukatne konstrukcije – tribina velike dvorane

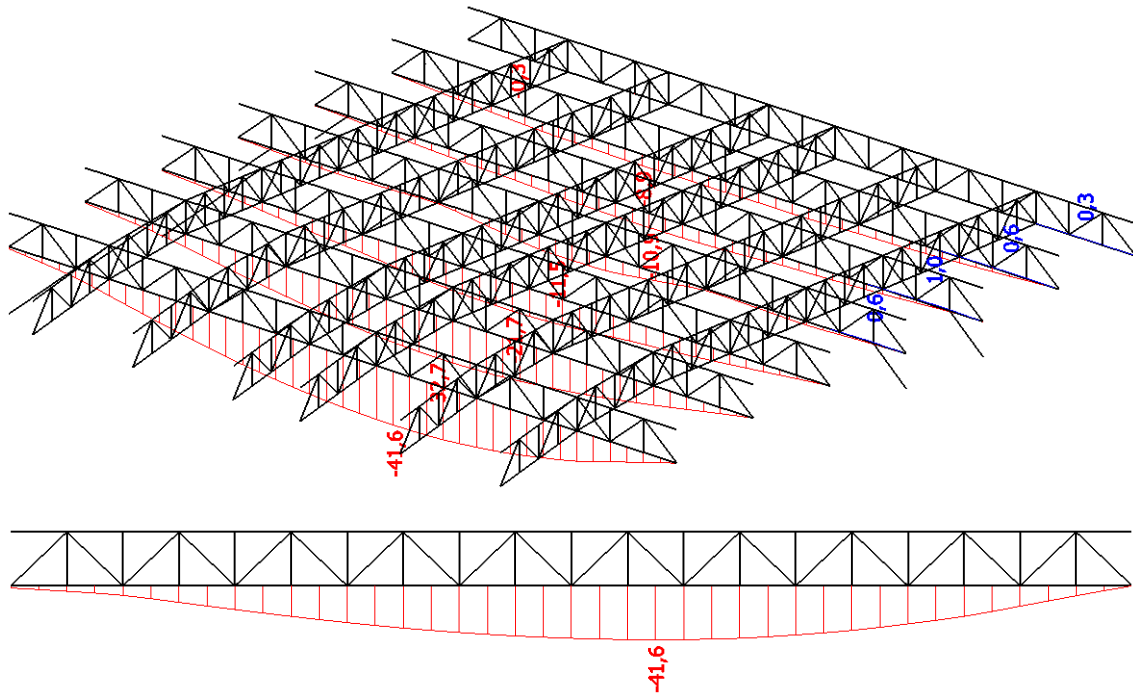

*Slika 9.1. Prikaz vertikalnog pomaka glavnog rešetkastog nosača – tribina velike dvorane*

Dopušteni vertikalni pomak (progib):

$$u_{dop} = \frac{l}{300} = \frac{31,44 \cdot 1000}{300} = 104,8 \text{ mm}$$

$$u_z = 41,6 \text{ mm} < u_{z,dop} = 104,8 \text{ mm} \quad \text{Zadovoljava}$$

-iskoristivost na GSU -  $41,6 \text{ mm} / 31,44 \text{ mm} = 0,40 = 40\%$

## 9.2. Dimenziniranje spregnute međukatne konstrukcije – tribina velike dvorane

### 9.2.1. Rezne sile – gornja pojasnica glavnog rešetkastog nosača

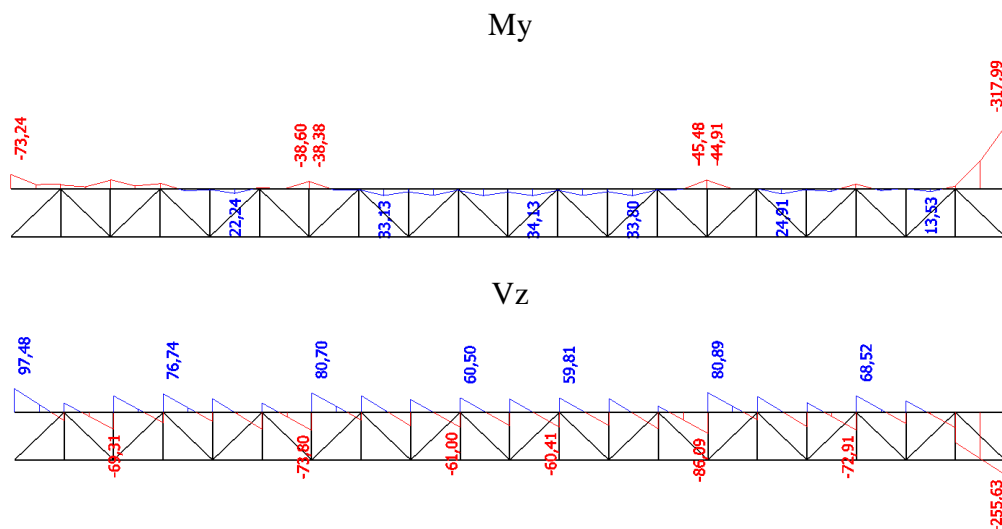

Slika 9.2. Prikaz reznih sila - gornja pojasnica glavnog rešetkastog nosača

-poprečni presjek nosača

Name	Gornja pojasnica glavnog rešetkastog nosača - tribina velike dvorane	
Type	HEB260	
Source description	Profil Arbed / Structural shapes / Edition Octobre 1995	
Item material	S 355	
Fabrication	rolled	
Flexural buckling y-y	b	
Flexural buckling z-z	c	
Lateral torsional buckling	Default	
Use 2D FEM analysis	x	
A [m²]	1,1840e-02	
A <sub>y, z</sub> [m²]	8,7661e-03	2,7927e-03
I <sub>y, z</sub> [m⁴]	1,4920e-04	5,1350e-05
I <sub>w</sub> [m⁵], I <sub>t</sub> [m⁴]	7,5365e-07	1,2380e-06
W <sub>el y, z</sub> [m³]	1,1480e-03	3,9500e-04
W <sub>pl y, z</sub> [m³]	1,2830e-03	6,0220e-04
d <sub>y, z</sub> [mm]	0	
c <sub>YUCS, ZUCS</sub> [mm]	130	130
α [deg]	0,00	
A <sub>L, D</sub> [m²/m]	1,5000e+00	1,4986e+00
M <sub>pl y, z</sub> +, - [Nm]	4,56e+05	4,56e+05
M <sub>pl z, y</sub> +, - [Nm]	2,14e+05	2,14e+05

Slika 9.3. Prikaz geometrijskih karakteristika nosača

## 9.2.2. Dimenzioniranje – gornja pojasnica glavnog rešetkastog nosača

SCIAENGINEER

### Composite Beam - Final stage

Linear calculation  
Class: All ULS  
Extreme 1D: Global  
Selection: B4121

### Composite beam verification

for beam B4121 at section 4.72 m, in accordance with EC EN 1994-1-1

#### 1. Geometry data

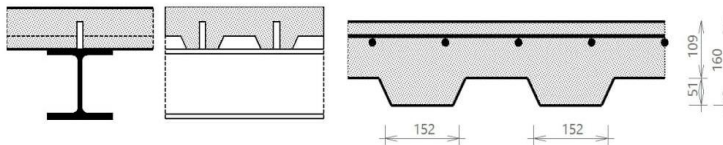

#### Continuous beam

Length of the current span	$L = 4.716 \text{ m}$
Length of previous span	$L_{\text{previous}} = 4.716 \text{ m}$
Beam spacing at the left	$L_{\text{left}} = 0 \text{ m}$
Beam spacing at the right	$L_{\text{right}} = 0 \text{ m}$
Checked section	$d_x = 4.716 \text{ m}$

Warning: For a continuous beam, intermediate buckling supports y-y are ignored in both the calculation of the effective width for the analysis model and the check.

#### 2. Cross-section & materials

##### 2.1 Steel section properties

##### 2.1.1 Cross-section

Cross-section	HEB260
Height	$h_a = 260 \text{ mm}$
Width	$b = 260 \text{ mm}$
Web thickness	$t_w = 10 \text{ mm}$
Flange thickness	$t_f = 17.5 \text{ mm}$
Radius	$r = 24 \text{ mm}$
Area	$A_a = 11840 \text{ mm}^2$
Moment of inertia	$I_y = 149 \cdot 10^6 \text{ mm}^4$
Radius of gyration	$i_z = 66 \text{ mm}$
Plastic section modulus	$W_{ply} = 1.283 \cdot 10^6 \text{ mm}^3$

##### 2.1.2 Material

Steel grade	S 355
Yield strength	$f_{yb} = 355 \text{ MPa}$
Ultimate strength	$f_{ub} = 490 \text{ MPa}$
E modulus	$E_b = 210000 \text{ MPa}$

##### 2.1.3 Cross-section classification

$$\epsilon = \sqrt{\frac{235}{355}} = 0.814$$

(EN 1993-1-1 §5.6 Tab. 5.2)

##### 2.1.3.1 Flange in compression

$$c_f = \frac{b - t_w - 2 \cdot r}{2} = \frac{260 \text{ mm} - 10 \text{ mm} - 2 \cdot 24 \text{ mm}}{2} = 101 \text{ mm}$$

$$\frac{c_f}{t_f} \leq 9 \cdot \epsilon$$

$$\frac{101 \text{ mm}}{17.5 \text{ mm}} \leq 9 \cdot 0.814$$

$$5.77 \leq 7.32$$

OK

Flange classified as Class 1.

Student version

2.1.3.2 Web in bending

$$c_w = h_a - 2 \cdot t_f - 2 \cdot r = 260 \text{ mm} - 2 \cdot 17.5 \text{ mm} - 2 \cdot 24 \text{ mm} = 177 \text{ mm}$$

$$\alpha_{cl} = 0.5$$

$$\frac{c_w}{t_w} \leq \frac{36 \cdot \epsilon}{\alpha_{cl}}$$

$$\frac{177 \text{ mm}}{10 \text{ mm}} \leq \frac{36 \cdot 0.814}{0.5}$$

$$17.7 \leq 58.6$$

OK

Web classified as Class 1.

**Cross-section classified as Class 1**

Cross-section Class OK.

**2.2 Concrete slab with profiled sheeting**

**2.2.1 Concrete slab**

2.2.1.1 Slab

Total height of the slab  $h_s = 160 \text{ mm}$

2.2.1.2 Material

Concrete class C30/37

Characteristic strength  $f_{ck} = 30 \text{ MPa}$

E modulus  $E_{cm} = 32800 \text{ MPa}$

**2.2.2 Profiled steel sheeting**

Sheeting with ribs transverse to the supporting beams

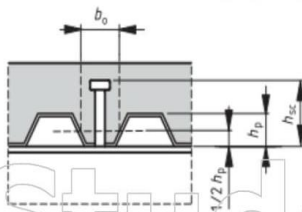

Name	Vulcraft 2 VLI 20
Depth of the ribs	$h_p = 50.8 \text{ mm}$
Height of full concrete	$h_c = 109.2 \text{ mm}$
Height of the re-entrant stiffener	$h_d = 0 \text{ mm}$
Spacing of the ribs	$b_s = 304.8 \text{ mm}$
Top width of the rib	$b_r = 127 \text{ mm}$
Bottom width of the rib	$b_b = 127 \text{ mm}$
Mean width of the ribs	$b_{0,rib} = 152.4 \text{ mm}$
Thickness of the sheeting	$t_p = 0.9093 \text{ mm}$

**2.2.3 Shear connectors**

2.2.3.1 Geometry

Name	H110
Diameter	$d_s = 25 \text{ mm}$
Nominal height	$h_{nom} = 110 \text{ mm}$
As-welded height	$h_{sc} = 105 \text{ mm}$
Amount per trough or section	$n_r = 1$

2.2.3.2 Material

Steel grade	S 355
Ultimate strength	$f_{us} = 490 \text{ MPa}$

**2.2.4 Reinforcement**

2.2.4.1 Geometry

Longitudinal bar diameter	$d_l = 16 \text{ mm}$
Longitudinal bar spacing	$s_l = 150 \text{ mm}$
Longitudinal bar cover	$c_l = 30 \text{ mm}$
Transverse bar diameter	$d_t = 16 \text{ mm}$
Transverse bar spacing	$s_t = 150 \text{ mm}$
Transverse bar cover	$c_t = 46 \text{ mm}$

2.2.4.2 Material

Material	B 500A
Characteristic yield strength	$f_{ykr} = 500 \text{ MPa}$

**3. Design values of loads**

Load Name : GSN 22

Content of combination : 1.35\*g-vlastitežina+1.35\*dg dodatnostalno+  
1.62\*q-promjenjivoopterećenje+1.35\*g-vlastitežina\_dryconcrete+  
1.35\*Wx-1kom.-Wz-poz+1.35\*s-opterećenjesnijegom

Bending moment  $M_{Ed,comp} = -317.989$  kNm  
Shear force  $V_{Ed,comp} = -255.631$  kN

**4. Partial safety factors**

Steel section  $\gamma_{M0} = 1$   
 $\gamma_{M1} = 1$   
Shear connectors  $\gamma_V = 1.25$   
Concrete  $\gamma_C = 1.5$   
Reinforcement  $\gamma_S = 1.15$

**5. ULS check of the Final stage**

**5.1 Shear connection**

**5.1.1 Design resistance of shear connectors**

**5.1.1.1 Shear connector in a solid slab**

$$\frac{h_{sc}}{d_s} > 4$$

$$4.2 > 4$$

$$\alpha = 1$$

$$f_{us} = \min(490; 450) \text{ MPa}$$

$$f_{us} = 450 \text{ MPa}$$

$$P_{Rd,solid,1} = \frac{0.8 \cdot f_{us} \cdot \left(\frac{\pi \cdot d_s^2}{4}\right)}{\gamma_V} = \frac{0.8 \cdot 450 \text{ MPa} \cdot \left(\frac{3.14 \cdot 25 \text{ mm}^2}{4}\right)}{1.25} = 141 \text{ kN}$$

$$P_{Rd,solid,2} = \frac{0.29 \cdot \alpha \cdot d_s^2 \cdot \sqrt{f_{ck} \cdot E_{cm}}}{\gamma_V} = \frac{0.29 \cdot 1 \cdot 25 \text{ mm}^2 \cdot \sqrt{30 \text{ MPa} \cdot 32800 \text{ MPa}}}{1.25} = 144 \text{ kN}$$

$$P_{Rd,solid} = \min(P_{Rd,solid,1}; P_{Rd,solid,2}) = \min(141 \text{ kN}; 144 \text{ kN}) = 141 \text{ kN}$$

**5.1.1.2 Shear connector in profiled sheeting**

Sheeting with ribs transverse to the supporting beams

$$k_t = \frac{0.7}{\sqrt{h_r}} \cdot \left(\frac{b_{0,rib}}{h_p}\right) \cdot \left(\frac{h_{sc}}{h_p} - 1\right) = \frac{0.7}{\sqrt{1}} \cdot \left(\frac{152 \text{ mm}}{50.8 \text{ mm}}\right) \cdot \left(\frac{105 \text{ mm}}{50.8 \text{ mm}} - 1\right) = 2.24$$

$$k_{t,max} = 0.85$$

$$k_t = \max(0; \min(k_t; k_{t,max})) = \max(0; \min(2.24; 0.85)) = 0.85$$

$$P_{Rd} = k_t \cdot P_{Rd,solid} = 0.85 \cdot 141 \text{ kN} = 120 \text{ kN}$$

Warning: The conditions given by EN 1994-1-1 Art.6.6.4.2 (3) are not fulfilled.

**5.1.2 Degree of shear connection**

**5.1.2.1 Determination of  $b_{eff}$  of the concrete flange and length  $L_e$**

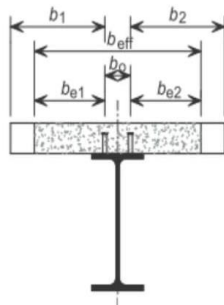

The effective width at the end support

$$L_{e0} = 0.85 \cdot L_2 = 0.85 \cdot 4.72 \text{ m} = 4.01 \text{ m}$$

**Left side of the beam**

No adjacent member or slab edge was found on the side.

$$b_{e10} = \frac{L_{e0}}{8} = \frac{4.01 \text{ m}}{8} = 0.501 \text{ m}$$

$$b_{e11} = \frac{L_{e1}}{8} = \frac{0 \text{ m}}{8} = 0 \text{ m}$$

$$b_{e12} = \frac{L_{e2}}{8} = \frac{0 \text{ m}}{8} = 0 \text{ m}$$

**Right side of the beam**

No adjacent member or slab edge was found on the side.

$$b_{e20} = \frac{L_{e0}}{8} = \frac{4.01 \text{ m}}{8} = 0.501 \text{ m}$$

$$b_{e21} = \frac{L_{e1}}{8} = \frac{0 \text{ m}}{8} = 0 \text{ m}$$

$$b_{e22} = \frac{L_{e2}}{8} = \frac{0 \text{ m}}{8} = 0 \text{ m}$$

**Calculation of  $b_{eff,0}$**

$$b_{eff,0} = b_0 + b_{e10} \cdot \beta_1 + b_{e20} \cdot \beta_2 = 0 \text{ mm} + 0.501 \text{ m} \cdot 0.75 + 0.501 \text{ m} \cdot 0.75 = 0.752 \text{ m}$$

**Calculation of  $b_{eff}$**

$$b_{eff} = b_{eff,0} = 0.752 \text{ m}$$

**Determination of  $L_e$**

$$L_e = L_{e0} = 4.01 \text{ m}$$

**5.1.2.2 Minimum degree of shear connection**

Warning: Conditions given by EN 1994-1-1 Art. 6.6.1.2 (3) are not fulfilled.

$$\eta_{min,calc} = 1 - \frac{355}{f_{yb}} \cdot (0.75 - 0.03 \cdot L_e)$$

$$\eta_{min,calc} = 1 - \frac{355}{355} \cdot (0.75 - 0.03 \cdot 4.01 \text{ m}) = 0.37$$

$$\eta_{min} = \max(\eta_{min,calc}, 0.4) = \max(0.37, 0.4) = 0.4$$

**5.1.2.3 Degree of shear connection present**

**5.1.2.3.1 Tension resistance of the reinforcement**

$$A_s = \frac{b_{eff}}{s_l} \cdot \left( \frac{d_l^2}{4} \right) \cdot \pi = \frac{0.752 \text{ m}}{150 \text{ mm}} \cdot \left( \frac{16 \text{ mm}^2}{4} \right) \cdot 3.14 = 1007 \text{ mm}^2$$

$$F_s = \frac{A_s \cdot f_{yk,r}}{\gamma_s} = \frac{1.01 \cdot 10^{-3} \cdot 500 \cdot 10^6}{1.15} = 438 \text{ kN}$$

**5.1.2.3.2 Tension resistance of the steel member**

$$N_{pl,a} = f_{yb} \cdot A_a = 355 \text{ MPa} \cdot 11840 \text{ mm}^2 = 4203.20 \text{ kN}$$

$$N_{c,r} = \min(F_s; N_{pl,a}) = \min(438 \text{ kN}; 4203.20 \text{ kN}) = 438.03 \text{ kN}$$

**5.1.2.3.3 Resistance of the shear connectors**

Number of full ribs available per length  $L_e$

$$n_{rib} = \frac{L_e}{b_s} = \frac{4.01 \text{ m}}{305 \text{ mm}}$$

$$n_{rib} = 13$$

$$l_s = b_s \cdot \text{trough} = 305 \text{ mm} \cdot 1 = 305 \text{ mm}$$

Number of shear studs available per length  $L_e/2$

$$n_{sp} = \frac{0.5 \cdot n_{rib} \cdot n_r}{\text{trough}} = \frac{0.5 \cdot 13 \cdot 1}{1} = 6.5$$

$$N_c = n_{sp} \cdot P_{Rid} = 6.5 \cdot 120166 = 781.08 \text{ kN}$$

$$\eta = \min\left(\frac{N_c}{N_{c,r}}; 1\right) = \min\left(\frac{781.08 \text{ kN}}{438.03 \text{ kN}}; 1\right) = 1$$

$$\eta \geq \eta_{min}$$

$$1 \geq 0.4$$

OK

The shear connection degree is adequate.



**5.2 Cross-sectional resistance of the composite beam****5.2.1 Shear buckling**

$$h_w = h_s - 2 \cdot t_f = 260 \text{ mm} - 2 \cdot 17.5 \text{ mm} = 225 \text{ mm}$$

$$\eta_{sb} = 1.2$$

$$\frac{h_w}{t_w} \leq \frac{72 \cdot \varepsilon}{\eta_{sb}}$$

$$\frac{225 \text{ mm}}{10 \text{ mm}} \leq \frac{72 \cdot 0.814}{1.2}$$

$$22.5 \leq 48.8$$

OK

The shear buckling resistance of the web does not need to be verified.

**5.2.2 Vertical shear**

The resistance to vertical shear should be taken as the resistance of the structural steel section.

$$A_v = A_s - 2 \cdot b \cdot t_f + (t_w + 2 \cdot r) \cdot t_f$$

$$= 0.0118 - 2 \cdot 0.26 \cdot 0.0175 + (0.01 + 2 \cdot 0.024) \cdot 0.0175 = 3755 \text{ mm}^2$$

$$A_{v,\min} = \eta_{sb} \cdot h_w \cdot t_w = 1.2 \cdot 0.225 \cdot 0.01 = 2700 \text{ mm}^2$$

$$A_v \geq A_{v,\min}$$

$$3755 \text{ mm}^2 \geq 2700 \text{ mm}^2$$

$$V_{pl,Rd} = \frac{A_v \cdot f_{yb}}{\sqrt{3} \cdot \gamma_{M0}} = \frac{3755 \text{ mm}^2 \cdot 355 \cdot 10^6}{\sqrt{3} \cdot 1} = 770 \text{ kN}$$

$$UC_{\text{comp}_V} = \frac{\text{abs}(V_{Ed,\text{comp}})}{V_{pl,Rd}} = \frac{\text{abs}(-255.631 \text{ kN})}{770 \text{ kN}} = 0.33$$

The shear resistance of the section is adequate.

**5.2.3 Bending moment****5.2.3.1 Longitudinal reinforcement****5.2.3.1.1 Centre of composite section**For buildings not intended mainly for storage the effects of creep in concrete beams may be taken into account by using an effective E modulus  $E_{\text{eff}} = E_{\text{cm}} / 2$ .

$$E_{\text{eff}} = \frac{E_{\text{cm}}}{2} = \frac{32800 \text{ MPa}}{2} = 16400 \text{ MPa}$$

$$\eta_E = \frac{E_b}{E_{\text{eff}}} = \frac{210000 \text{ MPa}}{16400 \text{ MPa}} = 12.8$$

$$y_d = \frac{A_a \cdot \left( \frac{h_a}{2} \right) + \left( \frac{1}{\eta_E} \right) \cdot b_{\text{eff}} \cdot (h_c - h_d) \cdot \left( h_a + h_s - \frac{h_c - h_d}{2} \right)}{A_a + \left( \frac{1}{\eta_E} \right) \cdot b_{\text{eff}} \cdot (h_c - h_d)}$$

$$= \frac{0.0118 \cdot \left( \frac{0.26}{2} \right) + \left( \frac{1}{12.8} \right) \cdot 0.752 \cdot (0.109 - 0) \cdot \left( 0.26 + 0.16 - \frac{0.109 - 0}{2} \right)}{0.0118 + \left( \frac{1}{12.8} \right) \cdot 0.752 \cdot (0.109 - 0)} = 213 \text{ mm}$$

**5.2.3.1.2 Degree of reinforcement**

$$A_s = \frac{b_{\text{eff}}}{s_l} \cdot \left( \frac{d_l^2}{4} \right) \cdot \pi = \frac{0.752 \text{ m}}{150 \text{ mm}} \cdot \left( \frac{16 \text{ mm}^2}{4} \right) \cdot 3.14 = 1007 \text{ mm}^2$$

$$A_c = b_{\text{eff}} \cdot (h_c - h_d) = 0.752 \cdot (0.109 - 0) = 82076 \text{ mm}^2$$

$$z_0 = \left( h_a + h_s - \frac{h_c - h_d}{2} \right) - y_d = \left( 0.26 + 0.16 - \frac{0.109 - 0}{2} \right) - 0.213 = 153 \text{ mm}$$

$$k_c = \min \left( \frac{1}{\left( 1 + \frac{h_c - h_d}{2 \cdot z_0} \right)} + 0.3; 1 \right) = \min \left( \frac{1}{\left( 1 + \frac{0.109 - 0}{2 \cdot 0.153} \right)} + 0.3; 1 \right) = 1$$

$$\rho_s = \delta \cdot \left( \frac{f_{yb}}{235} \right) \cdot \left( \frac{f_{ctm}}{f_{yk,r}} \right) \cdot \sqrt{k_c} = 1.1 \cdot \left( \frac{355}{235} \right) \cdot \left( \frac{2.9 \cdot 10^6}{500 \cdot 10^6} \right) \cdot \sqrt{1} = 0.964 \%$$

$$A_s \geq \rho_s \cdot A_c$$

$$1007 \text{ mm}^2 \geq 9.64 \cdot 10^{-3} \cdot 82076 \text{ mm}^2$$

$$1007 \text{ mm}^2 \geq 791 \text{ mm}^2$$

OK

The longitudinal reinforcement of the section is adequate.

5.2.3.2 Moment resistance

Moment resistance of a steel cross-section

$$M_{pl,Rd,a} = \frac{W_{ply} \cdot f_{yb}}{Y_{MO}} = \frac{1.28 \cdot 10^6 \text{ mm}^3 \cdot 355 \text{ MPa}}{1} = 455 \text{ kNm}$$

Influence of shear

$$\frac{V_{pl,Rd}}{2} > \text{abs}(V_{Ed,comp})$$

$$\frac{770 \text{ kN}}{2} > 256 \text{ kN}$$

$$385 \text{ kN} > 256 \text{ kN} \quad \text{OK}$$

The influence of the vertical shear on the bending moment resistance may be neglected.

$$f_{yb,w} = f_{yb} = 355 \text{ MPa}$$

Modified tension resistance of the steel member

$$r = 0 \text{ mm}$$

$$A_w = 2 \cdot t_f \cdot b + t_w \cdot (h_a - 2 \cdot t_f) = 2 \cdot 17.5 \text{ mm} \cdot 260 \text{ mm} + 10 \text{ mm} \cdot (260 \text{ mm} - 2 \cdot 17.5 \text{ mm}) = 11350 \text{ mm}^2$$

$$N_{pl,a} = A_w \cdot f_{yb} = 11350 \text{ mm}^2 \cdot 355 \text{ MPa} = 4029.25 \text{ kN}$$

Note: Roundings of the steel cross-section are neglected in bending resistance calculation.

$$N_{c,f} = \min(F_s, N_{pl,a}) = \min(438 \text{ kN}; 4029.25 \text{ kN}) = 438.03 \text{ kN}$$

Negative bending moment resistance calculation

The plastic neutral axis is located within the web of the steel section.

$$N_{at,f} = b \cdot t_f \cdot f_{yb} = 0.26 \cdot 0.0175 \cdot 355 \cdot 10^6 = 1615.25 \text{ kN}$$

$$N_{pl,a} - N_{at,f} - N_{at,w} = F_s + N_{at,f} + N_{at,w}$$

$$x = \frac{(N_{pl,a} - 2 \cdot N_{at,f} - F_s)}{(2 \cdot t_w \cdot f_{yb,w})} = \frac{(4029.25 \text{ kN} - 2 \cdot 1615.25 \text{ kN} - 438 \text{ kN})}{(2 \cdot 10 \text{ mm} \cdot 355 \text{ MPa})} = 50.8 \text{ mm}$$

Verification of the steel web classification.

$$\alpha_{cl} = \frac{c_w - x}{c_w} = \frac{177 - 50.8}{177} = 0.713$$

$$\frac{c_w}{t_w} \leq \frac{396 \cdot \epsilon}{13 \cdot \alpha_{cl} - 1}$$

$$\frac{177 \text{ mm}}{10 \text{ mm}} \leq \frac{396 \cdot 0.814}{13 \cdot 0.713 - 1}$$

$$17.7 \leq 39 \quad \text{OK}$$

Web classified as Class 1.

$$N_{at,w} = t_w \cdot x \cdot f_{yb,w} = 10 \text{ mm} \cdot 50.8 \text{ mm} \cdot 355 \text{ MPa} = 180.36 \text{ kN}$$

$$N_{a,c} = N_{pl,a} - N_{at,f} - N_{at,w} = 4029.25 \text{ kN} - 1615.25 \text{ kN} - 180.36 \text{ kN} = 2233.64 \text{ kN}$$

Leverage arm of the compression part of the steel section calculated to the PNA.

$$h_{cs} = \frac{(t_w \cdot (h_a - 2 \cdot t_f - x) \cdot 0.5 + t_f \cdot b \cdot (h_a - 1.5 \cdot t_f - x))}{t_w \cdot (h_a - 2 \cdot t_f - x) + t_f \cdot b}$$

$$= \frac{(10 \cdot (260 - 2 \cdot 17.5 - 50.8) \cdot 0.5 + 17.5 \cdot 260 \cdot (260 - 1.5 \cdot 17.5 - 50.8))}{10 \cdot (260 - 2 \cdot 17.5 - 50.8) + 17.5 \cdot 260} = 156 \text{ mm}$$

$$h_l = x + t_f + h_s - c_l + \frac{d_l}{2} = 0.0508 + 0.0175 + 0.16 - 0.03 + \frac{0.016}{2} = 190 \text{ mm}$$

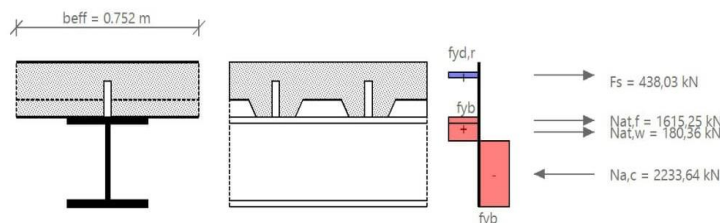

$$M_{pl,Rd} = F_s \cdot h_l + N_{at,f} \cdot \left(\frac{t_f}{2} + x\right) + \frac{N_{at,w} \cdot x}{2} + N_{a,c} \cdot h_{cs}$$

$$= 438 \cdot 190 + 1615.25 \cdot \left(\frac{17.5}{2} + 50.8\right) + \frac{180.36 \cdot 50.8}{2} + 2233.64 \cdot 156 = 533 \text{ kNm}$$

Design moment resistance according to EN 1994-1-1 Art.6.2.1.2

$$M_{Rd} = M_{pl,Rd} = 533 \text{ kNm}$$

$$\text{UC}_{comp,M} = \frac{\text{abs}(M_{Ed,comp})}{M_{Rd}} = \frac{\text{abs}(-317.989 \text{ kNm})}{533 \text{ kNm}} = 0.60$$

The bending moment resistance of the section is adequate.

**5.3 LTB resistance**

$$F = \left( 1 + \frac{t_w \cdot (h_a - t_f)}{4 \cdot b \cdot t_f} \right) \left( \frac{h_a - t_f}{t_w} \right)^{0.75} \left( \frac{t_f}{b} \right)^{0.25} = \left( 1 + \frac{10 \cdot (260 - 17.5)}{4 \cdot 260 \cdot 17.5} \right) \left( \frac{260 - 17.5}{10} \right)^{0.75} \left( \frac{17.5}{260} \right)^{0.25} = 6.31$$

$F_{lim} = 12.3$

$F \leq F_{lim}$

$6.31 \leq 12.3$

OK

The cross-section is qualified for verification of LTB by the simplified method.

$C_4 = 25$

$$\lambda_{LT,rel} = 5 \cdot \left( 1 + \frac{t_w \cdot (h_a - t_f)}{4 \cdot b \cdot t_f} \right) \left( \frac{h_a - t_f}{t_w} \right)^{0.75} \left( \frac{t_f}{b} \right)^{0.25} \left( \frac{f_{yb}}{E_b \cdot C_4} \right)^{0.5}$$

$$= 5 \cdot \left( 1 + \frac{0.01 \cdot (0.26 - 0.0175)}{4 \cdot 0.26 \cdot 0.0175} \right) \left( \frac{0.26 - 0.0175}{0.01} \right)^{0.75} \left( \frac{0.0175}{0.26} \right)^{0.25} \left( \frac{355 \cdot 10^6}{210 \cdot 10^9 \cdot 25} \right)^{0.5} = 0.259$$

$h_a/b \leq 2 \rightarrow$  Buckling curve 'a'

$\alpha_{LT} = 0.21$

$$\Phi_{LT} = 0.5 \cdot \left( 1 + \alpha_{LT} \cdot (\lambda_{LT,rel} - 0.2) + \lambda_{LT,rel}^2 \right) = 0.5 \cdot \left( 1 + 0.21 \cdot (0.259 - 0.2) + 0.259^2 \right) = 0.54$$

$$X_{LT} = \frac{1}{\Phi_{LT} + \sqrt{\Phi_{LT}^2 - \lambda_{LT,rel}^2}} = \frac{1}{0.54 + \sqrt{0.54^2 - 0.259^2}} = 0.987$$

$X_{LT} = \min(X_{LT}, 1) = \min(0.987; 1) = 0.987$

$M_{b,Rd} = X_{LT} \cdot M_{Rd} = 0.987 \cdot 533500 = 526.472 \text{ kNm}$

$$UC_{comp\_LTB} = \frac{\text{abs}(M_{Ed,comp})}{M_{b,Rd}} = \frac{\text{abs}(-317.989 \text{ kNm})}{526.472 \text{ kNm}} = 0.60$$

The later torsional buckling resistance of the section is adequate.

**5.4 Longitudinal shear**

**5.4.1 Transverse reinforcement**

Design shear flow

$h_f = h_c = 109 \text{ mm}$

$$v_{Ed} = \frac{F_{Rd}}{I_z - h_f} = \frac{1 \cdot 120 \text{ kN}}{305 \text{ mm} \cdot 109 \text{ mm}} = 3.61 \text{ MPa}$$

Transverse reinforcement

$$\frac{A_{st} \cdot f_{yk,r}}{\gamma_s \cdot s_f} \geq \frac{v_{Ed} \cdot h_f}{\cotg(\theta)}$$

$A_{st} = A_{st}/s_f$

$$A_{st} = \frac{v_{Ed} \cdot h_f}{\cotg(\theta) \cdot f_{yk,r}} = \frac{3.61 \cdot 10^6 \cdot 0.109}{\cotg(26.5) \cdot 500 \cdot 10^6} = 452 \text{ mm}^2/\text{m}$$

$$A_{t,prov} = \frac{1}{s_f} \left( \frac{d_t^2}{4} \right) \cdot 3.14 = \frac{1}{0.15} \cdot \left( \frac{0.016^2}{4} \right) \cdot 3.14 = 1340 \text{ mm}^2/\text{m}$$

$A_{t,prov} \geq A_{st}$

$1340 \text{ mm}^2/\text{m} \geq 452 \text{ mm}^2/\text{m}$  OK

The transverse reinforcement of the section is adequate.

ULS check of Final stage is OK.

$UC_{comp} = \max(0.33; 0.60; 0.60) = 0.60$

-iskoristivost elementa na GSN – 60%

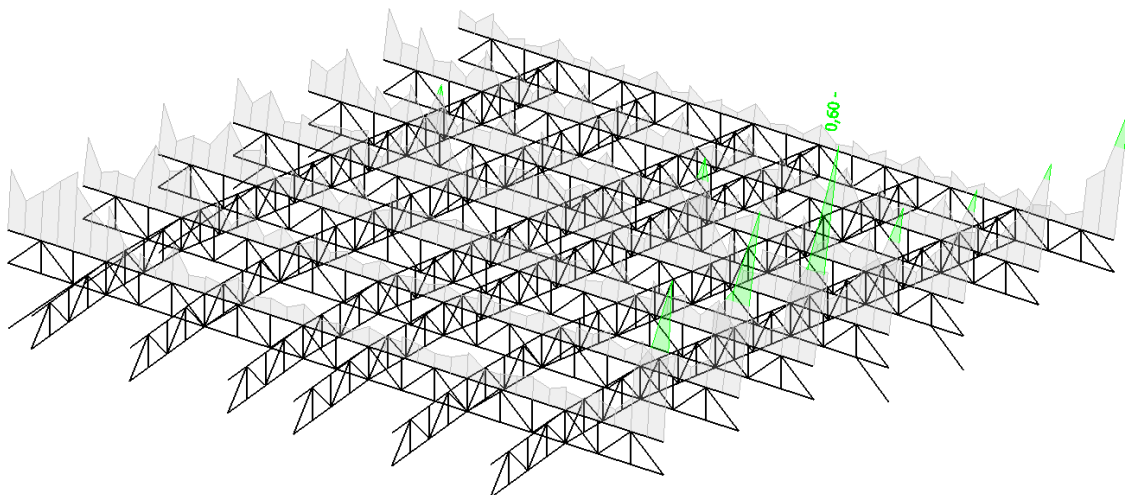

Slika 9.4. Prikaz iskoristivosti gornje pojasnice glavnog rešetkastog nosača

### 9.2.3. Rezne sile – donja pojasnica glavnog rešetkastog nosača

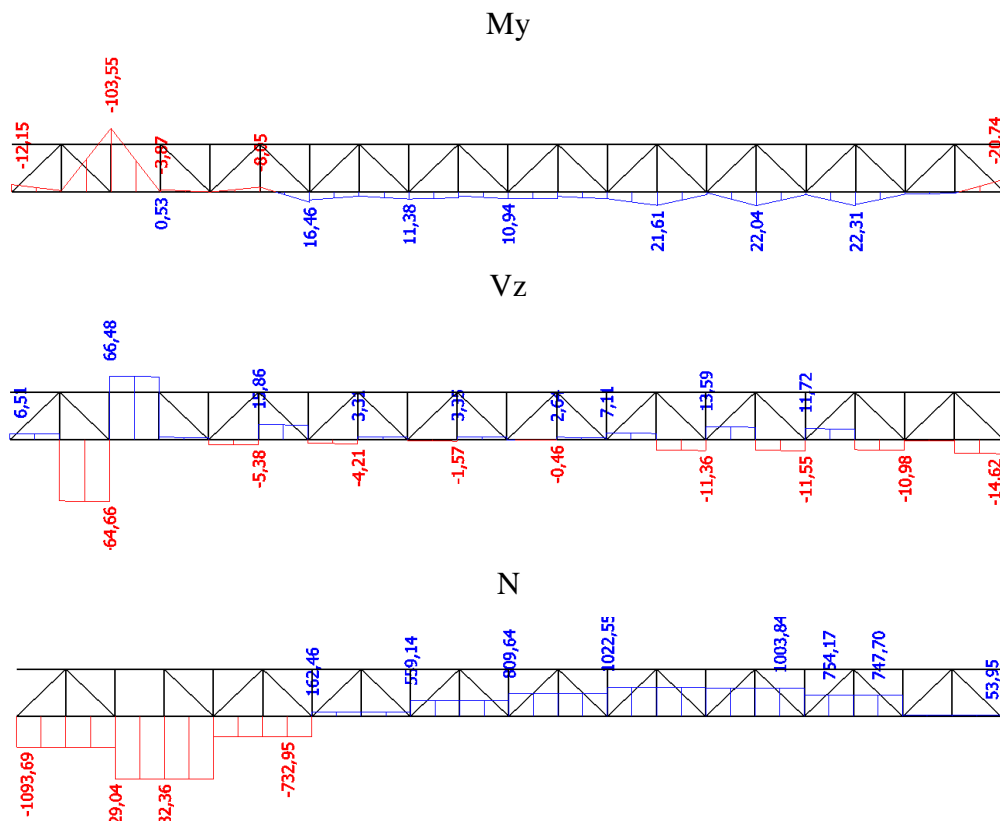

Slika 9.5. Prikaz reznih sila - donja pojasnica glavnog rešetkastog nosača

-poprečni presjek nosača

Name	Donja pojasnica glavnog rešetkastog nosača - tribina velike dvorane	
Type	F280X10	
Source description	Chinese Standard / GB 6728-2002	
Item material	S 355	
Fabrication	cold formed	
Flexural buckling y-y	c	
Flexural buckling z-z	c	
Lateral torsional buckling	Default	
Use 2D FEM analysis	*	
A [m <sup>2</sup> ]	1,0460e-02	
A <sub>y</sub> , z [m <sup>2</sup> ]	5,2251e-03	5,2251e-03
I <sub>y</sub> , z [m <sup>4</sup> ]	1,2479e-04	1,2479e-04
I <sub>w</sub> [m <sup>6</sup> ], I <sub>t</sub> [m <sup>4</sup> ]	1,4342e-06	2,0173e-04
W <sub>el</sub> y, z [m <sup>3</sup> ]	8,9100e-04	8,9100e-04
W <sub>pl</sub> y, z [m <sup>3</sup> ]	1,0463e-03	1,0463e-03
d <sub>y</sub> , z [mm]	0	0
c <sub>YUCS, ZUCS</sub> [mm]	140	140
α [deg]	0,00	
A <sub>L</sub> , D [m <sup>2</sup> /m]	1,0771e+00	2,0910e+00
M <sub>ply</sub> +, - [Nm]	3,71e+05	3,71e+05
M <sub>plz</sub> +, - [Nm]	3,71e+05	3,71e+05

Slika 9.6. Prikaz geometrijskih karakteristika nosača

## 9.2.4. Dimenzioniranje – donja pojasnica glavnog rešetkastog nosača

Member B3835	31,440 m	F280X10	S 355	GSN 26	0,93 -
--------------	----------	---------	-------	--------	--------

Note: EN 1993-1-3 article 1.1(3) specifies that this part does not apply to cold formed CHS and RHS sections. The default EN 1993-1-1 code check is executed instead of the EN 1993-1-3 code check.

Partial safety factors	
Gamma M0 for resistance of cross-sections	1,00
Gamma M1 for resistance to instability	1,00
Gamma M2 for resistance of net sections	1,25

Material		
Yield strength $f_y$	355,0	MPa
Ultimate strength $f_u$	510,0	MPa
Fabrication	Cold formed	

.....SECTION CHECK:.....

The critical check is on position 3.144 m

Internal forces	Calculated	Unit
N,Ed	-2229,04	kN
Vy,Ed	-2,47	kN
Vz,Ed	66,48	kN
T,Ed	-6,05	kNm
My,Ed	-103,55	kNm
Mz,Ed	-6,93	kNm

**Classification for cross-section design**

According to EN 1993-1-1 article 5.5.2

**Classification of Internal Compression parts**

According to EN 1993-1-1 Table 5.2 Sheet 1

Maximum width-to-thickness ratio	25,00
Class 1 Limit	26,85
Class 2 Limit	30,92
Class 3 Limit	43,90

=> Section classified as Class 1 for cross-section design

**Compression check**

According to EN 1993-1-1 article 6.2.4 and formula (6.9)

A	1,0460e-02	m <sup>2</sup>
Nc,Rd	3713,30	kN
Unity check	0,60	-

**Bending moment check for My**

According to EN 1993-1-1 article 6.2.5 and formula (6.12), (6.13)

Wpl,y	1,0463e-03	m <sup>3</sup>
Mpl,y,Rd	371,45	kNm
Unity check	0,28	-

**Bending moment check for Mz**

According to EN 1993-1-1 article 6.2.5 and formula (6.12), (6.13)

Wpl,z	1,0463e-03	m <sup>3</sup>
Mpl,z,Rd	371,45	kNm
Unity check	0,02	-

**Shear check for Vy**

According to EN 1993-1-1 article 6.2.6 and formula (6.17)

Eta	1,20	
Av	5,2300e-03	m <sup>2</sup>
Vpl,y,Rd	1071,94	kN
Unity check	0,00	-

**Shear check for Vz**

According to EN 1993-1-1 article 6.2.6 and formula (6.17)

Eta	1,20	
Av	5,2300e-03	m <sup>2</sup>
Vpl,z,Rd	1071,94	kN
Unity check	0,06	-

**Torsion check**

According to EN 1993-1-1 article 6.2.7 and formula (6.23)

Tau,t,Ed	4,2	MPa
Tau,Rd	205,0	MPa
Unity check	0,02	-

**Note:** The unity check for torsion is lower than the limit value of 0,05. Therefore torsion is considered as

Alpha	2,80	
MN,z,Rd	193,41	kNm
Beta	2,80	

Unity check (6.41) = 0,17 + 0,00 = 0,17 -

**Note:** Since the shear forces are less than half the plastic shear resistances their effect on the moment resistances is neglected.

The member satisfies the section check.

....:STABILITY CHECK:....

**Classification for member buckling design**

Decisive position for stability classification: 0,000 m

**Classification of Internal Compression parts**

According to EN 1993-1-1 Table 5.2 Sheet 1

Maximum width-to-thickness ratio	25,00
Class 1 Limit	26,85
Class 2 Limit	30,92
Class 3 Limit	36,68

=> Section classified as Class 1 for member buckling design

**Flexural Buckling check**

According to EN 1993-1-1 article 6.3.1.1 and formula (6.46)

Buckling parameters	yy	zz	
<small>*Student version* *Student version* *Student version* *Student version* *Student version* *Student version*</small>			
Sway type	sway	non-sway	
System length L	1,572	4,716	m
Buckling factor k	1,00	1,00	
Buckling length Lcr	1,572	4,716	m
Critical Euler load Ncr	104663,14	11629,24	kN
Slenderness Lambda	14,39	43,18	
Relative slenderness Lambda,rel	0,19	0,57	
Limit slenderness Lambda,rel,0	0,20	0,20	
Buckling curve	c	c	
Imperfection Alpha	0,49	0,49	
Reduction factor Chi	1,00	0,81	
Buckling resistance Nb,Rd	3713,30	2992,50	kN

Flexural Buckling verification		
<small>*Student version* *Student version* *Student version* *Student version* *Student version* *Student version*</small>		
Cross-section area A	1,0460e-02	m <sup>2</sup>
Buckling resistance Nb,Rd	2992,50	kN
Unity check	0,74	-

**Torsional(-Flexural) Buckling check**

According to EN 1993-1-1 article 6.3.1.1 and formula (6.46)

**Note:** The cross-section concerns a RHS section which is not susceptible to Torsional(-Flexural) Buckling.

**Lateral Torsional Buckling check**

According to EN 1993-1-1 article 6.3.2.1

**Note:** The cross-section concerns an RHS section with  $h / b < 10 / \text{Lambda,rel,z}$ .

This section is thus not susceptible to Lateral Torsional Buckling.

**Bending and axial compression check**

According to EN 1993-1-1 article 6.3.3 and formula (6.61),(6.62)

Bending and axial compression check parameters		
<small>*Student version* *Student version* *Student version* *Student version* *Student version* *Student version* *Student version* *Student version* *S</small>		
Interaction method	alternative method 1	
Cross-section area A	1,0460e-02	m <sup>2</sup>
Cross-section plastic modulus Wpl,y	1,0463e-03	m <sup>3</sup>
Cross-section plastic modulus Wpl,z	1,0463e-03	m <sup>3</sup>
Design compression force N,Ed	2229,04	kN
Design bending moment (maximum) My,Ed	-103,55	kNm
Design bending moment (maximum) Mz,Ed	-10,82	kNm
Characteristic compression resistance N,Rk	3713,30	kN
Characteristic moment resistance My,Rk	371,45	kNm
Characteristic moment resistance Mz,Rk	371,45	kNm
Reduction factor Chi,y	1,00	
Reduction factor Chi,z	0,81	
Reduction factor Chi,LT	1,00	
Interaction factor k,yy	0,93	
Interaction factor k,yz	0,51	
Interaction factor k,zy	0,58	
Interaction factor k,zz	0,77	

Maximum moment My,Ed is derived from beam B3835 position 3,144 m.

Maximum moment Mz,Ed is derived from beam B3835 position 4,716 m.

Interaction method 1 parameters		
<small>*Student version* *Student version* *Student version* *Student version* *Student version* *Student version* *Student version* *Student version* *S</small>		
Critical Euler load N,cr,y	104663,14	kN
Critical Euler load N,cr,z	11629,24	kN
Elastic critical load N,cr,T	688471,95	kN
Cross-section plastic modulus Wpl,y	1,0463e-03	m <sup>3</sup>
Cross-section elastic modulus Wel,y	8,9100e-04	m <sup>3</sup>
Cross-section plastic modulus Wpl,z	1,0463e-03	m <sup>3</sup>
Cross-section elastic modulus Wel,z	8,9100e-04	m <sup>3</sup>

\*Student version\* \*Student version\* \*Student version\* \*Student version\* \*Student version\* \*Student version\* \*Student version\* \*Student version\* \*S

Interaction method 1 parameters		
Second moment of area Iy	1,2479e-04	m <sup>4</sup>
Second moment of area Iz	1,2479e-04	m <sup>4</sup>
Torsional constant It	2,0173e-04	m <sup>4</sup>
Method for equivalent moment factor C <sub>my,0</sub>	Table A.2 Line 2 (General)	
Design bending moment (maximum) My,Ed	-103,55	kNm
Maximum relative deflection delta,z	0,6	mm
Equivalent moment factor C <sub>my,0</sub>	0,99	
Method for equivalent moment factor C <sub>mz,0</sub>	Table A.2 Line 1 (Linear)	
Ratio of end moments Psi,z	-0,08	
Equivalent moment factor C <sub>mz,0</sub>	0,75	
Factor mu,y	1,00	
Factor mu,z	0,96	
Factor epsilon,y	0,55	
Factor a,LT	0,00	
Critical moment for uniform bending M <sub>cr,0</sub>	13821,58	kNm
Relative slenderness Lambda <sub>rel,0</sub>	0,16	
Limit relative slenderness Lambda <sub>rel,0,lim</sub>	0,22	
Equivalent moment factor C <sub>my</sub>	0,99	
Equivalent moment factor C <sub>mz</sub>	0,75	
Equivalent moment factor C <sub>mLT</sub>	1,00	
Factor b,LT	0,00	
Factor c,LT	0,00	
Factor d,LT	0,00	
Factor e,LT	0,00	
Factor w,y	1,17	
Factor w,z	1,17	
Factor n,pl	0,60	
Maximum relative slenderness Lambda <sub>rel,max</sub>	0,57	
Factor C <sub>yy</sub>	1,09	
Factor C <sub>yz</sub>	1,09	
Factor C <sub>zy</sub>	1,00	
Factor C <sub>zz</sub>	1,14	

Unity check (6.61) =  $0,60 + 0,26 + 0,01 = 0,88$  -

Unity check (6.62) =  $0,74 + 0,16 + 0,02 = 0,93$  -

The member satisfies the stability check.

-iskoristivost elementa na GSN – 93%

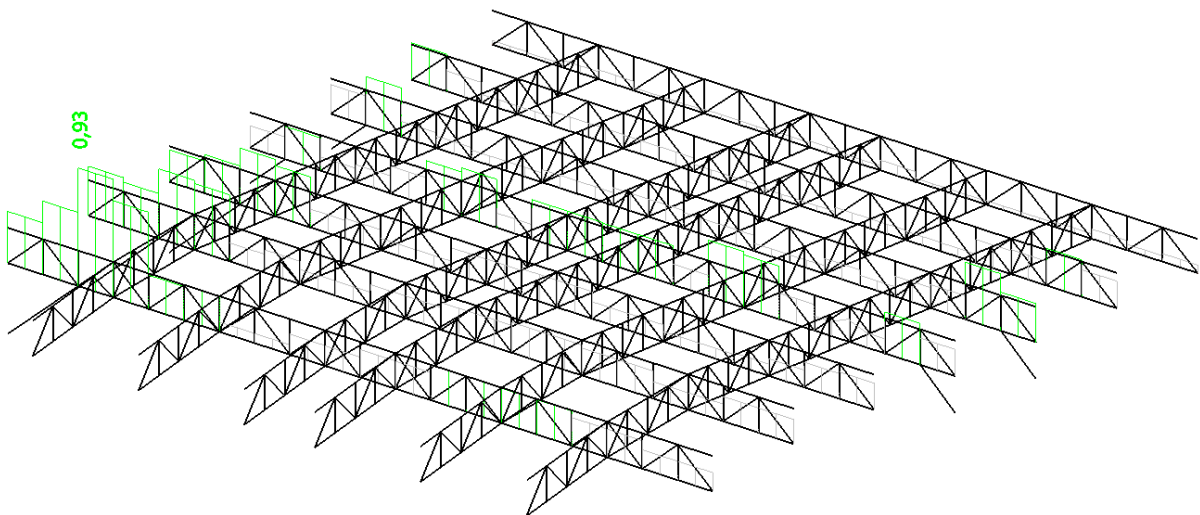

Slika 9.7. Prikaz iskoristivosti donje pojasnice glavnog rešetkastog nosača

### 9.2.5. Rezne sile – ispuna glavnog rešetkastog nosača

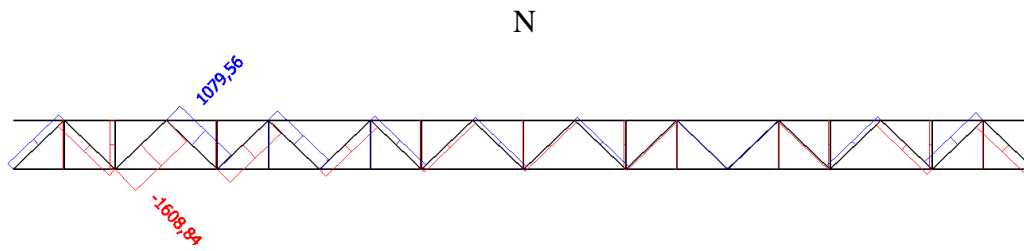

Slika 9.8. Prikaz reznih sila – ispuna glavnog rešetkastog nosača

-poprečni presjek nosača

Name	Ispuna glavnog rešetkastog nosača - tribina velike dvorane		
Type	CFRHS160X160X10		
Source description	Rautaruukki Oyj / Structural Hollow Sections EN10219 / Ed.2007		
Item material	S 355		
Fabrication	cold formed		
Flexural buckling y-y	c		
Flexural buckling z-z	c		
Lateral torsional buckling	Default		
Use 2D FEM analysis	*		
A [m <sup>2</sup> ]	5,6570e-03		
A <sub>y, z</sub> [m <sup>2</sup> ]	2,8251e-03		2,8251e-03
I <sub>y, z</sub> [m <sup>4</sup> ]	2,0477e-05		2,0477e-05
I <sub>w</sub> [m <sup>6</sup> ], I <sub>t</sub> [m <sup>4</sup> ]	8,7381e-08		3,4903e-05
W <sub>el y, z</sub> [m <sup>3</sup> ]	2,5596e-04		2,5596e-04
W <sub>pl y, z</sub> [m <sup>3</sup> ]	3,1095e-04		3,1095e-04
d <sub>y, z</sub> [mm]	0		0
c YUCS, ZUCS [mm]	80		80
α [deg]	0,00		
A <sub>L, D</sub> [m <sup>2</sup> /m]	5,9700e-01		1,1310e+00
M <sub>ply +, -</sub> [Nm]	1,10e+05		1,10e+05
M <sub>piz +, -</sub> [Nm]	1,10e+05		1,10e+05

Slika 9.9. Prikaz geometrijskih karakteristika nosača

-iskoristivost elementa na GSN – 93%

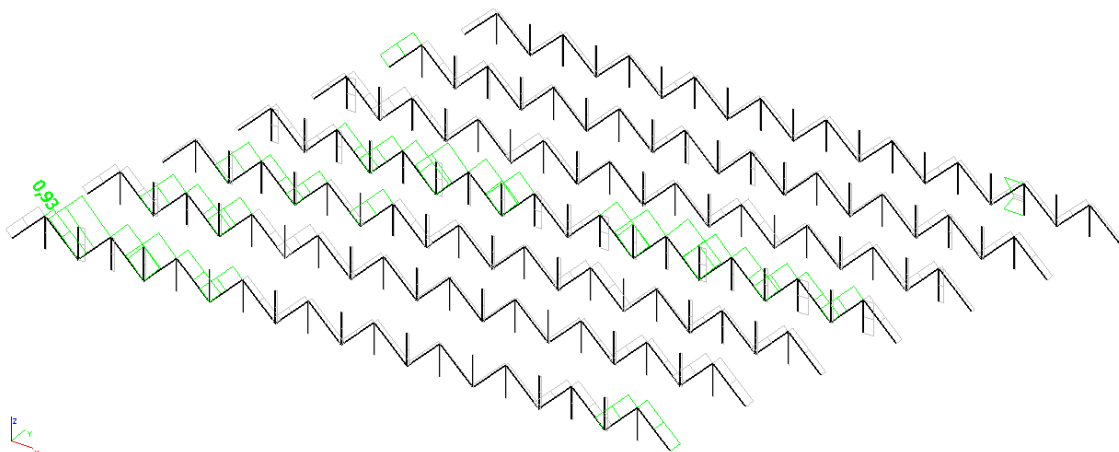

Slika 9.10. Prikaz iskoristivosti ispunje glavnog rešetkastog nosača



### 9.2.6. Dimenzioniranje – ispuna glavnog rešetkastog nosača

Member B3838	2,173 m	CFRHS160X160X10	S 355	GSN 26	0,93 -
--------------	---------	-----------------	-------	--------	--------

Note: EN 1993-1-3 article 1.1(3) specifies that this part does not apply to cold formed CHS and RHS sections. The default EN 1993-1-1 code check is executed instead of the EN 1993-1-3 code check.

Partial safety factors	
Gamma M0 for resistance of cross-sections	1,00
Gamma M1 for resistance to instability	1,00
Gamma M2 for resistance of net sections	1,25

Material		
Yield strength $f_y$	355,0	MPa
Ultimate strength $f_u$	510,0	MPa
Fabrication	Cold formed	

....:SECTION CHECK:....

The critical check is on position 0.000 m

Internal forces	Calculated	Unit
N,Ed	-1608,84	kN
Vy,Ed	0,00	kN
Vz,Ed	0,00	kN
T,Ed	0,00	kNm
My,Ed	0,00	kNm
Mz,Ed	0,00	kNm

**Classification for cross-section design**

According to EN 1993-1-1 article 5.5.2

**Classification of Internal Compression parts**

According to EN 1993-1-1 Table 5.2 Sheet 1

Maximum width-to-thickness ratio	13,00
Class 1 Limit	26,85
Class 2 Limit	30,92
Class 3 Limit	34,17

=> Section classified as Class 1 for cross-section design

**Compression check**

According to EN 1993-1-1 article 6.2.4 and formula (6.9)

A	5,6570e-03	m <sup>2</sup>
Nc,Rd	2008,23	kN
Unity check	0,80	-

The member satisfies the section check.

....:STABILITY CHECK:....

**Classification for member buckling design**

Decisive position for stability classification: 0,000 m

**Classification of Internal Compression parts**

According to EN 1993-1-1 Table 5.2 Sheet 1

Maximum width-to-thickness ratio	13,00
Class 1 Limit	26,85
Class 2 Limit	30,92
Class 3 Limit	34,17

=> Section classified as Class 1 for member buckling design

**Flexural Buckling check**

According to EN 1993-1-1 article 6.3.1.1 and formula (6.46)

Buckling parameters	yy	zz	
Sway type	sway	non-sway	
System length L	2,173	2,173	m
Buckling factor k	1,00	1,00	
Buckling length Lcr	2,173	2,173	m
Critical Euler load Ncr	8989,35	8989,35	kN
Slenderness Lambda	36,12	36,12	
Relative slenderness Lambda,rel	0,47	0,47	
Limit slenderness Lambda,rel,0	0,20	0,20	
Buckling curve	c	c	
Imperfection Alpha	0,49	0,49	
Reduction factor Chi	0,86	0,86	
Buckling resistance Nb,Rd	1723,38	1723,38	kN

Flexural Buckling verification		
Cross-section area A	5,6570e-03	m <sup>2</sup>
Buckling resistance Nb,Rd	1723,38	kN
Unity check	0,93	-

**Note:** The cross-section concerns a RHS section which is not susceptible to Torsional(-Flexural) Buckling.

The member satisfies the stability check.

9.2.7. Rezne sile – gornja pojasnica sekundarnog rešetkastog nosača

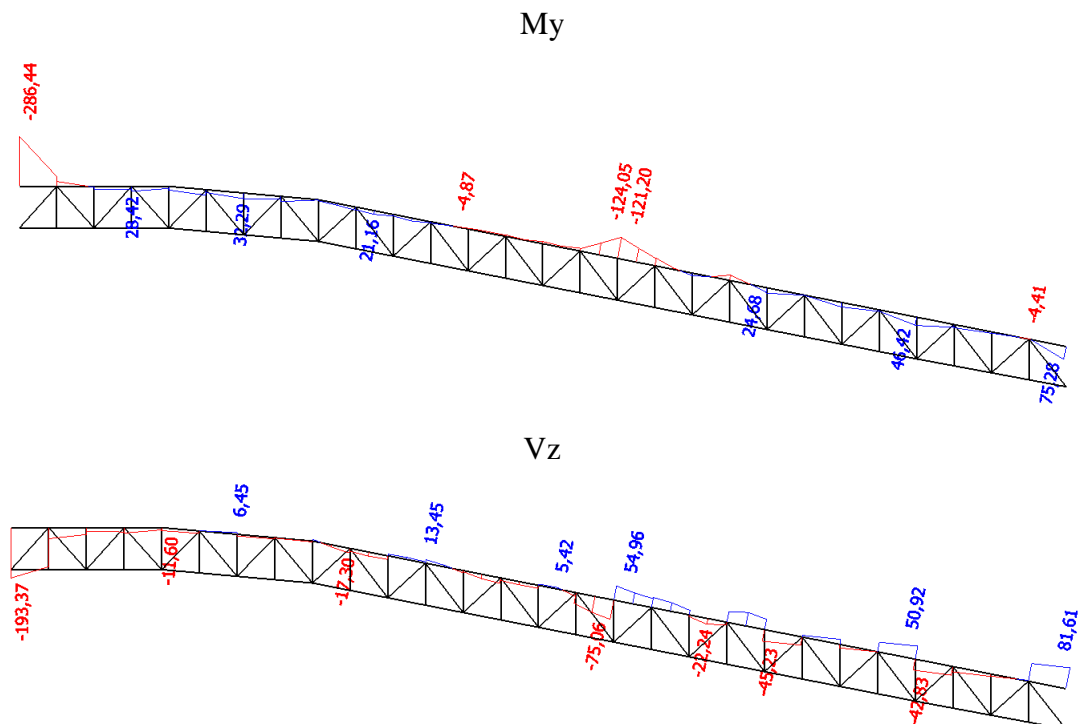

Slika 9.11. Prikaz reznih sila – gornja pojasnica sekundarnog rešetkastog nosača

-poprečni presjek nosača

Name	Gornja pojasnica sekundarnog rešetkastog nosača - tribina velike dvorane	
Type	HEB260	
Source description	Profil Arbed / Structural shapes / Edition Octobre 1995	
Item material	S 355	
Fabrication	rolled	
Flexural buckling y-y	b	
Flexural buckling z-z	c	
Lateral torsional buckling	Default	
Use 2D FEM analysis	*	
A [m²]	1,1840e-02	
A <sub>y</sub> , z [m²]	8,7661e-03	2,7927e-03
I <sub>y</sub> , z [m⁴]	1,4920e-04	5,1350e-05
I <sub>w</sub> [m⁶], i [m⁴]	7,5365e-07	1,2380e-06
W <sub>el</sub> y, z [m³]	1,1480e-03	3,9500e-04
W <sub>pl</sub> y, z [m³]	1,2830e-03	6,0220e-04
d y, z [mm]	0	0
c YUCS, ZUCS [mm]	130	130
α [deg]	0,00	
A L, D [m²/m]	1,5000e+00	1,4986e+00
M <sub>ply</sub> +, - [Nm]	4,56e+05	4,56e+05
M <sub>plz</sub> +, - [Nm]	2,14e+05	2,14e+05

Slika 9.12. Prikaz geometrijskih karakteristika nosača

## 9.2.8. Dimenzioniranje – gornja pojasnica sekundarnog rešetkastog nosača

SCIAENGINEER

### Composite Beam - Final stage

Linear calculation  
 Class: All ULS  
 Extreme 1D: Global  
 Selection: B4757

### Composite beam verification

for beam B4757 at section 5.4 m, in accordance with EC EN 1994-1-1

#### 1. Geometry data

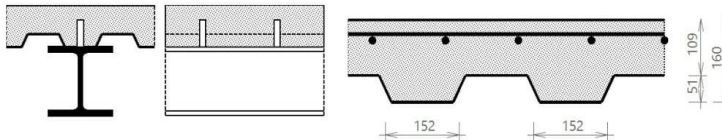

#### Simply supported beam

Length of the current span	$L = 5.4 \text{ m}$
Beam spacing at the left	$L_{\text{left}} = 3.14 \text{ m}$
Beam spacing at the right	$L_{\text{right}} = 4.72 \text{ m}$
Checked section	$d_x = 5.4 \text{ m}$

#### 2. Cross-section & materials

##### 2.1 Steel section properties

##### 2.1.1 Cross-section

Cross-section	HEB260
Height	$h_a = 260 \text{ mm}$
Width	$b = 260 \text{ mm}$
Web thickness	$t_w = 10 \text{ mm}$
Flange thickness	$t_f = 17.5 \text{ mm}$
Radius	$r = 24 \text{ mm}$
Area	$A_a = 11840 \text{ mm}^2$
Moment of inertia	$I_y = 149 \cdot 10^6 \text{ mm}^4$
Radius of gyration	$z = 66 \text{ mm}$
Plastic section modulus	$W_{\text{ply}} = 1.283 \cdot 10^6 \text{ mm}^3$

##### 2.1.2 Material

Steel grade	S 355
Yield strength	$f_{yb} = 355 \text{ MPa}$
Ultimate strength	$f_{ub} = 490 \text{ MPa}$
E modulus	$E_b = 210000 \text{ MPa}$

##### 2.1.3 Cross-section classification

$$\varepsilon = \sqrt{\frac{235}{355}} = 0.814$$

(EN 1993-1-1 §5.6 Tab. 5.2)

##### 2.1.3.1 Flange in compression

$$c_f = \frac{b - t_w - 2 \cdot r}{2} = \frac{260 \text{ mm} - 10 \text{ mm} - 2 \cdot 24 \text{ mm}}{2} = 101 \text{ mm}$$

$$\frac{c_f}{t_f} \leq 9 \cdot \varepsilon$$

$$\frac{101 \text{ mm}}{17.5 \text{ mm}} \leq 9 \cdot 0.814$$

$$5.77 \leq 7.32$$

OK

Flange classified as Class 1.

##### 2.1.3.2 Web in bending

$$c_w = h_a - 2 \cdot t_f - 2 \cdot r = 260 \text{ mm} - 2 \cdot 17.5 \text{ mm} - 2 \cdot 24 \text{ mm} = 177 \text{ mm}$$

$$\alpha_{cl} = 0.5$$

$$\frac{c_w}{t_w} \leq \frac{36 \cdot \varepsilon}{\alpha_{cl}}$$

$$\frac{177 \text{ mm}}{10 \text{ mm}} \leq \frac{36 \cdot 0.814}{0.5}$$

$$17.7 \leq 58.6$$

OK

Web classified as Class 1.

#### Cross-section classified as Class 1

Cross-section Class OK.

**2.2 Concrete slab with profiled sheeting**

**2.2.1 Concrete slab**

2.2.1.1 Slab

Total height of the slab  $h_s = 160 \text{ mm}$

2.2.1.2 Material

Concrete class	C30/37
Characteristic strength	$f_{ck} = 30 \text{ MPa}$
E modulus	$E_{cm} = 32800 \text{ MPa}$

**2.2.2 Profiled steel sheeting**

Sheeting with ribs parallel to the supporting beams

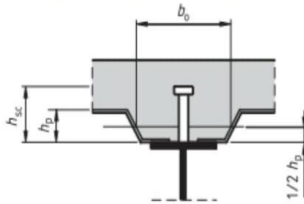

Name	Vulcraft 2 VLI 20
Depth of the ribs	$h_p = 50.8 \text{ mm}$
Height of full concrete	$h_c = 109.2 \text{ mm}$
Height of the re-entrant stiffener	$h_d = 0 \text{ mm}$
Spacing of the ribs	$b_s = 304.8 \text{ mm}$
Top width of the rib	$b_r = 127 \text{ mm}$
Bottom width of the rib	$b_b = 127 \text{ mm}$
Mean width of the ribs	$b_{0,rib} = 152.4 \text{ mm}$
Thickness of the sheeting	$t_p = 0.9093 \text{ mm}$

**2.2.3 Shear connectors**

2.2.3.1 Geometry

Name	H110
Diameter	$d_s = 25 \text{ mm}$
Nominal height	$h_{nom} = 110 \text{ mm}$
As-welded height	$h_{sc} = 105 \text{ mm}$
Amount per trough or section	$n_r = 1$

2.2.3.2 Material

Steel grade	S 355
Ultimate strength	$f_{us} = 490 \text{ MPa}$

**2.2.4 Reinforcement**

2.2.4.1 Geometry

Longitudinal bar diameter	$d_l = 16 \text{ mm}$
Longitudinal bar spacing	$s_l = 150 \text{ mm}$
Longitudinal bar cover	$c_l = 30 \text{ mm}$
Transverse bar diameter	$d_t = 16 \text{ mm}$
Transverse bar spacing	$s_t = 150 \text{ mm}$
Transverse bar cover	$c_t = 46 \text{ mm}$

2.2.4.2 Material

Material	B 500A
Characteristic yield strength	$f_{ykr} = 500 \text{ MPa}$

**3. Design values of loads**

Load Name : GSN 17

Content of combination :  $1.35 \cdot g$ -vlastitatežina+ $1.35 \cdot dg$ -dodatnostalno+

$1.62 \cdot q$ -promjenjivoopterećenje+ $1.35 \cdot g$ -vlastitatežina\_dryconcrete+

$1.35 \cdot Wx$ -2kom.-Wz-neg

Bending moment  $M_{Ed,comp} = -286.444 \text{ kNm}$

Shear force  $V_{Ed,comp} = -193.374 \text{ kN}$

4. Partial safety factors

Steel section	$\gamma_{M0} = 1$
	$\gamma_{M1} = 1$
Shear connectors	$\gamma_V = 1.25$
Concrete	$\gamma_C = 1.5$
Reinforcement	$\gamma_S = 1.15$

5. ULS check of the Final stage

5.1 Shear connection

5.1.1 Design resistance of shear connectors

5.1.1.1 Shear connector in a solid slab

$$\frac{h_{sc}}{d_s} > 4$$

$$4.2 > 4$$

$$\alpha = 1$$

$$f_{us} = \min(490; 500) \text{ MPa}$$

$$P_{Rd,solid,1} = \frac{0.8 \cdot f_{us} \cdot \left(\frac{\pi \cdot d_s^2}{4}\right)}{\gamma_V} = \frac{0.8 \cdot 490 \text{ MPa} \cdot \left(\frac{3.14 \cdot 25 \text{ mm}^2}{4}\right)}{1.25} = 154 \text{ kN}$$

$$P_{Rd,solid,2} = \frac{0.29 \cdot \alpha \cdot d_s^2 \cdot \sqrt{f_{ck} \cdot E_{cm}}}{\gamma_V} = \frac{0.29 \cdot 1 \cdot 25 \text{ mm}^2 \cdot \sqrt{30 \text{ MPa} \cdot 32800 \text{ MPa}}}{1.25} = 144 \text{ kN}$$

$$P_{Rd,solid} = \min(P_{Rd,solid,1}; P_{Rd,solid,2}) = \min(154 \text{ kN}; 144 \text{ kN}) = 144 \text{ kN}$$

5.1.1.2 Shear connector in profiled sheeting

Sheeting with ribs parallel to the supporting beams

$$k_1 = \frac{0.6 \cdot b_{0,rib}}{h_p} \cdot \left(\frac{h_{sc}}{h_p} - 1\right) = \frac{0.6 \cdot 152 \text{ mm}}{50.8 \text{ mm}} \cdot \left(\frac{105 \text{ mm}}{50.8 \text{ mm}} - 1\right) = 1.92$$

$$k_1 = 1$$

$$P_{Rd} = k_1 \cdot P_{Rd,solid} = 1 \cdot 144 \text{ kN} = 144 \text{ kN}$$

5.1.2 Degree of shear connection

5.1.2.1 Determination of  $b_{eff}$  of the concrete flange and length  $L_e$

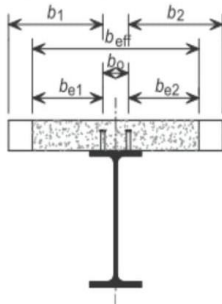

The effective width at the end support

$$L_{e0} = L_1 = 5.4 \text{ m}$$

Left side of the beam

$$b_1 = \frac{L_{perp, left}}{2} - \frac{b_0}{2} = \frac{3.14 \text{ m}}{2} - \frac{0 \text{ mm}}{2} = 1.57 \text{ m}$$

$$b_{e10} = \min\left(\frac{L_{e0}}{8}; b_1\right) = \min\left(\frac{5.4 \text{ m}}{8}; 1.57 \text{ m}\right) = 0.675 \text{ m}$$

$$b_{e11} = \min\left(\frac{L_{e1}}{8}; b_1\right) = \min\left(\frac{0 \text{ m}}{8}; 1.57 \text{ m}\right) = 0 \text{ m}$$

$$b_{e12} = \min\left(\frac{L_{e2}}{8}; b_1\right) = \min\left(\frac{0 \text{ m}}{8}; 1.57 \text{ m}\right) = 0 \text{ m}$$

$$\beta_{1,calc} = 0.55 + \frac{0.025 \cdot L_{e0}}{b_{e10}} = 0.55 + \frac{0.025 \cdot 5.4 \text{ m}}{0.675 \text{ m}} = 0.75$$

$$\beta_{1,calc} \leq 1.0$$

$$0.75 \leq 1.0$$

$$\beta_1 = \beta_{1,calc} = 0.75$$

OK

**Right side of the beam**

$$b_2 = \frac{L_{\text{perp, right}}}{2} - \frac{b_0}{2} = \frac{4.72 \text{ m}}{2} - \frac{0 \text{ mm}}{2} = 2.36 \text{ m}$$

$$b_{e20} = \min\left(\frac{L_{e0}}{8}, b_2\right) = \min\left(\frac{5.4 \text{ m}}{8}, 2.36 \text{ m}\right) = 0.675 \text{ m}$$

$$b_{e21} = \min\left(\frac{L_{e1}}{8}, b_2\right) = \min\left(\frac{0 \text{ m}}{8}, 2.36 \text{ m}\right) = 0 \text{ m}$$

$$b_{e22} = \min\left(\frac{L_{e2}}{8}, b_2\right) = \min\left(\frac{0 \text{ m}}{8}, 2.36 \text{ m}\right) = 0 \text{ m}$$

$$\beta_{2,\text{calc}} = 0.55 + \frac{0.025 \cdot L_{e0}}{b_{e20}} = 0.55 + \frac{0.025 \cdot 5.4 \text{ m}}{0.675 \text{ m}} = 0.75$$

$$\beta_{2,\text{calc}} \leq 1.0$$

$$0.75 \leq 1.0 \quad \text{OK}$$

$$\beta_2 = \beta_{2,\text{calc}} = 0.75$$

**Calculation of  $b_{\text{eff},0}$** 

$$b_{\text{eff},0} = b_0 + b_{e10} \cdot \beta_1 + b_{e20} \cdot \beta_2 = 0 \text{ mm} + 0.675 \text{ m} \cdot 0.75 + 0.675 \text{ m} \cdot 0.75 = 1.01 \text{ m}$$

**Calculation of  $b_{\text{eff}}$** 

$$b_{\text{eff}} = b_{\text{eff},0} = 1.01 \text{ m}$$

**Determination of  $L_e$** 

$$L_e = L_{e0} = 5.4 \text{ m}$$

**5.1.2.2 Minimum degree of shear connection**

Warning: Conditions given by EN 1994-1-1 Art. 6.6.1.2 (3) are not fulfilled.

$$\eta_{\text{min,calc}} = 1 - \frac{355}{f_{yb}} \cdot (0.75 - 0.03 \cdot L_e)$$

$$\eta_{\text{min,calc}} = 1 - \frac{355}{355} \cdot (0.75 - 0.03 \cdot 5.4 \text{ m}) = 0.41$$

$$\eta_{\text{min}} = \max(\eta_{\text{min,calc}}, 0.4) = \max(0.41, 0.4) = 0.41$$

**5.1.2.3 Degree of shear connection present****5.1.2.3.1 Tension resistance of the reinforcement**

$$A_s = \frac{b_{\text{eff}}}{s_l} \left( \frac{d_l^2}{4} \right) \cdot \pi = \frac{1.01 \text{ m}}{150 \text{ mm}} \cdot \left( \frac{16 \text{ mm}^2}{4} \right) \cdot 3.14 = 1357 \text{ mm}^2$$

$$F_s = \frac{A_s \cdot f_{yk,r}}{\gamma_s} = \frac{1.36 \cdot 10^{-3} \cdot 500 \cdot 10^6}{1.15} = 590 \text{ kN}$$

**5.1.2.3.2 Tension resistance of the steel member**

$$N_{pl,a} = f_{yb} \cdot A_a = 355 \text{ MPa} \cdot 11840 \text{ mm}^2 = 4203.20 \text{ kN}$$

$$N_{c,t} = \min(F_s, N_{pl,a}) = \min(590 \text{ kN}, 4203.20 \text{ kN}) = 590.07 \text{ kN}$$

**5.1.2.3.3 Resistance of the shear connectors**

$$l_s = \frac{L}{n_{\text{row}}} = \frac{5.4}{18} = 300 \text{ mm}$$

Number of shear studs available per length  $L_e/2$

$$n_{\text{sp}} = \frac{0.5 \cdot L_e}{l_s} \cdot n_r$$

$$n_{\text{sp}} = 9 \cdot 1 = 9$$

$$N_c = n_{\text{sp}} \cdot P_{Rd} = 9 \cdot 143835 = 1294.52 \text{ kN}$$

$$\eta = \min\left(\frac{N_c}{N_{c,t}}, 1\right) = \min\left(\frac{1294.52 \text{ kN}}{590.07 \text{ kN}}, 1\right) = 1$$

$$\eta \geq \eta_{\text{min}}$$

$$1 \geq 0.41 \quad \text{OK}$$

The shear connection degree is adequate.

Student version

**5.2 Cross-sectional resistance of the composite beam****5.2.1 Shear buckling**

$$h_w = h_s - 2 \cdot t_f = 260 \text{ mm} - 2 \cdot 17.5 \text{ mm} = 225 \text{ mm}$$

$$\eta_{sb} = 1.2$$

$$\frac{h_w}{t_w} \leq \frac{72 \cdot \varepsilon}{\eta_{sb}}$$

$$\frac{225 \text{ mm}}{10 \text{ mm}} \leq \frac{72 \cdot 0.814}{1.2}$$

$$22.5 \leq 48.8$$

OK

The shear buckling resistance of the web does not need to be verified.

**5.2.2 Vertical shear**

The resistance to vertical shear should be taken as the resistance of the structural steel section.

$$A_v = A_s - 2 \cdot b \cdot t_f + (t_w + 2 \cdot r) \cdot t_f$$

$$= 0.0118 - 2 \cdot 0.26 \cdot 0.0175 + (0.01 + 2 \cdot 0.024) \cdot 0.0175 = 3755 \text{ mm}^2$$

$$A_{v,min} = \eta_{sb} \cdot h_w \cdot t_w = 1.2 \cdot 0.225 \cdot 0.01 = 2700 \text{ mm}^2$$

$$A_v \geq A_{v,min}$$

$$3755 \text{ mm}^2 \geq 2700 \text{ mm}^2$$

$$V_{pl,Rd} = \frac{A_v \cdot f_{yb}}{\sqrt{3} \cdot \gamma_{M0}} = \frac{3755 \text{ mm}^2 \cdot 355 \cdot 10^6}{\sqrt{3} \cdot 1} = 770 \text{ kN}$$

$$UC_{comp,V} = \frac{abs(V_{Ed,comp})}{V_{pl,Rd}} = \frac{abs(-193.374 \text{ kN})}{770 \text{ kN}} = 0.25$$

The shear resistance of the section is adequate.

**5.2.3 Bending moment****5.2.3.1 Longitudinal reinforcement****5.2.3.1.1 Centre of composite section**For buildings not intended mainly for storage the effects of creep in concrete beams may be taken into account by using an effective E modulus  $E_{eff} = E_{cm} / 2$ .

$$E_{eff} = \frac{E_{cm}}{2} = \frac{32800 \text{ MPa}}{2} = 16400 \text{ MPa}$$

$$n_E = \frac{E_b}{E_{eff}} = \frac{210000 \text{ MPa}}{16400 \text{ MPa}} = 12.8$$

$$y_d = \frac{A_a \cdot \left( \frac{h_a}{2} \right) + \left( \frac{1}{n_E} \right) \cdot b_{eff} \cdot (h_c - h_d) \cdot \left( h_a + h_s - \frac{h_c - h_d}{2} \right)}{A_a + \left( \frac{1}{n_E} \right) \cdot b_{eff} \cdot (h_c - h_d)}$$

$$= \frac{0.0118 \cdot \left( \frac{0.26}{2} \right) + \left( \frac{1}{12.8} \right) \cdot 1.01 \cdot (0.109 - 0) \cdot \left( 0.26 + 0.16 - \frac{0.109 - 0}{2} \right)}{0.0118 + \left( \frac{1}{12.8} \right) \cdot 1.01 \cdot (0.109 - 0)} = 229 \text{ mm}$$

**5.2.3.1.2 Degree of reinforcement**

$$A_s = \frac{b_{eff}}{s_l} \cdot \left( \frac{d_l^2}{4} \right) \cdot \pi = \frac{1.01 \text{ m}}{150 \text{ mm}} \cdot \left( \frac{16 \text{ mm}^2}{4} \right) \cdot 3.14 = 1357 \text{ mm}^2$$

$$A_c = b_{eff} \cdot (h_c - h_d) = 1.01 \cdot (0.109 - 0) = 110565 \text{ mm}^2$$

$$z_0 = \left( h_a + h_s - \frac{h_c - h_d}{2} \right) - y_d = \left( 0.26 + 0.16 - \frac{0.109 - 0}{2} \right) - 0.229 = 136 \text{ mm}$$

$$k_c = \min \left( \frac{1}{\left( 1 + \frac{h_c - h_d}{2 \cdot z_0} \right)} + 0.3; 1 \right) = \min \left( \frac{1}{\left( 1 + \frac{0.109 - 0}{2 \cdot 0.136} \right)} + 0.3; 1 \right) = 1$$

$$\rho_s = \delta \cdot \left( \frac{f_{yb}}{235} \right) \cdot \left( \frac{f_{ctm}}{f_{ykr}} \right) \cdot \sqrt{k_c} = 1.1 \cdot \left( \frac{355}{235} \right) \cdot \left( \frac{2.9 \cdot 10^6}{500 \cdot 10^6} \right) \cdot \sqrt{1} = 0.964 \%$$

$$A_s \geq \rho_s \cdot A_c$$

$$1357 \text{ mm}^2 \geq 9.64 \cdot 10^{-3} \cdot 110565 \text{ mm}^2$$

$$1357 \text{ mm}^2 \geq 1066 \text{ mm}^2 \quad \text{OK}$$

The longitudinal reinforcement of the section is adequate.

5.2.3.2 Moment resistance

Moment resistance of a steel cross-section

$$M_{pl,Rd,a} = \frac{W_{ply} \cdot f_{yb}}{Y_{M0}} = \frac{1.28 \cdot 10^6 \text{ mm}^3 \cdot 355 \text{ MPa}}{1} = 455 \text{ kNm}$$

Influence of shear

$$\frac{V_{pl,Rd}}{2} > \text{abs}(V_{ed,comp})$$

$$\frac{770 \text{ kN}}{2} > 193 \text{ kN}$$

$$385 \text{ kN} > 193 \text{ kN} \quad \text{OK}$$

The influence of the vertical shear on the bending moment resistance may be neglected.

$$f_{yb,w} = f_{yb} = 355 \text{ MPa}$$

Modified tension resistance of the steel member

$$r = 0 \text{ mm}$$

$$A_s = 2 \cdot t_f \cdot b + t_w \cdot (h_a - 2 \cdot t_f) = 2 \cdot 17.5 \text{ mm} \cdot 260 \text{ mm} + 10 \text{ mm} \cdot (260 \text{ mm} - 2 \cdot 17.5 \text{ mm}) = 11350 \text{ mm}^2$$

$$N_{pl,a} = A_s \cdot f_{yb} = 11350 \text{ mm}^2 \cdot 355 \text{ MPa} = 4029.25 \text{ kN}$$

Note: Roundings of the steel cross-section are neglected in bending resistance calculation.

$$N_{c,f} = \min(F_s; N_{pl,a}) = \min(590 \text{ kN}; 4029.25 \text{ kN}) = 590.07 \text{ kN}$$

Negative bending moment resistance calculation

The plastic neutral axis is located within the web of the steel section.

$$N_{at,f} = b \cdot t_f \cdot f_{yb} = 0.26 \cdot 0.0175 \cdot 355 \cdot 10^6 = 1615.25 \text{ kN}$$

$$N_{pl,a} - N_{at,f} - N_{at,w} = F_s + N_{at,f} + N_{at,w}$$

$$x = \frac{(N_{pl,a} - 2 \cdot N_{at,f} - F_s)}{(2 \cdot t_w \cdot f_{yb,w})} = \frac{(4029.25 \text{ kN} - 2 \cdot 1615.25 \text{ kN} - 590 \text{ kN})}{(2 \cdot 10 \text{ mm} \cdot 355 \text{ MPa})} = 29.4 \text{ mm}$$

Verification of the steel web classification.

$$\alpha_{cl} = \frac{c_w - x}{c_w} = \frac{177 - 29.4}{177} = 0.834$$

$$\frac{c_w}{t_w} \leq \frac{396 \cdot \epsilon}{13 \cdot \alpha_{cl} + 1}$$

$$\frac{177 \text{ mm}}{10 \text{ mm}} \leq \frac{396 \cdot 0.814}{13 \cdot 0.834 + 1}$$

$$17.7 \leq 32.7 \quad \text{OK}$$

Web classified as Class 1.

$$N_{at,w} = t_w \cdot x \cdot f_{yb,w} = 10 \text{ mm} \cdot 29.4 \text{ mm} \cdot 355 \text{ MPa} = 104.34 \text{ kN}$$

$$N_{a,c} = N_{pl,a} - N_{at,f} - N_{at,w} = 4029.25 \text{ kN} - 1615.25 \text{ kN} - 104.34 \text{ kN} = 2309.66 \text{ kN}$$

Leverage arm of the compression part of the steel section calculated to the PNA.

$$h_{cs} = \frac{(t_w \cdot (h_a - 2 \cdot t_f - x) \cdot 0.5 + t_f \cdot b \cdot (h_a - 1.5 \cdot t_f - x))}{t_w \cdot (h_a - 2 \cdot t_f - x) + t_f \cdot b}$$

$$= \frac{(10 \cdot (260 - 2 \cdot 17.5 - 29.4) \cdot 0.5 + 17.5 \cdot 260 \cdot (260 - 1.5 \cdot 17.5 - 29.4))}{10 \cdot (260 - 2 \cdot 17.5 - 29.4) + 17.5 \cdot 260} = 172 \text{ mm}$$

$$h_l = x + t_f + h_s - c_l + \frac{d_l}{2} = 0.0294 + 0.0175 + 0.16 - 0.03 + \frac{0.016}{2} = 169 \text{ mm}$$

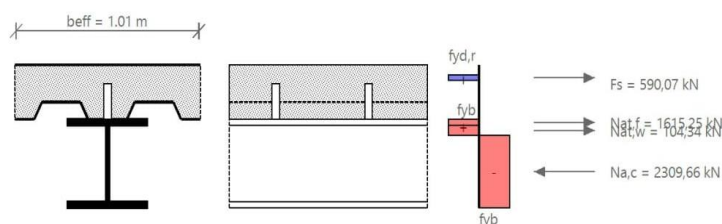

$$M_{pl,Rd} = F_s \cdot h_l + N_{at,f} \cdot \left( \frac{t_f}{2} + x \right) + \frac{N_{at,w} \cdot x}{2} + N_{a,c} \cdot h_{cs}$$

$$= 590 \cdot 169 + 1615.25 \cdot \left( \frac{17.5}{2} + 29.4 \right) + \frac{104.34 \cdot 29.4}{2} + 2309.66 \cdot 172 = 561 \text{ kNm}$$

Design moment resistance according to EN 1994-1-1 Art.6.2.1.2

$$M_{Rd} = M_{pl,Rd} = 561 \text{ kNm}$$

$$UC_{comp,M} = \frac{\text{abs}(M_{ed,comp})}{M_{Rd}} = \frac{\text{abs}(-286.444 \text{ kNm})}{561 \text{ kNm}} = 0.51$$

The bending moment resistance of the section is adequate.



**5.3 LTB resistance**

$$F = \left( 1 + \frac{t_w \cdot (h_a - t_f)}{4 \cdot b \cdot t_f} \right) \cdot \left( \frac{h_a - t_f}{t_w} \right)^{0.75} \cdot \left( \frac{t_f}{b} \right)^{0.25} = \left( 1 + \frac{10 \cdot (260 - 17.5)}{4 \cdot 260 \cdot 17.5} \right) \cdot \left( \frac{260 - 17.5}{10} \right)^{0.75} \cdot \left( \frac{17.5}{260} \right)^{0.25} = 6.31$$

$F_{lim} = 12.3$

$F \leq F_{lim}$

$6.31 \leq 12.3$

OK

The cross-section is qualified for verification of LTB by the simplified method.

$C_4 = 25$

$$\lambda_{LT,rel} = 5 \cdot \left( 1 + \frac{t_w \cdot (h_a - t_f)}{4 \cdot b \cdot t_f} \right) \cdot \left( \frac{h_a - t_f}{t_w} \right)^{0.75} \cdot \left( \frac{t_f}{b} \right)^{0.25} \cdot \left( \frac{f_{yb}}{E_b \cdot C_4} \right)^{0.5}$$

$$= 5 \cdot \left( 1 + \frac{0.01 \cdot (0.26 - 0.0175)}{4 \cdot 0.26 \cdot 0.0175} \right) \cdot \left( \frac{0.26 - 0.0175}{0.01} \right)^{0.75} \cdot \left( \frac{0.0175}{0.26} \right)^{0.25} \cdot \left( \frac{355 \cdot 10^6}{210 \cdot 10^9 \cdot 25} \right)^{0.5} = 0.259$$

$h_a/b \leq 2 \rightarrow$  Buckling curve 'a'

$\alpha_{LT} = 0.21$

$$\Phi_{LT} = 0.5 \cdot \left( 1 + \alpha_{LT} \cdot (\lambda_{LT,rel} - 0.2) + \lambda_{LT,rel}^2 \right) = 0.5 \cdot \left( 1 + 0.21 \cdot (0.259 - 0.2) + 0.259^2 \right) = 0.54$$

$$\chi_{LT} = \frac{1}{\Phi_{LT} + \sqrt{\Phi_{LT}^2 - \lambda_{LT,rel}^2}} = \frac{1}{0.54 + \sqrt{0.54^2 - 0.259^2}} = 0.987$$

$\chi_{LT} = \min(\chi_{LT}, 1) = \min(0.987, 1) = 0.987$

$M_{b,Rd} = \chi_{LT} \cdot M_{Rd} = 0.987 \cdot 560806 = 553.419 \text{ kNm}$

$UC_{comp\_LTB} = \frac{abs(M_{Ed,comp})}{M_{b,Rd}} = \frac{abs(-286.444 \text{ kNm})}{553.419 \text{ kNm}} = 0.52$

The later torsional buckling resistance of the section is adequate.

**5.4 Longitudinal shear**

**5.4.1 Transverse reinforcement**

Design shear flow

$h_f = h_c = 109 \text{ mm}$

$$V_{Ed} = \frac{R_{f,r} \cdot P_{Rd}}{2 \cdot l_s - h_f} = \frac{1 \cdot 144 \text{ kN}}{2 \cdot 300 \text{ mm} - 109 \text{ mm}} = 2.2 \text{ MPa}$$

Transverse reinforcement

$$\frac{A_{tr} \cdot f_{yk,r}}{s_t \cdot s_f} \geq \frac{V_{Ed} \cdot h_f}{\cotg(\theta)}$$

$A_t = A_{st}/s_f$

$$A_t = \frac{V_{Ed} \cdot h_f}{\cotg(\theta) \cdot f_{yk,r}} = \frac{2.2 \cdot 10^6 \cdot 0.109}{\cotg(26.5) \cdot 500 \cdot 10^6} = 275 \text{ mm}^2/\text{m}$$

$$A_{t,prov} = \frac{1}{s_t} \cdot \left( \frac{d_t^2}{4} \right) \cdot 3.14 = \frac{1}{0.15} \cdot \left( \frac{0.016^2}{4} \right) \cdot 3.14 = 1340 \text{ mm}^2/\text{m}$$

$A_{t,prov} \geq A_t$

$1340 \text{ mm}^2/\text{m} \geq 275 \text{ mm}^2/\text{m}$  OK

The transverse reinforcement of the section is adequate.

**ULS check of Final stage is OK.**

$UC_{comp} = \max(0.25; 0.51; 0.52) = 0.52$

-iskoristivost elementa na GSN – 52 %

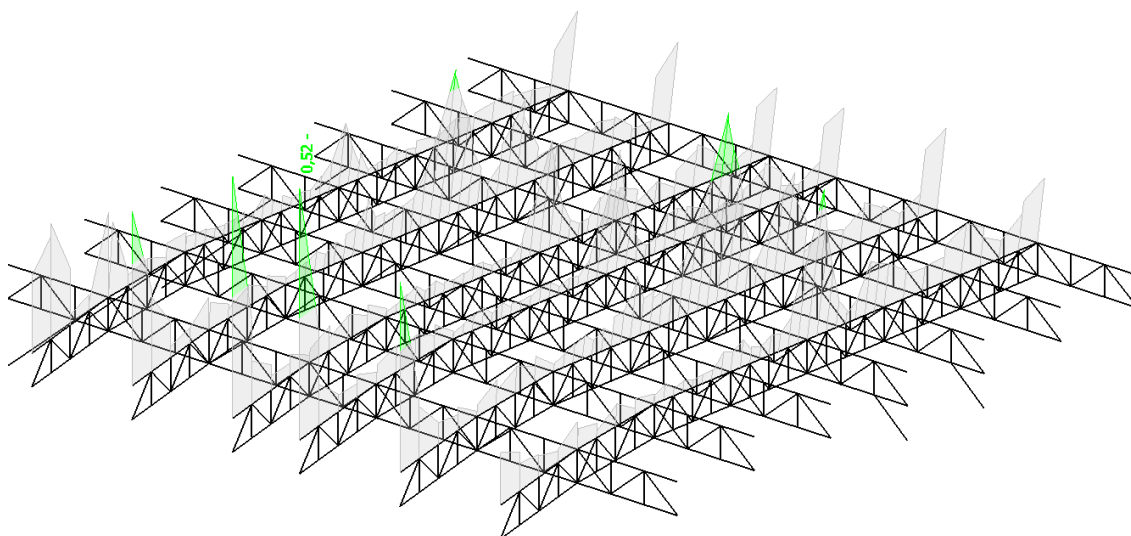

**Slika 9.13.** Prikaz iskoristivosti gornje pojasnice sekundarnog rešetkastog nosača

### 9.2.9. Rezne sile – donja pojasnica sekundarnog rešetkastog nosača

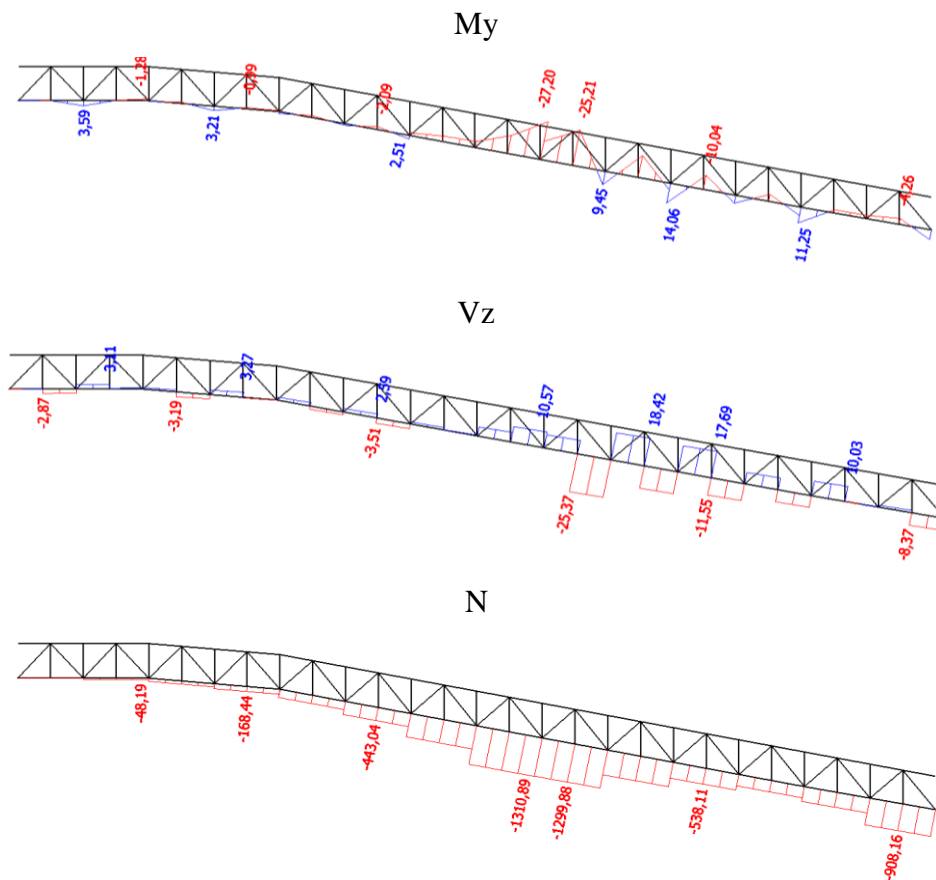

Slika 9.14. Prikaz reznih sila – donja pojasnica sekundarnog rešetkastog nosača

-poprečni presjek nosača

Name	Donja pojasnica sekundarnog rešetkastog nosača - tribina velike dvorane	
Type	F250X8	
Source description	Chinese Standard / GB 6728-2002	
Item material	S 355	
Fabrication	cold formed	
Flexural buckling y-y	c	
Flexural buckling z-z	c	
Lateral torsional buckling	Default	
Use 2D FEM analysis	x	
A [m <sup>2</sup> ]	7,5200e-03	
A <sub>y</sub> , z [m <sup>2</sup> ]	3,7601e-03	3,7601e-03
I <sub>y</sub> , z [m <sup>4</sup> ]	7,2290e-05	7,2290e-05
I <sub>w</sub> [m <sup>6</sup> ], I <sub>t</sub> [m <sup>4</sup> ]	6,5104e-07	1,1598e-04
W <sub>el</sub> y, z [m <sup>3</sup> ]	5,7800e-04	5,7800e-04
W <sub>pl</sub> y, z [m <sup>3</sup> ]	6,7577e-04	6,7577e-04
d <sub>y</sub> , z [mm]	0	0
c YUCS, ZUCS [mm]	125	125
α [deg]	0,00	
A <sub>L</sub> , D [m <sup>2</sup> /m]	9,6566e-01	1,8808e+00
M <sub>ply</sub> +, - [Nm]	2,40e+05	2,40e+05
M <sub>plz</sub> +, - [Nm]	2,40e+05	2,40e+05

Slika 9.15. Prikaz geometrijskih karakteristika nosača

## 9.2.10. Dimenzioniranje – donja pojasnica sekundarnog rešetkastog nosača

Member B4692	5,502 m	F250X8	S 355	GSN 24	0,79 -
--------------	---------	--------	-------	--------	--------

Note: EN 1993-1-3 article 1.1(3) specifies that this part does not apply to cold formed CHS and RHS sections. The default EN 1993-1-1 code check is executed instead of the EN 1993-1-3 code check.

Partial safety factors	
Gamma M0 for resistance of cross-sections	1,00
Gamma M1 for resistance to instability	1,00
Gamma M2 for resistance of net sections	1,25

Material		
Yield strength $f_y$	355,0	MPa
Ultimate strength $f_u$	510,0	MPa
Fabrication	Cold formed	

.....SECTION CHECK:.....

The critical check is on position 0.000 m

Internal forces	Calculated	Unit
N,Ed	-1310,89	kN
Vy,Ed	2,96	kN
Vz,Ed	10,57	kN
T,Ed	0,04	kNm
My,Ed	-27,20	kNm
Mz,Ed	-6,89	kNm

**Classification for cross-section design**

According to EN 1993-1-1 article 5.5.2

**Classification of Internal Compression parts**

According to EN 1993-1-1 Table 5.2 Sheet 1

Maximum width-to-thickness ratio	28,25
Class 1 Limit	26,85
Class 2 Limit	30,92
Class 3 Limit	39,59

=> Section classified as Class 2 for cross-section design

**Compression check**

According to EN 1993-1-1 article 6.2.4 and formula (6.9)

A	7,5200e-03	m <sup>2</sup>
Nc,Rd	2669,60	kN
Unity check	0,49	-

**Bending moment check for My**

According to EN 1993-1-1 article 6.2.5 and formula (6.12), (6.13)

Wpl,y	6,7577e-04	m <sup>3</sup>
Mpl,y,Rd	239,90	kNm
Unity check	0,11	-

**Bending moment check for Mz**

According to EN 1993-1-1 article 6.2.5 and formula (6.12), (6.13)

Wpl,z	6,7577e-04	m <sup>3</sup>
Mpl,z,Rd	239,90	kNm
Unity check	0,03	-

**Shear check for Vy**

According to EN 1993-1-1 article 6.2.8 and formula (6.17)

Eta	1,20	
Av	3,7600e-03	m <sup>2</sup>
Vpl,y,Rd	770,65	kN
Unity check	0,00	-

**Shear check for Vz**

According to EN 1993-1-1 article 6.2.6 and formula (6.17)

Eta	1,20	
Av	3,7600e-03	m <sup>2</sup>
Vpl,z,Rd	770,65	kN
Unity check	0,01	-

**Torsion check**

According to EN 1993-1-1 article 6.2.7 and formula (6.23)

Tau,t,Ed	0,0	MPa
Tau,Rd	205,0	MPa
Unity check	0,00	-

**Note:** The unity check for torsion is lower than the limit value of 0,05. Therefore torsion is considered as

Alpha	2,28	
MN,z,Rd	159,40	kNm
Beta	2,28	

Unity check (6.41) = 0,02 + 0,00 = 0,02 -

**Note:** Since the shear forces are less than half the plastic shear resistances their effect on the moment resistances is neglected.

The member satisfies the section check.

....:STABILITY CHECK:....

**Classification for member buckling design**

Decisive position for stability classification: 0,000 m

**Classification of Internal Compression parts**

According to EN 1993-1-1 Table 5.2 Sheet 1

Maximum width-to-thickness ratio	28,25
Class 1 Limit	26,85
Class 2 Limit	30,92
Class 3 Limit	39,59

=> Section classified as Class 2 for member buckling design

**Flexural Buckling check**

According to EN 1993-1-1 article 6.3.1.1 and formula (6.46)

Buckling parameters	yy	zz	
Sway type	sway	non-sway	
System length L	1,376	5,502	m
Buckling factor k	1,00	1,00	
Buckling length Lcr	1,376	5,502	m
Critical Euler load Ncr	79188,37	4949,27	kN
Slenderness Lambda	14,03	56,12	
Relative slenderness Lambda,rel	0,18	0,73	
Limit slenderness Lambda,rel,0	0,20	0,20	
Buckling curve	c	c	
Imperfection Alpha	0,49	0,49	
Reduction factor Chi	1,00	0,70	
Buckling resistance Nb,Rd	2669,60	1877,45	kN

Flexural Buckling verification		
Cross-section area A	7,5200e-03	m <sup>2</sup>
Buckling resistance Nb,Rd	1877,45	kN
Unity check	0,70	-

**Torsional(-Flexural) Buckling check**

According to EN 1993-1-1 article 6.3.1.1 and formula (6.46)

**Note:** The cross-section concerns a RHS section which is not susceptible to Torsional(-Flexural) Buckling.

**Lateral Torsional Buckling check**

According to EN 1993-1-1 article 6.3.2.1

**Note:** The cross-section concerns an RHS section with  $h/b < 10 / \text{Lambda,rel,z}$ .

This section is thus not susceptible to Lateral Torsional Buckling.

**Bending and axial compression check**

According to EN 1993-1-1 article 6.3.3 and formula (6.61),(6.62)

Bending and axial compression check parameters		
Interaction method	alternative method 1	
Cross-section area A	7,5200e-03	m <sup>2</sup>
Cross-section plastic modulus Wpl,y	6,7577e-04	m <sup>3</sup>
Cross-section plastic modulus Wpl,z	6,7577e-04	m <sup>3</sup>
Design compression force N,Ed	1310,89	kN
Design bending moment (maximum) My,Ed	-27,20	kNm
Design bending moment (maximum) Mz,Ed	9,37	kNm
Characteristic compression resistance N,Rk	2669,60	kN
Characteristic moment resistance My,Rk	239,90	kNm
Characteristic moment resistance Mz,Rk	239,90	kNm
Reduction factor Chi,y	1,00	
Reduction factor Chi,z	0,70	
Reduction factor Chi,LT	1,00	
Interaction factor k,yy	0,99	
Interaction factor k,yz	0,40	
Interaction factor k,zy	0,63	
Interaction factor k,zz	0,58	

Maximum moment My,Ed is derived from beam B4692 position 0,000 m.

Maximum moment Mz,Ed is derived from beam B4692 position 5,502 m.

Interaction method 1 parameters		
Critical Euler load N,cr,y	79188,37	kN
Critical Euler load N,cr,z	4949,27	kN
Elastic critical load N,cr,T	489553,58	kN
Cross-section plastic modulus Wpl,y	6,7577e-04	m <sup>3</sup>
Cross-section elastic modulus Wel,y	5,7800e-04	m <sup>3</sup>
Cross-section plastic modulus Wpl,z	6,7577e-04	m <sup>3</sup>
Cross-section elastic modulus Wel,z	5,7800e-04	m <sup>3</sup>

Interaction method 1 parameters		
Second moment of area Iy	7,2290e-05	m <sup>4</sup>
Second moment of area Iz	7,2290e-05	m <sup>4</sup>
Torsional constant It	1,1598e-04	m <sup>4</sup>
Method for equivalent moment factor C,my,0	Table A.2 Line 2 (General)	
Design bending moment (maximum) My,Ed	-27,20	kNm
Maximum relative deflection delta,z	0,3	mm
Equivalent moment factor C,my,0	1,00	
Method for equivalent moment factor C,mz,0	Table A.2 Line 1 (Linear)	
Ratio of end moments Psi,z	-0,74	
Equivalent moment factor C,mz,0	0,53	
Factor mu,y	1,00	
Factor mu,z	0,90	
Factor epsilon,y	0,27	
Factor a,LT	0,00	
Critical moment for uniform bending M <sub>cr,0</sub>	6825,21	kNm
Relative slenderness Lambda,rel,0	0,19	
Limit relative slenderness Lambda,rel,0,lim	0,29	
Equivalent moment factor C,my	1,00	
Equivalent moment factor C,mz	0,53	
Equivalent moment factor C,mLT	1,00	
Factor b,LT	0,00	
Factor c,LT	0,00	
Factor d,LT	0,00	
Factor e,LT	0,00	
Factor w,y	1,17	
Factor w,z	1,17	
Factor n,pl	0,49	
Maximum relative slenderness Lambda,rel,max	0,73	
Factor C,yy	1,02	
Factor C,yz	1,08	
Factor C,zy	0,88	
Factor C,zz	1,12	

Unity check (6.61) = 0,49 + 0,11 + 0,02 = 0,62 -  
 Unity check (6.62) = 0,70 + 0,07 + 0,02 = 0,79 -  
 The member satisfies the stability check.

-iskoristivost elementa na GSN – 79 %

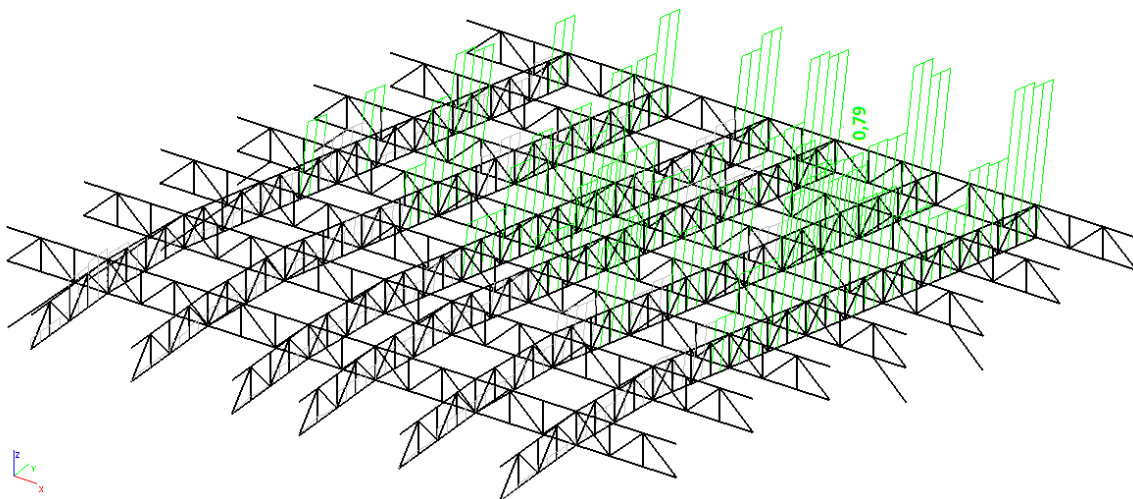

Slika 9.16. Prikaz iskoristivosti donje pojasnice sekundarnog rešetkastog nosača

### 9.2.11. Rezne sile – ispuna sekundarnog rešetkastog nosača

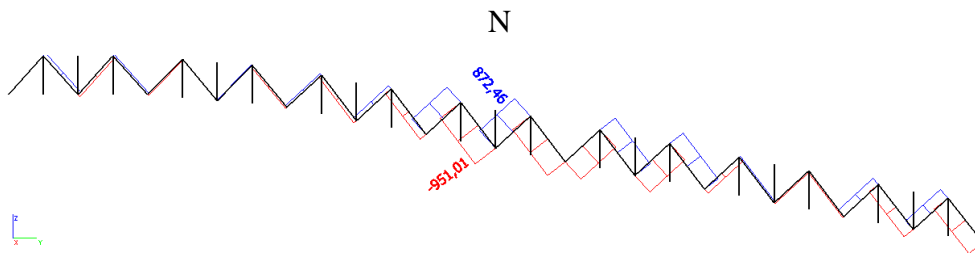

Slika 9.17. Prikaz reznih sila – ispuna sekundarnog rešetkastog nosača

-poprečni presjek nosača

Name	Ispuna sekundarnog rešetkastog nosča - tribina velike dvorane		
Type	CFRHS150X150X8		
Source description	Rautaruukki Oyj / Structural Hollow Sections EN10219 / Ed.2007		
Item material	S 355		
Fabrication	cold formed		
Flexural buckling y-y	c		
Flexural buckling z-z	c		
Lateral torsional buckling	Default		
Use 2D FEM analysis	x		
A [m <sup>2</sup> ]	4,3240e-03		
A <sub>y, z</sub> [m <sup>2</sup> ]	2,1601e-03		2,1601e-03
I <sub>y, z</sub> [m <sup>4</sup> ]	1,4118e-05		1,4118e-05
I <sub>w</sub> [m <sup>4</sup> ], I <sub>t</sub> [m <sup>4</sup> ]	5,0625e-08		2,3641e-05
W <sub>el y, z</sub> [m <sup>3</sup> ]	1,8824e-04		1,8824e-04
W <sub>pl y, z</sub> [m <sup>3</sup> ]	2,2596e-04		2,2596e-04
d <sub>y, z</sub> [mm]	0		0
c <sub>YUCS, ZUCS</sub> [mm]	75		75
α [deg]	0,00		
A <sub>L, D</sub> [m <sup>2</sup> /m]	5,6600e-01		1,0808e+00
M <sub>pl y, -</sub> [Nm]	8,01e+04		8,01e+04
M <sub>pl z, -</sub> [Nm]	8,01e+04		8,01e+04

Slika 9.18. Prikaz geometrijskih karakteristika nosača

-iskoristivost elementa na GSN – 74 %

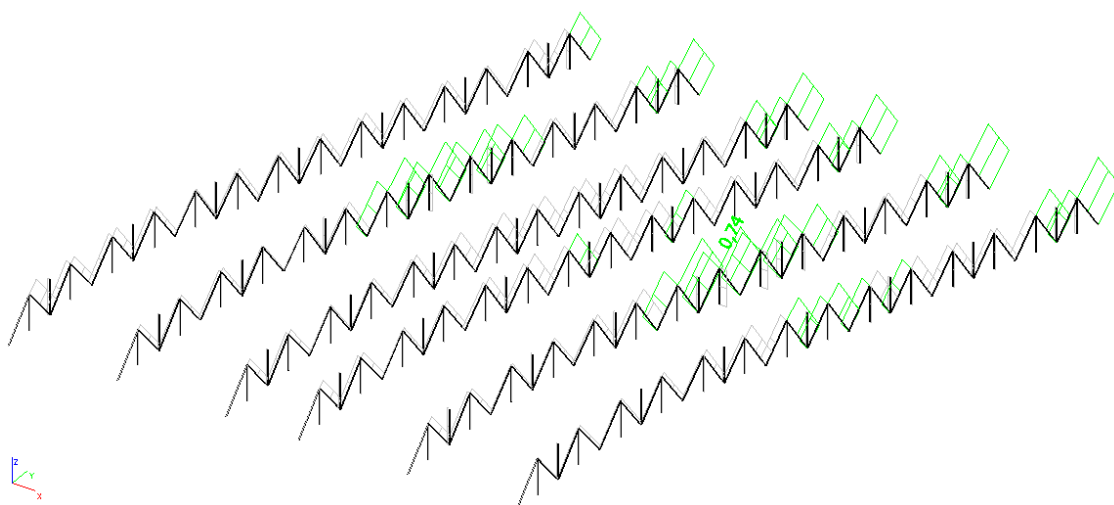

Slika 9.19. Prikaz iskoristivosti ispune sekundarnog rešetkastog nosača

## 9.2.12. Dimenzioniranje – ispuna sekundarnog rešetkastog nosača

Member B4606	2,221 m	CFRHS150X150X8	S 355	GSN 2	0,74 -
--------------	---------	----------------	-------	-------	--------

Note: EN 1993-1-3 article 1.1(3) specifies that this part does not apply to cold formed CHS and RHS sections. The default EN 1993-1-1 code check is executed instead of the EN 1993-1-3 code check.

Partial safety factors	
Gamma M0 for resistance of cross-sections	1,00
Gamma M1 for resistance to instability	1,00
Gamma M2 for resistance of net sections	1,25

Material	
Yield strength $f_y$	355,0 MPa
Ultimate strength $f_u$	510,0 MPa
Fabrication	Cold formed

....:SECTION CHECK:....

The critical check is on position 0.000 m

Internal forces	Calculated	Unit
N,Ed	-951,01	kN
Vy,Ed	0,00	kN
Vz,Ed	0,00	kN
T,Ed	0,00	kNm
My,Ed	0,00	kNm
Mz,Ed	0,00	kNm

Classification for cross-section design

According to EN 1993-1-1 article 5.5.2

Classification of Internal Compression parts

According to EN 1993-1-1 Table 5.2 Sheet 1

Maximum width-to-thickness ratio	15,75
Class 1 Limit	26,85
Class 2 Limit	30,92
Class 3 Limit	34,17

=> Section classified as Class 1 for cross-section design

Compression check

According to EN 1993-1-1 article 6.2.4 and formula (6.9)

A	4,3240e-03	m <sup>2</sup>
Nc,Rd	1535,02	kN
Unity check	0,62	-

The member satisfies the section check.

....:STABILITY CHECK:....

Classification for member buckling design

Decisive position for stability classification: 0,000 m

Classification of Internal Compression parts

According to EN 1993-1-1 Table 5.2 Sheet 1

Maximum width-to-thickness ratio	15,75
Class 1 Limit	26,85
Class 2 Limit	30,92
Class 3 Limit	34,17

=> Section classified as Class 1 for member buckling design

Flexural Buckling check

According to EN 1993-1-1 article 6.3.1.1 and formula (6.46)

Buckling parameters	yy	zz	
Sway type	sway	non-sway	
System length L	2,221	2,221	m
Buckling factor k	1,00	1,00	
Buckling length Lcr	2,221	2,221	m
Critical Euler load Ncr	5931,47	5931,77	kN
Slenderness Lambda	38,87	38,87	
Relative slenderness Lambda,rel	0,51	0,51	
Limit slenderness Lambda,rel,0	0,20	0,20	
Buckling curve	c	c	
Imperfection Alpha	0,49	0,49	
Reduction factor Chi	0,84	0,84	
Buckling resistance Nb,Rd	1286,51	1286,52	kN

Flexural Buckling verification	
Cross-section area A	4,3240e-03 m <sup>2</sup>
Buckling resistance Nb,Rd	1286,51 kN
Unity check	0,74 -

Note: The cross-section concerns a RHS section which is not susceptible to Torsional(-Flexural) Buckling.

The member satisfies the stability check.

## 10. PRORAČUN SPREGNUTE MEĐUKATNE KONSTRUKCIJE – TRIBINA SREDNJE DVORANE

### 10.1. Pomaci spregnute međukatne konstrukcije – tribina srednje dvorane

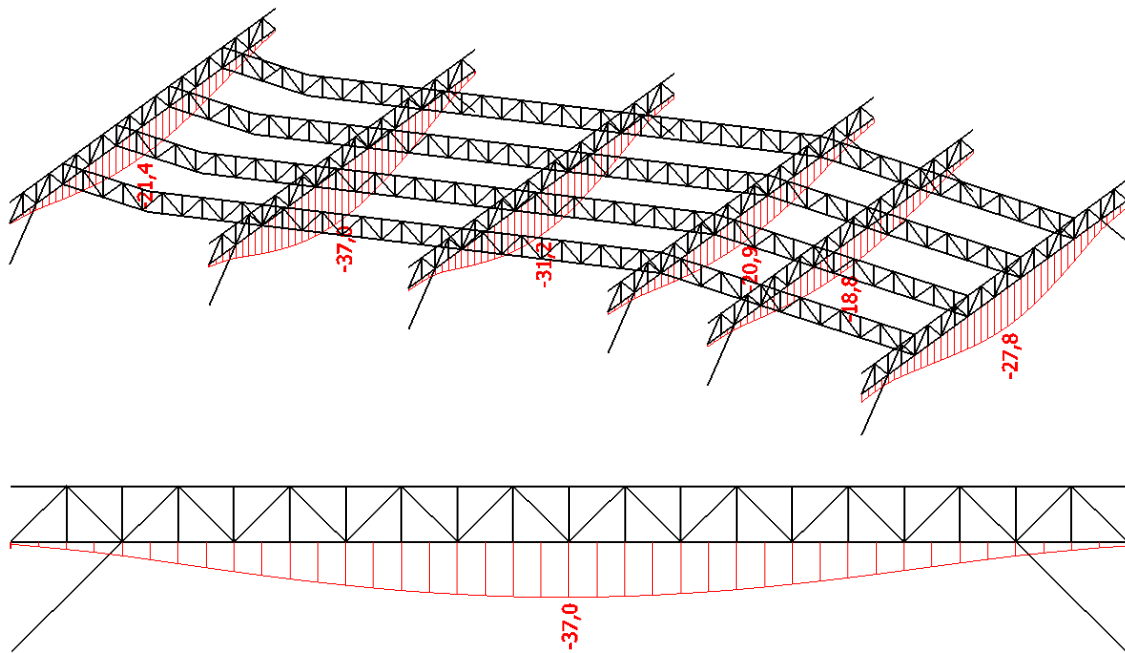

*Slika 10.1. Prikaz vertikalnog pomaka glavnog rešetkastog nosača – tribina srednje dvorane*

Dopušteni vertikalni pomak (progib):

$$u_{dop} = \frac{l}{300} = \frac{16,20 \cdot 1000}{300} = 54,0 \text{ mm}$$

$$u_z = 37,0 \text{ mm} < u_{z,dop} = 54,0 \text{ mm} \quad \text{Zadovoljava}$$

-iskoristivost na GSU -  $37,0 \text{ mm} / 54,0 \text{ mm} = 0,69 = 69\%$



## 10.2. Dimenziniranje spregnute međukatne konstrukcije – tribina srednje dvorane

### 10.2.1. Rezne sile – gornja pojasnica glavnog rešetkastog nosača

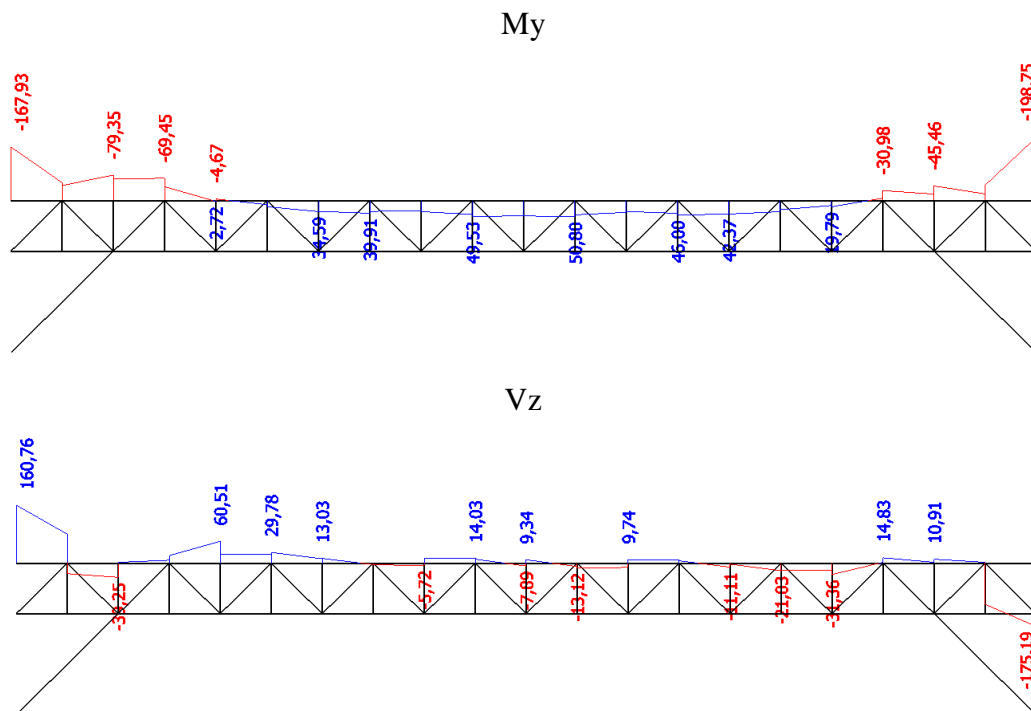

Slika 10.2. Prikaz reznih sila - gornja pojasnica glavnog rešetkastog nosača

-poprečni presjek nosača

Name	Gornja pojanica glavnog rešetkastog nosača - tribina srednje dvorane	
Type	HEB200	
Source description	Profil Arbed / Structural shapes / Edition Octobre 1995	
Item material	S 355	
Fabrication	rolled	
Flexural buckling y-y	b	
Flexural buckling z-z	c	
Lateral torsional buckling	Default	
Use 2D FEM analysis	*	
A [m <sup>2</sup> ]	7,8080e-03	
A <sub>y</sub> , z [m <sup>2</sup> ]	5,7750e-03	1,9112e-03
I <sub>y</sub> , z [m <sup>4</sup> ]	5,6960e-05	2,0030e-05
I <sub>w</sub> [m <sup>6</sup> ], I <sub>t</sub> [m <sup>4</sup> ]	1,7112e-07	5,9280e-07
W <sub>el y</sub> , z [m <sup>3</sup> ]	5,6960e-04	2,0030e-04
W <sub>pl y</sub> , z [m <sup>3</sup> ]	6,4250e-04	3,0580e-04
d y, z [mm]	0	0
c YUCS, ZUCS [mm]	100	100
α [deg]	0,00	
A <sub>L</sub> , D [m <sup>2</sup> /m]	1,1500e+00	1,1510e+00
M <sub>ply</sub> +, - [Nm]	2,28e+05	2,28e+05
M <sub>pz</sub> +, - [Nm]	1,09e+05	1,09e+05

Slika 10.3. Prikaz geometrijskih karakteristika nosača

## 10.2.2. Dimenzioniranje – gornja pojasnica glavnog rešetkastog nosača

SCIAENGINEER

### Composite Beam - Final stage

Linear calculation  
Class: All ULS  
Extreme 1D: Global  
Selection: B1888

### Composite beam verification

for beam B1888 at section 16.2 m, in accordance with EC EN 1994-1-1

#### 1. Geometry data

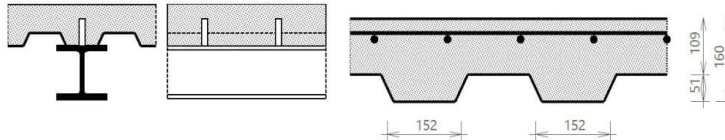

#### Continuous beam

Length of the current span	$L = 16.2$ m
Length of next span	$L_{\text{next}} = 5.4$ m
Beam spacing at the left	$L_{\text{left}} = 4.05$ m
Distance to the slab edge at the right	$L_{\text{right}} = 0$ m
Checked section	$d_x = 16.2$ m

*Warning: For a continuous beam, intermediate buckling supports  $y$ - $y$  are ignored in both the calculation of the effective width for the analysis model and the check.*

#### 2. Cross-section & materials

##### 2.1 Steel section properties

##### 2.1.1 Cross-section

Cross-section	HEB200
Height	$h_a = 200$ mm
Width	$b = 200$ mm
Web thickness	$t_w = 9$ mm
Flange thickness	$t_f = 15$ mm
Radius	$r = 18$ mm
Area	$A_a = 7808$ mm <sup>2</sup>
Moment of inertia	$I_y = 57 \cdot 10^6$ mm <sup>4</sup>
Radius of gyration	$i_z = 51$ mm
Plastic section modulus	$W_{\text{ply}} = 642500$ mm <sup>3</sup>

##### 2.1.2 Material

Steel grade	S 355
Yield strength	$f_{yb} = 355$ MPa
Ultimate strength	$f_{ub} = 490$ MPa
E modulus	$E_b = 210000$ MPa

##### 2.1.3 Cross-section classification

$$\varepsilon = \sqrt{\frac{235}{355}} = 0.814$$

(EN 1993-1-1 §5.6 Tab. 5.2)

##### 2.1.3.1 Flange in compression

$$c_f = \frac{b - t_w - 2 \cdot r}{2} = \frac{200 \text{ mm} - 9 \text{ mm} - 2 \cdot 18 \text{ mm}}{2} = 77.5 \text{ mm}$$

$$\frac{c_f}{t_f} \leq 9 \cdot \varepsilon$$

$$\frac{77.5 \text{ mm}}{15 \text{ mm}} \leq 9 \cdot 0.814$$

$$5.17 \leq 7.32$$

OK

Flange classified as Class 1.

Student version

2.1.3.2 Web in bending

$$c_w = h_a - 2 \cdot t_f - 2 \cdot r = 200 \text{ mm} - 2 \cdot 15 \text{ mm} - 2 \cdot 18 \text{ mm} = 134 \text{ mm}$$

$$\alpha_{cl} = 0.5$$

$$\frac{c_w}{t_w} \leq \frac{36 \cdot \epsilon}{\alpha_{cl}}$$

$$\frac{134 \text{ mm}}{9 \text{ mm}} \leq \frac{36 \cdot 0.814}{0.5}$$

$$14.9 \leq 58.6$$

OK

Web classified as Class 1.

**Cross-section classified as Class 1**

Cross-section Class OK.

**2.2 Concrete slab with profiled sheeting****2.2.1 Concrete slab**2.2.1.1 SlabTotal height of the slab  $h_s = 160 \text{ mm}$ 2.2.1.2 Material

Concrete class C30/37  
 Characteristic strength  $f_{ck} = 30 \text{ MPa}$   
 E modulus  $E_{cm} = 32800 \text{ MPa}$

**2.2.2 Profiled steel sheeting**

Sheeting with ribs parallel to the supporting beams

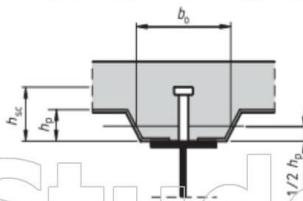

Name	Vulcraft 2 VUJ 20
Depth of the ribs	$h_p = 50.8 \text{ mm}$
Height of full concrete	$h_c = 109.2 \text{ mm}$
Height of the re-entrant stiffener	$h_d = 0 \text{ mm}$
Spacing of the ribs	$b_s = 304.8 \text{ mm}$
Top width of the rib	$b_r = 127 \text{ mm}$
Bottom width of the rib	$b_b = 127 \text{ mm}$
Mean width of the ribs	$b_{0,rib} = 152.4 \text{ mm}$
Thickness of the sheeting	$t_p = 0.9093 \text{ mm}$

**2.2.3 Shear connectors**2.2.3.1 Geometry

Name	H110
Diameter	$d_s = 25 \text{ mm}$
Nominal height	$h_{nom} = 110 \text{ mm}$
As-welded height	$h_{sc} = 105 \text{ mm}$
Amount per trough or section	$n_r = 1$

2.2.3.2 Material

Steel grade	S 355
Ultimate strength	$f_{us} = 490 \text{ MPa}$

**2.2.4 Reinforcement**2.2.4.1 Geometry

Longitudinal bar diameter	$d_l = 16 \text{ mm}$
Longitudinal bar spacing	$s_l = 150 \text{ mm}$
Longitudinal bar cover	$c_l = 30 \text{ mm}$
Transverse bar diameter	$d_t = 16 \text{ mm}$
Transverse bar spacing	$s_t = 150 \text{ mm}$
Transverse bar cover	$c_t = 46 \text{ mm}$

2.2.4.2 Material

Material	B 500A
Characteristic yield strength	$f_{yk,r} = 500 \text{ MPa}$

**3. Design values of loads**

Load Name : GSN 24

Content of combination : 1.35\*g-vlastitežina+1.35\*dg-dodatnostalno+  
1.62\*q-promjenjivoopterećenije+1.35\*g-vlastitežina\_dryconcrete+  
1.35\*Wy-1kom.-Wz-poz+1.35\*s-opterećenjesnijegom

Bending moment  $M_{Ed,comp} = -198.755 \text{ kNm}$   
Shear force  $V_{Ed,comp} = -175.194 \text{ kN}$

**4. Partial safety factors**

Steel section  $\gamma_{M0} = 1$   
 $\gamma_{M1} = 1$   
Shear connectors  $\gamma_V = 1.25$   
Concrete  $\gamma_C = 1.5$   
Reinforcement  $\gamma_S = 1.15$

**5. ULS check of the Final stage**

**5.1 Shear connection**

**5.1.1 Design resistance of shear connectors**

**5.1.1.1 Shear connector in a solid slab**

$$\frac{h_{sc}}{d_s} > 4$$

$$4.2 > 4$$

$$\alpha = 1$$

$$f_{us} = \min(490; 500) \text{ MPa}$$

$$P_{Rd,solid,1} = \frac{0.8 \cdot f_{us} \cdot \left(\frac{\pi \cdot d_s^2}{4}\right)}{\gamma_V} = \frac{0.8 \cdot 490 \text{ MPa} \cdot \left(\frac{3.14 \cdot 25 \text{ mm}^2}{4}\right)}{1.25} = 154 \text{ kN}$$

$$P_{Rd,solid,2} = \frac{0.29 \cdot \alpha \cdot d_s^2 \cdot \sqrt{f_{ck} \cdot E_{cm}}}{\gamma_V} = \frac{0.29 \cdot 1 \cdot 25 \text{ mm}^2 \cdot \sqrt{30 \text{ MPa} \cdot 32800 \text{ MPa}}}{1.25} = 144 \text{ kN}$$

$$P_{Rd,solid} = \min(P_{Rd,solid,1}; P_{Rd,solid,2}) = \min(154 \text{ kN}; 144 \text{ kN}) = 144 \text{ kN}$$

**5.1.1.2 Shear connector in profiled sheeting**

Sheeting with ribs parallel to the supporting beams

$$k_t = \frac{0.6 \cdot b_{0,rib}}{h_p} \cdot \left(\frac{h_{sc}}{h_p} - 1\right) = \frac{0.6 \cdot 152 \text{ mm}}{50.8 \text{ mm}} \cdot \left(\frac{105 \text{ mm}}{50.8 \text{ mm}} - 1\right) = 1.92$$

$$k_t = 1$$

$$P_{Rd} = k_t \cdot P_{Rd,solid} = 1 \cdot 144 \text{ kN} = 144 \text{ kN}$$

**5.1.2 Degree of shear connection**

**5.1.2.1 Determination of  $b_{eff}$  of the concrete flange and length  $L_e$**

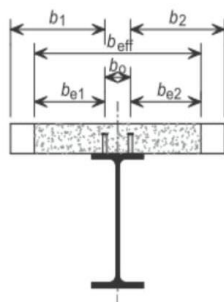

**The effective width at the internal support**

$$L_{e2} = 0.25 \cdot (L_1 + L_2) = 0.25 \cdot (16.2 \text{ m} + 5.4 \text{ m}) = 5.4 \text{ m}$$

**Left side of the beam**

$$b_1 = \frac{L_{\text{perp, left}}}{2} = \frac{b_0}{2} = \frac{4,05 \text{ m} - 0 \text{ mm}}{2} = 2,03 \text{ m}$$

$$b_{e10} = \min\left(\frac{L_{e0}}{8}; b_1\right) = \min\left(\frac{0 \text{ m}}{8}; 2,03 \text{ m}\right) = 0 \text{ m}$$

$$b_{e11} = \min\left(\frac{L_{e1}}{8}; b_1\right) = \min\left(\frac{0 \text{ m}}{8}; 2,03 \text{ m}\right) = 0 \text{ m}$$

$$b_{e12} = \min\left(\frac{L_{e2}}{8}; b_1\right) = \min\left(\frac{5,4 \text{ m}}{8}; 2,03 \text{ m}\right) = 0,675 \text{ m}$$

**Right side of the beam**

$$b_2 = L_{\text{perp, right}} - \frac{b_0}{2} = 0 \text{ m}$$

$$b_{e20} = \min\left(\frac{L_{e0}}{8}; b_2\right) = \min\left(\frac{0 \text{ m}}{8}; 0 \text{ m}\right) = 0 \text{ m}$$

$$b_{e21} = \min\left(\frac{L_{e1}}{8}; b_2\right) = \min\left(\frac{0 \text{ m}}{8}; 0 \text{ m}\right) = 0 \text{ m}$$

$$b_{e22} = \min\left(\frac{L_{e2}}{8}; b_2\right) = \min\left(\frac{5,4 \text{ m}}{8}; 0 \text{ m}\right) = 0 \text{ m}$$

**Calculation of  $b_{\text{eff},2}$** 

$$b_{\text{eff},2} = b_0 + b_{e12} + b_{e22} = 0 \text{ mm} + 0,675 \text{ m} + 0 \text{ m} = 0,675 \text{ m}$$

**Calculation of  $b_{\text{eff}}$** 

$$b_{\text{eff}} = b_{\text{eff},2} = 0,675 \text{ m}$$

**Determination of  $L_e$** 

$$L_e = L_{e2} = 5,4 \text{ m}$$

**5.1.2.2 Minimum degree of shear connection**

Warning: Conditions given by EN 1994-1-1 Art. 6.6.1.2 (3) are not fulfilled.

$$\eta_{\text{min,calc}} = 1 - \frac{355}{f_{yb}} \cdot (0,75 - 0,03 \cdot L_e)$$

$$\eta_{\text{min,calc}} = 1 - \frac{355}{355} \cdot (0,75 - 0,03 \cdot 5,4 \text{ m}) = 0,41$$

$$\eta_{\text{min}} = \max(\eta_{\text{min,calc}}; 0,4) = \max(0,41; 0,4) = 0,41$$

**5.1.2.3 Degree of shear connection present****5.1.2.3.1 Tension resistance of the reinforcement**

$$A_s = \frac{b_{\text{eff}}}{s_l} \cdot \left(\frac{d_l^2}{4}\right) \cdot \pi = \frac{0,675 \text{ m}}{150 \text{ mm}} \cdot \left(\frac{16 \text{ mm}^2}{4}\right) \cdot 3,14 = 905 \text{ mm}^2$$

$$F_s = \frac{A_s \cdot f_{yk,r}}{\gamma_s} = \frac{905 \cdot 10^{-6} \cdot 500 \cdot 10^6}{1,15} = 393 \text{ kN}$$

**5.1.2.3.2 Tension resistance of the steel member**

$$N_{pl,a} = f_{yb} \cdot A_a = 355 \text{ MPa} \cdot 7808 \text{ mm}^2 = 2771,84 \text{ kN}$$

$$N_{c,r} = \min(F_s; N_{pl,a}) = \min(393 \text{ kN}; 2771,84 \text{ kN}) = 393,38 \text{ kN}$$

**5.1.2.3.3 Resistance of the shear connectors**

$$l_s = \frac{L}{n_{\text{row}}} = \frac{16,2}{53} = 306 \text{ mm}$$

Number of shear studs available per length  $L_e/2$

$$n_{sp} = \frac{0,5 \cdot L_e}{l_s} \cdot n_r$$

$$n_{sp} = 8 \cdot 1 = 8$$

$$N_c = n_{sp} \cdot P_{Rd} = 8 \cdot 143835 = 1150,68 \text{ kN}$$

$$\eta = \min\left(\frac{N_c}{N_{c,r}}; 1\right) = \min\left(\frac{1150,68 \text{ kN}}{393,38 \text{ kN}}; 1\right) = 1$$

$$\eta \geq \eta_{\text{min}}$$

$$1 \geq 0,41$$

The shear connection degree is adequate. OK

**5.2 Cross-sectional resistance of the composite beam****5.2.1 Shear buckling**

$$h_w = h_s - 2 \cdot t_f = 200 \text{ mm} - 2 \cdot 15 \text{ mm} = 170 \text{ mm}$$

$$\eta_{sb} = 1.2$$

$$\frac{h_w}{t_w} \leq \frac{72 \cdot \varepsilon}{\eta_{sb}}$$

$$\frac{170 \text{ mm}}{9 \text{ mm}} \leq \frac{72 \cdot 0.814}{1.2}$$

$$18.9 \leq 48.8$$

OK

The shear buckling resistance of the web does not need to be verified.

**5.2.2 Vertical shear**

The resistance to vertical shear should be taken as the resistance of the structural steel section.

$$A_v = A_s - 2 \cdot b \cdot t_f + (t_w + 2 \cdot r) \cdot t_f$$

$$= 7.81 \cdot 10^{-3} - 2 \cdot 0.2 \cdot 0.015 + (9 \cdot 10^{-3} + 2 \cdot 0.018) \cdot 0.015 = 2483 \text{ mm}^2$$

$$A_{v,min} = \eta_{sb} \cdot h_w \cdot t_w = 1.2 \cdot 0.17 \cdot 9 \cdot 10^{-3} = 1836 \text{ mm}^2$$

$$A_v \geq A_{v,min}$$

$$2483 \text{ mm}^2 \geq 1836 \text{ mm}^2$$

$$V_{pl,Rd} = \frac{A_v \cdot f_{yb}}{\sqrt{3} \cdot \gamma_{M0}} = \frac{2483 \text{ mm}^2 \cdot 355 \cdot 10^6}{\sqrt{3} \cdot 1} = 509 \text{ kN}$$

$$UC_{comp,V} = \frac{abs(V_{Ed,comp})}{V_{pl,Rd}} = \frac{abs(-175.194 \text{ kN})}{509 \text{ kN}} = 0.34$$

The shear resistance of the section is adequate.

**5.2.3 Bending moment****5.2.3.1 Longitudinal reinforcement****5.2.3.1.1 Centre of composite section**For buildings not intended mainly for storage the effects of creep in concrete beams may be taken into account by using an effective E modulus  $E_{ceff} = E_{cm} / 2$ .

$$E_{ceff} = \frac{E_{cm}}{2} = \frac{32800 \text{ MPa}}{2} = 16400 \text{ MPa}$$

$$\eta_E = \frac{E_s}{E_{ceff}} = \frac{210000 \text{ MPa}}{16400 \text{ MPa}} = 12.8$$

$$y_d = \frac{A_s \cdot \left( \frac{h_a}{2} \right) + \left( \frac{1}{\eta_E} \right) \cdot b_{eff} \cdot (h_c - h_d) \cdot \left( h_a + h_s - \frac{h_c - h_d}{2} \right)}{A_s + \left( \frac{1}{\eta_E} \right) \cdot b_{eff} \cdot (h_c - h_d)}$$

$$= \frac{7.81 \cdot 10^{-3} \cdot \left( \frac{0.2}{2} \right) + \left( \frac{1}{12.8} \right) \cdot 0.675 \cdot (0.109 - 0) \cdot \left( 0.2 + 0.16 - \frac{0.109 - 0}{2} \right)}{7.81 \cdot 10^{-3} + \left( \frac{1}{12.8} \right) \cdot 0.675 \cdot (0.109 - 0)} = 187 \text{ mm}$$

**5.2.3.1.2 Degree of reinforcement**

$$A_{s,sl} = \frac{b_{eff}}{4} \cdot \left( \frac{d^2}{150 \text{ mm}} \right) \cdot \pi = \frac{0.675 \text{ m}}{150 \text{ mm}} \cdot \left( \frac{16 \text{ mm}^2}{4} \right) \cdot 3.14 = 905 \text{ mm}^2$$

$$A_c = b_{eff} \cdot (h_c - h_d) = 0.675 \cdot (0.109 - 0) = 73710 \text{ mm}^2$$

$$z_0 = \left( h_a + h_s - \frac{h_c - h_d}{2} \right) - y_d = \left( 0.2 + 0.16 - \frac{0.109 - 0}{2} \right) - 0.187 = 118 \text{ mm}$$

$$k_c = \min \left( \frac{1}{\left( 1 + \frac{h_c - h_d}{2 \cdot z_0} \right)} + 0.3; 1 \right) = \min \left( \frac{1}{\left( 1 + \frac{0.109 - 0}{2 \cdot 0.118} \right)} + 0.3; 1 \right) = 0.984$$

$$\rho_s = \delta \cdot \left( \frac{f_{yb}}{235} \right) \cdot \left( \frac{f_{ctm}}{f_{yk,r}} \right) \cdot \sqrt{k_c} = 1.1 \cdot \left( \frac{355}{235} \right) \cdot \left( \frac{2.9 \cdot 10^6}{500 \cdot 10^6} \right) \cdot \sqrt{0.984} = 0.956 \%$$

$$A_s \geq \rho_s \cdot A_c$$

$$905 \text{ mm}^2 \geq 9.56 \cdot 10^{-3} \cdot 73710 \text{ mm}^2$$

$$905 \text{ mm}^2 \geq 705 \text{ mm}^2$$

OK

The longitudinal reinforcement of the section is adequate.

5.2.3.2 Moment resistance

Moment resistance of a steel cross-section

$$M_{pl,Rd,a} = \frac{W_{ply} \cdot f_{yb}}{Y_{M0}} = \frac{642500 \text{ mm}^3 \cdot 355 \text{ MPa}}{1} = 228 \text{ kNm}$$

Influence of shear

$$\frac{V_{pl,Rd}}{2} > \text{abs}(V_{Ed,comp})$$

$$\frac{509 \text{ kN}}{2} > 175 \text{ kN}$$

$$254 \text{ kN} > 175 \text{ kN} \quad \text{OK}$$

The influence of the vertical shear on the bending moment resistance may be neglected.

$$f_{yb,w} = f_{yb} = 355 \text{ MPa}$$

Modified tension resistance of the steel member

$$r = 0 \text{ mm}$$

$$A_a = 2 \cdot t_f \cdot b + t_w \cdot (h_a - 2 \cdot t_f) = 2 \cdot 15 \text{ mm} \cdot 200 \text{ mm} + 9 \text{ mm} \cdot (200 \text{ mm} - 2 \cdot 15 \text{ mm}) = 7530 \text{ mm}^2$$

$$N_{pl,a} = A_a \cdot f_{yb} = 7530 \text{ mm}^2 \cdot 355 \text{ MPa} = 2673.15 \text{ kN}$$

Note: Roundings of the steel cross-section are neglected in bending resistance calculation.

$$N_{c,f} = \min(F_s, N_{pl,a}) = \min(393 \text{ kN}; 2673.15 \text{ kN}) = 393.38 \text{ kN}$$

Negative bending moment resistance calculation

The plastic neutral axis is located within the web of the steel section.

$$N_{at,f} = b \cdot t_f \cdot f_{yb} = 0.2 \cdot 0.015 \cdot 355 \cdot 10^6 = 1065.00 \text{ kN}$$

$$N_{pl,a} - N_{at,f} - N_{at,w} = F_s + N_{at,f} + N_{at,w}$$

$$x = \frac{(N_{pl,a} - 2 \cdot N_{at,f} - F_s)}{(2 \cdot t_w \cdot f_{yb,w})} = \frac{(2673.15 \text{ kN} - 2 \cdot 1065.00 \text{ kN} - 393 \text{ kN})}{(2 \cdot 9 \text{ mm} \cdot 355 \text{ MPa})} = 23.4 \text{ mm}$$

Verification of the steel web classification.

$$\alpha_{cl} = \frac{c_w - x}{c_w} = \frac{134 - 23.4}{134} = 0.825$$

$$\frac{c_w}{t_w} \leq \frac{396 \cdot \epsilon}{13 \cdot \alpha_{cl} + 1}$$

$$\frac{134 \text{ mm}}{9 \text{ mm}} \leq \frac{396 \cdot 0.814}{13 \cdot 0.825 - 1}$$

$$14.9 \leq 33.1 \quad \text{OK}$$

Web classified as Class 1.

$$N_{at,w} = t_w \cdot x \cdot f_{yb,w} = 9 \text{ mm} \cdot 23.4 \text{ mm} \cdot 355 \text{ MPa} = 74.88 \text{ kN}$$

$$N_{a,c} = N_{pl,a} - N_{at,f} - N_{at,w} = 2673.15 \text{ kN} - 1065.00 \text{ kN} - 74.88 \text{ kN} = 1533.27 \text{ kN}$$

Leverage arm of the compression part of the steel section calculated to the PNA.

$$h_{cs} = \frac{(t_w \cdot (h_a - 2 \cdot t_f - x)^2 \cdot 0.5 + t_f \cdot b \cdot (h_a - 1.5 \cdot t_f - x))}{t_w \cdot (h_a - 2 \cdot t_f - x) + t_f \cdot b}$$

$$= \frac{(9 \cdot (200 - 2 \cdot 15 - 23.4)^2 \cdot 0.5 + 15 \cdot 200 \cdot (200 - 1.5 \cdot 15 - 23.4))}{9 \cdot (200 - 2 \cdot 15 - 23.4) + 15 \cdot 200} = 129 \text{ mm}$$

$$h_l = x + t_f + h_s - c_1 + \frac{d_1}{2} = 0.0234 + 0.015 + 0.16 - 0.03 + \frac{0.016}{2} = 160 \text{ mm}$$

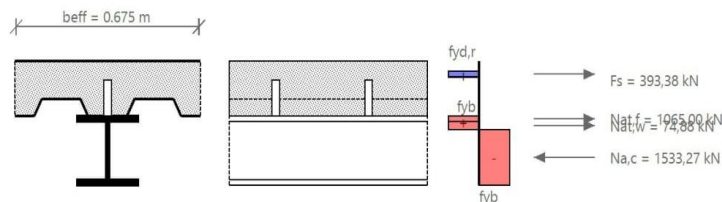

$$M_{pl,Rd} = F_s \cdot h_l + N_{at,f} \cdot \left(\frac{t_f}{2} + x\right) + \frac{N_{at,w} \cdot x}{2} + N_{a,c} \cdot h_{cs}$$

$$= 393 \cdot 160 + 1065.00 \cdot \left(\frac{15}{2} + 23.4\right) + \frac{74.88 \cdot 23.4}{2} + 1533.27 \cdot 129 = 295 \text{ kNm}$$

Design moment resistance according to EN 1994-1-1 Art.6.2.1.2

$$M_{Rd} = M_{pl,Rd} = 295 \text{ kNm}$$

$$UC_{comp,M} = \frac{\text{abs}(M_{Ed,comp})}{M_{Rd}} = \frac{\text{abs}(-198.755 \text{ kNm})}{295 \text{ kNm}} = 0.67$$

The bending moment resistance of the section is adequate.

**5.3 LTB resistance**

$$F = \left( 1 + \frac{t_w \cdot (h_a - t_f)}{4 \cdot b \cdot t_f} \right) \cdot \left( \frac{h_a - t_f}{t_w} \right)^{0.75} \cdot \left( \frac{t_f}{b} \right)^{0.25} = \left( 1 + \frac{9 \cdot (200 - 15)}{4 \cdot 200 \cdot 15} \right) \cdot \left( \frac{200 - 15}{9} \right)^{0.75} \cdot \left( \frac{15}{200} \right)^{0.25} = 5.75$$

$F_{lim} = 12.3$

$F \leq F_{lim}$

$5.75 \leq 12.3$

OK

The cross-section is qualified for verification of LTB by the simplified method.

$C_4 = 25$

$$\lambda_{LT,rel} = 5 \cdot \left( 1 + \frac{t_w \cdot (h_a - t_f)}{4 \cdot b \cdot t_f} \right) \cdot \left( \frac{h_a - t_f}{t_w} \right)^{0.75} \cdot \left( \frac{t_f}{b} \right)^{0.25} \cdot \left( \frac{f_{yb}}{E_b \cdot C_4} \right)^{0.5}$$

$$= 5 \cdot \left( 1 + \frac{9 \cdot 10^{-3} \cdot (0.2 - 0.015)}{4 \cdot 0.2 \cdot 0.015} \right) \cdot \left( \frac{0.2 - 0.015}{9 \cdot 10^{-3}} \right)^{0.75} \cdot \left( \frac{0.015}{0.2} \right)^{0.25} \cdot \left( \frac{355 \cdot 10^6}{210 \cdot 10^9 \cdot 25} \right)^{0.5} = 0.237$$

$h_a/b \leq 2 \rightarrow$  Buckling curve 'a'

$\alpha_{LT} = 0.21$

$$\Phi_{LT} = 0.5 \cdot \left( 1 + \alpha_{LT} \cdot (\lambda_{LT,rel} - 0.2) + \lambda_{LT,rel}^2 \right) = 0.5 \cdot \left( 1 + 0.21 \cdot (0.237 - 0.2) + 0.237^2 \right) = 0.532$$

$$X_{LT} = \frac{1}{\Phi_{LT} + \sqrt{\Phi_{LT}^2 - \lambda_{LT,rel}^2}} = \frac{1}{0.532 + \sqrt{0.532^2 - 0.237^2}} = 0.992$$

$X_{LT} = \min(X_{LT}, 1) = \min(0.992, 1) = 0.992$

$M_{b,Rd} = X_{LT} \cdot M_{Rd} = 0.992 \cdot 295331 = 292.951 \text{ kNm}$

$UC_{comp\_LTB} = \frac{abs(M_{Ed,comp})}{M_{b,Rd}} = \frac{abs(-198.755 \text{ kNm})}{292.951 \text{ kNm}} = 0.68$

The later torsional buckling resistance of the section is adequate.

**5.4 Longitudinal shear**

**5.4.1 Transverse reinforcement**

Design shear flow

$h_f = h_c = 109 \text{ mm}$

$$v_{Ed} = \frac{P_{Rd}}{I_y \cdot h_f} = \frac{1 \cdot 144 \text{ kN}}{306 \text{ mm} \cdot 109 \text{ mm}} = 4.31 \text{ MPa}$$

Transverse reinforcement

$$\frac{A_{st} \cdot f_{yk,r}}{y_s \cdot s_f} \geq \frac{v_{Ed} \cdot h_f}{\cot(\theta)}$$

$A_t = A_{st}/s_f$

$$A_t = \frac{v_{Ed} \cdot h_f}{\cot(\theta) \cdot f_{yk,r}} = \frac{4.31 \cdot 10^6 \cdot 0.109}{\cot(26.5) \cdot 500 \cdot 10^6} = 540 \text{ mm}^2/\text{m}$$

$$A_{t,prov} = \frac{1}{s_f} \cdot \left( \frac{d_t^2}{4} \right) \cdot 3.14 = \frac{1}{0.15} \cdot \left( \frac{0.016^2}{4} \right) \cdot 3.14 = 1340 \text{ mm}^2/\text{m}$$

$A_{t,prov} \geq A_t$

$1340 \text{ mm}^2/\text{m} \geq 540 \text{ mm}^2/\text{m}$  OK

The transverse reinforcement of the section is adequate.

**ULS check of Final stage is OK.**

$UC_{comp} = \max(0.34; 0.67; 0.68) = 0.68$

-iskoristivost elementa na GSN – 68 %

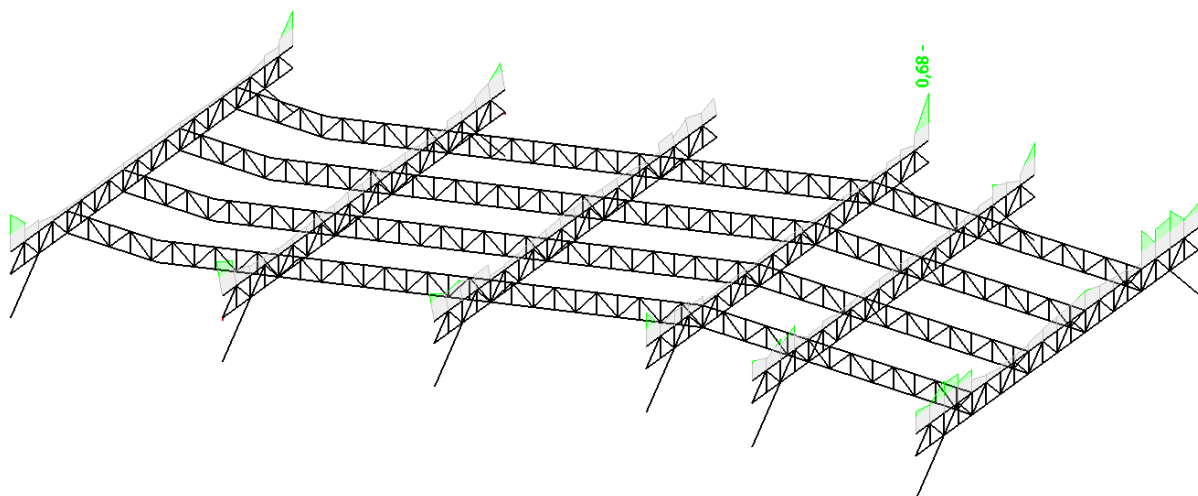

Slika 10.4. Prikaz iskoristivosti gornje pojasnice glavnog rešetkastog nosača



### 10.2.3. Rezne sile – donja pojasnica glavnog rešetkastog nosača

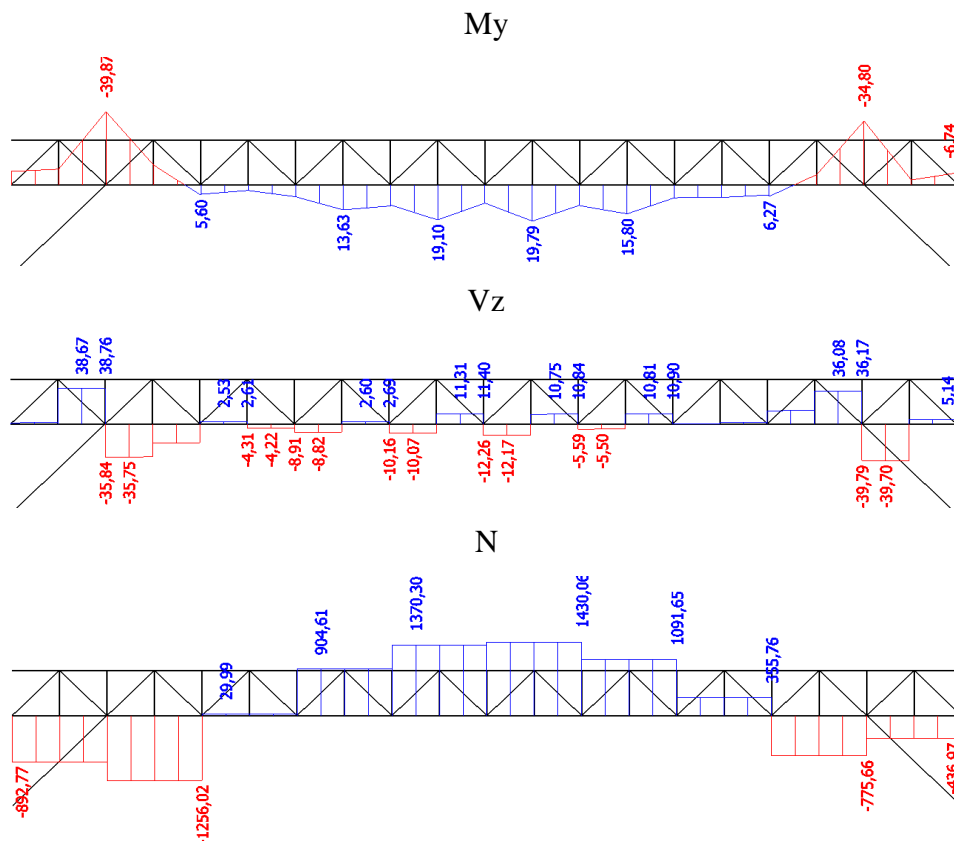

Slika 10.5. Prikaz reznih sila - donja pojasnica glavnog rešetkastog nosača

-poprečni presjek nosača

Name	Donja pojasnica glavnog rešetkastog nosača - tribina srednje dvorane		
Type	CFRHS180X180X10		
Source description	Rautaruukki Oyj / Structural Hollow Sections EN10219 / Ed.2007		
Item material	S 355		
Fabrication	cold formed		
Flexural buckling y-y	c		
Flexural buckling z-z	c		
Lateral torsional buckling	Default		
Use 2D FEM analysis	*		
A [m <sup>2</sup> ]	6,4570e-03		
A <sub>y</sub> , z [m <sup>2</sup> ]	3,2251e-03		3,2251e-03
I <sub>y</sub> , z [m <sup>4</sup> ]	3,0168e-05		3,0168e-05
I <sub>w</sub> [m <sup>6</sup> ], t [m <sup>4</sup> ]	1,5746e-07		5,0736e-05
W <sub>el</sub> y, z [m <sup>3</sup> ]	3,3520e-04		3,3520e-04
W <sub>pl</sub> y, z [m <sup>3</sup> ]	4,0351e-04		4,0351e-04
d <sub>y</sub> , z [mm]	0		0
c YUCS, ZUCS [mm]	90		90
α [deg]	0,00		
A <sub>L</sub> , D [m <sup>2</sup> /m]	6,7700e-01		1,2910e+00
M <sub>ply</sub> +, - [Nm]	1,43e+05		1,43e+05
M <sub>plz</sub> +, - [Nm]	1,43e+05		1,43e+05

Slika 10.6. Prikaz geometrijskih karakteristika nosača

### 10.2.4. Dimenzioniranje – donja pojasnica glavnog rešetkastog nosača

Member B1470	16,200 m	CFRHS180X180X10	S 355	GSN 26	0,94 -
--------------	----------	-----------------	-------	--------	--------

Note: EN 1993-1-3 article 1.1(3) specifies that this part does not apply to cold formed CHS and RHS sections. The default EN 1993-1-1 code check is executed instead of the EN 1993-1-3 code check.

Partial safety factors	
Gamma M0 for resistance of cross-sections	1,00
Gamma M1 for resistance to instability	1,00
Gamma M2 for resistance of net sections	1,25

Material		
Yield strength $f_y$	355,0	MPa
Ultimate strength $f_u$	510,0	MPa
Fabrication	Cold formed	

....SECTION CHECK:....

The critical check is on position 13.770 m

Internal forces	Calculated	Unit
N,Ed	-1256,02	kN
V <sub>y</sub> ,Ed	3,98	kN
V <sub>z</sub> ,Ed	-35,67	kN
T,Ed	2,30	kNm
M <sub>y</sub> ,Ed	-10,91	kNm
M <sub>z</sub> ,Ed	0,21	kNm

Classification for cross-section design

According to EN 1993-1-1 article 5.5.2

Classification of Internal Compression parts

According to EN 1993-1-1 Table 5.2 Sheet 1

Maximum width-to-thickness ratio	15,00
Class 1 Limit	26,85
Class 2 Limit	30,92
Class 3 Limit	37,17

=> Section classified as Class 1 for cross-section design

Compression check

According to EN 1993-1-1 article 6.2.4 and formula (6.9)

A	6,4570e-03	m <sup>2</sup>
N <sub>c,Rd</sub>	2292,24	kN
Unity check	0,55	-

Bending moment check for M<sub>y</sub>

According to EN 1993-1-1 article 6.2.5 and formula (6.12), (6.13)

W <sub>pl,y</sub>	4,0351e-04	m <sup>3</sup>
M <sub>pl,y,Rd</sub>	143,25	kNm
Unity check	0,08	-

Bending moment check for M<sub>z</sub>

According to EN 1993-1-1 article 6.2.5 and formula (6.12), (6.13)

W <sub>pl,z</sub>	4,0351e-04	m <sup>3</sup>
M <sub>pl,z,Rd</sub>	143,25	kNm
Unity check	0,00	-

Shear check for V<sub>y</sub>

According to EN 1993-1-1 article 6.2.6 and formula (6.17)

E <sub>t</sub>	1,20	
A <sub>v</sub>	3,2285e-03	m <sup>2</sup>
V <sub>pl,y,Rd</sub>	661,71	kN
Unity check	0,01	-

Shear check for V<sub>z</sub>

According to EN 1993-1-1 article 6.2.6 and formula (6.17)

E <sub>t</sub>	1,20	
A <sub>v</sub>	3,2285e-03	m <sup>2</sup>
V <sub>pl,z,Rd</sub>	661,71	kN
Unity check	0,05	-

Torsion check

According to EN 1993-1-1 article 6.2.7 and formula (6.23)

Tau <sub>t,Ed</sub>	4,0	MPa
Tau <sub>t,Rd</sub>	205,0	MPa
Unity check	0,02	-

Note: The unity check for torsion is lower than the limit value of 0,05. Therefore torsion is considered as

MN,y,Rd	83,15	kNm
Alpha	2,51	
MN,z,Rd	83,15	kNm
Beta	2,51	

Unity check (6.41) = 0,01 + 0,00 = 0,01 -

**Note:** Since the shear forces are less than half the plastic shear resistances their effect on the moment resistances is neglected.

The member satisfies the section check.

....:STABILITY CHECK:....

**Classification for member buckling design**

Decisive position for stability classification: 12,960 m

**Classification of Internal Compression parts**

According to EN 1993-1-1 Table 5.2 Sheet 1

Maximum width-to-thickness ratio	15,00
Class 1 Limit	26,85
Class 2 Limit	30,92
Class 3 Limit	35,82

=> Section classified as Class 1 for member buckling design

**Flexural Buckling check**

According to EN 1993-1-1 article 6.3.1.1 and formula (6.46)

Buckling parameters	yy	zz	
Sway type	sway	non-sway	
System length L	0,810	3,240	m
Buckling factor k	1,00	1,00	
Buckling length Lcr	0,810	3,240	m
Critical Euler load Ncr	95300,58	5956,29	kN
Slenderness Lambda	11,85	47,40	
Relative slenderness Lambda,rel	0,16	0,62	
Limit slenderness Lambda,rel,0	0,20	0,20	
Buckling curve	c	c	
Imperfection Alpha	0,49	0,49	
Reduction factor Chi	1,00	0,77	
Buckling resistance Nb,Rd	2292,24	1772,48	kN

**Flexural Buckling verification**

Cross-section area A	6,4570e-03	m <sup>2</sup>
Buckling resistance Nb,Rd	1772,48	kN
Unity check	0,71	-

**Torsional(-Flexural) Buckling check**

According to EN 1993-1-1 article 6.3.1.1 and formula (6.46)

**Note:** The cross-section concerns a RHS section which is not susceptible to Torsional(-Flexural) Buckling.

**Lateral Torsional Buckling check**

According to EN 1993-1-1 article 6.3.2.1

**Note:** The cross-section concerns an RHS section with  $h / b < 10 / \text{Lambda,rel,z}$ .

This section is thus not susceptible to Lateral Torsional Buckling.

**Bending and axial compression check**

According to EN 1993-1-1 article 6.3.3 and formula (6.61),(6.62)

**Bending and axial compression check parameters**

Interaction method	alternative method 1	
Cross-section area A	6,4570e-03	m <sup>2</sup>
Cross-section plastic modulus Wpl,y	4,0351e-04	m <sup>3</sup>
Cross-section plastic modulus Wpl,z	4,0351e-04	m <sup>3</sup>
Design compression force N,Ed	1256,02	kN
Design bending moment (maximum) My,Ed	-39,87	kNm
Design bending moment (maximum) Mz,Ed	9,88	kNm
Characteristic compression resistance N,Rk	2292,24	kN
Characteristic moment resistance My,Rk	143,25	kNm
Characteristic moment resistance Mz,Rk	143,25	kNm
Reduction factor Chi,y	1,00	
Reduction factor Chi,z	0,77	
Reduction factor Chi,LT	1,00	
Interaction factor k,yy	0,94	
Interaction factor k,yz	0,65	
Interaction factor k,zy	0,58	
Interaction factor k,zz	0,96	

Maximum moment My,Ed is derived from beam B1470 position 14,580 m.

Maximum moment Mz,Ed is derived from beam B1470 position 16,200 m.

**Interaction method 1 parameters**

Critical Euler load N,cr,y	95300,58	kN
Critical Euler load N,cr,z	5956,29	kN
Elastic critical load N,cr,T	441871,80	kN
Cross-section plastic modulus Wpl,y	4,0351e-04	m <sup>3</sup>
Cross-section elastic modulus Wel,y	3,3520e-04	m <sup>3</sup>
Cross-section plastic modulus Wpl,z	4,0351e-04	m <sup>3</sup>
Cross-section elastic modulus Wel,z	3,3520e-04	m <sup>3</sup>

\*Student version\* \*Student version\* \*Student version\* \*Student version\* \*Student version\* \*Student version\* \*Student version\* \*Student version\* \*S

Interaction method 1 parameters		
*Student version*	*Student version*	*Student version*
Second moment of area Iy	3,0168e-05	m <sup>4</sup>
Second moment of area Iz	3,0168e-05	m <sup>4</sup>
Torsional constant It	5,0736e-05	m <sup>4</sup>
Method for equivalent moment factor C,my,0	Table A.2 Line 2 (General)	
Design bending moment (maximum) My,Ed	-39,87	kNm
Maximum relative deflection delta,z	0,3	mm
Equivalent moment factor C,my,0	1,00	
Method for equivalent moment factor C,mz,0	Table A.2 Line 2 (General)	
Design bending moment (maximum) Mz,Ed	9,88	kNm
Maximum relative deflection delta,y	-0,8	mm
Equivalent moment factor C,mz,0	0,89	
Factor mu,y	1,00	
Factor mu,z	0,94	
Factor epsilon,y	0,61	
Factor a,LT	0,00	
Critical moment for uniform bending Mcr,0	4959,17	kNm
Relative slenderness Lambda,rel,0	0,17	
Limit relative slenderness Lambda,rel,0,lim	0,22	
Equivalent moment factor C,my	1,00	
Equivalent moment factor C,mz	0,89	
Equivalent moment factor C,mLT	1,00	
Factor b,LT	0,00	
Factor c,LT	0,00	
Factor d,LT	0,00	
Factor e,LT	0,00	
Factor w,y	1,20	
Factor w,z	1,20	
Factor n,pl	0,55	
Maximum relative slenderness Lambda,rel,max	0,62	
Factor C,yy	1,07	
Factor C,yz	1,04	
Factor C,zy	0,99	
Factor C,zz	1,11	

Unity check (6.61) =  $0,55 + 0,26 + 0,04 = 0,85$  -

Unity check (6.62) =  $0,71 + 0,16 + 0,07 = 0,94$  -

The member satisfies the stability check.

-iskoristivost elementa na GSN – 94 %

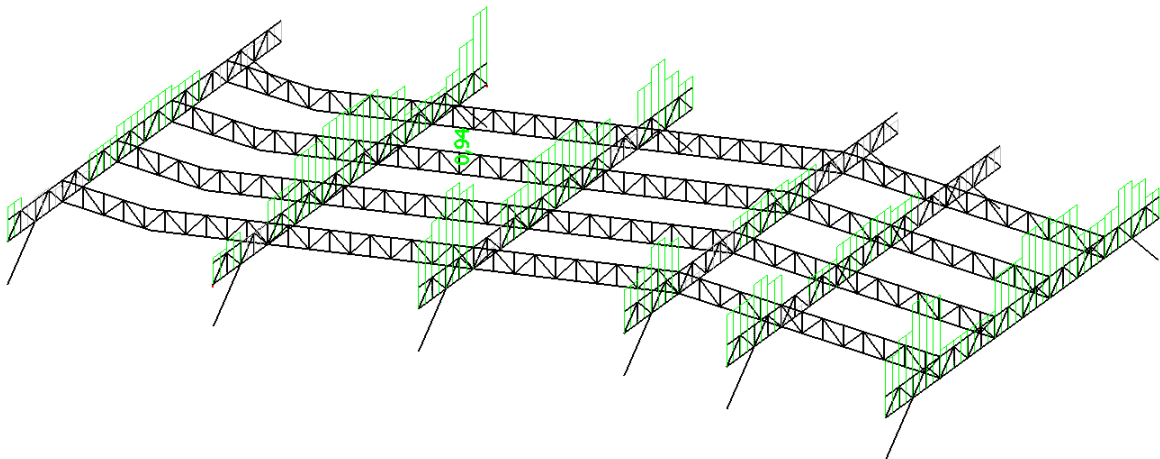

Slika 10.7. Prikaz iskoristivosti donje pojasnice glavnog rešetkastog nosača

### 10.2.5. Rezne sile – ispuna glavnog rešetkastog nosača

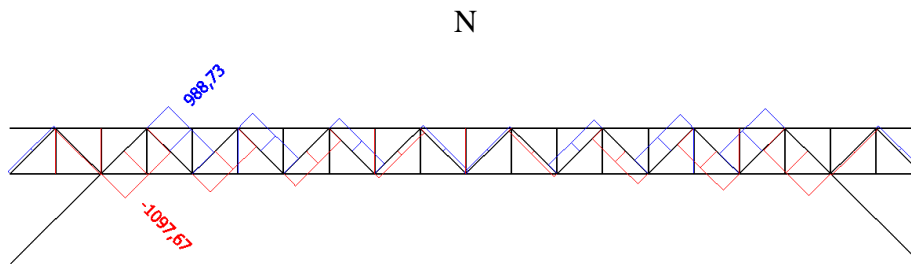

Slika 10.8. Prikaz reznih sila – ispuna glavnog rešetkastog nosača

-poprečni presjek nosača

Name	Ispuna glavnog rešetkastog nosača - tribina srednje dvorane	
Type	CFRHS120X120X8	
Source description	Rautaruukki Oyj / Structural Hollow Sections EN10219 / Ed.2007	
Item material	S 355	
Fabrication	cold formed	
Flexural buckling y-y	c	
Flexural buckling z-z	c	
Lateral torsional buckling	Default	
Use 2D FEM analysis	*	
A [m <sup>2</sup> ]	3,3640e-03	
A <sub>y, z</sub> [m <sup>2</sup> ]	1,6801e-03	1,6801e-03
I <sub>y, z</sub> [m <sup>4</sup> ]	6,7688e-06	6,7688e-06
I <sub>w</sub> [m <sup>6</sup> ], I <sub>t</sub> [m <sup>4</sup> ]	1,6589e-08	1,1629e-05
W <sub>el y, z</sub> [m <sup>3</sup> ]	1,1281e-04	1,1281e-04
W <sub>pl y, z</sub> [m <sup>3</sup> ]	1,3781e-04	1,3781e-04
d <sub>y, z</sub> [mm]	0	
c <sub>YUCS, ZUCS</sub> [mm]	60	60
α [deg]	0,00	
A <sub>L, D</sub> [m <sup>2</sup> /m]	4,4600e-01	8,4081e-01
M <sub>ply +, -</sub> [Nm]	4,88e+04	4,88e+04
M <sub>plz +, -</sub> [Nm]	4,88e+04	4,88e+04

Slika 10.9. Prikaz geometrijskih karakteristika nosača

-iskoristivost elementa na GSN – 99 %

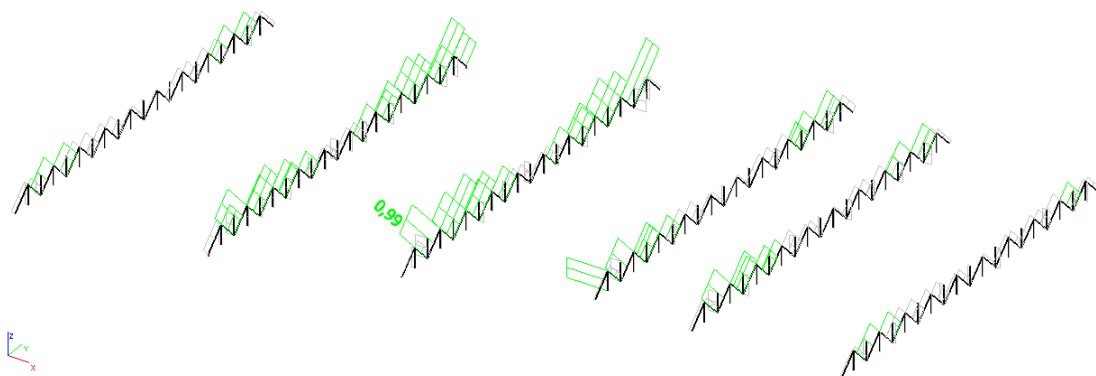

Slika 10.10. Prikaz iskoristivosti ispune glavnog rešetkastog nosača

### 10.2.6. Dimenzioniranje – ispunja glavnog rešetkastog nosača

Member B1495	1,138 m	CFRHS120X120X8	S 355	GSN 2	0,99 -
--------------	---------	----------------	-------	-------	--------

Note: EN 1993-1-3 article 1.1(3) specifies that this part does not apply to cold formed CHS and RHS sections. The default EN 1993-1-1 code check is executed instead of the EN 1993-1-3 code check.

Partial safety factors	
Gamma M0 for resistance of cross-sections	1,00
Gamma M1 for resistance to instability	1,00
Gamma M2 for resistance of net sections	1,25

Material	
Yield strength fy	355,0 MPa
Ultimate strength fu	510,0 MPa
Fabrication	Cold formed

....:SECTION CHECK:....

The critical check is on position 0.000 m

Internal forces	Calculated	Unit
N,Ed	-1101,24	kN
Vy,Ed	0,00	kN
Vz,Ed	0,00	kN
T,Ed	0,00	kNm
My,Ed	0,00	kNm
Mz,Ed	0,00	kNm

**Classification for cross-section design**

According to EN 1993-1-1 article 5.5.2

**Classification of Internal Compression parts**

According to EN 1993-1-1 Table 5.2 Sheet 1

Maximum width-to-thickness ratio	12,00
Class 1 Limit	26,85
Class 2 Limit	30,92
Class 3 Limit	34,17

=> Section classified as Class 1 for cross-section design

**Compression check**

According to EN 1993-1-1 article 6.2.4 and formula (6.9)

A	3,3640e-03	m <sup>2</sup>
Nc,Rd	1194,22	kN
Unity check	0,92	-

The member satisfies the section check.

....:STABILITY CHECK:....

**Classification for member buckling design**

Decisive position for stability classification: 0.000 m

**Classification of Internal Compression parts**

According to EN 1993-1-1 Table 5.2 Sheet 1

Maximum width-to-thickness ratio	12,00
Class 1 Limit	26,85
Class 2 Limit	30,92
Class 3 Limit	34,17

=> Section classified as Class 1 for member buckling design

**Flexural Buckling check**

According to EN 1993-1-1 article 6.3.1.1 and formula (6.46)

Buckling parameters	yy	zz	
Sway type	sway	non-sway	
System length L	1,138	1,138	m
Buckling factor k	1,00	1,00	
Buckling length Lcr	1,138	1,138	m
Critical Euler load Ncr	10824,11	10824,65	kN
Slenderness Lambda	25,38	25,38	
Relative slenderness Lambda,rel	0,33	0,33	
Limit slenderness Lambda,rel,0	0,20	0,20	
Buckling curve	c	c	
Imperfection Alpha	0,49	0,49	
Reduction factor Chi	0,93	0,93	
Buckling resistance Nb,Rd	1113,82	1113,82	kN

**Flexural Buckling verification**

Cross-section area A	3,3640e-03	m <sup>2</sup>
Buckling resistance Nb,Rd	1113,82	kN
Unity check	0,99	-

**Note:** The cross-section concerns a RHS section which is not susceptible to Torsional(-Flexural) Buckling. The member satisfies the stability check.

### 10.2.7. Rezne sile – podupora glavnog rešetkastog nosača

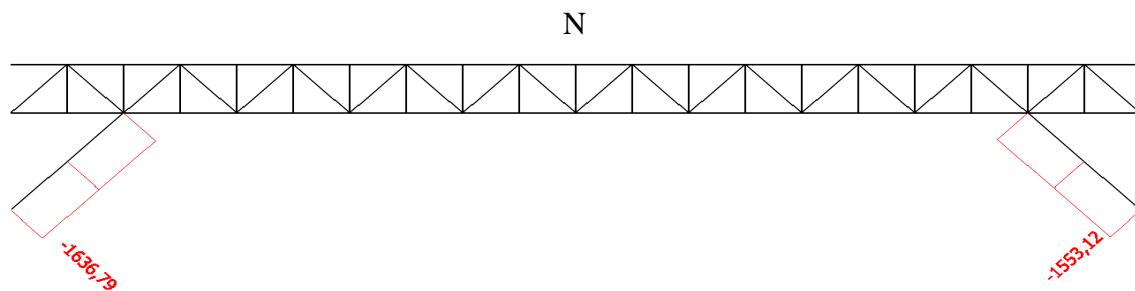

Slika 10.11. Prikaz reznih sila – podupora glavnog rešetkastog nosača

-poprečni presjek nosača

Name	Podupora donje pojasnice glavnog rešetkastog nosača - tribina srednje dvorane		
Type	CFRHS150X150X12.5		
Source description	Rautaruukki Oyj / Structural Hollow Sections EN10219 / Ed.2007		
Item material	S 355		
Fabrication	cold formed		
Flexural buckling y-y	c		
Flexural buckling z-z	c		
Lateral torsional buckling	Default		
Use 2D FEM analysis	x		
A [m <sup>2</sup> ]	6,2040e-03		
A <sub>y</sub> , z [m <sup>2</sup> ]	3,1067e-03		3,1067e-03
I <sub>y</sub> , z [m <sup>4</sup> ]	1,8174e-05		1,8174e-05
I <sub>w</sub> [m <sup>6</sup> ], t [m <sup>4</sup> ]	7,9102e-08		3,3208e-05
W <sub>el</sub> y, z [m <sup>3</sup> ]	2,4233e-04		2,4233e-04
W <sub>pl</sub> y, z [m <sup>3</sup> ]	3,0558e-04		3,0558e-04
d <sub>y</sub> , z [mm]	0		0
c <sub>YUCS</sub> , ZUCS [mm]	75		75
α [deg]	0,00		
A <sub>L</sub> , D [m <sup>2</sup> /m]	5,3600e-01		9,9249e-01
M <sub>ply</sub> +, - [Nm]	1,09e+05		1,09e+05
M <sub>plz</sub> +, - [Nm]	1,09e+05		1,09e+05

Slika 10.12. Prikaz geometrijskih karakteristika nosača

iskoristivost elementa na GSN – 91 %

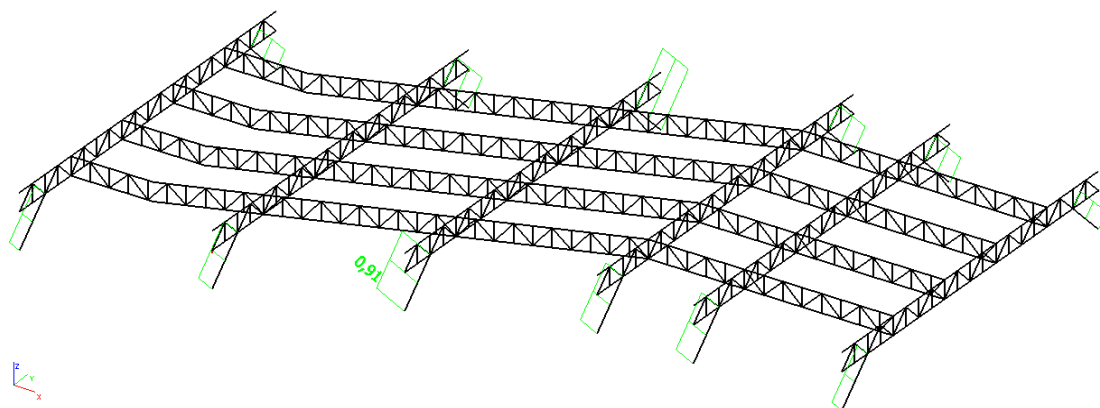

Slika 10.13. Prikaz iskoristivosti podupore glavnog rešetkastog nosača

### 10.2.8. Dimenzioniranje – podupora glavnog rešetkastog nosača

Member B5496	2,277 m	CFRHS150X150X12.5	S 355	GSN 2	0,91 -
--------------	---------	-------------------	-------	-------	--------

Note: EN 1993-1-3 article 1.1(3) specifies that this part does not apply to cold formed CHS and RHS sections. The default EN 1993-1-1 code check is executed instead of the EN 1993-1-3 code check.

Partial safety factors	
Gamma M0 for resistance of cross-sections	1,00
Gamma M1 for resistance to instability	1,00
Gamma M2 for resistance of net sections	1,25

Material	
Yield strength fy	355,0 MPa
Ultimate strength fu	510,0 MPa
Fabrication	Cold formed

....:SECTION CHECK:....

The critical check is on position 2.277 m

Internal forces	Calculated	Unit
N,Ed	-1636,79	kN
Vy,Ed	0,00	kN
Vz,Ed	0,00	kN
T,Ed	0,00	kNm
My,Ed	0,00	kNm
Mz,Ed	0,00	kNm

Classification for cross-section design

According to EN 1993-1-1 article 5.5.2

Classification of Internal Compression parts

According to EN 1993-1-1 Table 5.2 Sheet 1

Maximum width-to-thickness ratio	9,00
Class 1 Limit	26,85
Class 2 Limit	30,92
Class 3 Limit	34,17

=> Section classified as Class 1 for cross-section design

Compression check

According to EN 1993-1-1 article 6.2.4 and formula (6.9)

A	6,2040e-03	m <sup>2</sup>
Nc,Rd	2202,42	kN
Unity check	0,74	-

The member satisfies the section check.

....:STABILITY CHECK:....

Classification for member buckling design

Decisive position for stability classification: 0,000 m

Classification of Internal Compression parts

According to EN 1993-1-1 Table 5.2 Sheet 1

Maximum width-to-thickness ratio	9,00
Class 1 Limit	26,85
Class 2 Limit	30,92
Class 3 Limit	34,17

=> Section classified as Class 1 for member buckling design

Flexural Buckling check

According to EN 1993-1-1 article 6.3.1.1 and formula (6.46)

Buckling parameters	yy	zz
Sway type	sway	non-sway
System length L	2,277	2,277
Buckling factor k	1,00	1,00
Buckling length Lcr	2,277	2,277
Critical Euler load Ncr	7265,75	7266,12
Slenderness Lambda	42,07	42,07
Relative slenderness Lambda,rel	0,55	0,55
Limit slenderness Lambda,rel,0	0,20	0,20
Buckling curve	c	c
Imperfection Alpha	0,49	0,49
Reduction factor Chi	0,81	0,81
Buckling resistance Nb,Rd	1793,40	1793,41

Flexural Buckling verification	
Cross-section area A	6,2040e-03 m <sup>2</sup>
Buckling resistance Nb,Rd	1793,40 kN
Unity check	0,91

Note: The cross-section concerns a RHS section which is not susceptible to Torsional(-Flexural) Buckling.

The member satisfies the stability check.



10.2.9. Rezne sile – gornja pojasnica sekundarnog rešetkastog nosača

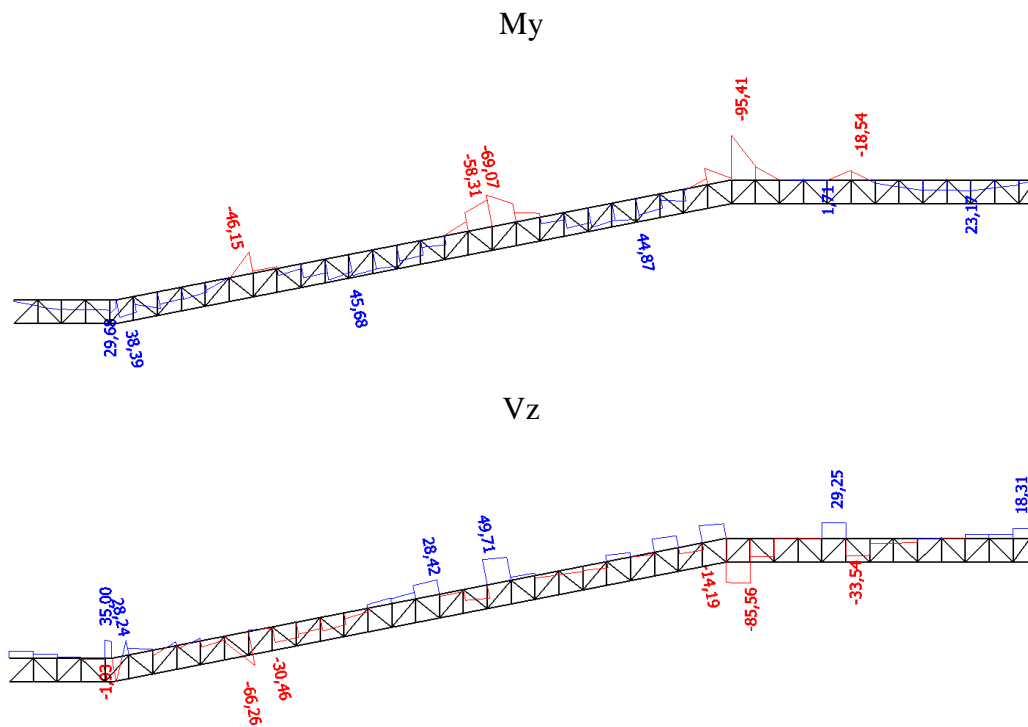

Slika 10.14. Prikaz reznih sila - gornja pojasnica sekundarnog rešetkastog nosača

-poprečni presjek nosača

Name	Gornja pojasnica sekundarnog rešetkastog nosača - tribina srednje dvorane	
Type	HEB200	
Source description	Profil Arbed / Structural shapes / Edition Octobre 1995	
Item material	S 355	
Fabrication	rolled	
Flexural buckling y-y	b	
Flexural buckling z-z	c	
Lateral torsional buckling	Default	
Use 2D FEM analysis	*	
A [m²]	7,8080e-03	
A y, z [m²]	5,7750e-03	1,9112e-03
I y, z [m⁴]	5,6960e-05	2,0030e-05
I w [m⁶], t [m⁴]	1,7112e-07	5,9280e-07
Wey, z [m³]	5,6960e-04	2,0030e-04
Wply, z [m³]	6,4250e-04	3,0580e-04
d y, z [mm]	0	0
c YUCS, ZUCS [mm]	100	100
α [deg]	0,00	
A L, D [m²/m]	1,1500e+00	1,1510e+00
Mply +, - [Nm]	2,28e+05	2,28e+05
Mpz +, - [Nm]	1,09e+05	1,09e+05

Slika 10.15. Prikaz geometrijskih karakteristika nosača

## 10.2.10. Dimenzioniranje – gornja pojasnica sekundarnog rešetkastog nosača

SCIAENGINEER

### Composite Beam - Final stage

Linear calculation  
 Class: All ULS  
 Extreme 1D: Global  
 Selection: B4987

### Composite beam verification

for beam B4987 at section 4.05 m, in accordance with EC EN 1994-1-1

#### 1. Geometry data

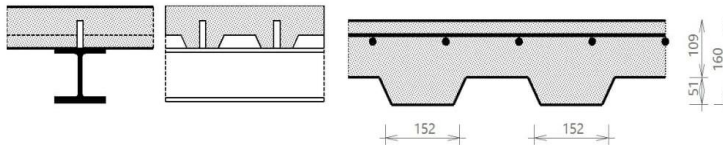

#### Continuous beam

Length of the current span	$L = 4.05$ m
Length of previous span	$L_{\text{previous}} = 6.25$ m
Beam spacing at the left	$L_{\text{left}} = 3.24$ m
Beam spacing at the right	$L_{\text{right}} = 3.24$ m
Checked section	$d_x = 4.05$ m

Warning: For a continuous beam, intermediate buckling supports y-y are ignored in both the calculation of the effective width for the analysis model and the check.

#### 2. Cross-section & materials

##### 2.1 Steel section properties

##### 2.1.1 Cross-section

Cross-section	HEB200
Height	$h_a = 200$ mm
Width	$b = 200$ mm
Web thickness	$t_w = 9$ mm
Flange thickness	$t_f = 15$ mm
Radius	$r = 18$ mm
Area	$A_a = 7808$ mm <sup>2</sup>
Moment of inertia	$I_y = 57 \cdot 10^6$ mm <sup>4</sup>
Radius of gyration	$i_z = 51$ mm
Plastic section modulus	$W_{\text{ply}} = 642500$ mm <sup>3</sup>

##### 2.1.2 Material

Steel grade	S 355
Yield strength	$f_{yb} = 355$ MPa
Ultimate strength	$f_{ub} = 490$ MPa
E modulus	$E_b = 210000$ MPa

##### 2.1.3 Cross-section classification

$$\epsilon = \sqrt{\frac{235}{355}} = 0.814$$

(EN 1993-1-1 §5.6 Tab. 5.2)

##### 2.1.3.1 Flange in compression

$$c_f = \frac{b - t_w - 2 \cdot r}{2} = \frac{200 \text{ mm} - 9 \text{ mm} - 2 \cdot 18 \text{ mm}}{2} = 77.5 \text{ mm}$$

$$\frac{c_f}{t_f} \leq 9 \cdot \epsilon$$

$$\frac{77.5 \text{ mm}}{15 \text{ mm}} \leq 9 \cdot 0.814$$

$$5.17 \leq 7.32$$

OK

Flange classified as Class 1.

Student version

2.1.3.2 Web in bending

$$c_w = h_a - 2 \cdot t_f - 2 \cdot r = 200 \text{ mm} - 2 \cdot 15 \text{ mm} - 2 \cdot 18 \text{ mm} = 134 \text{ mm}$$

$$\alpha_{cl} = 0.5$$

$$\frac{c_w}{t_w} \leq \frac{36 \cdot \epsilon}{\alpha_{cl}}$$

$$\frac{134 \text{ mm}}{9 \text{ mm}} \leq \frac{36 \cdot 0.814}{0.5}$$

$$14.9 \leq 58.6$$

OK

Web classified as Class 1.

**Cross-section classified as Class 1**

Cross-section Class OK.

**2.2 Concrete slab with profiled sheeting****2.2.1 Concrete slab**2.2.1.1 SlabTotal height of the slab  $h_s = 160 \text{ mm}$ 2.2.1.2 Material

Concrete class C30/37

Characteristic strength  $f_{ck} = 30 \text{ MPa}$ E modulus  $E_{cm} = 32800 \text{ MPa}$ **2.2.2 Profiled steel sheeting**

Sheeting with ribs transverse to the supporting beams

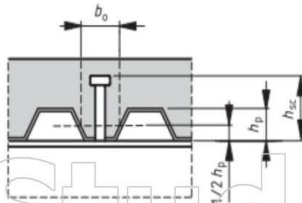

Name	Vulcraft 2 VLI 20
Depth of the ribs	$h_p = 50.8 \text{ mm}$
Height of full concrete	$h_c = 109.2 \text{ mm}$
Height of the re-entrant stiffener	$h_d = 0 \text{ mm}$
Spacing of the ribs	$b_s = 304.8 \text{ mm}$
Top width of the rib	$b_r = 127 \text{ mm}$
Bottom width of the rib	$b_b = 127 \text{ mm}$
Mean width of the ribs	$b_{0,rib} = 152.4 \text{ mm}$
Thickness of the sheeting	$t_p = 0.9093 \text{ mm}$

**2.2.3 Shear connectors**2.2.3.1 Geometry

Name	H110
Diameter	$d_s = 25 \text{ mm}$
Nominal height	$h_{nom} = 110 \text{ mm}$
As-welded height	$h_{sc} = 105 \text{ mm}$
Amount per trough or section	$n_r = 1$

2.2.3.2 Material

Steel grade	S 355
Ultimate strength	$f_{us} = 490 \text{ MPa}$

**2.2.4 Reinforcement**2.2.4.1 Geometry

Longitudinal bar diameter	$d_l = 16 \text{ mm}$
Longitudinal bar spacing	$s_l = 150 \text{ mm}$
Longitudinal bar cover	$c_l = 30 \text{ mm}$
Transverse bar diameter	$d_t = 16 \text{ mm}$
Transverse bar spacing	$s_t = 150 \text{ mm}$
Transverse bar cover	$c_t = 46 \text{ mm}$

2.2.4.2 Material

Material	B 500A
Characteristic yield strength	$f_{ykr} = 500 \text{ MPa}$

**3. Design values of loads**

Load Name : GSN 2

Content of combination : 1.35\*g-vlastitežina+1.35\*dg-dodatnostalno+  
1.80\*q-promjenjivoopterećenje+1.35\*g-vlastitežina\_dryconcrete

Bending moment  $M_{Ed,comp} = -97.521$  kNm

Shear force  $V_{Ed,comp} = -85.095$  kN

**4. Partial safety factors**

Steel section  $\gamma_{M0} = 1$   
 $\gamma_{M1} = 1$   
Shear connectors  $\gamma_V = 1.25$   
Concrete  $\gamma_C = 1.5$   
Reinforcement  $\gamma_S = 1.15$

**5. ULS check of the Final stage**

**5.1 Shear connection**

**5.1.1 Design resistance of shear connectors**

**5.1.1.1 Shear connector in a solid slab**

$$\frac{h_{sc}}{d_s} > 4$$

$$4.2 > 4$$

$$\alpha = 1$$

$$f_{us} = \min(490; 450) \text{ MPa}$$

$$f_{us} = 450 \text{ MPa}$$

$$P_{Rd,solid,1} = \frac{0.8 \cdot f_{us} \cdot \left(\frac{\pi \cdot d_s^2}{4}\right)}{\gamma_V} = \frac{0.8 \cdot 450 \text{ MPa} \cdot \left(\frac{3.14 \cdot 25 \text{ mm}^2}{4}\right)}{1.25} = 141 \text{ kN}$$

$$P_{Rd,solid,2} = \frac{0.29 \cdot \alpha \cdot d_s^2 \cdot \sqrt{f_{ck} \cdot E_{cm}}}{\gamma_V} = \frac{0.29 \cdot 1 \cdot 25 \text{ mm}^2 \cdot \sqrt{30 \text{ MPa} \cdot 32800 \text{ MPa}}}{1.25} = 144 \text{ kN}$$

$$P_{Rd,solid} = \min(P_{Rd,solid,1}; P_{Rd,solid,2}) = \min(141 \text{ kN}; 144 \text{ kN}) = 141 \text{ kN}$$

**5.1.1.2 Shear connector in profiled sheeting**

Sheeting with ribs transverse to the supporting beams

$$k_t = \frac{0.7}{\sqrt{n_r}} \cdot \left(\frac{b_{0,rib}}{h_p}\right) \cdot \left(\frac{h_{sc}}{h_p} - 1\right) = \frac{0.7}{\sqrt{1}} \cdot \left(\frac{152 \text{ mm}}{50.8 \text{ mm}}\right) \cdot \left(\frac{105 \text{ mm}}{50.8 \text{ mm}} - 1\right) = 2.24$$

$$k_{t,max} = 0.85$$

$$k_t = \max(0; \min(k_t; k_{t,max})) = \max(0; \min(2.24; 0.85)) = 0.85$$

$$P_{Rd} = k_t \cdot P_{Rd,solid} = 0.85 \cdot 141 \text{ kN} = 120 \text{ kN}$$

Warning: The conditions given by EN 1994-1-1 Art.6.6.4.2 (3) are not fulfilled.

**5.1.2 Degree of shear connection**

**5.1.2.1 Determination of  $b_{eff}$  of the concrete flange and length  $L_e$**

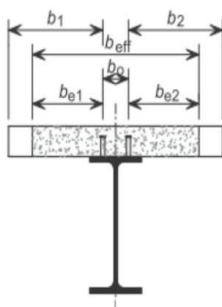

The effective width at the end support

$$L_{e0} = 0.85 \cdot L_2 = 0.85 \cdot 4.05 \text{ m} = 3.44 \text{ m}$$

**Left side of the beam**

$$b_1 = \frac{L_{\text{perp, left}}}{2} - \frac{b_0}{2} = \frac{3,24 \text{ m}}{2} - \frac{0 \text{ mm}}{2} = 1,62 \text{ m}$$

$$b_{e10} = \min\left(\frac{L_{e0}}{8}; b_1\right) = \min\left(\frac{3,44 \text{ m}}{8}; 1,62 \text{ m}\right) = 0,43 \text{ m}$$

$$b_{e11} = \min\left(\frac{L_{e1}}{8}; b_1\right) = \min\left(\frac{0 \text{ m}}{8}; 1,62 \text{ m}\right) = 0 \text{ m}$$

$$b_{e12} = \min\left(\frac{L_{e2}}{8}; b_1\right) = \min\left(\frac{0 \text{ m}}{8}; 1,62 \text{ m}\right) = 0 \text{ m}$$

**Right side of the beam**

$$b_2 = \frac{L_{\text{perp, right}}}{2} - \frac{b_0}{2} = \frac{3,24 \text{ m}}{2} - \frac{0 \text{ mm}}{2} = 1,62 \text{ m}$$

$$b_{e20} = \min\left(\frac{L_{e0}}{8}; b_2\right) = \min\left(\frac{3,44 \text{ m}}{8}; 1,62 \text{ m}\right) = 0,43 \text{ m}$$

$$b_{e21} = \min\left(\frac{L_{e1}}{8}; b_2\right) = \min\left(\frac{0 \text{ m}}{8}; 1,62 \text{ m}\right) = 0 \text{ m}$$

$$b_{e22} = \min\left(\frac{L_{e2}}{8}; b_2\right) = \min\left(\frac{0 \text{ m}}{8}; 1,62 \text{ m}\right) = 0 \text{ m}$$

**Calculation of  $b_{\text{eff},0}$**

$$b_{\text{eff},0} = b_0 + b_{e10} \cdot \beta_1 + b_{e20} \cdot \beta_2 = 0 \text{ mm} + 0,43 \text{ m} \cdot 0,75 + 0,43 \text{ m} \cdot 0,75 = 0,645 \text{ m}$$

**Calculation of  $b_{\text{eff}}$**

$$b_{\text{eff}} = b_{\text{eff},0} = 0,645 \text{ m}$$

**Determination of  $L_e$**

$$L_e = L_{e0} = 3,44 \text{ m}$$

**5.1.2.2 Minimum degree of shear connection**

Warning: Conditions given by EN 1994-1-1 Art. 6.6.1.2 (3) are not fulfilled.

$$\eta_{\text{min,calc}} = 1 - \frac{355}{f_{yb}} \cdot (0,75 - 0,03 \cdot L_e)$$

$$\eta_{\text{min,calc}} = 1 - \frac{355}{355} \cdot (0,75 - 0,03 \cdot 3,44 \text{ m}) = 0,35$$

$$\eta_{\text{min}} = \max(\eta_{\text{min,calc}}; 0,4) = \max(0,35; 0,4) = 0,4$$

**5.1.2.3 Degree of shear connection present**

**5.1.2.3.1 Tension resistance of the reinforcement**

$$A_s = \frac{b_{\text{eff}}}{s_l} \cdot \left(\frac{d_l^2}{4}\right) \cdot \pi = \frac{0,645 \text{ m}}{150 \text{ mm}} \cdot \left(\frac{16 \text{ mm}^2}{4}\right) \cdot 3,14 = 865 \text{ mm}^2$$

$$F_s = \frac{A_s \cdot f_{yk,r}}{\gamma_s} = \frac{865 \cdot 10^{-6} \cdot 500 \cdot 10^6}{1,15} = 376 \text{ kN}$$

**5.1.2.3.2 Tension resistance of the steel member**

$$N_{pl,a} = f_{yb} \cdot A_a = 355 \text{ MPa} \cdot 7808 \text{ mm}^2 = 2771,84 \text{ kN}$$

$$N_{c,r} = \min(F_s; N_{pl,a}) = \min(376 \text{ kN}; 2771,84 \text{ kN}) = 376,17 \text{ kN}$$

**5.1.2.3.3 Resistance of the shear connectors**

Number of full ribs available per length L<sub>s</sub>

$$n_{rib} = \frac{L_s}{b_s} = \frac{3.44 \text{ m}}{305 \text{ mm}}$$

$$n_{rib} = 11$$

$$l_s = b_s \cdot \text{trough} = 305 \text{ mm} \cdot 1 = 305 \text{ mm}$$

Number of shear studs available per length L<sub>s</sub>/2

$$n_{sp} = \frac{0.5 \cdot n_{rib} \cdot n_r}{\text{trough}} = \frac{0.5 \cdot 11 \cdot 1}{1} = 5.5$$

$$N_c = n_{sp} \cdot P_{Rd} = 5.5 \cdot 120166 = 660.91 \text{ kN}$$

$$\eta = \min \left( \frac{N_c}{N_{c,f}}; 1 \right) = \min \left( \frac{660.91 \text{ kN}}{376.17 \text{ kN}}; 1 \right) = 1$$

$$\eta \geq \eta_{min}$$

$$1 \geq 0.4$$

OK

The shear connection degree is adequate.

**5.2 Cross-sectional resistance of the composite beam**

**5.2.1 Shear buckling**

$$h_w = h_a - 2 \cdot t_f = 200 \text{ mm} - 2 \cdot 15 \text{ mm} = 170 \text{ mm}$$

$$\eta_{sb} = 1.2$$

$$\frac{h_w}{t_w} \leq \frac{72 \cdot \epsilon}{\eta_{sb}}$$

$$\frac{170 \text{ mm}}{9 \text{ mm}} \leq \frac{72 \cdot 0.814}{1.2}$$

$$18.9 \leq 48.8$$

OK

The shear buckling resistance of the web does not need to be verified.

**5.2.2 Vertical shear**

The resistance to vertical shear should be taken as the resistance of the structural steel section.

$$A_v = A_s = 2 \cdot b \cdot t_f + (t_w + 2 \cdot r) \cdot t_f$$

$$= 7.81 \cdot 10^{-3} - 2 \cdot 0.2 \cdot 0.015 + (9 \cdot 10^{-3} + 2 \cdot 0.018) \cdot 0.015 = 2483 \text{ mm}^2$$

$$A_{v,min} = \eta_{sb} \cdot h_w \cdot t_w = 1.2 \cdot 0.17 \cdot 9 \cdot 10^{-3} = 1836 \text{ mm}^2$$

$$A_v \geq A_{v,min}$$

$$2483 \text{ mm}^2 \geq 1836 \text{ mm}^2$$

$$V_{pl,Rd} = \frac{A_v \cdot f_{yb}}{\sqrt{3} \cdot \gamma_{M0}} = \frac{2483 \text{ mm}^2 \cdot 355 \cdot 10^6}{\sqrt{3} \cdot 1} = 509 \text{ kN}$$

$$UC_{comp,V} = \frac{abs(V_{Ed,comp})}{V_{pl,Rd}} = \frac{abs(-85.095 \text{ kN})}{509 \text{ kN}} = 0.17$$

The shear resistance of the section is adequate.

**5.2.3 Bending moment**

**5.2.3.1 Longitudinal reinforcement**

**5.2.3.1.1 Centre of composite section**

For buildings not intended mainly for storage the effects of creep in concrete beams may be taken into account by using an effective E modulus E<sub>ceff</sub> = E<sub>cm</sub> / 2.

$$E_{ceff} = \frac{E_{cm}}{2} = \frac{32800 \text{ MPa}}{2} = 16400 \text{ MPa}$$

$$\eta_E = \frac{E_b}{E_{ceff}} = \frac{210000 \text{ MPa}}{16400 \text{ MPa}} = 12.8$$

$$y_d = \frac{A_a \cdot \left( \frac{h_a}{2} \right) + \left( \frac{1}{\eta_E} \right) \cdot b_{eff} \cdot (h_c - h_d) \cdot \left( h_a + h_s - \frac{h_c - h_d}{2} \right)}{A_a + \left( \frac{1}{\eta_E} \right) \cdot b_{eff} \cdot (h_c - h_d)}$$

$$= \frac{7.81 \cdot 10^{-3} \cdot \left( \frac{0.2}{2} \right) + \left( \frac{1}{12.8} \right) \cdot 0.645 \cdot (0.109 - 0) \cdot \left( 0.2 + 0.16 - \frac{0.109 - 0}{2} \right)}{7.81 \cdot 10^{-3} + \left( \frac{1}{12.8} \right) \cdot 0.645 \cdot (0.109 - 0)} = 185 \text{ mm}$$

Student version

5.2.3.1.2 Degree of reinforcement

$$A_s = \frac{b_{eff} \cdot \left(\frac{d_f}{4}\right)^2 \cdot \pi}{s_l} = \frac{0.645 \text{ m} \cdot \left(\frac{16 \text{ mm}}{4}\right)^2}{150 \text{ mm}} \cdot \pi = 3.14 = 865 \text{ mm}^2$$

$$A_c = b_{eff} \cdot (h_c + h_d) = 0.645 \cdot (0.109 - 0) = 70485 \text{ mm}^2$$

$$z_0 = \left(h_a + h_s - \frac{h_c - h_d}{2}\right) - y_d = \left(0.2 + 0.16 - \frac{0.109 - 0}{2}\right) - 0.185 = 120 \text{ mm}$$

$$k_c = \min\left(\frac{1}{\left(1 + \frac{h_c - h_d}{2 \cdot z_0}\right)} + 0.3; 1\right) = \min\left(\frac{1}{\left(1 + \frac{0.109 - 0}{2 \cdot 0.12}\right)} + 0.3; 1\right) = 0.988$$

$$\rho_s = \delta \cdot \left(\frac{f_{yb}}{235}\right) \cdot \left(\frac{f_{ctm}}{f_{yk,r}}\right) \cdot \sqrt{k_c} = 1.1 \cdot \left(\frac{355}{235}\right) \cdot \left(\frac{2.9 \cdot 10^6}{500 \cdot 10^6}\right) \cdot \sqrt{0.988} = 0.958 \%$$

$$A_s \geq \rho_s \cdot A_c$$

$$865 \text{ mm}^2 \geq 9.58 \cdot 10^{-3} \cdot 70485 \text{ mm}^2$$

$$865 \text{ mm}^2 \geq 675 \text{ mm}^2 \quad \text{OK}$$

The longitudinal reinforcement of the section is adequate.

5.2.3.2 Moment resistance

Moment resistance of a steel cross-section

$$M_{pl,Rd,a} = \frac{W_{ply} \cdot f_{yb}}{Y_{MO}} = \frac{642500 \text{ mm}^3 \cdot 355 \text{ MPa}}{1} = 228 \text{ kNm}$$

Influence of shear

$$\frac{V_{pl,Rd}}{2} > \text{abs}(V_{Ed,comp})$$

$$\frac{509 \text{ kN}}{2} > 85.1 \text{ kN}$$

$$254 \text{ kN} > 85.1 \text{ kN} \quad \text{OK}$$

The influence of the vertical shear on the bending moment resistance may be neglected.

$$f_{yb,w} = f_{yb} = 355 \text{ MPa}$$

Modified tension resistance of the steel member

$$r = 0 \text{ mm}$$

$$A_a = 2 \cdot t_f \cdot b + t_w \cdot (h_a - 2 \cdot t_f) = 2 \cdot 15 \text{ mm} \cdot 200 \text{ mm} + 9 \text{ mm} \cdot (200 \text{ mm} - 2 \cdot 15 \text{ mm}) = 7530 \text{ mm}^2$$

$$N_{pl,a} = A_a \cdot f_{yb} = 7530 \text{ mm}^2 \cdot 355 \text{ MPa} = 2673.15 \text{ kN}$$

Note: Roundings of the steel cross-section are neglected in bending resistance calculation.

$$N_{c,f} = \min(F_s; N_{pl,a}) = \min(376 \text{ kN}; 2673.15 \text{ kN}) = 376.17 \text{ kN}$$

Negative bending moment resistance calculation

The plastic neutral axis is located within the web of the steel section.

$$N_{at,f} = b \cdot t_f \cdot f_{yb} = 0.2 \cdot 0.015 \cdot 355 \cdot 10^6 = 1065.00 \text{ kN}$$

$$N_{pl,a} - N_{at,f} - N_{at,w} = F_s + N_{at,f} + N_{at,w}$$

$$x = \frac{(N_{pl,a} - 2 \cdot N_{at,f} - F_s)}{(2 \cdot t_w \cdot f_{yb,w})} = \frac{(2673.15 \text{ kN} - 2 \cdot 1065.00 \text{ kN} - 376 \text{ kN})}{(2 \cdot 9 \text{ mm} \cdot 355 \text{ MPa})} = 26.1 \text{ mm}$$

Verification of the steel web classification.

$$\alpha_{cl} = \frac{c_w - x}{c_w} = \frac{134 - 26.1}{134} = 0.805$$

$$\frac{c_w}{t_w} \leq \frac{396 \cdot \epsilon}{13 \cdot \alpha_{cl} - 1}$$

$$\frac{134 \text{ mm}}{9 \text{ mm}} \leq \frac{396 \cdot 0.814}{13 \cdot 0.805 - 1}$$

$$14.9 \leq 34 \quad \text{OK}$$

Web classified as Class 1.

$$N_{at,w} = t_w \cdot x \cdot f_{yb,w} = 9 \text{ mm} \cdot 26.1 \text{ mm} \cdot 355 \text{ MPa} = 83.49 \text{ kN}$$

$$N_{a,c} = N_{pl,a} - N_{at,f} - N_{at,w} = 2673.15 \text{ kN} - 1065.00 \text{ kN} - 83.49 \text{ kN} = 1524.66 \text{ kN}$$

Leverage arm of the compression part of the steel section calculated to the PNA.

$$h_{cs} = \frac{(t_w \cdot (h_a - 2 \cdot t_f - x)^2 \cdot 0.5 + t_f \cdot b \cdot (h_a - 1.5 \cdot t_f - x))}{t_w \cdot (h_a - 2 \cdot t_f - x) + t_f \cdot b}$$

$$= \frac{(9 \cdot (200 - 2 \cdot 15 - 26.1)^2 \cdot 0.5 + 15 \cdot 200 \cdot (200 - 1.5 \cdot 15 - 26.1))}{9 \cdot (200 - 2 \cdot 15 - 26.1) + 15 \cdot 200} = 127 \text{ mm}$$

$$h_i = x + t_f + h_s - c_l + \frac{d_l}{2} = 0.0261 + 0.015 + 0.16 - 0.03 + \frac{0.016}{2} = 163 \text{ mm}$$

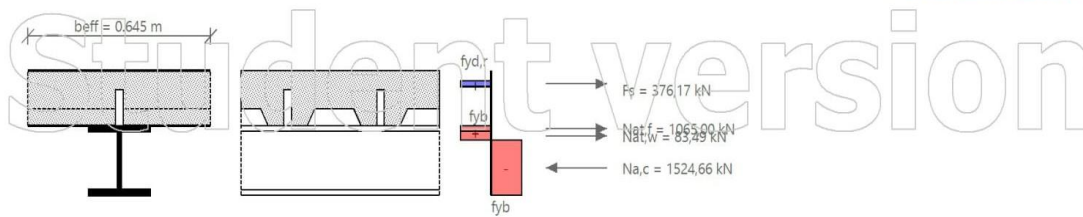

$$M_{pl,Rd} = F_s \cdot h_1 + N_{at,f} \cdot \left( \frac{t_f}{2} + x \right) + \frac{N_{at,w} \cdot x}{2} + N_{a,c} \cdot h_{cs}$$

$$= 376 \cdot 163 + 1065.00 \cdot \left( \frac{15}{2} + 26.1 \right) + \frac{83.49 \cdot 26.1}{2} + 1524.66 \cdot 127 = 293 \text{ kNm}$$

**Design moment resistance according to EN 1994-1-1 Art.6.2.1.2**

$$M_{Rd} = M_{pl,Rd} = 293 \text{ kNm}$$

$$UC_{comp,M} = \frac{abs(M_{Ed,comp})}{M_{Rd}} = \frac{abs(-97.521 \text{ kNm})}{293 \text{ kNm}} = 0.33$$

The bending moment resistance of the section is adequate.

**5.3 LTB resistance**

$$F = \left( 1 + \frac{t_w \cdot (h_a - t_f)}{4 \cdot b \cdot t_f} \right) \left( \frac{h_a - t_f}{t_w} \right)^{0.75} \cdot \left( \frac{t_f}{b} \right)^{0.25} = \left( 1 + \frac{9 \cdot (200 - 15)}{4 \cdot 200 \cdot 15} \right) \left( \frac{200 - 15}{9} \right)^{0.75} \cdot \left( \frac{15}{200} \right)^{0.25} = 5.75$$

$$F_{lim} = 12.3$$

$$F \leq F_{lim}$$

$$5.75 \leq 12.3$$

OK

The cross-section is qualified for verification of LTB by the simplified method.

$$C_4 = 25$$

$$\lambda_{LT,rel} = 5 \cdot \left( 1 + \frac{t_w \cdot (h_a - t_f)}{4 \cdot b \cdot t_f} \right) \left( \frac{h_a - t_f}{t_w} \right)^{0.75} \cdot \left( \frac{t_f}{b} \right)^{0.25} \cdot \left( \frac{f_{yb}}{E_b \cdot C_4} \right)^{0.5}$$

$$= 5 \cdot \left( 1 + \frac{9 \cdot 10^{-3} \cdot (0.2 - 0.015)}{4 \cdot 0.2 \cdot 0.015} \right) \cdot \left( \frac{0.2 - 0.015}{9 \cdot 10^{-3}} \right)^{0.75} \cdot \left( \frac{0.015}{0.2} \right)^{0.25} \cdot \left( \frac{355 \cdot 10^6}{210 \cdot 10^9 \cdot 25} \right)^{0.5} = 0.237$$

$h_a/b < 2 \rightarrow$  Buckling curve 'a'

$$\alpha_{LT} = 0.21$$

$$\Phi_{LT} = 0.5 \cdot \left( 1 + \alpha_{LT} \cdot (\lambda_{LT,rel} - 0.2) + \lambda_{LT,rel}^2 \right) = 0.5 \cdot \left( 1 + 0.21 \cdot (0.237 - 0.2) + 0.237^2 \right) = 0.532$$

$$X_{LT} = \frac{1}{\Phi_{LT} + \sqrt{\Phi_{LT}^2 - \lambda_{LT,rel}^2}} = \frac{1}{0.532 + \sqrt{0.532^2 - 0.237^2}} = 0.992$$

$$X_{LT} = \min(X_{LT}, 1) = \min(0.992, 1) = 0.992$$

$$M_{b,Rd} = X_{LT} \cdot M_{Rd} = 0.992 \cdot 292547 = 290.189 \text{ kNm}$$

$$UC_{comp\_LTB} = \frac{abs(M_{Ed,comp})}{M_{b,Rd}} = \frac{abs(-97.521 \text{ kNm})}{290.189 \text{ kNm}} = 0.34$$

The later torsional buckling resistance of the section is adequate.

**5.4 Longitudinal shear**

**5.4.1 Transverse reinforcement**

Design shear flow

$$h_f = h_c = 109 \text{ mm}$$

$$v_{Ed} = \frac{\eta_r \cdot P_{Rd}}{2 \cdot l_s \cdot h_f} = \frac{1 \cdot 120 \text{ kN}}{2 \cdot 305 \text{ mm} \cdot 109 \text{ mm}} = 1.81 \text{ MPa}$$

Transverse reinforcement

$$\frac{A_{st} \cdot f_{yk,r}}{\gamma_s \cdot s_f} \geq \frac{v_{Ed} \cdot h_f}{\cotg(\theta)}$$

$$A_t = A_{st}/s_f$$

$$A_t = \frac{v_{Ed} \cdot h_f}{\cotg(\theta) \cdot f_{yk,r}} = \frac{1.81 \cdot 10^6 \cdot 0.109}{\cotg(26.5) \cdot 500 \cdot 10^6} = 226 \text{ mm}^2/\text{m}$$

$$A_{t,prov} = \frac{1}{s_t} \cdot \left( \frac{d_t^2}{4} \right) \cdot 3.14 = \frac{1}{0.15} \cdot \left( \frac{0.016^2}{4} \right) \cdot 3.14 = 1340 \text{ mm}^2/\text{m}$$

$$A_{t,prov} \geq A_t$$

$$1340 \text{ mm}^2/\text{m} \geq 226 \text{ mm}^2/\text{m} \quad \text{OK}$$

The transverse reinforcement of the section is adequate.



SCIAENGINEER

ULS check of Final stage is OK.

 $UC_{comp} = \max(0.17; 0.33; 0.34) = 0.34$ 

Student version

-iskoristivost elementa na GSN – 34 %

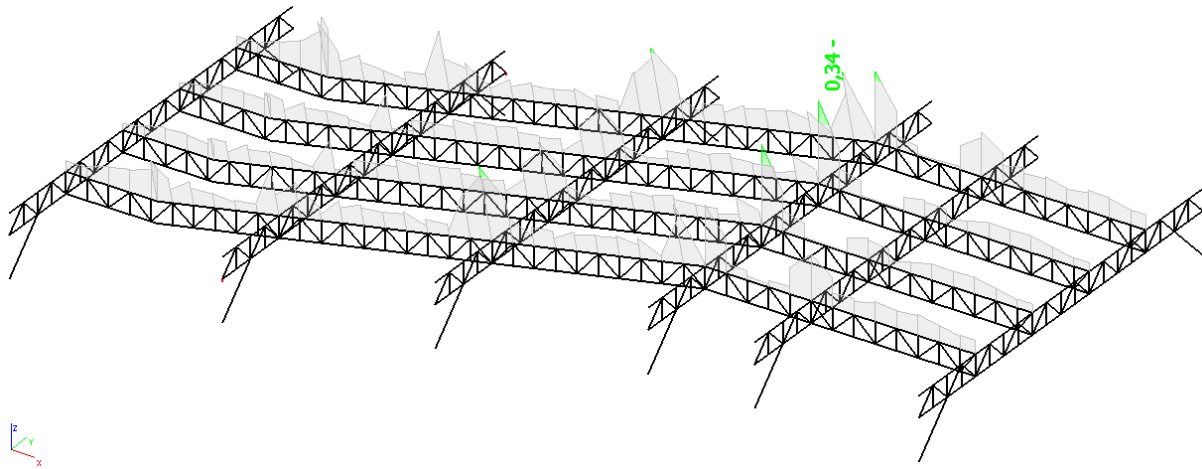

*Slika 10.16. Prikaz iskoristivosti gornje pojasnice sekundanog rešetkastog nosača*

### 10.2.11. Rezne sile – donja pojasnica sekundarnog rešetkastog nosača

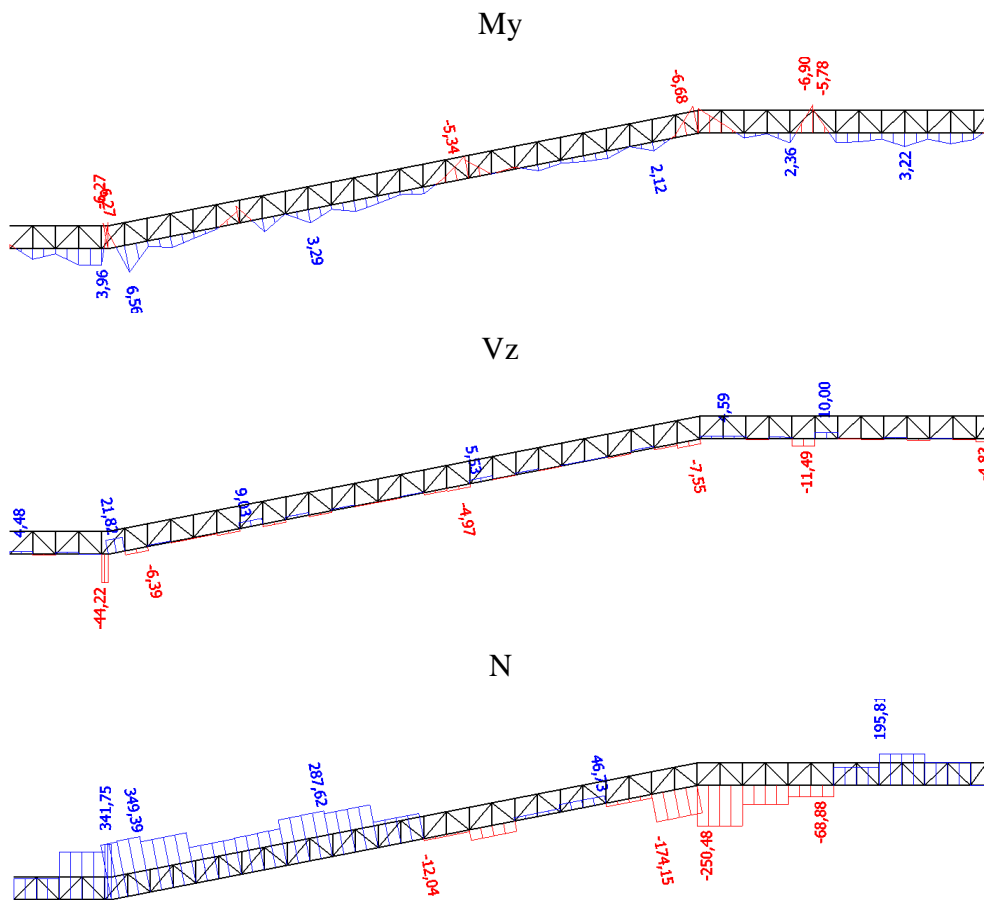

Slika 10.17. Prikaz reznih sila - donja pojasnica sekundarnog rešetkastog nosača

-poprečni presjek nosača

Name	Donja pojasnica sekundarnog rešetkastog nosača - tribina srednje dvorane	
Type	CFRHS150X150X8	
Source description	Rautaruukki Oyj / Structural Hollow Sections EN10219 / Ed.2007	
Item material	S 355	
Fabrication	cold formed	
Flexural buckling y-y	c	
Flexural buckling z-z	c	
Lateral torsional buckling	Default	
Use 2D FEM analysis	x	
A [m²]	4,3240e-03	
A y, z [m²]	2,1601e-03	2,1601e-03
I y, z [m⁴]	1,4118e-05	1,4118e-05
I w [m⁴], t [m⁴]	5,0625e-08	2,3641e-05
Wey y, z [m³]	1,8824e-04	1,8824e-04
Wpl y, z [m³]	2,2596e-04	2,2596e-04
d y, z [mm]	0	0
c YUCS, ZUCS [mm]	75	75
α [deg]	0,00	
A L, D [m²/m]	5,6600e-01	1,0808e+00
Mply +, - [Nm]	8,01e+04	8,01e+04
Mplz +, - [Nm]	8,01e+04	8,01e+04

Slika 10.18. Prikaz geometrijskih karakteristika nosača

### 10.2.12. Dimenzioniranje – donja pojasnica sekundarnog rešetkastog nosača

Member B1089	8,252 m	CFRHS150X150X8	S 355	GSN 2	0,58 -
--------------	---------	----------------	-------	-------	--------

Note: EN 1993-1-3 article 1.1(3) specifies that this part does not apply to cold formed CHS and RHS sections. The default EN 1993-1-1 code check is executed instead of the EN 1993-1-3 code check.

Partial safety factors	
Gamma M0 for resistance of cross-sections	1,00
Gamma M1 for resistance to instability	1,00
Gamma M2 for resistance of net sections	1,25

Material	
Yield strength $f_y$	355,0 MPa
Ultimate strength $f_u$	510,0 MPa
Fabrication	Cold formed

.....SECTION CHECK:....

The critical check is on position 7.427 m

Internal forces	Calculated	Unit
N,Ed	-173,31	kN
Vy,Ed	0,07	kN
Vz,Ed	-7,44	kN
T,Ed	0,49	kNm
My,Ed	-0,50	kNm
Mz,Ed	0,23	kNm

Classification for cross-section design

According to EN 1993-1-1 article 5.5.2

Classification of Internal Compression parts

According to EN 1993-1-1 Table 5.2 Sheet 1

Maximum width-to-thickness ratio	15,75
Class 1 Limit	26,85
Class 2 Limit	30,92
Class 3 Limit	35,37

=> Section classified as Class 1 for cross-section design

Compression check

According to EN 1993-1-1 article 6.2.4 and formula (6.9)

A	4,3240e-03	m <sup>2</sup>
Nc,Rd	1535,02	kN
Unity check	0,11	-

Bending moment check for My

According to EN 1993-1-1 article 6.2.5 and formula (6.12),(6.13)

Wpl,y	2,2596e-04	m <sup>3</sup>
Mpl,y,Rd	80,22	kNm
Unity check	0,01	-

Bending moment check for Mz

According to EN 1993-1-1 article 6.2.5 and formula (6.12),(6.13)

Wpl,z	2,2596e-04	m <sup>3</sup>
Mpl,z,Rd	80,22	kNm
Unity check	0,00	-

Shear check for Vy

According to EN 1993-1-1 article 6.2.6 and formula (6.17)

Eta	1,20	
Av	2,1620e-03	m <sup>2</sup>
Vpl,y,Rd	443,12	kN
Unity check	0,00	-

Shear check for Vz

According to EN 1993-1-1 article 6.2.6 and formula (6.17)

Eta	1,20	
Av	2,1620e-03	m <sup>2</sup>
Vpl,z,Rd	443,12	kN
Unity check	0,02	-

Torsion check

According to EN 1993-1-1 article 6.2.7 and formula (6.23)

Tau,t,Ed	1,5	MPa
Tau,Rd	205,0	MPa
Unity check	0,01	-

Note: The unity check for torsion is lower than the limit value of 0,05. Therefore torsion is considered as

MN,y,Rd	80,22	kNm
Alpha	1,68	
MN,z,Rd	80,22	kNm
Beta	1,68	

Unity check (6.41) = 0,00 + 0,00 = 0,00 -

**Note:** Since the shear forces are less than half the plastic shear resistances their effect on the moment resistances is neglected.

The member satisfies the section check.

....:STABILITY CHECK:....

**Classification for member buckling design**

Decisive position for stability classification: 0,000 m

**Classification of Internal Compression parts**

According to EN 1993-1-1 Table 5.2 Sheet 1

Maximum width-to-thickness ratio	15,75
Class 1 Limit	31,97
Class 2 Limit	36,81
Class 3 Limit	55,77

=> Section classified as Class 1 for member buckling design

**Flexural Buckling check**

According to EN 1993-1-1 article 6.3.1.1 and formula (6.46)

Buckling parameters	yy	zz	
Sway type	sway	non-sway	
System length L	0,825	8,252	m
Buckling factor k	1,00	1,00	
Buckling length Lcr	0,825	8,252	m
Critical Euler load Ncr	42974,83	429,75	kN
Slenderness Lambda	14,44	144,41	
Relative slenderness Lambda,rel	0,19	1,89	
Limit slenderness Lambda,rel,0	0,20	0,20	
Buckling curve	c	c	
Imperfection Alpha	0,49	0,49	
Reduction factor Chi	1,00	0,22	
Buckling resistance Nb,Rd	1535,02	331,67	kN

Flexural Buckling verification		
Cross-section area A	4,3240e-03	m <sup>2</sup>
Buckling resistance Nb,Rd	331,67	kN
Unity check	0,52	-

**Torsional(-Flexural) Buckling check**

According to EN 1993-1-1 article 6.3.1.1 and formula (6.46)

**Note:** The cross-section concerns a RHS section which is not susceptible to Torsional(-Flexural) Buckling.

**Lateral Torsional Buckling check**

According to EN 1993-1-1 article 6.3.2.1

**Note:** The cross-section concerns an RHS section with  $h/b < 10 / \text{Lambda,rel,z}$ .

This section is thus not susceptible to Lateral Torsional Buckling.

**Bending and axial compression check**

According to EN 1993-1-1 article 6.3.3 and formula (6.61),(6.62)

Bending and axial compression check parameters		
Interaction method	alternative method 1	
Cross-section area A	4,3240e-03	m <sup>2</sup>
Cross-section plastic modulus Wpl,y	2,2596e-04	m <sup>3</sup>
Cross-section plastic modulus Wpl,z	2,2596e-04	m <sup>3</sup>
Design compression force N,Ed	173,31	kN
Design bending moment (maximum) My,Ed	-6,68	kNm
Design bending moment (maximum) Mz,Ed	-0,30	kNm
Characteristic compression resistance N,Rk	1535,02	kN
Characteristic moment resistance My,Rk	80,22	kNm
Characteristic moment resistance Mz,Rk	80,22	kNm
Reduction factor Chi,y	1,00	
Reduction factor Chi,z	0,22	
Reduction factor Chi,LT	1,00	
Interaction factor k,yy	1,14	
Interaction factor k,yz	0,41	
Interaction factor k,zy	0,66	
Interaction factor k,zz	0,43	

Maximum moment My,Ed is derived from beam B1089 position 8,252 m.

Maximum moment Mz,Ed is derived from beam B1089 position 0,000 m.

Interaction method 1 parameters		
Critical Euler load N,cr,y	42974,83	kN
Critical Euler load N,cr,z	429,75	kN
Elastic critical load N,cr,T	292638,69	kN
Cross-section plastic modulus Wpl,y	2,2596e-04	m <sup>3</sup>
Cross-section elastic modulus Wel,y	1,8824e-04	m <sup>3</sup>
Cross-section plastic modulus Wpl,z	2,2596e-04	m <sup>3</sup>
Cross-section elastic modulus Wel,z	1,8824e-04	m <sup>3</sup>

Interaction method 1 parameters		
Second moment of area Iy	1,4118e-05	m <sup>4</sup>
Second moment of area Iz	1,4118e-05	m <sup>4</sup>
Torsional constant It	2,3641e-05	m <sup>4</sup>
Method for equivalent moment factor C,my,0	Table A.2 Line 2 (General)	
Design bending moment (maximum) My,Ed	-6,68	kNm
Maximum relative deflection delta,z	0,1	mm
Equivalent moment factor C,my,0	1,00	
Method for equivalent moment factor C,mz,0	Table A.2 Line 1 (Linear)	
Ratio of end moments Psi,z	-0,96	
Equivalent moment factor C,mz,0	0,40	
Factor mu,y	1,00	
Factor mu,z	0,65	
Factor epsilon,y	0,89	
Factor a,LT	0,00	
Critical moment for uniform bending Mcr,0	906,23	kNm
Relative slenderness Lambda,rel,0	0,30	
Limit relative slenderness Lambda,rel,0,lim	0,31	
Equivalent moment factor C,my	1,00	
Equivalent moment factor C,mz	0,40	
Equivalent moment factor C,mLT	1,00	
Factor b,LT	0,00	
Factor c,LT	0,00	
Factor d,LT	0,00	
Factor e,LT	0,00	
Factor w,y	1,20	
Factor w,z	1,20	
Factor n,pl	0,11	
Maximum relative slenderness Lambda,rel,max	1,89	
Factor C,yy	0,88	
Factor C,yz	0,97	
Factor C,zy	0,59	
Factor C,zz	1,02	

Unity check (6.61) = 0,11 + 0,09 + 0,00 = 0,21 -  
 Unity check (6.62) = 0,52 + 0,06 + 0,00 = 0,58 -  
 The member satisfies the stability check.

-iskoristivost elementa na GSN – 58 %

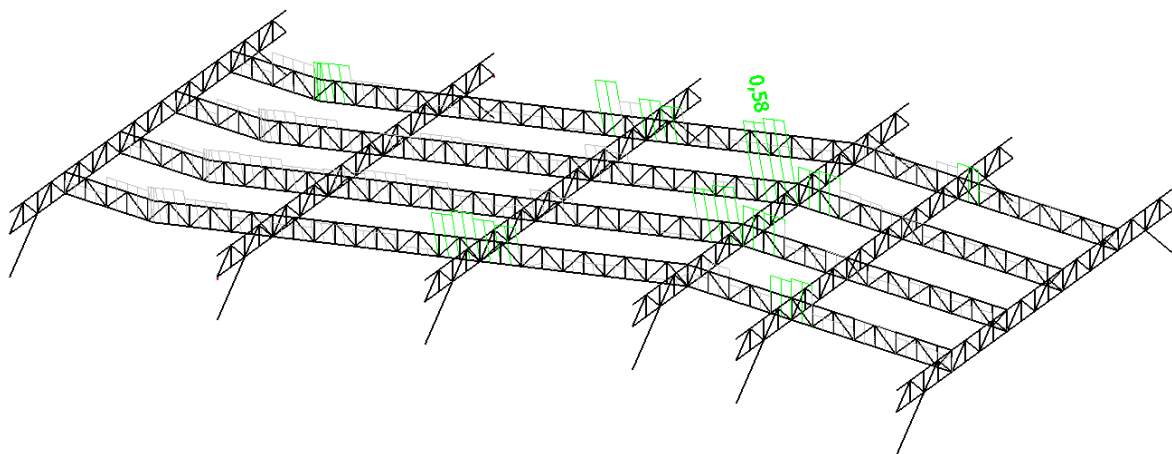

Slika 10.19. Prikaz iskoristivosti donje pojasnice sekundanog rešetkastog nosača

### 10.2.13. Rezne sile – ispuna sekundarnog rešetkastog nosača

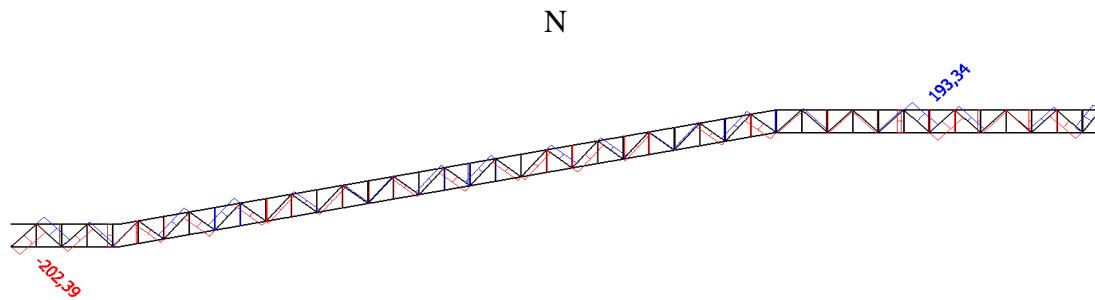

Slika 10.20. Prikaz reznih sila – ispuna glavnog rešetkastog nosača

-poprečni presjek nosača

Name	Ispuna sekundarnog rešetkastog nosača - tribina srednje dvorane		
Type	CFRHS80X80X5		
Source description	Rautaruukki Oyj / Structural Hollow Sections EN10219 / Ed.2007		
Item material	S 355		
Fabrication	cold formed		
Flexural buckling y-y	c		
Flexural buckling z-z	c		
Lateral torsional buckling	Default		
Use 2D FEM analysis	*		
A [m <sup>2</sup> ]	1,4360e-03		
A <sub>y, z</sub> [m <sup>2</sup> ]	7,1721e-04		7,1721e-04
I <sub>y, z</sub> [m <sup>4</sup> ]	1,3144e-06		1,3144e-06
I <sub>w</sub> [m <sup>6</sup> ], t [m <sup>4</sup> ]	1,3653e-09		2,1783e-06
W <sub>el y, z</sub> [m <sup>3</sup> ]	3,2860e-05		3,2860e-05
W <sub>pl y, z</sub> [m <sup>3</sup> ]	3,9740e-05		3,9740e-05
d <sub>y, z</sub> [mm]	0		0
c <sub>YUCS, ZUCS</sub> [mm]	40		40
α [deg]	0,00		
A <sub>L, D</sub> [m <sup>2</sup> /m]	3,0300e-01		5,7413e-01
M <sub>pl y, z</sub> [Nm]	1,41e+04		1,41e+04
M <sub>pl z, y</sub> [Nm]	1,41e+04		1,41e+04

Slika 10.21. Prikaz geometrijskih karakteristika nosača

-iskoristivost elementa na GSN – 47 %

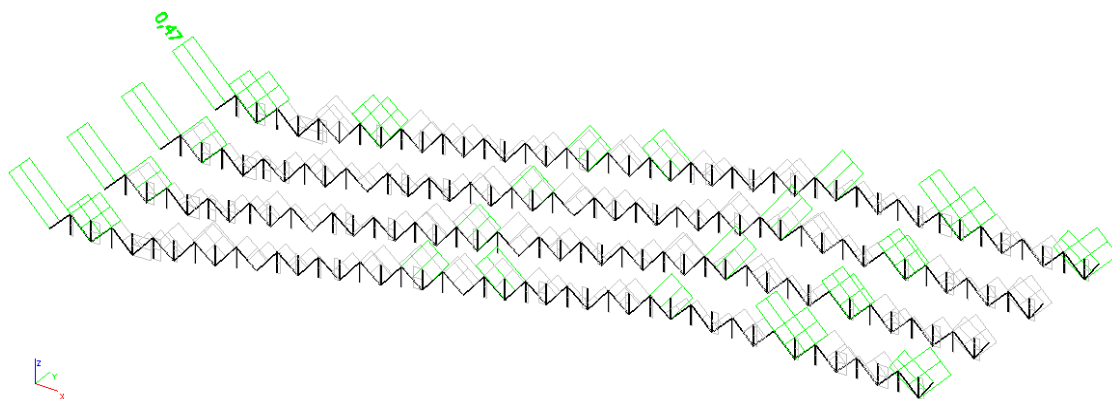

Slika 10.10. Prikaz iskoristivosti ispune glavnog rešetkastog nosača

### 10.2.14. Dimenzioniranje – ispuna sekundarnog rešetkastog nosača

Member B1098	1,138 m	CFRHS80X80X5	S 355	GSN 2	0,47 -
--------------	---------	--------------	-------	-------	--------

Note: EN 1993-1-3 article 1.1(3) specifies that this part does not apply to cold formed CHS and RHS sections. The default EN 1993-1-1 code check is executed instead of the EN 1993-1-3 code check.

Partial safety factors	
Gamma M0 for resistance of cross-sections	1,00
Gamma M1 for resistance to instability	1,00
Gamma M2 for resistance of net sections	1,25

Material	
Yield strength fy	355,0 MPa
Ultimate strength fu	510,0 MPa
Fabrication	Cold formed

....:SECTION CHECK:....

The critical check is on position 0.000 m

Internal forces	Calculated	Unit
N,Ed	-202,39	kN
Vy,Ed	0,00	kN
Vz,Ed	0,00	kN
T,Ed	0,00	kNm
My,Ed	0,00	kNm
Mz,Ed	0,00	kNm

**Classification for cross-section design**

According to EN 1993-1-1 article 5.5.2

**Classification of Internal Compression parts**

According to EN 1993-1-1 Table 5.2 Sheet 1

Maximum width-to-thickness ratio	13,00
Class 1 Limit	26,85
Class 2 Limit	30,92
Class 3 Limit	34,17

=> Section classified as Class 1 for cross-section design

**Compression check**

According to EN 1993-1-1 article 6.2.4 and formula (6.9)

A	1,4360e-03	m <sup>2</sup>
Nc,Rd	509,78	kN
Unity check	0,40	-

The member satisfies the section check.

....:STABILITY CHECK:....

**Classification for member buckling design**

Decisive position for stability classification: 0.000 m

**Classification of Internal Compression parts**

According to EN 1993-1-1 Table 5.2 Sheet 1

Maximum width-to-thickness ratio	13,00
Class 1 Limit	26,85
Class 2 Limit	30,92
Class 3 Limit	34,17

=> Section classified as Class 1 for member buckling design

**Flexural Buckling check**

According to EN 1993-1-1 article 6.3.1.1 and formula (6.46)

Buckling parameters	yy	zz	
Sway type	sway	non-sway	
System length L	1,138	1,138	m
Buckling factor k	1,00	1,00	
Buckling length Lcr	1,138	1,138	m
Critical Euler load Ncr	2101,88	2101,99	kN
Slenderness Lambda	37,63	37,63	
Relative slenderness Lambda,rel	0,49	0,49	
Limit slenderness Lambda,rel,0	0,20	0,20	
Buckling curve	c	c	
Imperfection Alpha	0,49	0,49	
Reduction factor Chi	0,85	0,85	
Buckling resistance Nb,Rd	431,88	431,88	kN

Flexural Buckling verification	
Cross-section area A	1,4360e-03 m <sup>2</sup>
Buckling resistance Nb,Rd	431,88 kN
Unity check	-

**Note:** The cross-section concerns a RHS section which is not susceptible to Torsional(-Flexural) Buckling. The member satisfies the stability check.

## 11. PRORAČUN SPREGNUTE MEĐUKATNE KONSTRUKCIJE KONZOLNI DIO

### 11.1. Pomaci spregnute međukatne konstrukcije – konzolni dio

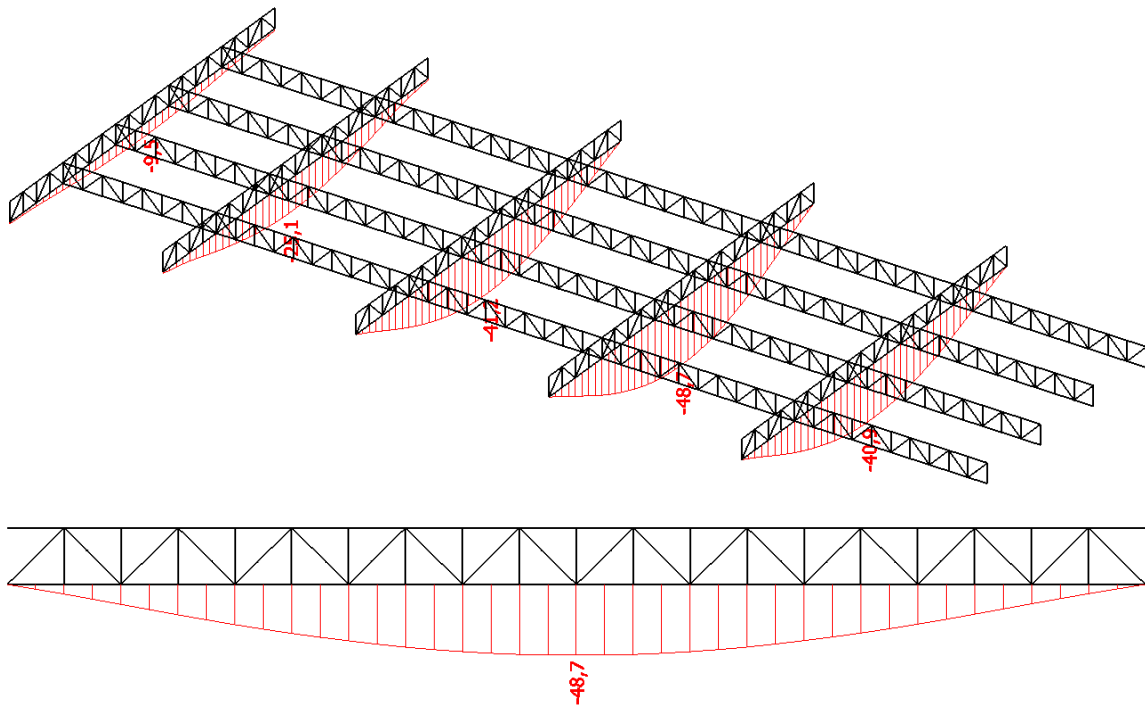

*Slika 11.1. Prikaz vertikalnog pomaka glavnog rešetkastog nosača – konzolni dio*

Dopušteni vertikalni pomak (progib):

$$u_{dop} = \frac{l}{300} = \frac{16,20 \cdot 1000}{300} = 54,0 \text{ mm}$$

$$u_z = 48,7 \text{ mm} < u_{z,dop} = 54,0 \text{ mm} \quad \text{Zadovoljava}$$

-iskoristivost na GSU -  $48,7 \text{ mm} / 54,0 \text{ mm} = 0,90 = 90\%$



## 11.2. Dimenziniranje spregnute međukatne konstrukcije–tribina srednje dvorane

### 11.2.1. Rezne sile – gornja pojasnica glavnog rešetkastog nosača

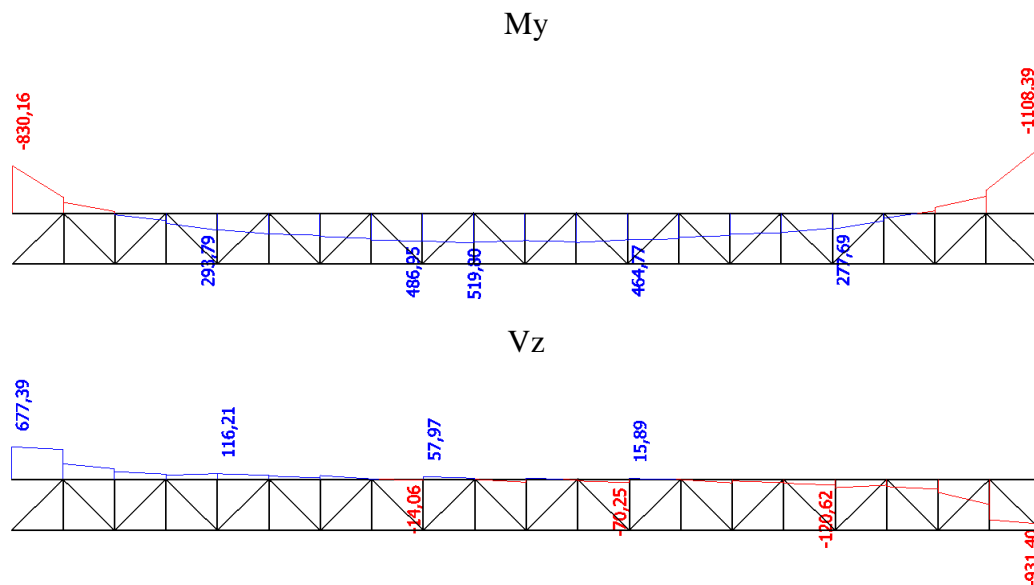

Slika 11.2. Prikaz reznih sila - gornja pojasnica glavnog rešetkastog nosača

-poprečni presjek nosača

Name	Gornja pojasnica glavnog rešetkastog nosača - kozolni dio	
Type	HEB340	
Source description	Profil Arbed / Structural shapes / Edition Octobre 1995	
Item material	S 355	
Fabrication	rolled	
Flexural buckling y-y	b	
Flexural buckling z-z	c	
Lateral torsional buckling	Default	
Use 2D FEM analysis	x	
A [m <sup>2</sup> ]	1,7090e-02	
A <sub>y</sub> , z [m <sup>2</sup> ]	1,2393e-02	4,3278e-03
I <sub>y</sub> , z [m <sup>4</sup> ]	3,6660e-04	9,6900e-05
I <sub>w</sub> [m <sup>3</sup> ], t [m <sup>4</sup> ]	2,4536e-06	2,5720e-06
W <sub>el</sub> y, z [m <sup>3</sup> ]	2,1560e-03	6,4600e-04
W <sub>pl</sub> y, z [m <sup>3</sup> ]	2,4080e-03	9,8570e-04
d y, z [mm]	0	0
c YUCS, ZUCS [mm]	150	170
α [deg]	0,00	
A <sub>L</sub> , D [m <sup>2</sup> /m]	1,8100e+00	1,8094e+00
M <sub>ply</sub> +, - [Nm]	8,55e+05	8,55e+05
M <sub>plz</sub> +, - [Nm]	3,50e+05	3,50e+05

Slika 11.3. Prikaz geometrijskih karakteristika nosača

## 11.2.2. Dimenzioniranje – gornja pojasnica glavnog rešetkastog nosača

SCIAENGINEER

### Composite Beam - Final stage

Linear calculation  
 Class: All ULS  
 Extreme 1D: Global  
 Selection: B5513

### Composite beam verification

for beam B5513 at section 3.24 m, in accordance with EC EN 1994-1-1

#### 1. Geometry data

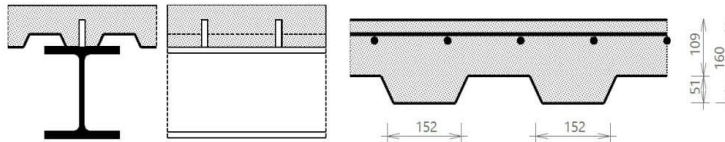

#### Simply supported beam

Length of the current span  $L = 16.2$  m  
 Beam spacing at the left  $L_{\text{left}} = 7.86$  m  
 Beam spacing at the right  $L_{\text{right}} = 7.86$  m  
 Checked section  $d_x = 3.24$  m

*Warning: For a continuous beam, intermediate buckling supports y-y are ignored in both the calculation of the effective width for the analysis model and the check.*

#### 2. Cross-section & materials

##### 2.1 Steel section properties

##### 2.1.1 Cross-section

Cross-section	HEB340
Height	$h_a = 340$ mm
Width	$b = 300$ mm
Web thickness	$t_w = 12$ mm
Flange thickness	$t_f = 21.5$ mm
Radius	$r = 27$ mm
Area	$A_a = 17090$ mm <sup>2</sup>
Moment of inertia	$I_y = 367 \cdot 10^6$ mm <sup>4</sup>
Radius of gyration	$i_z = 75$ mm
Plastic section modulus	$W_{\text{ply}} = 2.408 \cdot 10^6$ mm <sup>3</sup>

##### 2.1.2 Material

Steel grade	S 355
Yield strength	$f_{yb} = 355$ MPa
Ultimate strength	$f_{ub} = 490$ MPa
E modulus	$E_b = 210000$ MPa

##### 2.1.3 Cross-section classification

$$\varepsilon = \sqrt{\frac{235}{355}} = 0.814$$

(EN 1993-1-1 §5.6 Tab. 5.2)

##### 2.1.3.1 Flange in compression

$$c_f = \frac{b - t_w - 2 \cdot r}{2} = \frac{300 \text{ mm} - 12 \text{ mm} - 2 \cdot 27 \text{ mm}}{2} = 117 \text{ mm}$$

$$\frac{c_f}{t_f} \leq 9 \cdot \varepsilon$$

$$\frac{117 \text{ mm}}{21.5 \text{ mm}} \leq 9 \cdot 0.814$$

$$5.44 \leq 7.32$$

OK

Flange classified as Class 1.

Student version

2.1.3.2 Web in bending

$$c_w = h_a - 2 \cdot t_f - 2 \cdot r = 340 \text{ mm} - 2 \cdot 21.5 \text{ mm} - 2 \cdot 27 \text{ mm} = 243 \text{ mm}$$

$$\alpha_d = 0.5$$

$$\frac{c_w}{t_w} \leq \frac{36 \cdot \epsilon}{\alpha_d}$$

$$\frac{243 \text{ mm}}{12 \text{ mm}} \leq \frac{36 \cdot 0.814}{0.5}$$

$$20.3 \leq 58.6$$

OK

Web classified as Class 1.

**Cross-section classified as Class 1**

Cross-section Class OK.

**2.2 Concrete slab with profiled sheeting****2.2.1 Concrete slab**2.2.1.1 SlabTotal height of the slab  $h_s = 160 \text{ mm}$ 2.2.1.2 Material

Concrete class C30/37

Characteristic strength  $f_{ck} = 30 \text{ MPa}$ E modulus  $E_{cm} = 32800 \text{ MPa}$ **2.2.2 Profiled steel sheeting**

Sheeting with ribs parallel to the supporting beams

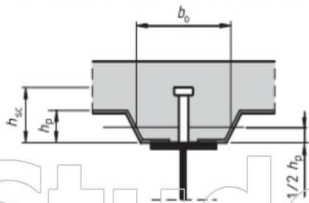

Name	Vulcraft 2 VU 20
Depth of the ribs	$h_p = 50.8 \text{ mm}$
Height of full concrete	$h_c = 109.2 \text{ mm}$
Height of the re-entrant stiffener	$h_d = 0 \text{ mm}$
Spacing of the ribs	$b_s = 304.8 \text{ mm}$
Top width of the rib	$b_r = 127 \text{ mm}$
Bottom width of the rib	$b_b = 127 \text{ mm}$
Mean width of the ribs	$b_{0,rib} = 152.4 \text{ mm}$
Thickness of the sheeting	$t_p = 0.9093 \text{ mm}$

**2.2.3 Shear connectors**2.2.3.1 Geometry

Name	H110
Diameter	$d_s = 25 \text{ mm}$
Nominal height	$h_{nom} = 110 \text{ mm}$
As-welded height	$h_{sc} = 105 \text{ mm}$
Amount per trough or section	$n_r = 1$

2.2.3.2 Material

Steel grade	S 355
Ultimate strength	$f_{us} = 490 \text{ MPa}$

**2.2.4 Reinforcement**2.2.4.1 Geometry

Longitudinal bar diameter	$d_l = 16 \text{ mm}$
Longitudinal bar spacing	$s_l = 150 \text{ mm}$
Longitudinal bar cover	$c_l = 30 \text{ mm}$
Transverse bar diameter	$d_t = 16 \text{ mm}$
Transverse bar spacing	$s_t = 150 \text{ mm}$
Transverse bar cover	$c_t = 46 \text{ mm}$

2.2.4.2 Material

Material	B 500A
Characteristic yield strength	$f_{yk,r} = 500 \text{ MPa}$

**3. Design values of loads**

Load Name : GSN 2

Content of combination : 1.35·g-vlastitetežina+1.35·cg-dodatnost;alno+  
1.80·q-promjenjivoopterećenje+1.35·g-vlastitetežina\_dryconcrete

Bending moment  $M_{Ed,comp} = -1108.390$  kNm

Shear force  $V_{Ed,comp} = -931.400$  kN

**4. Partial safety factors**

Steel section  $\gamma_{M0} = 1$   
 $\gamma_{M1} = 1$   
Shear connectors  $\gamma_V = 1.25$   
Concrete  $\gamma_C = 1.5$   
Reinforcement  $\gamma_S = 1.15$

**5. ULS check of the Final stage**

**5.1 Shear connection**

**5.1.1 Design resistance of shear connectors**

**5.1.1.1 Shear connector in a solid slab**

$$\frac{h_{sc}}{d_s} > 4$$

$$4.2 > 4$$

$$\alpha = 1$$

$$f_{us} = \min(490;500) \text{ MPa}$$

$$P_{Rd,solid,1} = \frac{0.8 \cdot f_{us} \cdot \left( \frac{\pi \cdot d_s^2}{4} \right)}{\gamma_V} = \frac{0.8 \cdot 490 \text{ MPa} \cdot \left( \frac{3.14 \cdot 25 \text{ mm}^2}{4} \right)}{1.25} = 154 \text{ kN}$$

$$P_{Rd,solid,2} = \frac{0.29 \cdot \alpha \cdot d_s^2 \cdot \sqrt{f_{ck} \cdot E_{cm}}}{\gamma_V} = \frac{0.29 \cdot 1 \cdot 25 \text{ mm}^2 \cdot \sqrt{30 \text{ MPa} \cdot 32800 \text{ MPa}}}{1.25} = 144 \text{ kN}$$

$$P_{Rd,solid} = \min(P_{Rd,solid,1}; P_{Rd,solid,2}) = \min(154 \text{ kN}; 144 \text{ kN}) = 144 \text{ kN}$$

**5.1.1.2 Shear connector in profiled sheeting**

Sheeting with ribs parallel to the supporting beams

$$k_t = \frac{0.6 \cdot b_{0,rib}}{h_p} \cdot \left( \frac{h_{sc}}{h_p} - 1 \right) = \frac{0.6 \cdot 152 \text{ mm}}{50.8 \text{ mm}} \cdot \left( \frac{105 \text{ mm}}{50.8 \text{ mm}} - 1 \right) = 1.92$$

$$k_t = 1$$

$$P_{Rd} = k_t \cdot P_{Rd,solid} = 1 \cdot 144 \text{ kN} = 144 \text{ kN}$$

**5.1.2 Degree of shear connection**

**5.1.2.1 Determination of  $b_{eff}$  of the concrete flange and length  $L_e$**

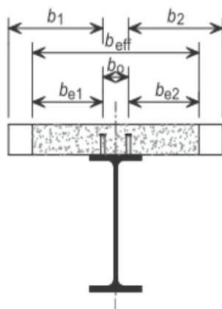

The effective width in the interval <0.25;0.75>

$$L_{e1} = L_1 = 16.2 \text{ m}$$

**Left side of the beam**

$$b_1 = \frac{L_{\text{perp, left}}}{2} - \frac{b_0}{2} = \frac{7.86 \text{ m}}{2} - \frac{0 \text{ mm}}{2} = 3.93 \text{ m}$$

$$b_{e10} = \min\left(\frac{L_{e0}}{8}; b_1\right) = \min\left(\frac{0 \text{ m}}{8}; 3.93 \text{ m}\right) = 0 \text{ m}$$

$$b_{e11} = \min\left(\frac{L_{e1}}{8}; b_1\right) = \min\left(\frac{16.2 \text{ m}}{8}; 3.93 \text{ m}\right) = 2.03 \text{ m}$$

$$b_{e12} = \min\left(\frac{L_{e2}}{8}; b_1\right) = \min\left(\frac{0 \text{ m}}{8}; 3.93 \text{ m}\right) = 0 \text{ m}$$

**Right side of the beam**

$$b_2 = \frac{L_{\text{perp, right}}}{2} - \frac{b_0}{2} = \frac{7.86 \text{ m}}{2} - \frac{0 \text{ mm}}{2} = 3.93 \text{ m}$$

$$b_{e20} = \min\left(\frac{L_{e0}}{8}; b_2\right) = \min\left(\frac{0 \text{ m}}{8}; 3.93 \text{ m}\right) = 0 \text{ m}$$

$$b_{e21} = \min\left(\frac{L_{e1}}{8}; b_2\right) = \min\left(\frac{16.2 \text{ m}}{8}; 3.93 \text{ m}\right) = 2.03 \text{ m}$$

$$b_{e22} = \min\left(\frac{L_{e2}}{8}; b_2\right) = \min\left(\frac{0 \text{ m}}{8}; 3.93 \text{ m}\right) = 0 \text{ m}$$

**Calculation of  $b_{\text{eff},1}$** 

$$b_{\text{eff},1} = b_0 + b_{e11} + b_{e21} = 0 \text{ mm} + 2.03 \text{ m} + 2.03 \text{ m} = 4.05 \text{ m}$$

**Calculation of  $b_{\text{eff}}$** 

$$b_{\text{eff}} = b_{\text{eff},1} = 4.05 \text{ m}$$

**Determination of  $L_e$** 

$$L_e = L_{e1} = 16.2 \text{ m}$$

**5.1.2.2 Minimum degree of shear connection**

Warning: Conditions given by EN 1994-1-1 Art. 6.6.1.2 (3) are not fulfilled.

$$\eta_{\text{min, calc}} = 1 - \frac{355}{f_{yb}} \cdot (0.75 - 0.03 \cdot L_e)$$

$$\eta_{\text{min, calc}} = 1 - \frac{355}{355} \cdot (0.75 - 0.03 \cdot 16.2 \text{ m}) = 0.74$$

$$\eta_{\text{min}} = \max(\eta_{\text{min, calc}}; 0.4) = \max(0.74; 0.4) = 0.74$$

**5.1.2.3 Degree of shear connection present****5.1.2.3.1 Tension resistance of the reinforcement**

$$A_s = \frac{b_{\text{eff}}}{s_l} \cdot \left(\frac{d_l^2}{4}\right) \cdot \pi = \frac{4.05 \text{ m}}{150 \text{ mm}} \cdot \left(\frac{16 \text{ mm}^2}{4}\right) \cdot 3.14 = 5429 \text{ mm}^2$$

$$F_s = \frac{A_s \cdot f_{yk,r}}{\gamma_s} = \frac{5.43 \cdot 10^{-3} \cdot 500 \cdot 10^6}{1.15} = 2360 \text{ kN}$$

**5.1.2.3.2 Tension resistance of the steel member**

$$N_{pl,a} = f_{yb} \cdot A_a = 355 \text{ MPa} \cdot 17090 \text{ mm}^2 = 6066.95 \text{ kN}$$

$$N_{c,f} = \min(F_s; N_{pl,a}) = \min(2360 \text{ kN}; 6066.95 \text{ kN}) = 2360.29 \text{ kN}$$

**5.1.2.3.3 Resistance of the shear connectors**

$$l_s = \frac{L}{n_{\text{row}}} = \frac{16.2}{53} = 306 \text{ mm}$$

Number of shear studs available per length  $L_e/2$

$$n_{\text{sp}} = \frac{0.5 \cdot L_e}{l_s} \cdot n_r$$

$$n_{\text{sp}} = 26 \cdot 1 = 26$$

$$N_c = n_{\text{sp}} \cdot P_{Rd} = 26 \cdot 143835 = 3739.72 \text{ kN}$$

$$\eta = \min\left(\frac{N_c}{N_{c,f}}; 1\right) = \min\left(\frac{3739.72 \text{ kN}}{2360.29 \text{ kN}}; 1\right) = 1$$

$$\eta \geq \eta_{\text{min}} \\ 1 \geq 0.74$$

The shear connection degree is adequate. OK

**5.2 Cross-sectional resistance of the composite beam****5.2.1 Shear buckling**

$$h_w = h_s - 2 \cdot t_f = 340 \text{ mm} - 2 \cdot 21.5 \text{ mm} = 297 \text{ mm}$$

$$\eta_{sb} = 1.2$$

$$\frac{h_w}{t_w} \leq \frac{72 \cdot \epsilon}{\eta_{sb}}$$

$$\frac{297 \text{ mm}}{12 \text{ mm}} \leq \frac{72 \cdot 0.814}{1.2}$$

$$24.8 \leq 48.8$$

OK

The shear buckling resistance of the web does not need to be verified.

**5.2.2 Vertical shear**

The resistance to vertical shear should be taken as the resistance of the structural steel section.

$$A_v = A_s - 2 \cdot b \cdot t_f + (t_w + 2 \cdot r) \cdot t_f$$

$$= 0.0171 - 2 \cdot 0.3 \cdot 0.0215 + (0.012 + 2 \cdot 0.027) \cdot 0.0215 = 5609 \text{ mm}^2$$

$$A_{v,min} = \eta_{sb} \cdot h_w \cdot t_w = 1.2 \cdot 0.297 \cdot 0.012 = 4277 \text{ mm}^2$$

$$A_v \geq A_{v,min}$$

$$5609 \text{ mm}^2 \geq 4277 \text{ mm}^2$$

$$V_{pl,Rd} = \frac{A_v \cdot f_{yb}}{\sqrt{3} \cdot \gamma_{M0}} = \frac{5609 \text{ mm}^2 \cdot 355 \cdot 10^6}{\sqrt{3} \cdot 1} = 1150 \text{ kN}$$

$$UC_{comp,V} = \frac{abs(V_{Ed,comp})}{V_{pl,Rd}} = \frac{abs(-931.400 \text{ kN})}{1150 \text{ kN}} = 0.81$$

The shear resistance of the section is adequate.

**5.2.3 Bending moment****5.2.3.1 Longitudinal reinforcement****5.2.3.1.1 Centre of composite section**

For buildings not intended mainly for storage the effects of creep in concrete beams may be taken into account by using an effective E modulus  $E_{eff} = E_{cm} / 2$ .

$$E_{eff} = \frac{E_{cm}}{2} = \frac{32800 \text{ MPa}}{2} = 16400 \text{ MPa}$$

$$\eta_E = \frac{E_b}{E_{eff}} = \frac{210000 \text{ MPa}}{16400 \text{ MPa}} = 12.8$$

$$y_d = \frac{A_s \cdot \left( \frac{h_a}{2} \right) + \left( \frac{1}{\eta_E} \right) \cdot b_{eff} \cdot (h_c - h_d) \cdot \left( h_a + h_s - \frac{h_c - h_d}{2} \right)}{A_s + \left( \frac{1}{\eta_E} \right) \cdot b_{eff} \cdot (h_c - h_d)}$$

$$= \frac{0.0171 \cdot \left( \frac{0.34}{2} \right) + \left( \frac{1}{12.8} \right) \cdot 4.05 \cdot (0.109 - 0) \cdot \left( 0.34 + 0.16 - \frac{0.109 - 0}{2} \right)}{0.0171 + \left( \frac{1}{12.8} \right) \cdot 4.05 \cdot (0.109 - 0)} = 354 \text{ mm}$$

**5.2.3.1.2 Degree of reinforcement**

$$A_s = \frac{b_{eff}}{s_l} \cdot \left( \frac{d_l^2}{4} \right) \cdot \pi = \frac{4.05 \text{ m}}{150 \text{ mm}} \cdot \left( \frac{16 \text{ mm}^2}{4} \right) \cdot 3.14 = 5429 \text{ mm}^2$$

$$A_c = b_{eff} \cdot (h_c - h_d) = 4.05 \cdot (0.109 - 0) = 442260 \text{ mm}^2$$

$$z_0 = \left( h_a + h_s - \frac{h_c - h_d}{2} \right) - y_d = \left( 0.34 + 0.16 - \frac{0.109 - 0}{2} \right) - 0.354 = 91.2 \text{ mm}$$

$$k_c = \min \left( \frac{1}{\left( 1 + \frac{h_c - h_d}{2 \cdot z_0} \right)} + 0.3; 1 \right) = \min \left( \frac{1}{\left( 1 + \frac{0.109 - 0}{2 \cdot 0.0912} \right)} + 0.3; 1 \right) = 0.925$$

$$\rho_s = \delta \cdot \left( \frac{f_{yb}}{235} \right) \cdot \left( \frac{f_{ctm}}{f_{yk,r}} \right) \cdot \sqrt{k_c} = 1.1 \cdot \left( \frac{355}{235} \right) \cdot \left( \frac{2.9 \cdot 10^6}{500 \cdot 10^6} \right) \cdot \sqrt{0.925} = 0.927 \%$$

$$A_s \geq \rho_s \cdot A_c$$

$$5429 \text{ mm}^2 \geq 9.27 \cdot 10^{-3} \cdot 442260 \text{ mm}^2$$

$$5429 \text{ mm}^2 \geq 4100 \text{ mm}^2 \quad \text{OK}$$

The longitudinal reinforcement of the section is adequate.

5.2.3.2 Moment resistance

Moment resistance of a steel cross-section

$$M_{pl,Rd,c} = \frac{W_{ply} \cdot f_{yb}}{Y_{MO}} = \frac{2.41 \cdot 10^6 \text{ mm}^3 \cdot 355 \text{ MPa}}{1} = 855 \text{ kNm}$$

Influence of shear

$$\frac{V_{pl,Rd}}{2} > \text{abs}(V_{Ed,comp})$$

$$\frac{1150 \text{ kN}}{2} > 931 \text{ kN}$$

575 kN > 931 kN NOT OK.

Yield strength reduction due to the vertical shear according to EN 1994-1-1 Art. 6.2.2.4 (2).

$$\rho = \left( \frac{2 \cdot \text{abs}(V_{Ed,comp})}{V_{pl,Rd}} - 1 \right)^2 = \left( \frac{2 \cdot \text{abs}(931.400 \text{ kN})}{1150 \text{ kN}} - 1 \right)^2 = 0.385$$

Note: The bending moment resistance is reduced due to the influence of the vertical shear.

$$f_{yb,w} = (1 - \rho) \cdot f_{yb}$$

$$f_{yb,w} = (1 - 0.385) \cdot 355 \text{ MPa} = 218 \text{ MPa}$$

Modified tension resistance of the steel member

$$N_{pl,a} = 2 \cdot t_f \cdot b \cdot f_{yb} + (h_a - 2 \cdot t_f) \cdot t_w \cdot f_{yb,w}$$

$$= 2 \cdot 21.5 \text{ mm} \cdot 300 \text{ mm} \cdot 355 \text{ MPa} + (340 \text{ mm} - 2 \cdot 21.5 \text{ mm}) \cdot 12 \text{ mm} \cdot 218 \text{ MPa} = 5357.80 \text{ kN}$$

Note: Roundings of the steel cross-section are neglected in bending resistance calculation.

$$N_{c,f} = \min(F_s; N_{pl,a}) = \min(2360 \text{ kN}; 5357.80 \text{ kN}) = 2360.29 \text{ kN}$$

Negative bending moment resistance calculation

The plastic neutral axis is located within the flange of the steel section.

$$N_{pl,a} - N_{a,f} = F_s + N_{a,f}$$

$$x = \frac{(N_{pl,a} - F_s)}{(2 \cdot b \cdot f_{yb})} = \frac{(5357.80 \text{ kN} - 2360 \text{ kN})}{(2 \cdot 300 \text{ mm} \cdot 355 \text{ MPa})} = 14.1 \text{ mm}$$

Verification of the steel web classification.

$$\alpha_{cl} = 1$$

$$\frac{c_w}{t_w} \leq \frac{396 \cdot \epsilon}{13 \cdot \alpha_{cl} - 1}$$

$$\frac{243 \text{ mm}}{12 \text{ mm}} \leq \frac{396 \cdot 0.814}{13 \cdot 1 - 1}$$

$$20.3 \leq 26.8$$

OK

Web classified as Class 1.

$$N_{a,t,f} = b \cdot x \cdot f_{yb} = 300 \text{ mm} \cdot 14.1 \text{ mm} \cdot 355 \text{ MPa} = 1498.75 \text{ kN}$$

$$N_{a,c} = N_{pl,a} - N_{a,t,f} = 5357.80 \text{ kN} - 1498.75 \text{ kN} = 3859.04 \text{ kN}$$

Leverage arm of the compression part of the steel section calculated to the PNA.

$$h_{cs} = \frac{\left( b \cdot (t_f - x)^2 \cdot 0.5 + (1 - \rho) \cdot t_w \cdot (h_a - 2 \cdot t_f) \cdot \left( \frac{h_a}{2} - x \right) + t_f \cdot b \cdot \left( h_a - \frac{t_f}{2} - x \right) \right)}{b \cdot (t_f - x) + (1 - \rho) \cdot t_w \cdot (h_a - 2 \cdot t_f) + t_f \cdot b}$$

$$= \frac{\left( 300 \cdot (21.5 - 14.1)^2 \cdot 0.5 + (1 - 0.385) \cdot 12 \cdot (340 - 2 \cdot 21.5) \cdot \left( \frac{340}{2} - 14.1 \right) + 21.5 \cdot 300 \cdot \left( 340 - \frac{21.5}{2} - 14.1 \right) \right)}{300 \cdot (21.5 - 14.1) + (1 - 0.385) \cdot 12 \cdot (340 - 2 \cdot 21.5) + 21.5 \cdot 300}$$

$$h_{cs} = 219 \text{ mm}$$

$$h_l = x + h_s - c_l + \frac{d_l}{2} = 0.0141 + 0.16 - 0.03 + \frac{0.016}{2} = 136 \text{ mm}$$

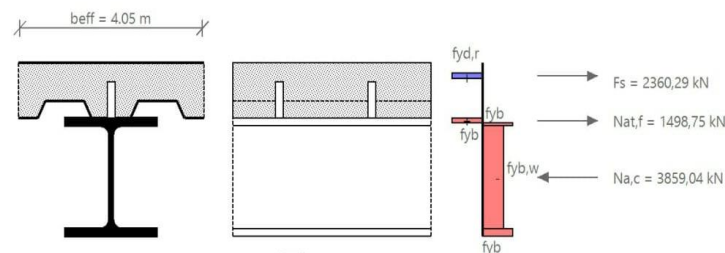

$$M_{pl,Rd} = F_s \cdot h_l + \frac{N_{a,t,f} \cdot x}{2} + N_{a,c} \cdot h_{cs} = 2360 \cdot 136 + \frac{1498.75 \cdot 14.1}{2} + 3859.04 \cdot 219 = 1178 \text{ kNm}$$

**Design moment resistance according to EN 1994-1-1 Art.6.2.1.2**

$$M_{Rd} = M_{pl,Rd} = 1178 \text{ kNm}$$

$$UC_{comp,M} = \frac{abs(M_{Ed,comp})}{M_{Rd}} = \frac{abs(-1108.350 \text{ kNm})}{1178 \text{ kNm}} = 0.94$$

The bending moment resistance of the section is adequate.

**5.3 LTB resistance**

$$F = \left(1 + \frac{t_w \cdot (h_a - t_f)}{4 \cdot b \cdot t_f}\right) \left(\frac{h_a - t_f}{t_w}\right)^{0.75} \cdot \left(\frac{t_f}{b}\right)^{0.25} = \left(1 + \frac{12 \cdot (340 - 21.5)}{4 \cdot 300 \cdot 21.5}\right) \cdot \left(\frac{340 - 21.5}{12}\right)^{0.75} \cdot \left(\frac{21.5}{300}\right)^{0.25} = 6.95$$

$$F_{lim} = 12.3$$

$$F \leq F_{lim}$$

$$6.95 \leq 12.3$$

OK

The cross-section is qualified for verification of LTB by the simplified method.

$$C_4 = 25$$

$$\lambda_{LT,rel} = 5 \cdot \left(1 + \frac{t_w \cdot (h_a - t_f)}{4 \cdot b \cdot t_f}\right) \left(\frac{h_a - t_f}{t_w}\right)^{0.75} \cdot \left(\frac{t_f}{b}\right)^{0.25} \cdot \left(\frac{f_{yb}}{E_b \cdot C_4}\right)^{0.5}$$

$$= 5 \cdot \left(1 + \frac{0.012 \cdot (0.34 - 0.0215)}{4 \cdot 0.3 \cdot 0.0215}\right) \cdot \left(\frac{0.34 - 0.0215}{0.012}\right)^{0.75} \cdot \left(\frac{0.0215}{0.3}\right)^{0.25} \cdot \left(\frac{355 \cdot 10^6}{210 \cdot 10^9 \cdot 25}\right)^{0.5} = 0.286$$

$h_a/b < 2 \rightarrow$  Buckling curve 'a'

$$\alpha_{LT} = 0.21$$

$$\Phi_{LT} = 0.5 \cdot (1 + \alpha_{LT} \cdot (\lambda_{LT,rel} - 0.2) + \lambda_{LT,rel}^2) = 0.5 \cdot (1 + 0.21 \cdot (0.286 - 0.2) + 0.286^2) = 0.55$$

$$\chi_{LT} = \frac{1}{\Phi_{LT} + \sqrt{\Phi_{LT}^2 - \lambda_{LT,rel}^2}} = \frac{1}{0.55 + \sqrt{0.55^2 - 0.286^2}} = 0.981$$

$$\chi_{LT} = \min(\chi_{LT}, 1) = \min(0.981, 1) = 0.981$$

$$M_{b,Rd} = \chi_{LT} \cdot M_{Rd} = 0.981 \cdot 1.18 \cdot 10^6 = 1155.116 \text{ kNm}$$

$$UC_{comp\_LTB} = \frac{abs(M_{Ed,comp})}{M_{b,Rd}} = \frac{abs(-1108.390 \text{ kNm})}{1155.116 \text{ kNm}} = 0.96$$

The later torsional buckling resistance of the section is adequate.

**5.4 Longitudinal shear**

**5.4.1 Transverse reinforcement**

Design shear flow

$$h_f = h_c = 109 \text{ mm}$$

$$V_{Ed} = \frac{n_f \cdot P_{Rd}}{2 \cdot I_s \cdot h_f} = \frac{1 \cdot 144 \text{ kN}}{2 \cdot 306 \text{ mm} \cdot 109 \text{ mm}} = 2.15 \text{ MPa}$$

Transverse reinforcement

$$\frac{A_{st} \cdot f_{yk,r}}{y_s \cdot s_f} \geq \frac{V_{Ed} \cdot h_f}{\cotg(\theta)}$$

$$A_t = A_{st}/s_f$$

$$A_t = \frac{V_{Ed} \cdot h_f}{\left(\frac{\cotg(\theta) \cdot f_{yk,r}}{y_s}\right)} = \frac{2.15 \cdot 10^6 \cdot 0.109}{\left(\frac{\cotg(26.5) \cdot 500 \cdot 10^6}{1.15}\right)} = 270 \text{ mm}^2/\text{m}$$

$$A_{t,prov} = \frac{1}{s_f} \cdot \left(\frac{d_t^2}{4}\right) \cdot 3.14 = \frac{1}{0.15} \cdot \left(\frac{0.016^2}{4}\right) \cdot 3.14 = 1340 \text{ mm}^2/\text{m}$$

$$A_{t,prov} \geq A_t$$

$$1340 \text{ mm}^2/\text{m} \geq 270 \text{ mm}^2/\text{m} \quad \text{OK}$$

The transverse reinforcement of the section is adequate.

**ULS check of Final stage is OK.**

$$UC_{comp} = \max(0.81; 0.94; 0.96) = 0.96$$

-iskoristivost elementa na GSN – 96 %

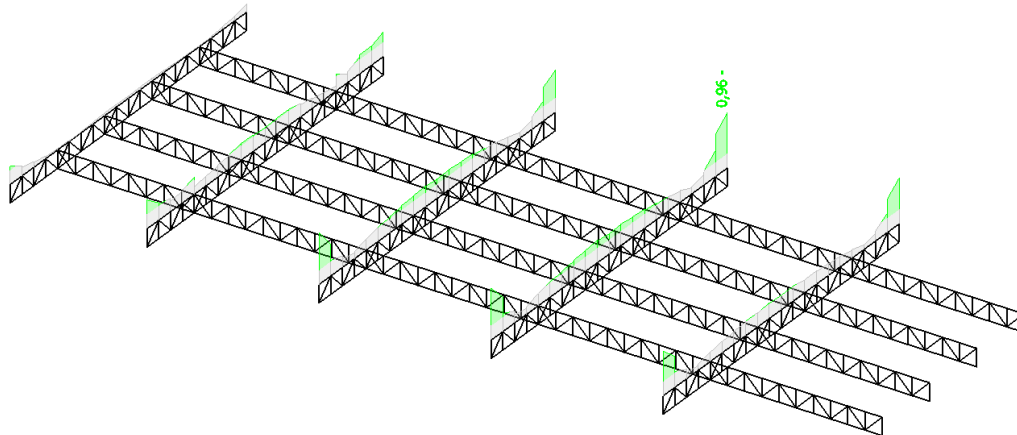

Slika 11.4. Prikaz iskoristivosti gornje pojasnice glavnog rešetkastog nosača



### 11.2.3. Rezne sile – gornja pojasnica glavnog rešetkastog nosača

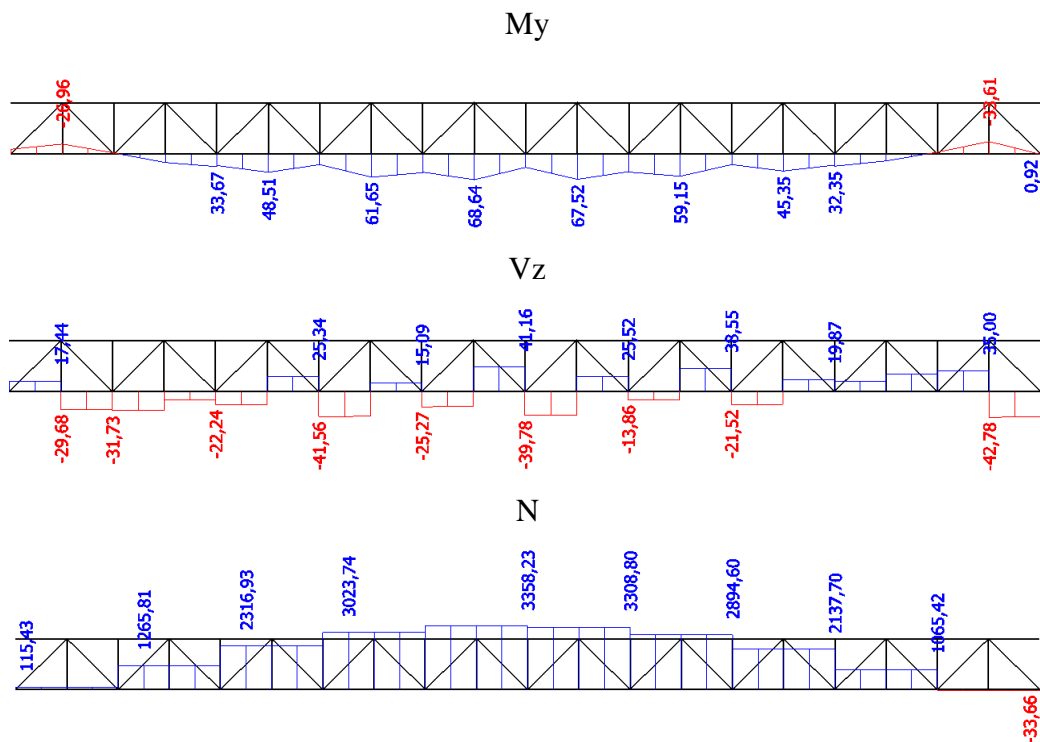

Slika 11.5. Prikaz reznih sila - donja pojasnica glavnog rešetkastog nosača

-poprečni presjek nosača

Name	Donja pojasnica glavnog rešetkastog nosača - konzolni dio	
Type	CFRHS250X250X12.5	
Source description	Rautaruukki Oyj / Structural Hollow Sections EN10219 / Ed.2007	
Item material	S 355	
Fabrication	cold formed	
Flexural buckling y-y	c	
Flexural buckling z-z	c	
Lateral torsional buckling	Default	
Use 2D FEM analysis	x	
A [m <sup>2</sup> ]	1,1204e-02	
A <sub>y, z</sub> [m <sup>2</sup> ]	5,5960e-03	5,5960e-03
I <sub>y, z</sub> [m <sup>4</sup> ]	1,0161e-04	1,0161e-04
I <sub>w</sub> [m <sup>6</sup> ], I <sub>t</sub> [m <sup>4</sup> ]	1,0173e-06	1,7283e-04
W <sub>el y, z</sub> [m <sup>3</sup> ]	8,1291e-04	8,1291e-04
W <sub>pl y, z</sub> [m <sup>3</sup> ]	9,7517e-04	9,7517e-04
d <sub>y, z</sub> [mm]	0	0
c <sub>YUCS, ZUCS</sub> [mm]	125	125
α [deg]	0,00	
A <sub>L, D</sub> [m <sup>2</sup> /m]	9,3600e-01	1,7922e+00
M <sub>ply +, -</sub> [Nm]	3,46e+05	3,46e+05
M <sub>plz +, -</sub> [Nm]	3,46e+05	3,46e+05

Slika 11.6. Prikaz geometrijskih karakteristika nosača

### 11.2.4. Dimenzioniranje – gornja pojasnica glavnog rešetkastog nosača

Member B1755	16,200 m	CFRHS250X250X12.5	S 355	GSN 2	0,95 -
--------------	----------	-------------------	-------	-------	--------

Note: EN 1993-1-3 article 1.1(3) specifies that this part does not apply to cold formed CHS and RHS sections. The default EN 1993-1-1 code check is executed instead of the EN 1993-1-3 code check.

Partial safety factors	
Gamma M0 for resistance of cross-sections	1,00
Gamma M1 for resistance to instability	1,00
Gamma M2 for resistance of net sections	1,25

Material	
Yield strength fy	355,0 MPa
Ultimate strength fu	510,0 MPa
Fabrication	Cold formed

....SECTION CHECK:....

The critical check is on position 8.910 m

Internal forces	Calculated	Unit
N,Ed	3358,23	kN
Vy,Ed	2,07	kN
Vz,Ed	40,86	kN
T,Ed	2,12	kNm
My,Ed	68,64	kNm
Mz,Ed	1,29	kNm

**Tension check**

According to EN 1993-1-1 article 6.2.3 and formula (6.5)

A	1,1204e-02	m <sup>2</sup>
Npl,Rd	3977,42	kN
Nu,Rd	4114,11	kN
Nt,Rd	3977,42	kN
Unity check	0,84	-

**Bending moment check for My**

According to EN 1993-1-1 article 6.2.5 and formula (6.12),(6.13)

Wpl,y	9,7517e-04	m <sup>3</sup>
Mpl,y,Rd	346,19	kNm
Unity check	0,20	-

**Bending moment check for Mz**

According to EN 1993-1-1 article 6.2.5 and formula (6.12),(6.13)

Wpl,z	9,7517e-04	m <sup>3</sup>
Mpl,z,Rd	346,19	kNm
Unity check	0,00	-

**Shear check for Vy**

According to EN 1993-1-1 article 6.2.6 and formula (6.17)

Eta	1,20	
Av	5,6020e-03	m <sup>2</sup>
Vpl,y,Rd	1148,18	kN
Unity check	0,00	-

**Shear check for Vz**

According to EN 1993-1-1 article 6.2.6 and formula (6.17)

Eta	1,20	
Av	5,6020e-03	m <sup>2</sup>
Vpl,z,Rd	1148,18	kN
Unity check	0,04	-

**Torsion check**

According to EN 1993-1-1 article 6.2.7 and formula (6.23)

Tau,t,Ed	1,5	MPa
Tau,Rd	205,0	MPa
Unity check	0,01	-

**Note:** The unity check for torsion is lower than the limit value of 0,05. Therefore torsion is considered as insignificant and is ignored in the combined checks.

**Combined bending, axial force and shear force check**

According to EN 1993-1-1 article 6.2.9.1 and formula (6.41)

MN,y,Rd	69,19	kNm
Alpha	6,00	
MN,z,Rd	69,19	kNm
Beta	6,00	

The member satisfies the section check.

....:STABILITY CHECK:....

**Lateral Torsional Buckling check**

According to EN 1993-1-1 article 6.3.2.1

**Note:** The cross-section concerns an RHS section with  $h / b < 10 / \lambda_{rel,z}$ .  
This section is thus not susceptible to Lateral Torsional Buckling.

**Bending and axial tension check**

According to EN 1993-1-3 article 6.3

Design tension force $N_{Ed}$	3358,23	kN
Design bending moment $M_{y,Ed}$	68,64	kNm
Design bending moment $M_{z,Ed}$	1,29	kNm
Tension resistance $N_{t,Rd}$	3977,42	kN
Bending resistance $M_{b,y,Rd}$	317,93	kNm
Bending resistance $M_{c,z,Rd,com}$	346,19	kNm

Unity check =  $0,22 + 0,00 - 0,84 = 0,62$  -

The member satisfies the stability check.

-iskoristivost elementa na GSN – 95 %

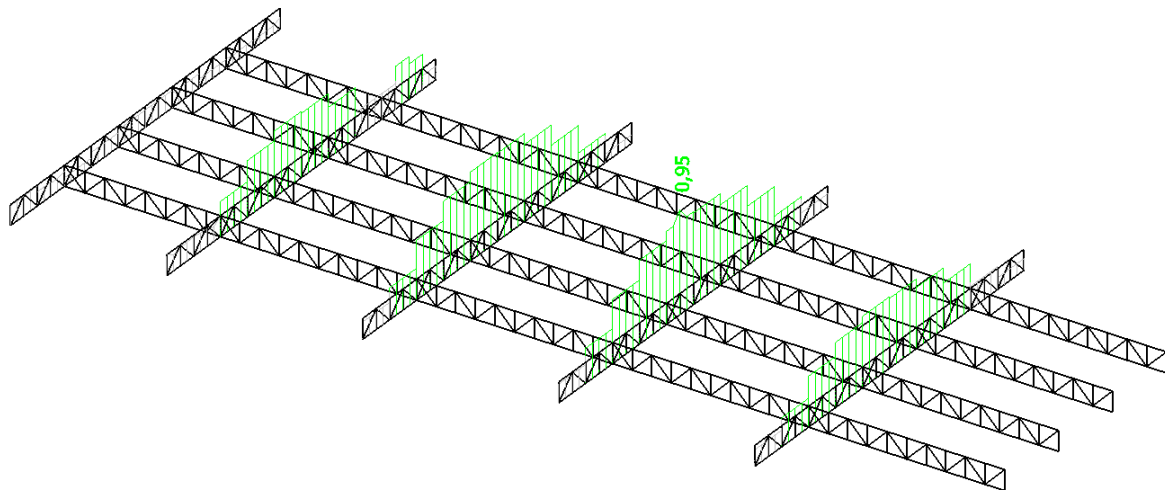

*Slika 11.7. Prikaz iskoristivosti donje pojasnice glavnog rešetkastog nosača*

### 11.2.5. Rezne sile – ispuna glavnog rešetkastog nosača

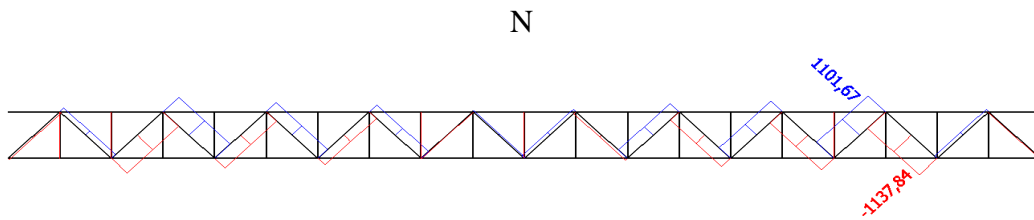

Slika 11.8. Prikaz reznih sila - ispuna glavnog rešetkastog nosača

-poprečni presjek nosača

Name	Ispuna glavnog rešetkastog nosača - konzolni dio	
Type	CFRHS160X160X6	
Source description	Rautaruukki Oyj / Structural Hollow Sections EN10219 / Ed.2007	
Item material	S 355	
Fabrication	cold formed	
Flexural buckling y-y	c	
Flexural buckling z-z	c	
Lateral torsional buckling	Default	
Use 2D FEM analysis	x	
A [m <sup>2</sup> ]	3,6030e-03	
A <sub>y</sub> , z [m <sup>2</sup> ]	1,8008e-03	1,8008e-03
I <sub>y</sub> , z [m <sup>4</sup> ]	1,4055e-05	1,4055e-05
I <sub>w</sub> [m <sup>6</sup> ], I <sub>t</sub> [m <sup>4</sup> ]	5,2429e-08	2,2389e-05
W <sub>el</sub> y, z [m <sup>3</sup> ]	1,7569e-04	1,7569e-04
W <sub>pl</sub> y, z [m <sup>3</sup> ]	2,0624e-04	2,0624e-04
d <sub>y</sub> , z [mm]	0	0
c <sub>YUCS, ZUCS</sub> [mm]	80	80
α [deg]	0,00	
A <sub>L, D</sub> [m <sup>2</sup> /m]	6,1900e-01	1,2010e+00
M <sub>pl</sub> y, z - [Nm]	7,32e+04	7,32e+04
M <sub>pl</sub> z, y - [Nm]	7,32e+04	7,32e+04

Slika 11.9. Prikaz geometrijskih karakteristika nosača

-iskoristivost elementa na GSN – 83 %

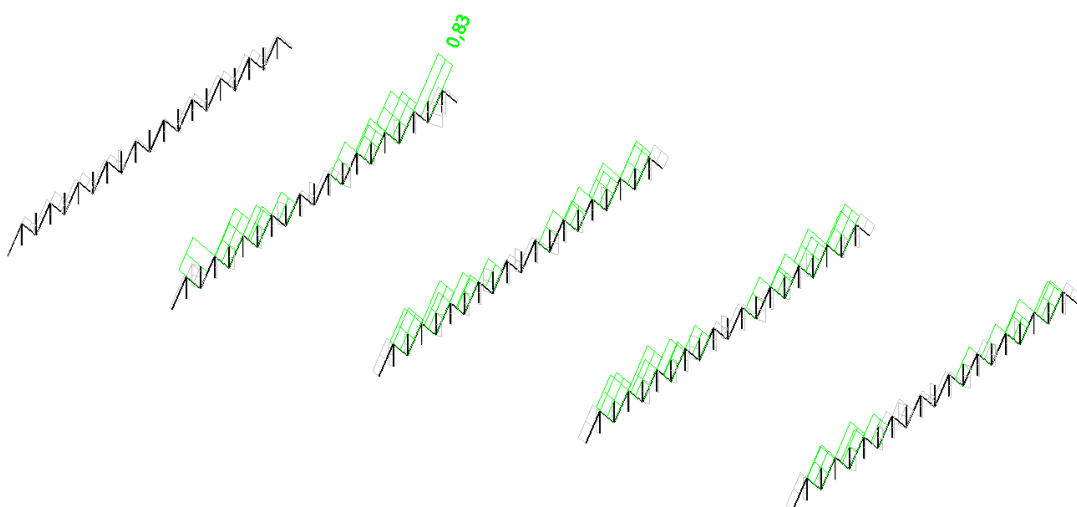

Slika 11.10. Prikaz iskoristivosti ispune glavnog rešetkastog nosača

### 11.2.6. Dimenzioniranje – ispuna glavnog rešetkastog nosača

Member B1709	1,138 m	CFRHS140X140X8	S 355	GSN 2	0,83 -
--------------	---------	----------------	-------	-------	--------

Note: EN 1993-1-3 article 1.1(3) specifies that this part does not apply to cold formed CHS and RHS sections. The default EN 1993-1-1 code check is executed instead of the EN 1993-1-3 code check.

Partial safety factors	
Gamma M0 for resistance of cross-sections	1,00
Gamma M1 for resistance to instability	1,00
Gamma M2 for resistance of net sections	1,25

Material	
Yield strength $f_y$	355,0 MPa
Ultimate strength $f_u$	510,0 MPa
Fabrication	Cold formed

....:SECTION CHECK:....

The critical check is on position 0,000 m

Internal forces	Calculated	Unit
N,Ed	-1137,84	kN
Vy,Ed	0,00	kN
Vz,Ed	0,00	kN
T,Ed	0,00	kNm
My,Ed	0,00	kNm
Mz,Ed	0,00	kNm

**Classification for cross-section design**

According to EN 1993-1-1 article 5.5.2

**Classification of Internal Compression parts**

According to EN 1993-1-1 Table 5.2 Sheet 1

Maximum width-to-thickness ratio	14,50
Class 1 Limit	26,85
Class 2 Limit	30,92
Class 3 Limit	34,17

=> Section classified as Class 1 for cross-section design

**Compression check**

According to EN 1993-1-1 article 6.2.4 and formula (6.9)

A	4,0040e-03	m <sup>2</sup>
Nc,Rd	1421,42	kN
Unity check	0,80	-

The member satisfies the section check.

....:STABILITY CHECK:....

**Classification for member buckling design**

Decisive position for stability classification: 0,000 m

**Classification of Internal Compression parts**

According to EN 1993-1-1 Table 5.2 Sheet 1

Maximum width-to-thickness ratio	14,50
Class 1 Limit	26,85
Class 2 Limit	30,92
Class 3 Limit	34,17

=> Section classified as Class 1 for member buckling design

**Flexural Buckling check**

According to EN 1993-1-1 article 6.3.1.1 and formula (6.46)

Buckling parameters	yy	zz
Sway type	sway	non-sway
System length L	1,138	1,138
Buckling factor k	1,00	1,00
Buckling length Lcr	1,138	1,138
Critical Euler load Ncr	18018,38	18019,28
Slenderness Lambda	21,46	21,46
Relative slenderness Lambda,rel	0,28	0,28
Limit slenderness Lambda,rel,0	0,20	0,20
Buckling curve	c	c
Imperfection Alpha	0,49	0,49
Reduction factor Chi	0,96	0,96
Buckling resistance Nb,Rd	1362,99	1363,00

Flexural Buckling verification	
Cross-section area A	4,0040e-03 m <sup>2</sup>
Buckling resistance Nb,Rd	1362,99 kN
Unity check	0,83 -

**Note:** The cross-section concerns a RHS section which is not susceptible to Torsional(-Flexural) Buckling. The member satisfies the stability check.

### 11.2.7. Rezne sile – gornja pojasnica sekundarnog rešetkastog nosača

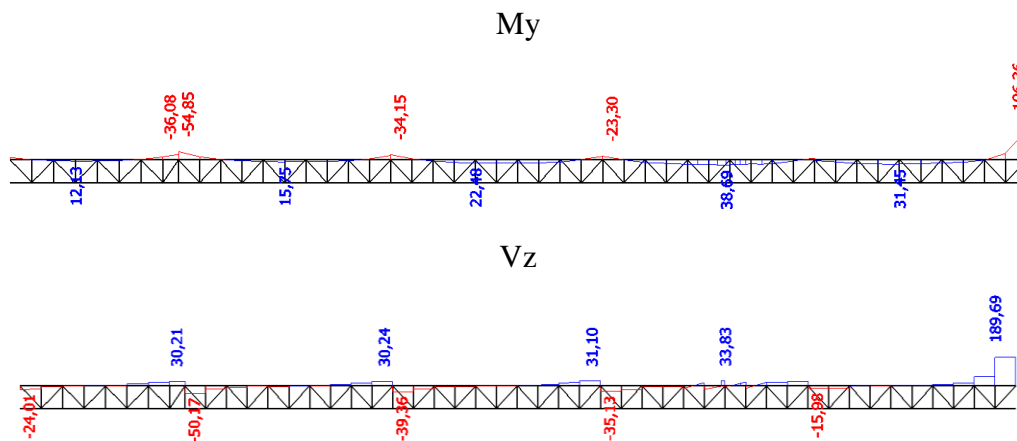

Slika 11.11. Prikaz reznih sila – gornja pojasnica sekundarnog rešetkastog nosača

-poprečni presjek nosača

Name	Gornja pojasnica sekundarnog rešetkastog nosača - kozolni dio	
Type	HEB200	
Source description	Profil Arbed / Structural shapes / Edition Octobre 1995	
Item material	S 355	
Fabrication	rolled	
Flexural buckling y-y	b	
Flexural buckling z-z	c	
Lateral torsional buckling	Default	
Use 2D FEM analysis	*	
A [m²]	7,8080e-03	
A y, z [m²]	5,7750e-03	1,9112e-03
I y, z [m⁴]	5,6960e-05	2,0030e-05
I w [m⁴], t [m⁴]	1,7112e-07	5,9280e-07
Wey, z [m³]	5,6960e-04	2,0030e-04
Wpl y, z [m³]	6,4250e-04	3,0580e-04
d y, z [mm]	0	0
c YUCS, ZUCS [mm]	100	100
α [deg]	0,00	
A L, D [m²/m]	1,1500e+00	1,1510e+00
Mply +, - [Nm]	2,28e+05	2,28e+05
Mplz +, - [Nm]	1,09e+05	1,09e+05

Slika 11.12. Prikaz geometrijskih karakteristika nosača

-iskoristivost elementa na GSN – 58 %

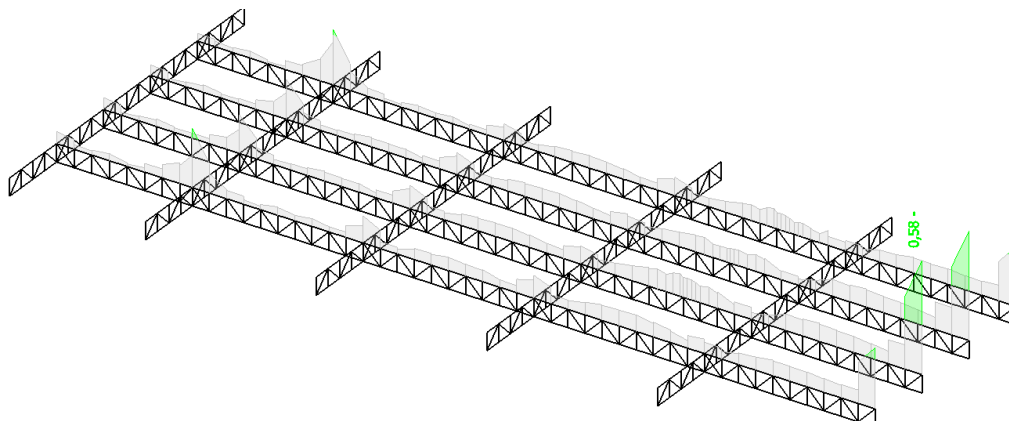

Slika 11.13. Prikaz iskoristivosti gornje pojasnice sekundarnog rešetkastog nosača

## 11.2.8. Dimenzioniranje – gornja pojasnica sekundarnog rešetkastog nosača

SCIAENGINEER

### Composite Beam - Final stage

Linear calculation  
 Class: All ULS  
 Extreme 1D: Global  
 Selection: B4952

### Composite beam verification

for beam B4952 at section 0 m, in accordance with EC EN 1994-1-1

#### 1. Geometry data

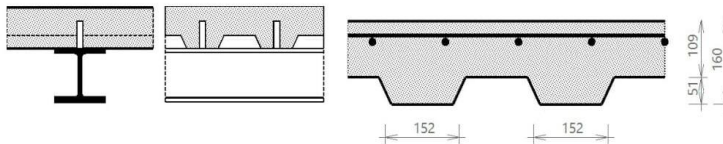

#### Continuous beam

Length of the current span	$L = 7.86 \text{ m}$
Length of next span	$L_{\text{next}} = 7.86 \text{ m}$
Beam spacing at the left	$L_{\text{left}} = 3.24 \text{ m}$
Beam spacing at the right	$L_{\text{right}} = 3.24 \text{ m}$
Checked section	$d_x = 0 \text{ m}$

#### 2. Cross-section & materials

##### 2.1 Steel section properties

##### 2.1.1 Cross-section

Cross-section	HEB200
Height	$h_a = 200 \text{ mm}$
Width	$b = 200 \text{ mm}$
Web thickness	$t_w = 9 \text{ mm}$
Flange thickness	$t_f = 15 \text{ mm}$
Radius	$r = 18 \text{ mm}$
Area	$A_{st} = 7808 \text{ mm}^2$
Moment of inertia	$I_y = 57 \cdot 10^6 \text{ mm}^4$
Radius of gyration	$i_z = 51 \text{ mm}$
Plastic section modulus	$W_{ply} = 642500 \text{ mm}^3$

##### 2.1.2 Material

Steel grade	S 355
Yield strength	$f_{yb} = 355 \text{ MPa}$
Ultimate strength	$f_{ub} = 490 \text{ MPa}$
E modulus	$E_b = 210000 \text{ MPa}$

##### 2.1.3 Cross-section classification

$$\varepsilon = \sqrt{\frac{235}{355}} = 0.814$$

(EN 1993-1-1 §5.6 Tab. 5.2)

##### 2.1.3.1 Flange in compression

$$c_f = \frac{b - t_w - 2 \cdot r}{2} = \frac{200 \text{ mm} - 9 \text{ mm} - 2 \cdot 18 \text{ mm}}{2} = 77.5 \text{ mm}$$

$$\frac{c_f}{t_f} \leq 9 \cdot \varepsilon$$

$$\frac{77.5 \text{ mm}}{15 \text{ mm}} \leq 9 \cdot 0.814$$

$$5.17 \leq 7.32$$

OK

Flange classified as Class 1.

Student version

2.1.3.2 Web in bending

$$c_w = h_a - 2 \cdot t_f - 2 \cdot r = 200 \text{ mm} - 2 \cdot 15 \text{ mm} - 2 \cdot 18 \text{ mm} = 134 \text{ mm}$$

$$\alpha_d = 0.5$$

$$\frac{c_w}{t_w} \leq \frac{36 \cdot \epsilon}{\alpha_d}$$

$$\frac{134 \text{ mm}}{9 \text{ mm}} \leq \frac{36 \cdot 0.814}{0.5}$$

$$14.9 \leq 58.6 \quad \text{OK}$$

Web classified as Class 1.

**Cross-section classified as Class 1**

Cross-section Class OK.

**2.2 Concrete slab with profiled sheeting****2.2.1 Concrete slab**2.2.1.1 Slab

Total height of the slab  $h_s = 160 \text{ mm}$

2.2.1.2 Material

Concrete class C30/37  
 Characteristic strength  $f_{ck} = 30 \text{ MPa}$   
 E modulus  $E_{cm} = 32800 \text{ MPa}$

**2.2.2 Profiled steel sheeting**

Sheeting with ribs transverse to the supporting beams

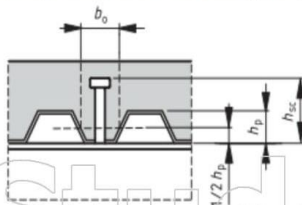

Name	Vulcraft 2 VLI 20
Depth of the ribs	$h_p = 50.8 \text{ mm}$
Height of full concrete	$h_c = 109.2 \text{ mm}$
Height of the re-entrant stiffener	$h_d = 0 \text{ mm}$
Spacing of the ribs	$b_s = 304.8 \text{ mm}$
Top width of the rib	$b_r = 127 \text{ mm}$
Bottom width of the rib	$b_b = 127 \text{ mm}$
Mean width of the ribs	$b_{0,rib} = 152.4 \text{ mm}$
Thickness of the sheeting	$t_p = 0.9093 \text{ mm}$

**2.2.3 Shear connectors**2.2.3.1 Geometry

Name	H110
Diameter	$d_s = 25 \text{ mm}$
Nominal height	$h_{nom} = 110 \text{ mm}$
As-welded height	$h_{sc} = 105 \text{ mm}$
Amount per trough or section	$n_r = 1$

2.2.3.2 Material

Steel grade	S 355
Ultimate strength	$f_{us} = 490 \text{ MPa}$

**2.2.4 Reinforcement**2.2.4.1 Geometry

Longitudinal bar diameter	$d_l = 16 \text{ mm}$
Longitudinal bar spacing	$s_l = 150 \text{ mm}$
Longitudinal bar cover	$c_l = 30 \text{ mm}$
Transverse bar diameter	$d_t = 16 \text{ mm}$
Transverse bar spacing	$s_t = 150 \text{ mm}$
Transverse bar cover	$c_t = 46 \text{ mm}$

2.2.4.2 Material

Material	B 500A
Characteristic yield strength	$f_{yk,r} = 500 \text{ MPa}$



**3. Design values of loads**

Load Name : GSN 22

Content of combination : 1.35\*g-vlastitežina+1.35\*dg-dodatnostalno+  
1.62\*q-promjenjivoopterećenje-1.35\*g-vlastitežina\_dryconcrete+  
1.35\*Wx-1kom.-Wz-poz+1.35\*s-opterećenjesnijegom

Bending moment  $M_{Ed,comp} = -196.194$  kNm  
Shear force  $V_{Ed,comp} = 187.782$  kN

**4. Partial safety factors**

Steel section  $\gamma_{M0} = 1$   
 $\gamma_{M1} = 1$   
Shear connectors  $\gamma_V = 1.25$   
Concrete  $\gamma_C = 1.5$   
Reinforcement  $\gamma_S = 1.15$

**5. ULS check of the Final stage**

**5.1 Shear connection**

**5.1.1 Design resistance of shear connectors**

**5.1.1.1 Shear connector in a solid slab**

$$\frac{h_{sc}}{d_s} > 4$$

$$4.2 > 4$$

$$\alpha = 1$$

$$f_{us} = \min(490; 450) \text{ MPa}$$

$$f_{us} = 450 \text{ MPa}$$

$$P_{Rd,solid,1} = \frac{0.8 \cdot f_{us} \cdot \left(\frac{\pi \cdot d_s^2}{4}\right)}{\gamma_V} = \frac{0.8 \cdot 450 \text{ MPa} \cdot \left(\frac{3.14 \cdot 25 \text{ mm}^2}{4}\right)}{1.25} = 141 \text{ kN}$$

$$P_{Rd,solid,2} = \frac{0.29 \cdot \alpha \cdot d_s^2 \cdot \sqrt{f_{ck} \cdot E_{cm}}}{\gamma_V} = \frac{0.29 \cdot 1 \cdot 25 \text{ mm}^2 \cdot \sqrt{30 \text{ MPa} \cdot 32800 \text{ MPa}}}{1.25} = 144 \text{ kN}$$

$$P_{Rd,solid} = \min(P_{Rd,solid,1}; P_{Rd,solid,2}) = \min(141 \text{ kN}; 144 \text{ kN}) = 141 \text{ kN}$$

**5.1.1.2 Shear connector in profiled sheeting**

Sheeting with ribs transverse to the supporting beams

$$k_t = \frac{0.7}{\sqrt{n_r}} \cdot \left(\frac{b_{0,rib}}{h_p}\right) \cdot \left(\frac{h_{sc}}{h_p} - 1\right) = \frac{0.7}{\sqrt{1}} \cdot \left(\frac{152 \text{ mm}}{50.8 \text{ mm}}\right) \cdot \left(\frac{105 \text{ mm}}{50.8 \text{ mm}} - 1\right) = 2.24$$

$$k_{t,max} = 0.85$$

$$k_t = \max(0; \min(k_t; k_{t,max})) = \max(0; \min(2.24; 0.85)) = 0.85$$

$$P_{Rd} = k_t \cdot P_{Rd,solid} = 0.85 \cdot 141 \text{ kN} = 120 \text{ kN}$$

Warning: The conditions given by EN 1994-1-1 Art.6.6.4.2 (3) are not fulfilled.

**5.1.2 Degree of shear connection**

**5.1.2.1 Determination of  $b_{eff}$  of the concrete flange and length  $L_e$**

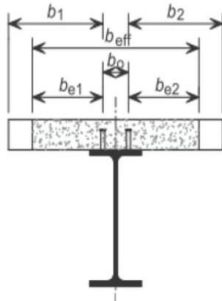

The effective width at the end support

$$L_{e0} = 0.85 \cdot L_1 = 0.85 \cdot 7.86 \text{ m} = 6.68 \text{ m}$$

**Left side of the beam**

$$b_1 = \frac{L_{\text{perp, left}}}{2} - \frac{b_0}{2} = \frac{3,24 \text{ m}}{2} - \frac{0 \text{ mm}}{2} = 1,62 \text{ m}$$

$$b_{e10} = \min\left(\frac{L_{e0}}{8}; b_1\right) = \min\left(\frac{6,68 \text{ m}}{8}; 1,62 \text{ m}\right) = 0,835 \text{ m}$$

$$b_{e11} = \min\left(\frac{L_{e1}}{8}; b_1\right) = \min\left(\frac{0 \text{ m}}{8}; 1,62 \text{ m}\right) = 0 \text{ m}$$

$$b_{e12} = \min\left(\frac{L_{e2}}{8}; b_1\right) = \min\left(\frac{0 \text{ m}}{8}; 1,62 \text{ m}\right) = 0 \text{ m}$$

$$\beta_{1, \text{calc}} = 0,55 + \frac{0,025 \cdot L_{e0}}{b_{e10}} = 0,55 + \frac{0,025 \cdot 6,68 \text{ m}}{0,835 \text{ m}} = 0,75$$

$$\beta_{1, \text{calc}} \leq 1,0$$

$$0,75 \leq 1,0 \quad \text{OK}$$

$$\beta_1 = \beta_{1, \text{calc}} = 0,75$$

**Right side of the beam**

$$b_2 = \frac{L_{\text{perp, right}}}{2} - \frac{b_0}{2} = \frac{3,24 \text{ m}}{2} - \frac{0 \text{ mm}}{2} = 1,62 \text{ m}$$

$$b_{e20} = \min\left(\frac{L_{e0}}{8}; b_2\right) = \min\left(\frac{6,68 \text{ m}}{8}; 1,62 \text{ m}\right) = 0,835 \text{ m}$$

$$b_{e21} = \min\left(\frac{L_{e1}}{8}; b_2\right) = \min\left(\frac{0 \text{ m}}{8}; 1,62 \text{ m}\right) = 0 \text{ m}$$

$$b_{e22} = \min\left(\frac{L_{e2}}{8}; b_2\right) = \min\left(\frac{0 \text{ m}}{8}; 1,62 \text{ m}\right) = 0 \text{ m}$$

$$\beta_{2, \text{calc}} = 0,55 + \frac{0,025 \cdot L_{e0}}{b_{e20}} = 0,55 + \frac{0,025 \cdot 6,68 \text{ m}}{0,835 \text{ m}} = 0,75$$

$$\beta_{2, \text{calc}} \leq 1,0$$

$$0,75 \leq 1,0 \quad \text{OK}$$

$$\beta_2 = \beta_{2, \text{calc}} = 0,75$$

**Calculation of  $b_{\text{eff},0}$** 

$$b_{\text{eff},0} = b_0 + b_{e10} \cdot \beta_1 + b_{e20} \cdot \beta_2 = 0 \text{ mm} + 0,835 \text{ m} \cdot 0,75 + 0,835 \text{ m} \cdot 0,75 = 1,25 \text{ m}$$

**Calculation of  $b_{\text{eff}}$** 

$$b_{\text{eff}} = b_{\text{eff},0} = 1,25 \text{ m}$$

**Determination of  $L_e$** 

$$L_e = L_{e0} = 6,68 \text{ m}$$

**5.1.2.2 Minimum degree of shear connection**

Warning: Conditions given by EN 1994-1-1 Art. 6.6.1.2 (3) are not fulfilled.

$$\eta_{\text{min, calc}} = 1 - \frac{355}{f_{yb}} \cdot (0,75 - 0,03 \cdot L_e)$$

$$\eta_{\text{min, calc}} = 1 - \frac{355}{355} \cdot (0,75 - 0,03 \cdot 6,68 \text{ m}) = 0,45$$

$$\eta_{\text{min}} = \max(\eta_{\text{min, calc}}; 0,4) = \max(0,45; 0,4) = 0,45$$

**5.1.2.3 Degree of shear connection present****5.1.2.3.1 Tension resistance of the reinforcement**

$$A_s = \frac{b_{\text{eff}}}{s_l} \cdot \left(\frac{d_l}{4}\right) \cdot \pi = \frac{1,25 \text{ m}}{150 \text{ mm}} \cdot \left(\frac{16 \text{ mm}^2}{4}\right) \cdot 3,14 = 1679 \text{ mm}^2$$

$$F_s = \frac{A_s \cdot f_{yk,r}}{\gamma_s} = \frac{1,68 \cdot 10^{-3} \cdot 500 \cdot 10^6}{1,15} = 730 \text{ kN}$$

**5.1.2.3.2 Tension resistance of the steel member**

$$N_{pl,a} = f_{yb} \cdot A_a = 355 \text{ MPa} \cdot 7808 \text{ mm}^2 = 2771,84 \text{ kN}$$

$$N_{c,t} = \min(F_s; N_{pl,a}) = \min(730 \text{ kN}; 2771,84 \text{ kN}) = 730,05 \text{ kN}$$

Student version

### 5.1.2.3.3 Resistance of the shear connectors

Number of full ribs available per length  $L_e$

$$n_{rib} = \frac{L_e}{b_s} = \frac{6.58 \text{ m}}{305 \text{ mm}}$$

$$n_{rib} = 21$$

$$l_s = b_s \cdot \text{trough} = 305 \text{ mm} \cdot 1 = 305 \text{ mm}$$

Number of shear studs available per length  $L_e/2$

$$n_{sp} = \frac{0.5 \cdot n_{rib} \cdot n_r}{\text{trough}} = \frac{0.5 \cdot 21 \cdot 1}{1} = 10.5$$

$$N_c = n_{sp} \cdot P_{Rd} = 10.5 \cdot 120166 = 1261.74 \text{ kN}$$

$$\eta = \min\left(\frac{N_c}{N_{c,f}}, 1\right) = \min\left(\frac{1261.74 \text{ kN}}{730.05 \text{ kN}}, 1\right) = 1$$

$$\eta \geq \eta_{\min}$$

$$1 \geq 0.45 \quad \text{OK}$$

The shear connection degree is adequate.

## 5.2 Cross-sectional resistance of the composite beam

### 5.2.1 Shear buckling

$$h_w = h_a - 2 \cdot t_f = 200 \text{ mm} - 2 \cdot 15 \text{ mm} = 170 \text{ mm}$$

$$\eta_{sb} = 1.2$$

$$\frac{h_w}{t_w} \leq \eta_{sb}$$

$$\frac{170 \text{ mm}}{9 \text{ mm}} \leq \frac{72 \cdot 0.814}{1.2}$$

$$18.9 \leq 48.8$$

OK

The shear buckling resistance of the web does not need to be verified.

### 5.2.2 Vertical shear

The resistance to vertical shear should be taken as the resistance of the structural steel section.

$$A_v = A_a = 2 \cdot b \cdot t_f + (t_w + 2 \cdot r) \cdot t_f$$

$$= 7.81 \cdot 10^{-3} - 2 \cdot 0.2 \cdot 0.015 + (9 \cdot 10^{-3} + 2 \cdot 0.018) \cdot 0.015 = 2483 \text{ mm}^2$$

$$A_{v,\min} = \eta_{sb} \cdot h_w \cdot t_w = 1.2 \cdot 0.17 \cdot 9 \cdot 10^{-3} = 1836 \text{ mm}^2$$

$$A_v \geq A_{v,\min}$$

$$2483 \text{ mm}^2 \geq 1836 \text{ mm}^2$$

$$V_{pl,Rd} = \frac{A_v \cdot f_{yb}}{\sqrt{3} \cdot \gamma_{M0}} = \frac{2483 \text{ mm}^2 \cdot 355 \cdot 10^6}{\sqrt{3} \cdot 1} = 509 \text{ kN}$$

$$UC_{\text{comp}_V} = \frac{\text{abs}(V_{Ed,\text{comp}})}{V_{pl,Rd}} = \frac{\text{abs}(187.782 \text{ kN})}{509 \text{ kN}} = 0.37$$

The shear resistance of the section is adequate.

### 5.2.3 Bending moment

#### 5.2.3.1 Longitudinal reinforcement

##### 5.2.3.1.1 Centre of composite section

For buildings not intended mainly for storage the effects of creep in concrete beams may be taken into account by using an effective E modulus  $E_{\text{eff}} = E_{\text{cm}} / 2$ .

$$E_{\text{eff}} = \frac{E_{\text{cm}}}{2} = \frac{32800 \text{ MPa}}{2} = 16400 \text{ MPa}$$

$$n_E = \frac{E_b}{E_{\text{eff}}} = \frac{210000 \text{ MPa}}{16400 \text{ MPa}} = 12.8$$

$$y_d = \frac{A_a \cdot \left(\frac{h_a}{2}\right) + \left(\frac{1}{n_E}\right) \cdot b_{\text{eff}} \cdot (h_c - h_d) \cdot \left(h_a + h_s - \frac{h_c - h_d}{2}\right)}{A_a + \left(\frac{1}{n_E}\right) \cdot b_{\text{eff}} \cdot (h_c - h_d)}$$

$$= \frac{7.81 \cdot 10^{-3} \cdot \left(\frac{0.2}{2}\right) + \left(\frac{1}{12.8}\right) \cdot 1.25 \cdot (0.109 - 0) \cdot \left(0.2 + 0.16 - \frac{0.109 - 0}{2}\right)}{7.81 \cdot 10^{-3} + \left(\frac{1}{12.8}\right) \cdot 1.25 \cdot (0.109 - 0)} = 219 \text{ mm}$$

Student version

5.2.3.1.2 Degree of reinforcement

$$A_s = \frac{b_{eff} \cdot \left(\frac{d_l}{4}\right)^2 \cdot \pi}{s_l} = \frac{1.25 \text{ m} \cdot \left(\frac{16 \text{ mm}^2}{4}\right) \cdot 3.14}{150 \text{ mm}} = 1679 \text{ mm}^2$$

$$A_c = b_{eff} \cdot (h_c - h_d) = 1.25 \cdot (0.109 - 0) = 136793 \text{ mm}^2$$

$$z_0 = \left(h_a + h_s - \frac{h_c - h_d}{2}\right) - y_d = \left(0.2 + 0.16 - \frac{0.109 - 0}{2}\right) - 0.219 = 86.7 \text{ mm}$$

$$k_c = \min\left(\frac{1}{\left(1 + \frac{h_c - h_d}{2 \cdot z_0}\right)} + 0.3; 1\right) = \min\left(\frac{1}{\left(1 + \frac{0.109 - 0}{2 \cdot 0.0867}\right)} + 0.3; 1\right) = 0.914$$

$$\rho_s = \delta \cdot \left(\frac{f_{yb}}{235}\right) \cdot \left(\frac{f_{ctm}}{f_{yk,r}}\right) \cdot \sqrt{k_c} = 1.1 \cdot \left(\frac{355}{235}\right) \cdot \left(\frac{2.9 \cdot 10^6}{500 \cdot 10^6}\right) \cdot \sqrt{0.914} = 0.921 \%$$

$$A_s \geq \rho_s \cdot A_c$$

$$1679 \text{ mm}^2 \geq 9.21 \cdot 10^{-3} \cdot 136793 \text{ mm}^2$$

$$1679 \text{ mm}^2 \geq 1260 \text{ mm}^2 \quad \text{OK}$$

The longitudinal reinforcement of the section is adequate.

5.2.3.2 Moment resistance

Moment resistance of a steel cross-section

$$M_{pl,Rd,a} = \frac{W_{ply} \cdot f_{yb}}{\gamma_{MO}} = \frac{642500 \text{ mm}^3 \cdot 355 \text{ MPa}}{1} = 228 \text{ kNm}$$

Influence of shear

$$\frac{V_{pl,Rd}}{2} > \text{abs}(V_{Ed,comp})$$

$$\frac{509 \text{ kN}}{2} > 188 \text{ kN}$$

$$254 \text{ kN} > 188 \text{ kN} \quad \text{OK}$$

The influence of the vertical shear on the bending moment resistance may be neglected.

$$f_{yb,w} = f_{yb} = 355 \text{ MPa}$$

Modified tension resistance of the steel member

$$r = 0 \text{ mm}$$

$$A_s = 2 \cdot t_f \cdot b + t_w \cdot (h_a - 2 \cdot t_f) = 2 \cdot 15 \text{ mm} \cdot 200 \text{ mm} + 9 \text{ mm} \cdot (200 \text{ mm} - 2 \cdot 15 \text{ mm}) = 7530 \text{ mm}^2$$

$$N_{pl,a} = A_s \cdot f_{yb} = 7530 \text{ mm}^2 \cdot 355 \text{ MPa} = 2673.15 \text{ kN}$$

Note: Roundings of the steel cross-section are neglected in bending resistance calculation.

$$N_{c,f} = \min(F_s; N_{pl,a}) = \min(730 \text{ kN}; 2673.15 \text{ kN}) = 730.05 \text{ kN}$$

Negative bending moment resistance calculation

The plastic neutral axis is located within the flange of the steel section.

$$N_{pl,a} - N_{a,f} = F_s + N_{a,f}$$

$$x = \frac{(N_{pl,a} - F_s)}{(2 \cdot b \cdot f_{yb})} = \frac{(2673.15 \text{ kN} - 730 \text{ kN})}{(2 \cdot 200 \text{ mm} \cdot 355 \text{ MPa})} = 13.7 \text{ mm}$$

Verification of the steel web classification.

$$\alpha_{cl} = 1$$

$$\frac{c_w}{t_w} \leq \frac{396 \cdot \epsilon}{13 \cdot \alpha_{cl} - 1}$$

$$\frac{134 \text{ mm}}{9 \text{ mm}} \leq \frac{396 \cdot 0.814}{13 \cdot 1 - 1}$$

$$14.9 \leq 26.8 \quad \text{OK}$$

Web classified as Class 1.

$$N_{a,f} = b \cdot x \cdot f_{yb} = 200 \text{ mm} \cdot 13.7 \text{ mm} \cdot 355 \text{ MPa} = 971.55 \text{ kN}$$

$$N_{a,c} = N_{pl,a} - N_{a,f} = 2673.15 \text{ kN} - 971.55 \text{ kN} = 1701.60 \text{ kN}$$

Leverage arm of the compression part of the steel section calculated to the PNA.

$$h_{cs} = \frac{\left(b \cdot (t_f - x)^2 \cdot 0.5 + t_w \cdot (h_a - 2 \cdot t_f) \cdot \left(\frac{h_a}{2} - x\right) + t_f \cdot b \cdot \left(h_a - \frac{t_f}{2} - x\right)\right)}{b \cdot (t_f - x) + t_w \cdot (h_a - 2 \cdot t_f) + t_f \cdot b}$$

$$= \frac{\left(200 \cdot (15 - 13.7)^2 \cdot 0.5 + 9 \cdot (200 - 2 \cdot 15) \cdot \left(\frac{200}{2} - 13.7\right) + 15 \cdot 200 \cdot \left(200 - \frac{15}{2} - 13.7\right)\right)}{200 \cdot (15 - 13.7) + 9 \cdot (200 - 2 \cdot 15) + 15 \cdot 200}$$

$$h_{cs} = 140 \text{ mm}$$

$$h_l = x + h_s - c_l + \frac{d_l}{2} = 0.0137 + 0.16 - 0.03 + \frac{0.016}{2} = 136 \text{ mm}$$

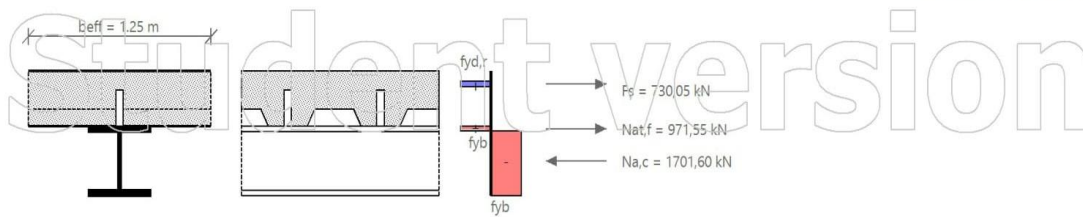

$$M_{pLRd} = F_s \cdot h_1 + \frac{N_{at,f} \cdot x}{2} + N_{a,c} \cdot h_{cs} = 730 \cdot 136 + \frac{971.55 \cdot 13.7}{2} + 1701.60 \cdot 140 = 343 \text{ kNm}$$

**Design moment resistance according to EN 1994-1-1 Art.6.2.1.2**

$$M_{Rd} = M_{pLRd} = 343 \text{ kNm}$$

$$UC_{comp,M} = \frac{abs(M_{Ed,comp})}{M_{Rd}} = \frac{abs(-196.194 \text{ kNm})}{343 \text{ kNm}} = 0.57$$

The bending moment resistance of the section is adequate.

**5.3 LTB resistance**

$$F = \left( 1 + \frac{t_w \cdot (h_a - t_f)}{4 \cdot b \cdot t_f} \right) \cdot \left( \frac{h_a - t_f}{t_w} \right)^{0.75} \cdot \left( \frac{t_f}{b} \right)^{0.25} = \left( 1 + \frac{9 \cdot (200 - 15)}{4 \cdot 200 \cdot 15} \right) \cdot \left( \frac{200 - 15}{9} \right)^{0.75} \cdot \left( \frac{15}{200} \right)^{0.25} = 5.75$$

$$F_{lim} = 12.3$$

$$F \leq F_{lim}$$

$$5.75 \leq 12.3$$

OK

The cross-section is qualified for verification of LTB by the simplified method.

$$C_4 = 25$$

$$\lambda_{LT,rel} = 5 \cdot \left( 1 + \frac{t_w \cdot (h_a - t_f)}{4 \cdot b \cdot t_f} \right) \cdot \left( \frac{h_a - t_f}{t_w} \right)^{0.75} \cdot \left( \frac{t_f}{b} \right)^{0.25} \cdot \left( \frac{f_{yb}}{E_b \cdot C_4} \right)^{0.5}$$

$$= 5 \cdot \left( 1 + \frac{9 \cdot 10^{-3} \cdot (0.2 - 0.015)}{4 \cdot 0.2 \cdot 0.015} \right) \cdot \left( \frac{0.2 - 0.015}{9 \cdot 10^{-3}} \right)^{0.75} \cdot \left( \frac{0.015}{0.2} \right)^{0.25} \cdot \left( \frac{355 \cdot 10^6}{210 \cdot 10^9 \cdot 25} \right)^{0.5} = 0.237$$

$h_w/b \leq 2 \rightarrow$  Buckling curve 'a'

$$\alpha_{LT} = 0.21$$

$$\Phi_{LT} = 0.5 \cdot \left( 1 + \alpha_{LT} \cdot (\lambda_{LT,rel} - 0.2) + \lambda_{LT,rel}^2 \right) = 0.5 \cdot \left( 1 + 0.21 \cdot (0.237 - 0.2) + 0.237^2 \right) = 0.532$$

$$X_{LT} = \frac{1}{\Phi_{LT} + \sqrt{\Phi_{LT}^2 - \lambda_{LT,rel}^2}} = \frac{1}{0.532 + \sqrt{0.532^2 - 0.237^2}} = 0.992$$

$$X_{LT} = \min(X_{LT}, 1) = \min(0.992, 1) = 0.992$$

$$M_{b,Rd} = X_{LT} \cdot M_{Rd} = 0.992 \cdot 343087 = 340.322 \text{ kNm}$$

$$UC_{comp\_LTB} = \frac{abs(M_{Ed,comp})}{M_{b,Rd}} = \frac{abs(-196.194 \text{ kNm})}{340.322 \text{ kNm}} = 0.58$$

The later torsional buckling resistance of the section is adequate.

**5.4 Longitudinal shear**

**5.4.1 Transverse reinforcement**

Design shear flow

$$h_f = h_c = 109 \text{ mm}$$

$$v_{Ed} = \frac{n_r \cdot P_{Rd}}{2 \cdot l_s \cdot h_f} = \frac{1 \cdot 120 \text{ kN}}{2 \cdot 305 \text{ mm} \cdot 109 \text{ mm}} = 1.81 \text{ MPa}$$

Transverse reinforcement

$$\frac{A_{st} \cdot f_{yk,r}}{s_f} \geq \frac{v_{Ed} \cdot h_f}{\cotg(\theta)}$$

$$A_t = A_{st}/s_f$$

$$A_t = \frac{v_{Ed} \cdot h_f}{\left( \frac{\cotg(\theta) \cdot f_{yk,r}}{s_f} \right)} = \frac{1.81 \cdot 10^6 \cdot 0.109}{\left( \frac{\cotg(26.5) \cdot 500 \cdot 10^6}{1.15} \right)} = 226 \text{ mm}^2/\text{m}$$

$$A_{t,prov} = \frac{1}{s_t} \cdot \left( \frac{d_t^2}{4} \right) \cdot 3.14 = \frac{1}{0.15} \cdot \left( \frac{0.016^2}{4} \right) \cdot 3.14 = 1340 \text{ mm}^2/\text{m}$$

$$A_{t,prov} \geq A_t$$

$$1340 \text{ mm}^2/\text{m} \geq 226 \text{ mm}^2/\text{m} \quad \text{OK}$$

The transverse reinforcement of the section is adequate.

**ULS check of Final stage is OK.**

$$UC_{comp} = \max(0.37; 0.57; 0.58) = 0.58$$

### 11.2.9. Rezne sile – donja pojasnica sekundarnog rešetkastog nosača

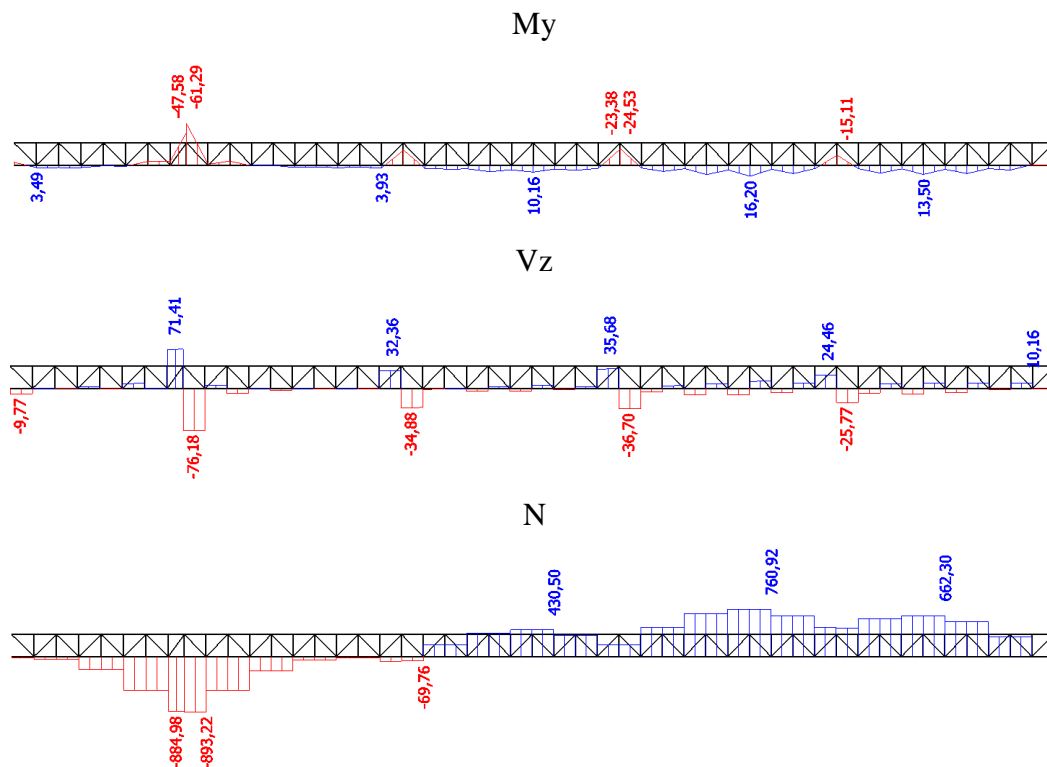

Slika 11.14. Prikaz reznih sila – donja pojasnica sekundarnog rešetkastog nosača

-poprečni presjek nosača

Name	Donja pojasnica sekundarnog rešetkastog nosača - konzolni dio	
Type	CFRHS220X220X10	
Source description	Rautaruukki Oyj / Structural Hollow Sections EN10219 / Ed.2007	
Item material	S 355	
Fabrication	cold formed	
Flexural buckling y-y	c	
Flexural buckling z-z	c	
Lateral torsional buckling	Default	
Use 2D FEM analysis	x	
A [m <sup>2</sup> ]	8,0570e-03	
A <sub>y, z</sub> [m <sup>2</sup> ]	4,0251e-03	4,0251e-03
I <sub>y, z</sub> [m <sup>4</sup> ]	5,7825e-05	5,7825e-05
I <sub>w</sub> [m <sup>6</sup> ], I <sub>t</sub> [m <sup>4</sup> ]	4,2947e-07	9,5328e-05
W <sub>el y, z</sub> [m <sup>3</sup> ]	5,2568e-04	5,2568e-04
W <sub>pl y, z</sub> [m <sup>3</sup> ]	6,2465e-04	6,2465e-04
d <sub>y, z</sub> [mm]	0	0
c <sub>YUCS, ZUCS</sub> [mm]	110	110
α [deg]	0,00	
A <sub>L, D</sub> [m <sup>2</sup> /m]	8,3700e-01	1,6110e+00
M <sub>ply +, -</sub> [Nm]	2,22e+05	2,22e+05
M <sub>plz +, -</sub> [Nm]	2,22e+05	2,22e+05

Slika 11.15. Prikaz geometrijskih karakteristika nosača

### 11.2.10. Dimenzioniranje – donja pojasnica sekundarnog rešetkastog nosača

Member B5083	7,860 m	CFRHS220X220X10	S 355	GSN 24	0,93 -
--------------	---------	-----------------	-------	--------	--------

Note: EN 1993-1-3 article 1.1(3) specifies that this part does not apply to cold formed CHS and RHS sections. The default EN 1993-1-1 code check is executed instead of the EN 1993-1-3 code check.

Partial safety factors	
Gamma M0 for resistance of cross-sections	1,00
Gamma M1 for resistance to instability	1,00
Gamma M2 for resistance of net sections	1,25

Material	
Yield strength $f_y$	355,0 MPa
Ultimate strength $f_u$	510,0 MPa
Fabrication	Cold formed

....SECTION CHECK:....

The critical check is on position 7.074 m

Internal forces	Calculated	Unit
N,Ed	-893,22	kN
V <sub>y</sub> ,Ed	-1,25	kN
V <sub>z</sub> ,Ed	-75,97	kN
T,Ed	-2,05	kNm
M <sub>y</sub> ,Ed	-1,49	kNm
M <sub>z</sub> ,Ed	-4,94	kNm

**Classification for cross-section design**

According to EN 1993-1-1 article 5.5.2

**Classification of Internal Compression parts**

According to EN 1993-1-1 Table 5.2 Sheet 1

Maximum width-to-thickness ratio	19,00
Class 1 Limit	26,85
Class 2 Limit	30,92
Class 3 Limit	34,71

=> Section classified as Class 1 for cross-section design

**Compression check**

According to EN 1993-1-1 article 6.2.4 and formula (6.9)

A	8,0570e-03	m <sup>2</sup>
N <sub>c,Rd</sub>	2860,24	kN
Unity check	0,31	-

**Bending moment check for M<sub>y</sub>**

According to EN 1993-1-1 article 6.2.5 and formula (6.12),(6.13)

W <sub>pl,y</sub>	6,2465e-04	m <sup>3</sup>
M <sub>pl,y,Rd</sub>	221,75	kNm
Unity check	0,01	-

**Bending moment check for M<sub>z</sub>**

According to EN 1993-1-1 article 6.2.5 and formula (6.12),(6.13)

W <sub>pl,z</sub>	6,2465e-04	m <sup>3</sup>
M <sub>pl,z,Rd</sub>	221,75	kNm
Unity check	0,02	-

**Shear check for V<sub>y</sub>**

According to EN 1993-1-1 article 6.2.6 and formula (6.17)

Eta	1,20	
A <sub>v</sub>	4,0285e-03	m <sup>2</sup>
V <sub>pl,y,Rd</sub>	825,68	kN
Unity check	0,00	-

**Shear check for V<sub>z</sub>**

According to EN 1993-1-1 article 6.2.6 and formula (6.17)

Eta	1,20	
A <sub>v</sub>	4,0285e-03	m <sup>2</sup>
V <sub>pl,z,Rd</sub>	825,68	kN
Unity check	0,09	-

**Torsion check**

According to EN 1993-1-1 article 6.2.7 and formula (6.23)

Tau <sub>t,Ed</sub>	2,3	MPa
Tau <sub>t,Rd</sub>	205,0	MPa
Unity check	0,01	-

**Note:** The unity check for torsion is lower than the limit value of 0,05. Therefore torsion is considered as

MN,y,Rd	197,27	kNm
Alpha	1,87	
MN,z,Rd	197,27	kNm
Beta	1,87	

Unity check (6.41) = 0,00 + 0,00 = 0,00 -

**Note:** Since the shear forces are less than half the plastic shear resistances their effect on the moment resistances is neglected.

The member satisfies the section check.

....:STABILITY CHECK:....

**Classification for member buckling design**

Decisive position for stability classification: 0,000 m

**Classification of Internal Compression parts**

According to EN 1993-1-1 Table 5.2 Sheet 1

Maximum width-to-thickness ratio	19,00
Class 1 Limit	37,73
Class 2 Limit	43,44
Class 3 Limit	62,10

=> Section classified as Class 1 for member buckling design

**Flexural Buckling check**

According to EN 1993-1-1 article 6.3.1.1 and formula (6.46)

Buckling parameters	yy	zz	
Sway type	sway	non-sway	
System length L	1,366	7,860	m
Buckling factor k	1,00	1,00	
Buckling length Lcr	1,366	7,860	m
Critical Euler load Ncr	64228,87	1939,93	kN
Slenderness Lambda	16,12	92,78	
Relative slenderness Lambda,rel	0,21	1,21	
Limit slenderness Lambda,rel,0	0,20	0,20	
Buckling curve	c	c	
Imperfection Alpha	0,49	0,49	
Reduction factor Chi	0,99	0,43	
Buckling resistance Nb,Rd	2844,16	1221,40	kN

Flexural Buckling verification		
Cross-section area A	8,0570e-03	m <sup>2</sup>
Buckling resistance Nb,Rd	1221,40	kN
Unity check	0,73	-

**Torsional(-Flexural) Buckling check**

According to EN 1993-1-1 article 6.3.1.1 and formula (6.46)

**Note:** The cross-section concerns a RHS section which is not susceptible to Torsional(-Flexural) Buckling.

**Lateral Torsional Buckling check**

According to EN 1993-1-1 article 6.3.2.1

**Note:** The cross-section concerns an RHS section with  $h/b < 10 / \text{Lambda,rel,z}$ .

This section is thus not susceptible to Lateral Torsional Buckling.

**Bending and axial compression check**

According to EN 1993-1-1 article 6.3.3 and formula (6.61),(6.62)

Bending and axial compression check parameters		
Interaction method	alternative method 1	
Cross-section area A	8,0570e-03	m <sup>2</sup>
Cross-section plastic modulus Wpl,y	6,2465e-04	m <sup>3</sup>
Cross-section plastic modulus Wpl,z	6,2465e-04	m <sup>3</sup>
Design compression force N,Ed	893,22	kN
Design bending moment (maximum) My,Ed	-61,29	kNm
Design bending moment (maximum) Mz,Ed	-5,93	kNm
Characteristic compression resistance N,Rk	2860,24	kN
Characteristic moment resistance My,Rk	221,75	kNm
Characteristic moment resistance Mz,Rk	221,75	kNm
Reduction factor Chi,y	0,99	
Reduction factor Chi,z	0,43	
Reduction factor Chi,LT	1,00	
Interaction factor k,yy	1,12	
Interaction factor k,yz	0,54	
Interaction factor k,zy	0,67	
Interaction factor k,zz	0,57	

Maximum moment My,Ed is derived from beam B5083 position 7,860 m.

Maximum moment Mz,Ed is derived from beam B5083 position 7,860 m.

Interaction method 1 parameters		
Critical Euler load N,cr,y	64228,87	kN
Critical Euler load N,cr,z	1939,93	kN
Elastic critical load N,cr,T	537412,45	kN
Cross-section plastic modulus Wpl,y	6,2465e-04	m <sup>3</sup>
Cross-section elastic modulus Wel,y	5,2568e-04	m <sup>3</sup>
Cross-section plastic modulus Wpl,z	6,2465e-04	m <sup>3</sup>
Cross-section elastic modulus Wel,z	5,2568e-04	m <sup>3</sup>

\*Student version\* \*Student version\* \*Student version\* \*Student version\* \*Student version\* \*Student version\* \*Student version\* \*Student version\* \*S



Interaction method 1 parameters		
Second moment of area Iy	5,7825e-05	m <sup>4</sup>
Second moment of area Iz	5,7825e-05	m <sup>4</sup>
Torsional constant It	9,5328e-05	m <sup>4</sup>
Method for equivalent moment factor C,my,0	Table A.2 Line 2 (General)	
Design bending moment (maximum) My,Ed	-61,29	kNm
Maximum relative deflection delta,z	0,8	mm
Equivalent moment factor C,my,0	1,00	
Method for equivalent moment factor C,mz,0	Table A.2 Line 1 (Linear)	
Ratio of end moments Psi,z	-0,66	
Equivalent moment factor C,mz,0	0,49	
Factor mu,y	1,00	
Factor mu,z	0,67	
Factor epsilon,y	1,05	
Factor a,LT	0,00	
Critical moment for uniform bending Mcr,0	3868,40	kNm
Relative slenderness Lambda,rel,0	0,24	
Limit relative slenderness Lambda,rel,0,lim	0,35	
Equivalent moment factor C,my	1,00	
Equivalent moment factor C,mz	0,49	
Equivalent moment factor C,mLT	1,00	
Factor b,LT	0,00	
Factor c,LT	0,00	
Factor d,LT	0,00	
Factor e,LT	0,00	
Factor w,y	1,19	
Factor w,z	1,19	
Factor n,pl	0,31	
Maximum relative slenderness Lambda,rel,max	1,21	
Factor C,yy	0,91	
Factor C,yz	1,00	
Factor C,zy	0,61	
Factor C,zz	1,07	

Unity check (6.61) =  $0,31 + 0,31 + 0,01 = 0,64$  -  
 Unity check (6.62) =  $0,73 + 0,19 + 0,02 = 0,93$  -

The member satisfies the stability check.

-iskoristivost elementa na GSN – 93 %

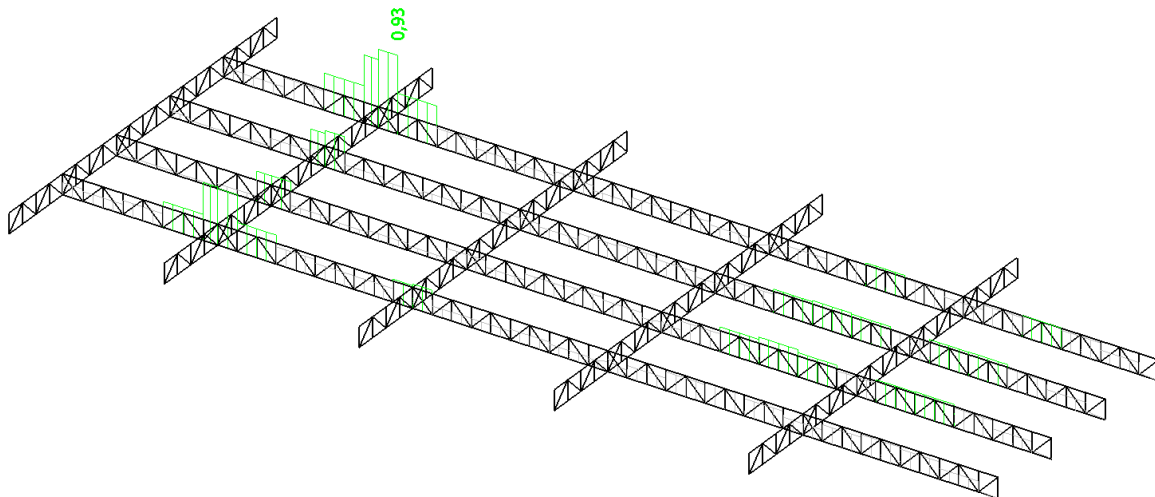

Slika 11.16. Prikaz iskoristivosti donje pojasnice sekundarnog rešetkastog nosača

### 11.2.11. Rezne sile – ispuna sekundarnog rešetkastog nosača

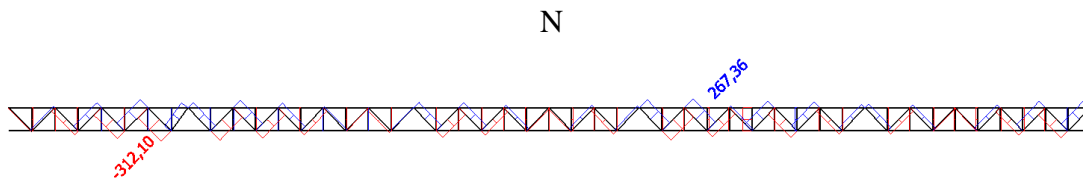

Slika 11.17. Prikaz reznih sila – ispuna sekundarnog rešetkastog nosača

-poprečni presjek nosača

Name	Ispuna sekundarnog rešetkastog nosača - konzolni dio	
Type	CFRHS90X90X6	
Source description	Rautaruukki Oyj / Structural Hollow Sections EN10219 / Ed.2007	
Item material	S 355	
Fabrication	cold formed	
Flexural buckling y-y	c	
Flexural buckling z-z	c	
Lateral torsional buckling	Default	
Use 2D FEM analysis	*	
A [m <sup>2</sup> ]	1,9230e-03	
A y, z [m <sup>2</sup> ]	9,6079e-04	9,6079e-04
I y, z [m <sup>4</sup> ]	2,2048e-06	2,2048e-06
I w [m <sup>5</sup> ], t [m <sup>4</sup> ]	2,9524e-09	3,6776e-06
W <sub>el</sub> y, z [m <sup>3</sup> ]	4,9000e-05	4,9000e-05
W <sub>pl</sub> y, z [m <sup>3</sup> ]	5,9540e-05	5,9540e-05
d y, z [mm]	0	0
c YUCS, ZUCS [mm]	45	45
α [deg]	0,00	
A L, D [m <sup>2</sup> /m]	3,3900e-01	6,4095e-01
M <sub>ply</sub> +, - [Nm]	2,11e+04	2,11e+04
M <sub>plz</sub> +, - [Nm]	2,11e+04	2,11e+04

Slika 11.18. Prikaz geometrijskih karakteristika nosača

-iskoristivost elementa na GSN – 52 %

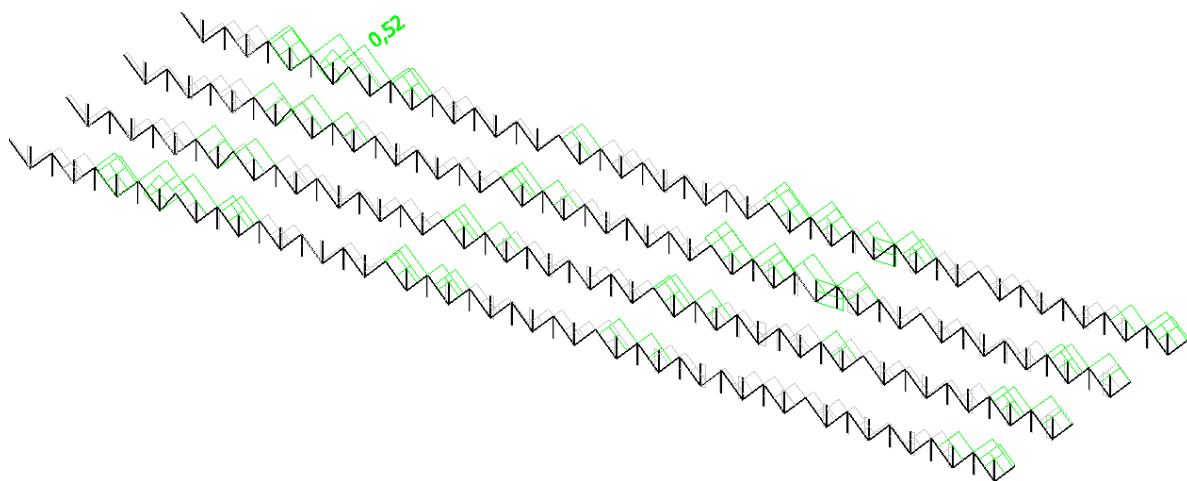

Slika 11.19. Prikaz iskoristivosti ispune sekundarnog rešetkastog nosača

### 11.2.12. Dimenzioniranje – ispuna sekundarnog rešetkastog nosača

Member B2203	1,138 m	CFRHS90X90X6	S 355	GSN 28	0,52 -
--------------	---------	--------------	-------	--------	--------

Note: EN 1993-1-3 article 1.1(3) specifies that this part does not apply to cold formed CHS and RHS sections. The default EN 1993-1-1 code check is executed instead of the EN 1993-1-3 code check.

Partial safety factors	
Gamma M0 for resistance of cross-sections	1,00
Gamma M1 for resistance to instability	1,00
Gamma M2 for resistance of net sections	1,25

Material	
Yield strength $f_y$	355,0 MPa
Ultimate strength $f_u$	510,0 MPa
Fabrication	Cold formed

....:SECTION CHECK:....

The critical check is on position 1.138 m

Internal forces	Calculated	Unit
N <sub>Ed</sub>	-312,10	kN
V <sub>y,Ed</sub>	0,00	kN
V <sub>z,Ed</sub>	0,00	kN
T <sub>Ed</sub>	0,00	kNm
M <sub>y,Ed</sub>	0,00	kNm
M <sub>z,Ed</sub>	0,00	kNm

Classification for cross-section design

According to EN 1993-1-1 article 5.5.2

Classification of Internal Compression parts

According to EN 1993-1-1 Table 5.2 Sheet 1

Maximum width-to-thickness ratio	12,00
Class 1 Limit	26,85
Class 2 Limit	30,92
Class 3 Limit	34,17

=> Section classified as Class 1 for cross-section design

Compression check

According to EN 1993-1-1 article 6.2.4 and formula (6.9)

A	1,9230e-03	m <sup>2</sup>
N <sub>c,Rd</sub>	682,66	kN
Unity check	0,46	-

The member satisfies the section check.

....:STABILITY CHECK:....

Classification for member buckling design

Decisive position for stability classification: 0,000 m

Classification of Internal Compression parts

According to EN 1993-1-1 Table 5.2 Sheet 1

Maximum width-to-thickness ratio	12,00
Class 1 Limit	26,85
Class 2 Limit	30,92
Class 3 Limit	34,17

=> Section classified as Class 1 for member buckling design

Flexural Buckling check

According to EN 1993-1-1 article 6.3.1.1 and formula (6.46)

Buckling parameters	yy	zz
Sway type	sway	non-sway
System length L	1,138	1,138
Buckling factor k	1,00	1,00
Buckling length L <sub>cr</sub>	1,138	1,138
Critical Euler load N <sub>cr</sub>	3525,74	3525,91
Slenderness Lambda	33,62	33,62
Relative slenderness Lambda <sub>rel</sub>	0,44	0,44
Limit slenderness Lambda <sub>rel,0</sub>	0,20	0,20
Buckling curve	c	c
Imperfection Alpha	0,49	0,49
Reduction factor Chi	0,88	0,88
Buckling resistance N <sub>b,Rd</sub>	597,97	597,98

Flexural Buckling verification

Cross-section area A	1,9230e-03	m <sup>2</sup>
Buckling resistance N <sub>b,Rd</sub>	597,97	kN
Unity check	0,52	-

Note: The cross-section concerns a RHS section which is not susceptible to Torsional-(Flexural) Buckling.

The member satisfies the stability check.

## 12. PRORAČUN REŠETKASTOG NOSAČA - KONZOLNI NOSAČ 1

### 12.1. Vertikalni pomak rešetkastog nosača – konzolni nosač 1

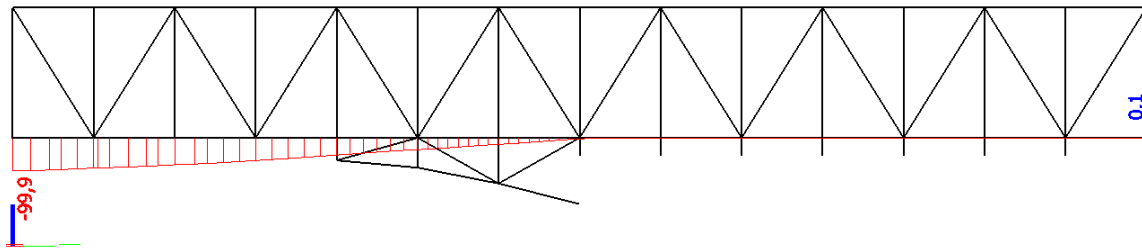

Slika 12.1. Prikaz vertikalnog pomaka konzolnog rešetkastog nosača

Dopušteni vertikalni pomak (progib):

$$u_{dop} = \frac{l}{300} = \frac{37,80 \cdot 1000}{300} = 126,0 \text{ mm}$$

$$u_z = 99,9 \text{ mm} < u_{z,dop} = 126,0 \text{ mm} \quad \text{Zadovoljava}$$

-iskoristivost na GSU -  $99,9 \text{ mm} / 126,0 \text{ mm} = 0,79 = 79\%$

## 12.2. Dimenziniranje rešetkastog nosača – konzolni nosač 1

### 12.2.1. Rezne sile – gornja pojasnica konzolnog rešetkastog nosača 1

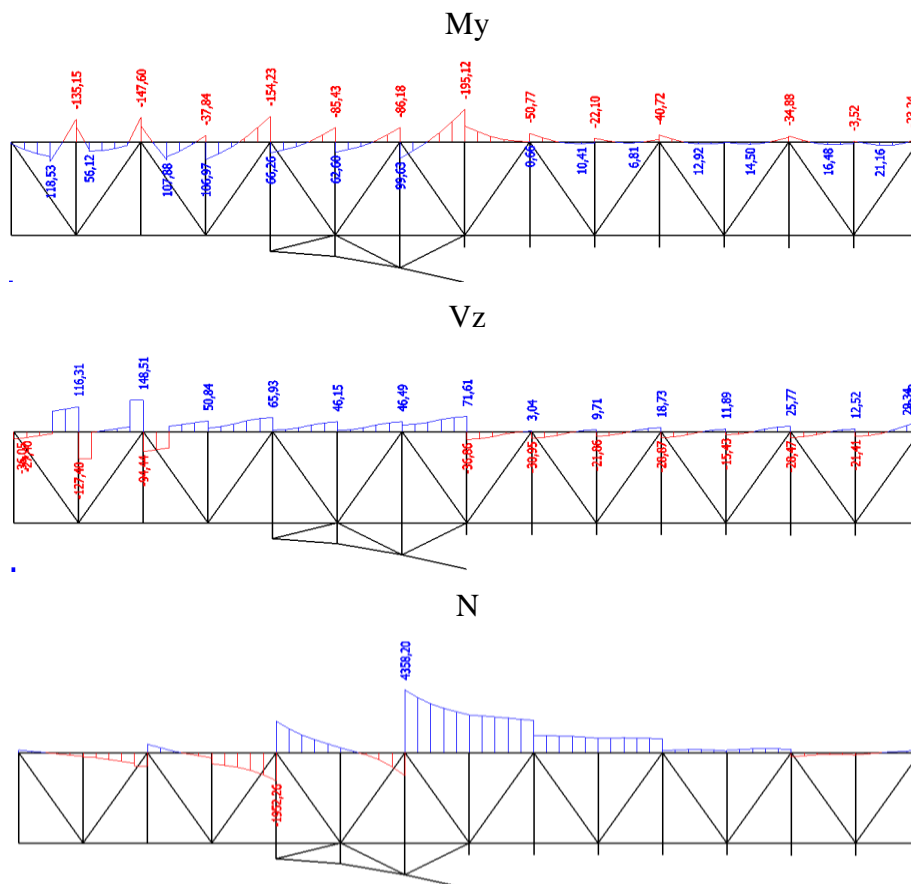

Slika 12.2. Prikaz reznih sila - gornja pojasnica konzolnog rešetkastog nosača

-poprečni presjek nosača

Name	Konzolni nosač 1 - gornja pojasnica	
Type	F400X10	
Source description	Chinese Standard / GB 6728-2002	
Item material	S 355	
Fabrication	rolled	
Flexural buckling y-y	a	
Flexural buckling z-z	a	
Lateral torsional buckling	Default	
Use 2D FEM analysis	x	
A [m <sup>2</sup> ]	1,5300e-02	
A <sub>y</sub> , z [m <sup>2</sup> ]	7,6251e-03	7,6251e-03
I <sub>y</sub> , z [m <sup>4</sup> ]	3,8216e-04	3,8216e-04
I <sub>w</sub> [m <sup>6</sup> ], t [m <sup>4</sup> ]	8,5333e-06	6,0431e-04
W <sub>el</sub> y, z [m <sup>3</sup> ]	1,9110e-03	1,9110e-03
W <sub>pl</sub> y, z [m <sup>3</sup> ]	2,2137e-03	2,2137e-03
d y, z [mm]	0	0
c YUCS, ZUCS [mm]	200	200
α [deg]	0,00	
A <sub>L</sub> , D [m <sup>2</sup> /m]	1,5571e+00	3,0510e+00
M <sub>pl</sub> y, z - [Nm]	7,85e+05	7,85e+05
M <sub>pl</sub> z, y - [Nm]	7,85e+05	7,85e+05

Slika 12.3. Prikaz geometrijskih karakteristika nosača

## 12.2.2. Dimenzioniranje – gornja pojasnica glavnog rešetkastog nosača 1

Member B1002	75,600 m	F400X10	S 355	GSN 22	0,81 -
--------------	----------	---------	-------	--------	--------

Partial safety factors	
Gamma M0 for resistance of cross-sections	1,00
Gamma M1 for resistance to instability	1,00
Gamma M2 for resistance of net sections	1,25

Material		
Yield strength $f_y$	355,0	MPa
Ultimate strength $f_u$	490,0	MPa
Fabrication	Rolled	

....SECTION CHECK:....

The critical check is on position 43.200 m

Internal forces	Calculated	Unit
N,Ed	4358,20	kN
Vy,Ed	-51,64	kN
Vz,Ed	31,24	kN
T,Ed	18,62	kNm
My,Ed	99,63	kNm
Mz,Ed	-72,68	kNm

### Tension check

According to EN 1993-1-1 article 6.2.3 and formula (6.5)

A	1,5300e-02	m <sup>2</sup>
Npl,Rd	5431,50	kN
Nu,Rd	5397,84	kN
Nt,Rd	5397,84	kN
Unity check	0,81	-

### Bending moment check for My

According to EN 1993-1-1 article 6.2.5 and formula (6.12),(6.13)

Wpl,y	2,2137e-03	m <sup>3</sup>
Mpl,y,Rd	785,88	kNm
Unity check	0,13	-

### Bending moment check for Mz

According to EN 1993-1-1 article 6.2.5 and formula (6.12),(6.13)

Wpl,z	2,2137e-03	m <sup>3</sup>
Mpl,z,Rd	785,88	kNm
Unity check	0,09	-

### Shear check for Vy

According to EN 1993-1-1 article 6.2.6 and formula (6.17)

Eta	1,20	
Av	7,6500e-03	m <sup>2</sup>
Vpl,y,Rd	1567,94	kN
Unity check	0,03	-

### Shear check for Vz

According to EN 1993-1-1 article 6.2.6 and formula (6.17)

Eta	1,20	
Av	7,6500e-03	m <sup>2</sup>
Vpl,z,Rd	1567,94	kN
Unity check	0,02	-

### Torsion check

According to EN 1993-1-1 article 6.2.7 and formula (6.23)

Tau,t,Ed	6,1	MPa
Tau,Rd	205,0	MPa
Unity check	0,03	-

**Note:** The unity check for torsion is lower than the limit value of 0,05. Therefore torsion is considered as insignificant and is ignored in the combined checks.

### Combined bending, axial force and shear force check

According to EN 1993-1-1 article 6.2.9.1 and formula (6.41)

MN,y,Rd	203,95	kNm
Alpha	6,00	
MN,z,Rd	203,95	kNm
Beta	6,00	

Unity check (6.41) = 0,01 + 0,00 = 0,02 -

**Note:** Since the shear forces are less than half the plastic shear resistances their effect on the moment

According to EN 1993-1-1 article 6.3.2.1

**Note:** The cross-section concerns an RHS section with  $h / b < 10 / \lambda_{rel,z}$ .  
This section is thus not susceptible to Lateral Torsional Buckling.

**Bending and axial tension check**

According to EN 1993-1-3 article 6.3

Design tension force $N_{Ed}$	4358,20	kN
Design bending moment $M_{y,Ed}$	99,63	kNm
Design bending moment $M_{z,Ed}$	-72,68	kNm
Tension resistance $N_{t,Rd}$	5397,84	kN
Bending resistance $M_{b,y,Rd}$	702,40	kNm
Bending resistance $M_{c,z,Rd,com}$	785,88	kNm

Unity check =  $0,14 + 0,09 - 0,81 = 0,57$

The member satisfies the stability check.

-iskoristivost elementa na GSN – 81 %

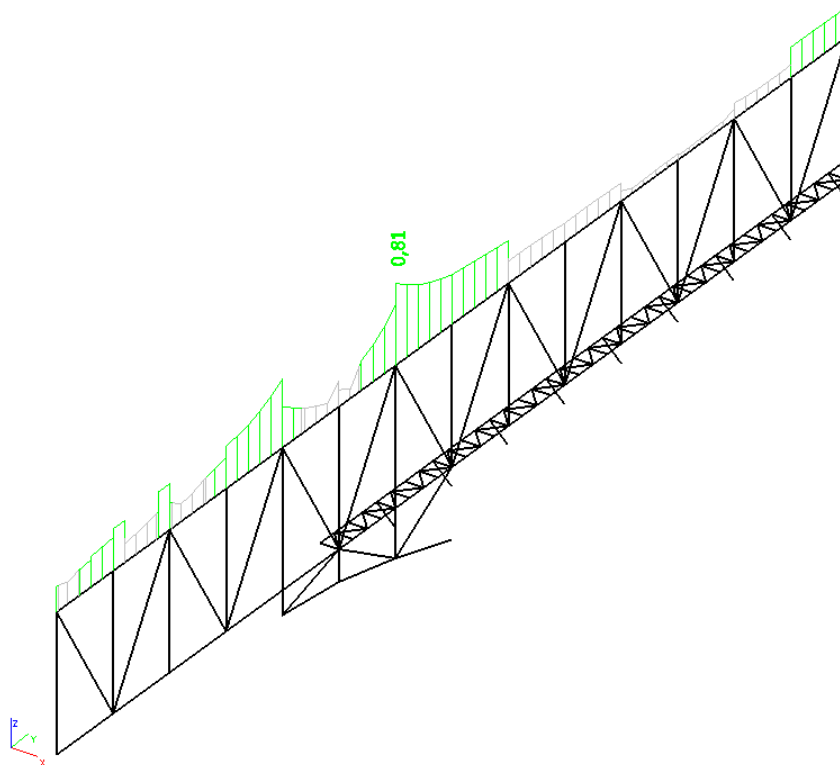

*Slika 12.4. Prikaz iskoristivosti gornje pojasnice konzolnog rešetkastog nosača*

12.2.3. Rezne sile – donja pojasnica konzolnog rešetkastog nosača 1

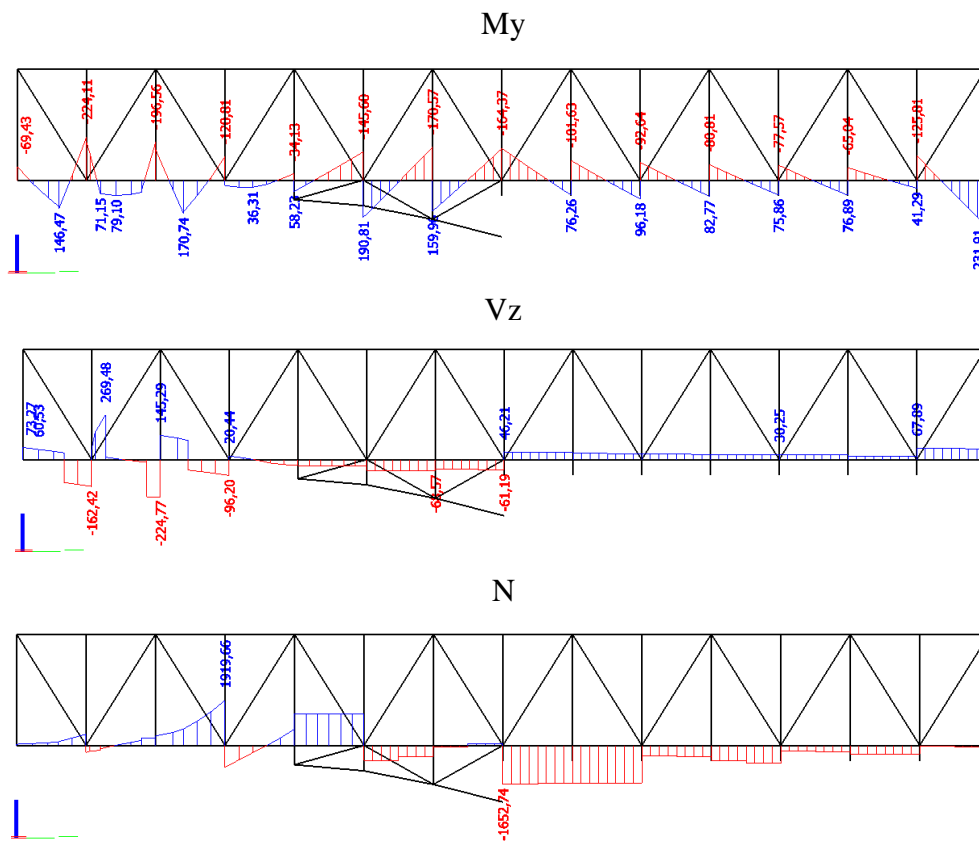

Slika 12.5. Prikaz reznih sila - donja pojasnica konzolnog rešetkastog nosača

-poprečni presjek nosača

Name	Konzolni nosač 1 - donja pojasnica	
Type	F400X10	
Source description	Chinese Standard / GB 6728-2002	
Item material	S 355	
Fabrication	rolled	
Flexural buckling y-y	a	
Flexural buckling z-z	a	
Lateral torsional buckling	Default	
Use 2D FEM analysis	x	
A [m <sup>2</sup> ]	1,5300e-02	
A y, z [m <sup>2</sup> ]	7,6251e-03	7,6251e-03
I y, z [m <sup>4</sup> ]	3,8216e-04	3,8216e-04
I w [m <sup>6</sup> ], t [m <sup>4</sup> ]	8,5333e-06	6,0431e-04
W el y, z [m <sup>3</sup> ]	1,9110e-03	1,9110e-03
W pl y, z [m <sup>3</sup> ]	2,2137e-03	2,2137e-03
d y, z [mm]	0	0
c YUCS, ZUCS [mm]	200	200
α [deg]	0.00	
A L, D [m <sup>2</sup> /m]	1,5571e+00	3,0510e+00
M pl y, z [- [Nm]	7,95e+05	7,95e+05
M pl z y, z [- [Nm]	7,85e+05	7,85e+05

Slika 12.6. Prikaz geometrijskih karakteristika nosača



## 12.2.4. Dimenzioniranje – donja pojasnica konzolnog rešetkastog nosača 1

Member B1001	75,600 m	F400X10	S 355	GSN 28	0,67 -
--------------	----------	---------	-------	--------	--------

Partial safety factors	
Gamma M0 for resistance of cross-sections	1,00
Gamma M1 for resistance to instability	1,00
Gamma M2 for resistance of net sections	1,25

Material		
Yield strength $f_y$	355,0	MPa
Ultimate strength $f_u$	490,0	MPa
Fabrication	Rolled	

....SECTION CHECK:....

The critical check is on position 37.800 m

Internal forces	Calculated	Unit
N,Ed	-1652,74	kN
Vy,Ed	-49,96	kN
Vz,Ed	46,21	kN
T,Ed	18,12	kNm
My,Ed	-164,37	kNm
Mz,Ed	19,53	kNm

**Classification for cross-section design**

According to EN 1993-1-1 article 5.5.2

**Classification of Internal Compression parts**

According to EN 1993-1-1 Table 5.2 Sheet 1

Maximum width-to-thickness ratio	37,00
Class 1 Limit	26,85
Class 2 Limit	30,92
Class 3 Limit	35,25

=> Section classified as Class 4 for cross-section design

**Compression check**

According to EN 1993-1-1 article 6.2.4 and formula (6.9)

Aeff	1,4206e-02	m <sup>2</sup>
Nc,Rd	5043,10	kN
Unity check	0,33	-

**Bending moment check for My**

According to EN 1993-1-1 article 6.2.5 and formula (6.12),(6.15)

Weff,y,min	1,8377e-03	m <sup>3</sup>
Mc,y,Rd	652,40	kNm
Unity check	0,25	-

**Bending moment check for Mz**

According to EN 1993-1-1 article 6.2.5 and formula (6.12),(6.15)

Weff,z,min	1,9006e-03	m <sup>3</sup>
Mc,z,Rd	674,70	kNm
Unity check	0,03	-

**Shear check for Vy**

According to EN 1993-1-1 article 6.2.6 and formula (6.17)

Eta	1,20	
Av	7,6500e-03	m <sup>2</sup>
Vpl,y,Rd	1567,94	kN
Unity check	0,03	-

**Shear check for Vz**

According to EN 1993-1-1 article 6.2.6 and formula (6.17)

Eta	1,20	
Av	7,6500e-03	m <sup>2</sup>
Vpl,z,Rd	1567,94	kN
Unity check	0,03	-

**Torsion check**

According to EN 1993-1-1 article 6.2.7 and formula (6.23)

Tau,t,Ed	6,0	MPa
Tau,Rd	205,0	MPa
Unity check	0,03	-

**Note:** The unity check for torsion is lower than the limit value of 0,05. Therefore torsion is considered as insignificant and is ignored in the combined checks.

Effective properties		
eN,y	0	mm
eN,z	0	mm
Weff,y	1,8377e-03	m <sup>3</sup>
Weff,z	1,9006e-03	m <sup>3</sup>

Normal stresses		
Sigma,N,Ed	116,3	MPa
Sigma,My,Ed	89,4	MPa
Sigma,Mz,Ed	10,3	MPa
Sigma,tot,Ed	216,1	MPa
Unity check	0,61	-

The member satisfies the section check.

....:STABILITY CHECK:....

**Classification for member buckling design**

Decisive position for stability classification: 37,800 m

**Classification of Internal Compression parts**

According to EN 1993-1-1 Table 5.2 Sheet 1

Maximum width-to-thickness ratio	37,00
Class 1 Limit	26,85
Class 2 Limit	30,92
Class 3 Limit	35,25

=> Section classified as Class 4 for member buckling design

Calculation effective area properties with direct method.

Properties					
sectional area A eff	1.4206e-02	m <sup>2</sup>			
Shear area Vy eff	7.1030e-03	m <sup>2</sup>	Vz eff	7.1030e-03	m <sup>2</sup>
radius of gyration iy eff	163	mm	iz eff	165	mm
moment of inertia Iy eff	3.7816e-04	m <sup>4</sup>	Iz eff	3.8611e-04	m <sup>4</sup>
elastic section modulus Wy eff	1.8377e-03	m <sup>3</sup>	Wz eff	1.9006e-03	m <sup>3</sup>
Eccentricity eny	0	mm	enz	0	mm

**Flexural Buckling check**

According to EN 1993-1-1 article 6.3.1.1 and formula (6.46)

Buckling parameters	yy	zz	
Sway type	sway	non-sway	
System length L	5,400	1,350	m
Buckling factor k	1,00	1,00	
Buckling length Lcr	5,400	1,350	m
Critical Euler load Ncr	27162,94	434607,01	kN
Slenderness Lambda	34,17	8,54	
Relative slenderness Lambda,rel	0,43	0,11	
Limit slenderness Lambda,rel,0	0,20	0,20	
Buckling curve	a	a	
Imperfection Alpha	0,21	0,21	
Reduction factor Chi	0,94	1,00	
Buckling resistance Nb,Rd	4763,05	5043,10	kN

Flexural Buckling verification		
Cross-section effective area Aeff	1,4206e-02	m <sup>2</sup>
Buckling resistance Nb,Rd	4763,05	kN
Unity check	0,35	-

**Torsional(-Flexural) Buckling check**

According to EN 1993-1-1 article 6.3.1.1 and formula (6.46)

**Note:** The cross-section concerns a RHS section which is not susceptible to Torsional(-Flexural) Buckling.

**Lateral Torsional Buckling check**

According to EN 1993-1-1 article 6.3.2.1

**Note:** The cross-section concerns an RHS section with 'h / b < 10 / Lambda,rel.z'.

This section is thus not susceptible to Lateral Torsional Buckling.

**Bending and axial compression check**

According to EN 1993-1-1 article 6.3.3 and formula (6.61),(6.62)

Bending and axial compression check parameters		
Interaction method	alternative method 1	
Cross-section effective area Aeff	1,4206e-02	m <sup>2</sup>
Cross-section effective modulus Weff,y	1,8377e-03	m <sup>3</sup>
Cross-section effective modulus Weff,z	1,9006e-03	m <sup>3</sup>
Design compression force N,Ed	1652,74	kN
Design bending moment (maximum) My,Ed	-164,37	kNm
Design bending moment (maximum) Mz,Ed	-47,92	kNm
Additional moment Delta My,Ed	0,00	kNm
Additional moment Delta Mz,Ed	0,00	kNm
Characteristic compression resistance N,Rk	5043,10	kN
Characteristic moment resistance My,Rk	652,40	kNm

Bending and axial compression check parameters		
Characteristic moment resistance $M_z, R_k$	674,70	kNm
Reduction factor $\chi_{i,y}$	0,94	
Reduction factor $\chi_{i,z}$	1,00	
Reduction factor $\chi_{i,LT}$	1,00	
Interaction factor $k_{yy}$	1,02	
Interaction factor $k_{yz}$	1,00	
Interaction factor $k_{zy}$	1,02	
Interaction factor $k_{zz}$	1,00	

Maximum moment  $M_{y,Ed}$  is derived from beam B1001 position 37,800 m.  
 Maximum moment  $M_{z,Ed}$  is derived from beam B1001 position 39,150 m.

Interaction method 1 parameters		
Critical Euler load $N_{cr,y}$	27162,94	kN
Critical Euler load $N_{cr,z}$	434607,01	kN
Elastic critical load $N_{cr,T}$	1171322,93	kN
Cross-section effective modulus $W_{eff,y}$	1,8377e-03	m <sup>3</sup>
Second moment of area $I_y$	3,8216e-04	m <sup>4</sup>
Second moment of area $I_z$	3,8216e-04	m <sup>4</sup>
Torsional constant $I_t$	6,0431e-04	m <sup>4</sup>
Method for equivalent moment factor $C_{my,0}$	Table A.2 Line 2 (General)	
Design bending moment (maximum) $M_{y,Ed}$	-164,37	kNm
Maximum relative deflection $\delta_{t,z}$	2,2	mm
Equivalent moment factor $C_{my,0}$	0,96	
Method for equivalent moment factor $C_{mz,0}$	Table A.2 Line 2 (General)	
Design bending moment (maximum) $M_{z,Ed}$	-47,92	kNm
Maximum relative deflection $\delta_{t,y}$	0,0	mm
Equivalent moment factor $C_{mz,0}$	1,00	
Factor $\mu_{y,0}$	1,00	
Factor $\mu_{z,0}$	1,00	
Factor $\epsilon_{y,0}$	0,77	
Factor $a_{LT}$	0,00	
Critical moment for uniform bending $M_{cr,0}$	159469,85	kNm
Relative slenderness $\lambda_{rel,0}$	0,06	
Limit relative slenderness $\lambda_{rel,0,lim}$	0,22	
Equivalent moment factor $C_{my}$	0,96	
Equivalent moment factor $C_{mz}$	1,00	
Equivalent moment factor $C_{mLT}$	1,00	

Unity check (6.61) =  $0,35 + 0,26 + 0,07 = 0,67$  -  
 Unity check (6.62) =  $0,33 + 0,26 + 0,07 = 0,66$  -  
 The member satisfies the stability check.



-iskoristivost elementa na GSN – 67 %

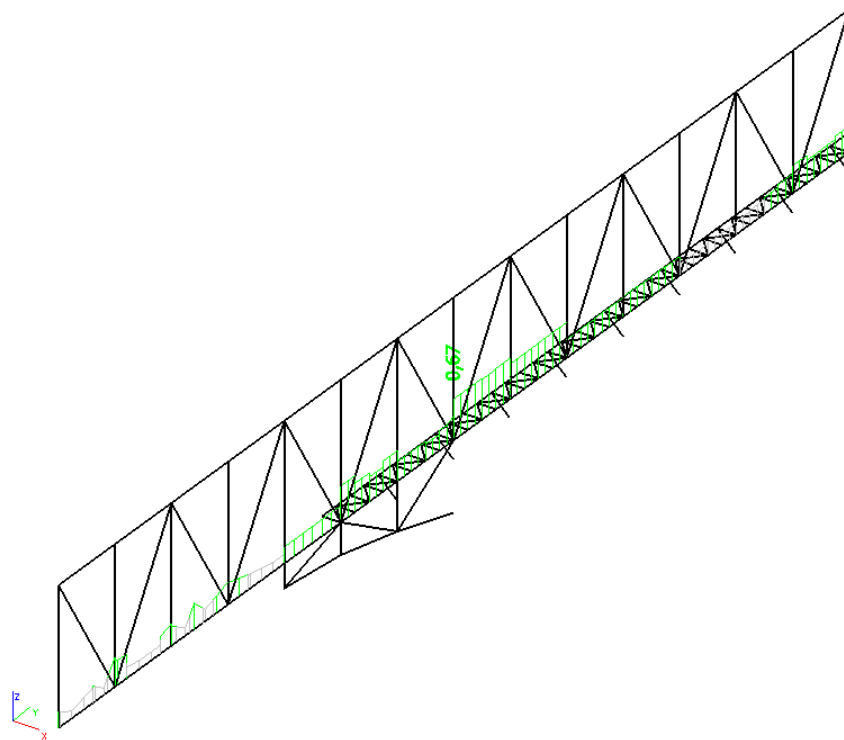

Slika 12.7. Prikaz iskoristivosti donje pojasnice konzolnog rešetkastog nosača

12.2.5. Rezne sile – vertikalna ispuna 1 konzolnog rešetkastog nosača 1

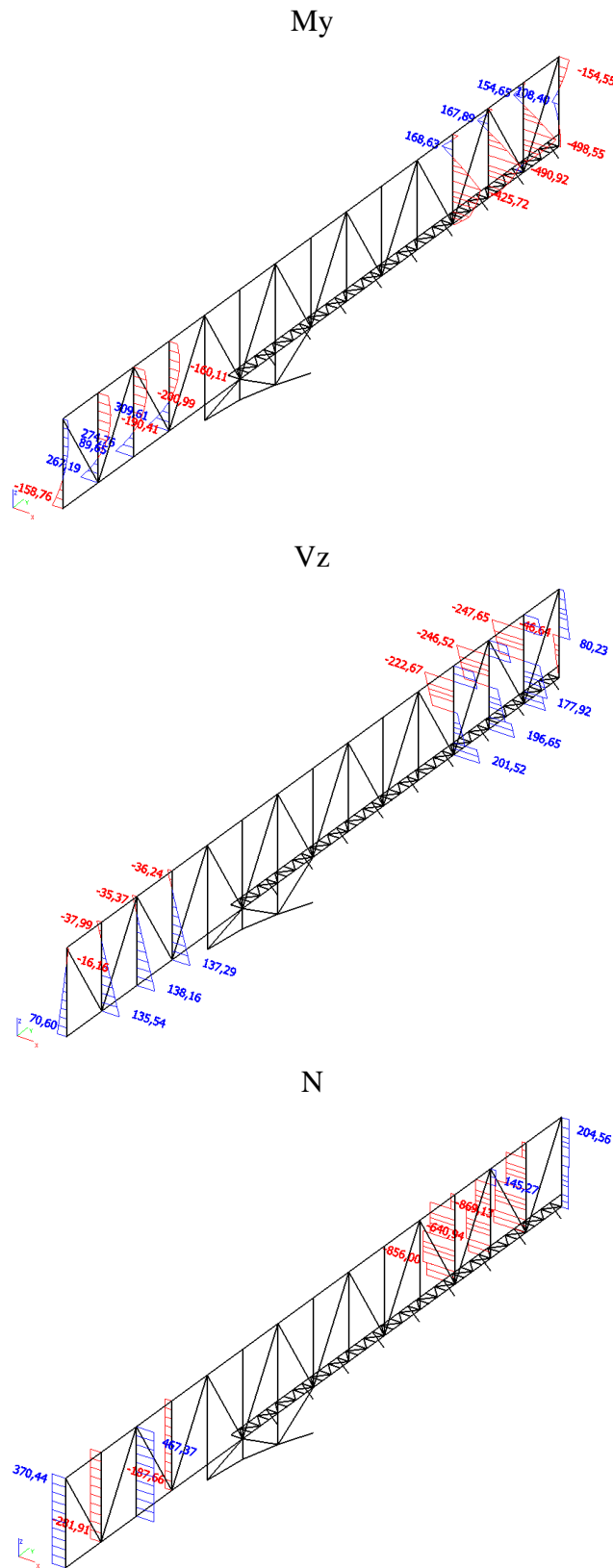

Slika 12.8. Prikaz reznih sila – vertikalna ispuna konzolnog rešetkastog nosača

-poprečni presjek nosača

Name	Konzolni nosač 1 - vertikalna ispuna 1	
Type	SHS400/400/10.0	
Source description	British Standard / BS 5950 part 1 : 1990 & EN 10210-2	
Item material	S 355	
Fabrication	rolled	
Flexural buckling y-y	a	
Flexural buckling z-z	a	
Lateral torsional buckling	Default	
Use 2D FEM analysis	x	

A [m <sup>2</sup> ]	1,5500e-02	
A y, z [m <sup>2</sup> ]	7,7126e-03	7,7126e-03
I y, z [m <sup>4</sup> ]	3,9130e-04	3,9130e-04
I w [m <sup>3</sup> , t [m <sup>4</sup> ]	8,5333e-06	6,0090e-04
Wey, z [m <sup>3</sup> ]	1,9560e-03	1,9560e-03
Wply, z [m <sup>3</sup> ]	2,2481e-03	2,2481e-03
d y, z [mm]	0	0
c YUCS, ZUCS [mm]	200	200
α [deg]	0,00	
A L, D [m <sup>2</sup> /m]	1,5700e+00	3,0855e+00
Mply +, - [Nm]	7,98e+05	7,98e+05
Mplz +, - [Nm]	7,98e+05	7,98e+05

Slika 12.9. Prikaz geometrijskih karakteristika nosača

-iskoristivost elementa na GSN – 97 %

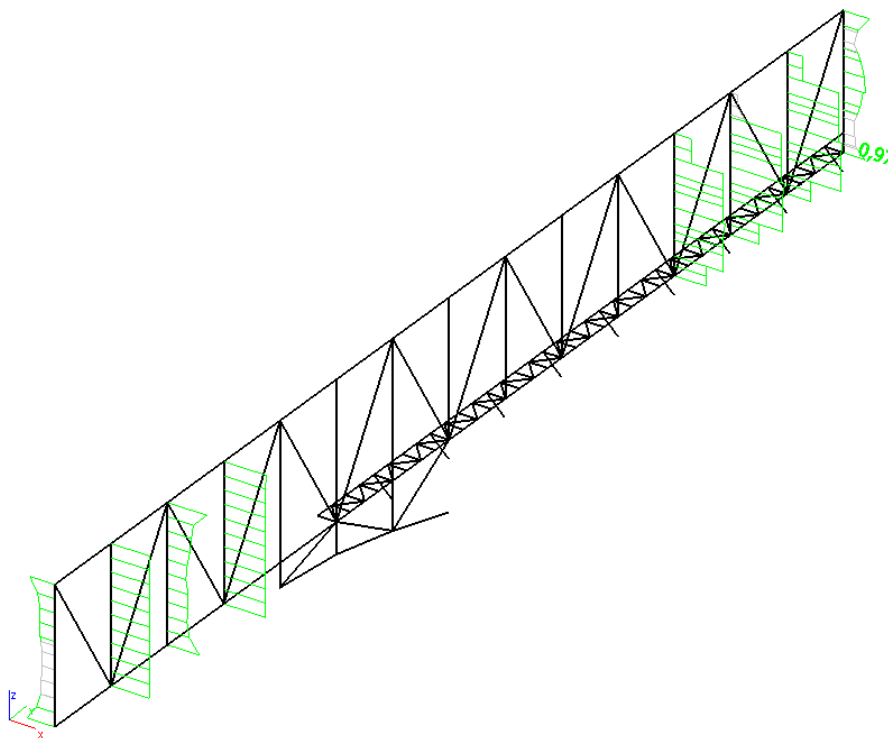

Slika 12.10. Prikaz iskoristivosti vertikalne ispune konzolnog rešetkastog nosača

### 12.2.6. Dimenzioniranje – vertikalna ispuna 1 konzolnog rešetkastog nosača 1

Member B1038	8,650 m	SHS400/400/10.0	S 355	GSN 22	0,97 -
--------------	---------	-----------------	-------	--------	--------

Partial safety factors	
Gamma M0 for resistance of cross-sections	1,00
Gamma M1 for resistance to instability	1,00
Gamma M2 for resistance of net sections	1,25

Material		
Yield strength $f_y$	355,0	MPa
Ultimate strength $f_u$	490,0	MPa
Fabrication	Rolled	

.....SECTION CHECK:.....

The critical check is on position 7.450 m

Internal forces	Calculated	Unit
N,Ed	-829,43	kN
Vy,Ed	-2,11	kN
Vz,Ed	177,92	kN
T,Ed	22,14	kNm
My,Ed	-60,98	kNm
Mz,Ed	-4,75	kNm

**Classification for cross-section design**

According to EN 1993-1-1 article 5.5.2

**Classification of Internal Compression parts**

According to EN 1993-1-1 Table 5.2 Sheet 1

Maximum width-to-thickness ratio	37,00
Class 1 Limit	26,85
Class 2 Limit	30,92
Class 3 Limit	36,36

=> Section classified as Class 4 for cross-section design

**Compression check**

According to EN 1993-1-1 article 6.2.4 and formula (6.9)

Aeff	1,4206e-02	m <sup>2</sup>
Nc,Rd	5043,10	kN
Unity check	0,16	-

**Bending moment check for My**

According to EN 1993-1-1 article 6.2.5 and formula (6.12),(6.15)

Weff,y,min	1,8377e-03	m <sup>3</sup>
Mc,y,Rd	652,40	kNm
Unity check	0,09	-

**Bending moment check for Mz**

According to EN 1993-1-1 article 6.2.5 and formula (6.12),(6.15)

Weff,z,min	1,9006e-03	m <sup>3</sup>
Mc,z,Rd	674,70	kNm
Unity check	0,01	-

**Shear check for Vy**

According to EN 1993-1-1 article 6.2.6 and formula (6.17)

Eta	1,20	
Av	7,7500e-03	m <sup>2</sup>
Vpl,y,Rd	1588,43	kN
Unity check	0,00	-

**Shear check for Vz**

According to EN 1993-1-1 article 6.2.6 and formula (6.17)

Eta	1,20	
Av	7,7500e-03	m <sup>2</sup>
Vpl,z,Rd	1588,43	kN
Unity check	0,11	-

**Torsion check**

According to EN 1993-1-1 article 6.2.7 and formula (6.23)

Tau,t,Ed	7,3	MPa
Tau,Rd	205,0	MPa
Unity check	0,04	-

**Note:** The unity check for torsion is lower than the limit value of 0,05. Therefore torsion is considered as insignificant and is ignored in the combined checks.

Effective properties		
Aeff	1,4206e-02	m <sup>2</sup>
eN,y	0	mm
eN,z	0	mm
Weff,y	1,8377e-03	m <sup>3</sup>
Weff,z	1,9006e-03	m <sup>3</sup>

Normal stresses		
Sigma,N,Ed	58,4	MPa
Sigma,My,Ed	33,2	MPa
Sigma,Mz,Ed	2,5	MPa
Sigma,tot,Ed	94,1	MPa
Unity check	0,26	-

The member satisfies the section check.

....:STABILITY CHECK:....

Classification for member buckling design

Decisive position for stability classification: 1,500 m

Classification of Internal Compression parts

According to EN 1993-1-1 Table 5.2 Sheet 1

Maximum width-to-thickness ratio	37,00
Class 1 Limit	26,85
Class 2 Limit	30,92
Class 3 Limit	35,76

=> Section classified as Class 4 for member buckling design

Calculation effective area properties with direct method.

Properties					
sectional area A eff	1,4206e-02	m <sup>2</sup>			
Shear area Vy eff	7,1030e-03	m <sup>2</sup>	Vz eff	7,1030e-03	m <sup>2</sup>
radius of gyration iy eff	163	mm	iz eff	165	mm
moment of inertia Iy eff	3,7816e-04	m <sup>4</sup>	Iz eff	3,8611e-04	m <sup>4</sup>
elastic section modulus Wy eff	1,8377e-03	m <sup>3</sup>	Wz eff	1,9006e-03	m <sup>3</sup>
Eccentricity eny	0	mm	enz	0	mm

Flexural Buckling check

According to EN 1993-1-1 article 6.3.1.1 and formula (6.46)

Buckling parameters	yy	zz	
Sway type	sway	non-sway	
System length L	2,950	8,650	m
Buckling factor k	1,00	1,00	
Buckling length Lcr	2,950	8,650	m
Critical Euler load Ncr	93193,34	10839,19	kN
Slenderness Lambda	18,57	54,44	
Relative slenderness Lambda,rel	0,23	0,68	
Limit slenderness Lambda,rel,0	0,20	0,20	
Buckling curve	a	a	
Imperfection Alpha	0,21	0,21	
Reduction factor Chi	0,99	0,86	
Buckling resistance Nb,Rd	5006,85	4316,80	kN

Flexural Buckling verification

Cross-section effective area Aeff	1,4206e-02	m <sup>2</sup>
Buckling resistance Nb,Rd	4316,80	kN
Unity check	0,19	

Torsional(-Flexural) Buckling check

According to EN 1993-1-1 article 6.3.1.1 and formula (6.46)

Note: The cross-section concerns a RHS section which is not susceptible to Torsional(-Flexural) Buckling.

Lateral Torsional Buckling check

According to EN 1993-1-1 article 6.3.2.1

Note: The cross-section concerns an RHS section with  $h / b < 10 / \text{Lambda,rel,z}$ .

This section is thus not susceptible to Lateral Torsional Buckling.

Bending and axial compression check

According to EN 1993-1-1 article 6.3.3 and formula (6.61),(6.62)

Bending and axial compression check parameters		
Interaction method	alternative method 1	
Cross-section effective area Aeff	1,4206e-02	m <sup>2</sup>
Cross-section effective modulus Weff,y	1,8377e-03	m <sup>3</sup>
Cross-section effective modulus Weff,z	1,9006e-03	m <sup>3</sup>
Design compression force N,Ed	829,43	kN
Design bending moment (maximum) My,Ed	-498,55	kNm
Design bending moment (maximum) Mz,Ed	13,12	kNm
Additional moment Delta My,Ed	0,00	kNm
Additional moment Delta Mz,Ed	0,00	kNm

Bending and axial compression check parameters		
Characteristic compression resistance N,Rk	5043,10	kN
Characteristic moment resistance My,Rk	652,40	kNm
Characteristic moment resistance Mz,Rk	674,70	kNm
Reduction factor Chi,y	0,99	
Reduction factor Chi,z	0,86	
Reduction factor Chi,LT	1,00	
Interaction factor k,y	1,01	
Interaction factor k,yz	1,02	
Interaction factor k,zy	0,99	
Interaction factor k,zz	1,01	

Maximum moment My,Ed is derived from beam B1038 position 4,500 m.  
 Maximum moment Mz,Ed is derived from beam B1038 position 1,500 m.

Interaction method 1 parameters		
Critical Euler load N,cr,y	93193,34	kN
Critical Euler load N,cr,z	10839,19	kN
Elastic critical load N,cr,T	965939,72	kN
Cross-section effective modulus Weff,y	1,8377e-03	m <sup>3</sup>
Second moment of area Iy	3,9130e-04	m <sup>4</sup>
Second moment of area Iz	3,9130e-04	m <sup>4</sup>
Torsional constant It	6,0090e-04	m <sup>4</sup>
Method for equivalent moment factor C,my,0	Table A.2 Line 2 (General)	
Design bending moment (maximum) My,Ed	-498,55	kNm
Maximum relative deflection delta,z	4,0	mm
Equivalent moment factor C,my,0	1,00	
Method for equivalent moment factor C,mz,0	Table A.2 Line 2 (General)	
Design bending moment (maximum) Mz,Ed	13,12	kNm
Maximum relative deflection delta,y	-0,3	mm
Equivalent moment factor C,mz,0	0,94	
Factor mu,y	1,00	
Factor mu,z	0,99	
Factor epsilon,y	4,65	
Factor a,LT	0,00	
Critical moment for uniform bending Mcr,0	22992,04	kNm
Relative slenderness Lambda,rel,0	0,17	
Limit relative slenderness Lambda,rel,0,lim	0,23	
Equivalent moment factor C,my	1,00	
Equivalent moment factor C,mz	0,94	
Equivalent moment factor C,mLT	1,00	

Unity check (6.61) = 0,17 + 0,77 + 0,02 = 0,95 -

Unity check (6.62) = 0,19 + 0,76 + 0,02 = 0,97 -

The member satisfies the stability check.



12.2.7. Rezne sile – vertikalna ispuna 2 konzolnog rešetkastog nosača 1

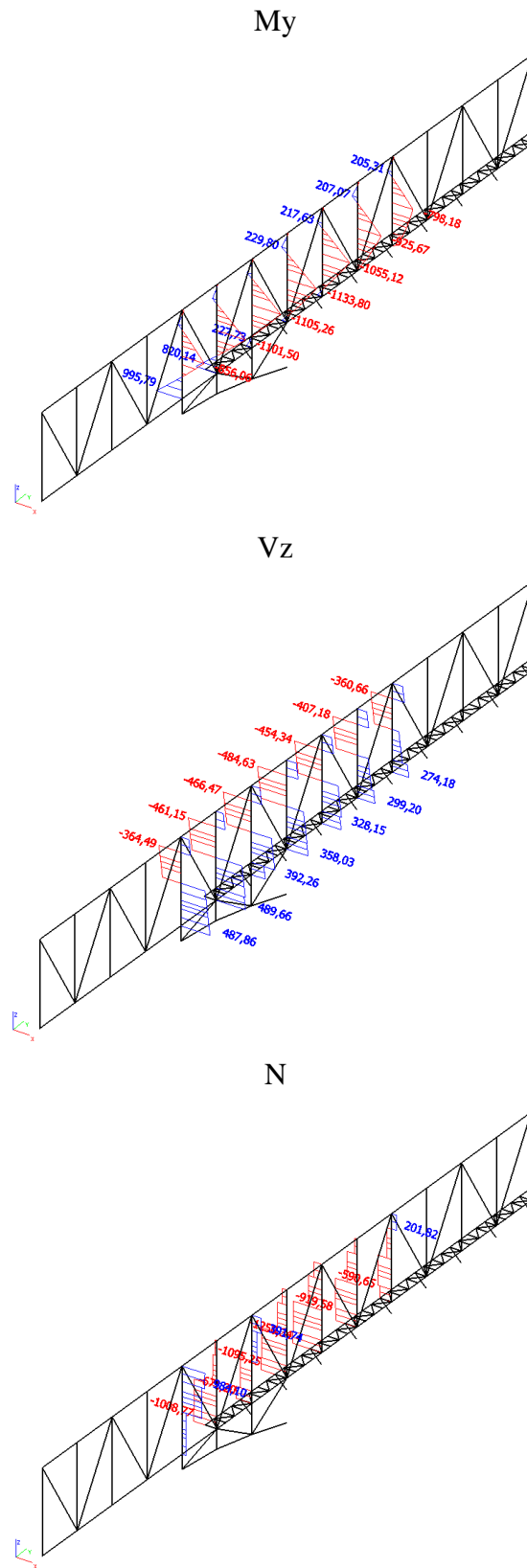

Slika 12.11. Prikaz reznih sila – vertikalna ispuna konzolnog rešetkastog nosača

-poprečni presjek nosača

Name	Konzolni nosač 1 - vertikalna ispuna 2	
Type	SHS400/400/20.0	
Source description	British Standard / BS 5950 part 1 : 1990 & EN 10210-2	
Item material	S 355	
Fabrication	rolled	
Flexural buckling y-y	a	
Flexural buckling z-z	a	
Lateral torsional buckling	Default	
Use 2D FEM analysis	x	

A [m <sup>2</sup> ]	3,0000e-02	
A <sub>y, z</sub> [m <sup>2</sup> ]	1,4850e-02	1,4850e-02
I <sub>y, z</sub> [m <sup>4</sup> ]	7,1530e-04	7,1530e-04
I <sub>w</sub> [m <sup>6</sup> ], I <sub>t</sub> [m <sup>4</sup> ]	1,7067e-05	1,1250e-03
W <sub>el y, z</sub> [m <sup>3</sup> ]	3,5770e-03	3,5770e-03
W <sub>pl y, z</sub> [m <sup>3</sup> ]	4,2019e-03	4,2019e-03
d <sub>y, z</sub> [mm]	0	0
c <sub>YUCS, ZUCS</sub> [mm]	200	200
α [deg]	0,00	
A <sub>L, D</sub> [m <sup>2</sup> /m]	1,5500e+00	2,9710e+00
M <sub>ply +, -</sub> [Nm]	1,49e+06	1,49e+06
M <sub>plz +, -</sub> [Nm]	1,49e+06	1,49e+06

Slika 12.12. Prikaz geometrijskih karakteristika nosača

-iskoristivost elementa na GSN – 92 %

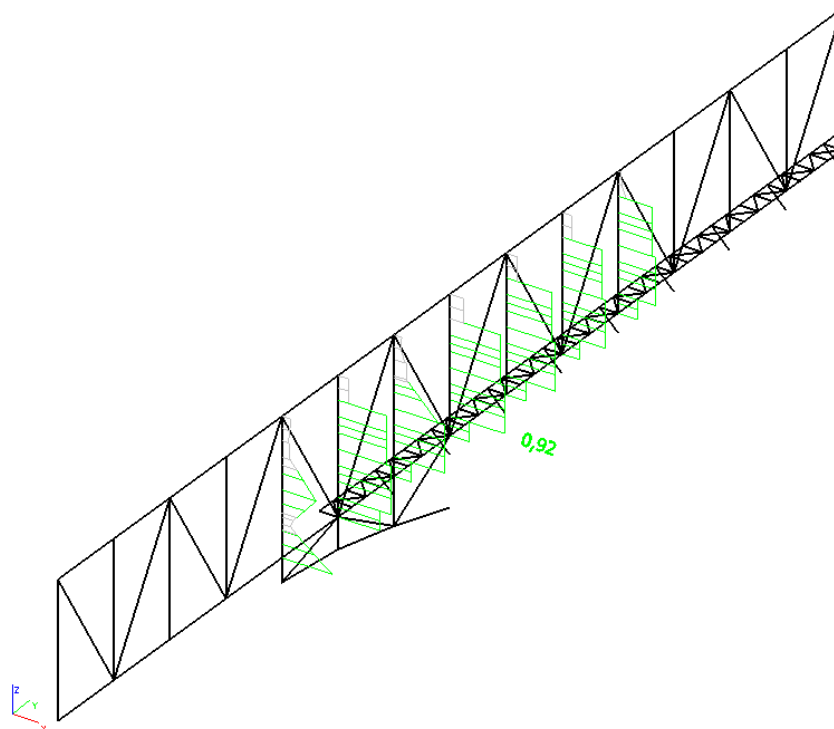

Slika 12.13. Prikaz iskoristivosti vertikalne ispune konzolnog rešetkastog nosača

### 12.2.8. Dimenzioniranje – vertikalna ispuna 2 konzolnog rešetkastog nosača 1

Member B1032	8,650 m	SHS400/400/20.0	S 355	GSN 22	0,92 -
--------------	---------	-----------------	-------	--------	--------

Partial safety factors	
Gamma M0 for resistance of cross-sections	1,00
Gamma M1 for resistance to instability	1,00
Gamma M2 for resistance of net sections	1,25

Material		
Yield strength $f_y$	355,0	MPa
Ultimate strength $f_u$	490,0	MPa
Fabrication	Rolled	

.....SECTION CHECK:....

The critical check is on position 7.450 m

Internal forces	Calculated	Unit
N,Ed	-1087,09	kN
V <sub>y</sub> ,Ed	29,37	kN
V <sub>z</sub> ,Ed	340,79	kN
T,Ed	-7,91	kNm
M <sub>y</sub> ,Ed	-215,75	kNm
M <sub>z</sub> ,Ed	108,14	kNm

#### Classification for cross-section design

According to EN 1993-1-1 article 5.5.2

#### Classification of Internal Compression parts

According to EN 1993-1-1 Table 5.2 Sheet 1

Maximum width-to-thickness ratio	17,00
Class 1 Limit	26,85
Class 2 Limit	30,92
Class 3 Limit	47,95

=> Section classified as Class 1 for cross-section design

#### Compression check

According to EN 1993-1-1 article 6.2.4 and formula (6.9)

A	3,0000e-02	m <sup>2</sup>
N <sub>c,Rd</sub>	10650,00	kN
Unity check	0,10	-

#### Bending moment check for M<sub>y</sub>

According to EN 1993-1-1 article 6.2.5 and formula (6.12),(6.13)

W <sub>pl,y</sub>	4,2019e-03	m <sup>3</sup>
M <sub>pl,y,Rd</sub>	1491,68	kNm
Unity check	0,14	-

#### Bending moment check for M<sub>z</sub>

According to EN 1993-1-1 article 6.2.5 and formula (6.12),(6.13)

W <sub>pl,z</sub>	4,2019e-03	m <sup>3</sup>
M <sub>pl,z,Rd</sub>	1491,68	kNm
Unity check	0,07	-

#### Shear check for V<sub>y</sub>

According to EN 1993-1-1 article 6.2.6 and formula (6.17)

E <sub>ta</sub>	1,20	
A <sub>v</sub>	1,5000e-02	m <sup>2</sup>
V <sub>pl,y,Rd</sub>	3074,39	kN
Unity check	0,01	-

#### Shear check for V<sub>z</sub>

According to EN 1993-1-1 article 6.2.6 and formula (6.17)

E <sub>ta</sub>	1,20	
A <sub>v</sub>	1,5000e-02	m <sup>2</sup>
V <sub>pl,z,Rd</sub>	3074,39	kN
Unity check	0,11	-

#### Torsion check

According to EN 1993-1-1 article 6.2.7 and formula (6.23)

Tau <sub>t,Ed</sub>	1,4	MPa
Tau <sub>t,Rd</sub>	205,0	MPa
Unity check	0,01	-

**Note:** The unity check for torsion is lower than the limit value of 0,05. Therefore torsion is considered as insignificant and is ignored in the combined checks.

Beta	1,68
------	------

Unity check (6.41) = 0,04 + 0,01 = 0,05 -

**Note:** Since the shear forces are less than half the plastic shear resistances their effect on the moment resistances is neglected.

The member satisfies the section check.

....:STABILITY CHECK:....

**Classification for member buckling design**

Decisive position for stability classification: 0,000 m

**Classification of Internal Compression parts**

According to EN 1993-1-1 Table 5.2 Sheet 1

Maximum width-to-thickness ratio	17,00
Class 1 Limit	26,85
Class 2 Limit	30,92
Class 3 Limit	40,48

=> Section classified as Class 1 for member buckling design

**Flexural Buckling check**

According to EN 1993-1-1 article 6.3.1.1 and formula (6.46)

Buckling parameters	yy	zz	
<small>*Student version* *Student version* *Student version* *Student version* *Student version* *Student version*</small>			
Sway type	sway	non-sway	
System length L	2,950	8,650	m
Buckling factor k	1,00	1,00	
Buckling length Lcr	2,950	8,650	m
Critical Euler load Ncr	170358,27	19814,13	kN
Slenderness Lambda	19,10	56,02	
Relative slenderness Lambda,rel	0,25	0,73	
Limit slenderness Lambda,rel,0	0,20	0,20	
Buckling curve	a	a	
Imperfection Alpha	0,21	0,21	
Reduction factor Chi	0,99	0,83	
Buckling resistance Nb,Rd	10532,05	8856,86	kN

Flexural Buckling verification		
<small>*Student version* *Student version* *Student version* *Student version* *Student version*</small>		
Cross-section area A	3,0000e-02	m <sup>2</sup>
Buckling resistance Nb,Rd	8856,86	kN
Unity check	0,12	-

**Torsional-(Flexural) Buckling check**

According to EN 1993-1-1 article 6.3.1.1 and formula (6.46)

**Note:** The cross-section concerns a RHS section which is not susceptible to Torsional-(Flexural) Buckling.

**Lateral Torsional Buckling check**

According to EN 1993-1-1 article 6.3.2.1

**Note:** The cross-section concerns a RHS section with  $h / b < 10 / \text{Lambda,rel,z}$ .

This section is thus not susceptible to Lateral Torsional Buckling.

**Bending and axial compression check**

According to EN 1993-1-1 article 6.3.3 and formula (6.61),(6.62)

Bending and axial compression check parameters		
<small>*Student version* *Student version* *Student version* *Student version* *Student version* *Student version* *Student version* *Student version* *Student version* *Student version*</small>		
Interaction method	alternative method 1	
Cross-section area A	3,0000e-02	m <sup>2</sup>
Cross-section plastic modulus Wpl,y	4,2019e-03	m <sup>3</sup>
Cross-section plastic modulus Wpl,z	4,2019e-03	m <sup>3</sup>
Design compression force N,Ed	1087,09	kN
Design bending moment (maximum) My,Ed	-1133,80	kNm
Design bending moment (maximum) Mz,Ed	143,39	kNm
Characteristic compression resistance N,Rk	10650,00	kN
Characteristic moment resistance My,Rk	1491,68	kNm
Characteristic moment resistance Mz,Rk	1491,68	kNm
Reduction factor Chi,y	0,99	
Reduction factor Chi,z	0,83	
Reduction factor Chi,LT	1,00	
Interaction factor k,yy	1,00	
Interaction factor k,yz	0,62	
Interaction factor k,zy	0,61	
Interaction factor k,zz	1,00	

Maximum moment My,Ed is derived from beam B1032 position 4,500 m.

Maximum moment Mz,Ed is derived from beam B1032 position 8,650 m.

Interaction method 1 parameters		
<small>*Student version* *Student version* *Student version* *Student version* *Student version* *Student version* *Student version* *Student version* *Student version* *Student version*</small>		
Critical Euler load N,cr,y	170358,27	kN
Critical Euler load N,cr,z	19814,13	kN
Elastic critical load N,cr,T	1915381,08	kN
Cross-section elastic modulus Wpl,y	4,2019e-03	m <sup>3</sup>
Cross-section elastic modulus Wel,y	3,5770e-03	m <sup>3</sup>
Cross-section plastic modulus Wpl,z	4,2019e-03	m <sup>3</sup>
Cross-section elastic modulus Wel,z	3,5770e-03	m <sup>3</sup>
Second moment of area Iy	7,1530e-04	m <sup>4</sup>
Second moment of area Iz	7,1530e-04	m <sup>4</sup>

\*Student version\* \*Student version\* \*Student version\* \*Student version\* \*Student version\* \*Student version\* \*Student version\* \*Student version\* \*Student version\* \*Student version\*

Interaction method 1 parameters		
Torsional constant $I_t$	1,1250e-03	m <sup>4</sup>
Method for equivalent moment factor $C_{my,0}$	Table A.2 Line 2 (General)	
Design bending moment (maximum) $M_{y,Ed}$	-1133,80	kNm
Maximum relative deflection $\delta_{t,z}$	5,0	mm
Equivalent moment factor $C_{my,0}$	1,00	
Method for equivalent moment factor $C_{mz,0}$	Table A.2 Line 2 (General)	
Design bending moment (maximum) $M_{z,Ed}$	143,39	kNm
Maximum relative deflection $\delta_{t,y}$	-1,7	mm
Equivalent moment factor $C_{mz,0}$	0,96	
Factor $\mu_y$	1,00	
Factor $\mu_z$	0,99	
Factor $\epsilon_{y,y}$	8,75	
Factor $a_{LT}$	0,00	
Critical moment for uniform bending $M_{cr,0}$	42541,58	kNm
Relative slenderness $\lambda_{rel,0}$	0,19	
Limit relative slenderness $\lambda_{rel,0,lim}$	0,23	
Equivalent moment factor $C_{my}$	1,00	
Equivalent moment factor $C_{mz}$	0,96	
Equivalent moment factor $C_{mLT}$	1,00	
Factor $b_{LT}$	0,00	
Factor $c_{LT}$	0,00	
Factor $d_{LT}$	0,00	
Factor $e_{LT}$	0,00	
Factor $w_y$	1,17	
Factor $w_z$	1,17	
Factor $n_{pl}$	0,10	
Maximum relative slenderness $\lambda_{rel,max}$	0,73	
Factor $C_{yy}$	1,00	
Factor $C_{yz}$	0,98	
Factor $C_{zy}$	0,98	
Factor $C_{zz}$	1,01	

Unity check (6.61) =  $0,10 + 0,76 + 0,06 = 0,92$  -

Unity check (6.62) =  $0,12 + 0,47 + 0,10 = 0,68$  -

The member satisfies the stability check.

### 12.2.9. Rezne sile – dijagonalna ispuna 1 konzolnog rešetkastog nosača 1

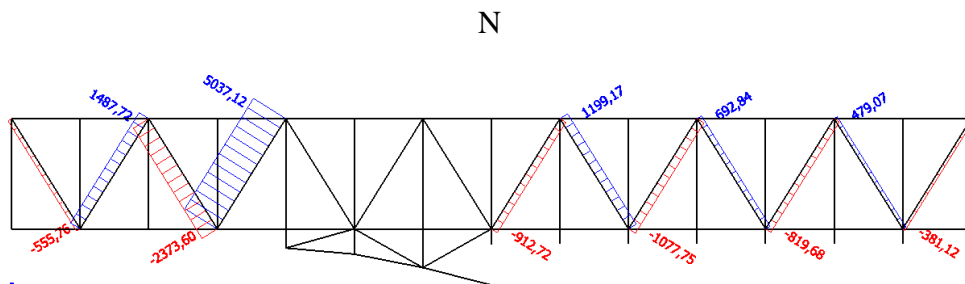

Slika 12.14. Prikaz reznih sila – dijagonalna ispuna konzolnog rešetkastog nosača

-poprečni presjek nosača

Name	Konzolni nosač 1 - dijagonalna ispuna 1	
Type	SHS400/400/10.0	
Source description	British Standard / BS 5950 part 1 : 1990 & EN 10210-2	
Item material	S 355	
Fabrication	rolled	
Flexural buckling y-y	a	
Flexural buckling z-z	a	
Lateral torsional buckling	Default	
Use 2D FEM analysis	✘	
A [m <sup>2</sup> ]	1,5500e-02	
A <sub>y</sub> , z [m <sup>2</sup> ]	7,7126e-03	7,7126e-03
I <sub>y</sub> , z [m <sup>4</sup> ]	3,9130e-04	3,9130e-04
I <sub>w</sub> [m <sup>6</sup> ], t [m <sup>4</sup> ]	8,5333e-06	6,0090e-04
W <sub>el</sub> y, z [m <sup>3</sup> ]	1,9560e-03	1,9560e-03
W <sub>pl</sub> y, z [m <sup>3</sup> ]	2,2481e-03	2,2481e-03
d <sub>y</sub> , z [mm]	0	0
c <sub>YUCS, ZUCS</sub> [mm]	200	200
α [deg]	0,00	
A <sub>L</sub> , D [m <sup>2</sup> /m]	1,5700e+00	3,0855e+00
M <sub>pl</sub> y, - [Nm]	7,98e+05	7,98e+05
M <sub>pl</sub> z, - [Nm]	7,98e+05	7,98e+05

Slika 12.15. Prikaz geometrijskih karakteristika nosača

### 12.2.10. Dimenzioniranje – dijagonalna ispuna 1 konzolnog rešetkastog nosača 1

Member B1062	10,197 m	SHS400/400/10.0	S 355	GSN 22	0,92 -
--------------	----------	-----------------	-------	--------	--------

Partial safety factors	
Gamma M0 for resistance of cross-sections	1,00
Gamma M1 for resistance to instability	1,00
Gamma M2 for resistance of net sections	1,25

Material		
Yield strength fy	355,0	MPa
Ultimate strength fu	490,0	MPa
Fabrication	Rolled	

....:SECTION CHECK:....

The critical check is on position 10.197 m

Internal forces	Calculated	Unit
N,Ed	5037,12	kN
Vy,Ed	0,00	kN
Vz,Ed	0,00	kN
T,Ed	0,00	kNm
My,Ed	0,00	kNm
Mz,Ed	0,00	kNm

Tension check

According to EN 1993-1-1 article 6.2.3 and formula (6.5)

A	1,5500e-02	m <sup>2</sup>
Npl,Rd	5502,50	kN
Nu,Rd	5468,40	kN
Nt,Rd	5468,40	kN
Unity check	0,92	-

The member satisfies the section check.

....:STABILITY CHECK:....

The member satisfies the stability check.

-iskoristivost elementa na GSN – 92 %

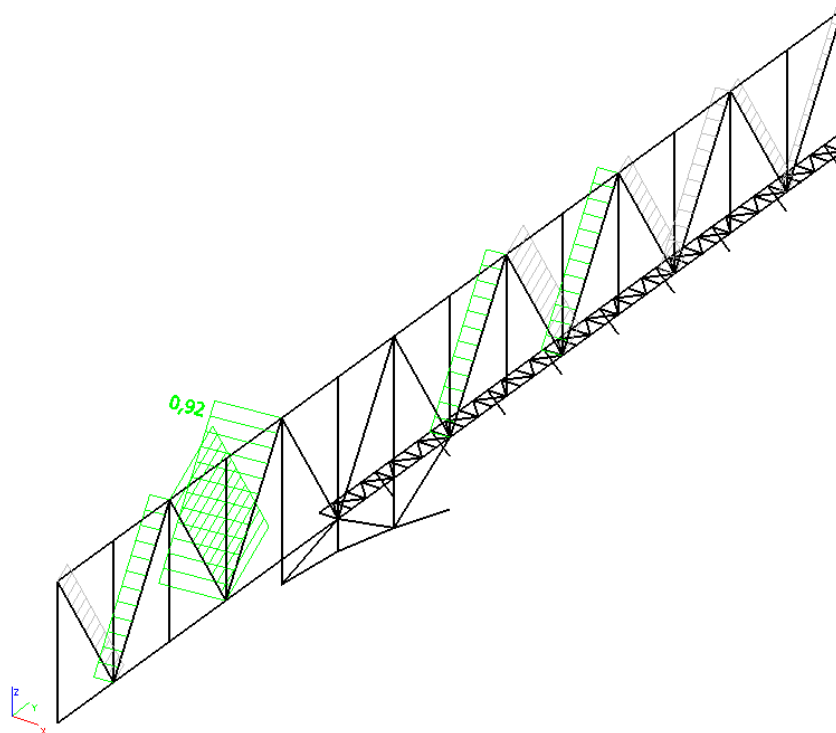

Slika 12.16. Prikaz iskoristivosti dijagonalne ispune konzolnog rešetkastog nosača

12.2.11. Rezne sile – dijagonalna ispuna 2 konzolnog rešetkastog nosača 1

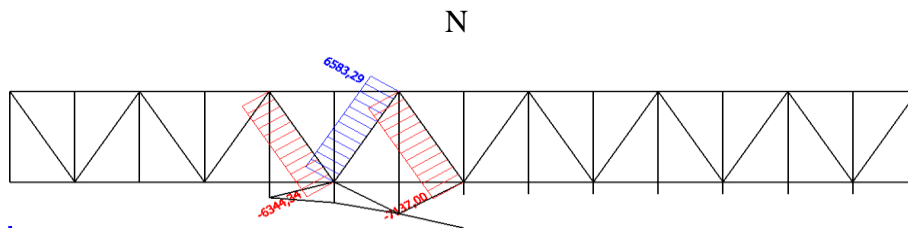

Slika 12.17. Prikaz reznih sile – dijagonalna ispuna konzolnog rešetkastog nosača

-poprečni presjek nosača

Name	Konzolni nosač 1 - dijagonalna ispuna 2		
Type	SHS400/400/16.0		
Source description	British Standard / BS 5950 part 1 : 1990 & EN 10210-2		
Item material	S 355		
Fabrication	rolled		
Flexural buckling y-y	a		
Flexural buckling z-z	a		
Lateral torsional buckling	Default		
Use 2D FEM analysis	✖		
A [m <sup>2</sup> ]	2,4300e-02		
A y, z [m <sup>2</sup> ]	1,2064e-02		1,2064e-02
I y, z [m <sup>4</sup> ]	5,9340e-04		5,9340e-04
I w [m <sup>5</sup> ], t [m <sup>4</sup> ]	1,3653e-05		9,2440e-04
Wey, z [m <sup>3</sup> ]	2,9670e-03		2,9670e-03
Wply, z [m <sup>3</sup> ]	3,4548e-03		3,4548e-03
d y, z [mm]	0		0
c YUCS, ZUCS [mm]	200		200
α [deg]	0,00		
A L, D [m <sup>2</sup> /m]	1,5600e+00		3,0168e+00
Mply +, - [Nm]	1,23e+06		1,23e+06
Mplz +, - [Nm]	1,23e+06		1,23e+06

Slika 12.18. Prikaz geometrijskih karakteristika nosača

-iskoristivost elementa na GSN – 96 %

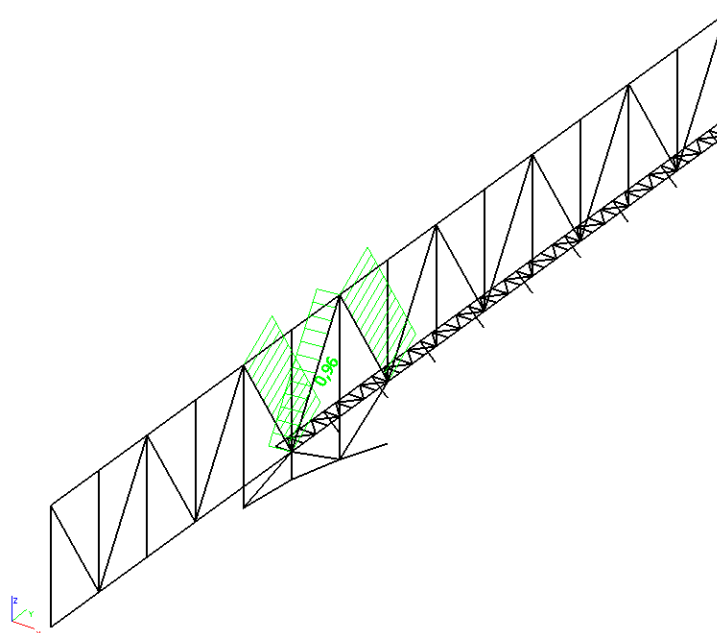

Slika 12.19. Prikaz iskoristivosti dijagonalne ispune konzolnog rešetkastog nosača



### 12.2.12. Dimenzioniranje – dijagonalna ispuna 2 konzolnog rešetkastog nosača 1

Member B1063	10,197 m	SHS400/400/16.0	S 355	GSN 22	0,96 -
--------------	----------	-----------------	-------	--------	--------

Partial safety factors	
Gamma M0 for resistance of cross-sections	1,00
Gamma M1 for resistance to instability	1,00
Gamma M2 for resistance of net sections	1,25

Material		
Yield strength fy	355,0	MPa
Ultimate strength fu	490,0	MPa
Fabrication	Rolled	

....:SECTION CHECK:....

The critical check is on position 10.197 m

Internal forces	Calculated	Unit
N,Ed	-6344,34	kN
Vy,Ed	0,00	kN
Vz,Ed	0,00	kN
T,Ed	0,00	kNm
My,Ed	0,00	kNm
Mz,Ed	0,00	kNm

**Classification for cross-section design**

According to EN 1993-1-1 article 5.5.2

**Classification of Internal Compression parts**

According to EN 1993-1-1 Table 5.2 Sheet 1

Maximum width-to-thickness ratio	22,00
Class 1 Limit	26,85
Class 2 Limit	30,92
Class 3 Limit	34,17

=> Section classified as Class 1 for cross-section design

**Compression check**

According to EN 1993-1-1 article 6.2.4 and formula (6.9)

A	2,4300e-02	m <sup>2</sup>
Nc,Rd	8626,50	kN
Unity check	0,74	-

The member satisfies the section check.

....:STABILITY CHECK:....

**Classification for member buckling design**

Decisive position for stability classification: 0,000 m

**Classification of Internal Compression parts**

According to EN 1993-1-1 Table 5.2 Sheet 1

Maximum width-to-thickness ratio	22,00
Class 1 Limit	26,85
Class 2 Limit	30,92
Class 3 Limit	34,17

=> Section classified as Class 1 for member buckling design

**Flexural Buckling check**

According to EN 1993-1-1 article 6.3.1.1 and formula (6.46)

Buckling parameters	yy	zz	
Sway type	sway	non-sway	
System length L	10,197	10,197	m
Buckling factor k	1,00	1,00	
Buckling length Lcr	10,197	10,197	m
Critical Euler load Ncr	11827,86	11828,46	kN
Slenderness Lambda	65,25	65,25	
Relative slenderness Lambda,rel	0,85	0,85	
Limit slenderness Lambda,rel,0	0,20	0,20	
Buckling curve	a)	a	
Imperfection Alpha	0,21	0,21	
Reduction factor Chi	0,76	0,76	
Buckling resistance Nb,Rd	6585,69	6585,81	kN

Flexural Buckling verification		
Cross-section area A	2,4300e-02	m <sup>2</sup>
Buckling resistance Nb,Rd	6585,69	kN
Unity check	0,96	-

**Torsional(-Flexural) Buckling check**

According to EN 1993-1-1 article 6.3.1.1 and formula (6.46)

**Note:** The cross-section concerns a RHS section which is not susceptible to Torsional(-Flexural) Buckling.

The member satisfies the stability check.

## 13. PRORAČUN REŠETKASTOG NOSAČA - KONZOLNI NOSAČ 2

### 13.1. Vertikalni pomak rešetkastog nosača – konzolni nosač 2

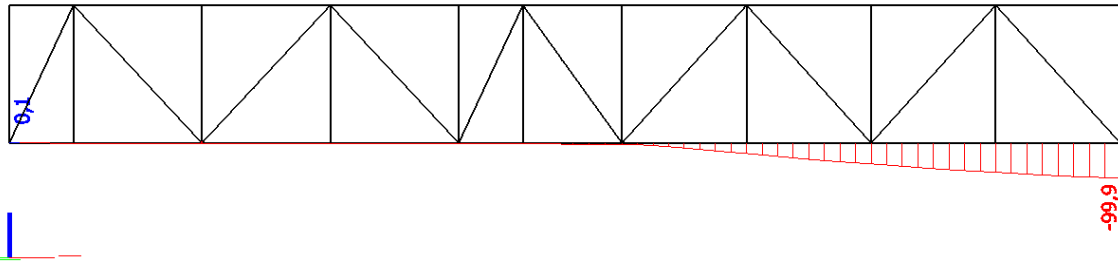

Slika 13.1. Prikaz vertikalnog pomaka konzolnog rešetkastog nosača

Dopušteni vertikalni pomak (progib):

$$u_{dop} = \frac{l}{300} = \frac{31,44 \cdot 1000}{300} = 104,8 \text{ mm}$$

$$u_z = 99,9 \text{ mm} < u_{z,dop} = 104,8 \text{ mm} \quad \text{Zadovoljava}$$

-iskoristivost na GSU -  $99,9 \text{ mm} / 104,8 \text{ mm} = 0,95 = 95\%$

### 13.2. Dimenziniranje rešetkastog nosača – konzolni nosač 2

#### 13.2.1. Rezne sile – gornja pojasnica konzolnog rešetkastog nosača 2

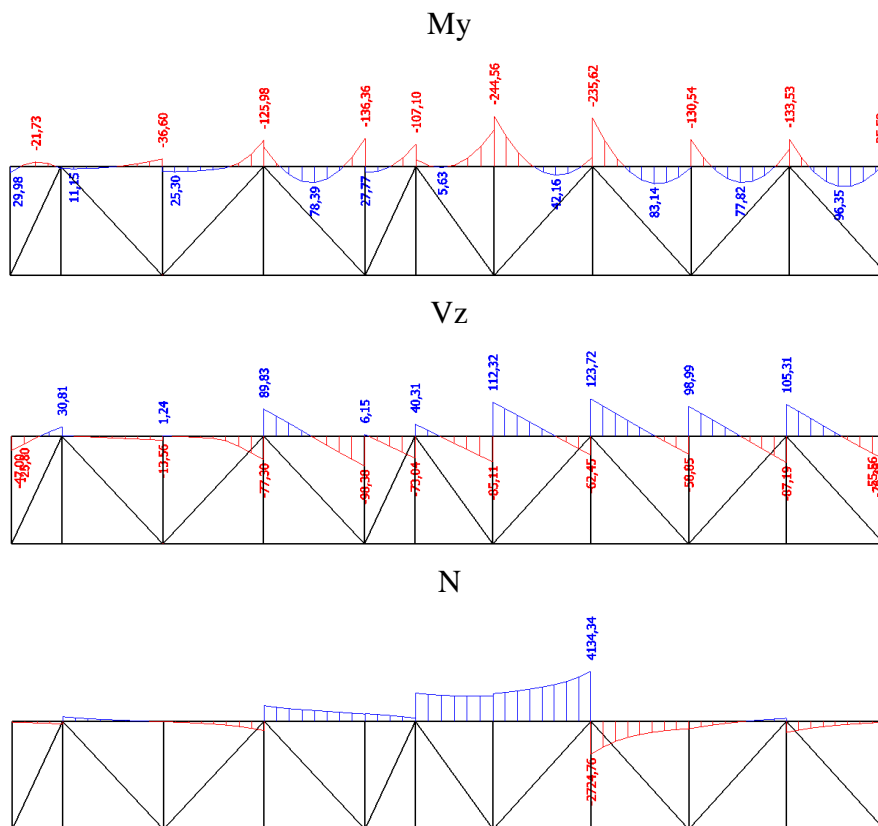

Slika 13.2. Prikaz reznih sila - gornja pojasnica konzolnog rešetkastog nosača

-poprečni presjek nosača

Name	Konzolni nosač 2 - gornja pojasnica	
Type	F400X12	
Source description	Chinese Standard / GB 6728-2002	
Item material	S 355	
Fabrication	rolled	
Flexural buckling y-y	a	
Flexural buckling z-z	a	
Lateral torsional buckling	Default	
Use 2D FEM analysis	x	
A [m²]	1,8000e-02	
A <sub>y</sub> , z [m²]	8,9972e-03	8,9972e-03
I <sub>y</sub> , z [m⁴]	4,4319e-04	4,4319e-04
I <sub>w</sub> [m⁶], t [m⁴]	1,0240e-05	7,1813e-04
W <sub>el</sub> y, z [m³]	2,2160e-03	2,2160e-03
W <sub>pl</sub> y, z [m³]	2,5874e-03	2,5874e-03
d <sub>y</sub> , z [mm]	0	0
c <sub>YUCS, ZUCS</sub> [mm]	200	200
α [deg]	0,00	
A <sub>L</sub> , D [m²/m]	1,5382e+00	3,0005e+00
M <sub>ply</sub> +, - [Nm]	9,18e+05	9,18e+05
M <sub>piz</sub> +, - [Nm]	9,18e+05	9,18e+05

Slika 13.3. Prikaz geometrijskih karakteristika nosača

### 13.2.2. Dimenzioniranje – gornja pojasnica glavnog rešetkastog nosača 2

Member B999	70,090 m	F400X12	S 355	GSN 24	0,80 -
-------------	----------	---------	-------	--------	--------

Partial safety factors	
Gamma M0 for resistance of cross-sections	1,00
Gamma M1 for resistance to instability	1,00
Gamma M2 for resistance of net sections	1,25

Material		
Yield strength $f_y$	355,0	MPa
Ultimate strength $f_u$	490,0	MPa
Fabrication	Rolled	

....SECTION CHECK:....

The critical check is on position 46.510 m

Internal forces	Calculated	Unit
N,Ed	-2724,76	kN
Vy,Ed	88,30	kN
Vz,Ed	123,72	kN
T,Ed	49,83	kNm
My,Ed	-235,62	kNm
Mz,Ed	-93,73	kNm

**Classification for cross-section design**

According to EN 1993-1-1 article 5.5.2

**Classification of Internal Compression parts**

According to EN 1993-1-1 Table 5.2 Sheet 1

Maximum width-to-thickness ratio	30,33
Class 1 Limit	26,85
Class 2 Limit	30,92
Class 3 Limit	49,54

=> Section classified as Class 2 for cross-section design

**Compression check**

According to EN 1993-1-1 article 6.2.4 and formula (6.9)

A	1,8000e-02	m <sup>2</sup>
Nc,Rd	6390,00	kN
Unity check	0,43	-

**Bending moment check for My**

According to EN 1993-1-1 article 6.2.5 and formula (6.12),(6.13)

Wpl,y	2,5874e-03	m <sup>3</sup>
Mpl,y,Rd	918,53	kNm
Unity check	0,26	-

**Bending moment check for Mz**

According to EN 1993-1-1 article 6.2.5 and formula (6.12),(6.13)

Wpl,z	2,5874e-03	m <sup>3</sup>
Mpl,z,Rd	918,53	kNm
Unity check	0,10	-

**Shear check for Vy**

According to EN 1993-1-1 article 6.2.6 and formula (6.47)

Eta	1,20	
Av	9,0000e-03	m <sup>2</sup>
Vpl,y,Rd	1844,63	kN
Unity check	0,05	-

**Shear check for Vz**

According to EN 1993-1-1 article 6.2.6 and formula (6.17)

Eta	1,20	
Av	9,0000e-03	m <sup>2</sup>
Vpl,z,Rd	1844,63	kN
Unity check	0,07	-

**Torsion check**

According to EN 1993-1-1 article 6.2.7 and formula (6.23)

Tau,t,Ed	13,8	MPa
Tau,Rd	205,0	MPa
Unity check	0,07	-

**Combined Shear and Torsion check for Vy and Tau,t,Rd**

According to EN 1993-1-1 article 6.2.6 & 6.2.7 and formula (6.25),(6.28)

Vpl,T,z,Rd	1720,52	kN
Unity check	0,07	-

**Combined bending, axial force and shear force check**  
According to EN 1993-1-1 article 6.2.9.1 and formula (6.41)

MN,y,Rd	687,21	kNm
Alpha	2,09	
MN,z,Rd	687,21	kNm
Beta	2,09	

Unity check (6.41) = 0,11 + 0,02 = 0,12 -

**Note:** Since the shear forces are less than half the plastic shear resistances their effect on the moment resistances is neglected.

The member satisfies the section check.

....:STABILITY CHECK:....

**Classification for member buckling design**

Decisive position for stability classification: 46,510 m

**Classification of Internal Compression parts**

According to EN 1993-1-1 Table 5.2 Sheet 1

Maximum width-to-thickness ratio	30,33
Class 1 Limit	26,85
Class 2 Limit	30,92
Class 3 Limit	49,54

=> Section classified as Class 2 for member buckling design

**Flexural Buckling check**

According to EN 1993-1-1 article 6.3.1.1 and formula (6.46)

Buckling parameters	yy	zz	
Sway type	sway	non-sway	
System length L	7,860	7,860	m
Buckling factor k	1,00	1,00	
Buckling length Lcr	7,860	7,860	m
Critical Euler load Ncr	14868,39	14868,39	kN
Slenderness Lambda	50,09	50,09	
Relative slenderness Lambda,rel	0,66	0,66	
Limit slenderness Lambda,rel,0	0,20	0,20	
Buckling curve	a	a	
Imperfection Alpha	0,21	0,21	
Reduction factor Chi	0,87	0,87	
Buckling resistance Nb,Rd	5544,20	5544,20	kN

Flexural Buckling verification		
Cross-section area A	1,8000e-02	m^2
Buckling resistance Nb,Rd	5544,20	kN
Unity check	0,49	-

**Torsional(-Flexural) Buckling check**

According to EN 1993-1-1 article 6.3.1.1 and formula (6.46)

**Note:** The cross-section concerns a RHS section which is not susceptible to Torsional(-Flexural) Buckling.

**Lateral Torsional Buckling check**

According to EN 1993-1-1 article 6.3.2.1

**Note:** The cross-section concerns an RHS section with  $h / b < 10 / \text{Lambda,rel,z}$ .

This section is thus not susceptible to Lateral Torsional Buckling.

**Bending and axial compression check**

According to EN 1993-1-1 article 6.3.3 and formula (6.61),(6.62)

Bending and axial compression check parameters		
Interaction method	alternative method 1	
Cross-section area A	1,8000e-02	m^2
Cross-section plastic modulus Wpl,y	2,5874e-03	m^3
Cross-section plastic modulus Wpl,z	2,5874e-03	m^3
Design compression force N,Ed	2724,76	kN
Design bending moment (maximum) My,Ed	-235,62	kNm
Design bending moment (maximum) Mz,Ed	-93,73	kNm
Characteristic compression resistance N,Rk	6390,00	kN
Characteristic moment resistance My,Rk	918,53	kNm
Characteristic moment resistance Mz,Rk	918,53	kNm
Reduction factor Chi,y	0,87	
Reduction factor Chi,z	0,87	
Reduction factor Chi,LT	1,00	
Interaction factor k,yy	0,96	
Interaction factor k,yz	0,58	
Interaction factor k,zy	0,61	
Interaction factor k,zz	0,91	

Maximum moment My,Ed is derived from beam B999 position 46,510 m.

Maximum moment Mz,Ed is derived from beam B999 position 46,510 m.

Interaction method 1 parameters		
Critical Euler load N,cr,y	14868,39	kN

Interaction method 1 parameters		
Critical Euler load N <sub>cr,z</sub>	14868,39	kN
Elastic critical load N <sub>cr,T</sub>	1184857,75	kN
Cross-section plastic modulus W <sub>pl,y</sub>	2,5874e-03	m <sup>3</sup>
Cross-section elastic modulus W <sub>el,y</sub>	2,2160e-03	m <sup>3</sup>
Cross-section plastic modulus W <sub>pl,z</sub>	2,5874e-03	m <sup>3</sup>
Cross-section elastic modulus W <sub>el,z</sub>	2,2160e-03	m <sup>3</sup>
Second moment of area I <sub>y</sub>	4,4319e-04	m <sup>4</sup>
Second moment of area I <sub>z</sub>	4,4319e-04	m <sup>4</sup>
Torsional constant I <sub>t</sub>	7,1813e-04	m <sup>4</sup>
Method for equivalent moment factor C <sub>my,0</sub>	Table A.2 Line 2 (General)	
Design bending moment (maximum) M <sub>y,Ed</sub>	-235,62	kNm
Maximum relative deflection delta <sub>z</sub>	-3,4	mm
Equivalent moment factor C <sub>my,0</sub>	0,86	
Method for equivalent moment factor C <sub>mz,0</sub>	Table A.2 Line 2 (General)	
Design bending moment (maximum) M <sub>z,Ed</sub>	-93,73	kNm
Maximum relative deflection delta <sub>y</sub>	0,2	mm
Equivalent moment factor C <sub>mz,0</sub>	0,82	
Factor mu <sub>y</sub>	0,97	
Factor mu <sub>z</sub>	0,97	
Factor epsilon <sub>y</sub>	0,70	
Factor a <sub>LT</sub>	0,00	
Critical moment for uniform bending M <sub>cr,0</sub>	29453,63	kNm
Relative slenderness Lambda <sub>rel,0</sub>	0,18	
Limit relative slenderness Lambda <sub>rel,0,lim</sub>	0,35	
Equivalent moment factor C <sub>my</sub>	0,86	
Equivalent moment factor C <sub>mz</sub>	0,82	
Equivalent moment factor C <sub>mLT</sub>	1,00	
Factor b <sub>LT</sub>	0,00	
Factor c <sub>LT</sub>	0,00	
Factor d <sub>LT</sub>	0,00	
Factor e <sub>LT</sub>	0,00	
Factor w <sub>y</sub>	1,17	
Factor w <sub>z</sub>	1,17	
Factor n <sub>pl</sub>	0,43	
Maximum relative slenderness Lambda <sub>rel,max</sub>	0,66	
Factor C <sub>yy</sub>	1,07	
Factor C <sub>yz</sub>	1,01	
Factor C <sub>zy</sub>	1,00	
Factor C <sub>zz</sub>	1,07	

Unity check (6.61) = 0,49 + 0,25 + 0,06 = 0,80 -  
 Unity check (6.62) = 0,49 + 0,16 + 0,09 = 0,74 -  
 The member satisfies the stability check.



-iskoristivost elementa na GSN – 80 %

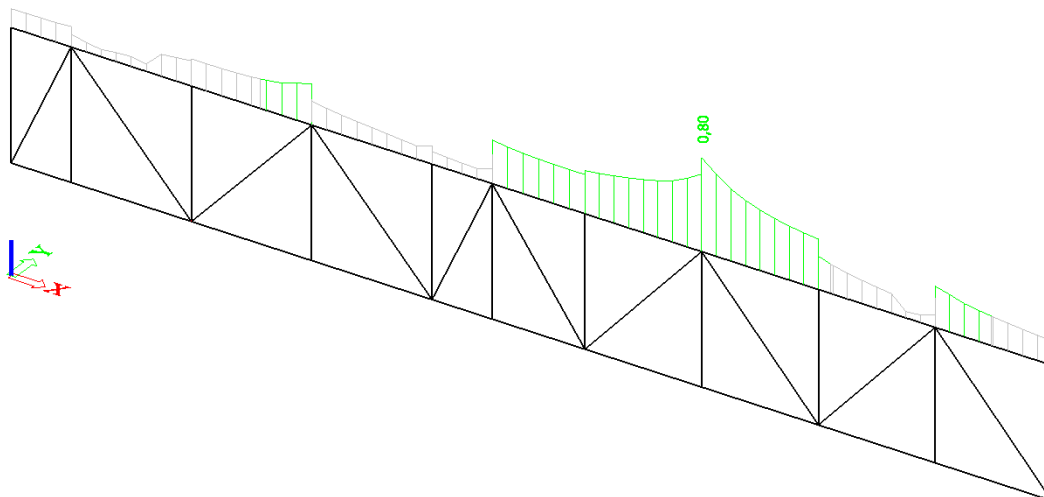

Slika 13.4. Prikaz iskoristivosti gornje pojasnice konzolnog rešetkastog nosača

### 13.2.3. Rezne sile – donja pojasnica konzolnog rešetkastog nosača 2

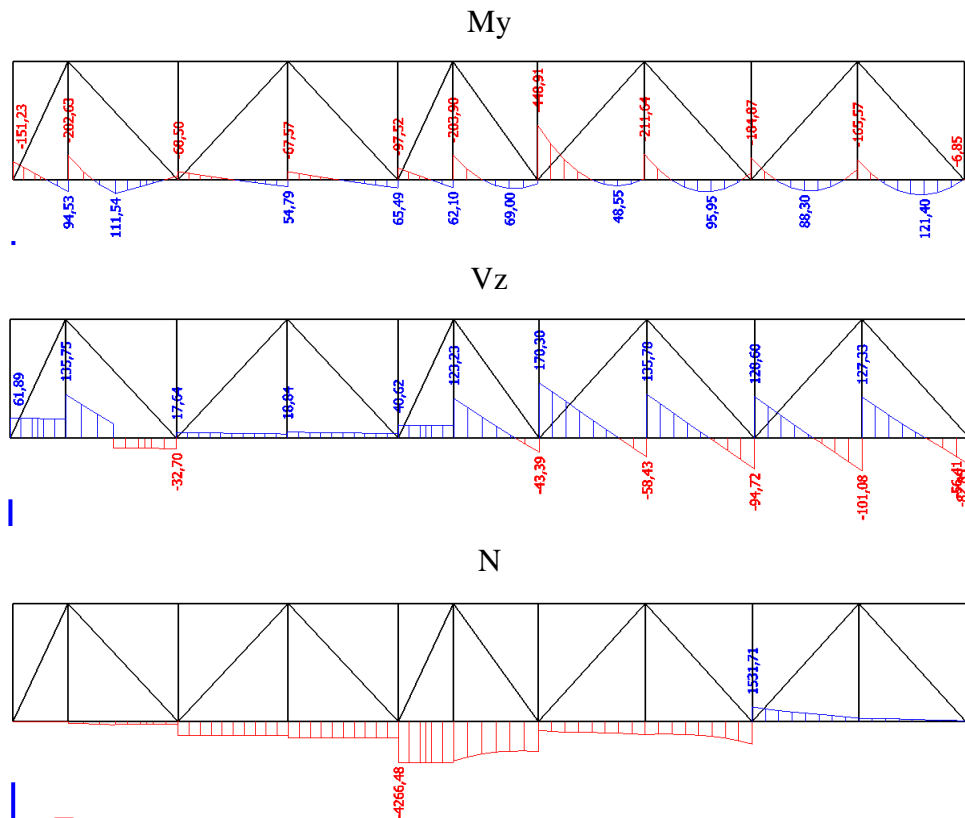

Slika 13.5. Prikaz reznih sila - donja pojasnica konzolnog rešetkastog nosača

-poprečni presjek nosača

Name	Konzolni nosač 2 - donja pojasnica	
Type	F400X12	
Source description	Chinese Standard / GB 6728-2002	
Item material	S 355	
Fabrication	rolled	
Flexural buckling y-y	a	
Flexural buckling z-z	a	
Lateral torsional buckling	Default	
Use 2D FEM analysis	x	

A [m <sup>2</sup> ]	1,8000e-02	
A <sub>y, z</sub> [m <sup>2</sup> ]	8,9972e-03	8,9972e-03
I <sub>y, z</sub> [m <sup>4</sup> ]	4,4319e-04	4,4319e-04
I <sub>w</sub> [m <sup>6</sup> ], I <sub>t</sub> [m <sup>4</sup> ]	1,0240e-05	7,1813e-04
W <sub>el y, z</sub> [m <sup>3</sup> ]	2,2160e-03	2,2160e-03
W <sub>pl y, z</sub> [m <sup>3</sup> ]	2,5874e-03	2,5874e-03
d <sub>y, z</sub> [mm]	0	0
c <sub>YUCS, ZUCS</sub> [mm]	200	200
α [deg]	0,00	
A <sub>L, D</sub> [m <sup>2</sup> /m]	1,5382e+00	3,0005e+00
M <sub>pl y, z</sub> [-, +] [Nm]	9,18e+05	9,18e+05
M <sub>plz y, z</sub> [-, +] [Nm]	9,18e+05	9,18e+05

Slika 13.6. Prikaz geometrijskih karakteristika nosača

### 3.2.4. Dimenzioniranje – donja pojasnica konzolnog rešetkastog nosača 2

Member B1000	70,090 m	F400X12	S 355	GSN 26	0,94 -
--------------	----------	---------	-------	--------	--------

Partial safety factors	
Gamma M0 for resistance of cross-sections	1,00
Gamma M1 for resistance to instability	1,00
Gamma M2 for resistance of net sections	1,25

Material		
Yield strength $f_y$	355,0	MPa
Ultimate strength $f_u$	490,0	MPa
Fabrication	Rolled	

.....SECTION CHECK:.....

The critical check is on position 32.400 m

Internal forces	Calculated	Unit
N,Ed	-4101,09	kN
Vy,Ed	8,34	kN
Vz,Ed	123,23	kN
T,Ed	92,80	kNm
My,Ed	-203,90	kNm
Mz,Ed	-60,14	kNm

#### Classification for cross-section design

According to EN 1993-1-1 article 5.5.2

#### Classification of Internal Compression parts

According to EN 1993-1-1 Table 5.2 Sheet 1

Maximum width-to-thickness ratio	30,33
Class 1 Limit	26,85
Class 2 Limit	30,92
Class 3 Limit	42,41

=> Section classified as Class 2 for cross-section design

#### Compression check

According to EN 1993-1-1 article 6.2.4 and formula (6.9)

A	1,8000e-02	m <sup>2</sup>
Nc,Rd	6390,00	kN
Unity check	0,64	-

#### Bending moment check for My

According to EN 1993-1-1 article 6.2.5 and formula (6.12),(6.13)

Wpl,y	2,5874e-03	m <sup>3</sup>
Mpl,y,Rd	918,53	kNm
Unity check	0,22	-

#### Bending moment check for Mz

According to EN 1993-1-1 article 6.2.5 and formula (6.12),(6.13)

Wpl,z	2,5874e-03	m <sup>3</sup>
Mpl,z,Rd	918,53	kNm
Unity check	0,07	-

#### Shear check for Vy

According to EN 1993-1-1 article 6.2.6 and formula (6.17)

Eta	1,20	
Av	9,0000e-03	m <sup>2</sup>
Vpl,y,Rd	1844,63	kN
Unity check	0,00	-

#### Shear check for Vz

According to EN 1993-1-1 article 6.2.6 and formula (6.17)

Eta	1,20	
Av	9,0000e-03	m <sup>2</sup>
Vpl,z,Rd	1844,63	kN
Unity check	0,07	-

#### Torsion check

According to EN 1993-1-1 article 6.2.7 and formula (6.23)

Tau,t,Ed	25,7	MPa
Tau,Rd	205,0	MPa
Unity check	0,13	-

#### Combined Shear and Torsion check for Vy and Tau,t,Rd

According to EN 1993-1-1 article 6.2.6 & 6.2.7 and formula (6.25),(6.28)



Vpl,T,z,Rd	1613,47	kN
Unity check	0,08	-

**Combined bending, axial force and shear force check**  
According to EN 1993-1-1 article 6.2.9.1 and formula (6.41)

MN,y,Rd	429,16	kNm
Alpha	3,11	
MN,z,Rd	429,16	kNm
Beta	3,11	

Unity check (6.41) = 0,10 + 0,00 = 0,10 -

**Note:** Since the shear forces are less than half the plastic shear resistances their effect on the moment resistances is neglected.

The member satisfies the section check.

....:STABILITY CHECK:...

**Classification for member buckling design**

Decisive position for stability classification: 32,400 m

**Classification of Internal Compression parts**

According to EN 1993-1-1 Table 5.2 Sheet 1

Maximum width-to-thickness ratio	30,33
Class 1 Limit	26,85
Class 2 Limit	30,92
Class 3 Limit	42,41

=> Section classified as Class 2 for member buckling design

**Flexural Buckling check**

According to EN 1993-1-1 article 6.3.1.1 and formula (6.46)

Buckling parameters	yy	zz	
Sway type	sway	non-sway	
System length L	6,250	6,250	m
Buckling factor k	1,00	1,00	
Buckling length Lcr	6,250	6,250	m
Critical Euler load Ncr	23515,22	23515,22	kN
Slenderness Lambda	39,83	39,83	
Relative slenderness Lambda,rel	0,52	0,52	
Limit slenderness Lambda,rel,0	0,20	0,20	
Buckling curve	a	a	
Imperfection Alpha	0,21	0,21	
Reduction factor Chi	0,92	0,92	
Buckling resistance Nb,Rd	5863,03	5863,03	kN

Flexural Buckling verification		
Cross-section area A	1,8000e-02	m <sup>2</sup>
Buckling resistance Nb,Rd	5863,03	kN
Unity check	0,70	-

**Torsional-(Flexural) Buckling check**

According to EN 1993-1-1 article 6.3.1.1 and formula (6.46)

**Note:** The cross-section concerns a RHS section which is not susceptible to Torsional-(Flexural) Buckling.

**Lateral Torsional Buckling check**

According to EN 1993-1-1 article 6.3.2.1

**Note:** The cross-section concerns an RHS section with  $h / b < 10 / \text{Lambda,rel,z}$ .

This section is thus not susceptible to Lateral Torsional Buckling.

**Bending and axial compression check**

According to EN 1993-1-1 article 6.3.3 and formula (6.61), (6.62)

Bending and axial compression check parameters		
Interaction method	alternative method 1	
Cross-section area A	1,8000e-02	m <sup>2</sup>
Cross-section plastic modulus Wpl,y	2,5874e-03	m <sup>3</sup>
Cross-section plastic modulus Wpl,z	2,5874e-03	m <sup>3</sup>
Design compression force N,Ed	4101,09	kN
Design bending moment (maximum) My,Ed	-203,90	kNm
Design bending moment (maximum) Mz,Ed	-60,14	kNm
Characteristic compression resistance N,Rk	6390,00	kN
Characteristic moment resistance My,Rk	918,53	kNm
Characteristic moment resistance Mz,Rk	918,53	kNm
Reduction factor Chi,y	0,92	
Reduction factor Chi,z	0,92	
Reduction factor Chi,LT	1,00	
Interaction factor k,yy	0,90	
Interaction factor k,yz	0,61	
Interaction factor k,zy	0,57	
Interaction factor k,zz	0,96	

Maximum moment My,Ed is derived from beam B1000 position 32,400 m.

Maximum moment Mz,Ed is derived from beam B1000 position 32,400 m.

Interaction method 1 parameters		
Critical Euler load N,cry	23515,22	kN

Interaction method 1 parameters		
Critical Euler load N <sub>cr,z</sub>	23515,22	kN
Elastic critical load N <sub>cr,T</sub>	1188914,88	kN
Cross-section plastic modulus W <sub>pl,y</sub>	2,5874e-03	m <sup>3</sup>
Cross-section elastic modulus W <sub>el,y</sub>	2,2160e-03	m <sup>3</sup>
Cross-section plastic modulus W <sub>pl,z</sub>	2,5874e-03	m <sup>3</sup>
Cross-section elastic modulus W <sub>el,z</sub>	2,2160e-03	m <sup>3</sup>
Second moment of area I <sub>y</sub>	4,4319e-04	m <sup>4</sup>
Second moment of area I <sub>z</sub>	4,4319e-04	m <sup>4</sup>
Torsional constant I <sub>t</sub>	7,1813e-04	m <sup>4</sup>
Method for equivalent moment factor C <sub>my,0</sub>	Table A.2 Line 2 (General)	
Design bending moment (maximum) M <sub>y,Ed</sub>	-203,90	kNm
Maximum relative deflection delta <sub>z</sub>	-1,5	mm
Equivalent moment factor C <sub>my,0</sub>	0,86	
Method for equivalent moment factor C <sub>mz,0</sub>	Table A.2 Line 2 (General)	
Design bending moment (maximum) M <sub>z,Ed</sub>	-60,14	kNm
Maximum relative deflection delta <sub>y</sub>	1,1	mm
Equivalent moment factor C <sub>mz,0</sub>	0,90	
Factor mu <sub>y</sub>	0,98	
Factor mu <sub>z</sub>	0,98	
Factor epsilon <sub>y</sub>	0,40	
Factor a <sub>LT</sub>	0,00	
Critical moment for uniform bending M <sub>cr,0</sub>	37104,24	kNm
Relative slenderness Lambda <sub>rel,0</sub>	0,16	
Limit relative slenderness Lambda <sub>rel,0,lim</sub>	0,36	
Equivalent moment factor C <sub>my</sub>	0,86	
Equivalent moment factor C <sub>mz</sub>	0,90	
Equivalent moment factor C <sub>mLT</sub>	1,00	
Factor b <sub>LT</sub>	0,00	
Factor c <sub>LT</sub>	0,00	
Factor d <sub>LT</sub>	0,00	
Factor e <sub>LT</sub>	0,00	
Factor w <sub>y</sub>	1,17	
Factor w <sub>z</sub>	1,17	
Factor n <sub>pl</sub>	0,64	
Maximum relative slenderness Lambda <sub>rel,max</sub>	0,52	
Factor C <sub>yy</sub>	1,13	
Factor C <sub>yz</sub>	1,06	
Factor C <sub>zy</sub>	1,08	
Factor C <sub>zz</sub>	1,12	

Unity check (6.61) = 0,70 + 0,20 + 0,04 = 0,94 -  
 Unity check (6.62) = 0,70 + 0,13 + 0,06 = 0,89 -  
 The member satisfies the stability check.



-iskoristivost elementa na GSN – 91 %

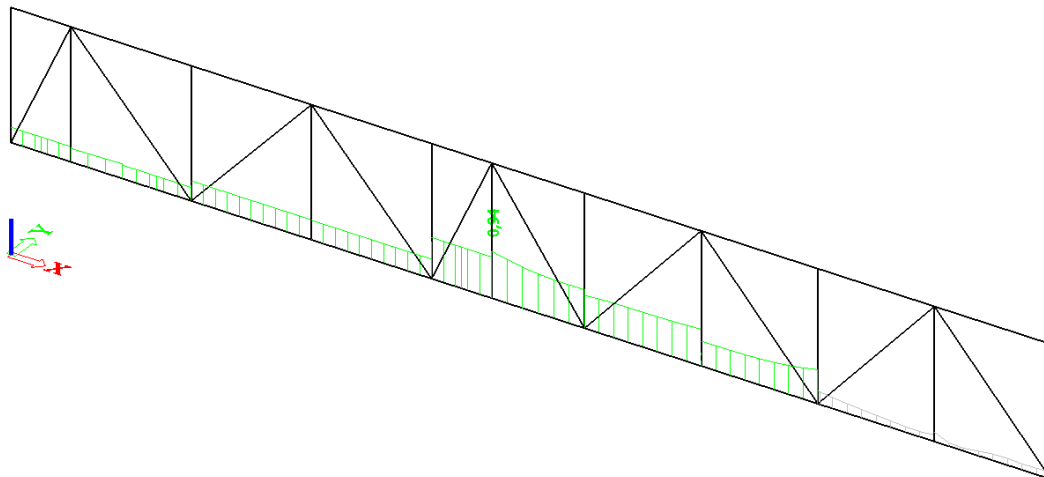

Slika 13.7. Prikaz iskoristivosti donje pojasnice konzolnog rešetkastog nosača

13.2.5. Rezne sile – vertikalna ispuna 1 konzolnog rešetkastog nosača 2

Mz

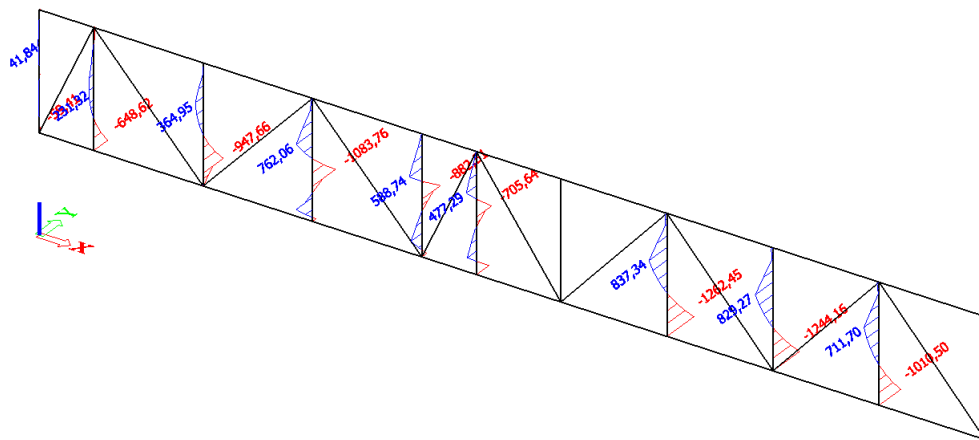

Vy

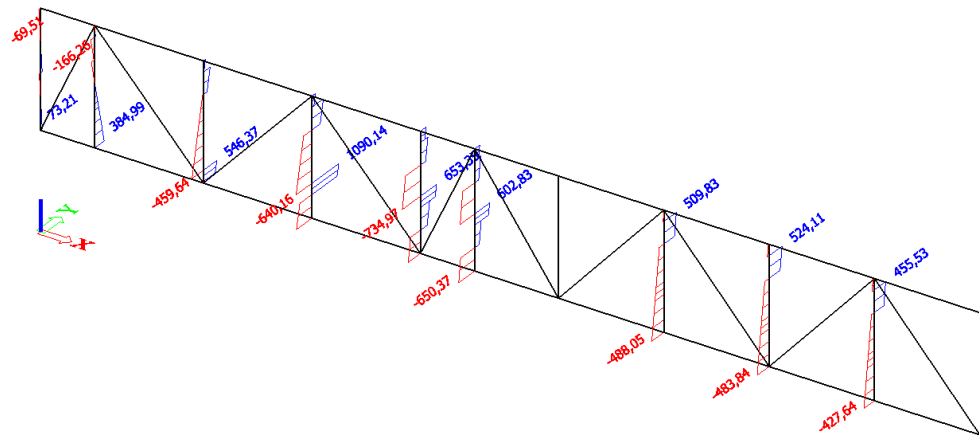

N

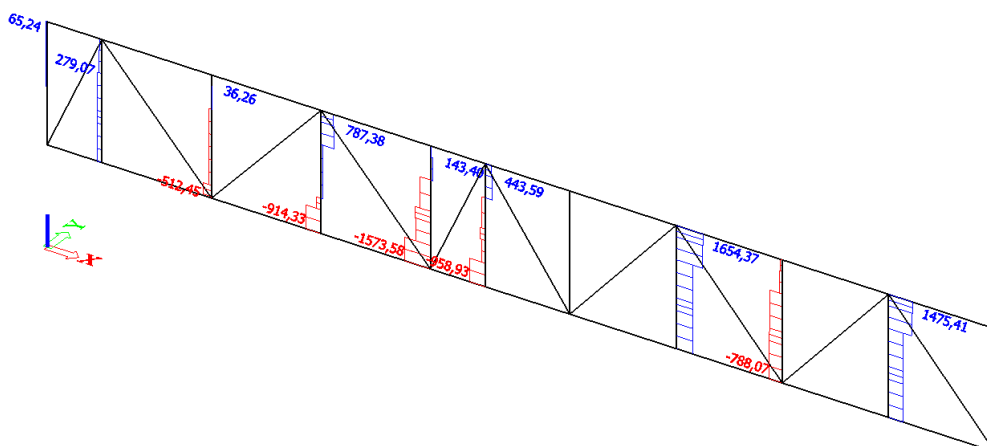

Slika 13.8. Prikaz reznih sila – vertikalna ispuna konzolnog rešetkastog nosača

-poprečni presjek nosača

Name	Konzolni nosač 2 - vertikalna ispuna 1	
Type	SHS400/400/20.0	
Source description	British Standard / BS 5950 part 1 : 1990 & EN 10210-2	
Item material	S 355	
Fabrication	rolled	
Flexural buckling y-y	a	
Flexural buckling z-z	a	
Lateral torsional buckling	Default	
Use 2D FEM analysis	*	

A [m <sup>2</sup> ]	3,0000e-02	
A <sub>y, z</sub> [m <sup>2</sup> ]	1,4850e-02	1,4850e-02
I <sub>y, z</sub> [m <sup>4</sup> ]	7,1530e-04	7,1530e-04
I <sub>w</sub> [m <sup>6</sup> ], t [m <sup>4</sup> ]	1,7067e-05	1,1250e-03
W <sub>el y, z</sub> [m <sup>3</sup> ]	3,5770e-03	3,5770e-03
W <sub>pl y, z</sub> [m <sup>3</sup> ]	4,2019e-03	4,2019e-03
d <sub>y, z</sub> [mm]	0	0
c <sub>YUCS, ZUCS</sub> [mm]	200	200
α [deg]	0,00	
A <sub>L, D</sub> [m <sup>2</sup> /m]	1,5500e+00	2,9710e+00
M <sub>ply +, -</sub> [Nm]	1,49e+06	1,49e+06
M <sub>plz +, -</sub> [Nm]	1,49e+06	1,49e+06

Slika 13.9. Prikaz geometrijskih karakteristika nosača

-iskoristivost elementa na GSN – 96 %

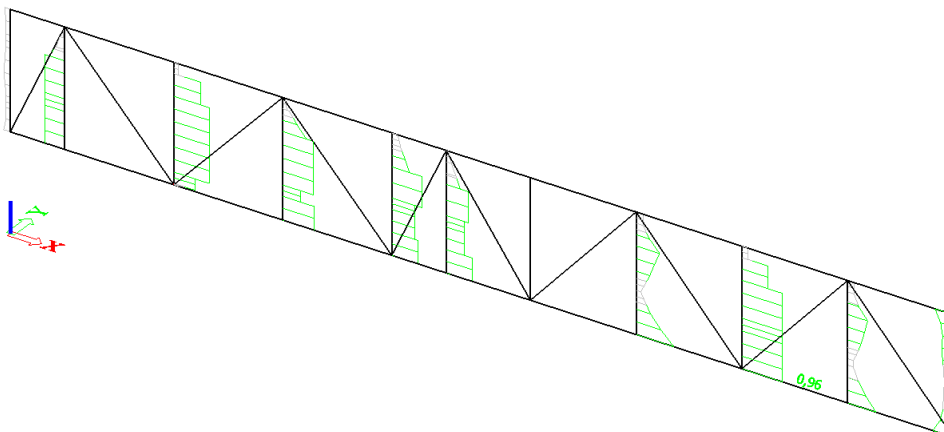

Slika 13.10. Prikaz iskoristivosti vertikalne ispune konzolnog rešetkastog nosača

## 13.2.6. Dimenzioniranje – vertikalna ispuna 1 konzolnog rešetkastog nosača 2

Member B1024	8,650 m	SHS400/400/20.0	S 355	GSN 24	0,96 -
--------------	---------	-----------------	-------	--------	--------

Partial safety factors	
Gamma M0 for resistance of cross-sections	1,00
Gamma M1 for resistance to instability	1,00
Gamma M2 for resistance of net sections	1,25

Material		
Yield strength $f_y$	355,0	MPa
Ultimate strength $f_u$	490,0	MPa
Fabrication	Rolled	

....SECTION CHECK:....

The critical check is on position 8.650 m

Internal forces	Calculated	Unit
N,Ed	-788,07	kN
V <sub>y</sub> ,Ed	-483,84	kN
V <sub>z</sub> ,Ed	-32,05	kN
T,Ed	-4,13	kNm
M <sub>y</sub> ,Ed	-136,26	kNm
M <sub>z</sub> ,Ed	-1244,16	kNm

Classification for cross-section design

According to EN 1993-1-1 article 5.5.2

Classification of Internal Compression parts

According to EN 1993-1-1 Table 5.2 Sheet 1

Maximum width-to-thickness ratio	17,00
Class 1 Limit	26,85
Class 2 Limit	30,92
Class 3 Limit	36,07

=> Section classified as Class 1 for cross-section design

Compression check

According to EN 1993-1-1 article 6.2.4 and formula (6.9)

A	3,0000e-02	m <sup>2</sup>
N <sub>c,Rd</sub>	10650,00	kN
Unity check	0,07	-

Bending moment check for M<sub>y</sub>

According to EN 1993-1-1 article 6.2.5 and formula (6.12),(6.13)

W <sub>pl,y</sub>	4,2019e-03	m <sup>3</sup>
M <sub>pl,y,Rd</sub>	1491,68	kNm
Unity check	0,09	-

Bending moment check for M<sub>z</sub>

According to EN 1993-1-1 article 6.2.5 and formula (6.12),(6.13)

W <sub>pl,z</sub>	4,2019e-03	m <sup>3</sup>
M <sub>pl,z,Rd</sub>	1491,68	kNm
Unity check	0,83	-

Shear check for V<sub>y</sub>

According to EN 1993-1-1 article 6.2.6 and formula (6.17)

Eta	1,20	
A <sub>v</sub>	1,5000e-02	m <sup>2</sup>
V <sub>pl,y,Rd</sub>	3074,39	kN
Unity check	0,16	-

Shear check for V<sub>z</sub>

According to EN 1993-1-1 article 6.2.6 and formula (6.17)

Eta	1,20	
A <sub>v</sub>	1,5000e-02	m <sup>2</sup>
V <sub>pl,z,Rd</sub>	3074,39	kN
Unity check	0,01	-

Torsion check

According to EN 1993-1-1 article 6.2.7 and formula (6.23)

Tau <sub>t,Ed</sub>	0,7	MPa
Tau <sub>Rd</sub>	205,0	MPa
Unity check	0,00	-

Note: The unity check for torsion is lower than the limit value of 0,05. Therefore torsion is considered as insignificant and is ignored in the combined checks.

Beta	1,67
------	------

Unity check (6.41) = 0,02 + 0,74 = 0,76 -

**Note:** Since the shear forces are less than half the plastic shear resistances their effect on the moment resistances is neglected.

The member satisfies the section check.

....:STABILITY CHECK:...

**Classification for member buckling design**

Decisive position for stability classification: 0,000 m

**Classification of Internal Compression parts**

According to EN 1993-1-1 Table 5.2 Sheet 1

Maximum width-to-thickness ratio	17,00
Class 1 Limit	29,82
Class 2 Limit	34,33
Class 3 Limit	53,68

=> Section classified as Class 1 for member buckling design

**Flexural Buckling check**

According to EN 1993-1-1 article 6.3.1.1 and formula (6.46)

Buckling parameters	yy	zz	
Sway type	sway	non-sway	
System length L	8,650	6,250	m
Buckling factor k	1,00	1,00	
Buckling length L <sub>cr</sub>	8,650	6,250	m
Critical Euler load N <sub>cr</sub>	19814,13	37953,10	kN
Slenderness Lambda	56,02	40,48	
Relative slenderness Lambda <sub>rel</sub>	0,73	0,53	
Limit slenderness Lambda <sub>rel,0</sub>	0,20	0,20	

**Note:** The slenderness or compression force is such that Flexural Buckling effects may be ignored according to EN 1993-1-1 article 6.3.1.2(4).

**Torsional-(Flexural) Buckling check**

According to EN 1993-1-1 article 6.3.1.1 and formula (6.46)

**Note:** The cross-section concerns a RHS section which is not susceptible to Torsional-(Flexural) Buckling.

**Lateral Torsional Buckling check**

According to EN 1993-1-1 article 6.3.2.1

**Note:** The cross-section concerns a RHS section with  $h/b < 10 / \text{Lambda}_{rel,z}$

This section is thus not susceptible to Lateral Torsional Buckling.

**Bending and axial compression check**

According to EN 1993-1-1 article 6.3.3 and formula (6.61),(6.62)

Bending and axial compression check parameters		
Interaction method	alternative method 1	
Cross-section area A	3,0000e-02	m <sup>2</sup>
Cross-section plastic modulus W <sub>pl,y</sub>	4,2019e-03	m <sup>3</sup>
Cross-section plastic modulus W <sub>pl,z</sub>	4,2019e-03	m <sup>3</sup>
Design compression force N <sub>Ed</sub>	788,07	kN
Design bending moment (maximum) M <sub>y,Ed</sub>	141,58	kNm
Design bending moment (maximum) M <sub>z,Ed</sub>	-1244,16	kNm
Characteristic compression resistance N <sub>Rk</sub>	10650,00	kN
Characteristic moment resistance M <sub>y,Rk</sub>	1491,68	kNm
Characteristic moment resistance M <sub>z,Rk</sub>	1491,68	kNm
Reduction factor Chi <sub>y</sub>	1,00	
Reduction factor Chi <sub>z</sub>	1,00	
Reduction factor Chi <sub>LT</sub>	1,00	
Interaction factor k <sub>yy</sub>	1,00	
Interaction factor k <sub>yz</sub>	0,61	
Interaction factor k <sub>zy</sub>	0,61	
Interaction factor k <sub>zz</sub>	1,00	

Maximum moment M<sub>y,Ed</sub> is derived from beam B1024 position 0,000 m.

Maximum moment M<sub>z,Ed</sub> is derived from beam B1024 position 8,650 m.

Interaction method 1 parameters		
Critical Euler load N <sub>cr,y</sub>	19814,13	kN
Critical Euler load N <sub>cr,z</sub>	37953,10	kN
Elastic critical load N <sub>cr,T</sub>	1924456,69	kN
Cross-section plastic modulus W <sub>pl,y</sub>	4,2019e-03	m <sup>3</sup>
Cross-section elastic modulus W <sub>el,y</sub>	3,5770e-03	m <sup>3</sup>
Cross-section plastic modulus W <sub>pl,z</sub>	4,2019e-03	m <sup>3</sup>
Cross-section elastic modulus W <sub>el,z</sub>	3,5770e-03	m <sup>3</sup>
Second moment of area I <sub>y</sub>	7,1530e-04	m <sup>4</sup>
Second moment of area I <sub>z</sub>	7,1530e-04	m <sup>4</sup>
Torsional constant I <sub>t</sub>	1,1250e-03	m <sup>4</sup>
Method for equivalent moment factor C <sub>my,0</sub>	Table A.2 Line 2 (General)	
Design bending moment (maximum) M <sub>y,Ed</sub>	141,58	kNm
Maximum relative deflection delta <sub>z</sub>	-1,2	mm
Equivalent moment factor C <sub>my,0</sub>	0,97	
Method for equivalent moment factor C <sub>mz,0</sub>	Table A.2 Line 2 (General)	
Design bending moment (maximum) M <sub>z,Ed</sub>	-1244,16	kNm
Maximum relative deflection delta <sub>y</sub>	4,3	mm

Interaction method 1 parameters		
*Student version*	*Student version*	*Student version*
Equivalent moment factor C,mz,0	0,98	
Factor mu,y	1,00	
Factor mu,z	1,00	
Factor epsilon,y	1,51	
Factor a,LT	0,00	
Critical moment for uniform bending Mcr,0	59016,87	kNm
Relative slenderness Lambda,rel,0	0,16	
Limit relative slenderness Lambda,rel,0,lim	0,30	
Equivalent moment factor C,my	0,97	
Equivalent moment factor C,mz	0,98	
Equivalent moment factor C,mLT	1,00	
Factor b,LT	0,00	
Factor c,LT	0,00	
Factor d,LT	0,00	
Factor e,LT	0,00	
Factor w,y	1,17	
Factor w,z	1,17	
Factor n,pl	0,07	
Maximum relative slenderness Lambda,rel,max	0,73	
Factor C,yy	1,00	
Factor C,yz	0,98	
Factor C,zy	0,99	
Factor C,zz	1,00	

Unity check (6.61) =  $0,07 + 0,10 + 0,51 = 0,68$  -

Unity check (6.62) =  $0,07 + 0,06 + 0,83 = 0,96$  -

The member satisfies the stability check.

Student version

**13.2.7. Rezne sile – vertikalna ispuna 2 konzolnog rešetkastog nosača 2**

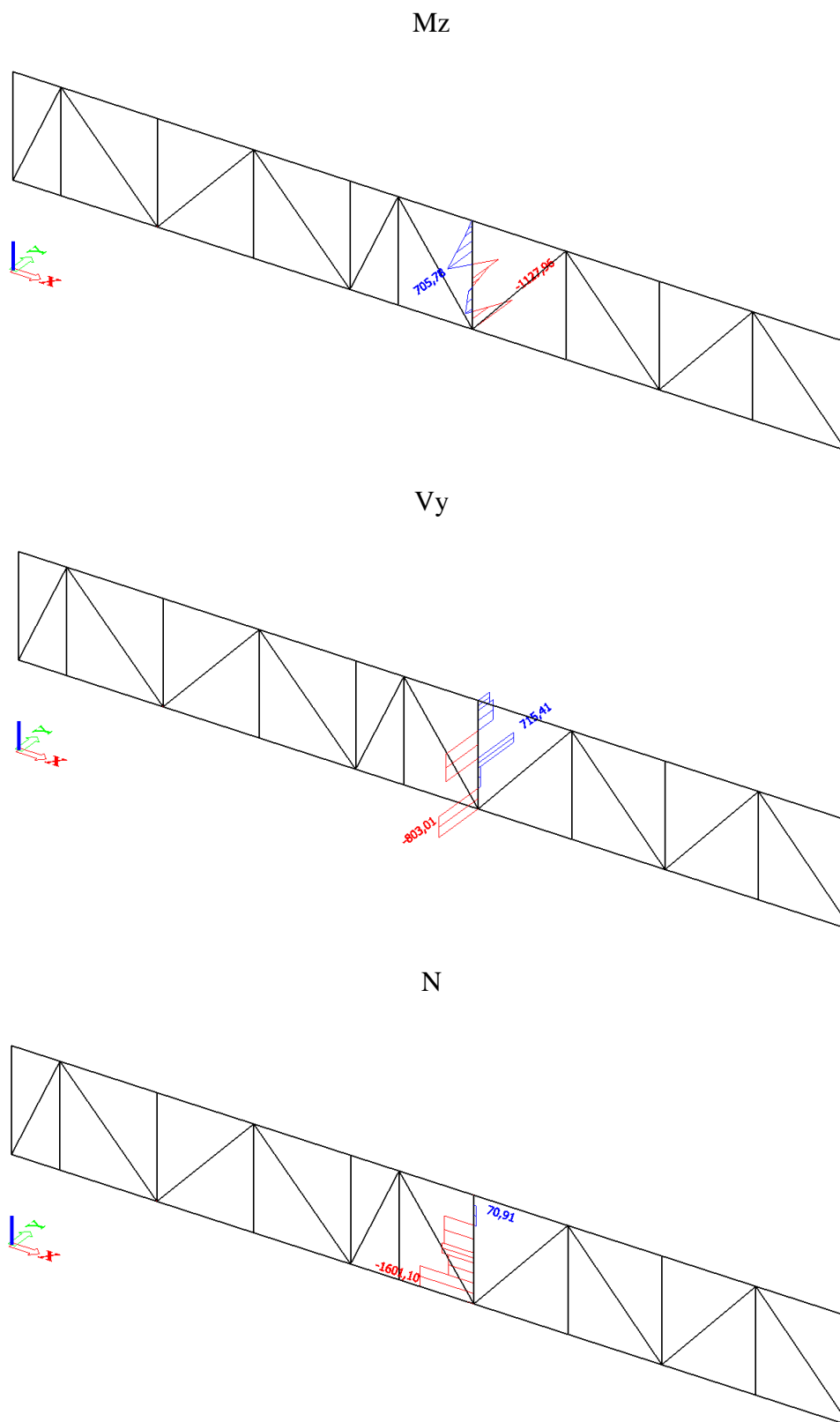

*Slika 13.11. Prikaz reznih sila – vertikalna ispuna konzolnog rešetkastog nosača*

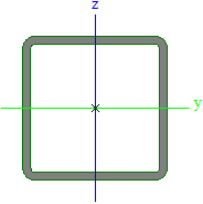

-poprečni presjek nosača

Name	Konzolni nosač 2 - vertikalna ispuna 2	
Type	SHS400/400/22.0	
Source description	British Standard / BS 5950 part 1 : 1990 & EN 10210-2	
Item material	S 355	
Fabrication	rolled	
Flexural buckling y-y	a	
Flexural buckling z-z	a	
Lateral torsional buckling	Default	
Use 2D FEM analysis	✖	
		
A [m <sup>2</sup> ]	3,2000e-02	
A <sub>y, z</sub> [m <sup>2</sup> ]	1,6209e-02	1,6209e-02
I <sub>y, z</sub> [m <sup>4</sup> ]	7,4710e-04	7,4710e-04
I <sub>w</sub> [m <sup>6</sup> ], I <sub>t</sub> [m <sup>4</sup> ]	1,8773e-05	1,2240e-03
W <sub>el y, z</sub> [m <sup>3</sup> ]	3,7350e-03	3,7350e-03
W <sub>pl y, z</sub> [m <sup>3</sup> ]	4,5587e-03	4,5587e-03
d <sub>y, z</sub> [mm]	0	0
c <sub>YUCS, ZUCS</sub> [mm]	200	200
α [deg]	0,00	
A <sub>L, D</sub> [m <sup>2</sup> /m]	1,5200e+00	2,9481e+00
M <sub>ply +, -</sub> [Nm]	1,62e+06	1,62e+06
M <sub>plz +, -</sub> [Nm]	1,62e+06	1,62e+06

Slika 13.12. Prikaz geometrijskih karakteristika nosača

-iskoristivost elementa na GSN – 99 %

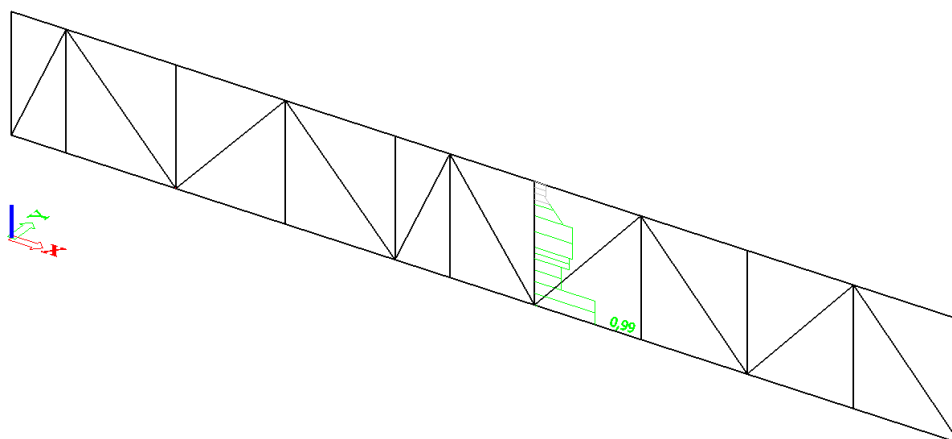

Slika 13.13. Prikaz iskoristivosti vertikalne ispune konzolnog rešetkastog nosača

## 13.2.8. Dimenzioniranje – vertikalna ispuna 2 konzolnog rešetkastog nosača 2

Member B1022	8,650 m	SHS400/400/22.0	S 355	GSN 26	0,99 -
--------------	---------	-----------------	-------	--------	--------

Partial safety factors	
Gamma M0 for resistance of cross-sections	1,00
Gamma M1 for resistance to instability	1,00
Gamma M2 for resistance of net sections	1,25

Material	
Yield strength $f_y$	355,0 MPa
Ultimate strength $f_u$	490,0 MPa
Fabrication	Rolled

....:SECTION CHECK:....

The critical check is on position 8.650 m

Internal forces	Calculated	Unit
N,Ed	-1601,10	kN
Vy,Ed	-803,01	kN
Vz,Ed	180,57	kN
T,Ed	47,70	kNm
My,Ed	511,50	kNm
Mz,Ed	-1127,96	kNm

Classification for cross-section design

According to EN 1993-1-1 article 5.5.2

Classification of Internal Compression parts

According to EN 1993-1-1 Table 5.2 Sheet 1

Maximum width-to-thickness ratio	15,18
Class 1 Limit	26,85
Class 2 Limit	30,92
Class 3 Limit	40,77

=> Section classified as Class 1 for cross-section design

Compression check

According to EN 1993-1-1 article 6.2.4 and formula (6.9)

A	3,2000e-02	m <sup>2</sup>
Nc,Rd	11360,00	kN
Unity check	0,14	-

Bending moment check for My

According to EN 1993-1-1 article 6.2.5 and formula (6.12),(6.13)

Wpl,y	4,5587e-03	m <sup>3</sup>
Mpl,y,Rd	1618,32	kNm
Unity check	0,32	-

Bending moment check for Mz

According to EN 1993-1-1 article 6.2.5 and formula (6.12),(6.13)

Wpl,z	4,5587e-03	m <sup>3</sup>
Mpl,z,Rd	1618,32	kNm
Unity check	0,70	-

Shear check for Vy

According to EN 1993-1-1 article 6.2.6 and formula (6.17)

Eta	1,20	
Av	1,6000e-02	m <sup>2</sup>
Vpl,y,Rd	3279,35	kN
Unity check	0,24	-

Shear check for Vz

According to EN 1993-1-1 article 6.2.6 and formula (6.17)

Eta	1,20	
Av	1,6000e-02	m <sup>2</sup>
Vpl,z,Rd	3279,35	kN
Unity check	0,06	-

Torsion check

According to EN 1993-1-1 article 6.2.7 and formula (6.23)

Tau,t,Ed	7,6	MPa
Tau,Rd	205,0	MPa
Unity check	0,04	-

**Note:** The unity check for torsion is lower than the limit value of 0,05. Therefore torsion is considered as insignificant and is ignored in the combined checks.

Beta	1,70
------	------

Unity check (6.41) = 0,14 + 0,54 = 0,68 -

**Note:** Since the shear forces are less than half the plastic shear resistances their effect on the moment resistances is neglected.

The member satisfies the section check.

.....**STABILITY CHECK**.....

**Classification for member buckling design**

Decisive position for stability classification: 4,600 m

**Classification of Internal Compression parts**

According to EN 1993-1-1 Table 5.2 Sheet 1

Maximum width-to-thickness ratio	15,18
Class 1 Limit	26,85
Class 2 Limit	30,92
Class 3 Limit	38,67

=> Section classified as Class 1 for member buckling design

**Flexural Buckling check**

According to EN 1993-1-1 article 6.3.1.1 and formula (6.46)

Buckling parameters	yy	zz	
Sway type	sway	non-sway	
System length L	4,050	1,650	m
Buckling factor k	1,00	1,00	
Buckling length L <sub>cr</sub>	4,050	1,650	m
Critical Euler load N <sub>cr</sub>	94403,42	568761,10	kN
Slenderness Lambda	26,51	10,80	
Relative slenderness Lambda <sub>rel</sub>	0,35	0,14	
Limit slenderness Lambda <sub>rel,0</sub>	0,20	0,20	

**Note:** The slenderness or compression force is such that Flexural Buckling effects may be ignored according to EN 1993-1-1 article 6.3.1.2(4).

**Torsional(-Flexural) Buckling check**

According to EN 1993-1-1 article 6.3.1.1 and formula (6.46)

**Note:** The cross-section concerns a RHS section which is not susceptible to Torsional(-Flexural) Buckling.

**Lateral Torsional Buckling check**

According to EN 1993-1-1 article 6.3.2.1

**Note:** The cross-section concerns a RHS section with  $h / b < 10 / \text{Lambda}_{rel,z}$

This section is thus not susceptible to Lateral Torsional Buckling.

**Bending and axial compression check**

According to EN 1993-1-1 article 6.3.3 and formula (6.61),(6.62)

Bending and axial compression check parameters		
--	--	--

Interaction method	alternative method 1	
Cross-section area A	3,2000e-02	m^2
Cross-section plastic modulus W <sub>pl,y</sub>	4,5587e-03	m^3
Cross-section plastic modulus W <sub>pl,z</sub>	4,5587e-03	m^3
Design compression force N <sub>Ed</sub>	1601,10	kN
Design bending moment (maximum) M <sub>y,Ed</sub>	511,50	kNm
Design bending moment (maximum) M <sub>z,Ed</sub>	-1127,96	kNm
Characteristic compression resistance N <sub>Rk</sub>	11360,00	kN
Characteristic moment resistance M <sub>y,Rk</sub>	1618,32	kNm
Characteristic moment resistance M <sub>z,Rk</sub>	1618,32	kNm
Reduction factor Chi <sub>y</sub>	1,00	
Reduction factor Chi <sub>z</sub>	1,00	
Reduction factor Chi <sub>LT</sub>	1,00	
Interaction factor k <sub>yy</sub>	0,96	
Interaction factor k <sub>yz</sub>	0,58	
Interaction factor k <sub>zy</sub>	0,58	
Interaction factor k <sub>zz</sub>	0,96	

Maximum moment M<sub>y,Ed</sub> is derived from beam B1022 position 8,650 m.

Maximum moment M<sub>z,Ed</sub> is derived from beam B1022 position 8,650 m.

Interaction method 1 parameters		
---------------------------------	--	--

Critical Euler load N <sub>cr,y</sub>	94403,42	kN
Critical Euler load N <sub>cr,z</sub>	568761,10	kN
Elastic critical load N <sub>cr,T</sub>	2423311,97	kN
Cross-section plastic modulus W <sub>pl,y</sub>	4,5587e-03	m^3
Cross-section elastic modulus W <sub>el,y</sub>	3,7350e-03	m^3
Cross-section plastic modulus W <sub>pl,z</sub>	4,5587e-03	m^3
Cross-section elastic modulus W <sub>el,z</sub>	3,7350e-03	m^3
Second moment of area I <sub>y</sub>	7,4710e-04	m^4
Second moment of area I <sub>z</sub>	7,4710e-04	m^4
Torsional constant I <sub>t</sub>	1,2240e-03	m^4
Method for equivalent moment factor C <sub>my,0</sub>	Table A.2 Line 2 (General)	
Design bending moment (maximum) M <sub>y,Ed</sub>	511,50	kNm
Maximum relative deflection delta <sub>z</sub>	-2,1	mm
Equivalent moment factor C <sub>my,0</sub>	0,99	
Method for equivalent moment factor C <sub>mz,0</sub>	Table A.2 Line 2 (General)	
Design bending moment (maximum) M <sub>z,Ed</sub>	-1127,96	kNm
Maximum relative deflection delta <sub>y</sub>	1,0	mm

\*Student version\* \*Student version\* \*Student version\* \*Student version\* \*Student version\* \*Student version\* \*Student version\* \*S

Interaction method 1 parameters		
<small>*Student version*</small>	<small>*Student version*</small>	<small>*Student version*</small>
Equivalent moment factor C,mz,0	1,00	
Factor mu,y	1,00	
Factor mu,z	1,00	
Factor epsilon,y	2,74	
Factor a,LT	0,00	
Critical moment for uniform bending Mcr,0	253687,45	kNm
Relative slenderness Lambda,rel,0	0,08	
Limit relative slenderness Lambda,rel,0,lim	0,23	
Equivalent moment factor C,my	0,99	
Equivalent moment factor C,mz	1,00	
Equivalent moment factor C,mLT	1,00	
Factor b,LT	0,00	
Factor c,LT	0,00	
Factor d,LT	0,00	
Factor e,LT	0,00	
Factor w,y	1,22	
Factor w,z	1,22	
Factor n,pl	0,14	
Maximum relative slenderness Lambda,rel,max	0,35	
Factor C,yy	1,04	
Factor C,yz	1,04	
Factor C,zy	1,04	
Factor C,zz	1,04	

Unity check (6.61) =  $0,14 + 0,30 + 0,40 = 0,85$  -

Unity check (6.62) =  $0,14 + 0,18 + 0,67 = 0,99$  -

The member satisfies the stability check.

Student version

13.2.9. Rezne sile – dijagonalna ispuna 1 konzolnog rešetkastog nosača 2

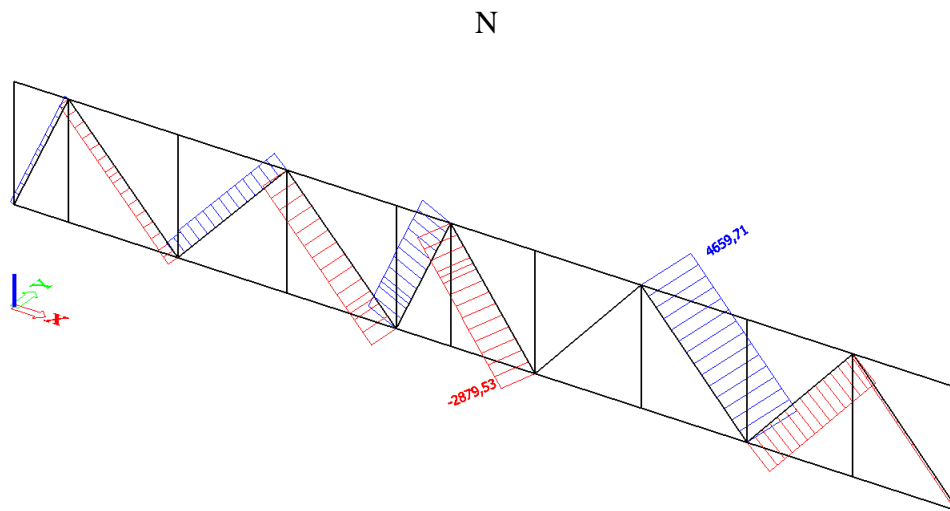

Slika 13.14. Prikaz reznih sila – dijagonalna ispuna konzolnog rešetkastog nosača

-poprečni presjek nosača

Name	Konzolni nosač 2 - dijagonalna ispuna 1	
Type	SHS400/400/10.0	
Source description	British Standard / BS 5950 part 1 : 1990 & EN 10210-2	
Item material	S 355	
Fabrication	rolled	
Flexural buckling y-y	a	
Flexural buckling z-z	a	
Lateral torsional buckling	Default	
Use 2D FEM analysis	x	
A [m <sup>2</sup> ]	1,5500e-02	
A <sub>y, z</sub> [m <sup>2</sup> ]	7,7126e-03	7,7126e-03
I <sub>y, z</sub> [m <sup>4</sup> ]	3,9130e-04	3,9130e-04
I <sub>w</sub> [m <sup>6</sup> ], I <sub>t</sub> [m <sup>4</sup> ]	8,5333e-06	6,0090e-04
W <sub>el y, z</sub> [m <sup>3</sup> ]	1,9560e-03	1,9560e-03
W <sub>pl y, z</sub> [m <sup>3</sup> ]	2,2481e-03	2,2481e-03
d <sub>y, z</sub> [mm]	0	0
c <sub>YUCS, ZUCS</sub> [mm]	200	200
α [deg]	0,00	
A <sub>L, D</sub> [m <sup>2</sup> /m]	1,5700e+00	3,0855e+00
M <sub>ply +, -</sub> [Nm]	7,98e+05	7,98e+05
M <sub>plz +, -</sub> [Nm]	7,98e+05	7,98e+05

Slika 13.15. Prikaz geometrijskih karakteristika nosača

### 13.2.10. Dimenzioniranje – dijagonalna ispuna 1 konzolnog rešetkastog nosača 2

Member B1012	11,688 m	SHS400/400/10.0	S 355	GSN 28	0,85 -
--------------	----------	-----------------	-------	--------	--------

Partial safety factors	
Gamma M0 for resistance of cross-sections	1,00
Gamma M1 for resistance to instability	1,00
Gamma M2 for resistance of net sections	1,25

Material		
Yield strength fy	355,0	MPa
Ultimate strength fu	490,0	MPa
Fabrication	Rolled	

....:SECTION CHECK:....

The critical check is on position 0.000 m

Internal forces	Calculated	Unit
N,Ed	4659,71	kN
Vy,Ed	0,00	kN
Vz,Ed	0,00	kN
T,Ed	0,00	kNm
My,Ed	0,00	kNm
Mz,Ed	0,00	kNm

**Tension check**

According to EN 1993-1-1 article 6.2.3 and formula (6.5)

A	1,5500e-02	m <sup>2</sup>
Npl,Rd	5502,50	kN
Nu,Rd	5468,40	kN
Nt,Rd	5468,40	kN
Unity check	0,85	-

The member satisfies the section check.

....:STABILITY CHECK:....

The member satisfies the stability check.

-iskoristivost elementa na GSN – 85 %

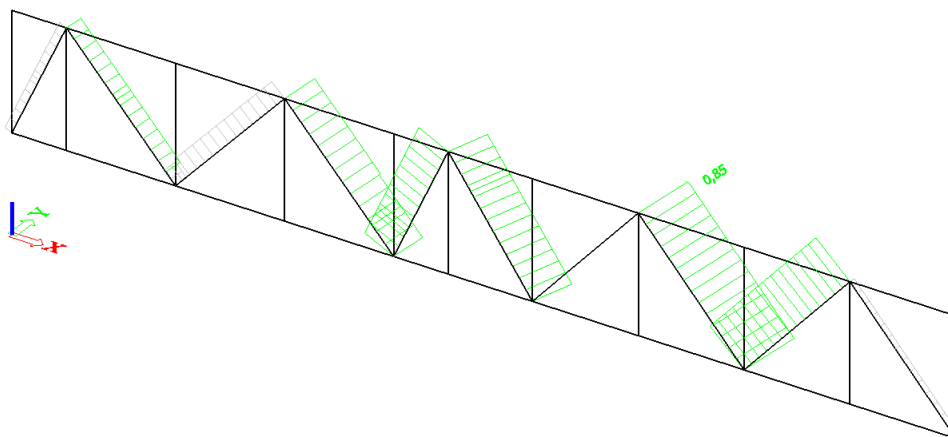

Slika 13.16. Prikaz iskoristivosti dijagonalne ispune konzolnog rešetkastog nosača

### 13.2.11. Rezne sile – dijagonalna ispuna 2 konzolnog rešetkastog nosača 2

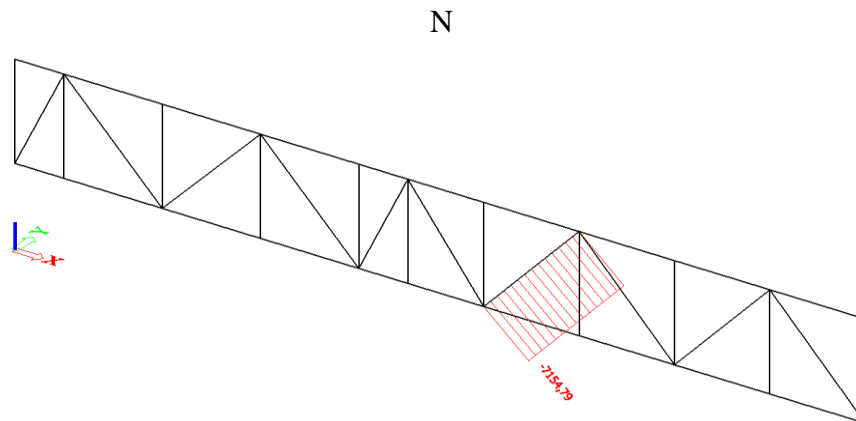

Slika 13.17. Prikaz reznih sila – dijagonalna ispuna konzolnog rešetkastog nosača -poprečni presjek nosača

Name		Konzolni nosač 2 - dijagonalna ispuna 2	
Type		SHS400/400/20.0	
Source description		British Standard / BS 5950 part 1 : 1990 & EN 10210-2	
Item material		S 355	
Fabrication		rolled	
Flexural buckling y-y		a	
Flexural buckling z-z		a	
Lateral torsional buckling		Default	
Use 2D FEM analysis		x	
A [m <sup>2</sup> ]		3,0000e-02	
A <sub>y, z</sub> [m <sup>2</sup> ]		1,4850e-02	1,4850e-02
I <sub>y, z</sub> [m <sup>4</sup> ]		7,1530e-04	7,1530e-04
I <sub>w</sub> [m <sup>4</sup> ], I <sub>t</sub> [m <sup>4</sup> ]		1,7067e-05	1,1250e-03
W <sub>el y, z</sub> [m <sup>3</sup> ]		3,5770e-03	3,5770e-03
W <sub>pl y, z</sub> [m <sup>3</sup> ]		4,2019e-03	4,2019e-03
d <sub>y, z</sub> [mm]		0	0
e <sub>YUCS, ZUCS</sub> [mm]		200	200
α [deg]		0,00	
A <sub>L, D</sub> [m <sup>2</sup> /m]		1,5500e+00	2,9710e+00
M <sub>ply +, -</sub> [Nm]		1,49e+06	1,49e+06
M <sub>plz +, -</sub> [Nm]		1,49e+06	1,49e+06

Slika 13.18. Prikaz geometrijskih karakteristika nosača

-iskoristivost elementa na GSN – 100 %

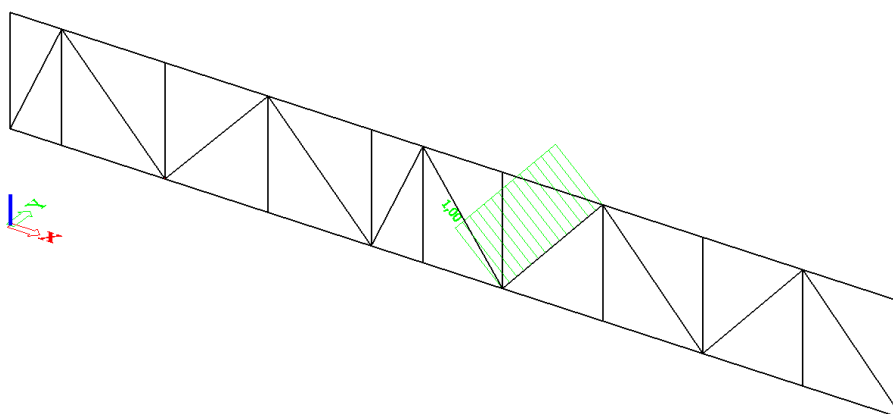

Slika 13.19. Prikaz iskoristivosti dijagonalne ispune konzolnog rešetkastog nosača

### 13.2.12. Dimenzioniranje – dijagonalna ispuna 2 konzolnog rešetkastog nosača 2

Member B1011	11,688 m	SHS400/400/20.0	S 355	GSN 28	1,00 -
--------------	----------	-----------------	-------	--------	--------

Partial safety factors	
Gamma M0 for resistance of cross-sections	1,00
Gamma M1 for resistance to instability	1,00
Gamma M2 for resistance of net sections	1,25

Material		
Yield strength fy	355,0	MPa
Ultimate strength fu	490,0	MPa
Fabrication	Rolled	

....:SECTION CHECK:....

The critical check is on position 0.000 m

Internal forces	Calculated	Unit
N,Ed	-7154,79	kN
Vy,Ed	0,00	kN
Vz,Ed	0,00	kN
T,Ed	0,00	kNm
My,Ed	0,00	kNm
Mz,Ed	0,00	kNm

Classification for cross-section design

According to EN 1993-1-1 article 5.5.2

Classification of Internal Compression parts

According to EN 1993-1-1 Table 5.2 Sheet 1

Maximum width-to-thickness ratio	17,00
Class 1 Limit	26,85
Class 2 Limit	30,92
Class 3 Limit	34,17

=> Section classified as Class 1 for cross-section design

Compression check

According to EN 1993-1-1 article 6.2.4 and formula (6.9)

A	3,0000e-02	m <sup>2</sup>
Nc,Rd	10650,00	kN
Unity check	0,67	-

The member satisfies the section check.

....:STABILITY CHECK:....

Classification for member buckling design

Decisive position for stability classification: 0,000 m

Classification of Internal Compression parts

According to EN 1993-1-1 Table 5.2 Sheet 1

Maximum width-to-thickness ratio	17,00
Class 1 Limit	26,85
Class 2 Limit	30,92
Class 3 Limit	34,17

=> Section classified as Class 1 for member buckling design

Flexural Buckling check

According to EN 1993-1-1 article 6.3.1.1 and formula (6.46)

Buckling parameters	yy	zz	
Sway type	sway	non-sway	
System length L	11,688	11,688	m
Buckling factor k	1,00	1,00	
Buckling length Lcr	11,688	11,688	m
Critical Euler load Ncr	10853,00	10853,00	kN
Slenderness Lambda	75,69	75,69	
Relative slenderness Lambda,rel	0,99	0,99	
Limit slenderness Lambda,rel,0	0,20	0,20	
Buckling curve	a	a	
Imperfection Alpha	0,21	0,21	
Reduction factor Chi	0,67	0,67	
Buckling resistance Nb,Rd	7158,56	7158,56	kN

Flexural Buckling verification		
Cross-section area A	3,0000e-02	m <sup>2</sup>
Buckling resistance Nb,Rd	7158,56	kN
Unity check	1,00	-

Torsional(-Flexural) Buckling check

According to EN 1993-1-1 article 6.3.1.1 and formula (6.46)

Note: The cross-section concerns a RHS section which is not susceptible to Torsional(-Flexural) Buckling.

The member satisfies the stability check.



## 14. PRORAČUN REŠETKASTOG NOSAČA - KONZOLNI NOSAČ 3

### 14.1. Vertikalni pomak rešetkastog nosača – konzolni nosač 3

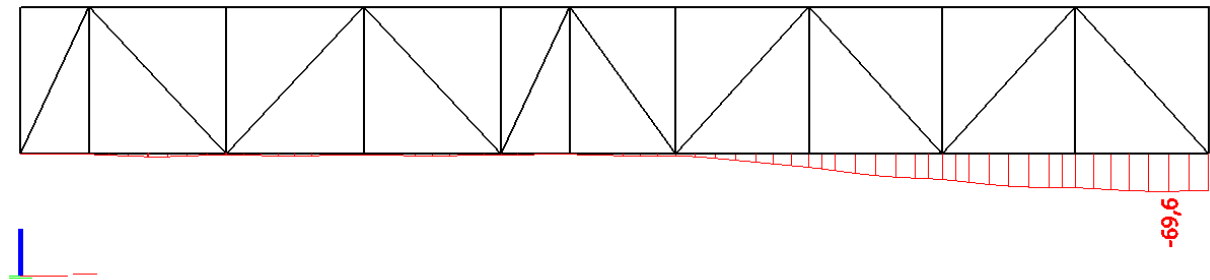

Slika 14.1. Prikaz vertikalnog pomaka konzolnog rešetkastog nosača

Dopušteni vertikalni pomak (progib):

$$u_{dop} = \frac{l}{300} = \frac{31,44 \cdot 1000}{300} = 104,8 \text{ mm}$$

$$u_z = 69,6 \text{ mm} < u_{z,dop} = 104,8 \text{ mm} \quad \text{Zadovoljava}$$

-iskoristivost na GSU -  $69,6 \text{ mm} / 104,8 \text{ mm} = 0,66 = 66\%$

## 14.2. Dimenziniranje rešetkastog nosača – konzolni nosač 3

### 14.2.1. Rezne sile – gornja pojasnica konzolnog rešetkastog nosača 3

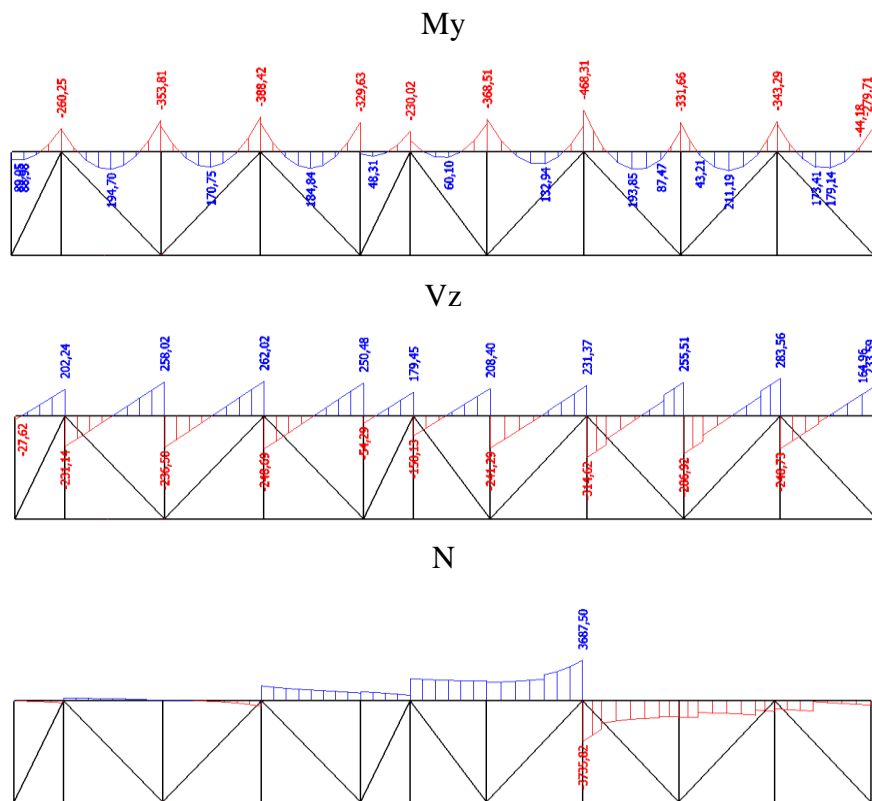

Slika 14.2. Prikaz reznih sila - gornja pojasnica konzolnog rešetkastog nosača

-poprečni presjek nosača

Name	Konzolni nosač 3 - gornja pojasnica	
Type	F400X14	
Source description	Chinese Standard / GB 6728-2002	
Item material	S 355	
Fabrication	cold formed	
Flexural buckling y-y	c	
Flexural buckling z-z	c	
Lateral torsional buckling	Default	
Use 2D FEM analysis	x	
A [m <sup>2</sup> ]	2,0800e-02	
A <sub>y</sub> , z [m <sup>2</sup> ]	1,0380e-02	1,0380e-02
I <sub>y</sub> , z [m <sup>4</sup> ]	5,0414e-04	5,0414e-04
I <sub>w</sub> [m <sup>6</sup> ], t [m <sup>4</sup> ]	1,1947e-05	8,2735e-04
W <sub>el y</sub> , z [m <sup>3</sup> ]	2,5210e-03	2,5210e-03
W <sub>pl y</sub> , z [m <sup>3</sup> ]	2,9626e-03	2,9626e-03
d <sub>y</sub> , z [mm]	0	0
c <sub>YUCS</sub> , ZUCS [mm]	200	200
α [deg]	0,00	
A <sub>L</sub> , D [m <sup>2</sup> /m]	1,5279e+00	2,9673e+00
M <sub>pl y</sub> +, - [Nm]	1,05e+06	1,05e+06
M <sub>pl z</sub> +, - [Nm]	1,05e+06	1,05e+06

Slika 14.3. Prikaz geometrijskih karakteristika nosača

### 14.2.2. Dimenzioniranje – gornja pojasnica glavnog rešetkastog nosača 3

Member B1004	70,090 m	F400X14	S 355	GSN 26	0,91 -
--------------	----------	---------	-------	--------	--------

Note: EN 1993-1-3 article 1.1(3) specifies that this part does not apply to cold formed CHS and RHS sections. The default EN 1993-1-1 code check is executed instead of the EN 1993-1-3 code check.

Partial safety factors	
Gamma M0 for resistance of cross-sections	1,00
Gamma M1 for resistance to instability	1,00
Gamma M2 for resistance of net sections	1,25

Material		
Yield strength $f_y$	355,0	MPa
Ultimate strength $f_u$	510,0	MPa
Fabrication	Cold formed	

....SECTION CHECK:....

The critical check is on position 23.580 m

Internal forces	Calculated	Unit
N,Ed	-3735,82	kN
Vy,Ed	-73,72	kN
Vz,Ed	-314,62	kN
T,Ed	174,97	kNm
My,Ed	-468,31	kNm
Mz,Ed	-41,44	kNm

**Classification for cross-section design**

According to EN 1993-1-1 article 5.5.2

**Classification of Internal Compression parts**

According to EN 1993-1-1 Table 5.2 Sheet 1

Maximum width-to-thickness ratio	25,57
Class 1 Limit	27,12
Class 2 Limit	31,23
Class 3 Limit	51,24

=> Section classified as Class 1 for cross-section design

**Compression check**

According to EN 1993-1-1 article 6.2.4 and formula (6.9)

A	2,0800e-02	m <sup>2</sup>
Nc,Rd	7384,00	kN
Unity check	0,51	-

**Bending moment check for My**

According to EN 1993-1-1 article 6.2.5 and formula (6.12), (6.13)

Wpl,y	2,9626e-03	m <sup>3</sup>
Mpl,y,Rd	1051,73	kNm
Unity check	0,45	-

**Bending moment check for Mz**

According to EN 1993-1-1 article 6.2.5 and formula (6.12), (6.13)

Wpl,z	2,9626e-03	m <sup>3</sup>
Mpl,z,Rd	1051,73	kNm
Unity check	0,04	-

**Shear check for Vy**

According to EN 1993-1-1 article 6.2.6 and formula (6.17)

Eta	1,20	
Av	1,0400e-02	m <sup>2</sup>
Vpl,y,Rd	2131,58	kN
Unity check	0,03	-

**Shear check for Vz**

According to EN 1993-1-1 article 6.2.6 and formula (6.17)

Eta	1,20	
Av	1,0400e-02	m <sup>2</sup>
Vpl,z,Rd	2131,58	kN
Unity check	0,15	-

**Torsion check**

According to EN 1993-1-1 article 6.2.7 and formula (6.23)

Tau,t,Ed	41,9	MPa
Tau,Rd	205,0	MPa
Unity check	0,20	-

**Combined Shear and Torsion check for Vy and Tau,t,Rd**

**Combined Shear and Torsion check for Vz and Tau,t,Rd**

According to EN 1993-1-1 article 6.2.6 & 6.2.7 and formula (6.25),(6.28)

Vpl,T,z,Rd	1695,39	kN
Unity check	0,19	-

**Combined bending, axial force and shear force check**

According to EN 1993-1-1 article 6.2.9.1 and formula (6.41)

MN,y,Rd	675,51	kNm
Alpha	2,34	
MN,z,Rd	675,51	kNm
Beta	2,34	

Unity check (6.41) = 0,43 + 0,00 = 0,43 -

**Note:** Since the shear forces are less than half the plastic shear resistances their effect on the moment resistances is neglected.

The member satisfies the section check.

.....**STABILITY CHECK:**.....

**Classification for member buckling design**

Decisive position for stability classification: 22.008 m

**Classification of Internal Compression parts**

According to EN 1993-1-1 Table 5.2 Sheet 1

Maximum width-to-thickness ratio	25,57
Class 1 Limit	26,85
Class 2 Limit	30,92
Class 3 Limit	37,09

=> Section classified as Class 1 for member buckling design

**Flexural Buckling check**

According to EN 1993-1-1 article 6.3.1.1 and formula (6.46)

Buckling parameters	yy	zz	
<small>*Student version* *Student version* *Student version* *Student version* *Student version* *Student version*</small>			
Sway type	sway	non-sway	
System length L	1,572	1,572	m
Buckling factor k	1,00	1,00	
Buckling length Lcr	1,572	1,572	m
Critical Euler load Ncr	422829,34	422829,34	kN
Slenderness Lambda	10,10	10,10	
Relative slenderness Lambda,rel	0,13	0,13	
Limit slenderness Lambda,rel,0	0,20	0,20	

**Note:** The slenderness or compression force is such that Flexural Buckling effects may be ignored according to EN 1993-1-1 article 6.3.1.2(4).

**Torsional(-Flexural) Buckling check**

According to EN 1993-1-1 article 6.3.1.1 and formula (6.46)

**Note:** The cross-section concerns a RHS section which is not susceptible to Torsional(-Flexural) Buckling.

**Lateral Torsional Buckling check**

According to EN 1993-1-1 article 6.3.2.1

**Note:** The cross-section concerns an RHS section with  $h / b < 10 / \text{Lambda,rel,z}$ .

This section is thus not susceptible to Lateral Torsional Buckling.

**Bending and axial compression check**

According to EN 1993-1-1 article 6.3.3 and formula (6.61),(6.62)

Bending and axial compression check parameters		
<small>*Student version* *Student version* *Student version* *Student version* *Student version* *Student version* *Student version* *Student version* *S</small>		
Interaction method	alternative method 1	
Cross-section area A	2,0800e-02	m^2
Cross-section plastic modulus Wpl,y	2,9626e-03	m^3
Cross-section plastic modulus Wpl,z	2,9626e-03	m^3
Design compression force N,Ed	3735,82	kN
Design bending moment (maximum) My,Ed	-468,31	kNm
Design bending moment (maximum) Mz,Ed	-41,44	kNm
Characteristic compression resistance N,Rk	7384,00	kN
Characteristic moment resistance My,Rk	1051,73	kNm
Characteristic moment resistance Mz,Rk	1051,73	kNm
Reduction factor Chi,y	1,00	
Reduction factor Chi,z	1,00	
Reduction factor Chi,LT	1,00	
Interaction factor k,yy	0,87	
Interaction factor k,yz	0,51	
Interaction factor k,zy	0,52	
Interaction factor k,zz	0,86	

Maximum moment My,Ed is derived from beam B1004 position 23.580 m.

Maximum moment Mz,Ed is derived from beam B1004 position 23.580 m.

Interaction method 1 parameters		
<small>*Student version* *Student version* *Student version* *Student version* *Student version* *Student version* *Student version* *Student version* *S</small>		
Critical Euler load N,cr,y	422829,34	kN
Critical Euler load N,cr,z	422829,34	kN
Elastic critical load N,cr,T	1585234,89	kN
Cross-section plastic modulus Wpl,y	2,9626e-03	m^3
Cross-section elastic modulus Wel,y	2,5210e-03	m^3
Cross-section plastic modulus Wpl,z	2,9626e-03	m^3

\*Student version\* \*Student version\* \*Student version\* \*Student version\* \*Student version\* \*Student version\* \*Student version\* \*Student version\* \*S

Interaction method 1 parameters		
*Student version*	*Student version*	*Student version*
Cross-section elastic modulus $W_{el,z}$	2,5210e-03	m <sup>3</sup>
Second moment of area $I_y$	5,0414e-04	m <sup>4</sup>
Second moment of area $I_z$	5,0414e-04	m <sup>4</sup>
Torsional constant $I_t$	8,2735e-04	m <sup>4</sup>
Method for equivalent moment factor $C_{my,0}$	Table A.2 Line 2 (General)	
Design bending moment (maximum) $M_{y,Ed}$	-468,31	kNm
Maximum relative deflection $\delta_{rel,z}$	0,7	mm
Equivalent moment factor $C_{my,0}$	1,00	
Method for equivalent moment factor $C_{mz,0}$	Table A.2 Line 2 (General)	
Design bending moment (maximum) $M_{z,Ed}$	-41,44	kNm
Maximum relative deflection $\delta_{rel,y}$	0,0	mm
Equivalent moment factor $C_{mz,0}$	0,99	
Factor $\mu_y$	1,00	
Factor $\mu_z$	1,00	
Factor $\epsilon_{pl,y}$	1,03	
Factor $a_{LT}$	0,00	
Critical moment for uniform bending $M_{cr,0}$	180255,40	kNm
Relative slenderness $\lambda_{rel,0}$	0,08	
Limit relative slenderness $\lambda_{rel,0,lim}$	0,26	
Equivalent moment factor $C_{my}$	1,00	
Equivalent moment factor $C_{mz}$	0,99	
Equivalent moment factor $C_{mLT}$	1,00	
Factor $b_{LT}$	0,00	
Factor $c_{LT}$	0,00	
Factor $d_{LT}$	0,00	
Factor $e_{LT}$	0,00	
Factor $w_y$	1,18	
Factor $w_z$	1,18	
Factor $n_{pl}$	0,51	
Maximum relative slenderness $\lambda_{rel,max}$	0,13	
Factor $C_{yy}$	1,16	
Factor $C_{yz}$	1,17	
Factor $C_{zy}$	1,17	
Factor $C_{zz}$	1,16	

Unity check (6.61) =  $0,51 + 0,39 + 0,02 = 0,91$  -  
 Unity check (6.62) =  $0,51 + 0,23 + 0,03 = 0,77$  -  
 The member satisfies the stability check.



-iskoristivost elementa na GSN – 91 %

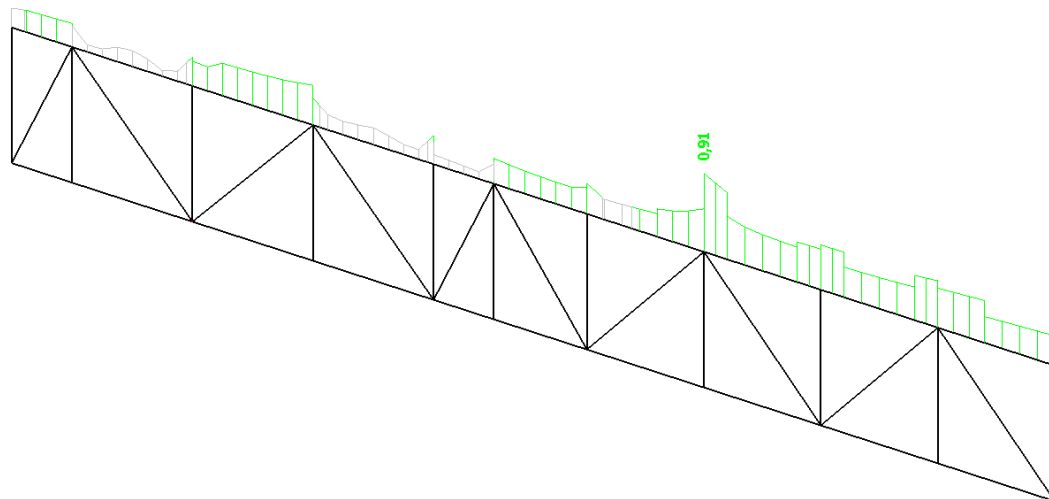

Slika 14.4. Prikaz iskoristivosti gornje pojasnice konzolnog rešetkastog nosača

### 14.2.3. Rezne sile – donja pojasnica konzolnog rešetkastog nosača 3

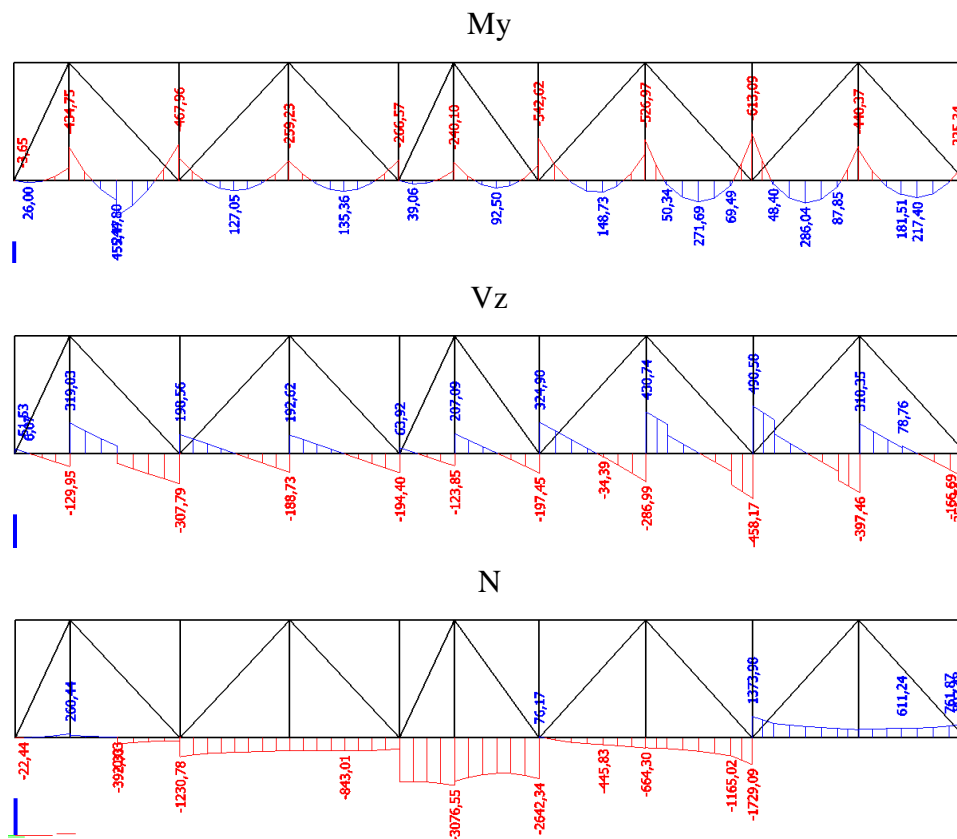

Slika 14.5. Prikaz reznih sila - donja pojasnica konzolnog rešetkastog nosača

-poprečni presjek nosača

Name	Konzolni nosač 3 - donja pojasnica	
Type	F400X12	
Source description	Chinese Standard / GB 6728-2002	
Item material	S 355	
Fabrication	cold formed	
Flexural buckling y-y	c	
Flexural buckling z-z	c	
Lateral torsional buckling	Default	
Use 2D FEM analysis	x	
A [m²]	1,8000e-02	
A y, z [m²]	8,9972e-03	8,9972e-03
I y, z [m⁴]	4,4319e-04	4,4319e-04
I w y, z [m⁴]	1,0240e-05	7,1813e-04
Wey, z [m³]	2,2160e-03	2,2160e-03
Wply, z [m³]	2,5874e-03	2,5874e-03
dy, z [mm]	0	0
c YUCS, ZUCS [mm]	200	200
α [deg]	0,00	
A L, D [m²/m]	1,5382e+00	3,0005e+00
Mply +, - [Nm]	9,18e+05	9,18e+05
Mplz +, - [Nm]	9,18e+05	9,18e+05

Slika 14.6. Prikaz geometrijskih karakteristika nosača

### 14.2.4. Dimenzioniranje – donja pojasnica konzolnog rešetkastog nosača 3

Member B1003	70,090 m	F400X12	S 355	GSN 2	0,97 -
--------------	----------	---------	-------	-------	--------

Note: EN 1993-1-3 article 1.1(3) specifies that this part does not apply to cold formed CHS and RHS sections. The default EN 1993-1-1 code check is executed instead of the EN 1993-1-3 code check.

Partial safety factors	
Gamma M0 for resistance of cross-sections	1,00
Gamma M1 for resistance to instability	1,00
Gamma M2 for resistance of net sections	1,25

Material		
Yield strength $f_y$	355,0	MPa
Ultimate strength $f_u$	510,0	MPa
Fabrication	Cold formed	

....SECTION CHECK:....

The critical check is on position 54.370 m

Internal forces	Calculated	Unit
N,Ed	-1729,09	kN
V <sub>y</sub> ,Ed	-8,94	kN
V <sub>z</sub> ,Ed	-458,17	kN
T,Ed	-202,00	kNm
M <sub>y</sub> ,Ed	-542,17	kNm
M <sub>z</sub> ,Ed	-5,05	kNm

**Classification for cross-section design**

According to EN 1993-1-1 article 5.5.2

**Classification of Internal Compression parts**

According to EN 1993-1-1 Table 5.2 Sheet 1

Maximum width-to-thickness ratio	30,33
Class 1 Limit	26,85
Class 2 Limit	30,92
Class 3 Limit	34,31

=> Section classified as Class 2 for cross-section design

**Compression check**

According to EN 1993-1-1 article 6.2.4 and formula (6.9)

A	1,8000e-02	m <sup>2</sup>
N <sub>c,Rd</sub>	6390,00	kN
Unity check	0,27	-

**Bending moment check for M<sub>y</sub>**

According to EN 1993-1-1 article 6.2.5 and formula (6.12),(6.13)

W <sub>pl,y</sub>	2,5874e-03	m <sup>3</sup>
M <sub>pl,y,Rd</sub>	918,53	kNm
Unity check	0,59	-

**Bending moment check for M<sub>z</sub>**

According to EN 1993-1-1 article 6.2.5 and formula (6.12),(6.13)

W <sub>pl,z</sub>	2,5874e-03	m <sup>3</sup>
M <sub>pl,z,Rd</sub>	918,53	kNm
Unity check	0,01	-

**Shear check for V<sub>y</sub>**

According to EN 1993-1-1 article 6.2.6 and formula (6.17)

Eta	1,20	
A <sub>v</sub>	9,0000e-03	m <sup>2</sup>
V <sub>pl,y,Rd</sub>	1844,63	kN
Unity check	0,00	-

**Shear check for V<sub>z</sub>**

According to EN 1993-1-1 article 6.2.6 and formula (6.17)

Eta	1,20	
A <sub>v</sub>	9,0000e-03	m <sup>2</sup>
V <sub>pl,z,Rd</sub>	1844,63	kN
Unity check	0,25	-

**Torsion check**

According to EN 1993-1-1 article 6.2.7 and formula (6.23)

Tau <sub>t,Ed</sub>	55,9	MPa
Tau <sub>t,Rd</sub>	205,0	MPa
Unity check	0,27	-

**Combined Shear and Torsion check for V<sub>y</sub> and Tau<sub>t,Rd</sub>**

**Combined Shear and Torsion check for Vz and Tau,t,Rd**

According to EN 1993-1-1 article 6.2.6 & 6.2.7 and formula (6.25),(6.28)

Vpl,T,z,Rd	1341,45	kN
Unity check	0,34	-

**Combined bending, axial force and shear force check**

According to EN 1993-1-1 article 6.2.9.1 and formula (6.41)

MN,y,Rd	873,89	kNm
Alpha	1,81	
MN,z,Rd	873,89	kNm
Beta	1,81	

Unity check (6.41) = 0,42 + 0,00 = 0,42 -

**Note:** Since the shear forces are less than half the plastic shear resistances their effect on the moment resistances is neglected.

The member satisfies the section check.

.....**STABILITY CHECK**.....

**Classification for member buckling design**

Decisive position for stability classification: 52,798 m

**Classification of Internal Compression parts**

According to EN 1993-1-1 Table 5.2 Sheet 1

Maximum width-to-thickness ratio	30,33
Class 1 Limit	26,85
Class 2 Limit	30,92
Class 3 Limit	41,50

=> Section classified as Class 2 for member buckling design

**Flexural Buckling check**

According to EN 1993-1-1 article 6.3.1.1 and formula (6.46)

Buckling parameters	yy	zz	
Sway type	sway	non-sway	
System length L	1,572	1,572	m
Buckling factor k	5,00	1,00	
Buckling length Lcr	7,860	1,572	m
Critical Euler load Ncr	14868,39	371709,71	kN
Slenderness Lambda	50,09	10,02	
Relative slenderness Lambda,rel	0,66	0,13	
Limit slenderness Lambda,rel,0	0,20	0,20	
Buckling curve	c	c	
Imperfection Alpha	0,49	0,49	
Reduction factor Chi	0,75	1,00	
Buckling resistance Nb,Rd	4805,16	6390,00	kN

Flexural Buckling verification		
Cross-section area A	1,8000e-02	m^2
Buckling resistance Nb,Rd	4805,16	kN
Unity check	0,36	-

**Torsional(-Flexural) Buckling check**

According to EN 1993-1-1 article 6.3.1.1 and formula (6.46)

**Note:** The cross-section concerns a RHS section which is not susceptible to Torsional(-Flexural) Buckling.

**Lateral Torsional Buckling check**

According to EN 1993-1-1 article 6.3.2.1

**Note:** The cross-section concerns an RHS section with  $h/b < 10 / \text{Lambda,rel,z}$ .

This section is thus not susceptible to Lateral Torsional Buckling.

**Bending and axial compression check**

According to EN 1993-1-1 article 6.3.3 and formula (6.61),(6.62)

Bending and axial compression check parameters		
Interaction method	alternative method 1	
Cross-section area A	1,8000e-02	m^2
Cross-section plastic modulus Wpl,y	2,5874e-03	m^3
Cross-section plastic modulus Wpl,z	2,5874e-03	m^3
Design compression force N,Ed	1729,09	kN
Design bending moment (maximum) My,Ed	-542,17	kNm
Design bending moment (maximum) Mz,Ed	30,96	kNm
Characteristic compression resistance N,Rk	6390,00	kN
Characteristic moment resistance My,Rk	918,53	kNm
Characteristic moment resistance Mz,Rk	918,53	kNm
Reduction factor Chi,y	0,75	
Reduction factor Chi,z	1,00	
Reduction factor Chi,LT	1,00	
Interaction factor k,yy	1,00	
Interaction factor k,yz	0,60	
Interaction factor k,zy	0,65	
Interaction factor k,zz	0,98	

Maximum moment My,Ed is derived from beam B1003 position 54,370 m.

Maximum moment Mz,Ed is derived from beam B1003 position 52,798 m.



Interaction method 1 parameters		
<small>*Student version* *Student version* *Student version* *Student version* *Student version* *Student version* *Student version* *S</small>		
Critical Euler load N <sub>cr,y</sub>	14868,39	kN
Critical Euler load N <sub>cr,z</sub>	371709,71	kN
Elastic critical load N <sub>cr,T</sub>	1352289,45	kN
Cross-section plastic modulus W <sub>pl,y</sub>	2,5874e-03	m <sup>3</sup>
Cross-section elastic modulus W <sub>el,y</sub>	2,2160e-03	m <sup>3</sup>
Cross-section plastic modulus W <sub>pl,z</sub>	2,5874e-03	m <sup>3</sup>
Cross-section elastic modulus W <sub>el,z</sub>	2,2160e-03	m <sup>3</sup>
Second moment of area I <sub>y</sub>	4,4319e-04	m <sup>4</sup>
Second moment of area I <sub>z</sub>	4,4319e-04	m <sup>4</sup>
Torsional constant I <sub>t</sub>	7,1813e-04	m <sup>4</sup>
Method for equivalent moment factor C <sub>my,0</sub>	Table A.2 Line 2 (General)	
Design bending moment (maximum) M <sub>y,Ed</sub>	-542,17	kNm
Maximum relative deflection delta <sub>z</sub>	0,7	mm
Equivalent moment factor C <sub>my,0</sub>	0,94	
Method for equivalent moment factor C <sub>mz,0</sub>	Table A.2 Line 2 (General)	
Design bending moment (maximum) M <sub>z,Ed</sub>	30,96	kNm
Maximum relative deflection delta <sub>y</sub>	0,0	mm
Equivalent moment factor C <sub>mz,0</sub>	1,00	
Factor mu <sub>y</sub>	0,97	
Factor mu <sub>z</sub>	1,00	
Factor epsilon <sub>y</sub>	2,55	
Factor a <sub>LT</sub>	0,00	
Critical moment for uniform bending M <sub>cr,0</sub>	157329,62	kNm
Relative slenderness Lambda <sub>rel,0</sub>	0,08	
Limit relative slenderness Lambda <sub>rel,0,lim</sub>	0,28	
Equivalent moment factor C <sub>my</sub>	0,94	
Equivalent moment factor C <sub>mz</sub>	1,00	
Equivalent moment factor C <sub>mLT</sub>	1,00	
Factor b <sub>LT</sub>	0,00	
Factor c <sub>LT</sub>	0,00	
Factor d <sub>LT</sub>	0,00	
Factor e <sub>LT</sub>	0,00	
Factor w <sub>y</sub>	1,17	
Factor w <sub>z</sub>	1,17	
Factor n <sub>pl</sub>	0,27	
Maximum relative slenderness Lambda <sub>rel,max</sub>	0,66	
Factor C <sub>yy</sub>	1,03	
Factor C <sub>yz</sub>	0,97	
Factor C <sub>zy</sub>	0,98	
Factor C <sub>zz</sub>	1,02	

Unity check (6.61) = 0,36 + 0,59 + 0,02 = 0,97 -  
 Unity check (6.62) = 0,27 + 0,38 + 0,03 = 0,69 -  
 The member satisfies the stability check.

-iskoristivost elementa na GSN – 97 %

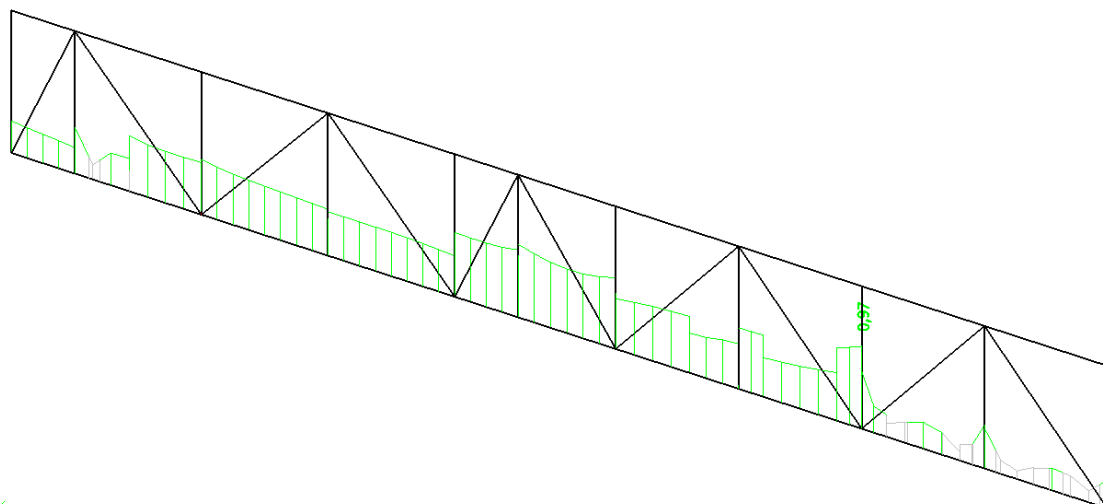

Slika 14.7. Prikaz iskoristivosti donje pojasnice konzolnog rešetkastog nosača

14.2.5. Rezne sile – vertikalna ispuna 1 konzolnog rešetkastog nosača 3

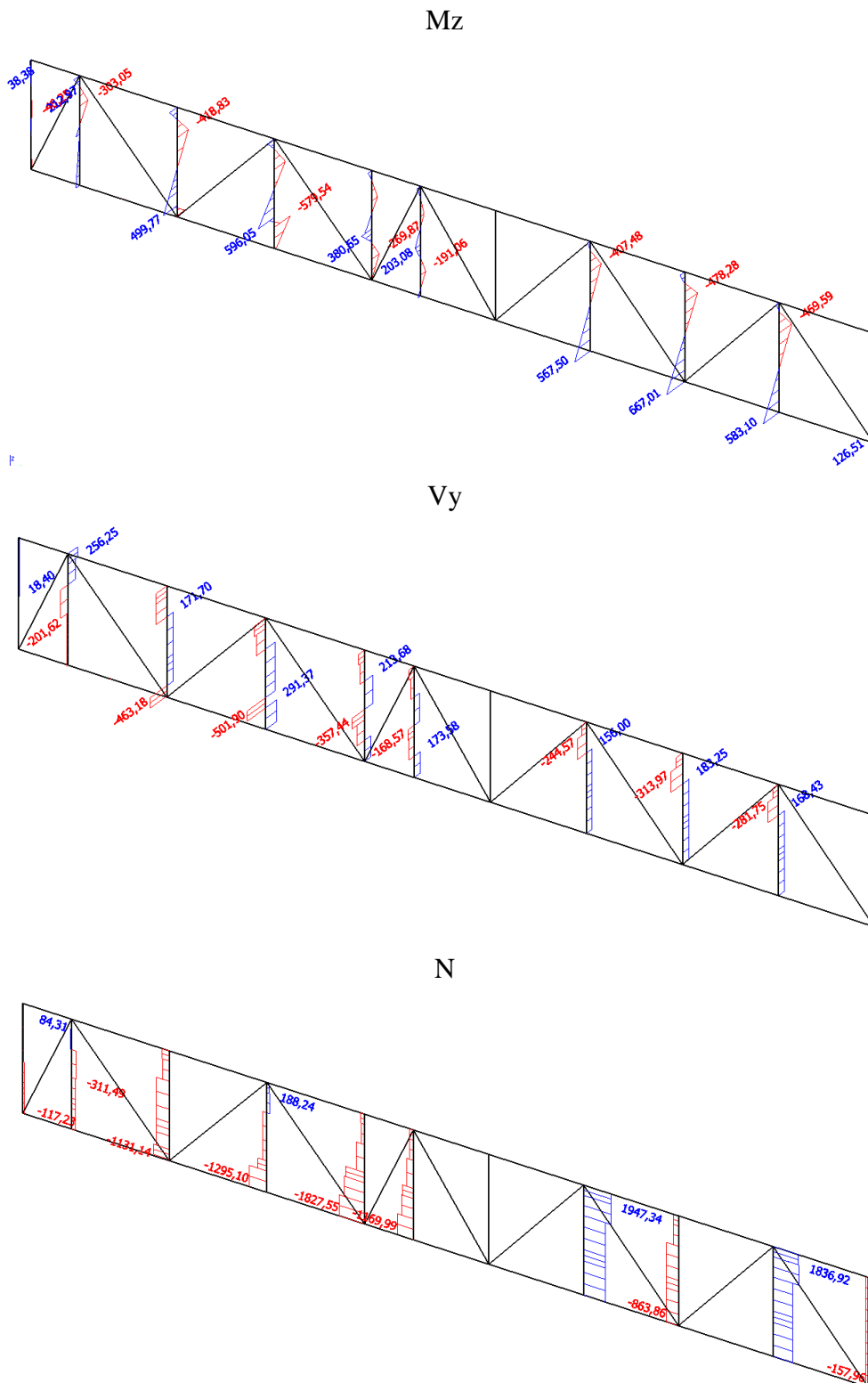

Slika 14.8. Prikaz reznih sila – vertikalna ispuna konzolnog rešetkastog nosača

-poprečni presjek nosača

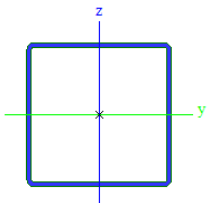
Name	Konzolni nosač 3 - vertikalna ispuna 1	
Type	SHS400/400/12.5	
Source description	British Standard / BS 5950 part 1 : 1990 & EN 10210-2	
Item material	S 355	
Fabrication	cold formed	
Flexural buckling y-y	c	
Flexural buckling z-z	c	
Lateral torsional buckling	Default	
Use 2D FEM analysis	*	
		
A [m <sup>2</sup> ]	1,9200e-02	
A <sub>y, z</sub> [m <sup>2</sup> ]	9,5509e-03	9,5509e-03
I <sub>y, z</sub> [m <sup>4</sup> ]	4,7840e-04	4,7840e-04
I <sub>w</sub> [m <sup>6</sup> ], I <sub>t</sub> [m <sup>4</sup> ]	1,0667e-05	7,3910e-04
W <sub>el y, z</sub> [m <sup>3</sup> ]	2,3920e-03	2,3920e-03
W <sub>pl y, z</sub> [m <sup>3</sup> ]	2,7636e-03	2,7636e-03
d <sub>y, z</sub> [mm]	0	0
c <sub>YUCS, ZUCS</sub> [mm]	200	200
α [deg]	0,00	
A <sub>L, D</sub> [m <sup>2</sup> /m]	1,5700e+00	3,0569e+00
M <sub>ply +, -</sub> [Nm]	9,81e+05	9,81e+05
M <sub>plz +, -</sub> [Nm]	9,81e+05	9,81e+05

Slika 14.9. Prikaz geometrijskih karakteristika nosača

-iskoristivost elementa na GSN – 89 %

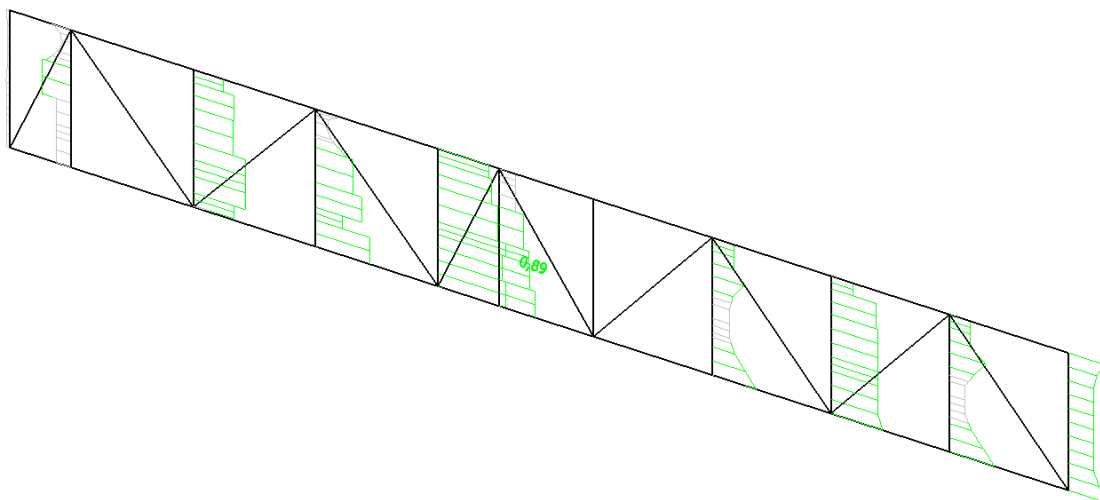

Slika 14.10. Prikaz iskoristivosti vertikalne ispune konzolnog rešetkastog nosača

### 14.2.6. Dimenzioniranje – vertikalna ispuna 1 konzolnog rešetkastog nosača 3

Member B1048	8,650 m	SHS400/400/12.5	S 355	GSN 2	0,89 -
--------------	---------	-----------------	-------	-------	--------

Note: EN 1993-1-3 article 1.1(3) specifies that this part does not apply to cold formed CHS and RHS sections. The default EN 1993-1-1 code check is executed instead of the EN 1993-1-3 code check.

Partial safety factors	
Gamma M0 for resistance of cross-sections	1,00
Gamma M1 for resistance to instability	1,00
Gamma M2 for resistance of net sections	1,25

Material	
Yield strength fy	355,0 MPa
Ultimate strength fu	510,0 MPa
Fabrication	Cold formed

....SECTION CHECK:....

The critical check is on position 5.400 m

Internal forces	Calculated	Unit
N,Ed	-1361,27	kN
Vy,Ed	-357,44	kN
Vz,Ed	186,70	kN
T,Ed	0,75	kNm
My,Ed	-323,91	kNm
Mz,Ed	94,69	kNm

Classification for cross-section design

According to EN 1993-1-1 article 5.5.2

Classification of Internal Compression parts

According to EN 1993-1-1 Table 5.2 Sheet 1

Maximum width-to-thickness ratio	29,00
Class 1 Limit	28,38
Class 2 Limit	32,68
Class 3 Limit	52,36

=> Section classified as Class 2 for cross-section design

Compression check

According to EN 1993-1-1 article 6.2.4 and formula (6.9)

A	1,9200e-02	m <sup>2</sup>
Nc,Rd	6816,00	kN
Unity check	0,20	-

Bending moment check for My

According to EN 1993-1-1 article 6.2.5 and formula (6.12),(6.13)

Wpl,y	2,7636e-03	m <sup>3</sup>
Mpl,y,Rd	981,06	kNm
Unity check	0,33	-

Bending moment check for Mz

According to EN 1993-1-1 article 6.2.5 and formula (6.12),(6.13)

Wpl,z	2,7636e-03	m <sup>3</sup>
Mpl,z,Rd	981,06	kNm
Unity check	0,10	-

Shear check for Vy

According to EN 1993-1-1 article 6.2.6 and formula (6.17)

Eta	1,20	
Av	9,6000e-03	m <sup>2</sup>
Vpl,y,Rd	1967,61	kN
Unity check	0,18	-

Shear check for Vz

According to EN 1993-1-1 article 6.2.6 and formula (6.17)

Eta	1,20	
Av	9,6000e-03	m <sup>2</sup>
Vpl,z,Rd	1967,61	kN
Unity check	0,09	-

Torsion check

According to EN 1993-1-1 article 6.2.7 and formula (6.23)

Tau,t,Ed	0,2	MPa
Tau,Rd	205,0	MPa
Unity check	0,00	-

Note: The unity check for torsion is lower than the limit value of 0,05. Therefore torsion is considered as

MN,y,Rd	981,06	kNm
Alpha	1,74	
MN,z,Rd	981,06	kNm
Beta	1,74	

Unity check (6.41) = 0,15 + 0,02 = 0,16 -

**Note:** Since the shear forces are less than half the plastic shear resistances their effect on the moment resistances is neglected.

The member satisfies the section check.

.....**STABILITY CHECK**.....

**Classification for member buckling design**

Decisive position for stability classification: 4,600 m

**Classification of Internal Compression parts**

According to EN 1993-1-1 Table 5.2 Sheet 1

Maximum width-to-thickness ratio	29,00
Class 1 Limit	26,85
Class 2 Limit	30,92
Class 3 Limit	48,07

=> Section classified as Class 2 for member buckling design

**Flexural Buckling check**

According to EN 1993-1-1 article 6.3.1.1 and formula (6.46)

Buckling parameters	yy	zz	
Sway type	sway	non-sway	
System length L	4,050	0,800	m
Buckling factor k	1,00	1,00	
Buckling length L <sub>cr</sub>	4,050	0,800	m
Critical Euler load N <sub>cr</sub>	60450,54	1549281,15	kN
Slenderness Lambda	25,66	5,07	
Relative slenderness Lambda <sub>rel</sub>	0,34	0,07	
Limit slenderness Lambda <sub>rel,0</sub>	0,20	0,20	

**Note:** The slenderness or compression force is such that Flexural Buckling effects may be ignored according to EN 1993-1-1 article 6.3.1.2(4).

**Torsional(-Flexural) Buckling check**

According to EN 1993-1-1 article 6.3.1.1 and formula (6.46)

**Note:** The cross-section concerns a RHS section which is not susceptible to Torsional(-Flexural) Buckling.

**Lateral Torsional Buckling check**

According to EN 1993-1-1 article 6.3.2.1

**Note:** The cross-section concerns a RHS section with  $h/b < 10 / \text{Lambda}_{rel,z}$

This section is thus not susceptible to Lateral Torsional Buckling.

**Bending and axial compression check**

According to EN 1993-1-1 article 6.3.3 and formula (6.61),(6.62)

Bending and axial compression check parameters		
Interaction method	alternative method 1	
Cross-section area A	1,9200e-02	m <sup>2</sup>
Cross-section plastic modulus W <sub>pl,y</sub>	2,7636e-03	m <sup>3</sup>
Cross-section plastic modulus W <sub>pl,z</sub>	2,7636e-03	m <sup>3</sup>
Design compression force N <sub>Ed</sub>	1361,27	kN
Design bending moment (maximum) M <sub>y,Ed</sub>	-473,27	kNm
Design bending moment (maximum) M <sub>z,Ed</sub>	380,65	kNm
Characteristic compression resistance N <sub>Rk</sub>	6816,00	kN
Characteristic moment resistance M <sub>y,Rk</sub>	981,06	kNm
Characteristic moment resistance M <sub>z,Rk</sub>	981,06	kNm
Reduction factor Chi <sub>y</sub>	1,00	
Reduction factor Chi <sub>z</sub>	1,00	
Reduction factor Chi <sub>LT</sub>	1,00	
Interaction factor k <sub>yy</sub>	0,97	
Interaction factor k <sub>yz</sub>	0,58	
Interaction factor k <sub>zy</sub>	0,58	
Interaction factor k <sub>zz</sub>	0,96	

Maximum moment M<sub>y,Ed</sub> is derived from beam B1048 position 4,600 m.

Maximum moment M<sub>z,Ed</sub> is derived from beam B1048 position 4,600 m.

Interaction method 1 parameters		
Critical Euler load N <sub>cr,y</sub>	60450,54	kN
Critical Euler load N <sub>cr,z</sub>	1549281,15	kN
Elastic critical load N <sub>cr,T</sub>	1891106,77	kN
Cross-section plastic modulus W <sub>pl,y</sub>	2,7636e-03	m <sup>3</sup>
Cross-section elastic modulus W <sub>el,y</sub>	2,3920e-03	m <sup>3</sup>
Cross-section plastic modulus W <sub>pl,z</sub>	2,7636e-03	m <sup>3</sup>
Cross-section elastic modulus W <sub>el,z</sub>	2,3920e-03	m <sup>3</sup>
Second moment of area I <sub>y</sub>	4,7840e-04	m <sup>4</sup>
Second moment of area I <sub>z</sub>	4,7840e-04	m <sup>4</sup>
Torsional constant I <sub>t</sub>	7,3910e-04	m <sup>4</sup>
Method for equivalent moment factor C <sub>my,0</sub>	Table A.2 Line 2 (General)	
Design bending moment (maximum) M <sub>y,Ed</sub>	-473,27	kNm
Maximum relative deflection delta <sub>z</sub>	2,6	mm
Equivalent moment factor C <sub>my,0</sub>	0,98	
Method for equivalent moment factor C <sub>mz,0</sub>	Table A.2 Line 2 (General)	

\*Student version\* \*Student version\* \*Student version\* \*Student version\* \*Student version\* \*Student version\* \*Student version\* \*Student version\* \*S

Interaction method 1 parameters		
Design bending moment (maximum) Mz,Ed	380,65	kNm
Maximum relative deflection delta,y	-0,2	mm
Equivalent moment factor C,mz,0	1,00	
Factor mu,y	1,00	
Factor mu,z	1,00	
Factor epsilon,y	2,79	
Factor a,LT	0,00	
Critical moment for uniform bending Mcr,0	382105,34	kNm
Relative slenderness Lambda,rel,0	0,05	
Limit relative slenderness Lambda,rel,0,lim	0,22	
Equivalent moment factor C,my	0,98	
Equivalent moment factor C,mz	1,00	
Equivalent moment factor C,mLT	1,00	
Factor b,LT	0,00	
Factor c,LT	0,00	
Factor d,LT	0,00	
Factor e,LT	0,00	
Factor w,y	1,16	
Factor w,z	1,16	
Factor n,pl	0,20	
Maximum relative slenderness Lambda,rel,max	0,34	
Factor C,yy	1,04	
Factor C,yz	1,04	
Factor C,zy	1,04	
Factor C,zz	1,04	

Unity check (6.61) =  $0,20 + 0,47 + 0,22 = 0,89$  -

Unity check (6.62) =  $0,20 + 0,28 + 0,37 = 0,85$  -

The member satisfies the stability check.

**14.2.7. Rezne sile – vertikalna ispuna 2 konzolnog rešetkastog nosača 3**

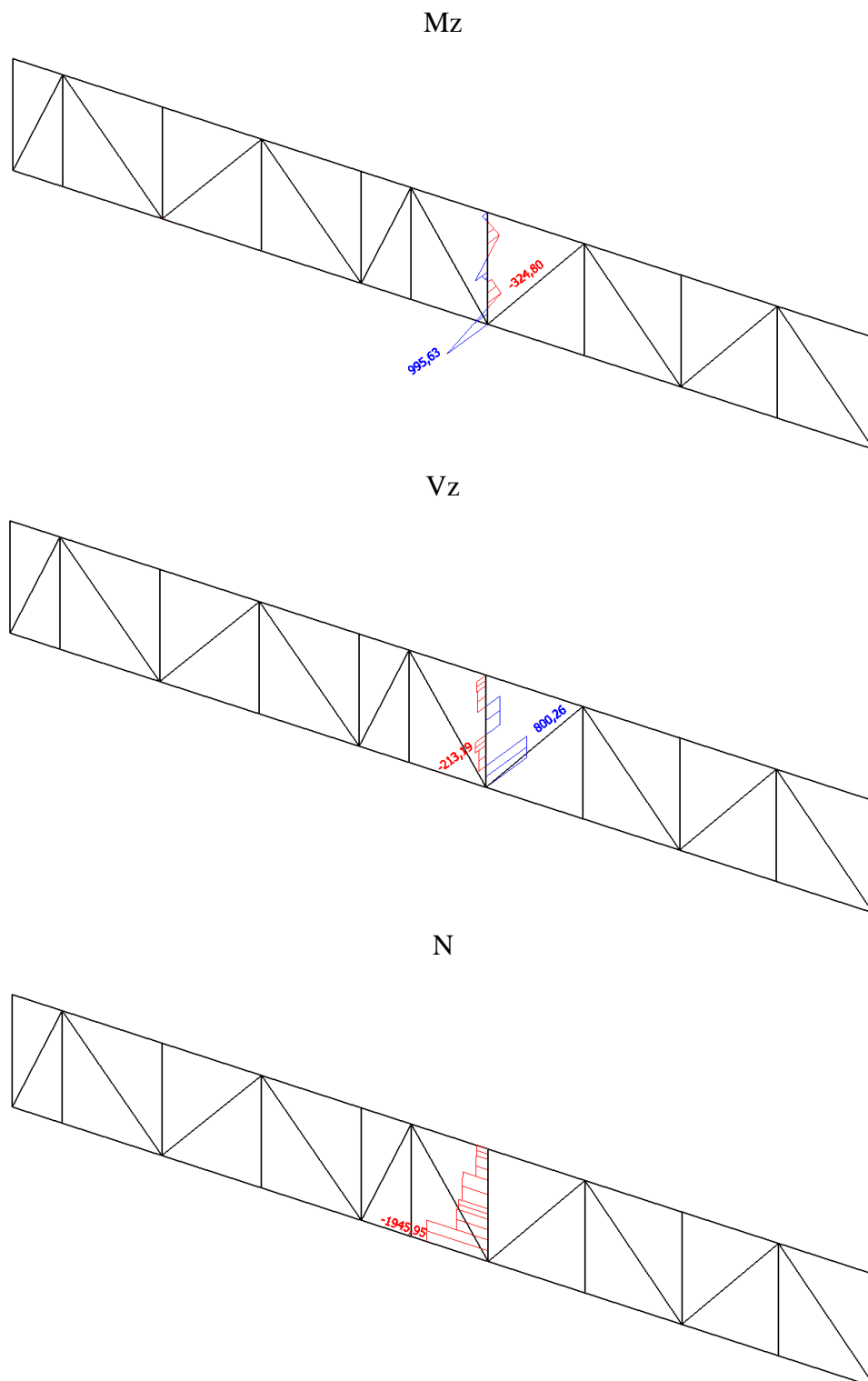

*Slika 14.11. Prikaz reznih sila – vertikalna ispuna konzolnog rešetkastog nosača*

-poprečni presjek nosača

Name	Konzolni nosač 3 - vertikalna ispuna 2	
Type	SHS400/400/20.0	
Source description	British Standard / BS 5950 part 1 : 1990 & EN 10210-2	
Item material	S 355	
Fabrication	cold formed	
Flexural buckling y-y	c	
Flexural buckling z-z	c	
Lateral torsional buckling	Default	
Use 2D FEM analysis	*	

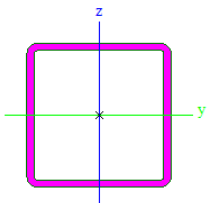

A [m <sup>2</sup> ]	3,0000e-02	
A <sub>y, z</sub> [m <sup>2</sup> ]	1,4850e-02	1,4850e-02
I <sub>y, z</sub> [m <sup>4</sup> ]	7,1530e-04	7,1530e-04
I <sub>w</sub> [m <sup>6</sup> ], t [m <sup>4</sup> ]	1,7067e-05	1,1250e-03
W <sub>el y, z</sub> [m <sup>3</sup> ]	3,5770e-03	3,5770e-03
W <sub>pl y, z</sub> [m <sup>3</sup> ]	4,2019e-03	4,2019e-03
d <sub>y, z</sub> [mm]	0	0
c <sub>YUCS, ZUCS</sub> [mm]	200	200
α [deg]	0,00	
A <sub>L, D</sub> [m <sup>2</sup> /m]	1,5500e+00	2,9710e+00
M <sub>ply +, -</sub> [Nm]	1,49e+06	1,49e+06
M <sub>plz +, -</sub> [Nm]	1,49e+06	1,49e+06

Slika 14.12. Prikaz geometrijskih karakteristika nosača

-iskoristivost elementa na GSN – 86 %

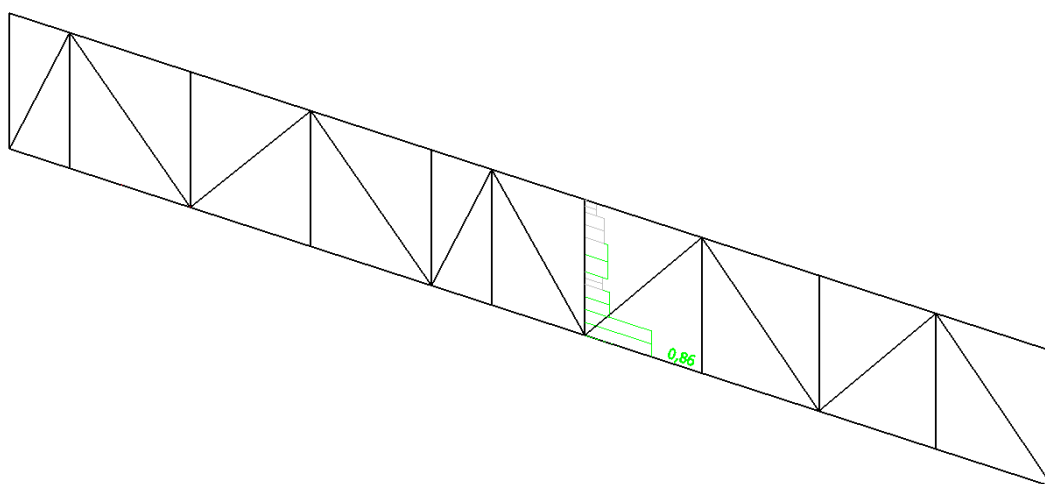

Slika 14.13. Prikaz iskoristivosti vertikalne ispune konzolnog rešetkastog nosača



### 14.2.8. Dimenzioniranje – vertikalna ispuna 2 konzolnog rešetkastog nosača 3

Member B1052	8,650 m	SHS400/400/20.0	S 355	GSN 2	0,86 -
--------------	---------	-----------------	-------	-------	--------

Note: EN 1993-1-3 article 1.1(3) specifies that this part does not apply to cold formed CHS and RHS sections. The default EN 1993-1-1 code check is executed instead of the EN 1993-1-3 code check.

Partial safety factors	
Gamma M0 for resistance of cross-sections	1,00
Gamma M1 for resistance to instability	1,00
Gamma M2 for resistance of net sections	1,25

Material		
Yield strength $f_y$	355,0	MPa
Ultimate strength $f_u$	510,0	MPa
Fabrication	Cold formed	

....SECTION CHECK:....

The critical check is on position 8.650 m

Internal forces	Calculated	Unit
N,Ed	-1945,95	kN
Vy,Ed	800,26	kN
Vz,Ed	36,06	kN
T,Ed	-34,12	kNm
My,Ed	109,85	kNm
Mz,Ed	995,63	kNm

**Classification for cross-section design**

According to EN 1993-1-1 article 5.5.2

**Classification of Internal Compression parts**

According to EN 1993-1-1 Table 5.2 Sheet 1

Maximum width-to-thickness ratio	17,00
Class 1 Limit	26,85
Class 2 Limit	30,92
Class 3 Limit	35,84

=> Section classified as Class 1 for cross-section design

**Compression check**

According to EN 1993-1-1 article 6.2.4 and formula (6.9)

A	3,0000e-02	m <sup>2</sup>
Nc,Rd	10650,00	kN
Unity check	0,18	-

**Bending moment check for My**

According to EN 1993-1-1 article 6.2.5 and formula (6.12),(6.13)

Wpl,y	4,2019e-03	m <sup>3</sup>
Mpl,y,Rd	1491,68	kNm
Unity check	0,07	-

**Bending moment check for Mz**

According to EN 1993-1-1 article 6.2.5 and formula (6.12),(6.13)

Wpl,z	4,2019e-03	m <sup>3</sup>
Mpl,z,Rd	1491,68	kNm
Unity check	0,67	-

**Shear check for Vy**

According to EN 1993-1-1 article 6.2.6 and formula (6.17)

Eta	1,20	
Av	1,5000e-02	m <sup>2</sup>
Vpl,y,Rd	3074,39	kN
Unity check	0,26	-

**Shear check for Vz**

According to EN 1993-1-1 article 6.2.6 and formula (6.17)

Eta	1,20	
Av	1,5000e-02	m <sup>2</sup>
Vpl,z,Rd	3074,39	kN
Unity check	0,01	-

**Torsion check**

According to EN 1993-1-1 article 6.2.7 and formula (6.23)

Tau,t,Ed	5,9	MPa
Tau,Rd	205,0	MPa
Unity check	0,03	-

**Note:** The unity check for torsion is lower than the limit value of 0,05. Therefore torsion is considered as

MN,y,Rd	1491,68	kNm
Alpha	1,73	
MN,z,Rd	1491,68	kNm
Beta	1,73	

Unity check (6.41) = 0,01 + 0,50 = 0,51 -

**Note:** Since the shear forces are less than half the plastic shear resistances their effect on the moment resistances is neglected.

The member satisfies the section check.

.....**STABILITY CHECK**.....

**Classification for member buckling design**

Decisive position for stability classification: 4,600 m

**Classification of Internal Compression parts**

According to EN 1993-1-1 Table 5.2 Sheet 1

Maximum width-to-thickness ratio	17,00
Class 1 Limit	26,85
Class 2 Limit	30,92
Class 3 Limit	35,84

=> Section classified as Class 1 for member buckling design

**Flexural Buckling check**

According to EN 1993-1-1 article 6.3.1.1 and formula (6.46)

Buckling parameters	yy	zz	
Sway type	sway	non-sway	
System length L	4,050	1,650	m
Buckling factor k	0,50	1,00	
Buckling length L <sub>cr</sub>	2,025	1,650	m
Critical Euler load N <sub>cr</sub>	361540,71	544552,02	kN
Slenderness Lambda	13,11	10,69	
Relative slenderness Lambda <sub>rel</sub>	0,17	0,14	
Limit slenderness Lambda <sub>rel,0</sub>	0,20	0,20	

**Note:** The slenderness or compression force is such that Flexural Buckling effects may be ignored according to EN 1993-1-1 article 6.3.1.2(4).

**Torsional(-Flexural) Buckling check**

According to EN 1993-1-1 article 6.3.1.1 and formula (6.46)

**Note:** The cross-section concerns a RHS section which is not susceptible to Torsional(-Flexural) Buckling.

**Lateral Torsional Buckling check**

According to EN 1993-1-1 article 6.3.2.1

**Note:** The cross-section concerns a RHS section with  $h/b < 10 / \text{Lambda}_{rel,z}$ .

This section is thus not susceptible to Lateral Torsional Buckling.

**Bending and axial compression check**

According to EN 1993-1-1 article 6.3.3 and formula (6.61),(6.62)

Bending and axial compression check parameters		
Interaction method	alternative method 1	

Cross-section area A	3,0000e-02	m <sup>2</sup>
Cross-section plastic modulus W <sub>pl,y</sub>	4,2019e-03	m <sup>3</sup>
Cross-section plastic modulus W <sub>pl,z</sub>	4,2019e-03	m <sup>3</sup>
Design compression force N <sub>Ed</sub>	1945,95	kN
Design bending moment (maximum) M <sub>y,Ed</sub>	109,85	kNm
Design bending moment (maximum) M <sub>z,Ed</sub>	995,63	kNm
Characteristic compression resistance N <sub>Rk</sub>	10650,00	kN
Characteristic moment resistance M <sub>y,Rk</sub>	1491,68	kNm
Characteristic moment resistance M <sub>z,Rk</sub>	1491,68	kNm
Reduction factor Chi <sub>y</sub>	1,00	
Reduction factor Chi <sub>z</sub>	1,00	
Reduction factor Chi <sub>LT</sub>	1,00	
Interaction factor k <sub>yy</sub>	0,95	
Interaction factor k <sub>yz</sub>	0,57	
Interaction factor k <sub>zy</sub>	0,57	
Interaction factor k <sub>zz</sub>	0,95	

Maximum moment M<sub>y,Ed</sub> is derived from beam B1052 position 8,650 m.

Maximum moment M<sub>z,Ed</sub> is derived from beam B1052 position 8,650 m.

Interaction method 1 parameters		
Critical Euler load N <sub>cr,y</sub>	361540,71	kN
Critical Euler load N <sub>cr,z</sub>	544552,02	kN
Elastic critical load N <sub>cr,T</sub>	2177927,40	kN
Cross-section plastic modulus W <sub>pl,y</sub>	4,2019e-03	m <sup>3</sup>
Cross-section elastic modulus W <sub>el,y</sub>	3,5770e-03	m <sup>3</sup>
Cross-section plastic modulus W <sub>pl,z</sub>	4,2019e-03	m <sup>3</sup>
Cross-section elastic modulus W <sub>el,z</sub>	3,5770e-03	m <sup>3</sup>
Second moment of area I <sub>y</sub>	7,1530e-04	m <sup>4</sup>
Second moment of area I <sub>z</sub>	7,1530e-04	m <sup>4</sup>
Torsional constant I <sub>t</sub>	1,1250e-03	m <sup>4</sup>
Method for equivalent moment factor C <sub>my,0</sub>	Table A.2 Line 2 (General)	
Design bending moment (maximum) M <sub>y,Ed</sub>	109,85	kNm
Maximum relative deflection delta <sub>z</sub>	-0,5	mm
Equivalent moment factor C <sub>my,0</sub>	1,00	
Method for equivalent moment factor C <sub>mz,0</sub>	Table A.2 Line 2 (General)	

\*Student version\* \*Student version\* \*Student version\* \*Student version\* \*Student version\* \*Student version\* \*Student version\* \*Student version\* \*S

Critical Euler load N <sub>cr,y</sub>	361540,71	kN
Critical Euler load N <sub>cr,z</sub>	544552,02	kN
Elastic critical load N <sub>cr,T</sub>	2177927,40	kN
Cross-section plastic modulus W <sub>pl,y</sub>	4,2019e-03	m <sup>3</sup>
Cross-section elastic modulus W <sub>el,y</sub>	3,5770e-03	m <sup>3</sup>
Cross-section plastic modulus W <sub>pl,z</sub>	4,2019e-03	m <sup>3</sup>
Cross-section elastic modulus W <sub>el,z</sub>	3,5770e-03	m <sup>3</sup>
Second moment of area I <sub>y</sub>	7,1530e-04	m <sup>4</sup>
Second moment of area I <sub>z</sub>	7,1530e-04	m <sup>4</sup>
Torsional constant I <sub>t</sub>	1,1250e-03	m <sup>4</sup>
Method for equivalent moment factor C <sub>my,0</sub>	Table A.2 Line 2 (General)	
Design bending moment (maximum) M <sub>y,Ed</sub>	109,85	kNm
Maximum relative deflection delta <sub>z</sub>	-0,5	mm
Equivalent moment factor C <sub>my,0</sub>	1,00	
Method for equivalent moment factor C <sub>mz,0</sub>	Table A.2 Line 2 (General)	

\*Student version\* \*Student version\* \*Student version\* \*Student version\* \*Student version\* \*Student version\* \*Student version\* \*Student version\* \*S

Interaction method 1 parameters		
Design bending moment (maximum) Mz,Ed	995,63	kNm
Maximum relative deflection delta,y	-0,8	mm
Equivalent moment factor C,mz,0	1,00	
Factor mu,y	1,00	
Factor mu,z	1,00	
Factor epsilon,y	0,47	
Factor a,LT	0,00	
Critical moment for uniform bending Mcr,0	237815,34	kNm
Relative slenderness Lambda,rel,0	0,08	
Limit relative slenderness Lambda,rel,0,lim	0,23	
Equivalent moment factor C,my	1,00	
Equivalent moment factor C,mz	1,00	
Equivalent moment factor C,mLT	1,00	
Factor b,LT	0,00	
Factor c,LT	0,00	
Factor d,LT	0,00	
Factor e,LT	0,00	
Factor w,y	1,17	
Factor w,z	1,17	
Factor n,pl	0,18	
Maximum relative slenderness Lambda,rel,max	0,17	
Factor C,yy	1,06	
Factor C,yz	1,06	
Factor C,zy	1,06	
Factor C,zz	1,06	

Unity check (6.61) =  $0,18 + 0,07 + 0,38 = 0,63$  -

Unity check (6.62) =  $0,18 + 0,04 + 0,63 = 0,86$  -

The member satisfies the stability check.

### 14.2.9. Rezne sile – dijagonalna ispuna 1 konzolnog rešetkastog nosača 3

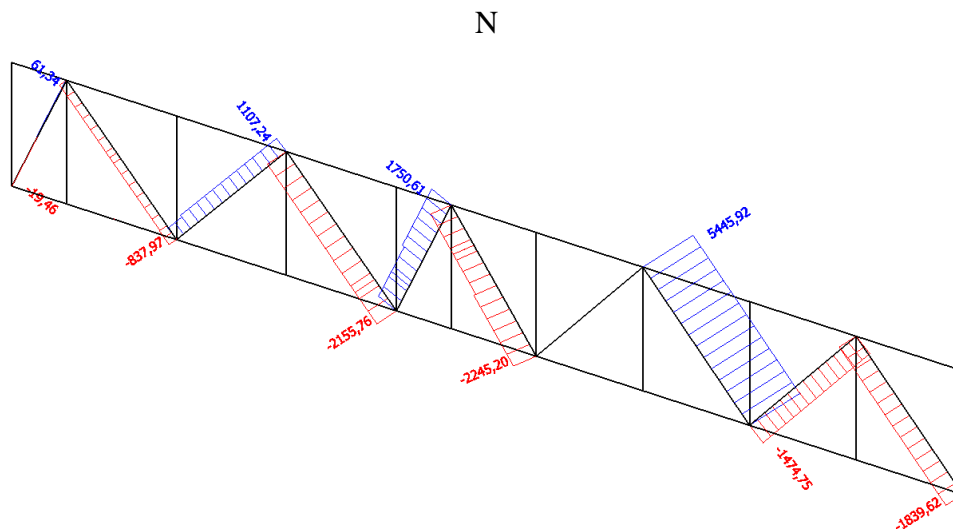

Slika 14.14. Prikaz reznih sila – dijagonalna ispuna konzolnog rešetkastog nosača

-poprečni presjek nosača

Name	Konzolni nosač 3 - dijagonalna ispuna 1	
Type	SHS400/400/12.5	
Source description	British Standard / BS 5950 part 1 : 1990 & EN 10210-2	
Item material	S 355	
Fabrication	cold formed	
Flexural buckling y-y	c	
Flexural buckling z-z	c	
Lateral torsional buckling	Default	
Use 2D FEM analysis	*	
A [m <sup>2</sup> ]	1,9200e-02	
A <sub>y, z</sub> [m <sup>2</sup> ]	9,5509e-03	9,5509e-03
I <sub>y, z</sub> [m <sup>4</sup> ]	4,7840e-04	4,7840e-04
I <sub>w</sub> [m <sup>6</sup> ], I <sub>t</sub> [m <sup>4</sup> ]	1,0667e-05	7,3910e-04
W <sub>el y, z</sub> [m <sup>3</sup> ]	2,3920e-03	2,3920e-03
W <sub>pl y, z</sub> [m <sup>3</sup> ]	2,7636e-03	2,7636e-03
d <sub>y, z</sub> [mm]	0	0
c <sub>YUCS, ZUCS</sub> [mm]	200	200
α [deg]	0,00	
A <sub>L, D</sub> [m <sup>2</sup> /m]	1,5700e+00	3,0569e+00
M <sub>ply +, -</sub> [Nm]	9,81e+05	9,81e+05
M <sub>plz +, -</sub> [Nm]	9,81e+05	9,81e+05

Slika 14.15. Prikaz geometrijskih karakteristika nosača

### 14.2.10. Dimenzioniranje – dijagonalna ispuna 1 konzolnog rešetkastog nosača 3

Member B1055	11,688 m	SHS400/400/12.5	S 355	GSN 26	0,80 -
--------------	----------	-----------------	-------	--------	--------

Note: EN 1993-1-3 article 1.1(3) specifies that this part does not apply to cold formed CHS and RHS sections. The default EN 1993-1-1 code check is executed instead of the EN 1993-1-3 code check.

Partial safety factors	
Gamma M0 for resistance of cross-sections	1,00
Gamma M1 for resistance to instability	1,00
Gamma M2 for resistance of net sections	1,25

Material		
Yield strength fy	355,0	MPa
Ultimate strength fu	510,0	MPa
Fabrication	Cold formed	

....:SECTION CHECK:....

The critical check is on position 0.000 m

Internal forces	Calculated	Unit
N,Ed	5445,92	kN
Vy,Ed	0,00	kN
Vz,Ed	0,00	kN
T,Ed	0,00	kNm
My,Ed	0,00	kNm
Mz,Ed	0,00	kNm

Tension check

According to EN 1993-1-1 article 6.2.3 and formula (6.5)

A	1,9200e-02	m <sup>2</sup>
Npl,Rd	6816,00	kN
Nu,Rd	7050,24	kN
Nt,Rd	6816,00	kN
Unity check	0,80	-

The member satisfies the section check.

....:STABILITY CHECK:....

The member satisfies the stability check.

-iskoristivost elementa na GSN – 80 %

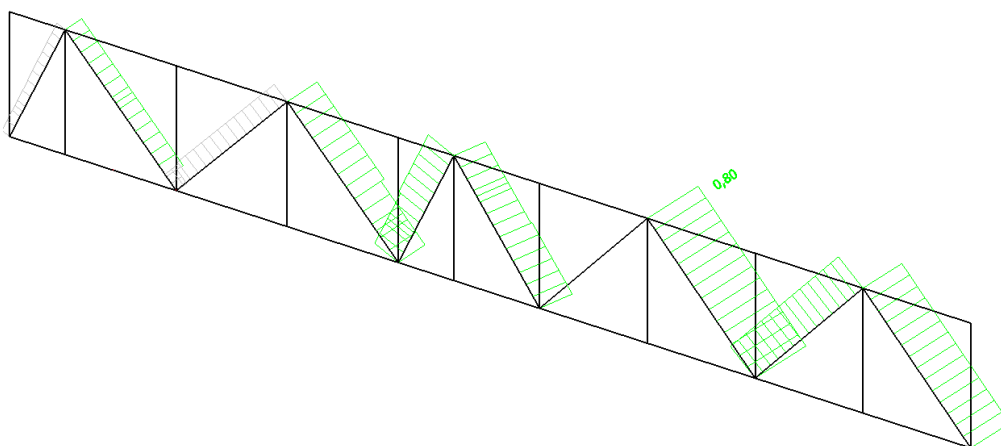

Slika 14.16. Prikaz iskoristivosti dijagonalne ispune konzolnog rešetkastog nosača

14.2.11. Rezne sile – dijagonalna ispuna 2 konzolnog rešetkastog nosača 3

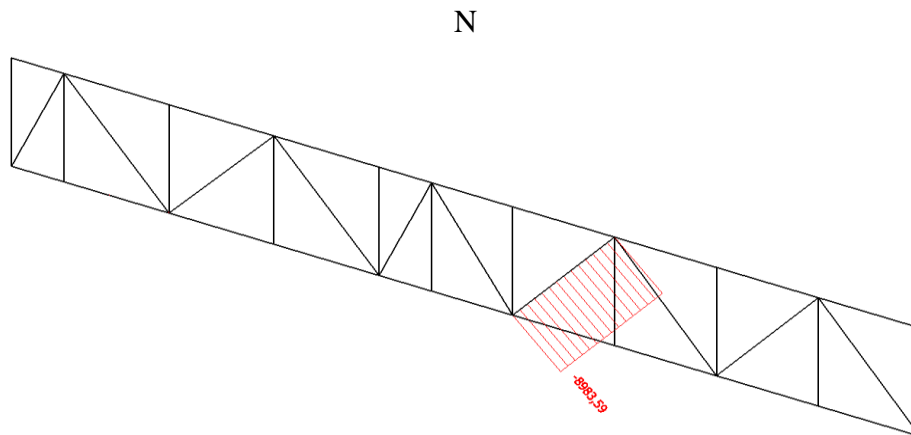

Slika 14.17. Prikaz reznih sila – dijagonalna ispuna konzolnog rešetkastog nosača -poprečni presjek nosača

Name	Konzolni nosač 3 - dijagonalna ispuna 2	
Type	SHS400/400/28.0	
Source description	Corus Advance Sections	
Item material	S 355	
Fabrication	rolled	
Flexural buckling y-y	a	
Flexural buckling z-z	a	
Lateral torsional buckling	Default	
Use 2D FEM analysis	x	

A [m <sup>2</sup> ]	3,9600e-02	
A <sub>y, z</sub> [m <sup>2</sup> ]	2,0147e-02	2,0147e-02
I <sub>y, z</sub> [m <sup>4</sup> ]	8,9000e-04	8,9000e-04
I <sub>w</sub> [m <sup>4</sup> ], I <sub>t</sub> [m <sup>4</sup> ]	2,3893e-05	1,4900e-03
W <sub>el y, z</sub> [m <sup>3</sup> ]	4,4500e-03	4,4500e-03
W <sub>pl y, z</sub> [m <sup>3</sup> ]	5,5582e-03	5,5582e-03
d <sub>y, z</sub> [mm]	0	0
c <sub>YUCS, ZUCS</sub> [mm]	200	200
α [deg]	0,00	
A <sub>L, D</sub> [m <sup>2</sup> /m]	1,5000e+00	2,8794e+00
M <sub>ply +, -</sub> [Nm]	1,97e+06	1,97e+06
M <sub>plz +, -</sub> [Nm]	1,97e+06	1,97e+06

Slika 14.18. Prikaz geometrijskih karakteristika nosača

-iskoristivost elementa na GSN – 98 %

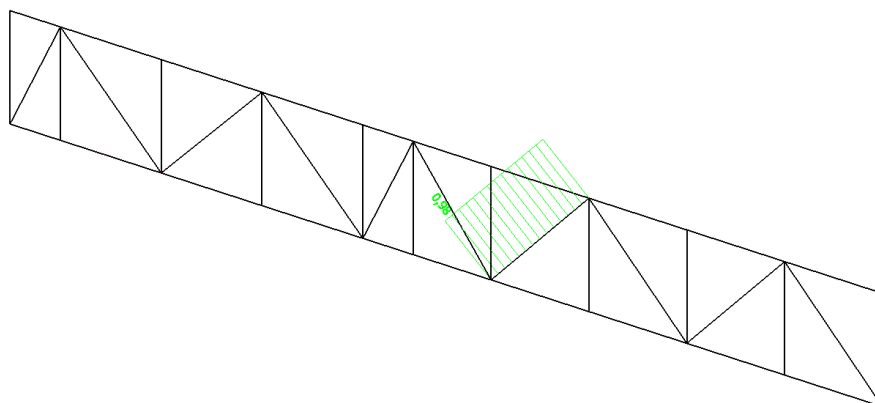

Slika 14.19. Prikaz iskoristivosti dijagonalne ispune konzolnog rešetkastog nosača

### 14.2.12. Dimenzioniranje – dijagonalna ispuna 2 konzolnog rešetkastog nosača 3

Member B1053	11,688 m	SHS400/400/28.0	S 355	GSN 26	0,98 -
--------------	----------	-----------------	-------	--------	--------

Partial safety factors	
Gamma M0 for resistance of cross-sections	1,00
Gamma M1 for resistance to instability	1,00
Gamma M2 for resistance of net sections	1,25

Material	
Yield strength fy	355,0 MPa
Ultimate strength fu	490,0 MPa
Fabrication	Rolled

....:SECTION CHECK:....

The critical check is on position 0.000 m

Internal forces	Calculated	Unit
N,Ed	-8983,59	kN
Vy,Ed	0,00	kN
Vz,Ed	0,00	kN
T,Ed	0,00	kNm
My,Ed	0,00	kNm
Mz,Ed	0,00	kNm

**Classification for cross-section design**

According to EN 1993-1-1 article 5.5.2

**Classification of Internal Compression parts**

According to EN 1993-1-1 Table 5.2 Sheet 1

Maximum width-to-thickness ratio	11,29
Class 1 Limit	26,85
Class 2 Limit	30,92
Class 3 Limit	34,17

=> Section classified as Class 1 for cross-section design

**Compression check**

According to EN 1993-1-1 article 6.2.4 and formula (6.9)

A	3,9600e-02	m <sup>2</sup>
Nc,Rd	14058,00	kN
Unity check	0,64	-

The member satisfies the section check.

....:STABILITY CHECK:....

**Classification for member buckling design**

Decisive position for stability classification: 0,000 m

**Classification of Internal Compression parts**

According to EN 1993-1-1 Table 5.2 Sheet 1

Maximum width-to-thickness ratio	11,29
Class 1 Limit	26,85
Class 2 Limit	30,92
Class 3 Limit	34,17

=> Section classified as Class 1 for member buckling design

**Flexural Buckling check**

According to EN 1993-1-1 article 6.3.1.1 and formula (6.46)

Buckling parameters	yy	zz
Sway type	sway	non-sway
System length L	11,688	11,688
Buckling factor k	1,00	1,00
Buckling length Lcr	11,688	11,688
Critical Euler load Ncr	13503,67	13503,67
Slenderness Lambda	77,96	77,96
Relative slenderness Lambda,rel	1,02	1,02
Limit slenderness Lambda,rel,0	0,20	0,20
Buckling curve	a)	a
Imperfection Alpha	0,21	0,21
Reduction factor Chi	0,65	0,65
Buckling resistance Nb,Rd	9157,14	9157,14

Flexural Buckling verification	
Cross-section area A	3,9600e-02 m <sup>2</sup>
Buckling resistance Nb,Rd	9157,14 kN
Unity check	0,98 -

**Torsional(-Flexural) Buckling check**

According to EN 1993-1-1 article 6.3.1.1 and formula (6.46)

**Note:** The cross-section concerns a RHS section which is not susceptible to Torsional(-Flexural) Buckling.

The member satisfies the stability check.

## 15. PRORAČUN GLAVNIH NOSAČA UNUTARNJIH STUBIŠTA

### 15.1. Vertikalni pomak glavnog nosača – stubište 1 (1. etaža)

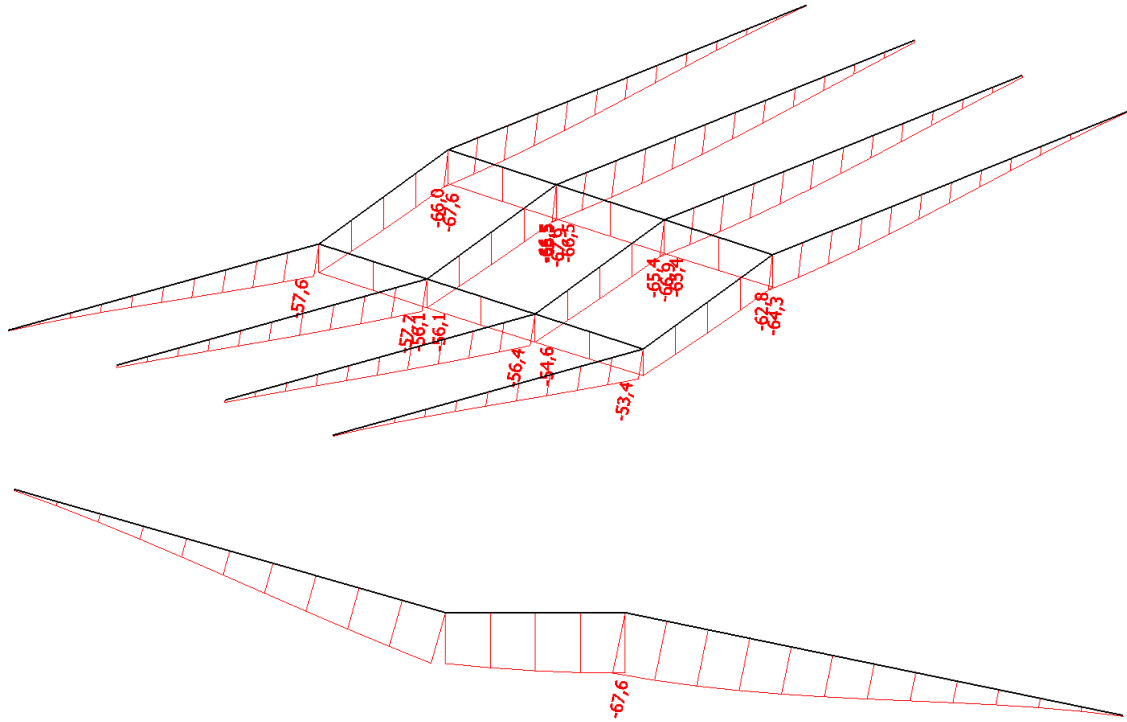

Slika 15.1. Prikaz vertikalnog pomaka glavnog nosača stubišta

Dopušteni vertikalni pomak (progib):

$$u_{dop} = \frac{l}{300} = \frac{22,10 \cdot 1000}{300} = 74,0 \text{ mm}$$

$$u_z = 67,6 \text{ mm} < u_{z,dop} = 74,0 \text{ mm} \quad \text{Zadovoljava}$$

-iskoristivost na GSU -  $67,6 \text{ mm} / 74,0 \text{ mm} = 0,91 = 91\%$



## 15.2. Dimenziniranje glavnog nosača – stubište 1 (1. etaža)

### 15.2.1. Rezne sile – glavni gredni nosač stubišta 1 (1. etaža)

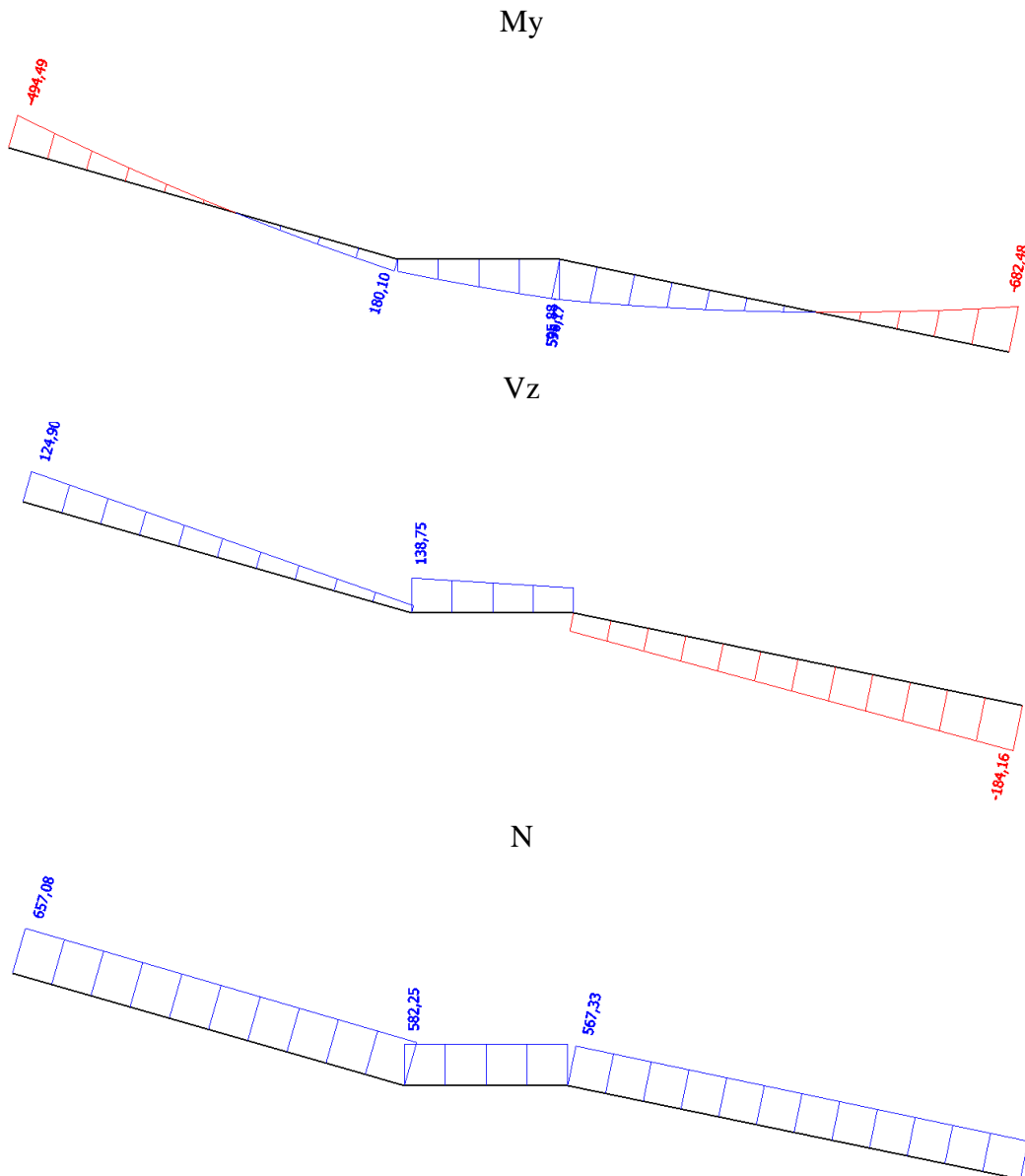

Slika 15.2. Prikaz reznih sila glavnog nosača stubišta

-poprečni presjek nosača

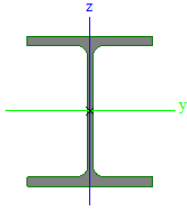
Name	Glavni nosač - stepenice 1 (1. etaža)	
Type	HEB360	
Source description	Profil Arbed / Structural shapes / Edition Octobre 1995	
Item material	S 355	
Fabrication	rolled	
Flexural buckling y-y	b	
Flexural buckling z-z	c	
Lateral torsional buckling	Default	
Use 2D FEM analysis	*	
		
A [m <sup>2</sup> ]	1,8060e-02	
A y, z [m <sup>2</sup> ]	1,2975e-02	4,7491e-03
I y, z [m <sup>4</sup> ]	4,3190e-04	1,0140e-04
I w [m <sup>5</sup> ], t [m <sup>4</sup> ]	2,8833e-06	2,9250e-06
Wey, z [m <sup>3</sup> ]	2,4000e-03	6,7610e-04
Wpl y, z [m <sup>3</sup> ]	2,6830e-03	1,0320e-03
d y, z [mm]	0	0
c YUCS, ZUCS [mm]	150	180
α [deg]	0,00	
A L, D [m <sup>2</sup> /m]	1,8500e+00	1,8484e+00
Mply +, - [Nm]	9,53e+05	9,53e+05
Mplz +, - [Nm]	3,67e+05	3,67e+05

Slika 15.3. Prikaz geometrijskih karakteristika nosača

-iskoristivost elementa na GSN – 84 %

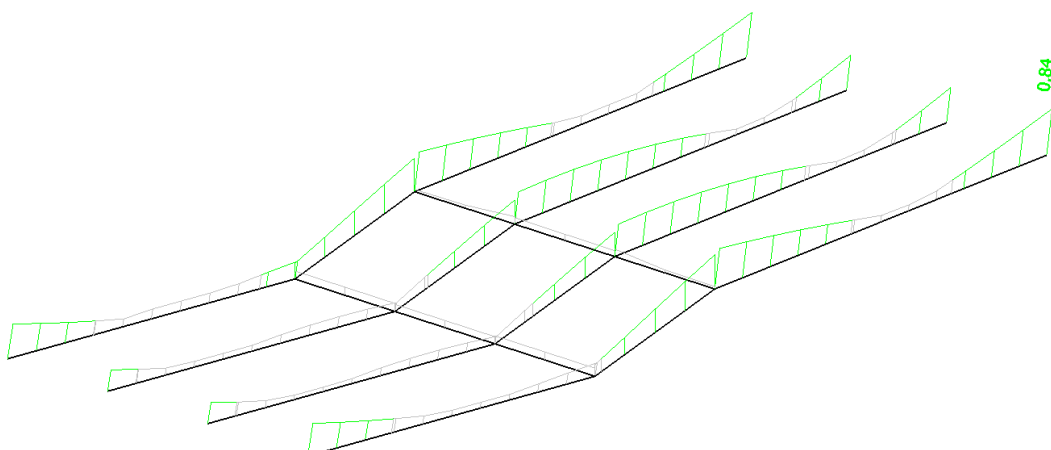

Slika 15.4. Prikaz iskoristivosti glavnog nosača stubišta

### 15.2.2. Dimenzioniranje – glavni gredni nosač stubišta 1 (1. etaža)

Member B950	9,904 m	HEB360	S 355	GSN 2	0,84 -
-------------	---------	--------	-------	-------	--------

Partial safety factors	
Gamma M0 for resistance of cross-sections	1,00
Gamma M1 for resistance to instability	1,00
Gamma M2 for resistance of net sections	1,25

Material		
Yield strength $f_y$	355,0	MPa
Ultimate strength $f_u$	490,0	MPa
Fabrication	Rolled	

....SECTION CHECK:....

The critical check is on position 9.904 m

Internal forces	Calculated	Unit
N,Ed	544,62	kN
V <sub>y</sub> ,Ed	-1,05	kN
V <sub>z</sub> ,Ed	-184,16	kN
T,Ed	-0,07	kNm
M <sub>y</sub> ,Ed	-682,48	kNm
M <sub>z</sub> ,Ed	-3,83	kNm

Classification for cross-section design

According to EN 1993-1-1 article 5.5.2

Classification of Internal Compression parts

According to EN 1993-1-1 Table 5.2 Sheet 1

Maximum width-to-thickness ratio	20,88
Class 1 Limit	68,61
Class 2 Limit	79,10
Class 3 Limit	136,92

=> Internal Compression parts Class 1

Classification of Outstand Flanges

According to EN 1993-1-1 Table 5.2 Sheet 2

Maximum width-to-thickness ratio	5,19
Class 1 Limit	7,32
Class 2 Limit	8,14
Class 3 Limit	11,23

=> Outstand Flanges Class 1

=> Section classified as Class 1 for cross-section design

Tension check

According to EN 1993-1-1 article 6.2.3 and formula (6.5)

A	1,8060e-02	m <sup>2</sup>
N <sub>pl,Rd</sub>	6411,30	kN
N <sub>u,Rd</sub>	6371,57	kN
N <sub>t,Rd</sub>	6371,57	kN
Unity check	0,09	-

Bending moment check for M<sub>y</sub>

According to EN 1993-1-1 article 6.2.5 and formula (6.12),(6.13)

W <sub>pl,y</sub>	2,6830e-03	m <sup>3</sup>
M <sub>pl,y,Rd</sub>	952,47	kNm
Unity check	0,72	-

Bending moment check for M<sub>z</sub>

According to EN 1993-1-1 article 6.2.5 and formula (6.12),(6.13)

W <sub>pl,z</sub>	1,0320e-03	m <sup>3</sup>
M <sub>pl,z,Rd</sub>	366,36	kNm
Unity check	0,01	-

Shear check for V<sub>y</sub>

According to EN 1993-1-1 article 6.2.6 and formula (6.17)

E <sub>t</sub>	1,20	
A <sub>v</sub>	1,3994e-02	m <sup>2</sup>
V <sub>pl,y,Rd</sub>	2868,15	kN
Unity check	0,00	-

Shear check for V<sub>z</sub>

According to EN 1993-1-1 article 6.2.6 and formula (6.17)

E <sub>t</sub>	1,20	
A <sub>v</sub>	6,0563e-03	m <sup>2</sup>
V <sub>pl,z,Rd</sub>	1241,29	kN
Unity check	0,15	-

Tau,Rd	205,0	MPa
Unity check	0,00	-

**Note:** The unity check for torsion is lower than the limit value of 0,05. Therefore torsion is considered as insignificant and is ignored in the combined checks.

**Combined bending, axial force and shear force check**

According to EN 1993-1-1 article 6.2.9.1 and formula (6.41)

Mpl,y,Rd	952,47	kNm
Alpha	2,00	
Mpl,z,Rd	366,36	kNm
Beta	1,00	

Unity check (6.41) = 0,51 + 0,01 = 0,52 -

**Note:** Since the shear forces are less than half the plastic shear resistances their effect on the moment resistances is neglected.

**Note:** Since the axial force satisfies both criteria (6.33) and (6.34) of EN 1993-1-1 article 6.2.9.1(4) its effect on the moment resistance about the y-y axis is neglected.

**Note:** Since the axial force satisfies criteria (6.35) of EN 1993-1-1 article 6.2.9.1(4) its effect on the moment resistance about the z-z axis is neglected.

The member satisfies the section check.

....:STABILITY CHECK:...

**Classification for member buckling design**

Decisive position for stability classification: 0,000 m

**Classification of Internal Compression parts**

According to EN 1993-1-1 Table 5.2 Sheet 1

Maximum width-to-thickness ratio	20,88
Class 1 Limit	70,95
Class 2 Limit	81,79
Class 3 Limit	145,74

=> Internal Compression parts Class 1

**Classification of Outstand Flanges**

According to EN 1993-1-1 Table 5.2 Sheet 2

Maximum width-to-thickness ratio	5,19
Class 1 Limit	7,32
Class 2 Limit	8,14
Class 3 Limit	11,25

=> Outstand Flanges Class 1

=> Section classified as Class 1 for member buckling design

**Lateral Torsional Buckling check**

According to EN 1993-1-1 article 6.3.2.1 & 6.3.2.2 and formula (6.54)

LTB parameters		
Method for LTB curve	General case	
Cross-section plastic modulus Wpl,y	2,6830e-03	m <sup>3</sup>
Elastic critical moment Mcr	2044,80	kNm
Relative slenderness Lambda,rel,LT	0,68	
Limit slenderness Lambda,rel,LT,0	0,20	
LTB curve	a	
Imperfection Alpha,LT	0,21	
Reduction factor Chi,LT	0,86	
Design buckling resistance Mb,Rd	815,13	kNm
Unity check	0,84	-

Mcr parameters		
LTB length L	9,904	m
Influence of load position	no influence	
Correction factor k	1,00	
Correction factor kw	1,00	
LTB moment factor C1	2,56	
LTB moment factor C2	0,18	
LTB moment factor C3	1,00	
Shear center distance d,z	0	mm
Distance of load application z,g	0	mm
Mono-symmetry constant beta,y	0	mm
Mono-symmetry constant z,j	0	mm

**Note:** C parameters are determined according to ECSS 119 2006 / Galea 2002.

**Bending and axial tension check**

According to EN 1993-1-3 article 6.3

Design tension force N,Ed	544,62	kN
Design bending moment My,Ed	-682,48	kNm
Design bending moment Mz,Ed	-3,83	kNm
Tension resistance Nt,Rd	6371,57	kN
Bending resistance Mb,y,Rd	815,13	kNm
Bending resistance Mc,z,Rd,com	366,36	kNm

Unity check = 0,84 + 0,01 - 0,09 = 0,76 -

**Shear Buckling check**

According to EN 1993-1-5 article 5 & 7.1 and formula (5.10) & (7.1)

Shear Buckling parameters		
Buckling field length a	9,904	m
Web	unstiffened	
Web height hw	315	mm
Web thickness t	13	mm
Material coefficient epsilon	0,81	
Shear correction factor Eta	1,20	

Shear Buckling verification		
Web slenderness hw/t	25,20	
Web slenderness limit	48,82	

**Note:** The web slenderness is such that Shear Buckling effects may be ignored according to EN 1993-1-5 article 5.1(2).  
The member satisfies the stability check.

### 15.3. Vertikalni pomak glavnog nosača – stubište 1 (2. etaža)

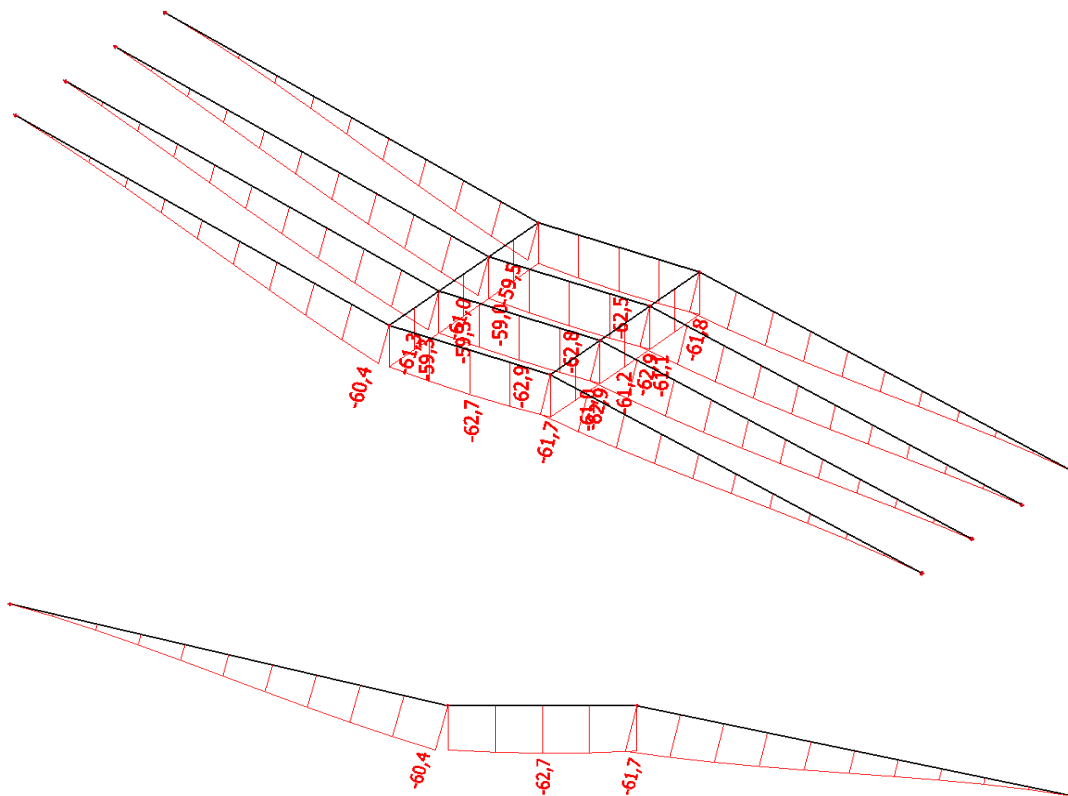

Slika 15.5. Prikaz vertikalnog pomaka glavnog nosača stubišta

Dopušteni vertikalni pomak (progib):

$$u_{dop} = \frac{l}{300} = \frac{20,70 \cdot 1000}{300} = 69,0 \text{ mm}$$

$$u_z = 62,7 \text{ mm} < u_{z,dop} = 69,0 \text{ mm} \quad \text{Zadovoljava}$$

-iskoristivost na GSU -  $62,7 \text{ mm} / 69,0 \text{ mm} = 0,90 = 90\%$

## 15.4. Dimenziniranje glavnog nosača – stubište 1 (2. etaža)

### 15.4.1. Rezne sile – glavni gredni nosač stubišta 1 (2. etaža)

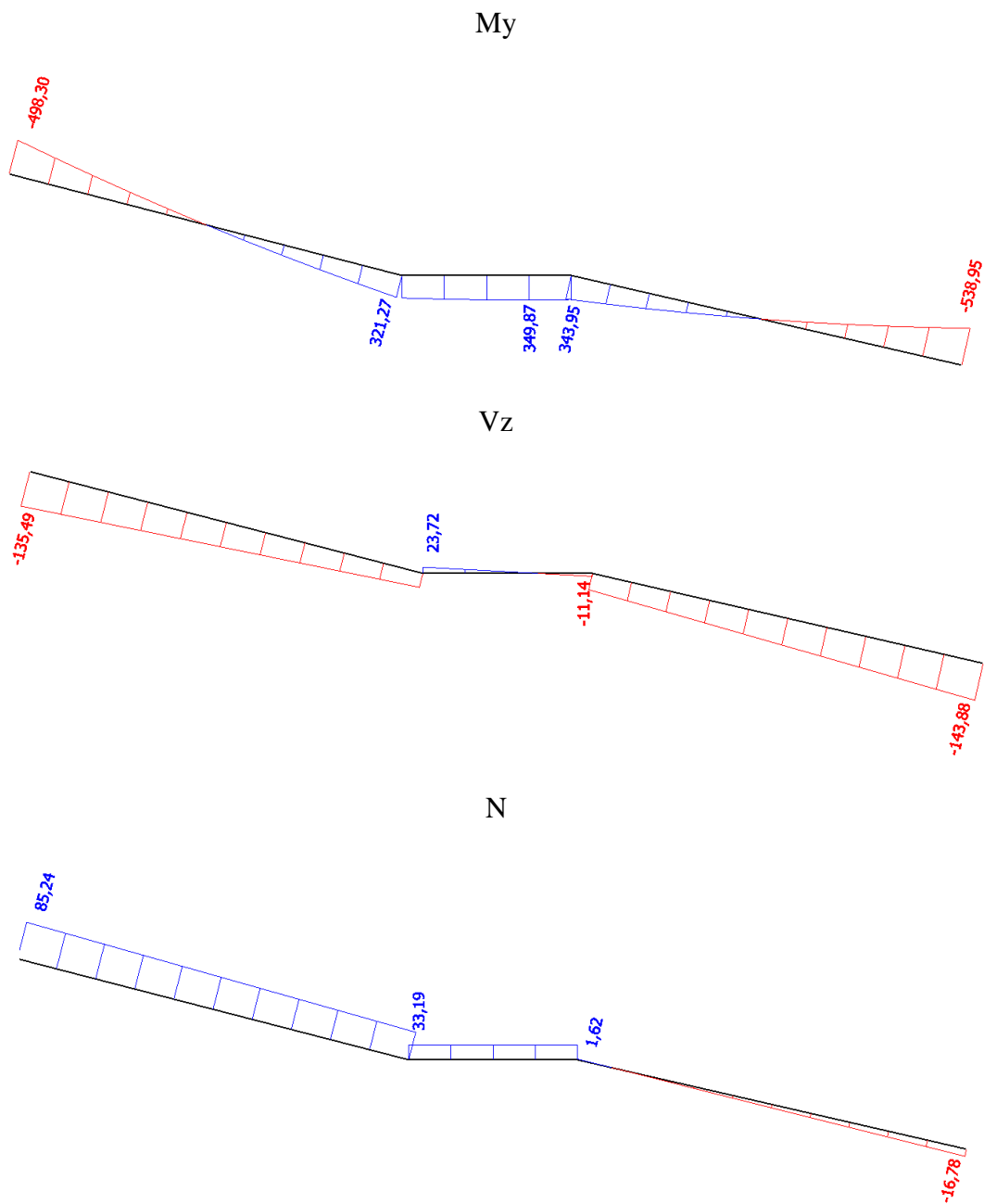

Slika 15.6. Prikaz reznih sila glavnog nosača stubišta

-poprečni presjek nosača

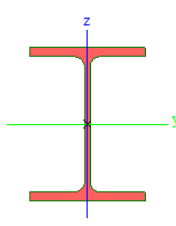
Name	Glavni nosač - stepenice 2 ( 2. etaža)	
Type	HEB400	
Source description	Profil Arbed / Structural shapes / Edition Octobre 1995	
Item material	S 355	
Fabrication	rolled	
Flexural buckling y-y	a	
Flexural buckling z-z	b	
Lateral torsional buckling	Default	
Use 2D FEM analysis	x	
		
A [m <sup>2</sup> ]	1,9780e-02	
A <sub>y, z</sub> [m <sup>2</sup> ]	1,3871e-02	5,6483e-03
I <sub>y, z</sub> [m <sup>4</sup> ]	5,7680e-04	1,0820e-04
I <sub>w</sub> [m <sup>6</sup> ], I <sub>t</sub> [m <sup>4</sup> ]	3,8172e-06	3,5570e-06
W <sub>el y, z</sub> [m <sup>3</sup> ]	2,8840e-03	7,2130e-04
W <sub>pl y, z</sub> [m <sup>3</sup> ]	3,2320e-03	1,1040e-03
d <sub>y, z</sub> [mm]	0	0
c <sub>YUCS, ZUCS</sub> [mm]	150	200
α [deg]	0,00	
A <sub>L, D</sub> [m <sup>2</sup> /m]	1,9300e+00	1,9264e+00
M <sub>ply +, -</sub> [Nm]	1,15e+06	1,15e+06
M <sub>plz +, -</sub> [Nm]	3,92e+05	3,92e+05

Slika 15.7. Prikaz geometrijskih karakteristika nosača

-iskoristivost elementa na GSN – 89 %

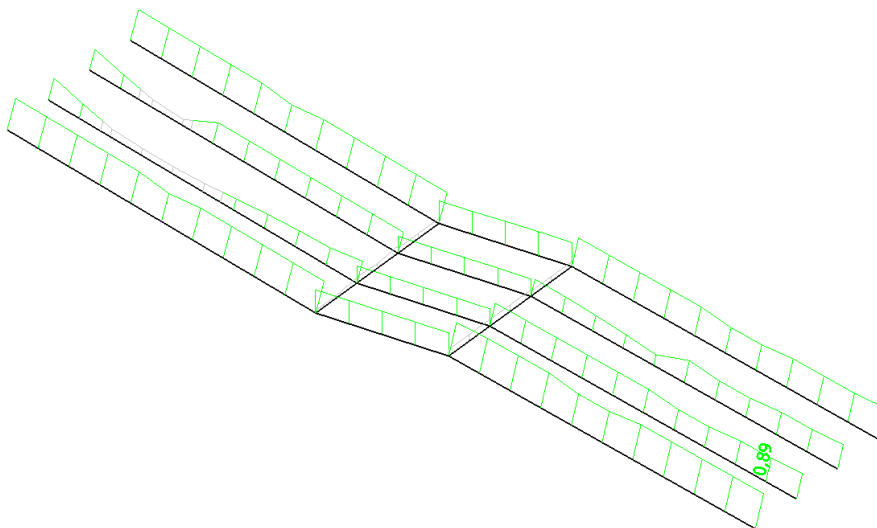

Slika 15.8. Prikaz iskoristivosti glavnog nosača stubišta

## 15.4.2. Dimenzioniranje – glavni gredni nosač stubišta 1 (2. etaža)

Member B2432	8,515 m	HEA360	S 355	GSN 2	0,89 -
--------------	---------	--------	-------	-------	--------

Partial safety factors	
Gamma M0 for resistance of cross-sections	1,00
Gamma M1 for resistance to instability	1,00
Gamma M2 for resistance of net sections	1,25

Material		
Yield strength $f_y$	355,0	MPa
Ultimate strength $f_u$	490,0	MPa
Fabrication	Rolled	

.....SECTION CHECK:....

The critical check is on position 8.515 m

Internal forces	Calculated	Unit
N,Ed	-16,78	kN
V <sub>y</sub> ,Ed	-3,84	kN
V <sub>z</sub> ,Ed	-143,88	kN
T,Ed	-0,04	kNm
M <sub>y</sub> ,Ed	-538,95	kNm
M <sub>z</sub> ,Ed	-17,04	kNm

#### Classification for cross-section design

According to EN 1993-1-1 article 5.5.2

#### Classification of Internal Compression parts

According to EN 1993-1-1 Table 5.2 Sheet 1

Maximum width-to-thickness ratio	26,10
Class 1 Limit	57,35
Class 2 Limit	66,04
Class 3 Limit	99,45

=> Internal Compression parts Class 1

#### Classification of Outstand Flanges

According to EN 1993-1-1 Table 5.2 Sheet 2

Maximum width-to-thickness ratio	6,74
Class 1 Limit	7,32
Class 2 Limit	8,14
Class 3 Limit	11,31

=> Outstand Flanges Class 1

=> Section classified as Class 1 for cross-section design

#### Compression check

According to EN 1993-1-1 article 6.2.4 and formula (6.9)

A	1,4300e-02	m <sup>2</sup>
N <sub>c,Rd</sub>	5076,50	kN
Unity check	0,00	-

#### Bending moment check for M<sub>y</sub>

According to EN 1993-1-1 article 6.2.5 and formula (6.12),(6.13)

W <sub>pl,y</sub>	2,0875e-03	m <sup>3</sup>
M <sub>pl,y,Rd</sub>	741,06	kNm
Unity check	0,73	-

#### Bending moment check for M<sub>z</sub>

According to EN 1993-1-1 article 6.2.5 and formula (6.12),(6.13)

W <sub>pl,z</sub>	8,0417e-04	m <sup>3</sup>
M <sub>pl,z,Rd</sub>	285,48	kNm
Unity check	0,06	-

#### Shear check for V<sub>y</sub>

According to EN 1993-1-1 article 6.2.6 and formula (6.17)

Eta	1,20	
A <sub>v</sub>	1,0870e-02	m <sup>2</sup>
V <sub>pl,y,Rd</sub>	2227,91	kN
Unity check	0,00	-

#### Shear check for V<sub>z</sub>

According to EN 1993-1-1 article 6.2.6 and formula (6.17)

Eta	1,20	
A <sub>v</sub>	4,9200e-03	m <sup>2</sup>
V <sub>pl,z,Rd</sub>	1008,40	kN
Unity check	0,14	-



**Note:** The unity check for torsion is lower than the limit value of 0,05. Therefore torsion is considered as insignificant and is ignored in the combined checks.

**Combined bending, axial force and shear force check**  
According to EN 1993-1-1 article 6.2.9.1 and formula (6.41)

Mpl,y,Rd	741,06	kNm
Alpha	2,00	
Mpl,z,Rd	285,48	kNm
Beta	1,00	

Unity check (6.41) = 0,53 + 0,06 = 0,59 -

**Note:** Since the shear forces are less than half the plastic shear resistances their effect on the moment resistances is neglected.

**Note:** Since the axial force satisfies both criteria (6.33) and (6.34) of EN 1993-1-1 article 6.2.9.1(4) its effect on the moment resistance about the y-y axis is neglected.

**Note:** Since the axial force satisfies criteria (6.35) of EN 1993-1-1 article 6.2.9.1(4) its effect on the moment resistance about the z-z axis is neglected.

The member satisfies the section check.

.....**STABILITY CHECK:**.....

**Classification for member buckling design**

Decisive position for stability classification: 0,000 m

**Classification of Internal Compression parts**

According to EN 1993-1-1 Table 5.2 Sheet 1

Maximum width-to-thickness ratio	26,10
Class 1 Limit	58,63
Class 2 Limit	67,59
Class 3 Limit	101,06

=> Internal Compression parts Class 1

**Classification of Outstand Flanges**

According to EN 1993-1-1 Table 5.2 Sheet 2

Maximum width-to-thickness ratio	6,74
Class 1 Limit	7,32
Class 2 Limit	8,14
Class 3 Limit	11,36

=> Outstand Flanges Class 1

=> Section classified as Class 1 for member buckling design

**Flexural Buckling check**

According to EN 1993-1-1 article 6.3.1.1 and formula (6.46)

Buckling parameters	yy	zz	
Sway type	sway	non-sway	
System length L	8,515	8,515	m
Buckling factor k	1,00	0,12	
Buckling length Lcr	8,515	1,000	m
Critical Euler load Ncr	9462,57	163529,48	kN
Slenderness Lambda	55,97	13,46	
Relative slenderness Lambda,rel	0,73	0,18	
Limit slenderness Lambda,rel,0	0,20	0,20	

**Note:** The slenderness or compression force is such that Flexural Buckling effects may be ignored according to EN 1993-1-1 article 6.3.1.2(4).

**Torsional(-Flexural) Buckling check**

According to EN 1993-1-1 article 6.3.1.1 and formula (6.46)

**Note:** For this I-section the Torsional(-Flexural) buckling resistance is higher than the resistance for Flexural buckling. Therefore Torsional(-Flexural) buckling is not printed on the output.

**Lateral Torsional Buckling check**

According to EN 1993-1-1 article 6.3.2.1 & 6.3.2.2 and formula (6.54)

LTB parameters		
Method for LTB curve	General case	
Cross-section plastic modulus Wpl,y	2,0875e+03	m <sup>3</sup>
Elastic critical moment Mcr	1869,60	kNm
Relative slenderness Lambda,rel,LT	0,63	
Limit slenderness Lambda,rel,LT,0	0,20	
LTB curve	a	
Imperfection Alpha,LT	0,21	
Reduction factor Chi,LT	0,88	
Design buckling resistance Mb,Rd	650,97	kNm
Unity check	0,83	-

Mcr parameters		
LTB length L	8,515	m
Influence of load position	no influence	
Correction factor k	1,00	
Correction factor kw	1,00	
LTB moment factor C1	2,91	
LTB moment factor C2	0,15	
LTB moment factor C3	1,00	
Shear center distance d,z	0	mm

\*Student version\* \*Student version\* \*Student version\* \*Student version\* \*Student version\*

Mcr parameters		
Distance of load application z,g	0	mm
Mono-symmetry constant beta,y	0	mm
Mono-symmetry constant z,j	0	mm

Note: C parameters are determined according to ECCS 119 2006 / Galea 2002.

**Bending and axial compression check**

According to EN 1993-1-1 article 6.3.3 and formula (6.61),(6.62)

Bending and axial compression check parameters		
Interaction method	alternative method 1	
Cross-section area A	1,4300e-02	m <sup>2</sup>
Cross-section plastic modulus Wpl,y	2,0875e-03	m <sup>3</sup>
Cross-section plastic modulus Wpl,z	8,0417e-04	m <sup>3</sup>
Design compression force N,Ed	16,78	kN
Design bending moment (maximum) My,Ed	-538,95	kNm
Design bending moment (maximum) Mz,Ed	-17,04	kNm
Characteristic compression resistance N,Rk	5076,50	kN
Characteristic moment resistance My,Rk	741,06	kNm
Characteristic moment resistance Mz,Rk	285,48	kNm
Reduction factor Chi,y	1,00	
Reduction factor Chi,z	1,00	
Reduction factor Chi,LT	0,88	
Interaction factor k,yy	1,00	
Interaction factor k,yz	0,91	
Interaction factor k,zy	0,63	
Interaction factor k,zz	0,61	

Maximum moment My,Ed is derived from beam B2432 position 8,515 m.

Maximum moment Mz,Ed is derived from beam B2432 position 8,515 m.

Interaction method 1 parameters		
Critical Euler load N,cr,y	9462,57	kN
Critical Euler load N,cr,z	163529,48	kN
Elastic critical load N,cr,T	6369,23	kN
Cross-section plastic modulus Wpl,y	2,0875e-03	m <sup>3</sup>
Cross-section elastic modulus Wel,y	1,8900e-03	m <sup>3</sup>
Cross-section plastic modulus Wpl,z	8,0417e-04	m <sup>3</sup>
Cross-section elastic modulus Wel,z	5,2600e-04	m <sup>3</sup>
Second moment of area Iy	3,3100e-04	m <sup>4</sup>
Second moment of area Iz	7,8900e-05	m <sup>4</sup>
Torsional constant It	1,4900e-06	m <sup>4</sup>
Method for equivalent moment factor C,my,0	Table A.2 Line 2 (General)	
Design bending moment (maximum) My,Ed	-538,95	kNm
Maximum relative deflection delta,z	9,8	mm
Equivalent moment factor C,my,0	1,00	
Method for equivalent moment factor C,mz,0	Table A.2 Line 1 (Linear)	
Ratio of end moments Psi,z	-0,92	
Equivalent moment factor C,mz,0	0,60	
Factor mu,y	1,00	
Factor mu,z	1,00	
Factor epsilon,y	243,03	
Factor a,LT	1,00	
Critical moment for uniform bending Mcr,0	641,72	kNm
Relative slenderness Lambda,rel,0	1,07	
Limit relative slenderness Lambda,rel,0,lim	0,34	
Equivalent moment factor C,my	1,00	
Equivalent moment factor C,mz	0,60	
Equivalent moment factor C,mLT	1,00	
Factor b,LT	0,03	
Factor c,LT	1,90	
Factor d,LT	1,76	
Factor e,LT	14,91	
Factor w,y	4,10	
Factor w,z	1,50	
Factor n,pl	0,00	
Maximum relative slenderness Lambda,rel,max	0,73	
Factor C,yy	1,00	
Factor C,yz	0,46	
Factor C,zy	0,82	
Factor C,zz	0,98	

Unity check (6.61) = 0,00 + 0,83 + 0,05 = 0,89 -

Unity check (6.62) = 0,00 + 0,52 + 0,04 = 0,56 -

**Shear Buckling check**

According to EN 1993-1-5 article 5 & 7.1 and formula (5.10) & (7.1)

Shear Buckling parameters		
Buckling field length a	8,515	m
Web	unstiffened	
Web height hw	315	mm
Web thickness t	10	mm
Material coefficient epsilon	0,81	
Shear correction factor Eta	1,20	

Shear Buckling verification		
Web slenderness hw/t	31,50	
Web slenderness limit	48,82	

Note: The web slenderness is such that Shear Buckling effects may be ignored according to EN 1993-1-5 article 5.1(2).

The member satisfies the stability check.

### 15.5. Vertikalni pomak glavnog nosača – stubište 2 (2. etaža)

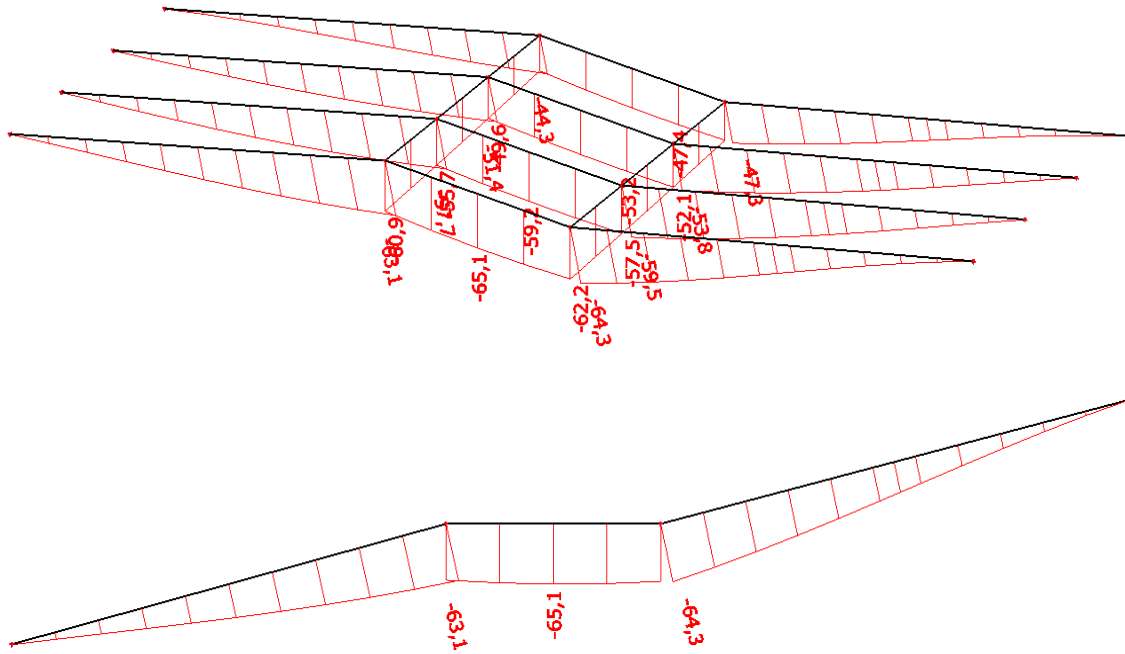

Slika 15.9. Prikaz vertikalnog pomaka glavnog nosača stubišta

Dopušteni vertikalni pomak (progib):

$$u_{dop} = \frac{l}{300} = \frac{21,30 \cdot 1000}{300} = 71,0 \text{ mm}$$

$$u_z = 65,1 \text{ mm} < u_{z,dop} = 71,0 \text{ mm} \quad \text{Zadovoljava}$$

$$\text{-iskoristivost na GSU - } 65,1 \text{ mm} / 71,0 \text{ mm} = 0,92 = 92\%$$

## 15.6. Dimenziniranje glavnog nosača – stubište 2 (2. etaža)

### 15.6.1. Rezne sile – glavni gredni nosač stubišta 2 (2. etaža)

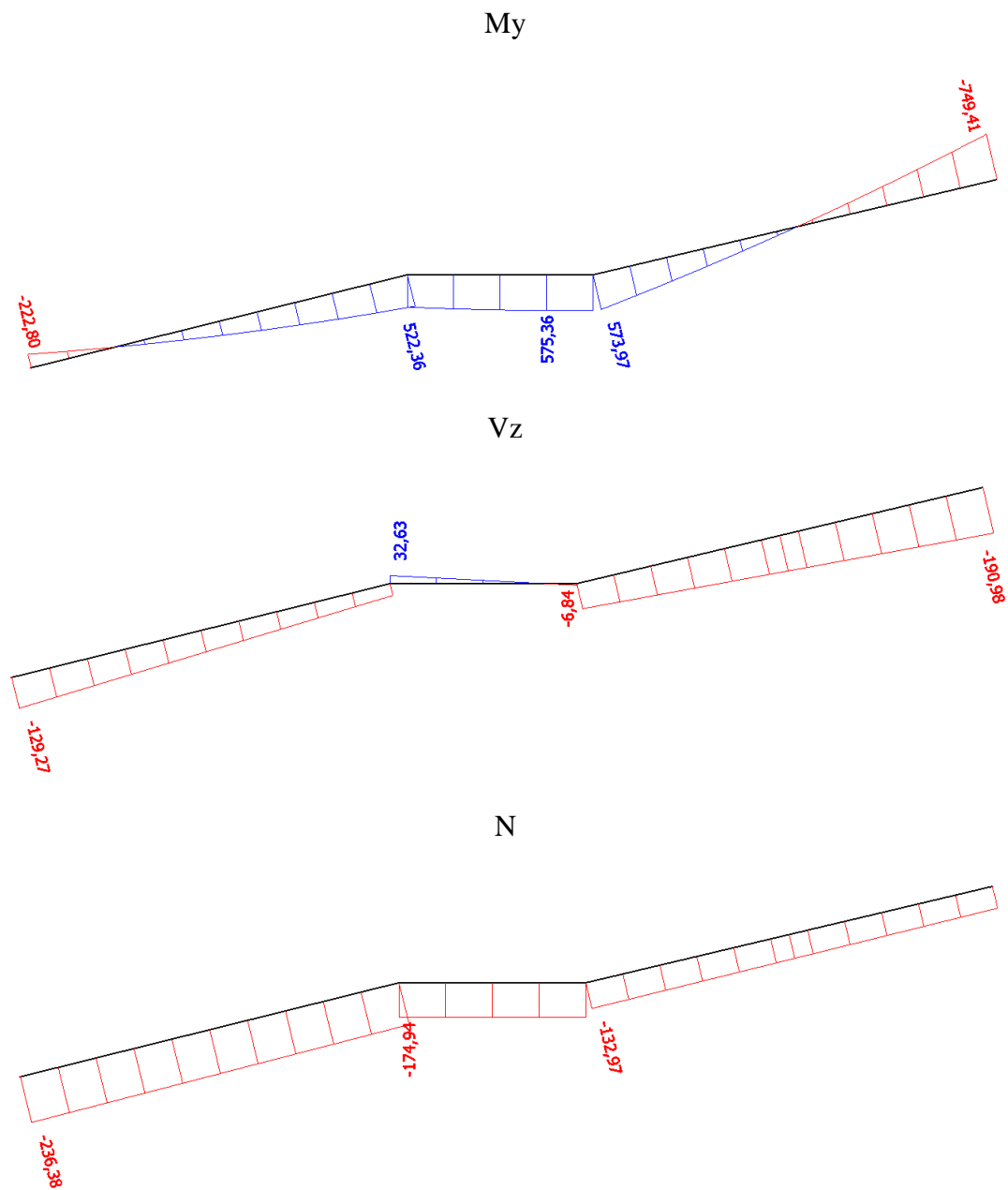

Slika 15.10. Prikaz reznih sila glavnog nosača stubišta

-poprečni presjek nosača

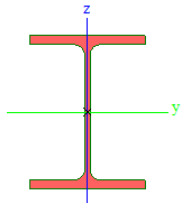
Name	Glavni nosač - stepenice 2 ( 2. etaža)	
Type	HEB400	
Source description	Profil Arbed / Structural shapes / Edition Octobre 1995	
Item material	S 355	
Fabrication	rolled	
Flexural buckling y-y	a	
Flexural buckling z-z	b	
Lateral torsional buckling	Default	
Use 2D FEM analysis	x	
		
A [m <sup>2</sup> ]	1,9780e-02	
A <sub>y</sub> , z [m <sup>2</sup> ]	1,3871e-02	5,6483e-03
I <sub>y</sub> , z [m <sup>4</sup> ]	5,7680e-04	1,0820e-04
I <sub>w</sub> [m <sup>6</sup> ], I <sub>t</sub> [m <sup>4</sup> ]	3,8172e-06	3,5570e-06
W <sub>el</sub> y, z [m <sup>3</sup> ]	2,8840e-03	7,2130e-04
W <sub>pl</sub> y, z [m <sup>3</sup> ]	3,2320e-03	1,1040e-03
d y, z [mm]	0	0
c YUCS, ZUCS [mm]	150	200
α [deg]	0,00	
A L, D [m <sup>2</sup> /m]	1,9300e+00	1,9264e+00
M <sub>ply</sub> +, - [Nm]	1,15e+06	1,15e+06
M <sub>plz</sub> +, - [Nm]	3,92e+05	3,92e+05

Slika 15.11. Prikaz geometrijskih karakteristika nosača

-iskoristivost elementa na GSN – 81 %

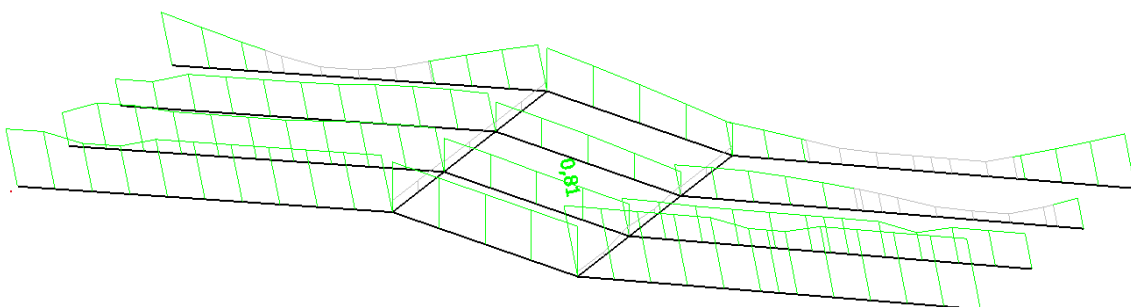

Slika 15.12. Prikaz iskoristivosti glavnog nosača stubišta

## 15.6.2. Dimenzioniranje – glavni gredni nosač stubišta 2 (2. etaža)

Member B2444	8,938 m	HEB400	S 355	GSN 2	0,81 -
--------------	---------	--------	-------	-------	--------

Partial safety factors	
Gamma M0 for resistance of cross-sections	1,00
Gamma M1 for resistance to instability	1,00
Gamma M2 for resistance of net sections	1,25

Material		
Yield strength $f_y$	355,0	MPa
Ultimate strength $f_u$	490,0	MPa
Fabrication	Rolled	

....SECTION CHECK:....

The critical check is on position 0.000 m

Internal forces	Calculated	Unit
N,Ed	-132,97	kN
Vy,Ed	3,58	kN
Vz,Ed	-105,14	kN
T,Ed	0,23	kNm
My,Ed	573,97	kNm
Mz,Ed	-17,11	kNm

#### Classification for cross-section design

According to EN 1993-1-1 article 5.5.2

#### Classification of Internal Compression parts

According to EN 1993-1-1 Table 5.2 Sheet 1

Maximum width-to-thickness ratio	22,07
Class 1 Limit	52,77
Class 2 Limit	60,77
Class 3 Limit	92,70

=> Internal Compression parts Class 1

#### Classification of Outstand Flanges

According to EN 1993-1-1 Table 5.2 Sheet 2

Maximum width-to-thickness ratio	4,84
Class 1 Limit	7,32
Class 2 Limit	8,14
Class 3 Limit	11,31

=> Outstand Flanges Class 1

=> Section classified as Class 1 for cross-section design

#### Compression check

According to EN 1993-1-1 article 6.2.4 and formula (6.9)

A	1,9780e-02	m <sup>2</sup>
Nc,Rd	7021,90	kN
Unity check	0,02	-

#### Bending moment check for My

According to EN 1993-1-1 article 6.2.5 and formula (6.12),(6.13)

Wpl,y	3,2320e-03	m <sup>3</sup>
Mpl,y,Rd	1147,36	kNm
Unity check	0,50	-

#### Bending moment check for Mz

According to EN 1993-1-1 article 6.2.5 and formula (6.12),(6.13)

Wpl,z	1,1040e-03	m <sup>3</sup>
Mpl,z,Rd	391,92	kNm
Unity check	0,04	-

#### Shear check for Vy

According to EN 1993-1-1 article 6.2.6 and formula (6.17)

Eta	1,20	
Av	1,4947e-02	m <sup>2</sup>
Vpl,y,Rd	3063,48	kN
Unity check	0,00	-

#### Shear check for Vz

According to EN 1993-1-1 article 6.2.6 and formula (6.17)

Eta	1,20	
Av	7,0000e-03	m <sup>2</sup>
Vpl,z,Rd	1434,72	kN
Unity check	0,07	-

**Note:** The unity check for torsion is lower than the limit value of 0,05. Therefore torsion is considered as insignificant and is ignored in the combined checks.

**Combined bending, axial force and shear force check**  
According to EN 1993-1-1 article 6.2.9.1 and formula (6.41)

Mpl,y,Rd	1147,36	kNm
Alpha	2,00	
Mpl,z,Rd	391,92	kNm
Beta	1,00	

Unity check (6.41) = 0,25 + 0,04 = 0,29 -

**Note:** Since the shear forces are less than half the plastic shear resistances their effect on the moment resistances is neglected.

**Note:** Since the axial force satisfies both criteria (6.33) and (6.34) of EN 1993-1-1 article 6.2.9.1(4) its effect on the moment resistance about the y-y axis is neglected.

**Note:** Since the axial force satisfies criteria (6.35) of EN 1993-1-1 article 6.2.9.1(4) its effect on the moment resistance about the z-z axis is neglected.

The member satisfies the section check.

.....**STABILITY CHECK**.....

**Classification for member buckling design**

Decisive position for stability classification: 0,000 m

**Classification of Internal Compression parts**

According to EN 1993-1-1 Table 5.2 Sheet 1

Maximum width-to-thickness ratio	22,07
Class 1 Limit	52,77
Class 2 Limit	60,77
Class 3 Limit	92,70

=> Internal Compression parts Class 1

**Classification of Outstand Flanges**

According to EN 1993-1-1 Table 5.2 Sheet 2

Maximum width-to-thickness ratio	4,84
Class 1 Limit	7,32
Class 2 Limit	8,14
Class 3 Limit	11,31

=> Outstand Flanges Class 1

=> Section classified as Class 1 for member buckling design

**Flexural Buckling check**

According to EN 1993-1-1 article 6.3.1.1 and formula (6.46)

Buckling parameters	yy	zz	
Sway type	sway	non-sway	
System length L	8,938	8,938	m
Buckling factor k	1,00	0,11	
Buckling length Lcr	8,938	1,000	m
Critical Euler load Ncr	14964,55	224257,15	kN
Slenderness Lambda	52,34	13,52	
Relative slenderness Lambda,rel	0,69	0,18	
Limit slenderness Lambda,rel,0	0,20	0,20	

**Note:** The slenderness or compression force is such that Flexural Buckling effects may be ignored according to EN 1993-1-1 article 6.3.1.2(4).

**Torsional(-Flexural) Buckling check**

According to EN 1993-1-1 article 6.3.1.1 and formula (6.46)

**Note:** For this I-section the Torsional(-Flexural) buckling resistance is higher than the resistance for Flexural buckling. Therefore Torsional(-Flexural) buckling is not printed on the output.

**Lateral Torsional Buckling check**

According to EN 1993-1-1 article 6.3.2.1 & 6.3.2.2 and formula (6.54)

LTB parameters		
Method for LTB curve	General case	
Cross-section plastic modulus Wpl,y	3,2320e-03	m <sup>3</sup>
Elastic critical moment Mcr	2932,06	kNm
Relative slenderness Lambda,rel,LT	0,63	
Limit slenderness Lambda,rel,LT,0	0,20	
LTB curve	a	
Imperfection Alpha,LT	0,21	
Reduction factor Chi,LT	0,88	
Design buckling resistance Mb,Rd	1009,73	kNm
Unity check	0,57	-

Mcr parameters		
LTB length L	8,938	m
Influence of load position	no influence	
Correction factor k	1,00	
Correction factor kw	1,00	
LTB moment factor C1	2,82	
LTB moment factor C2	0,12	
LTB moment factor C3	1,00	
Shear center distance d,z	0	mm

\*Student version\* \*Student version\* \*Student version\* \*Student version\* \*Student ver

Mcr parameters		
Distance of load application z,g	0	mm
Mono-symmetry constant beta,y	0	mm
Mono-symmetry constant z,j	0	mm

Note: C parameters are determined according to ECSS 119 2006 / Galea 2002.

**Bending and axial compression check**

According to EN 1993-1-1 article 6.3.3 and formula (6.61),(6.62)

Bending and axial compression check parameters		
Interaction method	alternative method 1	
Cross-section area A	1,9780e-02	m <sup>2</sup>
Cross-section plastic modulus Wpl,y	3,2320e-03	m <sup>3</sup>
Cross-section plastic modulus Wpl,z	1,1040e-03	m <sup>3</sup>
Design compression force N,Ed	132,97	kN
Design bending moment (maximum) My,Ed	-749,41	kNm
Design bending moment (maximum) Mz,Ed	-17,11	kNm
Characteristic compression resistance N,Rk	7021,90	kN
Characteristic moment resistance My,Rk	1147,36	kNm
Characteristic moment resistance Mz,Rk	391,92	kNm
Reduction factor Chi,y	1,00	
Reduction factor Chi,z	1,00	
Reduction factor Chi,LT	0,88	
Interaction factor k,y	1,01	
Interaction factor k,yz	0,93	
Interaction factor k,yz	0,61	
Interaction factor k,zz	0,68	

Maximum moment My,Ed is derived from beam B2444 position 8,938 m.  
Maximum moment Mz,Ed is derived from beam B2444 position 0,000 m.

Interaction method 1 parameters		
Critical Euler load N <sub>cr,y</sub>	14964,55	kN
Critical Euler load N <sub>cr,z</sub>	224257,15	kN
Elastic critical load N <sub>cr,T</sub>	11155,43	kN
Cross-section plastic modulus Wpl,y	3,2320e-03	m <sup>3</sup>
Cross-section elastic modulus Wel,y	2,8840e-03	m <sup>3</sup>
Cross-section plastic modulus Wpl,z	1,1040e-03	m <sup>3</sup>
Cross-section elastic modulus Wel,z	7,2130e-04	m <sup>3</sup>
Second moment of area Iy	5,7680e-04	m <sup>4</sup>
Second moment of area Iz	1,0820e-04	m <sup>4</sup>
Torsional constant It	3,5570e-06	m <sup>4</sup>
Method for equivalent moment factor C <sub>my,0</sub>	Table A.2 Line 2 (General)	
Design bending moment (maximum) My,Ed	-749,41	kNm
Maximum relative deflection delta,z	7,4	mm
Equivalent moment factor C <sub>my,0</sub>	0,99	
Method for equivalent moment factor C <sub>mz,0</sub>	Table A.2 Line 1 (Linear)	
Ratio of end moments Psi,z	-0,87	
Equivalent moment factor C <sub>mz,0</sub>	0,61	
Factor mu,y	1,00	
Factor mu,z	1,00	
Factor epsilon,y	38,66	
Factor a,LT	0,99	
Critical moment for uniform bending M <sub>cr,0</sub>	1041,35	kNm
Relative slenderness Lambda <sub>rel,0</sub>	1,05	
Limit relative slenderness Lambda <sub>rel,0,lim</sub>	0,33	
Equivalent moment factor C <sub>my</sub>	1,00	
Equivalent moment factor C <sub>mz</sub>	0,61	
Equivalent moment factor C <sub>mLT</sub>	1,00	
Factor b,LT	0,02	
Factor c,LT	1,63	
Factor d,LT	1,10	
Factor e,LT	13,05	
Factor w,y	-1,12	
Factor w,z	1,50	
Factor n,pl	0,02	
Maximum relative slenderness Lambda <sub>rel,max</sub>	0,69	
Factor C <sub>yy</sub>	1,00	
Factor C <sub>yz</sub>	0,45	
Factor C <sub>zy</sub>	0,86	
Factor C <sub>zz</sub>	0,89	

Unity check (6.61) = 0,02 + 0,75 + 0,04 = 0,81 -  
Unity check (6.62) = 0,02 + 0,45 + 0,03 = 0,50 -

**Shear Buckling check**

According to EN 1993-1-5 article 5 & 7.1 and formula (5.10) & (7.1)

Shear Buckling parameters		
Buckling field length a	8,938	m
Web	unstiffened	
Web height hw	352	mm
Web thickness t	14	mm
Material coefficient epsilon	0,81	
Shear correction factor Eta	1,20	

Shear Buckling verification	
Web slenderness hw/t	26,07
Web slenderness limit	48,82

Note: The web slenderness is such that Shear Buckling effects may be ignored according to EN 1993-1-5 article 5.1(2).  
The member satisfies the stability check.



### 15.7. Vertikalni pomak glavnog nosača – stubište 3 (2. etaža)

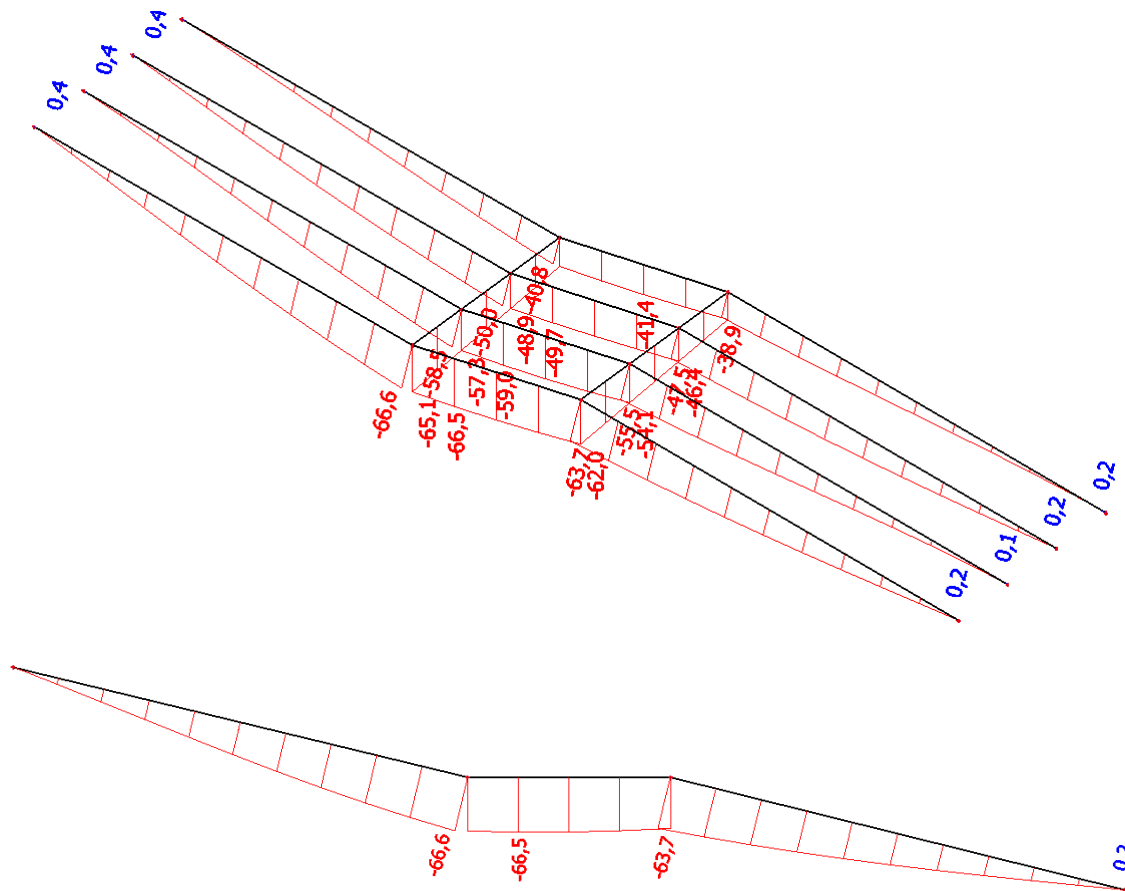

Slika 15.13. Prikaz vertikalnog pomaka glavnog nosača stubišta

Dopušteni vertikalni pomak (progib):

$$u_{dop} = \frac{l}{300} = \frac{20,80 \cdot 1000}{300} = 70,0 \text{ mm}$$

$$u_z = 66,6 \text{ mm} < u_{z,dop} = 70,0 \text{ mm} \quad \text{Zadovoljava}$$

-iskoristivost na GSU -  $66,6 \text{ mm} / 70,0 \text{ mm} = 0,95 = 95\%$

## 15.8. Dimenziniranje glavnog nosača – stubište 3 (2. etaža)

### 15.8.1. Rezne sile – glavni gredni nosač stubišta 3 (2. etaža)

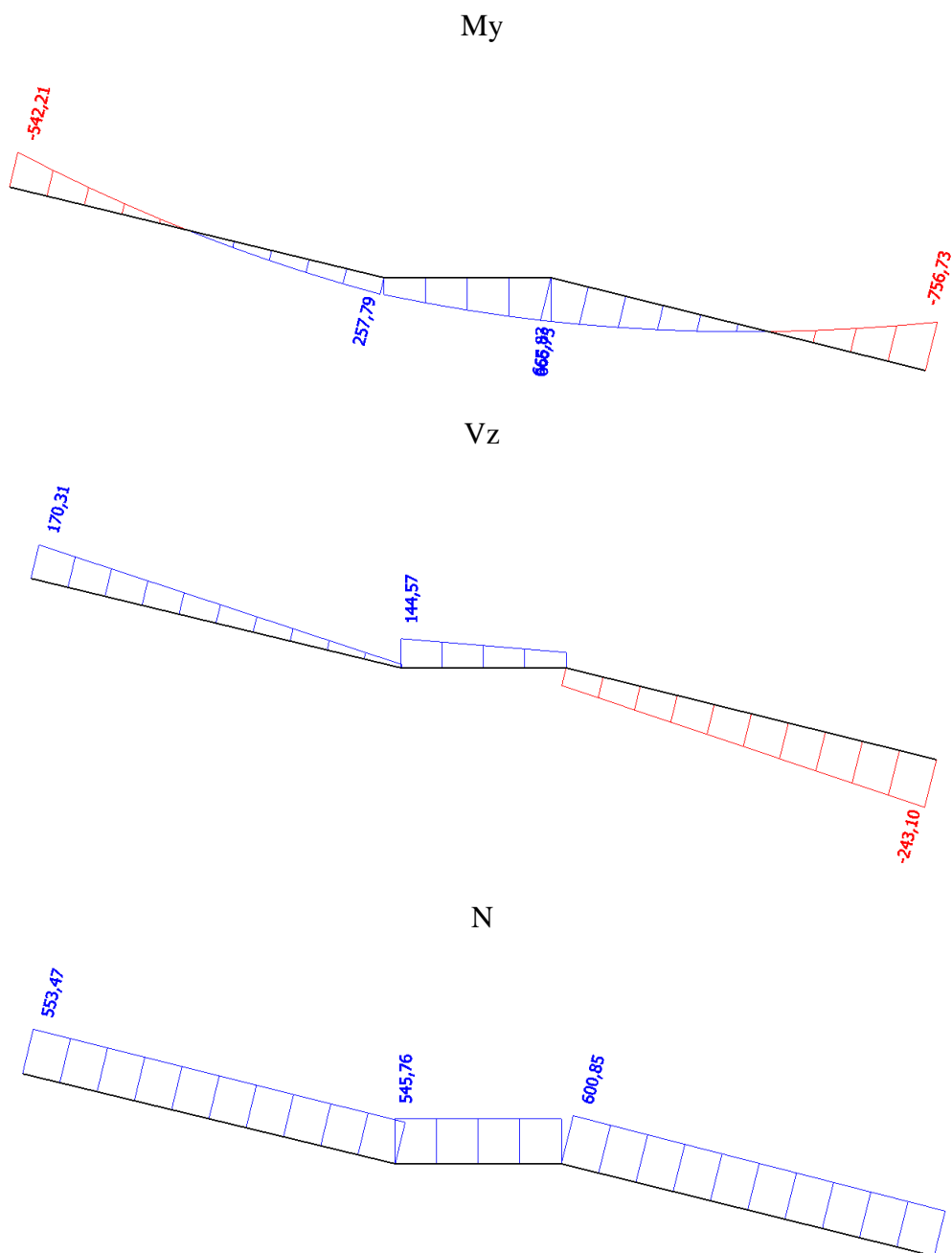

Slika 15.14. Prikaz reznih sila glavnog nosača stubišta

-poprečni presjek nosača

Name	Glavni nosač - stepenice 3 (2. etaža)	
Type	HEA360	
Source description	Profil Arbed / Structural shapes / Edition Octobre 1995	
Item material	S 355	
Fabrication	rolled	
Flexural buckling y-y	b	
Flexural buckling z-z	c	
Lateral torsional buckling	Default	
Use 2D FEM analysis	*	

A [m <sup>2</sup> ]	1,4300e-02	
A <sub>y, z</sub> [m <sup>2</sup> ]	1,0125e-02	3,6844e-03
I <sub>y, z</sub> [m <sup>4</sup> ]	3,3100e-04	7,8900e-05
I <sub>w</sub> [m <sup>6</sup> ], I <sub>t</sub> [m <sup>4</sup> ]	2,1766e-06	1,4900e-06
W <sub>el y, z</sub> [m <sup>3</sup> ]	1,8900e-03	5,2600e-04
W <sub>pl y, z</sub> [m <sup>3</sup> ]	2,0875e-03	8,0417e-04
d <sub>y, z</sub> [mm]	0	0
c <sub>YUCS, ZUCS</sub> [mm]	150	175
α [deg]	0,00	
A <sub>L, D</sub> [m <sup>2</sup> /m]	1,8300e+00	1,8334e+00
M <sub>pl y, z</sub> [Nm]	7,42e+05	7,42e+05
M <sub>pl z, y</sub> [Nm]	2,85e+05	2,85e+05

Slika 15.15. Prikaz geometrijskih karakteristika nosača

-iskoristivost elementa na GSN – 91 %

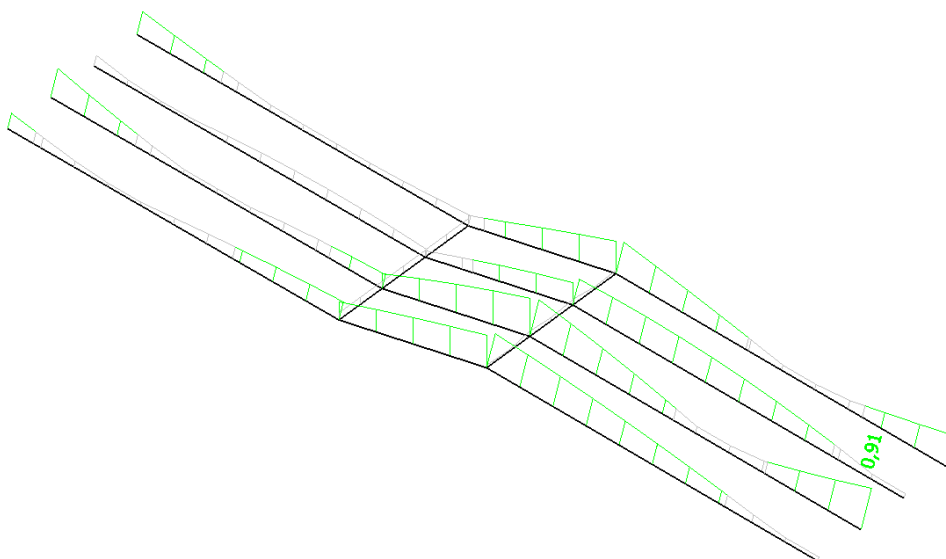

Slika 15.16. Prikaz iskoristivosti glavnog nosača stubišta

## 15.8.2. Dimenzioniranje – glavni gredni nosač stubišta 3 (2. etaža)

Member B2481	8,549 m	HEB360	S 355	GSN 2	0,91 -
--------------	---------	--------	-------	-------	--------

Partial safety factors	
Gamma M0 for resistance of cross-sections	1,00
Gamma M1 for resistance to instability	1,00
Gamma M2 for resistance of net sections	1,25

Material		
Yield strength $f_y$	355,0	MPa
Ultimate strength $f_u$	490,0	MPa
Fabrication	Rolled	

....SECTION CHECK:....

The critical check is on position 8.549 m

Internal forces	Calculated	Unit
N,Ed	563,01	kN
V <sub>y</sub> ,Ed	0,58	kN
V <sub>z</sub> ,Ed	-243,10	kN
T,Ed	0,44	kNm
M <sub>y</sub> ,Ed	-756,73	kNm
M <sub>z</sub> ,Ed	2,78	kNm

#### Classification for cross-section design

According to EN 1993-1-1 article 5.5.2

#### Classification of Internal Compression parts

According to EN 1993-1-1 Table 5.2 Sheet 1

Maximum width-to-thickness ratio	20,88
Class 1 Limit	67,83
Class 2 Limit	78,19
Class 3 Limit	133,99

=> Internal Compression parts Class 1

#### Classification of Outstand Flanges

According to EN 1993-1-1 Table 5.2 Sheet 2

Maximum width-to-thickness ratio	5,19
Class 1 Limit	7,32
Class 2 Limit	8,14
Class 3 Limit	11,22

=> Outstand Flanges Class 1

=> Section classified as Class 1 for cross-section design

#### Tension check

According to EN 1993-1-1 article 6.2.3 and formula (6.5)

A	1,8060e-02	m <sup>2</sup>
N <sub>pl,Rd</sub>	6411,30	kN
N <sub>u,Rd</sub>	6371,57	kN
N <sub>t,Rd</sub>	6371,57	kN
Unity check	0,09	-

#### Bending moment check for M<sub>y</sub>

According to EN 1993-1-1 article 6.2.5 and formula (6.12),(6.13)

W <sub>pl,y</sub>	2,6830e-03	m <sup>3</sup>
M <sub>pl,y,Rd</sub>	952,47	kNm
Unity check	0,79	-

#### Bending moment check for M<sub>z</sub>

According to EN 1993-1-1 article 6.2.5 and formula (6.12),(6.13)

W <sub>pl,z</sub>	1,0320e-03	m <sup>3</sup>
M <sub>pl,z,Rd</sub>	366,36	kNm
Unity check	0,01	-

#### Shear check for V<sub>y</sub>

According to EN 1993-1-1 article 6.2.6 and formula (6.17)

E <sub>t</sub>	1,20	
A <sub>v</sub>	1,3994e-02	m <sup>2</sup>
V <sub>pl,y,Rd</sub>	2868,15	kN
Unity check	0,00	-

#### Shear check for V<sub>z</sub>

According to EN 1993-1-1 article 6.2.6 and formula (6.17)

E <sub>t</sub>	1,20	
A <sub>v</sub>	6,0563e-03	m <sup>2</sup>
V <sub>pl,z,Rd</sub>	1241,29	kN
Unity check	0,20	-

Tau,Rd	205,0	MPa
Unity check	0,02	-

**Note:** The unity check for torsion is lower than the limit value of 0,05. Therefore torsion is considered as insignificant and is ignored in the combined checks.

**Combined bending, axial force and shear force check**  
According to EN 1993-1-1 article 6.2.9.1 and formula (6.41)

Mpl,y,Rd	952,47	kNm
Alpha	2,00	
Mpl,z,Rd	366,36	kNm
Beta	1,00	

Unity check (6.41) = 0,63 + 0,01 = 0,64 -

**Note:** Since the shear forces are less than half the plastic shear resistances their effect on the moment resistances is neglected.

**Note:** Since the axial force satisfies both criteria (6.33) and (6.34) of EN 1993-1-1 article 6.2.9.1(4) its effect on the moment resistance about the y-y axis is neglected.

**Note:** Since the axial force satisfies criteria (6.35) of EN 1993-1-1 article 6.2.9.1(4) its effect on the moment resistance about the z-z axis is neglected.

The member satisfies the section check.

...::STABILITY CHECK::...

**Classification for member buckling design**

Decisive position for stability classification: 0,000 m

**Classification of Internal Compression parts**

According to EN 1993-1-1 Table 5.2 Sheet 1

Maximum width-to-thickness ratio	20,88
Class 1 Limit	70,17
Class 2 Limit	80,89
Class 3 Limit	142,76

=> Internal Compression parts Class 1

**Classification of Outstand Flanges**

According to EN 1993-1-1 Table 5.2 Sheet 2

Maximum width-to-thickness ratio	5,19
Class 1 Limit	7,32
Class 2 Limit	8,14
Class 3 Limit	11,22

=> Outstand Flanges Class 1

=> Section classified as Class 1 for member buckling design

**Lateral Torsional Buckling check**

According to EN 1993-1-1 article 6.3.2.1 & 6.3.2.2 and formula (6.54)

LTB parameters		
Method for LTB curve	General case	
Cross-section plastic modulus Wpl,y	2,6830e-03	m^3
Elastic critical moment Mcr	2389,86	kNm
Relative slenderness Lambda,rel,LT	0,63	
Limit slenderness Lambda,rel,LT,0	0,20	
LTB curve	a	
Imperfection Alpha,LT	0,21	
Reduction factor Chi,LT	0,88	
Design buckling resistance Mb,Rd	836,01	kNm
Unity check	0,91	-

Mcr parameters		
LTB length L	8,549	m
Influence of load position	no influence	
Correction factor k	1,00	
Correction factor kw	1,00	
LTB moment factor C1	2,50	
LTB moment factor C2	0,19	
LTB moment factor C3	0,00	
Shear center distance d,z	0	mm
Distance of load application z,g	0	mm
Mono-symmetry constant beta,y	0	mm
Mono-symmetry constant z,j	0	mm

**Note:** C parameters are determined according to ECCS 119 2006 / Galea 2002.

**Bending and axial tension check**

According to EN 1993-1-3 article 6.3

Design tension force N,Ed	563,01	kN
Design bending moment My,Ed	-756,73	kNm
Design bending moment Mz,Ed	2,78	kNm
Tension resistance Nt,Rd	6371,57	kN
Bending resistance Mb,y,Rd	836,01	kNm
Bending resistance Mc,z,Rd,com	366,36	kNm

Unity check = 0,91 + 0,01 - 0,09 = 0,82 -

**Shear Buckling check**

According to EN 1993-1-5 article 5 & 7.1 and formula (5.10) & (7.1)

Shear Buckling parameters		
Buckling field length a	8,549	m
Web	unstiffened	
Web height hw	315	mm
Web thickness t	13	mm
Material coefficient epsilon	0,81	
Shear correction factor Eta	1,20	

Shear Buckling verification	
Web slenderness hw/t	25,20
Web slenderness limit	48,82

**Note:** The web slenderness is such that Shear Buckling effects may be ignored according to EN 1993-1-5 article 5.1(2).  
The member satisfies the stability check.

## 15.9. Vertikalni pomak glavnog nosača – ulazno stubište

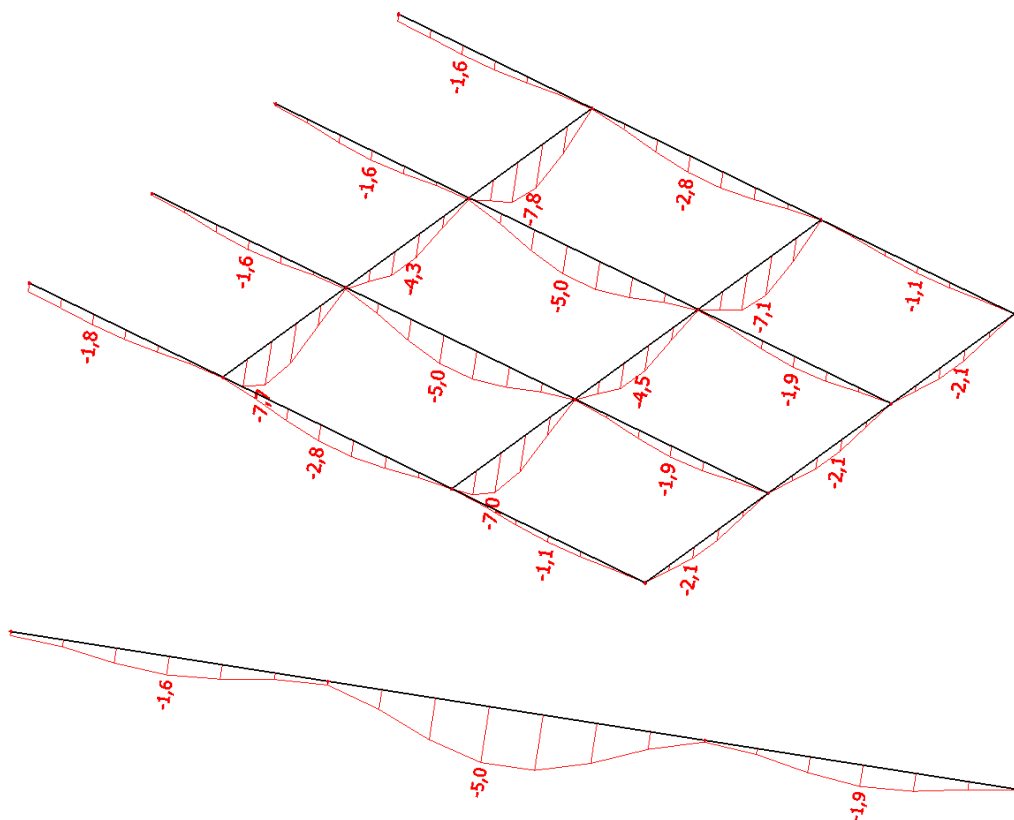

Slika 15.17. Prikaz vertikalnog pomaka glavnog nosača stubišta

Dopušteni vertikalni pomak (progib):

$$u_{dop} = \frac{l}{300} = \frac{6,70 \cdot 1000}{300} = 22,33 \text{ mm}$$

$$u_z = 5,0 \text{ mm} < u_{z,dop} = 22,33 \text{ mm} \quad \text{Zadovoljava}$$

-iskoristivost na GSU -  $5,0 \text{ mm} / 22,33 \text{ mm} = 0,22 = 22\%$

## 15.10. Dimenziniranje glavnog nosača – ulazno stubište

### 15.10.1. Rezne sile – glavni gredni nosač (ulazno stubište)

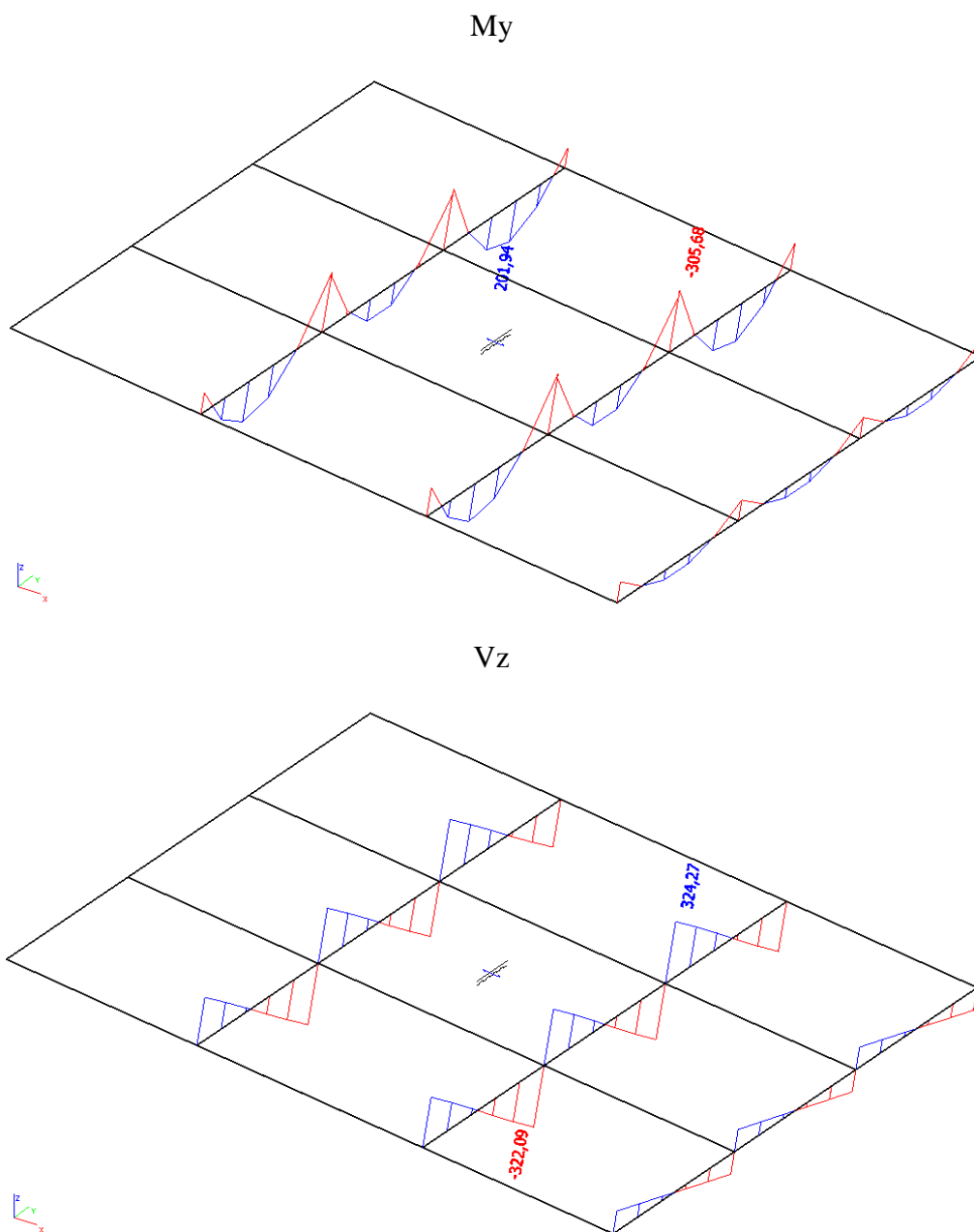

Slika 15.18. Prikaz reznih sila glavnog nosača stubišta

-poprečni presjek nosača

Name	Glavni nosač - ulazne stepenice	
Type	HEB240	
Source description	Profil Arbed / Structural shapes / Edition Octobre 1995	
Item material	S 355	
Fabrication	rolled	
Flexural buckling y-y	b	
Flexural buckling z-z	c	
Lateral torsional buckling	Default	
Use 2D FEM analysis	*	

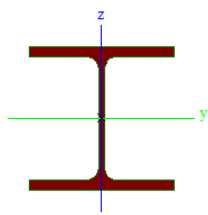

A [m <sup>2</sup> ]	1,0600e-02	
A y, z [m <sup>2</sup> ]	7,8218e-03	2,5536e-03
I y, z [m <sup>4</sup> ]	1,1260e-04	3,9230e-05
I w [m <sup>5</sup> ], t [m <sup>4</sup> ]	4,8695e-07	1,0270e-06
W <sub>el</sub> y, z [m <sup>3</sup> ]	9,3830e-04	3,2690e-04
W <sub>pl</sub> y, z [m <sup>3</sup> ]	1,0530e-03	4,9840e-04
d y, z [mm]	0	0
c YUCS, ZUCS [mm]	120	120
α [deg]	0,00	
A L, D [m <sup>2</sup> /m]	1,3800e+00	1,3838e+00
M <sub>ply</sub> +, - [Nm]	3,74e+05	3,74e+05
M <sub>plz</sub> +, - [Nm]	1,77e+05	1,77e+05

Slika 15.19. Prikaz geometrijskih karakteristika nosača

-iskoristivost elementa na GSN – 69 %

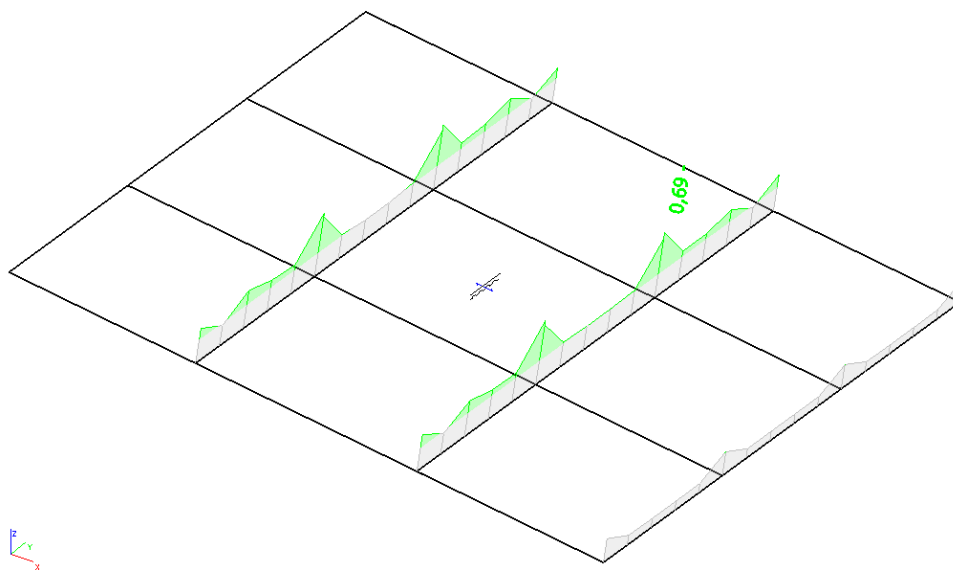

Slika 15.20. Prikaz iskoristivosti glavnog nosača stubišta



15.10.2. Dimenzioniranje – glavni gredni nosač (ulazno stubište)

SCIAENGINEER

Composite Beam - Final stage

Linear calculation  
 Class: All ULS  
 Extreme 1D: Global  
 Selection: B4840

Composite beam verification

for beam B4840 at section 0 m, in accordance with EC EN 1994-1-1

1. Geometry data

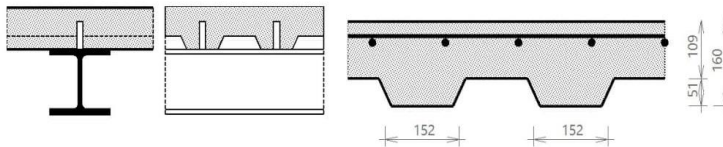

Continuous beam

Length of the current span	L = 5.4 m
Length of previous span	L <sub>previous</sub> = 5.4 m
Beam spacing at the left	L <sub>left</sub> = 0 m
Beam spacing at the right	L <sub>right</sub> = 0 m
Checked section	d <sub>x</sub> = 0 m

2. Cross-section & materials

2.1 Steel section properties

2.1.1 Cross-section

Cross-section	HEB240
Height	h <sub>a</sub> = 240 mm
Width	b = 240 mm
Web thickness	t <sub>w</sub> = 10 mm
Flange thickness	t <sub>f</sub> = 17 mm
Radius	r = 21 mm
Area	A <sub>w</sub> = 10600 mm <sup>2</sup>
Moment of inertia	I <sub>y</sub> = 113·10 <sup>6</sup> mm <sup>4</sup>
Radius of gyration	i <sub>z</sub> = 61 mm
Plastic section modulus	W <sub>ply</sub> = 1.053·10 <sup>6</sup> mm <sup>3</sup>

2.1.2 Material

Steel grade	S 355
Yield strength	f <sub>yb</sub> = 355 MPa
Ultimate strength	f <sub>ub</sub> = 490 MPa
E modulus	E <sub>b</sub> = 210000 MPa

2.1.3 Cross-section classification

$$\epsilon = \sqrt{\frac{235}{355}} = 0.814$$

(EN 1993-1-1 §5.6 Tab. 5.2)

2.1.3.1 Flange in compression

$$c_f = \frac{b - t_w - 2 \cdot r}{2} = \frac{240 \text{ mm} - 10 \text{ mm} - 2 \cdot 21 \text{ mm}}{2} = 94 \text{ mm}$$

$$\frac{c_f}{t_f} \leq 9 \cdot \epsilon$$

$$\frac{94 \text{ mm}}{17 \text{ mm}} \leq 9 \cdot 0.814$$

$$5.53 \leq 7.32$$

OK

Flange classified as Class 1.

Student version

**2.1.3.2 Web in bending**

$$c_w = h_a - 2 \cdot t_f - 2 \cdot r = 240 \text{ mm} - 2 \cdot 17 \text{ mm} - 2 \cdot 21 \text{ mm} = 164 \text{ mm}$$

$$\alpha_d = 0.5$$

$$\frac{c_w}{t_w} \leq \frac{36 \cdot \epsilon}{\alpha_d}$$

$$\frac{164 \text{ mm}}{10 \text{ mm}} \leq \frac{36 \cdot 0.814}{0.5}$$

$$16.4 \leq 58.6$$

OK

Web classified as Class 1.

**Cross-section classified as Class 1**

Cross-section Class OK.

**2.2 Concrete slab with profiled sheeting****2.2.1 Concrete slab****2.2.1.1 Slab**Total height of the slab  $h_s = 160 \text{ mm}$ **2.2.1.2 Material**

Concrete class C30/37  
 Characteristic strength  $f_{ck} = 30 \text{ MPa}$   
 E modulus  $E_{cm} = 32800 \text{ MPa}$

**2.2.2 Profiled steel sheeting**

Sheeting with ribs transverse to the supporting beams

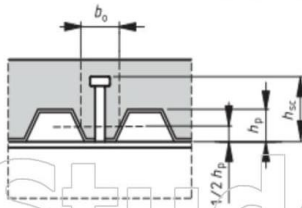

Name	Vulcraft 2 VLI 20
Depth of the ribs	$h_p = 50.8 \text{ mm}$
Height of full concrete	$h_c = 109.2 \text{ mm}$
Height of the re-entrant stiffener	$h_d = 0 \text{ mm}$
Spacing of the ribs	$b_s = 304.8 \text{ mm}$
Top width of the rib	$b_t = 127 \text{ mm}$
Bottom width of the rib	$b_b = 127 \text{ mm}$
Mean width of the ribs	$b_{0,rib} = 152.4 \text{ mm}$
Thickness of the sheeting	$t_p = 0.9093 \text{ mm}$

**2.2.3 Shear connectors****2.2.3.1 Geometry**

Name	H110
Diameter	$d_s = 25 \text{ mm}$
Nominal height	$h_{nom} = 110 \text{ mm}$
As-welded height	$h_{sc} = 105 \text{ mm}$
Amount per trough or section	$n_r = 1$

**2.2.3.2 Material**

Steel grade	S 355
Ultimate strength	$f_{us} = 490 \text{ MPa}$

**2.2.4 Reinforcement****2.2.4.1 Geometry**

Longitudinal bar diameter	$d_l = 16 \text{ mm}$
Longitudinal bar spacing	$s_l = 150 \text{ mm}$
Longitudinal bar cover	$c_l = 30 \text{ mm}$
Transverse bar diameter	$d_t = 16 \text{ mm}$
Transverse bar spacing	$s_t = 150 \text{ mm}$
Transverse bar cover	$c_t = 46 \text{ mm}$

**2.2.4.2 Material**

Material	B 500A
Characteristic yield strength	$f_{ykr} = 500 \text{ MPa}$

**3. Design values of loads**

Load Name : GSN 2  
 Content of combination : 1.35\*g-vlastitežina+1.35\*dg-dodatnostalno+  
 1.80\*q-promjenjivoopterećenje+1.35\*g-vlastitežina\_dryconcrete  
 Bending moment  $M_{Ed,comp} = -305.773 \text{ kNm}$   
 Shear force  $V_{Ed,comp} = 325.361 \text{ kN}$

**4. Partial safety factors**

Steel section  $\gamma_{M0} = 1$   
 $\gamma_{M1} = 1$   
 Shear connectors  $\gamma_V = 1.25$   
 Concrete  $\gamma_C = 1.5$   
 Reinforcement  $\gamma_S = 1.15$

**5. ULS check of the Final stage**

**5.1 Shear connection**

**5.1.1 Design resistance of shear connectors**

**5.1.1.1 Shear connector in a solid slab**

$$\frac{h_{sc}}{d_s} > 4$$

$$4.2 > 4$$

$$\alpha = 1$$

$$f_{us} = \min(490; 450) \text{ MPa}$$

$$f_{us} = 450 \text{ MPa}$$

$$P_{Rd,solid,1} = \frac{0.8 \cdot f_{us} \cdot \left(\frac{\pi \cdot d_s^2}{4}\right)}{\gamma_V} = \frac{0.8 \cdot 450 \text{ MPa} \cdot \left(\frac{3.14 \cdot 25 \text{ mm}^2}{4}\right)}{1.25} = 141 \text{ kN}$$

$$P_{Rd,solid,2} = \frac{0.29 \cdot \alpha \cdot d_s^2 \cdot \sqrt{f_{ck} \cdot E_{cm}}}{\gamma_V} = \frac{0.29 \cdot 1 \cdot 25 \text{ mm}^2 \cdot \sqrt{30 \text{ MPa} \cdot 32800 \text{ MPa}}}{1.25} = 144 \text{ kN}$$

$$P_{Rd,solid} = \min(P_{Rd,solid,1}; P_{Rd,solid,2}) = \min(141 \text{ kN}; 144 \text{ kN}) = 141 \text{ kN}$$

**5.1.1.2 Shear connector in profiled sheeting**

Sheeting with ribs transverse to the supporting beams

$$k_t = \frac{0.7}{\sqrt{n_r}} \cdot \left(\frac{b_{0,rib}}{h_p}\right) \cdot \left(\frac{h_{sc}}{h_p} - 1\right) = \frac{0.7}{\sqrt{1}} \cdot \left(\frac{152 \text{ mm}}{50.8 \text{ mm}}\right) \cdot \left(\frac{105 \text{ mm}}{50.8 \text{ mm}} - 1\right) = 2.24$$

$$k_{t,max} = 0.85$$

$$k_t = \max(0; \min(k_t; k_{t,max})) = \max(0; \min(2.24; 0.85)) = 0.85$$

$$P_{Rd} = k_t \cdot P_{Rd,solid} = 0.85 \cdot 141 \text{ kN} = 120 \text{ kN}$$

Warning: The conditions given by EN 1994-1-1 Art.6.6.4.2 (3) are not fulfilled.

**5.1.2 Degree of shear connection**

**5.1.2.1 Determination of  $b_{eff}$  of the concrete flange and length  $L_e$**

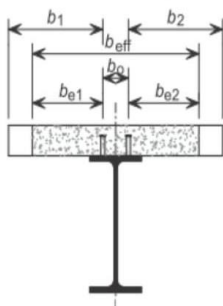

The effective width at the internal support

$$L_{e2} = 0.25 \cdot (L_1 + L_2) = 0.25 \cdot (5.4 \text{ m} + 5.4 \text{ m}) = 2.7 \text{ m}$$

**Left side of the beam**

No adjacent member or slab edge was found on the side.

$$b_{e10} = \frac{L_{e0}}{8} = \frac{0 \text{ m}}{8} = 0 \text{ m}$$

$$b_{e11} = \frac{L_{e1}}{8} = \frac{0 \text{ m}}{8} = 0 \text{ m}$$

$$b_{e12} = \frac{L_{e2}}{8} = \frac{2.7 \text{ m}}{8} = 0.338 \text{ m}$$

**Right side of the beam**

No adjacent member or slab edge was found on the side.

$$b_{e20} = \frac{L_{e0}}{8} = \frac{0 \text{ m}}{8} = 0 \text{ m}$$

$$b_{e21} = \frac{L_{e1}}{8} = \frac{0 \text{ m}}{8} = 0 \text{ m}$$

$$b_{e22} = \frac{L_{e2}}{8} = \frac{2.7 \text{ m}}{8} = 0.338 \text{ m}$$

**Calculation of  $b_{eff,2}$**

$$b_{eff,2} = b_0 + b_{e12} + b_{e22} = 0 \text{ mm} + 0.338 \text{ m} + 0.338 \text{ m} = 0.675 \text{ m}$$

**Calculation of  $b_{eff}$**

$$b_{eff} = b_{eff,2} = 0.675 \text{ m}$$

**Determination of  $L_e$**

$$L_e = L_{e2} = 2.7 \text{ m}$$

**5.1.2.2 Minimum degree of shear connection**

Warning: Conditions given by EN 1994-1-1 Art. 6.6.1.2 (3) are not fulfilled.

$$\eta_{min,calc} = 1 - \frac{355}{f_{yb}} \cdot (0.75 - 0.03 \cdot L_e)$$

$$\eta_{min,calc} = 1 - \frac{355}{355} \cdot (0.75 - 0.03 \cdot 2.7 \text{ m}) = 0.33$$

$$\eta_{min} = \max(\eta_{min,calc}; 0.4) = \max(0.33; 0.4) = 0.4$$

**5.1.2.3 Degree of shear connection present**

**5.1.2.3.1 Tension resistance of the reinforcement**

$$A_s = \frac{b_{eff}}{s_l} \cdot \left( \frac{d_l^2}{4} \right) \cdot \pi = \frac{0.675 \text{ m}}{150 \text{ mm}} \cdot \left( \frac{16 \text{ mm}^2}{4} \right) \cdot 3.14 = 905 \text{ mm}^2$$

$$F_s = \frac{A_s \cdot f_{yk,r}}{\gamma_s} = \frac{905 \cdot 10^{-6} \cdot 500 \cdot 10^6}{1.15} = 393 \text{ kN}$$

**5.1.2.3.2 Tension resistance of the steel member**

$$N_{pl,a} = f_{yb} \cdot A_a = 355 \text{ MPa} \cdot 10600 \text{ mm}^2 = 3763.00 \text{ kN}$$

$$N_{c,f} = \min(F_s; N_{pl,a}) = \min(393 \text{ kN}; 3763.00 \text{ kN}) = 393.38 \text{ kN}$$

**5.1.2.3.3 Resistance of the shear connectors**

Number of full ribs available per length  $L_e$

$$n_{rib} = \frac{L_e}{b_s} = \frac{2.7 \text{ m}}{305 \text{ mm}}$$

$$n_{rib} = 8$$

$$l_s = b_s \cdot \text{trough} = 305 \text{ mm} \cdot 1 = 305 \text{ mm}$$

Number of shear studs available per length  $L_e/2$

$$n_{sp} = \frac{0.5 \cdot n_{rib} \cdot n_r}{\text{trough}} = \frac{0.5 \cdot 8 \cdot 1}{1} = 4$$

$$N_c = n_{sp} \cdot P_{Rd} = 4 \cdot 120166 = 480.66 \text{ kN}$$

$$\eta = \min\left(\frac{N_c}{N_{c,f}}; 1\right) = \min\left(\frac{480.66 \text{ kN}}{393.38 \text{ kN}}; 1\right) = 1$$

$$\eta \geq \eta_{min}$$

$$1 \geq 0.4$$

The shear connection degree is adequate. OK

**5.2 Cross-sectional resistance of the composite beam****5.2.1 Shear buckling**

$$h_w = h_s - 2 \cdot t_f = 240 \text{ mm} - 2 \cdot 17 \text{ mm} = 206 \text{ mm}$$

$$\eta_{sb} = 1.2$$

$$\frac{h_w}{t_w} \leq \frac{72 \cdot \varepsilon}{\eta_{sb}}$$

$$\frac{206 \text{ mm}}{10 \text{ mm}} \leq \frac{72 \cdot 0.814}{1.2}$$

$$20.6 \leq 48.8$$

OK

The shear buckling resistance of the web does not need to be verified.

**5.2.2 Vertical shear**

The resistance to vertical shear should be taken as the resistance of the structural steel section.

$$A_v = A_s - 2 \cdot b \cdot t_f + (t_w + 2 \cdot r) \cdot t_f$$

$$= 0.0106 - 2 \cdot 0.24 \cdot 0.017 + (0.01 + 2 \cdot 0.021) \cdot 0.017 = 3324 \text{ mm}^2$$

$$A_{v,\min} = \eta_{sb} \cdot h_w \cdot t_w = 1.2 \cdot 0.206 \cdot 0.01 = 2472 \text{ mm}^2$$

$$A_v \geq A_{v,\min}$$

$$3324 \text{ mm}^2 \geq 2472 \text{ mm}^2$$

$$V_{pl,Rd} = \frac{A_v \cdot f_{yb}}{\sqrt{3} \cdot \gamma_{M0}} = \frac{3324 \text{ mm}^2 \cdot 355 \cdot 10^6}{\sqrt{3} \cdot 1} = 681 \text{ kN}$$

$$UC_{\text{comp}_V} = \frac{\text{abs}(V_{Ed,\text{comp}})}{V_{pl,Rd}} = \frac{\text{abs}(325.361 \text{ kN})}{681 \text{ kN}} = 0.48$$

The shear resistance of the section is adequate.

**5.2.3 Bending moment****5.2.3.1 Longitudinal reinforcement****5.2.3.1.1 Centre of composite section**

For buildings not intended mainly for storage the effects of creep in concrete beams may be taken into account by using an effective E modulus  $E_{\text{eff}} = E_{\text{cm}} / 2$ .

$$E_{\text{eff}} = \frac{E_{\text{cm}}}{2} = \frac{32800 \text{ MPa}}{2} = 16400 \text{ MPa}$$

$$\eta_E = \frac{E_b}{E_{\text{eff}}} = \frac{210000 \text{ MPa}}{16400 \text{ MPa}} = 12.8$$

$$y_d = \frac{A_a \cdot \left( \frac{h_a}{2} \right) + \left( \frac{1}{\eta_E} \right) \cdot b_{\text{eff}} \cdot (h_c - h_d) \cdot \left( h_a + h_s - \frac{h_c - h_d}{2} \right)}{A_a + \left( \frac{1}{\eta_E} \right) \cdot b_{\text{eff}} \cdot (h_c - h_d)}$$

$$= \frac{0.0106 \cdot \left( \frac{0.24}{2} \right) + \left( \frac{1}{12.8} \right) \cdot 0.675 \cdot (0.109 - 0) \cdot \left( 0.24 + 0.16 - \frac{0.109 - 0}{2} \right)}{0.0106 + \left( \frac{1}{12.8} \right) \cdot 0.675 \cdot (0.109 - 0)} = 199 \text{ mm}$$

**5.2.3.1.2 Degree of reinforcement**

$$A_s = \frac{b_{\text{eff}}}{s_l} \cdot \left( \frac{d_l^2}{4} \right) \cdot \pi = \frac{0.675 \text{ m}}{150 \text{ mm}} \cdot \left( \frac{16 \text{ mm}^2}{4} \right) \cdot 3.14 = 905 \text{ mm}^2$$

$$A_c = b_{\text{eff}} \cdot (h_c - h_d) = 0.675 \cdot (0.109 - 0) = 73710 \text{ mm}^2$$

$$z_0 = \left( h_a + h_s - \frac{h_c - h_d}{2} \right) - y_d = \left( 0.24 + 0.16 - \frac{0.109 - 0}{2} \right) - 0.199 = 146 \text{ mm}$$

$$k_c = \min \left( \frac{1}{\left( 1 + \frac{h_c - h_d}{2 \cdot z_0} \right)} + 0.3; 1 \right) = \min \left( \frac{1}{\left( 1 + \frac{0.109 - 0}{2 \cdot 0.146} \right)} + 0.3; 1 \right) = 1$$

$$\rho_s = \delta \cdot \left( \frac{f_{yb}}{235} \right) \cdot \left( \frac{f_{ctm}}{f_{ykr}} \right) \cdot \sqrt{k_c} = 1.1 \cdot \left( \frac{355}{235} \right) \cdot \left( \frac{2.9 \cdot 10^6}{500 \cdot 10^6} \right) \cdot \sqrt{1} = 0.964 \%$$

$$A_s \geq \rho_s \cdot A_c$$

$$905 \text{ mm}^2 \geq 9.64 \cdot 10^{-3} \cdot 73710 \text{ mm}^2$$

$$905 \text{ mm}^2 \geq 710 \text{ mm}^2$$

OK

The longitudinal reinforcement of the section is adequate.

5.2.3.2 Moment resistance

Moment resistance of a steel cross-section

$$M_{pl,Rd,a} = \frac{W_{ply} \cdot f_{yb}}{Y_{MO}} = \frac{1.05 \cdot 10^6 \text{ mm}^3 \cdot 355 \text{ MPa}}{1} = 374 \text{ kNm}$$

Influence of shear

$$\frac{V_{pl,Rd}}{2} > \text{abs}(V_{Ed,comp})$$

$$\frac{681 \text{ kN}}{2} > 325 \text{ kN}$$

$$341 \text{ kN} > 325 \text{ kN} \quad \text{OK}$$

The influence of the vertical shear on the bending moment resistance may be neglected.

$$f_{yb,w} = f_{yb} = 355 \text{ MPa}$$

Modified tension resistance of the steel member

$$r = 0 \text{ mm}$$

$$A_a = 2 \cdot t_f \cdot b + t_w \cdot (h_a - 2 \cdot t_f) = 2 \cdot 17 \text{ mm} \cdot 240 \text{ mm} + 10 \text{ mm} \cdot (240 \text{ mm} - 2 \cdot 17 \text{ mm}) = 10220 \text{ mm}^2$$

$$N_{pl,a} = A_a \cdot f_{yb} = 10220 \text{ mm}^2 \cdot 355 \text{ MPa} = 3628.10 \text{ kN}$$

Note: Roundings of the steel cross-section are neglected in bending resistance calculation.

$$N_{c,f} = \min(F_s, N_{pl,a}) = \min(393 \text{ kN}; 3628.10 \text{ kN}) = 393.38 \text{ kN}$$

Negative bending moment resistance calculation

The plastic neutral axis is located within the web of the steel section.

$$N_{at,f} = b \cdot t_f \cdot f_{yb} = 0.24 \cdot 0.017 \cdot 355 \cdot 10^6 = 1448.40 \text{ kN}$$

$$N_{pl,a} - N_{at,f} - N_{at,w} = F_s + N_{at,f} + N_{at,w}$$

$$x = \frac{(N_{pl,a} - 2 \cdot N_{at,f} - F_s)}{(2 \cdot t_w \cdot f_{yb,w})} = \frac{(3628.10 \text{ kN} - 2 \cdot 1448.40 \text{ kN} - 393 \text{ kN})}{(2 \cdot 10 \text{ mm} \cdot 355 \text{ MPa})} = 47.6 \text{ mm}$$

Verification of the steel web classification.

$$\alpha_{cl} = \frac{c_w - x}{c_w} = \frac{164 - 47.6}{164} = 0.71$$

$$\frac{c_w}{t_w} \leq \frac{396 \cdot \epsilon}{13 \cdot \alpha_{cl} - 1}$$

$$\frac{164 \text{ mm}}{10 \text{ mm}} \leq \frac{396 \cdot 0.814}{13 \cdot 0.71 - 1}$$

$$16.4 \leq 39.2 \quad \text{OK}$$

Web classified as Class 1.

$$N_{at,w} = t_w \cdot x \cdot f_{yb,w} = 10 \text{ mm} \cdot 47.6 \text{ mm} \cdot 355 \text{ MPa} = 168.96 \text{ kN}$$

$$N_{a,c} = N_{pl,a} - N_{at,f} - N_{at,w} = 3628.10 \text{ kN} - 1448.40 \text{ kN} - 168.96 \text{ kN} = 2010.74 \text{ kN}$$

Leverage arm of the compression part of the steel section calculated to the PNA.

$$h_{cs} = \frac{(t_w \cdot (h_a - 2 \cdot t_f - x)^2 \cdot 0.5 + t_f \cdot b \cdot (h_a - 1.5 \cdot t_f - x))}{t_w \cdot (h_a - 2 \cdot t_f - x) + t_f \cdot b}$$

$$= \frac{(10 \cdot (240 - 2 \cdot 17 - 47.6)^2 \cdot 0.5 + 17 \cdot 240 \cdot (240 - 1.5 \cdot 17 - 47.6))}{10 \cdot (240 - 2 \cdot 17 - 47.6) + 17 \cdot 240} = 142 \text{ mm}$$

$$h_1 = x + t_f + h_s - c_1 + \frac{d_1}{2} = 0.0476 + 0.017 + 0.16 - 0.03 + \frac{0.016}{2} = 187 \text{ mm}$$

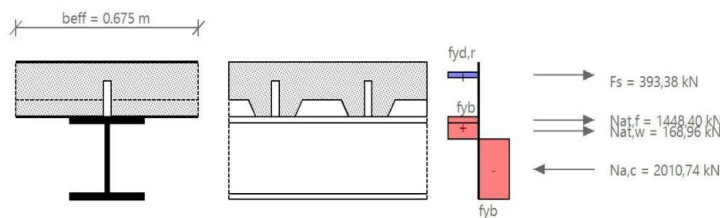

$$M_{pl,Rd} = F_s \cdot h_1 + N_{at,f} \cdot \left(\frac{t_f}{2} + x\right) + \frac{N_{at,w} \cdot x}{2} + N_{a,c} \cdot h_{cs}$$

$$= 393 \cdot 187 + 1448.40 \cdot \left(\frac{17}{2} + 47.6\right) + \frac{168.96 \cdot 47.6}{2} + 2010.74 \cdot 142 = 445 \text{ kNm}$$

Design moment resistance according to EN 1994-1-1 Art.6.2.1.2

$$M_{Rd} = M_{pl,Rd} = 445 \text{ kNm}$$

$$UC_{comp,M} = \frac{\text{abs}(M_{Ed,comp})}{M_{Rd}} = \frac{\text{abs}(-305.773 \text{ kNm})}{445 \text{ kNm}} = 0.69$$

The bending moment resistance of the section is adequate.

**5.3 LTB resistance**

$$F = \left( 1 + \frac{t_w \cdot (h_a - t_f)}{4 \cdot b \cdot t_f} \right) \cdot \left( \frac{h_a - t_f}{t_w} \right)^{0.75} \cdot \left( \frac{t_f}{b} \right)^{0.25} = \left( 1 + \frac{10 \cdot (240 - 17)}{4 \cdot 240 \cdot 17} \right) \cdot \left( \frac{240 - 17}{10} \right)^{0.75} \cdot \left( \frac{17}{240} \right)^{0.25} = 6.02$$

$$F_{lim} = 12.3$$

$$F \leq F_{lim}$$

$$6.02 \leq 12.3$$

OK

The cross-section is qualified for verification of LTB by the simplified method.

$$C_4 = 25$$

$$\lambda_{LT,rel} = 5 \cdot \left( 1 + \frac{t_w \cdot (h_a - t_f)}{4 \cdot b \cdot t_f} \right) \cdot \left( \frac{h_a - t_f}{t_w} \right)^{0.75} \cdot \left( \frac{t_f}{b} \right)^{0.25} \cdot \left( \frac{f_{yb}}{E_b \cdot C_4} \right)^{0.5}$$

$$= 5 \cdot \left( 1 + \frac{0.01 \cdot (0.24 - 0.017)}{4 \cdot 0.24 \cdot 0.017} \right) \cdot \left( \frac{0.24 - 0.017}{0.01} \right)^{0.75} \cdot \left( \frac{0.017}{0.24} \right)^{0.25} \cdot \left( \frac{355 \cdot 10^6}{210 \cdot 10^9 \cdot 25} \right)^{0.5} = 0.247$$

$h_a/b <= 2 \rightarrow$  Buckling curve 'a'

$$\alpha_{LT} = 0.21$$

$$\Phi_{LT} = 0.5 \cdot \left( 1 + \alpha_{LT} \cdot (\lambda_{LT,rel} - 0.2) + \lambda_{LT,rel}^2 \right) = 0.5 \cdot \left( 1 + 0.21 \cdot (0.247 - 0.2) + 0.247^2 \right) = 0.536$$

$$X_{LT} = \frac{1}{\Phi_{LT} + \sqrt{\Phi_{LT}^2 - \lambda_{LT,rel}^2}} = \frac{1}{0.536 + \sqrt{0.536^2 - 0.247^2}} = 0.99$$

$$X_{LT} = \min(X_{LT}, 1) = \min(0.99; 1) = 0.99$$

$$M_{b,Rd} = X_{LT} \cdot M_{Rd} = 0.99 \cdot 444956 = 440.290 \text{ kNm}$$

$$UC_{comp\_LTB} = \frac{\text{abs}(M_{Ed,comp})}{M_{b,Rd}} = \frac{\text{abs}(-305.773 \text{ kNm})}{440.290 \text{ kNm}} = 0.69$$

The later torsional buckling resistance of the section is adequate.

**5.4 Longitudinal shear**

**5.4.1 Transverse reinforcement**

Design shear flow

$$h_f = h_c = 109 \text{ mm}$$

$$v_{Ed} = \frac{F_{T,r} \cdot P_{Rd}}{I_s \cdot h_f} = \frac{1 \cdot 120 \text{ kN}}{305 \text{ mm} \cdot 109 \text{ mm}} = 3.61 \text{ MPa}$$

Transverse reinforcement

$$\frac{A_{st} \cdot f_{yk,r}}{s_t} \geq \frac{v_{Ed} \cdot h_f}{\cotg(\theta)}$$

$$A_t = A_{st}/s_t$$

$$A_t = \frac{v_{Ed} \cdot h_f}{\cotg(\theta) \cdot f_{yk,r}} = \frac{3.61 \cdot 10^6 \cdot 0.109}{\cotg(26.5) \cdot 500 \cdot 10^6} = 452 \text{ mm}^2/\text{m}$$

$$A_{t,prov} = \frac{1}{s_t} \cdot \left( \frac{d_t^2}{4} \right) \cdot 3.14 = \frac{1}{0.15} \cdot \left( \frac{0.016^2}{4} \right) \cdot 3.14 = 1340 \text{ mm}^2/\text{m}$$

$$A_{t,prov} \geq A_t$$

$$1340 \text{ mm}^2/\text{m} \geq 452 \text{ mm}^2/\text{m} \quad \text{OK}$$

The transverse reinforcement of the section is adequate.

**ULS check of Final stage is OK.**

$$UC_{comp} = \max(0.48; 0.69; 0.69) = 0.69$$

Student version

## 15.11. Dimenziniranje sekundarnog nosača – ulazno stubište

### 15.11.1. Rezne sile – sekundarni gredni nosač (ulazno stubište)

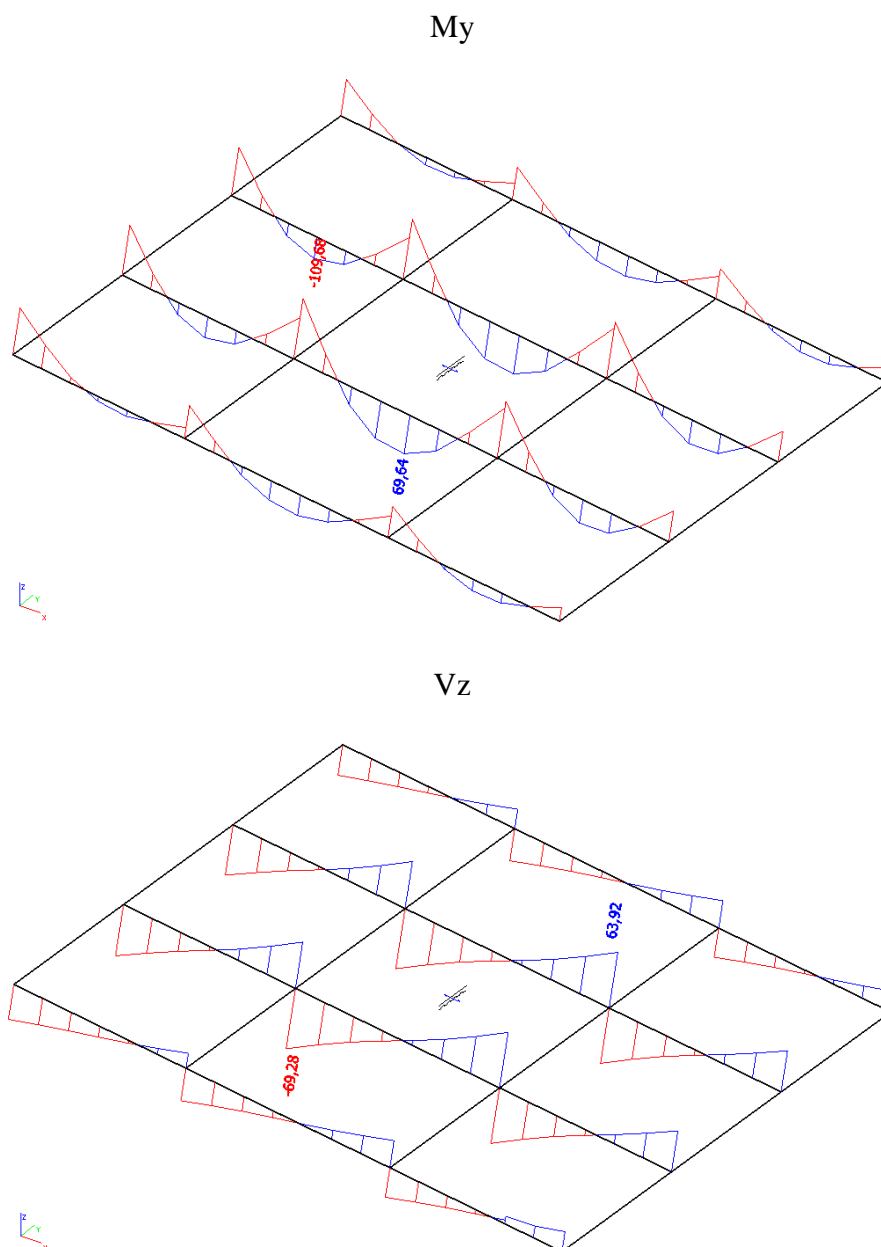

*Slika 15.21. Prikaz reznih sila sekundarnog nosača stubišta*



-poprečni presjek nosača

Name	Sekundarni nosač - ulazne stepenice	
Type	HEB200	
Source description	Profil Arbed / Structural shapes / Edition Octobre 1995	
Item material	S 355	
Fabrication	rolled	
Flexural buckling y-y	b	
Flexural buckling z-z	c	
Lateral torsional buckling	Default	
Use 2D FEM analysis	*	

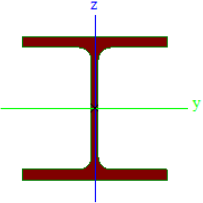

A [m <sup>2</sup> ]	7,8080e-03	
A <sub>y, z</sub> [m <sup>2</sup> ]	5,7750e-03	1,9112e-03
I <sub>y, z</sub> [m <sup>4</sup> ]	5,6960e-05	2,0030e-05
I <sub>w</sub> [m <sup>6</sup> ], I <sub>t</sub> [m <sup>4</sup> ]	1,7112e-07	5,9280e-07
W <sub>el y, z</sub> [m <sup>3</sup> ]	5,6960e-04	2,0030e-04
W <sub>pl y, z</sub> [m <sup>3</sup> ]	6,4250e-04	3,0580e-04
d <sub>y, z</sub> [mm]	0	0
c <sub>YUCS, ZUCS</sub> [mm]	100	100
α [deg]	0,00	
A <sub>L, D</sub> [m <sup>2</sup> /m]	1,1500e+00	1,1510e+00
M <sub>ply +, -</sub> [Nm]	2,28e+05	2,28e+05
M <sub>pz +, -</sub> [Nm]	1,09e+05	1,09e+05

Slika 15.22. Prikaz geometrijskih karakteristika nosača

-iskoristivost elementa na GSN – 36 %

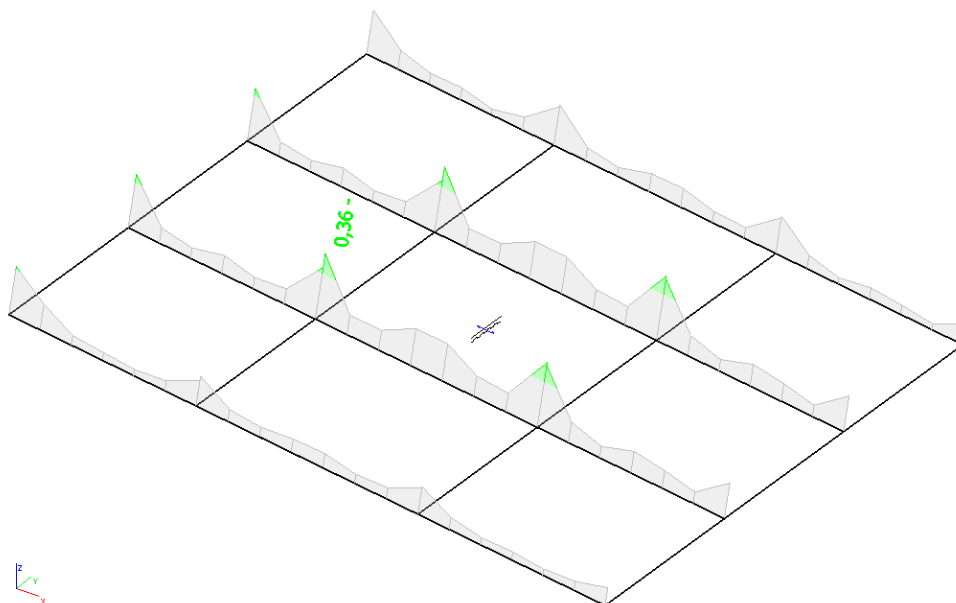

Slika 15.23. Prikaz iskoristivosti sekundanog nosača stubišta

### 15.11.2. Dimenzioniranje – sekundarni gredni nosač (ulazno stubište)

SCIAENGINEER

#### Composite Beam - Final stage

Linear calculation  
 Class: All ULS  
 Extreme 1D: Global  
 Selection: B4825

#### Composite beam verification

for beam B4825 at section 6.78 m, in accordance with EC EN 1994-1-1

##### 1. Geometry data

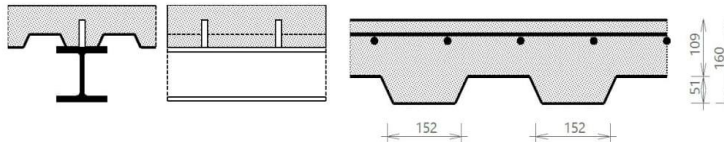

##### Continuous beam

Length of the current span	$L = 6.781 \text{ m}$
Length of previous span	$L_{\text{previous}} = 5.718 \text{ m}$
Length of next span	$L_{\text{next}} = 5.718 \text{ m}$
Beam spacing at the left	$L_{\text{left}} = 5.4 \text{ m}$
Distance to the slab edge at the right	$L_{\text{right}} = 5.4 \text{ m}$
Checked section	$d_x = 6.781 \text{ m}$

##### 2. Cross-section & materials

###### 2.1 Steel section properties

###### 2.1.1 Cross-section

Cross-section	HEB200
Height	$h_a = 200 \text{ mm}$
Width	$b = 200 \text{ mm}$
Web thickness	$t_w = 9 \text{ mm}$
Flange thickness	$t_f = 15 \text{ mm}$
Radius	$r = 18 \text{ mm}$
Area	$A_a = 7808 \text{ mm}^2$
Moment of inertia	$I_y = 57 \cdot 10^6 \text{ mm}^4$
Radius of gyration	$i_z = 51 \text{ mm}$
Plastic section modulus	$W_{\text{ply}} = 642500 \text{ mm}^3$

###### 2.1.2 Material

Steel grade	S 355
Yield strength	$f_{yb} = 355 \text{ MPa}$
Ultimate strength	$f_{ub} = 490 \text{ MPa}$
E modulus	$E_b = 210000 \text{ MPa}$

###### 2.1.3 Cross-section classification

$$\epsilon = \sqrt{\frac{235}{355}} = 0.814$$

(EN 1993-1-1 §5.6 Tab. 5.2)

###### 2.1.3.1 Flange in compression

$$c_f = \frac{b - t_w - 2 \cdot r}{2} = \frac{200 \text{ mm} - 9 \text{ mm} - 2 \cdot 18 \text{ mm}}{2} = 77.5 \text{ mm}$$

$$\frac{c_f}{t_f} \leq 9 \cdot \epsilon$$

$$\frac{77.5 \text{ mm}}{15 \text{ mm}} \leq 9 \cdot 0.814$$

$$5.17 \leq 7.32$$

OK

Flange classified as Class 1.

Student version

2.1.3.2 Web in bending

$$c_w = h_a - 2 \cdot t_f - 2 \cdot r = 200 \text{ mm} - 2 \cdot 15 \text{ mm} - 2 \cdot 18 \text{ mm} = 134 \text{ mm}$$

$$\alpha_{cl} = 0.5$$

$$\frac{c_w}{t_w} \leq \frac{36 \cdot \epsilon}{\alpha_{cl}}$$

$$\frac{134 \text{ mm}}{9 \text{ mm}} \leq \frac{36 \cdot 0.814}{0.5}$$

$$14.9 \leq 58.6$$

OK

Web classified as Class 1.

**Cross-section classified as Class 1**

Cross-section Class OK.

**2.2 Concrete slab with profiled sheeting****2.2.1 Concrete slab**2.2.1.1 SlabTotal height of the slab  $h_s = 160 \text{ mm}$ 2.2.1.2 Material

Concrete class C30/37

Characteristic strength  $f_{ck} = 30 \text{ MPa}$ E modulus  $E_{cm} = 32800 \text{ MPa}$ **2.2.2 Profiled steel sheeting**

Sheeting with ribs parallel to the supporting beams

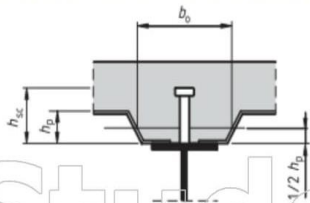

Name	Vulcraft 2 VLI 20
Depth of the ribs	$h_p = 50.8 \text{ mm}$
Height of full concrete	$h_c = 109.2 \text{ mm}$
Height of the re-entrant stiffener	$h_d = 0 \text{ mm}$
Spacing of the ribs	$b_s = 304.8 \text{ mm}$
Top width of the rib	$b_r = 127 \text{ mm}$
Bottom width of the rib	$b_b = 127 \text{ mm}$
Mean width of the ribs	$b_{0,rib} = 152.4 \text{ mm}$
Thickness of the sheeting	$t_p = 0.9093 \text{ mm}$

**2.2.3 Shear connectors**2.2.3.1 Geometry

Name	H110
Diameter	$d_s = 25 \text{ mm}$
Nominal height	$h_{nom} = 110 \text{ mm}$
As-welded height	$h_{sc} = 105 \text{ mm}$
Amount per trough or section	$n_r = 1$

2.2.3.2 Material

Steel grade	S 355
Ultimate strength	$f_{us} = 490 \text{ MPa}$

**2.2.4 Reinforcement**2.2.4.1 Geometry

Longitudinal bar diameter	$d_l = 16 \text{ mm}$
Longitudinal bar spacing	$s_l = 150 \text{ mm}$
Longitudinal bar cover	$c_l = 30 \text{ mm}$
Transverse bar diameter	$d_t = 16 \text{ mm}$
Transverse bar spacing	$s_t = 150 \text{ mm}$
Transverse bar cover	$c_t = 46 \text{ mm}$

2.2.4.2 Material

Material	B 500A
Characteristic yield strength	$f_{ykr} = 500 \text{ MPa}$

**3. Design values of loads**

Load Name : GSN 26

Content of combination : 1.35\*g-vlastitežina+1.35\*dg-dodatnostalno+  
1.62\*q-promjenjivoopterećenije+1.35\*g-vlastitežina\_dryconcrete+  
1.35\*Wx-2kom.-Wz-poz+1.35\*s-opterećenjesnijegom

Bending moment  $M_{Ed,comp} = -109.678$  kNm  
Shear force  $V_{Ed,comp} = -69.282$  kN

**4. Partial safety factors**

Steel section  $\gamma_{M0} = 1$   
 $\gamma_{M1} = 1$   
Shear connectors  $\gamma_V = 1.25$   
Concrete  $\gamma_C = 1.5$   
Reinforcement  $\gamma_S = 1.15$

**5. ULS check of the Final stage**

**5.1 Shear connection**

**5.1.1 Design resistance of shear connectors**

**5.1.1.1 Shear connector in a solid slab**

$$\frac{h_{sc}}{d_s} > 4$$

$$4.2 > 4$$

$$\alpha = 1$$

$$f_{us} = \min(490; 500) \text{ MPa}$$

$$P_{Rd,solid,1} = \frac{0.8 \cdot f_{us} \cdot \left(\frac{\pi \cdot d_s^2}{4}\right)}{\gamma_V} = \frac{0.8 \cdot 490 \text{ MPa} \cdot \left(\frac{3.14 \cdot 25 \text{ mm}^2}{4}\right)}{1.25} = 154 \text{ kN}$$

$$P_{Rd,solid,2} = \frac{0.29 \cdot \alpha \cdot d_s^2 \cdot \sqrt{f_{ck} \cdot E_{cm}}}{\gamma_V} = \frac{0.29 \cdot 1 \cdot 25 \text{ mm}^2 \cdot \sqrt{30 \text{ MPa} \cdot 32800 \text{ MPa}}}{1.25} = 144 \text{ kN}$$

$$P_{Rd,solid} = \min(P_{Rd,solid,1}; P_{Rd,solid,2}) = \min(154 \text{ kN}; 144 \text{ kN}) = 144 \text{ kN}$$

**5.1.1.2 Shear connector in profiled sheeting**

Sheeting with ribs parallel to the supporting beams

$$k_t = \frac{0.6 \cdot b_{0,rib}}{h_p} \cdot \left(\frac{h_{sc}}{h_p} - 1\right) = \frac{0.6 \cdot 152 \text{ mm}}{50.8 \text{ mm}} \cdot \left(\frac{105 \text{ mm}}{50.8 \text{ mm}} - 1\right) = 1.92$$

$$k_t = 1$$

$$P_{Rd} = k_t \cdot P_{Rd,solid} = 1 \cdot 144 \text{ kN} = 144 \text{ kN}$$

**5.1.2 Degree of shear connection**

**5.1.2.1 Determination of  $b_{eff}$  of the concrete flange and length  $L_e$**

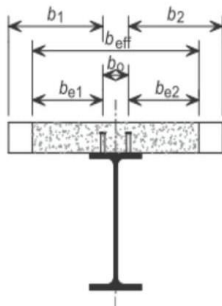

The effective width at the internal support

$$L_{e2} = 0.25 \cdot (L_2 + L_3) = 0.25 \cdot (6.78 \text{ m} + 5.72 \text{ m}) = 3.12 \text{ m}$$

**Left side of the beam**

$$b_1 = \frac{L_{\text{perp, left}}}{2} - \frac{b_0}{2} = \frac{5,4 \text{ m}}{2} - \frac{0 \text{ mm}}{2} = 2,7 \text{ m}$$

$$b_{e10} = \min\left(\frac{L_{e0}}{8}; b_1\right) = \min\left(\frac{0 \text{ m}}{8}; 2,7 \text{ m}\right) = 0 \text{ m}$$

$$b_{e11} = \min\left(\frac{L_{e1}}{8}; b_1\right) = \min\left(\frac{0 \text{ m}}{8}; 2,7 \text{ m}\right) = 0 \text{ m}$$

$$b_{e12} = \min\left(\frac{L_{e2}}{8}; b_1\right) = \min\left(\frac{3,12 \text{ m}}{8}; 2,7 \text{ m}\right) = 0,391 \text{ m}$$

**Right side of the beam**

$$b_2 = L_{\text{perp, right}} - \frac{b_0}{2} = 5,4 \text{ m}$$

$$b_{e20} = \min\left(\frac{L_{e0}}{8}; b_2\right) = \min\left(\frac{0 \text{ m}}{8}; 5,4 \text{ m}\right) = 0 \text{ m}$$

$$b_{e21} = \min\left(\frac{L_{e1}}{8}; b_2\right) = \min\left(\frac{0 \text{ m}}{8}; 5,4 \text{ m}\right) = 0 \text{ m}$$

$$b_{e22} = \min\left(\frac{L_{e2}}{8}; b_2\right) = \min\left(\frac{3,12 \text{ m}}{8}; 5,4 \text{ m}\right) = 0,391 \text{ m}$$

**Calculation of  $b_{\text{eff},2}$** 

$$b_{\text{eff},2} = b_0 + b_{e12} + b_{e22} = 0 \text{ mm} + 0,391 \text{ m} + 0,391 \text{ m} = 0,781 \text{ m}$$

**Calculation of  $b_{\text{eff}}$** 

$$b_{\text{eff}} = b_{\text{eff},2} = 0,781 \text{ m}$$

**Determination of  $L_e$** 

$$L_e = L_{e2} = 3,12 \text{ m}$$

**5.1.2.2 Minimum degree of shear connection**

Warning: Conditions given by EN 1994-1-1 Art. 6.6.1.2 (3) are not fulfilled.

$$\eta_{\text{min, calc}} = 1 - \frac{355}{f_{yb}} \cdot (0,75 - 0,03 \cdot L_e)$$

$$\eta_{\text{min, calc}} = 1 - \frac{355}{355} \cdot (0,75 - 0,03 \cdot 3,12 \text{ m}) = 0,34$$

$$\eta_{\text{min}} = \max(\eta_{\text{min, calc}}; 0,4) = \max(0,34; 0,4) = 0,4$$

**5.1.2.3 Degree of shear connection present****5.1.2.3.1 Tension resistance of the reinforcement**

$$A_s = \frac{b_{\text{eff}}}{s_l} \cdot \left(\frac{d_l^2}{4}\right) \cdot \pi = \frac{0,781 \text{ m}}{150 \text{ mm}} \cdot \left(\frac{16 \text{ mm}^2}{4}\right) \cdot 3,14 = 1047 \text{ mm}^2$$

$$F_s = \frac{A_s \cdot f_{yk,r}}{\gamma_s} = \frac{1,05 \cdot 10^{-3} \cdot 500 \cdot 10^6}{1,15} = 455 \text{ kN}$$

**5.1.2.3.2 Tension resistance of the steel member**

$$N_{pl,a} = f_{yb} \cdot A_a = 355 \text{ MPa} \cdot 7808 \text{ mm}^2 = 2771,84 \text{ kN}$$

$$N_{c,f} = \min(F_s; N_{pl,a}) = \min(455 \text{ kN}; 2771,84 \text{ kN}) = 455,25 \text{ kN}$$

**5.1.2.3.3 Resistance of the shear connectors**

$$l_s = \frac{L}{n_{\text{row}}} = \frac{6,78}{22} = 308 \text{ mm}$$

Number of shear studs available per length  $L_e/2$

$$n_{sp} = \frac{0,5 \cdot L_e}{l_s} \cdot n_r$$

$$n_{sp} = 5 \cdot 1 = 5$$

$$N_c = n_{sp} \cdot P_{Rd} = 5 \cdot 143835 = 719,18 \text{ kN}$$

$$\eta = \min\left(\frac{N_c}{N_{c,f}}; 1\right) = \min\left(\frac{719,18 \text{ kN}}{455,25 \text{ kN}}; 1\right) = 1$$

$$\eta \geq \eta_{\text{min}}$$

$$1 \geq 0,4$$

The shear connection degree is adequate. OK

**5.2 Cross-sectional resistance of the composite beam****5.2.1 Shear buckling**

$$h_w = h_s - 2 \cdot t_f = 200 \text{ mm} - 2 \cdot 15 \text{ mm} = 170 \text{ mm}$$

$$\eta_{sb} = 1.2$$

$$\frac{h_w}{t_w} \leq \frac{72 \cdot \varepsilon}{\eta_{sb}}$$

$$\frac{170 \text{ mm}}{9 \text{ mm}} \leq \frac{72 \cdot 0.814}{1.2}$$

$$18.9 \leq 48.8$$

OK

The shear buckling resistance of the web does not need to be verified.

**5.2.2 Vertical shear**

The resistance to vertical shear should be taken as the resistance of the structural steel section.

$$A_v = A_s - 2 \cdot b \cdot t_f + (t_w + 2 \cdot r) \cdot t_f$$

$$= 7.81 \cdot 10^{-3} - 2 \cdot 0.2 \cdot 0.015 + (9 \cdot 10^{-3} + 2 \cdot 0.018) \cdot 0.015 = 2483 \text{ mm}^2$$

$$A_{v,\min} = \eta_{sb} \cdot h_w \cdot t_w = 1.2 \cdot 0.17 \cdot 9 \cdot 10^{-3} = 1836 \text{ mm}^2$$

$$A_v \geq A_{v,\min}$$

$$2483 \text{ mm}^2 \geq 1836 \text{ mm}^2$$

$$V_{pl,Rd} = \frac{A_v \cdot f_{yb}}{\sqrt{3} \cdot \gamma_{M0}} = \frac{2483 \text{ mm}^2 \cdot 355 \cdot 10^6}{\sqrt{3} \cdot 1} = 509 \text{ kN}$$

$$UC_{\text{comp}_V} = \frac{\text{abs}(V_{Ed,\text{comp}})}{V_{pl,Rd}} = \frac{\text{abs}(-69.282 \text{ kN})}{509 \text{ kN}} = 0.14$$

The shear resistance of the section is adequate.

**5.2.3 Bending moment****5.2.3.1 Longitudinal reinforcement****5.2.3.1.1 Centre of composite section**For buildings not intended mainly for storage the effects of creep in concrete beams may be taken into account by using an effective E modulus  $E_{\text{ceff}} = E_{\text{cm}} / 2$ .

$$E_{\text{ceff}} = \frac{E_{\text{cm}}}{2} = \frac{32800 \text{ MPa}}{2} = 16400 \text{ MPa}$$

$$\eta_E = \frac{E_b}{E_{\text{ceff}}} = \frac{210000 \text{ MPa}}{16400 \text{ MPa}} = 12.8$$

$$y_d = \frac{A_a \cdot \left( \frac{h_a}{2} \right) + \left( \frac{1}{\eta_E} \right) \cdot b_{\text{eff}} \cdot (h_c - h_d) \cdot \left( h_a + h_s - \frac{h_c - h_d}{2} \right)}{A_a + \left( \frac{1}{\eta_E} \right) \cdot b_{\text{eff}} \cdot (h_c - h_d)}$$

$$= \frac{7.81 \cdot 10^{-3} \cdot \left( \frac{0.2}{2} \right) + \left( \frac{1}{12.8} \right) \cdot 0.781 \cdot (0.109 - 0) \cdot \left( 0.2 + 0.16 - \frac{0.109 - 0}{2} \right)}{7.81 \cdot 10^{-3} + \left( \frac{1}{12.8} \right) \cdot 0.781 \cdot (0.109 - 0)} = 195 \text{ mm}$$

**5.2.3.1.2 Degree of reinforcement**

$$A_s = \frac{b_{\text{eff}}}{s_l} \cdot \left( \frac{d_l^2}{4} \right) \cdot \pi = \frac{0.781 \text{ m}}{150 \text{ mm}} \cdot \left( \frac{16 \text{ mm}^2}{4} \right) \cdot 3.14 = 1047 \text{ mm}^2$$

$$A_c = b_{\text{eff}} \cdot (h_c - h_d) = 0.781 \cdot (0.109 - 0) = 85302 \text{ mm}^2$$

$$z_0 = \left( h_a + h_s - \frac{h_c - h_d}{2} \right) - y_d = \left( 0.2 + 0.16 - \frac{0.109 - 0}{2} \right) - 0.195 = 111 \text{ mm}$$

$$k_c = \min \left( \frac{1}{\left( 1 + \frac{h_c - h_d}{2 \cdot z_0} \right)} + 0.3; 1 \right) = \min \left( \frac{1}{\left( 1 + \frac{0.109 - 0}{2 \cdot 0.111} \right)} + 0.3; 1 \right) = 0.97$$

$$\rho_s = \delta \cdot \left( \frac{f_{yb}}{235} \right) \cdot \left( \frac{f_{ctm}}{f_{yk,r}} \right) \cdot \sqrt{k_c} = 1.1 \cdot \left( \frac{355}{235} \right) \cdot \left( \frac{2.9 \cdot 10^6}{500 \cdot 10^6} \right) \cdot \sqrt{0.97} = 0.949 \%$$

$$A_s \geq \rho_s \cdot A_c$$

$$1047 \text{ mm}^2 \geq 9.49 \cdot 10^{-3} \cdot 85302 \text{ mm}^2$$

$$1047 \text{ mm}^2 \geq 810 \text{ mm}^2$$

OK

The longitudinal reinforcement of the section is adequate.

5.2.3.2 Moment resistance

Moment resistance of a steel cross-section

$$M_{pl,Rd,s} = \frac{W_{ply} \cdot f_{yb}}{Y_{MO}} = \frac{642500 \text{ mm}^3 \cdot 355 \text{ MPa}}{1} = 228 \text{ kNm}$$

Influence of shear

$$\frac{V_{pl,Rd}}{2} > \text{abs}(V_{ed,comp})$$

$$\frac{509 \text{ kN}}{2} > 69.3 \text{ kN}$$

254 kN > 69.3 kN OK

The influence of the vertical shear on the bending moment resistance may be neglected.

$$f_{yb,w} = f_{yb} = 355 \text{ MPa}$$

Modified tension resistance of the steel member

$$r = 0 \text{ mm}$$

$$A_a = 2 \cdot t_f \cdot b + t_w \cdot (h_a - 2 \cdot t_f) = 2 \cdot 15 \text{ mm} \cdot 200 \text{ mm} + 9 \text{ mm} \cdot (200 \text{ mm} - 2 \cdot 15 \text{ mm}) = 7530 \text{ mm}^2$$

$$N_{pl,a} = A_a \cdot f_{yb} = 7530 \text{ mm}^2 \cdot 355 \text{ MPa} = 2673.15 \text{ kN}$$

Note: Roundings of the steel cross-section are neglected in bending resistance calculation.

$$N_{c,f} = \min(F_s; N_{pl,a}) = \min(455 \text{ kN}; 2673.15 \text{ kN}) = 455.25 \text{ kN}$$

Negative bending moment resistance calculation

The plastic neutral axis is located within the web of the steel section.

$$N_{at,f} = b \cdot t_f \cdot f_{yb} = 0.2 \cdot 0.015 \cdot 355 \cdot 10^6 = 1065.00 \text{ kN}$$

$$N_{pl,a} - N_{at,f} - N_{at,w} = F_s + N_{at,f} + N_{at,w}$$

$$x = \frac{(N_{pl,a} - 2 \cdot N_{at,f} - F_s)}{(2 \cdot t_w \cdot f_{yb,w})} = \frac{(2673.15 \text{ kN} - 2 \cdot 1065.00 \text{ kN} - 455 \text{ kN})}{(2 \cdot 9 \text{ mm} \cdot 355 \text{ MPa})} = 13.8 \text{ mm}$$

Verification of the steel web classification.

$$\alpha_{cl} = \frac{c_w - x}{c_w} = \frac{134 - 13.8}{134} = 0.897$$

$$\frac{c_w}{t_w} \leq \frac{396 \cdot \epsilon}{13 \cdot \alpha_{cl} - 1}$$

$$\frac{134 \text{ mm}}{9 \text{ mm}} \leq \frac{396 \cdot 0.814}{13 \cdot 0.897 - 1}$$

$$4.9 \leq 30.2 \quad \text{OK}$$

Web classified as Class 1.

$$N_{at,w} = t_w \cdot x \cdot f_{yb,w} = 9 \text{ mm} \cdot 13.8 \text{ mm} \cdot 355 \text{ MPa} = 43.95 \text{ kN}$$

$$N_{a,c} = N_{pl,a} - N_{at,f} - N_{at,w} = 2673.15 \text{ kN} - 1065.00 \text{ kN} - 43.95 \text{ kN} = 1564.20 \text{ kN}$$

Leverage arm of the compression part of the steel section calculated to the PNA.

$$h_{cs} = \frac{(t_w \cdot (h_a - 2 \cdot t_f - x)^2 \cdot 0.5 + t_f \cdot b \cdot (h_a - 1.5 \cdot t_f - x))}{t_w \cdot (h_a - 2 \cdot t_f - x) + t_f \cdot b}$$

$$= \frac{(9 \cdot (200 - 2 \cdot 15 - 13.8)^2 \cdot 0.5 + 15 \cdot 200 \cdot (200 - 1.5 \cdot 15 - 13.8))}{9 \cdot (200 - 2 \cdot 15 - 13.8) + 15 \cdot 200} = 136 \text{ mm}$$

$$h_i = x + t_f + h_s - c_i + \frac{d_i}{2} = 0.0138 + 0.015 + 0.16 - 0.03 + \frac{0.016}{2} = 151 \text{ mm}$$

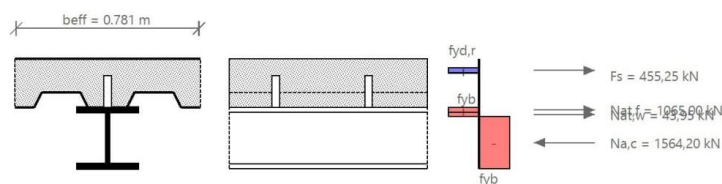

$$M_{pl,Rd} = F_s \cdot h_i + N_{at,f} \cdot \left(\frac{t_f}{2} + x\right) + \frac{N_{at,w} \cdot x}{2} + N_{a,c} \cdot h_{cs}$$

$$= 455 \cdot 151 + 1065.00 \cdot \left(\frac{15}{2} + 13.8\right) + \frac{43.95 \cdot 13.8}{2} + 1564.20 \cdot 136 = 305 \text{ kNm}$$

Design moment resistance according to EN 1994-1-1 Art.6.2.1.2

$$M_{Rd} = M_{pl,Rd} = 305 \text{ kNm}$$

$$UC_{comp,M} = \frac{\text{abs}(M_{ed,comp})}{M_{Rd}} = \frac{\text{abs}(-109.678 \text{ kNm})}{305 \text{ kNm}} = 0.36$$

The bending moment resistance of the section is adequate.

**5.3 LTB resistance**

$$F = \left( 1 + \frac{t_w \cdot (h_a - t_f)}{4 \cdot b \cdot t_f} \right) \cdot \left( \frac{h_a - t_f}{t_w} \right)^{0.75} \cdot \left( \frac{t_f}{b} \right)^{0.25} = \left( 1 + \frac{9 \cdot (200 - 15)}{4 \cdot 200 \cdot 15} \right) \cdot \left( \frac{200 - 15}{9} \right)^{0.75} \cdot \left( \frac{15}{200} \right)^{0.25} = 5.75$$

$$F_{lim} = 12.3$$

$$F \leq F_{lim}$$

$$5.75 \leq 12.3$$

OK

The cross-section is qualified for verification of LTB by the simplified method.

$$C_4 = 25$$

$$\lambda_{LT,rel} = 5 \cdot \left( 1 + \frac{t_w \cdot (h_a - t_f)}{4 \cdot b \cdot t_f} \right) \cdot \left( \frac{h_a - t_f}{t_w} \right)^{0.75} \cdot \left( \frac{t_f}{b} \right)^{0.25} \cdot \left( \frac{f_{yb}}{E_b \cdot C_4} \right)^{0.5}$$

$$= 5 \cdot \left( 1 + \frac{9 \cdot 10^{-3} \cdot (0.2 - 0.015)}{4 \cdot 0.2 \cdot 0.015} \right) \cdot \left( \frac{0.2 - 0.015}{9 \cdot 10^{-3}} \right)^{0.75} \cdot \left( \frac{0.015}{0.2} \right)^{0.25} \cdot \left( \frac{355 \cdot 10^6}{210 \cdot 10^9 \cdot 25} \right)^{0.5} = 0.237$$

$h_a/b < 2 \rightarrow$  Buckling curve 'a'

$$\alpha_{LT} = 0.21$$

$$\Phi_{LT} = 0.5 \cdot \left( 1 + \alpha_{LT} \cdot (\lambda_{LT,rel} - 0.2) + \lambda_{LT,rel}^2 \right) = 0.5 \cdot \left( 1 + 0.21 \cdot (0.237 - 0.2) + 0.237^2 \right) = 0.532$$

$$X_{LT} = \frac{1}{\Phi_{LT} + \sqrt{\Phi_{LT}^2 - \lambda_{LT,rel}^2}} = \frac{1}{0.532 + \sqrt{0.532^2 - 0.237^2}} = 0.992$$

$$X_{LT} = \min(X_{LT}, 1) = \min(0.992, 1) = 0.992$$

$$M_{b,Rd} = X_{LT} \cdot M_{Rd} = 0.992 \cdot 304957 = 302.500 \text{ kNm}$$

$$UC_{comp\_LTB} = \frac{\text{abs}(M_{Ed,comp})}{M_{b,Rd}} = \frac{\text{abs}(-109.678 \text{ kNm})}{302.500 \text{ kNm}} = 0.36$$

The later torsional buckling resistance of the section is adequate.

**5.4 Longitudinal shear****5.4.1 Transverse reinforcement**

Design shear flow

$$h_f = h_c = 109 \text{ mm}$$

$$V_{Ed} = \frac{F_{Rd} \cdot P_{Rd}}{I_s \cdot h_f} = \frac{1 \cdot 144 \text{ kN}}{308 \text{ mm} \cdot 109 \text{ mm}} = 4.27 \text{ MPa}$$

Transverse reinforcement

$$\frac{A_{st} \cdot f_{yk,r}}{V_s \cdot s_f} \geq \frac{V_{Ed} \cdot h_f}{\cotg(\theta)}$$

$$A_t = A_{st}/s_f$$

$$A_t = \frac{V_{Ed} \cdot h_f}{\frac{\cotg(\theta) \cdot f_{yk,r}}{V_s}} = \frac{4.27 \cdot 10^6 \cdot 0.109}{\left( \frac{\cotg(26.5) \cdot 500 \cdot 10^6}{1.15} \right)} = 535 \text{ mm}^2/\text{m}$$

$$A_{t,prov} = \frac{1}{s_t} \cdot \left( \frac{d_t^2}{4} \right) \cdot 3.14 = \frac{1}{0.15} \cdot \left( \frac{0.016^2}{4} \right) \cdot 3.14 = 1340 \text{ mm}^2/\text{m}$$

$$A_{t,prov} \geq A_t$$

$$1340 \text{ mm}^2/\text{m} \geq 535 \text{ mm}^2/\text{m} \quad \text{OK}$$

The transverse reinforcement of the section is adequate.

**ULS check of Final stage is OK.**

$$UC_{comp} = \max(0.14; 0.36; 0.36) = 0.36$$

Student version



## 16. PRORAČUN STUPOVA

### 16.1. Horizontalni pomak stupova

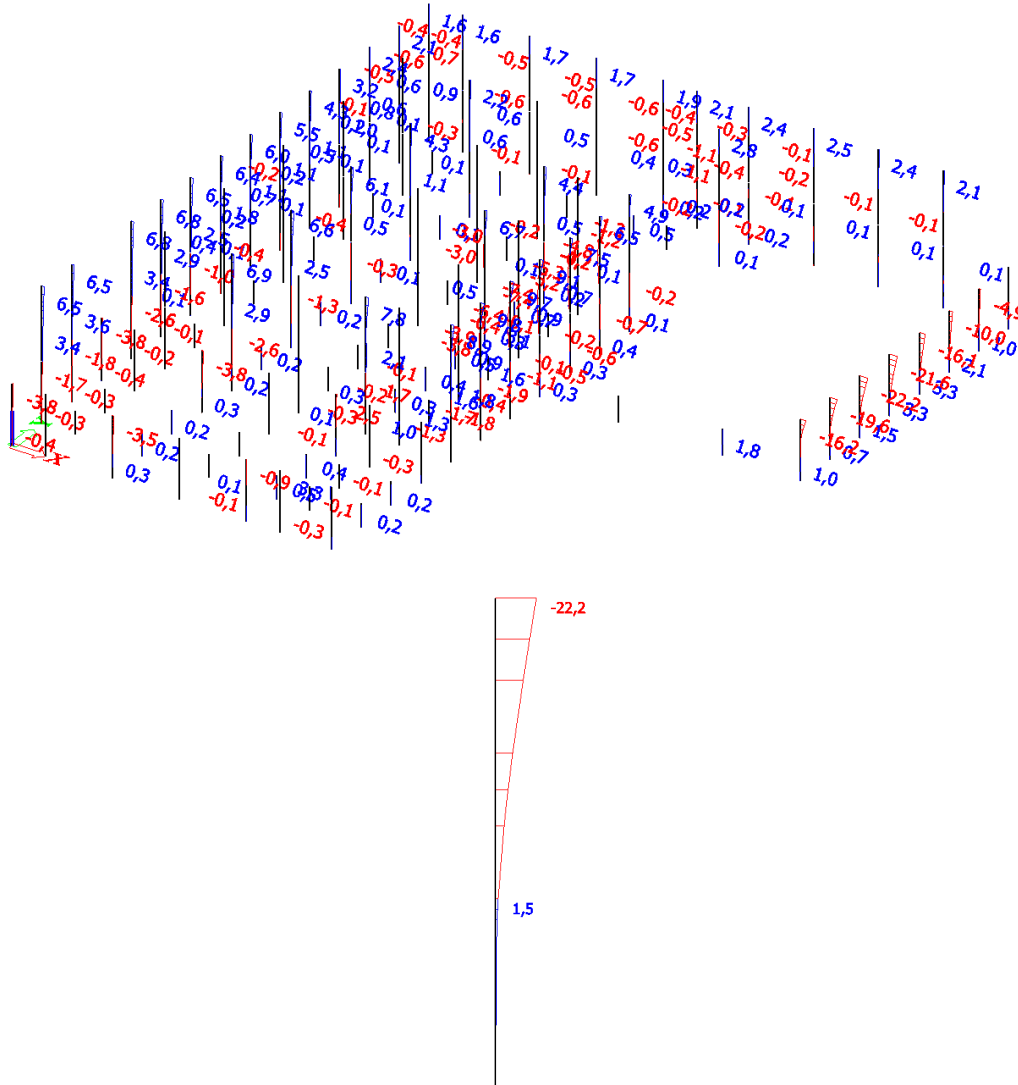

Slika 16.1. Prikaz horizontalnog pomaka stupova

Dopušteni horizontalni pomak:

$$u_{dop} = \frac{h}{200} = \frac{7,2 \cdot 1000}{200} = 36,0 \text{ mm}$$

$$u_x = 22,2 \text{ mm} < u_{x,dop} = 36,0 \text{ mm} \quad \text{Zadovoljava}$$

-iskoristivost na GSU -  $22,2 \text{ mm} / 36,0 \text{ mm} = 0,62 = 62\%$

## 16.2. Dimenziniranje - stupovi prizemlja

### 16.2.1. Rezne sile – stup 1 (prizemlje)

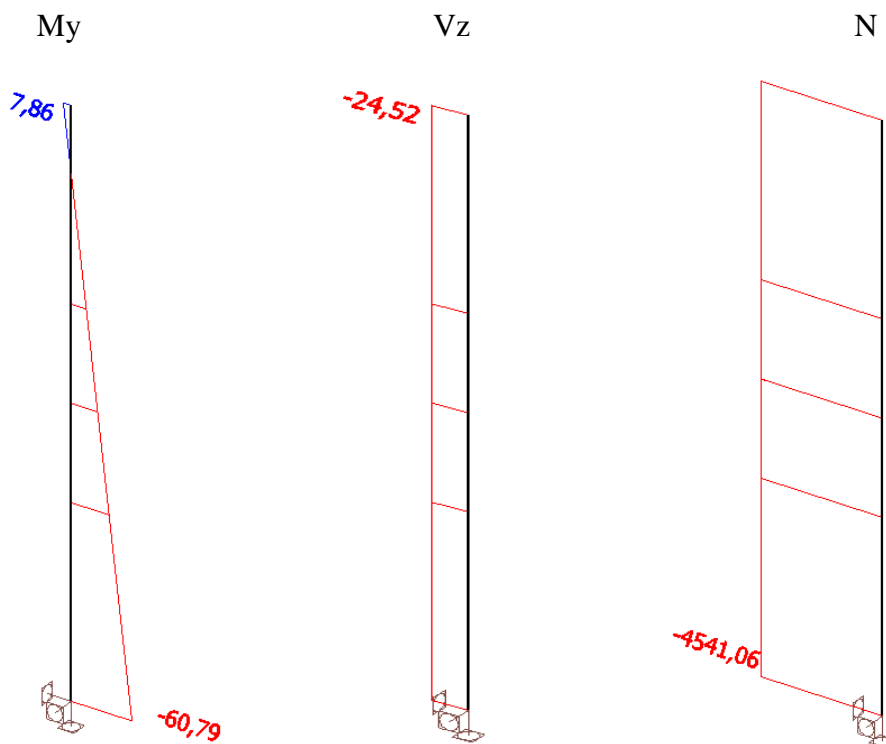

Slika 16.2. Prikaz reznih sila nosača - stup 1 (prizemlje)

-poprečni presjek nosača

Name	Stup 1 - prizemlje	
Type	HEB500	
Source description	Profil Arbed / Structural shapes / Edition Octobre 1995	
Item material	S 355	
Fabrication	rolled	
Flexural buckling y-y	a	
Flexural buckling z-z	b	
Lateral torsional buckling	Default	
Use 2D FEM analysis	x	
A [m²]	2,3860e-02	
A <sub>y, z</sub> [m²]	1,6161e-02	7,4905e-03
I <sub>y, z</sub> [m⁴]	1,0720e-03	1,2620e-04
I <sub>w</sub> [m⁴], I <sub>t</sub> [m⁴]	7,0177e-06	5,3840e-06
W <sub>el y, z</sub> [m³]	4,2870e-03	8,4160e-04
W <sub>pl y, z</sub> [m³]	4,8150e-03	1,2920e-03
d <sub>y, z</sub> [mm]	0	0
c <sub>YUCS, ZUCS</sub> [mm]	150	250
α [deg]	0,00	
A <sub>L, D</sub> [m²/m]	2,1300e+00	2,1244e+00
M <sub>ply +, -</sub> [Nm]	1,71e+06	1,71e+06
M <sub>plz +, -</sub> [Nm]	4,59e+05	4,59e+05

Slika 16.3. Prikaz geometrijskih karakteristika nosača

## 16.2.2. Dimenzioniranje – stup 1 (prizemlje)

Member B82	2,800 m	HEB500	S 355	GSN 26	0,64 -
------------	---------	--------	-------	--------	--------

Partial safety factors	
Gamma M0 for resistance of cross-sections	1,00
Gamma M1 for resistance to instability	1,00
Gamma M2 for resistance of net sections	1,25

Material		
Yield strength $f_y$	355,0	MPa
Ultimate strength $f_u$	490,0	MPa
Fabrication	Rolled	

.....SECTION CHECK:....

The critical check is on position 2.800 m

Internal forces	Calculated	Unit
N,Ed	-4541,05	kN
V <sub>y</sub> ,Ed	5,27	kN
V <sub>z</sub> ,Ed	-24,52	kN
T,Ed	0,01	kNm
M <sub>y</sub> ,Ed	-60,79	kNm
M <sub>z</sub> ,Ed	8,56	kNm

### Classification for cross-section design

According to EN 1993-1-1 article 5.5.2

### Classification of Internal Compression parts

According to EN 1993-1-1 Table 5.2 Sheet 1

Maximum width-to-thickness ratio	26,90
Class 1 Limit	26,85
Class 2 Limit	30,92
Class 3 Limit	35,46

=> Internal Compression parts Class 2

### Classification of Outstand Flanges

According to EN 1993-1-1 Table 5.2 Sheet 2

Maximum width-to-thickness ratio	4,13
Class 1 Limit	7,32
Class 2 Limit	8,14
Class 3 Limit	11,24

=> Outstand Flanges Class 1

=> Section classified as Class 2 for cross-section design

### Compression check

According to EN 1993-1-1 article 6.2.4 and formula (6.9)

A	2,3860e-02	m <sup>2</sup>
N <sub>c,Rd</sub>	8470,30	kN
Unity check	0,54	-

### Bending moment check for M<sub>y</sub>

According to EN 1993-1-1 article 6.2.5 and formula (6.12),(6.13)

W <sub>pl,y</sub>	4,8150e-03	m <sup>3</sup>
M <sub>pl,y,Rd</sub>	1709,33	kNm
Unity check	0,04	-

### Bending moment check for M<sub>z</sub>

According to EN 1993-1-1 article 6.2.5 and formula (6.12),(6.13)

W <sub>pl,z</sub>	1,2920e-03	m <sup>3</sup>
M <sub>pl,z,Rd</sub>	458,66	kNm
Unity check	0,02	-

### Shear check for V<sub>y</sub>

According to EN 1993-1-1 article 6.2.6 and formula (6.17)

Eta	1,20	
A <sub>v</sub>	1,7402e-02	m <sup>2</sup>
V <sub>pl,y,Rd</sub>	3566,65	kN
Unity check	0,00	-

### Shear check for V<sub>z</sub>

According to EN 1993-1-1 article 6.2.6 and formula (6.17)

Eta	1,20	
A <sub>v</sub>	8,9780e-03	m <sup>2</sup>
V <sub>pl,z,Rd</sub>	1840,13	kN
Unity check	0,01	-

**Note:** The unity check for torsion is lower than the limit value of 0,05. Therefore torsion is considered as insignificant and is ignored in the combined checks.

**Combined bending, axial force and shear force check**  
According to EN 1993-1-1 article 6.2.9.1 and formula (6.41)

MN,y,Rd	930,61	kNm
Alpha	2,00	
MN,z,Rd	405,27	kNm
Beta	2,68	

Unity check (6.41) = 0,00 + 0,00 = 0,00 -

**Note:** Since the shear forces are less than half the plastic shear resistances their effect on the moment resistances is neglected.

The member satisfies the section check.

...:STABILITY CHECK:...:

**Classification for member buckling design**

Decisive position for stability classification: 0,000 m

**Classification of Internal Compression parts**

According to EN 1993-1-1 Table 5.2 Sheet 1

Maximum width-to-thickness ratio	26,90
Class 1 Limit	26,85
Class 2 Limit	30,92
Class 3 Limit	34,34

=> Internal Compression parts Class 2

**Classification of Outstand Flanges**

According to EN 1993-1-1 Table 5.2 Sheet 2

Maximum width-to-thickness ratio	4,13
Class 1 Limit	7,32
Class 2 Limit	8,14
Class 3 Limit	11,23

=> Outstand Flanges Class 1

=> Section classified as Class 2 for member buckling design

**Flexural Buckling check**

According to EN 1993-1-1 article 6.3.1.1 and formula (6.46)

Buckling parameters	yy	zz	
Sway type	sway	non-sway	
System length L	2,800	2,800	m
Buckling factor k	1,00	1,00	
Buckling length Lcr	2,800	2,800	m
Critical Euler load Ncr	283398,64	33362,79	kN
Slenderness Lambda	13,21	38,50	
Relative slenderness Lambda,rel	0,17	0,50	
Limit slenderness Lambda,rel,0	0,20	0,20	
Buckling curve	a	b	
Imperfection Alpha	0,21	0,34	
Reduction factor Chi	1,00	0,88	
Buckling resistance Nb,Rd	8470,30	7475,02	kN

Flexural Buckling verification		
Cross-section area A	2,3860e-02	m <sup>2</sup>
Buckling resistance Nb,Rd	7475,02	kN
Unity check	0,61	-

**Torsional(-Flexural) Buckling check**

According to EN 1993-1-1 article 6.3.1.1 and formula (6.46)

**Note:** For this I-section the Torsional(-Flexural) buckling resistance is higher than the resistance for Flexural buckling. Therefore Torsional(-Flexural) buckling is not printed on the output.

**Lateral Torsional Buckling check**

According to EN 1993-1-1 article 6.3.2.1 & 6.3.2.2 and formula (6.54)

LTB parameters		
Method for LTB curve	General case	
Cross-section plastic modulus Wpl,y	4,8150e-03	m <sup>3</sup>
Elastic critical moment Mcr	16703,26	kNm
Relative slenderness Lambda,rel,LT	0,32	
Limit slenderness Lambda,rel,LT,0	0,20	

**Note:** The slenderness or bending moment is such that Lateral Torsional Buckling effects may be ignored according to EN 1993-1-1 article 6.3.2.2(4).

Mcr parameters		
LTB length L	2,800	m
Influence of load position	no influence	
Correction factor k	1,00	
Correction factor kw	1,00	
LTB moment factor C1	1,91	
LTB moment factor C2	0,00	

\*Student version\* \*Student version\* \*Student version\* \*Student version\* \*Student ver

Mcr parameters		
<i>*Student version* *Student version* *Student version* *Student version* *Student ver</i>		
LTB moment factor C3	1,00	
Shear center distance d,z	0	mm
Distance of load application z,g	0	mm
Mono-symmetry constant beta,y	0	mm
Mono-symmetry constant z,j	0	mm

Note: C parameters are determined according to ECCS 119 2006 / Galea 2002.

**Bending and axial compression check**

According to EN 1993-1-1 article 6.3.3 and formula (6.61),(6.62)

Bending and axial compression check parameters		
<i>*Student version* *Student version* *Student version* *Student version* *Student version* *Student version* *S</i>		
Interaction method	alternative method 1	
Cross-section area A	2,3860e-02	m <sup>2</sup>
Cross-section plastic modulus Wpl,y	4,8150e-03	m <sup>3</sup>
Cross-section plastic modulus Wpl,z	1,2920e-03	m <sup>3</sup>
Design compression force N,Ed	4541,05	kN
Design bending moment (maximum) My,Ed	-60,79	kNm
Design bending moment (maximum) Mz,Ed	8,56	kNm
Characteristic compression resistance N,Rk	8470,30	kN
Characteristic moment resistance My,Rk	1709,33	kNm
Characteristic moment resistance Mz,Rk	458,66	kNm
Reduction factor Chi,y	1,00	
Reduction factor Chi,z	0,88	
Reduction factor Chi,LT	1,00	
Interaction factor k,yy	1,06	
Interaction factor k,yz	0,50	
Interaction factor k,zy	0,57	
Interaction factor k,zz	0,77	

Maximum moment My,Ed is derived from beam B82 position 2,800 m.

Maximum moment Mz,Ed is derived from beam B82 position 2,800 m.

Interaction method 1 parameters		
<i>*Student version* *Student version* *Student version* *Student version* *Student version* *Student version* *S</i>		
Critical Euler load N,cr,y	283398,64	kN
Critical Euler load N,cr,z	33362,79	kN
Elastic critical load N,cr,T	45603,04	kN
Cross-section plastic modulus Wpl,y	4,8150e-03	m <sup>3</sup>
Cross-section elastic modulus Wel,y	4,2870e-03	m <sup>3</sup>
Cross-section plastic modulus Wpl,z	1,2920e-03	m <sup>3</sup>
Cross-section elastic modulus Wel,z	8,4160e-04	m <sup>3</sup>
Second moment of area Iy	1,0720e-03	m <sup>4</sup>
Second moment of area Iz	1,2620e-04	m <sup>4</sup>
Torsional constant It	5,3840e-06	m <sup>4</sup>
Method for equivalent moment factor C,my,0	Table A.2 Line 2 (General)	
Design bending moment (maximum) My,Ed	-60,79	kNm
Maximum relative deflection delta,z	0,1	mm
Equivalent moment factor C,my,0	0,99	
Method for equivalent moment factor C,mz,0	Table A.2 Line 2 (General)	
Design bending moment (maximum) Mz,Ed	8,56	kNm
Maximum relative deflection delta,y	-0,1	mm
Equivalent moment factor C,mz,0	0,90	
Factor mu,y	1,00	
Factor mu,z	0,98	
Factor epsilon,y	0,07	
Factor a,LT	0,99	
Critical moment for uniform bending Mcr,0	8740,93	kNm
Relative slenderness Lambda,rel,0	0,44	
Limit relative slenderness Lambda,rel,0,lim	0,26	
Equivalent moment factor C,my	0,99	
Equivalent moment factor C,mz	0,90	
Equivalent moment factor C,mLT	1,12	
Factor b,LT	0,00	
Factor c,LT	0,01	
Factor d,LT	0,00	
Factor e,LT	0,16	
Factor w,y	1,12	
Factor w,z	1,50	
Factor n,pl	0,54	
Maximum relative slenderness Lambda,rel,max	0,50	
Factor C,yy	1,06	
Factor C,yz	1,43	
Factor C,zy	1,00	
Factor C,zz	1,32	

Unity check (6.61) = 0,54 + 0,04 + 0,01 = 0,58 -

Unity check (6.62) = 0,61 + 0,02 + 0,01 = 0,64 -

**Shear Buckling check**

According to EN 1993-1-5 article 5 & 7.1 and formula (5.10) & (7.1)

Shear Buckling parameters		
<i>*Student version* *Student version* *Student version* *Student version* *Student version* *Student version* *S</i>		
Buckling field length a	2,800	m
Web	unstiffened	
Web height hw	444	mm

*\*Student version\* \*Student version\* \*Student version\* \*Student version\* \*Student version\* \*Student version\* \*S*

Shear Buckling parameters		
Web thickness $t$	15	mm
Material coefficient epsilon	0,81	
Shear correction factor Eta	1,20	

Shear Buckling verification		
Web slenderness $hw/t$	30,62	
Web slenderness limit	48,82	

**Note:** The web slenderness is such that Shear Buckling effects may be ignored according to EN 1993-1-5 article 5.1(2).  
The member satisfies the stability check.

-iskoristivost elementa na GSN – 64 %

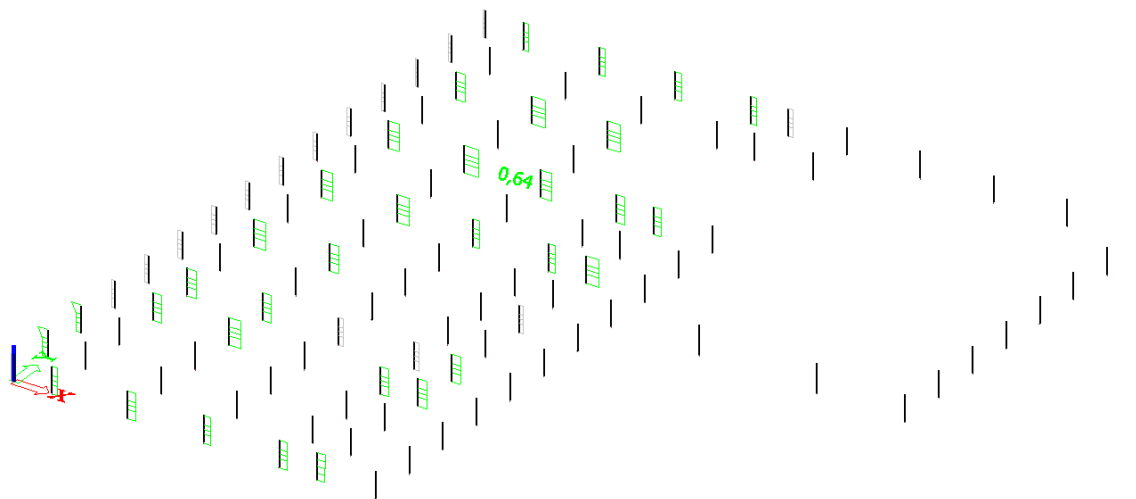

**Slika 16.4.** Prikaz iskoristivosti nosača – stup 1 (prizemlje)

16.2.3. Rezne sile – stup 2 (prizemlje)

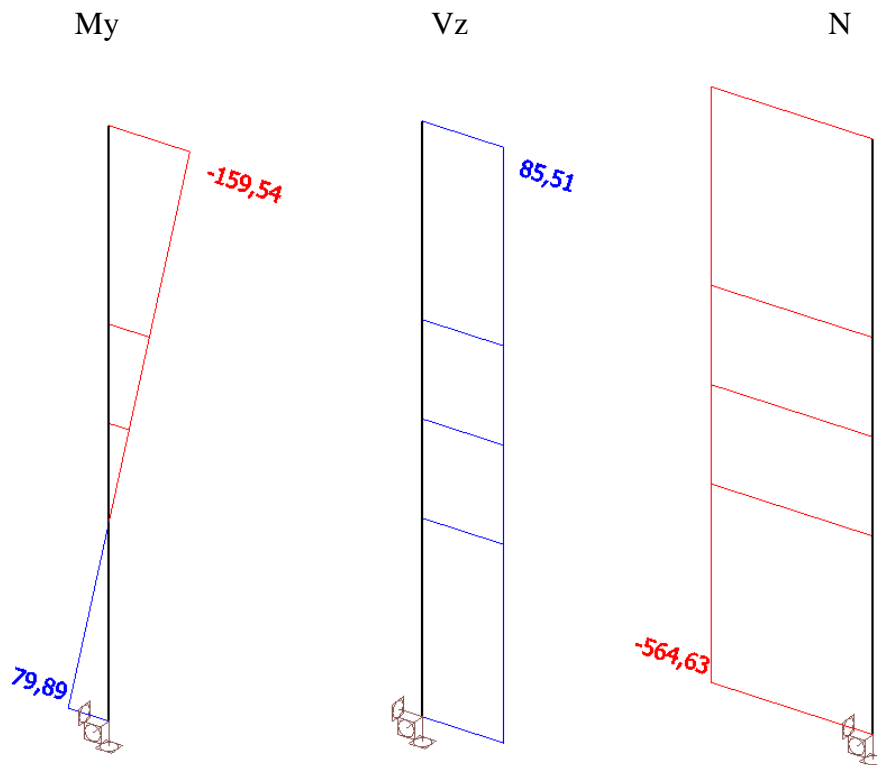

Slika 16.5. Prikaz reznih sila nosača – stup 2 (prizemlje)

-poprečni presjek nosača

Name	Stup 2 - prizemlje	
Type	HEA340	
Source description	Profil Arbed / Structural shapes / Edition Octobre 1995	
Item material	S 355	
Fabrication	rolled	
Flexural buckling y-y	b	
Flexural buckling z-z	c	
Lateral torsional buckling	Default	
Use 2D FEM analysis	x	
A [m²]	1,3400e-02	
A y, z [m²]	9,5495e-03	3,3201e-03
I y, z [m⁴]	2,7700e-04	7,4400e-05
I w [m⁵], t [m⁴]	1,8244e-06	1,2700e-06
Wey, z [m³]	1,6800e-03	4,9600e-04
Wply, z [m³]	1,8500e-03	7,5417e-04
d y, z [mm]	0	0
c YUCS, ZUCS [mm]	150	165
α [deg]	0,00	
A L, D [m²/m]	1,8000e+00	1,7944e+00
Mply +, - [Nm]	6,57e+05	6,57e+05
Mplz +, - [Nm]	2,68e+05	2,68e+05

Slika 16.6. Prikaz geometrijskih karakteristika nosača

## 16.2.4. Dimenzioniranje – stup 2 (prizemlje)

Member B79	2,800 m	HEA340	S 355	GSN 22	0,40 -
------------	---------	--------	-------	--------	--------

Partial safety factors	
Gamma M0 for resistance of cross-sections	1,00
Gamma M1 for resistance to instability	1,00
Gamma M2 for resistance of net sections	1,25

Material		
Yield strength $f_y$	355,0	MPa
Ultimate strength $f_u$	490,0	MPa
Fabrication	Rolled	

....SECTION CHECK:....

The critical check is on position 2.800 m

Internal forces	Calculated	Unit
N,Ed	-564,63	kN
Vy,Ed	-8,63	kN
Vz,Ed	85,51	kN
T,Ed	0,00	kNm
My,Ed	79,89	kNm
Mz,Ed	-10,62	kNm

#### Classification for cross-section design

According to EN 1993-1-1 article 5.5.2

#### Classification of Internal Compression parts

According to EN 1993-1-1 Table 5.2 Sheet 1

Maximum width-to-thickness ratio	25,58
Class 1 Limit	26,85
Class 2 Limit	30,92
Class 3 Limit	48,79

=> Internal Compression parts Class 1

#### Classification of Outstand Flanges

According to EN 1993-1-1 Table 5.2 Sheet 2

Maximum width-to-thickness ratio	7,17
Class 1 Limit	7,32
Class 2 Limit	8,14
Class 3 Limit	11,40

=> Outstand Flanges Class 1

=> Section classified as Class 1 for cross-section design

#### Compression check

According to EN 1993-1-1 article 6.2.4 and formula (6.9)

A	1,3400e-02	m <sup>2</sup>
Nc,Rd	4757,00	kN
Unity check	0,12	-

#### Bending moment check for My

According to EN 1993-1-1 article 6.2.5 and formula (6.12),(6.13)

Wpl,y	1,8500e-03	m <sup>3</sup>
Mpl,y,Rd	656,75	kNm
Unity check	0,12	-

#### Bending moment check for Mz

According to EN 1993-1-1 article 6.2.5 and formula (6.12),(6.13)

Wpl,z	7,5417e-04	m <sup>3</sup>
Mpl,z,Rd	267,73	kNm
Unity check	0,04	-

#### Shear check for Vy

According to EN 1993-1-1 article 6.2.6 and formula (6.17)

Eta	1,20	
Av	1,0247e-02	m <sup>2</sup>
Vpl,y,Rd	2100,17	kN
Unity check	0,00	-

#### Shear check for Vz

According to EN 1993-1-1 article 6.2.6 and formula (6.17)

Eta	1,20	
Av	4,5477e-03	m <sup>2</sup>
Vpl,z,Rd	932,10	kN
Unity check	0,09	-



**Note:** The unity check for torsion is lower than the limit value of 0,05. Therefore torsion is considered as insignificant and is ignored in the combined checks.

**Combined bending, axial force and shear force check**  
According to EN 1993-1-1 article 6.2.9.1 and formula (6.41)

MN <sub>y</sub> ,R <sub>d</sub>	656,75	kNm
Alpha	2,00	
Mpl,z,R <sub>d</sub>	267,73	kNm
Beta	1,00	

Unity check (6.41) = 0,01 + 0,04 = 0,05 -

**Note:** Since the shear forces are less than half the plastic shear resistances their effect on the moment resistances is neglected.

**Note:** Since the axial force satisfies criteria (6.35) of EN 1993-1-1 article 6.2.9.1(4) its effect on the moment resistance about the z-z axis is neglected.

The member satisfies the section check.

....:**STABILITY CHECK**:...

**Classification for member buckling design**

Decisive position for stability classification: 0,000 m

**Classification of Internal Compression parts**

According to EN 1993-1-1 Table 5.2 Sheet 1

Maximum width-to-thickness ratio	25,58
Class 1 Limit	32,32
Class 2 Limit	37,22
Class 3 Limit	58,14

=> Internal Compression parts Class 1

**Classification of Outstand Flanges**

According to EN 1993-1-1 Table 5.2 Sheet 2

Maximum width-to-thickness ratio	7,17
Class 1 Limit	7,32
Class 2 Limit	8,14
Class 3 Limit	11,37

=> Outstand Flanges Class 1

=> Section classified as Class 1 for member buckling design

**Flexural Buckling check**

According to EN 1993-1-1 article 6.3.1.1 and formula (6.46)

Buckling parameters	yy	zz	
Sway type	sway	non-sway	
System length L	2,800	2,800	m
Buckling factor k	1,00	1,00	
Buckling length L <sub>cr</sub>	2,800	2,800	m
Critical Euler load N <sub>cr</sub>	73228,94	19668,71	kN
Slenderness Lambda	19,47	37,58	
Relative slenderness Lambda <sub>rel</sub>	0,25	0,49	
Limit slenderness Lambda <sub>rel,0</sub>	0,20	0,20	

**Note:** The slenderness or compression force is such that Flexural Buckling effects may be ignored according to EN 1993-1-1 article 6.3.1.2(4).

**Torsional(-Flexural) Buckling check**

According to EN 1993-1-1 article 6.3.1.1 and formula (6.46)

Torsional buckling length L <sub>cr</sub>	2,800	m
Elastic critical load N <sub>cr,T</sub>	22303,10	kN
Elastic critical load N <sub>cr,TF</sub>	19668,71	kN
Relative slenderness Lambda <sub>rel,T</sub>	0,49	
Limit slenderness Lambda <sub>rel,0</sub>	0,20	

**Note:** The slenderness or compression force is such that Torsional(-Flexural) Buckling effects may be ignored according to EN 1993-1-1 article 6.3.1.2(4).

**Lateral Torsional Buckling check**

According to EN 1993-1-1 article 6.3.2.1 & 6.3.2.2 and formula (6.54)

LTB parameters		
Method for LTB curve	General case	
Cross-section plastic modulus W <sub>pl,y</sub>	1,8500e-03	m <sup>3</sup>
Elastic critical moment M <sub>cr</sub>	7908,21	kNm
Relative slenderness Lambda <sub>rel,LT</sub>	0,29	
Limit slenderness Lambda <sub>rel,LT,0</sub>	0,20	

**Note:** The slenderness or bending moment is such that Lateral Torsional Buckling effects may be ignored according to EN 1993-1-1 article 6.3.2.2(4).

Mcr parameters		
LTB length L	2,800	m
Influence of load position	no influence	
Correction factor k	1,00	
Correction factor k <sub>w</sub>	1,00	
LTB moment factor C <sub>1</sub>	2,33	
LTB moment factor C <sub>2</sub>	0,00	

\*Student version\* \*Student version\* \*Student version\* \*Student version\* \*Student ver

Mcr parameters		
LTB moment factor C3	1,00	
Shear center distance d,z	0	mm
Distance of load application z,g	0	mm
Mono-symmetry constant beta,y	0	mm
Mono-symmetry constant z,j	0	mm

Note: C parameters are determined according to ECCS 119 2006 / Galea 2002.

**Bending and axial compression check**

According to EN 1993-1-1 article 6.3.3 and formula (6.61),(6.62)

Bending and axial compression check parameters		
Interaction method	alternative method 1	
Cross-section area A	1,3400e-02	m <sup>2</sup>
Cross-section plastic modulus Wpl,y	1,8500e-03	m <sup>3</sup>
Cross-section plastic modulus Wpl,z	7,5417e-04	m <sup>3</sup>
Design compression force N,Ed	564,63	kN
Design bending moment (maximum) My,Ed	-159,54	kNm
Design bending moment (maximum) Mz,Ed	13,53	kNm
Characteristic compression resistance N,Rk	4757,00	kN
Characteristic moment resistance My,Rk	656,75	kNm
Characteristic moment resistance Mz,Rk	267,73	kNm
Reduction factor Chi,y	1,00	
Reduction factor Chi,z	1,00	
Reduction factor Chi,LT	1,00	
Interaction factor k,yy	1,01	
Interaction factor k,yz	0,67	
Interaction factor k,zy	0,53	
Interaction factor k,zz	1,00	

Maximum moment My,Ed is derived from beam B79 position 0,000 m.

Maximum moment Mz,Ed is derived from beam B79 position 0,000 m.

Interaction method 1 parameters		
Critical Euler load N,cr,y	73228,94	kN
Critical Euler load N,cr,z	19668,71	kN
Elastic critical load N,cr,T	22303,10	kN
Cross-section plastic modulus Wpl,y	1,8500e-03	m <sup>3</sup>
Cross-section elastic modulus Wel,y	1,6800e-03	m <sup>3</sup>
Cross-section plastic modulus Wpl,z	7,5417e-04	m <sup>3</sup>
Cross-section elastic modulus Wel,z	4,9600e-04	m <sup>3</sup>
Second moment of area Iy	2,7700e-04	m <sup>4</sup>
Second moment of area Iz	7,4400e-05	m <sup>4</sup>
Torsional constant It	1,2700e-06	m <sup>4</sup>
Method for equivalent moment factor C,my,0	Table A.2 Line 2 (General)	
Design bending moment (maximum) My,Ed	-159,54	kNm
Maximum relative deflection delta,z	0,7	mm
Equivalent moment factor C,my,0	0,99	
Method for equivalent moment factor C,mz,0	Table A.2 Line 2 (General)	
Design bending moment (maximum) Mz,Ed	13,53	kNm
Maximum relative deflection delta,y	-0,1	mm
Equivalent moment factor C,mz,0	0,98	
Factor mu,y	1,00	
Factor mu,z	1,00	
Factor epsilon,y	2,25	
Factor a,LT	1,00	
Critical moment for uniform bending Mcr,0	3391,71	kNm
Relative slenderness Lambda,rel,0	0,44	
Limit relative slenderness Lambda,rel,0,lim	0,30	
Equivalent moment factor C,my	1,00	
Equivalent moment factor C,mz	0,98	
Equivalent moment factor C,mLT	1,02	
Factor b,LT	0,00	
Factor c,LT	0,09	
Factor d,LT	0,07	
Factor e,LT	-1,14	
Factor w,y	1,10	
Factor w,z	1,50	
Factor n,pl	0,12	
Maximum relative slenderness Lambda,rel,max	0,49	
Factor C,yy	1,01	
Factor C,yz	1,05	
Factor C,zy	0,99	
Factor C,zz	1,01	

Unity check (6.61) = 0,12 + 0,25 + 0,03 = 0,40 -

Unity check (6.62) = 0,12 + 0,13 + 0,05 = 0,30 -

**Shear Buckling check**

According to EN 1993-1-5 article 5 & 7.1 and formula (5.10) & (7.1)

Shear Buckling parameters		
Buckling field length a	2,800	m
Web	unstiffened	
Web height hw	297	mm

\*Student version\* \*Student version\* \*Student version\* \*Student version\* \*Student version\*

Shear Buckling parameters		
Web thickness t	10	mm
Material coefficient epsilon	0,81	
Shear correction factor Eta	1,20	

Shear Buckling verification		
Web slenderness hw/t	31,26	
Web slenderness limit	48,82	

**Note:** The web slenderness is such that Shear Buckling effects may be ignored according to EN 1993-1-5 article 5.1(2).  
The member satisfies the stability check.

-iskoristivost elementa na GSN – 40 %

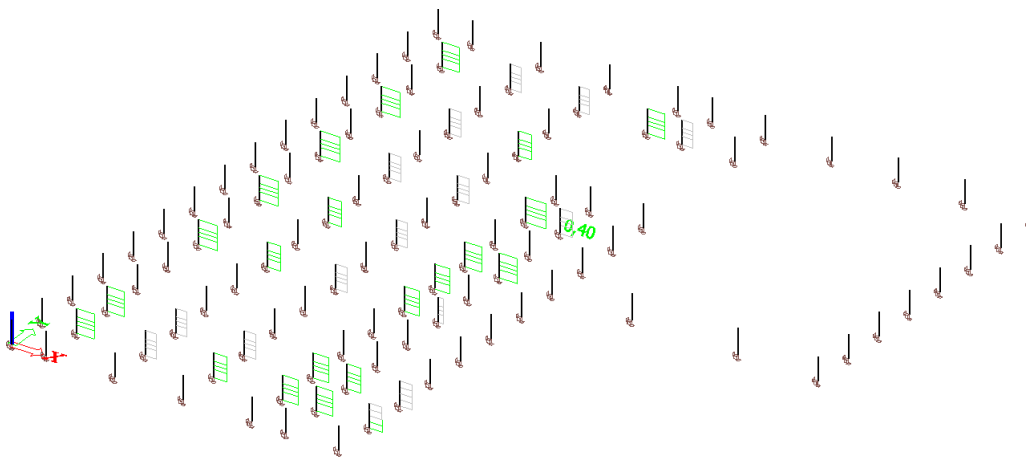

Slika 16.7. Prikaz iskoristivosti nosača – stup 2 (prizemlje)

16.2.5. Rezne sile – stup 1 (1. etaža)

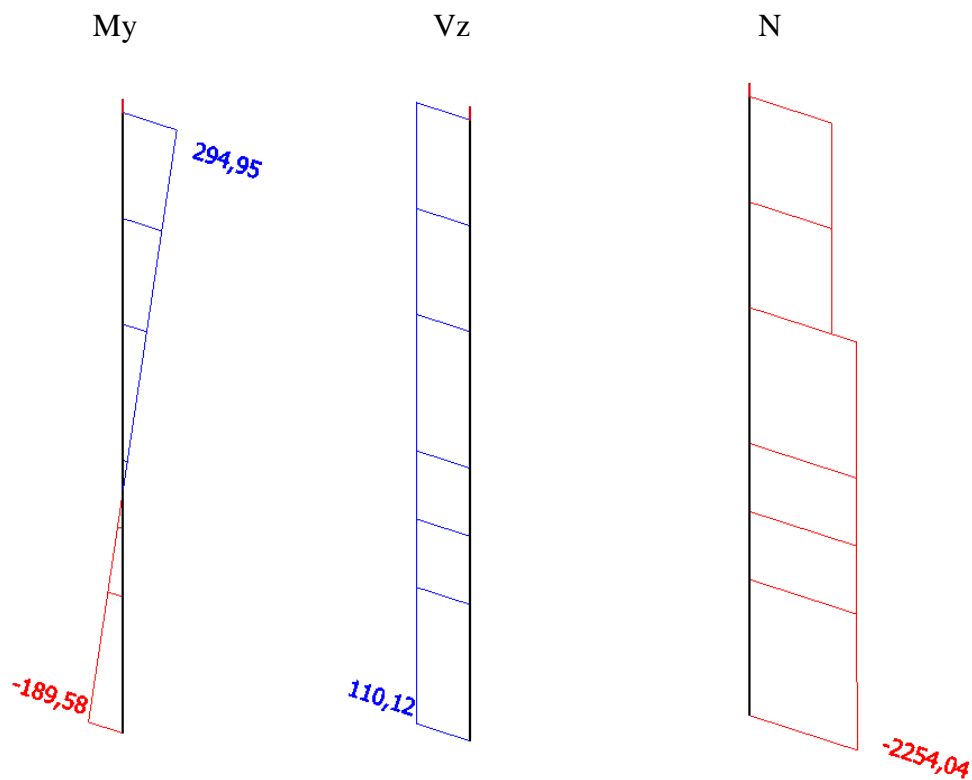

Slika 16.8. Prikaz reznih sila nosača – stup 1 (1. etaža)

-poprečni presjek nosača

Name	Stup 1 - 1. etaža	
Type	HEB500	
Source description	Profil Arbed / Structural shapes / Edition Octobre 1995	
Item material	S 355	
Fabrication	rolled	
Flexural buckling y-y	a	
Flexural buckling z-z	b	
Lateral torsional buckling	Default	
Use 2D FEM analysis	x	
A [m <sup>2</sup> ]	2,3860e-02	
A <sub>y, z</sub> [m <sup>2</sup> ]	1,6161e-02	7,4905e-03
I <sub>y, z</sub> [m <sup>4</sup> ]	1,0720e-03	1,2620e-04
I <sub>w</sub> [m <sup>6</sup> ], I <sub>t</sub> [m <sup>4</sup> ]	7,0177e-06	5,3840e-06
W <sub>el y, z</sub> [m <sup>3</sup> ]	4,2870e-03	8,4160e-04
W <sub>pl y, z</sub> [m <sup>3</sup> ]	4,8150e-03	1,2920e-03
d <sub>y, z</sub> [mm]	0	0
c <sub>YUCS, ZUCS</sub> [mm]	150	250
α [deg]	0,00	
A <sub>L, D</sub> [m <sup>2</sup> /m]	2,1300e+00	2,1244e+00
M <sub>ply +, -</sub> [Nm]	1,71e+06	1,71e+06
M <sub>plz +, -</sub> [Nm]	4,59e+05	4,59e+05

Slika 16.9. Prikaz geometrijskih karakteristika nosača

### 16.2.6. Dimenzioniranje – stup 1 (1.etaža)

Member B807	4,400 m	HEB500	S 355	GSN 2	0,96 -
-------------	---------	--------	-------	-------	--------

Partial safety factors	
Gamma M0 for resistance of cross-sections	1,00
Gamma M1 for resistance to instability	1,00
Gamma M2 for resistance of net sections	1,25

Material	
Yield strength $f_y$	355,0 MPa
Ultimate strength $f_u$	490,0 MPa
Fabrication	Rolled

.....SECTION CHECK:....

The critical check is on position 0.000 m

Internal forces	Calculated	Unit
N,Ed	-2254,04	kN
V <sub>y</sub> ,Ed	-157,30	kN
V <sub>z</sub> ,Ed	110,12	kN
T,Ed	-0,02	kNm
M <sub>y</sub> ,Ed	-189,58	kNm
M <sub>z</sub> ,Ed	187,83	kNm

**Classification for cross-section design**

According to EN 1993-1-1 article 5.5.2

**Classification of Internal Compression parts**

According to EN 1993-1-1 Table 5.2 Sheet 1

Maximum width-to-thickness ratio	26,90
Class 1 Limit	26,85
Class 2 Limit	30,92
Class 3 Limit	41,50

=> Internal Compression parts Class 2

**Classification of Outstand Flanges**

According to EN 1993-1-1 Table 5.2 Sheet 2

Maximum width-to-thickness ratio	4,13
Class 1 Limit	7,32
Class 2 Limit	8,14
Class 3 Limit	12,00

=> Outstand Flanges Class 1

=> Section classified as Class 2 for cross-section design

**Compression check**

According to EN 1993-1-1 article 6.2.4 and formula (6.9)

A	2,3860e-02	m <sup>2</sup>
N <sub>c,Rd</sub>	8470,30	kN
Unity check	0,27	-

**Bending moment check for M<sub>y</sub>**

According to EN 1993-1-1 article 6.2.5 and formula (6.12),(6.13)

W <sub>pl,y</sub>	4,8150e-03	m <sup>3</sup>
M <sub>pl,y,Rd</sub>	1709,33	kNm
Unity check	0,11	-

**Bending moment check for M<sub>z</sub>**

According to EN 1993-1-1 article 6.2.5 and formula (6.12),(6.13)

W <sub>pl,z</sub>	1,2920e-03	m <sup>3</sup>
M <sub>pl,z,Rd</sub>	458,66	kNm
Unity check	0,41	-

**Shear check for V<sub>y</sub>**

According to EN 1993-1-1 article 6.2.6 and formula (6.17)

Eta	1,20	
A <sub>v</sub>	1,7402e-02	m <sup>2</sup>
V <sub>pl,y,Rd</sub>	3566,65	kN
Unity check	0,04	-

**Shear check for V<sub>z</sub>**

According to EN 1993-1-1 article 6.2.6 and formula (6.17)

Eta	1,20	
A <sub>v</sub>	8,9780e-03	m <sup>2</sup>
V <sub>pl,z,Rd</sub>	1840,13	kN
Unity check	0,06	-

**Note:** The unity check for torsion is lower than the limit value of 0,05. Therefore torsion is considered as insignificant and is ignored in the combined checks.

**Combined bending, axial force and shear force check**

According to EN 1993-1-1 article 6.2.9.1 and formula (6.41)

MN <sub>y,Rd</sub>	1472,27	kNm
Alpha	2,00	
Mpl <sub>z,Rd</sub>	458,66	kNm
Beta	1,33	

Unity check (6.41) = 0,02 + 0,30 = 0,32 -

**Note:** Since the shear forces are less than half the plastic shear resistances their effect on the moment resistances is neglected.

**Note:** Since the axial force satisfies criteria (6.35) of EN 1993-1-1 article 6.2.9.1(4) its effect on the moment resistance about the z-z axis is neglected.

The member satisfies the section check.

.....**STABILITY CHECK**.....

**Classification for member buckling design**

Decisive position for stability classification: 0,000 m

**Classification of Internal Compression parts**

According to EN 1993-1-1 Table 5.2 Sheet 1

Maximum width-to-thickness ratio	26,90
Class 1 Limit	26,85
Class 2 Limit	30,92
Class 3 Limit	41,50

=> Internal Compression parts Class 2

**Classification of Outstand Flanges**

According to EN 1993-1-1 Table 5.2 Sheet 2

Maximum width-to-thickness ratio	4,13
Class 1 Limit	7,32
Class 2 Limit	8,14
Class 3 Limit	12,00

=> Outstand Flanges Class 1

=> Section classified as Class 2 for member buckling design

**Flexural Buckling check**

According to EN 1993-1-1 article 6.3.1.1 and formula (6.46)

Buckling parameters	yy	zz	
Sway type	sway	non-sway	
System length L	4,400	2,900	m
Buckling factor k	1,00	1,00	
Buckling length L <sub>cr</sub>	4,400	2,900	m
Critical Euler load N <sub>cr</sub>	114764,74	31101,58	kN
Slenderness Lambda	20,76	39,88	
Relative slenderness Lambda <sub>rel</sub>	0,27	0,52	
Limit slenderness Lambda <sub>rel,0</sub>	0,20	0,20	
Buckling curve	a	b	
Imperfection Alpha	0,21	0,34	
Reduction factor Chi	0,98	0,87	
Buckling resistance N <sub>b,Rd</sub>	8335,02	7406,44	kN

Flexural Buckling verification		
Cross-section area A	2,3860e-02	m <sup>2</sup>
Buckling resistance N <sub>b,Rd</sub>	7406,44	kN
Unity check	0,30	-

**Torsional(-Flexural) Buckling check**

According to EN 1993-1-1 article 6.3.1.1 and formula (6.46)

**Note:** For this I-section the Torsional(-Flexural) buckling resistance is higher than the resistance for Flexural buckling. Therefore Torsional(-Flexural) buckling is not printed on the output.

**Lateral Torsional Buckling check**

According to EN 1993-1-1 article 6.3.2.1 & 6.3.2.2 and formula (6.54)

LTB parameters		
Method for LTB curve	General case	
Cross-section plastic modulus W <sub>pl,y</sub>	4,8150e-03	m <sup>3</sup>
Elastic critical moment M <sub>cr</sub>	20667,10	kNm
Relative slenderness Lambda <sub>rel,LT</sub>	0,29	
Limit slenderness Lambda <sub>rel,LT,0</sub>	0,20	

**Note:** The slenderness or bending moment is such that Lateral Torsional Buckling effects may be ignored according to EN 1993-1-1 article 6.3.2.2(4).

Mcr parameters		
LTB length L	2,900	m
Influence of load position	no influence	
Correction factor k	1,00	
Correction factor k <sub>w</sub>	1,00	

Mcr parameters	
LTB moment factor C1	2,52
LTB moment factor C2	0,00
LTB moment factor C3	1,00
Shear center distance d,z	0 mm
Distance of load application z,g	0 mm
Mono-symmetry constant beta,y	0 mm
Mono-symmetry constant z,j	0 mm

Note: C parameters are determined according to ECSS 119 2006 / Galea 2002.

**Bending and axial compression check**

According to EN 1993-1-1 article 6.3.3 and formula (6.61),(6.62)

Bending and axial compression check parameters	
Interaction method	alternative method 1
Cross-section area A	2,3860e-02 m <sup>2</sup>
Cross-section plastic modulus Wpl,y	4,8150e-03 m <sup>3</sup>
Cross-section plastic modulus Wpl,z	1,2920e-03 m <sup>3</sup>
Design compression force N,Ed	2254,04 kN
Design bending moment (maximum) My,Ed	294,95 kNm
Design bending moment (maximum) Mz,Ed	-268,33 kNm
Characteristic compression resistance N,Rk	8470,30 kN
Characteristic moment resistance My,Rk	1709,33 kNm
Characteristic moment resistance Mz,Rk	458,66 kNm
Reduction factor Chi,y	0,98
Reduction factor Chi,z	0,87
Reduction factor Chi,LT	1,00
Interaction factor k,yy	1,03
Interaction factor k,yz	0,60
Interaction factor k,zy	0,59
Interaction factor k,zz	0,95

Maximum moment My,Ed is derived from beam B807 position 4,400 m.

Maximum moment Mz,Ed is derived from beam B807 position 2,900 m.

Interaction method 1 parameters	
Critical Euler load N,cr,y	114764,74 kN
Critical Euler load N,cr,z	31101,58 kN
Elastic critical load N,cr,T	43099,14 kN
Cross-section plastic modulus Wpl,y	4,8150e-03 m <sup>3</sup>
Cross-section elastic modulus Wel,y	4,2870e-03 m <sup>3</sup>
Cross-section plastic modulus Wpl,z	1,2920e-03 m <sup>3</sup>
Cross-section elastic modulus Wel,z	8,4160e-04 m <sup>3</sup>
Second moment of area Iy	1,0720e-03 m <sup>4</sup>
Second moment of area Iz	1,2620e-04 m <sup>4</sup>
Torsional constant It	5,3840e-06 m <sup>4</sup>
Method for equivalent moment factor C,my,0	Table A.2 Line 2 (General)
Design bending moment (maximum) My,Ed	294,95 kNm
Maximum relative deflection delta,z	-0,7 mm
Equivalent moment factor C,my,0	0,99
Method for equivalent moment factor C,mz,0	Table A.2 Line 3 (General)
Design bending moment (maximum) Mz,Ed	-268,33 kNm
Maximum relative deflection delta,y	2,1 mm
Equivalent moment factor C,mz,0	0,95
Factor mu,y	1,00
Factor mu,z	0,99
Factor epsilon,y	0,73
Factor a,LT	0,99
Critical moment for uniform bending Mcr,0	8204,55 kNm
Relative slenderness Lambda,rel,0	0,46
Limit relative slenderness Lambda,rel,0,lim	0,31
Equivalent moment factor C,my	0,99
Equivalent moment factor C,mz	0,95
Equivalent moment factor C,mLT	1,05
Factor b,LT	0,01
Factor c,LT	0,07
Factor d,LT	0,56
Factor e,LT	0,77
Factor w,y	1,12
Factor w,z	1,50
Factor n,pl	0,27
Maximum relative slenderness Lambda,rel,max	0,52
Factor C,yy	1,03
Factor C,yz	1,17
Factor C,zy	0,93
Factor C,zz	1,06

Unity check (6.61) = 0,27 + 0,18 + 0,35 = 0,80 -

Unity check (6.62) = 0,30 + 0,10 + 0,56 = 0,96 -

**Shear Buckling check**

According to EN 1993-1-5 article 5 & 7.1 and formula (5.10) & (7.1)

Shear Buckling parameters	
Buckling field length a	4,400 m

Shear Buckling parameters		
<small>*Student version* *Student version* *Student version* *Student version* *Stude</small>		
Web	unstiffened	
Web height $h_w$	444	mm
Web thickness $t$	15	mm
Material coefficient epsilon	0,81	
Shear correction factor Eta	1,20	

Shear Buckling verification	
<small>*Student version* *Student version* *Student version* *Stud</small>	
Web slenderness $h_w/t$	30,62
Web slenderness limit	48,82

**Note:** The web slenderness is such that Shear Buckling effects may be ignored according to EN 1993-1-5 article 5.1(2).  
The member satisfies the stability check.

-iskoristivost elementa na GSN – 96 %

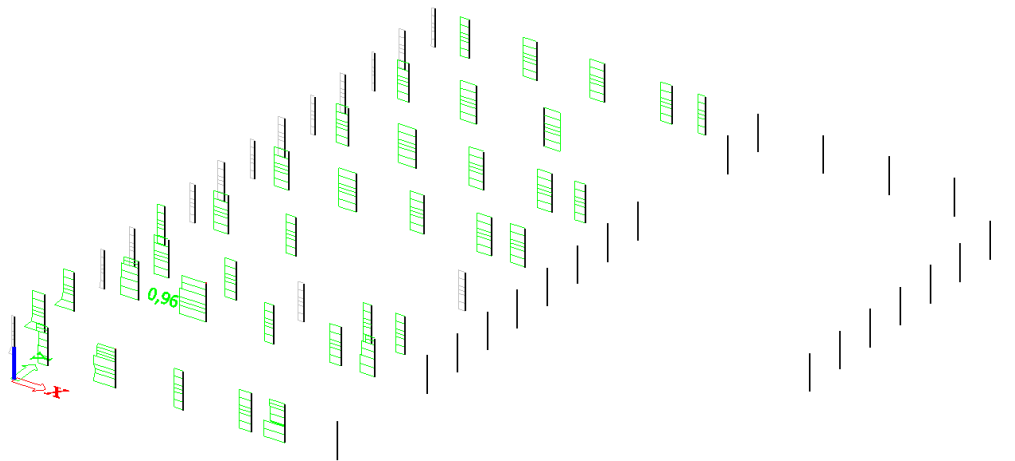

Slika 16.10. Prikaz iskoristivosti nosača – stup 1 (1. etaža)



16.2.7. Rezne sile – stup 1 (2. etaža)

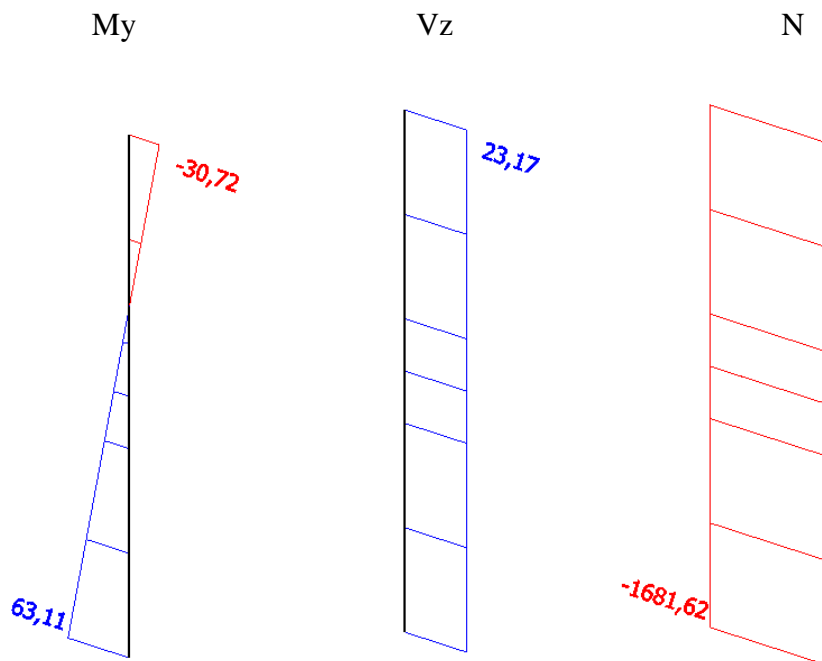

Slika 16.11. Prikaz reznih sila nosača – stup 1 (2. etaža)

-poprečni presjek nosača

Name		Stup 1 - 2. etaža	
Type		HEB450	
Source description		Profil Arbed / Structural shapes / Edition Octobre 1995	
Item material		S 355	
Fabrication		rolled	
Flexural buckling y-y		a	
Flexural buckling z-z		b	
Lateral torsional buckling		Default	
Use 2D FEM analysis		x	
A [m²]	2,1800e-02		
A y, z [m²]	1,5015e-02	6,5456e-03	
I y, z [m⁴]	7,9890e-04	1,1720e-04	
I w [m⁶], t [m⁴]	5,2584e-06	4,4050e-06	
Wel y, z [m³]	3,5510e-03	7,8140e-04	
Wpl y, z [m³]	3,9820e-03	1,1980e-03	
d y, z [mm]	0	0	
c YUCS, ZUCS [mm]	150	225	
α [deg]	0,00		
A L, D [m²/m]	2,0300e+00	2,0254e+00	
Mply +, - [Nm]	1,41e+06	1,41e+06	
Mplz +, - [Nm]	4,25e+05	4,25e+05	

Slika 16.12. Prikaz geometrijskih karakteristika nosača

## 16.2.8. Dimenzioniranje – stup 1 (2.etaža)

Member B2324	4,050 m	HEB450	S 355	GSN 28	0,64 -
--------------	---------	--------	-------	--------	--------

Partial safety factors	
Gamma M0 for resistance of cross-sections	1,00
Gamma M1 for resistance to instability	1,00
Gamma M2 for resistance of net sections	1,25

Material		
Yield strength $f_y$	355,0	MPa
Ultimate strength $f_u$	490,0	MPa
Fabrication	Rolled	

.....SECTION CHECK:.....

The critical check is on position 4.050 m

Internal forces	Calculated	Unit
N,Ed	-1681,62	kN
Vy,Ed	-45,61	kN
Vz,Ed	23,17	kN
T,Ed	0,00	kNm
My,Ed	63,11	kNm
Mz,Ed	-33,33	kNm

#### Classification for cross-section design

According to EN 1993-1-1 article 5.5.2

#### Classification of Internal Compression parts

According to EN 1993-1-1 Table 5.2 Sheet 1

Maximum width-to-thickness ratio	24,57
Class 1 Limit	26,85
Class 2 Limit	30,92
Class 3 Limit	37,92

=> Internal Compression parts Class 1

#### Classification of Outstand Flanges

According to EN 1993-1-1 Table 5.2 Sheet 2

Maximum width-to-thickness ratio	4,46
Class 1 Limit	7,32
Class 2 Limit	8,14
Class 3 Limit	11,51

=> Outstand Flanges Class 1

=> Section classified as Class 1 for cross-section design

#### Compression check

According to EN 1993-1-1 article 6.2.4 and formula (6.9)

A	2,1800e-02	m <sup>2</sup>
Nc,Rd	7739,00	kN
Unity check	0,22	-

#### Bending moment check for My

According to EN 1993-1-1 article 6.2.5 and formula (6.12),(6.13)

Wpl,y	3,9820e-03	m <sup>3</sup>
Mpl,y,Rd	1413,61	kNm
Unity check	0,04	-

#### Bending moment check for Mz

According to EN 1993-1-1 article 6.2.5 and formula (6.12),(6.13)

Wpl,z	1,1980e-03	m <sup>3</sup>
Mpl,z,Rd	425,29	kNm
Unity check	0,08	-

#### Shear check for Vy

According to EN 1993-1-1 article 6.2.6 and formula (6.17)

Eta	1,20	
Av	1,6174e-02	m <sup>2</sup>
Vpl,y,Rd	3315,01	kN
Unity check	0,01	-

#### Shear check for Vz

According to EN 1993-1-1 article 6.2.6 and formula (6.17)

Eta	1,20	
Av	7,9680e-03	m <sup>2</sup>
Vpl,z,Rd	1633,12	kN
Unity check	0,01	-

**Note:** The unity check for torsion is lower than the limit value of 0,05. Therefore torsion is considered as insignificant and is ignored in the combined checks.

**Combined bending, axial force and shear force check**  
According to EN 1993-1-1 article 6.2.9.1 and formula (6.41)

MN <sub>y,Rd</sub>	1289,87	kNm
Alpha	2,00	
Mpl,z,Rd	425,29	kNm
Beta	1,09	

Unity check (6.41) = 0,00 + 0,06 = 0,07 -

**Note:** Since the shear forces are less than half the plastic shear resistances their effect on the moment resistances is neglected.

**Note:** Since the axial force satisfies criteria (6.35) of EN 1993-1-1 article 6.2.9.1(4) its effect on the moment resistance about the z-z axis is neglected.

The member satisfies the section check.

.....**STABILITY CHECK**.....

**Classification for member buckling design**

Decisive position for stability classification: 0,000 m

**Classification of Internal Compression parts**

According to EN 1993-1-1 Table 5.2 Sheet 1

Maximum width-to-thickness ratio	24,57
Class 1 Limit	26,85
Class 2 Limit	30,92
Class 3 Limit	36,05

=> Internal Compression parts Class 1

**Classification of Outstand Flanges**

According to EN 1993-1-1 Table 5.2 Sheet 2

Maximum width-to-thickness ratio	4,46
Class 1 Limit	7,32
Class 2 Limit	8,14
Class 3 Limit	12,13

=> Outstand Flanges Class 1

=> Section classified as Class 1 for member buckling design

**Flexural Buckling check**

According to EN 1993-1-1 article 6.3.1.1 and formula (6.46)

Buckling parameters	yy	zz	
Sway type	sway	non-sway	
System length L	4,050	4,050	m
Buckling factor k	1,00	1,00	
Buckling length L <sub>cr</sub>	4,050	4,050	m
Critical Euler load N <sub>cr</sub>	100948,86	14809,37	kN
Slenderness Lambda	21,16	55,24	
Relative slenderness Lambda <sub>rel</sub>	0,28	0,72	
Limit slenderness Lambda <sub>rel,0</sub>	0,20	0,20	
Buckling curve	a	b	
Imperfection Alpha	0,21	0,34	
Reduction factor Chi	0,98	0,77	
Buckling resistance N <sub>b,Rd</sub>	7606,19	5963,86	kN

Flexural Buckling verification		
Cross-section area A	2,1800e-02	m <sup>2</sup>
Buckling resistance N <sub>b,Rd</sub>	5963,86	kN
Unity check	0,28	-

**Torsional(-Flexural) Buckling check**

According to EN 1993-1-1 article 6.3.1.1 and formula (6.46)

**Note:** For this I-section the Torsional(-Flexural) buckling resistance is higher than the resistance for Flexural buckling. Therefore Torsional(-Flexural) buckling is not printed on the output.

**Lateral Torsional Buckling check**

According to EN 1993-1-1 article 6.3.2.1 & 6.3.2.2 and formula (6.54)

LTB parameters		
Method for LTB curve	General case	
Cross-section plastic modulus W <sub>pl,y</sub>	3,9820e-03	m <sup>3</sup>
Elastic critical moment M <sub>cr</sub>	9096,33	kNm
Relative slenderness Lambda <sub>rel,LT</sub>	0,39	
Limit slenderness Lambda <sub>rel,LT,0</sub>	0,20	

**Note:** The slenderness or bending moment is such that Lateral Torsional Buckling effects may be ignored according to EN 1993-1-1 article 6.3.2.2(4).

Mcr parameters		
LTB length L	4,050	m
Influence of load position	no influence	
Correction factor k	1,00	
Correction factor k <sub>w</sub>	1,00	

Mcr parameters		
LTB moment factor C1	2,34	
LTB moment factor C2	0,00	
LTB moment factor C3	1,00	
Shear center distance d,z	0	mm
Distance of load application z,g	0	mm
Mono-symmetry constant beta,y	0	mm
Mono-symmetry constant z,j	0	mm

Note: C parameters are determined according to ECCS 119 2006 / Galea 2002.

**Bending and axial compression check**

According to EN 1993-1-1 article 6.3.3 and formula (6.61),(6.62)

Bending and axial compression check parameters		
Interaction method	alternative method 1	
Cross-section area A	2,1800e-02	m <sup>2</sup>
Cross-section plastic modulus Wpl,y	3,9820e-03	m <sup>3</sup>
Cross-section plastic modulus Wpl,z	1,1980e-03	m <sup>3</sup>
Design compression force N,Ed	1681,62	kN
Design bending moment (maximum) My,Ed	63,11	kNm
Design bending moment (maximum) Mz,Ed	151,38	kNm
Characteristic compression resistance N,Rk	7739,00	kN
Characteristic moment resistance My,Rk	1413,61	kNm
Characteristic moment resistance Mz,Rk	425,29	kNm
Reduction factor Chi,y	0,98	
Reduction factor Chi,z	0,77	
Reduction factor Chi,LT	1,00	
Interaction factor k,yy	0,78	
Interaction factor k,yz	0,67	
Interaction factor k,zy	0,41	
Interaction factor k,zz	0,97	

Maximum moment My,Ed is derived from beam B2324 position 4,050 m.

Maximum moment Mz,Ed is derived from beam B2324 position 0,000 m.

Interaction method 1 parameters		
Critical Euler load N <sub>cr,y</sub>	100948,86	kN
Critical Euler load N <sub>cr,z</sub>	14809,37	kN
Elastic critical load N <sub>cr,T</sub>	24278,29	kN
Cross-section plastic modulus Wpl,y	3,9820e-03	m <sup>3</sup>
Cross-section elastic modulus Wel,y	3,5510e-03	m <sup>3</sup>
Cross-section plastic modulus Wpl,z	1,1980e-03	m <sup>3</sup>
Cross-section elastic modulus Wel,z	7,8140e-04	m <sup>3</sup>
Second moment of area Iy	7,9890e-04	m <sup>4</sup>
Second moment of area Iz	1,1720e-04	m <sup>4</sup>
Torsional constant It	4,4050e-06	m <sup>4</sup>
Method for equivalent moment factor C <sub>my,0</sub>	Table A.2 Line 1 (Linear)	
Ratio of end moments Psi <sub>y</sub>	-0,49	
Equivalent moment factor C <sub>my,0</sub>	0,68	
Method for equivalent moment factor C <sub>mz,0</sub>	Table A.2 Line 2 (General)	
Design bending moment (maximum) Mz,Ed	151,38	kNm
Maximum relative deflection delta <sub>y</sub>	-5,2	mm
Equivalent moment factor C <sub>mz,0</sub>	0,94	
Factor mu <sub>y</sub>	1,00	
Factor mu <sub>z</sub>	0,97	
Factor epsilon <sub>y</sub>	0,23	
Factor a <sub>LT</sub>	0,99	
Critical moment for uniform bending M <sub>cr,0</sub>	3887,05	kNm
Relative slenderness Lambda <sub>rel,0</sub>	0,60	
Limit relative slenderness Lambda <sub>rel,0,lim</sub>	0,29	
Equivalent moment factor C <sub>my</sub>	0,79	
Equivalent moment factor C <sub>mz</sub>	0,94	
Equivalent moment factor C <sub>mLT</sub>	1,00	
Factor b <sub>LT</sub>	0,00	
Factor c <sub>LT</sub>	0,04	
Factor d <sub>LT</sub>	0,07	
Factor e <sub>LT</sub>	0,16	
Factor w <sub>y</sub>	1,12	
Factor w <sub>z</sub>	1,50	
Factor n <sub>pl</sub>	0,22	
Maximum relative slenderness Lambda <sub>rel,max</sub>	0,72	
Factor C <sub>yy</sub>	1,02	
Factor C <sub>yz</sub>	1,10	
Factor C <sub>zy</sub>	0,98	
Factor C <sub>zz</sub>	1,07	

Unity check (6.61) = 0,22 + 0,03 + 0,24 = 0,49 -

Unity check (6.62) = 0,28 + 0,02 + 0,34 = 0,64 -

**Shear Buckling check**

According to EN 1993-1-5 article 5 & 7.1 and formula (5.10) & (7.1)

Shear Buckling parameters		
Buckling field length a	4,050	m
Web	unstiffened	

\*Student version\* \*Student version\* \*Student version\* \*Student version\* \*Student version\*

Shear Buckling parameters		
<small>*Student version* *Student version* *Student version* *Student version* *Stu</small>		
Web height hw	398	mm
Web thickness t	14	mm
Material coefficient epsilon	0,81	
Shear correction factor Eta	1,20	

Shear Buckling verification	
<small>*Student version* *Student version* *Student version* *Stu</small>	
Web slenderness hw/t	28,43
Web slenderness limit	48,82

**Note:** The web slenderness is such that Shear Buckling effects may be ignored according to EN 1993-1-5 article 5.1(2).  
The member satisfies the stability check.

-iskoristivost elementa na GSN – 63 %

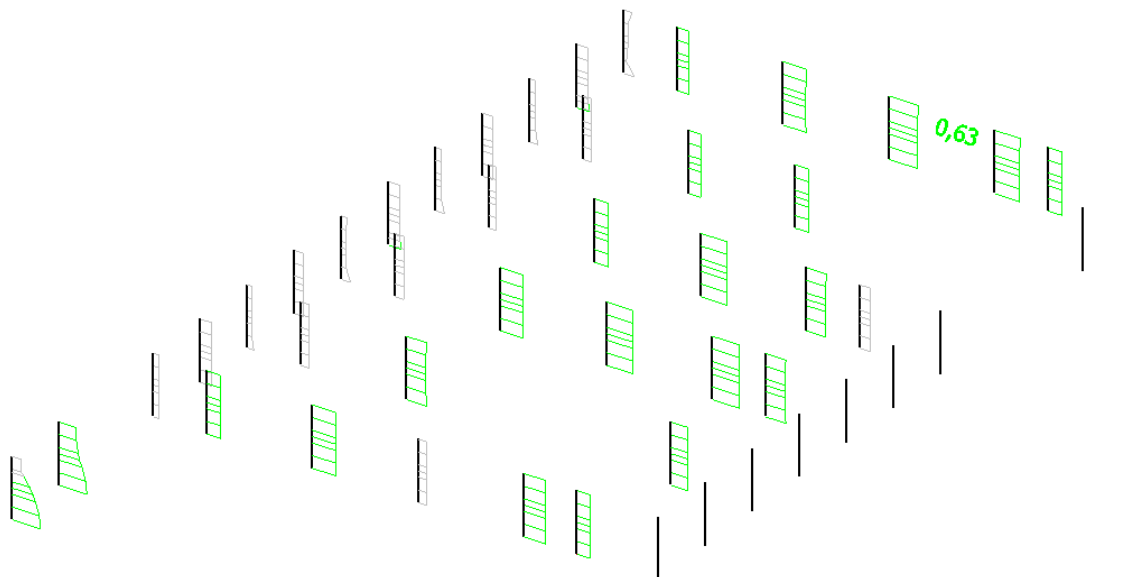

**Slika 16.13.** Prikaz iskoristivosti nosača – stup 1 (2. etaža)

16.2.9. Rezne sile – stup 1 (3. etaža)

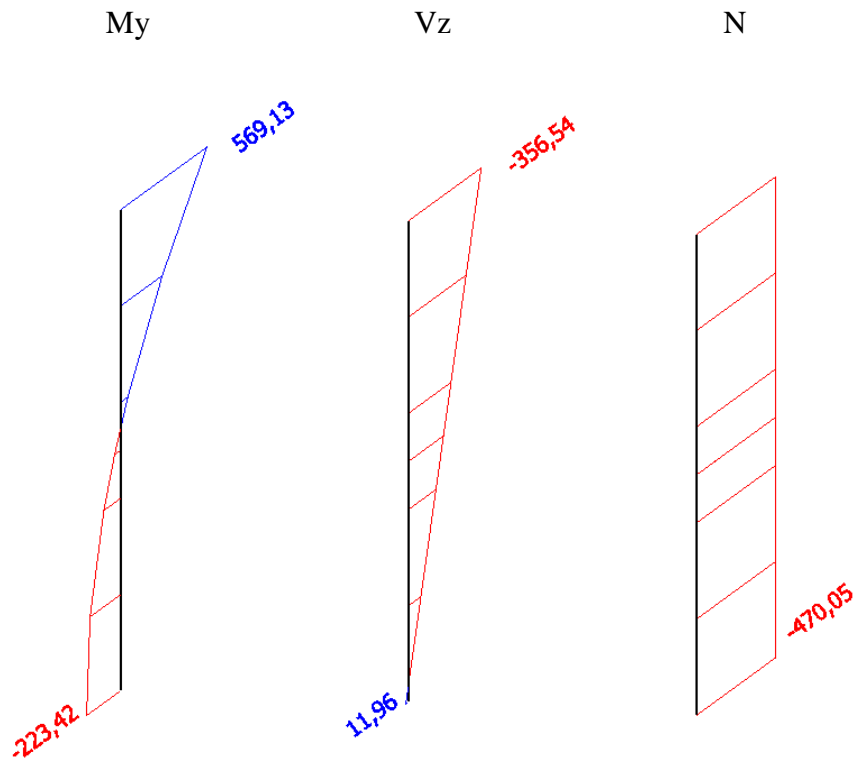

Slika 16.14. Prikaz reznih sila nosača – stup 1 (3. etaža)

-poprečni presjek nosača

Name	Stup 1 - 3. etaža	
Type	HEB400	
Source description	Profil Arbed / Structural shapes / Edition Octobre 1995	
Item material	S 355	
Fabrication	rolled	
Flexural buckling y-y	a	
Flexural buckling z-z	b	
Lateral torsional buckling	Default	
Use 2D FEM analysis	x	
A [m²]	1,9780e-02	
A <sub>y, z</sub> [m²]	1,3871e-02	5,6483e-03
I <sub>y, z</sub> [m⁴]	5,7680e-04	1,0820e-04
I <sub>w</sub> [m⁶], I <sub>t</sub> [m⁴]	3,8172e-06	3,5570e-06
W <sub>el y, z</sub> [m³]	2,8840e-03	7,2130e-04
W <sub>pl y, z</sub> [m³]	3,2320e-03	1,1040e-03
d <sub>y, z</sub> [mm]	0	0
c <sub>YUCS, ZUCS</sub> [mm]	150	200
α [deg]	0,00	
A <sub>L, D</sub> [m²/m]	1,9300e+00	1,9264e+00
M <sub>pl +, -</sub> [Nm]	1,15e+06	1,15e+06
M <sub>plz +, -</sub> [Nm]	3,92e+05	3,92e+05

Slika 16.15. Prikaz geometrijskih karakteristika nosača

### 16.2.10. Dimenzioniranje – stup 1 (3.etaža)

Member B2499	4,600 m	HEB400	S 355	GSN 24	0,63 -
--------------	---------	--------	-------	--------	--------

Partial safety factors	
Gamma M0 for resistance of cross-sections	1,00
Gamma M1 for resistance to instability	1,00
Gamma M2 for resistance of net sections	1,25

Material		
Yield strength fy	355,0	MPa
Ultimate strength fu	490,0	MPa
Fabrication	Rolled	

.....SECTION CHECK:.....

The critical check is on position 0.000 m

Internal forces	Calculated	Unit
N,Ed	-467,04	kN
Vy,Ed	10,29	kN
Vz,Ed	-356,54	kN
T,Ed	0,00	kNm
My,Ed	569,13	kNm
Mz,Ed	-22,37	kNm

**Classification for cross-section design**

According to EN 1993-1-1 article 5.5.2

**Classification of Internal Compression parts**

According to EN 1993-1-1 Table 5.2 Sheet 1

Maximum width-to-thickness ratio	22,07
Class 1 Limit	42,25
Class 2 Limit	48,65
Class 3 Limit	79,22

=> Internal Compression parts Class 1

**Classification of Outstand Flanges**

According to EN 1993-1-1 Table 5.2 Sheet 2

Maximum width-to-thickness ratio	4,84
Class 1 Limit	7,32
Class 2 Limit	8,14
Class 3 Limit	11,33

=> Outstand Flanges Class 1

=> Section classified as Class 1 for cross-section design

**Compression check**

According to EN 1993-1-1 article 6.2.4 and formula (6.9)

A	1,9780e-02	m <sup>2</sup>
Nc,Rd	7021,90	kN
Unity check	0,07	-

**Bending moment check for My**

According to EN 1993-1-1 article 6.2.5 and formula (6.12),(6.13)

Wpl,y	3,2320e-03	m <sup>3</sup>
Mpl,y,Rd	1147,36	kNm
Unity check	0,50	-

**Bending moment check for Mz**

According to EN 1993-1-1 article 6.2.5 and formula (6.12),(6.13)

Wpl,z	1,1040e-03	m <sup>3</sup>
Mpl,z,Rd	391,92	kNm
Unity check	0,06	-

**Shear check for Vy**

According to EN 1993-1-1 article 6.2.6 and formula (6.17)

Eta	1,20	
Av	1,4947e-02	m <sup>2</sup>
Vpl,y,Rd	3063,48	kN
Unity check	0,00	-

**Shear check for Vz**

According to EN 1993-1-1 article 6.2.6 and formula (6.17)

Eta	1,20	
Av	7,0000e-03	m <sup>2</sup>
Vpl,z,Rd	1434,72	kN
Unity check	0,25	-

**Note:** The unity check for torsion is lower than the limit value of 0,05. Therefore torsion is considered as insignificant and is ignored in the combined checks.

**Combined bending, axial force and shear force check**

According to EN 1993-1-1 article 6.2.9.1 and formula (6.41)

Mpl,y,Rd	1147,36	kNm
Alpha	2,00	
Mpl,z,Rd	391,92	kNm
Beta	1,00	

Unity check (6.41) = 0,25 + 0,06 = 0,30 -

**Note:** Since the shear forces are less than half the plastic shear resistances their effect on the moment resistances is neglected.

**Note:** Since the axial force satisfies both criteria (6.33) and (6.34) of EN 1993-1-1 article 6.2.9.1(4) its effect on the moment resistance about the y-y axis is neglected.

**Note:** Since the axial force satisfies criteria (6.35) of EN 1993-1-1 article 6.2.9.1(4) its effect on the moment resistance about the z-z axis is neglected.

The member satisfies the section check.

.....**STABILITY CHECK**.....

**Classification for member buckling design**

Decisive position for stability classification: 0,000 m

**Classification of Internal Compression parts**

According to EN 1993-1-1 Table 5.2 Sheet 1

Maximum width-to-thickness ratio	22,07
Class 1 Limit	42,25
Class 2 Limit	48,65
Class 3 Limit	79,22

=> Internal Compression parts Class 1

**Classification of Outstand Flanges**

According to EN 1993-1-1 Table 5.2 Sheet 2

Maximum width-to-thickness ratio	4,84
Class 1 Limit	7,32
Class 2 Limit	8,14
Class 3 Limit	11,33

=> Outstand Flanges Class 1

=> Section classified as Class 1 for member buckling design

**Flexural Buckling check**

According to EN 1993-1-1 article 6.3.1.1 and formula (6.46)

Buckling parameters	yy	zz	
Sway type	sway	non-sway	
System length L	4,600	4,600	m
Buckling factor k	1,00	1,00	
Buckling length Lcr	4,600	4,600	m
Critical Euler load Ncr	56497,42	10598,16	kN
Slenderness Lambda	26,94	62,20	
Relative slenderness Lambda,rel	0,35	0,81	
Limit slenderness Lambda,rel,0	0,20	0,20	
Buckling curve	a	b	
Imperfection Alpha	0,21	0,34	
Reduction factor Chi	0,96	0,72	
Buckling resistance Nb,Rd	6775,28	5026,21	kN

Flexural Buckling verification		
Cross-section area A	1,9780e-02	m <sup>2</sup>
Buckling resistance Nb,Rd	5026,21	kN
Unity check	0,09	-

**Torsional(-Flexural) Buckling check**

According to EN 1993-1-1 article 6.3.1.1 and formula (6.46)

**Note:** For this I-section the Torsional(-Flexural) buckling resistance is higher than the resistance for Flexural buckling. Therefore Torsional(-Flexural) buckling is not printed on the output.

**Lateral Torsional Buckling check**

According to EN 1993-1-1 article 6.3.2.1 & 6.3.2.2 and formula (6.54)

LTB parameters		
Method for LTB curve	General case	
Cross-section plastic modulus Wpl,y	3,2320e-03	m <sup>3</sup>
Elastic critical moment Mcr	8958,80	kNm
Relative slenderness Lambda,rel,LT	0,36	
Limit slenderness Lambda,rel,LT,0	0,20	
LTB curve	a	
Imperfection Alpha,LT	0,21	
Reduction factor Chi,LT	0,96	
Design buckling resistance Mb,Rd	1105,55	kNm
Unity check	0,51	-



Mcr parameters		
LTB length L	4,600	m
Influence of load position	no influence	
Correction factor k	1,00	
Correction factor kw	1,00	
LTB moment factor C1	3,38	
LTB moment factor C2	0,43	
LTB moment factor C3	1,00	
Shear center distance d,z	0	mm
Distance of load application z,g	0	mm
Mono-symmetry constant beta,y	0	mm
Mono-symmetry constant z,j	0	mm

Note: C parameters are determined according to ECSS 119 2006 / Galea 2002.

**Bending and axial compression check**

According to EN 1993-1-1 article 6.3.3 and formula (6.61),(6.62)

Bending and axial compression check parameters		
Interaction method	alternative method 1	
Cross-section area A	1,9780e-02	m <sup>2</sup>
Cross-section plastic modulus Wpl,y	3,2320e-03	m <sup>3</sup>
Cross-section plastic modulus Wpl,z	1,1040e-03	m <sup>3</sup>
Design compression force N,Ed	467,04	kN
Design bending moment (maximum) My,Ed	569,13	kNm
Design bending moment (maximum) Mz,Ed	24,95	kNm
Characteristic compression resistance N,Rk	7021,90	kN
Characteristic moment resistance My,Rk	1147,36	kNm
Characteristic moment resistance Mz,Rk	391,92	kNm
Reduction factor Chi,y	0,96	
Reduction factor Chi,z	0,72	
Reduction factor Chi,LT	0,96	
Interaction factor k,yy	1,03	
Interaction factor k,yz	0,50	
Interaction factor k,zy	0,55	
Interaction factor k,zz	0,59	

Maximum moment My,Ed is derived from beam B2499 position 0,000 m.  
 Maximum moment Mz,Ed is derived from beam B2499 position 4,600 m.

Interaction method 1 parameters		
Critical Euler load N,cr,y	56497,42	kN
Critical Euler load N,cr,z	10598,16	kN
Elastic critical load N,cr,T	19092,33	kN
Cross-section plastic modulus Wpl,y	3,2320e-03	m <sup>3</sup>
Cross-section elastic modulus Wel,y	2,8840e-03	m <sup>3</sup>
Cross-section plastic modulus Wpl,z	1,1040e-03	m <sup>3</sup>
Cross-section elastic modulus Wel,z	7,2130e-04	m <sup>3</sup>
Second moment of area Iy	5,7680e-04	m <sup>4</sup>
Second moment of area Iz	1,0820e-04	m <sup>4</sup>
Torsional constant It	3,5570e-06	m <sup>4</sup>
Method for equivalent moment factor C,my,0	Table A.2 Line 2 (General)	
Design bending moment (maximum) My,Ed	569,13	kNm
Maximum relative deflection delta,z	1,3	mm
Equivalent moment factor C,my,0	0,99	
Method for equivalent moment factor C,mz,0	Table A.2 Line 1 (Linear)	
Ratio of end moments Psi,z	-0,90	
Equivalent moment factor C,mz,0	0,58	
Factor mu,y	1,00	
Factor mu,z	0,99	
Factor epsilon,y	8,36	
Factor a,LT	0,99	
Critical moment for uniform bending Mcr,0	2947,14	kNm
Relative slenderness Lambda,rel,0	0,69	
Limit relative slenderness Lambda,rel,0,lim	0,36	
Equivalent moment factor C,my	1,00	
Equivalent moment factor C,mz	0,58	
Equivalent moment factor C,mLT	1,03	
Factor b,LT	0,01	
Factor c,LT	0,41	
Factor d,LT	0,14	
Factor e,LT	1,06	
Factor w,y	1,12	
Factor w,z	1,50	
Factor n,pl	0,07	
Maximum relative slenderness Lambda,rel,max	0,81	
Factor C,yy	1,00	
Factor C,yz	0,85	
Factor C,zy	0,96	
Factor C,zz	1,01	

Unity check (6.61) = 0,07 + 0,53 + 0,03 = 0,63 -  
 Unity check (6.62) = 0,09 + 0,28 + 0,04 = 0,41 -

**Shear Buckling check**

According to EN 1993-1-5 article 5 & 7.1 and formula (5.10) & (7.1)

Shear Buckling parameters		
Buckling field length a	4,600	m
Web	unstiffened	
Web height hw	352	mm
Web thickness t	14	mm
Material coefficient epsilon	0,81	
Shear correction factor Eta	1,20	

Shear Buckling verification		
Web slenderness hw/t	26,07	
Web slenderness limit	48,82	

**Note:** The web slenderness is such that Shear Buckling effects may be ignored according to EN 1993-1-5 article 5.1(2).  
The member satisfies the stability check.

-iskoristivost elementa na GSN – 63 %

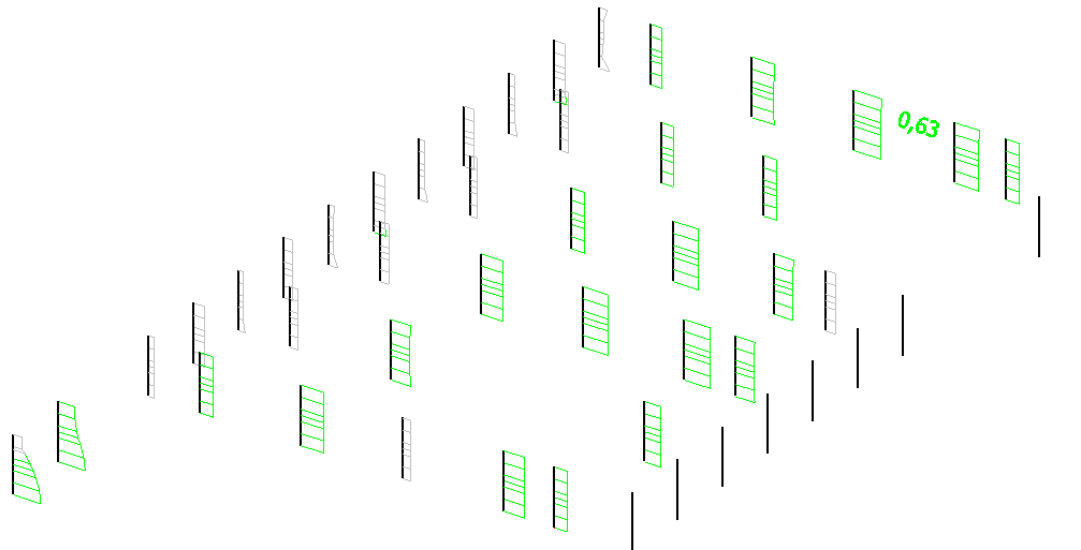

**Slika 16.16.** Prikaz iskoristivosti nosača – stup 1 (3. etaža)

16.2.11. Rezne sile – stup 1 (velika dvorana)

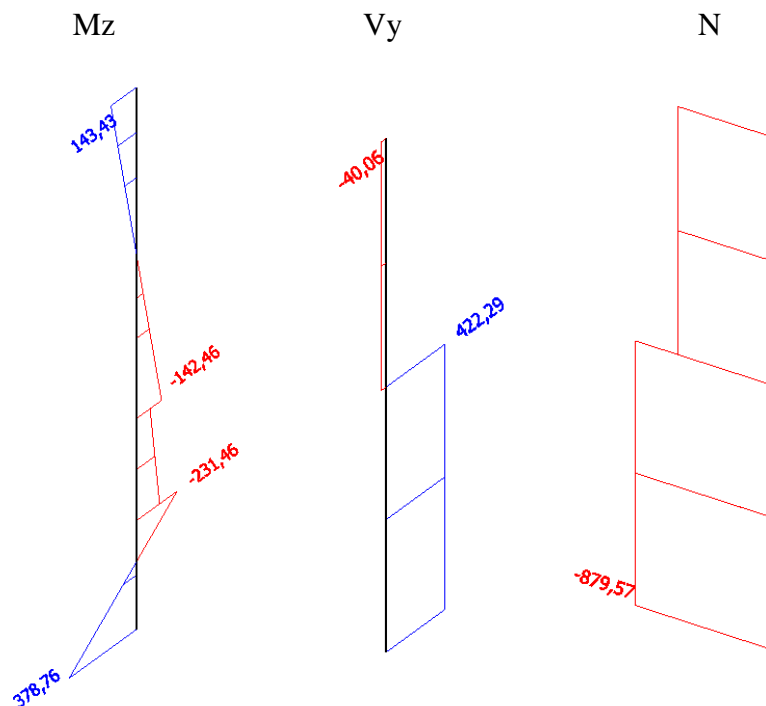

Slika 16.17. Prikaz reznih sila nosača – stup 1 (velika dvorana)

-poprečni presjek nosača

Name	Stup 3 - 3. etaža	
Type	HEM500	
Source description	Profil Arbed / Structural shapes / Edition Octobre 1995	
Item material	S 355	
Fabrication	rolled	
Flexural buckling y-y	a	
Flexural buckling z-z	b	
Lateral torsional buckling	Default	
Use 2D FEM analysis	x	
A [m²]	3,4430e-02	
A y, z [m²]	2,4483e-02	1,1242e-02
I y, z [m⁴]	1,6200e-03	1,9200e-04
I w [m⁵], t [m⁴]	1,1187e-05	1,5390e-05
Wei y, z [m³]	6,1800e-03	1,2520e-03
Wpl y, z [m³]	7,0940e-03	1,9320e-03
d y, z [mm]	0	0
c YUCS, ZUCS [mm]	153	262
α [deg]	0,00	
A L, D [m²/m]	2,1800e+00	2,1834e+00
Mpl y, z - [Nm]	2,52e+06	2,52e+06
Mpl z +, - [Nm]	6,86e+05	6,86e+05

Slika 16.18. Prikaz geometrijskih karakteristika nosača

### 16.2.12. Dimenzioniranje – stup 1 (3.etaža)

Member B141	2,800 m	HEM500	S 355	GSN 22	0,83 -
-------------	---------	--------	-------	--------	--------

Partial safety factors	
Gamma M0 for resistance of cross-sections	1,00
Gamma M1 for resistance to instability	1,00
Gamma M2 for resistance of net sections	1,25

Material		
Yield strength $f_y$	355,0	MPa
Ultimate strength $f_u$	490,0	MPa
Fabrication	Rolled	

....SECTION CHECK:....

The critical check is on position 2.800 m

Internal forces	Calculated	Unit
N,Ed	-879,57	kN
Vy,Ed	422,29	kN
Vz,Ed	-386,48	kN
T,Ed	1,18	kNm
My,Ed	338,25	kNm
Mz,Ed	378,76	kNm

#### Classification for cross-section design

According to EN 1993-1-1 article 5.5.2

#### Classification of Internal Compression parts

According to EN 1993-1-1 Table 5.2 Sheet 1

Maximum width-to-thickness ratio	18,57
Class 1 Limit	43,15
Class 2 Limit	49,69
Class 3 Limit	57,48

=> Internal Compression parts Class 1

#### Classification of Outstand Flanges

According to EN 1993-1-1 Table 5.2 Sheet 2

Maximum width-to-thickness ratio	2,89
Class 1 Limit	7,32
Class 2 Limit	8,14
Class 3 Limit	12,39

=> Outstand Flanges Class 1

=> Section classified as Class 1 for cross-section design

#### Compression check

According to EN 1993-1-1 article 6.2.4 and formula (6.9)

A	3,4430e-02	m <sup>2</sup>
Nc,Rd	12222,65	kN
Unity check	0,07	-

#### Bending moment check for My

According to EN 1993-1-1 article 6.2.5 and formula (6.12),(6.13)

Wpl,y	7,0940e-03	m <sup>3</sup>
Mpl,y,Rd	2518,37	kNm
Unity check	0,13	-

#### Bending moment check for Mz

According to EN 1993-1-1 article 6.2.5 and formula (6.12),(6.13)

Wpl,z	1,9320e-03	m <sup>3</sup>
Mpl,z,Rd	685,86	kNm
Unity check	0,55	-

#### Shear check for Vy

According to EN 1993-1-1 article 6.2.6 and formula (6.17)

Eta	1,20	
Av	2,5488e-02	m <sup>2</sup>
Vpl,y,Rd	5224,00	kN
Unity check	0,08	-

#### Shear check for Vz

According to EN 1993-1-1 article 6.2.6 and formula (6.17)

Eta	1,20	
Av	1,2950e-02	m <sup>2</sup>
Vpl,z,Rd	2654,22	kN
Unity check	0,15	-

**Note:** The unity check for torsion is lower than the limit value of 0,05. Therefore torsion is considered as insignificant and is ignored in the combined checks.

**Combined bending, axial force and shear force check**

According to EN 1993-1-1 article 6.2.9.1 and formula (6.41)

Mpl,y,Rd	2518,37	kNm
Alpha	2,00	
Mpl,z,Rd	685,86	kNm
Beta	1,00	

Unity check (6.41) = 0,02 + 0,55 = 0,57 -

**Note:** Since the shear forces are less than half the plastic shear resistances their effect on the moment resistances is neglected.

**Note:** Since the axial force satisfies both criteria (6.33) and (6.34) of EN 1993-1-1 article 6.2.9.1(4) its effect on the moment resistance about the y-y axis is neglected.

**Note:** Since the axial force satisfies criteria (6.35) of EN 1993-1-1 article 6.2.9.1(4) its effect on the moment resistance about the z-z axis is neglected.

The member satisfies the section check.

**...:STABILITY CHECK:...:**

**Classification for member buckling design**

Decisive position for stability classification: 1,355 m

**Classification of Internal Compression parts**

According to EN 1993-1-1 Table 5.2 Sheet 1

Maximum width-to-thickness ratio	18,57
Class 1 Limit	43,17
Class 2 Limit	49,72
Class 3 Limit	73,68

=> Internal Compression parts Class 1

**Classification of Outstand Flanges**

According to EN 1993-1-1 Table 5.2 Sheet 2

Maximum width-to-thickness ratio	2,89
Class 1 Limit	7,32
Class 2 Limit	8,14
Class 3 Limit	11,88

=> Outstand Flanges Class 1

=> Section classified as Class 1 for member buckling design

**Flexural Buckling check**

According to EN 1993-1-1 article 6.3.1.1 and formula (6.46)

Buckling parameters	yy	zz	
<small>*Student version* *Student version* *Student version* *Student version* *Student version* *Student version*</small>			
Sway type	sway	non-sway	
System length L	1,445	1,445	m
Buckling factor k	1,00	1,00	
Buckling length Lcr	1,445	1,445	m
Critical Euler load Ncr	1608045,60	190583,18	kN
Slenderness Lambda	6,66	19,35	
Relative slenderness Lambda,rel	0,09	0,25	
Limit slenderness Lambda,rel,0	0,20	0,20	

**Note:** The slenderness or compression force is such that Flexural Buckling effects may be ignored according to EN 1993-1-1 article 6.3.1.2(4).

**Torsional(-Flexural) Buckling check**

According to EN 1993-1-1 article 6.3.1.1 and formula (6.46)

**Note:** For this I-section the Torsional(-Flexural) buckling resistance is higher than the resistance for Flexural buckling. Therefore Torsional(-Flexural) buckling is not printed on the output.

**Lateral Torsional Buckling check**

According to EN 1993-1-1 article 6.3.2.1 & 6.3.2.2 and formula (6.54)

LTB parameters		
<small>*Student version* *Student version* *Student version* *Student version* *Student version* *Student version*</small>		
Method for LTB curve	General case	
Cross-section plastic modulus Wpl,y	7,0940e+03	m <sup>3</sup>
Elastic critical moment Mcr	69191,59	kNm
Relative slenderness Lambda,rel,LT	0,19	
Limit slenderness Lambda,rel,LT,0	0,20	

**Note:** The slenderness or bending moment is such that Lateral Torsional Buckling effects may be ignored according to EN 1993-1-1 article 6.3.2.2(4).

Mcr parameters		
<small>*Student version* *Student version* *Student version* *Student version* *Student version* *Student version*</small>		
LTB length L	1,445	m
Influence of load position	no influence	
Correction factor k	1,00	
Correction factor kw	1,00	
LTB moment factor C1	1,43	
LTB moment factor C2	0,00	
LTB moment factor C3	1,00	
Shear center distance d,z	0	mm
Distance of load application z,g	0	mm
Mono-symmetry constant beta,y	0	mm
Mono-symmetry constant beta,z	0	mm



Shear Buckling verification	
<small>*Student version* *Student version* *Student version* *Stud</small>	
Web slenderness $hw/t$	21,14
Web slenderness limit	48,82

**Note:** The web slenderness is such that Shear Buckling effects may be ignored according to EN 1993-1-5 article 5.1(2).  
The member satisfies the stability check.

-iskoristivost elementa na GSN – 83 %

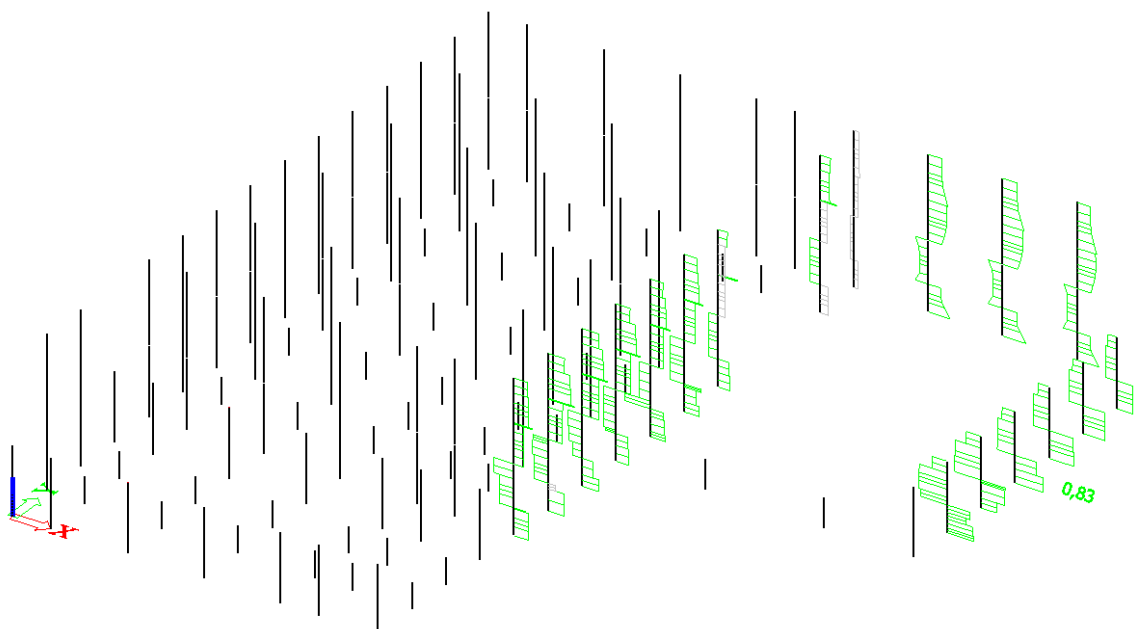

*Slika 16.19. Prikaz iskoristivosti nosača – stup 1 (velika dvorana)*

### 16.2.13. Rezne sile – krajnji stup konzolnog nosača

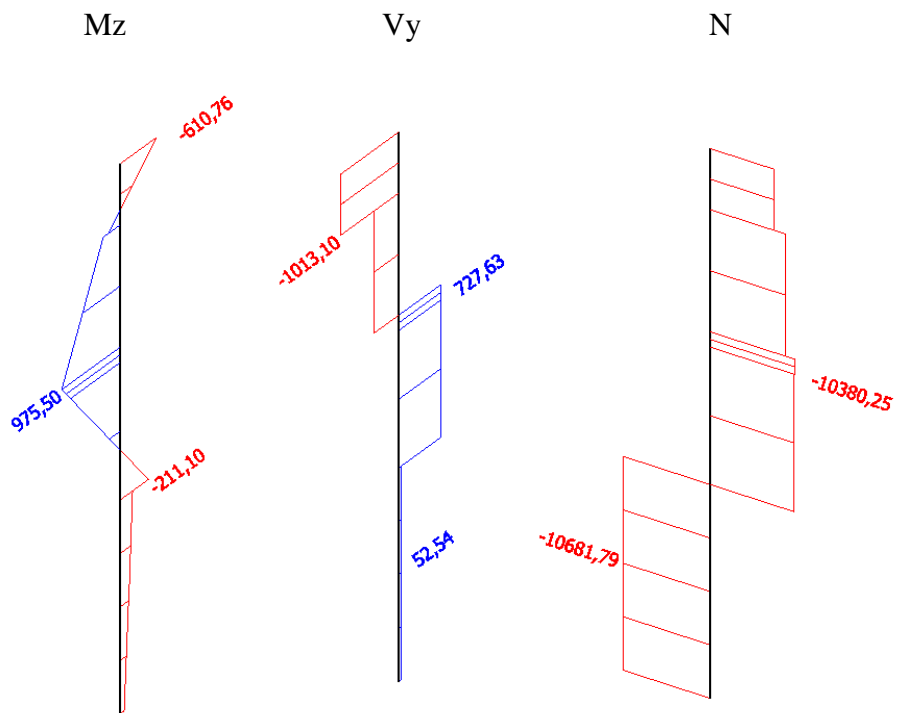

Slika 16.20. Prikaz reznih sila nosača – krajnji stup konzolnog nosača

-poprečni presjek nosača

Name	Krajnji stup konzolnog nosača	
Type	SHS550/550/28.0	
Source description	Corus Advance Sections	
Item material	S 355	
Fabrication	cold formed	
Flexural buckling y-y	c	
Flexural buckling z-z	c	
Lateral torsional buckling	Default	
Use 2D FEM analysis	*	
A [m²]	5,6400e-02	
A y, z [m²]	2,8547e-02	2,8547e-02
I y, z [m⁴]	2,5200e-03	2,5200e-03
I w [m⁶], t [m⁴]	1,1743e-04	4,0900e-03
Wpl y, z [m³]	9,1500e-03	9,1500e-03
Wpl y, z [m³]	1,1088e-02	1,1088e-02
d y, z [mm]	0	0
c YUCS, ZUCS [mm]	275	275
α [deg]	0,00	
A L, D [m²/m]	2,1000e+00	4,0794e+00
Mply +, - [Nm]	3,94e+06	3,94e+06
Mplz +, - [Nm]	3,94e+06	3,94e+06

Slika 16.21. Prikaz geometrijskih karakteristika nosača



## 16.2.14. Dimenzioniranje – krajnji stup konzolnog nosača

Member B784	4,400 m	SHS550/550/28.0	S 355	GSN 26	0,92 -
-------------	---------	-----------------	-------	--------	--------

Partial safety factors	
Gamma M0 for resistance of cross-sections	1,00
Gamma M1 for resistance to instability	1,00
Gamma M2 for resistance of net sections	1,25

Material		
Yield strength $f_y$	355,0	MPa
Ultimate strength $f_u$	490,0	MPa
Fabrication	Rolled	

....SECTION CHECK:....

The critical check is on position 1.800 m

Internal forces	Calculated	Unit
N,Ed	-10380,25	kN
Vy,Ed	727,63	kN
Vz,Ed	-836,74	kN
T,Ed	7,08	kNm
My,Ed	328,80	kNm
Mz,Ed	829,98	kNm

#### Classification for cross-section design

According to EN 1993-1-1 article 5.5.2

#### Classification of Internal Compression parts

According to EN 1993-1-1 Table 5.2 Sheet 1

Maximum width-to-thickness ratio	16,64
Class 1 Limit	26,85
Class 2 Limit	30,92
Class 3 Limit	36,58

=> Section classified as Class 1 for cross-section design

#### Compression check

According to EN 1993-1-1 article 6.2.4 and formula (6.9)

A	5,6400e-02	m <sup>2</sup>
Nc,Rd	20022,00	kN
Unity check	0,52	-

#### Bending moment check for My

According to EN 1993-1-1 article 6.2.5 and formula (6.12),(6.13)

Wpl,y	1,1088e-02	m <sup>3</sup>
Mpl,y,Rd	3936,09	kNm
Unity check	0,08	-

#### Bending moment check for Mz

According to EN 1993-1-1 article 6.2.5 and formula (6.12),(6.13)

Wpl,z	1,1088e-02	m <sup>3</sup>
Mpl,z,Rd	3936,09	kNm
Unity check	0,21	-

#### Shear check for Vy

According to EN 1993-1-1 article 6.2.6 and formula (6.17)

Eta	1,20	
Av	2,8200e-02	m <sup>2</sup>
Vpl,y,Rd	5779,85	kN
Unity check	0,13	-

#### Shear check for Vz

According to EN 1993-1-1 article 6.2.6 and formula (6.17)

Eta	1,20	
Av	2,8200e-02	m <sup>2</sup>
Vpl,z,Rd	5779,85	kN
Unity check	0,14	-

#### Torsion check

According to EN 1993-1-1 article 6.2.7 and formula (6.23)

Tau,t,Ed	0,5	MPa
Tau,Rd	205,0	MPa
Unity check	0,00	-

**Note:** The unity check for torsion is lower than the limit value of 0,05. Therefore torsion is considered as insignificant and is ignored in the combined checks.

Beta	2,38
------	------

Unity check (6.41) = 0,01 + 0,08 = 0,08 -

**Note:** Since the shear forces are less than half the plastic shear resistances their effect on the moment resistances is neglected.

The member satisfies the section check.

....:STABILITY CHECK:...

**Classification for member buckling design**

Decisive position for stability classification: 0,000 m

**Classification of Internal Compression parts**

According to EN 1993-1-1 Table 5.2 Sheet 1

Maximum width-to-thickness ratio	16,64
Class 1 Limit	26,85
Class 2 Limit	30,92
Class 3 Limit	49,96

=> Section classified as Class 1 for member buckling design

**Flexural Buckling check**

According to EN 1993-1-1 article 6.3.1.1 and formula (6.46)

Buckling parameters	yy	zz	
<small>*Student version* *Student version* *Student version* *Student version* *Student version* *Student version*</small>			
Sway type	sway	non-sway	
System length L	2,600	2,000	m
Buckling factor k	1,00	1,00	
Buckling length L <sub>cr</sub>	2,600	2,000	m
Critical Euler load N <sub>cr</sub>	772632,34	1305748,66	kN
Slenderness Lambda	12,30	9,46	
Relative slenderness Lambda <sub>rel</sub>	0,16	0,12	
Limit slenderness Lambda <sub>rel,0</sub>	0,20	0,20	

**Note:** The slenderness or compression force is such that Flexural Buckling effects may be ignored according to EN 1993-1-1 article 6.3.1.2(4).

**Torsional(-Flexural) Buckling check**

According to EN 1993-1-1 article 6.3.1.1 and formula (6.46)

**Note:** The cross-section concerns a RHS section which is not susceptible to Torsional(-Flexural) Buckling.

**Lateral Torsional Buckling check**

According to EN 1993-1-1 article 6.3.2.1

**Note:** The cross-section concerns an RHS section with  $h/b < 10 / \text{Lambda}_{rel,z}$

This section is thus not susceptible to Lateral Torsional Buckling.

**Bending and axial compression check**

According to EN 1993-1-1 article 6.3.3 and formula (6.61),(6.62)

Bending and axial compression check parameters
<small>*Student version* *Student version* *Student version* *Student version* *Student version* *Student version* *Student version* *Student version* *Student version* *Student version*</small>

Interaction method	alternative method 1	
Cross-section area A	5,6400e-02	m <sup>2</sup>
Cross-section plastic modulus W <sub>pl,y</sub>	1,1088e-02	m <sup>3</sup>
Cross-section plastic modulus W <sub>pl,z</sub>	1,1088e-02	m <sup>3</sup>
Design compression force N <sub>Ed</sub>	10380,25	kN
Design bending moment (maximum) M <sub>y,Ed</sub>	-1312,99	kNm
Design bending moment (maximum) M <sub>z,Ed</sub>	975,50	kNm
Characteristic compression resistance N <sub>Rk</sub>	20022,00	kN
Characteristic moment resistance M <sub>y,Rk</sub>	3936,09	kNm
Characteristic moment resistance M <sub>z,Rk</sub>	3936,09	kNm
Reduction factor Chi <sub>y</sub>	1,00	
Reduction factor Chi <sub>z</sub>	1,00	
Reduction factor Chi <sub>LT</sub>	1,00	
Interaction factor k <sub>yy</sub>	0,85	
Interaction factor k <sub>yz</sub>	0,50	
Interaction factor k <sub>zy</sub>	0,50	
Interaction factor k <sub>zz</sub>	0,84	

Maximum moment M<sub>y,Ed</sub> is derived from beam B784 position 4,400 m.

Maximum moment M<sub>z,Ed</sub> is derived from beam B784 position 2,000 m.

Interaction method 1 parameters
<small>*Student version* *Student version* *Student version* *Student version* *Student version* *Student version* *Student version* *Student version* *Student version* *Student version*</small>

Critical Euler load N <sub>cr,y</sub>	772632,34	kN
Critical Euler load N <sub>cr,z</sub>	1305748,66	kN
Elastic critical load N <sub>cr,T</sub>	4377653,53	kN
Cross-section plastic modulus W <sub>pl,y</sub>	1,1088e-02	m <sup>3</sup>
Cross-section elastic modulus W <sub>el,y</sub>	9,1500e-03	m <sup>3</sup>
Cross-section plastic modulus W <sub>pl,z</sub>	1,1088e-02	m <sup>3</sup>
Cross-section elastic modulus W <sub>el,z</sub>	9,1500e-03	m <sup>3</sup>
Second moment of area I <sub>y</sub>	2,5200e-03	m <sup>4</sup>
Second moment of area I <sub>z</sub>	2,5200e-03	m <sup>4</sup>
Torsional constant I <sub>t</sub>	4,0900e-03	m <sup>4</sup>
Method for equivalent moment factor C <sub>my,0</sub>	Table A.2 Line 2 (General)	
Design bending moment (maximum) M <sub>y,Ed</sub>	-1312,99	kNm
Maximum relative deflection delta <sub>z</sub>	1,0	mm
Equivalent moment factor C <sub>my,0</sub>	0,99	
Method for equivalent moment factor C <sub>mz,0</sub>	Table A.2 Line 2 (General)	
Design bending moment (maximum) M <sub>z,Ed</sub>	975,50	kNm
Maximum relative deflection delta <sub>y</sub>	-0,2	mm

\*Student version\* \*Student version\* \*Student version\* \*Student version\* \*Student version\* \*Student version\* \*Student version\* \*Student version\* \*Student version\* \*Student version\*

Interaction method 1 parameters		
*Student version*	*Student version*	*Student version*
Equivalent moment factor C,mz,0	0,99	
Factor mu,y	1,00	
Factor mu,z	1,00	
Factor epsilon,y	0,78	
Factor a,LT	0,00	
Critical moment for uniform bending Mcr,0	714703,99	kNm
Relative slenderness Lambda,rel,0	0,07	
Limit relative slenderness Lambda,rel,0,lim	0,28	
Equivalent moment factor C,my	0,99	
Equivalent moment factor C,mz	0,99	
Equivalent moment factor C,mLT	1,00	
Factor b,LT	0,00	
Factor c,LT	0,00	
Factor d,LT	0,00	
Factor e,LT	0,00	
Factor w,y	1,21	
Factor w,z	1,21	
Factor n,pl	0,52	
Maximum relative slenderness Lambda,rel,max	0,16	
Factor C,yy	1,19	
Factor C,yz	1,20	
Factor C,zy	1,20	
Factor C,zz	1,19	

Unity check (6.61) =  $0,52 + 0,28 + 0,12 = 0,92$  -  
 Unity check (6.62) =  $0,52 + 0,17 + 0,21 = 0,89$  -  
 The member satisfies the stability check.

-iskoristivost elementa na GSN – 92 %

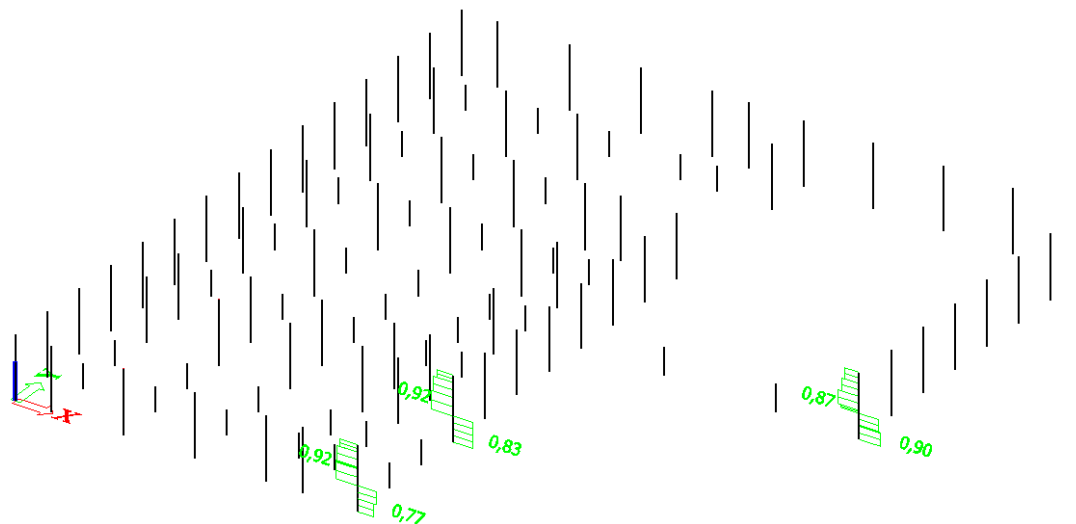

Slika 16.22. Prikaz iskoristivosti nosača – krajnji stup konzolnog nosača

## 17. DINAMIČKA ANALIZA

Računsko ubrzanje tla očitano je sa Seizmičke karte Republike Hrvatske i iznosi:  $a_g = 0,22 \text{ g}$ . Klasificiranjem vrste temeljnog tla utvrđeno je da se građevina nalazi na tlu klasa A koja se odnosi na stijenu ili drugu geološku formaciju s najviše 5 m slabijeg tla pri površini i krute naslage pijeska, šljunka ili prekonsolidirane gline. Za proračun seizmičkog opterećenja korištena je višemodalna spektralna analiza. Konstrukcija je proučavana u dva međusobno okomita horizontalna pravca. Odgovor konstrukcije dobiven je metodom spektra odgovora.

- Seizmičko područje: IX zona
- Računsko ubrzanje tla:  $a_g = 0,22 \text{ g}$ ,  $g = 9,81 \text{ m/s}^2$
- Srednja kategorija duktilnosti DC“M“ (konstrukcije posebno otporne na potres, ne dolazi do krhkog loma pod cikličkim djelovanjem sila potresa u području plastičnih zglobova)
- Kategorija tla: A
- Faktor značaja:  $\gamma = 1.0$  (obične zgrade, stambene)

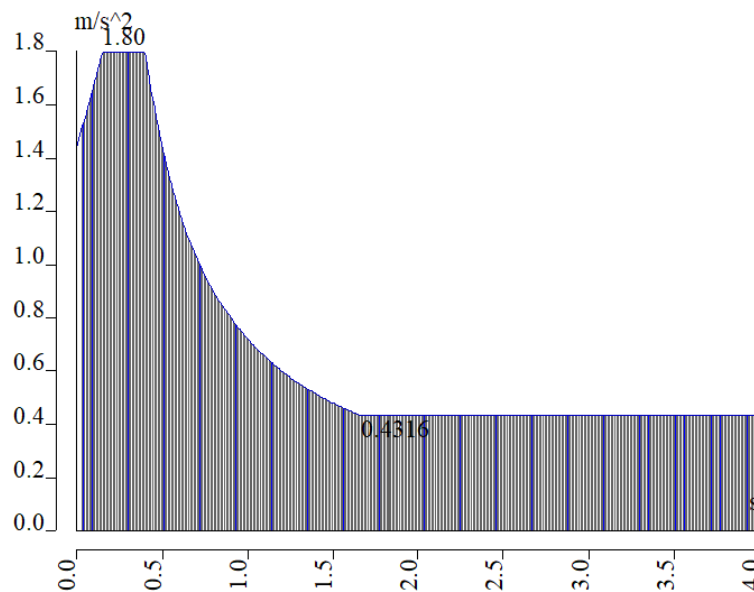

Slika 17.1. Ulazni projektni spektar odgovora

Modalna analiza



Calculation protocol

Solution of Free vibration

Number of 2D elements	14800
Number of 1D elements	10005
Number of mesh nodes	16591
Number of equations	99546
Combination of mass groups	MC1 CM1
Number of frequencies	90
Method	Lanczos
Bending theory	Mindlin
Type of analysis model	Standard
Start of calculation	21.07.2017 00:26
End of calculation	21.07.2017 00:27

Sum of masses

	X [kg]	Y [kg]	Z [kg]
1	44331133,2	44331133,2	44331133,2

Relative modal masses

Mode	mega [rad/!]	Period [s]	Freq. [Hz]	W <sub>xi</sub> /W <sub>xtot</sub>	W <sub>vi</sub> /W <sub>vtot</sub>	W <sub>zi</sub> /W <sub>ztot</sub>	W <sub>xi,R</sub> /W <sub>xtot,R</sub>	W <sub>vi,R</sub> /W <sub>vtot,R</sub>	W <sub>zi,R</sub> /W <sub>ztot,R</sub>
1	3.23125	1,94	0,51	0.00649451	2.00447e-006	3.00082e-008	5.06267e-008	0.00026795	0.000430966
2	3.55666	1,77	0,57	1.63406e-005	0.00552185	1.34724e-006	0	3.11456e-007	0.000744144
3	4.02259	1,56	0,64	8.5312e-005	0.00673326	3.58784e-008	2.81097e-008	5.83362e-006	0.00182718
4	4.05569	1,55	0,65	4.94158e-006	0.00463333	3.74605e-006	3.75502e-006	7.56368e-006	0.00198494
5	5.02836	1,25	0,80	0.000143611	1.01266e-005	0.0046701	0.00060742	0.000618385	5.01151e-006
6	5.08726	1,24	0,81	0.000983933	3.07241e-005	0.00493248	0.000278489	0.000330854	0.00129405
7	5.18579	1,21	0,83	0.000652399	4.13445e-005	0.00791313	0.01118583	0.0100186	0.00120586
8	5.41263	1,16	0,86	0.00102631	2.9407e-005	0.00453769	0.00303477	0.0017872	0.000773908
9	6.41253	0,98	1,02	0.00146757	0.000429607	5.88821e-006	5.49702e-006	0.000121346	0.00171145
10	6.56344	0,96	1,04	0.00284921	0.000734711	1.28293e-005	2.48196e-005	0.000153103	0.00335913
11	6.61142	0,95	1,05	0.323503	0.0752394	0.00234138	0.00548094	0.0127703	0.367073
12	6.65114	0,94	1,06	0.000738837	0.00090792	0.00233857	0.00274451	0.00368592	0.000474026
13	7.27541	0,86	1,16	4.12972e-005	7.45494e-007	0.000177604	2.36411e-005	3.81093e-005	5.71767e-006
14	7.81903	0,80	1,24	0.00473483	0.0264784	0.111771	0.109796	0.218074	0.0458829
15	8.53804	0,74	1,36	0.000790553	0.00308193	0.0276247	0.0232947	0.0309874	0.00228125
16	9.04366	0,69	1,44	4.34696e-006	0.000291499	0.00944628	0.00482946	0.01866	0.00542198
17	9.73403	0,65	1,55	0.00619827	0.00853526	0.0122721	0.0325859	0.0186147	0.000224422
18	10.6736	0,59	1,70	0.111843	0.445153	0.00343687	0.00157213	0.00390981	0.00202812
19	10.7877	0,58	1,72	0.00268777	0.0128914	0.00236819	0.00207017	0.00316502	1.63789e-005
20	10.8271	0,58	1,72	0.0101852	0.0345602	0.00101846	0.00685713	0.000290973	5.21065e-005
21	11.1967	0,56	1,78	3.62564e-005	0.000821311	0.000927922	0.000111295	0.000194053	3.9838e-005
22	11.6157	0,54	1,85	0.00119792	0.00560596	0.0131968	0.0164185	0.00410392	0.000418452
23	11.6466	0,54	1,85	3.41614e-005	0.00108443	5.80213e-005	0.00231923	4.66284e-005	7.55614e-005
24	11.8847	0,53	1,89	1.13577e-005	0.000719268	0.0327366	0.050246	0.01679	2.37078e-005
25	12.0916	0,52	1,92	0.00448782	0.00124207	0.000848187	0.00137549	0.000859613	0.00399954
26	12.2029	0,51	1,94	0.0537596	7.4411e-007	0.0058778	0.00107015	0.0248978	0.036017
27	12.2192	0,51	1,94	0.000171719	4.3674e-005	0.00378438	0.000124229	0.000502181	5.03601e-005
28	12.3472	0,51	1,97	3.17271e-005	3.24382e-005	0.00124828	0.00241652	1.00669e-007	2.98581e-005
29	12.6101	0,50	2,01	5.6686e-007	2.5328e-005	0.0018503	0.00835263	1.81717e-005	7.11792e-006
30	12.6965	0,49	2,02	4.5955e-007	3.13848e-005	0.000195709	3.63162e-005	1.96916e-007	1.39078e-006
31	12.7613	0,49	2,03	0.00214768	0.000145518	0.00546828	0.00446039	0.000532528	0.000700291
32	12.8652	0,49	2,05	0.00146827	1.98323e-005	0.00834562	0.00912069	0.00167186	0.00114146
33	12.9605	0,48	2,06	1.22195e-005	0.000848988	0.00217811	8.5672e-005	0.000703068	5.55148e-007
34	13.0675	0,48	2,08	0.0106606	0.00162613	2.56223e-005	0.00509139	0.000247876	0.0155912
35	13.3257	0,47	2,12	2.89856e-005	0.000141311	0.00204454	0.000213195	0.00149012	0.00019414
36	13.4482	0,47	2,14	7.01273e-005	7.26871e-005	0.00982666	0.0107108	0.00350017	3.72667e-005
37	13.7593	0,46	2,19	0.0130488	0.0011879	0.000877274	0.00153959	0.00693693	0.0177022
38	13.8486	0,45	2,20	0.061579	0.0109769	0.00786406	0.000133619	5.82825e-007	0.0750728
39	13.9033	0,45	2,21	0.00924937	0.00119573	0.00199552	0.000361045	0.00156842	0.0105545
40	13.9934	0,45	2,23	0.000273178	5.79029e-007	0.00606126	0.00733678	0.00228085	0.000278234
41	14.234	0,44	2,27	3.44426e-005	0.000257509	0.0340367	0.0906144	0.0203417	0.000175086
42	14.2396	0,44	2,27	5.90026e-005	1.01309e-006	0.000437295	0.000525257	0.00150358	3.02151e-006
43	14.3803	0,44	2,29	0.0157113	0.0104212	0.0113165	0.00386735	0.00138162	0.024929
44	14.4059	0,44	2,29	0.0615441	0.0227046	0.00090265	0.0105065	0.00117232	0.0968691
45	14.6174	0,43	2,33	0.000151629	0.000502656	0.00295908	0.00354131	0.00129105	0.000255316



Mode	mega [rad/s]	Period [s]	Freq. [Hz]	$W_{xl}/W_{xtot}$	$W_{yl}/W_{ytot}$	$W_{zl}/W_{ztot}$	$W_{xl,R}/W_{xtot,R}$	$W_{yl,R}/W_{ytot,R}$	$W_{zl,R}/W_{ztot,R}$
46	14.8401	0,42	2,36	5.80109e-005	2.2217e-005	0.0726051	0.00715348	0.0708877	0.000115853
47	15.0849	0,42	2,40	0.000581243	3.95175e-005	0.000126144	0.0013221	0.0138383	0.000529602
48	15.1333	0,42	2,41	7.96911e-006	2.66092e-005	0.00932153	0.00671075	0.00693106	2.2496e-006
49	15.3819	0,41	2,45	0.0244595	0.0218767	0.00685873	0.000998188	0.00027214	0.0422517
50	15.423	0,41	2,45	0.000839639	0.000400722	0.0102168	0.000494772	0.0114144	0.00111723
51	15.4416	0,41	2,46	0.00101056	0.0012516	0.000167484	0.000234131	0.000446966	0.00183156
52	15.4696	0,41	2,46	5.63211e-006	2.07563e-007	0.00062019	0.000974802	0.000477168	2.23924e-005
53	15.6469	0,40	2,49	0.00160362	0.00396764	0.000549106	0.00133115	0.000524354	0.00364136
54	15.7027	0,40	2,50	8.3253e-005	0.000114062	0.000826496	0.00213142	0.000556919	4.9758e-005
55	15.7421	0,40	2,51	0.000602449	0.000317847	0.00181936	3.59673e-005	0.00579112	0.000857166
56	15.8818	0,40	2,53	0.000218924	3.16023e-005	0.00956288	0.012726	0.00504521	0.000331645
57	15.971	0,39	2,54	6.8427e-007	1.52723e-006	2.84483e-008	0.000188289	1.54435e-007	4.60236e-006
58	15.9779	0,39	2,54	5.36589e-007	3.78803e-006	0.000362959	0.000639289	0.0011673	5.22072e-008
59	16.0983	0,39	2,56	7.36967e-007	0.000183614	1.93094e-005	0.000574889	4.38873e-006	1.98057e-007
60	16.2265	0,39	2,58	3.6977e-005	1.09199e-006	0.0016685	0.0026725	0.00132874	3.36894e-005
61	16.34	0,38	2,60	0.000756111	0.000132689	0.00447172	0.00421253	0.00235179	0.00072688
62	16.4495	0,38	2,62	0.000559283	0.0019767	0.0174531	0.0206724	3.76465e-007	0.00115719
63	16.456	0,38	2,62	7.36518e-005	3.96876e-007	0.000918021	0.000359624	0.00127078	3.40013e-005
64	16.5006	0,38	2,63	0.00668376	0.00283036	5.57565e-006	0.00474468	0.00184169	0.00506218
65	16.7143	0,38	2,66	3.56935e-005	0.000927838	0.000229612	5.19514e-005	5.30713e-006	0.000227639
66	16.7646	0,37	2,67	0.000178762	0.000327	5.75732e-005	0.000453075	2.39082e-006	3.97243e-005
67	16.8234	0,37	2,68	0.00072604	1.26451e-005	0.000195902	0.00158004	0.00060511	0.000267127
68	17.1192	0,37	2,72	3.20306e-005	0.00057637	4.47956e-005	0.00108763	0.00489142	3.74806e-006
69	17.1961	0,37	2,74	0.000338257	1.63836e-005	1.16724e-005	0.000837147	5.76688e-005	0.000187814
70	17.3481	0,36	2,76	0.000177816	0.00397951	0.00157636	0.0112491	0.00209187	1.0513e-006
71	17.3922	0,36	2,77	1.8707e-005	0.000237768	0.000171713	0.0031602	0.00146721	3.10497e-006
72	17.6803	0,36	2,81	3.01527e-007	3.45666e-006	0.000846836	0.00060733	0.000670152	1.90851e-006
73	17.6819	0,36	2,81	1.16325e-006	3.29023e-007	0.00128005	0.00103442	0.000350734	1.2288e-007
74	17.7313	0,35	2,82	5.32395e-006	7.86391e-006	0.000872818	0.000945086	1.78049e-006	3.33125e-007
75	17.771	0,35	2,83	3.82621e-006	2.0311e-006	3.16436e-007	1.12578e-005	1.33745e-005	1.67397e-006
76	17.9981	0,35	2,86	7.30279e-006	2.5669e-005	0.00384132	0.000749449	0.000681382	2.87473e-005
77	18.016	0,35	2,87	5.65558e-005	3.28877e-006	0.000441758	1.67486e-005	0.000294112	0.000132927
78	18.0526	0,35	2,87	0.00040362	0.000385201	0.00208236	0.00263971	0.00360043	0.000990169
79	18.1133	0,35	2,88	0.00388666	0.00109184	0.0162548	7.14569e-005	0.0140659	0.00737543
80	18.1404	0,35	2,89	0.00235068	2.88316e-005	0.00771826	0.00227906	0.0116662	0.00473976
81	18.3493	0,34	2,92	1.47165e-007	3.98801e-006	1.72897e-006	2.79254e-008	2.09737e-006	2.31906e-008
82	18.4845	0,34	2,94	1.19464e-006	5.24932e-006	0.000120655	0.000335561	0.000123504	5.42727e-006
83	19.3161	0,33	3,07	0.000153265	1.94227e-005	0.00104509	0.000105239	5.00675e-005	0.00171083
84	19.4145	0,32	3,09	2.95824e-005	0.00223104	0.00109351	0.000561671	0.00197939	0.000876112
85	19.5262	0,32	3,11	3.24176e-006	0.030964	0.00107334	5.06433e-005	0.0082932	3.50673e-005
86	19.6012	0,32	3,12	5.99153e-008	3.20145e-006	0.000330008	0.000584266	0.000232659	2.27498e-007
87	19.6571	0,32	3,13	3.96337e-006	3.76733e-005	0.0011674	0.000949241	0.000571604	2.32622e-005
88	19.6883	0,32	3,13	1.25953e-005	0.000378701	0.000108894	0.00078698	0.000307476	0.000130185
89	19.7132	0,32	3,14	4.86126e-005	0.0039632	0.00234487	0.00183604	0.000202146	0.000597794
90	19.7556	0,32	3,14	0.000143859	0.000840285	0.00242946	0.00444279	0.00106556	0.000167296
				0.756601	0.764401	0.532873	0.54038	0.593057	0.796297

Seismicity

Number of 2D elements	14800
Number of 1D elements	10005
Number of mesh nodes	16591
Mass in analysis	Participating mass only
Signed results	x
Load case	Sx
Combination of mass groups	CM1
Bending theory	Mindlin
Type of analysis model	Standard
Start of calculation	21.07.2017 00:26
End of calculation	21.07.2017 00:27

Seismicity

Number of 2D elements	14800
Number of 1D elements	10005
Number of mesh nodes	16591
Mass in analysis	Participating mass only
Signed results	x
Load case	Sy
Combination of mass groups	CM1
Bending theory	Mindlin
Type of analysis model	Standard
Start of calculation	21.07.2017 00:26
End of calculation	21.07.2017 00:27

Prvi vlastiti vektor

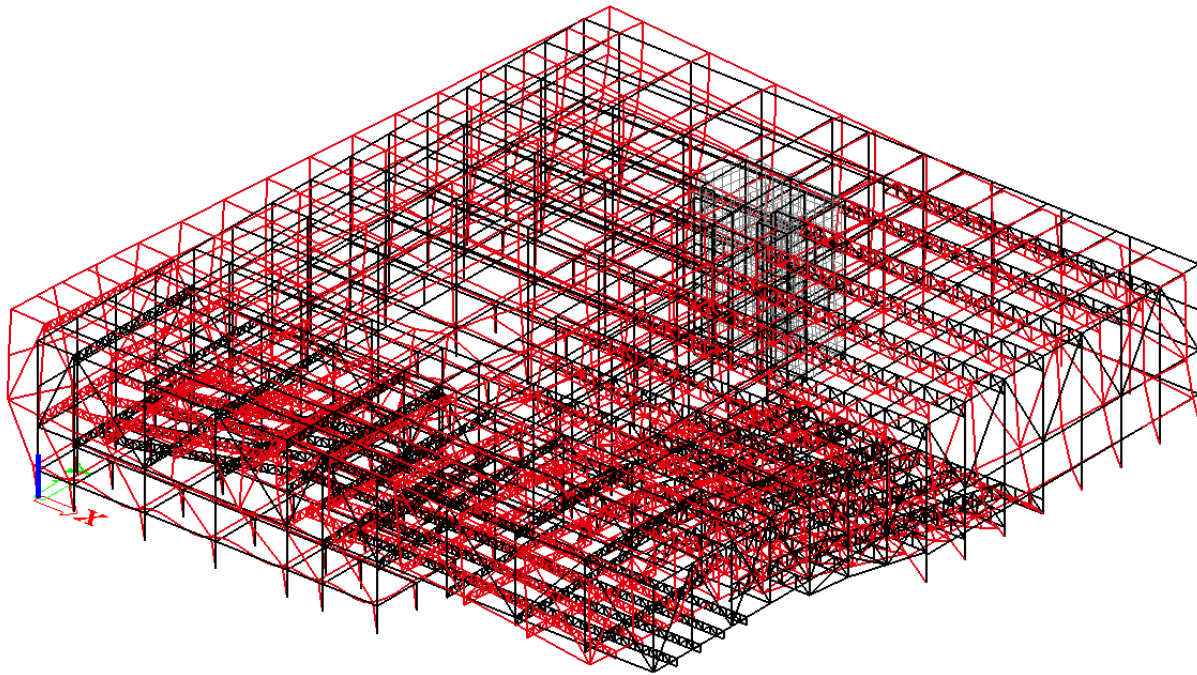

*Slika 17.2. Prikaz prvog vlastitog vektora*

Drugi vlastiti vektor

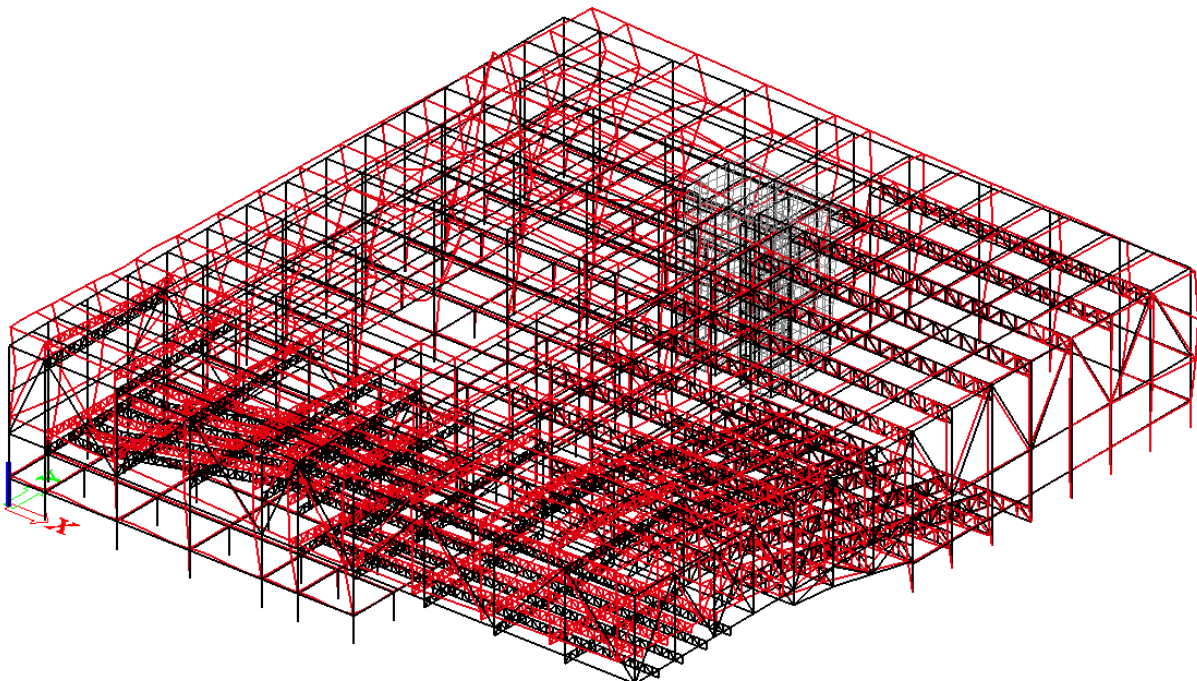

*Slika 17.3. Prikaz drugog vlastitog vektora*

Treći vlastiti vektor

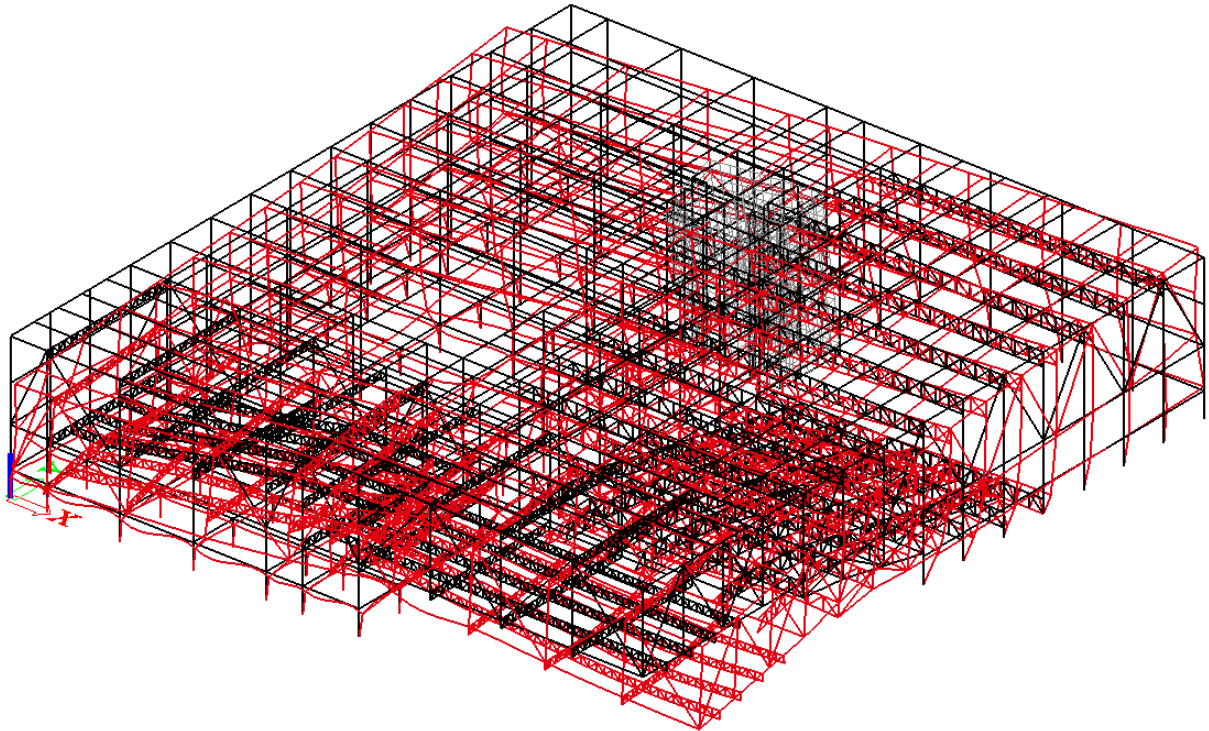

*Slika 17.4. Prikaz trećeg vlastitog vektora*

Potresno djelovanje u obzir treba uzeti kod konstrukcije koja je položena u seizmički aktivnom području i pri tome u obzir treba uzeti opterećenje čiji je uzrok seizmičko podrhtavanje tla.

Lokacija ove konstrukcije nalazi se u seizmički aktivnom području ( $a = 0.22 \cdot g$ ), no specifičan odabira materijala (čelik, uz manji broj elemenata od armiranog betona) rezultira malom masom konstrukcije, stoga je i potresno opterećenje relativno malo s obzirom na opterećenje vjetrom koja je dominantno djelovanje. Iz navedenog se može zaključiti da potresno opterećenje u ovom slučaju nije potrebno detaljnije razmatrati te da ga je moguće zanemariti.



## 18. SPOJEVI

### 18.1. Proračun spoja stupa s temeljom

#### POPREČNI PRESJEK

HEA 340

$$A = 134,0 \quad \text{cm}^2$$

$$h = 330 \quad \text{mm}$$

$$b = 300 \quad \text{mm}$$

$$t_f = 17 \quad \text{mm}$$

$$t_w = 10 \quad \text{mm}$$

#### MATERIJAL

Osnovni materijal: Fe 490 (S335)

**Vijci: M16, k.v. 10,9 ( $f_{yb} = 900 \text{ MPa}$ ;  $f_{ub} = 1000 \text{ MPa}$ )**

#### REZNE SILE

$$N_{sd} = -564,63 \text{ kN}$$

$$V_{sd} = 85,51 \text{ kN}$$

$$M_{sd} = 79,89 \text{ kNm}$$

#### *Raspodjela sila po presjeku*

#### POJASNICE

Vlačna sila od momenta savijanja

$$N_P^M = \frac{M_{sd}}{h - t_f} = \frac{79,89 \cdot 100}{33 - 1,7} = 275,23 \text{ kN}$$

Tlačna sila od uzdužne sile

$$N_P^N = \frac{A_P}{A} \cdot N_{sd} = \frac{30 \cdot 1,7}{134,0} \cdot 564,63 = -214,89 \text{ kN}$$

Ukupna vlačna sila u pojasnici

$$N_p = N_p^M + N_p^N = 255,23 - 214,89 = 40,34 \text{ kN} = F_{w,Sd}$$

### Kontrola varova

Dužina vara pojasnice:  $L_w \approx 2 \cdot b = 2 \cdot 300 = 600 \text{ mm}$

Dužina vara hrpta:  $L_w \approx 2 \cdot (h - 2 \cdot t_f) = 2 \cdot (340 - 2 \cdot 17) = 612 \text{ mm}$

Maksimalna debljina vara:  $a_{\max} = 0,7 \cdot t_{\min} = 0,7 \cdot 10,0 = 7,0 \text{ mm}$

Za pretpostavljeni var:  $a = 7,0 \text{ mm}$

$$F_{w,Rk} = \frac{f_u}{\sqrt{3} \cdot \beta_w} \cdot a \cdot L$$

Uzdužna sila:

$$F_{w,Rd} = \frac{F_{w,Rk}}{\gamma_{Mw}} \cdot \frac{L_w}{100} = \frac{229}{1,25} \cdot \frac{600}{100} = 1099,2 \text{ kN} > N_{sd} = 564,63 \text{ kN}$$

Poprečna sila:

$$F_{w,Rd} = \frac{F_{w,Rk}}{\gamma_{Mw}} \cdot \frac{L_w}{100} = \frac{229 \cdot 0}{1,25} \cdot \frac{612}{100} = 1121,18 \text{ kN} > V_{sd} = 85,51 \text{ kN}$$

### Proračun vijaka

Uz pretpostavku vijaka M-20 udaljenost  $c_{\min}$  vijaka od ruba pojasnice iznosi:

$$c_{\min} = 2 \cdot d_0 + a \cdot \sqrt{2} = 2 \cdot 18 + 7 \cdot \sqrt{2} = 44.89 \text{ mm}$$

Usvojeni  $c = 45 \text{ mm}$ .

- ekscentricitet uzdužne sile

$$e = \frac{M_{Sd}}{N_{Sd}} = \frac{79.89}{564.63} = 0.141(m)$$

$$x_1 = h - t_f / 2 = 330 + 45 - 17 / 2 = 322(mm) = 0.367(m)$$

$$x_2 = e - h/2 + t_f/2 = 141 - 330/2 + 17/2 = 15,5 \text{ (mm)} = 0,016 \text{ (m)}$$

$$N_{Sd} \cdot x_2 = F_{t,Sd} \cdot x_1$$

$$\Rightarrow F_{t,Sd} = N_{Sd} \cdot \frac{x_2}{x_1} = 564,63 \cdot \frac{0,016}{0,367} = 24,61 \text{ (kN)}$$

Otpornost vijaka na vlak

$$F_{t,Rd} = \frac{F_{t,Rk}}{\gamma_{Mb}} = \frac{141,3}{1,25} = 113,0 \text{ kN} > \frac{F_{t,Sd}}{2} = \frac{40,34}{4} = 10,09 \text{ kN}$$

Otpornost vijaka na posmik

$$F_{v,Rd} = \frac{F_{v,Rk}}{\gamma_{Mb}} = \frac{78,5}{1,25} = 62,8 \text{ kN} > F_{v,Sd} = \frac{V_{Sd}}{8} = \frac{85,51}{8} = 10,68 \text{ kN}$$

Interakcija uzdužne i odrezne sile

$$\frac{F_{v,Sd}}{F_{v,Rd}} + \frac{F_{t,Sd}}{1,4 \cdot F_{t,Rd}} = \frac{10,68}{62,8} + \frac{10,09}{1,4 \cdot 113,0} = 0,24 < 1,0$$

## Proračun ploče

Dimenzije ploče

$$a_{\min}^{pl} = h + 2 \cdot c + 2 \cdot e_1 = 330 + 2 \cdot 45 + 2 \cdot 40 = 500 \text{ mm}$$

$$b_{\min}^{pl} = b + 2 \cdot a \cdot \sqrt{2} + 20 = 300 + 2 \cdot 7 \cdot \sqrt{2} + 20 = 339,80 \text{ mm}$$

$$= 2 \cdot e_2 + p_2 = 2 \cdot 30 + 55 = 115 \text{ mm}$$

Odabrano: 500 x 350 mm

Debljina ploče

Pritisak po omotaču rupe osnovnog materijala

$$F_{v,Sd} = \frac{V_{Sd}}{8} = \frac{85,51}{8} = 10,68 \text{ kN} = F_{b,Sd}$$

$$F_{b,Rd} = \frac{F_{b,Rk}}{\gamma_{Mb}} \cdot \frac{t^{pl}}{10} = \frac{151,1}{1,25} \cdot \frac{t^{pl}}{10} = F_{b,Sd} = 62,8 \text{ kN} \Rightarrow t^{pl} > \frac{62,8 \cdot 1,25 \cdot 10}{151,1}$$

$$t^{pl} = 5,2 \text{ mm}$$

Savijanje ploče od odgovora betonske podloge

$$s = (a_{pl} - h + t_f^{\min}) / 2 = (500 - 330 + 17) / 2 = 94 \text{ mm} = 9,4 \text{ cm}$$

$$R = F_{t,Sd} + N_{Sd} = 40,34 + 564,63 = 604,97 \text{ kN}$$

Naprezanje na betonu (C20/25)

$$f_{B,sd} = \frac{R}{\frac{3 \cdot s \cdot b_{pl}}{2}} = \frac{604,97}{\frac{3 \cdot 9,4 \cdot 34}{2}} = 1,23 \frac{\text{kN}}{\text{cm}^2} \leq \frac{f_{ck}}{1,5} = \frac{20}{1,5} = 13,33$$

Savijanje ploče

$$M_{Sd} = F_1 \cdot \frac{s}{2} + F_2 \cdot \frac{2}{3} s = \frac{2}{3} \cdot f_{B,sd} \cdot s \cdot b_{pl} \cdot \frac{s}{2} + \frac{1}{3} \cdot \frac{f_{B,sd} \cdot s \cdot b_{pl}}{2} \cdot \frac{2}{3} \cdot s$$

$$M_{Sd} = \frac{2}{3} \cdot 12300 \cdot 0,094 \cdot 0,34 \cdot \frac{0,094}{2} + \frac{1}{3} \cdot \frac{12300 \cdot 0,094 \cdot 0,34}{2} \cdot \frac{2}{3} \cdot 0,094 = 16,42 \text{ kNm}$$

Savijanje ploče od vlačnih vijaka

$$M_{Sd} = F_{t,Sd} \cdot (c + t_f / 2) = 40,34 \cdot (0,045 + 0,0085) = 2,16 \text{ kNm}$$

$$M_{Sd} < \frac{W_{\min} \cdot f_y}{\gamma_{M0}} = \frac{b_{pl} \cdot t_{pl}^2 \cdot f_y}{6 \cdot \gamma_{M0}} \Rightarrow t_{pl} > \sqrt{\frac{6 \cdot \gamma_{M0} \cdot M_{Sd}}{b_{pl} \cdot f_y}} = \sqrt{\frac{6 \cdot 1,1 \cdot 216,0}{34 \cdot 35,5}} = 1,08 \text{ cm}$$

Odabrane dimenzije ploče 500 x 350 x 12 mm

## 18.2. Proračun spoja stup - greda

### POPREČNI PRESJEK

HEB 450

$$A = 218,0 \quad \text{cm}^2$$

$$h = 450 \quad \text{mm}$$

$$b = 300 \quad \text{mm}$$

$$t_f = 26 \quad \text{mm}$$

$$t_w = 14 \quad \text{mm}$$

### MATERIJAL

Osnovni materijal: Fe 490 (S355)

**Vijci: M27, k.v. 10,9 ( $f_{yb} = 900 \text{ MPa}$ ;  $f_{ub} = 1000 \text{ MPa}$ )**

### REZNE SILE

$$N_{sd} = 109,35 \text{ kN}$$

$$V_{sd} = 420,40 \text{ kN}$$

$$M_{sd} = 822,07 \text{ kNm}$$

### *Raspodjela sila po presjeku*

#### POJASNICE

Vlačna sila od momenta savijanja

$$N_p^M = \frac{M_{sd}}{h - t_f} = \frac{822,07 \cdot 100}{45 - 2,6} = 1838,84 \text{ kN}$$

Tlačna sila od uzdužne sile

$$N_p^N = \frac{A_p}{A} \cdot N_{sd} = \frac{30 \cdot 2,6}{218,0} \cdot 109,35 = 39,12 \text{ kN}$$

Ukupna vlačna sila u pojasnici

$$N_p = N_p^M + N_p^N = 1838,84 + 39,12 = 1877,96 \text{ kN} = F_{w, sd}$$

**Kontrola varova**

Dužina vara pojasnice:  $L_w \approx 2 \cdot b = 2 \cdot 300 + 2 \cdot 100 = 800 \text{ mm}$

Dužina vara hrpta:  $L_w \approx 2 \cdot (h - 2 \cdot t_f) = 2 \cdot (450 - 2 \cdot 26) = 796 \text{ mm}$

Maksimalna debljina vara:  $a_{\max} = 0,7 \cdot t_{\min} = 0,7 \cdot 14,0 = 9,8 \text{ mm}$

Za pretpostavljeni var:  $a = 9,0 \text{ mm}$

$$F_{w,Rk} = \frac{f_u}{\sqrt{3} \cdot \beta_w} \cdot a \cdot L$$

Uzdužna sila:

$$F_{w,Rd} = \frac{F_{w,Rk}}{\gamma_{Mw}} \cdot \frac{L_w}{100} = \frac{294,4}{1,25} \cdot \frac{800}{100} = 1884,16 \text{ kN} > N_{sd} = 1877,96 \text{ kN}$$

Poprečna sila:

$$F_{w,Rd} = \frac{F_{w,Rk}}{\gamma_{Mw}} \cdot \frac{L_w}{100} = \frac{294,4}{1,25} \cdot \frac{796}{100} = 1874,73 \text{ kN} > V_{sd} = 420,40 \text{ kN}$$

**Proračun vijaka**

Uz pretpostavku vijaka M-27 udaljenost  $c_{\min}$  vijaka od ruba pojasnice iznosi:

$$c_{\min} = 2 \cdot d_0 + a \cdot \sqrt{2} = 2 \cdot 30 + 7 \cdot \sqrt{2} = 69,89 \text{ mm}$$

Usvojeni  $c = 70 \text{ mm}$ .

- ekscentricitet uzdužne sile

$$e = \frac{M_{sd}}{N_{sd}} = \frac{822,07}{1877,97} = 0,438(m)$$

$$x_1 = h - t_f / 2 = 450 - 26 / 2 = 437(mm) = 0,437(m)$$

$$x_2 = e - h/2 + t_f / 2 = 438 - 450 / 2 + 26 / 2 = 226 (mm) = 0,226(m)$$

$$N_{sd} \cdot x_2 = F_{t,sd} \cdot x_1$$

$$\Rightarrow F_{t,Sd} = N_{Sd} \cdot \frac{x_2}{x_1} = 1877,97 \cdot \frac{0,226}{0,437} = 971,22 \text{ (kN)}$$

Otpornost vijaka na vlak

$$F_{t,Rd} = \frac{F_{t,Rk}}{\gamma_{Mb}} = \frac{413,1}{1,25} = 330,48 \text{ kN} > \frac{F_{t,Sd}}{4} = \frac{971,22}{4} = 242,81 \text{ kN}$$

Otpornost vijaka na posmik

$$F_{v,Rd} = \frac{F_{v,Rk}}{\gamma_{Mb}} = \frac{229,5}{1,25} = 183,6 \text{ kN} > F_{v,Sd} = \frac{V_{Sd}}{6} = \frac{420,40}{6} = 70,07 \text{ kN}$$

Interakcija uzdužne i odrezne sile

$$\frac{F_{v,Sd}}{F_{v,Rd}} + \frac{F_{t,Sd}}{1,4 \cdot F_{t,Rd}} = \frac{70,07}{183,6} + \frac{242,18}{1,4 \cdot 330,48} = 0,91 < 1,0$$

### Proračun ploče

Dimenzije ploče

$$a_{\min}^{pl} = h + 2 \cdot c + 2 \cdot e_1 = 450 + 2 \cdot 70 + 2 \cdot 70 = 730 \text{ mm}$$

$$b_{\min}^{pl} = b + 2 \cdot a \cdot \sqrt{2} + 20 = 300 + 2 \cdot 9 \cdot \sqrt{2} + 20 = 345,45 \text{ mm}$$

$$= 2 \cdot e_2 + p_2 = 2 \cdot 55 + 90 = 200 \text{ mm}$$

Odabrano: 730x 350 mm

Debljina ploče

Pritisak po omotaču rupe osnovnog materijala

$$F_{v,Sd} = \frac{V_{Sd}}{6} = \frac{420,40}{6} = 70,07 \text{ kN} = F_{b,Sd}$$

$$F_{b,Rd} = \frac{F_{b,Rk}}{\gamma_{Mb}} \cdot \frac{t^{pl}}{10} = \frac{258,2}{1,25} \cdot \frac{t^{pl}}{10} = F_{b,Sd} = 70,07 \text{ kN} \Rightarrow t^{pl} > \frac{70,07 \cdot 1,25 \cdot 10}{258,2}$$

$$t^{pl} = 3,4 \text{ mm}$$

Savijanje ploče od vlačnih vijaka

$$M_{Sd} = F_{t,Sd} \cdot (c + t_f / 2) = 242,81 \cdot (0,07 + 0,013) = 20,15 \text{ kNm}$$

$$M_{sd} < \frac{W_{\min} \cdot f_y}{\gamma_{M0}} = \frac{b_{pl} \cdot t_{pl}^2 \cdot f_y}{6 \cdot \gamma_{M0}} \Rightarrow t_{pl} > \sqrt{\frac{6 \cdot \gamma_{M0} \cdot M_{sd}}{b_{pl} \cdot f_y}} = \sqrt{\frac{6 \cdot 1,1 \cdot 20,52}{34 \cdot 23,5}} = 3,17 \text{ cm}$$

Odabrane dimenzije ploče - 730 x 350 x 32 mm

Odabrani vijci - 8 vijaka M27

### 18.3. Proračun spoja – montažni nastavak gornje pojasnice rešetkastog nosača

#### POPREČNI PRESJEK

HEB 240

<b>A</b>	=	106,0	cm <sup>2</sup>
<b>h</b>	=	240	mm
<b>b</b>	=	240	mm
<b>t<sub>f</sub></b>	=	17	mm
<b>t<sub>w</sub></b>	=	10	mm
<b>r</b>	=	21	mm

#### MATERIJAL

Osnovni materijal: Fe 490 (S355)

**Vijci: M16, 10.9 k.v. ( $f_{yb} = 900 \text{ MPa}$ ;  $f_{ub} = 1000 \text{ MPa}$ )**

#### REZNE SILE

$$N_{sd} = 336,40 \text{ kN}$$

$$V_{sd} = 50,13 \text{ kN}$$

#### Kontrola varova

Dužina vara pojasnice:  $L_w \approx 2 \cdot b = 2 \cdot 240 = 480 \text{ mm}$

Dužina vara hrpta:  $L_w \approx 2 \cdot (h - 2 \cdot t_f) = 2 \cdot (240 - 2 \cdot 17) = 412 \text{ mm}$

Maksimalna debljina vara:  $a_{\max} = 0,7 \cdot t_{\min} = 0,7 \cdot 10 = 7,0 \text{ mm}$

Za pretpostavljeni var:  $a = 5,0 \text{ mm}$



$$F_{w,Rk} = \frac{f_u}{\sqrt{3} \cdot \beta_w} \cdot a \cdot L$$

Uzdužna sila:

$$F_{w,Rd} = \frac{F_{w,Rk}}{\gamma_{Mw}} \cdot \frac{L_w}{100} = \frac{163,6}{1,25} \cdot \frac{480}{100} = 628,24 \text{ kN} > N_{sd} = 336,40 \text{ kN}$$

Poprečna sila:

$$F_{w,Rd} = \frac{F_{w,Rk}}{\gamma_{Mw}} \cdot \frac{L_w}{100} = \frac{163,6}{1,25} \cdot \frac{412}{100} = 539,22 \text{ kN} > V_{sd} = 50,13 \text{ kN}$$

### Proračun vijaka

Uz pretpostavku vijaka M-20 udaljenost  $c_{min}$  vijaka od ruba pojasnice iznosi:

$$c_{min} = 2 \cdot d_0 + a \cdot \sqrt{2} = 2 \cdot 18 + 5 \cdot \sqrt{2} = 43,07 \text{ mm}$$

Usvojeni  $c = 45 \text{ mm}$ .

Otpornost vijaka na vlak

$$F_{t,Rd} = \frac{F_{t,Rk}}{\gamma_{Mb}} = \frac{176,4}{1,25} = 141,12 \text{ kN} > \frac{F_{t,Sd}}{4} = \frac{336,40}{4} = 84,10 \text{ kN}$$

Otpornost vijaka na posmik

$$F_{v,Rd} = \frac{F_{v,Rk}}{\gamma_{Mb}} = \frac{78,50}{1,25} = 62,80 \text{ kN} > F_{v,Sd} = \frac{V_{sd}}{6} = \frac{50,13}{6} = 8,36 \text{ kN}$$

Interakcija uzdužne i odrezne sile

$$\frac{F_{v,Sd}}{F_{v,Rd}} + \frac{F_{t,Sd}}{1,4 \cdot F_{t,Rd}} = \frac{8,36}{62,80} + \frac{84,10}{1,4 \cdot 141,12} = 0,56 < 1,0$$

### Proračun ploče

Dimenzije ploče

$$a_{min}^{pl} = h + 2 \cdot c + 2 \cdot e_1 = 240 + 2 \cdot 45 + 2 \cdot 40 = 410 \text{ mm}$$

$$b_{\min}^{pl} = b + 2 \cdot a \cdot \sqrt{2} + 20 = 240 + 2 \cdot 5 \cdot \sqrt{2} + 20 = 274,14 \text{ mm}$$

$$= 2 \cdot e_2 + p_2 = 2 \cdot 30 + 55 = 115 \text{ mm}$$

Odabrano: 420 x 280 mm

Debljina ploče

Pritisak po omotaču rupe osnovnog materijala

$$F_{v,Sd} = \frac{V_{Sd}}{6} = \frac{50,13}{6} = 8,36 \text{ kN} = F_{b,Sd}$$

$$F_{b,Rd} = \frac{F_{b,Rk}}{\gamma_{Mb}} \cdot \frac{t^{pl}}{10} = \frac{151,1}{1,25} \cdot \frac{t^{pl}}{10} = F_{b,Sd} = 8,36 \text{ kN} \Rightarrow t^{pl} > \frac{8,36 \cdot 1,25 \cdot 10}{151,1}$$

$$t^{pl} = 1.6 \text{ mm}$$

Savijanje ploče od vlačnih vijaka

$$M_{Sd} = F_{t,Sd} \cdot (c + t_f / 2) = 336,40 \cdot (0,045 + 0,0085) = 17,98 \text{ kNm}$$

$$M_{Sd} < \frac{W_{\min} \cdot f_y}{\gamma_{M0}} = \frac{b_{pl} \cdot t_{pl}^2 \cdot f_y}{6 \cdot \gamma_{M0}} \Rightarrow t_{pl} > \sqrt{\frac{6 \cdot \gamma_{M0} \cdot M_{Sd}}{b_{pl} \cdot f_y}} = \sqrt{\frac{6 \cdot 1,1 \cdot 1798}{28 \cdot 35,5}} = 3,45 \text{ cm}$$

Odabrane dimenzije ploče 420 x 280 x 12 mm

Odabrani vijci - 8 vijaka M16

## 18.4. Proračun spoja – montažni nastavak donje pojasnice rešetkastog nosača

### POPREČNI PRESJEK

F 280/280/10

$A$	=	104,6	cm <sup>2</sup>
$h$	=	280	mm
$b$	=	280	mm
$s$	=	10	mm
$r$	=	25	mm
$r_l$	=	15	mm

### MATERIJAL

Osnovni materijal: Fe 490 (S355)

**Vijci: M27, 10.9 k.v. ( $f_{yb} = 900$  MPa;  $f_{ub} = 1000$  MPa)**

### REZNE SILE

$$N_{sd} = 1304,56 \text{ kN}$$

$$V_{sd} = 15,03 \text{ kN}$$

### Kontrola varova

Dužina vara pojasnice:  $L_w \approx 2 \cdot b = 2 \cdot 280 + 2 \cdot 100 = 760 \text{ mm}$

Dužina vara hrpta:  $L_w \approx 2 \cdot (h - 2 \cdot t_f) = 2 \cdot (280 - 2 \cdot 10) = 520 \text{ mm}$

Maksimalna debljina vara:  $a_{\max} = 0,7 \cdot t_{\min} = 0,7 \cdot 10 = 7,0 \text{ mm}$

Za pretpostavljeni var:  $a = 7,0 \text{ mm}$

$$F_{w,Rk} = \frac{f_u}{\sqrt{3} \cdot \beta_w} \cdot a \cdot L$$

Uzdužna sila:

$$F_{w,Rd} = \frac{F_{w,Rk}}{\gamma_{Mw}} \cdot \frac{L_w}{100} = \frac{229}{1,25} \cdot \frac{760}{100} = 1392,32 \text{ kN} > N_{sd} = 1304,56 \text{ kN}$$

Poprečna sila:

$$F_{w,Rd} = \frac{F_{w,Rk}}{\gamma_{Mw}} \cdot \frac{L_w}{100} = \frac{229,0}{1,25} \cdot \frac{520}{100} = 952,64 \text{ kN} > V_{Sd} = 15,03 \text{ kN}$$

### Proračun vijaka

Uz pretpostavku vijaka M-20 udaljenost  $c_{min}$  vijaka od ruba pojasnice iznosi:

$$c_{min} = 2 \cdot d_0 + a \cdot \sqrt{2} = 2 \cdot 30 + 7 \cdot \sqrt{2} = 69,89 \text{ mm}$$

Usvojeni  $c = 70 \text{ mm}$ .

Otpornost vijaka na vlak

$$F_{t,Rd} = \frac{F_{t,Rk}}{\gamma_{Mb}} = \frac{413,1}{1,25} = 330,48 \text{ kN} > \frac{F_{t,Sd}}{4} = \frac{1304,56}{4} = 326,14 \text{ kN}$$

Otpornost vijaka na posmik

$$F_{v,Rd} = \frac{F_{v,Rk}}{\gamma_{Mb}} = \frac{229,5}{1,25} = 183,6 \text{ kN} > F_{v,Sd} = \frac{V_{Sd}}{8} = \frac{15,03}{8} = 1,87 \text{ kN}$$

Interakcija uzdužne i odrezne sile

$$\frac{F_{v,Sd}}{F_{v,Rd}} + \frac{F_{t,Sd}}{1,4 \cdot F_{t,Rd}} = \frac{1,87}{183,61} + \frac{326,14}{1,4 \cdot 330,48} = 0,72 < 1,0$$

### Proračun ploče

Dimenzije ploče

$$a_{min}^{pl} = h + 2 \cdot c + 2 \cdot e_1 = 280 + 2 \cdot 70 + 2 \cdot 70 = 560 \text{ mm}$$

$$b_{min}^{pl} = b + 2 \cdot a \cdot \sqrt{2} + 20 = 280 + 2 \cdot 7 \cdot \sqrt{2} + 20 = 319,80 \text{ mm}$$

$$= 2 \cdot e_2 + p_2 = 2 \cdot 55 + 90 = 200 \text{ mm}$$

Odabrano: 560 x 320 mm

Debljina ploče

Savijanje ploče od vlačnih vijaka

$$M_{Sd} = F_{t,Sd} \cdot (c + t_f / 2) = 326,14 \cdot (0,07 + 0,005) = 24,46 \text{ kNm}$$

$$M_{Sd} < \frac{W_{\min} \cdot f_y}{\gamma_{M0}} = \frac{b_{pl} \cdot t_{pl}^2 \cdot f_y}{6 \cdot \gamma_{M0}} \Rightarrow t_{pl} > \sqrt{\frac{6 \cdot \gamma_{M0} \cdot M_{Sd}}{b_{pl} \cdot f_y}} = \sqrt{\frac{6 \cdot 1,1 \cdot 2446}{32 \cdot 35,5}} = 3,76 \text{ cm}$$

Odabrane dimenzije ploče 560 x 320 x 38 mm

Odabrani vijci - 8 vijaka M27

## 18.5. Proračun spoja - montažni nastavak dijagonalne ispune rešetkastog nosača

### POPREČNI PRESJEK

CFRHS 180/180/8

$A$	=	52,84	cm <sup>2</sup>
$h$	=	180	mm
$b$	=	180	mm
$s$	=	8	mm
$r$	=	20	mm
$r_1$	=	12	mm

### MATERIJAL

Osnovni materijal: Fe 490 (S355)

**Vijci: M20, 10.9 k.v. ( $f_{yb} = 900 \text{ MPa}$ ;  $f_{ub} = 1000 \text{ MPa}$ )**

### REZNE SILE

$$N_{Sd} = 457.39 \text{ kN}$$

### Kontrola varova

Dužina vara pojasnice:  $L_w \approx 2 \cdot b = 2 \cdot 180 = 360 \text{ mm}$

Dužina vara hrpta:  $L_w \approx 2 \cdot (h - 2 \cdot t_f) = 2 \cdot (180 - 2 \cdot 8) = 328 \text{ mm}$

Maksimalna debljina vara:  $a_{\max} = 0,7 \cdot t_{\min} = 0,7 \cdot 8 = 5,6 \text{ mm}$

Za pretpostavljeni var:  $a = 5,0 \text{ mm}$

$$F_{w,Rk} = \frac{f_u}{\sqrt{3} \cdot \beta_w} \cdot a \cdot L$$

Uzdužna sila:

$$F_{w,Rd} = \frac{F_{w,Rk}}{\gamma_{Mw}} \cdot \frac{L_w}{100} = \frac{163,6}{1,25} \cdot \frac{360}{100} = 471,17 \text{ kN} > N_{sd} = 457,39 \text{ kN}$$

### Proračun vijaka

Uz pretpostavku vijaka M-20 udaljenost  $c_{min}$  vijaka od ruba pojasnice iznosi:

$$c_{min} = 2 \cdot d_0 + a \cdot \sqrt{2} = 2 \cdot 22 + 5 \cdot \sqrt{2} = 51,07 \text{ mm}$$

Usvojeni  $c = 55 \text{ mm}$ .

Otpornost vijaka na vlak

$$F_{t,Rd} = \frac{F_{t,Rk}}{\gamma_{Mb}} = \frac{220,5}{1,25} = 176,4 \text{ kN} > \frac{F_{t,Sd}}{4} = \frac{457,39}{4} = 114,34 \text{ kN}$$

### Proračun ploče

Dimenzije ploče

$$a_{min}^{pl} = h + 2 \cdot c + 2 \cdot e_1 = 180 + 2 \cdot 55 + 2 \cdot 50 = 390 \text{ mm}$$

$$b_{min}^{pl} = b + 2 \cdot a \cdot \sqrt{2} + 20 = 180 + 2 \cdot 5 \cdot \sqrt{2} + 20 = 214,15 \text{ mm}$$

$$= 2 \cdot e_2 + p_2 = 2 \cdot 40 + 70 = 150 \text{ mm}$$

Odabrano: 390 x 240 mm

Debljina ploče

Savijanje ploče od vlačnih vijaka

$$M_{sd} = F_{t,Sd} \cdot (c + t_f / 2) = 114,34 \cdot (0,055 + 0,004) = 6,73 \text{ kNm}$$

$$M_{sd} < \frac{W_{min} \cdot f_y}{\gamma_{M0}} = \frac{b_{pl} \cdot t_{pl}^2 \cdot f_y}{6 \cdot \gamma_{M0}} \Rightarrow t_{pl} > \sqrt{\frac{6 \cdot \gamma_{M0} \cdot M_{sd}}{b_{pl} \cdot f_y}} = \sqrt{\frac{6 \cdot 1,1 \cdot 673}{22 \cdot 35,5}} = 2,38 \text{ cm}$$

Odabrane dimenzije ploče 390 x 240 x 24 mm

Odabrani vijci - 8 vijaka M20

## 19. DIMENZIONIRANJE TEMELJA SAMCA

### 19.1. Dimenzioniranje temelja samca za stup 1

#### Proračun dimenzija temelja samca

Dimenzije temelja: 3000x3000x500 mm

Dopušteno naprezanje :  $\sigma = 500$  Mpa

$$N_{sd} = 4541,06 \text{ kN}$$

$$M_{sd} = 60,79 \text{ kN}$$

$$h = 50 \text{ cm}$$

$$a = \sqrt{\frac{P}{\sigma}} = \sqrt{\frac{4541,06}{500,00}} = 2,98 \text{ m} \Rightarrow \text{odabrano } a = 3,00 \text{ m}$$

Maksimalno djelovanje na temelj:

$$N_{Ed, \max} = 4541,06 \text{ [kN] tlak}$$

$$\text{Težina temelja: } N_t = 3,20 \cdot 3,2 \cdot 0,5 \cdot 25 = 128,0 \text{ (kN)}$$

$$N_{Ed} = N'_{Ed} + N_t = 4541,06 + 128,0 = 4669,06 \text{ [kN] tlak}$$

Naprezanje ispod temelja:

$$\sigma_{1,2} \leq \sigma_{dop, \text{tla}} = 500,0 \left( \frac{\text{kN}}{\text{m}^2} \right)$$

$$\sigma_{1,2} = \frac{N_{Ed}}{A} \pm \frac{M_{Ed}}{W}$$

$$A = 3,2 \cdot 3,2 = 10,24 \text{ (m}^2\text{)};$$

$$W = \frac{b \cdot a^2}{6} = \frac{3,2^3}{6} = 5,46 \text{ (m}^3\text{)}$$

$$\sigma_{1,2} = \frac{4669,06}{10,24} \pm \frac{60,79}{5,46};$$

$$\sigma_1 = 467,10 \text{ kN/m}^2 < 500 \text{ kN/m}^2$$

$$\sigma_2 = 444,82 \text{ kN/m}^2 < 500 \text{ kN/m}^2$$

## 19.2. Dimenzioniranje temelja samca za stup 2

### Proračun dimenzija temelja samca

Dimenzije temelja: 1500x1500x500 mm

Dopušteno naprezanje :  $\sigma=500$  Mpa

$$N_{sd} = 564,63 \text{ kN}$$

$$M_{sd} = 79,89 \text{ kN}$$

$$h = 50 \text{ cm}$$

$$a = \sqrt{\frac{P}{\sigma}} = \sqrt{\frac{564,63}{500,00}} = 1,06 \text{ m} \Rightarrow \text{odabrano } a = 1,5 \text{ m}$$

Maksimalno djelovanje na temelj:

$$N_{Ed, \max} = 564,63 \text{ [kN] tlak}$$

$$\text{Težina temelja: } N_t = 1,5 \cdot 1,5 \cdot 0,5 \cdot 25 = 28,13 \text{ (kN)}$$

$$N_{Ed} = N'_{Ed} + N_t = 564,63 + 28,13 = 592,76 \text{ [kN] tlak}$$

Naprezanje ispod temelja:

$$\sigma_{1,2} \leq \sigma_{dop, tla} = 500,0 \left( \frac{\text{kN}}{\text{m}^2} \right)$$

$$\sigma_{1,2} = \frac{N_{Ed}}{A} \pm \frac{M_{Ed}}{W}$$

$$A = 1,5 \cdot 1,5 = 2,25 \text{ (m}^2\text{)};$$

$$W = \frac{b \cdot a^2}{6} = \frac{1,5^3}{6} = 0,56 \text{ (m}^3\text{)}$$

$$\sigma_{1,2} = \frac{592,76}{2,25} \pm \frac{79,89}{0,56};$$

$$\sigma_1 = 406,11 \text{ kN/m}^2 < 500 \text{ kN/m}^2$$

$$\sigma_2 = 120,78 \text{ kN/m}^2 < 500 \text{ kN/m}^2$$



## **20. NACRTI**

## **21. LITERATURA**

- [1] Androić, Dujmović, Džeba, Metalne konstrukcije 1, IGH Zagreb, 1994.
- [2] Androić, Dujmović, Džeba, Metalne konstrukcije 2; IA Projektiranje Zagreb, 1995.
- [3] Androić, Dujmović, Džeba, Metalne konstrukcije 3, IA Projektiranje, Zagreb, 1995.
- [4] Androić, Dujmović, Lukačević, Projektiranje spregnutih konstrukcija prema Eurocode 4, IA Projektiranje, Zagreb, 2012

TLOCRT

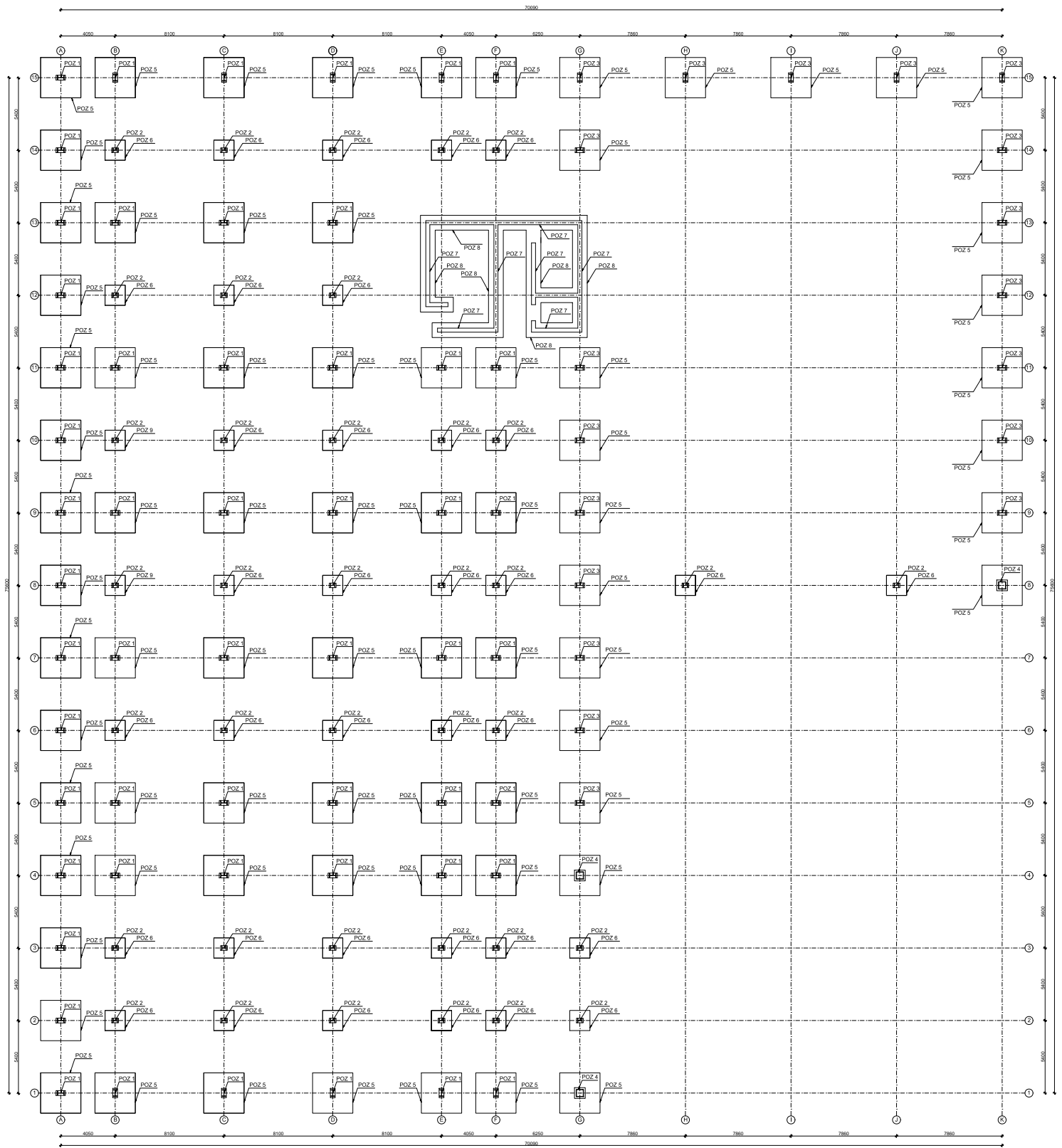

PRIKAZ I OPIS POZICIJA		
POZICIJA	PROFIL	NAZIV
POZ 1	HEB 500	Stup - 1. prizemlje
POZ 2	HEA 340	Stup - 2. prizemlje
POZ 3	HEM 500	Stup - velika dvorana
POZ 4	SHS 550/550/28	Stup - konzolni nosač
POZ 5	3000/3000/500	Temelj samac 1
POZ 6	1500/1500/500	Temelj samac 2
POZ 7	d = 300	AB jezgra
POZ 8	1100/500	Temelj AB jezgre

PLAN POZICIJA NOSIVE KONSTRUKCIJE  
 POZICIJA - 00  
 M 1:100  
 ČELIK S355  
 BETON C 30/37

TLOCRT

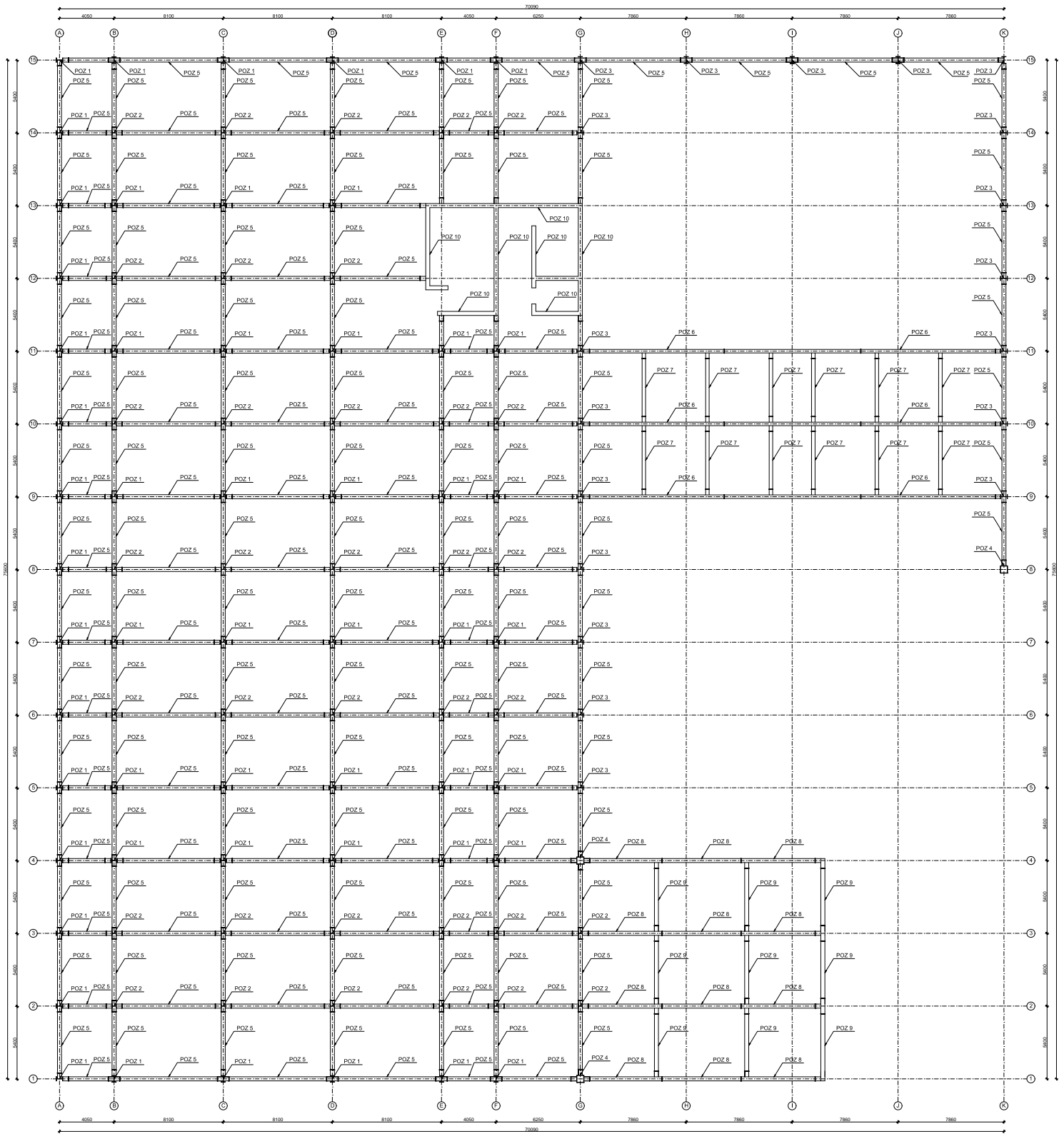

PRIKAZI I OPIS POZICIJA		
POZICIJA	PROFIL	NAZIV
POZ 1	HEB 500	Stup - 1. prizemlje
POZ 2	HEA 340	Stup - 2. prizemlje
POZ 3	HEM 500	Stup - velika dvorana
POZ 4	SHS 550/550/28	Stup - horizontalni nosač
POZ 5	HEA 340	Gredni nosač 1 - poz 100
POZ 6	HEB 260	Gornja pojasnica glavnog rešetkastog nosača - tribina velike dvorane
POZ 7	HEB 260	Gornja pojasnica sekundarnog rešetkastog nosača - tribina velike dvorane
POZ 8	HEB 200	Glavni gredni nosač - ulazno stubište
POZ 9	HEB 200	Sekundarni gredni nosač - ulazno stubište
POZ 10	d = 300	AB jrgnja

PLAN POZICIJA NOSIVE KONSTRUKCIJE  
 POZICIJA - 100  
 M 1:100  
 ČELIK S355  
 BETON C 30/37

	DIPLOMSKI RAD	
	KONSTRUKCIJA KONGRESNOG CENTRA	
	Zagreb	
Autor: Viljan Didović 602	Mentor: dr. sc. N. Totić	Datum: 2017
Naslov: PLAN POZICIJA KONSTRUKCIJE	Skala: 1:100	Broj: 2

TLOCRT

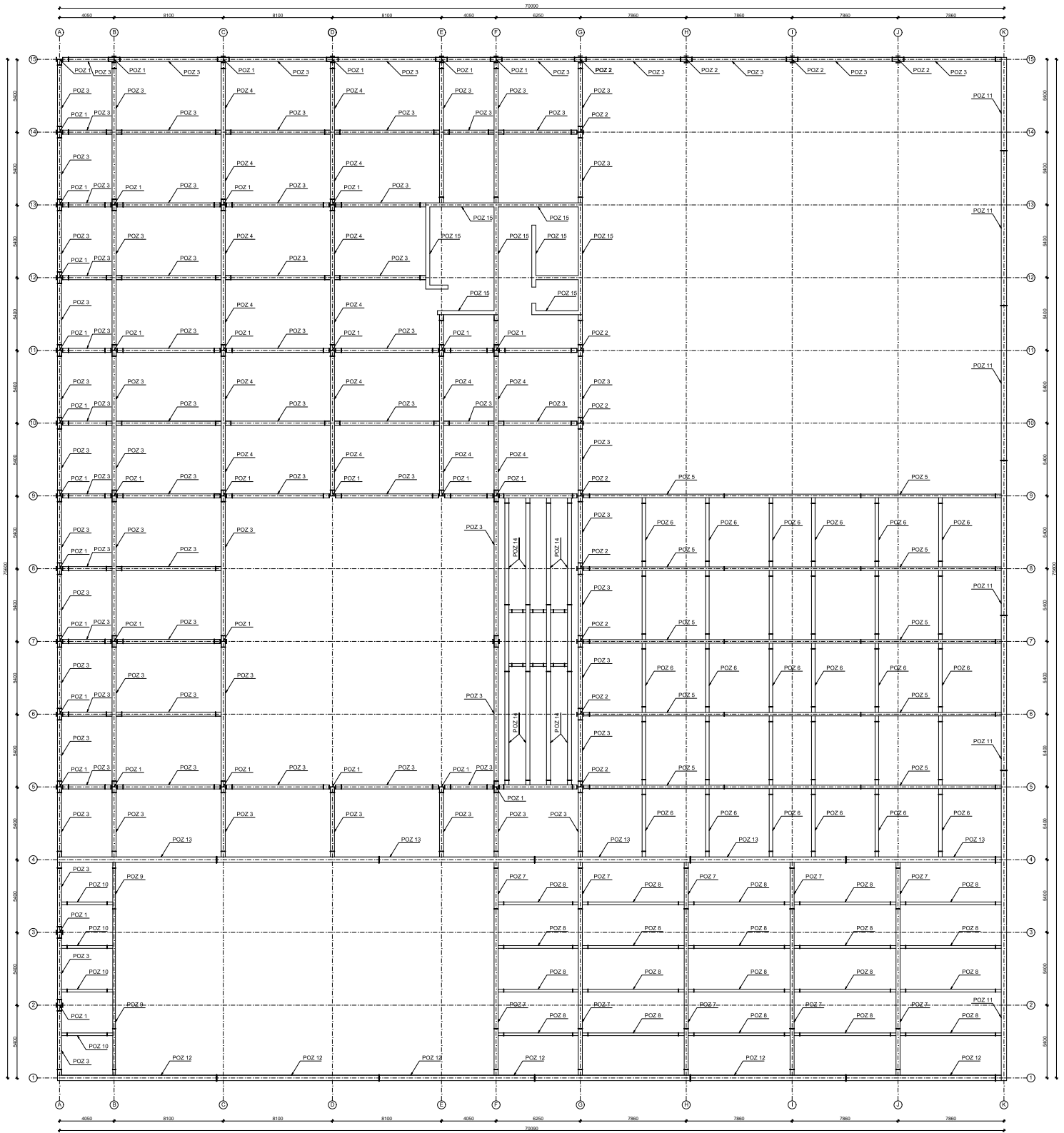

PRIKAZ I OPIS POZICIJA		
POZICIJA	PROFIL	NAZIV
POZ 1	HEB 500	Stup - 1. etaža
POZ 2	HEM 500	Stup - velika dvorana
POZ 3	HEA 400	Gredni nosač 1 - poz 200
POZ 4	HEB 450	Gredni nosač 2 - poz 200
POZ 5	HEB 260	Gornja pojasnica glavnog rešetkastog nosača - tribina velike dvorane
POZ 6	HEB 260	Gornja pojasnica sekundarnog rešetkastog nosača - tribina velike dvorane
POZ 7	HEB 200	Gornja pojasnica glavnog rešetkastog nosača - konzolni dio
POZ 8	HEB 200	Gornja pojasnica sekundarnog rešetkastog nosača - konzolni dio
POZ 9	HEB 200	Gornja pojasnica glavnog rešetkastog nosača - tribina srednje dvorane
POZ 10	HEB 200	Gornja pojasnica sekundarnog rešetkastog nosača - tribina srednje dvorane
POZ 11	F 400/10	Donji pojasnica konzolnog rešetkastog nosača 1
POZ 12	F 400/12	Donji pojasnica konzolnog rešetkastog nosača 2
POZ 13	F 400/12	Donji pojasnica konzolnog rešetkastog nosača 3
POZ 14	HEB 360	Glavni gredni nosač - stubište 1
POZ 15	d = 300	AB jezgra

PLAN POZICIJA NOSIVE KONSTRUKCIJE  
 POZICIJA - 200  
 M 1:100  
 ČELIK S355  
 BETON C 30/37

	DIPLOMSKI RAD	
	KONSTRUKCIJA KONGRESNOG CENTRA	
NADZORNIK Viljan Didović-BOZ	MENTOR dr. sc. N. Tobiš	PROF. DR. SC. I. Bekić
NADZORNIK dr. sc. N. Tobiš	MENTOR dr. sc. N. Tobiš	PROF. DR. SC. I. Bekić
NADZORNIK dr. sc. N. Tobiš	MENTOR dr. sc. N. Tobiš	PROF. DR. SC. I. Bekić

TLOCRT

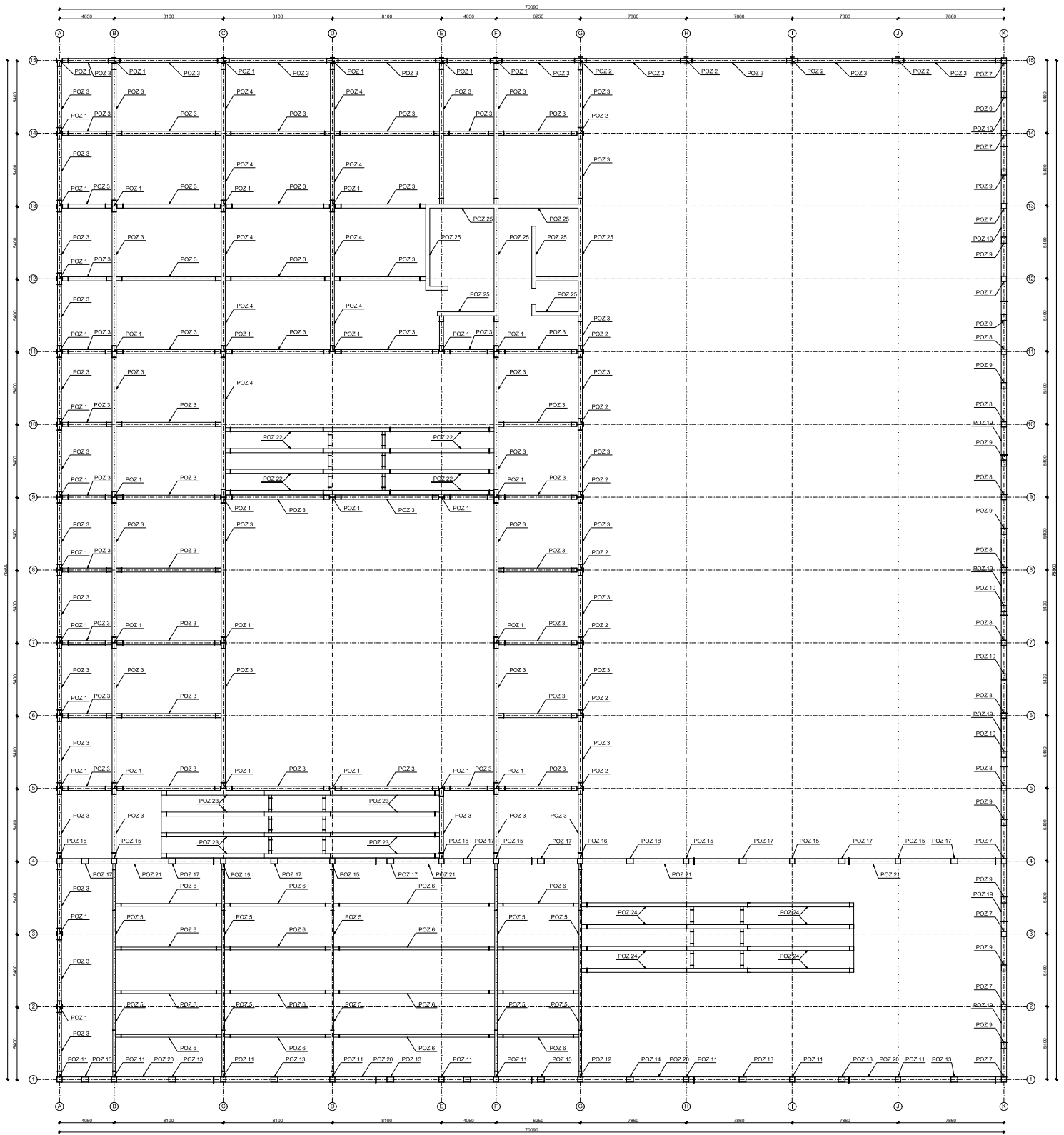

POZICIJA	PROFIL	PRIKAZ I OPIS POZICIJA	NAZIV
POZ 1	HEB 450	Stup - 2. etaža	
POZ 2	HEM 500	Stup - velika dvorana	
POZ 3	HEA 400	Gredni nosač 1 - poz 300	
POZ 4	HEB 450	Gredni nosač 2 - poz 300	
POZ 5	HEB 200	Gornja pojasnica glavnog rešetkastog nosača - tribina srednje dvorane	
POZ 6	HEB 200	Gornja pojasnica sekundarnog rešetkastog nosača - tribina srednje dvorane	
POZ 7	SHS 400/400/10	Vertikalna ispušna 1 konzolnog rešetkastog nosača 1	
POZ 8	SHS 400/400/20	Vertikalna ispušna 2 konzolnog rešetkastog nosača 1	
POZ 9	SHS 400/400/10	Diagonalna ispušna 1 konzolnog rešetkastog nosača 1	
POZ 10	SHS 400/400/16	Diagonalna ispušna 2 konzolnog rešetkastog nosača 1	
POZ 11	SHS 400/400/20	Vertikalna ispušna 1 konzolnog rešetkastog nosača 2	
POZ 12	SHS 400/400/22	Vertikalna ispušna 2 konzolnog rešetkastog nosača 2	
POZ 13	SHS 400/400/10	Diagonalna ispušna 1 konzolnog rešetkastog nosača 2	

POZICIJA	PROFIL	PRIKAZ I OPIS POZICIJA	NAZIV
POZ 14	SHS 400/400/20	Diagonalna ispušna 2 konzolnog rešetkastog nosača 2	
POZ 15	SHS 400/400/12,5	Vertikalna ispušna 1 konzolnog rešetkastog nosača 3	
POZ 16	SHS 400/400/20	Vertikalna ispušna 2 konzolnog rešetkastog nosača 3	
POZ 17	SHS 400/400/12,5	Diagonalna ispušna 1 konzolnog rešetkastog nosača 3	
POZ 18	SHS 400/400/28	Diagonalna ispušna 2 konzolnog rešetkastog nosača 3	
POZ 19	F 400/10	Donji pojasnica konzolnog rešetkastog nosača 1	
POZ 20	F 400/12	Donji pojasnica konzolnog rešetkastog nosača 2	
POZ 21	F 400/12	Donji pojasnica konzolnog rešetkastog nosača 3	
POZ 22	HEA 360	Glavni gredni nosač - stubište 1	
POZ 23	HEB 400	Glavni gredni nosač - stubište 2	
POZ 24	HEB 360	Glavni gredni nosač - stubište 3	
POZ 25	d = 300	AB jezgra	

PLAN POZICIJA NOSIVE KONSTRUKCIJE  
 POZICIJA - 300  
 M 1:100  
 ČELIK S355  
 BETON C 30/37

TLOCRT

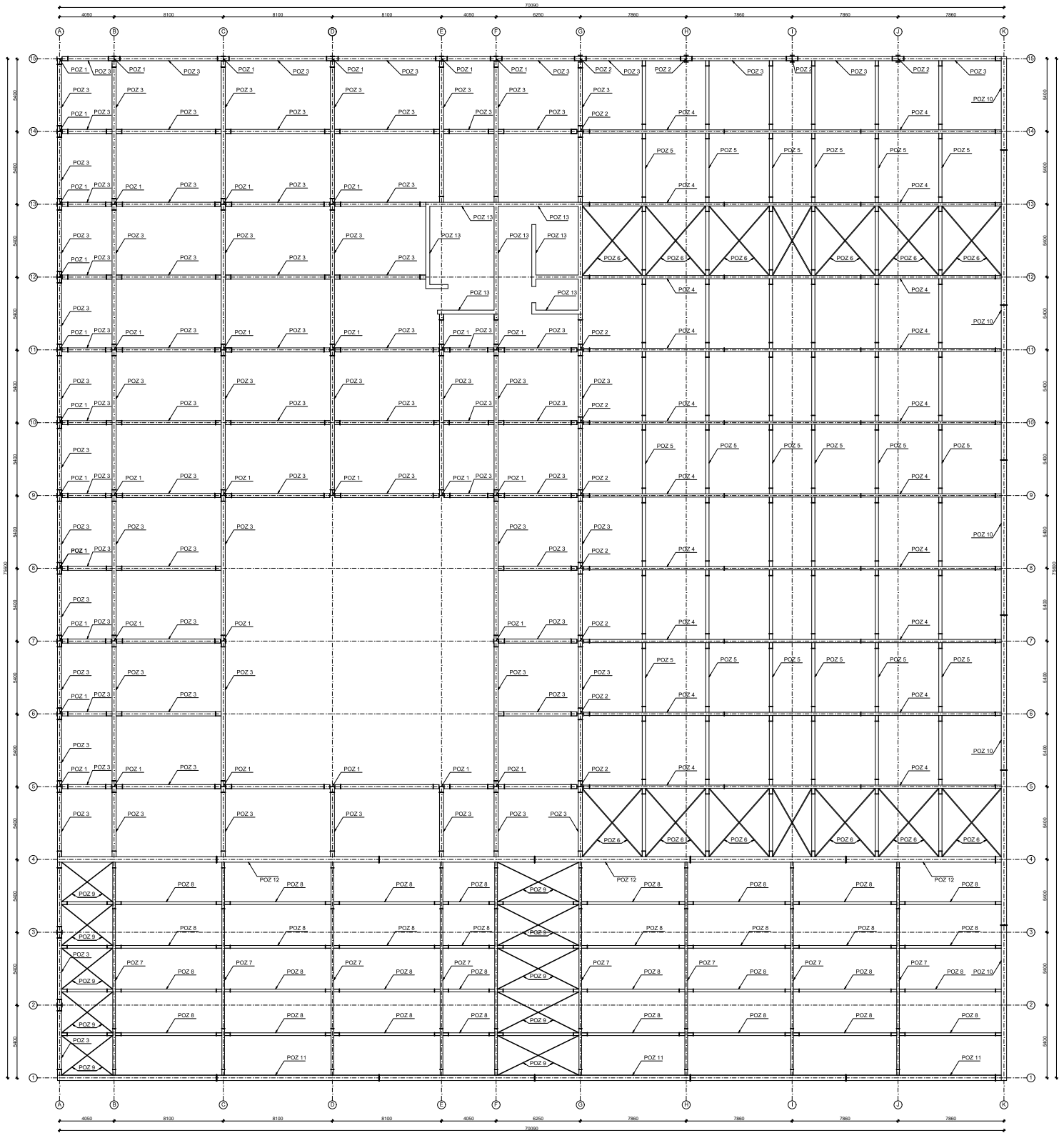

PRIKAZ I OPIS POZICIJA		
POZICIJA	PROFIL	NAZIV
POZ 1	HEB 400	Stup - 3. etaža
POZ 2	HEM 500	Stup - velika dvorana
POZ 3	HEB 450	Krovna gređa - pos 400
POZ 4	HEB 240	Gornja pojasnica glavnog rešetkastog nosača - krov velike dvorane
POZ 5	HEB 240	Sekundarni gredni nosač - krov velike dvorane
POZ 6	RD 55	Sprej - krov velike dvorane
POZ 7	HEB 200	Gornja pojasnica glavnog rešetkastog nosača - krov srednje dvorane
POZ 8	HEB 200	Sekundarni gredni nosač - krov srednje dvorane
POZ 9	RD 30	Sprej - krov srednje dvorane
POZ 10	F 400/10	Gornja pojasnica konzolnog rešetkastog nosača 1
POZ 11	F 400/12	Gornja pojasnica konzolnog rešetkastog nosača 2
POZ 12	F 400/14	Gornja pojasnica konzolnog rešetkastog nosača 3
POZ 13	d = 300	AB jezgra

PLAN POZICIJA NOSIVE KONSTRUKCIJE

POZICIJA - 400

M 1:100

ČELIK S355

BETON C 30/37

	DIPLOMSKI RAD	
	KONSTRUKCIJA KONGRESNOG CENTRA	
NADZORNIK Viljan Didović 602	NADZORNIK dr. sc. N. Totić	PROF. DR. SC. I. Bekić
NADZORNIK OŠKUP-IGUST 2017		NADZORNIK 1:100
NADZORNIK 5		NADZORNIK 5

POGLED A-K

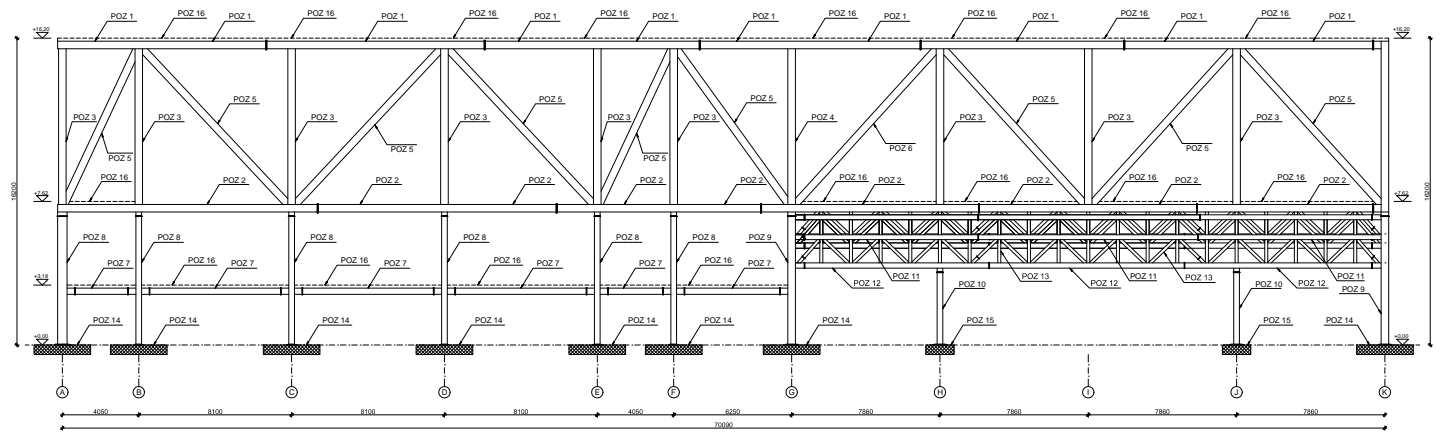

PRIKAZ I OPIS POZICIJA		
POZICIJA	PROFIL	NAZIV
POZ 1	F 400/12	Gornja pojasnica konzolnog rešetkastog nosača 2
POZ 2	F 400/12	Donja pojasnica konzolnog rešetkastog nosača 2
POZ 3	SHS 400/400/20	Vertikalna ispunna 1 konzolnog rešetkastog nosača 2
POZ 4	SHS 400/400/22	Vertikalna ispunna 2 konzolnog rešetkastog nosača 2
POZ 5	SHS 400/400/10	Diagonalna ispunna 1 konzolnog rešetkastog nosača 2
POZ 6	SHS 400/400/20	Diagonalna ispunna 2 konzolnog rešetkastog nosača 2
POZ 7	HEA 340	Gredni nosač 1 - poz 100
POZ 8	HEB 500	Stup - 1. prizemlje
POZ 9	SHS 550/550/28	Stup - konzolni nosač
POZ 10	HEA 340	Stup - 2. prizemlje
POZ 11	HEB 260	Gornja pojasnica glavnog rešetkastog nosača - tribina velike dvorane
POZ 12	F 280	Donja pojasnica glavnog rešetkastog nosača - tribina velike dvorane
POZ 13	F 280	Ispuna glavnog rešetkastog nosača - tribina velike dvorane
POZ 14	3000/3000/500	Temelj samac 1
POZ 15	1500/1500/500	Temelj samac 2
POZ 16	d = 160	Spregnuta betonska ploča

POGLED 1-15

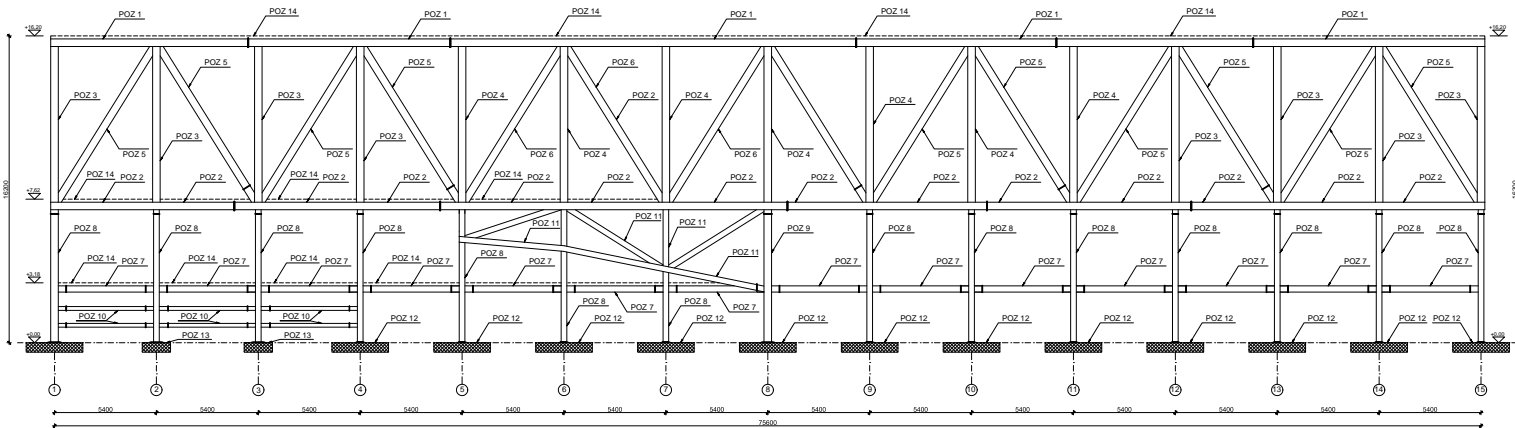

PRIKAZ I OPIS POZICIJA		
POZICIJA	PROFIL	NAZIV
POZ 1	F 400/10	Gornja pojasnica konzolnog rešetkastog nosača 1
POZ 2	F 400/10	Donja pojasnica konzolnog rešetkastog nosača 1
POZ 3	SHS 400/400/10	Vertikalna ispunna 1 konzolnog rešetkastog nosača 1
POZ 4	SHS 400/400/20	Vertikalna ispunna 2 konzolnog rešetkastog nosača 1
POZ 5	SHS 400/400/10	Diagonalna ispunna 1 konzolnog rešetkastog nosača 1
POZ 6	SHS 400/400/16	Diagonalna ispunna 2 konzolnog rešetkastog nosača 1
POZ 7	HEA 340	Gredni nosač 1 - poz 100
POZ 8	HEB 500	Stup - 1. prizemlje
POZ 9	SHS 550/550/28	Stup - konzolni nosač
POZ 10	HEB 200	Sekundarni gredni nosač - ulazno stubište
POZ 11	F 300	Podupora glavnog rešetkastog nosača 1
POZ 12	3000/3000/500	Temelj samac 1
POZ 13	1500/1500/500	Temelj samac 2
POZ 14	d = 160	Spregnuta betonska ploča

PLAN POZICIJA NOSIVE KONSTRUKCIJE  
 POGLEDI  
 M 1:100  
 ČELIK S355  
 BETON C 30/37



# Spoj stup 2 - temelj 2

## Tlocrt

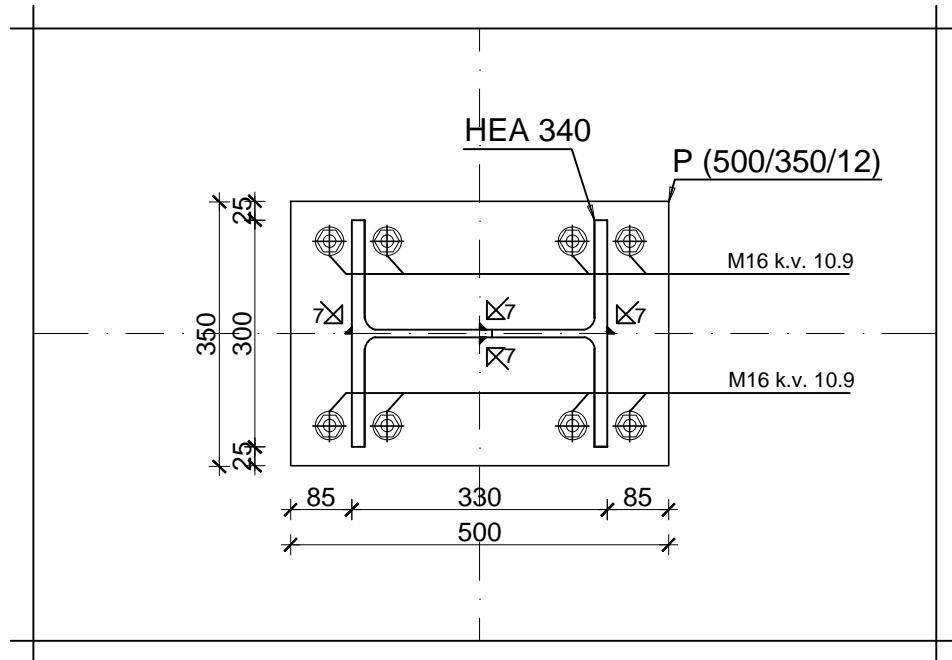

## Pogled

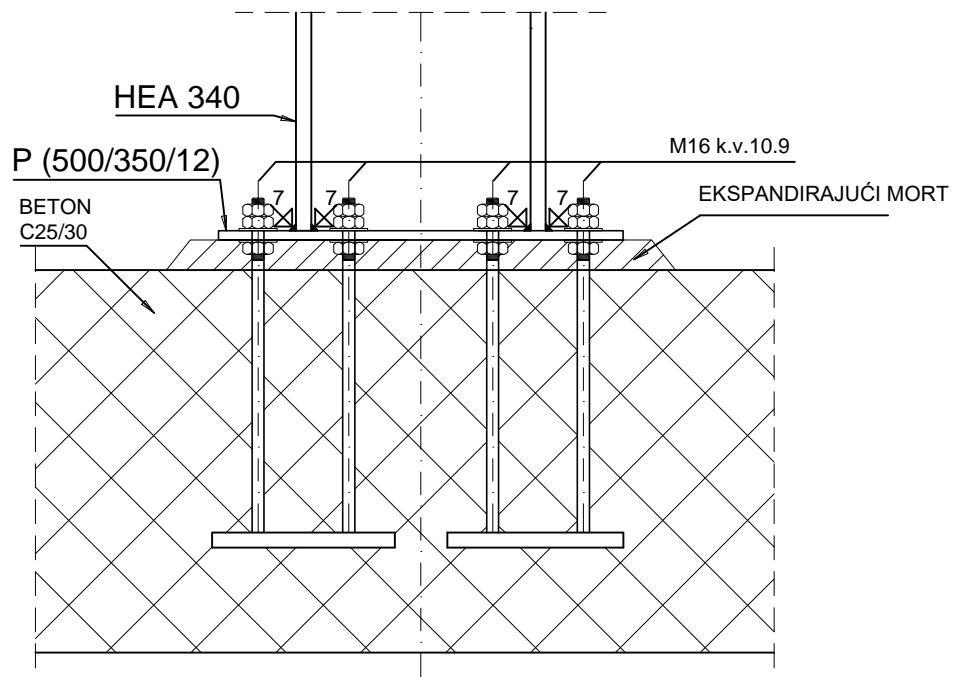

FAKULTET GRAĐEVINARSTVA, ARHITEKTURE I  
GEODEZIJE  
KATEDRA ZA METALNE I DRVENE KONSTRUKCIJE  
21000 SPLIT, MATICE HRVATSKE 15

TEMA:	KONSTRUKCIJA KONGRESNOG CENTRA ŽNJAN		
STUDENT:	MENTOR	Prof. dr. sc. I.Boko	
	KOMENTOR	dr.sc. N.Torić	
SADRŽAJ	SPOJ STUP - TEMELJ		MJERILO 1:10
DATUM	ožujak-rujan 2017.		PRILOG 7

# Spoj stup - greda

## Tlocrt

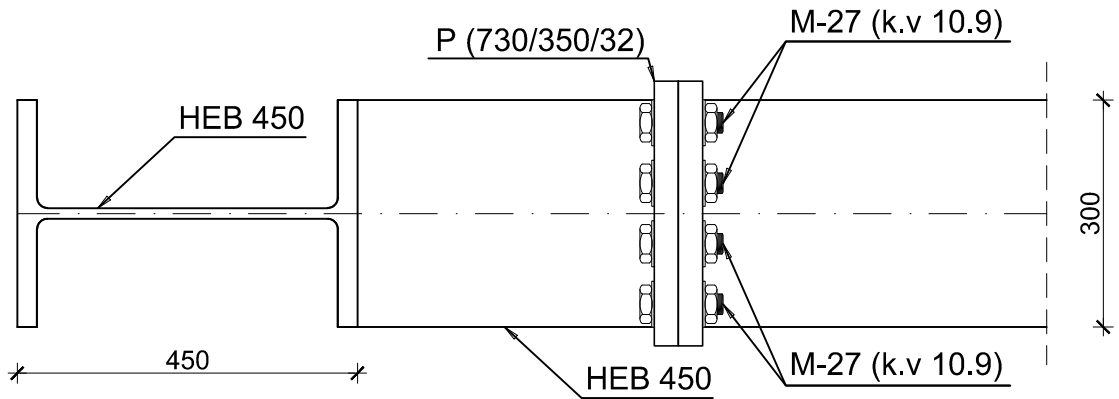

## Pogled

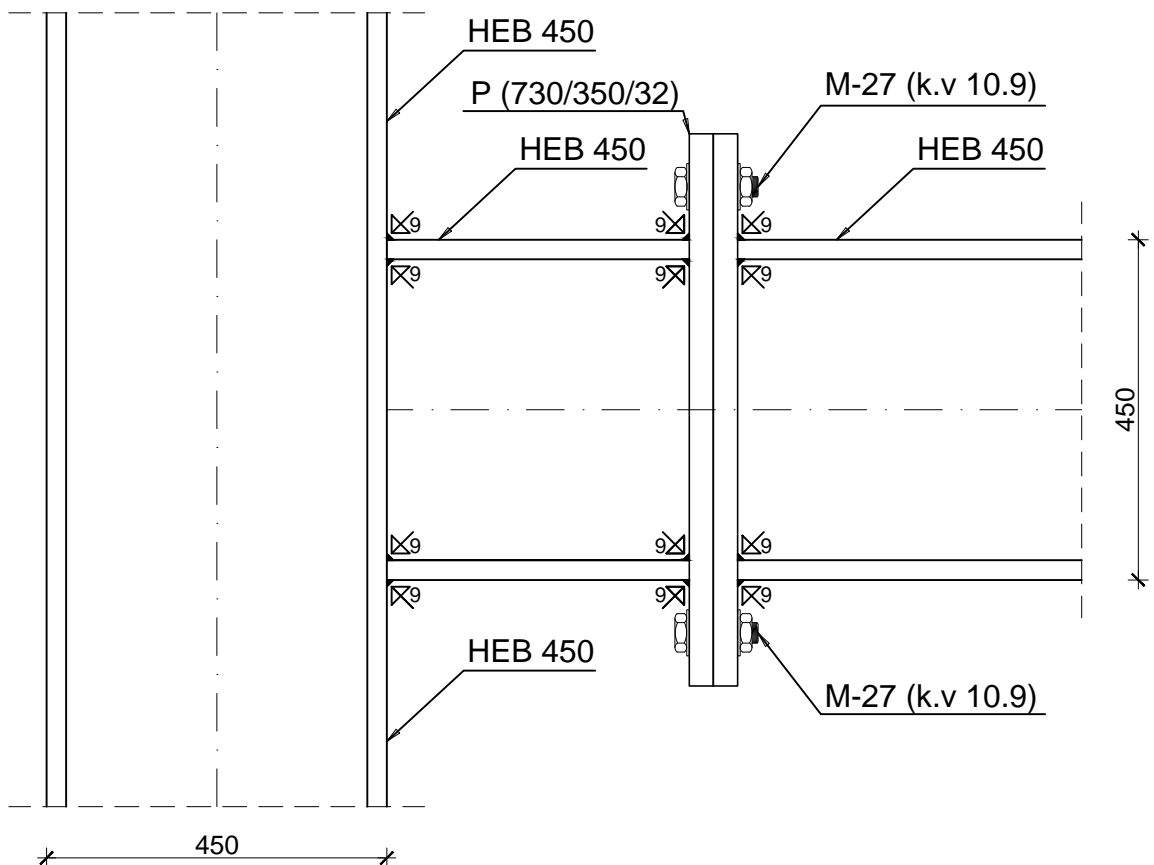

FAKULTET GRAĐEVINARSTVA, ARHITEKTURE I  
GEODEZIJE  
KATEDRA ZA METALNE I DRVENE KONSTRUKCIJE  
21000 SPLIT, MATICE HRVATSKE 15

TEMA: KONSTRUKCIJA KONGRESNOG CENTRA  
ŽNJAN

STUDENT: Viljan Didović, 602

MENTOR Prof. dr. sc. I.Boko

KOMENTOR dr.sc. N.Torić

SADRŽAJ SPOJ STUP - GREDA

MJERILO 1:10

DATUM ožujak-rujan 2017.

PRILOG 8

# Montažni nastavak gornjege pojasnice krovnog rešetkastog nosača

## Tlocrt

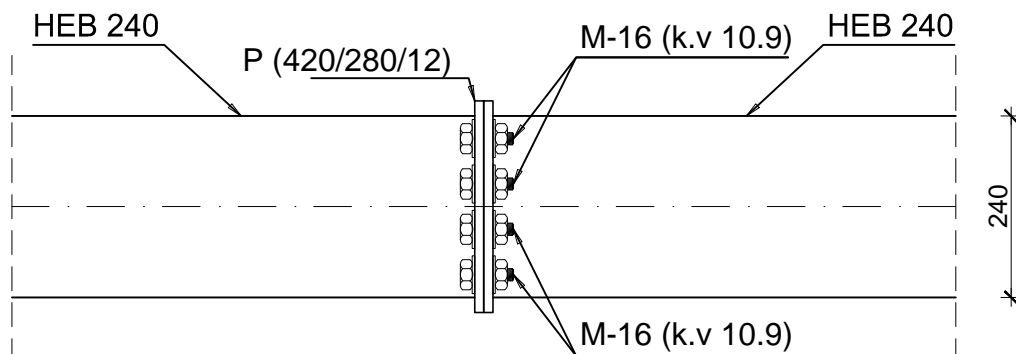

## Pogled

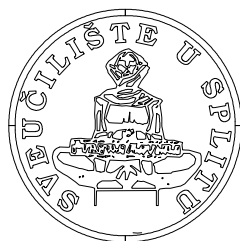
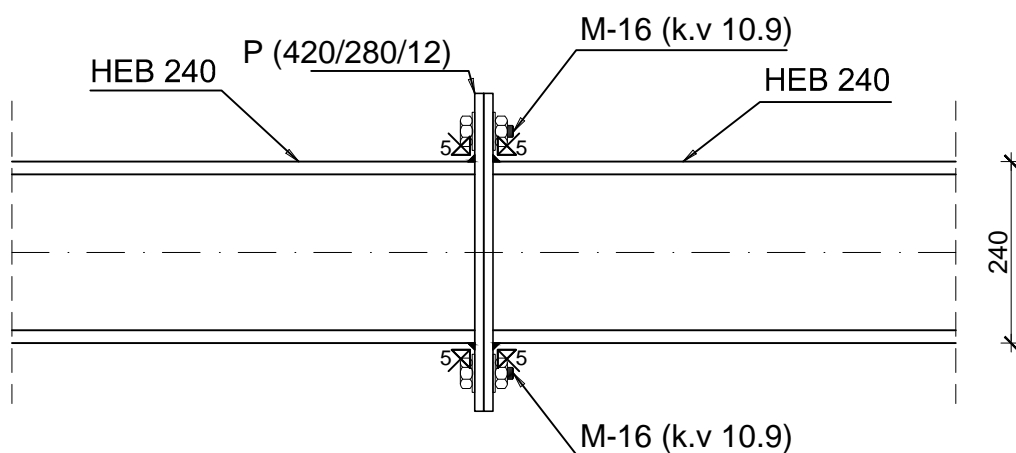

FAKULTET GRAĐEVINARSTVA, ARHITEKTURE I  
GEODEZIJE  
KATEDRA ZA METALNE I DRVENE KONSTRUKCIJE  
21000 SPLIT, MATICE HRVATSKE 15

TEMA: KONSTRUKCIJA KONGRESNOG CENTRA  
ŽNJAN

STUDENT:  
Viljan Didović, 602

MENTOR Prof. dr. sc. I. Boko

KOMENTOR dr. sc. N. Torić

SADRŽAJ MONTAŽNI NASTAVAK

MJERILO 1:10

DATUM ožujak-rujan 2017.

PRILOG 9

# Montažni nastavak donje pojasnice krovnog rešetkastog nosača

## Tlocrt

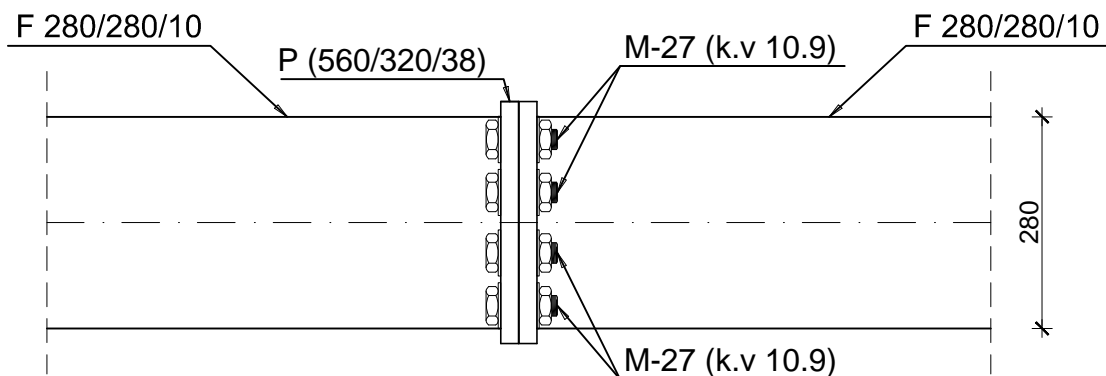

## Pogled

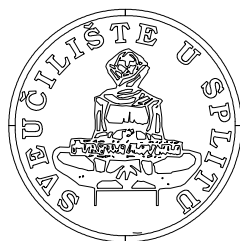
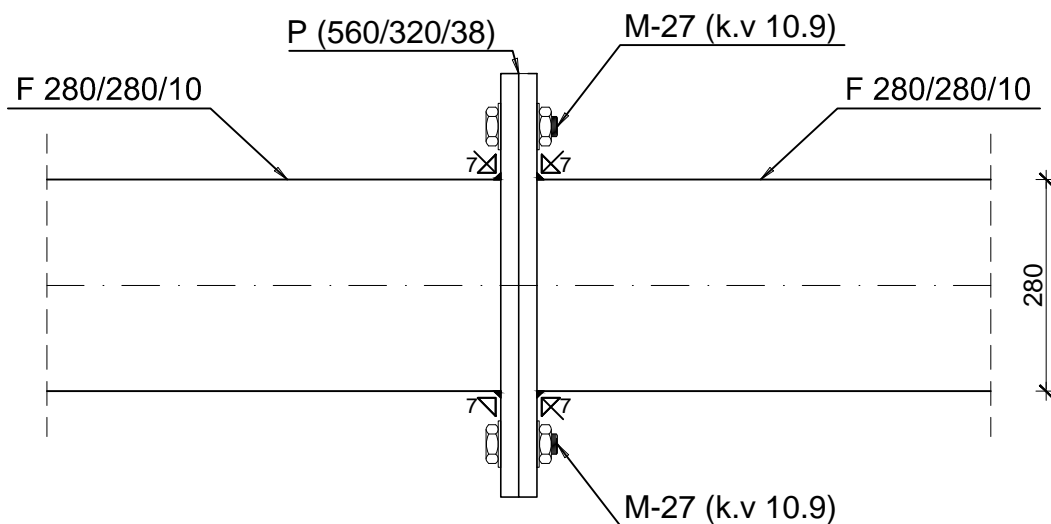

FAKULTET GRAĐEVINARSTVA, ARHITEKTURE I  
GEODEZIJE  
KATEDRA ZA METALNE I DRVENE KONSTRUKCIJE  
21000 SPLIT, MATICE HRVATSKE 15

TEMA: KONSTRUKCIJA KONGRESNOG CENTRA  
ŽNJAN

STUDENT:  
Viljan Didović, 602

MENTOR  
Prof. dr. sc. I. Boko

KOMENTOR  
dr. sc. N. Torić

SADRŽAJ  
MONTAŽNI NASTAVAK

MJERILO  
1:10

DATUM  
ožujak-rujan 2017.

PRILOG  
10

# Montažni nastavak ispune krovnog rešetkastog nosača

## Tlocrt

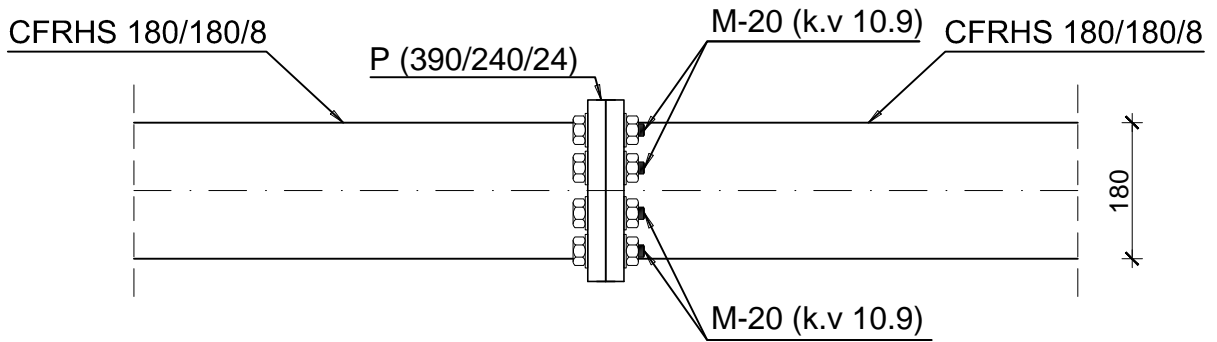

## Pogled

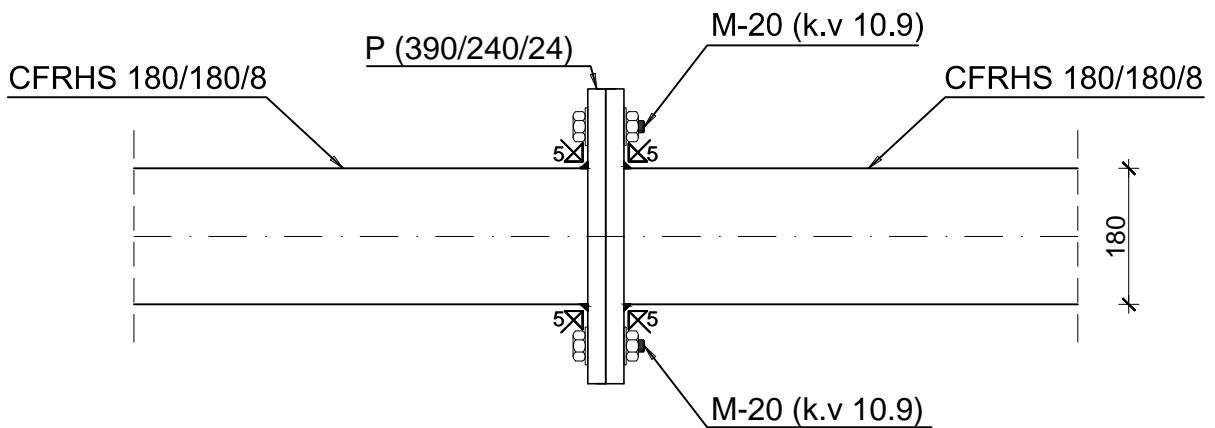

FAKULTET GRADEVINARSTVA, ARHITEKTURE I  
GEODEZIJE  
KATEDRA ZA METALNE I DRVENE KONSTRUKCIJE  
21000 SPLIT, MATICE HRVATSKE 15

TEMA: KONSTRUKCIJA KONGRESNOG CENTRA  
ŽNJAN

STUDENT:  
Viljan Didović, 602

MENTOR Prof. dr. sc. I. Boko

KOMENTOR dr. sc. N. Torić

SADRŽAJ MONTAŽNI NASTAVAK

MJERILO 1:10

DATUM ožujak-rujan 2017.

PRILOG 11