



Strathprints Institutional Repository

Lazakis, Iraklis and Turan, Osman (2009) The effect of increasing the thickness of the ship's structural members on the Generalised Life Cycle Maintenance Cost (GLCMC). In: Proceedings of IMPROVE Final Workshop. University of Zagreb, Zagreb. ,

This version is available at <http://strathprints.strath.ac.uk/47097/>

Strathprints is designed to allow users to access the research output of the University of Strathclyde. Unless otherwise explicitly stated on the manuscript, Copyright © and Moral Rights for the papers on this site are retained by the individual authors and/or other copyright owners. Please check the manuscript for details of any other licences that may have been applied. You may not engage in further distribution of the material for any profitmaking activities or any commercial gain. You may freely distribute both the url (<http://strathprints.strath.ac.uk/>) and the content of this paper for research or private study, educational, or not-for-profit purposes without prior permission or charge.

Any correspondence concerning this service should be sent to Strathprints administrator: strathprints@strath.ac.uk



Proceedings of IMPROVE Final Workshop

***Design of Improved and Competitive Ships
using an Integrated Decision Support System
for Ship Production and Operation***

***17th - 19th of September 2009
Dubrovnik, Croatia***

Conference Papers, Vol. I

*Edited by
Vedran Žanić and Jerolim Andrić*



University of Zagreb
Faculty of Mech. Eng. and Naval Architecture

Zagreb 2009

Proceedings of IMPROVE Final Workshop

Design of Improved and Competitive Ships using an Integrated Decision Support System for Ship Production and Operation

Conference papers, Vol. I

Edited by

Vedran Žanić

vedran.zanic@fsb.hr

Faculty of Mechanical Engineering and Naval Architecture
University of Zagreb, Croatia

Jerolim Andrić

jerolim.andric@fsb.hr

Faculty of Mechanical Engineering and Naval Architecture
University of Zagreb, Croatia

Project co-ordinator:

Philippe Rigo

ph.rigo@ulg.ac.be

ANAST

University of Liege, Belgium

September 17-19, Dubrovnik, Croatia

IMPROVE Consortium Members

	ANAST, University of Liege	Belgium
	STX Europa	France
	Uljanik shipyard (ULJANIK, USCS)	Croatia
	Szczecin New Shipyard (SSN)	Poland
	Grimaldi	Italy
	Exmar	Belgium
	Tankerska Plovidba Zadar (TPZ)	Croatia
	Bureau Veritas (BV)	France
	Design Naval & Transport (DN&T)	Belgium
	Ship Design Group (SDG)	Romania
	MEC	Estonia
	Helsinki University of Technology (TKK)	Finland
	University of Zagreb (UZ)	Croatia
	NAME, Universities of Glasgow & Strathclyde	UK
	Centre of Maritime Technologies (CMT)	Germany
	BALANCE Technology Consulting GmbH (BAL)	Germany
	WEGEMT	UK

The project is supported by the European Commission under the Growth Programme of the 6th Framework Programme. Contract No. FP6 – 031382

More information about the IMPROVE project can be found at the project website

<http://www.improve-project.eu>

Workshop is organised by:

Faculty of Mechanical Engineering and Naval Architecture, University of Zagreb, Croatia
Centre for Advanced Academic Studies (CAAS), Dubrovnik, Croatia

under requirements of:

Task 9.3 of IMPROVE Work Package 9.

Proceedings are in fullfilement of Deliverable D9.4:

‘Synthetic report about conclusions of the workshop’ with project and work package summaries and their conclusions presented and discussed at the workshop.

Additional CD with the conference papers and presentations is also prepared by UZ.



AGENDA

1.day - THURSDAY 17th September 2009 (Invited lecture + methods presentations)

08:30 to 09:00: Arrival of partners, (Coffee break)

09:00 to 09:15: Welcome, introduction of workshop contents (V. Zanic, I. Grubisic (Dean) UZ)

09:15 to 10:00: Overview of **IMPROVE project** (Ph Rigo-ANAST)

10:00 to 10:45: Invited lecture 1: Lecture on rational structural design methodology (O.F. Hughes, Virginia Tech.)

10:45 to 11:15: Coffee break

TOOLS FOR EARLY DESIGN STAGE- BLOCK 1 - Modules

11:15 to 12:15: **WP 3-** Modules for the structural response and load calculation (UZ+ WP3 partners)

12:15 to 12:45: Panel discussion

12:45 to 14:00: LUNCH

TOOLS FOR EARLY DESIGN STAGE- BLOCK 2 - Modules

14.00 to 15:00: **WP4-** Production & operational modules (CMT/NAME + WP4 partners)

15.00 to 15:30: Panel discussion

15:30 to 16:00: Coffee break

TOOLS FOR EARLY DESIGN STAGE- BLOCK 3 – Integration & Tools

16:00 to 16:15: Integration platform of IMPROVE project (USCS, BAL)

16:15 to 16:45: Tools presentation: LBR5 software (ANAST)

16:45 to 17:15: Tools presentation: OCTOPUS/MAESTRO software (UZ)

17:15 to 17:45: Tools presentation: CONSTRUCT software (TKK)

19:15 to 20:00: Cocktail in Maritime Museum of Dubrovnik

20:00: Boat trip to Cavtat, Dinner

2.day- FRIDAY 18th September 2009 (Invited lecture + PRODUCTS presentations)

08:30 to 09:00: Arrival of partners, (Coffee break)

09:00 to 09:15: Welcome, introduction of workshop contents (V. Zanic-UZ)

09:15 to 10:00: Invited lecture 2: Lecture on general ship design methodology (Kai Levander, SeaKey Naval Architecture Ltd..)

10:00 to 10:20: Coffee break

PRODUCT presentation: LNG carrier

10:20 to 10:40: LNG carrier- Ship owner requirements, markets + technical trends – (EXMAR)

10:40 to 11:00: LNG carrier- General ship design (performance, stability, power – (STX)

11:00 to 11:20: LNG carrier- Structural design aspects (STX, ANAST)

11:20 to 11:40 LNG carrier- achievements through project, conclusion (EXMAR, STX, ANAST, BV)

11:40 to 12:00: Coffee break

PRODUCT presentation: ROPAX ship

12:00 to 12:20: ROPAX carrier- Ship owner requirements, markets + technical trends – (GRIMALDI)

12:20 to 12:40: ROPAX- Basic design, performance, stability (ULJANIK)

12:40 to 13:00: ROPAX- Structural design aspects (ULJANIK, UZ)

13:00 to 13:20: ROPAX- achievements through IMPROVE, conclusion (GRIMALDI, ULJ, UZ)

13:20 to 14:50: LUNCH

PRODUCT presentation: Chemical tanker

14:50 to 15:10: Chemical tanker - Ship owner requirements, markets + technical trends – (TPZ)

15:10 to 15:30: Chemical tanker - Basic design, performance, stability (SSN, TKK)

15:30 to 15:50: Chemical tanker - Structural design aspects (SSN, TKK)

15:50 to 16:10: Chemical tanker - achievements through IMPROVE, conclusion (TPZ, SSN, TKK)

16:10 to 16:30: Coffee break

16:30 to 17.15: Closing a workshop, final conclusions (V.Zanic + project Coordinator)

18:30: Bus to Konavle from Hilton parking

19:30 : Reception in Konavle with appetitive, Dinner

3.day- SATURDAY 19 th September 2009 (Social event)

09:30 to 10:00: Arrival of partners

10:00: Excursion to Ston/Trsteno-Arboretum/Orasac (bus), Flavours of Dalmatia - food testing + Lunch

FOREWORD

The IMPROVE final workshop is a result of more than three years of considerable effort of a sizeable number of experienced senior researchers and designers, their junior colleagues from 18 respectable companies and institutions, building together, not only a better ship design methodology for the ships of the future, but also contributing to the formation of European Research Area. ERA should provide valuable interactions between researchers and designers of different generations, backgrounds and affiliations in creating new competitive ideas and research objectives as the longstanding European goal. The same applies to the Vision 2020 objectives of CESA/COREDES or in general of the EU Waterborne platform.

The project started at an island in the Helsinki archipelago in 2005, where principal partners from Liege, Helsinki and Zagreb Universities (Philippe Rigo, Petri Varsta and Vedran Zanic, including a guest Izvor Grubisic) together with their PhD students gathered together and wrote down the backbone of the project. The missing partner was Frank Rolland from Hamburg based CMT, who was consulted previously.

For most of us, engaged for many years in European Naval Architecture and shipbuilding problems, it was obvious that:

(1) European shipbuilding industry and ship-owners/operators need development of the new generation of more complex and sophisticated ships for the most basic transport needs in multimodal transport of goods and energents/chemicals to improve or regain their competitiveness and serve European strategic needs.

(2) That it should be achieved through application of the most advanced and mature techniques and immediately used in the practical vessel design, production and operation. We have been deeply surprised that revolutionary products are always looked for, while the wisdom of the quality product improvement, based on the mature, existing procedures is not given its proper position and the benefits are not properly collected.

(3) That such urgent and strangely foreseen possibility of practical (non-academic, non-exotic) and profitable improvements, despite measurable achievements on the number of operating ships in the last two decades, requires the synergetic consortium of the basic stakeholders in the product design. Consortium should include respectable European designers, Yards and Owners/Operators, a representative of the regulatory organizations (Class Society), besides a cluster of research teams at academia, institutes and SME-s as to jointly improve:

- design problem definition and solution,
- its production streamlining
- its operation/maintenance costs

and achieve competitive product with recognizable 'European quality' generating gains simultaneously to the owner, builder and operator.

(4) Those improvements should be proved to the profession via demonstration of practical designs obtained:

- by focusing the project on the concept/preliminary design stages, since the main functionally and technologically-driven parameters are defined in the concept design stage (almost 80% of the resources are allocated/fixed at this phase).
- by early defining (in the concept design phase) the attributes and measures of design quality following extensive recommendations from many European institutions e.g. requests for:
 - robustness, cleanliness, safety and comfort of product and its service
 - reduced operational/maintenance costs and energy consumption
 - integration of advanced, low-mass materials and structures in the vessel design
 - rated performance at low initial and maintenance costs;
- by developing the improved generic ship designs based upon multi-criteria mathematical models. Generic models should be adjusted to the most demanding requirements of the transport of goods, people and vehicles relevant for European and other transport chains.
- by developing an integrated decision support system in the design of ship structures that can assist designer in challenging those tasks. This novel design approach should therefore take into consideration, besides the usual technical requirements, also producibility, production cost, quality control, risk, performance, cost and customer requirements, operation costs, environmental concerns, passenger comfort, and maintenance/life-cycle issues, i.e. the lifetime societal and owner's gains / losses caused by the product.
- by generating, not single solution, but the set of efficient (non-dominated) designs (members of the Pareto frontier) and by displaying them to the stakeholders for their final (multi-stakeholder) selection of the preferred design. Those

designs should exhibit, when used by the same experienced designer and for the same class. society Rules, the increase in design quality measures particularly the key performance indicators (KPIs).

- by implementation of DS system in practical design process and ensuring that it is clear that such new design environment or integrated decision support would not replace the designer, but to the contrary, provide the most experienced designers with better insight into the design problem. The designer should be navigating within the “decision support system” generating sound base for the top-level decision making and improving the design through the supported exploration of the ‘design space’, but based on his own talent.
- by the improvement of design methodology of the EU designers, achieved by concentrating effort on advanced synthesis skills, which are defined as the 21st century focus and not on multiple complex analyses, which were achievements of the 20th century engineering.

The proposed name of the project was reminding some among us of the wisdom of the famous Professor Y. Ueda from another remarkable shipbuilding nation, when he stated informally at ISSC 2000: ‘the spirit of my people is to IMPROVE things and processes they are involved with’. It was also close to the spirit of us, who gathered in Helsinki in 2005.

In closing, we are very grateful to our most distinguished invited lecturers for their enlightening papers, to project coordinator and lecturers from the IMPROVE consortium, from both Industry and Academia, for their written contributions, participation and valuable suggestions.

We gratefully acknowledge the support of European Commission under the FP6 Sustainable Surface Transport Programme – Contract No. FP6 – 031382. We would also like to take this opportunity to thank all those involved in the organization of this workshop, particularly the Dean and employees of the Faculty of Mechanical Engineering and Naval Architecture, the Director and staff of the Centre for Advanced Academic Studies, both of the University of Zagreb and to our research assistants that spent many hours in creating and designing these Proceedings.

Finally, among the elegant designs of Dubrovnik fortresses and palaces, we hope that participants may be inspired to design their ships in simple, natural and austere shapes, using the most reliable modern methods and materials and to operate those ships with respect and pleasure.

September 2009.

Vedran Žanić
Jerolim Andrić

TABLE OF CONTENTS

IMPROVE PROJECT OVERVIEW

IMPROVE - Design of Innovative Ship Concepts using an Integrated Decision Support System for Ship Production and Operation	2
<i>Philippe Rigo - ANAST, University of Liège</i>	

INVITED LECTURERS

Next Generation Ship Structural Design	20
<i>Owen F. Hughes, Virginia Tech.</i>	
Ship Design for Performance	26
<i>Kai Levander - SeaKey Naval Architecture</i>	

METHODS and TOOLS

Tools for Early Design Stage - Modules for the Structural Response and Load Calculations (WP3)

New and Updated Modules to Performed Stress and Strength Analysis	37
<i>V. Zanic, T.Jancijev, J. Andric, M. Grgic, S. Kitarovic, P.Prebeg - University of Zagreb, Faculty of Mechanical Engineering and Naval Architecture</i>	
<i>P. Rigo, C. Toderan, D. Desmidts, A. Amrane, T. Richir, E. Pircalabu - ANAST, University of Liege</i>	
<i>M. Lappy - DN&T</i>	
Local and global ship vibrations	41
<i>A. Constantinescu & Ph. Rigo -University of Liège</i>	
<i>I. Chirica, S. Giuglea & V.Giuglea -Ship Design Group</i>	
Assessment of ultimate strength at the early design stage	46
<i>H. Naar and M. Mäesalu - MEC-Insenerilahendused</i>	
<i>S. Kitarovic, J. Andric and V. Zanic - University of Zagreb, Faculty of Mechanical Engineering and Naval Architecture</i>	
Rational models to assess fatigue at the early design stage	50
<i>H. Remes, M. Liigsoo - Helsinki University of Technology</i>	
<i>A. Amrane - ANAST University of Liège</i>	
<i>I. Chirica, V. Giuglea, S. Giuglea - Ship Design Group</i>	
Sloshing Loads to be Applied on LNG Carriers' Inner Hull Structure	53
<i>L. Diebold, N. Moirod & Ph. Corrigan - Bureau Veritas</i>	

Tools for Early Design Stage - Production, Operational and Robustness Modules (WP4)

Production, Operation and Robustness Module	55
<i>J.D. Caprace, F. Bair - ANAST University of Liège</i>	
<i>M. Hübler - Center of Maritime Technologie</i>	
<i>I. Lazakis, O. Turan - NAME Universities of Glasgow & Strathclyde</i>	
<i>V. Zanic, J. Andric, P. Prebeg, K. Piric - University of Zagreb</i>	
The effect of increasing the thickness of the ship's structural members on the Generalised Life Cycle Maintenance Cost (GLCMC)	61
<i>I. Lazakis, O. Turan - NAME Universities of Glasgow & Strathclyde</i>	

Tools for Early Design Stage - Integration and Tools

Software integration in the context of the IMPROVE project (WP5)	68
<i>S. Wurst & M. Lehne - BALance Technology Consulting GmbH</i>	
<i>B. Cupic - Uljanik Shipbuilding Computer Systems d.o.o.</i>	
Tools for early design stage: presentation of LBR-5 Software	71
<i>Ph.Rigo, F.Bair, Caprace J., D.Desmidts, A.Amrane, A.Constantinescu, R.Warnotte - ANAST – University of Liège</i>	
<i>A.Hage, E.Pircalabu, M.Lapy - DN&T</i>	
Tools for early design stage: OCTOPUS and MAESTRO Software	74
<i>V.Zanic, J.Andric, M.Stipcevic, P.Prebeg, S.Kitarovic, M.Grgic, K.Piric, N.Hadzic - University of Zagreb, Faculty of Mechanical Engineering and Naval Architecture</i>	
ConStruct - Platform for Conceptual Structural Design	80
<i>H. Remes, A. Klanac, P. Varsta, S. Ehlers - Helsinki University of Technology</i>	

APPLICATION CASES

Product Presentation: LNG Carrier (WP6)

LNG Carrier – Ship Owner requirements, markets and technical trends	85
<i>F. Van Nuffel - EXMAR</i>	
An innovative LNG Carrier	87
<i>L. Claes - STX Europe</i>	
<i>J.-L. Guillaume-Combecave - STX Europe</i>	
LNG carrier- Structural design aspects	90
<i>A. Amrane, A. Constantinescu, F. Bair and P. Rigo - ANAST, University of Liege</i>	
<i>V. Zanic, J. Andric, N. Hadzic - University of Zagreb, Faculty of Mechanical Engineering and Naval Architecture</i>	

LNG carrier – new innovative product	96
<i>A. Constantinescu & Ph. Rigo - University of Liege</i>	
<i>J.-L. Guillaume Combecave - STX-Europe</i>	

Product Presentation: ROPAX Ship (WP7)

ROPAX Carrier Ship Owner requirements, markets and future trends	100
<i>Dario Bocchetti - Grimaldi Group</i>	
New innovative ROPAX vessel	102
<i>Đ. Dundara, O. Kuzmanović - Uljanik Shipyard</i>	
<i>V. Zanic, J. Andric, P. Prebeg, N. Hadzic - University of Zagreb, Faculty of Mechanical Engineering and Naval Architecture</i>	
RoPaX- Structural design aspects	107
<i>V. Zanic, J. Andric, P. Prebeg, M. Stipcevic, M. Grgic, S. Kitarović, N. Hadzic, K. Priric - University of Zagreb, Faculty of Mechanical Engineering and Naval Architecture</i>	
<i>I. Chirica, S. Giuglea & V. Giuglea - Ship Design Group</i>	
<i>O. Turan, H. Khalid - NAME Universities of Glasgow & Strathclyde</i>	
<i>P. Rigo - ANAST, University of Liege</i>	

Product Presentation: Chemical Tanker (WP8)

The IMPROVED chemical tanker: Owner requirements	115
<i>A. Klanac - Helsinki University of Technology</i>	
<i>M. Magaš, Z. Brzić, I. Pupovac - Tankerska plovidba Zadar</i>	
The basic design, performance and stability of the IMPROVED chemical tanker	119
<i>S. Ehlers - Helsinki University of Technology</i>	
<i>K. Kapuścik - Szczecin New Shipyard</i>	
<i>H. Khalid, O. Turan - University of Glasgow & Strathclyde</i>	
The IMPROVED chemical tanker	123
<i>S. Ehlers, A. Klanac, H. Remes - Helsinki University of Technology</i>	
<i>K. Kapuścik - Szczecin New Shipyard</i>	
<i>H. Naar - MEC</i>	
<i>J. Andric, V. Zanic, M. Grgic - University of Zagreb</i>	
<i>E. Pircalabu - Design Naval & Transport</i>	
<i>F. Bair - ANAST, University of Liege</i>	

CONCLUSIONS

Final Conclusions of Workshop	132
--------------------------------------	------------

IMPROVE PROJECT OVERVIEW

IMPROVE - Design of Innovative Ship Concepts using an Integrated Decision Support System for Ship Production and Operation

Philippe Rigo, ANAST,
Univ. of Liège, ph.rigo@ulg.ac.be
IMPROVE coordinator

SHORT ABSTRACT: The EU FP6-IMPROVE Project proposes to deliver an integrated decision support system for a methodological assessment of ship designs to provide a rational basis for making decisions pertaining to the design, production and operation of three new ship generations (LNG, RoPax, chemical tanker). These ship designs enhance the importance of early stage structural optimization and integrated design procedure, which contribute reducing the life-cycle costs and improving the performance of those ship generations.

ABSTRACT: IMPROVE has aimed to use advanced synthesis and analysis techniques at the earliest stage of the design process, considering structure, production, operational performance, and safety criteria on a current basis. The nature of shipbuilding in Europe is to build small series of specialised ships. Thus, the IMPROVE project has addressed ships which, with their complex structures and design criteria, are at the top of the list for customisation.

The specific objectives of the project have been to:

develop improved generic ship designs based upon multiple criteria mathematical models improve and apply rational models for estimation of the design characteristics (capacity, production costs, maintenance costs, availability, safety, reliability and robustness of ship structure) in the early design phase

use and reformulate basic models of multiple criteria ship design, and include them into an integrated decision support system for ship production and operation.

The operators buying specialised ships generally plan to operate them for the majority of their lives. This means that the maintenance characteristics of the design are very important and for this reason, IMPROVE has focused on designing for a reduction in operation costs. Designing ship structures in such a way as to reduce the problems, for instance, of structural fatigue can help in this cause. Additionally, designing for minimal operational costs can help in increase the structural reliability and reduction of failures thus increasing safety.

The targets have been to increase shipyard competitiveness by 10% to 20% and reduce manufacturing costs by 8%-15%, production lead-times by 10%-15%, and to find benefit of 5%-10% on maintenance costs related to structure (painting, corrosion, and plate replacement induced by fatigue).

Front and centre of the IMPROVE project, however, has been the three specific ship types selected for the study.

The first of these is a 220 000m³: capacity LNG Carrier with free ballast tanks, designed by STX-France S.A.

The second ship type is a large Ro-Pax ship, with capacity for 3000 lane metres of freight and 300 cars, plus 1600 passengers, with design by Uljanik Shipyard (Croatia).

The third ship is a 40,000dwt chemical tanker, designed by Szczecin Shipyard (SSN, Poland).

1 INTRODUCTION

IMPROVE, <http://www.improve-project.eu>, is a three-year research project (2006-2009) supported by the European Commission under the 6th Framework Programme (Annex 1). The main goal of IMPROVE is to perform new innovative ship designs (called products):

LNG Carrier, Fig.1 – STX - Europe has designed and built 17 LNG carriers (from 50 000 m³ to latest 154 500 m³). In the framework of IMPROVE, they studied the design of a 220 000 m³ unit with free ballast tanks to fulfill the shipowner requirements and reducing the life-cycle costs.

Large RoPax ship, Fig.2 - ULJANIK Shipyard (Croatia) in the last 5 years has designed several car-carriers, ConRo and RoPax vessels. For a long period. ULJANIK has a strong cooperation with the GRIMALDI GROUP as respectable ship owner regarding market needs and trends.

Chemical tanker, Fig.3 - SZCZECIN shipyard (SSN, Poland) has recently built several chemical tankers (40000 DWT) and developed in the framework of IMPROVE a new general arrangement of chemical tankers, saving production cost by reducing amount of duplex steel and using extensively corrugated bulkheads.

As the proposed methodology is based on multi-criteria structural optimization, the consortium contains not only designers, but also shipyards and ship-owners / operators (one per product). The research activity was divided in three main phases:

Definition of stakeholders' requirements and specification of optimization targets and key performance indicators. In addition, project partners (particularly the shipyards) designed reference or prototype ships, one per each ship type, in a "first design loop".

Technical and R&D developments relating to the selected structural optimization tools. Several modules such as fatigue assessment, vibration, ultimate strength, sloshing load assessment, production and maintenance cost, optimization robustness have been delivered and most of them integrated into these existing tools (LBR5, OCTOPUS, and CONSTRUCT).

Application of the developed optimization platforms for the three target products.

The applications are described in detail for the LNG Carrier in Toderan et al. (2008) and in IMPROVE-RINA(2009), the RoPax ship in Dundara et al. (2008) and in IMPROVE-RINA(2008), and the chemical tanker in Klanac et al. (2008).



Figure 1. 220 000 m³ LNG carrier studied by STX- France



Figure 2. RoPax vessel designed by ULJANIK Shipyard (Croatia)

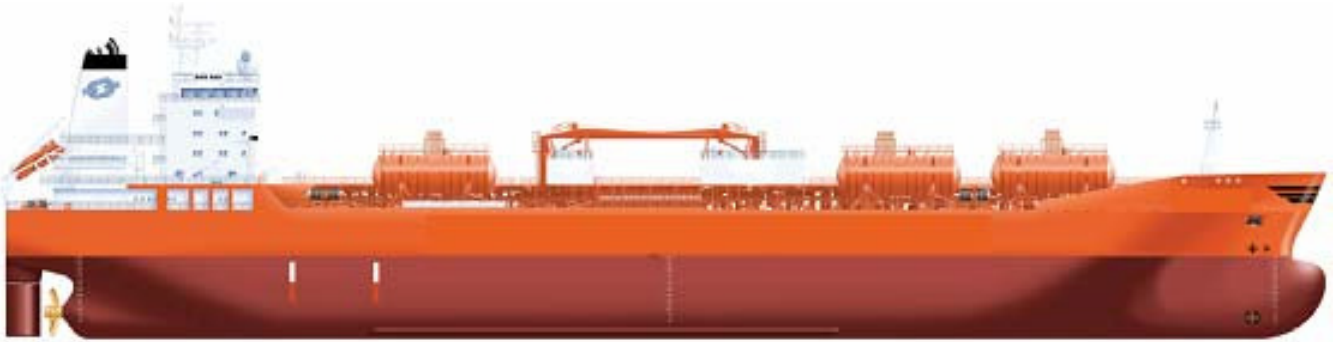

Figure 3. 40 000 DWT chemical tanker by SSN (Poland)

2 PROJECT OBJECTIVES

2.1 The background

The IMPROVE project focuses on developing and promoting concepts for one-off, small series and mass customization production environments specific to European surface transport, based on the innovative use of advanced design and manufacturing. The objective is to increase shipyard competitiveness through improved product quality and performance based on cost effective and environmentally friendly production systems on a life-cycle basis. Target is to increase the shipyard competitiveness. Research seeks to reduce manufacturing costs, production lead-times and maintenance costs of the ship structure.

The main objective is to design three different types of new generation vessels by integrating different aspects of ship structural design into one formal framework. The nature of shipbuilding in Europe is to build small series of very specialized ships. Following this, IMPROVE consortium identified next-generation prototypes of a large RoPax ship, a product/chemical carrier and an LNG carrier with reduced ballast tanks as the most suitable vessels to study (see Annex 1).

The operators using these ships generally operate them for the most of the ships' life, making maintenance characteristics of the design very important. Therefore, IMPROVE aimed to design for lower operation costs. Designing ship structure in such a way as to reduce problems such as fatigue can help in this cause. Additionally, designing for minimal operational costs helps to increase structural reliability and reduction of failures thus increasing safety.

The full life-cycle design approach is the key issue in future design of ship structures. So IMPROVE proposes coupling of decision-support problem (DSP) environments (multi-attribute and multi-stakeholder concurrent design problem) with life-cycle analysis, while deploying modern advanced assessment and design approaches. Ship-owners

want to minimize short term investments but above all maximize their long term benefits. Currently however, design of ships considers the life-cycle costs with limitations, thus opening doors for significant improvements with respect to ship's economics and her competitiveness. Formal integration of the life-cycle cost in the design procedure and creating a long-term competitive ship could be used as a valid selling argument.

An integrated decision support system (DSS) for the design of ship structures can assist designer in challenging this task. This novel design approach considers the usual technical requirements, but also producibility, production cost, risk, performance, customer requirements, operation costs, environmental concerns, maintenance and the life-cycle issues. IMPROVE has developed this new design environment. The purpose is not to replace the designer but to provide experienced designers with better insight into the design problem using advanced techniques and tools, which give quantitative and qualitative assessment on how the current design satisfies all stakeholders and their goals and requirements.

Keeping in mind that IMPROVE focuses on the concept/preliminary design stage, since the main functionally and technologically driven parameters are defined in the concept design stage.

2.2 Scientific and technological objectives of the project

In order to improve their competitiveness, the European shipbuilding industry and ship-owners/operators need development of new generations of ships (products) for the most valuable and significant transportation needs:

- multimodal transport of goods (advanced generic RoPax),
- transport of energents (gas, oil)/chemicals (advanced gas carriers and chemical tankers).
- This should be achieved through the application of:

- multi-stakeholder and multi-attribute design optimization
- risk-based maintenance procedures,
- manufacturing simulation,
- and immediately used in the practice for ship design, production and operation.

Motivation came also from the fact that the IMPROVE members were surprised by the constant quest for revolutionary products, while the wisdom of quality product improvement based on the mature design procedures was not been properly harvested. For example, by using advanced optimization techniques, significant improvements in the design and production are available but still not used.

Now the feasibility of such potential improvements have been proved and confirmed owing to the three practical ship designs done by IMMPROVE, i.e:

- Early definition of requirements and measures of design quality:
- Generation of sets of efficient competitive designs and displaying them to the stakeholders for the final top-level selection.
- Selection of preferred design alternatives by different stakeholders, exhibiting measurable and verifiable indicators, defined as “Key Performance Indicators” (KPI). At the start of the IMPROVE project, it was expected that the generated design alternatives will experience the following improvements:
 - o Increase in carrying capacity of at least 5% of the steel mass (about 15% may be expected for novel designs) compared to design obtained using classical methods,
 - o Decrease of steel cost of at least 8% (and more for novel designs) compared to the design obtained using classical methods,
 - o Decrease of production cost corresponding to standard production of more than 8-10% and even more for novel designs,
 - o Increase in safety measures due to rational distribution of material and a priori avoidance of the design solutions prone to multimodal failure,
 - o Reduced fuel consumption,
 - o Improved operational performance and efficiency, including a benefit on maintenance costs for structure (painting, corrosion, plate/stiffener replacement induced by fatigue, etc.) and machinery.

Now, the project is over. Even if all these objectives have not been reached, a significant part has been achieved (see here after).

2.3 Long-term benefit of IMPROVE

The long-term goal of the project is to improve design methodology by concentrating effort on advanced synthesis skills rather than improving multiple complex analyses. It has been shown that the structural design must integrate various technical and non-technical activities, namely structure, performance, operational aspects, production, and safety. Otherwise, it is highly possible to define a ship design which is difficult to produce, requires high amounts of material or labor, contains some design flaws, or may be not cost-effective in maintenance and operation. Additionally, ships can be robust, with high performance in cost and customer requirements criteria.

2.4 The IMPROVE Methodology

IMPROVE is based on existing design platforms and analytical tools, which allow partners to use simulation and visualization techniques to assess ship performance across its lifecycle. IMPROVE has implemented in these platforms an advanced decision support system (including optimization capabilities) by coupling the decision-based design (multi-attribute and multi-stakeholder concurrent design problem) with the life-cycle analysis.

3 FUNDAMENTAL DESIGN SUPPORT SYSTEMS IN IMPROVE

The following three design support systems (DSS) are used in IMPROVE:

The LBR5 software is an integrated package to perform cost, weight and inertia optimization of stiffened ship structures, *Rigo (2001, 2003), Rigo and Toderan (2003)*, allowing:

- a 3D analyses of the general behavior of the structure (usually one cargo hold);
- inclusion of all the relevant limit states of the structure (service limit states and ultimate limit states) in an analysis of the structure based on the general solid-mechanics;
- an optimization of the scantlings (profile sizes, dimensions and spacing);
- a production cost assessment considering the unitary construction costs and the production sequences in the optimization process (through a production-oriented cost objective function);

LBR5 is linked with the MARS (Bureau Veritas) tool. MARS data (geometry and loads) can be automatically used to establish the LBR5 models.

Only basic characteristics such as L, B, T, C_B, the global structure layout, and applied loads are the mandatory required data. It is not necessary to provide a feasible initial scantling. Typical CPU time is 1 hour using a standard desktop computer.

MAESTRO software combines rapid ship-oriented ship structural modelling, large scale global and fine mesh finite element analysis, structural failure evaluation, and structural optimization in an integrated yet modular software package. Basic function also include natural frequency analysis, both dry mode and wet mode. *MAESTRO*'s core capabilities represent a system for rationally-based optimum design of large, complex thin-walled structures. In essence, *MAESTRO* is a synthesis of finite element analysis, failure, or limit state, analysis, and mathematical optimization, all of which is smoothly integrated under an ease-of-use of a Windows-based graphical user interface for generating models and visualizing results.

OCTOPUS is a concept design tool developed within MAESTRO environment, *Zanic et al. (2002, 2004)*. Concept design methodology for monotonous, tapered thin-walled structures (wing/fuselage/ship) is including modules for: model generation; loads; primary (longitudinal) and secondary (transverse) strength calculations; structural feasibility (buckling/fatigue/ultimate strength criteria); design optimization modules based on ES/GA/FFE; graphics.

CONSTRUCT is a modular tool for structural assessment and optimization of ship structures in the early design stage of ships. It is primarily intended for design of large passenger ship with multiple decks and large openings in the structure. It is also applicable for ships with simpler structural layouts as those tackled in IMPROVE. CONSTRUCT can generate a mathematical model of the ship automatically, either through import of structural topology from NAPA Steel or the topology can be generated within CONSTRUCT.

CONSTRUCT applies the method of Coupled Beams, *Naar et al. (2005)*, to rapidly evaluate the structural response, fundamental failure criteria, i.e. yielding, buckling, tripping, etc., and omni-optimization procedure for generation of competitive design alternatives, *Klanac and Jelovica (2007)*. CONSTRUCT at the moment can apply VOP algorithms to solve the optimization problem, *Klanac and Jelovica (2009)*.

The philosophy behind CONSTRUCT is outmost flexibility. Therefore, it can concurrently tackle large number of criteria, either considering them as objectives or constraints, depending on the current user interests. Design variables are handled as discrete values based on the specified databases, e.g. table of bulb profiles, stock list of available plates, etc. Also, new computational modules can be easily included, e.g. to calculate crashworthiness of ships.

4 CONTRIBUTION TO ENHANCING THE STATE-OF-THE-ART IN SHIP STRUCTURE OPTIMIZATION

4.1 *Enhancement of the rational ship structure synthesis methods and DSP approaches*

IMPROVE has developed new mathematical optimization methods. IMPROVE focused on the DSS based approach to the design of ship structures and not on search algorithms. IMPROVE aimed for more efficient use of the available optimization packages and their integration in the design procedure. IMPROVE focused on the methodology/procedure that a designer and shipyard should follow to improve efficiency in designing, scheduling and production of ships. This methodology was used to enhance the link between design, scheduling and production, with close link to the global cost. IMPROVE has confirmed that it is only through such integration that specific optimization tools can be proposed to shipyards to improve their global competitiveness.

4.2 *Enhancement of particular multidisciplinary links in the synthesis models*

The IMPROVE DSS-based approach has enhanced:

- Link of “design” with “maintenance and operational requirements” which may differ from the shipyard interest
- Link of “design procedure” with “production” through an iterative optimization procedure
- Link of “design procedure” with “cost assessment” and therefore drive the design to a least-cost design (or a least weight if preferred)
- Link of “production” with “simulation” and therefore drive the design to a higher labor efficiency and a better use of man-power and production facilities

4.3 Enhancement of confidence in the structural DSS approaches through the development of three innovative ship products

IMPROVE has enhanced the present design procedure state-of-art using new improved synthesis models and has

- demonstrated the feasibility on an increase of the shipyard competitiveness by introducing multi-disciplinary optimization tools,
- demonstrated acceleration of the design procedure by using integrated tool such as LBR5,
- Proposed new alternatives to designs that may or may not fit with standards and Class Rules. Such revised designs have to be considered by the designers as opportunities to “reconsider the problem, its standards and habitudes”, to think about the feasibility of alternative solutions, etc.
- validated newly developed design approach tested on three real applications (RoPax, LNG carrier, chemical tanker) by associating a shipyard, a classification society, a ship owner and a university.
- enhanced modeling of advanced structural problems in the early-design optimization tools (e.g. crashworthy hull structure, ultimate strength, vibration, fatigue limit state in structures, sloshing load).

5 RESEARCH WORKS PERFORMED WITHIN IMPROVE

IMPROVE includes 7 inter-dependent work packages (WP2-WP8). The schematic representation of these WPs with the exchanges of information/data is shown in Fig. 4.

Figure 4. The IMPROVE flowchart

5.1 Problem & Model Definition (WP2)

In WP2, the consortium defined the structure of the integrated framework for design of ship structures to increase the functional performance and to improve manufacturing of those designs. The core of this WP was to identify rational decision making methods for the use in the design of ship structures within the shipyard environment.

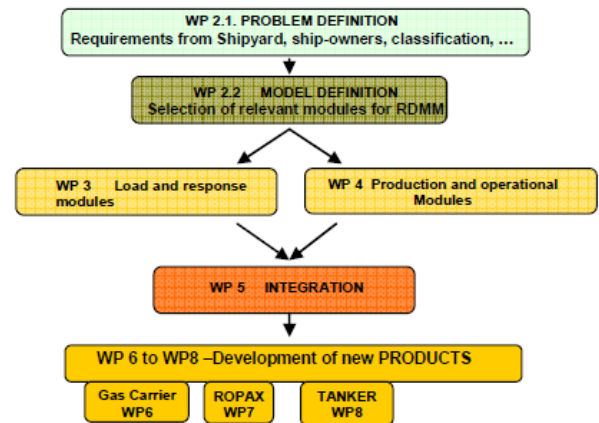

Figure 4. The IMPROVE flowchart

- Specific objectives of this work package were:
- Definition of the multi-stakeholder framework in design of ship structures,
- Definition of particular interests of stakeholder for the specific application cases,
- Definition of design criteria (objectives and attributes), variables and constraints,
- Identification and selection of methods to solve the structural, production and operational issues affecting design,
- Synthesis of needed actions into a framework.

One of the significant and valuable results of IMPROVE is the extensive list of design objectives and design variables selected for the concerned ships (which has been published by the ISSC international scientific association). Quality measures, key performance indicators and potential selected tools were also listed.

5.2 Load & Response Modules (WP3)

In WP3 the load and response calculation modules were identified. These modules were selected and upgraded to fit with the design problems and design methods identified in WP2. For instance with the 11 loads and response modules identified in WP3, there are:

- Response calculations for large complex structural models, including equivalent modeling
- Very fast execution of numerous safety criteria checks, including ultimate strength, vibration, based on library of various modes of failure under combined loads.
- Module accommodation for calculation of structural redundancy, vibration and stress concentration for fatigue assessment.

5.3 Production & operational modules (WP4)

A new module for tankers was developed to assess the life cycle impacts, applying simple and advanced existing tools, *Rigo (2001)*, *Caprace et al. (2006)*. The WP tasks contained the following activities:

- Implementation of a operation and life-cycle cost estimator for tanker vessels,
- Implementation of a production simulation to assess the impact of different design alternatives on the fabrication,
- Implementation of a production cost assessment module to calculate of workforces needed for each sub assemblies used inside the production simulation.

In the framework of IMPROVE all these tools were integrated into the global decision tools.

5.4 Modules Integration (WP5)

Main features of the IMPROVE Integration Platform are:

- A design desktop as central component and control centre,
- All calculations can be initiated and their results can be stored project-wise,
- Iterations and comparisons will be supported,
- Applications and file exchange organized based on workflow definition..

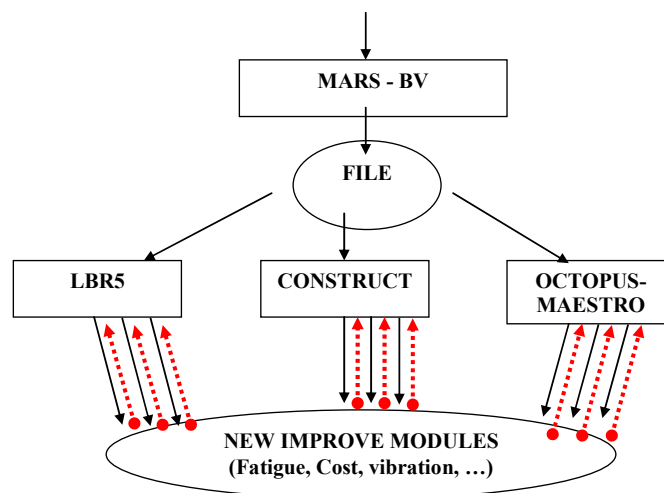

Figure 5. The IMPROVE optimization approach

As MARS-BV is used by most of the partners, the MARS-BV database becomes the reference data concerning geometry and loads. This means that all the module interfaces (fatigue, vibration, cost, ...) have considered the MARS data as reference data, Fig.5. Of course, additional specific data were required to make the link with the optimization tools (LBR5, CONSTRUCT, OCTOPUS)

6 LNG Carrier – “An innovative concept for a large liquefied natural gas carrier (LNGC)”

A new forward-looking design for a 220,000m³ capacity liquefied natural gas carrier (Fig 6) has emerged as part of the EU-funded IMPROVE project, following a study by STX France S.A.

Over recent years, the Saint-Nazaire shipyard (formerly Chantiers de l’Atlantique), currently STX France S.A., has designed and built several LNG carriers for different shipowners implementing innovative ideas such as the first

diesel-electric dual-fuel LNG carrier. Continuing a long tradition of innovation, the French shipyard proposes once more a new design concept for liquefied natural gas carriers.

The Saint-Nazaire shipyard’s designers propose a solution to reduce the need for ballasting in order to prevent biological invasions of marine organisms transported in ballast water and sediment transfer. Moreover, energy and thus money will be saved by decreasing the huge amounts of sea water transported, almost unnecessarily.

As part of the IMPROVE project, STX France has been meticulous in addressing a host of vessel attributes that add up to a state of the art ship design for LNG transportation.

These range from ensuring the large cargo carrying capacity within minimum dimensions, the observance of best practice in shipbuilding, high levels of safety, economic feasibility, low maintenance, high crew comfort, and security in terms of environmental protection.

The standard LNGC features, such as a complete double-hull, worldwide trade, speed of 19.5 knots or the accommodation quarters in the aft part are maintained. The ship will also feature five membrane cargo tanks, with suitable cofferdams.

The innovative part is a change of the hull shape in combination with an adapted with type of propulsion unit.

The solution is based on a V-shape hull and pod type propulsion technology to make the need for ballast water unnecessary in good sea way conditions. The special hull form allows a sufficient draught in most loading condition with a reduced volume of ballast water.

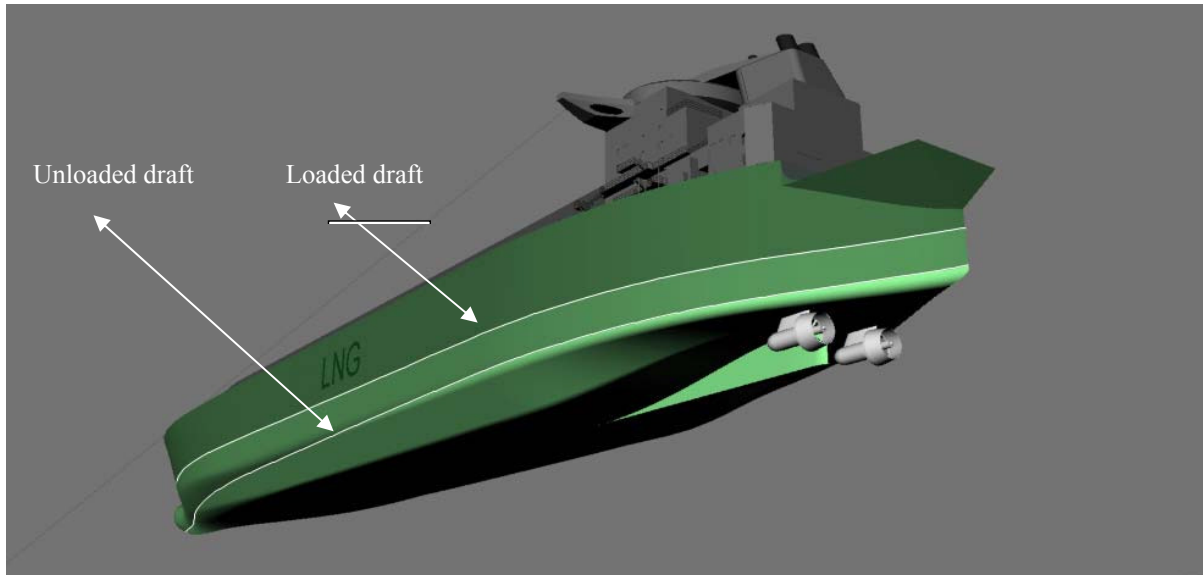

Figure 6. The STX France new concept suggests a 'two-draught' vessel, using minimal or even no ballast water in the unloaded condition

Ballast difference

A conventional design for such a LNGC size requires more than 65,000 tons of ballast water. There are sea water ballast tank (SWBTs) arranged in the double-hull tanks, forward and aft.

In the STX design, in the unloaded condition, the ship will be able to sail with a minimum volume of sea water, or even with none at all. The use of these SWBTs is in stark contrast to ballast tanks onboard a conventional LNG carrier, where the vessel is either full of LNG with empty SWBTs ("loaded") or empty of LNG with full SWBTs (unloaded).

The SWBTs may be called upon in two particular situations only:

- Situation 1: during the loading/unloading operations of LNG, to reach a draught to be within the range of the loading arms.
- Situation 2: if the vessel meets bad weather conditions during a voyage and the master wishes to achieve a safer sailing condition from his point of view.

Whatever the particular situation, the design means that the ship will not have to renew or clean the sea water within the SWBTs when the ship is sailing. In short, this can be envisaged as;

- In the situation 1: used sea water is discharged before departure or in a zone close to the terminal at the beginning of the sailing.
- In the situation 2: sea water used to reach a safer situation is considered as clean.

Thus the International Maritime Organization (IMO) recommendation to treat the ballast water is fulfilled or respectively not needed.

Machinery

A diesel-electric power station is proposed using engines four-stroke dual-fuel (running on boil off gas or marine diesel oil) at 514 revs/min. At the start of the project, this thinking was based on the dual fuel engines supplied by Wärtsilä although, since the study began, other dual fuel main engines options have surfaced from MAN Diesel.

For the propulsion itself, two electric engines within two CONVERTEAM may be used. Other types of propellers

may also be considered, subject to further studies, according to STX France.

Cargo containment

The proposed containment system is of the membrane type, five (5) tanks based on Gas Transport and Technigaz (GTT) technology. Sloshing problems will be avoided by following the GTT and classification society requirements.

The insulation of the cargo tanks has been designed to give a natural boil-off-rate (BOR) to about 0.135 % (per day) of the loaded cargo volume.

Other containment solutions with independent tanks such as Aluminium Double Barrier Tank (ADBT) are possible and adaptable to the ship design with further studies.

The hull form is designed with more than 80 % of developable surfaces, and minimizes the cost of production of the hull.

For a conventional LNGC the exploitation conditions are 50 % of the time in a loaded condition and 50 % of the time in an unloaded condition. For the STX France design, the partition of the exploitation conditions are the same but, within the unloaded condition, 80 % of the time only a minimum volume of sea water is required, which may be nil, and the remaining in considered with full SWBT.

Under such assumptions, around 8.6 tons of LNG used as fuel can be saved per day. This is equivalent to a 9 % saving when compared to a diesel electric dual fuel LNG carrier with about the same size and conventional features.

STX France is currently designing other LNGC size such as & “medmax” LNGC with the same principle.

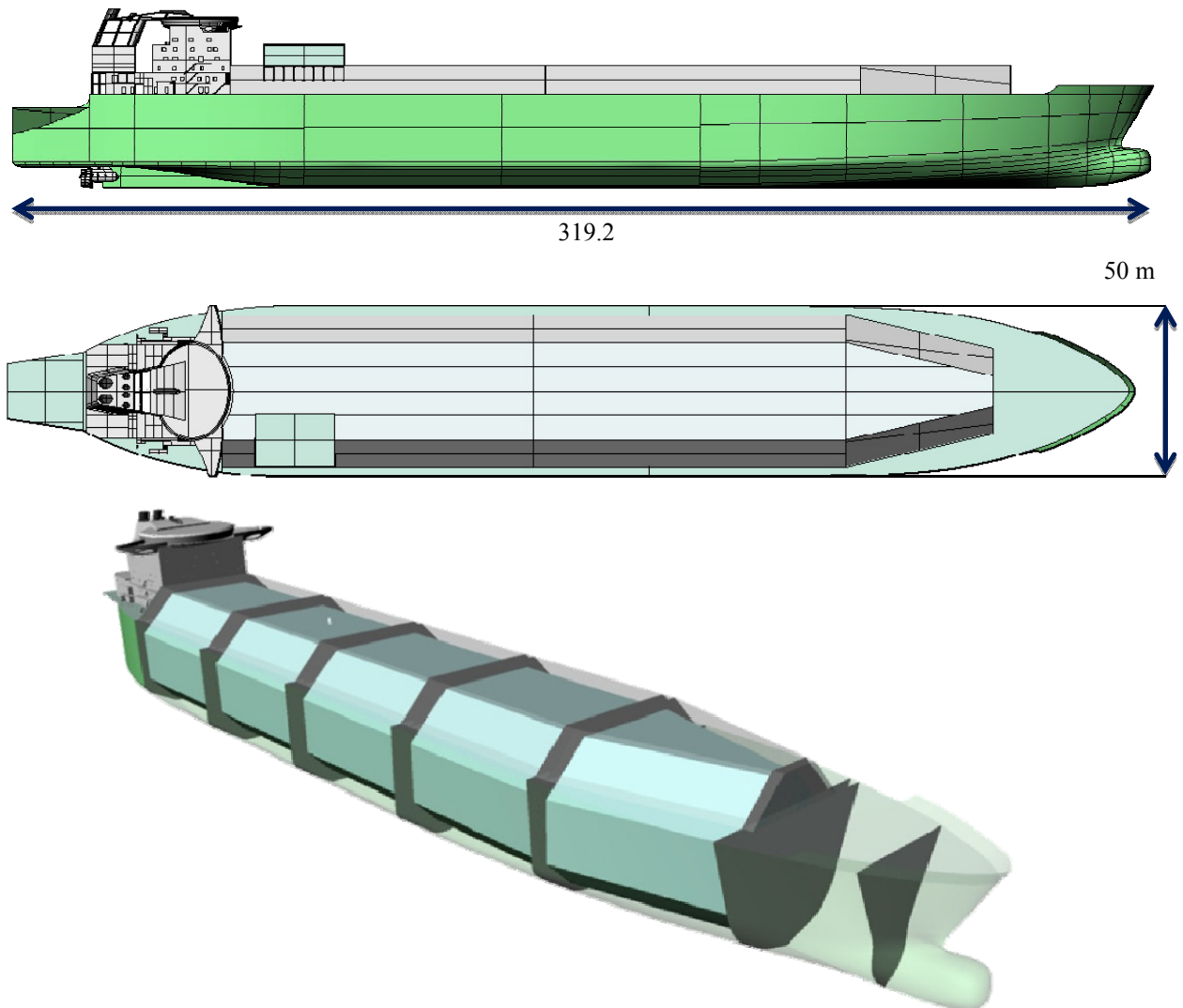

Figure 7. The LNG with five cargo tanks, offering a large capacity of 220,000m³, with length limited to 319.

Structural optimisation (least weight, least cost)

In the framework of IMPROVE the scantling of the cargo tanks has been optimized (including frame and stiffener spacings), considering sloshing assessment performed by BV.

The least weight optimization (objective function being the minimization of the weight) reveals a potentials gain of

the order of 15 % (including the cofferdams). Concerning the production cost (least cost optimisation) the gain is around 5%.

Production simulation

Simulation of the assembling in the St Nazaire dry dock has been performed to validate the scheduling. Figure 8 shows the status after 120 days and 420 days

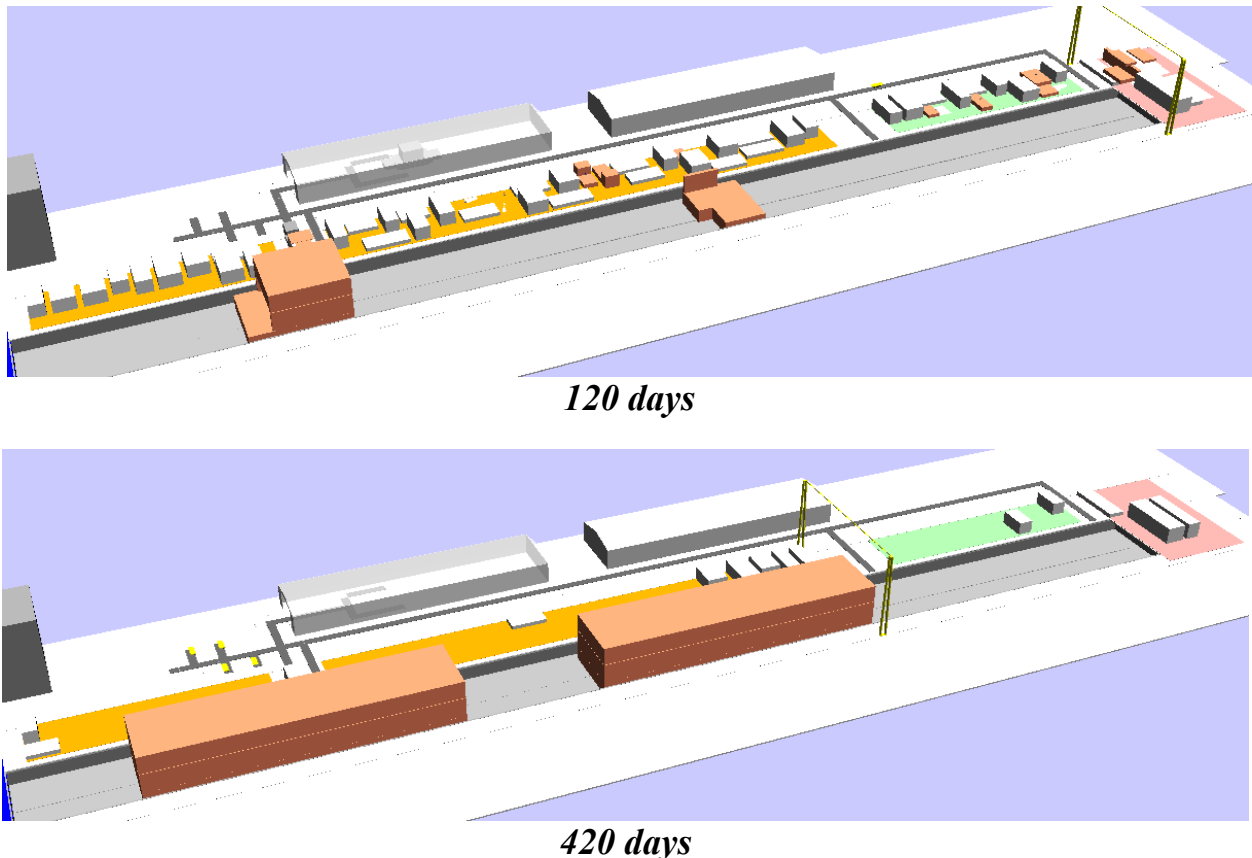

Figure 8. Simulation model at different processing times

7 ROPAX

An innovative ROPAX design with capacity for 3000 lane metres of freight and 300 cars, plus 1600 passengers was designed (Figure 9)

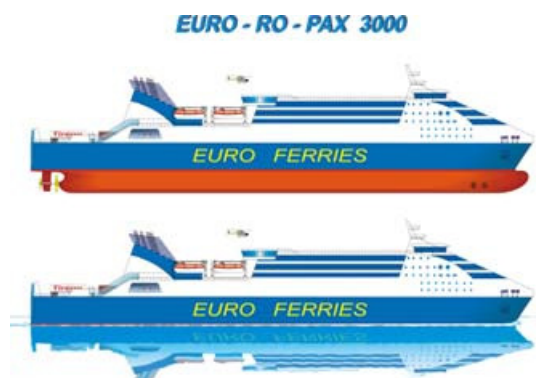

Figure 9. IMPROVE RO-PAX DESIGN

The design was based on a successful existing design of a STANDARD SHIP used as a prototype. Then a NEW SHIP was designed during the first period of the project. This design was improved in terms of main particulars, general arrangement, hydrodynamic and propulsion performance. Then IMPROVE SHIP was designed based on the NEW SHIP design using multi-criteria structural optimisation including production and maintenance models. The leading partner for the design of the IMPROVE Ro-Pax vessel is a highly experienced car-carrier, con-ro and ro-pax shipbuilding yard. Extensive multi-objective structural optimisation of a Ro-Pax structure using OCTOPUS-MAESTRO software was performed resulting in the developing a ship design with minimum initial cost, minimum weight, high level of safety, while also satisfying structural constraints such as yielding, buckling, displacements, and ultimate strength of hull girder

and ship panels. Meanwhile, large operational savings were realized due to the adoption of a novel propulsion concept. The main dimension criteria required a ship with a maximum length of slipway 230m, and maximum breadth given as 30.40m which were satisfied. In response to feedback from owners, the new vessel was developed for Mediterranean Sea operations. The vessel was designed for load carrying flexibility and improved operational performance and efficiency as compared to the existing (STANDARD) ships. The design also achieved redundancy and simplicity of systems; improved manoeuvrability; optimised sea-keeping performance; maximised comfort and minimised vibrations. Following ship-owners' feedback, the vessel was designed with 8% increase in carrying capacity (lane metres) on the tank top by decreasing the length of the engine room. This involved development of a new stern design. Within set requirements the design considered large variations in seasonal trade (summer 3000pax, winter 100pax).

A mono-hull was selected that features a superstructure that may be constructed using steel or composite but not aluminium. Ultimate vessel dimensions were optimised to improve hydrodynamic performance, while a slow-speed main engine was selected to reduce maintenance costs and fuel consumption

Other challenges which were successfully tackled were:

- A minimum height of deck transverses.
- Improvement in design using existing and improved tools for early design phase
- Rule calculation and simplified CAD modelling leading to simplified FEM and LBR5 modelling.
- Minimum weight of freeboard deck transverses.
- Minimum height of deck No.3 and deck No.4 transverses.
- Accurate calculation at the early design stage of building tolerances and deformation constraints.
- Superstructure deck effectiveness in the longitudinal strength.
- Web frame spacing and longitudinal spacing optimisation.
- No pillars in the cargo space area.

Furthermore the design has been optimised in terms of lifecycle maintenance costs over a 25 year period. The

design also takes into account the probability of a potential conversion after 10 years due to new rules or comfort standards (thus the current ship's design is flexible enough for easy conversion). Cargo handling is of the traditional type with stern door and internal ramps. In terms of seakeeping performance improvement no fin stabilisers have been fitted, instead the design caters for internal active stabiliser tanks. The design offers an estimated 10% reduction in production costs, 12% reduction in fuel oil consumption and 10% reduction in the expected maintenance costs. The production process has been simplified via standardisation, increase in subassembly activities and reducing hull erection time on berth from 18 to 9 weeks (plus three weeks for completion). Production costs are further reduced by decreasing the number of erection blocks from 330 to 130 blocks, with all parts painted prior to the erection.

For the new design, extensive structural analyses (global and detailed FE analysis) were performed to evaluate structural feasibility and eliminate hot spots and stress concentration problems. The arrangement of cargo space without pillars required sophisticated structural solutions. Reducing the height of deck structure was also proved to be a very demanding task. However it was beneficial as the final design offers:

- Lower VCG (better stability).
- Reduced light ship weight (increased deadweight).
- Lower gross tonnage.

The main challenge was to improve rule structural design at the early stages of design (conceptual design stage). Rule structural design was improved at the conceptual stage and the optimal design solution was chosen using tools developed within IMPROVE. The design process, at the preliminary stage, involved detailed FEM analyses on the optimum design. Regarding the general ship design the other design characteristics included:

Selection of low resistance hullform for reduced fuel consumption, Figure 10.

Smaller propulsion engine for same speed.

Design of hullform to reduce length of engine room (increased length of cargo space), Figure 11

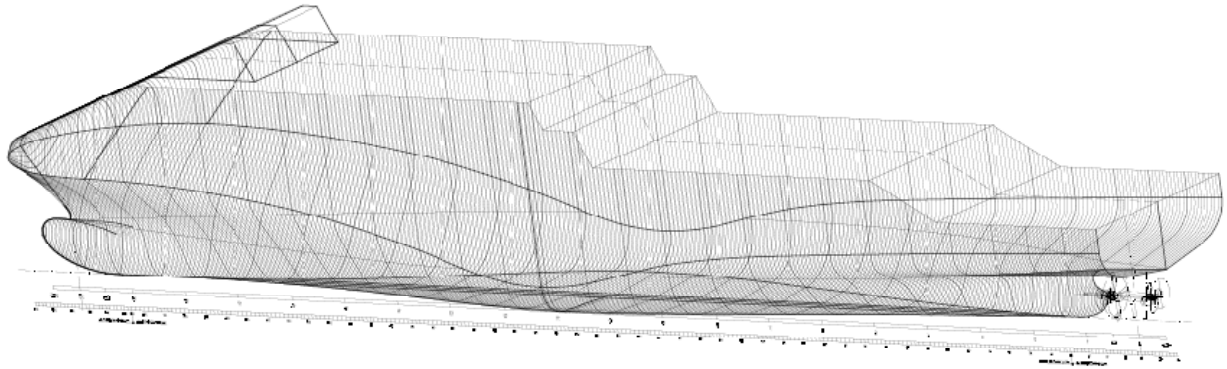

Figure 10. Body Lines of New ROPAX Ship

The length of engine room was reduced (increased length of cargo space). Small Main propulsion engine was chosen which allows for a smaller engine room i.e. more cargo space available. A comfort-friendly hull form and general arrangement were designed. Various structural arrangements were analyzed by the shipyards and universities involved as a multi-objective design problem i.e. accommodations - two and three tiers. Lower garage breadths - 15.36 m, 16.56 m and 17.76 m. The design with two superstructure decks and additional car space was finally selected (Version 2). In total number six ro-pax ship model designs were investigated. Structural FEM optimization was performed for three modules per model between frames 72

and 200. Optimization modules contained a total number of 9 decks for the first accommodation layout and 8 for the second one. Only the 5th deck was not modeled because it is a mobile deck thus does not contribute in ship's strength. Ramps linking decks were also not modeled. The lower cargo hold is enclosed between transverse bulkheads at frames 72 and 200, inner bottom and deck 3 and two longitudinal bulkheads. Its height mainly depends on its breadth (based on damage stability criteria). In the conceptual design phase structural elements forming longitudinal bulkheads between decks 6 and 9 (6 and 8 for second layout) were ignored during the optimization.

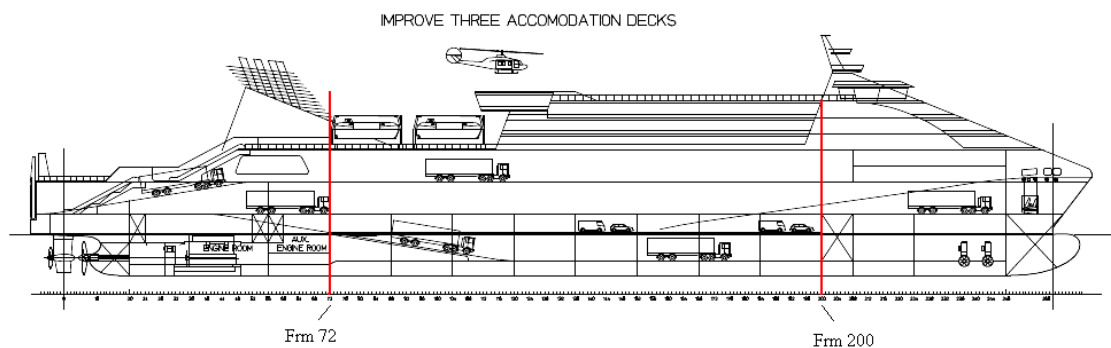

Figure 11. IMPROVE RO-PAX deck arrangement (version 2)

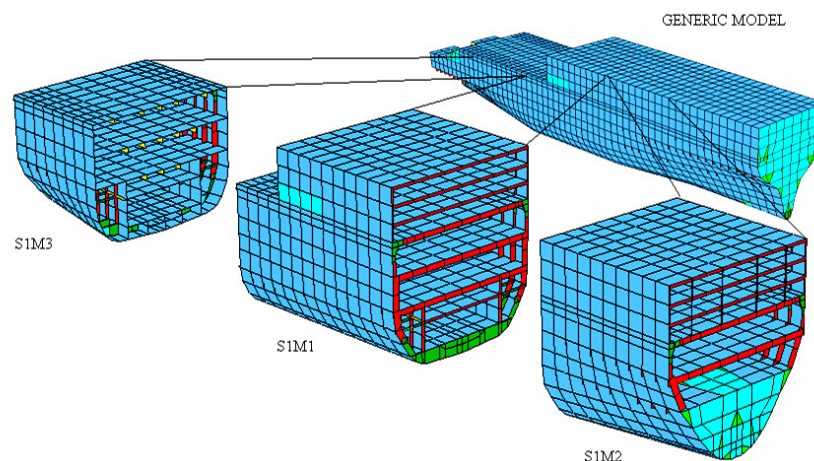

Figure 12. Selected ship zone for structural optimization

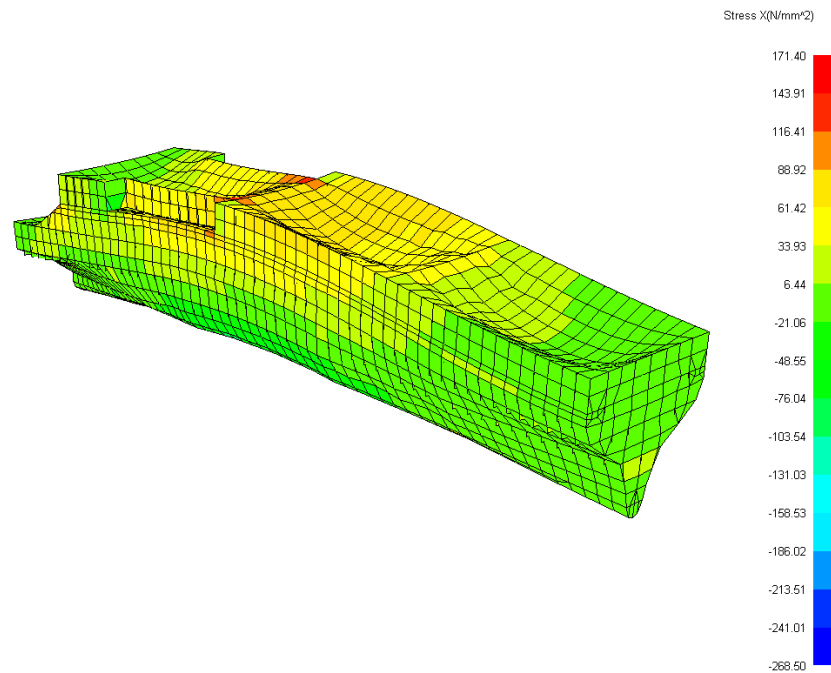

Figure 13. σ_x stresses

Four load cases were defined for the FEM models, Figure 13, based on BV classification requirements

In terms of the propulsion system, two propulsion system options were the most suitable:

- Option 1.
 - A slow speed main engine directly coupled to fix pitch propeller.
 - An active rudder/azipod with propulsion bulb to increase main propeller efficiency.
- Option 2
 - Two medium speed main engines coupled via gearbox to CP-propeller.
 - Two retractable side thrusters.

The aim was to minimize the need of running of electrically driven thrusters in seagoing condition i.e. use them only during manoeuvring in harbour to eliminate the need for tugs. Thus obtain a 100% redundancy notation. The owners' basic requirement was that ship must never stop. The owners preferred the configuration of two main engines coupled via gearbox to one CP-propeller (Option 2). This arrangement gives the ability to operate vessel with one main engine running and carry out maintenance on the other main engine.

CONCLUSIONS

An innovative ropax design has been created following a multi-stakeholder approach where shipyards and ship-

operators were involved. Structural design satisfies Bureau Veritas (BV) rules. To maximize the key performance indicators (KPI) for a ropax product various aspects of ship structural designs were integrated into the multi-criteria optimization process via several modern tools developed within IMPROVE EU project. The design was based on a successful existing design of a STANDARD SHIP used as a prototype. The design has significant advantages as compared with traditional ropax ships including improved redundancy and simplicity of systems; manoeuvrability; optimised sea-keeping performance; maximised comfort and minimised vibrations. Following ship-owners' feedback, the vessel was designed with an 8% increase in carrying capacity (lane metres) on the tank top by decreasing the length of the engine room. Within set requirements the design considered large variations in seasonal trade (summer 3000pax, winter 100pax).

8 CHEMICAL TANKER

The third product being developed under the IMPROVE project is a chemical Tanker suitable to carry chemical cargoes IMO type I/II/III, petroleum products, vegetable animal and fish oils and molasses.

A new generation design of a 40,000dwt chemical tanker (Fig 14, Fig 15) has emerged as an outcome of the IMPROVE project. Advanced synthesis and analysis techniques at the earliest stage of the design process were used considering structure, production, operational performance, and safety criteria on a concurrent basis.

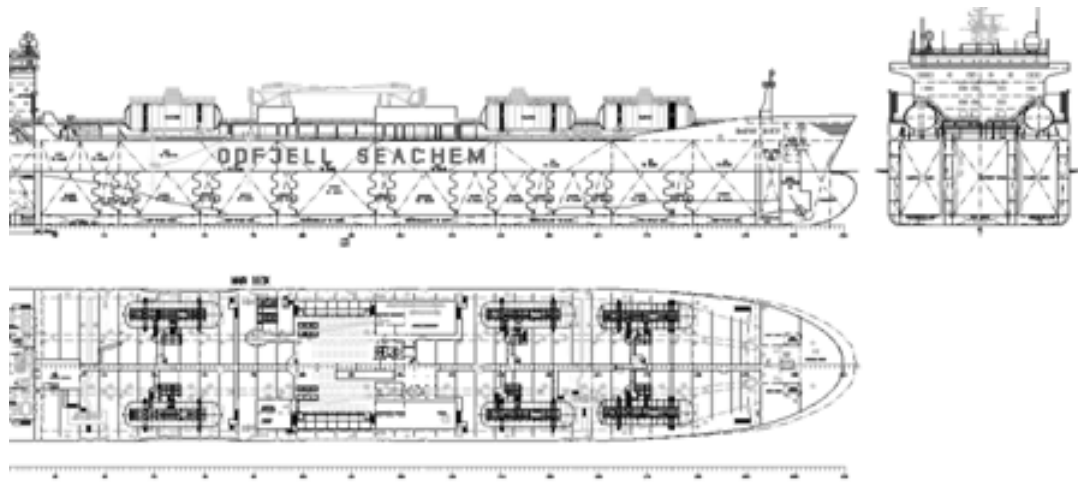

Figure 14. 40 000 DWT chemical tanker by SSN (Poland)

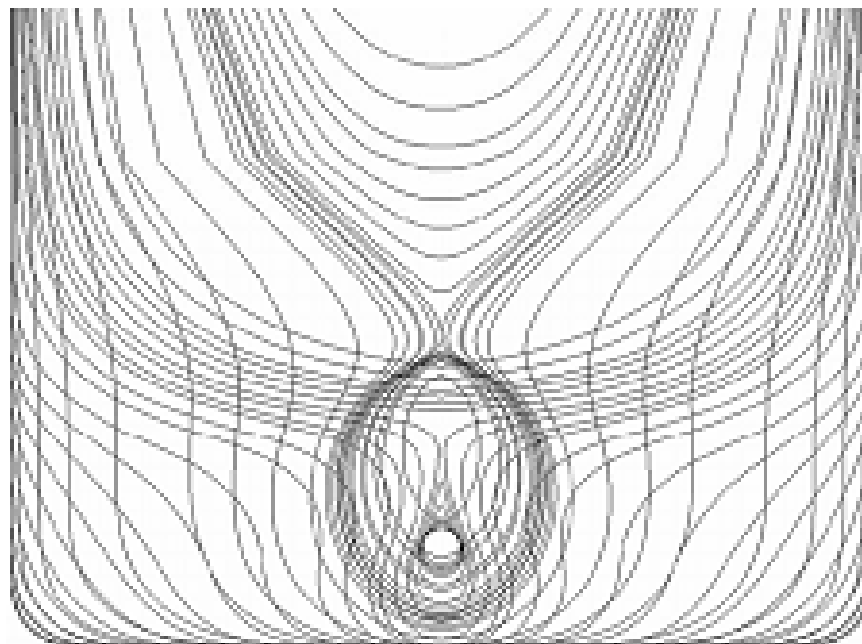

Figure 15. Body plan of IMPROVE Chemical Tanker

- 1) The first phase was attributed to the identification of stakeholder's requirements and the definition of key performance indicators. The project partners (particularly the shipyards) designed reference or prototype ships. As part of this phase, it was realised that operators require ships with the longest possible lifetime and that this can be achieved by improving quality and performance. The main design objectives were the reduction of manufacturing costs and production lead-time as well as the reduction in the structural maintenance costs for ship owners. Several calculations were performed to test existing tools and identify potential gains at the conceptual stage of design.
- 2) The second phase was concerned with the development of new modules to be integrated in

- the optimization tools in order to satisfy the requirements defined in the first phase. All technical developments were based on selected structural optimization tools. Several modules such as fatigue assessment, vibration level investigation, ultimate strength, load assessment, production cost and maintenance cost reduction were delivered and integrated into existing tools e.g. LBR5, OCTOPUS, CONSTRUCT, etc.
- 3) The final phase was the application of the new (improved) optimization tools for the final chemical carrier design. In brief IMPROVE delivered an integrated decision support system for a methodological assessment of ship designs. This system provided a rational basis for making decisions regarding the design, production and

operation of a highly innovative chemical carrier. This support system can be used make careful decisions that can contribute to reducing the life-cycle costs and improving the performance of a ship. Based on this system all the aspects related to the general arrangement, propulsion, hull shape and dimensioning of the structure were investigated.

The relation between structural variables and relevant cost/earning elements has been explored in detail. The developed model is restricted to the relevant life-cycle cost and earning elements, namely production costs, periodic maintenance costs, fuel oil costs, operational earnings and dismantling earnings. The maintenance/repair data were collected from three ship operators and were used for the purposes of a regression analysis. The design is based on a multi-objective optimisation of the structure using guided search versus conventional concurrent optimisation. The results of the adopted approach were compared with the conventional concurrent optimisation of all objectives utilising genetic algorithm NSGA-II. The results showed that the guided search brings benefits particularly with respect to structural weight, which is normally a very challenging parameter to successfully optimize.

IMPROVE partner shipyard based the design on a reference design, the B588-III chemical carrier, aiming mainly to achieve lower building costs. The following alternatives of the reference design were considered:

Alternative 1

- Main dimensions as in original design B588-III.
- Wing cargo tanks made of mild steel instead of Duplex steel.

- Reduction of number of centre cargo tanks from eighteen to twelve.
- Reduction of service speed to 15.0 kn.
- Not including a shaft generator.

Alternative 2

- Reduction of cargo tanks capacity to abt. 45 000 m³.
- Removal of cofferdam bulkheads and replacing them by vertically corrugated bulkheads.
- Reduction of depth of the vessel to 15.0 m.
- Using of Duplex steel for centre tanks only.
- Removal of six deck tanks.
- Reduction of service speed to 15.0 kn.
- Not including a shaft generator.

Alternative 3

As Alternative 2 apart from the arrangement of Duplex tanks which are arranged in the middle part of the vessel / wing and centre tanks.

Calculation of building costs done based on 2007 market data showed that the most effective cost reduction was realised adopting Alternative 3. Thus the partners decided to develop this design and optimize it using IMPROVE tools. The seakeeping analyses, based on this design, indicated that in general, the vessel is expected to exhibit good seakeeping characteristics as most of the worst response modal periods are either far off from the dominant wave periods or wave headings may be adjusted to avoid severe responses. A thorough fatigue analysis was implemented. The hull optimization resulted in significant production cost reduction. Life cycle costs were also assessed

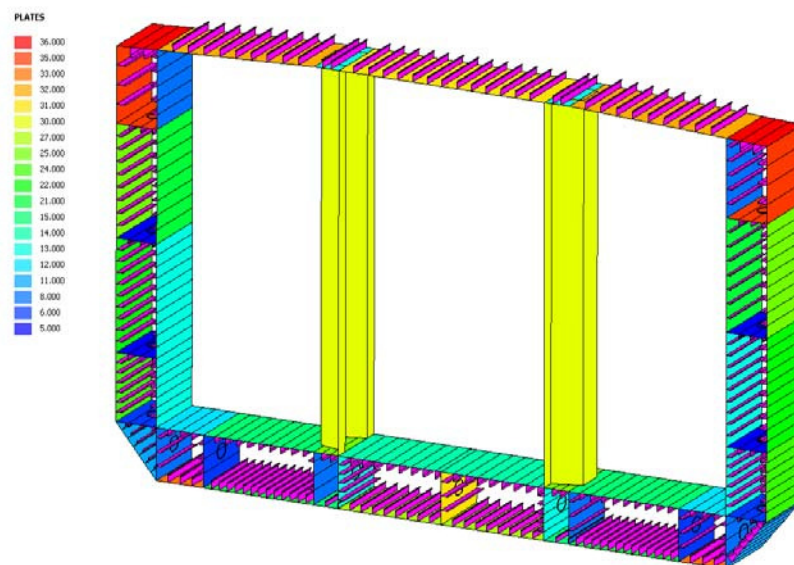

Figure 16. Structural assessment of the Chemical Tanker

Analyses also showed that the IMPROVE Chemical Tanker satisfies the stability requirements of applicable rules and regulations (Figs 16 and 17).

For the optimization of cargo tank arrangement the main target was to reduce the quantity of Duplex steel to minimize cost. For the final design the total optimum number of Duplex stainless steel tanks is eighteen with varying capacities. Duplex stainless steel cargo tanks are separated from the mild steel cargo tanks by cofferdams.

Moreover longitudinal bulkheads are vertically corrugated and transverse bulkheads may be vertically or horizontally corrugated. Interfaces between longitudinal vertically corrugated bulkheads and transverse horizontally corrugated bulkheads were subjected to FEM analyses.

Calculations of cargo tanks capacity and arrangement for three different specific gravities of acid 1.50, 1.65, and 1.85 t/m³ have been performed

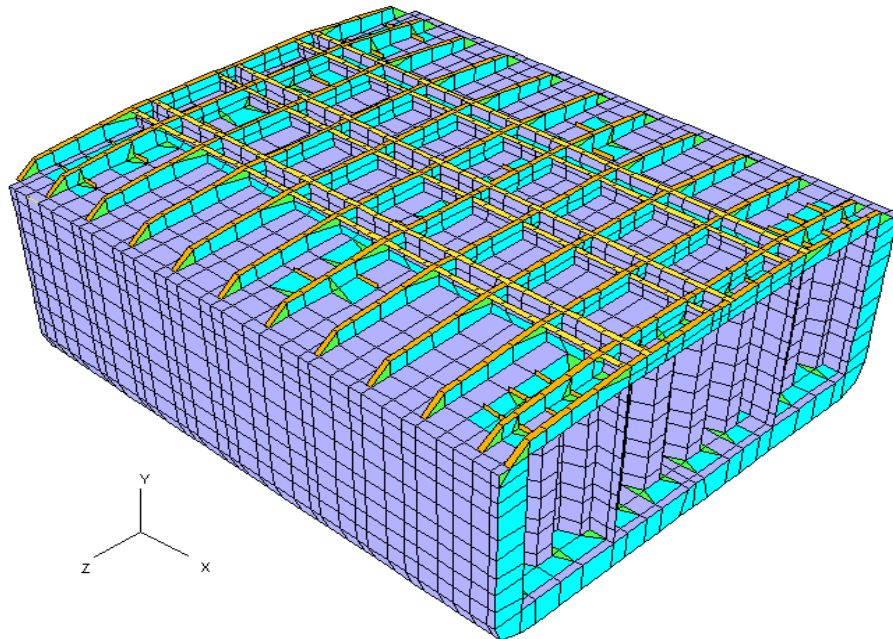

Figure 17. 3D Model of the Chemical Tanker

The propulsion system consists of a low speed two stroke diesel ME driving directly FP propeller at service speed to be 15.0 kn. Three types of main engines have been evaluated:

- 5S60 - MC - C7,
- 6S50 - ME - B9,
- 6S50 - ME - B8.

Main engine type 6S50 - ME -B9 was chosen for the chemical carrier design.

9 CONCLUSIONS

This introductory paper of the IMPROVE DUBROVNIK workshop (Sept 2009) introduces the objectives of the IMPROVE FP6 project, its methodology and the three innovative ships developed from 2006 to 2009 by multidisciplinary teams of researchers (shipyard, shipowner, designer, classification society and university).

This paper presents briefly the 3 product, given their specific objectives and the main outcomes. More detailed information are available in the companion papers also presented at this Dubrovnik workshop.

In short, main outcomes of the IMPROVE projects are:

The design by STX France of a new concept of LNG carriers with reduced ballast, that provides a significant benefit for the shipowners. In addition, a weight saving of 10-15% has been identified and a reduction of production cost of 5% is also reached.

The design by Uljanik Shipyard (Croatia) of an improved ROPAX, with reduced fuel consumption due to new Ropax propulsion concept. The structural optimisation has also show a significant reduction of the weight for a improved safety with regards to the BV classification society requirements.

The design of a new general arrangement of a chemical tanker including, reduced weight of duplex steel, intensive

use of corrugated bulkhead, for a improved safety with regards to the classification society requirements.

Detailed conclusions with quantitative assessment of the benefits of the three new IMPROVE concepts are given in the Dubrovnik papers dedicated respectively to the LNG, ROPAX and Chemical Tanker.

ACKNOWLEDGEMENTS

The present paper was supported by the European Commission under the FP6 Sustainable Surface Transport Programme, namely the STREP project IMPROVE (Design of Improved and Competitive Products using an Integrated Decision Support System for Ship Production and Operation) - Contract No. FP6 – 031382. The European Community and the authors shall not in any way be liable or responsible for the use of any such knowledge, information or data, or of the consequences thereof.

REFERENCES

- CAPRACE, J.D.; RIGO, P.; WARNOTTE, R.; LE VIOL, S. (2006), *An analytical cost assessment module for the detailed design stage*, COMPIT'2006, Oegstgeest, pp.335-345
- DUNDARA, D.; BOCCHETTI, D.; KUZMANOVIC, O.; ZANIC, V.; ANDRIC, J., PREBEG, P. (2008), *Development of a new innovative concept of RoPax ship*, COMPIT'2008, Edit. Rigo-Bertram, Univ. of Liege, Belgium, ISBN-10 2-9600785-0-0
- IMPROVE –RINA (2008), *RO-RO Technology, Building to Improve Standards*, The Naval Architect, April 2008
- IMPROVE –RINA (2009), *Move to IMPROVE LNG Carrier Design*, The Naval Architect, May 2009
- KLANAC, A.; JELOVICA, J. (2007), *A concept of omni-optimization for ship structural design*, Advancements in Marine Structures, Proceedings of MARSTRUCT 2007, 1st Int. Conf. on Marine Structures, Glasgow, UK., Guedes Soares & Das (eds), Taylor & Francis: London, pp.473-481
- KLANAC, A.; JELOVICA (2009), *J. Vectorization and constraint grouping to enhance optimization of marine structures*, Marine Structures, Volume 22, Issue 2, pp 225-245
- KLANAC, A.; NIEMELÄINEN, M.; JELOVICA, J.; REMES, H.; DOMAGALLO, S. (2008), *Structural omni-optimization of a tanker*, COMPIT'2008, Edit. Rigo-Bertram, Univ. of Liege, Belgium, ISBN-10 2-9600785-0-0
- MAESTRO Version 8.5 (2005), *Program documentation*, Proteus engineering, Stensville, MD, USA
- NAAR H.; VARSTA, P.; KUJALA, P. (2004), *A theory of coupled beams for strength assessment of passenger ships*, Marine Structures **17**(8), pp.590-611
- RIGO, P. (2001), *Least-cost structural optimization oriented preliminary design*, J. Ship Production, 17/4, pp.202-215
- RIGO, P. (2003), *An integrated software for scantling optimization and least production cost*, Ship Technology Research 50, pp.126-141
- RIGO P.; TODERAN, C. (2003), *Least cost optimisation of a medium capacity gas carrier*, COMPIT'03, Hamburg, pp.94-107
- TODERAN, C.; GUILLAUME-COMBECAVE, J.L.; BOUCKAERT, M.; HAGE, A.; CARTIER, O.; CAPRACE, J.D.; AMRANE, A.; CONSTANTINESCU, PIRCALABU, E.; A.; RIGO, P. (2008), *Structural optimization of a 220000 m³ LNG carrier*, COMPIT'2008, Edit. Rigo-Bertram, Univ. of Liege, Belgium, ISBN-10 2-9600785-0-0
- ZANIC, V.; ROGULJ, A.; JANCICEV, T.; BRALIĆ, S.; HOZMEC, J. (2002), *Methodology for evaluation of ship structural safety*, 10th Int. Congress IMAM 2002, Crete
- ZANIC, V.; PREBEG, P. (2004), *Primary response assessment method for concept design of monotonous thin-walled structures*, 4th Int. Conf. on Advanced Engineering Design, Glasgow, pp.1-10



IMPROVE

**DESIGN OF IMPROVED AND COMPETITIVE
PRODUCTS USING AN INTEGRATED DECISION SUPPORT SYSTEM
FOR SHIP PRODUCTION AND OPERATION**

The IMPROVE project proposes to deliver an integrated decision support system for a methodological assessment of ship designs to provide a rational basis for making decisions pertaining to the design, production and operation of three new ship generations. Such support can be used to make more informed decisions, which in turn will contribute to reducing the life-cycle costs and improving the performance of those ship generations.

IMPROVE Project

IMPROVE is a three-year research project which started on the 1st October 2006. The project is supported by the European Commission under the Growth Programme of the 6th Framework Programme.
Contract No. FP6 - 031382.

Project Partners:

ANAST, University of Liege	Belgium (project coordinator)
STX-France shipyard	France
Uljanik shipyard	Croatia
Szczecin New Shipyard	Poland
Grimaldi	Italy
Exmar	Belgium
Tankerska Plovidba Zadar	Croatia
Bureau Veritas	France
Design Naval & Transport	Belgium
Ship Design Group	Romania
MEC	Estonia
Helsinki University of Technology	Finland
University of Zagreb	Croatia
NAME, Universities of Glasgow & Strathclyde	United Kingdom
Centre of Maritime Technologies	Germany
BALance Technology Consulting GmbH	Germany
WEGEMT	United Kingdom

Further Information

More information about the IMPROVE project can be found at the project website
<http://www.improve-project.eu/> or <http://www.anast-eu.ulg.ac.be/>

Alternatively you can contact the project co-ordinator:

Prof. Philippe Rigo
at ph.rigo@ulg.ac.be (+32-4-366 9366), ANAST, University of Liege, Belgium

INVITED LECTURERS

Next Generation Ship Structural Design

Owen F. Hughes

Virginia Tech., Blacksburg, Virginia, USA

ABSTRACT: Ship structural design continues to pose challenges for the design team to effectively address inherent complexities, evolving performance requirements from owners and regulators, and need for efficient integration with the overall ship design process. Next generation ship structural design tools and methods must further unify structural design process sub-elements into a more efficient and higher fidelity process that supports the realization of engineering integrity with optimized performance for the owner/operator. Advances in design tool architecture, geometry and topology modeling, loads analysis, and structural evaluation must be better unified in order to achieve progress toward these objectives. The paper gives some examples and suggestions as to how these needs (more unity among the structural design process sub-elements and better integration with the overall ship design process) can be achieved.

1 INTRODUCTION

Ship structural design continues to pose challenges for the design team to effectively address inherent complexities, evolving performance requirements from owners and regulators, and need for efficient integration with the overall ship design process. Next generation ship structural design tools and methods must further unify structural design process sub-elements into a more efficient and higher fidelity process that supports the realization of engineering integrity with optimized performance for the owner/operator. Advances in design tool architecture, geometry and topology modeling, loads analysis, and structural evaluation must be better unified in order to achieve progress toward these objectives.

2 HISTORICAL PERSPECTIVE

In describing a vision of next generation ship structural design from the vantage point of 2009, it is interesting to reflect on personal experience from a very different vantage point, the 1970's. In the 1970's personal computers did not exist, and engineering design and analysis processes and tools were in the early days of transitioning to ("mainframe") computer utilization. This was certainly the case for ship structural design. The transition to computer based methods offered opportunities to change the traditional empirical approach for ship structural design to a "rational" approach, which can be characterized by:

Design which is directly and entirely based on structural theory and computer-based methods of structural analysis

and optimization, and which achieves an optimum structure on the basis of a designer-selected measure of merit.

The vision of using the computer to implement and apply a rational approach for ship structural design became the focal point of my research. This vision's approach was to unify four technologies; structural analysis using the finite element method, structural failure theory, optimization, and the computer, into a methodology that could perform rationally-based ship structural design in pace with the normal preliminary design process. This vision was presented in (Hughes et al., 1980) and fully documented in "*Ship Structural Design*" (Hughes, 1983) and the vision was implemented at that time in the computer program *MAESTRO*. Figure 1 highlights the overall methodology of this implementation, including six basic aspects of rationally-based structural design. The approach implemented in *MAESTRO* has been in practice since its release in 1984 and has withstood many tests of time and undergone many significant changes. Further, there are ongoing and planned evolutionary developments that confirm the complexity of ship design and the need for continued development of the technology for rationally-based design.

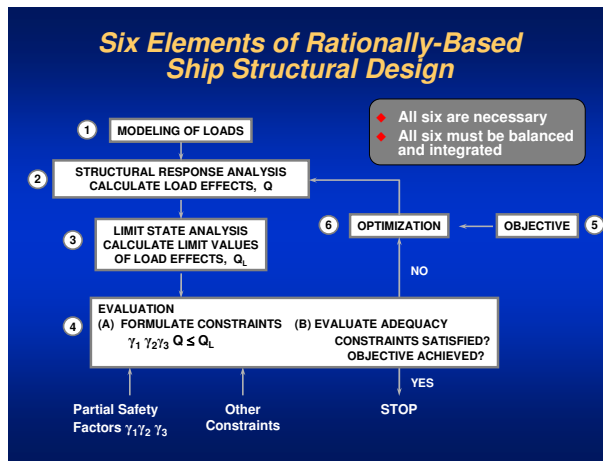

Figure 1. Six Basic Aspects of Rationally-Based Ship Structural Design

3 SHIP STRUCTURAL DESIGN EVOLUTION

Since the early manifestations of computer-based ship structural design and rationally-based design, significant evolution has taken place and many improvements have been developed. An overview of ship structural design evolution from “Strength of Ships and Ocean Structures” follows:

"The drive toward more efficient ship designs has led to increased sophistication in both the designs themselves and in the techniques and tools required to develop the design. Concepts such as finite element analysis, computational fluid dynamics, and probabilistic techniques for evaluating a ship's stability and structural reliability are now integral to the overall design process. The classification societies have released the common structural rules for tankers and bulk carriers, which rely heavily on first principles engineering, use of finite element analysis for strength and fatigue assessments, and more sophisticated approaches to analysis such as are used for ultimate strength assessment for the hull girder. The International Maritime Organization now relies on probabilistic approaches for evaluating intact and damage stability and oil outflow. Regulations are increasingly performance-based, allowing application of creative solutions and state-of-the-art tools. Risk assessment techniques have become essential tools of the practicing naval architect." (Mansour and Liu, 2008)

The structural design technology evolution summarized above can be further defined in several categories:

Finite Element Analysis (FEA). Great strides have been made in FEA theoretical and computational technology in both software and in computers, including reduction in cost, increasing dramatically the application of FEA for ship structural design.

Structural Limit State Evaluation. “In the past, criteria and procedures for the design of steel-plated structures were primarily based on allowable stresses and simplified buckling checks for structural components. However, it is now well recognized that the limit state approach is a better basis for design since it is difficult to determine the real safety margin of any structure using linear elastic methods alone.” (Paik and Thayamballi, 2008) Limit state evaluation improvements have been in the form of new theory implemented in practical codes/software, limits at both the stiffened panel level and at the hull girder level, and automation in checking large numbers of panels for multiple load cases.

Optimization Methods and Tools. Multiple individual decision support/optimization methods are now being organized into multi-criteria structural optimization capabilities that address design criteria (serviceability, ultimate strength) and design quality (cost, weight, reliability, robustness) within an efficient system that supports global and local structural optimization.

Software Development Technology and Environments. Continuous change and evolution has taken place in the languages, tools, and development and data management environments used to design and implement ship structural analysis codes. These improvements enable more robust tool development, facilitate code change and evolution, and support broader integration of structural design tools with other disciplines of the ship design such as topological modeling and loads analyses.

Collectively, the progressive evolution of these technologies and tools have dramatically changed the approach to ship structural design, and yet many new developments continue today and for the foreseeable future.

4 NEXT GENERATION SHIP STRUCTURAL DESIGN REQUIREMENTS

Figure 2 illustrates the relationship between the early stage concept development of a ship and the ability to influence the life-cycle performance in terms of operational performance, cost and other factors. The influence is highest early in the design development and rapidly diminishes as the design matures toward start of lead ship construction. Figure 2 (Wheelwright and Clark, 1995) also highlights the interaction that takes place, with varying degrees of completeness and accuracy, between the ship owners and operators, who determine the requirements and budgetary bounds of the ship, and the design developers.

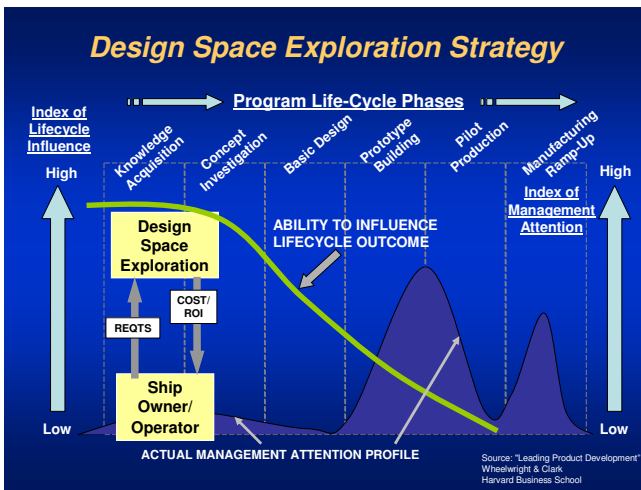

Figure 2. Design Space Exploration

A critical characteristic of the ship design process is the frequency and accuracy with which the design team can report back to the owner/operators to provide a description of the design and its performance and cost attributes. Since structure is a major contributor to the construction cost and to the operational and financial performance of the ship, improved knowledge and accuracy of the ship’s structure is a critical factor in the development of the design.

This paradigm of ship design development translates into a movement toward accomplishing higher degrees of physics-based engineering analysis and design as early in the design process as possible. Figure 3 (Wood, 2007) illustrates the relationship between computer aided engineering (CAE), which includes structural analysis and design, and computer aided design (typically the hull form and arrangements) and computer aided manufacturing (planning construction processes). Figure 3 highlights the need to move CAE activities earlier in the overall design process. This objective and trend applies to structural analysis and design. Key structural performance parameters include:

- Higher performance structures—reduced weight with higher degrees of safety and reliability
- Lower fabrication costs
- Better economic performance in terms of lower contribution to light ship and hence larger payload fractions
- Reduced structural maintenance costs over the life-cycle
- Recognition of social responsibility in terms of environmental protection, collision/damage tolerance, reduced risk of failure, etc.

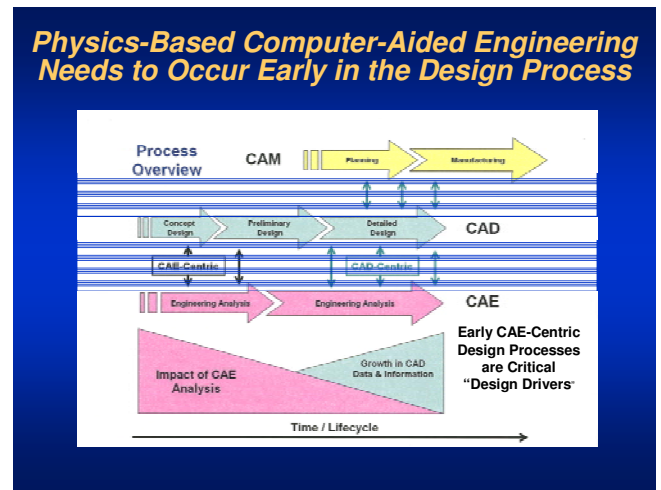

Figure 3. Physics-Based Computer-Aided Engineering Early in the Design Process

5 IMPROVED INTEGRATION WITH OVERALL SHIP DESIGN PROCESS

Ship designs are now routinely developed initially in the form of surface models representing the hull and major decks and bulkheads of the ship. This surface model can also be viewed as a topological model that organizes the three dimensional spaces of the ship, and defines the purposes of the spaces and the relationships between the spaces. Advanced topology models become the master ‘organizers’ of a ship design. The challenge for CAE models and analyses is to have a functional linkage or relationship with the surface-based topology model(s).

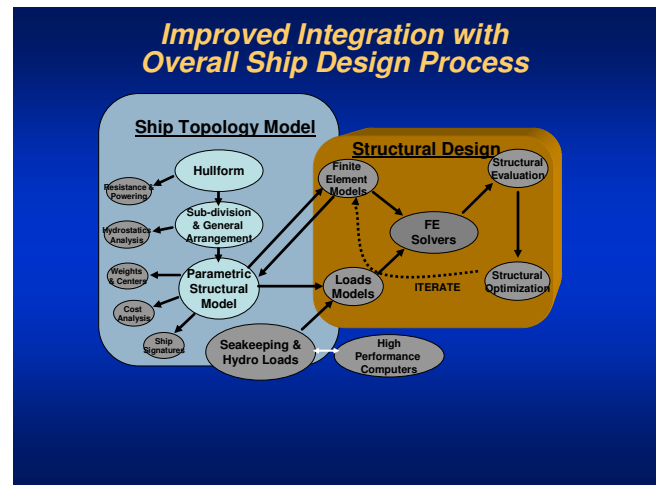

Figure 4. Structural Design Coupled with the Ship Design Process

Figure 4 depicts:

- Close coupling of ship surface topology with structural analysis and design models, including finite element models.

- Automated generation and updating of structural models in response to changes in ship hull form, deck and bulkhead arrangements or other aspects of the ship design that affect structure, and feedback/updating of the ship design model(s) with changes in structure resulting from the structural analysis/design process.
- Creating a parametric parent ship structural object model by defining structural attributions for the *Topology Model*.
- Spawning/automating multiple structural analysis models (including different detail levels of finite element models) from the parent structural object model.
- Using open architecture software to facilitate interfacing structural analysis models with various load prediction analyses and tools, such as 2D/3D time and/or frequency domain hydrodynamic analyses.
- Open architecture supports various special purpose analyses and different tools, such as Dynamic Load Approach, Spectral Fatigue Analysis, Underwater Shock, and forced vibration, some of which require the generation of input data for other analysis programs (Nastran, Ansys, etc.).
- Automated structural panel evaluations (MAESTRO limit state sets; ALPS/ ULSAP; ALPS/Hull; Naval Vessel Rules; High Speed Naval Craft, etc.).
- Structural optimization to refine and improve the structural performance and meet design requirements and objectives.
- Coupling between the structure and the ship's weights/centers and cost estimation models.

A further stage or phase of integration between the ship design topology and naval architecture analyses models and structural design and analysis is depicted in Figure 5. In fact, this same process can be applied not just to structural design but to the overall ship design as well. The emergence of novel ship concepts and advanced marine vehicles, as well as the refinement of competitive conventional ship designs, demand synthesis techniques that enable decision support problem (DSP) formulation as a basis for rational decision making.

“...the designer has at his disposal a large amount of information and possibilities which enable creation of a comprehensive picture of the design: the quality of satisfying the conditions of every particular attribute; the relation of attributes with corresponding attributes in other design solutions; and information on what should be considered with special attention in further phases of the design development.” (Zanic and Cudina, 2008)

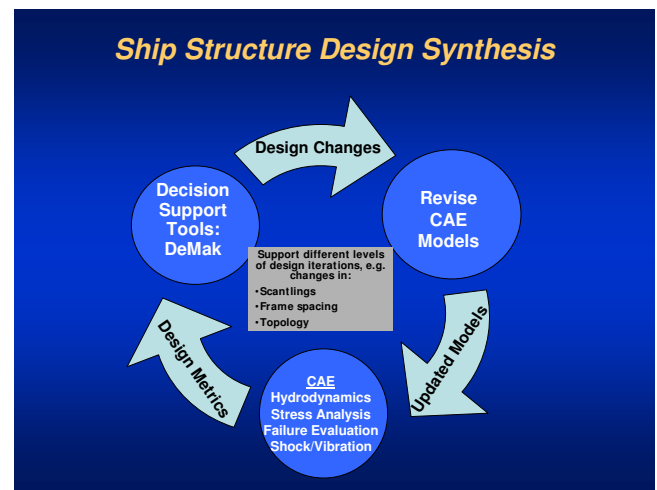

Figure 5. Design Synthesis Approach

6 DESIGN OF HIGHER PERFORMANCE STRUCTURES

The trend towards higher performance ship structures continues with goals to provide greater safety and reliability while minimizing structural weight and cost. This trend is driven by economic and performance factors from the ship owners and operators, from safety and environmental concerns from society, and from competitive pressures between shipbuilders. Higher performance, safe and reliable structures can only be achieved by using progressively more rigorous and accurate design and construction processes. The following kinds of ship structural design process components are evolving today and form the basis of the next generation of ship structural design.

Hydrodynamic loads predictions interfaced to structural analysis models. As structural design methods have developed, so have tools for hydrodynamic load predictions. To make the application of predicted loads efficient, these loads need to be automatically interfaced and applied to the structural model(s). This type of loads interface is being developed and refined so that more comprehensive and more accurate loads can be incorporated into the structural design process. Figure 6 indicates how this type of interface initiates many stages of ship structural analysis and design.

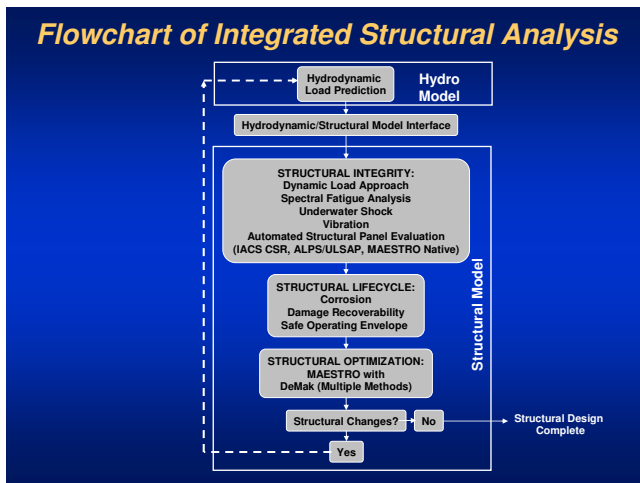

Figure 6. Structural Design Process

Open architecture structural design toolsets allow special purpose analyses such as Dynamic Load Approach analysis, Spectral Fatigue Analysis, underwater shock response analysis for warships, free and forced vibrations, to be introduced as requirements as defined by ship classification societies and other safety authorities. “During the last few decades, methods useful for ultimate limit state assessment of marine structures have been developed in the literature. It is considered that such methods are now mature enough to enter day-to-day design practice.” (Paik, et al., 2007) An open architecture hosts multiple sets of structural integrity analysis and evaluation capabilities that can be invoked by the design team on a basis customized to meet a specific set of ship requirements. The open architecture further enables the efficient introduction of new analysis technologies as they transition from research to applied practice.

Structural optimization methods provide capabilities to move the structural design toward objective goals such as reduced weight and cost, while ensuring that all the necessary structural integrity constraints and safety margins are maintained. Hybrid solvers such as *DeMak* (Zanic et al., 2009) have been developed that organize multiple optimization procedures that can be applied to specific aspects of the structural design/optimization problem. *DeMak* includes five methods: 1) multilevel multi criteria search strategy; 2) fractional factorial design; 3) cross section optimizer; 4) genetic algorithms; and, 5) multi-objective particle swarm optimization. These methods are controlled via a ‘sequencer’ that gives the design team direct control over the application of the different optimization methods to different aspects of the structural design.

Structural lifecycle considerations including corrosion, fatigue, damage recoverability, and structural Safe Operating Envelope determination, comprise another set of complex ship structural performance elements which must be addressed as integral aspects with the design process.

These areas evolve from research and development, safety authority procedures, and owner/operator guidance and requirements. An interesting source of these requirements has been the development of ship classification rules for naval vessels.

“The rapidity and extent of the post-Cold War downsizing has caught many navies by surprise, forcing a global re-think of policies regarding acquisition, operations and maintenance of warships on a scale not seen since the Second World War. These navies are beginning to look to classification societies as an important element in preserving the technical standards of their current and future fleets, through the development of Rules, certification and classification procedures for design, construction and through-life maintenance.” (Ferreiro et al., 2001)

Feedback loop to the ship design model to return changes in the structural design to the baseline ship design model(s) for re-analysis and evaluation. As Figure 6 indicates the ship structural design process will evolve toward a more unified set of modeling and analysis capabilities and a more efficient and more effective set of computer-based tools for performing the design development.

7 SUMMARY AND CONCLUSION

Next generation ship structural design tools and methods must further unify structural design process sub-elements into a more efficient and higher fidelity process that supports the realization of engineering integrity with optimized performance for the owner/operator. Advances in design tool architecture, geometry and topology modeling, loads analysis, and structural evaluation must be better unified in order to achieve progress toward these objectives. Strategies for implementing these improvements have been in place for several decades now, and elements of the early strategies, for example the tenants of rationally-based structural design, have borne the test of time. On the other hand, the degree of complexity of ship structural design continues to grow driven by the results of scientific development coupled with the ever-competitive environment of ship owners and operators. As presented herein, the vision of next generation ship structural design requires more complete unification with both the basic ship topology design and with the multiple aspects of ship loading and structural design. Furthermore, decision support technologies and methods are here to stay and are becoming more widely applied and accepted. Next generation structural design will depend more on these technologies to effectively explore the design space and generate the best designs for ships of tomorrow.

REFERENCES

- Basu, R.I. et al., "Guidelines for Evaluation of Ship Structural Finite Element Analysis," SSC Report, SSC-387, Abstract, 1993.
- Ferrero, Larry, Ashe, Glen, Ingram, Thomas, "Building the Rules: The ABS Perspective on Developing Classification Rules for Naval Vessels," RINA Symposium, Warship, 2001.
- Hughes, Owen, Mistree, Farrokh, Zanic, Vedran: "A Practical Method for the Rational Design of Ship Structures, Journal of Ship Research, " Vol. 24, No. 2, June 1980.
- Hughes, Owen, "Ship Structural Design," John Wiley & Sons, New York, NY, 1983.
- Mansour and Liu, "The Principles of Naval Architecture Series: Strength of Ships and Ocean Structures," SNAME, Jersey City, New Jersey, Forward, 2008.
- Paik J., and Thayamballi, "Ultimate Limit State Design of Steel-Plated Structures," John Wiley & Sons, Ltd, West Sussex, England, 2008.
- Paik, J. et al., "Methods for Ultimate Limit State Assessment of Marine Structures: A Benchmark Study," International Conference on Advancements in Marine Structures, Glasgow, UK, 2007.
- Wheelwright and Clark, "Leading Product Development," Harvard Business School, 1995.
- Wood, R., Moore, S., "The National Shipbuilding Research Program Improved Methods for the Generation of Full-Ship Simulation/Analysis Models," NSRP Advanced Shipbuilding Enterprise, 2007.
- Zanic, V., Adric, J., Prebeg, P., Kitarovic, S., Piric, K., "Multi-Objective Optimization of Ship Structural Topology and Scantlings," Proceedings of the International Marine Design Conference, IMDC, Trondheim, 2009.
- Zanic, V., Cudina, P., "Multiattribute Decision Making Methodology in the Concept Design of Tankers and Bulk Carriers," Brodogradnja / Shipbuilding , Vol 60, No.1, 2009.

Ship Design for Performance

Kai Levander

SeaKey Naval Architecture, Turku, Finland

ABSTRACT: Naval architects need a methodology for ship design that guides them through the design process. This methodology should be open for new solutions and innovations. The capacity and performance of alternative solutions are evaluated against a few major design criteria to optimize the ship for the intended mission. Key performance indicators are used to select the most suitable design. Today energy efficiency and reduction of emissions have become very important among these performance indicators.

1 INTRODUCTION

1.1 *System based ship design*

In their book "Theory of Technical Systems" Vladimir Hubka and Ernest Eder describe the base for technical systems and the benefits of system thinking in the design work of complex products. Their methodology can be used also in ship design, especially in the development of new solutions. A ship must perform many different functions, which all can be described as individual systems, but integrated into the "total" ship mission. By defining each system and the performance requirements for this system we get a framework for the ship design. This is here called "System Based Ship Design". By adding simple algorithms much of the ship design calculations can be "automated" and performed by computer. This automation of the design work makes it possible for the naval architect to spend more time on improving the design and finding alternative solutions. To compare different solutions and select the

most suitable design the naval architect must have clear goals and evaluation criteria for the sea transport mission.

The essentials of system thinking Hubka and Eder summarize as follows :

- The theory of technical systems delivers the relationships that are valid for all products
- System thinking presents an opportunity to treat problems as a whole
- This is a necessary pre-condition for a successful design and engineering effort
- System thinking provides a framework for the design task and formalize many logical operations
- Use of computers during the design process depends on formulating algorithms for those design operations, where logical treatment is possible
- System thinking also supports those human operations, that are not strictly logical, like intuition and creativity

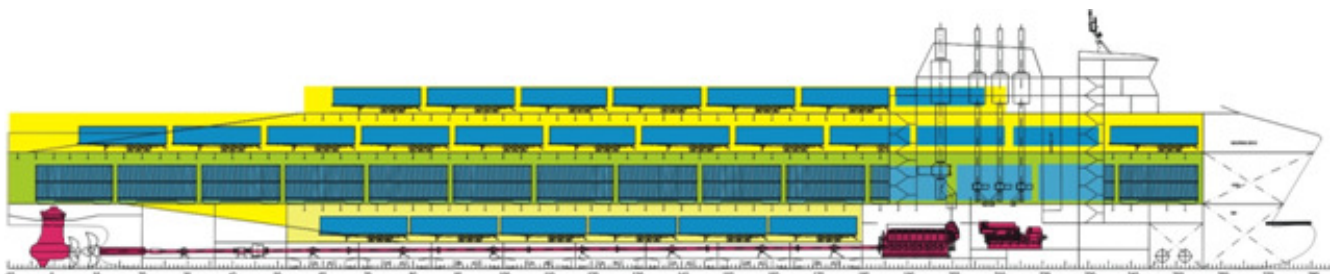

1.2 *Cargo transportation business*

Transportation by sea is often the best alternative for large volumes and long distances. But the owner of the cargo should also evaluate other alternatives, like transport by road or rail or perhaps by air if fast delivery is important.

The cargo owner has in fact the possibility to relocate the factory closer to the market to reduce the logistic cost. If transportation by sea is chosen the cargo must be transferred to the port, loaded into the ship, unloaded in the port of destination and distributed to the customer. The cargo must

be protected from damage, heat, cold, moisture and theft. Selecting a suitable “package” or cargo unit has become very important, especially in a multi-modal transport chain.

The cargo owner, the ship owner and the shipyard are all “partners” in the business of sea transport. All of them have several different “business” factors to consider and decide on. These factors can be arranged into a hierarchy showing

the influence and responsibility of the cargo owner, ship operator and shipyard, (Figure 2). Naval architects and engineers are often asked to solve technical problems or to find new technical solutions. They are looking for “how” problems can be solved. But a designer must also understand “why” it is important to solve this problem and what influence it has on the ship performance.

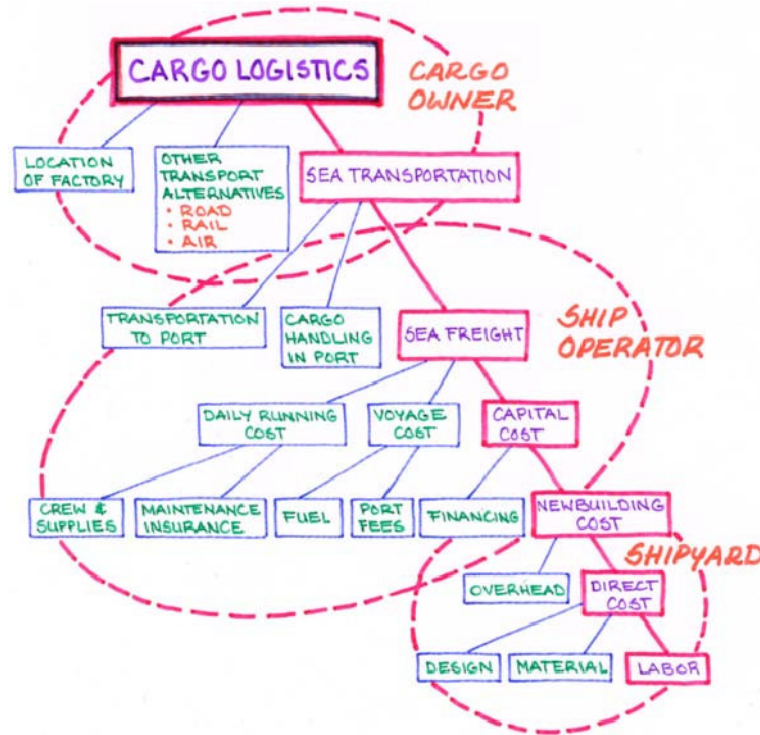

Figure 2. Cargo transportation business

1.3 The ship design task

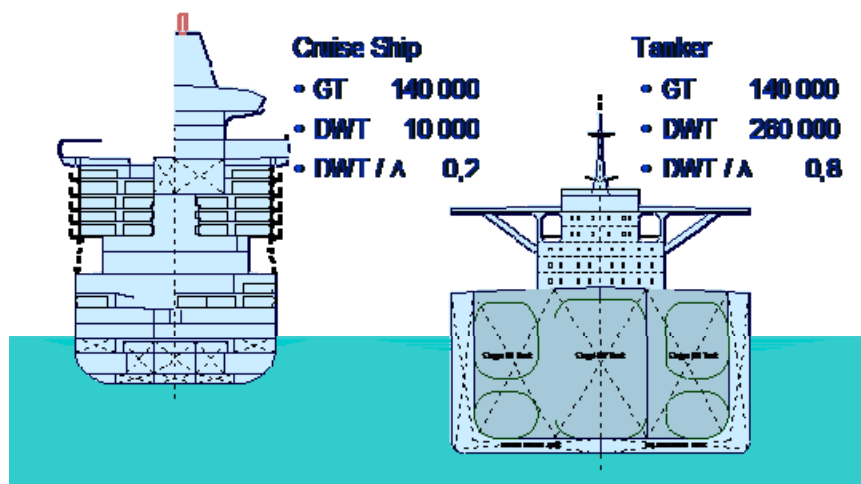

Figure 3. Deadweight and capacity carriers

There are many types of ships built for different cargoes and operating conditions. Payload capacity and performance varies and the goal for the design is not the same for all ship owners. The naval architect must consider these different requirements and expectation in his design task (Figure 3). To be successful the naval architect needs a simple but

efficient ship design methodology. The most common way to describe the ship design has been by a spiral model, capturing the sequential and iterative nature of the process. The work structure is “design-evaluate-redesign”.

This model easily locks the naval architect to his first assumption. He will patch and repair this single design concept rather than generate alternative. An approach that better supports innovation and creativity should be used. System based design starts from the mission specified for the ship. There are two types of input data, demands that

must be followed and preferences that describe goals. Dividing requirements into “musts” and “wants” makes it possible to reduce the design work needed to find a technically feasible and economically preferable solution (Figure 4).

Mission statement

- Payload capacity, speed and range
- Restrictions in ports and on route
- Geographical conditions, like sea currents, tropical weather, ice

Initial sizing of the ship

- Capacity carriers, like container vessels, ferries and cruise ships, where the volume of the payload determines the size of the vessel
- Deadweight carriers, like oil tankers and bulk carriers, where the weight of the payload determines the size of the vessel

Parametric exploration

- Variation of main dimensions, hull form and lay out of spaces onboard in order to satisfy the demand for space for both the payload and ship functions

Engineering synthesis

- Calculating and optimising ship performance, speed, endurance and safety

Evaluation of the design

- Calculating building cost and operation economics



Figure 4. Ship design phases

Initial sizing of the ship

The initial sizing is based on the space needed for the payload and for the supporting systems needed onboard the ship. In a tanker the volume of the cargo tanks and the protecting double hull defines a major part of the space needed in that ship (Figure 5). The double hull is used for ballast water on the return voyage, when there is no oil in the cargo tanks.

In a cruise ship the sizing is based on the passenger facilities needed onboard. But also crew and service spaces demand much space. In addition technical spaces for machinery, tanks for fuel, fresh water, etc. requires much space (Figure 6). But this sizing principle is basically the same for all ship types and gives the total volume of the ship in m³.

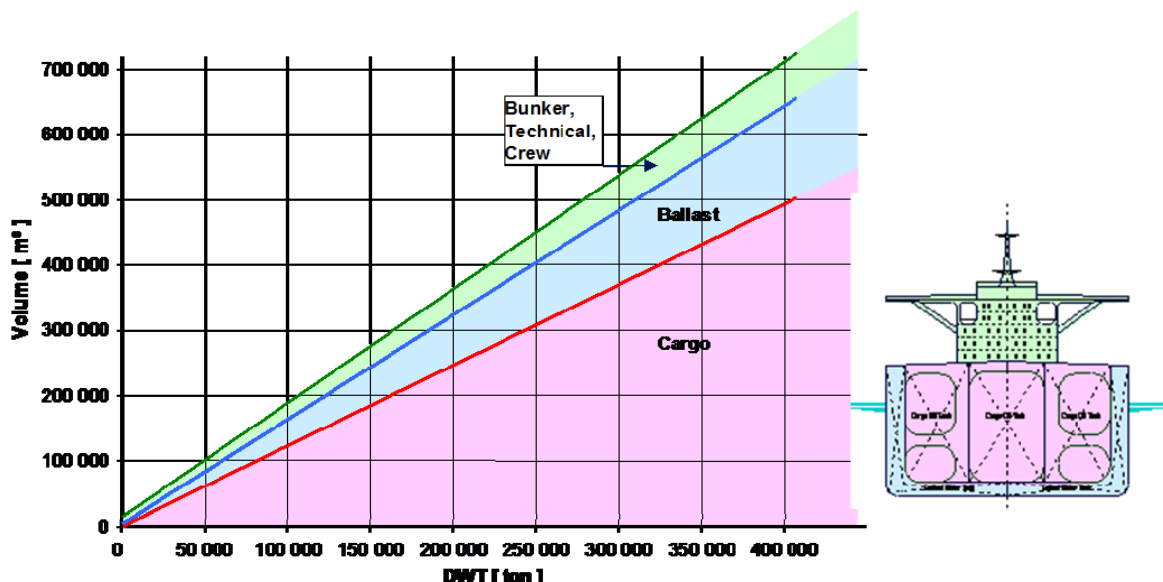

Figure 5. Initial sizing of double hull tanker

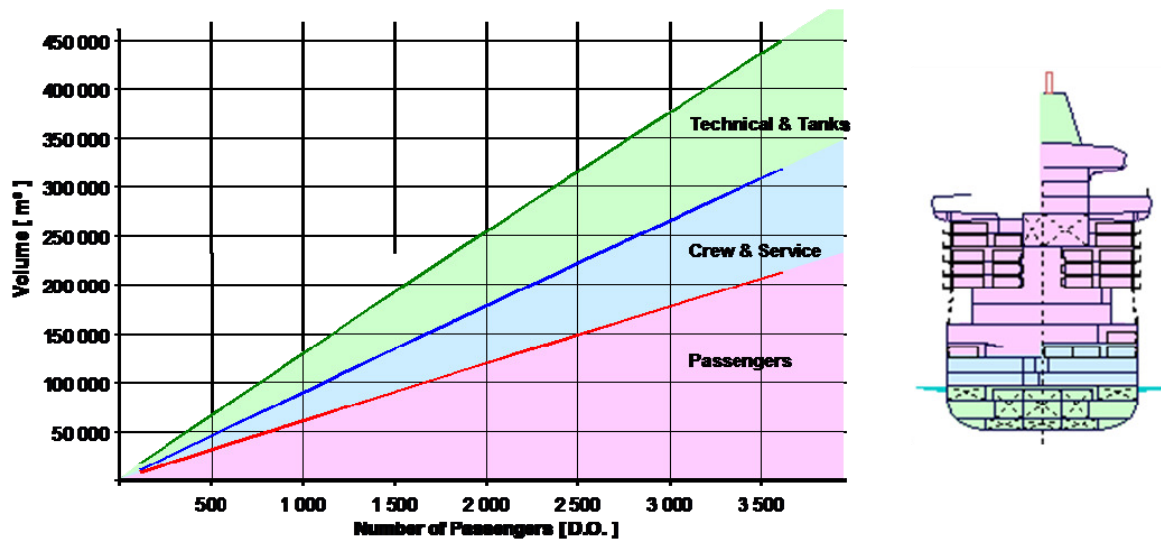

Figure 6. Initial sizing of cruise ship

Defining ship size

There are other ways to define the size of a ship. For tankers and bulk carriers deadweight is used to indicate the cargo capacity. Deadweight includes cargo, bunkers and stores so the actual payload capacity will to some extent depend on the length of the route. For container vessels it is more logical to indicate the number of containers that can be carried, but then also the average weight of the containers must be considered. In RoRo vessels the length of the cargo lanes is used to indicate how many trailers and lorries that can be loaded.

If ships of different type shall be compared with each other the total volume of the vessel should be used. This “Gross Volume” is express as the Gross Tonnage. Back in time when ships were built in wood the Gross Tonnage was based on the cargo spaces inside the ship and was measured in 100 cubic feet. Today the Gross Volume of the ship, calculated in cubic meters is converted to the dimensionless Gross Tonnage by the formula agreed upon at the “International Conference on Tonnage Measurement of Ships 1969 (Figure 7).

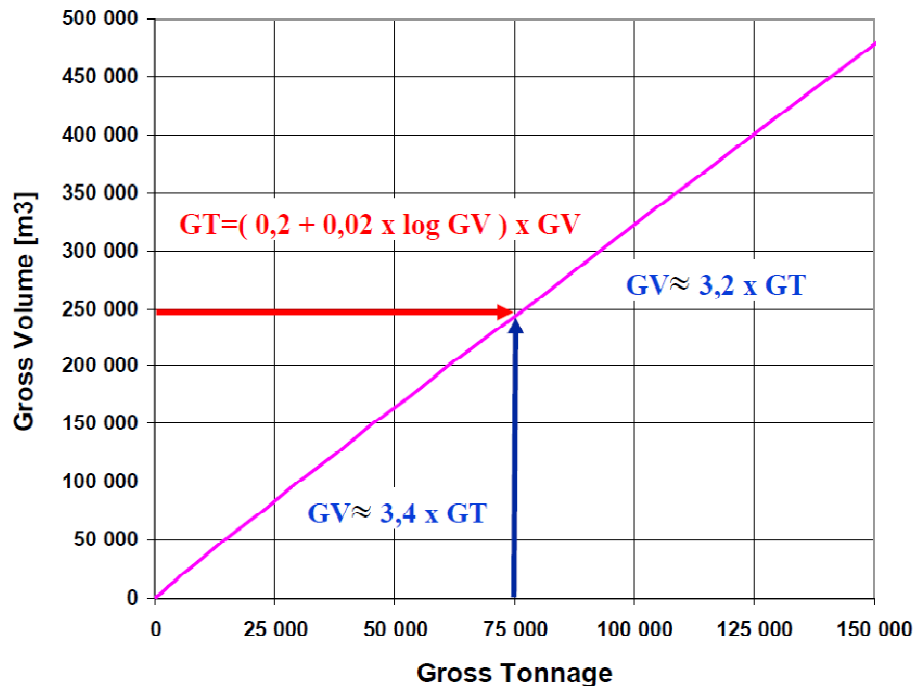

Figure 7. Relation between Gross Tonnage and Gross Volume

Another measurement of ship size is displacement, which indicates the weight of the ship itself and the cargo and stores carried onboard. The displacement governs the selection of main dimensions and hull shape (Figure 8)

This has great impact on the power needed for propulsion of the ship at the desired speed. The main task for naval architects is to establish the Gross Volume and displacement needed in the ship to fulfil the intended transport task.

$$\text{Displacement} = \text{LWT} + \text{DWT} = 1,025 \times L \times B \times T \times C_B$$

Figure 8. Archimedes' Law

1.4 Ship design process

The starting point is the mission and the functions of the ship (Figure 9). All systems needed to perform the defined tasks are first listed. The areas and volumes demanded in the ship to accommodate all systems are then calculated. The ship systems are divided into two main categories, payload function and ship function. In a cargo vessel the payload functions consist of cargo spaces, cargo handling equipment and spaces needed for cargo treatment onboard.

The ship functions are related to carrying the payload safely from port to port (Figure 10). This design method does not need pre-selected main dimensions, hull lines or standard layouts. System based design is like a checklist that reminds the designer of all the factors that affect the design and record his choices. The result is a complete system description for the new ship, which will act as the base for further design work (Figure 11).

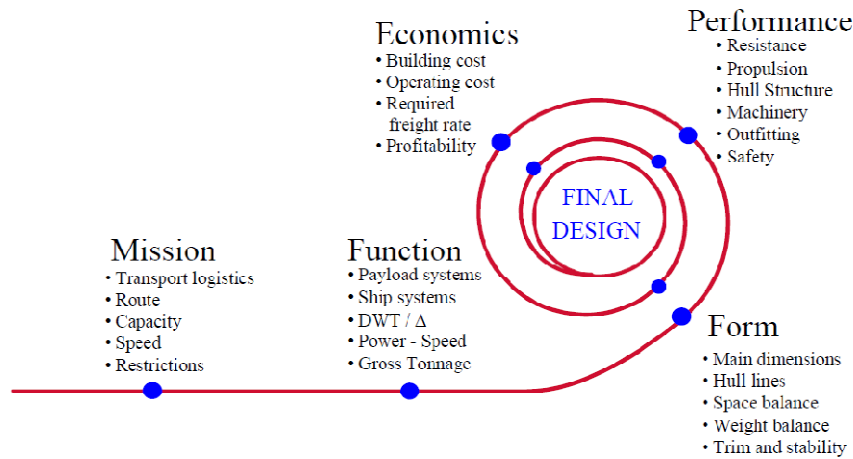

Figure 9. The ship design process

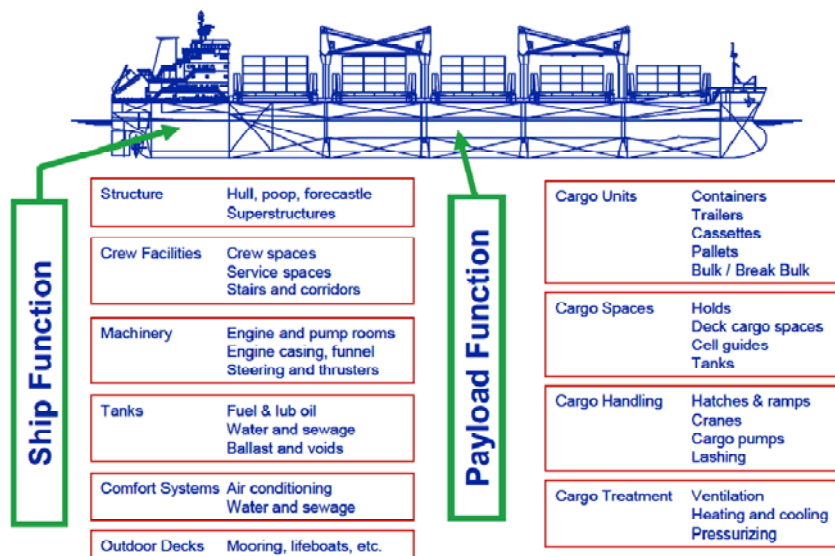
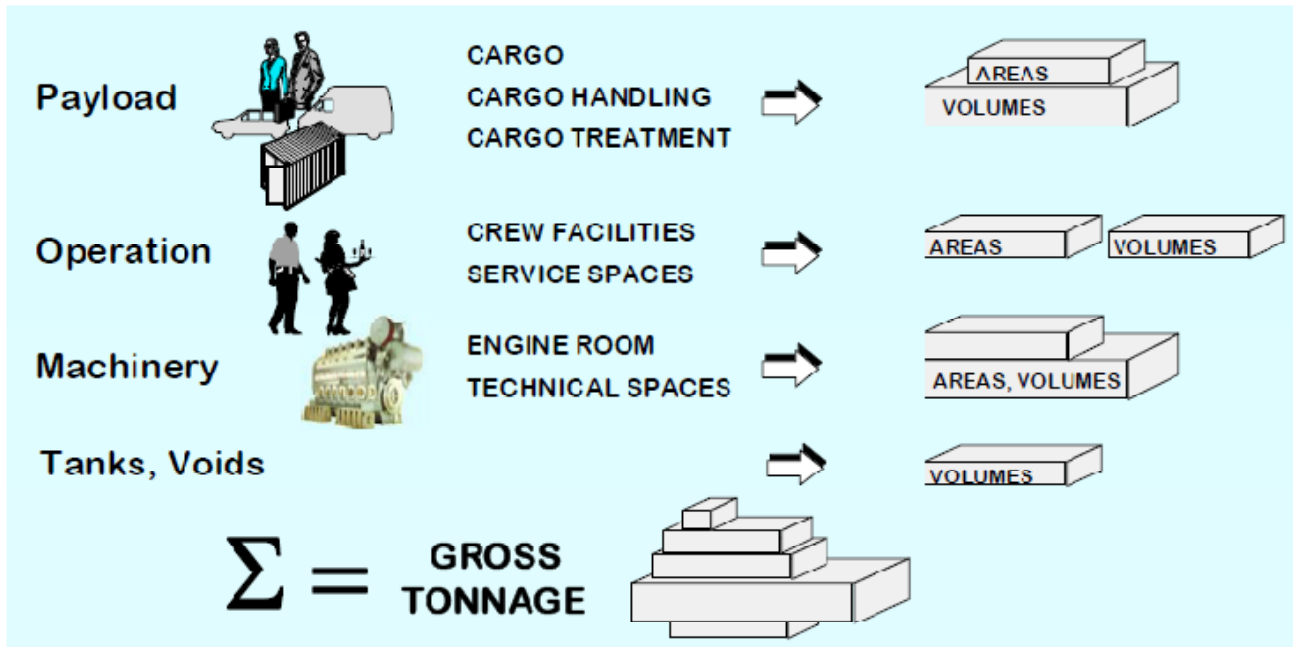

Figure 10. Payload and ship functions

MISSION ROUTE, CAPACITY, SPEED, RESTRICTIONS



FUNCTION AND SYSTEM DESCRIPTION



WEIGHT

Lightweight
 Deadweight



BUILDING COST

Design
 Material
 Labour

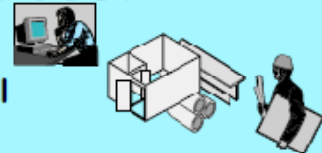

FORM AND PERFORMANCE

- Main Dimensions
- Hull Generation
- Space balance
- Weight balance
- Speed & power
- Hydrostatics

$$L \cdot B \cdot T \cdot C_B = \nabla$$

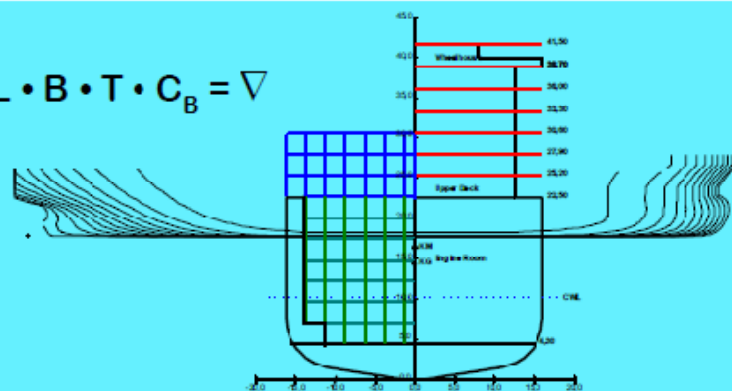
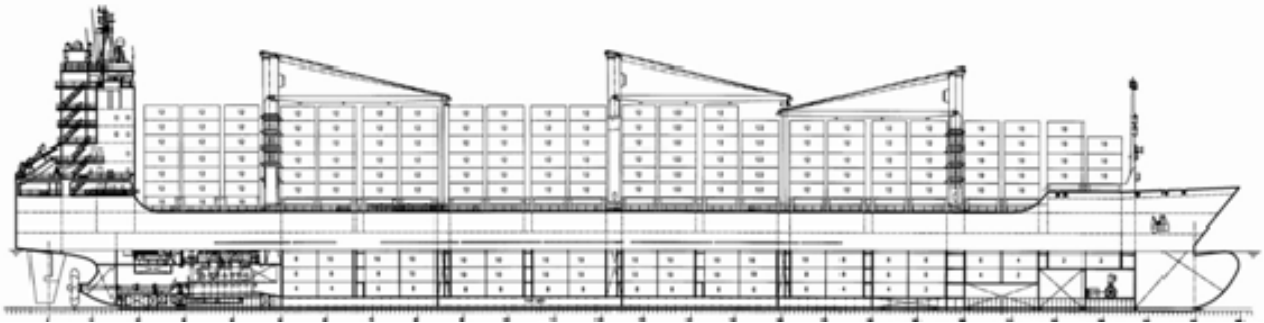

Figure 11. System based ship design

2 SHIP DESIGN CRITERIA

2.1 Design criteria for cargo ships



For cargo ships there are 3 main factor affecting the technical feasibility and the profitability of the design

Design Criteria No 1:

The deadweight / displacement ratio indicates how much payload, bunker oil and stores the ship can carry in relation to the total displacement. Tankers and bulk carriers have the highest ratio, while RoPax ferries have low deadweight due to the increase of lightweight from the passenger spaces (Fig 2.1.1).

Design Criteria No 2:

The Speed & Power shall be judged in relation to the displacement of the vessel (Fig 2.1.2). At speeds below 20 knots the power demand increases slowly with increasing displacement. But at 30 or 35 knots the power curves become very steep and high power is needed already for a vessel with little displacement.

Design Criteria No 3:

The third factor to observe is the lightweight density, which is an easy way for a first weight estimate. Lightweight is also the major factor affecting the building cost of the ship and is also needed for a first price estimate (Fig 2.1.3).

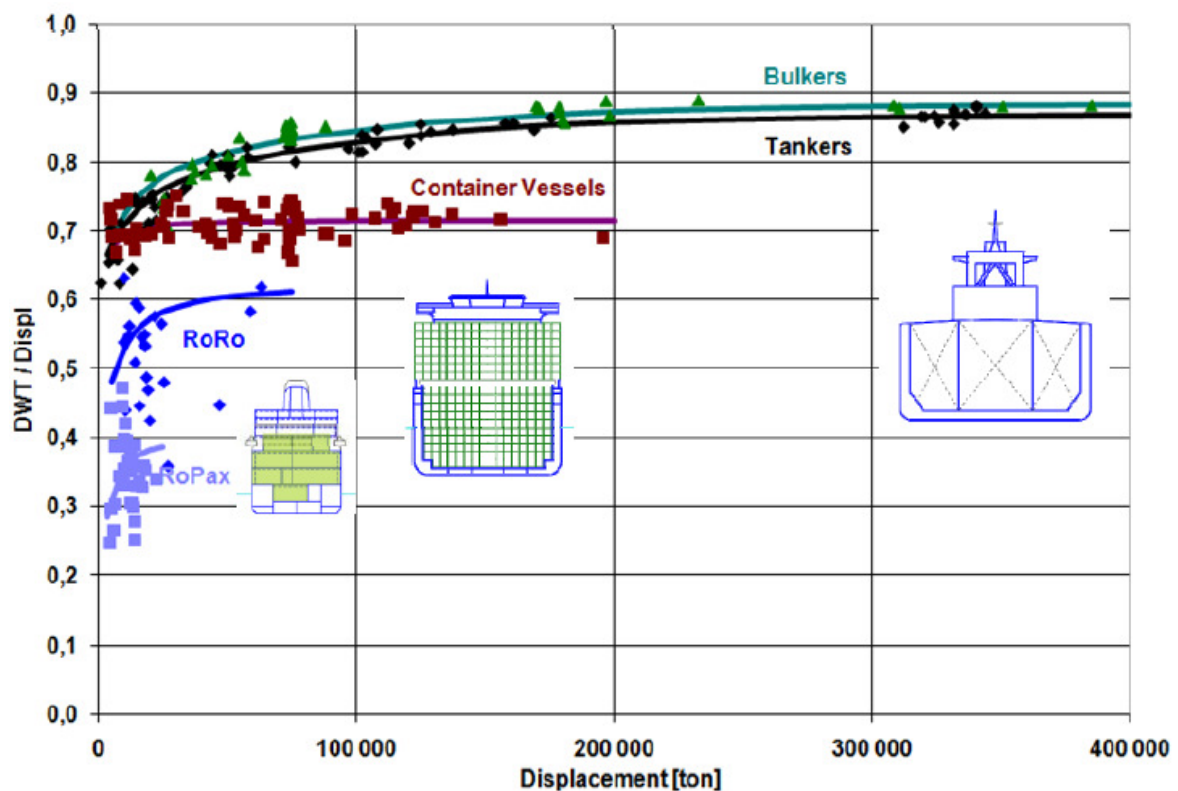

Figure 12. Design Criteria No.1 - DWT/Displacement

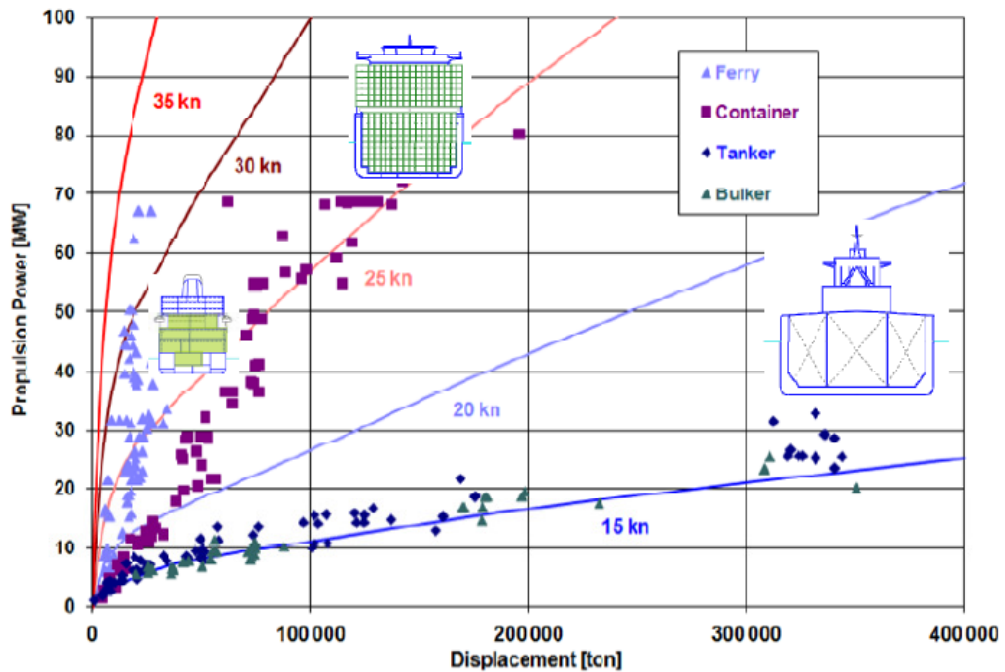

Figure 13. Design Criteria No.2 - Speed & Power

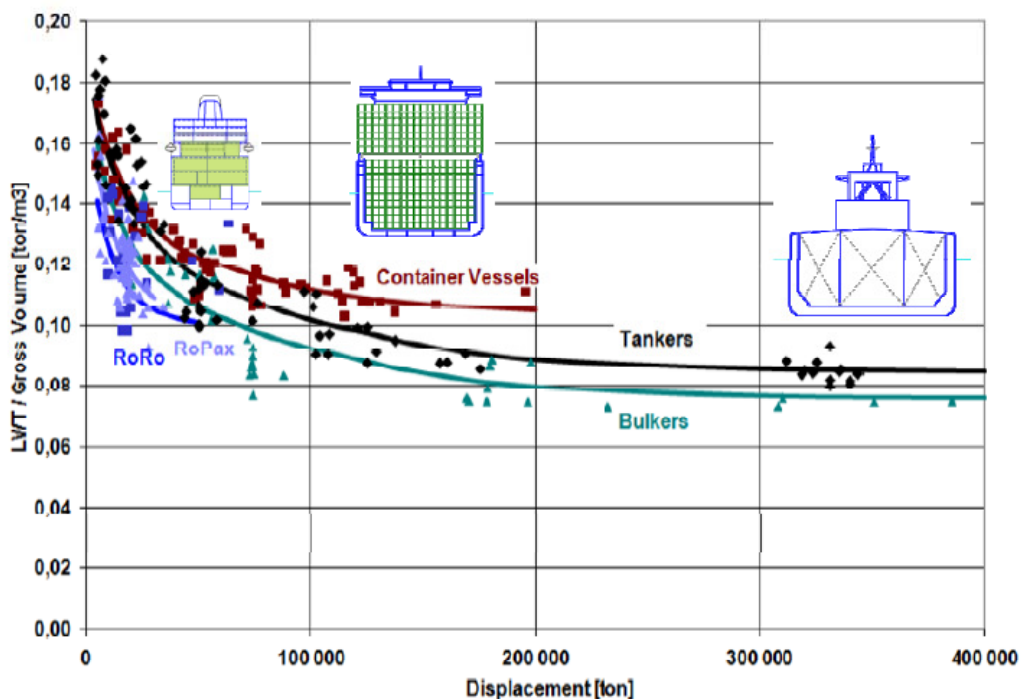

Figure 13. Design Criteria No.3 - Lightweight Density

2.2 Key performance Indicators

The most important performance indicators for cargo vessels are summarised in Figure 14. For the ship owner the building cost of the vessel in relation to payload capacity is always high on the list. But in the long run the transport efficiency should be used as the main criteria. Both operating income and operating cost must be considered, not only building cost. This shows the money making potential of the new design.

We can expect bunker cost to stay high in the future and the selection of machinery, hull form and propulsion arrangement will become more and more important. Minimum demands for safety and environmental friendliness are stipulated in international agreements, but some ship owners will demand higher standards for their vessels and use this to improve their competitive position in the market.

Impact Area	Technology Drivers	Goal	Indicator
Construction	Design Concept Standard Solutions Modular Construction Supplier Networking	Construction Efficiency	Building cost [USD / Payload unit]
Payload Functions	Payload Capacity Speed & Power Cargo Units Cargo Handling	Transport Capacity	Money making potential [RFR]
Ship Functions	Hull Form Propulsion Solution Fuel Type & Consumption Heat Recovery	Propulsion Efficiency	Bunker cost [USD / Year] Carbon Footprint [CO ₂ / ton·nm]
	Navigation Machinery Operation Docking & Mooring	Automation	Crew cost [USD / Year]
	Planned Maintenance Preventive Maintenance Condition Monitoring	Reliability	Keep schedule Time saving
Social Values	Fire prevention Grounding prevention Collision Prevention	Safety	Casualties Insurance cost Repair & replacement cost
	Smoke, NOX, SOX Waste, Sewage, Ballast Wake & Noise Recycling & Scrapping	Environmental Friendliness	Health Risk Environment fees & fines Disposal cost

Figure 14. Key performance indicators for cargo vessels

2.3 Energy efficiency

$$EEDI = \text{Energy Efficiency Design Index} = \frac{\sum C_F \cdot SFC \cdot P}{\text{Capacity} \cdot V_{ref}}$$

IMO is interested in the environmental friendliness of shipping and wants to establish a energy efficiency index to help designers, builders and operators to evaluate the carbon emissions of ships and to establish goals for the reduction efforts. The equation above could be incorporated as part of the IMO regulations on the EED.

This Energy Efficiency Index is very similar to the “Power Factor” that compares the power demanded to the ship deadweight and service speed. This Power Factor can also be used as the design criteria for CO₂ emissions. CO₂ emissions are directly related to fuel consumption for ships operated on the same fuel.

Power Factor

$$PF = \frac{\text{Propulsion power}}{DWT \times \text{Speed}} \left[\frac{kWh}{ton \times nm} \right]$$

The Power Factor is a good indicator for the energy efficiency of different ship types and sizes. In Figure 15 you can see the benefits of large, slow tankers and bulk carriers. Even very large container vessels cannot compete with the min fuel efficiency.

Also RoRo vessels are far above tankers and bulk carriers in fuel consumption per transported cargo and nautical mile. Today all these ship types have diesel-mechanical machinery and use MDO or HFO as fuel.

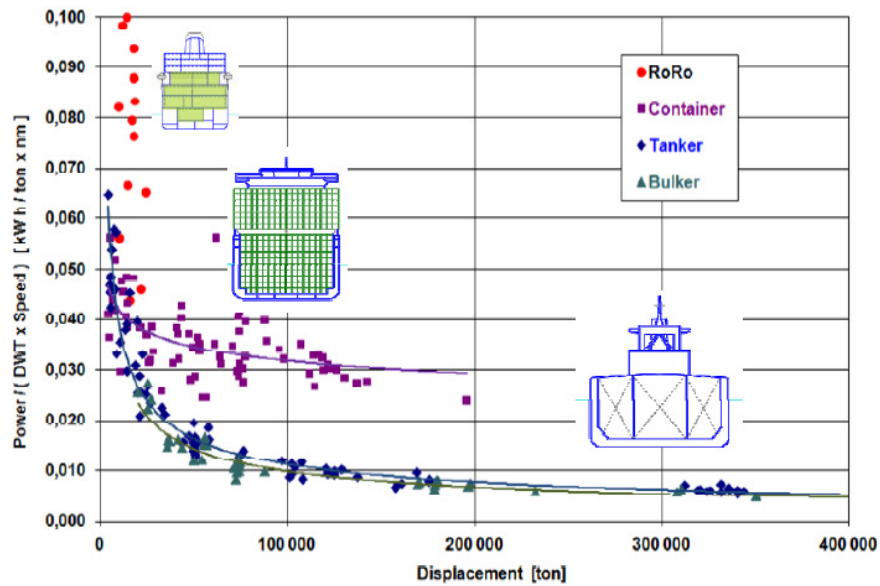

Figure 15. Power Factor for different ship types and sizes

2.4 Reducing CO2 emissions from ships

To reach the EU goal of 20% reduction of CO2 emissions also in shipping we basically have to improve the Power Factor. A lower Power Factor indicates that less power is needed to transport the desired deadweight at the required service speed.

For ships using MDO or HFO as fuel the CO2 emissions are directly related to the fuel consumption. The main possibilities for reductions are shown in Figure 16.

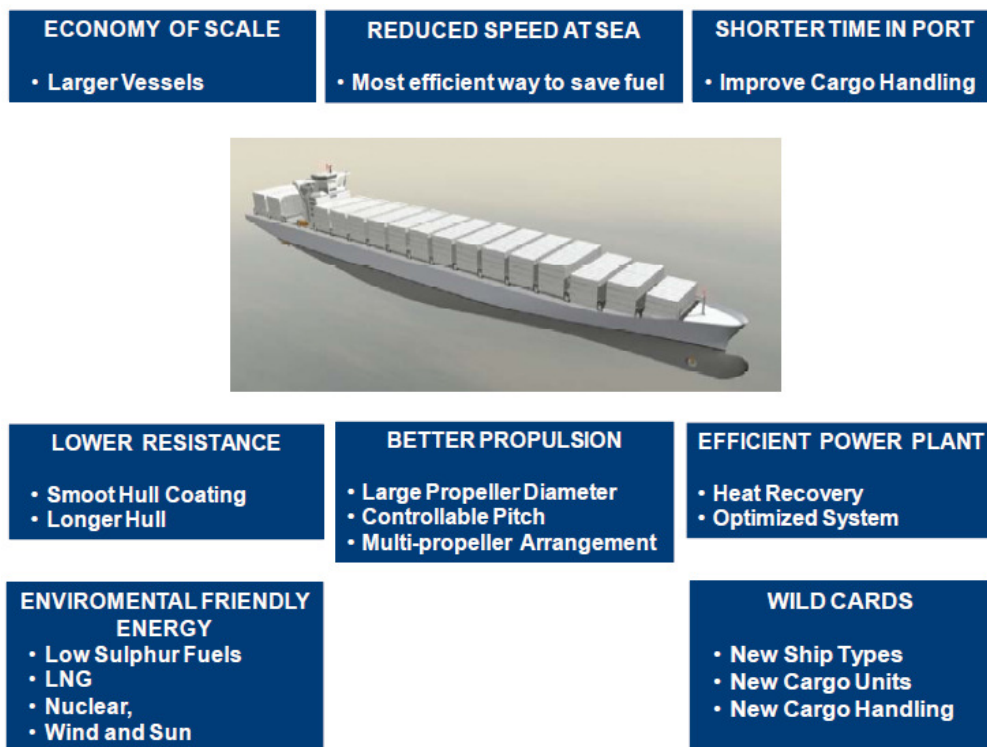

Figure 16. CO2 reduction possibilities

REFERENCES

Hubka & Eder: "Theory of Technical Systems", Springer Verlag, Berlin 1988
 Lamb, Thomas, Editor: "Ship Design and Construction", SNAME 2003

Levander, Kai: "System Based Passenger Ship Design", Proceedings/IMSDC 91, Kobe 1991
 Levander, Kai: "Innovative Ship Design – Can innovative ships be designed in a methodological way", Proceedings/IMSDC 03, Athens 200

METHODS and TOOLS

New and Updated Modules to Performed Stress and Strength Analysis

V. Zanic, T.Jancijev, J. Andric, M. Grgic, S. Kitarovic, P.Prebeg

UZ, University of Zagreb, Faculty of Mechanical Engineering and Naval Architecture, Zagreb, Croatia

P. Rigo, C. Toderan, D. Desmidts, A. Amrane, T. Richir, E. Pircalabu

ANAST, University of Liege, Liege, Belgium

M. Lappy

DN&T, Liege, Belgium

ABSTRACT: The overall objective of this was to develop and validate missing calculation modules that will be integrated with the core design tools (LBR5, OCTOPUS, CONSTRUCT) through integration tasks. The load and response calculation modules, corresponding to the design problem and design methods previously identified, form the core of the design feasibility control of the entire IMPROVE approach. They must be streamlined to fit the synthesis methods with specific requirements (fast execution for multiple inputs of design parameters). They may also be relaxed to fit tolerances of the concept design phase. Through this task UZ, ANAST and DNT made extensive developments that included different structural aspects such as (equivalent modeling of corrugated bulkhead, double bottom element, equivalent model for cofferdam structure, etc.) Extensive validations and comparison of newly developed models were performed.

1 INTRODUCTION

Through this sub task UZ, ANAST and DNT made extensive developments that included different structural aspects. Deliverable contains three groups of activities:

- A. Development of fast and effective calculation methods for the concept design. It was best achieved through development of efficient equivalent modeling methods/modules capable of simplifying data input and increasing calculation speed, yet maintaining sufficient accuracy for this design phase. Modules developed enable efficient calculations of corrugated bulkheads, cofferdams and double bottoms.
- B. Verification and validation of the existing response modules, including their improvements. This was performed for 2D and 3D FEM analytical models. New design procedure for multi-deck ships, based on generic ship models was introduced.
- C. Development and improvements in the optimization methods using developed/ improved modules. Additionally feasibility module according to BV Rules criteria was developed

2 EQUIVALENT MODELING

2.1 *Finite element for modeling of equivalent corrugated bulkhead*

Through this sub-task the development and validation of eight-node isoparametric finite element for corrugated bulkhead was carried out, Fig. 1. The element was developed through introduction of anisotropy into plane shell isoperimetric finite element (Bathe, 1980) for plane stiffened panels and was incorporated into OCTOPUS modulus for transverse strength calculation. For the purposes of comparison and verification the fine mesh NASTRAN FE model of the corrugated bulkhead was developed. Two types of boundary conditions were applied to investigate its influences on the analyzed dominant part of the bulkhead.

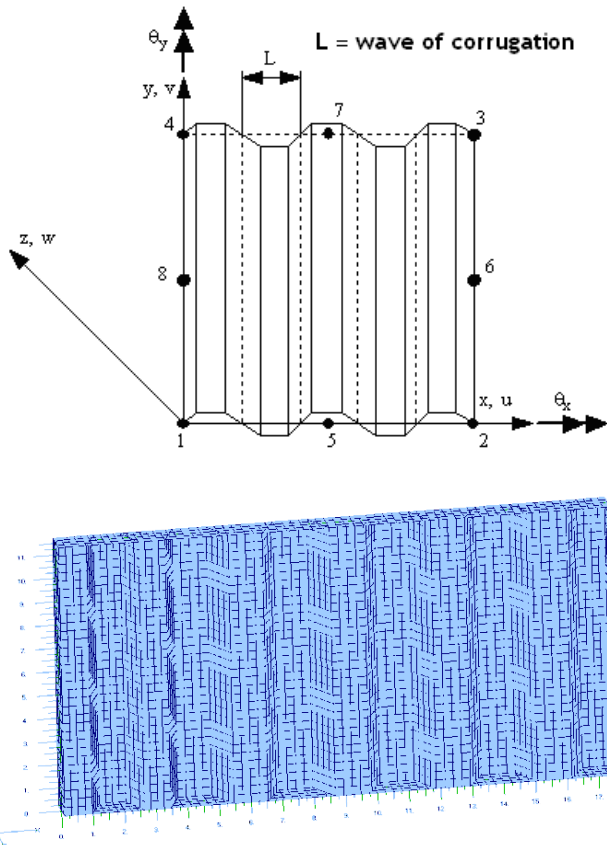

Figure 1 Eight - node isoparametric finite element for analysis of the corrugated bulkheads and fine mesh validation model in NASTRAN

For the evaluation of a quality of coarse macroelement mesh using anisotropic finite elements, two 2D OCTOPUS models were generated: one with the simple plate elements with stiffeners (model A1) and the other with the anisotropic finite elements (model A2). The results of OCTOPUS models were compared with the NASTRAN model, Fig. 2.

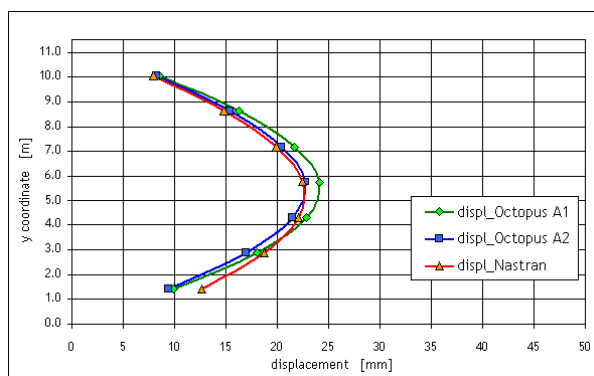

Figure 2. Comparison of displacements of OCTOPUS and NASTRAN model

Comparison of OCTOPUS model A2 with NASTRAN fine mesh model shows very good agreement of displacements and σ_y normal stress. For model A2 the displacements vary up to 5% and σ_y normal stresses vary

up to 15%. The results of OCTOPUS model with simple plate elements with stiffeners (model A1) are not acceptable compared with the results of the model A2.

2.2 Equivalent modeling of double bottom elements

Through this sub-task the development and validation of the double-hull element was performed taking into account the additional stiffness brought by the double-hull web frames as well as the link they constitute between these web frames and the double-hull plating (inner hull and outer hull), (Rigo, 2005). The integration of the double-hull element inside the optimization process, involving the (analytical) computation of sensitivities with respect to design variables was achieved.

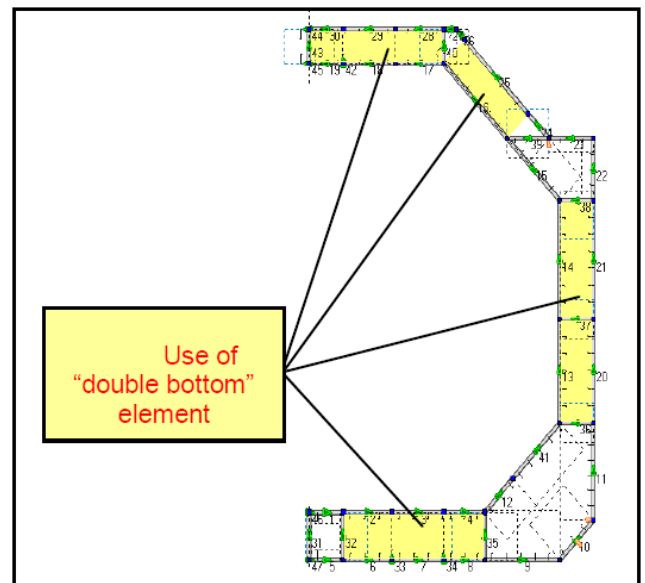

Figure 3. Modeling of the structure in LBR-5

This new functionality has been validated by comparing results obtained with those coming from Finite Element Analysis and Solid Mechanics Theory. Convergence of the results obtained with LBR-5 in terms of the number of Fourier terms as well as the order of magnitude of these results are totally acceptable.

2.3 Equivalent modeling of cofferdam

Through this sub-task the development and validation of modeling of cofferdams using LBR-5 software is presented. The goal of this task is to allow the optimization tool to take into account the cofferdam structure during the structural analysis and the optimization process.

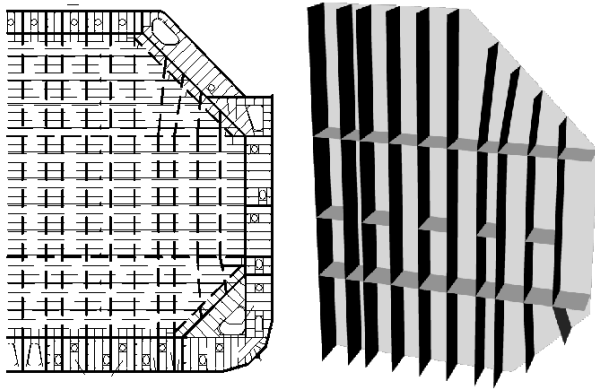

Figure 2. Drawing of the cofferdam and model in Rhino

The stresses obtained in the symmetry axis with LBR5 are in average 15-20% higher than the FEM solution for the two load cases. The differences are due to several reasons, including the LBR5 geometry and scantlings approximations and the differences between the two considered methods for the analysis. The differences at the extremities are influenced by the boundary conditions and the rectangular shape used by the LBR5 model, therefore they will not be considered in the calibration. The proposed methodology can be considered as a general way to optimize several structures (or sub-structures) at the same time, but the development done in this chapter is only focusing on the LNG cofferdam structure.

3 VALIDATION OF STRESS / STRENGTH MODULES FOR CONCEPT DESIGN

3.1 Modules for direct calculation of the longitudinal and transverse strength

Modules for direct calculation of the longitudinal and transverse strength have been examined and improved in OCTOPUS software. The comparison between 2D OCTOPUS and generic 3D MAESTRO models of RoPax are carried out. Accuracy of longitudinal stress distribution over ships height in OCTOPUS model found to be satisfactory compared to generic 3D MAESTRO model for the purpose of concept designs. Accuracy of stress distribution over the transverse beams breadth in OCTOPUS model was found to be satisfactory compared to the 3D FE model. Similar validation has been performed with LBR-5 modules and compared to VERISTAR results. It also gave satisfactory results for the concept design phase.

3.2 Development and validation of simplified generic 3D FEM models for concept design

Simplified way of modeling complex primary structural response of the multi-deck ships (eg. RoPax) has been

established using the generic coarse mesh 3D FE models, Fig.2.

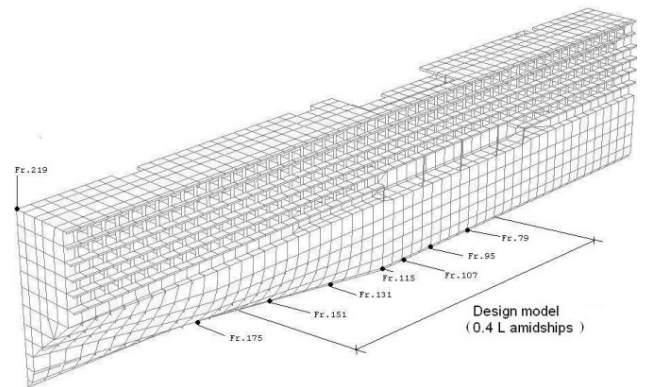

Figure 2. Generic 3D coarse mesh FE model of multi-deck ship

Special considerations are given to the equivalent modeling of large side openings due to fact that can significantly influence the longitudinal hull girder bending response. Methods for equivalent modeling of side openings are presented and validated with an objective to ease their integration into generic FE models. This approach enables correct consideration of the longitudinal strength of RoPax ship and ensures rapid generation and comparison of different structural topological concepts, as requested for concept design phase for such ship types (Zanic et al., 2007).

3.3 Module for structural safety calculation

Structural safety calculation based on BV structural safety criteria (yielding and buckling), necessary for a structural evaluation was programmed and evaluated (BV, 2008). Each criterion is separately encoded into different FORTRAN subroutine and all the subroutines are subsequently added to the library of structural adequacy criteria. The full incorporation/implementation of BV Rule given structural adequacy criteria (Buckling) into the OCTOPUS computer program for structural evaluation was carried out. This encompasses the criteria applicable to the following structural members: corrugated bulkheads, curved panels, plane panels, ordinary stiffeners and primary support members.

4 OPTIMIZATION MODULES

4.1 Development of discrete optimization module

Development of a discrete optimization module in the LBR-5 software. It uses a dedicated algorithm (CONLIN) that performs very well to solve the problem at hand.

A limitation in this algorithm is that it considers only real variables. However, some variables of the problem take integer values or values chosen within a specified set.

The CONLIN solver doesn't comply with the discrete nature of such variables since non-integer values are allowed to appear in the optimal solution. This drawback implies a post processing phase in which the designer has to round off the non-integer values, which usually reduces the benefit. To avoid such procedure a new optimization method was developed that would consider the discrete nature of the design variables.

4.2 Development of multi structure module

Development of a multi-structure module in the LBR-5 software has been performed. The objective of this task is to optimize not one section (midship, tank, etc.) of a ship but several sections (or several sub-structures). The idea is to optimize simultaneously various sub-structures which share some common design variables, instead to optimize them separately. A new methodology has been developed and the LBR5 software is currently re-shaped to consider this new approach. Application of this new concept has been used to optimize the LNG by optimizing simultaneously the cofferdam and the tanks.

5 CONCLUSIONS

Extensive descriptions of theoretical models, their validation and verification examples together with implementation flowcharts are parts of this work. All modules / methodologies developed through this task, together with the other newly developed modules, were integrated into the existing design tools (OCTOPUS, LBR-5, CONSTRUCT) for extensive usage in application cases.

They ensured necessary extension of the existing analytical and synthetical (optimization) infrastructure for the rational structural design and therefore the improvement of vessels designed in the IMPROVE project.

REFERENCES

- Bathe, K. J. (1980), *Finite Element Procedures in Engineering Analysis*, Prentice Hall.
- Bureau Veritas, (2008), *Rules for the Classification of Steel Ships, Part B: Hull and Stability*.
- Rigo, P. (2005), "Differential Equations of Stiffened Panels of Ship Structures & Fourier Series Expansions", *Ship Technology Research, Schiffahrts-Verslag "Hansa"*, Hamburg, Vol.52, 2005, pp. 82-100.
- Zanic, V., Andric, J., Prebeg, P., (2007), "Design Environment for Structural Design: Application to Modern Multi-deck Ships ", *IMAM 2007*, pp.445-454, Varna, Bulgaria

Local and global ship vibrations

A. Constantinescu & Ph. Rigo

University of Liège, liege, Belgium

I. Chirica & S. Giuglea & V. Giuglea

Ship Design Group, Galati, Romania

ABSTRACT: Nowadays, noise and vibration problems tend to become an important part of the design process in the naval industry. Vibrations often affect the passengers comfort, but more dangerously may damage the structure, embarked merchandise and equipments. A simple way to avoid vibrations is to prevent the resonance conditions. The paper presents a study of the local (stiffened panels) and global (hull beam) vibration with application in the marine industry. The both vibration analytical models, i.e. local and global, have been written in FORTRAN and they are used into a structural optimization process at the early stage design of the ship. Finite element simulations were carried out to validate the both numerical tools

1 INTRODUCTION

The main application of this study refers to the marine field and particularly to ferries and RO-RO ships for which the vibrational behavior is often verified in the preliminary design stage process or during the structural design phase. A ferry or RO-RO ship is characterized by very large decks that may suffer from fatigue due to vibrations. The LNG's tank walls can be also affected by vibrations, but in this case we must take into account the fluid-structure interaction. Compared to analytical models, the 3D-FEM models are preferred because almost structural details and mass distribution can be modeled. However, the FE simulations cannot be always used in multi-criteria structural optimization design processes due to its very large CPU times. Or, today the naval industry has very strict deadlines and the optimization was pushed in the early-stage design process. In this phase, a sub-critical or a super-critical vibration designs can be formulated for the local structures. Generally, a sub-critical design (all natural frequencies of the system are higher than the highest significant excitation frequency) is preferred. The super-critical design is more exigent and requires verification by the response calculations (Asmussen, 2001).

Empirical formulae used for the vibration assessment of the stiffened panels were delivered by SDG. These formulae were determined based on the numerical calculation on sensitivity analysis of the panel vibrations with COSMOS. The coefficients of the polynomial functions were

determined with a special soft, INTERPOL, made by SDG, for functions of one variable and REGRESS for quadratic functions of n variables.

The work presented in this paper also covers the global vibrations of these ships. A methodology to determine the global vibrations of the ship hull was made. The methodology can be used in the optimizing process, by taking into account the added mass. The added masses are determined based on the analytical-experimental methods.

A module, written in FORTRAN, to determine the global vibrations of the ship hull was created. The results obtained with this module are compared with the ones obtained with a special soft UGAL and with 3D model using COSMOS/M. These results are good enough for the preliminary stage of the ship design. These results are good

2 LOCAL VIBRATIONS

The first part of the research work covers analytical vibration modeling of 3D beam structures and 3D stiffened shells (orthotropic panel), as well as the finite element analyses necessary to validate and assess the limitation of the method. This modeling allows to easily taking into account the concentrated masses distributed on the panel surface. The numerical model constituted the base of a vibration module.

2.1 Analytical model and particularities

The analytical method is based on the elastic, homogeneous and isotropic material hypothesis. The Euler-Bernoulli formulation assumes that cross-section, which are initially plane and perpendicular to the axis of the beam, remain plane and perpendicular to this axis. The transverse shear deformation is thereby neglected.

Using the dynamic equations of mechanical continuum beams systems and the strength of materials formulae, it is possible to obtain an expression between nodal local forces (F^L , six per node) and nodal local displacements (U^L , six per node), Eq. 1.

$$[F^L]_{12 \times 1} = [K^L(\omega, C_{mp})]_{12 \times 12} [U^L]_{12 \times 1} \quad (1)$$

where C_{mp} represents the mechanical and physical characteristics of the beam. The matrix K^L represents the continuous stiffness and mass matrix. This matrix is non-symmetrical and the circular frequency ω is located inside the \sin , \cos , \sinh and \cosh functions.

In the case of a 3D multi-beam structure, the nodal local efforts and displacements are projected into a global coordinate system. A global continuous stiffness and mass matrix will be obtained. This matrix connects the global nodal effort with the global nodal displacements and allows us to calculate the eigenfrequencies of the system:

$$[F^G]_{12 \times 1} = [K^G(\omega, C_{mp})]_{12 \times 12} [U^G]_{12 \times 1} \quad (2)$$

where "dof" represents the total number of degrees of freedom. The natural eigenfrequencies of the structural system are obtained by the cancellation of the determinant of the matrix K^G , Eq. 3, because the resonant phenomena express by very important structural displacements.

$$\det([K^G(\omega, C_{mp})]_{dof \times dof}) = 0 \quad (3)$$

This first, named classic dichotomy, supposes to divide the relevant frequency interval into small fixed intervals and calculate the determinant at each frequency step. A change of the determinant sign indicates a solution of the characteristic equation. The accuracy of this method is influenced by the frequency step dimension, but smaller is the step larger is the CPU calculation time.

In order to diminish the CPU time, a second method, named discrete method. It supposes to dissociate the matrix $K^G(\omega, C_{mp})$ into a mass matrix $M^G(C_{mp})$ and a static stiffness matrix $K^G(C_{mp})$ similar to the discrete systems.

These matrices are independents of the frequency f . The CPU time is considerably reduced for larger structures.

2.2 Stiffened panels modeling

To calculate analytically the eigenfrequencies of a stiffened panel we employ a virtual artifice that consists in the decomposition of the panel into a beam grid, as presented in the Figure 1. The vibration analysis uses then the beam model already described. This choice allows us to use the beam theory, described above, to solve the problem. At the same time it will be easily to assess vibration for complex structures like stiffened panels - beams assemblies and also to take into account concentrated masses distributed on the panel surface. The main condition is to preserve the global inertia of the stiffened panel and total mass of the structure.

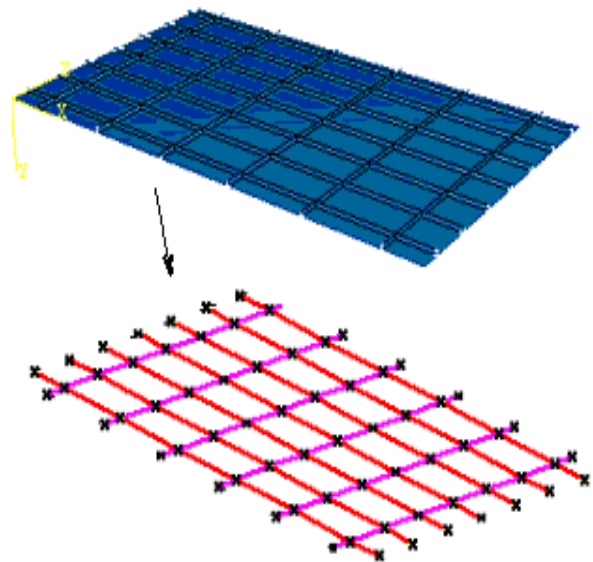

Figure 1. Decomposition of a stiffened panel into a beam grid

After the splitting of the stiffened panel into a beam grid, the second moments of area of each beam section of the new structure is calculated with respect to the principal axes passing through the barycenter of the considered cross section of each beam, noted C1 on Figure 2.

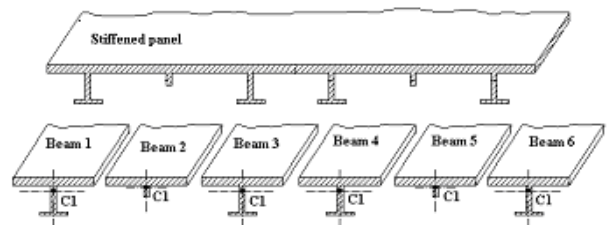

Figure 2. Decomposition of a transversal side of a stiffened panel into a beam grid

2.3 Validation

The vibration module is automated to analyze isolated planar stiffened panels, i.e. stiffened panels having independent boundary conditions from the other neighbor panels. Knowing the initial dimensions of the panel, the positions and the geometry of the stiffeners, the vibration module decomposes automatically the stiffened panel into a beam grid, calculates the necessary data (second moments of area, areas), applies the boundary conditions and evaluate the first natural frequency. The first validation of this vibration tool was realized on 3D beam structures. The FE simulations used a beam modeling. The both numerical methods (classic dichotomy and discrete method) give practically the same results, but with different CPU times (greater for the classic dichotomy). These results are also in very good correlation with FE results. The FE modeling uses only shell elements. The second validation of the local vibration module uses planar stiffened panels. Again, the results given by the vibration module are in very agreement with those of FE simulations.

3 SHIP HULL GENERAL VIBRATION

3.1 Ship hull natural vibrations

The global vibrations model uses the dynamic equation of the ship hull:

$$(\mathbf{M} + \mathbf{M}_a)\ddot{\mathbf{A}} + \mathbf{K}\mathbf{A} = \mathbf{F} \quad (4)$$

where \mathbf{M} is matrix of inertia of the ship hull structure, \mathbf{M}_a is matrix of inertia of the cargo and added mass (hydrodynamic masses), \mathbf{K} is stiffness matrix, determine by assembling the hull elements, modelled as 3D beams. \mathbf{A} is vector of the displacements of the nodes. As it is seen, the damping is neglected. The ship hull natural vibrations problem is considered when $\mathbf{F}=\mathbf{0}$.

The based analytical-experimental method to determine the added mass is the method proposed by F.M. Lewis. He has calculated the added mass of a ship section vibrating in water with unlimited deep and without free surface, (the length of the ship is considered as infinite). Complex mathematical development were achieved in order to compute the added mass coefficients which are influenced by the form of the ship section. Due to the fact the fluid moving is 3D one, the ad-ded masses are to be amended by reduction factor J_n .

3.2 Module for ship hull vibration calculation

Based on this theory, a module for hull vibration calculation was made in FORTRAN.

The vibration assessment module requires a single INPUT file (Figure 3). This module will be called at each increment of the optimization loop. The Output data (the first 3 natural frequencies of the ship hull) will be compared with the most important excitation frequency. The ship hull is divided into 3 parts: aft part and fore part are unchangeable during the optimising process. The optimized area (middle part of the ship) will be modifiable during the optimizing process. Also, it is possible to be modifiable the end parts (this means the optimised area is whole part of the ship).

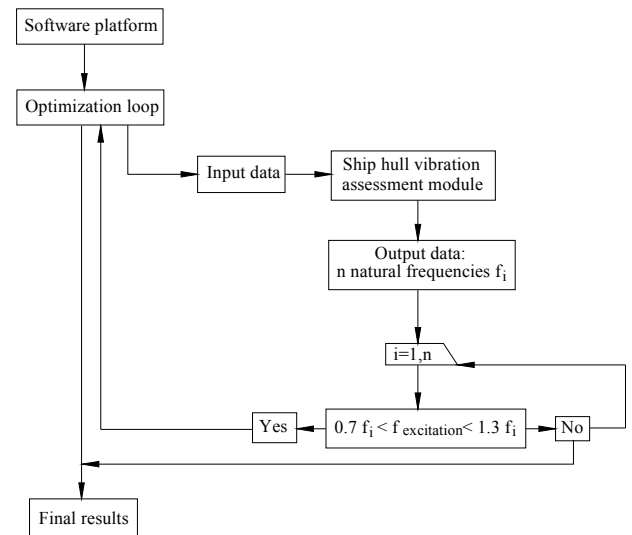

Figure 3. Data flow

The ship hull is divided into n ship hull beam element, taken into account the three parts of the ship hull. For each element, the sectional, inertial and hydrostatic characteristics are to be delivering in the input data file for VIBHULL module.

3.3 Application test for a tanker vibration calculus

A test on the vertical bending vibrations of the tanker hull was done. The main characteristics of the ship are: length of the ship 220 m, breadth of the ship 43 m and draught of the ship 16 m.

The calculus was done for vibrations in air and for vibration in water. The results were compared with the ones obtained by modelling with 3D shells using licensed soft COSMOS/M. The ship hull was divided into 20 hull beam elements, having the same length. The first 3 natural modal vibrations for vertical and horizontal bending and first natural mode for torsion are requested. The results obtained with the soft COSMOS/M and module VIBHULL are presented in tables 3 and 4. In Figures 4 to 7, the pictures concerning the 3D FEM model and vertical modal shapes obtained with COSMOS/M code are presented.

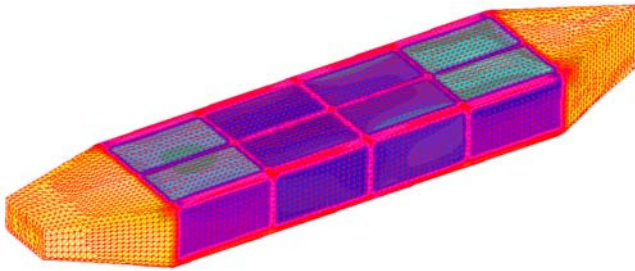

Figure 4. FEM 3D model (COSMOS)

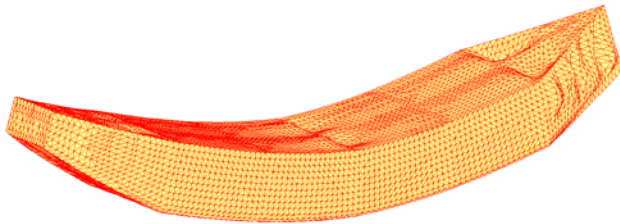

Figure 5. 3D first vertical modal shape (COSMOS)

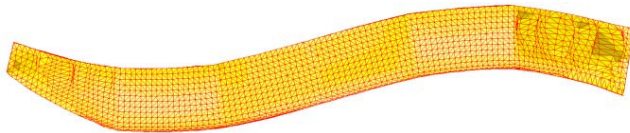

Figure 6. Second vertical modal shape (COSMOS)

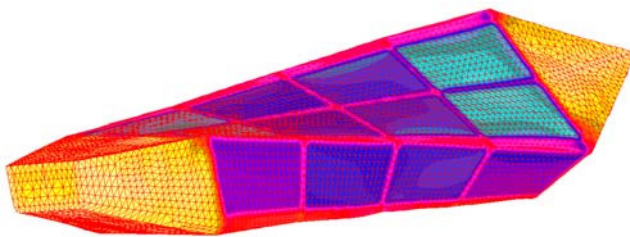

Figure 7. First torsional modal shape (COSMOS)

Mode No.	Vibrations in water		
	VIBHULL	COSMOS/M	Diff. (%)
1-vert.bend.	0.86	0.75	12.79
2-vert.bend.	1.94	1.68	13.40
3-vert.bend.	3.26	2.88	11.65
1-horiz.bend.	2.56	2.41	5.85
2-horiz.bend.	6.42	6.01	6.38
3-horiz.bend.	12.36	11.02	10.84
1-torsion	-	-	-

Table 1. Modal frequencies for ship hull vibrations in air

Mode No.	Vibrations in water		
	VIBHULL	COSMOS/M	Diff. (%)
1-vert.bend.	2.64	2.52	4.54
2-vert.bend.	6.49	6.11	5.85
3-vert.bend.	9.04	8.74	3.31
1-horiz.bend.	4.71	4.41	6.36
2-horiz.bend.	13.13	11.87	9.59
3-horiz.bend.	21.97	19.33	12.01
1-torsion	9.61	8.95	6.86

Table 2. Modal frequencies for ship hull vibrations in water

4 CONCLUSIONS

In this paper, the first numerical approach is used to calculate the first resonant frequency for stiffened panels. It can take into account three types of boundary conditions for the non-connected nodes, i.e. clamped, simply supported and free (6 dof per node). Finite element simulations were carried out to validate the numerical tool. In practical dimensioning, only the first natural frequency is the most relevant. The value calculated with the vibration tool is very close to that given by FE software for all problems treated in this paper. Taking into account the limitations of the method, it is appreciated that the numerical tool can be successfully used to calculate correctly at least the two first resonant frequencies for beam structures and stiffened panels.

The results obtained for global vibration of the tanker, so for vibration in air and for the vibrations (vertical, horizontal and torsional modes) in water (taking into account the added masses) were compared with the results obtained with licensed software (COSMOS/M) based on 3D model (plate elements) so for structure vibration analysis and for added mass calculus. The deviation of the results obtained with VIBHULL and COSMOS/M are increasing since the frequency is increasing for vibrations in water. For the first natural vibration, the differences are of 3.31 % in air and 12.79 % in water.

As it is seen, the difference is large for vibration in air due to different methodology used in the two codes (for COSMOS model, the added mass was introduced as supplementary mass density of the plates). To determine more precisely added masses, FEM for water modelling is to use. Nevertheless, this method is a very large time consuming. The time consuming for the code VIBHULL is very small (< 2 s for the application performed in this work). The results obtained for natural frequencies taking into account the added masses are good enough for the initial stage of ship design.

REFERENCES

- Asmussen, I., Menzel, W., Mumm, H., “*Ship Vibration*”, Germanischer Lloyd, 2001.
- International Standard ISO 6954, “Mechanical vibration – Guidelines for the measurements, reporting and evaluation of vibration with regard to habitability on passenger and merchant ships”, 2000.
- International Standard ISO 2631-2, “Mechanical vibration and shock – Evaluation of human exposure to whole-body vibration, Part 2: Continuous and shock induced vibration in buildings (1-80 Hz)”, 1989.
- Blevins, R., “*Formulas for natural frequency and mode shape*”, Van Nostrand Reinhold Company, New York, 1979
- Bertram, V., “Ship Vibrations. Lecture Notes prepared for MSN and ANO”, 2004
- Krilov, A.N., “*Vibratia sudov*“, Leningrad, 1936
- Korotkin, A., I., “*Prisoedinennie massi sudna*”, Leningrad, 1986

Assessment of ultimate strength at the early design stage

Hendrik Naar and Meelis Mäesalu

MEC-Insenerilahendused, Estonia

Stanislav Kitarovic, Jerolim Andric and Vedran Zanic

UZ-FMENA – University of Zagreb, Faculty of Mechanical Engineering and Naval Architecture, Croatia

ABSTRACT: Objective of the task T3.2 was to give an overview regarding the applicability of coupled beam method (CB) and modified smith (MS) method for various ships types for hull girder ultimate strength estimation. The theory of both approaches is presented. A detailed description of ultimate strength module based on coupled beam approach is given as well. The extensive validation of MS and CB-approaches against FE-approach is accomplished for prismatic chemical tanker structure and for various types of multi-deck ships.

1 INTRODUCTION

Ultimate strength module is part of the decision making software used for the development of the new and innovative products developed in WP6-WP8.

The implementation of task 3.2 should provide bases for selection of relevant tools for ultimate strength assessment in early design stage. Methods used in tools should allow assessment of hull girder ultimate strength in early design stage, when detailed three-dimensional finite element modeling is not practical. Furthermore, in the case of optimization process, where large number of designs is considered, semi-analytical methods offer advantages over finite element analysis.

Main requirements for methods

- In early design stage, only main structural components are defined in general level. Actual topology and dimensions of those components are still subject to significant alterations. The method should allow for convenient and time-effective ways to implement those major alterations in design.
- To evaluate different design variants with respect to hull girder ultimate strength, as one of design attributes.

- Despite the requirement of simplicity, for precise assessment the method could include the possibility to count for:
- large shear forces due to discontinuous loading,
- reduction of hull girder ultimate strength due to low shear strength of some longitudinal elements such as bulkhead or deck.

2 METHODS FOR SHIP HULL ULTIMATE STRENGTH ANALYSIS

Since the ultimate strength might be perceived as the most meaningful safety measure of the ship's hull girder structure, prediction of the ultimate bending moment becomes essential and unavoidable part of the ship structural concept design process. Methods employed should support multiple failure modes and their interactions, while giving precise prediction of collapse and post-collapse behavior of the structural members involved (particularly those under compression). On the other hand, multiple executions within design loop demand utilization of stable, robust and sufficiently fast algorithms.

2.1 *Improved incremental-iterative method for ultimate strength assessment of hull girder*

Improved incremental-iterative method for longitudinal ultimate strength assessment is based on IACS prescribed incremental-iterative method [IACS, 2006 and Smith, 1977], see Figure 1a. Modifications of

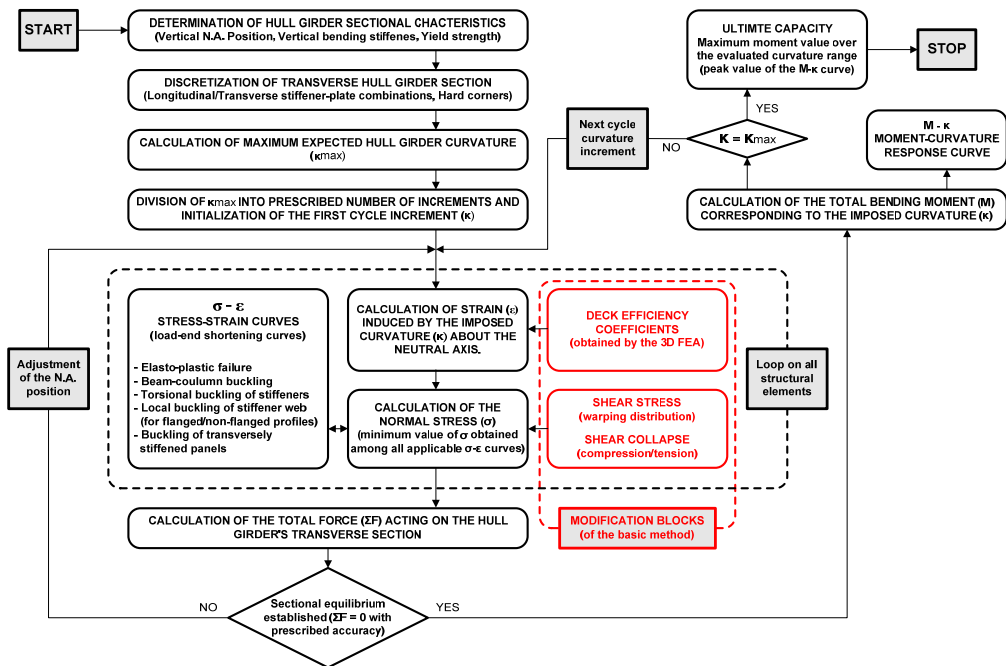

Figure 1b. Flowchart of the improved incremental-iterative method for the longitudinal ultimate strength assessment.

the basic method are introduced in effort to enable inclusion of the effects disregarded by the basic method and thus improve the overall accuracy of the analysis. Incorporated method particularities include contemporary advances which improve the accuracy during multi-deck ship application, as well as the ability to consider vertical shear force influence on the ultimate hull girder strength. Influence of the shear stress and deck efficiency is incorporated into basic method in a manner illustrated by the figure 1b.

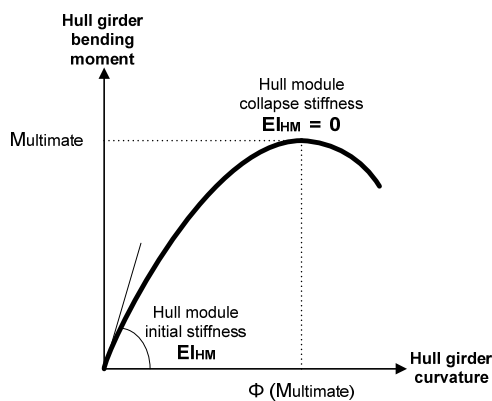

Figure 1a. Qualitative hull module moment to curvature ($M-\Phi$) response curve, obtained by utilization of the Bernoulli-Euler beam idealization of the hull girder.

The effect of the vertical shear force on the hull girder ultimate strength is considered through the influence of the warping induced shear stress distribution of the hull module on the collapse (buckling, yield) of the principal structural members, where energy based numerical method and

decomposition of a cross section into the line finite elements are used for the shear stress calculation.

An approximate procedure using linear-elastic 3D FEM analysis is used for prediction of the efficiency of each principal structural element in order to correct strains in case of multi-deck ships cross-section. Although implementation of this modification has limitations regarding overall accuracy, relatively simple and not so time consuming nature of the procedure enables better structural response assessment and renders this modification of the basic method as convenient for the application within the optimization based concept design loop.

Incremental nature of the method enables prediction of the structural collapse dynamics and establishment of the collapse sequence of the principal structural members of the hull module. This enables subsequent redesign of the critical components resulting in a globally safer structure, especially if the methodology is employed within the optimization based concept design loop.

2.2 Non-linear coupled beam method

The CB-method is developed for global bending response of a ship with a long multi-deck superstructure. According to the idea the ship hull is divided into longitudinal beams that have bending and axial stiffness. Each beam consists of part of deck or side structure and is connected to neighbor beam or beams, see Figure 2. The beams are connected by distributed springs, which transfer vertical forces and longitudinal shear forces between the beams. The stiffness of springs corresponds to the vertical elongation stiffness of the bulkhead or the side shell and to

the shear deformation stiffness of the structure connecting two decks. All stiffness parameters can have non-linear definitions corresponding to buckling or material yielding.

The longitudinally distributed line load can be applied on each beam separately or as a resultant load on the lower beam. Detailed description of the theory is presented by Naar et al. [Naar et al., 2004] and [Naar., 2006].

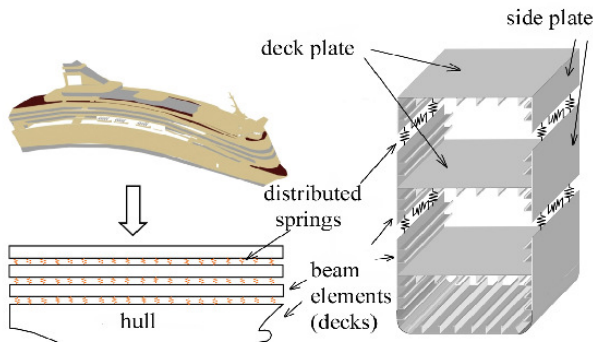

Figure 2. The basic concept to estimate the bending response of a passenger ship.

2.3 Validation

The intense validation of MS and CB-approaches against FE-approach is accomplished for prismatic chemical tanker structure and for various types of multi-deck ships. As finite element solver the explicit FE-code called LS-DYNA was used. All ships were modeled in full length as prismatic structures.

Validation confirmed good agreement of both methods with FE results for chemical tanker case. The accuracy of the MS-method compared to FE-approach is 3%. The accuracy for CB-method is smaller reaching to 10% compared to FE-results.

As an example of FEM simulation the tanker structure in sagging loading is presented in Figure 3.

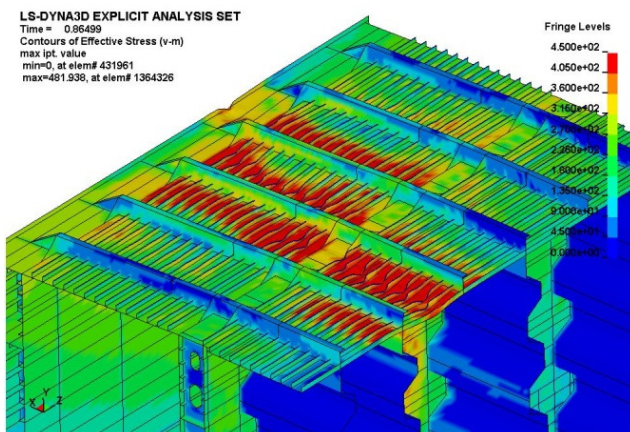

Figure 3. Chemical tanker deck structure failure in sagging loading.

For the multi-deck ship cases agreement in results of both methods compared to FEM varies depending on the considered loading scenario. The accuracy of the CB-method compared to FE-approach in case of multi-deck ship depends whether the hogging or sagging loading is considered. In hogging the difference between the FE and CB results is between 2% and 6%, see Figure 4. In sagging the difference is more drastic by changing from 18-45%. For MS-method the difference between FE-results is between 2-21% for hogging between 0.1-4% for sagging.

3 ULTIMATE STRENGTH MODULE BASED ON CB-APPROACH

The present CB-method is implemented as C++ code (SHIPBEAM) which can be utilized as independent solver or as a part of CONSTRUCT tool. In case of independent solver the input data defining the structure is given in a form of text file and after solution the output data will be printed into results files.

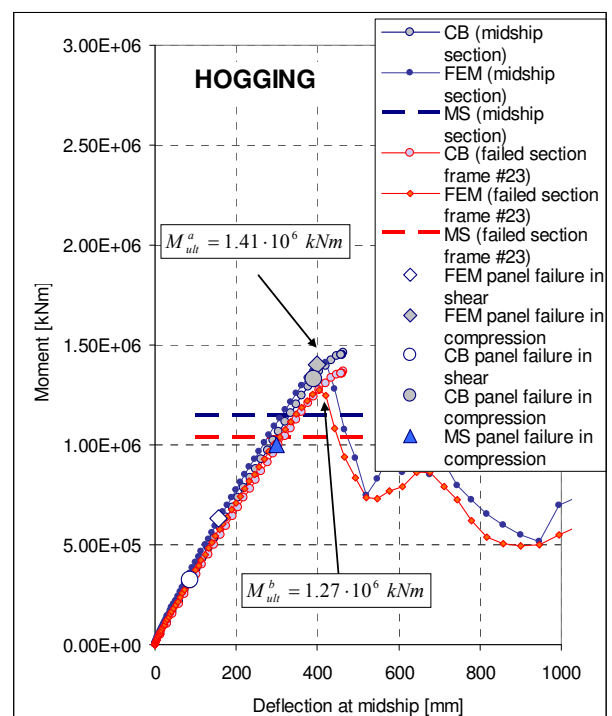

Figure 4. Moment to deflection curves for non-prismatic multi-deck structure in hogging.

REFERENCES

Bleich HH. Nonlinear distribution of bending stresses due to distortion of the cross section. J. Applied Mechanics, Vol. 20, 1952, p. 95.

Crisfield MA. A fast incremental/iterative solution procedure that handles "Snap-through". Computers & Structures, Vol. 13, 1981, pp 55-62

Crisfield MA. Non-Linear Finite Element Analysis of Solids and Structures. Vol 1. John Willey & Sons, West Sussex, England, 1991.

Fransman J. The influence of passenger ship superstructures on the response of the hull girder. Trans. RINA, 1988.

Gere JM and Timoshenko SP. Mechanics of Materials: Third Edition. PWS-KENT Publishing Company, Boston, 1990, pp. 693-694.

Hughes, Owen F.: 'Ship Structural Design - A Rationally-Based Computer-Aided Optimization Approach', The Society of Naval Architects and Marine Engineers, 1988.

IACS: 'Common Structural Rules for Double Hull Oil Tankers', January 2006.

ISSC 2006 Ultimate strength. Committee III.1 Report. Proceedings of the 16th Int. Ship and Offshore Congress. Vol 1. 20 – 25 August, Southampton, UK. pp. 353 -437.

Naar, H. Ultimate strength of hull girder for passenger ships. Espoo : Helsinki. University of Technology, 2006. 102 p. (TKK Dissertations ; 22).

Naar H, Varsta P and Kujala P (2004). A theory of coupled beams for strength assessment of passenger ships. Marine Structures, Vol.17, pp. 590-611.

Paik, Jeom K.: 'Ultimate Limit State Design of Steel-Plated Structures', John Wiley and Sons Ltd., 2003.

Smith, C. S.: 'Influence of Local Compressive Failure on Ultimate Longitudinal Strength of a Ship's Hull', Proceedings of the International Symposium on Practical Design in Shipbuilding - PRADS 1977, pp.73-79, Tokyo, Japan, 1977.

Žanić, V., Prebeg, P.: 'Primary response assessment method for concept design of monotonous thin-walled structures', Acta Polytechnica, Vol 45, No 4/2005, pp. 96-103.

Yao, T., Imayasu, E., Maeno, Y., Fujii, Y.: 'Influence of Warping due to Vertical Shear Force on Ultimate Hull Girder Strength', 9th Symposium on Practical Design of Ships and Other Floating Structures, Luebeck-Travemuende, Germany, 2004.

Rational models to assess fatigue at the early design stage

H. Remes, M. Liigsoo

Helsinki University of Technology, Espoo, Finland

A. Amrane

ANAST University of Liège, Liège, Belgium

I. Chirica, V. Giuglea, S. Giuglea

Ship Design Group, Galati, Romania

ABSTRACT: The fatigue assessment of complex ship structures is commonly based on hot-spot or notch stress method, where fatigue-effective stresses are obtained from the detailed FE analysis. This approach is time-consuming and it requires information of structural details. Therefore, the fatigue assessment is usually carried out after the preliminary design stage. This is a significant obstacle, because the decisions done in early design stage have a strong influence on the fatigue life of the hull girder. Structural modifications done after the early design stage are usually limited and expensive for production. This paper presents an approach for fatigue assessment at early design stage. It utilizes generic structural elements with pre-defined hotspot points based on the damage statistics.

1 INTRODUCTION

Design of ships is an interactive process, where major decisions are made in an early design stage covering for example the general arrangements. However, information of structural details, which are the requirements for reliable fatigue assessment, is available in the following design stages. This is a significant obstacle for the early design stage, because the decisions done in this stage have a strong influence on the fatigue life of the hull girder. Structural modifications done after the early design stage are usually limited and expensive for production.

EU-funded Improve project and WP 3.3 provides an approach for fatigue assessments in the early design stage. The main focus is on the approach, which is able to overcome the challenges due to limited information in the early design stage. Additionally, the requirements from the practical application of approach are considered; the linkage to existing design tools and structural optimisation.

2 FATIGUE-CRITICAL CONNECTIONS

A main challenge in the development of a fatigue approach for early design stage is to identify all potential fatigue-critical connections and structural details, which should be

included to the fatigue analysis. This is obtained with help of the reviewing the damage statistics of fatigue failures in ship structures. The reviewed statistics includes 108 ships, where was found more than 8000 fatigue failures. An example of the distribution of the fatigue cracks is presented in Figure 1. The damage statistics gives also possibility to indentify generic and ship- depended features in fatigue assessment.

Some characteristics affecting the fatigue strength of the hull girder are strongly depended on the ship type. These are for instance main dimensions, shape of the hull girder, geometry of the main frame, the steel arrangement and scantlings. These differences affect mainly on wave and cargo induced fatigue loading and response of hull girder in nominal stress level. However, structural details and connections are quite similar between different ship types. Based on the results from the review, the end of longitudinal stiffeners, particularly beam brackets and cut-outs are the most critical details, see e.g. Figure 2. Important are also connection between stiffened plates, for example at the hopper tank in LNG carriers. Additionally, the ends of pillars and web frames are fatigue-critical in the case of Ropax. Several different the fatigue-critical details lead to the conclusion that some sophisticated grouping of

structural details will be required in the fatigue approach for the early design stage.

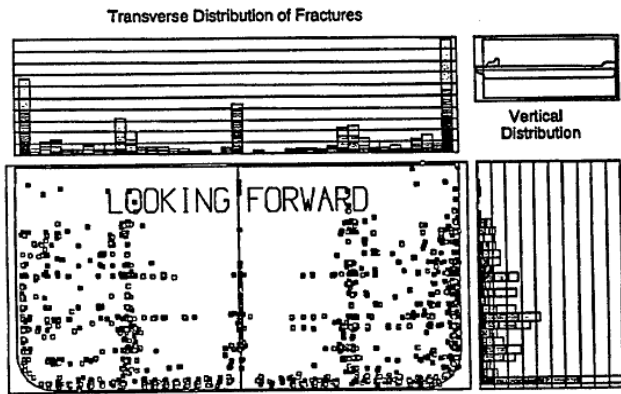

Figure 1: Distribution of fatigue cracks in Class C tanker (Sucharski 1997)

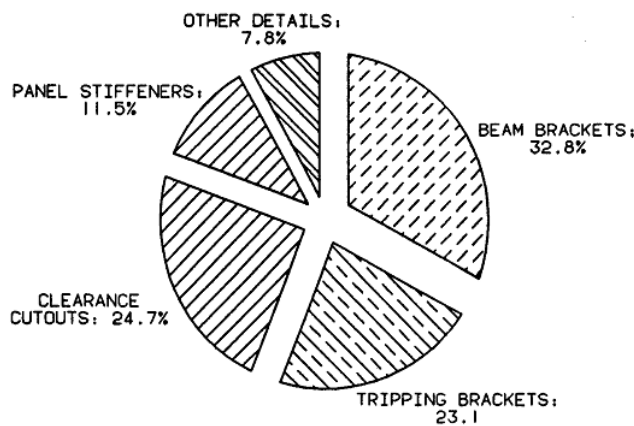

Figure 2: Failure percentage of structural details (Liu and Thayamballi 1991).

3 FATIGUE APPROACH FOR EARLY DESIGN

The approach is based on linear damage rule, long-term stress distribution defined by a Weibull distribution, and notch stress method. Important features of the approach is three level response analyses and the utilisation of generic structural elements. With the help of damage statistics, the three structural elements have been suggested: stiffened plate, girder and pillar, see Figure 3. These elements can describe the geometry of the hull structure. Additionally, they are suitable units for transformations of the ship-dependent features from existing design tool, as the response analysis is divided into three levels. In the first level, Sigma 1 and 2 response of the hull girder is evaluated based on wave and pressure loading and representative for the whole ship model. This is done within existing design tools. In the second level the local nominal stress is evaluated in fatigue-critical locations, and in the third level the notch stress is

obtained based on the hot-spot and notch stress factor. The basic principle of the fatigue approach is presented in Figure 4. The second and third level of response analysis together with the fatigue evaluation is carried out using generic and fast computational methods. Fatigue assessment is carried out on pre-selected 3 or 4 fatigue-critical details, which are determined based on damage statistics. Utilising different loading modes and superposition principle, the purposed approach is applicable for structural optimisation of different ship types such as tanker, Ropax and LNG carrier.

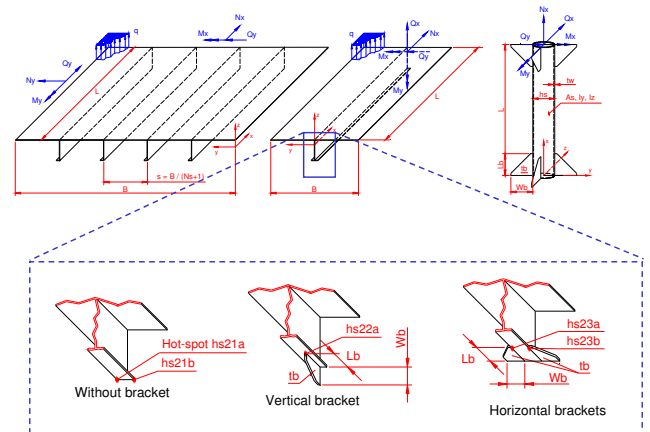

Figure 3: Generic structural element of the approach (stiffened plate, web frame and pillar) and structural details for web frame connection.

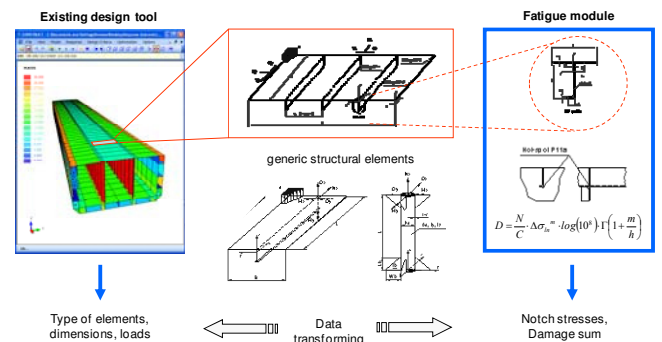

Figure 4: Basic principle of the fatigue approach for early design stage.

4 VALIDATION

The validation of the fatigue approach is based on the stresses in hot-spot points of the selected structural details such as the end of stiffener, the end of sloping plate and pillar connection subjected to tension, bending and pressure loading. The FE -analyses of the validation cases is carried out according to Hobbacher (2007). The analysis applies parabolic shell elements, which size in the hot-spot area is half of the plate thickness t . The hot-spot stresses are evaluated using linear extrapolation, where the reference points are located at $0.5 t$ and $1.5 t$ from the hot-spot point.

An example of FE –model is presented in Figure 5. In average, the difference between the FE –analysis and the fatigue approach is 8% having maximum value of 15%. The results of the validation shows also that calculation time of the fatigue approach is extremely short, a few milli seconds.

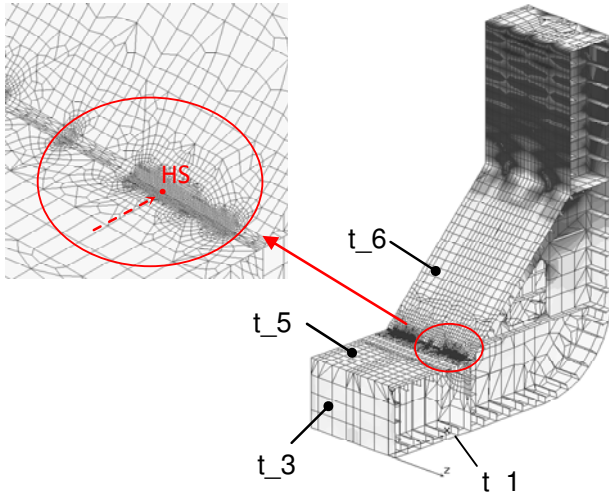

Figure 5: Example of FE –model applied for the validation of the fatigue approach.

5 CONCLUSION

In EU-improve project WP 3.3, an approach for fatigue assessment in the early design stage has been developed. To overcome the challenges due to limited information in the

early design stage, generic structural elements and predefined fatigue-critical details are applied. This allows the development of a common approach for different ship types, which is also applicable for optimisation purposes. Based on the validation results, it is concluded that the fatigue approach gives acceptable prediction for conceptual structural design, where the information of structural details is not usually available and sophisticated approximation has to apply. The results of the validation indicated also suitable calculation speed for structural optimisation as well.

REFERENCES

- Hobbacher, A. / IIW Joint Working Group XIII-XV. 2007. Recommendations for fatigue design of welded joints and components. IIW document XIII-2151-07 / XV-1254-07. Paris, France. 149 p.
- Liu, D; Thayamballi, A. 1997. Classification Societies Viewpoint Local Cracking in Ships: Causes, Consequences, and Control. American Bureau of Shipping (ABS). Committee of Marine Structures. Prevention of Fracture in Ship Structure.
- Sucharski, D. 1997. Owner and Operators Viewpoint Crude Oil Tanker Hull Structure Fracturing: An Owner's Perspective. ARCO Marine, Inc. Committee of Marine Structures. Prevention of Fracture in Ship Structure.

Sloshing Loads to be Applied on LNG Carriers' Inner Hull Structure

L. Diebold, N. Moirod & Ph. Corrigan

Bureau Veritas, Neuilly-Sue-Seine, France

ABSTRACT: The objective of the Task 3-4 (WP3) of the Improve Project was to provide (through a calculation module) quasi-static pressures to be applied on the inner hull structure supporting membrane cargo containment system, to account, at preliminary design stage, for the additional loads generated by liquid sloshing in the tanks of Liquefied Natural Gas Carriers. These quasi-static pressures denote the representative design pressures (acting on stiffeners and platings) which are to be taken into account for structural verification according to BUREAU VERITAS Rules (Bureau Veritas, 2007 and 2004).

Four LNGC tank capacity ranges were to be considered in this task of the Improve Project: <125 000 m³ / 125 000 to 140 000 m³ / 140 000 m³ to 155 000 m³ / 155 000 m³ to 180 000 m³. Some reserves are given for the capacities larger than 155 000 m³. Standard filling ratios were considered (ie less than 10%H and above 70%H) and ship service conditions were defined as world-wide. In addition, within the Task 6-2 (WP6) Bureau Veritas carried out a complete liquid motion analysis for a STX Europe 220,000 m³ LNGC in order to provide at preliminary stage the quasi-static loads to be applied on the inner hull structure

1 INTRODUCTION

Sloshing phenomenon represents one of the major considerations in the design of vessels carrying liquid cargo, and in particular for vessels operating LNG. Sloshing may be defined as a violent behaviour of the liquid contents in tanks that are subjected to the external forced motions.

The present work exhibited within Improve Project is focused on the hydrodynamic part of sloshing impact, i.e. evaluation of the sloshing loads on the structure, involving BV long experience in LNGCs and the existing sloshing data base from LNGCs under BV Class.

2 BUREAU VERITAS METHODOLOGY

The sloshing analysis of a LNGC consists of 2 main steps. First, the hydrodynamic analysis which allows to calculate the motion of the LNGC, once the environmental data is given. Second, the sloshing analysis itself which consists in experiments (called also small scale sloshing model tests) and numerical calculations using numerical tools such as Computational Fluid Dynamics. BUREAU VERITAS overall methodology for sloshing assessment of LNG vessels (Bureau Veritas, 2005) is essentially based on the comparative approach based on the LNGC reference case 138,000 m³.

Finally, quasi-static pressure loads to be applied on the inner hull structure are derived from the obtained sloshing loads.

2.1 Hydrodynamic & Spectral Analysis

The purpose of hydrodynamic analysis (HydroSTAR, 2009) is to evaluate range of wave first order motions in order to determine sloshing excitation for either numerical or small-scale model tank. After having obtained the transfer functions, the motions in irregular waves of a given wave energy spectrum are obtained by performing spectral calculations. The results include significant magnitude and average period of the motions.

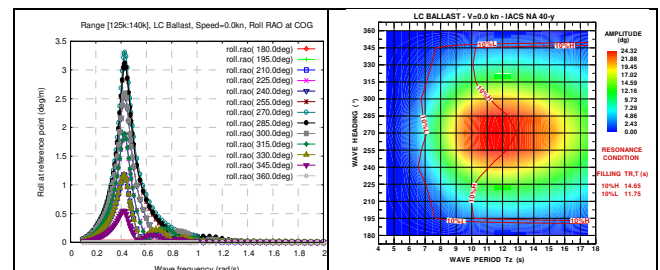

Figure 1. Examples of roll transfer function and roll spectral calculation cartography for a LNGC in the range [120k:140k]

Because ship service conditions for subject LNGC in the Improve project have been defined as world-wide, the environmental data for sloshing analysis refer to North

Atlantic trade route with 40-years return period wave height envelope (Bureau Veritas, 2005).

2.2 Sloshing Analysis – Model Tests

The small scale sloshing model tests consist in moving a model tank (scale 1/70 for the BV tests) with water at ambient conditions, in order to measure pressures at various locations for a given case (filling ratio, heading, ship speed, wave period). Sloshing small-scale model tests provide identification and confirmation of the most critical cases. Because impacts pressures depend on many parameters like (density ratio, hydro-elasticity, cryogenic environment with free surface condition at boiling point of gas etc...) which are difficult to reproduce at model scale, sloshing model tests are used in a comparative manner.

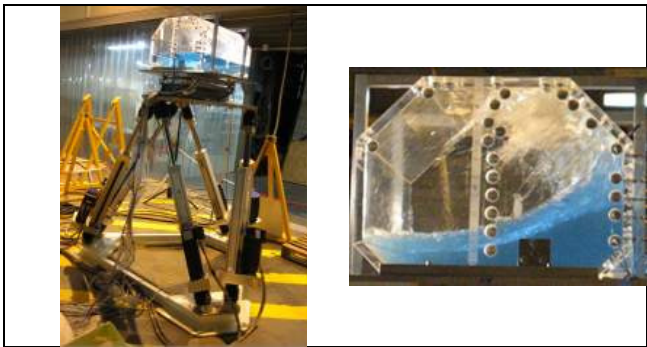

Figure 2. Example of the Test Rig (Ecole Centrale de Nantes) used for BV sloshing model tests. Tank (Courtesy of GTT).

2.3 Sloshing Analysis – CFD Calculations

Numerical sloshing simulations provide overall evaluation of fluid kinematics and independent verification of sloshing effects on cargo tank walls, and overall for the Task 3-4 (WP3) of the Improve Project) evaluation of representative design loads on ship inner-hull structure.

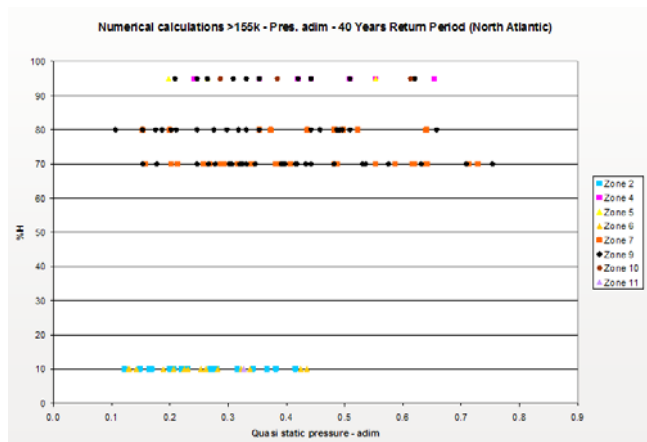

Figure 3. Normalized representative quasi-static pressure loads for a LNGC in the range [155k:180k]

Present sloshing analyses have been carried out using numerical CFD software FLOW3D® (currently used in BV) whose mathematical formulation is based on Navier-Stokes equations (mass and momentum conservation), Volume of Fluid (VOF) modelling technique and Finite Volume discretization.

3 SLOSHING LOADS

3.1 Sloshing Loads Module

The objective of the Task 3.4 (WP3) related to sloshing loads was to provide through a calculation module quasi-static pressures to be applied on the inner hull structure for four LNGC tank capacity ranges: <math> < 125\,000\text{ m}^3 / 125\,000 </math> to $140\,000\text{ m}^3 / 140\,000\text{ m}^3$ to $155\,000\text{ m}^3 / 155\,000\text{ m}^3$ to $180\,000\text{ m}^3$. **Some reserves are given for the capacities larger than 155 000 m³.**

The input data describe the ship's cargo capacity, the number of tanks and the reference tank defined as the tank of biggest capacity with the furthest location relative to the centre of gravity of the considered ship. This reference tank is described through its dimensions: length, breadth, height, lower chamfer, upper chamfer.

The output data represent the representative design pressure p_w (Bureau Veritas, 2007) on one quarter of the tank for symmetry reasons.

3.2 Sloshing Loads for STX Europe LNGC

The BV objective of this Task 6-2 (WP6) was to provide quasi-static pressures generated by sloshing to be applied on the inner hull structure of a STX Europe 220,000 m³ LNGC membrane tank in order to perform its structural optimization (only for standard fillings; below 10%H and above 70%H).

Thus, a complete liquid motion analysis (hydrodynamic, spectral and liquid motion analysis) was performed and led from one hand to the preliminary sloshing feasibility which should be confirmed by some dedicated model tests and from the other hand to the representative design pressure loads to be applied on the inner hull structure.

REFERENCES

- Bureau Veritas Rules for Steel Ships, July 2007.
- Bureau Veritas Guidance Note, 2004, "Guidelines for structural analysis of membrane LNG Carriers".
- Bureau Veritas Preliminary Guidance, 2005, "Sloshing Assessment for Membrane Type LNG Vessels & Offshore Units".
- HydroSTAR for Experts, v.6.0 (Bureau Veritas).

Production, Operation and Robustness Module

J.D. Caprace, F. Bair

ANAST University of Liège, Liège, Belgium

M. Hübler

Center of Maritime Technologies, Hamburg, Germany

I. Lazakis, O. Turan

NAME Universities of Glasgow & Strathclyde, Glasgow, United Kingdom

V. Zanic, J. Andric, P. Prebeg, K. Piric

University of Zagreb, Zagreb, Croatia

ABSTRACT: Nowadays, simulation and Life Cycle Cost (LCC) assessment becomes more and more important in shipbuilding industry. In order to survive in the competitive market environment, manufacturers now have to consider reducing the cost of the entire life cycle of a product, called LCC. This research was initiated with the idea of developing a methodology/framework to be able to assess the life cycle cost/earning of production and maintenance/repair with respect to the scantlings structural optimization variables to be used during the conceptual ship design stage. Three main modules as been implemented during this project: A life cycle cost/earning of production and maintenance/repair, a detailed Discrete Event Simulation (DES) for production and scheduling and a design robustness of the structural solution related to various fabrication and operational parameters. These three modules as well as the main results are briefly presented here.

1 INTRODUCTION

In order to improve the design of products and reduce design changes, cost, and time to market, life cycle engineering has emerged as an effective approach to address these issues in today's competitive global market. As over 70% of the total Life Cycle Cost (LCC) of a product is committed at the early design stage, designers can substantially reduce the life cycle cost of products by giving due consideration to the life cycle implications of their design decisions [Seo et al., 2002].

People are always concerned about product cost, which encompasses the entire product life from conception to disposal. Manufacturers usually consider only how to reduce the cost of materials acquisition, production and logistics. In order to survive in the competitive market environment, manufacturers now have to consider reducing the cost of the entire life cycle of a product, called LCC.

1.1 Goal of the research project

This research was initiated with the idea of developing a methodology/framework to be able to assess the life cycle cost/earning of production and maintenance/repair with respect to the scantlings structural optimization variables to

be used during the conceptual ship design stage. It is a fact that changes in scantlings might have a big cost impact on production and maintenance/repair due to the variation of steel weight and thicknesses. In general, lighter weight and smaller plate thickness may possibly mean less production cost and more extensive steel replacement during the ship life. However, heavier lightship also means heavier displacement and hence a higher fuel cost or smaller deadweight capacity, and hence lower operational income for a bigger production cost.

Present practical applications of the robustness techniques to the large number of industrial cases have proven their usefulness and theoretical critiques have always been balanced with their large practical success. In that respect, designs optimized for robustness is recognized in IMPROVE as practical measure that can save the designer's/yard's effort on control of the parameter variation.

1.2 Challenges of the research project

The challenge of the project was to:

- Keep the high performance of the optimisation loop with a very low response time cost calculation module

- Keep sufficient detail in modelling for a good simulation of production problems (sequencing, transport, human resources, space allocation etc.)

- To introduce robustness into design process as practical measure that can save the designer's/yard's effort on control of the parameter variation.

In order to achieve these challenges 3 main modules as been implemented during this project:

- A life cycle cost/earning of production and maintenance/repair
- A detailed Discrete Event Simulation (DES) for production and scheduling
- A design robustness of the structural solution related to various fabrication and operational parameters

2 LIFE CYCLE ASSESSMENT

2.1 Introduction

Design improvement in such a way that maintenance is easier and that ship problems are less frequent or less important may certainly reduce the cost of exploitation and increase safety. Currently, the LCC is not yet a major issue of the shipyards. This is an economic and strategic mistake. Integration of the LCC including maintenance and operating costs in the design procedure could be used by designer and shipyards as a huge selling argument. If the shipyard can show to the ship-owner that the proposed design satisfies the standard technical requirements and the usual ship-owner specifications but also considers maintenance and operation issues, the shipyard may get order even if its offer is not the cheapest. Ship-owners want to minimize short term investment but above all maximize their benefits.

The primary objective of the design effort, besides creating the information needed to build the ship, is to satisfy the ship owner requirements at minimum cost. An owner requires a ship which will give him the best possible returns for his initial investment and running costs (Eyes, 2001). Life cycle costs have often been a major consideration for commercial ship owners who must look at the bottom line for profit and a return on their investment. For instance, if the cost of design and production cannot be coupled within a reasonable amount of time, the ship will not be built. In the same way, if the operating and maintenance costs exceed operating revenues, again the ship will not be built. Design methods for minimizing the life cycle cost of the product thus become very important and valuable.

2.2 Development of a module

A life cycle cost module has been implemented. This module contains 5 sub-modules: the production and material cost, the cost of periodic maintenance, the fuel consumption, the operational revenues and the dismantling revenues. A corrosion model according to the new Common Structural Rules (CSR) for tanker ships that modifies the behaviour of the LCC module has also been implemented.

This basic module is able to compute the material cost (as a function of weight), the labour cost and the LCC using a simplified methodology. The advantage of this module is to find a result as fast as possible. This module is already integrated into the design optimization loop of LBR5, OCTOPUS and CONSTRUCT. In order to link the objective function to the design variables, the unitary costs of raw materials, the productivity rates for welding, cutting, assembling must be specified by the user as well as the lightweight and the deadweight of the ship. These unitary costs vary according to the type and the size of the structure, the manufacturing technology (manual welding, robots, etc.), the experience and facilities of the construction site, the country, etc.

2.3 Results and conclusions

From the work carried out in this study, the following are main contributions:

- The developed life-cycle maintenance/repair cost model is robust enough to be used within the IMPROVE's integrated search platform. That is to find maintenance/repair related cost/earning values for the Chemical tanker vessel with respect to design of experiments throughout the optimisation
- The developed method can efficiently help designers, ship owners and production engineers to make rational decisions during early design phases
- Although the model is able to calculate generalized life-cycle maintenance cost, it can also be used for what if scenario analyses with respect to other parameters of the model, such as unit price of steel replacement per kg, price of fuel oil, and so on
- This model can further be improved with the inclusion of other life-cycle cost elements to be able to find the (significant) cost drivers of the vessels

The examination of the effect of additional steel weight on the original design in order to minimize the steel repairs throughout the life cycle of a ship proved to be feasible under certain assumptions.

3 PRODUCTION SIMULATION ASSESSMENT

3.1 Introduction

Production simulation or Virtual Manufacturing (VM) enables the modelling and simulation of production systems and processes to ensure, in advance of the start of production, that they operate at peak efficiency. Simulation is a key new technology of the millennium with considerable expected growth rates per year (Hübler, 2006, Bair, 2009).

Production simulation is the process of designing a model of a real or imagined product and conducting experiments with that model. The purpose of simulation experiments is to understand the behaviour of the product and to evaluate strategies for the production/operation of the product.

Discrete Event Simulation (DES) programs like Plant Simulation from Siemens solution allows the mobilization of virtual plant like shipyards where product data contains all geometrical and methodical information about the ship while the simulation model includes all parameters describing the production facilities, resources (machines, humans, etc.) and processes. One of the major advantages of the production simulation is that it is possible to integrate the operating rules of each workshop and simulate the complex interactions between the different actors (human and material resources, transportation, machinery and tools, etc.). The production simulation is particularly effective to tackle phenomena such as the surface management, transport management, flow management (identification of bottlenecks), management of failures and hazards, etc. that a simple analytic workload simulation cannot integrate.

The cost assessment of a product starting from simulation model is a quite easy task. Indeed, all individual process times of the manufacturing tasks are a result of the simulation and linked to various resources. To assess the cost of the process, we can just multiply the operating time of each resource by his dedicated cost rate (Euros/hour).

3.2 Development of a module

The second assessment method based on a detailed production simulation validated and improved the first LCC assessment mentioned above. The advantage of this module is to find a more accurate result than the previous one. Therefore, due to the need for more detailed input data, time consumption and the high number of constraints and interdependencies considered, this module have been implemented outside of the design optimization loop. The

results are lead time and a manufacturing cost with a high degree of accuracy.

This module has been developed following 3 stages:

- 1 The implementation of simulation database supporting data for the cost and budget calculation as well as for the simulation process.
- 2 The implementation of budget assessment module based on all welding data as the welding length, welding position as well as the welding throat or the plate thickness.
- 3 The implementation of simulation models (AKERYARDS - Figure 1. (a), ULJANIK Figure 1. (b)) based on event oriented simulation for production using the Simulation Toolkit for Shipbuilder developed for Plant Simulation working with high degree of details and accuracy.

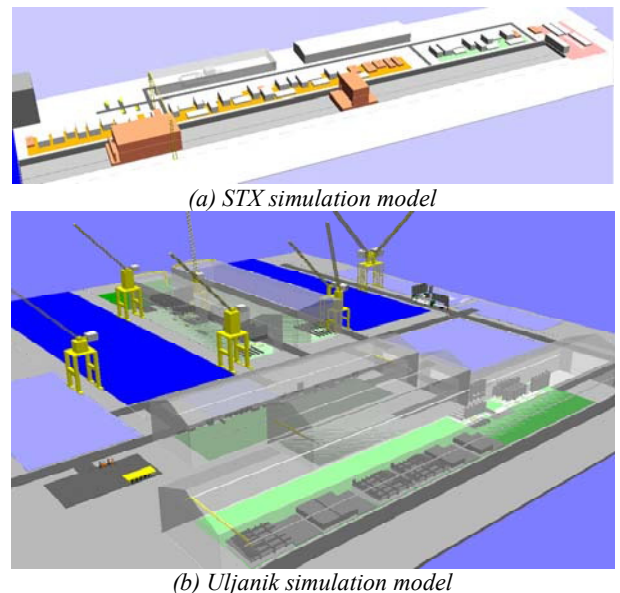

Figure 1. Production simulation models

3.3 Results

Different ships alternatives have been considered for the both simulation model (STX and Uljanik). And a relative comparison of results between each ship alternative has been performed.

The different ship alternatives for the simulation take into account of the following elements:

- STX model
 - A standard membrane LNG carrier and the innovative concept of a free ballast membrane LNG carrier have been considered.
 - Two blocks and sections splitting have been considered for the production simulation. The first one considering a maximum weight of

blocks of 800 tons and a second one with a maximum weight of blocks of 1200 tons (see Figure 2.).

- Two states of the scantling have been considered in the production simulation. The first one is the initial scantling provided by the STX shipyard and the second one is the optimized scantling provided after the optimization thanks to LBR5 software.

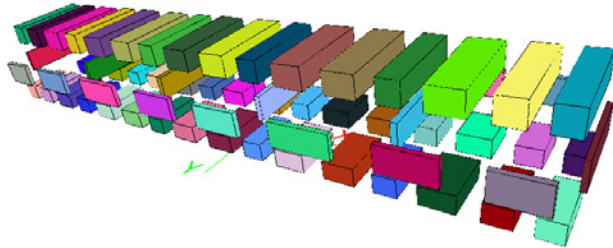

(a) 800 tons block splitting strategy (#70)

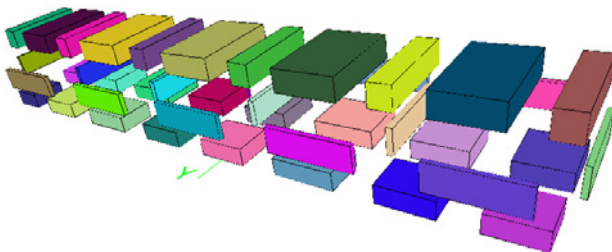

(b) 1200 tons block splitting strategy (#43)

Figure 2. Block splitting strategies

- Uljanik model
 - A standard design of a ROPAX and two new designs regarding the arrangement of internal bulkhead have been considered.
 - Two states of the scantling have been considered in the production simulation. The first one is the initial scantling provided by the Uljanik shipyard and the second one is the optimized scantling provided after the optimization thanks to OCTOPUS software.

The lead time, the production cost (Transport cost + Labour cost + Surface utilization cost) as well as the space allocation and the workload are measured and compared for each ship alternative as the result of the project.

Main trends of the results regarding the STX model are that significant lead time and cost can be save after the scantling optimization of the amidships section of the ship. The main factors acting on the cost reduction is the diminution of the plate thickness as well as the diminution of the stiffener welding length. However, the results shows also that much more can be save if we reorganize or improve also the production process, e.g. another block splitting, sequencing and key resources like cranes.

Similar findings have also been obtained for the Uljanik model. In the same way, the reduction of plate thicknesses and stiffener welding length lead to the diminution of the lead time and cost. Nevertheless, in this model, a key additional point is the limited space for production. We highlighted that the organizational improvements of the allocation of the assemblies may effect heavily the lead time and cost.

3.4 Conclusion

The use of simulation-based design and virtual reality technologies facilitates higher efficiency in terms of work strategy planning, and offers, as a result, significant productivity gains.

Different aspects also partially investigated during this project are promising:

- The optimization of the erection sequence
- The combination of production simulation and space allocation optimization (Integration of OptiView and Simulation models)
- The optimization inside of the ship production process using simulation and optimization tools

4 ROBUSTNESS OF THE STRUCTURAL SOLUTION

Methodology for robustness calculation is based on design of experiments theory. Taguchi's and Suh's measures of robustness have been developed and implemented in the new and fast computational module. The basic theory, descriptions of all developed functions, implementation procedure, worked examples and relevant features of the robustness module are briefly explained in the sequel. Module can be implemented for robustness computation with respect to various structural, fabrication and operational parameters. Identification of the most influential parameters and/or interactions between them can be efficiently investigated.

4.1 Experimental design

Statisticians have developed efficient test plans, which are referred to as fractional factorial experiments (FfEs) (Montgomery (1991, Ross, 1988). FfEs use only a portion of the total possible combinations to estimate the main factor effects and some, not all, of the interactions. Simple example is presented in Table 1.

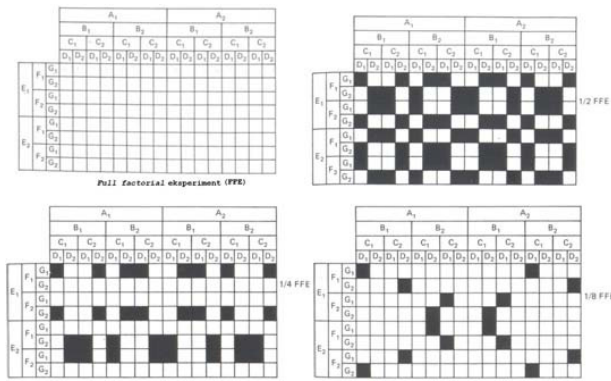

Table 1. Reduction of number of experiment for problem with 7 factor on two levels [3]

4.2 Robustness measures

Signal-to-noise ratio (SNR) developed by Taguchi is performance measure to choose control levels that best cope with uncertainty of some factors. The SNR takes both the mean and variability into account. In its simplest form, the SNR is a ratio of the mean (signal) to the standard deviation (noise). The SNR definition depends on the criterion for the quality characteristic to be optimized. While there are many different possible SNR definitions, three of them are considered standard and are generally applicable in the following situation:

- Smallest is best quality characteristic
- Nominal is best quality characteristic
- Biggest is best quality characteristic

Among the designs that are equally acceptable, one of these designs may be superior to other in terms of the probability of achieving the design goal (probability of success) as expressed by the criteria requirements. Information Axiom, defined by (Suh, 2001) states that the design with the highest probability of success is the best design.

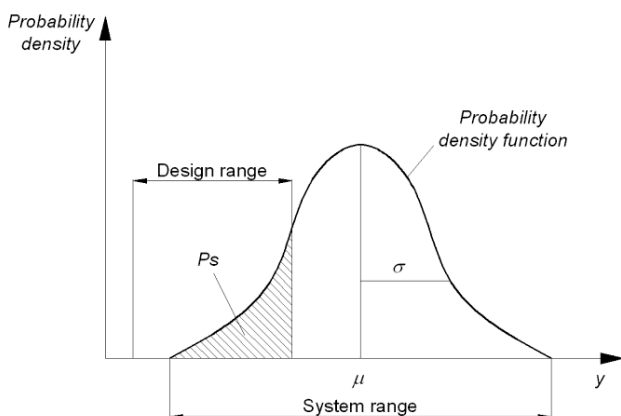

Figure 3. System range, design range and probability of success (Suh, 2001)

The probability of success can be computed by specifying the design range and system range. Figure 3 illustrates these two ranges graphically.

4.3 Practical example

Example shows the bottom panel robustness calculation for the Ropax ship, using experimental design with the inner array (where user assigns controllable factors) and the outer array (where user assigns uncontrollable-noise factors). For that purpose, four different controllable and noise factors are selected, as follows:

Controllable factors (scantlings)

1. t_p – Thickness of plate, in [mm]
2. s – Spacing of ordinary stiffeners, in [mm]
3. h_w – Web height of ordinary stiffener, in [mm]
4. t_w – Web thickness of ordinary stiffener, in [mm]

Noise factors (loads)

1. σ_x – Normal stress in x-direction, in [N/mm²]
2. σ_y – Normal stress in y-direction, in [N/mm²]
3. τ – Shear stress, in [N/mm²]
4. p – Pressure, in [kN/m²]

For given panel dimensions, scantlings and loads the following feasibility criteria functions set (yield, and buckling criteria) should be satisfied:

1. SYCP – Stiffener Yield Compression Plate
2. SYCF – Stiffener Yield Compression Flange
3. PP_CB – Plane Panel Compression and Bending
4. PP_BACS– Plane Panel Bi-axial Compression and Shear
5. OS_VBM– Ordinary Stiffener Various Buckling Modes
6. OS_US – Ordinary Stiffener Ultimate Strength

Results are presented in Figure 4 and Figure 5 where 27 experimental designs (e =1-27) are sorted according to the volume/weight of material (normalized to the heaviest design e=1). Standard safety measures: deterministic (minimal achieved normalised safety factor – g_{min} , with range -1 to 1) and probability based (p. of success for given statistical data using CALREL software - P_s) are presented. P_s is normalized to the most safe design. In Figure 4 the most robust designs are identified by maximization of Taguchi's SNR ratio

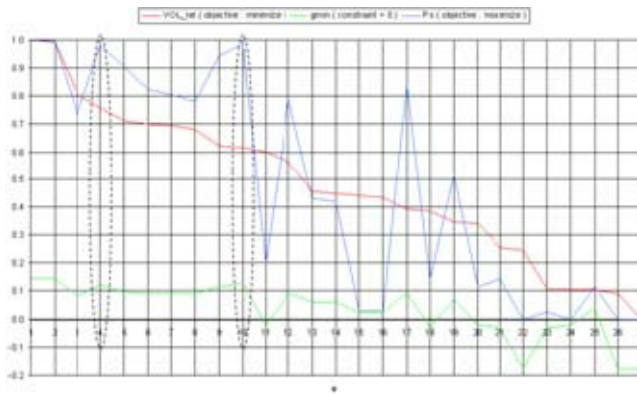

Figure 4. Example results: Deterministic (green line) and Probabilistic safety measures (blue line)-designs are sorted according to Volume (red line)

It can be observed that, besides the trivial heaviest designs ($e = 1$ or 2), the competitive robust designs ($e=4$, $e=10$) are identified having considerably smaller volume. Suh's robustness measure gave the same results.

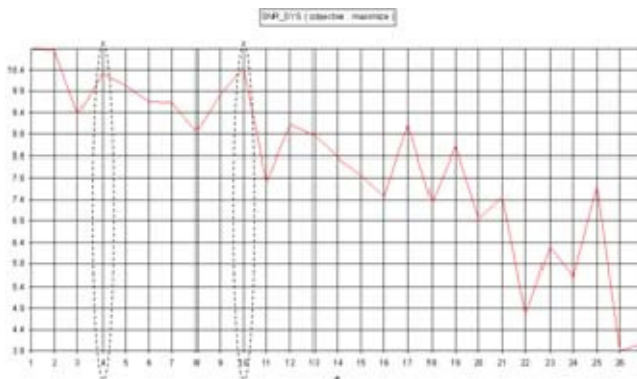

Figure 5. Example results: Robustness according to Taguchi's method

The safety measures used for validation (see Figure 5), also have identified those designs as preferred, but not so clearly ($gmin$) or with much more computational effort (P_s).

4.4 Conclusion on robustness module

Experimentation with robustness attributes is bringing a new dimension to the selection of preferred design, enabling balancing of the original attribute and its (in)sensitivity to uncontrollable parameters. In that respect, design optimization for robustness is recognized in IMPROVE as practical measure that can save the designer's/yard's effort on control of the parameters variation.

It have to be underlined again that robustness measure calculations are much simpler and faster compared to e.g P_s calculations, as described above, and with accuracy acceptable in concept design phase.

5 CONCLUSIONS

The 3 modules implemented during this project:

- the life cycle cost/earning of production and maintenance/repair,
- the detailed Discrete Event Simulation (DES) for production and scheduling,
- and the design robustness of the structural solution related to various fabrication and operational parameters,

helped to support and prove the effectiveness of the three scantling optimization software's (LBR5, OCTOPUS and CONSTRUCT).

The importance of considering simultaneously the LCC, the production aspect and the robustness of the design solutions has been demonstrated in this study.

REFERENCES

- Bair, F. (2009). Developments of Tools Focused on Production Simulation to Improve Productivity in Shipyards Workshops. PhD thesis, University of Liege.
- Eyres, D. (2001). *Ship Construction*. Butterworth and Heinemann.
- Grubisic I., Zanic V., Trincas G. (1997): Sensitivity of Multiattribute Design to Economy Environment: Shortsea Ro-Ro Vessels, IMDC 1997, Newcastle
- Hübler, M., Krause, M., Roland, F., Steinhauer, D. Simulation of production process - a helpful tool for planning and scheduling in shipbuilding. Black Sea 2006, pages 64-68
- Liu P.L., Lin H.Z. and Der Kiureghian A (1989): CALREL software for reliability calculation, Univ. of California, Berkeley.
- Montgomery D.C.(1991). Design and Analysis of Experiments, John Wiley & Sons, Int.
- Ross P.J (1988). Taguchi Techniques for Quality Engineering, McGraw-Hill, Int.
- Seo, K., Park, J., Jang, D., and Wallace, D. (2002). *Approximate Estimation of the Product Life Cycle Cost Using Artificial Neural Networks in Conceptual Design*. The international journal of advanced manufacturing technology.
- Suh N.P.(2001). Axiomatic design, Oxford University Press, New York.

The effect of increasing the thickness of the ship's structural members on the Generalised Life Cycle Maintenance Cost (GLCMC)

I. Lazakis & O. Turan

NAME Universities of Glasgow & Strathclyde, Glasgow, United Kingdom

ABSTRACT: In the context of the EU funded IMPROVE project, the research work of a Generalised Life Cycle Maintenance Cost (GLCMC) was initiated in order to investigate the influence of a weight oriented ship structural design on its production and operational characteristics. Following this, an increase in the structural scantlings of the ship was examined following the IACS Common Structural Rules (CSR) for double hull oil tankers. A case study for a Chemical tanker is shown considering an addition in its bottom plate thickness and three different cases of mean annual corrosion rates applied. A comparison regarding the "Gross gains", "Gross expenses" and "Net gains" for this ship is also presented. Moreover, an evaluation of the extra cost for the additional steel weight used is shown together with the outcome on the repair-free operation of the ship for different additional plate thickness. Finally, a sensitivity analysis is carried out for the most likely case ("Case 2") and the variation of different amount of days spent in the ship repair yard.

1 INTRODUCTION

The initial concept about the effect of increasing the thickness of the ship's structural members on the Generalised Life Cycle Maintenance Cost (GLCMC) originated from the research work carried out at Turan et al (2009) in the framework of the EU funded IMPROVE project.

In summary, the GLCMC includes five different models, namely:

- Model 1 (M1): Production cost
- Model 2 (M2): Cost of periodic maintenance
- Model 3 (M3): Cost of fuel oil for main engine(s)
- Model 4 (M4): Operational earning or revenue and
- Model 5 (M5): Dismantling earning

In the first place, the main aim was to investigate the optimisation of ship's structural scantlings to identify the most favourable design from owners'/operators' point of view. Two different scenarios were examined

1. Constant displacement
2. Constant DWT

As a further step towards achieving the aims of this research, a "corrosion model" was introduced in order to examine how the additional thickness of the structural

member affects the steel repairs of the ship during its life-cycle. Moreover, the effect that this will have on the fuel consumption, operational and dismantling earning of the ship by creating a heavier lightweight ship design.

This paper is organised as follows: Chapter 2 presents a review of various research works on corrosion wastage models. Chapter 3 explains the introduction of the "corrosion model" of the GLCMC in accordance with the Common Structural Rules (CSR) method and formulations (IACS 2007, 2008). More specifically, it is based on the CSR "Net thickness approach" which differentiates between the local and the global corrosion effect (CSR-4.3.4). In order to demonstrate the results of this approach, a case study is also shown in Chapter 4 including a simple cost benefit analysis.

In Chapter 5 the results of this paper are presented so as to compare the variation of the different models in the previous examined condition ("BEFORE corrosion addition") and the new one ("AFTER corrosion addition") for the scenario of constant DWT. Finally Chapter 6 presents the discussion and conclusions of this paper.

2 REVIEW

In this chapter, a brief review of the relevant research works carried out will be mentioned. In fact, there are several authors who have developed various studies regarding corrosion related models and corrosion rates for

single hull oil tankers. Gratsos & Zachariadis (2005) also present a comparative table of different mean annual corrosion values from various sources.

In Soares & Garbatov paper (1999), a model for the non-linear general wastage of steel plates in the presence of a corrosion protective system is presented. Qin & Cui (2002) examine the ultimate strength of ships with particular reference to the corrosion model related to the work of Paik & Thayamballi (2002) and proceed furthermore by introducing another corrosion prediction model. Paik & Thayamballi (2003) have also published their work on corrosion data prediction models and their relation to the ultimate strength of various structural members of ships based on actual measured corrosion wastage data from oil tankers and bulk carriers. Melchers (1999) discusses the most important factors affecting marine corrosion and develops a probabilistic model for time-dependent material loss of mild and low alloy steel products.

3 METHODOLOGY

In this chapter, the methodology followed is described, while details are given in Appendix I. At this point, the most important features of this approach will be presented (Appendix II).

Initially, the additional corrosion thickness for the local structural member is defined. This is given by:

$$t_{corr-local} = t_{was} + t_{corr-2.5} \text{ (mm)} \quad (1)$$

where: $t_{corr-local}$ = local corrosion addition, t_{was} = total wastage allowance of the considered structural member, $t_{corr-2.5}$ = 0.5 mm, wastage allowance in reserve for corrosion occurring in the two and a half years between Intermediate and Special surveys.

The total wastage allowance (t_{was}) of the considered structural member is given by:

$$t_{was} = t_{was-1} + t_{was-2} \text{ (mm)} \quad (2)$$

where: t_{was-1} = wastage allowance for side one of the structural member considering the contents of the compartment to which it is exposed, t_{was-2} = wastage allowance for side two of the structural member considering the contents of the compartment to which it is exposed.

The wastage allowances (t_{was-1} and t_{was-2}) are provided from the table attached in IACS CSR (Section 12.1.4) for the different compartment types and structural members. In it, different wastage allowances are defined for the ballast and cargo tanks, void and dry spaces, plating and stiffeners, etc.

By adding them up and rounding them to the next 0.5mm, the corrosion margin for the local structural member is obtained. In addition to the corrosion margin, 0.5 mm are added which is the wastage allowance in reserve for corrosion occurring in the two and a half years between Intermediate and Special surveys ($t_{corr-2.5}$). Next, according to IACS CSR (Section 2/4.3.4.5):

“The overall average corrosion for primary support members and the hull girder cross-section is given by deducting half the local corrosion addition ($0.5t_{corr}$) from all structural elements comprising the respective cross-sections.”

$$t_{corr-global} = t_{corr-local} / 2 \text{ (mm)} \quad (3)$$

where: $t_{corr-global}$ = The overall average corrosion margin for the primary support members i.e. bottom plate area.

At this point it is important to mention that in order for a hull structural member to be renewed, either one of the following criteria must be fulfilled:

- Either the corrosion addition margin for the local structural member is surpassed or
- The global corrosion margin for the whole area examined is exceeded.

Subsequently, the owner's additional thickness requirement is added so as to get the total corrosion thickness margin. From this step onwards, we proceed with examining the effect of the different mean annual corrosion rates on the total corrosion thickness margin. A sensitivity analysis is carried out for the three different annual corrosion rates so as to investigate their effect on the time that the ship will have to undertake steel repairs. This will be more clearly established in the case study given in the following section.

4 CASE STUDY

The case study described herein assists in obtaining an explicit picture of the application of this research work. A sensitivity analysis will also take place regarding the impact of different mean annual corrosion rates applied. The following assumptions will be taken into consideration:

- The present investigation refers to the Generalised Life Cycle Maintenance Cost and more specifically to the bottom plate area of a double hull Chemical tanker.
- For the steel deterioration general corrosion pattern is applied.
- Mean values of corrosion rates used are based on the Gratsos & Zachariadis summarised table

(2005). The suggested mean corrosion wastage rates which will be used are 0.12, 0.20, and 0.4 mm/year.

- The scenario for the Chemical tanker examined is the one for the original LWT case (9,500 tons).
- Steel price at new-building stage: 1,500 Euro/ton
- Steel price at repair stage: 5,000 Euro/ton (for big quantities of steel repairs)
- Productivity of ship repair yard: 7 tons of steel/day.
- An amount of 30% of extra weight regarding the internal stiffeners for the steel plates used is added.
- Flat bottom plate area is approximately 4,830 m² (S = 150.0 x 32.2)

The application of the case study is shown below. According to the initial illustrative example presented in Turan et al (2009), the structural member examined concerns the bottom plate of a double hull chemical tanker ship. So, the wastage allowance for the two sides of the plate is:

$$t_{was-1} = 1.2 \text{ mm}$$

$$t_{was-2} = 1.2 \text{ mm}$$

According to (2):

$$t_{was} = t_{was-1} + t_{was-2} = 1.2 + 1.2 = 2.4 \text{ mm}$$

Rounding up to the next 0.5 mm (CSR rules), provides a value of:

$$t_{was} = 2.5 \text{ mm}$$

Following (1), the local corrosion addition is:

$$t_{corr} = t_{was} + t_{corr-2.5} = 2.5 + 0.5 = 3.0 \text{ mm}$$

The global corrosion addition is given by (3):

$$t_{corr-global} = t_{corr-local} / 2 = 3.0 / 2 = 1.5 \text{ mm}$$

Also, by adding the ship owner's additional thickness requirement we get the total thickness margin:

$$t_{total} = t_{corr-global} + t_{own} \quad (\text{mm}) \quad (4)$$

where: t_{total} = Total thickness margin (including owner's addition), t_{own} = Owner's additional thickness margin.

In this case, the renewal thickness for the bottom plate area is:

$$t_{ren} = 17 - 1.5 = 15.5 \text{ mm}$$

Following, by applying the three different annual corrosion rates, we derive the time (in years) before steel renewals will take place. It should be noted that a 5 years free-of-repairs period is also added because of the initial coating layers applied during the construction phase of the ship. That is:

$$T = Coa + (t_{total} / cor_{rate}) \quad (\text{mm}) \quad (5)$$

where: T = Time before steel renewals, in years, Coa = Coating period of 5 years, cor_{rate} = Mean annual corrosion rate, in mm.

By applying equation (5) for 2.5 mm additional thickness we get:

$$T_1 = Coa + (t_{total} / cor_{rate}) = 5 + (4.0 / 0.12) = 38.33 \text{ years}$$

$$T_2 = Coa + (t_{total} / cor_{rate}) = 5 + (4.0 / 0.20) = 25 \text{ years}$$

$$T_3 = Coa + (t_{total} / cor_{rate}) = 5 + (4.0 / 0.40) = 15 \text{ years}$$

5 RESULTS

The results of applying the above mentioned methodology (keeping DWT constant) for models 2, 3, 4 and 5 are demonstrated before and after the introduction of the additional corrosion margins. Three different cases are described:

- "case 1-0.12mm/year" : mean annual corrosion rate of 0.12mm
- "case 2-0.20mm/year" : mean annual corrosion rate of 0.20mm
- "case 3-0.40mm/year" : mean annual corrosion rate of 0.40mm

A comparison regarding the "Gross gains", "Gross expenses" and "Net gains" is also presented. The figures are derived from the "illustrative example cases" for the chemical tanker ship mentioned before. In Table 1 and Figures 1-2, the results for the first case are shown.

Maintenance models	Before	After	δ (%)	δ (€)
Model 2	59,430,877	51,436,290	-13.45	7,994,588
Model 4	425,172,506	430,219,849	1.19	5,047,343
Model 5	1,311,676	1,334,362	1.73	22,685
Gross gains				13,064,616
Model 3	21,952,913	22,231,444	1.27	- 278,531
Add. steel cost	11,400,000	11,475,348	0.66	- 75,348
Gross expenses				-353,879
Net gains				12,710,738

Table 1 Results of the different models after the introduction of the additional corrosion margin – “case 1-0.12mm/year”

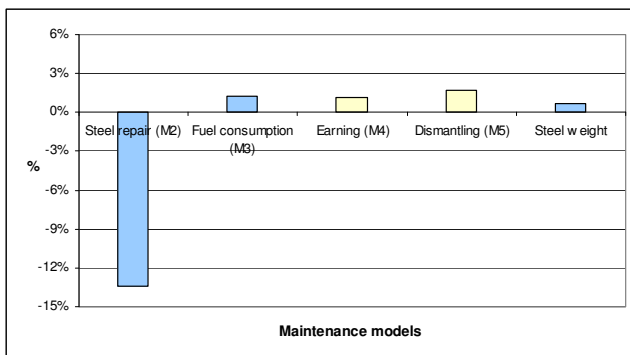

Figure 1 Variation of maintenance models (%) after the introduction of the additional corrosion margin-“case 1-0.12mm/year” (blue=gains, white=losses)

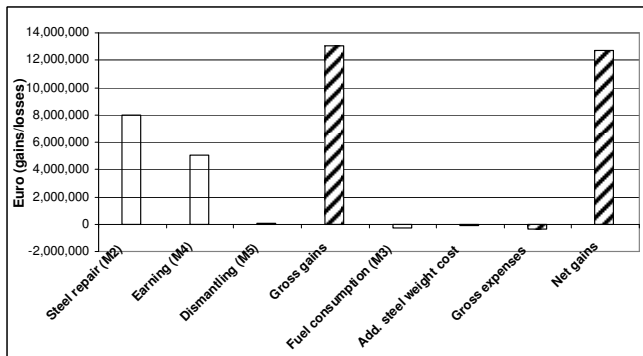

Figure 2 Earning & cost elements after the additional steel weight using “case 1-0.12mm/year” (gross gains, gross expenses and net gains with lined pattern)

In Table 2 and Figures 3-4, the results for the second case are shown.

Maintenance models	Before	After	δ (%)	δ (€)
Model 2	59,430,877	51,436,290	-13.45	7,994,588
Model 4	425,172,506	430,219,849	1.19	5,047,343
Model 5	1,311,676	1,368,390	4.32	56,714
Gross gains				3,098,644
Model 3	21,952,913	22,258,312	1.39	- 305,399
Add. steel cost	11,400,000	11,588,370	1.65	- 188,370
Gross expenses				- 493,769
Net gains				12,604,875

Table 2 Results of the different models after the introduction of the additional corrosion margin – “case 2-0.20mm/year”

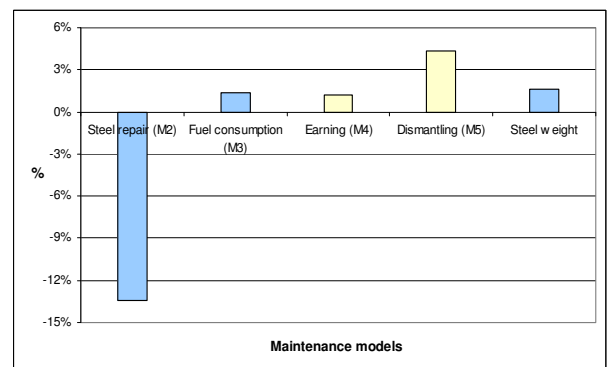

Figure 3 Variation of maintenance models (%) after the introduction of the additional corrosion margin-“case 2-0.20mm/year” (blue=gains, white=losses)

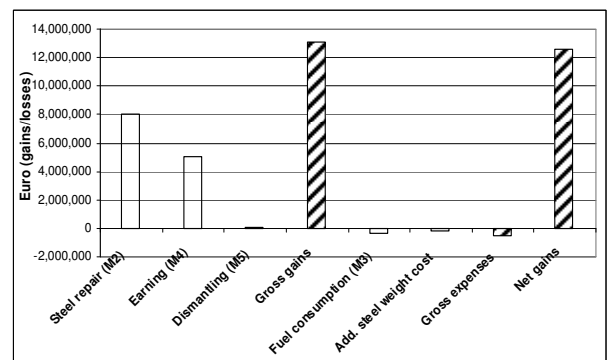

Figure 4 Earning & cost elements after the additional steel weight using “case 2-0.20mm/year” (gross gains, gross expenses and net gains with lined pattern)

In Table 3 and Figures 5-6, the results for the third case are shown.

Maintenance models	Before	After	δ (%)	δ (€)
Model 2	59,430,877	51,436,290	-13.45	7,994,588
Model 4	425,172,506	430,219,849	1.19	5,047,343
Model 5	1,311,676	1,459,132	11.24	147,455
Gross gains				13,189,386
Model 3	21,952,913	22,329,883	1.72	- 376,969
Add. steel cost	11,400,000	11,889,762	4.30	- 489,762
Gross expenses				- 866,731
Net gains				12,322,655

Table 3 Results of the different models after the introduction of the additional corrosion margin – “case 3-0.40mm/year”

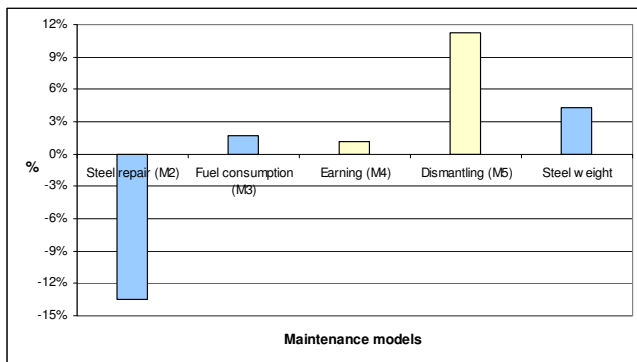

Figure 5 Variation of maintenance models (%) after the introduction of the additional corrosion margin-“case 3-0.40mm/year” (blue=gains, white=losses)

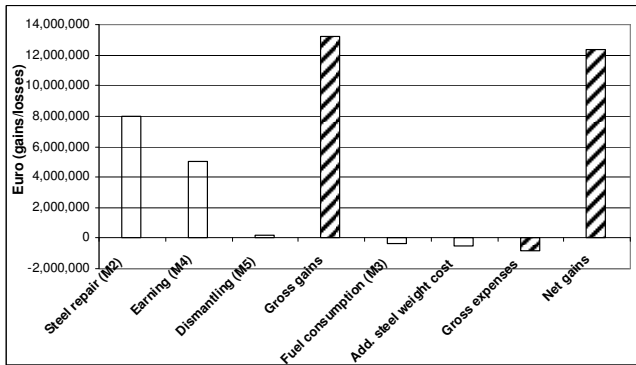

Figure 6 Earning & cost elements after the additional steel weight using “case 3-0.40mm/year” (gross gains, gross expenses and net gains with lined pattern)

Also, in Table 4 and Fig. 7, a comparison is presented in terms of the extra cost for the additional steel material used and the cost occurring from the repaired steel during the life of the Chemical tanker ship.

Sensitivity analysis		tons	Euro
Corrosion rate/year	Initial repair	593.00	2,965,000
0.12 mm	1mm addition	50.232	75,348
0.20 mm	2.5mm addition	125.58	188,370
0.40 mm	6.5mm addition	326.51	489,762

Table 4 Comparison among the initial repair cost and the additional steel cost for introducing extra plate thickness for the case study

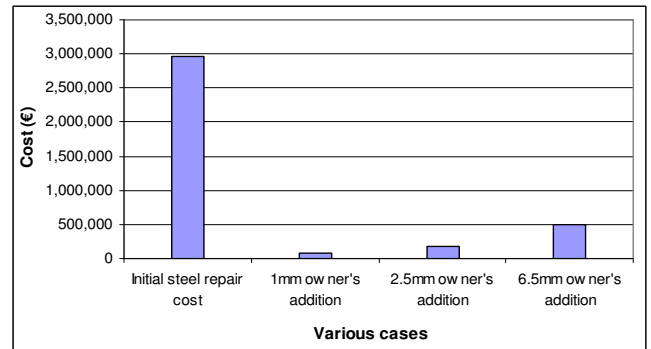

Figure 7 Comparison among the initial repair cost and the additional steel cost for introducing extra plate thickness for the case study

As it may be seen, the cost of the extra plate thickness due to the ship owner's requirement is much less than the cost due to the steel repairs that will occur during the life cycle of the ship.

In Table 5 and Fig. 8, the effect on the free-of-repairs operational period of the ship for different owner's thickness addition for the three different mean annual corrosion rates “Case 1”, “Case 2” and “Case 3” is presented as well.

	Case 1 (0.12mm/year)	Case 2 (0.20mm/year)	Case 3 (0.40mm/year)
mm	years		
0	17.50	12.50	8.75
1	25.83	17.50	11.25
2	34.17	22.50	13.75
2.5	38.33	25.00	15.00
3	42.50	27.50	16.25
4	50.83	32.50	18.75
5	59.17	37.50	21.25
6	67.50	42.50	23.75
6.5	71.67	45.00	25.00

Table 5 The effect on the free-of-repairs operational period of the ship for different owner's thickness addition for the three different mean annual corrosion rates “Case 1”, “Case 2” and “Case 3”

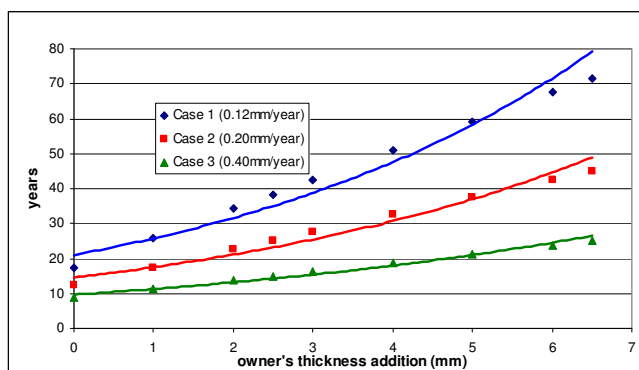

Figure 8 The effect on the free-of-repairs operational period of the ship for different owner's thickness addition for the three different mean annual corrosion rates "Case 1", "Case 2" and "Case 3"

Moreover, in order to expand the research work regarding the parameter of the unavailable days, a sensitivity analysis is carried out for the most likely case ("Case 2") and the variation of different days spent in the ship repair yard (Table 6 and 7). This is performed so as to see the effect that a fluctuating amount of days spent in the shipyard has on the "Total net gains" for the various cases.

Age (years)	5	7.5	10	12.5	15	17.5	20	22.5	25
Original case	21.9	25.6	29.4	33.1	36.9	40.6	44.4	48.1	51.9
Case 2a	21.5	25.0	25.0	25.0	25.0	25.0	25.0	25.0	25.0
Case 2b	21.5	25.0	28.4	28.4	28.4	28.4	28.4	28.4	28.4
Case 2c	21.5	25.0	28.4	30.0	30.0	30.0	30.0	30.0	30.0
Case 2d	21.5	25.0	28.4	32.0	34.4	35.5	35.5	35.5	35.5

Table 6 Comparison of days spent in shipyard during the dry-docking period for the "original case" and "Case 2a", "Case 2b", "Case 2c" and "Case 2d"

where: Original case = The first condition without any additional thickness or corrosion rate applied, Case 2a = "Case 2" including a max amount of 25 days of repairs after year 7.5, Case 2b = "Case 2" including a max amount of 28.4 days of repairs after year 10, Case 2c = "Case 2" including a max amount of 30 days of repairs after year 12.5, Case 2d = "Case 2" including a max amount of 35.5 days of repairs after year 17.5.

Maintenance models	Original case	Case 2a	Case 2b	Case 2c	Case 2d
Model 2	59.43	41.791	45.740	47.230	51.436
Model 3	21.95	22.632	22.479	22.421	22.258
Model 4	425.172	437.453	434.491	433.374	430.219
Model 5	1.311	1.368	1.368	1.368	1.368
Steel weight	11.400	11.588	11.588	11.588	11.588
Total net gains	n.a.	29.109	22.352	19.802	12.604

Table 7 Comparison of maintenance models and "Total net gains" (in million Euro) for: original case, case 2a, 2b, 2c & 2d (for 25 years of operation)

As it may be seen, the amount of "Total net gains" increases with the more available days that the ship spends operating.

6 DISCUSSION/CONCLUSIONS

When DWT is constant (in which case the ship retains the same cargo capacity), it may be observed that in all three different cases, the gross gains are higher than the gross expenses occurring from the thickness addition in the initial design phase. In detail, steel repairs (model 2) are reduced by more than 13% while earnings (model 4) are also increased by 1.19% due to the increased number of operational days. Another positive feature is the extra income originating from dismantling (model 5). In total, these figures can easily compensate for the loss of income due to additional fuel consumption (model 3) and increase of the steel weight used, demonstrating the overall positive net gains. In short, for a ship's operational life of 25 years, earning improvements of a few millions euro can be achieved.

Another observation is that, the supplementary capital cost of the extra plate thickness due to the ship owner's requirement is much less than the cost due to the steel repairs that will occur during the life cycle of the ship.

Moreover, in all three different cases of mean annual corrosion rates, the free-of-repair period of the vessel is also increased. Having in mind the initial assumptions when starting this investigation, it is obvious that by investing on extra steel plate thickness there will be considerable benefits in the long term. More specifically, this will have an effect regarding two aspects: the ship will spend less time in the repair yard reducing its repair/dry-docking budget and the ship will have more days available to operate and thus to increase its operational earning.

ACKNOWLEDGEMENTS

This research work was partially funded from the EU FP6 project IMPROVE (Design of improved and competitive products using an integrated decision support system for ship production and operation).

REFERENCES

- Gratsos, G.A. and Zachariadis, P. (2005). Life cycle cost of maintaining the effectiveness of a ship's structure and environmental impact of ship design parameters, *RINA International conference: Design and operation of bulk carriers*, 95-122, 18-19 October, London.
- IACS (2008). *Common Structural Rules for double hull oil tankers*,

- <http://www.iacs.org.uk/publications/CommonRulePublications.aspx?pageid=4§ionid=2>, accessed 25/03/09.
- IACS (2007). *Requirements concerning SURVEY AND CERTIFICATION-UR Z*,
<http://www.iacs.org.uk/publications/CommonRulePublications.aspx?pageid=4§ionid=2>, accessed 25/03/09.
- Melchers, R.E. (1999). Corrosion uncertainty modelling for steel structures, *Journal of Constructional Steel Research*, 52: 3–19.
- Paik, J.K. and Thayamballi, A.K. (2002). *Ultimate Limit State Design of Steel Plated Structures*, John Wiley, Chichester.
- Paik, J.K. et al (2003). Time-Dependent Risk Assessment of Aging Ships Accounting for General / Pit Corrosion, Fatigue Cracking and Local Denting Damage, *SNAME Annual Meeting*, 17-20 October, San Francisco, US.
- Qin, S.P. and Cui, W.C. (2002). A discussion of the ultimate strength of ageing ships, with particular reference to the corrosion model, Institution of Mechanical Engineers, 216, *Part M: Journal of Engineering for the Maritime Environment*, 155-160.
- Soares, C.G. and Garbatov, Y. (1999). Reliability of maintained, corrosion protected plates subjected to non-linear corrosion and compressive loads, *Marine Structures*, 12: 425-445.
- Wang, G. et al. (2003). Estimation of corrosion rates of structural members in oil tankers, *Proceedings of the 22nd International Conference on Offshore Mechanics and Arctic Engineering*, 8-13 June, Cancun, Mexico.
- Turan, O. et al (2009). Maintenance/repair and production-oriented life cycle cost/earning model for ship structural optimisation during conceptual design stage, *Journal of Ships and Offshore Structures*, 4, 2: 107-125.

Software integration in the context of the IMPROVE project

Stephan Wurst & Markus Lehne

BALance Technology Consulting GmbH, Bremen, Germany

Bernard Cupic

Uljanik Shipbuilding Computer Systems d.o.o., Pula, Croatia

ABSTRACT: Although IMPROVE is primarily not a software development project, different tools have been developed. Since these modules have to be connected to external applications and additionally share common data, an integration concept was needed. The focus of this concept was a pragmatic realization while keeping in mind the further usage and extensibility towards a more complex and network based implementation. Major components of the IMPROVE integration are common libraries, an IMPROVE data base and a graphical user interface.

1 INTRODUCTION

One issue to be solved within the IMPROVE project was the integration of the software modules developed in the different workpackages. This integration comprises the data view which reflects the fact that the IMPROVE algorithms need information generated by external design applications and also create data that will be further processed by other IMPROVE or external tools. Therefore one goal was the definition of a common data model for all new IMPROVE tools.

A second task of the integration workpackage was the generation of an IMPROVE framework that makes available the software-related results of the project as a unified interface for application developers as well as for end-users.

A basic principle of the IMPROVE integration is the realization of a pragmatic approach considering the fact that software development is not a central concern of the project. However, the solution is still generic enough to make it useful for users outside IMPROVE.

2 GENERAL APPROACH

IMPROVE integration takes place on three different levels:

- Data exchange
- Programming interface
- User interface

Each of these three areas has been covered by a software module. The first two modules have been kept as independent as possible from each other to ensure that use of them can be customized to the specific needs of the application context.

Figure 1 shows the grouping of the integration components. The IMPROVE database stores all information relevant for the exchange between external applications and the IMPROVE tools. The IMPROVE Toolbox DLL establishes a unified interface of the different algorithms to external applications while the IMPROVE GUI supports the manual interaction with each of the components.

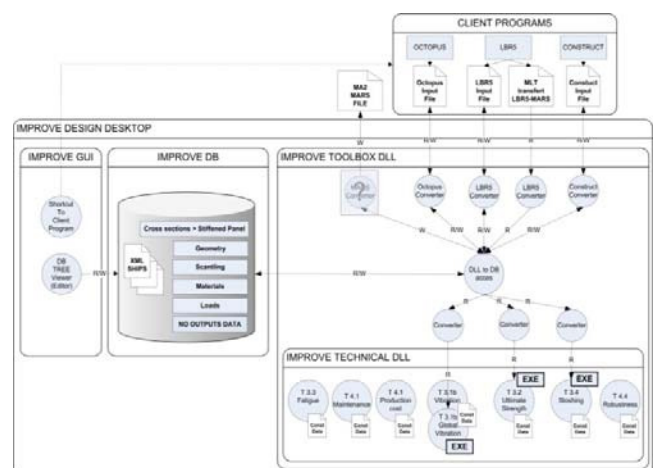

Figure 1. IMPROVE integration architecture

3 IMPROVE DATA MODEL

In order to avoid the definition of yet another ship design data model it has been decided to use the BV MARS data model and adapt it to the needs of IMPROVE. The reason for this decision was the possibility to directly import and export this format in some of the basic applications used in the project. Implementation of the model was realized as an XML database file that was attached to a C++ and a Java interface. Therefore access to the exchange data can easily be implemented without low level access to the XML file.

As a support for the data exchange process, converters from OCTOPUS and MARS into the XML format and vice versa have been developed.

4 INTEGRATION ON API LEVEL

Application programmers can integrate the IMPROVE functions into their own components via the IMPROVE toolbox DLL. For each algorithm and each converter, wrapper functions have been created. C, C++ and Java applications can use the algorithms without caring about different programming languages and compiler types as these low-level technical problems are hidden inside the dynamic library. This issue had to be addressed since the IMPROVE algorithms have been implemented with different FORTRAN and C++ compilers.

A second library provides similar access to the IMPROVE data model. By linking these two function sets to an application, the full IMPROVE functionality is available. The only restriction is that integration is currently limited to MS Windows systems.

5 INTEGRATION ON USER LEVEL

The IMPROVE algorithms are developed as extensions to existing design applications such as OCTOPUS or LBR-5. Therefore they are typically not called directly. However, some parts of the IMPROVE integration environment are also useful when opened interactively. Furthermore, tests of the algorithms can be performed easier when having direct access to them via a graphical user interface.

The IMPROVE GUI enables the user to load a model, view and edit it, and to run the different algorithms. It also offers direct access to the converters to support the import and export of databases by means of the proprietary application formats.

When opening the GUI, the user can first select a model which is then opened and viewed as a tree of data (figure 2). While the overall structure of the tree cannot be changed (it is determined by the underlying XML structure), each data

field can be edited in order to correct errors and to test different parameter sets. The different values are transferred into the algorithm configuration tab sheets where this makes sense.

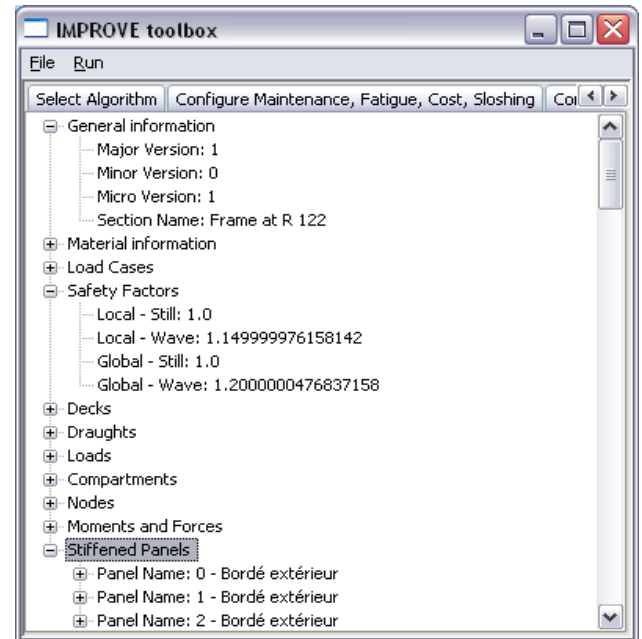

Figure 2. Database tree view

Another task is the configuration of the algorithms. While some of the parameters are stored in the database this is not the case for all of them. They can be manually entered before the algorithm is run. After performing the calculation the results can be shown on the screen, stored in the database or saved to a separate file, depending on the intended use. Figure 3 shows the configuration of the fatigue algorithm.

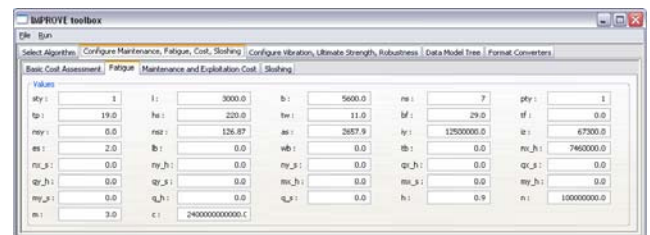

Figure 3. Algorithm configuration

6 INTEGRATION ON NETWORK LEVEL

An even higher integration level has been tackled during the integration. Algorithms should be made available as services running on remote computers. Support of workflows was planned to become an additional feature. Although experiments with two different integration platforms (Reconfigurable Computing Environment/RCE and Virtual Integration Platform/VIP) which were developed in parallel research projects yielded promising results, the complexity was too high to realize a useable

solution within the scope of IMPROVE. Nevertheless the implementation of the local integration environment, namely the Java implementation, has been implemented in a way that supports the easy adaptation to a networked environment at a later point in time.

7 CONCLUSION

The goal to realize a pragmatic integration environment as part of the IMPROVE project has been realized as planned. The toolbox is useable for integrating the IMPROVE algorithms into external applications. Further options such as the distributed provision of services remain possible as part of ongoing activities after the end of IMPROVE

Tools for early design stage: presentation of LBR-5 Software

Ph.Rigo, F.Bair, Caprace J., D.Desmidts, A.Amrane, A.Constantinescu, R.Warnotte
(ANAST – University of Liège, Liège, Belgium)

A.Hage, E.Pircalabu, M.Lapy
(DN&T, Liège, Belgium)

ABSTRACT: LBR-5 is a tool for early design stage. Taking into account numerous kinds of constraints – structural, geometrical, etc. – an optimum scantling can quickly be found. In the framework of IMPROVE European project many new modules have been implemented to increase the quality of the optimised scantling. Mainly 6 major changes have been brought: implementation of a sloshing module, a fatigue module, a multi-structure module, a multi-materials module, a life cycle cost module and finally a vibration module. Tests to validate these modules have been carried out on the three ships studied in the IMPROVE project: a LNG, a Chemical Tanker and a ROPAX.

1 INTRODUCTION

To be attractive for shipyards, scantling optimisation has to be performed at the preliminary design stage. It is indeed the most relevant period to assess the construction cost, to compare fabrication sequences and, to find the best frame/stiffener spacings and most suitable scantlings to minimize the production costs. The LBR-5 package performs such early design least cost optimisation.

In the framework of IMPROVE new developments have been carried out in order to improve the quality of the optimised scantling. New phenomenon as fatigue or vibration fatigue can now be taken into account – problems that were rarely studied in the early design stage.

2 PRESENTATION OF LBR-5

LBR5 is built around three basic modules, respectively, OPTI, CONSTRAINT and OBJECTIVE. The OPTI module contains the mathematical optimisation algorithm to solve non-linear constrained optimisation problems. The CONSTRAINT module includes:

- Technological constraints that provide the upper and lower bounds of the design variables;
- Geometrical constraints that are generally based on “good practice” rules to avoid local strength failures;

- Structural constraints that represent limit states in order to avoid yielding, buckling, cracks, etc. and to limit deflection, stress, etc;
- Global constraints that represent constraints affecting the whole structure – as the gravity centre position, global inertia, etc;
- Equality constraints to guarantee homogeneity in the structure.

The OBJECTIVE module assesses the objective function. It could be the construction cost – that includes labour costs and material cost – the global inertia or the weight.

A powerful graphical interface helps users to define their model and all characteristics and constraints. A 3D-view is also available – see Figure 1. Managements of results are easy thanks to this interface.

LBR-5 is also an efficient tool to assess and compare different alternatives. A major capability of the method is to quantitatively assess a change of the production technology on the construction cost. For instance, effect of an improved welding procedure (lower unitary welding cost) can be assessed by comparing the least cost optimum scantling obtained with and without the improvement.

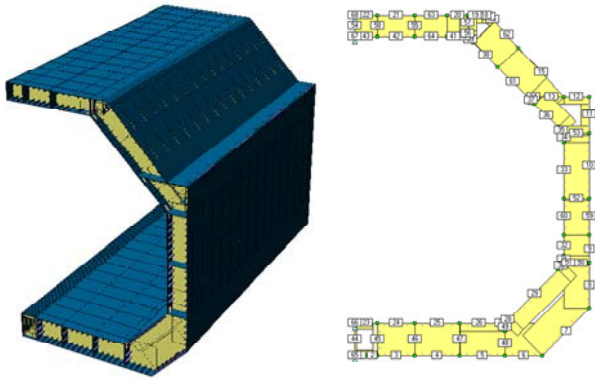

Figure 1. 2D and 3D-view of a LBR-5 model

3 NEW MODULES INTEGRATED IN THE FRAMEWORK OF IMPROVE

Different new modules have been integrated into LBR-5 to perform the optimisation of the three ships. These modules reinforce strongly the efficiency of the software.

The first module is the **sloshing module**. The LBR-5 sloshing module is based on sloshing pressures provided by the *Bureau Veritas* sloshing module. It furnishes quasi-static pressures to be applied on the inner hull structure supporting the membrane cargo containment system, to account, at preliminary design stage. These quasi-static sloshing pressures were obtained through numerical CFD calculations carried out by *Bureau Veritas* and crosschecked with different sloshing model tests campaigns carried out by *Bureau Veritas* in cooperation with *Ecole Centrale de Nantes* and *GTT*.

The second module is the **fatigue module**. It calculates at the early stage design the fatigue damage on critical connections of the ship structures. The procedure adopted is based on the “nominal stress” approach and uses Miner’s rule. Generic structural elements have been defined (stiffened panels, web frame or girder and pillars) with pre-defined load modes and fatigue-critical structural details based on results of the damage statistics and pre-existing knowledge. The nominal stress is calculated using beam and plate theory. These analytical formulas are suitable for structural optimization (fast calculation method). The notch stress is obtained based on the hot-spot and notch stress factor. A library of stress concentration factors for a various structural details is predefined.

The third module is the **multi-structure module**. It allows the LBR-5 optimisation tool to optimize several sub-structures simultaneously. The main interest is the possibility to link design variable between these sub-structures.

The fourth module is the **multi-materials module**. To carry out an optimisation structural constraints are imposed at critical areas where stresses are important. Material used influences strongly values of these constraints. It has also an impact on the objective function – weight or production cost. Before this new module only one material could be defined for all the structure. This limitation is now over.

The fifth module is the **Life Cycle Cost module (LCC)**. Rather than to optimise the production cost, it is now possible to optimise the life cycle cost. This module contains four sub-modules: the cost of periodic maintenance, the fuel consumption, the operational revenues and the dismantling revenues. Each sub-module can be chosen individually or with others. These new costs can be added to the production cost. A corrosion model that modifies the behaviour of the LCC module can also be selected.

And finally the last module implemented is the **vibration module**. Two methods were developed in order to obtain precisely the first natural frequency. The first, named classic dichotomy is based on Euler-Bernoulli equations and is purely analytical. The main advantage of this method is the accuracy of the results. Nevertheless, this accuracy is limited by the modeling and is influenced by frequency step size. The main inconvenience is the large CPU calculation time in case of complex structures. A second method was developed, named discrete approach. The calculation time becomes very small even for structures with many degrees of freedom and the parasite frequencies disappear. This method was validated with simplified FEA. The both methods allow to obtain only the resonant frequencies corresponding to global vibration modes of the stiffened panel. For the moment, the local vibrations cannot be assessed yet.

Applications of the sloshing, fatigue and multi-structures module have been carried out on the LNG. The multi-materials and Life Cycle Cost module have been used to optimise the Chemical Tanker. Finally the vibration module has been applied on the ROPAX.

4 CONCLUSION

All these new modules have been implemented into LBR-5. Concrete applications were done in optimising each of the three ships studied in the framework of IMPROVE: a LNG ship, a Chemical Tanker and a ROPAX.

Impacts of each module on the optimised scantling have been highlighted.

LBR-5 is now very complete and competitive software to optimise scantling of a ship at very early design stage

with management of critical problems studied normally at a later step of the design.

REFERENCES

- Asmussen, I., Menzel, W. and Mumm, H. (2001). Ship Vibration. *Germanischer Lloyd*.
- Bureau Veritas. (1998) Fatigue strength of welded ship structures.
- Constantinescu, A., Nême, A. and Rigo, Ph. (2009) Vibration Assessment of Ship Structures. *ISOPE, Osaka, Japon*.
- Bertram V., Maisonneuve J.-J., Caprace J., Rigo Ph. (2005). Cost Assessment in Ship Production. *RINA*.
- Giuglea, S., Chirica, I., Giuglea, V. and Rigo, Ph. (2008) IMPROVE - Design of Improved and Competitive Products. *DBlaS'2008, I&CT Intern. Conf.*
- Least Cost Optimization of Large Passenger Vessels (2007). *Ships & Offshore Structures*, vol.2, pp. 339-345.
- Toderan C. et al (2008). Structural Optimization of a 220 000 m³ LNG Carrier. *Conference on Computer Applications and Information Technology in the Maritime Industries (COMPIT)*.
- Toderan C., Pircalabu E., Caprace J. and Rigo Ph. (2007). Integration of a Bottom-Up Production Cost Model in LBR-5 Optimization Tool. *Conference on Computer Applications and Information Technology in the Maritime Industries (COMPIT)*.
- Turan, O. et al (2009). Maintenance/repair and production-oriented life cycle cost/earning model for ship structural optimisation during conceptual design stage. *Ships and Offshore Structures*, vol. 4, is. 2, pp. 107-125.

Tools for early design stage: OCTOPUS and MAESTRO Software

V.Zanic, J.Andric, M.Stipcevic, P.Prebeg, S.Kitarovic, M.Grgic, K.Piric, N.Hadzic

UZ-FMENA – University of Zagreb, Faculty of Mechanical Engineering and Naval Architecture, Croatia

ABSTRACT: OCTOPUS and MAESTRO software tools represent an integrated ship structural modeling, analysis, and optimization systems for concept and preliminary design phase, respectively. Incorporation of the modules developed within the scope of the IMPROVE framework into OCTOPUS software further enhanced its capabilities in ship design and provided the designer/user with even more extensive and more sophisticated support in decision making at the early design stage.

1 MAESTRO SOFTWARE

MAESTRO is an integrated ship structural modeling, analysis, and optimization system for the preliminary design phase. It combines rapid ship-oriented structural modeling, large scale global and fine mesh 3D finite element analysis, structural failure evaluation, and structural optimization. Its core capabilities represent a system for rationally-based optimum design of large, complex thin-walled structures. Since the modeling and analysis capabilities are not geometrically limited in any sense, accommodation of any type of geometry or structural configuration is possible, meaning that MAESTRO can be used for analysis and design of many different types of thin-wall stiffened structures. It has been used for virtually every type of ship, from large tankers, container ships and bulk carriers to high speed ferries, multi-hull vessels, SWATHs, as well as smaller vessels such as fishing vessels and patrol craft.

MAESTRO enables full-ship FEM modeling (Figure 1) and some basic modeling entities and features are:

- Embedded fine mesh module with the fast refinement of the coarse mesh critical regions;
- Geometry of each section is modeled separately with endpoints (nodes);
- Stiffened panel macroelements are generated between nodes in the longitudinal and/or transverse structure. Stiffening can be transversal or longitudinal;
- Transverse frames and longitudinal girders can be represented by: bracketed beam macroelements, eccentric beam elements, modified eccentric beam elements and hybrid beam elements;
- Symmetric (full or half) or nonsymmetrical sections can be modeled.

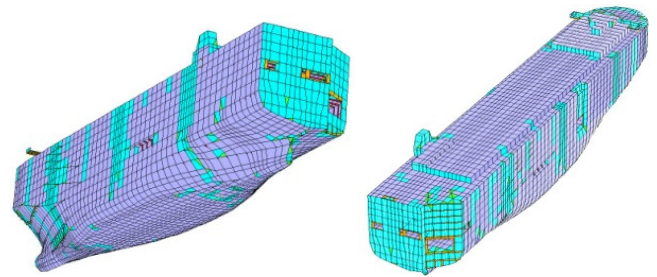

Figure 1. MAESTRO full-ship 3D FEM structural model of the Car Carrier.

Ordinary finite elements can be used for fine-mesh modeling of stress concentration areas (Figure 3). There are two distinct approaches to the FE analysis of the critical details that can be used in MAESTRO system:

- Embedded fine mesh module with the fast refinement of the coarse mesh critical regions;
- Top-down fine mesh approach, where the displacement vector generated through the global coarse mesh FE analysis is directly transferred as the displacement boundary condition for the fine mesh FE model.

MAESTRO offers a ship-oriented, flexible and highly automated specification of loads which are realistically applied to the structural model. The MAESTRO allows the user to define multiple load cases with various combinations of any of the following load types:

- Lightship Mass Distribution: The Lightship Weight Distribution curve may be easily matched by specifying the weight per unit section which can vary along the ship length;
- Hydrostatic Loads: The user may specify any waterline, optionally with a wave profile and heading, and MAESTRO will automatically apply the hydrostatic pressure to the hull;

- Cargo Masses: The user may define the footprint and specific mass of cargo and other significant load items;
- Accelerations: In addition to the acceleration due to gravity, MAESTRO allows the user to apply a rotational or translational acceleration to model;
- Pressure Loads: A constant pressure plane or linearly varying pressures can be applied to the model;
- External Bending Moments and Shear Forces: If only a portion of the ship is being analyzed (e.g. 3 holds), the user can apply external moments (vertical, horizontal and torsion) and shear forces to the ends of the model;
- Boundary Conditions: The model can be restrained in 6 degrees of freedom to prevent rigid body motion.

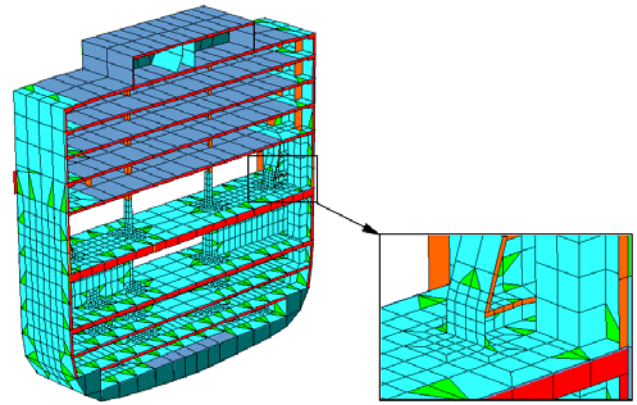

Figure 3. MAESTRO full-ship 3D FEM structural model of the Car Carrier.

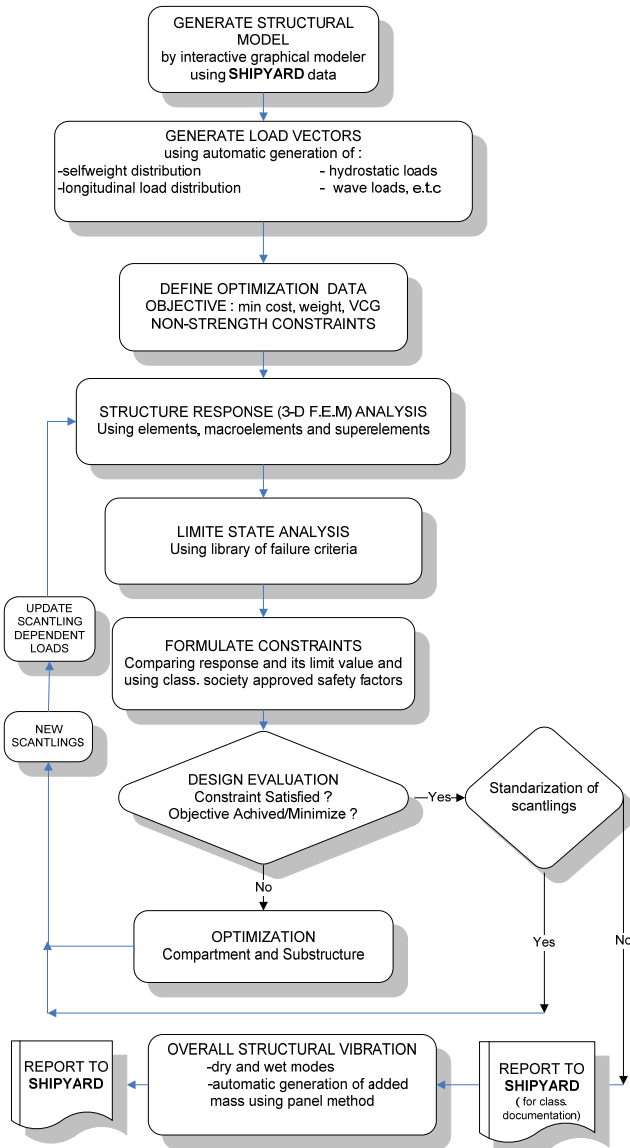

Figure 2. MAESTRO general design procedure.

MAESTRO FEM analysis is usually applied to the complete structure, and deflections and stresses are determined for all principal structural members and for all load cases (Figure 4). MAESTRO can also analyze the natural frequencies of the structure.

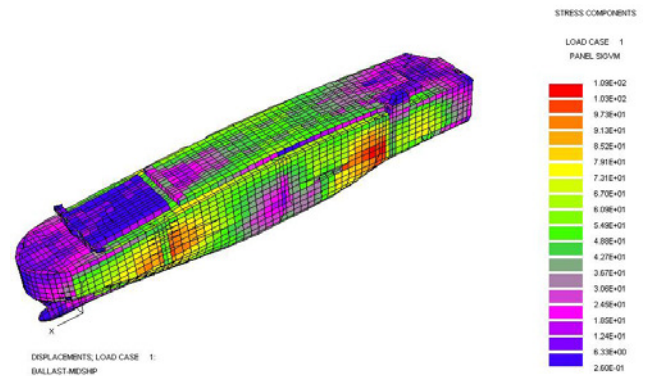

Figure 4. MAESTRO vonMises stress distribution of the Car Carrier.

The major capability of MAESTRO is the structural evaluation, or failure analysis, where each of the principal structural members is evaluated subsequent to the finite element analysis for all possible failure modes. The principal structural members of the global MAESTRO model typically include all of the stiffened panels and their associated beams, transverse frame segments and longitudinal girders. These failure modes address yielding, buckling, plastic hinge formation and other major failure modes and design limits such as deflections. There are a total of 25 failure modes at the individual principal structural member level, and 10 at the overall or multi-member level. MAESTRO is also fully integrated with the ALPS system for the limit state analysis

The failure analysis provides a quantified evaluation of each of these failure modes for each principal structural member, for each load case that is being analyzed. Structural failure evaluation results are used by the user to assess the adequacy or the degree of conservatism that is represented by the design, and are also used by MAESTRO as constraints for the structural optimization.

MAESTRO can also perform Multiple criteria optimization (minimum weight, minimum cost, vertical centre of gravity control) utilizing very reliable and robust

Sequential Linear Programming (SLP) algorithm (Dual formulation with special linearization and constraint accumulation techniques).

MAESTRO is the first and most widely spread software for 'first principles' calculation of ship structures and preliminary design phase optimization, while its user community includes navies, classification societies, design offices and universities. MAESTRO software is distributed and maintained by the DRS-C3 Advanced Tech. Center, Stevensville, MD, USA.

2 OCTOPUS SOFTWARE

OCTOPUS is an integrated ship structural analysis, evaluation and optimization system for concept design phase. It combines two distinct software tools, namely: OCTOPUS Designer (design synthesis) and OCTOPUS Analyzer (design analysis), resulting in the design environment capable of supporting decision making process for the ship or ship structures concept design problems.

Generally, decision support problem (DSP) solution requires practical implementation of selected methodology through two basic calculation (mathematical) models:

A Design analysis model for technical (performance, response, safety) and economical (cost) evaluations can be decomposed into six meta-systems of which two basic ones provide physical (Φ) and environmental (ϵ) definitions of the problem, while other four are behavioral systems for modeling of its response (ρ), adequacy (α), reliability (π) and quality (Ω).

B Design synthesis model includes the design definition modules (Δ), optimization and sensitivity solvers (Σ), databases, visualization and selection modules (Γ).

Modules of the analysis model can be invoked into the design problem definition modules and coupled with different optimization solvers into multi-attribute multi-level hybrid design procedure.

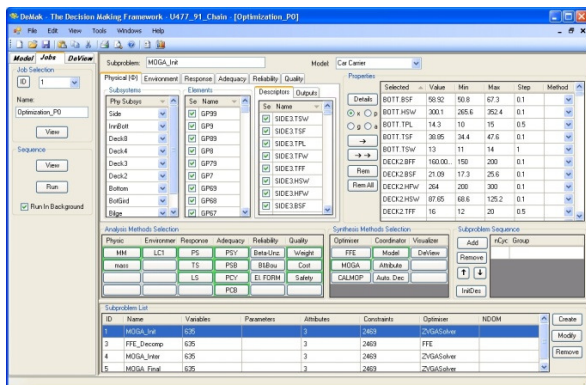

Figure 5. DeMak framework main input form.

Problem sequencer permits flexible control of decision making process for the hierarchically structured designed system Figure 8.

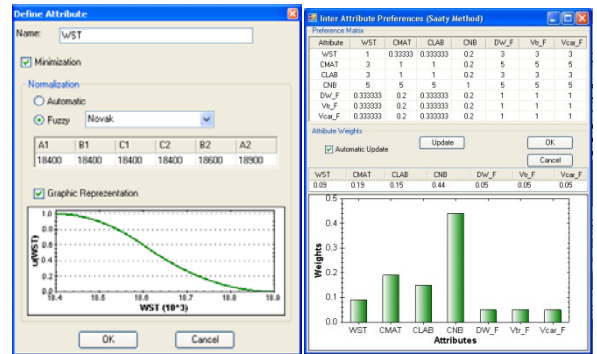

Figure 6. Definition of inter/intra attribute preferences.

Mathematical definition of the design problem implies definition of the design parameters (e.g. scantlings) in Φ , design quality measures in Ω (e.g. minimal weight) and the corresponding structure of sets/spaces used for efficient design description and calculation. Γ modules enable graphic insight.

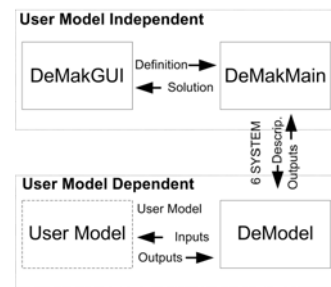

Figure 7. OCTOPUS Designer components diagram.

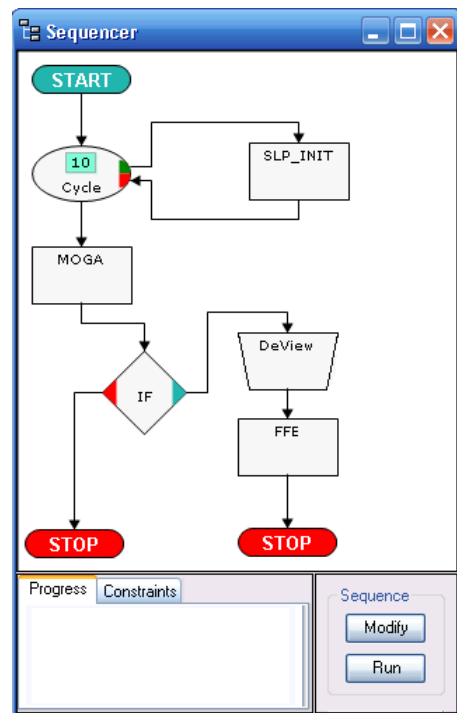

Figure 8. DeMak sequencer.

OCTOPUS Designer is the framework for the decision support problem manipulation with components *DeMak* (Δ and Σ) and *DeView* (Γ), (Zanic et al. 2007, 2009) represented by figures 5 to 10. Figure 7 shows diagram of the OCTOPUS Designer components and their interactions.

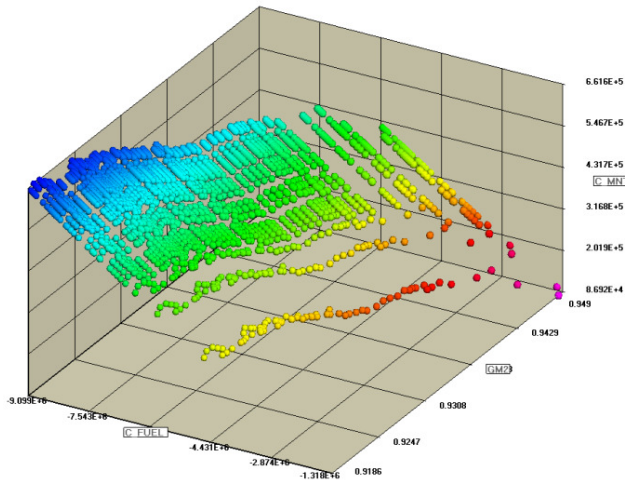

Figure 9. Design space in Γ module.

It is important to notice that DeMakGUI and DeMakMain are problem (model) independent. DeModel component wraps User Model component (e.g. OCTOPUS Analyzer for structural problems) and gives prescribed interface for up to 6 Engineering Systems. This enables communication between User Model and User Model Independent components.

OCTOPUS model (2.5D FEM) is generated on the basis of one bay model produced manually using the MAESTRO software and/or by automated CAD to FEM data transfer using TRIDENT software. Both approaches are based on macroelements combining numerical and analytical approaches to logical meta-structures (stiffened panels, bracketed and locally reinforced girders, cell elements). Macroelement employment simplifies and speeds up the design work since they are used to generate response fields of accuracy adequate to coarse mesh classification requirements for structurally 'logical' portion of structure with respect to failure modes and their mathematical definition. Furthermore, they are used to combine primary (hull girder), secondary (girders supporting plating) and tertiary (plate between stiffeners) responses, needed for some of the failure modes, using numerical and analytical knowledge. Used macro-elements include: bracketed beam, stiffened panel and stiffened membrane macroelement. Also, a family of eight-node and nine-node isoparametric quadrilateral stiffened shell elements was developed and implemented.

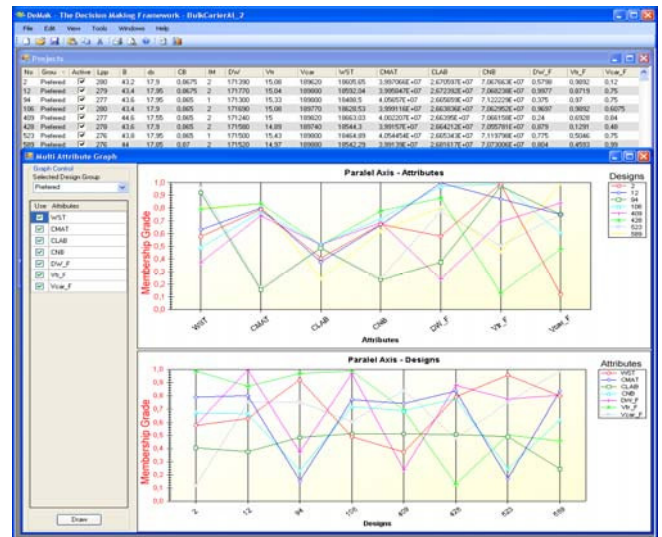

Figure 10. Parallel axis of the selected preferred designs.

OCTOPUS Analyzer (Zanic et al. 2009) is an integrated set of analytical modules in two distinct versions, namely: OCTAN and CREST.

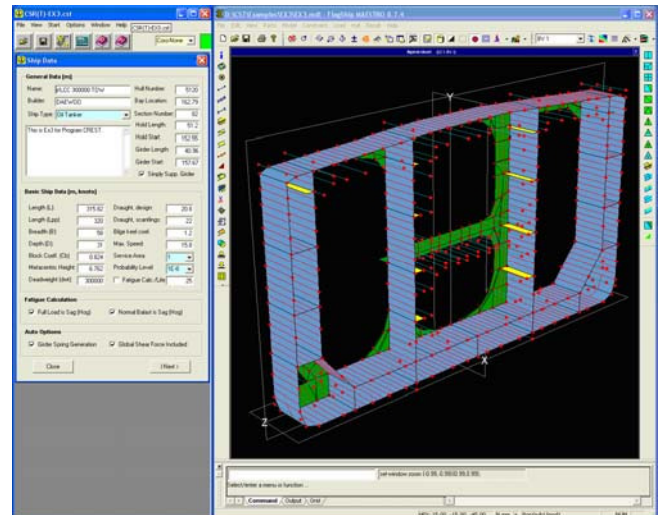

Figure 11. GUI for pre/post-processing and analysis employing OCTOPUS/CREST Analyzer and MAESTRO.

OCTAN represents the most general tool for structural evaluation of thinwalled structures (naval, aerospace, etc.), while CREST comes in four different variants specifically suited for ship structural evaluation based on class society rules: IACS Common Structural Rules for Double-hull Oil Tankers (CREST CSR(T), 2006) and Bulk Carriers (CREST CSR(BC), 2009), IMPROVE developed (CREST BV), Croatian Register of Shipping (CREST CRS). For full operation OCTOPUS Analyzer employs MAESTRO software for pre/post-processing and working environment layout is presented in Figure 11. The flowchart showing execution sequence of the consecutive phases of structural evaluation, along with some results representation capabilities, is given by Figures 12 to 17.

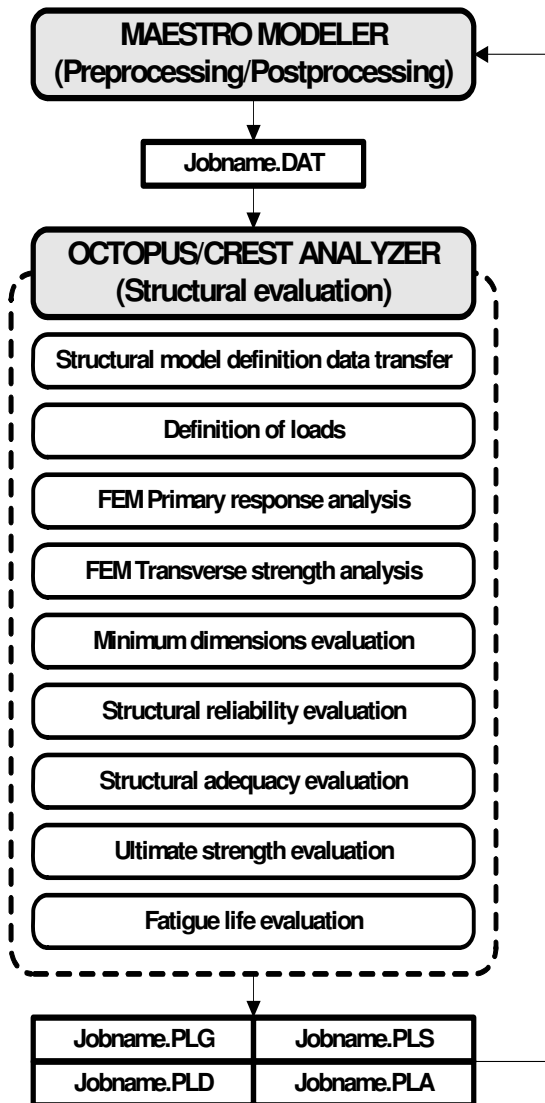

Figure 12. Structural evaluation sequence in OCTOPUS/CREST Analyzer.

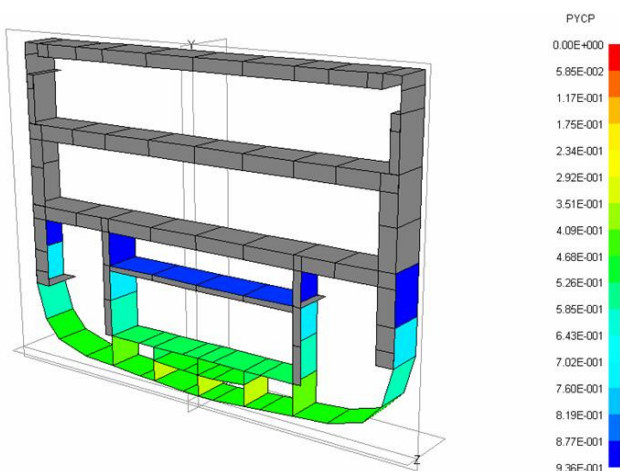

Figure 13. OCTOPUS ROPAX module, BV ordinary stiffeners ultimate strength criteria visualization.

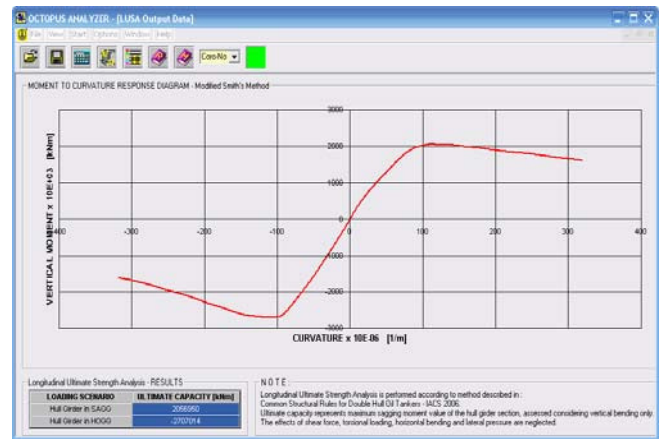

Figure 15. OCTOPUS vertical bending moment to curvature diagram resulting from the hull girder longitudinal ultimate strength evaluation.

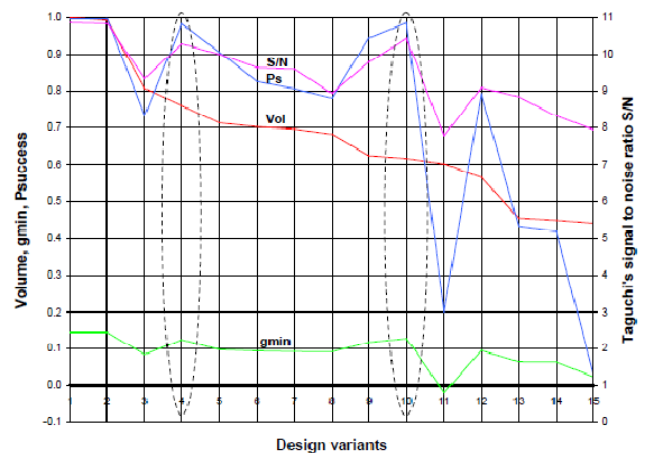

Figure 17. Robust designs for Taguchi's Signal to Noise Ratio compared to probabilistic and deterministic safety measures vs. design variant volume.

3 IMPROVE MODULES IN OCTOPUS

Within the scope of the IMPROVE framework OCTOPUS was successfully integrated with the Robustness calculation module (Σ) on the OCTOPUS Designer level, while following modules were incorporated on the OCTOPUS Analyzer level: Fatigue calculation module (α -FAT), Local vibrations calculation module (α -VIB), Production cost module (Ω -PRO) and Lifecycle cost module (Ω -LCC).

BV structural adequacy criteria for buckling and yielding (α -BV) were also added to the OCTOPUS criteria library and the ultimate strength calculation module (α) was modified to include the influence of shear. OCTOPUS loading module (ϵ -BV) was adjusted to accommodate the definition of loads according to BV rules. Figure 18 describes dataflow between tools used within the IMPROVE framework.

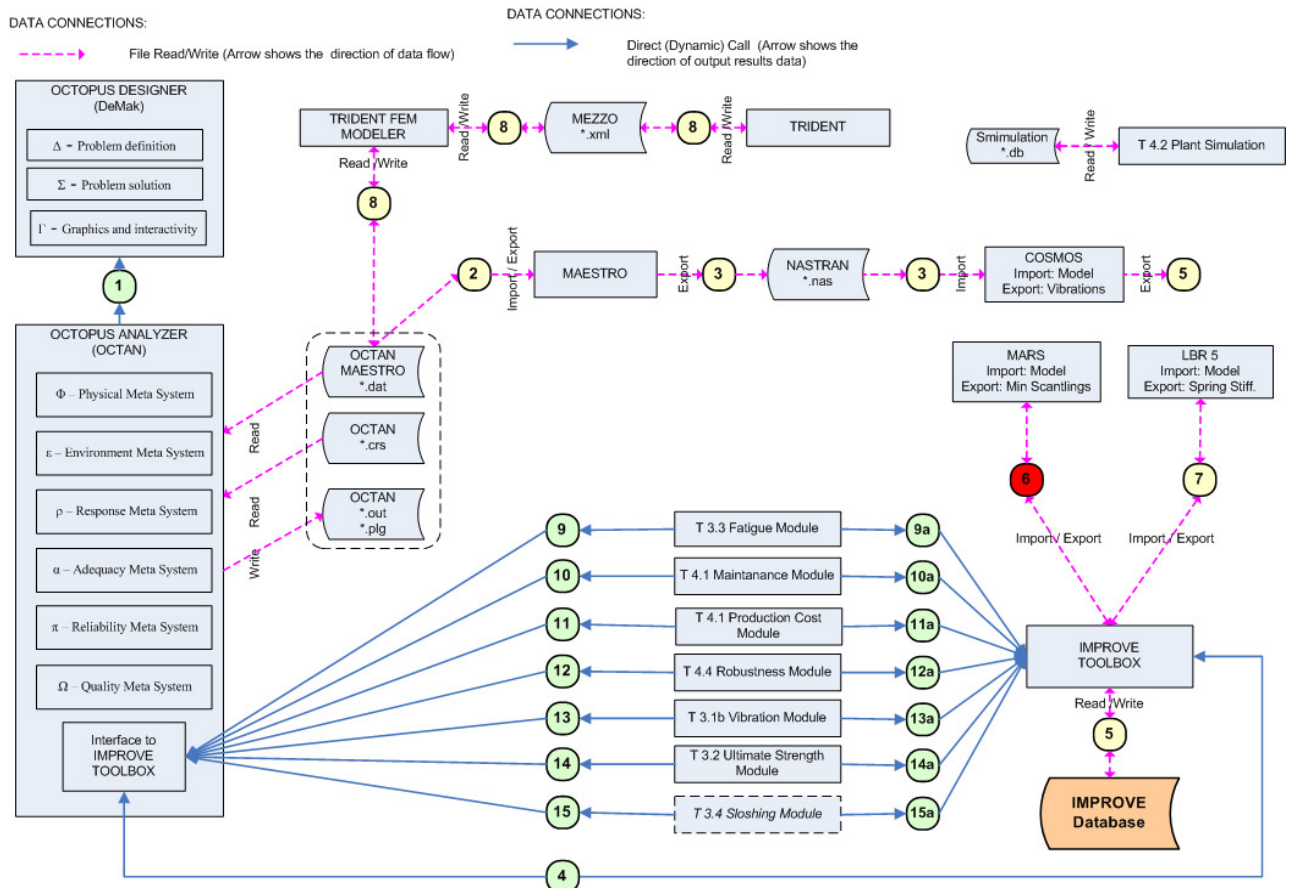

Figure 18. Scheme of the dataflow used for OCTOPUS and MAESTRO tools within the scope of the IMPROVE framework.

REFERENCES

- OCTOPUS v3.0, *Software documentation*, University of Zagreb, Faculty of Mechanical Engineering and Naval Architecture, Zagreb, 2006.
- CREST CSR(BC) v1.0, *Software documentation*, Croatian Register of Shipping, University of Zagreb, Faculty of Mechanical Engineering and Naval Architecture, Split-Zagreb, 2009.
- CREST CSR(T) v1.0, *Software documentation*, Croatian Register of Shipping, University of Zagreb, Faculty of Mechanical Engineering and Naval Architecture, Split-Zagreb, 2006.

- MAESTRO v8.7, *Software documentation*, DRS-C3 Advanced Tech. Center, Stevensville, MD, USA
- Zanic, V. Prebeg, P. Kitarovic S. 2007. Decision Support Problem Formulation for Structural Concept Design of Ship Structures. *Proceedings of MARSTRUCT 2007*, 499-509.
- Zanic, V. Jancijev, T. Kitarovic, S. Piric, K. Rogulj, A. 2009. Concept Design of Modern Tankers and Bulk Carriers Using IACS Common Structural Rules in the Design Loop. *Proceedings of IMAM 2009*.
- Zanic, V. Andric, J. Prebeg, P. Kitarovic S. Piric, K. 2009.. Multi-Objective Optimization of Ship Structural Topology and Scantlings. *Proceedings of IMDC 2009*.

ConStruct - Platform for Conceptual Structural Design

H. Remes, A. Klanac, P. Varsta, S. Ehlers

Helsinki University of Technology, Espoo, Finland

ABSTRACT: The design of novel ship concepts is often restricted by the limited reference database. Therefore, the structural design in the concept stage is a challenge. Especially, as the strength analysis of new ship concepts with complex structures is usually carried out with the help of FE analysis. However, FE analysis is time-consuming and inefficient. To improve this situation, a new platform for the Conceptual Structural design (ConStruct) was developed in a national TEKES-funded research project at the Helsinki University of Technology. The platform provided a time-efficient structural design tool and also the utilisation of new research results for future industrial applications. Recently, the ConStruct platform is utilised in EU-funded Improve project to develop a new chemical tanker concept.

1 INTRODUCTION

The structural design of new ships concepts is very challenging due to complex functional demands. For instance, in the case of modern passenger ships balcony openings, promenades, large restaurants, theatres, and atriums cause a non-linear normal stress distribution in the cross-section of the hull girder; see Figure 1. Because of the structural discontinuities, the strength evaluation of the hull girder is usually performed with linear elastic FE (Finite Element) analysis. However, the FE analysis is time-consuming and is not suitable for an iterative design process in the concept stage. Therefore, structural design is commonly carried out after the concept design stage. However, in this stage the general arrangement of the ship is already fixed, and thus possibilities for structural modifications are limited. In order to include structural design in the concept stage, a more time-efficient method is required.

Furthermore, weight and cost efficient structures are required, since ship sizes have increased drastically during last 30 years. Advanced structural solutions and new analysis methods for structures have been developed in research projects. However, the industrial application of the new structural concepts is very demanding, because of the tight schedule in design process of the ship new building. Thus, there is a demand for a design platform which is capable to adapt these new innovations already in the concept design stage. Therefore, this paper introduces a new platform for the conceptual structural design of novel ship concepts, namely the ConStruct platform. This platform enables a time-efficient design process and an easy

utilisation of new research results for industrial applications. The platform was built in a Finnish national TEKES-funded research project and utilised in EU-funded Improve project.

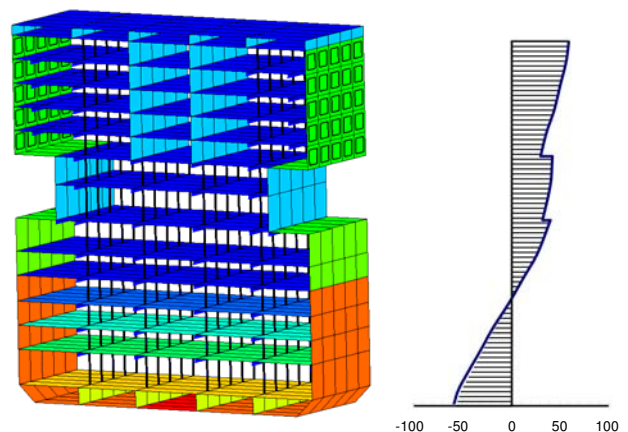

Figure 1. Main frame of modern passenger ship with large balcony openings and several pillar lines (left) leads to low shear stiffness and non-linear distribution of normal stress (right).

2 CONSTRUCT PLATFORM

2.1 Basic principles

The development of a platform for the conceptual structural design is a challenging task from a technical and scientific point of view. Figure 2 shows the basic elements of the ConStruct platform. It has advanced functions for fast geometry modelling, structural response analysis, and efficient post-processing of results. These functionalities are essential for an iterative design, where the available time is very limited. The software architecture of ConStruct

platform supports the continuous implementation of the latest research results. Therefore it is possible to create innovative ship concepts efficiently with the ConStruct platform.

2.2 Methods for structural analysis

An important feature of the ConStruct platform lays on the sophisticated structural response and strength analyses. The hull girder of ship consists of one or more sections making it possible to study prismatic or non-prismatic hull beam problems. Each of these sections is composed of macro-elements, whose properties are obtained from pre-defined material and profile tables (Niemeläinen 2007). The approach fits well to the iterative process in the concept design stage, where analysis starts from the mid-ship section and later expands to the whole ship length. The structural analysis is carried out with the help of the Coupled Beam method (Naar *et al.* 2004). This method has been developed to estimate the response of hull girders with large multi-deck superstructure and openings. The strength requirements of structural elements are evaluated by fast analytical formulae (Mantere 2007), which enables fast

screening over the whole hull girder and thus, automates the process for optimisation (Niemeläinen 2007) where the number of variables is extremely large and they are typically discrete. The design space of multi-attributes has a non-convex shape, and thus evolution-based optimisation methods are most suitable. The ConStruct platform uses the Genetic Algorithm, which is implemented in a novel way to create the Pareto surface (Klanac *et al.* 2008, Klanac and Jelovica 2009).

2.3 Software implementation

The ConStruct software is composed of a central unit, ship model database and independent calculation modules. The central unit controls the database and the calculation modules with the help of a functional library. The calculation modules include all methods required for techno-economical analysis, and it is separated into an own unit to implement new research results easily. The software is also designed user-friendly, see Figure 3. The user-interface consists of main menu, model view for visualisation, and database tree with datasheets.

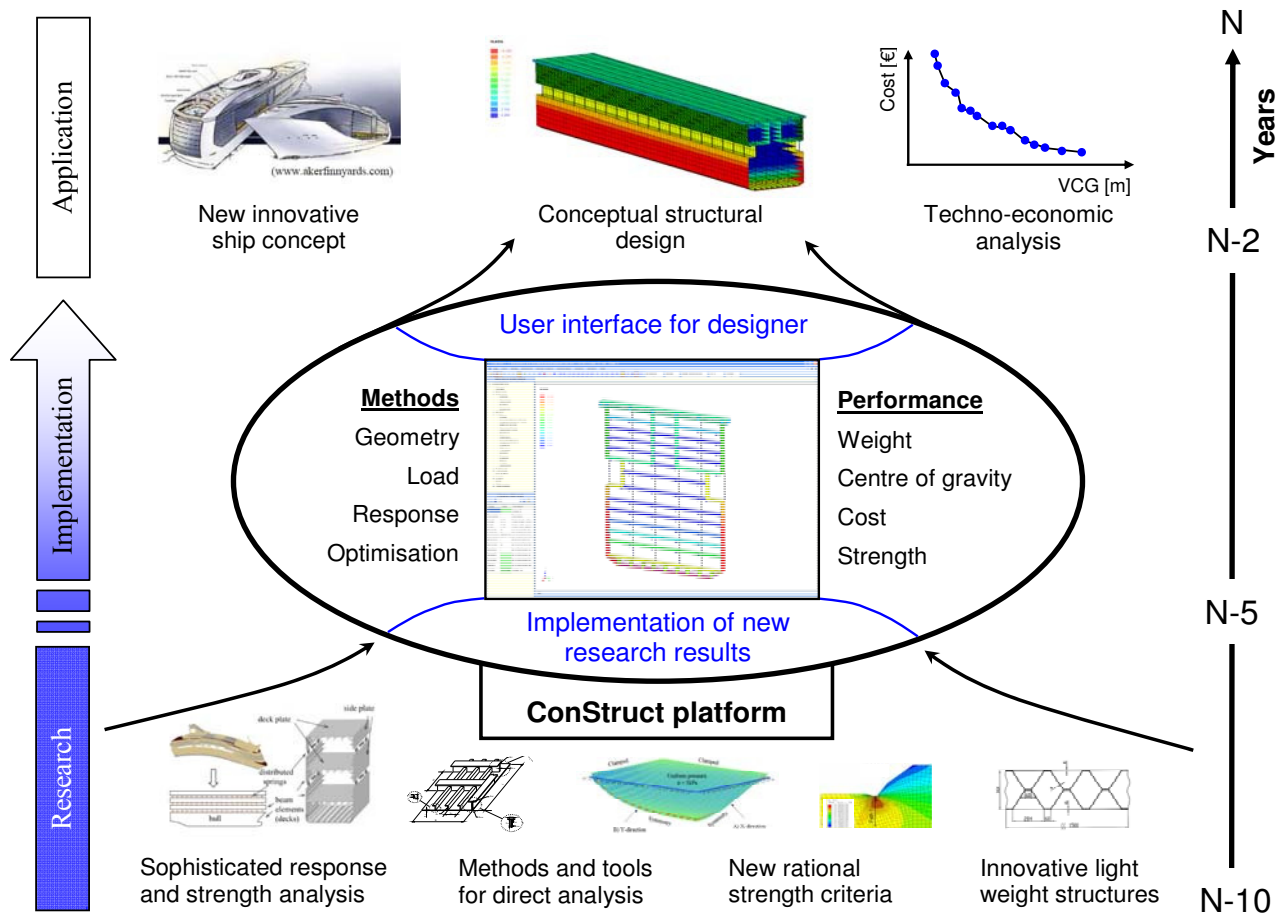

Figure 2. Principle of the ConStruct platform, including interfaces for the designer and implementation of new research results.

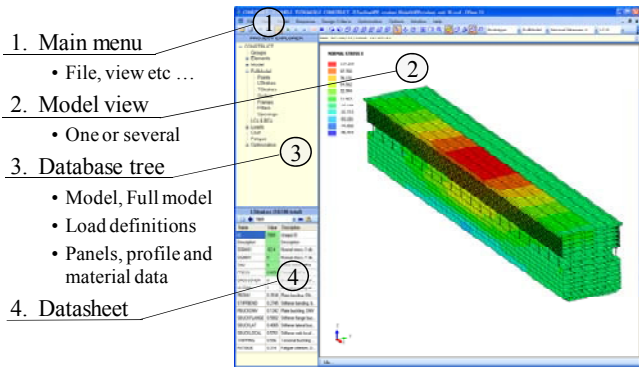

Figure 3. Graphical user interface of ConStruct software.

The operational principle of the ConStruct software is presented in Figure 4. The starting point of the conceptual structural design is the digital information of previous design steps, where for instance general arrangement and hull shape are created. Based on this information the steel general arrangement, loads and structural discretion for CB-analysis are determined. These initial definitions are done once, since scantlings with stiffener spacing are only varied during structural optimisation. During the optimisation process design alternatives are stored to have wide coverage of the objective space, which is exploited for the creation of Pareto surface. The ConStruct platform allows studying thousands of design alternatives within a few days. The designer has two options: manual design generation or optimisation.

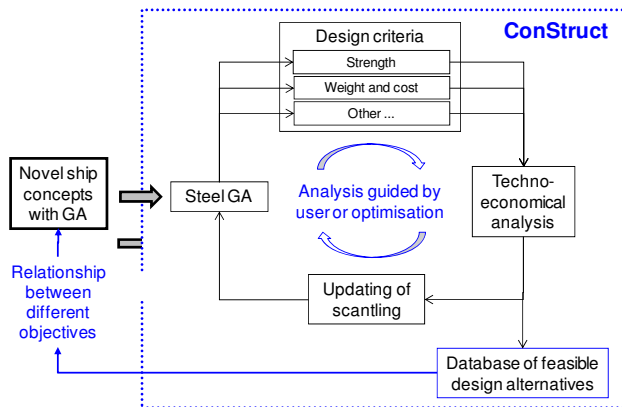

Figure 4. Operating principle of the ConStruct platform.

3 UTILISATION IN EU-IMPROVE

3.1 Objectives

In the EU-funded Improve research project, the ConStruct platform is used to develop a new chemical tanker concept within the design targets of shipyard and ship owner. Figure 5 shows the main parameters of the tanker giving a starting point for conceptual design process.

$$L_{pp} = 175.25 \text{ m}$$

$$B = 32.2 \text{ m}$$

$$T = 10.8 \text{ m}$$

$$T_{SC} = 11.5 \text{ m}$$

$$C_b = 0.8$$

$$Z = 27 \text{ m}^3$$

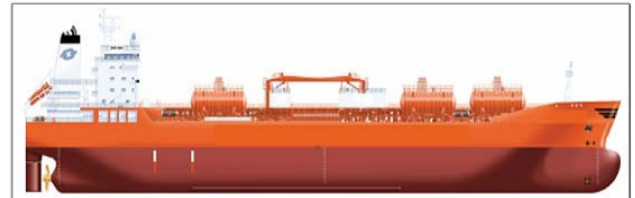
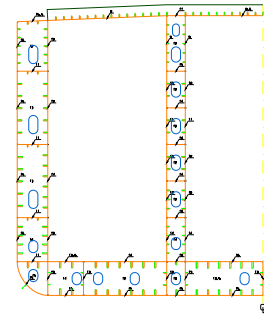

Figure 5. Main dimension of tanker developed in EU-Improve project using the ConStruct platform.

3.2 EU-Improve analysis modules

Based on the interviews of the shipyard and the ship owner, the important structural design objectives for the tanker are building cost, steel weight and fatigue life. The Improve project provides calculation modules for cost and fatigue life.

The cost module is based on steel weight and weld seam lengths. Furthermore, the module utilises shipyard's database for production cost. The module is an executable file and enables efficient analysis of all structural elements of the ship. Similar to the cost module, the fatigue module is stand-alone executable file, and thus suitable for automated structural analysis. The input of the fatigue module consists of the general information of structural members, the global response of hull girder and local pressure loads. The calculation module evaluates all potential fatigue-critical structural elements using analytical formulas for the notch stress approach.

3.3 Structural optimisation of the tanker

Flow chart of the tanker optimisation is presented in Figure 6. The optimisation starts with the definition of the optimisation problem, where the scantlings are design variables and strength criteria define the constraints of the optimisation problem. The range of the design variables is based on the production requirements given by the shipyard. The object functions composed of cost, weight and fatigue life. Weight factor of the each objectives are varied, and several parallel optimisations are run at same time to obtain full coverage of the objective space.

As a final result, the Pareto frontier for different objectives is obtained. An example is given Figure 6, where the

relation between cost and fatigue life is shown. Similar relation between design objectives can be obtained for all objectives to enable an efficient design support for the designer.

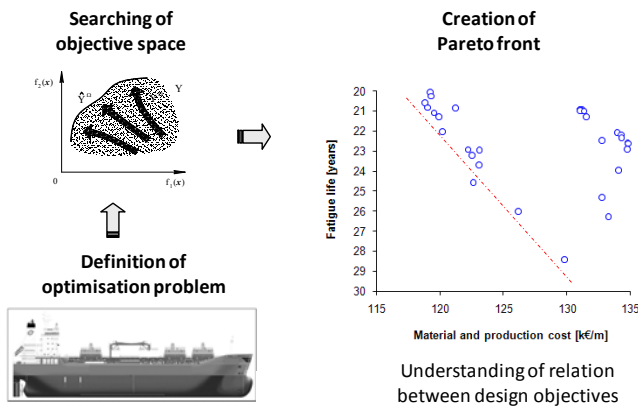

Figure 6. Schematic presentation of ConStruct optimisation to define the relation between different objectives.

4 CONCLUSION

The ConStruct platform for the structural design of novel ships in the conceptual stage was developed in the Finnish national TEKES-funded research project. The platform allows an efficient structural design and the utilisation of new research results. The ConStruct platform provides the scantlings of hull structure and also the information about relations between different design objectives. This information gives remarkable support for the designer before preliminary and details design stages. The ConStruct

platform is successfully utilised in EU-funded Improve project, where the rational based methods are applied on the structural design of chemical tanker.

ACKNOWLEDGEMENTS

ConStruct platform was developed in Finnish research project funded by Tekes, STX Europe and Napa Ltd. The financial support is gratefully appreciated.

REFERENCES

- Klanac, A., Jelovica, J. 2009. Vectorization and constraint grouping to enhance optimization of marine structures. *Marine Structures*, Vol 22, No 2, p. 225-245.
- Klanac, A., Jelovica, J., Niemeläinen, M., Damagallo, S., Remes, H., Romanoff, J. 2008, Structural Omni-Optimization of a Tanker, Proc. 7th International Conference on Computer Applications and Information Technology in the Maritime Industries – COMPIT '08, Liege, Belgium.
- Mantere, H. 2007. Strength Analysis for the Design of Local Ship Structures in Concept Stage. Master's Thesis. Helsinki University of Technology, Department of Mechanical Engineering, Ship Laboratory. Espoo.
- Naar, H.; Varsta, P.; Kujala, P. 2004. A theory of coupled beams for strength assessment of passenger ships. *Marine Structures*, Vol 17, No. 8, p. 590-611.
- Niemeläinen, M. 2007. Computational Method for Evaluation of Hull Girder Strength in Concept Design Stage. Master's Thesis. Helsinki University of Technology, Department of Mechanical Engineering, Ship Laboratory. Espoo.

APPLICATION CASES

LNG Carrier – Ship Owner requirements, markets and technical trends

F. Van Nuffel

EXMAR, Antwerp, Belgium

1 SHIP OWNER REQUIREMENTS

LNG vessels are today constructed with structural life time of 40 years in North-Atlantic conditions. At this moment, some of the LNG vessels built in the seventies are still sailing. To keep the vessels in a proper and safe condition throughout this long lifetime, high efforts from the Ship Owner and Operator are required.

Generally, LNG vessels are high valued vessels on which high quality materials are being used, especially for the cargo part. In this area corrosion problems can be expected but fatigue is an important topic. The propulsion of the LNG vessels built before 2005 is generally steam propulsion. The steam turbines have an excellent track record and do not require a lot of maintenance either.

On the other hand, to keep the vessel in a good shape, one can expect serious maintenance has to be done for the hull itself, for the ballast system and for the electrical/automation plant.

If the correct choices are made in the early stage of the design, it is obvious the Ship Owner can save costs on maintenance works during the vessel's lifetime. Special areas to focus on are:

- Equipment arrangement
- Deck & engine room layout
- Equipment selection
- Material selection
- Ballast tank & underwater hull coating

As compared with other types of vessels, reducing the consumption for certain speeds is not really a primary design requirement. The LNG is transported in a condition close to its boiling point at atmospheric pressure. As such, the LNG vessel has a daily production of boil-off gas in laden voyage. This boil-off gas is generally used as fuel for the propulsion. Reducing the consumption too much would basically mean that there would be an excess of boil-off gas which has to be disposed of, if the cargo tank insulation

characteristics remain the same. While optimizing the consumption, also a design speed optimization based on the daily boil-off gas rate should be performed.

Research is ongoing to improve the insulation properties and as such a speed optimization, especially for the larger vessel needs to be done.

For the project IMPROVE the Ship Owner requirements had to be focussed on items which were related to structural optimisation. These requirements have been formulated as follows:

- Minimizing the amount of ballast tanks
- Minimizing the amount of structure in the ballast tanks
- Maximise the usage of profiles with rounded edges and flat bars in the ballast tanks
- Design for a fatigue life of more than 40 years in North-Atlantic conditions
- Minimize the lightship weight, taking into account above requirements

2 GLOBAL LNG VESSELS MARKET

When designing an LNG vessel, a few major decisions have to be taken in order to define the vessel. These are:

Capacity of the vessel (generally given in m³)

Cargo Containment system: Membrane, Moss or SPB (mostly depending on the shipyard license)

Propulsion system: Steam (S), Diesel-Electric (DFDE) or slow-speed diesel (DRL)

Looking at the history of the LNG vessel design (see graph) we can see that until 2005 the standard size was in the range 120,000 m³ – 140,000 m³. From 2005 onwards the “standard” size has been increased slightly to the 150,000 m³ - 170,000 m³ range. Next to these vessels, also so called Q-Flex vessels (220,000 m³) and Q-Max vessels (260,000 m³) have been ordered and built.

Number and capacity of newbuild LNG tankers

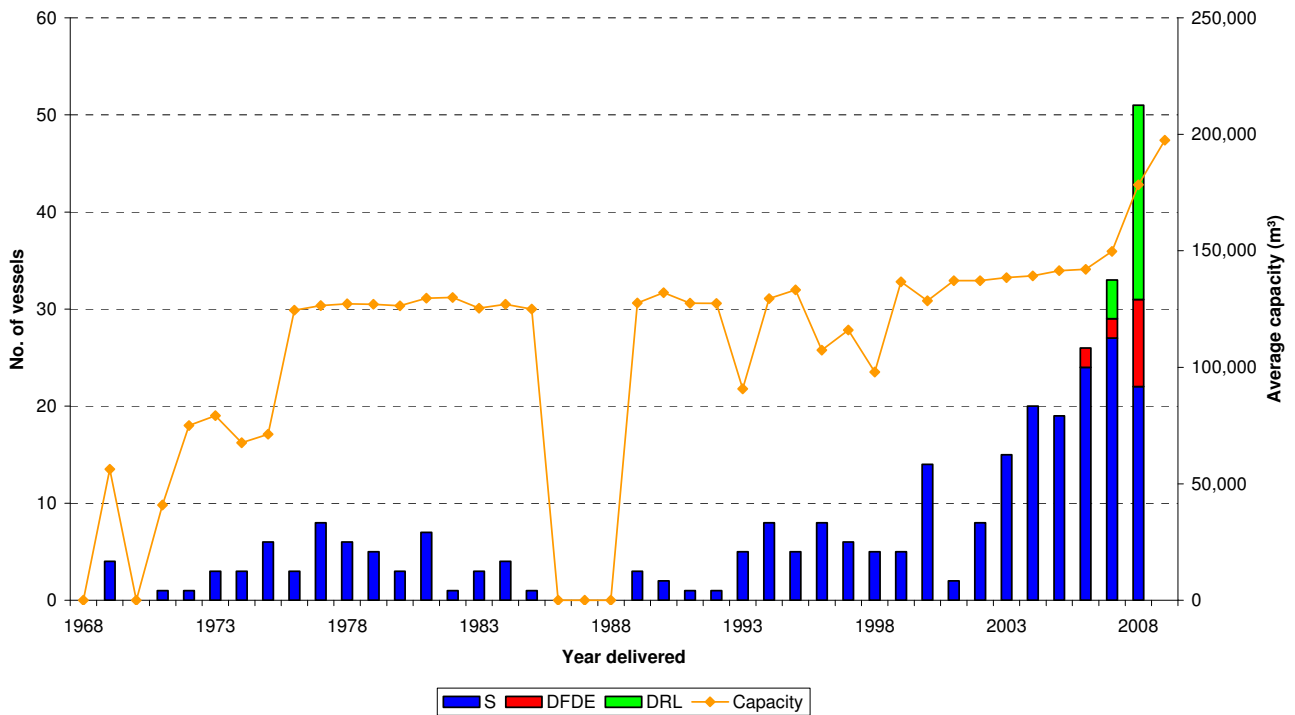

This trend from the last couple of years is certainly driven by the economics-of-scale. Nevertheless, there are certain limits to the size of the vessel, which are mostly related to the LNG producing and receiving terminals which can only allow vessels of a certain length, depth and/or displacement. Vessels designed for trading on the spot market will therefore be not larger as 170,000 m³ (Atlantic Max).

For the IMPROVE project it has been decided to go for a 220,000 m³ vessel. It is generally assumed this size will become a standard for future fixed LNG trading.

The cargo containment type and propulsion has been decided by the shipyard.

3 TECHNICAL TRENDS

The evolution on the technical side is obviously closely related to the market requirements. The last years more and more focus is being put at the environment and the way seagoing vessels are interacting with the environment. One important topic which is closely related to the IMPROVE project is the handling and treatment of ballast water. This will become mandatory and the less ballast water a vessel has, the easier and the more cost-effective it is to operate the vessel.

An innovative LNG Carrier

L. Claes

STX Europe, St.-Nazaire, France

J.-L. Guillaume-Combecave

STX Europe, St.-Nazaire, France

ABSTRACT: Over recent years, Saint-Nazaire shipyard (former Chantiers de l'Atlantique), French part of STX Europe, has designed and built several LNG carriers for different shipowners implementing really innovative ideas such as the first diesel-electric dual-fuel LNG carrier. Continuing a long tradition of innovation, the French shipyard proposes once more a new design concept for liquefied natural gas carriers

1 INTRODUCTION

A new forward-looking design for a 220,000m³ capacity liquefied natural gas carrier has emerged as part of the EU-funded IMPROVE project, following a study by STX Europe.

Saint-Nazaire shipyard's designers propose a solution to reduce the need for ballasting in order to prevent biological invasions of marine organisms transported in ballast water and sediment transfer. Moreover, this permits to save energy and thus money by decreasing the huge amounts of sea water transported almost unnecessarily.

As part of the IMPROVE project, STX Europe has been meticulous in addressing a host of vessel attributes that add up to a state of the art ship design for LNG transportation.

These range from ensuring the large cargo carrying capacity within minimum dimensions, the observance of best practice in shipbuilding, high levels of safety, economic feasibility, low maintenance, high crew comfort, and security in terms of environmental protection.

2 AN INNOVATIVE LNG CARRIER

The standard LNGC features such as a complete double hull, worldwide trade, speed of 19.5 knots or the accommodation quarters in the aft part are maintained. The ship will also feature five membrane cargo tanks, with suitable cofferdams.

The innovative part is a change of the hull shape in combination with a adapted type of propulsion unit. The

solution is based on a V-shape hull and pod type propulsion technology to make the need for ballast water unnecessary in good sea way conditions. The special hull form allows a sufficient draft in most loading conditions with a reduced volume of ballast water.

2.1 Ballast differencet

A conventional design for such a LNGC size requires more than 65,000 tons of water ballast. There are sea water ballast tanks (SWBTs) arranged in double hull tanks and forward and aft.

In the STX design, in the unloaded condition, the ship will be able to sail with a minimum volume of sea water, or even with none at all. The use of these SWBTs is in stark contrast to ballast tanks onboard a conventional LNG carrier, where: the vessel is either full of LNG with empty SWBTs ("loaded") or empty of LNG with full SWBTs ("unloaded").

The SWBTs may be called upon in two particular situations only:

Situation 1: during the loading/unloading operations of LNG, to reach a draught to be within the range of the loading arms.

Situation 2: if the vessel meets bad weather conditions during a voyage and the master wishes to achieve a safer sailing condition from his point of view.

Whatever the particular situation, the design means that the ship will not have to renew or clean the sea water within

the SWBTs when the ship is sailing. In short, this can be envisaged as;

In the situation 1: used sea water is discharged before departure or in a zone close to the terminal at the beginning of the sailing.

In the situation 2: the sea water used to reach a safer situation is considered as clean.

Thus the International Maritime Organisation (IMO) recommendation to treat the ballast water is fulfilled or respective not needed.

2.2 Machinery

A Diesel-Electric power station is proposed using engines of four-stroke dual-fuel type (running on boil off gas or marine diesel oil) at 514 rpm. At the start of the project, this thinking was based on the dual fuel engines supplied by Wärtsilä although, since the study began, other dual fuel main engines options have surfaced from MAN Diesel

For the propulsion itself, two electric engines within two INOVELIS pods developed by CONVERTEAM may be used. Other types of propellers may also be considered, subject to further studies, according to STX Europe.

2.3 Cargo containment

The proposed containment system is of the membrane type, five (5) tanks based on Gaz Transport and Technigaz (GTT) technology. Sloshing problem will be avoided by following the GTT and classification society requirements.

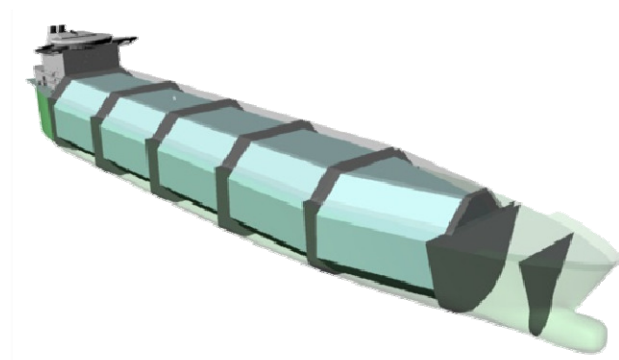

The insulation of the cargo tanks has been designed to give a natural boil-off-rate (BOR) to about 0.135 % (per day) of the loaded cargo volume.

Others containment solutions with independant tanks such as Aluminium Double Barrier Tank (ADBT) are possible and adaptable to the ship design with further studies.

2.4 Production advantages



The hull form is designed with more than 80% of developable surfaces, minimises the cost of production of the hull.

2.5 Operational advantages

For a conventional LNGC the exploitation conditions are 50% of the time in a loaded condition and 50% of the time in an unloaded condition. For the STX Europe design, the partition of the exploitation conditions are same but within the unloaded condition, 80% of the time only a minimum volume of sea water, which may be null, is used, and the remaining time is considered with full SWBT.

Under such assumption, around 8.6 tonnes of LNG used as fuel can be saved per day. This is equivalent to a 9% saving when compared to a DEDF LNG carrier with about the same size and conventional features.

STX Europe is currently designing other LNGC sizes such as “medmax” LNGC with the same principle.

3 PANEL

STX Europe LNG carrier design – principal particulars

Length over all	319.20 m
Length between perpendiculars	309.90 m
Breadth moulded	50.00 m
Depth at main deck	27.40 m
Depth at trunk deck	36.00 m
Design draught (moulded)	13.05 m
Scantling draft	14.10 m
Light ballast draught	7,00 m
Fully ballasted draught	9.80 m
Air draft, from B.L.	59.00 m
Total deadweight at design draught	105,400 t
Cargo total volume	220,340 m ³
Ballast capacity	64,000 m ³
INOVELIS pods	2
Classification	Bureau Veritas

Typical class notation

REFERENCES

Bureau Veritas I, ✘ HULL, ✘ MACH, Liquefied Gas Carrier LNG, Unrestricted Navigation, ✘ VeriSTAR-HULL, ✘ AUT-UMS, SYS-NEQ1, MONSHAFT, CARGOCONTROL, GREENSHIP, MANOVR, SDS

LNG carrier- Structural design aspects

A. Amrane, A. Constantinescu, F. Bair and P. Rigo

ANAST, University of Liege, Liege, Belgium

V. Zanic, J. Andric, N. Hadzic

UZ, University of Zagreb, Faculty of Mechanical Engineering and Naval Architecture, Zagreb, Croatia

ABSTRACT: This document reports on the global analysis of the next generation of the LNG carrier. It focuses on the least cost and least weight optimizations by analyzing the influence of the new IMPROVE modules (sloshing, fatigue and multi-structure) on the optimized scantling using LBR-5 code. This local optimization is completed by a global one using FE Maestro simulations. Then, the article presents the fatigue calculations with VeriSTAR software necessary to validate the fatigue module results.

1 INTRODUCTION

2 STRENGTH ASSESSMENT & SCANTLING OPTIMIZATION

2.1 *Standard design*

2.1.1 Initial geometry

The initial scantling is characterized by a weight of 18054.74 kN and a cost of 3164759.61 €. These values are considered for a half of tank having 40.5 m of length. Five most critical load cases were defined for this design.

After the least cost optimization with LBR-5, without the new IMPROVE modules, the weight of the structure becomes 16508.41 kN, and the cost 2860384.92 €. Thus, the cost's gain compared to the initial scantling is approximately **9.7 %**.

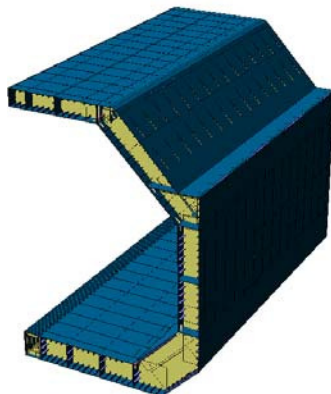

Figure 1. 3D view of the "Standard" design

2.1.2 Optimization without new IMPROVE modules

2.1.3 Optimization using the new IMPROVE sloshing module

The sloshing module takes into account the sloshing dynamic pressures by adding new constraints for the inner hull. These constraints refer to plate thickness, section modulus and shear sectional area of the stiffeners. In consequence, the least cost optimization process delivers bigger weight (16627.84 kN) and bigger cost (3001482.47 €) compared to the solution without sloshing. The cost's gain decreases to **5.25 %**. The increase of cost is mainly determined by the decrease of web-frame spacing compared to the previous solution.

The Von Mises stresses in plates and at the plate-webframe junctions remains below the admissible limits.

2.1.4 Optimization using the new IMPROVE multi-structure module

The IMPROVE multi-structure module allows to LBR-5 code to optimize simultaneously several sub-structures that belong to the same global structure. The main application concerns the tank and cofferdams. In these simulations, the sloshing module is not considered. Taking into account the equality constraints, the optimization process return a gain in cost of **18.9 %** for the cofferdam. This result reveals that the cofferdam is not strongly constrained. For the main tank, the gain in cost remains the same (**9.7 %**).

2.1.5 Post-analysis using the new IMPROVE fatigue module

A fatigue assessment has been done by using the new Improve fatigue module integrated on LBR-5 code. Following Bureau VERITAS recommendations, special structural details relevant to LNGC have been considered.

A comparison is done in order to validate the fatigue results obtained with LBR-5 code by FE results using VeriSTAR software provided by Bureau VERITAS (Figure 2).

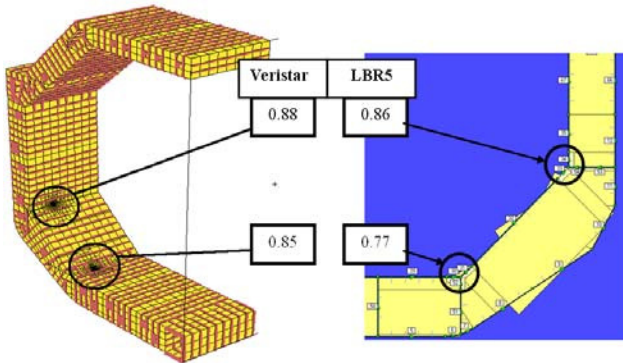

Figure 18: Fine mesh for fatigue assessment

On Table 1, are presented LBR-5 fatigue results on some panels. We can see that there are great fatigue damage values after optimization even if there are no fatigue problems before optimization.

Therefore, corrections have been done on those panels to avoid fatigue cracks.

To decrease the damage values, the inertia of the stiffener with the attached plate has been increased for the hot spots situated on stiffeners. For the hot spots situated on the plates, the plate thickness has been increased.

After making the corrections described above, we have no fatigue problems (Table 1).

		Before optimization	after optimization	after optimization (fatigue correction)
		DAMAGE	DAMAGE	DAMAGE
Panel	8	0.579	7.596	0.758
Panel	9	0.367	0.339	0.335
Panel	24	0.49	14.061	0.733
Panel	25	0.421	13.292	0.631
Panel	26	0.346	12.428	0.513

Table 1: Comparison LBR5 / VeriSTAR: fatigue results

By correcting the scantling after optimization process with sloshing module, we have a production cost of 3015410.64 €, and the gain compared to the initial scantling is approximately 4.58%.

The correction to avoid fatigue problems increases the cost and weight comparatively to the scantling after optimization process with sloshing module by 0.51 % and 1.13 % respectively.

The most part of the increase on the total cost is induced by the material cost. This is logical because we modified only the plate thickness and stiffeners scantling.

2.2 Free ballast Design (reduced ballast concept)

The “Free ballast” design was developed in order to navigate 90% of its life without ballast. The main difference between two designs (“Standard” and “Free ballast”) is located in the bottom slope zone, where a newer constructive solution was chosen for the last design in order to allow the navigation without ballast.

2.2.1 Initial geometry

The initial scantling is characterized by a weight of 18106.36 kN and a cost of 3137525.49 €. As for “Standard” design, these values are considered for a half of tank having 40.5 m of length. Seven most critical load cases were defined for this design. From these, two load cases represent cases with ballast (10% of its life navigates with ballast).

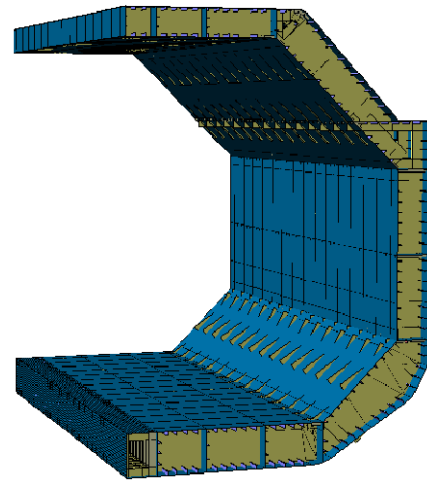

Figure 19. 3D view of the “Standard” design

2.2.2 Optimization without new IMPROVE modules

After the least cost optimization with LBR-5, without the new IMPROVE modules, the weight of the structure becomes 16430.16 kN, and the cost 2957714.44 €. Thus, the cost's gain compared to the initial scantling is approximately **5.81 %**.

2.2.3 Optimization using the new IMPROVE sloshing module

The sloshing preliminary analyses reveal more than 50 % unsatisfied sloshing restrictions on the initial scantling of the “Free ballast” design.

The least cost optimization results indicate a weight of 16819.77 kN and a cost of 3043892.69 €. The cost's gain is less important; but it remains positive, **3.06 %**. As for the "Standard" design, the increase of cost is mainly determined by the decrease of web-frame spacing compared to the previous solution.

The Von Mises stresses in plates and at the plate-webframe junctions remains below the admissible limits.

2.2.4 Optimization using the new IMPROVE multi-structure module

The cofferdam model remains the same as for the "Standard", Figure 4..

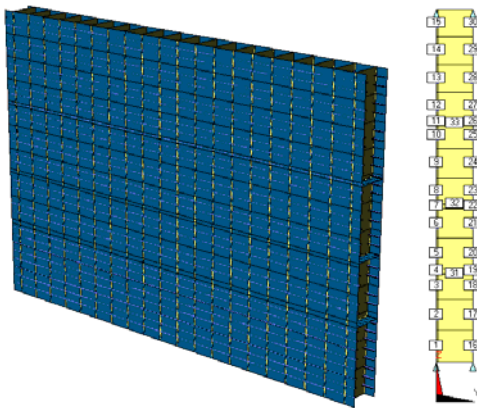

Figure 20. Simplified model of the cofferdam

The sloshing constraints are not taken into account. The concurrent optimization of the cofferdam and main tank return the same gain for the cofferdam, instead the gain on main tank decreases from 5.81 % to **5.75 %**.

We observe for both designs that the optimum is be more leaded by the main structure behavior rather than by the cofferdam that is not strongly constrained.

2.2.5 Post-analysis using the new IMPROVE fatigue module

The same procedure described on paragraph 2.1.5 has been applied to make fatigue assessment on the free ballast design.

Like the standard design, on some panels, there are great fatigue damage values after optimization even if there are no fatigue problems before optimization on these panels.

Therefore, corrections have been done on those panels to avoid fatigue cracks.

To decrease the damage values, the inertia of the stiffener with the attached plate has been increased for the hot spots situated on stiffeners. For the hot spots situated on the plates, the plate thickness has been increased. After

making the corrections described above, we have no fatigue problems (Table 2).

		Before optimization	after optimization	after optimization (fatigue correction)
		damage	damage	damage
Panel	11	0.63	4.894	0.659
Panel	12	0.685	0.719	0.686
Panel	27	0.52	7.382	0.713
Panel	28	0.422	6.512	0.562
Panel	29	0.301	5.154	0.373

Table 2: Comparison LBR5 / VeriSTAR: fatigue results

By correcting the scantling after optimization process with sloshing module, we have a production cost of 3052437.67 €, and the gain compared to the initial scantling is approximately 2.71%. The correction to avoid fatigue problems increases the cost and weight comparatively to the scantling after optimization process with sloshing module by 0.28% and 1.74% respectively.

As the standard design, the most part of the increase on the total cost is induced by the material cost.

2.2.6 Global optimization of tank and cofferdam structure using MAESTRO

The objective of UZ task in WP6 was to develop, analyze and optimize a structure of LNG ship, based on a global 3D FE model, in concept and preliminary design phase. The design environment of MAESTRO software, capable of imbedding multiple quality criteria for structural design, was used to provide the decision support problem (DSP) rationale for multicriterial (weight, cost and centre of gravity) based optimization. In that respect three hold FEM model used for the prototype analysis and optimization of LNG ship was developed in MAESTRO software (Maestro, 2008) based on the available version of model made in VERISTAR, see Fig.5

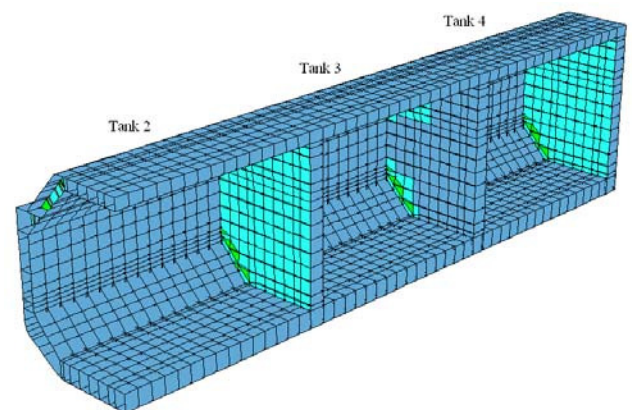

Figure 5. Three hold Maestro model of LNG ship

A set of 14 design variables (tpl, hsw, tsw...) was used during optimization for each strake. Design variables were identified in central tank and in cofferdam structure. Structural design constraints based on yield and buckling, in-built in MAESTRO, were used and their safety factors were adjusted to the BV Rules requirements. Sloshing constrains defined by BV were included. Also, using BV load case requirements, seventeen load cases were formed (full load, ballast condition and alternate condition - upright "a", "b" and inclined "d"). Optimization was performed using MAESTRO dual SLP optimizer. The objective of the whole optimization process was to distribute the material more effectively in order to reduce weight and to improve the structural safety (Jancijev et al, 2000), (Zanic et al. 2003). The design procedure was performed in three design steps:

CONCEPT DESIGN PHASE: First step of the concept design procedure was initial exploration of the design space which was done for initial model within six design cycles. Structural mass and VCG were successfully decreased and safety was increased (Table 3).

	Design solution	Structural mass (middle tank)	Mass savings, %	Safety (TNUC)	VCG, mm	Normalized cost
Concept desing	Initial, P ⁰	3931	/	110	16155	1.00
	Optimal, O ^{3Concept}	3457	12.0	42	15957	0.87
Preliminary design	Optimal, O ^{3Preliminary}	3251	17.3	3	15931	0.85
	Standardized, D ⁴	3507	10.8	0	15951	0.95

Table 3 - Summary of achieved results

Second step of the concept design procedure was sensitivity analysis in order to inspect the sensitivity of breadth between stiffeners, material type and web frame spacing to the defined design objectives. Sensitivity analysis has shown, that by increasing web frame spacing and decreasing breadth between stiffeners, it is possible to gain additional savings.

PRELIMINARY DESIGN PHASE: Based on the conclusions of the concept design phase, the third step of the overall design procedure was performed i.e. the standard preliminary design phase optimization. It resulted with the optimal design O^{3,Preliminary}. Complete re-analysis was performed in order to determine strength and safety level of the final standardized design D⁴ of LNG ship obtained from the optimal design O^{3,Preliminary}, see Table 3. The results of the adequacy analysis were considered satisfactory for the preliminary design phase w.r.t. BV requirements. Optimization history of mass changes (central tank) during preliminary design, including the scantling standardization cycle no. 4, is presented in Figure 6.

A comparison between the results reveals that proposed design D⁴ (standardized scantlings) is offering 10.8% of savings in structural mass and 5% of savings in the cost of structure. Optimal design O^{3,Preliminary}, where savings are up to 17%, can undergo more refined standardization, if Yard preferences are revealed, to get even better results.

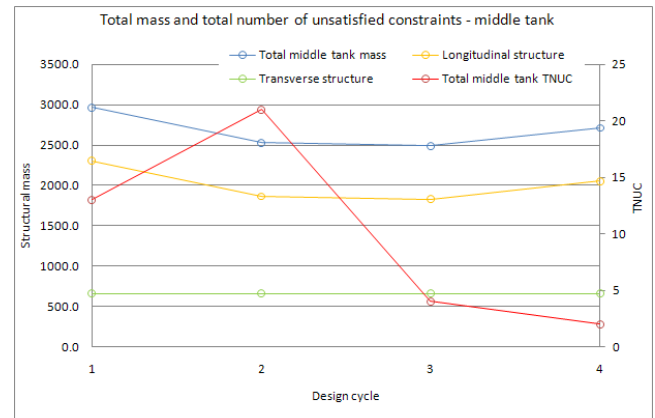

Figure 6 – Optimization history (central tank)

A comparison of achieved results (structural mass) is given in Figure 7.

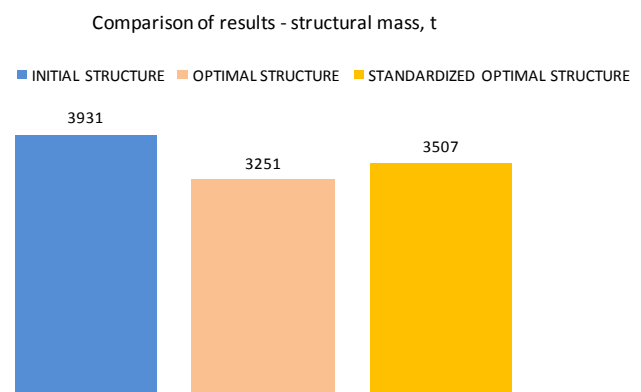

Figure 7. Comparison of results – structural mass

2.3 Finite element analysis for fatigue assessment using VeriSTAR-HULL

Veristar Hull has a powerful tool witch is “**VeriSTAR element work ratio**”.

A Veristar element work ratio, called also stress ratio can be defined as “ratio between the stress on the considered element by the admissible limit”.

We can distinguish to kinds of stress ratios:

- Yielding ratio
- Buckling ratio

On the yielding ratio the limit stress is the yield stress of the element material. On the buckling ratio, the limit stress is the Euler critical buckling stress.

An element with a ratio greater than 1,0 is not in agreement with the BV-Rules.

On the Figure 8, we can see the stress ratio distribution on the central part of the LNG carrier.

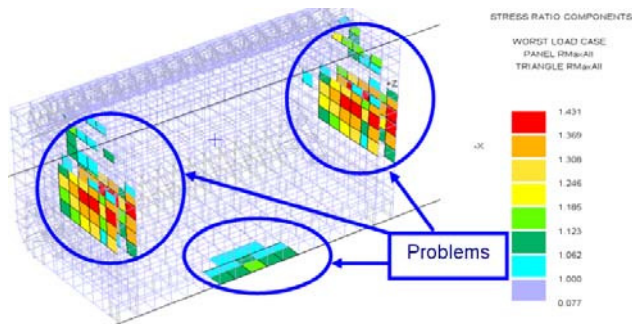

Figure 8: Stress ratio distribution on the central part of the LNGC

Both designs (standard and free ballast) present the same problems: stiffeners buckling and plate buckling by uni-axial or bi-axial compression for plane panel on the cofferdams or bottom areas.

Also there are some yielding problems on the intersection of the double bottom and cofferdams and also on the cofferdam webs.

For fatigue analysis, different intersections and critical details were studied by very fine mesh in order to evaluate the hot spot stress on the interesting areas.

No fatigue problems on the two designs except a connection of one side longitudinal ordinary stiffener with stiffener of cofferdam on the standard design. This problem can be solved by adding a bracket.

The goal of this study is to calibrate the New Improve fatigue module fatigue module.

On Figure 9, we can see an example of a fine mesh done with VeriSTAR software.

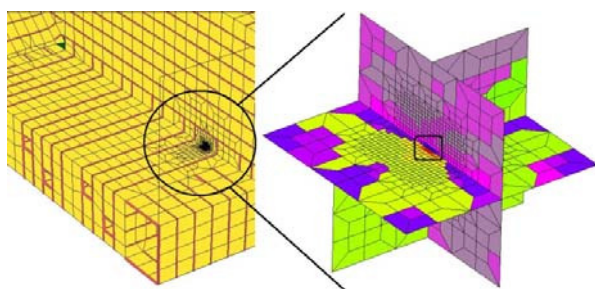

Figure 9: Fine mesh for fatigue assessment

3 CONCLUSIONS

The gain in cost is less important for the “Free ballast” design (3.06 %) compared to the “Standard” design (5.25 %). These results can be explained by more severe loading conditions imposed to the “Free ballast” design. However, these facts are quite acceptable considering all advantages of the new LNG “Free ballast” concept.

A last comparison was achieved between the initial and the optimized scantlings of the “Standard” design to find which “cost type” controls the gain of the global cost-keeping in mind that the global cost is constituted by the material cost (proportional to the weight), the labour cost and the consumables cost. In this purpose, we calculate a parameter which is the cost per kilogram (€/kg). For the initial scantling the value is 1.71 €/kg and after optimization (with sloshing) this parameter becomes 1.77 €/kg. Even if this parameter increases, the global cost decreases (5.25%) as the weight strongly decreases (7.90%).

Comparatively to the scantling after optimization process with sloshing module, for the “Standard” design, corrections done to avoid fatigue problems induced an increase of 1.13 % of the weight and 0.51 % of the cost. Concerning “Free ballast” design, this induced an increase of 1.74% of the weight and 0.28% of the cost. The most part of the increase on the total cost is induced by the material cost.

Global FE based optimization with MAESTRO gave similar results. A comparison between the results reveals that proposed design (standardized scantlings) is offering simultaneously savings in structural mass and cost. Knowledge of the optimal (non-standardized) design scantlings (and its savings in structural weight) are offering the Yard designer an excellent opportunity to perform the refined standardization procedure regarding material quantities and production considerations.

In conclusion, the LNG reduction cost is strongly influenced by the decrease of the global weight of the structure. The same variation can be observed for the “Free ballast” design. The above analysis confirms that performing a least cost structural optimization with LBR5 corresponds at the end to a multi-objective optimization, as the production cost and the weight are merged in the objective function.

REFERENCES

- Bureau Veritas, fatigue strength of welded ship structures, 1998
- Bureau Veritas, Guidelines for structural analysis of membrane LNG carriers, 2005

- Bureau Veritas, Rules for Steel Ships, Part B-Hull and Stability, 2007
- MAESTRO Version 8.9 (2007), Program documentation, DRS Technologies, Stevensville, MD, USA
- Jancijev, T., Zanic, V., Andric, J. (2000). Mathematical Models for Analysis and Optimization in Concept and Preliminary Ship Structural Design, Proceedings of IMAM 2000 Congress, pp.15-22, Napoli, Italy, 2000.
- Rigo, P. & Fleury C., "Scantling Optimization Based on Convex Linearizations and a Dual Approach", *Marine Structures, Elsevier Science Ltd.*, vol 14/6, Nov. 2001, pp. 631- 649
- Rigo, P., "An Integrated Software for Scantling Optimization and Least Production Cost", *Ship Technology Research*, 50: pp. 126-141, 2003.
- Rigo P. "Differential Equations of Stiffened Panels of Ship Structures & Fourier Series Expansions", *Ship Technology Research*, Hamburg, vol.52, 2005, pp. 82-100
- Rigo P., "Least-Cost Structural Optimization Oriented Preliminary Design", *Journal of Ship Production*, USA, vol.17/4, Nov. 2001, pp.202-215.
- Zanic, V., Andric, J., Frank, D. (2003.) Structural Optimization Method for the Concept Design of Ship Structures, International Marine Design Conference, IMDC 2003, Vol 2, pp.205-218. Athens, Greece, 2003.
- Zanic, V., Andric, J., Prebeg, P. (2009). Design Environment for Structural Design: Application to Modern Multideck Ships, Proc.IMEchE, part M, Journal of Engineering for the Maritime Environment, Vol.223, No.M1, pp.105-120, February 2009.

LNG carrier – new innovative product

A. Constantinescu & Ph. Rigo

University of Liege, Liege, Belgium

J. L. Guillaume Combecave

STX-Europe, St. Nazaire, France

ABSTRACT: The EU FP6-IMPROVE Project proposes to deliver an integrated decision support system for a methodological assessment of ship designs to provide a rational basis for making decisions pertaining to the design, production and operation of three new ship generations (LNG, RoPax, Chemical Tanker). The article focuses on the first innovative ship designed by the LNG carrier, and presents a short overview of the innovative V-shaped hull design. This novel constructive solution is characterized by a reduced need for ballast in order to prevent biological invasions of marine organisms transported in ballast water and sediment transfer. Moreover, this permits to save energy and thus money by decreasing the huge amounts of sea water transported almost unnecessarily. The new design is compared to the reference solution (classic design), which has exactly the same tanks and engines but standard hull lines. The least cost and least weight optimization results are compared for both designs and the influence of the new IMPROVE modules on the optimized scantling is analyzed.

1 INTRODUCTION

Based on the knowledge of all involved partners and more precisely on STX-Europe practice, a new generation design of a 220,000 m³ capacity liquefied natural gas (LNG) carrier has emerged within the framework of the EU - funded project IMPROVE. This new solution, based on the INOVELIS Pod technology and a V-shaped hull, makes the need for ballast unnecessary in good sea way conditions. Sea keeping study will permit to determine the need for ballast (or not) according to seaway conditions.

In spite of a worse propeller efficiency of the proposed design, in comparison with a conventional LNG carrier with the same main dimensions, LNG savings (consumed by engines) reach between 0.56% and 10%, corresponding to 0.53 and 9.5 tons of gas per day. Furthermore, the quantity of ballast water transported is more than 80% reduced in the most pessimistic hypothesis.

2 METHODOLOGY

The present LNG carrier design has been performed in three main phases.

The first phase identified the multi-stakeholders' requirements and defined the key performance indicators (KPI). The project partners (particularly the shipyards)

designed reference or prototype ships. They analyzed and proposed the geometry (exterior hull, tanks etc...), the propulsion, and the general and machinery arrangements. More than that, several initial calculations (CFD simulations to obtain the pressure field on the exterior hull, sea-keeping, maneuverability, stability) were achieved.

The second stage was dedicated to the development of new IMPROVE modules. These modules, based on selected structural optimization tools, are today integrated in the optimization tools used in IMPROVE project (LBR-5, OCTOPUS, CONSTRUCT) in order to take into account the requirements defined in the first phase. Among these modules, the LNG product simulations principally use the sloshing, fatigue and cost modules.

The last phase is identified to the application of the new IMPROVE modules for the LNG carrier design. IMPROVE project delivered an integrated decision support system for a methodological assessment of ship designs. This system provided a rational basis for making decisions regarding the design, production and operation of a highly innovative LNG carrier. This support system can be used make careful decisions that can contribute to reducing the life-cycle costs and improving the performance of a ship. Based on this system all the aspects related to the general arrangement, propulsion, hull shape and dimensioning of the structure were investigated.

2.1 New IMPROVE modules used for LNG carrier

The sloshing module provides quasi-static pressures to be applied on the inner hull structure supporting the membrane cargo containment system, to account, at preliminary design stage. These quasi-static sloshing pressures were obtained through numerical CFD calculations carried out by Bureau Veritas and cross-checked with different sloshing model tests campaigns carried out by Bureau Veritas in cooperation with Ecole Centrale de Nantes and GTT.

The fatigue module calculates at the early stage design the fatigue damage on critical connections of the ship structures, based on the “nominal stress” approach and uses Miner’s rule. Generic structural elements have been defined (stiffened panels, web frame or girder and pillars) with pre-defined load modes and fatigue-critical structural details based on results of the damage statistics and pre-existing knowledge. The nominal stress is calculated using beam and plate theory. These analytical formulas are suitable for structural optimization (fast calculation method). The notch stress is obtained based on the hot-spot and notch stress factor. A library of stress concentration factors for a various structural details is predefined.

The cost module provides a reliable assessment of the ship structure production cost including material cost, labour cost and consumable cost, starting from unitary costs of raw materials and productivity rates like welding, cutting or assembling parameters. In order to increase the quality of cost estimation, a *bottom-up* module has been developed. Sensitivity analyses of the economic data on the optimum scantling can also be performed, thus providing the manager with valuable information for improving the yard. The interest of European shipyards to optimize the ship structure is basically related to the production cost and mainly to the labour cost.

2.2 Other new IMPROVE modules

The multi-structure module allows the optimization tool to analyze simultaneously several sub-structures that belong to the same global structure. The main application concerns the tank and cofferdams. For the moment, this module remains specific to LBR-5 code.

The vibration module permits to calculate the eigenfrequency of local panel structures (stiffened panels having longitudinal and/or transversal stiffeners). This semi-analytical modeling is based on the decomposition of the stiffened shell structure into a complex beam grid and allows us to use the beam vibration theory to solve the problem. This module remains specific to RO-Pax ships, car-carriers.

3 LNG CARRIER DESIGNS

Two designs are analyzed and afterwards optimized within IMPROVE project. The first design is designed by the reference vessel and it will be named “Standard” design. The second design is represented by the innovative solution, and it will be called “Free ballast” design.

The LNG carrier (both designs) are composed by five tanks, four prismatic of 40.5 meters long and one non-prismatic, according to Figure 1.

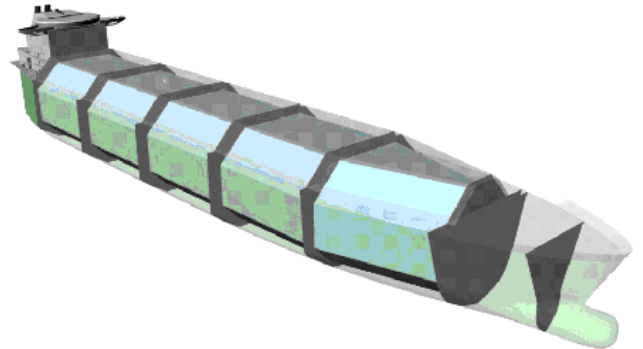

Figure 1. LNG – tank arrangement

The main advantage of “Free ballast” design is its lower wetted surface, particularly at unloaded draught. Its main disadvantage is its worse propeller efficiency.

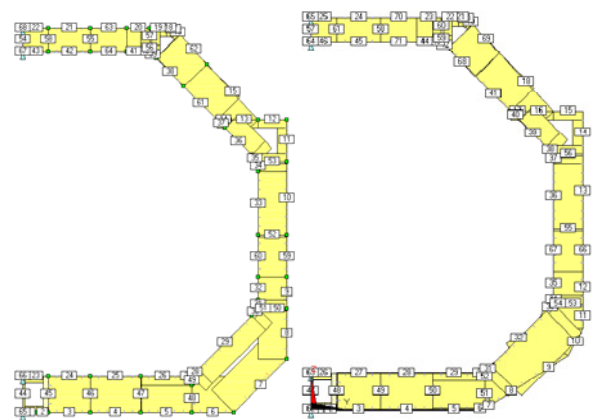

Figure 2. Midship section; “Standard” design at left, “Free ballast” design at right

The main difference between two designs (“Standard” and “Free ballast”) is located in the bottom slope zone of the mid-ship section. More precisely, this zone has a pronounced V-shape offering a positive impact on the structure. Compared to the midship section of an equivalent typical LNG carrier, the neutral axis is higher and, therefore, critical stress at the top is lower, Figure 2. This implies a lower cross-section area that contributes to decrease the mass of steel structure.

3.1 Optimization results

ANAST laboratory (University of Liege), DN&T and University of Zagreb carried out strength, least production cost and least weight assessments based on scantlings optimization of the both LNG designs using the LBR-5 and MAESTRO software.

The next table presents a qualitative comparison in term of weight and cost between the scantlings before and after the optimization with LBR-5 code. The objective function was to minimize the production COST (least cost optimization). The global production cost is represented by the material cost, the labour cost and the consumables cost. It is therefore strongly influenced by the quantity of material (weight). The values indicated in the next table are obtained for the half of a single LNG tank (40.5 m of length) without cofferdams

Design	Standard	Free ballast
	Initial scantling	
Mass [tons]	1 840.44	1845.70
Cost [M€]	3.16	3.13
	Optimized scantling with sloshing	
Mass [tons]	1694.98	1 714.55
Cost [M€]	3.00	3.04
	Gains	
Gain in cost	5.25 %	3.06 %
Gain in weight (*) (least cost optimization)	7.90 %	7.10 %

Table 1. “Standard” Design vs. “Free ballast” Design; Optimization of the COST with LBR-5

(*) Note that a least weight optimization can drive to a weight saving up to 15 %, but it is associated to a higher production cost.

Initially, the scantlings, the weight and the costs of both designs are very similar. The “Standard” design is slightly lighter than the “Free ballast” design, but it is also a bit more expensive. After optimization, the two designs have almost the same price and the same weight. The “Free ballast” design is approximately 1 % more expensive and heavier. The gain in cost is less important for the “Free ballast” design (3.06 %) compared to the “Standard” design (5.25 %). These results can be explained by more severe loading conditions imposed to the New Design. However, these facts are quite acceptable considering all advantages of the new LNG Free ballast concept.

The least weight optimization (objective function being the minimization of the weight) of the “Standard design” reveals a gain of 15.84 %, but an increase of the cost of 24.68 % (cost after optimization 3.94 M€, 3.16 M€ before optimization). The “Free ballast” design is characterized by a gain of weight of 14.41 % and an increase of the cost of

18.21 % (cost after optimization 3.70 M€, 3.13 M€ before optimization).

These large differences in term of cost between “least cost” and “least weight” optimizations can be explained by the strong variation of the scantling. “Least cost” and “least weight” optimizations of the “Standard Design” drive to quite different scantlings, which are presented in the Table 2.

	Least cost (global)	Least weight
Plate thickness	10 ÷ 25 mm	10 ÷ 24 mm
Stiffeners spacing	870 mm	400-600 mm
Web-frames spacing	2600 mm	1950 mm

Table 2. “Least cost (global)” optimization vs. “least weight” optimization, for the “Standard” design, with LBR-5

We conclude that the “least weight” is definitively not a relevant solution for commercial ships as LNG.

A last comparison was achieved between the initial and the optimized scantlings of the “Standard Design” to find which “cost type” controls the gain of the global cost-keeping in mind that the global cost is constituted by the material cost (proportional to the weight), the labour cost and the consumables cost. In this purpose, we calculate a parameter which is the cost per kilogram (€/kg). For the initial scantling the value is 1.71 €/kg and after optimization (with sloshing) this parameter becomes 1.77 €/kg. Even if this parameter increases the global cost decreases (5.25%) as the weight strongly decreases (7.90%).

The OCTOPUS software reveals results very close to those obtained with LBR-5. For example, the “Standard” design is characterized by a cost’s gain of 5 % and weight’s gain of 10.8% on the standardized scantling.

4 CONCLUSIONS

The hull form of the “Free ballast” design virtually eliminates the need for ballast water within a wide range of sea states. This innovative hull form allows a sufficient draught in most loading conditions with no or with significantly reduced need for ballast water. In the unloaded condition, the ship is able to navigate safely carrying a minimum amount or even without carrying any amount of ballast water. Although there are Sea Water Ballast Tanks (SWBTs) their utilization is significantly reduced as compared with any existing LNG carrier. Most commonly a conventional vessel is either fully loaded with LNG or ballasted with sea water. The present design does not require ballast water even when it is unloaded.

However, the “Free ballast” design has one main disadvantage. Its 13 meter design draught is bigger than draught restriction in some terminals. Consequently, such a design would be better adapted to smaller ships. Furthermore, smaller ships which usually have shorter routes are more concerned by time and energy wasted for ballast operations. Finally, manifold maximum height for gas transfer is less constricting.

Concerning the optimization process, we state that the LNG reduction cost is strongly influenced by the decrease of the global weight of the structure. The above analysis confirms that performing a least cost structural optimization with an optimization tool corresponds at the end to a multi-objective optimization, as the production cost and the weight are merged in the objective function.

REFERENCES

Asmussen, I., Menzel, W. and Mumm, H., „Ship Vibration”, *Germanischer Lloyd*, 2001

- Bureau Veritas*, “Fatigue strength of welded ship structures”, 1998
- Constantinescu, A., Nême, A. and Rigo, Ph., “Vibration Assessment of Ship Structures”, *ISOPE Conference, Osaka, Japon*, 2009
- Rigo, P., “An Integrated Software for Scantling Optimization and Least Production Cost”, *Ship Technology Research*, 50: pp. 126-141, 2003.
- Rigo P. “Differential Equations of Stiffened Panels of Ship Structures & Fourier Series Expansions”, *Ship Technology Research*, Hamburg, vol.52, 2005, pp. 82-100
- Rigo P., “Least-Cost Structural Optimization Oriented Preliminary Design”, *Journal of Ship Production*, USA, vol.17/4, Nov. 2001, pp.202-215
- Zanic, V; Andric, J; Frank, D, “Structural Optimization Method for the Concept Design of Ship Structures”, *Proceedings of the 8th International Marine Design Conference*, Vol 1; Papanikolaou, A.D. (ed.), Athens, 2003, pp. 99-110.

ROPAX Carrier Ship Owner requirements, markets and future trends

Dario Bocchetti,
Grimaldi Group, Napoli, Italy

1 ROPAX CARRIER SHIP OWNER REQUIREMENTS, MARKETS AND FUTURE TRENDS



RoPax Vessels are built to combine basically, and of course to take profit on it, 2 genre of transport: the roll on roll of services (as trailer, semi trailers, cars and special cargo) and the passenger transfer.

To make the difference in a competitive market the essential aspects are mainly two.

The first aspect is the creation of a solid network to guarantee to each client the most flexible and wide range of possibilities. With this vision since the beginning of Improve Project three years ago, Grimaldi Group has extended the initial RoPax fleet of only 5 Vessels into an exponential growth with a huge new building program and controlling two major RoPax operators: Minoan for Greek links and Finnlines for Scandinavian routes.



The second utmost is to have a young, competitive, environmentally friendly and most efficient fleet. Considering the daily operative cost a RoPax (and nowadays still more with economic crisis) only an extremely high efficiency can allow to remain on the market.

For above reasons. the global goal of the Improve project for a RoPax project have been:

- Reduced production cost;
- Reduced fuel oil consumptions;
- Reduced maintenance cost;
- Increased lane metres on tank top;



Other main design constraints regards capacity to achieve load carrying *flexibility* (as example reducing the number of pillars in cargo space) and to optimize the sea keeping performance minimizing vibrations and maximizing structural robustness.

Fatigue life of 25 year has to be ensured. Structural reliability considerations are very important. Usage of *mild steel* has to be maximized (minimum 75 %).

Unless otherwise constrained by owner's requirements, Shipyard will often make extensive use of *high tensile steel* to construct a more efficient and lighter structure resulting in the reduced construction costs. On the other side, high tensile steel can be more susceptible to fatigue failure. Also, lighter scantlings associated with high tensile steel affect structural flexibility and buckling strength.

Painted surface has to be minimized and the quality of coating system has to be ensured, especially in the ballast tanks. Extra initial investment in more durable coatings can lead to

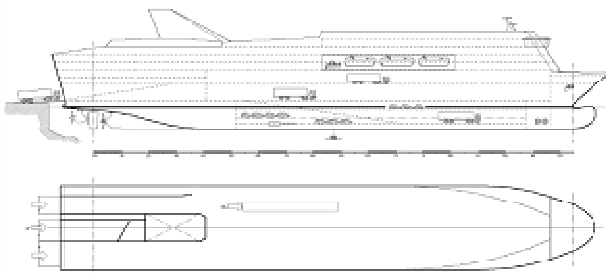

future cost savings through: lower cash outlays for coating maintenance and more importantly, through positive revenue gain due to reduced time required for repairs.



2 TECHNICAL TRENDS

Vessel of the future will have to be more and more efficient in terms of fuel consumption and related to the environment (even applying alternative power sources) or with a high flexibility in routes and cargo spaces.

The structural aspect also is essential because to maintain the scheduled itinerary every day no damage and no stop can be planned. So during design phase all the structures have to be dimensioned to avoid and to be resistant to fatigue, cracks and corrosion as much as possible.

A close cooperation between the Shipyard and the Owner during the design phase and during the preparation of the technical specification is a key point to achieve above results.

New Innovative ROPAX Vessel

D. Dundara, O. Kuzmanovic

Uljanik Shipyard, Pula, Croatia

V. Zanic, J. Andric, P. Prebeg, N. Hadzic

UZ, University of Zagreb, Faculty of Mechanical Engineering and Naval Architecture, Zagreb, Croatia

ABSTRACT: The objective of this paper is short summary report about design of the new innovative ROPAX vessel inside project IMPROVE. The main characteristics of the ship, based upon Owner's and Yards design task definition, are presented with the possible propulsion design alternatives. The primary focus will be on the general ship design (Naval Architecture calculations: speed, power, damage stability, etc.) performed at ULJANIK and corresponding comparisons of selected propulsion variants: 1) one slow speed main engine directly coupled to fix pitch propeller with one active rudder/azipod with propulsion bulb to increase main propeller efficiency; 2) two medium speed main engine coupled via gearbox to CP-propeller with two retractable side thrusters. The main idea of novel propulsion concept is to avoid as much as possible the running of electrically driven thrusters in seagoing condition i.e. to use it only: a) during maneuvering in harbour (no needs of tugs) b) in order to obtain 100% redundancy notation. Various structural arrangements were also analyzed by ULJANIK and UZ as a multi-objective design problem: 1) accommodations - two and three tiers; b) three variants lower garage breadths. Optimal structural variant with two superstructure decks and additional car space was selected.

1 INTRODUCTION

The **main objective** of the IMPROVE project is to design 3 different types of a next generation vessels by integrating different aspects of ship structural design into one formal framework and applying it. The nature of shipbuilding in Europe is to build small series of very specialized ships (the opposite of the Korean and Chinese shipyards). Thus, the IMPROVE project will address ships which, with their complex structures and design criteria, are at the top of the list for customization. The IMPROVE consortium has identified the next generation of Large ROPAX ship, Product/chemical carrier and LNG gas carrier as the vessels the most suitable for European yards to focus their energies on (Dundara et al. 2008 and Zanic et al. 2008).

ULJANIK Shipyard in the last 5 years has designed several car-carriers, ConRo and ROPAX vessels for different ship-owners (Zanic et al, 2001). For a long period ULJANIK has strong cooperation with GRIMALDI GROUP as respectable ship owner regarding market needs and trends.

For a new design of ROPAX ship extensive structural analysis (global and detail FE analysis) were performed to evaluate global structural feasibility and eliminate hard

spots regarding stress concentrations problem and can result in many benefits regarding general ship design, e.g

- Lower VCG (better stability).
- Reduced light ship weight (reduced displacement and propulsion power)
- Reduced maintenance cost

The challenge is to improve Rule structural design at the early stage of design (concept stage) and to find optimal design solution with the IMPROVE tools and continue the design process in a preliminary stage (where a more detailed FEM calculations are performed) with the better starting point/design. Reduction of production cost (optimum sequence of production for ULJANIK environment) is the relevant design objective.

Regarding general ship design the targets are:

- Selection of resistance friendly hull form
- Smaller propulsion engine for the same speed
- Reduced fuel oil consumption
- Selection of a hull form in order to reduce a length of the engine room (increased length of cargo space)

The objectives in the multi-criteria decision making process will be considered using rational models:

- To assess a sea keeping and a maneuvering performances

- To assess a design loads and an accidental loads at the early design stage
- To assess a fatigue at the early design stage
- For assessment of an ultimate strength at the early design stage
- To assess a vibrations at the early design stage.

To achieve defined objectives an existing line of vessels, as designed by ULJANIK shipyard and GRIMALDI GROUP, will be re-assessed (structural limit states, production cost, maintenance assessment) with IMPROVE.. This will help to tune the new tools/procedures within ULJANIK and GRIMALDI design/maintenance environments for the tasks of new ROPAX design.

2 DESIGN METHODOLOGY

The design methodology in the IMPROVE project defines three design levels:

- 1 *STANDARD SHIP* is the existing ship or Yard prototype
- 2 *NEW SHIP* will be designed during the first period of the project. The design will be realized using mainly the existing methodology and will include improvements to the main dimensions, general arrangement, hydrodynamics and propulsion
- 3 *IMPROVE PROJECT SHIP* will be obtained from Level 2 design using multicriterial structural optimization including the production and maintenance models.

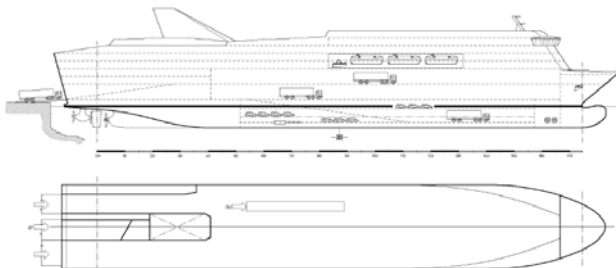

Fig 1. Standard Ship

The project of ROPAX, recently analyzed by ULJANIK, will be considered as standard ship, Fig.1.

3 NAVAL ARCHITECTURE CALCULATIONS

The main characteristics of this ship are given below.

- Main dimensions: Length overall – 193 + 4 m, Breadth – 29.0 m, Draft design – 6.7 m
- Trial speed – 24.5 knots
- Cargo capacities – Trailers 3000 lane meters + 300 cars
- Capacities: HFO – 1400 m³, DO – 250 t, FW – 1200 m³, SW – 600 m³

- Passengers: 166 cabins + 400 aircraft seats
- Crew 74 cabins

The designed ship had to be propelled by two pods behind two skegs.

Main dimensions of ROPAX concept design are optimized using TRIDENT/SEAKING software (USCS software, see <http://www.uscs.hr>) in order to obtain minimal main engine power and sufficient stability. A new application was developed, which finds a best combination of main dimensions. In comparison with standard ship, optimized design needs 2900 kW (abt. 11 %) less power.

After main dimension optimization, it was decided that new ROPAX will have fixed pitch propeller (FPP) as the main, and active rudder as the auxiliary propulsion. Auxiliary propeller is driven by direct electric drive of 5000 kW using bevel gears at the top and the bottom of the leg (inside circular torpedo body). Planetary gears for steering are driven by frequency controlled electric motors. Original hull form was Uljanik's PCTC, which was then transformed into new (level 2) form (see Fig 2).

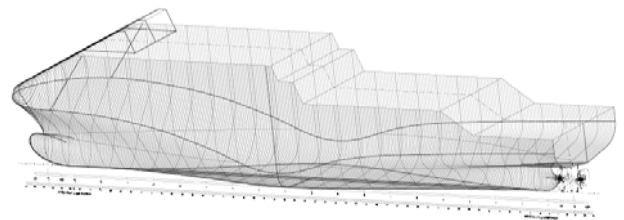

Fig. 2. Body Lines of New Ship

In comparison with standard ship, new design needs almost 7900 kW less power, weight of machinery is reduced by 450 t, fuel oil consumption is 28% less and finally, propulsion system is more reliable. Index of redundancy is 100% (2 independent engine rooms and 2 independent propulsion systems).

The main characteristics of a new ship:

- Length overall abt 193 m
- Length between perpendiculars: 180 m
- Breadth: 29.8 m
- Design draft: 7.5 m
- Block coefficient: 0.53
- Trial speed: 24.5 knots
- Main engine power (MCR): 14940 kW
- Active rudder output: 5000 kW
- Capacities: HFO – 860 m³, DO – 440 t, FW – 1000 m³, SW – 600 m³
- Passengers: 350 cabins + 200 aircraft seats
- Crew 85 cabins

Loading/unloading of vehicles is done via stern ramp over four decks. Trucks and trailers are parked on tank top, freeboard deck and upper deck, while cars and smaller vehicles are located on second deck. The total lane length is 3000 m plus 300 cars. There are two fixed ramp ways for transport connection between decks, one going from tank top to main deck with bridge extension to second deck and the other from main to upper deck, see Fig.3.

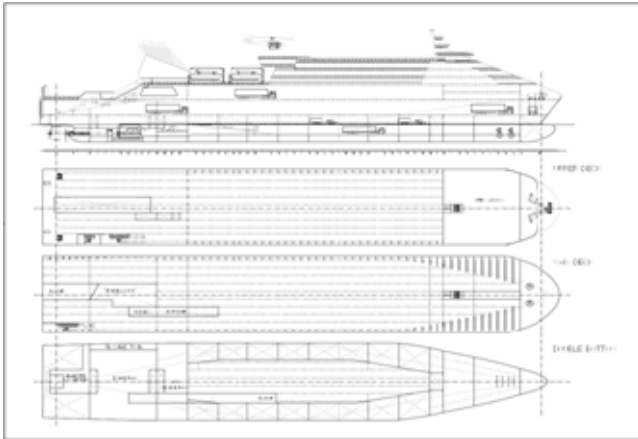

Fig 3. General Arrangement of New Ship

Passenger embarkment is done also via stern ramp over elevators to accommodation decks

There are also various service and entertainment facilities. Engine room space is divided into three parts: main engine room with main engine with power of 14900 kW, auxiliary engine room with 4 engines with total power of about 9000 kW and electric converters room for driving active rudder propeller.

The owner requirement in the IMPROVE project was that ship must never stop and requested selection of two main engines coupled via gearbox to one CP-propeller. This arrangement gives the possibility to operate vessel with one main engine running and carry out maintenance on the other main engine. This arrangement shows smaller efficiency 9 %.

Engine room space is divided into four parts: main engine room with main two engines of 8400 kW each, auxiliary engine room with 4 engines with total power of about 8000 kW, bow retractable thruster room and electric stern retractable thruster room. Retractable thrusters will operate in port only.

IMPROVE ship has 4 % less lightship weight in comparison with NEW ship and because of this, required propulsion power and fuel oil consumption are 5 % less (19560 kW instead of 20500 kW). The gain of 5 % more trailer lanes on tank top is achieved by investigating different positions of longitudinal ballast tank bulkhead and at the same time ballast volume is minimized.

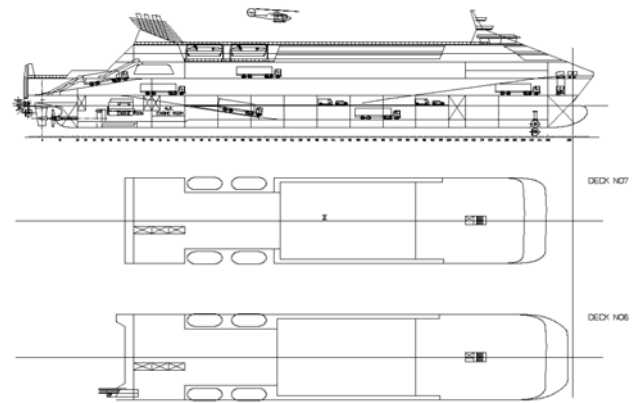

Fig 4. General Arrangement of IMPROVE Ship

4 DSP BASED ON MULTI-OBJECTIVE DESIGN

On the general ship level topological/geometrical concepts have been evaluated:

1. Number of superstructure decks. Two variants of superstructure (x^T : two and three tiers), but with the same total area of accommodation decks.
2. Transverse position of longitudinal bulkhead between deck 1 and deck 3 (x^G). Three different positions will be examined.

According to the agreement ULJANIK performed general naval architecture calculations (stability, power, resistance, cargo capacity, etc.) for each of three variants of second variable in Table 1 and calculated the height of deck 3 which satisfy damage stability. Two variants of superstructure (first variable in Table 1) were attached to each of three variants obtained by ULJANIK. In that way a total number of six different model variants were formulated in order to perform structural optimization for each of them, Fig. 5.

V	DESIGN VARIABLES PROPERTIES				Comment
	Name	N _{in}	N _{ax}	S _{tep}	
	Number of SS decks	2	3	1	Booth version have the same area of accommodation decks
	Lower hold breadth	15360 mm	17760 mm	1200 mm	One or more car lane (height of deck 3 is function of this variable)
	Structural elements				Min/Max values based on class. rules, technology demands, experience, etc.

Table 1. Design variables

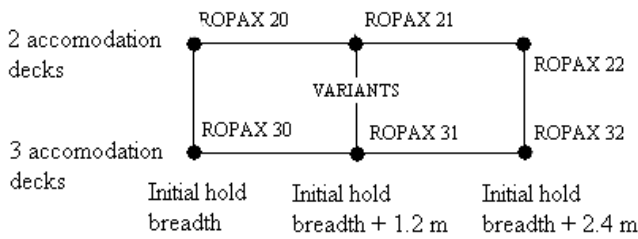

Figure 5. RoPax topological/geometrical variants

General design procedure has been included with two optimization blocks:

- **Block 1:** Structural optimization of generic coarse mesh FE structural model (six different models that include around 0.8 ship length).
- **Block 2:** Subjective selection of generated designs based on designer/shipowner preferences has been performed with respect to various design attributes (damage stability, cargo capacity, etc.).

Based on structural optimization results and additional calculation of ship stability and cargo handling for all variants, ULJANIK designers have specified six criteria for the final selection: Parking are, Ship stability, Air draught, Producibility, Passenger comfort and Structural Safety.

Values of six design criteria for all examined RoPax variants are summarized in Fig.6.

Nondominated Designs						
No	PARK_AR	STABILITY	AIR_DRAUG	PRODUCTIO	PASS_COMF	SAFETY
1	10150	13375	32250	2991	36765	0.9599
2	10360	13405	32400	3038	35964	0.9497
3	10570	13450	32550	3058	35479	0.9519
4	10150	12797	29250	2930	33345	0.9469
5	10360	12870	29400	2958	32634	0.9415
6	10570	12906	29550	3000	32209	0.9451

Legend:

Design 1 - Ropax 30; Design 2 - Ropax 31; Design 3 - Ropax 32
 Design 4 - Ropax 20; Design 5 - Ropax 21; Design 6 - Ropax 22

Figure 6. Values of design criteria for different variants

Designers' and Owner's subjective intra-attribute and inter-attribute preferences were revealed. Novak's fuzzy functions were used to model intra-attribute preferences, Fig.7, while Saaty's AHP method was used for inter-attribute preferences, see Fig.8.

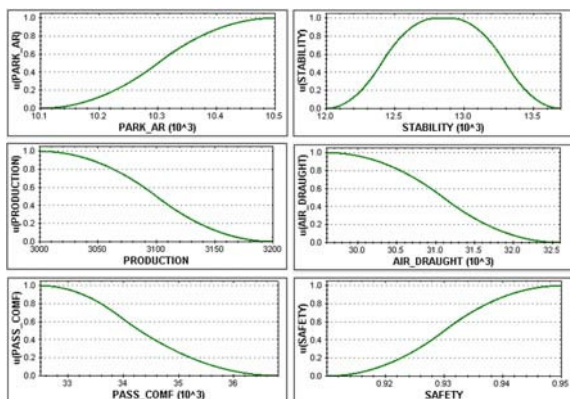

Figure 7. Intra attribute preferences-fuzzy function

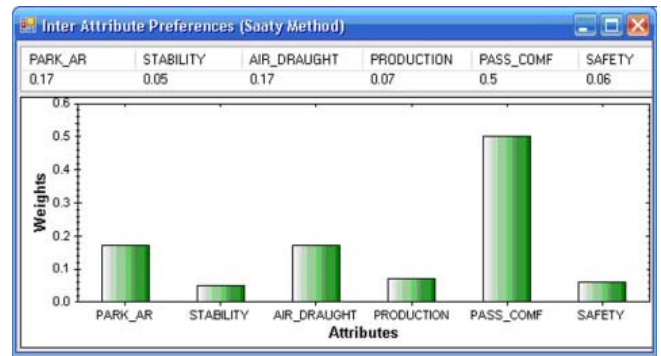
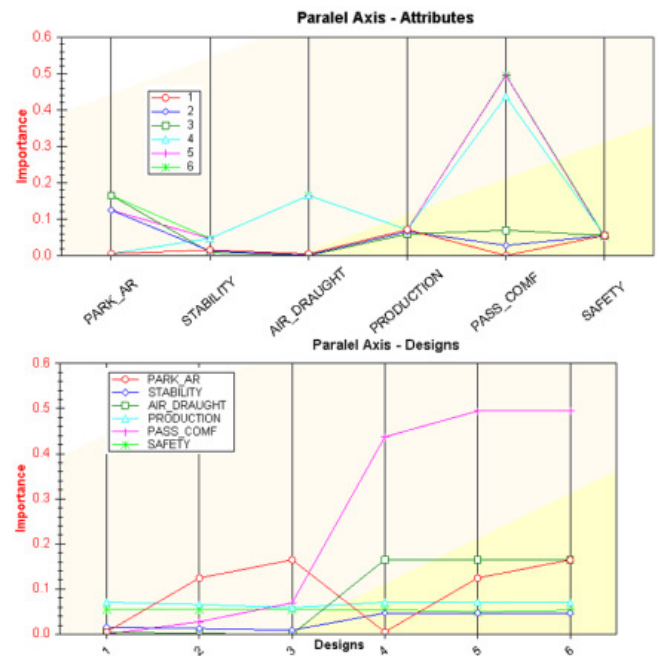

Figure 8. Inter Attribute preferences (Saaty Method)

Final selection of the preferred variant **Ropax 22** was performed by ULJANIK shipyard head designer on the *Parallel axis plot* of selected criteria's in OCTOPUS Designer DeView Tool (Fig. 9.) based on Designer's and Ship Owner's subjective intra-attribute and inter- attribute preferences.



Legend:

Design 1 - Ropax 30; Design 2 - Ropax 31; Design 3 - Ropax 32
 Design 4 - Ropax 20; Design 5 - Ropax 21; Design 6 - Ropax 22

Figure 9. Parallel axis plot of criteria for 6 variants

Some of the highlights of the preferred variant are: additional 403.2 m² of parking area with respect to the starting variant Ropax 30, no additional ballasting – the vessel will sail at smaller draught in arrival condition, 2.5 m smaller air draught with respect to Ropax 32, reduced weight of wing tank blocks and smaller distance to water line, which directly improves passenger comfort. Structure inside wing tanks is modified in order to avoid erection of scaffoldings for inspection.

5 CONCLUSIONS

IMPROVE goals regarding achievement in fuel oil consumptions (12%) and increased lane meter on tank top (cargo capacity) of has been achieved.

In comparison with *Standard* ship, *New* design needs almost 7900 kW less power, weight of machinery is reduced by 450 t, fuel oil consumption is 28% less and finally, propulsion system is more reliable. Index of redundancy is 100% (2 independent engine rooms and 2 independent propulsion systems).

IMPROVE ship has 4 % less lightship weight in comparison with *New* ship and because of this, required propulsion power and fuel oil consumption are 5 % less (19560 kW instead of 20500 kW). The gain of 5% more trailer lanes on tank top is achieved by investigating different positions of longitudinal ballast tank bulkhead and at the same time ballast volume is minimized.

Various structural arrangements were analyzed by ULJANIK and UZ as a multi-objective design problem. Preferred topological/geometrical concept has been chosen and served as the starting point for the more detailed structural optimization.

REFERENCES

- Dundara, D., Ferlatti B., Kuzmanović O., Lalović I., (2008), Development of a New Innovative Concept of Ropax Ship Project IMPROVE, XVIII Symposium on Theory and Practice of Shipbuilding-SORTA 2008, pp.187-197, Pula, 2008.
- Zanić, V., Jancijev, T., Andric, J., Frank, D., Bralic, S., Sponza, D., Dundara, D. (2001). Racking Analysis of Car-Truck-Carriers", Brodogradnja, 49, Vol. 2, pp. 181-190, Zagreb, 2001.
- Zanic, V., Prebeg, P., Andric, J., Kitarovic S., Grgic, M., *Multicriteria structural design of ropax ship: specification of design problem roadmap for EU FP6 Project IMPROVE*, XVIII Symposium on Theory and Practice of Shipbuilding-SORTA 2008, pp.267-278, Pula, 2008.

RoPaX- Structural design aspects

V. Zanic, J. Andric, P. Prebeg, M. Stipcevic, M. Grgic, S. Kitarović, N. Hadzic, K. Piric

UZ, University of Zagreb, Faculty of Mechanical Engineering and Naval Architecture, Zagreb, Croatia

I. Chirica, S. Giuglea & V. Giuglea

Ship Design Group, Galati, Romania

O. Turan, & H. Khalid

NAME, Universities of Glasgow and Strathclyde, Glasgow, Scotland, United Kingdom

P. Rigo

ANAST, University of Liege, Liege, Belgium

ABSTRACT: The novel decision support methodology for the concept and preliminary design of multi-deck ship structures was applied to the structural design of the next generation of the RoPax ship. Approach combines three design steps for the fast generation of different design variants regarding topological, geometrical and scantlings variables. Step 1: The generic ship 3D-FEM MAESTRO models (based on macro-elements), were analyzed according to BV rules and optimized for cost, weight and VCG position. In the context of general design, designer's selection was performed using appropriate design quality measures among 6 optimized variants. Step 2: Control structures (bays) of different ship segments were modeled, using the computationally very fast 2.5D FEM models, in generation of design alternatives on the Pareto frontier. They were validated using the IMPROVE developed adequacy and quality measures (vibration, fatigue, robustness, safety and production cost). IMPROVE LCC module was used in determination of the optimal combination of different generated substructures, as starting points for the next, preliminary design phase. Step 3: The full ship 3D FEM models were developed to validate and synthesize optimal design variants using safety, weight, cost, fatigue and forced vibrations criteria. Direct load calculations were applied to generate design loads.

Decision making implied objective optimization procedures (dual SLP and MOGA) combined with the stakeholders' subjective decision making (selection) on the generated Pareto frontiers. Procedure resulted in optimal structural design of RoPax with two superstructure decks, optimal parking area on lower decks, VCG position, etc., combined with minimization of the ship lightweight and related savings in fuel and other operational costs.

1 INTRODUCTION

The structural design methodology, capable of imbedding multiple design quality criteria, is presented on the complex application example of the modern RoPax ship (Zanic et al.,2008). The decision support rationale was provided for design phases where the cost-wise most far-reaching decisions are made. Problem is particularly demanding for such modern multi-deck ships characterized with the extensive super-structures (Zanic et al.,2009a). Their influence on the primary strength has to be taken into account starting from the concept design phase (Andric, 2007). Only the full ship 3D FEM analysis is considered

sufficient for the correct assessment of the structural response. The challenge was to generate optimal design solutions for concept and preliminary design phases, using such demanding models, further enhanced with the IMPROVE developed design criteria on production and operational aspects.

2 OVERALL DESIGN PROCEDURE

For a concept structural design of RoPax product an efficient multi step procedure have been established to solve topology (and interwoven scantling/geometry) optimization. It consists of two main tasks (Zanic et al.,2009b).

- (1) topology / geometry optimization
- (2) scantling / material optimization of the preferred variants from task (1).

The complete 3-step procedure is presented in Figure 1 based on interconnected optimization blocks (1) - (9). First two steps (blocks 1-7) are used for concept design phase while the third step meets preliminary design requirements.

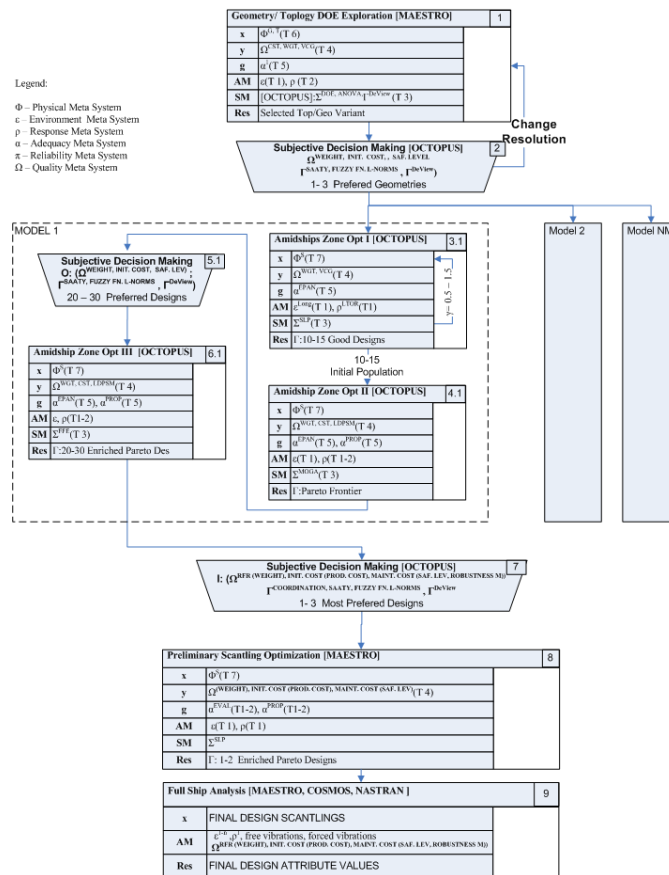

Figure 1. Decision support problem sequence diagram for ROPAX Application Case

2.1 Design STEP 1- Topology and geometry optimization (Blocks 1 & 2)

Step 1 represents concept design procedure for the multi-deck ships and contains topology and geometry optimization (blocks 1 and 2). Geometry exploration is based on extruded generic 3D FEM MAESTRO (MAESTRO, 2006) models (Figure 2.) with geometric variables determined using DOE (Ross, 1988). Subjective decision of preferred geometry is based on designer's preferences.

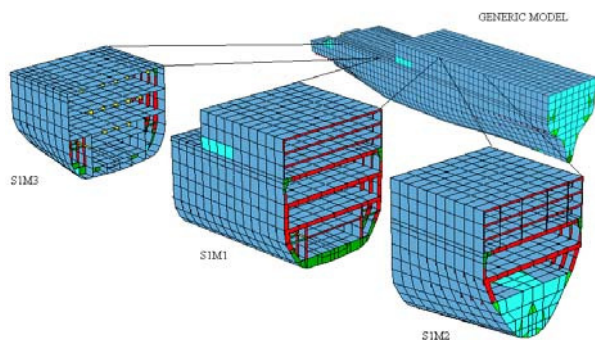

Figure 2. MAESTRO generic model of Ropax ship

As presented in (Dundara et al., 2009) the design variables used in Step 1 are divided into topological- x^T , geometrical- x^G and scantling- x^S variables. The topological variable was the number of superstructure decks; the geometrical was the breadth of lower hold (position of longitudinal bulkhead in cargo space) and scantling variables were scantlings of structural elements. Obtained model variants with appropriate names are shown in Figure 3.

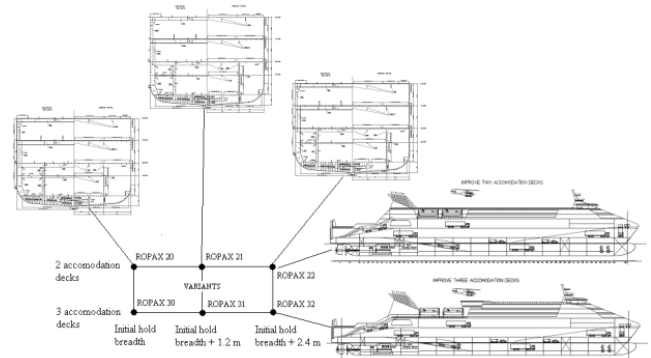

Figure 3. RoPax model variants

Design constraints and requirements were determined in several ways. Minimum and maximum values for the height of frame web of deck transverses were specified by ULJANIK yard. Minimum values for the thickness of plating and stiffener section modulus were determined according to the requirements of BV, as minimum allowable thickness of plating and section modulus that can support wheel loads. To satisfy structural strength, the adapted set of MAESTRO adequacy parameters was used (Hughes et al. 1980).

The Design objectives used for optimization of all 6 structural variants were: structural weight, cost of material and position of vertical centre of gravity.

All variants were optimized using MAESTRO SLP optimizer. Figure 4 shows the structural mass history as well as the changes in total number of unsatisfied constraints with respect to the cycle number design variant RoPax 22.

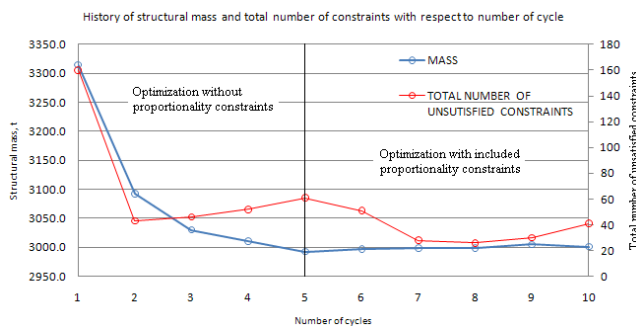

Figure 4. History of mass and safety objectives for R22

Optimal variants of all design variants are visualized using OCTOPUS Designer DeView Tool, see Figure 5.

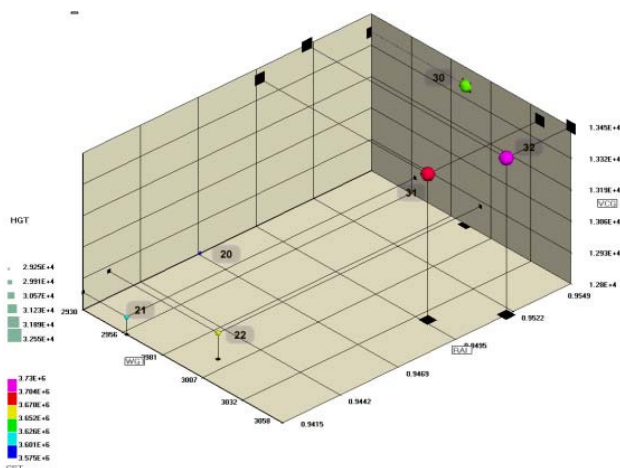

Figure 5. Optimal Design Variants presented in DeView

Based on structural optimization results and additional calculation of ship stability and cargo handling for all variants, ULJANIK designer had specified six criteria for the final selection: Parking area, Ship stability, Air drought, Producibility, Passenger comfort and Structural Safety

based on which the preferred variant RoPax 22 was selected by ULJANIK shipyard.

2.2 Design STEP 2- Conceptual multicriterial scantling optimization of selected variant

For the selected design variant (RoPax 22) two OCTOPUS Analyzer (OCTOPUS, 2008) one-bay models were created: Model at midship section (Frame 129) and Model at Frame 184 (Figure 6). Models are based on the MAESTRO 3D FEM generic models for selected variant. Model at frame 129 directly influences the dimensions of scantlings of structure modeled by module S1M1 (Figure 2), while model at frame 184 influences dimensions of S1M2. In addition, since it is known that dimensions of module S1M3 are to some extent dependent on the dimensions of module S1M1, that part of ship structure was also taken into account during calculation of structural mass and production cost. The same was applied for module S1M4 which is influenced by module S1M2.

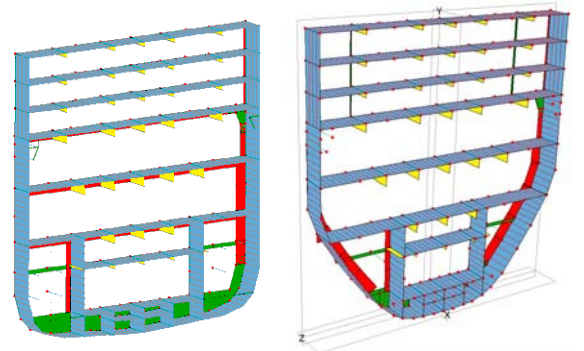

Figure 6 OCTOPUS Analyzer frames 129 & 184

MAESTRO generic model was also used for calculation of hull girder decks coefficients to be implemented for the corrected stress distribution in the OCTOPUS 1 bay models.

For each of the structural models the respective synthesis models was created. Design variables for each of the design blocks from 2-7 are scantlings of longitudinal and transverse structure.

2.2.1 Design Block 3-Fast MODM exploration of the design space

In this block Fast MODM exploration of the design space and educated generation of the initial population for block 4 was applied. As can be seen in Figure 1, the design constraints used for this block were BV adequacy criteria (implemented in OCTOPUS Analyzer) for longitudinal part of structure. Objectives were weight and position of vertical centre of gravity. This block has generated 10 designs for each OCTOPUS Analyzer model, with proper distribution

of material in the longitudinal structure, using SLP optimizer

2.2.2 Design Block 4-Multiobjective optimization using MOGA optimizer

In this design block extensive multi-objective optimization using MOGA optimizer was applied. In all optimization blocks of STEP 2, design variables that govern stiffening of stiffened panels were defined as discrete. Complex variables (variables that describe HP stiffener) are transformed to profile number. In this way number of design variables is reduced and only real profiles are used.

Design constraints used for this block were BV adequacy criteria together with the same min/max constraints as described in Block 1. Maximum weight is prescribed as additional constraint in order to reduce the extent of Pareto frontier to the subset of interest to RoPaX stakeholders. IMPROVE module for calculation of local vibrations was used to check avoidance of propeller excitation with natural frequencies of accommodation decks. IMPROVE module for calculation of fatigue was used to check critical details.

Design objectives used in this block were: Production cost calculated using IMPROVE Production cost module (Caprace et al. 2006), structural weight and structural safety measure based on local adequacy of stiffened panels.

The resulting Pareto frontiers, with approximately 500 solutions for optimization models on frame 129 and frame 184 are shown in Figure 7 and Figure 8 respectively.

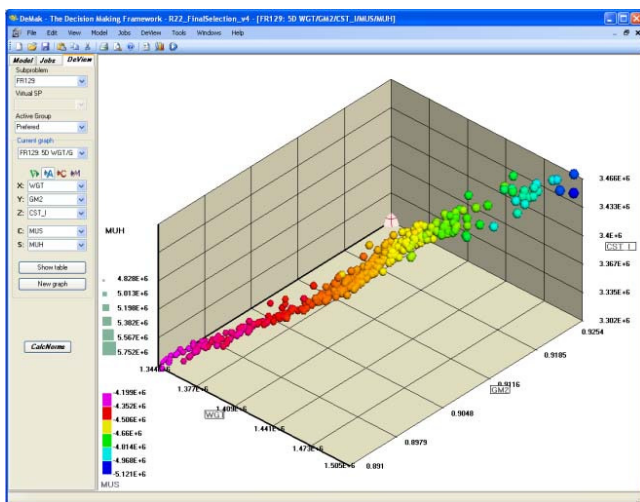

Figure 7 Obtained Pareto Frontier for Frame 129

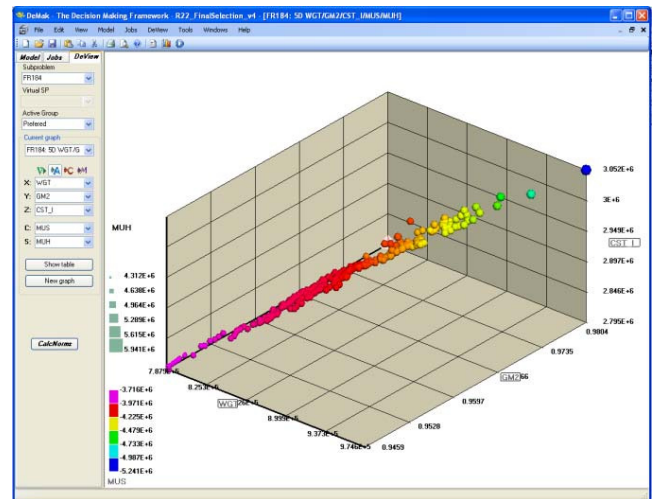

Figure 8 Obtained Pareto Frontier for Frame 184

2.2.3 Design Block 6-Multiobjective optimization (MOGA optimizer) for reduced analysis block

In this block additional calculation of complex and time consuming design attributes has been performed. Although it was originally planned to reduce the number of Pareto solutions from block 4, due to increased speed of OCTOPUS Analyzer, it was possible to calculate ultimate strength for all obtained Pareto Solutions.

2.2.4 Design Block 7 Final selection of preferred design in concept design phase

The main goal of this block was selection of a preferred design. First, it was necessary to create ship designs based on the results from the models at Frame 129 and 184. Resultant Pareto frontier is obtained by generating all possible combinations of Pareto results from two models, see Figure 9.

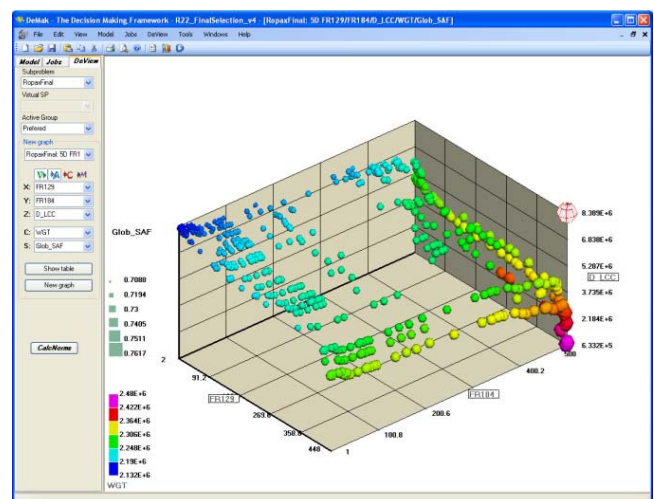

Figure 9 Generated solutions after Pareto filtering

In addition for all generated designs IMPROVE Life Cycle Cost module was used to calculate Periodic maintenance cost, Fuel Cost, Earning and Dismantling cost.

From obtained costs, the costs of the referent ULJANIK shipyard model was deducted in order to present directly differences between the referent model and each design variant.

All calculated attributes with their aspiration direction (Minimize or Maximize) are presented in Table 1, while those which are used as objectives for Pareto filtering have their type marked bold.

After Pareto filtering the resulting Pareto frontier was interactively presented to the ULJANIK shipyard head designer in order to select final design.

No	Acronym	Type	Description
1	D_LWT	Min	Delta Lightship weight
2	DC_PROD	Min.	Delta production cost
3	DC_MAINT	Min.	Delta Maintenance cost
4	DC_FUEL	Min.	Delta fuel cost
5	D_EARN	Max.	Delta earning
6	D_DISM	Max.	Delta dismantling
7	D_LCC	Max.	Delta Life cycle cost
8	gmean	Max.	Local safety measure
9	SAF	Max.	Global (US) safety measure

Table 1 Design attributes for the final selection

After detailed interactive analysis of the resultant Pareto frontier, in OCTOPUS Designer DeView (Figure 10 and Figure 11), the next conclusions have been made:

- The designs with low weight at the same time have low production cost and fuel cost while the maintenance cost is high
- Influence of the maintenance cost on the total life cycle cost is significantly smaller then influence of a fuel cost
- The preferred designs for both the shipyard and the ship-owner are actually the same, since at the same time designs with low weight offer smallest Production Cost (important for shipyard) and highest Profit (important for ship-owner).

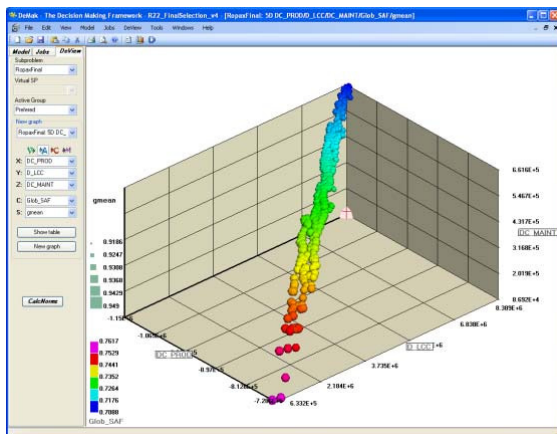

Figure 10 Resultant Pareto frontier (DC_PROD, D_LCC, DC_MAINT)

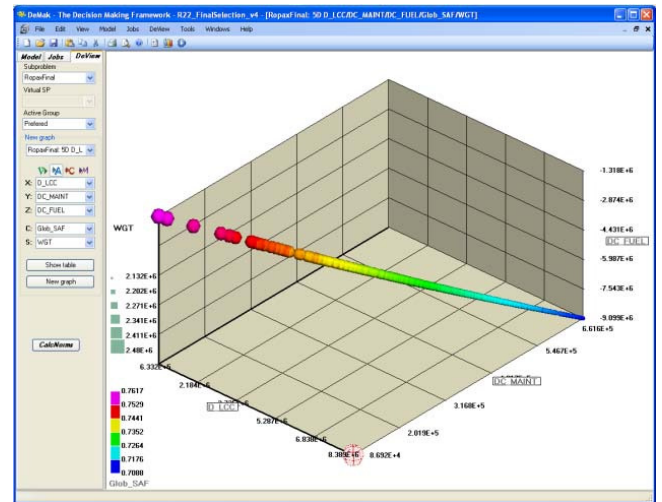

Figure 11 Resultant Pareto frontier (D_LCC, DC_MAINT, DC_FUEL)

With respect to the above stated conclusions ULJANIK shipyard head designer have selected the design with the maximal profit for the GRIMALDI ship-owner.

Table 2 summarizes attribute values for selected design, while Figure 12 presents some of safety related calculations, performed by OCTOPUS Analyzer on the selected design.

No	Acronym	Value	%
1	D_LWT	-504 t	-3.9
2	DC_PROD	- 1.144·10⁶ €	-16.9
3	DC_MAINT	0.6662·10 ⁶ €	17.6
4	DC_FUEL	-9.086·10⁶ €	4.0
5	D_DISM	-0.2286·10 ⁶ €	-4.0
6	D_LCC	8.376·10⁶ €	3.4

Table 2 Characteristics of the selected design (with respect to reference Ropax 22 Yard Design variant)

* minus sign denotes reduction of physical value,
 ** bolded values denotes aspirated changes

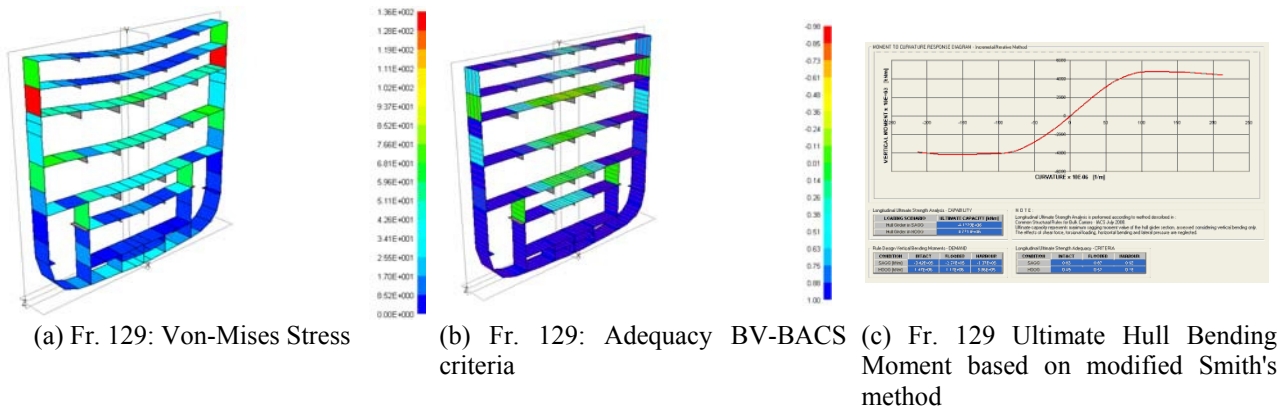

Figure 12- Results of structural calculations performed on selected design using OCTOPUS Analyzer

2.3 Design Step 3: Problem Solution - RoPax Preliminary Design Phase

Preliminary design phase includes:

Block 8 - Final structural optimization is based upon refined loads model and full ship 3D FEM model obtained by merging and refining ship generic model and bay models with optimal scantlings.

Block 9 - Final Analysis of the selected preferred design (from Block 8) including forced vibration analysis, building cost simulation, LCC analysis, final check of panel safety measures, ultimate strength and fatigue life of critical details.

2.3.1 Wave induced hydrodynamic load calculation

NAME has carried out sea keeping analysis of IMPROVE RoPax vessel to estimate the load as well as the motion transfer functions / response amplitude operators (RAOs).

A software module has been developed that combines these RAOs with the user defined sea spectra to predict the ‘short term’ wave induced loads comprising of wave pressures, hull girder loads and slamming characteristics. The software is also capable of predicting the ‘long term’ (10^{-8} probability of exceedance) design pressures and hull girder loads in line with the requirement laid down in IACS SR11.

The working principle of the wave induced load calculator (WILC) is depicted in Figure 13. This software uses the relevant RAOs as input to predict the design loads as per the method suggested by Parunov et al.(2004) and that of the BV (2008).

The whole analysis procedure comprises of two phases. Phase-I concerns estimation of load and/or motion RAOs using WASIM software (DNV, 2006). In phase-II, these RAOs are combined with the idealized sea spectra of operation area to predict the design wave loads. WILC

combines the RAOs calculated in phase-I, with the user defined sea spectra (JONSWAP / Pierson-Moskowitz with/without cosine squared spreading) to estimate the dynamic wave induced loads. The ‘short term’ loads are calculated using the standard spectral techniques (Salvesen et al., 1970).

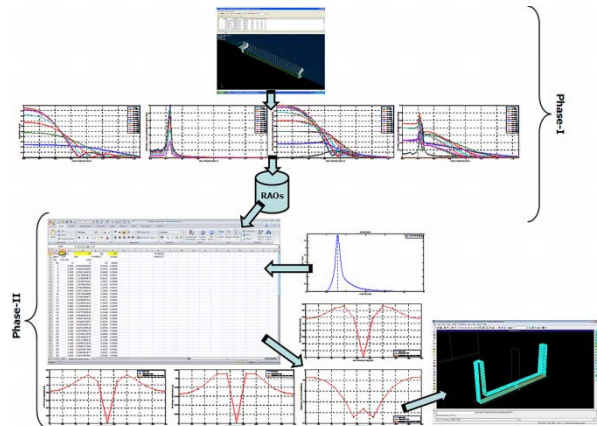

Figure 13. Schematic diagram of WILC

On the other hand, two different procedures (Parunov et al., 2004; BV, 2008) are used by the software to predict the ‘long term’ design loads with 10^{-8} probability of exceedance. WILC also implements (Ochi-Motter, 1973) slamming pressure calculation procedure to predict bow and stern slamming events and associated loads

Validation of the structural loads was carried out by comparing the computed wave induced pressures and hull girder loads with the ones estimated using BV rules (BV, 2003).

In general, except for the forward part (almost 30% LBP), the Rule based pressures are higher in magnitudes than the direct calculation methods. This may be attributed to the implicit safety factors incorporated into the rules.

The graphs comparing the design vertical bending moments are shown in Figure 14. It is evident from this figure that the direct calculation methods predict bending moments as being higher than the rule values for the stations amidships. In particular, the method by Parunov et al.(2004)

predicts the highest values. On the other hand the rule-based values are higher than the direct approach for the forward part of the ship. This makes sense as the rules implicitly take account of slamming loads by extending the midship bending moment to forward sections. BV rules approach was selected.

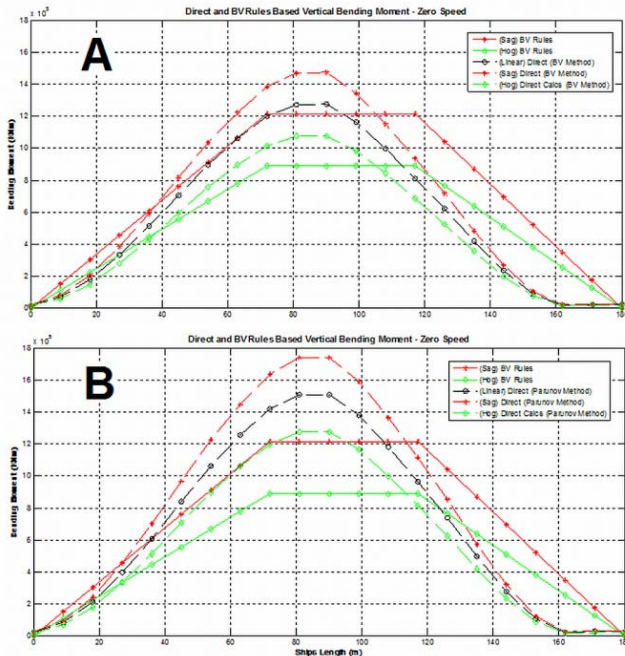

Figure 14. Comparison vertical bending moments

2.3.2 Design Block 8 - Full ship 3D FEM model based optimization

Full ship 3D FEM model using optimal scantlings for all ship zones (selected in *Block 7*) was developed (see Figure 15).

Rule wave load components (pressure fields, accelerations, etc.) were implemented on the full ship 3D FEM model for selective re-optimization of critical or unsatisfactory substructures.

Optimization results and active constraints are analyzed and final scantling standardization is performed using considerations based upon production simulation models developed by ANAST and CMT.

2.3.3 Design Block 9 - Full ship 3D FEM model based analysis (in progress)

Direct wave loads components (pressure field, accelerations, etc.) are being implemented on the full ship 3D FEM model for the final evaluation of structural scantlings.

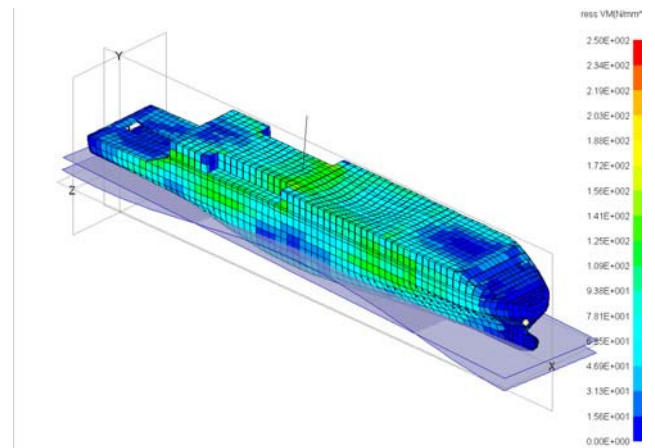

Figure 15. Full-ship model of RoPax – VM response

Final 3D FEM response and feasibility analysis is performed. Final conclusions regarding deformations, safety and feasibility criteria are made – prior to the Detail Design Phase. Ultimate and fatigue strength re-analysis are also performed regarding local and global safety (IMPROVE modules α -FAT (TKK) and α -LUSA (MEC and UZ) are used).

2.3.4 Vibration calculation of RoPax aft part

Forced Vibration calculus of RoPax aft part was performed by SDG using COSMOS software based on the CAD model supplied by ULJANIK. The model was clamped in fore part, in the section of the engine room aft bulkhead. The first 150 natural vibrations were determined. In Figure 16 the second global bending vibration mode of the aft part is presented.

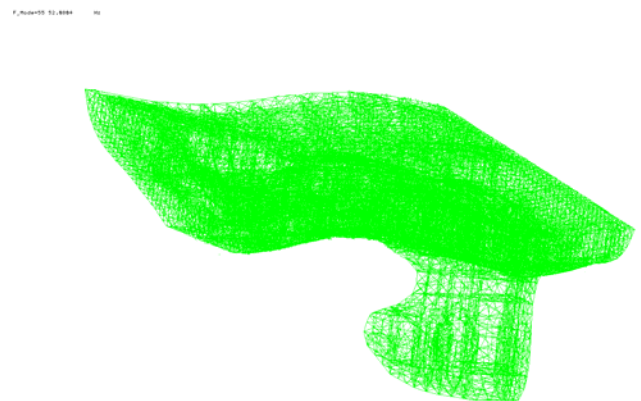

Figure 16. Mode 2 global vibration (52 Hz)

3 CONCLUSIONS

The decision support problem formulation for ROPAX ship structure is presented based upon multi-criteria structural optimization in concept and preliminary design phases. Conceptual phase obtained savings in cargo space weight of approx. 300 tons have in Step 1, while Step 2 obtained additional 200 tons.

Problem identification implied reduction of design variable sets, design criteria (serviceability, ultimate strength) and relative measures of design quality (cost, weight, and IMPROVE based feasibility and economy quality measures) to ones with dominant effect on the design quality.

Relative quality measures (enabling correct ordering of design variants) are used as objectives in building of the preference structure needed in generation of the non-dominated Pareto frontier in the Design Selection Blocks 2, 5.x and 7 including safety and cost robustness assessments. Interactivity in *DeView* module was instrumental for comfortable work with Yard head designer.

The OCTOPUS / MAESTRO decision support system includes specially developed, fast and balanced collection of analysis and synthesis modules/methods. Part of those modules was only developed under this EU FP6 IMPROVE project, using full synergy of the consortium.

Novel design procedure used for multi-deck ships like RoPax, with complex distribution of primary stresses, included coordinated cascade of structural models: (1) tapered generic ship models, (2) fast one bay 'control structures', and (3) their synthesis in full ship model. Problem sequencer and OCTOPUS / MAESTRO modeling environment enabled seamless transfer between models and efficient design work.

The design environment is believed to be a flexible and robust design tool of fidelity required in the concept and preliminary design phases.

REFERENCES

- Andric, J. (2007). "Decision support methodology for concept design of the ship structures with hull-superstructure interaction", PhD dissertation, University of Zagreb, Croatia.
- BV (2003). *Rules for the Classification of Steel Ships* - December 2003 Edition, Bureau Veritas, France.
- BV (2008). *BV Comments on NAME Long Term Analysis Procedure*, Bureau Veritas.

- DNV (2006). *Wave Loads on Vessels with Forward Speed (Wasim)* Technical Documentation, DNV.
- Caprace, J.D.; Rigo, P.; Warnotte, R.; Le Viol, S. (2006), *An analytical cost assessment module for the detailed design stage*, COMPIT'2006, Oegstgeest, pp.335-345
- Dundara, D., Kuzmanovic O., Zanic V, Andric, J., Prebeg, P., Hadzic, N. (2009) "New Innovative ROPAX Vessel" EU FP6 project IMPROVE-Final Conference, Dubrovnik, CROATIA..
- Hughes, O.F, Mistree, F, Zanic, V. (1980) "A Practical Method for the Rational Design of Ship Structures", *Journal of Ship Research*, Vol. 24
- ISSC, (1997). Technical Committee II.1, "Quasi-Static Response", Proc. of the 13th International Ship and Offshore Structures Congress Trondheim, Norway.
- MAESTRO Version 8.6. (2006.) Program documentation, DRS Technologies, Stevensville, MD, USA.
- Ochi, M. and Motter, L. (1973). Prediction of Slamming Characteristics and Hull Responses for Ship Design. *Trans. SNAME* 81: 144-176.
- OCTOPUS manuals (2008), FMENA, University of Zagreb
- Parunov, J., Senjanovic, I. and Pavicevic, M. (2004). Determination of Design Wave Bending Moments by Hydrodynamic Analysis. *16th Symposium "Theory and Practice of Naval Architecture"-SORTA 2004*.
- Ross, P. J. (1988) "Taguchi Techniques for Quality Engineering", McGraw-Hill Book Company, USA.
- Salvesen, N., Tuck, E. and Faltinsen, O. (1970). "Ship Motions and Sea Loads." *Transactions Society of the Naval Architects and Marine Engineers* 78: 250-287.
- Zanic, V., Prebeg, P., Andric, J., Kitarovic S., Grgic, M., Multicriteria structural design of ropax ship: specification of design problem roadmap for EU FP6 Project IMPROVE, XVIII Symposium on Theory and Practice of Shipbuilding-SORTA 2008, pp.267-278, Pula, 2008.
- Zanic, V., Andric, J., Prebeg, P. (2009). Design Environment for Structural Design: Application to Modern Multideck Ships, Proc.IMEchE, part M, *Journal of Engineering for the Maritime Environment*, Vol.223, No.M1, pp.105-120, February 2009
- Zanic, V., Adric, J., Prebeg, P., Kitarovic, S., Piric, K., "Multi-Objective Optimization of Ship Structural Topology and Scantlings," Proceedings of the International Marine Design Conference, IMDC, Trondheim, 2009.

The IMPROVED chemical tanker: Owner requirements

A. Klanac¹, M. Magaš², Z. Brzić², I. Pupovac²

¹- Helsinki University of Technology, Finland

²- Tankerska plovidba Zadar, Croatia

ABSTRACT: This paper accommodates the new chemical tanker design and outlines the design changes identified by SSN. This new tanker design serves as the initial layout for the scantlings optimization using the novel IMPROVE modules for the assessment of design quality in the early design stage. Furthermore, it describes the process of design selection according to the assessed preferences of ship design's stakeholders, namely the shipowner and shipyard. Quality of the selected design alternatives is also analysed through the assessment of ultimate strength of hull girder, strength assessment of structural details, etc. A very important feature of this document is the sensitivity analysis for the discover and established of the general design drivers for such a type of chemical tanker, aiming to give best-practice guidance for future chemical tanker designs.

1 INTRODUCTION

This paper presents the chemical tanker owner requirements for design. The general requirements are presented here as defined in to the deliverable D2.1 (Zanic and Petricic 2007) and according to the Key Performance Indexes table give in the end of this paper. These are further extended with the findings elicited through the interviews with the Owner, but also with the Yard representatives who also conferred to their previous experience on owner requirements.

2 GENERAL REQUIREMENTS

Owner's main requirements for design are the following:

- General ship design objectives:
 - a. Maximize cargo volume per ship dimensions by reducing the void spaces, by using sandwich spaces instead of voids where possible and by reducing the internal subdivisions (non-cargo tanks) in number and in volume; Increase carrying capacity by reducing the steel mass; Minimize the cost of the main engine and machinery; Improve the vessels' operational performance and efficiency; Maximize the operational flexibility (no. of different types of cargo that can be carried simultaneously, no. of allowed loading conditions, efficient loading/discharging/stowage of cargo etc.);
 - b. Structural Design Objectives: Minimize the use of DUPLEX steel; Decrease the cost of structural steel

(including optimization of the geometry of corrugations); Maximize structural safety by maximizing both global and local safety measures; Minimize probability of the foreseeable structural failures by means of inspection focusing and repair prioritization; Maximize the fatigue life (FL > 45 years should be ensured);

- c. Operation, Maintenance and Repair Objectives: Minimize maintenance and other operational costs by minimizing the need for tank inspection, by minimizing painted surface, especially in the ballast tanks and by maximizing the maintainability of the ship structure; Maximize the reliability of the ship's machinery;

3 INTERVIEWS

Two set of interviews had been performed with the owner. First interviews were performed to confirm the indicated design drivers, the KPIs and also get a better insight into what is expected from the improvements in hull structure through optimization. Second set of interviews followed after structural optimization was made, and after several alternatives were identified as the potential good compromises for both stakeholders. Purified versions of transcripts of both sets of interviews are given in the deliverable D8.2 (Klanac et al. 2009)

Trough the semi-structured interviews, the interviewees were asked questions according to the following prepared list

- 1) What is your role in the company? Could you please explain your duties and professional experiences?
- 2) What is a 'good' ship for you?
- 3) Observing the General Arrangement of the tanker, how would you describe it in short?
- 4) What would you indicate as its advantages and what as deficiencies?
- 5) In previous activities you have indicated certain priorities which were indicated in the deliverable D2.1. Do you consider that this design will fulfil these priorities? Please explain.
- 6) Have the main objectives and KPIs changed for you?
- 7) What technical details do you see relevant for fulfilling the objective of design? Which features in your opinion could be improved through optimization study?
- 8) If I were to ask you to rank several design alternatives of this ship, do you think you would be able to do this? On what information or features would you base your ranking?
- 9) In your daily work how much are your decisions based on formalized information, and how much are they based on experience, hear say, experience of others, brainstorming and meetings?
- 10) Would you say that in your work (ship design) you make consistent decisions? If yes, please explain. If not, what contributes to the inconsistencies?

The second set of interviews concentrated question towards the obtained design alternatives. The main questions asked were:

- 1) How fatigue, costs, and weight are preferred?
 - a) Is a unit of equivalent change dependent on the magnitude of the attribute
 - b) Are they equally preferred even though the values of other attributes differ
 - c) Is a unit of equivalent change dependent on the value of other attributes
- 2) Both owner and yard engage in value exchange, meaning that costs induced by the desire to increase benefits will be shared.
 - a) We employ for this reason two realistic compensation factors p_{12} and p_{21} where first is the added ship price for the owner for the increased fatigue life, and it is based on the increased production costs for the yard.
 - b) The second factor, p_{21} , is the penalty for the lost deadweight caused by the weight increase.
- 3) The amount the owner is willing to pay to increase the fatigue life of this ship by 1 year.
 - a) Let us consider three values for the moment: 0, 100k€ and 1M€.
 - b) Find the actual value

4 FINDINGS

The first set of interviews resulted in the following findings.

- Owner does not take part in the conceptual structural design of the vessel, but is interested in her characteristics. Specifically, that the vessel in operation is safe, that there are no cracks in the structure and that there is no need for repainting.
- Other characteristics related to safety, e.g. ultimate strength is of no relevance to the owner, but it is covered with the previous statement that the vessel should be safe.
- The lightship mass of the vessel is also of no particular concern for the owner since vessels are usually purchased as existing projects which guarantees their capacity, or deadweight.
- Due to the requirements for cargo capacity and safety (chemicals), yard is specially interested in controlling the mass of the hull and in its fatigue characteristics to maintain a higher reliability of ship structure.
- Fatigue is typically controlled through design of structural details since loss of cargo capacity is not preferred
- Losing 1000t of capacity for a vessel is huge!
- In case that owner is interested in increased vessel's structural safety, this is reflected in the ship price. The ship price is not standard but is based on the calculations founded on observed vessel design

The second set of interviews, with respect to the results of optimization, yielded the following findings

- Owner expresses no interest to increase the fatigue life beyond required minimum, set by class, since it becomes difficult to find cargo for the vessel older than 15 years.
- On the other hand, it makes sense to increase the reliability of the vessel, but the vessel's capacity should not be sacrificed, and it should not cost any significant amount. The re-design should concentrate on the structural details, and on painting.
- The yard mentions, from the experience of dealings with chemical tanker owners, that the fatigue life of this chemical tanker should be 30 years (40 years is too long, and 25 too short). There is a special class for a 30-year fatigue life vessel.
- Chemical tanker owners are in principle not selling for the reasons to avoid creation of competition. Thus they maintain and use their vessels until the scrapping

- Yard estimates the upper value of investment into one year of fatigue life to be 100 000 EURO.

5 SUMMARY WITH CONCLUSIONS

Observing the findings from the interviews and comparing them with initial set of requirements we can notice some inconsistencies in preferences, e.g. related to fatigue life. In this case, fatigue life of 45 years was initially considered as a target, but Owner, in direct interview, confirmed that such high fatigue life is irrelevant since the tanker will have difficulty to be employed on the market, unless the Owner has long standing contracts. This factor nicely confirms therefore that the business model in which Owner operates is the key to their requirements. If the Owner could secure long term contract for the aged vessel even as 40+ years such a fatigue life would be worth the investment, if not, then it should not be pursued. Yard on the other hand gave an interesting supplement to this

conclusion, that their experience with other chemical tanker owners is such that they usually request a fatigue life of 30 years, since it give a good mixture of reliability, but also it allows the owners to operate and employ tanker up to this age. Increase beyond 30 years of fatigue life was very rarely requested.

REFERENCES

- Remes, H., Klanac, A., Varsta, P., Ehlers, S., ConStruct – Platform for Conceptual Structural Design. IMPROVE-Final Conference, Dubrovnik, Croatia 17-19. Sept. 2009.
- Zanic, V., Petricic, M. 2007, Deliverable D2.8 - Requirements from Operators and Ship-owners, IMPROVE project.
- Klanac, A., Ehlers, S., Remes, H., Bair, F., 2009. Deliverable D8.2 – Report presenting the identified parameters having the larger positive or negative impacts on the optimum solution/RDMM procedure, IMPROVE project.

Key Performance Indicators (KPI)	STAKEHOLDERS		YARD PROTOTYPE SHIP LEVEL 1	PROTOTYPE CONCEPT + OWNER'S REQUIREMENTS LEVEL 2a (GAIN : LEVEL 2a vs. LEVEL 1)	ASSOCIATED DESIGN VARIABLES	OBJECTIVES	IMPROVE PROJECT SHIP OWNER AND YARD EXPECTATIONS		GAIN (%) LEVEL 3 vs. LEVEL 2a or LEVEL 3 vs. LEVEL 2b *)	
	Shipyard SSN	Owner TPZ					INITIAL DESIGN LEVEL 2b (GAIN : LEVEL 2b vs. LEVEL 1)	LEVEL 3 (GAIN : LEVEL 3 vs. LEVEL 1)		
1.0	SHIP FUNCTIONS -PERFORMANCES OTHER THEN COST & SAFETY									
1.1	MASSES, SPACES, CAPACITIES									
	Hull structure mass [t]	HI		10500		hull structure total	Minimize			3%
	Volume of ballast tanks [m ³]	MID	MID	16080		GA	Minimize	16080	16080	
	Number of ballast tanks [#]	MID	MID	21		GA	Minimize	17 (19 %)	17 (19 %)	
1.2	STRUCTURE									
	DUPLEX steel mass [t]	HI		2900		scantlings, structural layout	Minimize			3 – 5 %
	Fatigue life [years]	MID	HI	45	45	detail design		45	45	
	Use of MS (% of black steel mass)	HI	HI	34%		Material type	Maximize	60%		26%
	Painted surface [m ²]	HI	HI			structural layout, scantlings	Minimize			1.5%
	Longitudinal spacing [mm]	HI		various	various	structural layout	optimized	optimized		

The basic design, performance and stability of the IMPROVED chemical tanker

S. Ehlers¹, K. Kapuścik², H. Khalid³, O. Turan³

1- Helsinki University of Technology, Finland

2- Szczecin New Shipyard, Poland

3- University of Glasgow & Strathclyde, UK

ABSTRACT: This paper accommodates the initial tanker design and outlines its weaknesses from a competitive point of view. In other words, the proven initial design is outlined and the critical, respectively cost intensive, details are discussed. Additionally SSN outlines the new design from a ship yard point of view. This new tanker design will serve as the initial layout for the scantlings optimization using the IMPROVE developments. Furthermore, NAME carried out the seakeeping and stability analyses of IMPROVE Chemical Tanker.

1 INTRODUCTION

This paper presents the expertise of the Szczecin Shipyard (SSN) with respect to chemical and product tankers. The choices of improvements are outlined based on the expertise of SSN and their evaluations. The purpose of the improved design is to lower the amount of duplex steel due to its significant influence on the total cost. The drawings of the initial and improved vessel are presented.

Furthermore, NAME carried out the seakeeping and stability analyses of IMPROVE Chemical Tanker. The regular and stochastic real sea analyses of the vessel are carried out using a 2D strip theory based numerical code. In general, the vessel is expected to exhibit good seakeeping characteristics as most of the worst response modal periods are either far off from the dominant wave periods of operational area or wave headings may be adjusted to avoid severe responses.

2 THE 40 000 DWT CHEMICAL TANKER, B588-III TZPE ND INPUT DATA DESCRIPTION

During 2003 - 2007 eight (8) fully Duplex stainless steel chemical tankers were delivered by SSN for Norwegian owner Odfjell ASA, the one of the biggest chemical tanker operators.

The main data of these vessels are as follows:

- Length o.a. - 182.88 m,
- Length b.p. - 175.25 m,
- Breadth - 32.20 m,
- Depth - 17.95 m,
- Draught - 11.50 m,
- Deadweight - 40 000 DWT,
- Cargo tanks capacity - 52 126 m³,
- Number of cargo tanks - 34 + 6 /deck tanks/,
- Service speed - 15.5 kn,
- Class - DNV.

These vessels are the biggest in the world fully Duplex stainless steel tankers with all cargo tanks / center, wing and deck tanks / made of solid Duplex stainless steel. The vessels have been designed for the niche between product and chemical tankers and as compared to standard chemical tanker have cargo tanks capacity bigger by about 15%. This allows operating the vessels in CPP market utilizing the full deadweight. From the operation point of view the vessels are very flexible thanks to cofferdam bulkheads between center and wing tanks, arrangement of center tanks and deck tanks.

As consequence of such design, building costs for such vessels are very high, mainly due to:

- high lightship weight of the vessels,
- amount of Duplex steel equal to 3 000 t per vessel,
- sophisticated propulsion system,
- amount of cargo tanks and associated piping systems.

In 2007, with very high material cost, building cost of such vessel was on the level 140 mil. USD, that was far above market expectation.

Because the chemical tankers are considered as one of our specialization, Shipyard decided to redesign the B588-III vessel to get the building cost which could be accepted by the market.

The following alternatives have been considered:

Alternative 1

- main dimensions as in original design B588-III,
- wing cargo tanks made of mild steel instead of Duplex steel,
- reduction of number of center cargo tanks from eighteen /18 / to twelve /12 /,
- reduction of service speed to 15.0 kn,
- deleting of shaft generator.

Alternative 2

- reduction of cargo tanks capacity to abt. 45 000 m³,
- deleting of cofferdam bulkheads and replacing them by vertically corrugated bulkheads,
- reduction of depth of the vessel to 15.0 m,
- using of Duplex steel for center tanks only,
- deleting of six / 6 / deck tanks,
- reduction of service speed to 15.0 kn,
- deleting of shaft generator.

Alternative 3

As Alternative 2 except the arrangement of Duplex tanks which are arranged in the middle part of the vessel / wing and center tanks /.

Calculation of building cost done for 2007 condition shows that the most effective cost reduction is Alternative 3, and Shipyard decided to develop this design and optimize it using the IMPROVE tools.

3 THE IMPROVE TANKER

3.1 Design assumptions

The IMPROVE design is based on the following assumptions:

- specific gravity of sulfuric acid varies between abt.1.55 - 1.85 t/m³,
- capacity of Duplex stainless steel tanks should allow to carry a/m
- acid with 50% of consumables, utilizing full deadweight of the vessel,
- total number of Duplex stainless steel tanks to be eighteen /18/ with different capacities

- Duplex stainless steel cargo tanks to be separated from the mild steel cargo tanks by cofferdams,
- longitudinal bulkheads to be vertically corrugated,
- transverse bulkheads to be vertically or horizontally corrugated
 - Connection between longitudinal vertically corrugated bulkheads and transverse horizontally corrugated bulkheads to be subject of FEM analyses
- propulsion system consists of slow speed ME driving directly FP propeller,
- service speed to be 15.0 kn.

Calculation of cargo tanks capacity and arrangements for three /3/ different specific gravities of acid 1.50, 1.65, and 1.85 t/m³ has been performed and is presented in the drawing. For further optimization, cargo tanks arrangement for specific gravity 1.50 t/m³ was taken. The main target for optimization was reducing of quantity of Duplex steel due to a very high price of this material.

The following structures are subject to optimization:

- scantling as shown on drawing Midship Section, see Figure 1,
- transverse bulkheads, horizontally corrugated,
- longitudinal bulkheads, vertically corrugated as shown on Figure 1.

3.2 The improved design

Based on the given assumptions the main particulars of IMPROVE project are as follows:

- Length o.a. - 182.88 m,
- Length b.p. - 175.25 m, Breadth - 32.20 m,
- Depth - 15.00 m,
- Draught - 11.10 m,
- Deadweight - 40 000 mt,
- Cargo tanks capacity / total / - 44 000 m³,
- Number of cargo tanks - 30,
- Capacity of Duplex cargo tanks - 26 800 m³,
- Number of Duplex cargo tanks - 18,
- Service speed - 15.0 kn.

The main frame is given in Figure 1 and the arrangement of the vessel is shown in Figure 2.

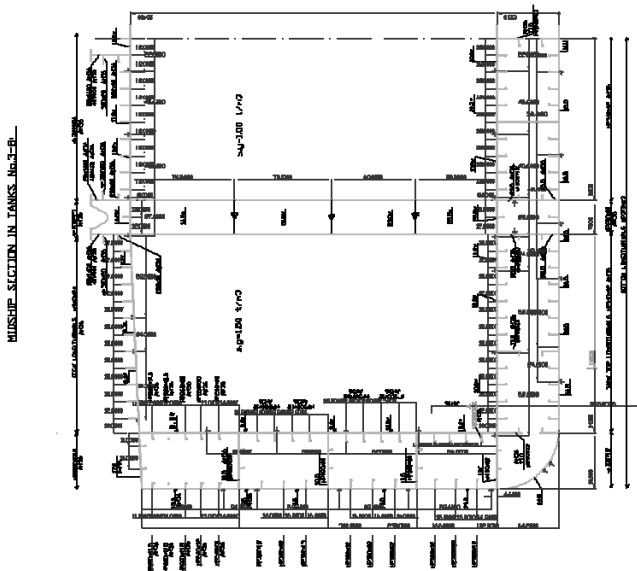

Figure 1. Main frame of the IMPROVE tanker

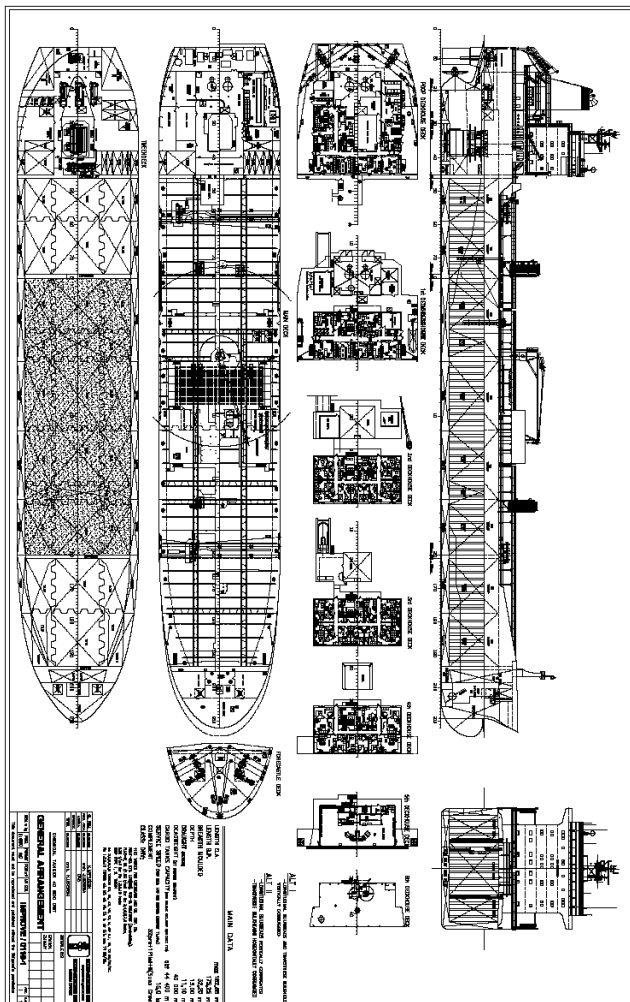

Figure 2. General Arrangement of the IMPROVE tanker

3.3 The Propulsion system

Proposed propulsion system consists of single diesel main engine, low speed, two stroke type,

driving directly FP propeller. Three types of main engines have been evaluated:

- 5S60 - MC - C7,
- 6S50 - ME - B9,
- 6S50 - ME - B8.

Main engine type 6S50 - ME -B9 is chosen for this project.

3.4 Seakeeping and stability analysis

The regular and stochastic real sea analyses of the vessel are carried out using a 2D strip theory based numerical code. In general, the vessel is expected to exhibit good seakeeping characteristics as most of the worst response modal periods are either far off from the dominant wave periods of operational area or wave headings may be adjusted to avoid severe responses. The seakeeping responses evaluated include:

- Response Amplitude Operators (RAOs)
- Root Mean Square (RMS) Motions
- Extreme (1% Probability of Exceedance in 6 hours) Motions
- Motion Sickness Incidences (MSIs)
- Motion Induced Interruptions (MIIs)
- Deck Wetness Probabilities
- Deck Wetness Rate
- Keel Emergence Probabilities
- Keel Emergence Rate
- Most Probable Slamming Pressure
- Extreme (1% Probability of Exceedance) Slamming Pressure
- RMS Horizontal Shear Force
- Horizontal Shear Force Zero-Up Crossing Periods
- Extreme (1% Probability of Exceedance) Horizontal Shear Force
- RMS Vertical Shear Force
- Vertical Shear Force Zero-Up Crossing Periods
- Extreme (1% Probability of Exceedance) Vertical Shear Force
- RMS Torsion Bending Moment
- Torsion Bending Moment Zero-Up Crossing Periods
- Extreme (1% Probability of Exceedance) Torsion Bending Moment
- RMS Vertical Bending Moment
- Vertical Bending Moment Zero-Up Crossing Periods
- Extreme (1% Probability of Exceedance) Vertical Bending Moment
- RMS Horizontal Bending Moment
- Horizontal Bending Moment Zero-Up Crossing Periods
- Extreme (1% Probability of Exceedance) Horizontal Bending Moment

There are 18 sea going conditions defined in the stability booklet of the vessel (Sondaj 2008) with a range of displacements, positions of centre of gravities and trim. There is a large difference in the displacements of ballast and cargo conditions (more than 15 000 Te). In addition, a wide variation (range = 7787.2) is also existing between the cargo condition. It was, therefore, decided to carryout seakeeping analysis for at least three loading conditions corresponding to minimum, mean and maximum displacements

3.5 Hydrostatic and Hydrodynamic

For the analyses carried out, the hydrostatic and hydrodynamic features of vessels given in Table 1 were modelled in the seakeeping software. It may be noted that roll gyration radii for the three loading conditions were assumed to be around 0.35 x moulded beam, whereas, the pitch gyration radii were calculated by the seakeeping software using the detailed breakdown of loads. The later were defined from the stability booklet (Sondaj 2008) to facilitate calculation of structural load (shear forces and bending moments).

Description	LC 003	LC 018	LC 019
Height of centre of gravity	7.24m	8.96m	9.15m
Corrected Transverse Metacentric Height	8.59m	4.42m	4.01m
Dry pitch radius of gyration (calculated)	48.720m	43.188m	43.810m
Roll radius of gyration in water (assumed as 0.35B)	11.270m	11.270m	11.270m

Table 1. Hydrostatic & hydrodynamic parameters of Chemical Tanker

3.6 Analysis procedure

This section of the paper briefly explains the procedure adopted for the seakeeping evaluation of IMPROVE Chemical Tanker. The overall procedure for the estimation of seakeeping characteristics of any vessel is simple two phase problem depicted in Figure 3. The first phase comprises of vessel's response transfer functions, also called response amplitude operators, RAOs; calculations.

In the second phase, RAOs are combined with the irregular sea idealised spectra to estimate RMS, expected

extreme and extreme (1% probability of exceedance) vessel response.

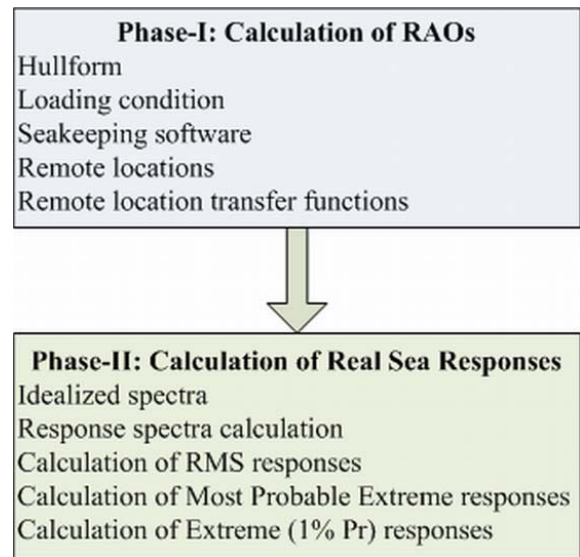

Figure 3. Typical seakeeping analysis phases

4 SUMMARY AND CONCLUSIONS

This paper presents the initial, yet uncompetitive design, of the chemical tanker to be improved. The improvements are presented and discussed from the shipyards point of view. As an example some technical drawings are given. This improved shipyard design serves as a basis for the optimization of the structure in the EU-IMPROVE project.

The stability and seakeeping calculations show that the IMPROVE Chemical Tanker satisfies the stability requirements of applicable rules and regulations.

REFERENCES

- Sondaj, G. (2008). Improve / 042-3: Information on Stability and Longitudinal Strength - Chemical Tanker 40000 Dwt. STOCZNIA SZCZECINSKA NOWA Spółka z o.o. (Ltd). Biuro Projektowe: 112.

The IMPROVED chemical tanker

S. Ehlers¹, A. Klanac¹, H. Remes¹, K. Kapuścik², H. Naar³, J. Andric⁴, V. Zanic⁴, M. Grgic⁴, E. Pircalabu⁵, F. Bair⁶.

¹- *Helsinki University of Technology, Finland*

²- *Szczecin New Shipyard, Poland*

³- *MEC, Estonia*

⁴- *University of Zagreb, Croatia*

⁵- *Design Naval & Transport, Belgium*

⁶- *ANAST, University of Liege, Belgium*

ABSTRACT: This paper accommodates the new chemical tanker design and outlines the design changes identified by SSN. This new tanker design serves as the initial layout for the scantlings optimization using the novel IMPROVE modules for the assessment of design quality in the early design stage. Furthermore, it describes the process of design selection according to the assessed preferences of ship design's stakeholders, namely the shipowner and shipyard. Quality of the selected design alternatives is also analysed through the assessment of ultimate strength of hull girder, strength assessment of structural details, etc. A very important feature of this document is the sensitivity analysis for the discover and established of the general design drivers for such a type of chemical tanker, aiming to give best-practice guidance for future chemical tanker designs.

1 INTRODUCTION

This paper presents the structural optimisation carried out to identify the IMPROVED chemical tanker design. The general IMPROVE design is outlined and identified in details in deliverable 8.1, mainly based on the shipyards identified improvements. The structural optimisation is made with the ConStruct tool to identify the pareto optimal structural solutions fulfilling the service loads and maximum pressure loading per panel. The optimisation includes the identification of the optimal transverse corrugated bulkhead thickness and the optimal longitudinal bulkhead corrugation angle and thickness. Furthermore, the fatigue life and cost IMPROVE module is used during the optimisation.

Furthermore, it describes the process of design selection according to the assessed preferences of ship design's stakeholders. The selected design alternative fulfilling the stakeholders preferences is validated by the the finite element method and with the LBR-5 tool using both Bureau Veritas (BV) rules and maximum pressure loads. The ultimate strength is calculated for the final selected IMPROVE design with the ConStruct tool and the finite

element method for validation. Additionally, the life cycle cost is assessed for the initial design and the IMPROVE design using the LBR-5 tool and the IMPROVE life cycle cost dll.

As a result, the IMPROVE chemical tanker design is obtained and its improvements are summarized.

2 SHIP AND INPUT DATA DESCRIPTION

Within the ConStruct tool, the ship was modeled as a prismatic ship. This was obtained by applying the dimensions of main frame in every sections of ship over its length. The general arrangement of steel structures such as bulkhead locations and stiffener orientation was based on the drawing IMROVE/104, IMROVE/110 and IMROVE/120 provided by shipyard in deliverable 8.1. Ship length was 175 m and breadth about 32 m.

3 STRUCTURAL OPTIMIZATION TO GENERATE PARETO FRONTIER

3.1 Optimization Problem definition

According to preliminary shipyard and ship owner opinions the cost, weight and fatigue life was included as objectives into structural optimization. The knowledge of the relationship between these different objectives was required to obtain reliable techno-economical evaluation of tanker structures, see Figure 1. The relationship between the objectives was determinate using optimization method and “multiple run” approach. In this approach, several optimisation models with fixed and specified weight factors for objectives were run, and as results the Pareto surface was created including all potential candidates for optimum design alternative. Totally 6 different models were run where one, two or three objective were active to obtain coverage of whole design space.

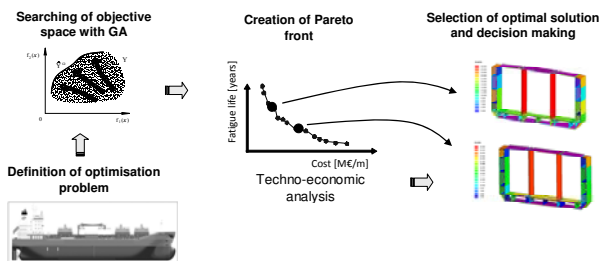

Figure 1. Schematic presentation of techno-economical evaluation of tanker structure using optimisation and decision making

The constraints of the optimization were strength criteria and production requirements according to shipyard specification. Production requirements were considered as minimum and maximum values of the design variable ranges. The tanker structure included totally 22 different stiffened panels, which each have three design variables: plate thickness of a panel, number of stiffeners of panels and stiffener type. In the case of corrugated panel, panel 23, the stiffener was not applied, but shape and height (H) of corrugations was varied. The type of this structure was a corrugated bulkhead without stiffener.

3.2 Loads (Loads (ConStruct tool))

The loading included the vertical bending moment as a global load and dynamic pressure loads as a local load. These loads are specified according to the Shipyard load manual and classification rules (DNV Classification notes No.30.7.). For quasi-static strength evaluation the vertical bending moments were

- $M_{hog} = +2\,933\,000\text{ kNm}$
- $M_{sag} = -2\,410\,000\text{ kNm}$

and for fatigue loading

- $M_{hog} = +1\,593\,000\text{ kNm}$
- $M_{sag} = -1\,708\,600\text{ kNm}$

The fatigue loading corresponded to probability level 10⁻⁸, and Weibull shape parameter equal to 1.034 was applied describing the long-term stress distribution during ship life. The pressure includes the loads due to wave-induced external pressure and the deck load due to ship motions. The pressure loads were modeled as uniform pressure acting at each stiffened panel, see Figure 2 and 3. Quasi-static and dynamic pressure loads were applied strength and fatigue analysis, respectively.

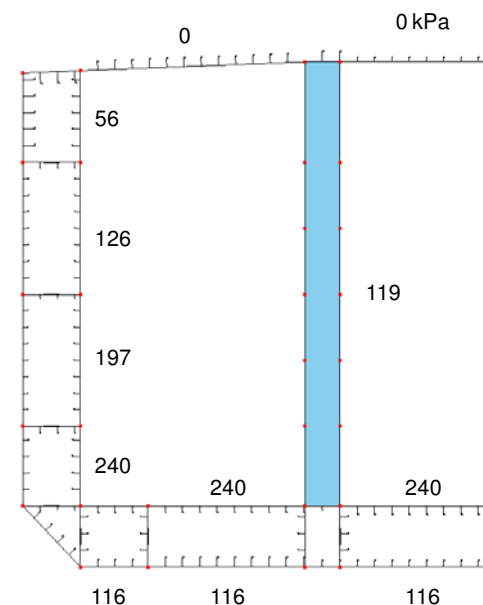

Figure 2. Quasi-static pressure loads for each stiffened panel.

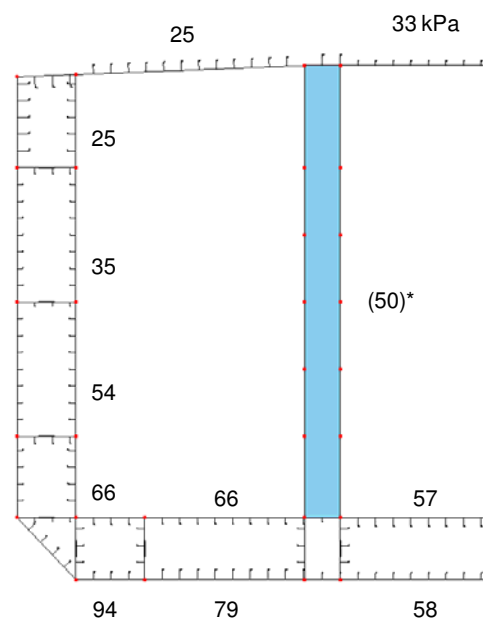

Figure 3. Dynamic pressure loads for each stiffened panel.

3.3 Optimization of longitudinal structure

The response is divided into two parts: global and local analysis. The global analysis was carried out ConStruct tool using CB-method (Naar et al., 2004). This analysis determines the boundary forces of stiffened panel, which were used in the local analysis. The local analysis was carried out using the fast analytical approaches (Mantere, 2007) and IMPROVE Fatigue module, see Deliverable T3.3. The analysis covered yielding and buckling of the plate and stiffener as well as fatigue strength.

3.4 Fatigue

The IMPROVE Fatigue module, see Deliverable 3.3, is used to assess the fatigue strength of the structural details corresponding to notch stresses are specified by S-N curve. Initial point for selection to design S-N curve was IIW recommendation (Hobbacher 2007). Up to this, an additional safety factor equal to 1.6 was included. Thus, the parameter of S-N curve is: $C=5.75E+12$ and $m=3$. These values are also equal to DNV Classification notes No.30.7. Allowed value for accumulated damage ratio equal to 1 is applied. The response of hull girder is evaluated using ConStruct design tool and CB-method for fatigue loads at 10-8 probability level. The notch stress and fatigue analysis are carried out using IMPROVE fatigue module. The fatigue analysis applies a linear cumulative damage theory, and result in a damage ratio D . The estimated fatigue life N is calculated from damage ratio and its design value D_{cri}

$$N = N_D \cdot \frac{D_{cri}}{D}, \text{ where } N_D \text{ is design life.}$$

3.5 Ultimate strength

The ultimate strength of the final selected IMPROVE design alternative according to the structural optimisation is investigated using non-linear coupled beam method (Naar, 2006), which is a further development of the linear coupled beam method. The method is based on the assumption that the ship structure can be modeled as a set of coupled beams, see Figure 4. Each deck in the hull structure is considered as a thin-walled beam. The beams are coupled to adjacent beams with non-linear springs called vertical and shear members, modeling the stiffness properties of the longitudinal bulkheads and side shells. The non-linear structural behavior of the each beam is modeled with help of the load-end shortening curves. The method enables one to estimate the non-linear response and ultimate strength of hull girder subjected to longitudinal bending.

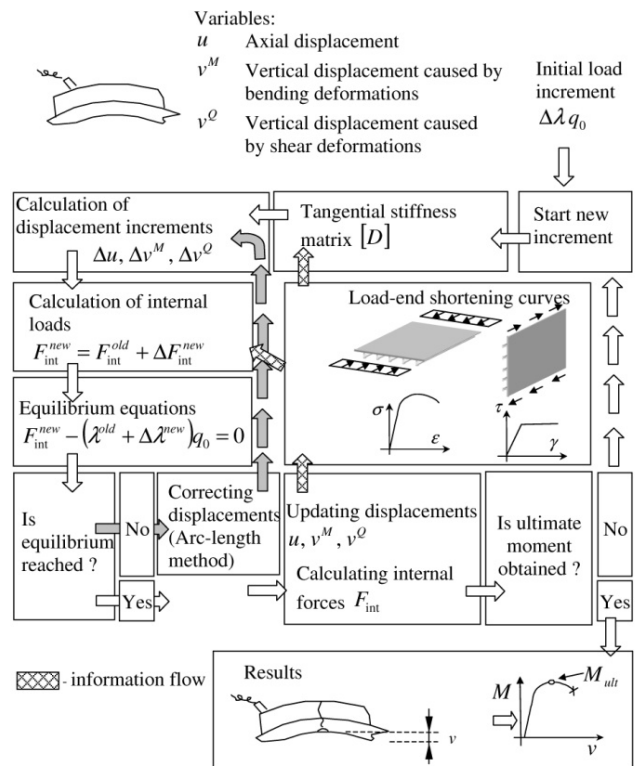

Figure 4. Flow chart of the non-linear CB-method (Naar 2006)

3.6 ConStruct limitations

The ConStruct tool aim is to assess the longitudinal strength of hull girder, and thus, it includes only vertical bending for the response evaluation of the hull girder. Therefore, torsion and horizontal bending were neglected in the present analysis.

3.7 ConStruct results

Figure 5 shows the relationship between fatigue, cost, and weight. It is interesting to observe that relationship between fatigue life and cost are almost linear. For design alternative with 30 years fatigue life, the ultimate strength is also clearly increased compared to minimum weight design, but in this case the cost and weight are also increased, from 10% to 15%.

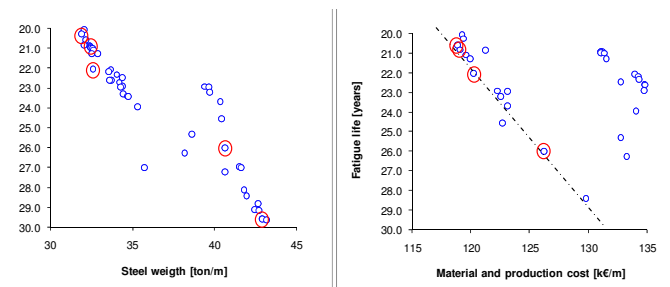

Figure 5. Pareto optimal solutions showing the relationship between fatigue, cost, and weight. The selected potential and interested design alternatives are marked with circles

3.8 Ultimate strength results

The ultimate strength of the selected candidates was evaluated with non-linear CB methods. The results of the analysis are given in Figure 6, and the values of ultimate strength are compared to design moment in hogging and sagging condition. In the case of minimum weight and cost design the margin of ultimate strength to design moment is about two. For design alternative with 30 years fatigue life, the ultimate strength is increased having value 2.5.

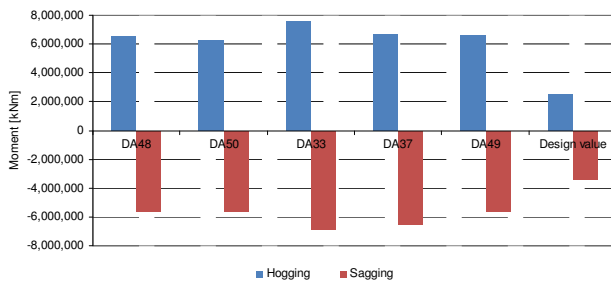

Figure 6. Results of the ultimate strength analysis compared to design loads

3.9 Transverse bulkhead optimization

Structural optimizations of a horizontally corrugated transverse bulkhead (TBHD) made of duplex steel (5000÷6000 €/tons) were performed by University of Zagreb (UZ). Structural optimization was performed based on partial two hold 3D FE MAESTRO model of chemical tanker (CT), Figure 7. Bulkheads plating were represented by the standard Q4 shell elements. Geometry of the corrugation was defined by SSN and remained constant. Plate thicknesses of corrugations were used as design variables. Design variables, n_v , were identified in central tank ($n_v=17$) and in wing tanks ($n_v=18$). Structural design constrains based on yield and buckling, in-built in MAESTRO, were used and their safety factors were adjusted according to the BV Rules. Twelve load cases were formed from two critical loading conditions (alternate and chessboard loading) using BV load case requirements (upright “a”, “b” and inclined “d” case).

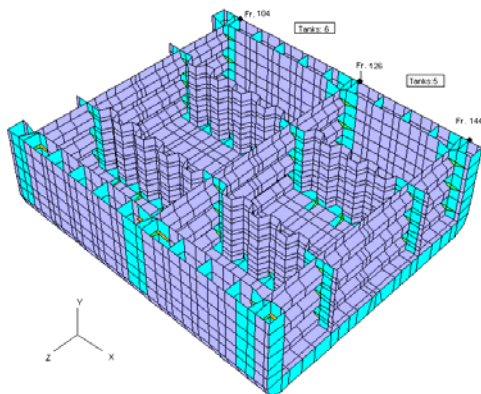

Figure 7. Two hold FE model horizontal corrugation

Optimization was performed using MAESTRO dual SLP optimizer. Optimization history regarding mass changes, including the scantling standardization cycle no. 8, is presented in Figure 8.

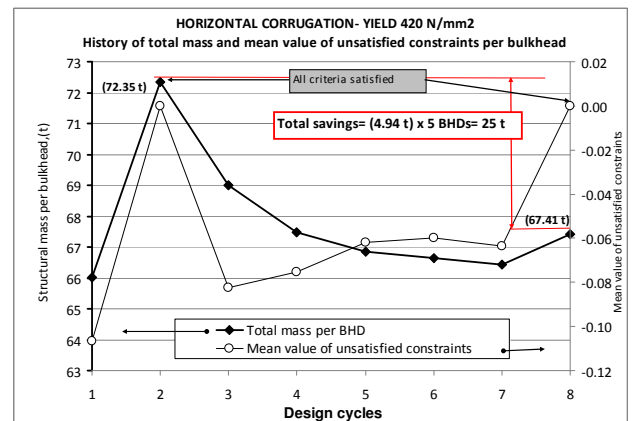

Figure 8. Optimization history

4 DESIGN SELECTION

From the created set of Pareto optimal alternatives, we need to select now one design alternative as a recommendation for stakeholders as the best compromise for their preferences. The multi-stakeholder decision-making methodology is applied for this purpose (Klanac et al. 2007). In its extensive form, the methodology combines data on stakeholder preferences, obtained through semi-structured interviews with stakeholders, with formal assessment of stakeholder utility functions. Once the stakeholder utility functions are established, utilities of Pareto optimal design alternatives are conflicted in the utility space. In the end, the alternative which is the best compromise for both stakeholders is identified using the concept of *Competitive optimum*.

4.1 Assessment of stakeholder preferences

Stakeholder preferences towards generated design alternatives have been elicited through a series of action, most notably through the semi-structured interviews. However, prior to this, we identified the relevant design drivers for both stakeholders, e.g. minimize the mass of duplex steel, maximize fatigue life, etc. The extensive evaluation of these drivers and their measures, i.e. the Key Performance Indicators, had been performed in deliverables D2.1 and D2.2. These KPIs are the key for defining the formal preference of a stakeholder towards a design alternative. Instead of observing its descriptors, i.e. the design variables, stakeholders effectively observe design characteristics, and based on this performance determine their preference. After performing interviews and their transcription, a formal design framework was established through which stakeholder multi-attribute utility functions

could be determined. These functions, in the end, serve as the basis for multi-stakeholder decision-making.

4.2 Interviews

Two set of interviews had been performed with stakeholders. First interviews were performed to confirm the indicated design drivers, the KPIs and also get a better insight into what is expected from the improvements in hull structure through optimization. Second set of interviews followed after structural optimization was made, and after several alternatives were identified as the potential good compromises for both stakeholders.

The first set of interviews resulted in the following findings.

- Owner does not take part in the conceptual structural design of the vessel, but is interested in her characteristics. Specifically, that the vessel in operation is safe, that there are no cracks in the structure and that there is no need for repainting.
- Other characteristics related to safety, e.g. ultimate strength is of no relevance to the owner, but it is covered with the previous statement that the vessel should be safe.
- The lightweight mass of the vessel is also of no particular concern for the owner since vessels are usually purchased as existing projects which guarantees their capacity, or deadweight.
- Due to the requirements for cargo capacity and safety (chemicals), yard is especially interested in controlling the mass of the hull and in its fatigue characteristics to maintain a higher reliability of ship structure.
- Fatigue is typically controlled through design of structural details since loss of cargo capacity is not preferred
- Loosing 1000t of capacity for a vessel is huge!
- In case that owner is interested in increased vessel's structural safety, this is reflected in the ship price. The ship price is not standard but is based on the calculations founded on observed vessel design

The second set of interviews, with respect to the results of optimization, yielded the following findings

- Owner expresses no interest to increase the fatigue life beyond required minimum, set by class, since it becomes difficult to find cargo for the vessel older than 15 years.
- On the other hand, it makes sense to increase the reliability of the vessel, but the vessel's capacity should not be sacrificed, and it should not cost any

significant amount. The re-design should concentrate on the structural details, and on painting.

- The yard mentions, from the experience of dealings with chemical tanker owners, that the fatigue life of this chemical tanker should be 30 years (40 years is too long, and 25 too short). There is a special class for a 30-year fatigue life vessel.
- Chemical tanker owners are in principle not selling for the reasons to avoid creation of competition. Thus they maintain and use their vessels until the scraping
- Yard estimates the upper value of investment into one year of fatigue life to be 100 000 EURO.

4.3 Definition of the multi-attribute utility functions

The second set of interviews obviously returned somewhat contradicting views of the Yard and the Owner, and not necessarily such as would have been expected. This precisely refers to the aspect of fatigue life increase and views on the profitability of such an endeavour. Furthermore, based on the results of optimization and on the finding of the interviews, we assume the following. These assumptions are necessary to determine the utility functions.

- Chemical tanker is designed in the 'small' market, meaning that there are firm market prices established for the vessel type, and also that there are no direct competitors involved in the process of negotiation. Two design scenario are anticipated in this spirit:
 1. High returns are expected from the increase in fatigue life (based on the conclusions of the 2nd interview with the Yard). One year of fatigue life is valued at 1M€.
 2. Low returns are expected from the increase in fatigue life (based on the conclusions of the 2nd interview with the Owner). One year of fatigue life is valued at 100k€.
 3. Fatigue is not to be increase¹. Value of one year of additional fatigue life equals 0€.
- Three attributes are considered here: the mass of hull, the costs required to produce it and the estimated fatigue life. They are observed by the two stakeholder in the following context:

¹This scenario is tried for the sense of validation of results.

- The yard:
 - Minimize production costs, but with intention that all extra production costs to that of the standard minimum mass design are transferred to the owner
 - Do not significantly decrease the cargo capacity
- The owner:
 - Increase fatigue life
 - Do not significantly decrease the cargo capacity
- Both owner and yard engage in value exchange, meaning that costs induced by the desire to increase benefits will be shared. We employ for this reason two probabilities p_{12} and p_{21} where first is the chance that the owner will accept the added ship price for the increased fatigue life, and it is based on the increased production costs of the yard. The second p_{21} is the chance that the yard accepts the penalties for the lost deadweight caused by the mass increase.

Stakeholder preferences are represented now in the space of stakeholders' utilities $\mathbf{Z} = \mathfrak{R}^m$, where utility $u_j(\mathbf{x})$ formalizes the ranking of design alternative (DA), \mathbf{x} , for every stakeholder $j \in [1, m]$, where $m = 2$. Utility indicates cardinal ordering of alternatives, where higher the utility, higher the preference, or the ranking of the alternative. If multiple attributes influence onto alternative's ranking, as is the case here, the utility function needs to have the multi-attribute form

$$u = f \{r_1 [y_1(\mathbf{x})], \dots, r_n [y_n(\mathbf{x})], k_1, \dots, k_n\}$$

where r marks the preference of the attribute value $y(\mathbf{x})$, often noted as the marginal utility, and k is a scaling constant indicating contribution of a particular attribute. Thus, the multi-attribute utility of an alternative is a joint outcome of the preferences over n attribute values.

The first step in the assessment of utility functions is to choose for every stakeholder their reservation and aspiration values of attributes. These lead to form the reservation and aspiration points.

Klanac et al. (2006) and Klanac et al. (2007) propose three fundamental conditions to be satisfied by the alternative \mathbf{u}^* that maximally satisfies stakeholders' preferences in ship design process. The presumption now is that we can use the same concept to estimate the quality of generated design alternatives with respect to the satisfaction of ship designers' preferences. See also deliverable D2.5 for more info on the selection conditions.

The resulting design alternative are addressed as the *Competitive optimum* (CO). The wording 'competitive' leads from the assumed competitive relationship amongst the stakeholders. CO is therefore a strongly Pareto optimal member of the minimal contour of the weighted Chebyshev metrics, see Figure 8b. Since CO is obtained following normalization, in Figure 8a we can see the equivalent, non-normalized position of the CO.

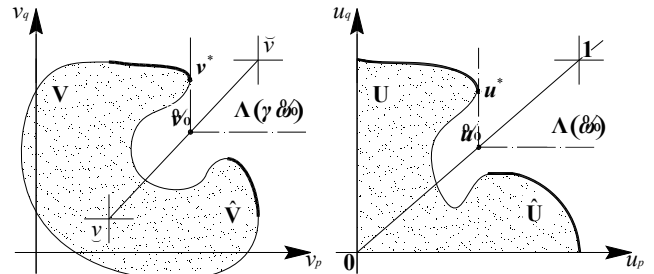

Figure 8: Competitive optimum in a) original and b) normalized problems for some p and q designers

4.4 Design selection

First, we assume a standard distribution of cost – according to the results of the interviews, where any of the generated additional production costs for the Yard are transferred to the Owner. Now, the algorithm seeks for each of the three valuations of fatigue life increase (see assumption 'b') the optimal compensation factors' values which increase the most the yard's and owner's utilities and in that sense identify the best design alternatives. The results are the following

Design scenario	Value of 1 year of fatigue life increase [k€]	DA	Quality index	P1	P2	P1P2
1	1000	4	0.28	0	1	
2	100	4	0.45	0	1	
3	0	48	0	0	1	

Added fatigue life [year]	Deadweight loss [t]	Yard's financial gain [M€]	Owner's financial gain [M€]
6.75	684	0	6.4
6.75	684	0	6.4
		0.05	0.1890

Table 1. Proposed Competitive Optima for three design scenarios.

In the table we can also see the overall design quality index which indicates with one value how far away is the selected design from the maximum satisfaction of yard's and owner's utilities. It also indicates how big are the compromises that these stakeholders need to undergo to select this design alternative. The smaller the value the better.

5 VALIDATION OF THE PARETO OPTIMA

5.1 Finite element simulations

To validate the ConStruct pareto optimum result a detailed finite element analysis is carried out by MEC. The finite element model includes tanker structure with the length of 73.4 m. The structure is loaded with external water pressure, cargo pressure and boundary moments. In total six loading cases are analysed. Also accelerations are included where necessary by including them into gravity constants and calculating the equivalent pressure based on gravity. Loading set up is shown in Figure 9.

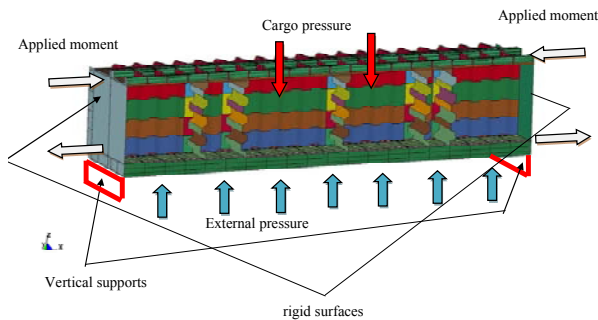

Figure 9. Loading setup of the FE-model

The finite element model is defined with the element size suitable also for ultimate strength estimation. In total the model has about 1.6 million nodes and 1.75 million elements. The plating and T-profiles are modelled with four node shell elements. HP-profiles are modelled with combination of plate and beam elements. An example of the model is presented in Figure 2. In total 6 loading conditions are according to Bureau Veritas are analysed. An example of the resulting stresses are given in Figure 10.

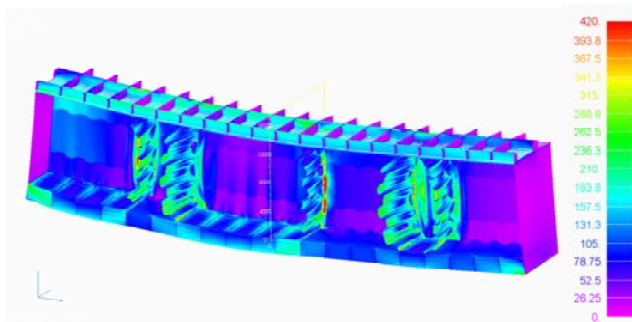

Figure 10. Von-Mises stress in the longitudinal bulkhead

5.2 LBR-5

The optimised scantlings are validated with LBR-5 – an optimisation software developed by ANAST and DN&T – to study if LBR-5 constraints are violated or not. At first, the analysis is done with loads defined by ANAST and *Bureau Veritas*. In the second part the ConStruct loads are used.

5.3 Life cycle evaluation

In the framework of IMPROVE a Life Cycle Cost (LCC) Module has been developed by NAME. This module estimates the life cycle cost in a simplified fashion. The module has been implemented into the LBR-5 software to be used as new objective function. As a result, this evaluation shows that the life cycle cost is not influenced significantly by the optimised structural design.

5.4 Seakeeping and stability analysis

The regular and stochastic real sea analyses of the vessel are carried out using a 2D strip theory based numerical code. In general, the vessel is expected to exhibit good seakeeping characteristics as most of the worst response modal periods are either far off from the dominant wave periods of operational area or wave headings may be adjusted to avoid severe responses.

The calculations show that the IMPROVE Chemical Tanker satisfies the stability requirements of applicable rules and regulations.

6 SUMMARY AND CONCLUSIONS

The total weight reduction after the structural optimization is 10% compared to the initial shipyard design. This fact, besides the possibility to increase the fatigue life or the ultimate strength of the concept structure, clearly indicates the benefit of the optimization done in the EU-IMPROVE project. The general optimization is made with the ConStruct tool, which is however limited to the longitudinal structural members. Therefore, the transverse bulkhead optimization is carried out with MAESTRO. This results in a decrease in weight of the bulkhead of 5t compared to the prescribed prototype design with all structural constraints being satisfied. The total savings for five duplex made transverse bulkheads of about 25 t can be expected with cost benefit of up to 150 000 €, showing the rationale of preliminary design phase optimization procedure.

The 3D finite element stress analysis unveiled that the global strength of the structure is sufficient. However, the shear stresses at maximum shear force locations exceeding the limit value slightly. This is a result of the missing ConStruct capability to change the thickness of the corrugated bulkhead in horizontal direction. Therefore, the longitudinal bulkhead was optimised separately and therefore the shear stiffness of this bulkhead was reduced. Due to this the bulkhead carries less shear load than in case of ConStruct model. High local bending stresses are generated also in the crossing of transversal and longitudinal bulkheads. To reduce the stress the plate thickness can be

increased in the bulkhead crossing only. Another option is to increase the stiffness of transversal bulkheads, resulting in a higher bending stiffness. However, these aspects are to be considered in the detail design stage. From a conceptual design stage of view, this IMPROVED structure represents a significant improvement over the initial shipyard design.

As a result of the structural optimization and decision making process we can conclude the following:

- a) If fatigue improvement is not important, then light weight design is good, which is expected.
- b) If fatigue is to be improved, and the owner is willing to pay 100k€ or 1M€ for 1 year of increase, than it would be rational to accept the design alternative 4 with the improvements of 6.7 years in fatigue life. Higher investments would prove to be too high for the owner.
- c) In both cases when there is a desire to increase the fatigue life, it seems that the quality of the engineered design alternatives is not as good as with present design, meaning that considerable reservations from the stakeholders are possible to accept proposed solution.

REFERENCES

- Hobbacher, A., 2007, IIW Joint Working Group XIII-XV. 2007.2007. Recommendations for fatigue design of welded joints and components. IIW document XIII-2151-07 / XV-1254-07. Paris, France.
- Mantere, H. 2007. Strength Analysis for the Design of Local Ship Structures in Concept Stage. Master's Thesis. Helsinki University of Technology, Department of Mechanical Engineering, Ship Laboratory. Espoo.
- Naar, H.; Varsta, P.; Kujala, P. 2004. A theory of coupled beams for strength assessment of passenger ships. Marine Structures, Vol 17, No. 8, p. 590-611.
- Naar, H. 2006. Ultimate Strength of Hull Girder for Passenger Ships. Doctoral dissertation. TKK Dissertations 22. Helsinki University of Technology, Department of Mechanical Engineering, Ship Laboratory. Espoo.
- Klanac, A., Jalonen, R., Varsta, P. 2007, Multi-stakeholder decision-making in the risk-based design of a Ro-Pax double bottom for grounding, Journal of Engineering for the Maritime Environment, Vol 221, No. 1, p. 1-15.
- Klanac, A., Jelovica, J., Niemeläinen, M., Damagallo, S., Remes, H., Romanoff, J. 2008, Structural Omni-Optimization of a Tanker, Proc. 7th International Conference on Computer Applications and Information Technology in the Maritime Industries – COMPIT '08, Liege, Belgium.
- Remes, H., Klanac, A., Varsta, P., Ehlers, S., ConStruct – Platform for Conceptual Structural Design. IMPROVE-Final Conference, Dubrovnik, Croatia 17-19. Sept. 2009.

CONCLUSIONS

Final Conclusions of Workshop

Workshop was subdivided into two main themes:

(1) *Methods and Tools*

(2) *Application cases - IMPROVED Products*

Each theme presentation was preceded by invited lecture given by the most respectable persons in the field:
Prof. O. F. Hughes from United States regarding Ship Structural Design,

Prof. K. Levander from Finland regarding General Ship Design,

to contrast the global trends in the field with the IMPROVE achievements.

1. Methods and Tools - Results

The results obtained in WP3, WP4 and WP5 are presented in the corresponding Chapters of this Proceedings. Detailed conclusions for each of the work packages / tasks are presented in the form of summaries and recommendations based upon the performed work in the closure of the Chapter.

The IMPROVE methods and tools, oriented to concept design phase (pre-contract phase), were underlined as very important, due to the fact that in that phase the most important decisions are made and approximately 80 % of assets have to be fixed. All of decisions, usually done by the most experienced designers, have to be based on small amount of data available, large uncertainty and lower fidelity mathematical models.

2. Application cases: IMPROVED Products

Results obtained in WP6, WP7 and WP8 are presented in the corresponding Chapters of this Proceedings. Achievements obtained using IMPROVED tools and methods are summarized for three examined ships: LNG, Ro-Pax and Chemical Tanker and corresponding conclusions were derived.

Key Performance Indicators (KPI) were evaluated and compared to those obtained with standard design procedure. Results were subdivided concerning two basic design aspects: general ship design level and structural design level. Also, the influence of structural solutions on ship performance was investigated in more detail to obtain competitive designs for the future.

3. Final Conclusions expressed at the Closing Session of the IMPROVE Workshop

- O. F. Hughes, keynote lecturer: IMPROVE is a unique forum where shipyards, ship-owners and universities share the same interest. Therefore the IMPROVE spirit has to be continued (for instance using the “User Group” as support).
- K. Levander, keynote lecturer: Optimizing a ship is not only reducing cost (expenses). Increasing the benefits can in fact be more effective. Innovative approaches have to be encouraged. Innovations that increase money making potential of ship are the key issue for success in ferry/cruise ship market.
- STX Europe will use the new technology/concept (ballast free), developed within IMPROVE, for other ship sizes (smaller) → new market seems to be occurring.
- Grimaldi Group proposes to study the feasibility of a 10 (20) years guaranty concept that the shipyard may propose to ship-owners. With such guaranty, ship-owners will be more prone to accept higher cost as they have the guaranty of the live cycle cost (no bad surprise can happen). As there is no guaranty that the shipyard will still be “alive” after 10 or 20 years, it is proposed that instead of the shipyard, a specific organization will provide this service, including the maintenance (as a garage for the cars).
- Uljanik Shipyard will continue to use of optimization approach in collaboration with UZ to make reliable and competitive products. Uljanik will also consider implementation of IMPROVE tested production/simulation tools into practice.

- BV: IMPROVE sloshing module is correlated with the new BV Sloshing Rules. Development will be continued and the module will be constantly improved and calibrated with new data for model and full scale measurements.
- University of Liege, U. of Glasgow and Strathclyde and U. of Zagreb highlighted the importance of life cycle cost and maintenance for future developments, but the scope should not be limited to hull structure and must be extended to equipment and painting.
- TKK: Implementation of stakeholder's preferences into design is opening a new opportunity for design process and raising a lot of open questions how to handle different preferences.
- Corrosion of ballast, and therefore the plate replacement cost can be totally avoided if good and reliable coating is considered (as done on LNG).
- Following the Balance proposal, the Helsinki University of Technology will lead the new User group's platform for validation and verification of modules developed through IMPROVE project. Maybe Coordination of Action can be r
- ANAST: The Users Group (virtual IMPROVE WP 10) will enable platform for further testing of optimization tools. Future PhD candidates will be attracted to work on platform. Also, cooperation and sharing knowledge in the area of structural optimization will be promoted. Better definition of stakeholder preferences and understanding of ship-owner requirements will be one of challenging tasks.
- UZ: emphasized the importance and convenience or risk based methods in multi-criteria Decision Making. Also, the vibration aspects have to be improved as well as the fatigue assessment. Nonlinear structural analysis methods are becoming the real challenge of the Decision Support Procedures in ship design.
- Partners in EU FP project for the first time (UZ, ULJ, TPZ) have underlined the importance and benefits of being the part of common EU research area (ERA) and to work on the joint projects. The mutual benefits from the joint work with partners from all over the EU have been expressed.
- Life Cycle Cost (LCC) as design criterion will become more and more important and EU shipbuilding industry has to develop projects following that request. Collection of data still seems to be very difficult issue. It is very hard to collect reliable data necessary to develop a model for maintenance and production simulation. But the effort is worthwhile since the ship-owners are willing to pay more for the acquisition cost if, at the end, the Life Cycle Cost will be lower. This was, anyway, the essence of the IMPROVE project.

Finally, today, to develop complex ships with the added value, close cooperation between all stakeholders (ship-owners, shipbuilders, etc.) is necessity rather than an option. IMPROVE project has proven, that using proposed approach, complex ships performance could be improved regarding structural aspects that at the end are influencing production and operational costs and gave benefits for both stakeholders - shipyards and ship owners.

Note: Proceedings with the short articles regarding summary of achieved results presented at the Workshop have been prepared within Task 9.3. In addition, the CD-Rom was developed, with a pdf copy of the Proceedings and also with all PowerPoint presentations of partners and invited lecturers.