

The University of Tokyo
Graduate School of Engineering

**A New TDMA-based MAC Protocol to Achieve
High Reliability of One-hop Broadcast in
Vehicular Ad Hoc Network**

(車車間アドホックネットワークにおける
1 ホップブロードキャスト転送の信頼度を
向上可能とする TDMA ベース新 MAC プロトコル)

A Thesis in
Department of Electrical Engineering and Information Systems
by
Han Fei

Supervised by
Prof. Wakahara Yasushi

© 2015 Han Fei
Master of Engineering
February 2015

Abstract

Vehicular Ad Hoc Network (VANET) is considered one of the most promising Mobile Ad Hoc Network (MANET). One-hop broadcast which is time-triggered plays a leading basic role in VANET. Since the primary applications in VANET are life-safety related, there is a strong need of high reliability related to packet transmission and reception. Though IEEE 802.11p has been defined as an international standard for VANET, IEEE 802.11p has in practice some limitations in terms of reliability. Then, other MAC protocols such as MS-Aloha have been proposed to achieve higher reliability. MS-Aloha has become recommended by ETSI after evaluation, making it a promising substitute to IEEE 802.11p. However, because of inefficient use of radio channels and the problem of continuous blockings, the reliability of MS-Aloha is still not satisfying especially under very congested traffic conditions.

In this thesis, a new MAC protocol named Reliable TDMA-based One-hop Broadcast (RTOB) is proposed. RTOB takes MS-Aloha as groundwork, inheriting all its advantages, which makes it advanced and easy to be applied. Compared with MS-Aloha, RTOB can achieve much higher reliability by two principles – Efficient Timeslot Usage (ETU) and Timeslot Sharing (TSS). Moreover, to evaluate the reliability from the viewpoint of life-safety applications, a novel metric named Cover Ratio (CR) which is more appropriate than the conventional Packet Delivery Ratio (PDR) is proposed too. The definition and advantages of CR are given out.

Besides the explanations of the main principles of RTOB, via computer simulation, this thesis quantitatively demonstrates its sufficiently high reliability under congested traffic conditions, no matter in urban, rural or highway scenarios.

Table of Contents

Acknowledgments	v
Chapter 1	
INTRODUCTION	6
1.1 Background	6
1.1.1 Vehicular Ad-hoc Network	6
1.1.2 Dedicated Short-range Communications.....	6
1.1.3 Cooperative Awareness Message.....	6
1.2 Motivation and Goal.....	7
1.3 Organization of The Thesis	7
Chapter 2	
RELATED WORKS	8
2.1 IEEE 802.11p	8
2.2 STDMA	9
2.3 MS-Aloha	12
2.4 Other MAC Protocols	14
Chapter 3	
NEED OF HIGH RELIABILITY	15
3.1 The Reason Why Take MS-Aloha as Groundwork	15
3.2 Flaws of MS-Aloha	15
3.2.1 Inefficient Timeslot Usage	15
3.2.1.1 Low Spatial Timeslot Reuse	16
3.2.1.2 Single Frame Reference for the Judgment on the Use of Timeslot	16
3.2.1.3 Inefficient Timeslot Reallocation in Case of Collision	16
3.2.2 Continuous Blockings.....	16
Chapter 4	
PROPOSED PROTOCOL – RTOB	17
4.1 Efficient Timeslot Usage	17
4.1.1 Higher spatial TS reuse.....	17
4.1.2 Multiple Frames Reference.....	17
4.1.3 Efficient Timeslot Reallocation	18
4.2 Timeslot Sharing.....	19
Chapter 5	
METRICS FOR EVALUATION	23
5.1 Existing Metrics	23
5.1.1 Packet Delivery Ratio	23
5.1.2 Data Reception Rate.....	23
5.1.3 Channel Utilization	23
5.2 Proposed Metric – Cover Ratio	23
5.2.1 Definition	24
5.2.2 Comparison with PDR	24
Chapter 6	
EVALUATION	26
6.1 Overhead and Cost to Apply.....	26
6.2 Computer Simulation	26
6.2.1 Simulators, Settings and Scenarios	26
6.2.2 Result	31
6.2.2.1 Scenario 1 (urban)	31
6.2.2.2 Scenario 2 (rural)	33
6.2.2.3 Scenario 3 (highway)	35
6.2.3 Analysis.....	37

6.2.4	The Effect of Scaling-down	38
Chapter 7		
FURTHER CONSIDERATION – PACKET COLLISION PREVENTION		40
Chapter 8		
CONCLUSIONS		41
Bibliography		42
Publications		43

Acknowledgments

Sincerely I want to thank my instructor, Professor Wakahara Yasushi. Without his earnest and patience, I would not have finished this thesis. I also appreciate the help from Assistant Professor Miyamoto Daisuke. They taught me not only the attributes of real researchers, but also the right way to be a useful person.

Chapter 1

INTRODUCTION

1.1 Background

1.1.1 Vehicular Ad-hoc Network

A Vehicular Ad-hoc Network (VANET) uses vehicles as mobile nodes in a Mobile Ad-hoc Network (MANET) to create a mobile network [1]. A VANET turns every participating vehicle into a wireless router or node, allowing vehicles approximately 100 to 300 meters of each other to connect and, in turn, create a network with a wide range. As vehicles fall out of the signal range and drop out of the network, other vehicles can join in. Automotive companies like General Motors, Toyota, Nissan, DaimlerChrysler, BMW and Ford promote this term.

1.1.2 Dedicated Short-range Communications

Dedicated Short-range Communications (DSRC) are one-way or two-way short-range to medium-range wireless communication channels specifically designed for VANET [2] and a corresponding set of protocols and standards.

In October 1999, the United States Federal Communications Commission (FCC) allocated 75 MHz of spectrum in the 5.9 GHz band to be used by VANET [3]. In August 2008, the European Telecommunications Standards Institute (ETSI) allocated 30 MHz of spectrum in the 5.9 GHz band for VANET [4].

1.1.3 Cooperative Awareness Message

The Cooperative Awareness Messages (CAMs) provide information of presence, positions as well as basic status of communicating VANET nodes to neighboring VANET nodes that are located within a single hop distance. All VANET nodes shall be able to generate, send and receive CAMs, as long as they participate in (Vehicle to Vehicle) V2V or (Vehicle to Infrastructure) V2I networks. By receiving CAMs, the VANET nodes are aware of other nodes in its neighborhood area as well as their positions, movement, basic attributes and basic sensor information. At receiver side, reasonable efforts can be taken to evaluate the relevance of the messages and the information. This allows VANET nodes to get information about its situation and act accordingly.

With CAMs, there are many applications which can be realized. Among them, life-safety applications are the hotspot of research.

Below are some main life-safety applications:

- Traffic Signal Violation Warning
- Curve Speed Warning

- Emergency Electronic Brake Light
- Pre-Crash Sensing for Cooperative Collision Mitigation
- Cooperative Forward Collision Warning (FCW) System
- Left Turn Assistant
- Lane Change Warning
- Stop Sign Movement Assistant
- Security Requirements for High-Priority Applications

1.2 Motivation and Goal

In VANET, the life-safety applications utilizing CAMs are considered important to guarantee safe driving, and one-hop broadcast plays a leading basic role in those applications. Thus, there is a strong need of high reliability related to packet transmission and reception since those applications are life-safety related. Though IEEE 802.11p has been defined as an international MAC layer standard for VANET, IEEE 802.11p has in practice some limitations in terms of reliability in broadcast. Therefore, many new MAC protocols have been proposed from which some classic ones will be introduced in Chapter 2. However, they all have particular limitations compromising the reliability. Thus to design a new MAC protocol of high reliability in different scenarios is the goal of this thesis.

1.3 Organization of The Thesis

In Chapter 2, some classic MAC protocols including the international standard IEEE 802.11p for VANET are introduced. Another MAC protocol MS-Aloha is specially introduced in detail. Because the understanding of MS-Aloha is significant to the understanding of the whole mechanism of the proposed MAC protocol Reliable TDMA-based One-hop Broadcast (RTOB) in this thesis. In Chapter 3, the reason why MS-Aloha is taken as the groundwork of RTOB is explained. And the two flaws of MS-Aloha which are supposed to be revised are pointed out too, from the viewpoint of improving reliability. In Chapter 4, the mechanism of the proposed MAC protocol RTOB in this thesis is specifically explained. In Chapter 5, the existing metrics which are commonly used to evaluate the reliability are shown, and a novel metric in this thesis named Cover Ratio (CR) is also defined and analyzed. CR was proposed from the viewpoint of life-safety applications, which makes it more proper to evaluate the reliability of a MAC protocol than other existing metrics. In Chapter 6, RTOB is evaluated in terms of overhead, cost and reliability. The means to evaluate its reliability is using computer simulation and comparing the simulation results with MS-Aloha. In Chapter 7, a possible study aiming to realize packet collision prevention is explained, which can be a future work. Finally in Chapter 8, conclusion of this thesis is given.

Chapter 2

RELATED WORKS

2.1 IEEE 802.11p

IEEE 802.11p is an approved amendment to the IEEE 802.11 standard to add wireless access in vehicular environments (WAVE), a vehicular communication system. It defines enhancements to 802.11 required to support Intelligent Transportation Systems (ITS) applications. This includes data exchange between high-speed vehicles and between the vehicles and the roadside infrastructure in the licensed ITS band of 5.9 GHz (5.85-5.925 GHz).

IEEE 802.11p specifies the functions of two layers – PHY and MAC. In IEEE 802.11p PHY, it defines 7 channels including 6 Service Channels (SCHs) and 1 Control Channel (CCH) to use as shown in Fig. 1.

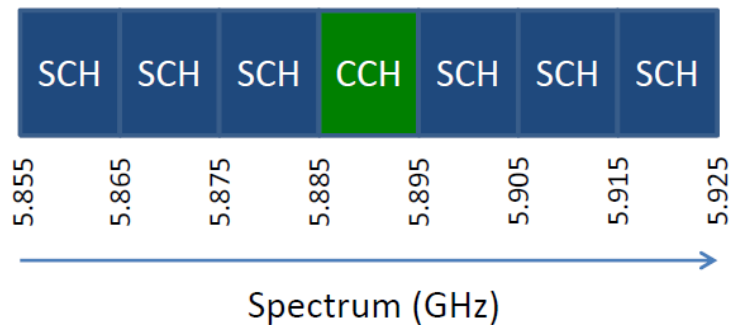

Fig. 1 Spectrum of IEEE 802.11p

All safety-related applications use the CCH whereas entertainment applications use the SCH.

IEEE 802.11p MAC uses carrier sense multiple accesses with collision avoidance (CSMA/CA) for channel access. In computer networking, CSMA/CA is a network multiple access method in which carrier sensing is used, but nodes attempt to avoid collisions by transmitting only when the channel is sensed to be “idle”.

Prior to transmitting, a node first listens to the shared medium to determine whether another node is transmitting or not. Note that the hidden node problem means another node may be transmitting which goes undetected at this stage.

In unicast transmissions every packet is acknowledged (ACK). In other words, the receiver transmits a receipt upon successful reception. The backoff procedure is then also invoked when an ACK is missing. During high network utilization periods ACKs can be lost due to simultaneous transmissions caused by hidden nodes or wireless channel impairments such as fading. For every attempt to transmit a specific packet (where the ACK from the receiver is repeatedly missing), the node

doubles the Contention Window (CW), resulting in a greater spread of simultaneous transmission attempts during high utilization periods. CSMA is therefore reliable in unicast mode since packets are retransmitted until a successful ACK is received.

CSMA/CA can optionally be supplemented by the exchange of a Request to Send (RTS) packet sent by the sender S, and a Clear to Send (CTS) packet sent by the intended receiver R, thus alerting all nodes within range of the sender, receiver or both, to not transmit for the duration of the main transmission. This is known as the IEEE 802.11 RTS/CTS exchange. Implementation of RTS/CTS helps to partially solve the hidden node problem that is often found in wireless networking.

The simplified algorithm of CSMA/CA is shown in Fig. 2.

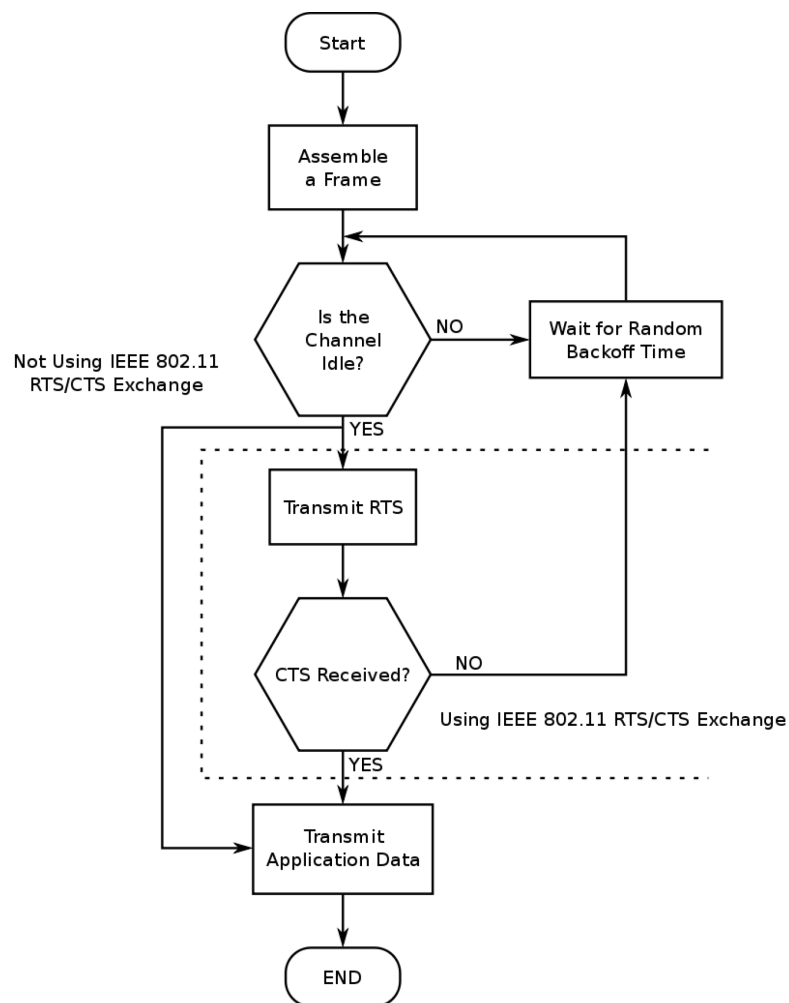

Fig. 2 Mechanism of CSMA/CA (http://en.wikipedia.org/wiki/Carrier_sense_multiple_access_with_collision_avoidance)

However, RTS/CTS which are used in unicast cannot be used in broadcast according to IEEE 802.11p, meaning it cannot deal with hidden node problem. What's worse, ACK cannot be used, implying that the backoff procedure is only invoked once: if the channel becomes busy during the initial sensing period, T_{AIFS} . Therefore, the feature with doubling the CW during high utilization periods is never used.

2.2 STDMA [5]

STDMA is a time slotted self-organizing MAC method, that always grants channel access for all packets before a predetermined time, regardless of the number of competing nodes. Therefore, STDMA is scalable without violating fairness and channel access delay. The channel access delay is upper bounded, implying that STDMA is predictable and it is perfectly suited for real-time communication applications such as road traffic safety. Since all nodes have equal opportunity to access the channel the algorithm is fair despite the number of nodes. Through careful scheduling of transmissions in space during high network utilization periods the reliability is maintained for the closest receivers of a transmitter (which ought to be the most interesting nodes to reach). The price paid for the better performance of STDMA is the required network synchronization through a global navigation satellite system, e.g. GPS.

When the node is turned on it follows four different phases: *initialization*, *network entry*, *first frame*, and *continuous* operation.

During the *initialization* the node listens to the channel activity for one frame to determine the current slot allocation. During this time, the node builds its own frame map to reflect the occupied slots and it also collects information about the status (e.g. position, speed, and heading) of the current members of the network. The STDMA frame in the automatic identification (AIS) system (STDMA is already in commercial use for the shipping industry) starts every UTC minute and the slots are numbered from 0 to 2249. The local frame start for a node does not necessarily coincide with the STDMA frame start. Instead the first slot the node listened to will be the local frame start for that node. In the example in Fig. 3, the node starts its local frame with slot number 6.

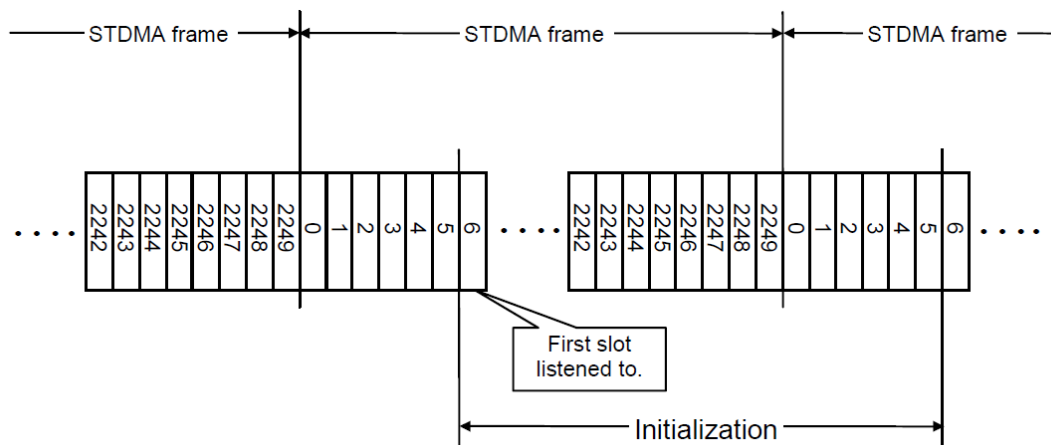

Fig. 3 Initialization of STDMA

The *network entry* phase follows the *initialization*. In this phase the node introduces itself to the network for the first time. The *network entry* phase only lasts for a minor part of the frame: from the last slot in the *initialization* phase until the first transmission slot has been selected, i.e. the first Nominal Transmission Slot (NTS). When the last slot in the *initialization* phase is reached, the node randomly selects a slot located between the last slot and Nominal Increment (NI) slots away and assigns this slot to be the Nominal Start Slot (NSS). In Fig. 4, this procedure is depicted and Selection Interval (SI) is placed with NSS in the middle. After the *initialization* phase the node is aware about the slot allocation in the whole frame and consequently which slots that are occupied in its current SI. The node now randomly selects a slot that the node perceives as being free among the slots in its SI. Note

that the node is only allowed to choose a slot for transmission within its SI. If there are no free slots within SI, the node will use an occupied slot for its transmission, which belongs to the node situated furthest away from itself geographically. Recall that each node knows the position of every other node in the network due to the exchange of position messages.

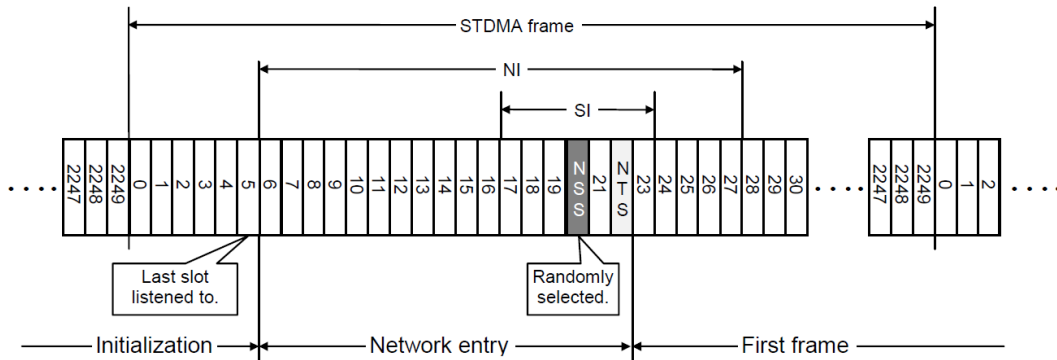

Fig. 4 Network entry of STDMA

During the *first frame* the node continues to allocate slots, i.e. NTS, and attach random integers, n , to every NTS. One NI is added to the NSS and this new slot in the center of the next SI is called NS. Note that the actual transmission does not necessarily take place in NSS or NS - they are merely used to position each SI evenly in the frame. Instead, a new transmission slot is randomly selected within this new SI among the candidate slots (the slots within SI that are perceived to be free by this node) and is denoted NTS. When a transmission is performed in a selected NTS, the offset to the next upcoming NTS is also included in the transmission made in the current NTS, i.e. prior to transmission of current NTS the next NTS is selected to be able to include the offset to the next NTS in the current NTS. This is done to avoid concurrent transmissions by nodes temporarily being hidden from one another due of fading or shadowing. This is a feature to cope with the natural impairments of the wireless channel.

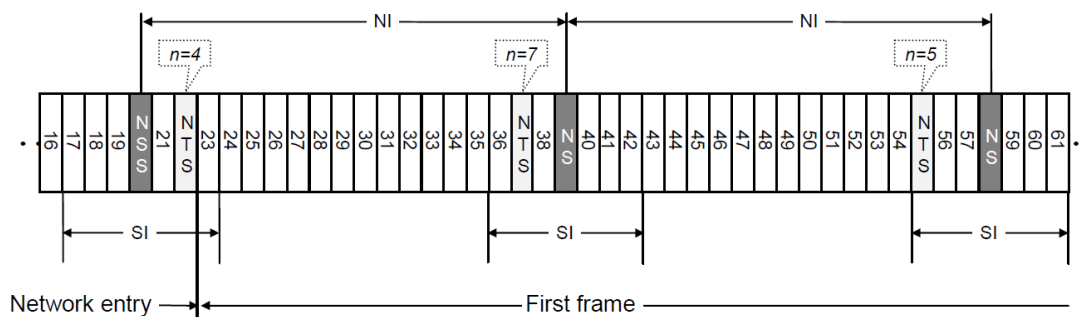

Fig. 5 First frame of STDMA

When the node reaches its NSS again (one frame has elapsed) and it has allocated all NTS determined by the Report Rate (RR) during the *first frame* phase the node enters *continuous operation*. Now the node is introduced to the network and the rest of the nodes, being in radio range of this node, are aware about upcoming transmissions. The NSS, and all NS and SI now remain constant during the continuous operation. Instead new NTS are selected regularly. In Fig. 6, it is also pointed out that the random number attached to each NTS has been decremented as a new frame advances. When the number of times one NTS is allowed to be used has reach zero, the node select a new slot within the

same SI among the slots that are currently perceived as free. A node is not allowed to use the same NTS again by just attaching a new random number to it. It is forced to select a new NTS and attach a new random number to it from the uniform distribution [TMO_MIN, TMO_MAX]. This is done to avoid using of the same slot of nodes within radio range that selected their slots when there were out of range of each other. This is a feature to cope with network topology changes.

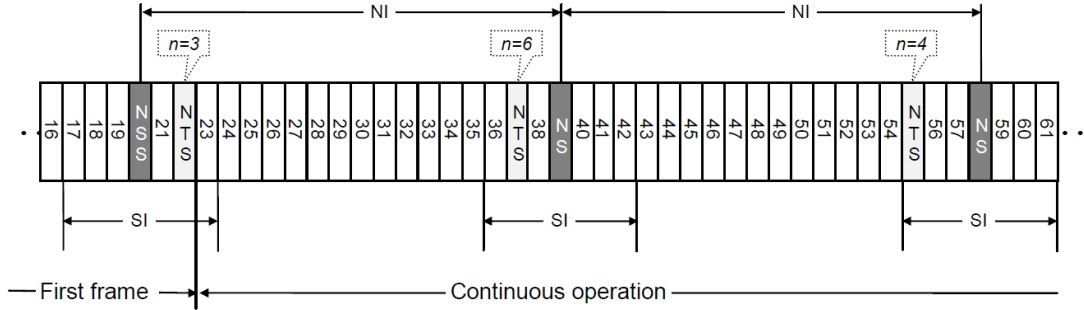

Fig. 6 Continuous operation of STDMA

STDMA can make nodes dynamically choose a free timeslot to use. Even though all timeslots are assumed occupied within a SI, the node can still choose a timeslot which is used relatively far away, to alleviate the interference as much as possible. However, it is unable to solve the hidden node problem because one node can only sense the timeslot occupation within one-hop range. At this point, STDMA is somehow like IEEE 802.11p MAC where RTS/CTS cannot be used.

2.3 MS-Aloha

MS-Aloha is a synchronous slotted TDMA-based MAC protocol specifically designed for VANET. In MS-Aloha, all the vehicles store their information of location, speed and direction in the payloads of packets and broadcast them in their predetermined timeslots (TSs). This information will be periodically propagated to only their one-hop neighbors per frame, which means each vehicle must choose a TS in every frame beforehand. Only one transceiver is assumed to be equipped with each vehicle. All the vehicles are supposed to share a common synchronous source such as GPS to achieve the synchronization for TDMA. A common periodic frame of 0.1s duration is divided into N TSs. Every vehicle judges the usage (free, busy, collision) of each TS on the receptions of packets in the TSs and appends an exhaustive list of the judgment results in the Frame Informations (FIs) to every packet in its own TS. Since there are N TSs in each frame, there are also N FIs in each TS to describe the usages of N TSs. N is set to 131, which has been calculated based on other already-known parameters [6].

FI consists of three subfields of Source Temporary Identifier (STI), Priority Status Field (PSF) and State. STI is an identifier of the vehicle occupying the corresponding TS, which is calculated by hash function. PSF shows a priority of the occupation of the TS. State shows the state of the occupied TS, and it has two bits, where one is named Busy and the other is named Collision. Frame Check Sequence (FCS) is used to check error bit due to transmission. The frame structure is shown in Fig. 7.

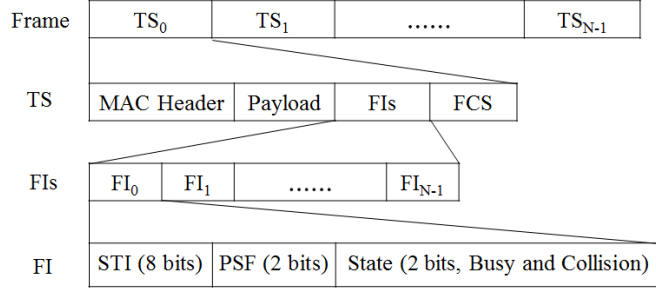

Fig. 7 MS-Aloha frame structure

The purpose of FI is to propagate the network information of TS usage over three hops, where one hop is defined as a distance of packet transmission range without any relay, in order to avoid unintentional TS reuse and therefore collision of the TS use. In other words, even though the payload in every packet will not be relayed, the information in FIs in every packet will be relayed after being aggregated, up to three hops. For example, assume a vehicle V_A judges the state of a certain TS_i based on its own direct sensing results of the TS_i and the relations among the received FI_i s (the FIs referring to TS_i) from its neighbors. If V_A directly (here “directly” means V_A receives FI_i in TS_i) receives FI_i whose State is (Busy:1 Collision:0), V_A takes that TS_i is used by one-hop away vehicle. If V_A indirectly (here “indirectly” means V_A receives FI_i in TS_j , where $i \neq j$) receives FI_i whose State is (Busy:1 Collision:0) or (Busy:1 Collision:1), V_A takes that TS_i is used by two-hop or three-hop away vehicle, respectively. If V_A indirectly receives FI_i whose State is (Busy:1 Collision:1), V_A will transmit FI_i whose State is (Busy:0 Collision:0) to indicate TS_i is free, so that any other vehicles which are four-hop away or further can reuse TS_i . Fig. 8 depicts how to determine how far away TS_i is used by FI_i .

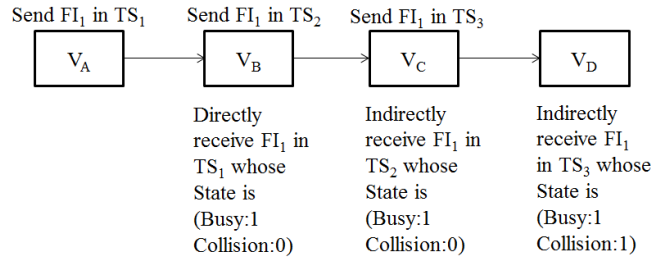

Fig. 8 Role of FI and its propagation mechanism

If multiple FIs referring to the same TS with different numbers of hops are received by a vehicle, only the FI with the smallest number of hops will be utilized and other FIs will be discarded.

When a vehicle broadcasts a packet, the vehicle will always turn on its transceiver for receiving packets in every TS. Cyclic Redundancy Check (CRC) is implemented as FCS algorithm. Thus a transmission error in a packet covering FIs can be detected. When a packet is received, FCS will be checked to detect a transmission error due to packet collision. If an error is detected, the vehicle will broadcast Collision Notification (FIs includes the State of (Busy:0 Collision:1)) to notify its one-hop neighbors that there are vehicles using the same TS. On receiving this Collision Notification, a vehicle will do TS reallocation.

In MS-Aloha, a node reserves a slot based on its direct and indirect channel perception and reservations are confirmed at each transmission. This helps to manage mobility in a completely

distributed way, without any central decision. Collisions may occur in the initial contention phase, but, thanks to the continuous forwarding of channel allocation, they can be effectively detected and resolved. This redundancy not only prevents hidden terminal but also counteracts the effects of fading on signaling.

2.4 Other MAC Protocols

Besides the protocols introduced above, there are other MAC protocols proposed for VANET. One is named VeMAC [7] which improves an existing MAC protocol named ADHOC MAC [8]. However VeMAC is supposed to be applied for the applications broadcasting decentralized environmental notification messages (DENM) which are event-driven messages, generated as a result of a hazard, different from CAMs which are time-triggered, assumed in this thesis. Moreover the issue of how to balance access collisions and merging collisions still remains. Therefore VeMAC will not be further introduced.

Chapter 3

NEED OF HIGH RELIABILITY

The reliability mentioned in this thesis is related to packet transmission and reception. In other words, if every packet can be on time transmitted by each vehicle and the packet can be successfully received by all its neighbors, we can say the MAC protocol is of great reliability. And the reliability is no doubt the most important property for life-safety applications in VANET.

3.1 The Reason Why Take MS-Aloha as Groundwork

As aforementioned, MS-Aloha is taken as the groundwork of RTOB in this thesis. The reason for this is that MS-Aloha has many characteristics which make it possible to be applied and achieve high reliability.

First, MS-Aloha is compatible to the international standard IEEE 802.11p which also defines specifications for PHY layers. According to IEEE 802.11p, the band of 75 MHz is divided into seven 10 MHz channels with a safety margin of 5 MHz at the lower end of the band. One channel acts as CCH, in which all safety relevant messages, e.g. CAMs, are broadcast. And the other six channels acts as SCH which less critical applications must use. Since in this thesis, RTOB is expected to be easily applied in current VANET, it should be compatible to existing protocols of other layers as much as possible.

Second, MS-Aloha can relay the information of TS usage further than the single transmission range via FI, which is unique in MAC protocols for one-hop broadcast. As a result, each vehicle is able to know a relatively overall state of TS usage, so as to make a right decision on when to transmit the next packet is safe, without causing packet collision.

Third, with MS-Aloha, each receiver is able to carry the ACK piggyback to the transmitter by means of FI. For example, if vehicle V_A successfully transmitted a packet to another neighboring vehicle V_B , and V_B also successfully transmitted a packet to V_A , the FI in the packet from V_B , referring to the TS which V_A used should has the STI of V_A . Moreover, the FI is expected to present “two-hop away”, because before V_A received this FI, the number of hops was increased by one at V_B . Undoubtedly, this kind of ACK can benefit the reliability.

3.2 Flaws of MS-Aloha

MS-Aloha is such a good MAC protocol because of its characteristics. However, inefficient TS usage makes MS-Aloha cannot achieve high reliability in congested scenarios where vehicles are very dense. What’s more, continuous blockings may exist making some vehicles “disappeared”. Then those vehicles are dangerous to the others nearby, compromising the reliability of the MAC protocol.

3.2.1 Inefficient Timeslot Usage

3.2.1.1 Low Spatial Timeslot Reuse

Under the assumption of two-hop interference (radio interference only exists within two-hop range) [1], the optimal strategy for TS reuse should be that every TS is reused at intervals of four-hop. In MS-Aloha, a TS might not be reused within six-hop range as shown in Fig. 9 in the worst case. Such inefficient TS reuse will become a serious issue in congested scenarios with a lot of vehicles.

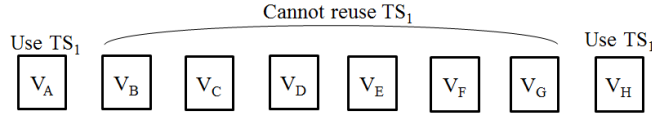

Fig. 9 The case that TS_1 cannot be reused within six-hop

3.2.1.2 Single Frame Reference for the Judgment on the Use of Timeslot

In MS-Aloha, the TS which will be used in the current frame are decided on the basis of the FIs received during the last frame. This seems good if the received signal strength is always stable and deterministic. However, the signal strength is in practice probabilistic because of e.g. fading. Thus it is considered unreliable that deciding which TS to use by referring to the FIs in only the last frame, and MS-Aloha leads to the inefficiency of preferable TS use.

3.2.1.3 Inefficient Timeslot Reallocation in Case of Collision

When there is a packet collision, the related vehicles are notified of the collision, and a “free” TS should be reallocated to each of the vehicles for the next frame. In MS-Aloha, the TS with the collision would not be used by these vehicles in the next frame because the vehicles will not take the TS “free”. Such nonuse of this TS by any of these vehicles would be a waste. On the other hand, if we let those vehicles take the TS “free”, all of them may unfortunately choose this TS in the next frame, leading to continuous collision. Apparently two or more continuous packet collisions (collisions by the same vehicles in consecutive frames) are more dangerous than single collision, especially for life-safety application.

3.2.2 Continuous Blockings

In MS-Aloha, continuous blockings may happen to a node in very dense network. For example, if V_A received a CN which orders it to select another TS to avoid packet collision, but according to the received FIs there is no free TS, V_A will block its transmission in the next frame. And if there is still no free TS to use in the next frame, V_A will unfortunately block its transmission once again. On the other hand, the vehicles around V_A may monopolize TSs since V_A just seems “disappeared” for them. No doubt this kind of disappearance is very dangerous for life-safety applications.

Chapter 4

PROPOSED PROTOCOL – RTOB

The proposed protocol RTOB consists of two principles –Efficient Timeslot Usage (ETU) and Timeslot Sharing (TSS). ETU aims to improve the reliability by means of improving timeslot usage. And TSS is used to make two or more vehicles alternatively use the same TS in very dense conditions, counteracting continuous blockings, improving the reliability.

4.1 Efficient Timeslot Usage

ETU is realized via three sub-principles.

4.1.1 Higher spatial TS reuse

When TS allocation is necessary, each vehicle should select a new TS following the basic rule: firstly try to reuse a TS which is used exactly four-hop away, otherwise try to reuse a TS which is not used within four-hop. If all TSs are used, just block the next transmission. Thus ideally every TS will be reused at intervals of four-hop, making higher spatial TS reuse.

To this end, FI must be able to propagate network information over four hops, rather than just three. However in MS-Aloha, there are only five states of free, collision, one-hop, two-hop and three-hop.

For the purpose of avoiding increasing overhead of additional bit, a difference between free and four-hop are made utilizing STI. Even though both free and four-hop are represented by the same State of FI (Busy:0 Collision:0), a rule is made that all vehicles can use STIs only from 1 to 255. Then the STI of 0 is reserved for free. TABLE I gives the summary of the proposed principle for the use of STI and State.

TABLE I. USE OF STI AND FI

<i>State</i>	<i>STI</i>	<i>Busy</i>	<i>Collision</i>	<i>Sensing</i>
<i>Free</i>	0	0	0	either directly or indirectly
<i>One-hop</i>	1 to 255	1	0	directly
<i>Two-hop</i>	1 to 255	1	0	indirectly
<i>Three-hop</i>	1 to 255	1	1	indirectly
<i>Four-hop</i>	1 to 255	0	0	indirectly
<i>Collision</i>	1 to 255	0	1	directly

4.1.2 Multiple Frames Reference

A significant difference between MS-Aloha and the proposed RTOB about choosing TS for the next frame is that the number of referred frames is different as shown in Fig. 10.

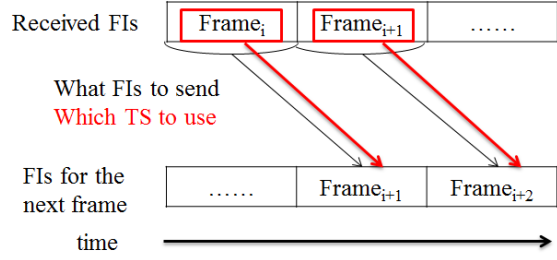

(a) MS-Aloha

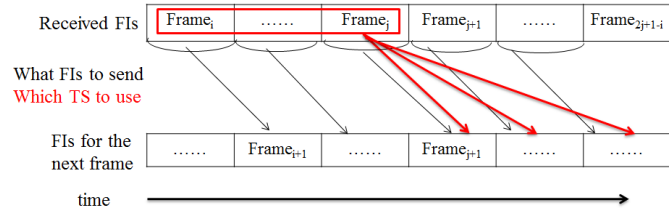

(b) Proposed RTOB

Fig. 10 Comparisons of frames used for creating FIs and choosing a TS by (a) MS-Aloha and (b) the proposed RTOB

In MS-Aloha, a new TS used for a broadcast is decided every frame by referring to FIs of only the last frame as shown in Fig. 10 (a). In RTOB, on the other hand, this decision will be carried out every several frames by referring to FIs of the last several frames as shown in Fig. 10 (b). It should be noted that new FIs are made by referring to FIs of only the last frame in both MS-Aloha and RTOB.

There are two merits in this proposed principle as follows:

Which TS should be used in the next frame will be determined referring to more than one frame. Thus the probability becomes lower for the case where a TS is actually used but it is mistaken as “free”, caused by temporal decrease in the received signal strength.

Vehicles should not be too sensitive to Collision Notification, because some packet collisions may have been caused by only temporal increase in the received signal strength. In other words, the case in which the collision is yet far enough away from the required communication range of safety applications is appropriately processed by RTOB to achieve efficient use of radio channel.

4.1.3 Efficient Timeslot Reallocation

In general, any two vehicles V_A and V_B using the same TS cannot recognize each other since only one transceiver is deployed in each vehicle and each vehicle cannot send and receive at the same time. To cope with this restriction, Collision Notification is always broadcast by a third vehicle. If this third vehicle V_C can know that V_A and V_B are using the same TS before their actual packet collision and that they are likely to make collision soon, V_C can inform V_A and V_B of this potential collision using a special value of STI of the collided TS in CN, where the special value will be specified later. On receiving this STI, V_A and V_B become able to decide whether they should select a new TS.

The proposed principle for the rule to specify the STI of the collided TS in CN is the largest STI among all the STIs in all the FIs referring to the same TS (say i). The purpose of this rule is to make all the vehicles (including V_C) that broadcast Collision Notification choose the same STI. Thus each of all

the vehicles that are using TS_i will check if the STI is equal to its own STI after receiving the CN. If it is the case, the vehicle should keep using TS_i . Otherwise, the vehicle must use a new TS.

4.2 Timeslot Sharing

To counteract continuous blockings, Timeslot Sharing (TSS) is proposed. Fig.11 shows the examples of continuous blockings and the ideal timeslot usage. The main idea of TSS is that when slots are inadequate, e.g. all TSs are used with three-hop according to received FIs, two vehicles which are two-hop away will alternatively use the same TS.

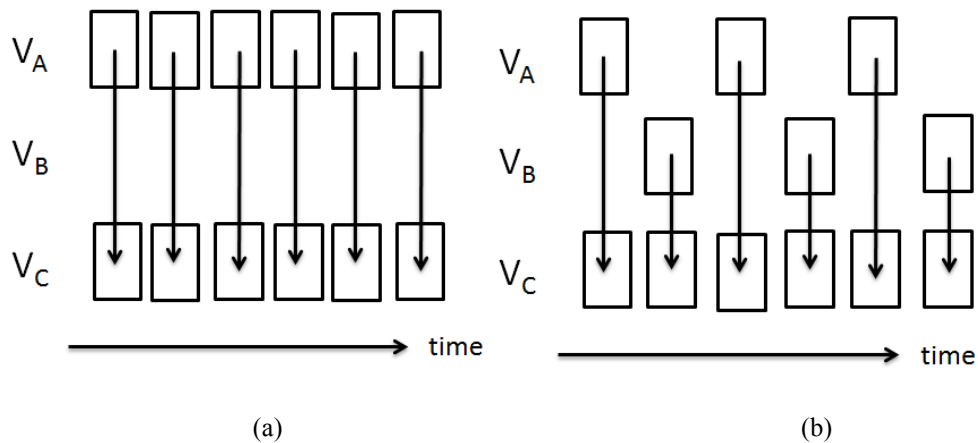

Fig. 11 Example of continuous blockings (a) and ideal timeslot usage (b)

There are three rules of TSS:

1. When a node receives a CN referring to its currently used TS and no other TSs can be used, the node will switch into TSS mode. Whether to send in the next frame depends on the STI of the collided TS in the CN. If the STI equals the node's own, send in the next frame and vice versa.
2. If a node has been already in the process of TSS and receive a CN referring to its currently used TS, whether to send in the next frame depends on the current status of the node. For example if its current state is "send", the transmission in the next frame will be blocked and vice versa.
3. If a node has been already in the process of TSS and no CN is received, whether to send in the next frame depends on the received FI referring to the TS currently used by the node. For example if the received FI is feedback (FI has the STI of the node's own and presents 2-hop away), the node will send in the next frame and vice versa.

Fig. 12 gives an example that how TSS works in three vehicles.

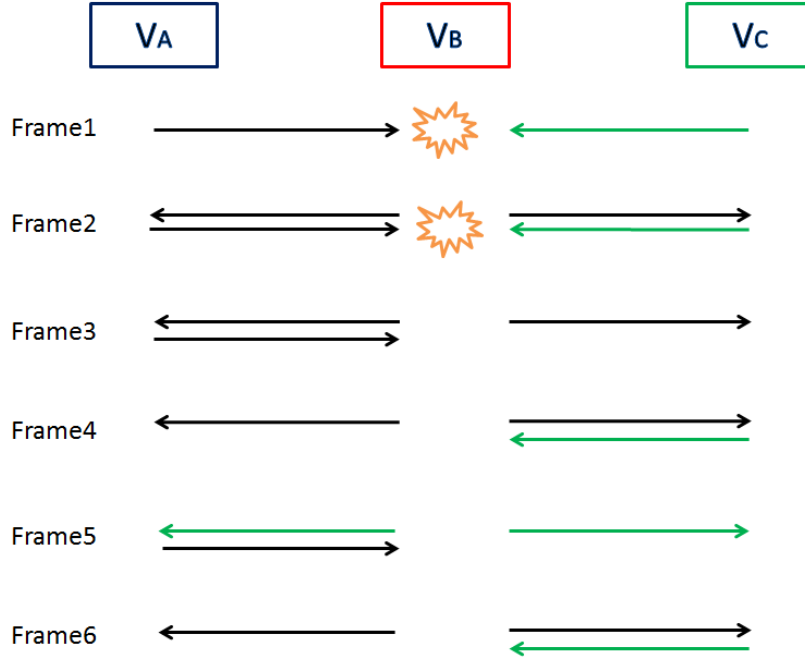

Fig. 12 the mechanism of TSS in three vehicles where $STI_A > STI_C$ (colors represent the STIs of different vehicles)

Frame 1: The assumed situation is that V_A and V_C using the same TS_i has caused packet collision at V_B . And for both V_A and V_C , there is no free TS to use.

Frame 2: V_B after sensing the first collision in Frame1 broadcasts Collision Notification (CN) referring to TS_i whose STI of FI_i equals STI_A because $STI_A > STI_C$. Since the CN is one-frame-delayed, V_A and V_C cause the second collision in Frame 2.

Frame 3: V_A after receiving the first CN in Frame 2, finding the STI of FI_i equals to STI_A , will continuously use TS_i based on Rule 1. On the other hand, V_C after receiving the first CN in Frame 2, finding the STI of FI_i equals to STI_A , will block its own transmission based on Rule 1. V_B once again broadcasts CN due to the second collision.

Frame 4: V_A after receiving the second CN in Frame 2 will block the transmission in Frame 4 based on Rule 2, because V_A has already used TS_i in Frame 3, whereas V_C will now use TS_i based on Rule 2. V_B broadcasts normal packet whose FI_i has STI_A .

Frame 5: Note in Frame 4, neither V_A nor V_C has received CN, but instead they both received the normal packet from V_B whose FI_i has STI_A . Then in Frame5, V_C after receiving the packet from V_B in Frame 4, finding the STI of FI_i equals to STI_A , will block the transmission based on Rule 3. Meanwhile, V_A will use TS_i base on Rule 3 too. V_B broadcasts the packet whose FI_i has STI_C .

Frame 6: Frame 6 is similar to Frame 5.

Then Frame 5 and Frame 6 will be repeated if only V_A and V_C can receive the packet from V_B whose FI_i has the STI of its opponent.

Note if V_A and V_C no longer use the same TS_i , meaning V_A and V_C can no longer receive the normal packet from V_B whose FI_i has the STI of its opponent, V_A and V_C will quit this repetition.

Also, TSS will be carried out only when for both V_A and V_C all TSs are used, namely there is no free TS, including the TSs which are used exactly four-hop away. Furthermore, for each frame in TSS, this requirement will be checked, which is to say if there is any free TS for V_A or V_C , V_A or V_C will quit TSS. In fact, TSS is the last choice for a vehicle which is in very dense network.

Below gives two more complex cases explaining how TSS works in five vehicles.

Fig. 12 shows one possible case when $STI_A < STI_C$ and $STI_C > STI_E$ (the case when $STI_A > STI_C$ and $STI_C < STI_E$ is similar)

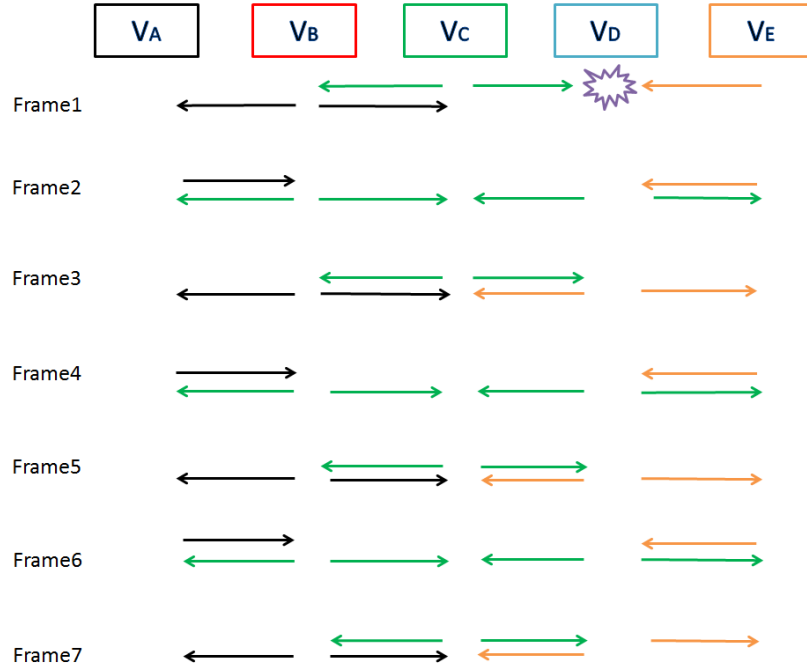

Fig. 13 the mechanism of TSS in five vehicles where $STI_A < STI_C$ and $STI_C > STI_E$ (colors represent the STIs of different vehicles)

Frame 1: V_A , V_C and V_E use the same TS_i. V_A and V_C have been already in the process of TSS and now V_E comes, colliding with V_C at V_D .

Frame 2: Since CN from V_D is one-frame-delayed, V_E will continue sending and V_C will not send because it is still in the process of TSS with V_A . V_D sends CN whose FI_i has STI_E because $STI_C < STI_E$.

Frame 3: Recall Rule 2, V_C will send in Frame3 because its status in Frame 2 is “block”. And recall rule 1, V_E will block because of the reception of CN whose FI_i has STI_C .

Frame 4, 5, 6 and 7: No more CN will be sent and V_A , V_C and V_E has become repeating ideally.

Fig. 14 shows another case when $STI_A < STI_C < STI_E$ (the case when $STI_A > STI_C > STI_E$ is similar)

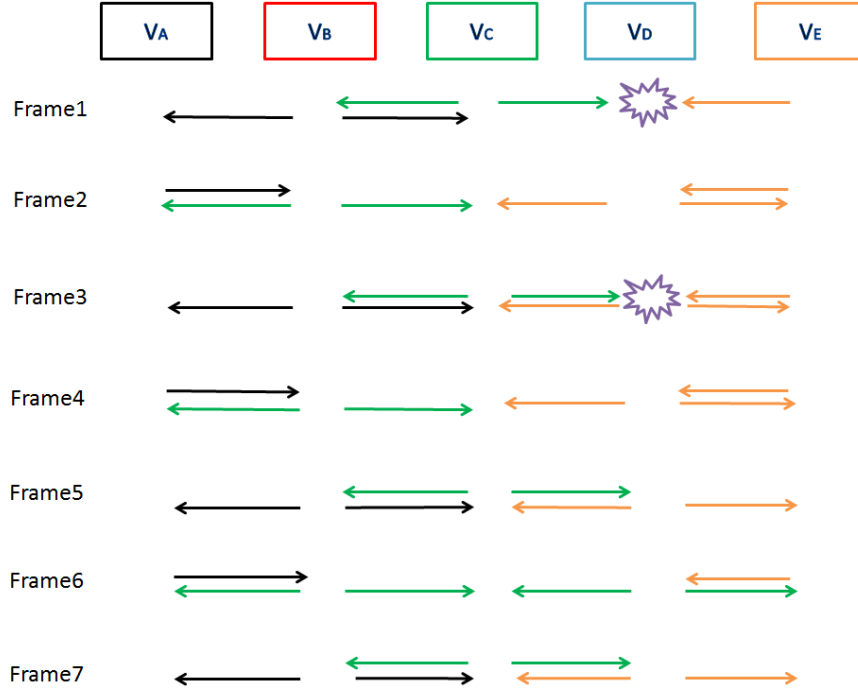

Fig. 14 the mechanism of TSS in five vehicles where $STI_A < STI_C < STI_E$ (colors represent the STIs of different vehicles)

Frame 1: V_A , V_C and V_E use the same TS_i . V_A and V_C have been already in the process of TSS and now V_E comes, colliding with V_C at V_D .

Frame 2: Since CN from V_D is one-frame-delayed, V_E will continue sending and V_C will not send because it is still in the process of TSS with V_A . V_D sends CN whose FI_i has STI_E because $STI_C < STI_E$.

Frame 3: Recall rule 2, for V_C , even though it received the CN whose FI_i has STI_E in Frame 2, it will send in Frame 3 because its status in Frame 2 is “block”. However V_E does not know this and also send in Frame 3 because of the reception of CN in Frame 2, based on Rule 1. So collision happens again.

Frame 4: Recall Rule 3, V_C will block its transmission because the reception of FI_i from V_B has STI_A (the reception of the FI_i from V_D having STI_E just makes the same result). But V_E will send because of the reception of feedback from V_D in Frame 3.

Frame 5: Recall Rule 2, V_C sends because its status in Frame 4 is “block”. V_E will block transmission based on Rule 2 as well.

Frame 6, 7: Now there is no more CN, so V_A , V_C and V_E can work only obeying Rule 3. V_A and V_E send at the same time and V_C send at the different frame, which is expected.

The benefits of TSS:

First, with TSS, there is no longer any vehicle which continuously blocks its transmissions even in very dense network, which can improve the reliability considering life-safety applications.

Second, without TSS, collisions due to TS reallocation may happen because we just cannot guarantee that TS is ideally allocated even though based on the received FIs. But after utilizing TSS, both V_A and V_C are not asked to use another TS, avoiding collision due to TS reallocation.

Chapter 5

METRICS FOR EVALUATION

5.1 Existing Metrics

5.1.1 Packet Delivery Ratio

Usually Packet Delivery Ratio (PDR) is used as a metric for evaluating the reliability related to packet transmission and reception, where PDR is defined as the number of received packets divided by the number of transmitted packets.

In the simulations of this thesis, only the receptions when the distance between a sender and a receiver is less than 150m will be taken into account, because the required communication range is 150m for most safety applications [9]. The definition of PDR is shown in equation (1).

$$\text{PDR} = \frac{\sum R_{real}}{\sum R_{max}} \quad (1)$$

where R_{real} is the number of actually received packets from vehicles within 150 range for each vehicle and R_{max} is the number of packets transmitted by vehicles within 150m range for each vehicle.

5.1.2 Data Reception Rate

Date Reception Rate (DRR) means how frequently a receiver can receive packets from a certain sender. It is important for life-safety applications in evaluating the reliability. In [10], the DRR of CAMs for Forward Collision Warning (FCW) should be higher than 4Hz in most scenarios for small tolerance region of 5m distance.

5.1.3 Channel Utilization

Channel Utilization (CU) is used to evaluate how many TSs are used to successfully receive packets in one frame. Equation (2) gives its detailed definition.

$$\text{channel utilization} = \frac{\sum TS_{recv}}{\sum TS_{all}} \quad (2)$$

where TS_{recv} is the number of TSs in which packets have been successfully received for each vehicle and TS_{all} is the number of TSs of each vehicle.

5.2 Proposed Metric – Cover Ratio

Even though PDR can be used to evaluate the reliability somehow, it still cannot tell us how much the vehicles are considered safe to their neighbors. From the viewpoint of the objective of CAMs, what

we expect is that one vehicle could receive packets from all its neighbors, and the time interval between two packets from a certain neighbor should be less than a certain value. An example of the required time interval is 0.5s [11].

Thus to appropriately evaluate the reliability of protocols, a novel metric named Cover Ratio (CR) is proposed in this thesis. This metric is designed to describe the proportion of the time when the vehicles are considered safe.

5.2.1 Definition

Assuming FCW as safety applications, CR is defined as the total periods when a receiver can actually receive consecutive packets from the same sender within a certain predefined time interval and a predefined distance, divided by the total periods when the receiver is expected to receive from the sender within the same predefined distance. The required time interval is set to 0.5s, and the predefined distance is 150m for FCW [.

The formal definition of CR is given in equation (3).

$$CR = \frac{\sum_A \sum_B \sum_n (T_{ABn} - T_{ABn-1})}{\sum_A \sum_B \sum_m (T_{ABm} - T_{ABm-1})} \quad (3)$$

$$T_{ABn} - T_{ABn-1} < 0.5s \quad Dist(V_A, V_B) \leq 150m$$

where T_{ABn} are the times when V_A received the n-th packet from V_B and $Dist(V_A, V_B)$ is the distance between V_A and V_B .

5.2.2 Comparison with PDR

CR can provide an accurate evaluation of the reliability for the life-safety related application and it is calculated for each vehicle based on the receptions from all its neighbors. Only when the time interval between consecutive receptions from the same neighbor is less than a certain threshold (0.5s in this thesis), the time interval (<0.5s) will be taken into account. Also all its neighbors will be calculated individually, so that the higher the CR is, the safer the vehicles are. Meanwhile, PDR is not proper for evaluating the reliability because PDR does not take into account blocked packets. It should be noted that transmission of packets will be blocked if it is judged based on FIs in the last frame that there is no free TS when TS reallocation is necessary. For example, if 8 packets were blocked out of 10 packets i.e. 2 packets were transmitted and only 1 of the 2 packets was actually received during 1s, the PDR is 50%; if 2 out of 10 packets (no packets were blocked) were received, the PDR is only 20%. Apparently, the latter case of 2 packet reception is better than the former case of 1 packet reception from the safety viewpoint. Although the reliabilities of such cases are not appropriately evaluated by PDR, the reliability can be reasonably evaluated by the proposed metric of CR.

Another reason why CR is better than PDR is that PDR has nothing to do with the length of the time interval between two consecutive receptions from the same neighbor. For example, assume that a vehicle received 10 out of 20 packets (no blocked packets) during 2s from a neighbor. If all the 10 packets were received during the first 1s, then the receiver is in danger during the last 1s, since this

interval of no packet reception is too long (≥ 0.5 s). While such danger cannot be evaluated by PDR, it can be evaluated actually by CR.

100% CR means the vehicles are all always safe from any danger from its neighbors. And if a MAC protocol can achieve high CR, this MAC protocol is considered reliable.

Chapter 6

EVALUATION

6.1 Overhead and Cost to Apply

To evaluate a MAC protocol, it is preferred to notice the overhead and cost of applying the protocol. Compared to MS-Aloha, in RTOB there is no additional bit attached to each packet, meaning the overhead in transmission is zero. But since the decision of which TS to use refers to the FIs received in multiple frames, the cost of storage capacity increases. However, even though every frame contains $131^2 = 17161$ FIs, every FI is only 1.5 Bytes. Thus the additional cost will be just dozens of KB which is trivial for current DSRC devices.

Furthermore, since RTOB is a MAC layer protocol which is compatible to IEEE 802.11p PHY layer, it is convenient to apply. The coexistence between RTOB and IEEE 802.11p MAC layer is out of the range of this thesis, but similar issue about the coexistence between MS-Aloha and IEEE 802.11p MAC layer has been discussed in ETSI TR 102 861.

6.2 Computer Simulation

6.2.1 Simulators, Settings and Scenarios

Simulators

Two simulators – SUMO and ns-2 – were used. SUMO is used to create the trace file of movements for all vehicles. In SUMO, vehicles are generated and set out at a certain Start Point. On the other hand, there is always a certain End Point at which when the vehicle has arrived, the vehicle will disappear. The decision of Start Point and End Point of each vehicle is uniformly at random. As for the route of each vehicle, for simplicity, Dijkstra's shortest path algorithm is used, which means every vehicle only always choose the shortest path between its Start Point and End Point whatever if that path is full of other vehicles.

Simulator ns-2 which is widely used to simulate wired and wireless networks with various protocols including TCP, routing and MAC protocols, is used here to simulate communications among vehicles.

Vehicular traffic in simulation is generated on the basis of Poisson distribution in order to simulate a realistic environment. The λ of Poisson distribution is a main parameter which shows how many new vehicles are put into the network per unit time. Typically, the bigger λ is, the more congested the network is with vehicles.

Settings

Settings in communications are shown in TABLE II.

TABLE II. SETTINGS IN COMMUNICATIONS

<i>Propagation model</i>	Nakagami propagation model
<i>Antenna</i>	Omni-antenna
<i>Antenna height</i>	1.5m
<i>Antenna Gr</i>	1
<i>Antenna Gt</i>	1
<i>Transmitting power</i>	7dBm
<i>Bandwidth</i>	600kbps
<i>SINR for data capture</i>	10dB
<i>Receiving threshold</i>	-96dBm
<i>TS size</i>	375B
<i>TS period</i>	5ms
<i>Frame period</i>	100ms

One important thing to note is that the target VANET of RTOB should be of large enough scale, and the target road network is supposed to be congested with vehicles. However, the number of required vehicles is too large to run in simulator SUMO, which cannot generate traces for more than 900 vehicles [12]. The following trick is implemented for scaling-down. The number of TSs per frame is decreased from 131 to 20. Thus the number of vehicles we need is drastically reduced. Although there are other parameters which seem possible for scaling-down, they all have troubles making them actually unavailable. As for the transmission range, if we make it smaller, we just need more vehicles within each transmission range for each vehicle. As for road length, it is in relation to transmission range so can be simply adjusted. As for maximum speed, it has trivial influence when the network is congested with vehicles.

More specific settings of Nakagami propagation model and radio attenuation due to obstacle can be found in [.

Scenarios

To sufficiently evaluate the reliability of RTOB in diverse cases, three scenarios representing different environments have been conducted.

Scenario 1 is carried out to simulate the case of urban environment, where traffic signals should be taken into consideration. Also the road length is assumed relatively short, and crossings are typically close to each other. Moreover, the influence of obstacles such as buildings at each block must not be neglected, which means the case of non-line-of-sight (NLOS) will be taken into account. The mean λ is set to four different values to simulate the cases of different vehicular densities. Parameters in Scenario 1 are shown in TABLE III.

TABLE III. PARAMETERS IN SCENARIO 1

<i>Max vehicle speed</i>	72 km/h (20 m/s)
<i>Road network topology</i>	6x6 Manhattan-grid
<i>Road network area size</i>	1500x1500 m ²
<i>Number of lanes for each direction</i>	1
<i>Traffic signals</i>	Yes
<i>Obstacles</i>	Yes
<i>1/λ</i>	0.7, 0.9, 1.2, 1.5 s/vehicle
<i>Mean number of active vehicles (300~400 s)</i>	294, 198, 155, 117
<i>Mean following distance</i>	143, 212, 271, 359 m

(300~400 s)

The number of active vehicles with time elapsing is shown in Fig. 15.

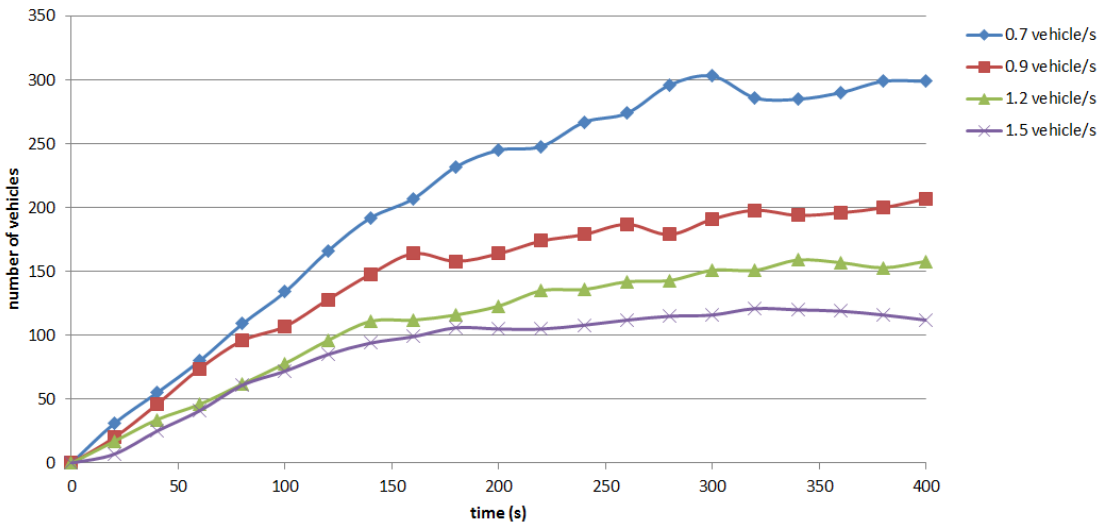

Fig. 15 number of active vehicles in scenario 1

The probability distribution of vehicle speed during 300~400 s is shown in Fig. 16.

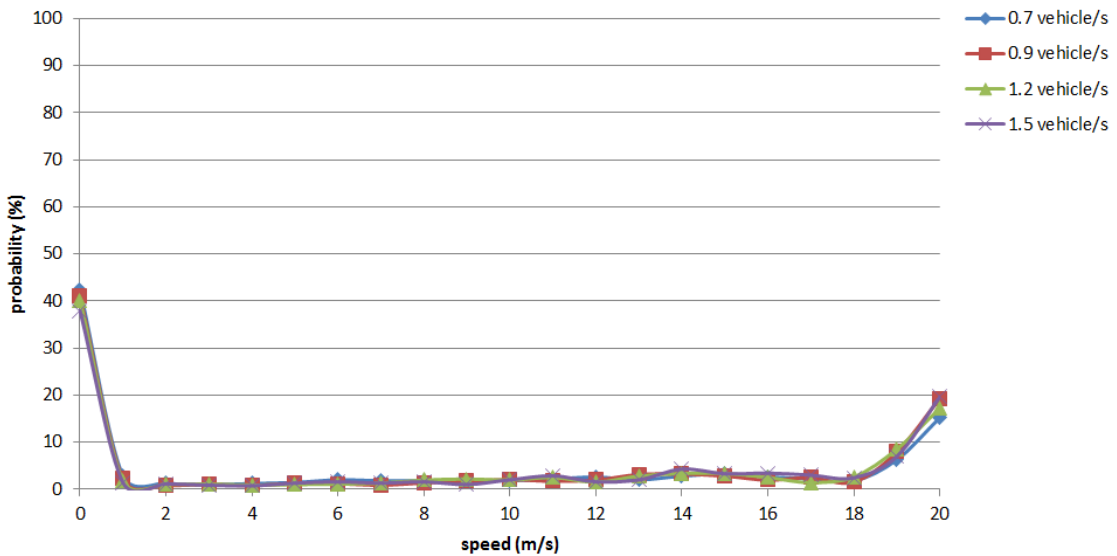

Fig. 16 probability distribution of vehicle speed during 300~400 s in scenario 1

From Fig. 16, it is clear that traffic signals influence the speed of vehicles a lot.

Scenario 2 aims at simulating the case of rural environment, where traffic signals will not be set up. The road length should be longer than that in urban case, and accordingly crossings are scattered located. Obstacles such as buildings will not be assumed in this kind of scenario. The mean λ is set to four different values to simulate the cases of different vehicular densities. Parameters in Scenario 2 are shown in TABLE IV.

TABLE IV. PARAMETERS IN SCENARIO 2

<i>Max vehicle speed</i>	90km/h (25m/s)
<i>Road network topology</i>	3x3 Manhattan-grid
<i>Road network area size</i>	1500x1500m ²
<i>Number of lanes for each direction</i>	1
<i>Traffic signals</i>	No
<i>Obstacles</i>	No
<i>1/λ</i>	0.8, 0.9, 1, 1.2 s/vehicle
<i>Mean number of active vehicles (400~500 s)</i>	183, 143, 119, 102
<i>Mean following distance (400~500 s)</i>	131, 168, 202, 235m

The number of active vehicles with time elapsing is shown in Fig. 17.

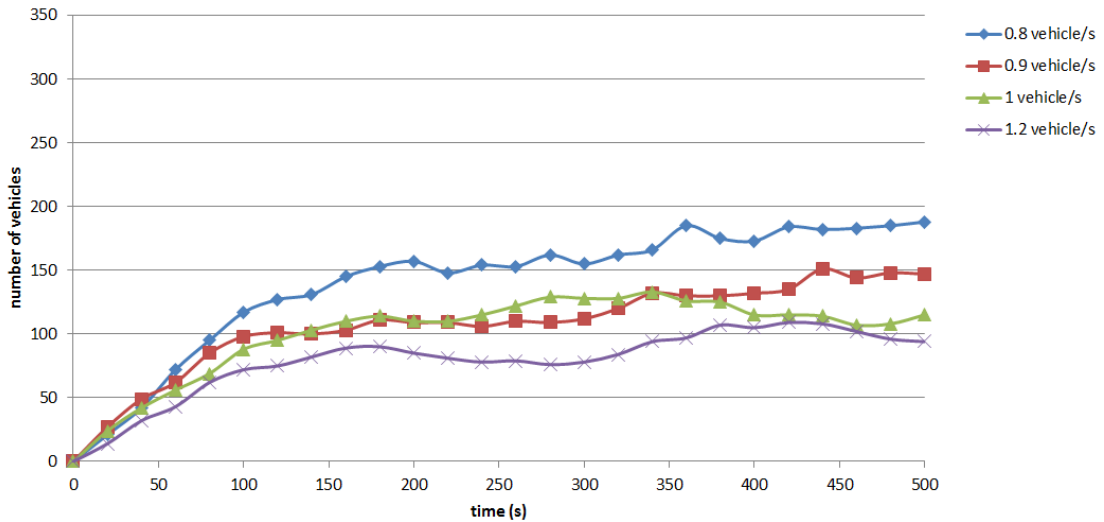

Fig. 17 number of active vehicles in scenario 2

The probability distribution of vehicle speed during 400~500 s is shown in Fig. 18.

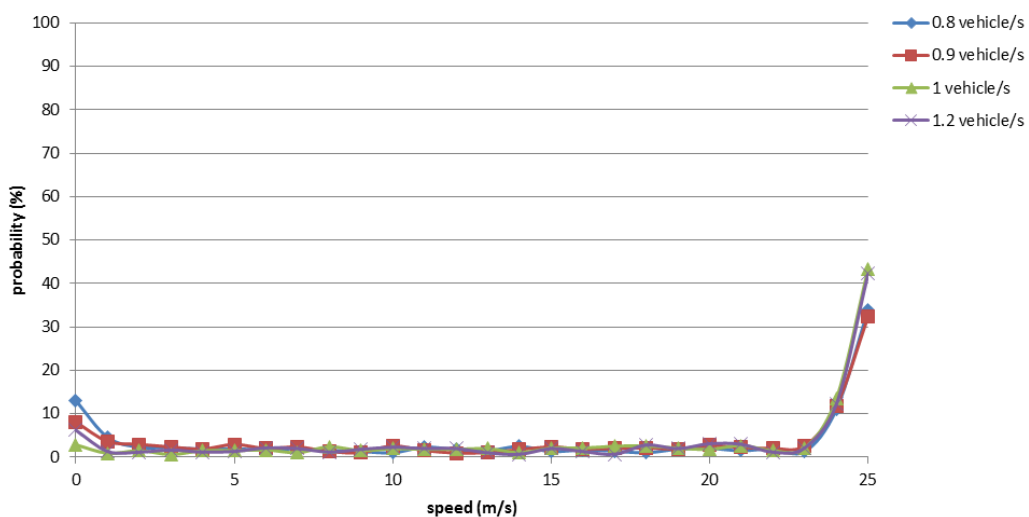

Fig. 18 probability distribution of vehicle speed during 400~500 s in scenario 2

Fig. 18 shows that vehicles in an urban scenario have higher speed which is reasonable.

Scenario 3 represents the case of highway, where there is neither traffic signal nor crossing. For simplicity, the topology of this case is assumed as a square. Each edge should be long enough, so as to

alleviate the effects of corners where radio interference exists between too vehicles even running at different edges. Certainly obstacles are not assumed in this case. The mean λ is set to four different values to simulate the cases of different vehicular densities. Parameters in Scenario 3 are shown in TABLE V.

TABLE V. PARAMETERS IN SCENARIO 3

<i>Max vehicle speed</i>	144km/h (40m/s)
<i>Road network topology</i>	Square
<i>Road network area size</i>	1500x1500m ²
<i>Number of lanes for each direction</i>	2
<i>Traffic signals</i>	No
<i>Obstacles</i>	No
<i>1/λ</i>	0.5, 0.7, 1, 1.2 s/vehicle
<i>Mean number of active vehicles (300~400s)</i>	195, 151, 131, 101
<i>Mean following distance (300~400s)</i>	123, 159, 183, 238 m

The number of active vehicles with time elapsing is shown in Fig. 19.

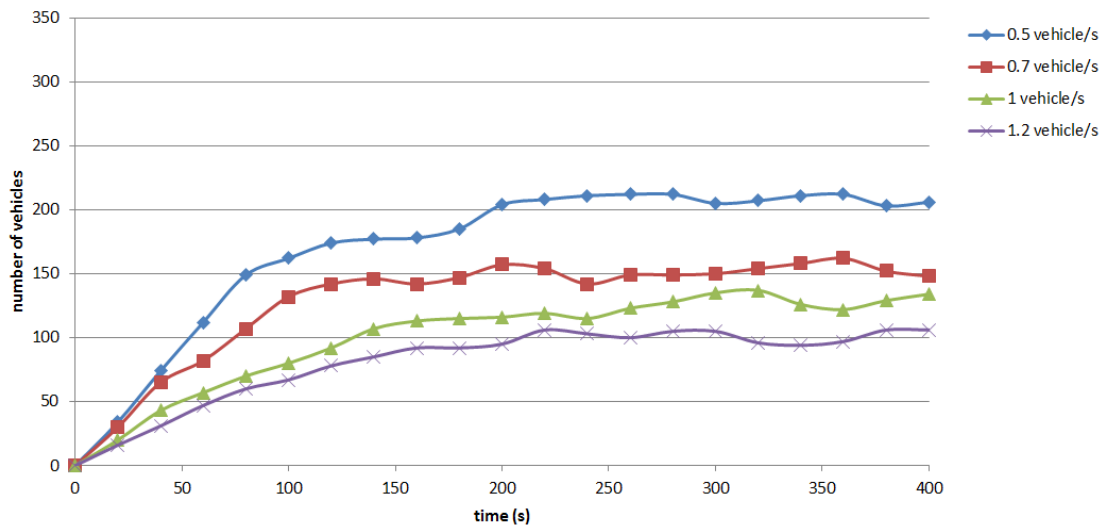

Fig. 19 number of active vehicles in scenario 3

The probability distribution of vehicle speed during 300~400 s is shown in Fig. 20.

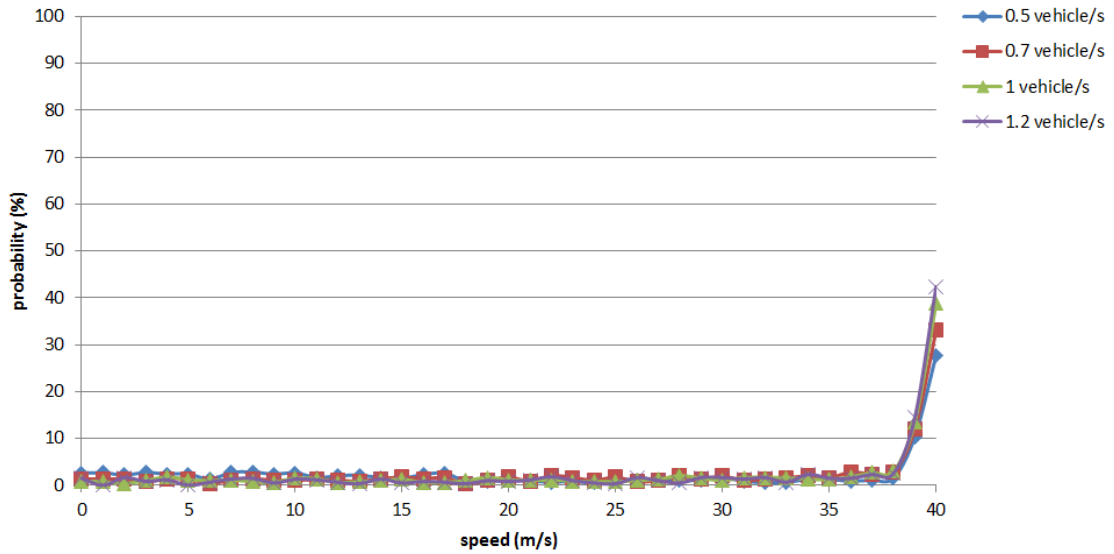

Fig. 20 probability distribution of vehicle speed during 300~400 s in scenario 3

Fig. 20 classifies that almost all vehicles run at very high speed in a highway scenario.

6.2.2 Result

To evaluate the usefulness of ETU and TSS, MS-Aloha, “ETU 1 frame” (1 frame reference in 4.1.2.), “ETU 2 frames”, “ETU 3 frames” and “ETU+TSS 2 frames” will be compared. The reason why “ETU 4 frames” is not tested is that when the necessary of slot reallocation is checked every 4 frames, the worst cast when packet collision happens is that the vehicle is unable to select another TS until 0.5s later than the collision. Considering the threshold of 0.5s in CR (5.2.), “ETU 4 frames” is improper. And the reason why “ETU+TSS 3 frames” has not been tested is that in terms of CR which is the most important metric to evaluate the reliability in this thesis, “ETU 2 frames” shows higher CR than “ETU 3 frames”, so there is no need to test “ETU+TSS 3 frames”.

Note 5% positive and negative potential error amounts are shown in all figures.

6.2.2.1 Scenario 1 (urban)

Scenario 1 aims to simulate an urban scenario. All obtained data is from 300~400 s from the beginning of the simulations.

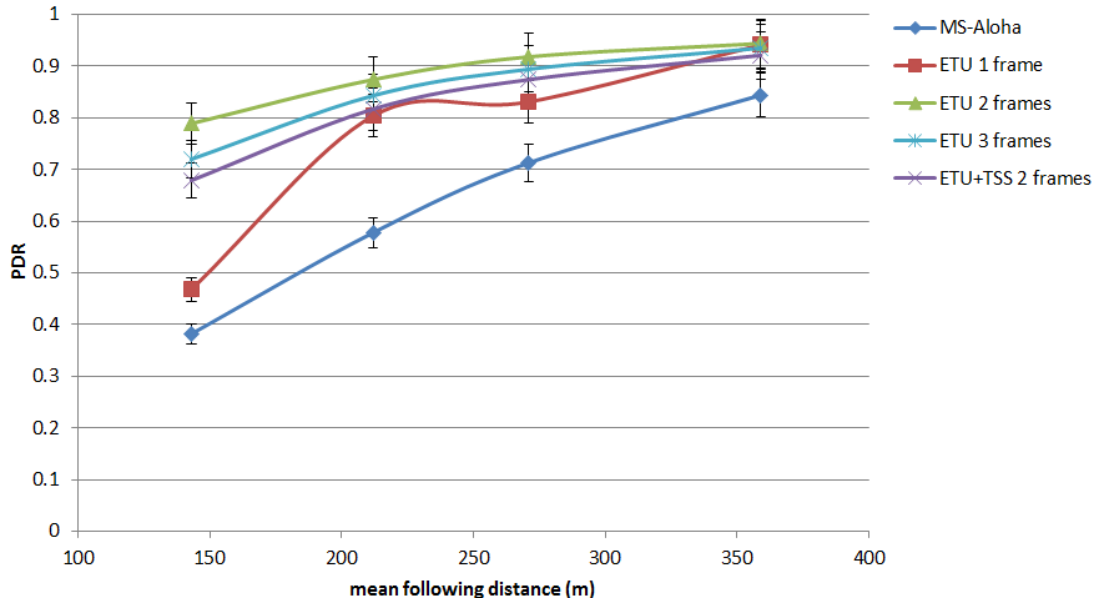

Fig. 21 PDRs of different protocols in Scenario 1

Fig. 21 shows the comparisons in terms of PDR. “ETU 2 frames” has the highest PDR. Even though the PDR of “ETU+TSS 2 frames” is lower than that of “ETU 2 frames” and “ETU 3 frames”, recall the explanation in 5.2.2., PDR is not a primary metric to evaluate the reliability.

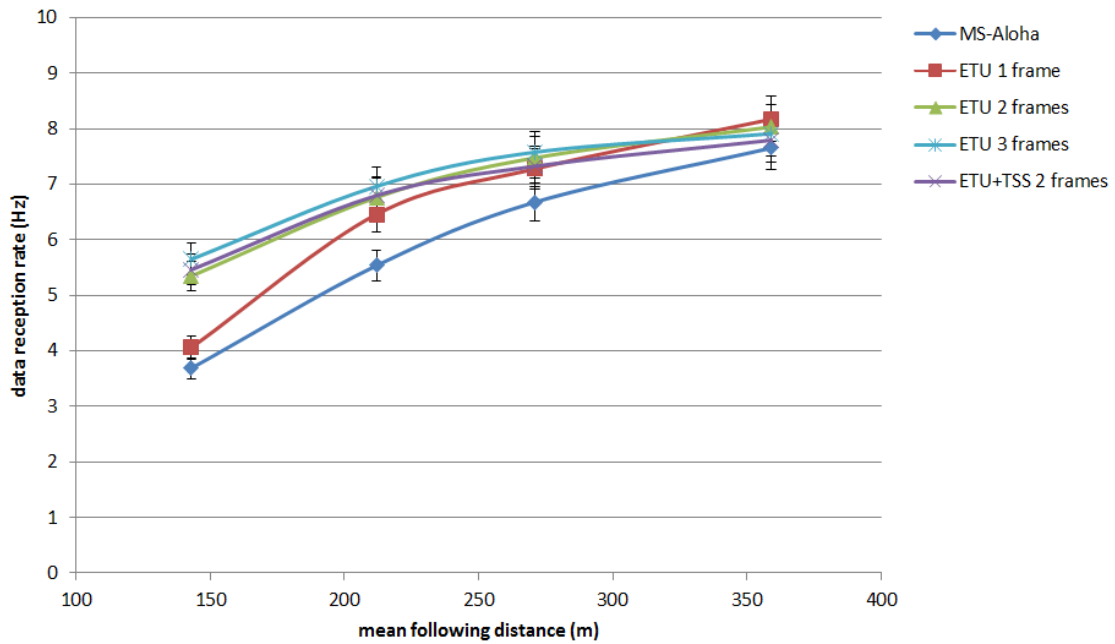

Fig. 22 Data reception rates of different protocols in Scenario 1

Fig. 22 shows that “ETU 3 frames” has the highest data reception rate in very dense conditions. Furthermore, their data receptions rates of “ETU 2 frames”, “ETU 3 frames” and “ETU+TSS 2 frames” are all higher than 4Hz even in the worst case, which is satisfying (5.1.2.).

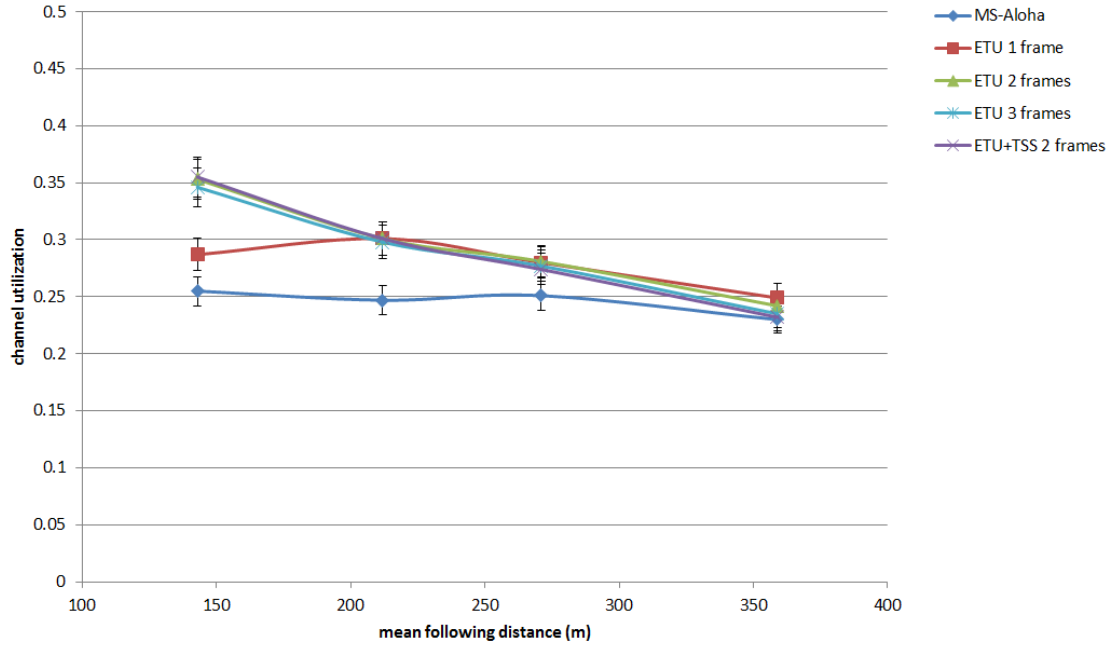

Fig. 23 Channel utilizations of different protocols in Scenario 1

Fig. 23 shows that in “ETU 2 frames”, “ETU 3 frames” and “ETU+TSS 2 frames”, channel utilization keeps growing with the increase of vehicular density even in the worst case, clarifying the efficient timeslot usage.

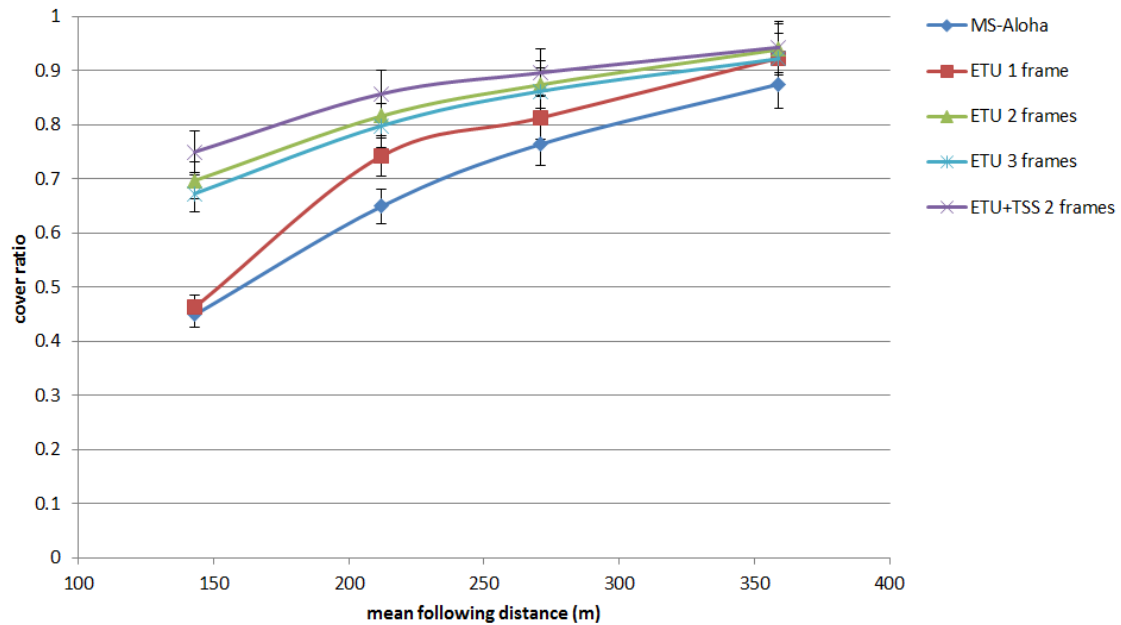

Fig. 24 CRs of different protocols in Scenario 1

Fig. 24 shows that as expected “ETU+TSS 2 frames” has the highest CR, proving the usefulness of TSS in dense conditions. Moreover, “ETU 2 frames” and “ETU 3 frames” take the second and third places, implying that the implement of ETU indeed improves the reliability.

6.2.2.2 Scenario 2 (rural)

Scenario 2 aims to simulate a rural scenario. All obtained data is from 400~500 s from the beginning of the simulations.

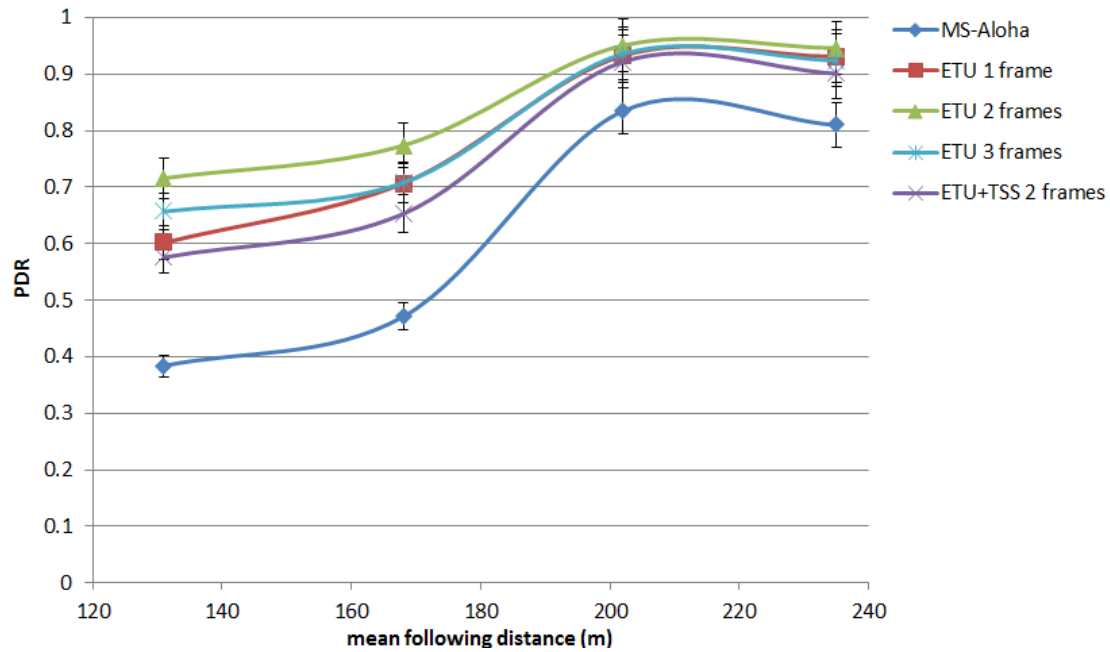

Fig. 25 PDRs of different protocols in Scenario 2

Fig. 25 shows the comparisons in terms of PDR. “ETU 2 frames” has the highest PDR. Even though the PDR of “ETU+TSS 2 frames” is lower than that of others except MS-Aloha, recall the explanation in 5.2.2., PDR is not a primary metric to evaluate the reliability.

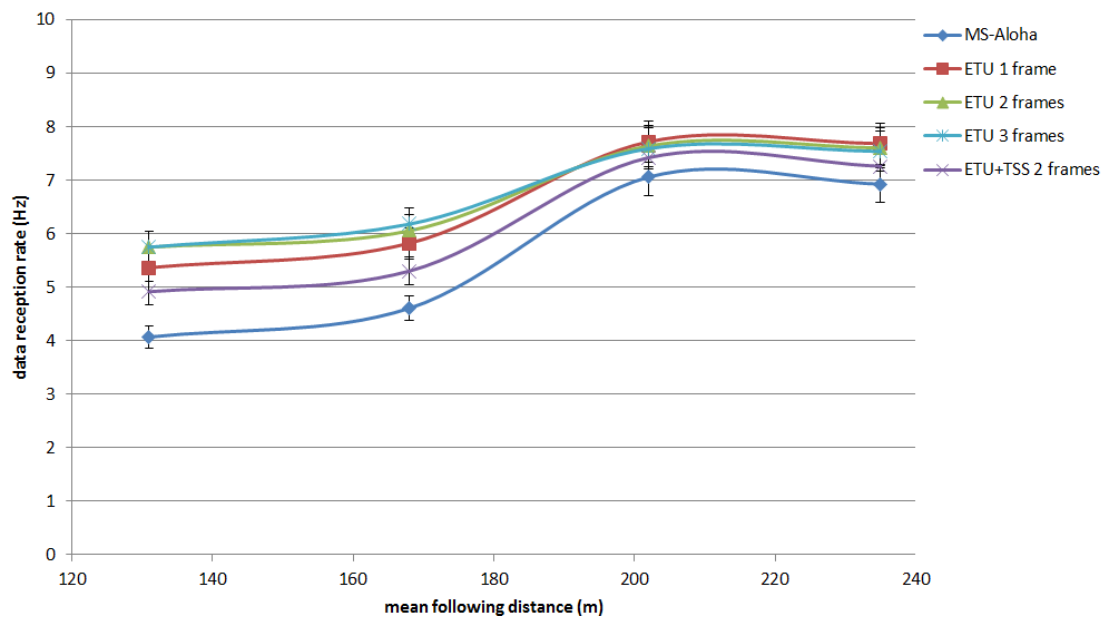

Fig. 26 Data reception rates of different protocols in Scenario 2

Fig. 26 shows that both “ETU 2 frames” and “ETU 3 frames” have the highest data reception rate in very dense conditions. The data receptions rates of all protocols are all higher than 4Hz in the worst case, even though MS-Aloha is barely eligible.

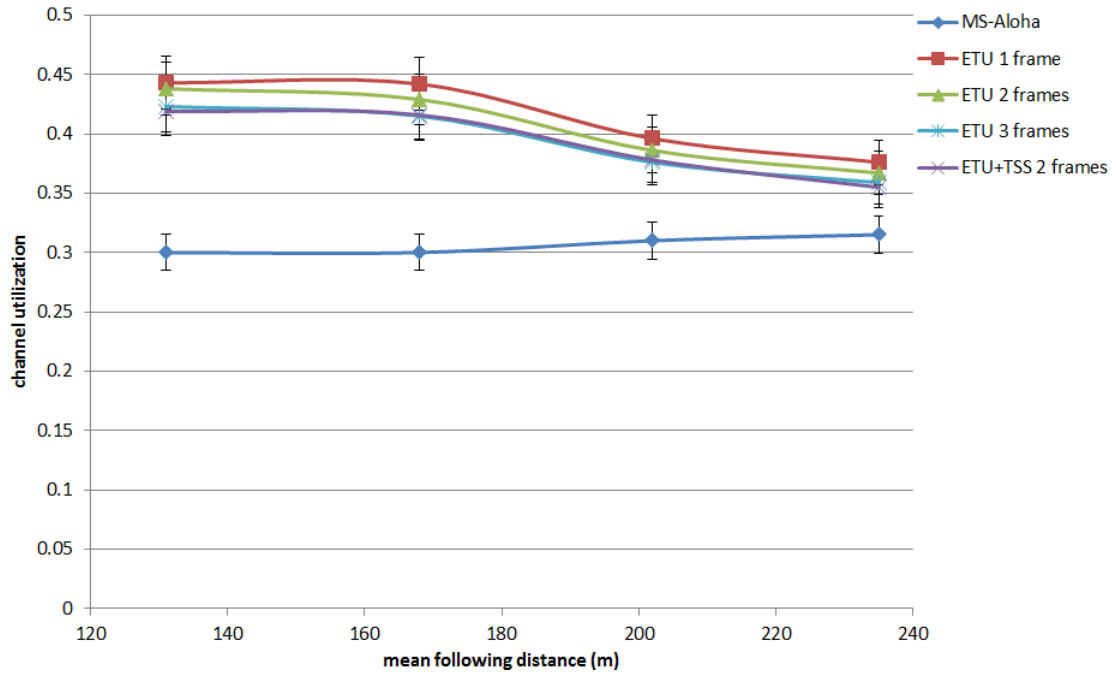

Fig. 27 Channel utilizations of different protocols in Scenario 2

Fig. 27 shows that except MS-Aloha, channel utilization keeps growing with the increase of vehicular density in other protocols, clarifying the efficient timeslot usage.

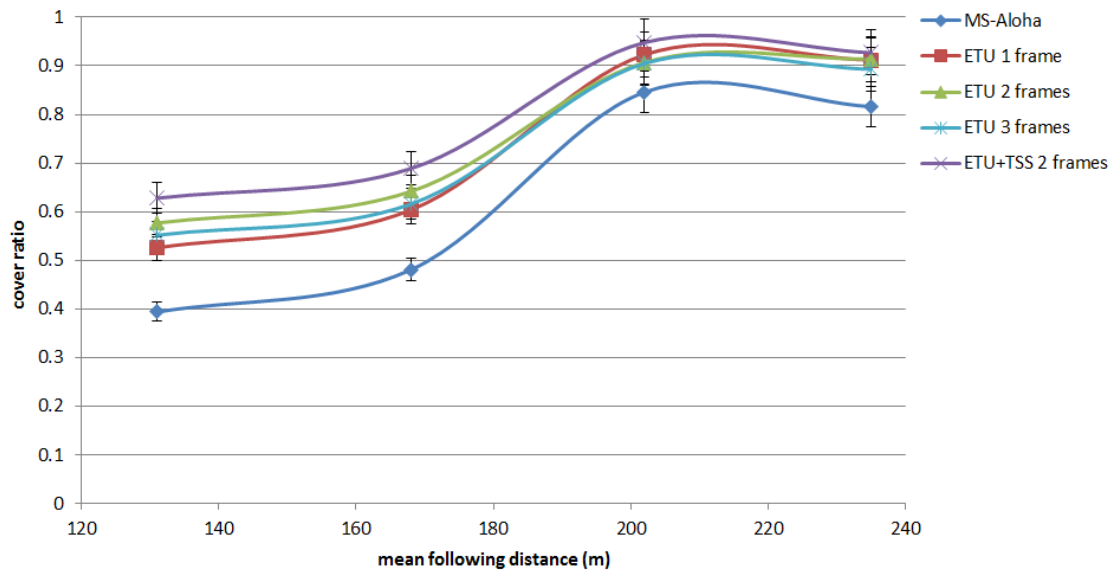

Fig. 28 CRs of different protocols in Scenario 2

Fig. 28 shows that as expected “ETU+TSS 2 frames” has the highest CR, proving the usefulness of TSS in dense conditions. Moreover, “ETU 2 frames” and “ETU 3 frames” take the second and third places, implying that the implement of ETU indeed improves the reliability.

6.2.2.3 Scenario 3 (highway)

Scenario 3 aims to simulate a highway scenario. All obtained data is from 300~400 s from the beginning of the simulations.

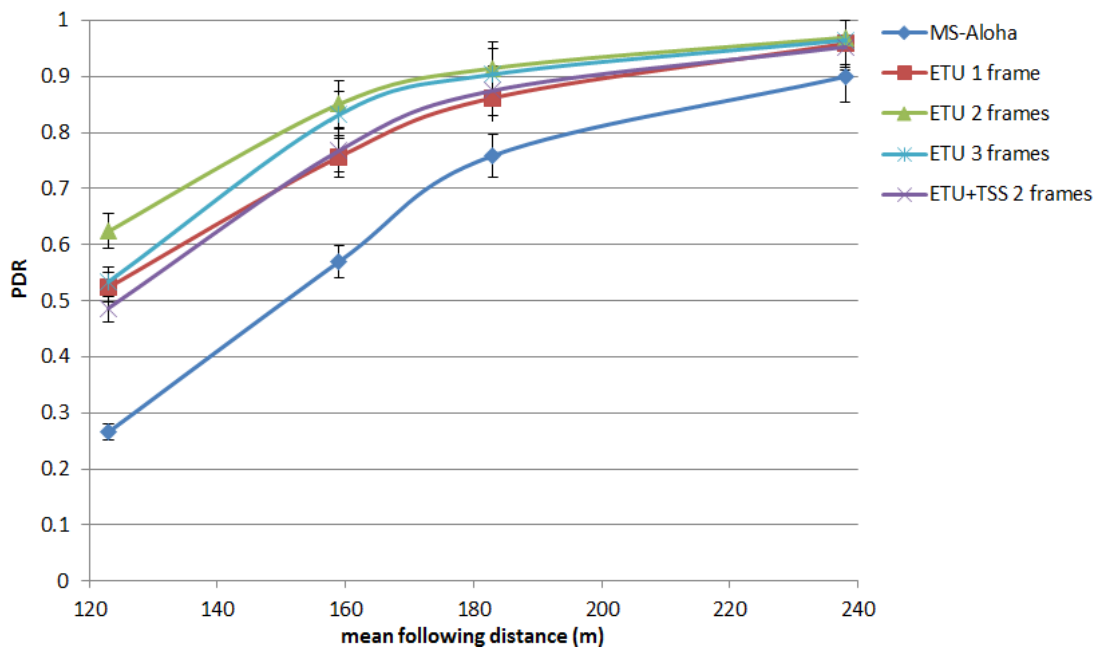

Fig. 29 PDRs of different protocols in Scenario 3

Fig. 29 shows the comparisons in terms of PDR. “ETU 2 frames” has the highest PDR. Even though the PDR of “ETU+TSS 2 frames” is lower than “ETU 2 frames” in all cases, recall the explanation in 5.2.2., PDR is not a primary metric to evaluate the reliability.

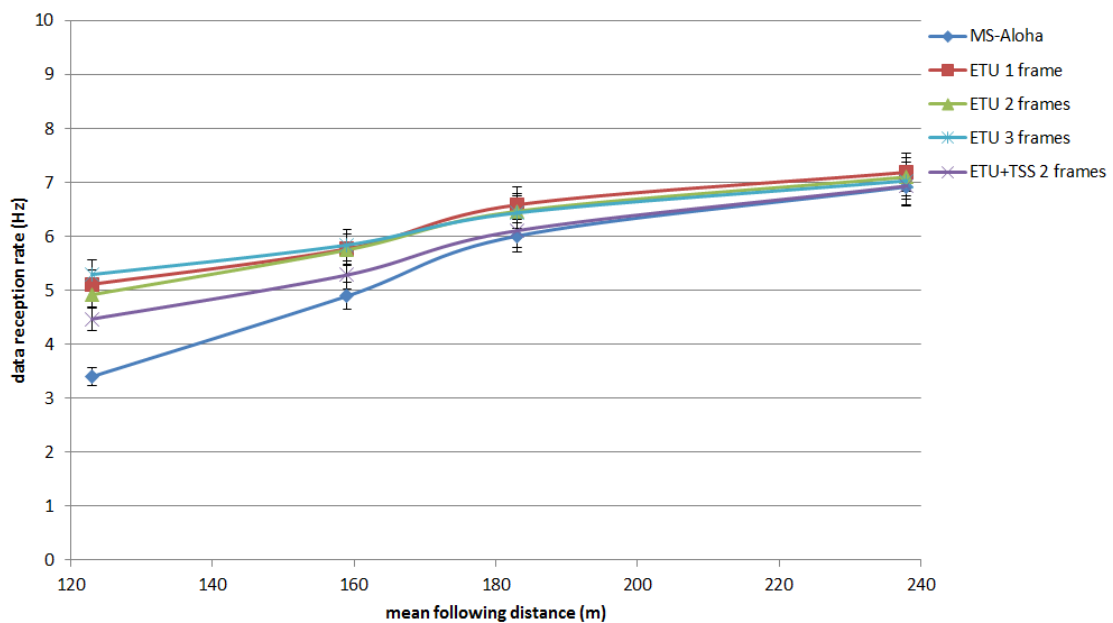

Fig. 30 Data reception rates of different protocols in Scenario 3

Fig. 30 shows that “ETU 1 frames”, “ETU 2 frames” and “ETU 3 frames” have similar data reception rate. Furthermore, the data reception rates of all protocols except MS-Aloha are higher than 4Hz even in the worst case, which is satisfying.

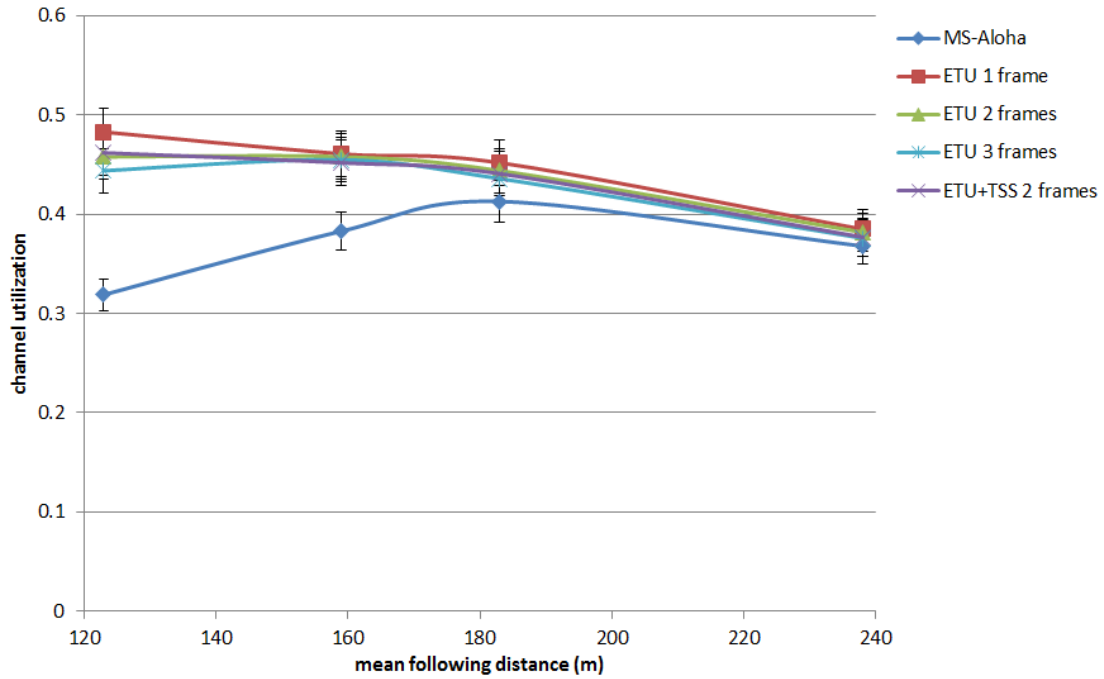

Fig. 31 Channel utilizations of different protocols in Scenario 3

Fig. 31 shows that channel utilization of “ETU 1 frame” keeps growing with the increase of vehicular density. The channel utilization of MS-Aloha decreases a lot with the increase of vehicular density compared to the others.

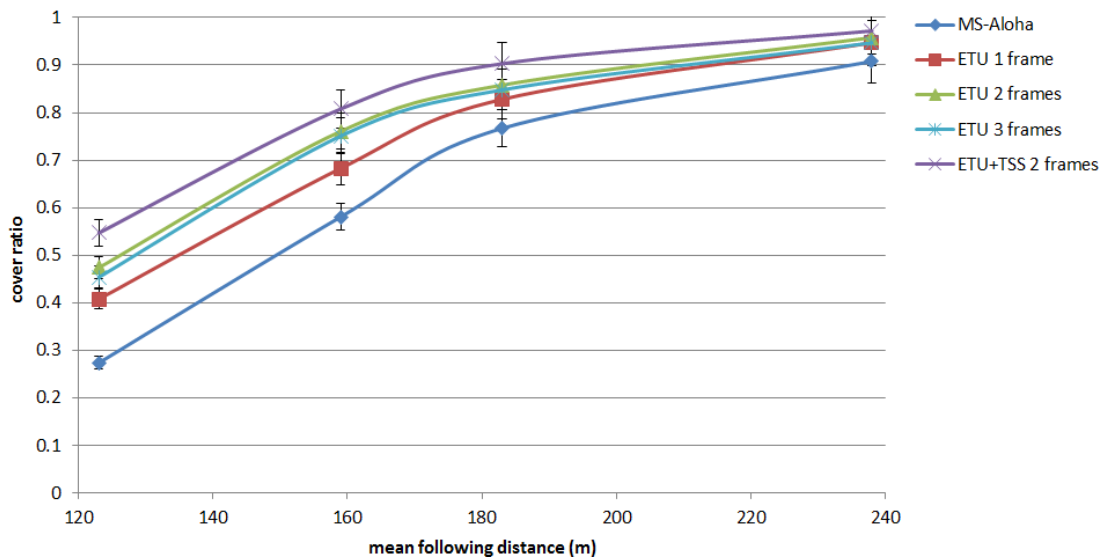

Fig. 32 CRs of different protocols in Scenario 3

Fig. 32 shows that as expected “ETU+TSS 2 frames” has the highest CR, proving the usefulness of TSS in dense conditions. Moreover, “ETU 2 frames” and “ETU 3 frames” take the second and third places, implying that the implement of ETU indeed improves the reliability.

6.2.3 Analysis

From the results of three different scenarios, some common points can be concluded.

First, as for the most important metric used to evaluate the reliability in this thesis, “ETU+TSS 2 frames” shows the highest CR in all cases, whichever the scenario or the vehicular density is. This definitely clarifies that RTOB indeed improved the reliability which is the goal of this thesis.

Second, in all three scenarios, in terms of PDR, “ETU+TSS 2 frames” never takes the first place, implying that PDR as a conventional metric to evaluate the reliability is improper here, from the viewpoint of safety-related applications. On the contrary, the proposed metric CR is more practical and useful.

Third, in terms of data reception rate, even though those values vary in different scenarios, data reception rates of all protocols only except MS-Aloha satisfy the requirement of 4Hz in all cases.

6.2.4 The Effect of Scaling-down

Due to the limitation of simulator SUMO where no more than 900 vehicles can be traced meanwhile, the number of TSS per frame in former simulations was decreased from 131 to 20 as aforementioned, in order to decrease the required number of vehicles.

To estimate the effect of this scaling-down, one more set of simulations have been conducted. The new topology for this set of simulations is a 4x4, 1000x1000 m² grid. The mean number of vehicles is 361. Since the essential factor to describe the density of the network is vehicles/km², here instead of mean following distance, vehicles/m² is used. The density of this set of simulations is 361 vehicles/km² which is practical. Also the effect of obstacles is taken into account as well as Scenario 1. The only factor varying in this set of simulations is the number of TSS per frame. The reason why only 20, 40, 60 and 80 TSS/frame have been simulated is due to the limited computer performance. With the increasing number of TSS per frame, one simulation will even take several days. Nevertheless, we can still deduce the result when there are 131 TSS in each frame.

For simplicity, only MS-Aloha and “ETU+TSS 2 frames” were compared. The results are shown below.

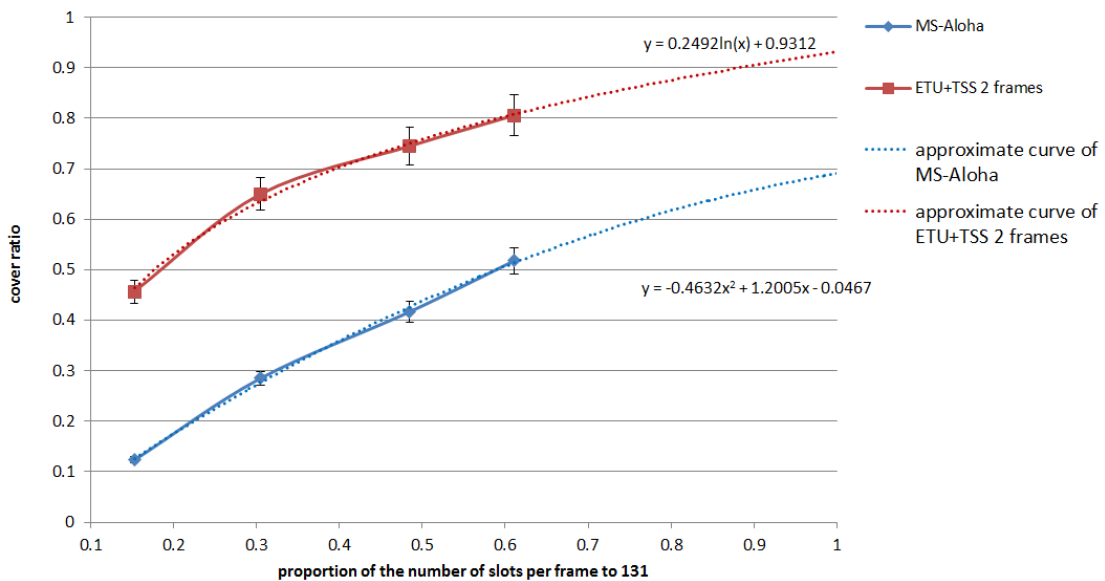

Fig. 33 CRs of MS-Aloha and ETU+TSS 2 frames related to the number of slots per frame

In Fig.33, approximate curves are drawn with Microsoft Excel to infer the CRs of two protocols when the number of TSs per frame is 131 (when the x-coordinate is 1). Even the CRs of both two protocols grow as the number of TSs per frame increases, the superiority of “ETU+TSS 2 frames” keeps evident.

Chapter 7

FURTHER CONSIDERATION – PACKET COLLISION PREVENTION

Thanks to the function of FI, it is possible to prevent packet collision since vehicles can know the TS usages within four-hop range. In detail, assume V_A and V_B are using the same TS. If there is another V_C between them and able to receive the FIs having the STIs of both V_A and V_B , and deduce they are approaching, V_C can broadcast a special message to notify V_A or V_B to let one of them select another TS.

To this end, the first issue is how V_C can accurately decide how far away V_A and V_B are, and accordingly if they are approaching to each other. In complex situations, V_C may receive FIs having STIs of V_A and V_B from many vehicles nearby and those FIs might be relayed several different times (once being relayed, NH plus 1). So the method to decide how many hops away V_A and V_B are should be statistical for accuracy.

The second issue is how far away when V_A and V_B are from V_C , V_C is supposed to notify V_A and V_B , letting one of them select another free TS. Since in RTOB, ideally, vehicles reuse TSs at four-hop intervals, if V_A and V_B are now four-hop away (assume the decision of the distance is correct), V_A (or V_B) should select another free TS when they become three-hop away. Because when they become two-hop away, packet collision will happen.

The third issue is that whether we should use another new type of packet besides CN to let V_C notify V_A and V_B . If the new message is necessary, overhead may occur. If we just let CN do this work, whether it is compatible should be further considered.

The fourth issue is that if TSS is compatible with this proposal. Since TSS has been proposed under the assumption that two vehicles using the same TS are two-hop away and already caused packet collision, whether TSS can be adopted to the situation that two vehicles are three-hop away needs more considerations.

As future work, Packet Collision Prevention no doubt is worth further study. In this thesis, four important issues have been pointed out for reference.

Chapter 8

CONCLUSIONS

In this thesis, a new TDMA-based MAC protocol named RTOB is proposed. RTOB takes MS-Aloha as groundwork because of some advanced properties of MS-Aloha. To guarantee high reliability of transmissions and receptions, RTOB effectively solves two main flaws – inefficient timeslot usage and continuous blockings – of MS-Aloha. RTOB achieves efficient timeslot usage via three schemes: higher spatial timeslot reuse, multiple frames reference and efficient timeslot reallocation. Also, RTOB functions with timeslot sharing, counteracting continuous blockings.

From the viewpoint of the objective of CAMs, a kind of messages broadcast among vehicles for cooperative awareness, a new metric named Cover Ratio (CR) is proposed to evaluate the reliabilities of MAC protocols. Unlike the conventionally used metric PDR, CR can evaluate the reliability more practically and accurately.

Computer Simulations under three different scenarios were conducted to classify the usefulness of RTOB. As expected, the protocol “ETU+TSS 2 frames” which is of full functions of RTOB, shows the highest reliability especially when vehicular density is high, under all three scenarios. The simulation results prove that RTOB is a reliable MAC protocol and versatile in diverse situations.

As a future work, the possibility and four issues of packet collision prevention are pointed out.

Bibliography

- [1] Azimi, R.; Bhatia, G.; Rajkumar, R.; Mudalige, P., “Vehicular Networks for Collision Avoidance at Intersections”, Society for Automotive Engineers (SAE) World Congress, April, 2011.
- [2] Harvey J. Miller; Shih-Lung Shaw (2001). Geographic Information Systems for Transportation. Oxford University Press. ISBN 0-19-512394-8.
- [3] “Federal Communications Commission. News Release, October 1999”. FCC. Retrieved 2009-08-16.
- [4] “European Telecommunications Standards Institute. News release, September 2008”. ETSI. Retrieved 2009-08-16.
- [5] ETSI TR 102 862 V1.1.1 (2011-12) Intelligent Transport Systems (ITS); Performance Evaluation of Self-Organizing TDMA as Medium Access Control Method Applied to ITS; Access Layer Part.
- [6] ETSI TR 102 861 V1.1.1 (2012-01) Intelligent Transport Systems (ITS); STDMA recommended parameters and settings for cooperative ITS; Access Layer Part.
- [7] Omar, H.A.; Weihua Zhuang; Li Li, “VeMAC: A TDMA-Based MAC Protocol for Reliable Broadcast in VANETs”, Mobile Computing, IEEE Transactions on (Volume:12 , Issue: 9), pp. 1724 – 1736, 24 July 2013.
- [8] Borgonovo, F.; Capone, A.; Cesana, M.; Fratta, L., “ADHOC MAC: new MAC architecture for ad hoc networks providing efficient and reliable point-to-point and broadcast services,” Wireless Networks, vol.10, no. 4, pp. 359-366, 2004
- [9] Vehicle Safety Communications Project, Task 3 Final Report, Identify Intelligent Vehicle Safety Applications Enabled by DSRC, DOT HS 809 859, March 2005.
- [10] An, N.; Maile, M.; Jiang, D.; Mittag, J., “Balancing the requirements for a zero false positive/negative Forward Collision Warning,” Wireless On-demand Network Systems and Services (WONS), 2013 10th Annual Conference on, pp.191 – 195, 18-20 March 2013.
- [11] Fan Bai; Krishnan, H., “Reliability Analysis of DSRC Wireless Communication for Vehicle Safety Applications”, Intelligent Transportation Systems Conference, 2006. ITSC '06. IEEE, pp.355 – 362, 17-20 Sept. 2006.
- [12] Cozzetti, H.A.; Scopigno, R.M., “Scalability and QoS in MS-Aloha VANETs: Forced TS re-use versus pre-emption,” Intelligent Transportation Systems (ITSC), 2011 14th International IEEE Conference on, pp.1759 – 1766, Oct. 2011.

Publications

[1] Fei Han; Daisuke Miyamoto; Yasushi Wakahara, “RTOB: a TDMA-based MAC protocol to improve reliability for one-hop broadcast in VANET”, 5th IEICE Steering Committee on Network Software, Oct. 2014.

[2] Fei Han; Daisuke Miyamoto; Yasushi Wakahara, “Reliable TDMA-based One-hop Broadcast for Safety Applications in VANET”, IEICE General Conference 2015, March 2015.

[3] Fei Han; Daisuke Miyamoto; Yasushi Wakahara, “RTOB: a TDMA-based MAC protocol to improve reliability for one-hop broadcast in VANET”, 12th IEEE Workshop on Managing Ubiquitous Communications and Services (MUCS 2015) part of PerCom 2015, March 2015.