

Effects of low frequency magnetic fields on dna synthesis

著者	Ronan P., Nafalski A., Yamada Sotoshi, Gunji Y., Harada Shin-ichi, Yamamoto H.
journal or publication title	IEEE Transactions on Magnetics
volume	32
number	5 PART 2
page range	5115-5117
year	1996-01-01
URL	http://hdl.handle.net/2297/6898

EFFECT OF LOW FREQUENCY MAGNETIC FIELDS AND INDUCED CURRENT ON DNA DIGESTION

P. Ronan, and A. Nafalski
School of Electrical Engineering, University of South Australia,
E-mail: ronan@magstar.ec.t.kanazawa-u.ac.jp

S. Yamada, and Y. Gunji
Laboratory of Magnetic Field Control and Applications, Faculty of Engineering, Kanazawa University

S. Harada, and H. Yamamoto
Department of Biochemistry, School of Medicine, Kanazawa University,

Abstract

Magnetic fields have been a concern to engineers, scientists, and the general public for a number of years because of their prevalence in modern society. This paper looks at power frequency magnetic fields and the induced current effect on DNA digestion *in vitro*. DNA digestion is measured by electrophoresis patterns. By comparing the exposed and control cases it was found that the induced current enhanced the DNA digestion for current densities of 0.5 and 1.0 $\mu\text{A}/\text{mm}^2$.

1. INTRODUCTION

The effect of Electromagnetic Fields (EMF) on health has been a concern to the scientific and general communities for the last 20 years. Modern society produces a large number of EMF of varying frequency and magnitude. We are constantly exposed to a wide variety of these fields as we lead our normal lives. Common sources of EMF are electrical appliances, power lines, radio waves, cellular phones, and X-rays to name a few. This paper deals with the Extremely Low Frequency (ELF) EMF, frequencies below 300 Hz.

EMF are present everywhere in modern day society. This is one of the reasons that an answer must be found to the question as to whether EMF is a health hazard and if so what levels are safe. Previous studies have shown mixed results [1] - [3]. One of the problems with the research being done on EMF is that because the field is so large that studies cannot often be compared because of different frequencies used and the differences in biological studies. Also the major area of concern is the fact that experimental results have not been reproducible by independent sources. Another problem is the fact that the exact site of interaction between magnetic fields and biochemical reactions has not yet been determined. This must be found before an answer can be found to the debate as to whether Magnetic fields have an adverse health effect or not.

In order to understand the influence of magnetic fields on living organisms, it is important to investigate the influence of magnetic fields on each biochemical reaction. The experiments *in vitro* have the advantage of being reproducible and being able to limit the reaction to that which is desirable. Therefore it becomes easier to provide a quantitative discussion and to

determine whether or not the magnetic field has an influence on that particular biochemical reaction.

The experiment used two different methods to expose the medium to a current to determine if the current effected the digestion of DNA. The first was to use an electromagnet supplied with a 60 Hz alternating magnetic field stimuli which resulted in an approximate current density of 0.21 $\mu\text{A}/\text{mm}^2$ and a magnetic field of 1.0 T in the experiment medium. The second used a 60 Hz voltage supply with a current density of 0.5 and 1.0 $\mu\text{A}/\text{mm}^2$ in the experiment medium. The restriction enzyme used in the reaction was EcoRI.

The experiment involves using the restriction enzyme to determine if the magnetic field and the induced current or the current by it self produce an effect or not. An effect results if the DNA digestion process is changed by the presents of the magnetic field or current. This is determined by analyzing the electrophoresis pattern.

2. EXPERIMENT PRINCIPLE

The plasmid DNA used in this experiment was prepared by CsCl gradient solution method. After this process was completed, the CsCl was removed by dialysis. Before digestion with the restriction enzyme the plasmid DNA has two forms, open circular and super coil forms. After the complete digestion and electrophoresis the linearized form of DNA becomes visible.

The process by which EcoRI digests the plasmid DNA is shown in fig. 1. The figure shows the circular form of the DNA. The restriction enzyme recognizes a specific site in the DNA sequence and after complete digestion

has occurred this part of the DNA is removed and only the linearized DNA remains. Partial digestion occurs when not all of the possible DNA has been digested.

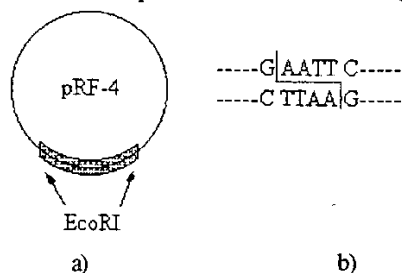

Fig. 1: a) Plasmid DNA; b) EcoRI recognition site

Two different methods were used to expose the DNA to a current. The first was to use an electromagnet as shown in fig. 2 and the second was to use an electric source, see fig. 3 for the circuit diagram. In the first method the current is induced by a magnetic field and thus the DNA is exposed to both the magnetic field and the induced current. Whereas the second method only exposes the reaction to a current.

The electromagnet was constructed of two E-type cores with their poles placed face to face. The experimental space was a 13 mm air gap and was situated in the central leg. A supply of 190 A at 60 Hz was found to generate a peak magnetic field of 1.0 T in the experimental space. The magnetic field was measured to be within 2% in the experimental space. The conductivity of the buffer used was measured at 0.12 S/m, then the maximum induced current density in the experiment well with a 6 mm diameter was estimated to be $0.21 \mu\text{A}/\text{mm}^2$. An incubator was set up in the experiment gap and the temperature kept at 37°C by circulating water through the incubator chamber.

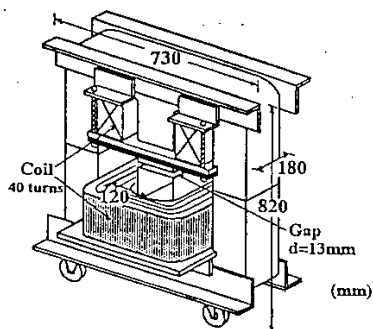

Fig. 2: Electromagnet for biomagnetic experiments

The second method used a electric source to generate a 60 Hz supply voltage. Variable resistors were used to vary the current in the experiment tubes. Platinum electrodes were used to reduce the possibility of contamination of the sample, also the tubes and electrodes were sterilized by autoclave before each experiment. The tubes used were approximately 20 mm in length and a diameter of 2 mm. The tubes were

placed inside an air incubator set at 37°C with the rest of the experiment placed outside the incubator and connect by shielded wires to reduce noise. The temperature was controlled using two thermocouples placed next to the tubes inside the incubator.

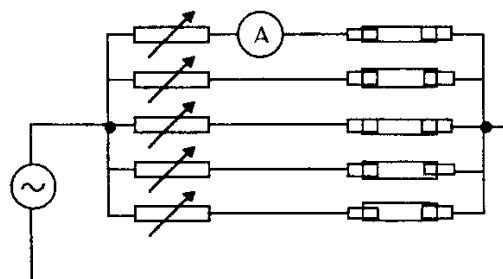

Fig. 3: Exposed current circuit for biomagnetic experiments

3. DNA DIGESTION DEPENDENCE ON MAGNETIC FIELDS AND INDUCED CURRENT

The sample as shown in Table 1 was used for both experiments.

Table 1: Sample makeup

Ingredient	Volume (μl)
d H ₂ O	33
10 × Buffer (H)	5
DNA (500 $\eta\text{g}/\mu\text{l}$)	1
EcoRI (6 or 12 $\text{u}/\mu\text{l}$)	1
	40

Figs. 4 and 5 show the experiment procedure for the magnetic field exposure and the current exposure respectively. First all the ingredients were mixed on ice. The sample was then placed into the well for exposure to the magnetic field and induced or placed into the tube for exposure to the current. Also a sample was placed into the magnetic field generator with no field present to determine a control. The same was done for the current experiment. Various time intervals of 0, 5, 20 and 60 minutes were used for both the exposed and control cases. After the exposure time had elapsed the reaction was stopped by mixing the sample with 2 μl of 0.5 M EDTA, pH 8.0 so as to stop DNA digestion by removing the magnesium from the enzyme. This makes the enzyme inactive.

Finally the solution was mixed with a dye and electrophoresed in 1% Agarose gel for 1 hour at 50 V dc. The results shown in figs. 6, 7 and 8 were obtained for 0.21 , 0.5 and $1.0 \mu\text{A}/\text{mm}^2$ respectively.

The $\lambda\text{HindIII}$ band in figs. 6, 7, and 8 is a DNA size marker. This provides a reference for the length of the DNA strands in the solution. DNA consists of the four

bases, A, G, C and T. The y-axis scale is the number of base pairs in each DNA strand. So the figures 6, 7, and 8 show the digestion of the DNA over time.

Starting with the intact DNA which consists of the two types, open circular and super coil as shown in the figures. After 60 minutes in both the control and exposed case of figure 6 the DNA is completely digested as shown by the two bands at 3.8 kb and 2.8 kb. The other two figures are interpreted in the same way with complete digestion occurring after 20 minutes for $J = 0.5 \mu\text{A}/\text{mm}^2$ and 5 minutes for $J = 1.0 \mu\text{A}/\text{mm}^2$. Whereas the control for both of these cases is not completely digested after 60 minutes.

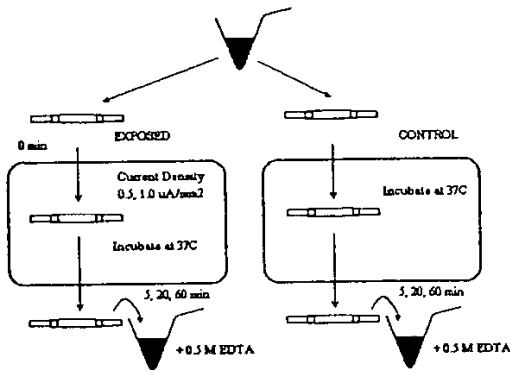

Fig. 4: Experiment procedure for magnetic field exposure

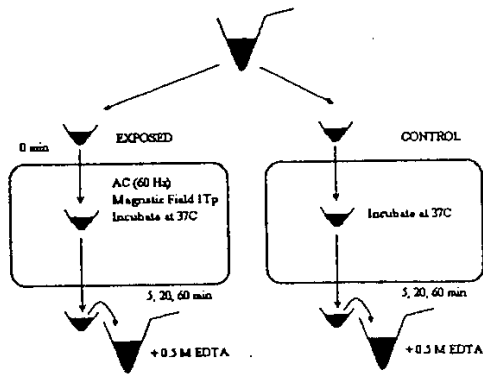

Fig. 5: Experiment procedure for current exposure

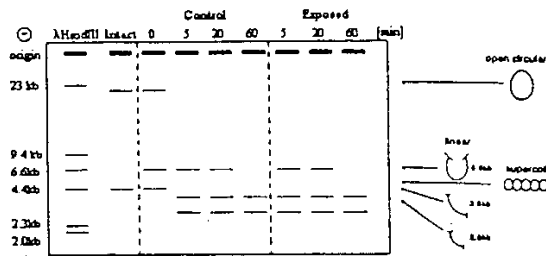

Fig. 6: Magnetic field and induced current exposure. Max. induced current estimated $0.21 \mu\text{A}/\text{mm}^2$

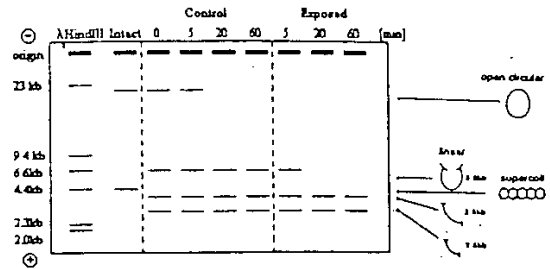

Fig. 7: Current exposure, $J = 0.5 \mu\text{A}/\text{mm}^2$

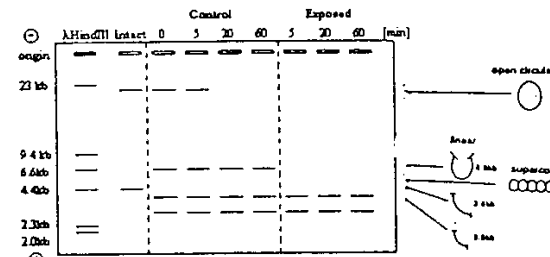

Fig. 8: Current exposure, $J = 1.0 \mu\text{A}/\text{mm}^2$

4. DISCUSSION

From the results shown in the above figures it was seen that for a current density of 0.5 and $1.0 \mu\text{A}/\text{mm}^2$ there was an enhancement of DNA digestion due to the exposed current. There was no effect on the digestion when exposed to a magnetic field of 1.0 T and an induced current of $0.21 \mu\text{A}/\text{mm}^2$.

The buffer used in the reaction contains NaCl. The presence of the NaCl is required to activate the enzyme. When the solution was excited with the current, the movement of the NaCl ions through the solution could have been increased. This increase in motion would increase the activation of the enzyme EcoRI and hence enhance the digestion of DNA.

The experiment was not conclusive as a number of problems were encountered during the experiment. The major problem was that the results were not as consistent as could be desired but the general trend was for an enhancement of the DNA digestion when exposed to the current alone.

There are a number of reasons as to what could have caused the problems that were encountered. The principle factor is that the DNA digestion reaction is very susceptible to environmental changes, for example small changes in temperature could result in the digestion being effected. The use of a number of thermocouples in the incubator was designed to try and reduce this problem.

Another problem was the fact that the amount of EcoRI theoretically required for complete digestion of the DNA present was much smaller than the final concentration used. It was found that for any concentration of EcoRI under 6 u/ μ l complete digestion was not accomplished. However it was observed for these lower concentrations that digestion of DNA was still enhanced by the presents of the induced current.

5. CONCLUSION

From this experiment it was found that there was an effect on the digestion of DNA by the restriction enzyme EcoRI for the case when the current was present at the magnitudes of 0.5 and 1.0 μ A/ mm^2 .

There was no effect from the combination of the magnetic field and the current induced by the magnetic field but the value of the induced current was smaller than that used for the experiment with the current alone. There is also the fact that the magnitude and distribution of the currents are different between the two cases.

Further experimentation needs to be done on this effect to determine a clearer answer and to determine how the exposed current increases the DNA digestion rate. This is proposed to be done by using different enzymes and current densities.

6. REFERENCE

- [1] Stephan P. Albert Bren, "60 Hz EMF Health Effects-A Scientific Uncertainty", IEEE Engineering in Medicine and Biology, Vol. 14, No. 4, July-Aug. '95, pp. 370-4.
- [2] Eugene M. Goodman, Ben Greenebaum and Michael T. Marron, "Effects of Electric Fields on Molecules and Cells", International Review of Cytology, Vol. 158.
- [3] S. Yamada, M. Kawasaki, Y. Gunji, P. Ronan, S. Harada, and H. Yamamoto, "Effects of Low Frequency Magnetic Fields on DNA Synthesis", Digests of INTERMAG '96, GR-3, 1996.