

Sci. Rep. Kanazawa Univ.

Vol. 39, No.2, pp. 39 ~46

December 1994

The synthesis of carbon nanotubes and nanoparticles by alternating current arc - discharge evaporation method

YOSHINORI HIRATA, MASAYUKI OKUNO and TAKEO MATSUMOTO

Department of Earth Sciences, Faculty of Science, Kanazawa University, Kakuma, Kanazawa, 920-11, Japan

Abstract: Carbon nanotubes and nanoparticles have been synthesized by the alternating current (a.c.) arc-discharge evaporation method. A carbon rod and a carbon string were used as the source material for carbon. The synthesis of carbon nanotubes and nanoparticles was carried out under the following conditions, a voltage of 6~15 V, a current of 8~20 A and with helium gas at approximately 700 Torr. As a result of these conditions, carbon nanotubes and nanoparticles were found on the electrode. The morphology of the nanotubes is similar to those reported from the direct current (d.c.) arc-discharge evaporation method (Iijima et al. (1992)). However, in the present study a few nanotubes were observed to be bent in the middle section and completely sealed by a cap at the each end. Two types of nanoparticles were found on the carbon electrodes, (1) a spherical nanoparticle with a hollow and (2) a nanoparticle with a similar shape as those observed on the nanotube tips. There were no nanotubes or nanoparticles found on the glass substrate used for the collection of carbon materials deposited in the reaction chamber.

1. Introduction

Diamond and graphite are well known as the two polymorphs of carbon. Recently "C₆₀", a new form of carbon was found by Kroto et al. (1985). They synthesized C₆₀ by the vaporization of a graphite disk in a high density helium flow, using a focused pulsed laser. The C₆₀, which is called "buckminsterfullerene", has a truncated icosahedron structure similar to a sphere and has 32 faces, 12 of which are pentagon and 20 are hexagon. Carbon nanotubes, which are the other new form of carbon were synthesized by Iijima (1991). By using a direct current arc-discharge evaporation method, he has synthesized the needles of the carbon nanotubes and the nanoparticles at the negative end of the carbon electrodes. A structural model for a carbon nanotube reported by Iijima (1991) is shown in Fig.1. However, the synthesis of carbon nanotubes and nanoparticles using alternating current has not previously been reported. In this paper the authors report on the synthesis of carbon nanotubes and nanoparticles by using the a.c. arc-discharge evaporation method.

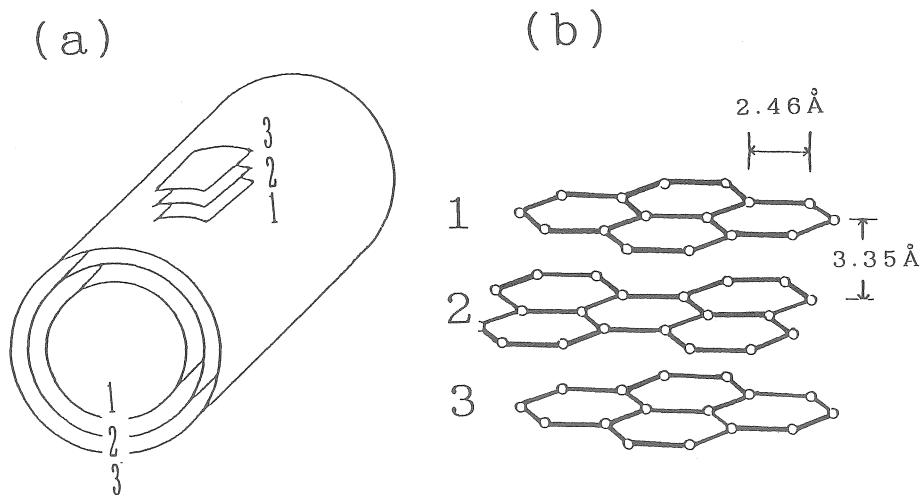

Fig. 1. (a) Schematic diagram of the structural model of the carbon nanotube reported by Iijima (1991). The number corresponds to the rolling of graphite layers.
 (b) Schematic diagram of the three sheets of graphite.

2. Experimental

2.1 Apparatus

Fig. 2 shows a schematic diagram of the carbon nanotube synthesis apparatus, which employs the a.c. arc-discharge evaporation technique used in this study. This apparatus is similar to that reported by Iijima (1991). The reaction chamber is made of pyrex glass, 13 cm long and 6 cm in diameter. The electrodes of the carbon sticks, the carbon string and the tungsten basket heater were supported by copper rods that were 0.45 cm in diameter. A plate of glass substrate was set up 9 mm above the electrode in the apparatus in order to collect synthesized carbon materials.

2.2 Synthesis

Three types of syntheses were undertaken. The differences were related to the source material of the electrode.

(a) Synthesis using carbon string

A carbon string 5 mm in diameter was used for the synthesis. Initially, the air in the reaction chamber was removed using a rotary pump and helium gas at approximately 700 Torr was introduced. The carbon discharge arc was generated by running an alternating current of 8~10 A at 15 V. The samples for TEM observation were collected from the carbon string in the reaction chamber.

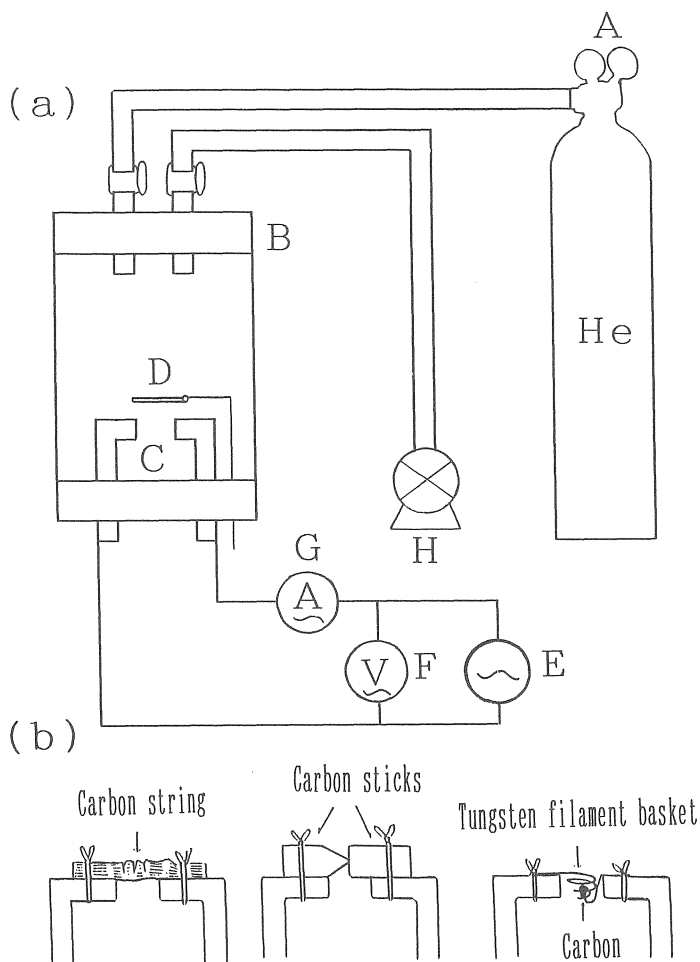

Fig. 2. (a) Schematic diagram of a.c. arc-discharge evaporation method apparatus. A, pressure gauge; B, reaction chamber; C, copper rod; D, substrate; E, slide rheostat; F, voltmeter; G, ammeter; H, rotary pump.

(b) Close up schematic diagram of electrodes.

(b) Synthesis using carbon sticks

Two carbon rods 6 mm in diameter for spectrum analysis (Shimadzu Co Ltd) were used for this synthesis. The sharpened point of a carbon rod was contacted against another rod with a flat face for arc-discharge evaporation. Similar to the first synthesis, the reaction chamber was filled with helium gas at approximately 700 Torr. The carbon discharge arc was generated by running an alternating current of 10~20 A at 10 V. The samples for TEM observation were collected from the carbon sticks in the reaction chamber.

(c) Synthesis by tungsten basket heater

A small lump of carbon approximately 3 mm and 0.02 g in weight was placed in a tungsten basket heater. As in the first synthesis, the reaction chamber was filled with helium gas at approximately 700 Torr. This synthesis was carried out under the current of 13~15 A at 6 V. This synthesis using the tungsten basket heater is a type of evaporation method. The samples for TEM observation were collected from the carbon stick in the tungsten basket heater.

3. Results and discussion

The TEM (TOPCON EM 002B, 200kV) examination, confirmed the carbon rod and string used for the source material showed a graphitic structure. The TEM revealed the products of the syntheses, the carbon nanotubes and nanoparticles to be found on the electrodes in all three syntheses. However, they were not observed on the substrate, except for one nanoparticle discovered in the synthesis using carbon sticks.

3.1 Carbon nanotube

The straight carbon nanotubes 5~20 nm in diameter were always formed on the surface of the carbon string and carbon rods, while no carbon nanotubes were formed on the substrate. As the temperature of substrate is lower than that of electrode, this indicates that carbon nanotubes were grown in higher temperature conditions. The majority of carbon nanotubes have polyhedral caps similar to those reported by Iijima et al. (1992). However, some of the nanotubes in the present study were bent and had two polyhedral caps. The carbon nanotubes were bent in the middle section and were formed in synthesis (a).

Fig. 3(a), Fig. 4 and Fig. 5 show the typical carbon nanotubes that were formed in synthesis (a), synthesis (b) and synthesis (c) respectively. Fig. 3 (a) shows the carbon nanotube 10 nm in diameter and is bent in the middle section. This tube has two caps, thus both ends of this tube are perfectly closed.

The nanotube consists of nine carbon-hexagon sheets, with a inner tube (making a total of ten) that is closed approximately 20 nm from the tip of the nanotube. On the left side of the nanotube, the ten tubes each have a thickness of approximately 0.34 nm, which is constant along the length of the nanotube (Fig. 3(b)). It is important to note the thickness of carbon-hexagon layers of graphite is 0.335 nm. Hence, the dark lines on the left side of the nanotube correspond to graphitic layers. On the right side of the nanotube the thickness of the carbon layers is not constant from the tip to the middle section of the nanotube (Fig. 3(b)). The thickness of each layer is 0.34 nm at the tip and is 0.39 nm at the middle section on average. Visible from the tip of the right side of the nanotube are two distinct carbon sections. The wider section consists of six carbon layers, while the narrower section consists of the three carbon layers.

The cap of the nanotube consists of three facets. Iijima et al. (1992) suggested that the occurrence of a pentagon in a hexagon network of a nanotube will result in strain around the pentagon, causing the tip of the nanotube to be closed by the occurrence of the six pentagons. It is considered that the apexes of the tube tip in Fig. 3(b) consist of four pentagons. Only four pentagons are visible in Fig. 3(b) because TEM figure is a type of projection and may not show all six apexes. Fig. 4 shows the carbon nanotubes accompanied by many nanoparticles. This figure indicates that the nanotubes have no preferred growth direction. In addition, the majority of nanotubes in this figure are straight.

Fig. 5 shows the two carbon nanotubes produced using the tungsten basket (synthesis method(c)), which are approximately 7.7 nm in diameter and have 10 graphite layers. Each of the nanotubes overlap each other at the upper end. These two nanotubes display the same number of graphite layers and similar diameters. Therefore, it is possible that these nanotubes can be regarded as one bent tube, and the concentric circle shows a cross section of this nanotube.

Iijima et al. (1992) indicated that the flux density of carbon atoms decreases towards the end of the arc discharge, and as soon as the arc stops, the tube tips are quickly closed by the formation of a pentagon. However, the present study used the alternating current and not the direct current method. Therefore, the flux density of carbon atoms was more

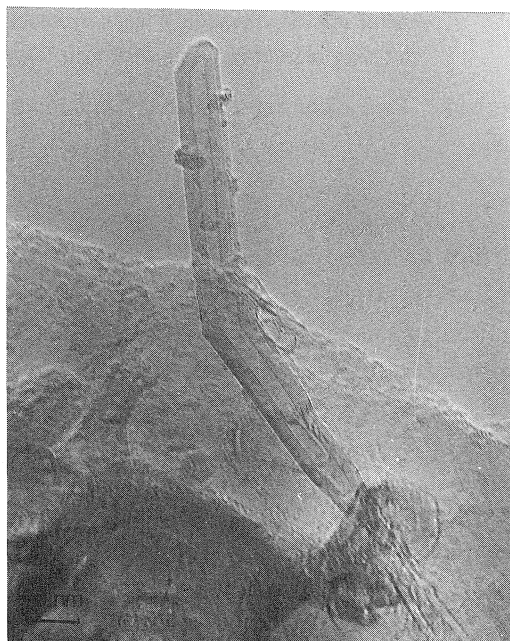

Fig. 3. (a) Electron micrograph showing carbon nanotube consisting of two caps. This nanotube was formed on the carbon string and is bending in the middle section.

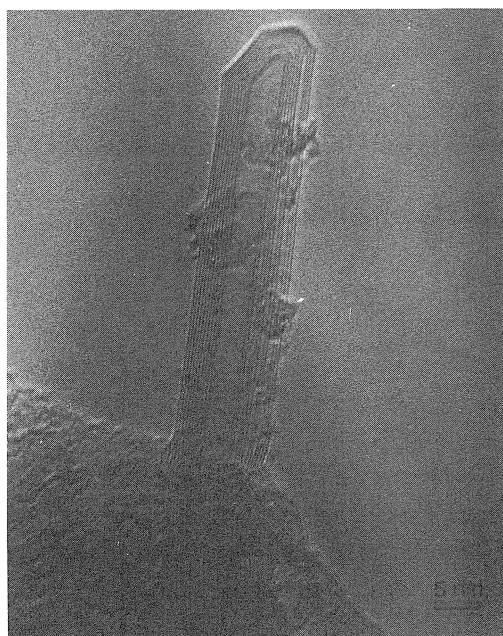

Fig. 3. (b) Close up micrograph of (a). The graphite layer structure $\{002\}$ can be observed.

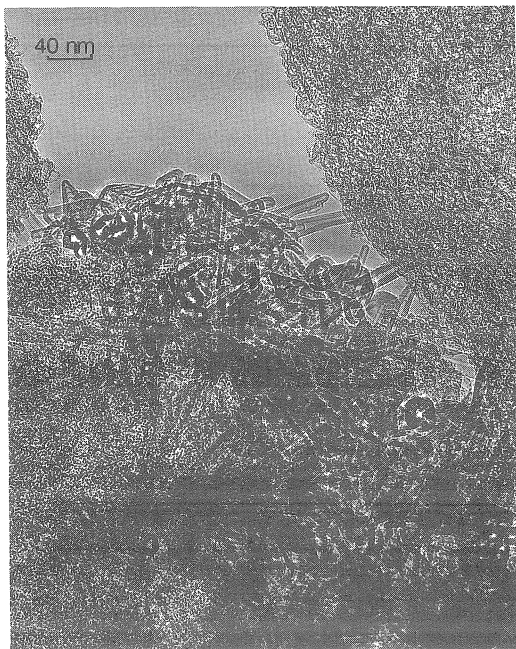

Fig. 4. Electron micrograph of carbon nanotubes and nanoparticles that were formed on the carbon string.

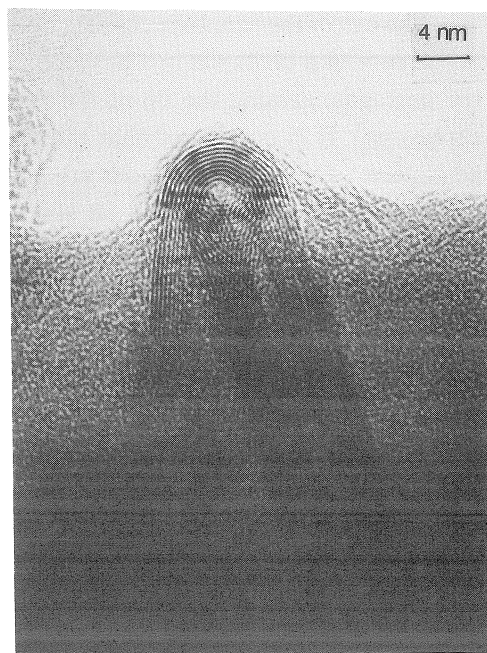

Fig. 5. Electron micrograph of two carbon nanotubes that overlap each other at the end of it. Individual dark line corresponds to the graphite sheets separated by 0.34 nm.

irregular than that used in the direct current method. This is consistent with the existence of many types of nanotubes in the present study.

3.2 Nanoparticle

The nanoparticles were formed on the surface of source carbon in all experiments. However, the existence of nanoparticles on the glass substrate was observed only from the carbon sticks (2-2(b)) synthesis. The majority of the nanoparticles were observed near the carbon nanotubes. This suggests that the nanoparticles were grown under the same conditions to that of the carbon nanotubes.

The present study identified two types of nanoparticles. The first type was nearly spherical with a hollow (Fig. 6). And the second type was a similar shape to those of the tips of the nanotubes (Fig. 8). Fig. 6, Fig. 7 and Fig. 8 display the nanoparticles formed in synthesis (a), synthesis (b) and synthesis (c) respectively. The cross section of the nanotube also shows a concentric circle of graphite layers. Therefore it is possible that the nanoparticles in Fig. 6 and Fig. 7 are cross sections of the nanotubes. However, if it is a cross section of nanotubes, the nanotube is orientated vertically on the micro grid. There are many of the nearly spherical nanoparticles together with nanotubes in Fig. 4. It is difficult to propose that many parts of these nanoparticles show cross sections of the

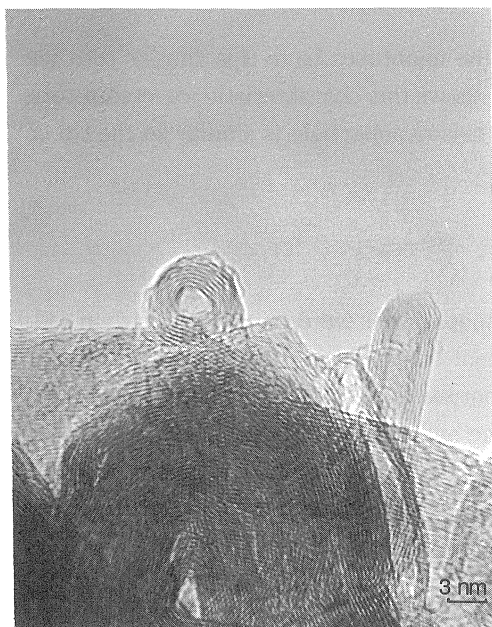

Fig. 6. Electron micrograph of a near spherical nanoparticle with a hollow found on the carbon string.

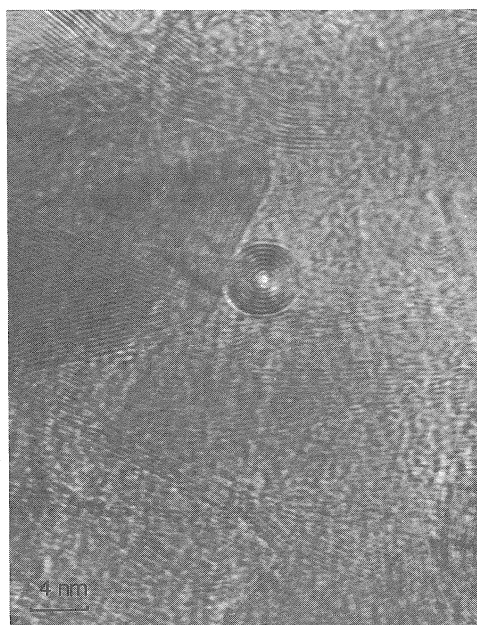

Fig. 7. Electron micrograph of a near spherical nanoparticle. This nanoparticle is 5.1 nm in diameter. The minimum circle in the center is approximately 0.7 nm in diameter.



Fig. 8. Electron micrograph of a nanoparticle similar to the tips of nanotubes. The nanoparticle, which overlaps the nanotube, is found in the soot in the tungsten basket heater.

nanotubes, because the probability of the vertical arrangements of nanotubes is very small. Therefore, the spherical materials in Fig. 6 and Fig. 7 are not cross sections of nanotubes but are nanoparticles. Iijima (1980) reported similar morphologies to those observed in the present study. Iijima (1980) observed small particles of graphitized carbon in amorphous carbon films, produced by the vacuum deposition method. Recently, it has been indicated that the C_{60} was included in the center of the spherical nanoparticle. The size of the minimum circle of the nanoparticle in Fig. 7 is approximately 0.7 nm in diameter. Given the size of C_{60} is 0.71 nm in diameter, this suggests that the nanoparticle in Fig. 7 may include C_{60} in the center.

Fig. 8 shows a nanoparticle that overlaps

the nanotube. Iijima et al. (1992) reported that the nanotubes have tips similar to a ice-cream corn in shape. The nanoparticle in Fig. 8 shows this characteristic ice-cream corn morphology. In other words, the morphology of this nanoparticle is similar to the tip of a nanotube.

4. Conclusions

In the present study, carbon nanotubes and nanoparticles were grown on a carbon rod, a carbon string and a carbon in a tungsten filament basket, using the a.c. arc-discharge evaporation method. The morphology of the nanotube tips is approximately the same as reported for the d.c. arc-discharge evaporation method used in previous works (Iijima et al. (1992)). However, using the a.c. arc-discharge method a bent nanotube was produced as shown in Fig. 3. The nanoparticles observed in the present study can be classified into two types, (1) spherical with a hollow and (2) similar to the tip of the nanotube. However, the variation between the nanotubes and the nanoparticles is not significantly distinct.

Acknowledgements

The authors wish to thank Mrs. Kate Webster and Mr. Jody Webster for their careful reading of this manuscript.

References

- Ebbesen, T.W. and Ajayan, P.M. (1992). Large-scale synthesis of carbon nanotubes. *Nature*, 358, 220-222.
- Iijima, S. (1980). Direct observation of the tetrahedral bonding in graphitized carbonblack by high resolution electron microscopy. *Journal of Crystal Growth*, 50, 675-683.
- Iijima, S. (1991). Helical microtubes of graphitic carbon. *Nature*, 354, 56-58.
- Iijima, S., Ajayan, P.M. and Ichikashi, T. (1992). Growth model for carbon nanotubes. *Physical review letters*, 3100-3103.
- Iijima, S., Ichikashi, T. and Ando, Y. (1992). Pentagons,heptagons and negative curvature in graphite microtube growth. *Nature*, 356, 776-778.
- Iijima, S. and Ichihashi, T. (1993). Single-shell carbon nanotubes of 1-nm diameter. *Nature*, 363, 603-605.
- Kroto, H.W., Heath, J.R., O'Brien, S.C., Curl, R.F. and Smalley, R.E. (1985). C₆₀: Buckminsterfullerene. *Nature*, 318, 162-163.
- Tsang, S.C., Harris, P.J.F. and Green, M.L.H. (1993). Thinning and opening of carbon nanotubes by oxidation using carbon dioxide. *Nature*, 362, 520-522.