

# AC high magnetic field generator based on the eddy-current effect

著者	Bessho Kazuo, Yamada Sotoshi, Sakai N., Minamitani T
journal or publication title	IEEE Transactions on Maggetics
volume	22
number	5
page range	970-972
year	1986-09-01
URL	<a href="http://hdl.handle.net/2297/48348">http://hdl.handle.net/2297/48348</a>

AC HIGH MAGNETIC FIELD GENERATOR BASED ON THE EDDY-CURRENT EFFECT

K. Bessho, S. Yamada, N. Sakai, T. Minamitani  
 Electrical Energy Conversion Laboratory  
 Faculty of Technology, Kanazawa University  
 Kodatsuno 2-40-20, Kanazawa 920, Japan

This paper describes a new method for generating sinusoidal high magnetic fields. The fundamental principle is that the flux applied by an electromagnet is concentrated into the slit between conductive plates and is compressed to an AC high magnetic flux density with eddy currents in the conductive plate. There are few methods which generate AC high magnetic fields.

INTRODUCTION

There have been various high magnetic generators such as superconducting magnet and various kinds of pulse magnets with normal conductor. These generators, however, are for only DC high magnetic field and cannot generate alternating high magnetic field. The new generator described in this paper can generate AC high magnetic field. There have been few physical experiments in AC high magnetic field until now. Therefore, we expect that the apparatus will bring new physical phenomena and technical applications in an AC high magnetic field.

MAGNETIC SHIELD EFFECT OF A CONDUCTIVE PLATE

We consider a conductive plate between magnetic poles as shown in Fig.1. The steady-state flux passes through the conductive plate on the DC excitation. But as the frequency becomes higher on the alternating excitation, the flux passing through the plate decreases.

We assume for simplicity that all materials in Fig.1 are linear and isotropic. As a sinusoidal exciting current is applied to coils, eddy currents are induced in the conductive plate and the expression of the flux density  $B = \sqrt{2} \hat{B} \exp(j\omega t)$  in the conductor is given as,

$$\nabla^2 \hat{B} = j \omega \mu \sigma \hat{B} \quad \dots(1)$$

where  $\mu$ ,  $\sigma$ ,  $\omega$  are permeability, conductivity and angular frequency of an exciting current respectively. If the angular frequency is supposed to be infinite ( $\omega\mu\sigma = \infty$ ), the condition  $\hat{B} = 0$  should be satisfied in the

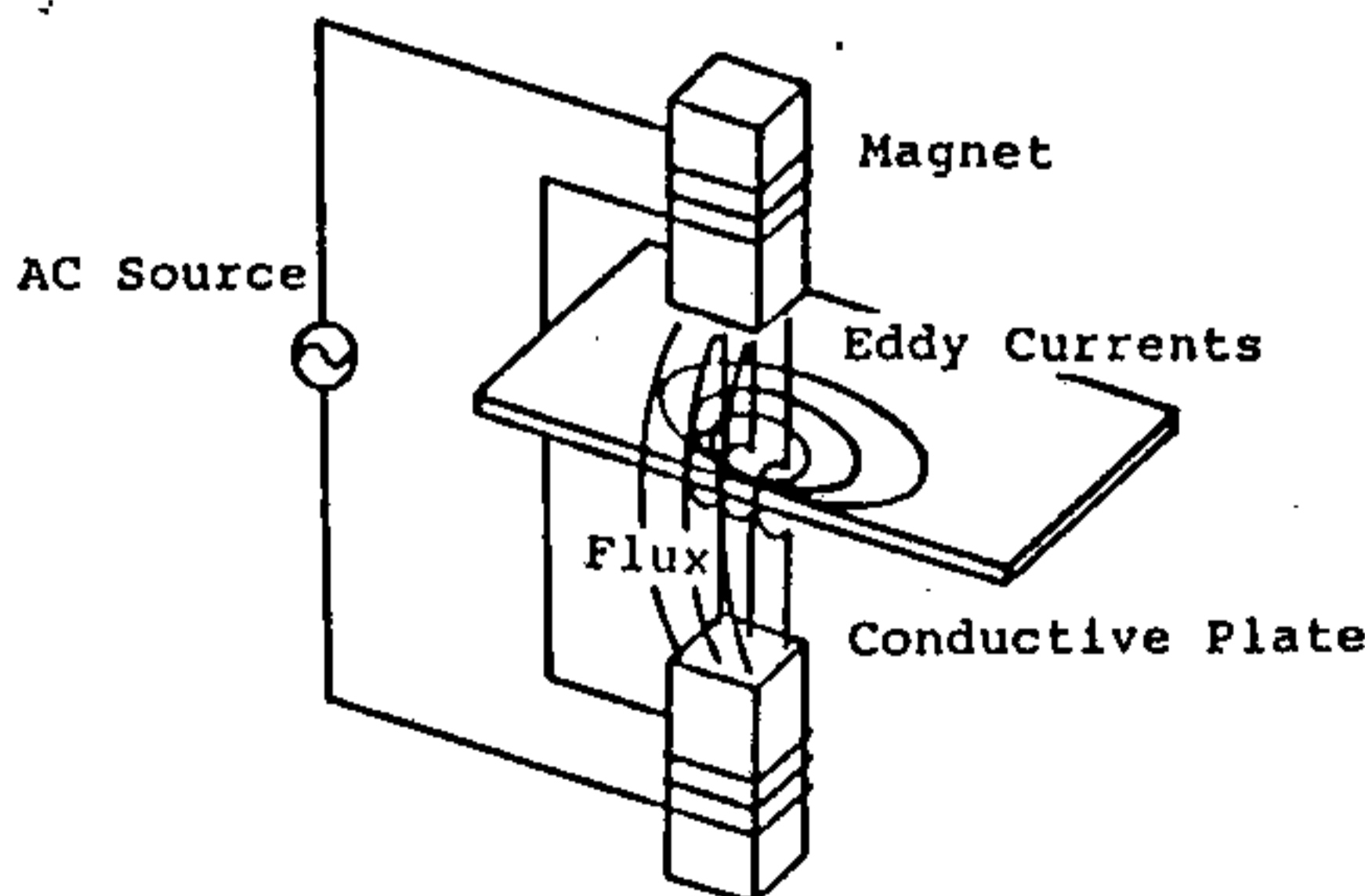

Fig.1 Magnetic shield effect of conductive plate

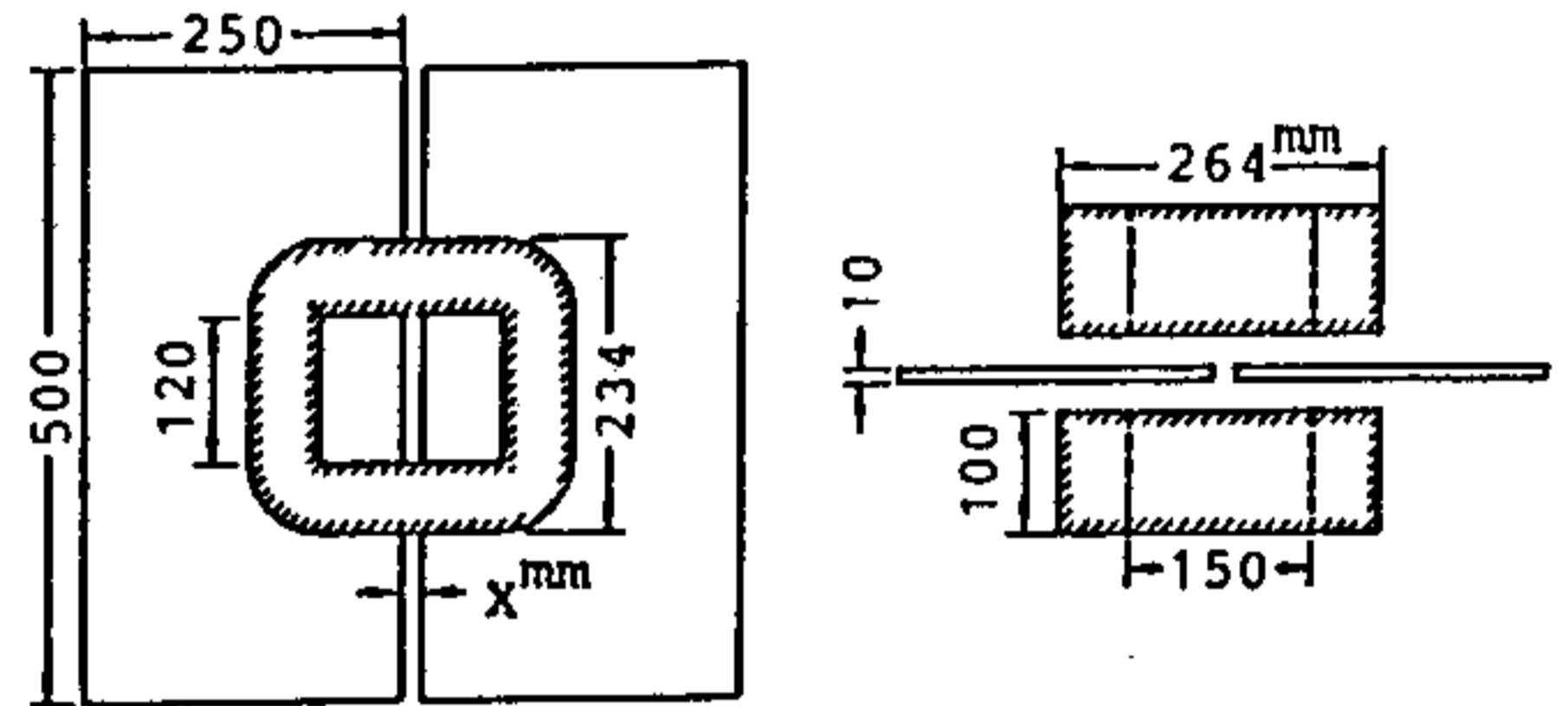

Fig.2 Arrangement of exciting coils and copper plates

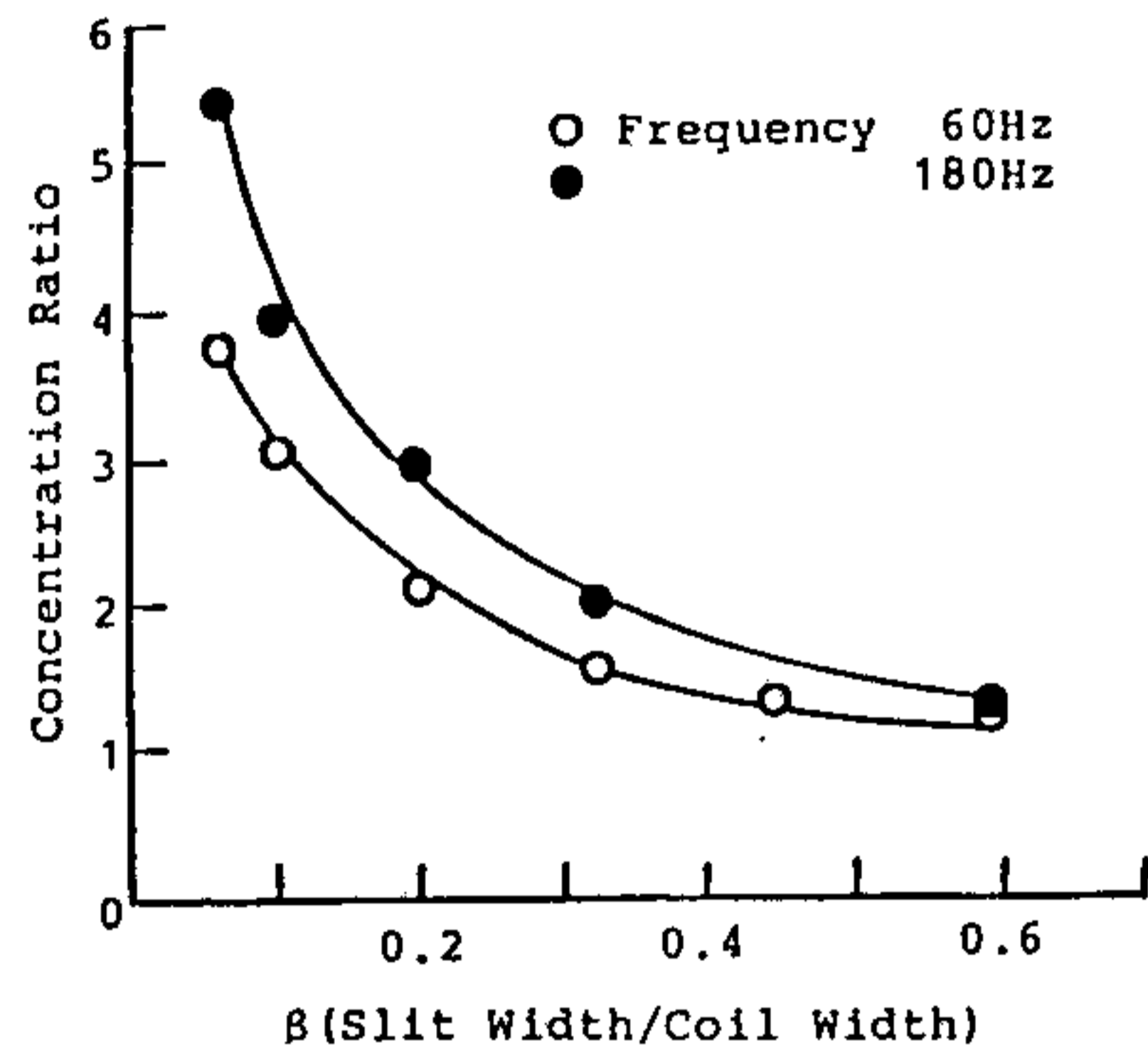

Fig.3 Relations between  $\beta$  and concentration ratio for exciting frequency

conductive plate so that the diffusion term of  $\nabla^2 \hat{B}$ , the left-hand side of Eq.(1), is finite. Therefore, a magnetic flux cannot penetrate the conductive plate and eddy currents exist in the surface of the plate. This phenomenon is the magnetic shielding effect of a conductive plate.

MAGNETIC FLUX CONCENTRATION

By the magnetic shield effect of the two conductive plates, the AC flux applied by the electromagnet can be concentrated into the air slit between two plates and an AC high magnetic field can be resulted.

We have made experiments on the equipment as shown in Fig.2. The air slit is put between two copper plates and the coils are excited by a sinusoidal alternating current at 60 Hz. In this case the conductive plates cannot be shielded perfectly from magnetic flux because of finite frequency. We recognize by Eq.(1) that the magnetic shielding effect of the conductive plates becomes remarkable with increasing angular frequency. Figure 3 shows the relations between  $\beta$  (slit width / coil width) and the concentration ratio in the exciting frequencies of 60 and 180 Hz. The

concentration ratio indicates the ratio of flux density without the plates to concentrated flux density. We confirmed that the concentration ratio is larger in frequency with 180 than 60 Hz. As the results, the maximum concentration ratios are 5.4 in 180 Hz and 3.7 at 60 Hz.

The flux concentration depends on the thickness of conductive plate too. Figure 4 shows the relations between  $\beta$  and the concentration ratio as the function of the thickness. The concentration ratio in the thickness of 20 mm is better than the other. In this experiment, the maximum concentration ratio is 5.2 in a thickness of 20 mm.

Figure 5 shows the flux distribution measured in the equipment. The flux distributions show that fluxes are concentrated into the slit but some of them penetrate through the plate.

Figure 6 shows the comparison between concentration ratios in the slit and the hole

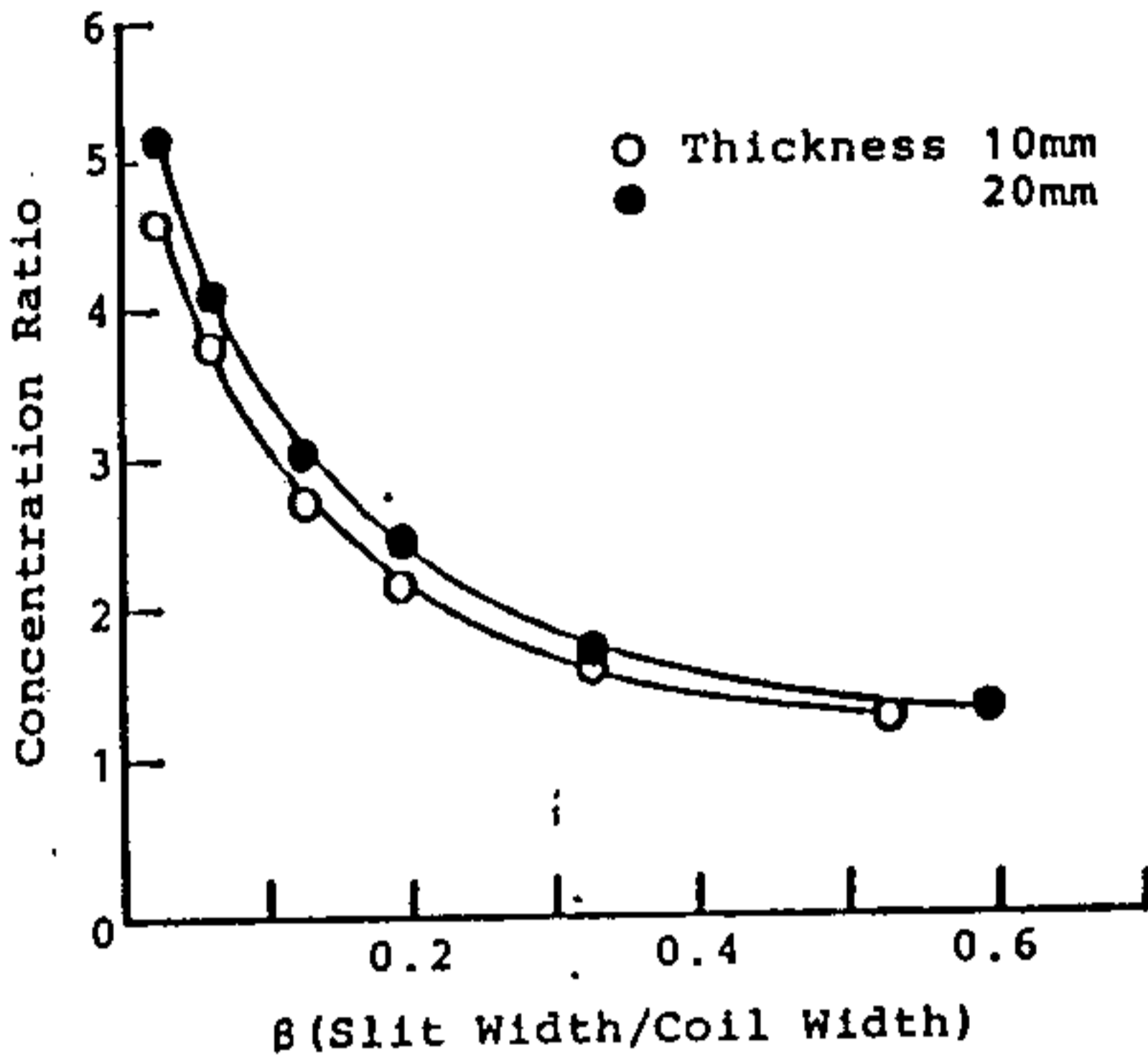

Fig.4 Relations between  $\beta$  and concentration ratio for thickness of plates

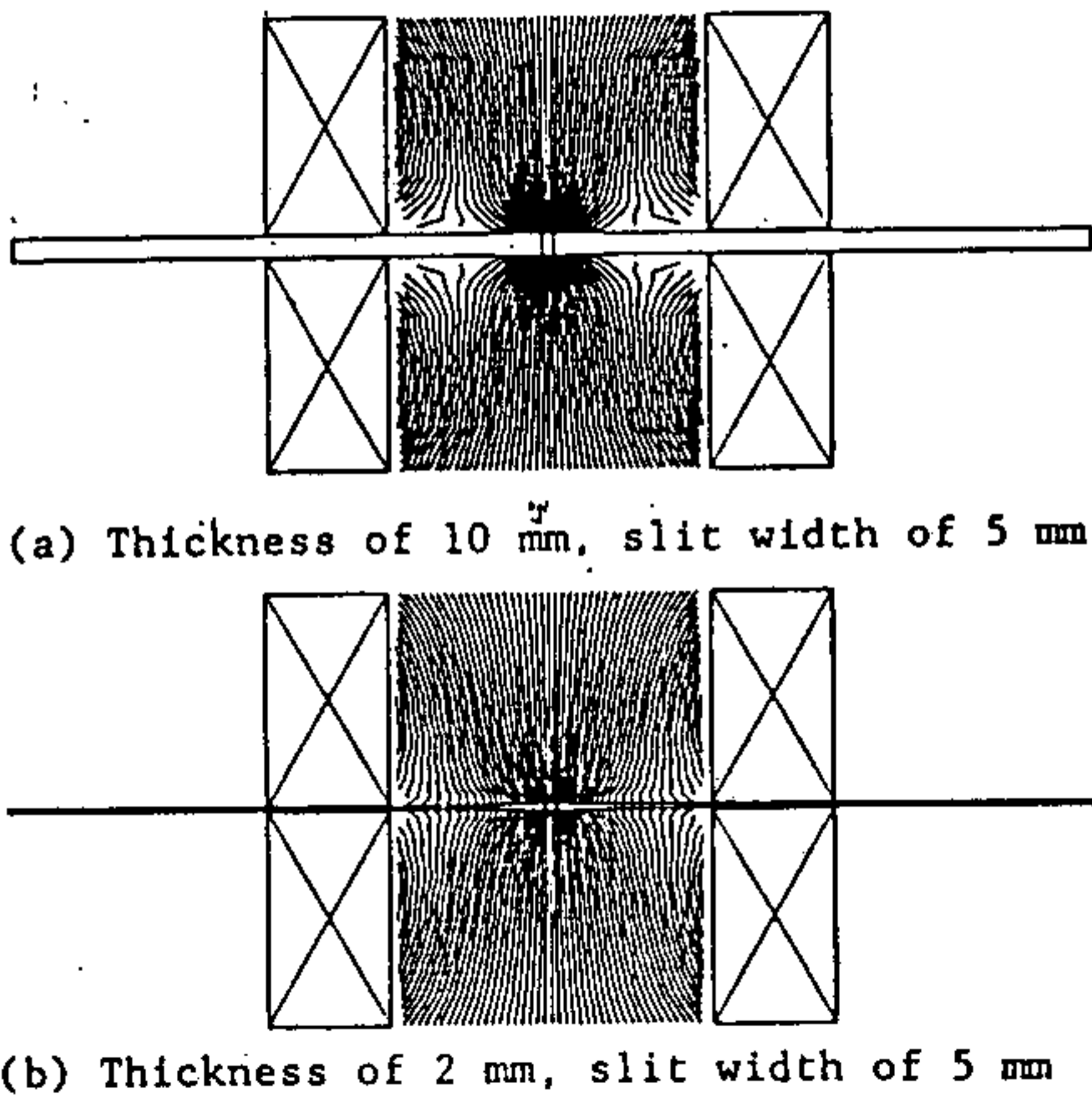

Fig.5 Flux distribution

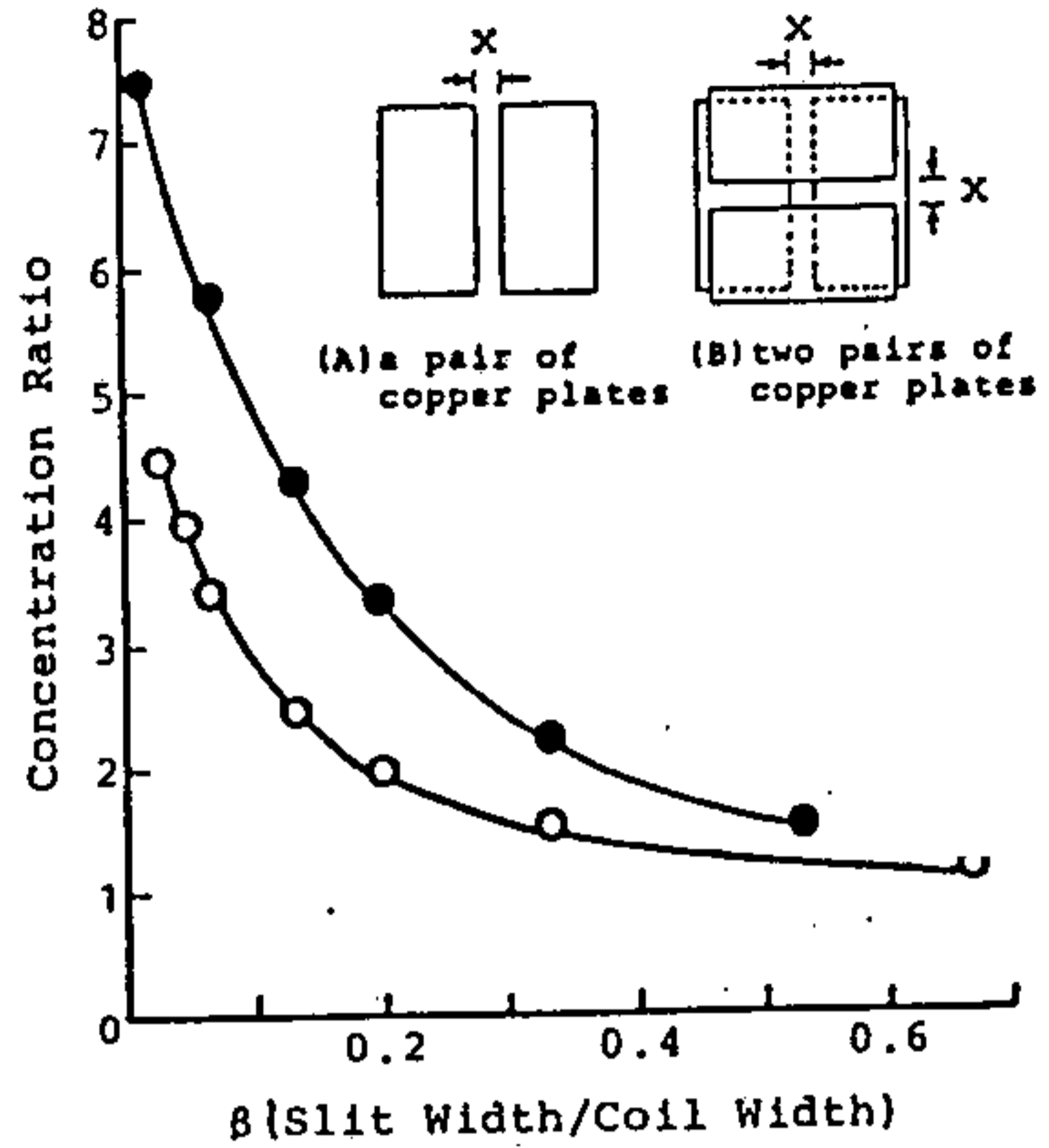

Fig.6 Relations between  $\beta$  and concentration ratio for number of plates

surrounded with four conductive plates. The plates are isolated from each other. The maximum concentration ratio becomes 7.4. In these experiments, the value of an input voltage is kept constant in order to apply the same value of the magnetic flux. In this case, an input current changes with changing a coil impedance.

AC HIGH MAGNETIC FIELD GENERATOR

Based on the above-mentioned results, we designed and constructed the AC high magnetic field generator excited by a commercial source. The outline of the apparatus is illustrated in Fig.7. The gap length of magnetic poles can be adjusted from 45 to 200 mm and the slit from 0 to 30 mm. The specification of the equipment are;

Electromagnet	
Cross section of yoke	: 10*10 cm <sup>2</sup>
Number of turns	: 336*2 turns
Exciting current	: 300 A
Conductive plate	
Material	: copper
Width	: 25*50 cm <sup>2</sup>
Thickness	: 2 cm

The characteristics of the equipment are shown in Fig.8. These results were measured by applying a commercial source (60 Hz, 3300 V) to the coil. Figure 8(a) shows the relations between (slit width / coil width) and concentration ratio. Figure 8(b) shows the relations between gap length and flux density. These curves in Fig.8 (a) are nearly hyperbolic and the concentration ratio becomes large with increasing the width of slit. Figure 8(b) suggests that the highest flux density is obtained in the gap length of 45 mm and the value does not remarkably decrease for larger gaps.

Figure 9 shows the waveforms of the magnetic flux density in the slit of 2.5 mm width. The AC magnetic field density of about 7.4 T<sub>peak</sub> can be realized and the concentration ratio<sub>peak</sub> is 3.9.

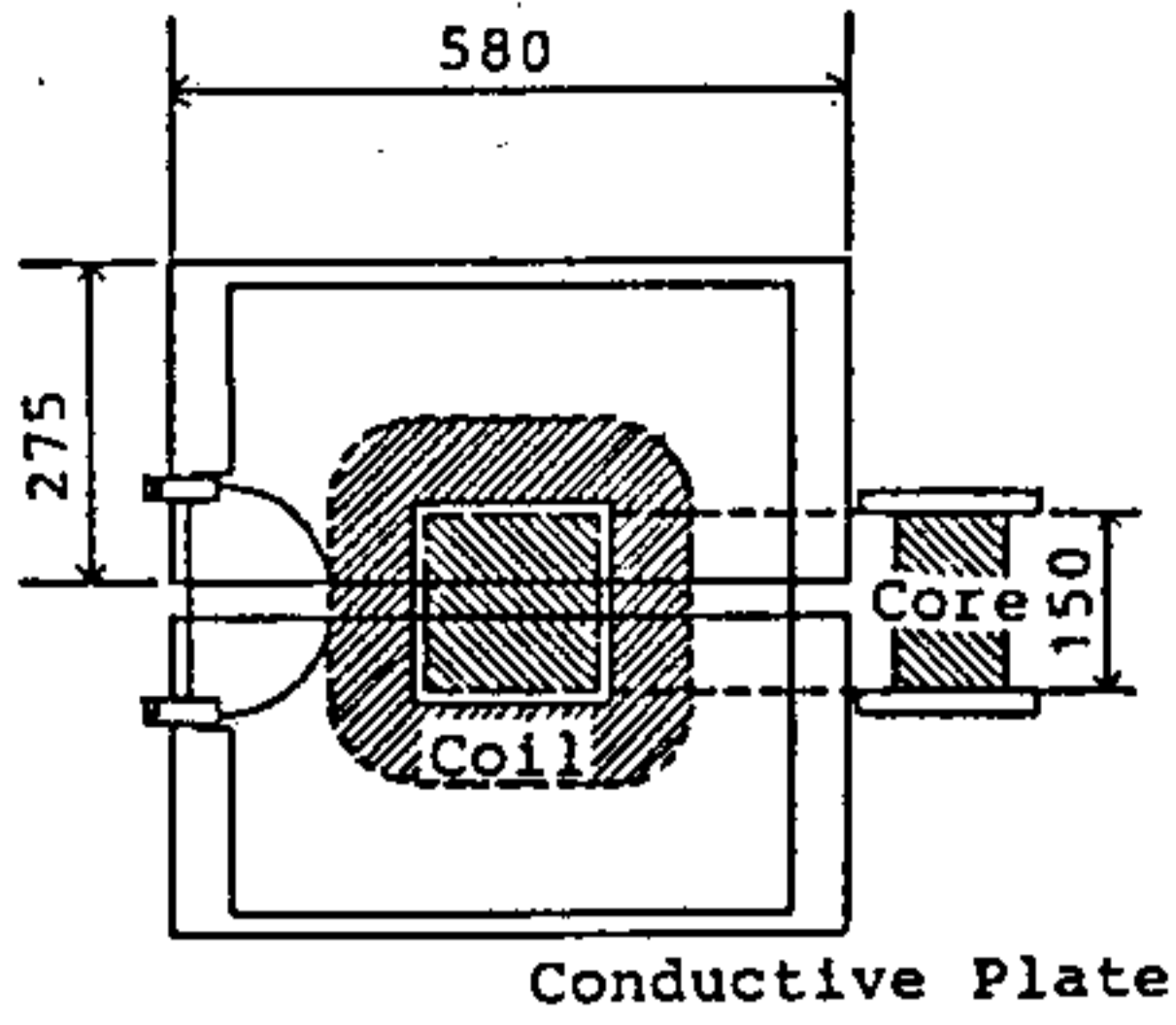

(a) Plane

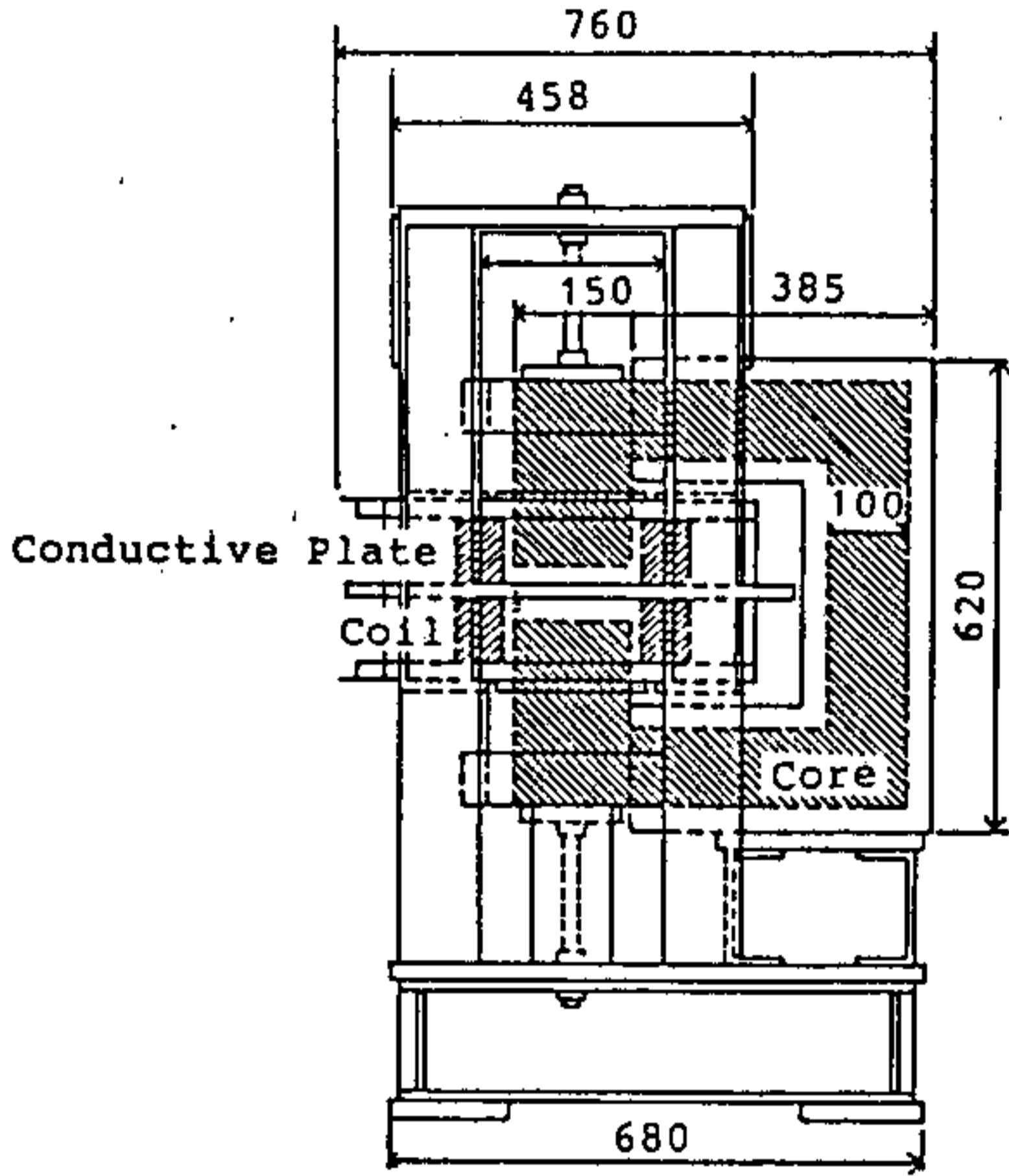

(b) Side view

Fig.7 AC high magnetic field generator

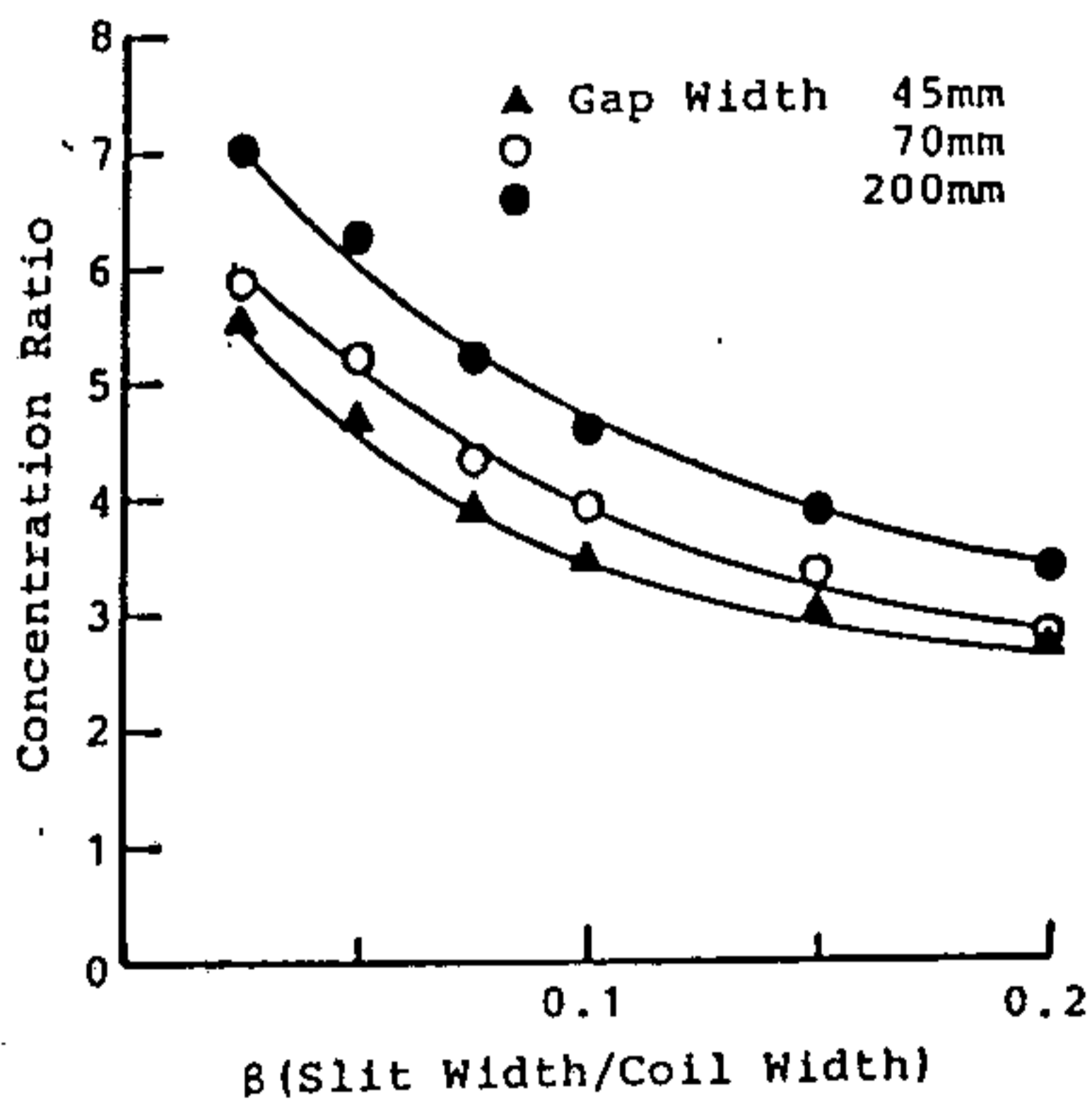

(a) Relations between  $\beta$  and concentration ratio for gap width

Fig.8 Characteristics of AC high magnetic field generator

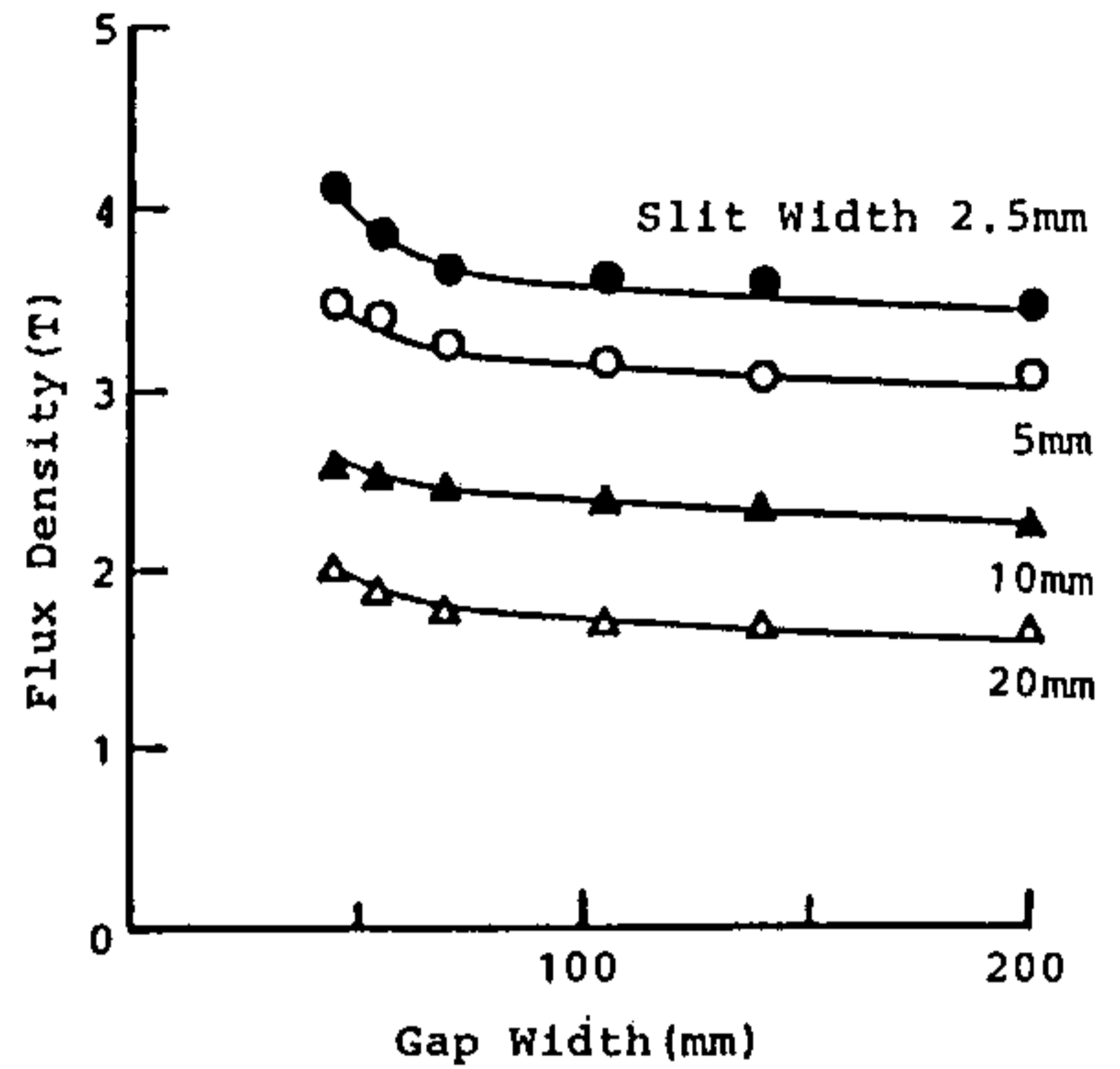

(b) Relations between gap width and flux density for  $\beta$

Fig.8 Characteristics of AC high magnetic field generator

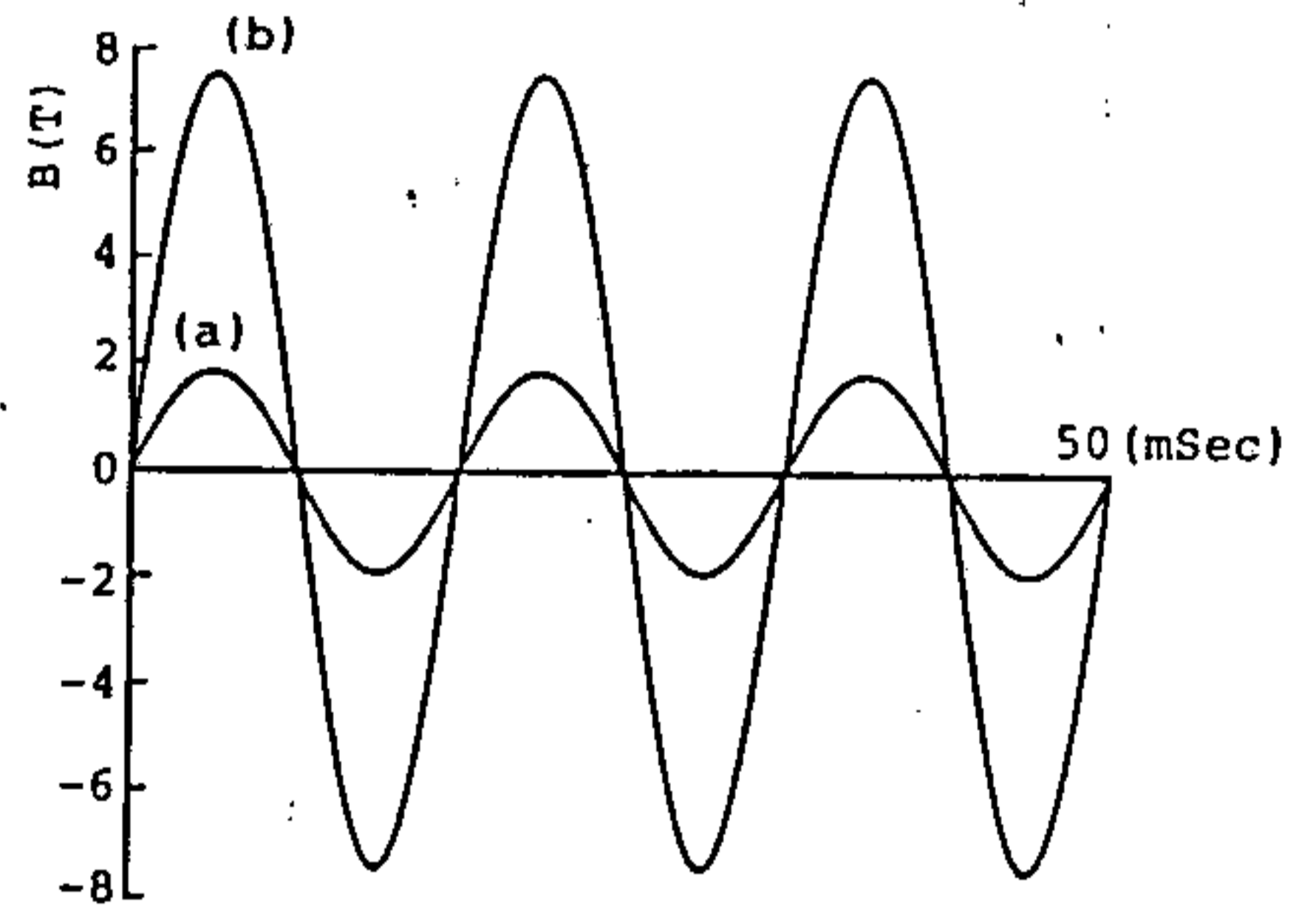

(a) Without plates (b) with plates

Fig.9 Waveforms of a high magnetic field

CONCLUSION

This paper described a new method for generating AC high magnetic field. By setting conductive plates in the gap of magnet only, an AC flux applied by an electromagnet is concentrated in the slit surrounded by plates. We confirmed the concentration effect of the AC magnetic field by eddy currents, and we could obtain the AC high magnetic flux density of about 7.4T by a commercial source. For the longer duration, we must solve an important problem of cooling.

REFERENCES

[1] K.Bessho, S.Yamada, N.Miura : "High-speed Rotating Disc Generator for High Magnetic Field", *IEEE Trans. Magnetics*, Vol.MAG-19, No.5, p2069, '83.  
 [2] K.Bessho, T.Morisue, S.Yamada, N.Sakai, H.Nishino : "Asymmetrical Eddy Currents and Concentration Effect of Flux in a High-speed Rotation Disc", *IEEE Trans. Magnetics*, Vol.MAG-21, No.5, '85.