

A Neuron Model Capable of Learning Expansion/Contraction Movement Detection without Teacher's Signal

著者	Todo Yuki, Tamura Hiroki
journal or publication title	International Journal of Innovative Computing, Information and Control = International Journal of Innovative Computing, Information and Control
volume	9
number	12
page range	4931-4941
year	2013-01-01
URL	http://hdl.handle.net/2297/35991

A NEURON MODEL CAPABLE OF LEARNING EXPANSION/CONTRACTION MOVEMENT DETECTION WITHOUT TEACHER'S SIGNALS

YUKI TODO¹ AND HIROKI TAMURA²

¹School of Electrical and Computer Engineering
Kanazawa University
Kakuma-machi, Kanazawa 920-1192, Japan
yktodo@se.kanazawa-u.ac.jp

²Department of Environmental Robotics
University of Miyazaki
Gakuenkibanadai-nishi, Miyazaki 889-2192, Japan
htamura@cc.miyazaki-u.ac.jp

Received January 2013; revised May 2013

ABSTRACT. *Neuron has the characteristic of reacting to a specific stimulus. The characteristic is said to be from the dendritic morphology of neuron. A neuron which reacts to a specific stimulus has its unique dendritic morphology. Traditional McCulloch-Pitts neuron model failed to include such dendritic functions. In this paper, we propose a neuron model that includes such nonlinear functions on dendrite and show that the model is capable of learning Expansion/Contraction movement detection without teacher's signals. The proposed model consists of the retina, LGN (lateral geniculate nucleus), V1 (primary visual cortex) and MST (medial superior temporal area). The neuron model of MST learns the Expansion/Contraction movement detection function by plasticity. Plasticity of the model neuron is expressed by back-propagation-like algorithm. Furthermore, we propose a method of creating teacher's signals automatically from the output state of the neuron in MST. We initialize the model neuron with an arbitrarily dendrite randomly and use the model neuron to learn to detect the movement of Expansion/Contraction. Our simulation results show that the model neuron can learn the movement detection of Expansion/Contraction pattern without teacher's signals and can develop its dendritic structure, such as the location of synapses and type of synaptic inputs by eliminating un-useful dendritic branches and synapse.*

Keywords: Neuron, Dendrite, Learning, Response selectivity, Plasticity, Teacher's signal

1. Introduction. In recent years, a detailed analysis of nerve cells has made more and more characteristics of nerve cells become more and more apparent although they are still partial. Hundreds of neurons have been identified, and each of the neurons has a unique shape of dendritic tree. In addition, it is also been found that a slight variation on these morphological differences would generate a great functional difference. For example, with respect to visual motion, [1,2], the cells to detect the direction of motion have been found in MT (Middle Temporal) area and 4B of V1 (first-field primary) of monkey cortex, and cells in MST area (Medial Superior Temporal) which react to horizontal movement, or expansion/contraction movement, or the rotation movement around a point [1-3]. It is very nature to think that each of them has different dendritic trees. Furthermore, recent researches have found that such dendrite serves as computational building blocks, which may play a key role in overall computation performed by the neurons [4-7]. However, the

detailed dendrites of these neurons are still unknown and there is no effective method to identify them.

In our previous papers [8,9], we proposed a neuron model with interaction among synapses on dendrite and trained the model to learn the directionally selective problem and the depth rotation problem successfully [10-14]. In this paper, we train the neuron model to learn the two-dimensional expansion/contraction motion detection problem using a simple learning algorithm that requires no teacher signal for the output, and hence, no comparisons to predetermined ideal responses. The training set consists of solely input vector and desired output pattern comes from the input patterns. We describe how such an unsupervised rule may allow the neuron to modify synapses from moving stimuli, and show that such an unsupervised learning can be used to train 2-dimensional expansion/contraction motion detection problem. The resulting dendrite after the unsupervised learning tells its dendritic structure, such as the location of synapses and type of synaptic inputs, and at least gives a predictive dendritic structure of the neuron. The method could be used in experimental understanding to neurons that are usually hard to see or measure, and neuron computer – a device that can perform more powerful calculations using the nonlinear function of dendritic mechanics.

2. Model.

2.1. Neuron model. The first neuron model was proposed by McCulloch and Pitts in 1943 [19], and has been widely used for almost 70 years. However, the model was designed to mimic the first-order characteristics of biological neuron. The nonlinear function of dendrite, i.e., the second-order characteristic was not considered, resulting in that the single-layer networks were incapable of solving many simple problems, even a simple logical exclusive-or operation [20].

Focusing on the function and plasticity of dendrites of biological neurons, the authors have proposed the neuron model that includes the nonlinear interaction on dendrites and can adjust the input-output relationship by changing the state of synapses on the dendrites through supervised learning [8,9].

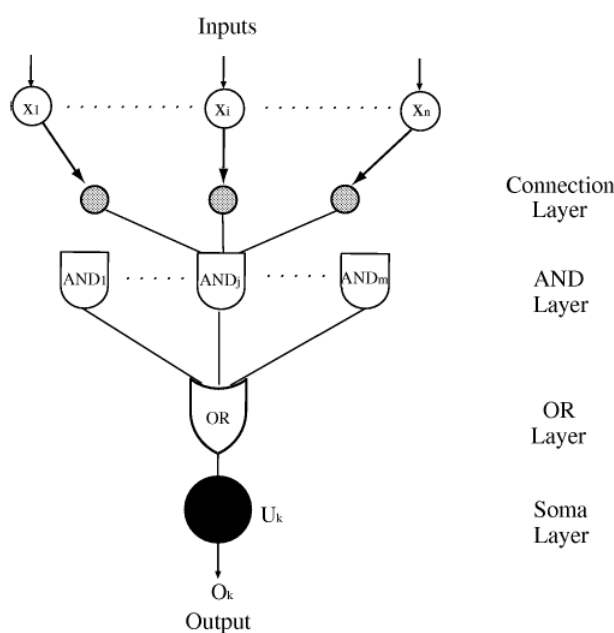

FIGURE 1. The model neuron

The proposed neuron model has a four-layer structure as shown in Figure 1. The first layer is the connection layer, representing synaptic connections to dendrite of neurons. The second layer is the AND layer, representing the interaction among synapses on the dendrites of nerve cells. The third layer is the OR layer, representing a branch point dendrites of nerve cells. It can be expressed as a logical OR function. The fourth layer is the Soma layer, acting as the nerve cell bodies. Note that it is because we add a Soma layer that unsupervised learning becomes possible.

Because the input to a model neuron is either 0 or 1, a desired input-output relationship of the model neuron can be realized by changing the connection state of the connection layer. In this paper, we use the back-propagation-like rule (hereinafter referred to as the BP rule) to adjust the connection status of the connection layer of the model neuron although it is unknown that such mechanism is actually carried out in vivo. However, a similar phenomenon that pulse is propagated reversely in nerve cells has been found from Stryker and Fregnacfs experimental results [15]. In order to apply the BP rule, we substitute the logic AND function of the second layer and the logic OR function of the third layer with a continuously differential soft-minimum function, and a soft-maximum function, respectively.

Then, the first layer is the connection layer that represents the interaction among the synaptic connections on the dendrites. The connection from input to AND layer has four states: 0-connection, 1-connection, direct connection and inversed connection. Because both input and output are either 0 or 1, the connection state from the i -th input $X_i(t)$ ($0 \leq i \leq n$) to the j -th ($0 \leq j \leq N$) dendrite of model neuron k ($0 \leq k \leq N$) can be described as the following sigmoid function:

$$Y_{kij} = f(u_{kij}) = \frac{1}{1 + e^{-gu_{kij}}} \tag{1}$$

where $u_{kij} = w_{kij}X_i + \theta_{kij}(1 - X_i(t))$, w_{kij} and θ_{kij} are the connection parameters, and Y_{kij} is the output from the synapse to the dendrite. In addition, g is a constant. From the relationship of the connection parameters of the sigmoid function, the connection can be classified into one of the 4 connection states as shown in Figure 2. In our previous papers [8,9], we have used the model neuron to learn one-dimensional directionally selective problem successfully [10-14].

However, learning was based on supervised one that compares desired and actual outputs, feeding processed corrections back through the network. It is difficult to conceive of such a training mechanism existing in the brain [21]. In this paper, we propose a far more plausible mode of learning in the biological system. We assume that the last layer

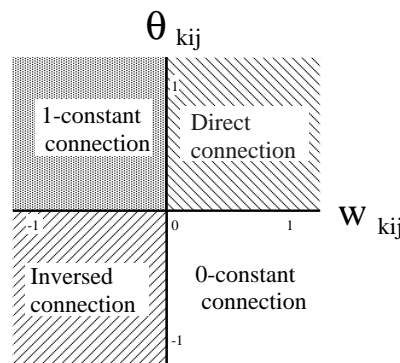

FIGURE 2. Sigmoid function output characteristics and its equivalent connection states

is the Soma layer that receives and sums the inputs (OR_k) from layer OR. Soma has an internal state (U_k) and a threshold (θ_{soma_k}), and the internal state is initialized to 0 when input pattern to a model neuron is completed. The model neuron fires ($O_k = 1$) when the accumulated internal state exceeds the threshold value. Once a model neuron fired, it will not ignite within a certain period of time (Timer) no matter how high the internal state of the model neuron becomes (refractory period). It is possible to prevent only a specific model neuron to be ignited for all input patterns by learning. The relationship between the output of the Soma (O_k) and its internal state (U_k) is given by,

$$U_k = \sum_{t=1}^p OR_k(t) \tag{2}$$

$$O_k = \begin{cases} 1 & (U_k - \theta_{soma_k} \geq 0 \text{ and Timer} = 0) \\ 0 & (U_k - \theta_{soma_k} \geq 0 \text{ and Timer} > 0) \\ 0 & (U_k - \theta_{soma_k} < 0) \end{cases} \tag{3}$$

where p is the time to input patterns and the output of the Soma is the output of the model neuron. However, if a model neuron once fired, the Timer is set to a positive constant A (Timer = A) and it will be decreased by 1 until it gets to zero when a new pattern is applied.

2.2. Network model for motion detection. In this section, we propose a network model that can detect movement. In the last section, we described a neuron model that can be used to learn movement direction selection function and the model neurons have been trained to react selectively with respect to the four directions of movement, i.e., right, left, up and down directions [10-14]. Using these model neurons, we propose a network for two-dimensional expansion/contraction movement detection. Figure 3 shows a block diagram of the proposed network model. The stimulus from the retina (receptive field) is applied to the primary visual cortex (V1) layer through the large lateral geniculate nucleus (LGN) layer. After processed by the directional detection neurons of the V1 layer, the neurons in the MST field detect the two-dimensional expansion/contraction movement.

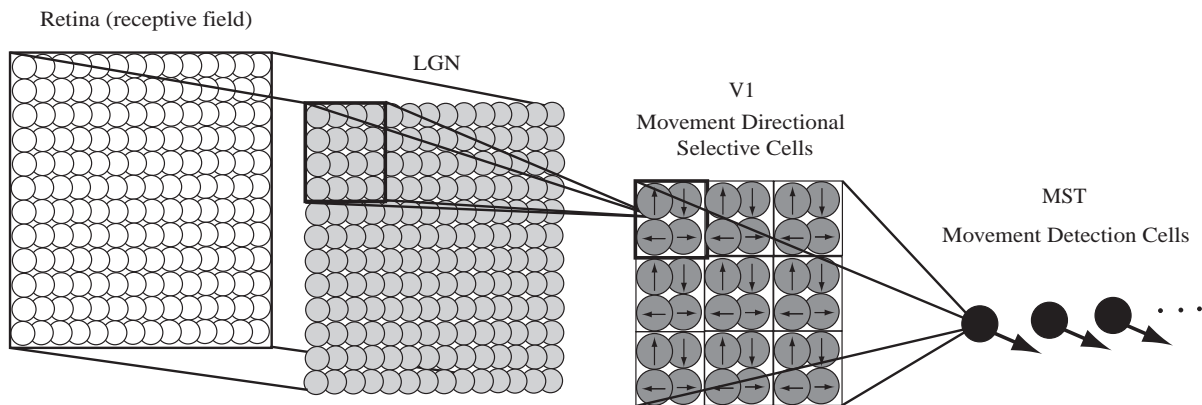

FIGURE 3. A network model for expansion/contraction motion detection

First, the processing in the retina layer serves only to convey stimulus. Next, a neuron in the larger cell LGN layer serves to indicate the transient response of the input. It is said that the cells of the LGN layer respond only to input change. Thus, we assume that the neuron of the LGN layer responded as

$$L_{x,t} = \begin{cases} 1 & |R_{x,t} - R_{x,t-1}| > 0 \\ 0 & |R_{x,t} - R_{x,t-1}| = 0 \end{cases} \tag{4}$$

where $L_{x,t}$ is the output of the neuron x of the LGN layer at time t , and $R_{x,t}$ is the input to the neuron x of the LGN layer at time t .

Then, the directionally selective cells in V1 have four types of cells that react to selectively to four directions (down ↓, left ←, up ↑ and right →) on the inputs from the LGN receptive field. For example, a right direction detection neuron fires to the stimulus that moves in the right direction (→) on the retina, and never ignites for any other directions (↓, ↑, ←). Such one-directional detection neurons have been synthesized using the model neurons, [10-14] and they react differently to the different directional motion inputs from the retina. Output state of the directionally selective cells of the V1 layer is then transmitted to the two-dimensional Expansion/Contraction movement detection cells of the MST field.

The Expansion/Contraction detection cells in the MST field receive the output states of the one-directional selection cells of the V1 layer, and respond selectively to motion. Because there are more than one neuron to perform motion detection in the same receptive field of the MST field, these neurons will be referred to as column for convenience in this paper. It is these neurons that are used to learn the two-dimensional Expansion/Contraction movement detection problems.

Figure 4 shows the response states of the directionally selective cell of the V1 layer with respect to the Expansion/Contraction motion stimuli. The inputs to the V1 layer from the retina is divided into 64 areas with 8×8 . We call it as the receptive field. Each area (the receptive field) has four directionally detective cells that respond to the movements

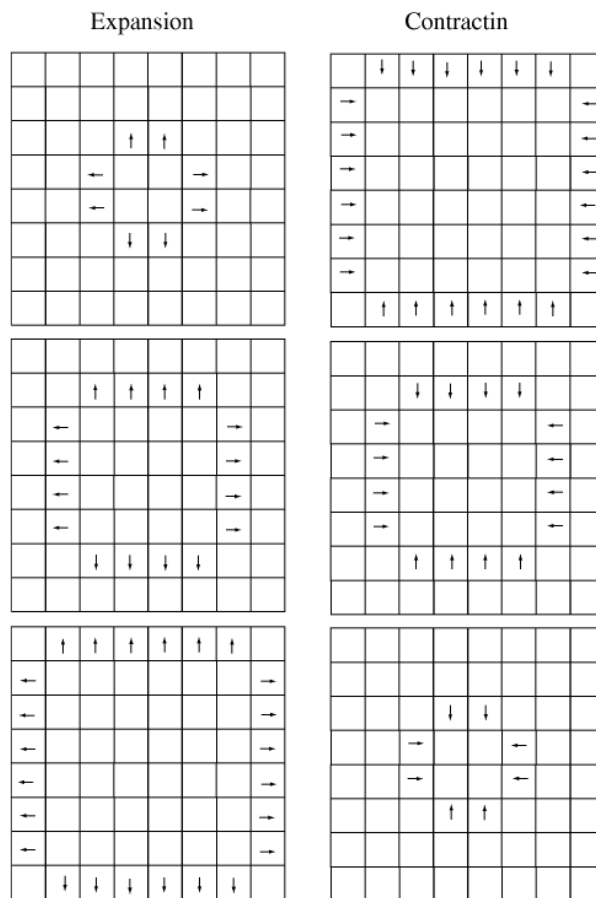

FIGURE 4. The state of V1 at the time of Expansion/Contraction pattern

at the directions (down \downarrow , left \leftarrow , up \uparrow and right \rightarrow), respectively. Symbols \downarrow , \leftarrow , \uparrow , \rightarrow in Figure 4 indicate that cells detected the movements at the directions (down \downarrow , left \leftarrow , up \uparrow and right \rightarrow) and fired. The blank areas mean that no such movement was detected. Thus, the two-dimensional expansion/contraction motion detective cells in the MST layer would respond selectively to the patterns of the expansion/contraction motions shown in Figure 4.

2.3. Learning algorithm. Recently, researches on the self-organization and synaptic plasticity of neuronal cells have been extensively carried out and the mechanism of neuronal plasticity has become clear though still very few. It has been found that the neuronal plasticity is achieved by adjusting the stimulated synapse and its neighbor synapses. In 1949, Hebb first suggested a synaptic learning rule as that “the transmission efficiency of synaptic connections is higher if both neurons fire at the same time” [16]. This law has been demonstrated by the results of recent researches. Furthermore, it has been revealed that the brain nerve cells with the reaction selectivity to react only to specific patterns show a column structure and the layer structure and network in the same layer of such a column have some effect on the self-organization of the nerve cells. Toyama investigated the evolution of the lateral geniculate body II, III and IV layers of the cat pups, and found that a large plasticity was found in II, III and IV layers, and little plasticity in IV layer to visual signal. It is also found that visual signal was transmitted from the lateral geniculate IV layer to II, III layers. As a result, Toyama et al. guessed that the neurons in the IV layer that have response selectivity would perform some kind of teacher’s function and guidance of learning the neurons of the II and III layers. In addition, experimental results have shown that they were formed according to Hebb rule [17]. In this paper, we propose a simple learning algorithm that produces teacher’s signal for BP learning mentioned in 2.1 using a network with one-layer of the column structure of the nerve cells.

The one-layer column consists of more than one proposed model neurons and a simple rule for teacher’s signal is created. The simple rule is to make a neuron fire more easily if the neuron fired to an input pattern and a neuron to fire more difficultly if the neuron did not fire and other neurons fired to an input pattern. Also, if no any neuron fires in the column, all neurons will be encouraged to fire. Thus, the model neurons in the same column will share to fire to different input patterns to the column.

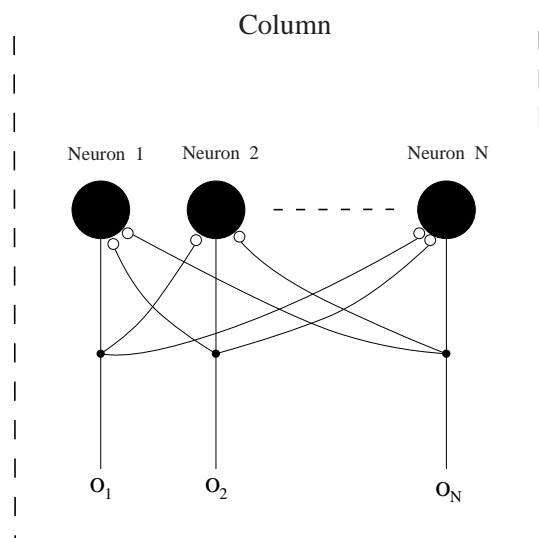

FIGURE 5. Structure of column by the model neurons

Figure 5 shows a column consisting of the N model neurons model. The model neuron in Figure 5 has a structure as shown in Figure 3, respectively. If a neuron receives a signal $I(\sum_{k=1}^N O_k)$ from a fired neuron in the same column, the connection parameters w_{kij} and θ_{kij} of the model neuron will be adjusted to be unfired, meaning a teacher's signal ($T = 0$) is applied to the model neuron. In addition, if a neuron fired to an input pattern, the connection parameters w_{kij} and θ_{kij} will be adjusted to fire more easily, meaning a teacher's signal ($T = 1$) is applied to the neuron. In other words, the firing information the neurons in the same column can be used to create teacher's signal. However, if there is no any neuron fired to an input pattern, the connection parameters w_{kij} and θ_{kij} of these neurons will be adjusted to fire more easily, meaning teacher's signals ($T = 1$) will be applied to all neurons of the column. In other words, the teacher's signal can be obtained with the rule mentioned above. The rule can be simply expressed as,

$$T_k = \begin{cases} 1 & (O_k = 1) \\ 1 & (O_k = 0 \text{ and } I = 0) \\ 0 & (O_k = 0 \text{ and } I > 0) \end{cases} \quad (5)$$

$$\eta_k = \begin{cases} \eta_1 & (O_k = 1) \\ \eta_2 & (O_k = 0 \text{ and } I = 0) \\ \eta_3 & (O_k = 0 \text{ and } I > 0) \end{cases} \quad (6)$$

$$\Delta w_{kij} = -\eta_k \sum_{t=1}^p (OR_k(t) - T_k) \cdot \frac{\partial OR_k(t)}{\partial w_{kij}(t)} \quad (7)$$

$$\Delta \theta_{kij} = -\eta_k \sum_{t=1}^p (OR_k(t) - T_k) \cdot \frac{\partial OR_k(t)}{\partial \theta_{kij}(t)} \quad (8)$$

where η_k are learning parameters with $\eta_k > 0$. Using this learning rule, the model neurons are capable of learning without a teacher's signal.

3. Simulations. In this paper, we performed numerical simulations on the model neuron to show how the model neuron learned to selectively react to the two-dimensional expansion/Contraction movement without teacher's signal.

In simulations, we used the column consisting of the model neurons of Figure 5 to learn to react selectively to the two-dimensional expansion/contraction movement of Figure 2 without teacher's signals. The connection parameters were initialized randomly within $-1 < W_{kij}, \theta_{kij} < 1$. In simulations, we used the learning parameters as shown in Table 1. A column with 10 model neurons and each neuron having 10 dendritic branches (the number of AND was 10) was used to simulate the two-dimensional expansion/contraction movement problem. The stimuli were applied with an expansion pattern and a contraction pattern alternately. In addition, in simulations, a neuron once fired to an input pattern would not be allowed to fire again until the input pattern was applied ($A = 1$).

TABLE 1. Learning parameters

The learning constant η_1	0.2
The learning constant η_2	0.1
The learning constant η_3	0.5
The learning constant θ_{soma_k}	0.65
The positive constant g of sigmoid function	5.0

TABLE 2. The internal state (U) and output (O) of the model neurons before learning

Neuron number		1	2	3	4	5	6
Expansion	O_k	0	0	0	0	0	0
	(U_k)	(0.570)	(0.567)	(0.570)	(0.573)	(0.551)	(0.521)
Contraction	O_k	0	0	0	0	0	0
	(U_k)	(0.564)	(0.574)	(0.583)	(0.566)	(0.540)	(0.516)

Neuron number		7	8	9	10
Expansion	O_k	0	0	0	0
	(U_k)	(0.609)	(0.605)	(0.588)	(0.554)
Contraction	O_k	0	0	0	0
	(U_k)	(0.604)	(0.607)	(0.594)	(0.553)

TABLE 3. The internal state (U) and output (O) of the model neurons after learning

Neuron number		1	2	3	4	5	6
Expansion	O_k	0	0	0	0	0	0
	(U_k)	(0.570)	(0.567)	(0.570)	(0.573)	(0.551)	(0.521)
Contraction	O_k	0	0	0	0	0	0
	(U_k)	(0.564)	(0.574)	(0.583)	(0.566)	(0.540)	(0.516)

Neuron number		7	8	9	10
Expansion	O_k	1	1	0	0
	(U_k)	(2.532)	(3.306)	(0.372)	(0.209)
Contraction	O_k	0	0	1	0
	(U_k)	(0.485)	(0.376)	(3.253)	(0.206)

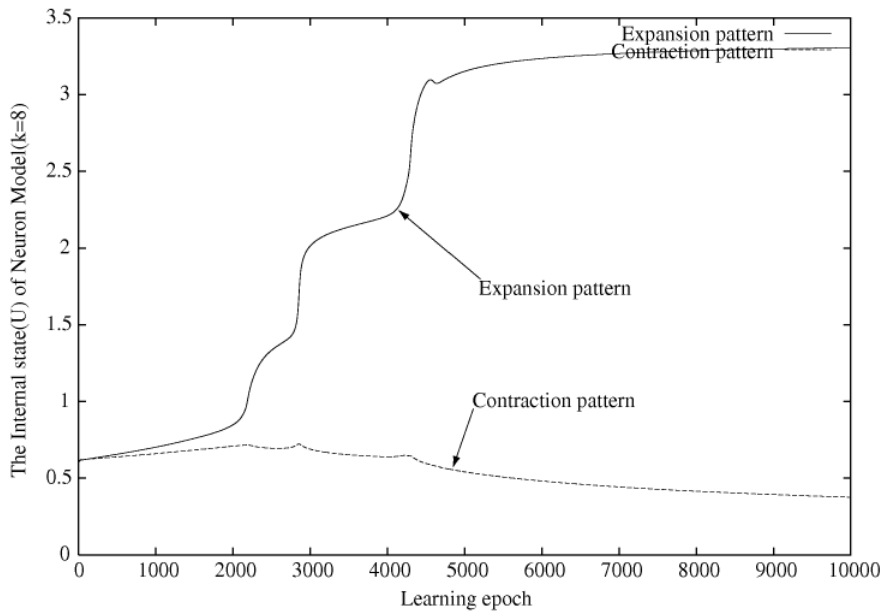

FIGURE 6. Change of the internal state (U_8) of the model neuron ($k = 8$)

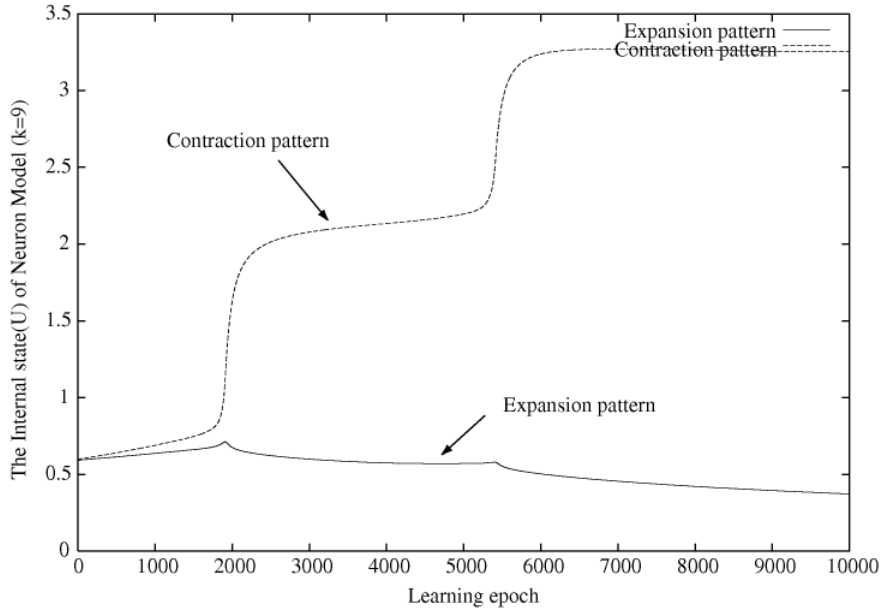

FIGURE 7. Change of the internal state (U_9) of the model neuron ($k = 9$)

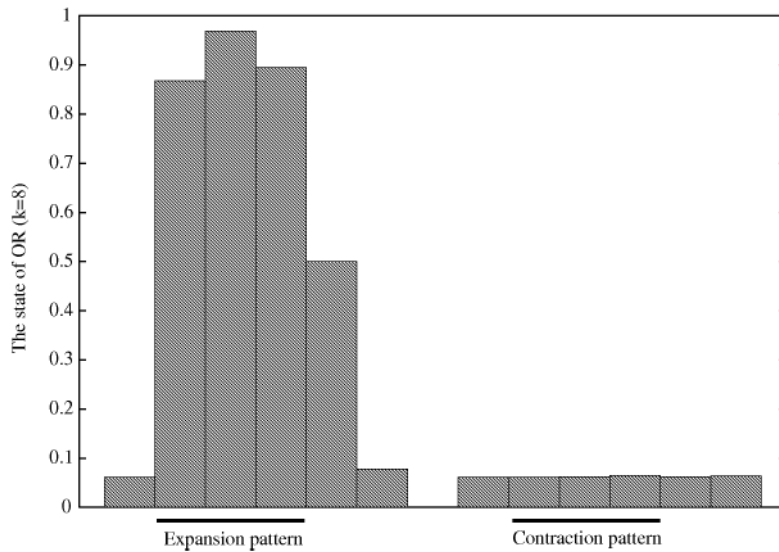

FIGURE 8. The $OR_8(t)$ of the model neuron ($k = 8$) after learning

The stimuli patterns were applied 1000 times. Tables 2 and 3 show the outputs (O_k) and the sum of the internal state (U_k) to the expansion pattern and the contraction pattern before learning (Table 2) and after (Table 3) learning. As can be seen from Tables 2 and 3, no any neuron fired to all input patterns before learning, while different neurons fired to different input patterns after learning. The model neurons $k = 7$ and 8 , fired to the expansion patterns and model neuron $k = 9$ to the contraction patterns, which means that the proposed model neuron was capable of learning the two-dimensional expansion/contraction movement problem without teacher's signals. Figures 6 and 7 show the change of the internal states of the expansion detection neuron ($k = 8$) and the contraction detection neuron ($k = 9$) to the expansion stimuli and the contraction stimuli, respectively. From Figures 6 and 7, we can see that up to 2000 learning, the internal

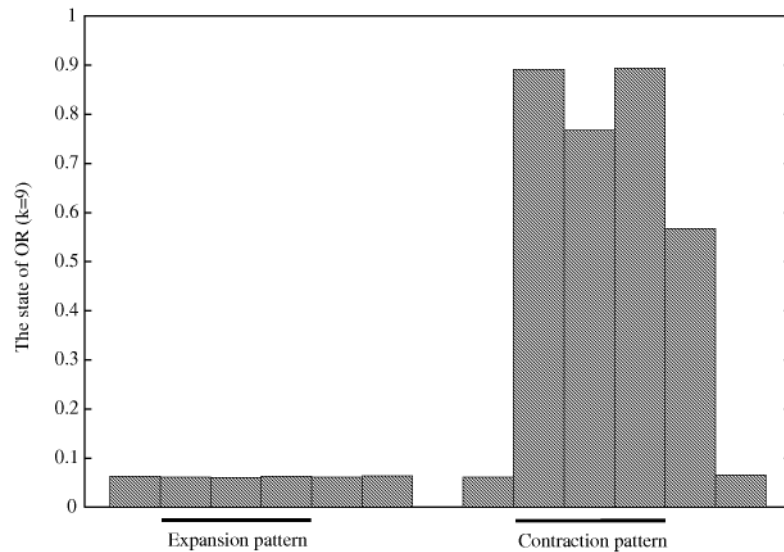

FIGURE 9. The $OR_9(t)$ of the model neuron ($k = 9$) after learning

states of the model neurons seemed to increase to both expansion input patterns and contraction input patterns, and then started to respond selectively to the input patterns, i.e., the expansion detection neuron ($k = 8$) to only the expansion movement and the contraction detection neuron ($k = 9$) to only the contraction movement. Figures 8 and 9 show the stimuli transmitted to the cell body ($OR_8(t)$, $OR_9(t)$) of $k = 8$, and 9 after learning when the expansion and contraction movement patterns were applied. Obviously the stimuli to the model neurons were very different with different input patterns.

4. Conclusions. In this paper, we have proposed a neuron model including the synaptic interaction on the dendrites and used it to learn Expansion/Contraction movement detection without teacher's signals. We initialized the model neuron with an arbitrarily dendrite randomly and used the model neuron to learn to detect the movement of Expansion/Contraction. Our simulation results showed that the model neuron was capable of learning the movement detection of Expansion/Contraction pattern without teacher's signals and could develop its dendritic structure, such as the location of synapses and type of synaptic inputs by eliminating un-useful dendritic branches and synapse.

REFERENCES

- [1] M. Saito, The structure of visual neurons and its information processing, *Information Processing*, vol.30, pp.1127-1147, 1983.
- [2] J. H. Maunsell, Functional properties of neurons in middle temporal visual area of macaque monkey. I. Selectivity for stimulus direction, speed and orientation, *J. Neurophysiol.*, vol.49, pp.1127-1147, 1983.
- [3] H. Saito, M. Yukiie, K. Tanaka, K. Hikosaka, Y. Fukuda and E. Iwai, Integration of direction signals of image motion in the superior temporal sulcus of the macaque monkey, *J. Neuroscience*, vol.6, no.1, pp.145-157, 1986.
- [4] S. Single and A. Borst, Dendritic integration and its role in computing image velocity, *Science*, no.281, pp.1848-1850, 1998.
- [5] J. C. Anderson, T. Binzegger, O. Kahana, K. A. Martin and I. Segev, Dendritic asymmetry cannot account for directional response of neurons in visual cortex, *Nature Neuroscience*, vol.2, pp.820-824, 1999.
- [6] T. Euler and P. B. Detwiler, Directionally selective calcium signals in dendrites of starburst amacrine cells, *Nature*, vol.418, pp.845-852, 2002.

- [7] H. Agmon-Snir, C. E. Carr and J. Rinzel, The role of dendrites in auditory coincidence detection, *Nature*, vol.393, pp.268-272, 1998.
- [8] Z. Tang, M. Kuratu, H. Tamura, H. Ishizuka and K. Tanno, A neuron model based on dendritic mechanism, *IEICE*, vol.83, pp.486-498, 2000.
- [9] Z. Tang, H. Tamura, H. Ishizuka and K. Tanno, A neuron model with interaction among synapses, *IEEJ*, no.7, pp.1012-1019, 2000.
- [10] H. Tamura, Z. Tang and M. Ishii, The neuron model consisting difference of time of inputs and its movement direction selection function, *IEEJ*, no.122-C, pp.1094-1103, 2002.
- [11] H. Tamura, Z. Tang, O. Ishizuka and K. Tanno, Directionally selective cells have a δ -like morphology, *International Symposium on Nonlinear Theory and Its Application*, pp.215-218, 1999.
- [12] Y. Sekiya, H. Zhu, T. Aoyama and Z. Tang, Learning-possibility for neuron model in medical superior temporal area, *Proc. of the 15th Korea Automatic Control Conference*, pp.517-520, 2000.
- [13] Y. Sekiya, Q. Wang, T. Aoyama and Z. Tang, Tang learning-possibility that neuron model can recognize depth-rotation in three-dimension, *Proc. of the 6th International Symposium on Artificial Life and Robotics*, pp.486-489, 2001.
- [14] Y. Sekiya, T. Aoyama, H. Tamura and Z. Tang, A neuron model that a moving object can recognize in the planer region, *Proc. of the 1st International Conference on Control Automation and Systems*, pp.149, 2001.
- [15] H. O. Reiter and M. P. Stryker, Neural plasticity without postsynaptic action potentials: Lessactive inputs become dominant when kitten visual cortical cells are pharmacologically inhibited, *Proc. of Natl. Acad. Sci. USA*, vol.85, pp.3623-3627, 1988.
- [16] D. O. Hebb, *Organization of Behavior*, John Wiley and Sons, New York, 1949.
- [17] K. Toyama, Y. Komatsu, J. Maeda and H. Sakaguchi, Differential localization of plastic synapses in the visual cortex of the young kitten, *Biomedical Res. Supp.*, pp.117-124, 1982.
- [18] K. Toyama and Y. Komatsu, Visual cortical plasticity in infant kittens, *Acta Neurochir*, vol.41, pp.68-77, 1987.
- [19] W. McCluch and W. Pitts, A logical calculus of the ideas immanent in nervous activity, *Bulletin of Mathematical Biophysics*, vol.5, pp.115-133, 1943.
- [20] M. Minsky and S. Papert, *Perceptrons*, MIT Press, Cambridge, MA, 1969.
- [21] P. D. Wasserman, *Neural Computing*, Van Nostrand Reinhold, New York, 1989.