

A method to control LED blinking for position detection of devices on conductive clothes

著者	Isoyama Naoya, Terada Tsutomu, Akita Junichi, Tsukamoto Masahiko
journal or publication title	ACM International Conference Proceeding Series
volume	2011
page range	123-130
year	2011-01-01
URL	http://hdl.handle.net/2297/30339

doi: 10.1145/2095697.2095721

A Method to Control LED Blinking for Position Detection of Devices on Conductive Clothes

Naoya ISOYAMA
Kobe University
Kobe, Japan
isoyama@stu.kobe-
u.ac.jp

Junichi AKITA
Kanazawa University
Kanazawa, Japan
akita@is.t.kanazawa-
u.ac.jp

Tsutomu TERADA
Kobe University
PRESTO, JST
Kobe, Japan
tsutomu@eedept.kobe-
u.ac.jp

Masahiko TSUKAMOTO
Kobe University
Kobe, Japan
tuka@kobe-u.ac.jp

ABSTRACT

Various wearable computing devices face problems with their power supplies, communication channels, and placement. Conductive clothes can resolve these problems, but it is still difficult to know the positions of devices on the conductive fabric. Therefore, we have devised a method to detect the positions of such devices by using a camera. To detect the positions our method blinks the LEDs on the devices according to their ID. Additionally, we propose several methods to shorten the time for detection. An experimental evaluation confirmed that compared with conventional method our methods reduce the time to detect the positions of the devices.

Categories and Subject Descriptors

B.4 [Input/Output And Data Communications]: Miscellaneous

General Terms

Algorithms

Keywords

position detection, conductive fabric, LED

1. INTRODUCTION

Users of wearable computing devices would like to be able to install them simply by attaching them to their clothes because the combination of necessary devices changes everyday according to a user's plans for the day. To provide an environment where users can place and use devices freely on their body, one faces certain problems restricting devices: power supply, networking ability, and positions.

Permission to make digital or hard copies of all or part of this work for personal or classroom use is granted without fee provided that copies are not made or distributed for profit or commercial advantage and that copies bear this notice and the full citation on the first page. To copy otherwise, to republish, to post on servers or to redistribute to lists, requires prior specific permission and/or a fee.

MoMM2011, 5-7 December, 2011, Ho Chi Minh City, Vietnam.
Copyright 2011 ACM 978-1-4503-0785-7/11/12 ...\$10.00.

Clothes made of conductive fabric have been studied as a way to solve the problems. Conductive clothes enable devices to be installed freely because they supply electric power and a communication channel without the need for cables or other wiring. This paper supposes a network system using conductive fabric called *TextileNet*[1]. Users can install adequate devices according to applications, and sufficient electric power for operation as well as communication channels can be supplied to the devices using *TextileNet*. However, *TextileNet* by itself cannot detect the positions of devices because its conductive cloth acts as a uniform solid electrode, while knowing the position of a device is important information for a system to assign the functions to the devices automatically since there is a strong relationship between the position and the function of each device.

Therefore, we propose a method for detecting the positions of worn devices by using a camera. Our method blinks LEDs on the devices according to their ID so that the camera can detect their positions efficiently. Our method shortens the time for detection by adding several different blinking patterns.

The remainder of this paper is organized as follows. Section 2 explains the background of this research, and Section 3 details our method. Section 4 describes the implementation, and Section 5 evaluates our method by comparing it with a conventional method. Section 6 presents our conclusions and outlines future work.

2. RELATED WORK

In wearable computing environments, there are many applications using the actuators and sensors on clothes[2, 3]. The left of Figure 1 shows an example in which many devices are installed on a clothing, and the right of the figure shows an example of someone wearing many LED devices[4]. Conductive clothes have attracted a great deal of attention as a way to permit such a flexible placement of wearable devices. Conductive clothes are made from conductive fabric or conductive thread, and a user can install devices such as buttons, sliders, and LEDs on a wear, moreover operates them with electric power supplied from the wear. These characteristics of conductive fabrics solve the problems of wiring, communication, flexible placement, and power supply.

As researches on systems using conductive fabrics, *Networked Vest*[5] uses conductive fabric on both sides of the wear, and the devices attached to the vest have DC-PLC (Power Line Communi-



Figure 1: Wearing devices

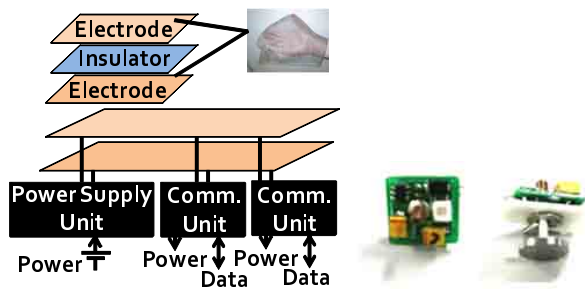

Figure 2: TextileNet system

cation) modems that provide DC power from a single power supply as well as modulated analog signal communication. *Electronic Textiles*[6] uses a conductive thread with an insulator coating for horizontal and vertical directions as well as insulator thread. *Communication-Wear*[7] is a clothing concept that augments a mobile phone by enabling expressive messages to be remotely exchanged between people. It conveys the sense/ experience of touch, and presence through sensations delivered by e-textiles. Mattmann has developed a way for body postures to be recognized using strain sensors in textiles[8]. In this study, we employ *TextileNet*[1] on which the user can freely install devices and easily arrange their layout (the system structure and devices are shown in Figure 2). There is an electrode of conductive fabric on both sides of the clothing, and we can install pin-shaped devices on the fabric. It is possible to supply electric power by connecting a battery to the fabric and to have devices communicate among themselves by using broadcast. Since the conductive cloth is a uniform solid electrode, *TextileNet* cannot detect the positions of worn devices.

The position of a device on the conductive fabric is important information for the system because there is a strong relationship between the positions of I/O devices and the functions to be assigned to them. This fact is discussed in [9], which proposes a method to automatically allocate functions to devices on conductive fabric, called Pin&Play. This method makes allocations in accordance with user profiles, functions to be assigned, device types, and device positions.

There have been several methods to ascertain the positions of

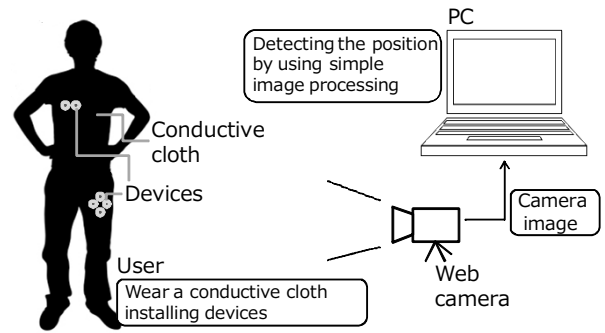

Figure 3: System structure

many distributed devices. Helin detected the rough positions of devices by dividing up a conductive board[10]. However, since we envision the possibility of several devices being on the same area of the cloth, it is difficult for us to apply this method to our system. RSSI on wireless LANs could be used[11], but although this method has enough robustness it is not low accurate. Shinoda proposed a method to measure the positions of devices on thin sheets[12]. However, this method cannot be applied to our system since our clothing supposes flexible conductive fabrics. Finally, we propose a method for image processing method using a web camera. This method does not require us to make changes to the *TextileNet* system.

There are a member of methods for detecting the positions of devices by using a camera, such as those using high-speed cameras[13, 14]. These systems, however, need many costly cameras. In contrast, our method requires only a cheap web camera. *ID Cam*[15] detects positions with a camera by sending the ID information of the devices based on lighting patterns in a time series. This system can detect the positions regardless of the distance between the camera and the devices. However, it is not suited to wearable computing since it needs a relatively long time to synchronize the beacon and camera. *firefly*[16] efficiently detects the position of each LED by taking images of the LED lights. The system allocates 8-bit local addresses to each lighting elements, and it turns on the LEDs according to their ID in parallel. However, this method is prone to misdetections because it cannot always distinguish the positions of multiple devices when their LEDs are blinking at the same time. Our method solves this problem through its integrative use of parallel and serial blinking of LEDs.

3. PROPOSED METHOD

Our method detects the positions of devices worn on conductive clothes. In the *TextileNet* system, all devices have an LED for checking operations. Our method uses this LED to detect the device's position by using simple image processing with a web camera. We suppose that each device has its own ID and a user, who wears conductive clothing with devices attached to it, stands in front of a camera while the system detects the positions of the devices from their blinking LEDs. Figure 3 illustrates the structure of our system. As to the intended environment, we envision that a user would decide on the applications to be used that day, and install devices that would be suitable for the applications before going out every day. The user would then stand in front of a mirror equipped with a camera, and the system would detect the positions of devices and automatically allocate functions to them.

Table 1: Example of Parallel blinking

Decimal	Binary	1st	2nd	3rd	4th
1	0001	-	-	-	ON
2	0010	-	-	ON	-
3	0011	-	-	ON	ON
4	0100	-	ON	-	-
8	1000	ON	-	-	-
15	1111	ON	ON	ON	ON

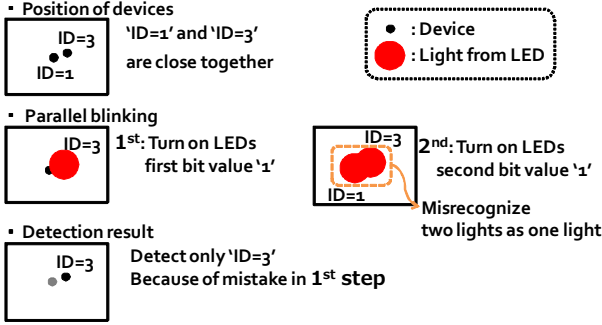

Figure 4: Example of misdetection

3.1 Blinking Algorithm

The simplest method of detecting positions with a camera turns on LEDs corresponding to the IDs one by one. Because TextileNet cannot know in advance of the existence of installed devices, this method must turn on all possible IDs. Therefore, it cannot be used efficiently if there are many devices since it would take a lot of time to detect all of them. On the other hand, there is a method that turns on LEDs in parallel according to IDs. It takes only a little time, but it has a certain probability of misdetection. Therefore, we propose a new algorithm, two-phase LED blinking, to detect position efficiently and accurately.

Phase 1. Parallel blinking: Detect the positions of LEDs by turning on all LED in parallel.

Phase 2. Sequential blinking: Sequentially turn on LEDs for IDs that have been not decided on *Parallel blinking*.

Parallel blinking detects positions in parallel by switching multiple LEDs on and off based on the devices' IDs. On the N 'th blink, the system turns on the LEDs whose the N 'th bit of ID is 1. For example, when the ID is 4 bits long, a device whose ID is 1 blinks only at the 4th blink period, a device whose ID is 3 blinks in the 4th and 3rd blink periods as shown in Table 1. In this phase, when ID is expressed as N bits, the system can detect the positions of devices in N blink period, thereby dramatically reducing the detection time. However, this method is still prone to misdetections when devices are placed close to each. For example, Figure 4 shows closely placed devices whose IDs are 1 and 3. By parallel blinking, blinks from the two LEDs could be misrecognized as being from one LED. In the example, the system detects only one device whose ID is 3. In addition, the system must have a positional margin (we call this margin the *Misdetection radius*) for the LED to be detected since the user may move during the detection phases. Thus detections within the *Misdetection radius* are treated as being from the same LED. The *Misdetection radius* may be the cause of a number of misdetections, as shown in Figure 4.

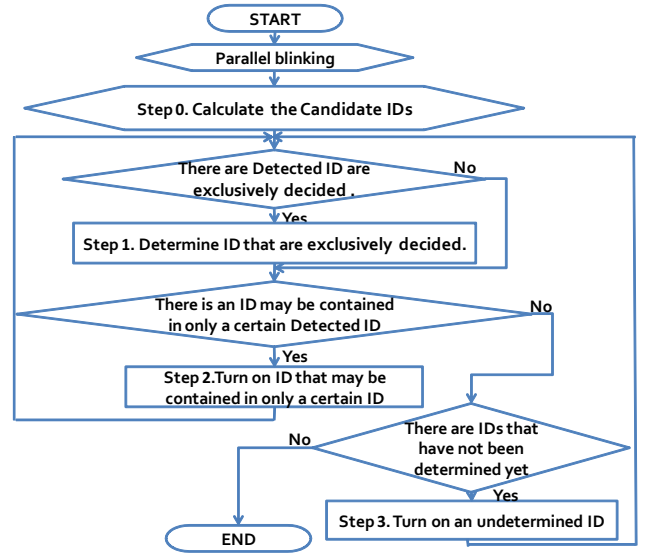

Figure 5: Flow of Sequential blinking

The Sequential blinking phase solves this problem by checking for detection errors with additional blinks after the Parallel blinking phase. In the following explanation, we suppose that the *Detected ID* refers to IDs that have been detected with Parallel blinking, and the *Candidate ID* means IDs that may be attributed to certain ID. For example, the *Candidate IDs* of a detected device whose ID is 3 are 1, 2, and 3. The procedure of Sequential blinking is as follows:

Step 0 Calculate the Candidate IDs for each Detected ID.

Step 1 Determine Detected IDs that are exclusively decided.

Step 2 If there is an ID that may be contained in only a certain Detected ID, turn on it and return to *Step 1*.

Step 3 If there are IDs that have not been determined yet, turn on one of them and return to *Step 1*.

Figure 5 and 6 show the flow of Sequential blinking and the pseudo code for it. In the following, we will explain the procedure for each step using the example in Figure 7, which shows a situation in which a user installed devices for operating a music player application. In this example, each device has a 4-bit ID, as shown on the right of Figure 7. The IDs detected by Parallel blinking and including errors are 1, 3, 5, 11, 14, and 14, while the correct IDs are 1, 2, 3, 5, 6, 9, 10, 12, and 14.

Step 0: Calculate the Candidate IDs

Our method makes a list of the Candidate IDs for each Detected ID. Table 2 shows Candidate IDs for each Detected ID in the example. If an ID is determined, the ID is removed from all Candidate IDs.

Step 1: Determine Detected IDs that are exclusively decided

Our method turns on LEDs of devices that have the possibility of being misdected. For efficient detection of these LEDs, our method employs a procedure to determine IDs without re-blinking. Concretely, for each $n(1, 2, \dots, \text{bit length of ID})$, if there is no Candidate ID whose n 'th bit is 1 when the n 'th bit in its Detected

```

Algorithm Sequential blinking
Blinking_Times = Device_Bit_Length;
Dictionary Candidate_Group; // List of Candidate ID
List Bit_List[]; // Numbers of each Bit

Step0
Candidate_Group.Add(Candidate-ID);
Step1
for i = 1 to Candidate_Group[i].Count{
  for j = 1 to Bit_List[j].Count{
    if (Bit_List[j].Contain(Candidate_Group[i]))
      contain_times++;
    if (contain_times == 1){
      Delete(Candidate_Group[i][k], Candidate_Group);
    }
  }
}
Step2
if (Candidate_Group.Contain(Candidate_Group[i][j])){
  contain_times++;
}
if (contain_times == 1)
  Temp_Step2_Blinking_List.Add(Candidate_Group[i][j]);
Candidate_Group[i].minimun(Temp_Step2_Blinking_List);
Step2_Blinking_List.Add(Candidate_Group[i][j]);
Delete(Candidate_Group[i][j], Candidate_Group);
}
if(Step2_Blinking_List.Count > 0){
  Turn_On(Step2_Blinking_List);
  Blinking_Times++;
  to Step1;}
else{
  to Step3;}
Step3
if(Candidate_Group.Count > 0){
  Turn_On(Candidate_Group[i][j]);
  Blinking_Times++;
  to Step1;
  Delete(Candidate_Group[i][j], Candidate_Group);
}
else{return(0);}

```

Figure 6: Pseudo code for Sequential blinking

ID is 1, the Detected ID can be deleted from Candidate IDs of all Detected IDs. This is because this case means there is no other blink without the Detected ID in the n th blink. This procedure is executed again until no ID can be determined.

In the example, the LED whose ID is 1 is determined first. Then, the LED whose ID is 3 is determined because the LED whose ID is 1 has already been determined. In the same way, the LED whose ID is 5 is determined (see also Table 3).

Step 2: Turn on Candidate IDs that may be contained in only a certain ID

Our method turns on multiple LEDs simultaneously according to the following procedure.

For each Candidate ID, our method counts the number of Detected IDs that have the ID as the Candidate ID. Then, for each Detected ID, if it has Candidate IDs whose count is 1, our method chooses one of the Candidate IDs as the blinking ID. All blinking IDs can be turned on in the same time since there is no possibility they are at the same place. If there is a blinking ID, the method goes back to Step 1.

In the example, the blinking ID candidates are 6, 9, 11, 12, and 14. IDs of 6, 12, and 14 have the same Detected ID 14, and IDs of 9 and 11 have the same Detected ID 11. Therefore, LEDs whose IDs are 6 and 9 can be turned on simultaneously, and both of them are determined. After returning to Step 1, this step turns on LEDs

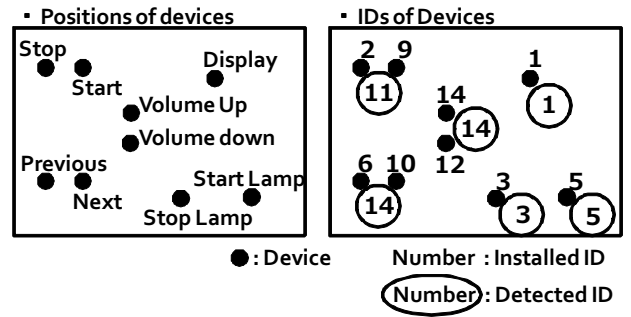

Figure 7: Example of device layout and detection result

Table 2: State after Step 0

Detected	Candidate	Fixed
1	1	
3	1, 2, 3	
5	1, 4, 5	
11	1, 2, 3, 8, 9, 10, 11	
14	2, 4, 6, 8, 10, 12, 14	
14	2, 4, 6, 8, 10, 12, 14	

whose IDs are 11 and 12, and the system knows the position of LED whose ID is 12 and the fact there is no LED whose ID is 11 (see Table 4).

Step 3: Turning on an unfixed ID

The remaining LEDs must be turned on one by one. As such, the system turns on one of the undetermined ID and returns to Step 1. In the example, it turns on the LEDs whose IDs are 2, 4, 8, and 10 in order. After turning on the LED whose ID is 10, Step 1 determines the LED whose ID is 14, as shown in Table 5. To complete the detection, our method takes only 10 blinks, whereas 15 blinks are required if IDs were determined one by one.

3.2 Enhancement of Method by using Parity

Our method takes fewer blinks to detect the positions of LEDs through its integrative use of parallel and sequential blinking. There is another way to reduce the blinks by using additional parity-like bits. It works because sequential blinking takes longer than parallel blinking. This enhancement enlarges the time period of parallel blinking but shortens that of sequential blinking.

We call the method described in Section 3.1 the *Basic method*. Here, we describe three enhanced methods: the *Reverse method*, *Partition method*, and *Pair method*.

Reverse method

The Reverse method adds bits that are the reverse in value of those of the original ID, which means that the length of the encoded ID is twice as long as that of the original ID. During parallel blinking, the method turns on LEDs on the basis of the encoded ID. For example, if the ID is 0010 (= 2), the encoded ID is 00101101, which has additional 4 bits of parity.

During parallel blinking, there is a characteristic that the detection of 0 means all Candidate IDs have 0 in that bit, while the detection of 1 means at least one of the Candidate IDs has 1 in that bit. The Reverse method increases the chance of detecting 0 and thereby dramatically decreases the Candidate IDs. In addition, if

Table 3: State after Step 1

Detected	Candidate	Fixed
1		1
3	2	3
5	4	5
11	2, 8, 9, 10, 11	
14	2, 4, 6, 8, 10, 12, 14	
14	2, 4, 6, 8, 10, 12, 14	

Table 4: State after Step 2

Detected	Candidate	Fixed
1		1
3	2	3
5	4	5
11	2, 8, 10	9
14	2, 4, 8, 10, 14	6
14	2, 4, 8, 10, 14	12

Table 5: Results of procedure

Detected	Candidate	Fixed
1		1
3		3
5		5
11		2, 9
14		6, 10
14		12, 14

Table 6: Example of lighting pattern in the Reverse method

	ID	Binary	Reverse	1st	2nd	3rd	4th	5th	6th	7th	8th
Position	9	1001	0110	ON	-	-	ON	-	ON	ON	-
	10	1010	0101	ON	-	ON	-	-	ON	-	ON
Detected	11	1011	0111	ON	-	ON	ON	-	ON	ON	ON
Candidate		*0**	1***		Fixed			Fixed			

Table 7: Example of lighting pattern in the Partition method (1 bit)

	ID	Binary	Reverse	1st	2nd	3rd	4th	5th	6th	7th	8th	9th	10th	11th	12th
Position	2	0010	1101	-	ON	-	ON	-	ON	-	-	-	-	-	-
	3	0011	1100	-	ON	ON	ON	-	-	-	-	-	-	-	-
	10	1010	0101	-	-	-	-	-	-	-	ON	-	ON	-	ON
	14	1110	0001	-	-	-	-	-	-	ON	ON	-	-	-	ON
Detected (MSB '0')	3	011	101	-	ON	ON	ON	-	ON	-	-	-	-	-	-
Detected (MSB '1')	14	110	101	-	-	-	-	-	-	ON	ON	-	ON	-	ON

Table 8: Example of lighting pattern in the Partition method (2 bit)

	ID	Binary	1st	2nd	3rd	4th	5th	6th	7th	8th	9th	10th	11th	12th	13th	14th	15th	16th
	2	0010	ON	-	-	ON	-	-	-	-	-	-	-	-	-	-	-	-
	3	0011	ON	ON	-	-	-	-	-	-	-	-	-	-	-	-	-	-
	10	1010	-	-	-	-	-	-	-	ON	-	-	ON	-	-	-	-	-
	14	1110	-	-	-	-	-	-	-	-	-	-	ON	-	-	-	-	ON
00	3	11	ON	ON	-	ON	-	-	-	-	-	-	-	-	-	-	-	-
01	-	00	-	-	-	-	-	-	-	-	-	-	-	-	-	-	-	-
10	10	10	-	-	-	-	-	-	-	ON	-	-	ON	-	-	-	-	-
11	14	10	-	-	-	-	-	-	-	-	-	-	-	ON	-	-	-	ON

the Detected ID is not consistent with its reverse part, our method knows that it has misdetected.

Table 6 shows an example of a misdetection happening because there are two LEDs whose IDs are 9 and 10 within the Misdetection radius. The 2nd and 5th bits did not blink in this case, so the Candidate IDs are 10** (i.e. 8, 9, 10, or 11), instead of *0** (i.e. 1, 2, 3, 8, 9, 10, or 11) in the Basic method.

Partition method

The Partition method divides LEDs into two or more groups and parallel blinking is performed per group to decrease the chance of misdetection. For example, our method decides to divide LEDs into two groups as to whether the 1st bit of the ID is 1 or not. Then, it uses the Reverse method to detect each unit's position. Table 7 shows an example where LEDs whose IDs are 2, 3, 10, and 14 are within the Misdetection radius. Our method blinks IDs whose 1st bit is 0, and then blinks the other IDs. Since the 1st bit for all IDs do not have to be blinked, it takes 12 blinkings for parallel blinking, and in total 12 blinkings are required to detect all IDs. The Basic method needs 19 blinkings in this case.

On the other hand, when there are four groups, the method divides LEDs according to the patterns of the 1st bit and 2nd bit; 00, 01, 10, and 11. Table 8 shows an example of this case.

Pair method

The Pair method divides an ID in steps of 2 bits, and adds encoded bits according to the patterns of the pair; 00, 01, 10, and 11, after performing the basic method. Table 9 shows an example where LEDs whose IDs are 9 and 10 are nearby each other. This method detects all IDs that have 10** in the 5th, 7th, 9th, and 11th blinks, and detects all IDs that have either **01 or **10. In this case it can detect two LEDs whose IDs are 9 and 10 directly without turning on any LED again.

4. IMPLEMENTATION

We implemented a prototype system incorporating our method. The prototype consisted of a camera, multiple devices, and conductive cloth (TextileNet). Figure 8 shows the use of the prototype. We used a Lenovo ThinkPad X200 computer (CPU 2.4 GHz, RAM 3.0 GB), with the Windows 7 operating system, Microsoft Visual C++.NET 2005 and OpenCV[17] to implement our method and the application. We used a Logitech Qcam Orbit AF web camera to capture images. The prototype recognized body parts by web camera, turned on LEDs installed on TextileNet's conductive fabric via Bluetooth, and detected the position of the LEDs automatically. We confirmed that the method accurately detected functions. The prototype turns on LEDs two times per second because the web camera

Table 9: Example of lighting pattern in the Pair method

	ID	Binary					00		01		10		11	
			1st	2nd	3rd	4th	5th	6th	7th	8th	9th	10th	11th	12th
Position	9	1001	ON	-	-	ON	-	-	-	ON	ON	-	-	-
	10	1010	ON	-	ON	-	-	-	-	-	ON	ON	-	-
Detected	11	1011	ON	-	ON	ON	-	-	-	ON	ON	ON	-	-

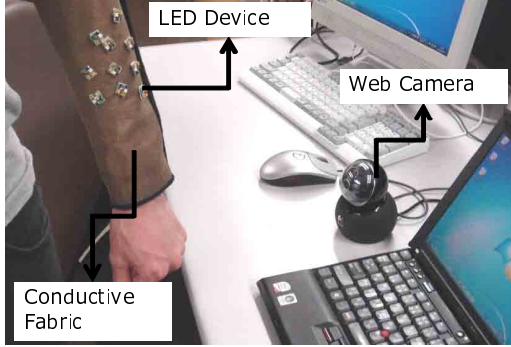

Figure 8: Snapshot of user wearing prototype

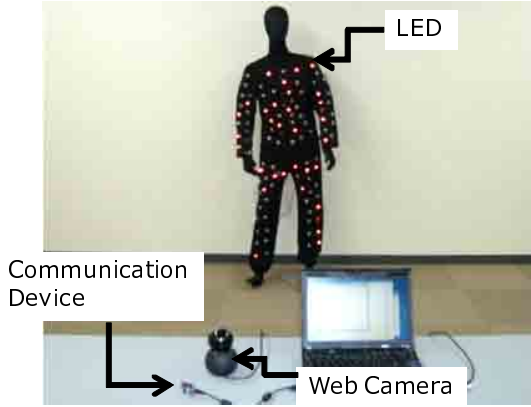

Figure 9: Snapshot of user wearing LEDs

needed a period of time to detect light.

In addition, we implemented an application for controlling a lot of LEDs on the cloth flexibly and intuitively. Figure 9 and 10 show snapshots of using the prototype. The number of worn devices was 100, and each device had 7-bit IDs. Since our method automatically detects the positions of all LEDs, we can control the LED states by drawing a circle to decide the area in which to turn on the LEDs.

5. EVALUATION

We implemented a simulator in which we could set the number of devices, detection methods, size of the misdetection radius, ID length, and resolution of the camera. We evaluated our methods from the viewpoint of blinking time of LEDs, which represents the time to complete the detection. This is because the user of our system stands still in front of the camera, and people cannot stand still for a long time. The comparative method, called the *Conventional method* turned on LEDs one by one. Table 10 shows the parameters of the evaluation.

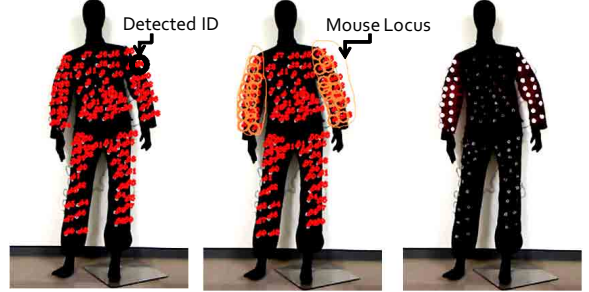

Figure 10: Snapshots of using the application

Table 10: Parameters for evaluation

Number of devices	0~250
Resolution of camera	640×480 [pixel]
Misdetection radius	10, 20 [pixel]
Bit length of ID	7~12 [bit]
Trial times	1000

5.1 Effect of Varying Bit Length

If there are a lot of different devices, the bit lengths for identifying the devices would be long. Since all devices should have own IDs, the length of the ID is determined by the application model, and the length has a significant effect on the performance of position detection. Therefore, we evaluated the blinking times by varying the ID length. Figure 11 shows the result. When there were a few misdetections because few devices were placed on the conductive fabric, the Reverse method performed best since it had fewer parallel blinkings. When Misdetection radius was large, the ID length long, or the number of devices large, the Pair method was the best since it could reduce sequential blinking by adding bits in parallel blinking procedure.

In most cases, the enhanced methods were far superior to the Conventional method and Basic method. Moreover, the enhanced methods that had several types of parity checking had much higher performance compared with the Basic method. These results confirmed the effectiveness of the proposed method and the enhancements.

5.2 Effect of Varying Number of Devices

The number of installed devices increases with the number of applications to be used. Therefore, we evaluated the blinking times while varying the number of worn devices. Figure 12 shows the results of the evaluation. If a user can stand still for one minute, the limit of blinking times is 120 in our setting. If the length of the ID is 8 bits and the Misdetection radius is 10 pixels, every method can detect more than 250 IDs within one minute. If the Misdetection radius is 20 pixels, the Partition method can detect all IDs within one minute. On the other hand, If the length of the ID is 12 bits,

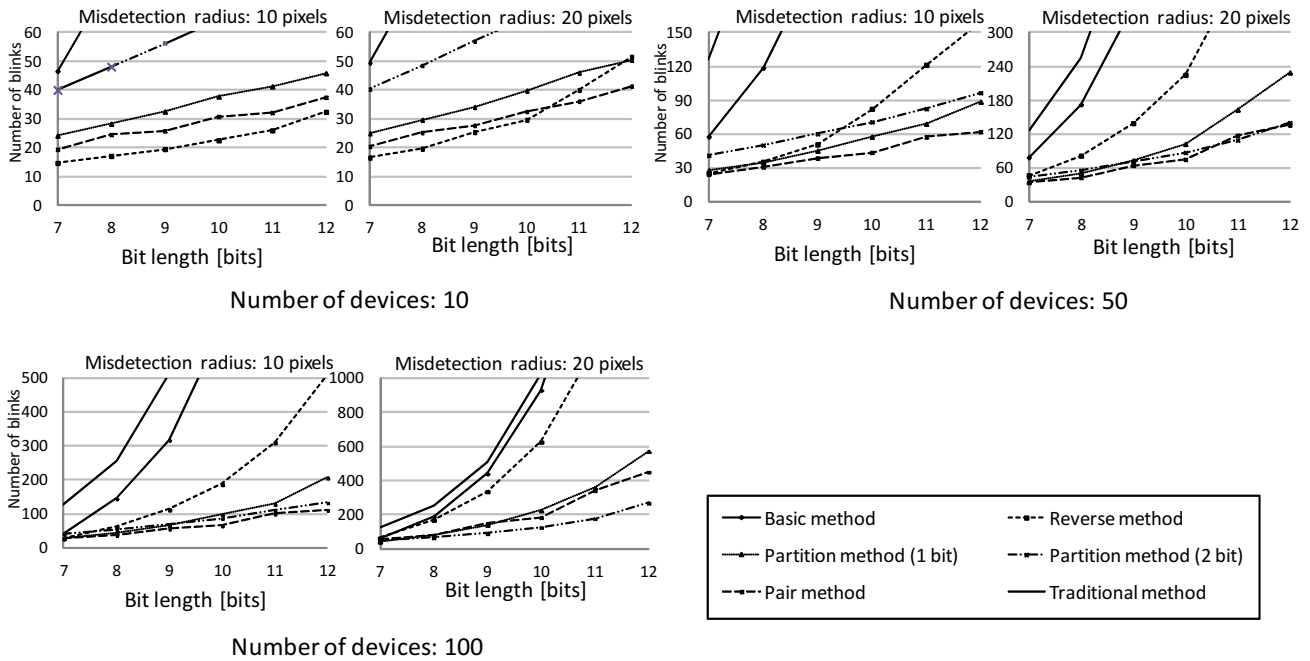

Figure 11: Effect of varying bit length

and the number of devices to be detected is small, the Pair method can detect 40 IDs within one minute.

In addition, when the ID length is 8 bits, the number of blinks converges to a certain number. This is because too many Candidate IDs destroys the advantageous effect of parallel blinking.

5.3 Effect on Misdetection radius

Depending on the brightness of the environment where the system detects the positions of the devices, the precision of a camera, and so on, the system may need to change the Misdetection radius. Therefore, we evaluated the blinking times while varying the Misdetection radius. Figure 13 shows the results. When the ID length is 8 bits and number of devices is 50, the Partition method (2 bit) can detect all devices within one minute if Misdetection radius is less than 70 pixels. It decreases to 40 pixels when the number of devices is 100. On the other hand, when the ID length is 12 bits and number of devices is 50, the radius decreases to 10 pixels.

6. CONCLUSIONS

In this paper, we proposed a method for detecting the positions of devices on a conductive cloth by using a camera. Our method blinks the LEDs on the devices according to their IDs and detects their positions. We developed several detection algorithms for reducing the total number of blinks required. Evaluation, confirmed that our methods are more efficient than a conventional serial blinking method.

In the future, we will consider a method that can cope effectively with errors in which LEDs do not turn on in spite of having received a signal to turn on.

7. REFERENCES

[1] T. Murakami, J. Akita, and M. Toda: Power Line Communication Transceiver on Conductive Wear for Wearable

Computing, *International Transactions on Systems Science and Applications*, Vol. 4, No. 3, pp. 287–291, 2008.

[2] R. Ueoka, H. Kobayashi, and M. Hirose: SoundTag: RFID Based Wearable Computer Play Tool for Children, *Transactions on Edutainment III*, Vol. 5940, pp. 36–47, 2009.

[3] L. Buechley, M. Eisenberg, J. Catchen, and A. Crockett: The LilyPad Arduino: using computational textiles to investigate engagement, aesthetics, and diversity in computer science education, *Proc. of the 26th International Conference on Human Factors in Computing Systems (CHI 2008)*, pp. 423–432, 2008.

[4] Lighting Choreographer, http://www.dr-popeye.com/Site/Wearable_LED_Performance.html.

[5] E. Wade and H. Asada: Conductive Fabric Garment for a Cable-Free Body Area Network, *Proc. of the 5th International Conference on Pervasive Computing (Pervasive 2007)*, Vol. 6, No. 1, pp. 52–58, 2007.

[6] N. B. Bharatula, P. Lukowicz, and G. Tröster: Functionality–power–packaging considerations in context aware wearable systems, *Personal and Ubiquitous Computing*, Vol. 12, No. 2, pp. 123–141, 2008.

[7] S. Baurley, P. Brock, E. Geelhoed, and A. Moore: Communication–Wear: User Feedback as Part of a Co-Design Process, *Proc. of the 2nd Haptic and Audio Interaction Design (HAID 2007)*, Vol. 4813, pp. 56–68, 2007.

[8] C. Mattmann, F. Clemens, and G. Tröster: Sensor for measuring strain in textile: *Sensors*, vol. 8, no. 6, pp. 3719–3732, 2008.

[9] K. Matsui, T. Terada, and S. Nishio: User Preference Learning System for Tangible User Interfaces, *Proc. of the 3rd International Conference on Complex, Intelligent, and Software Intensive Systems (CISIS 2009)*, pp. 766–771, 2009.

[10] F. Helin, T. Høglund, R. Zackaroff, M. Hakansson, S.

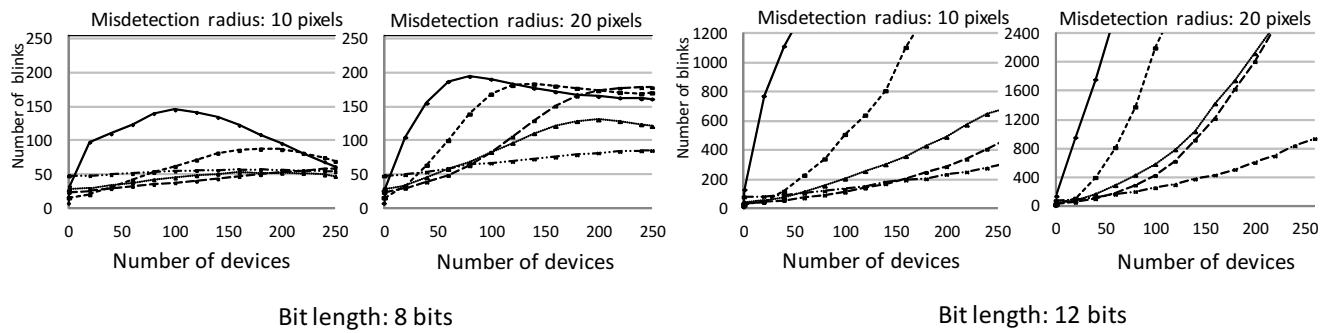

Figure 12: Effect of varying number of devices

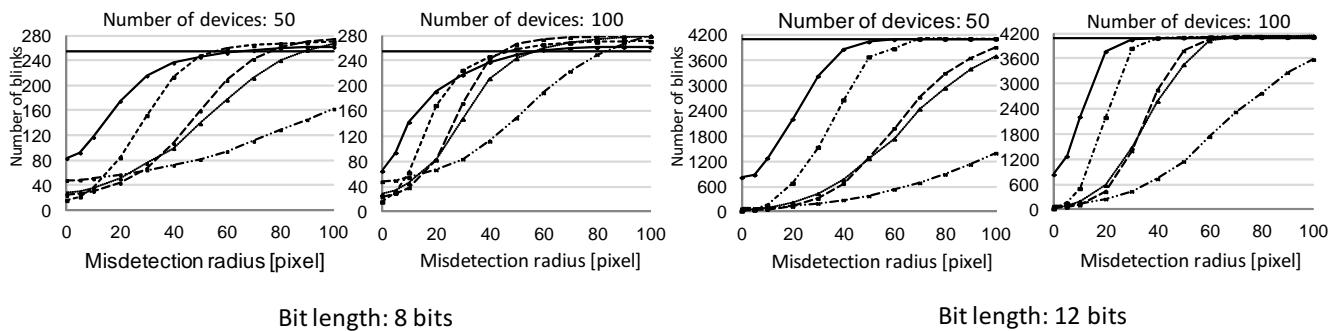

Figure 13: Effect of varying Misdetection radius

Ljungblad, and L. E. Holmquist: Supporting Collaborative Scheduling with Interactive Pushpins and Networking Surfaces, *Proc. of the 6th International Conference on Ubiquitous Computing (UbiComp 2004)*, demo, 2004.

- [11] T. Roos, P. Myllymaki, H. Tirri, P. Miskangas, and J. Sievanen: A Probabilistic Approach to WLAN User Location Estimation, *International Journal of Wireless Information Networks (IJWIN)*, Vol. 9, No. 3, pp. 155–164, 2002.
- [12] K. Nakatsuma and H. Shinoda: High Accuracy Position and Orientation Detection in Two Dimensional Communication Network. *Proc. of the 28th International Conference on Human Factors in Computing Systems (CHI 2010)*, pp. 2297–2306, 2010.
- [13] PhoeniX Technologies: The Visualey System, <http://ptiphoenix.com/>.
- [14] PhageSpace, Inc.: Phase Space motion digitizer, <http://www.phasespace.com/>.
- [15] N. Matsushita, D. Hihara, T. Ushiro, S. Yoshimura, J. Rekimoto, and Y. Yamamoto: ID CAM: a smart camera for scene capturing and ID recognition, *Proc. of the 2nd International Symposium on Mixed and Augmented Reality (ISMAR 2003)*, pp. 227–236, 2003.
- [16] A. Chandler, J. Finney, C. Lewis, and A. Dix: Toward Emergent Technology for Blended Public Displays, *Proc. of the 11th International Conference on Ubiquitous Computing (UbiComp 2009)*, pp. 101–104, 2009.
- [17] OpenCV. <http://opencv.jp/>.