

Wearable electromyography measurement system using cable-free network system on conductive fabric

著者	Akita Junichi, Shinmura Toru, Sakurazawa Shigeru, Yanagihara Keisuke, Kunita Mihoko, Toda Masashi, Iwata Kunio
journal or publication title	Artificial Intelligence in Medicine
volume	42
number	2
page range	99-108
year	2008-02-01
URL	http://hdl.handle.net/2297/9043

doi: 10.1016/j.artmed.2007.11.003

Wearable Electromyography Measurement System using Cable Free Network System on Conductive Fabric

Junichi Akita^{a,*} Toru Shinmura^a Shigeru Sakurazawa^b
Keisuke Yanagihara^b Mihoko Kunita^b Masashi Toda^b
Kunio Iwata^b

^a*Kanazawa University, Kakuma, Kanazawa, 920-1192 Japan*

^b*Future University–Hakodate, 116-2 Kamedanakano, Hakodate, 041-8655 Japan*

Key words: Wearable Computing, Electromyography, Biomedical Monitoring, Conductive Wear

Summary

Objective: To solve the complicated wires and battery maintainance problems in the application of weararable computing for biomedical monitoring, the electromyography (EMG) measurement system using conductive fabric for power supply and electric shield for noise reduction is proposed.

Material and Methods: The basic cable-free network system using conductive fabric, named as “TextileNet” is developed. The conductive fabric has the function of electric shield for noise reduction in EMG measurement, and it enables the precise EMG measurement with wearable system.

Results: The specifications of the developed prototype TextileNet system using wear with conductive fabric were communication speed of 9600 bit per second and power supply of 3W for each device. The electric shield effect was evaluated for precise EMG measurement, and the shield efficacy of conductive fabric was estimated as high as that of shield room.

Conclusions: TextileNet system solves both the problems of complicated wires and battery maintainance in wearable computing systems. Conductive fabric

* Phone:+81-76-234-4864, FAX:+81-76-264-6404, E-mail:akita@is.t.kanazawa-u.ac.jp

used in TextileNet system is also effective for precise EMG measurement as electric shield. The combination of TextileNet system and EMG measurement device will implement the cable-free, battery-free wearable EMG measurement system.

1 Introduction

Based on the drastic development of computers and network systems, a new paradigm of computing system, wearable computing is widely attracted and studied. Biomedical monitoring system is expected to be one of the most important applications of wearable computing[1,2].

The wearable computing system requires a lot of devices on our body, and all the devices need both the power supply and the communication channel.

Physical ways of sensing in biomedical monitoring system, such as the type of sensors, the number of sensors, the positions of sensors on the user's body, and so on, should be flexible in arrangement for various applications of individual users. Although this requirement for sensing ways is important for intrinsically usable wearable biomonitoring system, the problems of ways to provide both the power and communication channel often limits the flexibility in arrangement. For example, it is easy to use the wires for power supply and communication, but it results the uncomfortable wearable biomonitoring system for the user, which it should be a most important factor in the intrinsically practical wearable computing system. The embodied wires in the wear is one of the solutions for this problem, but it makes the system inflexible in arrangement for each application, which is also an important factor for intrinsically practical wearable computing system.

In addition, external noise, such as hum noise from power line, is also often the critical problem in precise and stable biomonitoring. The noise rejection technique, such as filter circuit, also makes modifications on the target signal, and this often becomes the fatal problem in precise signal measurement. The electro-magnetic shield room is one solution against the noise, but the usage of the shield room limits the applications of biomonitoring in the rest condition of the user.

We aim at developing the novel type of wearable biomonitoring system using the wear made of conductive fabric to solve the problems described above, which has the following merits.

- Cable Free, Independent-battery Free: the cables are replaced by the wear made of conductive fabric.

- Wearable Shield Room: the wear made of conductive fabric has the efficacy of rejecting the extern noise.

In this paper, we describe the flexible network infrastructure for wearable computing systems using the wear made of conductive fabric, that can solve both problems of complicated, which is named as “TextileNet[3].” Next, we discuss the electro-magnetic shielding capability of the wear made of conductive fabric for precise electromyography (EMG) measurement. Finally, we also discuss the integration of TextileNet system and electromyography measurement system for the wearable electromyography measurement system that can solve the problems of complicated cables and power supply methodologies.

2 Related Works on Wearable Network System

There are a lot of related works on the new wearable computing systems.

‘Networked Vest’[4] uses conductive fabric for both sides of the wear, and the devices attached on this vest have direct current-power line communication (DC-PLC) modem in order to obtain DC power from single power supply, as well as modulated analog signal communication. Although the attached devices can be supplied sufficient power, communication signals are broadcasted to whole the wear as analog signals, and there are no arbitration mechanisms implemented for point-to-point communication. The details of electric characteristics are discussed and evaluated, but it cannot provide the wide band-width of communication channels.

‘Push&Pin’ system[5] aims at the network system on a pair of conductive surface, including conductive fabric wear as well as the wall, but it employs 1-Wire[6] system for physical implementation.

In the 1-Wire system’s specifications, the flexibility of network configuration is limited as master-slave architecture, and the communication speed is as slow as approximately 1200[bps], that is not fast enough for practical wearable computing systems.

‘PinPlay’ system[7] also uses a pair of conductive surface for power supply in order to build distributed computing systems, but the communications among devices are implemented by wireless manner.

C.Randell et al.[8] implements the wear with a pair of conductive fabric for power supply, electro-magnetic detector, and thermal source for display, but there no implementation on networking system.

There are other groups of wearable computing system without complicated

cables.

‘E-textile’[9] combines a conductive thread and an insulator thread to weave a cloth for the wear, and the conductive thread forms the embedded wiring. It can implement a cable-less wearable computing system for the specified applications, but it is impossible to arrange the layout of devices. The electro-magnetic shield effect is also proposed in this system[10], but the quantitative evaluation and implementation are not performed.

‘Electronic Textiles’[11] uses a conductive thread with insulator coating for horizontal and vertical directions as well as an insulator thread. The devices are attached at the cross point of the horizontal and vertical conductive threads in order to form the electronic circuit. It can implement the cable-less wearable computing system, but it is impossible to obtain the complete flexibility of installation, since the positions of the devices are restricted to the cross points of conductive threads.

A lot of studies on wearable computing system with complicated cables are reported[12,13]. Medical monitoring system is one of the most important applications of wearable computing systems. There are medical monitoring systems with complicated cables[14,15] and without cables[16], but all of them have the serious problems in either complicated wiring or power supply as described in the previous section.

There are wireless communication systems with wireless power supply. Co-BIT[17] system uses the solar cell as the receiver, and the power and the modulated signal are provided to the transmitter. However, only a few milliwatts can be supplied to its devices due to the restrictions of light intensity. Radio-frequency identification (RFID) systems[18] have the variations of passive tag which receives the electric power via the electro-magnetic wave from the transmitter as well as communication signal, but the available power on the devices is also restricted by the strength of electro-magnetic wave.

3 Cable Free Network System on Conductive Fabric

There are two possible physical configuration of the whole system. One is the wired system, and the other is the wireless system.

In the wired system, the devices, for example, the sensors or data acquisition equipment, are connected each other by wires which provide both power supply and communication channels. The wired systems essentially have a problem in wiring. It is a burden for the user to install the wires at initial and during the operation. It is more serious and fatal to arrange the physical layout of

the devices, since the complicated wires exist on the wear. This problem of complicated cables is one of the most serious problems in biomonitoring system which requires a number of sensors on the user's body.

In the wireless system, users can install and arrange the layout of devices more flexibly, since there are no wires among devices. However, the wireless systems have another essential problem; power supply problem. All the devices require the power supply for their operations, but there are no power supply cables for devices from the central battery in the wireless system. The battery operation is one of the solutions for power supply, but the devices cannot be permanently in operation for the restriction of battery life. This power supply problem becomes fatal, especially when the wearable computing systems are extended, since as the number of the devices increases, it becomes difficult to maintain the batteries of so many devices for a long period of operation time.

As described above, the wearable computing systems require the power supply and the communication network, while neither the conventional wired nor the wireless systems can completely provide them with keeping the comfortable-ness for user and the flexibility of installing and arranging layout of devices.

TextileNet system described in this paper has the following features compared with the existing systems based on the newly developed circuitry.

- Cable-free
- Comfortable wear with conductive fabric
- Free installation on the wear by pins
- High communication ability (Point-to-point)
- High power supply ability (approx. 3W)

Figure 1 shows the practical situation of using wearable computing system. As shown in Fig.1(a), the conventional wired wearable computing system has the problem of complicated wires. TextileNet system is expected to solve this problem as shown in Fig.1(b), as well as power supply problem of each device.

3.1 Conductive fabric and wear

We have developed electric conductive wear for the TextileNet system as shown in Fig.2. This wear consists of three layers; the conductive fabric for both outer sides of the wear with one insulator fabric between them. These three layers of fabrics are sewn by using a conventional sewing machine. Conductive fabric employed here is a product for the electro-magnetic shield cloth whose surface resistance is about $0.5\Omega/\text{sq.}$, as shown in Fig.3. This conductive fabric is made of meshed conductive thread, and it is adequate for comfortable fit, which is a 'basic function' of wear.

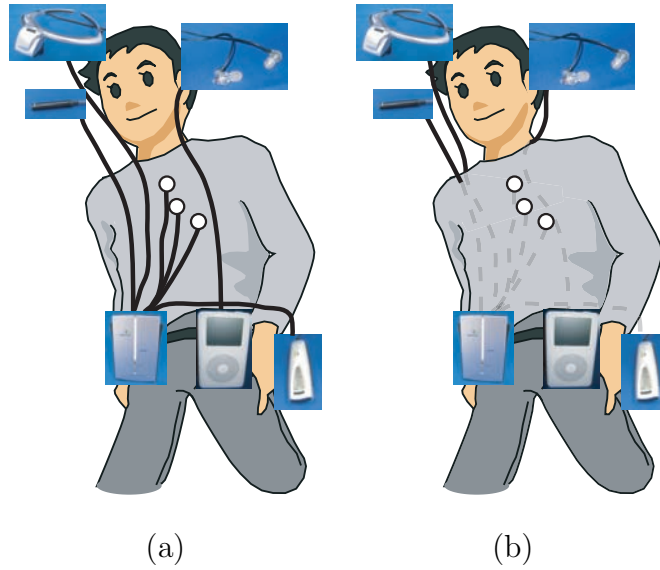

Fig. 1. Practical situation of using wearable computing system.(a)Wired system, (b)TextileNet system.



Fig. 2. Developed wear using conductive fabric.

3.2 Communication unit and power supply unit

The 1-Wire system[6] is a wiring system using a pair of cables which provide power supply and communication channels. In the 1-Wire system's specifications, the flexibility of network configuration is limited as master-slave architecture, and the communication speed is as slow as approximately 1200 bit



Fig. 3. Electro-magnetic shield cloth.

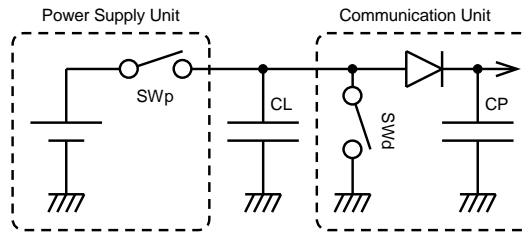

Fig. 4. Circuit architecture of data communication and power supply unit of TextileNet.

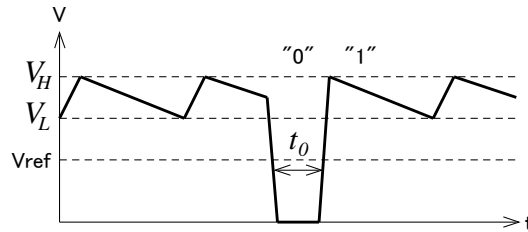

Fig. 5. Voltage wave of developed TextileNet system.

per second (bps), that is not fast enough for practical wearable computing systems.

From the application point of view, the devices attached on the wear should be physically small enough to suit the comfortable wearable computing application. In order to implement such small communication devices, we employed the DC-based architecture for power supply with occasional pull-down strategy for communication. We newly designed the power supply and communication circuit architecture using a pair of electrodes as shown in Fig.4. It is composed of one power supply unit, the communication units installed on the TextileNet and a pair of electrodes as the surfaces of the wear.

The energy supplied from the power supply (the battery connected to the power supply unit) is charged in the power capacitor, C_P at each communication unit, and the voltage of the surface of the wear, V_L is controlled to keep



Fig. 6. Developed communication unit.

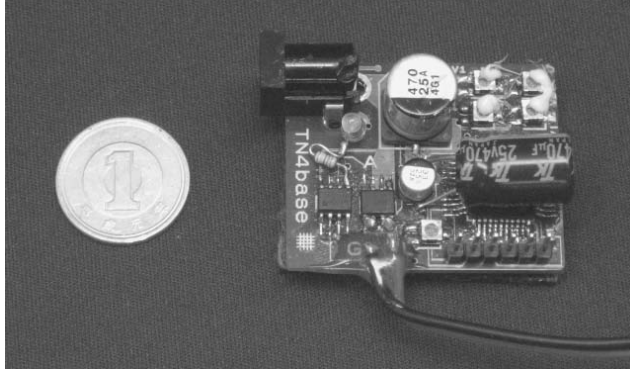

Fig. 7. Developed power supply unit.

approximately 15V by the power supply unit as shown in Fig.5. When one of the communication units starts to send some data, V_L is pulled-down to low voltage of 0V for a certain moment, t_0 , and all the communication units on the TextileNet receive this data of ‘0’ simultaneously. At this moment, the power supply unit detects this drop of V_L and turns the pull-up switch off. This pull-up switch is again turned on after a certain term of t_1 , where $t_0 < t_1$, in order to continue power supply to each device. The energy of communication units for the term of $V_L = 0$ is supplied by the power capacitor, C_P in each communication unit. The data of ‘1’ can be represented as the high V_L , and data transmission can be initiated by the start bit as the first ‘0’, as a conventional asynchronous serial communication.

The functions required for each communication unit are (1) power regulation, (2) one bit transmission by pull-down switch, and (3) data receive, which enables to implement the small size of the communication device. Figure 6 shows a developed communication device whose size is $10\text{mm} \times 10\text{mm}$, and it has the power supply capability of up to 3W. Figure 7 shows a developed power supply unit. The communication speed of this prototype device is designed to become 9600[bps] in order to keep the enough margin of operation. The developed prototype system of TextileNet has the communication ability of one byte broadcasting, and arbitration of data transmission and error correction can be implemented by the higher protocol layers in our future work.

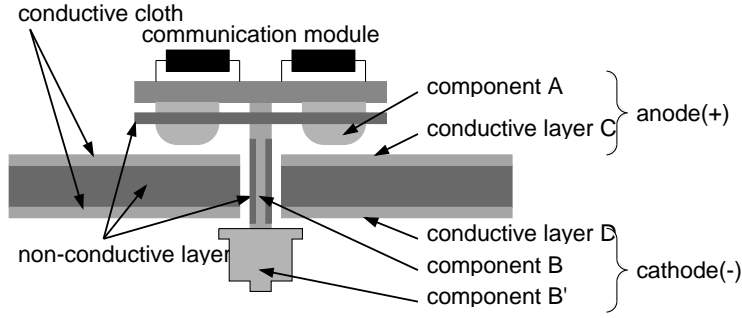

Fig. 8. Structure of electric contact.

Table 1

Devices used in the evaluation experiment of TextileNet.

Device	Function	Communication
#0	Switch	'0' or '1' to device #2
#1	Switch	'0' or '1' to device #2
#2	LED display (Red&Green)	data from device #0 & #1
#3	PC connection	0 to 9 to device #4
#4	LED display (numeric)	data from device #3

3.3 Electronic contact

Both the communication units and the power supply unit should be electrically connected to both side of the wear by sticking. Figure 8 shows a structure of the developed contact. The unit is contacted to the outer side of the wear by the electrode of the unit, and to the inner side of the wear by the pin with insulator and snap.

3.4 Operation of TextileNet system

We carried out the evaluation operation of the developed TextileNet system. We've built five devices using the communication units as shown in Tab.1. Two switch devices (#0 & #1) transmit on/off state to the light emitting diode (LED) display device (#2). When each switch is pushed, red or green LED on LED display device (#2) turns on. The personal computer (PC) connection device (#3) receives the character of '0' to '9' from the PC using asynchronous serial communication. This device (#3) transmits the received data to the LED numerical display device (#4), which displays the number

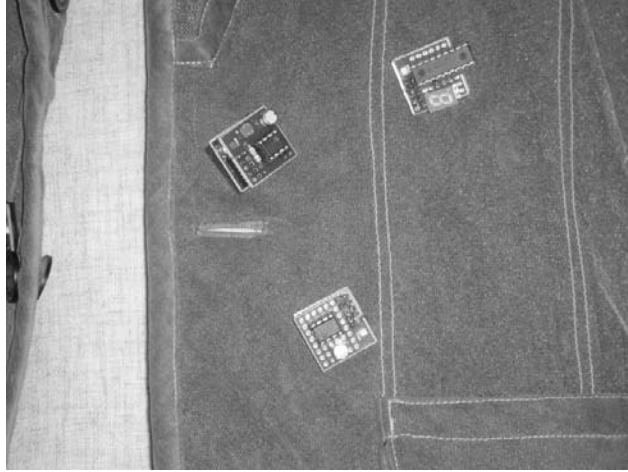

Fig. 9. Test usage of TextileNet.

of 0 to 9. All the devices are attached on the wear made of conductive fabric as shown in Fig.9. All the data transmission is carried out through TextileNet on the wear, and the entire devices without independent battery receives the power from power supply unit. We have confirmed they are operational. The devices are also in operation when the positions on the wear are changed.

4 Electromyography Measurement using Conductive Fabric

The external noise, especially induction noise from AC electric power line, so called “hum noise” is a critical factor which disturbs the precise biomedical monitoring. The wear made of conductive fabric used in TextileNet system is expected to have the electro-magnetic shield efficacy against the external noise for its low surface resistance.

We carried out the evaluation of the electro-magnetic shield efficacy of the TextileNet wear for electromyography measurement.

4.1 Setup of measurement

Figure 10 shows the system configuration of electromyography measurement.

Two Ag/AgCl electrodes are attached to the subject’s arm with the paste, and the signals from these electrodes are connected to the amplifier. The amplifier is located inside the wear made of conductive fabric with wires from outside the wear for the amplified EMG signal and power supply. By using TextileNet system, the measured EMG signal can be transmitted to the data acquisition equipment after analog-to-digital conversion through the surface of the wear.

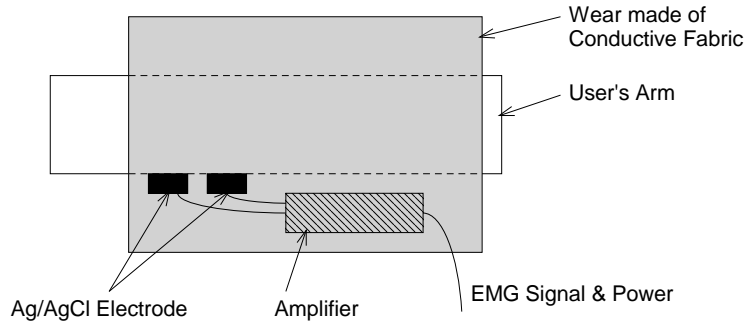
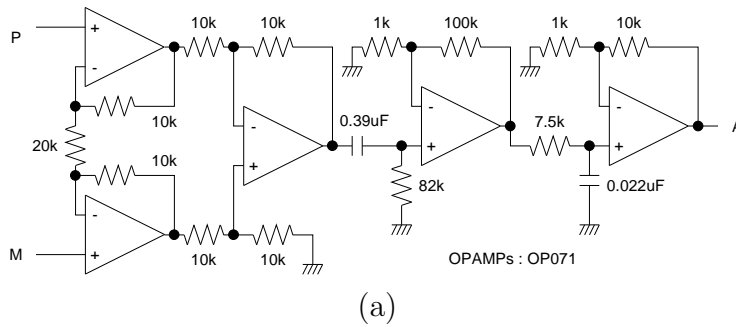
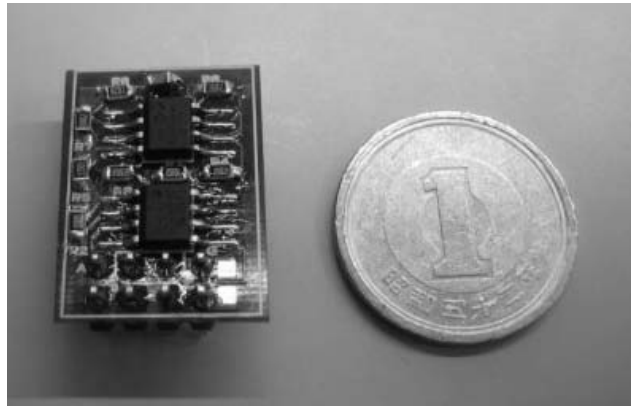

Fig. 10. System configuration of electromyography measurement.



(a)



(b)

Fig. 11. Developed EMG amplifier. (a)circuit diagram, and (b)device.

In this experiment, we do not use the TextileNet system for data transmission in order to confirm the electro-magnetic shield efficacy of the wear made of conductive fabric for electromyography measurement.

Figure 11 shows the circuit diagram of developed amplifier for electromyography signal. The myoelectric signals on the subject's body are amplified by the differential amplifier with gain of 1000. It has the high pass filter (HPF) whose cut-off frequency is 5Hz in order to reject the very low frequency signal derived from physical cable swing. It also has the low pass filter (LPF) whose cut-off frequency is 1000Hz in order to reject higher frequency signal components.



Fig. 12. Shield room for condition **(2)**.

The EMG is recorded as well as its spectrum by data sampler on PC for following three conditions.

- (1) with no electro-magnetic shield,
- (2) with shield room made of copper mesh
- (3) with the TextileNet wear with the power supply unit and the communication units in operation.

Both the subject and the amplifier are inside the shield room in condition **(2)** as shown in Fig.12. In condition **(3)**, the subject's arm is inside the TextileNet wear made of conductive fabric, because the subject "wears" the TextileNet wear, and the amplifier is also placed inside the TextileNet wear as shown in Fig.10.

The shield room and the back side of TextileNet wear are connected to the electric ground of the amplifier, and the amplifier is operated by independent battery in these experiments for comparison. In condition **(3)**, the power supply unit of TextileNet is also connected to the wear to imitate the actual operation of TextileNet system.

4.2 *Experimental results*

Figure 13 shows the measured EMG waveform in condition **(a)**, with no electro-magnetic shield. In Fig.13, a large hum noise appears on measured EMG signal.

Figure 14(a) and (b) show the measured EMG waveform and its spectrum, respectively, in condition **(2)**, with the shield room. The hum noise is eliminated by shield room, and a clear EMG signal was measured.

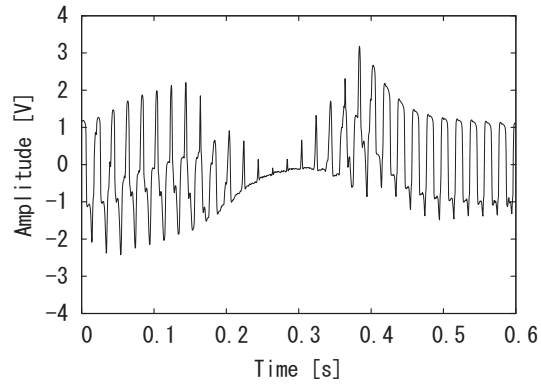
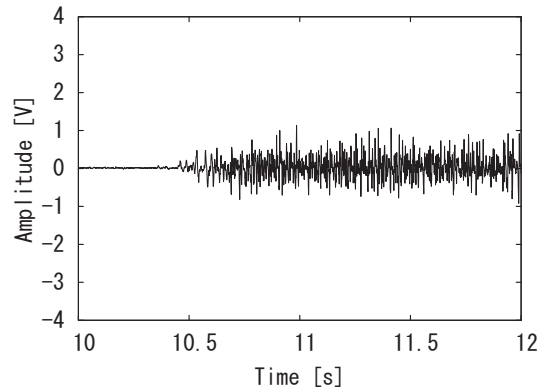
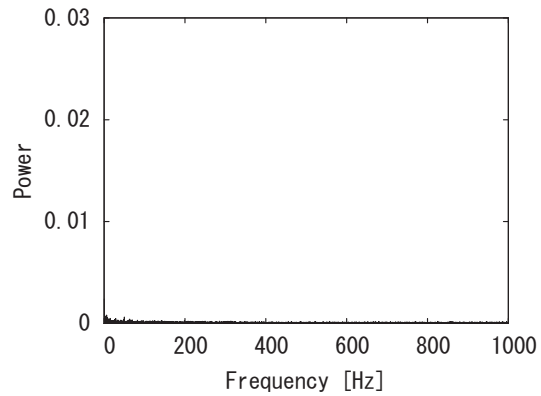

Fig. 13. Measured EMG with no shield, without force on the arm.



(a)



(b)

Fig. 14. Measured EMG using shield room. (a)Waveform (without force on the arm before 10.5s and with force after 10.5s), (b)Spectrum with no force.

Figure 15(a) and (b) shows the measured EMG waveform and its spectrum, respectively, in condition **(3)**, with the TextileNet wear when the subject didn't apply any force on the arm. The hum noise is well eliminated by electromagnetic shield efficacy of the conductive fabric. In addition, a small noise at approximately 375Hz appears in the spectrum in Fig.15(b), which is derived from power supply control on the TextileNet system. This signal component

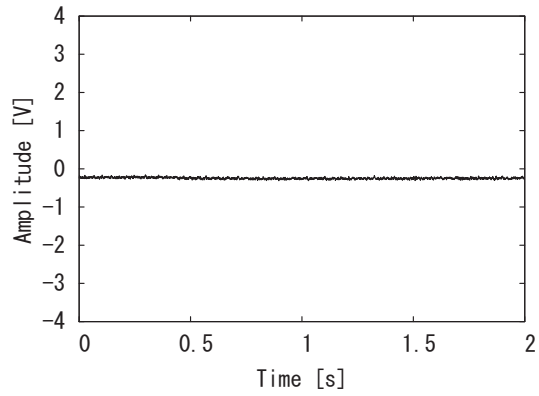

(a)

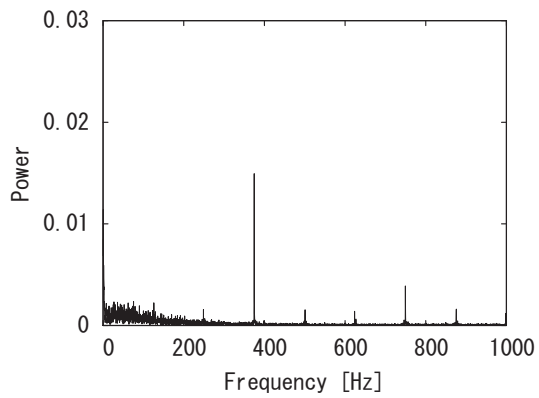

(b)

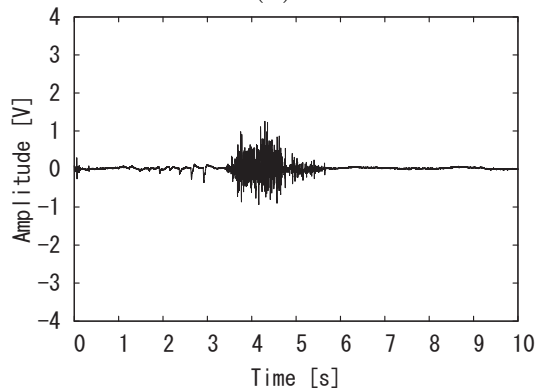

(c)

Fig. 15. Measured EMG using TextileNet. (a)Waveform without force, (b)Spectrum without force, and (c)Waveform with force on the arm.

derived from power supply control is a noise against EMG measurement, but its amplitude is small enough for EMG measurement as shown in Fig.15(a). Fig.15(c) shows the measured EMG signal in condition **(3)**, when the subject applied force on his arm.

These results show that the TextileNet system can realize the wearable EMG measurement system with shield efficacy against the external hum noise, with

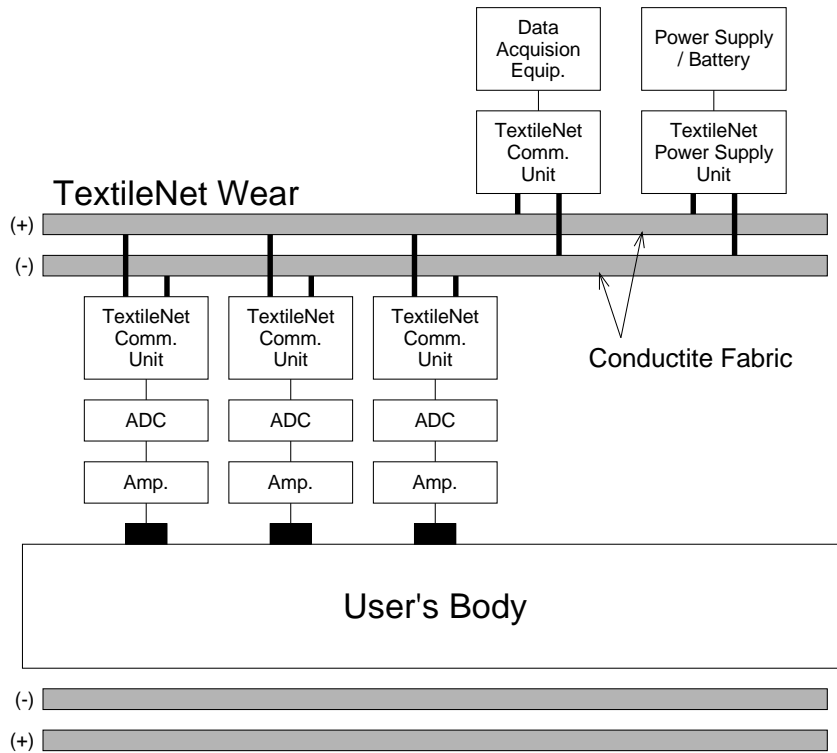

Fig. 16. Configuration of EMG measurement system using TextileNet.

keeping the merits of TextileNet system; no cables to the sensors, no battery problem.

5 Electromyography measurement using TextileNet

The EMG amplifier and data acquisition equipment is connected by a wire for signaling and powering in the experiment described in the previous section. It is possible to integrate the EMG amplifier and TextileNet system for realizing the wearable EMG measurement system as shown in Fig.16.

EMG signal at each measurement point is measured by EMG measurement device, which is composed of EMG amplifier and analog-to-digital converter (ADC). The converted digital value of EMG signal is transmitted to the data acquisition equipment through TextileNet communication channel. Since the EMG measurement devices are powered by power supply unit in TextileNet system, they do not need to have independent batteries. In addition, there are no complicated wires exist on the user's body, and the hum noise can be eliminated by the electro-magnetic shield efficacy of TextileNet wear.

The actual integration of these systems and its evaluation are now in progress, and will be reported in our future work.

6 Conclusions

In this paper, we described the cable-free network system using the wear made of conductive fabric for wearable computing systems, named as TextileNet. TextileNet system also has the merits of no independent batteries on attached devices, and location arrangement flexibility.

We also evaluated the electro-magnetic shield efficacy against the external noise of the TextileNet wear for EMG measurement, and the experimental results show that the TextileNet wear can eliminate the external noise for clear EMG measurement.

We also discussed the integration of TextileNet system and EMG measurement system in order to build the wearable EMG measurement system with merits of cable free, independent battery free. The implementation and evaluation of integrated EMG measurement system using TextileNet are now in progress, and will be reported in our future work.

References

- [1] D. Rossi, F.Carpi, F.Lorussi, A.Mozzoldi, R.Paradiso, E.P.Scilingo, A.Tognetti, Electroactive fabrics and wearable biomonitoring devices, *AUTEX Research Journal* 3 (4) (2003) 180–185.
- [2] U.Anliker, et al., Amon: A wearable multiparameter medical monitoring and alert system, *IEEE Transactions on Information Technology in Biomedicine* 8 (4) (2004) 415–427.
- [3] J.Akita, T.Shinmura, T.Murakami, M.Yao, M.Toda, Textilenet: Flexible network infrastructure for wearable computing using conductive fabric, *International Transactions on Systems Science and Applications* 1 (2) (2006) 201–205.
- [4] E.Wade, H.Asada, Cable-free wearable sensor system using a dc powerline body network in a conductive fabric vest, *26th Annual International Conference of the IEEE Engineering in Medicine and Biology Society (IEMBS04)* 2 (2004) 5376–5379.
- [5] J.Lifton, D.Seetharam, M.Broxton, J.Raradiso, Pushpin computing system overview: a platform for distributed, embedded, ubiquitous sensor networks, in: F.Mattern, M.Naghshineh (Eds.), *Proc. of Pervasive Computing 2002*, Berlin: Springer, 2002, pp. 139–151.
- [6] <http://www.maxim-ic.com/>, (Accessed: 13 November 2007).
- [7] K.V.Laerhoven, N.Villar, H.W.Gellersen, A layered approach to wearable textile networks, *IEE Eurowearable 2003* (2003) 61–67.

- [8] C.Randell, S.Baurley, M.Chalmers, H.Muller, Textile tools for wearable computing, in: O.Herzog, H.Kenn, M.Larwo, P.Lukowicz, G.Troster (Eds.), Proc. of 1st International Forum on Applied Wearable Computing (IFAWC 2004), Berlin: VDE Verlag, 2004, pp. 63–74.
- [9] M.Jones, T.Martin, Z.Nakad, A service backplane for e-textile applications, in: K.Gharachorloo (Ed.), Proc. of Workshop on Modeling, Analysis, and Middleware Support for Electronic Textiles (MAMSET), New York: Association for Computing Machinery, 2002, pp. 15–22.
- [10] D.Marculescu, et al., Electronic textiles: A platform for pervasive computing, Proceedings of IEEE 91 (12) (2003) 1995–2018.
- [11] N.B.Bharatula, M.Stager, P.Lukowicz, G.Troster, Power and size optimized multisensor context recognition platform, in: I. C. Society (Ed.), Proc. of Ninth International Symposium on Wearable Computing (ISWC2005), Los Alamitos: Institute of Electrical and Electronic Engineers, 2005, pp. 194–195.
- [12] R.DeVaul, M.Sung, J.Gips, A.Pentland, Mithril 2003: applications and architecture, in: I. C. S. T. C. on Wearable Information Systems (Ed.), Proc. of Seventh International Symposium on Wearable Computing (ISWC2003), Los Alamitos: Institute of Electrical and Electronic Engineers, 2003, pp. 4–11.
- [13] <http://www.scottevest.com/>, (Accessed: 13 November 2007).
- [14] <http://www.vivometrics.com/>, (Accessed: 13 November 2007).
- [15] S.Park, K.Mackenzie, S.Jayaraman, The wearable motherboard: a framework for personalized mobile information processing (pmip), in: A. SIG-DA (Ed.), Proc. of 2002 39th Design Automation Conference (DAC'02), New York: Association for Computing Machinery, 2002, p. 170.
- [16] R.Dunkler, Body area network – wireless communication close to the body makes patients monitoring mobile, Technical Report of Fraunhofer IIS, Erlangen: Fraunhofer IIS (2001).
- [17] T.Nishimura, et al., A compact battery-less information terminal (cobit) for location-based support, Proceedings of SPIE 2 (1) (2002) 334–338.
- [18] K.Finkenzeller, RFID Handbook, Hoboken: Wiley&Sons, 1999.