

An image sensor with fast extraction of objects' positions - Rough vision processor

著者	Watanabe Akira, Miyama Masayuki, Tooyama Osamu, Yoshimoto Masahiko, Akita Junichi
journal or publication title	IEEE International Conference on Image Processing
volume	2
page range	1105-1108
year	2001-10-01
URL	http://hdl.handle.net/2297/3527

AN IMAGE SENSOR WITH FAST EXTRACTION OF OBJECTS' POSITIONS — ROUGH VISION PROCESSOR

Akira Watanabe Osamu Tooyama
Masayuki Miyama Masahiko Yoshimoto

Kanazawa University
2-40-20 Kodatsuno, Kanazawa, Japan

Junichi Akita*

Future University - Hakodate
116-2 Kamedanakano, Hakodate, Japan
akita@fun.ac.jp

1. INTRODUCTION

Most conventional image processing systems employ the CCD camera for image acquisition, and the sequential processor with the frame memory storing images for signal processing. In these systems, the data transfer between the camera and the signal processing system and that between the processor and the frame memory often become one of the most critical bottle-necks for the faster image processing.

An integration of the signal processing circuits with the image acquiring device, which is called vision chip and can process information parallelly, is proposed for the faster image processing[1, 2], but most studies on the vision chip aim at implementing simple image processing because the circuit area is restricted.

In applications for the robot vision, not only the detailed information, such as shape or texture, but also the rough information, such as 'something is around here', are important and useful.

In this paper, we consider detecting centroids of objects in the focal plain as the rough vision processing, which is useful in the practical application, and describe its implementation using two components; the centroid detector and the coordinate generator. At first, we describe the fast flag generation algorithm indicating the centroid of objects, and its implementation using analog parallel signal processing architecture. Next, we describe the novel encoding algorithm of flag positions indicating the centroids in order to obtain their coordinates, which will be more useful for the further signal processing.

2. CENTROID DETECTOR ARCHITECTURE

2.1. Voltage distribution in the resistive network

Figure 1 shows an example of the voltage distribution in the resistive network generated by the photo current of the

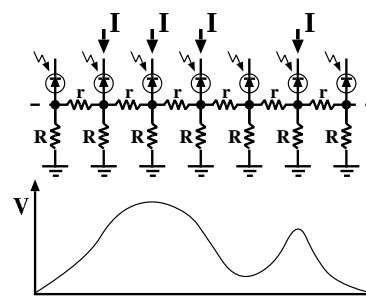

Fig. 1. Voltage distribution in resistive network

exposed pixels in one dimensional case. The voltage tends to become higher if pixels are more exposed, and the local maximum point of the voltage distribution can be regarded as the center of the exposed area or the centroid of the 'object' corresponding to the exposed area.

This voltage distribution in the resistive network reaches the stable state within the time of time constant $RC \sim 10\mu s$. If the local maximum point in the voltage distribution is detected, this electrical phenomena can be regarded as the centroid detection processing, which is considerably fast because of this kind of parallel signal processing mechanism, compared with the conventional processor-based image processing system. Note that the processing speed is expected not to decrease even if the number of pixels increases because this method has the parallel processing ability.

2.2. Local maximum point detector

The local maximum point of the voltage distribution can be detected by the circuit as shown in Fig.2. The comparator compares the voltage of the pixel in the resistive network with the reference voltage V_{ref} which decreases as time goes by (See Fig.3(a)). When V_{ref} decreases to reach the local maximum point as shown in Fig.3(b), the comparator of this pixel makes the output of '1', and it sets the flag indicating the local maximum pixel, P_n to '1'. This output of the comparator propagates to the neighbour pixels in order

*This research is aided by South Hokkaido Science Promotion Foundation.

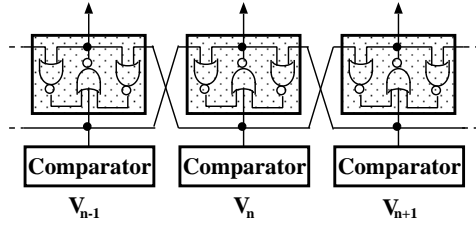

Fig. 2. Structure of local maximum detector

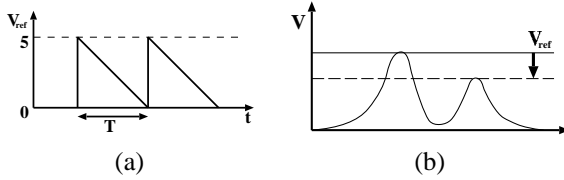

Fig. 3. Reference voltage for the comparator(a) and voltage distribution and reference voltage(b)

to prevent them from making '1' of P_{n-1} and so on, while the comparators in neighbour pixels make '1' as V_{ref} decreases, which will further prevents their neighbour pixels from making '1' of P_{n-2} and so on. This structure makes the output P_n indicate the local maximum point in the voltage distribution, whose processing speed is expected not to depend on the number of pixels. This characteristic implies the possibility of the drastic improvement in the processing speed of the centroid detection for a larger image.

2.3. Another centroid detection architecture

The centroid detection algorithm described above has the serious problem in switching noise which is generated in resistive network since the voltage in resistive network is very small. We considered to use pulse width modulation which operates in a time domain in order to detect centroids as another implementation.

The arithmetical operation performed in the resistive network is to make the average of neighbour pixel voltages. If the pixel's 'value' is represented as the width of pulse instead of the magnitude of voltage, as shown in Fig.4(a), the resistive network is replaced by pulse width adder, and Figure 4(b) shows the circuit diagram of one pixel. In this case, the summation of neighbour pixels' values is calculated instead of their average. The calculation of pixels' 'value' is iterated until it converges, or it reaches the predefined magnitude of pulse width.

Figure 5 shows the circuit diagram of pulse width adder, which operates in the following steps.

1. Load capacitor C is discharged at the beginning of every calculation cycle.

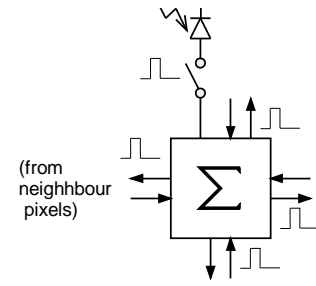

(a)

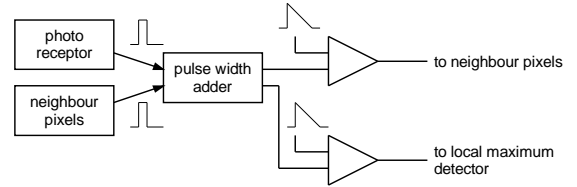

(b)

Fig. 4. Centroid detector architecture using pulse width modulation(a) and circuit diagram of one pixel(b)

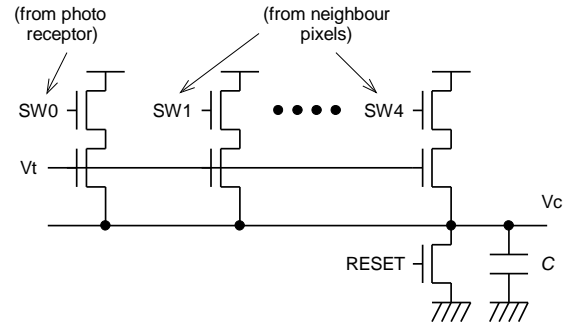

Fig. 5. Circuit of pulse width adder

2. C is charged for the cycle of each pulse is '1', and C is finally charged according to the summation of neighbour pixels' and its own pulse width.
3. The output pulse is generated by using the voltage of C and the external reference voltage, whose width is proportional to the summation of neighbour pixels' and its own pulse width.

The centroid is detected as the pixel whose pulse width, or the voltage of C , is large enough, in the same manner as is described in the previous section.

Since pulse width modulation is stable enough against switching noise, it is useful for more stable centroid detection system.

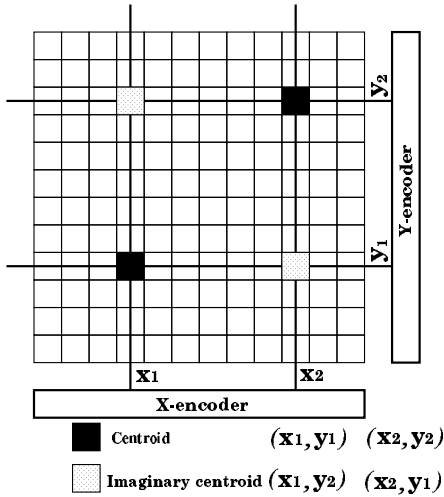

Fig. 6. n to binary encoders generating the coordinates of the flag positions

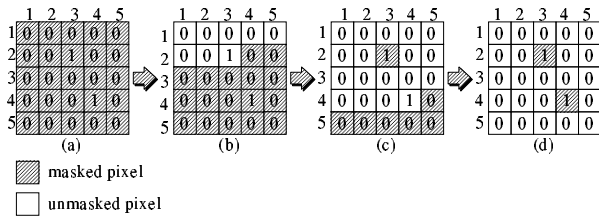

Fig. 7. Procedure of masking flags

3. CENTROID POSITION ENCODER ARCHITECTURE

3.1. Position encoder for one point

In the condition described in the previous section, the flag P_n indicating the centroid of the exposed area is set in the plain, but it is convenient to express its position by using coordinates, (x, y) for the further image processing. One of the good and simple ideas to generate coordinates is employing the n to binary encoders at x and y axes. Here, n is the number of pixels in one side, and encoder's inputs are given as the logical OR of each row and column pixels, as shown in Fig.6. The processing time for generating coordinates of the flag can be expected not to depend on the number of pixels, but this algorithm fails to generate the coordinates if there are more than one flags in the plain simultaneously, which often occurs for the practical application as shown in Fig.6

3.2. Point masking algorithm

Figure 7 shows the novel algorithm which resolves the encoding problem of more than one flags we propose. It can

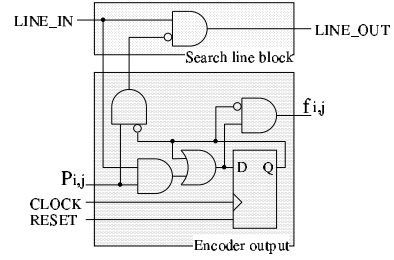

Fig. 8. Circuit of the scan path for one pixel

be solved by the following steps.

1. The whole flags are masked, or forced to make '0' regardless of the value of the flag, P_n at first, as shown in Fig.7(a).
2. The flag search signal S is fed in the upper-left corner pixel, and it propagates along the scan path from the left to the right, and then the upper to the lower pixels, until the pixel in this scan path has the flag of '1', as shown in Fig.7(b). S doesn't propagate to the pixels after this pixel, so as to keep the other flags of '1' to be masked. In this step, there is only one flag of '1' in the plain, that can be encoded to the coordinates correctly.
3. After encoding this flag's coordinates, the previously encoded pixel is masked, and S again propagates along the scan path until next pixel whose flag is '1', and S stops there again, as shown in Fig.7(c). At this point, there is only another one flag of '1' in the plain to be encoded to the coordinates.
4. After all the pixels whose flag is '1' are encoded to the coordinates in order, the flag search signal S finally reaches the end of the scan path at the lower-right corner, as shown in Fig.7(d), and it indicates the end of the position detection procedure.

Figure 8 shows the designed circuit of the scan path for one pixel. The clock signal, CK, is provided simply to change the masking procedure, while the flag search signal S along the scan path propagates not with the clock signal, but with the logic delay, which is expected to be much faster than the clock cycle time. This algorithm can encode all the centroids in the time proportional to not the number of whole pixels, but the number of the flags to be encoded. It is expected to have the possibility of the drastic improvement in the centroid detection and its coordinates generation processing of the image by combining this coordinate generation structure with the fast flag generation mechanism, such as local maximum detector of the voltage distribution described in the previous section.

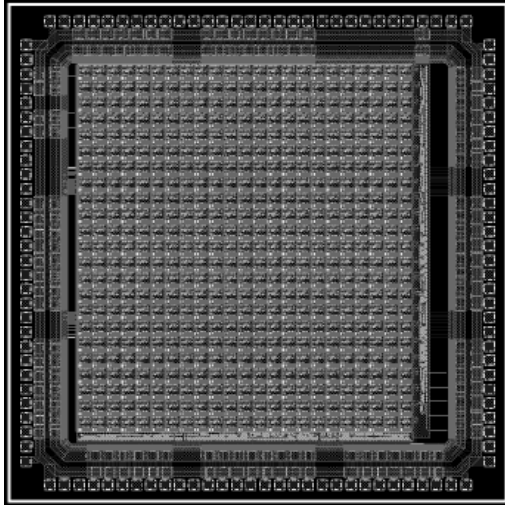

Fig. 9. Designed layout of the centroid detection image sensor

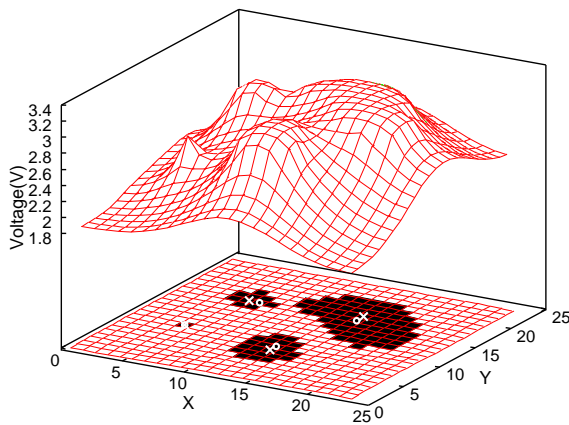

Fig. 10. Simulation result of centroid detection

4. DESIGN OF CENTROID DETECTION IMAGE SENSOR

We designed the whole centroid detection image sensor using voltage distribution in the resistive network with photo receptors as shown in Fig.9¹. The number of pixels is 23×23 for 4.5mm square chip with $0.6\mu\text{m}$, 3 metal layers CMOS process, and the number of transistors is 69,575. More pixels can be integrated in one chip by using smaller process; for example 100×100 pixels by using $0.15\mu\text{m}$ technology. Note that the pulse width modulation architecture for centroid detection is expected to be stable for smaller transistor size, while it requires the larger pixel area.

¹The VLSI chip in this study has been fabricated in the chip fabrication program of VLSI Design and Education Center(VDEC), the University of Tokyo with the collaboration by Rohm Corporation and Toppan Printing Corporation.

Figure 10 shows the result of spice simulation for the designed circuit with four exposed areas, which are shown at the floor of the graph. The detected centroids by the designed circuit are shown by the circle in Fig.10, which is close enough to the true centroids which is shown by the cross. The centroid detection time is $50\mu\text{s}$ for 23×23 pixels, which is fast enough for the fast vision system[3], and the processing time is expected not to increase so much if the image size becomes larger. This characteristic is suitable for very fast image processing of robot vision.

5. CONCLUSION

In this paper, we described the novel algorithms of the fast centroid detection of the exposed area, as well as the algorithm of the fast coordinate generation for the flags in the plain, which have the possibility of the drastic improvement in the processing time against the conventional processor-based image processing system.

The designed circuit is capable of the rough vision processing of the centroid detection within $50\mu\text{s}$ for 23×23 pixels, and the processing time is expected not to increase so much even if the number of pixels increases, which will be an advantage against the conventional processor-based image processing system.

6. REFERENCES

- [1] J.E.Eklued et al., "Global feature extraction operations for near-sensor image processing," *IEEE Trans. Image Processing*, vol. 5, no. 1, pp. 102–110, Jan. 1996.
- [2] W.Bair & C.Koch, "Real-time motion detection using an analog vlsi zero crossing chip," *Proc. SPIE, Visual Information Processing: From Neurons to Chip*, vol. 1473, pp. 59–65, 1991.
- [3] I.Ishii et al., "Target tracking algorithm for 1ms visual feedback system using massive parallel processing," in *Proc. IEEE Int.Conf.Robotics and Automation*, 1996, pp. 2309–2314.